

BA135M NEUTRON ACER TENDL-2024 LIBRARY; T=0.K

Principal cross sections

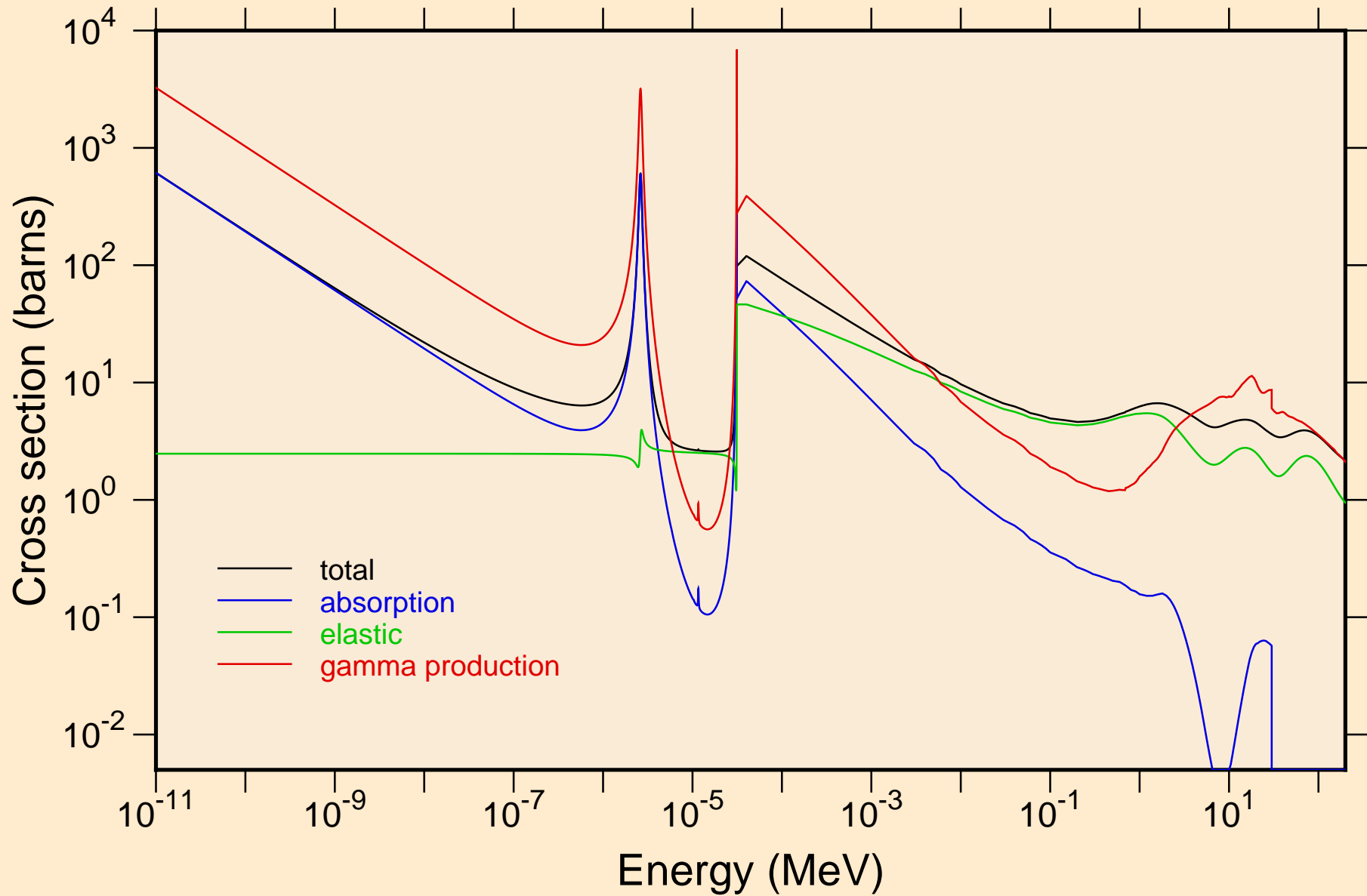

BA135M NEUTRON ACER TENDL-2024 LIBRARY; T=0.K
Heating

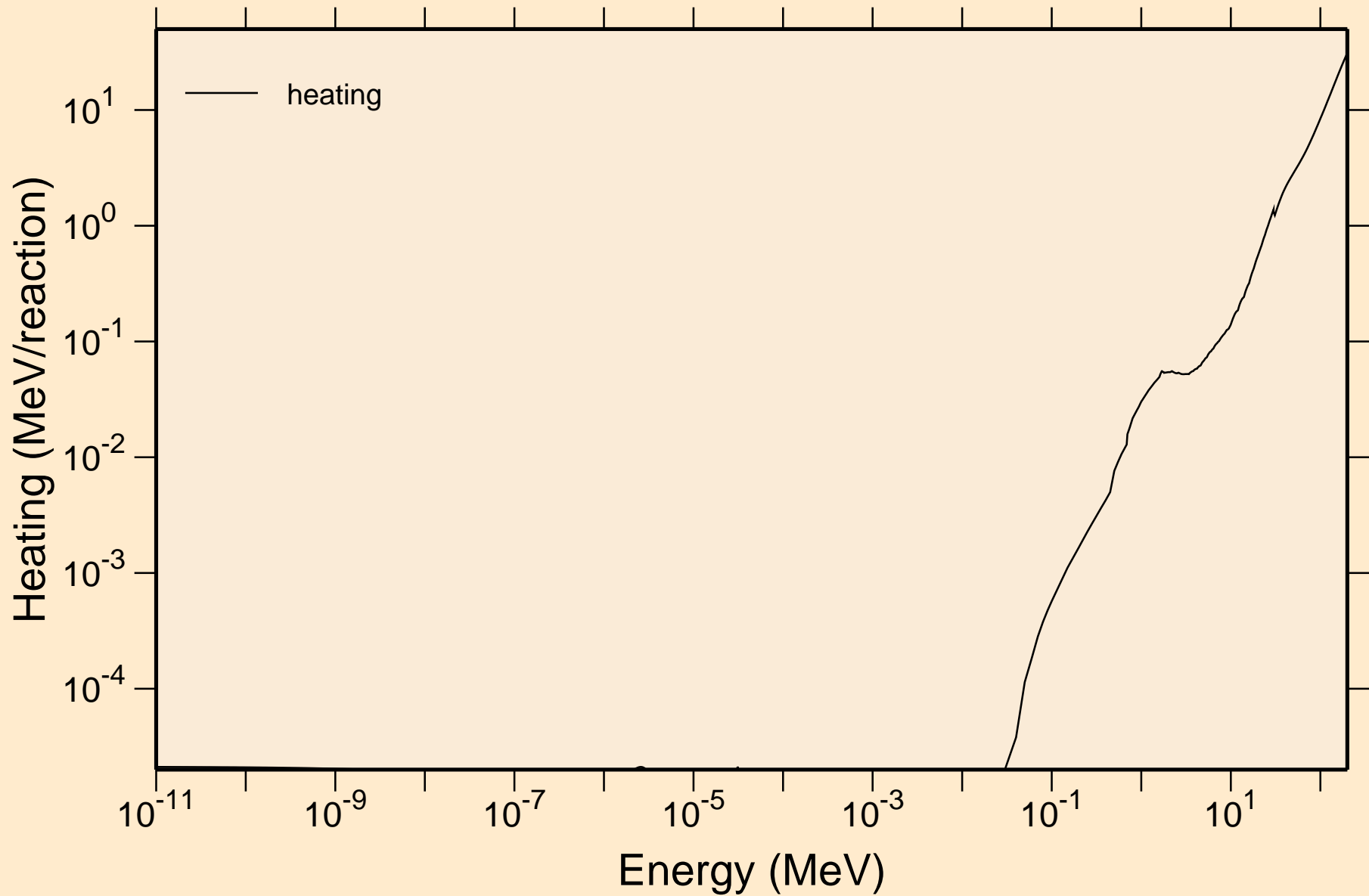

BA135M NEUTRON ACER TENDL-2024 LIBRARY; T=0.K
Damage

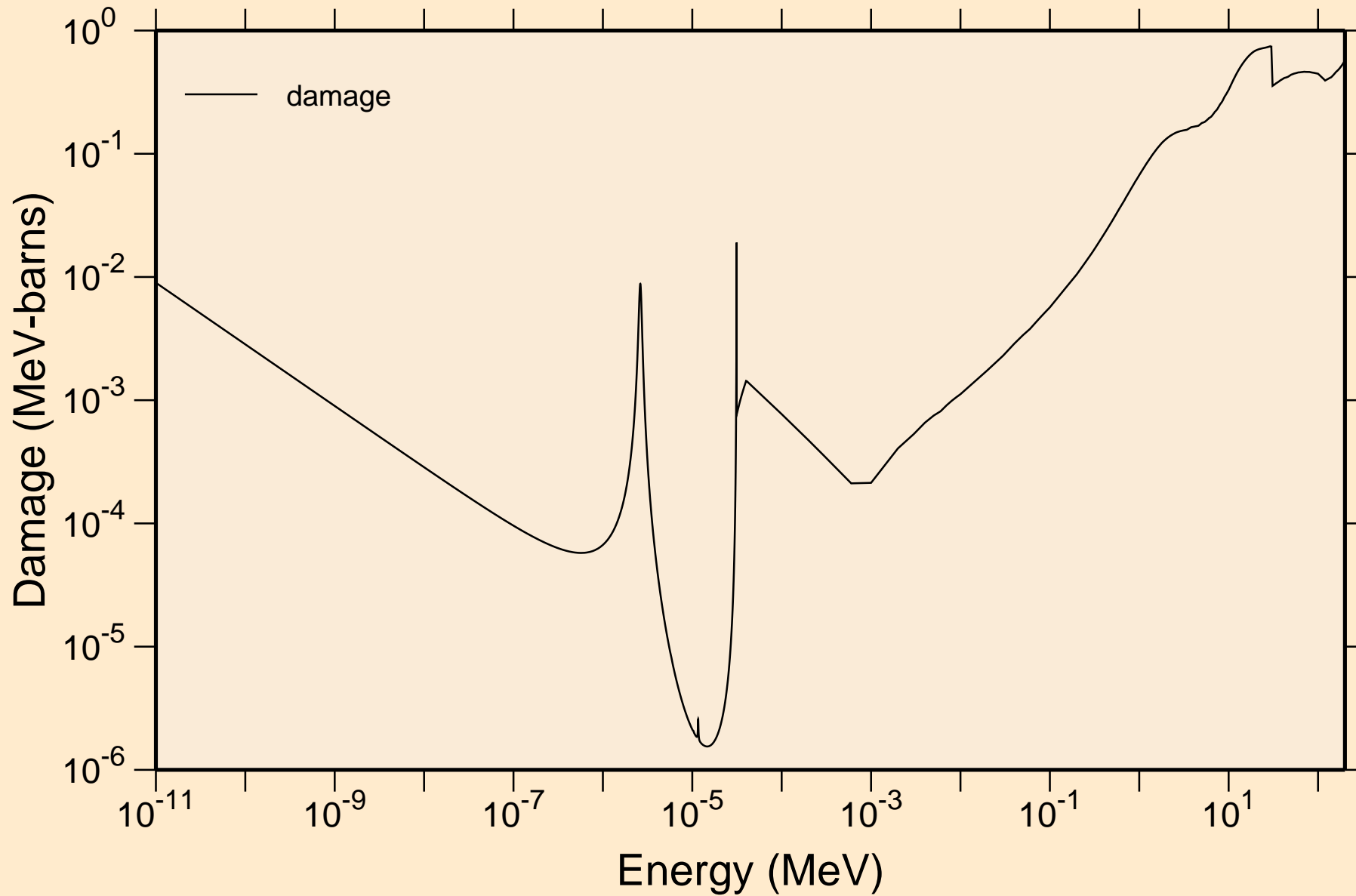

BA135M NEUTRON ACER TENDL-2024 LIBRARY; T=0.K

Non-threshold reactions

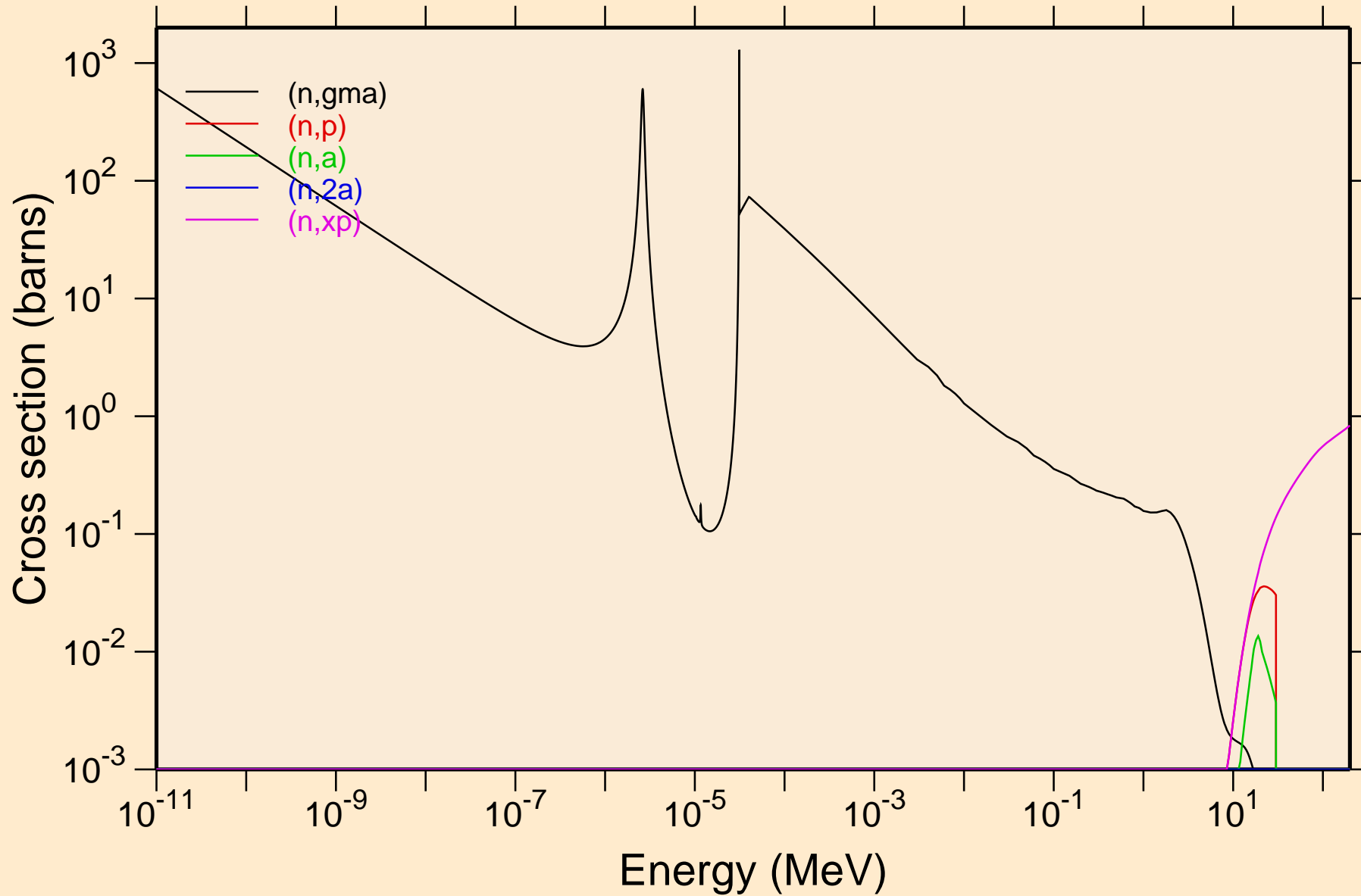

BA135M NEUTRON ACER TENDL-2024 LIBRARY; T=0.K
Non-threshold reactions

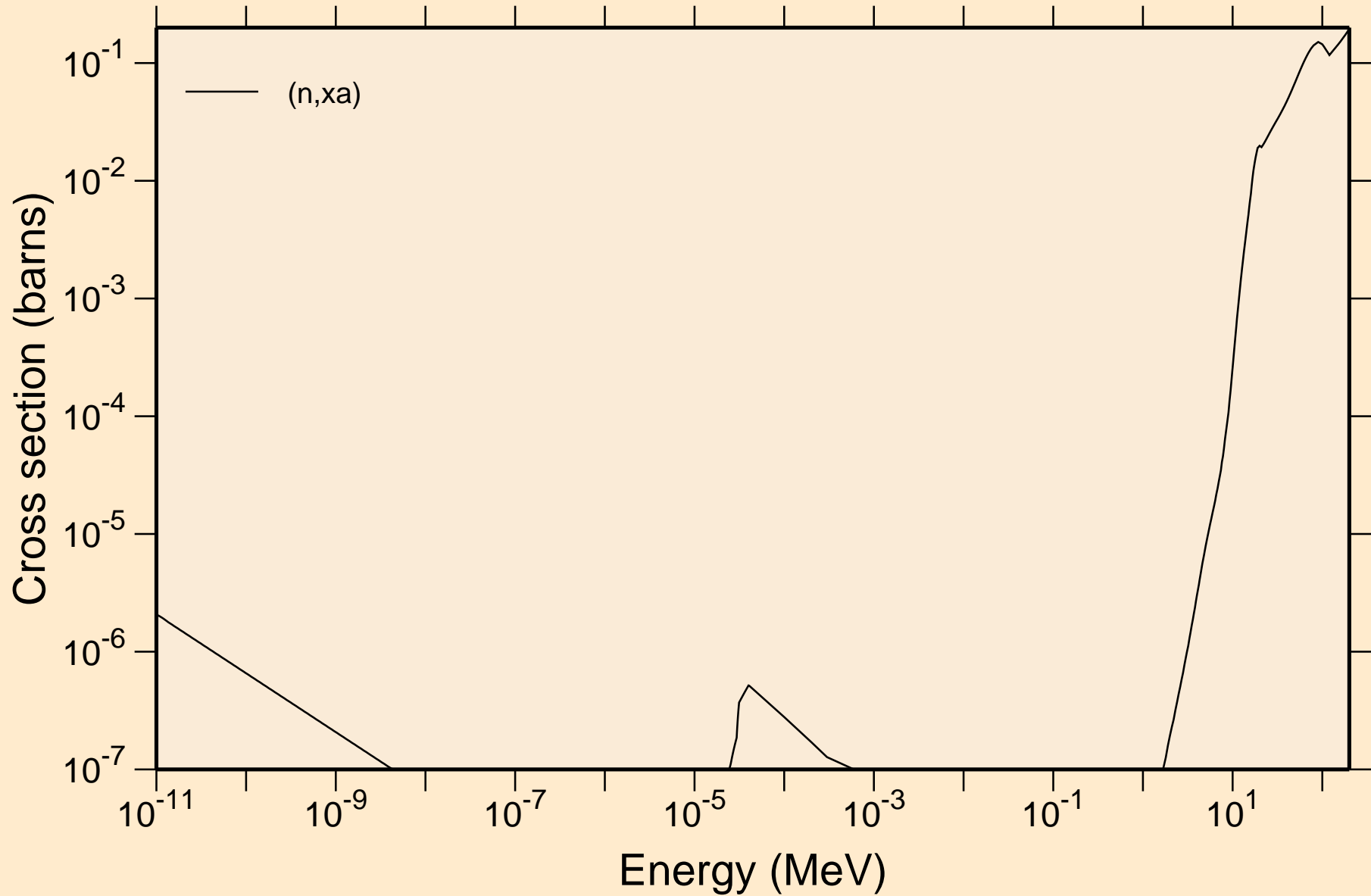

BA135M NEUTRON ACER TENDL-2024 LIBRARY; T=0.K

Principal cross sections

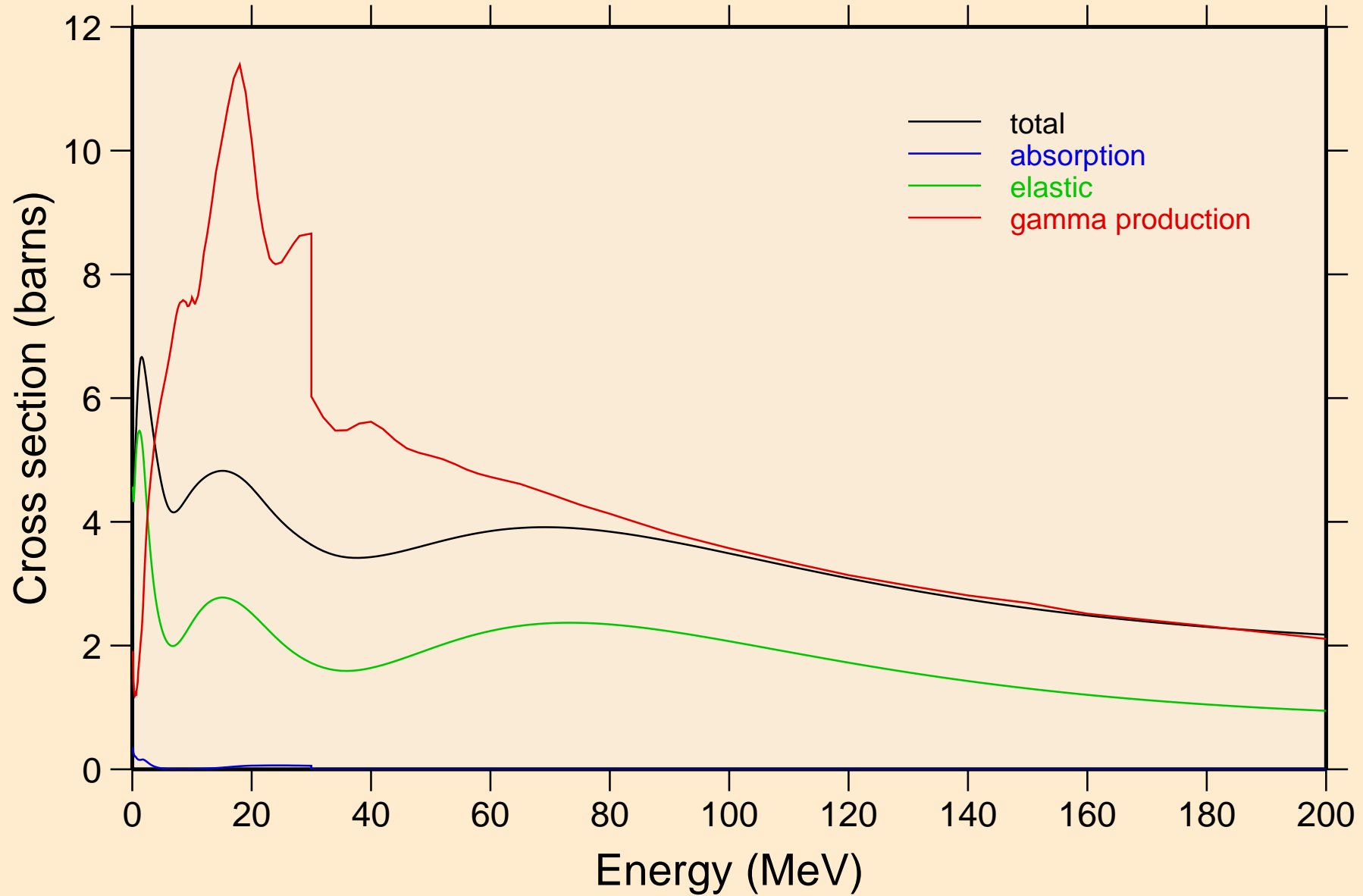

BA135M NEUTRON ACER TENDL-2024 LIBRARY; T=0.K

Heating

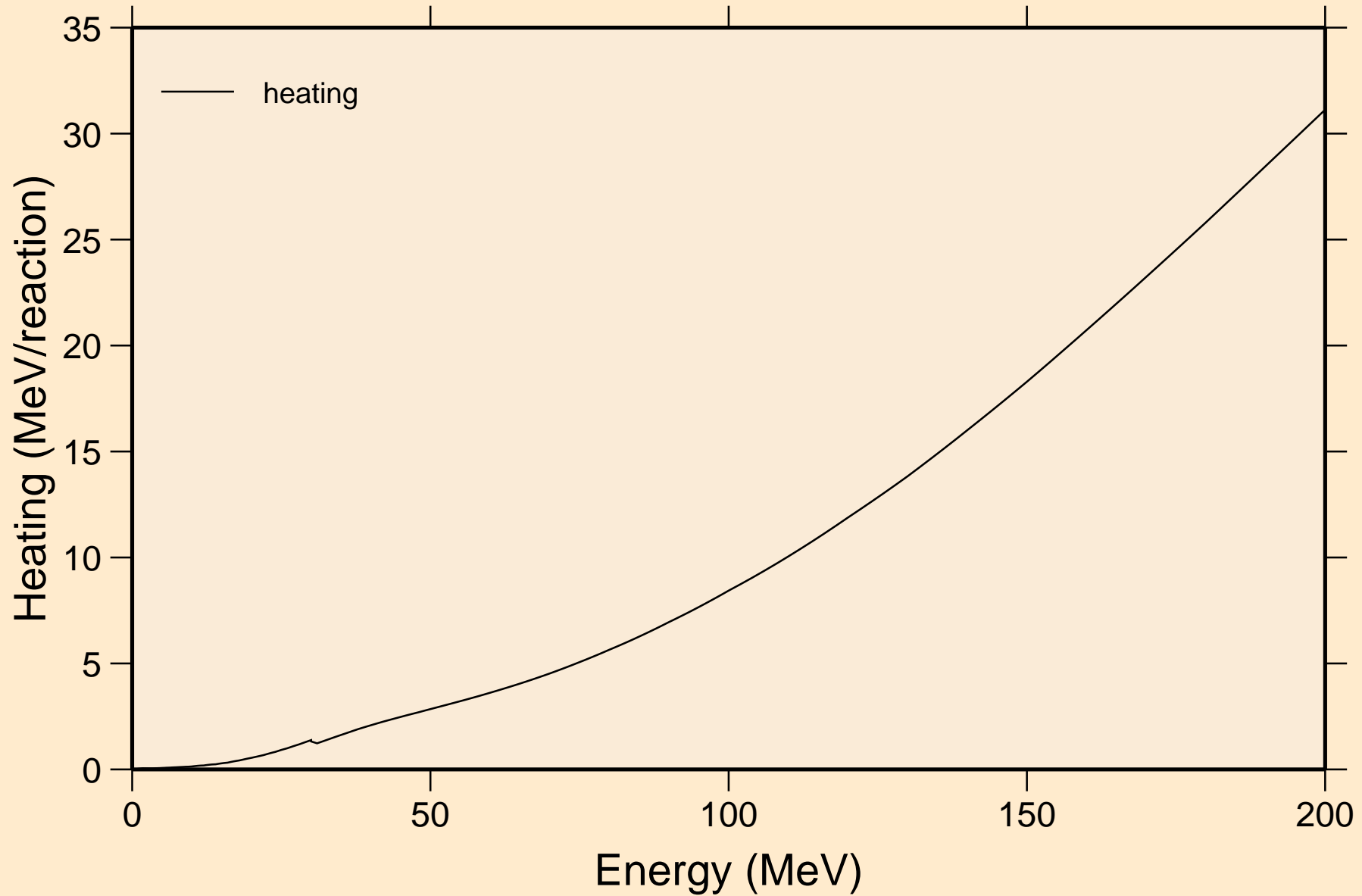

BA135M NEUTRON ACER TENDL-2024 LIBRARY; T=0.K
Damage

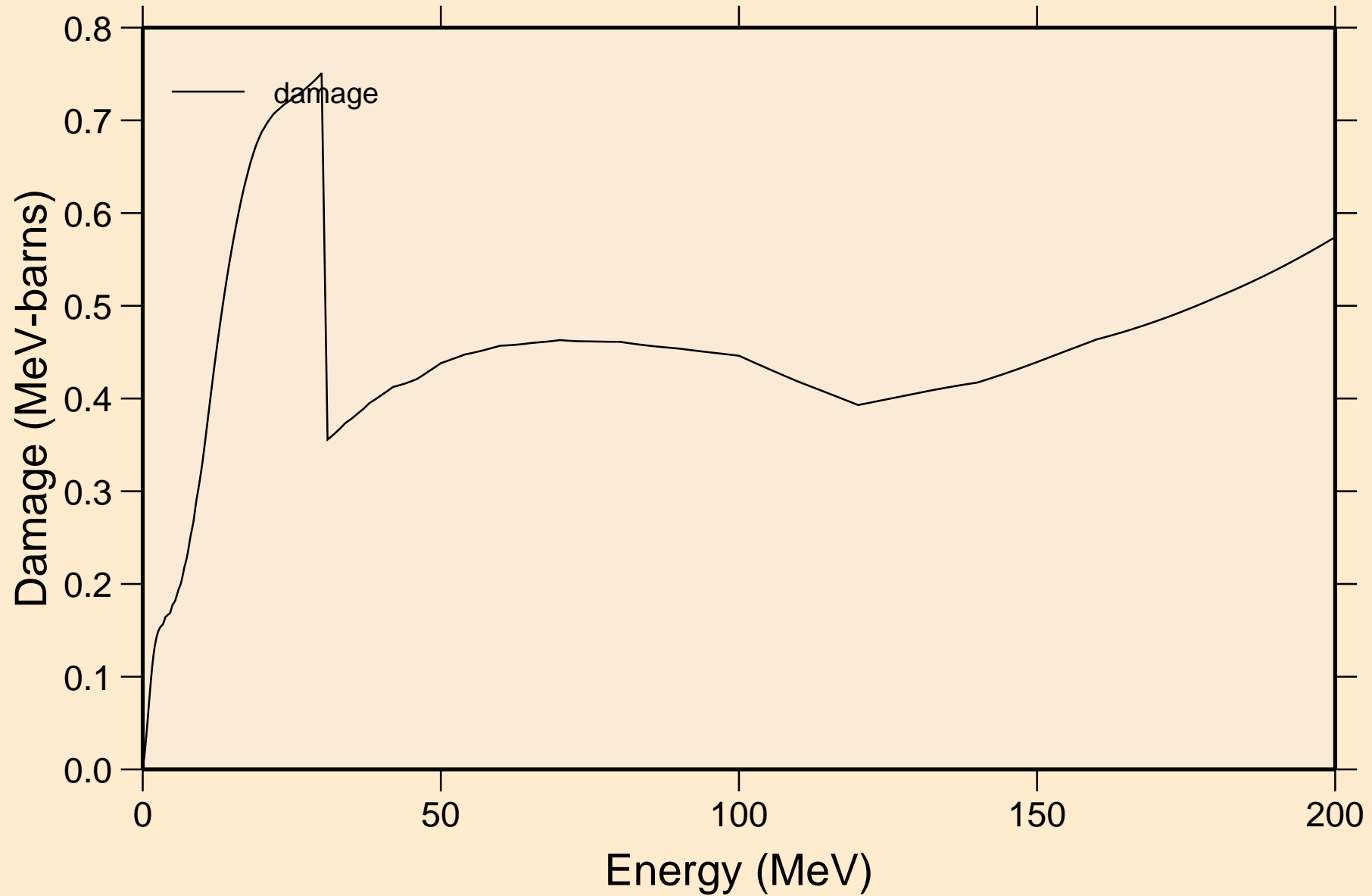

BA135M NEUTRON ACER TENDL-2024 LIBRARY; T=0.K
Non-threshold reactions

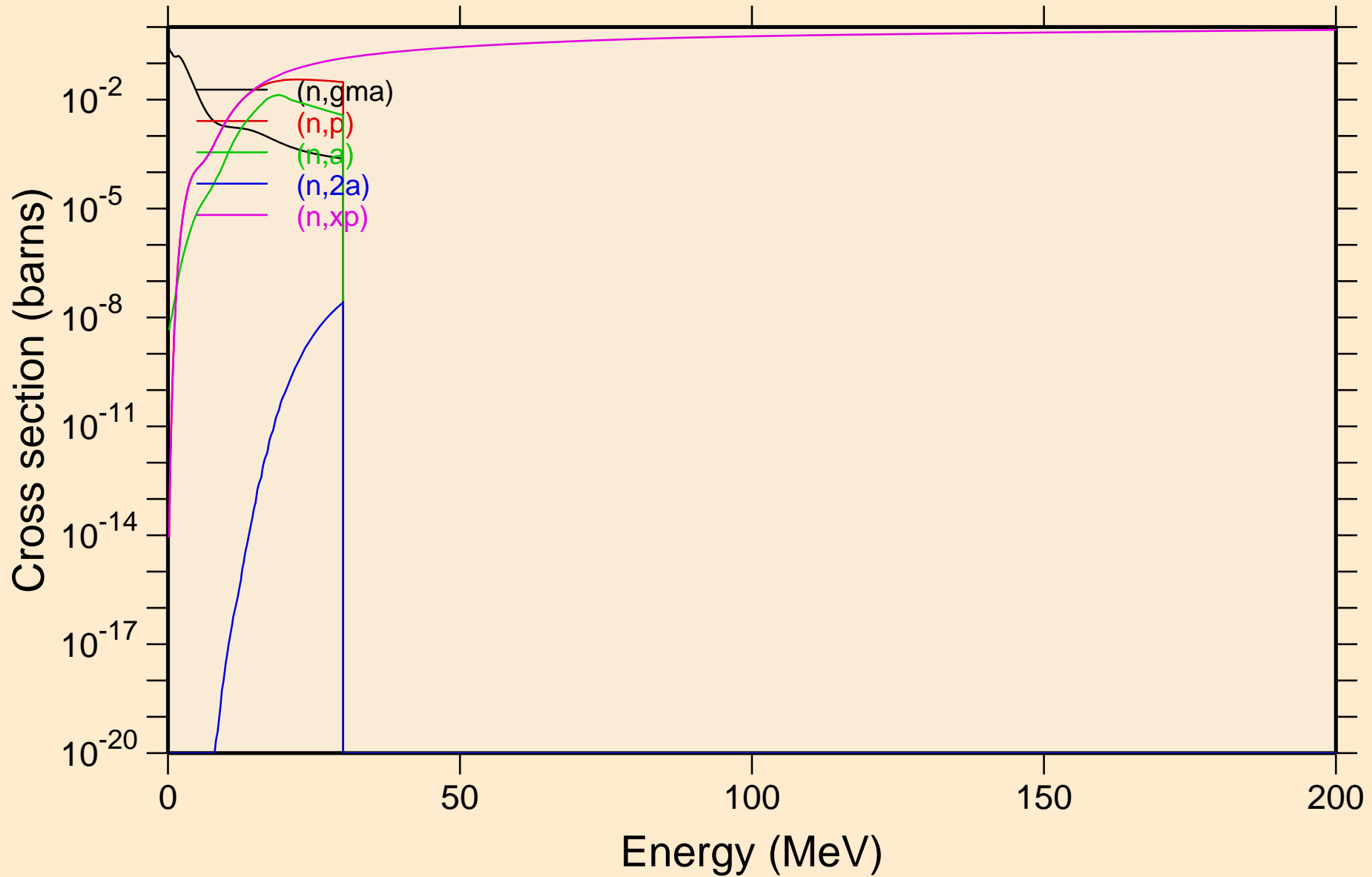

BA135M NEUTRON ACER TENDL-2024 LIBRARY; T=0.K
Non-threshold reactions

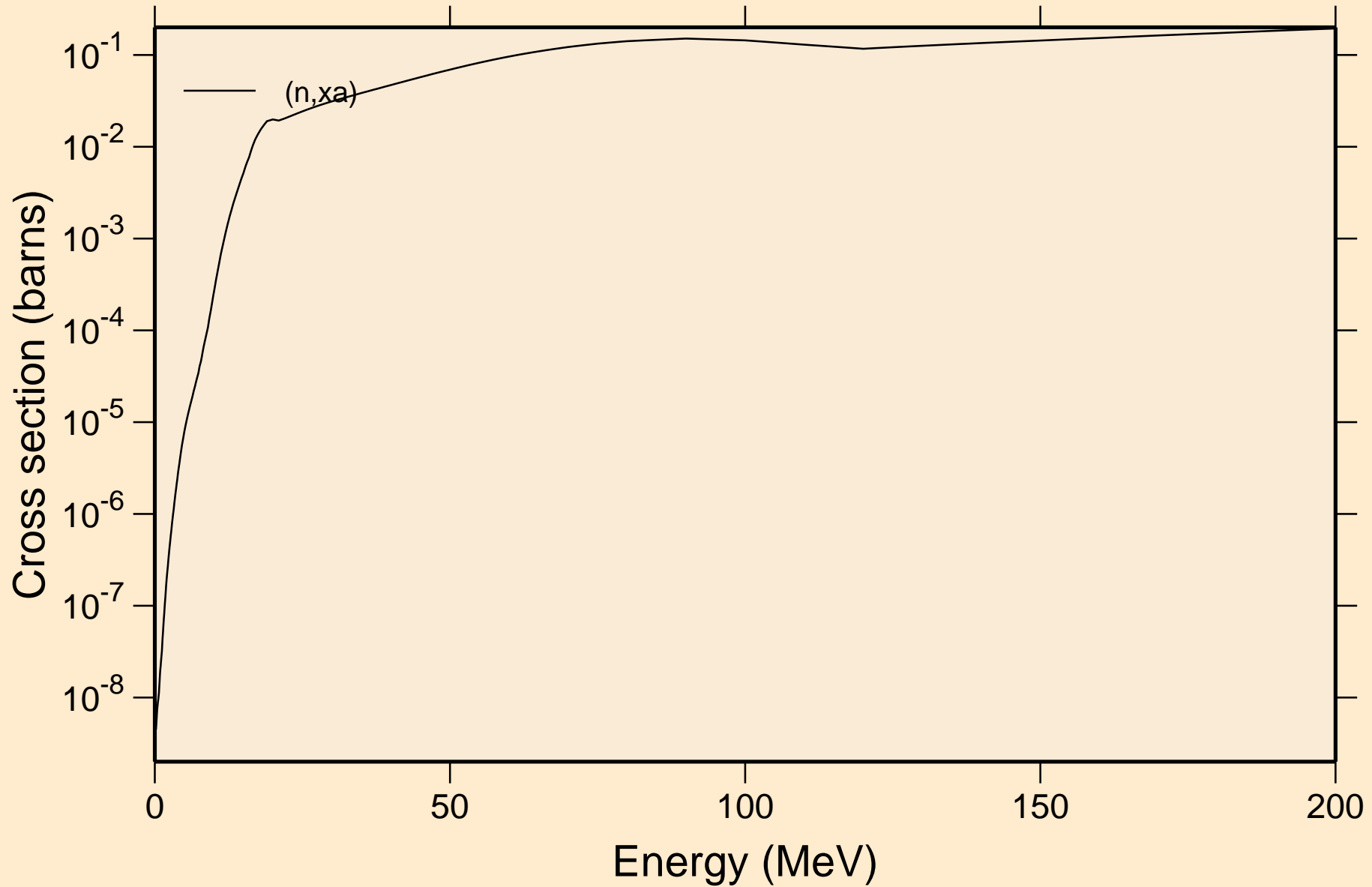

BA135M NEUTRON ACER TENDL-2024 LIBRARY; T=0.K

Inelastic levels

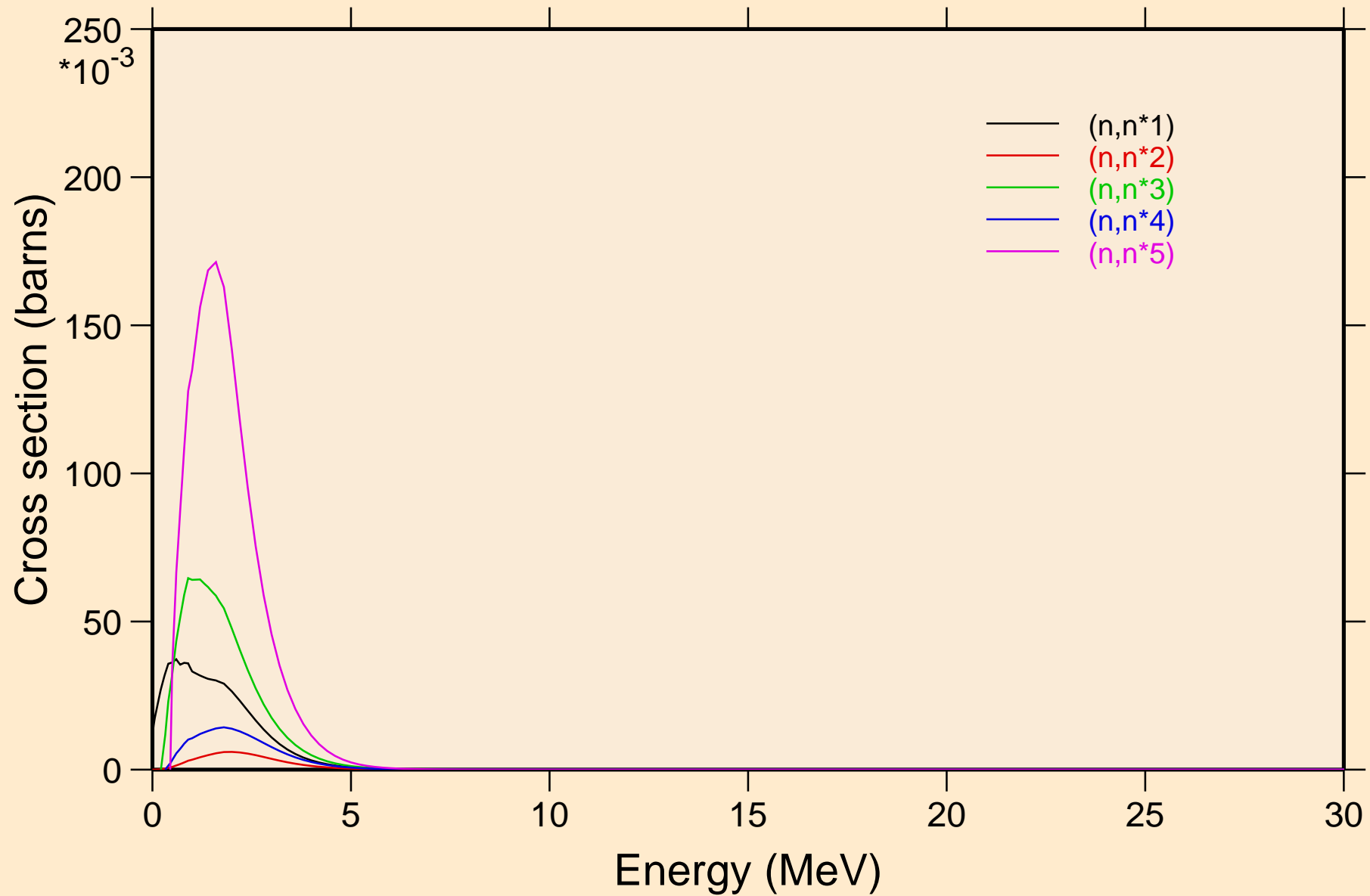

BA135M NEUTRON ACER TENDL-2024 LIBRARY; T=0.K
Inelastic levels

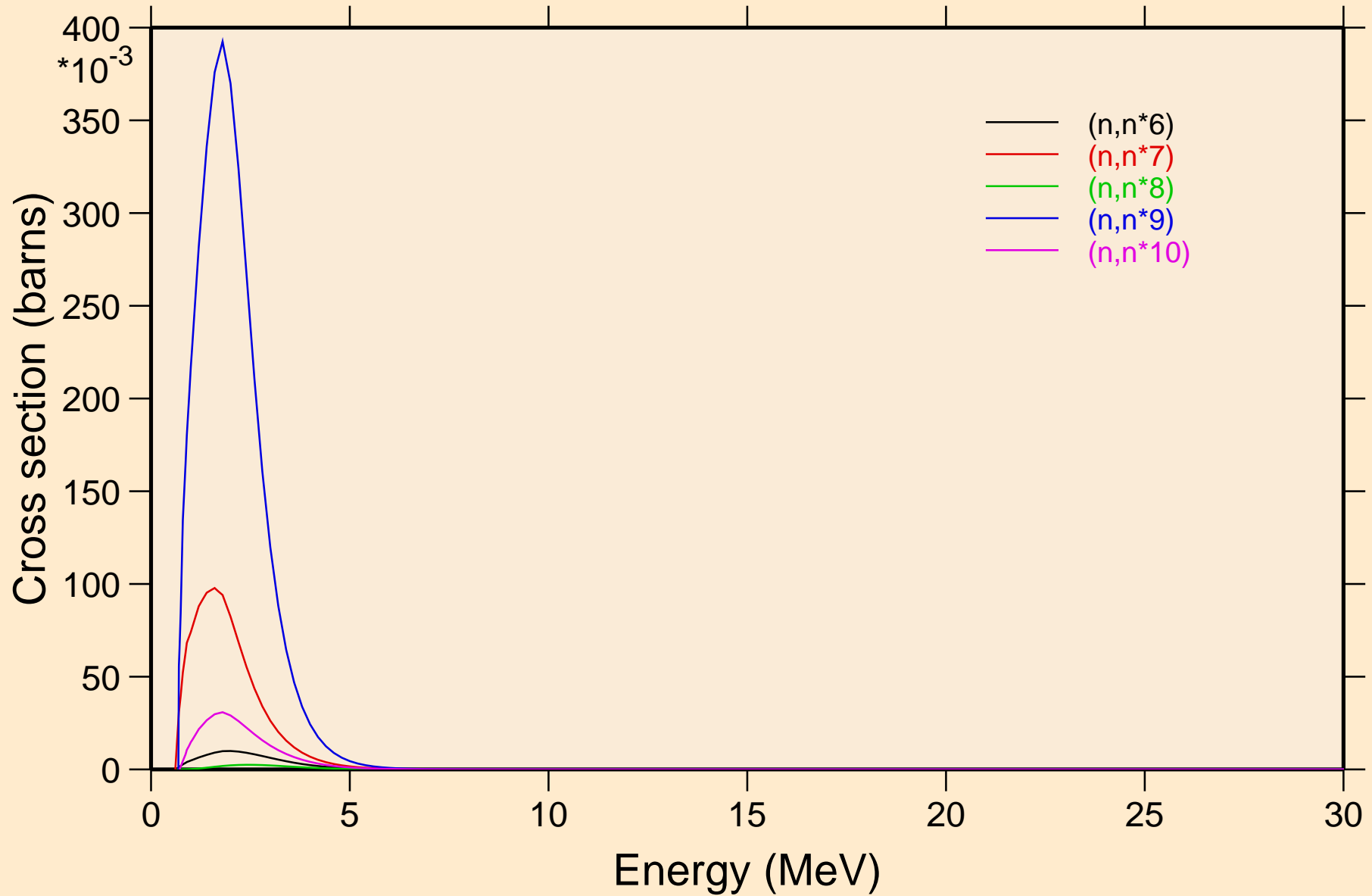

BA135M NEUTRON ACER TENDL-2024 LIBRARY; T=0.K
Inelastic levels

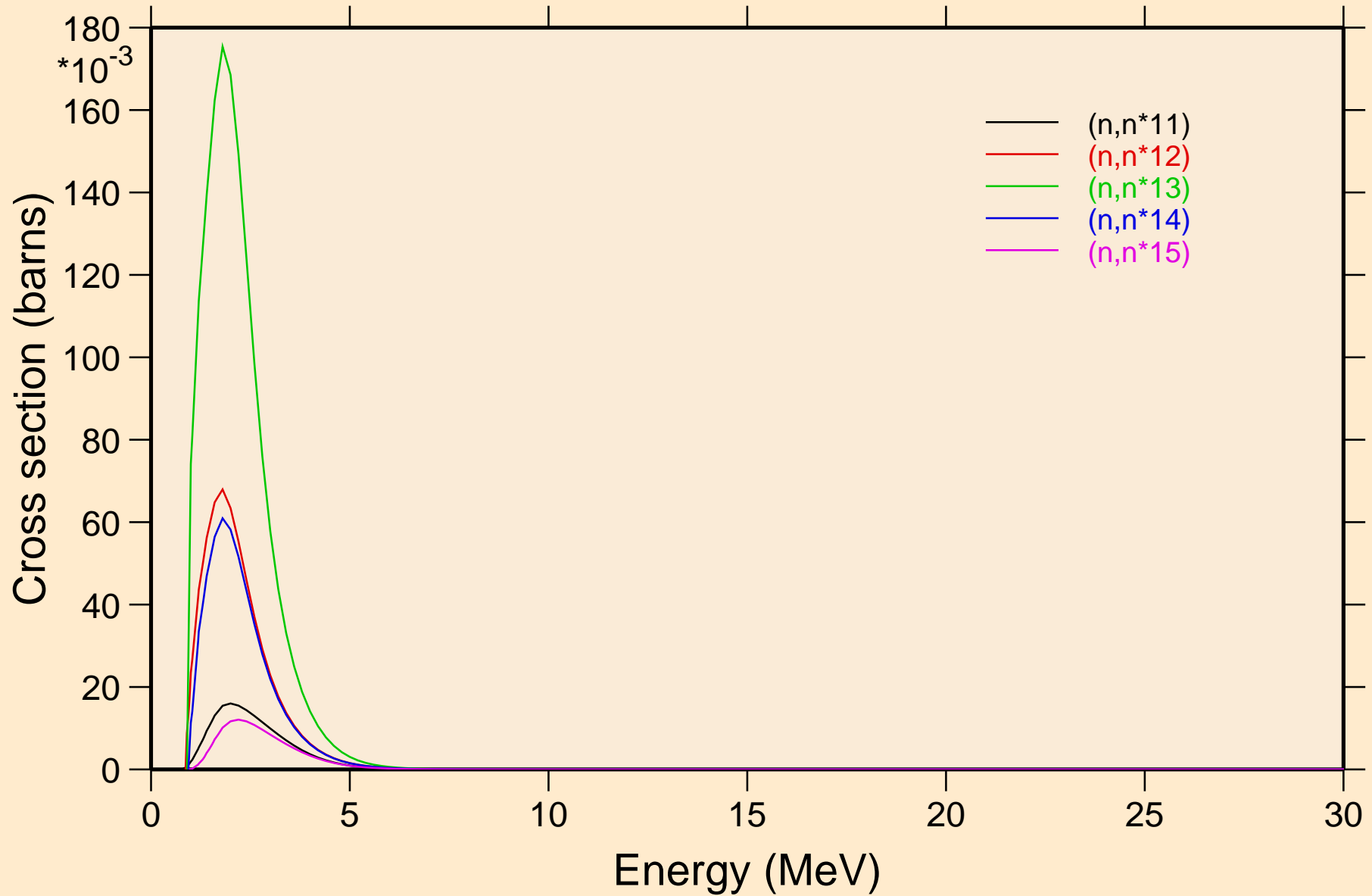

BA135M NEUTRON ACER TENDL-2024 LIBRARY; T=0.K
Inelastic levels

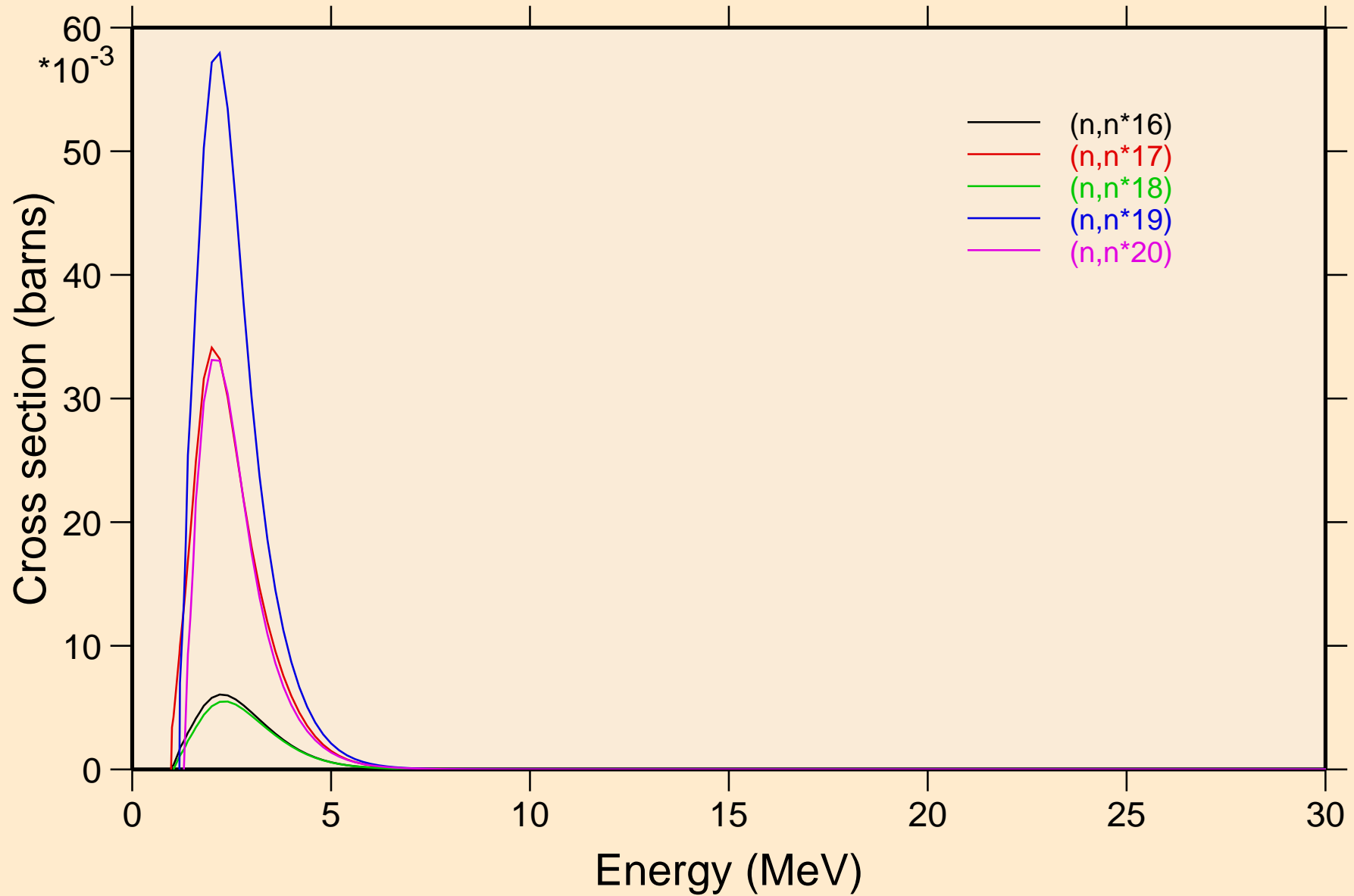

BA135M NEUTRON ACER TENDL-2024 LIBRARY; T=0.K
Inelastic levels

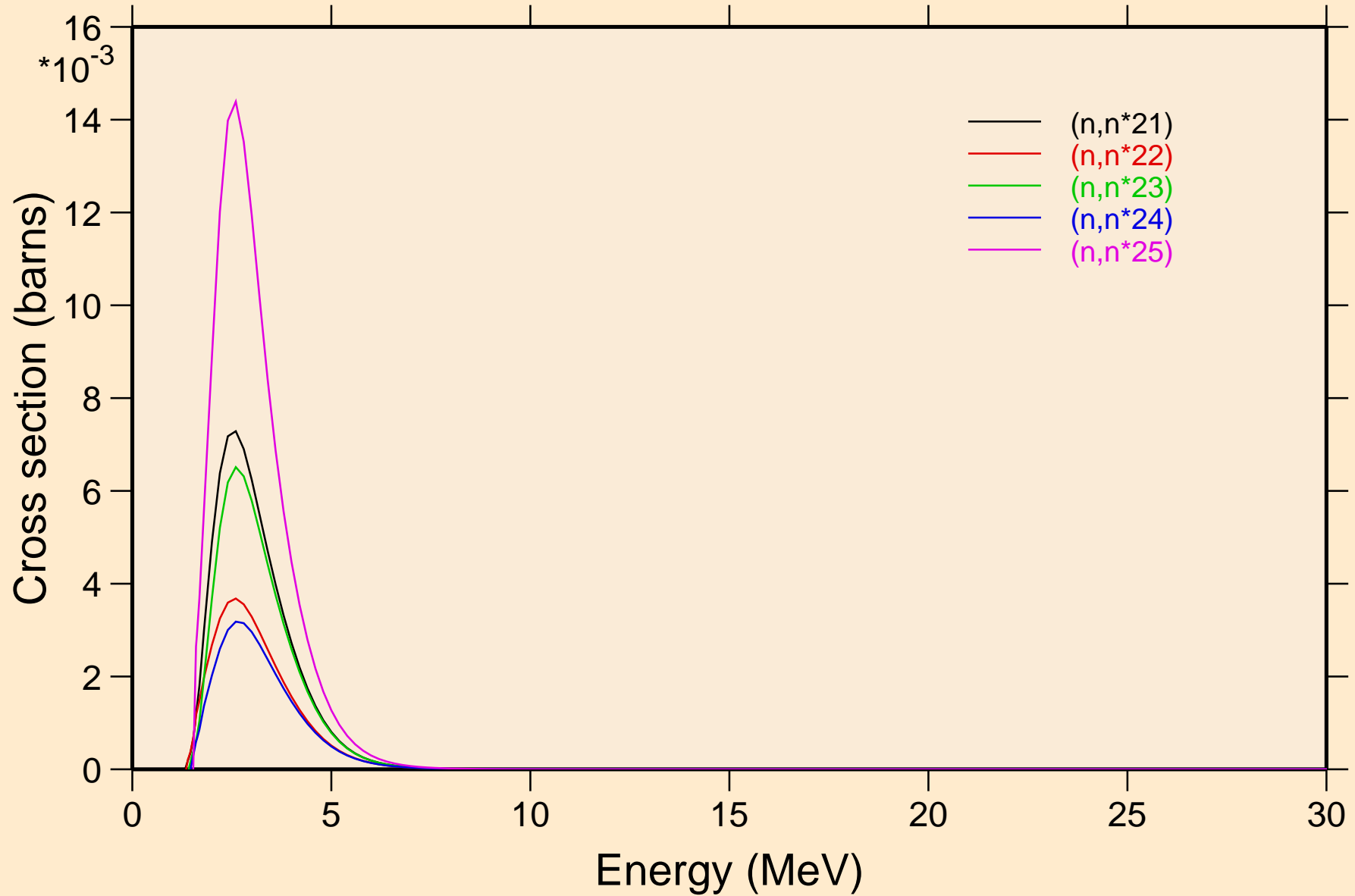

BA135M NEUTRON ACER TENDL-2024 LIBRARY; T=0.K
Threshold reactions

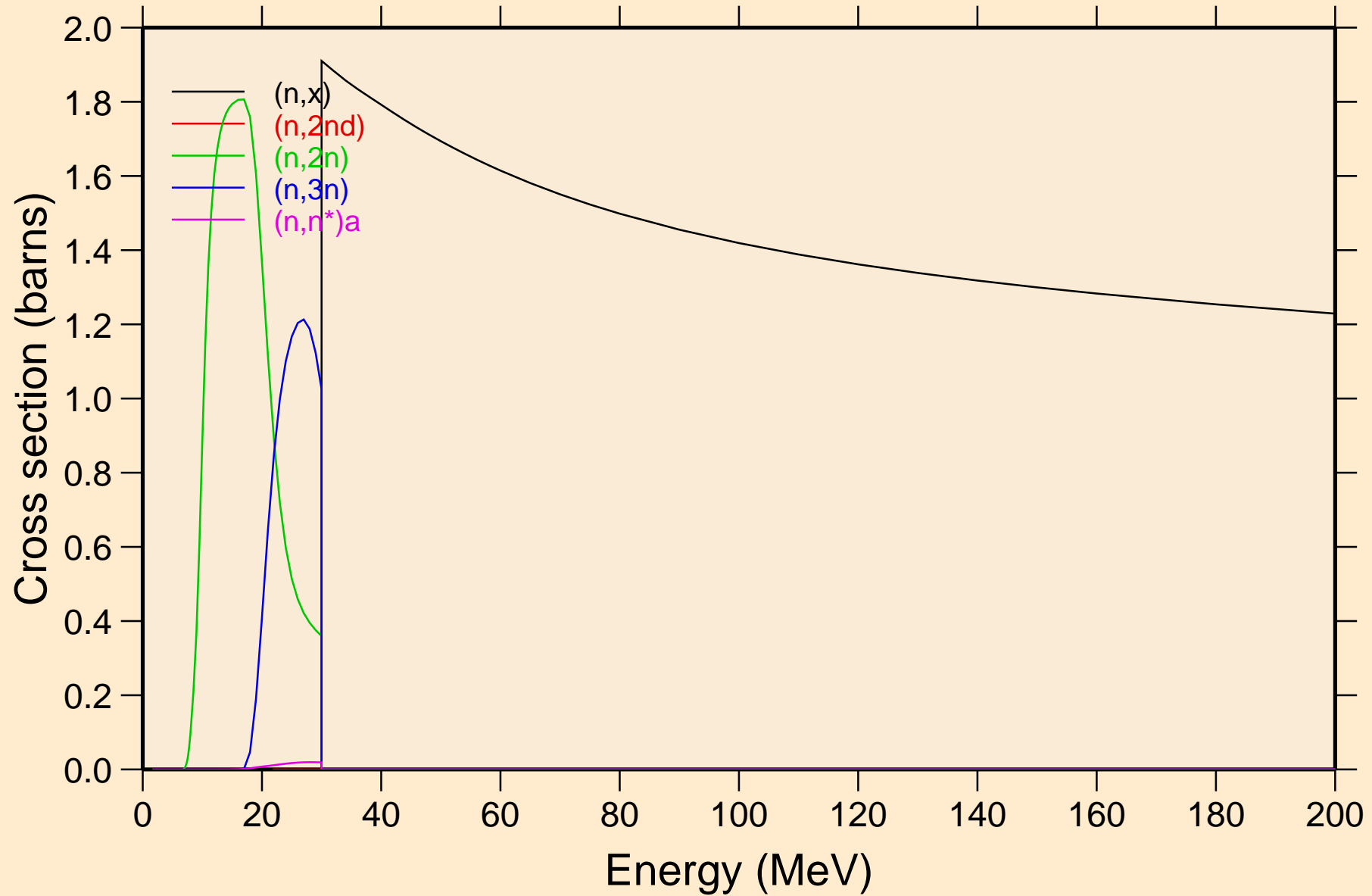

BA135M NEUTRON ACER TENDL-2024 LIBRARY; T=0.K
Threshold reactions

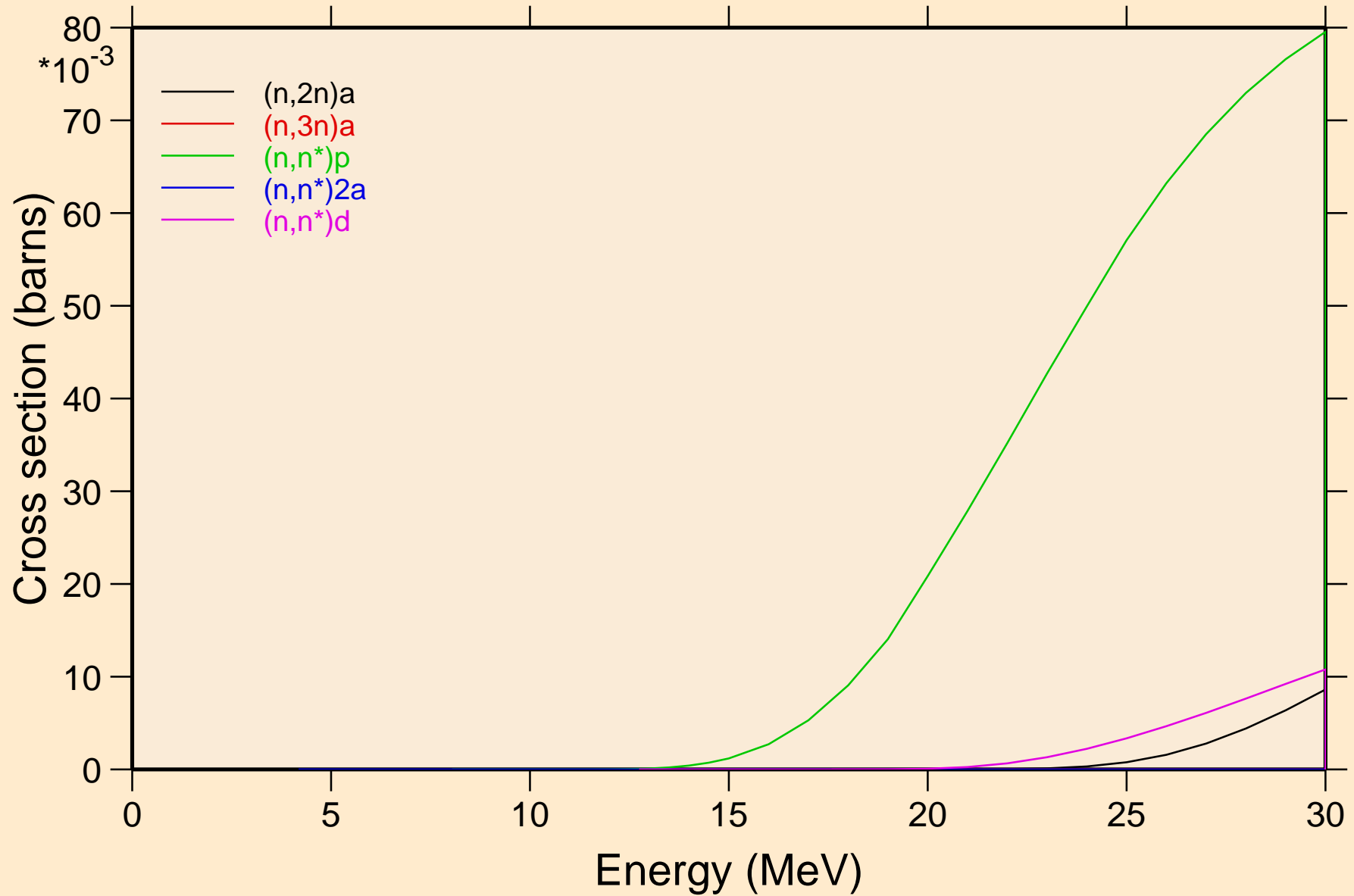

BA135M NEUTRON ACER TENDL-2024 LIBRARY; T=0.K

Threshold reactions

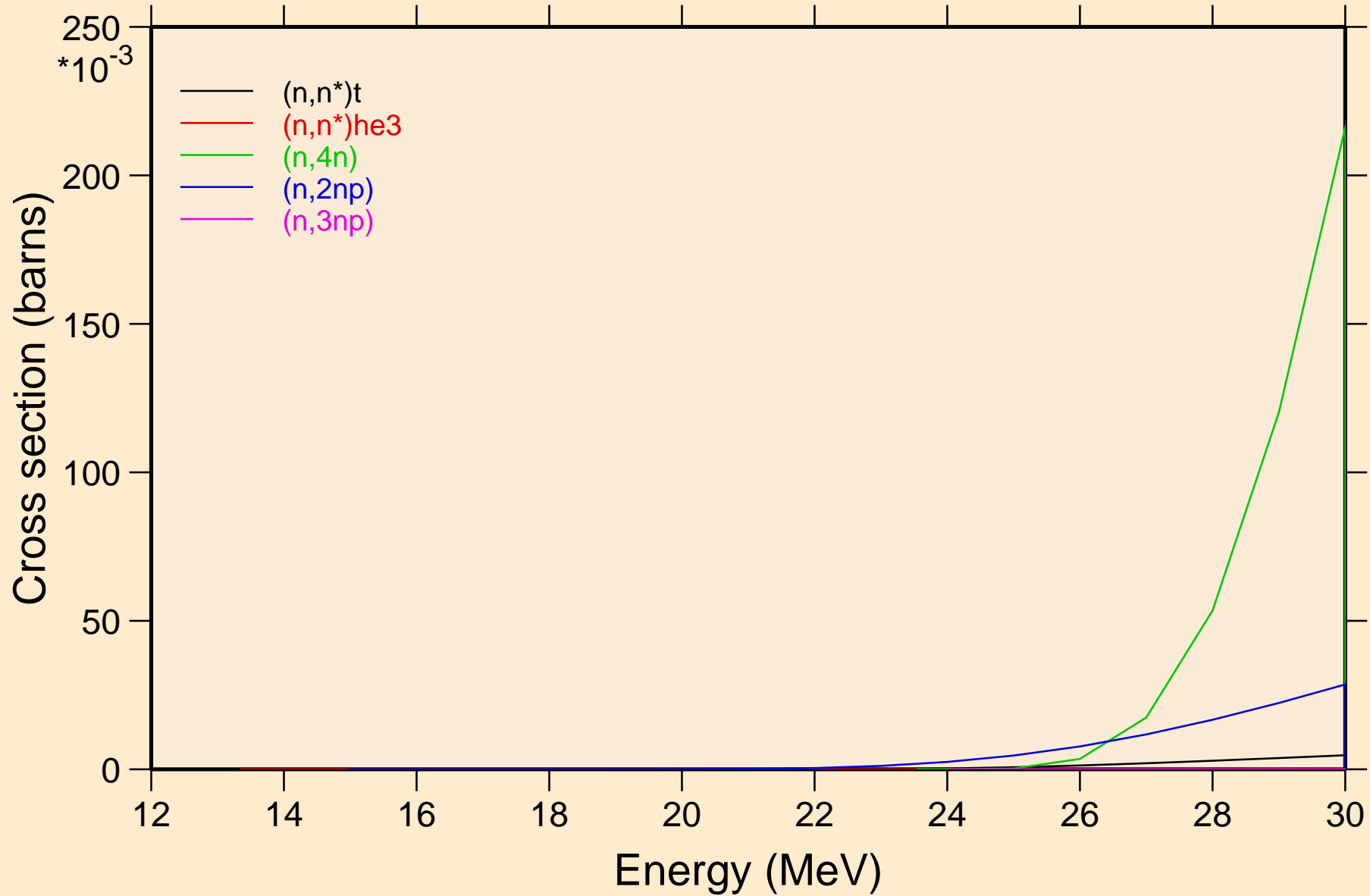

BA135M NEUTRON ACER TENDL-2024 LIBRARY; T=0.K

Threshold reactions

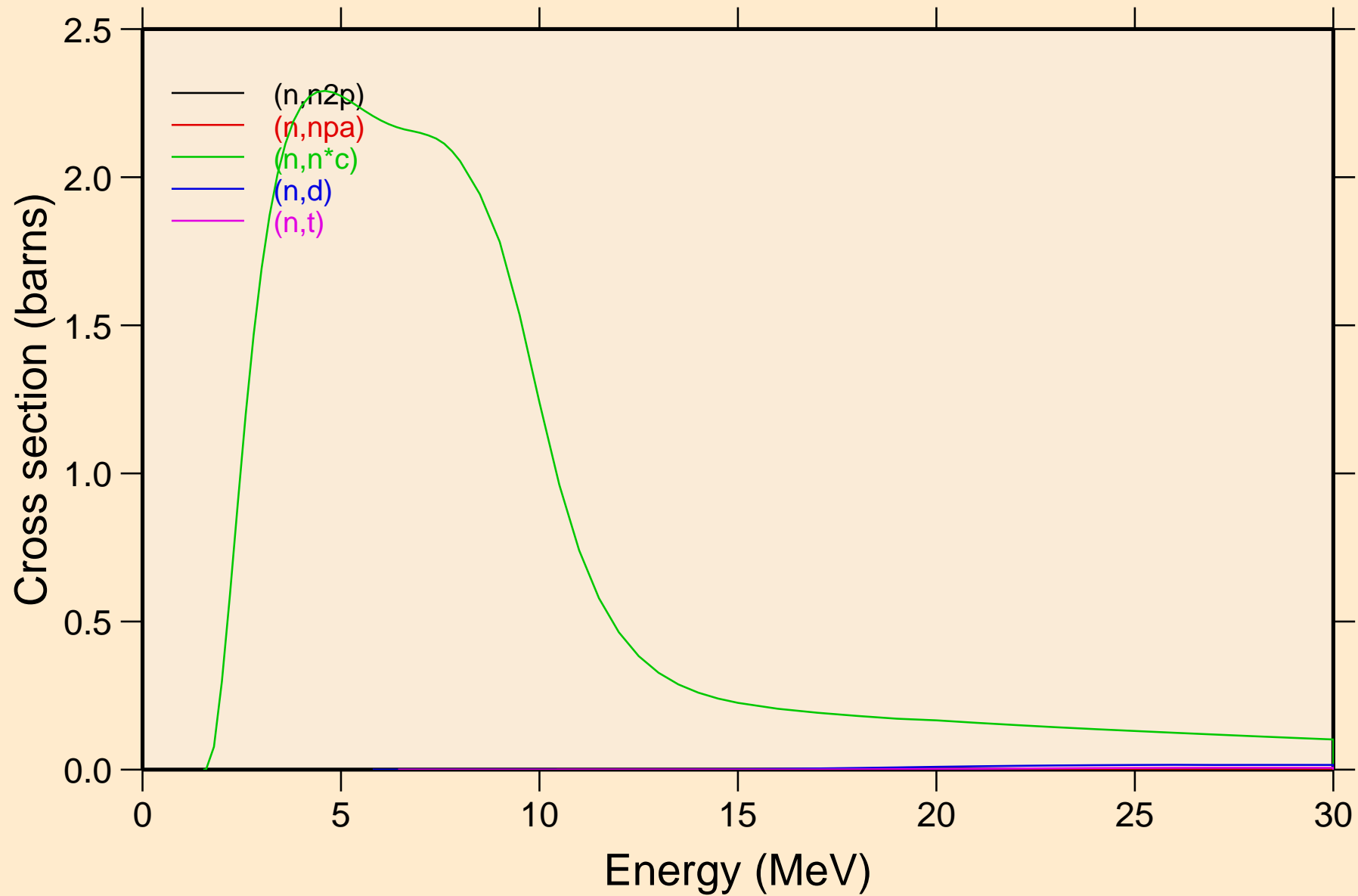

BA135M NEUTRON ACER TENDL-2024 LIBRARY; T=0.K

Threshold reactions

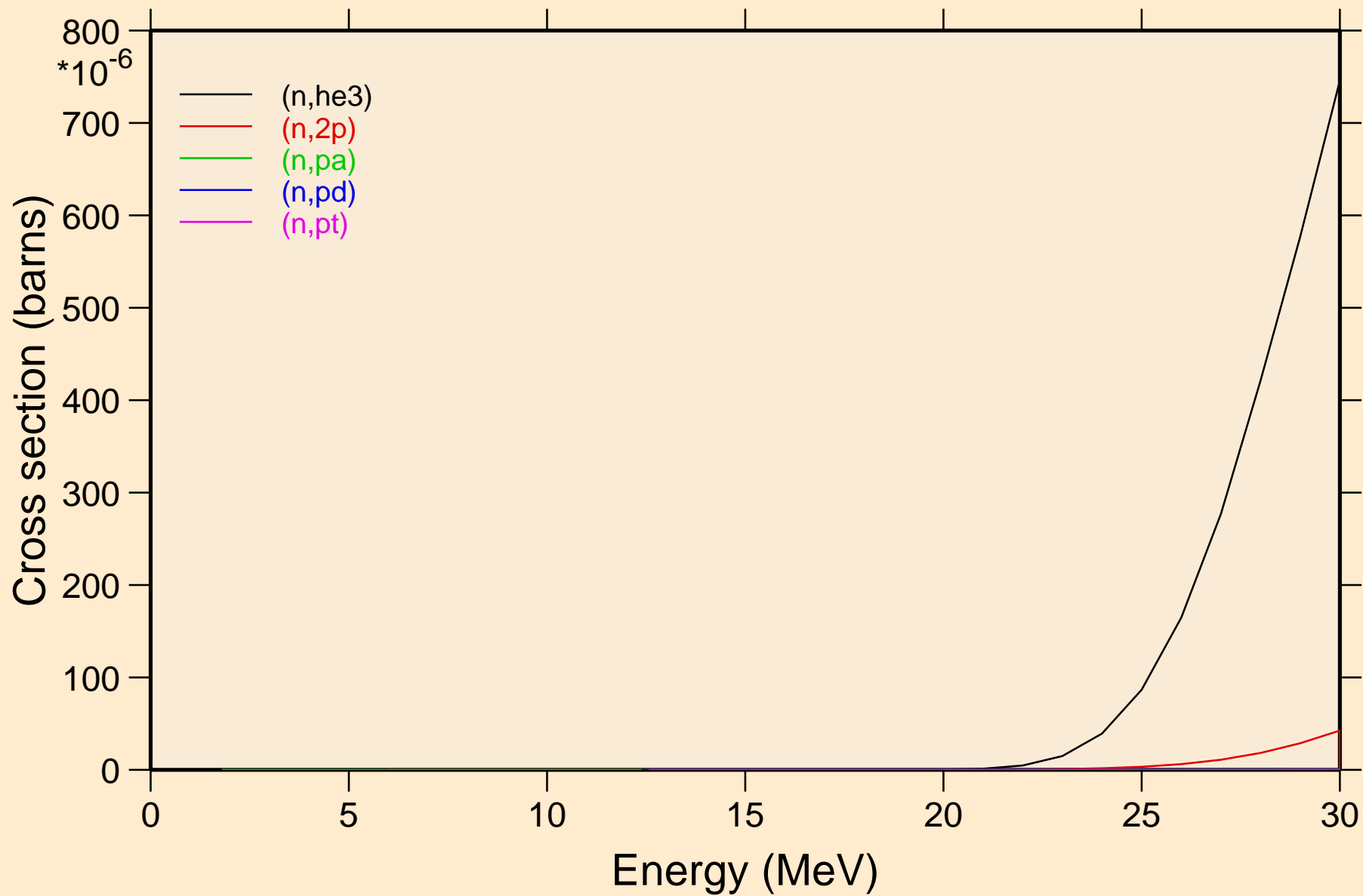

BA135M NEUTRON ACER TENDL-2024 LIBRARY; T=0.K
Threshold reactions

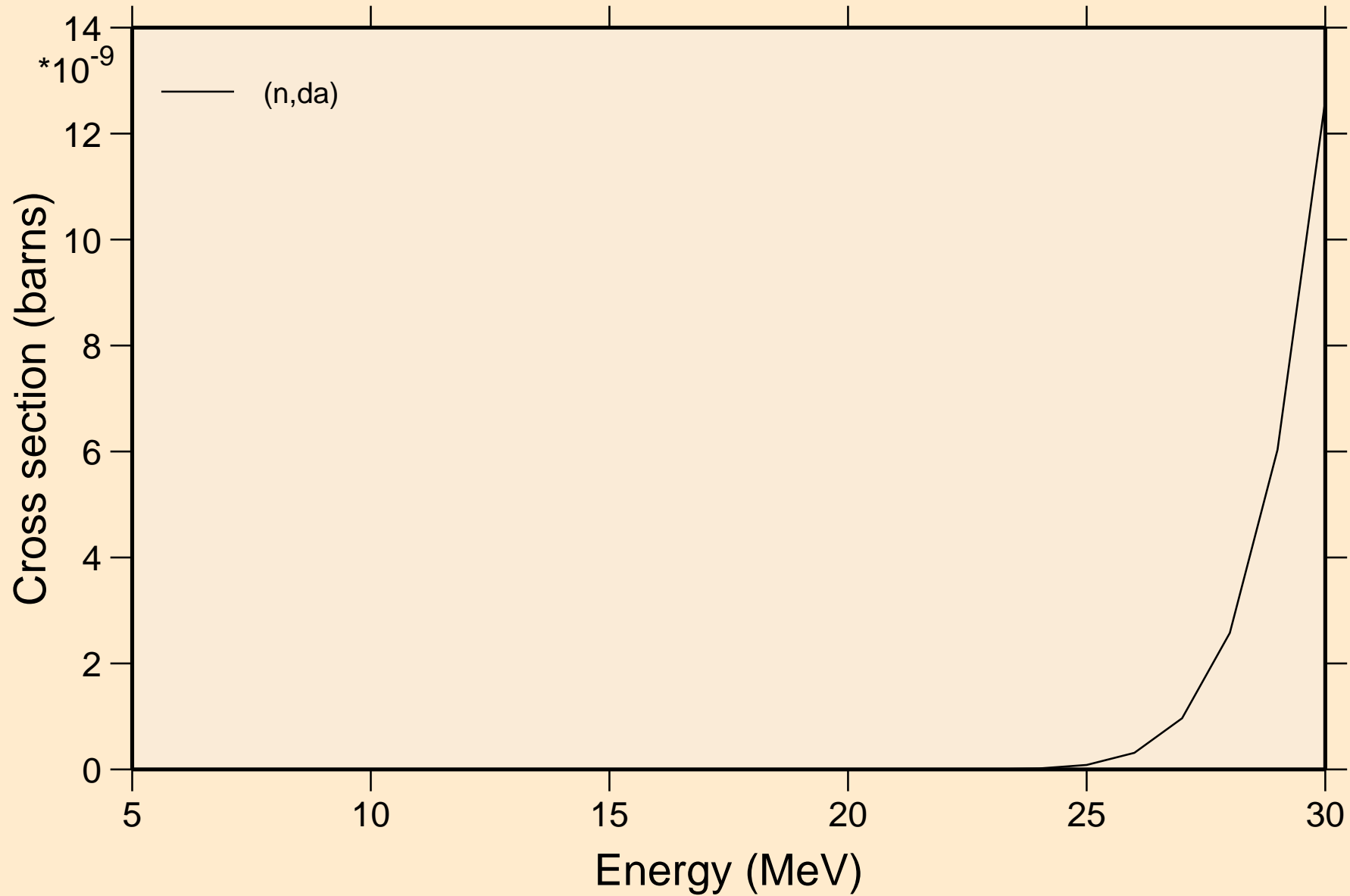

BA135M NEUTRON ACER TENDL-2024 LIBRARY; T=0.K
Threshold reactions

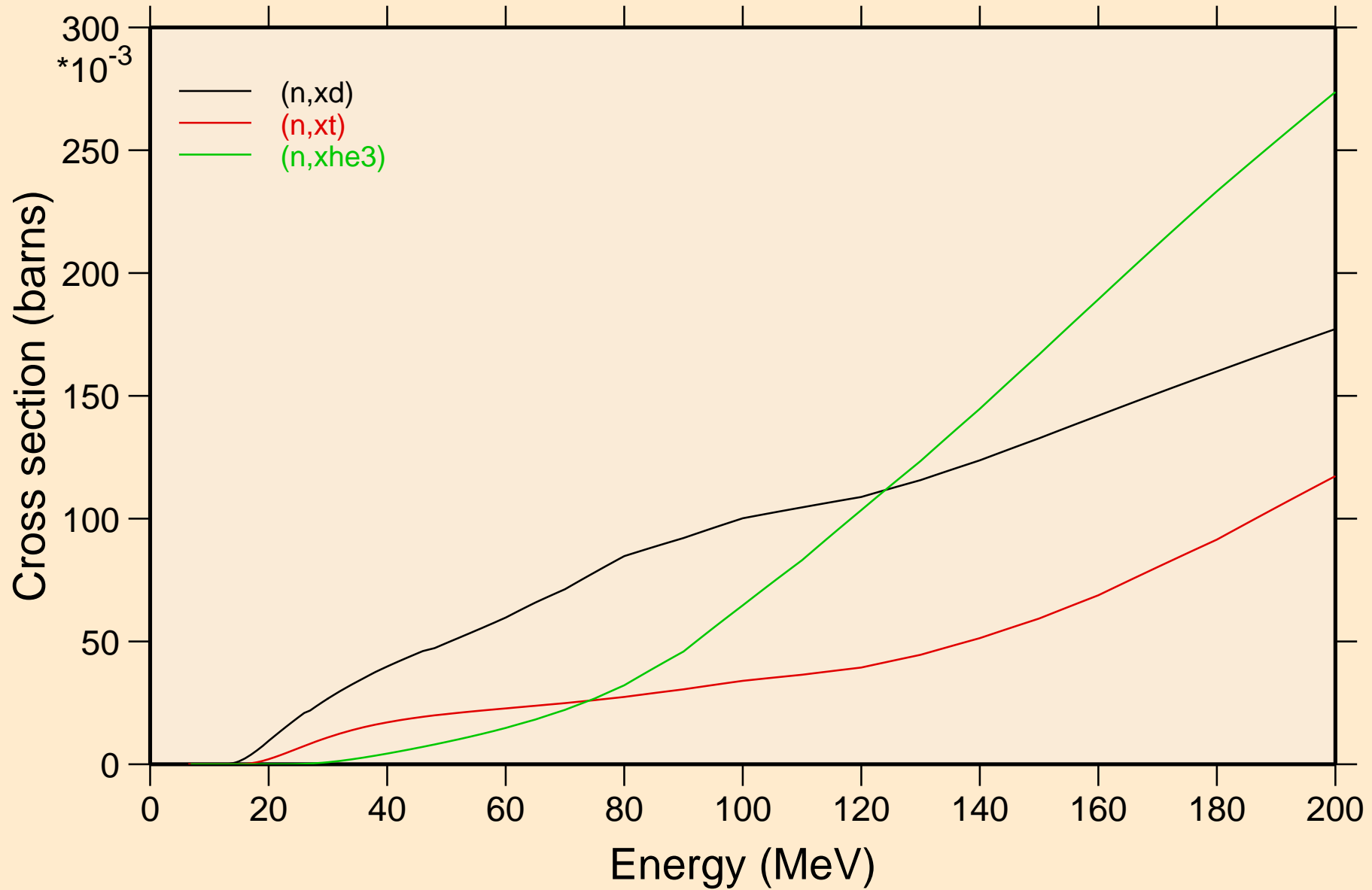

BA135M NEUTRON ACER TENDL-2024 LIBRARY; T=0.K
angular distribution for elastic

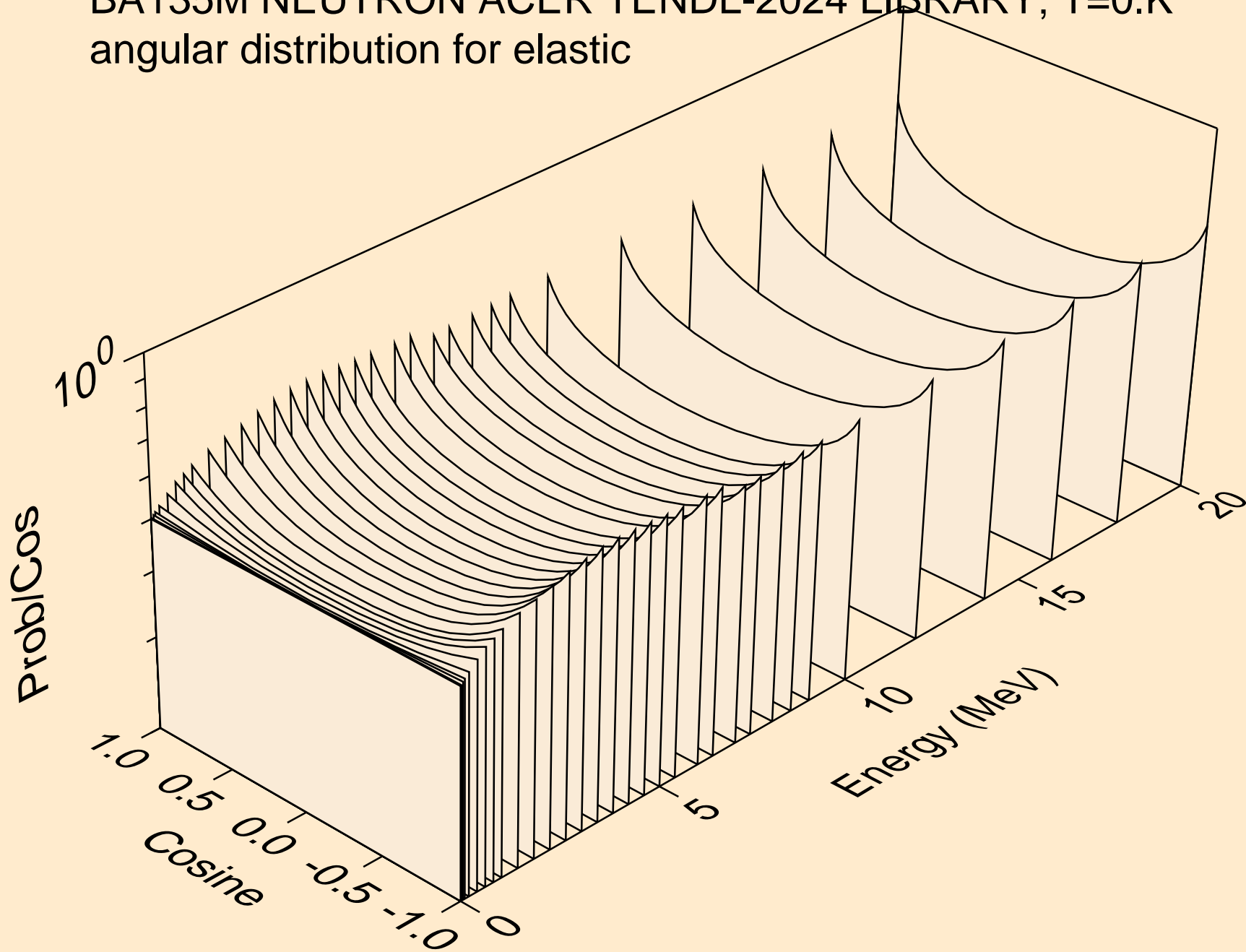

BA135M NEUTRON ACER TENDL-2024 LIBRARY; T=0.K
angular distribution for elastic

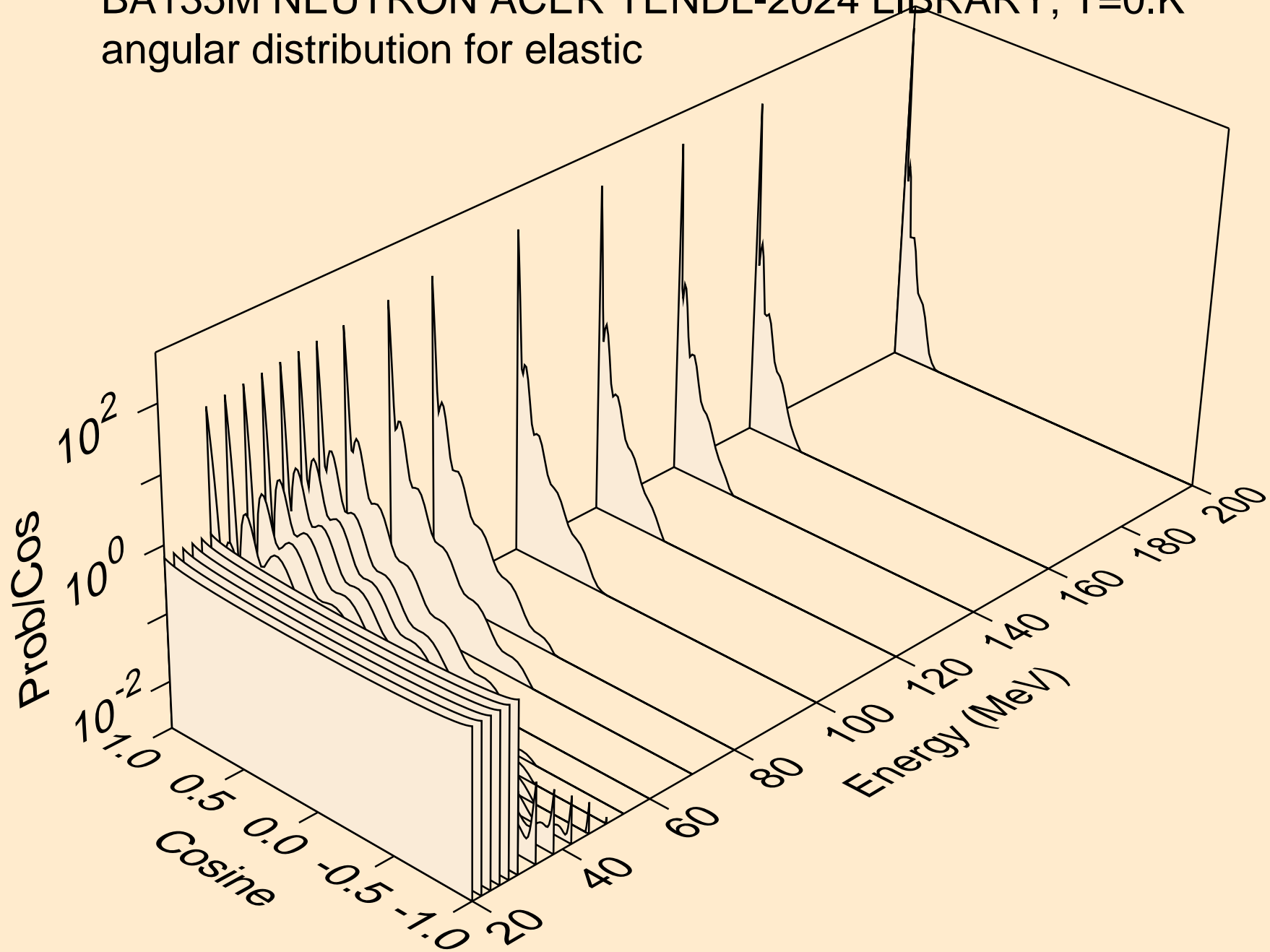

BA135M NEUTRON ACER TENDL-2024 LIBRARY; T=0.K
angular distribution for (n,n*1)

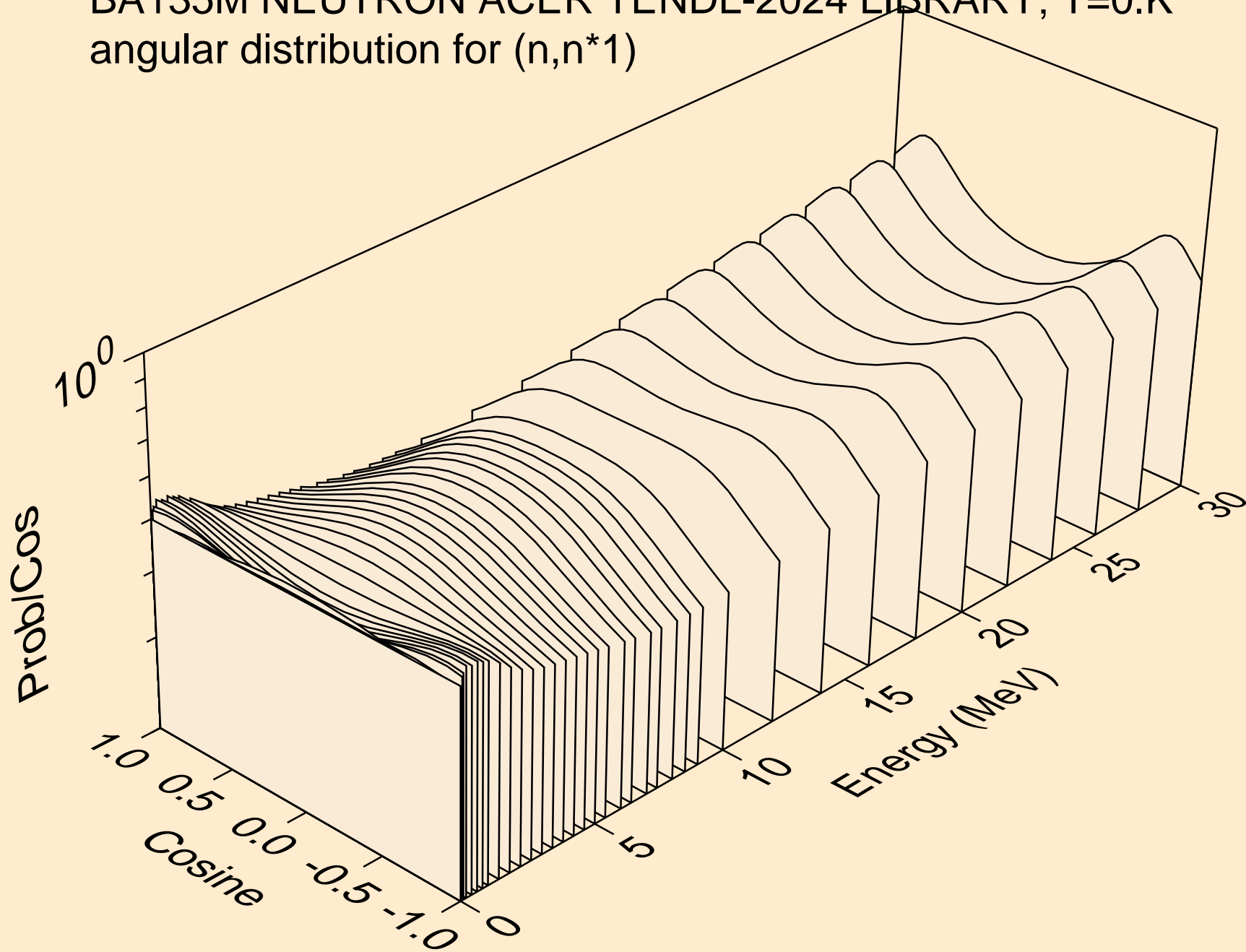

BA135M NEUTRON ACER TENDL-2024 LIBRARY; T=0.K
angular distribution for (n,n*2)

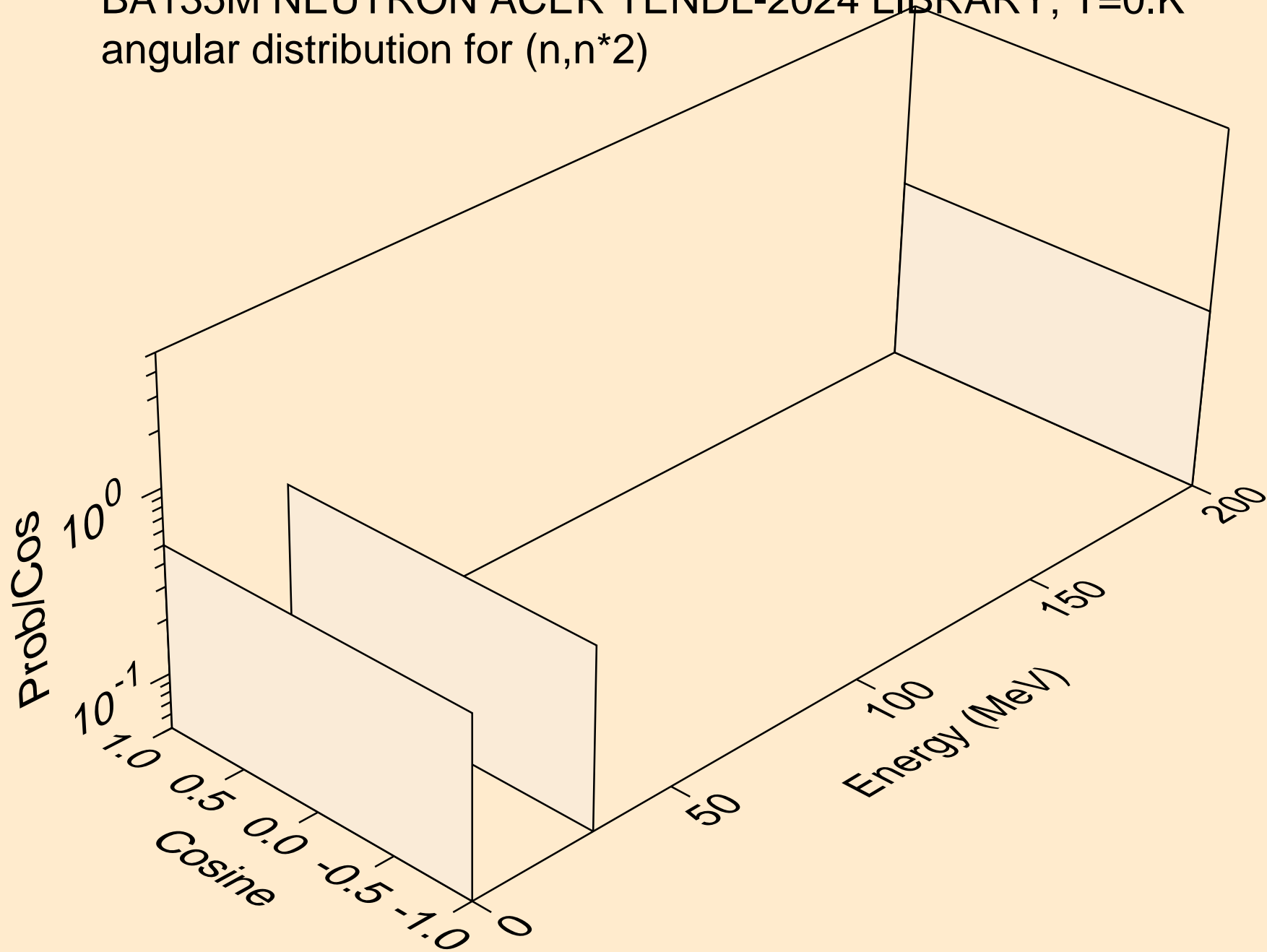

BA135M NEUTRON ACER TENDL-2024 LIBRARY; T=0.K
angular distribution for (n,n*3)

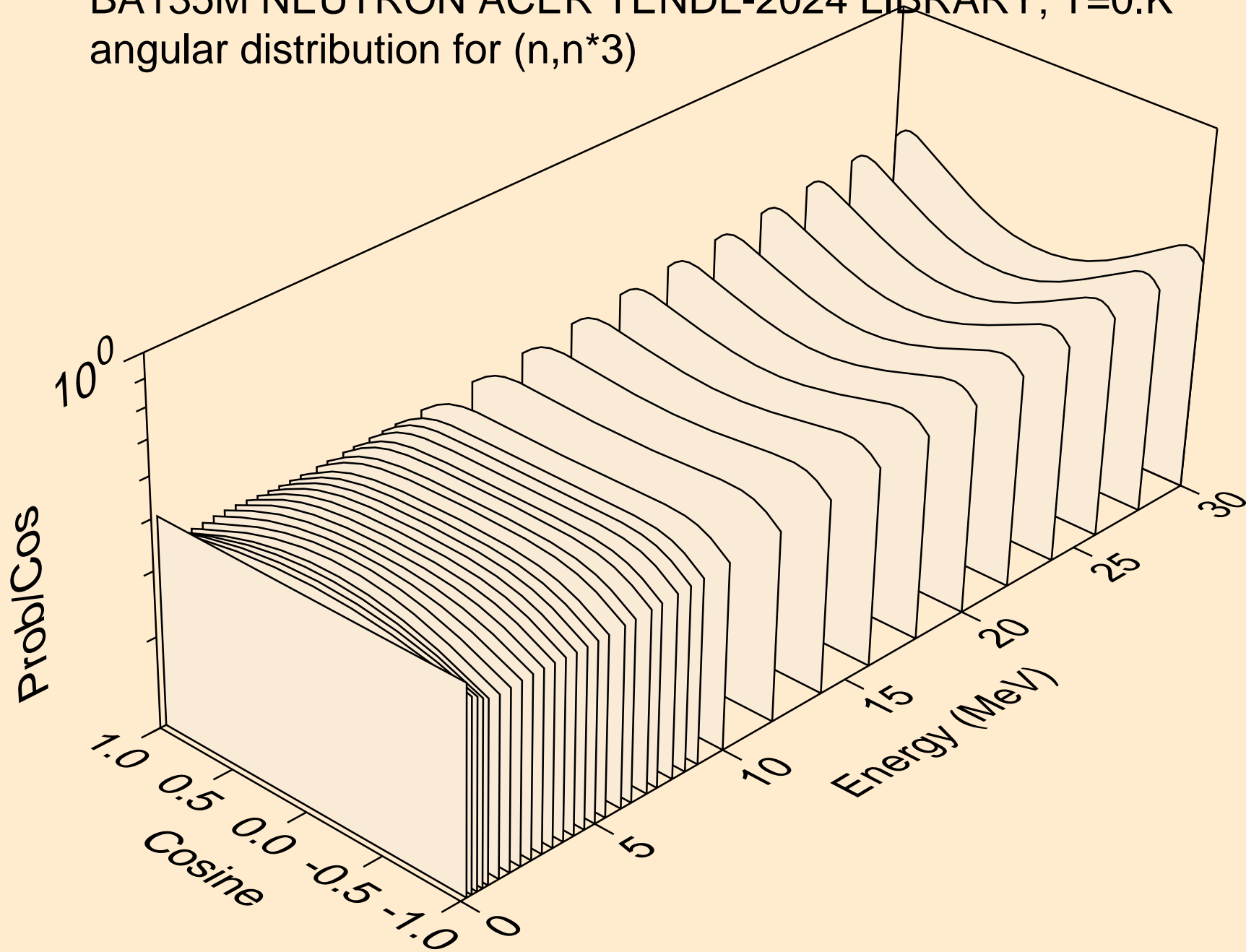

BA135M NEUTRON ACER TENDL-2024 LIBRARY; T=0.K
angular distribution for (n,n*4)

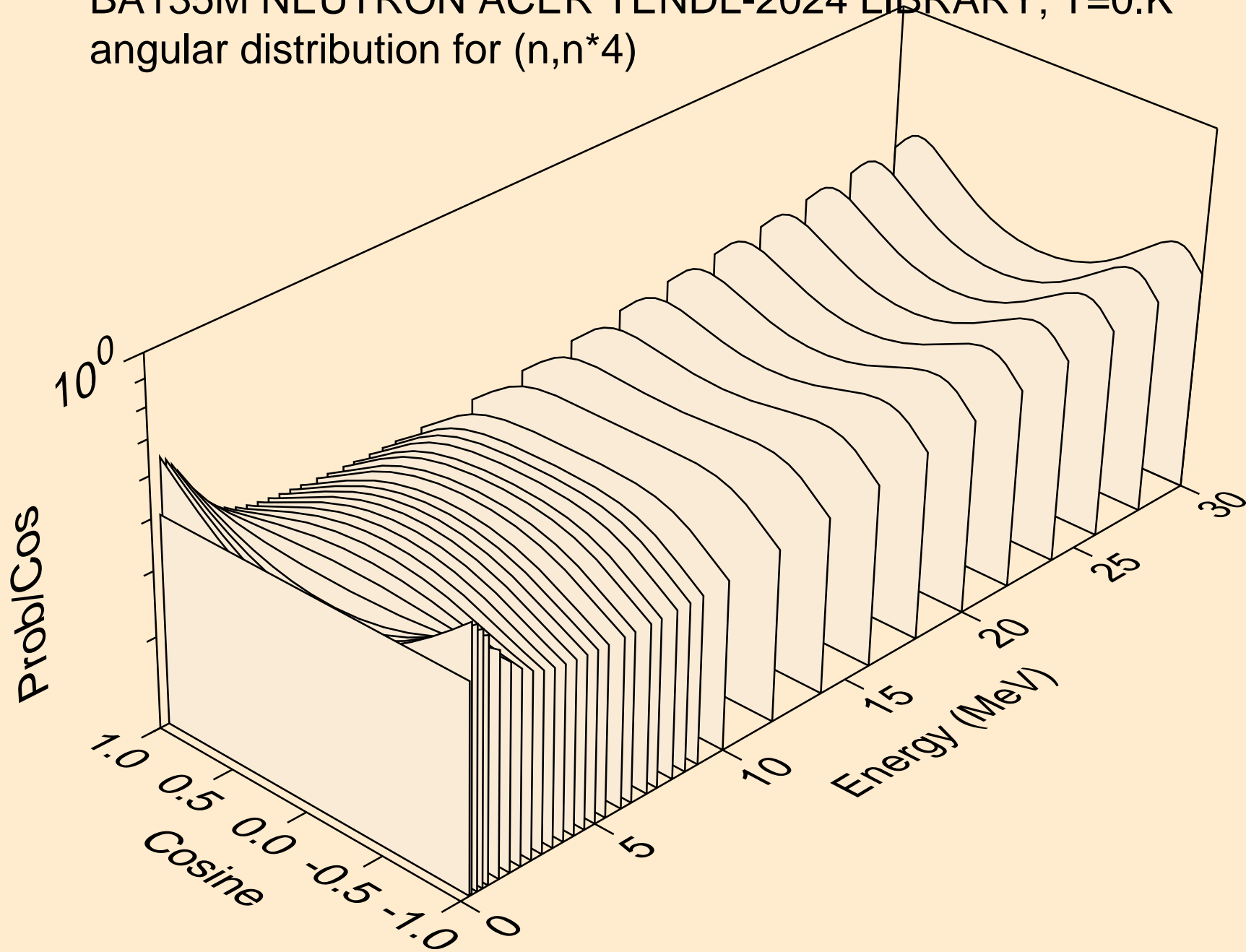

BA135M NEUTRON ACER TENDL-2024 LIBRARY; T=0.K
angular distribution for (n,n*5)

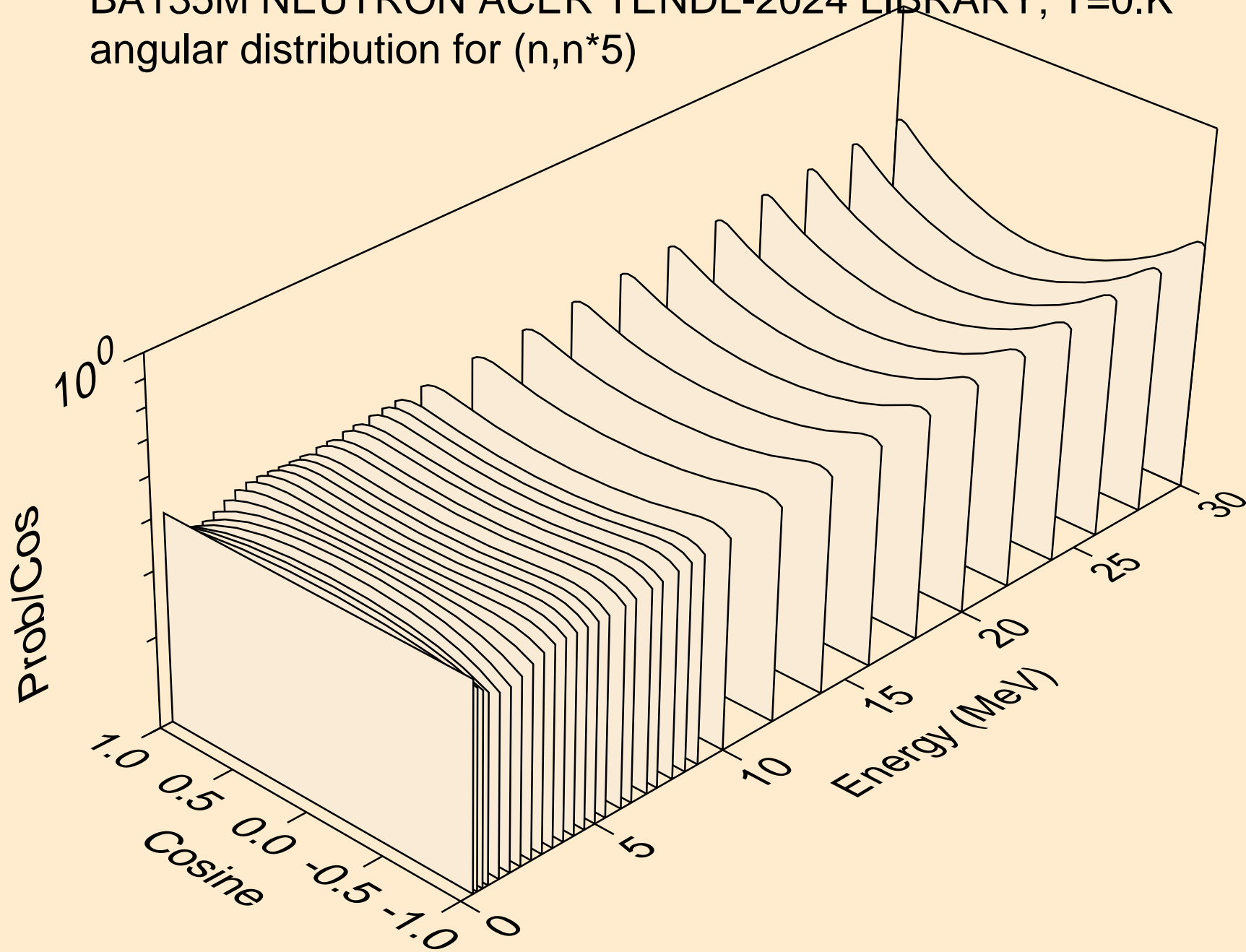

BA135M NEUTRON ACER TENDL-2024 LIBRARY; T=0.K
angular distribution for (n,n*6)

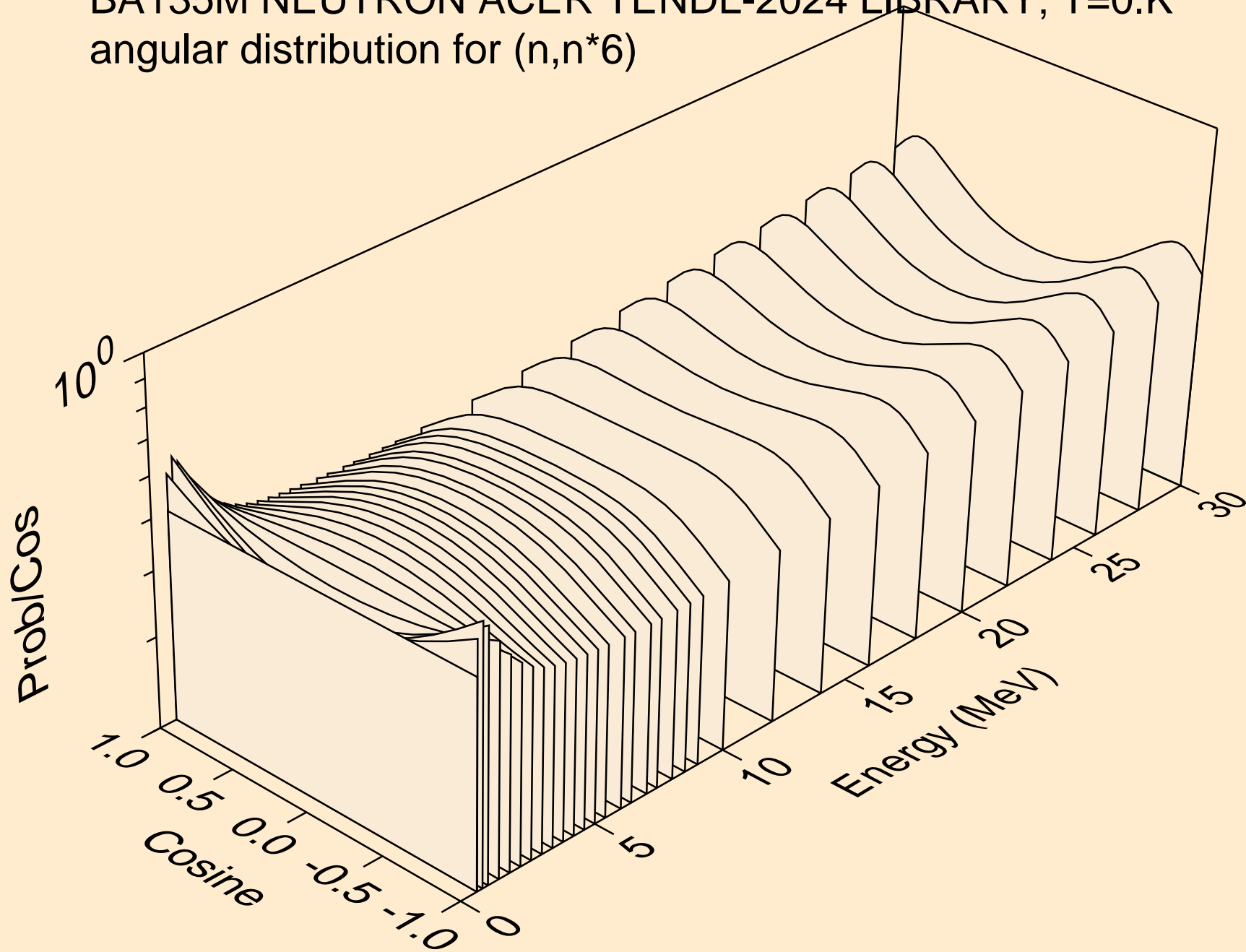

BA135M NEUTRON ACER TENDL-2024 LIBRARY; T=0.K
angular distribution for (n,n*7)

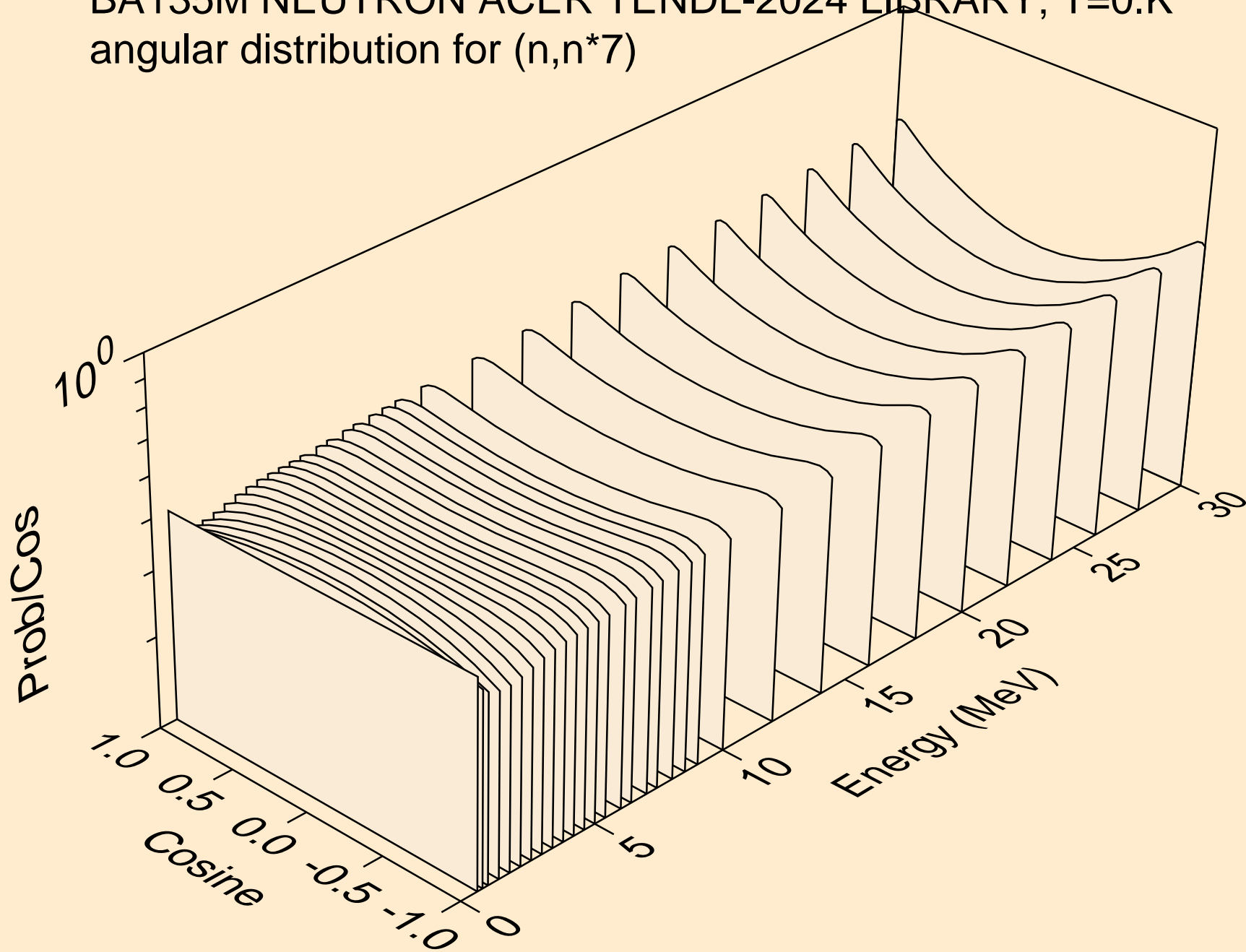

BA135M NEUTRON ACER TENDL-2024 LIBRARY; T=0.K
angular distribution for (n,n*8)

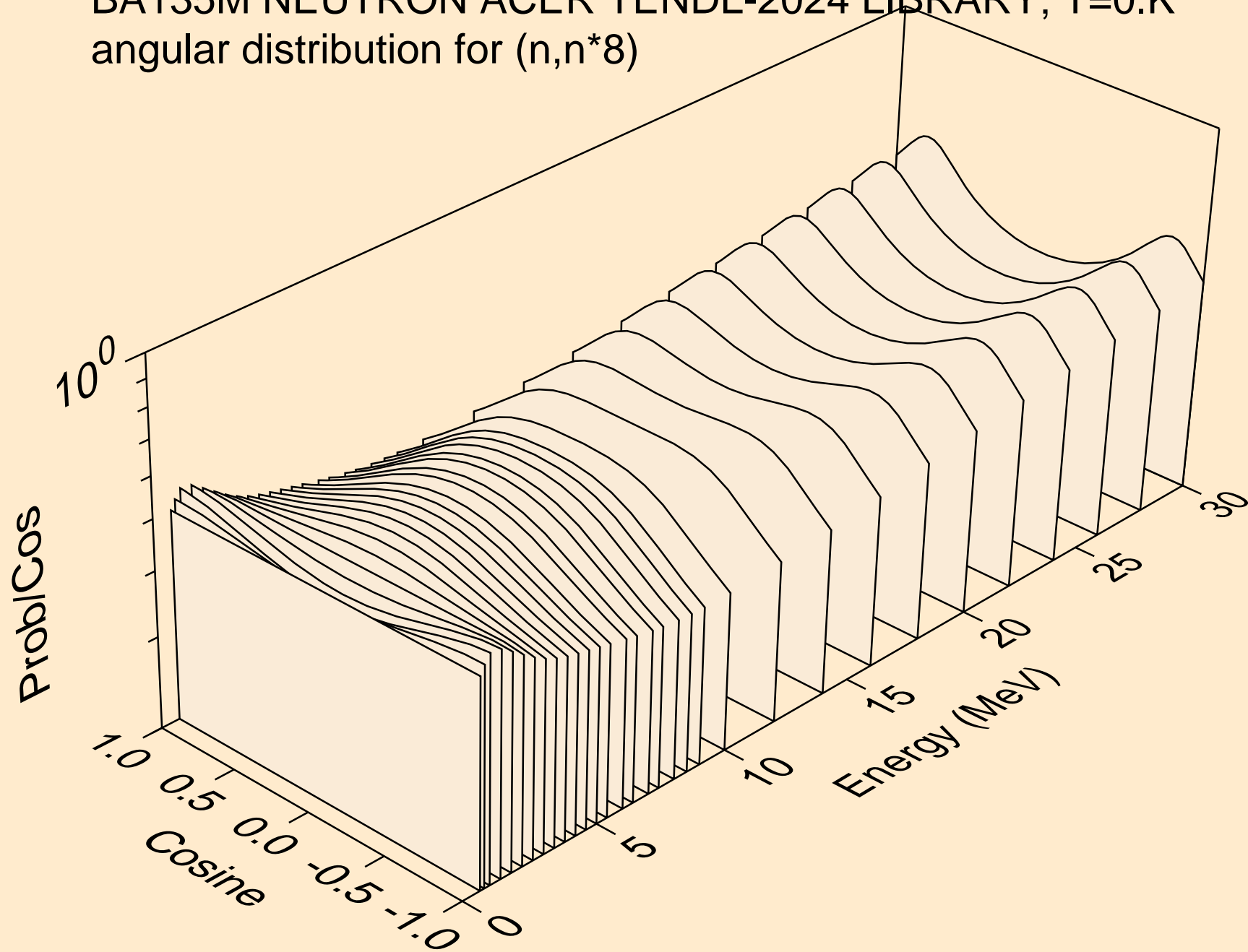

BA135M NEUTRON ACER TENDL-2024 LIBRARY; T=0.K
angular distribution for (n,n*9)

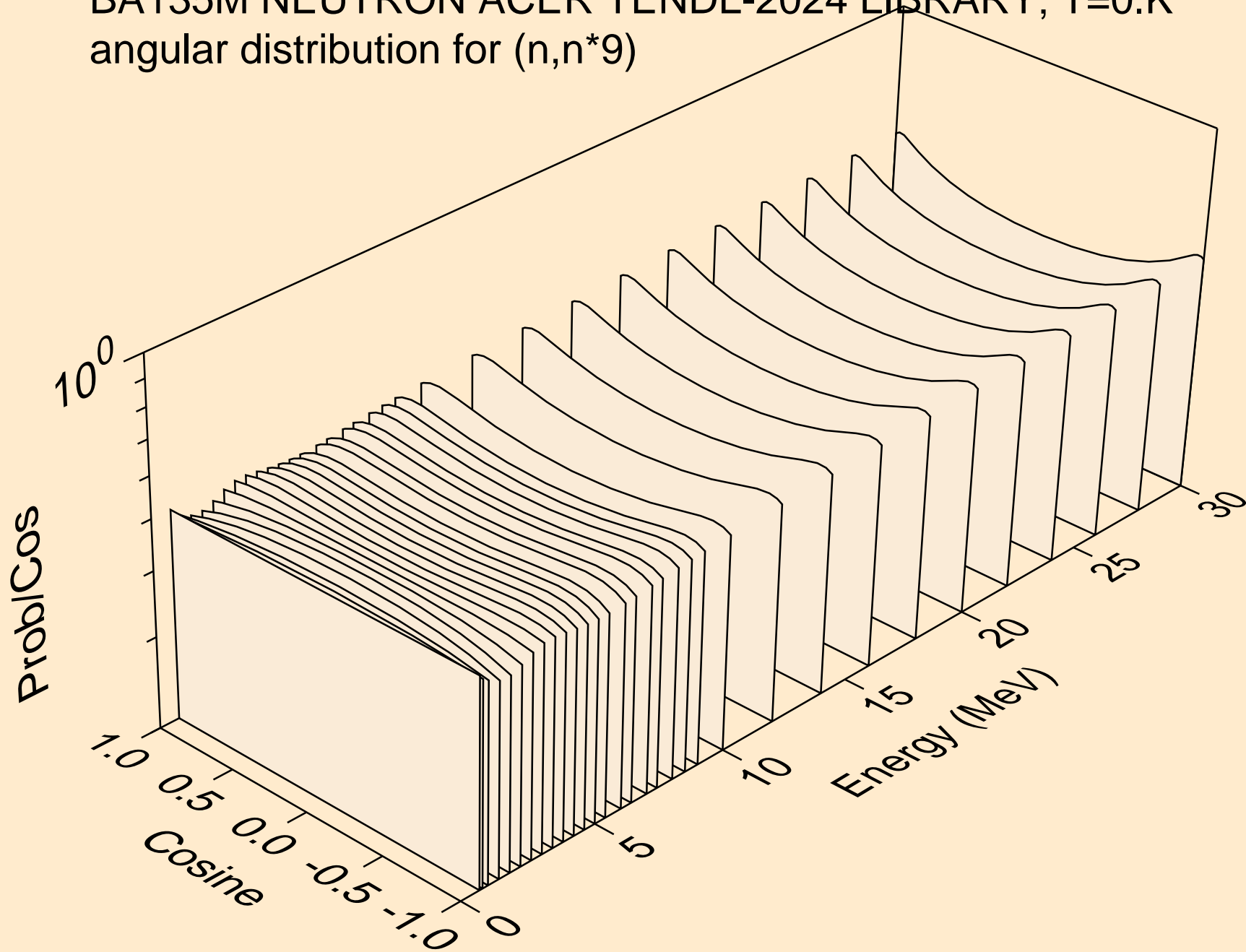

BA135M NEUTRON ACER TENDL-2024 LIBRARY; T=0.K
angular distribution for (n,n*10)

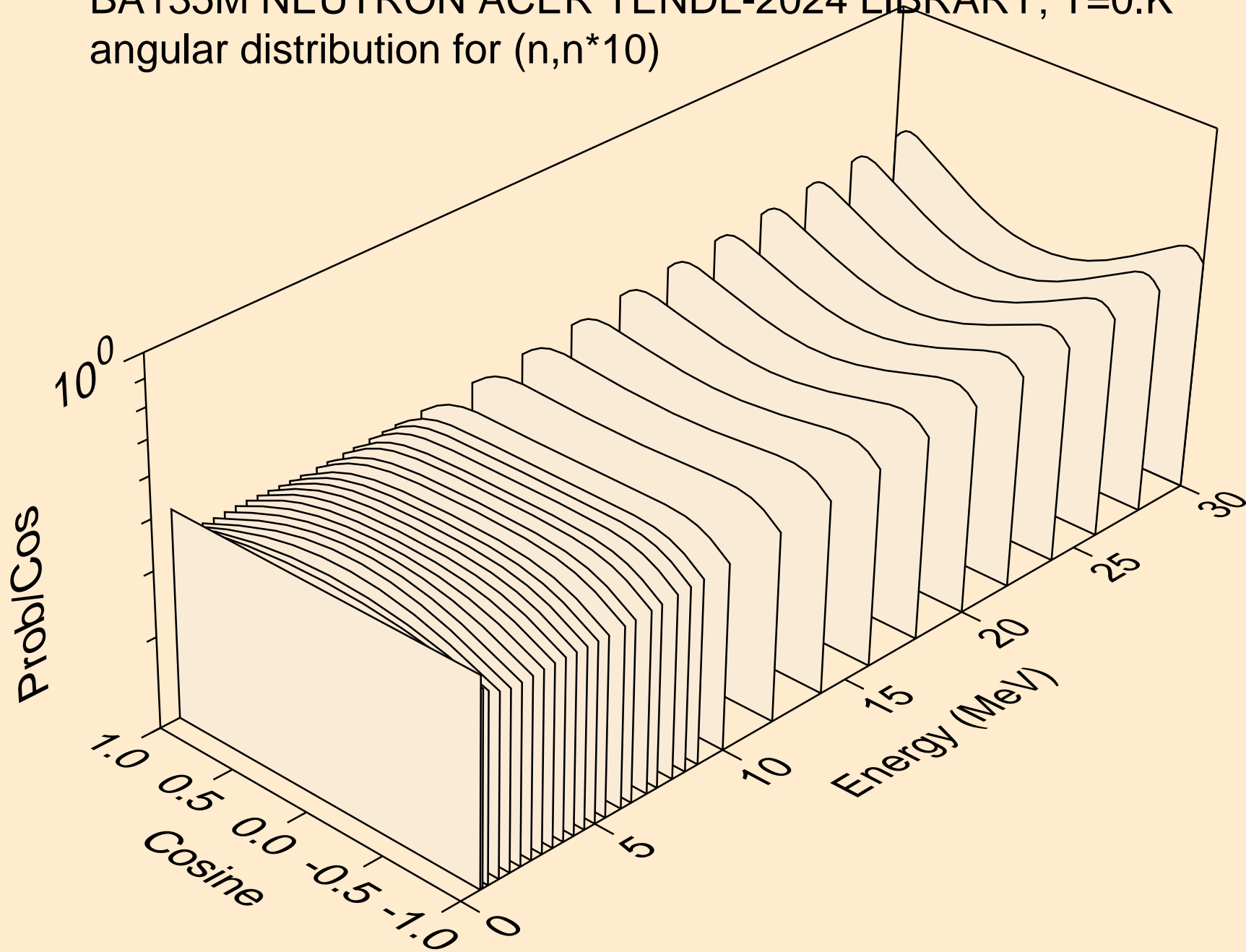

BA135M NEUTRON ACER TENDL-2024 LIBRARY; T=0.K
angular distribution for (n,n*11)

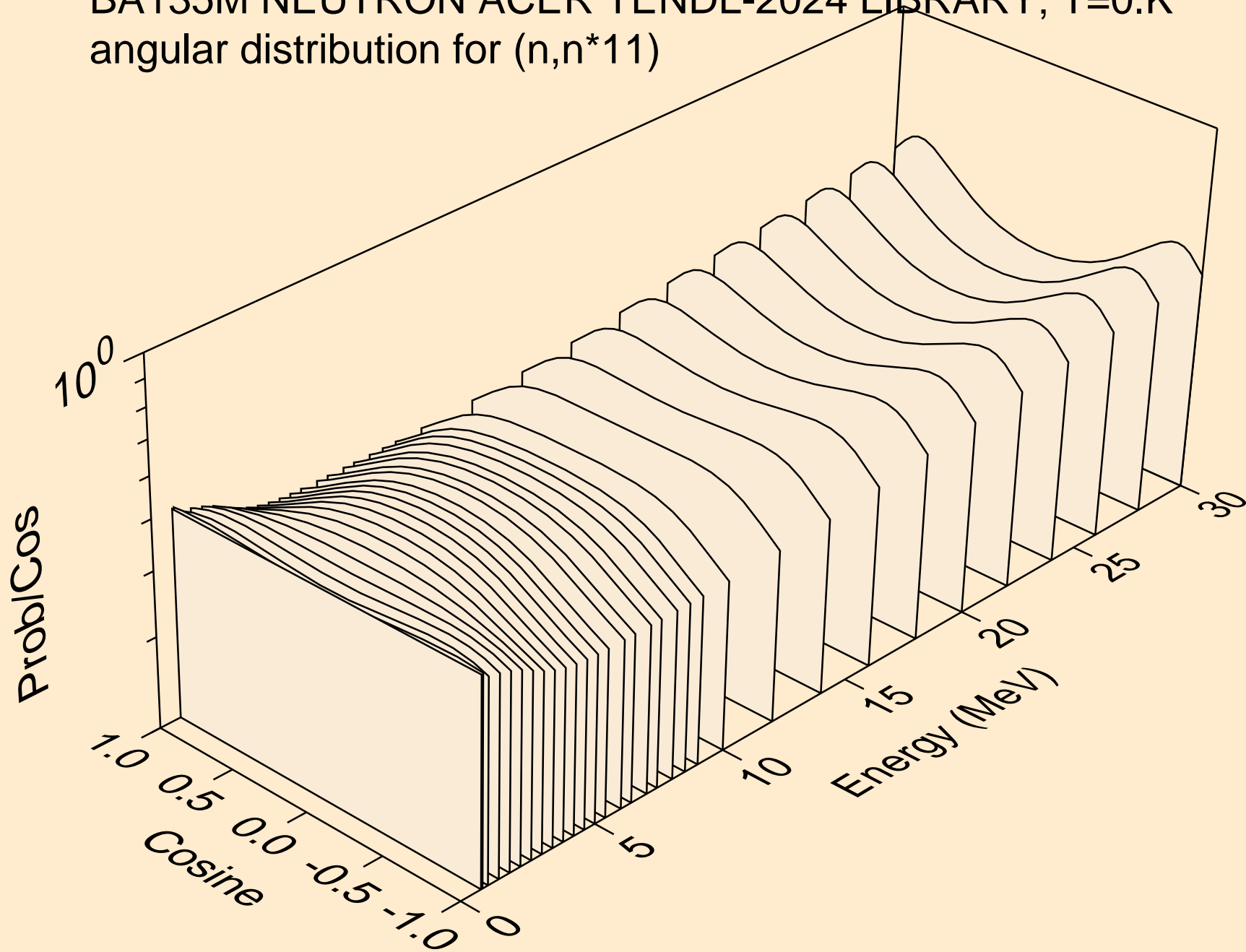

BA135M NEUTRON ACER TENDL-2024 LIBRARY; T=0.K
angular distribution for (n,n*12)

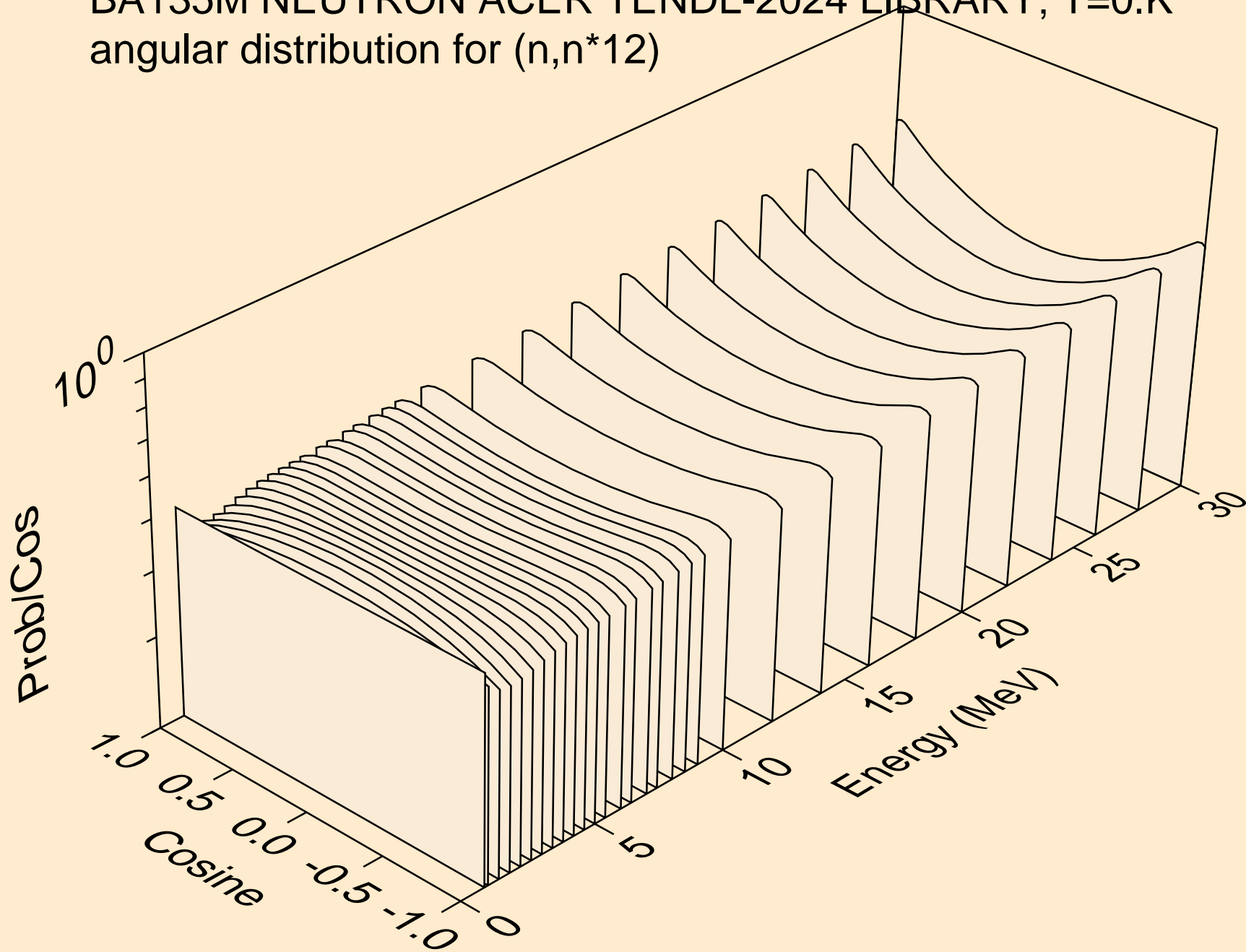

BA135M NEUTRON ACER TENDL-2024 LIBRARY; T=0.K
angular distribution for (n,n*13)

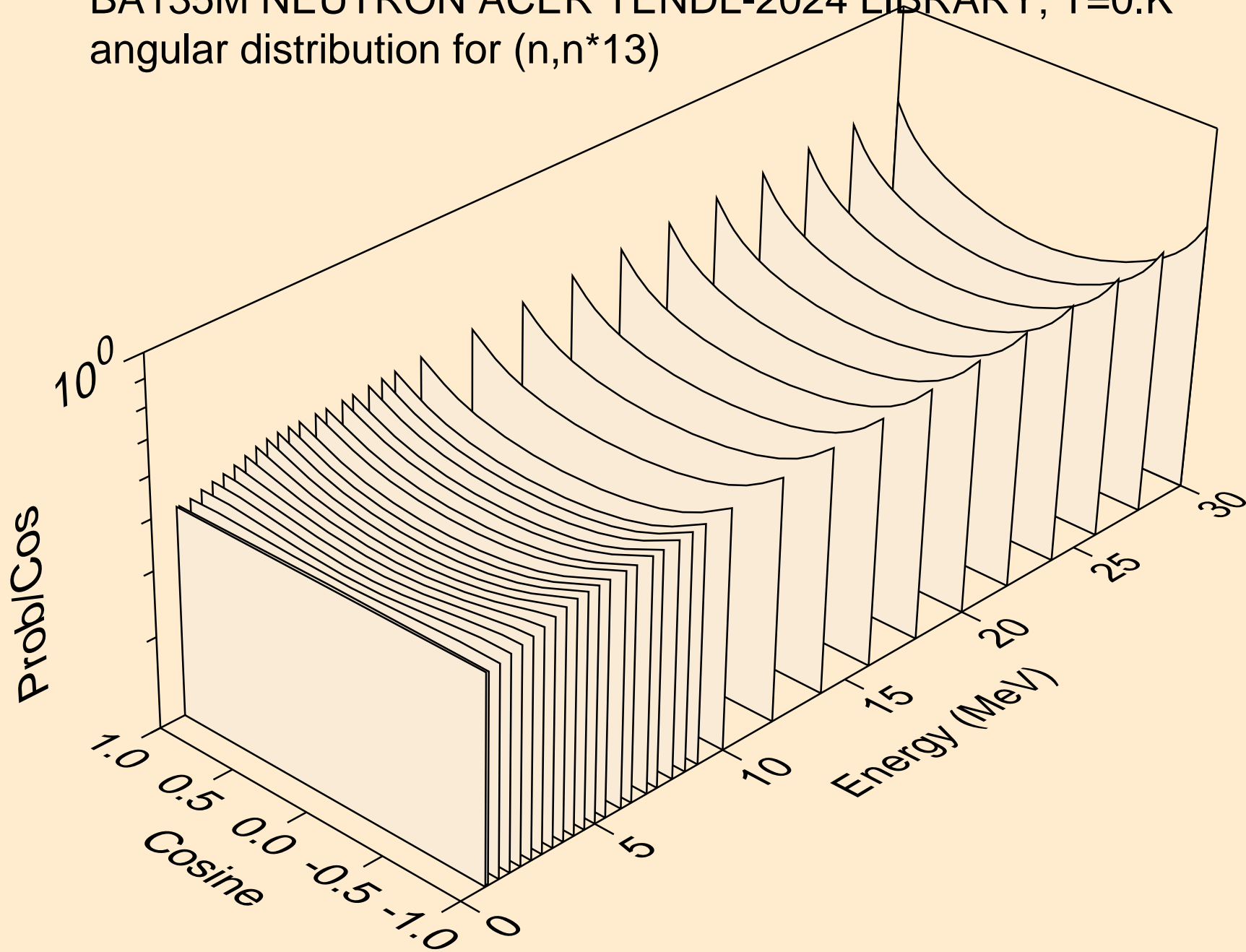

BA135M NEUTRON ACER TENDL-2024 LIBRARY; T=0.K
angular distribution for (n,n*14)

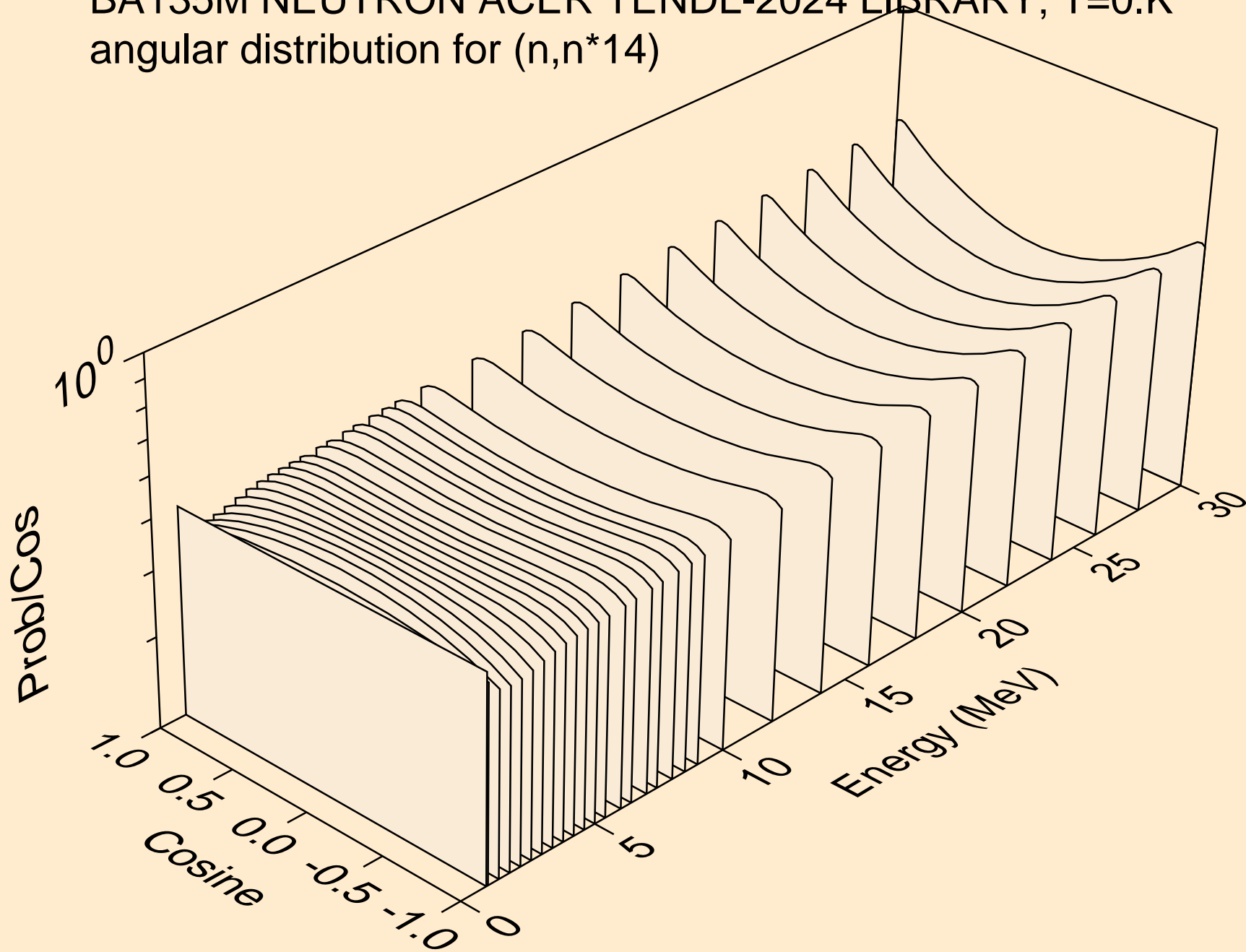

BA135M NEUTRON ACER TENDL-2024 LIBRARY; T=0.K
angular distribution for (n,n*15)

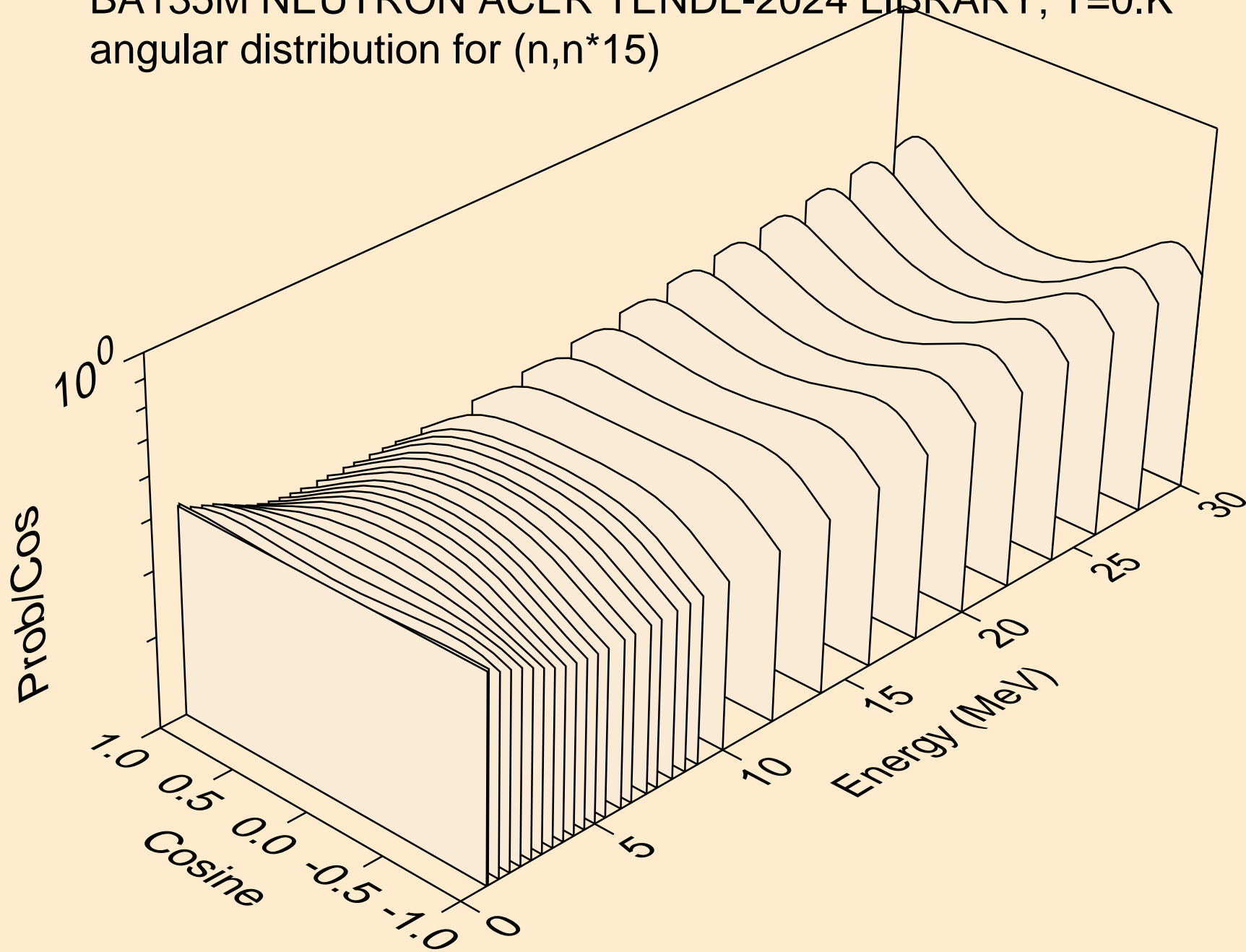

BA135M NEUTRON ACER TENDL-2024 LIBRARY; T=0.K
angular distribution for (n,n*16)

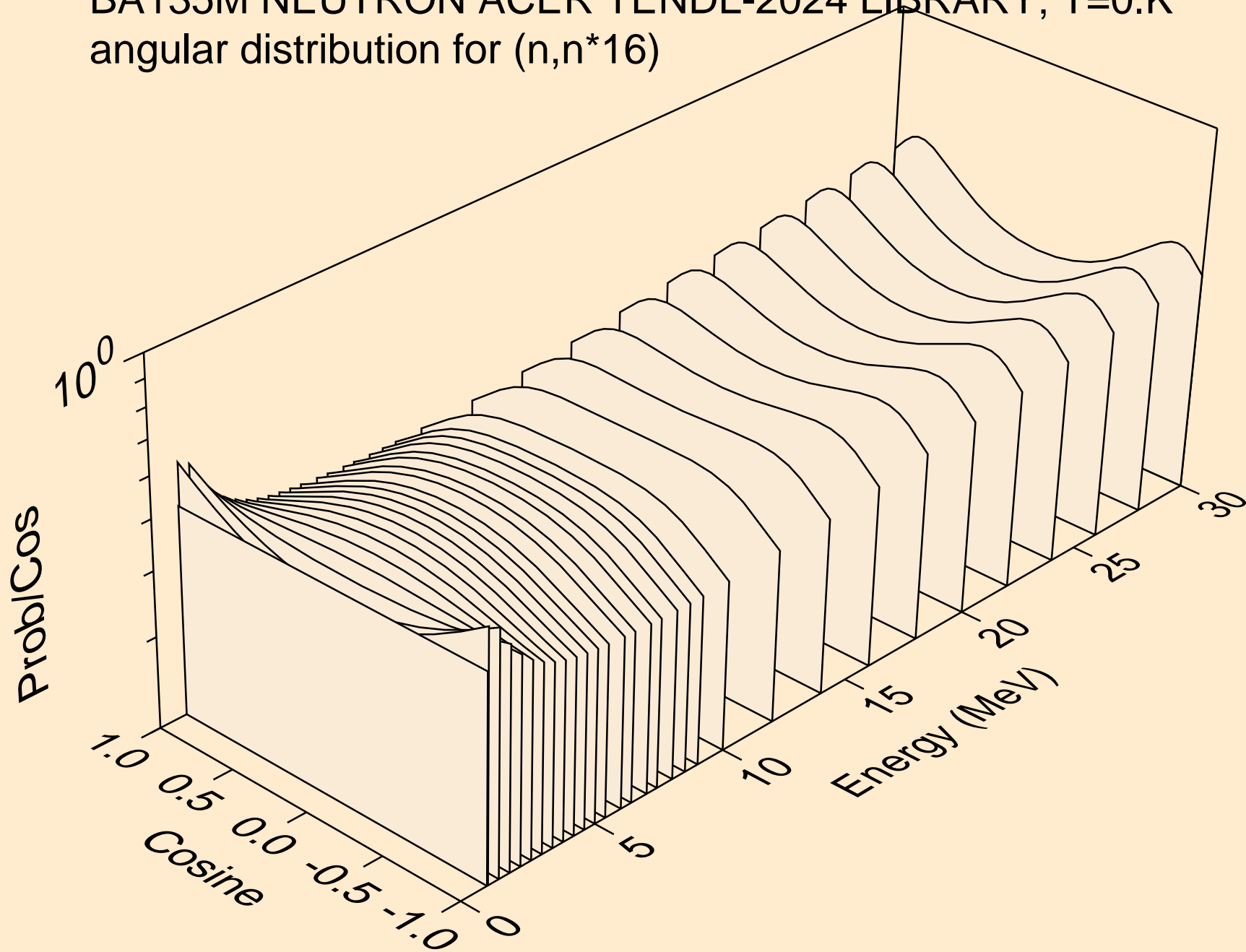

BA135M NEUTRON ACER TENDL-2024 LIBRARY; T=0.K
angular distribution for (n,n*17)

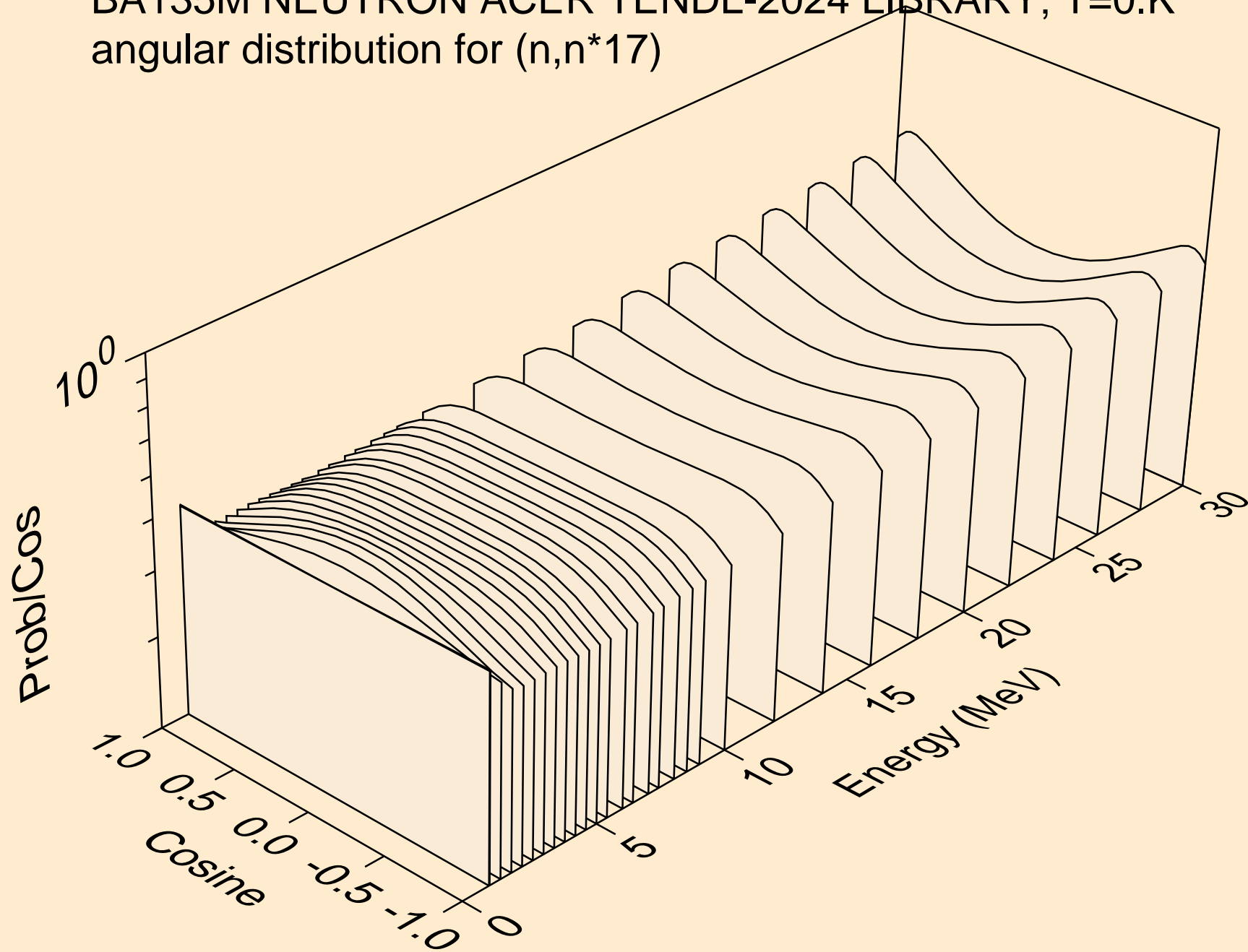

BA135M NEUTRON ACER TENDL-2024 LIBRARY; T=0.K
angular distribution for (n,n*18)

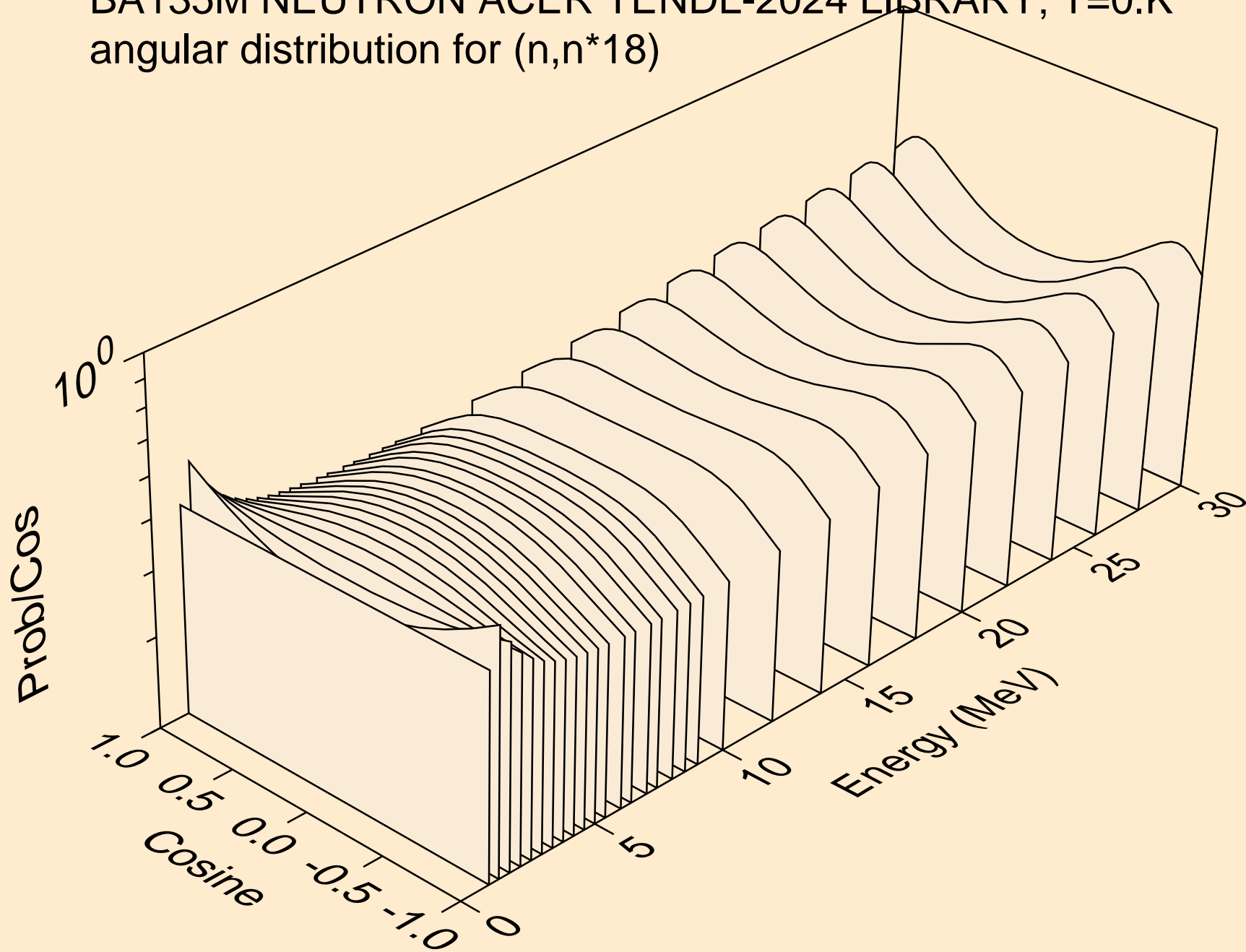

BA135M NEUTRON ACER TENDL-2024 LIBRARY; T=0.K
angular distribution for (n,n*19)

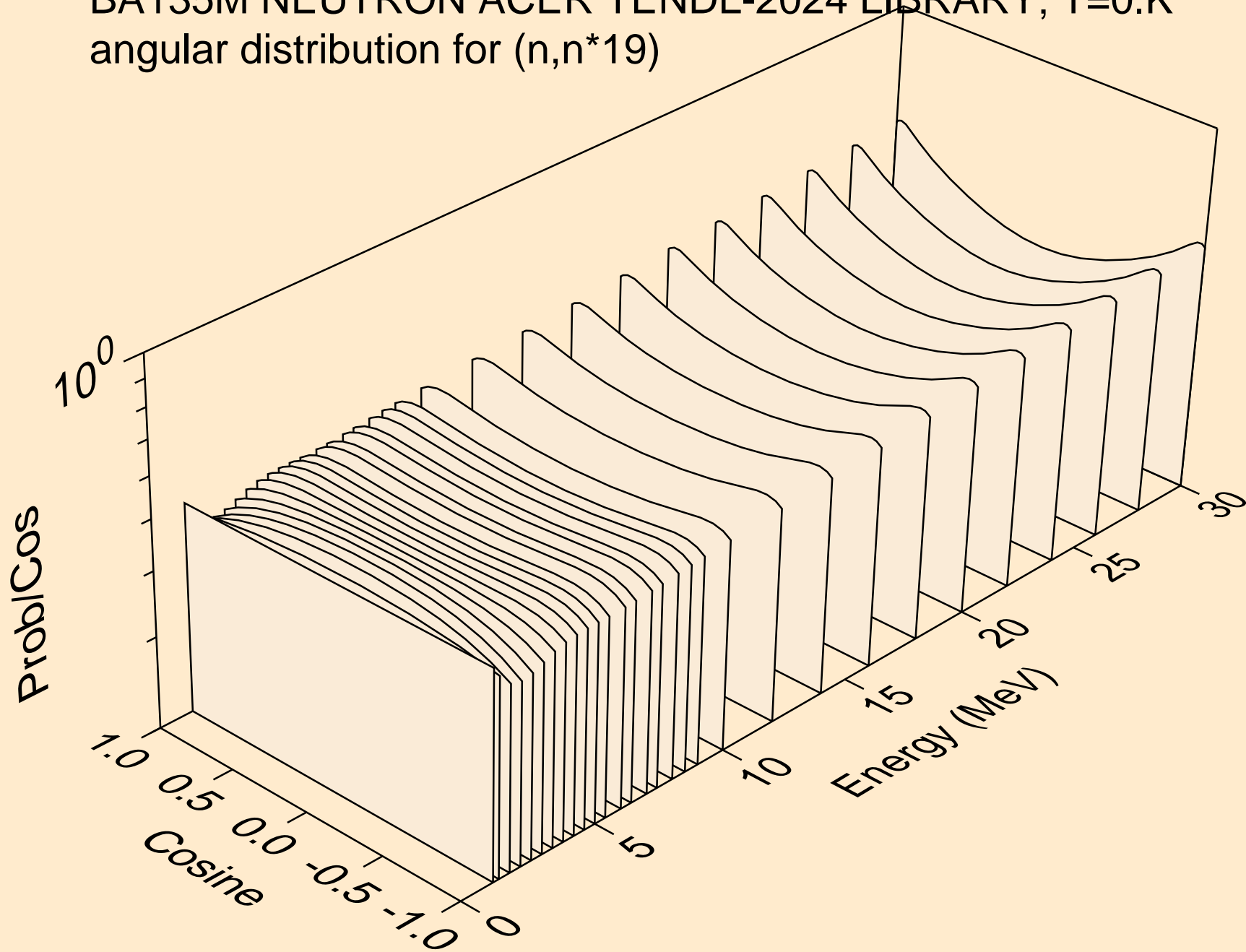

BA135M NEUTRON ACER TENDL-2024 LIBRARY; T=0.K
angular distribution for (n,n*20)

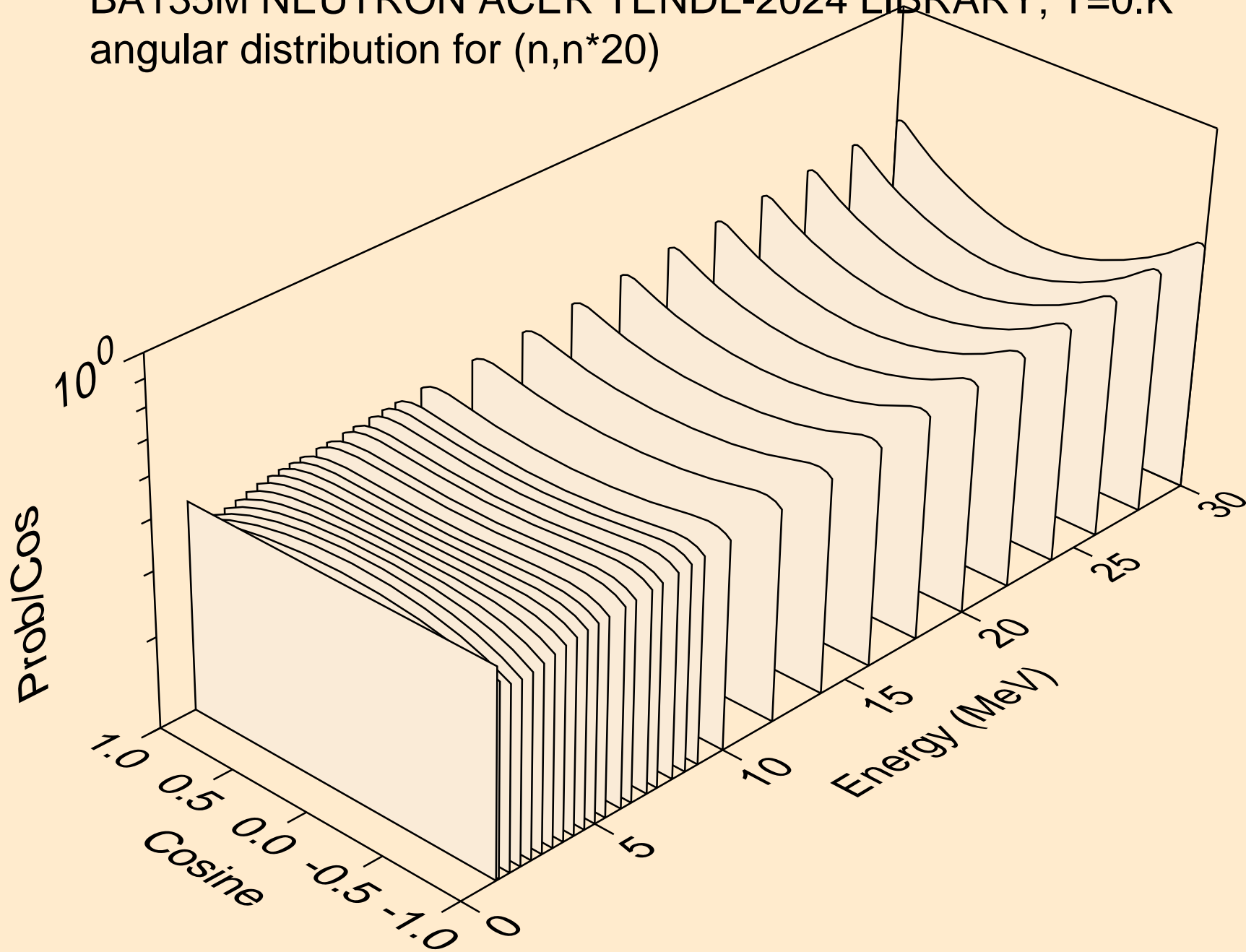

BA135M NEUTRON ACER TENDL-2024 LIBRARY; T=0.K
angular distribution for (n,n*21)

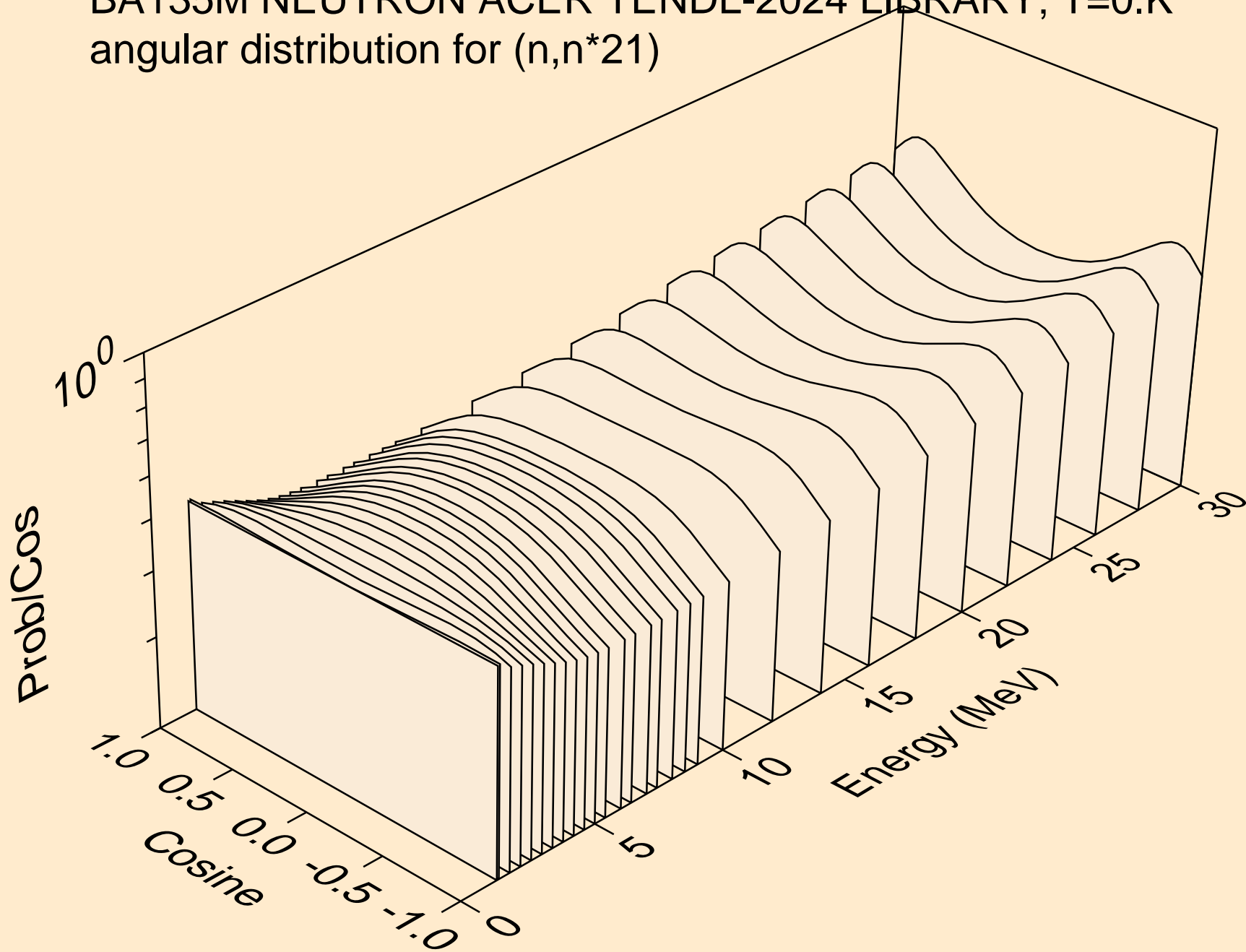

BA135M NEUTRON ACER TENDL-2024 LIBRARY; T=0.K
angular distribution for (n,n*22)

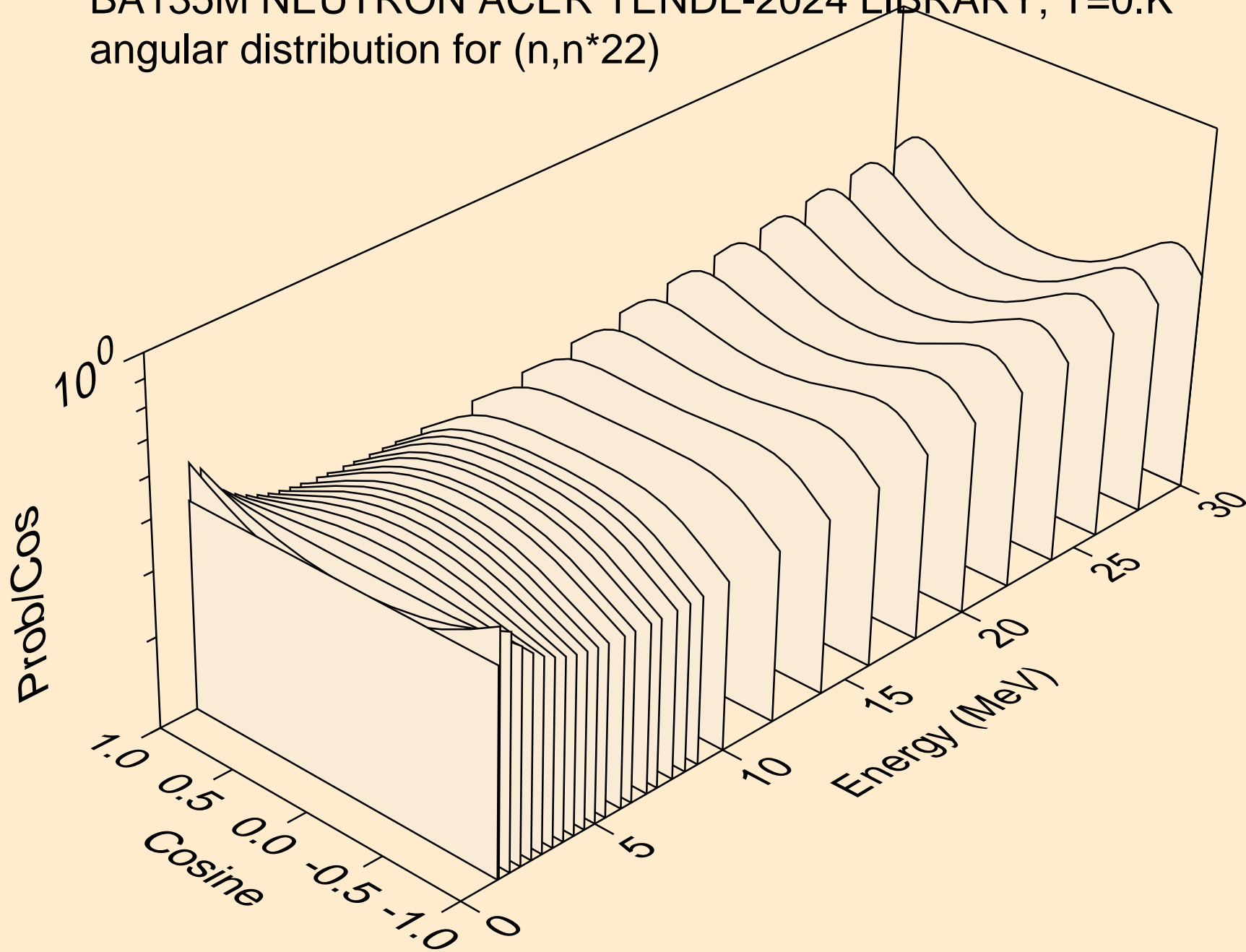

BA135M NEUTRON ACER TENDL-2024 LIBRARY; T=0.K
angular distribution for (n,n*23)

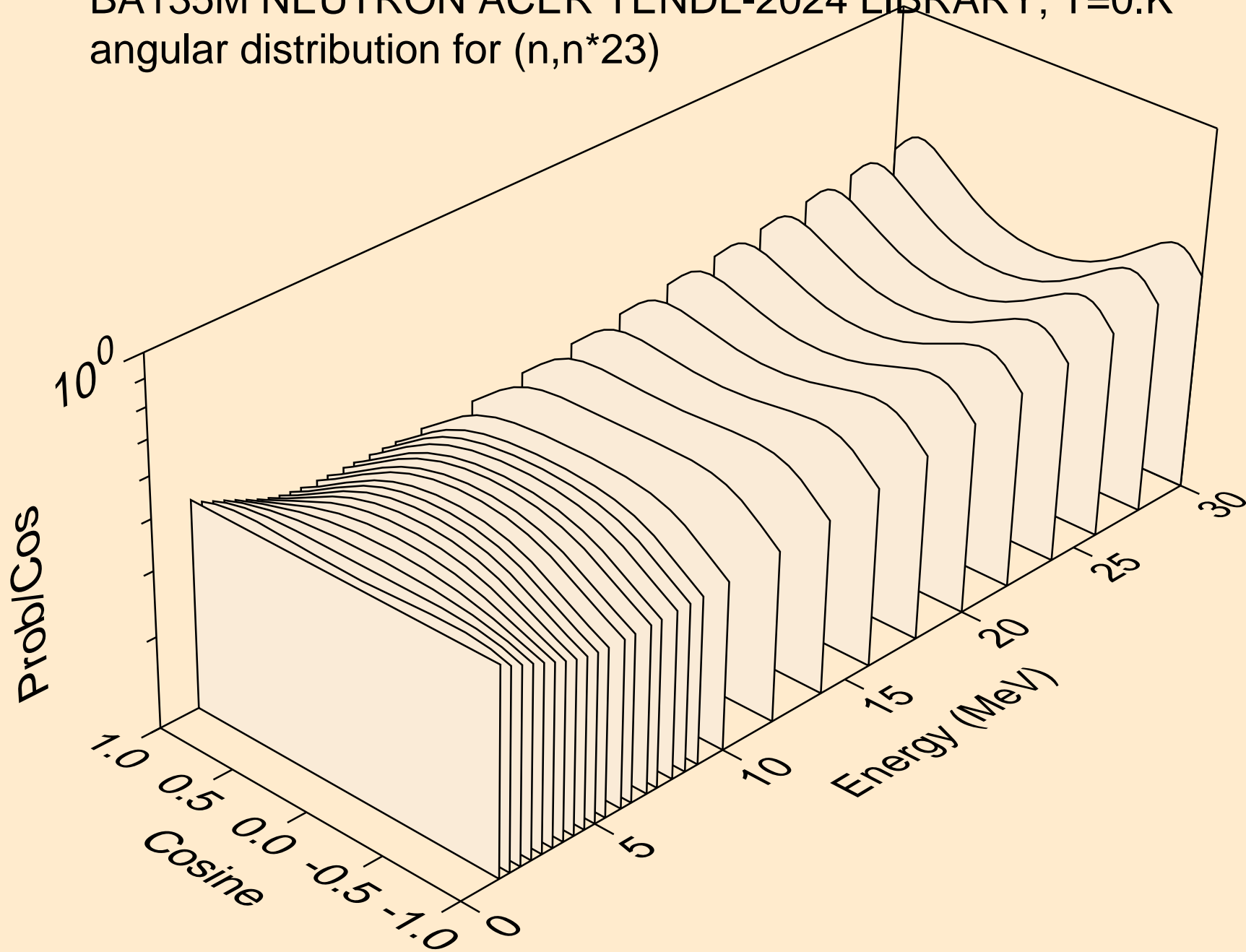

BA135M NEUTRON ACER TENDL-2024 LIBRARY; T=0.K
angular distribution for (n,n*24)

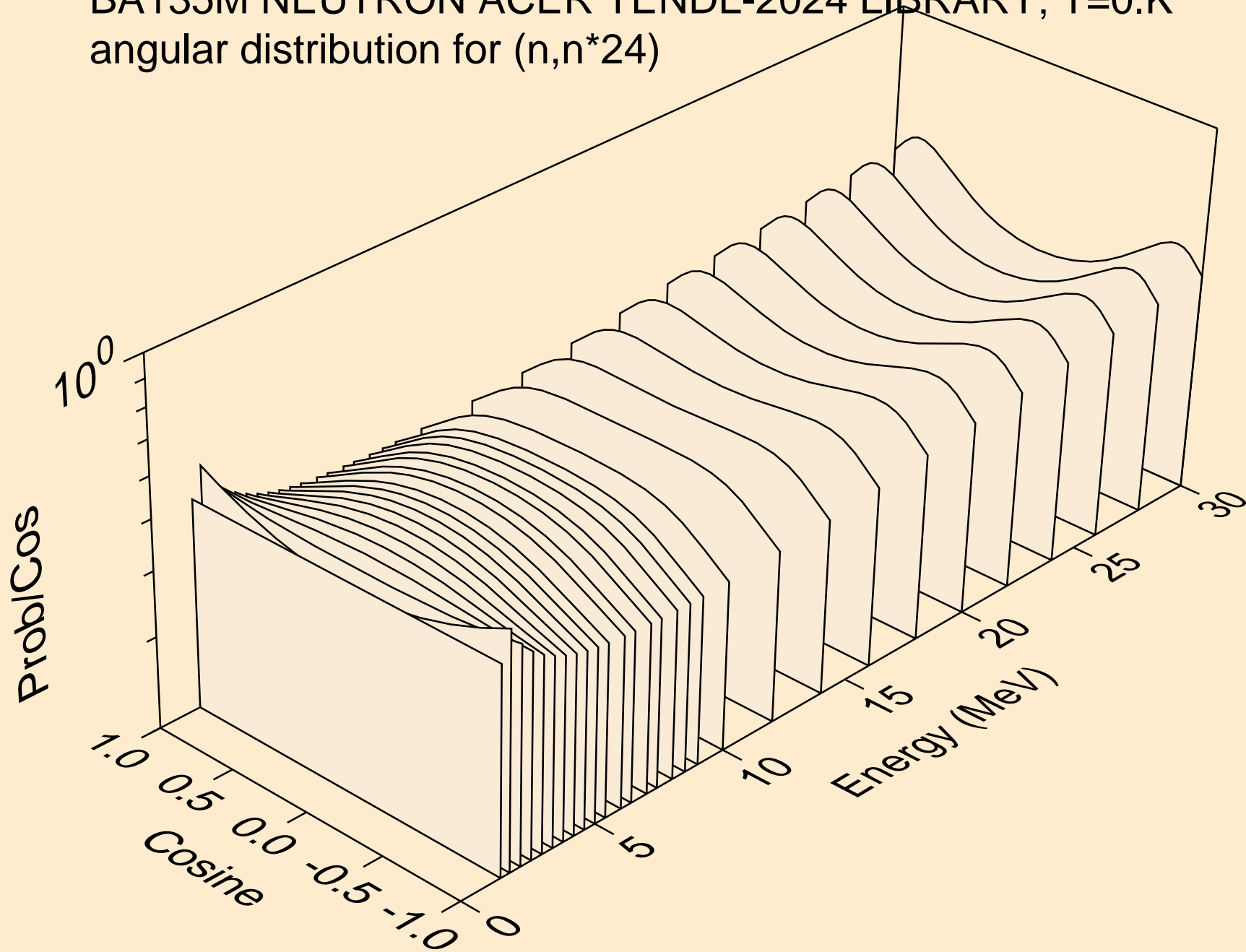

BA135M NEUTRON ACER TENDL-2024 LIBRARY; T=0.K
angular distribution for (n,n*25)

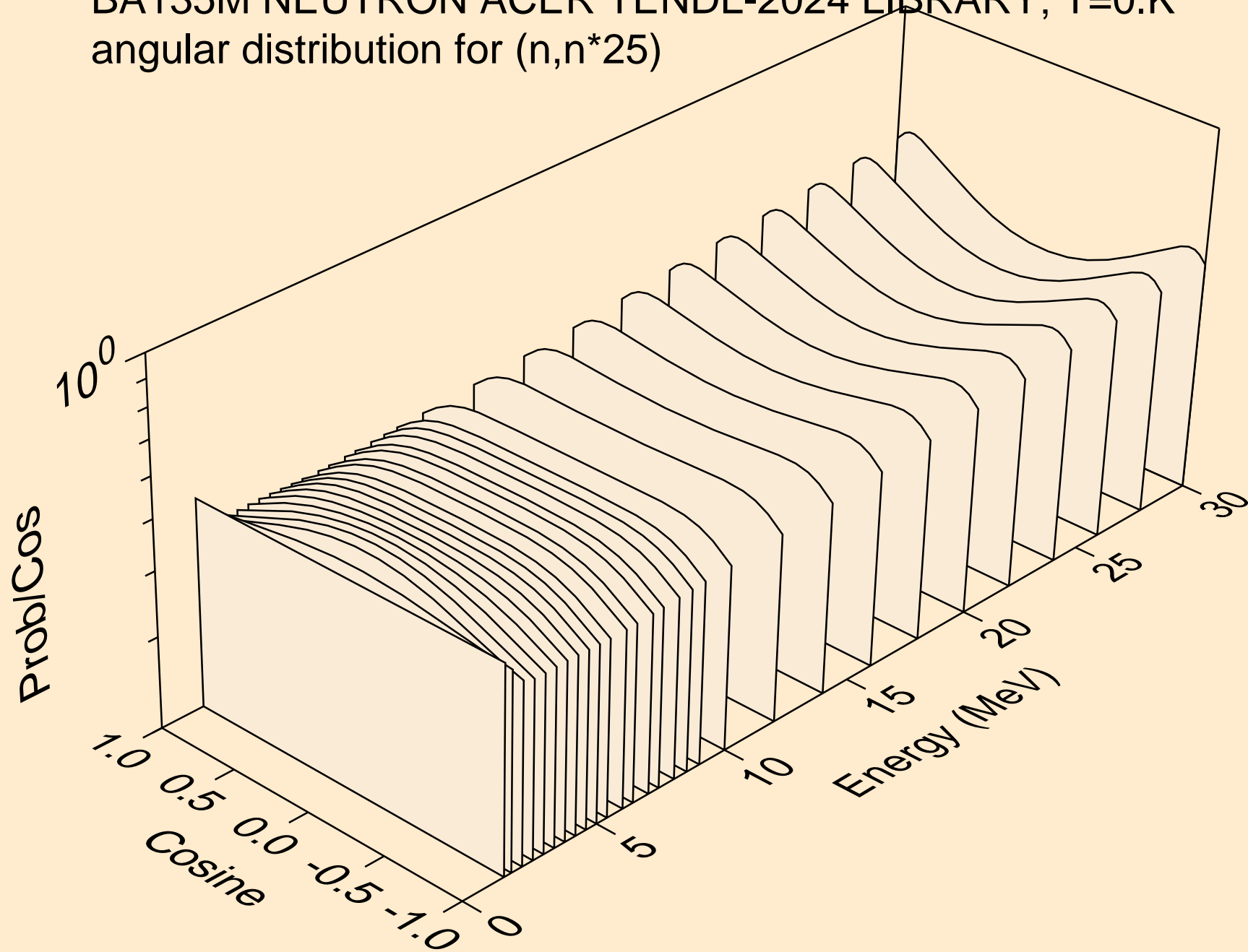

BA135M NEUTRON ACER TENDL-2024 LIBRARY; T=0.K
Neutron emission for (n,x)

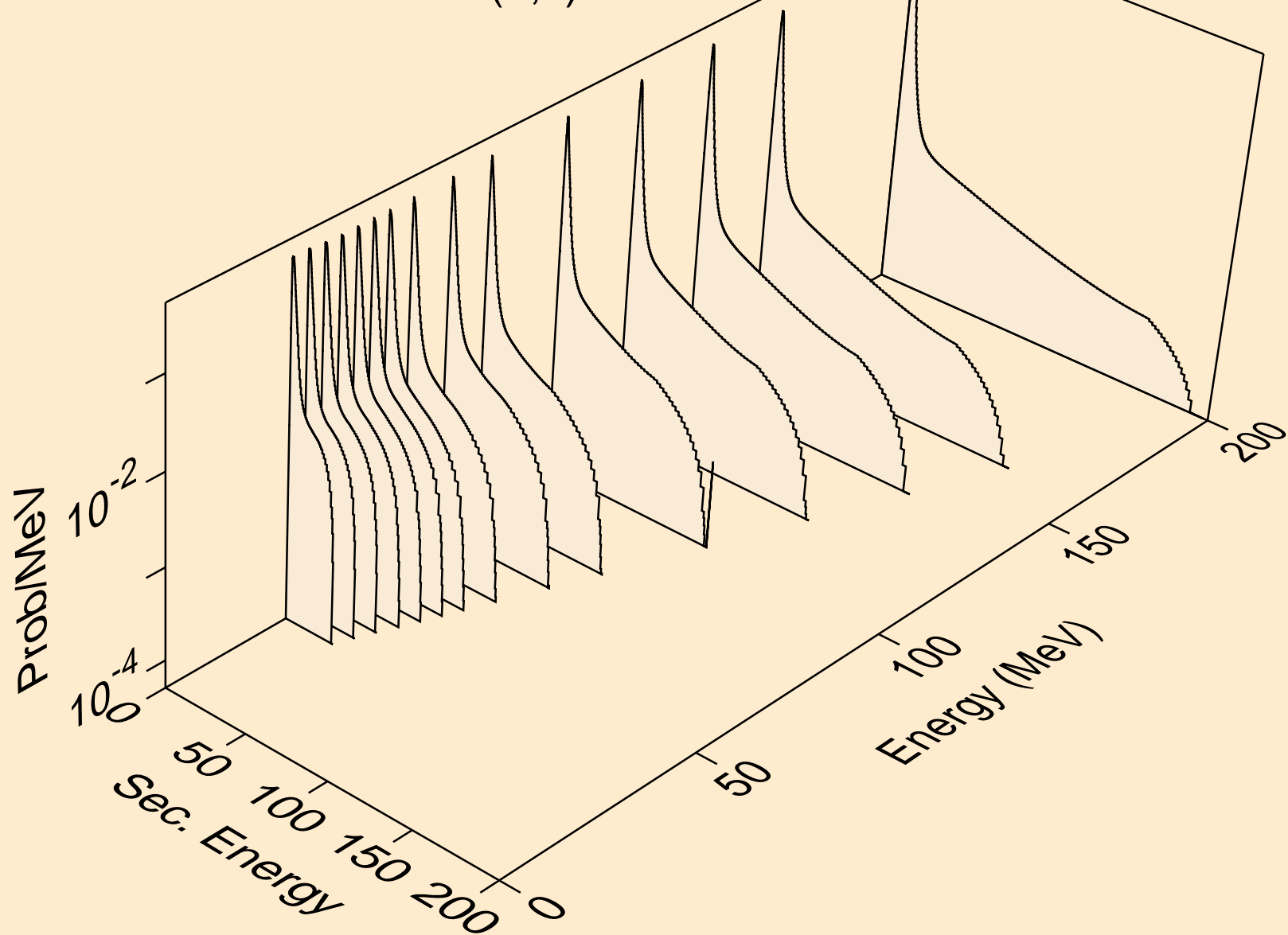

BA135M NEUTRON ACER TENDL-2024 LIBRARY; T=0.K
Neutron emission for (n,2nd)

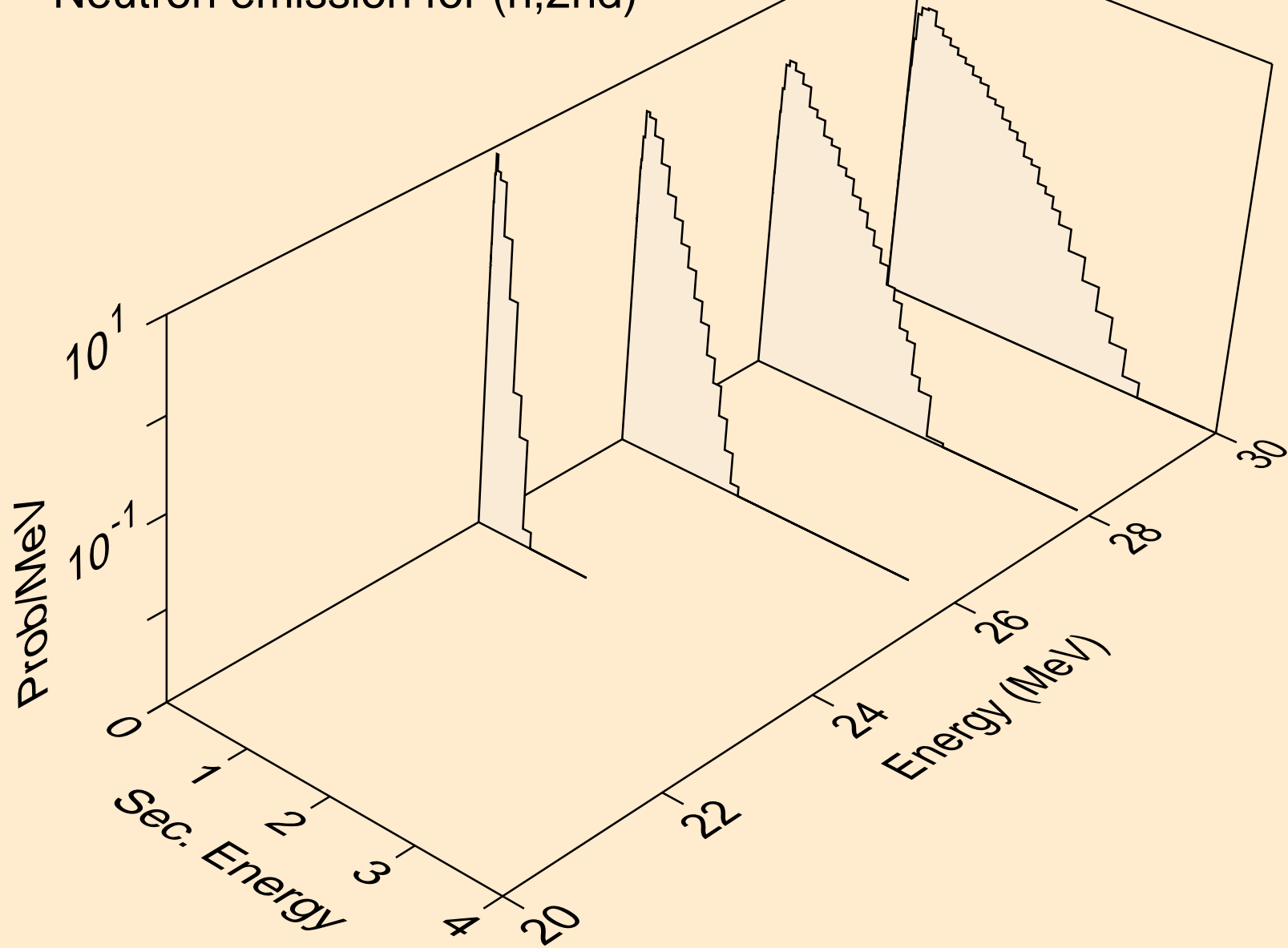

BA135M NEUTRON ACER TENDL-2024 LIBRARY; T=0.K
Neutron emission for (n,2n)

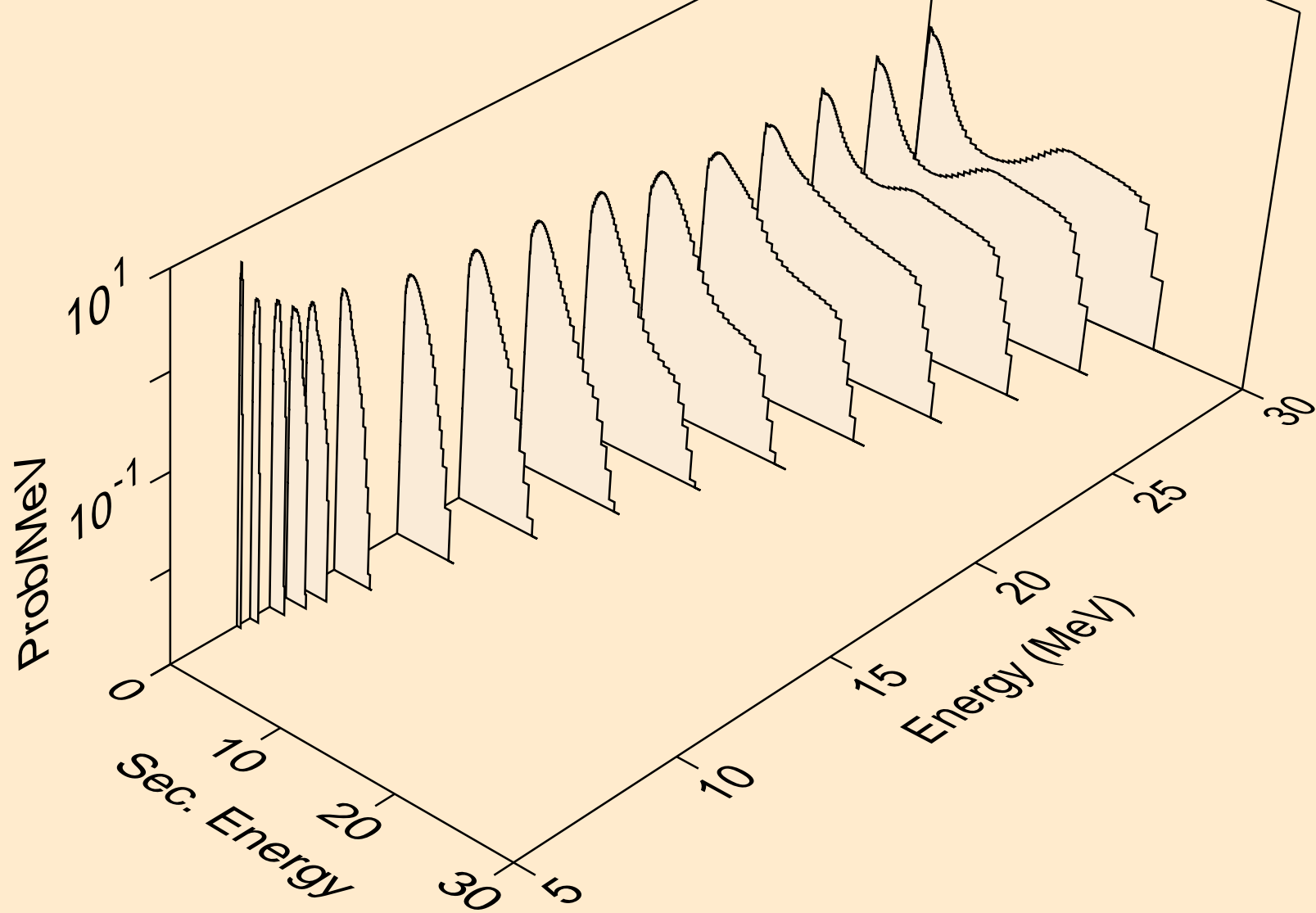

BA135M NEUTRON ACER TENDL-2024 LIBRARY; T=0.K
Neutron emission for (n,3n)

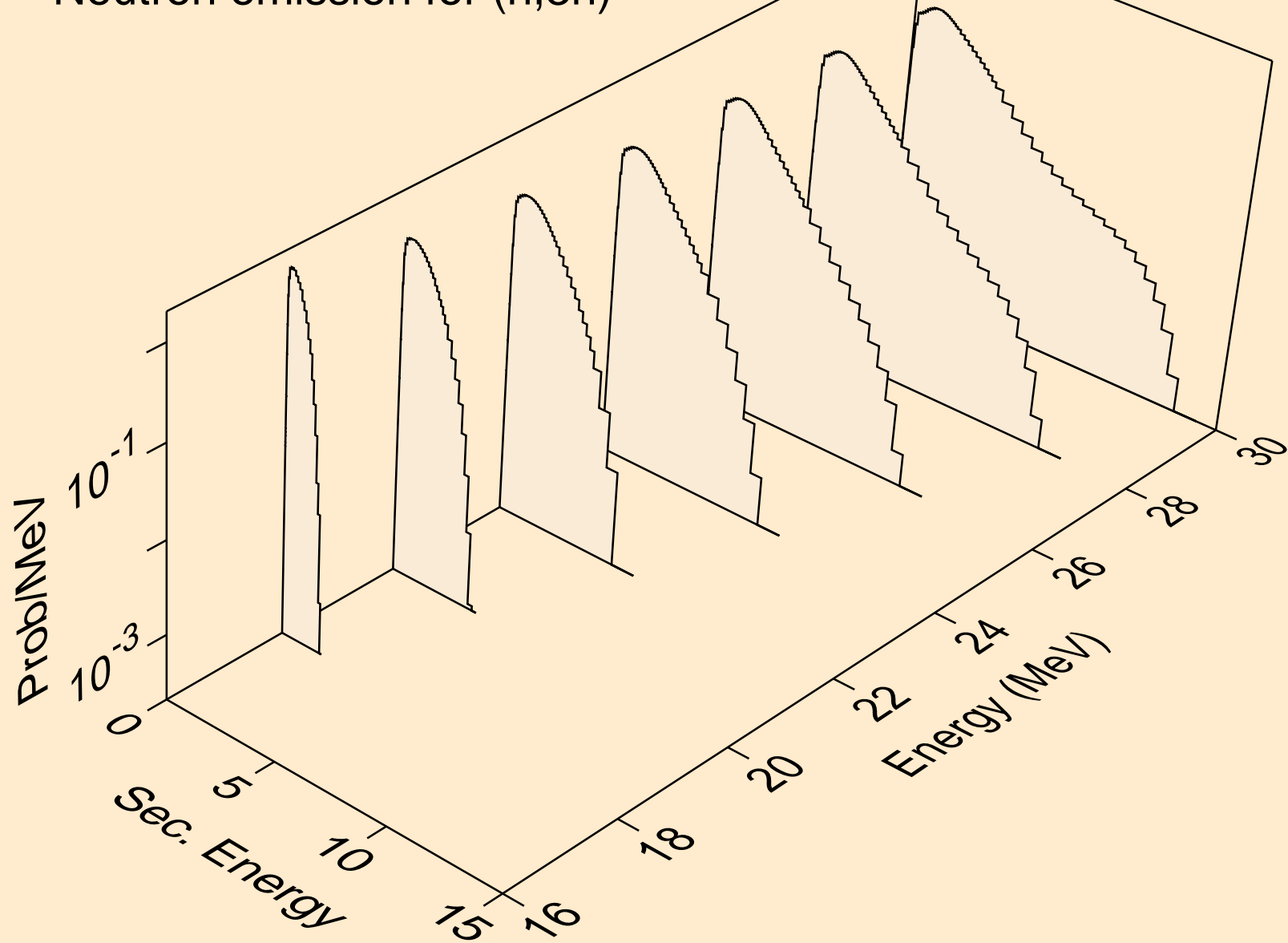

BA135M NEUTRON ACER TENDL-2024 LIBRARY; T=0.K
Neutron emission for (n,n*)a

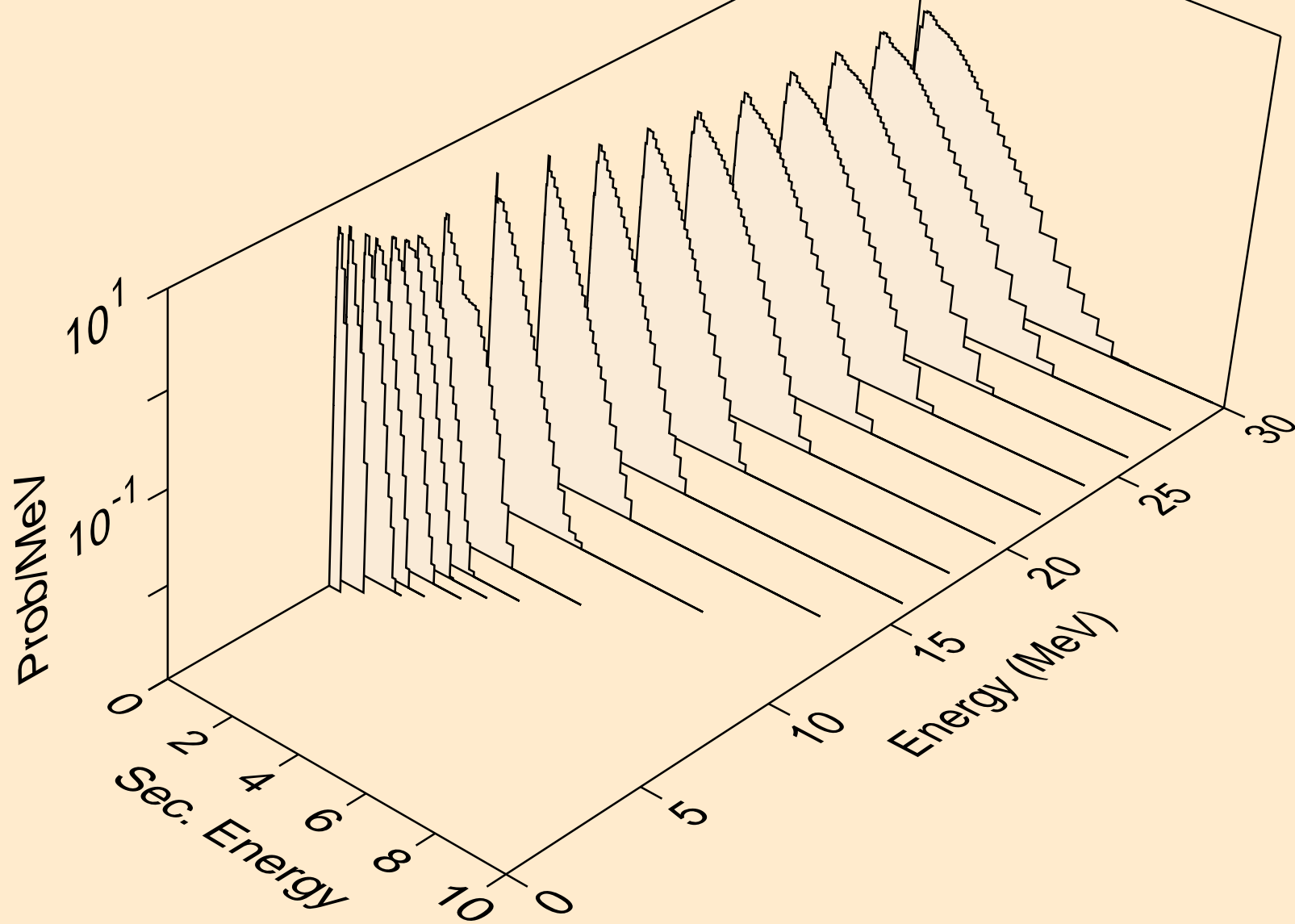

BA135M NEUTRON ACER TENDL-2024 LIBRARY; T=0.K
Neutron emission for (n,2n)a

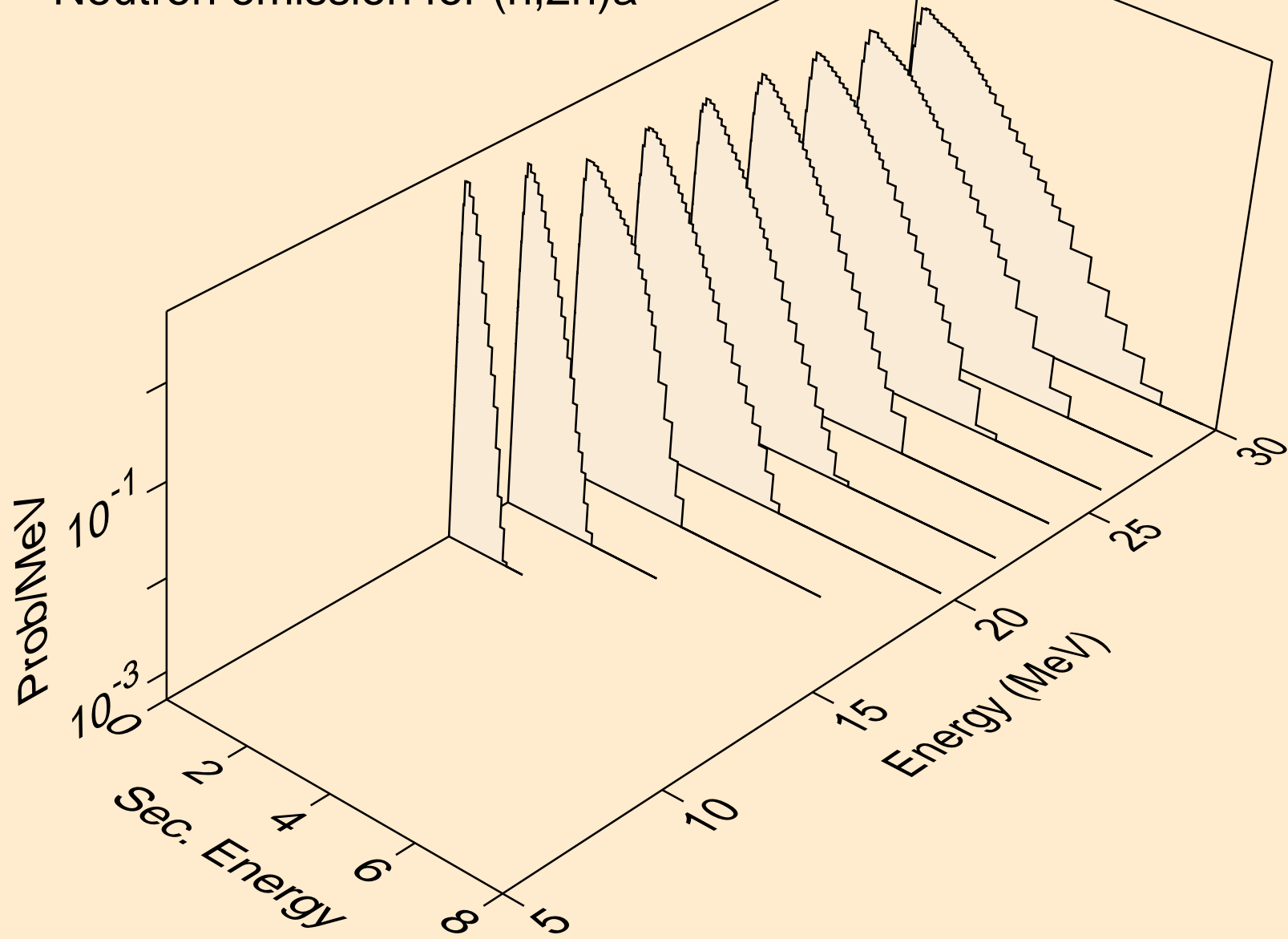

BA135M NEUTRON ACER TENDL-2024 LIBRARY; T=0.K
Neutron emission for (n,3n)a

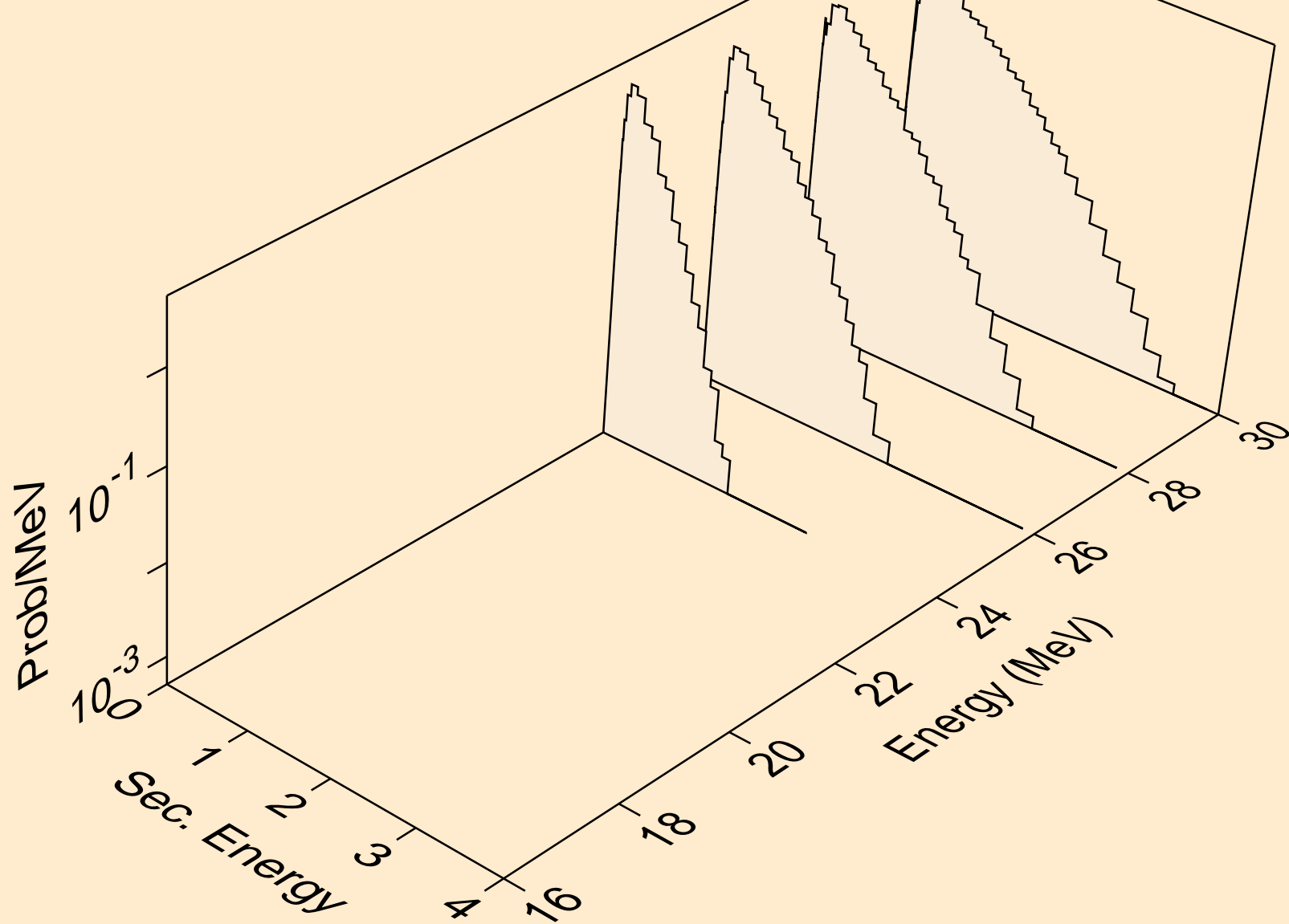

BA135M NEUTRON ACER TENDL-2024 LIBRARY; T=0.K
Neutron emission for (n,n*)p

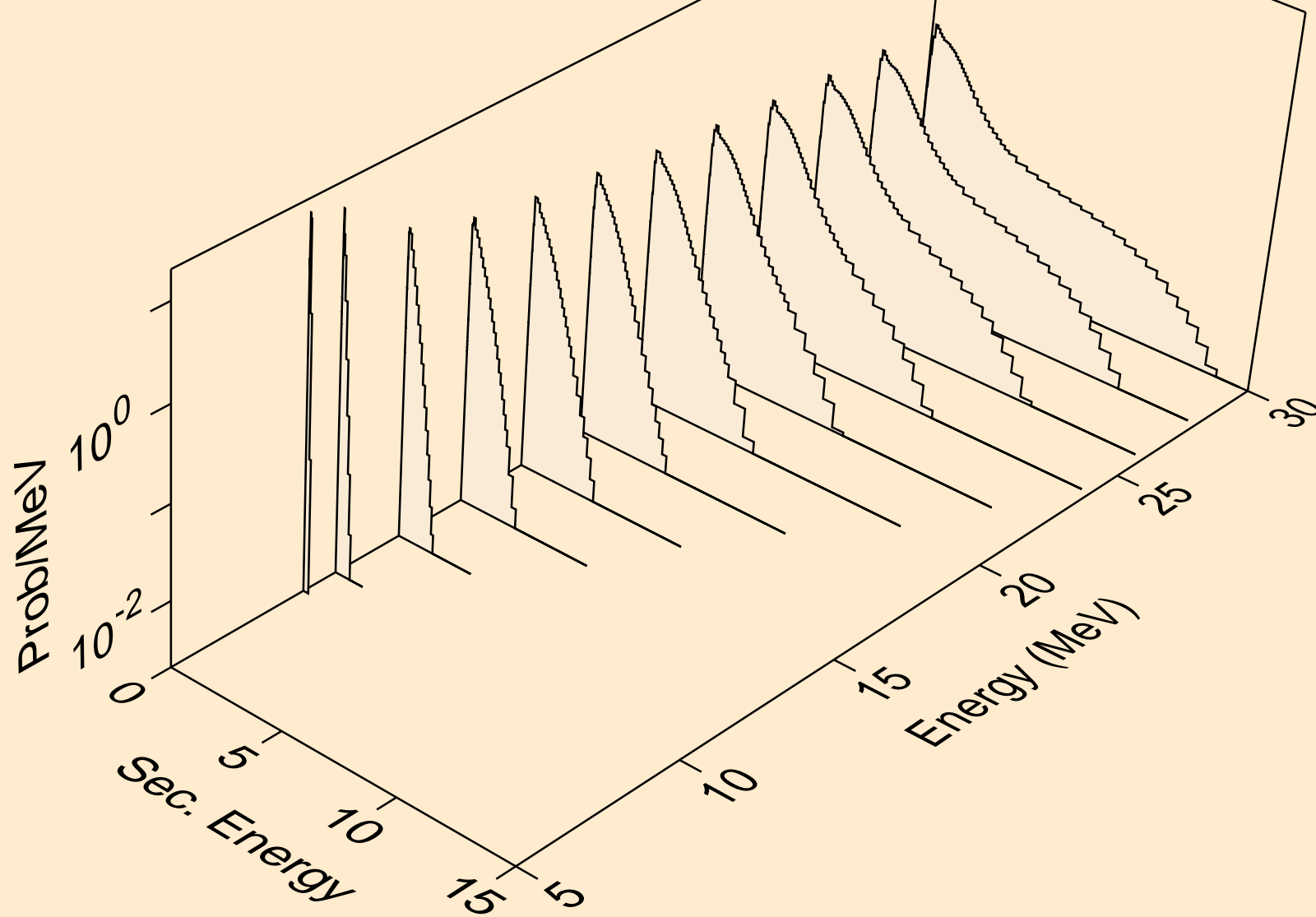

BA135M NEUTRON ACER TENDL-2024 LIBRARY; T=0.K
Neutron emission for (n,n*)2a

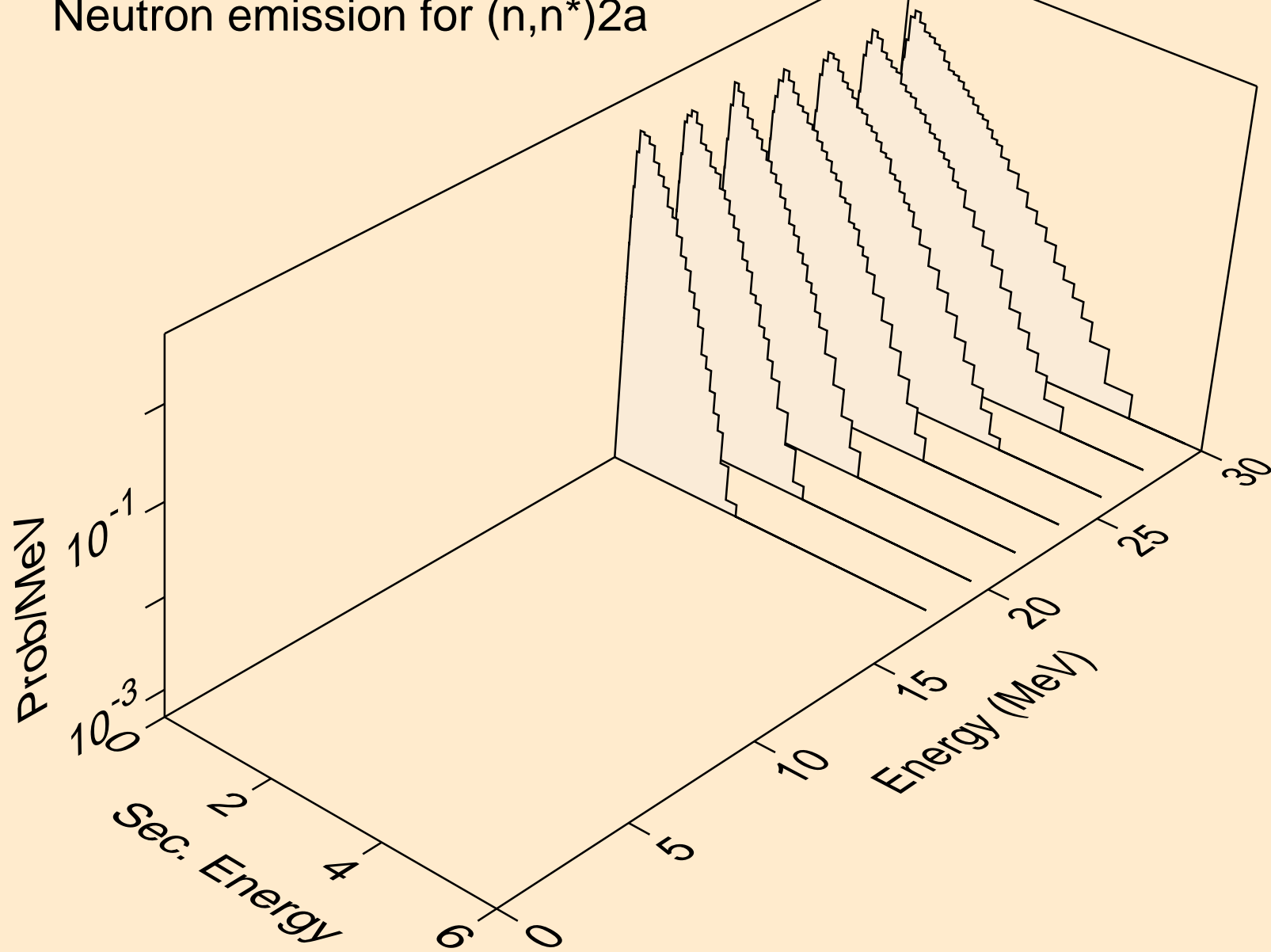

BA135M NEUTRON ACER TENDL-2024 LIBRARY; T=0.K
Neutron emission for (n,n*)d

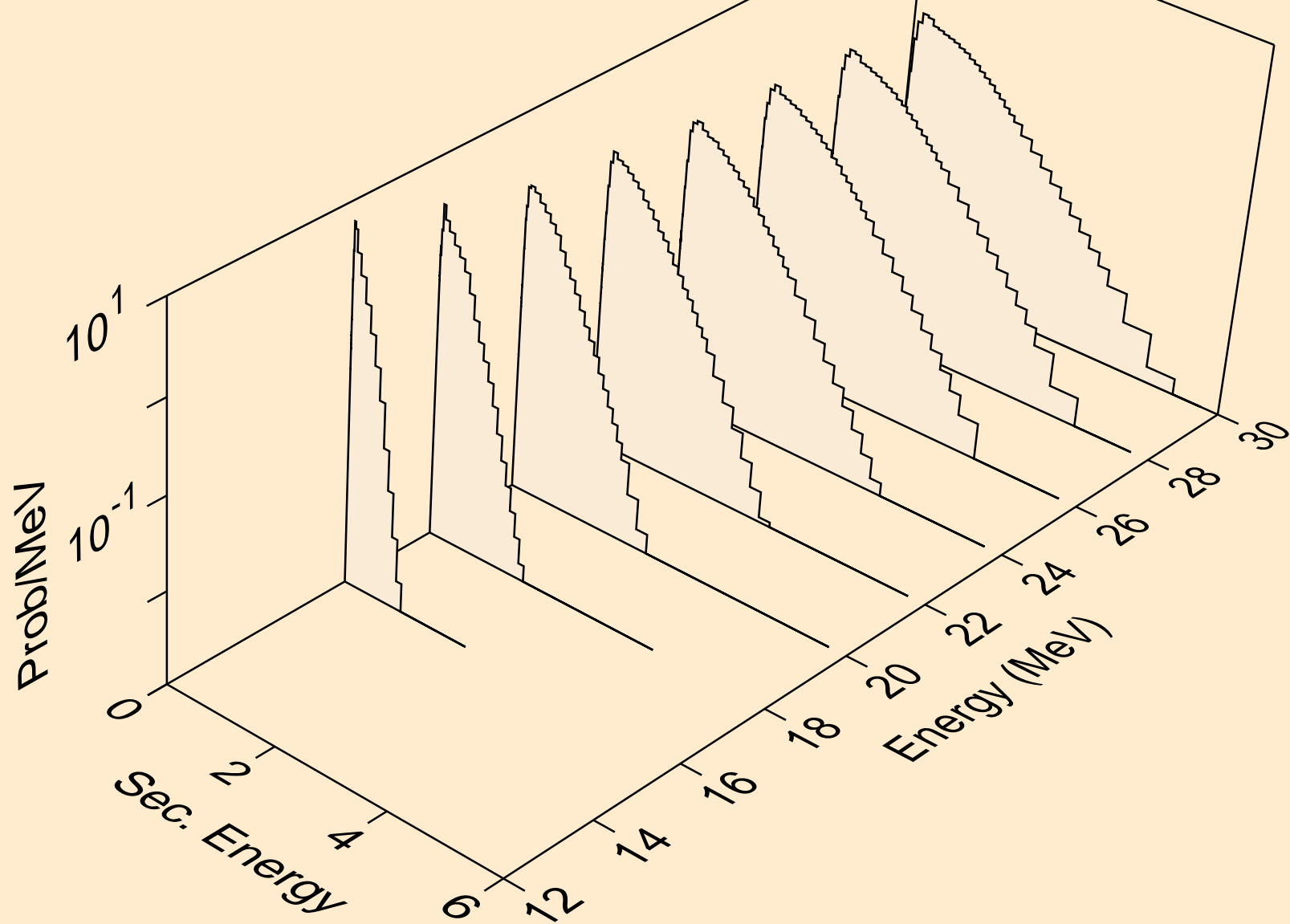

BA135M NEUTRON ACER TENDL-2024 LIBRARY; T=0.K
Neutron emission for (n,n*)t

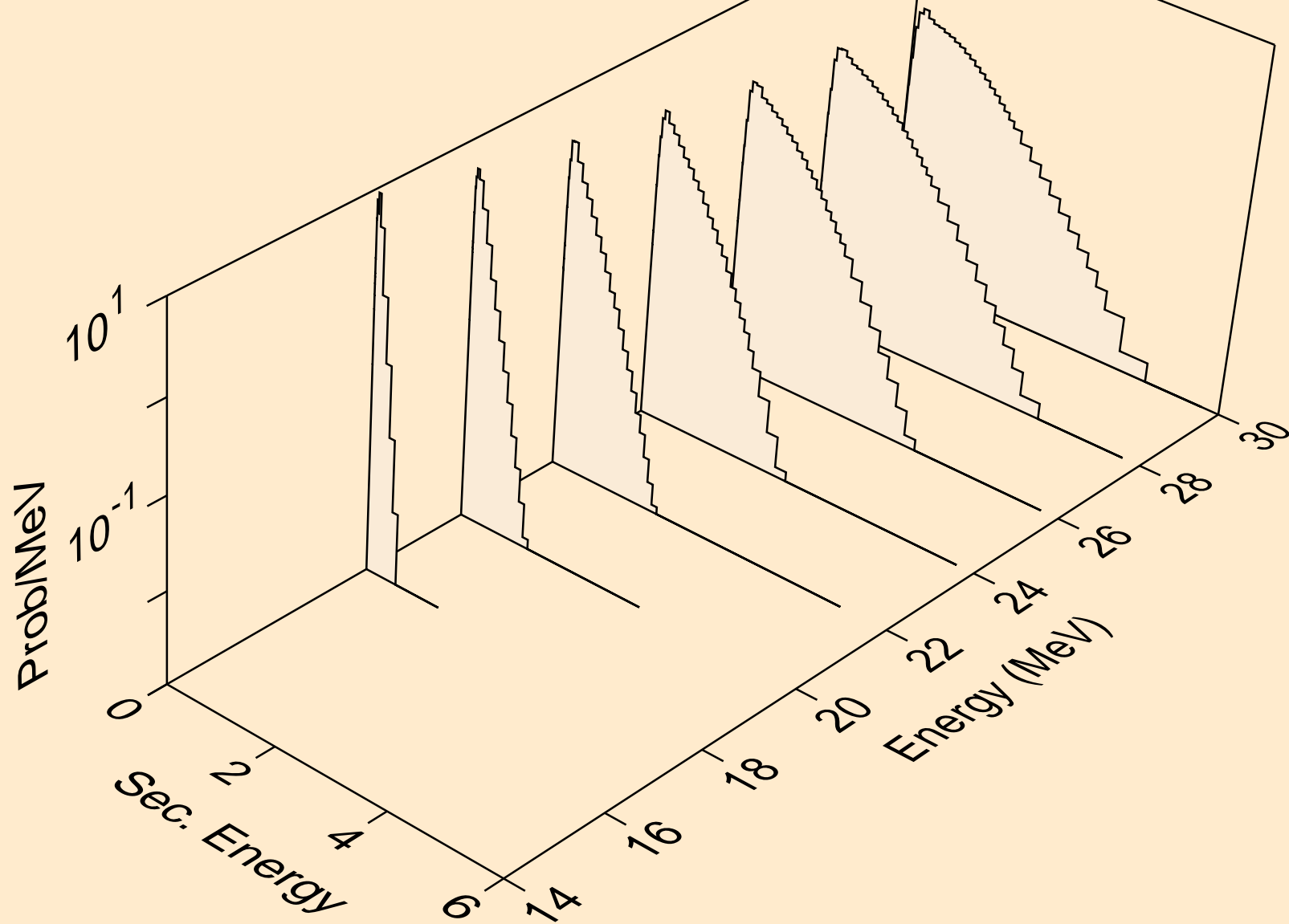

BA135M NEUTRON ACER TENDL-2024 LIBRARY; T=0.K
Neutron emission for (n,n*)he3

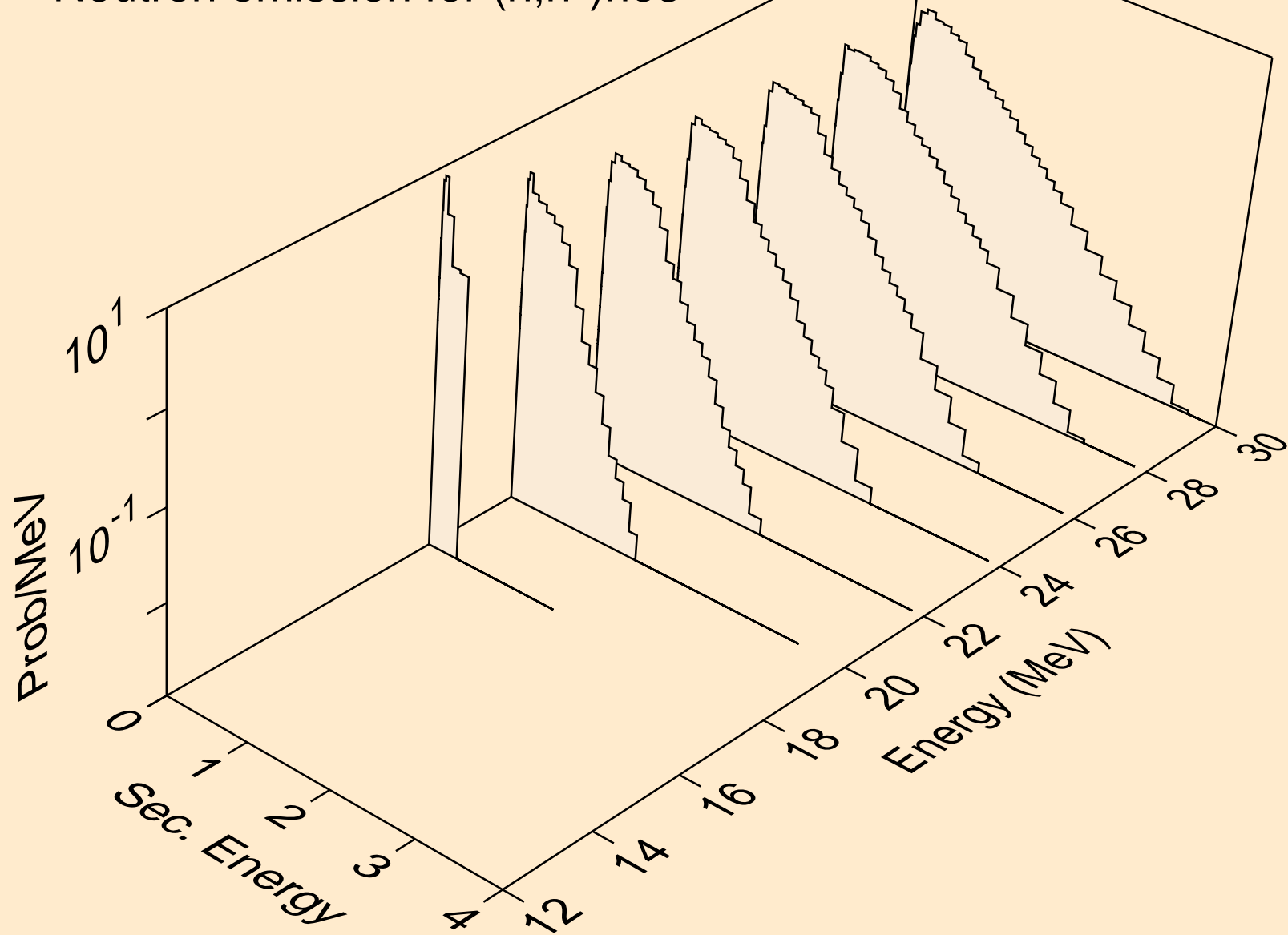

BA135M NEUTRON ACER TENDL-2024 LIBRARY; T=0.K
Neutron emission for (n,4n)

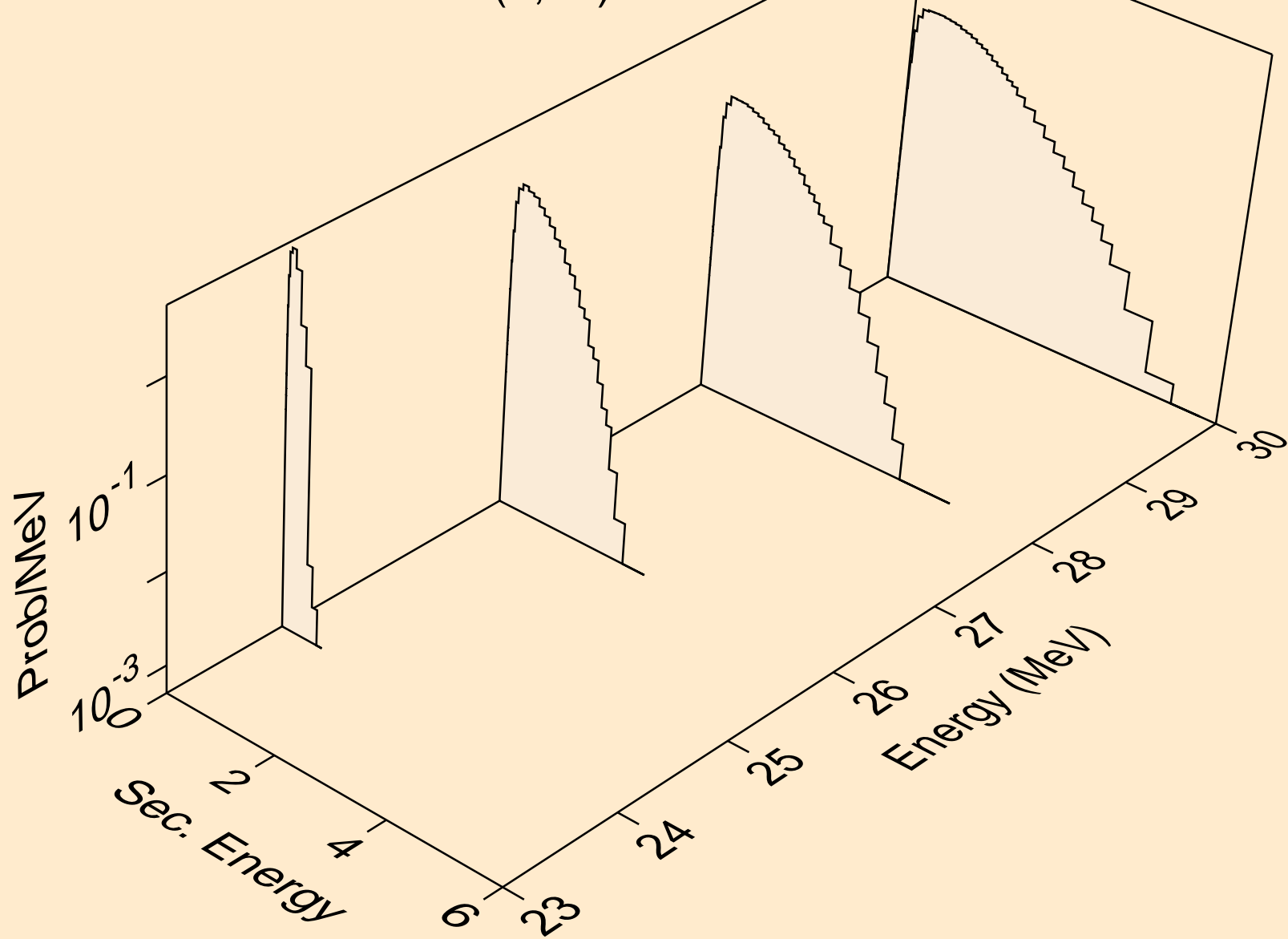

BA135M NEUTRON ACER TENDL-2024 LIBRARY; T=0.K
Neutron emission for (n,2np)

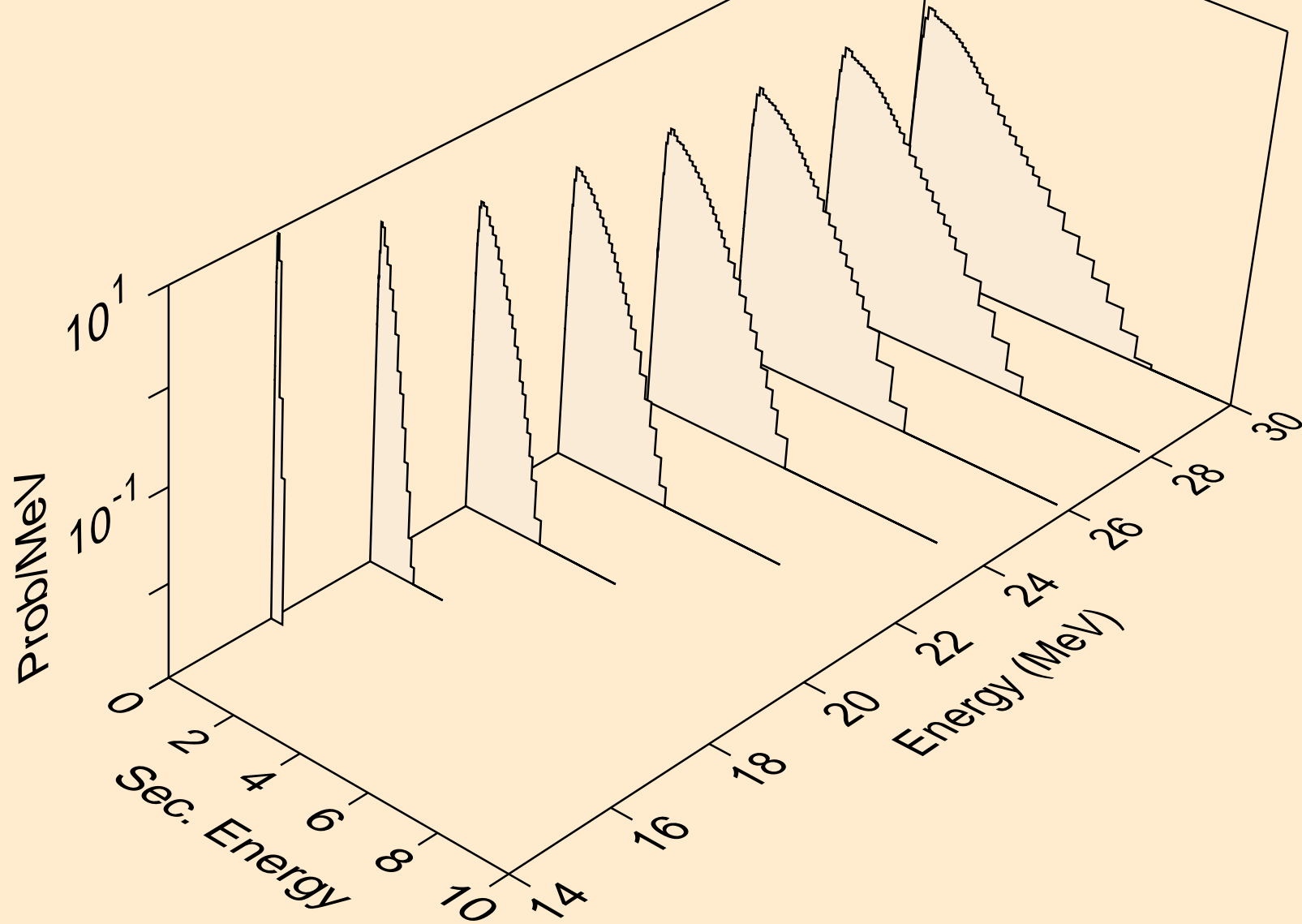

BA135M NEUTRON ACER TENDL-2024 LIBRARY; T=0.K
Neutron emission for (n,3np)

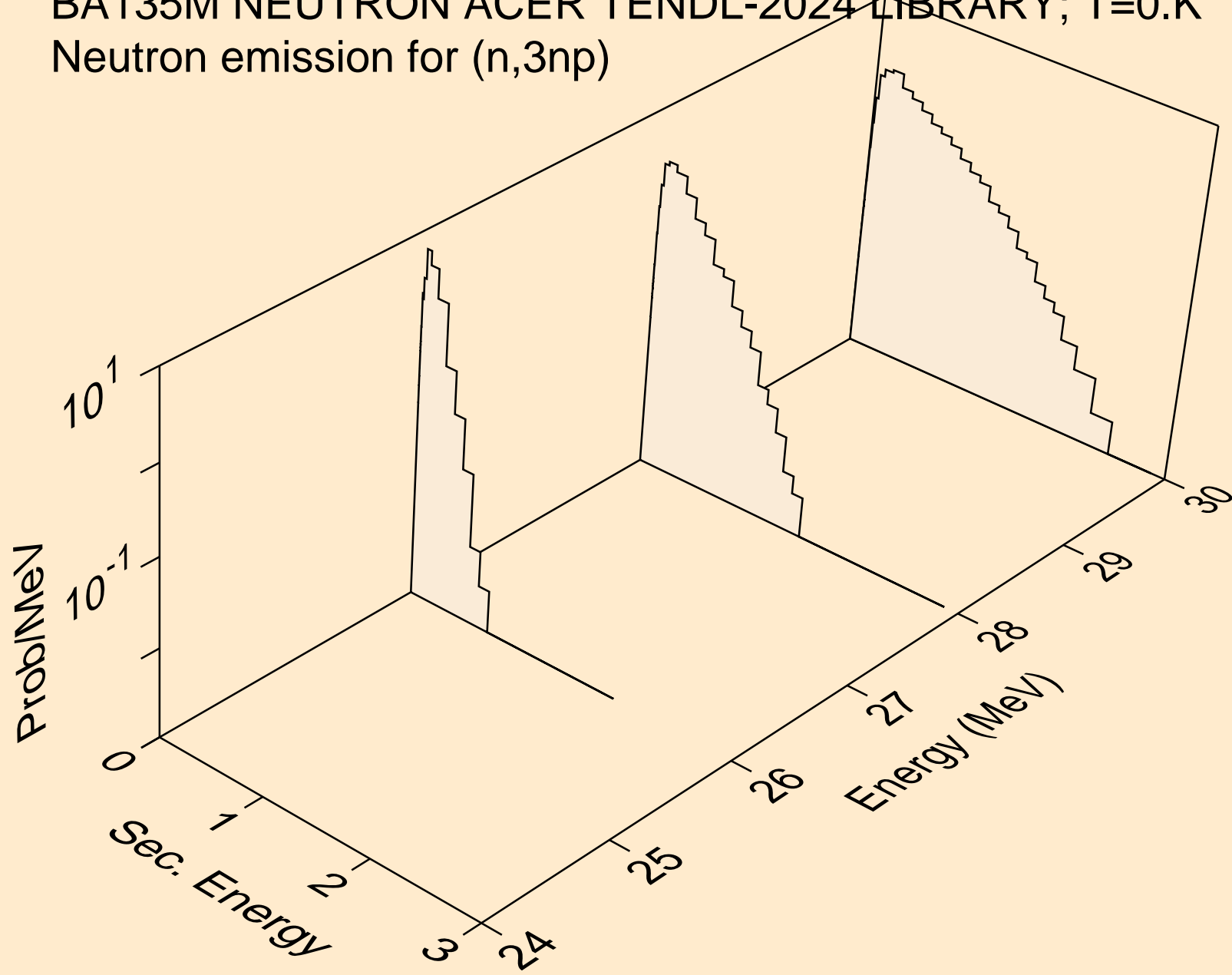

BA135M NEUTRON ACER TENDL-2024 LIBRARY; T=0.K
Neutron emission for (n,n2p)

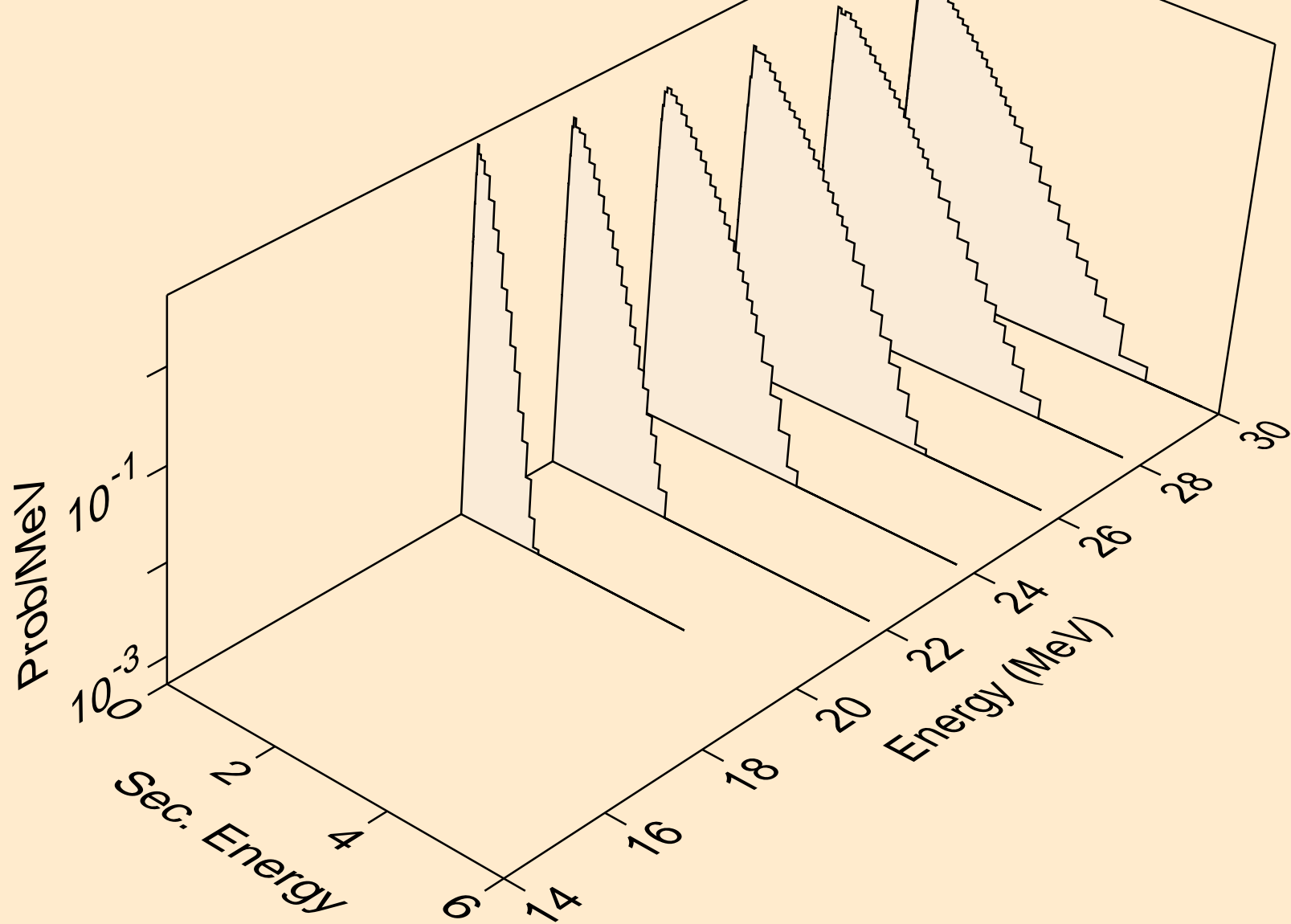

BA135M NEUTRON ACER TENDL-2024 LIBRARY; T=0.K
Neutron emission for (n,npa)

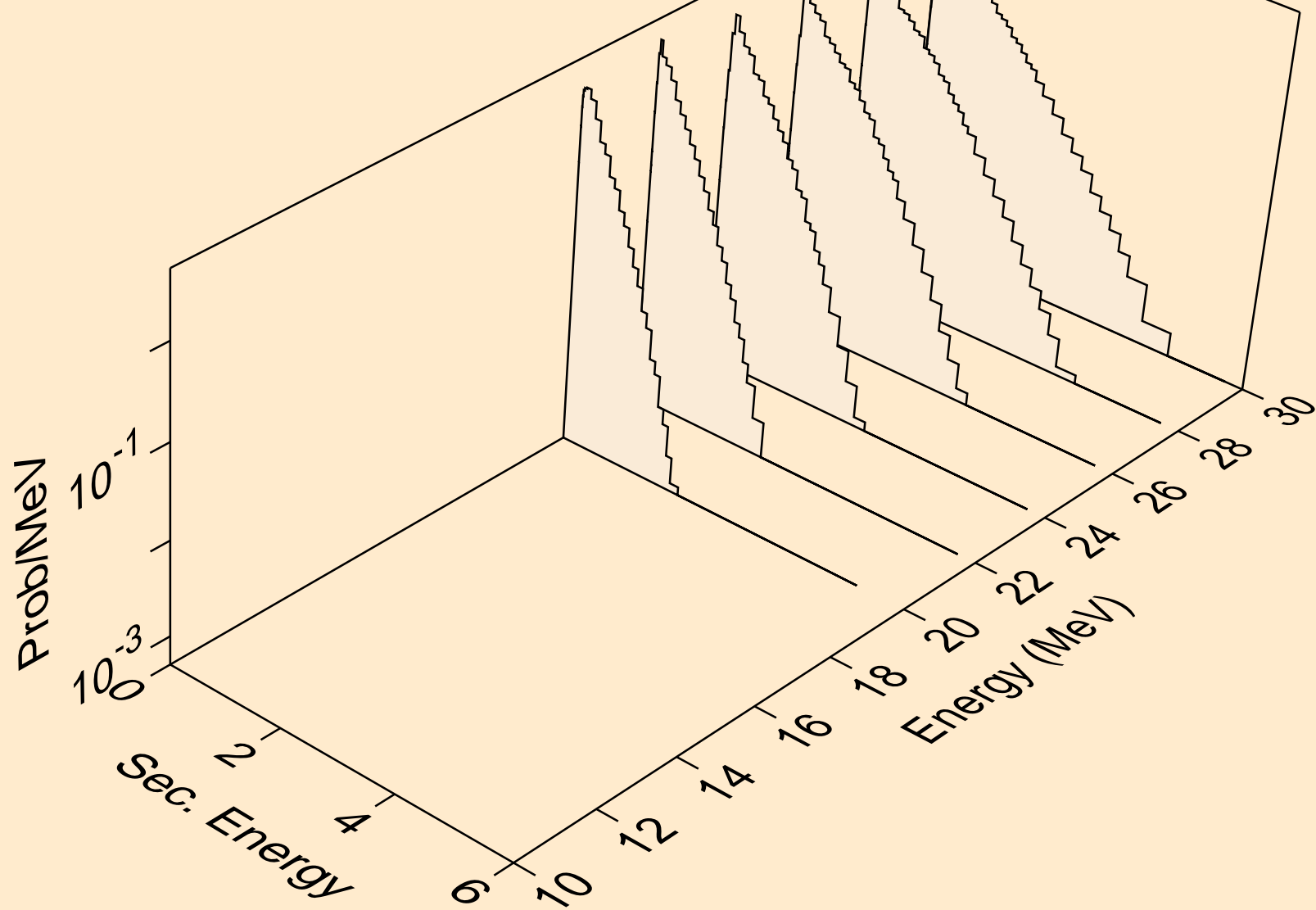

BA135M NEUTRON ACER TENDL-2024 LIBRARY; T=0.K
Neutron emission for (n,n*c)

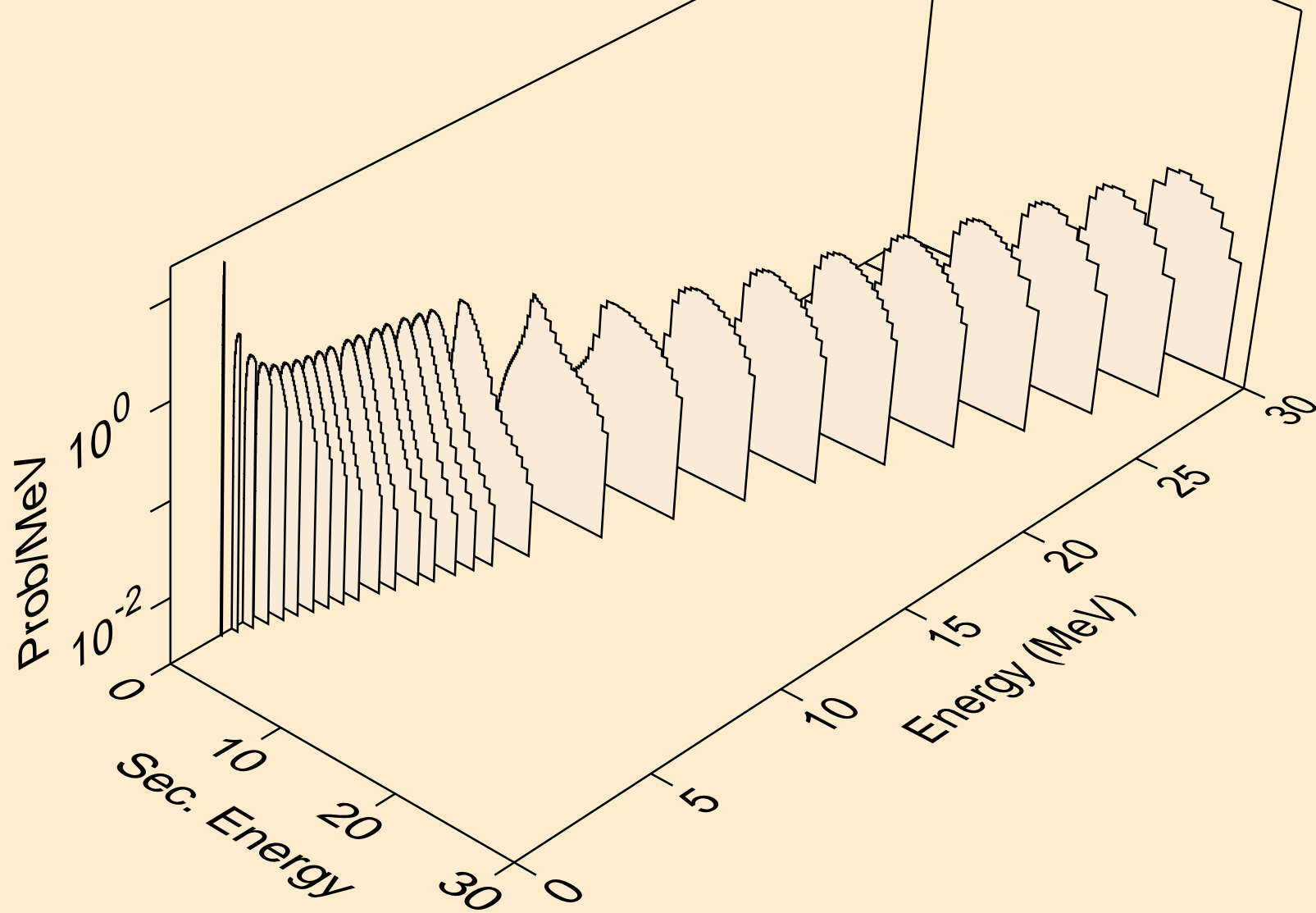

BA135M NEUTRON ACER TENDL-2024 LIBRARY; T=0.K
Photon emission for (n,x)

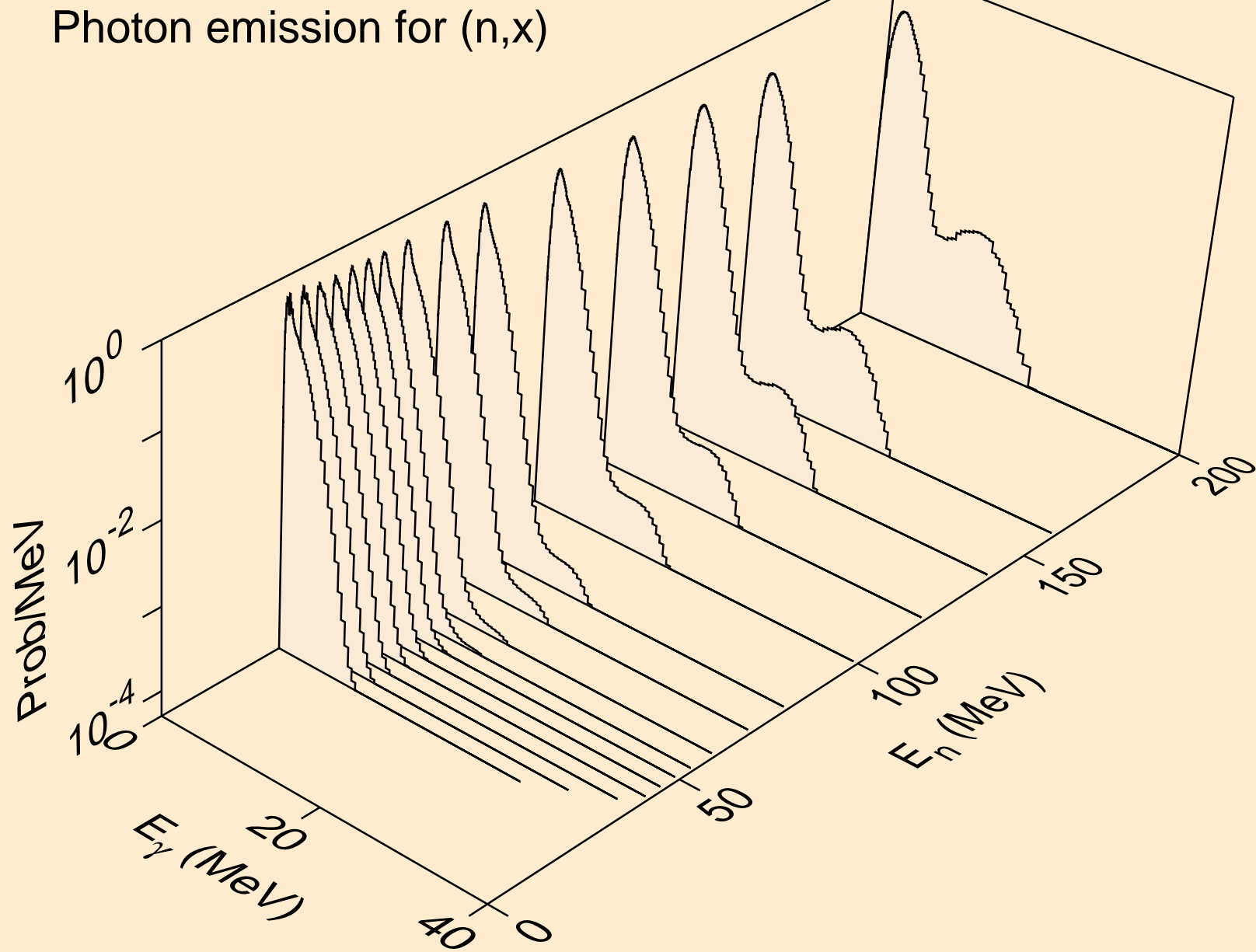

BA135M NEUTRON ACER TENDL-2024 LIBRARY; T=0.K
Photon emission for (n,2nd)

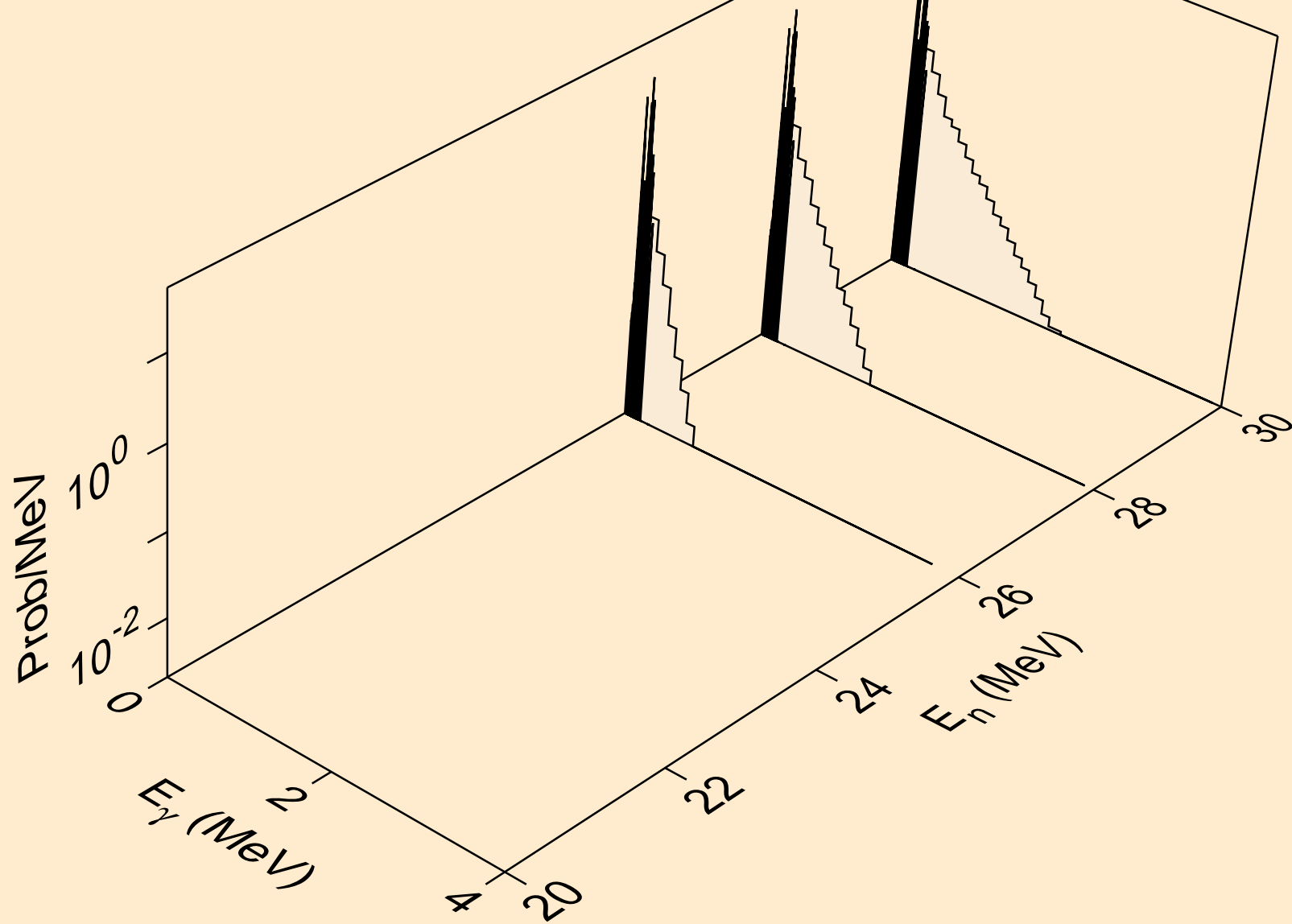

BA135M NEUTRON ACER TENDL-2024 LIBRARY; T=0.K
Photon emission for (n,2n)

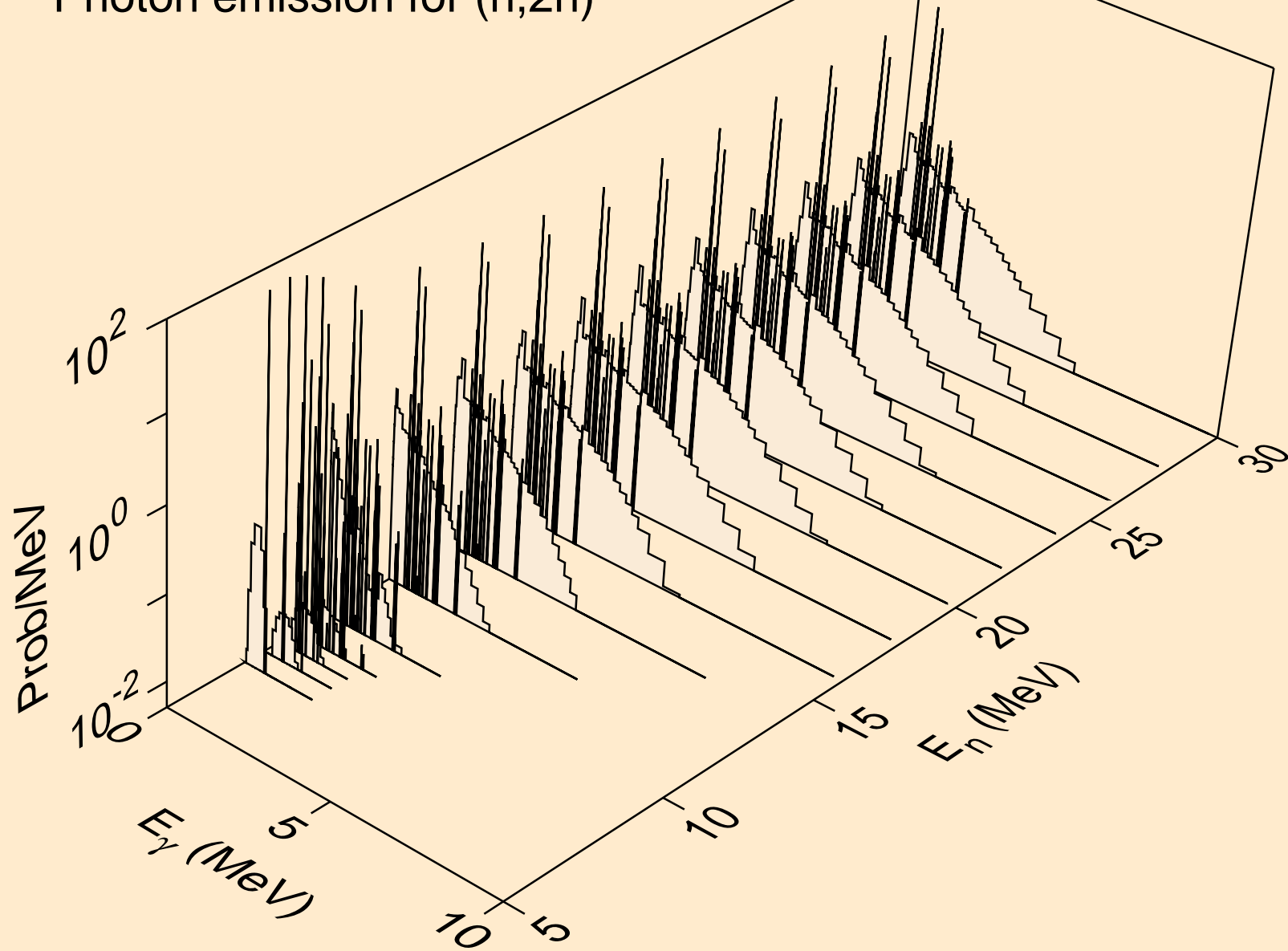

BA135M NEUTRON ACER TENDL-2024 LIBRARY; T=0.K
Photon emission for (n,3n)

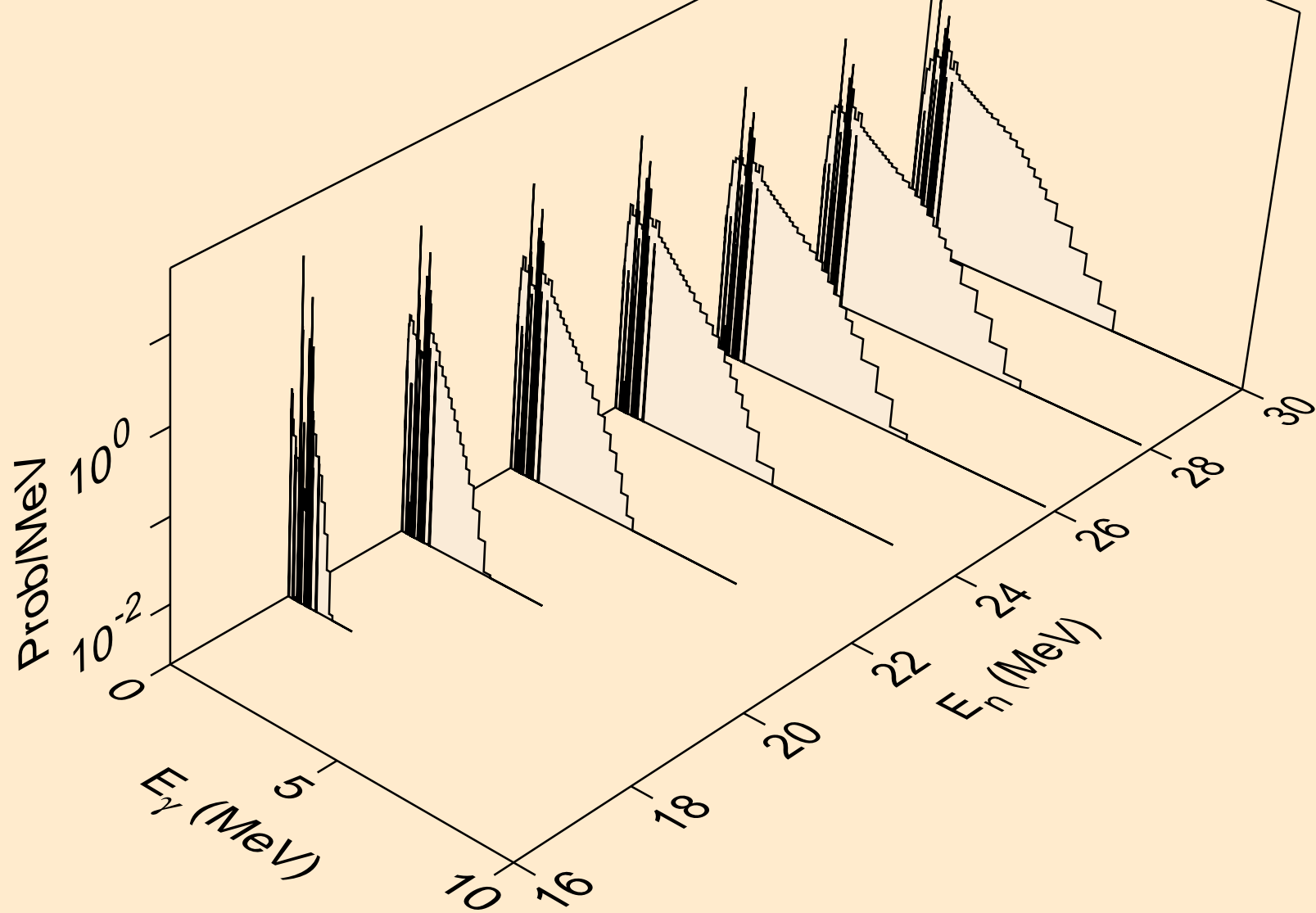

BA135M NEUTRON ACER TENDL-2024 LIBRARY; T=0.K
Photon emission for (n,n*)a

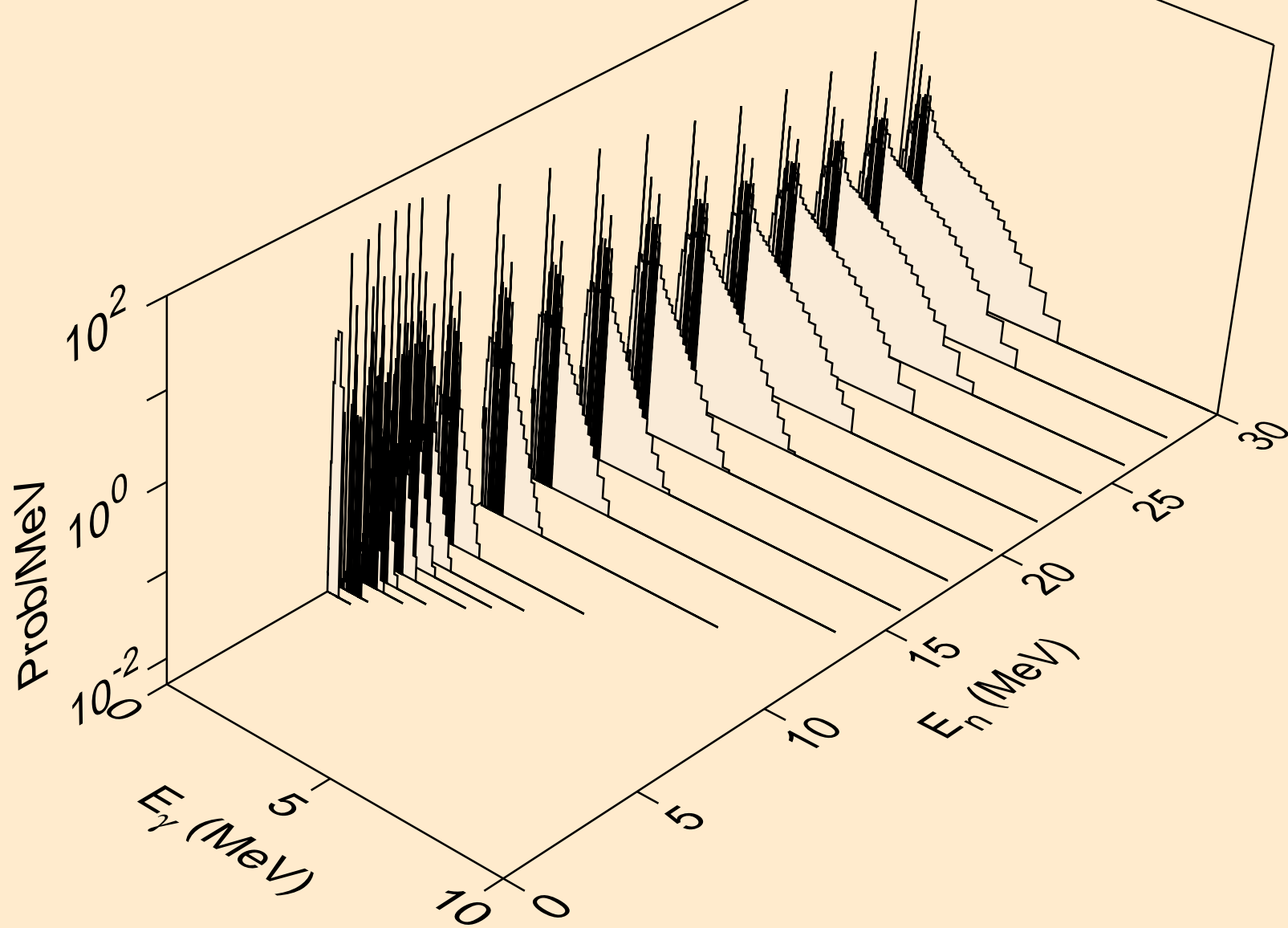

BA135M NEUTRON ACER TENDL-2024 LIBRARY; T=0.K
Photon emission for (n,2n)a

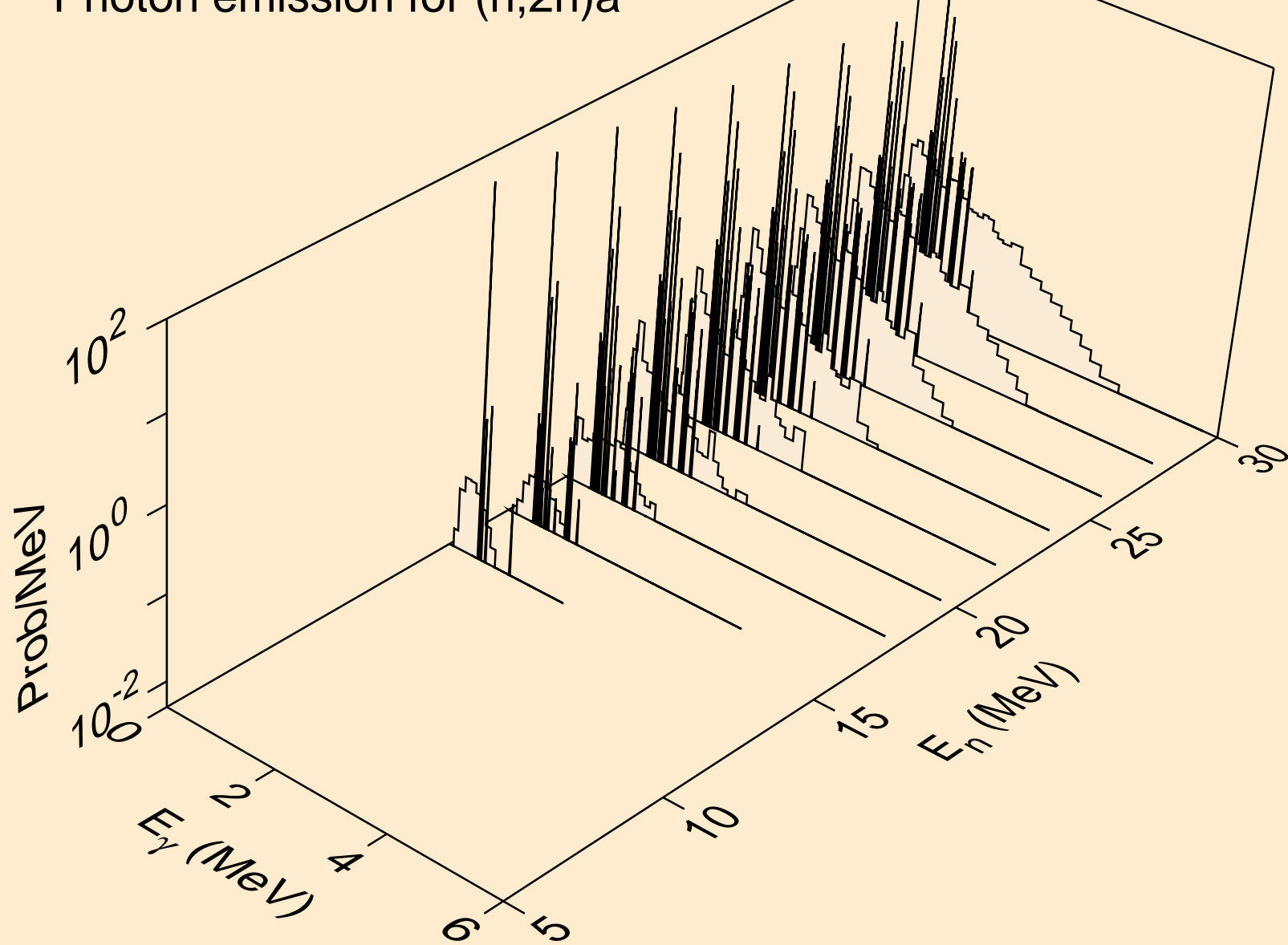

BA135M NEUTRON ACER TENDL-2024 LIBRARY; T=0.K
Photon emission for (n,3n)a

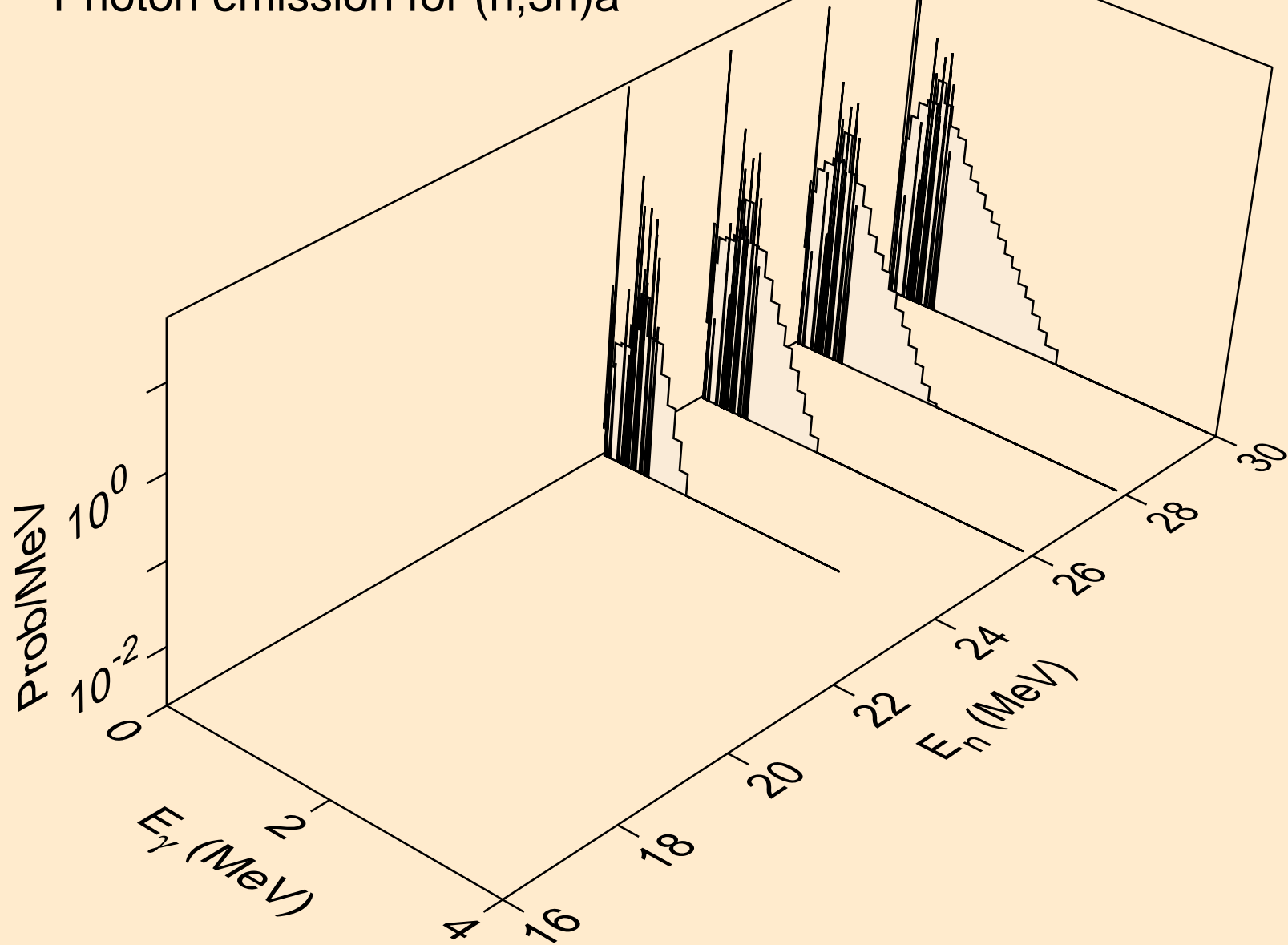

BA135M NEUTRON ACER TENDL-2024 LIBRARY; T=0.K
Photon emission for (n,n*)p

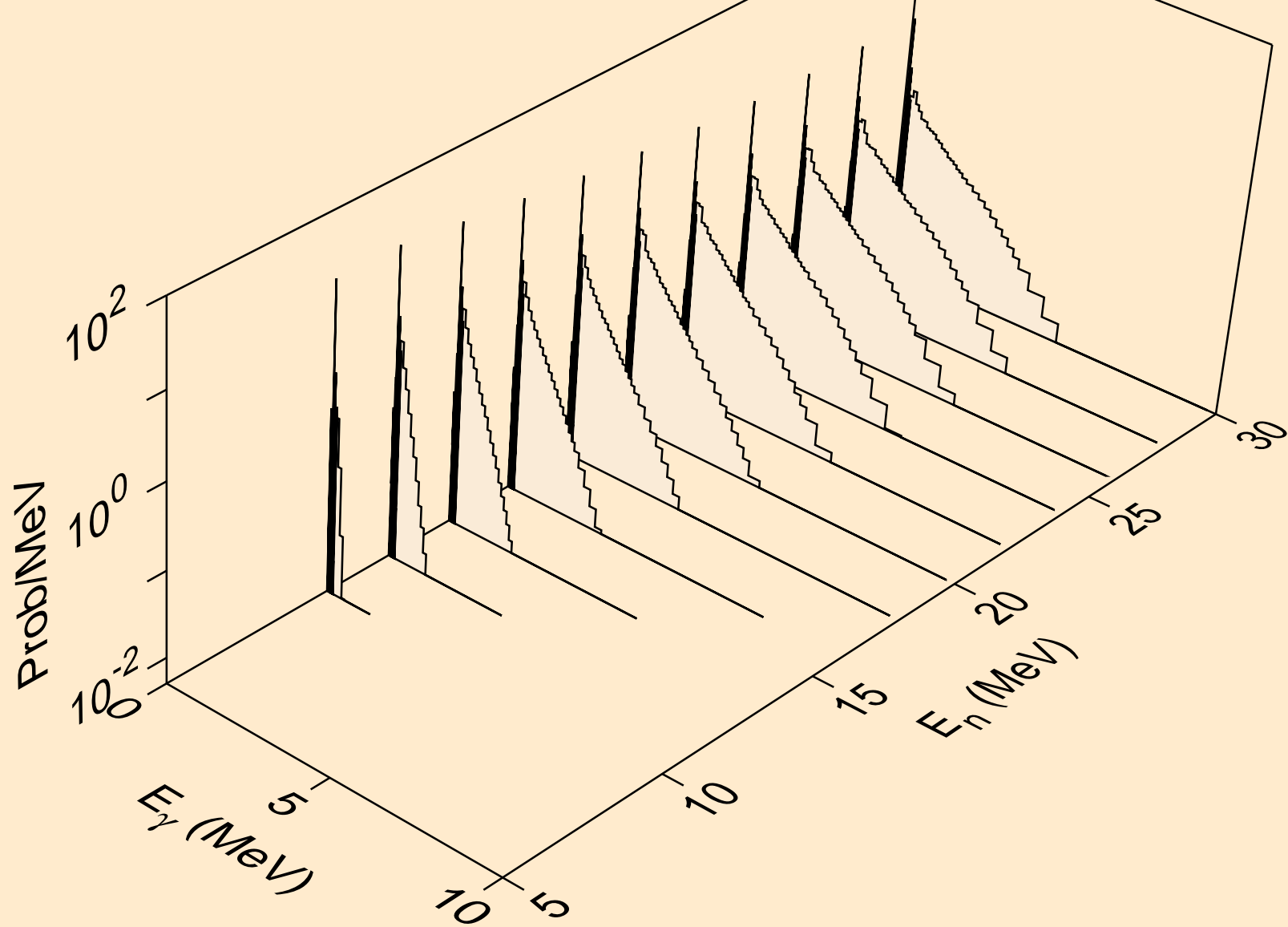

BA135M NEUTRON ACER TENDL-2024 LIBRARY; T=0.K
Photon emission for (n,n*)2a

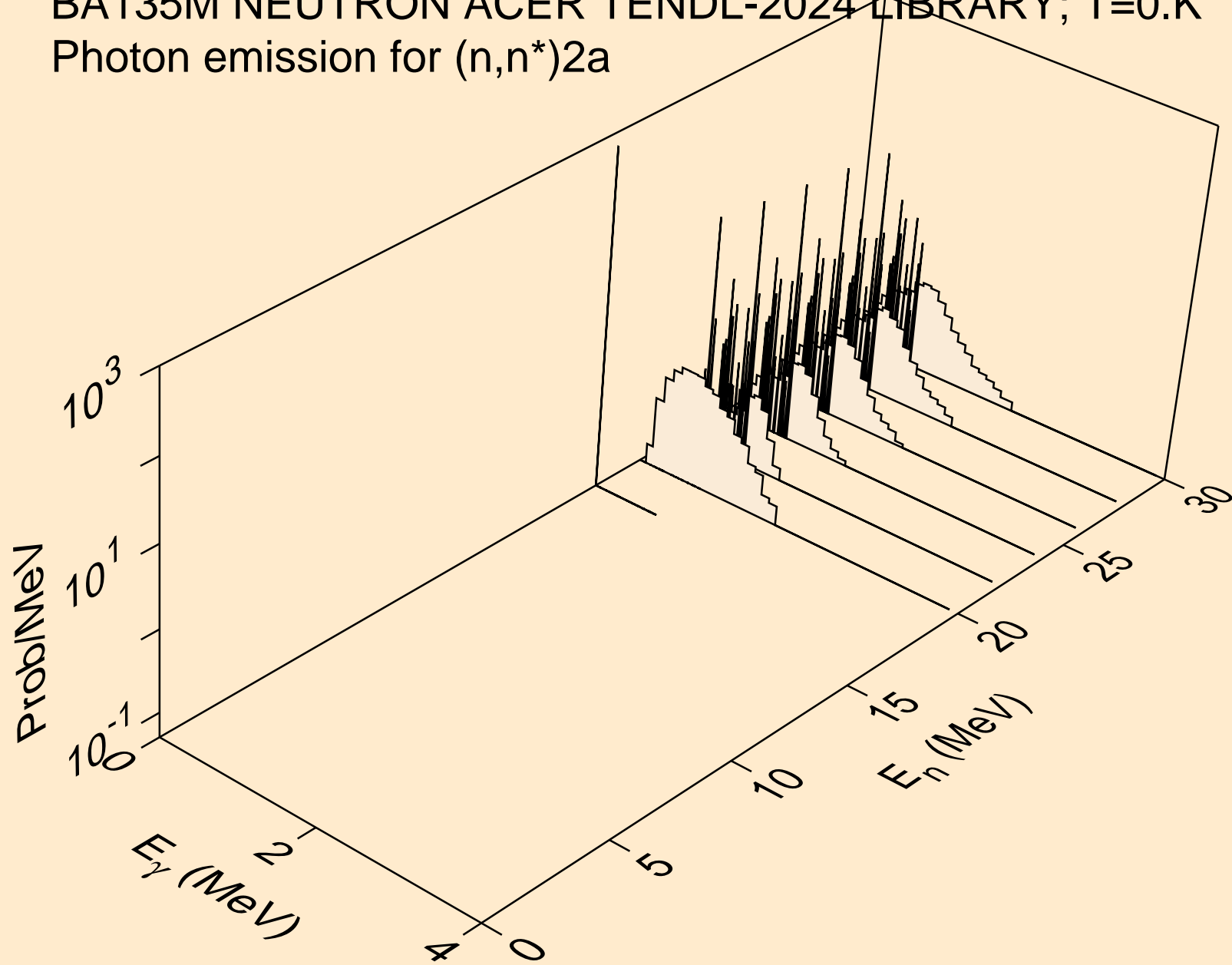

BA135M NEUTRON ACER TENDL-2024 LIBRARY; T=0.K
Photon emission for (n,n*)d

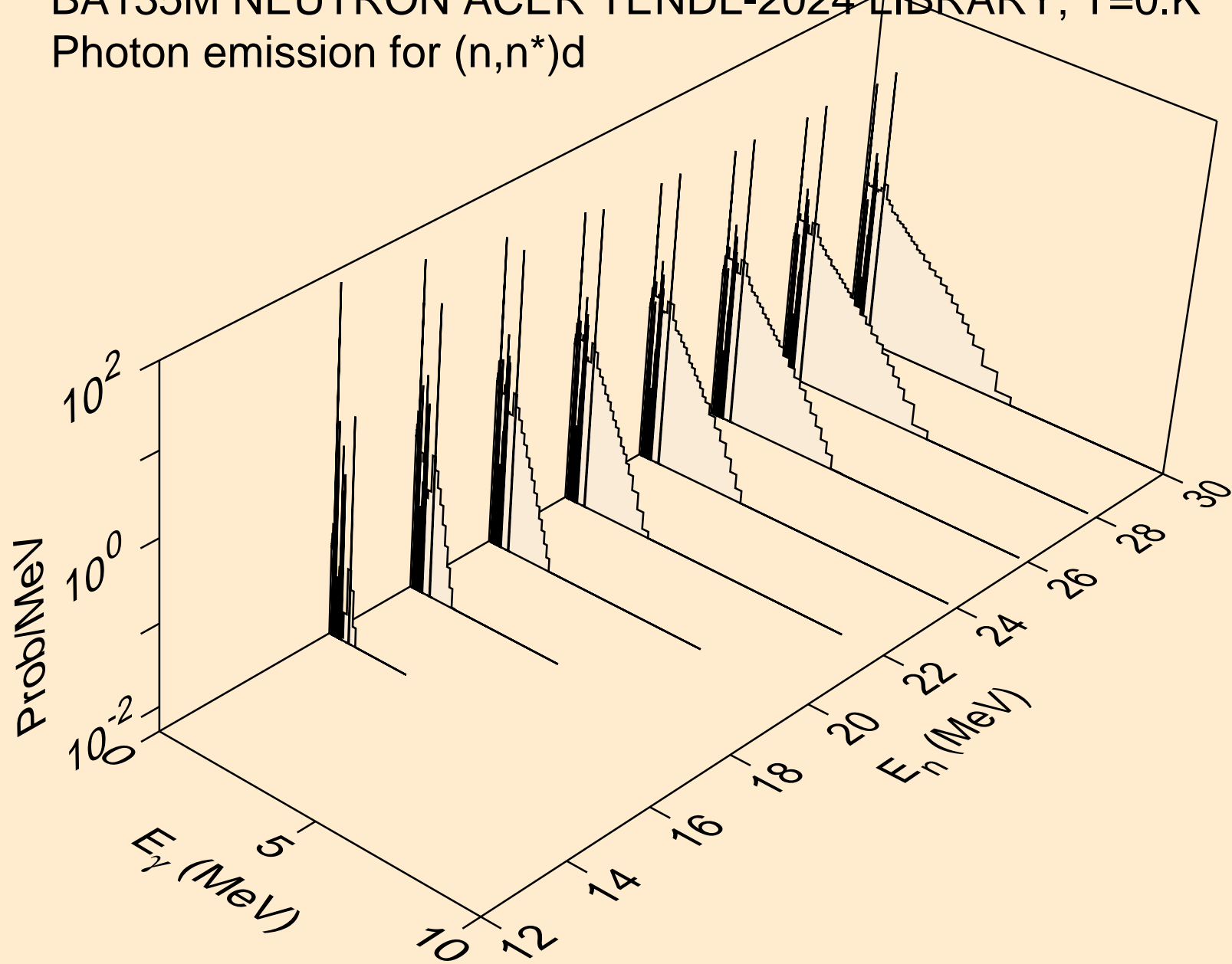

BA135M NEUTRON ACER TENDL-2024 LIBRARY; T=0.K
Photon emission for (n,n*)t

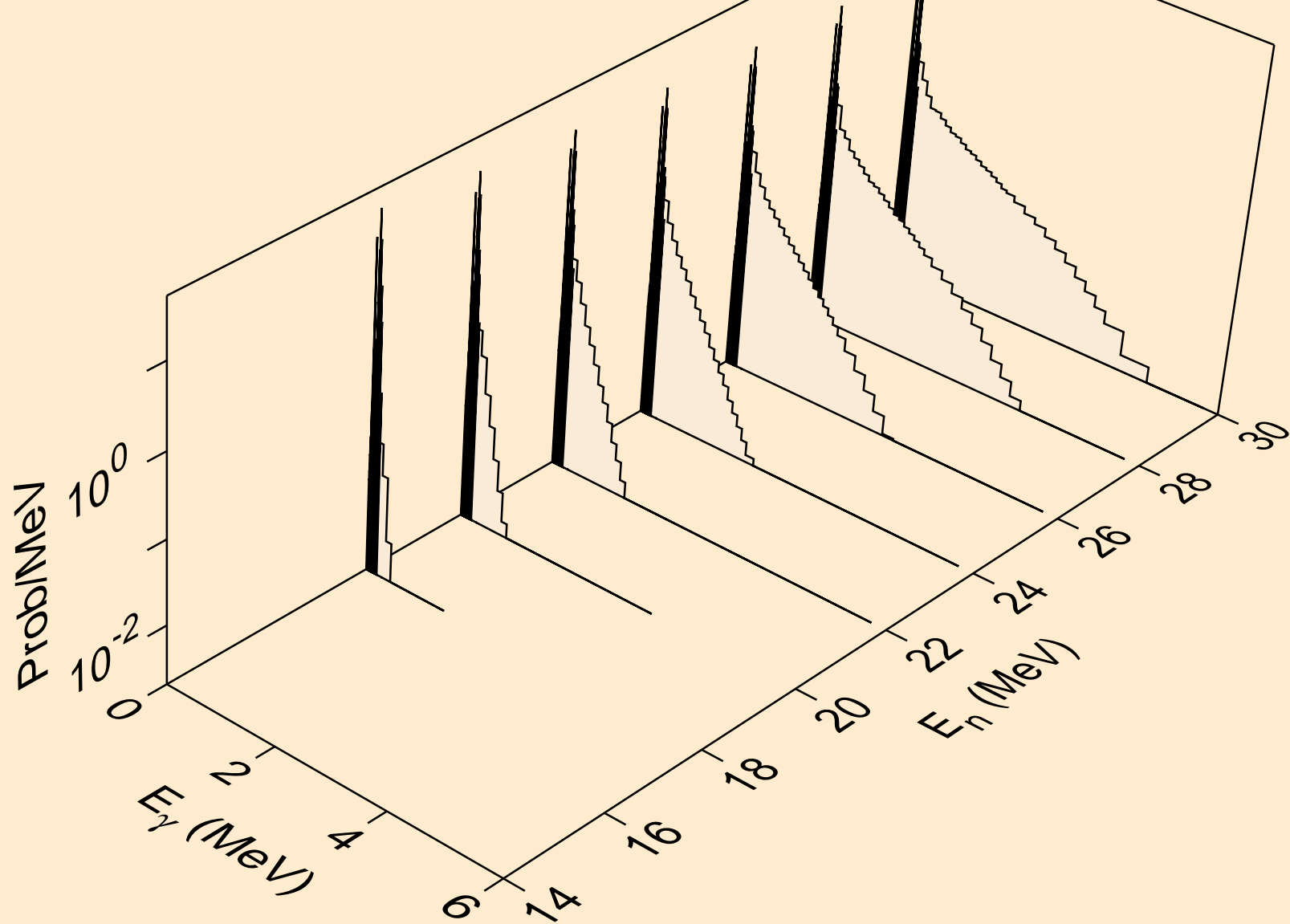

BA135M NEUTRON ACER TENDL-2024 LIBRARY; T=0.K
Photon emission for (n,n*)he3

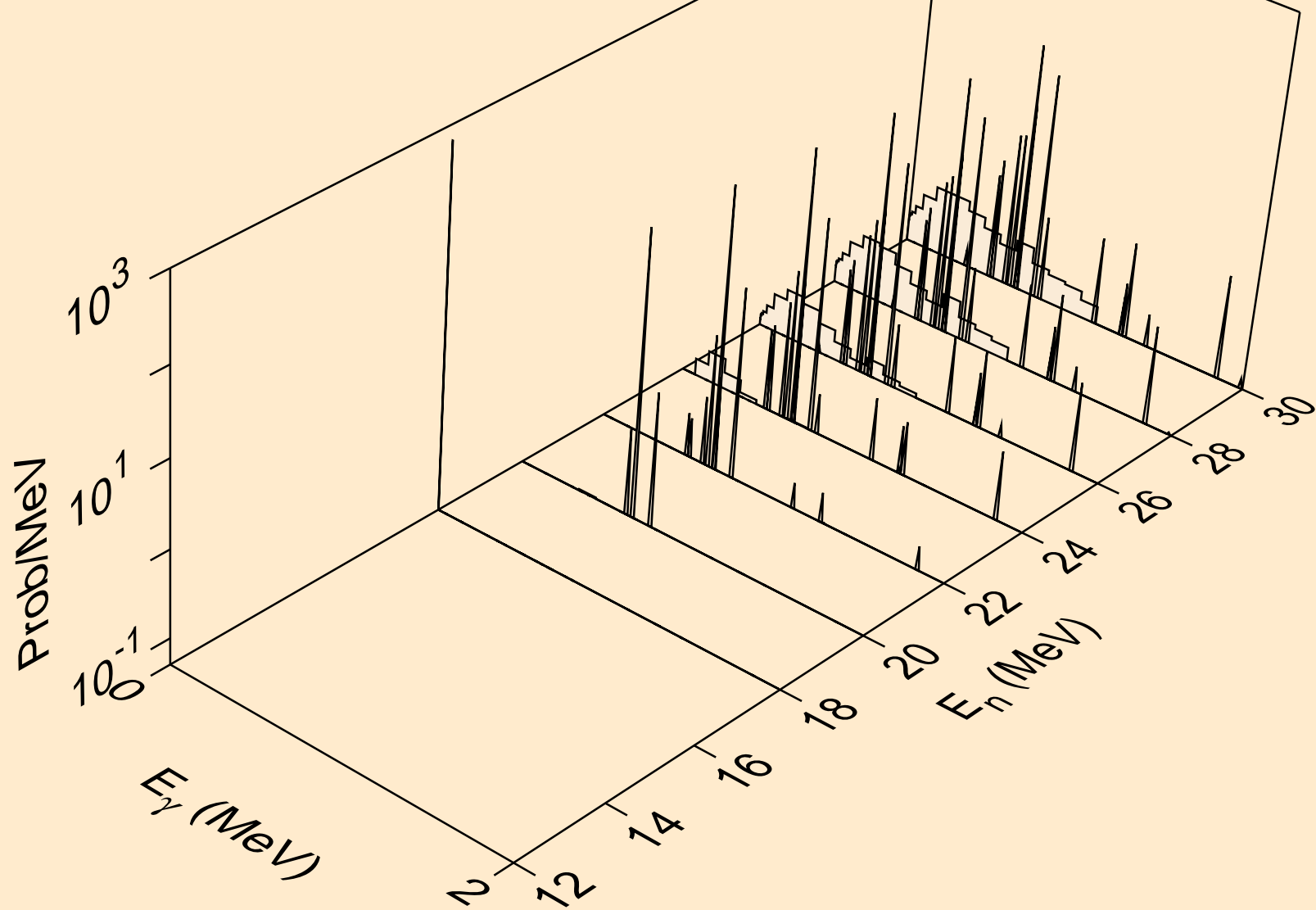

BA135M NEUTRON ACER TENDL-2024 LIBRARY; T=0.K
Photon emission for (n,4n)

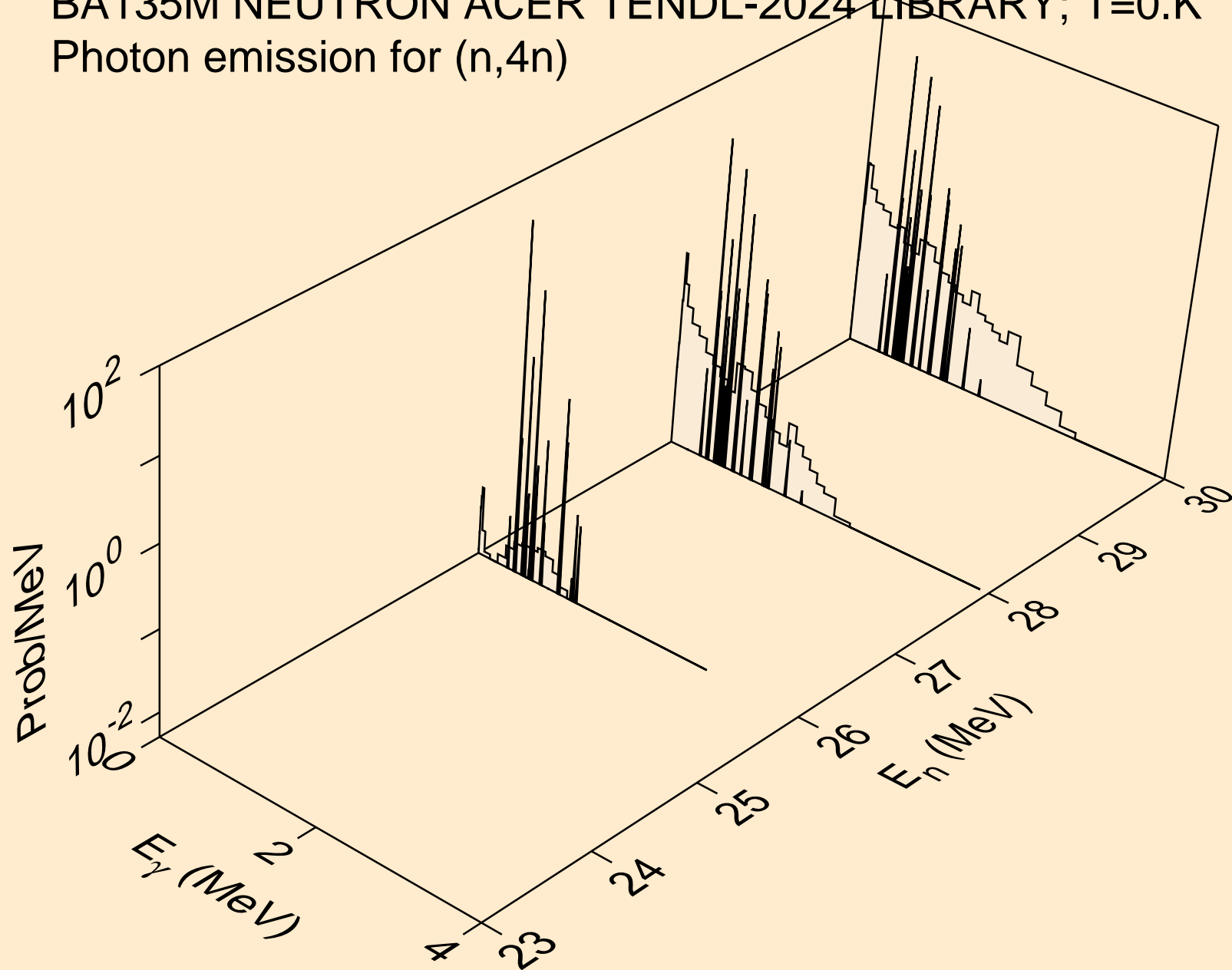

BA135M NEUTRON ACER TENDL-2024 LIBRARY; T=0.K
Photon emission for (n,2np)

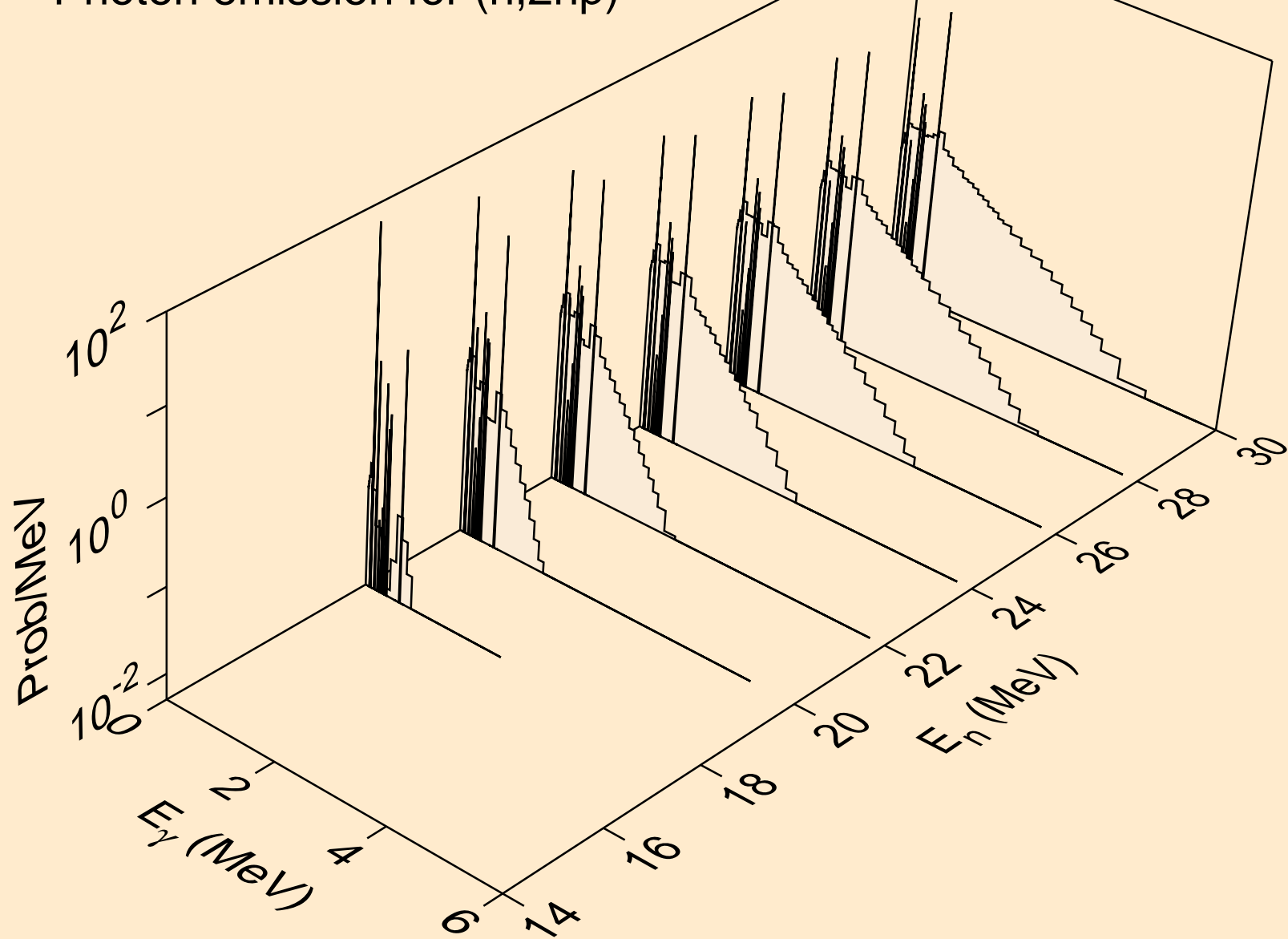

BA135M NEUTRON ACER TENDL-2024 LIBRARY; T=0.K
Photon emission for (n,3np)

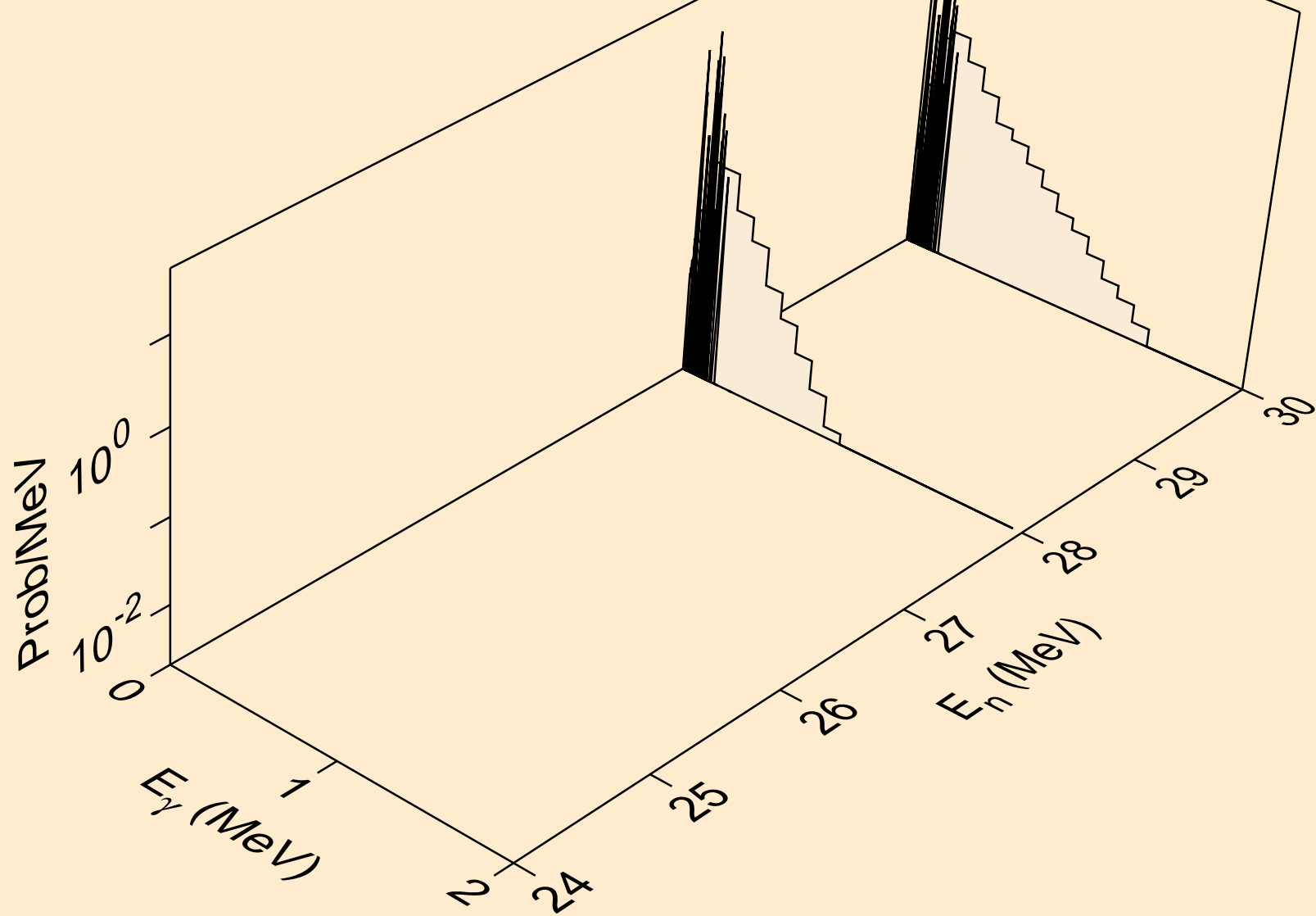

BA135M NEUTRON ACER TENDL-2024 LIBRARY; T=0.K
Photon emission for (n,n2p)

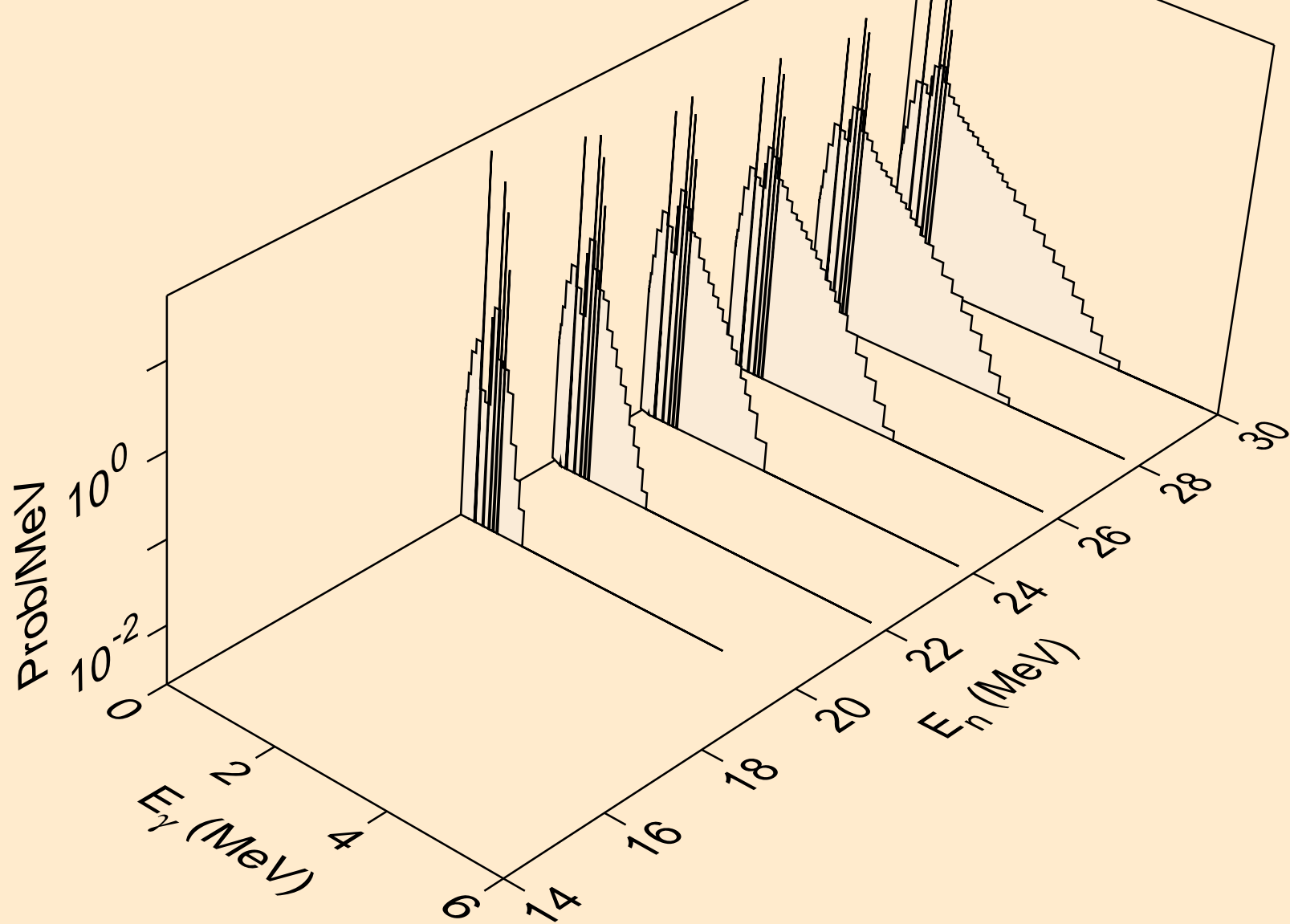

BA135M NEUTRON ACER TENDL-2024 LIBRARY; T=0.K
Photon emission for (n,npa)

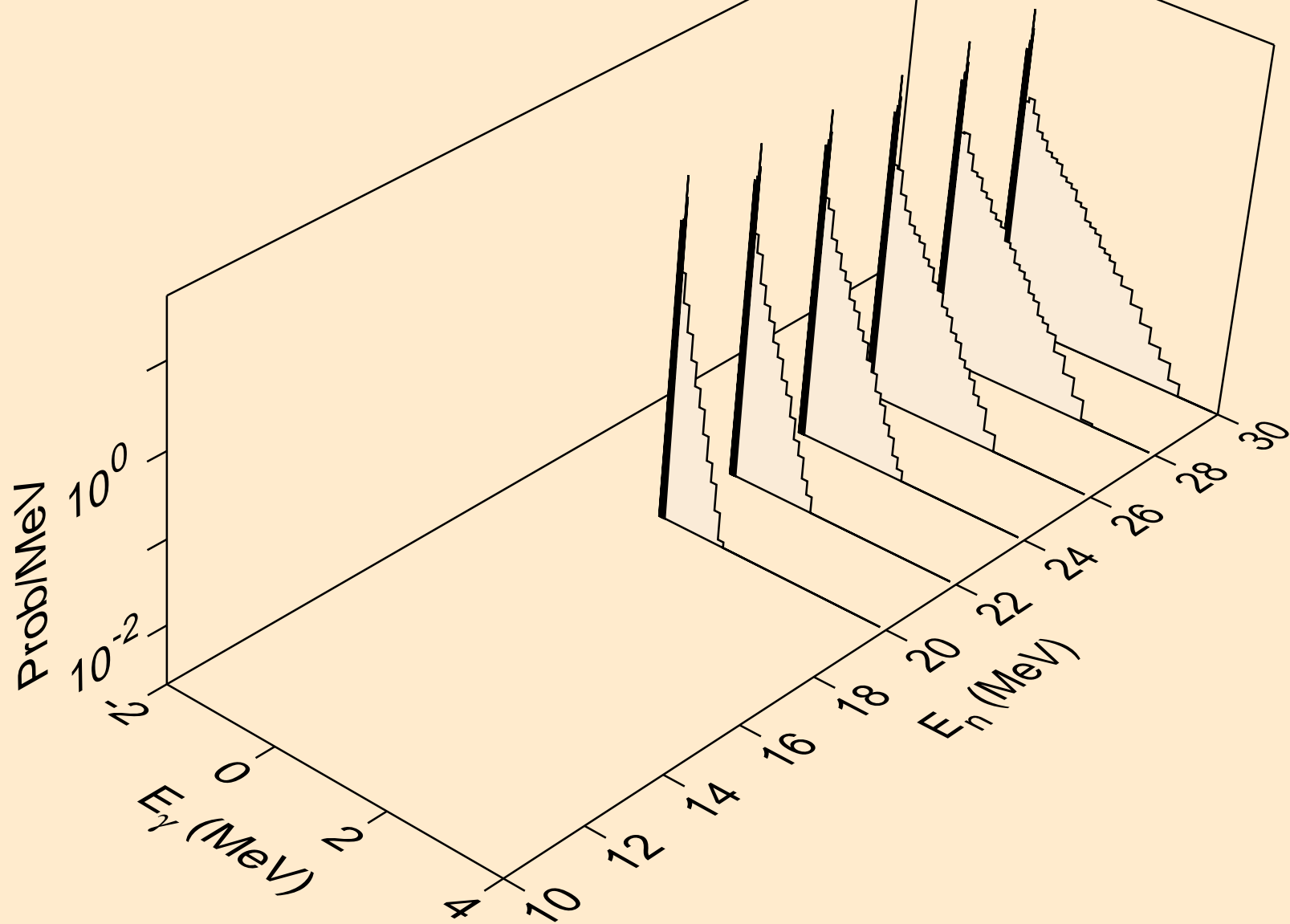

BA135M NEUTRON ACER TENDL-2024 LIBRARY; T=0.K
Photon emission for (n,n*1)

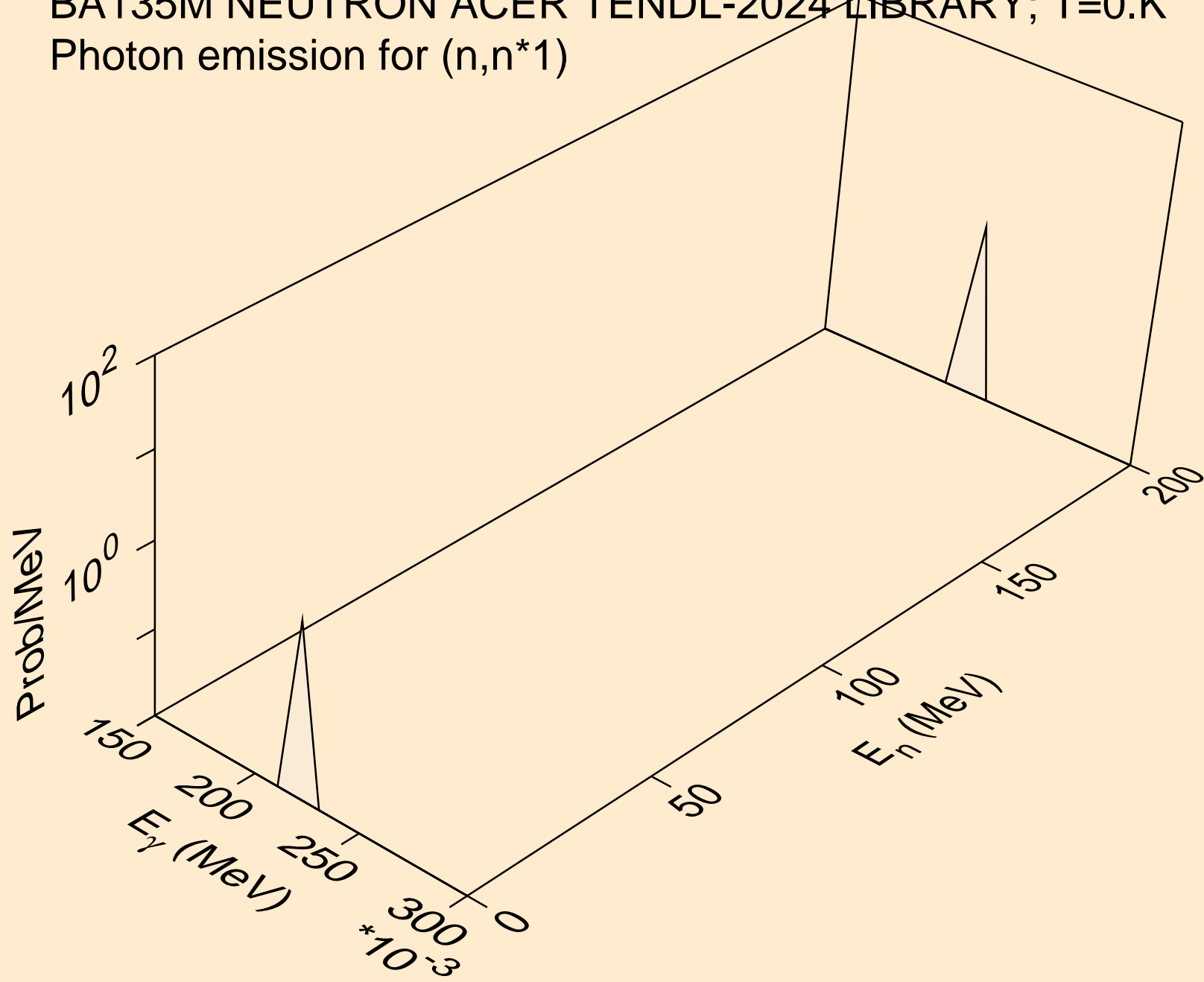

BA135M NEUTRON ACER TENDL-2024 LIBRARY; T=0.K
Photon emission for (n,n*3)

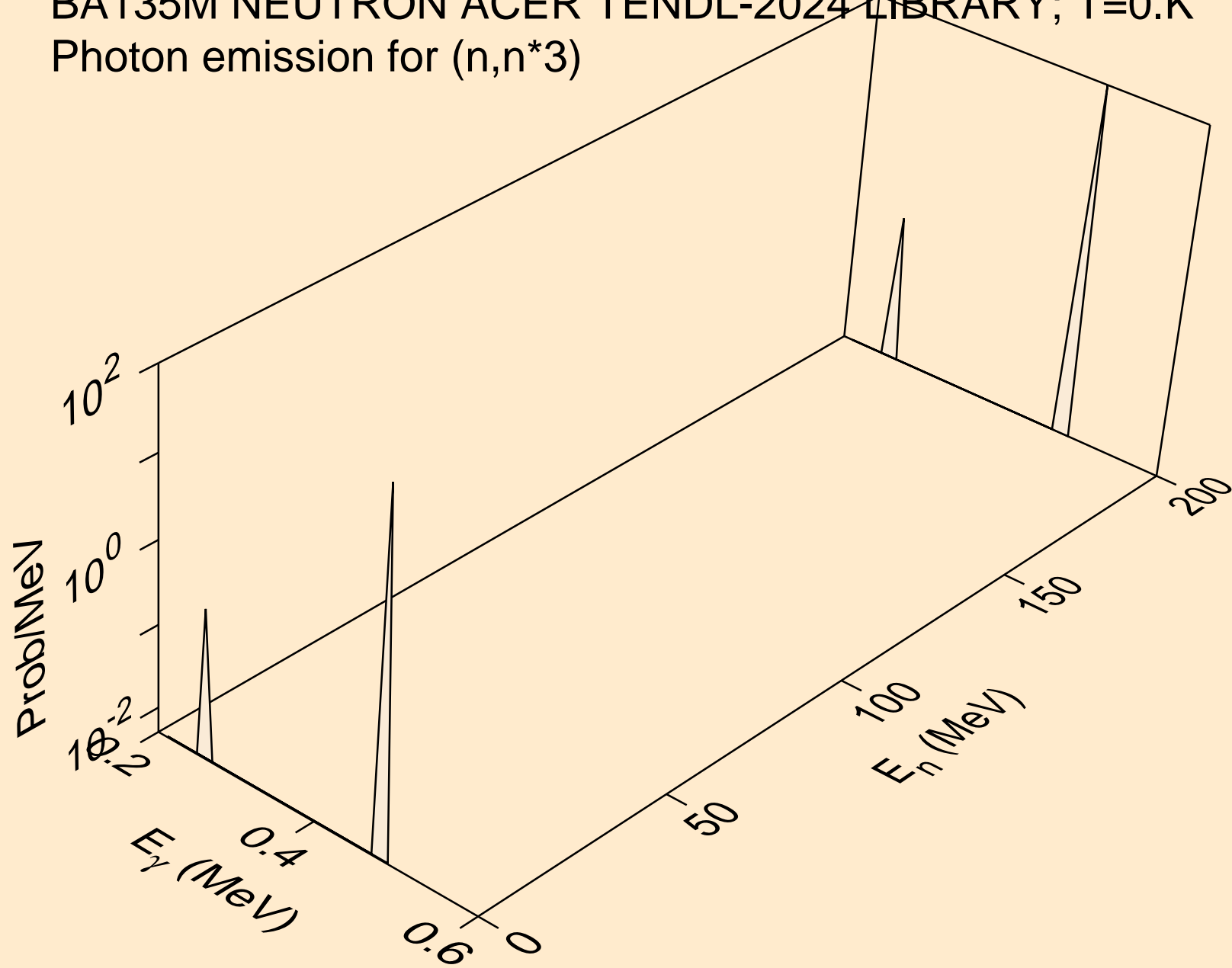

BA135M NEUTRON ACER TENDL-2024 LIBRARY; T=0.K
Photon emission for (n,n*4)

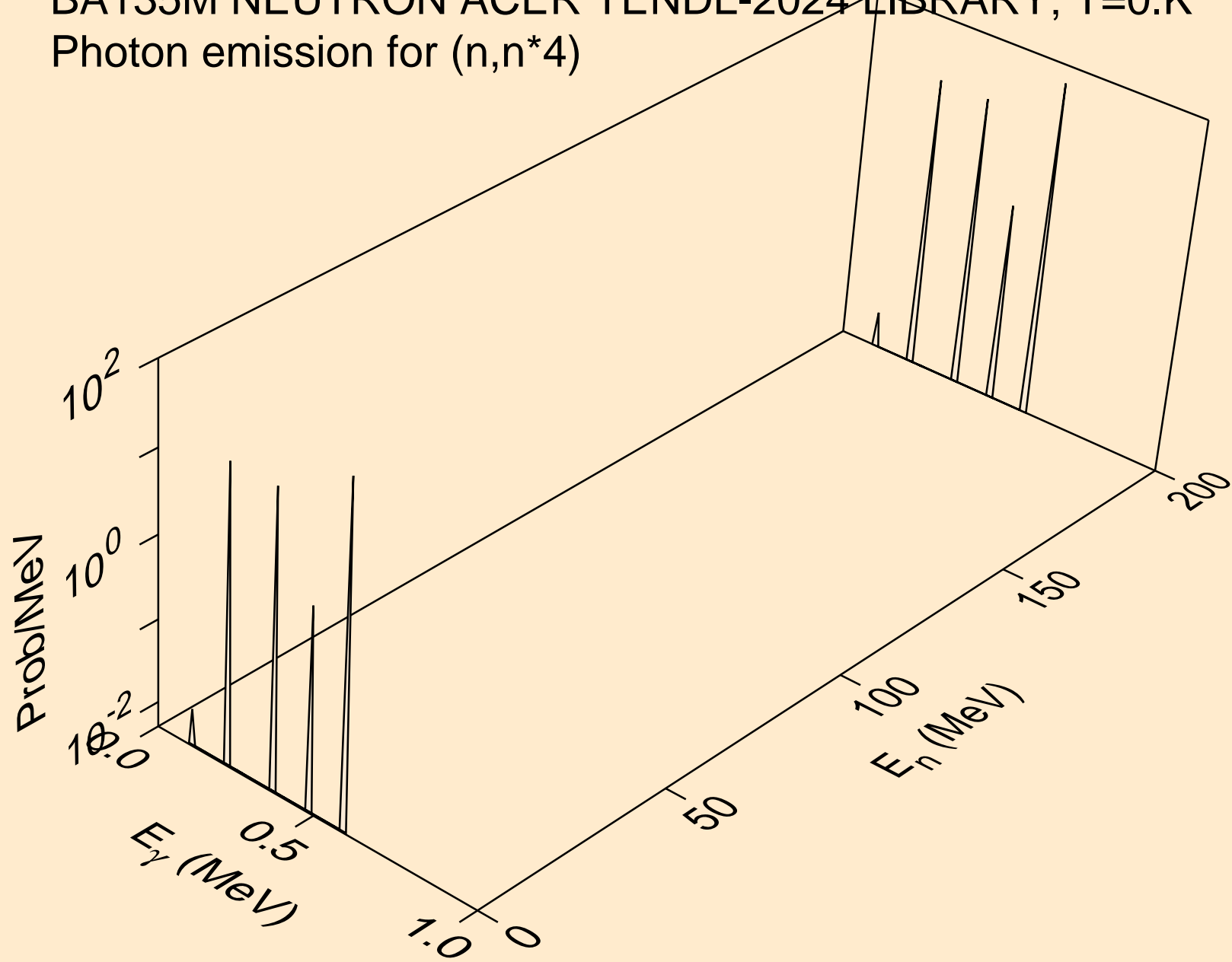

BA135M NEUTRON ACER TENDL-2024 LIBRARY; T=0.K
Photon emission for (n,n*5)

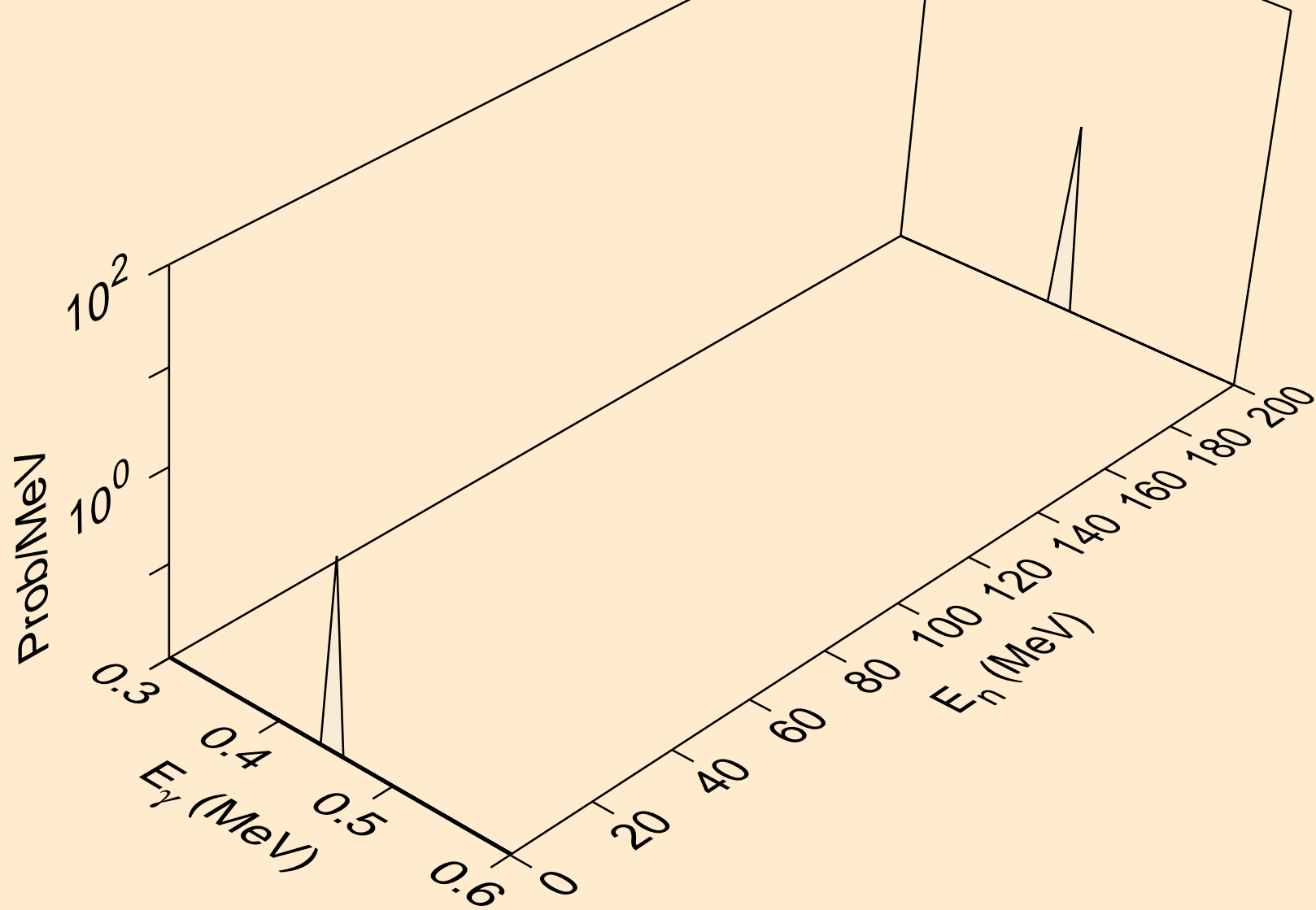

BA135M NEUTRON ACER TENDL-2024 LIBRARY; T=0.K
Photon emission for (n,n*6)

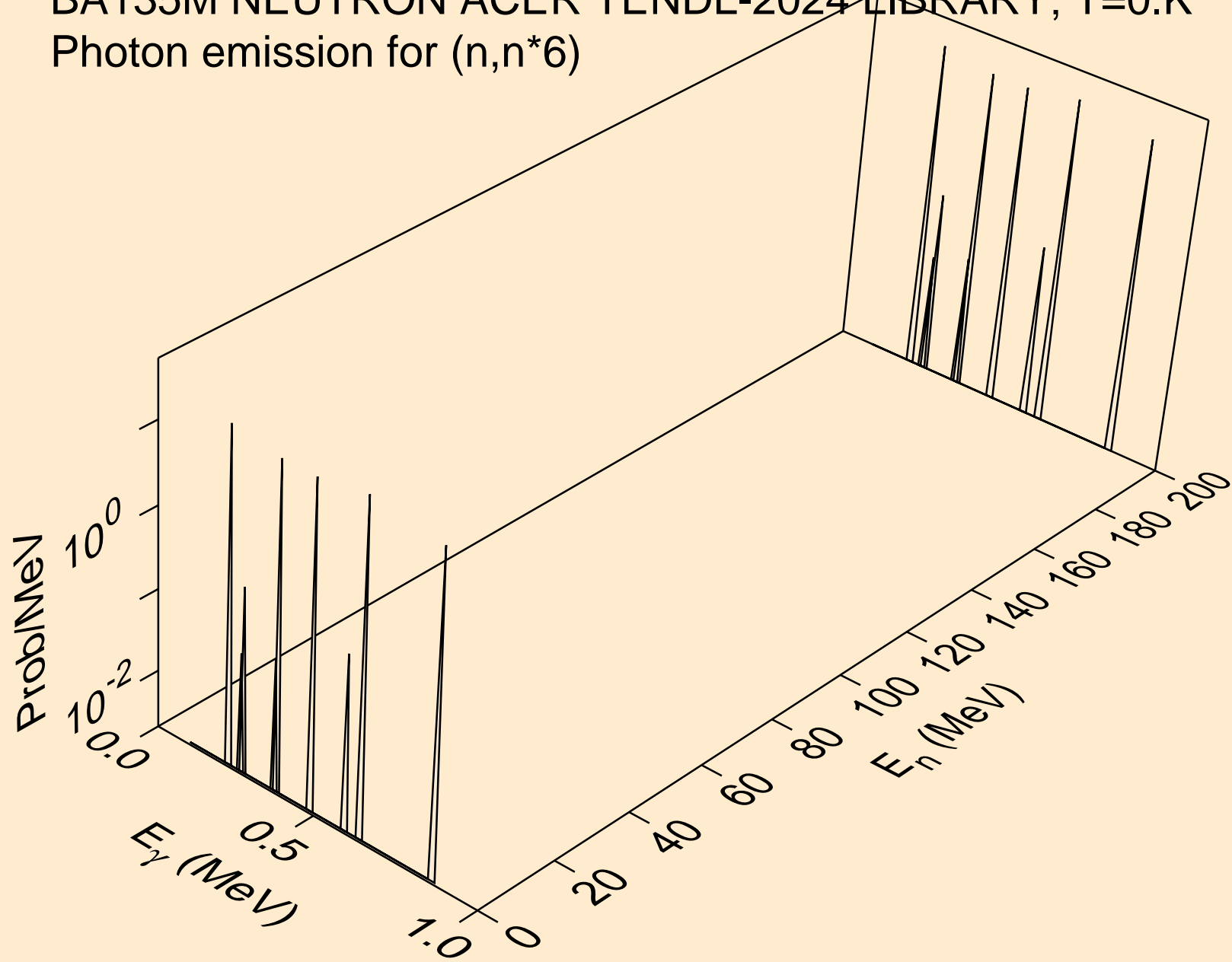

BA135M NEUTRON ACER TENDL-2024 LIBRARY; T=0.K
Photon emission for (n,n*7)

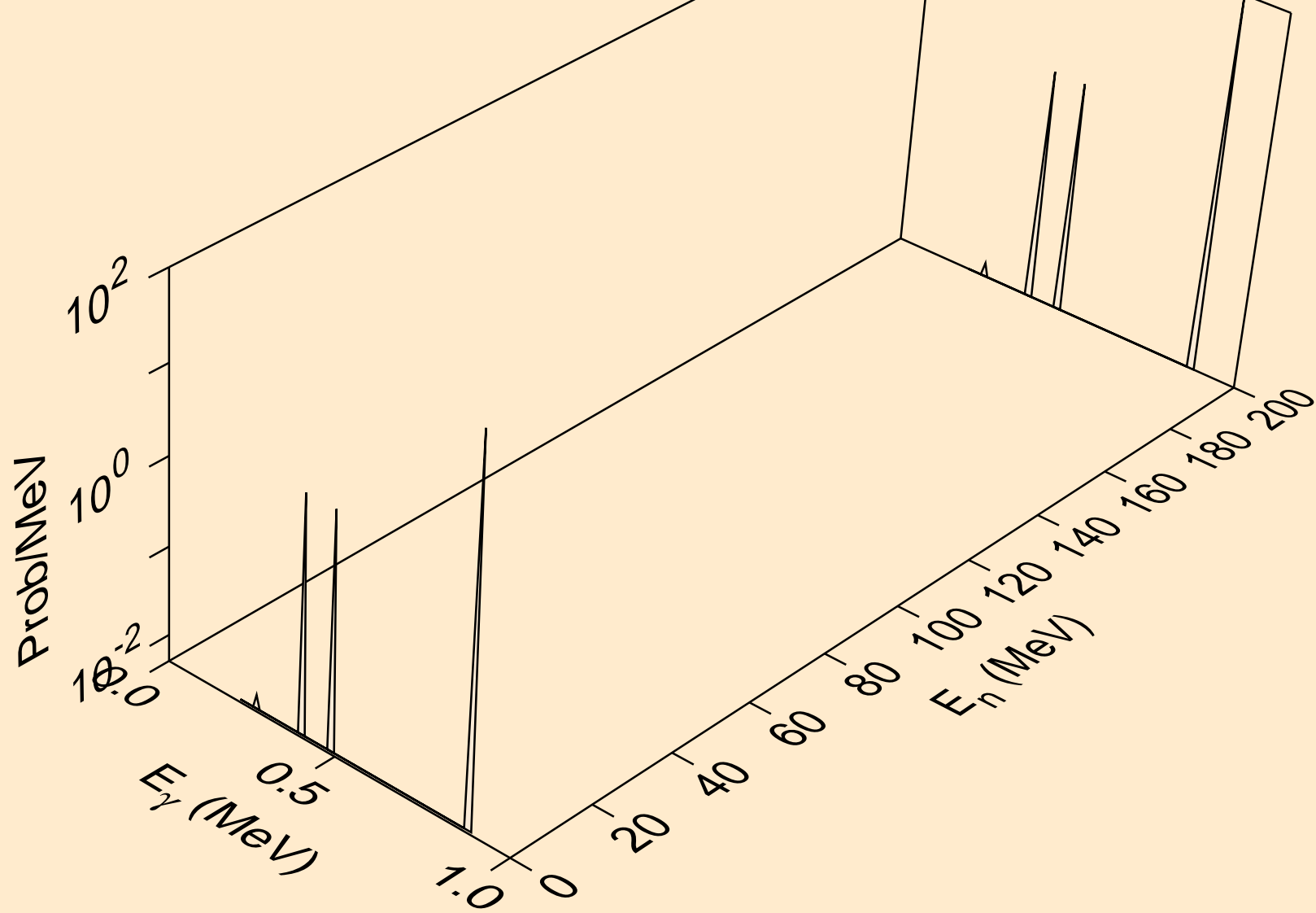

BA135M NEUTRON ACER TENDL-2024 LIBRARY; T=0.K
Photon emission for (n,n*8)

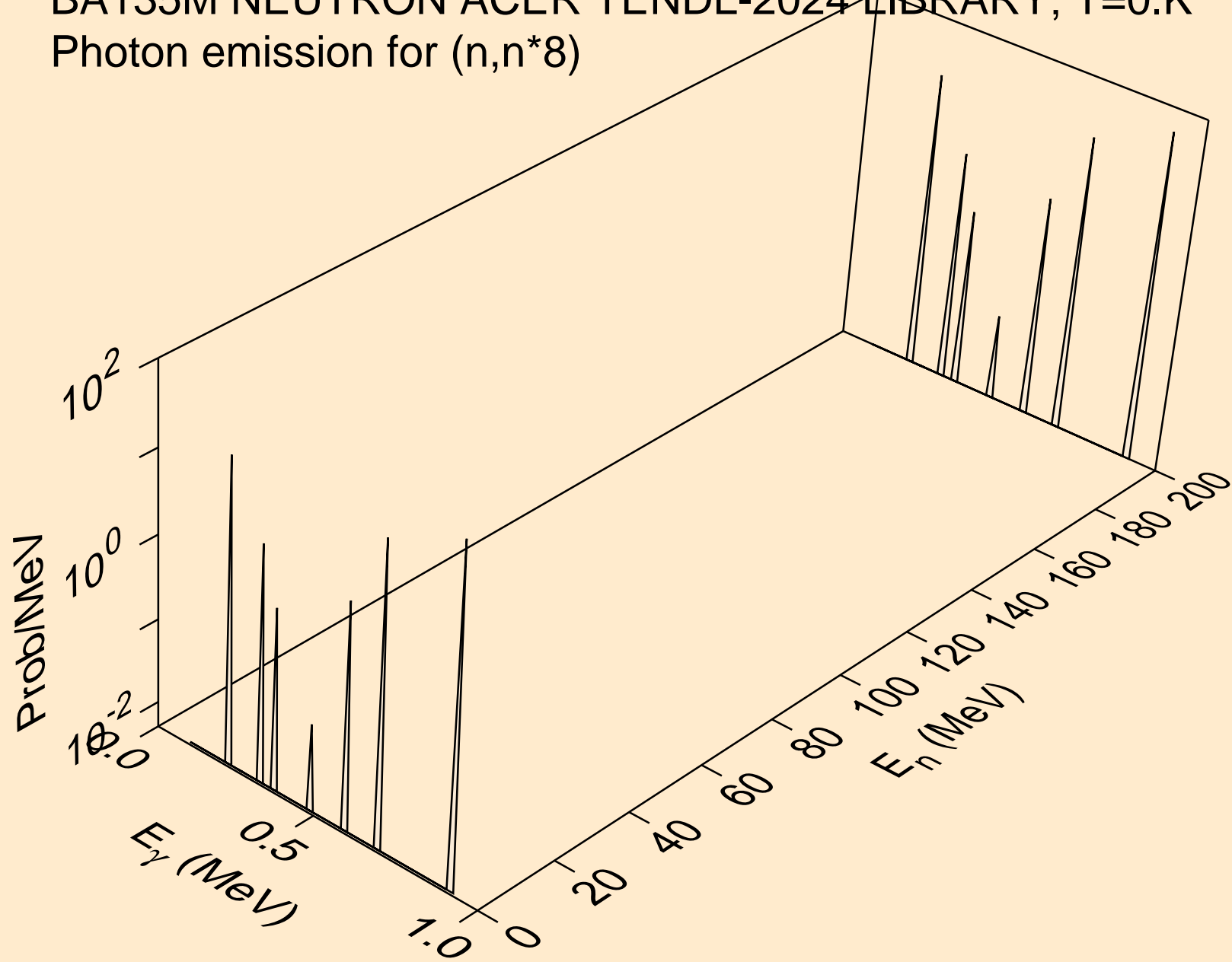

BA135M NEUTRON ACER TENDL-2024 LIBRARY; T=0.K
Photon emission for (n,n*9)

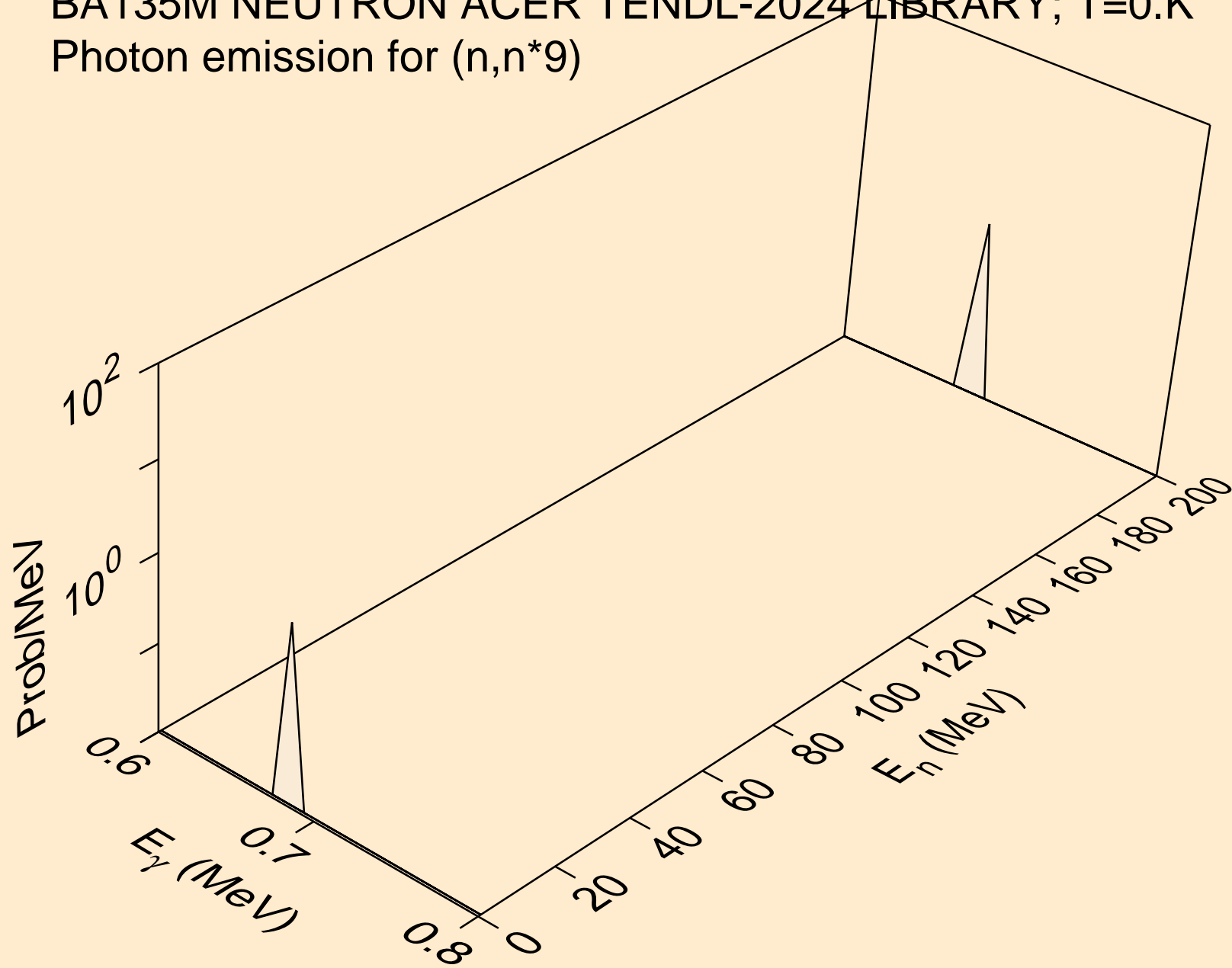

BA135M NEUTRON ACER TENDL-2024 LIBRARY; T=0.K
Photon emission for (n,n*10)

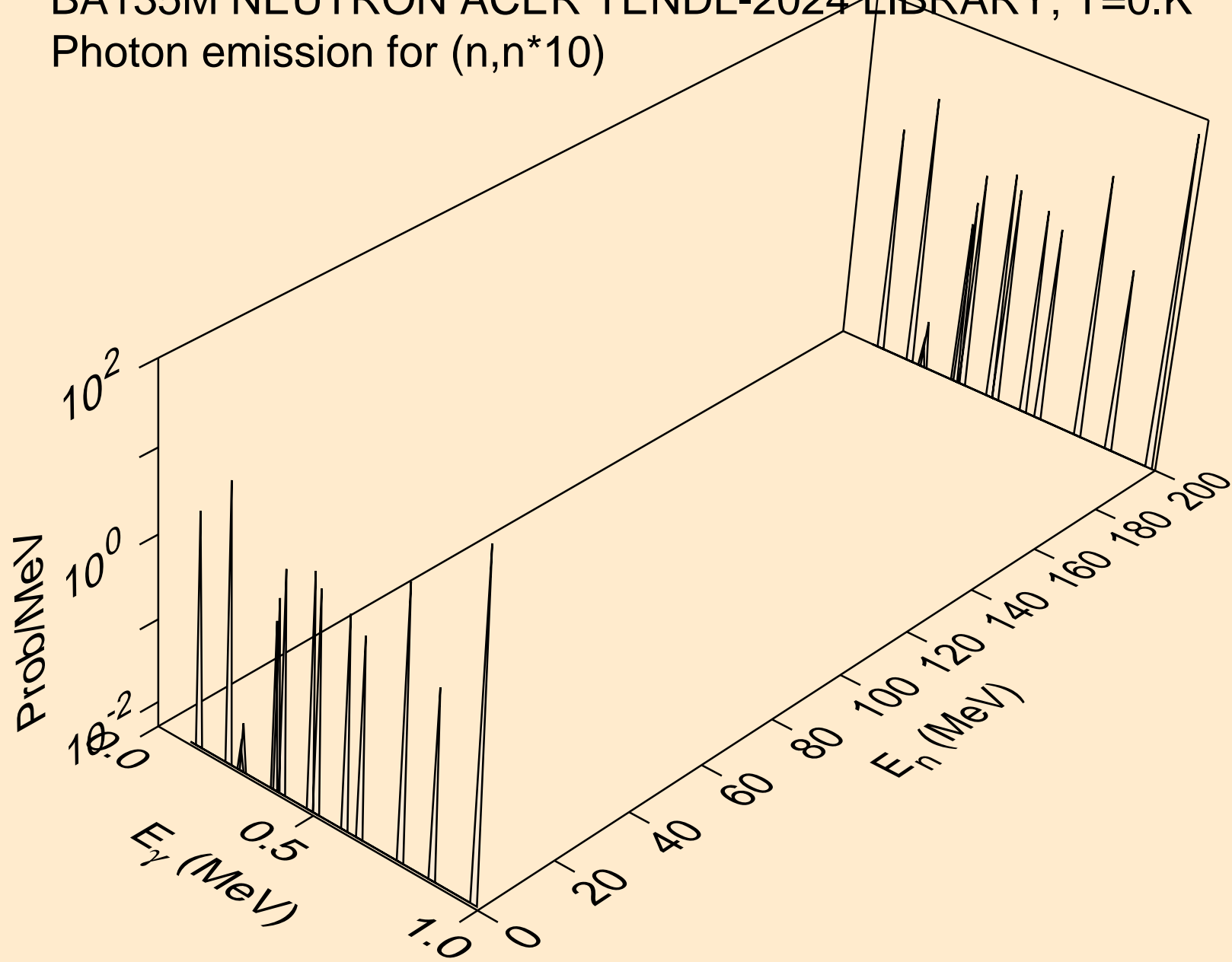

BA135M NEUTRON ACER TENDL-2024 LIBRARY; T=0.K
Photon emission for (n,n*11)

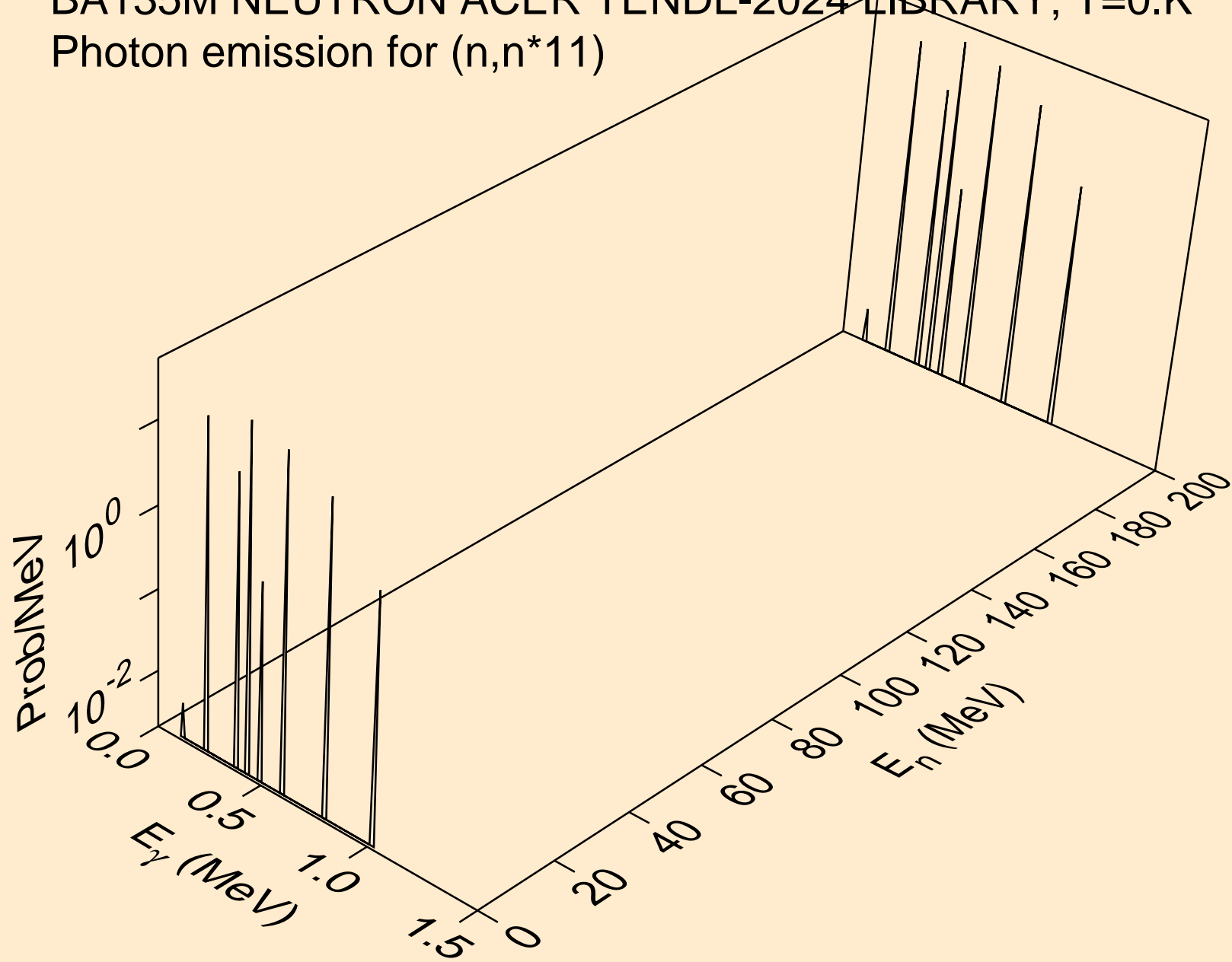

BA135M NEUTRON ACER TENDL-2024 LIBRARY; T=0.K
Photon emission for (n,n*12)

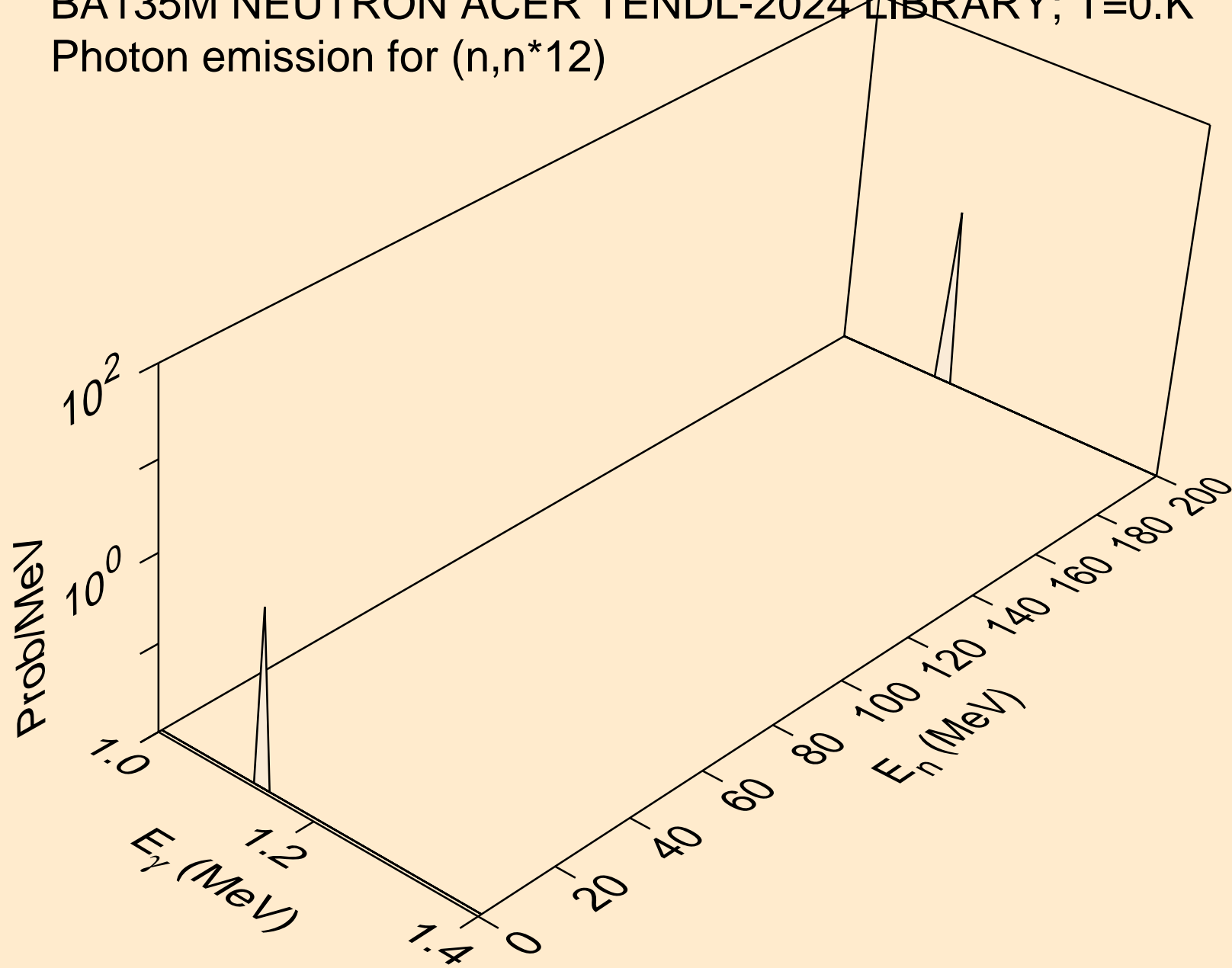

BA135M NEUTRON ACER TENDL-2024 LIBRARY; T=0.K
Photon emission for (n,n*13)

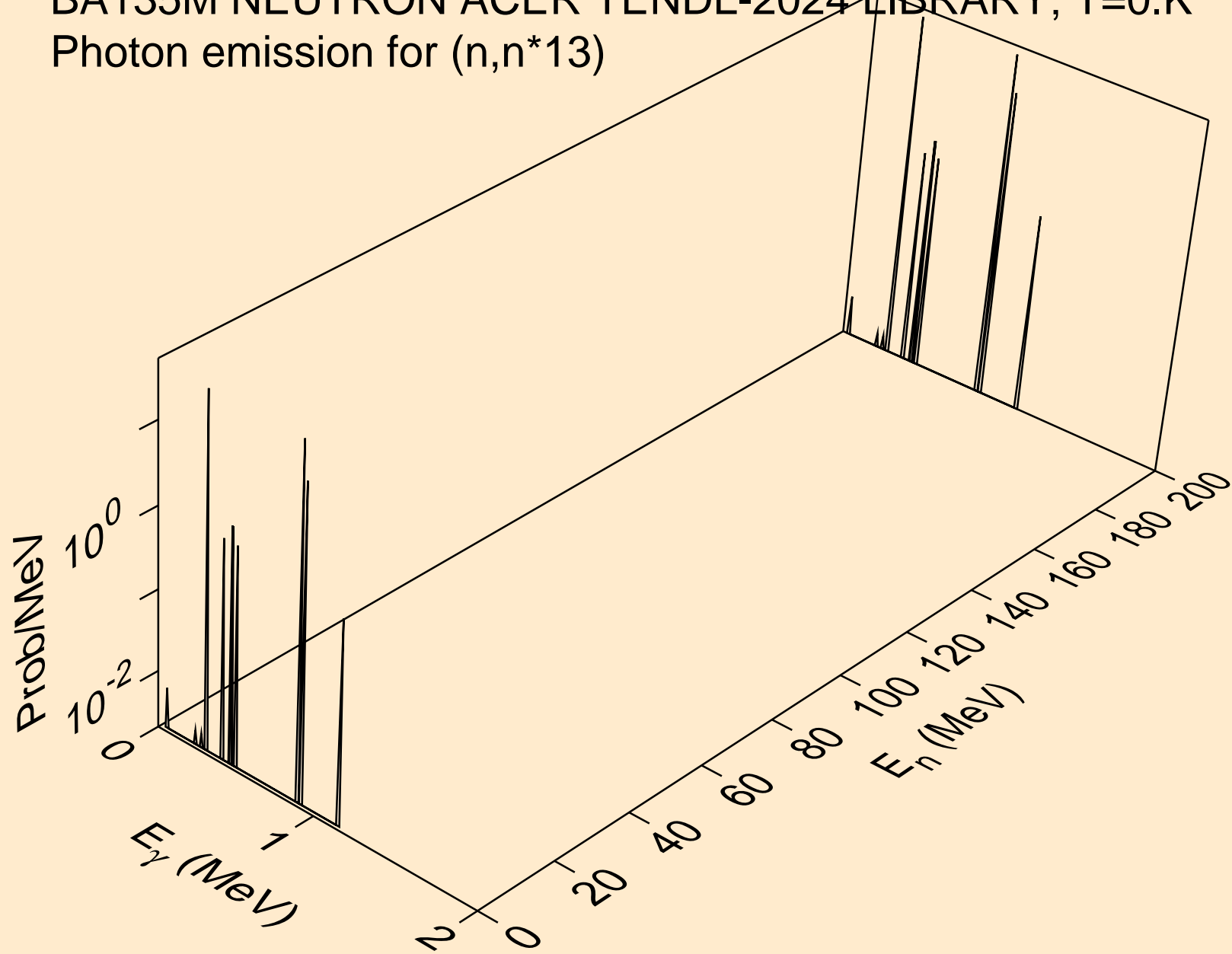

BA135M NEUTRON ACER TENDL-2024 LIBRARY; T=0.K
Photon emission for (n,n*14)

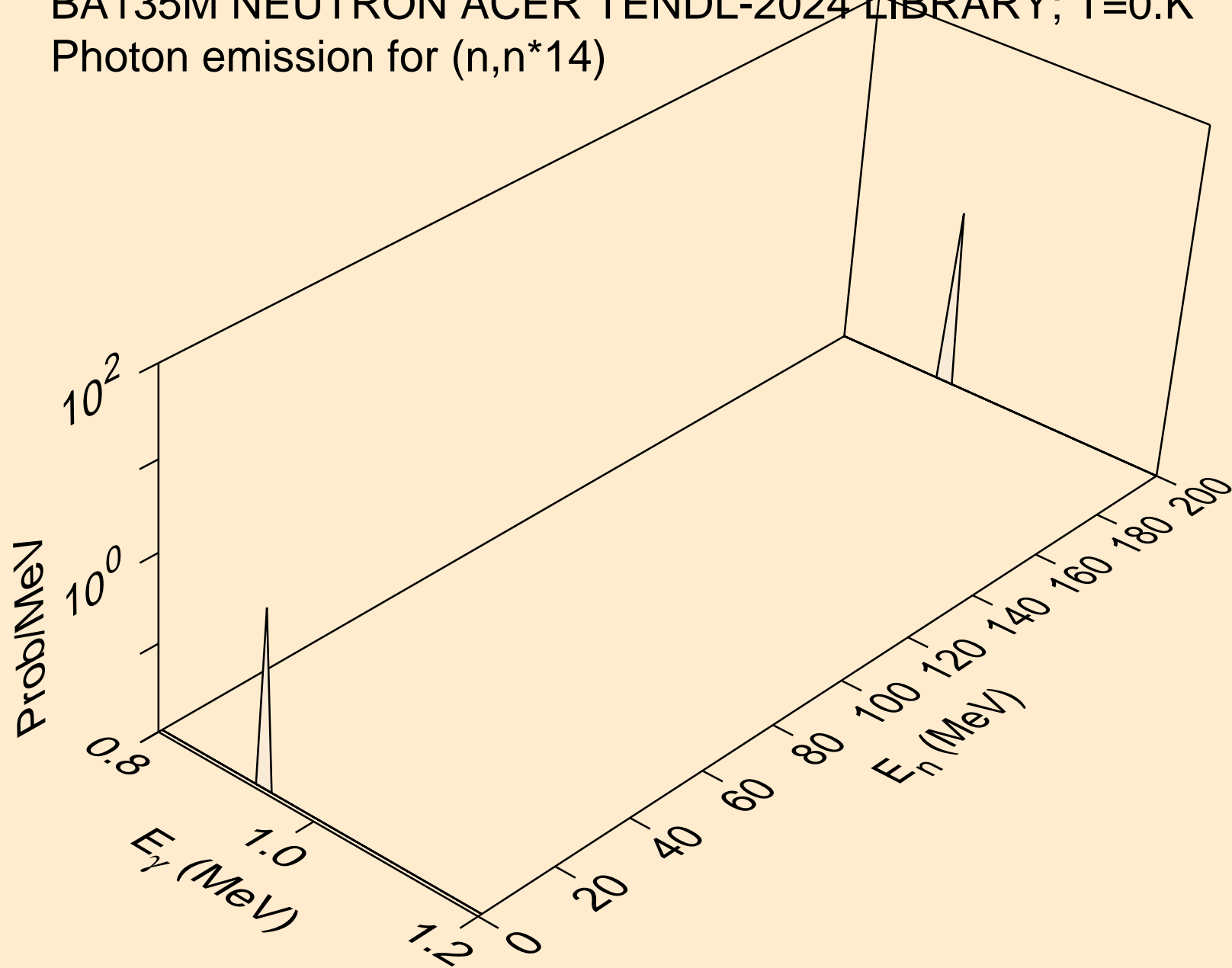

BA135M NEUTRON ACER TENDL-2024 LIBRARY; T=0.K
Photon emission for (n,n*15)

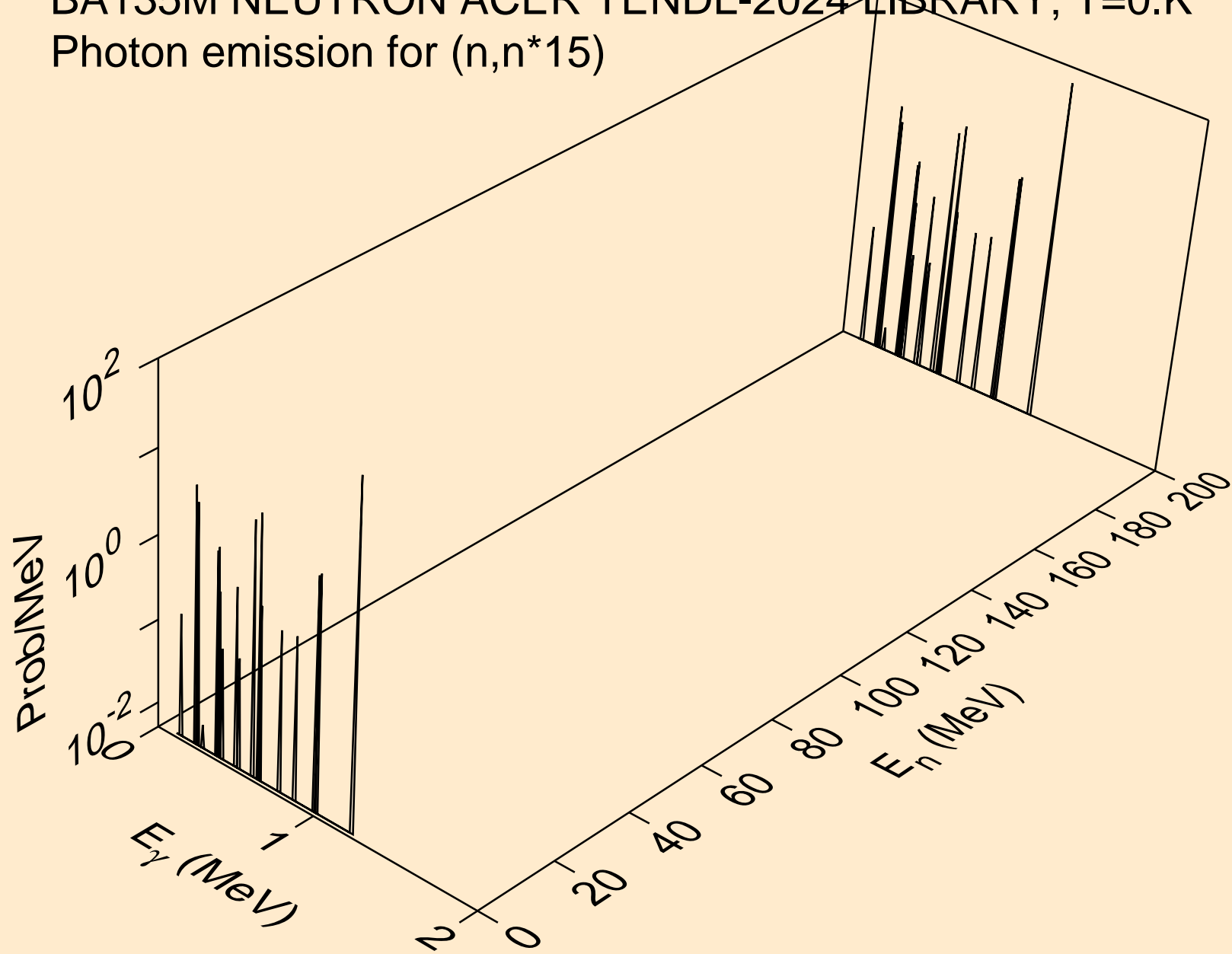

BA135M NEUTRON ACER TENDL-2024 LIBRARY; T=0.K
Photon emission for (n,n*16)

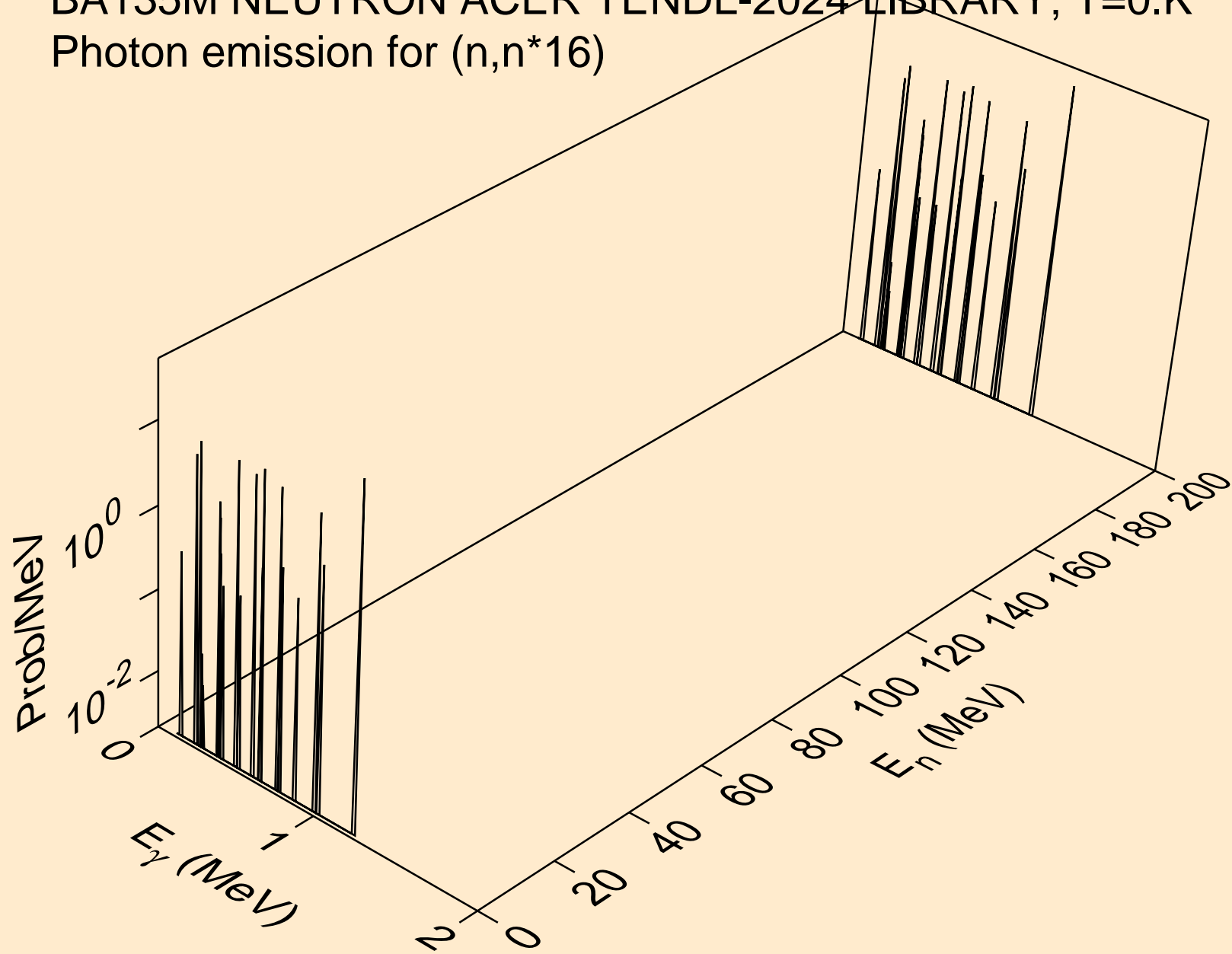

BA135M NEUTRON ACER TENDL-2024 LIBRARY; T=0.K
Photon emission for (n,n*17)

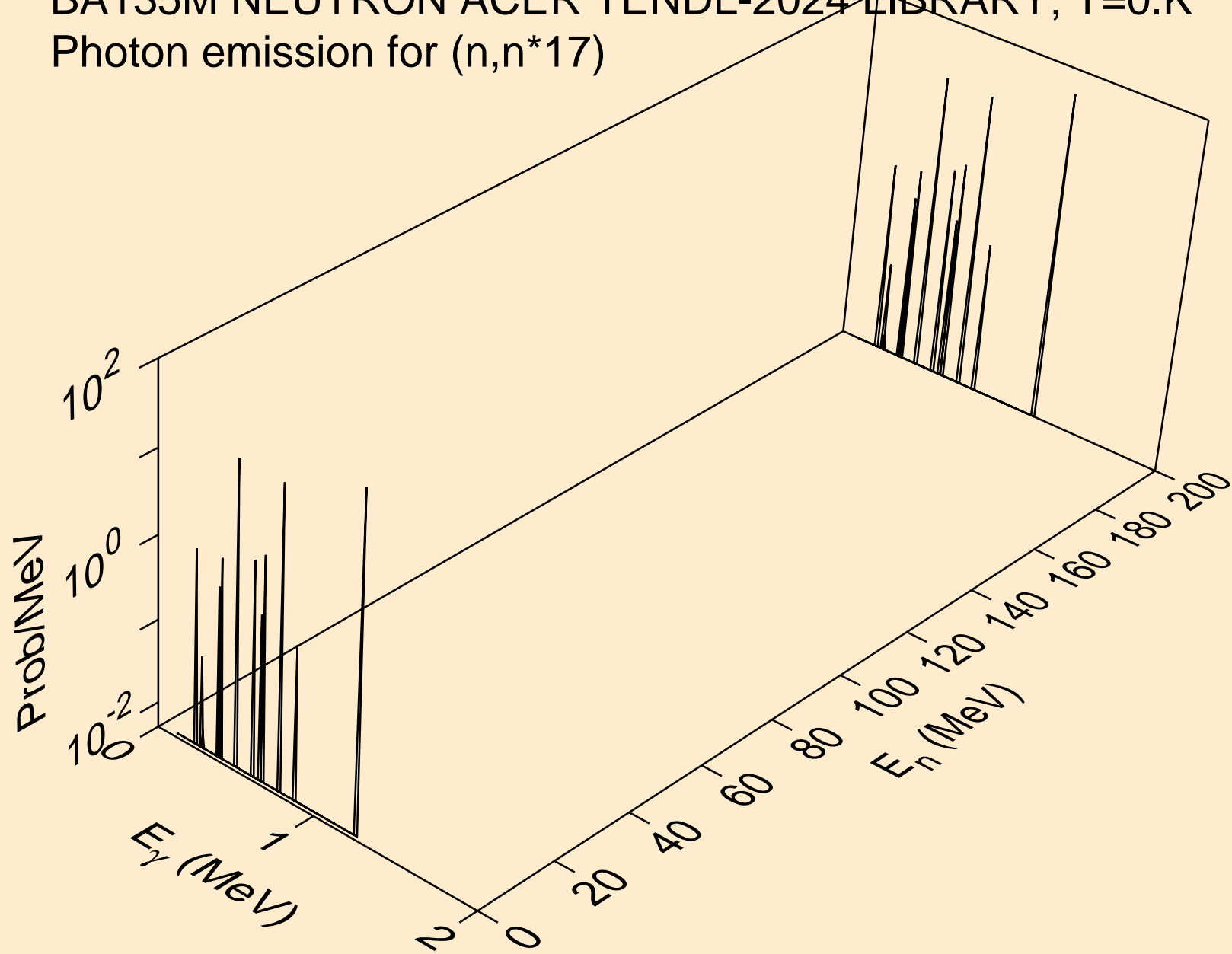

BA135M NEUTRON ACER TENDL-2024 LIBRARY; T=0.K
Photon emission for (n,n*18)

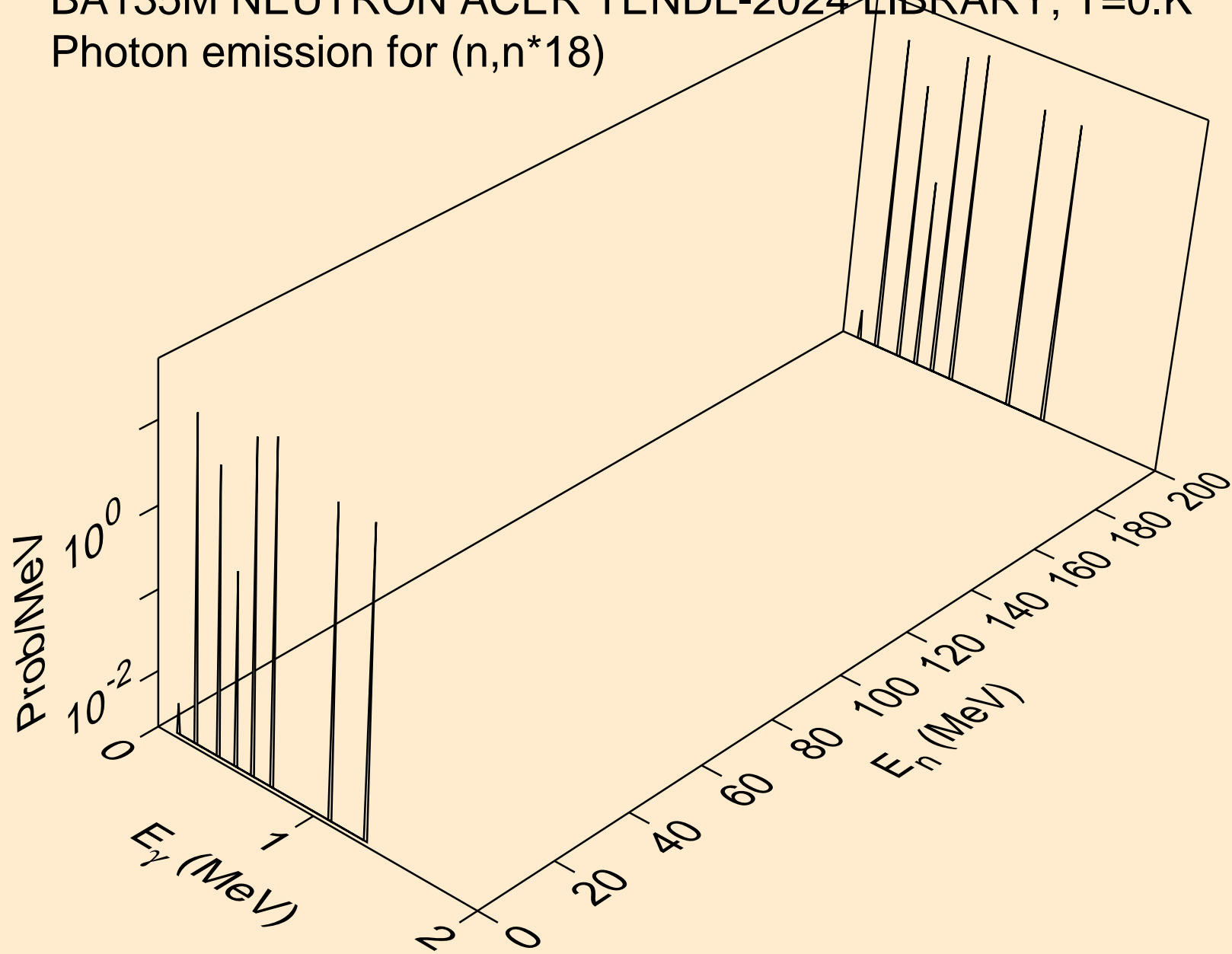

BA135M NEUTRON ACER TENDL-2024 LIBRARY; T=0.K
Photon emission for (n,n*19)

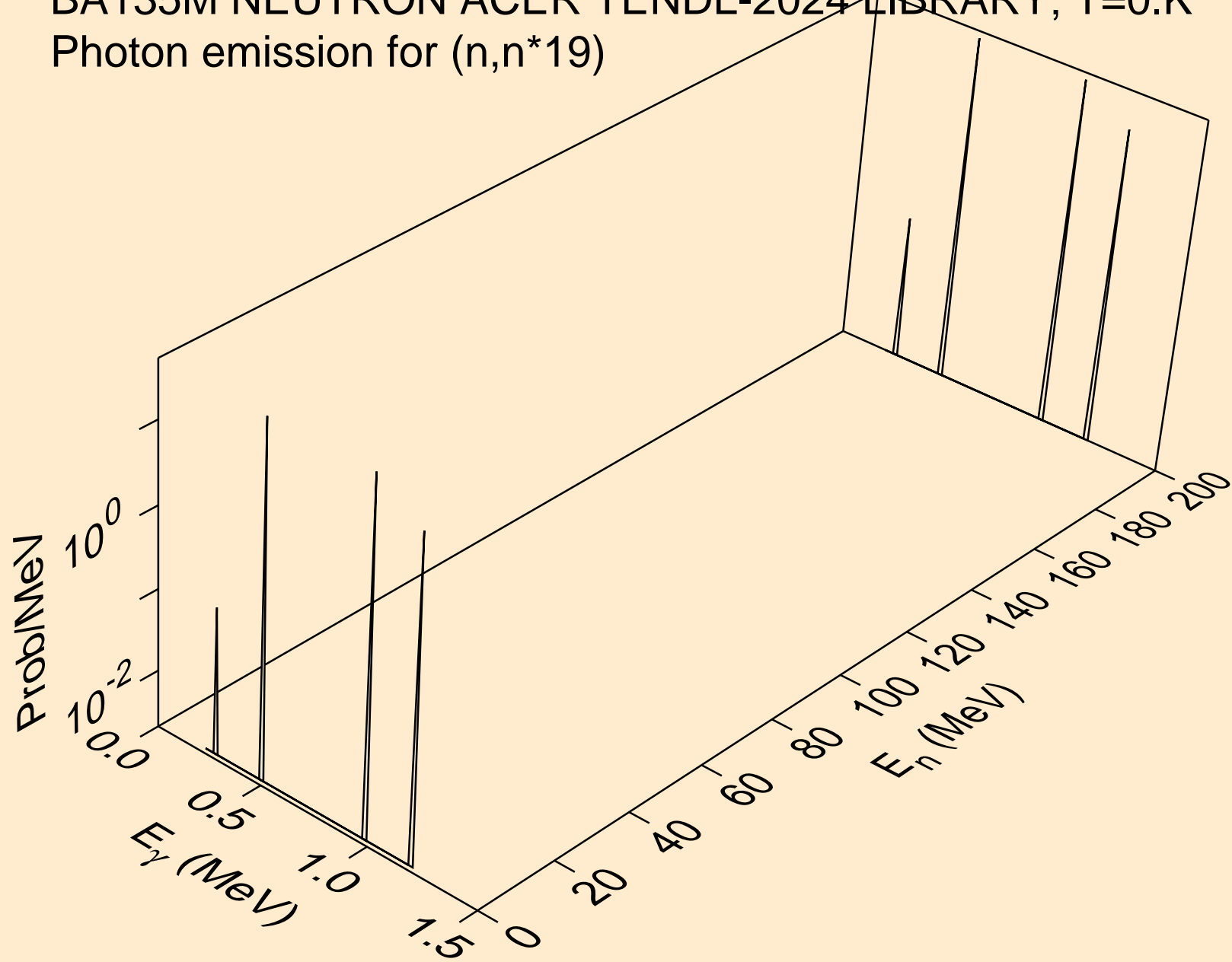

BA135M NEUTRON ACER TENDL-2024 LIBRARY; T=0.K
Photon emission for (n,n*20)

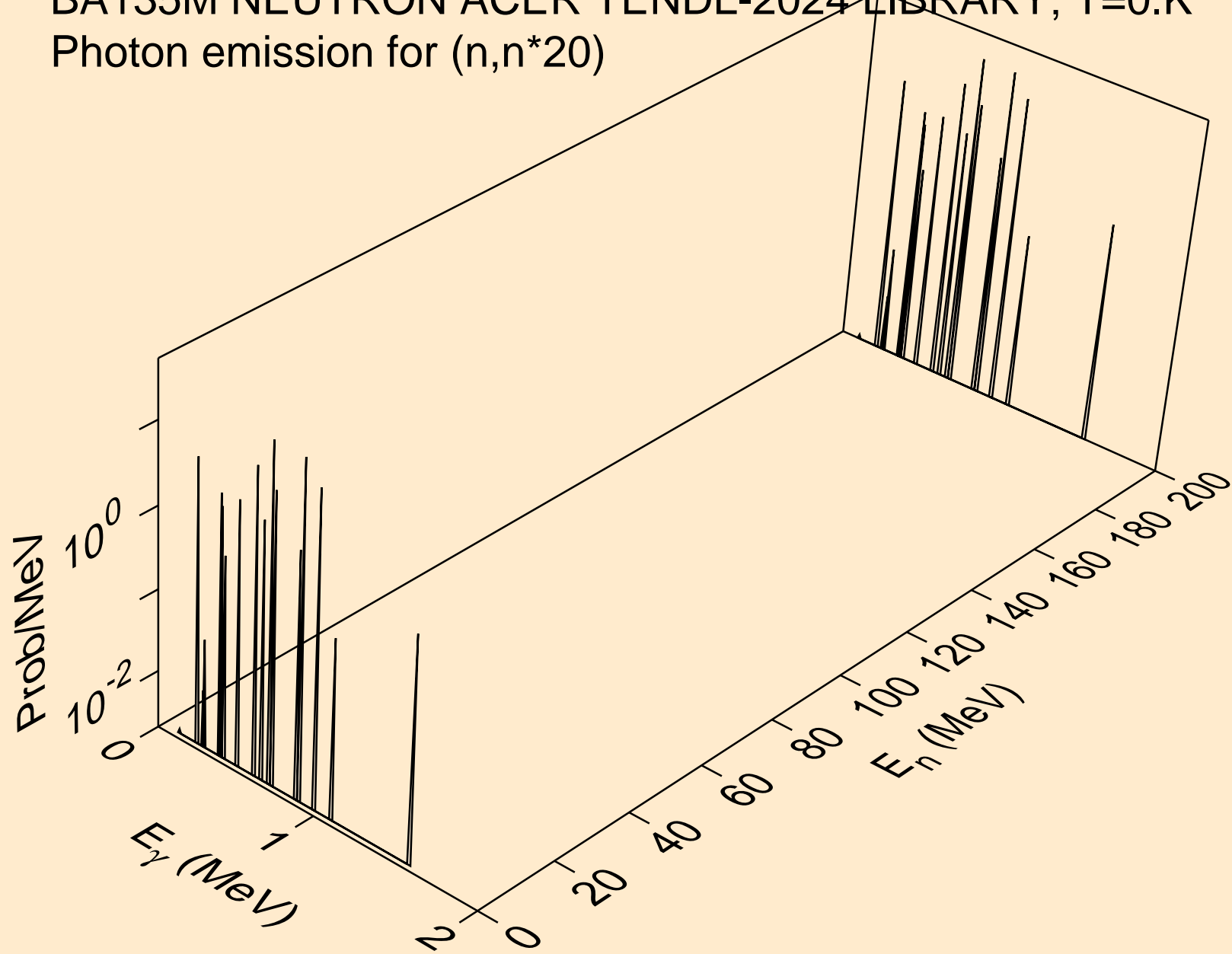

BA135M NEUTRON ACER TENDL-2024 LIBRARY; T=0.K
Photon emission for (n,n*21)

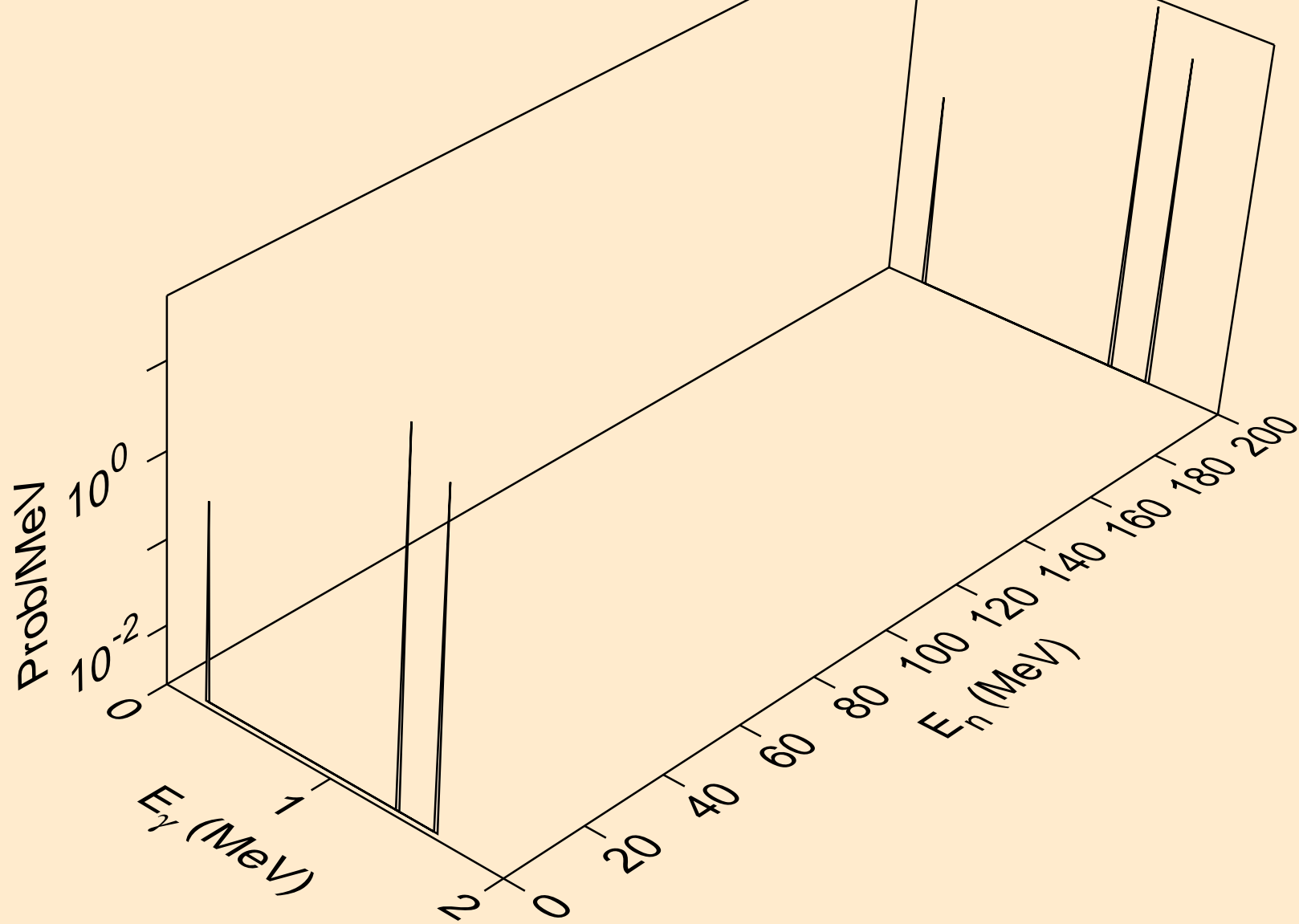

BA135M NEUTRON ACER TENDL-2024 LIBRARY; T=0.K
Photon emission for (n,n*22)

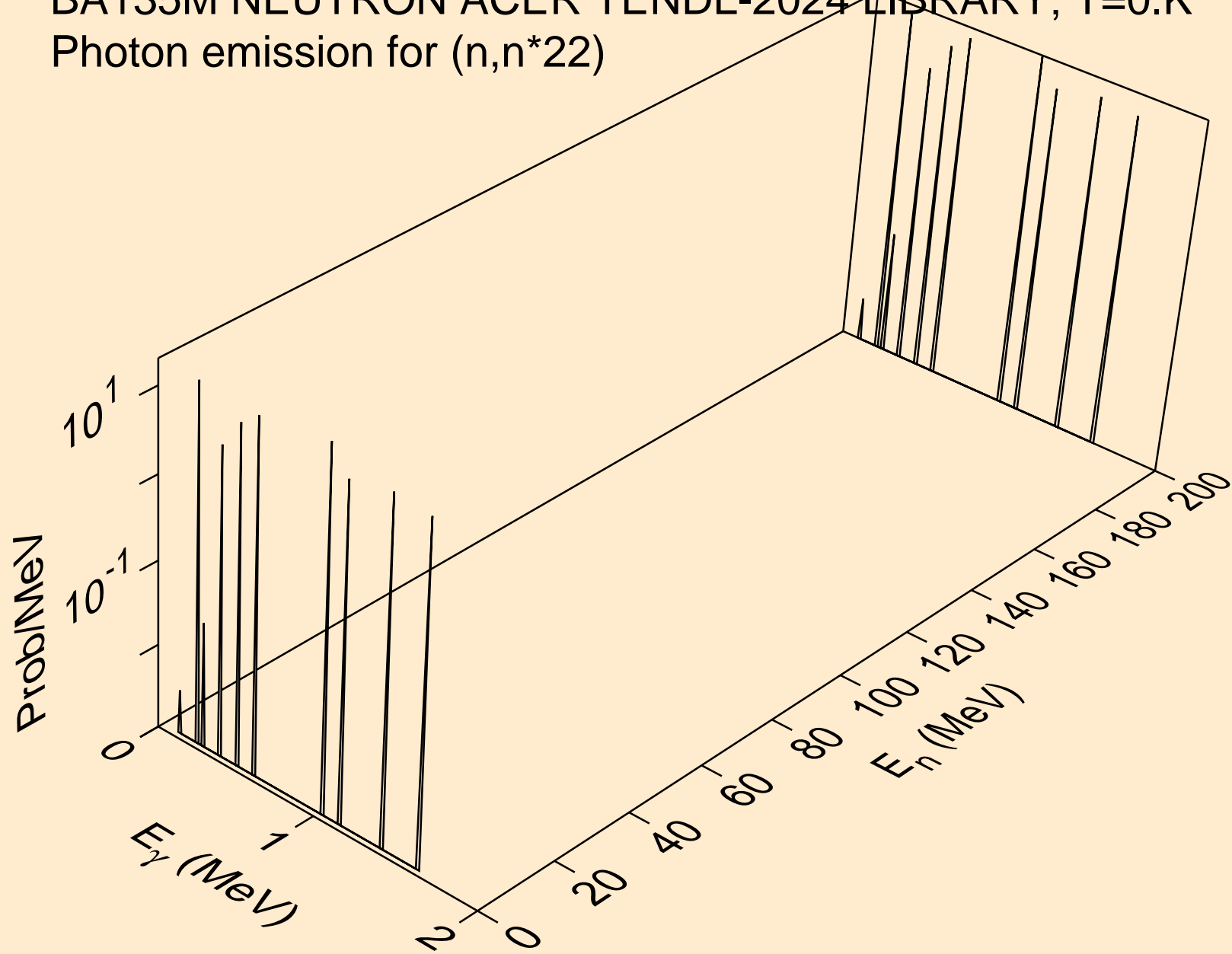

BA135M NEUTRON ACER TENDL-2024 LIBRARY; T=0.K
Photon emission for (n,n*23)

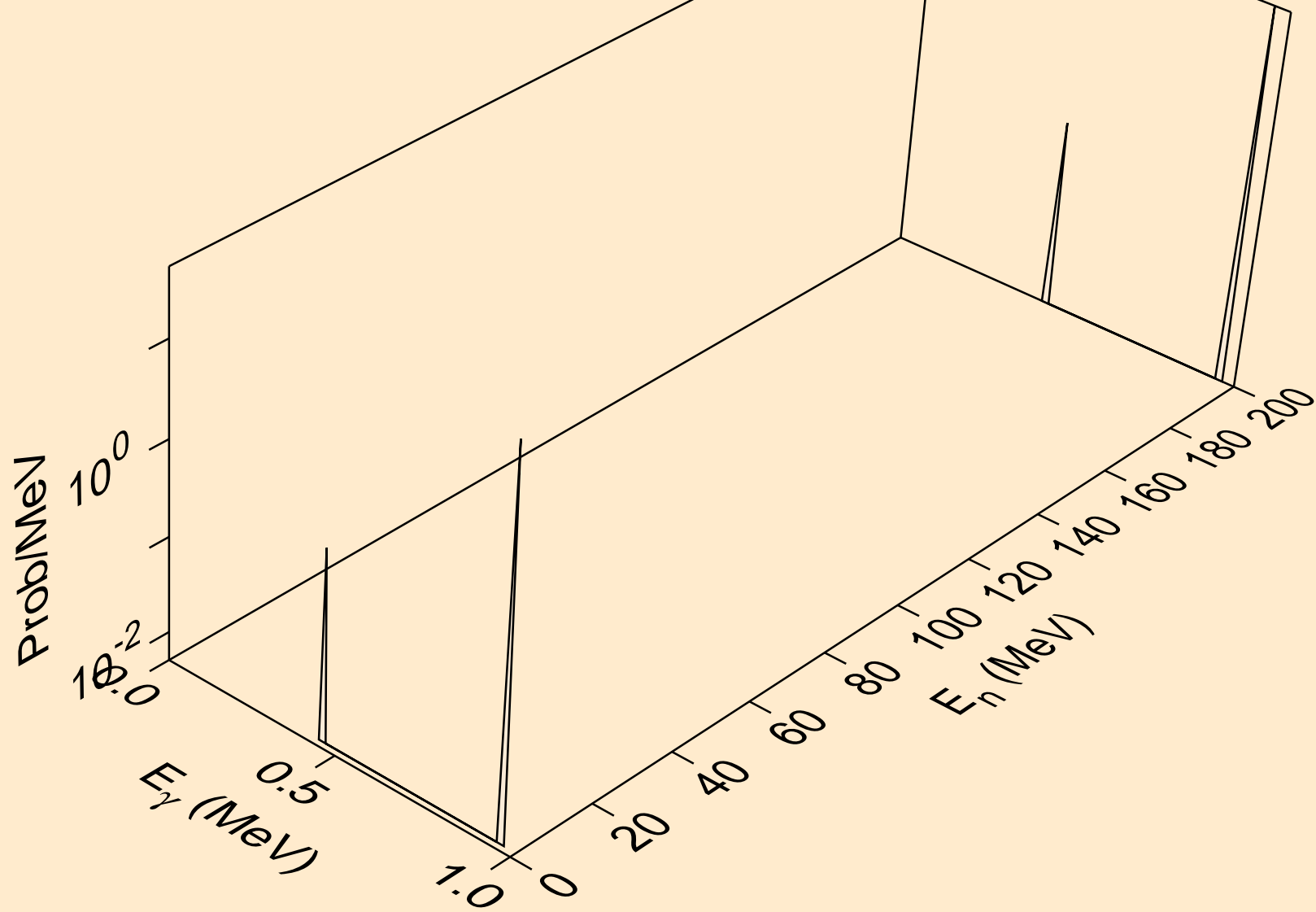

BA135M NEUTRON ACER TENDL-2024 LIBRARY; T=0.K
Photon emission for (n,n*24)

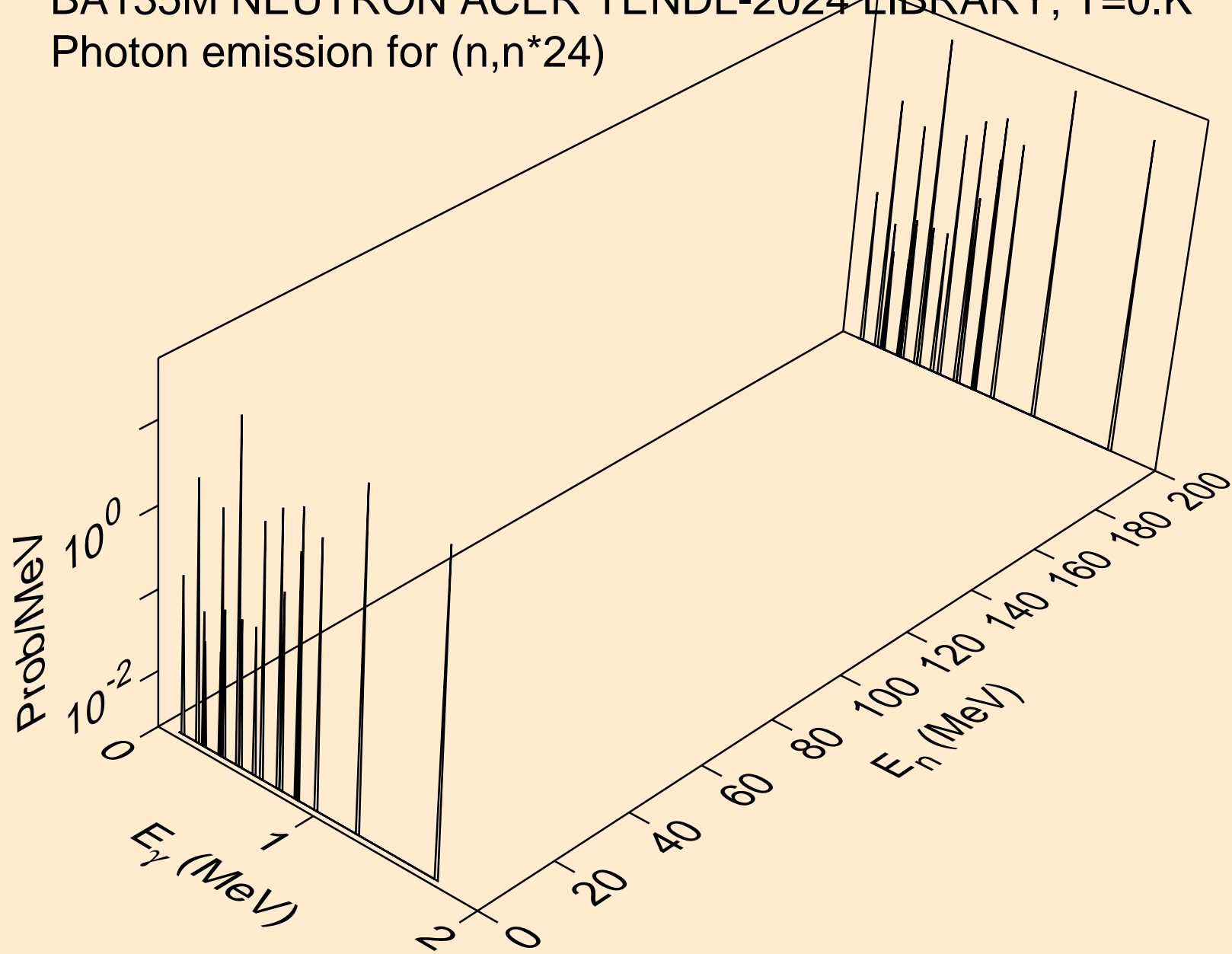

BA135M NEUTRON ACER TENDL-2024 LIBRARY; T=0.K
Photon emission for (n,n*25)

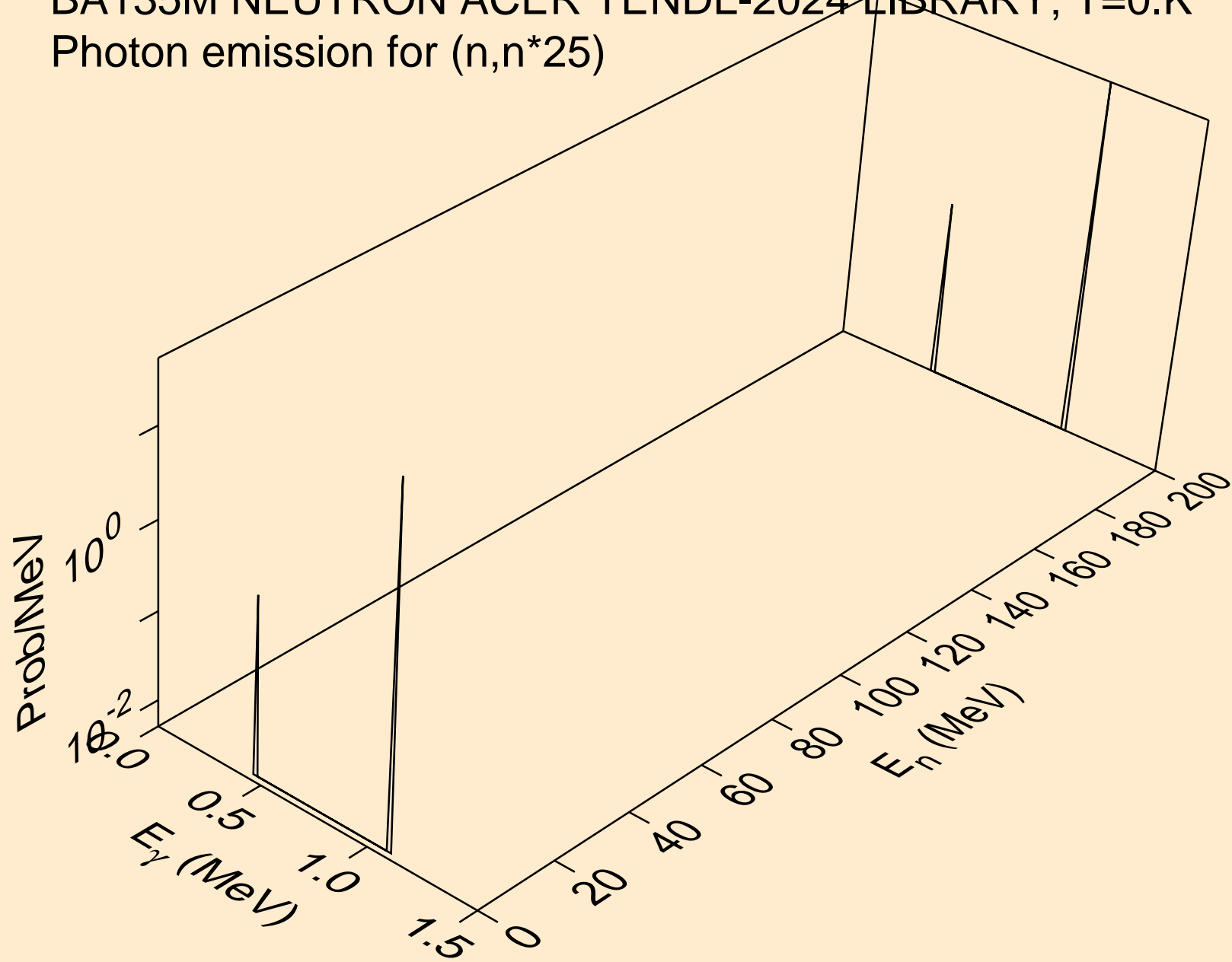

BA135M NEUTRON ACER TENDL-2024 LIBRARY; T=0.K
Photon emission for (n,n*c)

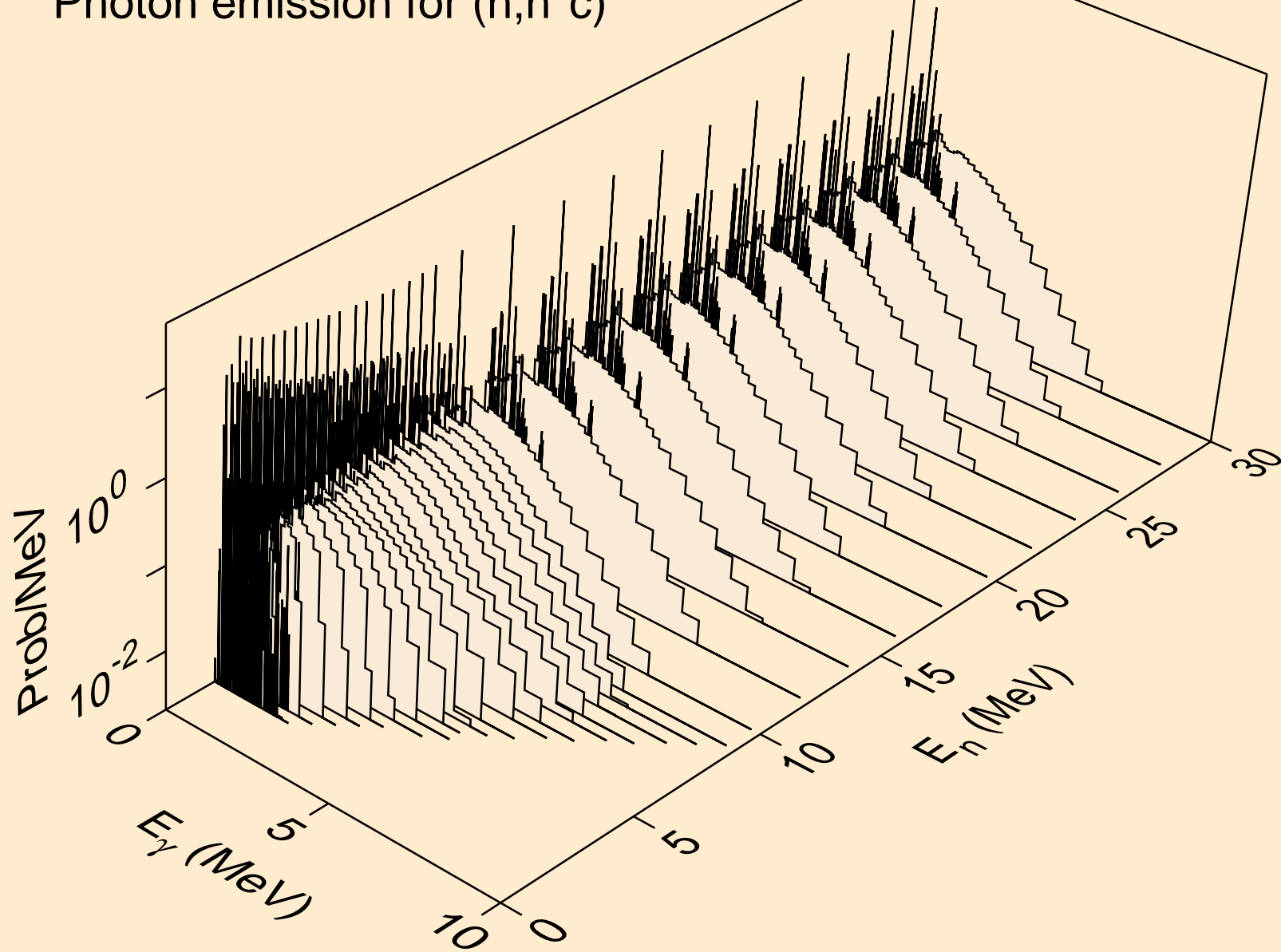

BA135M NEUTRON ACER TENDL-2024 LIBRARY; T=0.K
Photon emission for (n,gma)

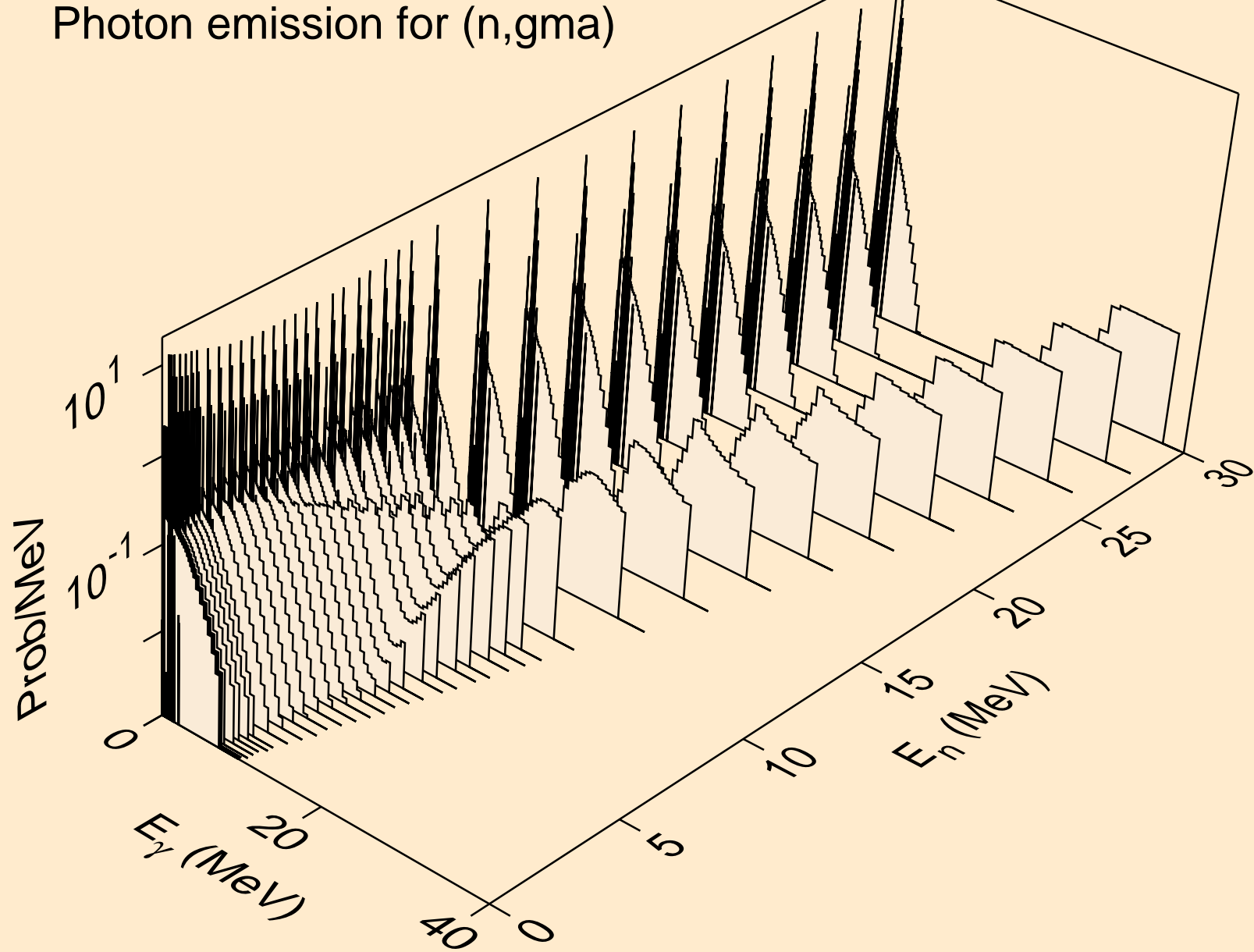

BA135M NEUTRON ACER TENDL-2024 LIBRARY; T=0.K
Photon emission for (n,p)

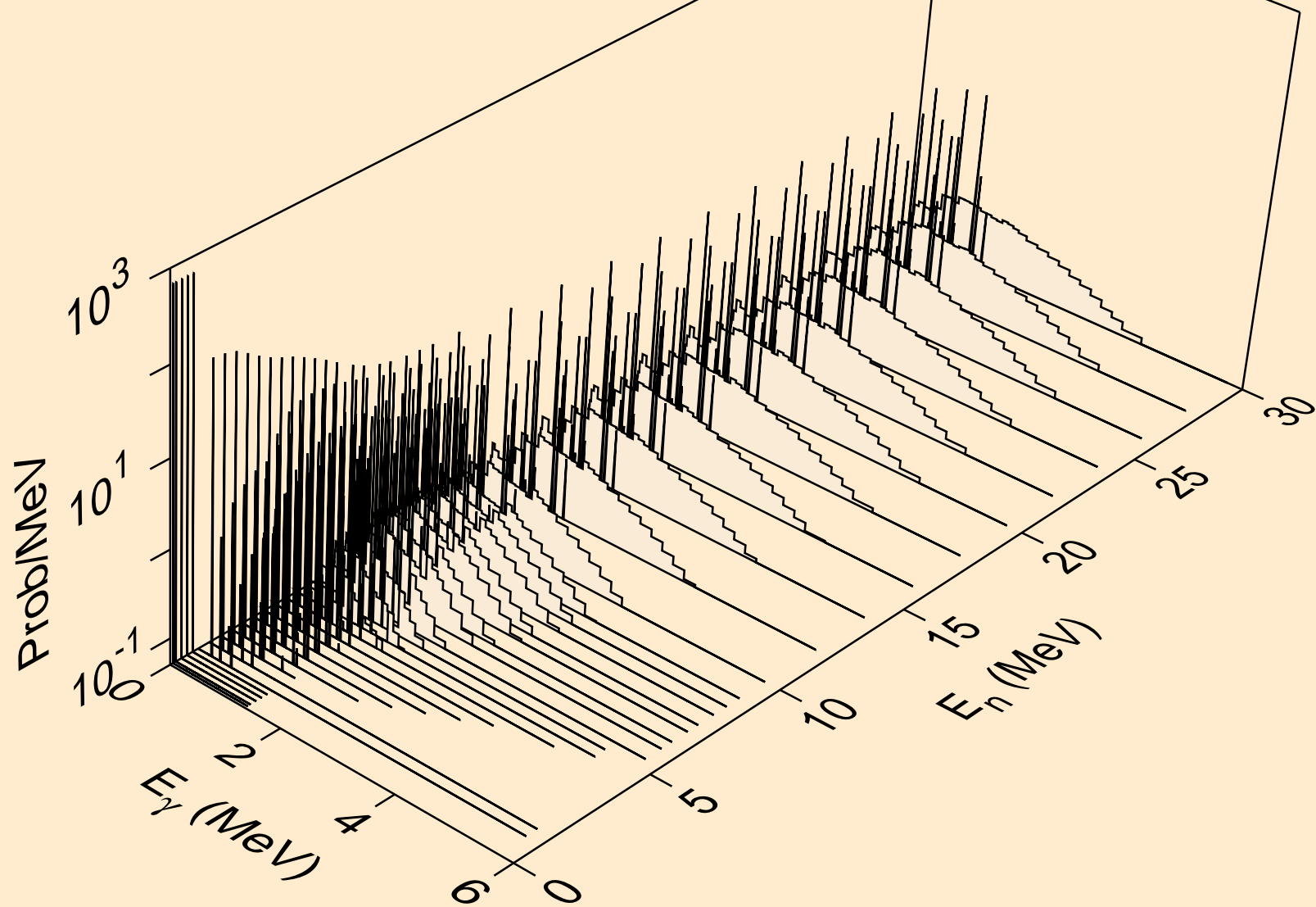

BA135M NEUTRON ACER TENDL-2024 LIBRARY; T=0.K
Photon emission for (n,d)

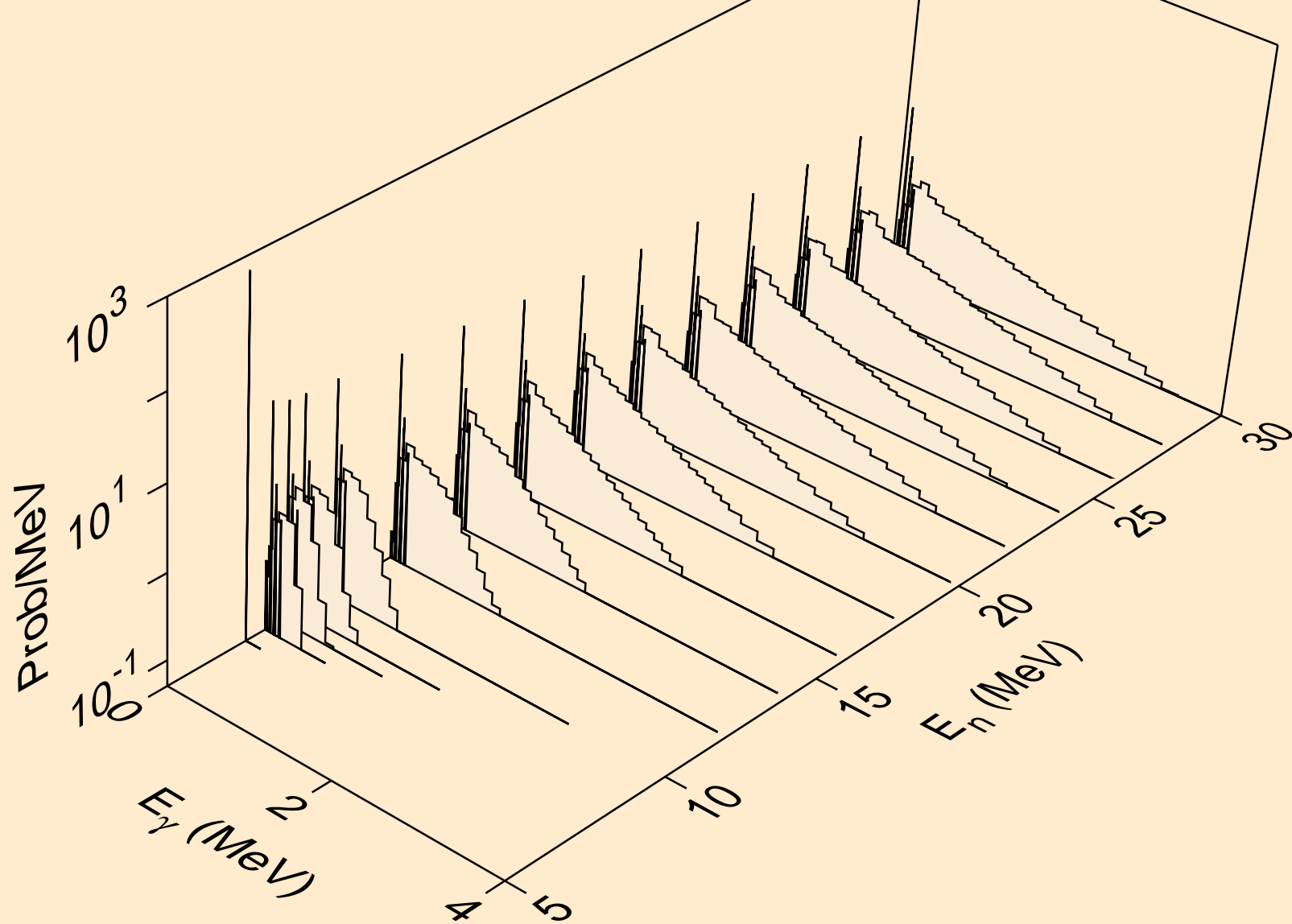

BA135M NEUTRON ACER TENDL-2024 LIBRARY; T=0.K
Photon emission for (n,t)

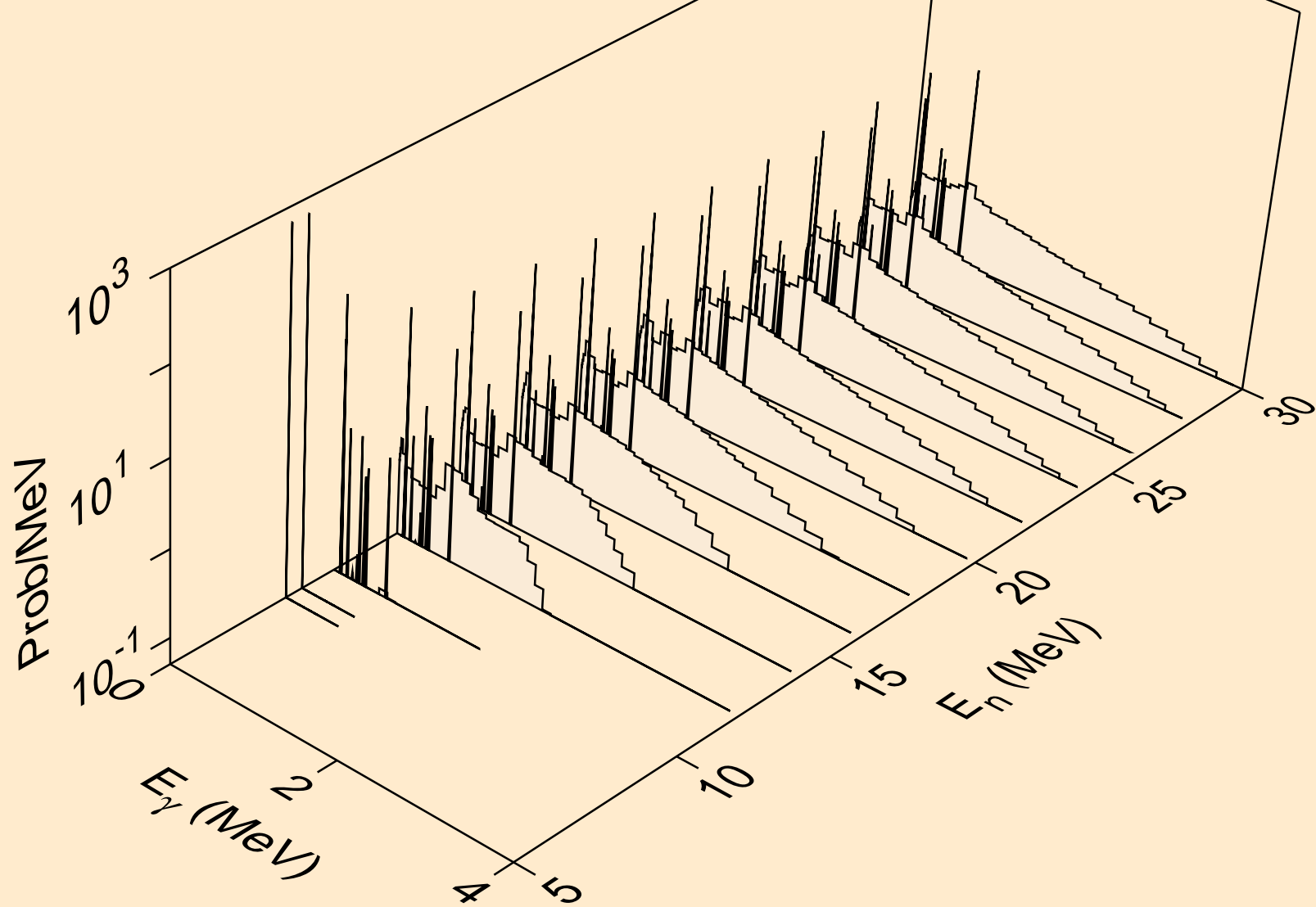

BA135M NEUTRON ACER TENDL-2024 LIBRARY; T=0.K
Photon emission for (n,he3)

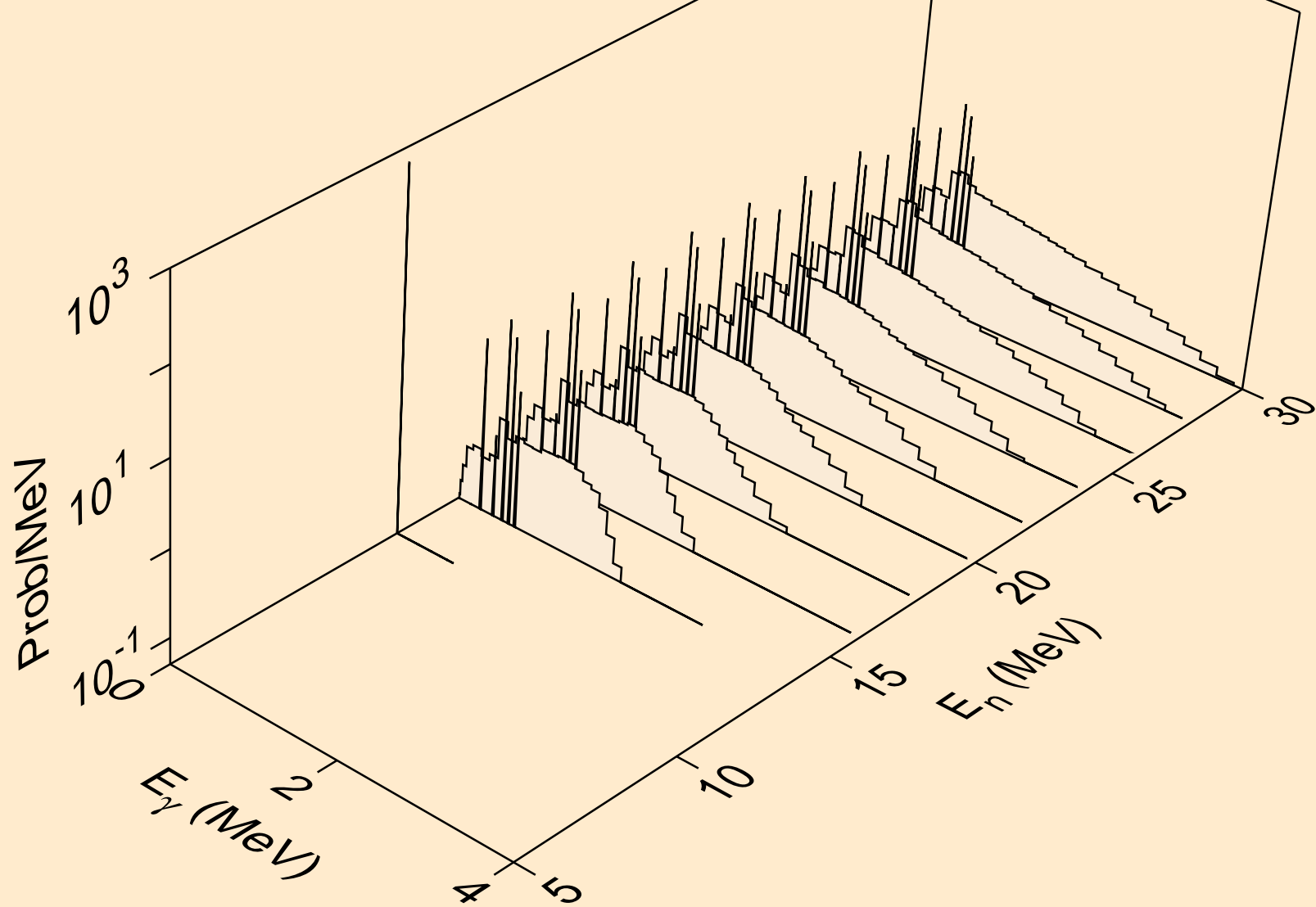

BA135M NEUTRON ACER TENDL-2024 LIBRARY; T=0.K
Photon emission for (n,a)

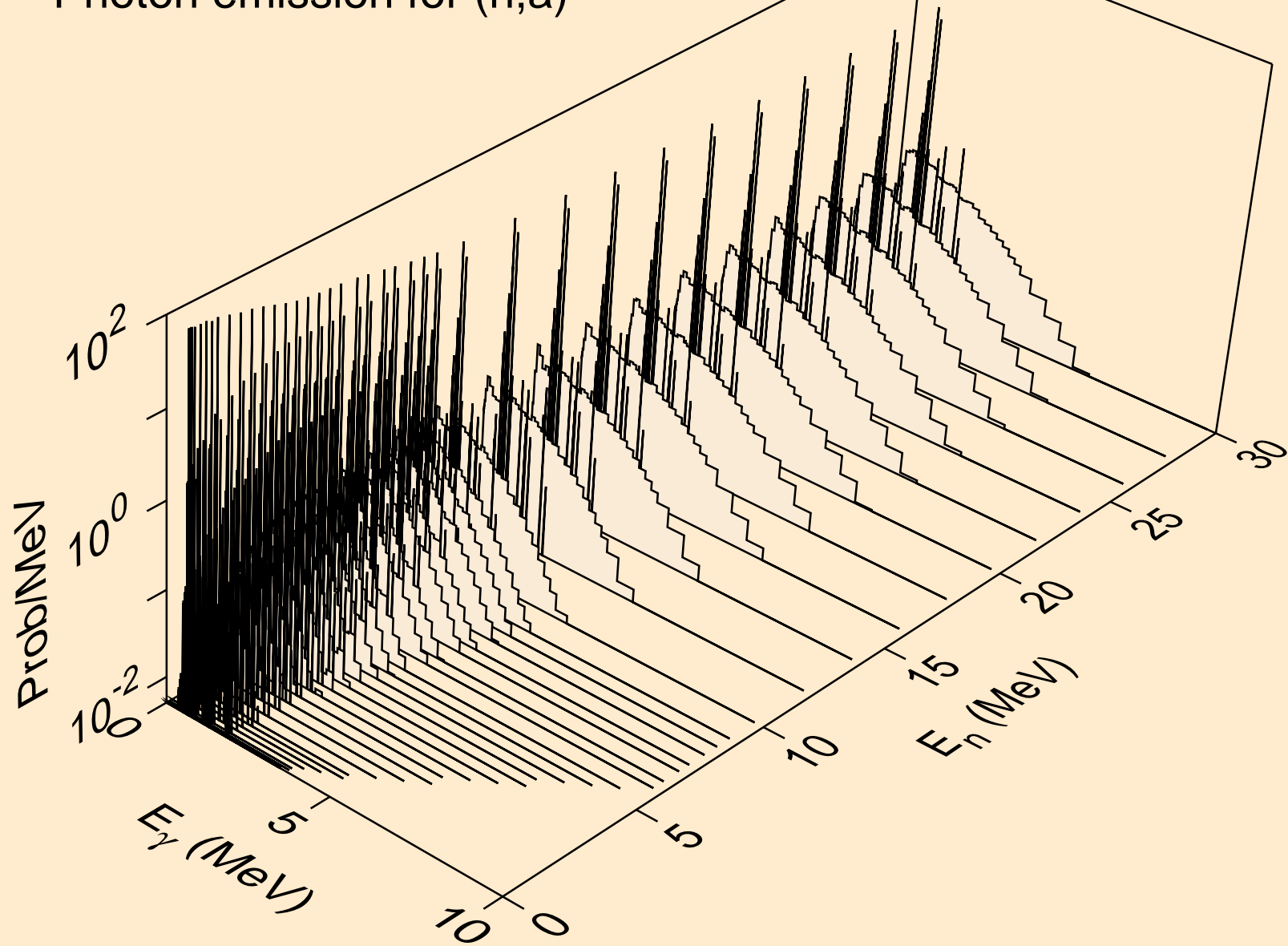

BA135M NEUTRON ACER TENDL-2024 LIBRARY; T=0.K
Photon emission for (n,2a)

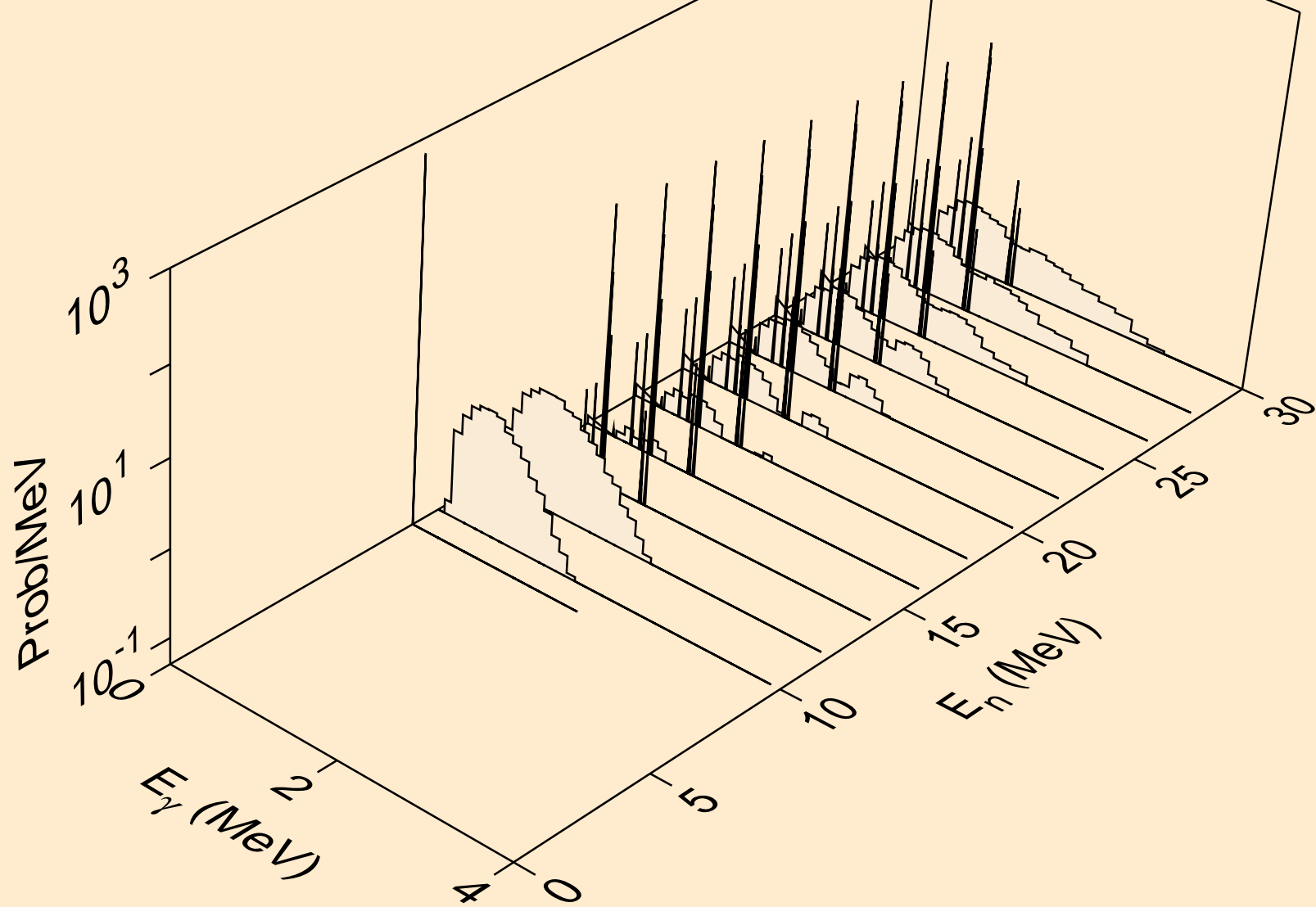

BA135M NEUTRON ACER TENDL-2024 LIBRARY; T=0.K
Photon emission for (n,2p)

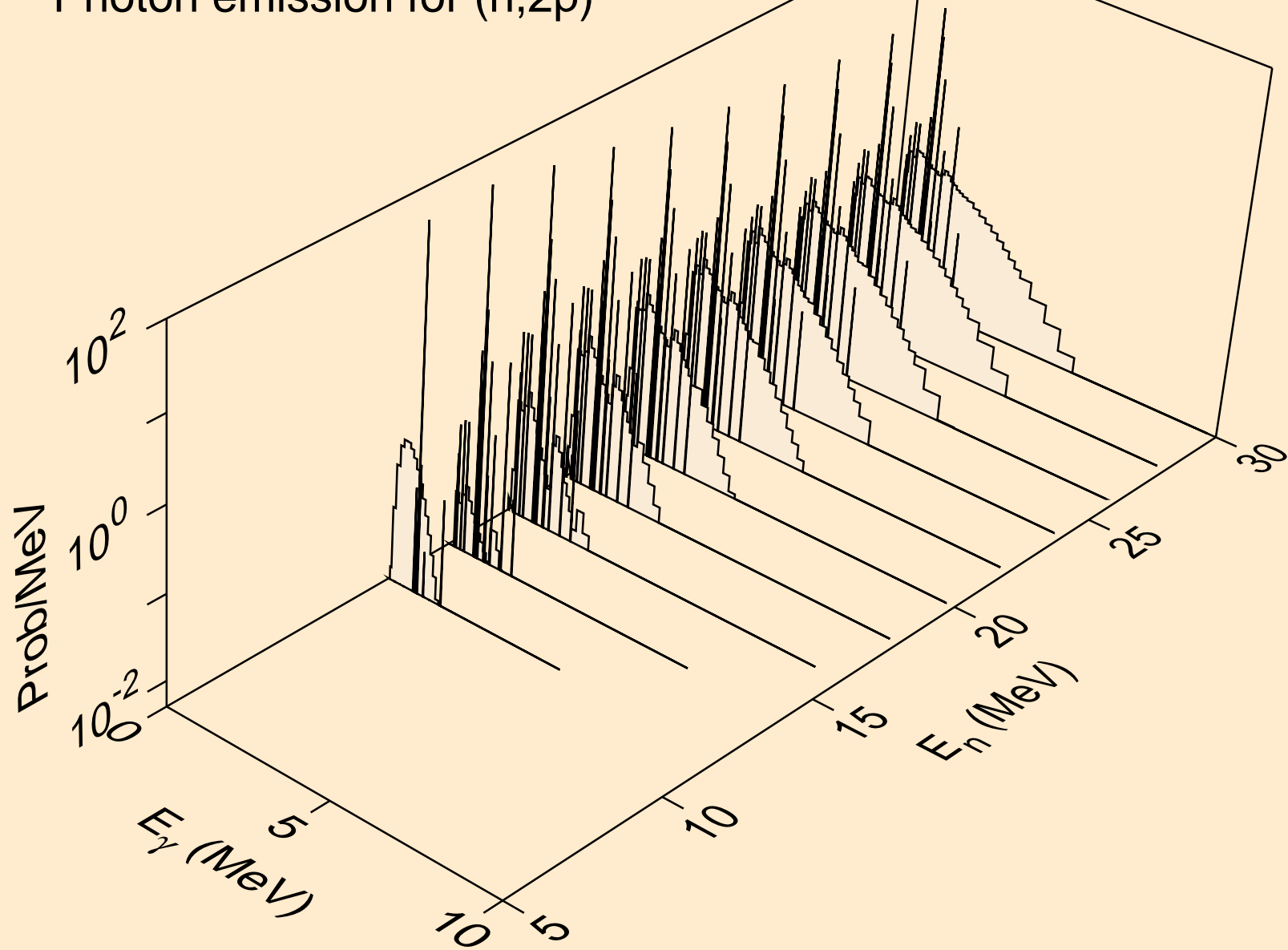

BA135M NEUTRON ACER TENDL-2024 LIBRARY; T=0.K
Photon emission for (n,p)

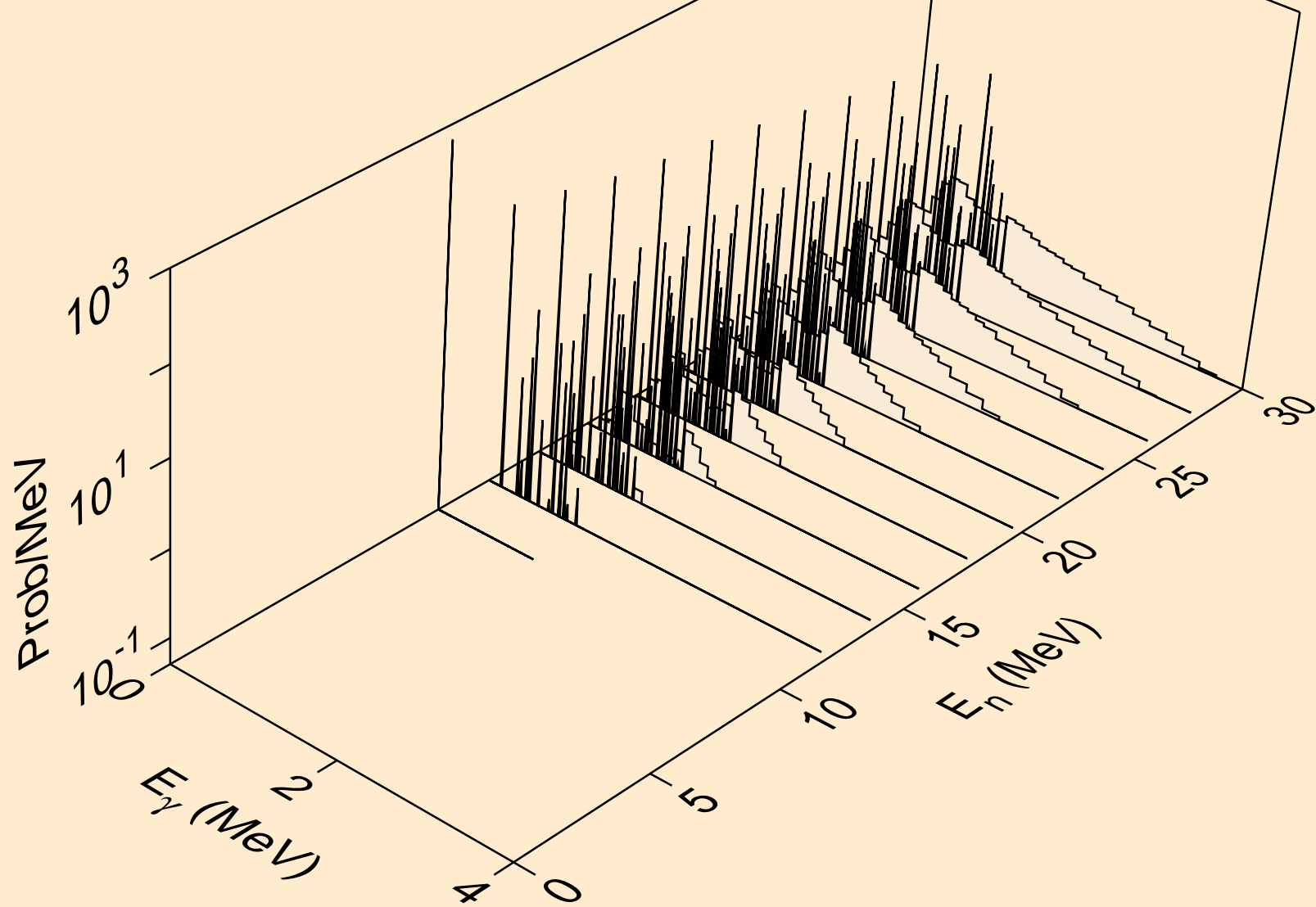

BA135M NEUTRON ACER TENDL-2024 LIBRARY; T=0.K
Photon emission for (n,pd)

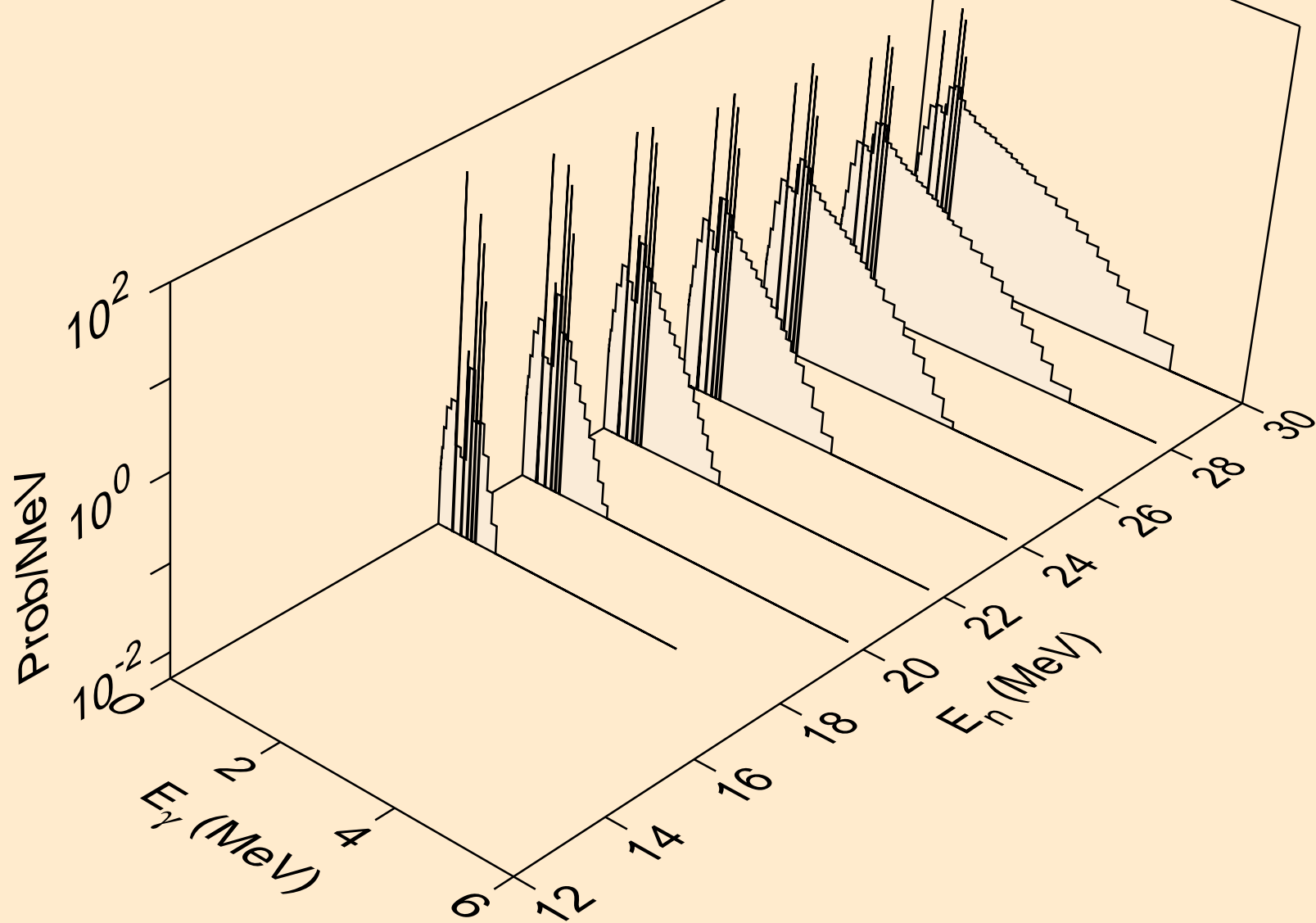

BA135M NEUTRON ACER TENDL-2024 LIBRARY; T=0.K
Photon emission for (n,pt)

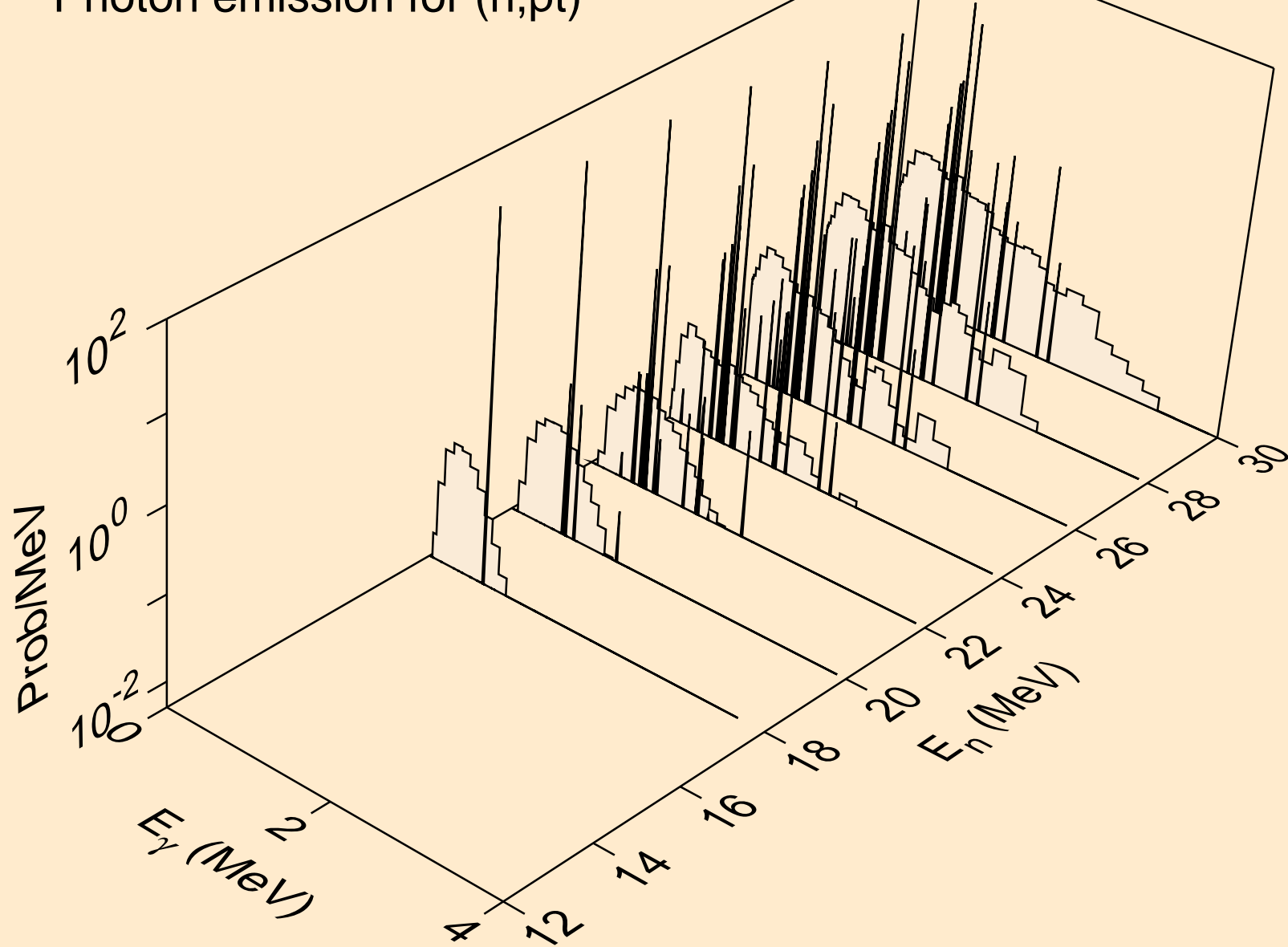

BA135M NEUTRON ACER TENDL-2024 LIBRARY; T=0.K
Photon emission for (n,da)

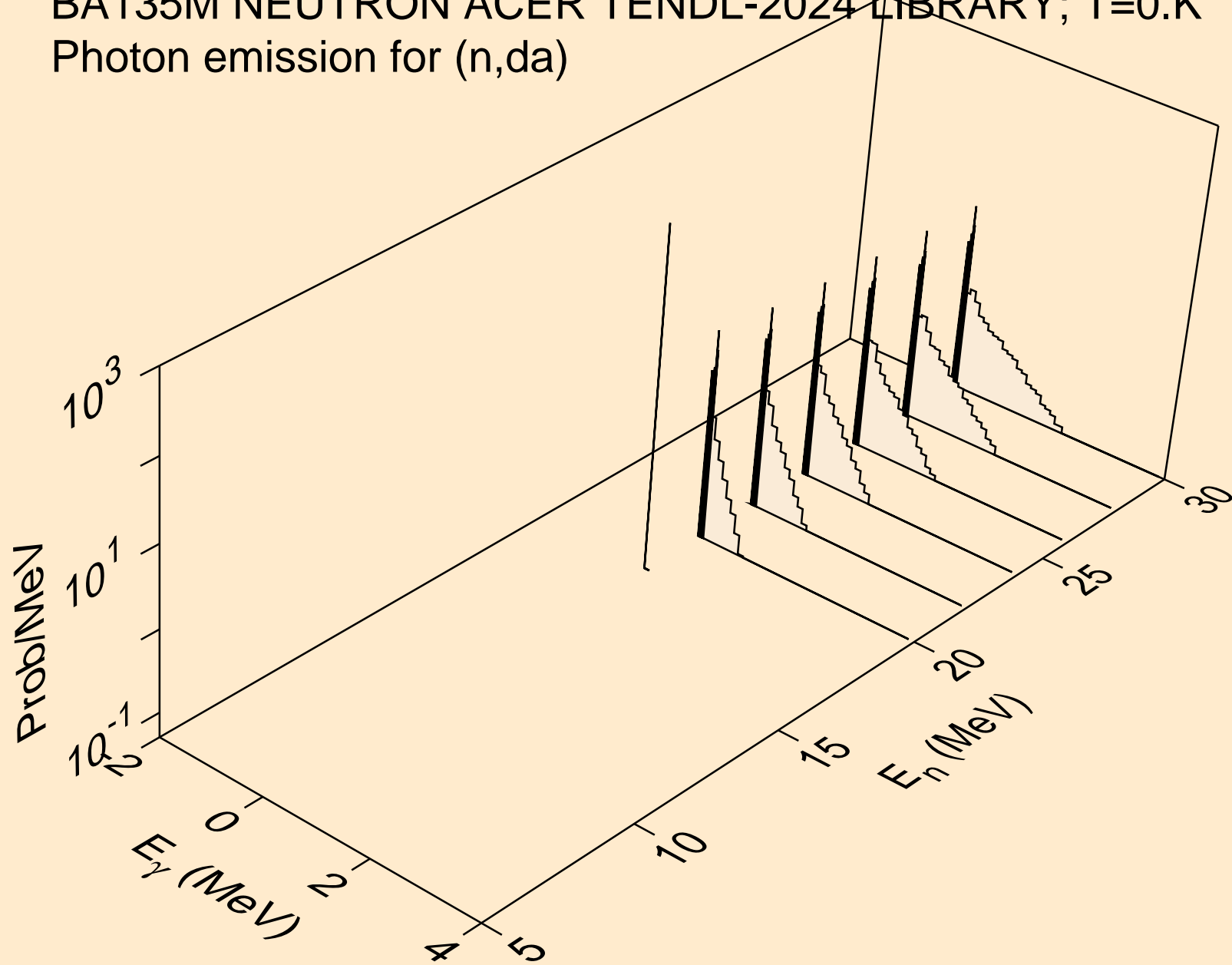

BA135M NEUTRON ACER TENDL-2024 LIBRARY; T=0.K
thermal capture photon spectrum

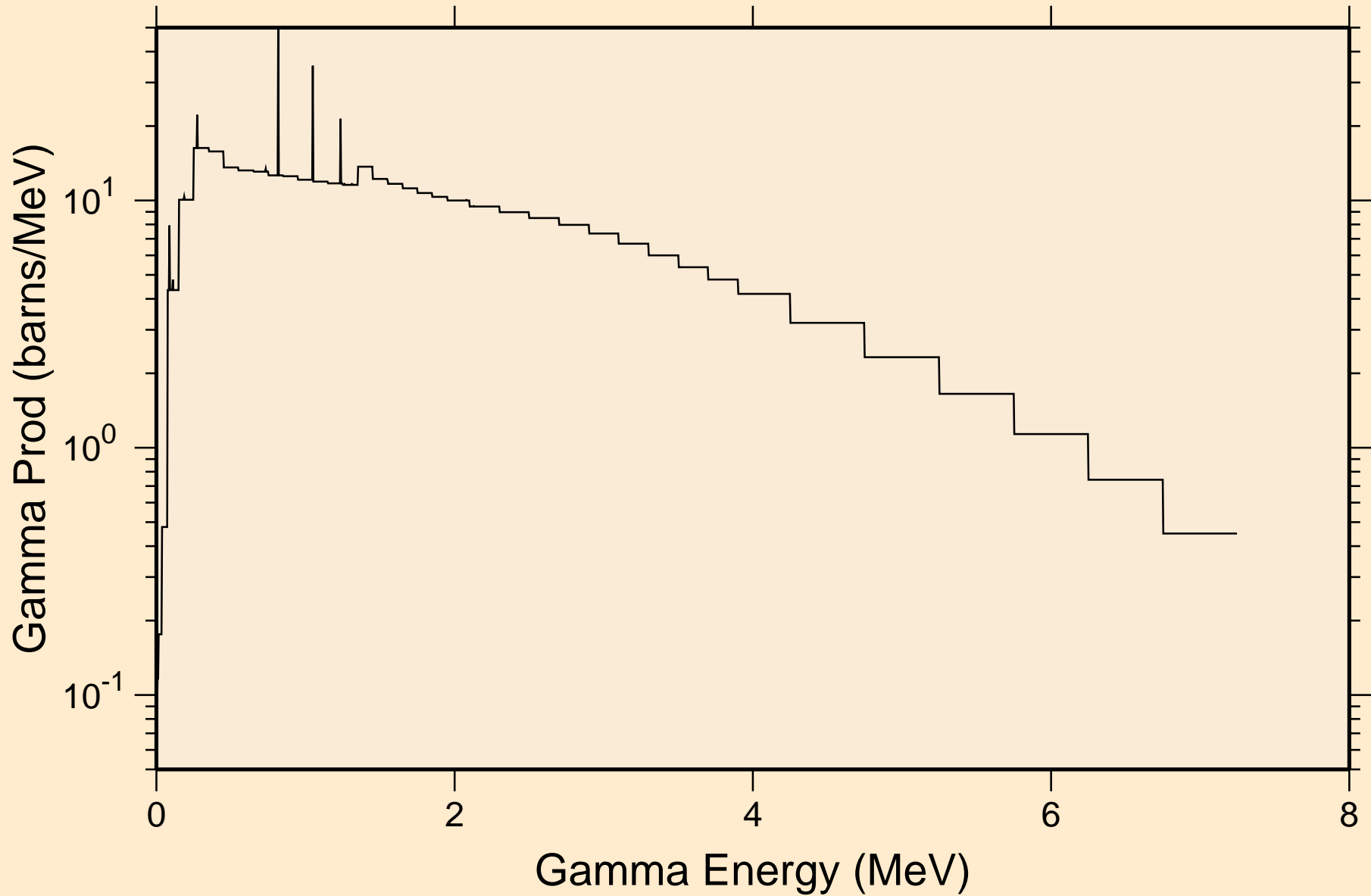

BA135M NEUTRON ACER TENDL-2024 LIBRARY; T=0.K
14 MeV photon spectrum

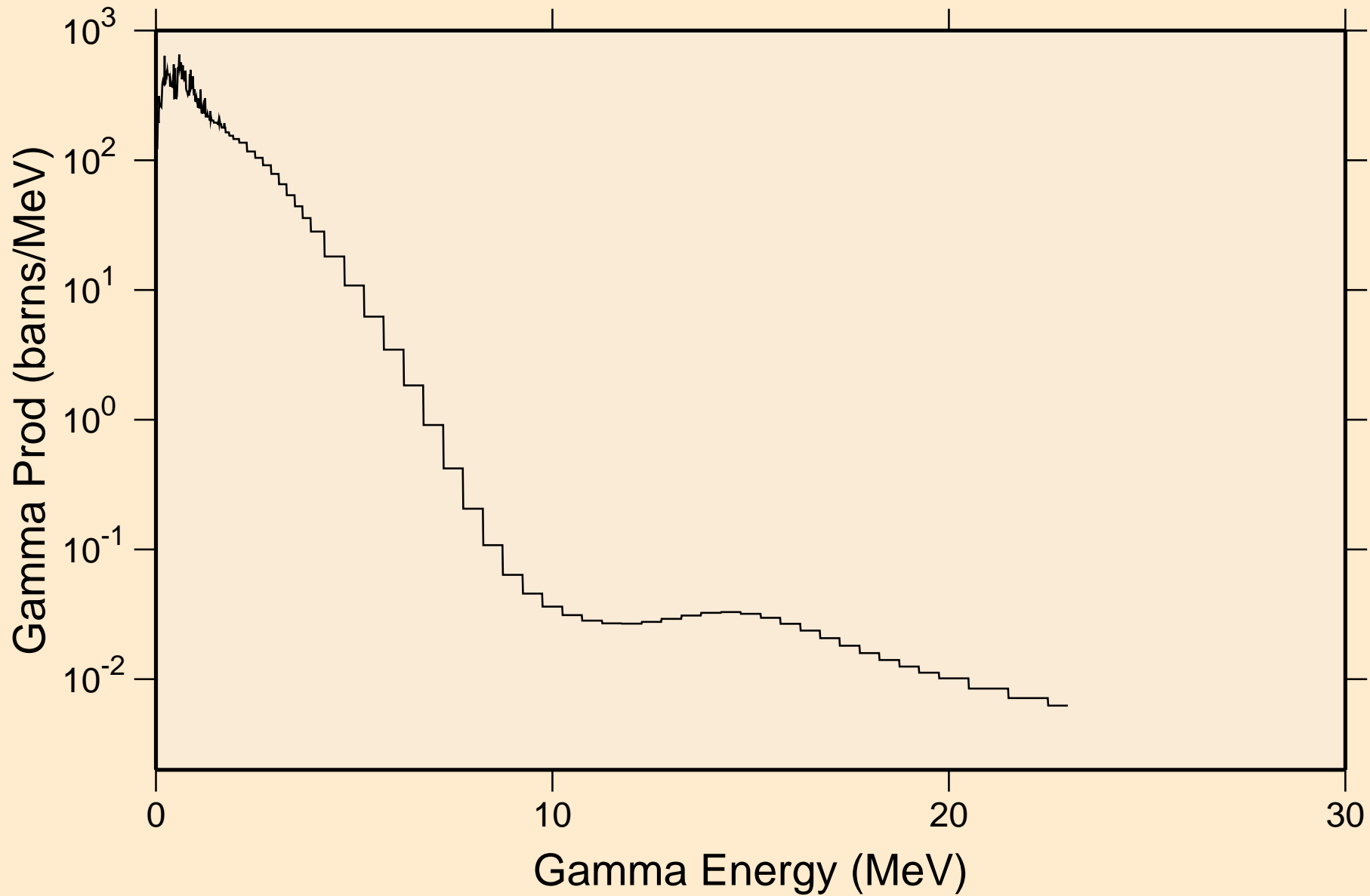

BA135M NEUTRON ACER TENDL-2024 LIBRARY; T=0.K
Particle heating contributions

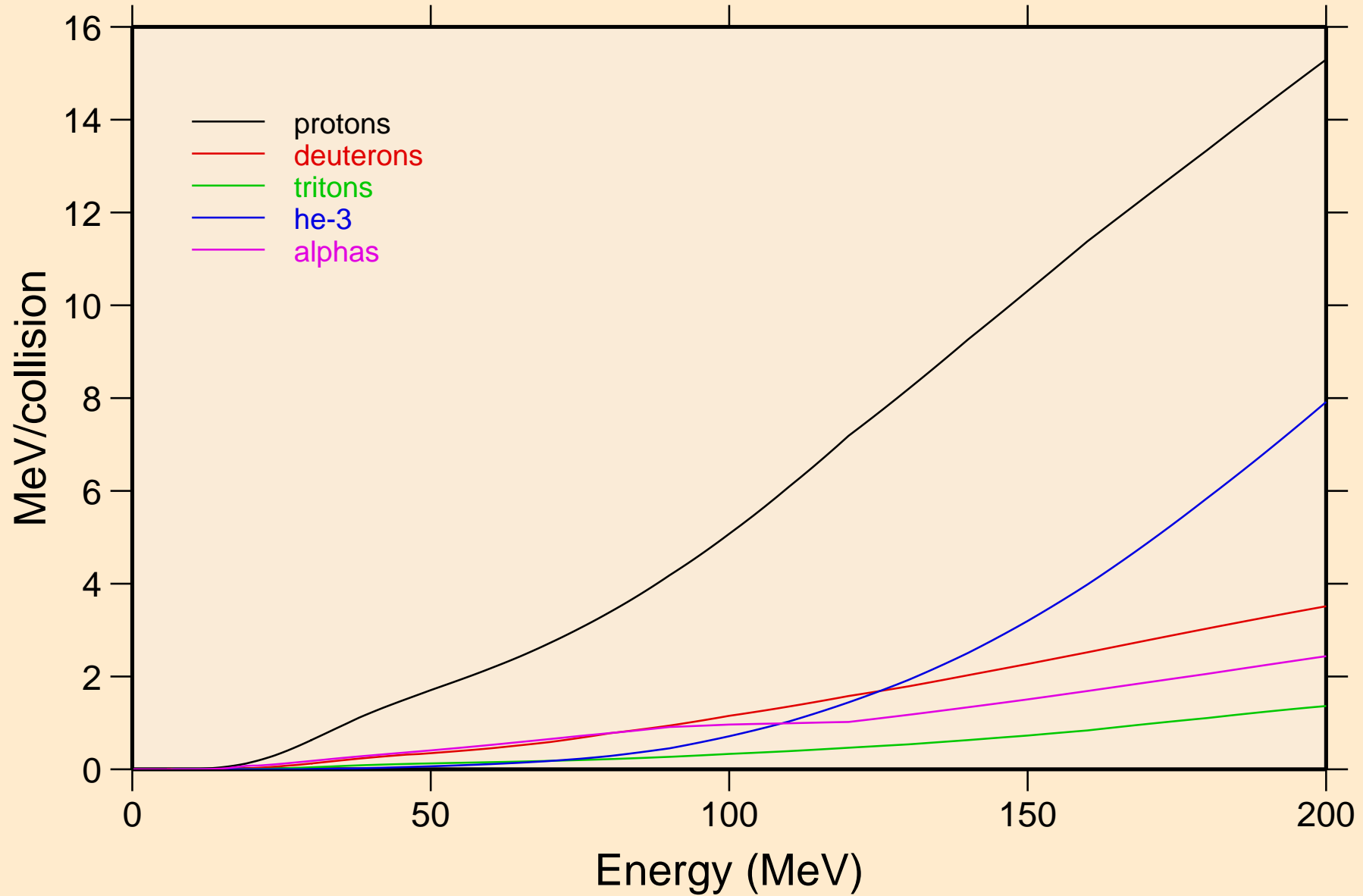

BA135M NEUTRON ACER TENDL-2024 LIBRARY; T=0.K

Recoil Heating

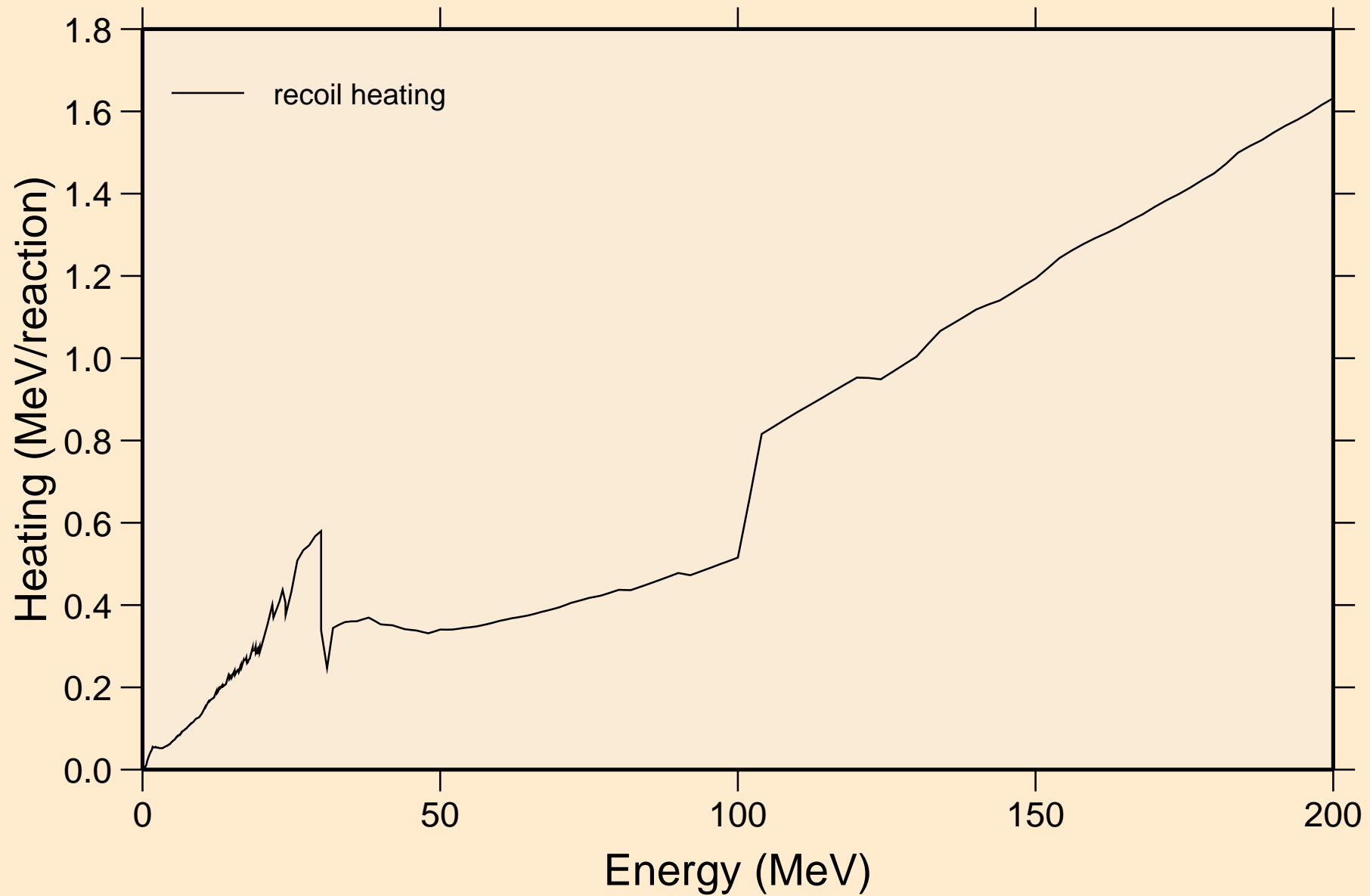

BA135M NEUTRON ACER TENDL-2024 LIBRARY; T=0.K
Particle production cross sections

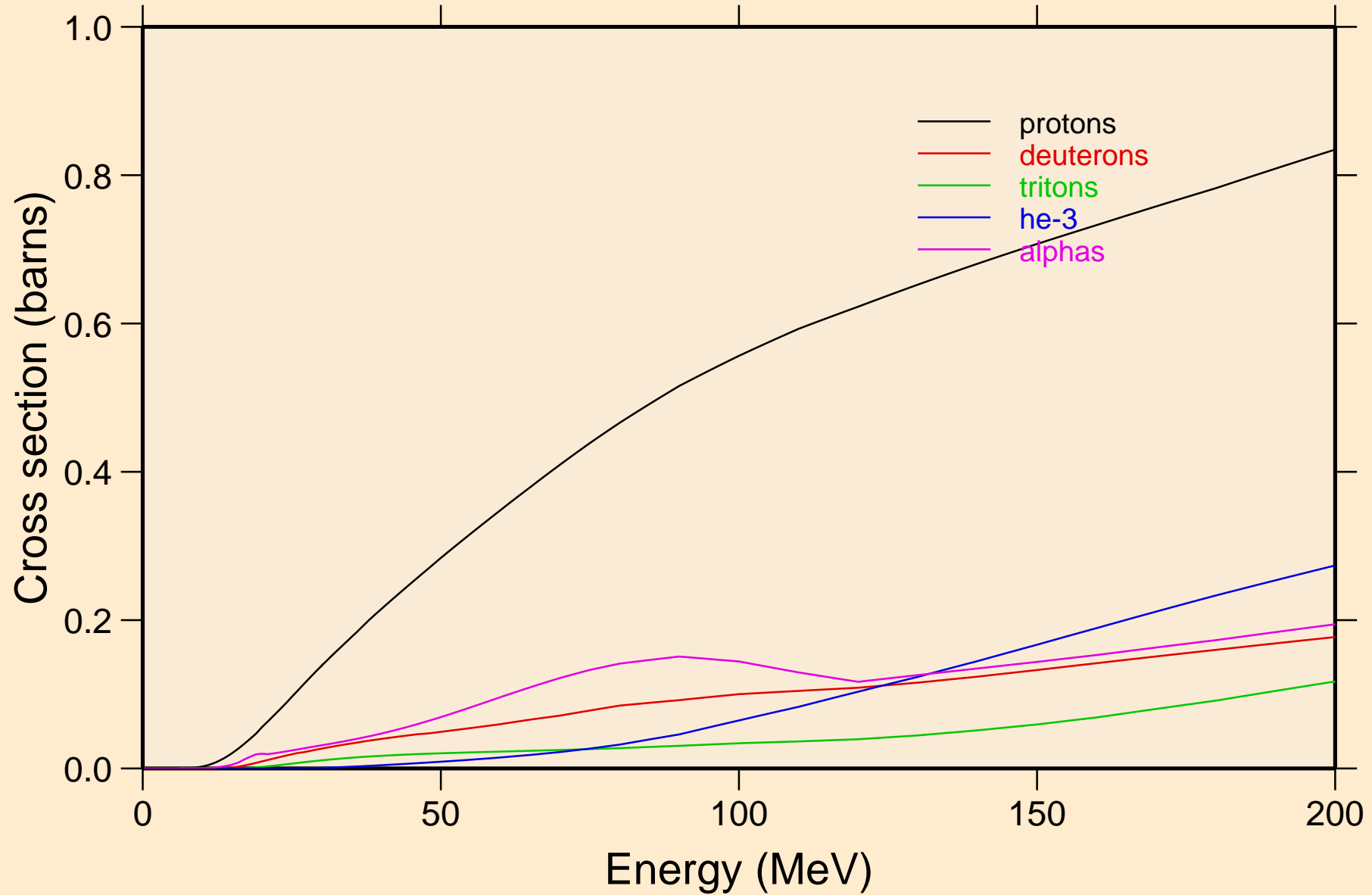

BA135M NEUTRON ACER TENDL-2024 LIBRARY; T=0.K
protons from (n,x)

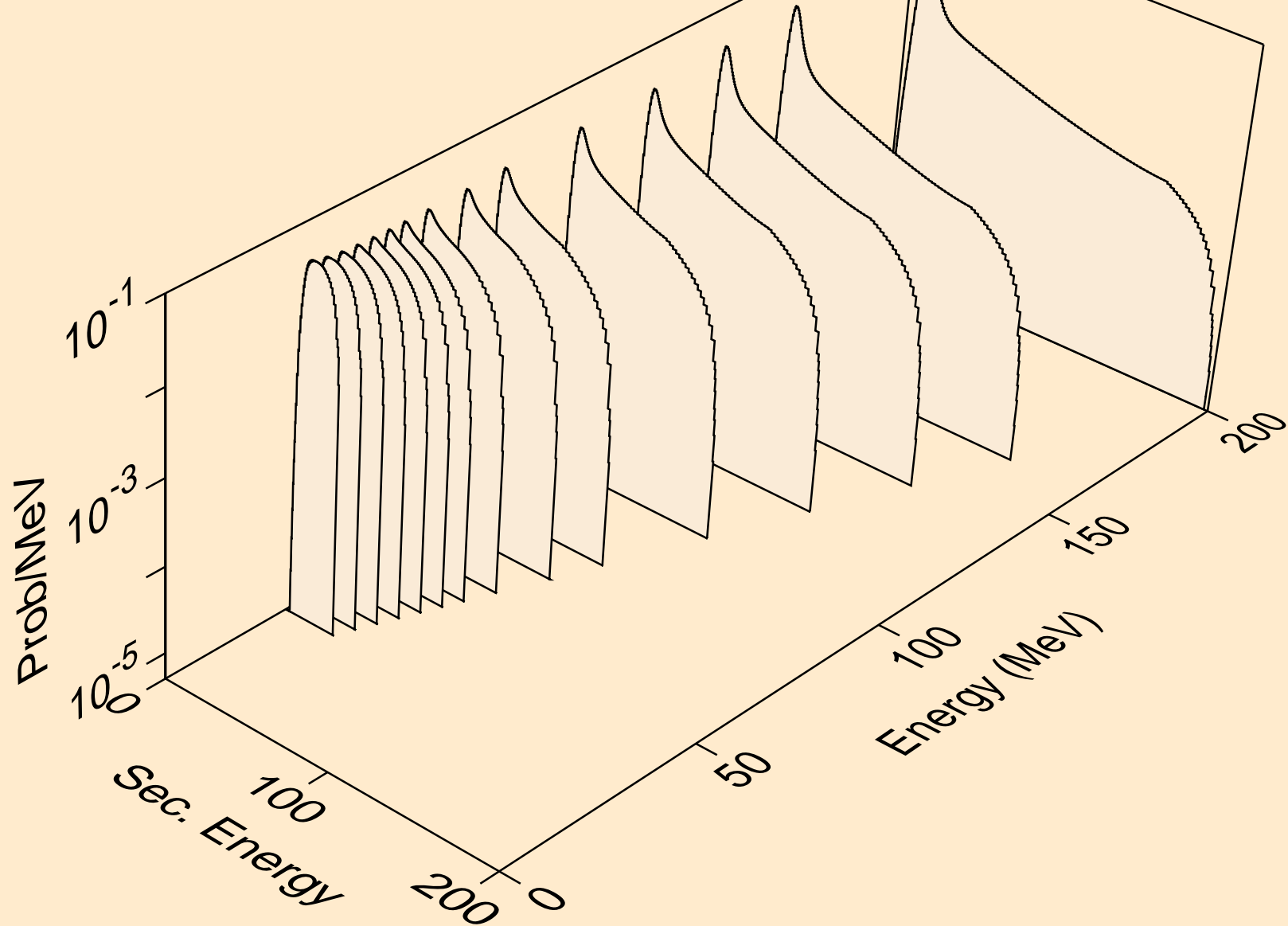

BA135M NEUTRON ACER TENDL-2024 LIBRARY; T=0.K
protons from (n,n*)p

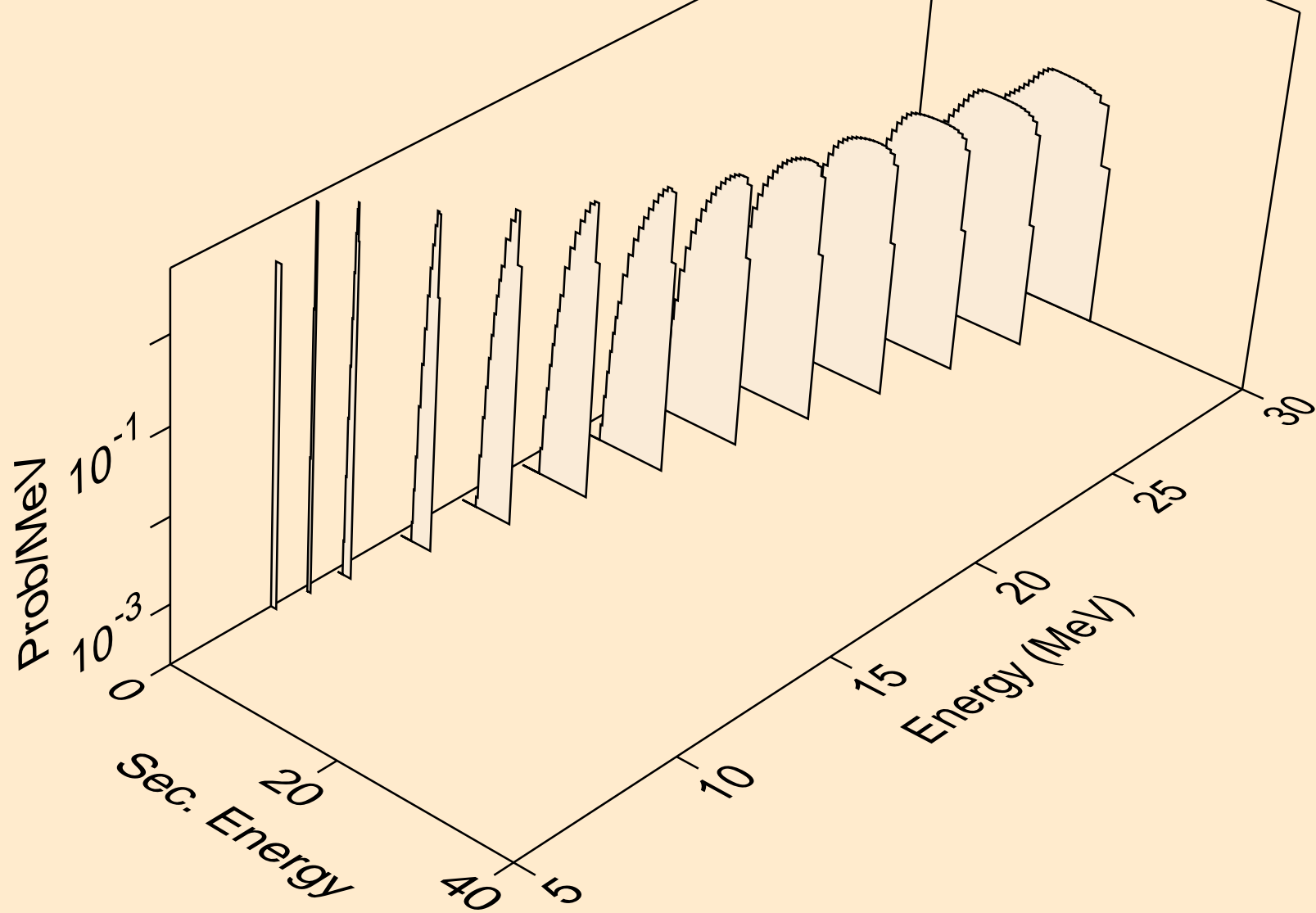

BA135M NEUTRON ACER TENDL-2024 LIBRARY; T=0.K
protons from (n,2np)

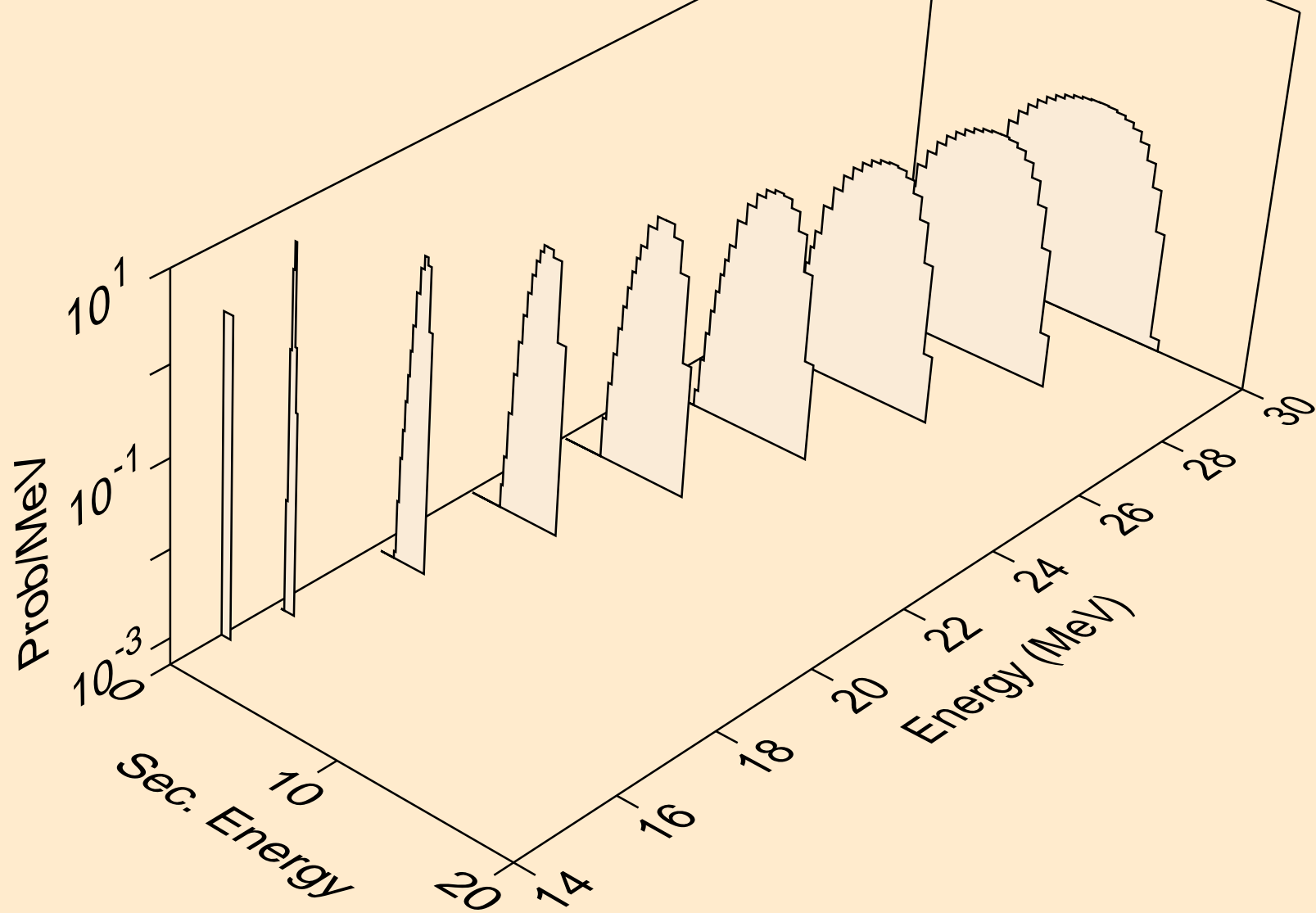

BA135M NEUTRON ACER TENDL-2024 LIBRARY; T=0.K
protons from (n,3np)

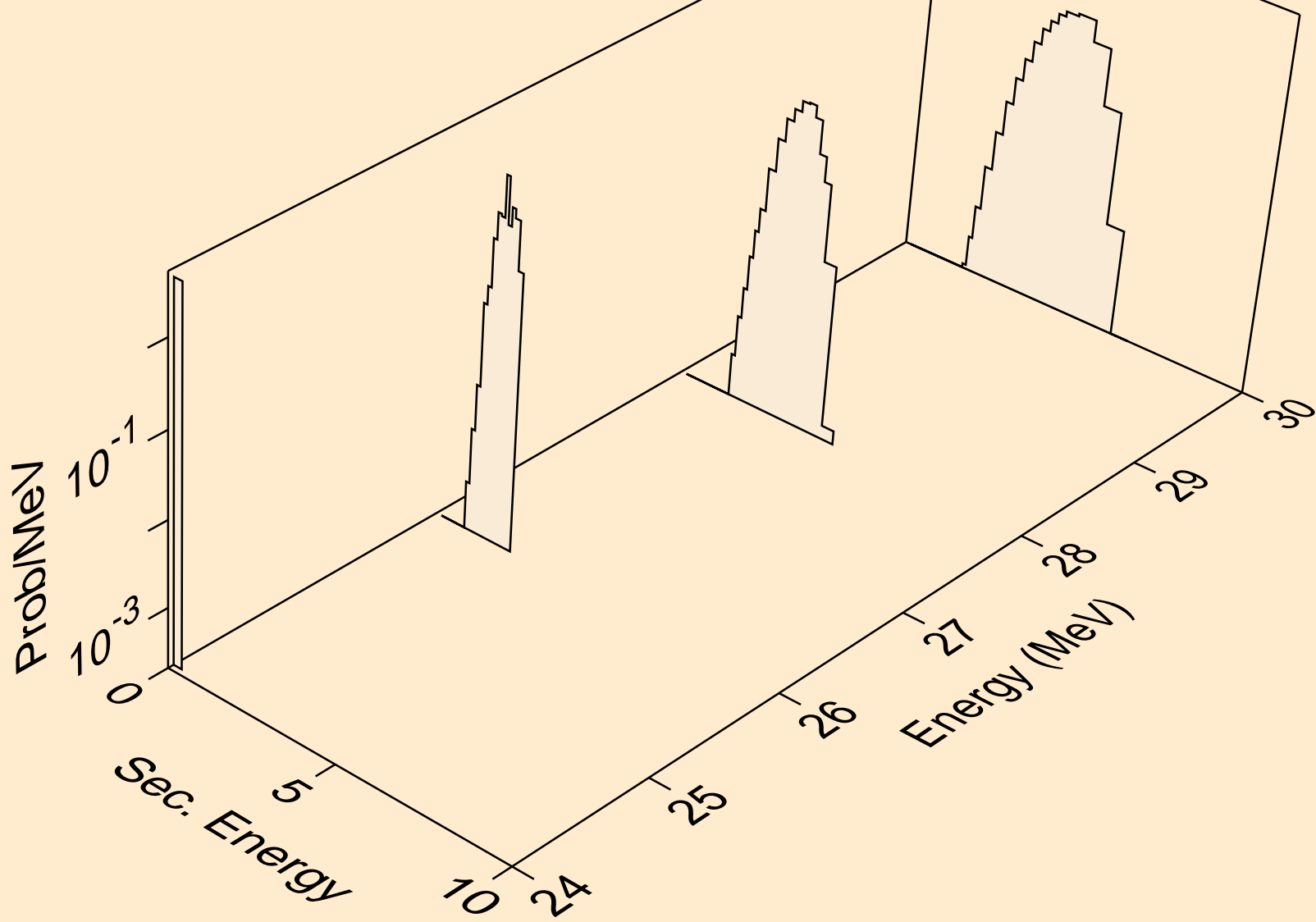

BA135M NEUTRON ACER TENDL-2024 LIBRARY; T=0.K
protons from (n,n2p)

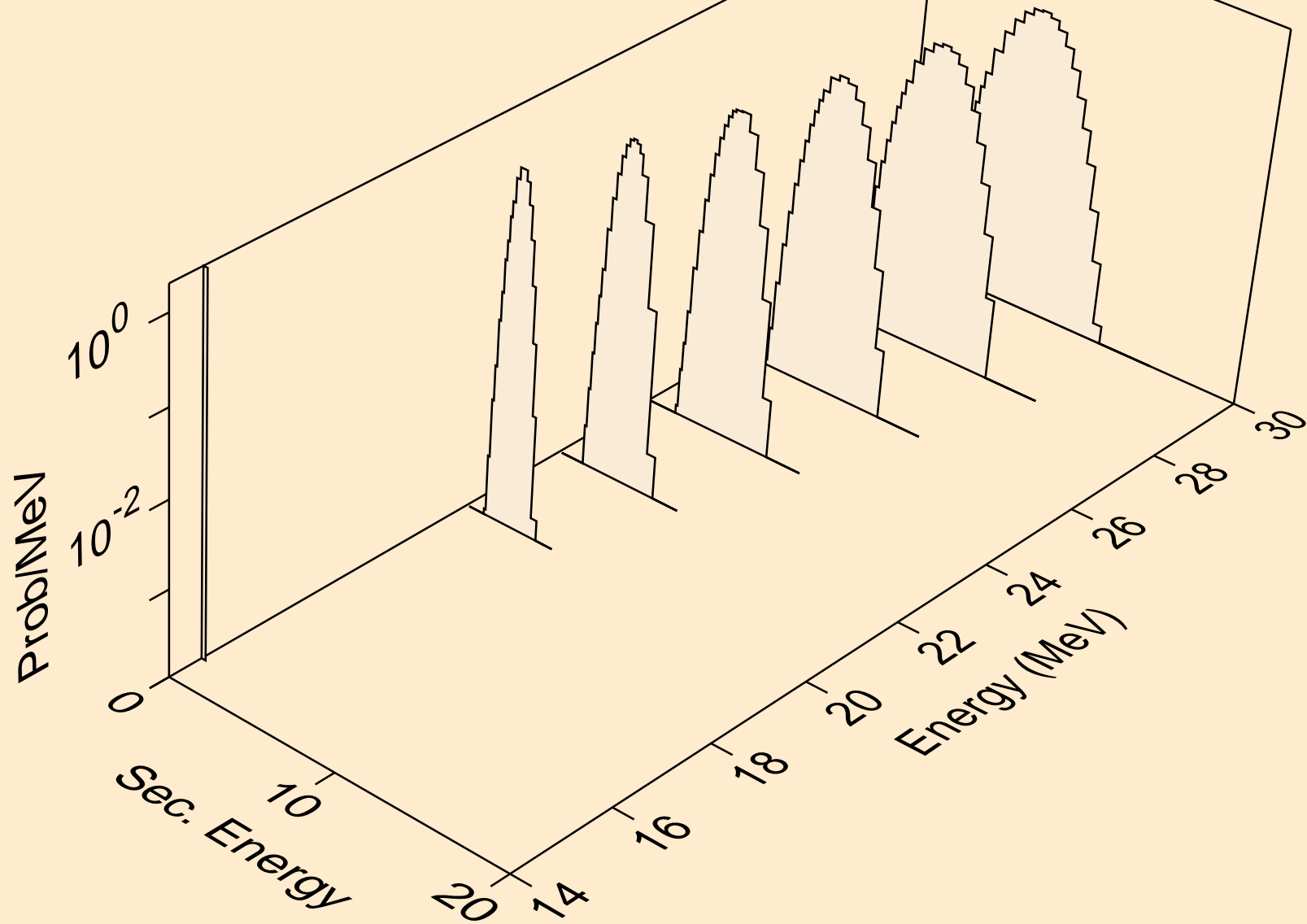

BA135M NEUTRON ACER TENDL-2024 LIBRARY; T=0.K
protons from (n,npa)

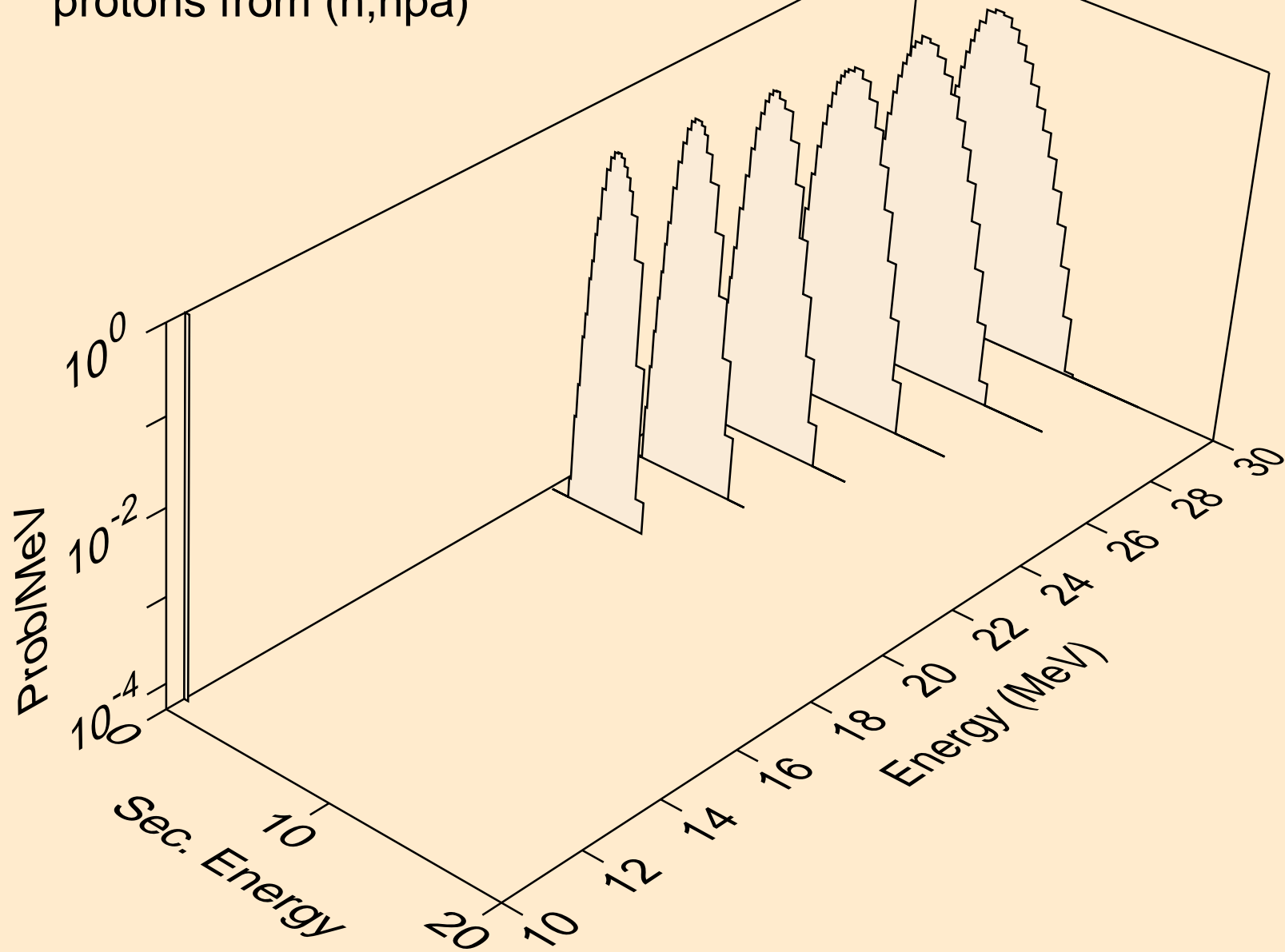

BA135M NEUTRON ACER TENDL-2024 LIBRARY; T=0.K
protons from (n,p)

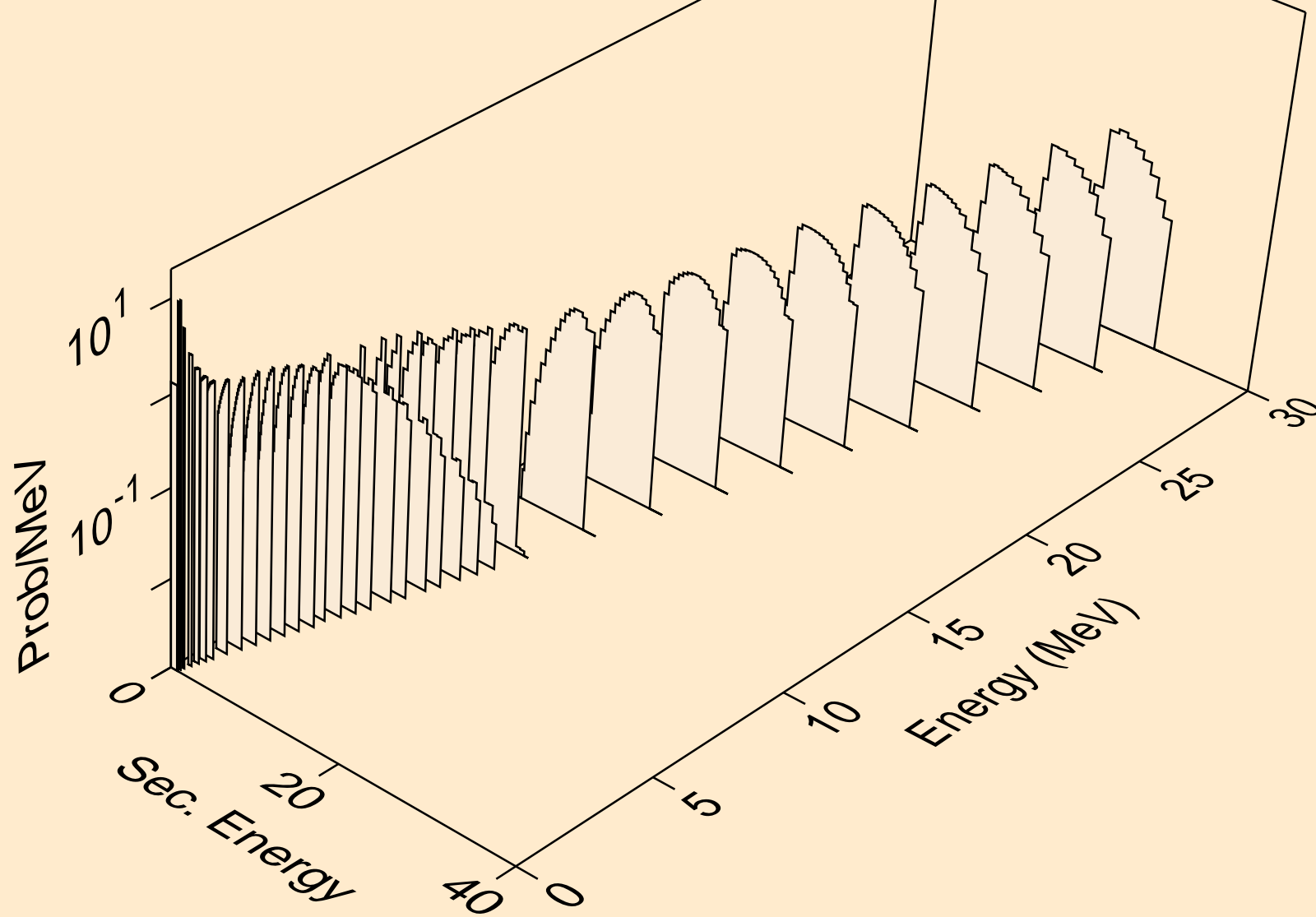

BA135M NEUTRON ACER TENDL-2024 LIBRARY; T=0.K
protons from (n,2p)

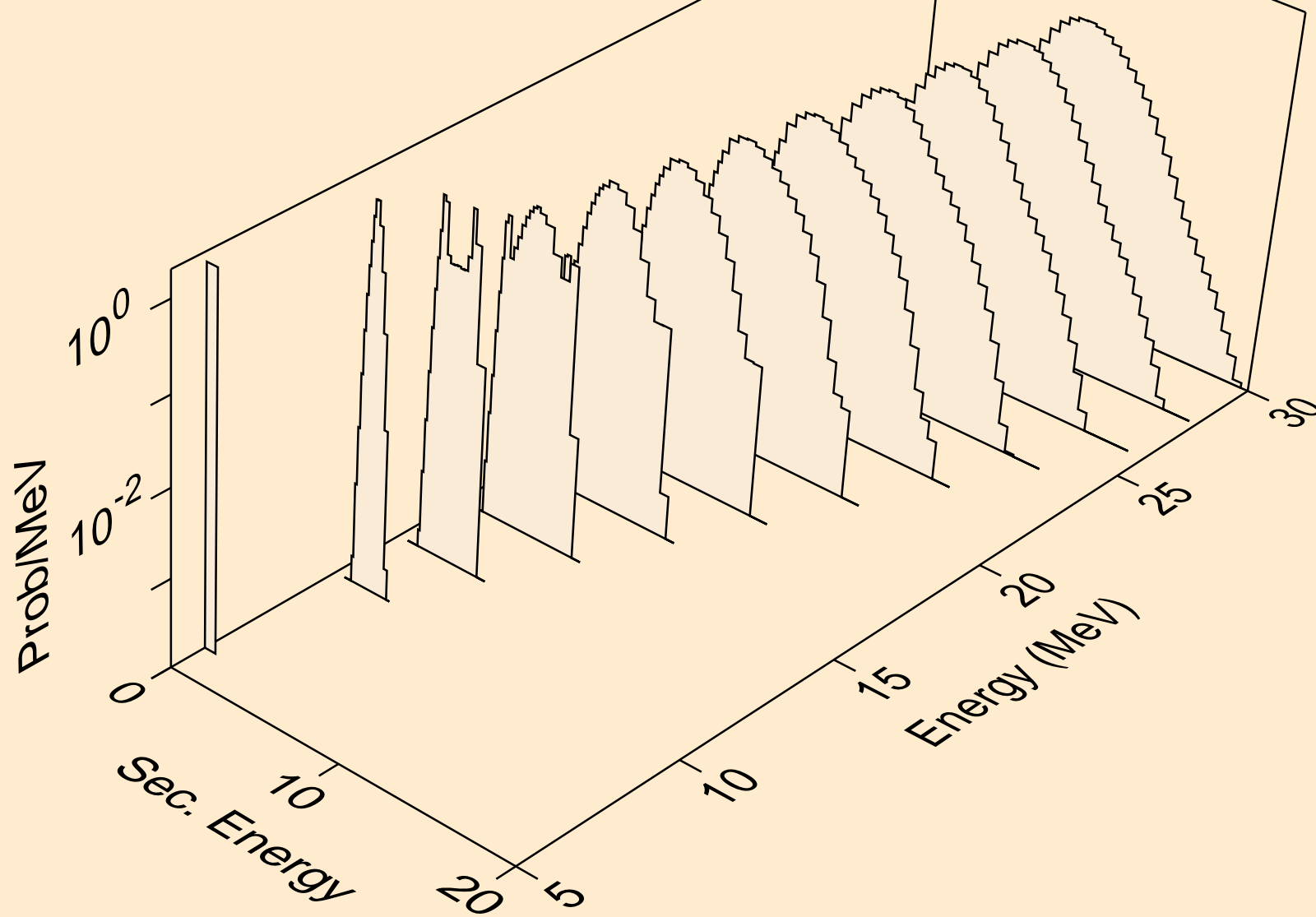

BA135M NEUTRON ACER TENDL-2024 LIBRARY; T=0.K
protons from (n,p)

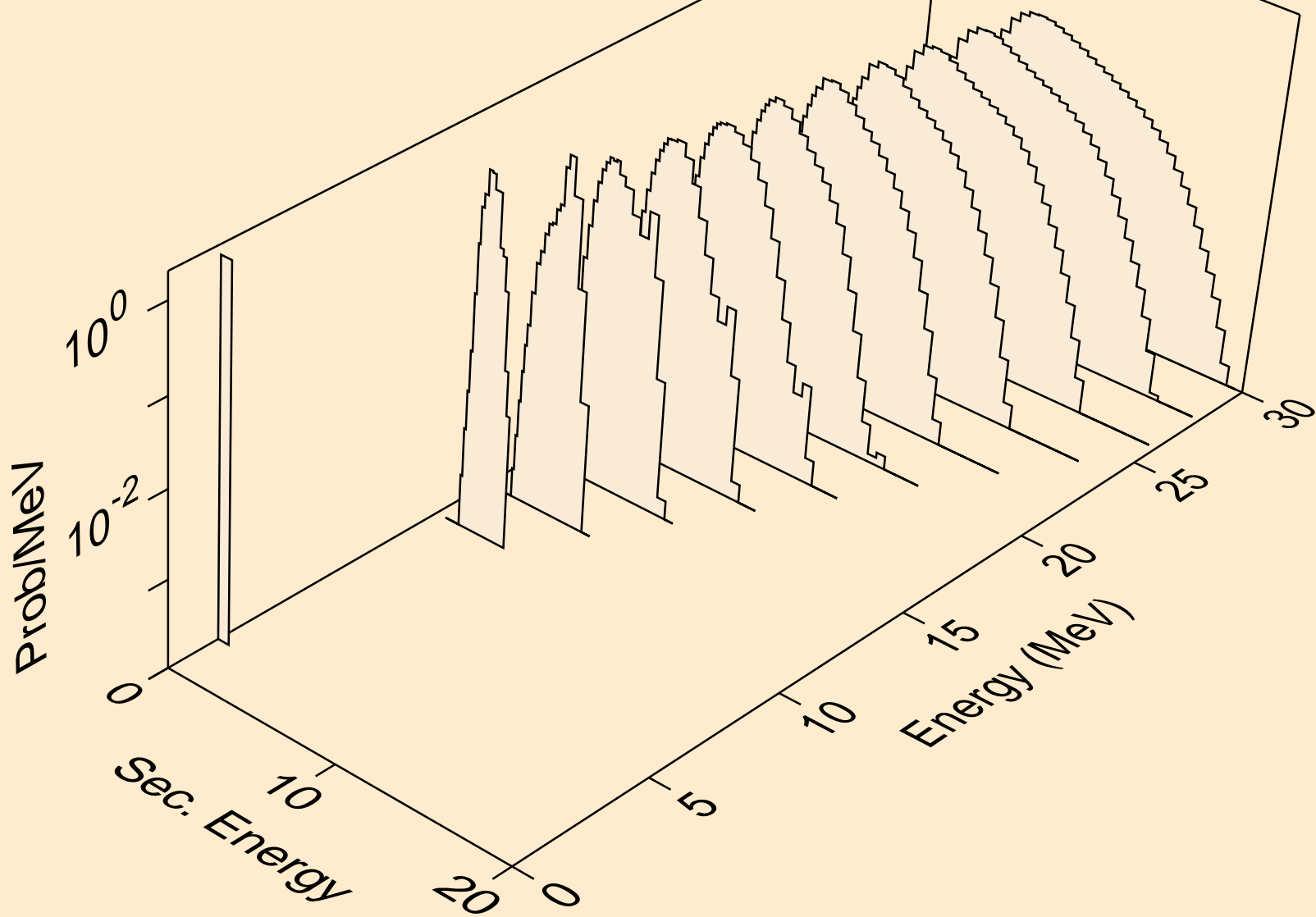

BA135M NEUTRON ACER TENDL-2024 LIBRARY; T=0.K
protons from (n,pd)

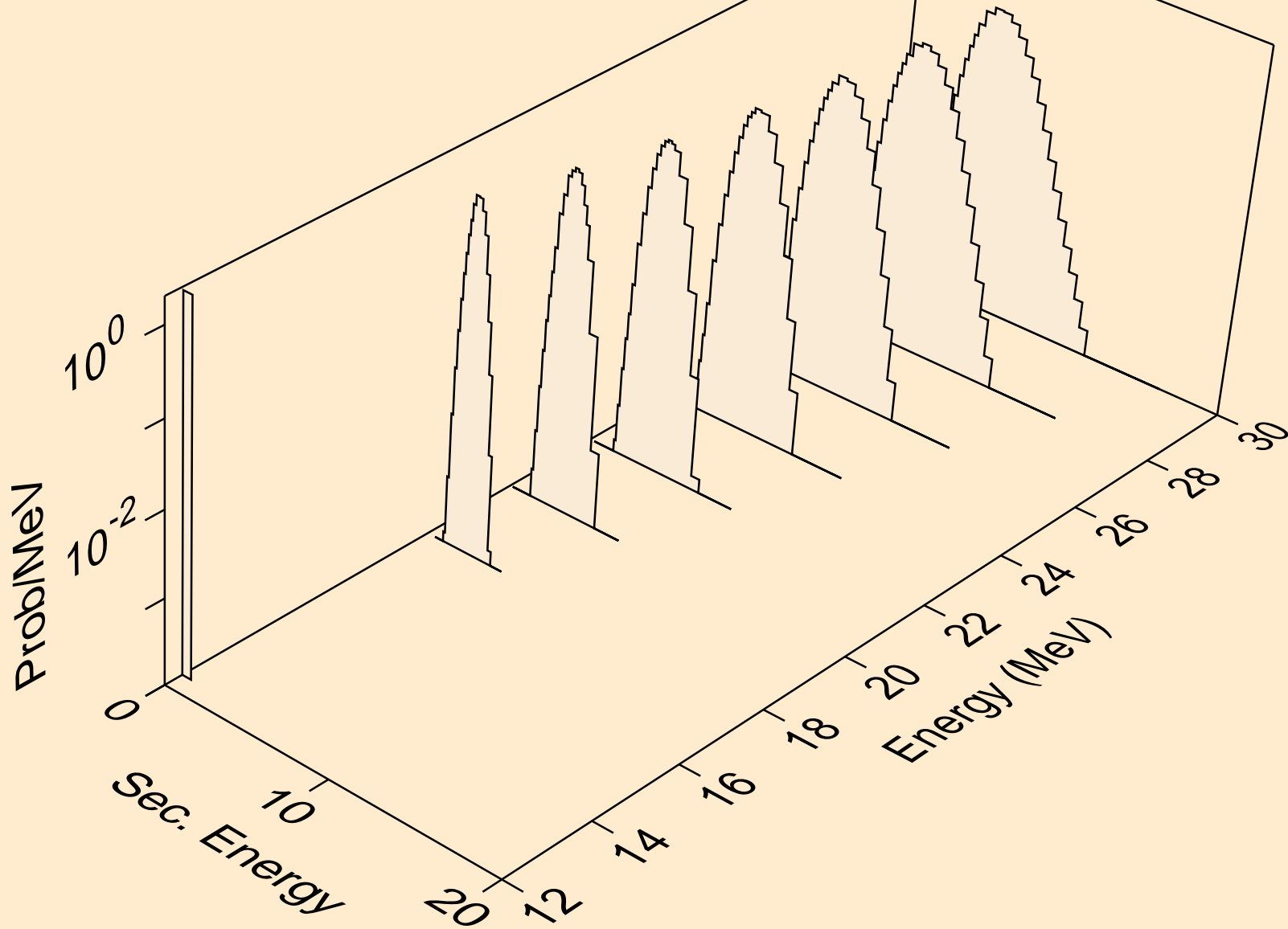

BA135M NEUTRON ACER TENDL-2024 LIBRARY; T=0.K
protons from (n,pt)

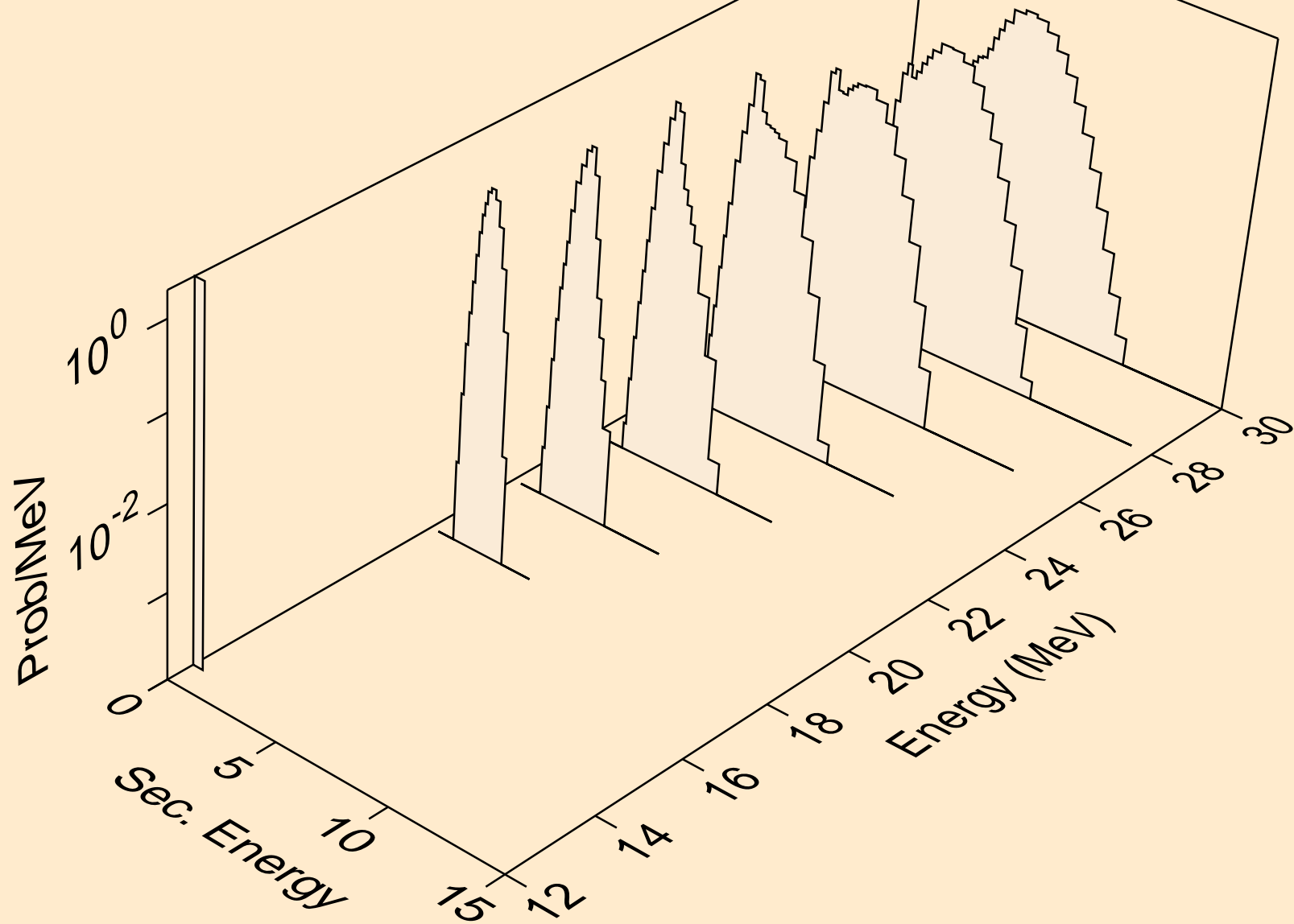

BA135M NEUTRON ACER TENDL-2024 LIBRARY; T=0.K
deuterons from (n,x)

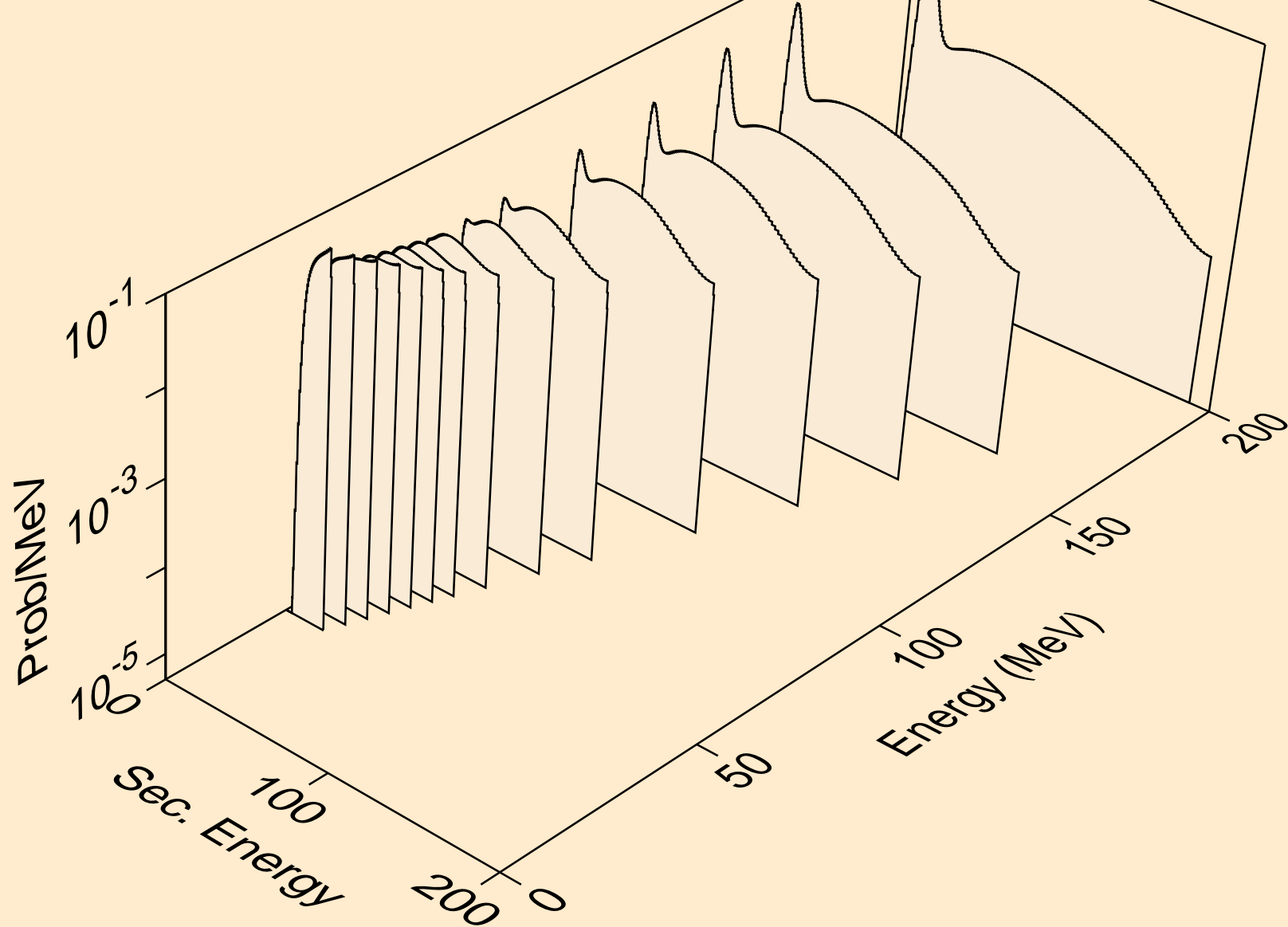

BA135M NEUTRON ACER TENDL-2024 LIBRARY; T=0.K
deuterons from (n,2nd)

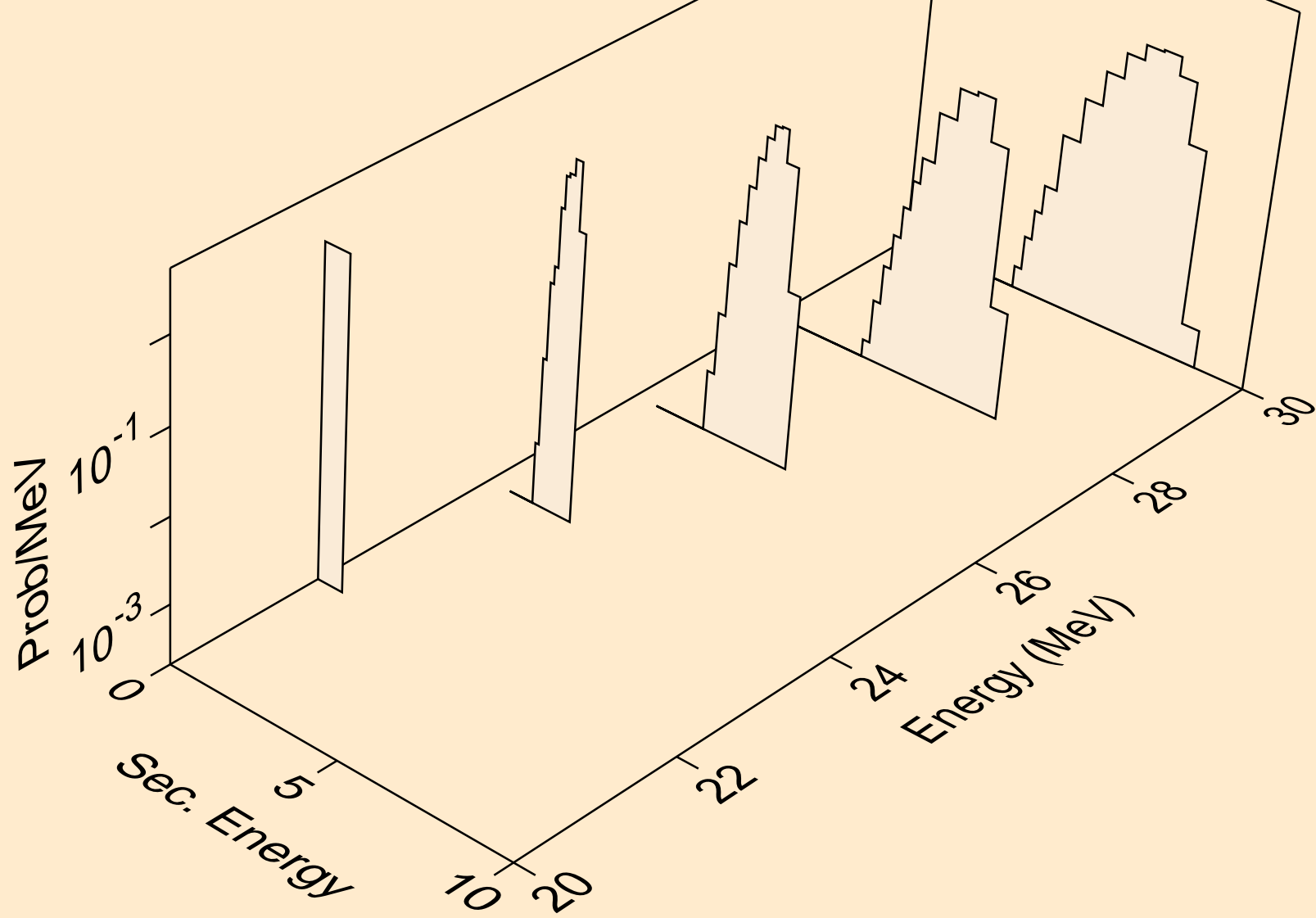

BA135M NEUTRON ACER TENDL-2024 LIBRARY; T=0.K
deuterons from (n,n*)d

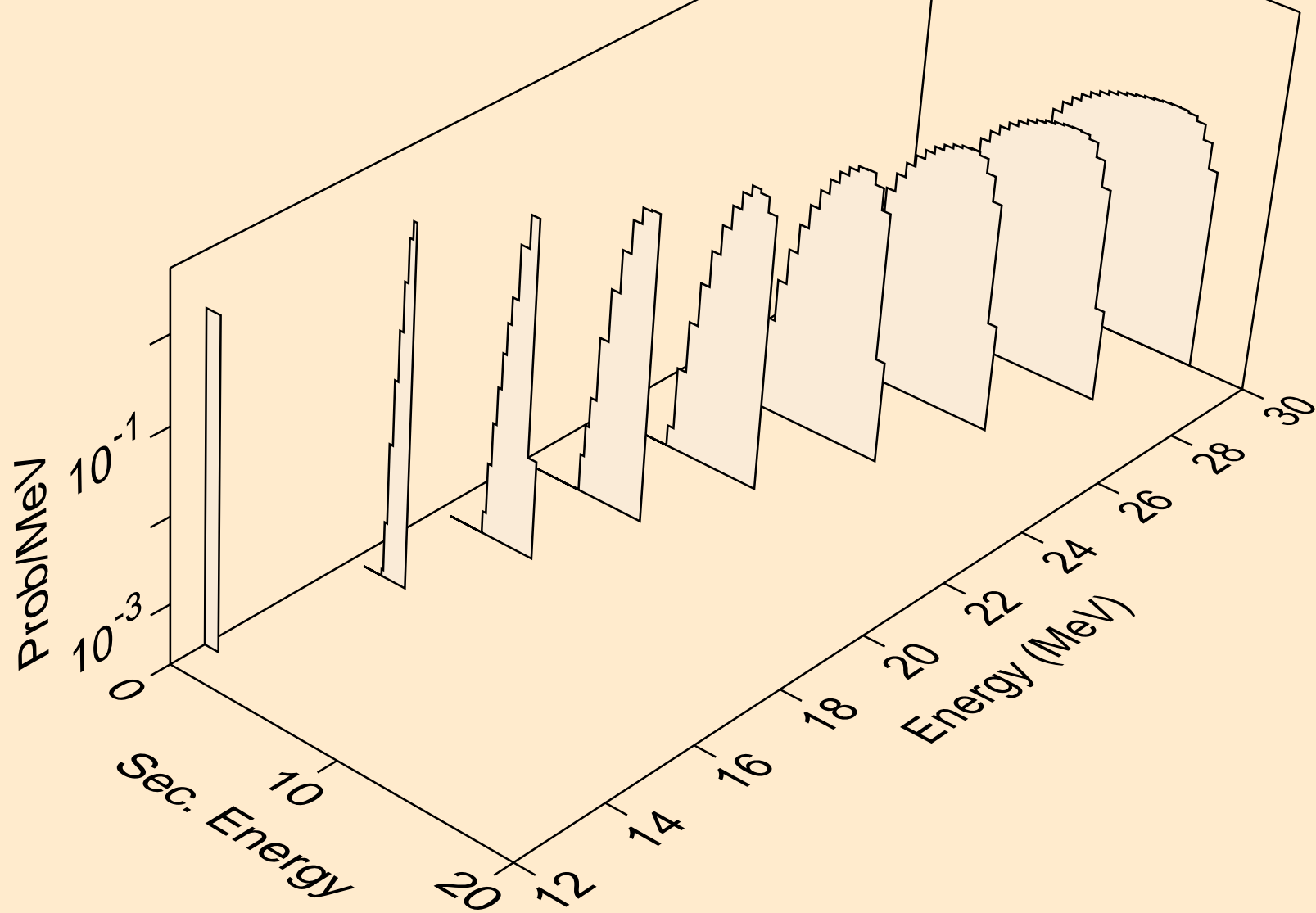

BA135M NEUTRON ACER TENDL-2024 LIBRARY; T=0.K
deuterons from (n,d)

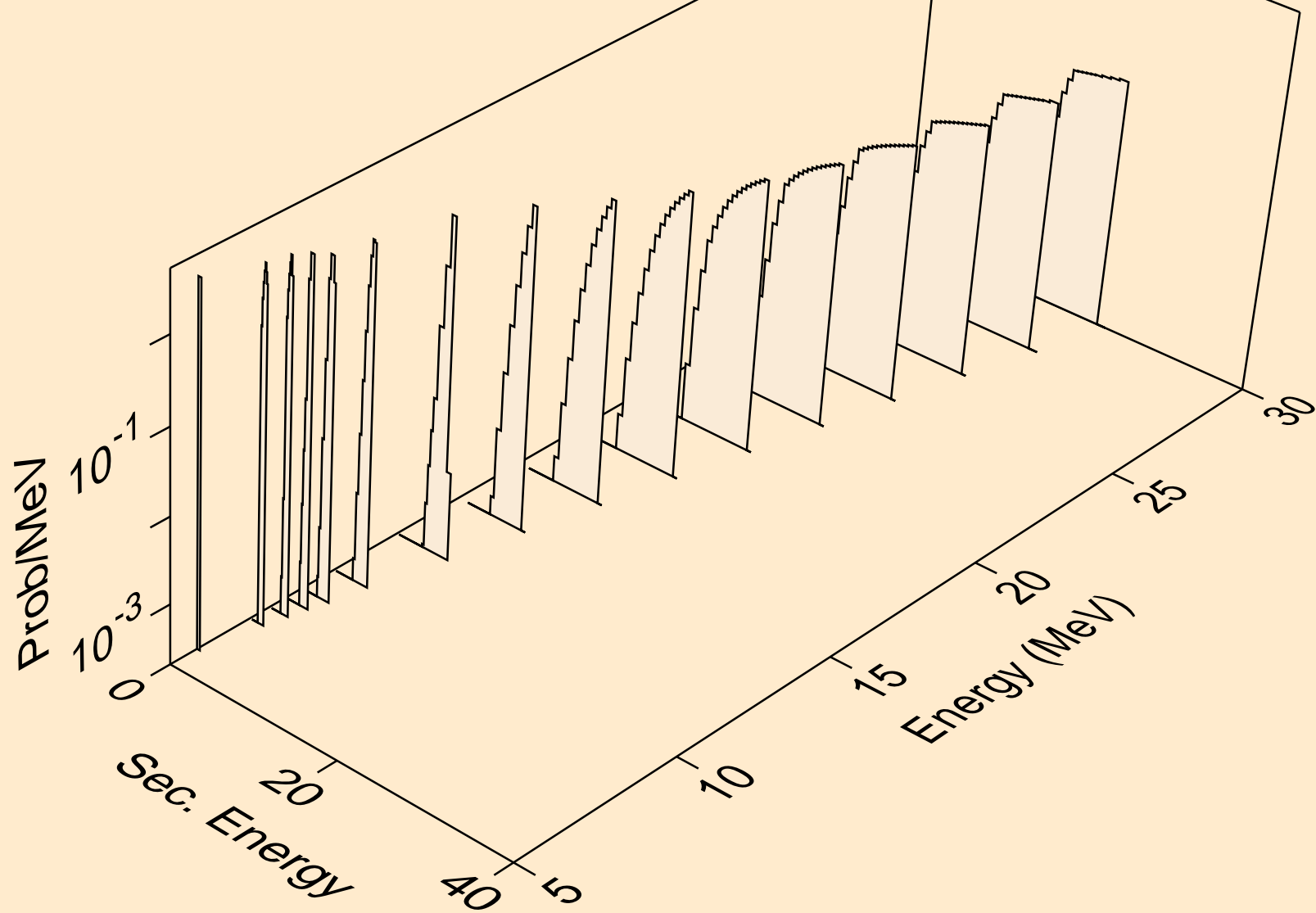

BA135M NEUTRON ACER TENDL-2024 LIBRARY; T=0.K
deuterons from (n,pd)

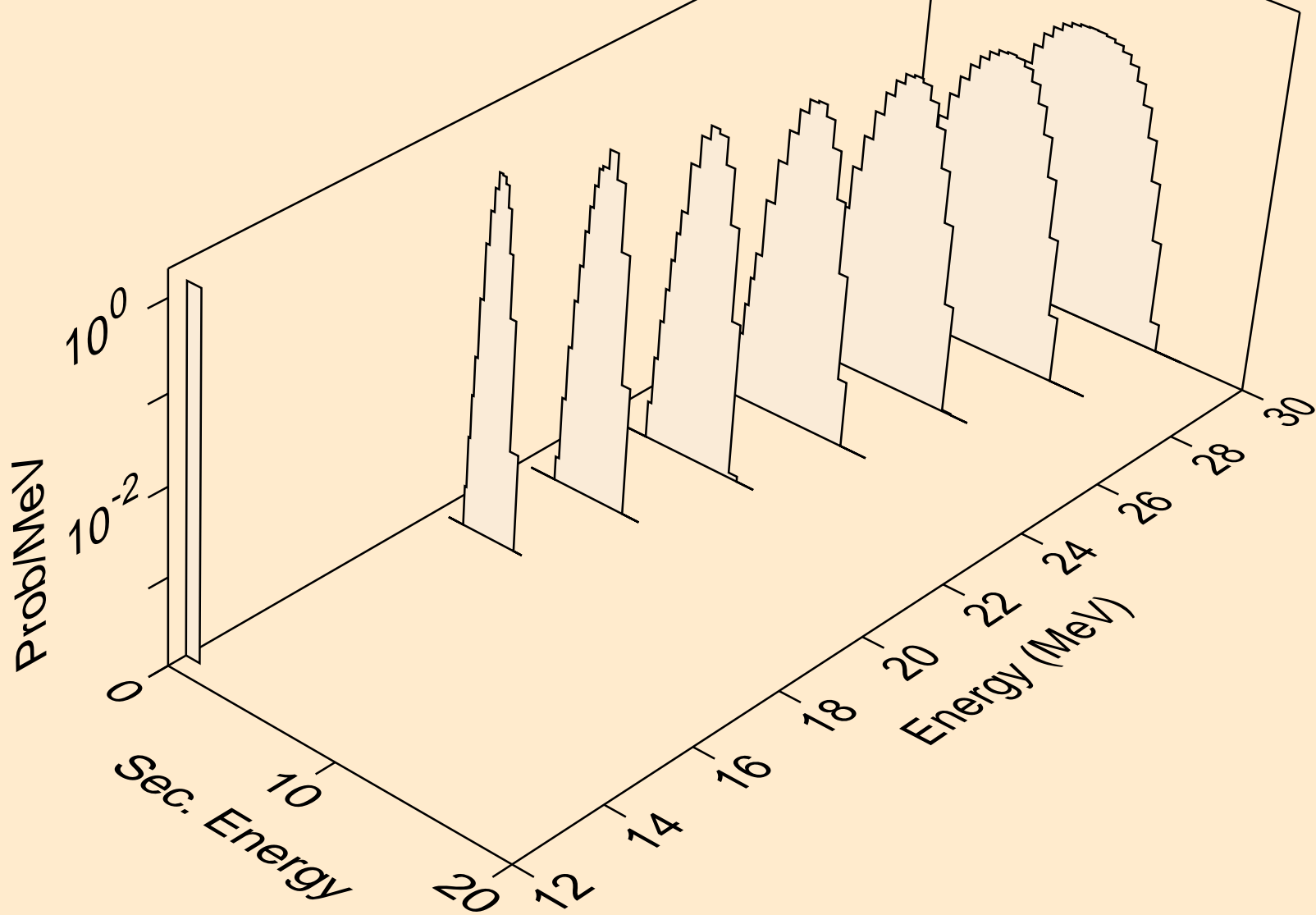

BA135M NEUTRON ACER TENDL-2024 LIBRARY; T=0.K
deuterons from (n,da)

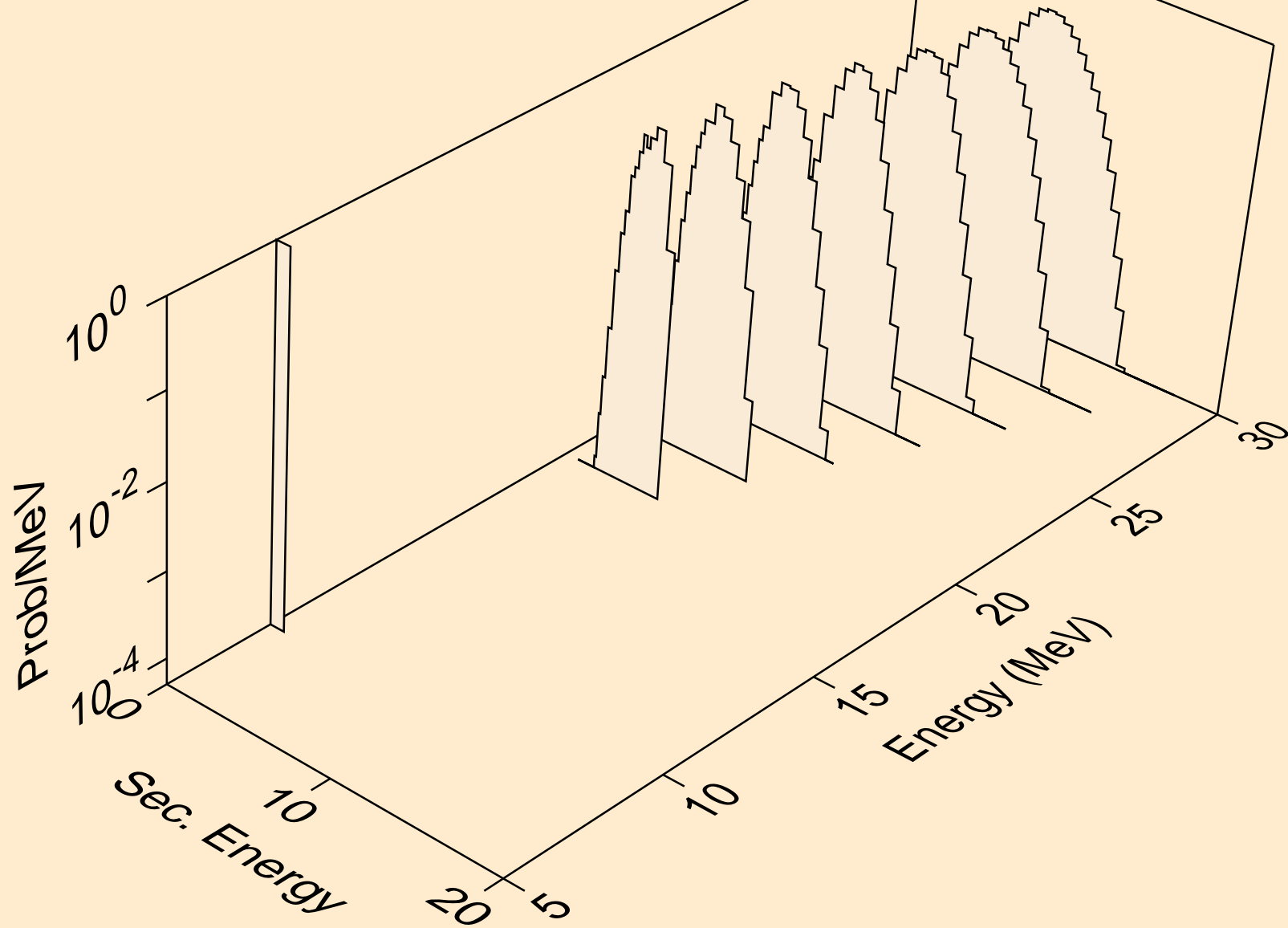

BA135M NEUTRON ACER TENDL-2024 LIBRARY; T=0.K
tritons from (n,x)

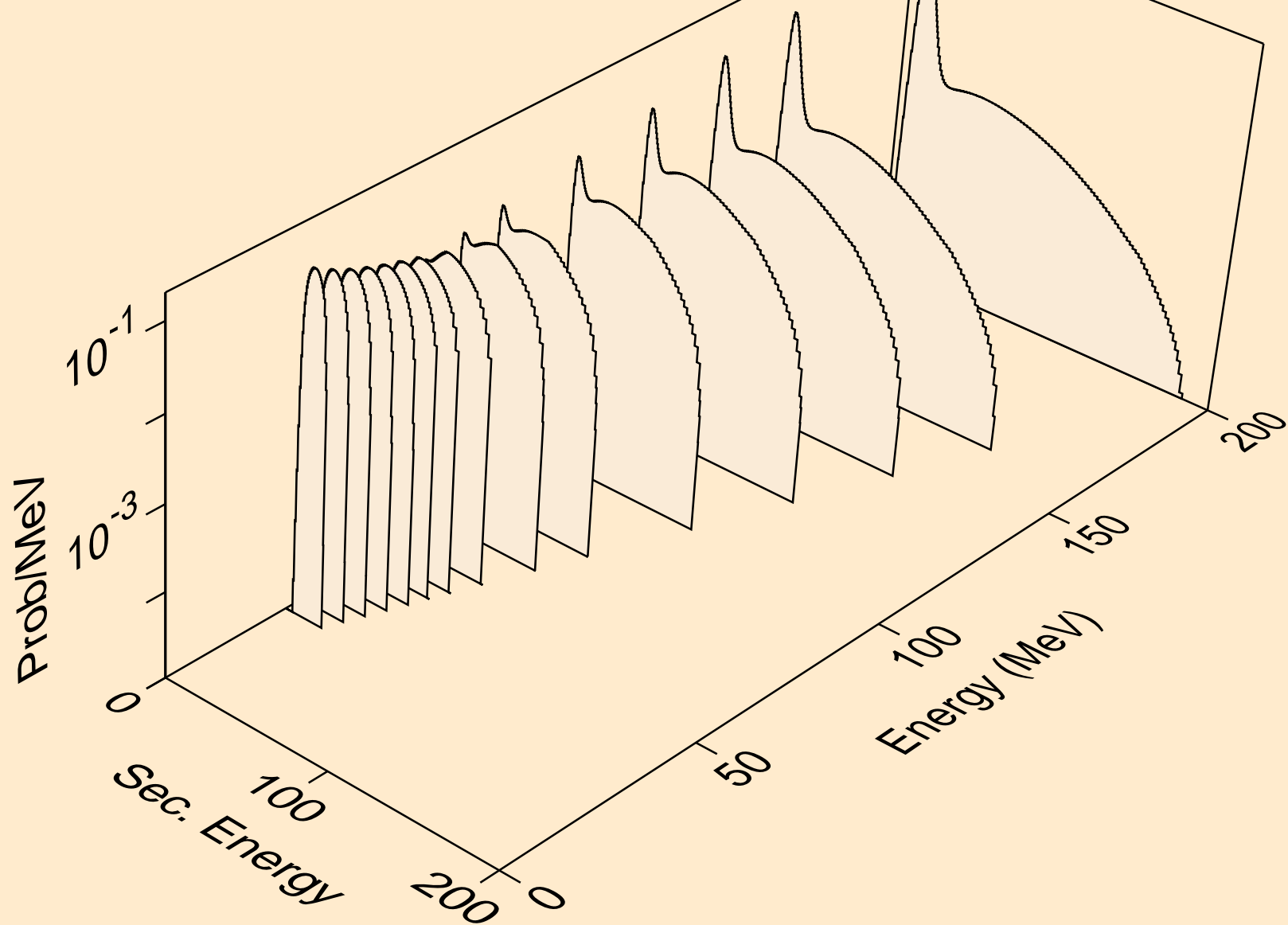

BA135M NEUTRON ACER TENDL-2024 LIBRARY; T=0.K
tritons from (n,n*)t

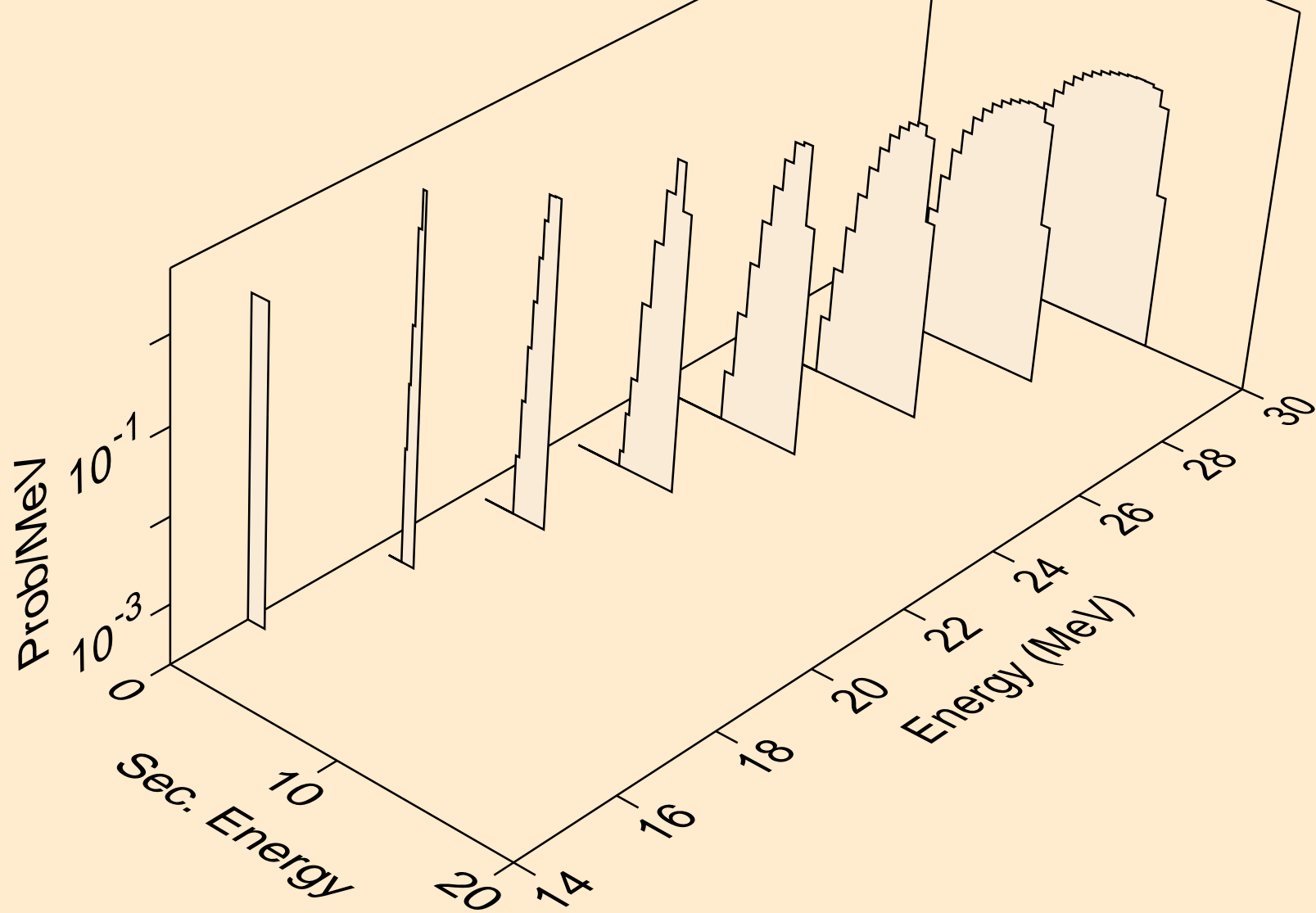

BA135M NEUTRON ACER TENDL-2024 LIBRARY; T=0.K
tritons from (n,t)

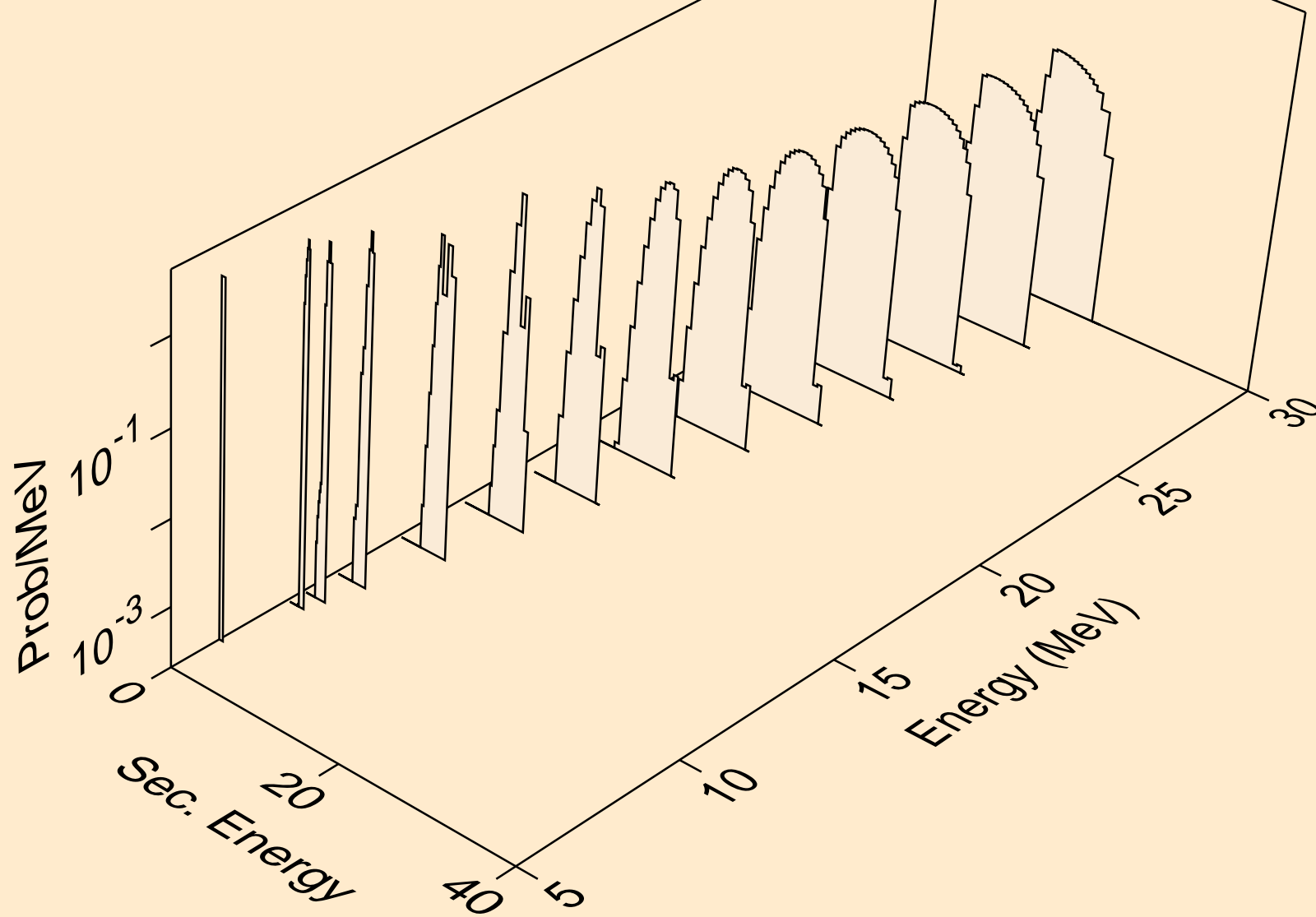

BA135M NEUTRON ACER TENDL-2024 LIBRARY; T=0.K
tritons from (n,pt)

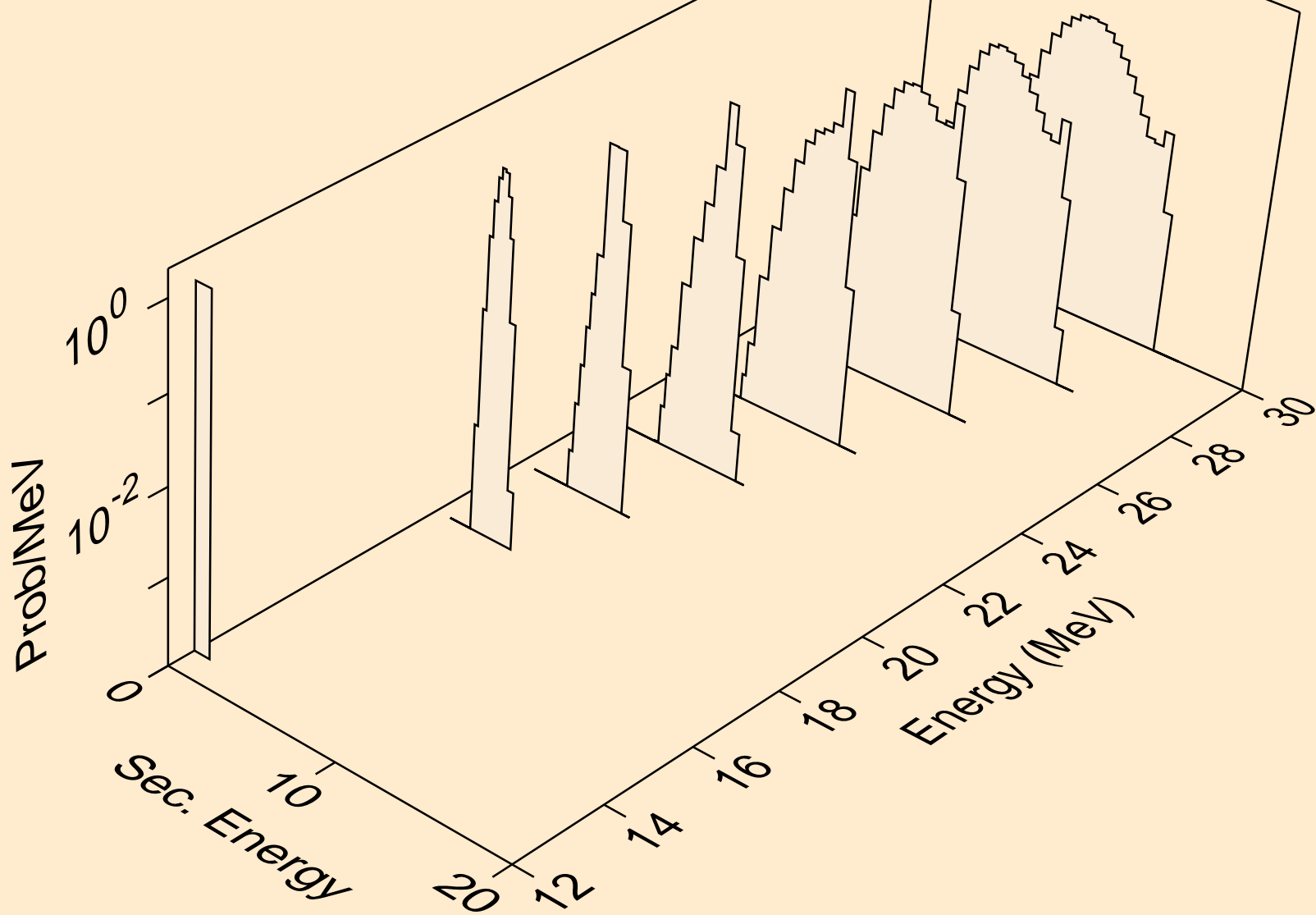

BA135M NEUTRON ACER TENDL-2024 LIBRARY; T=0.K
he3s from (n,x)

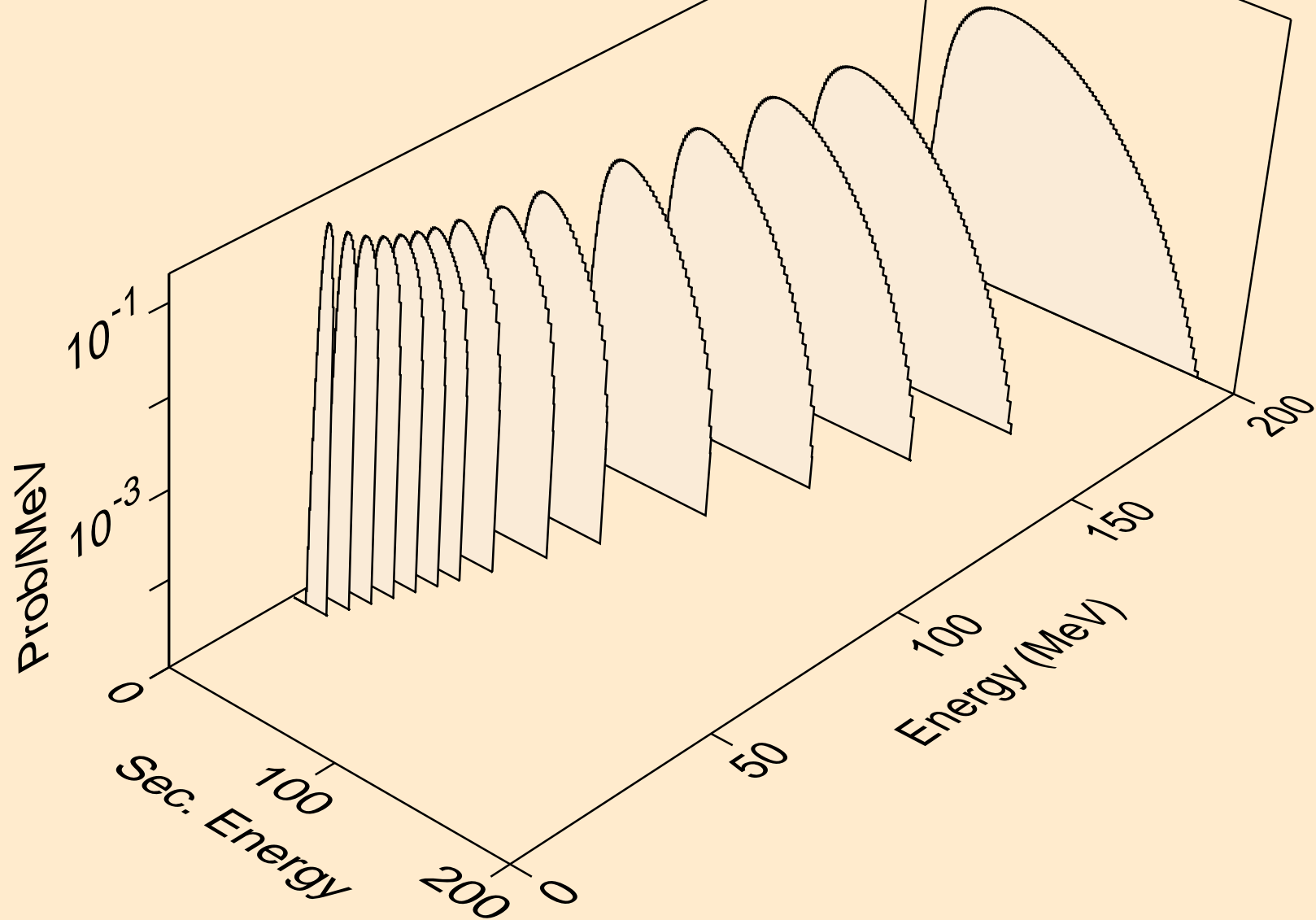

BA135M NEUTRON ACER TENDL-2024 LIBRARY; T=0.K
he3s from (n,n*)he3

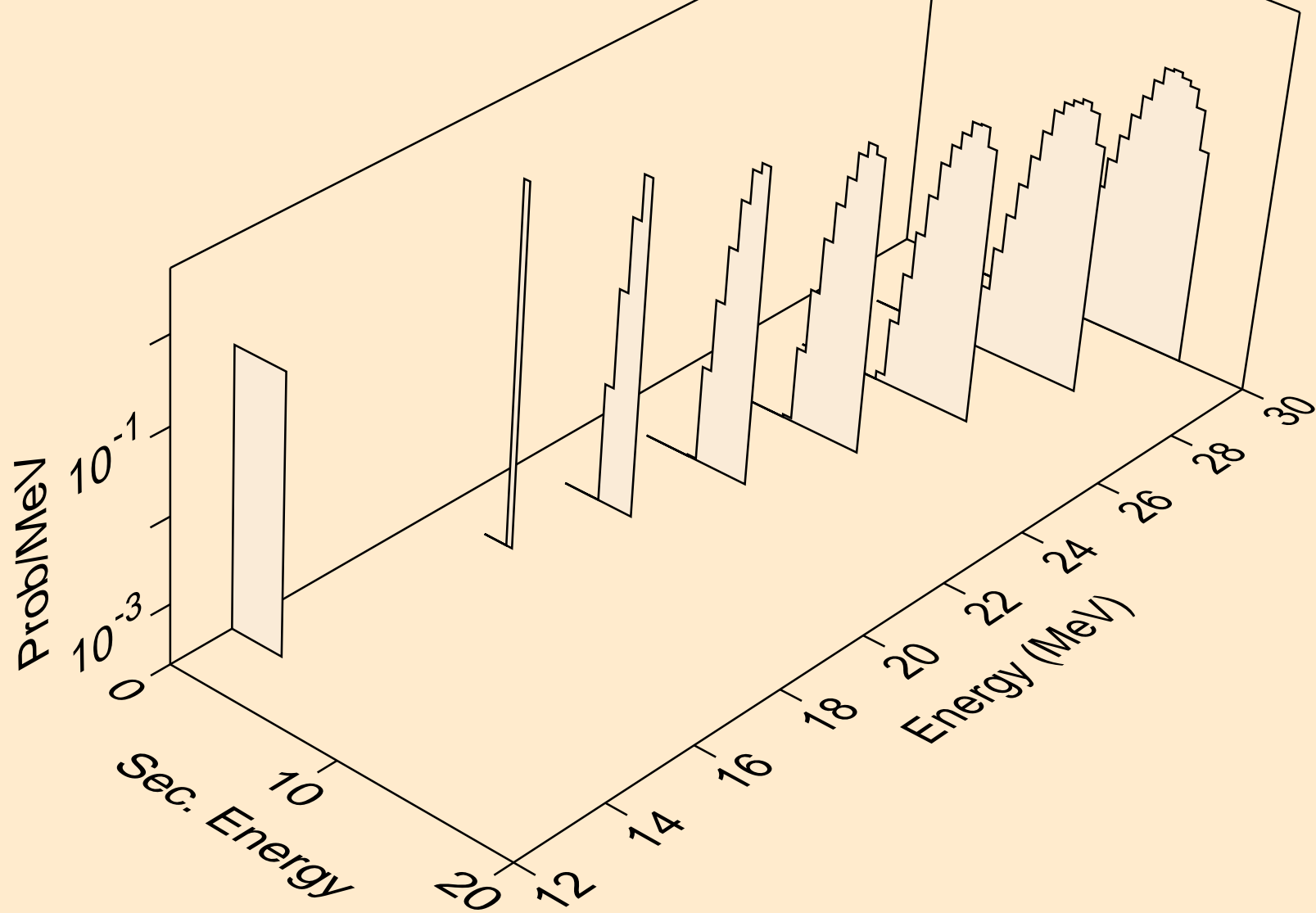

BA135M NEUTRON ACER TENDL-2024 LIBRARY; T=0.K
he3s from (n,he3)

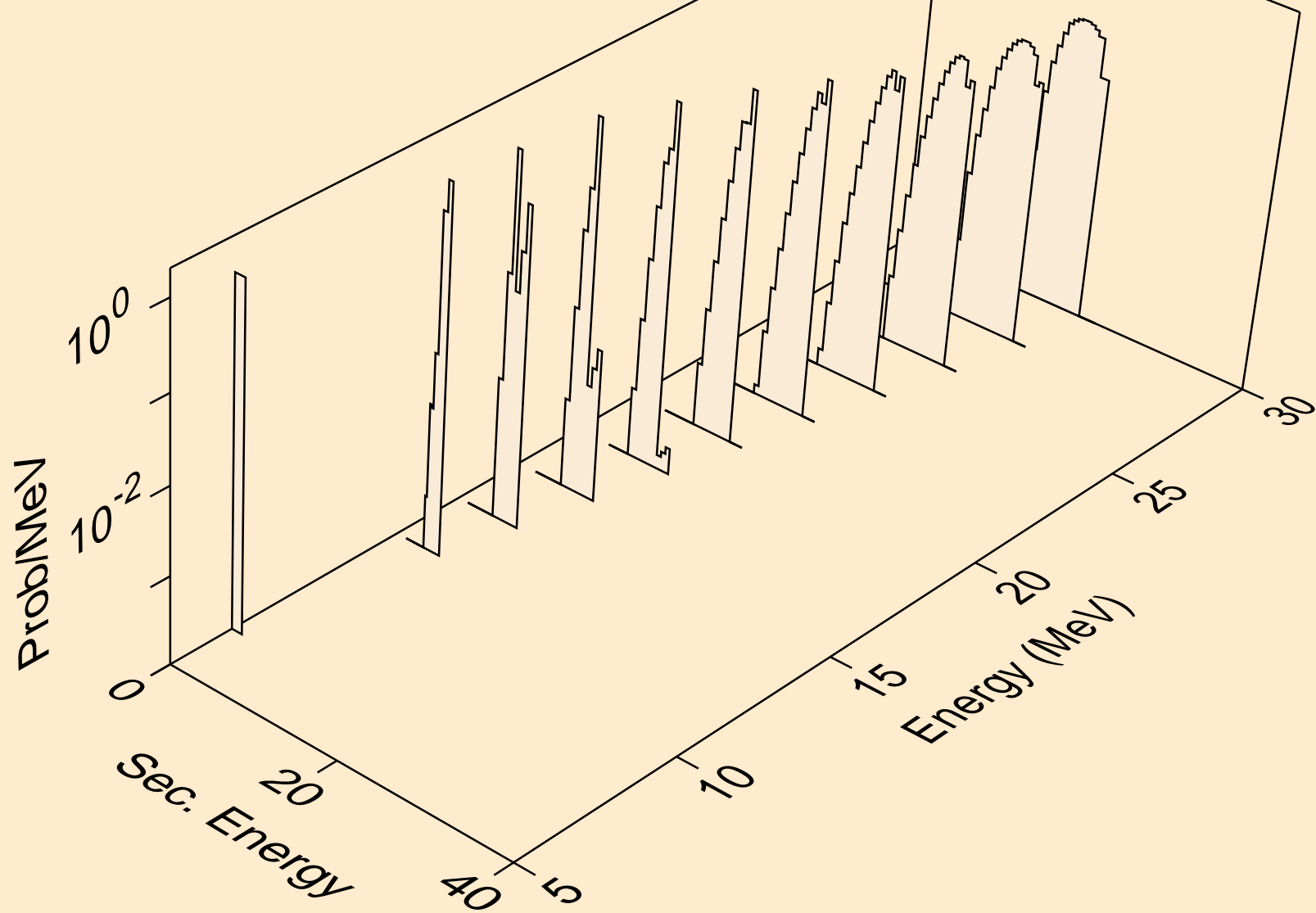

BA135M NEUTRON ACER TENDL-2024 LIBRARY; T=0.K
alphas from (n,x)

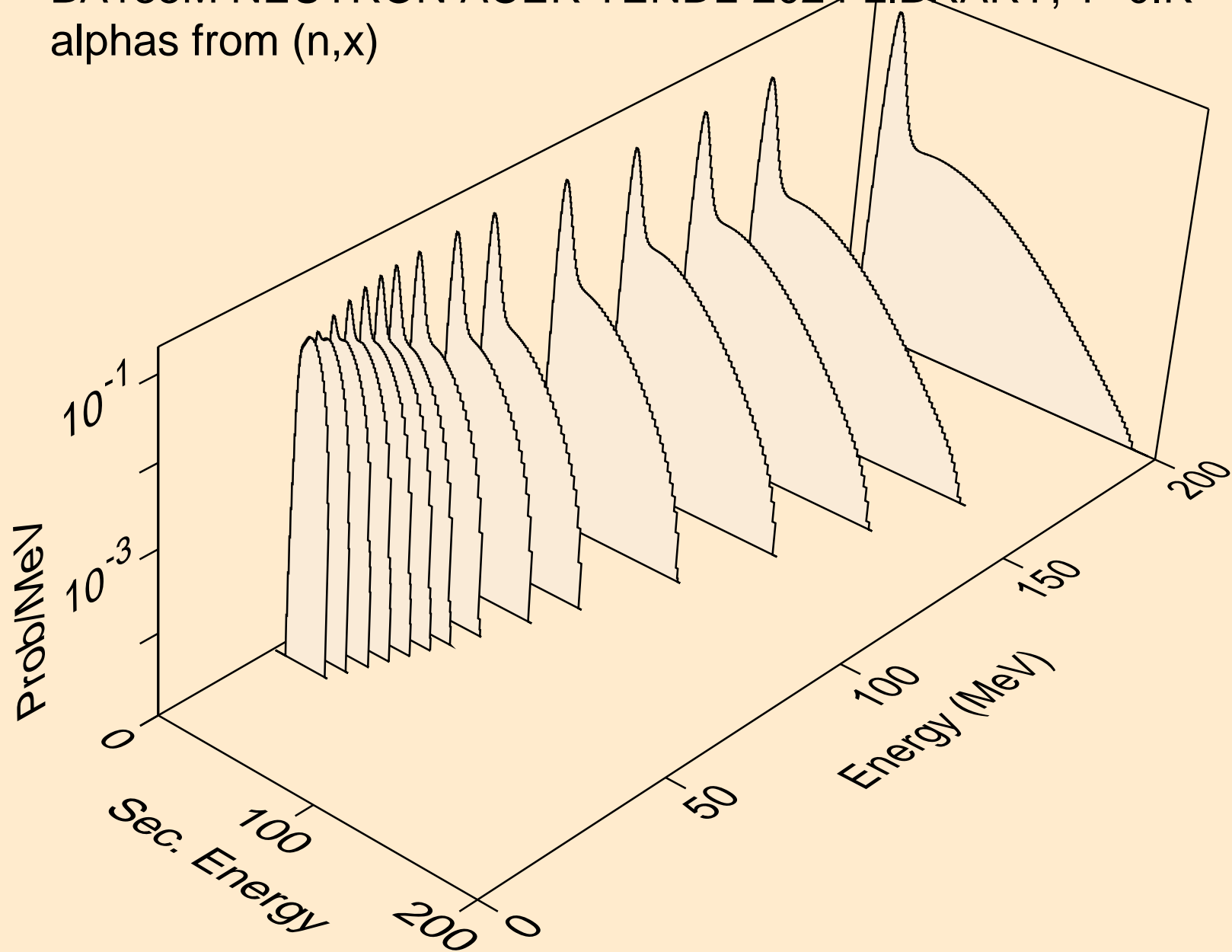

BA135M NEUTRON ACER TENDL-2024 LIBRARY; T=0.K
alphas from (n,n*)a

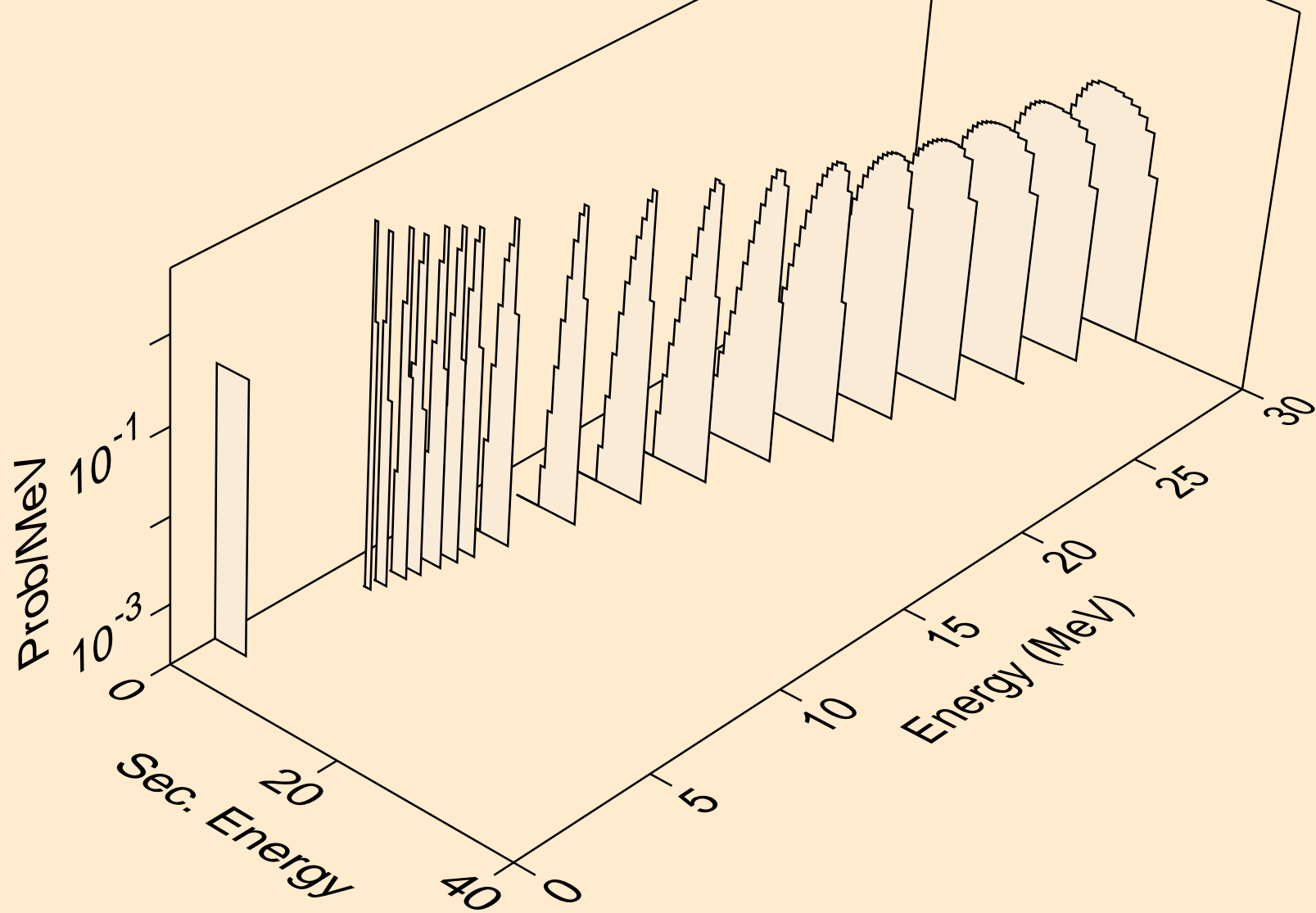

BA135M NEUTRON ACER TENDL-2024 LIBRARY; T=0.K
alphas from (n,2n)a

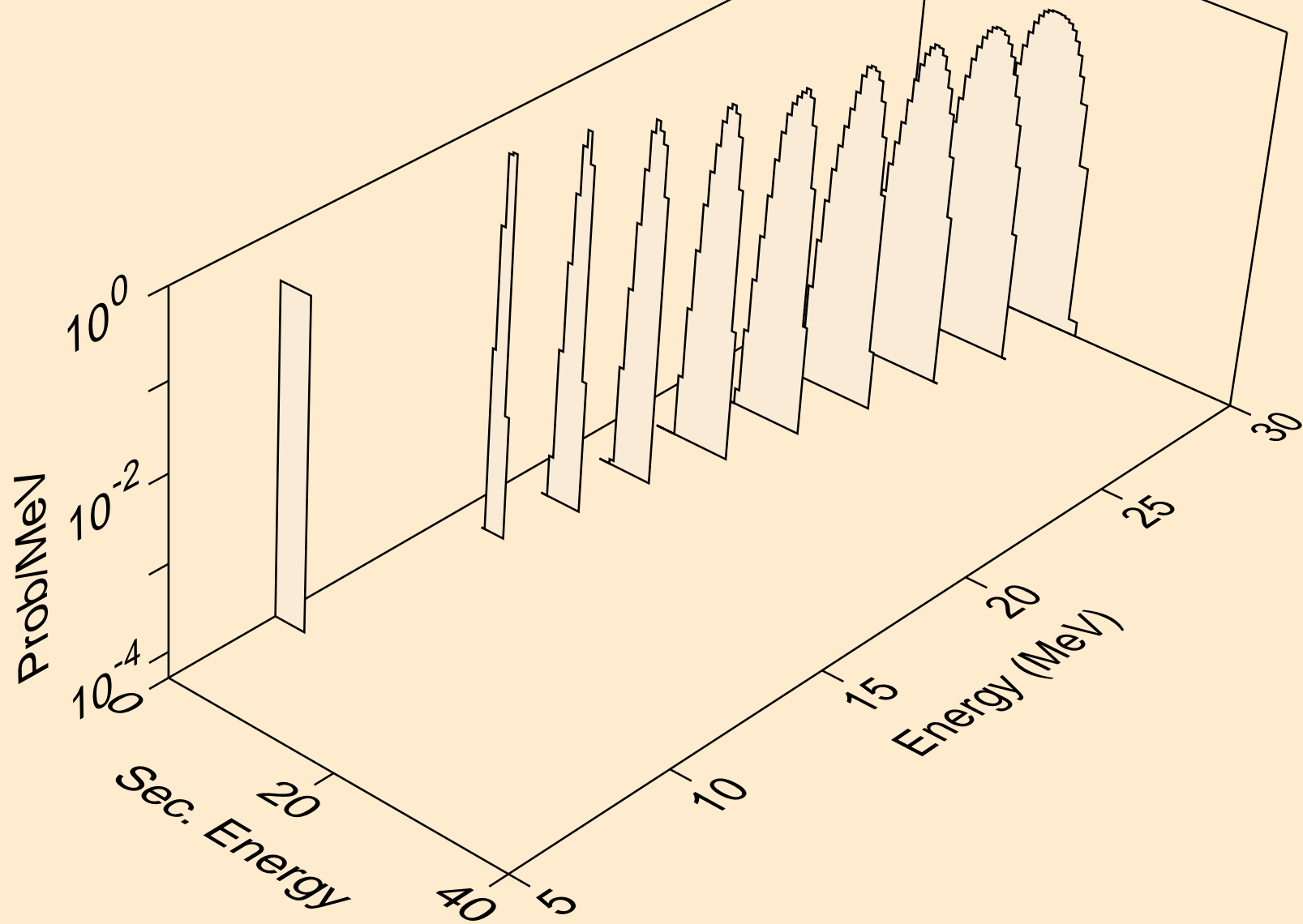

BA135M NEUTRON ACER TENDL-2024 LIBRARY; T=0.K
alphas from (n,3n)a

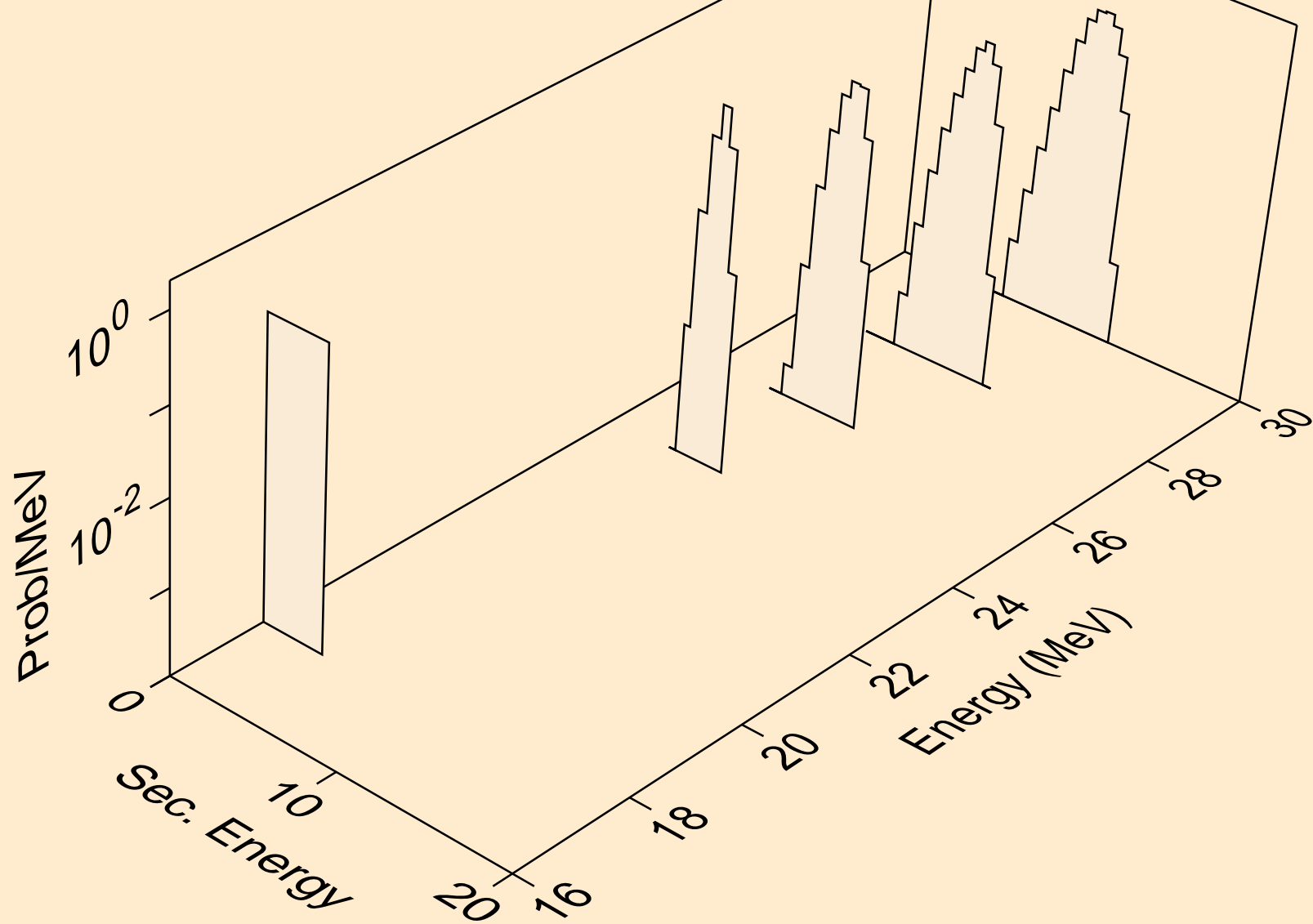

BA135M NEUTRON ACER TENDL-2024 LIBRARY; T=0.K
alphas from (n,n*)2a

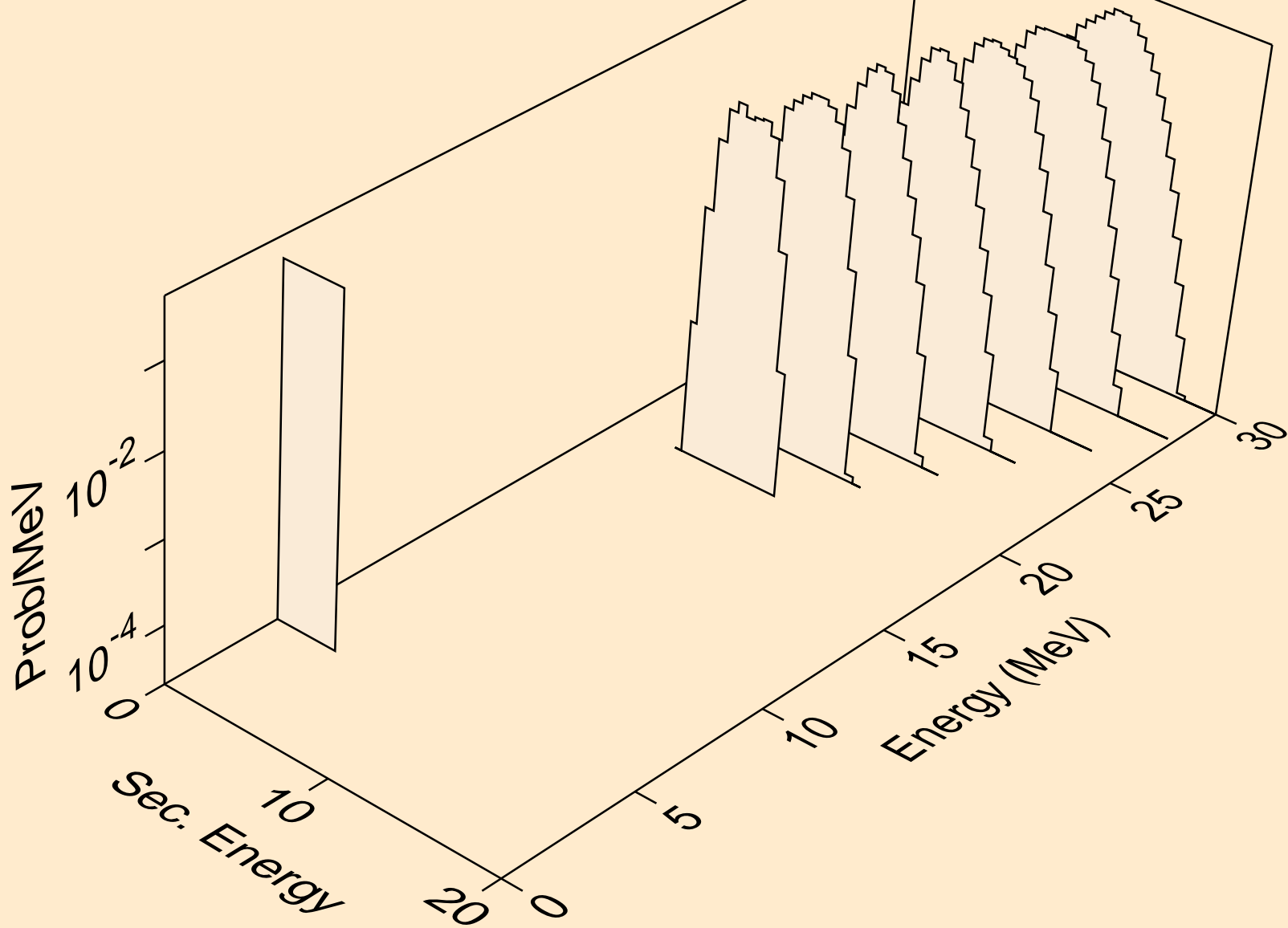

BA135M NEUTRON ACER TENDL-2024 LIBRARY; T=0.K
alphas from (n,npa)

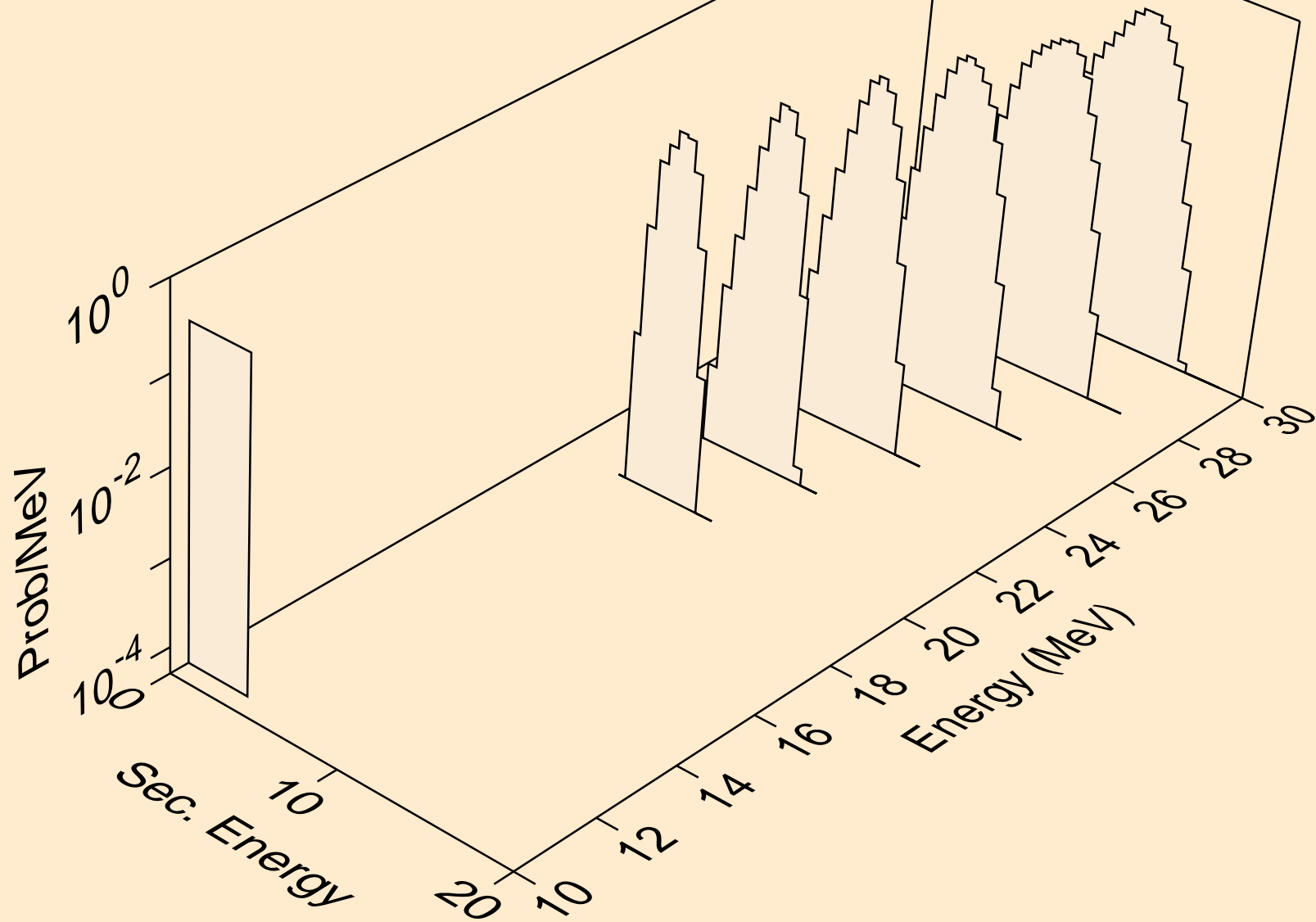

BA135M NEUTRON ACER TENDL-2024 LIBRARY; T=0.K
alphas from (n,a)

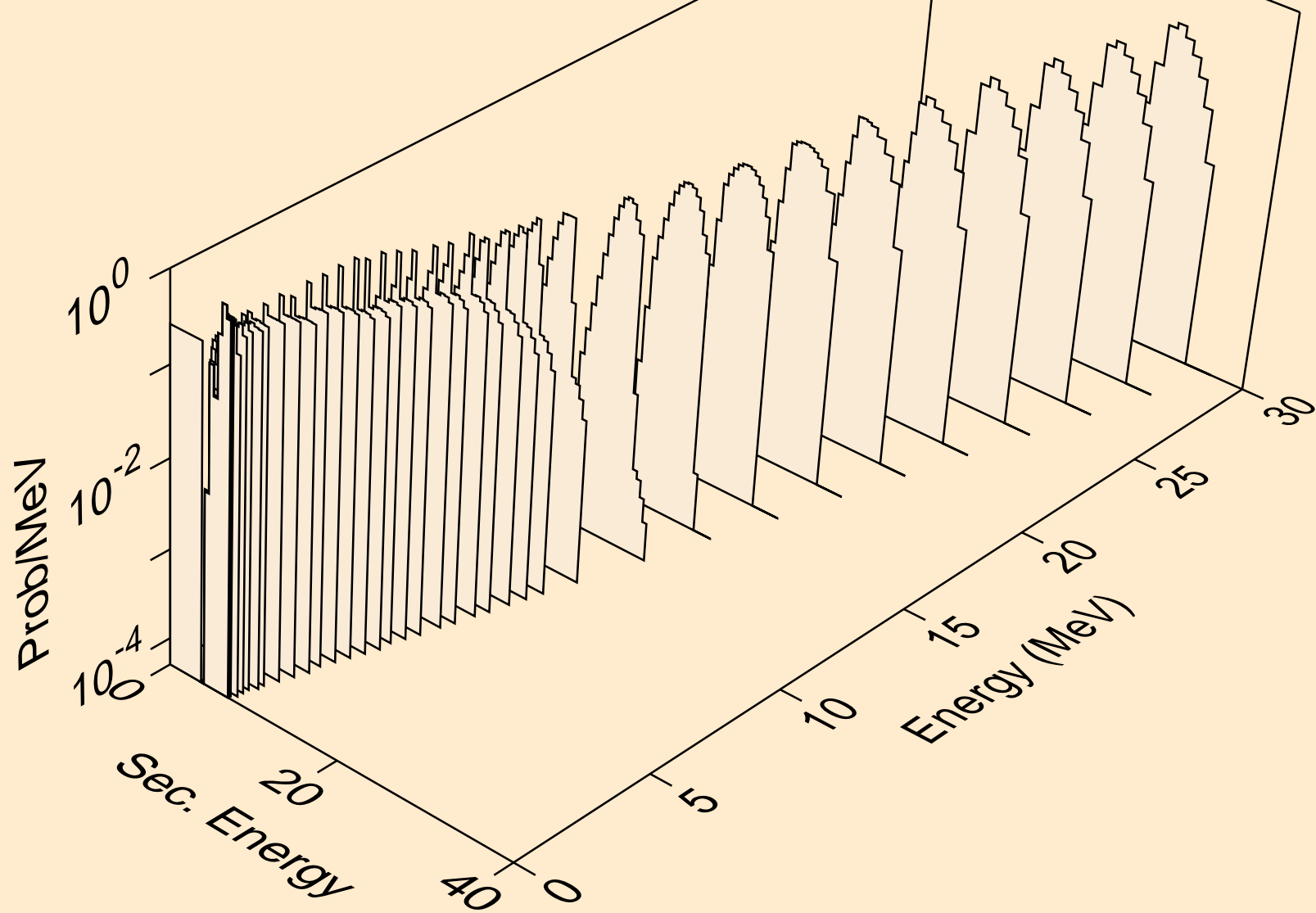

BA135M NEUTRON ACER TENDL-2024 LIBRARY; T=0.K
alphas from (n,2a)

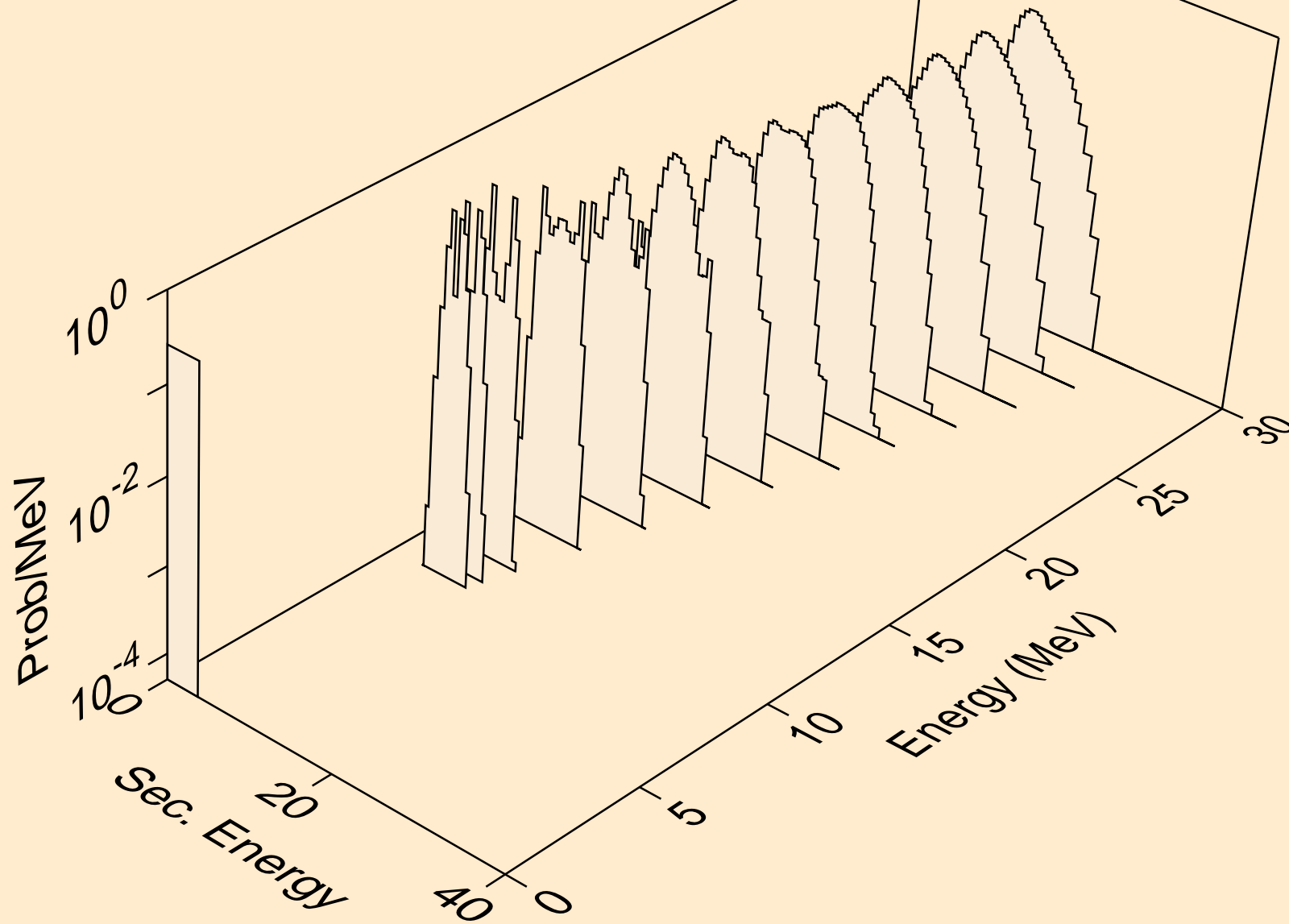

BA135M NEUTRON ACER TENDL-2024 LIBRARY; T=0.K
alphas from (n,pa)

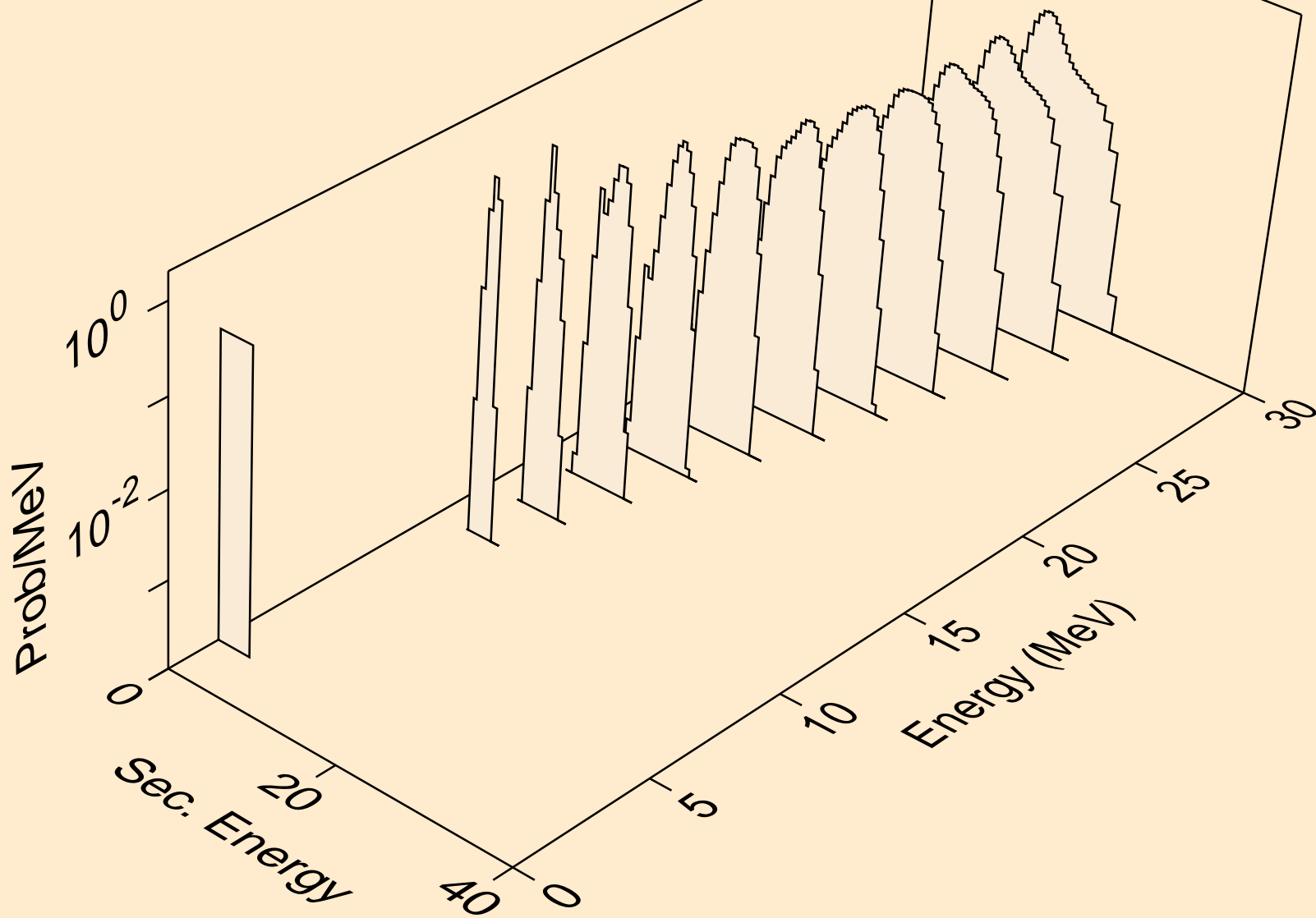

BA135M NEUTRON ACER TENDL-2024 LIBRARY; T=0.K
alphas from (n,da)

