

# BA138 NEUTRON ACER TENDL-2024 LIBRARY; T=0.K

## Principal cross sections

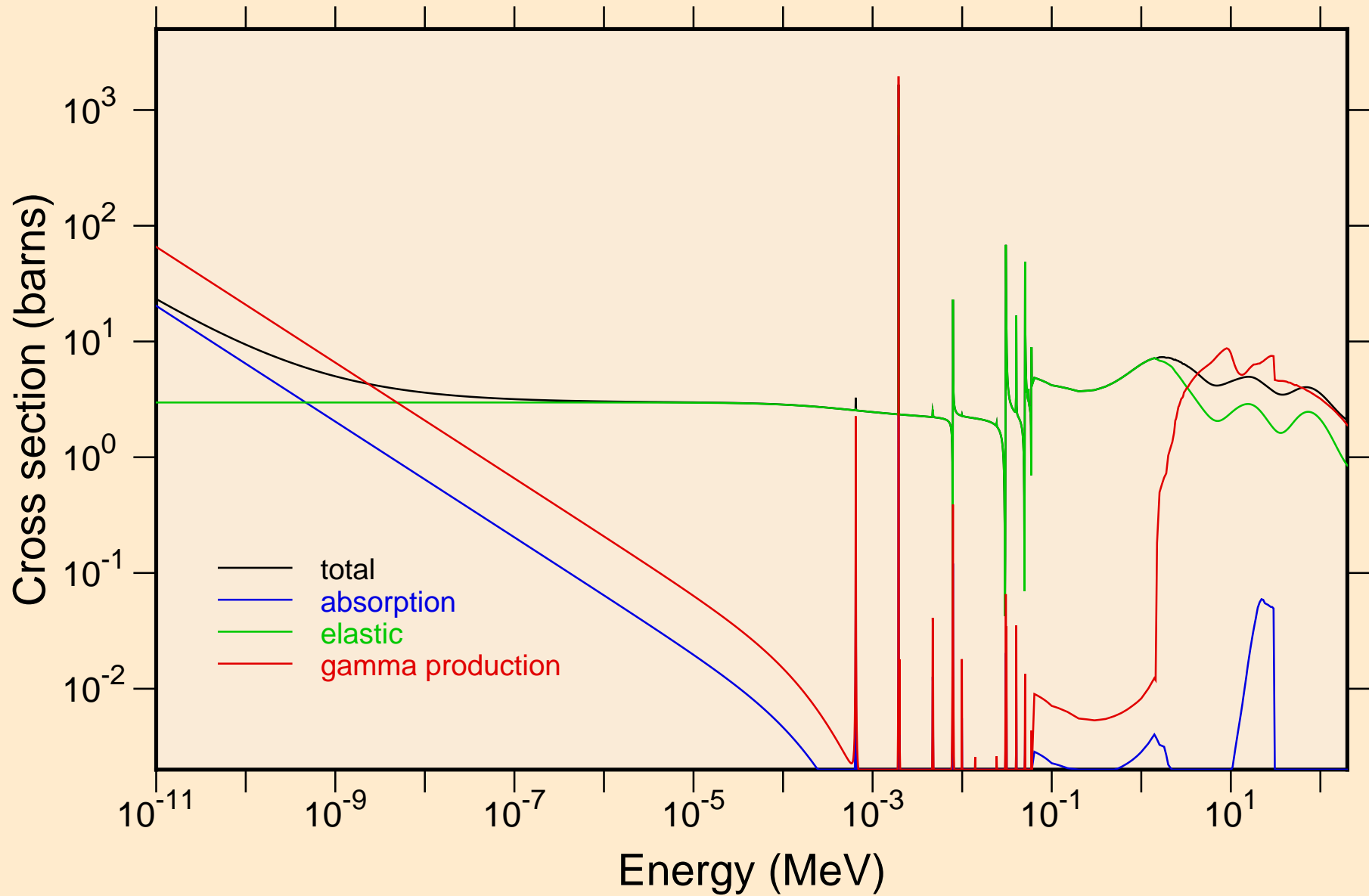

BA138 NEUTRON ACER TENDL-2024 LIBRARY; T=0.K  
resonance total cross section

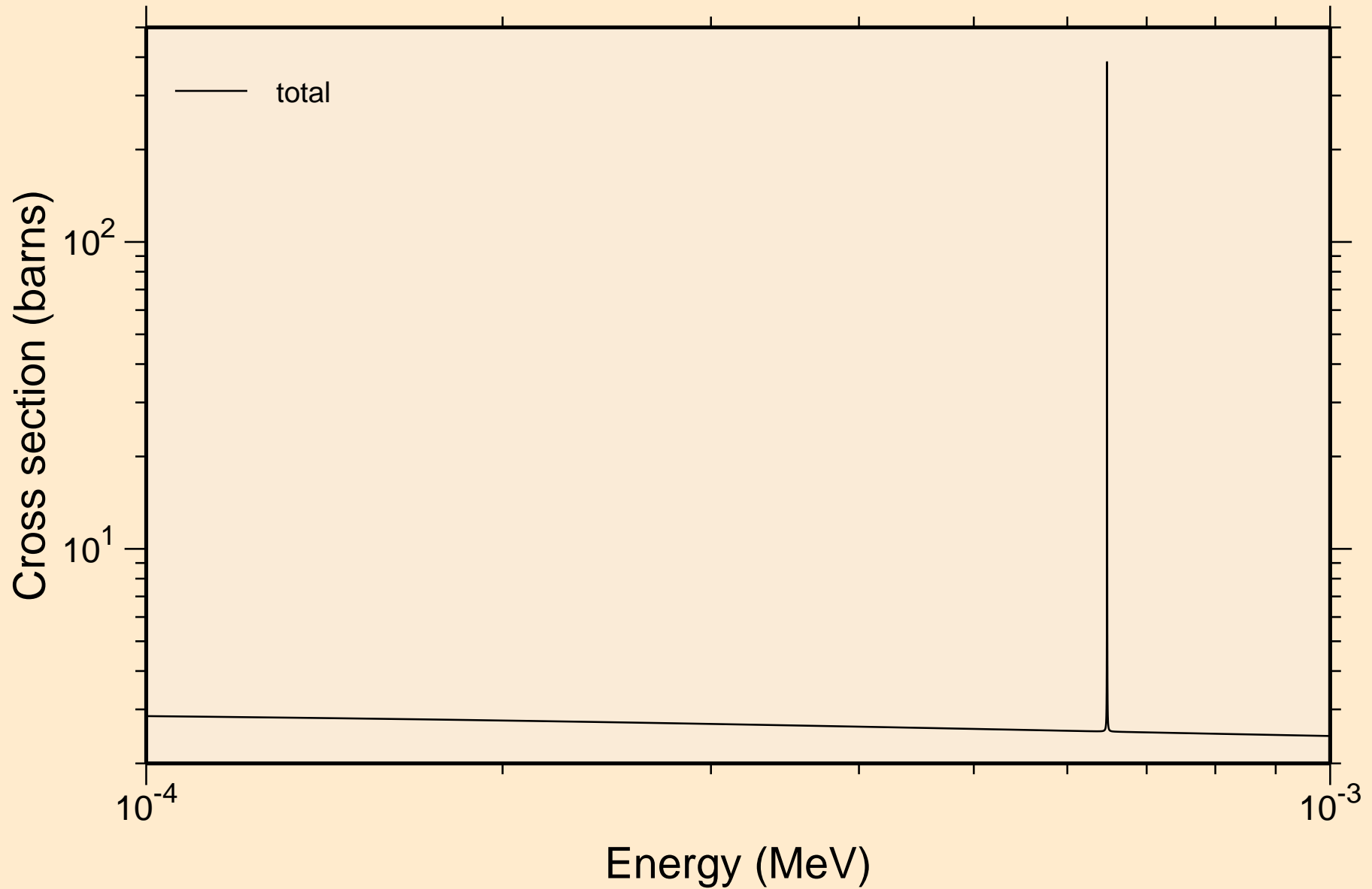

BA138 NEUTRON ACER TENDL-2024 LIBRARY; T=0.K  
resonance total cross section

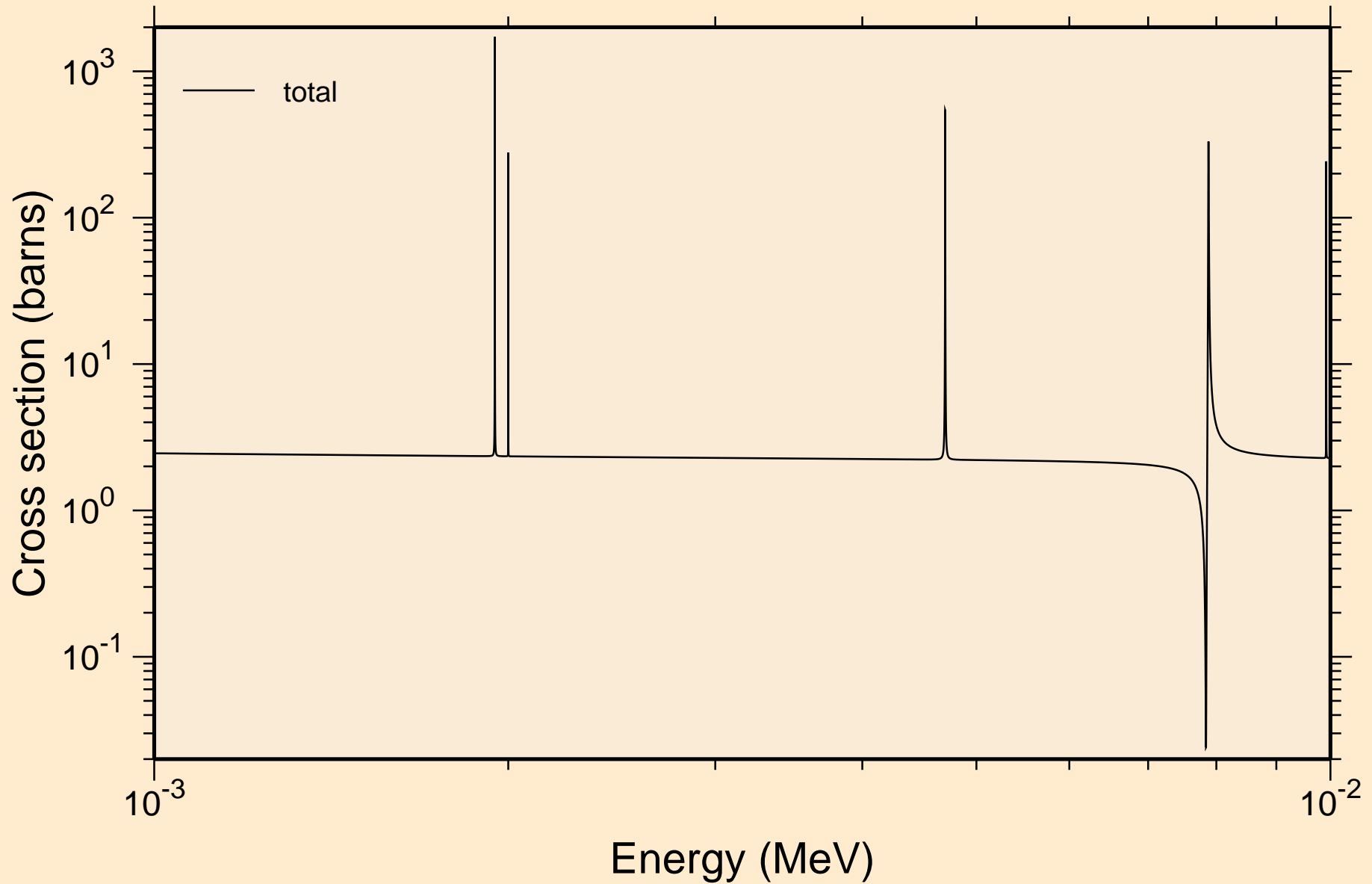

BA138 NEUTRON ACER TENDL-2024 LIBRARY; T=0.K  
resonance total cross section

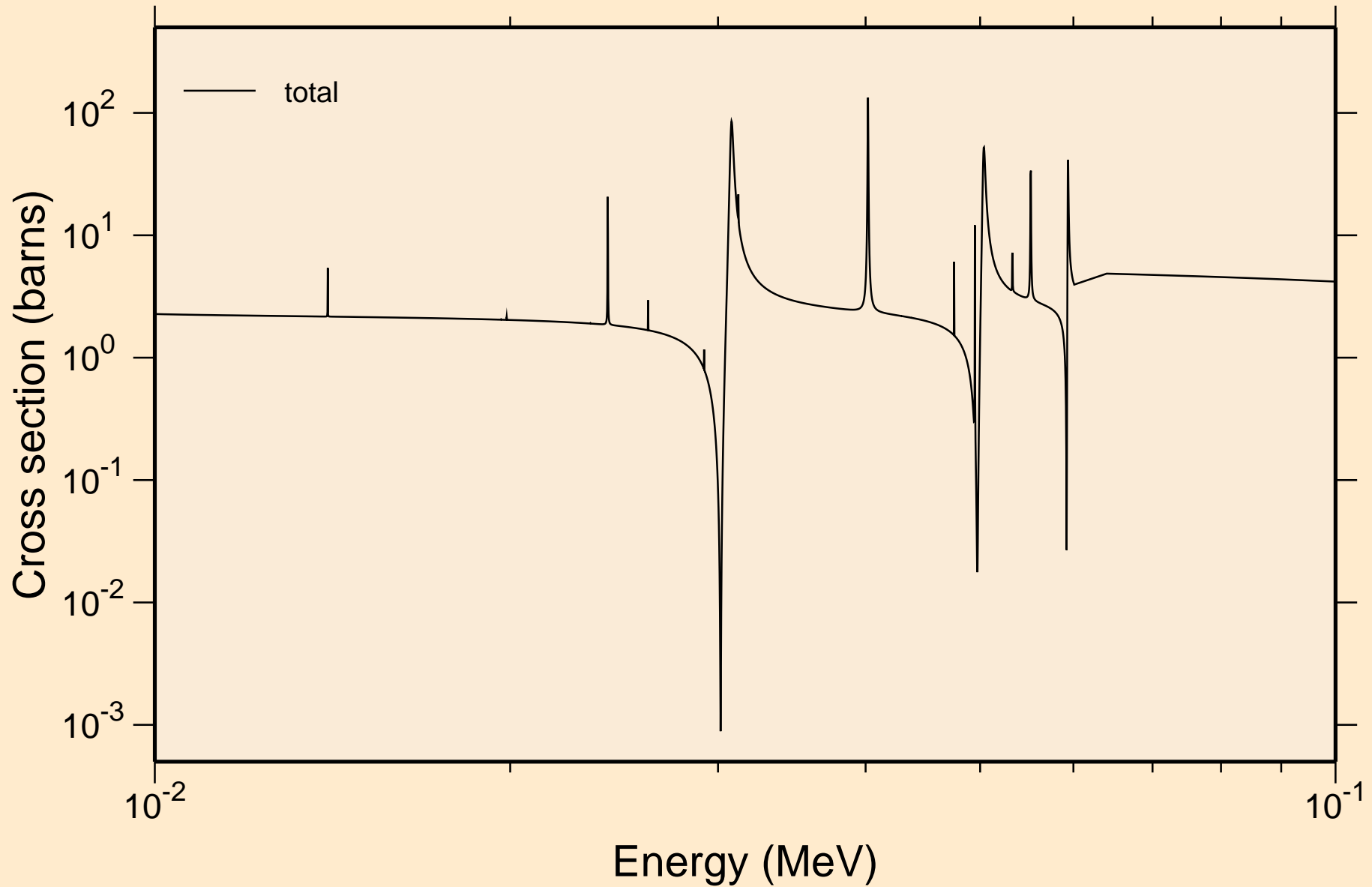

BA138 NEUTRON ACER TENDL-2024 LIBRARY; T=0.K  
resonance total cross section

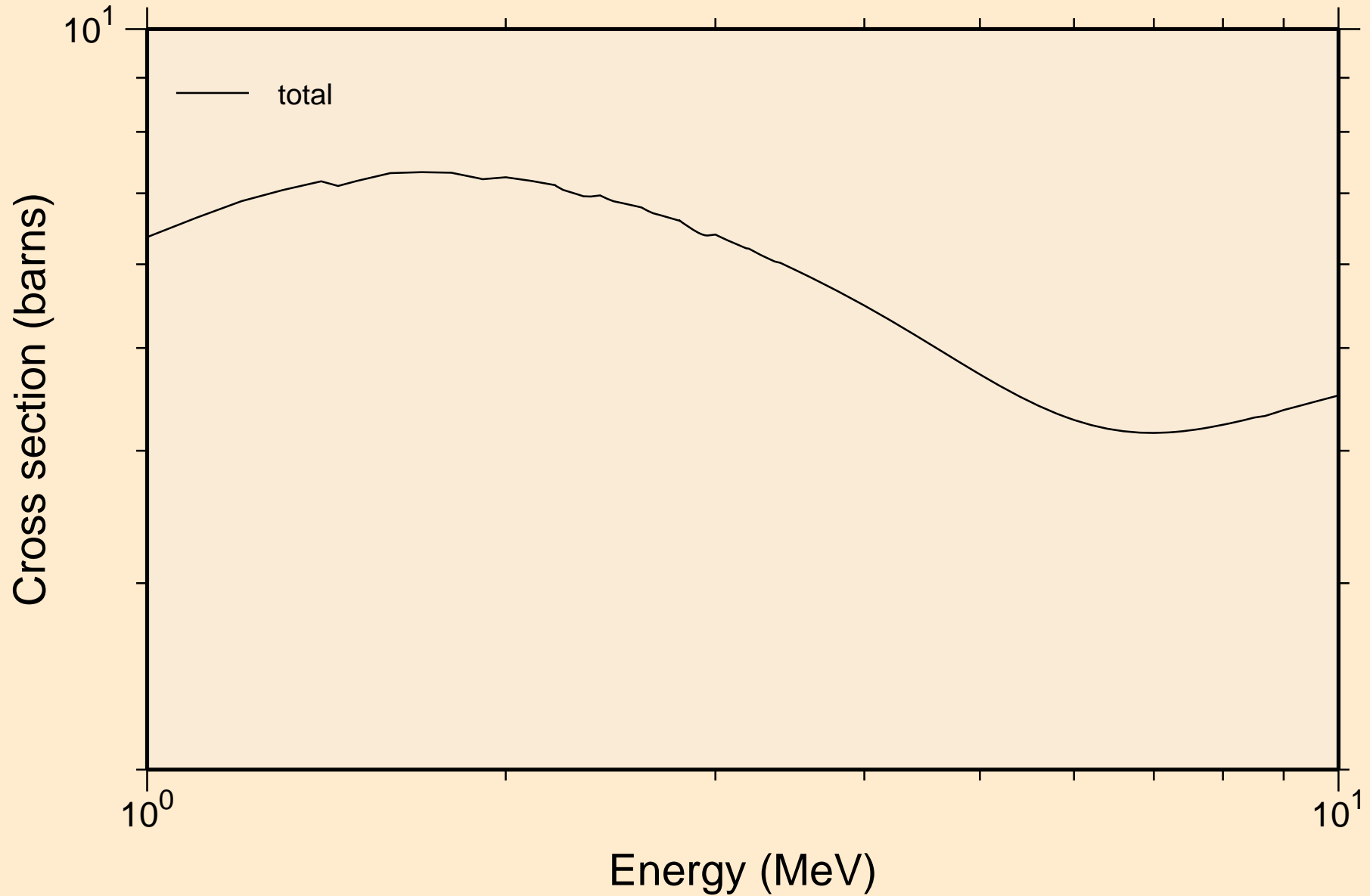

BA138 NEUTRON ACER TENDL-2024 LIBRARY; T=0.K  
resonance absorption cross sections

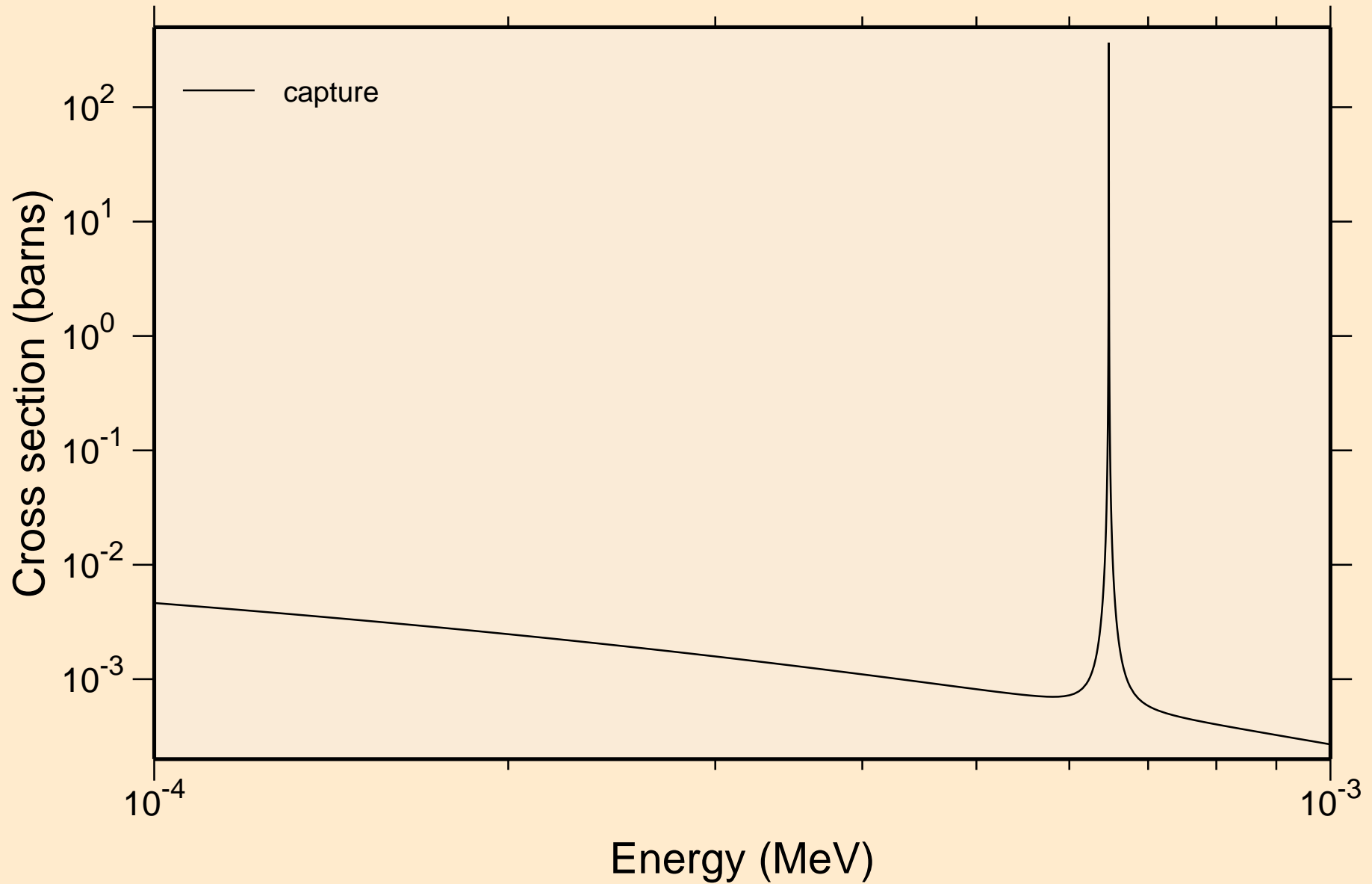

BA138 NEUTRON ACER TENDL-2024 LIBRARY; T=0.K  
resonance absorption cross sections

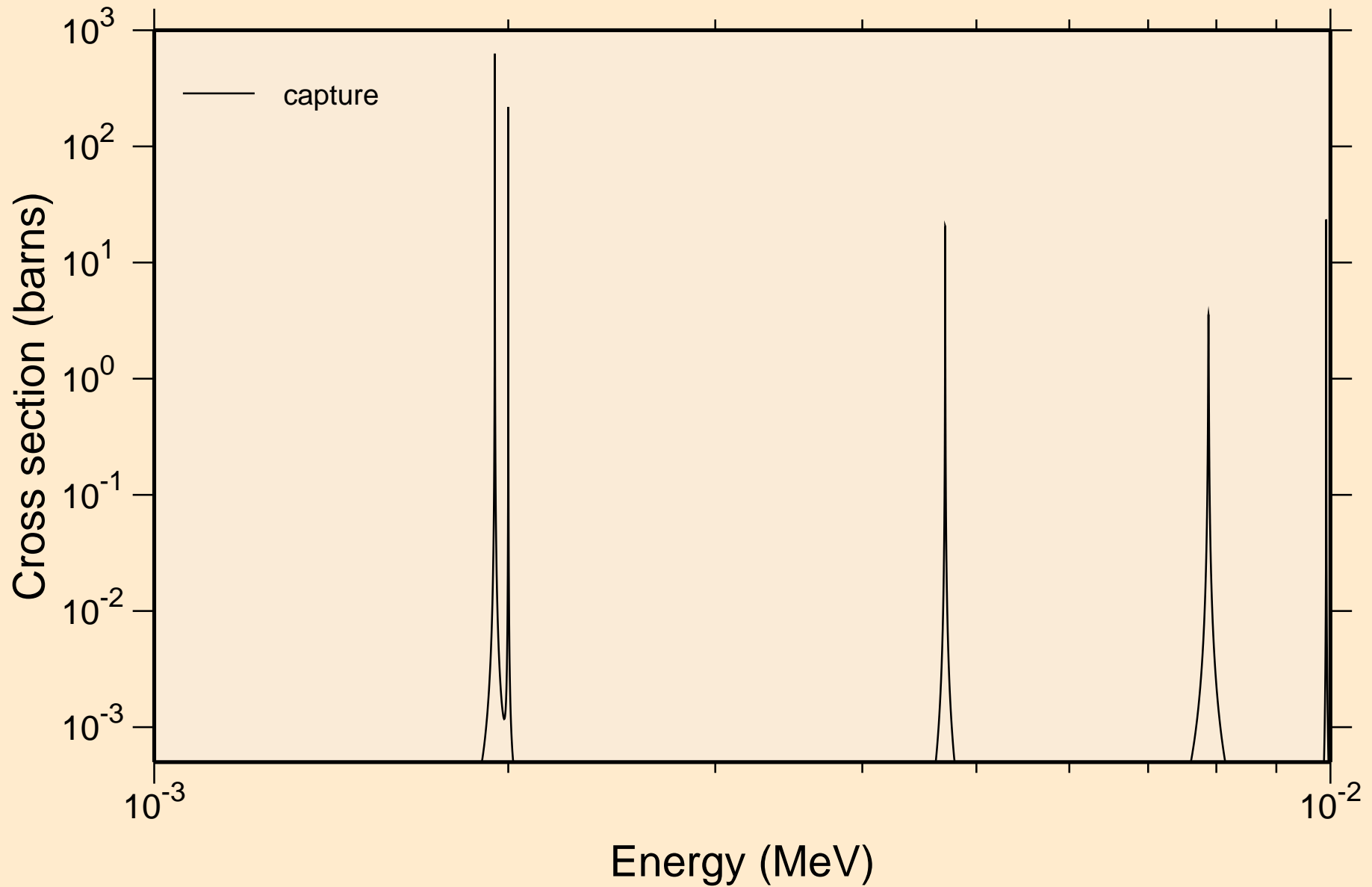

BA138 NEUTRON ACER TENDL-2024 LIBRARY; T=0.K  
resonance absorption cross sections

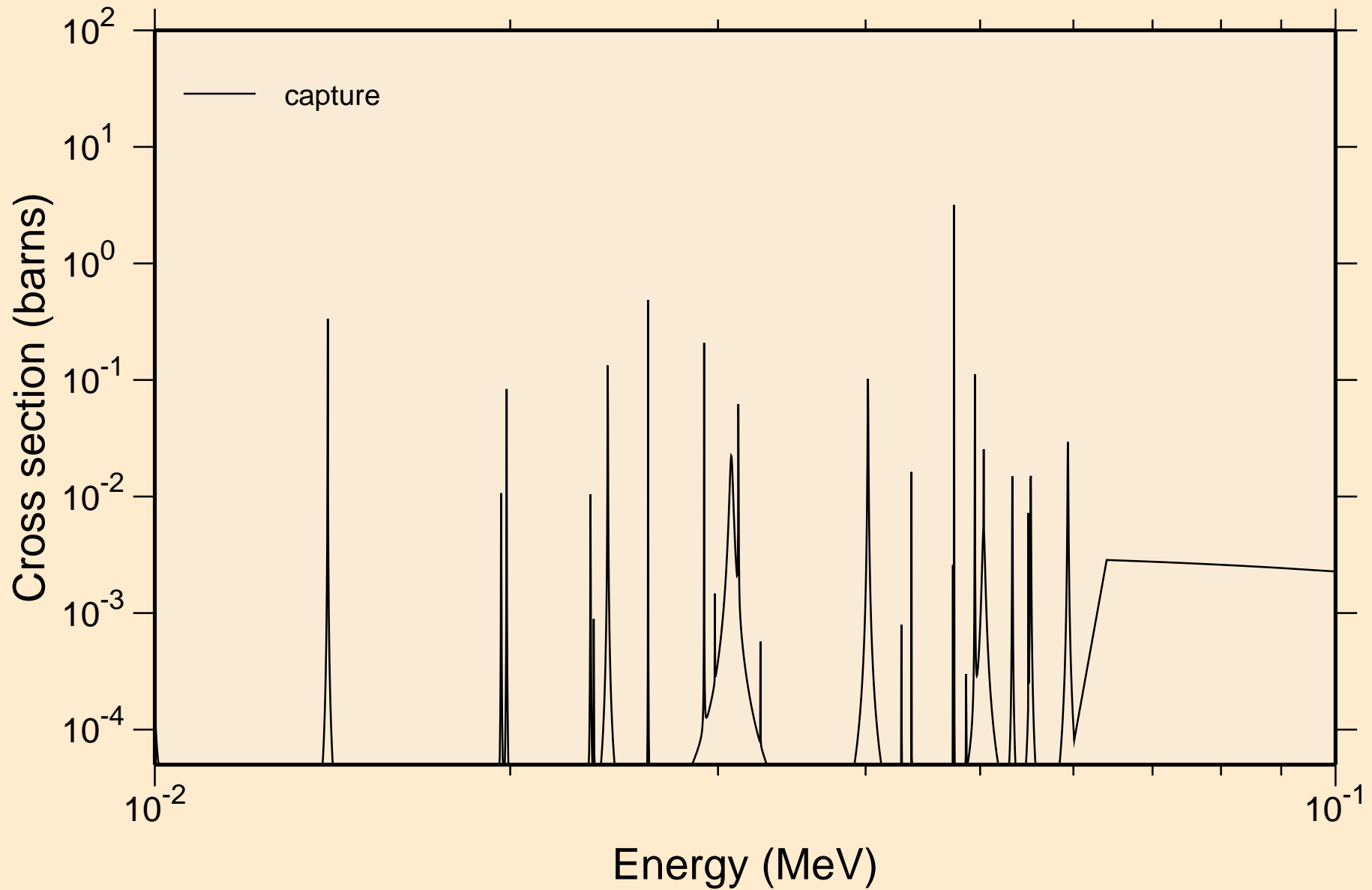



BA138 NEUTRON ACER TENDL-2024 LIBRARY; T=0.K  
resonance absorption cross sections

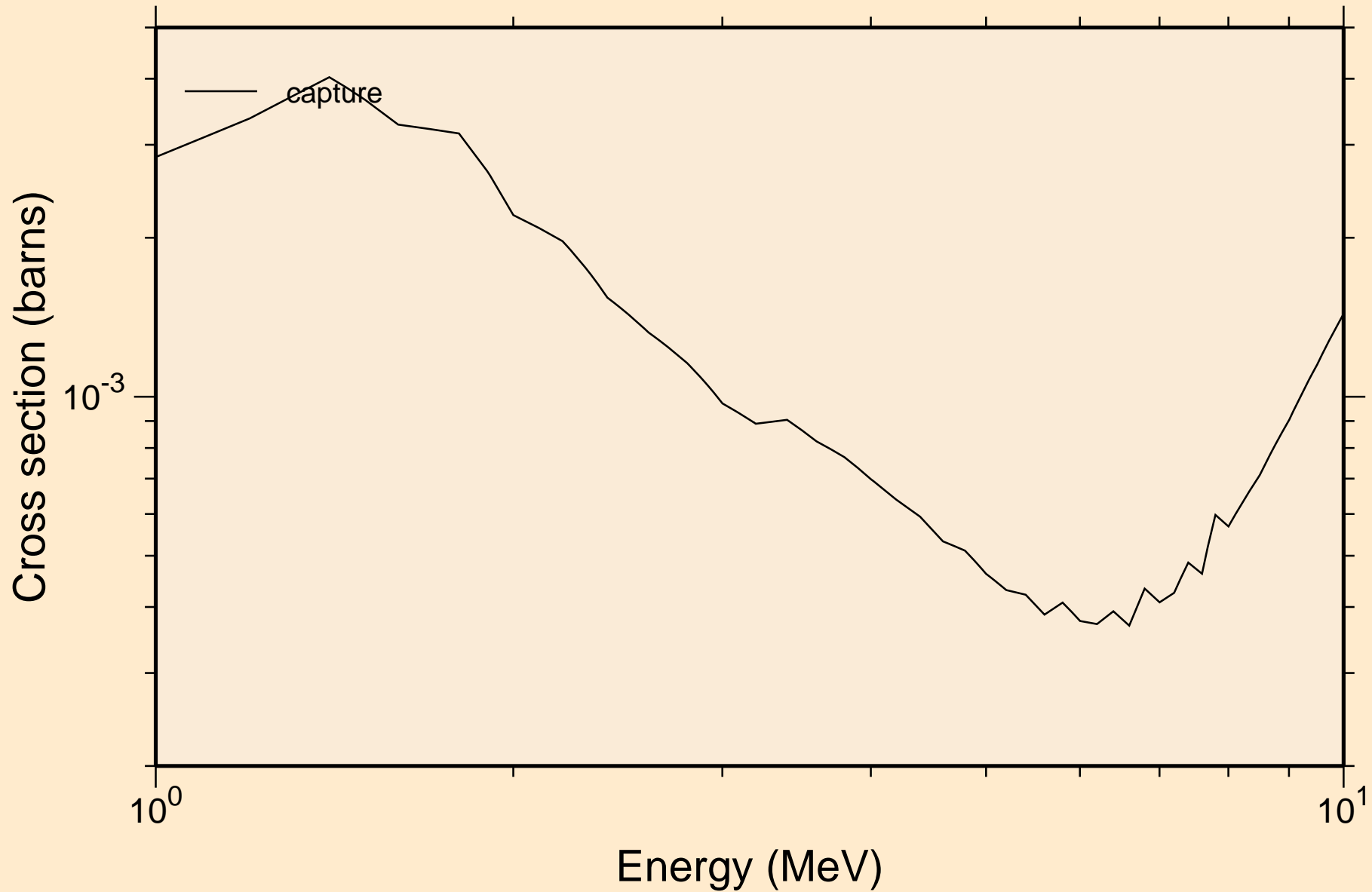

BA138 NEUTRON ACER TENDL-2024 LIBRARY; T=0.K  
Heating

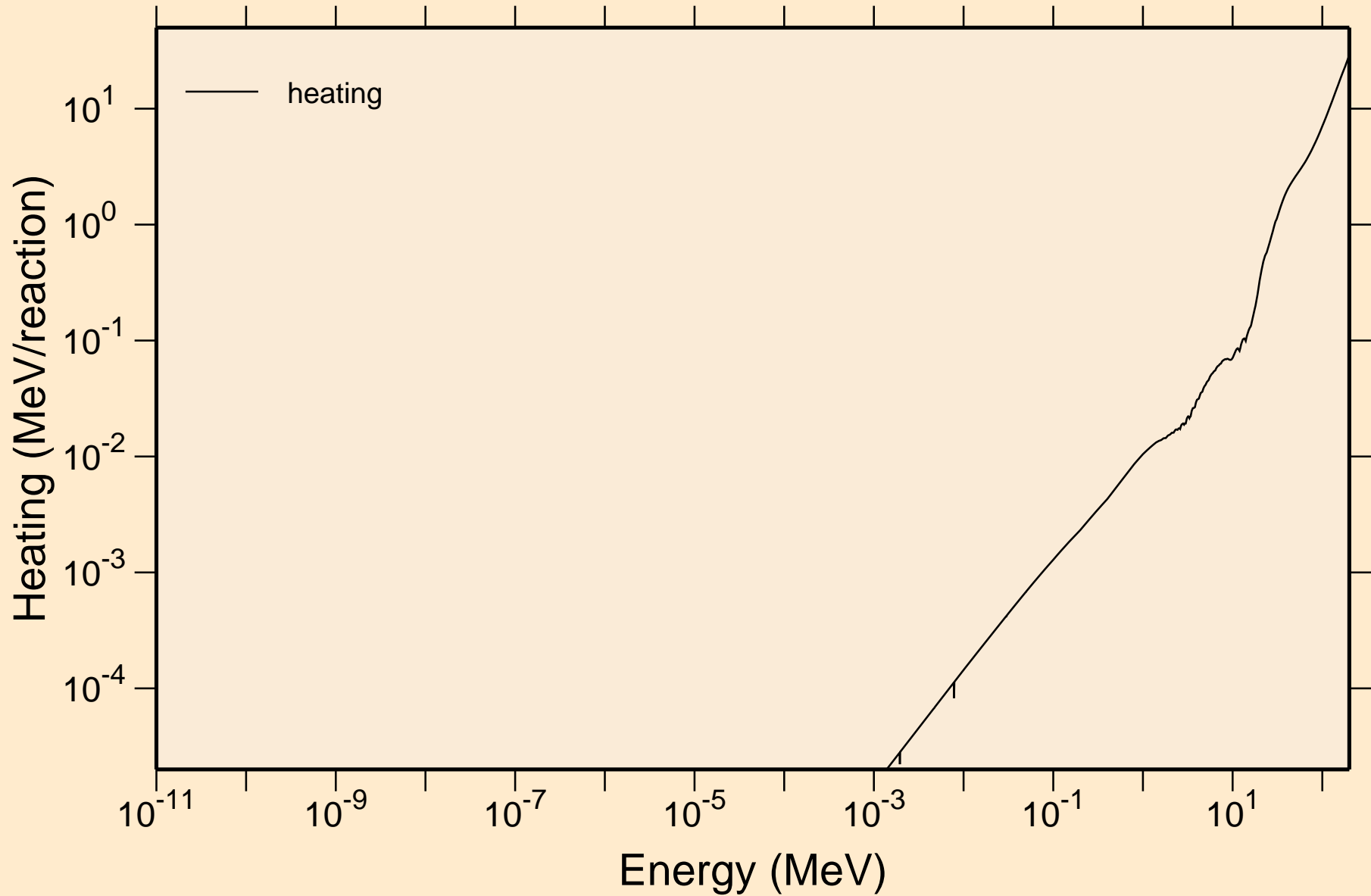

BA138 NEUTRON ACER TENDL-2024 LIBRARY; T=0.K  
Damage

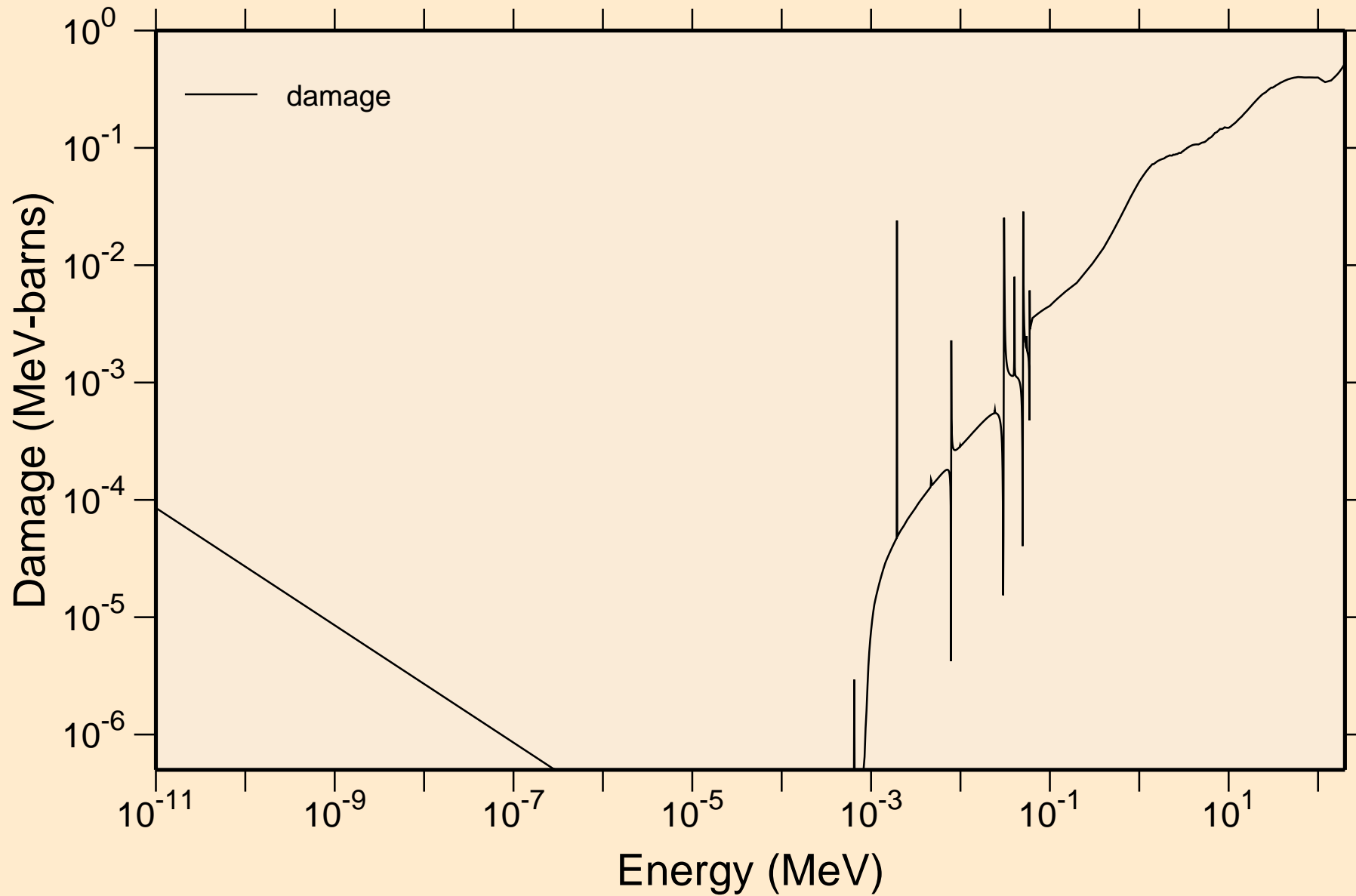

# BA138 NEUTRON ACER TENDL-2024 LIBRARY; T=0.K

## Non-threshold reactions

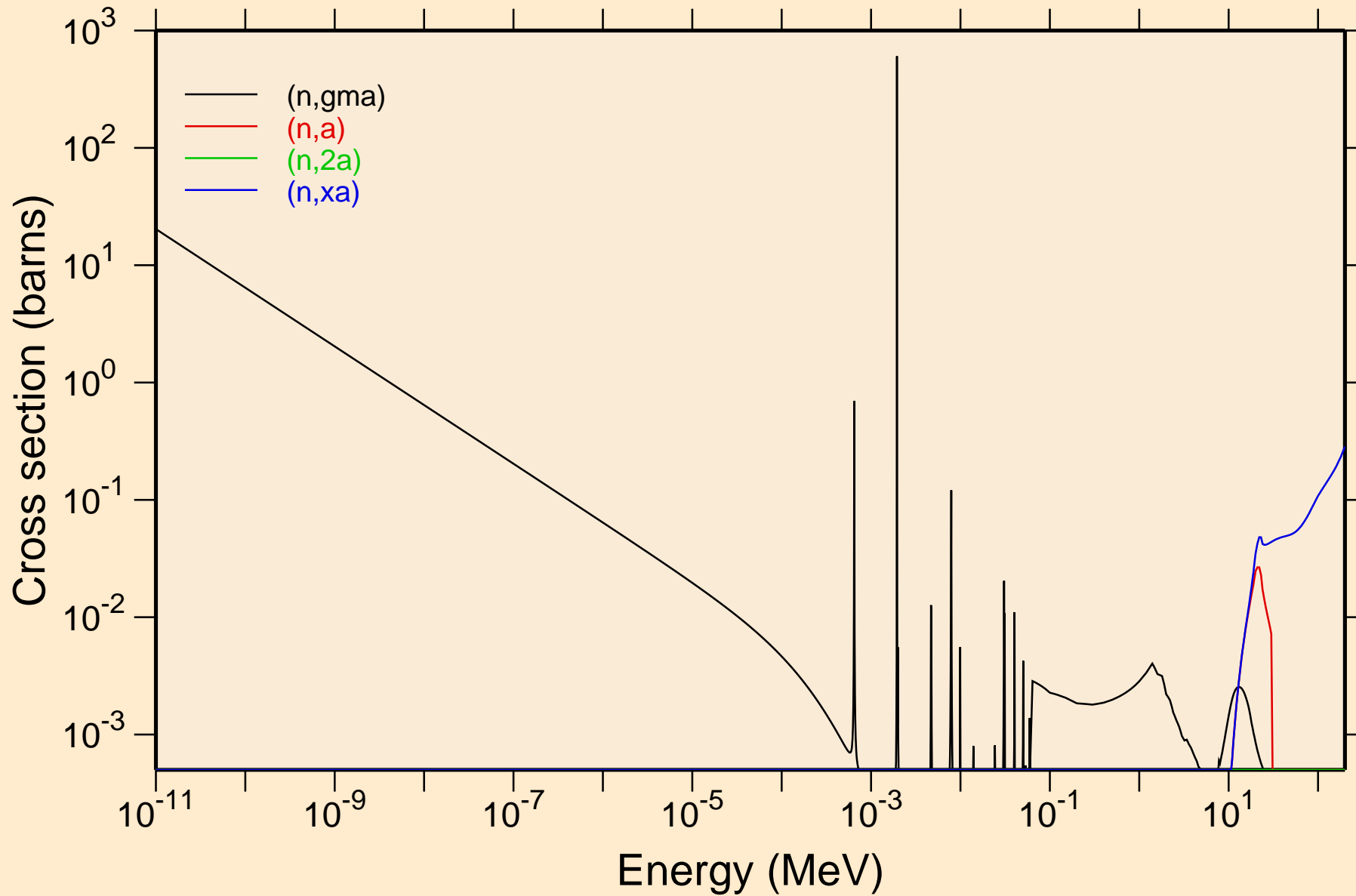

# BA138 NEUTRON ACER TENDL-2024 LIBRARY; T=0.K

## Principal cross sections

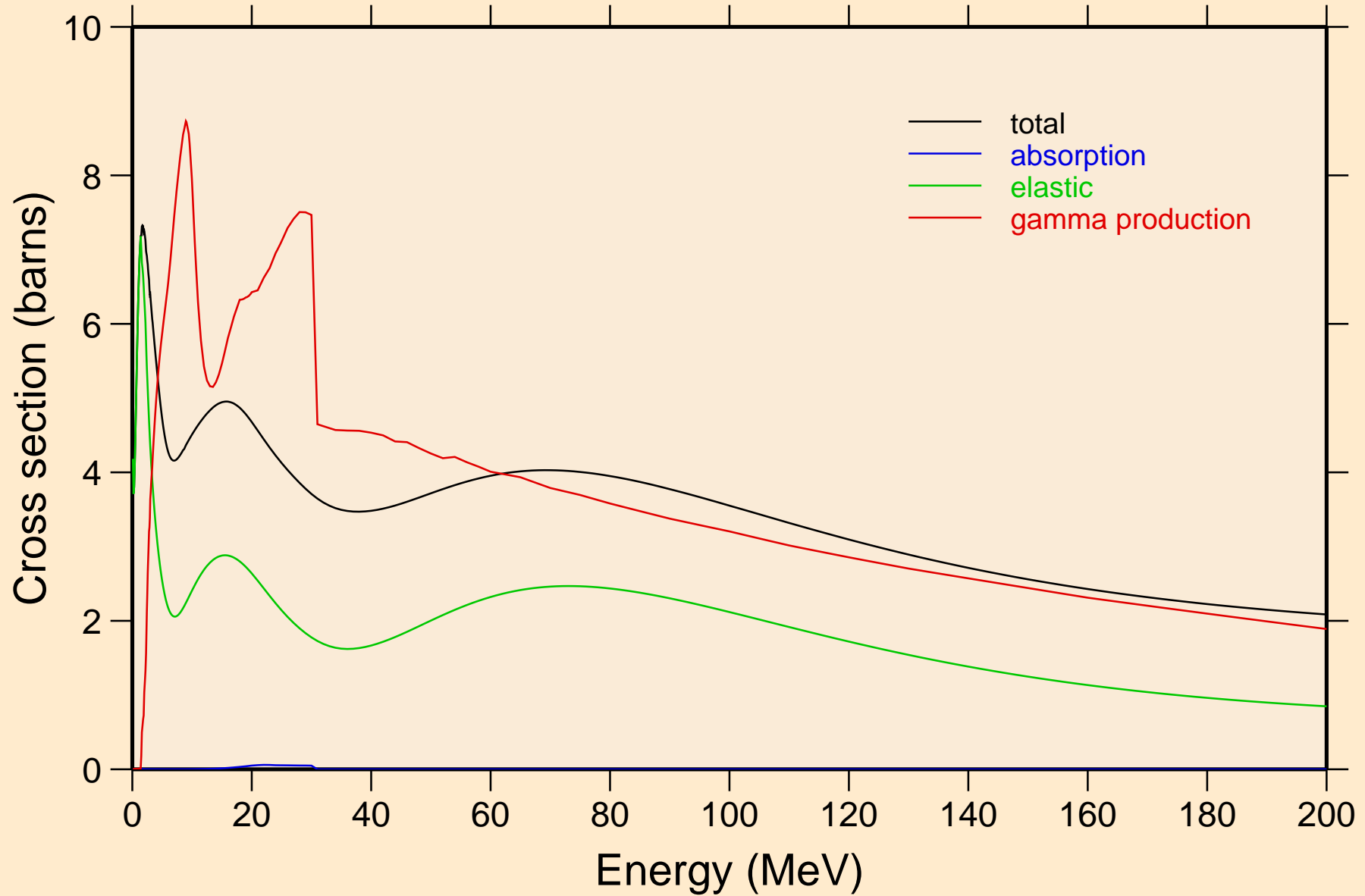

# BA138 NEUTRON ACER TENDL-2024 LIBRARY; T=0.K

## Heating

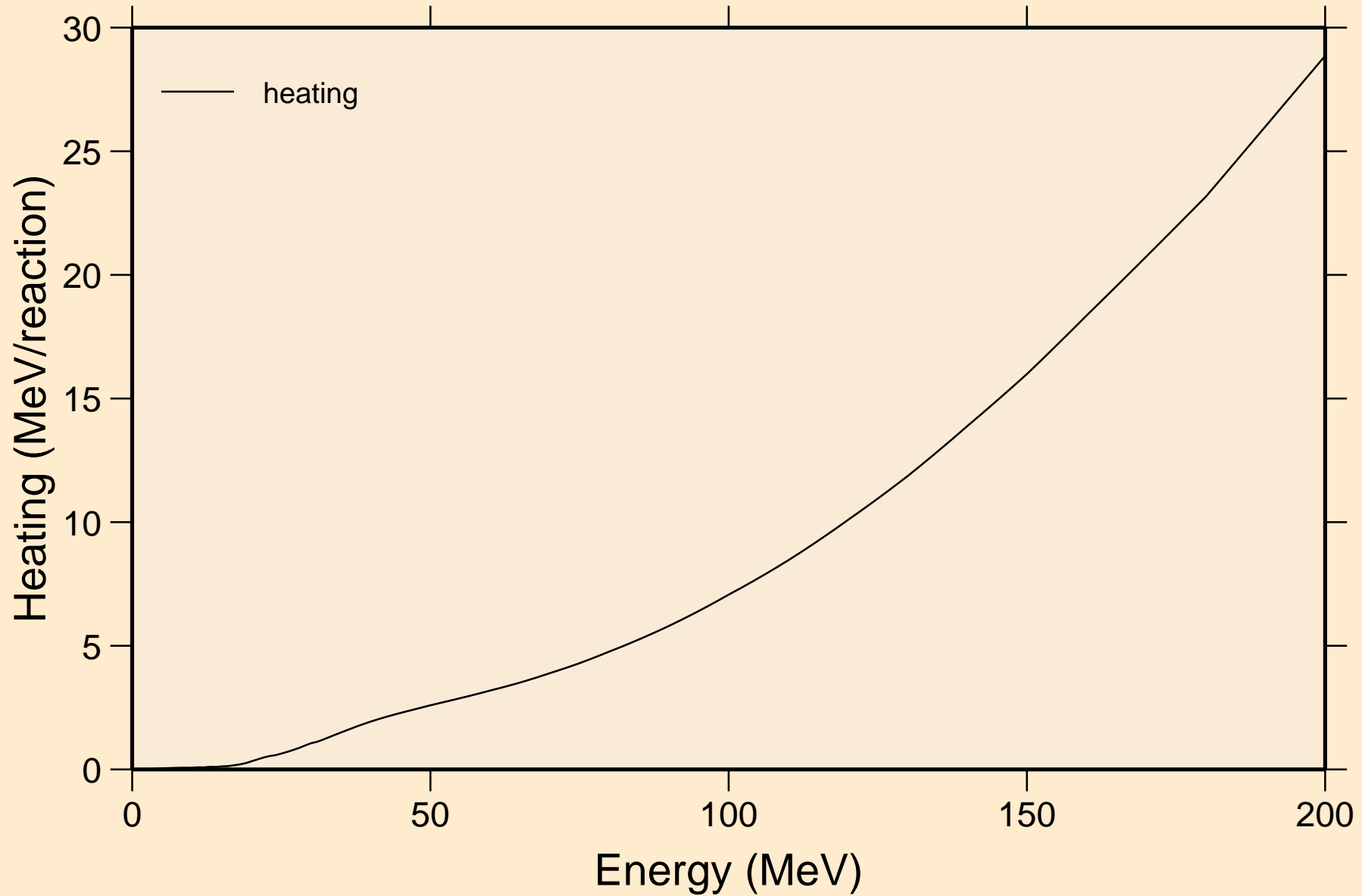

BA138 NEUTRON ACER TENDL-2024 LIBRARY; T=0.K  
Damage

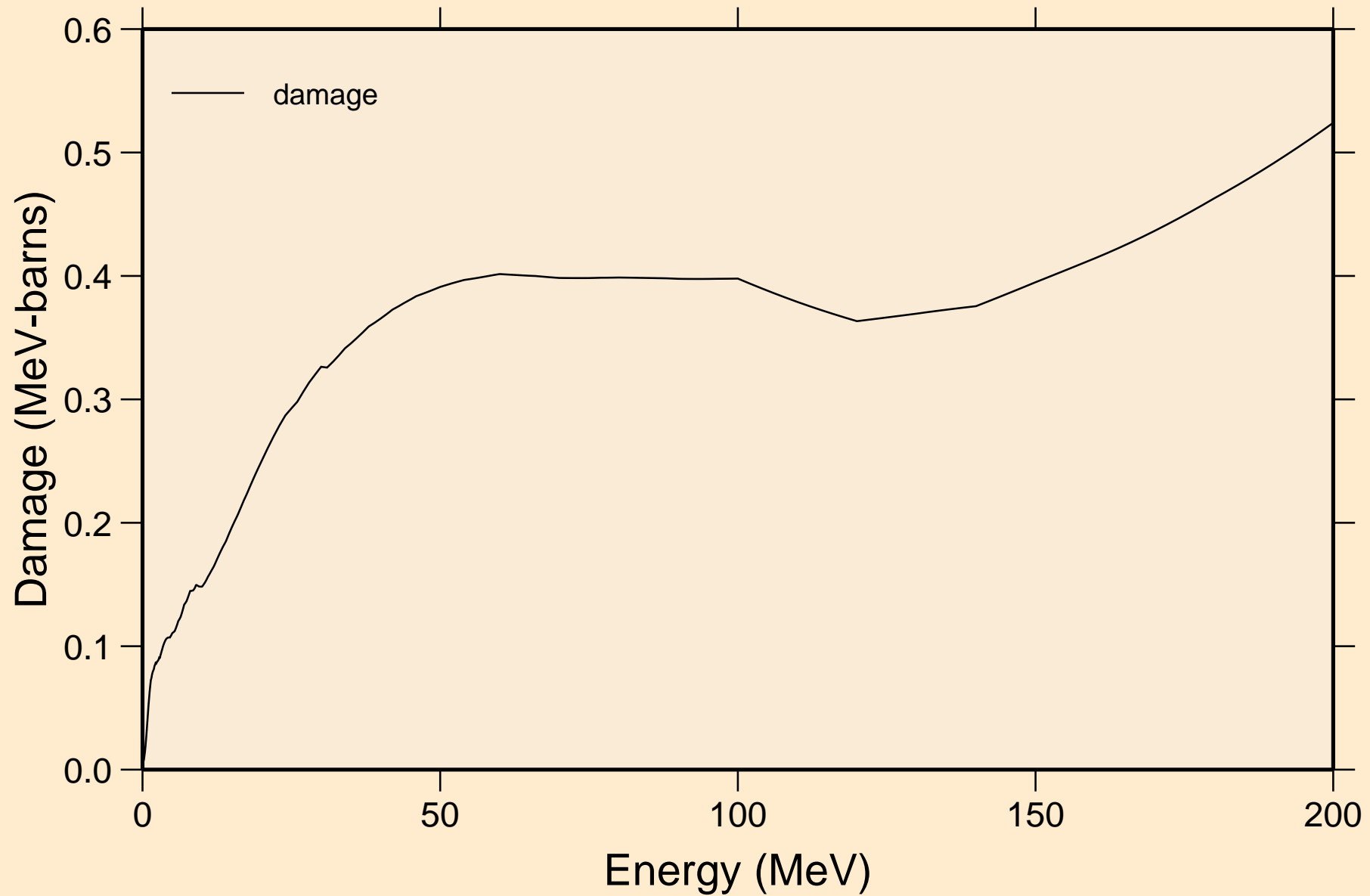

# BA138 NEUTRON ACER TENDL-2024 LIBRARY; T=0.K

## Non-threshold reactions

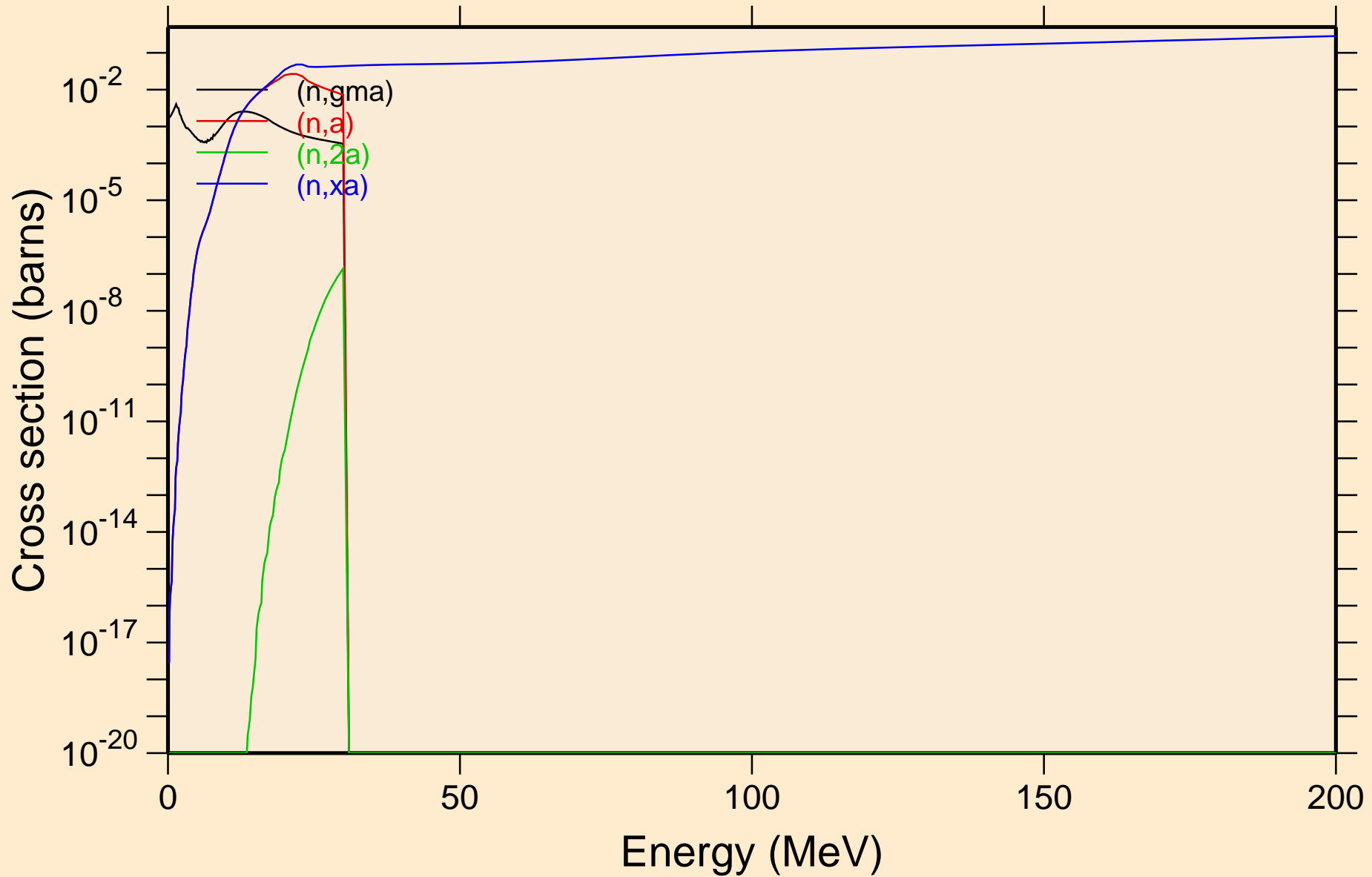



BA138 NEUTRON ACER TENDL-2024 LIBRARY; T=0.K  
Inelastic levels

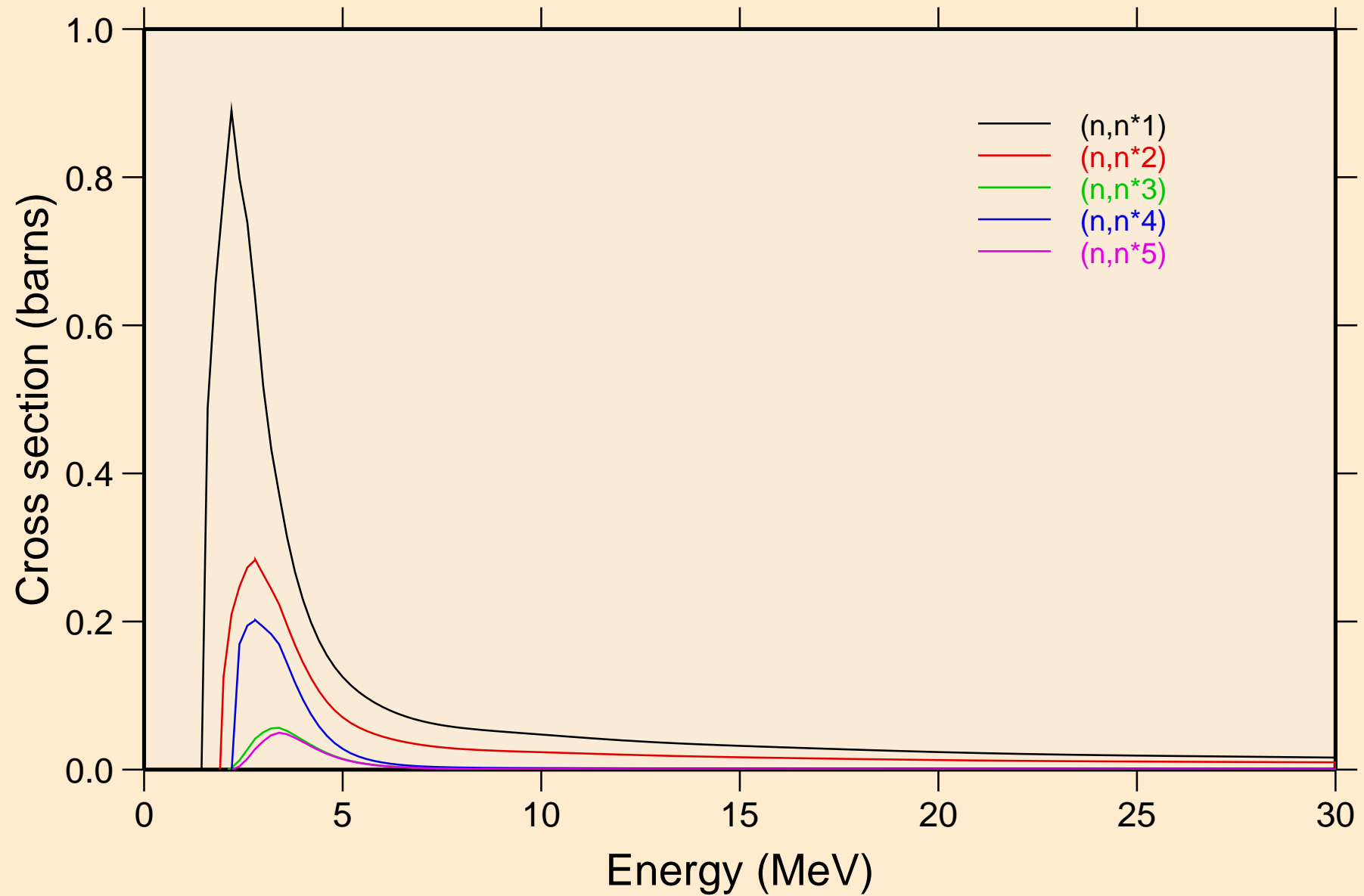

BA138 NEUTRON ACER TENDL-2024 LIBRARY; T=0.K  
Inelastic levels

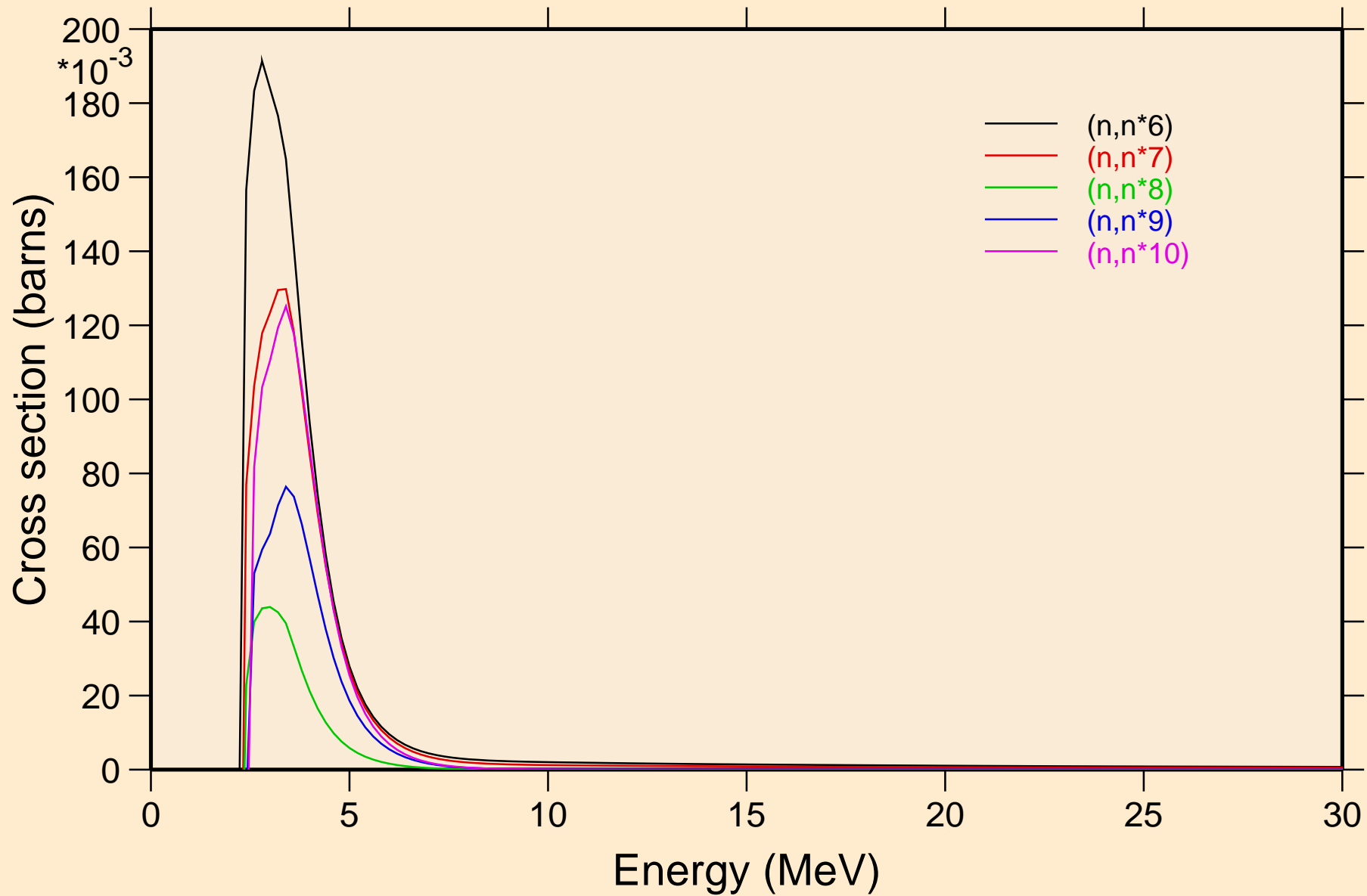

BA138 NEUTRON ACER TENDL-2024 LIBRARY; T=0.K  
Inelastic levels

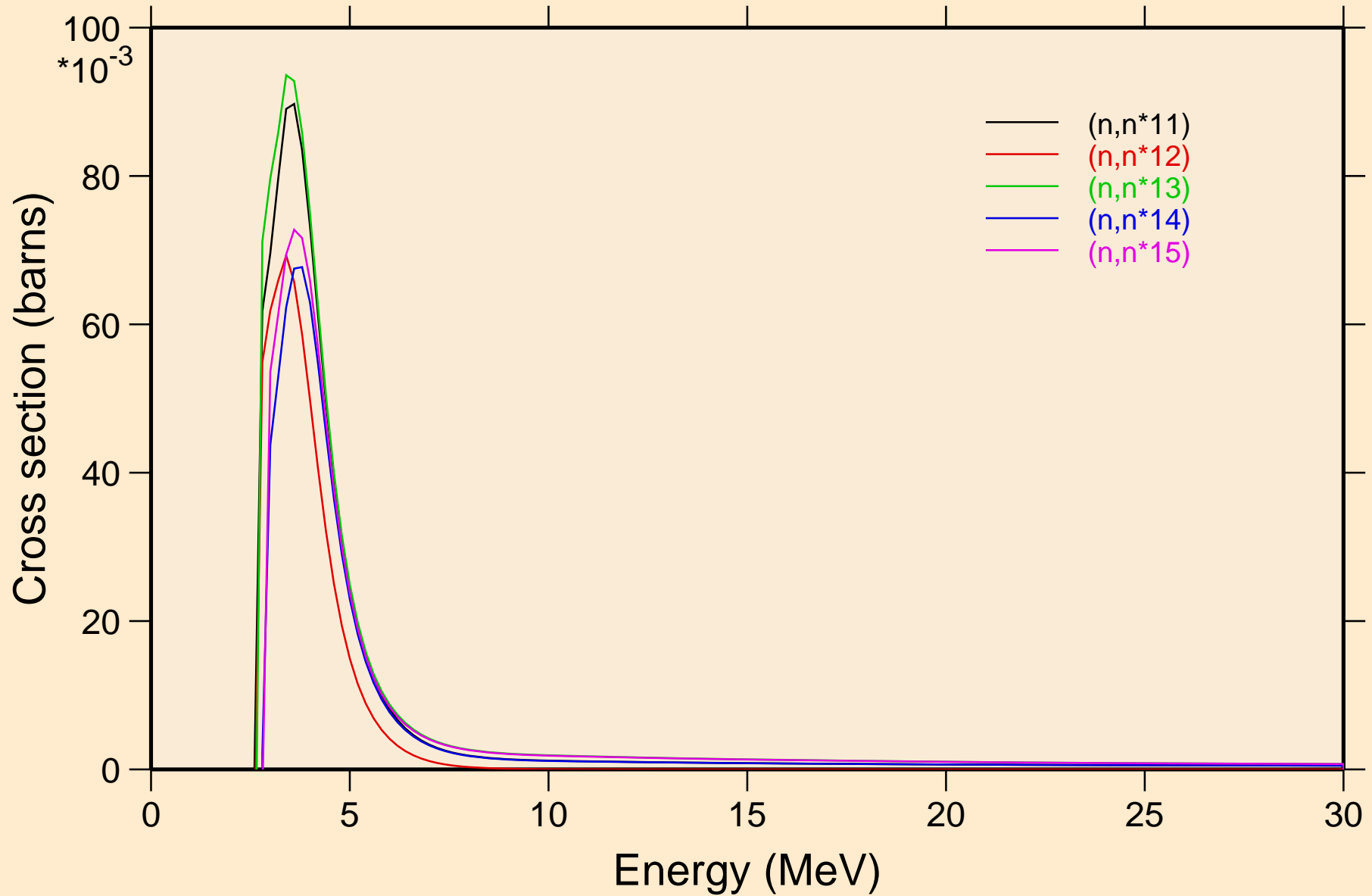

BA138 NEUTRON ACER TENDL-2024 LIBRARY; T=0.K  
Inelastic levels

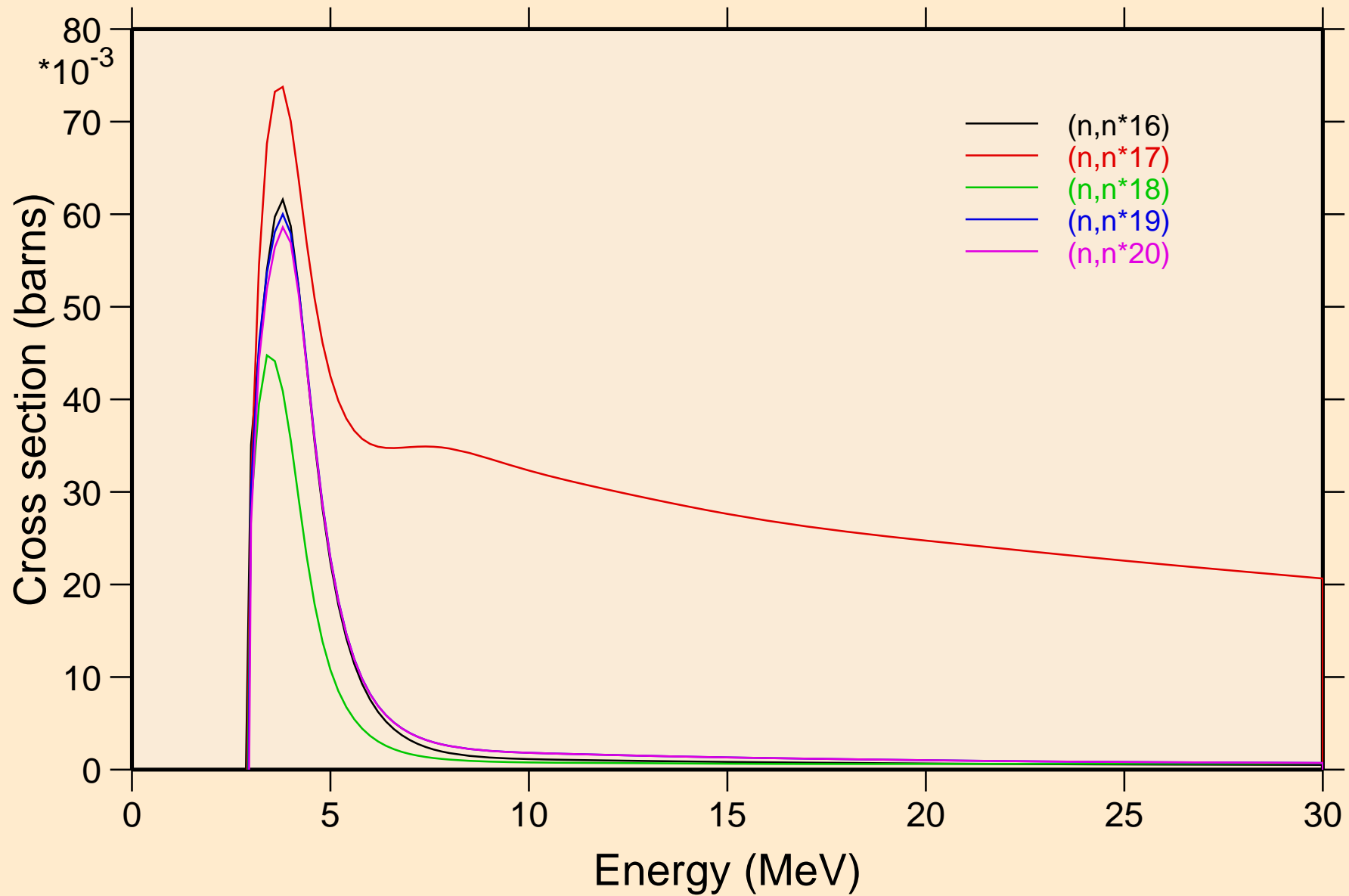

BA138 NEUTRON ACER TENDL-2024 LIBRARY; T=0.K  
Inelastic levels

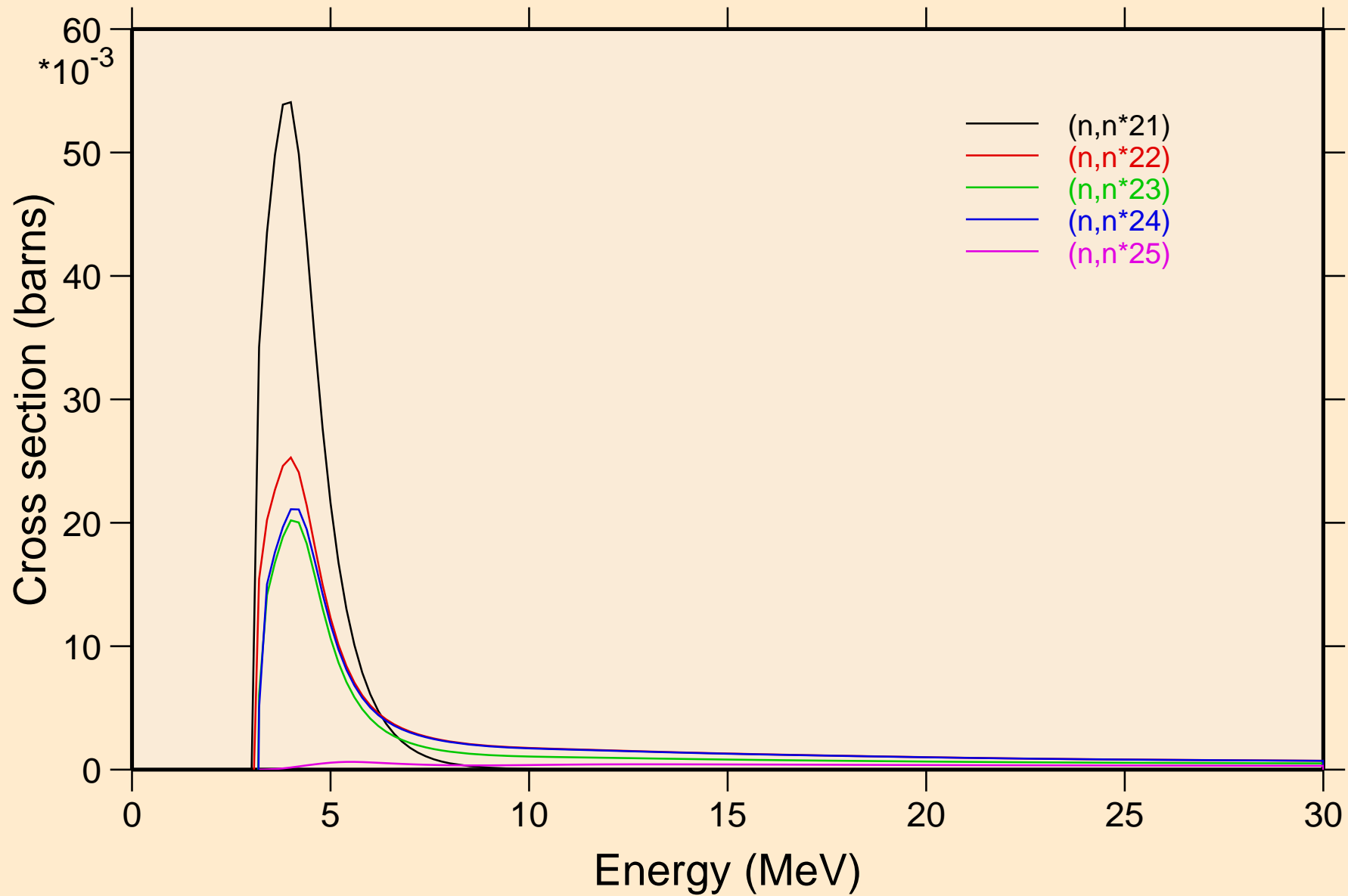

BA138 NEUTRON ACER TENDL-2024 LIBRARY; T=0.K  
Inelastic levels

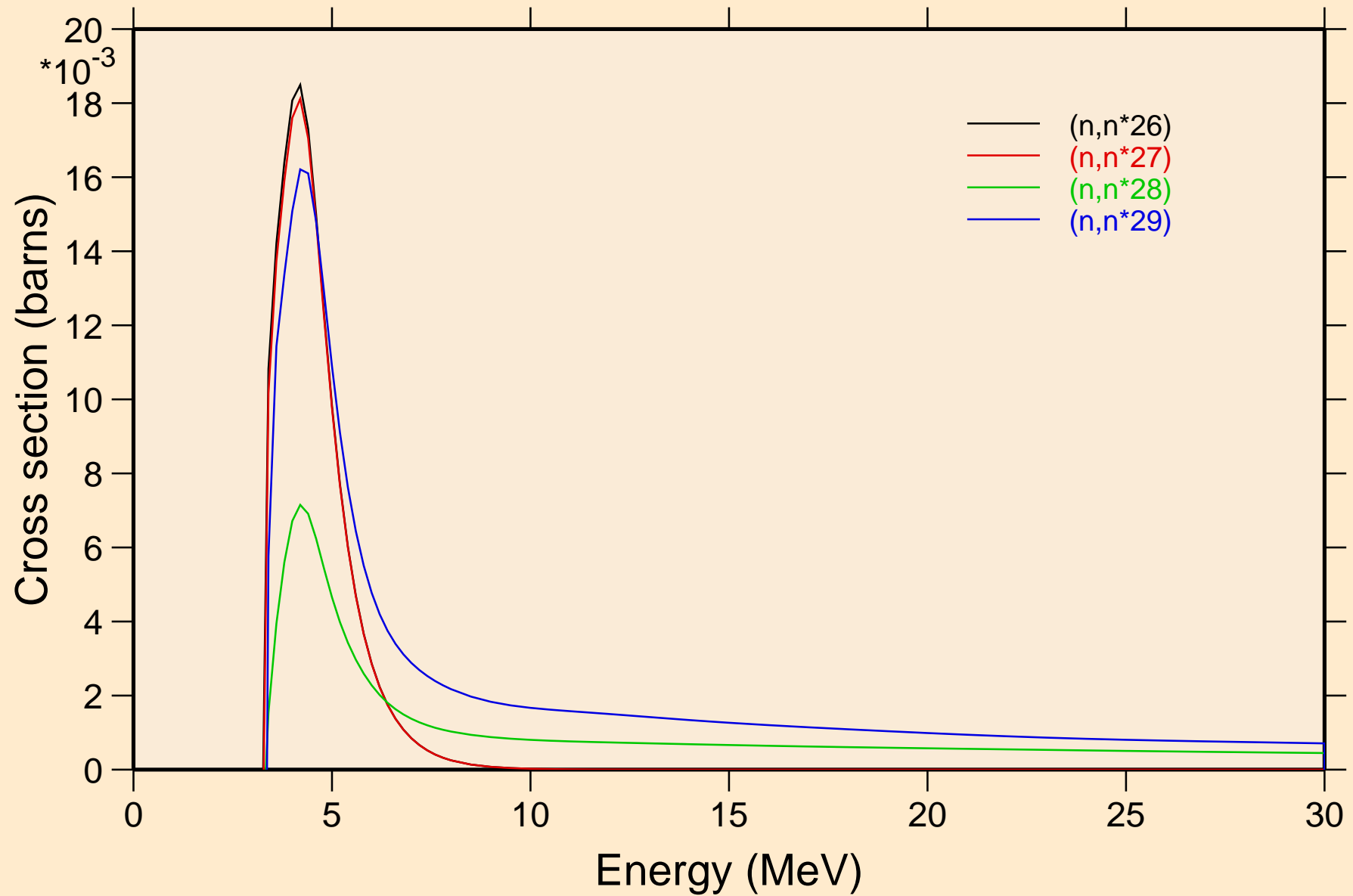

BA138 NEUTRON ACER TENDL-2024 LIBRARY; T=0.K  
Threshold reactions

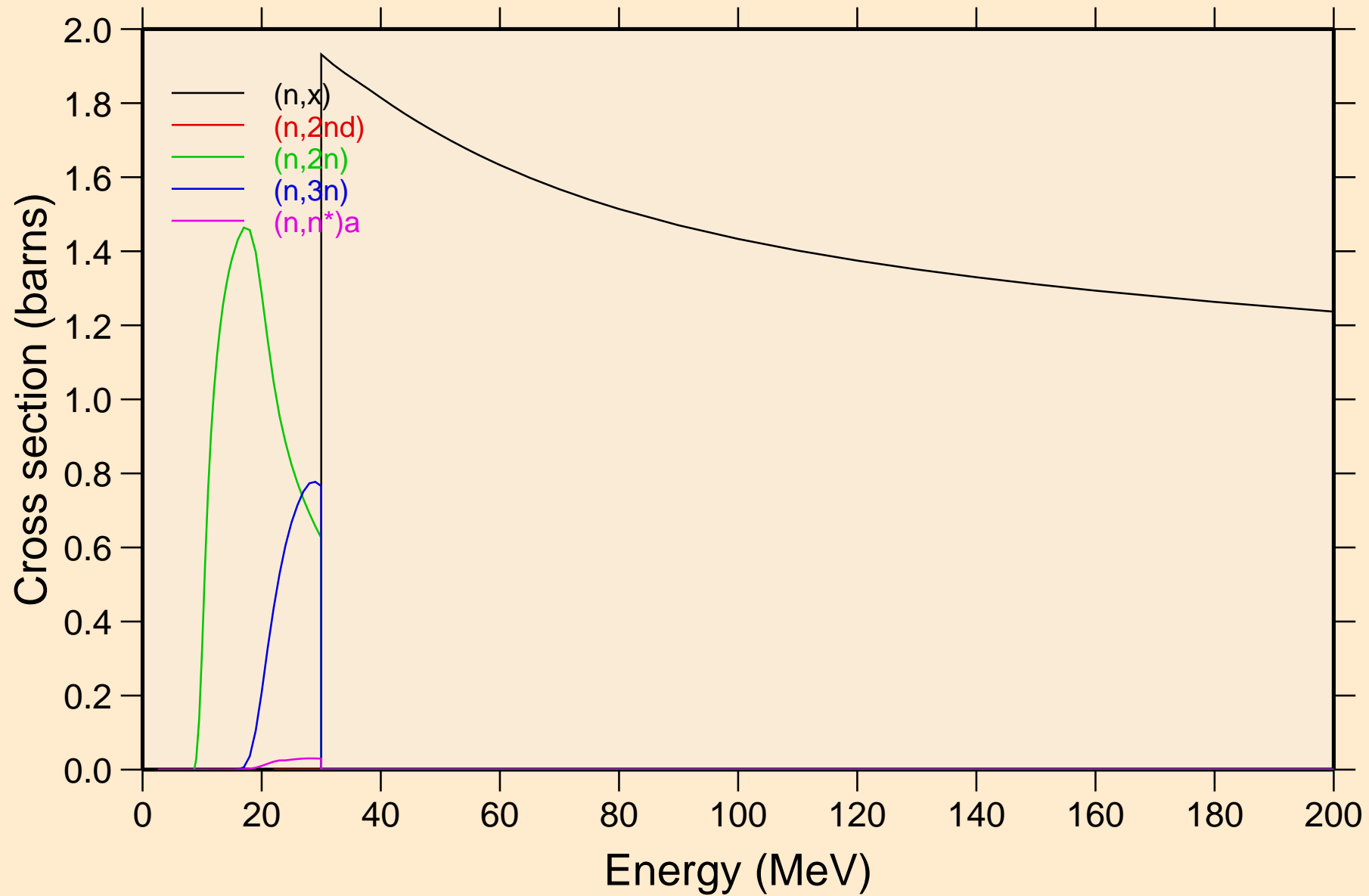

# BA138 NEUTRON ACER TENDL-2024 LIBRARY; T=0.K

## Threshold reactions

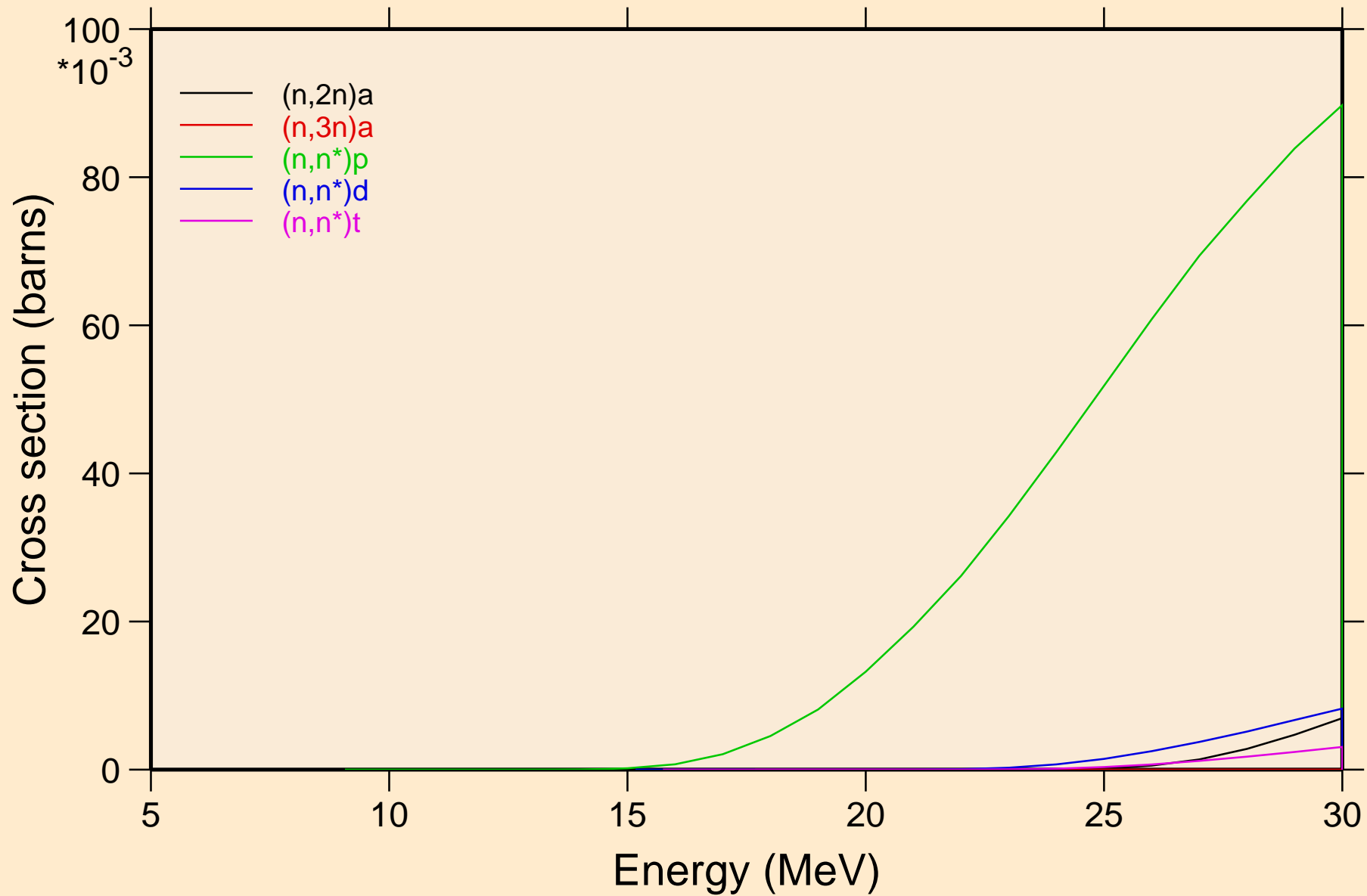



BA138 NEUTRON ACER TENDL-2024 LIBRARY; T=0.K  
Threshold reactions

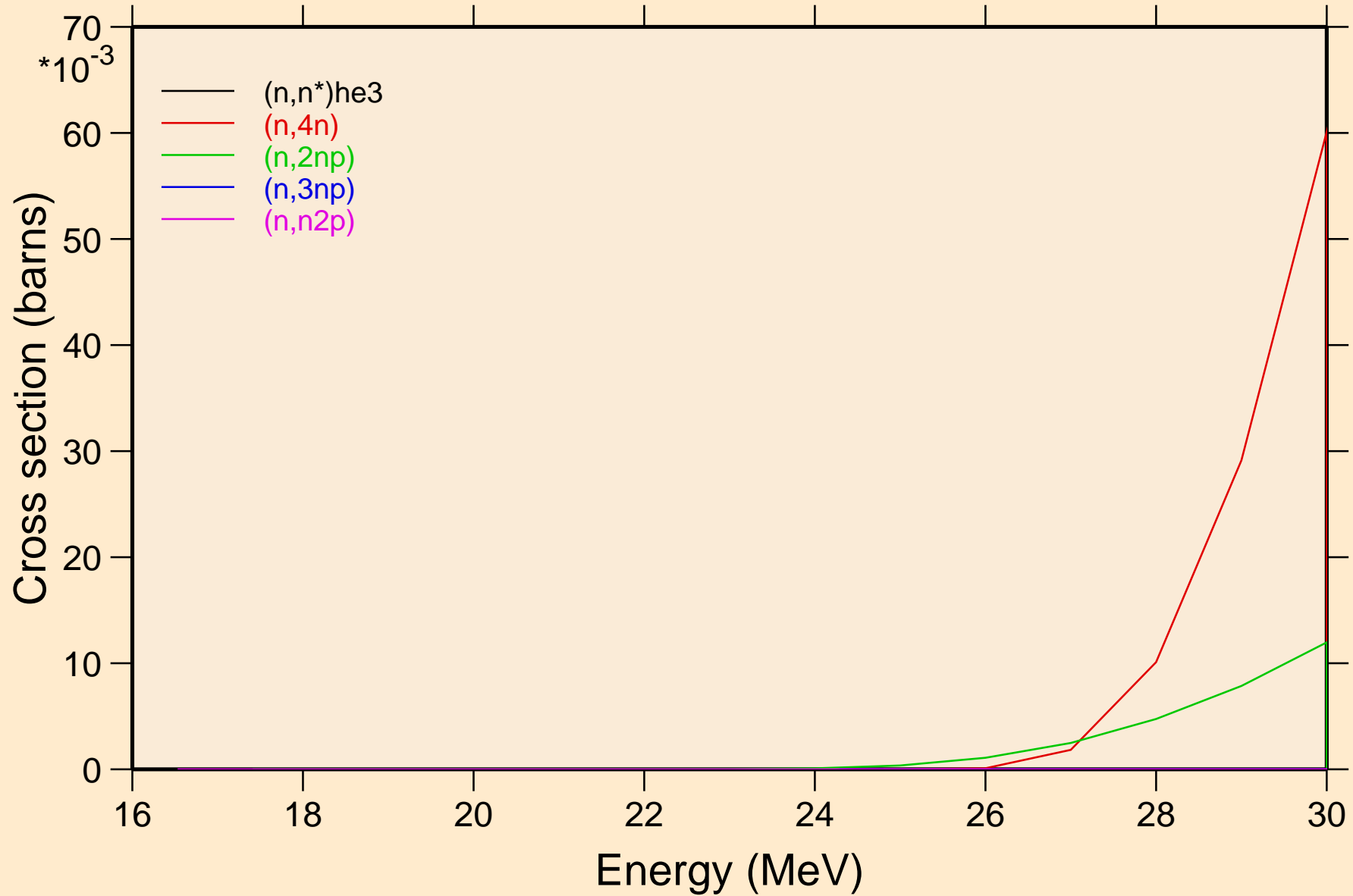

# BA138 NEUTRON ACER TENDL-2024 LIBRARY; T=0.K

## Threshold reactions

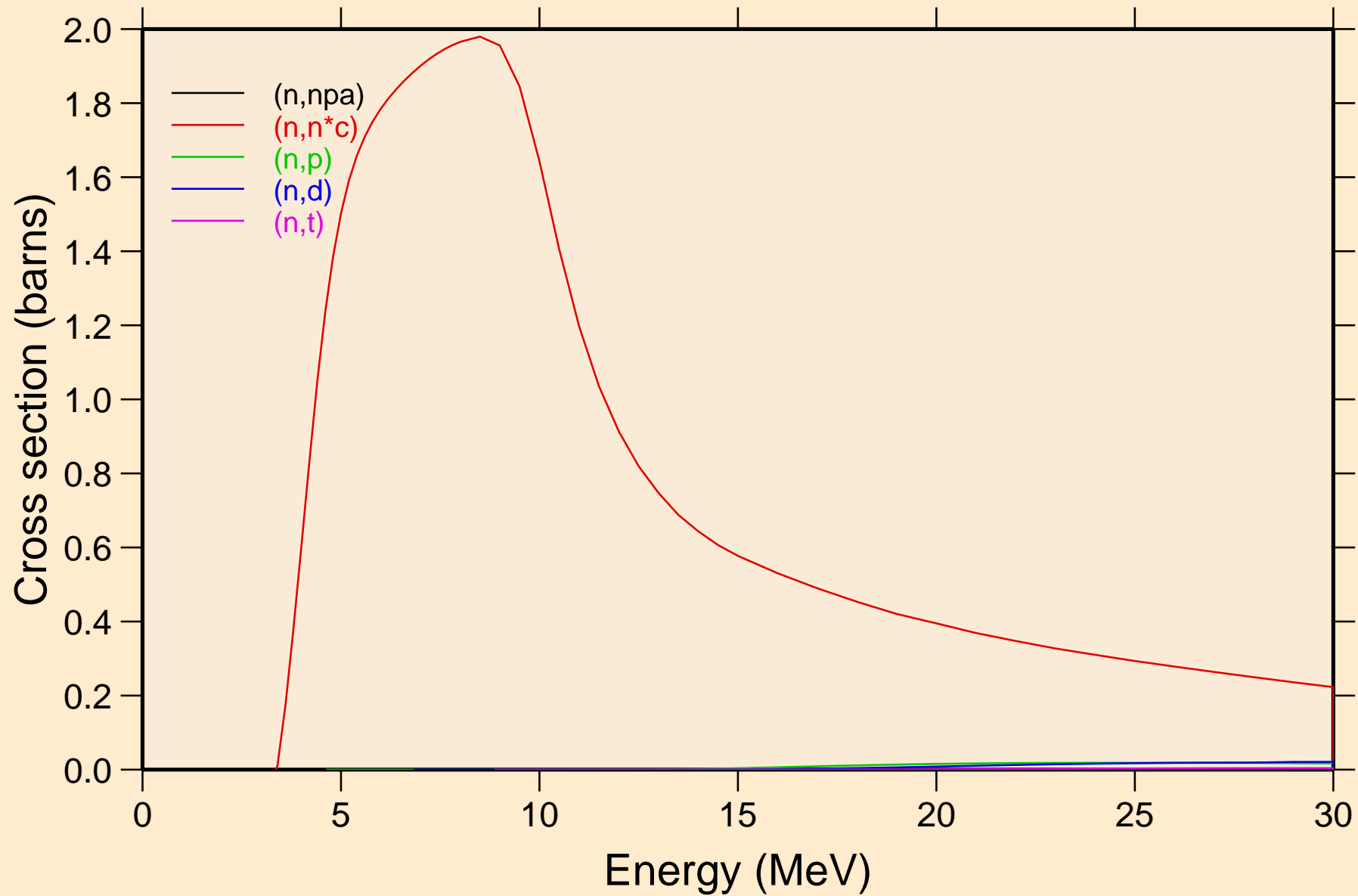

BA138 NEUTRON ACER TENDL-2024 LIBRARY; T=0.K  
Threshold reactions

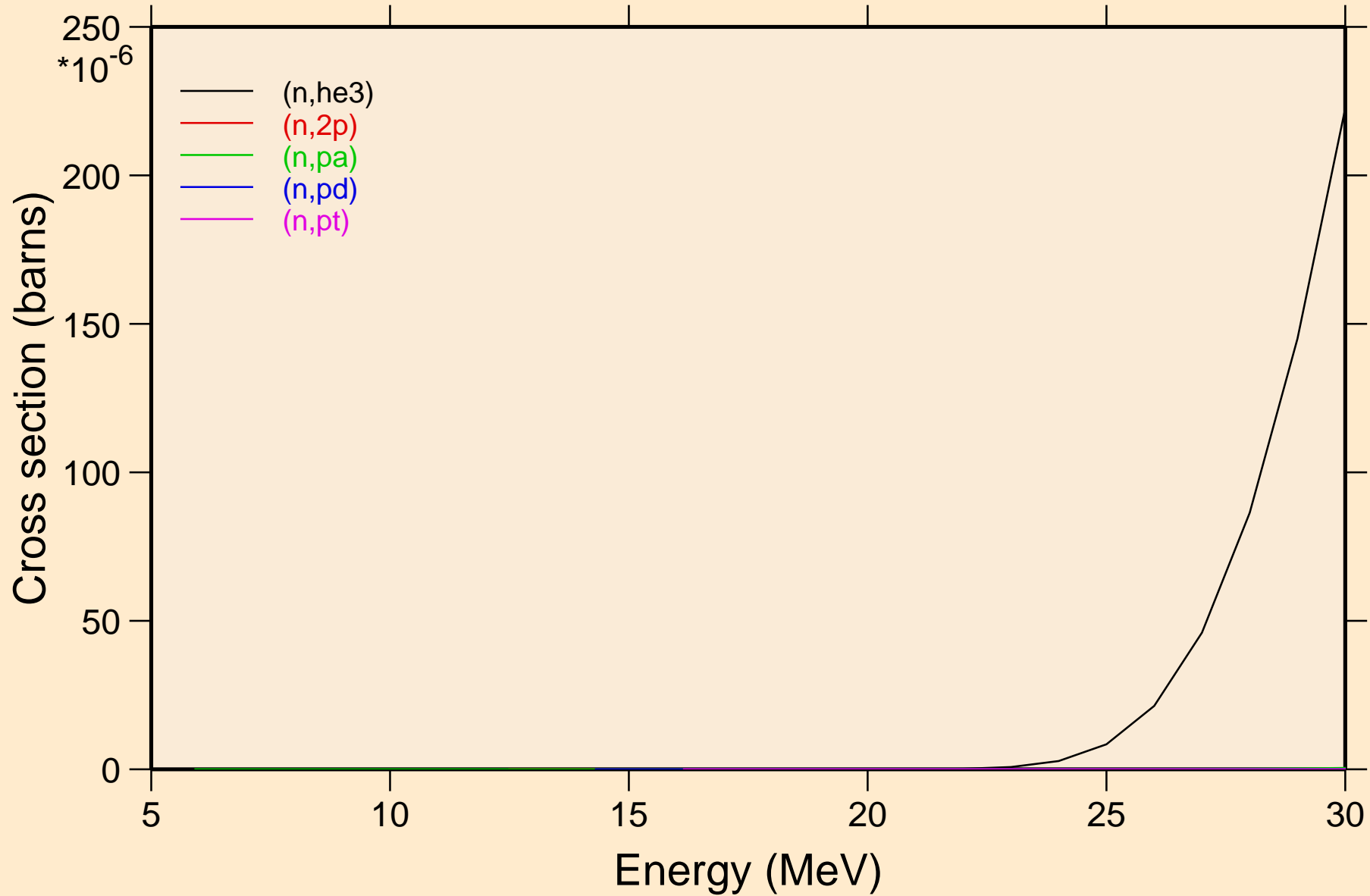

BA138 NEUTRON ACER TENDL-2024 LIBRARY; T=0.K  
Threshold reactions

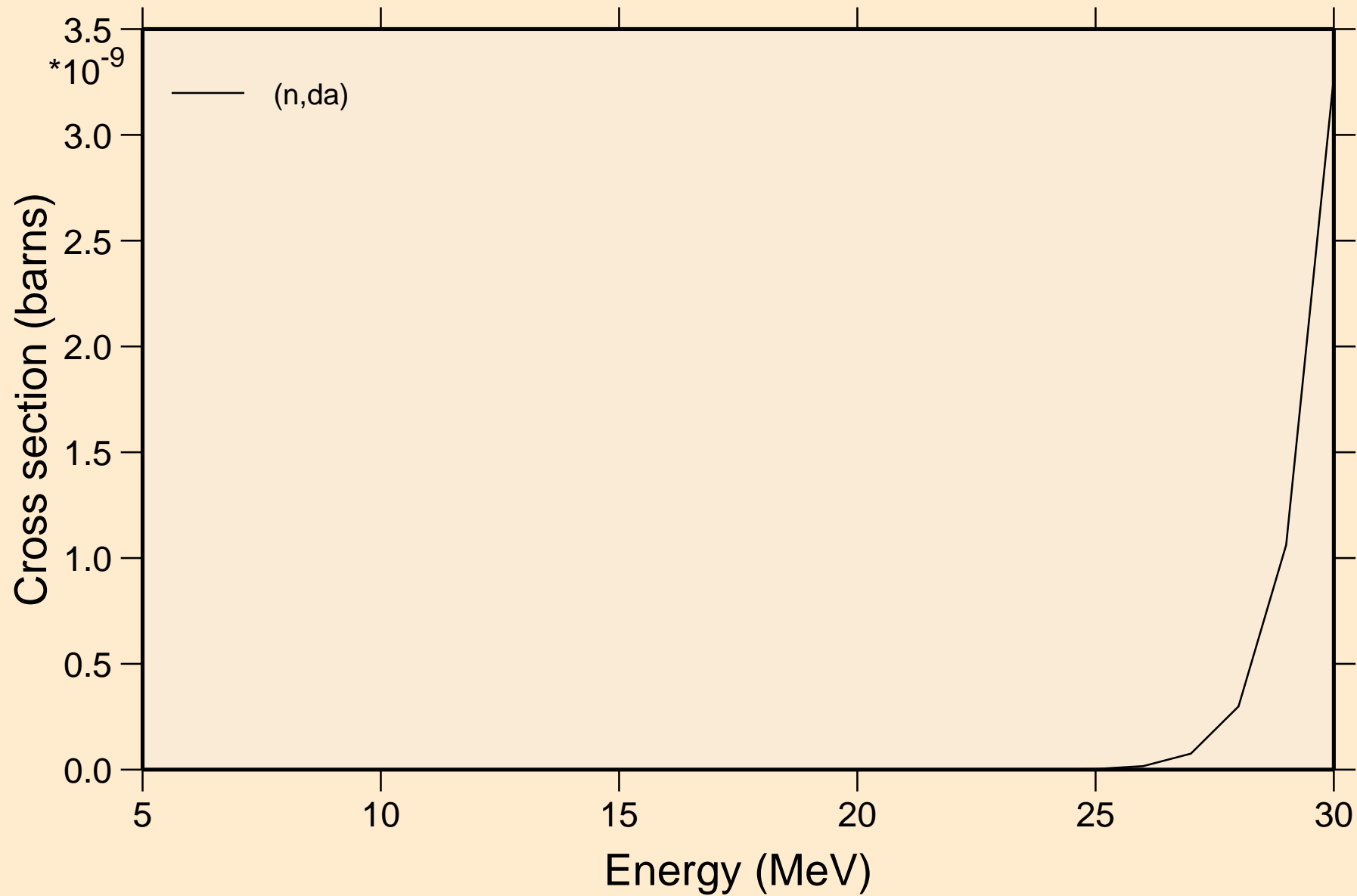

# BA138 NEUTRON ACER TENDL-2024 LIBRARY; T=0.K

## Threshold reactions

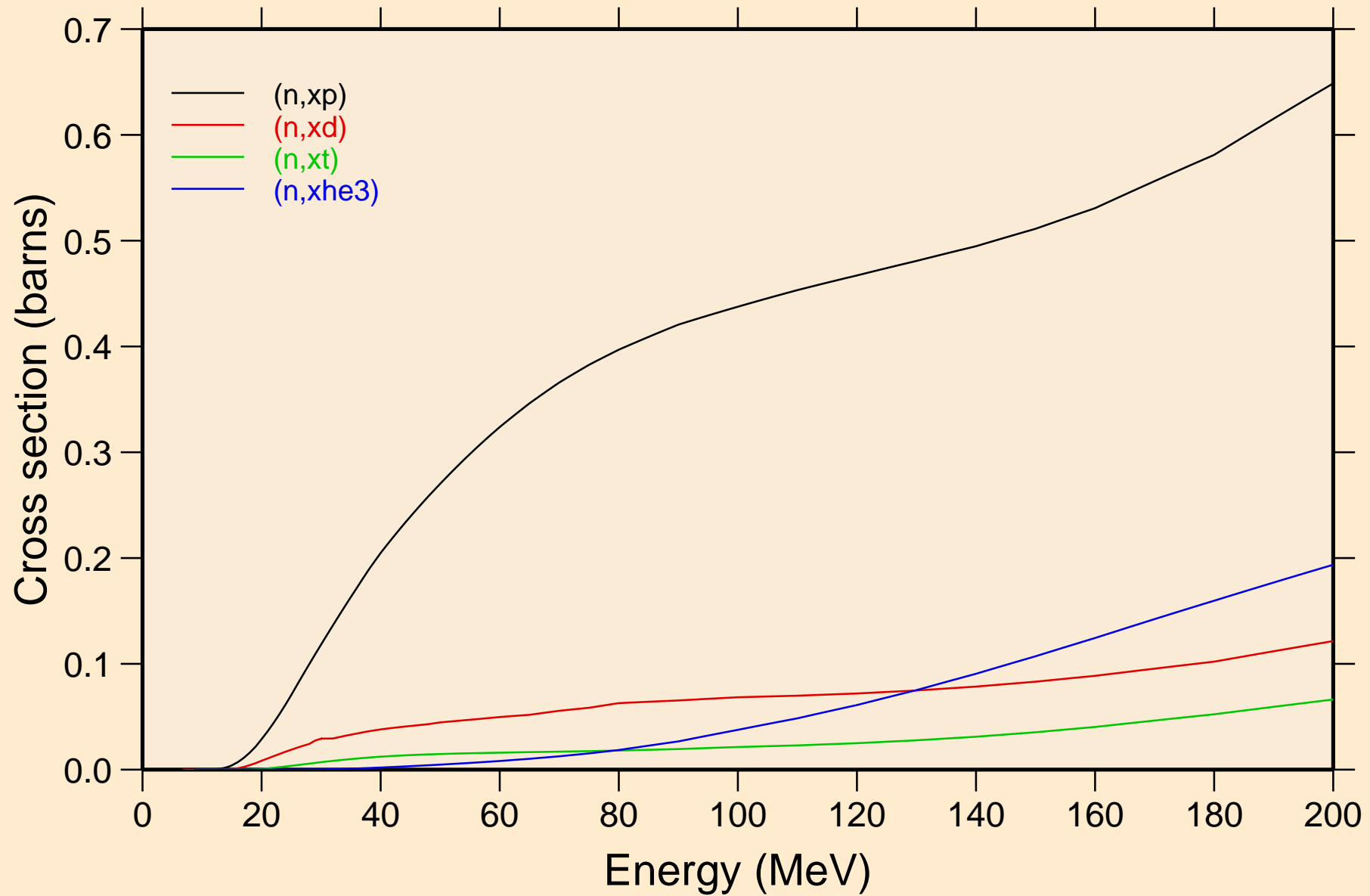

BA138 NEUTRON ACER TENDL-2024 LIBRARY; T=0.K  
angular distribution for elastic

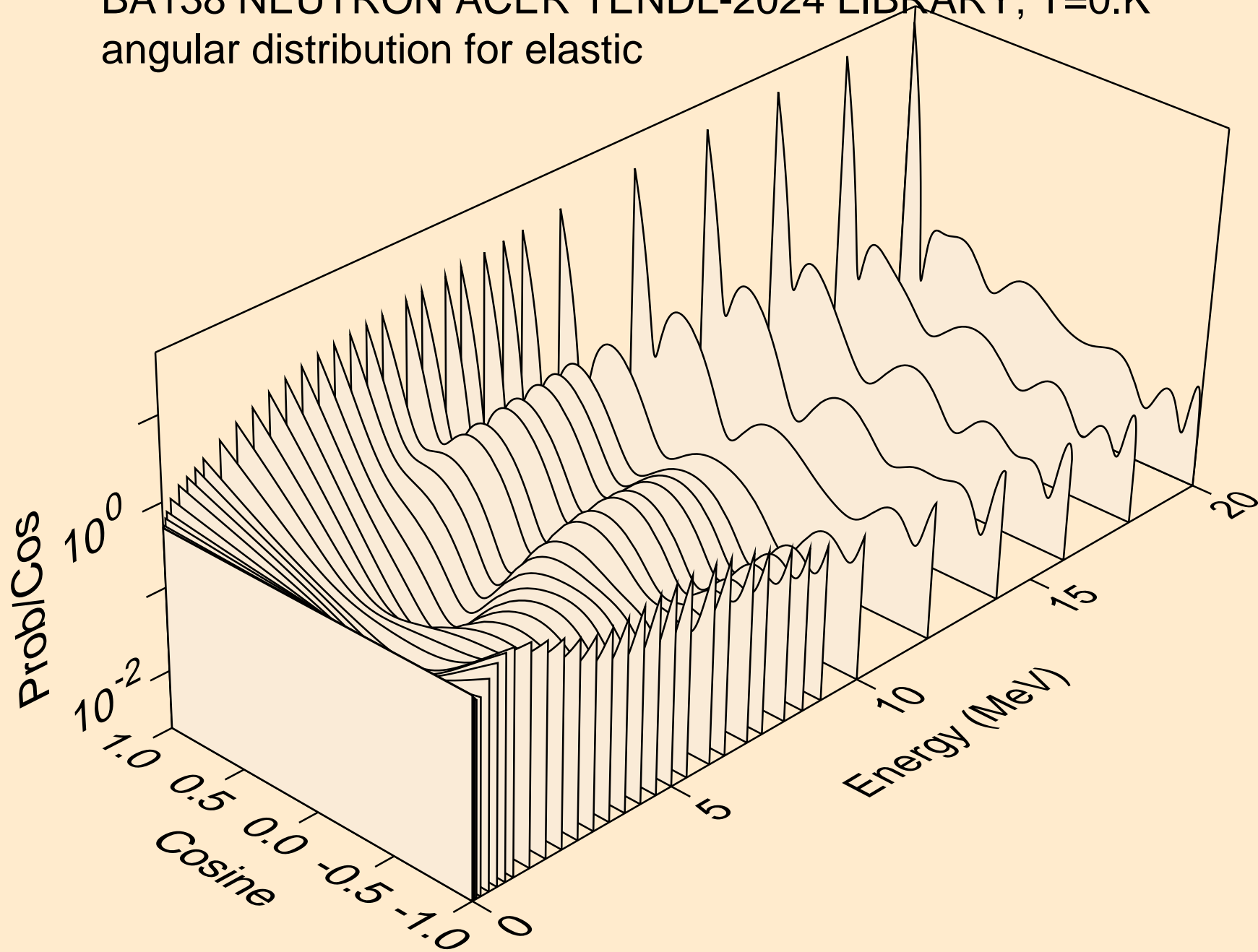

BA138 NEUTRON ACER TENDL-2024 LIBRARY; T=0.K  
angular distribution for elastic

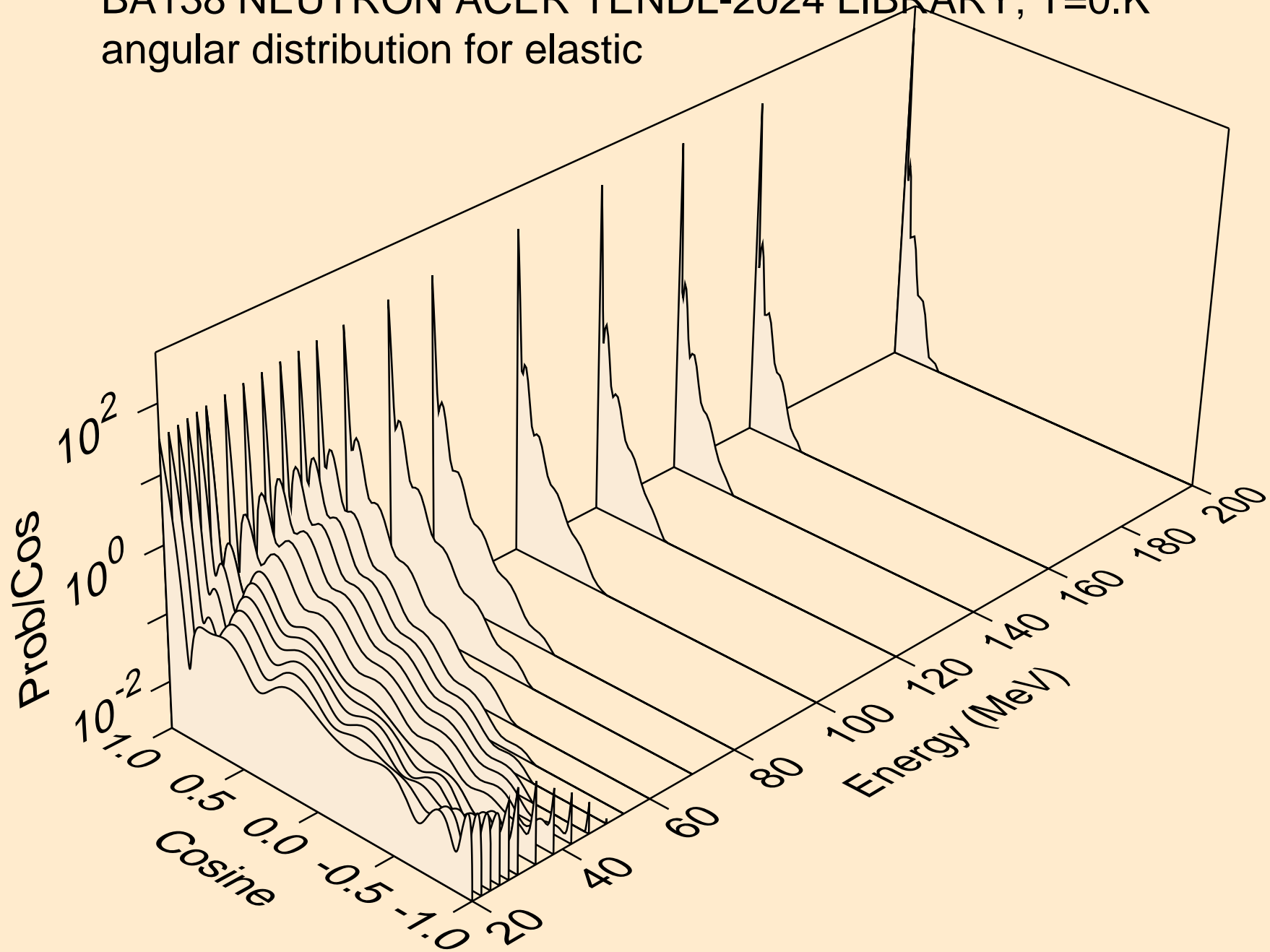

BA138 NEUTRON ACER TENDL-2024 LIBRARY; T=0.K  
angular distribution for (n,n\*1)

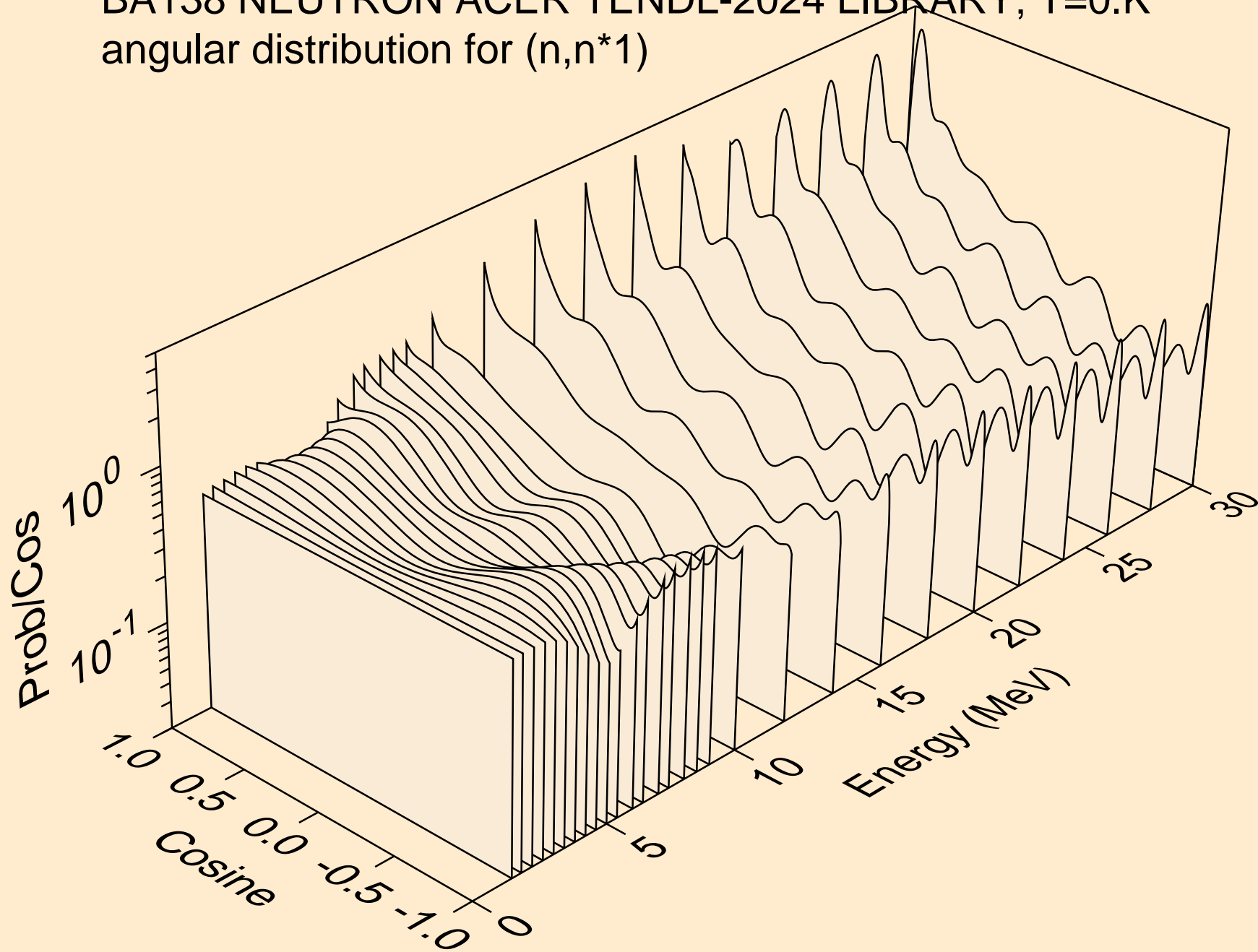



BA138 NEUTRON ACER TENDL-2024 LIBRARY; T=0.K  
angular distribution for (n,n\*2)

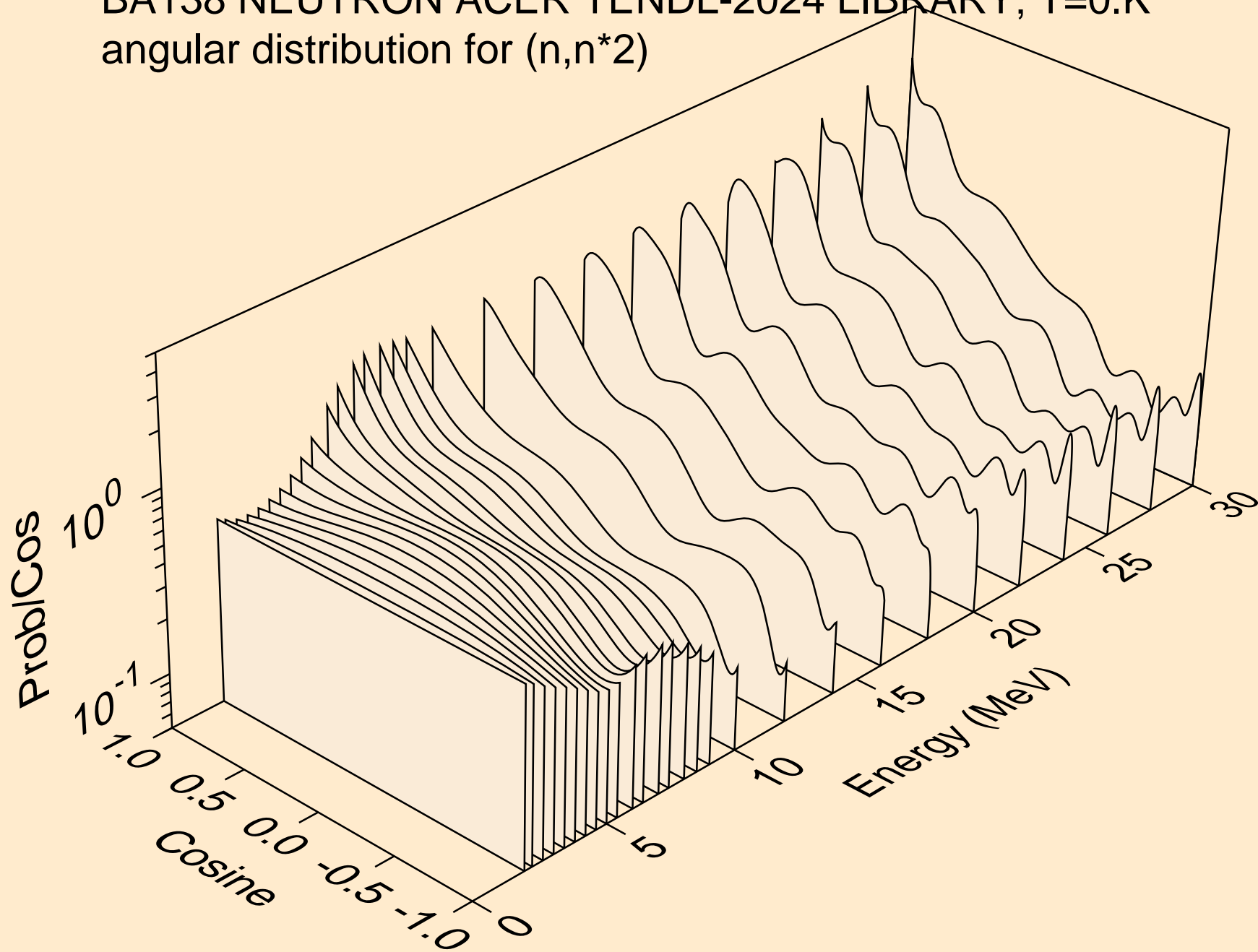

BA138 NEUTRON ACER TENDL-2024 LIBRARY; T=0.K  
angular distribution for (n,n\*3)

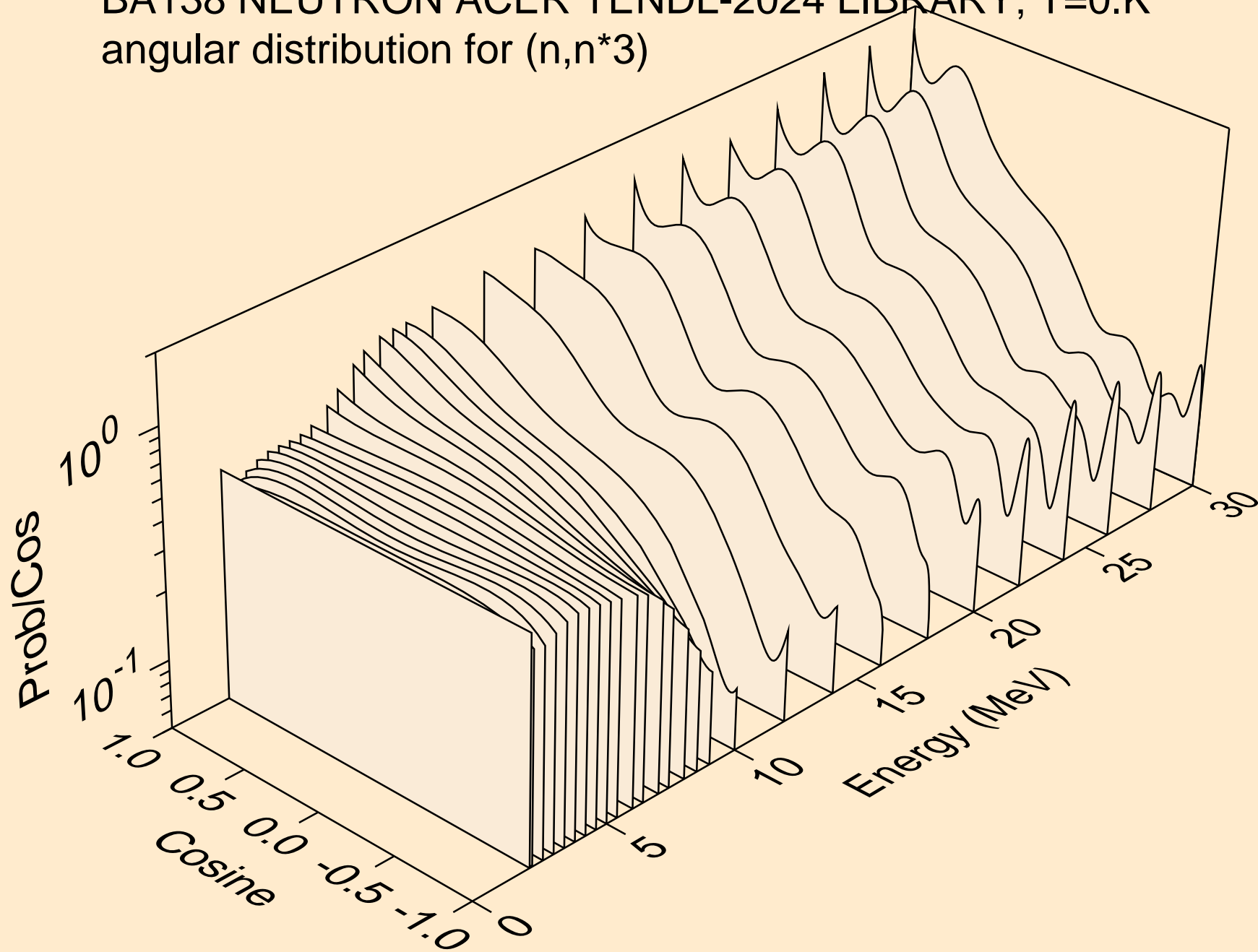

BA138 NEUTRON ACER TENDL-2024 LIBRARY; T=0.K  
angular distribution for (n,n\*4)

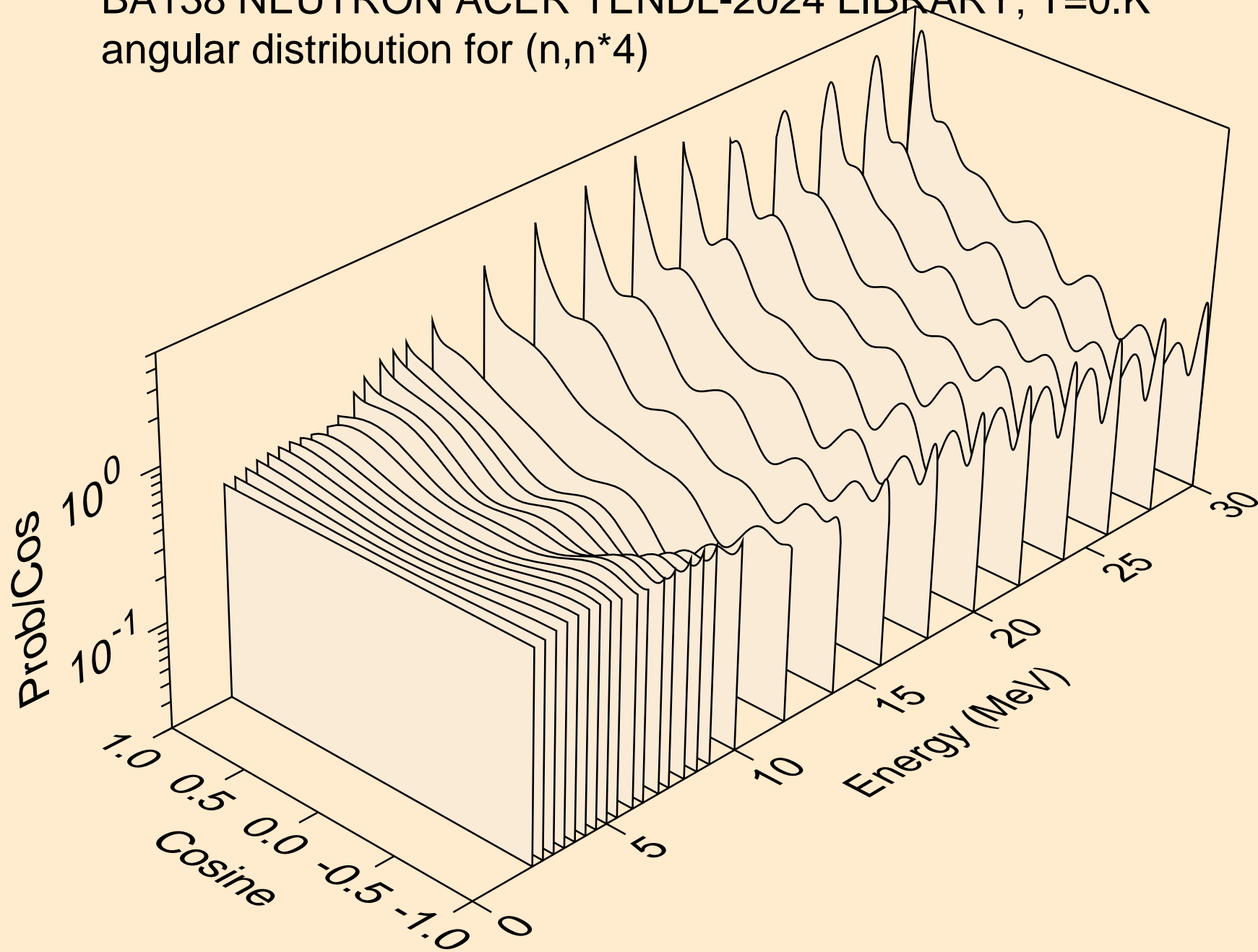

BA138 NEUTRON ACER TENDL-2024 LIBRARY; T=0.K  
angular distribution for (n,n\*5)

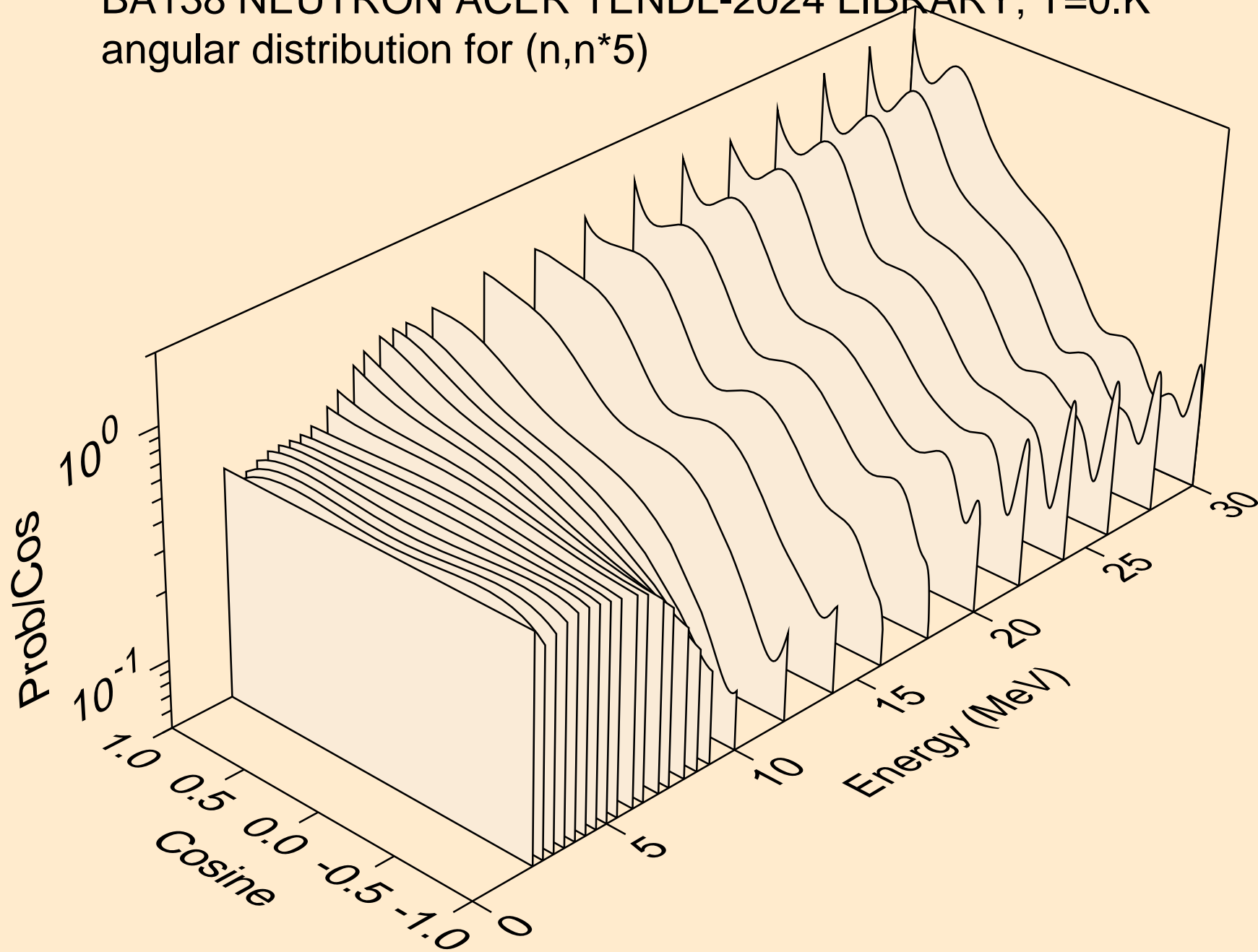

BA138 NEUTRON ACER TENDL-2024 LIBRARY; T=0.K  
angular distribution for (n,n\*6)

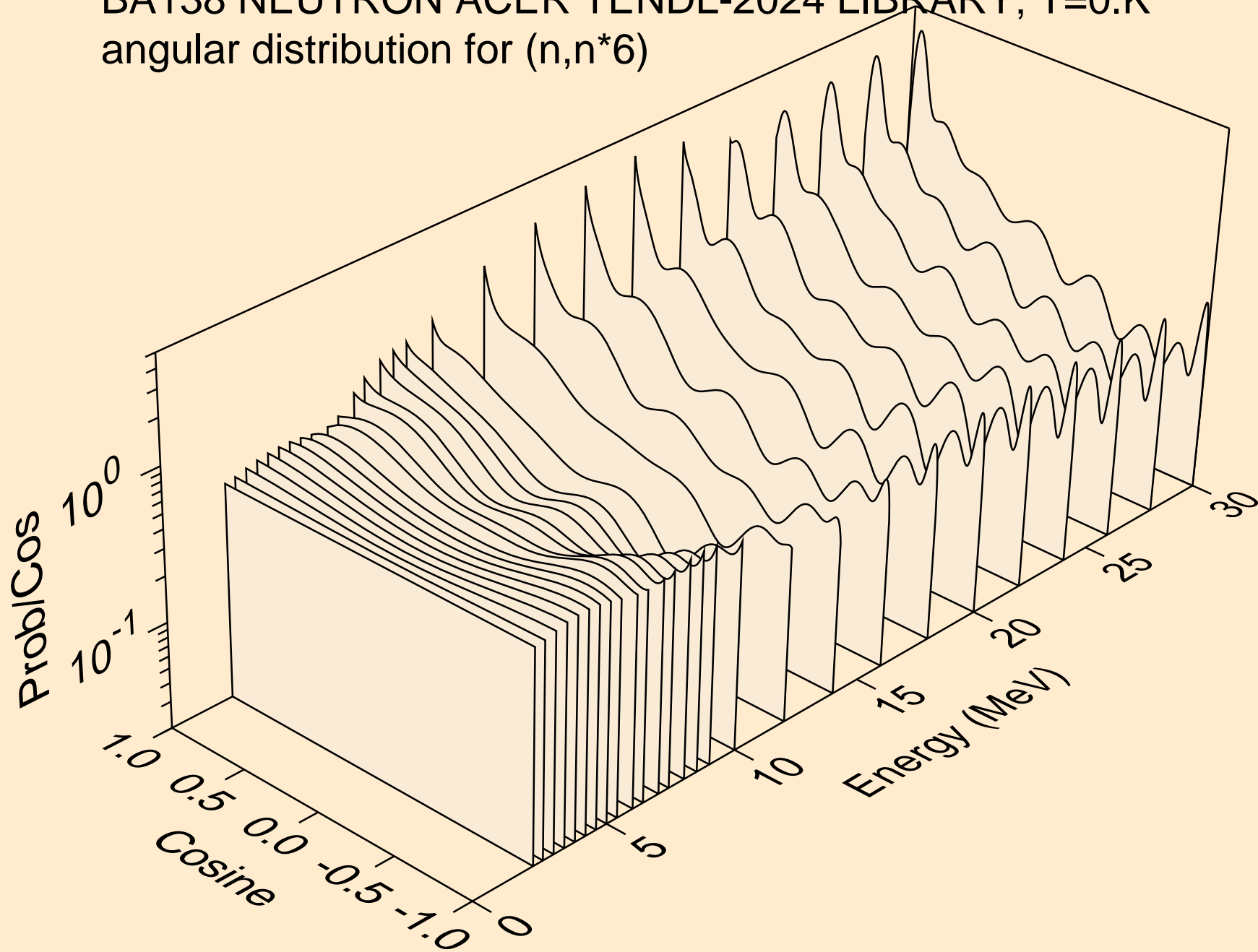

BA138 NEUTRON ACER TENDL-2024 LIBRARY; T=0.K  
angular distribution for (n,n\*7)

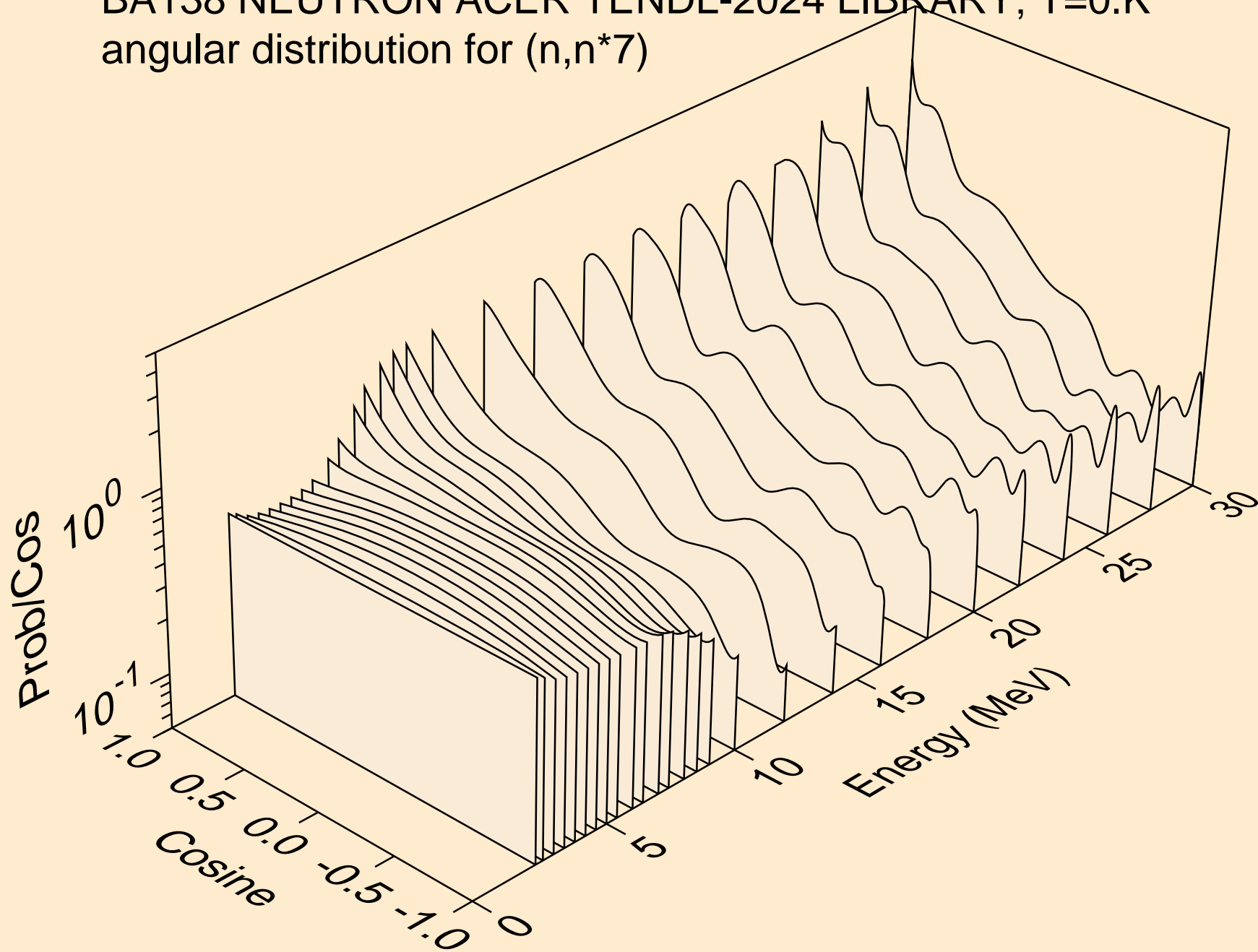

BA138 NEUTRON ACER TENDL-2024 LIBRARY; T=0.K  
angular distribution for (n,n\*8)

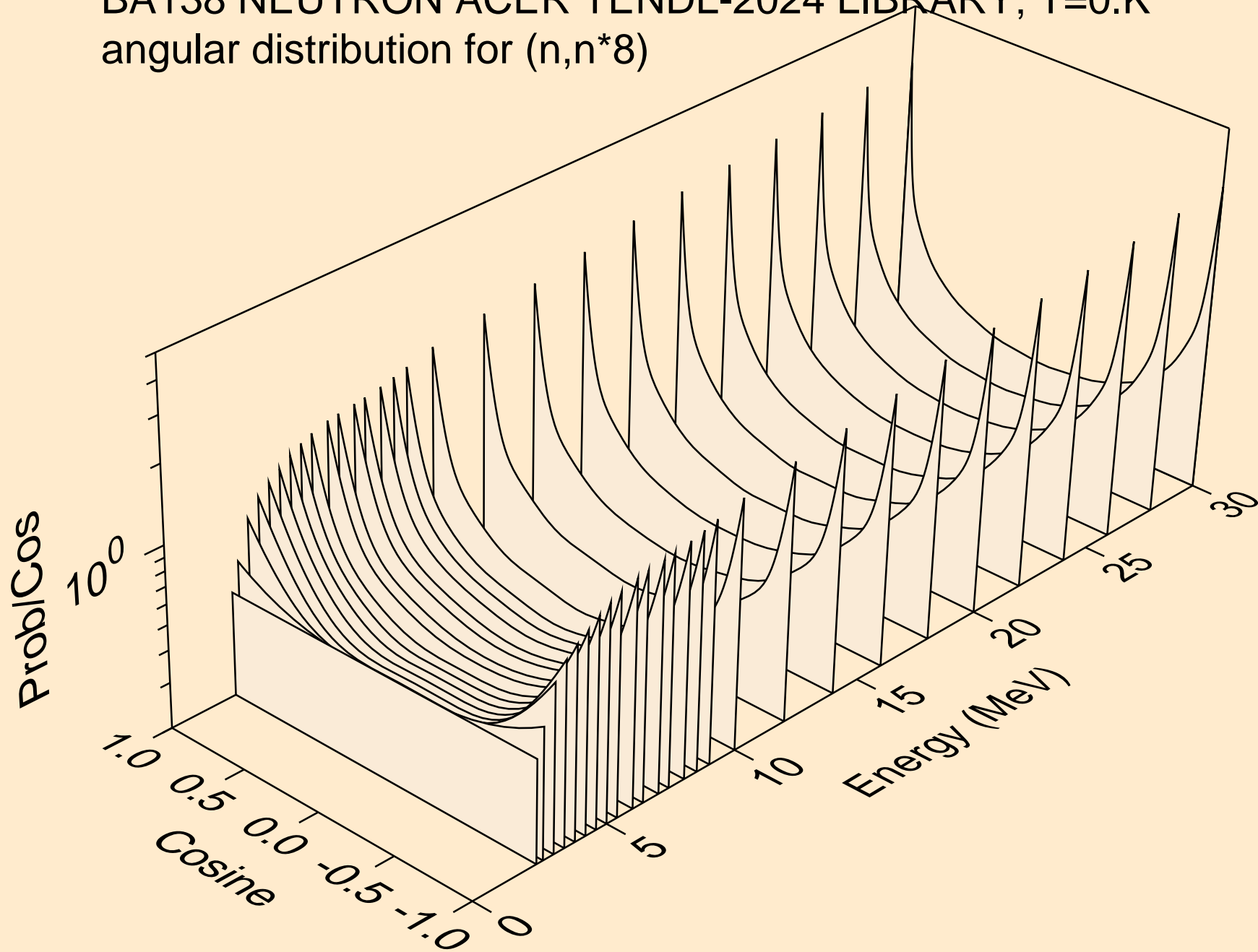

BA138 NEUTRON ACER TENDL-2024 LIBRARY; T=0.K  
angular distribution for (n,n\*9)

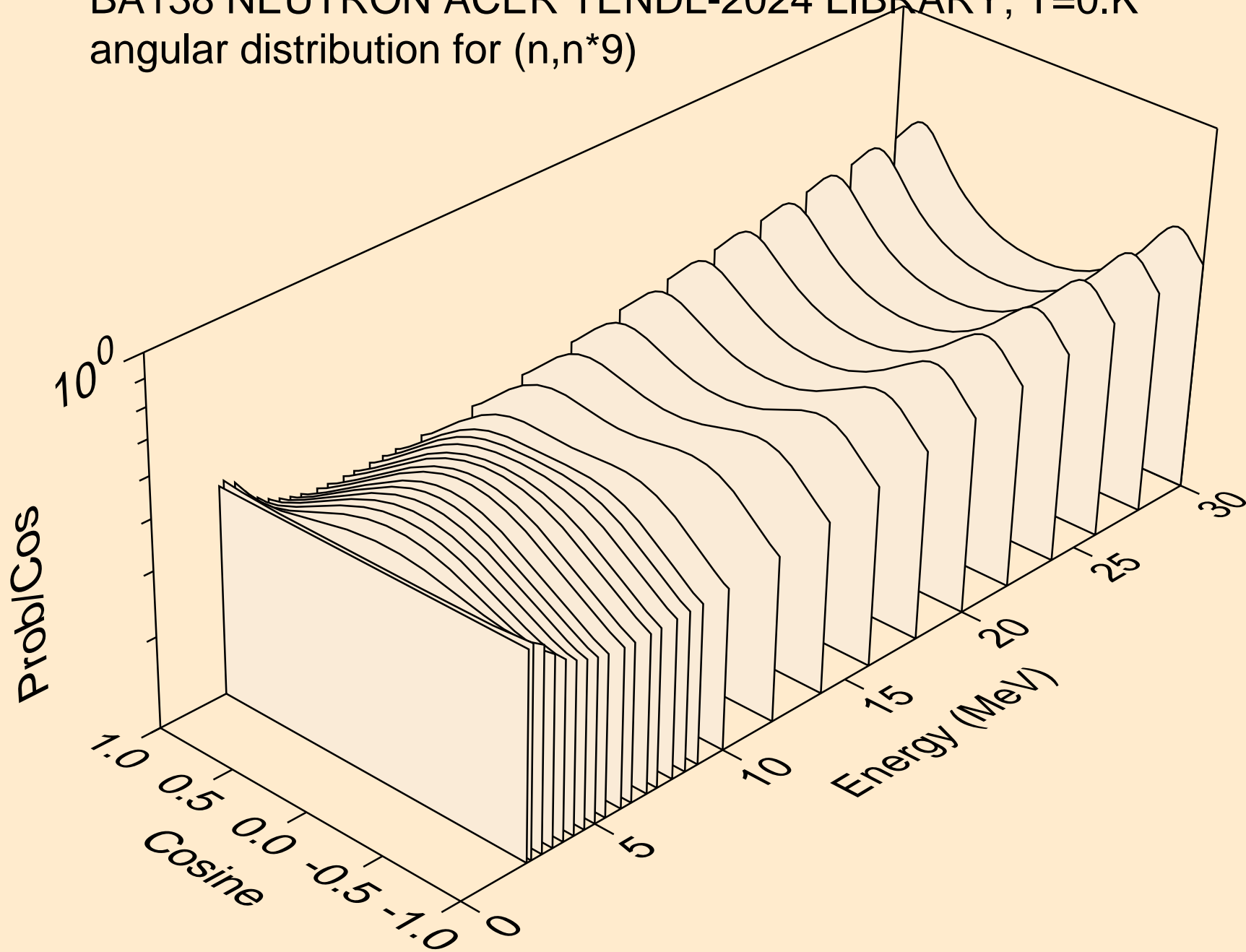



BA138 NEUTRON ACER TENDL-2024 LIBRARY; T=0.K  
angular distribution for (n,n\*10)

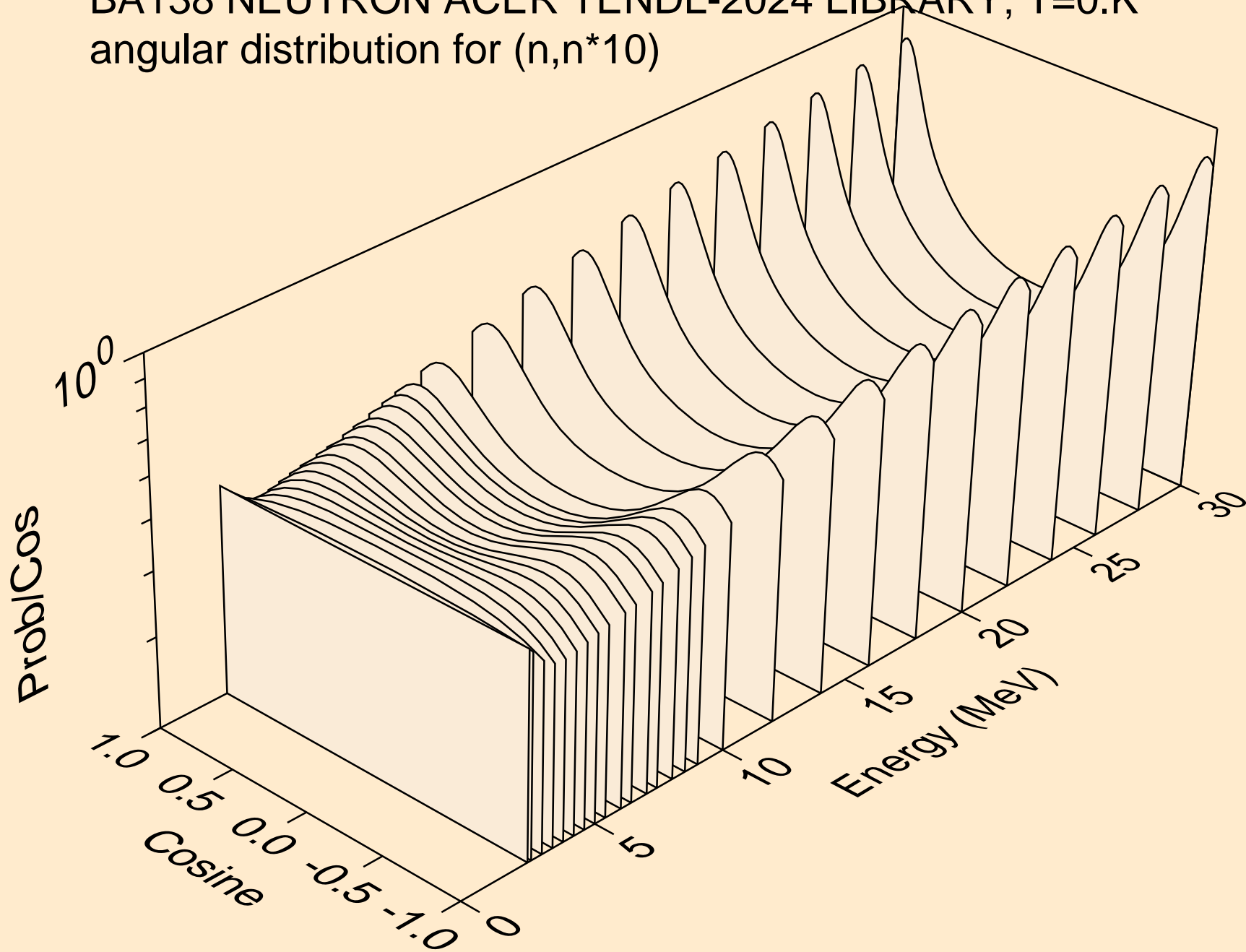

BA138 NEUTRON ACER TENDL-2024 LIBRARY; T=0.K  
angular distribution for (n,n\*11)

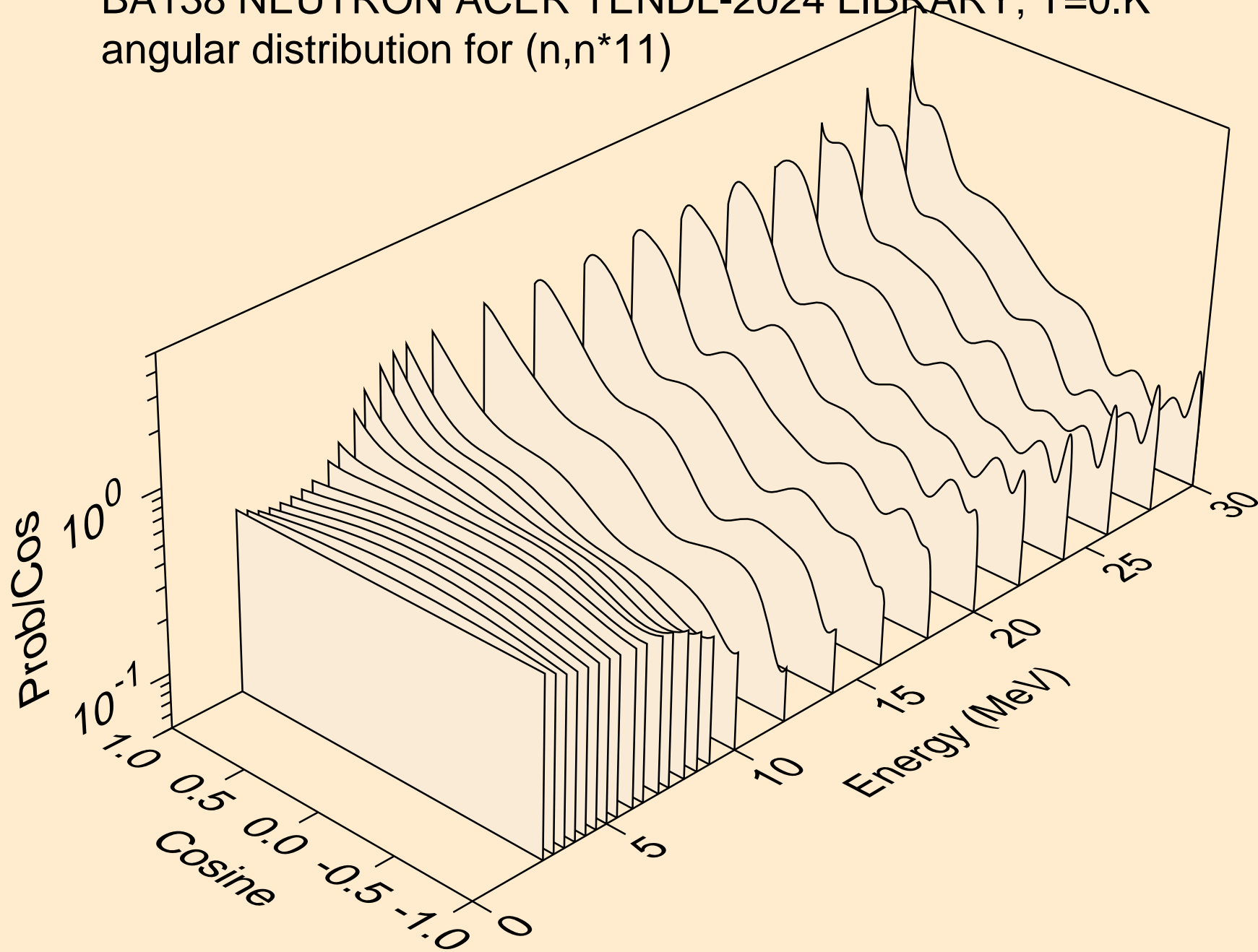

BA138 NEUTRON ACER TENDL-2024 LIBRARY; T=0.K  
angular distribution for (n,n\*12)

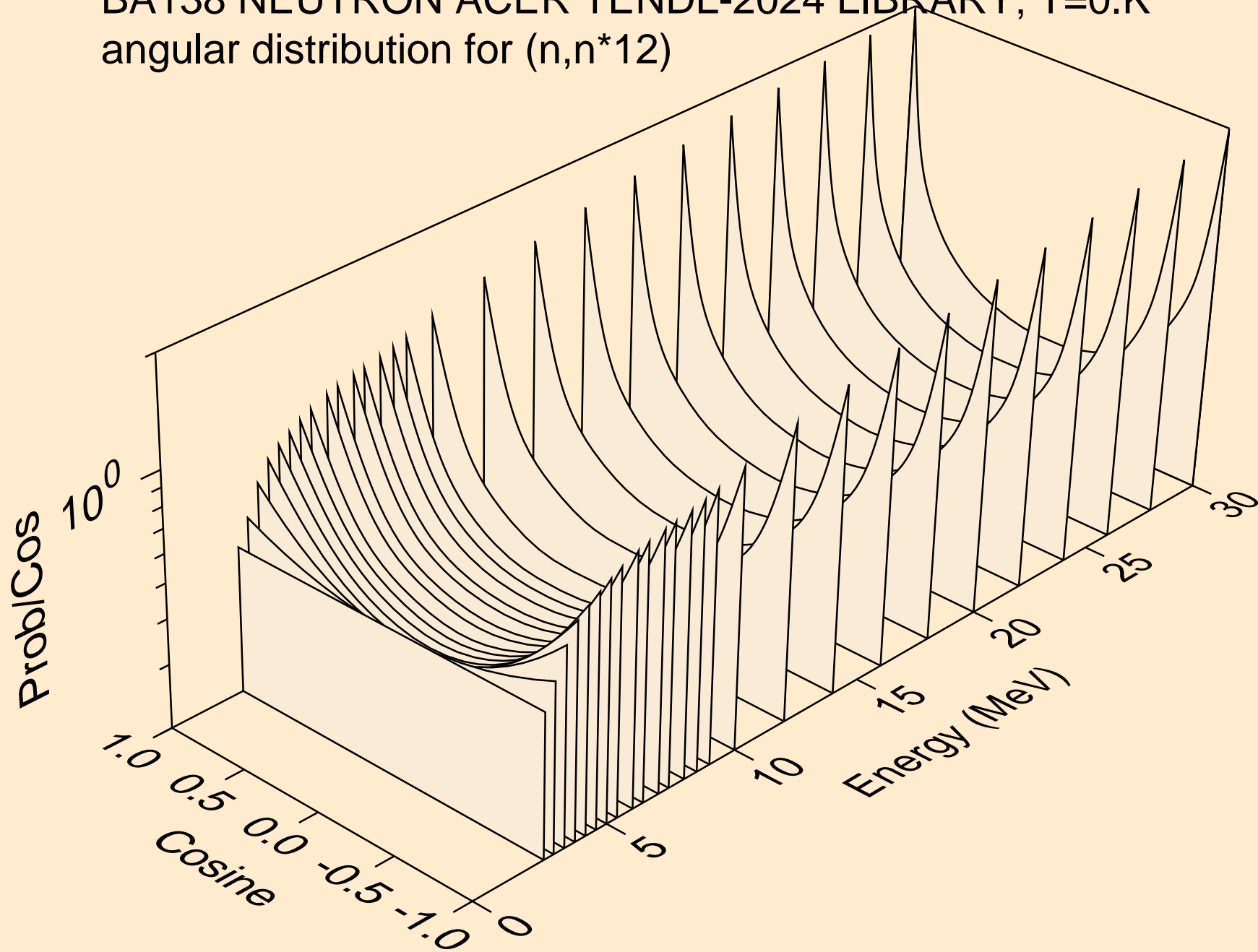

BA138 NEUTRON ACER TENDL-2024 LIBRARY; T=0.K  
angular distribution for (n,n\*13)

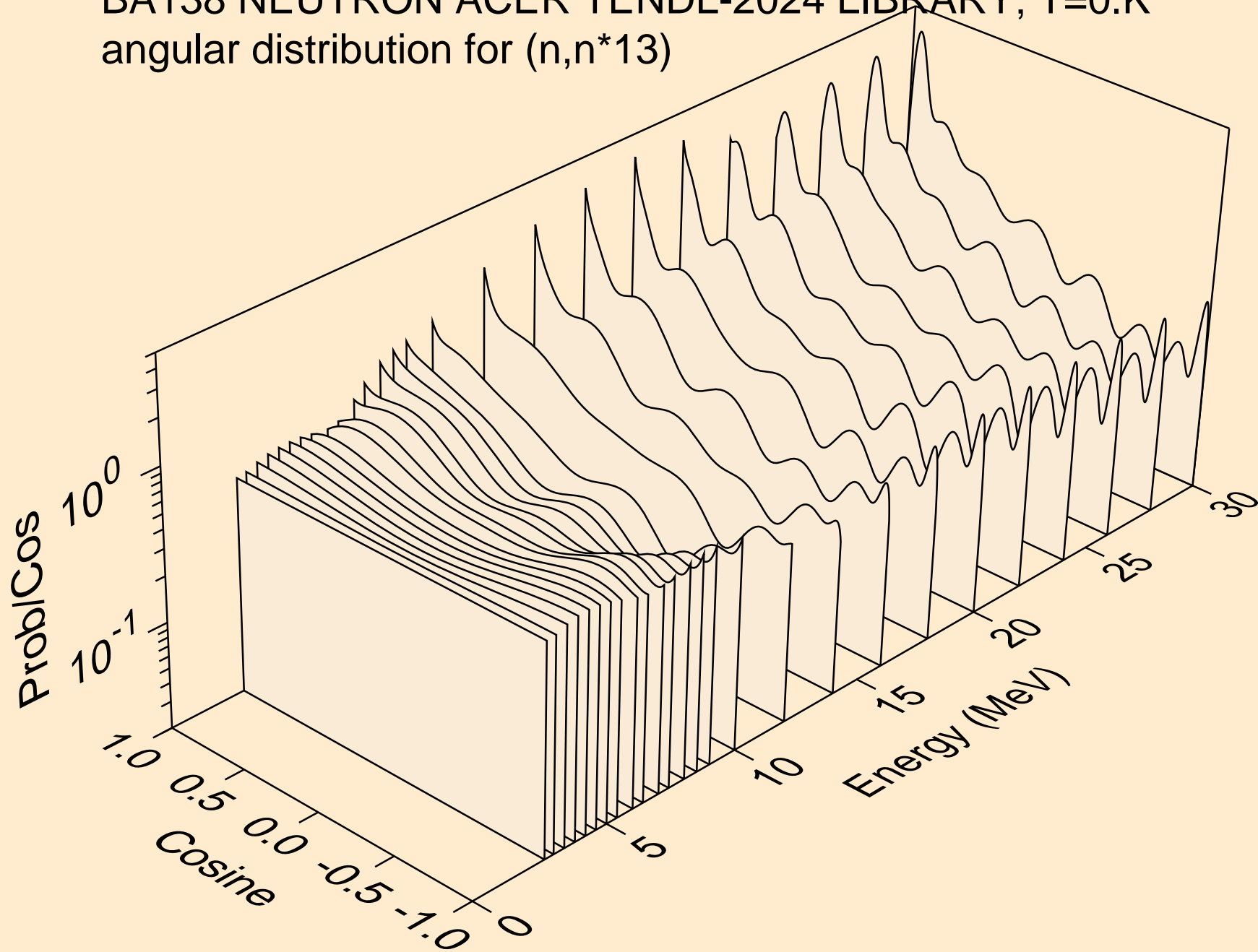

BA138 NEUTRON ACER TENDL-2024 LIBRARY; T=0.K  
angular distribution for (n,n\*14)

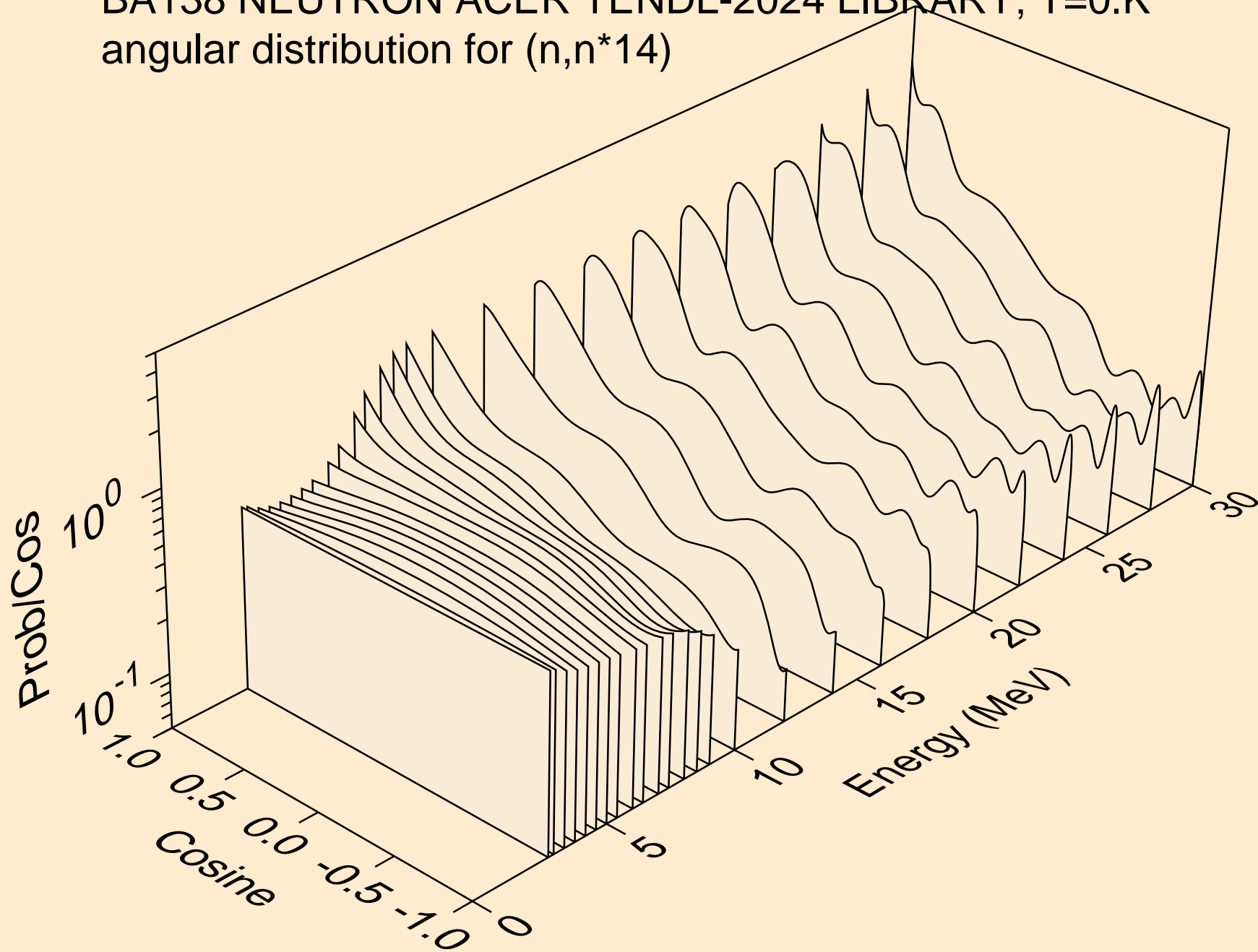

BA138 NEUTRON ACER TENDL-2024 LIBRARY; T=0.K  
angular distribution for (n,n\*15)

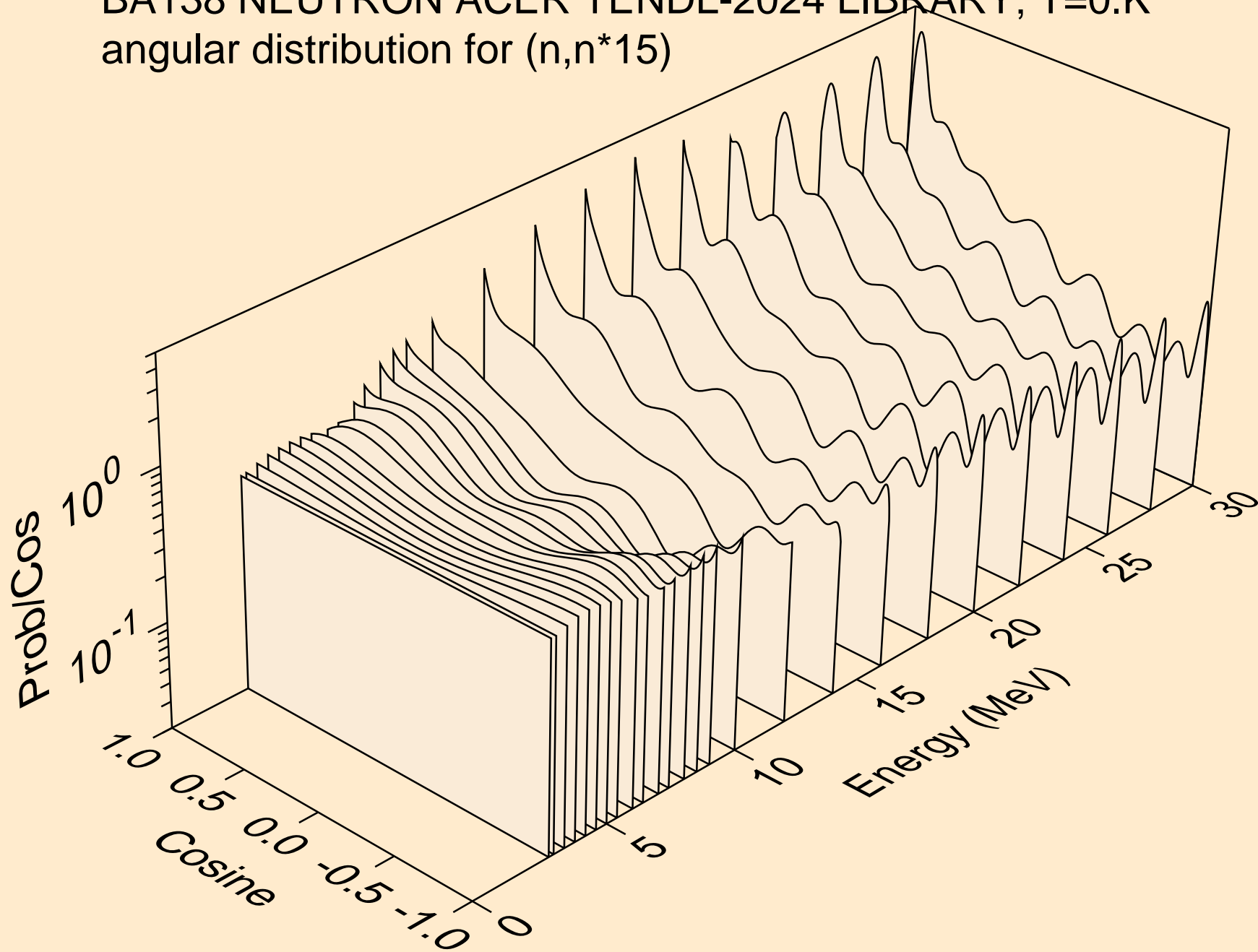

BA138 NEUTRON ACER TENDL-2024 LIBRARY; T=0.K  
angular distribution for (n,n\*16)

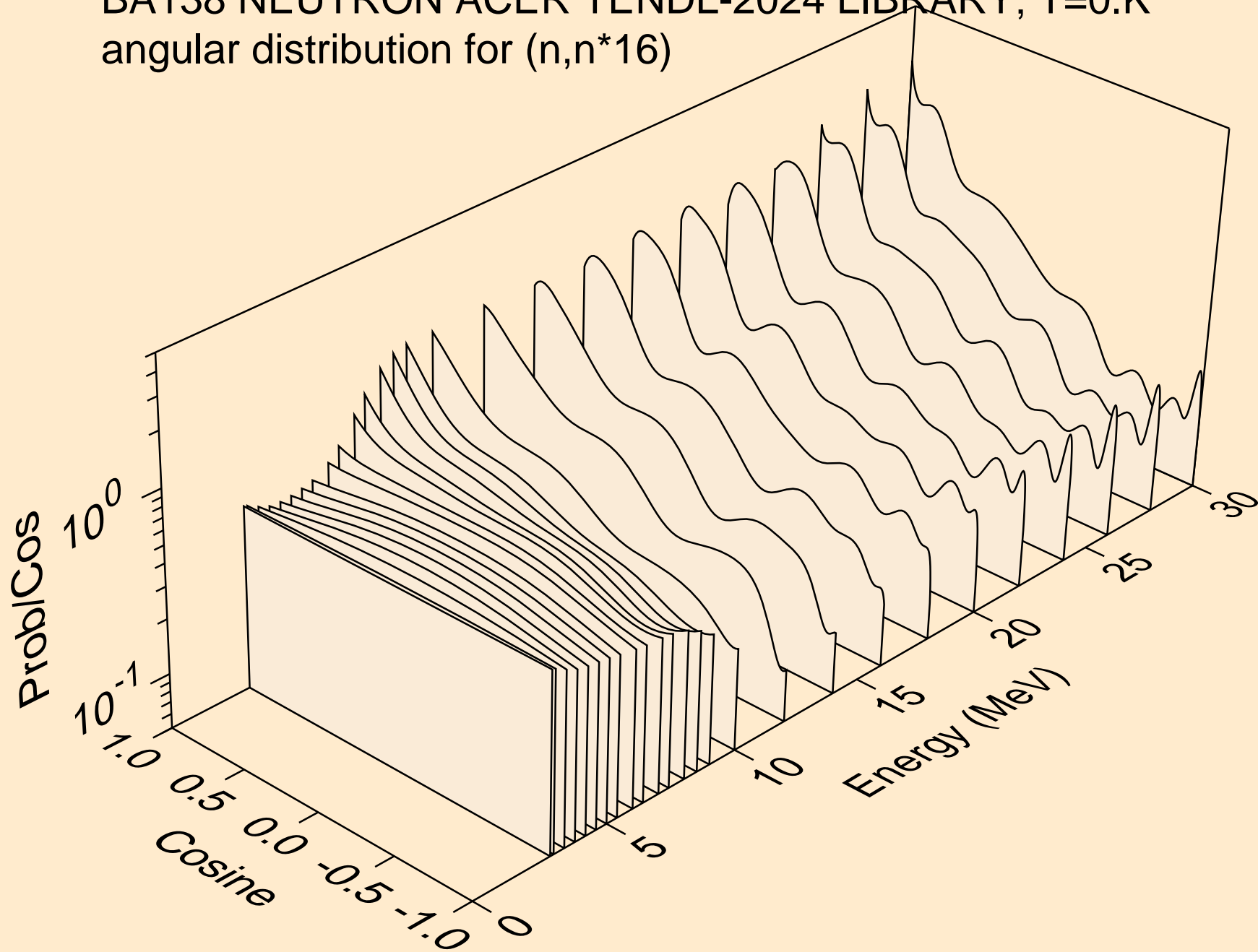

BA138 NEUTRON ACER TENDL-2024 LIBRARY; T=0.K  
angular distribution for (n,n\*17)

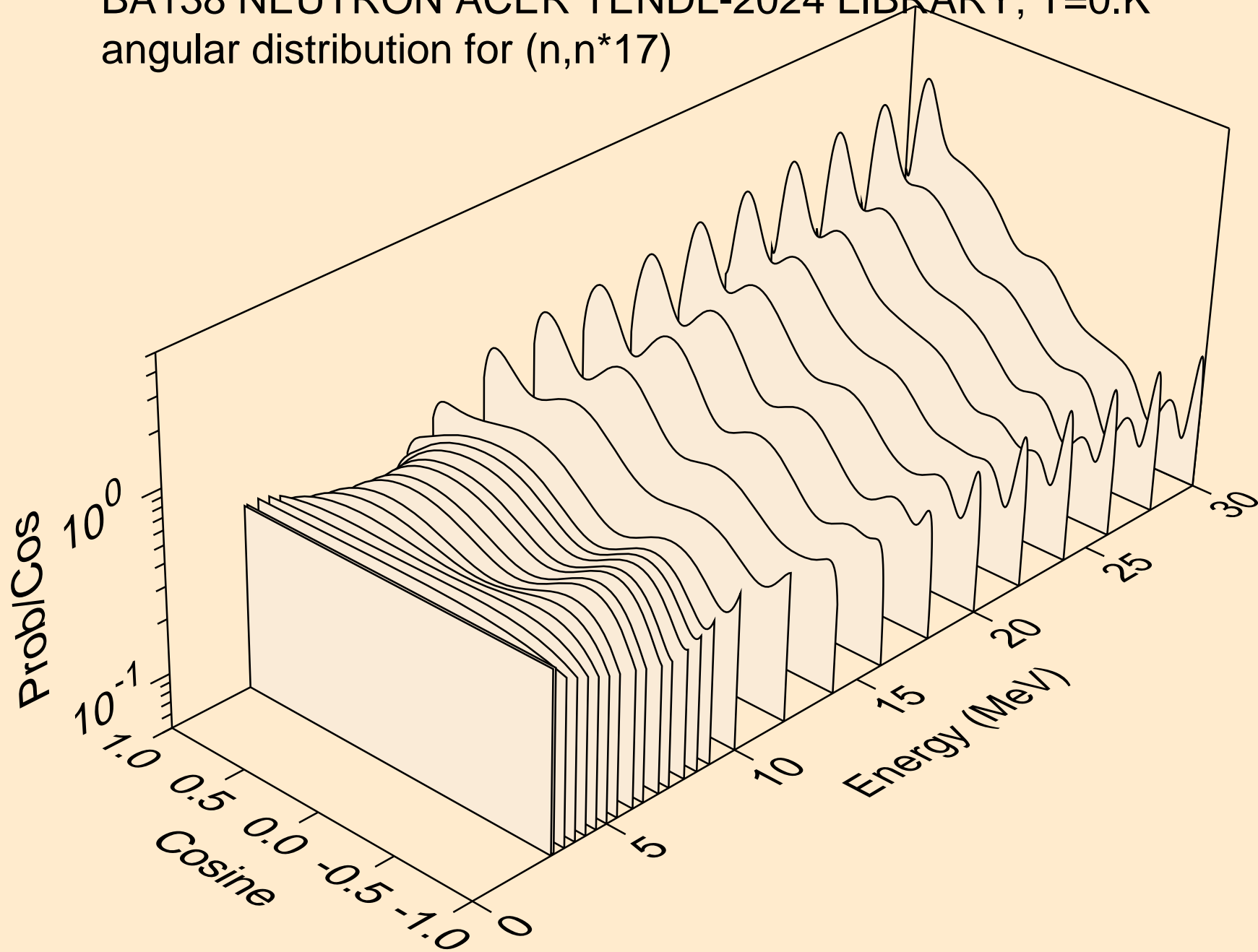



BA138 NEUTRON ACER TENDL-2024 LIBRARY; T=0.K  
angular distribution for (n,n\*18)

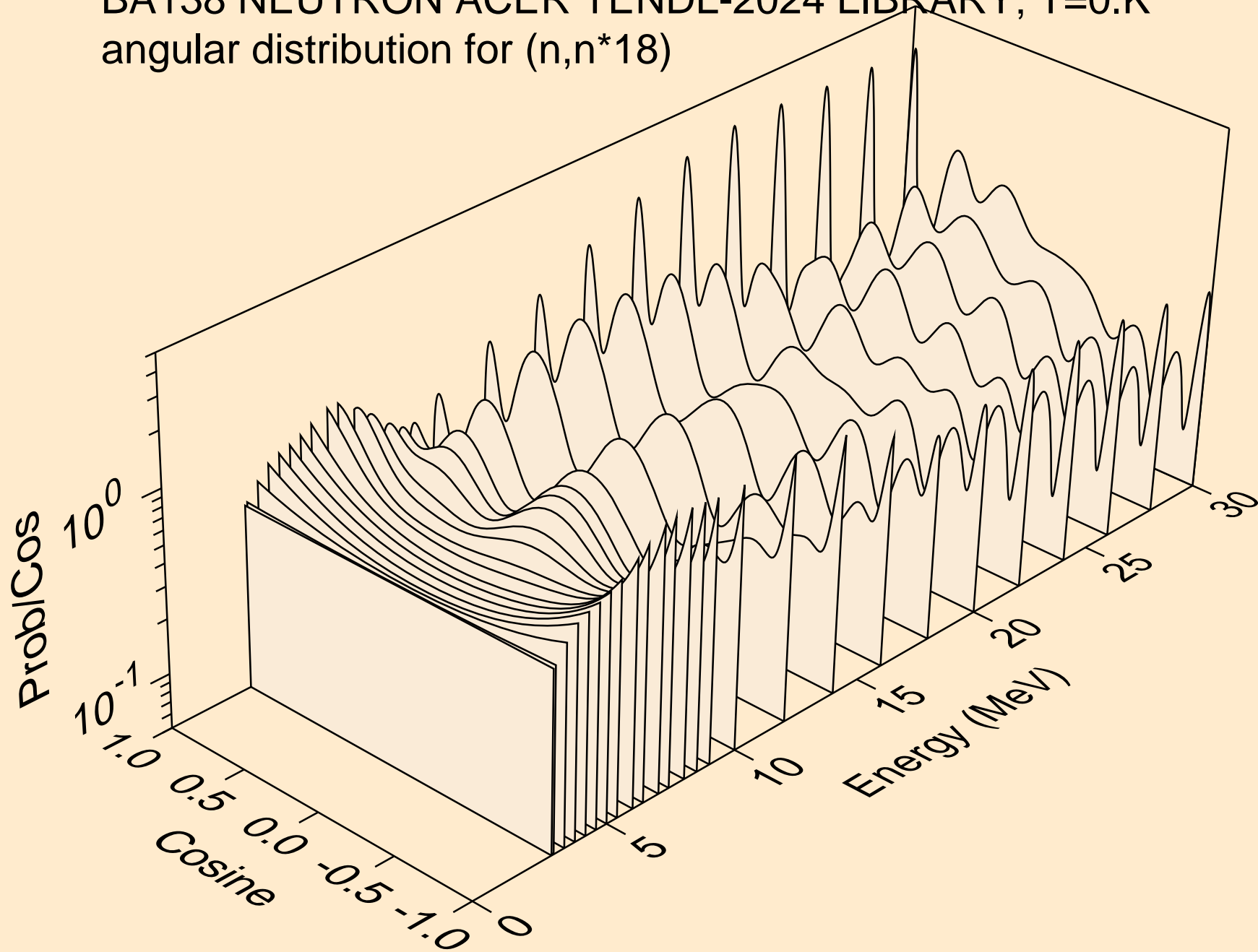

BA138 NEUTRON ACER TENDL-2024 LIBRARY; T=0.K  
angular distribution for (n,n\*19)

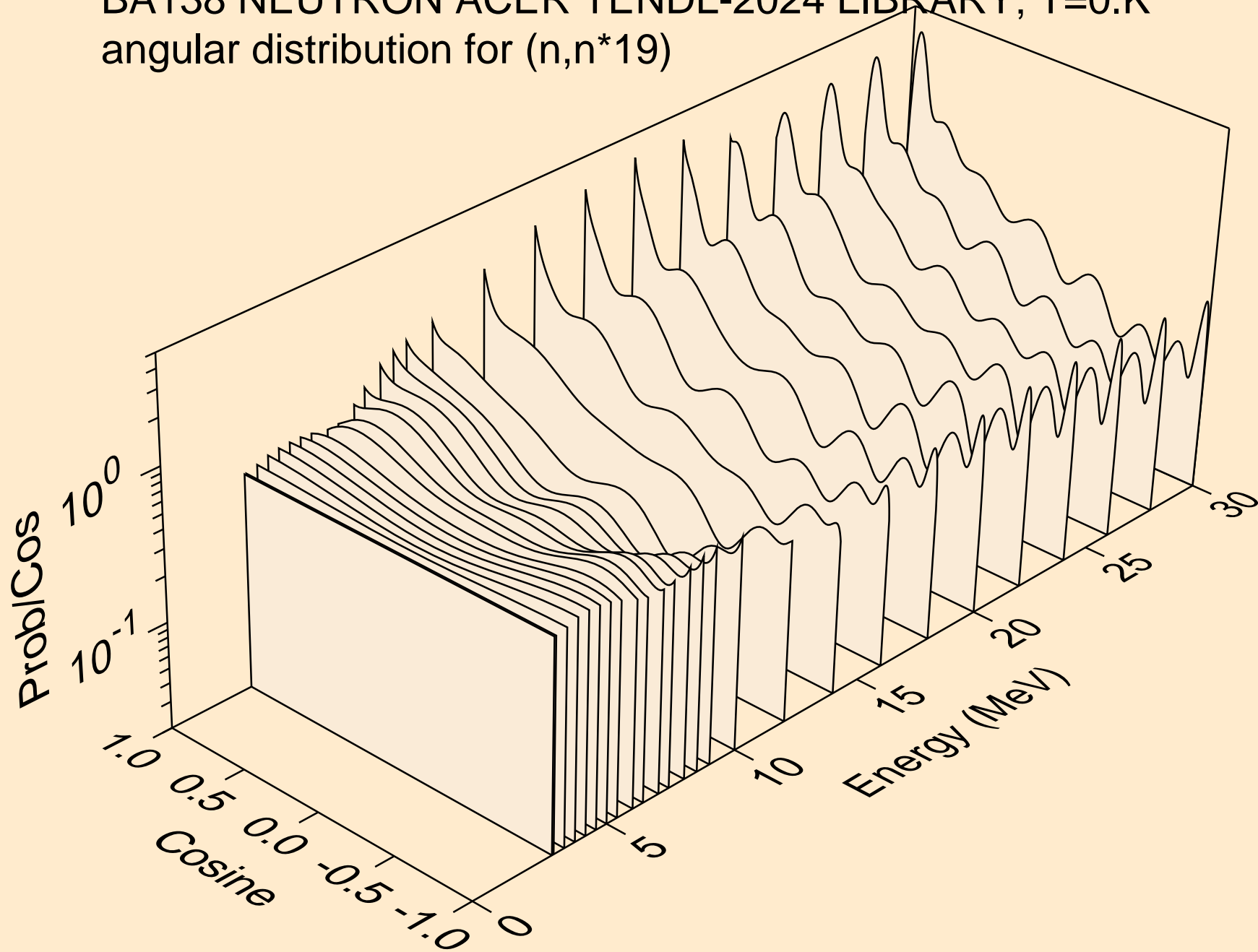

BA138 NEUTRON ACER TENDL-2024 LIBRARY; T=0.K  
angular distribution for (n,n\*20)

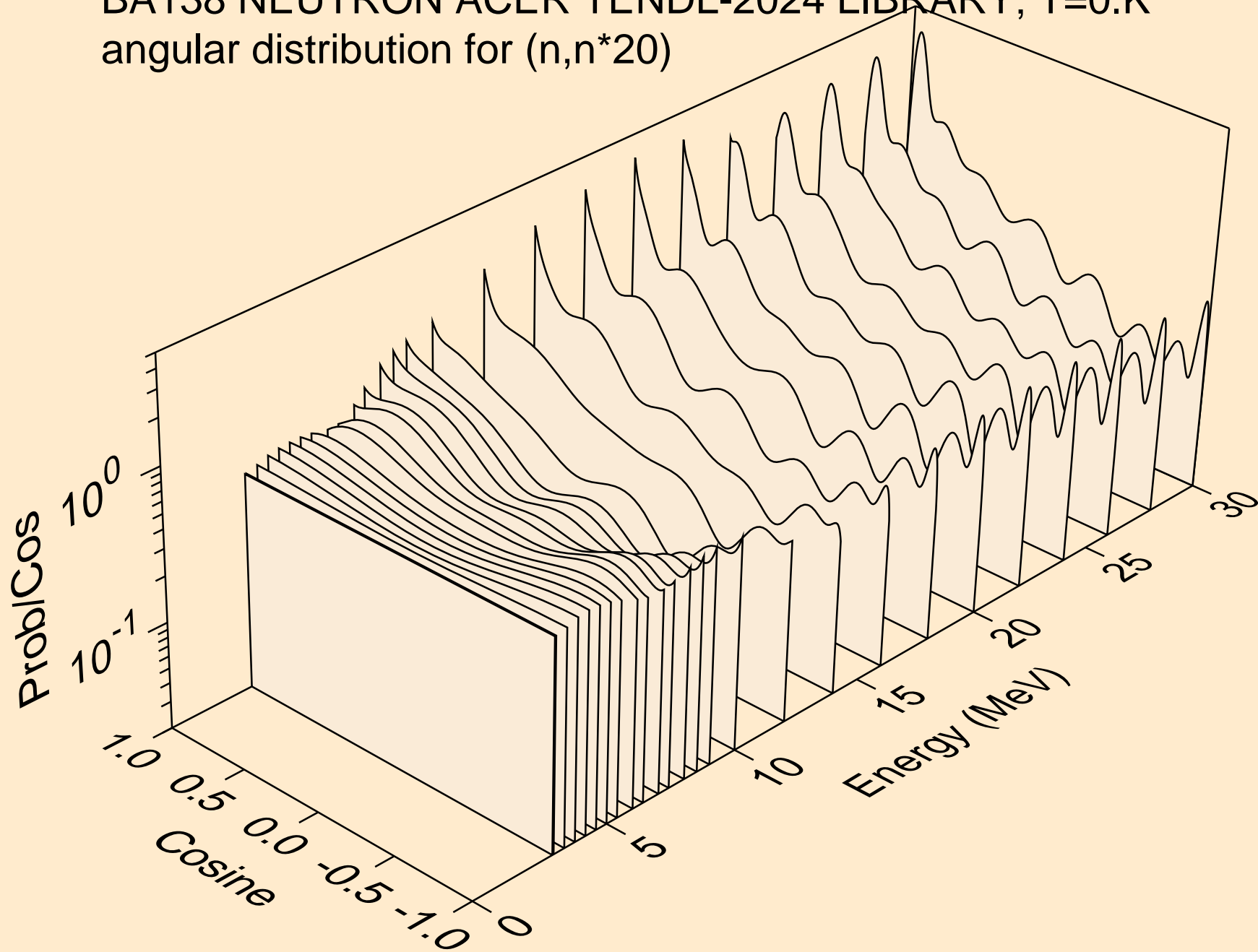

BA138 NEUTRON ACER TENDL-2024 LIBRARY; T=0.K  
angular distribution for (n,n\*21)

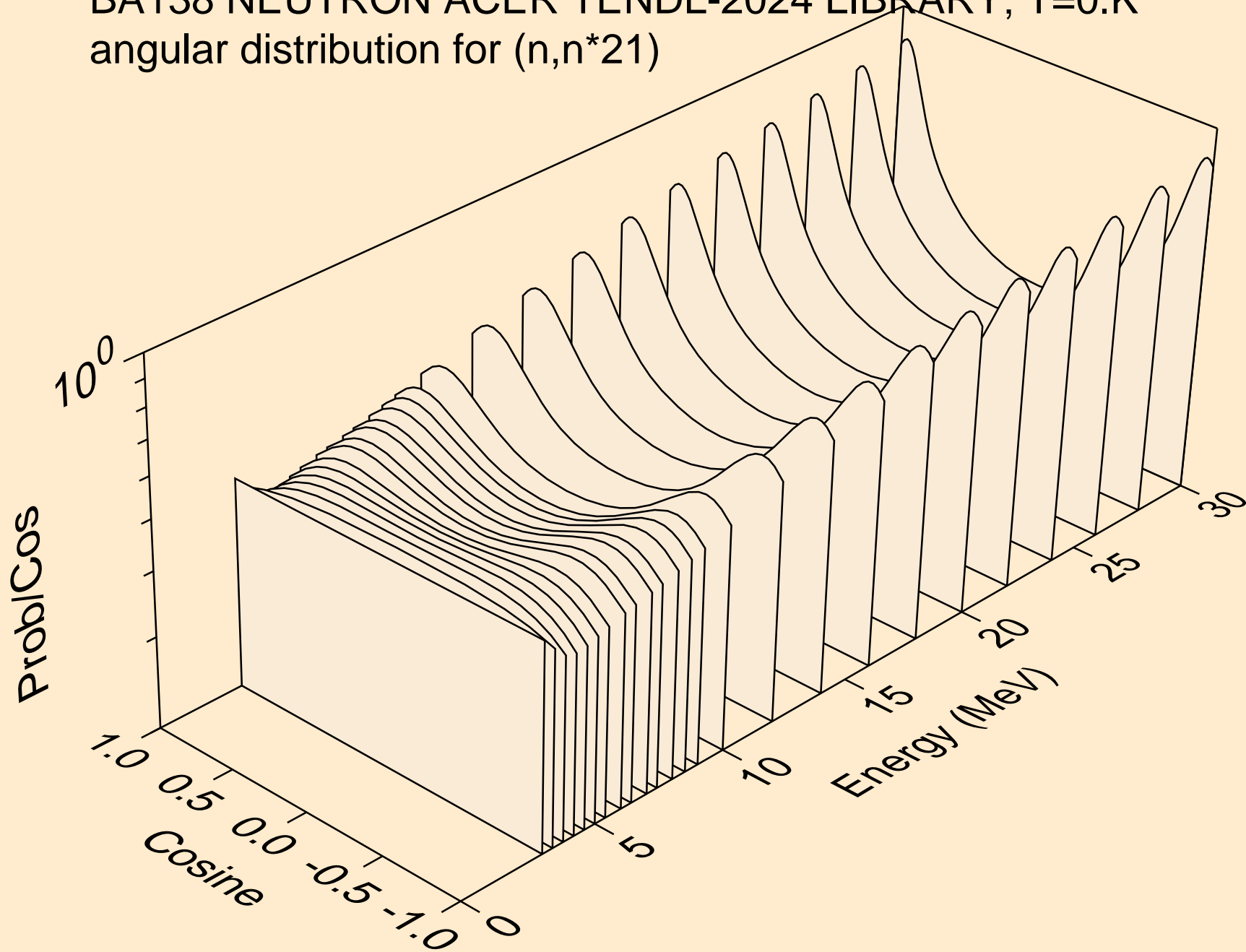

BA138 NEUTRON ACER TENDL-2024 LIBRARY; T=0.K  
angular distribution for (n,n\*22)

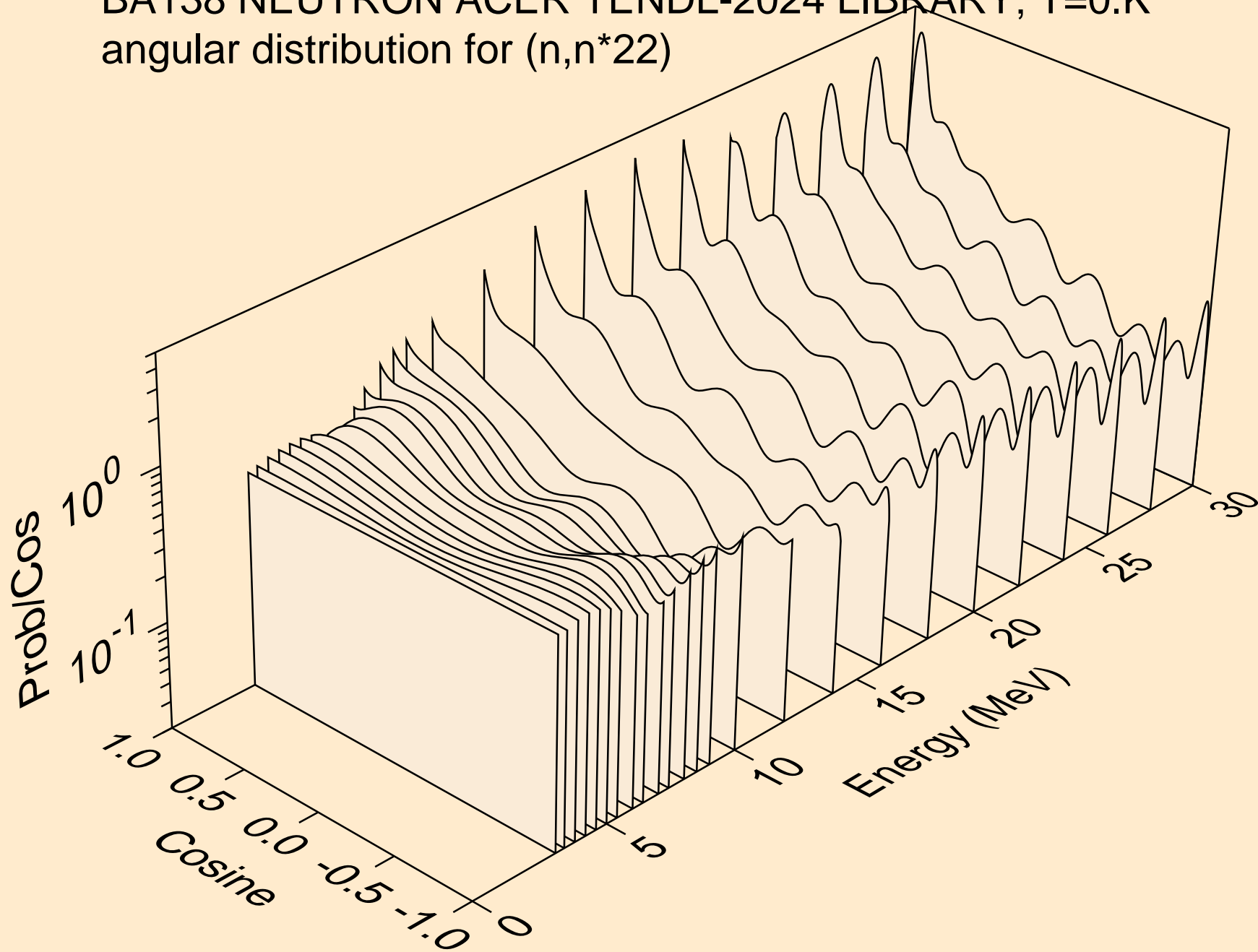

BA138 NEUTRON ACER TENDL-2024 LIBRARY; T=0.K  
angular distribution for (n,n\*23)

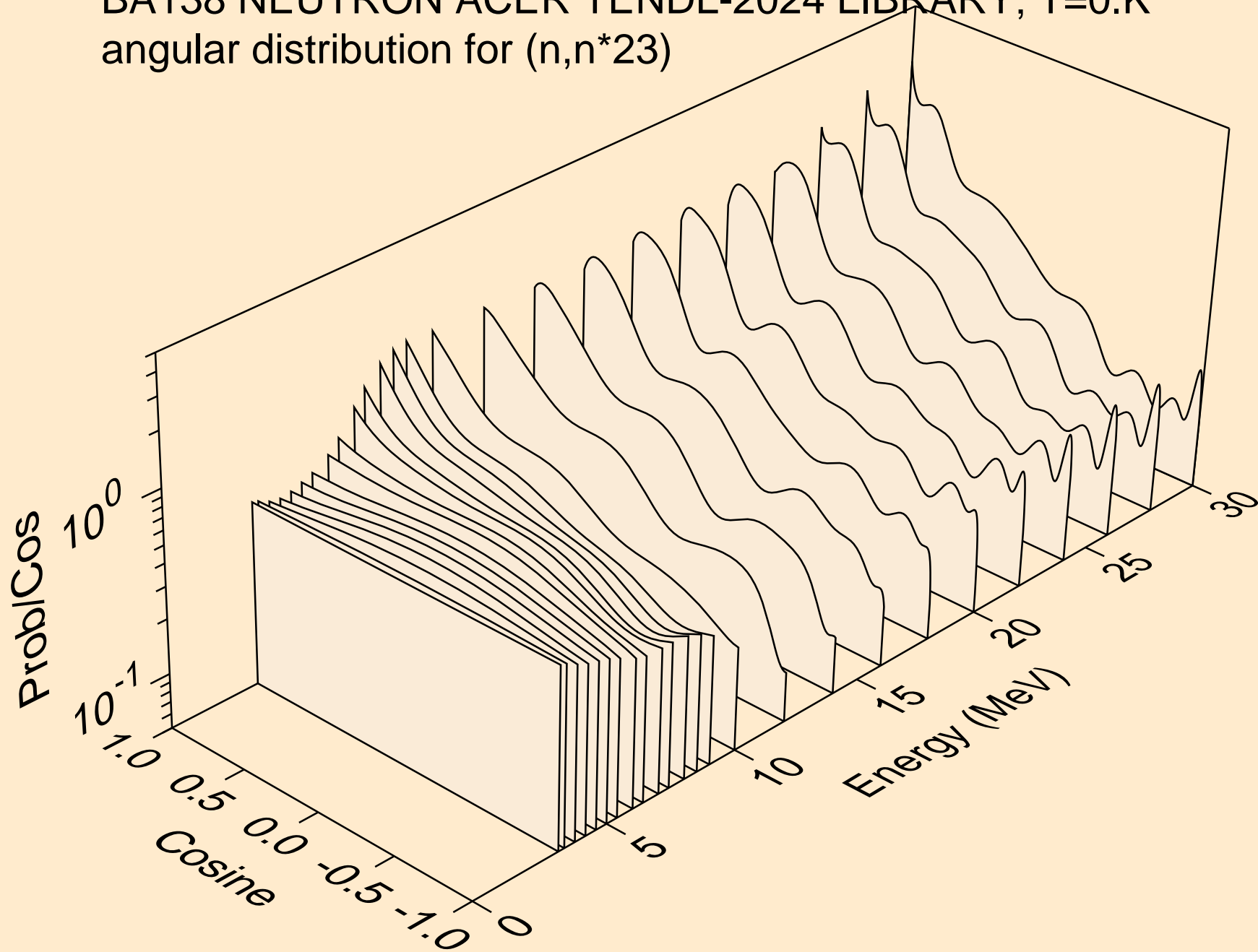

BA138 NEUTRON ACER TENDL-2024 LIBRARY; T=0.K  
angular distribution for (n,n\*24)

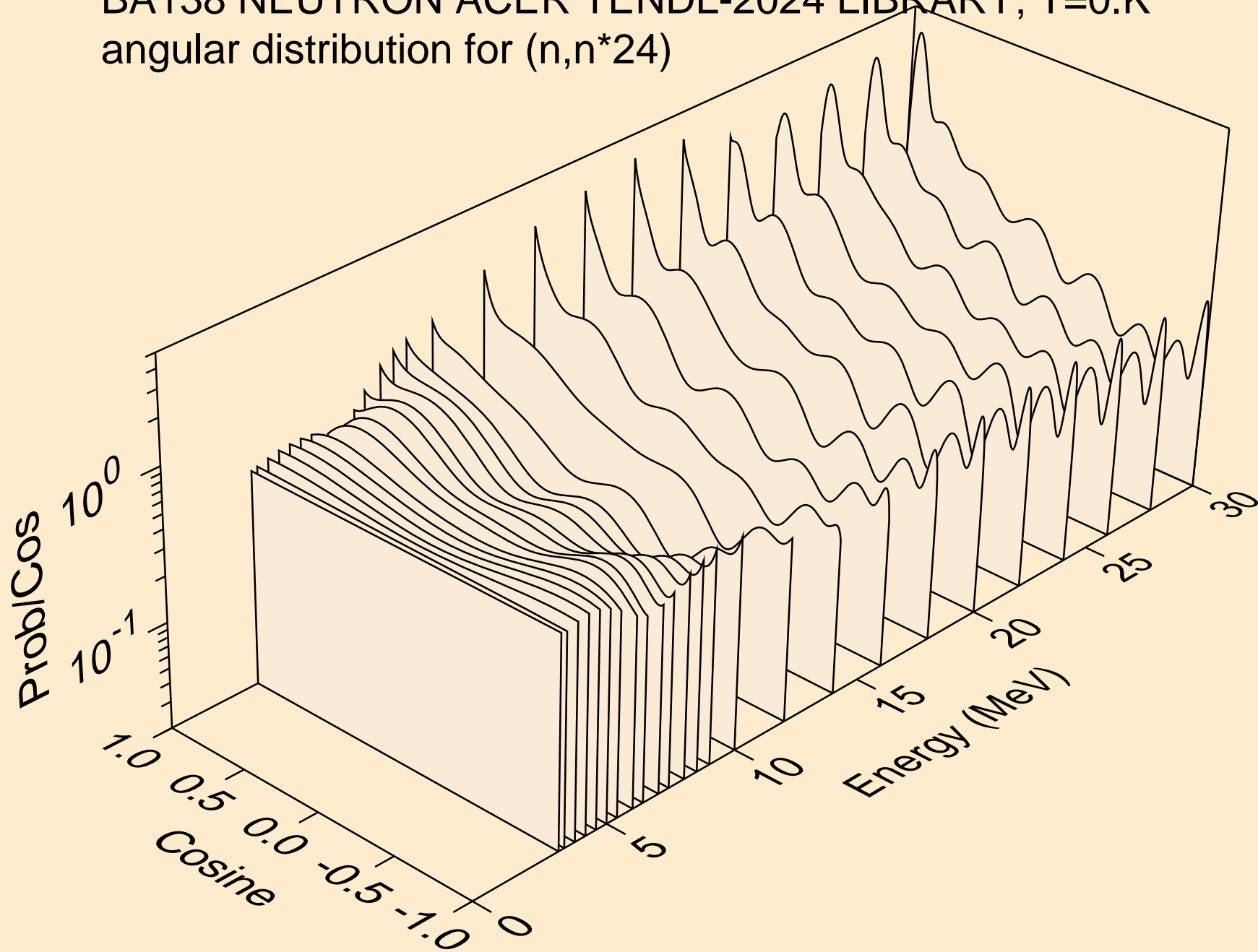

BA138 NEUTRON ACER TENDL-2024 LIBRARY; T=0.K  
angular distribution for (n,n\*25)

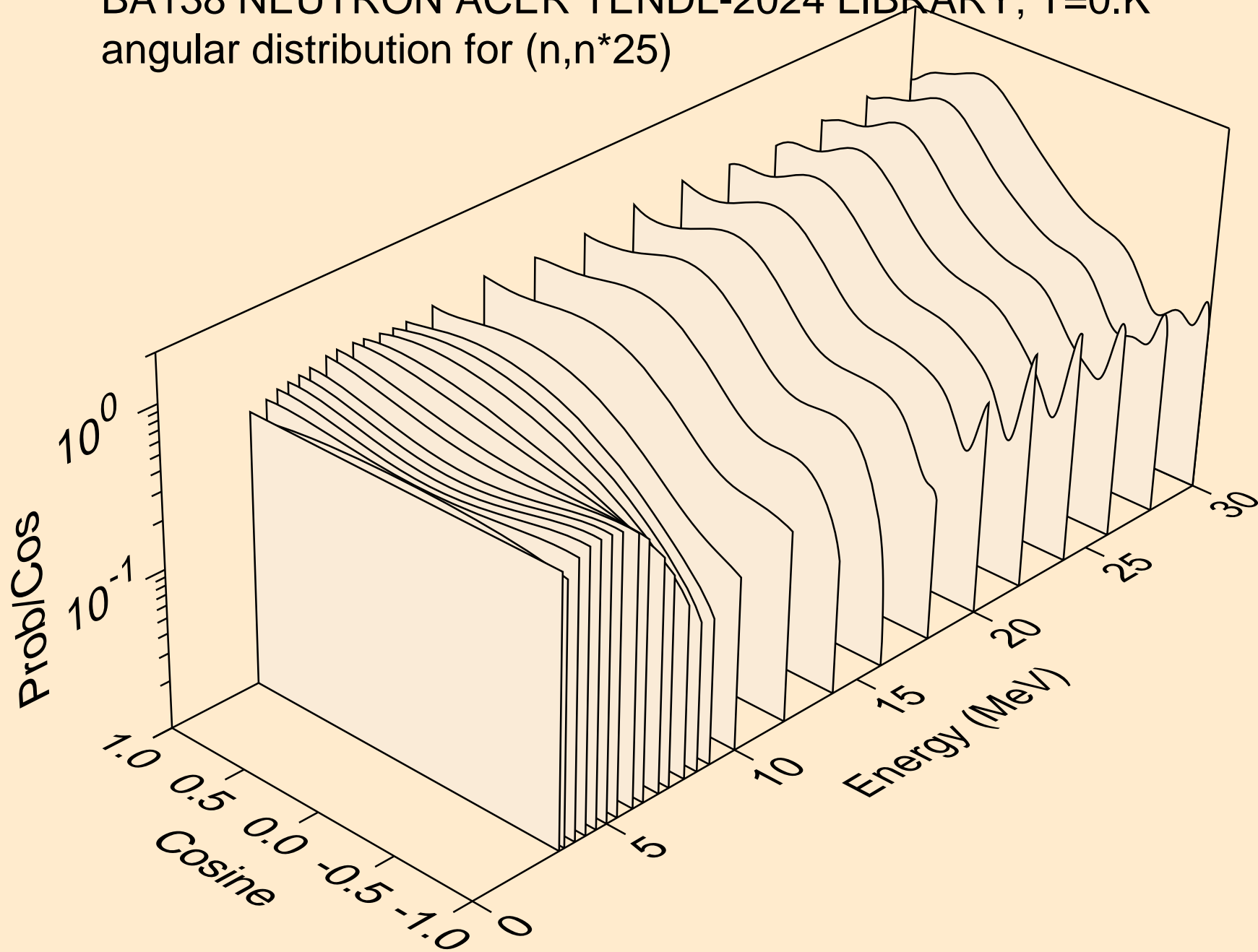



BA138 NEUTRON ACER TENDL-2024 LIBRARY; T=0.K  
angular distribution for (n,n\*26)

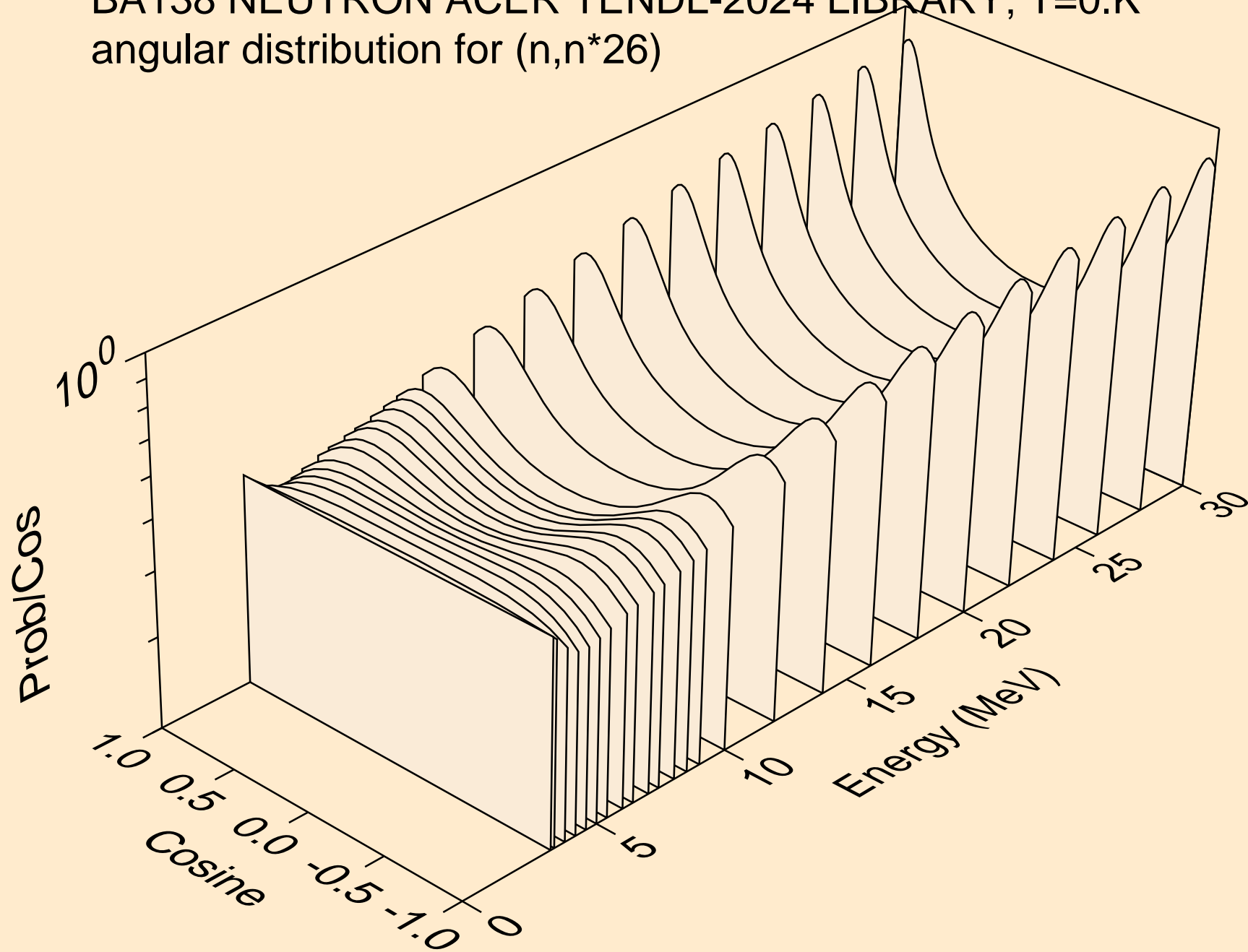

BA138 NEUTRON ACER TENDL-2024 LIBRARY; T=0.K  
angular distribution for (n,n\*27)

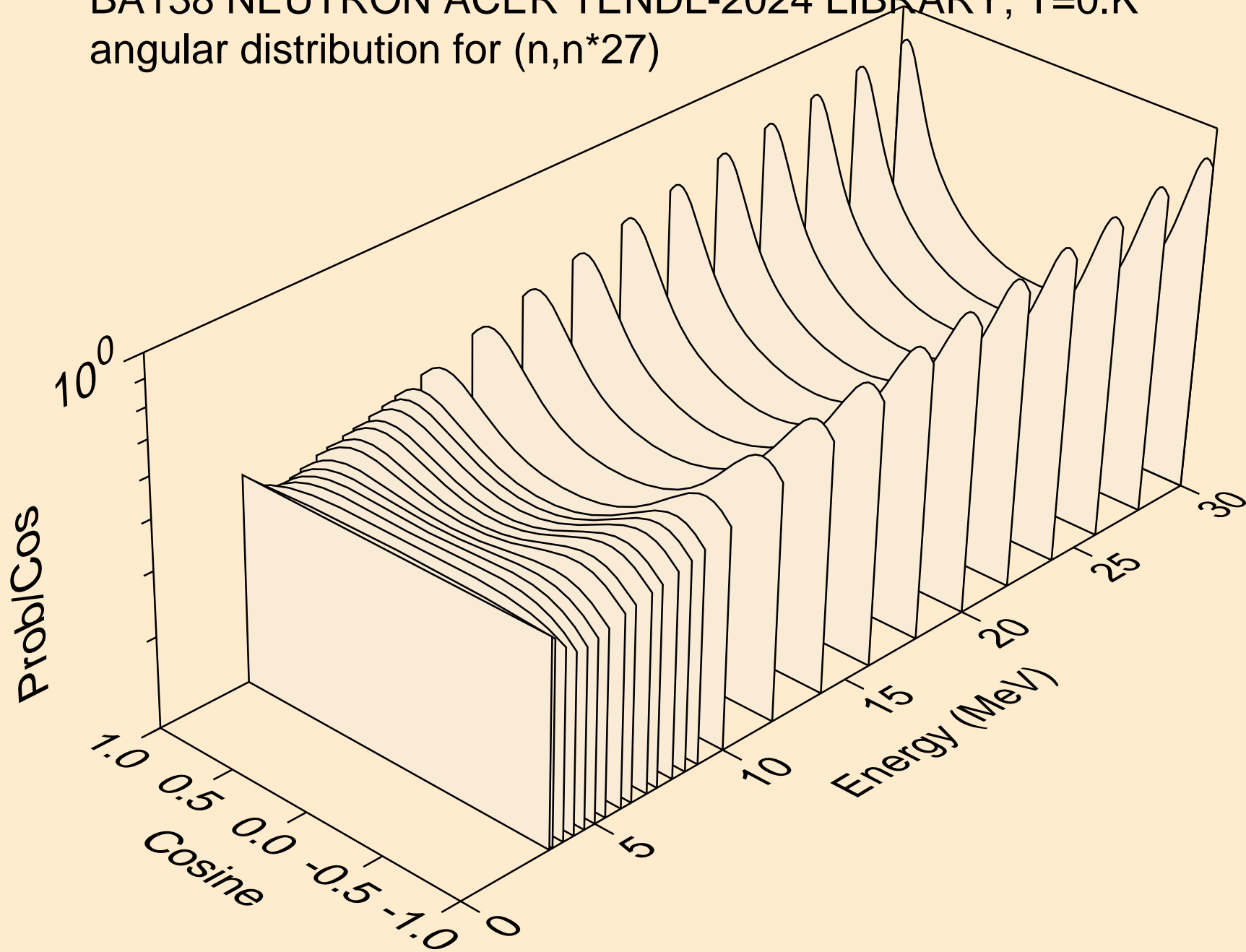

BA138 NEUTRON ACER TENDL-2024 LIBRARY; T=0.K  
angular distribution for (n,n\*28)

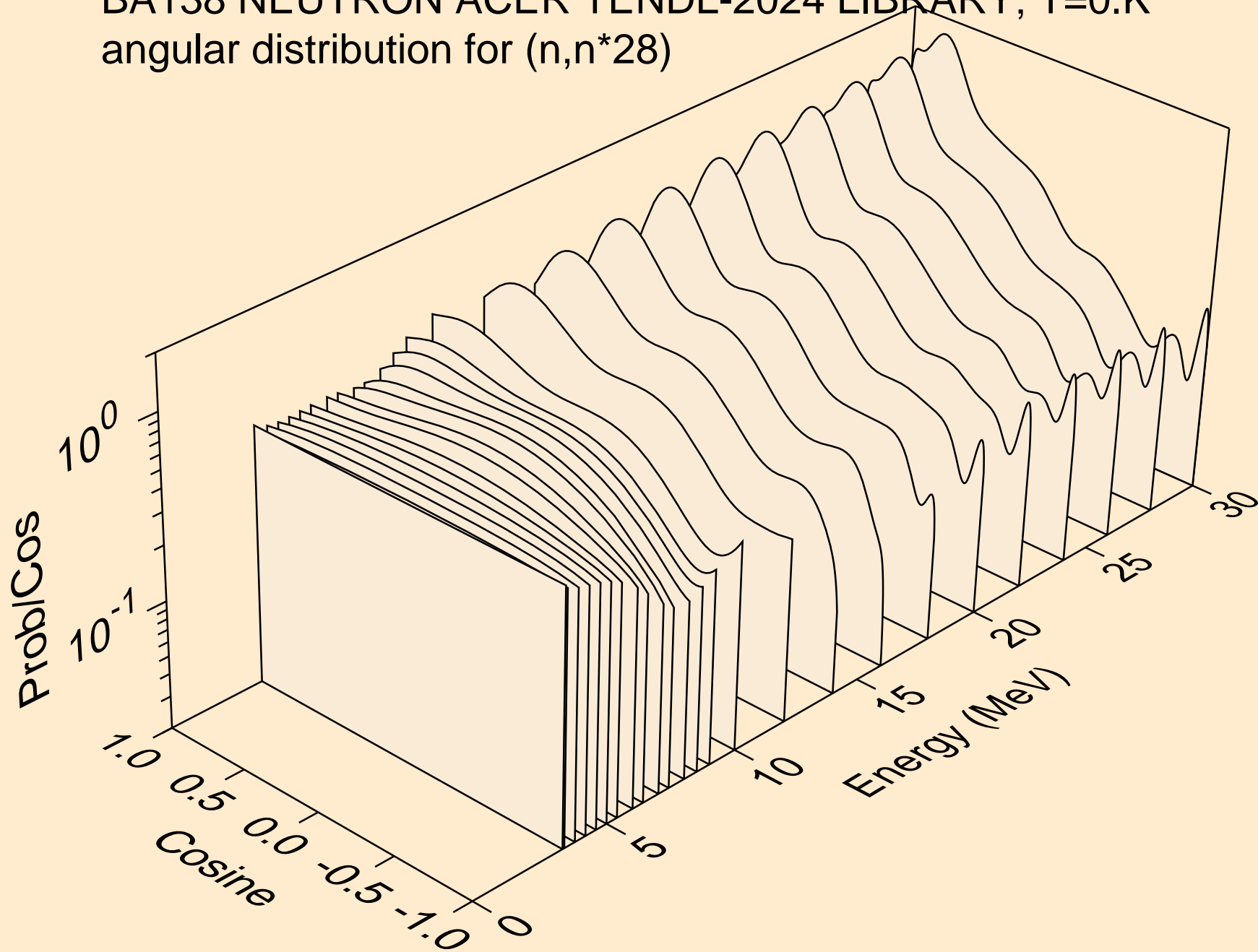

BA138 NEUTRON ACER TENDL-2024 LIBRARY; T=0.K  
angular distribution for (n,n\*29)

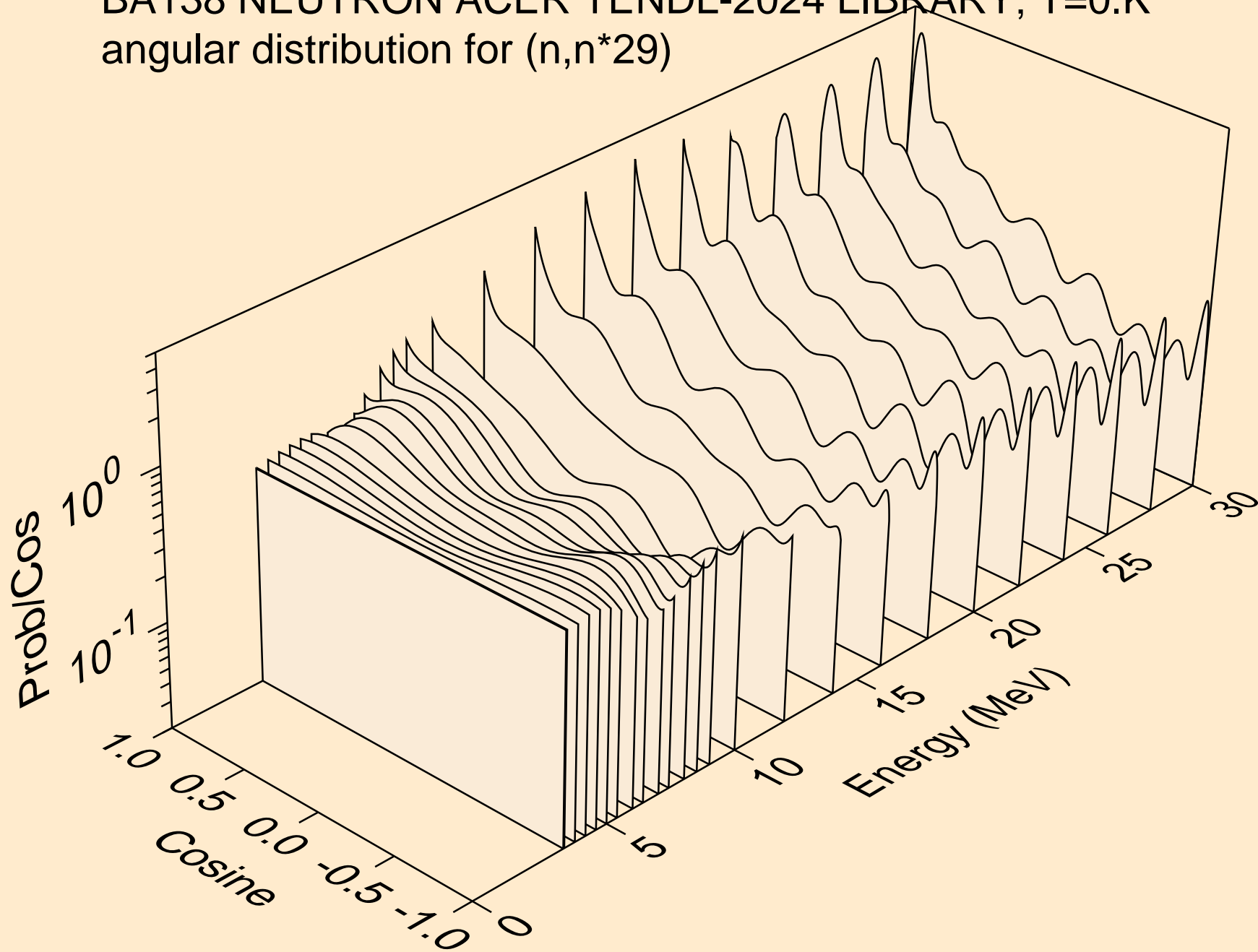

BA138 NEUTRON ACER TENDL-2024 LIBRARY; T=0.K  
Neutron emission for (n,x)

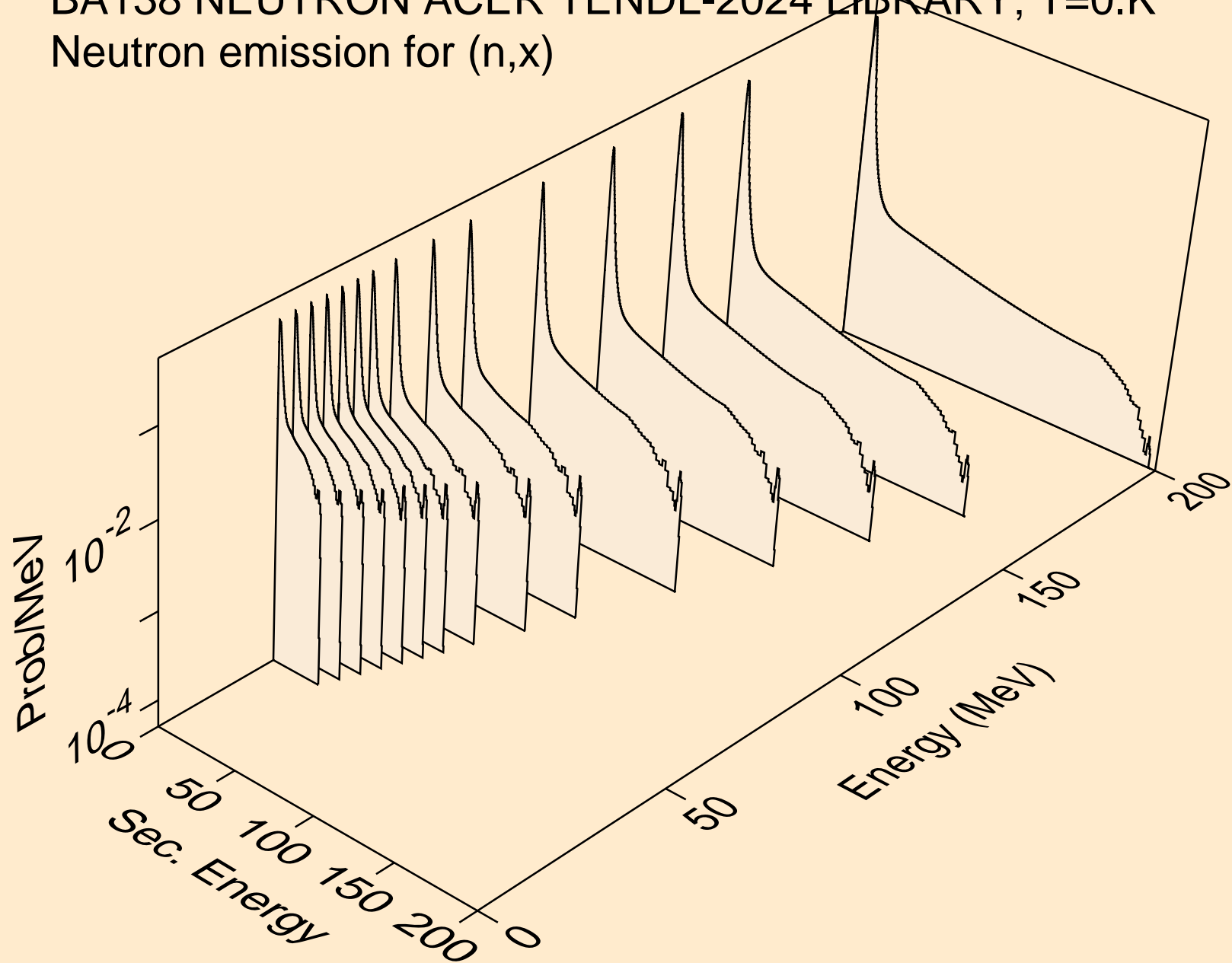

BA138 NEUTRON ACER TENDL-2024 LIBRARY; T=0.K  
Neutron emission for (n,2nd)

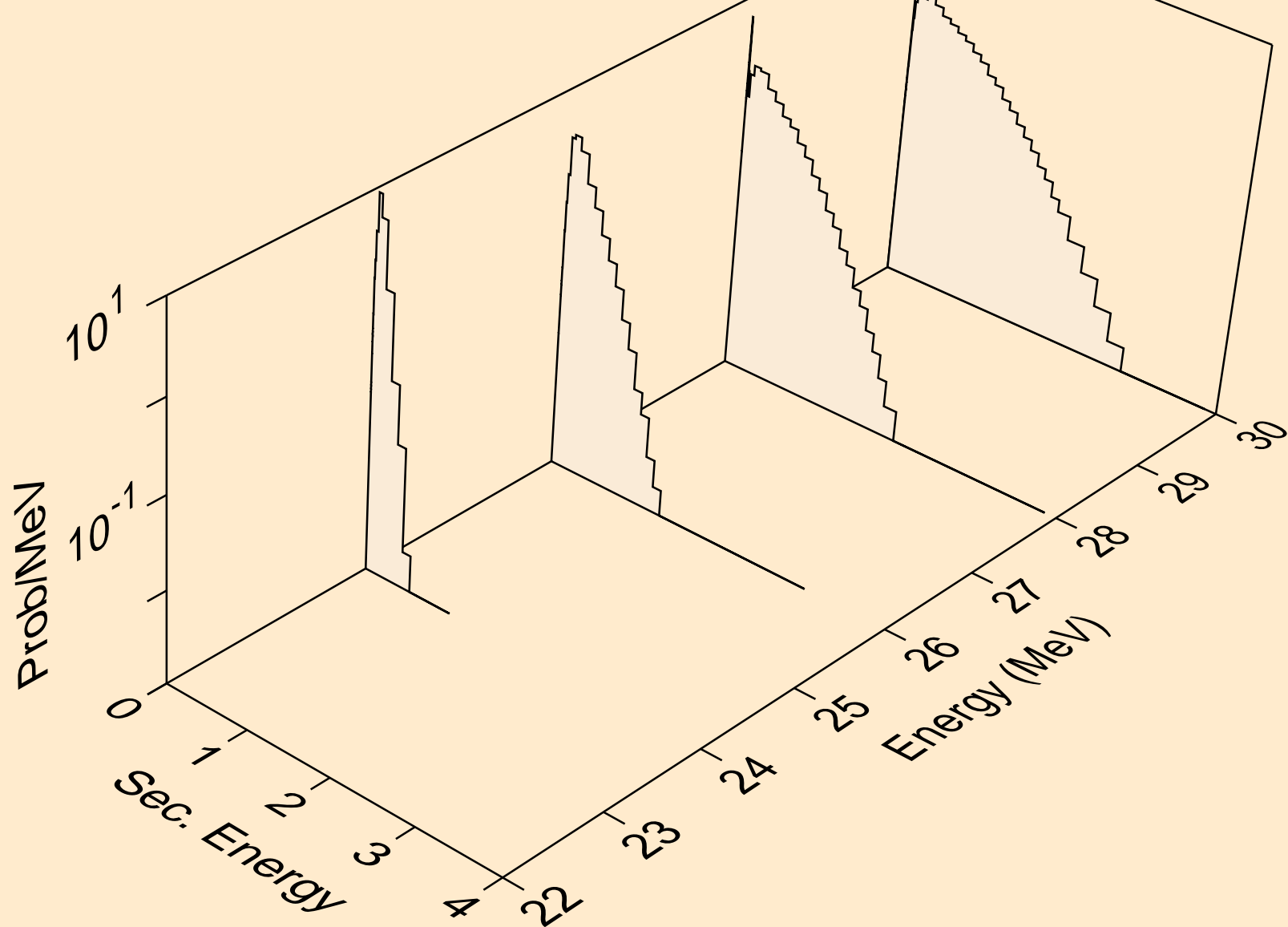

BA138 NEUTRON ACER TENDL-2024 LIBRARY; T=0.K  
Neutron emission for (n,2n)

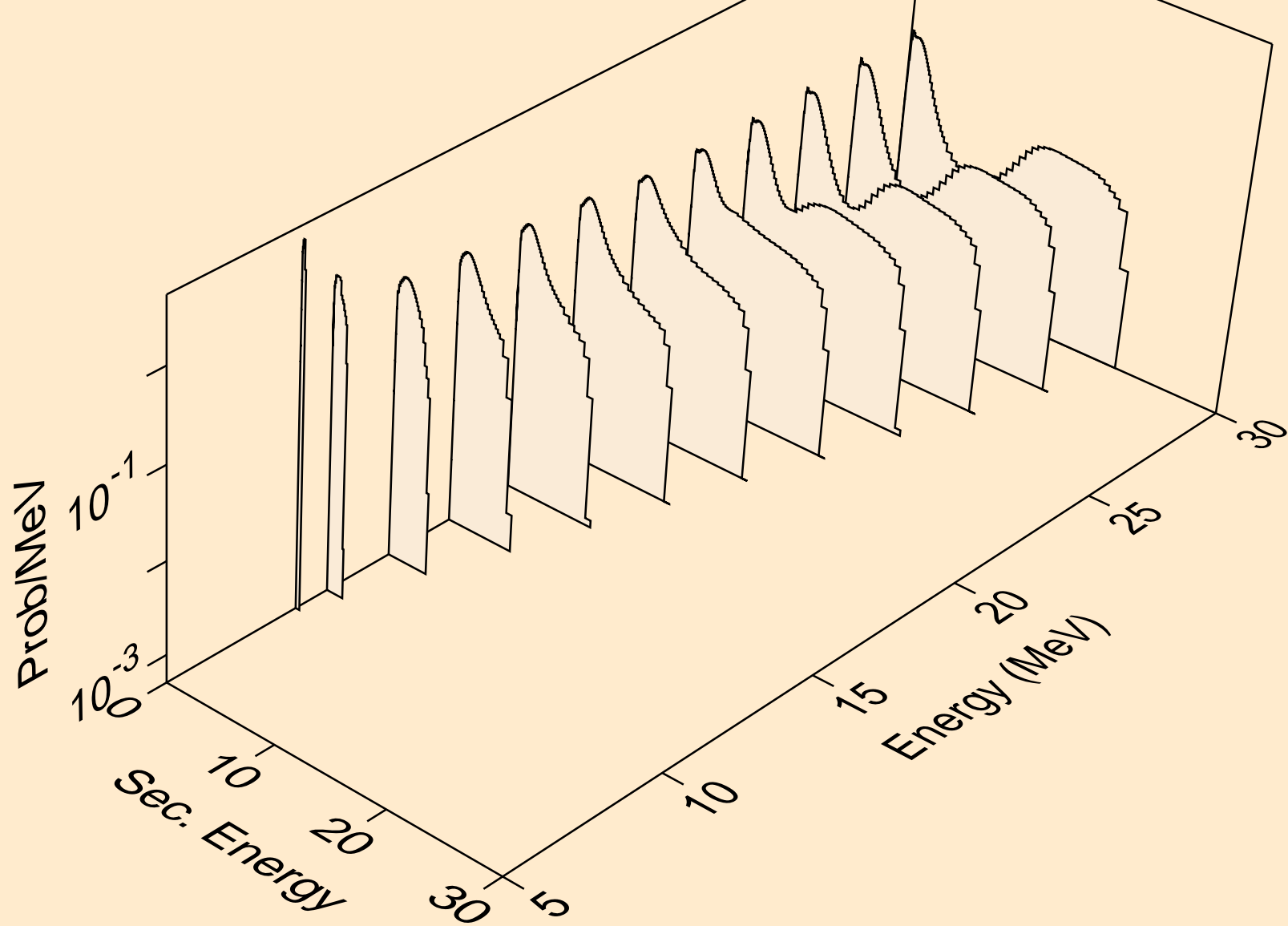

BA138 NEUTRON ACER TENDL-2024 LIBRARY; T=0.K  
Neutron emission for (n,3n)

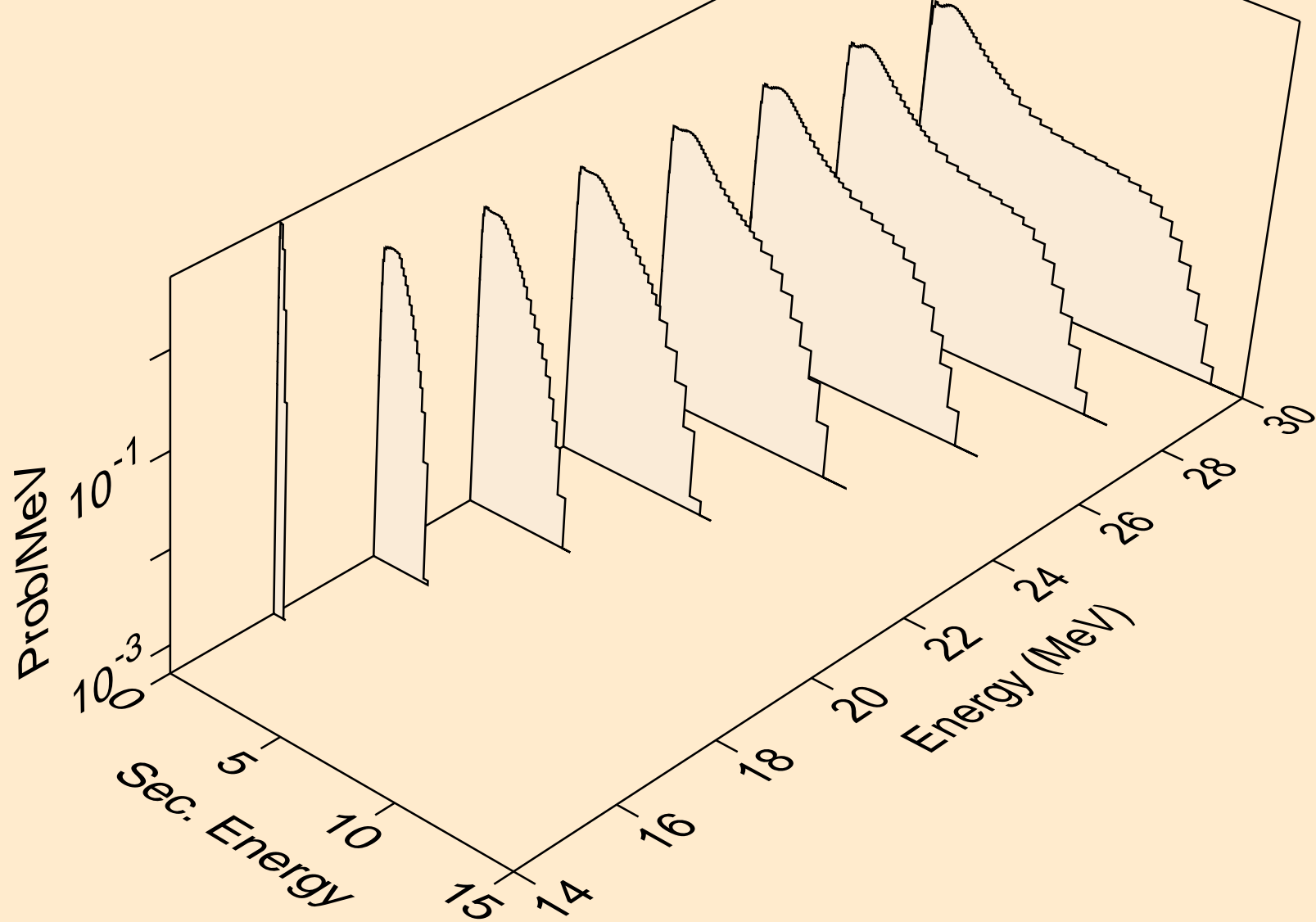



BA138 NEUTRON ACER TENDL-2024 LIBRARY; T=0.K  
Neutron emission for (n,n\*)a

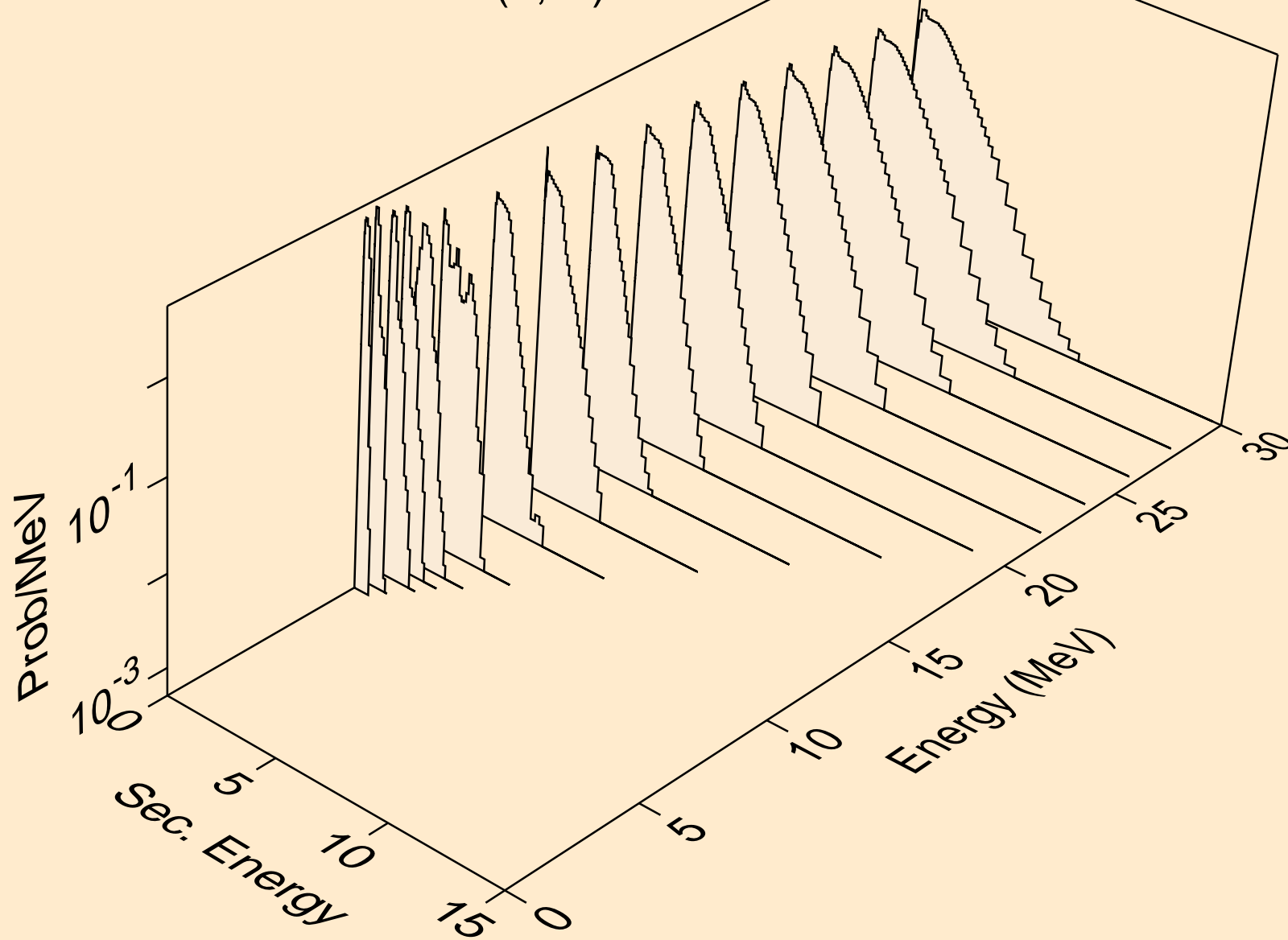

BA138 NEUTRON ACER TENDL-2024 LIBRARY; T=0.K  
Neutron emission for (n,2n)a

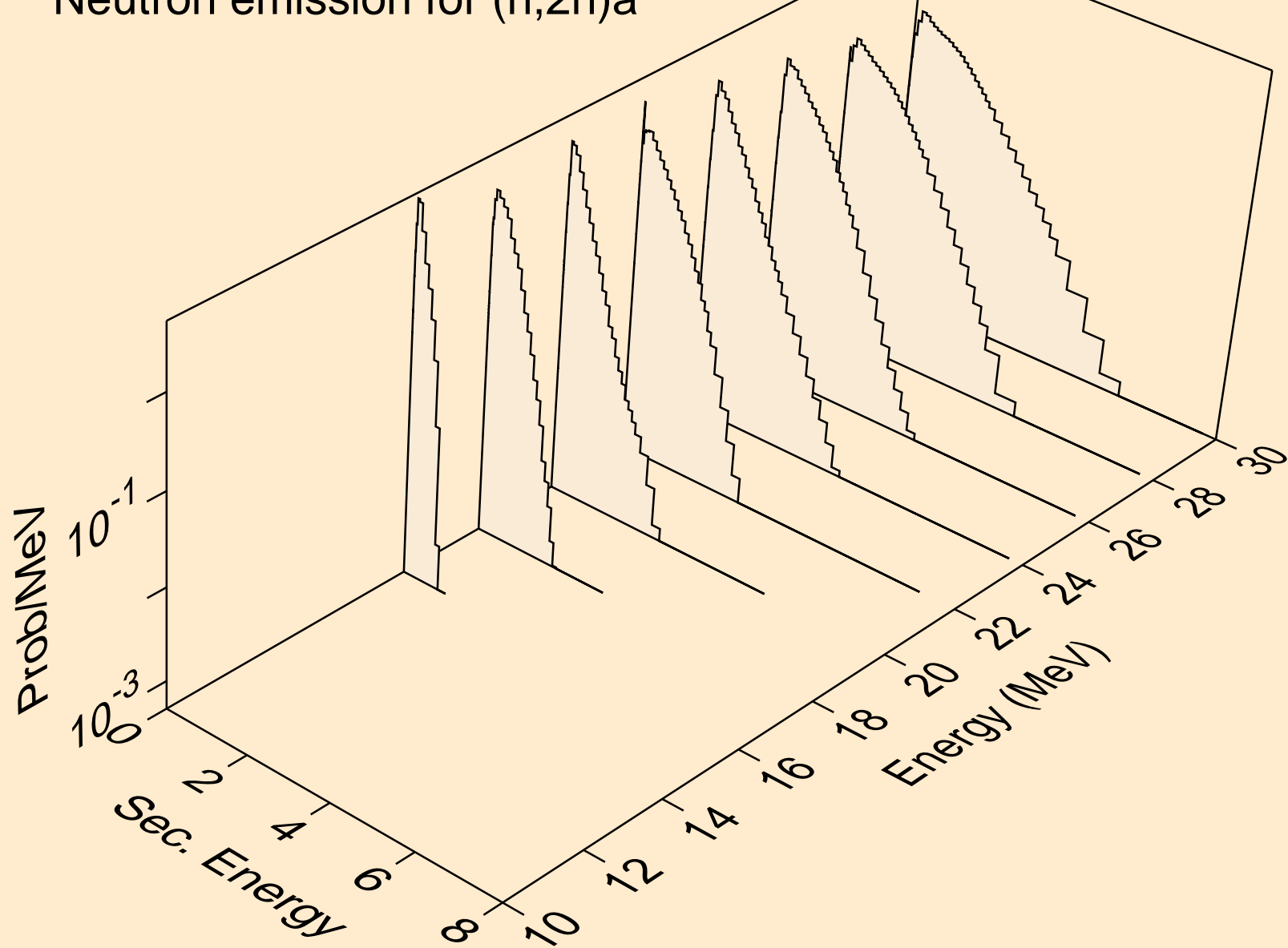

BA138 NEUTRON ACER TENDL-2024 LIBRARY; T=0.K  
Neutron emission for (n,3n)a

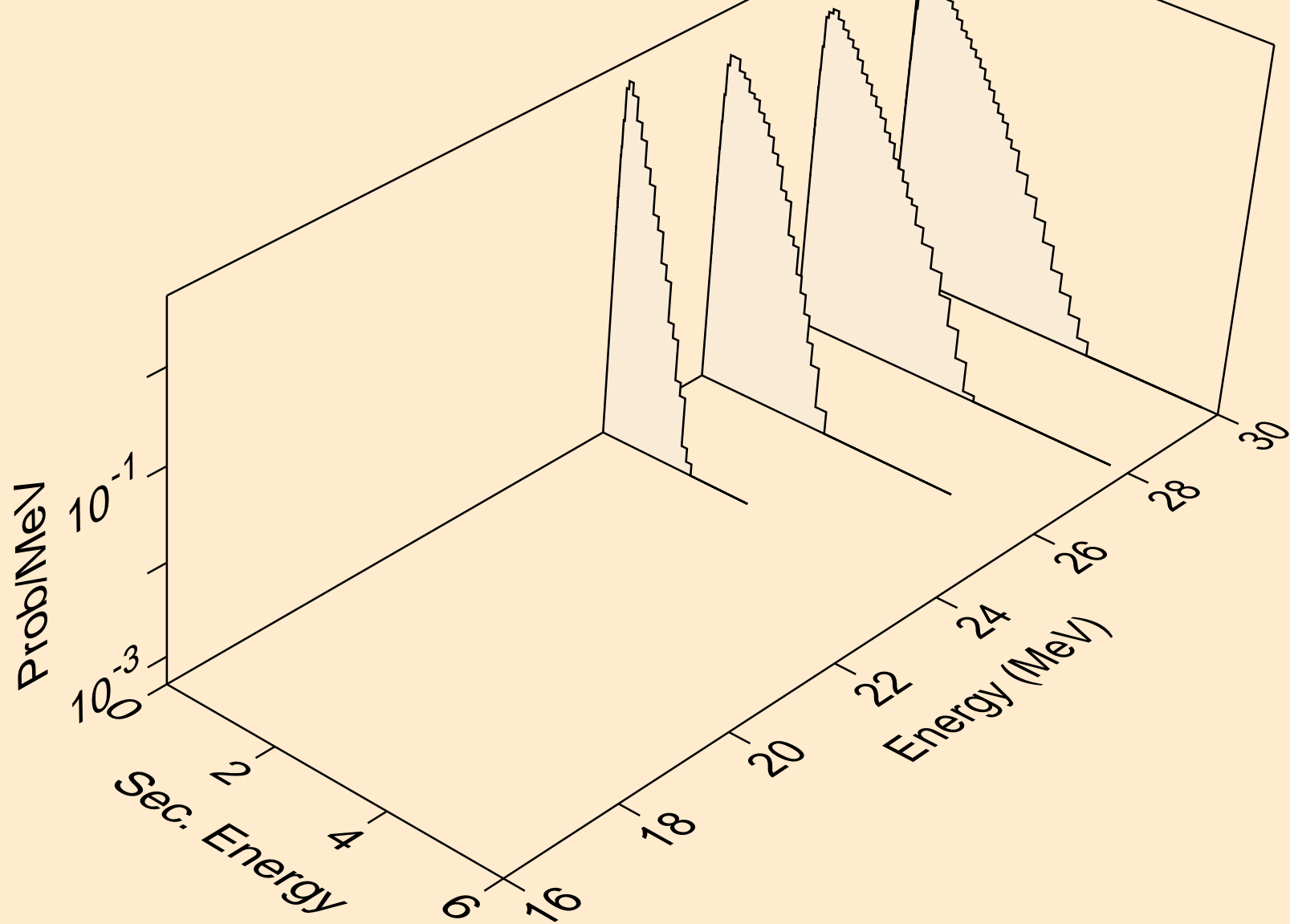

BA138 NEUTRON ACER TENDL-2024 LIBRARY; T=0.K  
Neutron emission for (n,n\*)p

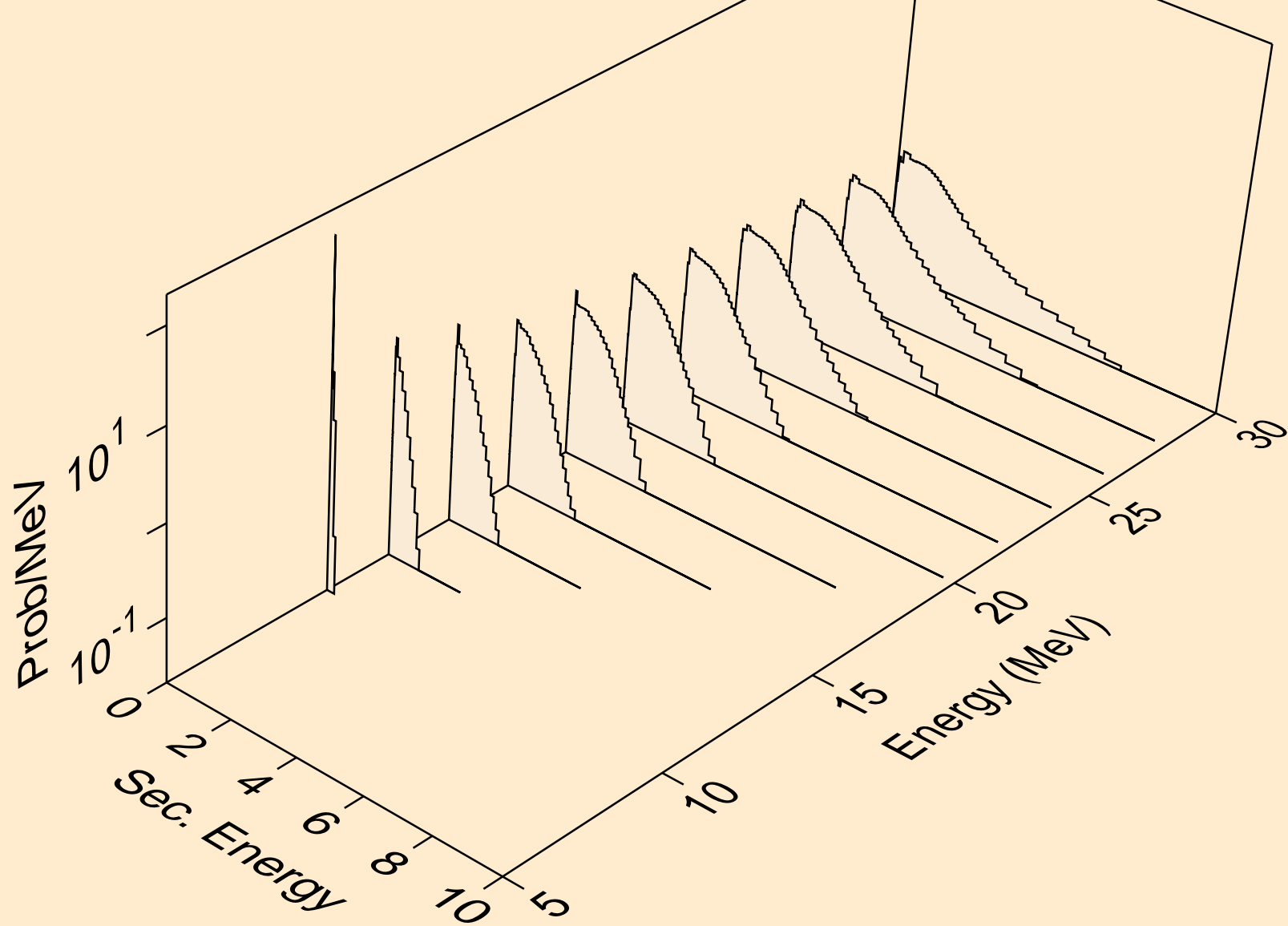

BA138 NEUTRON ACER TENDL-2024 LIBRARY; T=0.K  
Neutron emission for (n,n\*)d

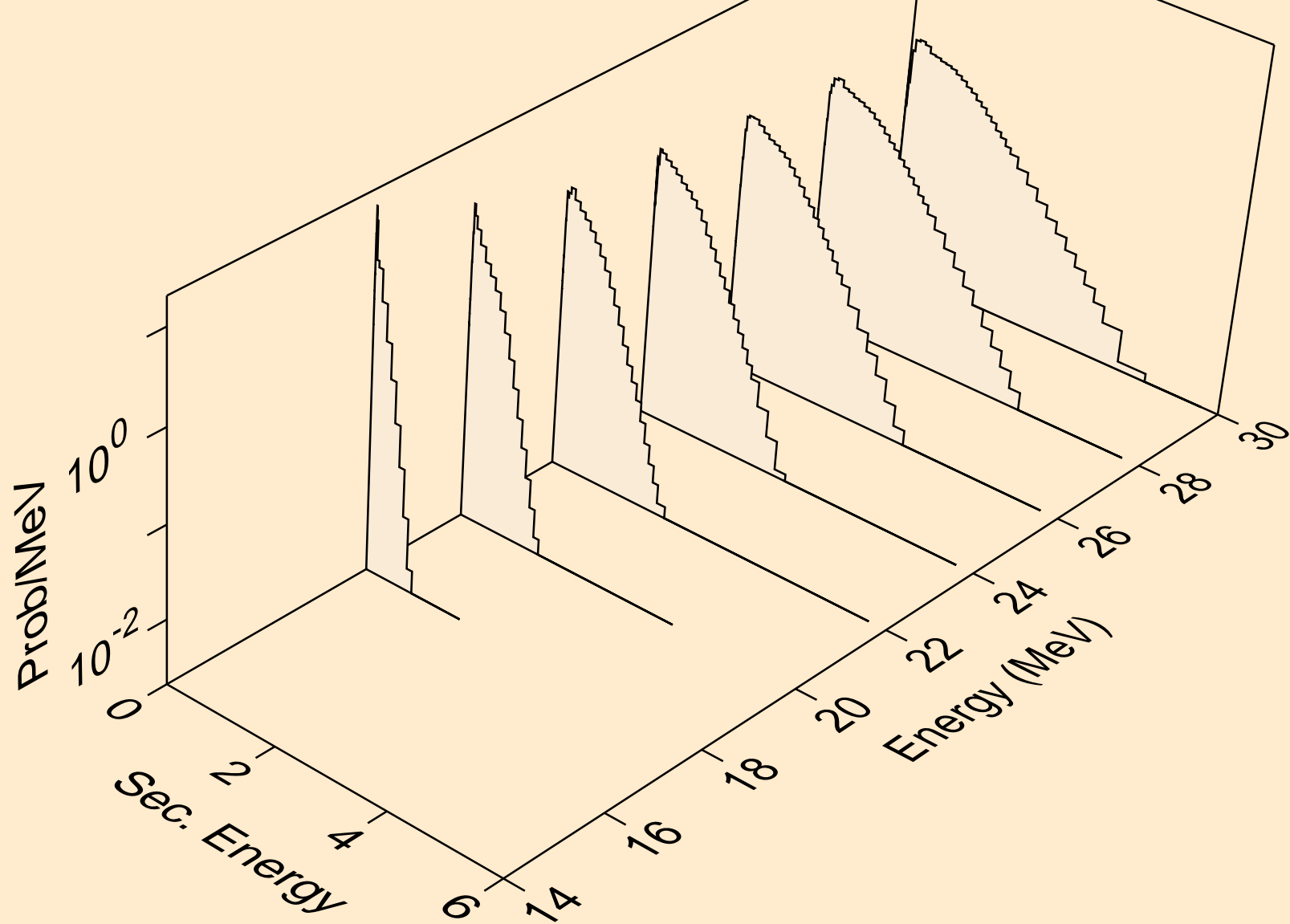

BA138 NEUTRON ACER TENDL-2024 LIBRARY; T=0.K  
Neutron emission for (n,n\*)t

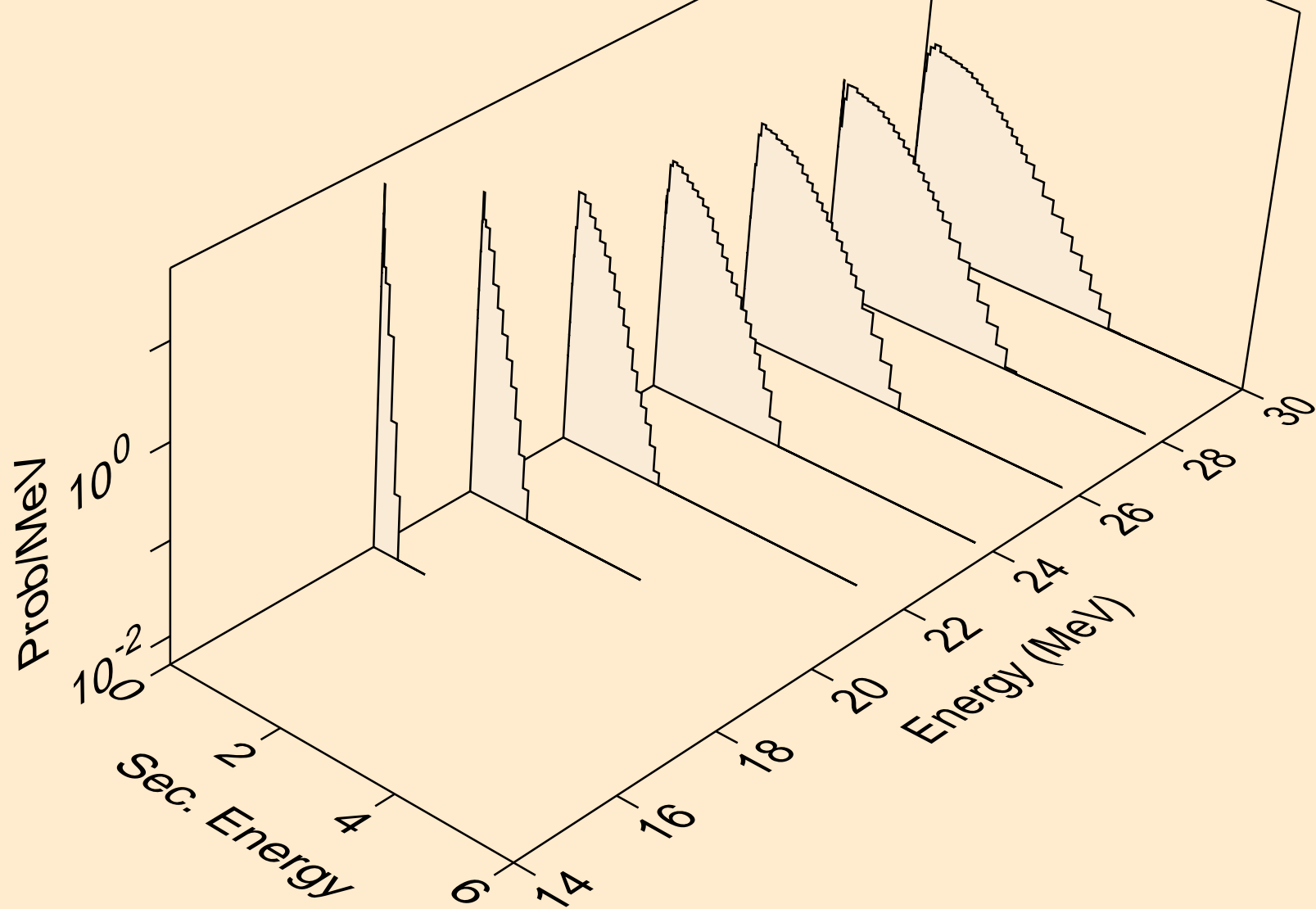

BA138 NEUTRON ACER TENDL-2024 LIBRARY; T=0.K  
Neutron emission for (n,n\*)he3

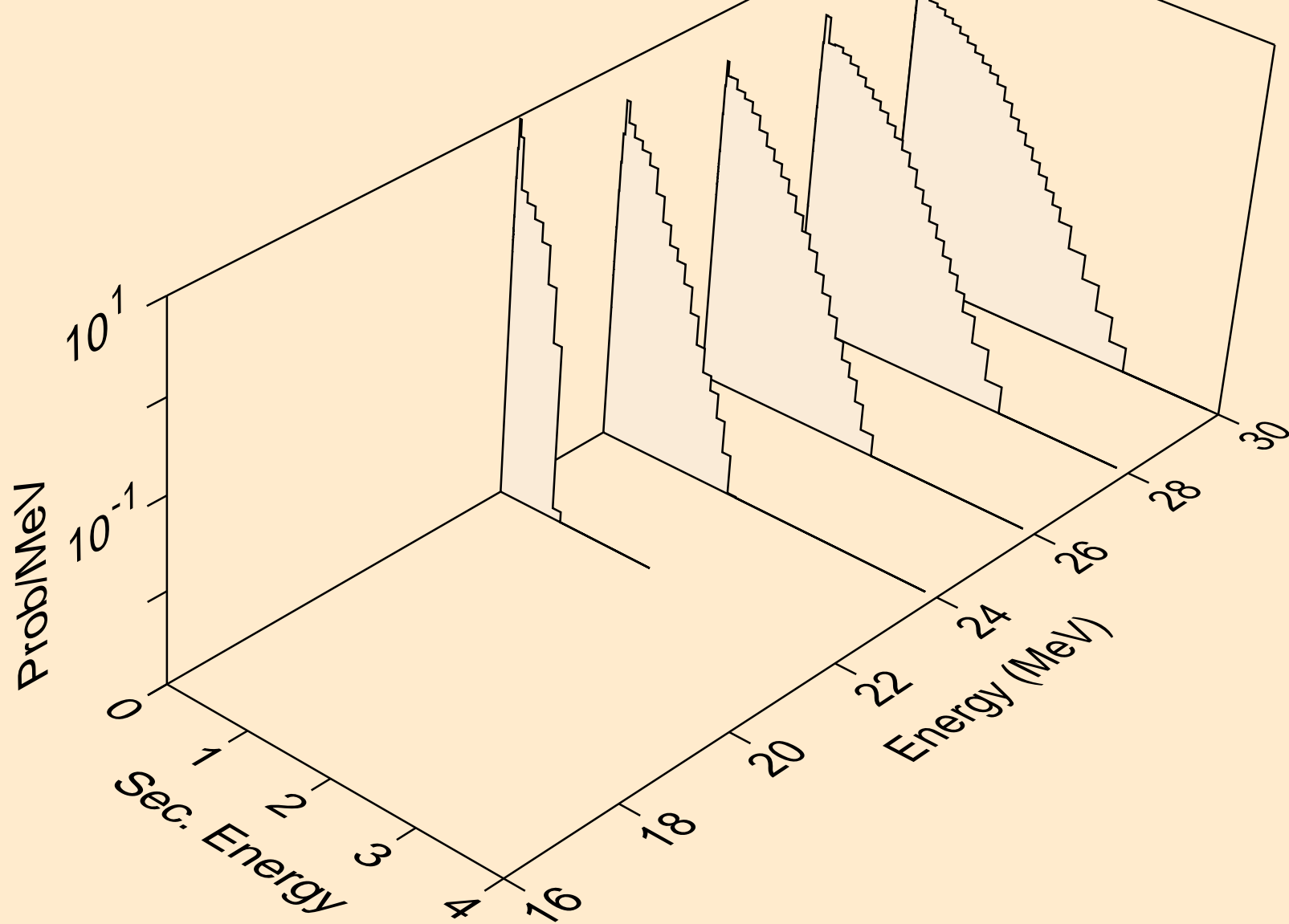

BA138 NEUTRON ACER TENDL-2024 LIBRARY; T=0.K  
Neutron emission for (n,4n)

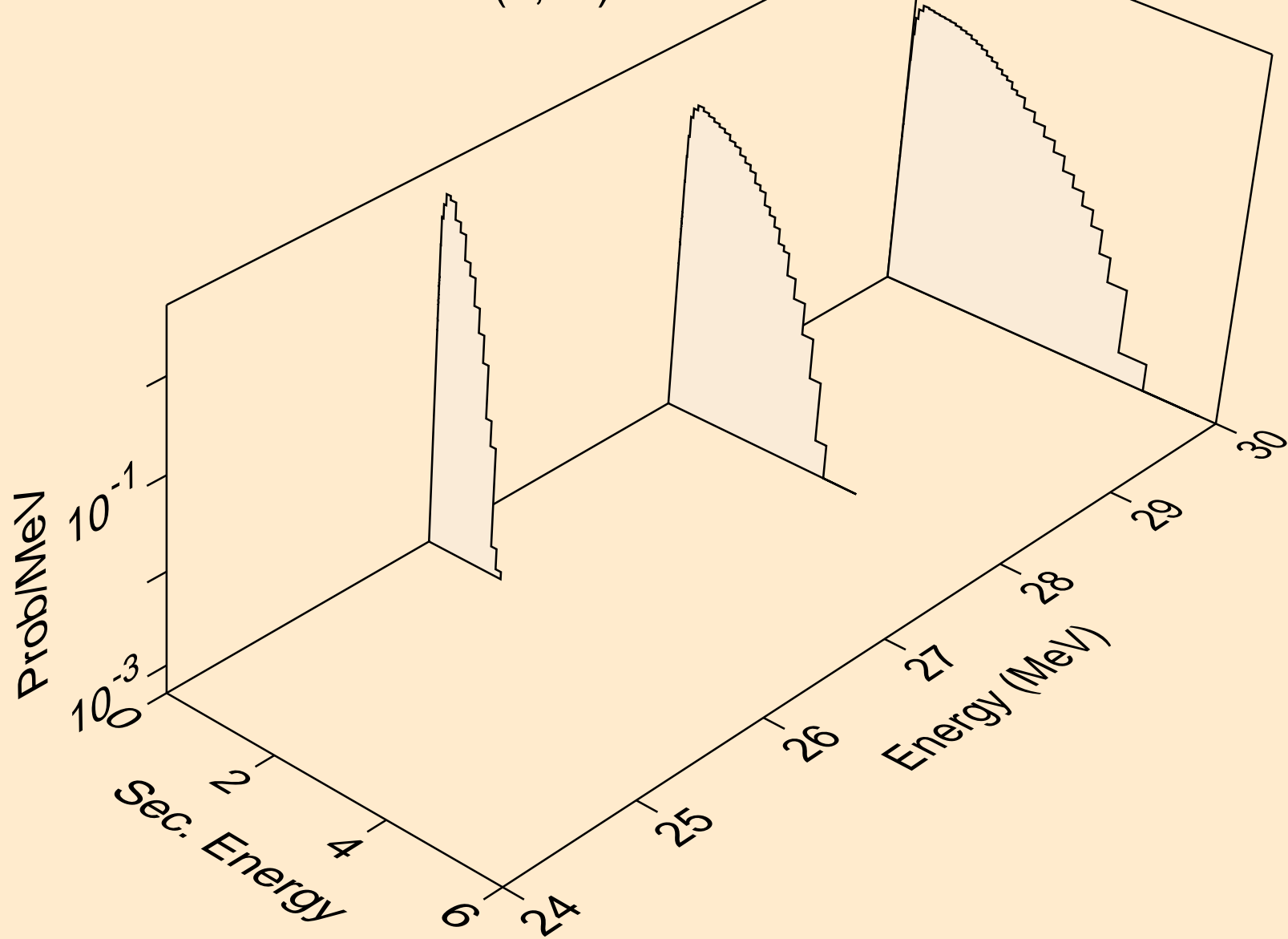



BA138 NEUTRON ACER TENDL-2024 LIBRARY; T=0.K  
Neutron emission for (n,2np)

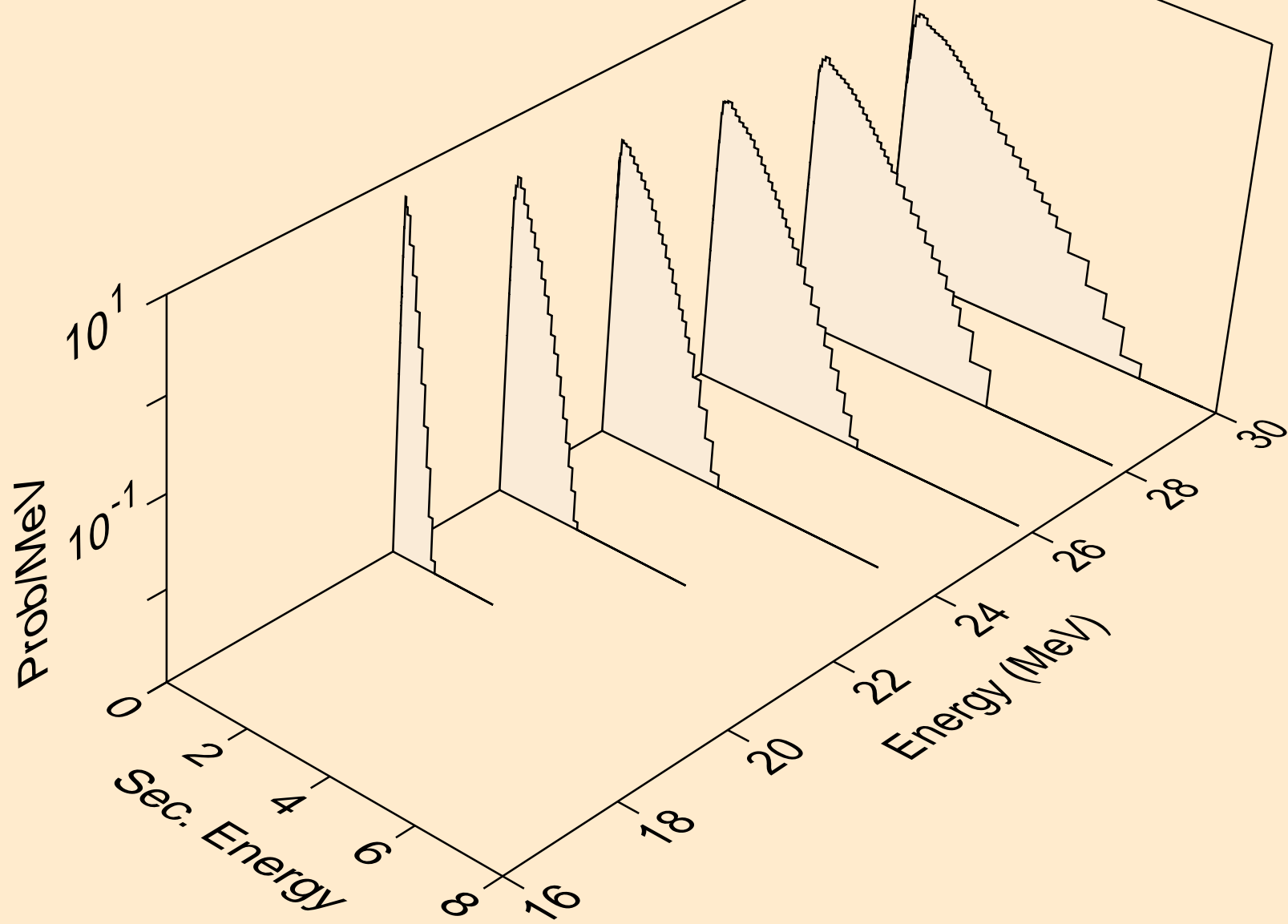

BA138 NEUTRON ACER TENDL-2024 LIBRARY; T=0.K  
Neutron emission for (n,3np)

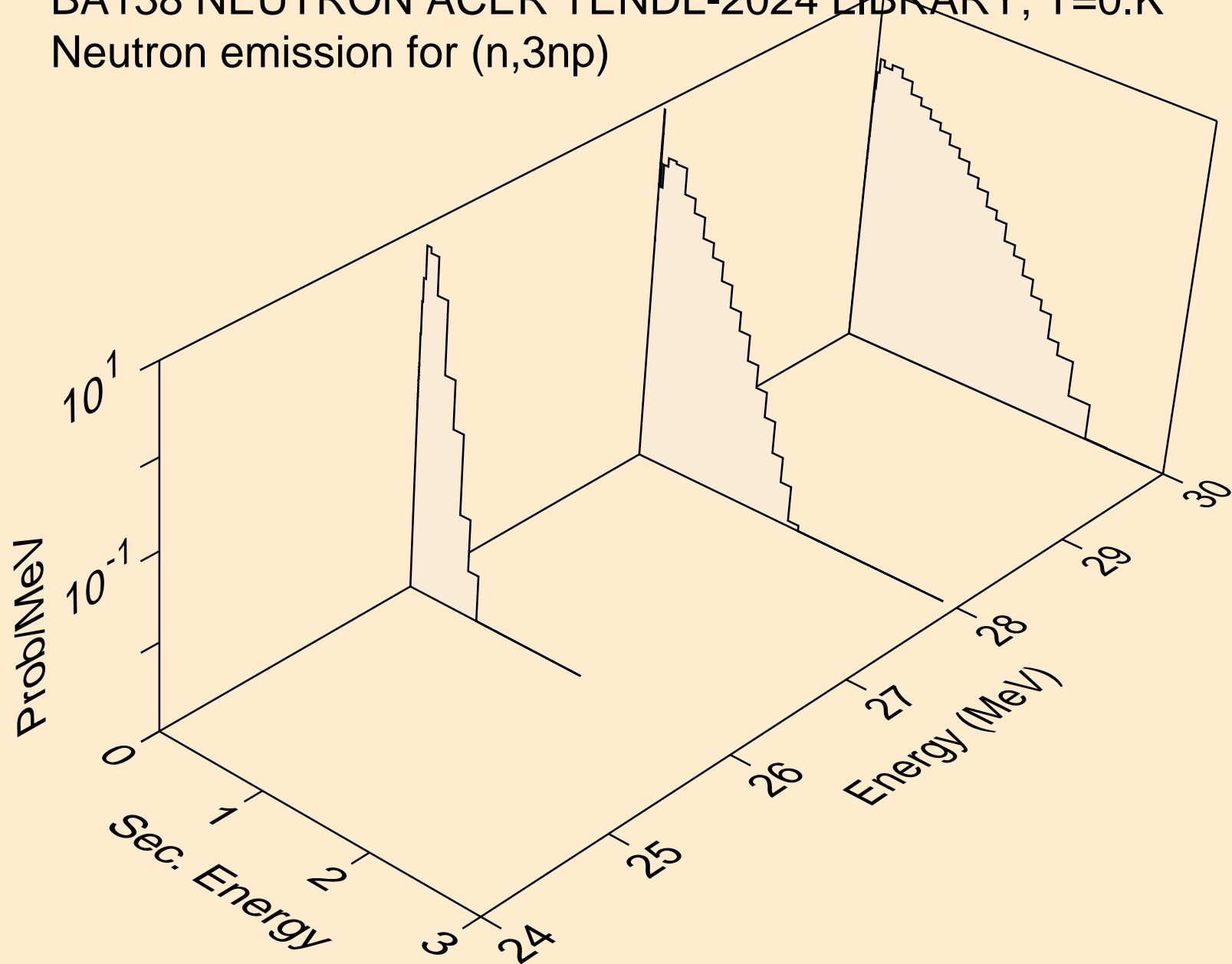

BA138 NEUTRON ACER TENDL-2024 LIBRARY; T=0.K  
Neutron emission for (n,n2p)

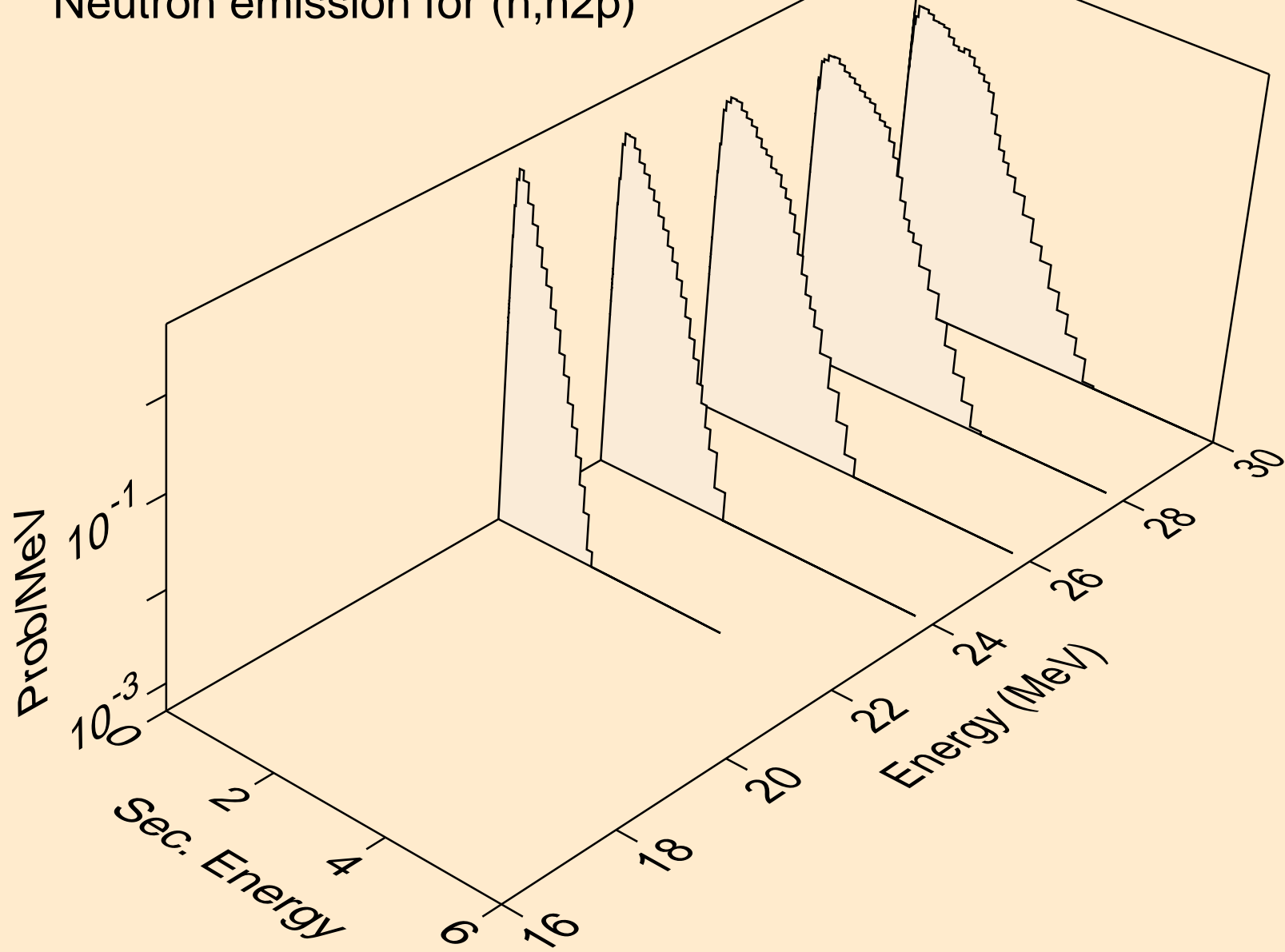

BA138 NEUTRON ACER TENDL-2024 LIBRARY; T=0.K  
Neutron emission for (n,npa)

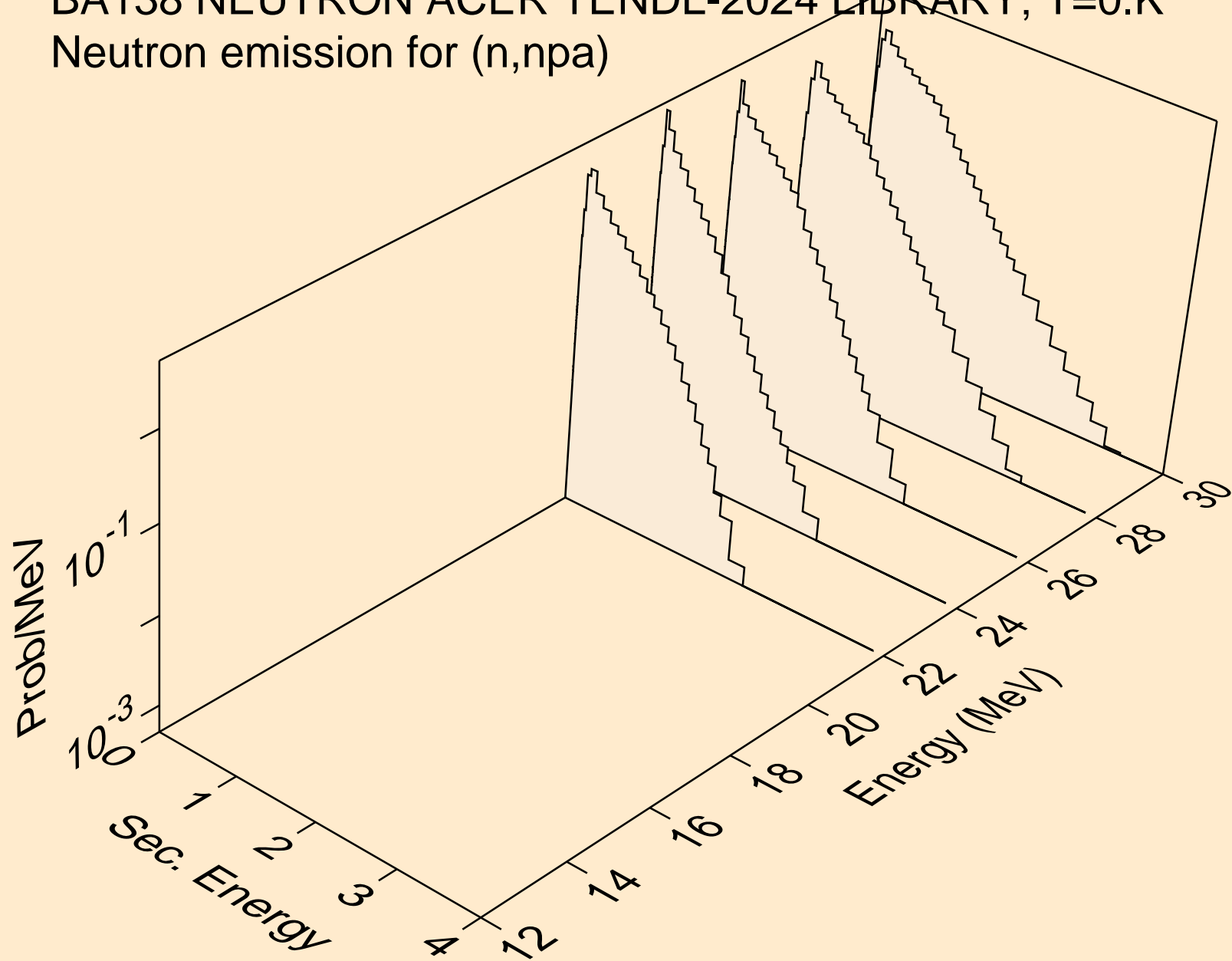

BA138 NEUTRON ACER TENDL-2024 LIBRARY; T=0.K  
Neutron emission for (n,n\*c)

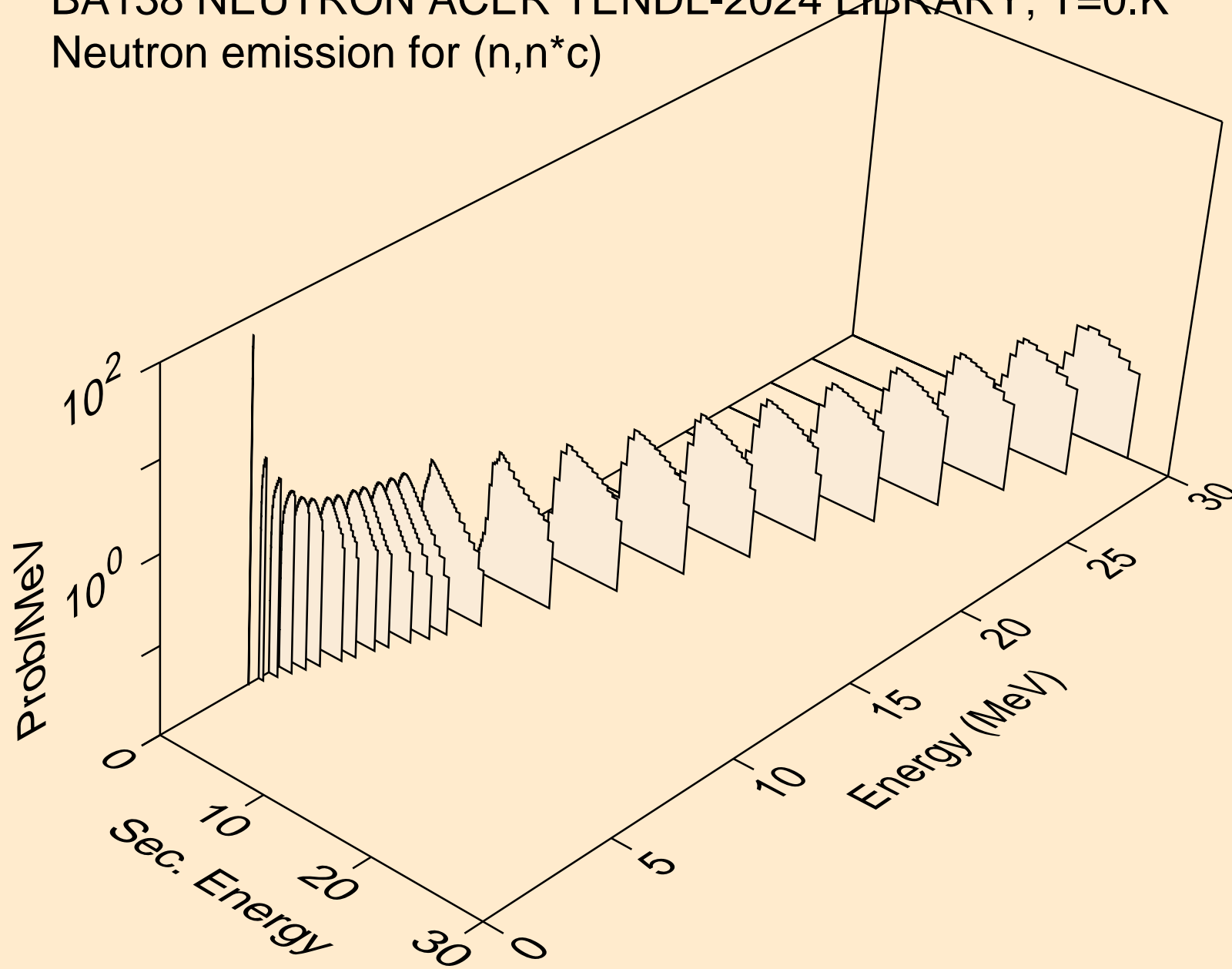

BA138 NEUTRON ACER TENDL-2024 LIBRARY; T=0.K  
Photon emission for (n,x)

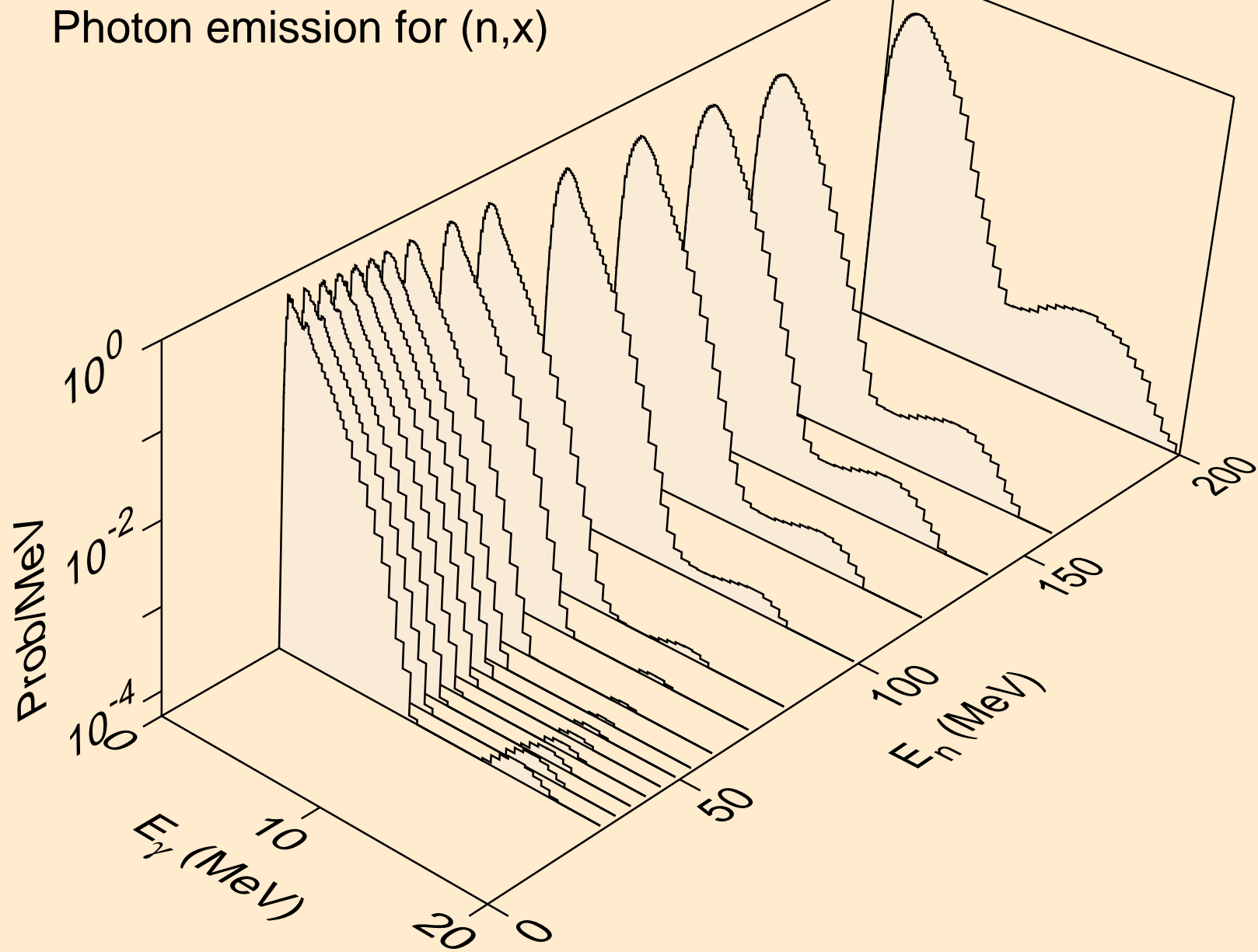

BA138 NEUTRON ACER TENDL-2024 LIBRARY; T=0.K  
Photon emission for (n,2nd)

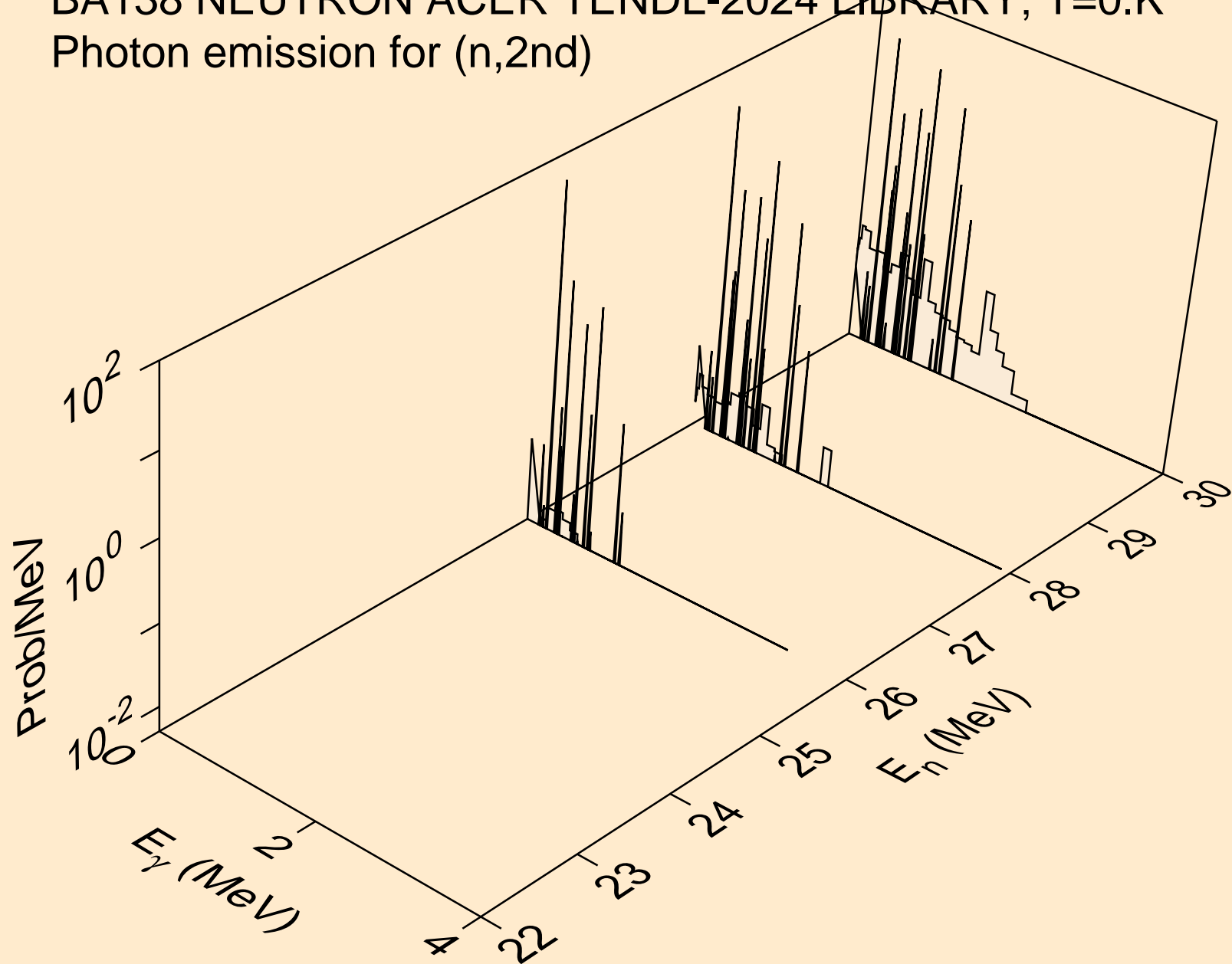

BA138 NEUTRON ACER TENDL-2024 LIBRARY; T=0.K  
Photon emission for (n,2n)

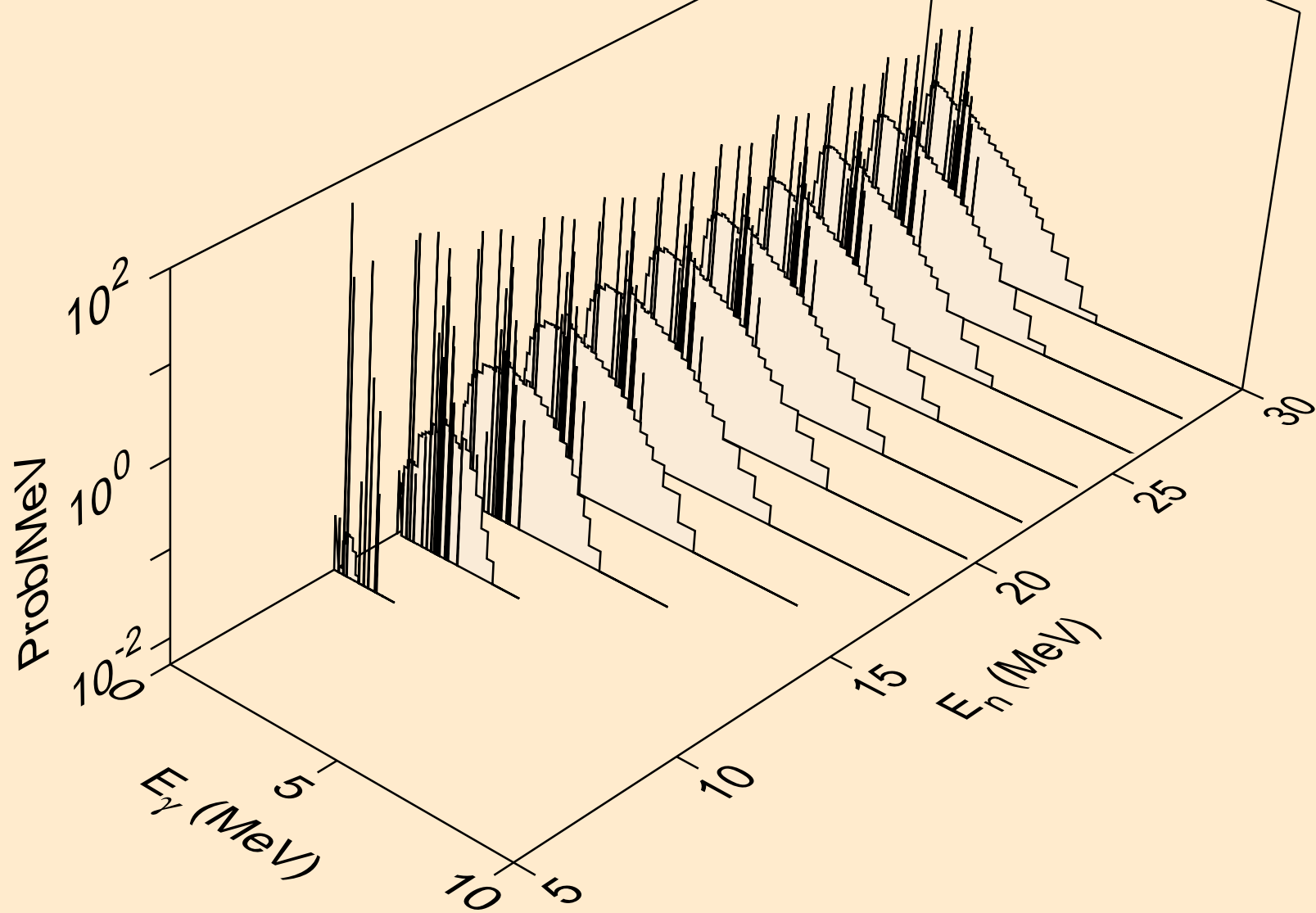



BA138 NEUTRON ACER TENDL-2024 LIBRARY; T=0.K  
Photon emission for (n,3n)

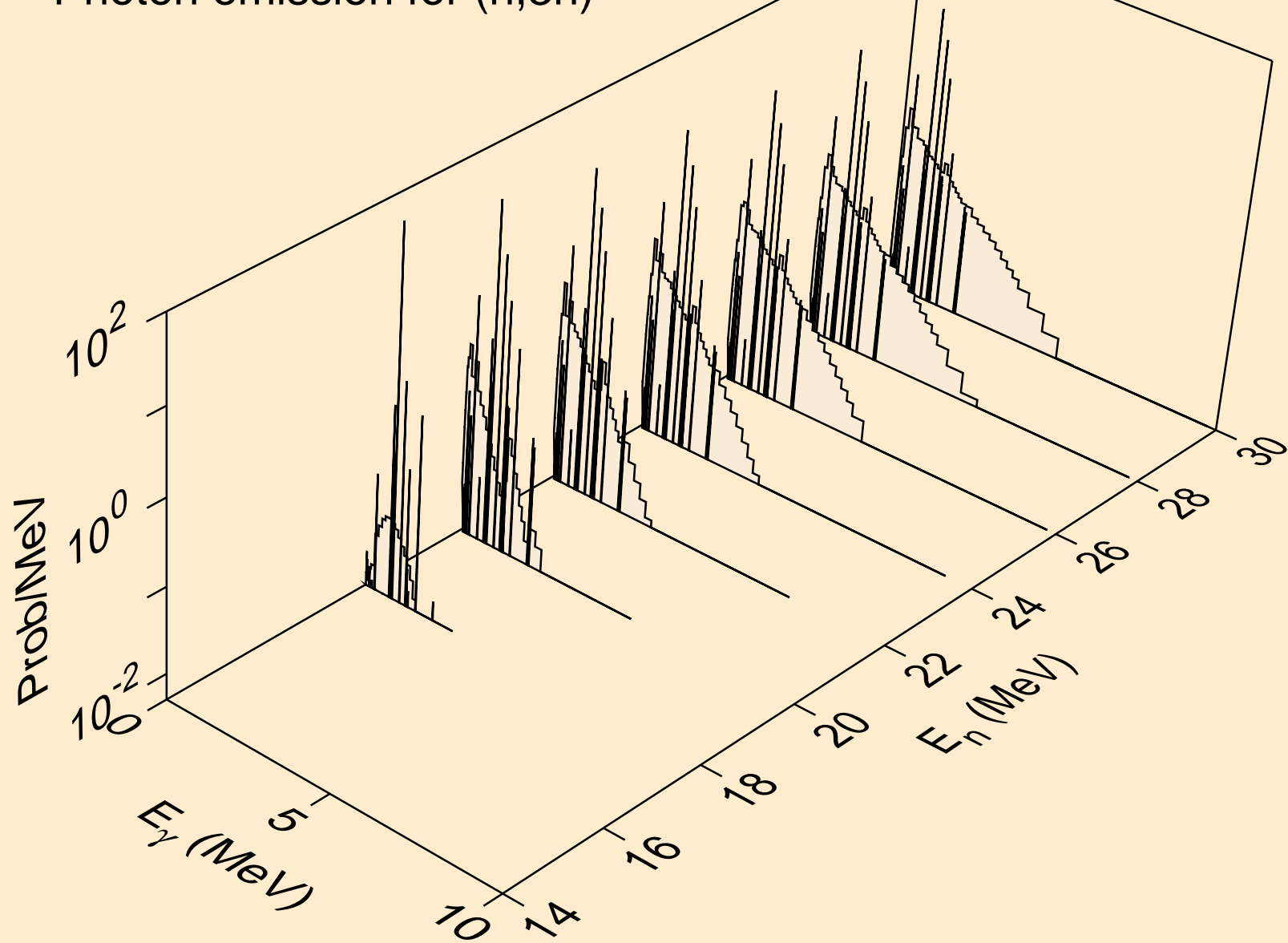

BA138 NEUTRON ACER TENDL-2024 LIBRARY; T=0.K  
Photon emission for (n,n\*)a

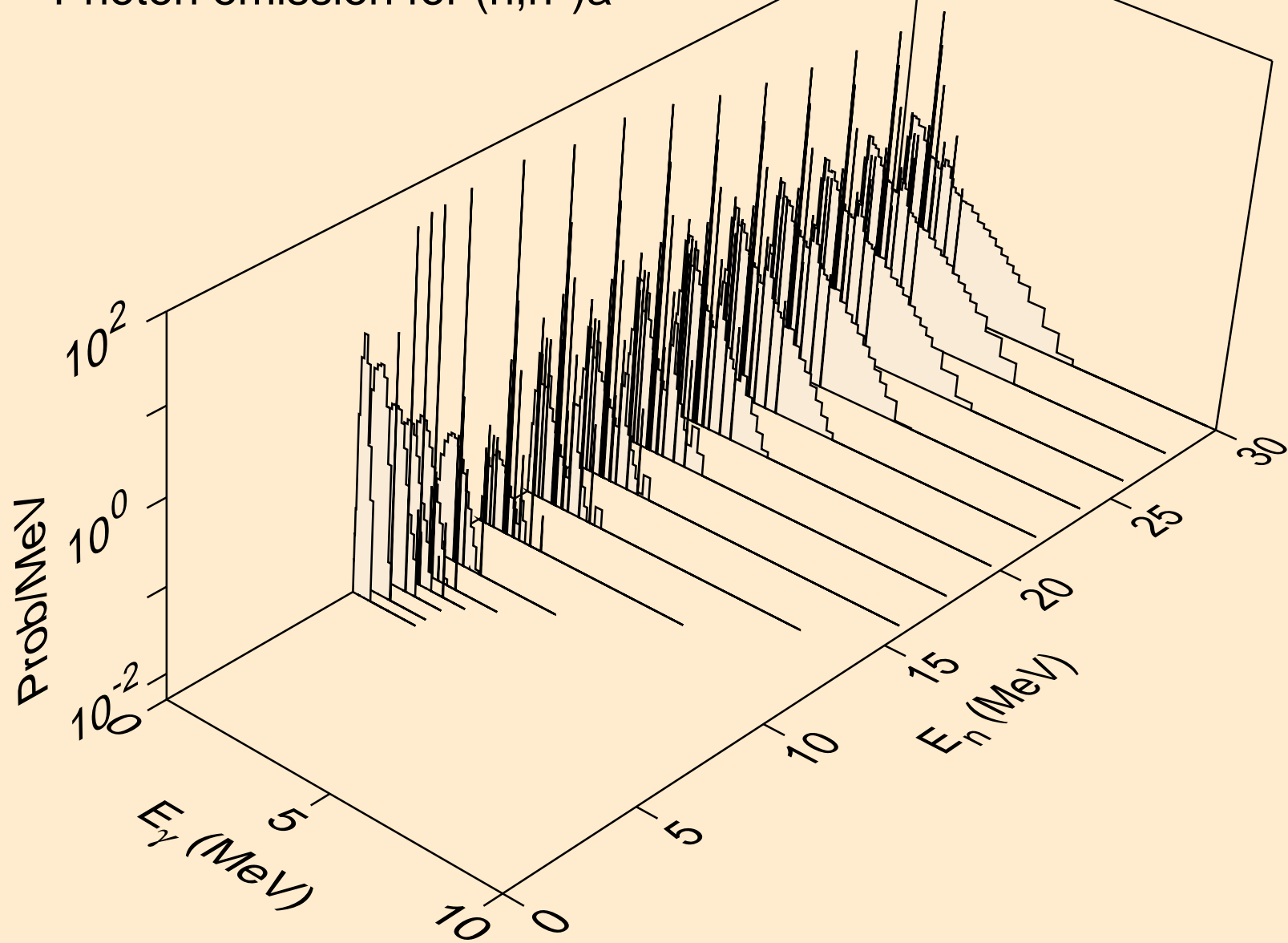

BA138 NEUTRON ACER TENDL-2024 LIBRARY; T=0.K  
Photon emission for (n,2n)a

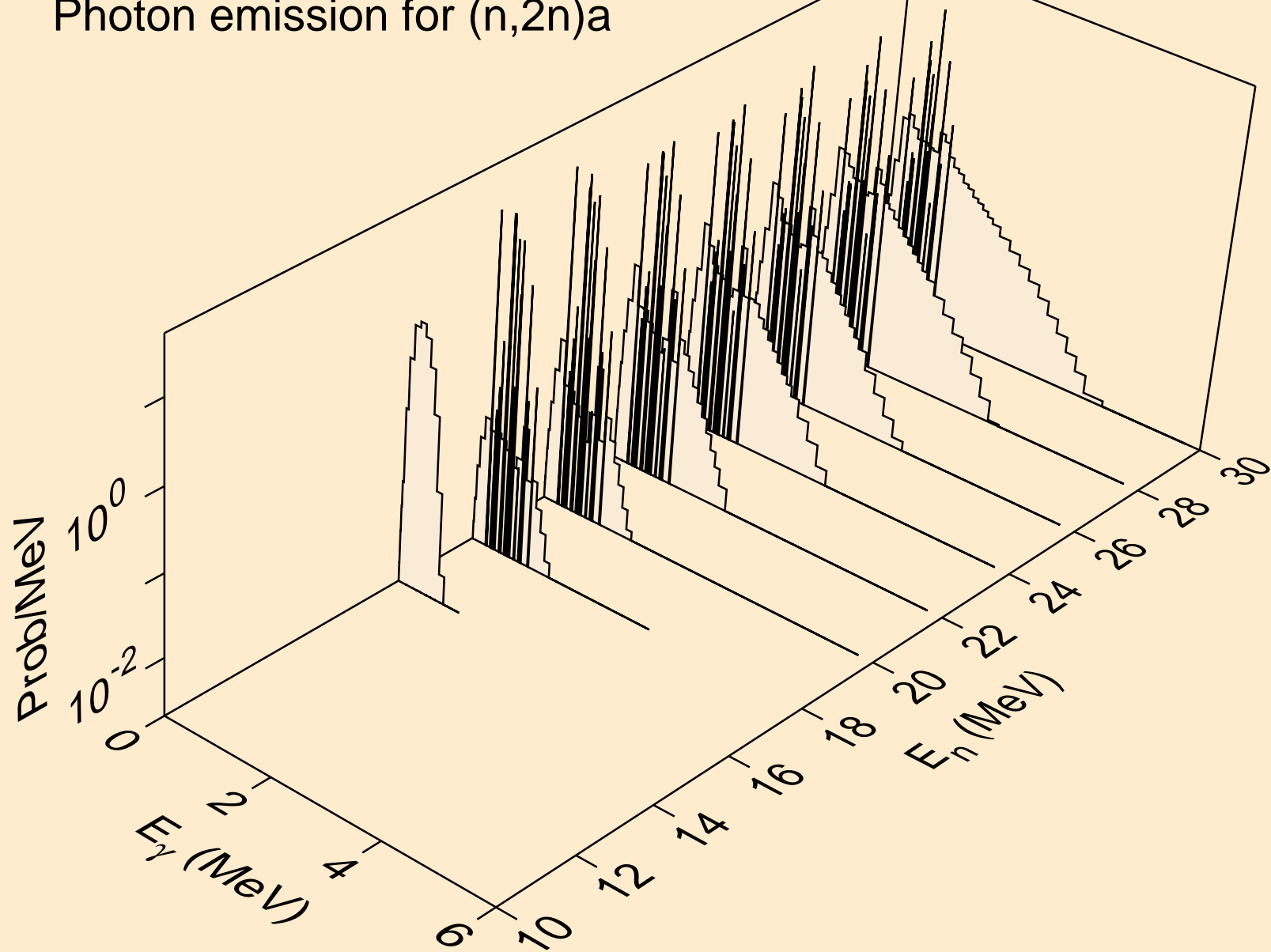

BA138 NEUTRON ACER TENDL-2024 LIBRARY; T=0.K  
Photon emission for (n,3n)a

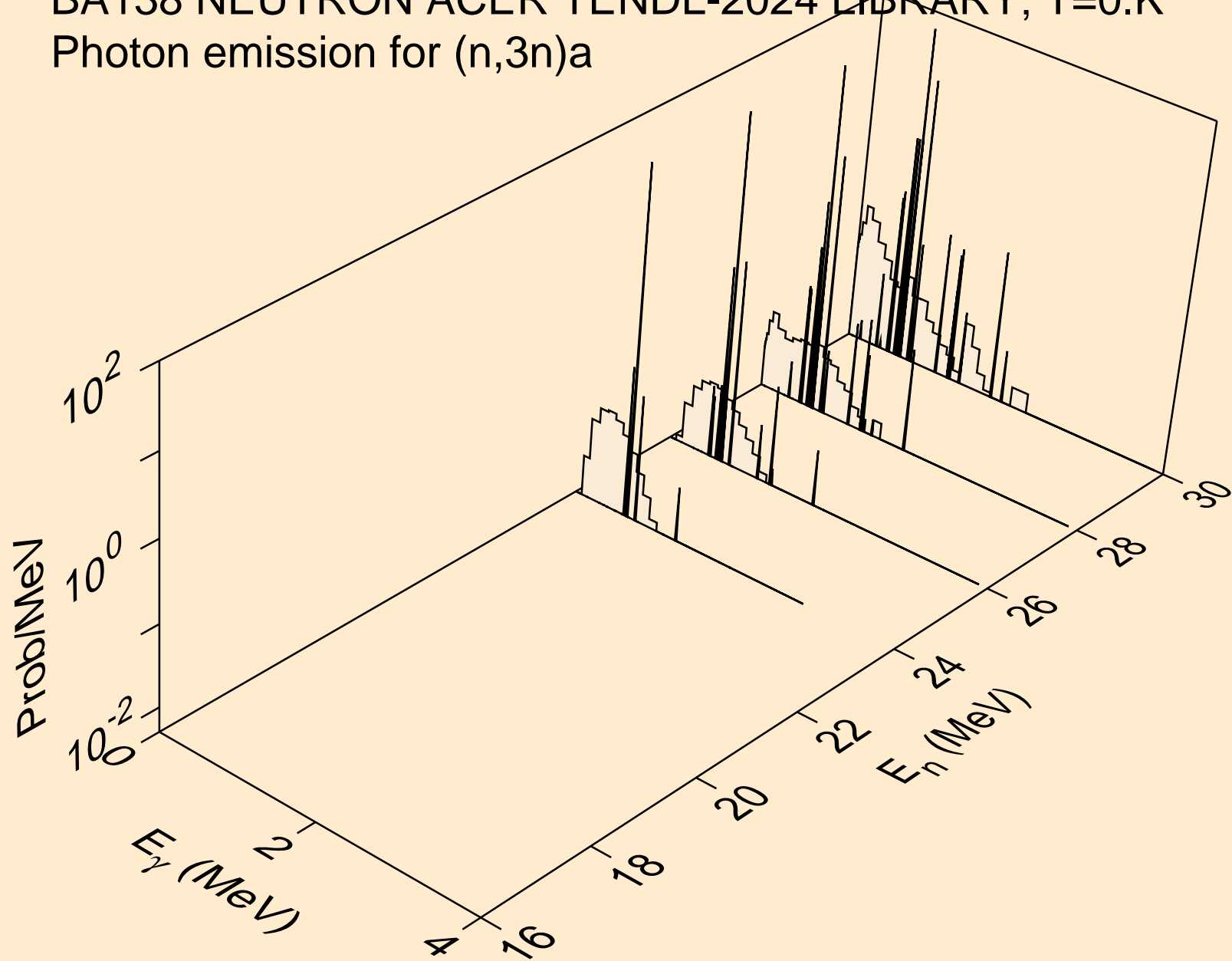

BA138 NEUTRON ACER TENDL-2024 LIBRARY; T=0.K  
Photon emission for (n,n\*)p

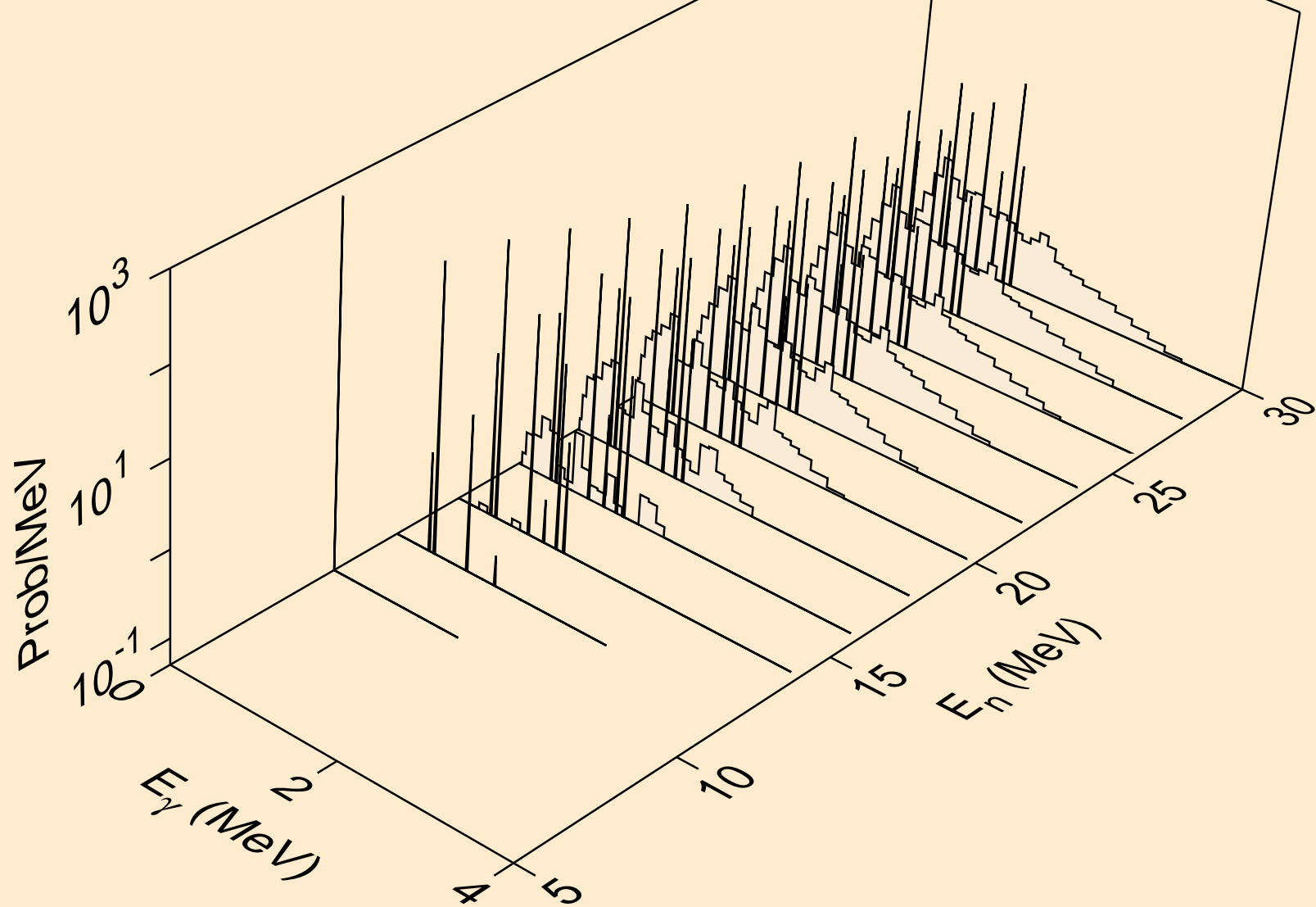

BA138 NEUTRON ACER TENDL-2024 LIBRARY; T=0.K  
Photon emission for (n,n\*)d

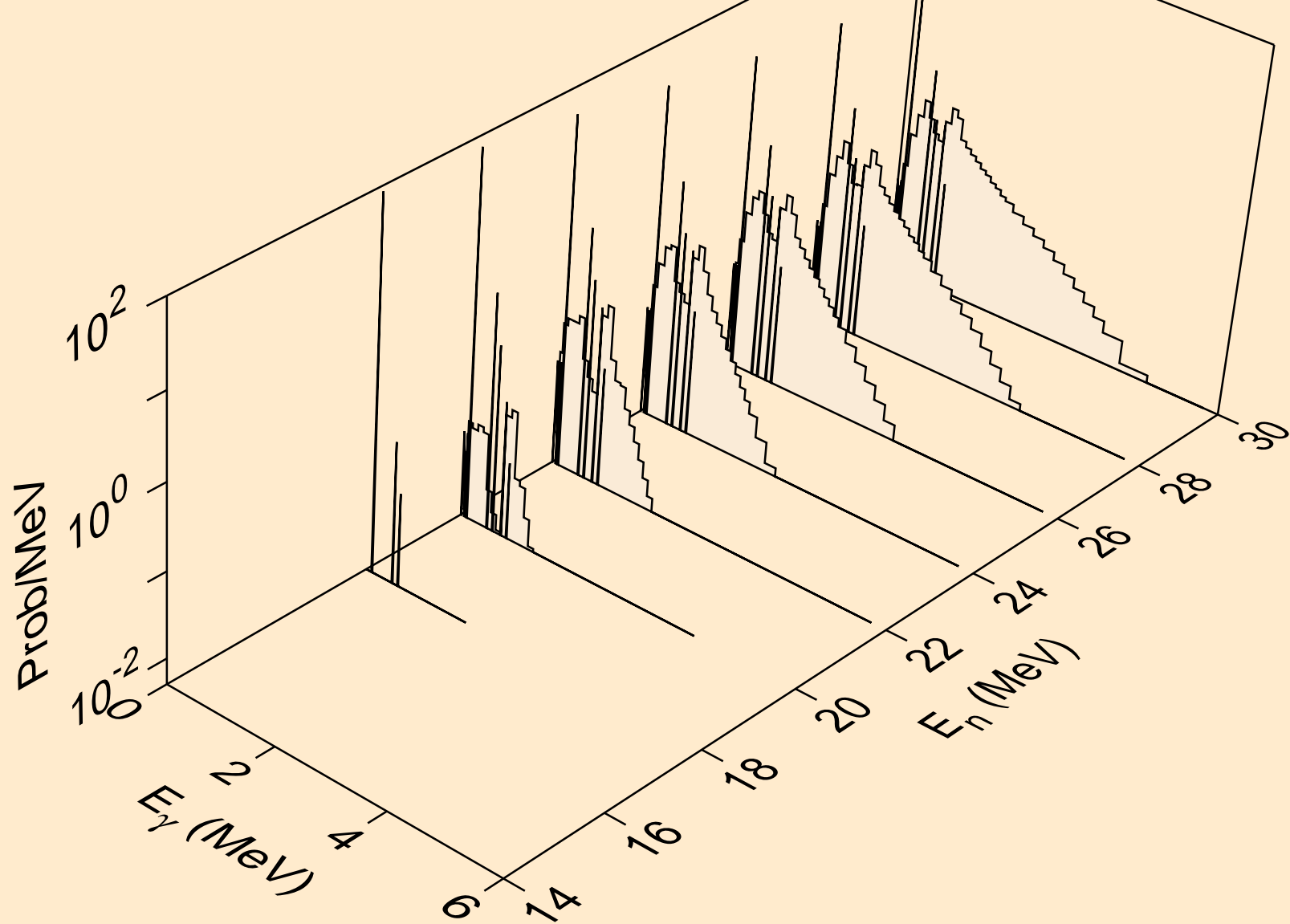

BA138 NEUTRON ACER TENDL-2024 LIBRARY; T=0.K  
Photon emission for (n,n\*)t

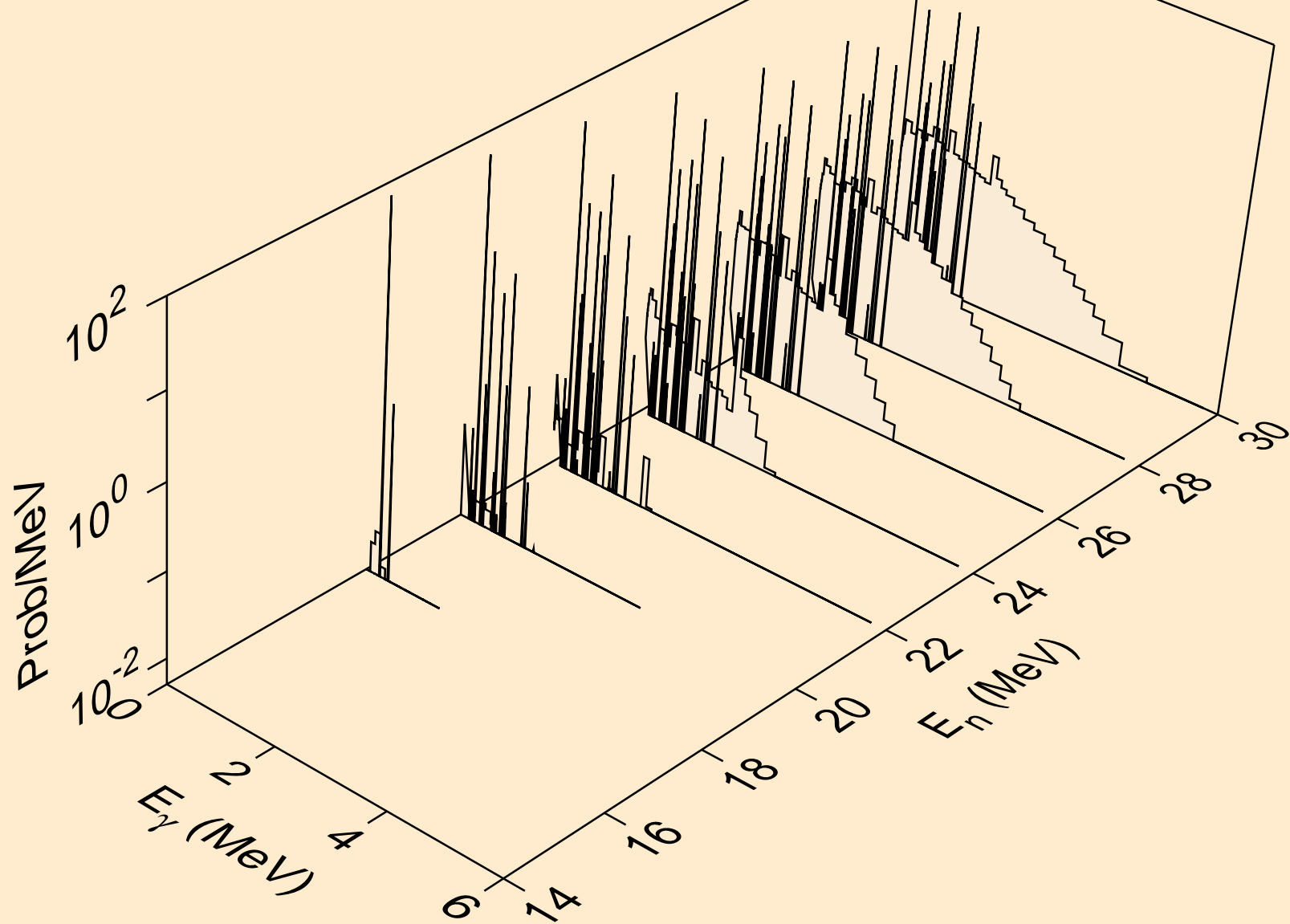

BA138 NEUTRON ACER TENDL-2024 LIBRARY; T=0.K  
Photon emission for (n,n\*)he3

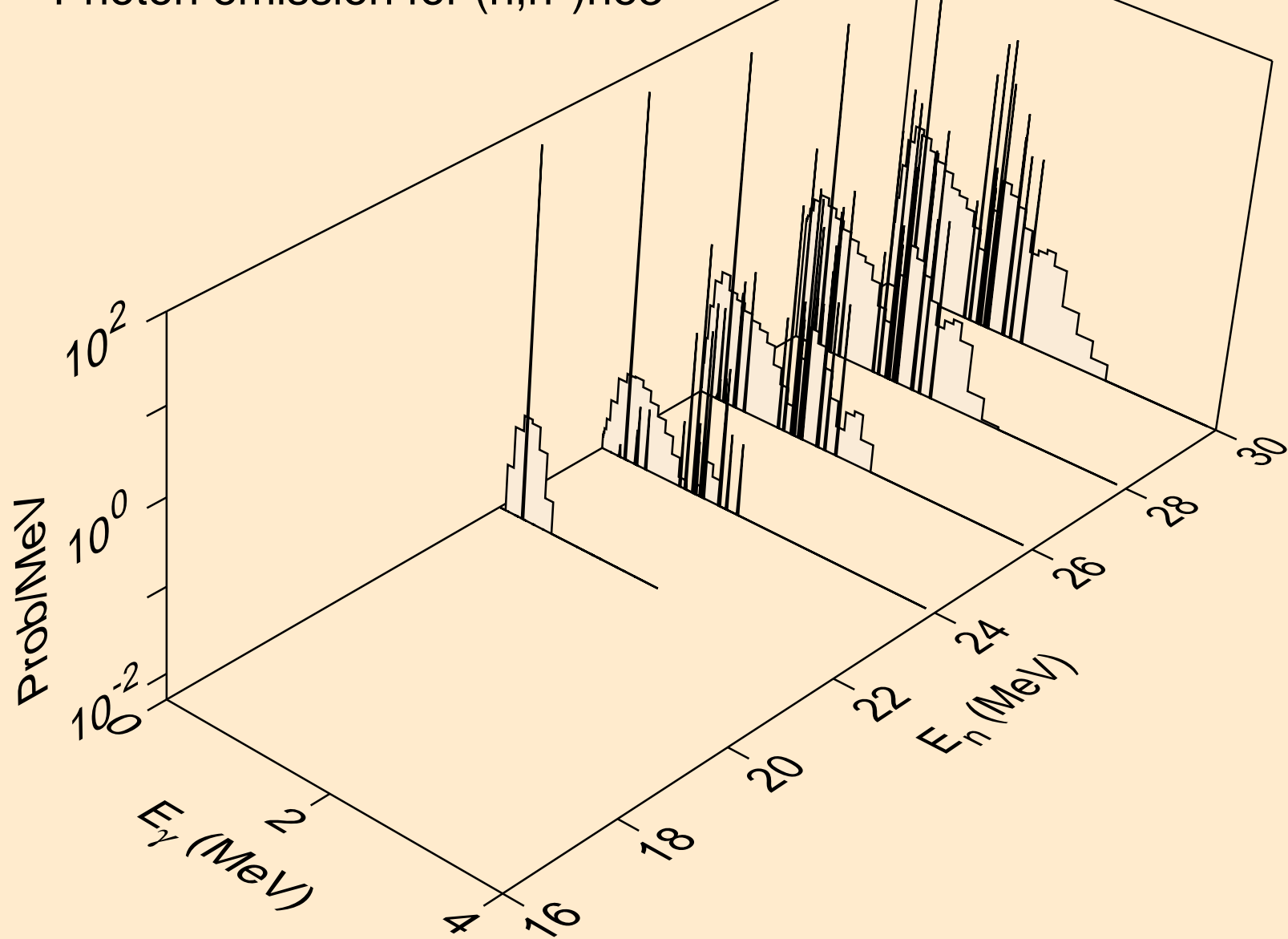



BA138 NEUTRON ACER TENDL-2024 LIBRARY; T=0.K  
Photon emission for (n,4n)

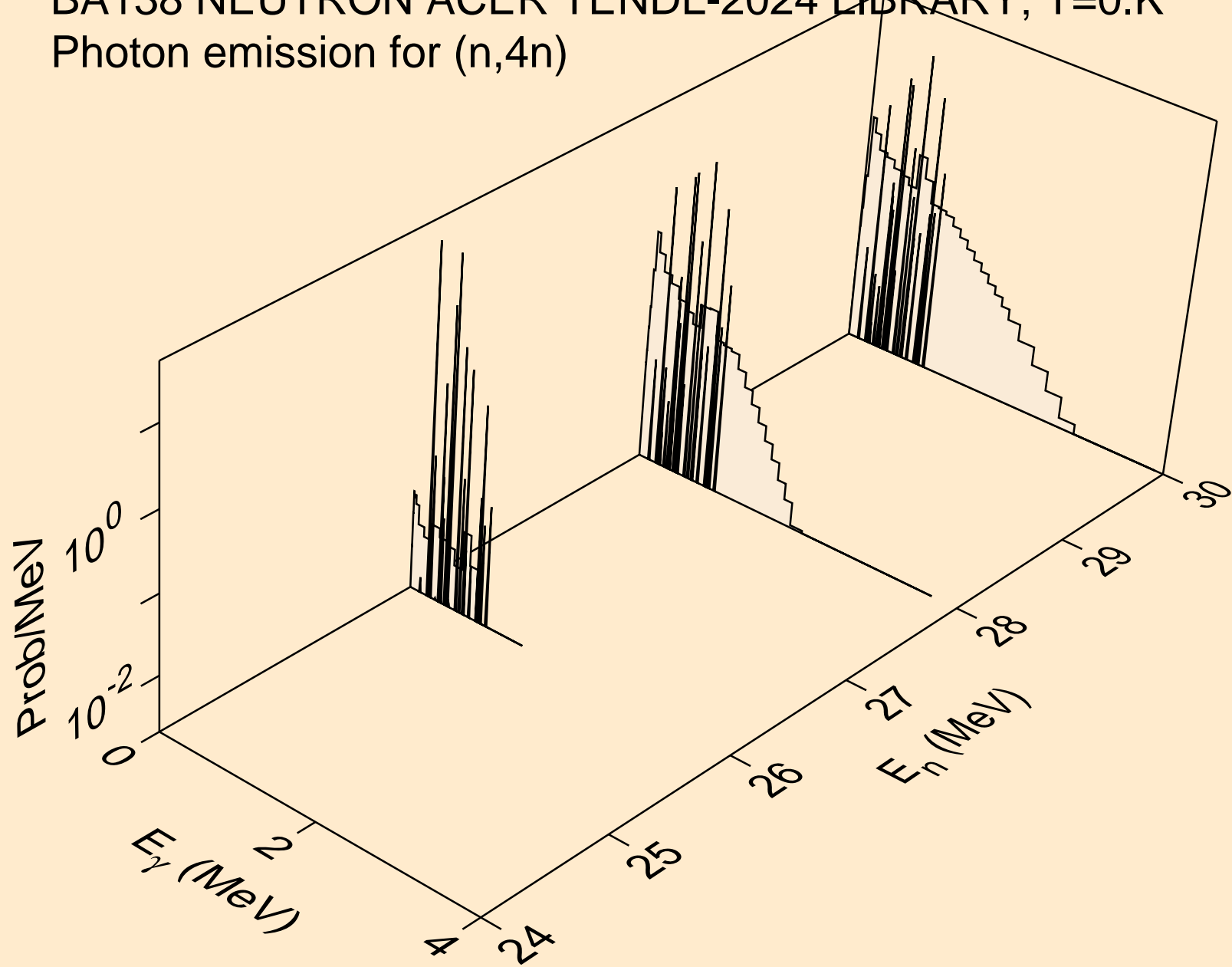

BA138 NEUTRON ACER TENDL-2024 LIBRARY; T=0.K  
Photon emission for (n,2np)

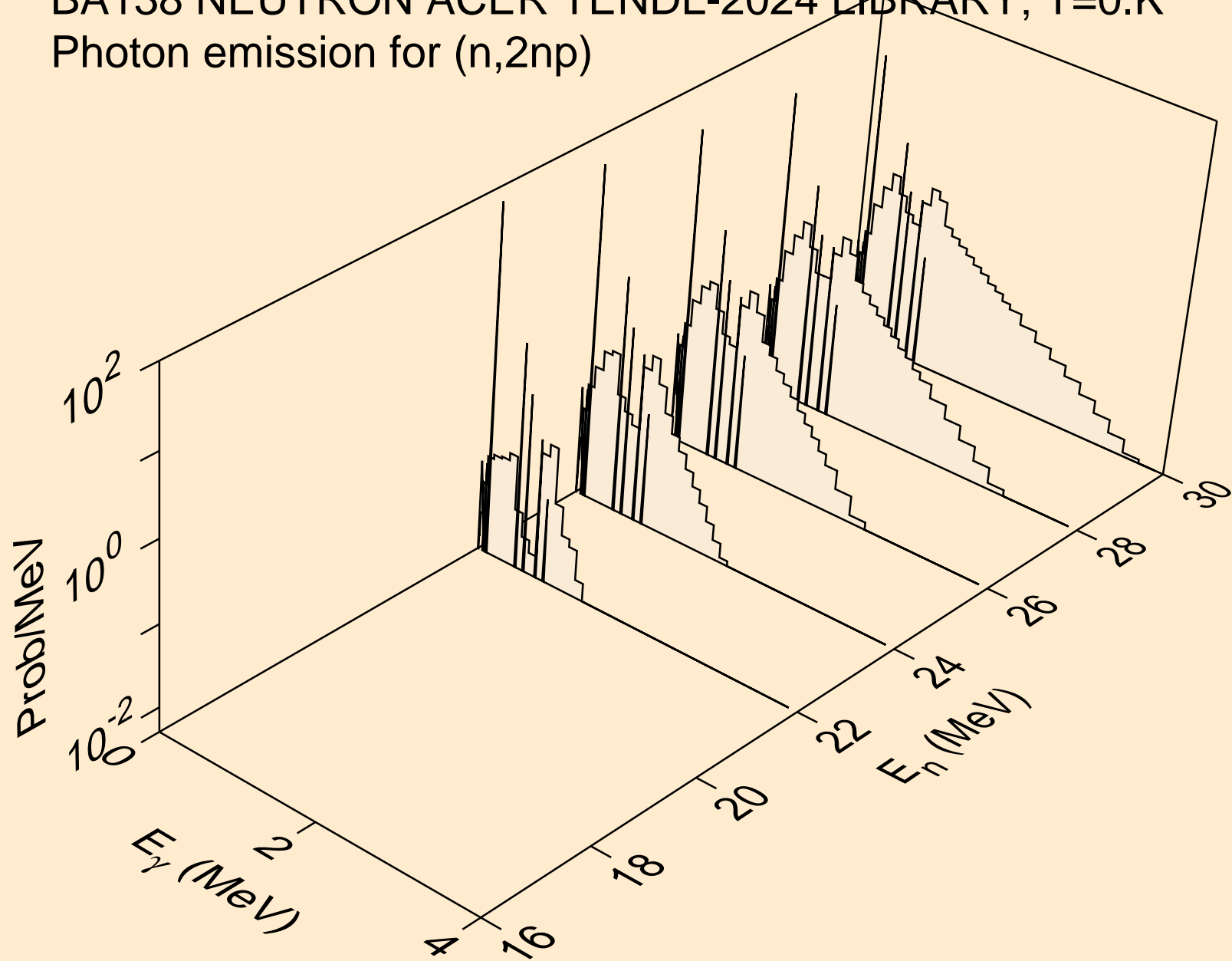

BA138 NEUTRON ACER TENDL-2024 LIBRARY; T=0.K  
Photon emission for (n,3np)

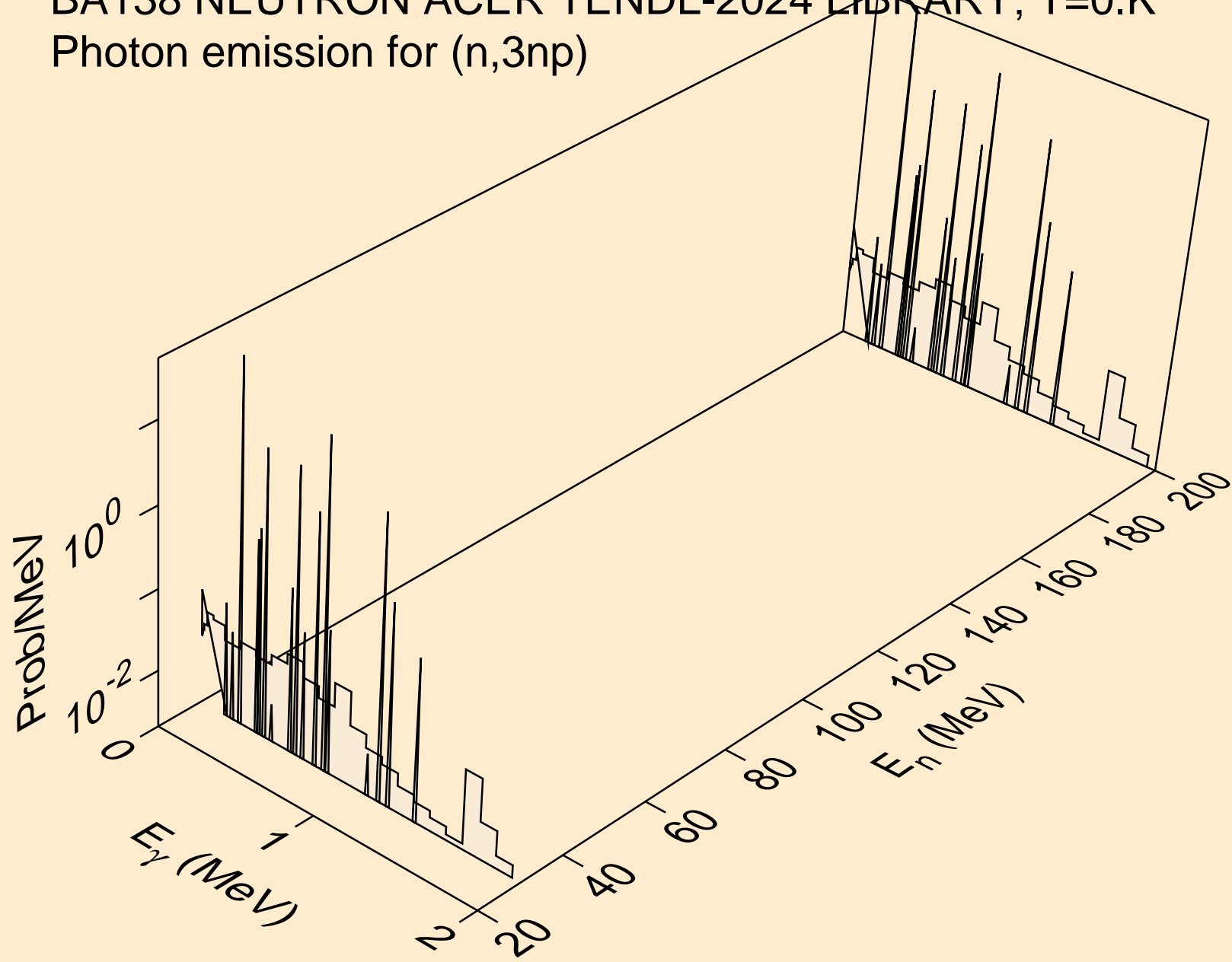

BA138 NEUTRON ACER TENDL-2024 LIBRARY; T=0.K  
Photon emission for (n,n2p)

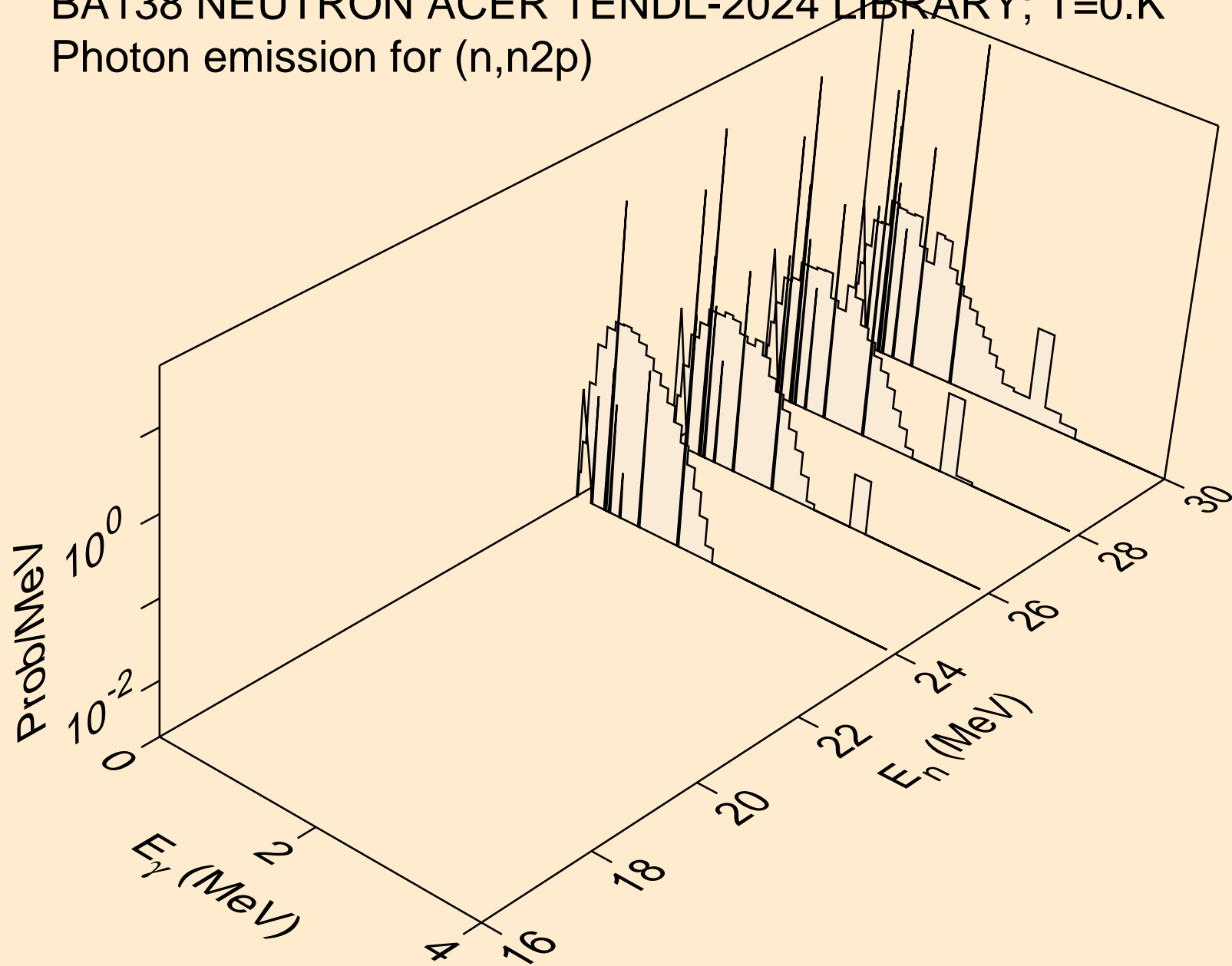

BA138 NEUTRON ACER TENDL-2024 LIBRARY; T=0.K  
Photon emission for (n,npa)

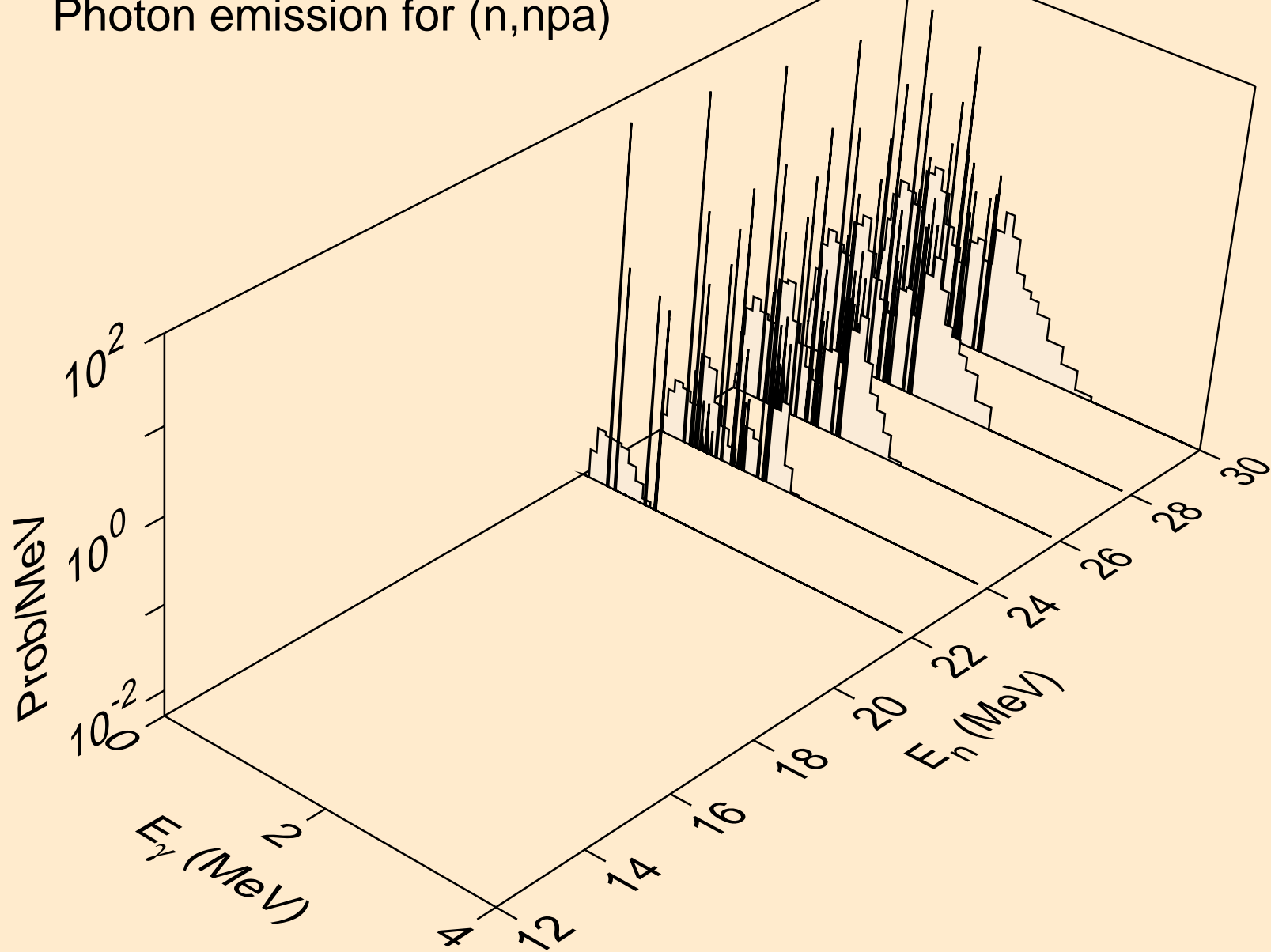

BA138 NEUTRON ACER TENDL-2024 LIBRARY; T=0.K  
Photon emission for (n,n\*c)

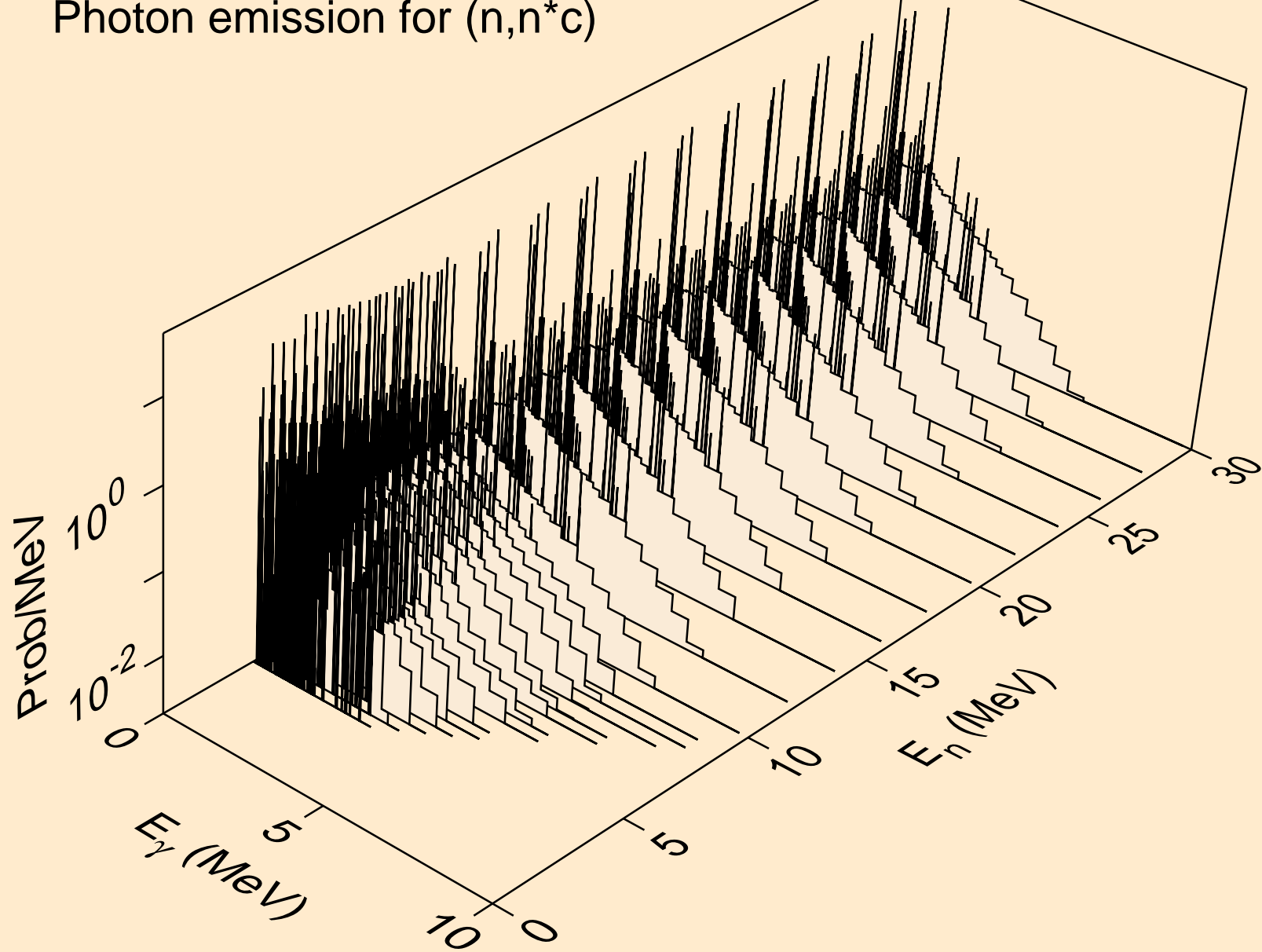

BA138 NEUTRON ACER TENDL-2024 LIBRARY; T=0.K  
Photon emission for (n,gma)

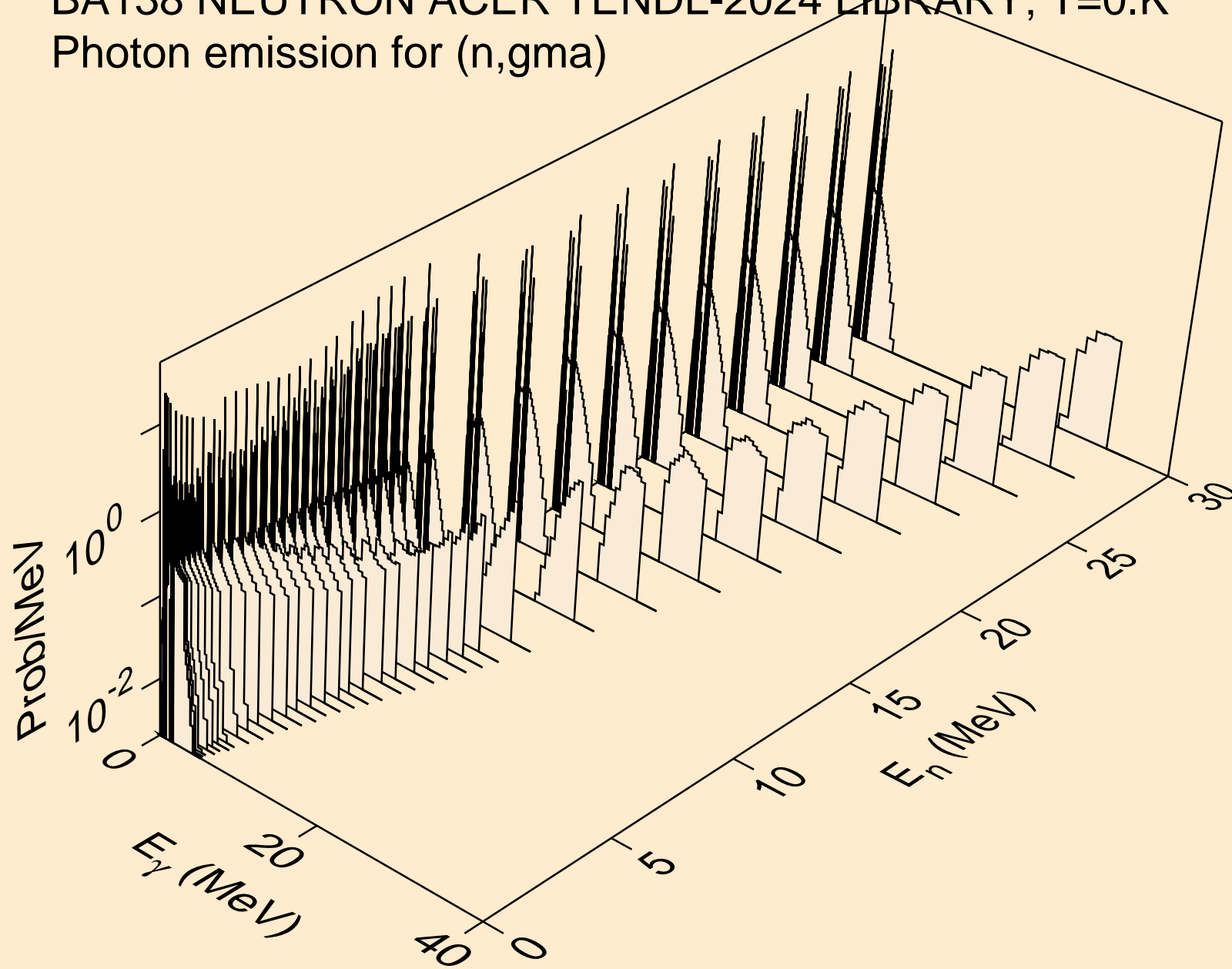

BA138 NEUTRON ACER TENDL-2024 LIBRARY; T=0.K  
Photon emission for (n,p)

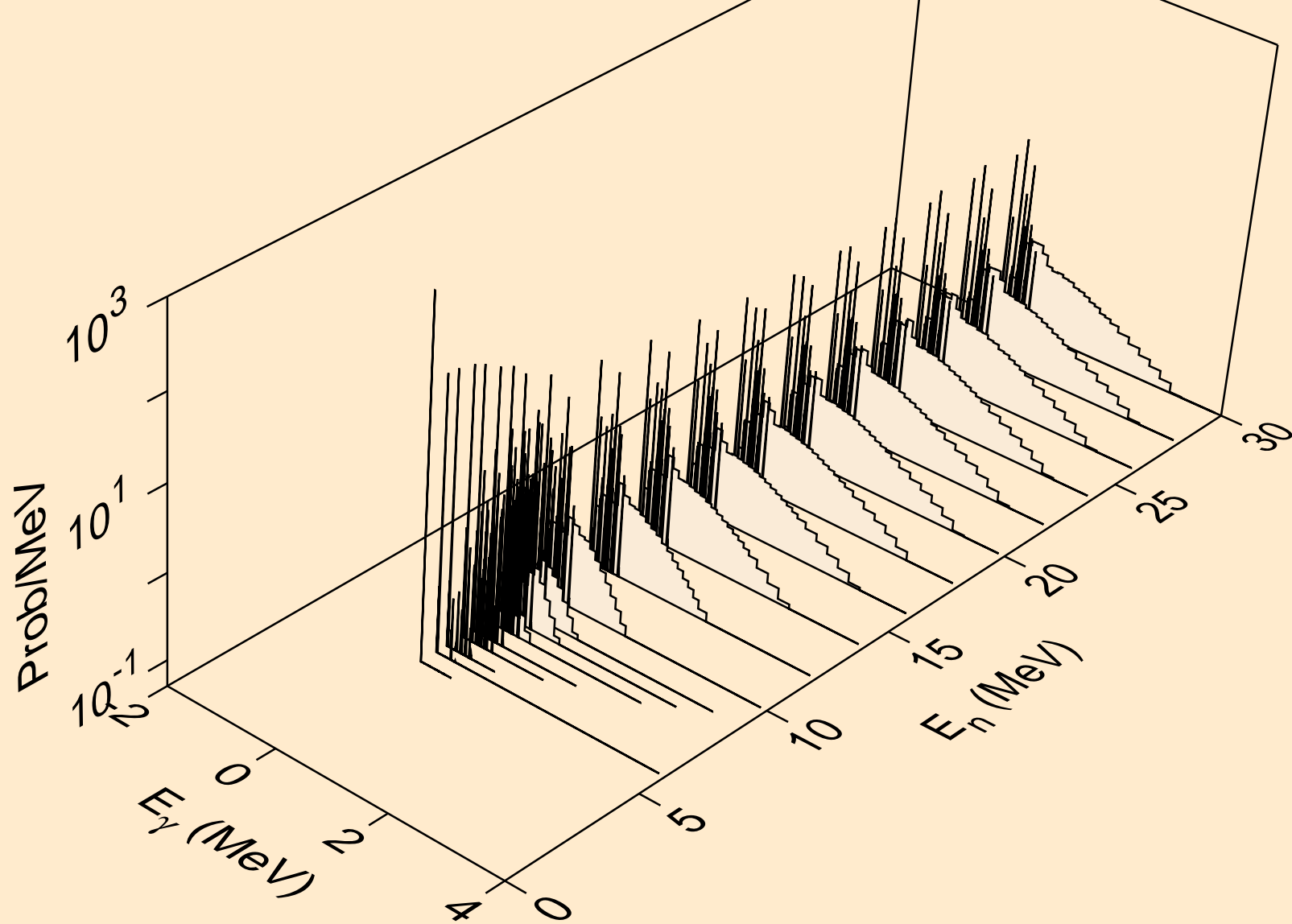



BA138 NEUTRON ACER TENDL-2024 LIBRARY; T=0.K  
Photon emission for (n,d)

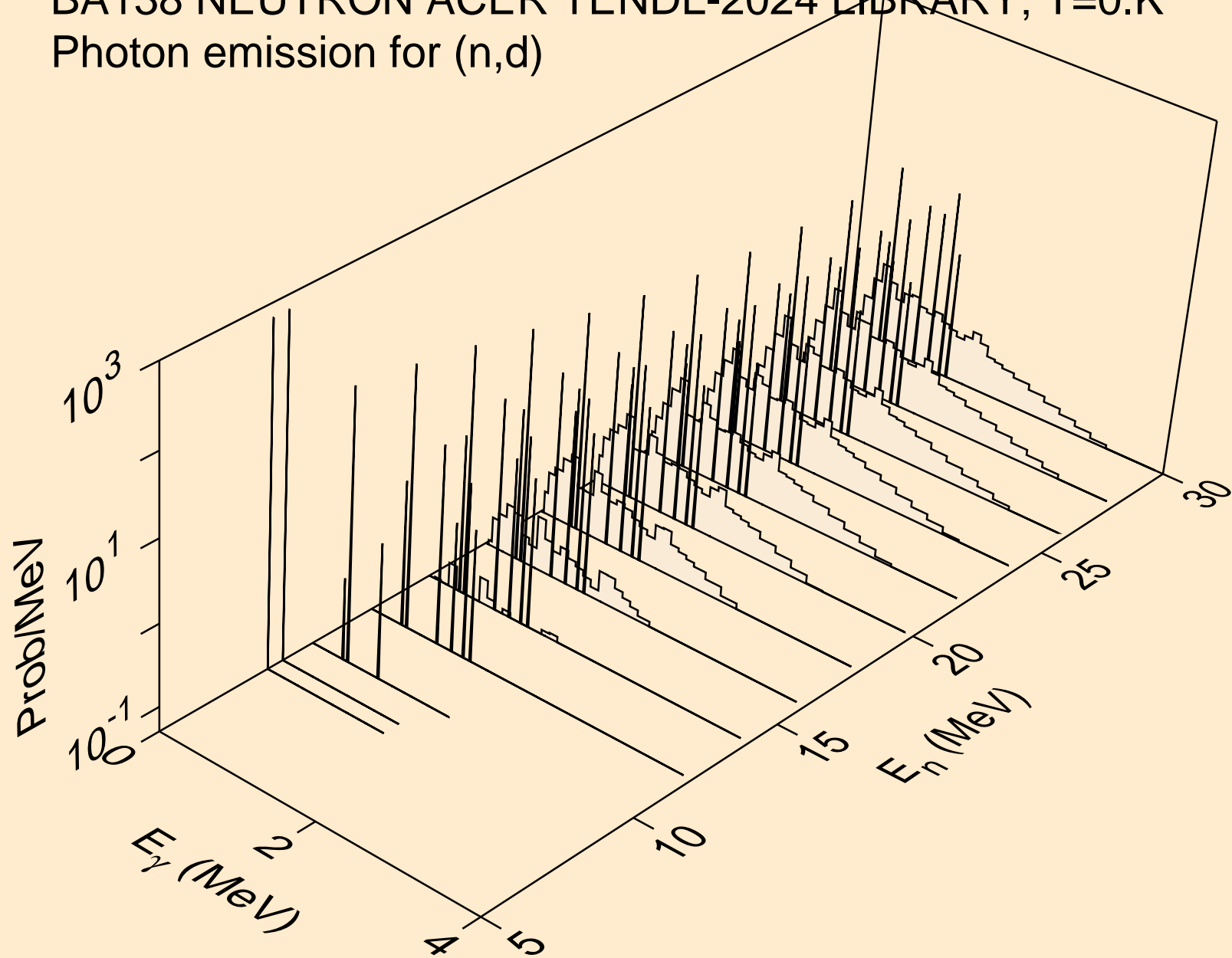

BA138 NEUTRON ACER TENDL-2024 LIBRARY; T=0.K  
Photon emission for (n,t)

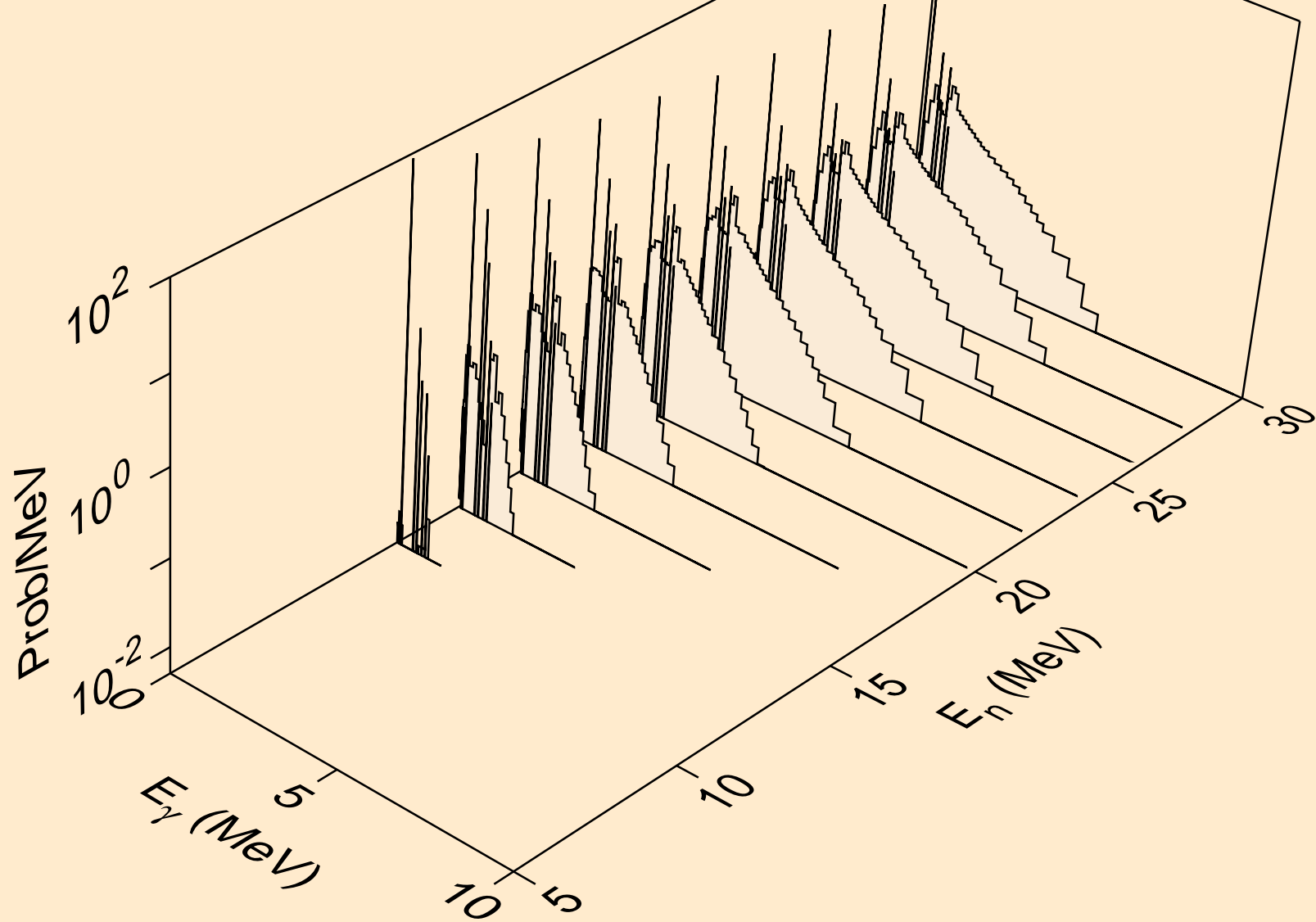

BA138 NEUTRON ACER TENDL-2024 LIBRARY; T=0.K  
Photon emission for (n,he3)

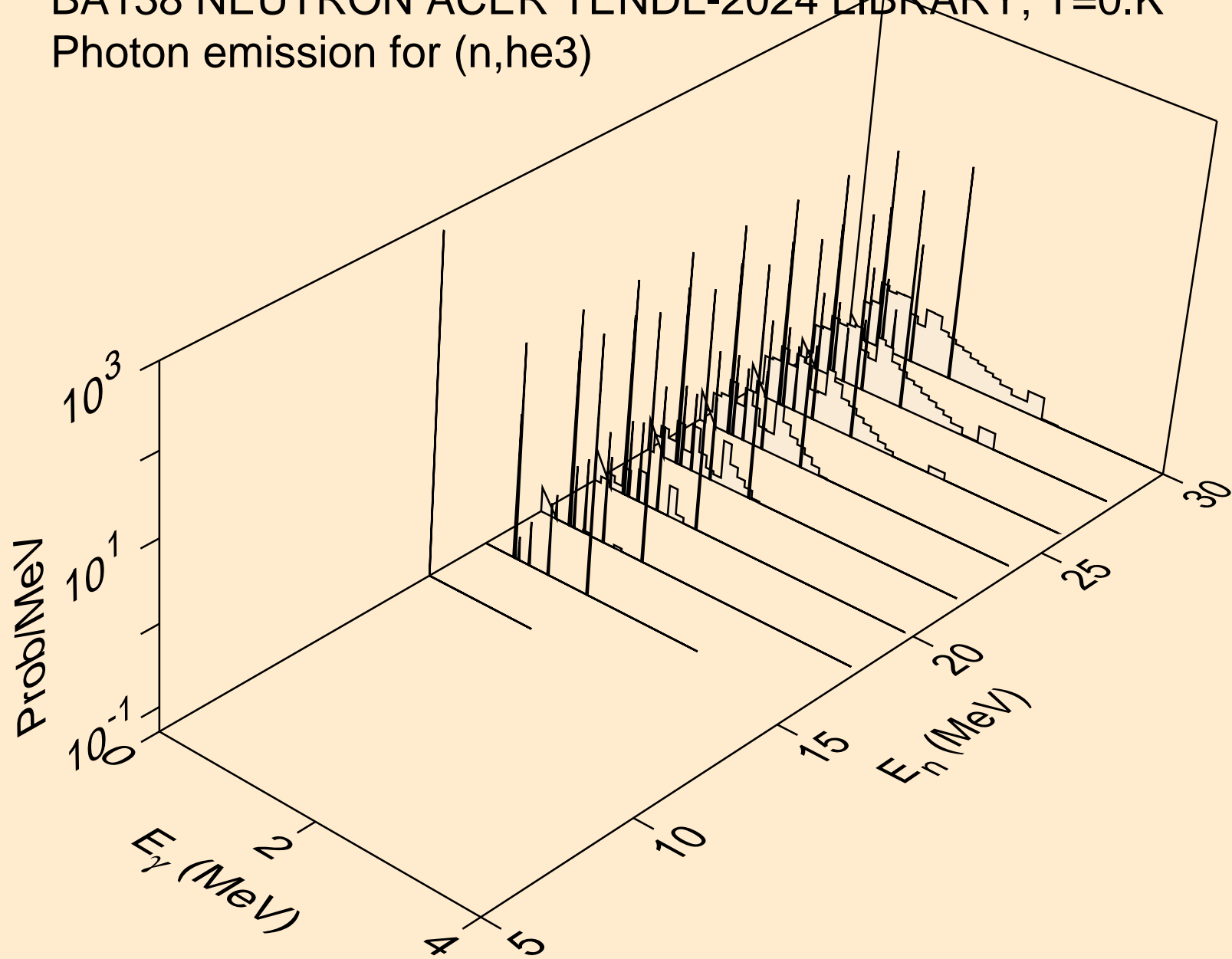

BA138 NEUTRON ACER TENDL-2024 LIBRARY; T=0.K  
Photon emission for (n,a)

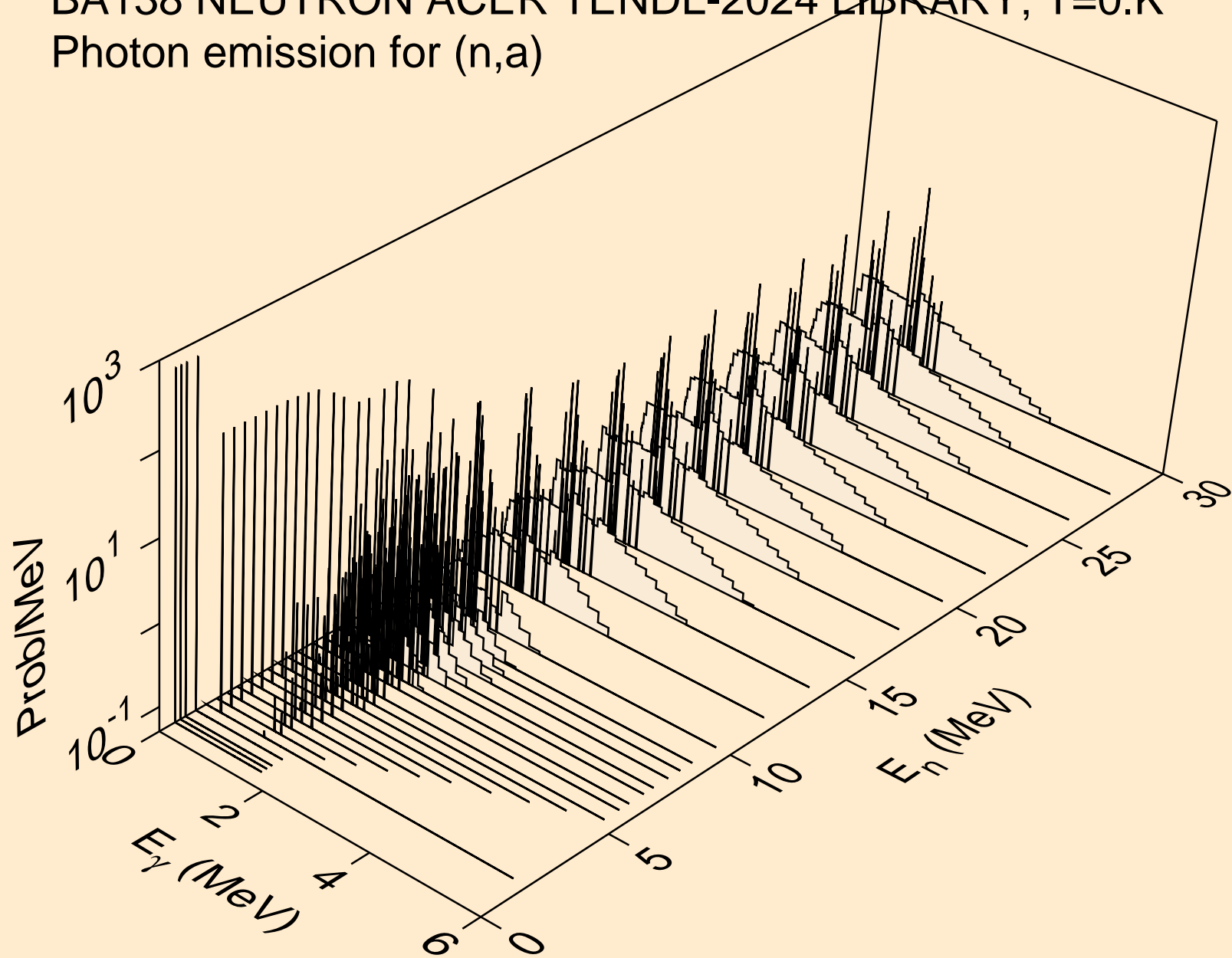

BA138 NEUTRON ACER TENDL-2024 LIBRARY; T=0.K  
Photon emission for (n,2a)

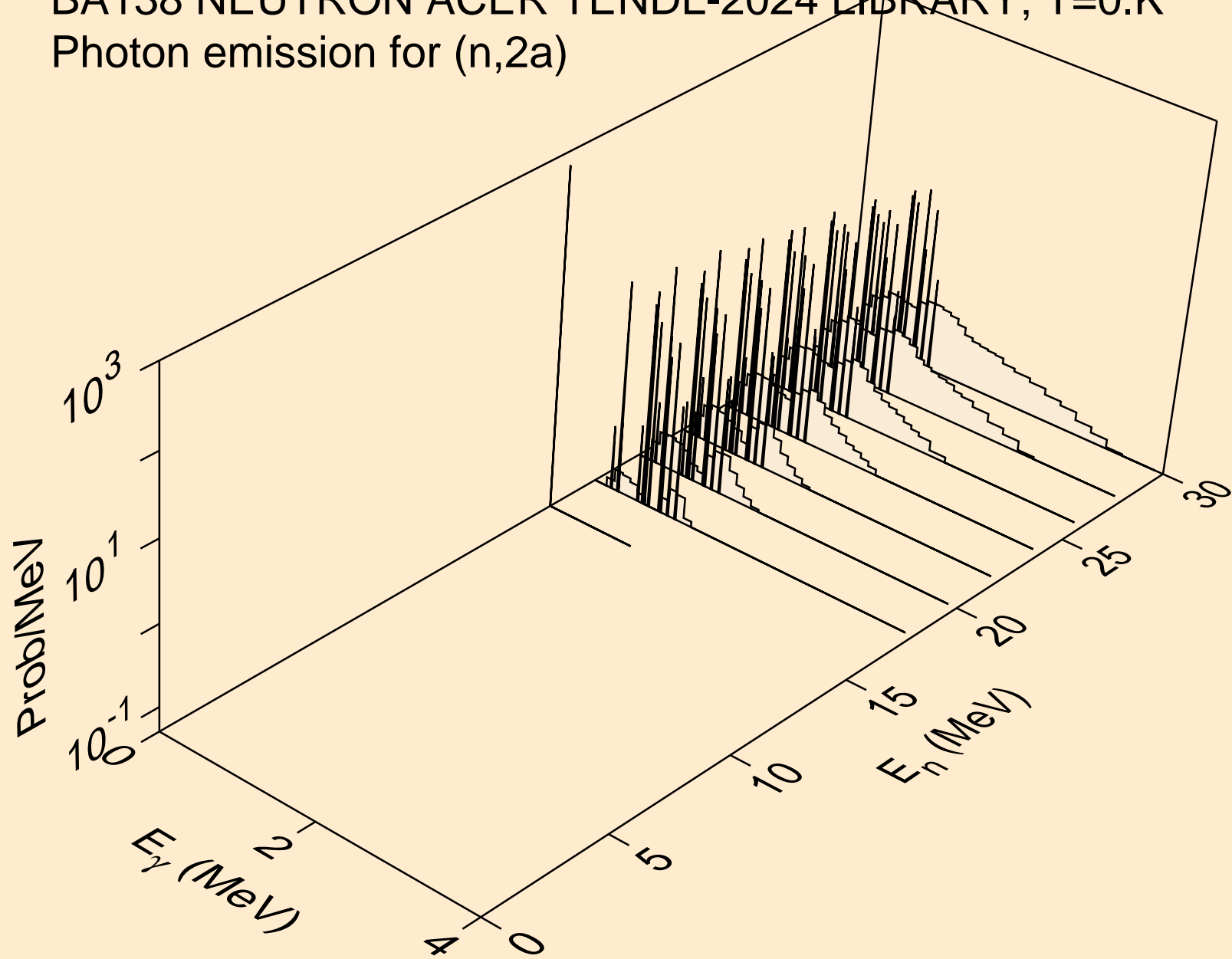

BA138 NEUTRON ACER TENDL-2024 LIBRARY; T=0.K  
Photon emission for (n,2p)

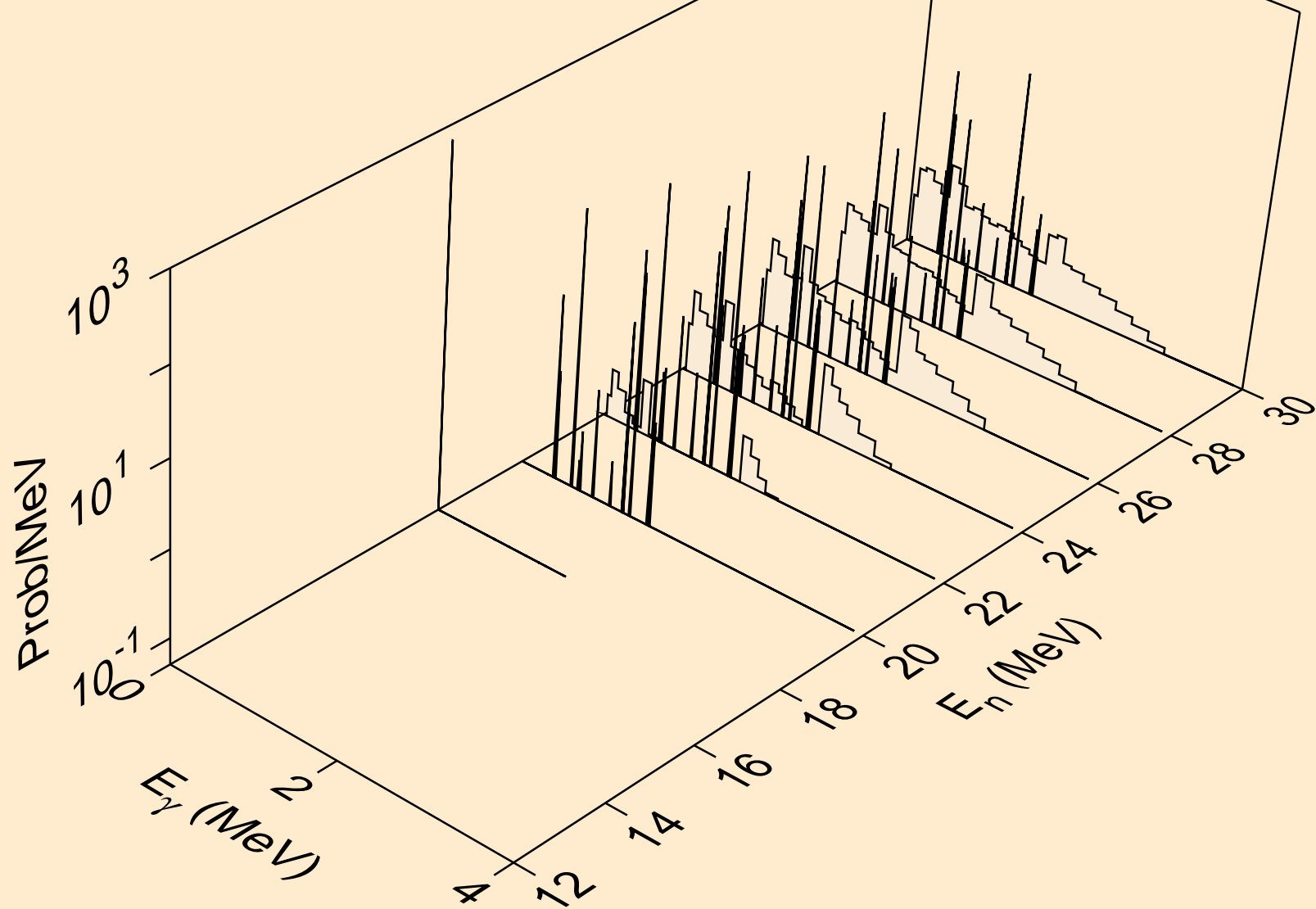

BA138 NEUTRON ACER TENDL-2024 LIBRARY; T=0.K  
Photon emission for (n,p)

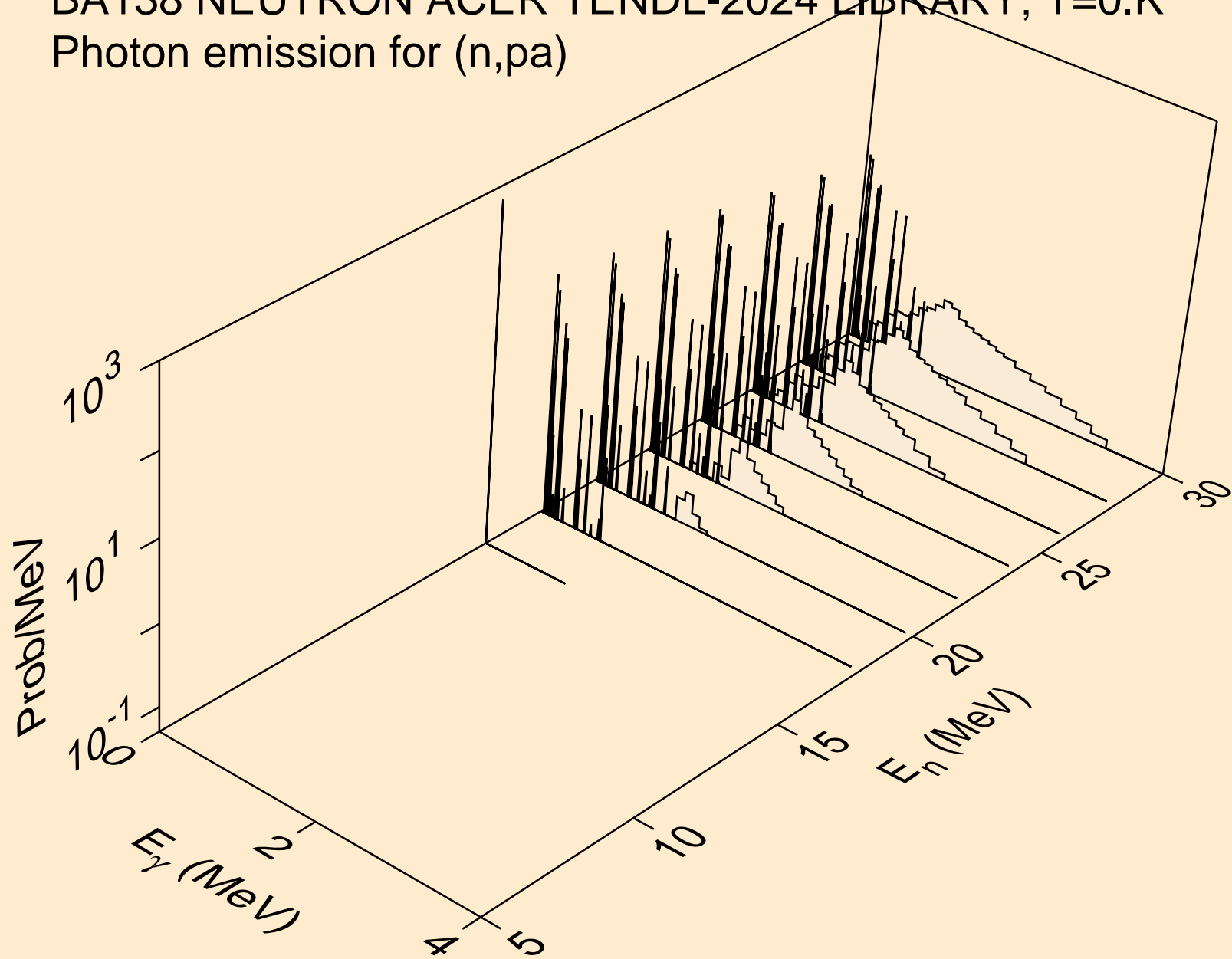

BA138 NEUTRON ACER TENDL-2024 LIBRARY; T=0.K  
Photon emission for (n,pd)

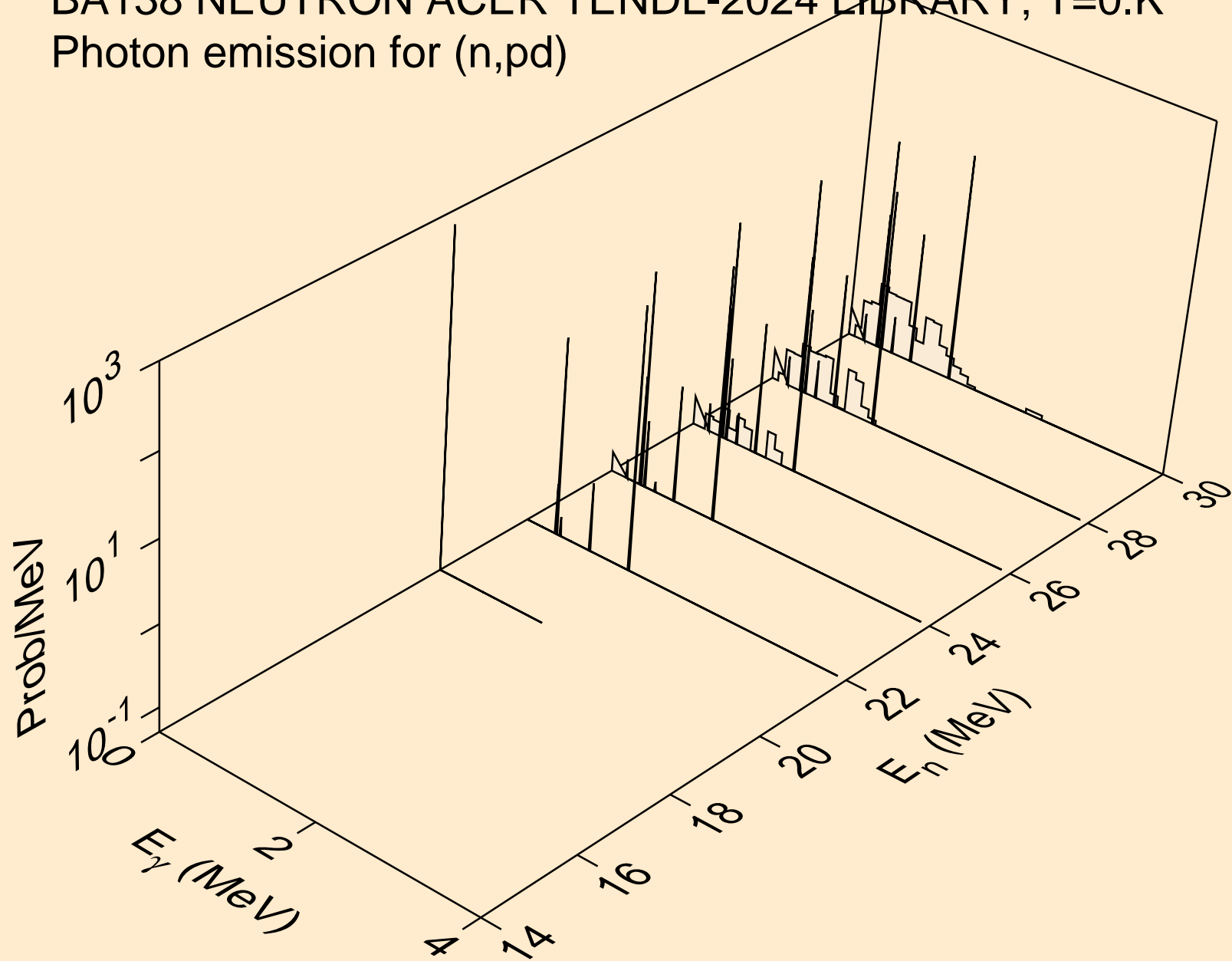



BA138 NEUTRON ACER TENDL-2024 LIBRARY; T=0.K  
Photon emission for (n,pt)

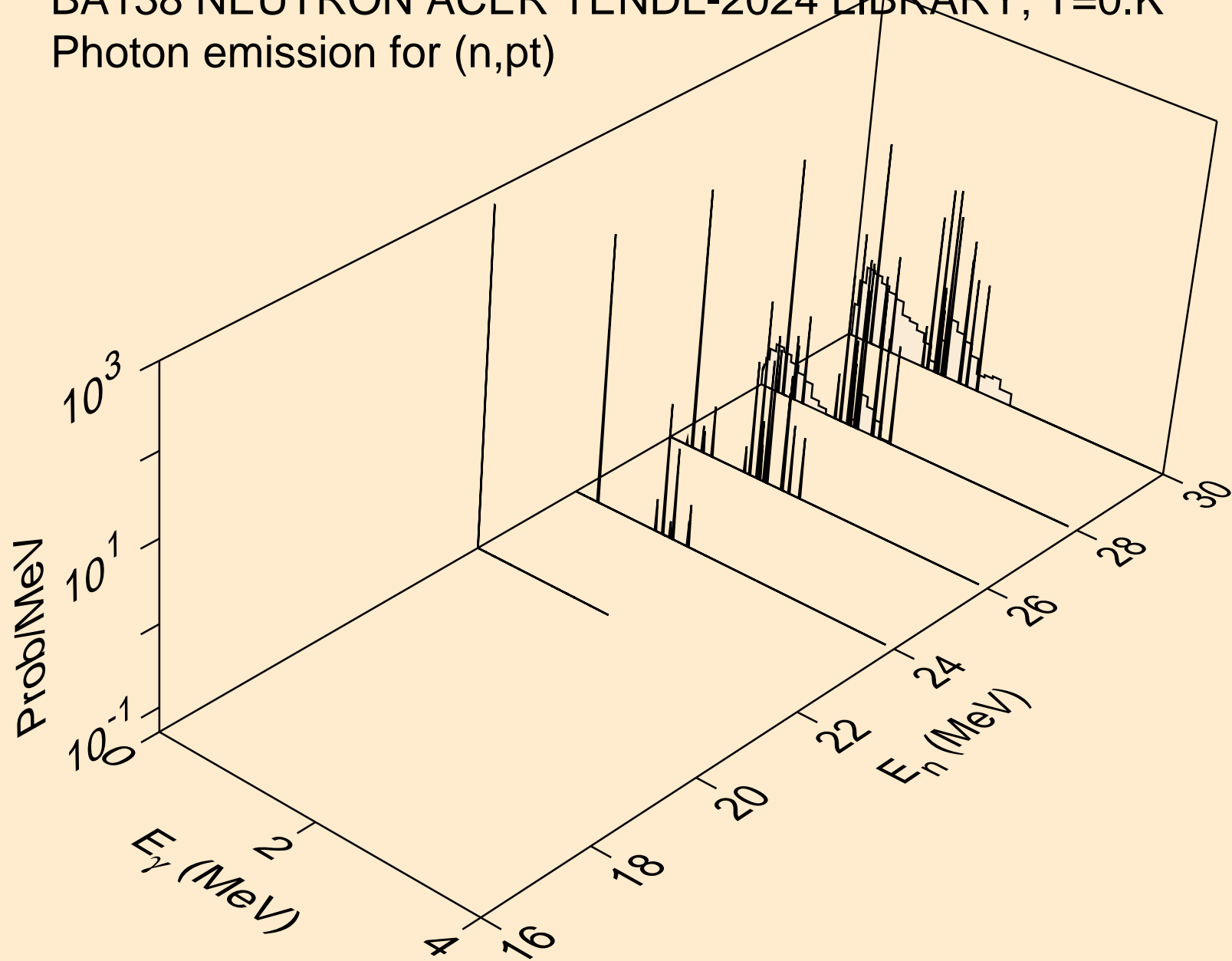

BA138 NEUTRON ACER TENDL-2024 LIBRARY; T=0.K  
Photon emission for (n,da)

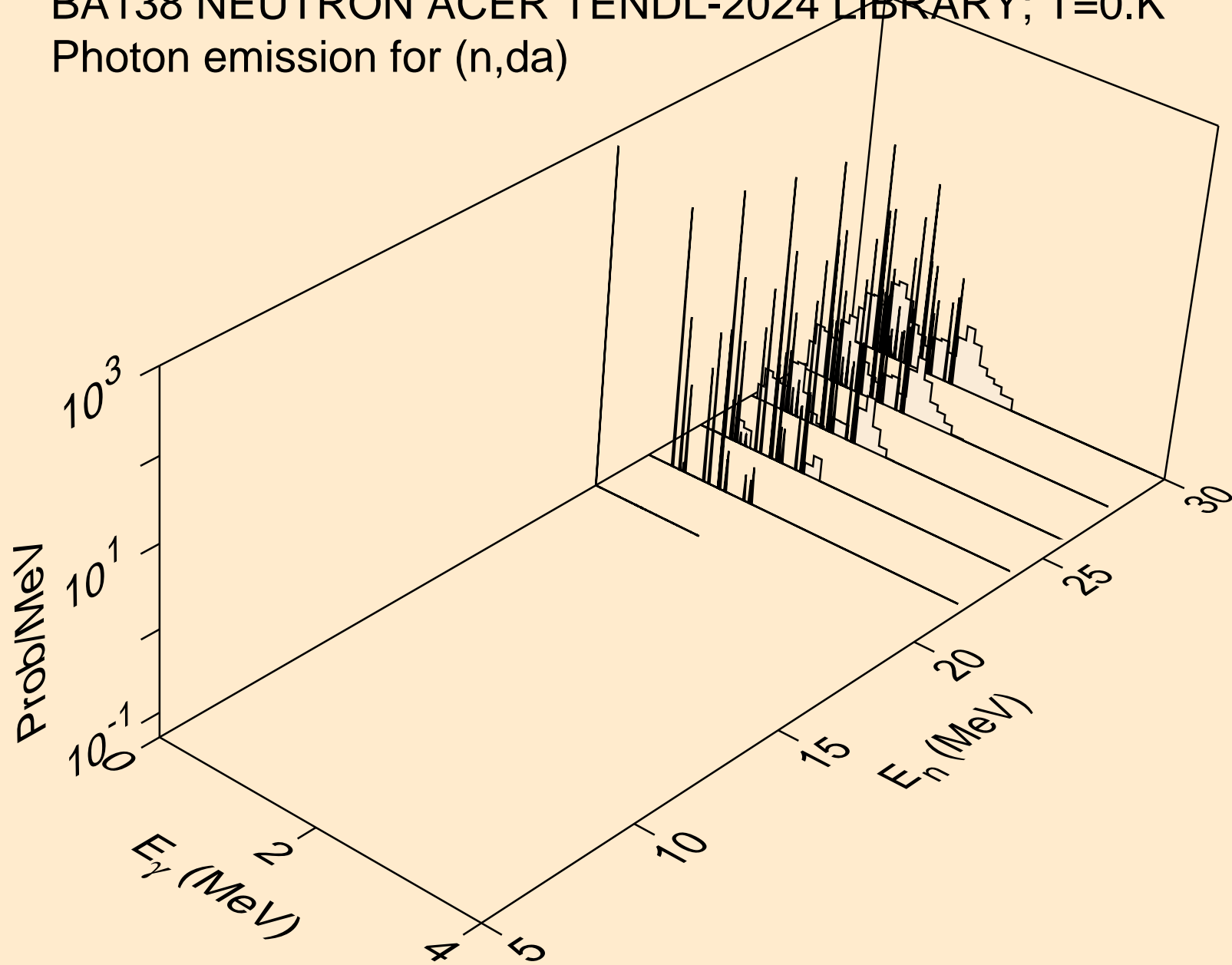

BA138 NEUTRON ACER TENDL-2024 LIBRARY; T=0.K  
thermal capture photon spectrum

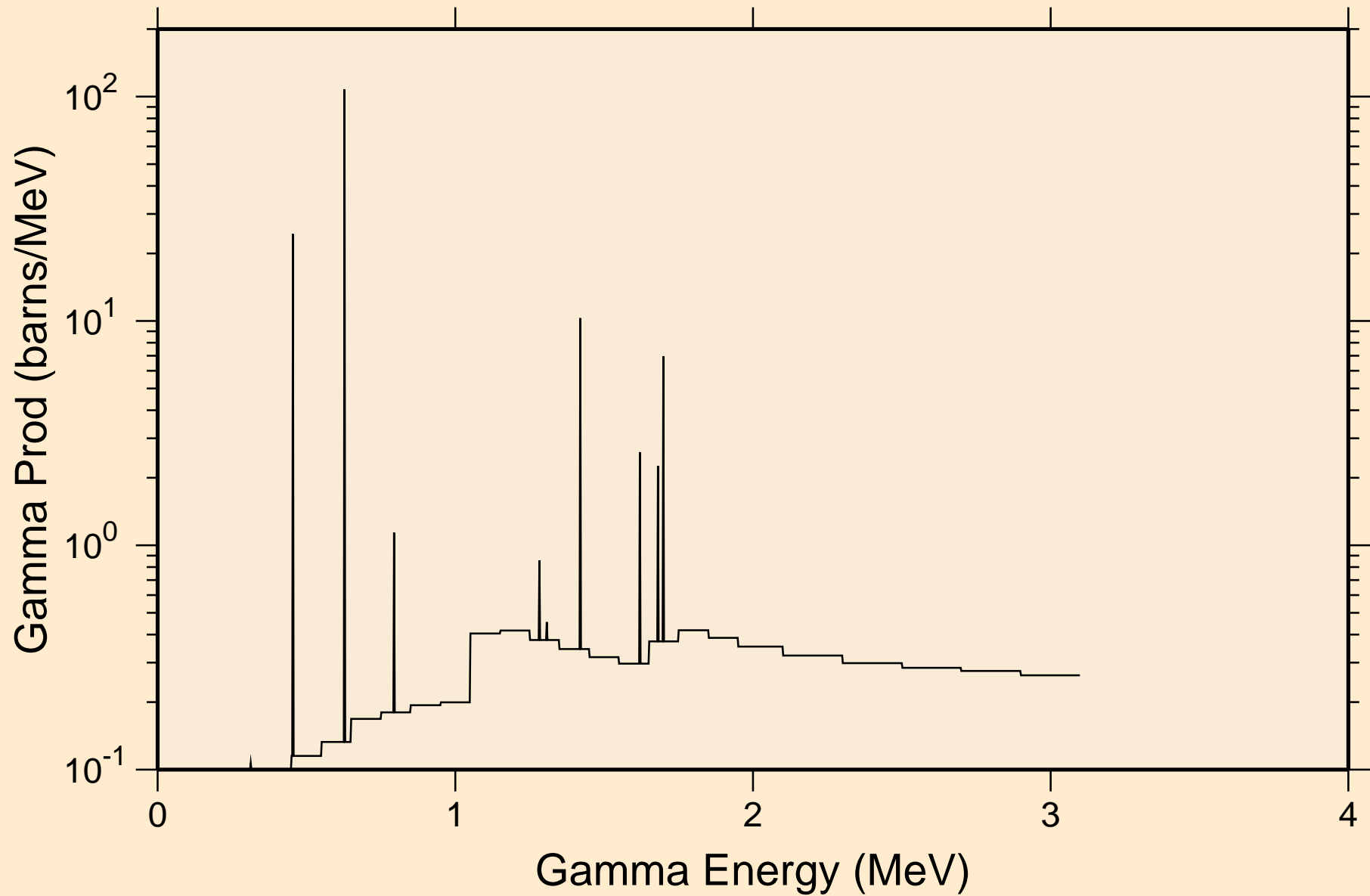

BA138 NEUTRON ACER TENDL-2024 LIBRARY; T=0.K  
14 MeV photon spectrum

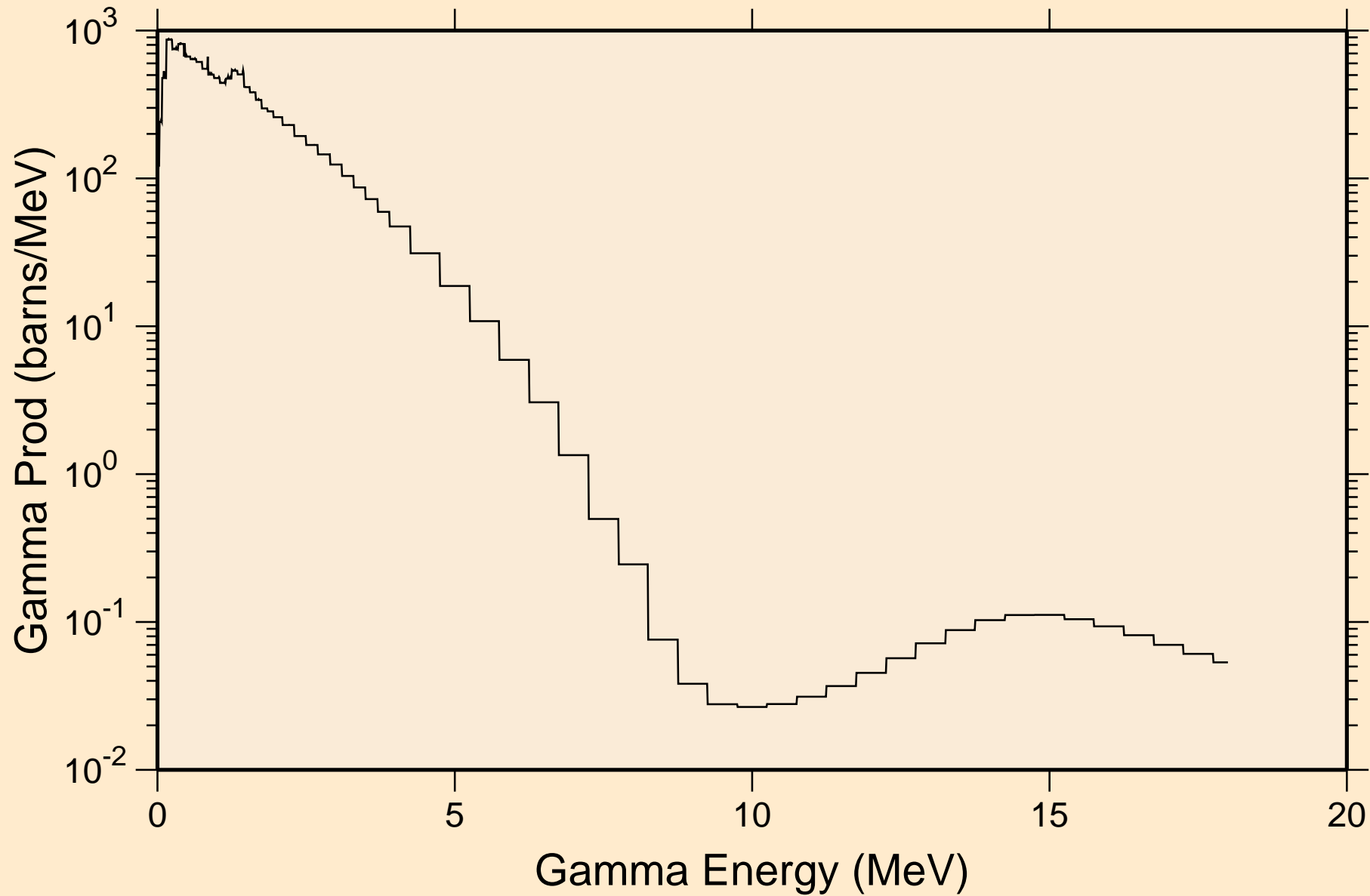

# BA138 NEUTRON ACER TENDL-2024 LIBRARY; T=0.K

## Particle heating contributions

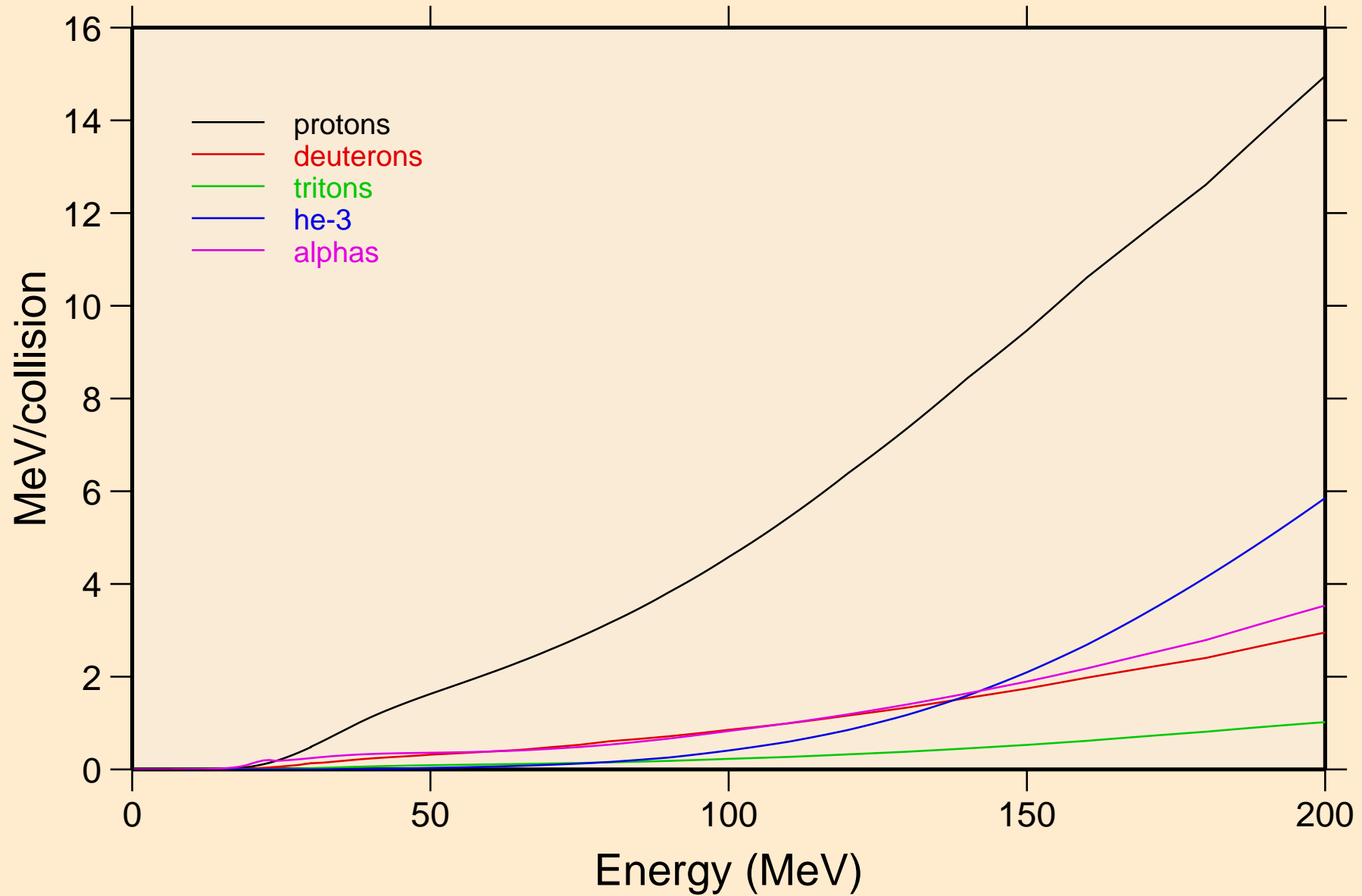

BA138 NEUTRON ACER TENDL-2024 LIBRARY; T=0.K  
Recoil Heating

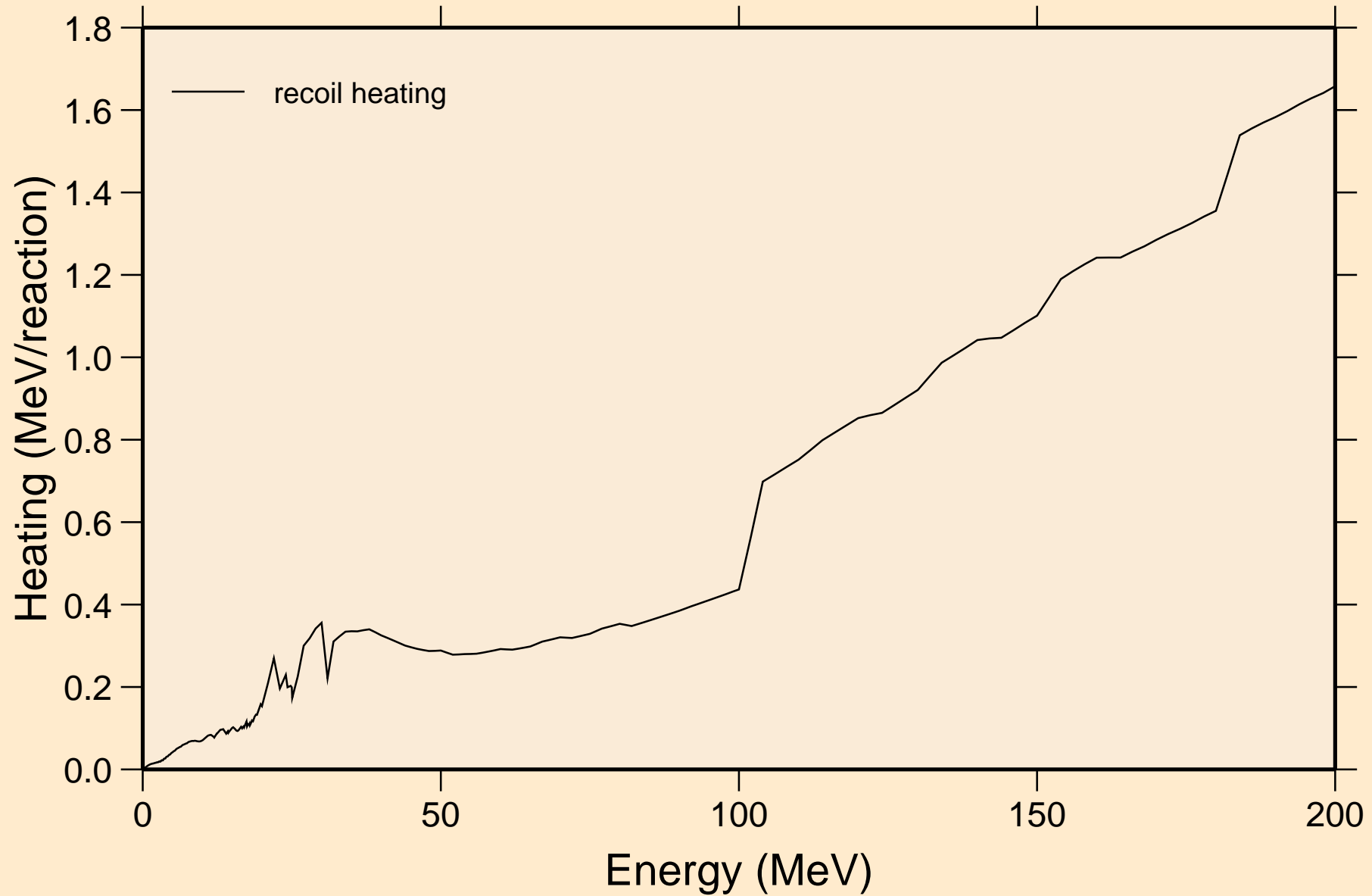

BA138 NEUTRON ACER TENDL-2024 LIBRARY; T=0.K  
Particle production cross sections

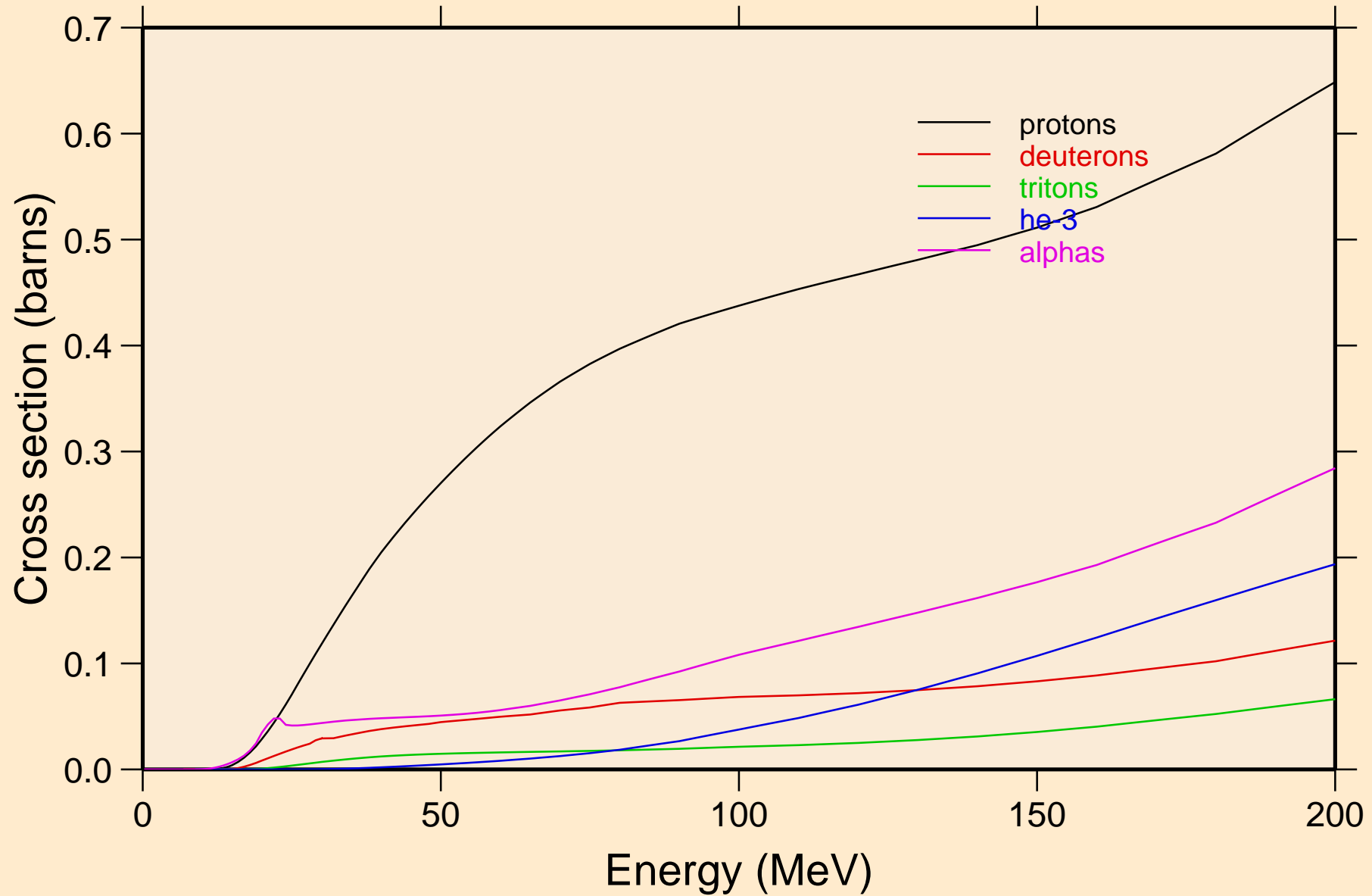

BA138 NEUTRON ACER TENDL-2024 LIBRARY; T=0.K  
protons from (n,x)

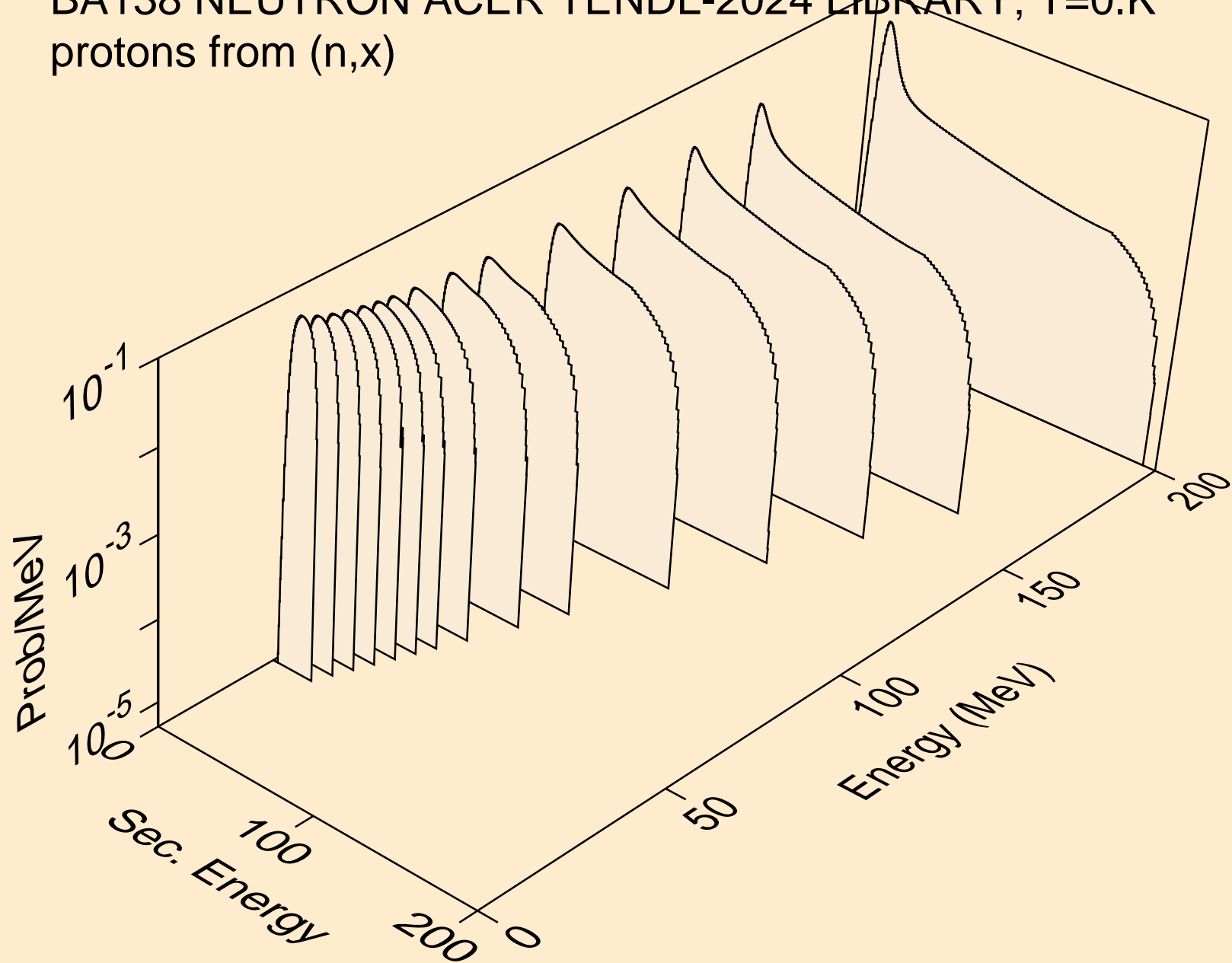



BA138 NEUTRON ACER TENDL-2024 LIBRARY; T=0.K  
protons from (n,n\*)p

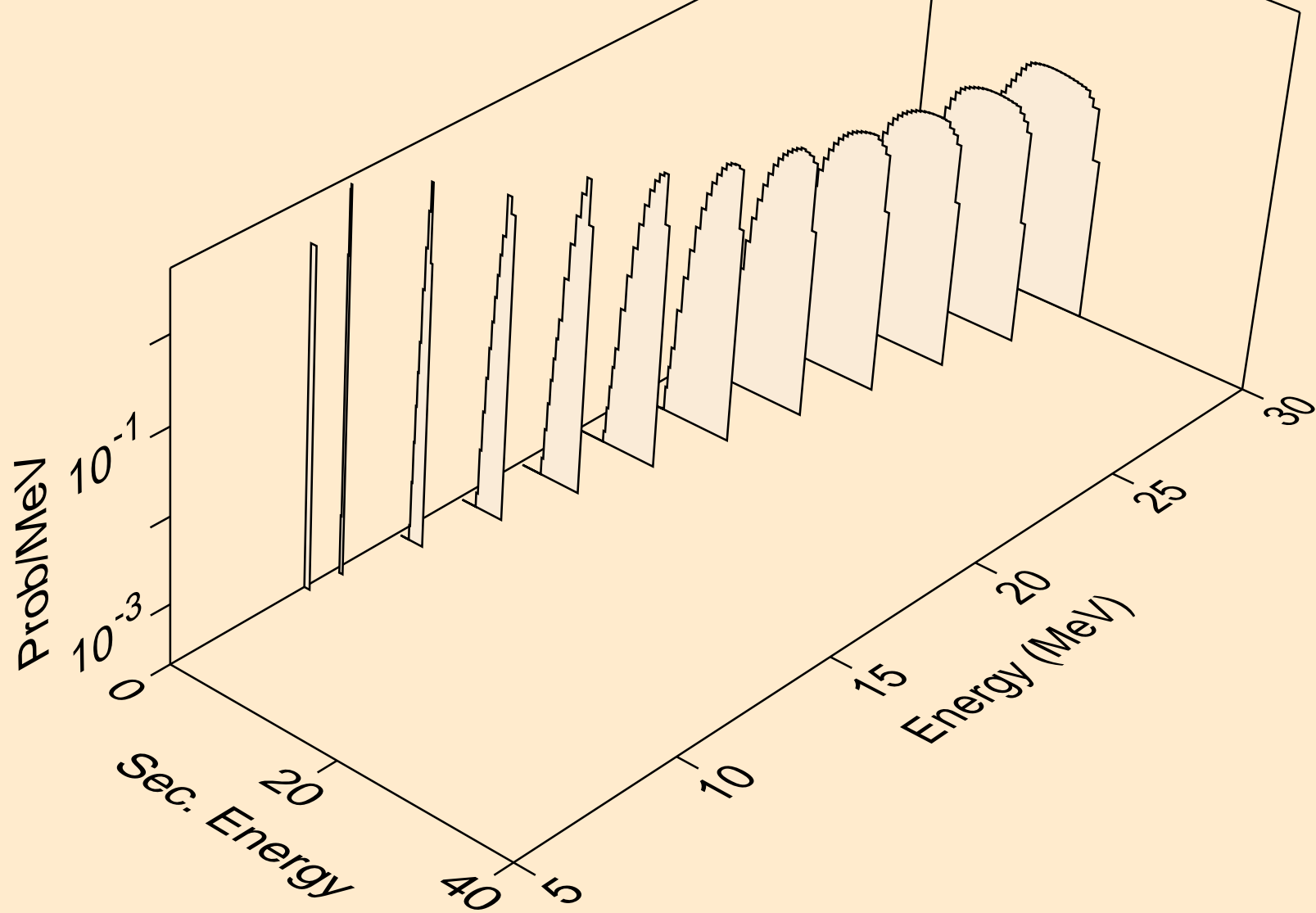

BA138 NEUTRON ACER TENDL-2024 LIBRARY; T=0.K  
protons from (n,2np)

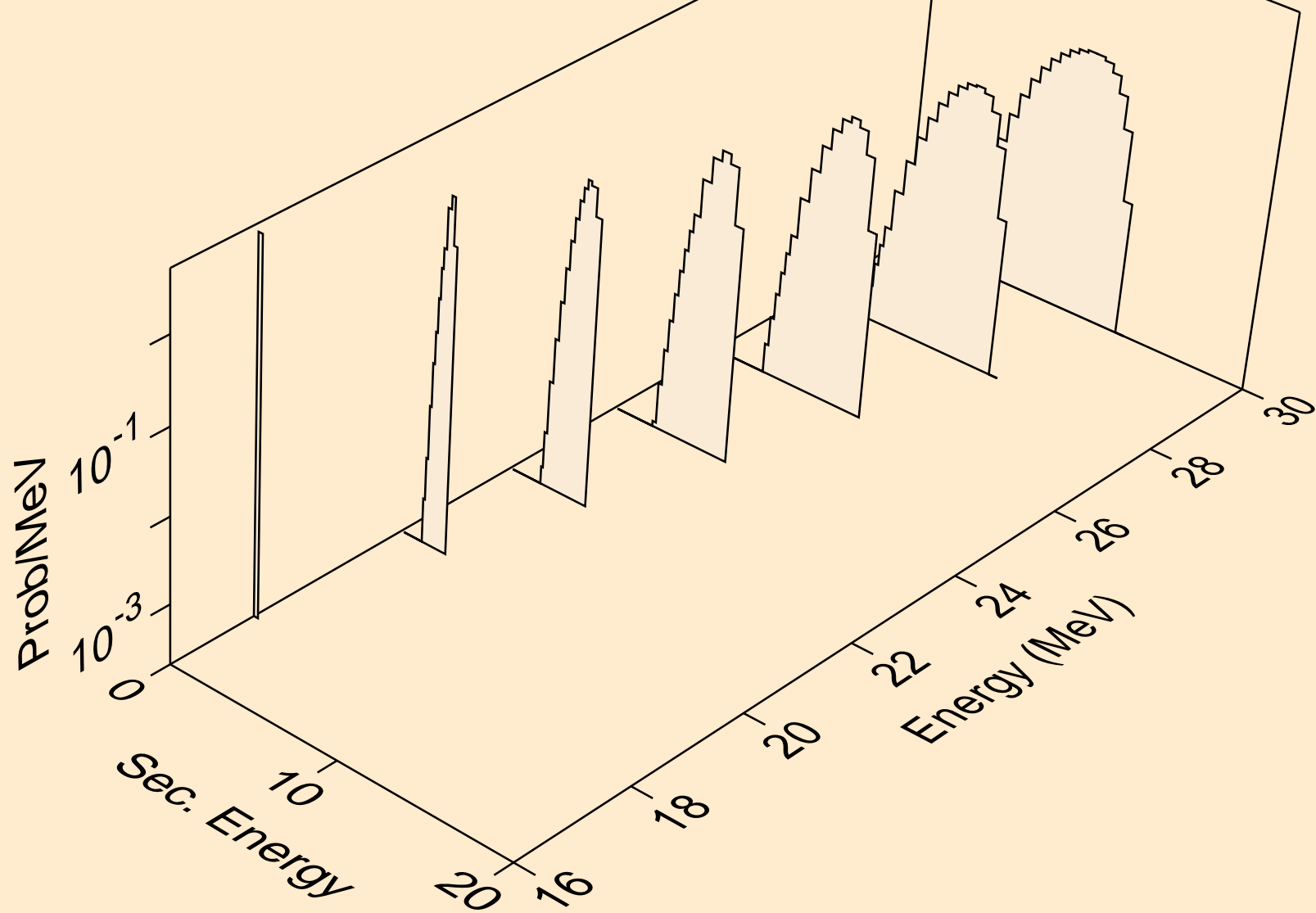

BA138 NEUTRON ACER TENDL-2024 LIBRARY; T=0.K  
protons from (n,3np)

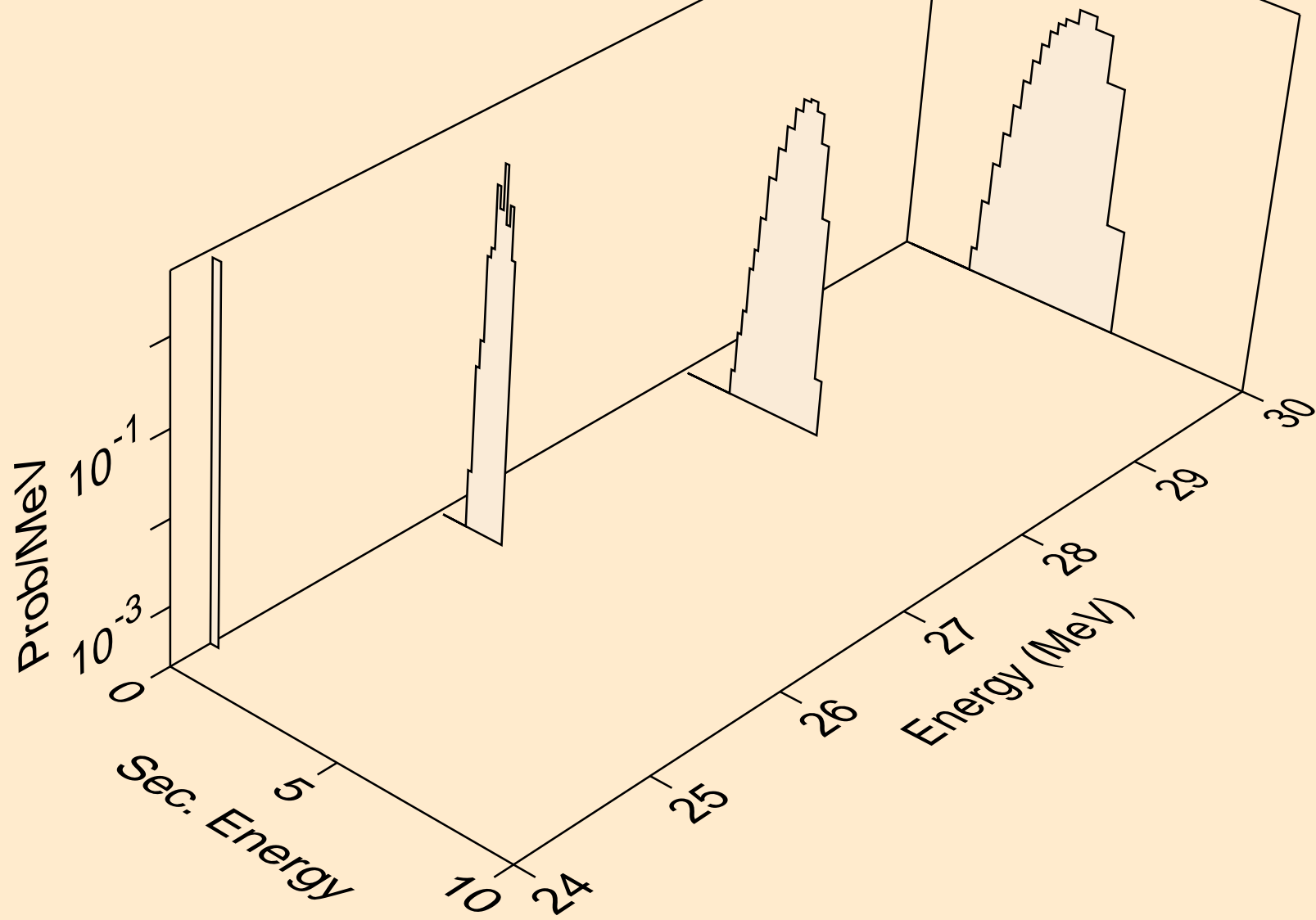

BA138 NEUTRON ACER TENDL-2024 LIBRARY; T=0.K  
protons from (n,n2p)

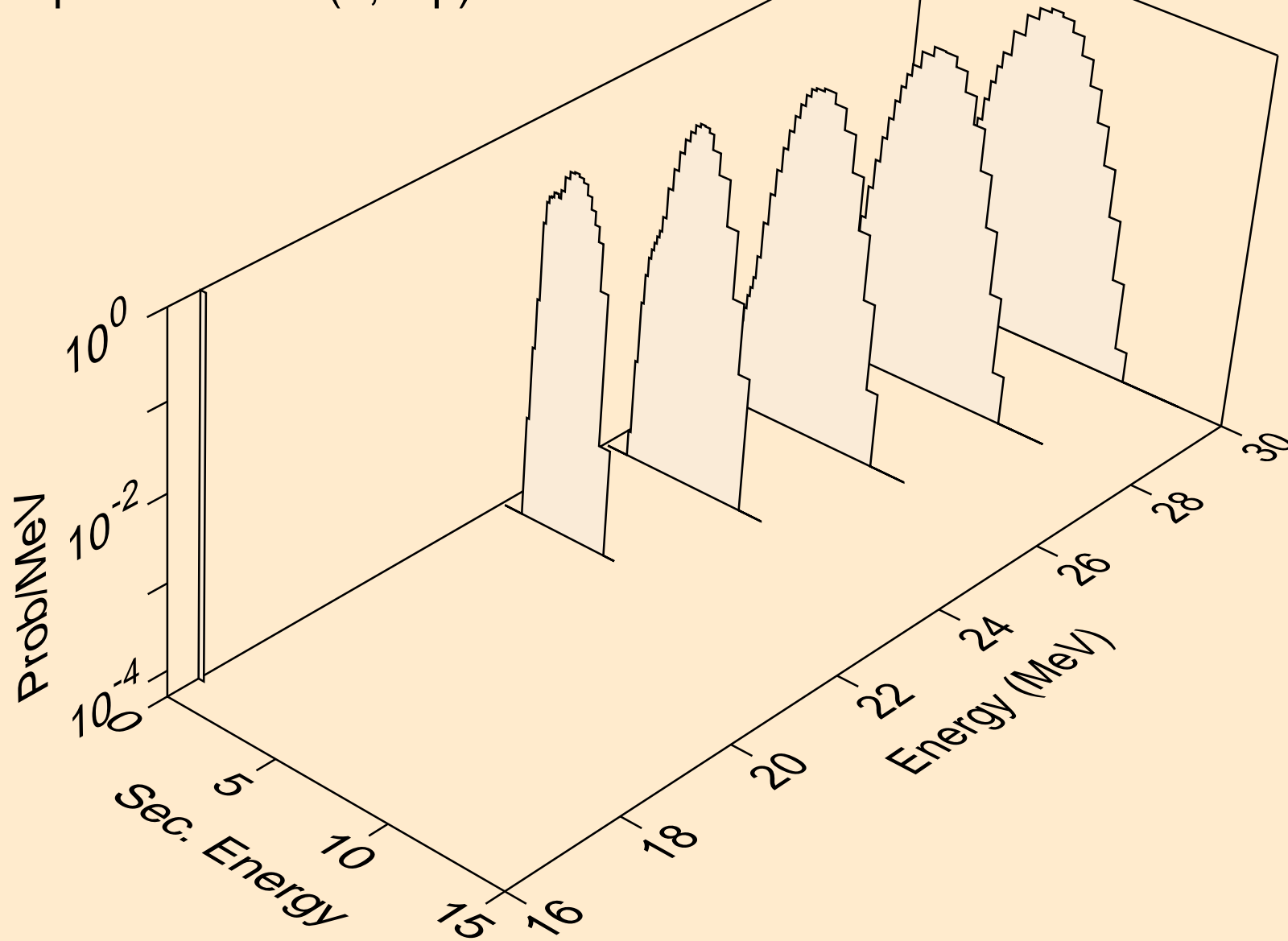

BA138 NEUTRON ACER TENDL-2024 LIBRARY; T=0.K  
protons from (n,npa)

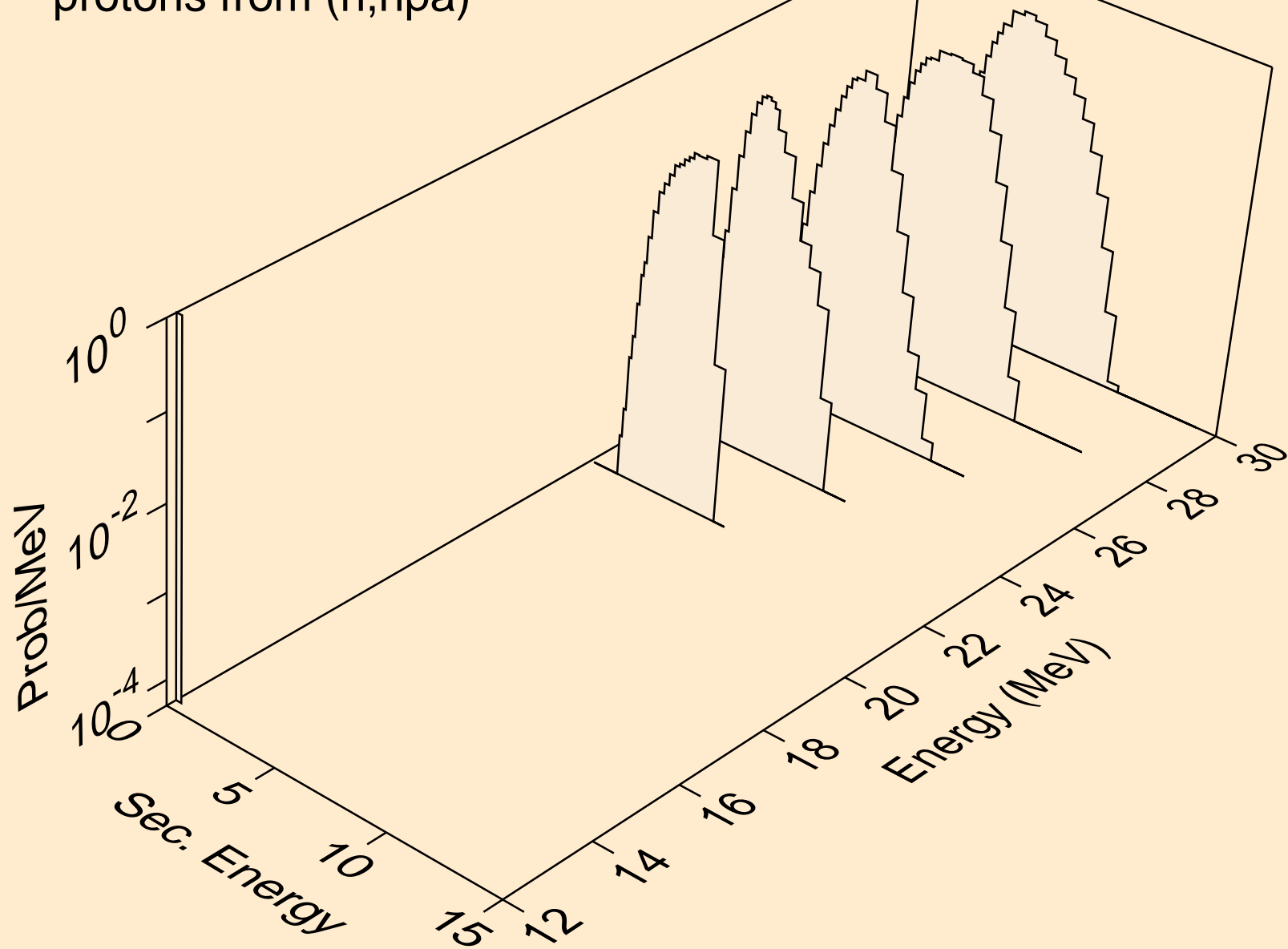

BA138 NEUTRON ACER TENDL-2024 LIBRARY; T=0.K  
protons from (n,p)

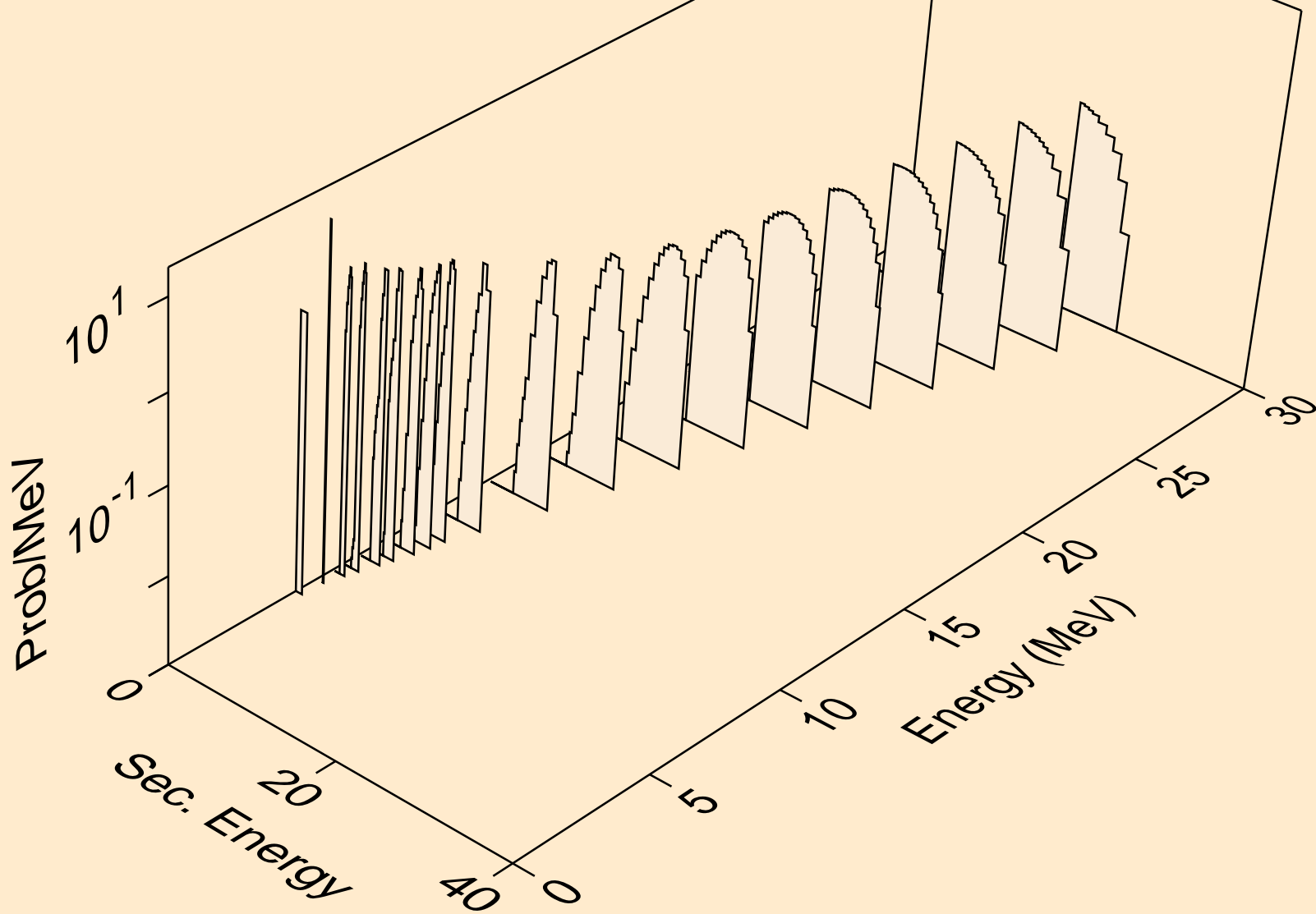

BA138 NEUTRON ACER TENDL-2024 LIBRARY; T=0.K  
protons from (n,2p)

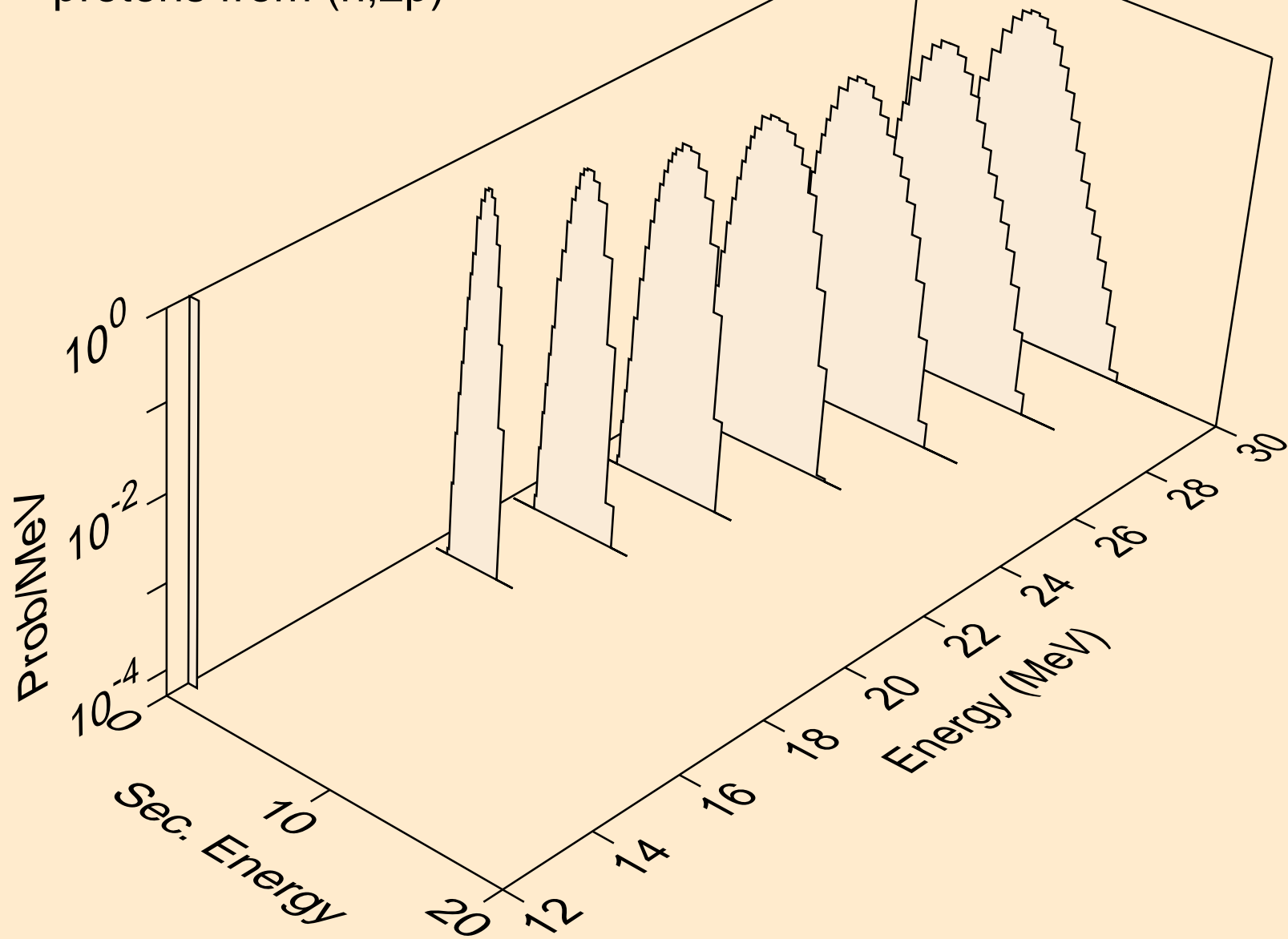

BA138 NEUTRON ACER TENDL-2024 LIBRARY; T=0.K  
protons from (n,p)

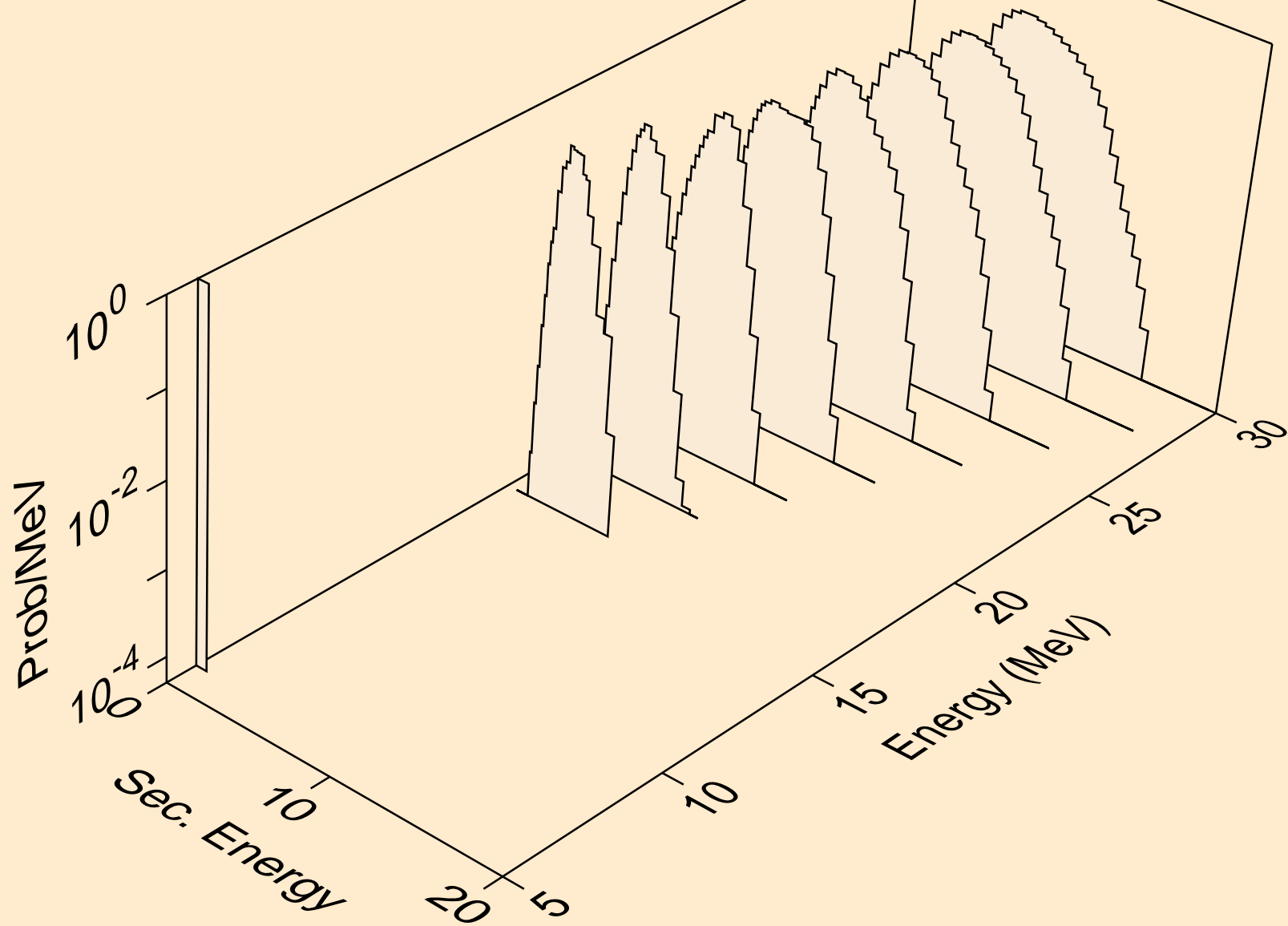



BA138 NEUTRON ACER TENDL-2024 LIBRARY; T=0.K  
protons from (n,pd)

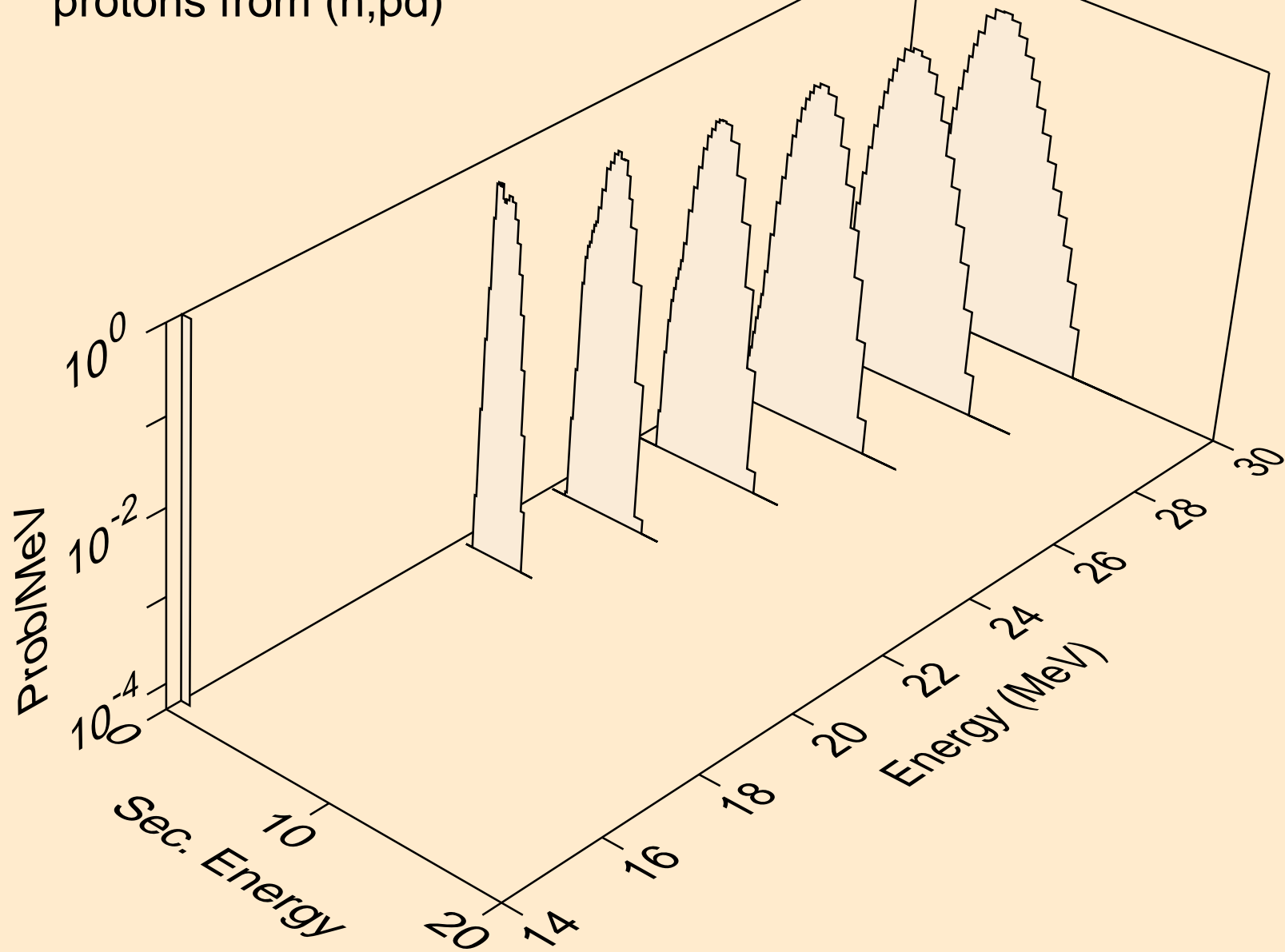

BA138 NEUTRON ACER TENDL-2024 LIBRARY; T=0.K  
protons from (n,pt)

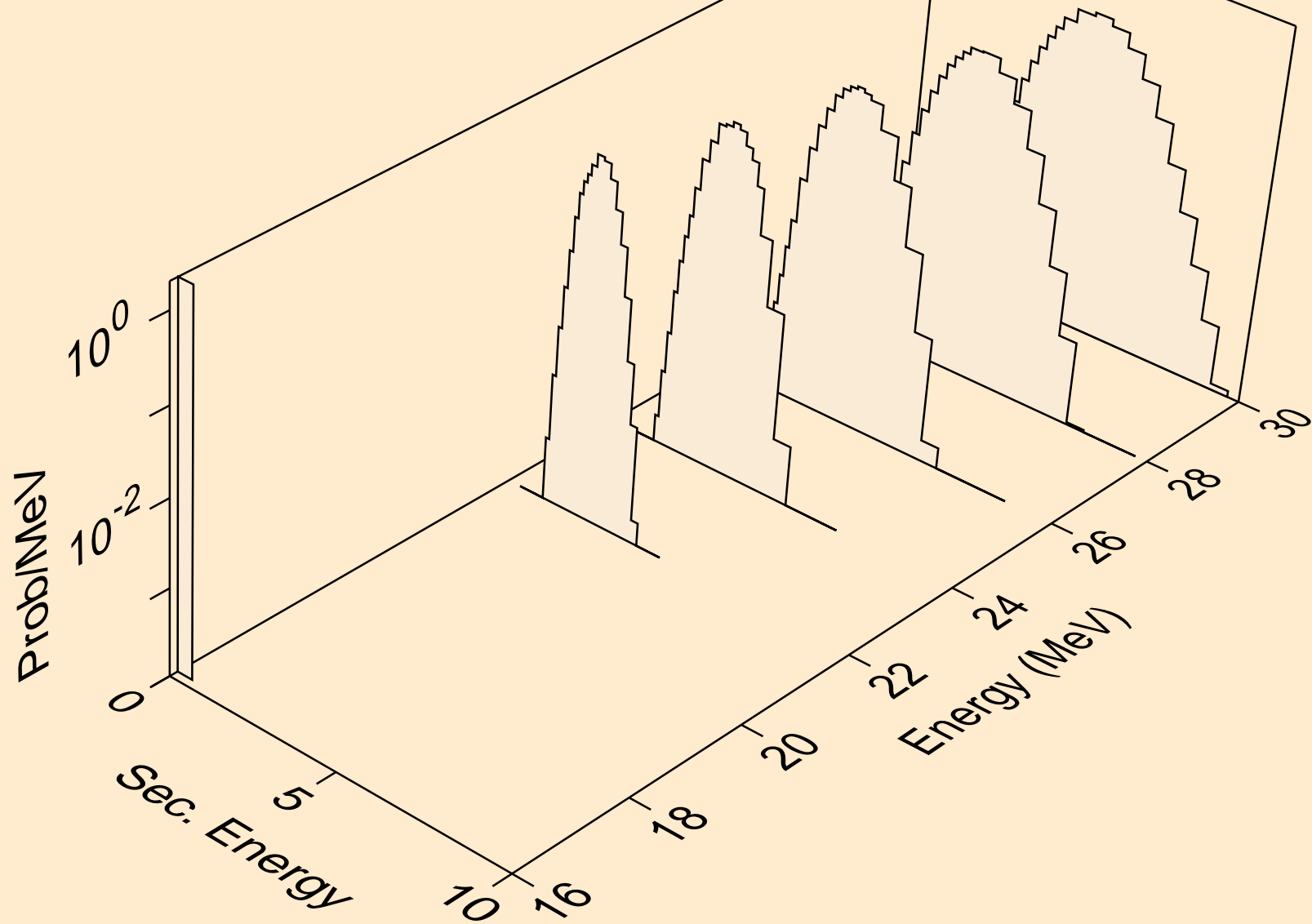

BA138 NEUTRON ACER TENDL-2024 LIBRARY; T=0.K  
deuterons from (n,x)

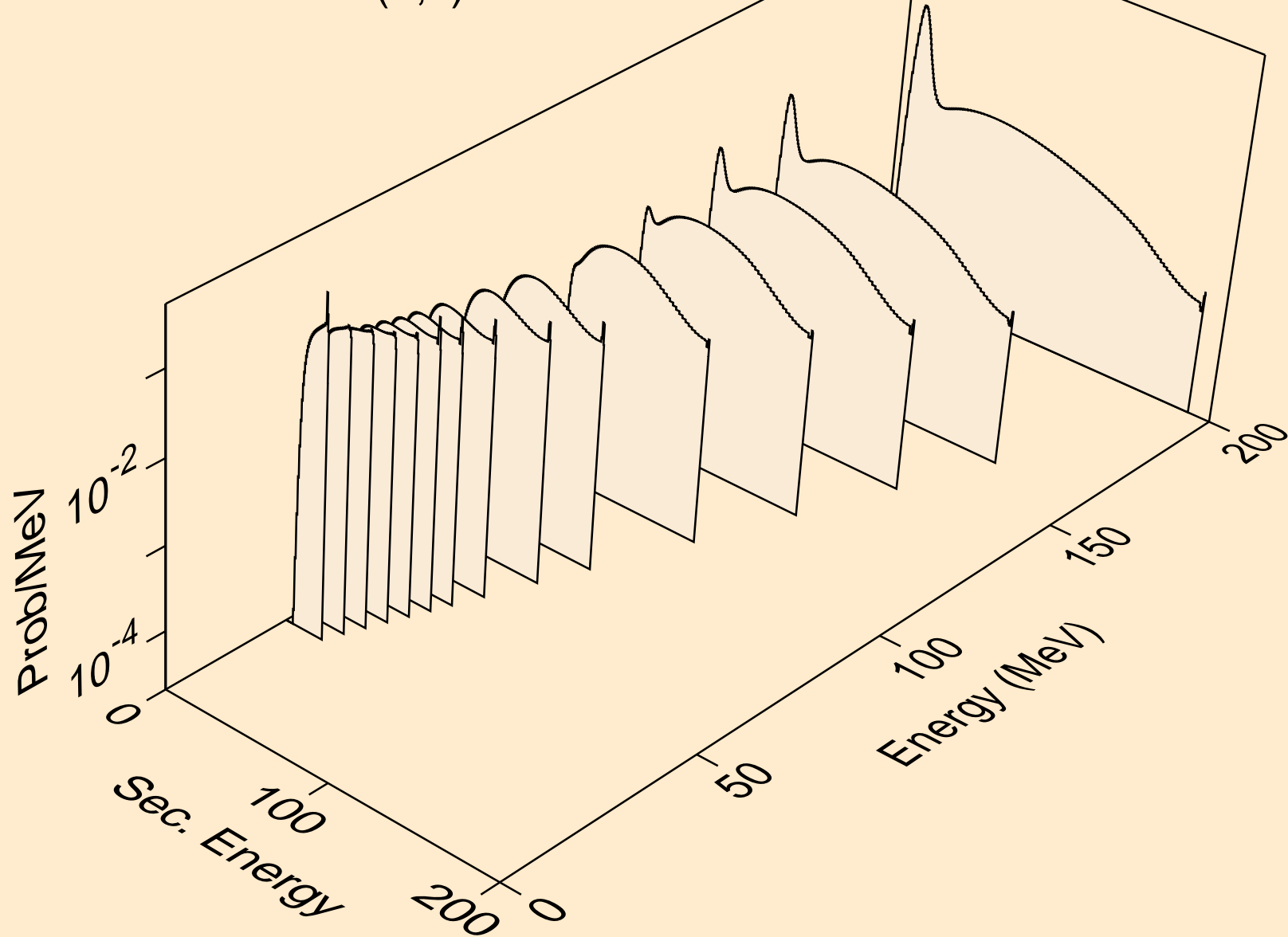

BA138 NEUTRON ACER TENDL-2024 LIBRARY; T=0.K  
deuterons from (n,2nd)

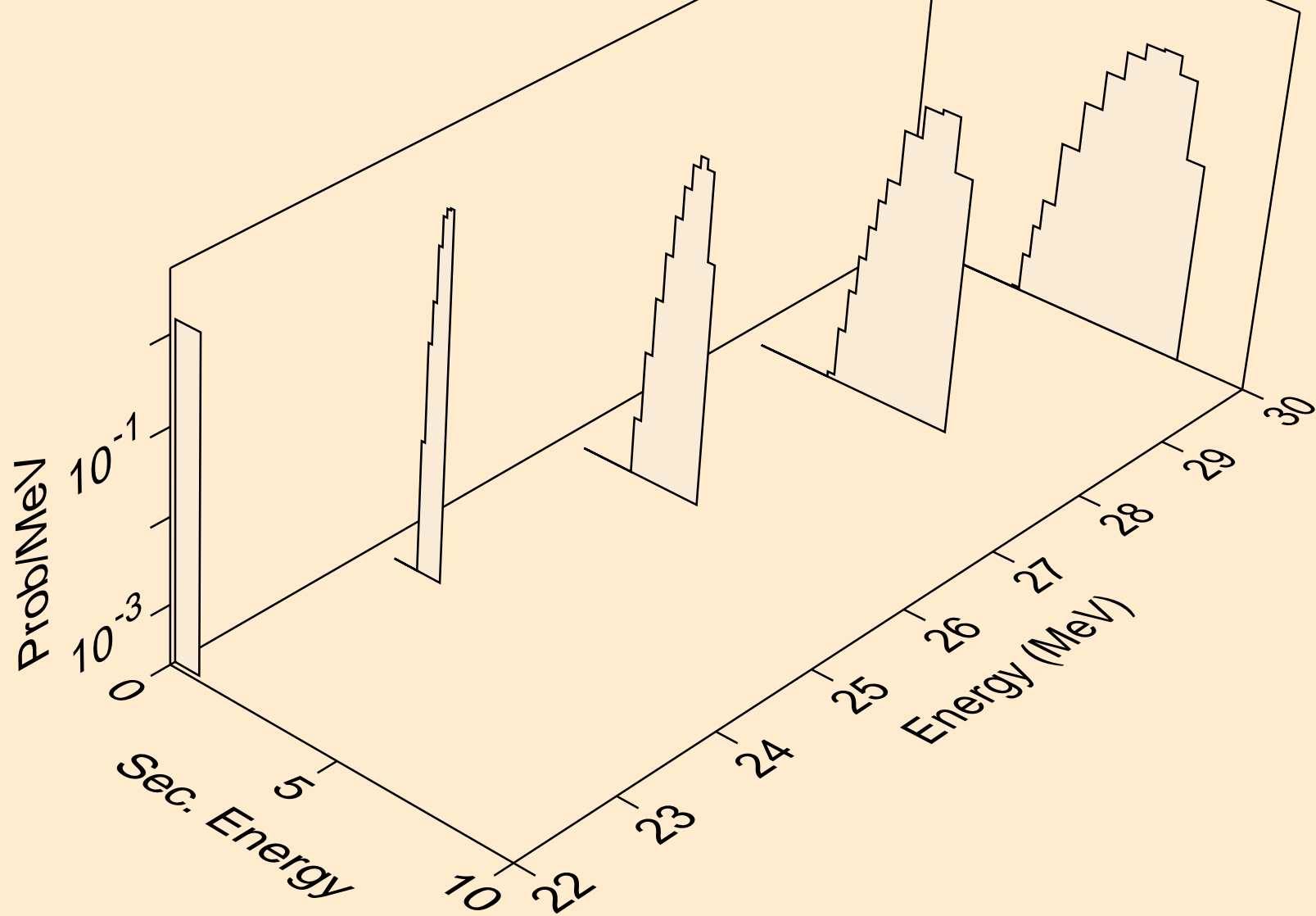

BA138 NEUTRON ACER TENDL-2024 LIBRARY; T=0.K  
deuterons from (n,n\*)d

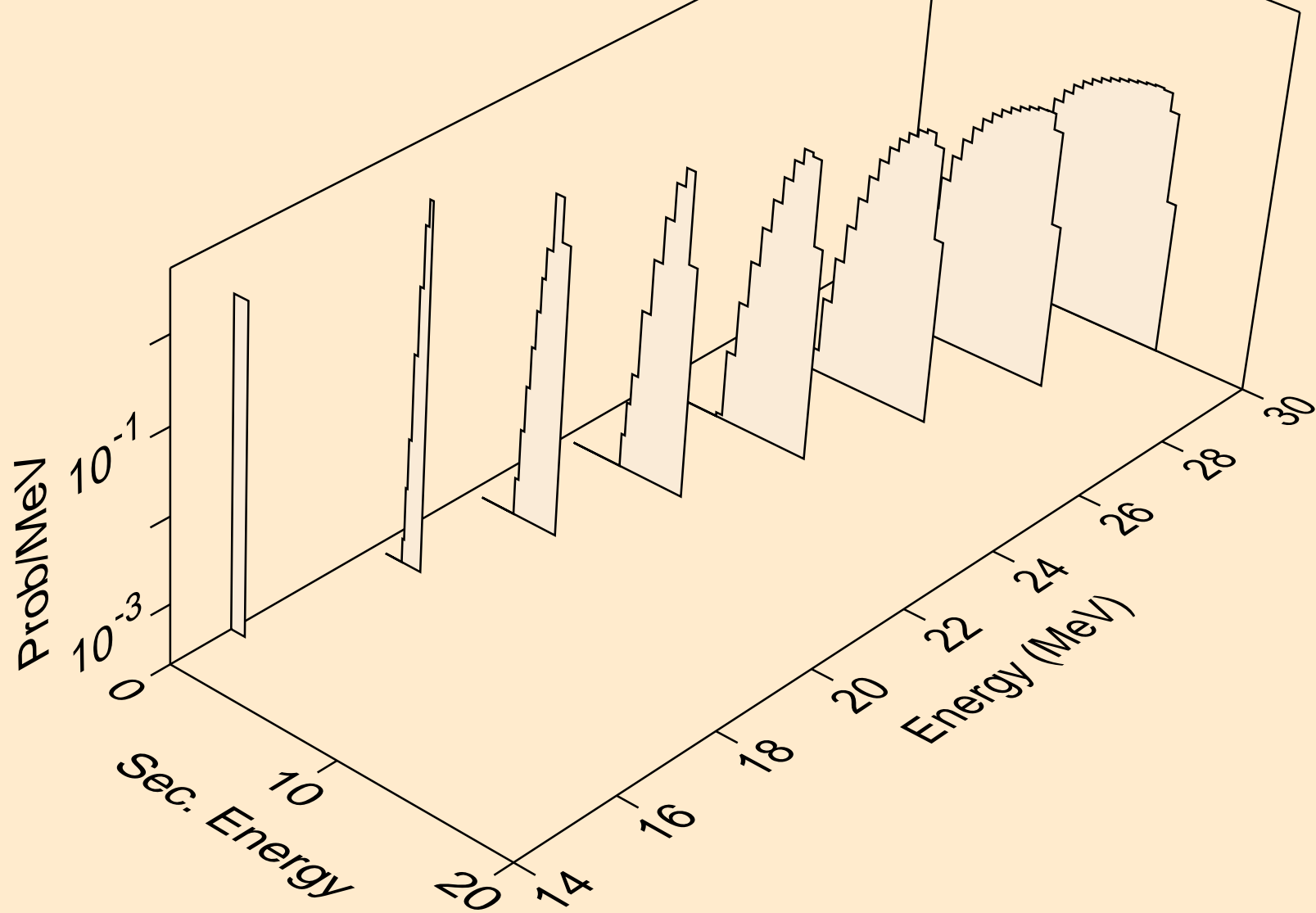

BA138 NEUTRON ACER TENDL-2024 LIBRARY; T=0.K  
deuterons from (n,d)

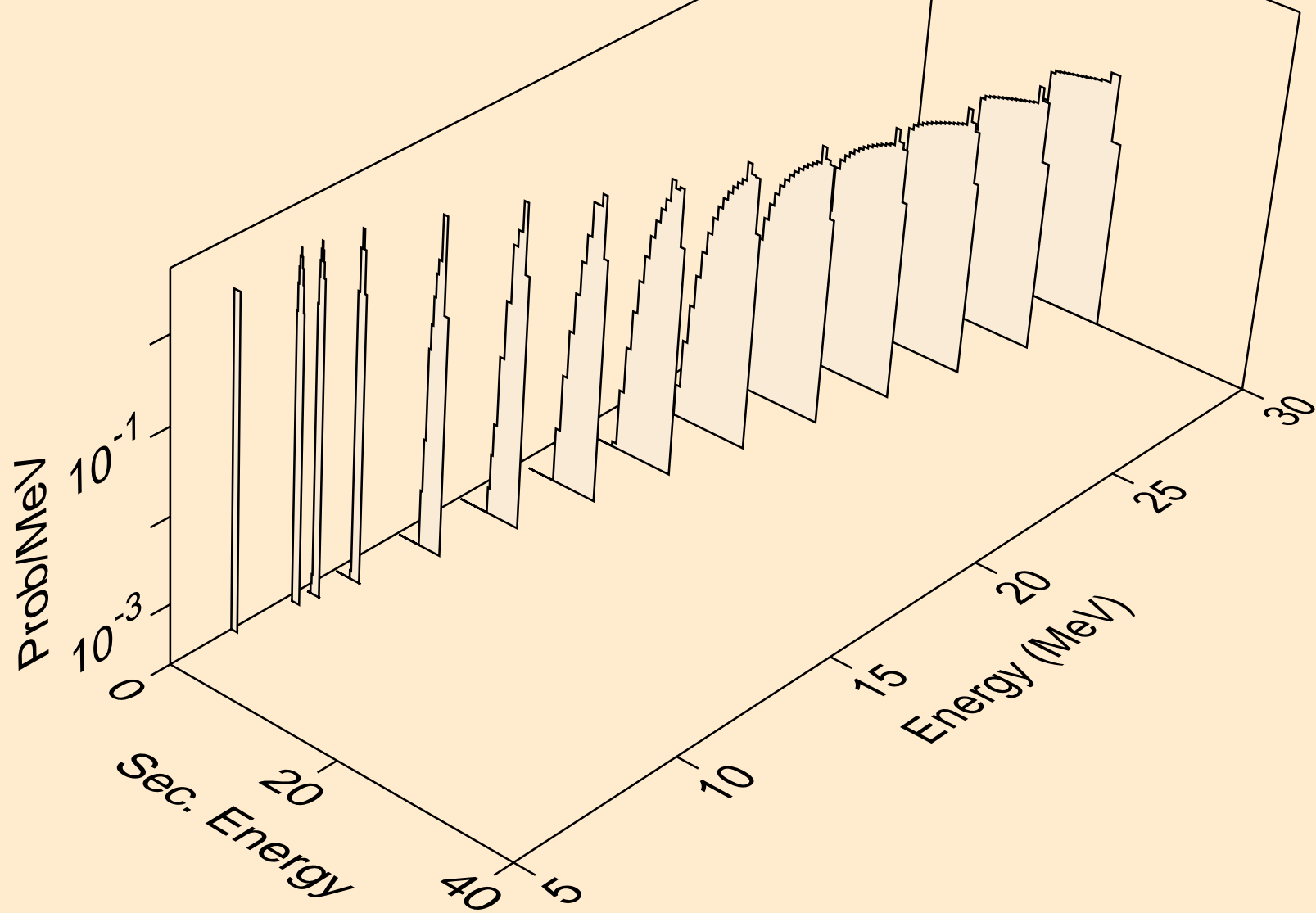

BA138 NEUTRON ACER TENDL-2024 LIBRARY; T=0.K  
deuterons from (n,pd)

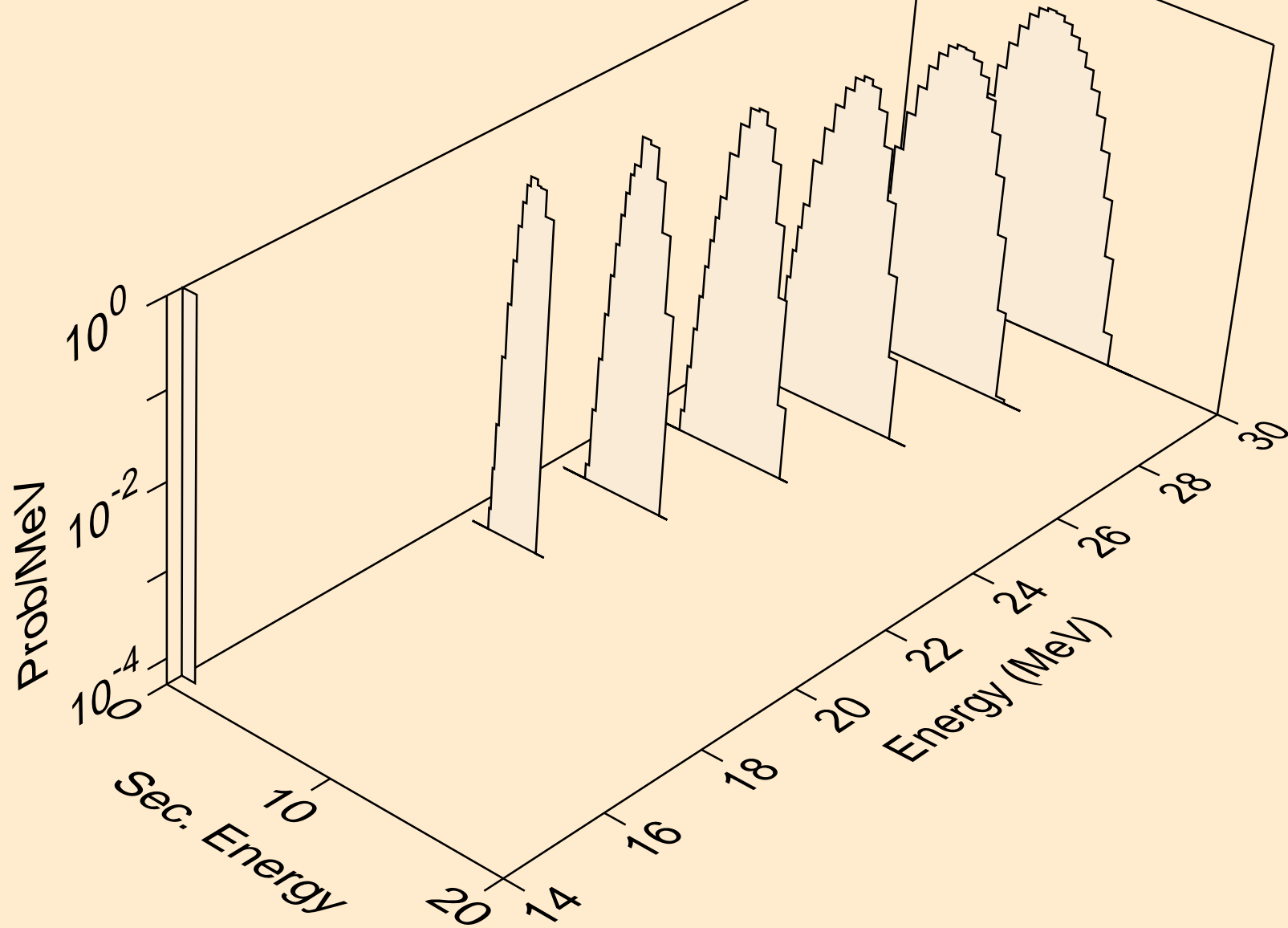

BA138 NEUTRON ACER TENDL-2024 LIBRARY; T=0.K  
deuterons from (n,da)

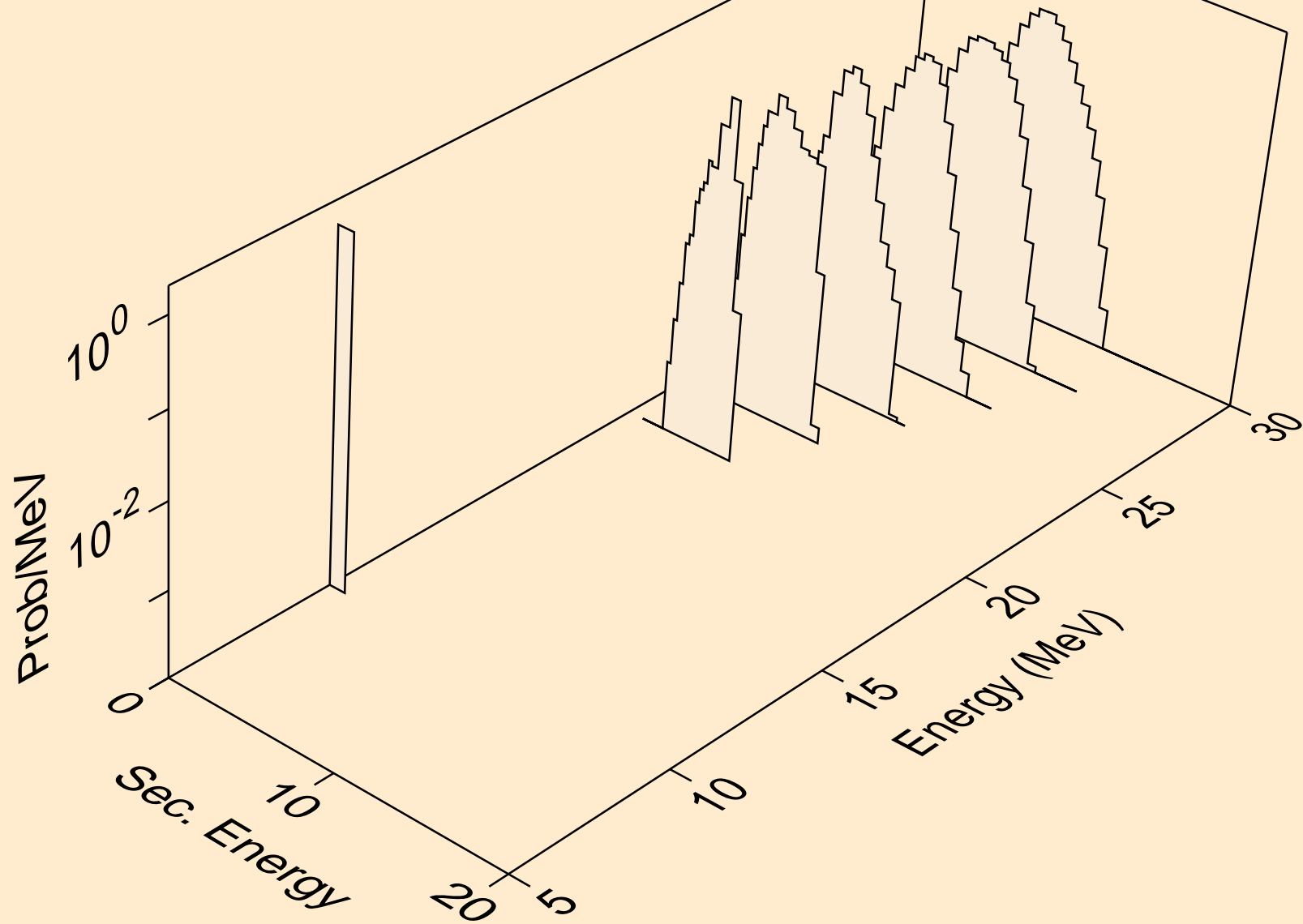



BA138 NEUTRON ACER TENDL-2024 LIBRARY; T=0.K  
tritons from (n,x)

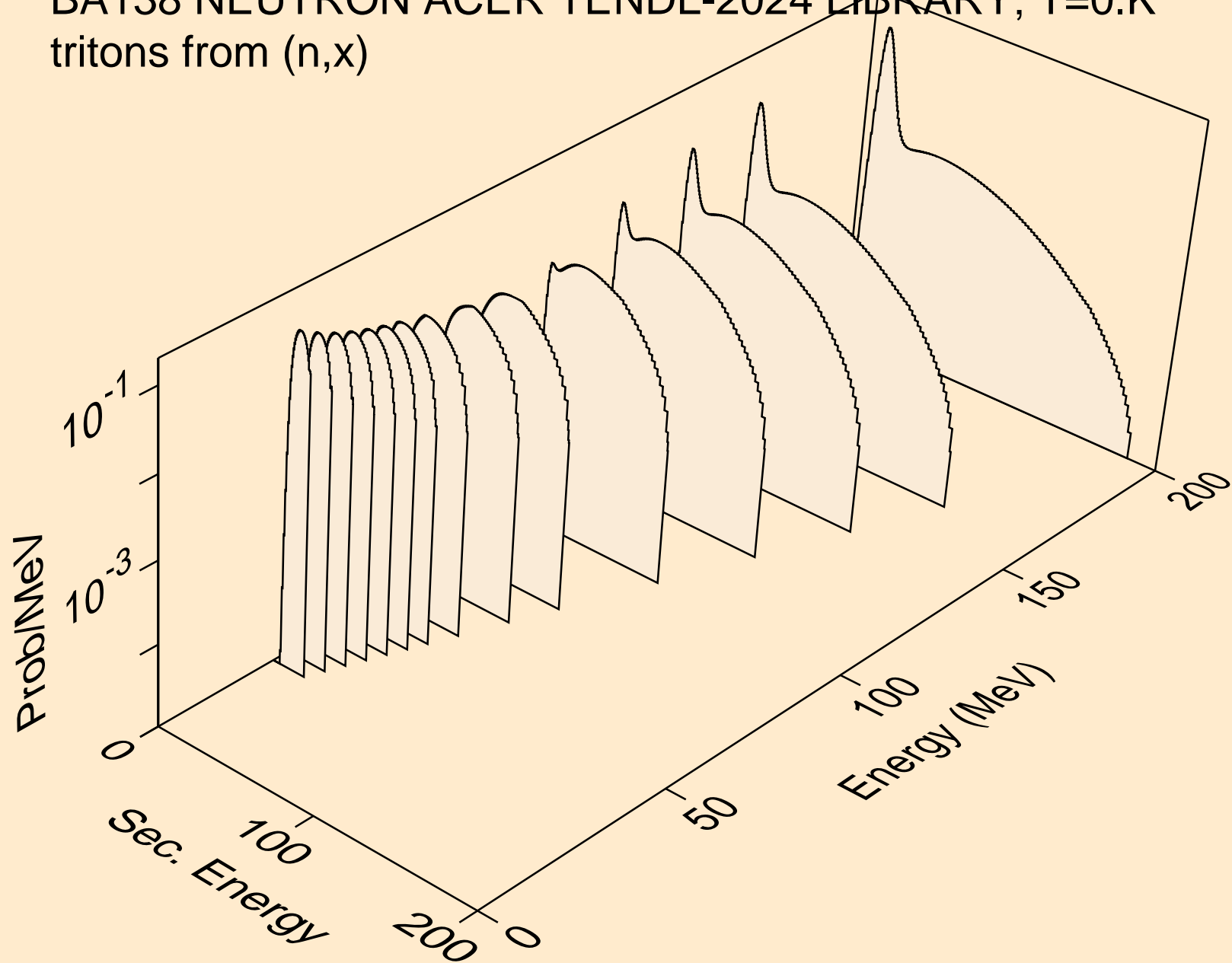

BA138 NEUTRON ACER TENDL-2024 LIBRARY; T=0.K  
tritons from (n,n\*)t

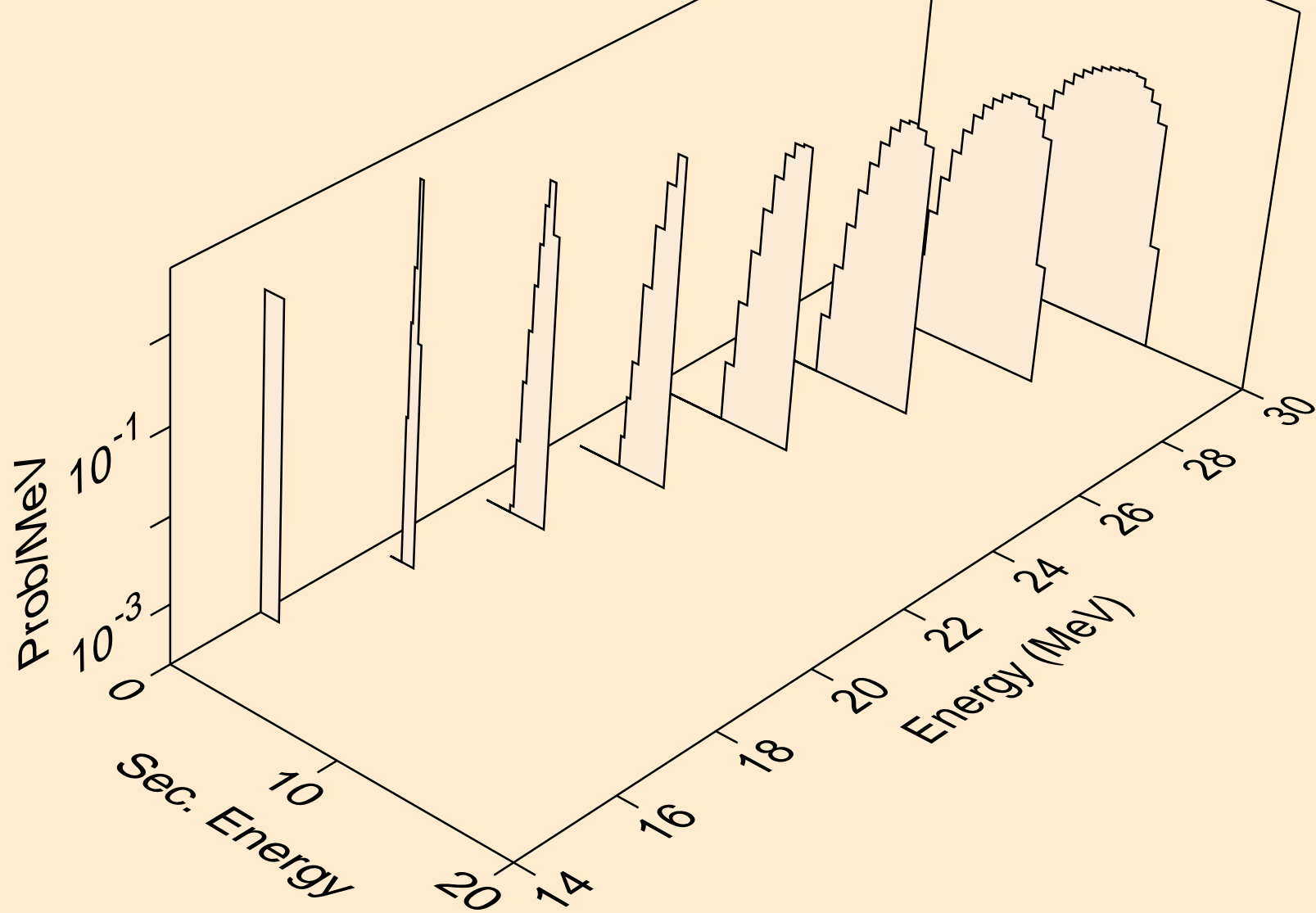

BA138 NEUTRON ACER TENDL-2024 LIBRARY; T=0.K  
tritons from (n,t)

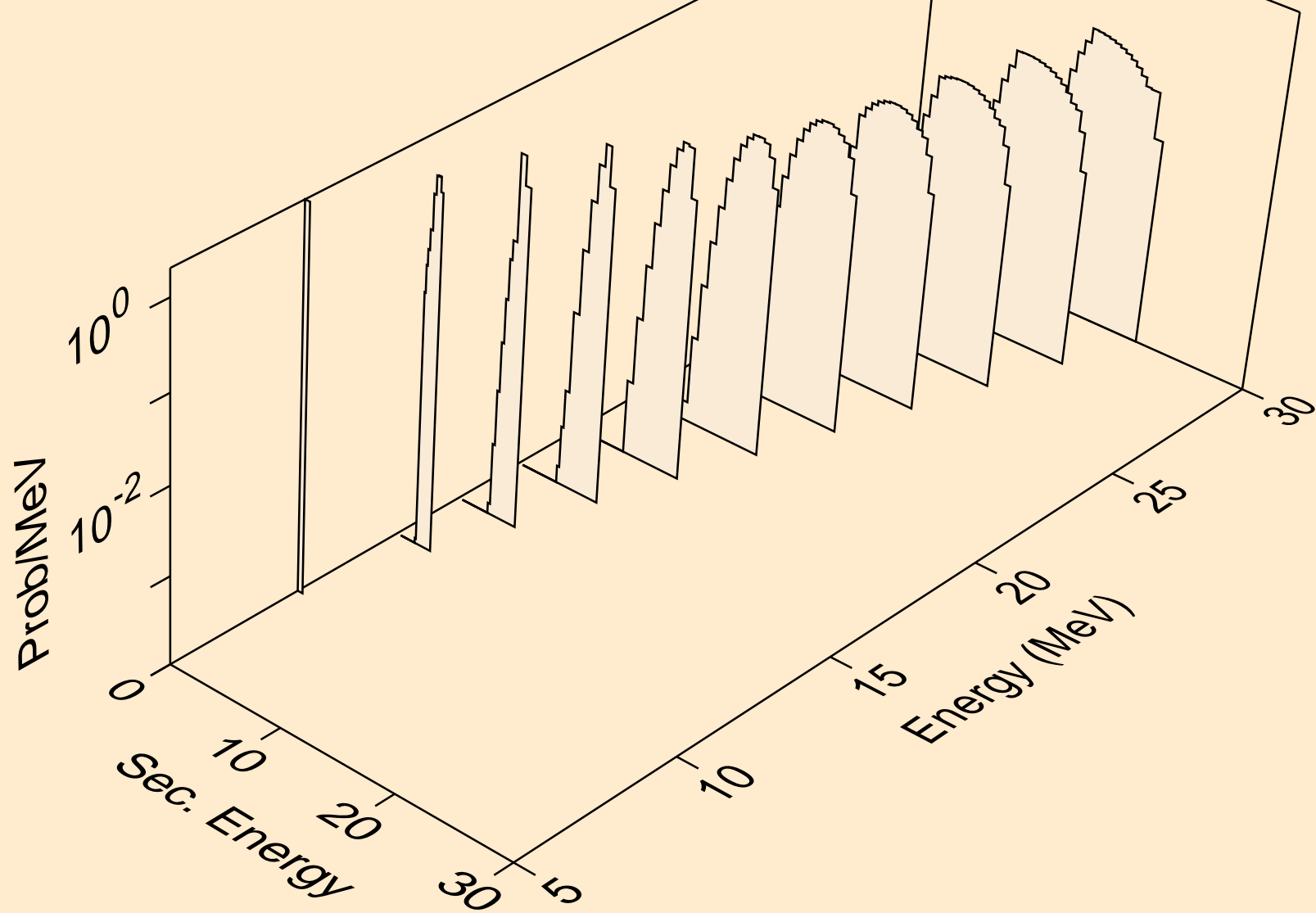

BA138 NEUTRON ACER TENDL-2024 LIBRARY; T=0.K  
tritons from (n,pt)

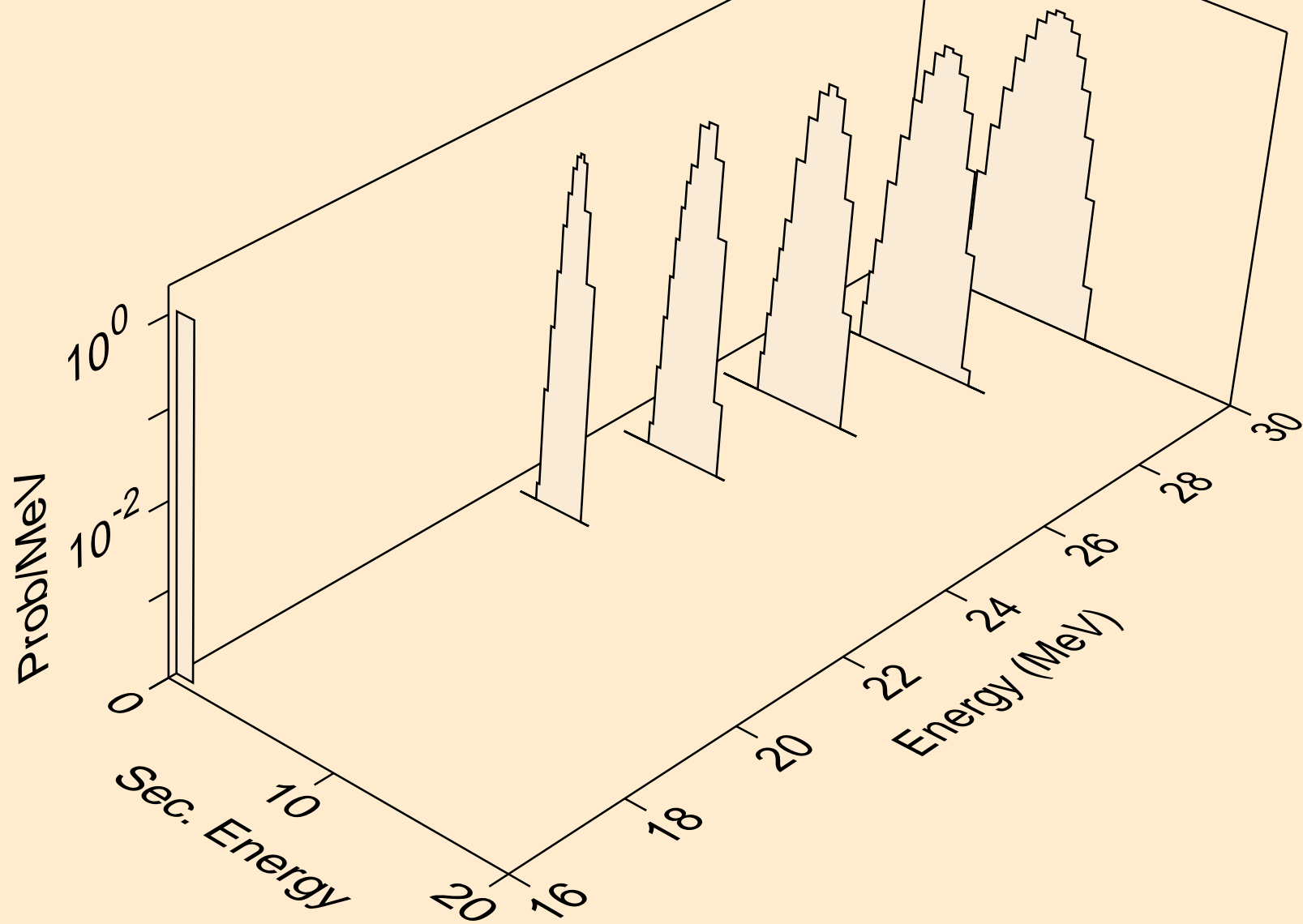

BA138 NEUTRON ACER TENDL-2024 LIBRARY; T=0.K  
he3s from (n,x)

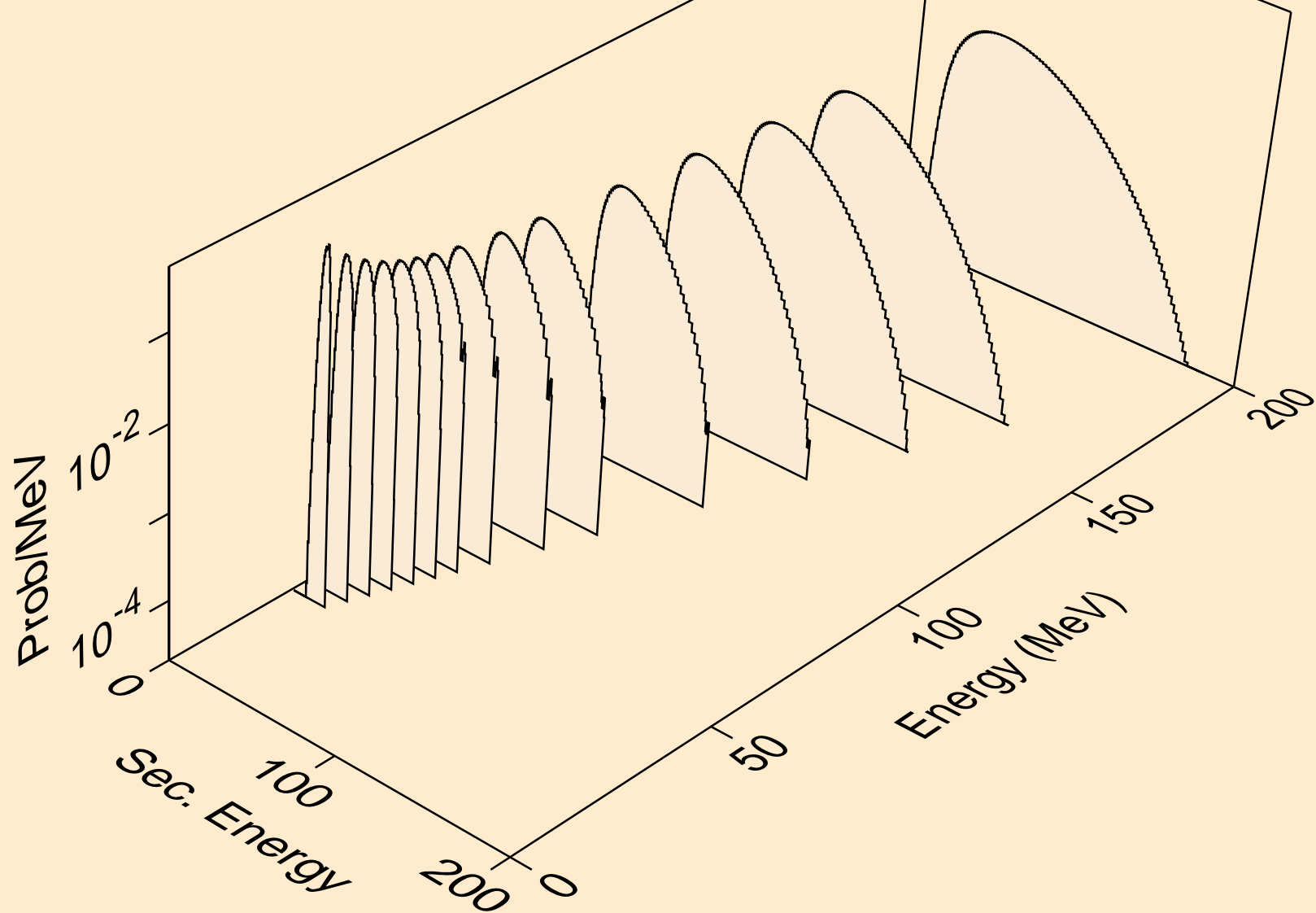

BA138 NEUTRON ACER TENDL-2024 LIBRARY; T=0.K  
he3s from (n,n\*)he3

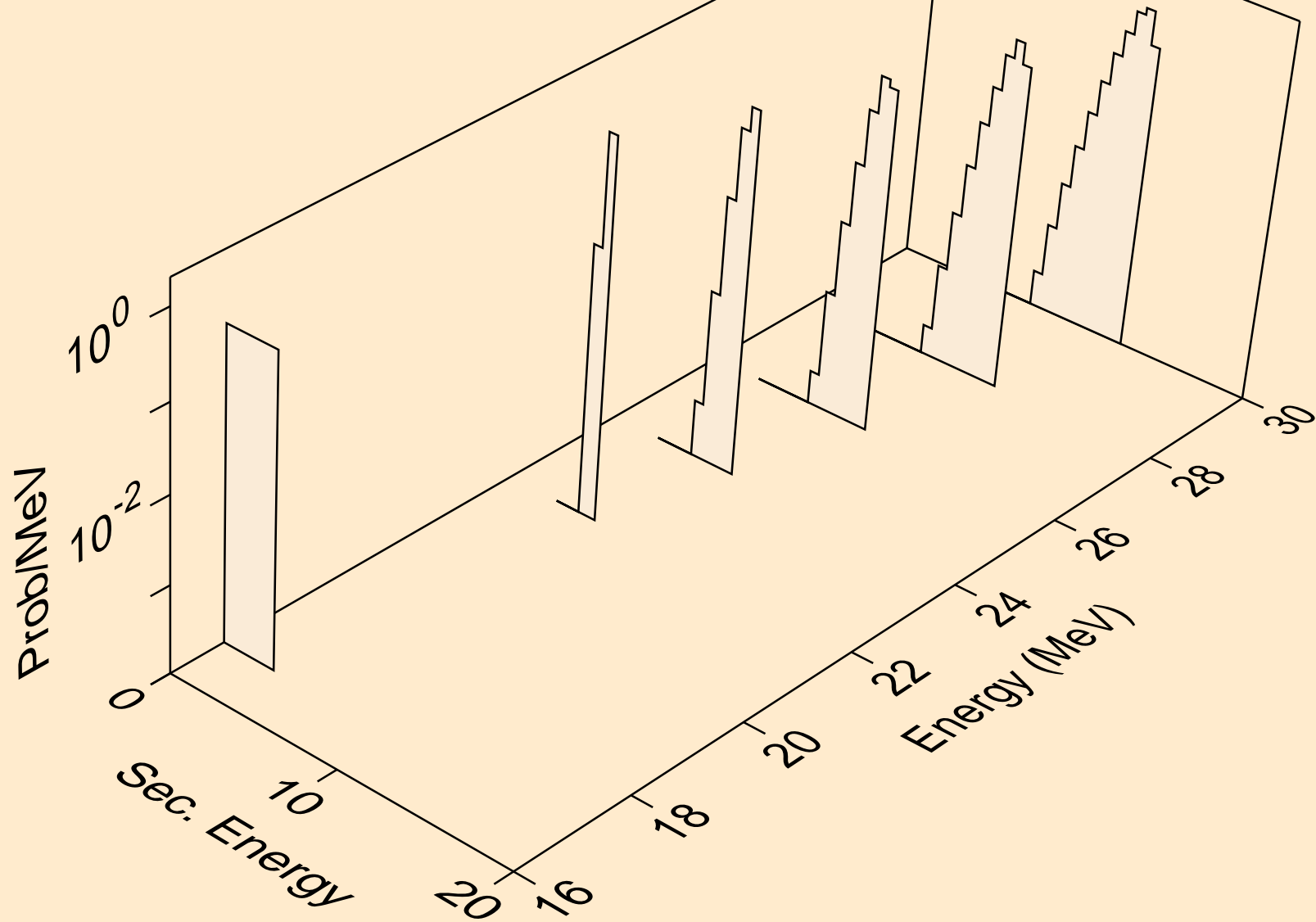

BA138 NEUTRON ACER TENDL-2024 LIBRARY; T=0.K  
he3s from (n,he3)

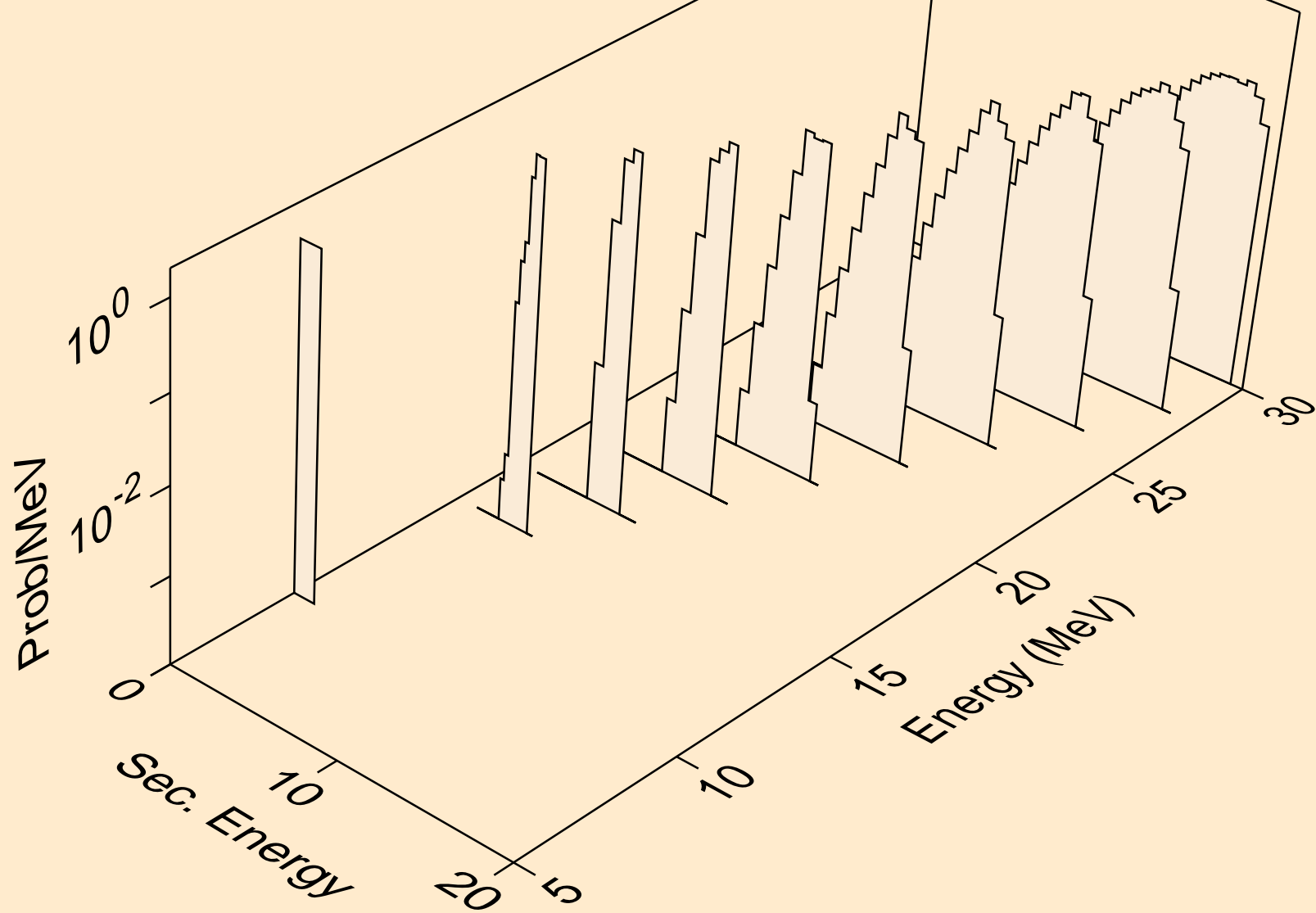

BA138 NEUTRON ACER TENDL-2024 LIBRARY; T=0.K  
alphas from (n,x)

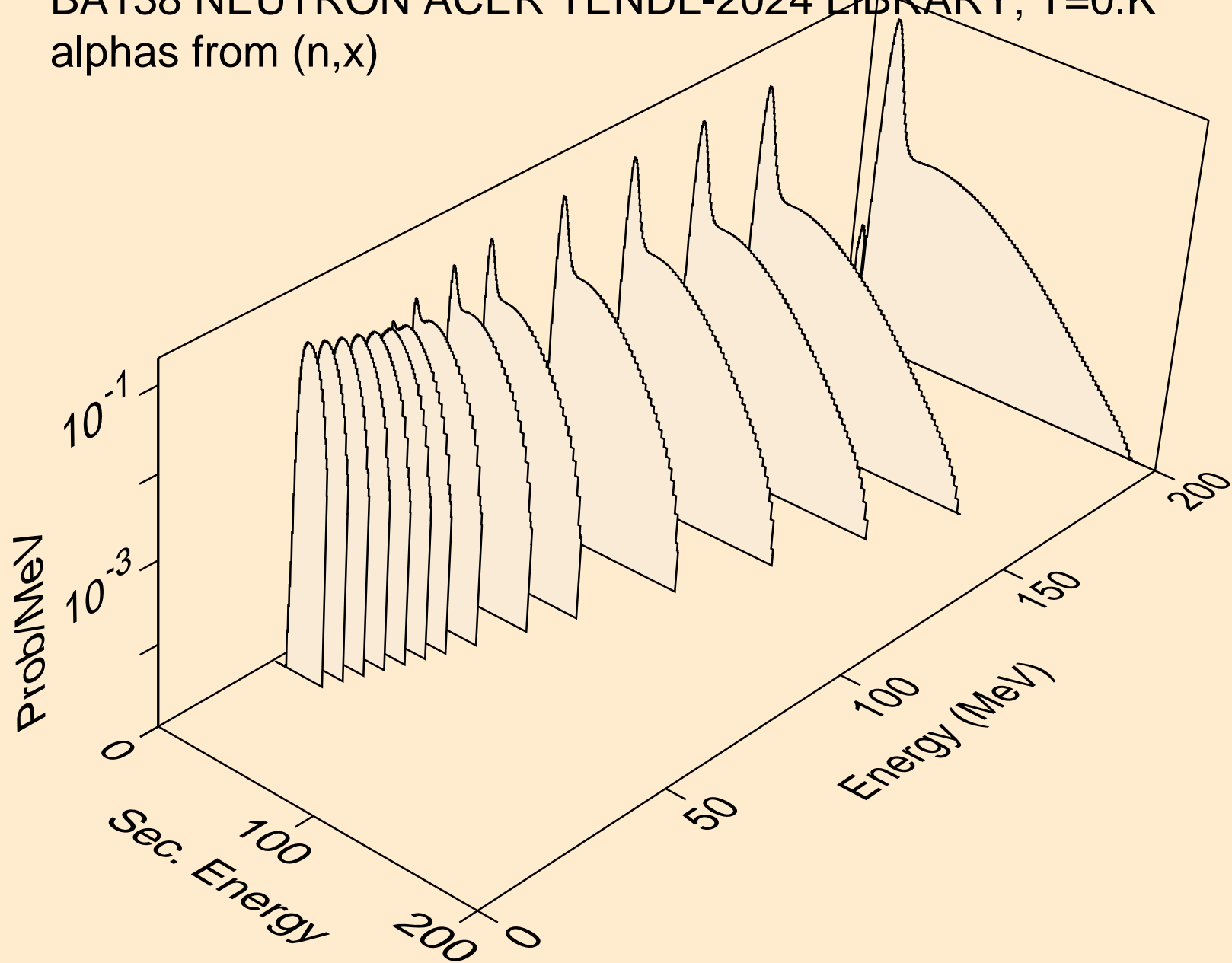



BA138 NEUTRON ACER TENDL-2024 LIBRARY; T=0.K  
alphas from (n,n\*)a

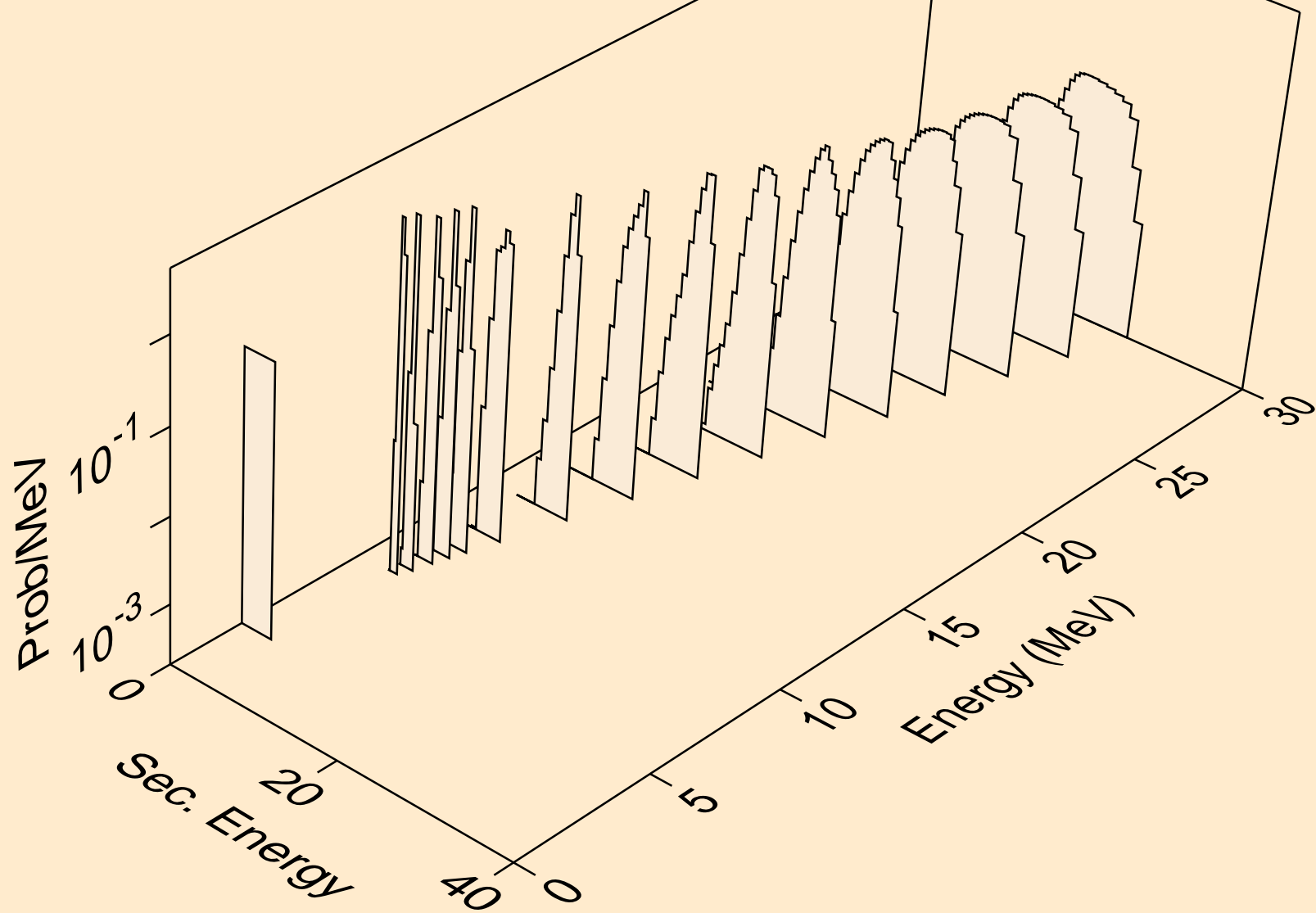

BA138 NEUTRON ACER TENDL-2024 LIBRARY; T=0.K  
alphas from (n,2n)a

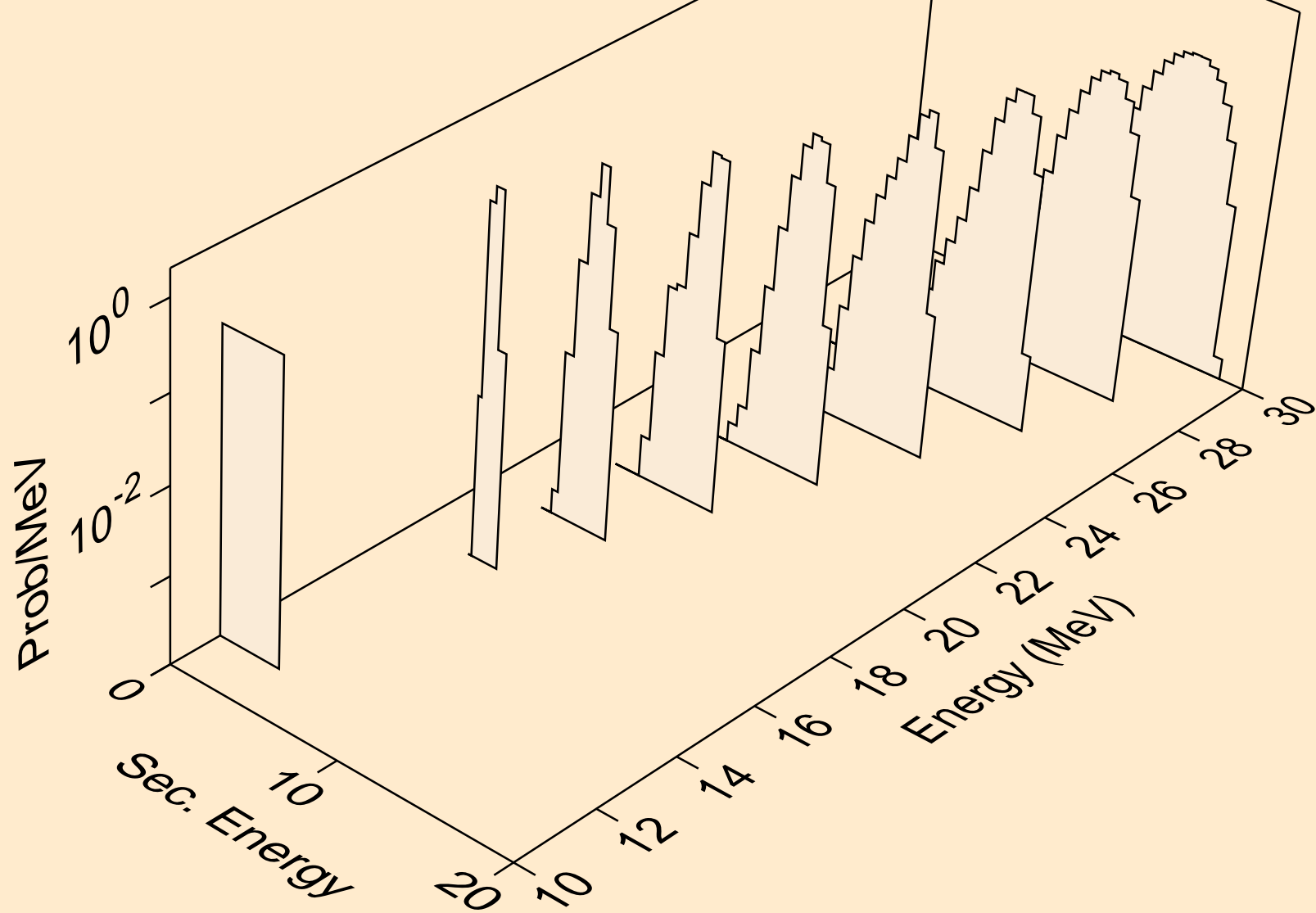

BA138 NEUTRON ACER TENDL-2024 LIBRARY; T=0.K  
alphas from (n,3n)a

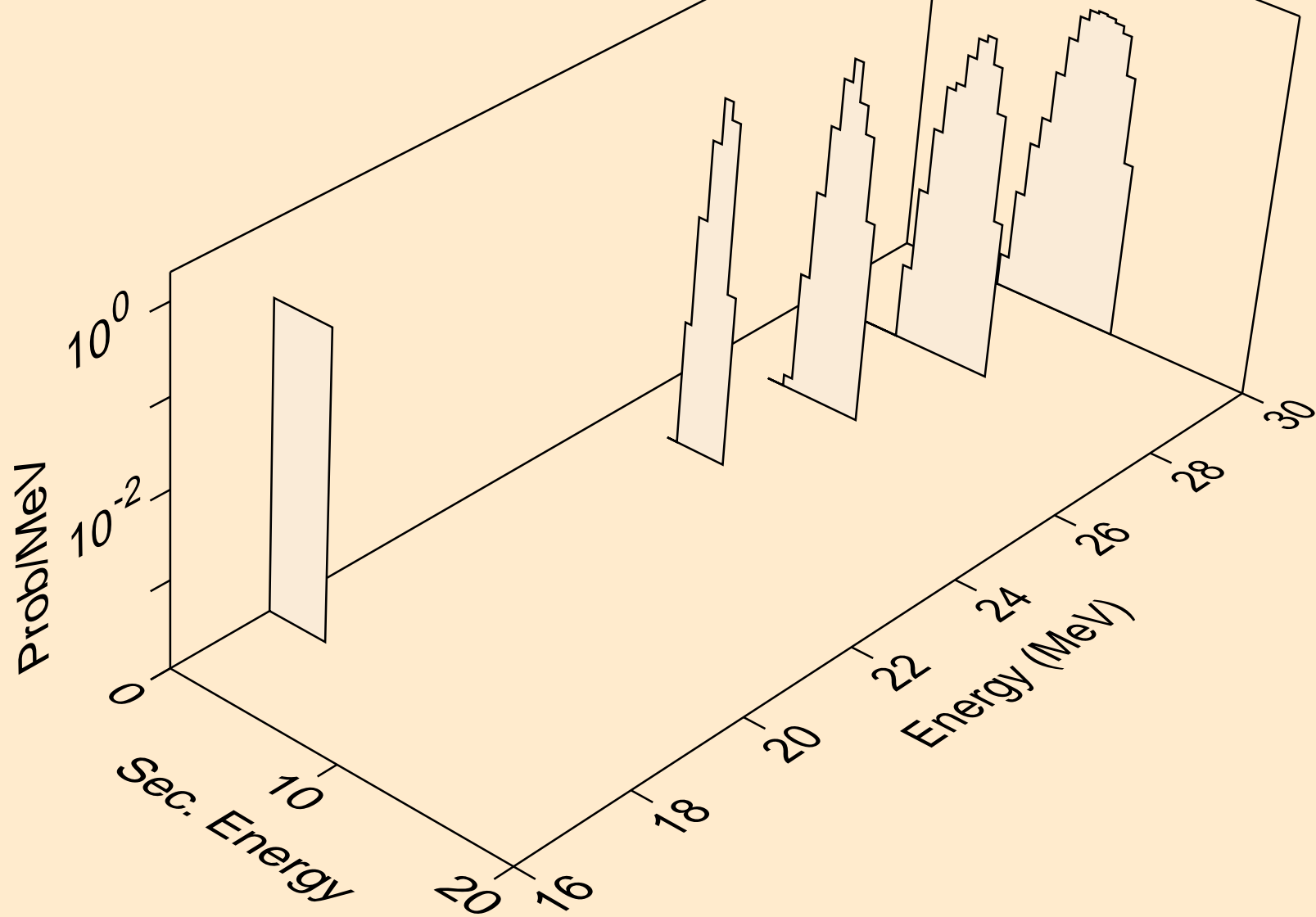

BA138 NEUTRON ACER TENDL-2024 LIBRARY; T=0.K  
alphas from (n,npa)

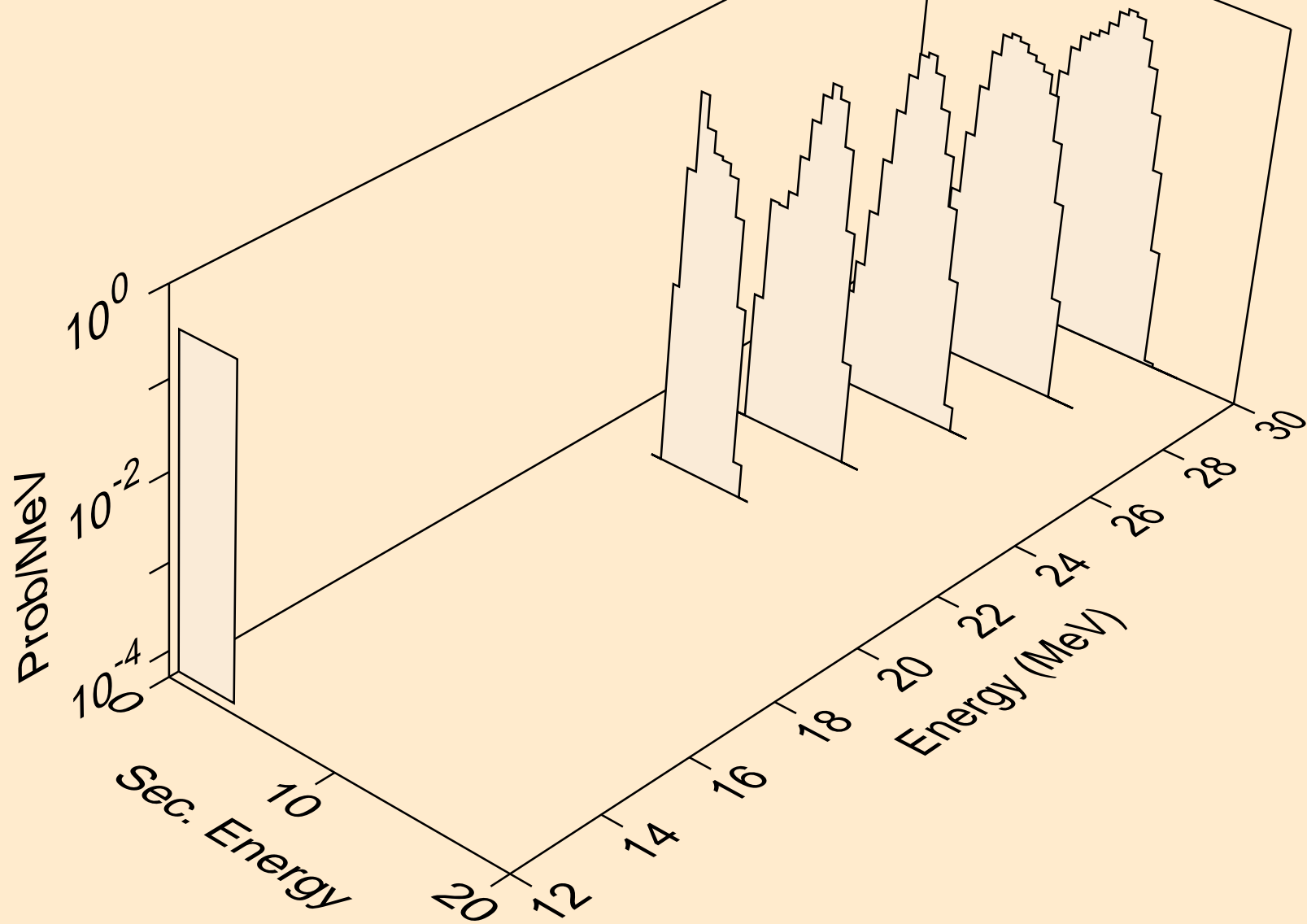

BA138 NEUTRON ACER TENDL-2024 LIBRARY; T=0.K  
alphas from (n,a)

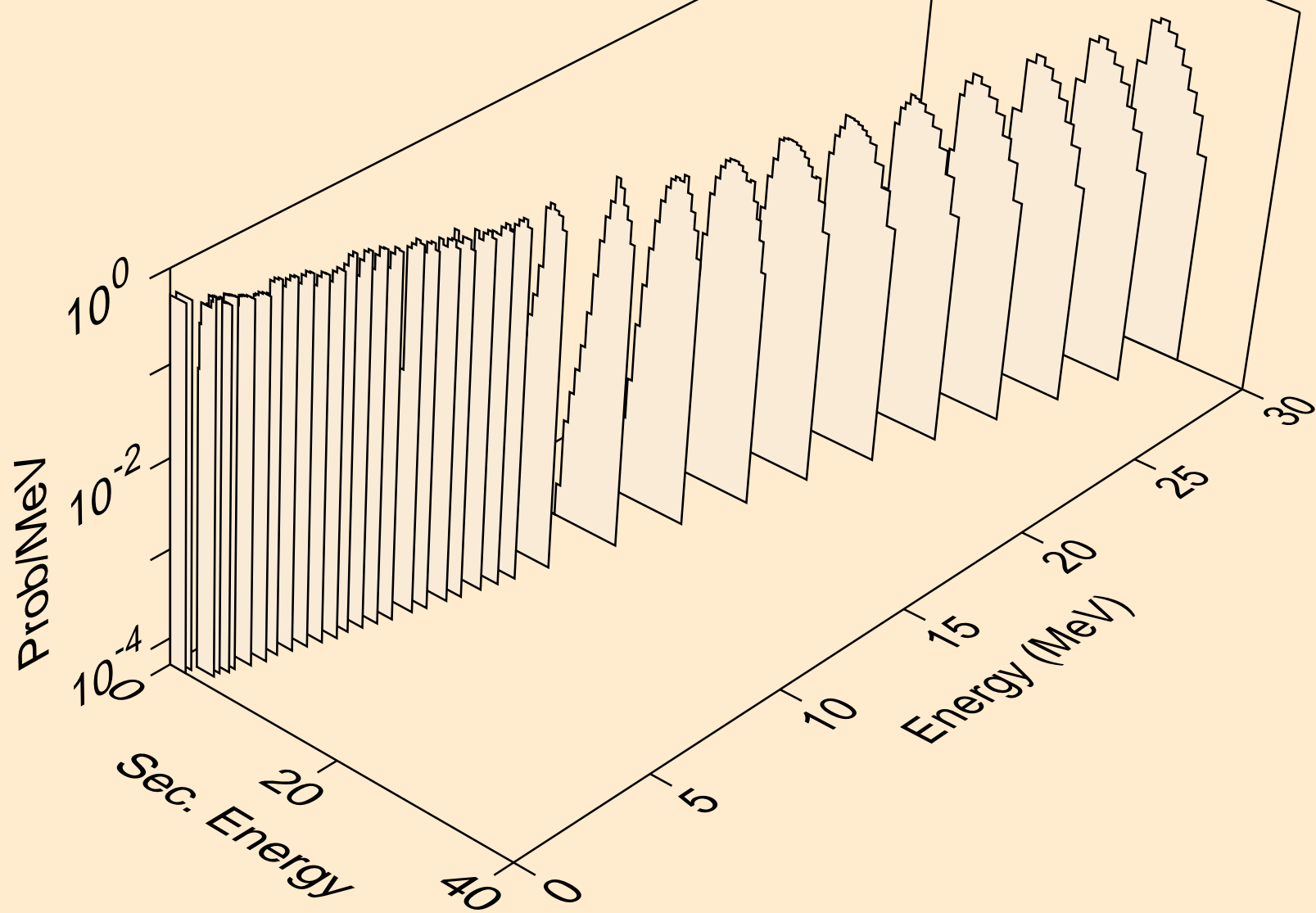

BA138 NEUTRON ACER TENDL-2024 LIBRARY; T=0.K  
alphas from (n,2a)

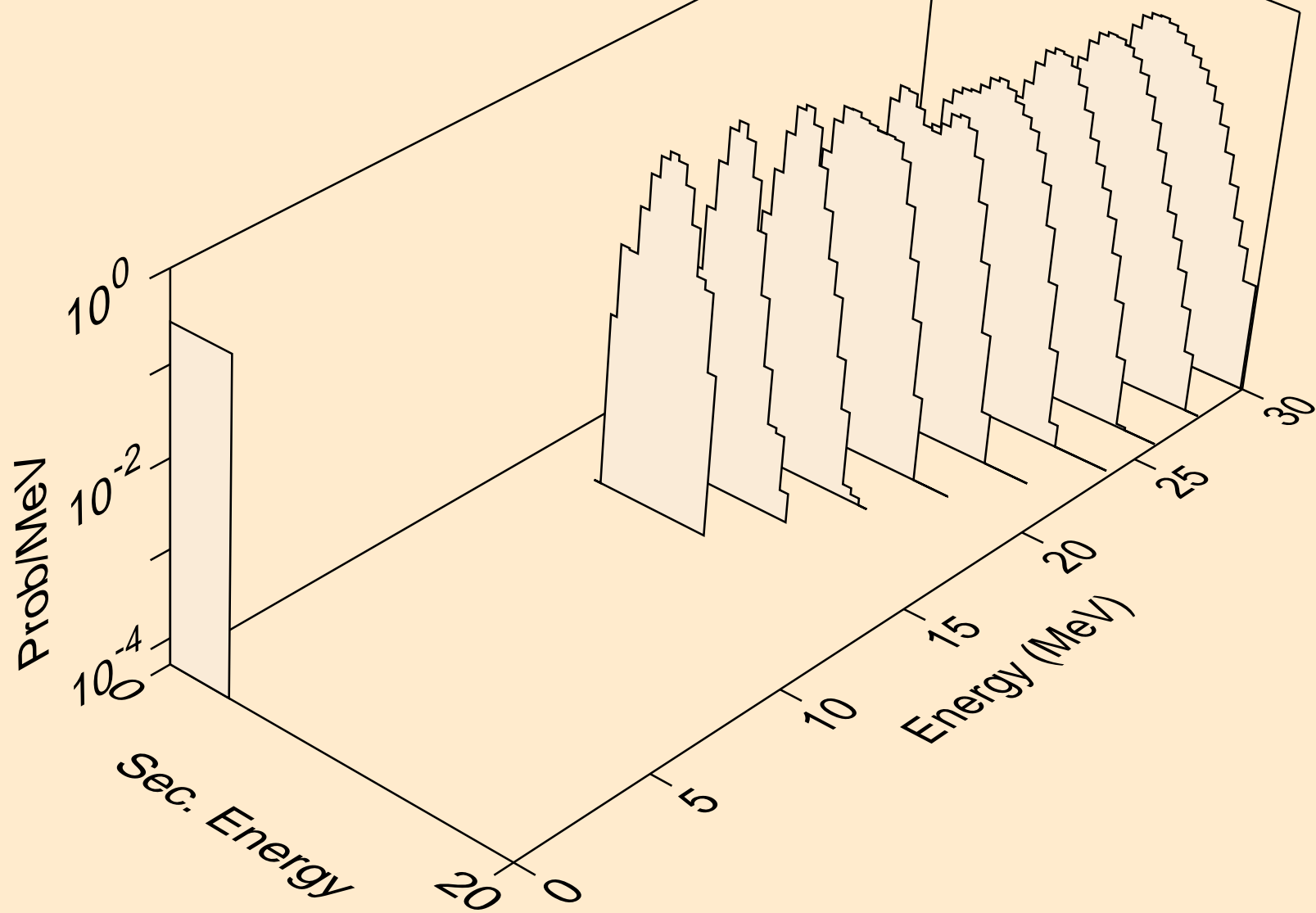

BA138 NEUTRON ACER TENDL-2024 LIBRARY; T=0.K  
alphas from (n,pa)

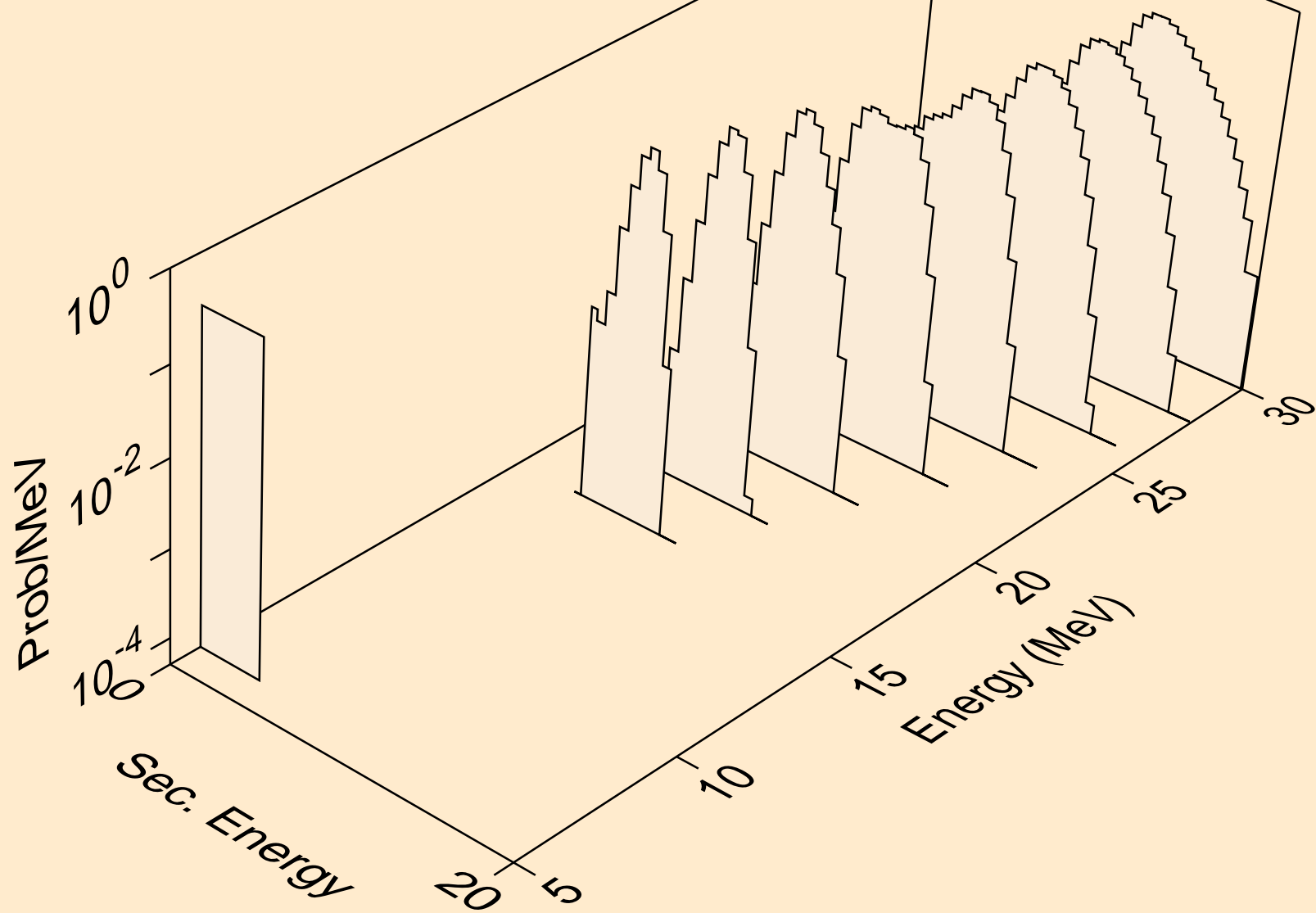

BA138 NEUTRON ACER TENDL-2024 LIBRARY; T=0.K  
alphas from (n,da)

