

Program EVALPLOT
(Version 2021-1)

by

Dermott E. Cullen
(Present Contact Information)

Dermott E. Cullen
1466 Hudson Way
Livermore, CA 94550
U.S.A.

Tele: 925-443-1911

E.Mail:redcullen1@comcast.net

Web:redcullen1.net/HOMEPAGE.NEW

Press Mouse Button to Start

MAT 5658

Neutron Major
293 Kelvin Cross Sections

56-Ba-141

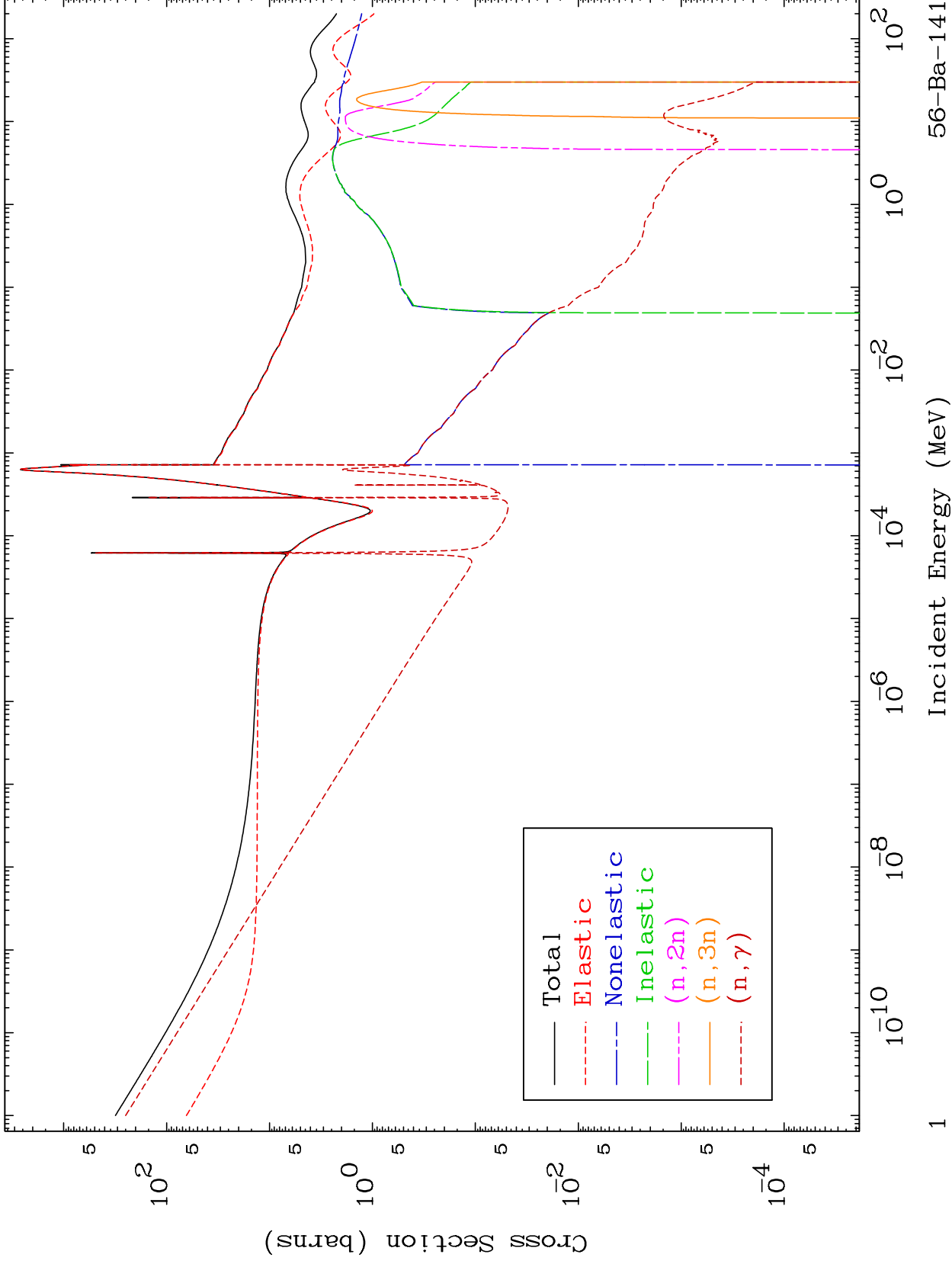

MAT 5658

Neutron Absorption
293 Kelvin Cross Sections

56-Ba-141

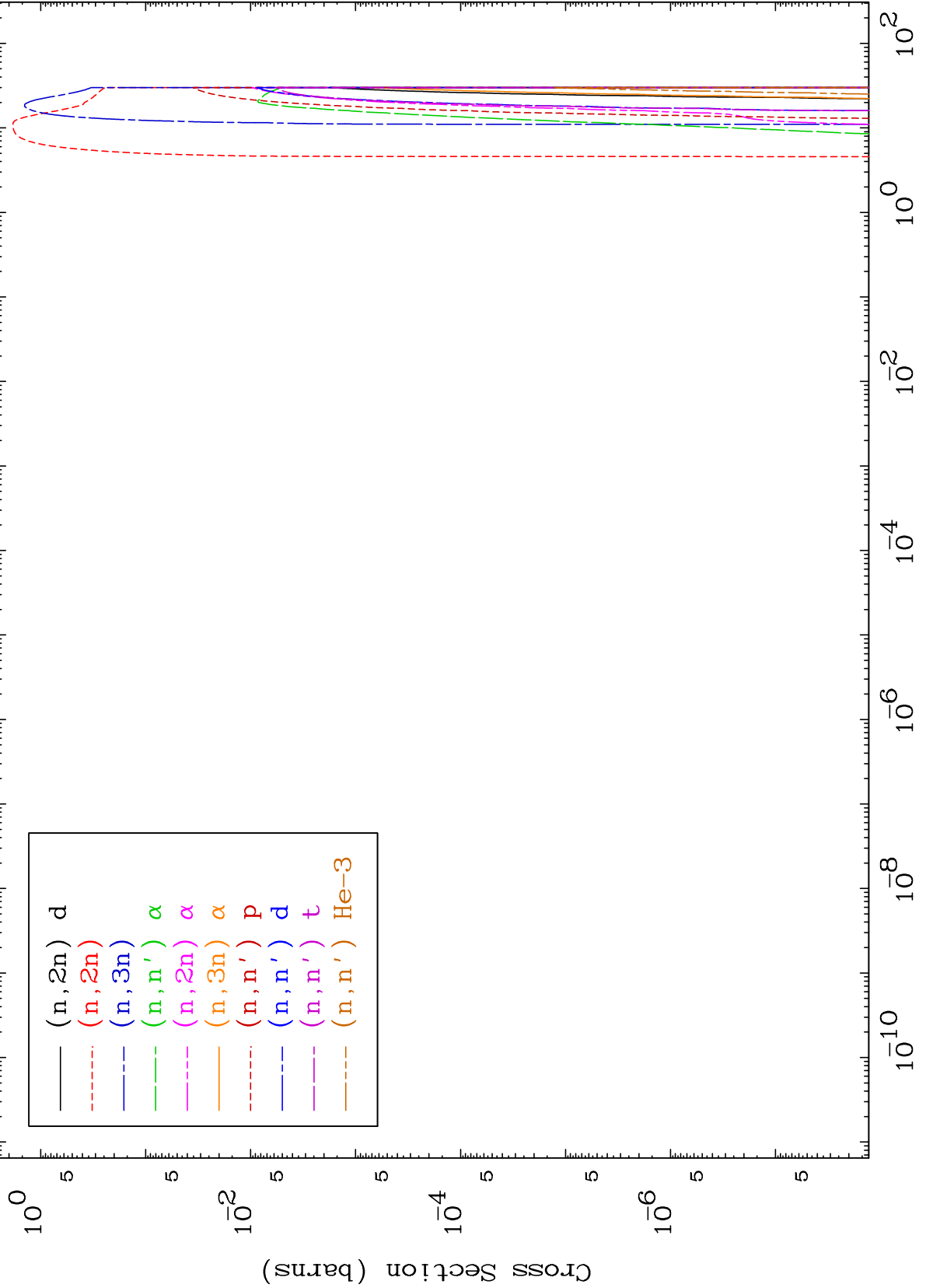

MAT 5658

Neutron Absorption
293 Kelvin Cross Sections

56-Ba-141

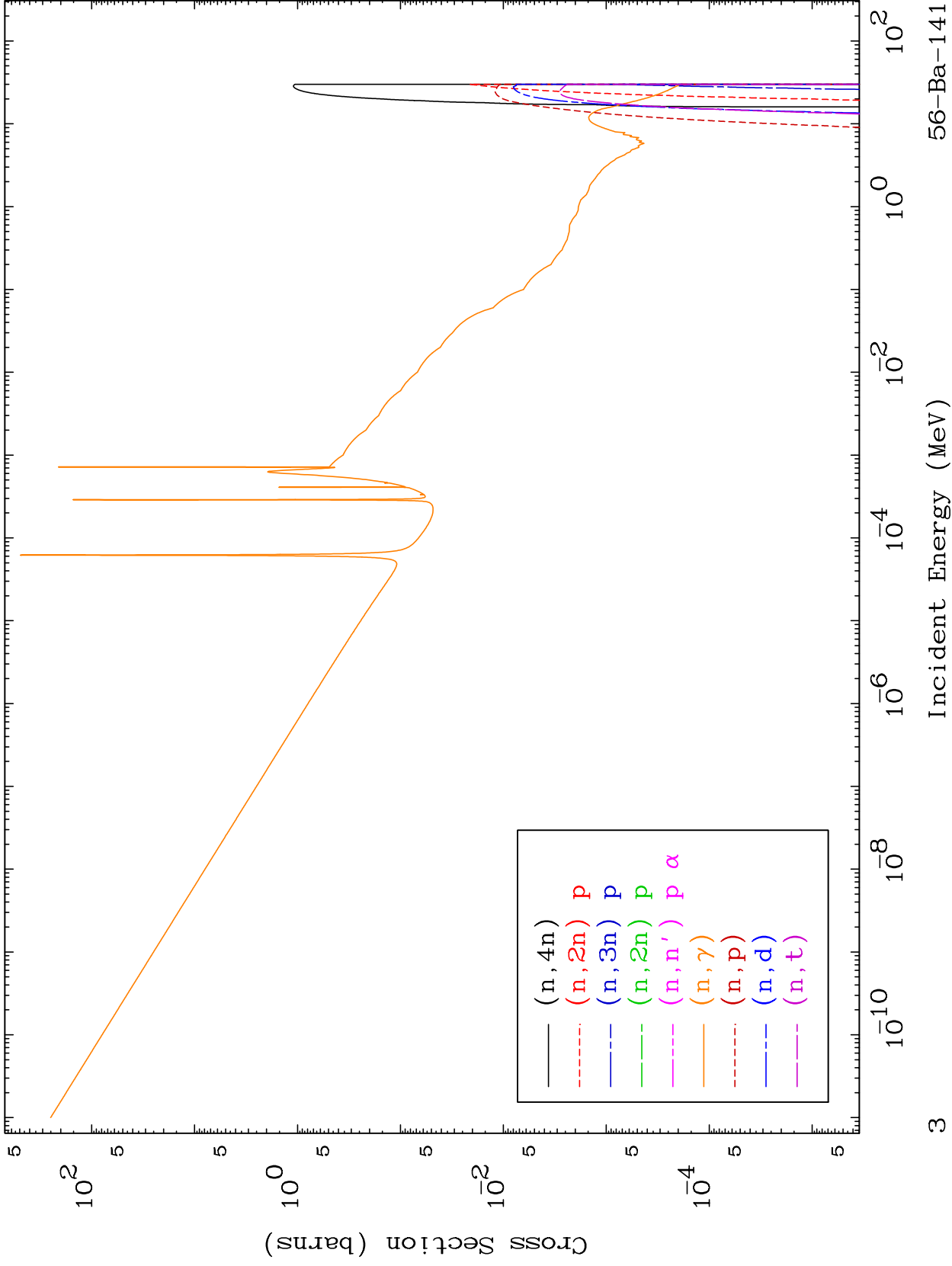

MAT 5658

Neutron Absorption
293 Kelvin Cross Sections

56-Ba-141

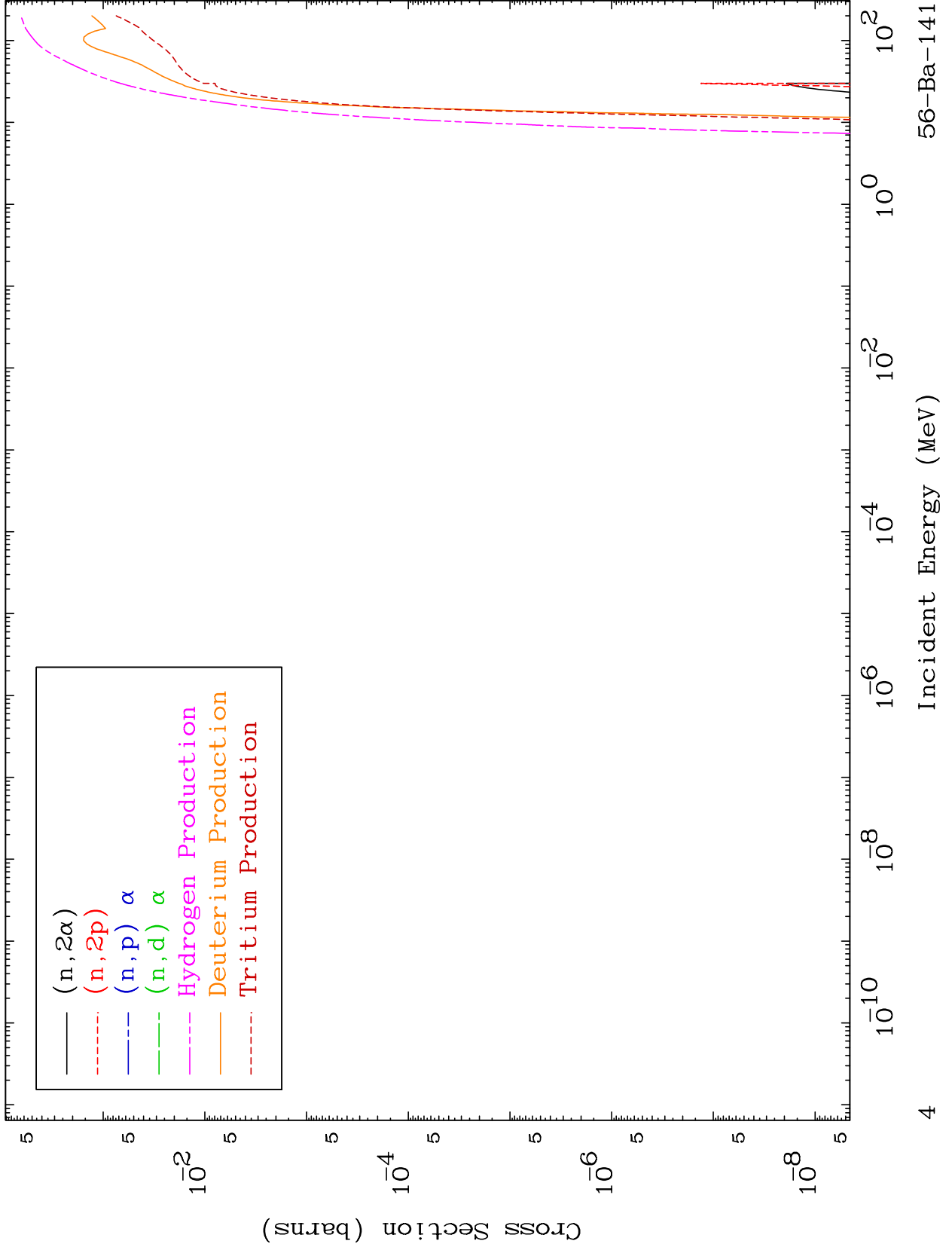

MAT 5658

Charged Particle
293 Kelvin Cross Sections

56-Ba-141

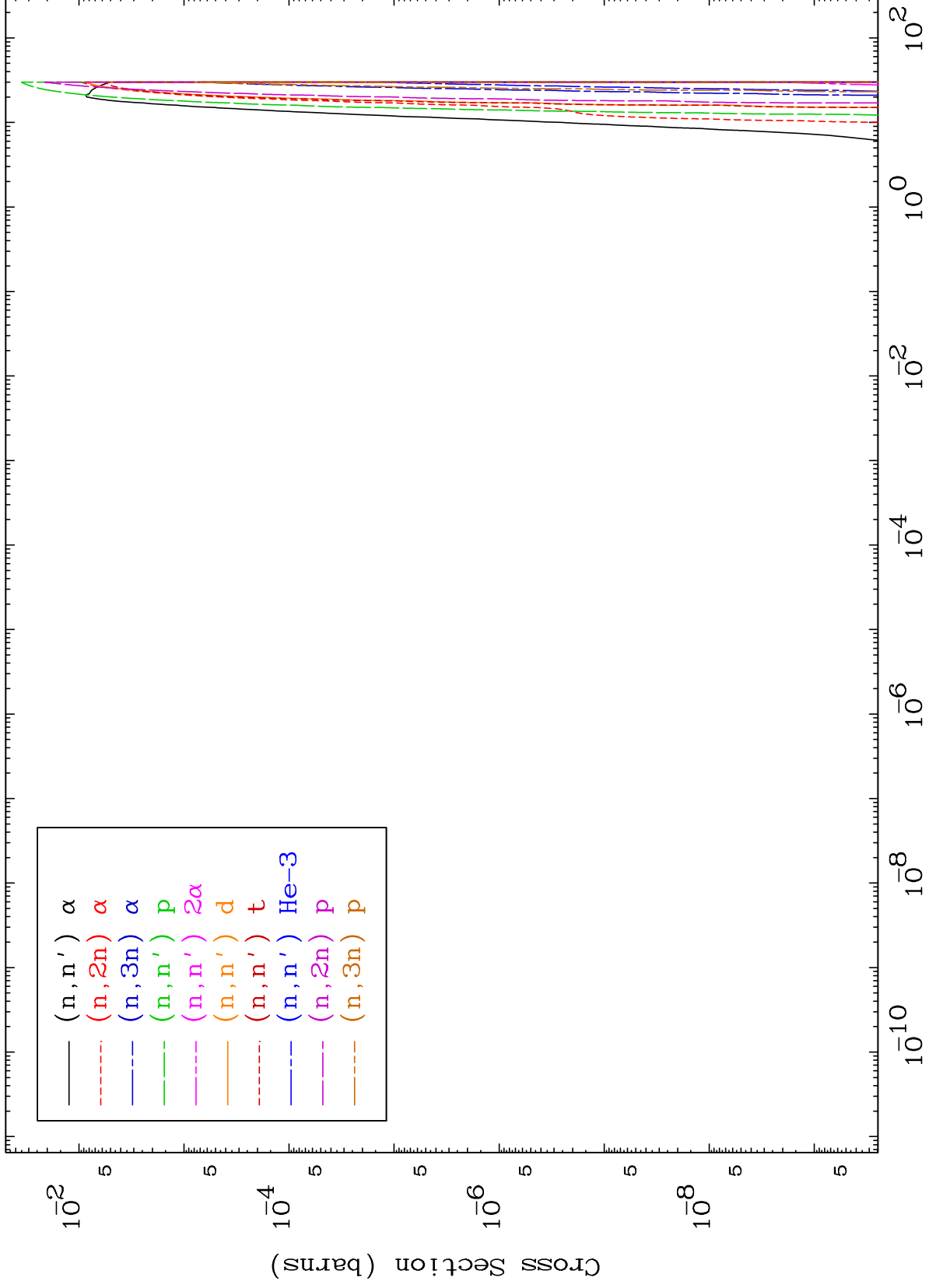

5

Incident Energy (MeV)

56-Ba-141

MAT 5658

Charged Particle
293 Kelvin Cross Sections

56-Ba-141

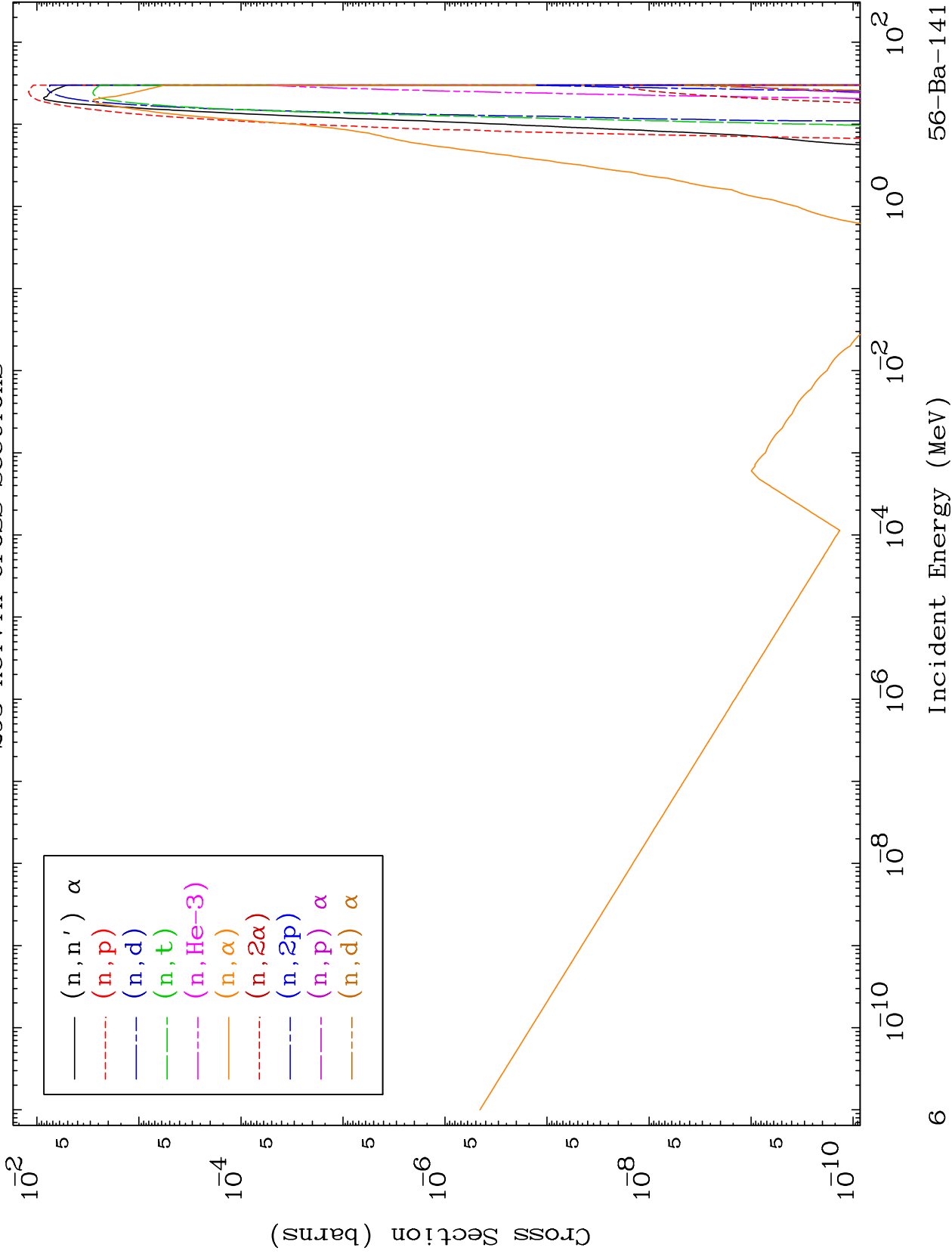

MAT 5658

Particle Production
293 Kelvin Cross Sections

56-Ba-141

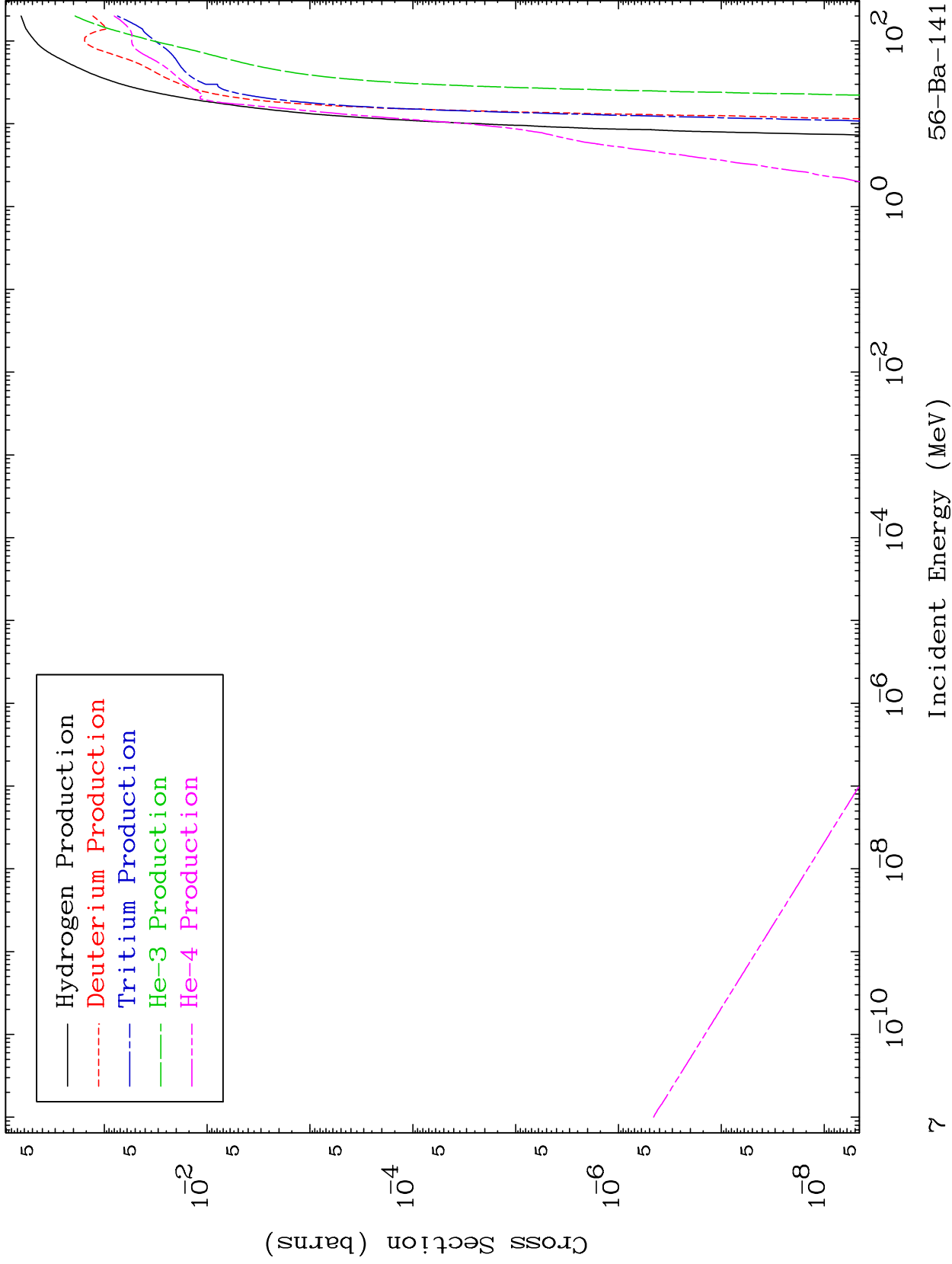

MAT 5658

(n,n') Levels

56-Ba-141

293 Kelvin Cross Sections

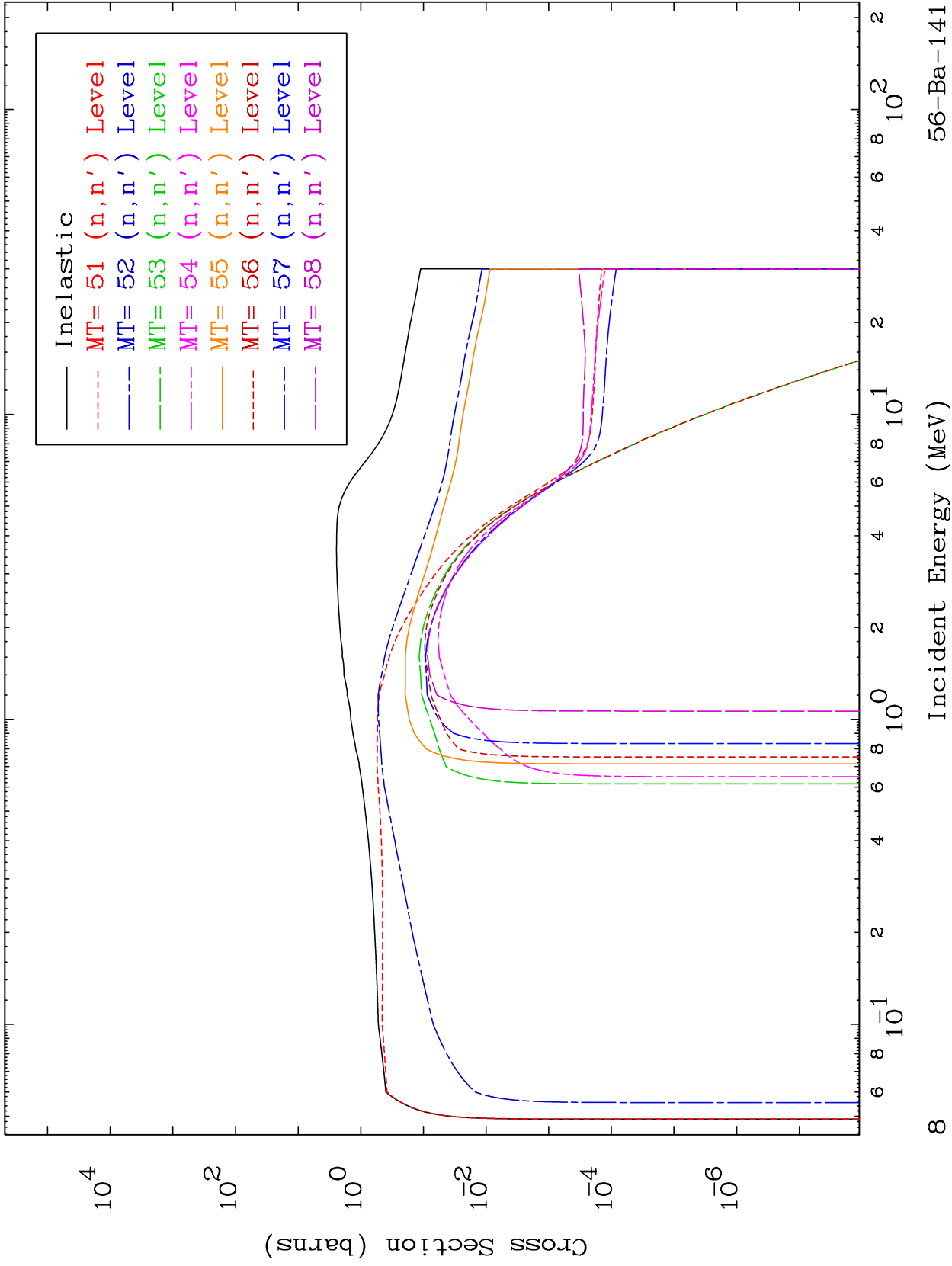

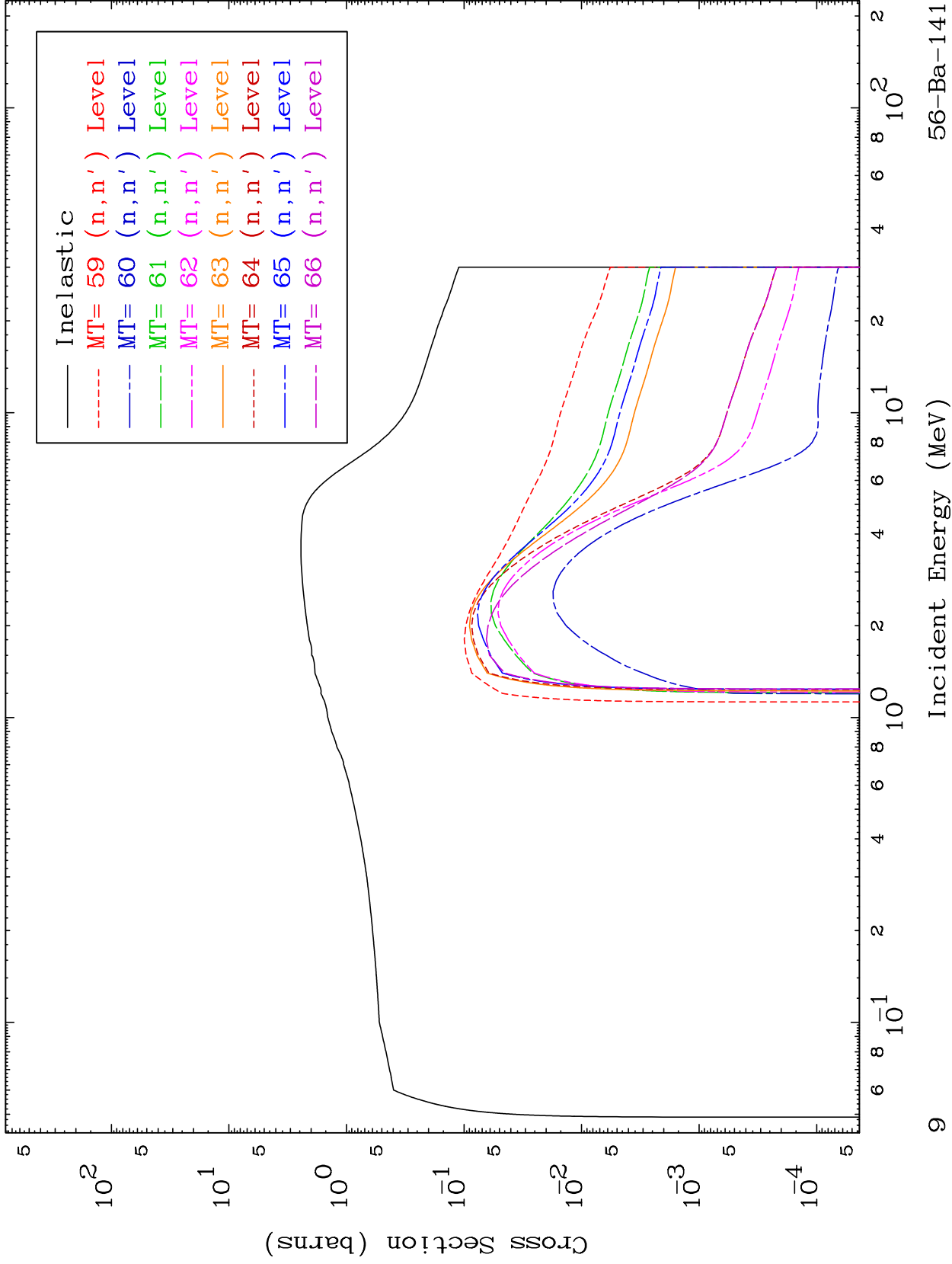

MAT 5658

56-Ba-141

(n,n') Levels
293 Kelvin Cross Sections

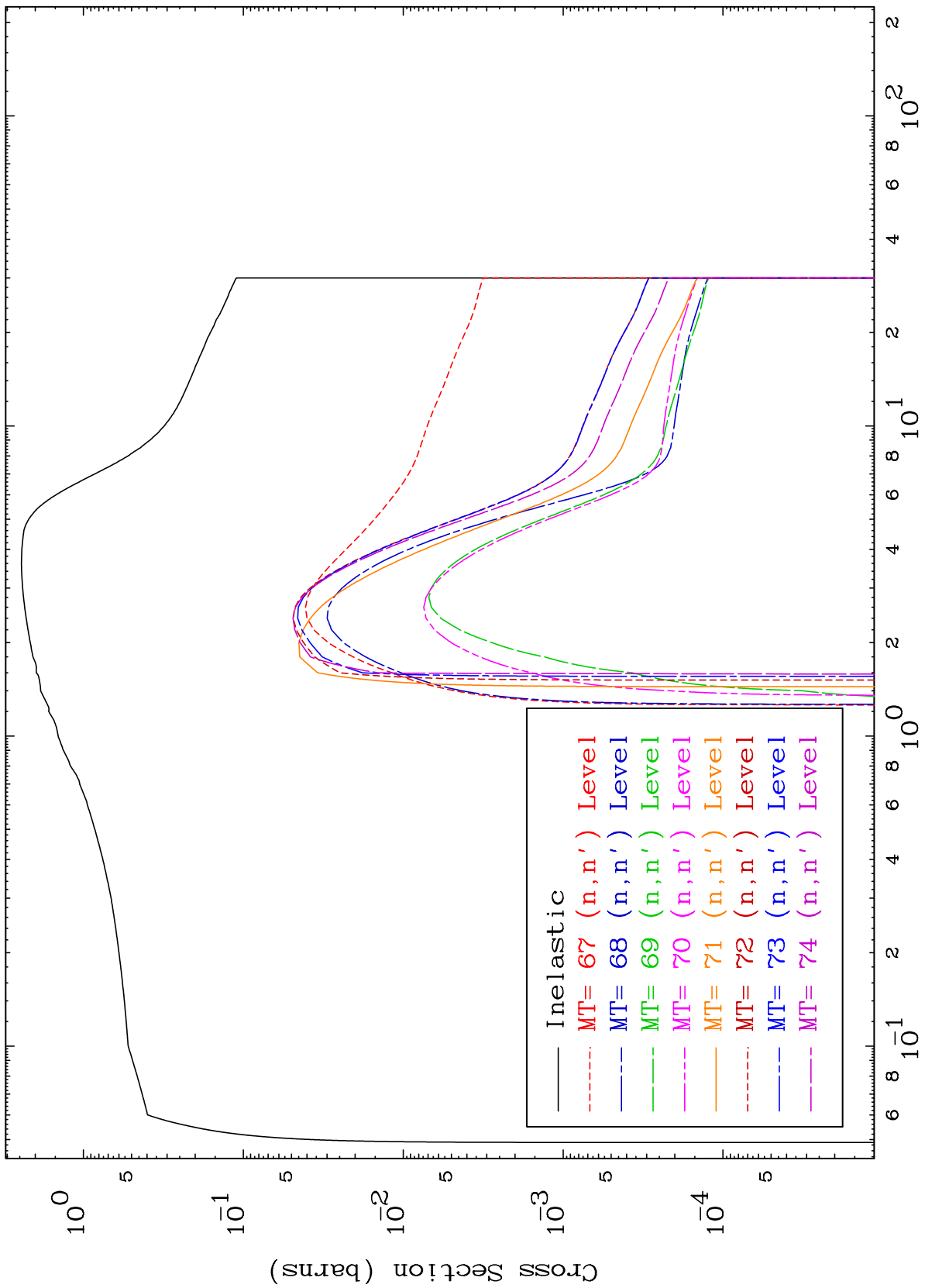

56-Ba-141

Incident Energy (MeV)

10

(n,n') Levels
293 Kelvin Cross Sections

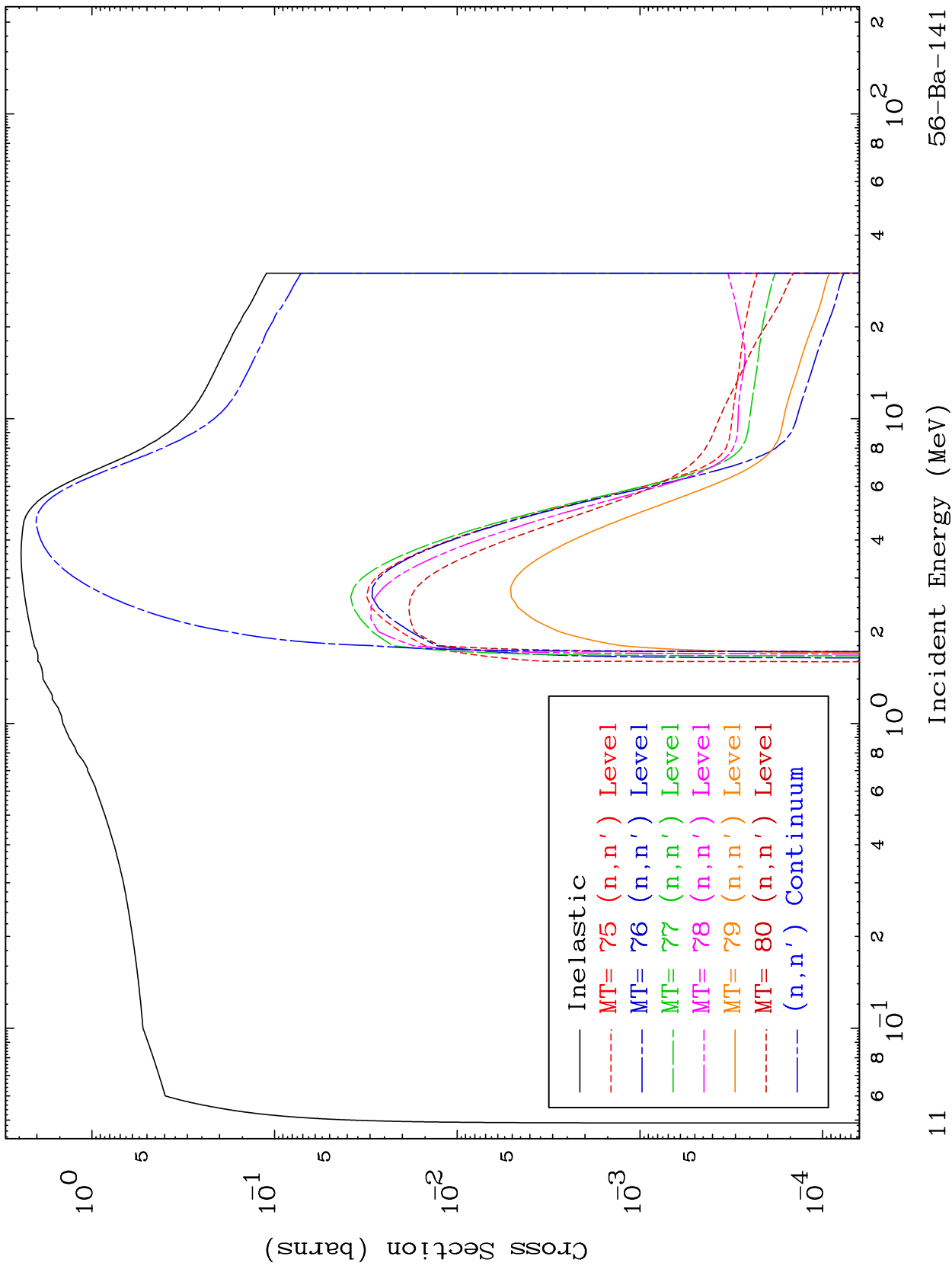

MAT 5658

(n,p) Levels
293 Kelvin Cross Sections

56-Ba-141

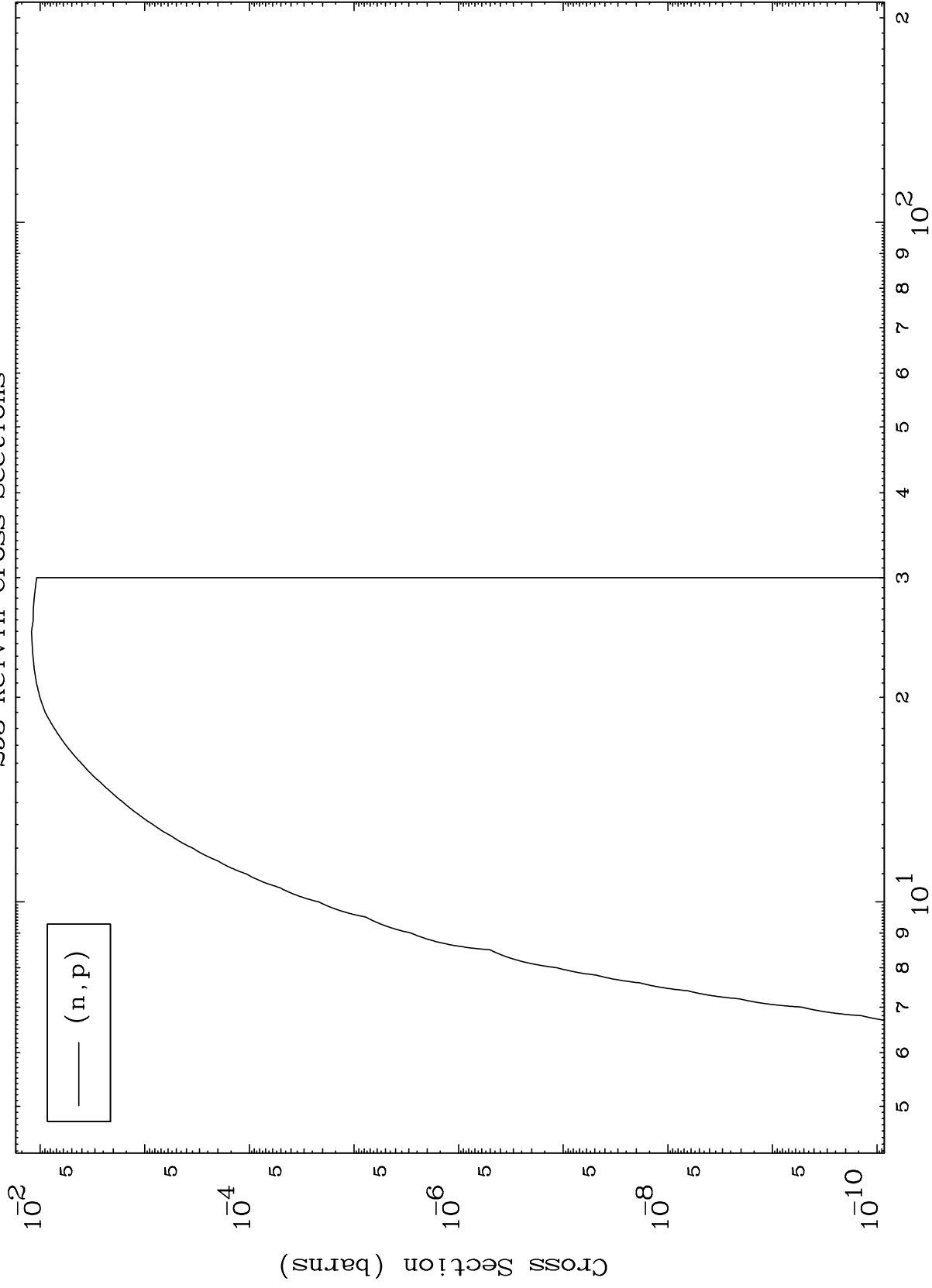

12

Incident Energy (MeV)

56-Ba-141

MAT 5658

(n,d) Levels
293 Kelvin Cross Sections

56-Ba-141

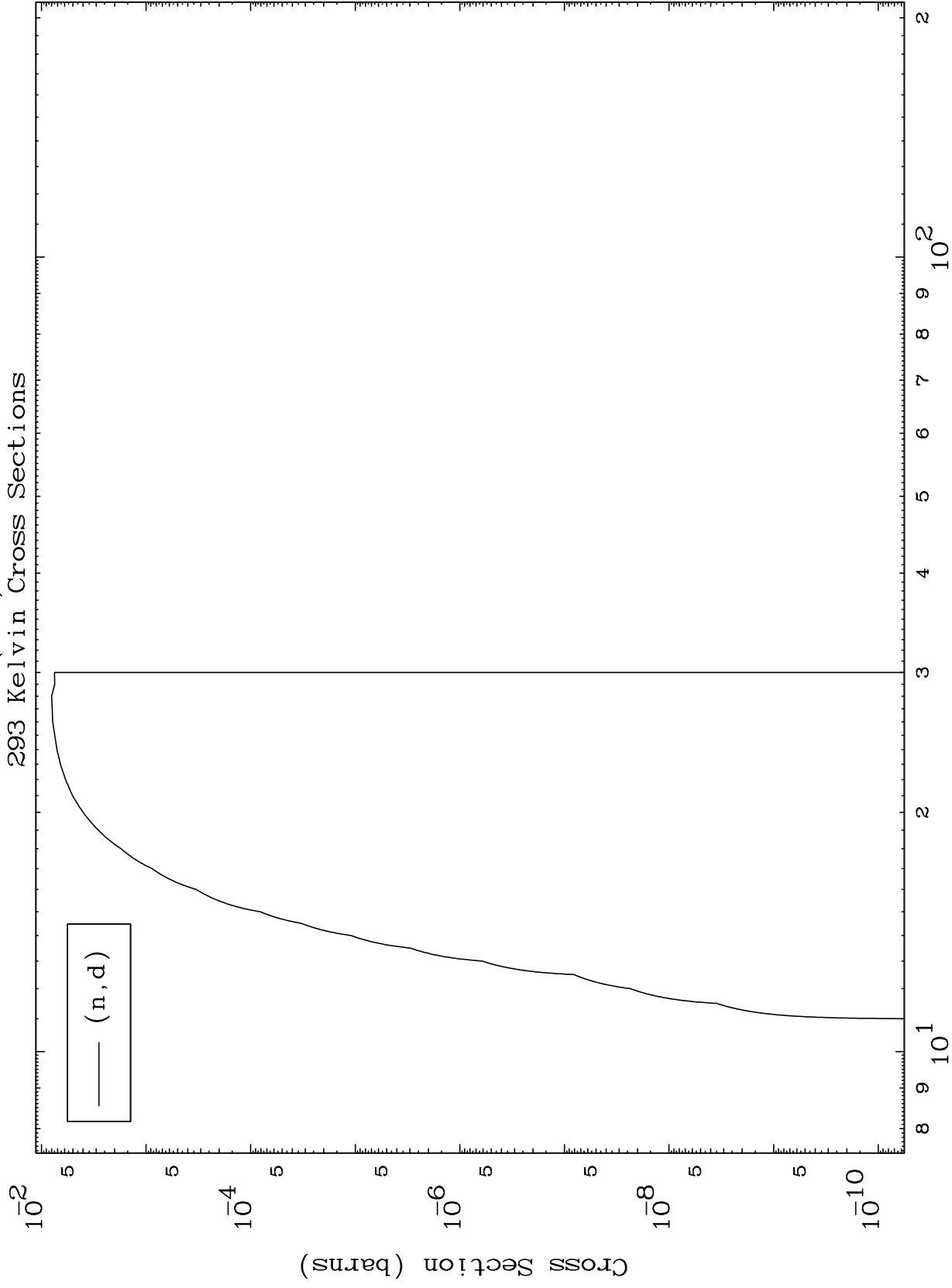

13

Incident Energy (MeV)

56-Ba-141

MAT 5658

(n,t) Levels
293 Kelvin Cross Sections

56-Ba-141

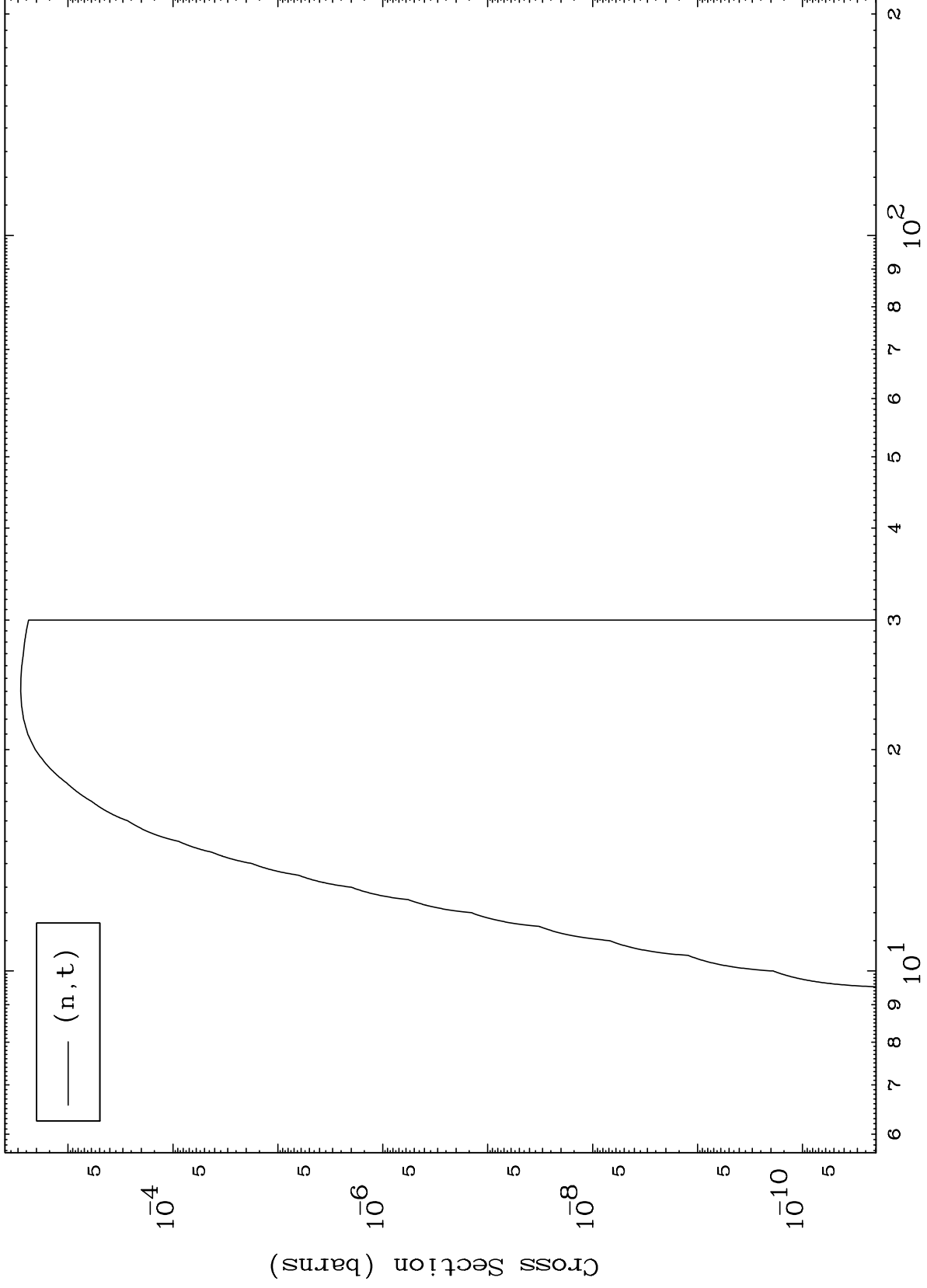

14

Incident Energy (MeV)

56-Ba-141

MAT 5658

(n,He3) Levels
293 Kelvin Cross Sections

56-Ba-141

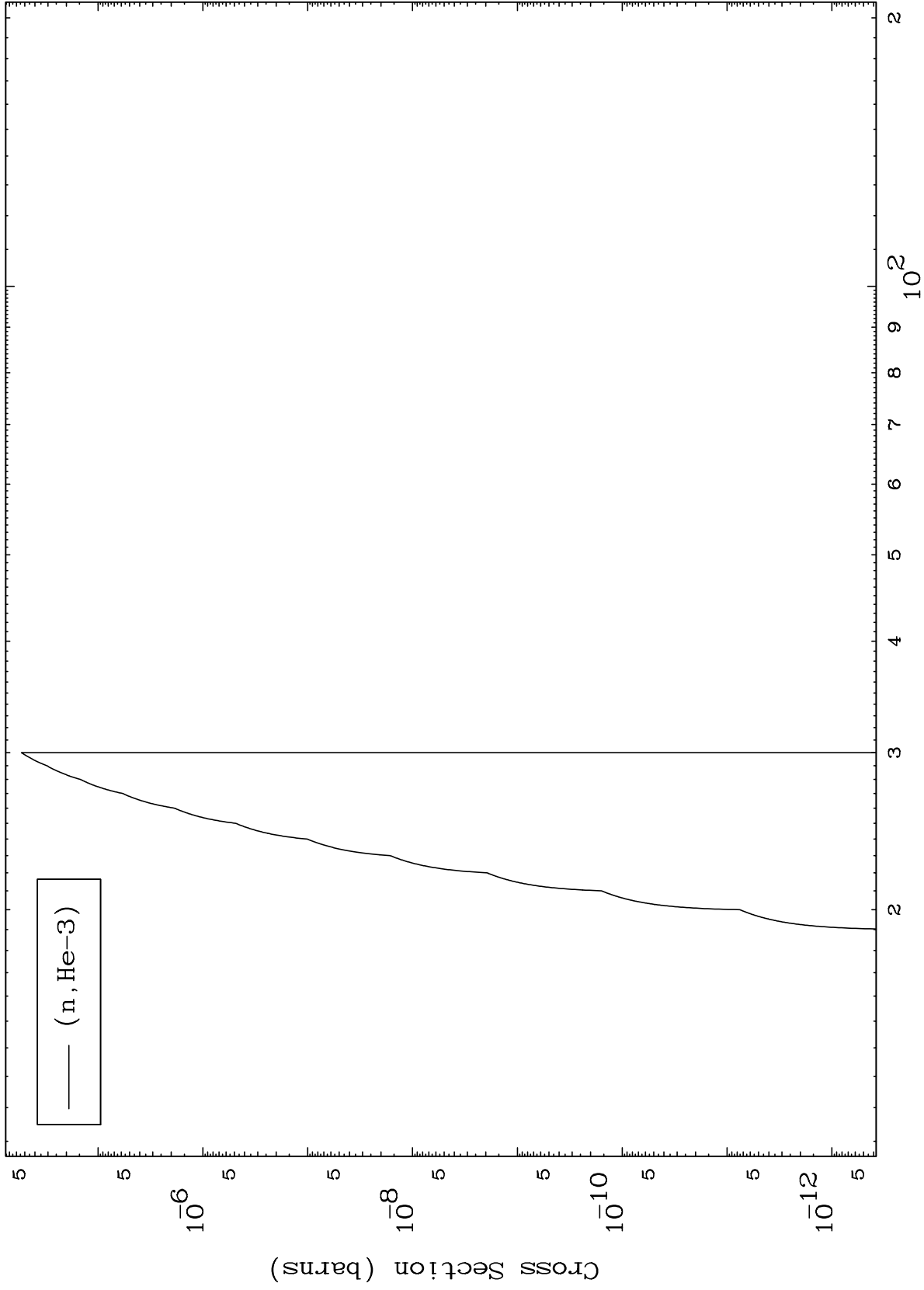

15

Incident Energy (MeV)

56-Ba-141

MAT 5658

(n, α) Levels
293 Kelvin Cross Sections

56-Ba-141

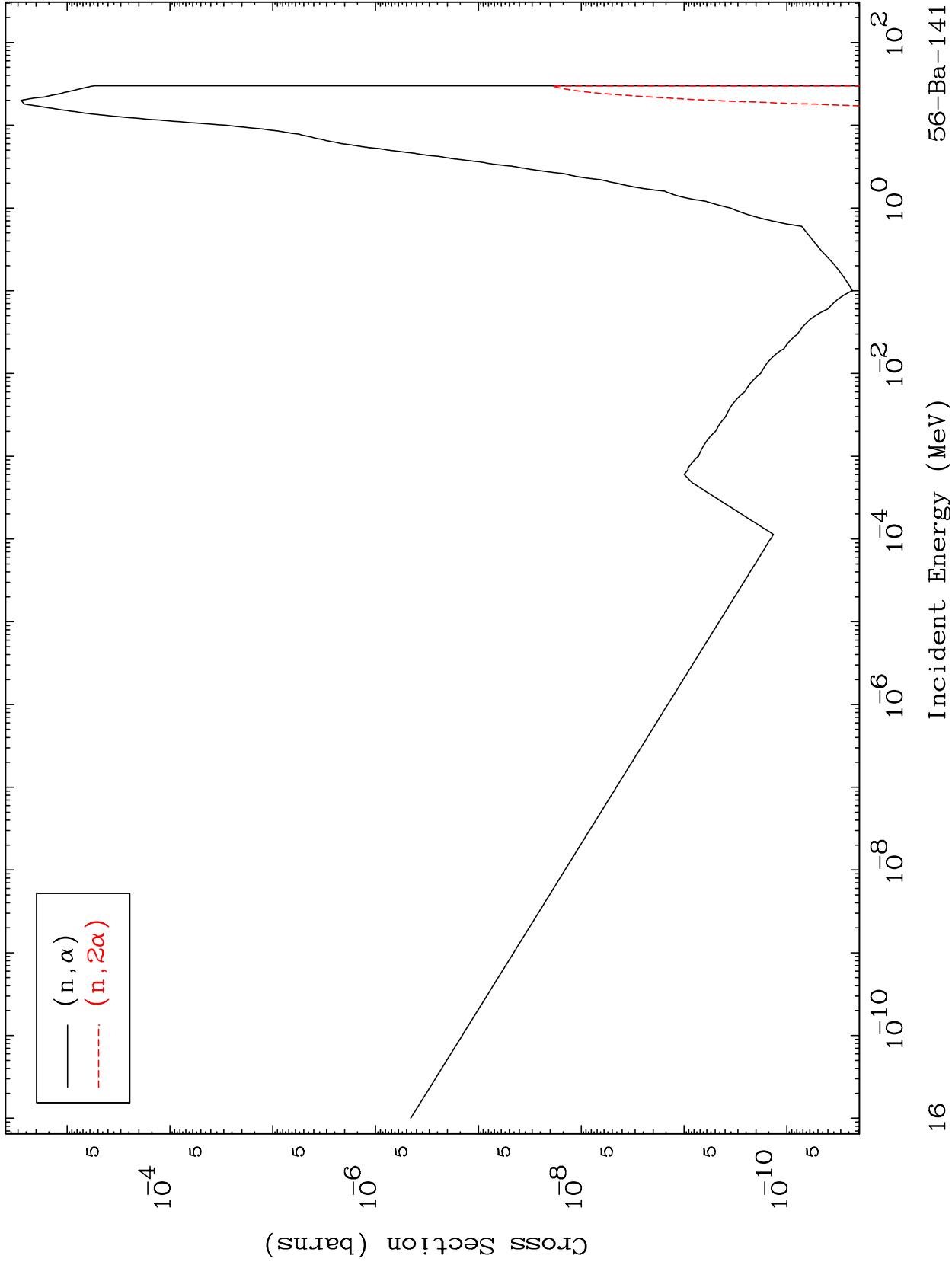

16

MAT 5658

Elastic Legendre Coefficients

56-Ba-141

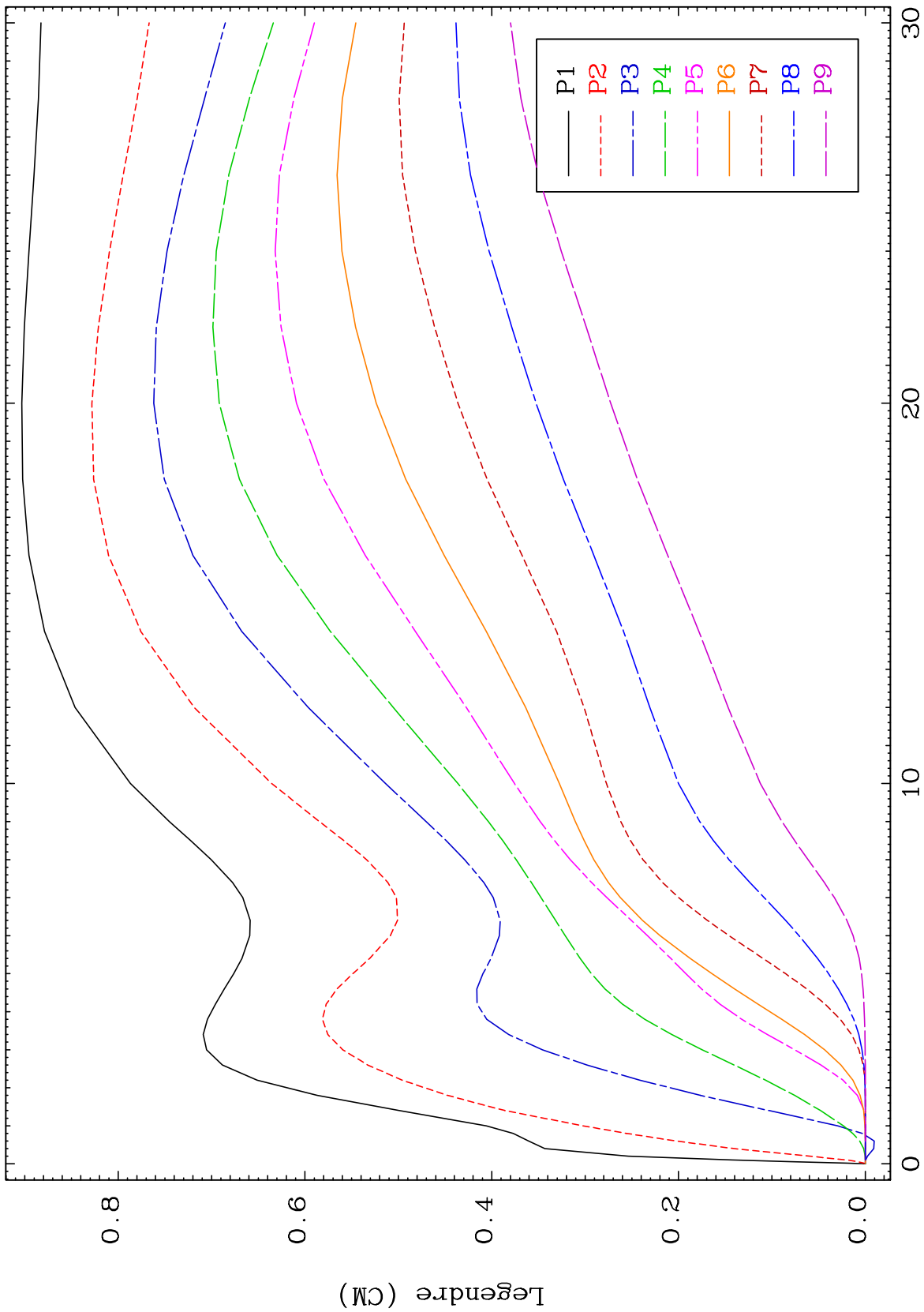

17

Incident Energy (MeV)

56-Ba-141

MAT 5658

Elastic Legendre Coefficients

56-Ba-141

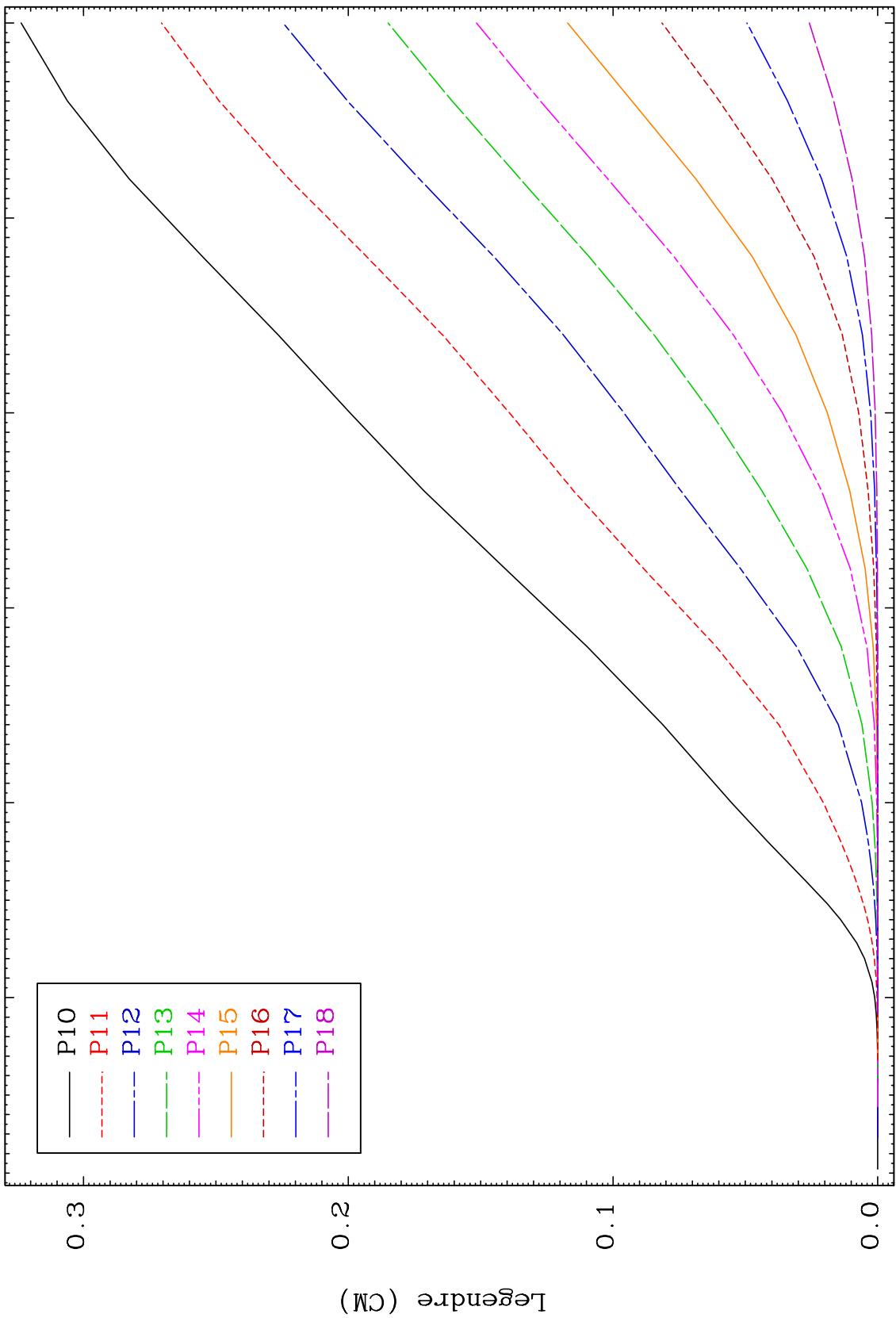

18

56-Ba-141

Incident Energy (MeV)

MAT 5658

Elastic
Legendre Coefficients

56-Ba-141

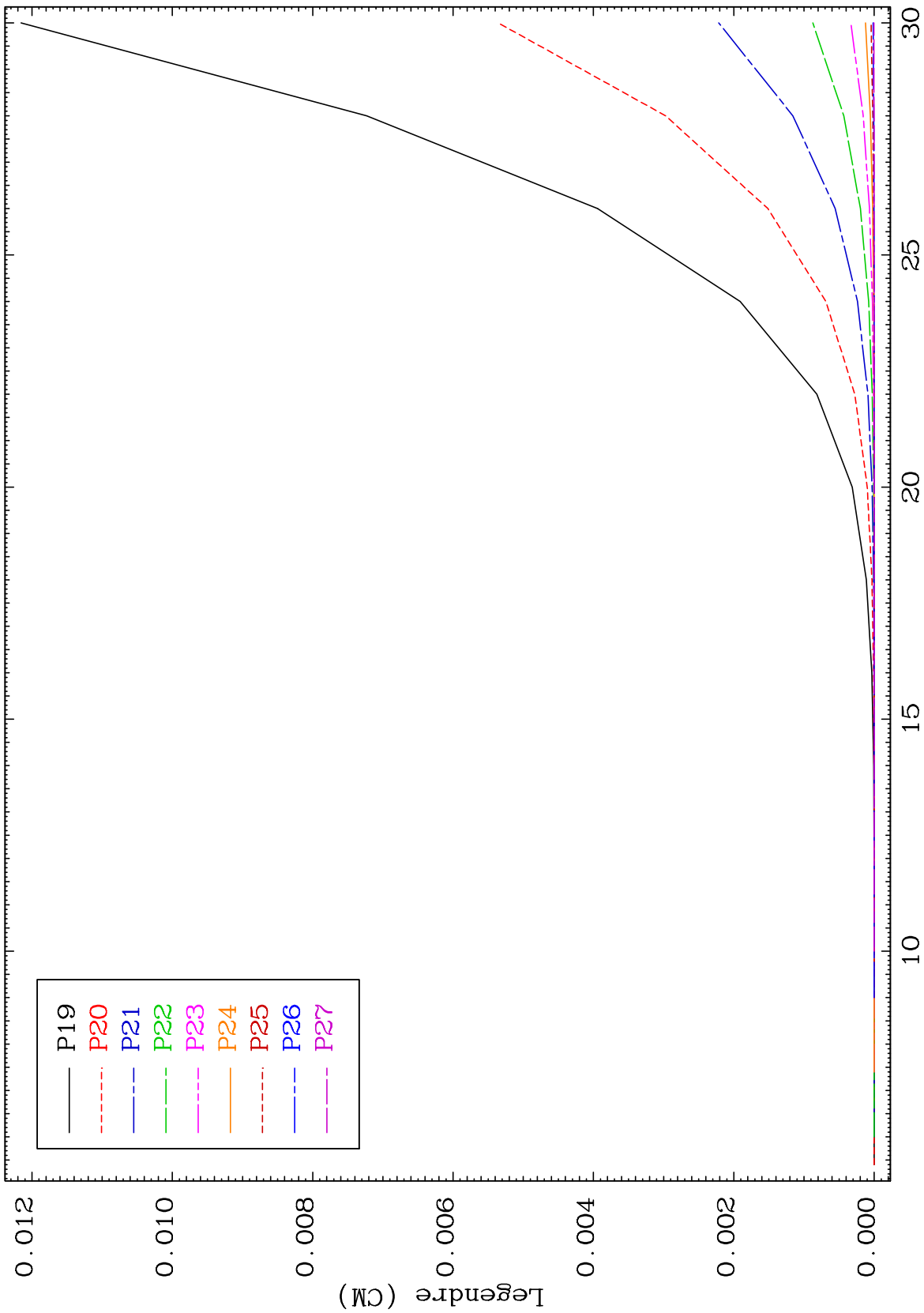

19

Incident Energy (MeV)

56-Ba-141

MAT 5658

Elastic Legendre Coefficients

56-Ba-141

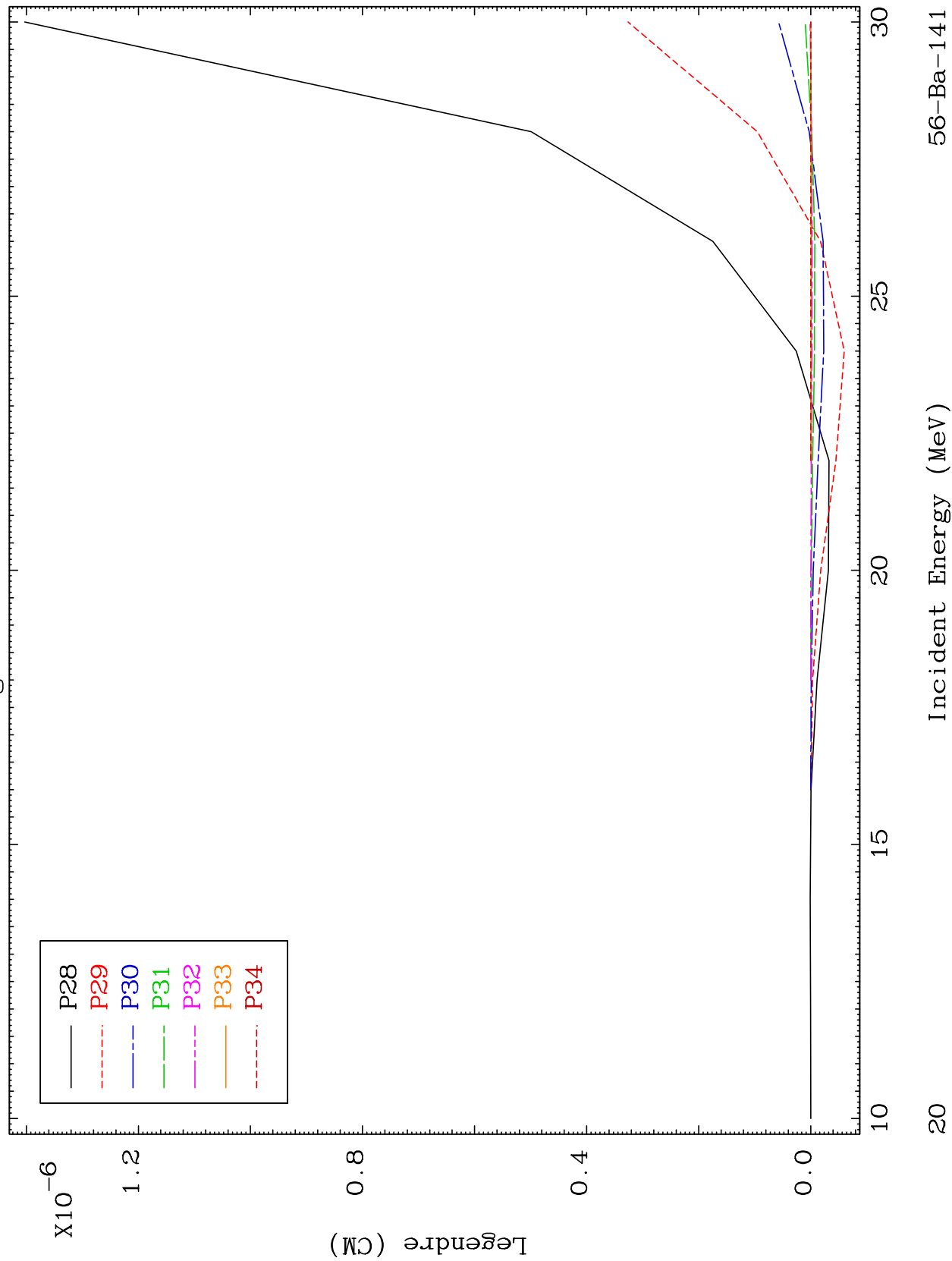

56-Ba-141

Incident Energy (MeV)

20

MAT 5658

MT= 51 (n,n') Level
Legendre Coefficients

56-Ba-141

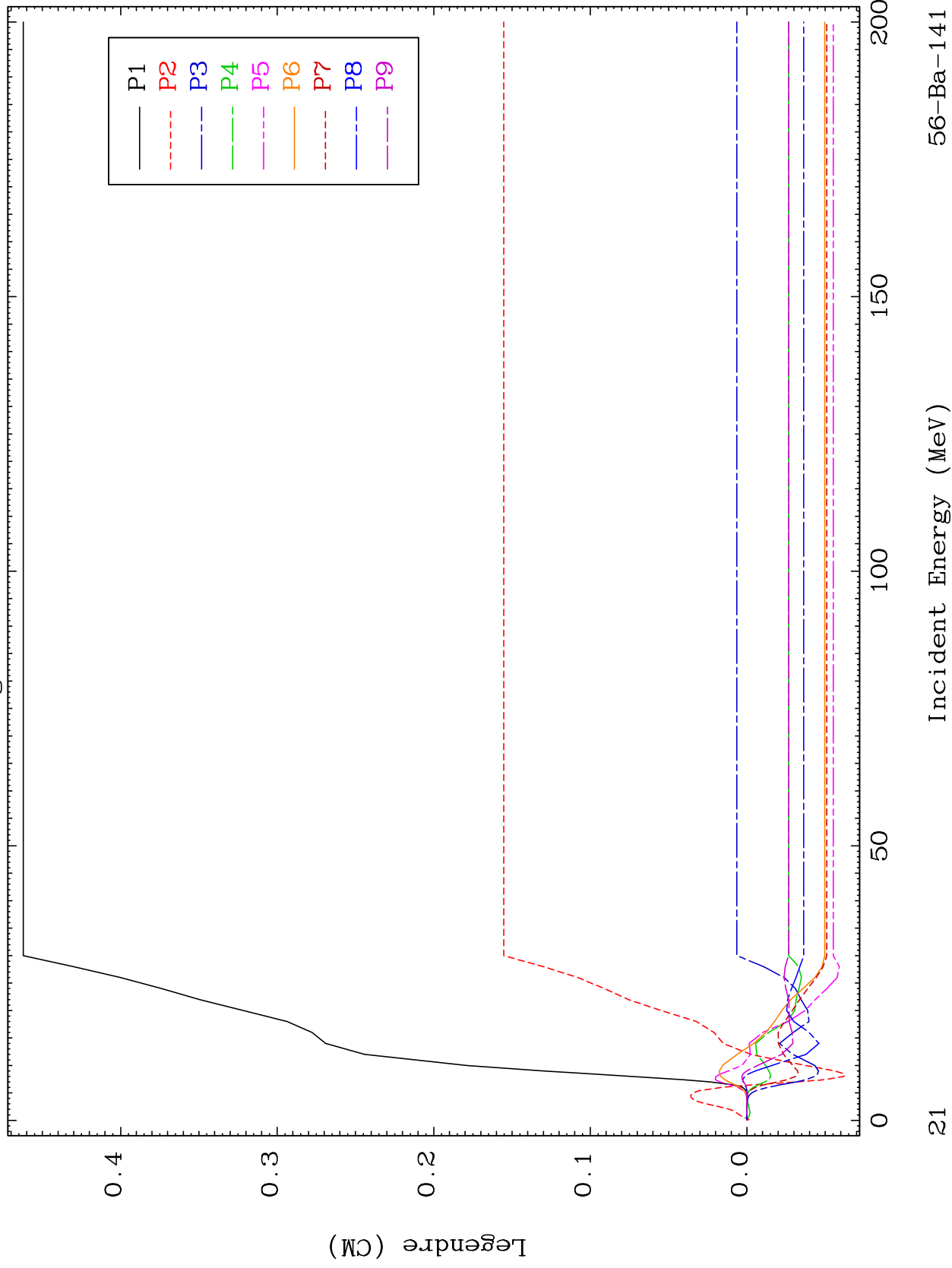

56-Ba-141

Incident Energy (MeV)

21

MAT 5658

MT= 51 (n,n') Level
Legendre Coefficients

56-Ba-141

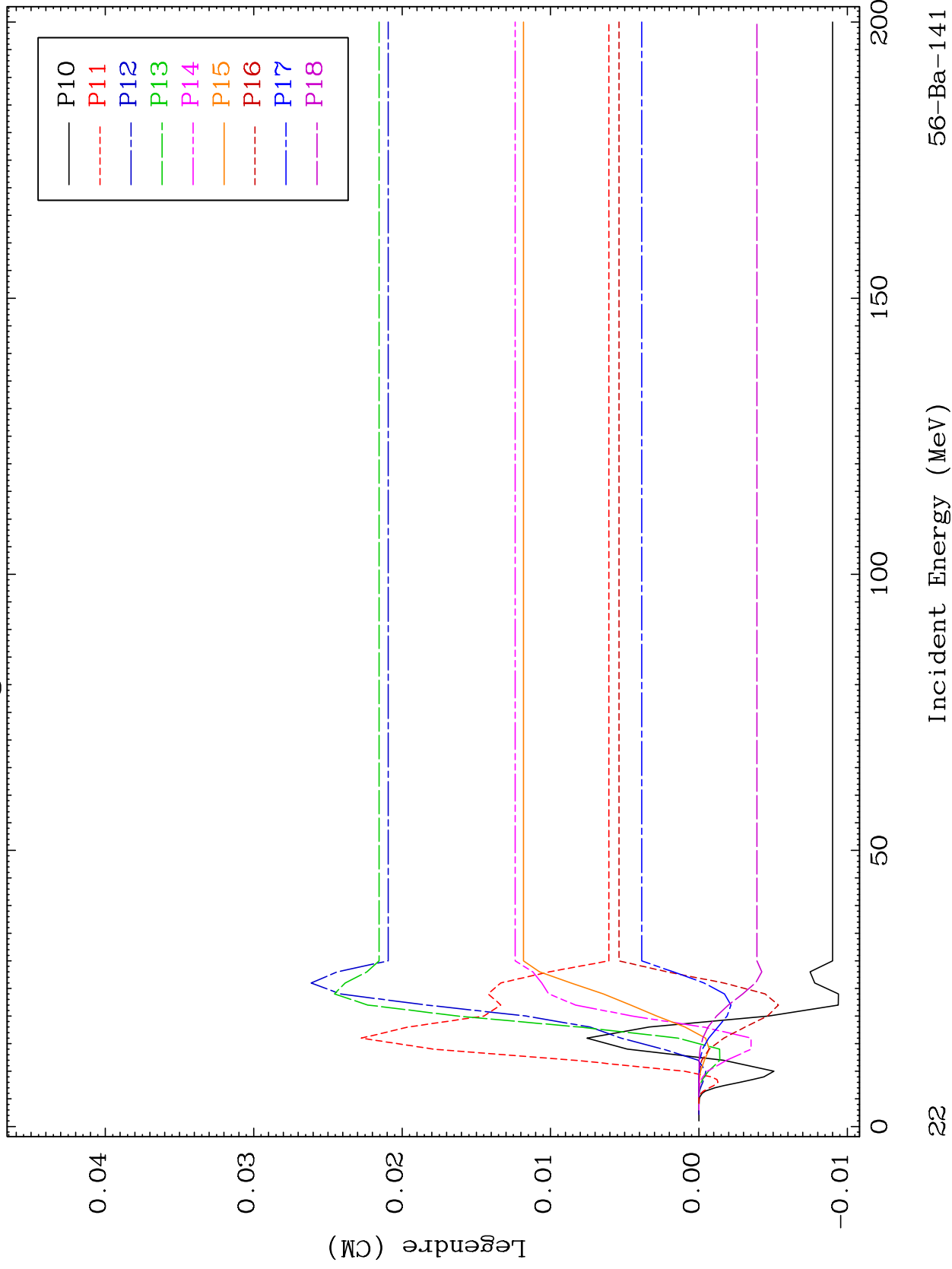

56-Ba-141

Incident Energy (MeV)

22

MAT 5658

MT= 51 (n,n') Level
Legendre Coefficients

56-Ba-141

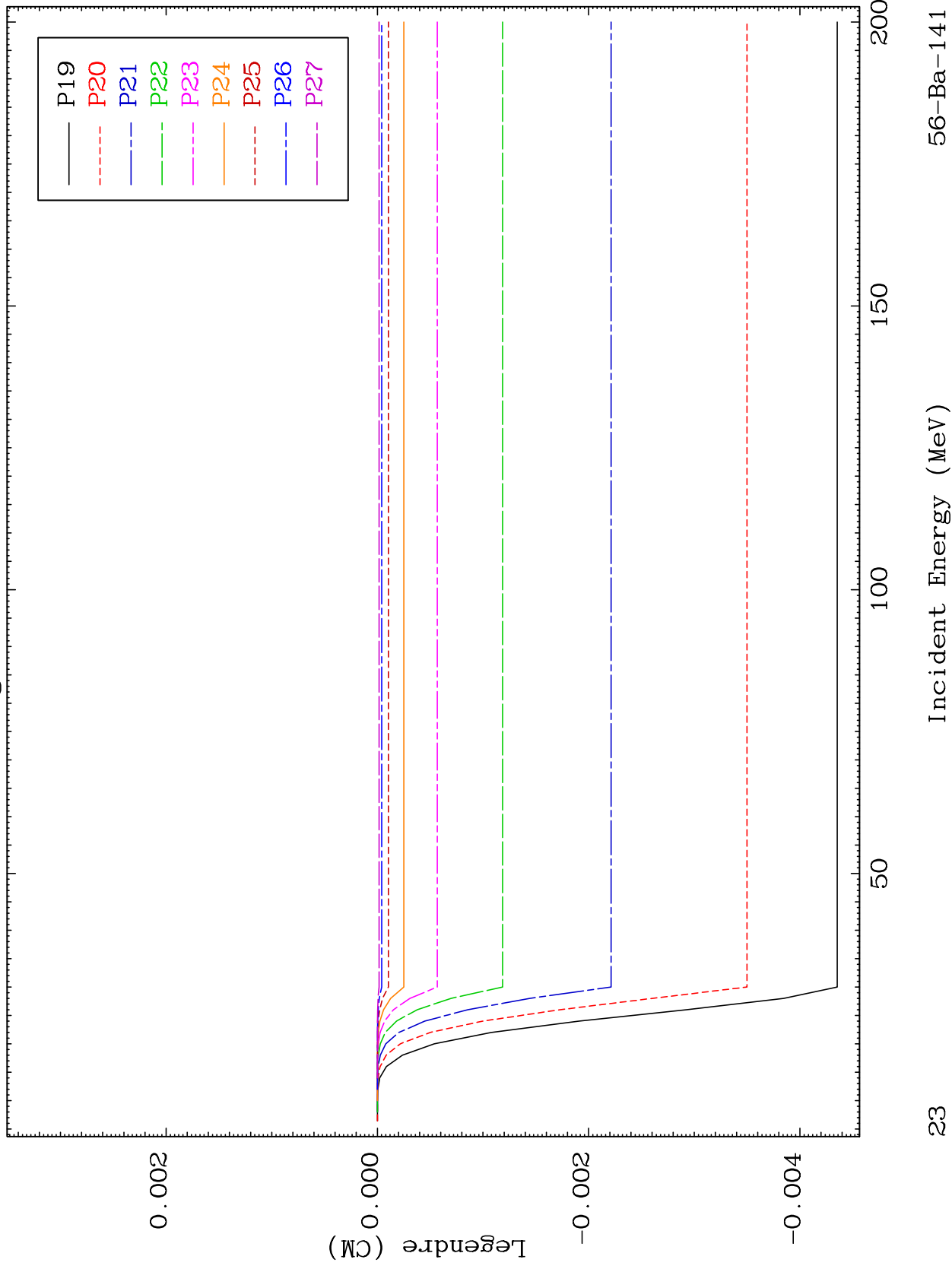

23

Incident Energy (MeV)

56-Ba-141

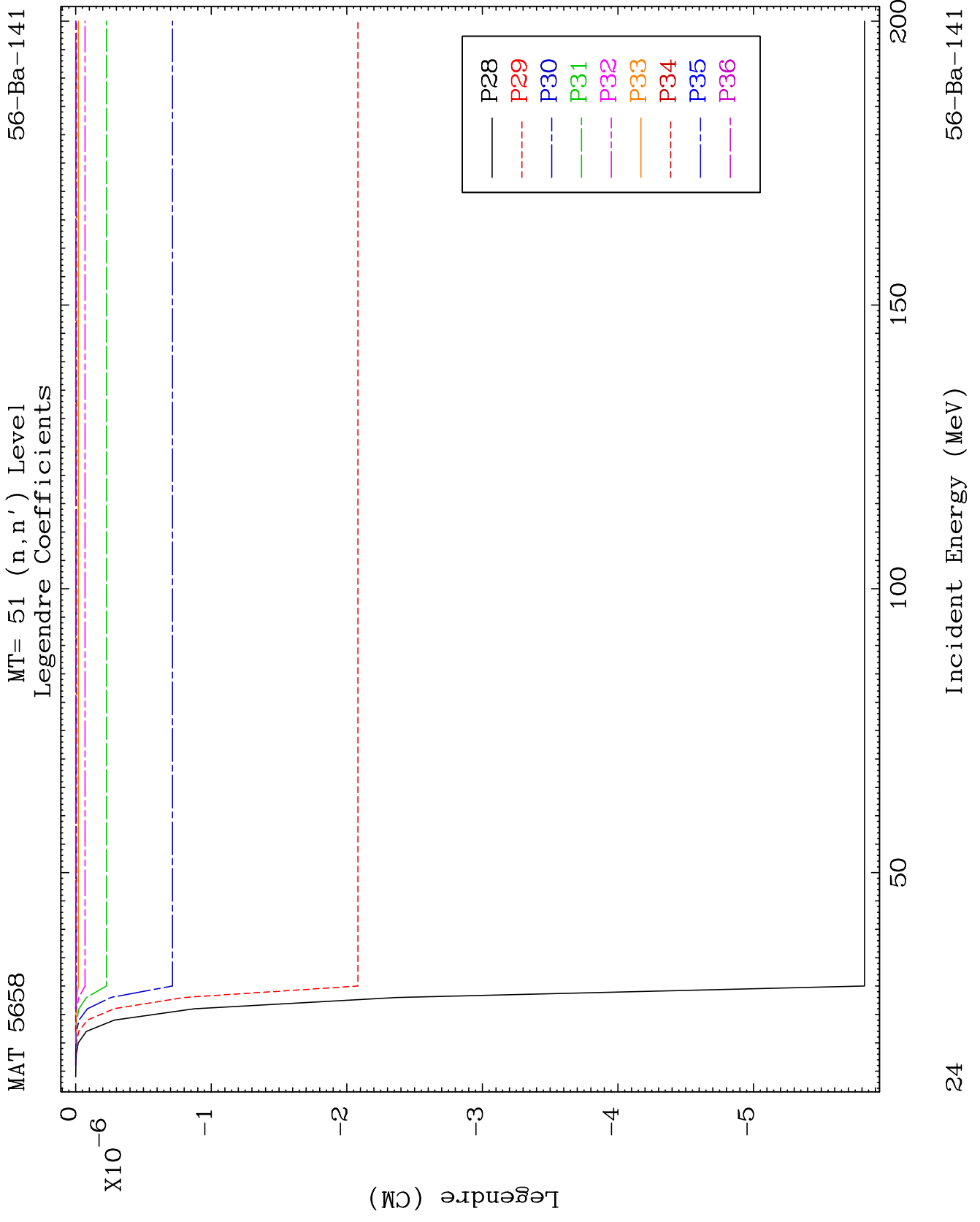

MAT 5658

MT= 52 (n,n') Level
Legendre Coefficients

56-Ba-141

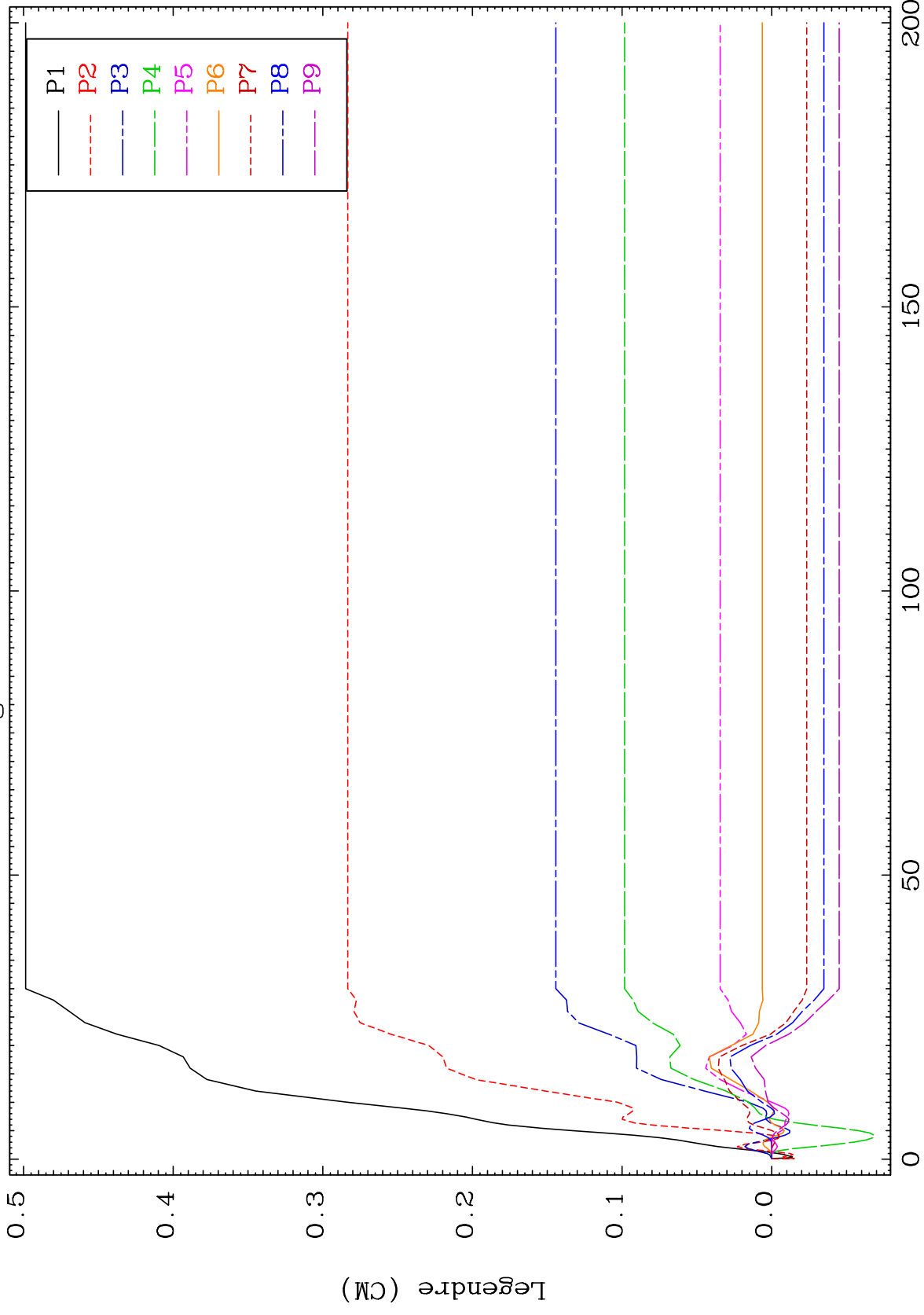

56-Ba-141

Incident Energy (MeV)

25

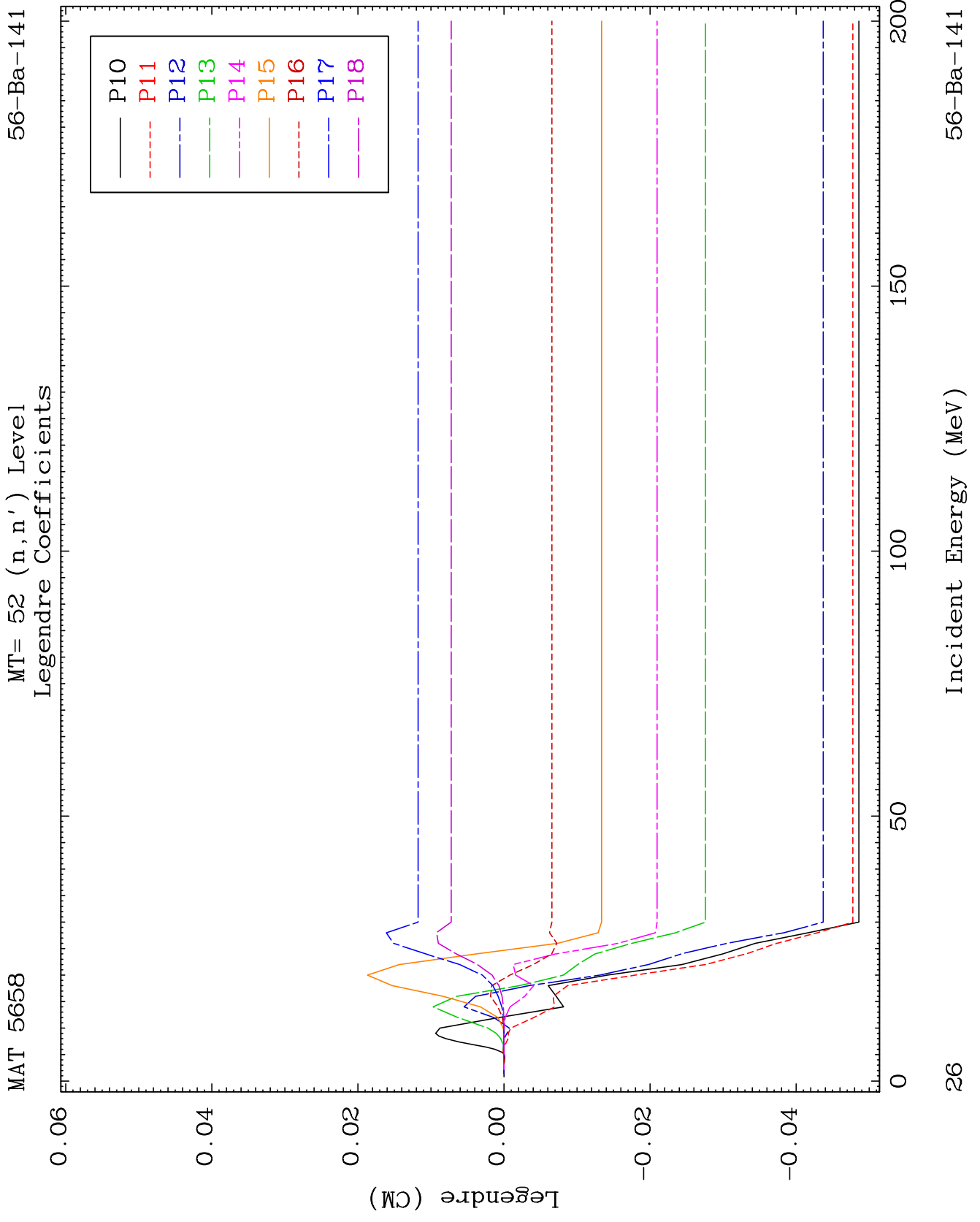

MAT 5658

MT= 52 (n,n') Level
Legendre Coefficients

56-Ba-141

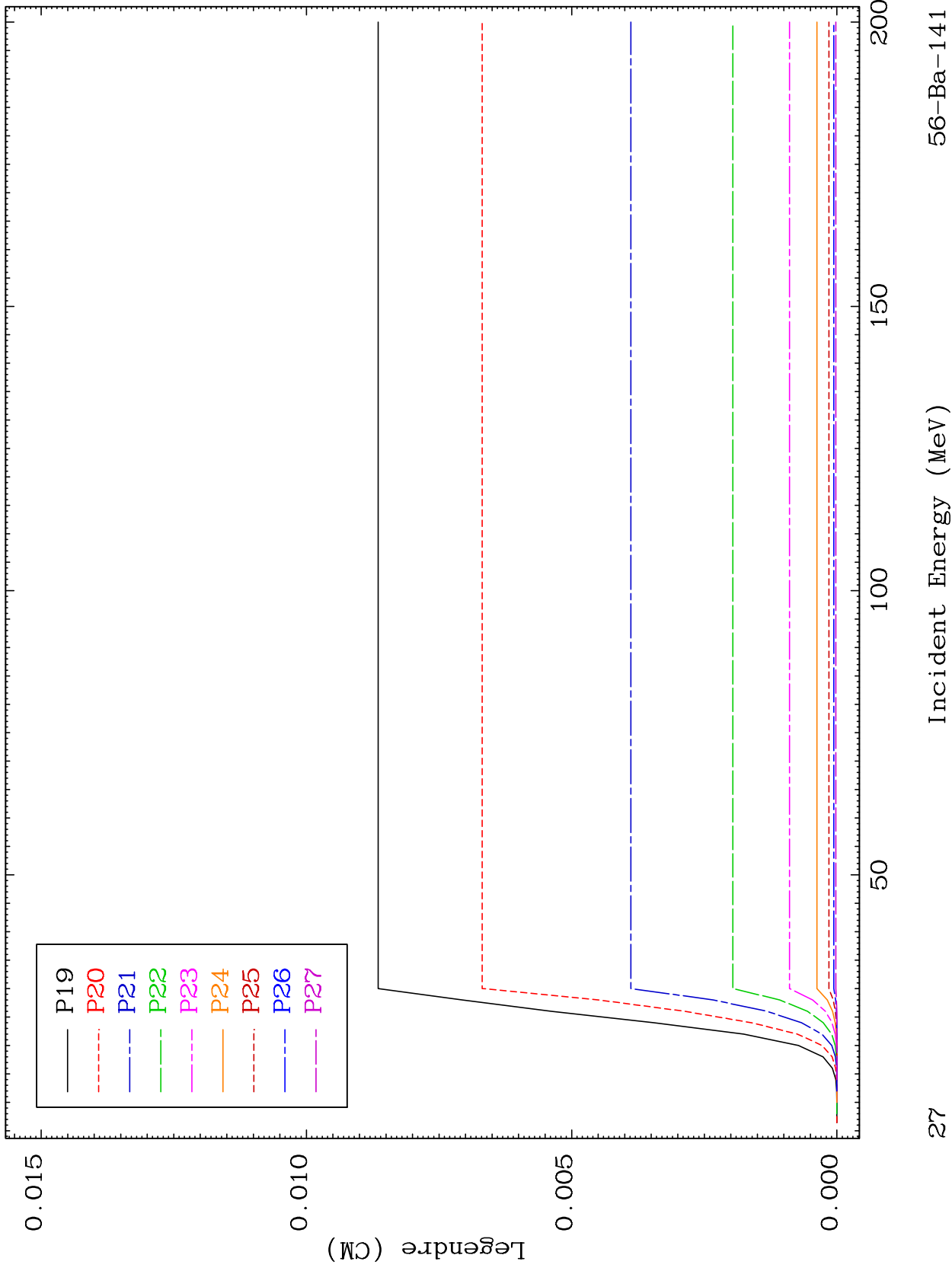

27

56-Ba-141

MAT 5658

MT= 52 (n,n') Level
Legendre Coefficients

56-Ba-141

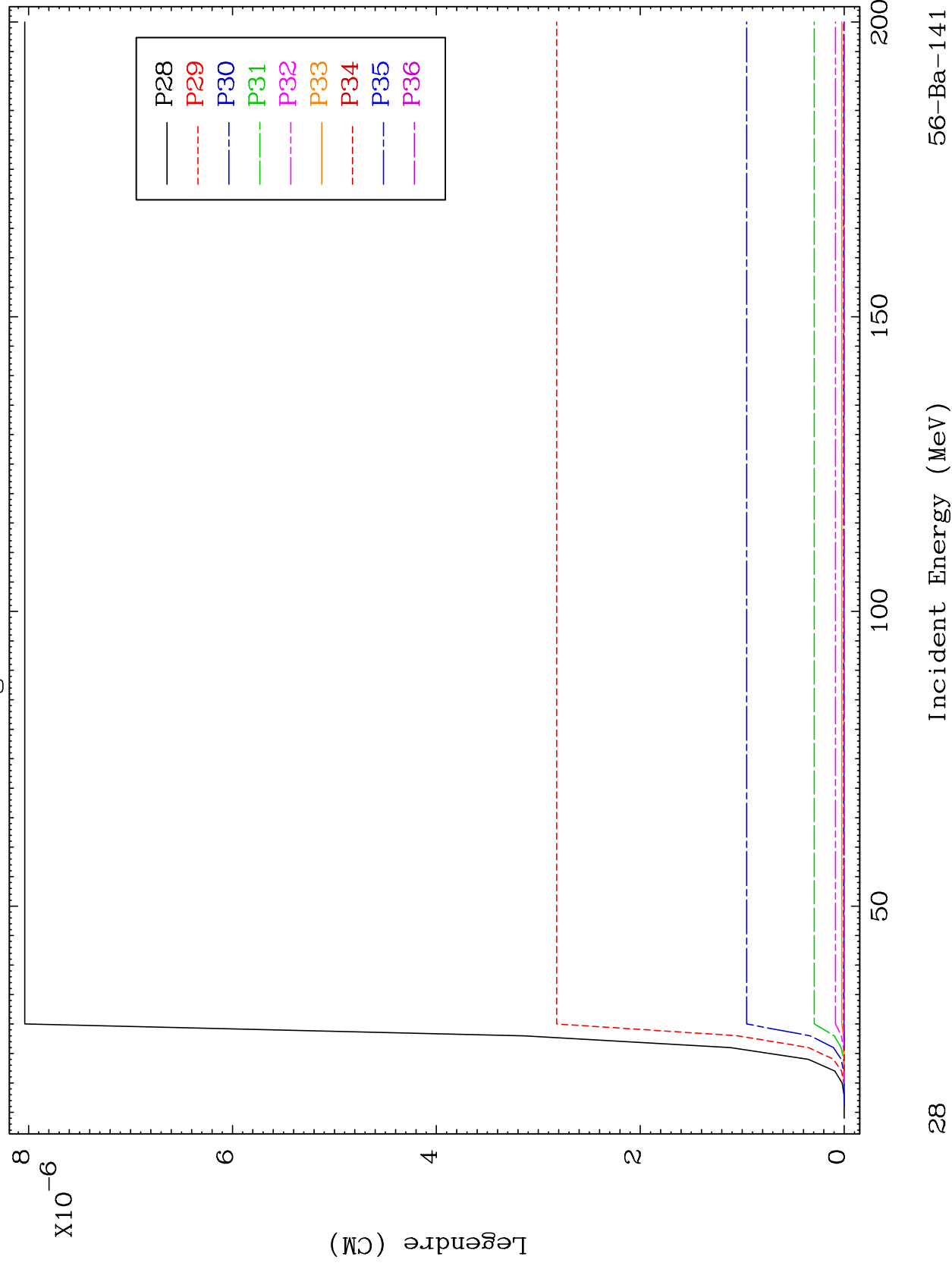

28

Incident Energy (MeV)

56-Ba-141

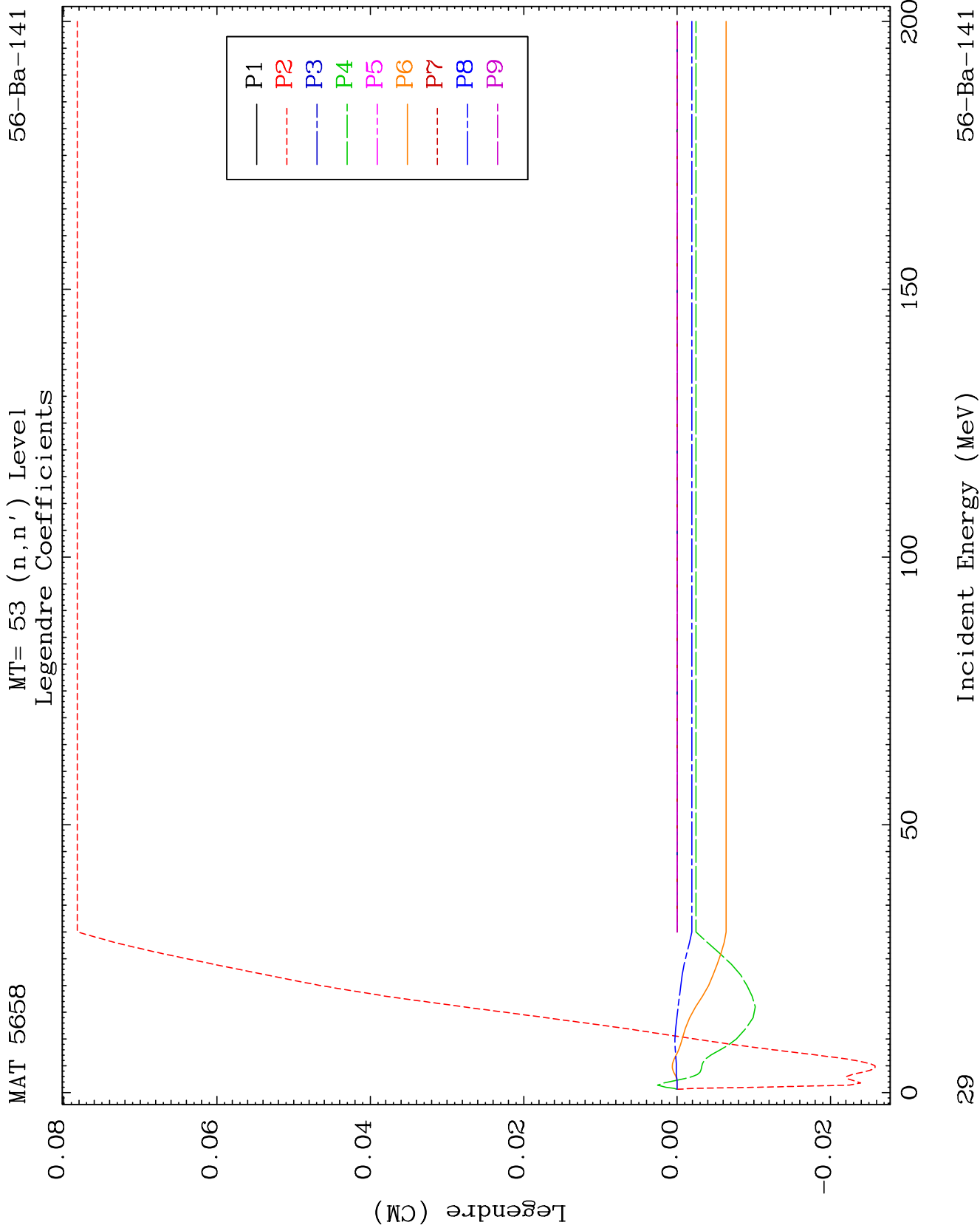

MAT 5658

MT= 53 (n,n') Level
Legendre Coefficients

56-Ba-141

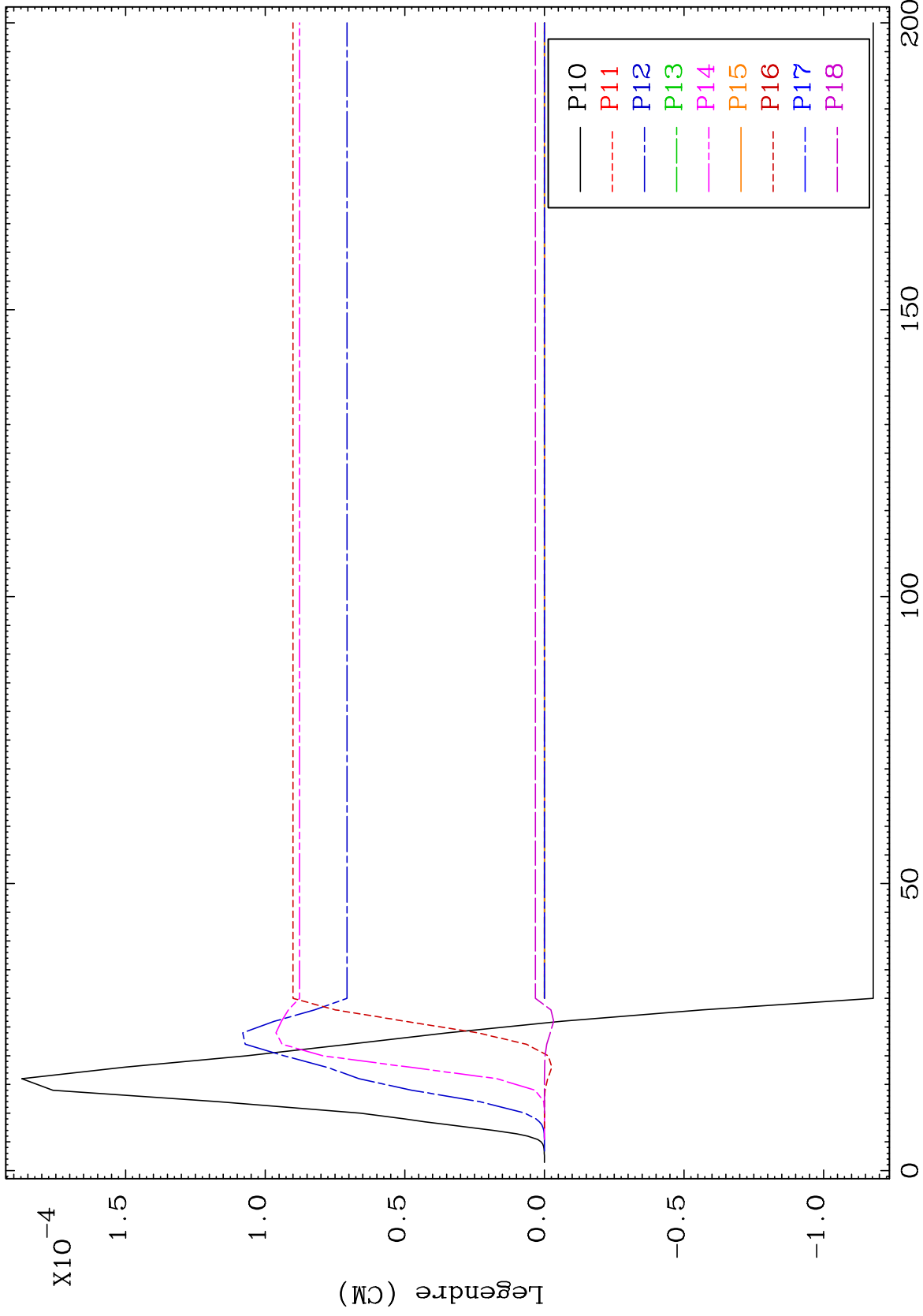

30

Incident Energy (MeV)

56-Ba-141

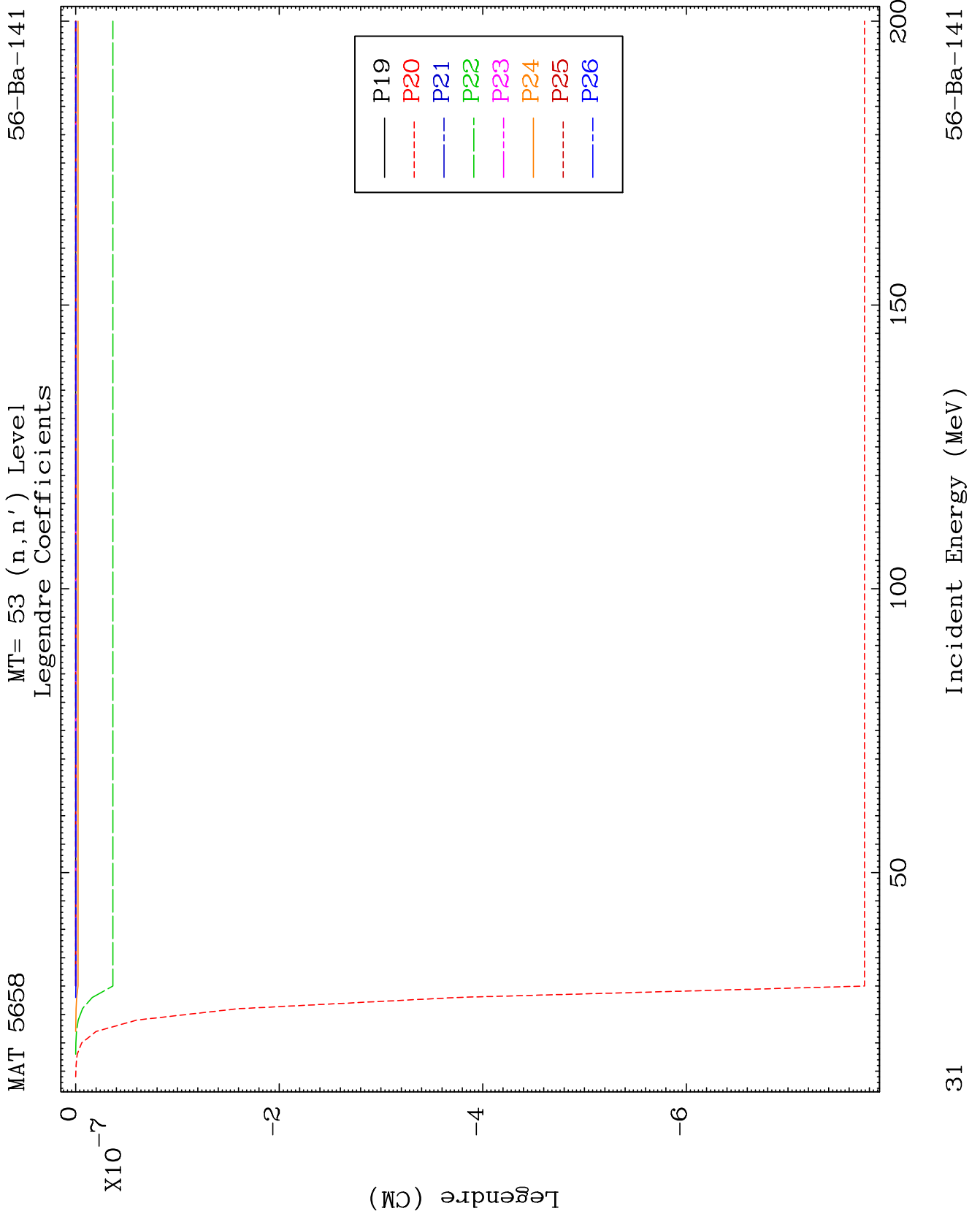

MAT 5658

MT= 54 (n,n') Level
Legendre Coefficients

56-Ba-141

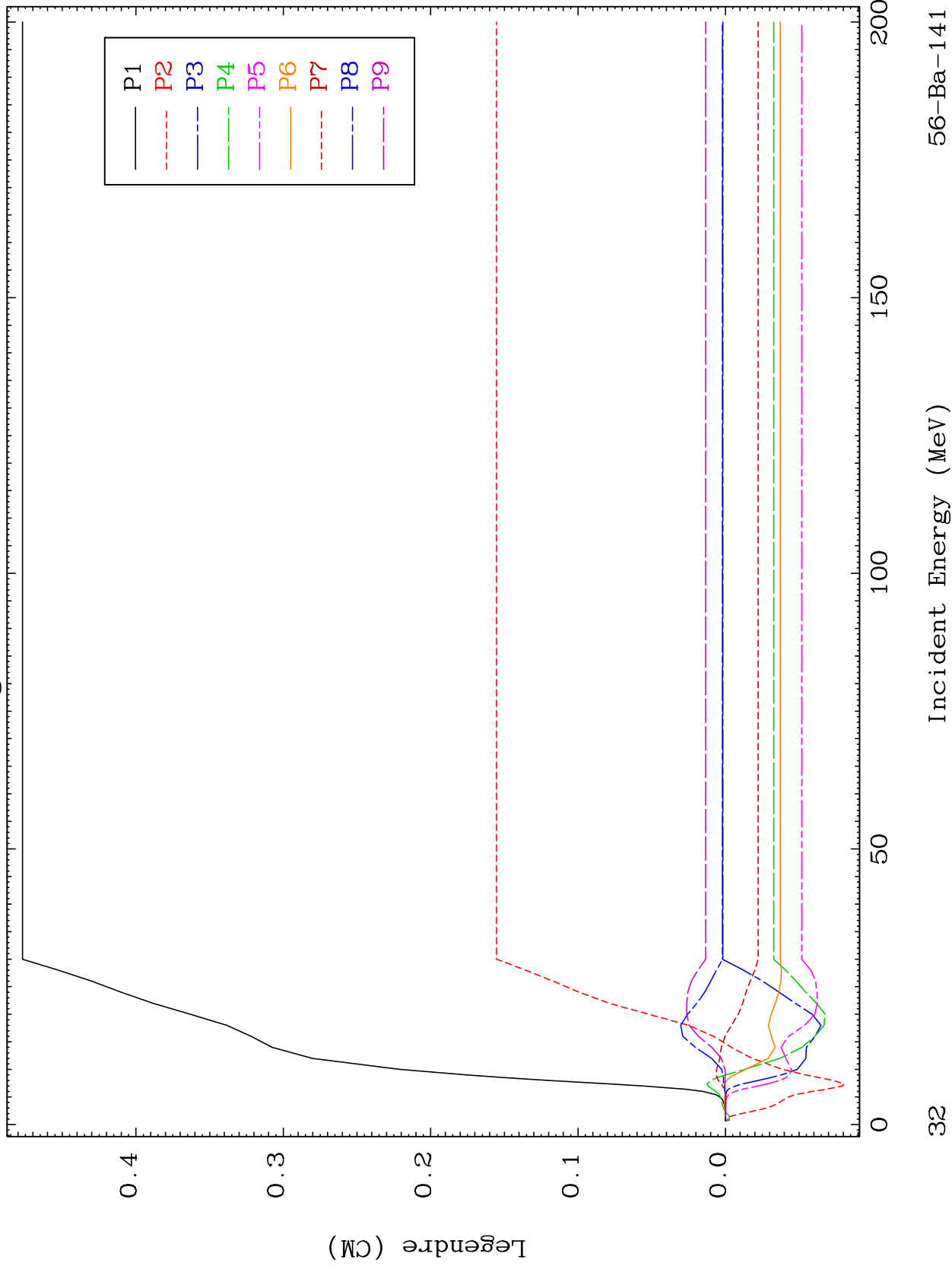

56-Ba-141

Incident Energy (MeV)

32

MAT 5658

MT= 54 (n,n') Level
Legendre Coefficients

56-Ba-141

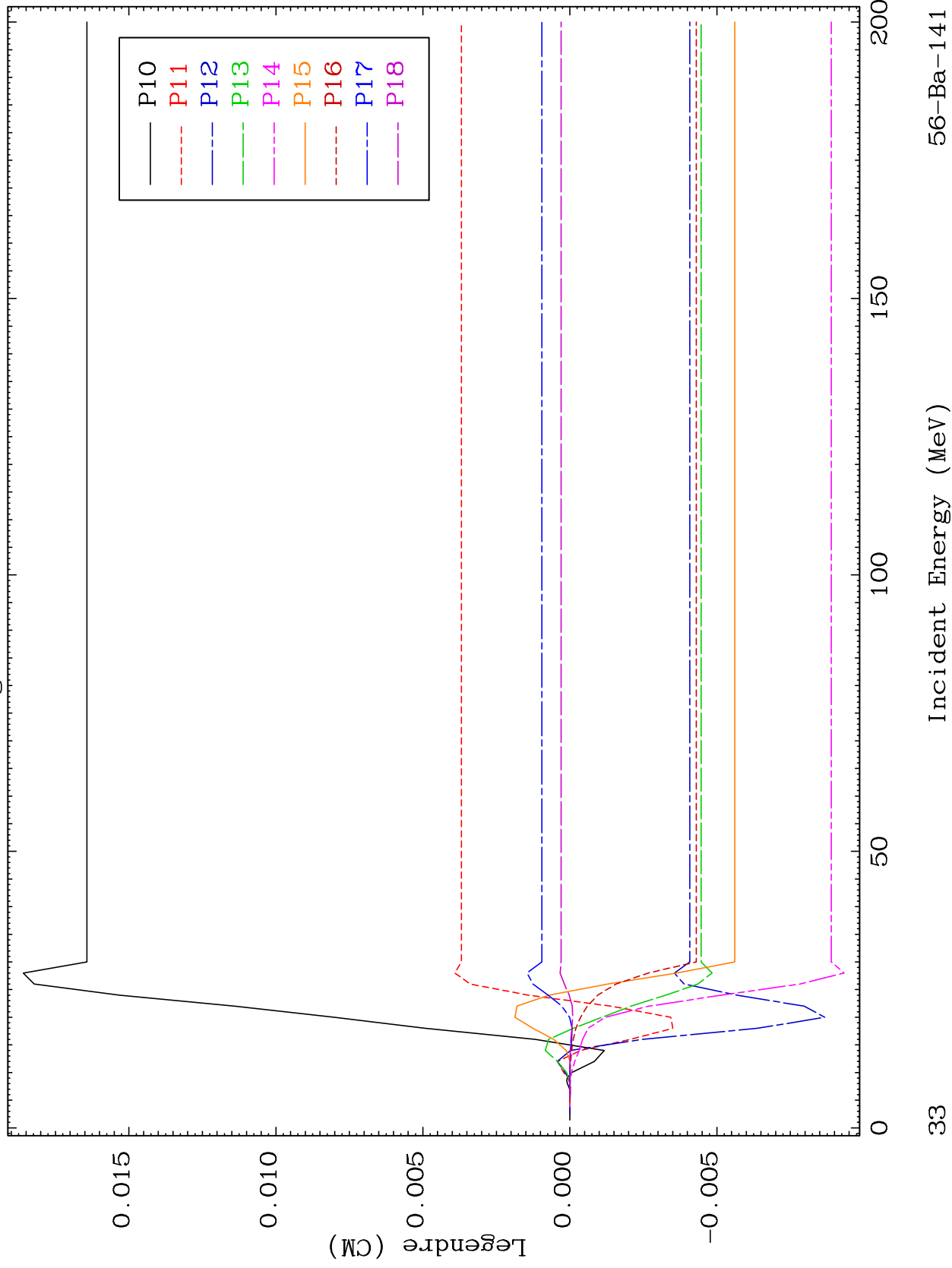

33

56-Ba-141

MAT 5658

MT= 54 (n,n') Level
Legendre Coefficients

56-Ba-141

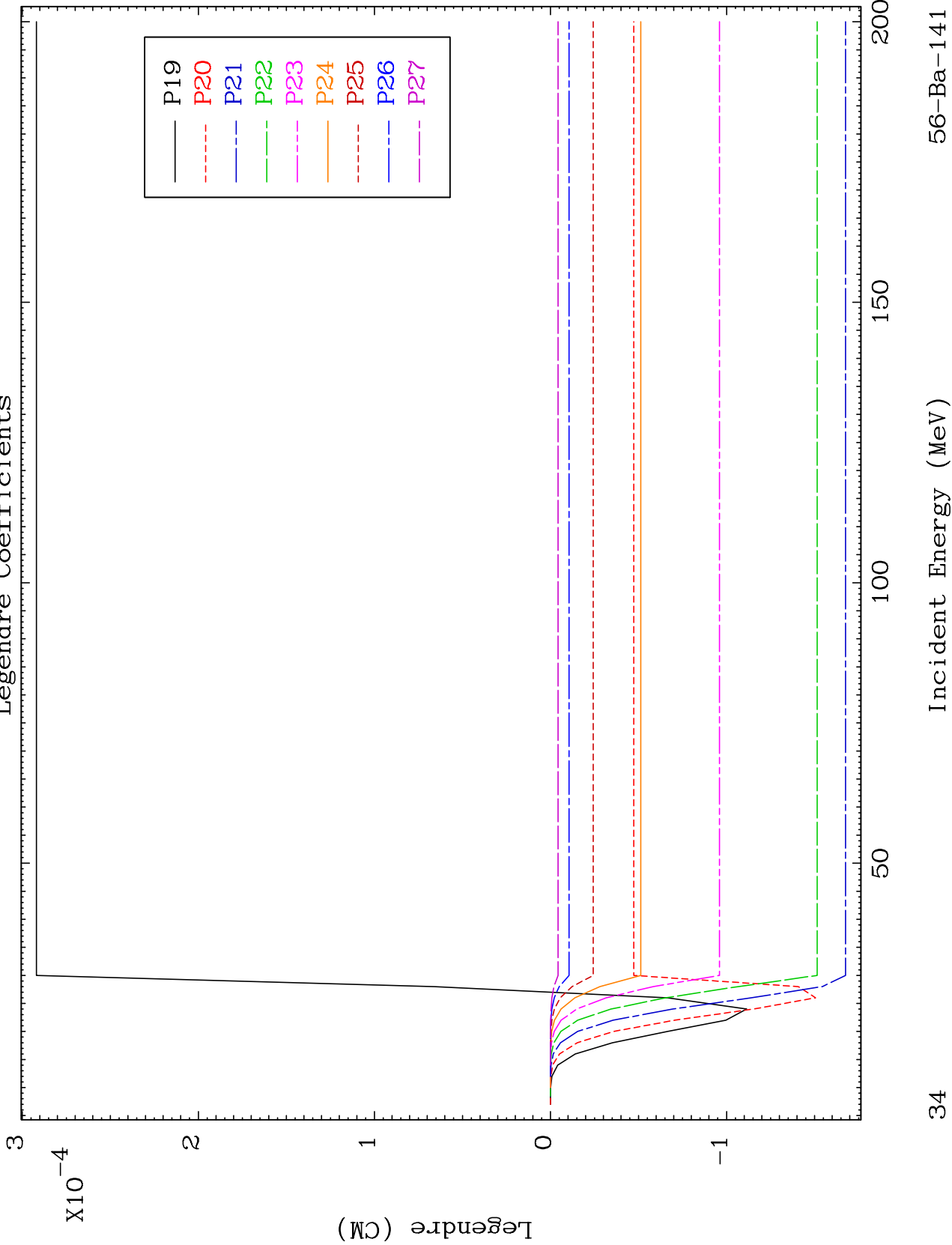

34

Incident Energy (MeV)

56-Ba-141

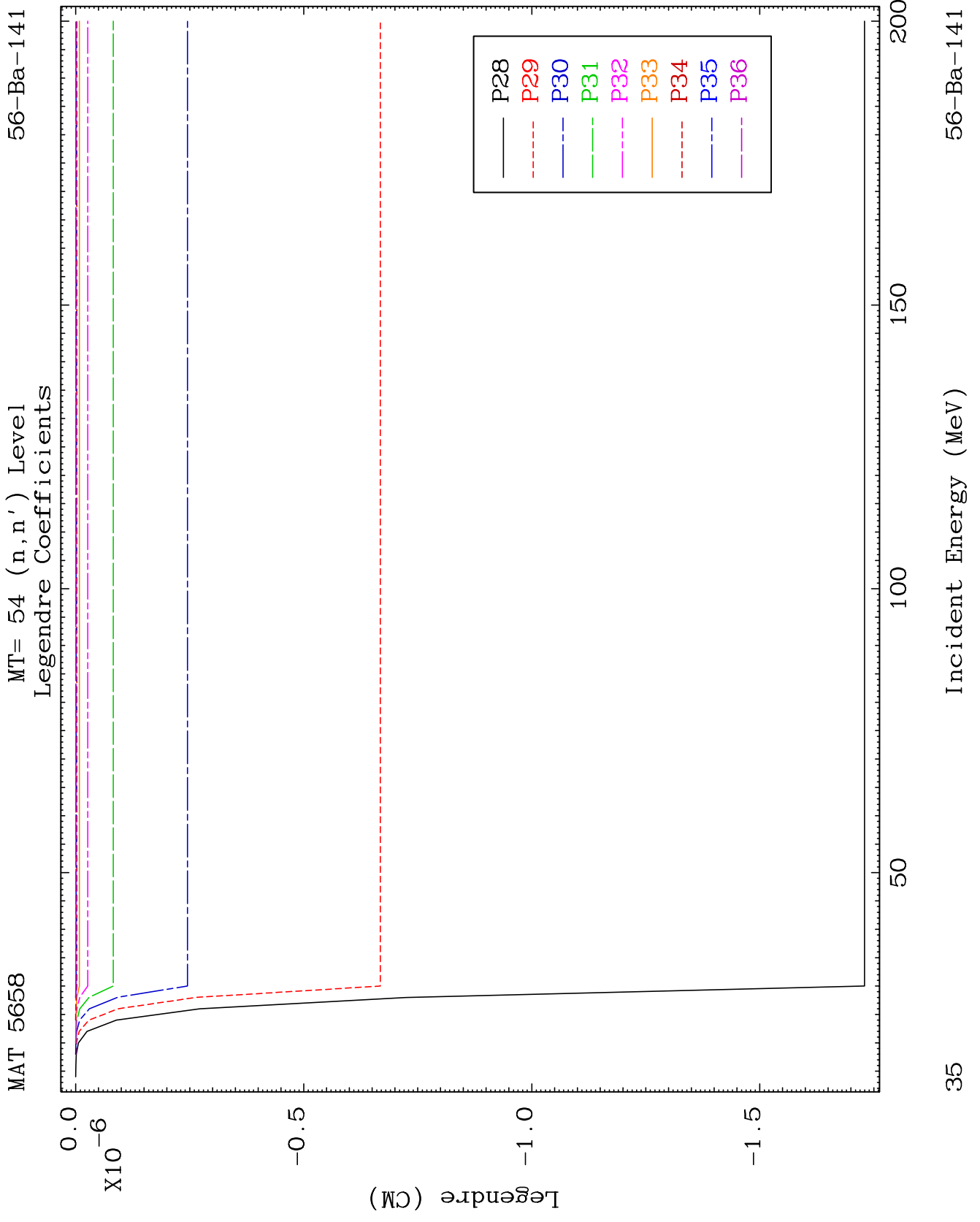

MAT 5658

MT= 55 (n,n') Level
Legendre Coefficients

56-Ba-141

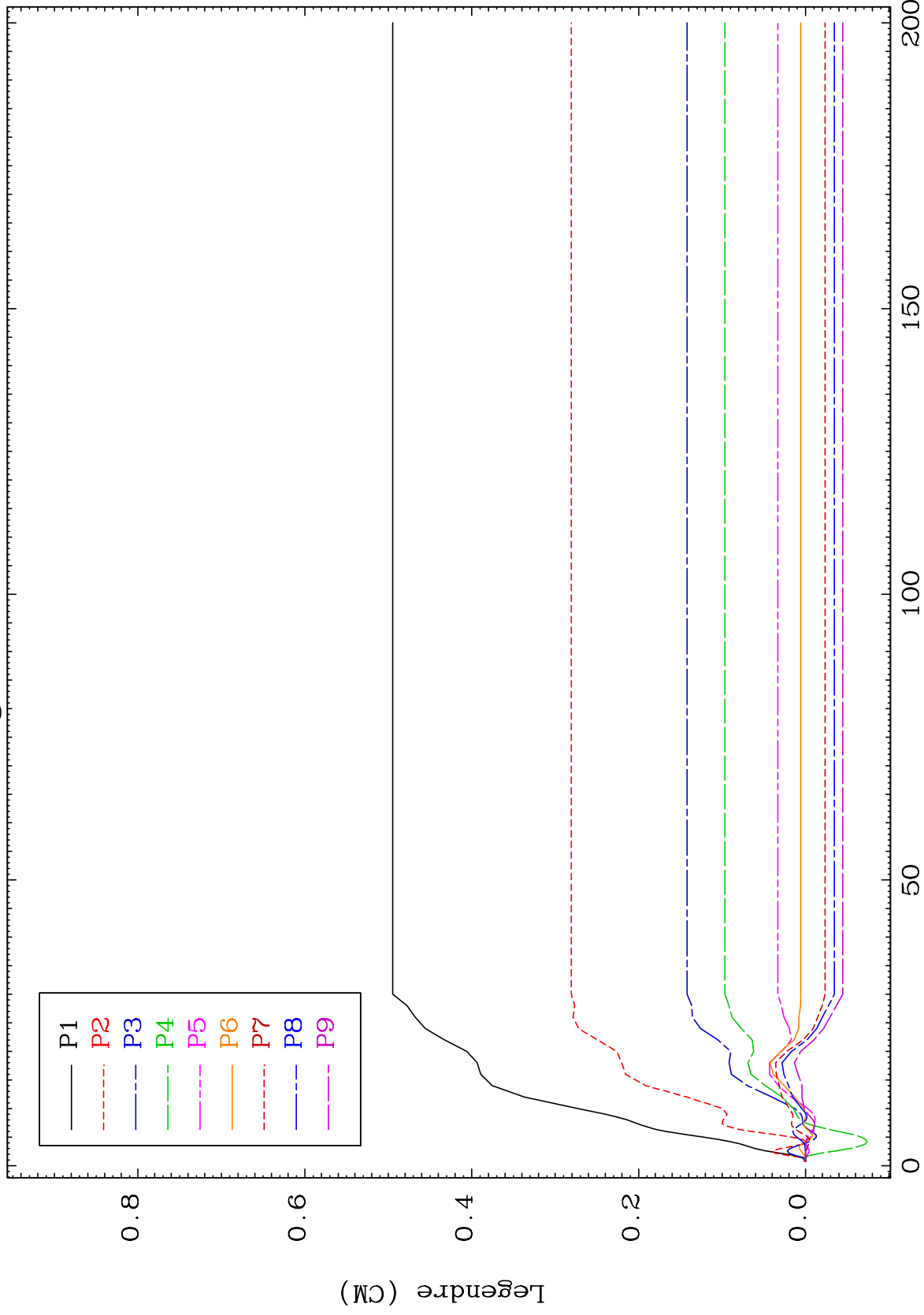

36

Incident Energy (MeV)

56-Ba-141

MAT 5658

MT= 55 (n,n') Level
Legendre Coefficients

56-Ba-141

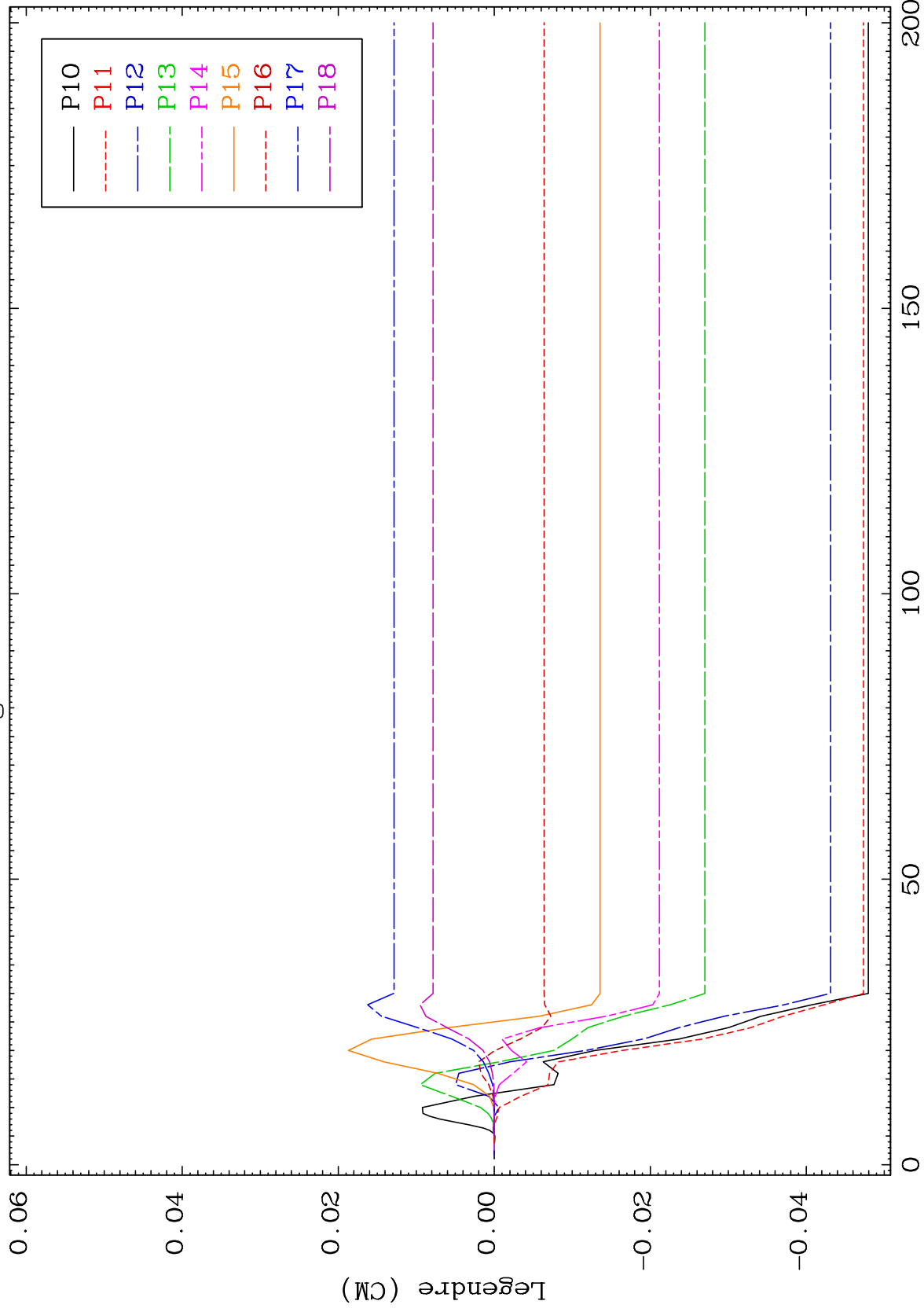

37

Incident Energy (MeV)

56-Ba-141

MAT 5658

MT= 55 (n,n') Level
Legendre Coefficients

56-Ba-141

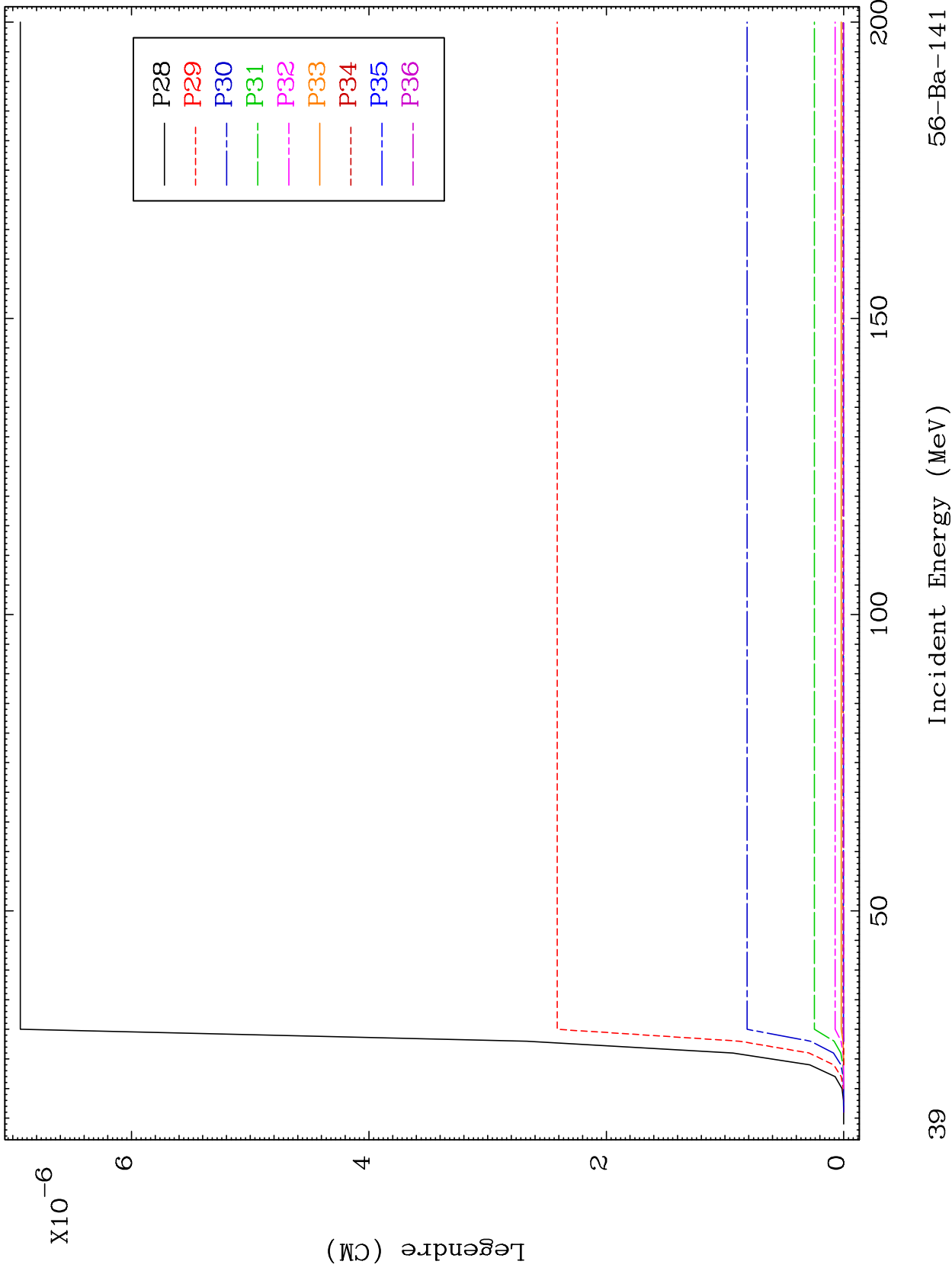

39

Incident Energy (MeV)

56-Ba-141

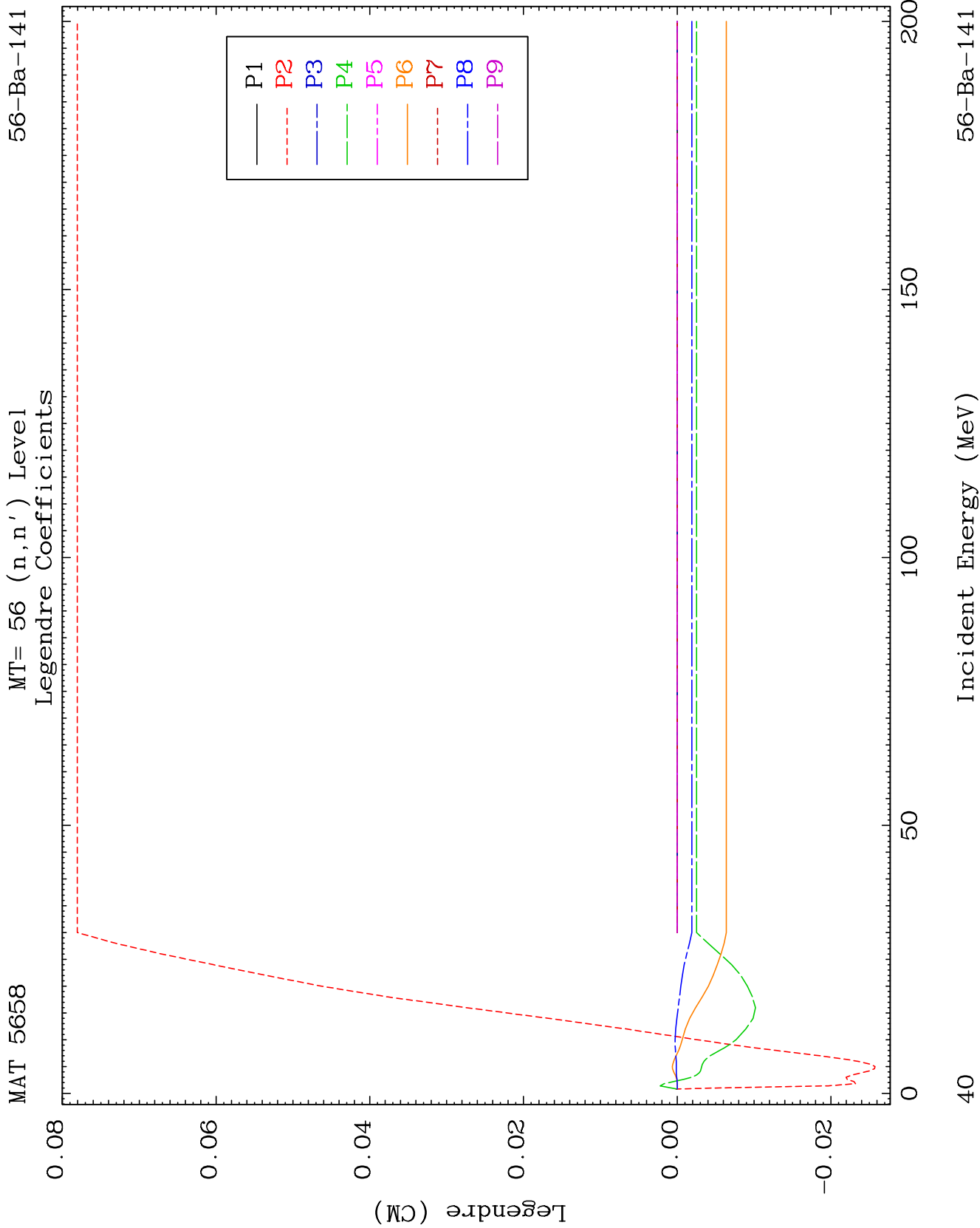

MAT 5658

MT= 56 (n,n') Level
Legendre Coefficients

56-Ba-141

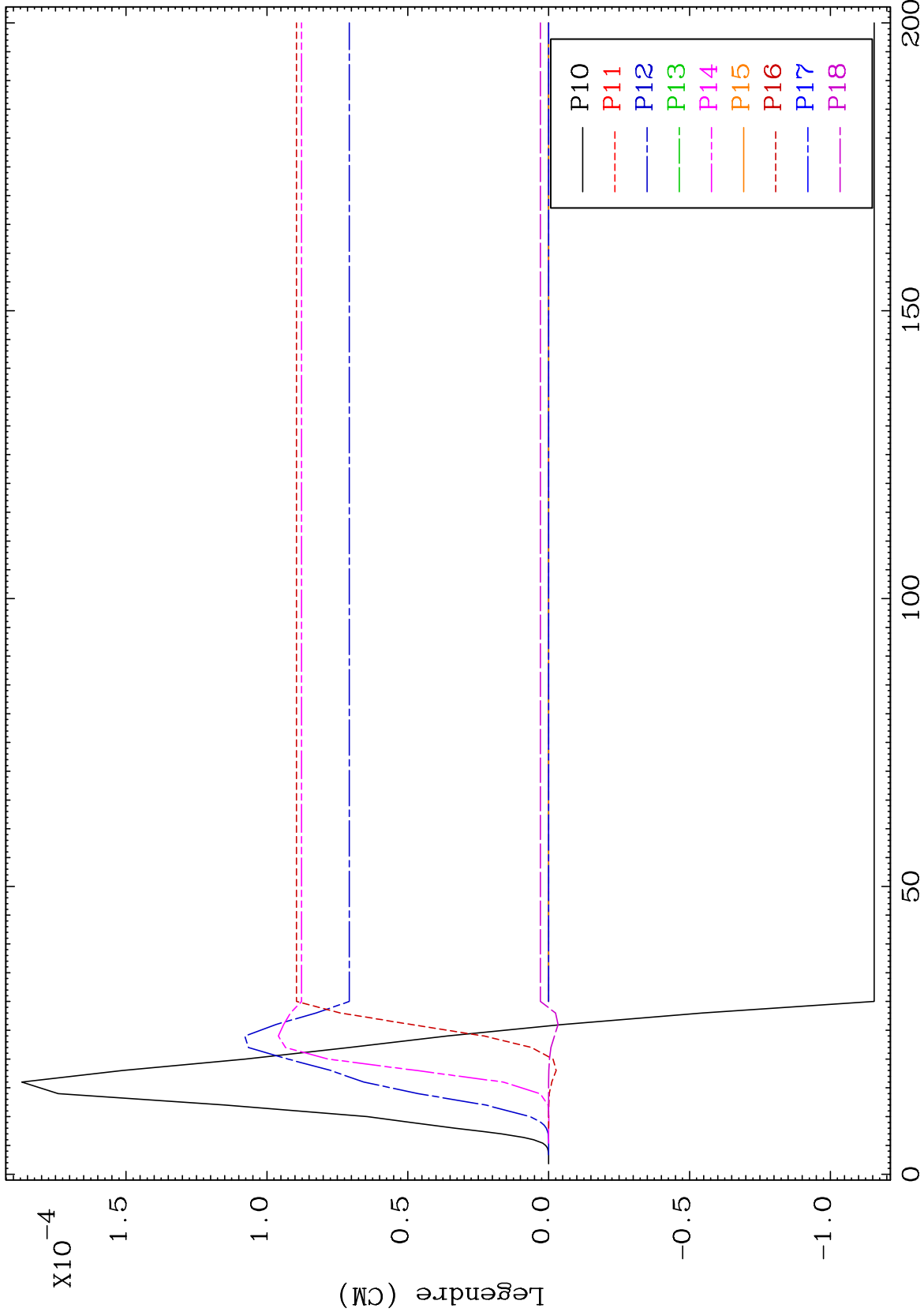

41

56-Ba-141

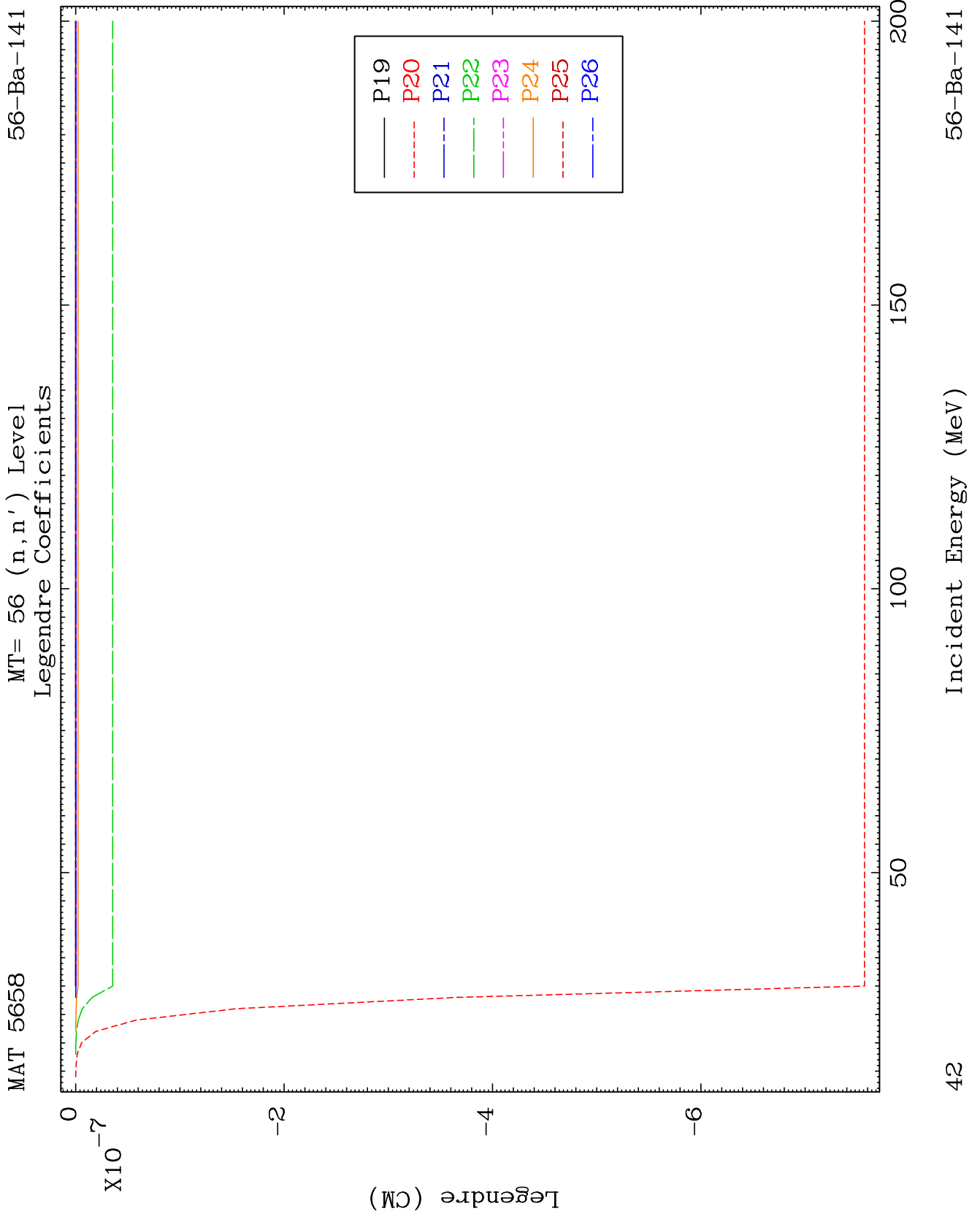

MAT 5658

MT= 57 (n,n') Level
Legendre Coefficients

56-Ba-141

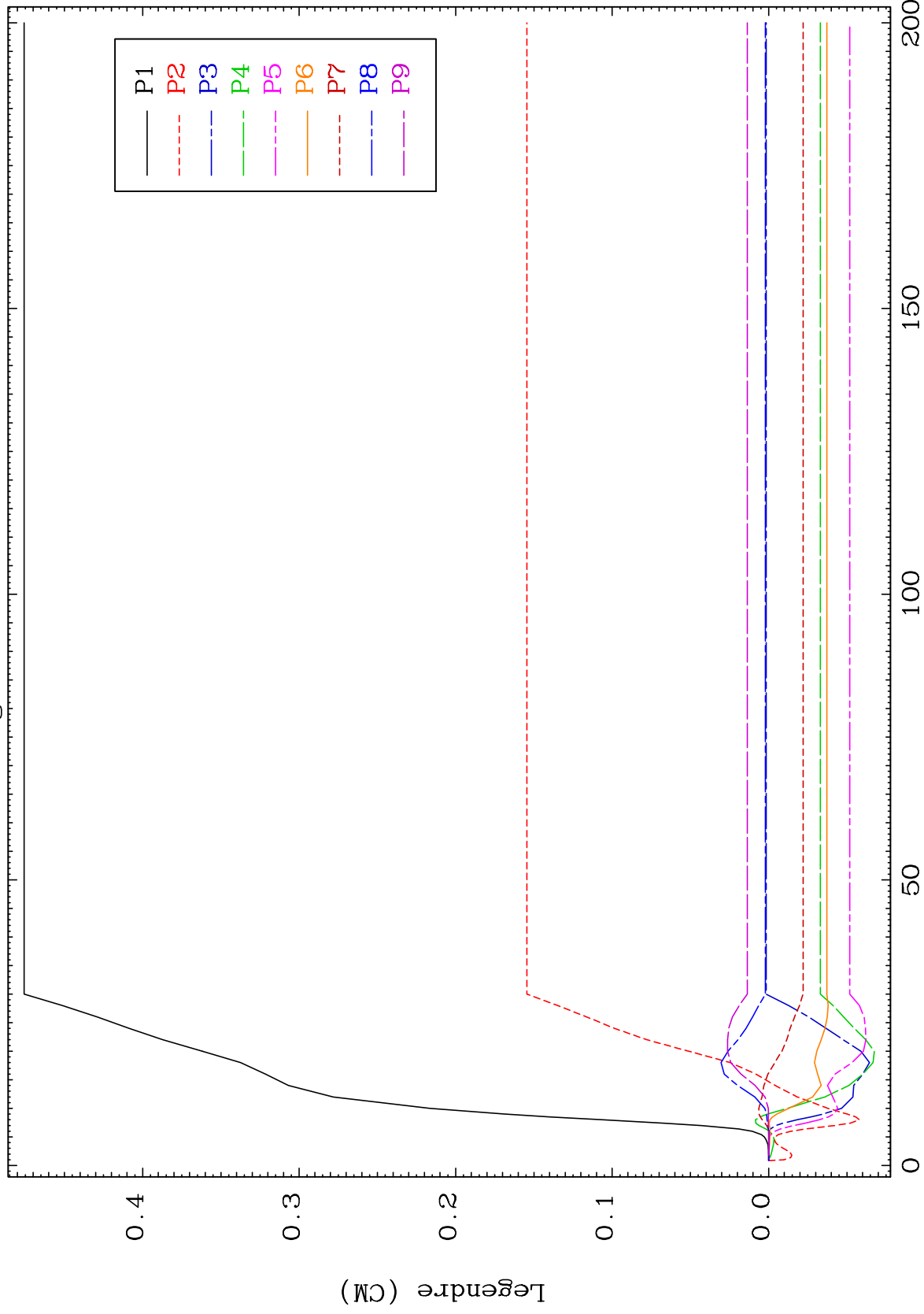

43

56-Ba-141

MAT 5658

MT= 57 (n,n') Level
Legendre Coefficients

56-Ba-141

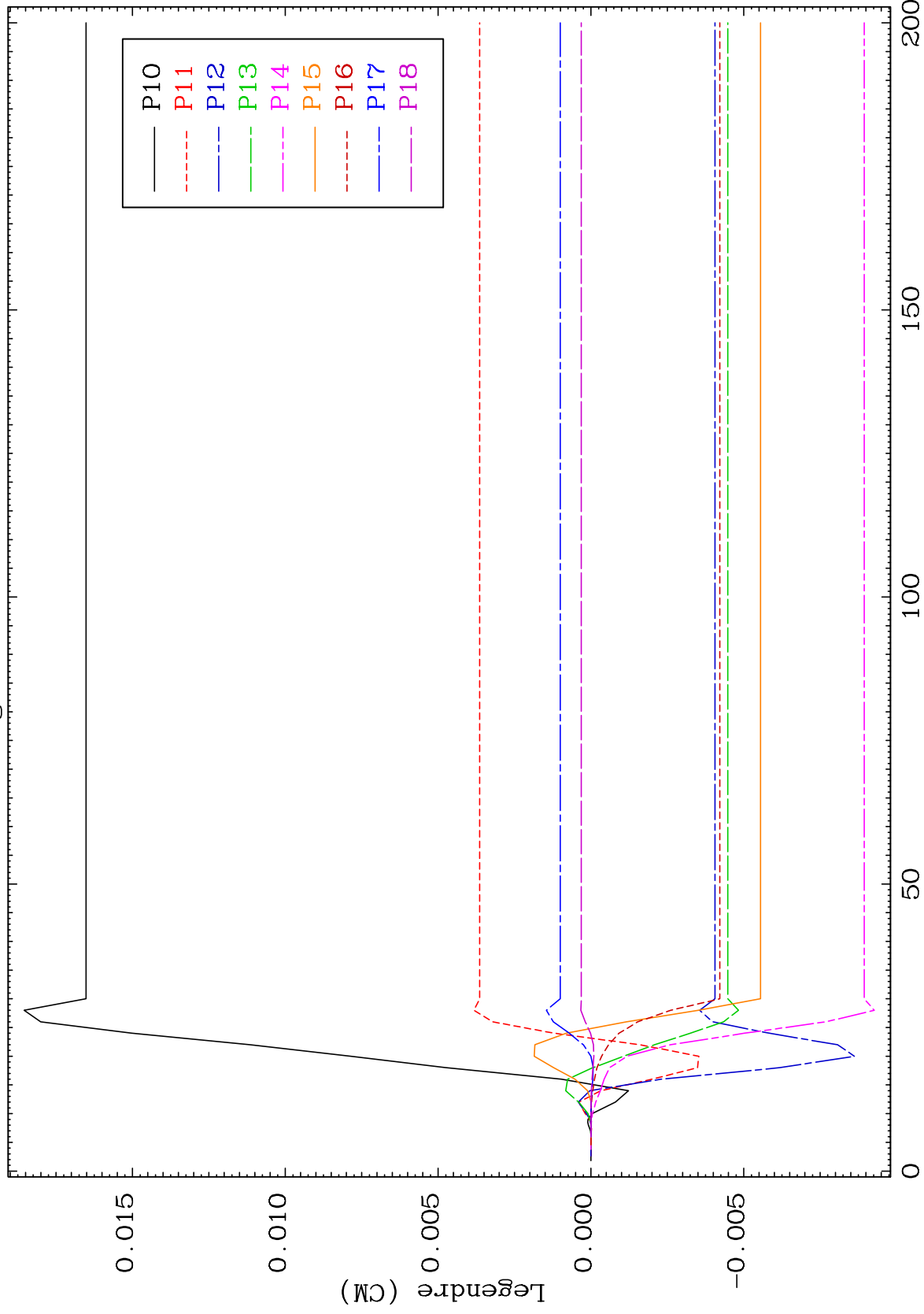

44

56-Ba-141

MAT 5658

MT= 57 (n,n') Level
Legendre Coefficients

56-Ba-141

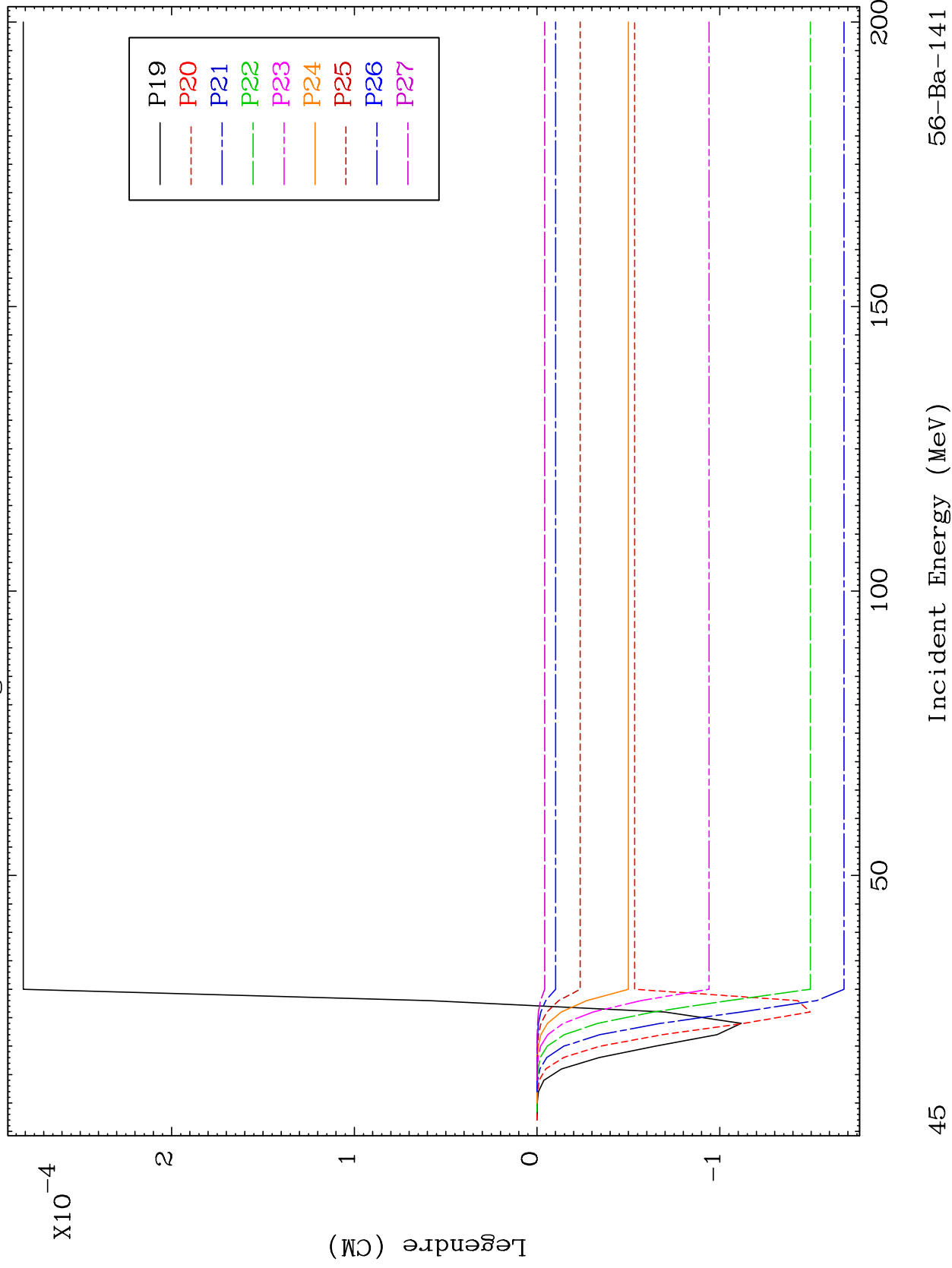

45

Incident Energy (MeV)

56-Ba-141

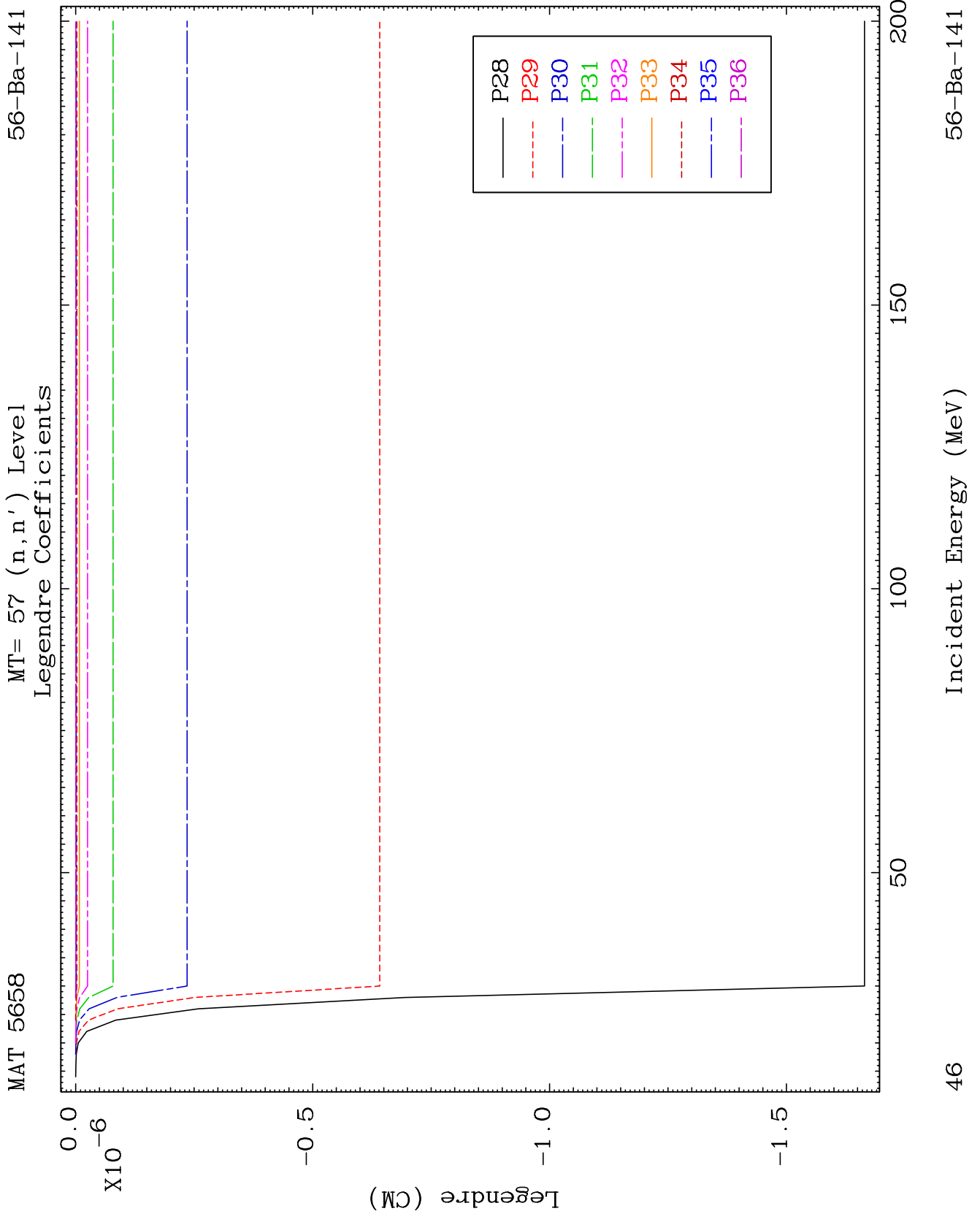

MAT 5658

MT= 58 (n,n') Level
Legendre Coefficients

56-Ba-141

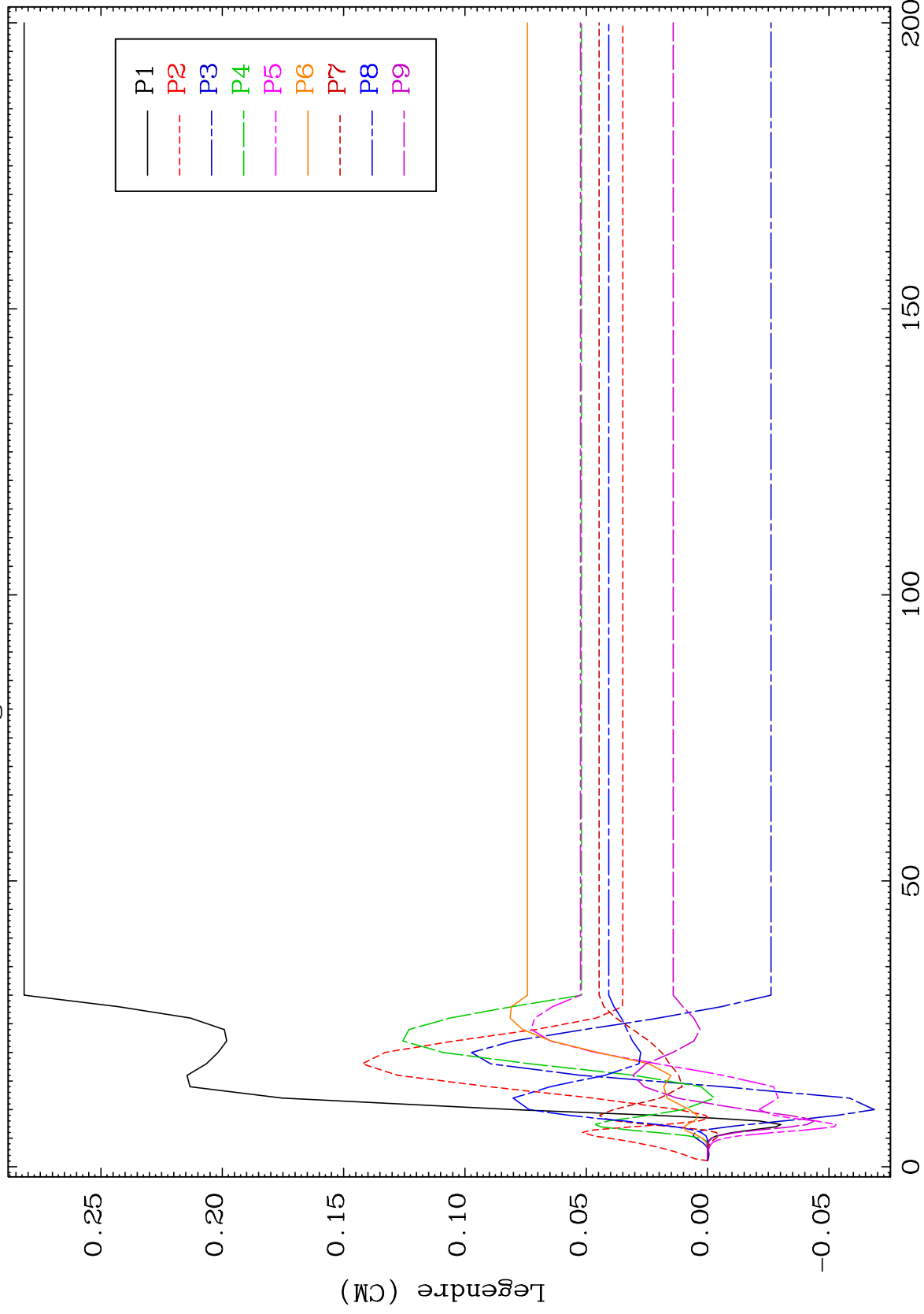

47

Incident Energy (MeV)

56-Ba-141

MAT 5658

56-Ba-141

MT= 58 (n,n') Level
Legendre Coefficients

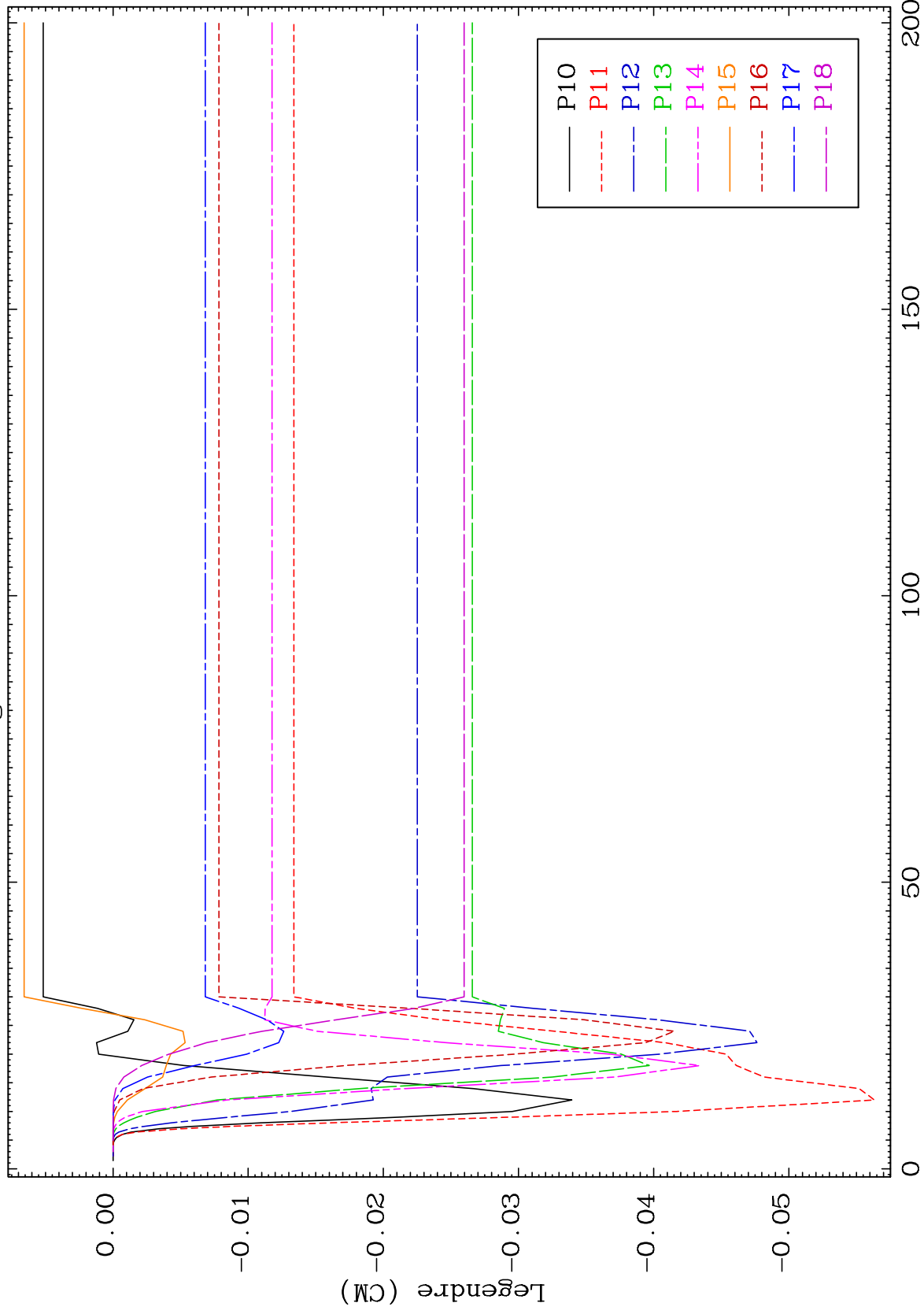

48

Incident Energy (MeV)

56-Ba-141

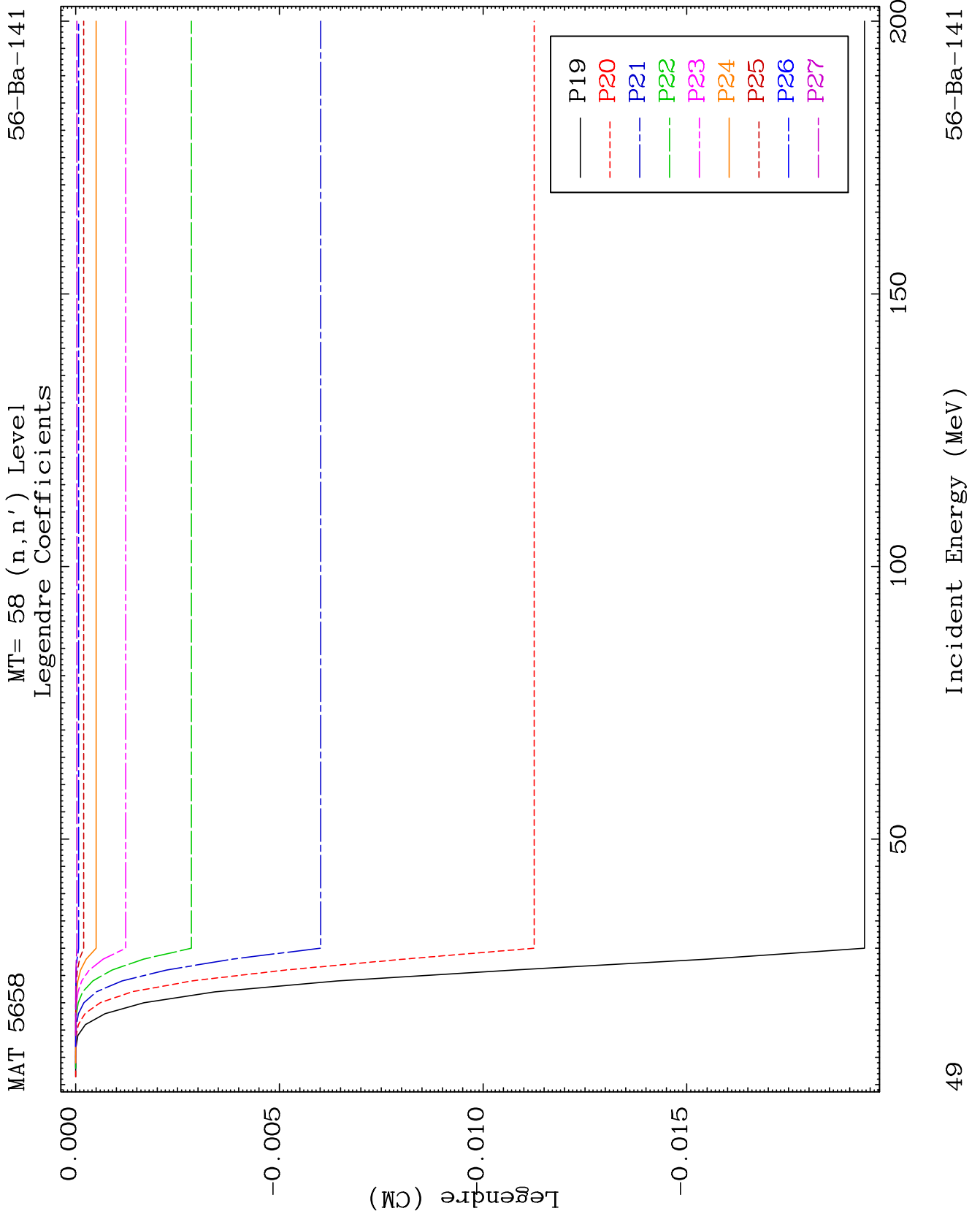

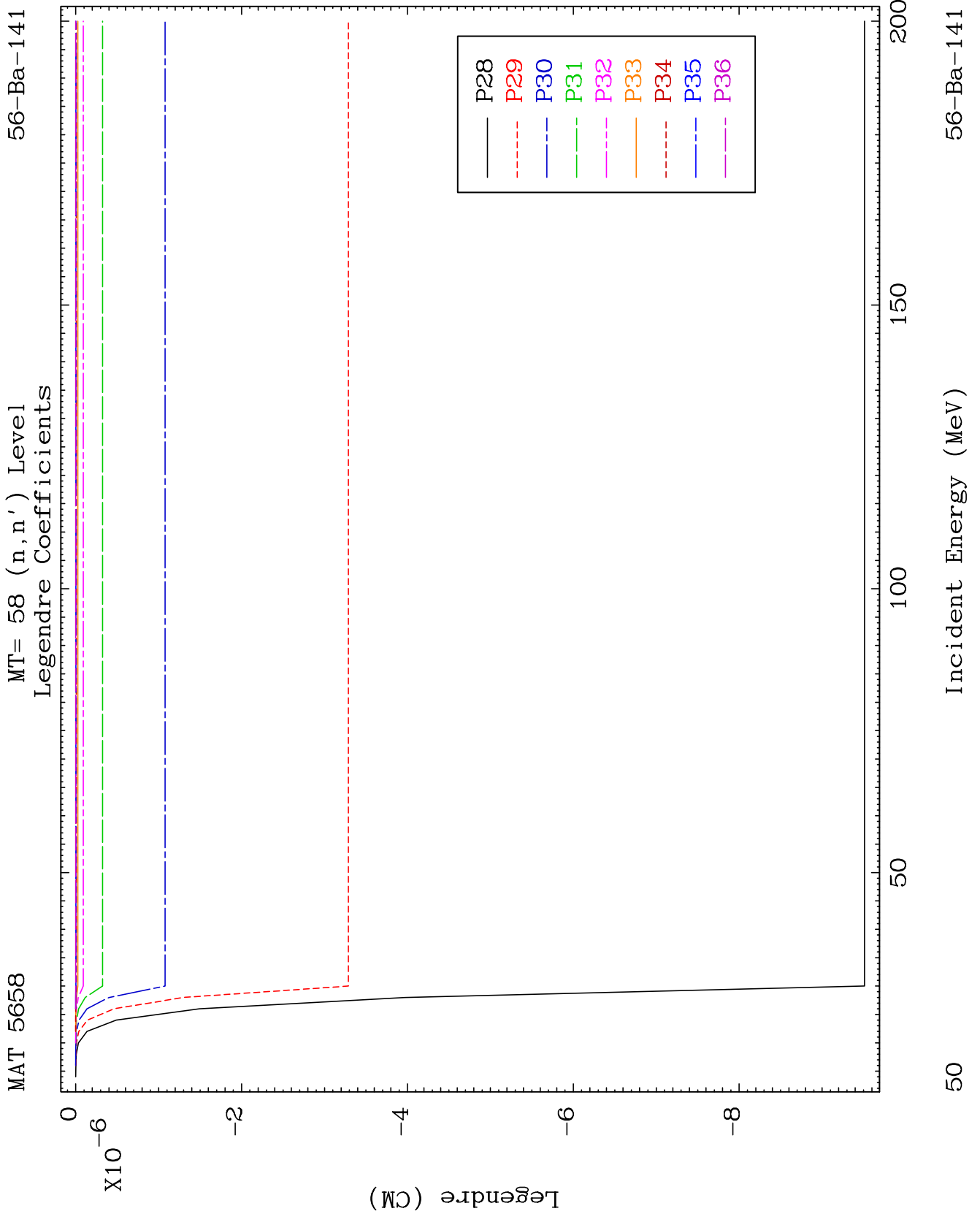

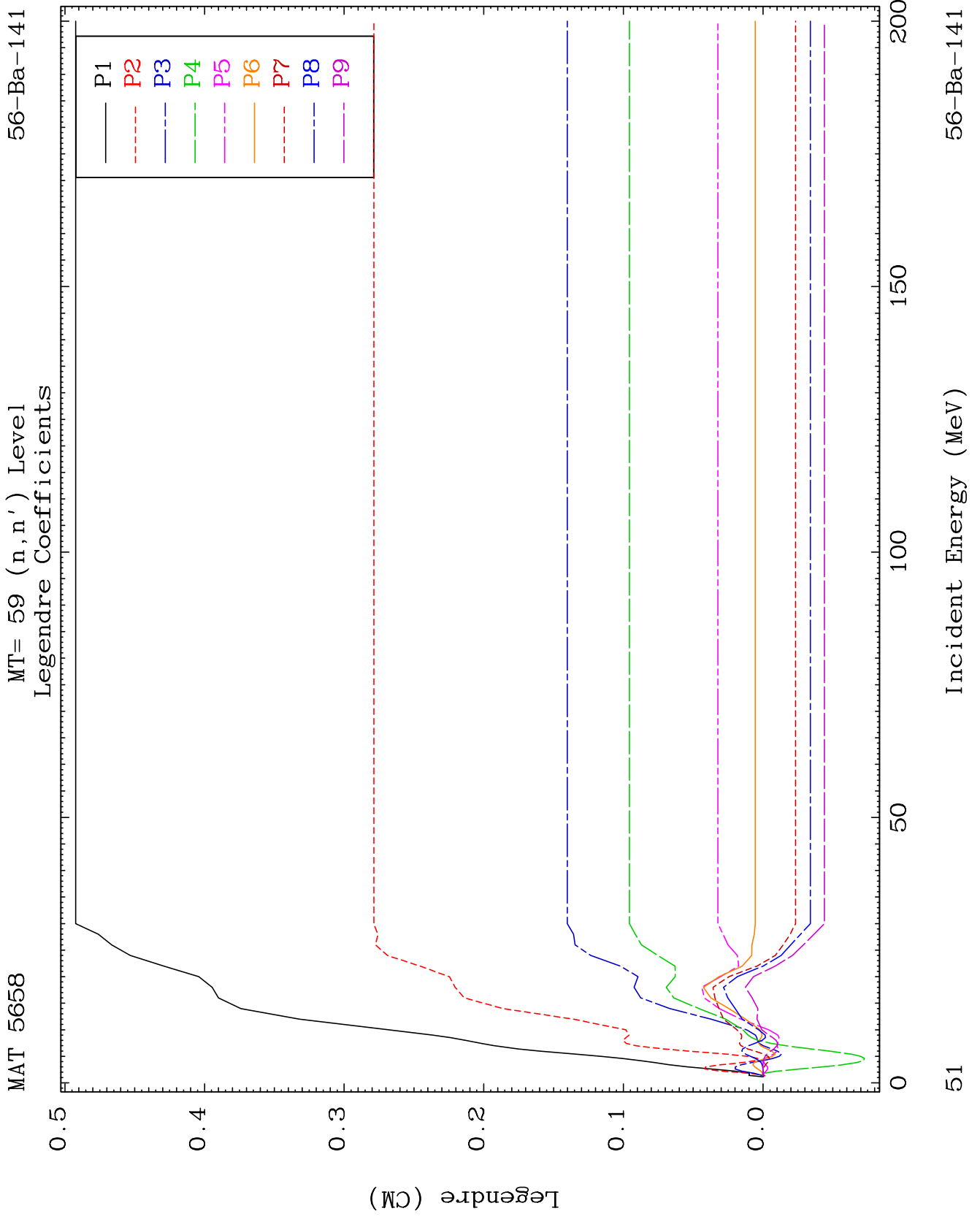

MAT 5658

MT= 59 (n,n') Level
Legendre Coefficients

56-Ba-141

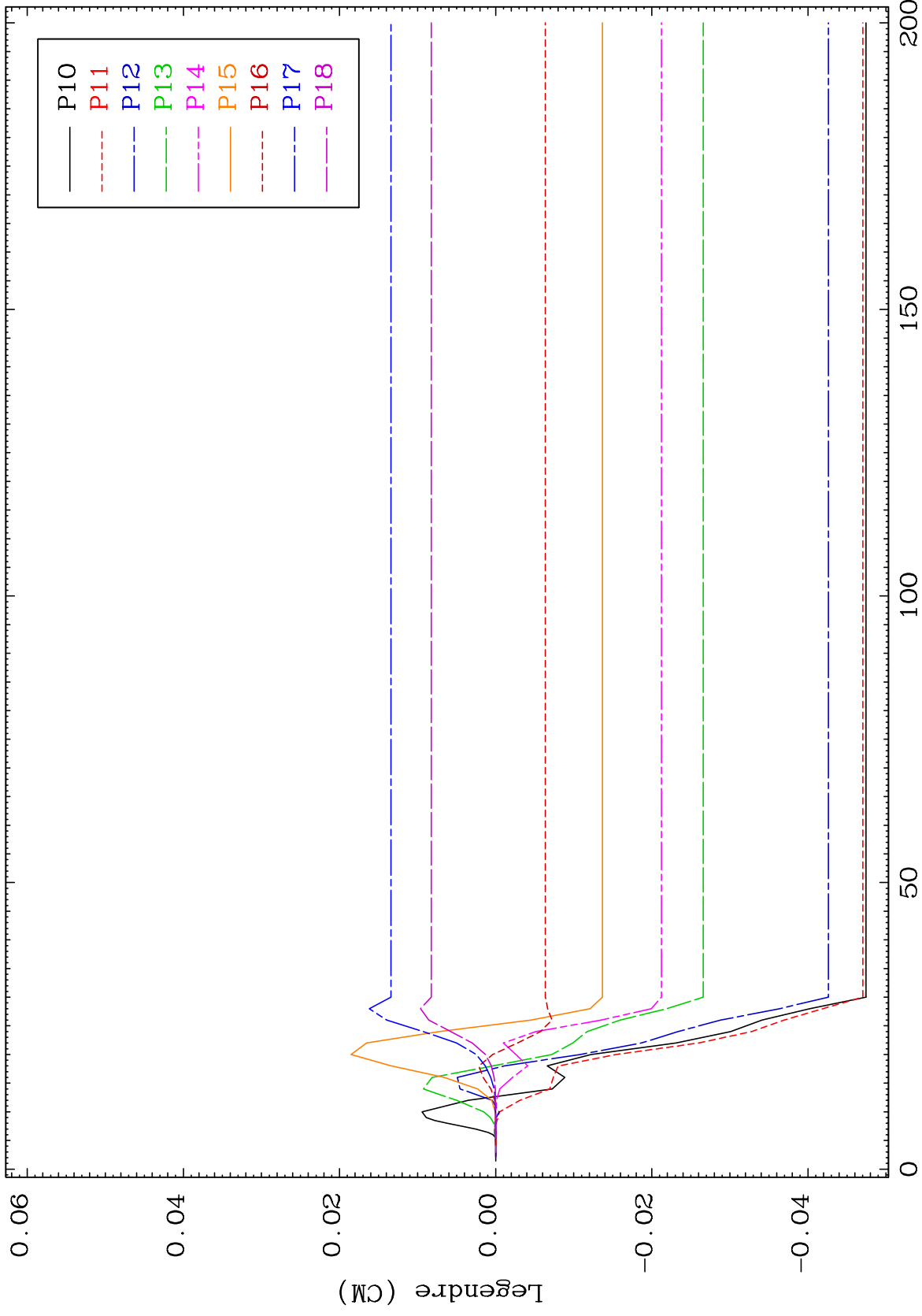

52

Incident Energy (MeV)

56-Ba-141

MAT 5658

MT= 59 (n,n') Level
Legendre Coefficients

56-Ba-141

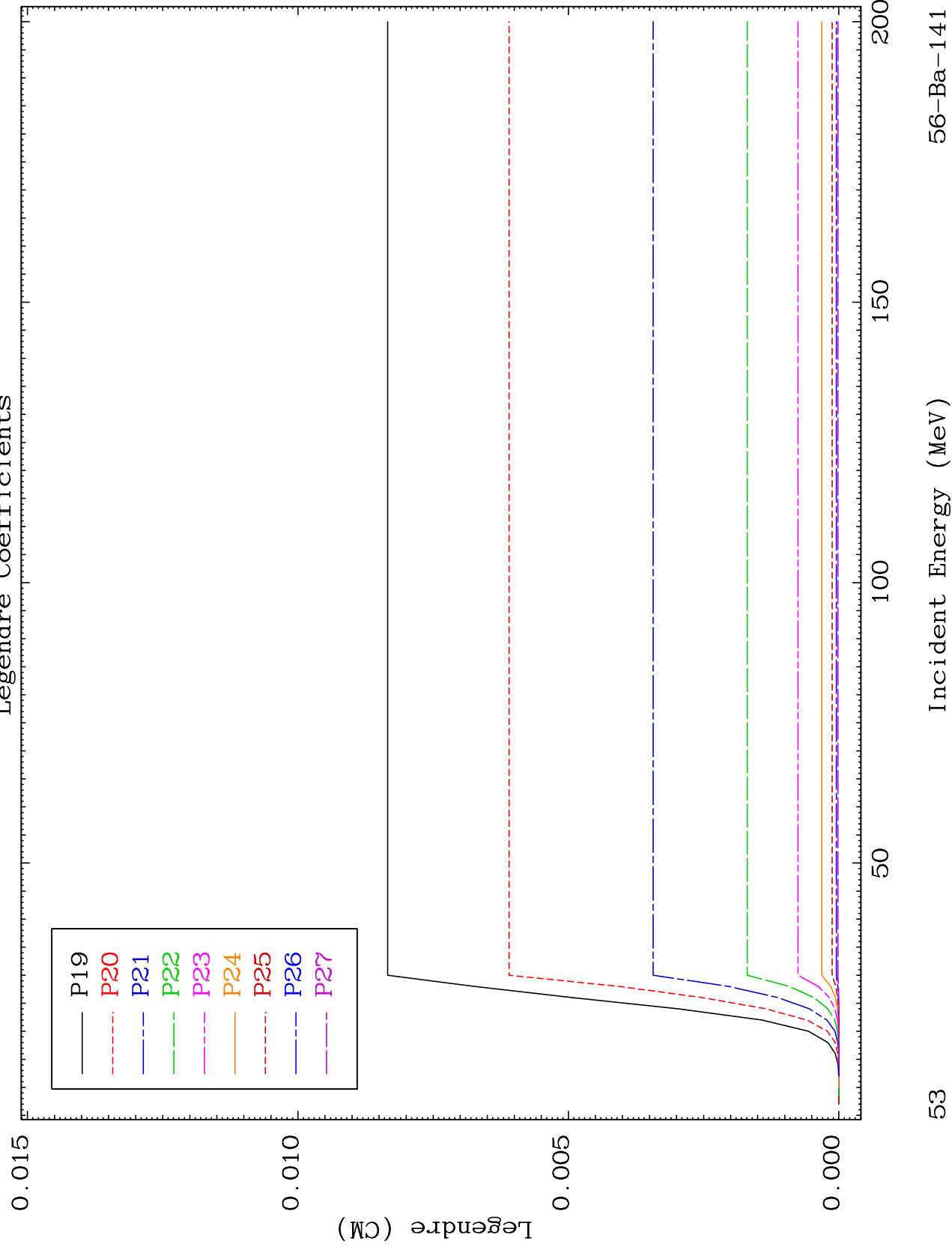

53

Incident Energy (MeV)

56-Ba-141

MAT 5658

MT= 59 (n,n') Level
Legendre Coefficients

56-Ba-141

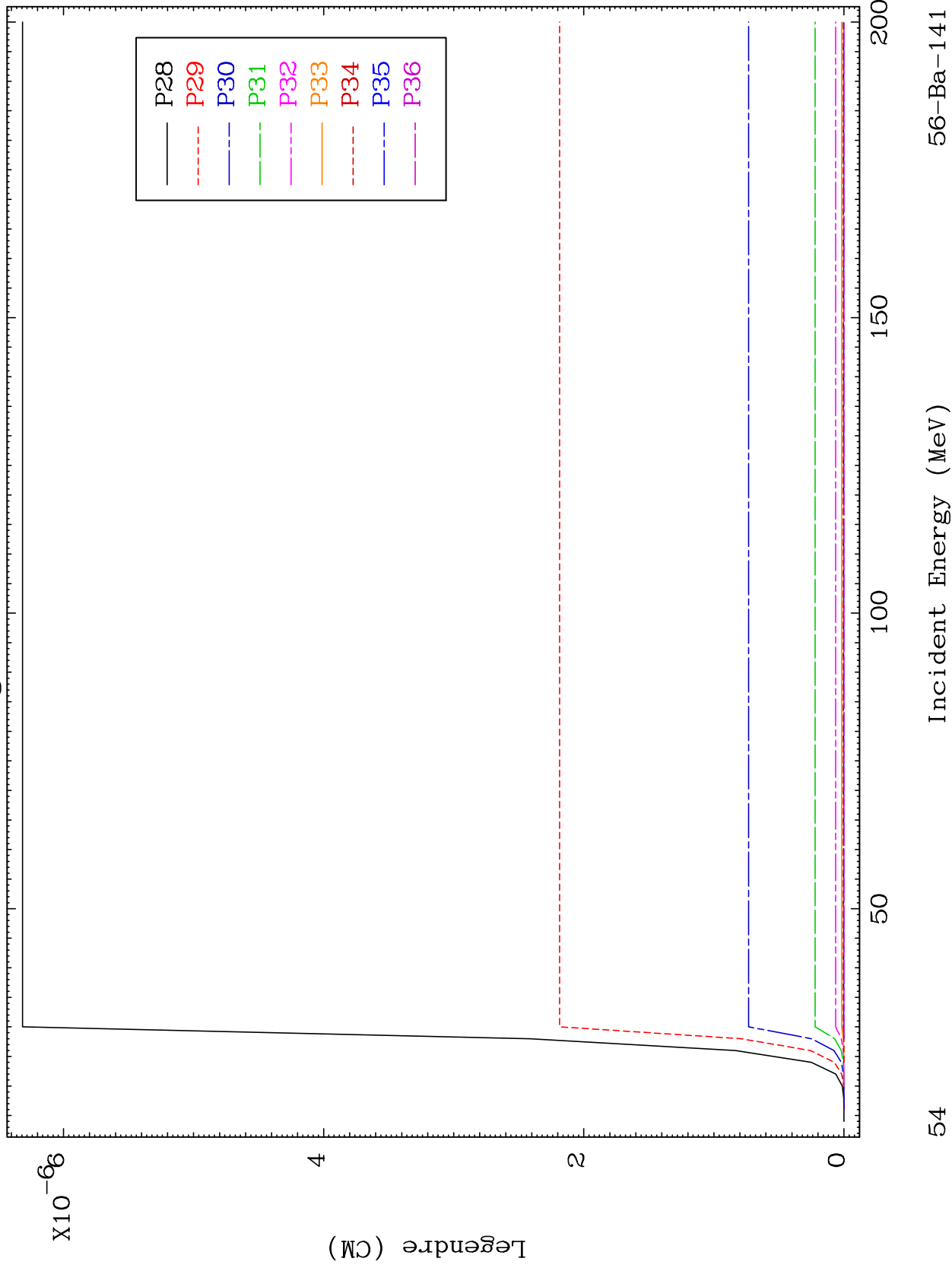

54

Incident Energy (MeV)

56-Ba-141

MAT 5658

MT= 60 (n,n') Level
Legendre Coefficients

56-Ba-141

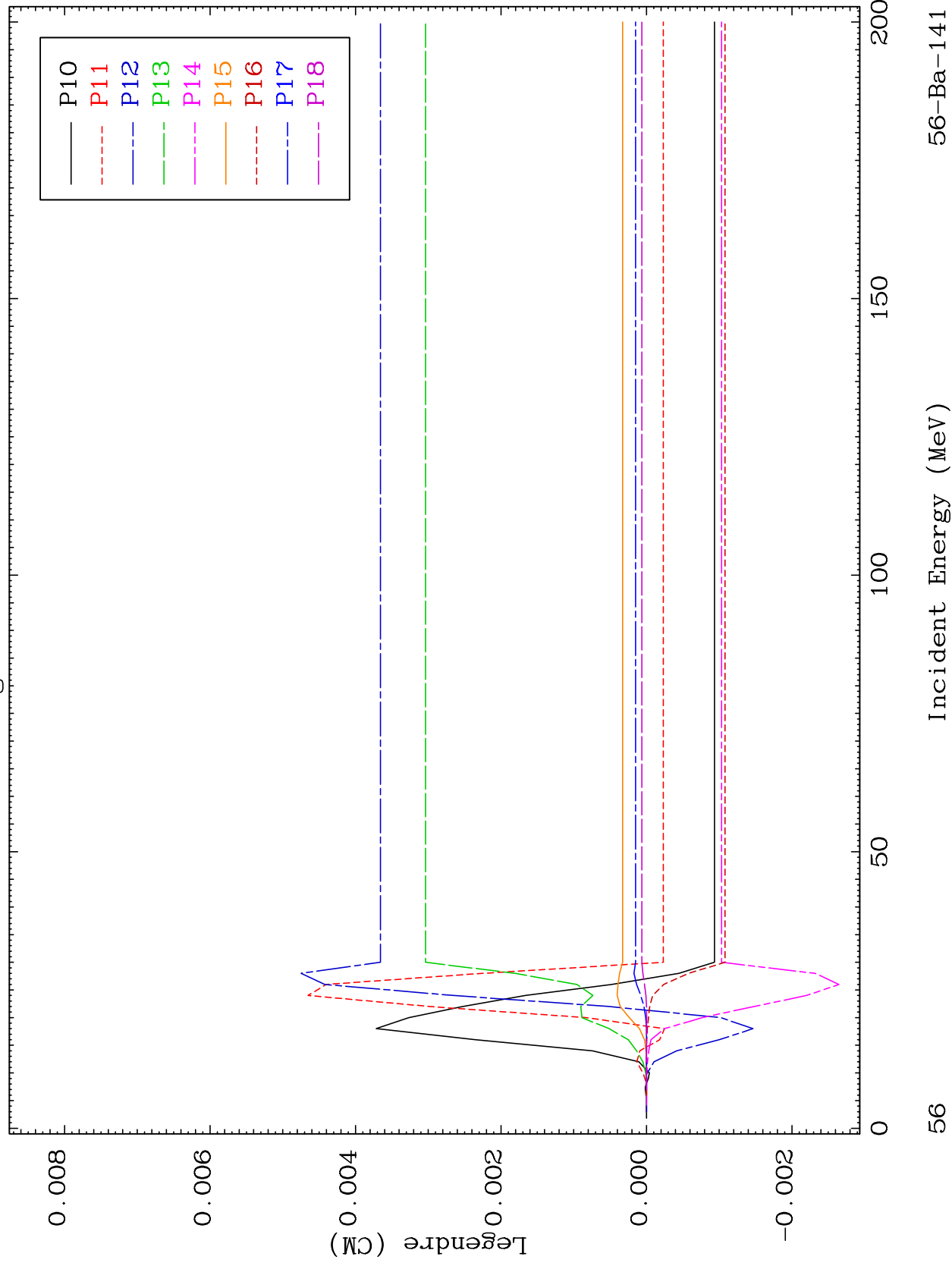

MAT 5658

MT= 60 (n,n') Level
Legendre Coefficients

56-Ba-141

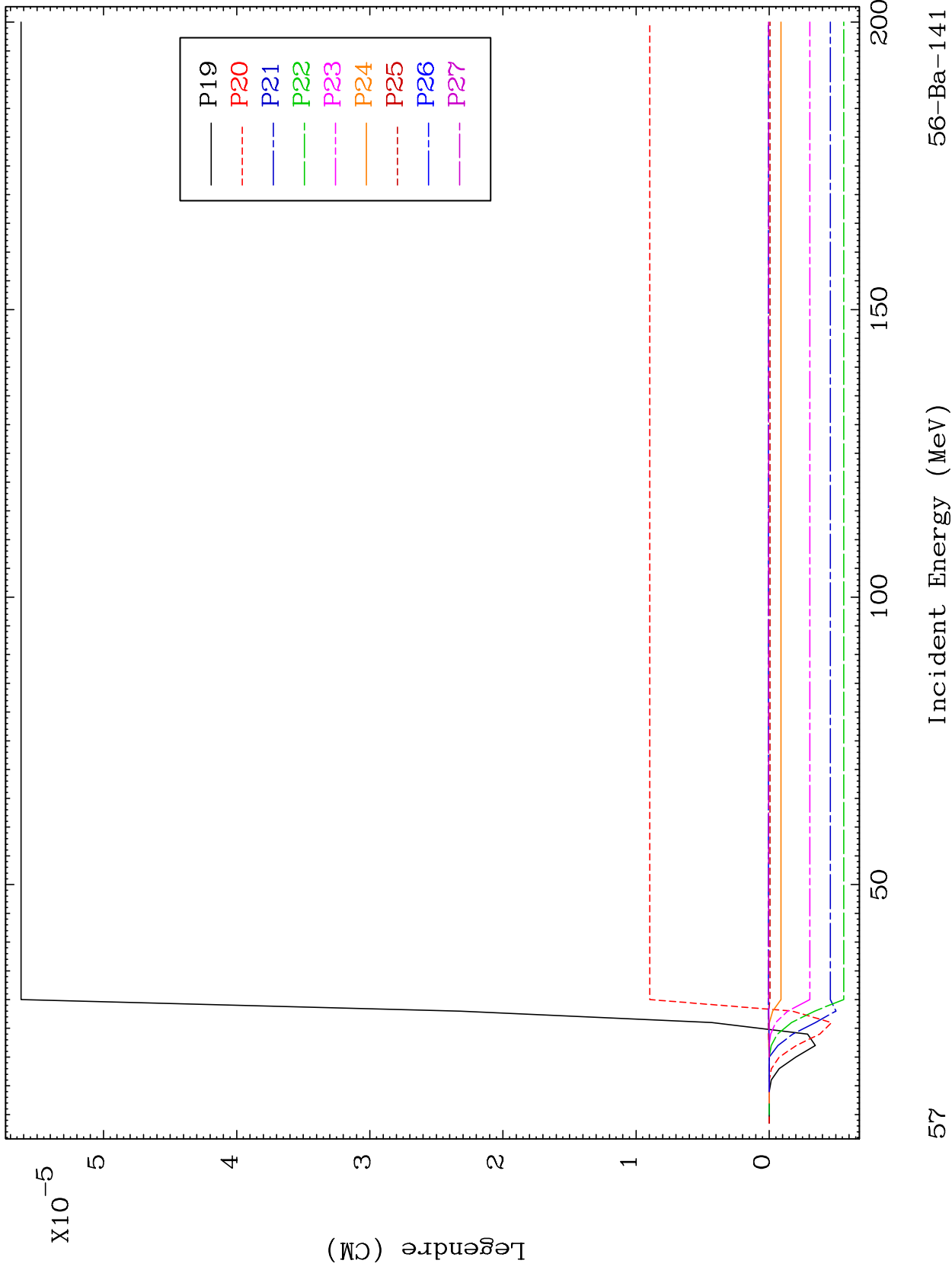

57

56-Ba-141

MAT 5658

MT= 60 (n,n') Level
Legendre Coefficients

56-Ba-141

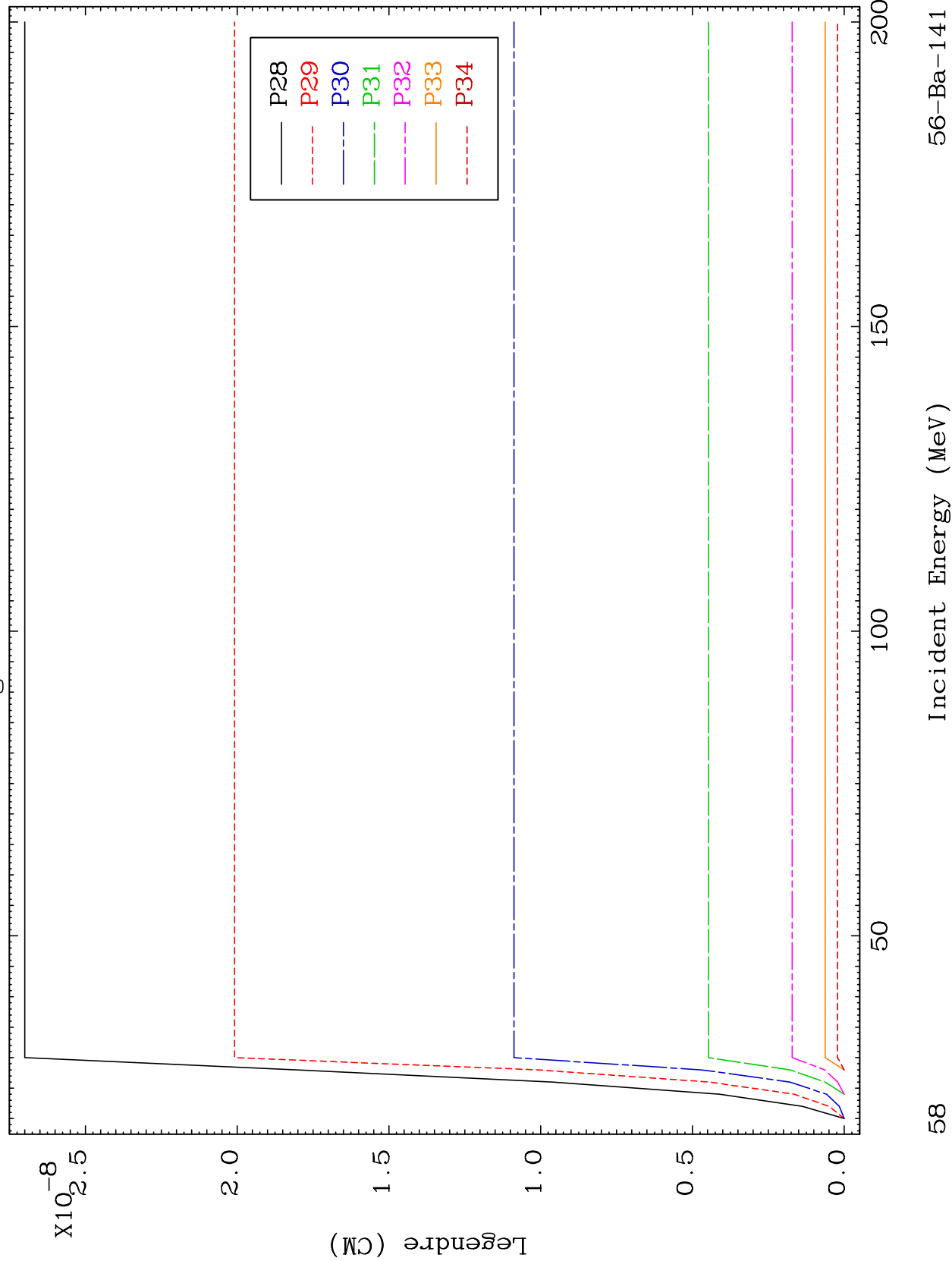

58

Incident Energy (MeV)

56-Ba-141

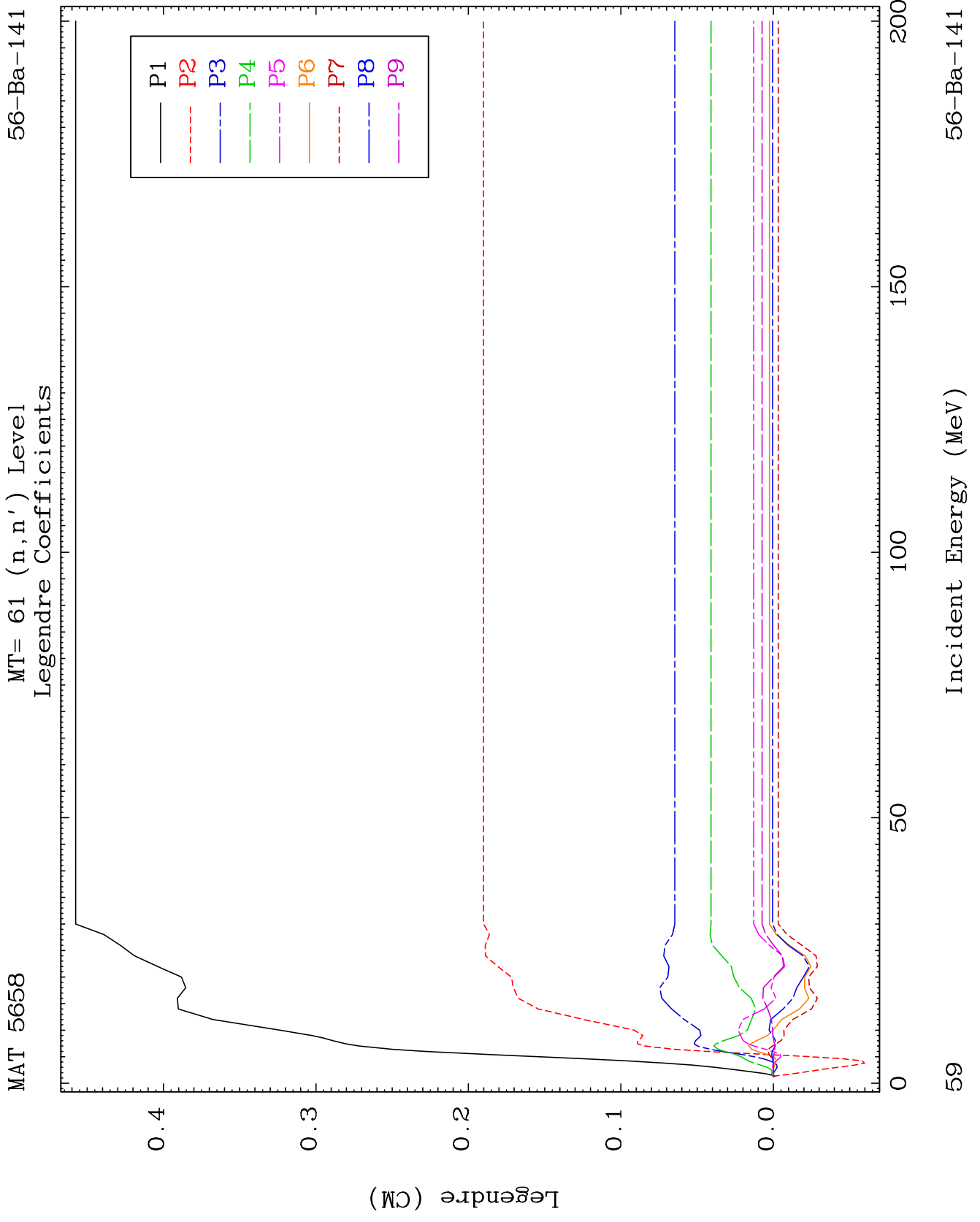

MAT 5658

MT= 61 (n,n') Level
Legendre Coefficients

56-Ba-141

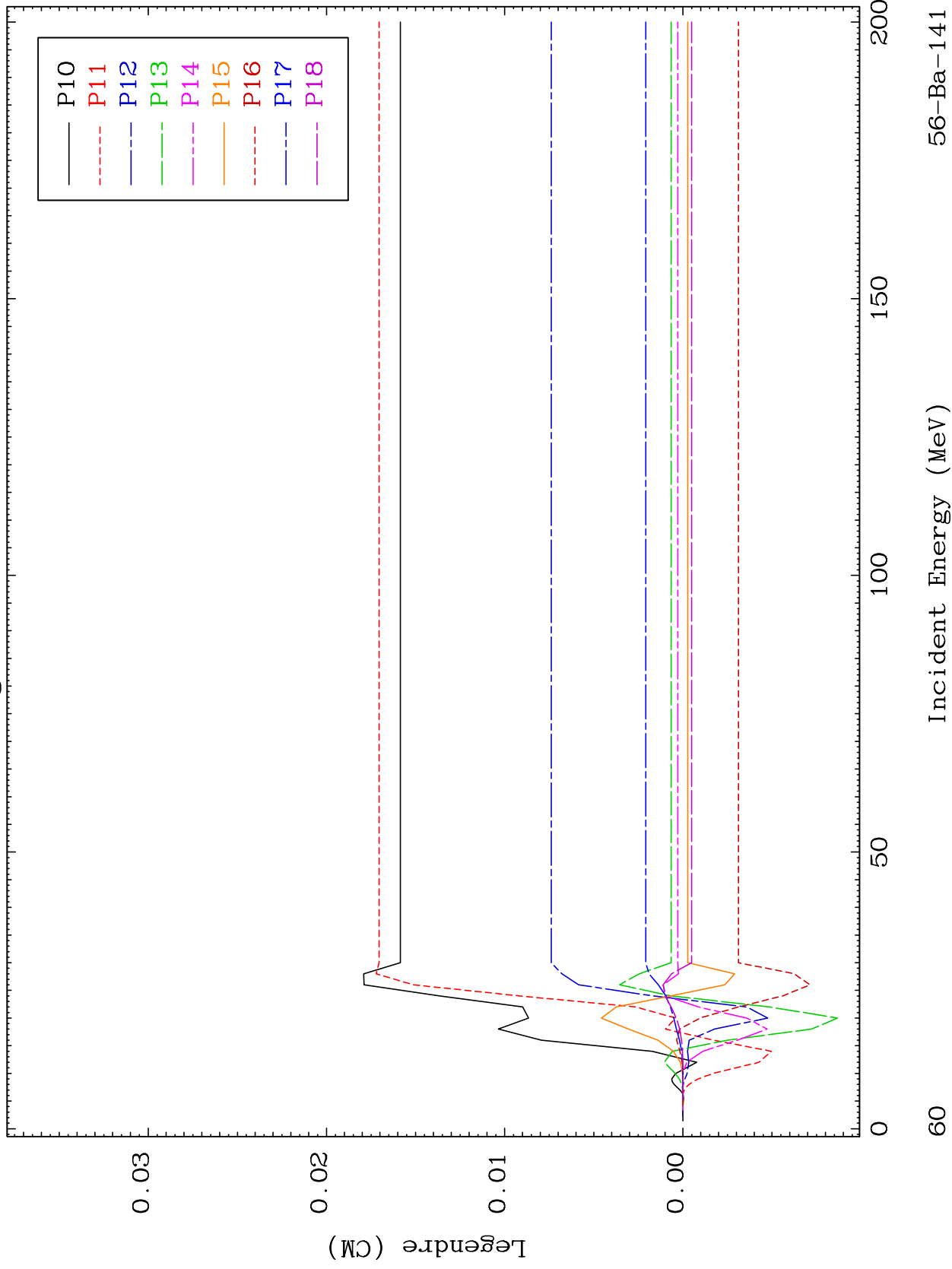

MAT 5658

MT= 61 (n,n') Level
Legendre Coefficients

56-Ba-141

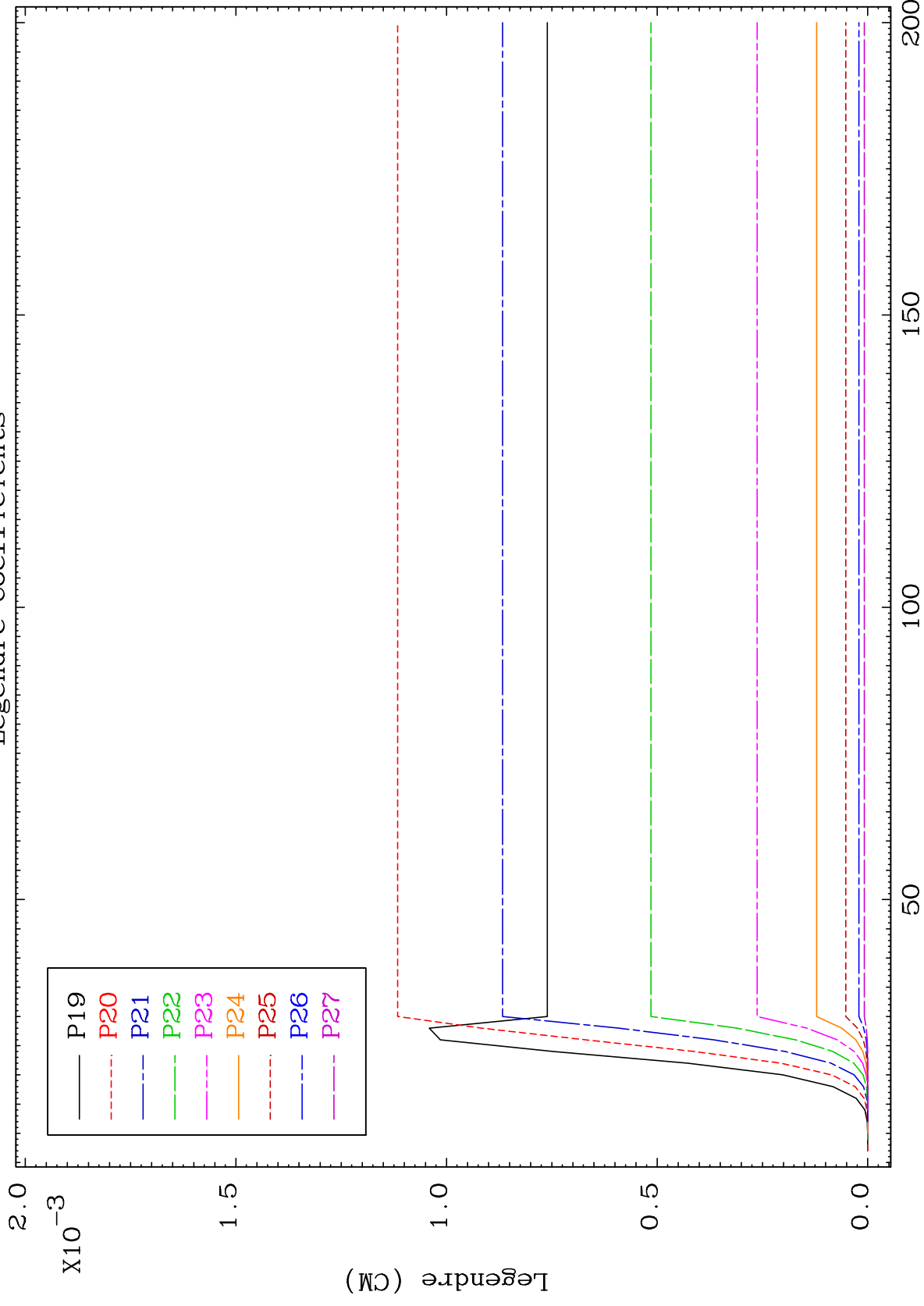

61

Incident Energy (MeV)

56-Ba-141

MAT 5658

MT= 61 (n,n') Level
Legendre Coefficients

56-Ba-141

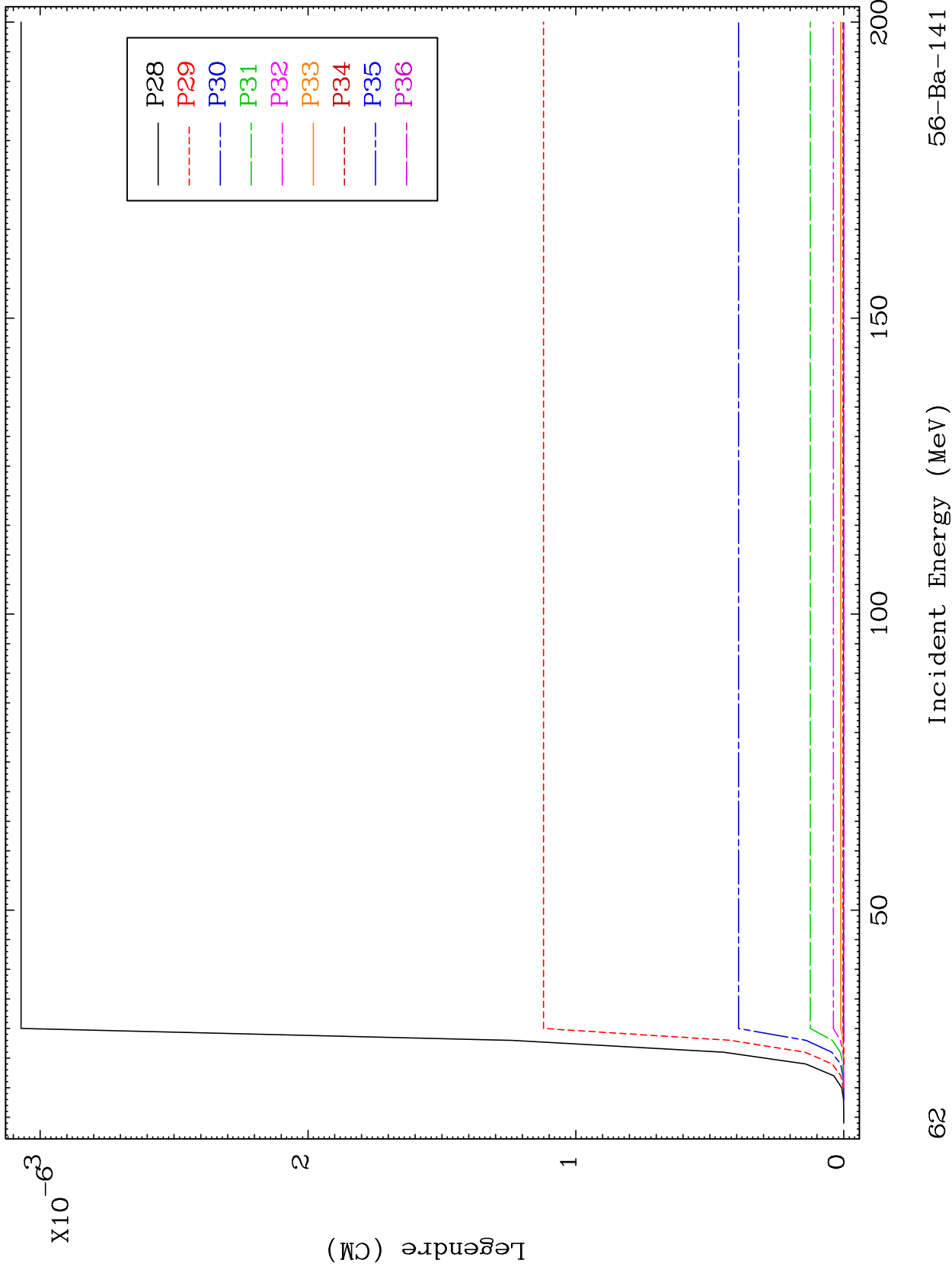

MAT 5658

MT= 62 (n,n') Level
Legendre Coefficients

56-Ba-141

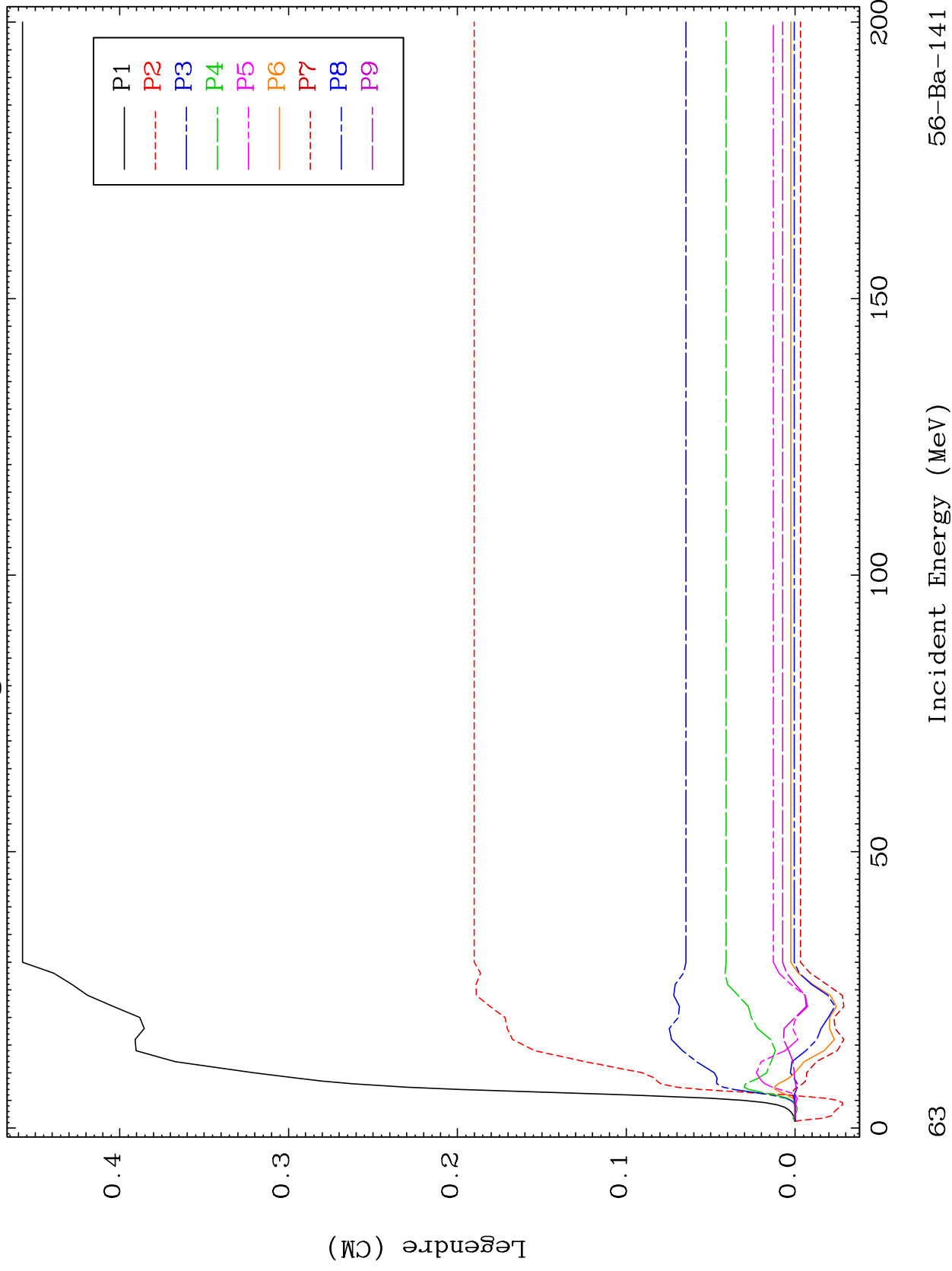

56-Ba-141

Incident Energy (MeV)

63

MAT 5658

MT= 62 (n,n') Level
Legendre Coefficients

56-Ba-141

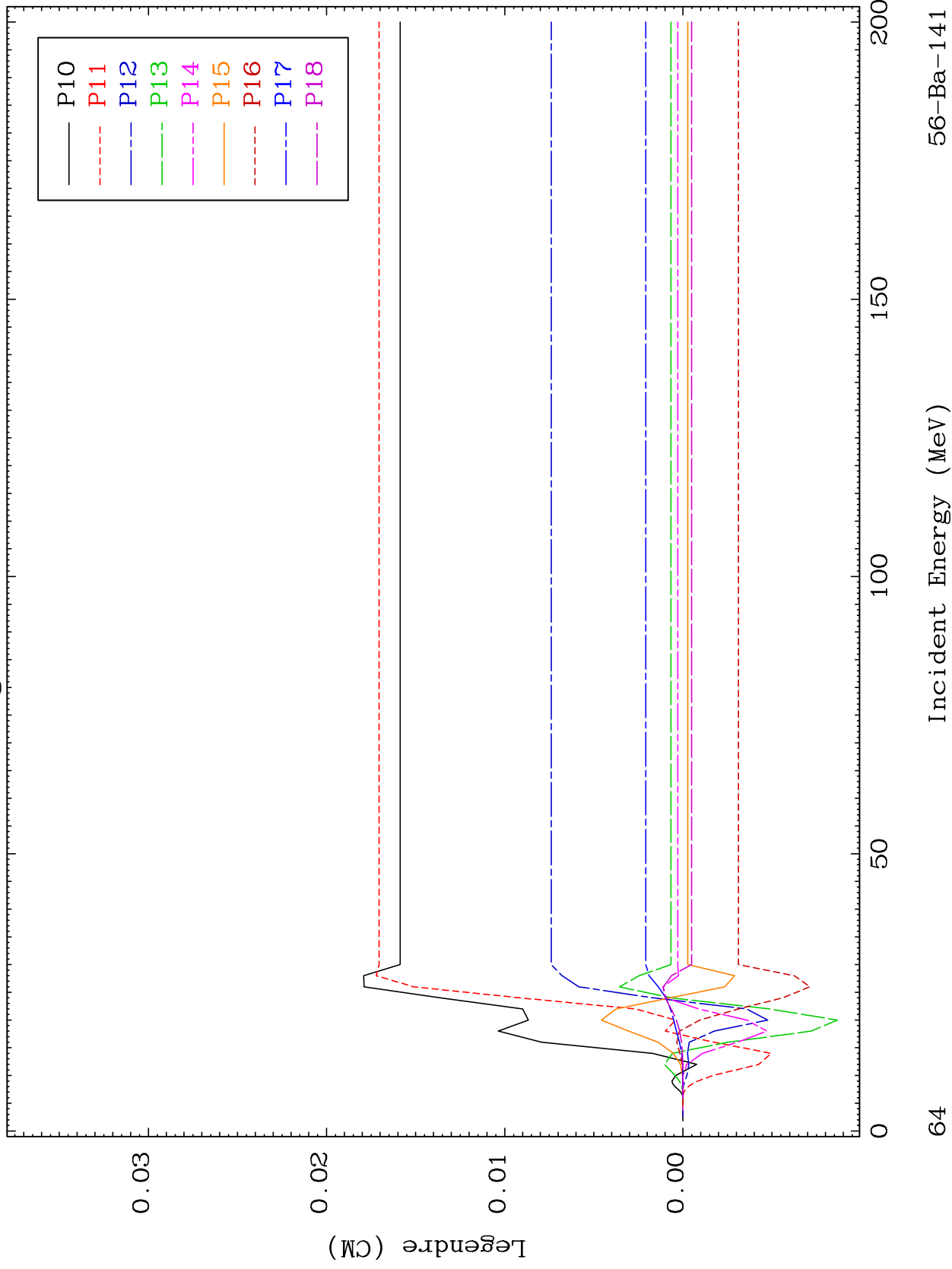

56-Ba-141

Incident Energy (MeV)

64

MAT 5658

MT= 62 (n,n') Level
Legendre Coefficients

56-Ba-141

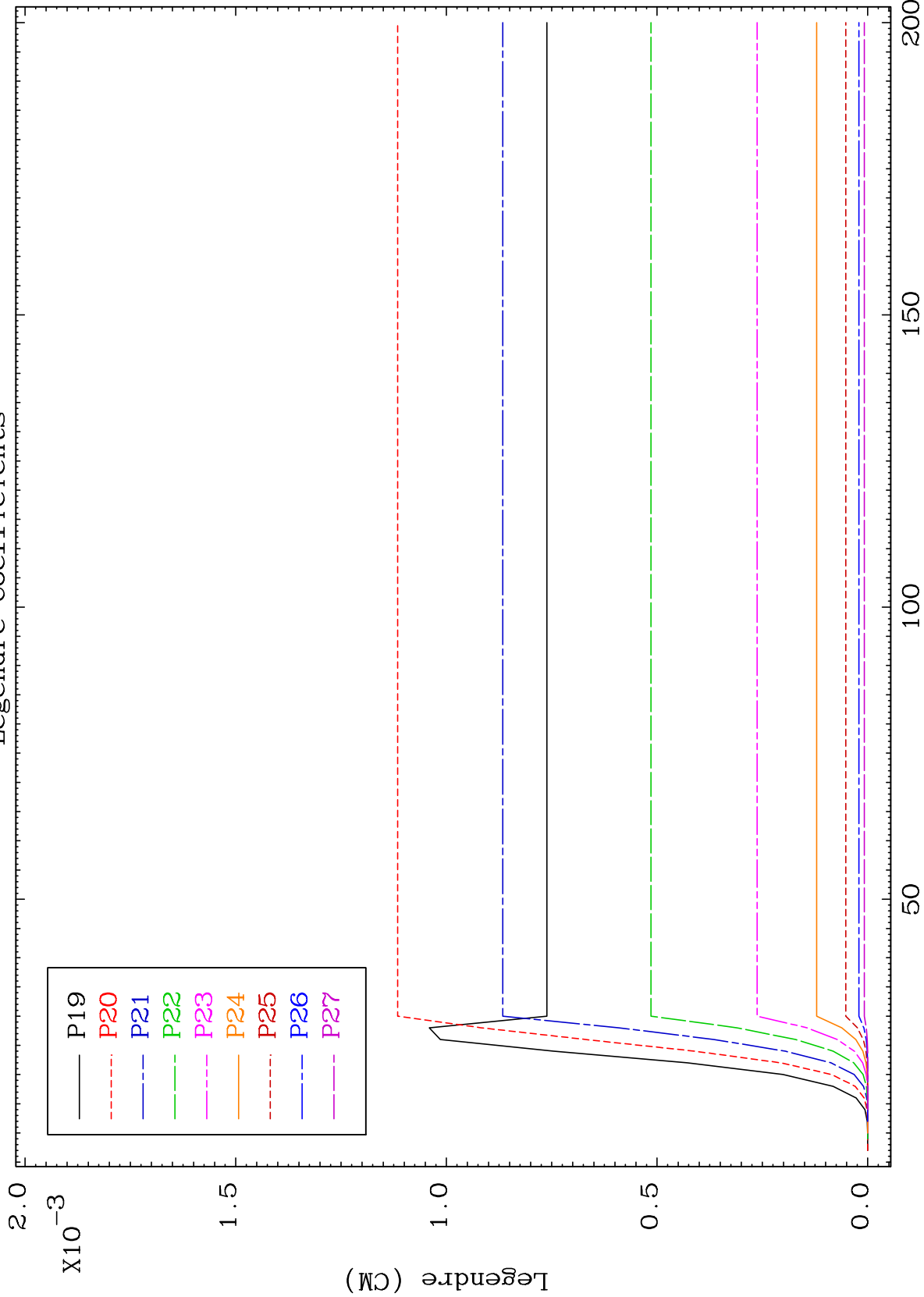

65

Incident Energy (MeV)

56-Ba-141

MAT 5658

MT= 62 (n,n') Level
Legendre Coefficients

56-Ba-141

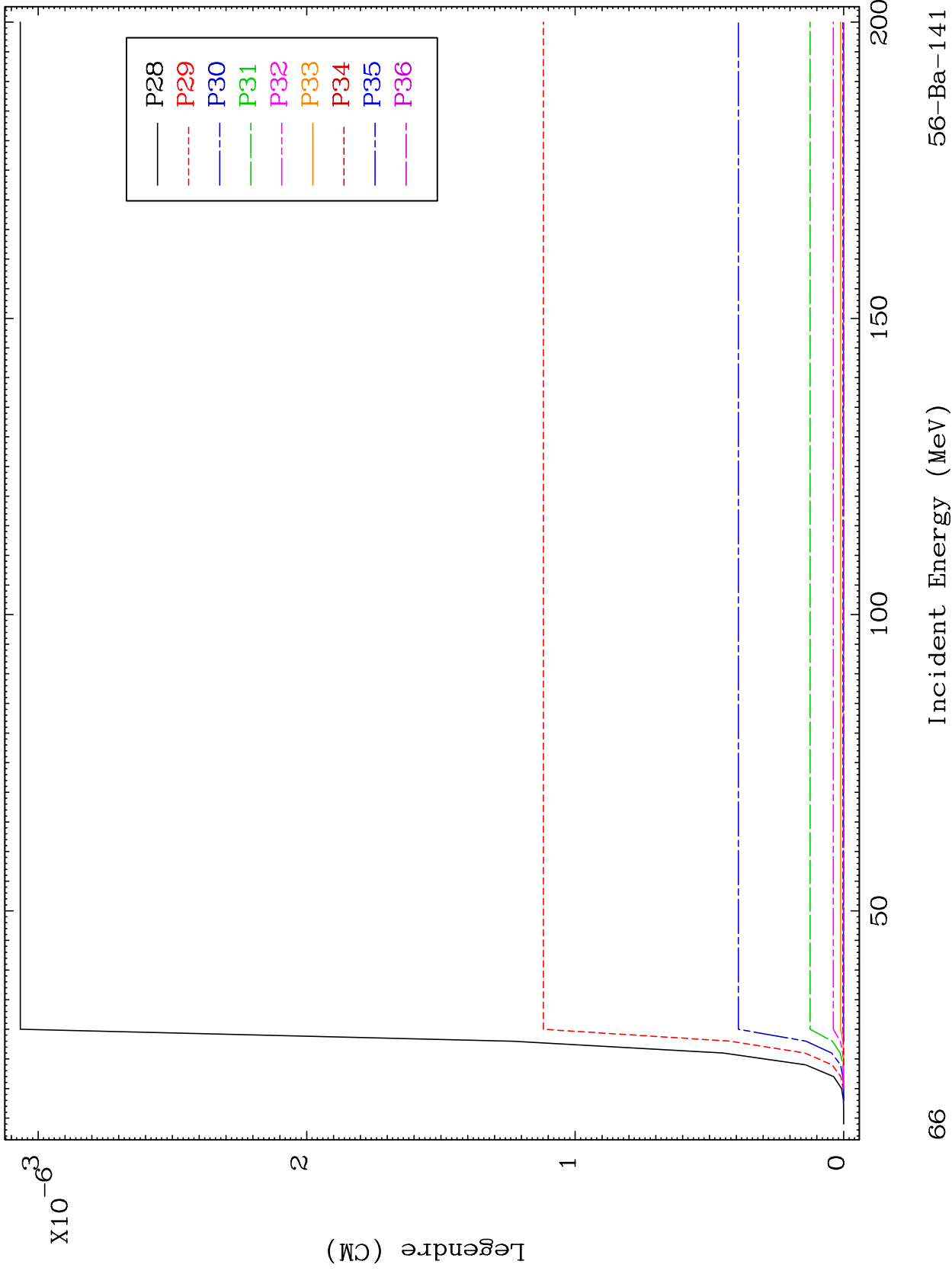

66

56-Ba-141

MAT 5658

MT= 63 (n,n') Level
Legendre Coefficients

56-Ba-141

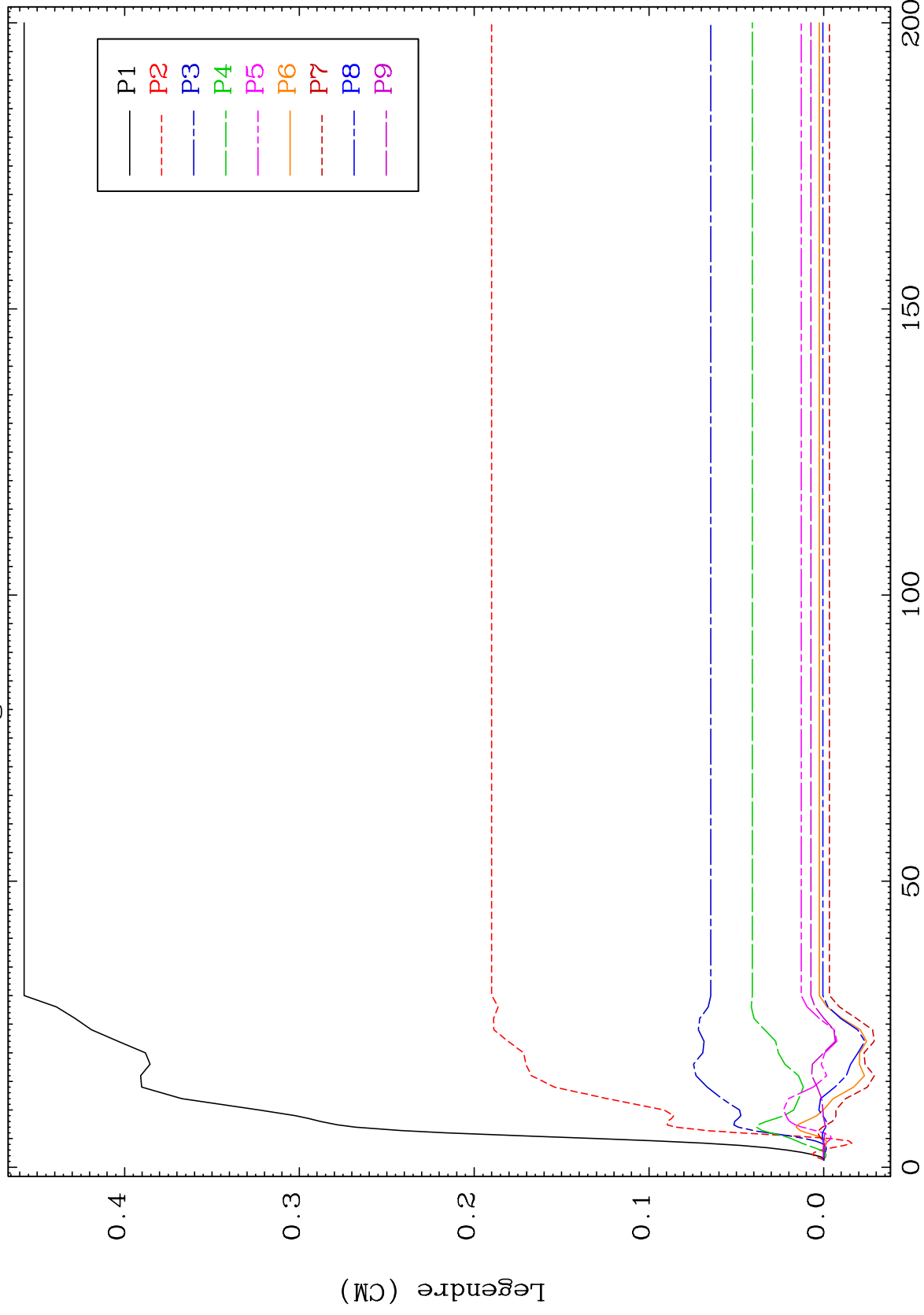

67

56-Ba-141

MAT 5658

MT= 63 (n,n') Level
Legendre Coefficients

56-Ba-141

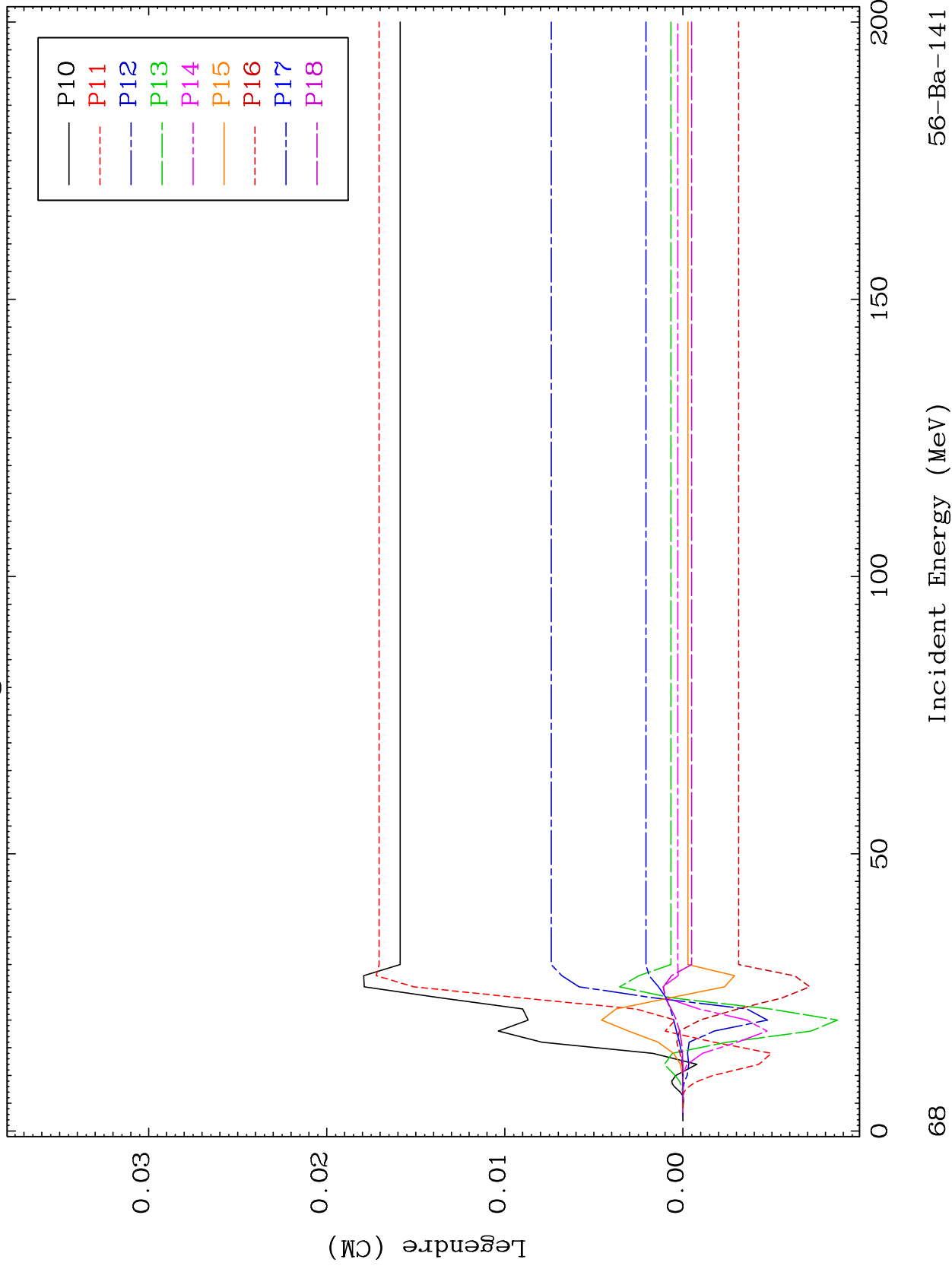

56-Ba-141

Incident Energy (MeV)

68

MAT 5658

MT= 63 (n,n') Level
Legendre Coefficients

56-Ba-141

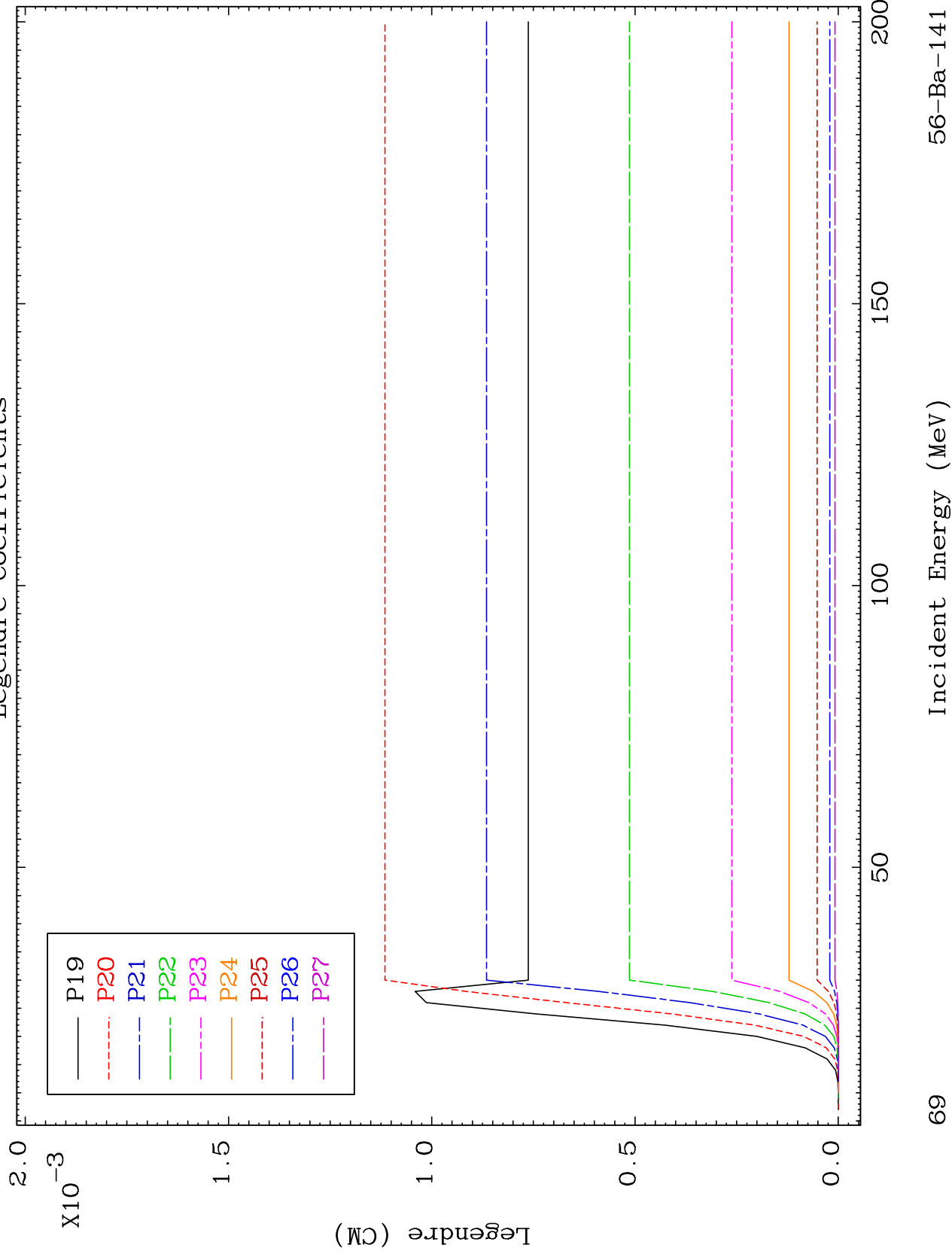

MAT 5658

MT= 63 (n,n') Level
Legendre Coefficients

56-Ba-141

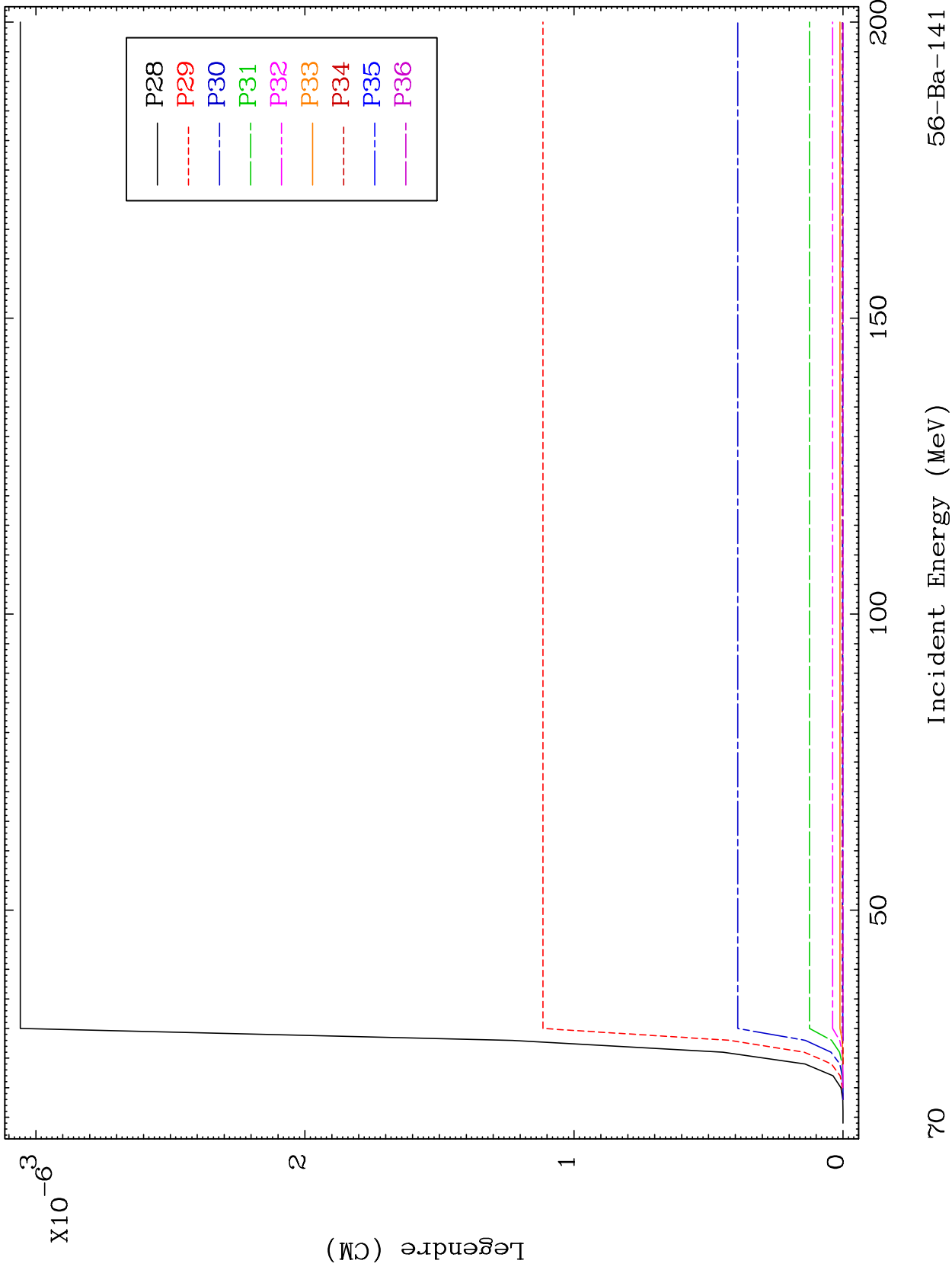

70

Incident Energy (MeV)

56-Ba-141

200

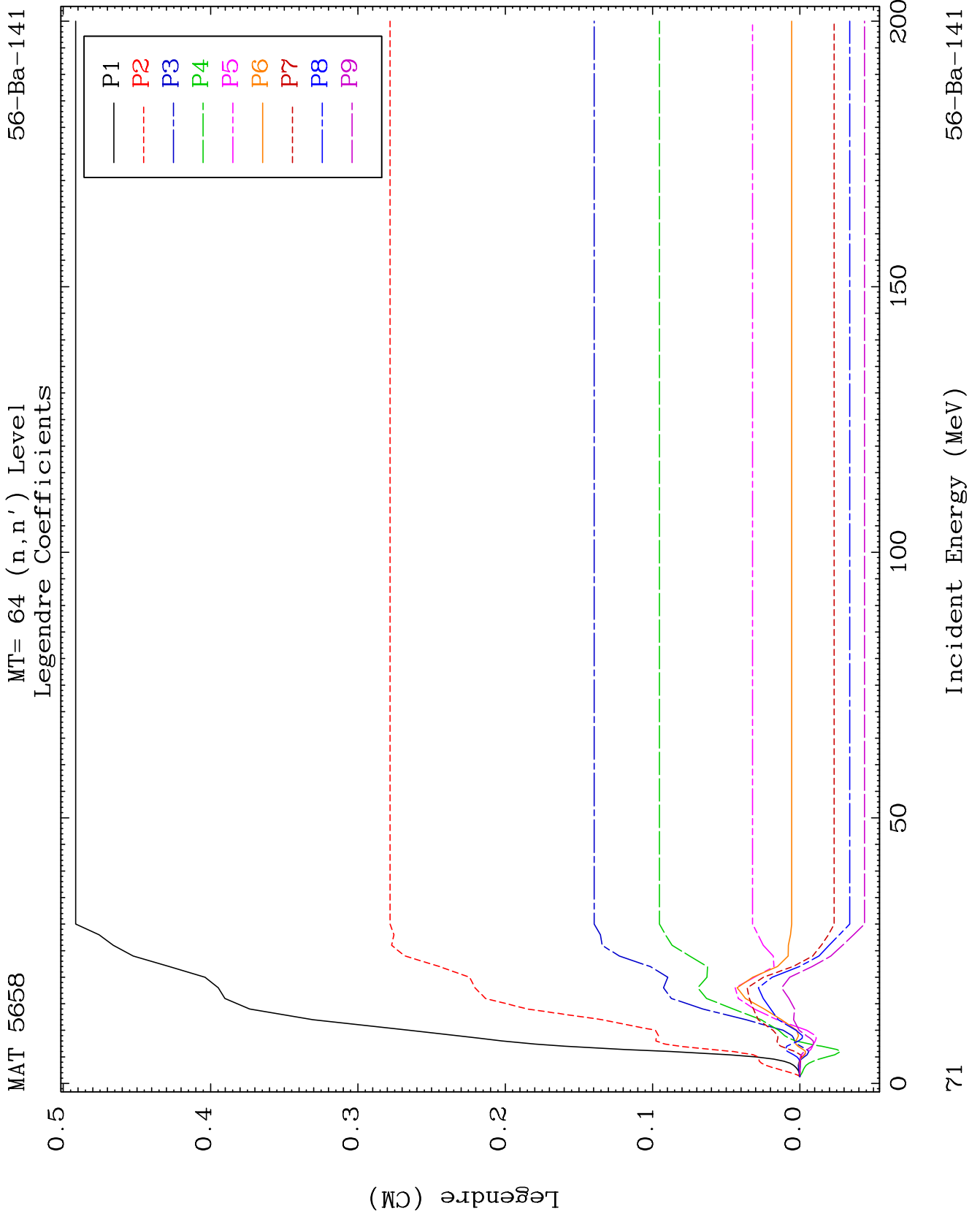

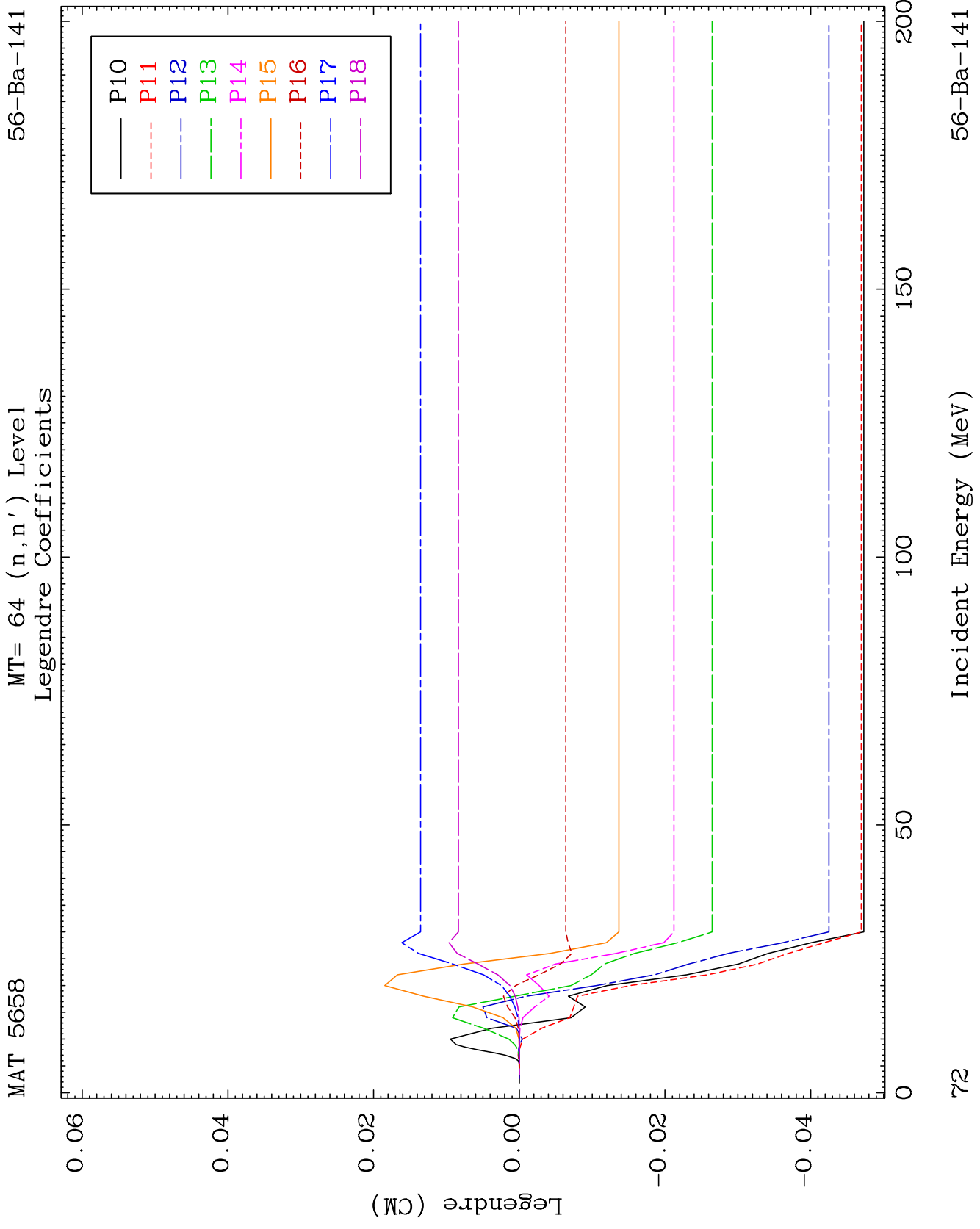

MAT 5658

MT= 64 (n,n') Level
Legendre Coefficients

56-Ba-141

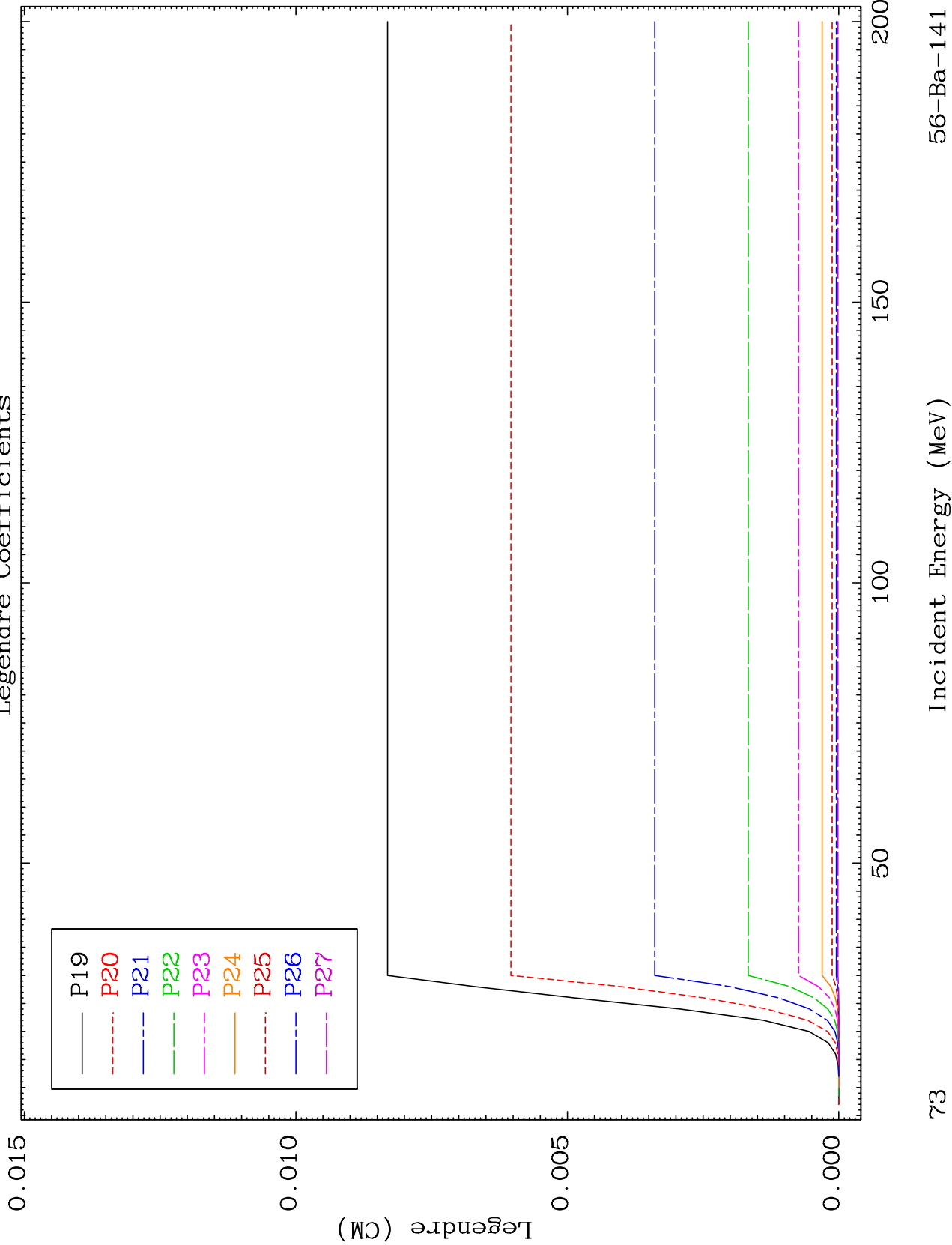

73

56-Ba-141

Incident Energy (MeV)

MAT 5658

MT= 64 (n,n') Level
Legendre Coefficients

56-Ba-141

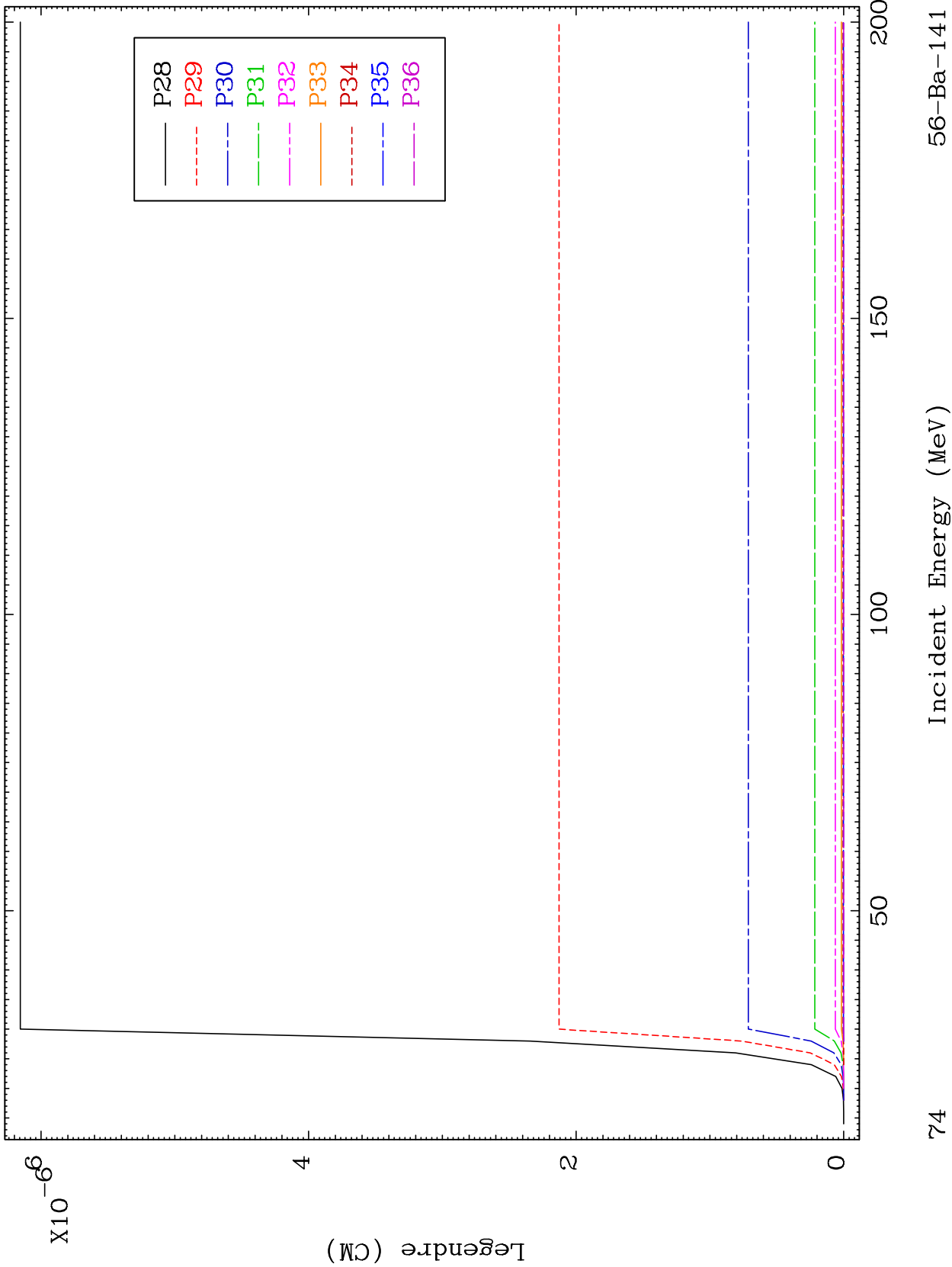

MAT 5658

MT= 65 (n,n') Level
Legendre Coefficients

56-Ba-141

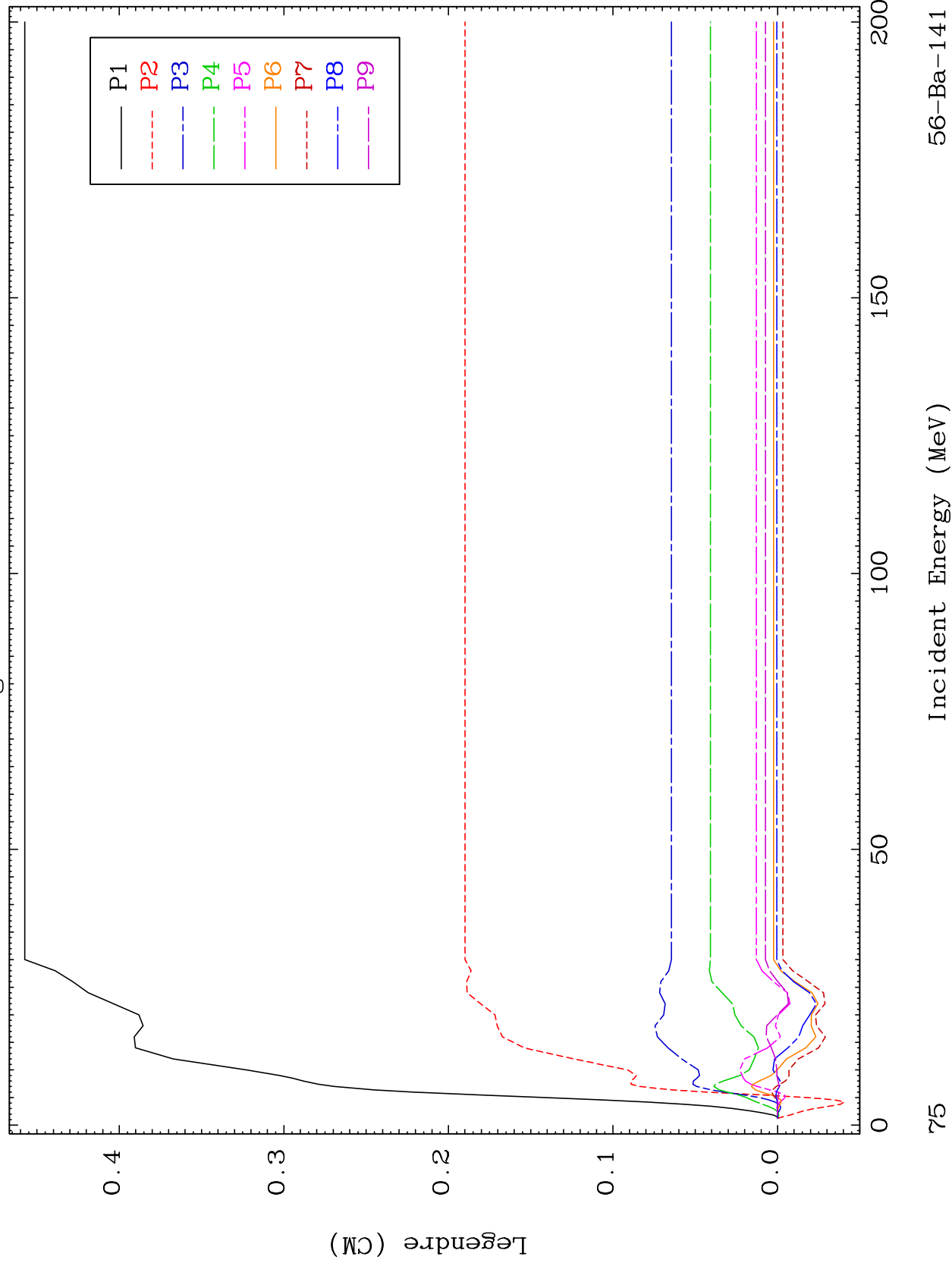

56-Ba-141

Incident Energy (MeV)

75

MAT 5658

MT= 65 (n,n') Level
Legendre Coefficients

56-Ba-141

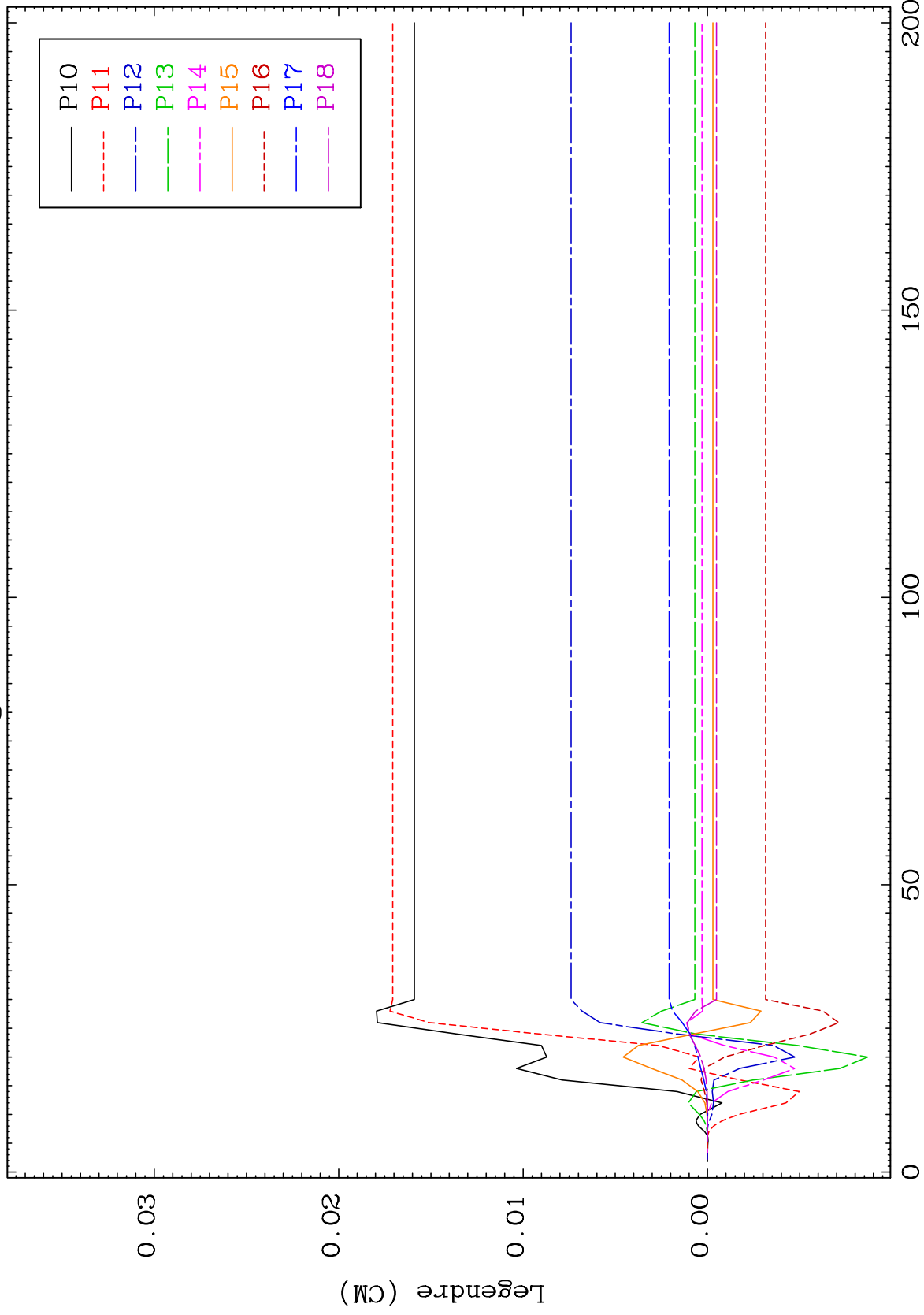

76

Incident Energy (MeV)

56-Ba-141

MAT 5658

MT= 65 (n,n') Level
Legendre Coefficients

56-Ba-141

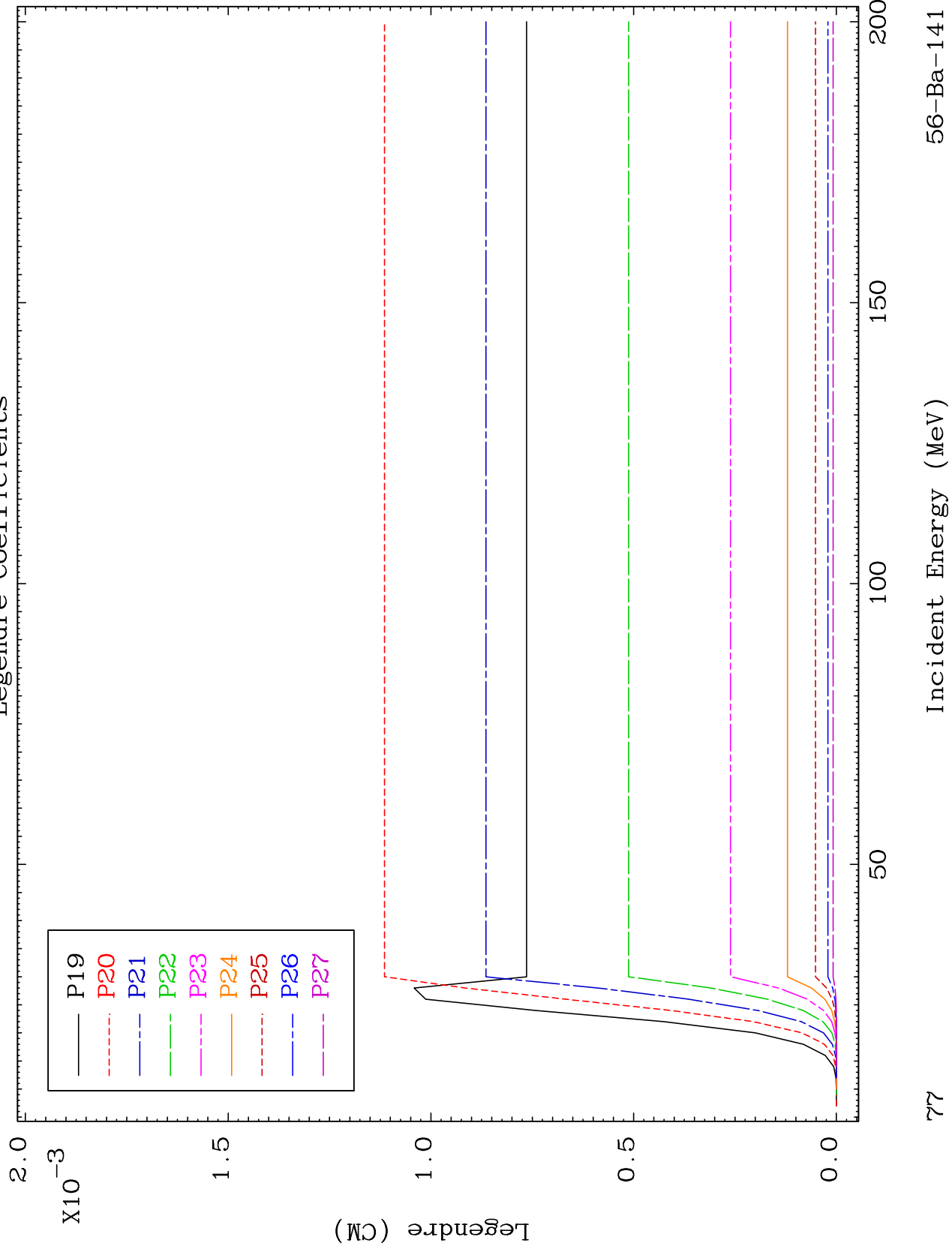

MAT 5658

MT= 65 (n,n') Level
Legendre Coefficients

56-Ba-141

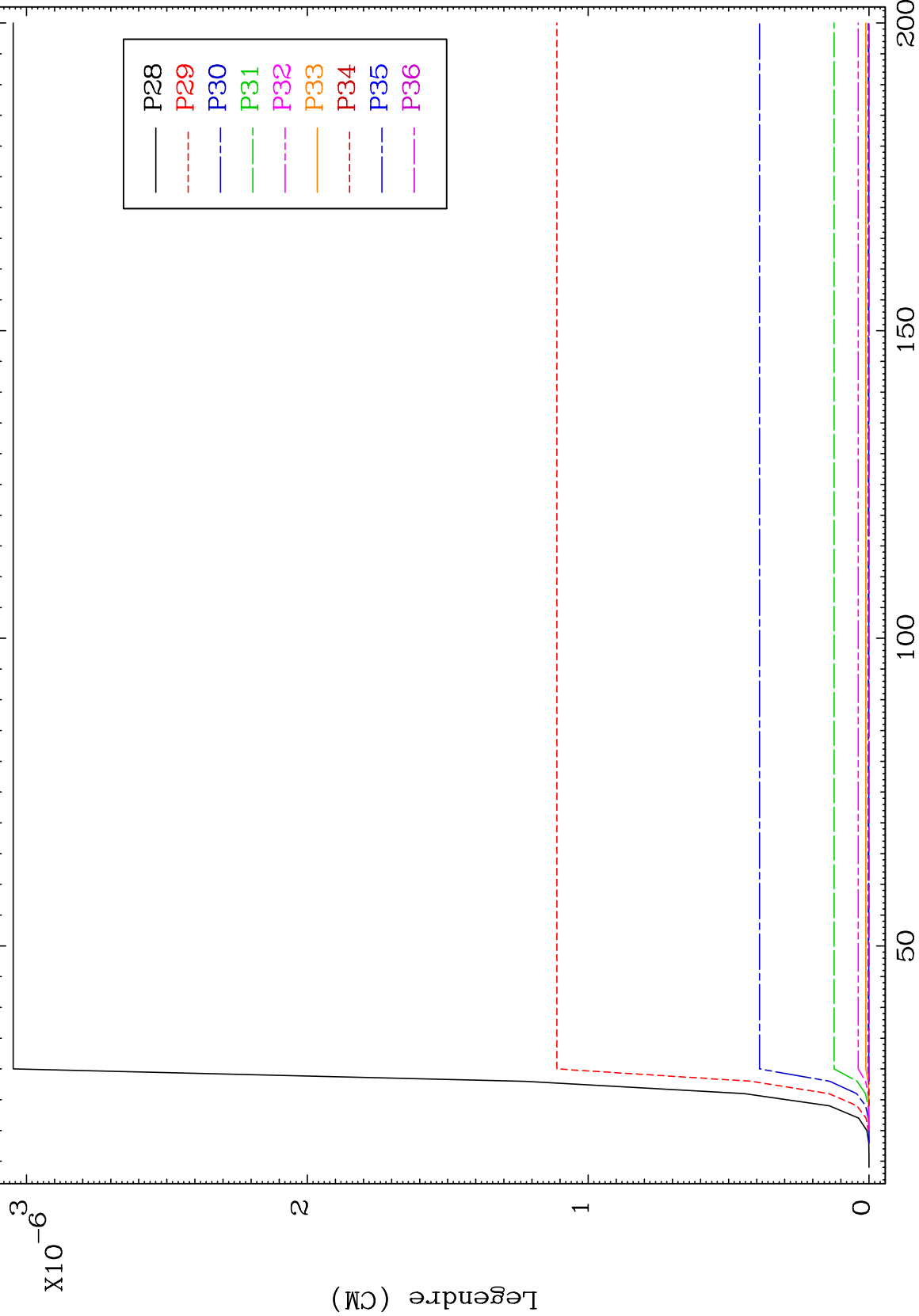

78

Incident Energy (MeV)

56-Ba-141

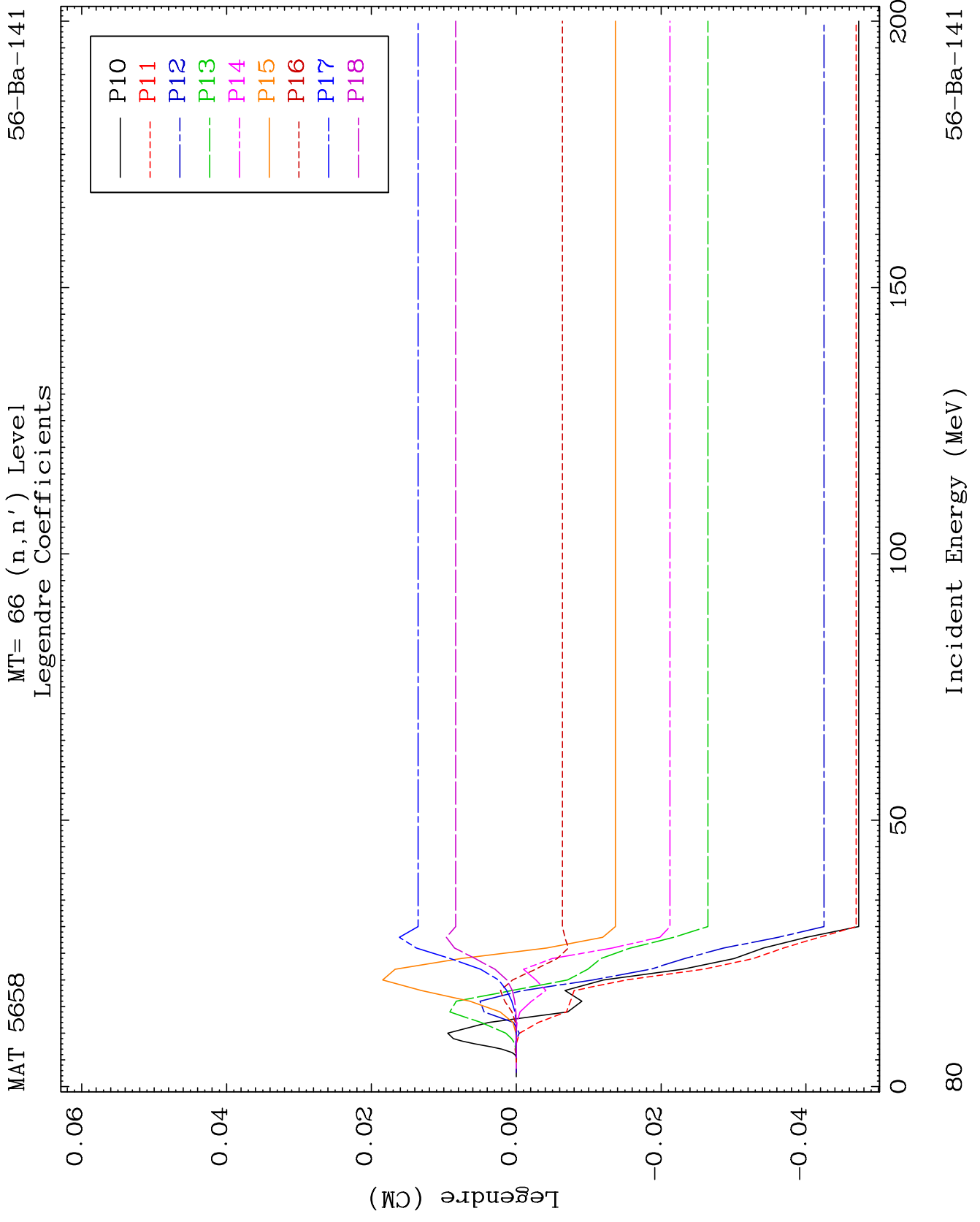

MAT 5658

MT= 66 (n,n') Level
Legendre Coefficients

56-Ba-141

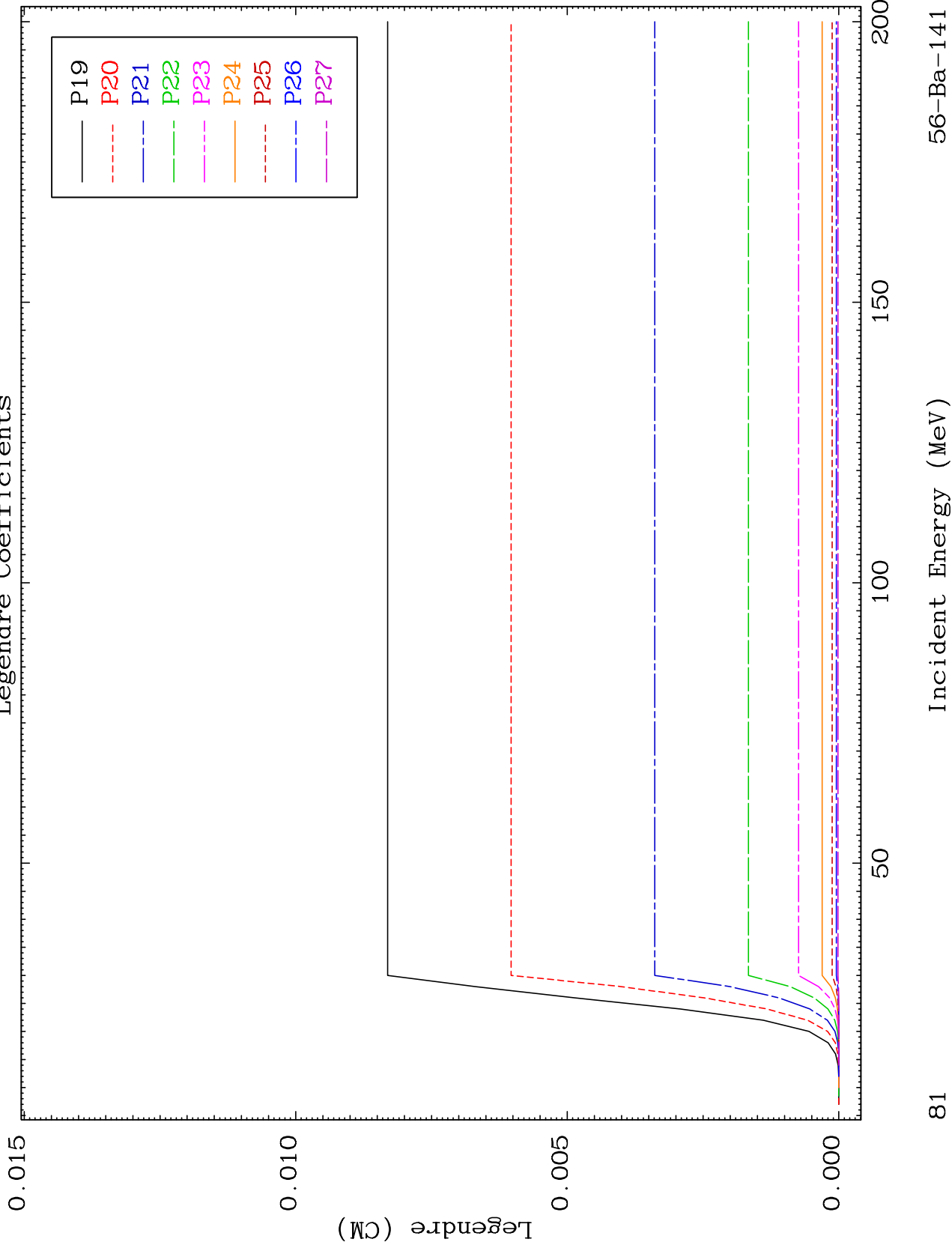

81

Incident Energy (MeV)

56-Ba-141

MAT 5658

MT= 66 (n,n') Level
Legendre Coefficients

56-Ba-141

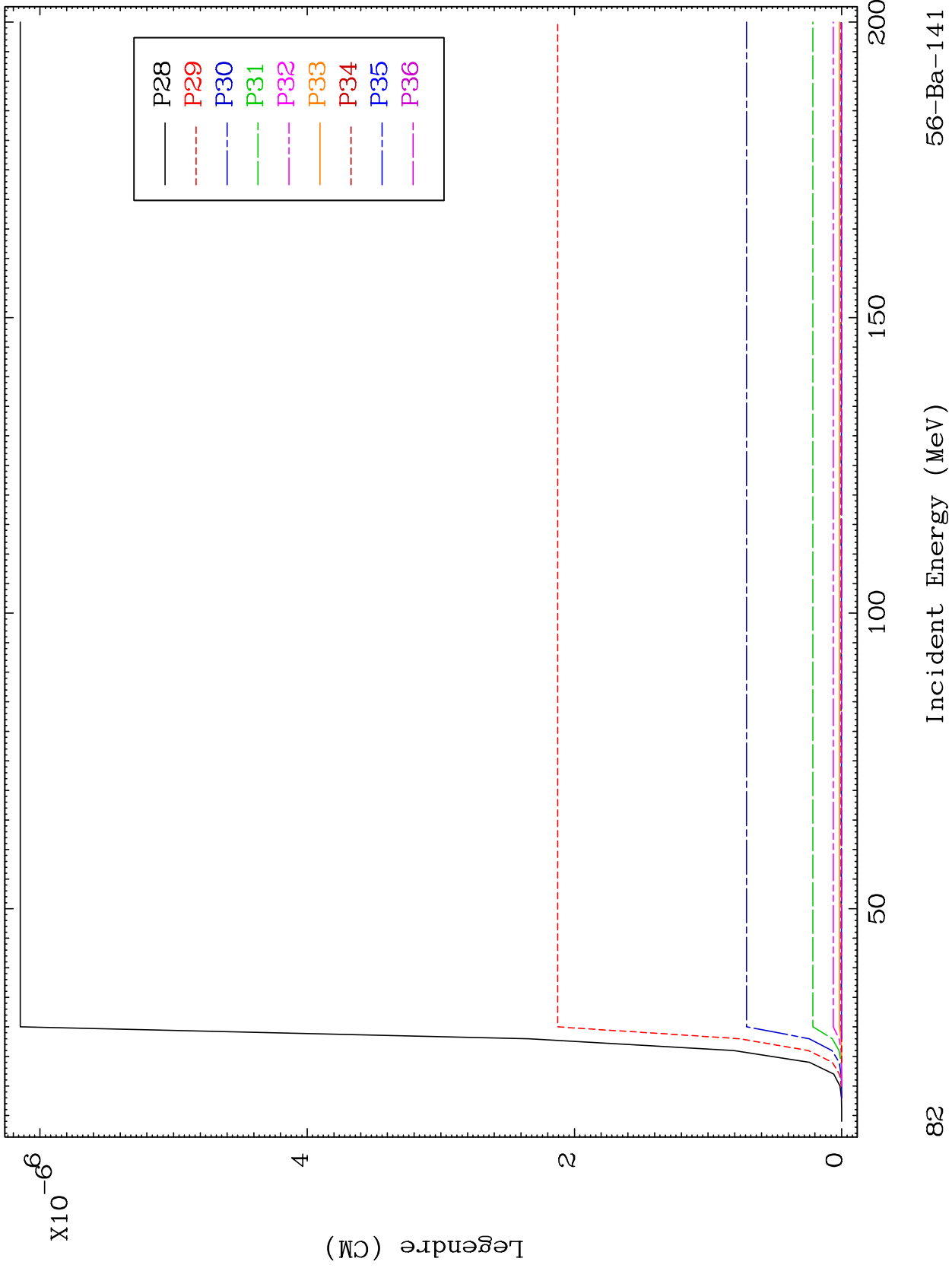

MAT 5658

MT= 67 (n,n') Level
Legendre Coefficients

56-Ba-141

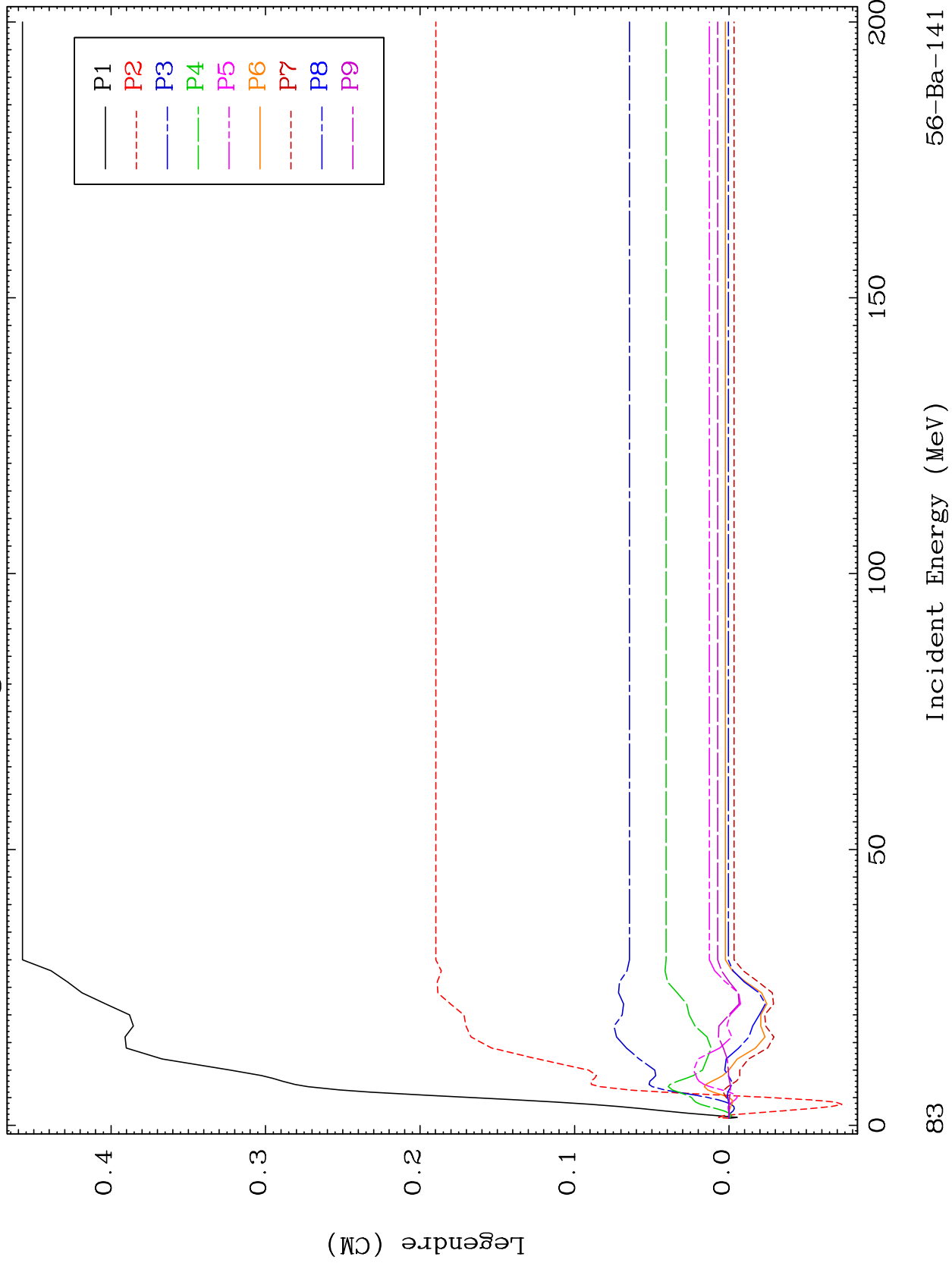

56-Ba-141

Incident Energy (MeV)

83

MAT 5658

MT= 67 (n,n') Level
Legendre Coefficients

56-Ba-141

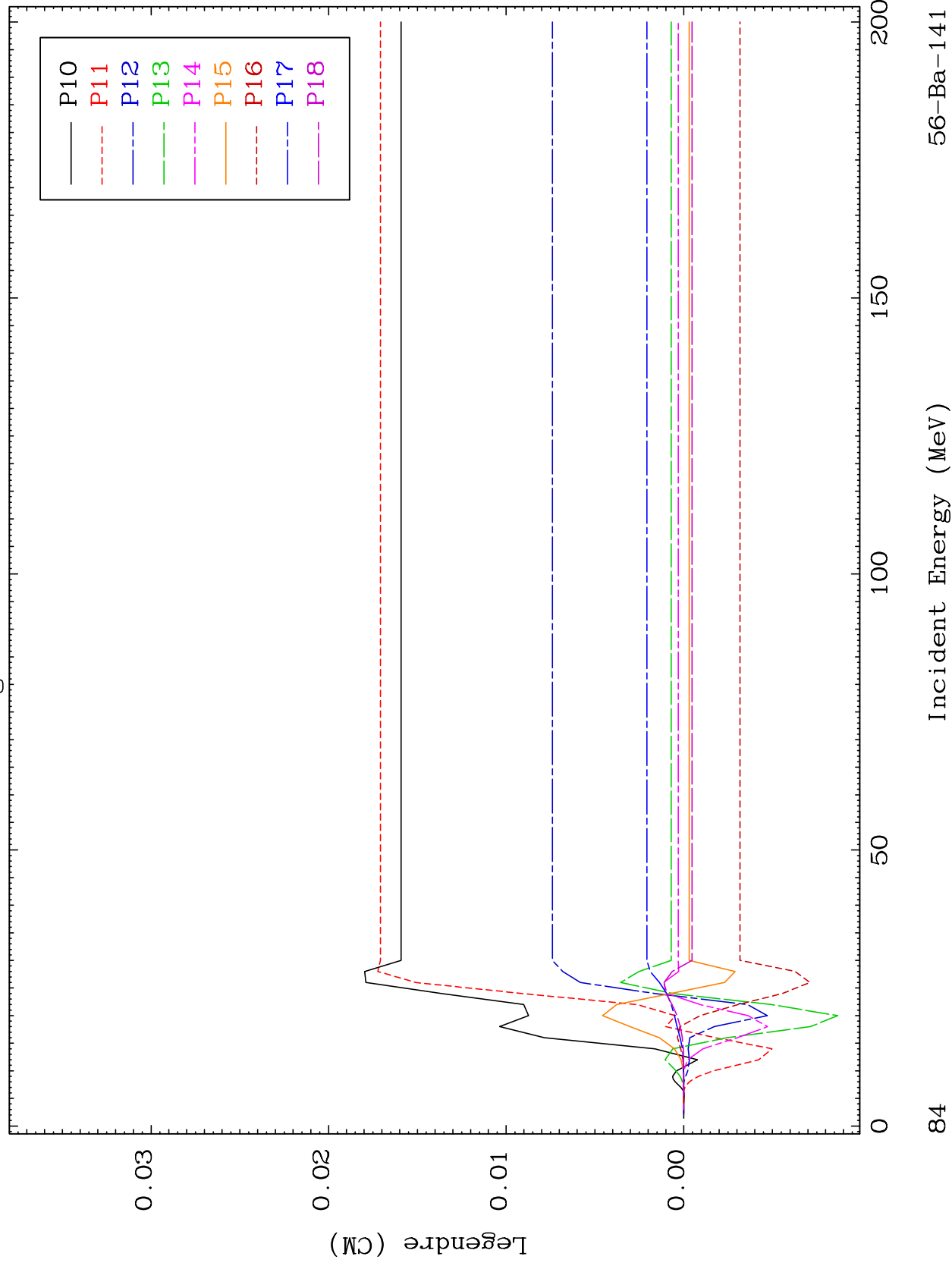

56-Ba-141

Incident Energy (MeV)

84

MAT 5658

MT= 67 (n,n') Level
Legendre Coefficients

56-Ba-141

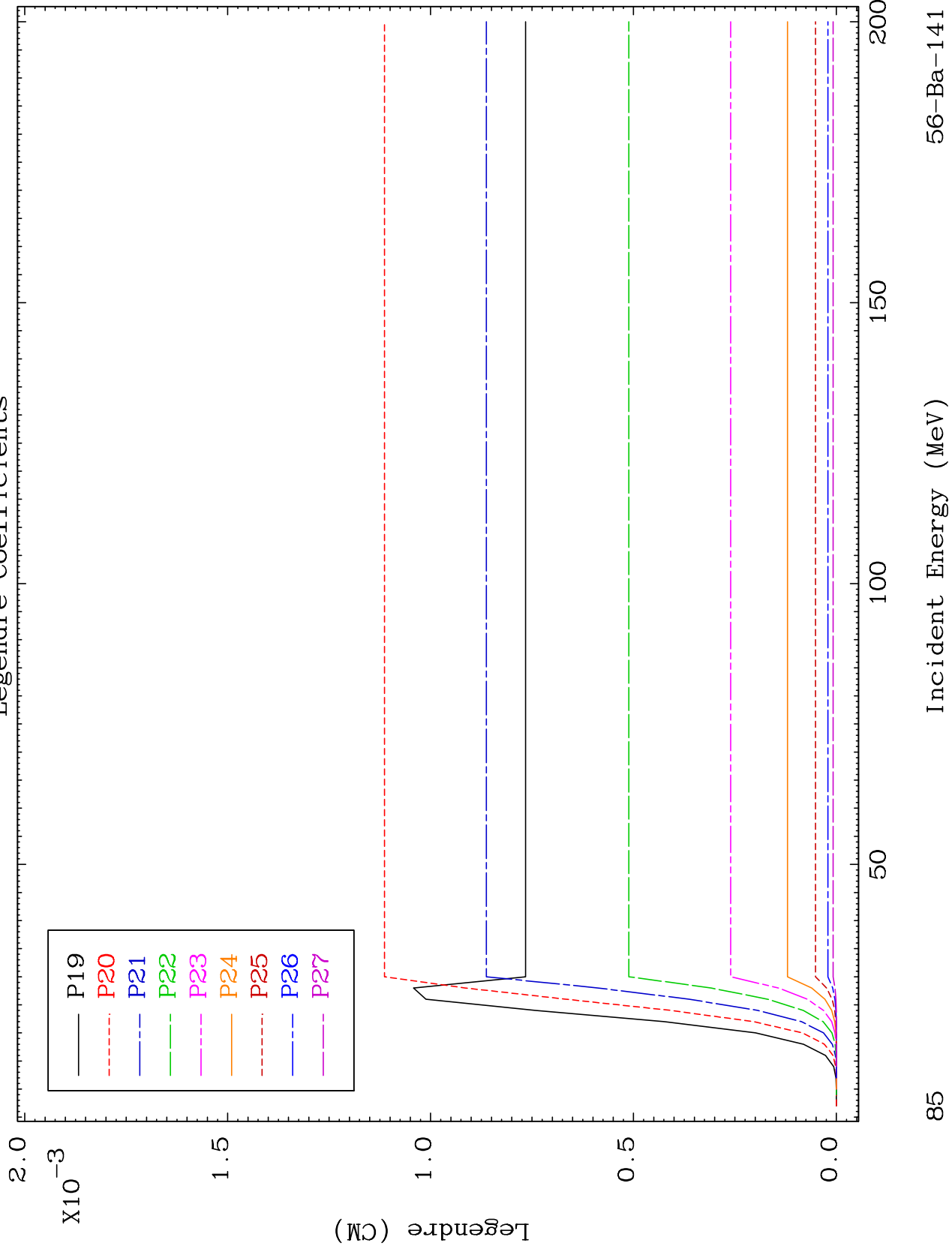

MAT 5658

MT= 67 (n,n') Level
Legendre Coefficients

56-Ba-141

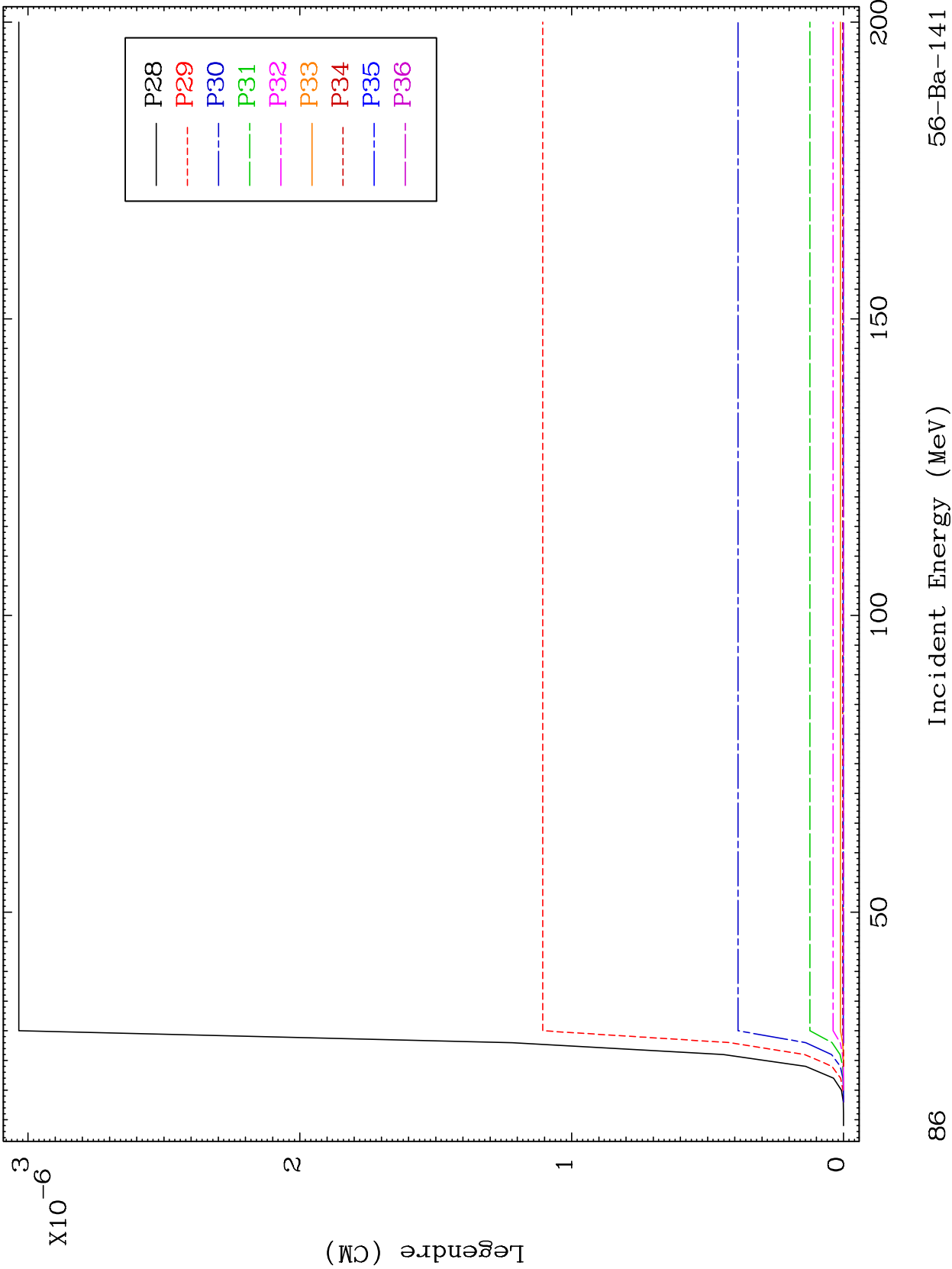

86

Incident Energy (MeV)

56-Ba-141

MAT 5658

MT= 68 (n,n') Level
Legendre Coefficients

56-Ba-141

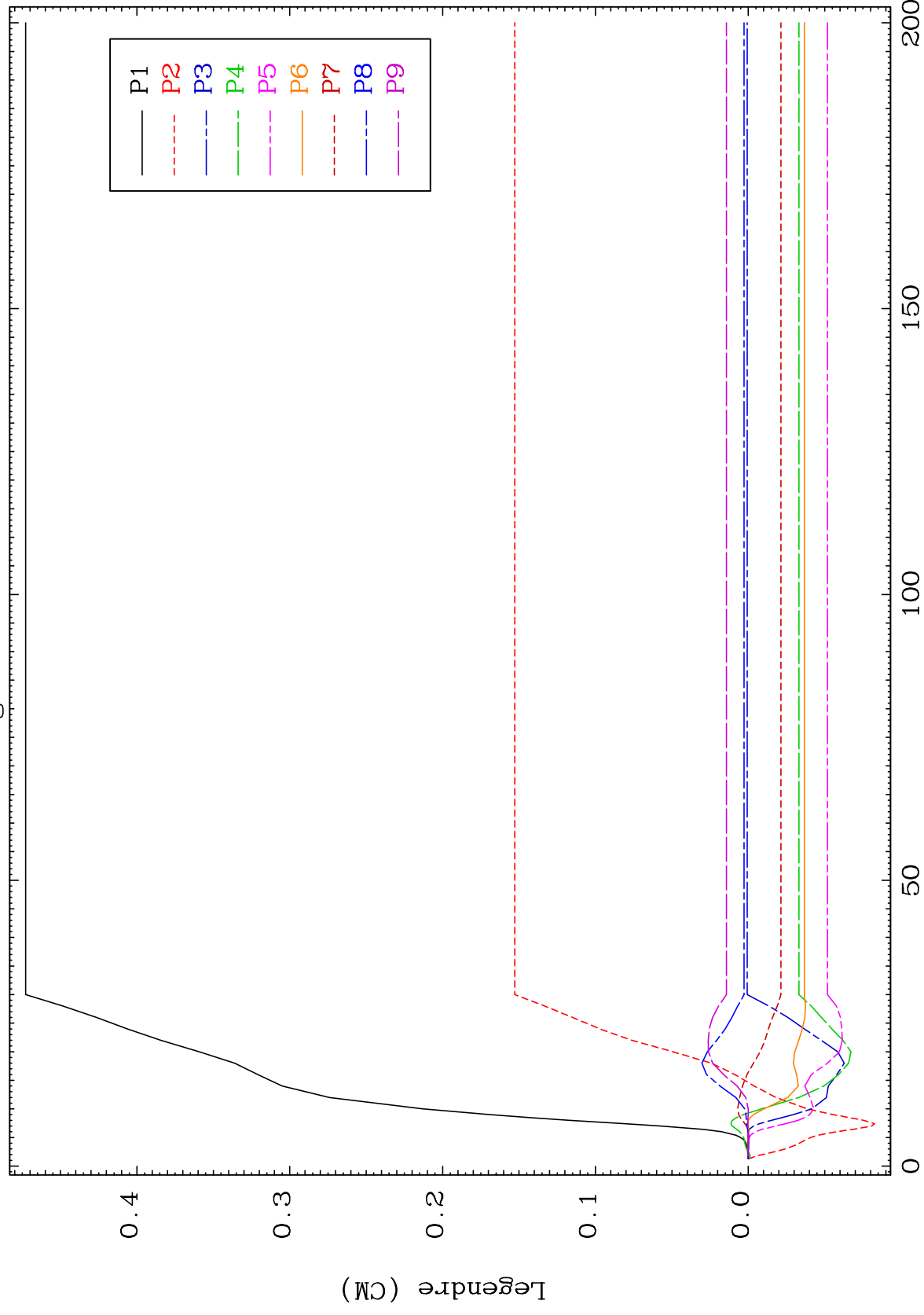

56-Ba-141

Incident Energy (MeV)

87

MAT 5658

MT= 68 (n,n') Level
Legendre Coefficients

56-Ba-141

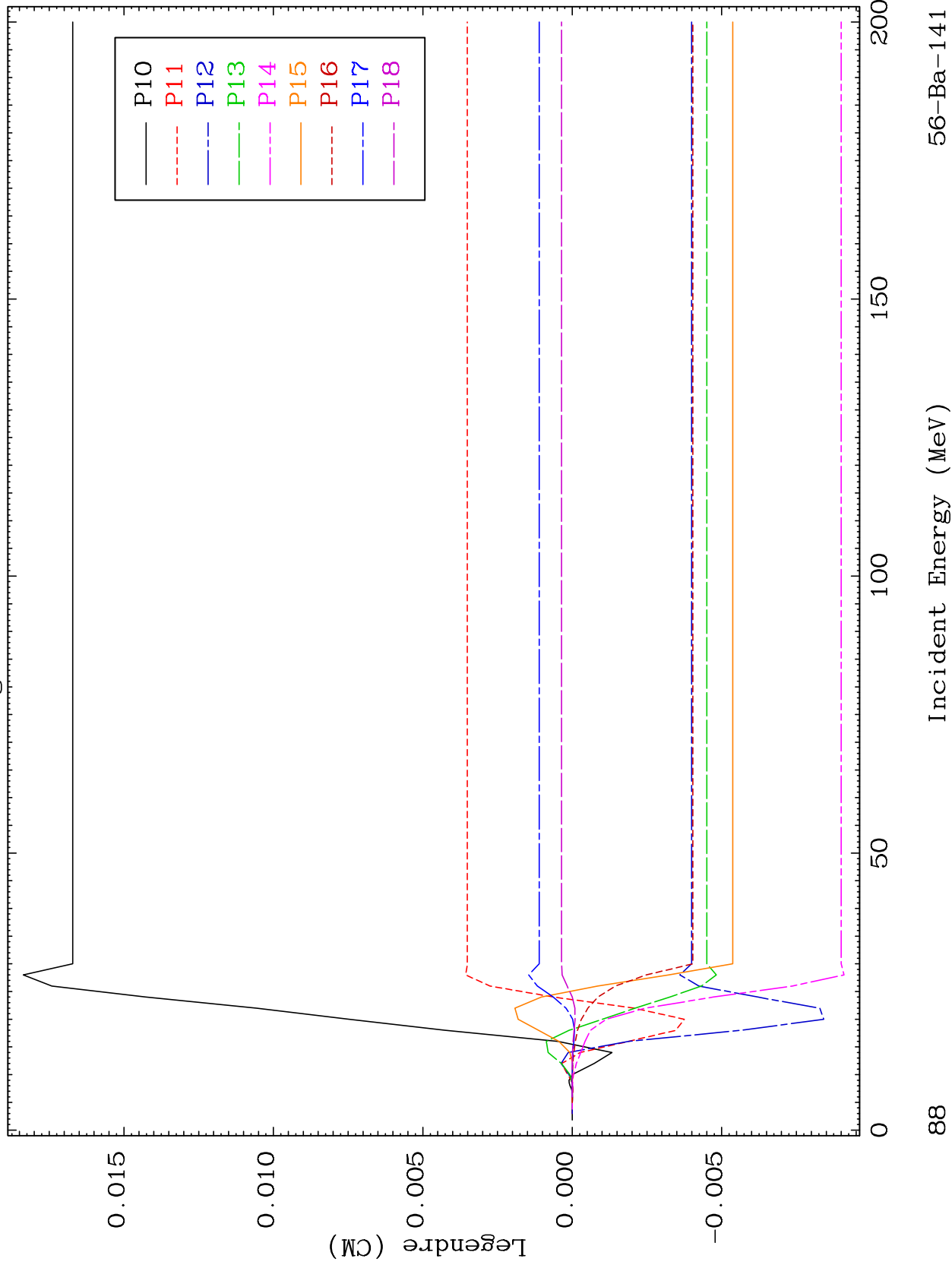

88

Incident Energy (MeV)

56-Ba-141

MAT 5658

MT= 68 (n,n') Level
Legendre Coefficients

56-Ba-141

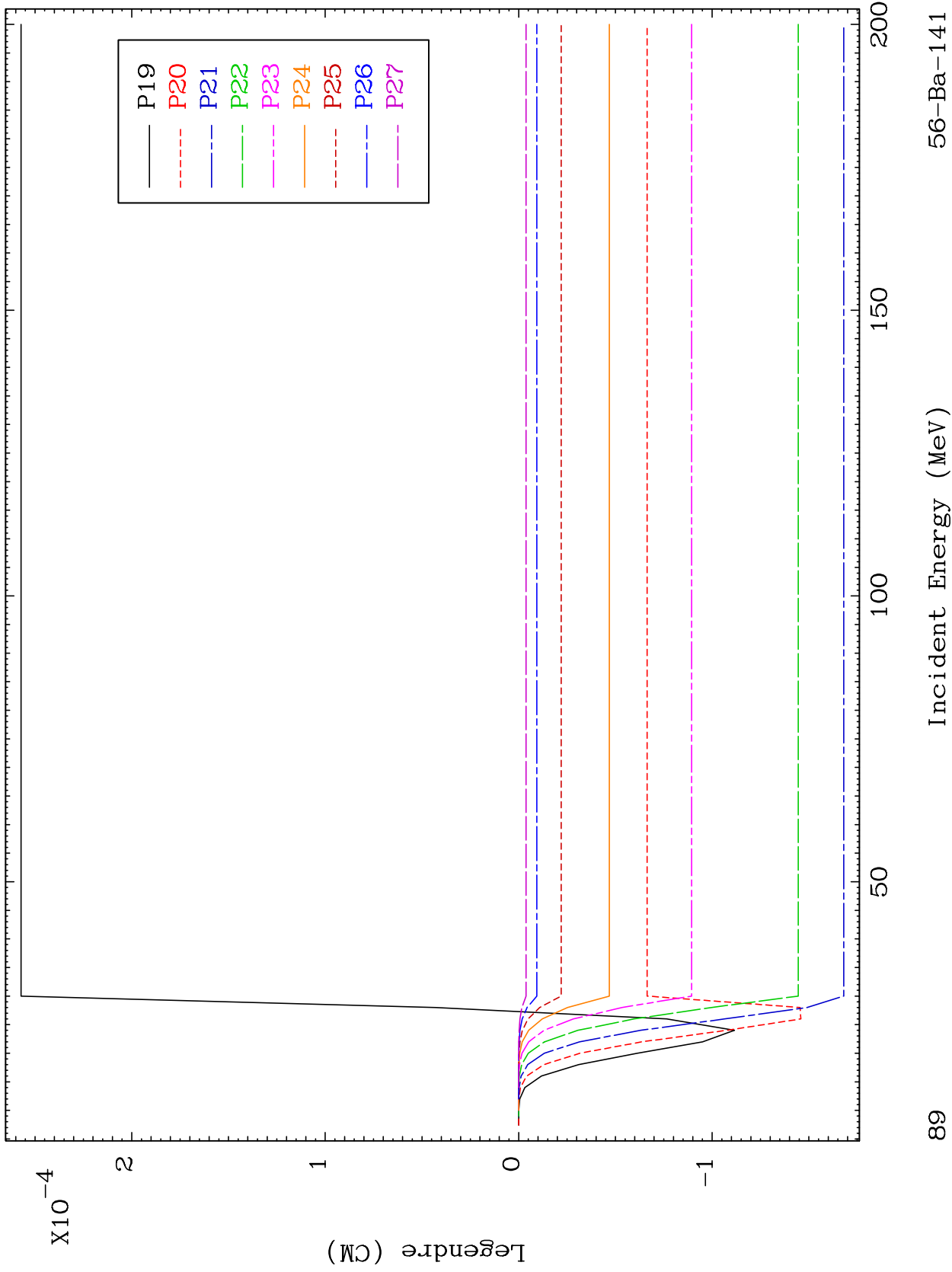

89

Incident Energy (MeV)

56-Ba-141

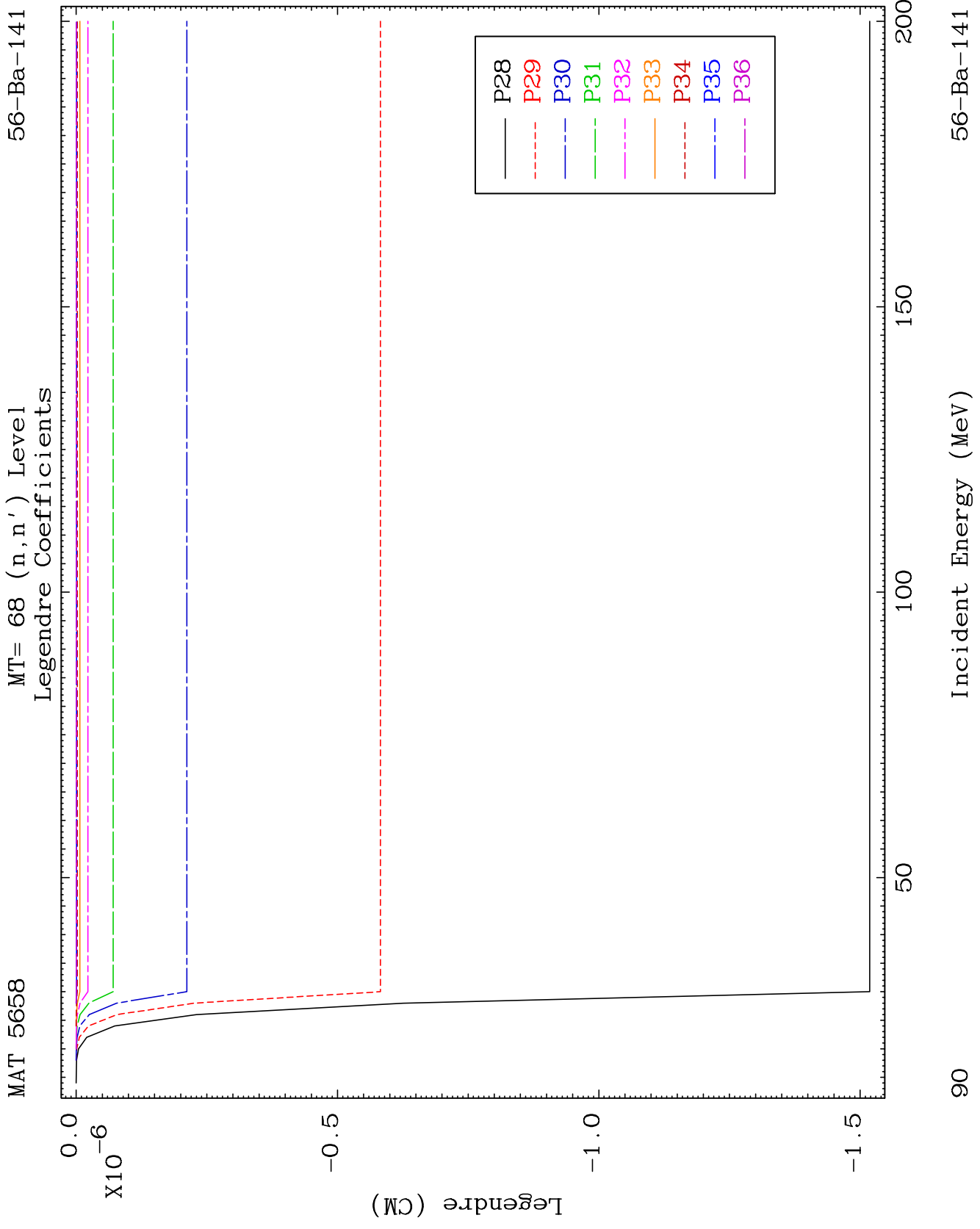

MAT 5658

MT= 69 (n,n') Level
Legendre Coefficients

56-Ba-141

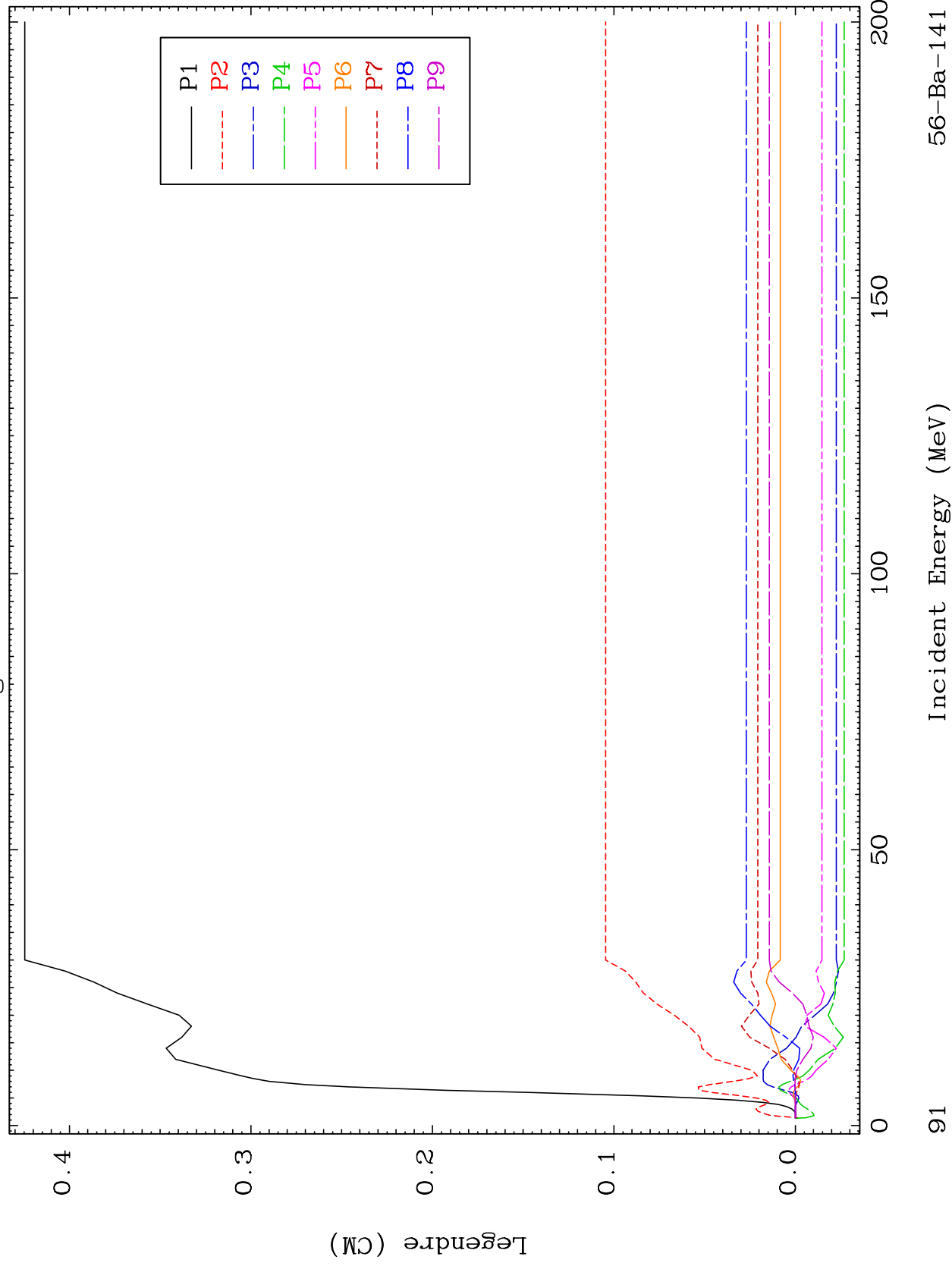

91

56-Ba-141

MAT 5658

MT= 69 (n,n') Level
Legendre Coefficients

56-Ba-141

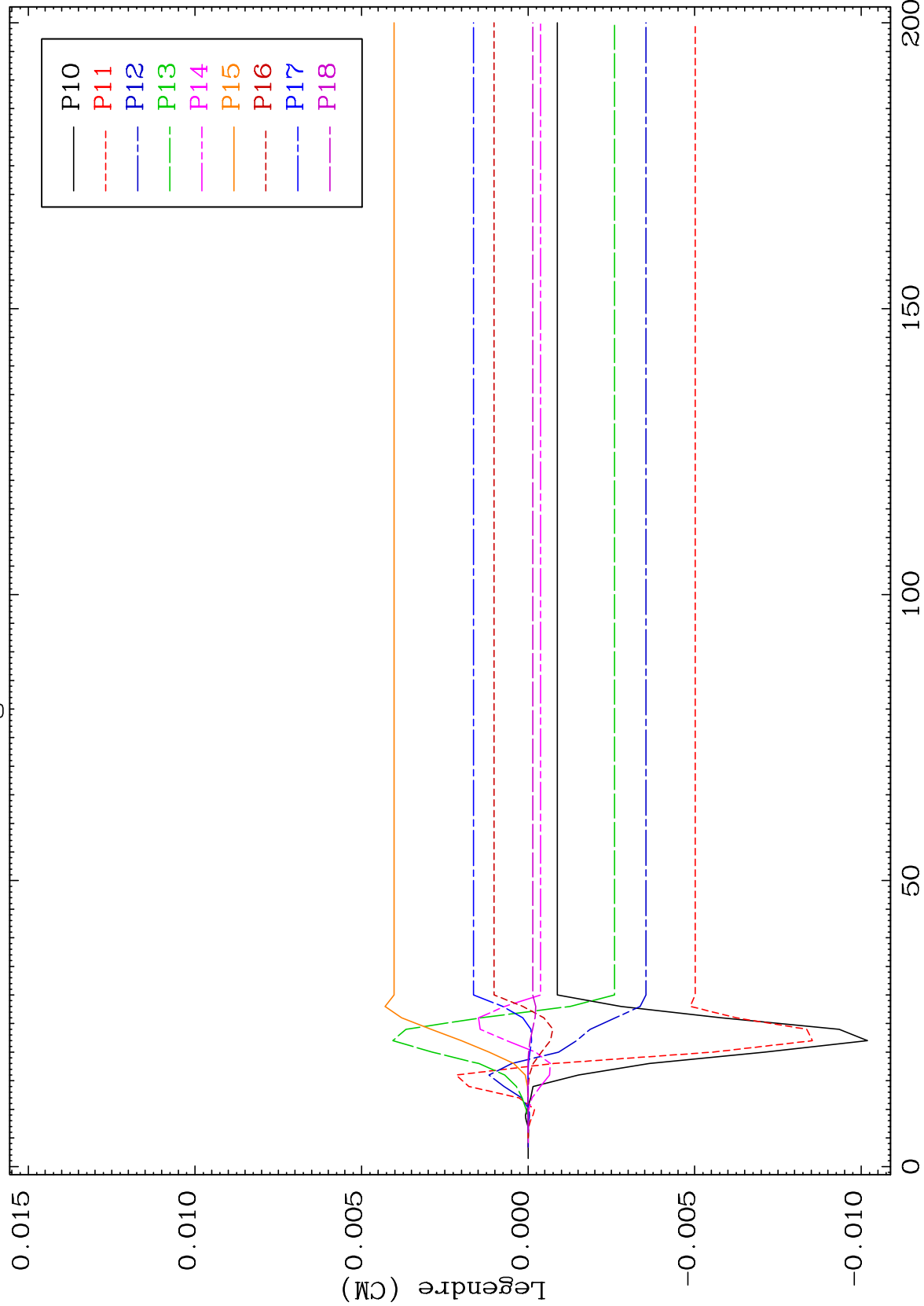

92

Incident Energy (MeV)

56-Ba-141

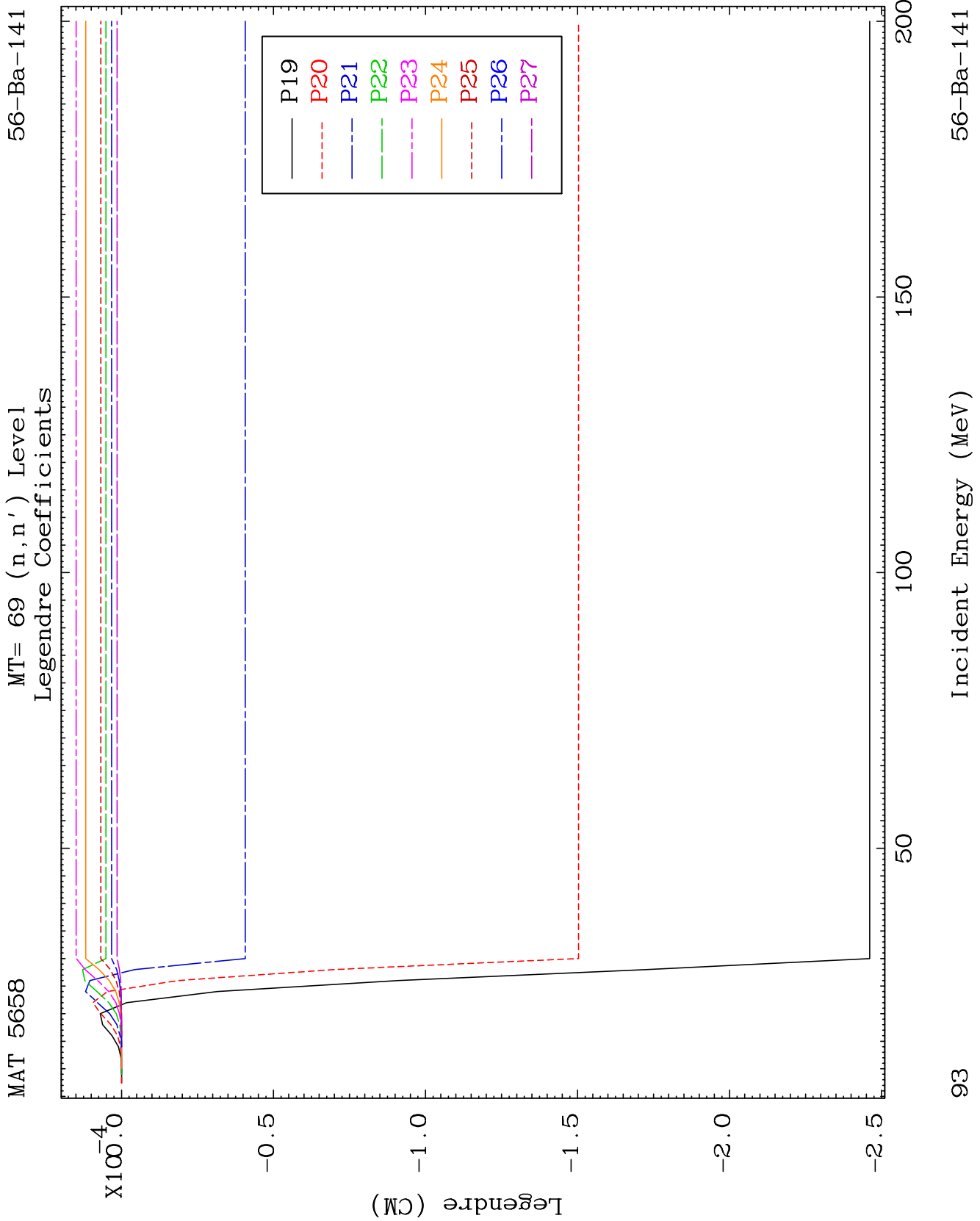

MAT 5658

MT= 69 (n,n') Level
Legendre Coefficients

56-Ba-141

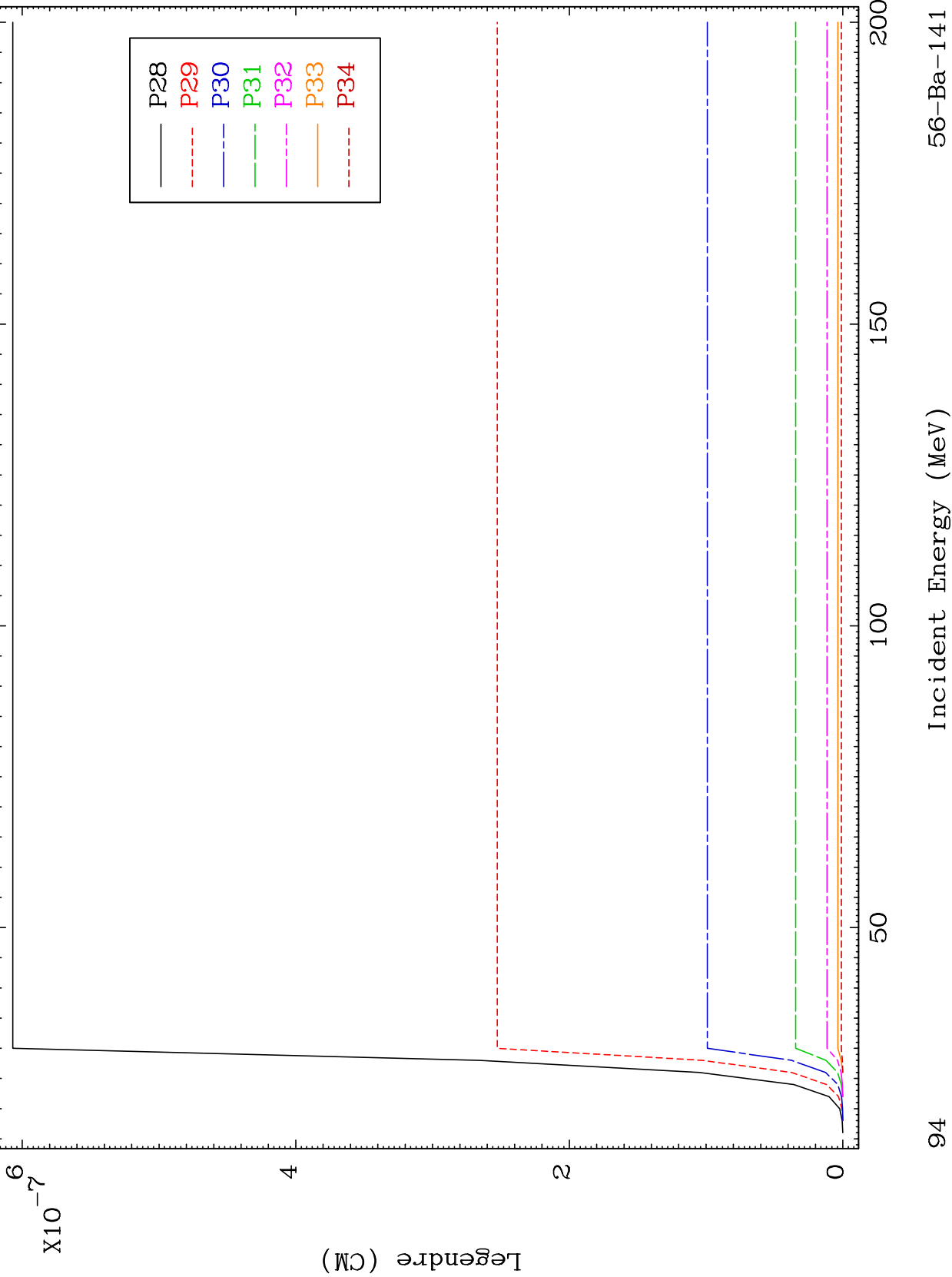

94

Incident Energy (MeV)

56-Ba-141

MAT 5658

MT= 70 (n,n') Level
Legendre Coefficients

56-Ba-141

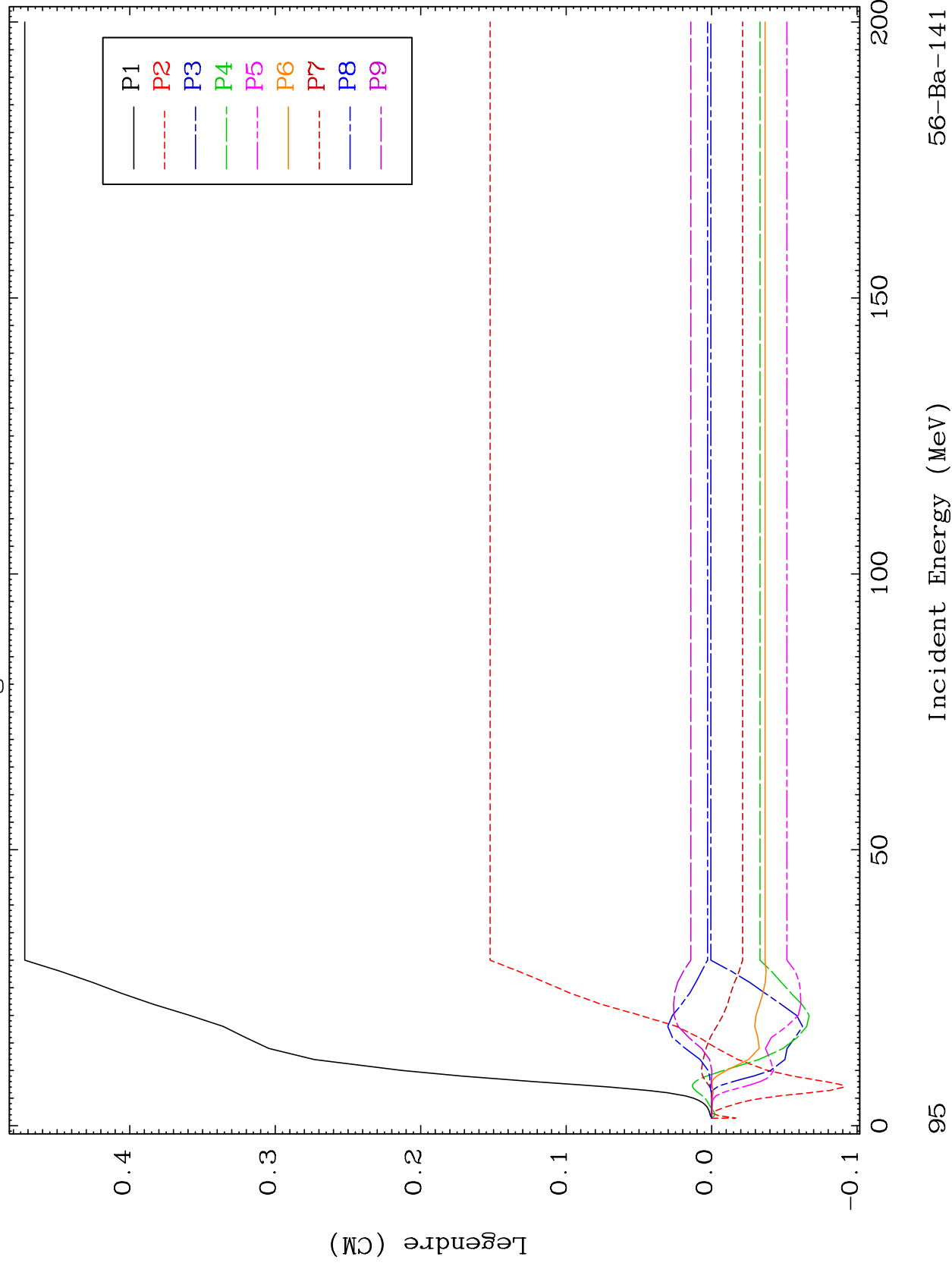

95

Incident Energy (MeV)

56-Ba-141

MAT 5658

MT= 70 (n,n') Level
Legendre Coefficients

56-Ba-141

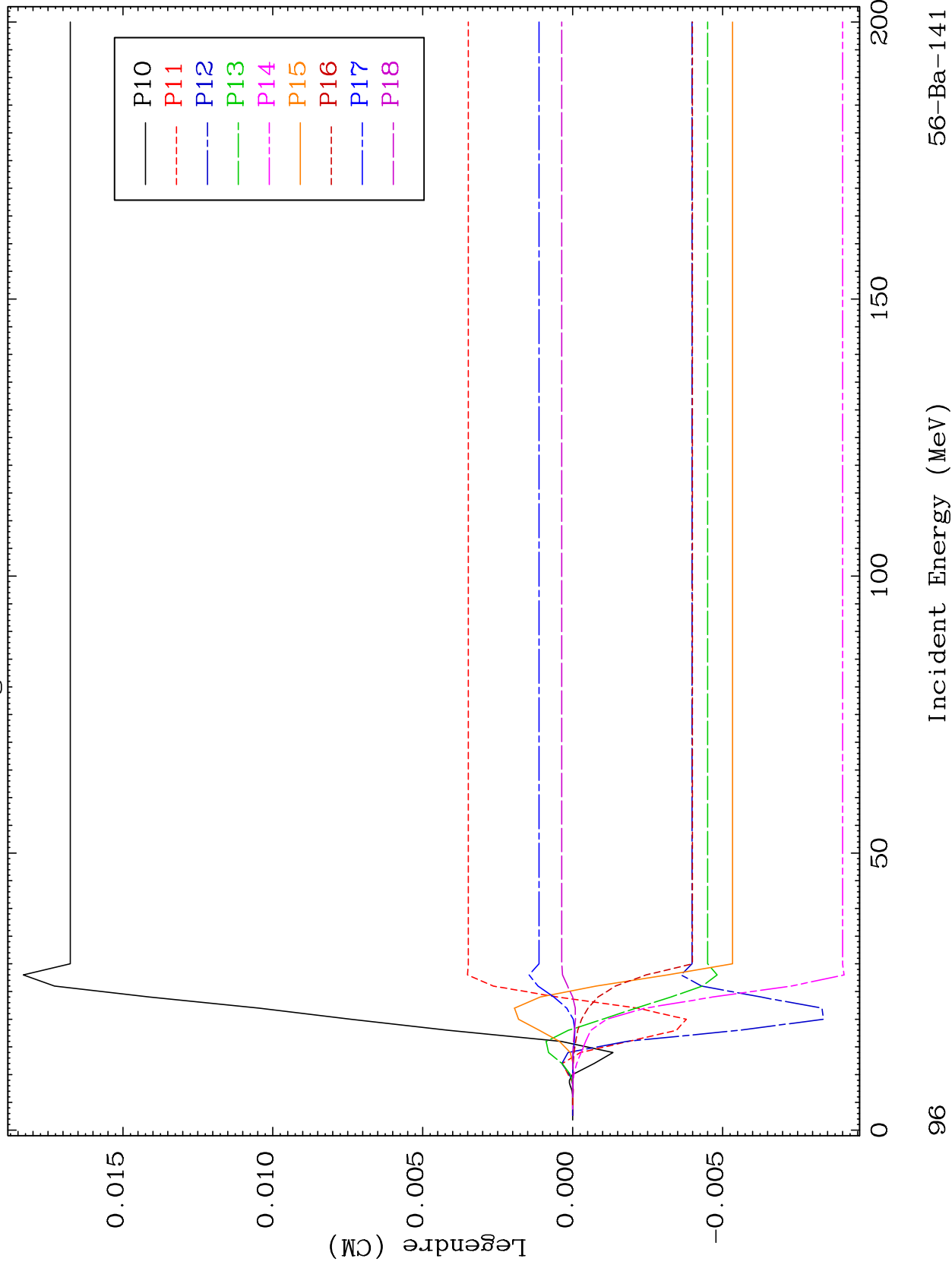

96

Incident Energy (MeV)

56-Ba-141

MAT 5658

MT= 70 (n,n') Level
Legendre Coefficients

56-Ba-141

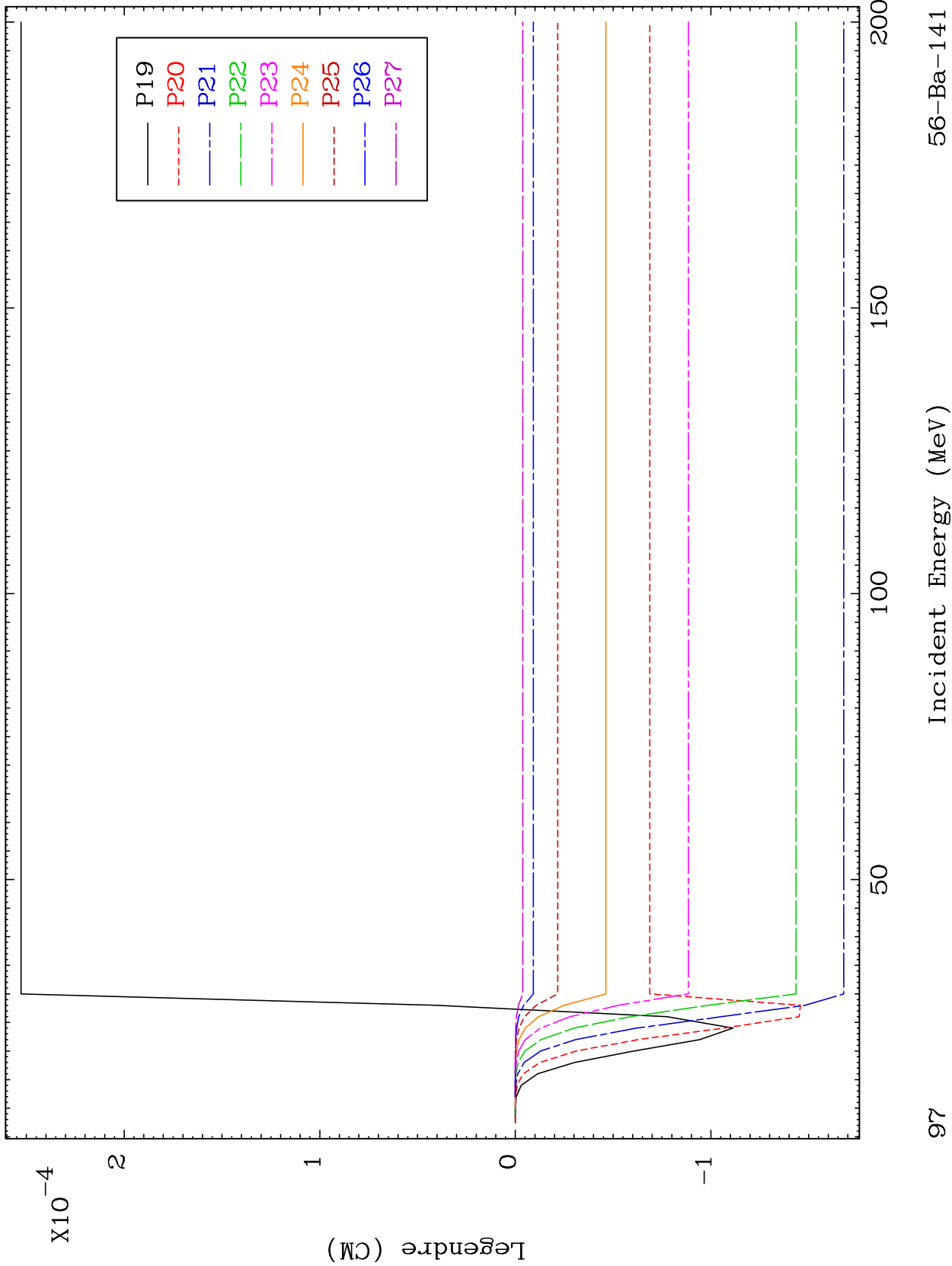

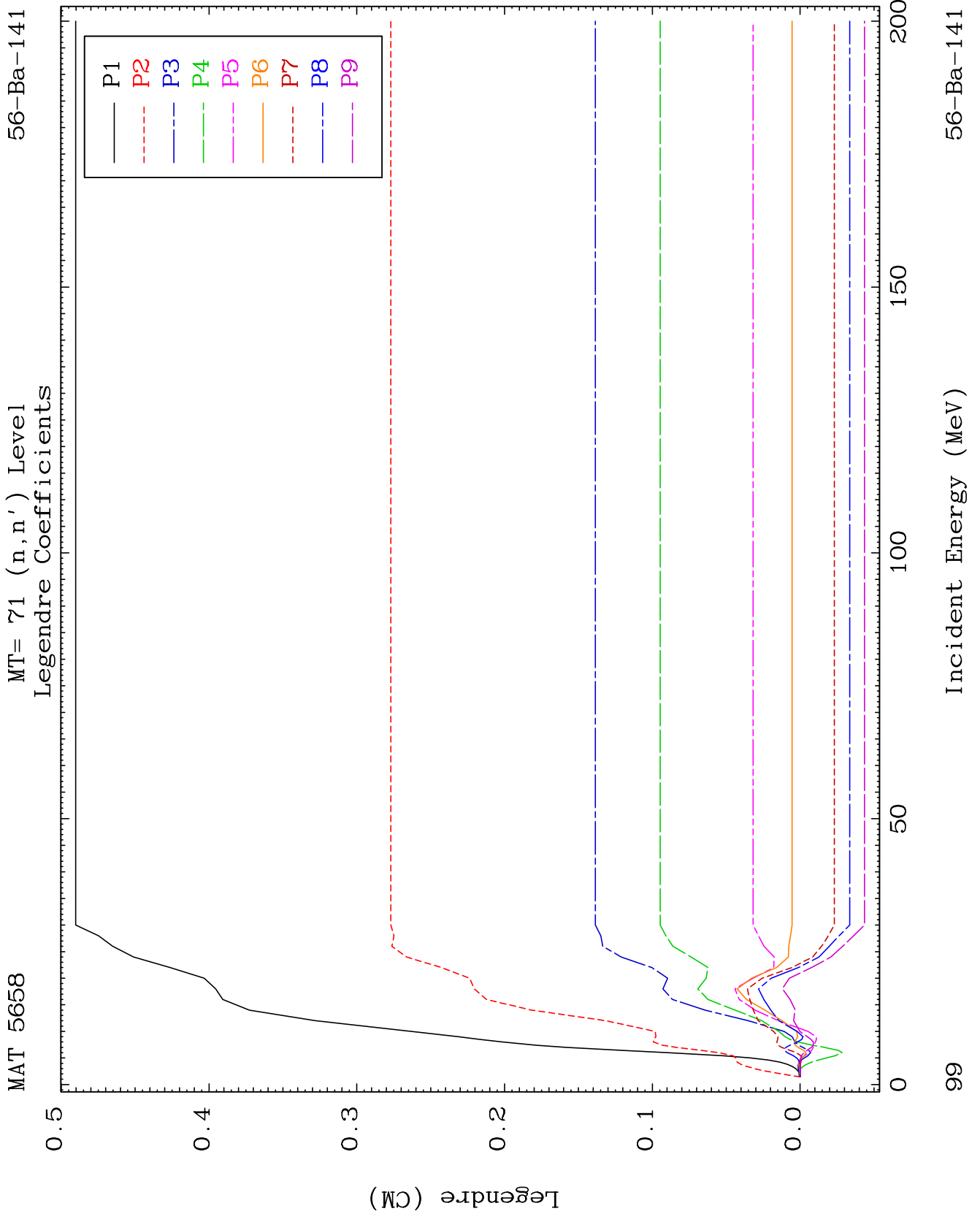

MAT 5658

MT= 71 (n,n') Level
Legendre Coefficients

56-Ba-141

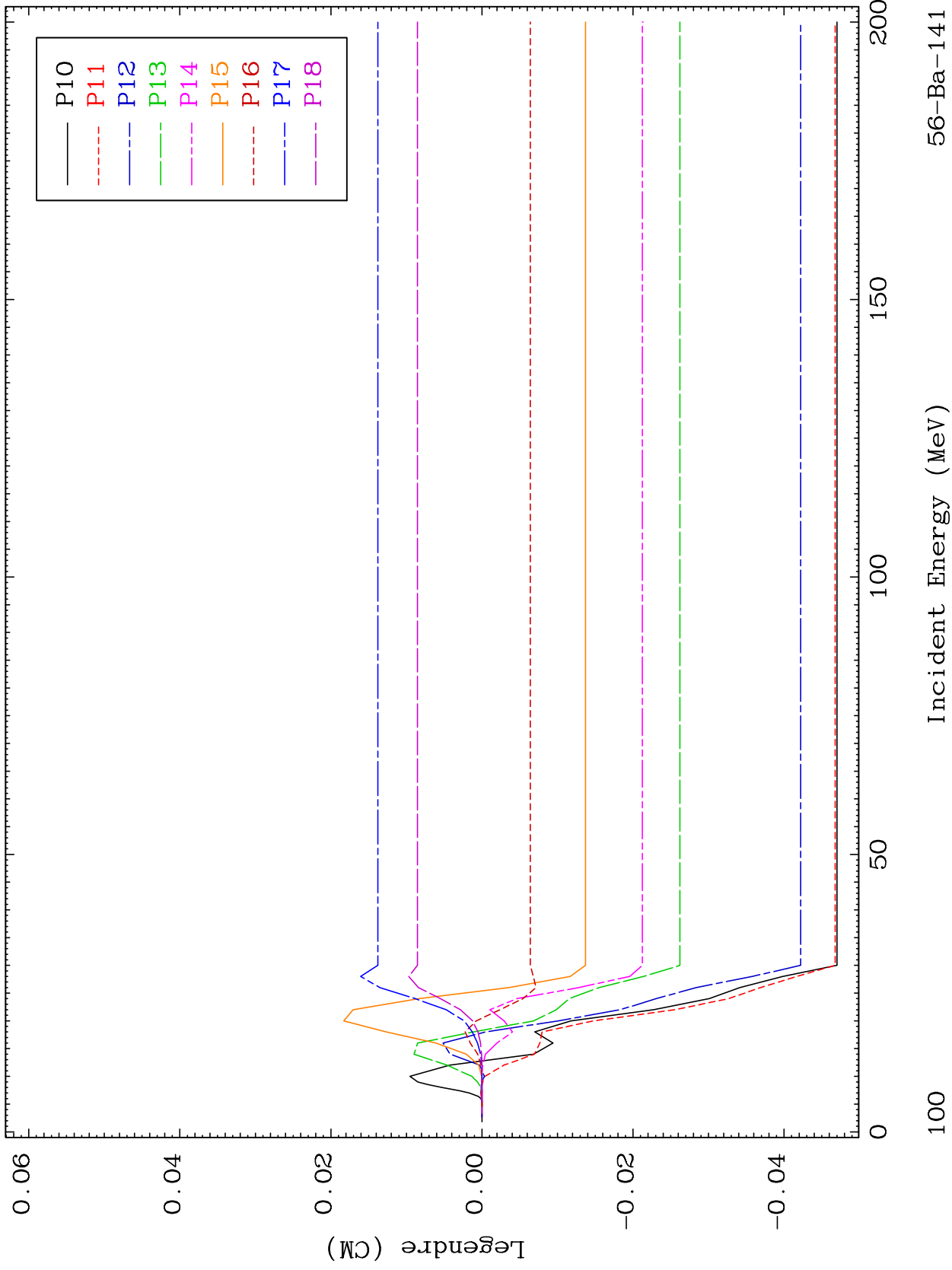

56-Ba-141

MAT 5658

MT= 71 (n,n') Level
Legendre Coefficients

56-Ba-141

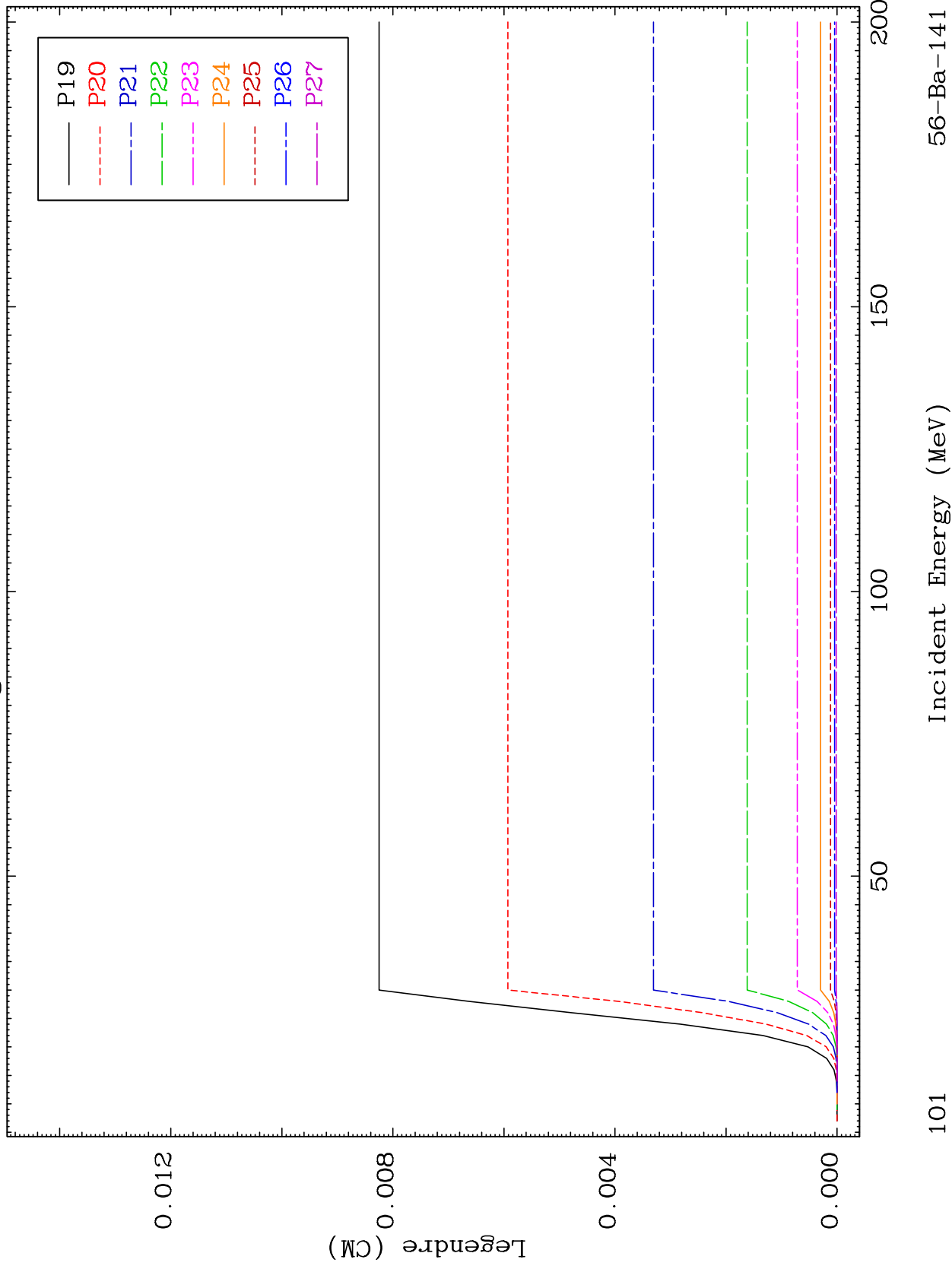

101

56-Ba-141

MAT 5658

MT= 71 (n,n') Level
Legendre Coefficients

56-Ba-141

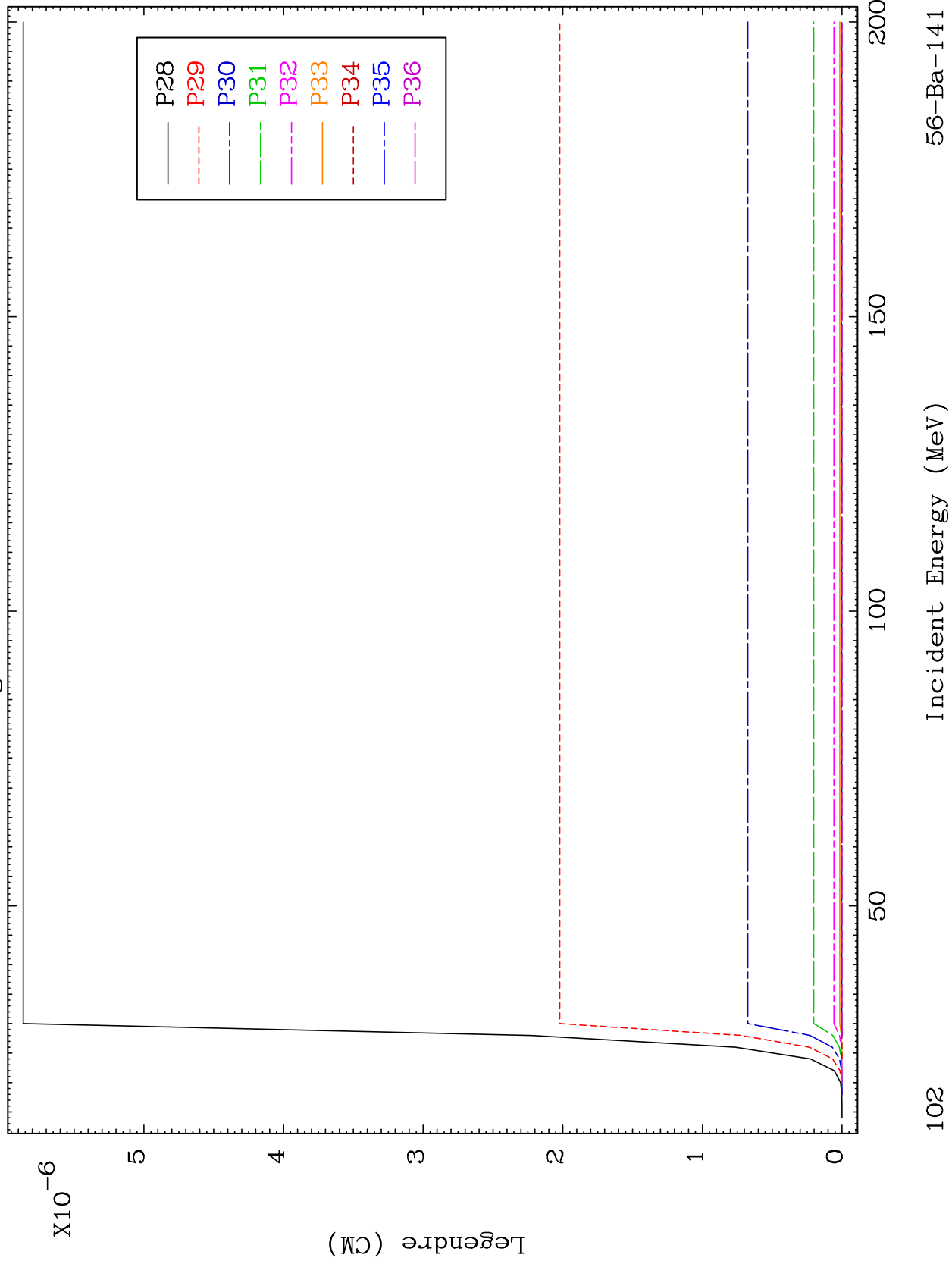

MAT 5658

MT= 72 (n,n') Level
Legendre Coefficients

56-Ba-141

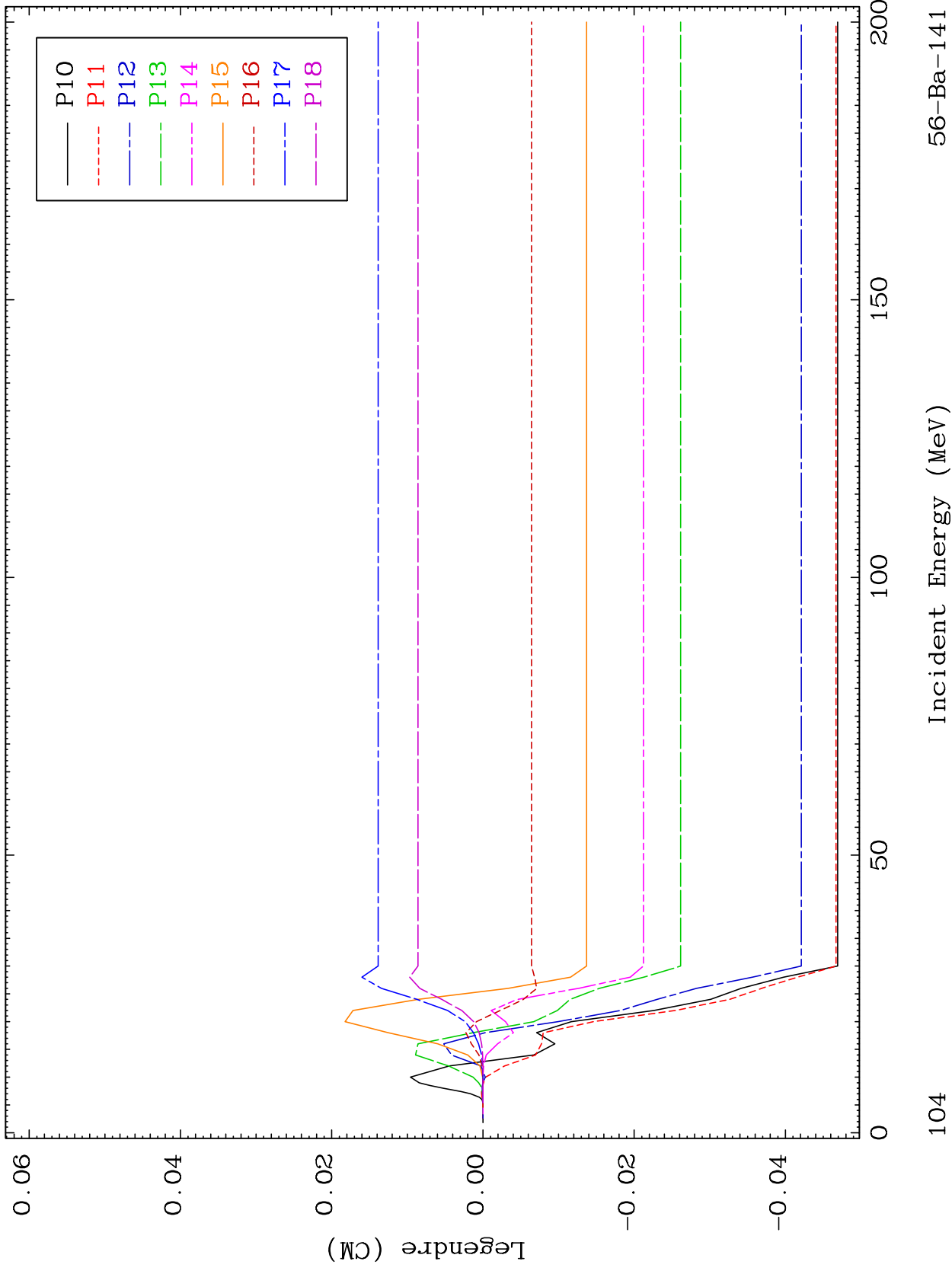

56-Ba-141

Incident Energy (MeV)

104

MAT 5658

MT= 72 (n,n') Level
Legendre Coefficients

56-Ba-141

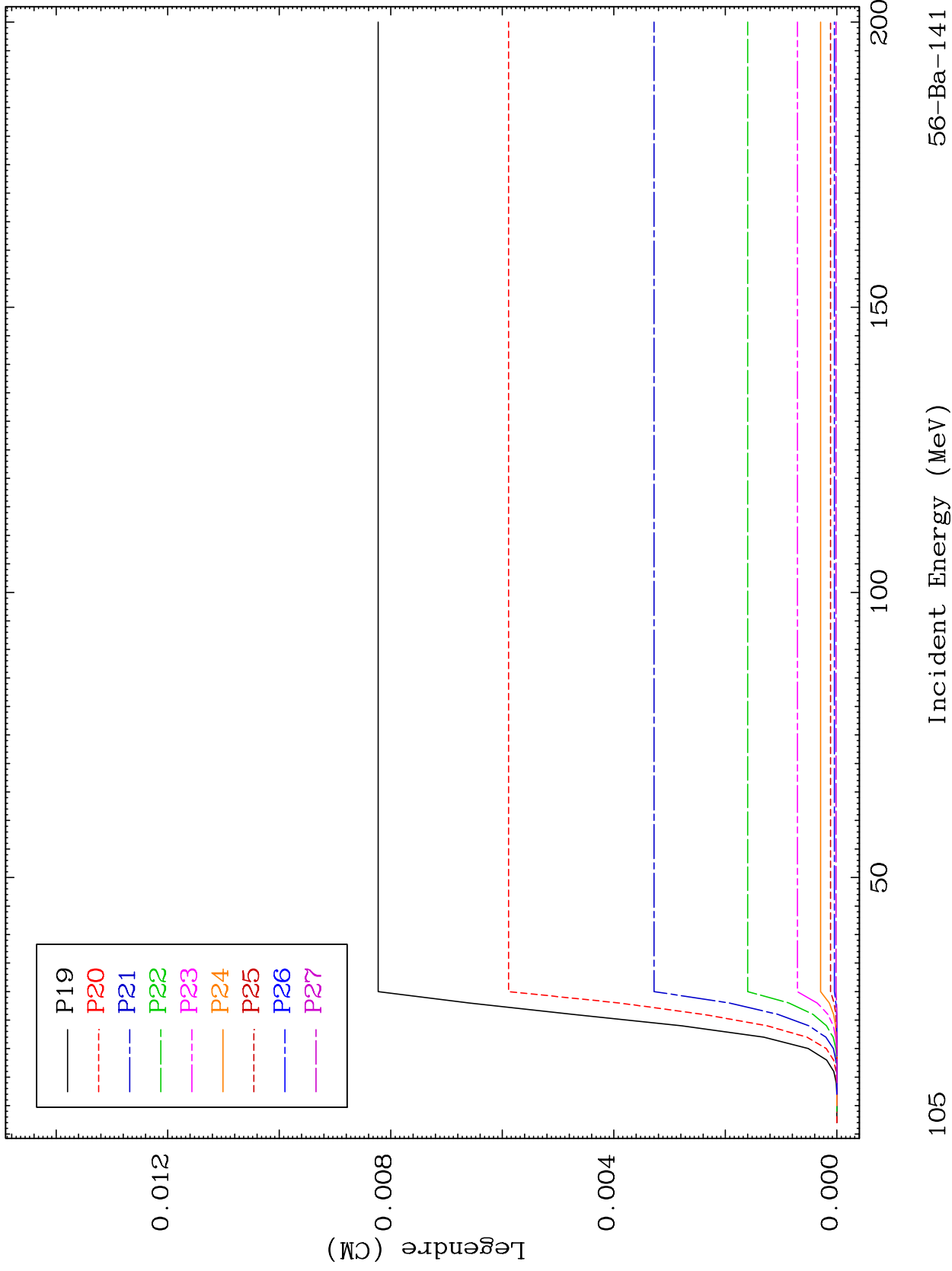

105

Incident Energy (MeV)

56-Ba-141

MAT 5658

MT= 72 (n,n') Level
Legendre Coefficients

56-Ba-141

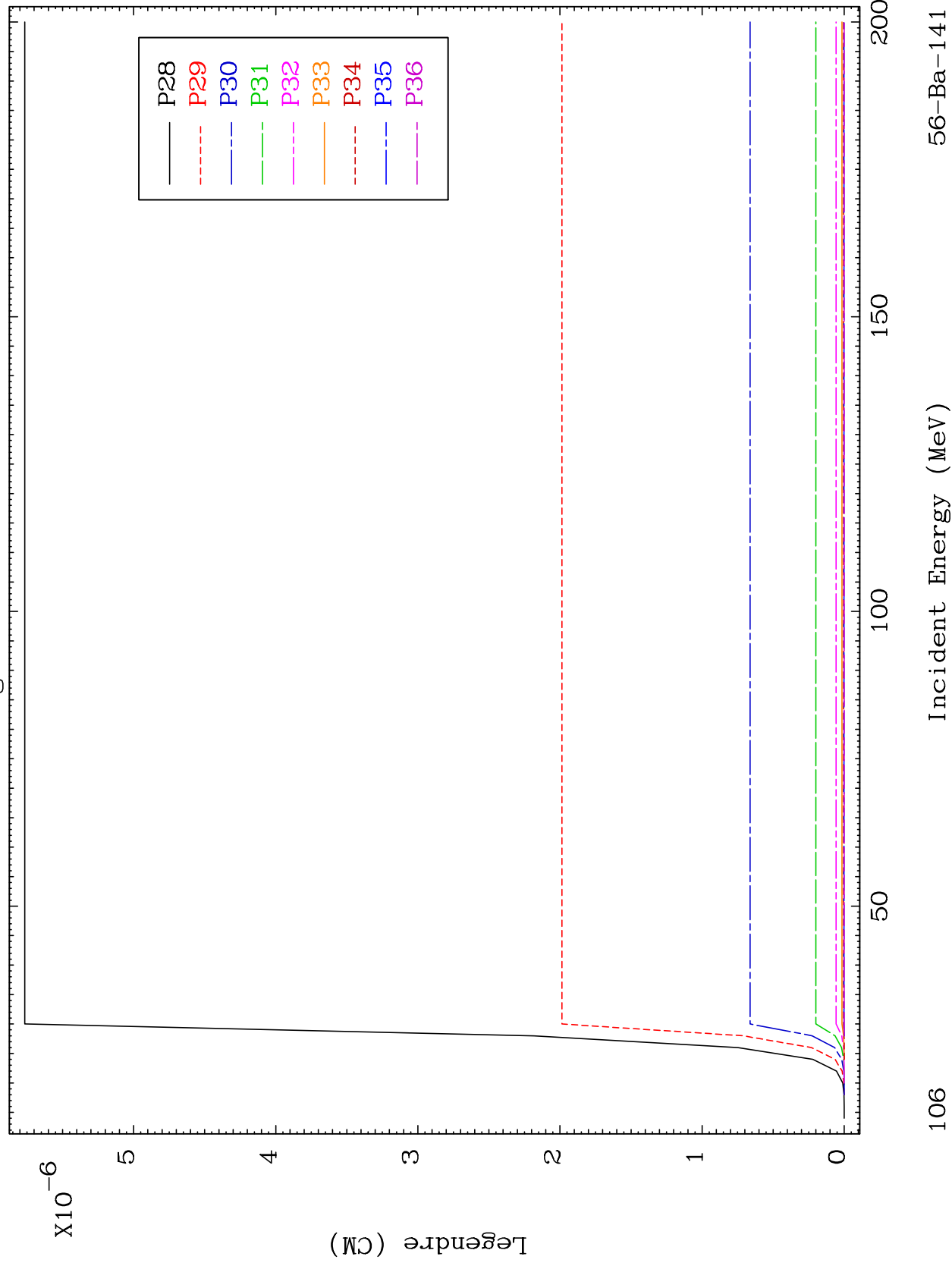

106

Incident Energy (MeV)

56-Ba-141

MAT 5658

MT= 73 (n,n') Level
Legendre Coefficients

56-Ba-141

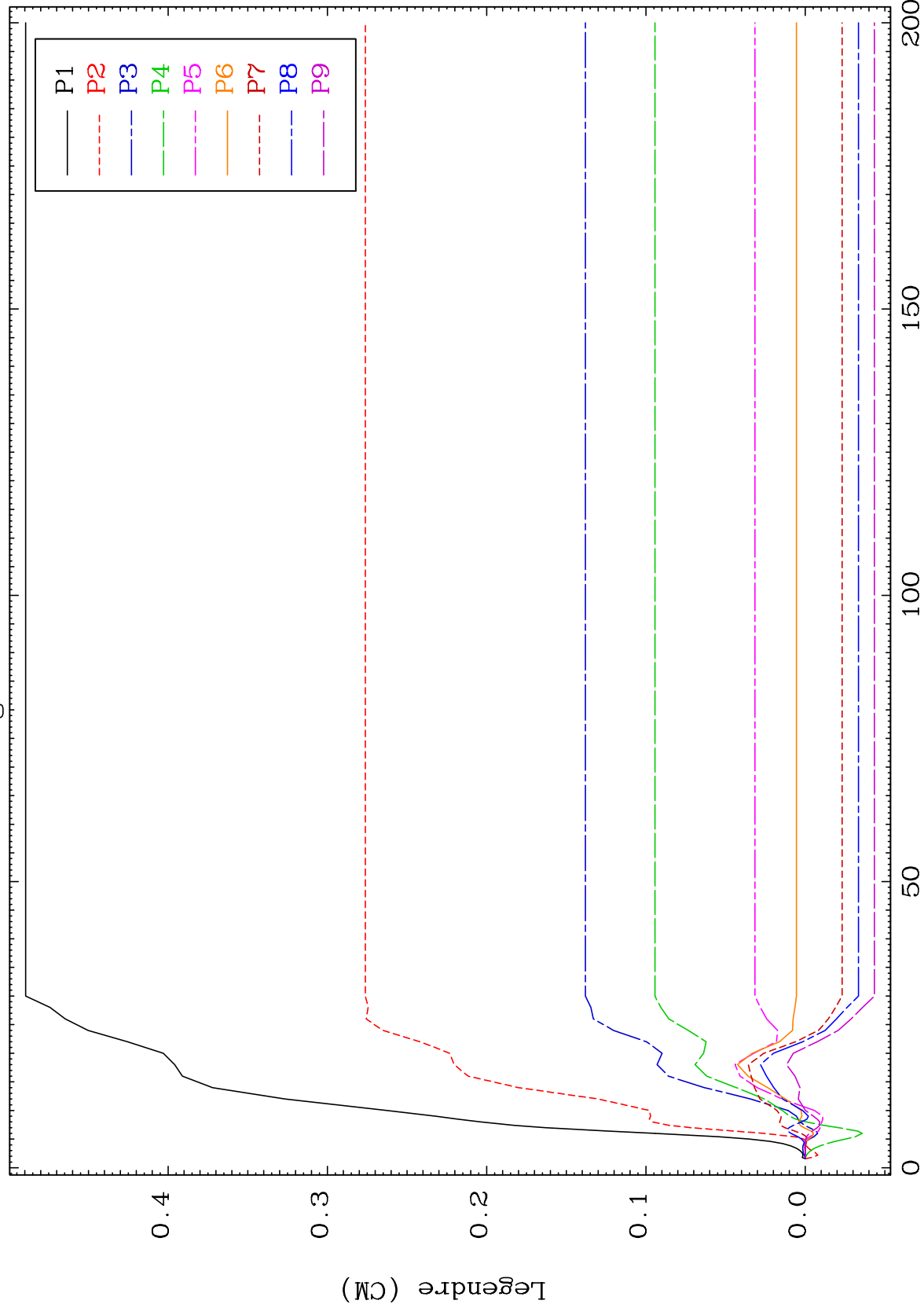

56-Ba-141

Incident Energy (MeV)

107

MAT 5658

MT= 73 (n,n') Level
Legendre Coefficients

56-Ba-141

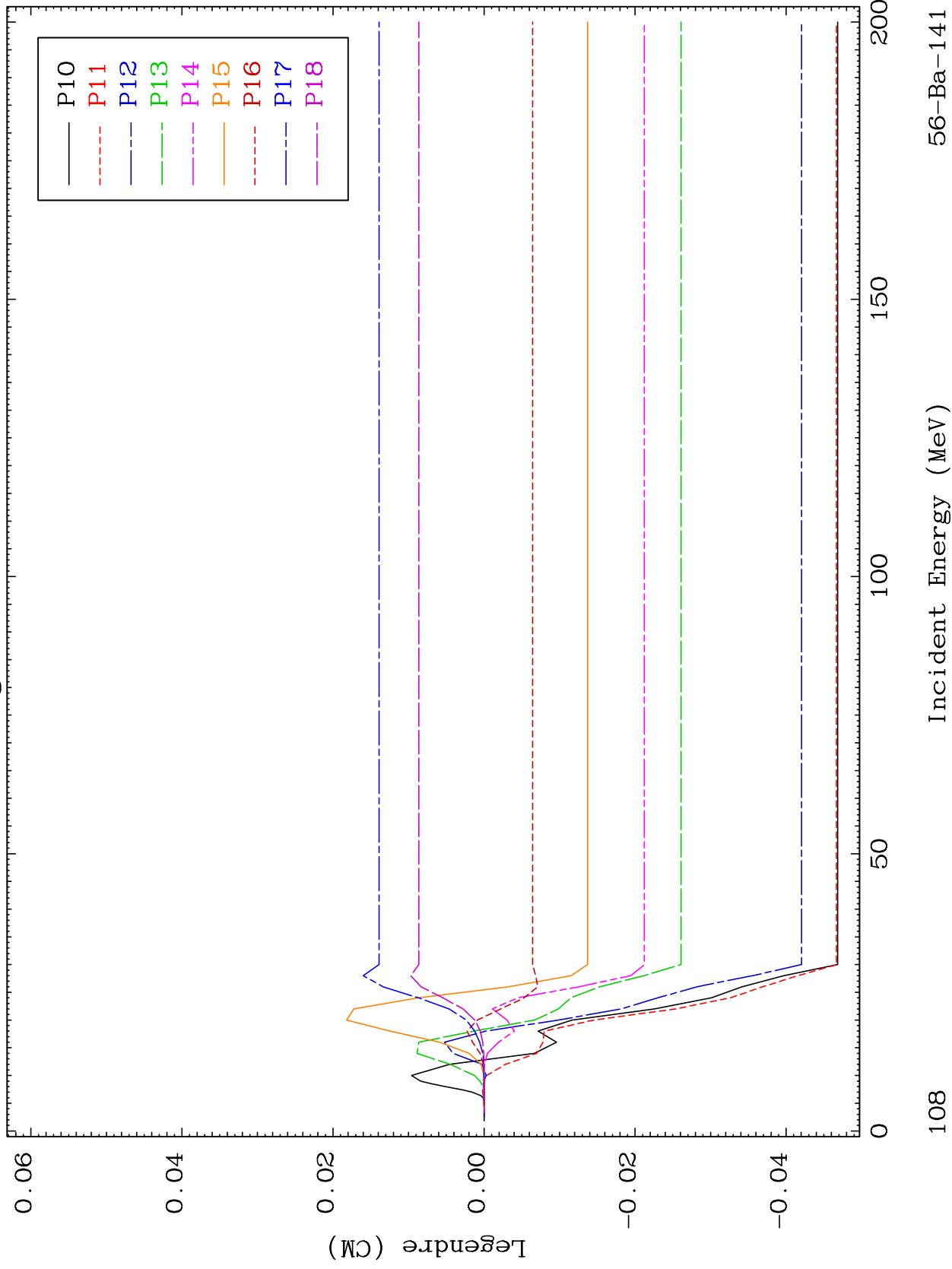

56-Ba-141

Incident Energy (MeV)

108

MAT 5658

MT= 73 (n,n') Level
Legendre Coefficients

56-Ba-141

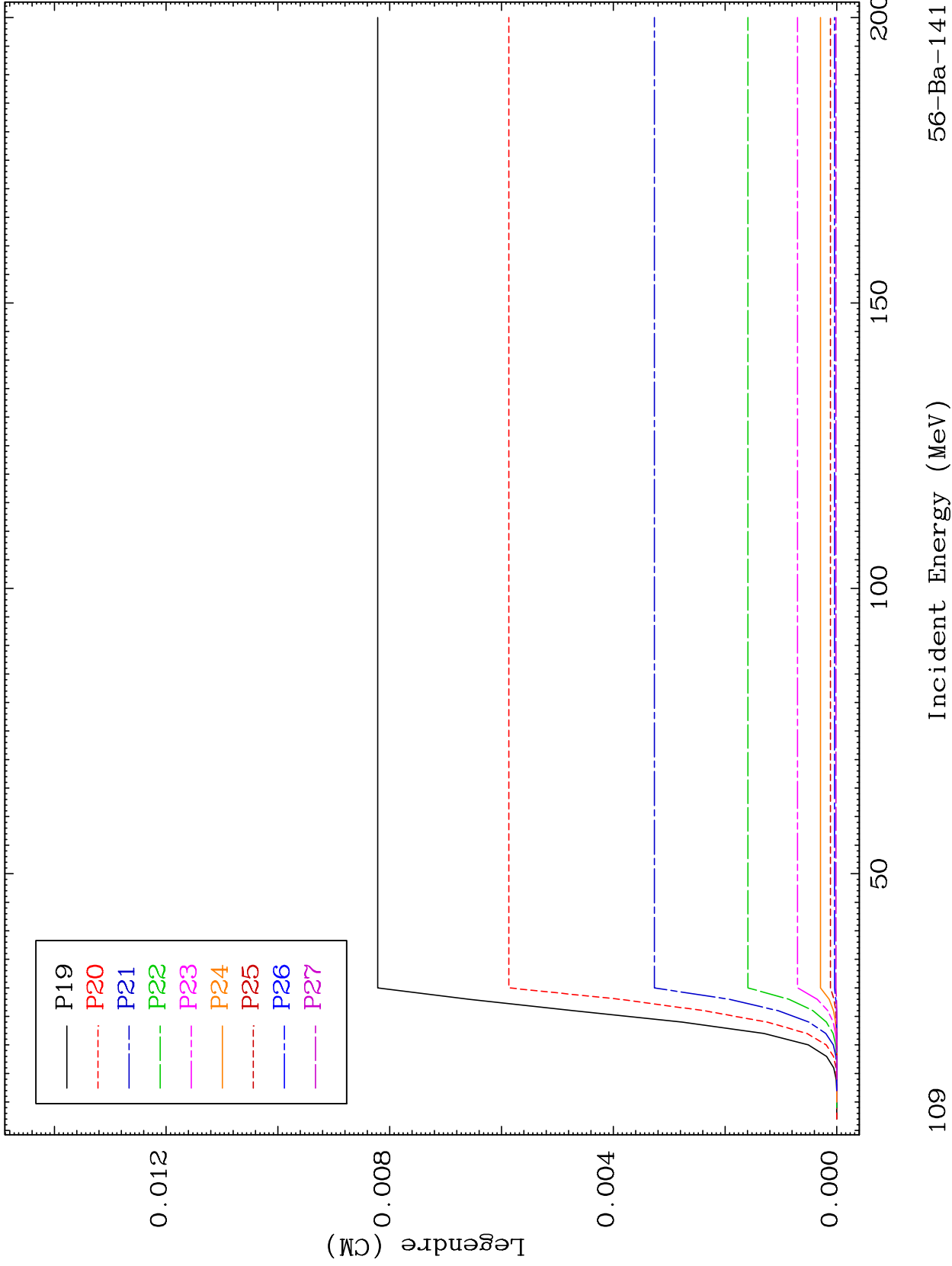

109

Incident Energy (MeV)

56-Ba-141

MAT 5658

MT= 73 (n,n') Level
Legendre Coefficients

56-Ba-141

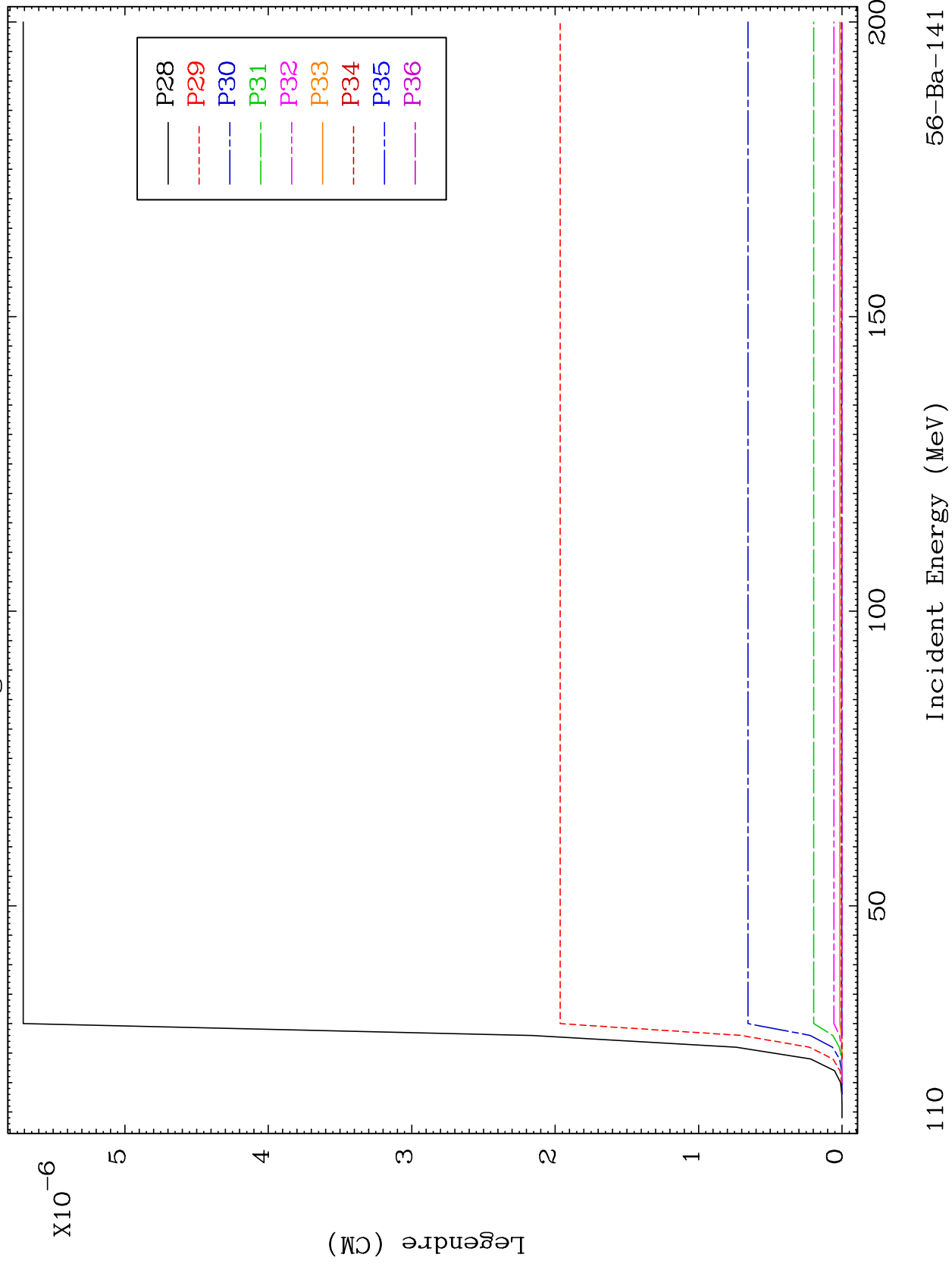

MAT 5658

MT= 74 (n,n') Level

56-Ba-141

Legendre Coefficients

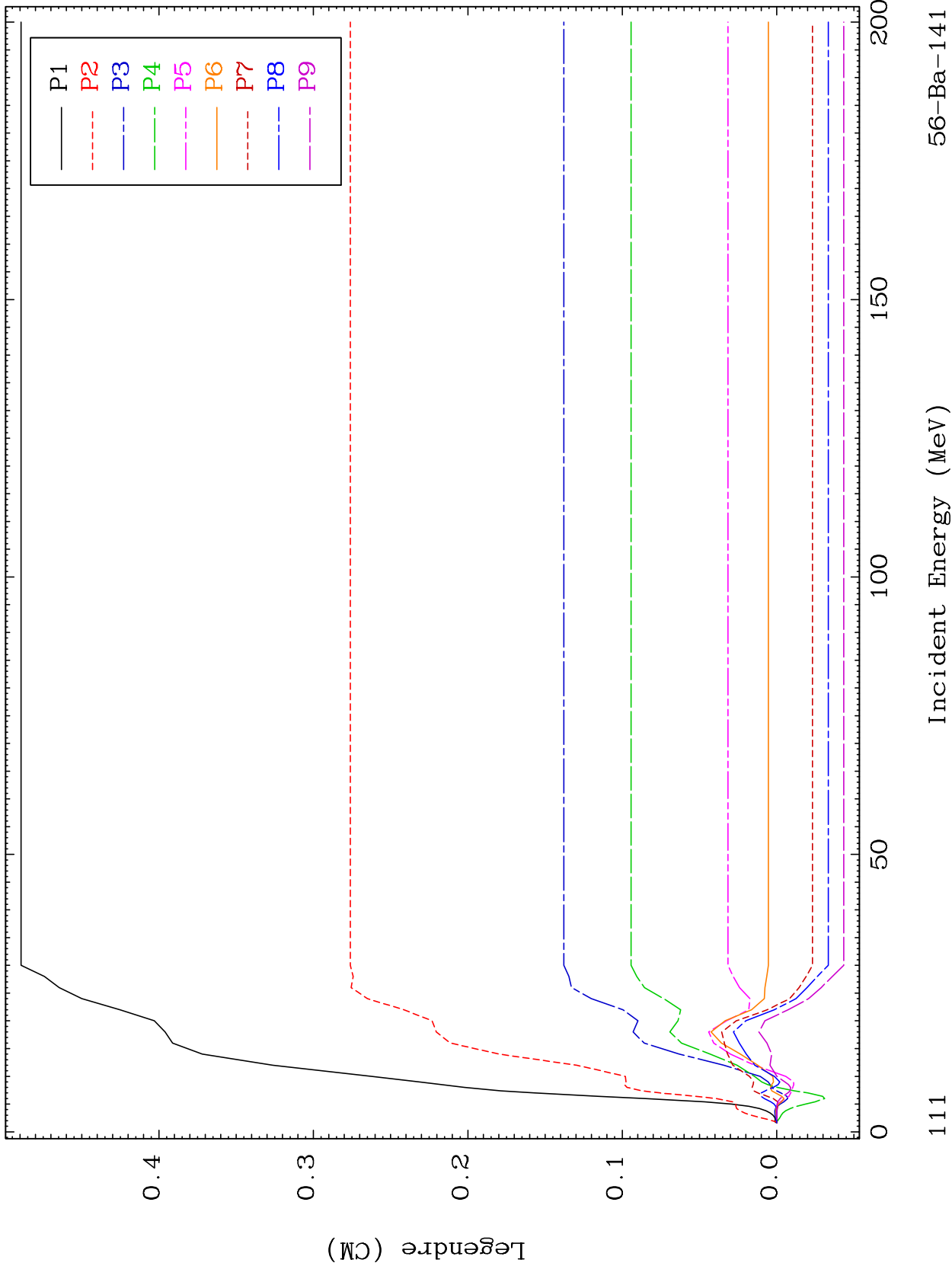

111

Incident Energy (MeV)

56-Ba-141

MAT 5658

MT= 74 (n,n') Level
Legendre Coefficients

56-Ba-141

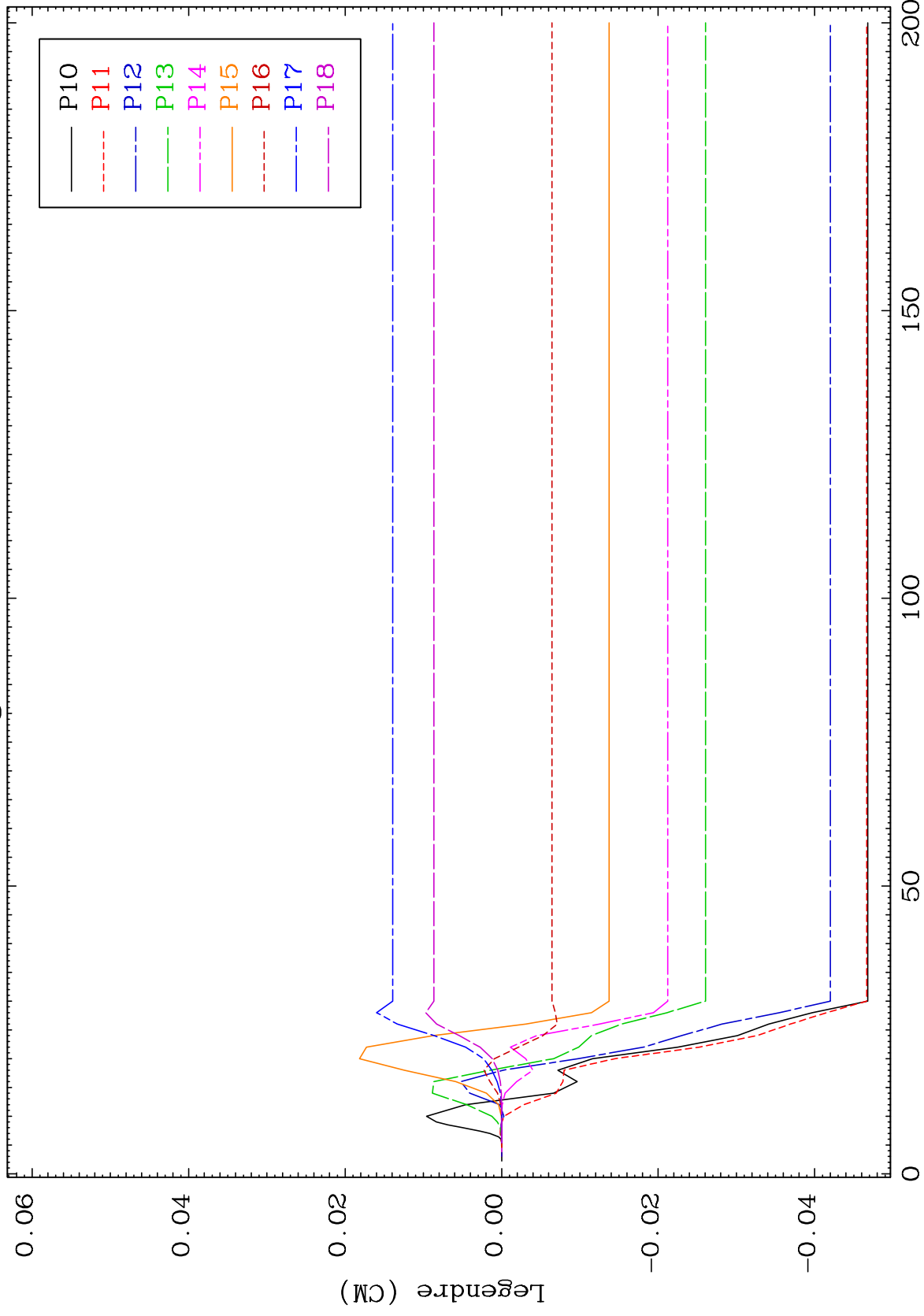

112

Incident Energy (MeV)

56-Ba-141

MAT 5658

MT= 74 (n,n') Level
Legendre Coefficients

56-Ba-141

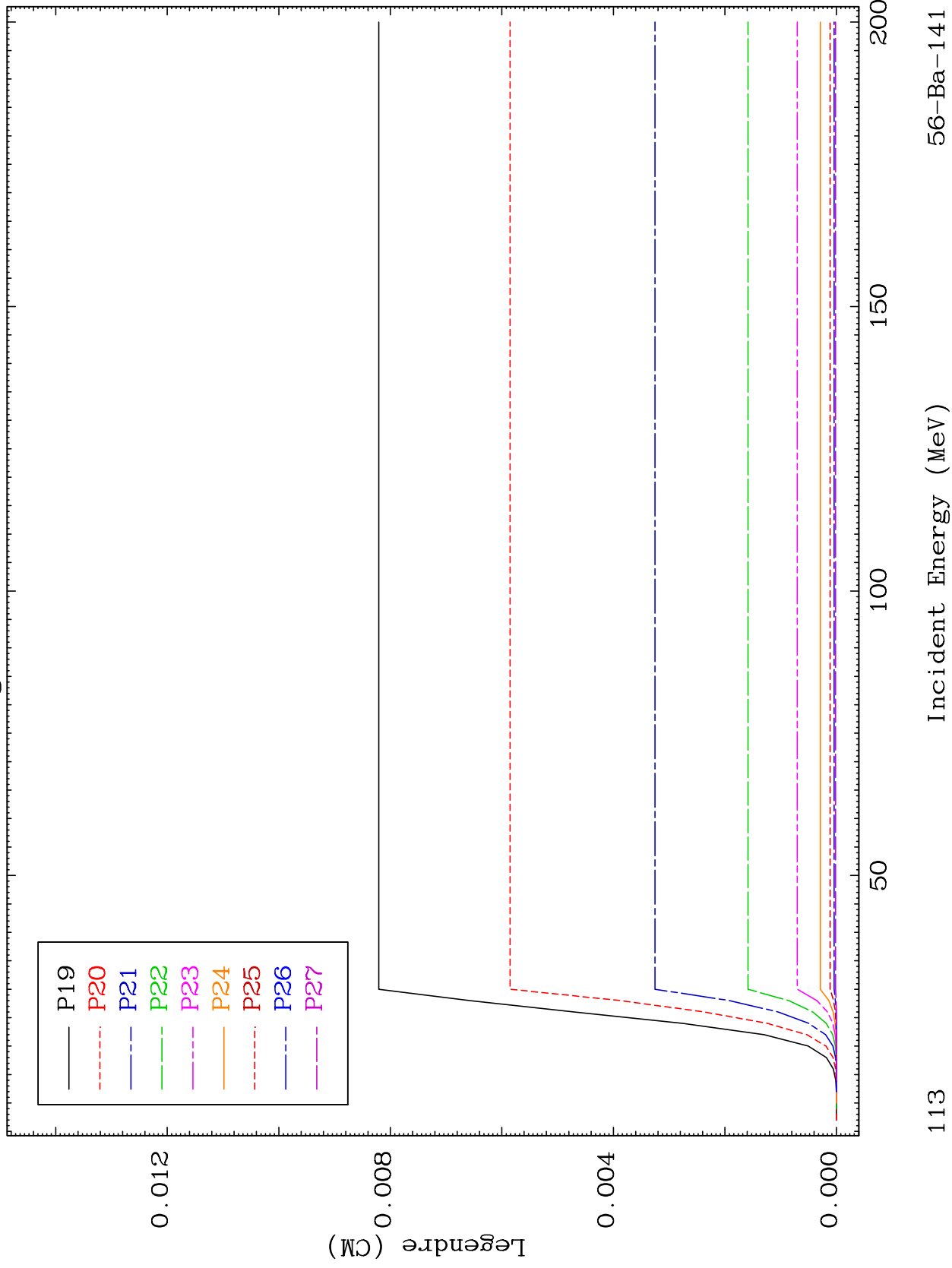

113

56-Ba-141

MAT 5658

MT= 74 (n,n') Level
Legendre Coefficients

56-Ba-141

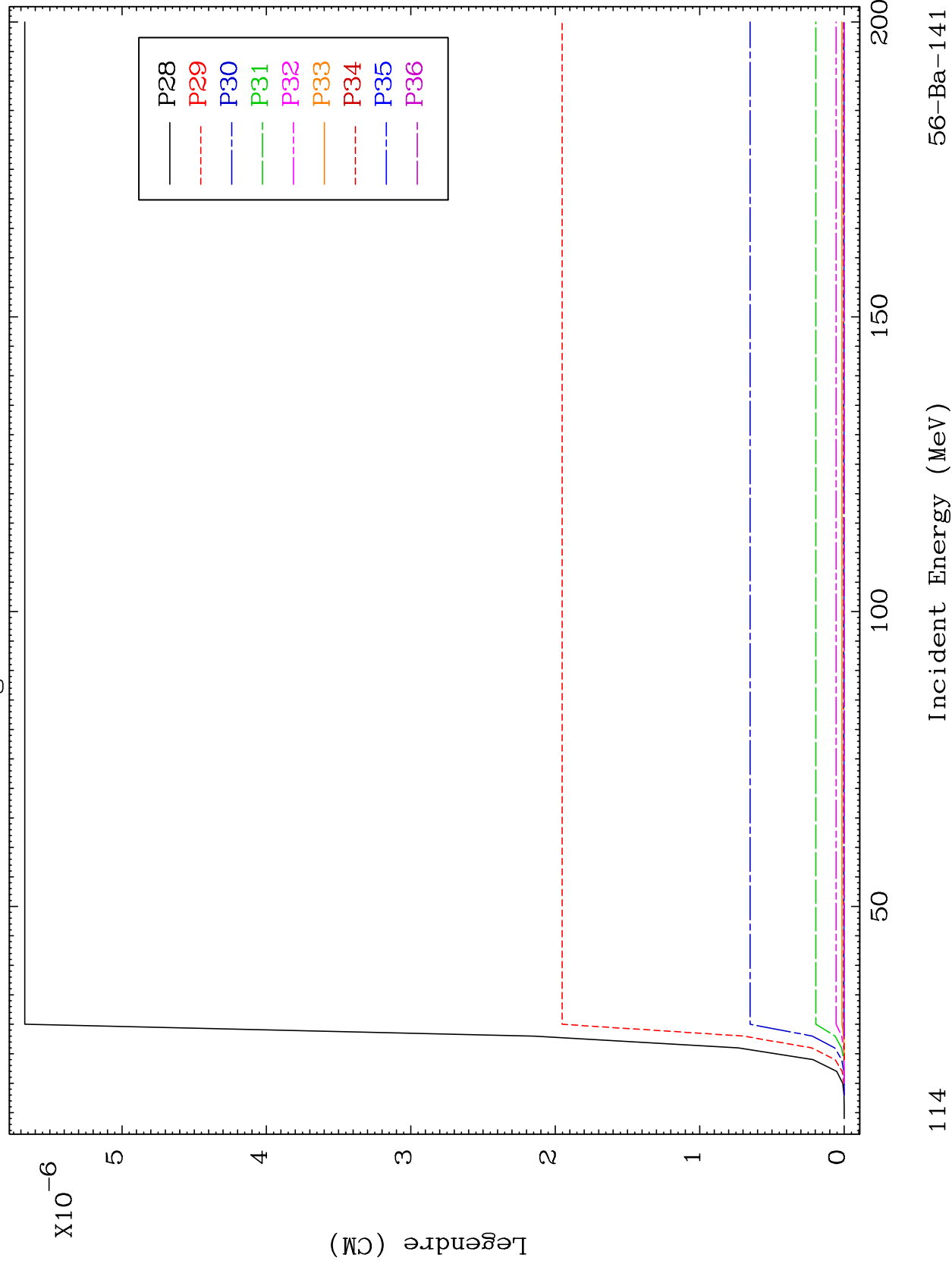

114

Incident Energy (MeV)

56-Ba-141

MAT 5658

MT= 75 (n,n') Level
Legendre Coefficients

56-Ba-141

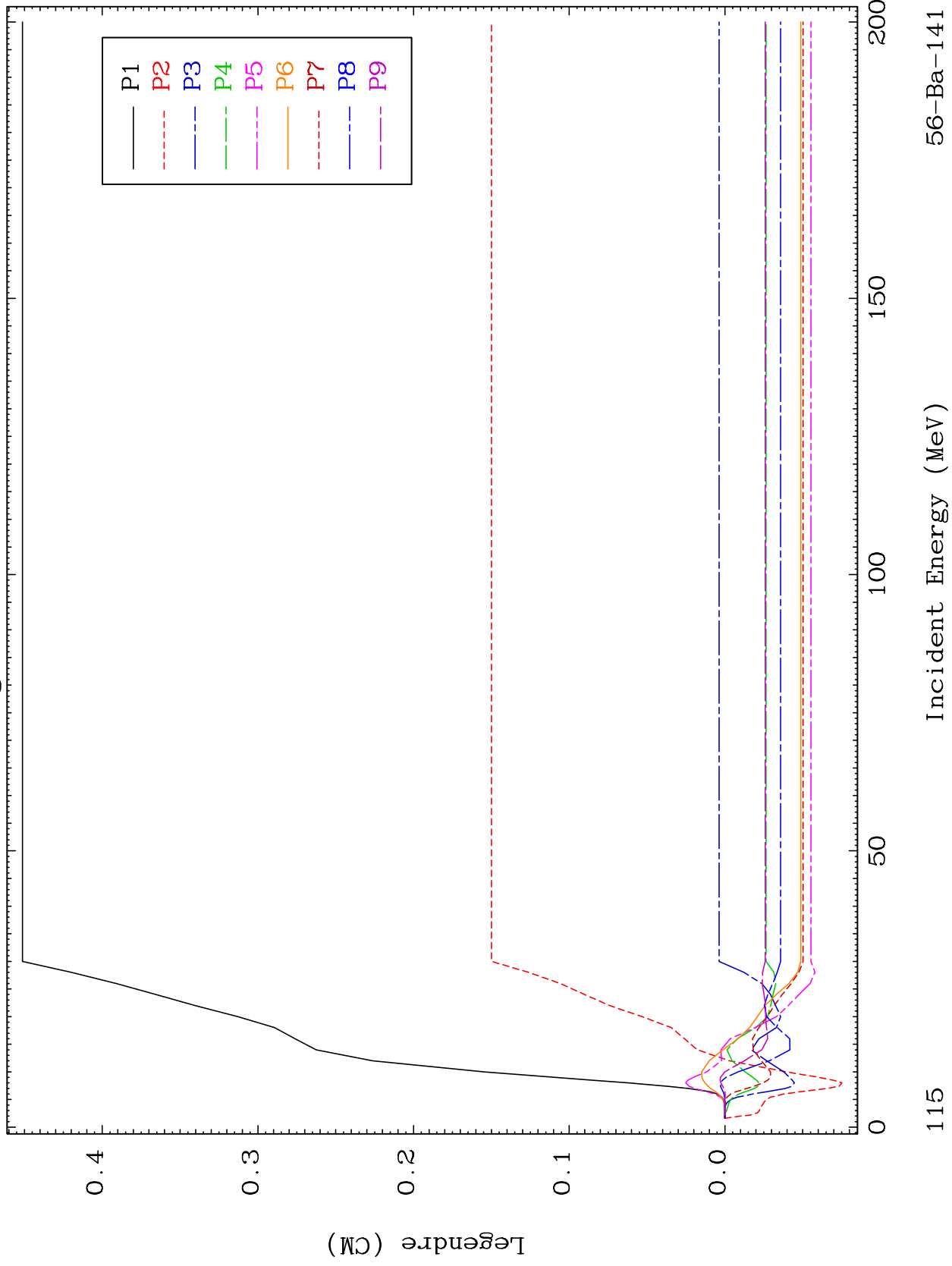

56-Ba-141

Incident Energy (MeV)

115

MAT 5658

MT= 75 (n,n') Level
Legendre Coefficients

56-Ba-141

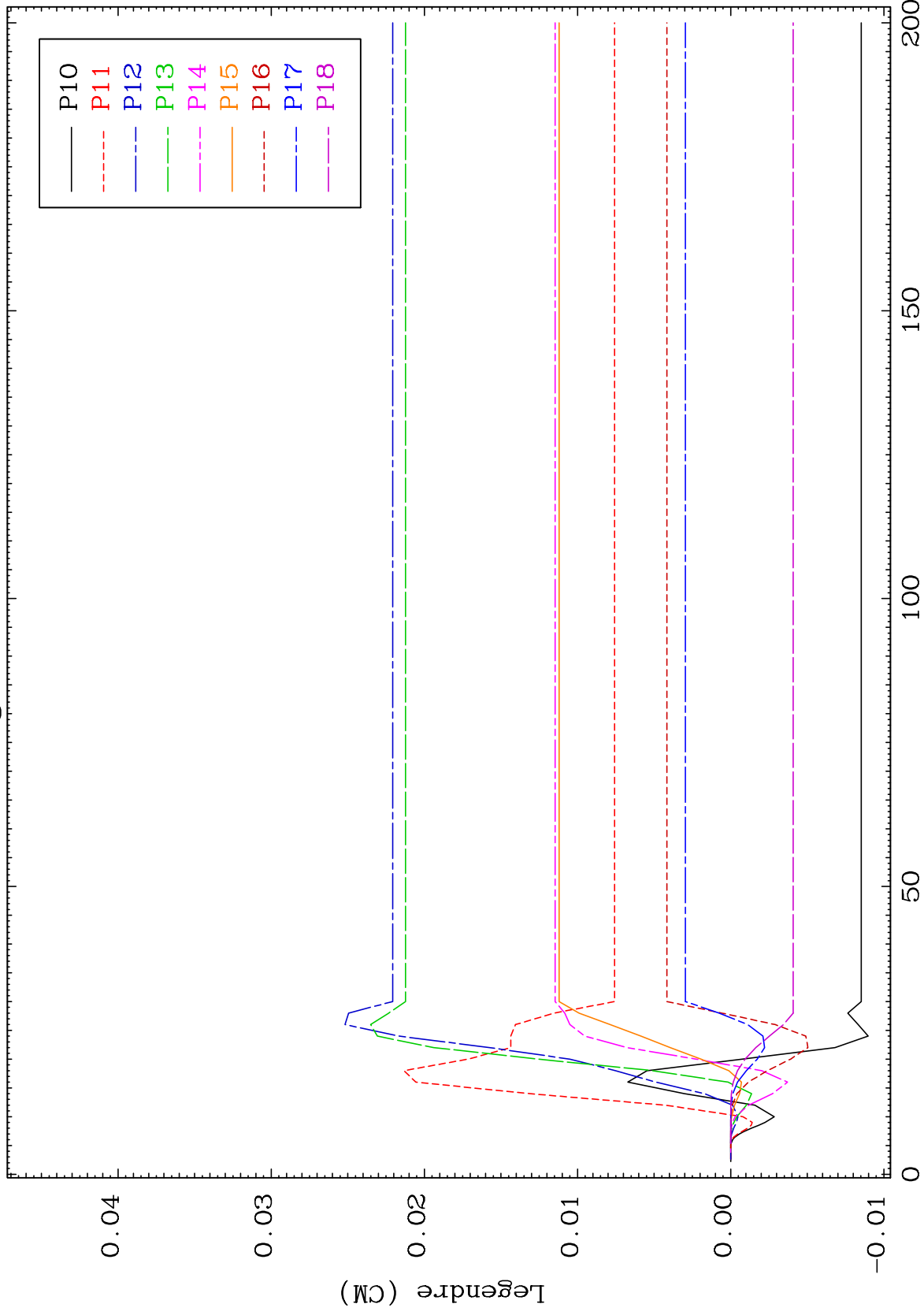

116

Incident Energy (MeV)

56-Ba-141

MAT 5658

MT= 75 (n,n') Level
Legendre Coefficients

56-Ba-141

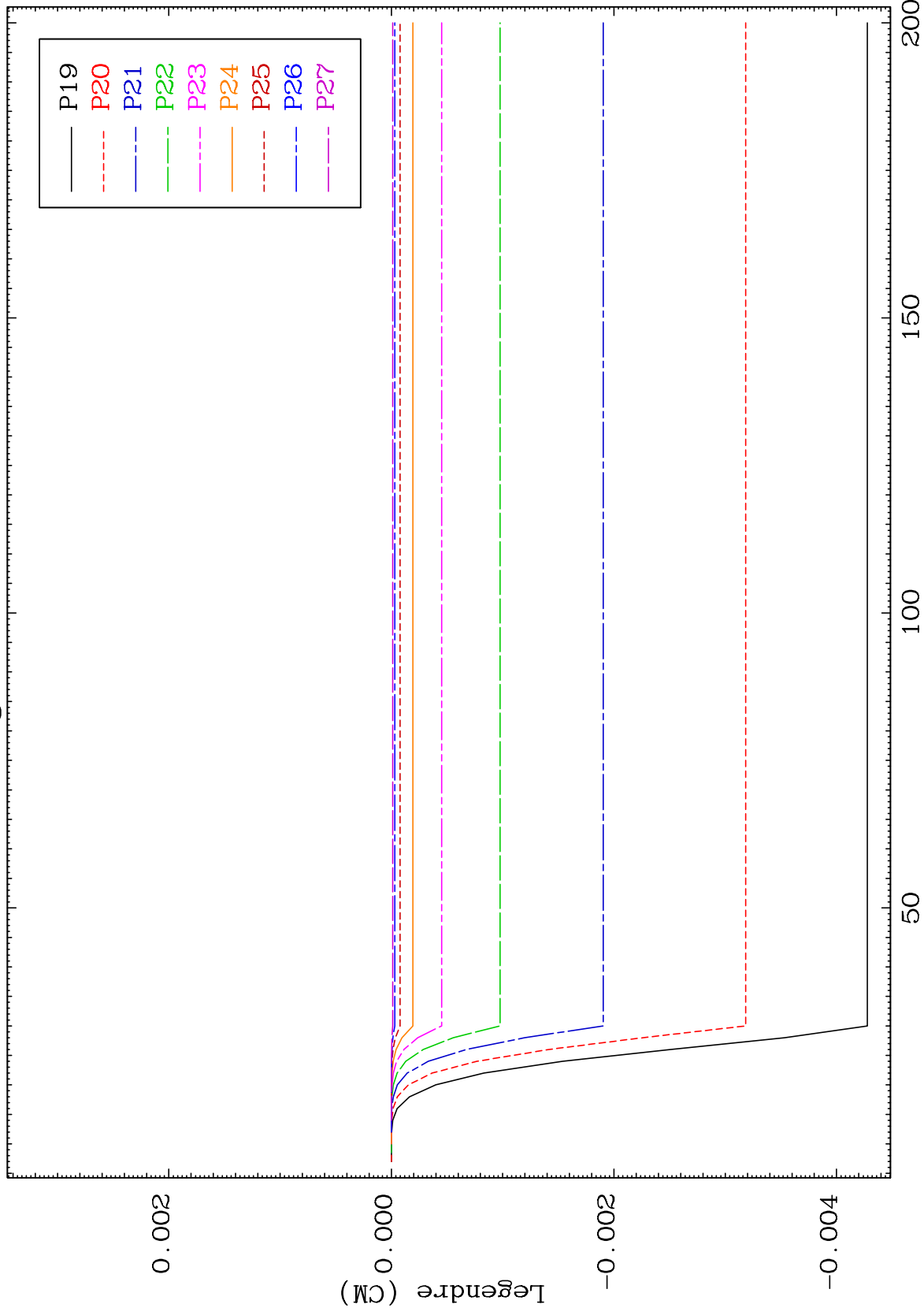

117

Incident Energy (MeV)

56-Ba-141

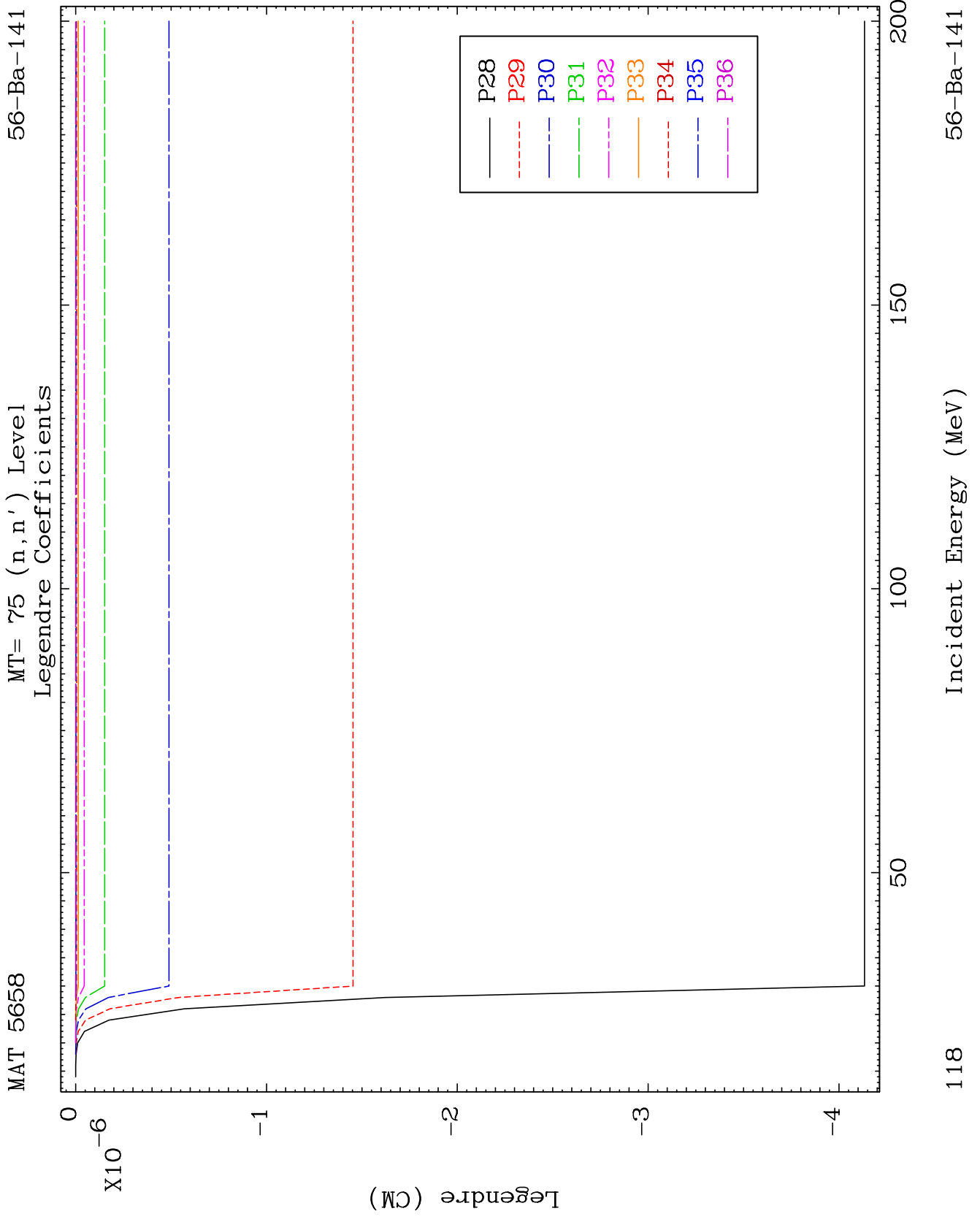

MAT 5658

MT= 76 (n,n') Level
Legendre Coefficients

56-Ba-141

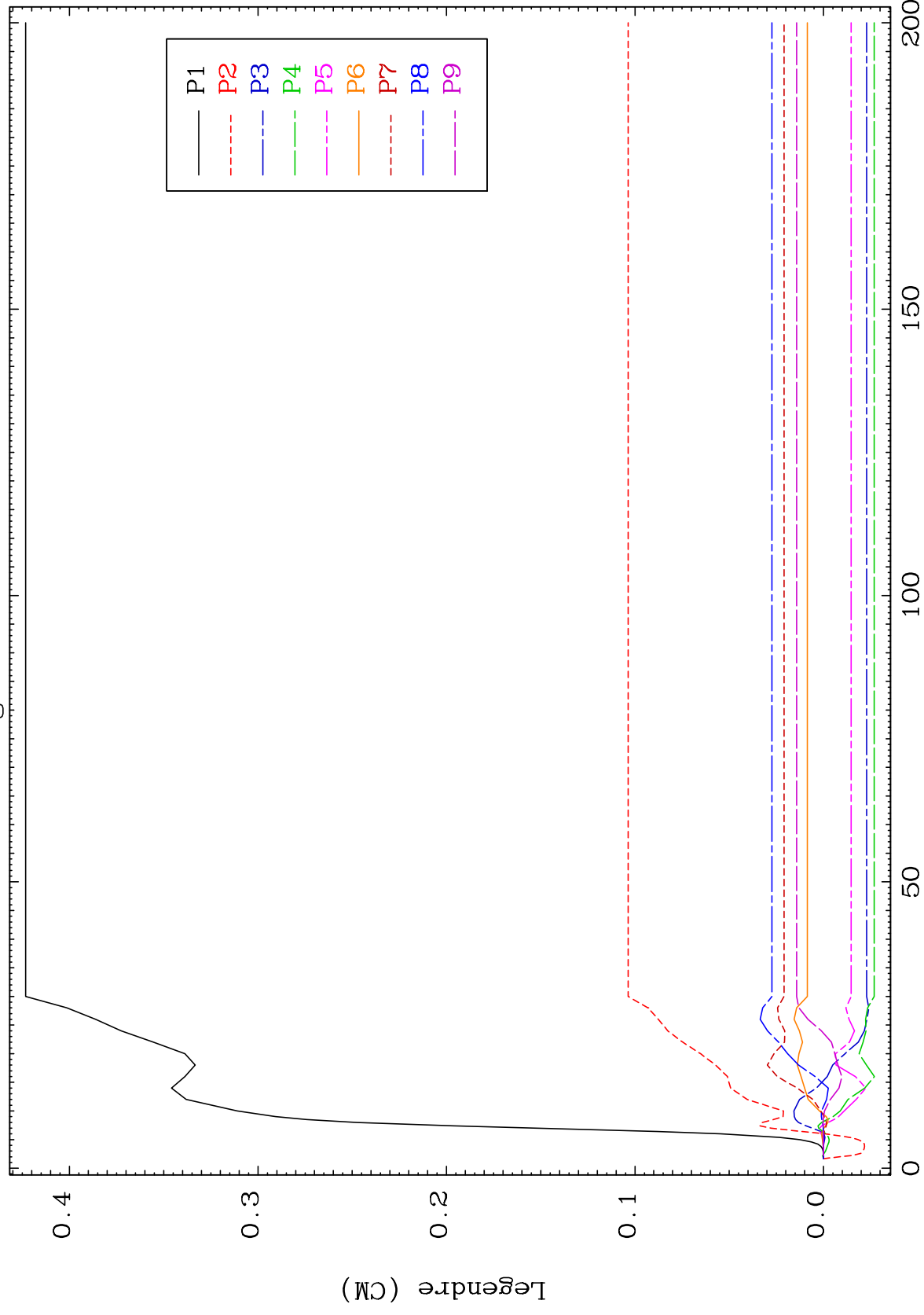

119

Incident Energy (MeV)

56-Ba-141

MAT 5658

MT= 76 (n,n') Level
Legendre Coefficients

56-Ba-141

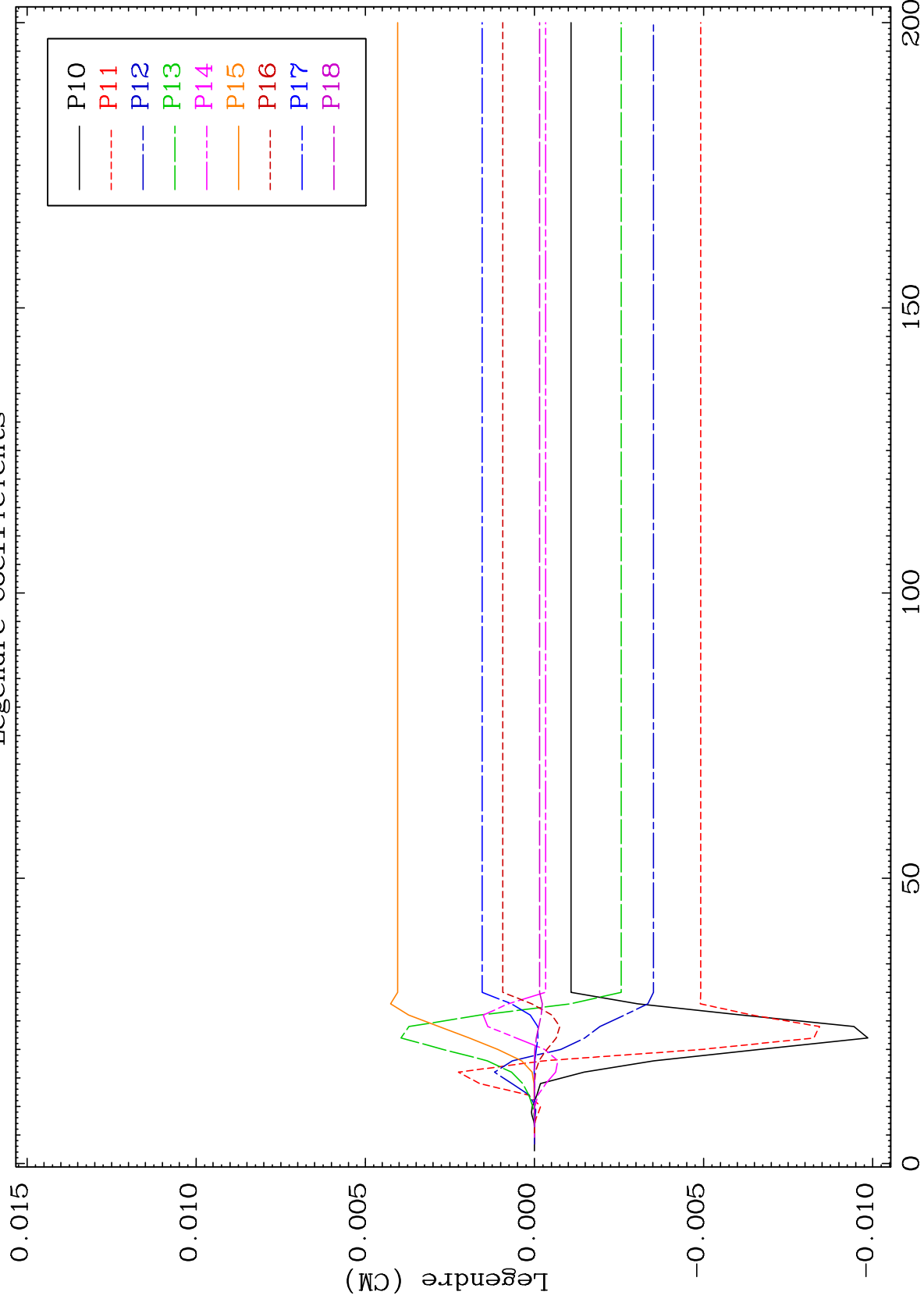

120

Incident Energy (MeV)

56-Ba-141

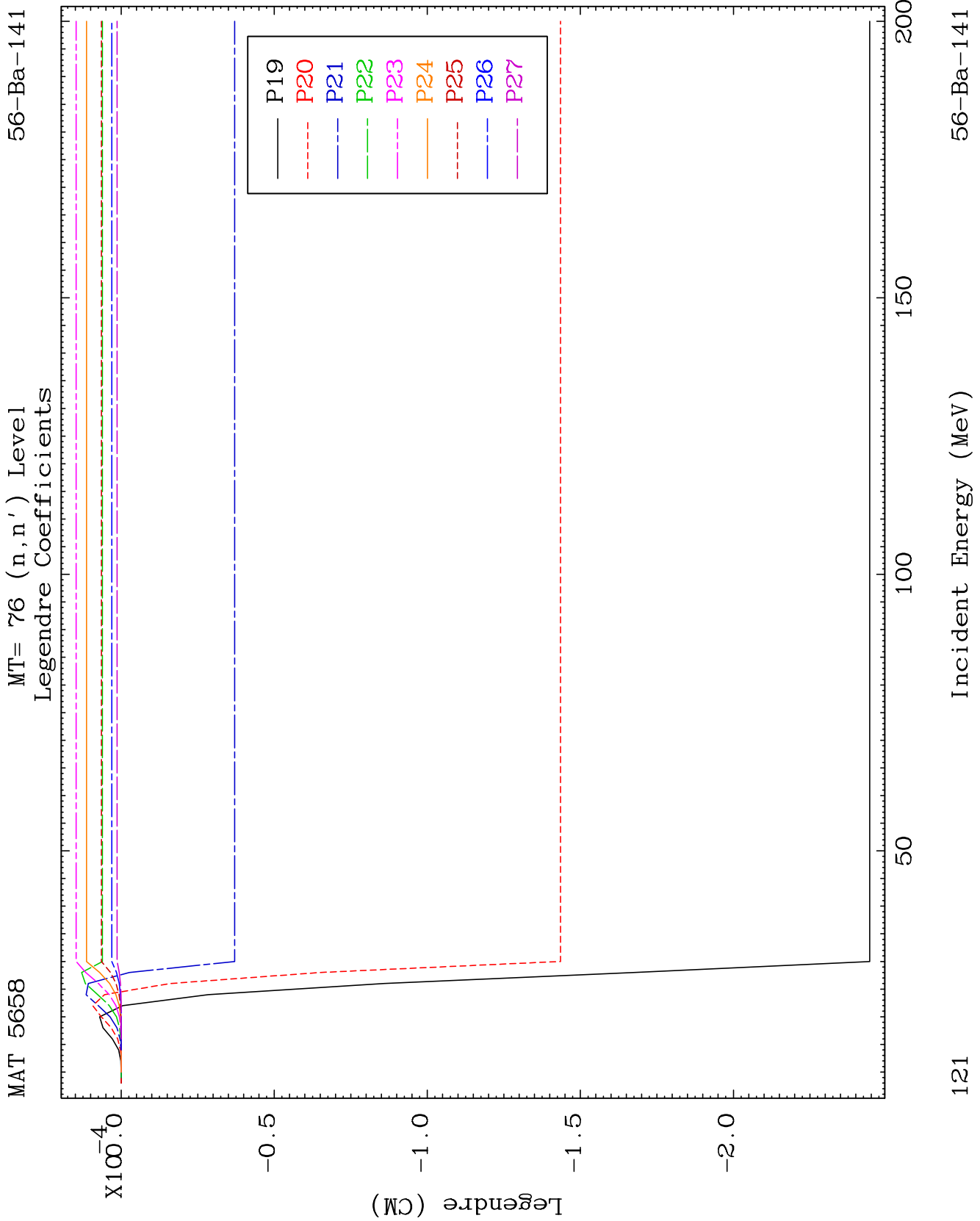

MAT 5658

MT= 76 (n,n') Level
Legendre Coefficients

56-Ba-141

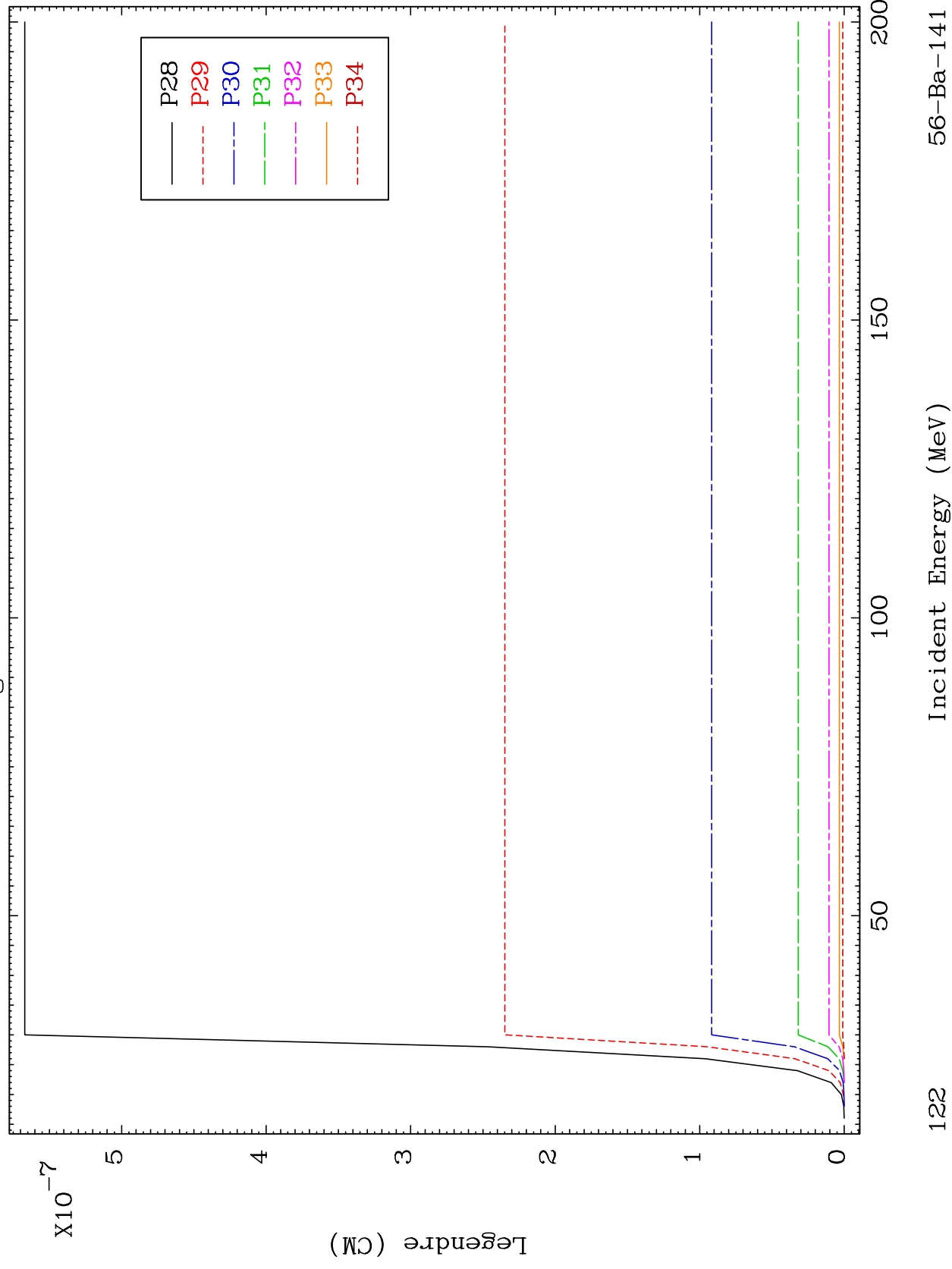

122

Incident Energy (MeV)

56-Ba-141

MAT 5658

MT= 77 (n,n') Level
Legendre Coefficients

56-Ba-141

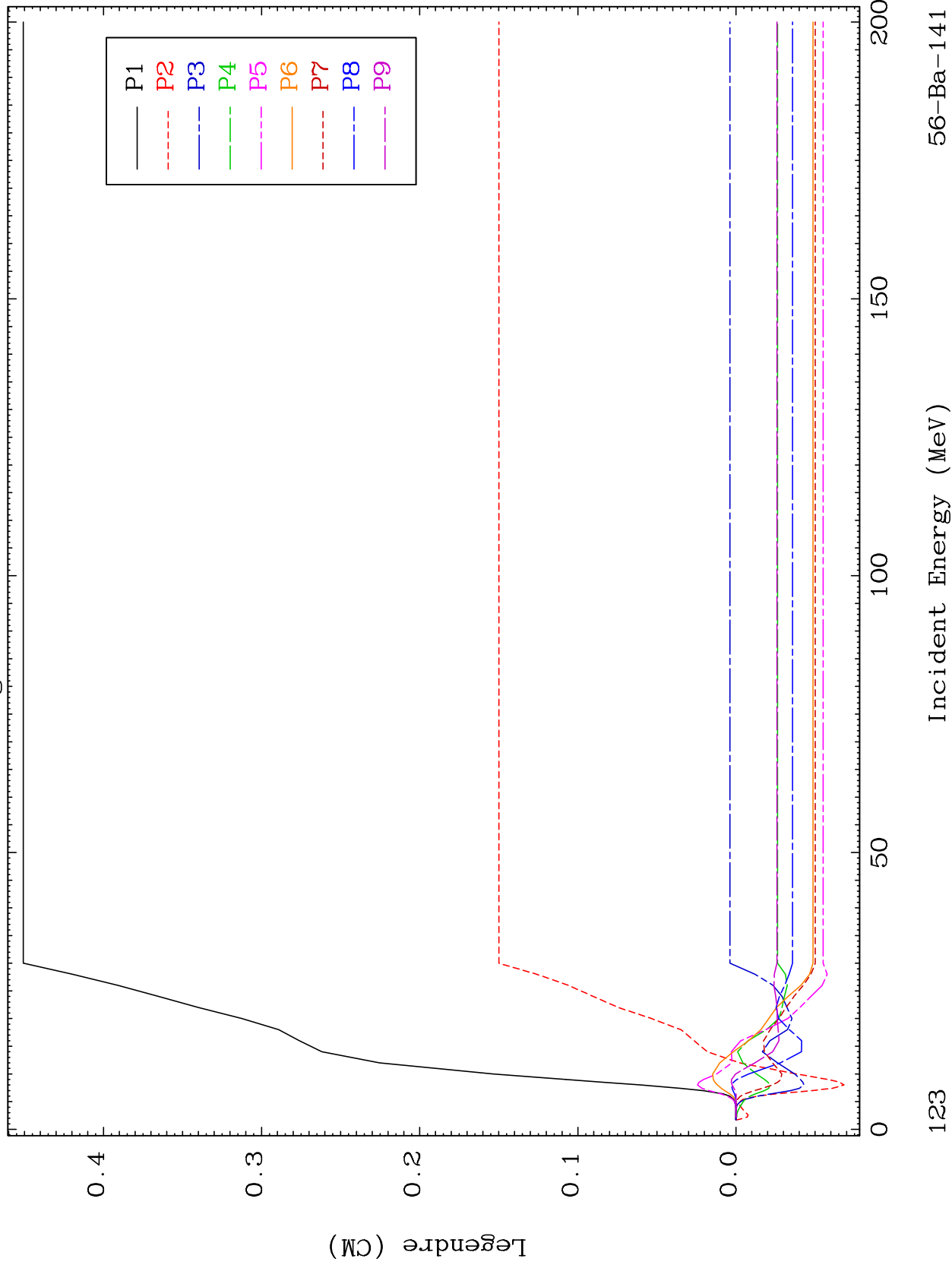

56-Ba-141

Incident Energy (MeV)

123

MAT 5658

MT= 77 (n,n') Level
Legendre Coefficients

56-Ba-141

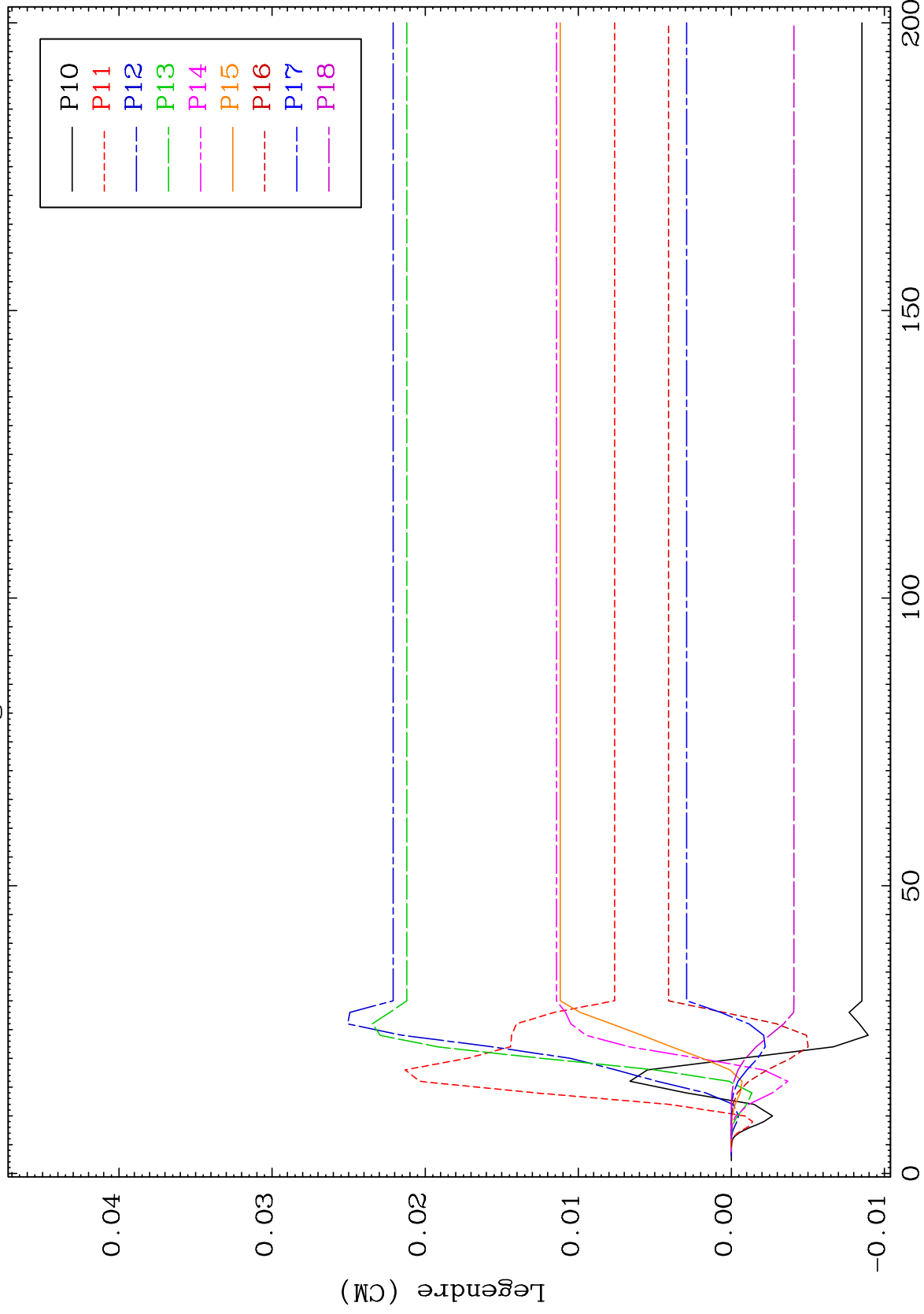

124

Incident Energy (MeV)

56-Ba-141

MAT 5658

MT= 77 (n,n') Level
Legendre Coefficients

56-Ba-141

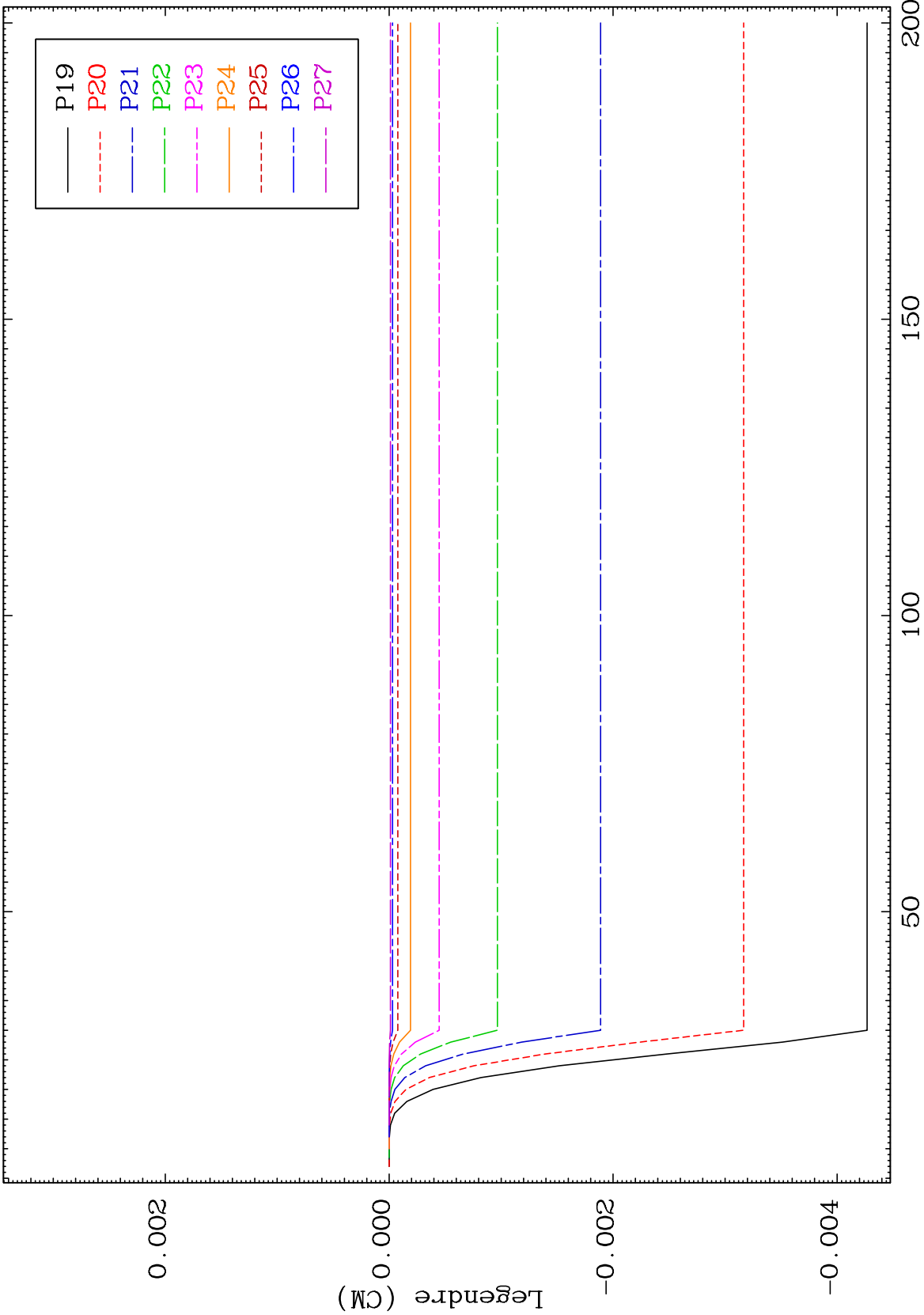

125

Incident Energy (MeV)

56-Ba-141

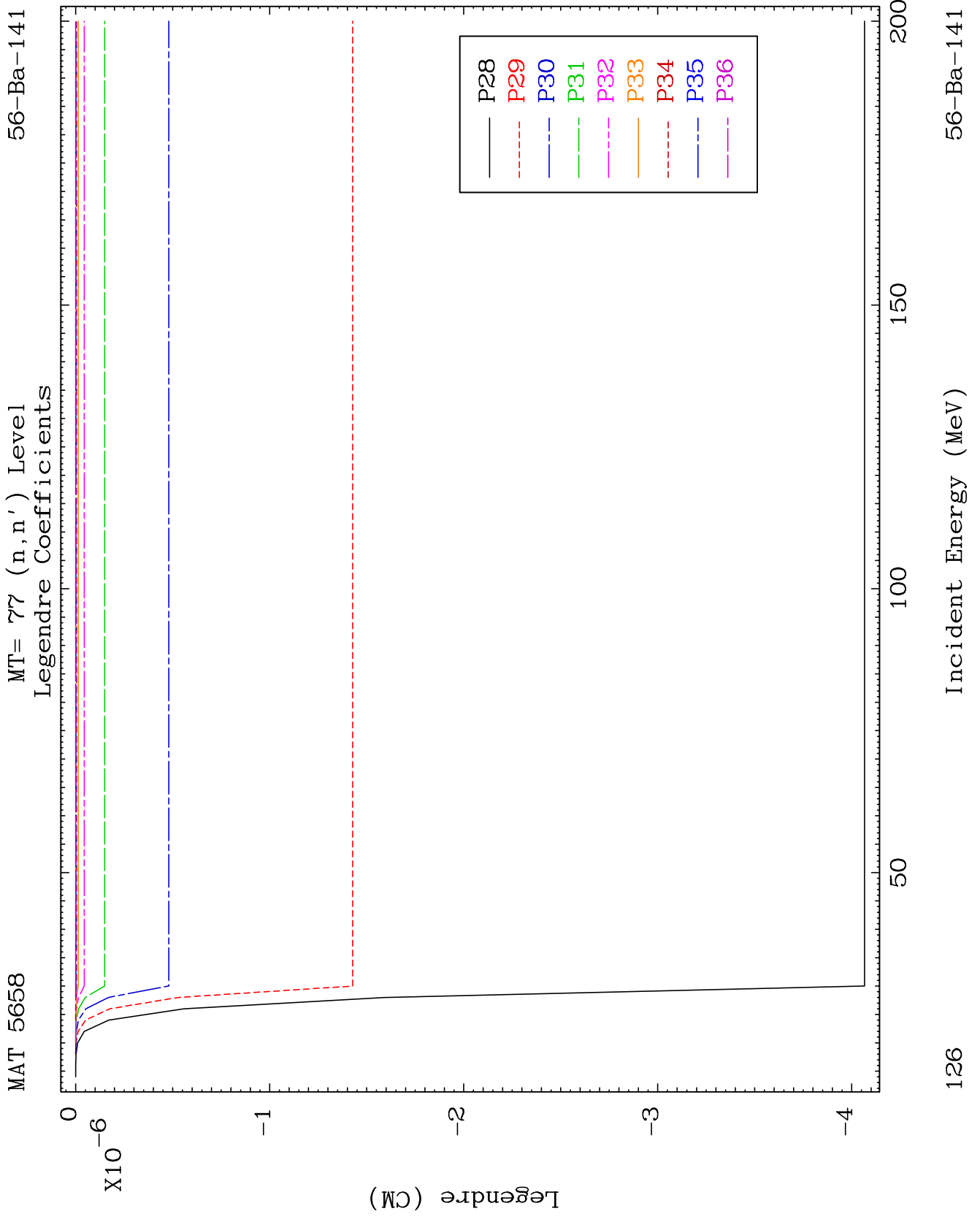

MAT 5658

MT= 78 (n,n') Level
Legendre Coefficients

56-Ba-141

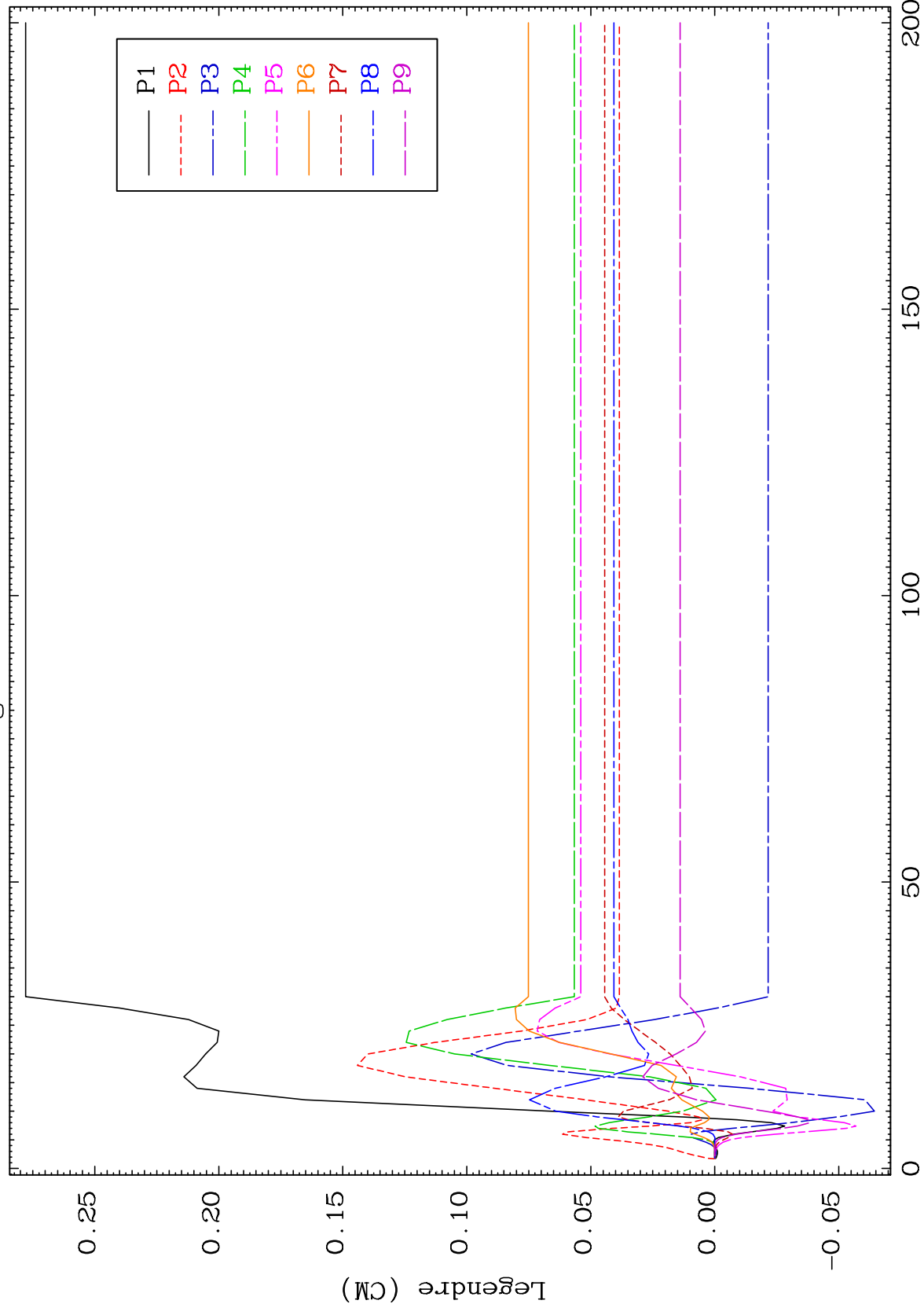

56-Ba-141

Incident Energy (MeV)

127

MAT 5658

56-Ba-141

MT= 78 (n,n') Level
Legendre Coefficients

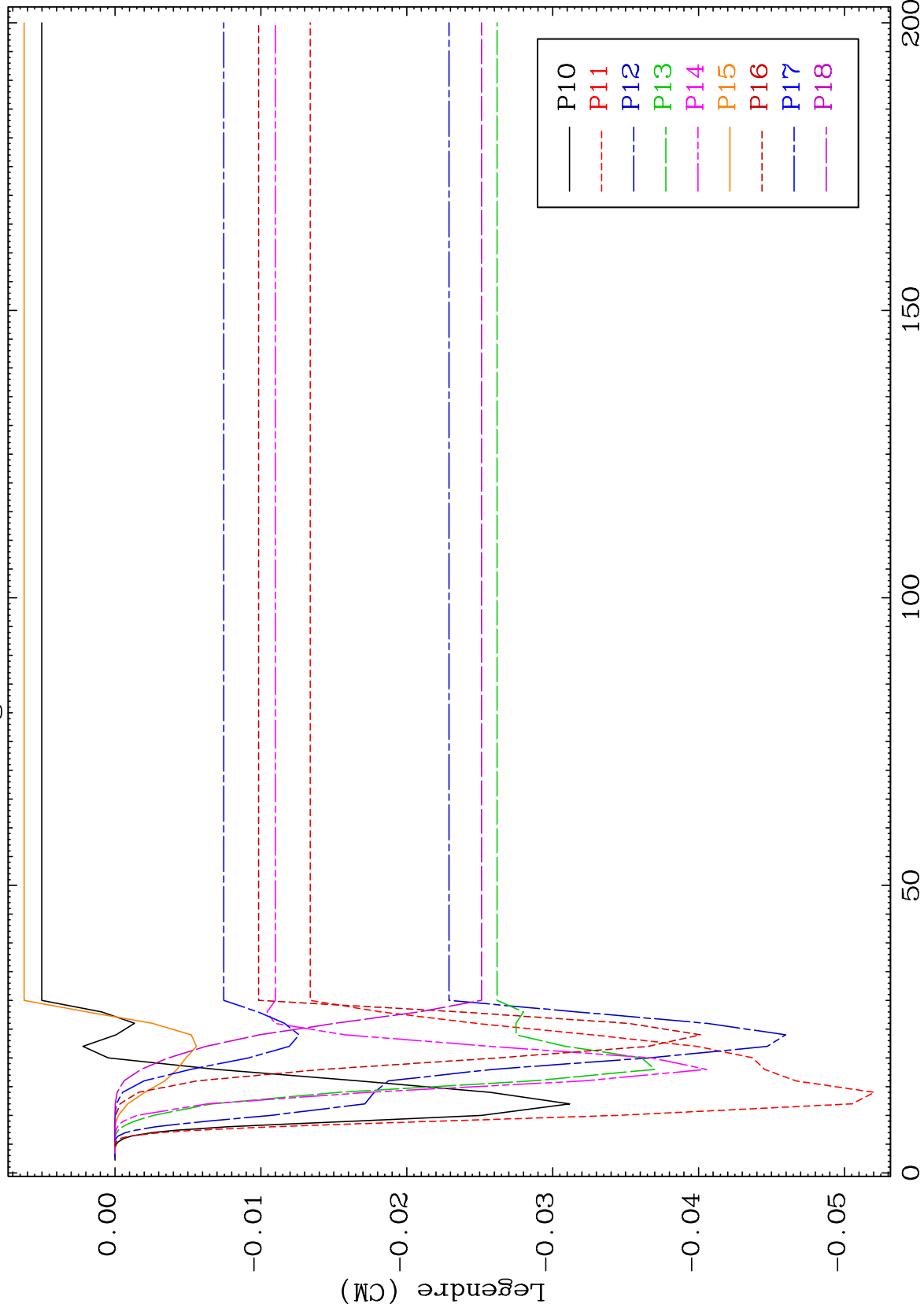

56-Ba-141

Incident Energy (MeV)

128

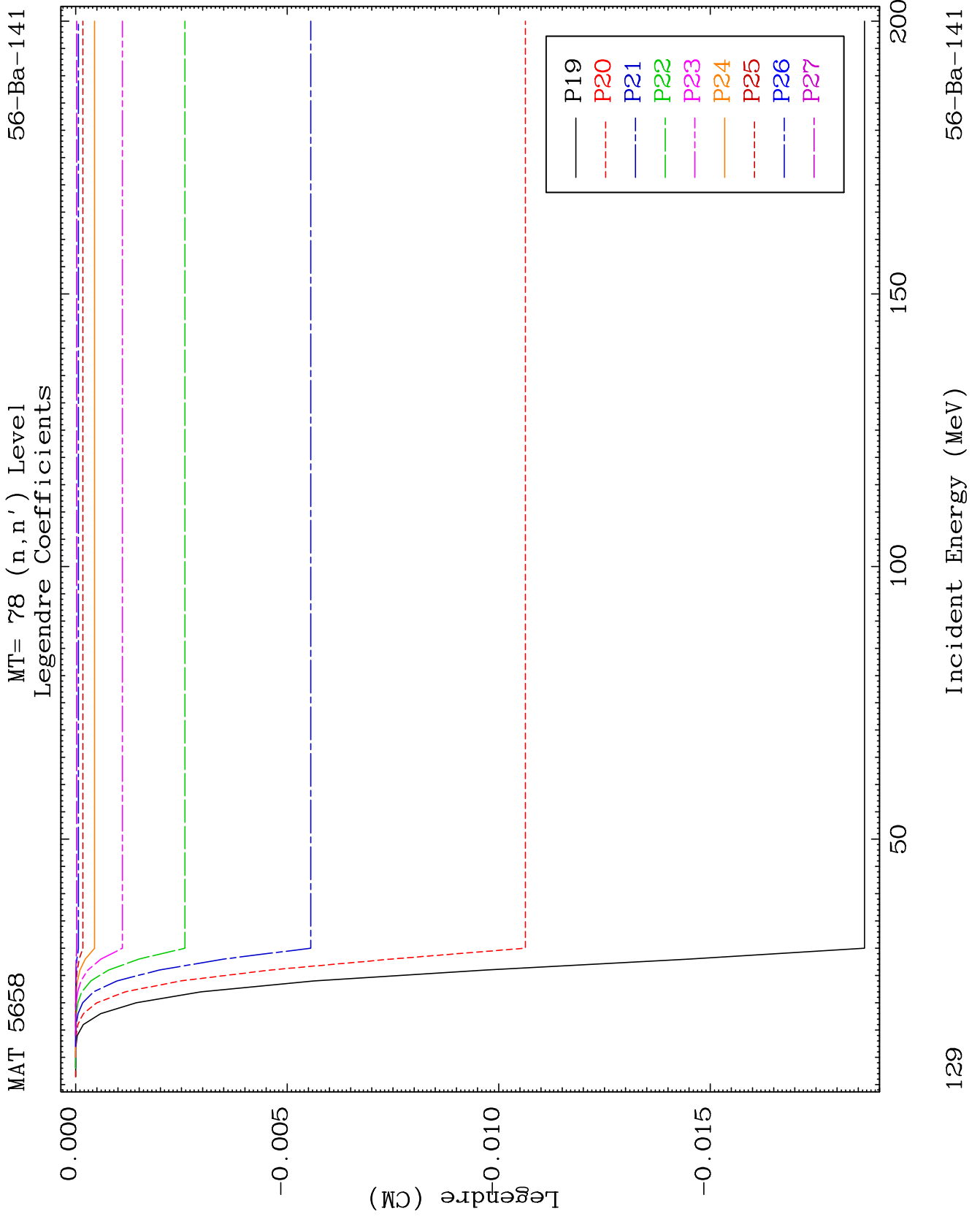

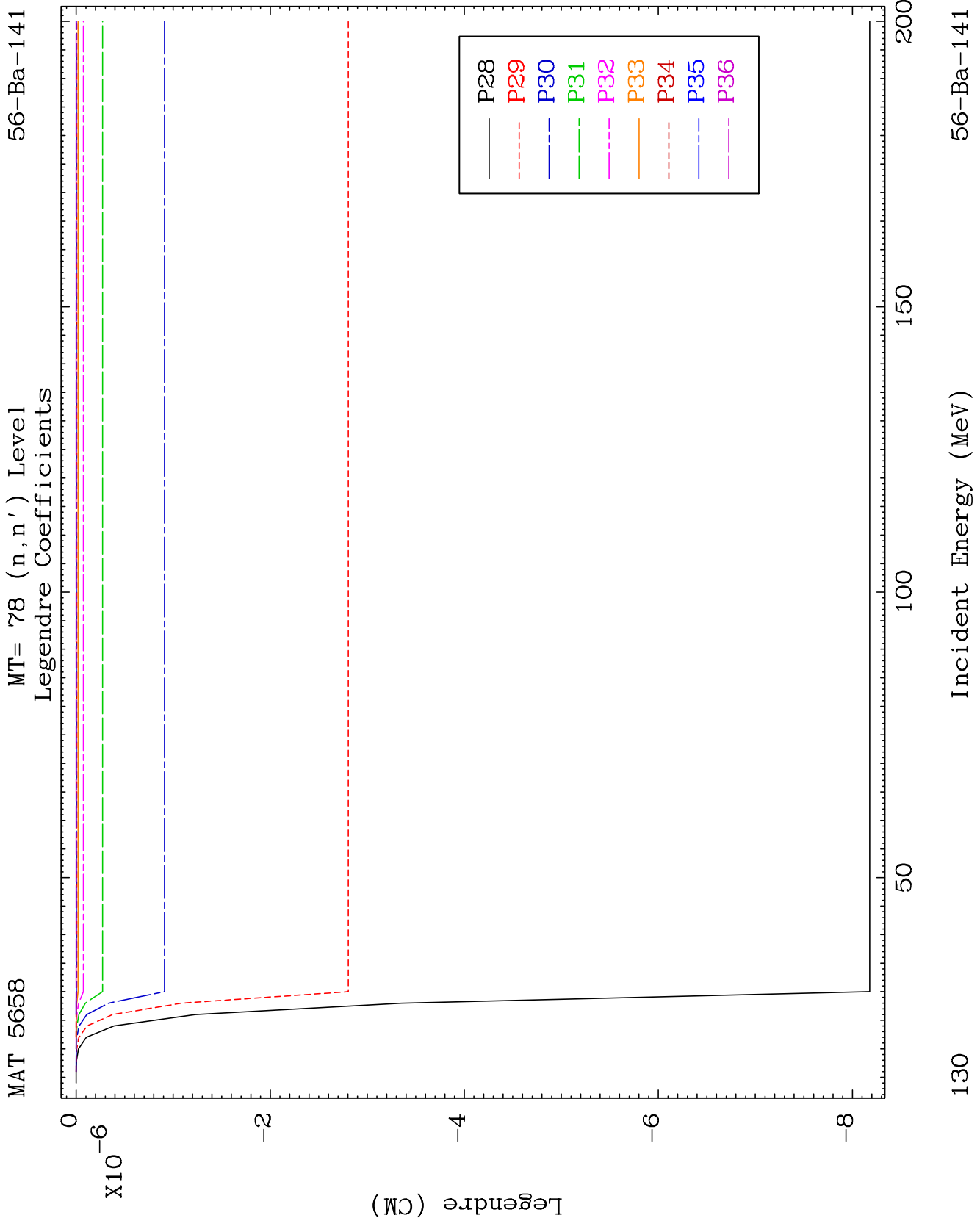

MAT 5658

MT= 79 (n,n') Level
Legendre Coefficients

56-Ba-141

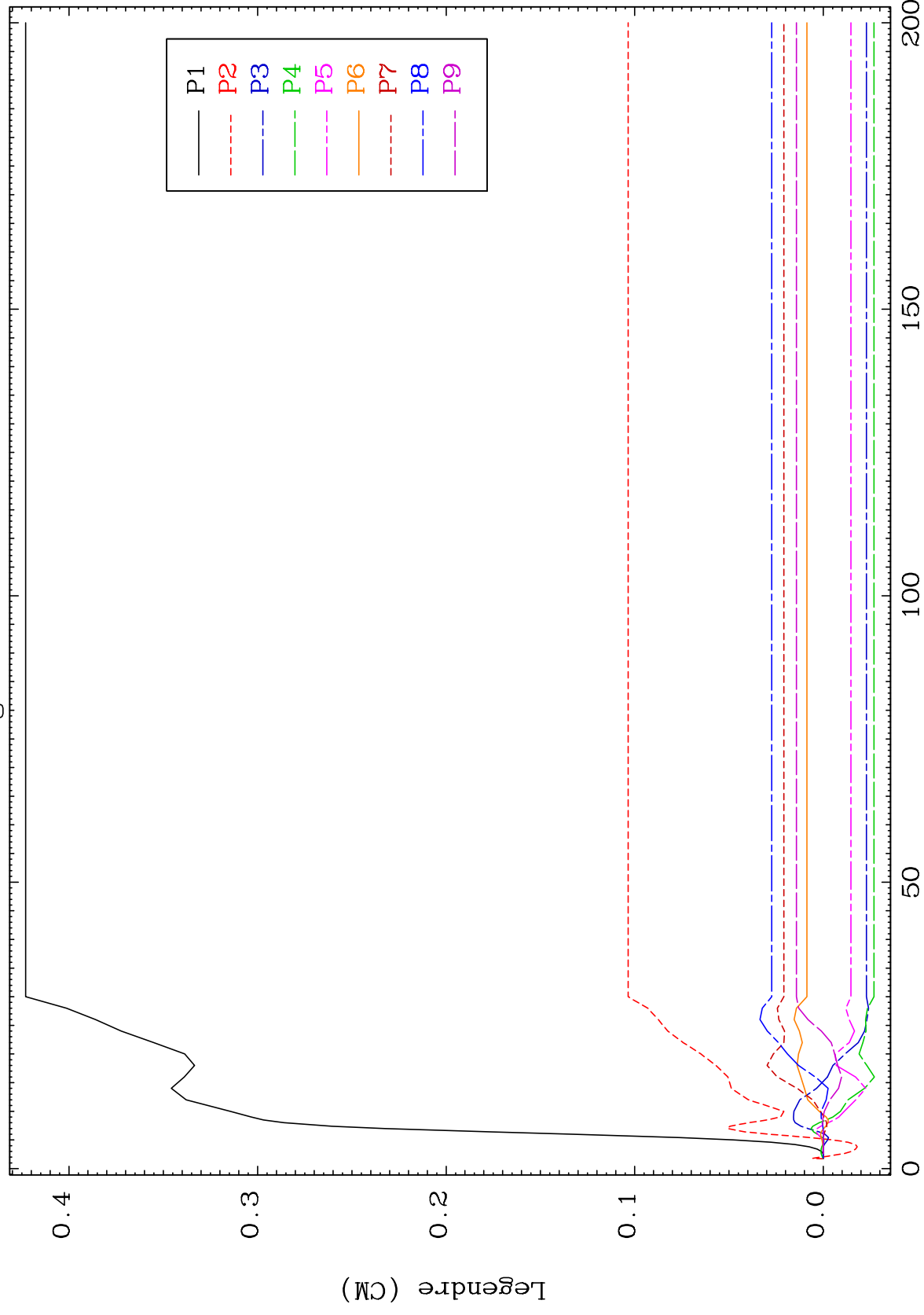

56-Ba-141

Incident Energy (MeV)

131

MAT 5658

MT= 79 (n,n') Level
Legendre Coefficients

56-Ba-141

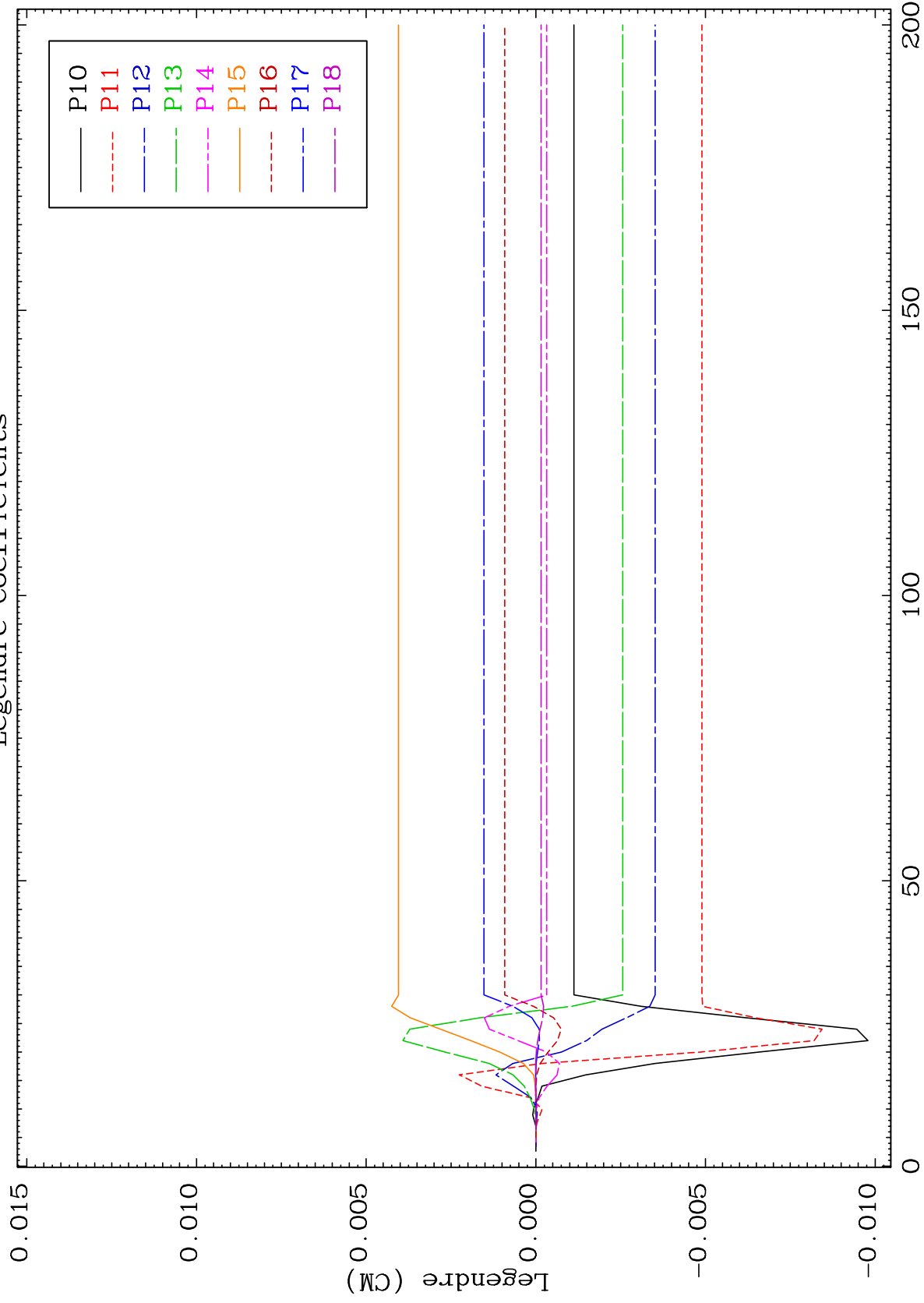

132

Incident Energy (MeV)

56-Ba-141

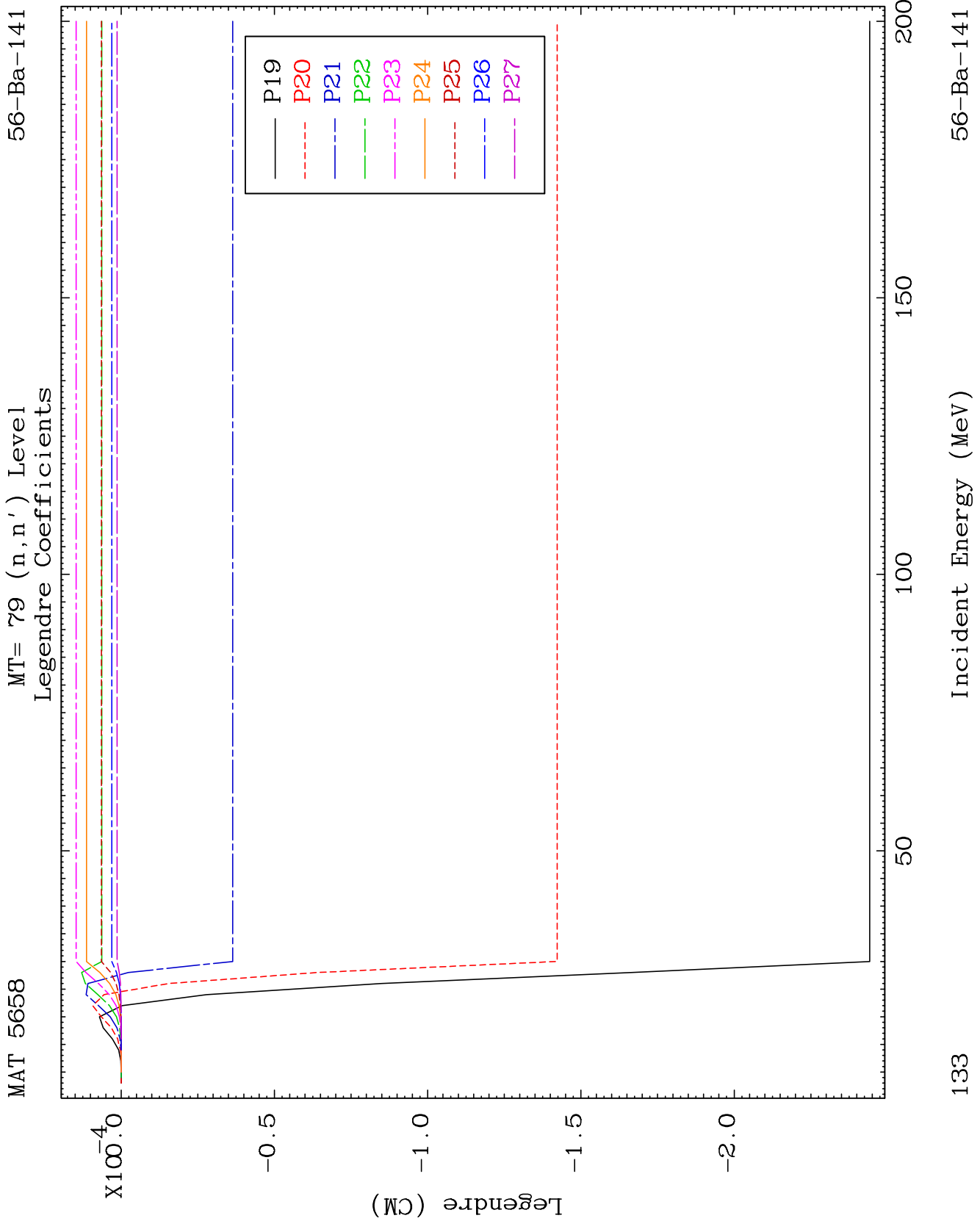

MAT 5658

MT= 79 (n,n') Level
Legendre Coefficients

56-Ba-141

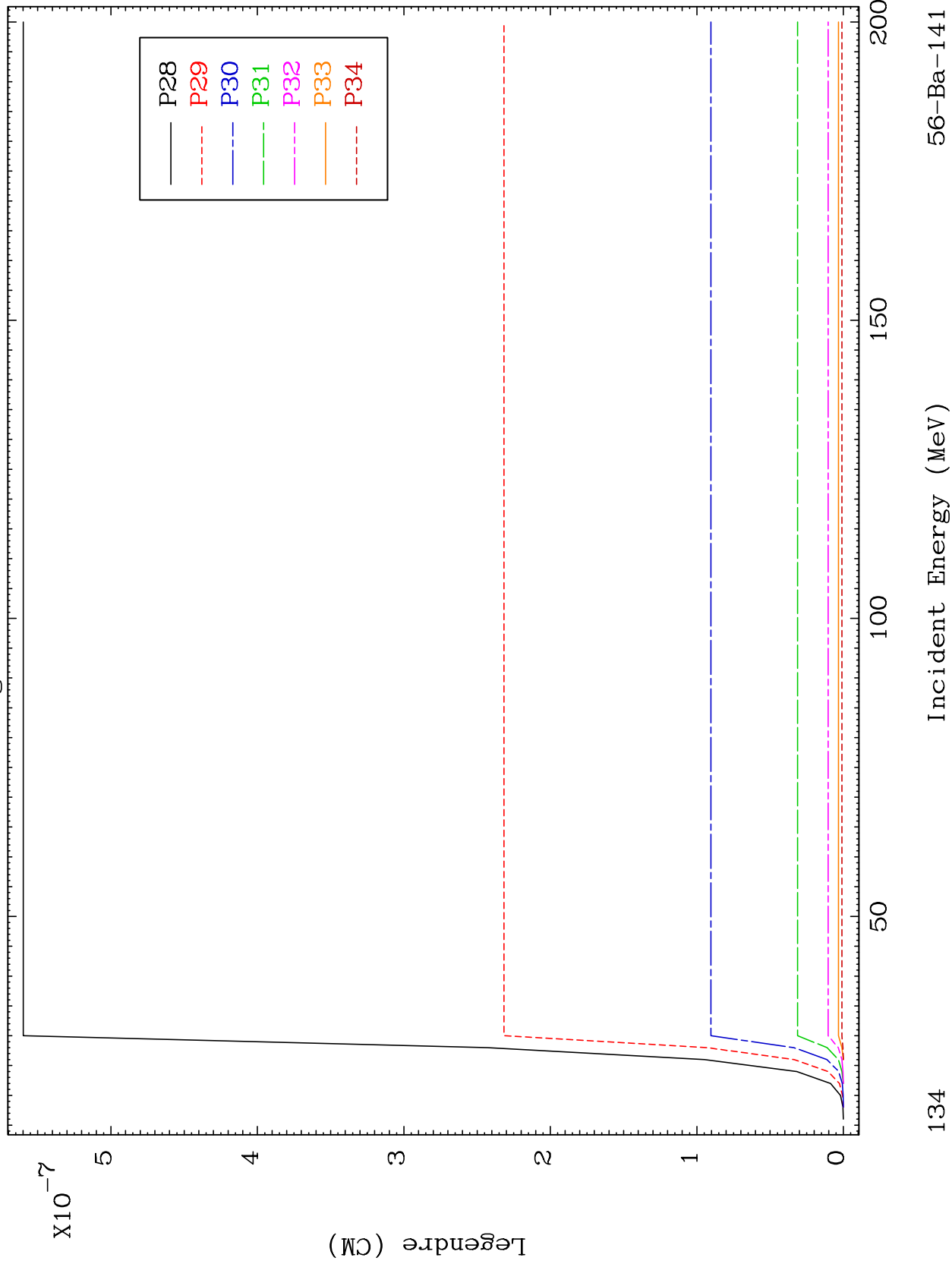

134

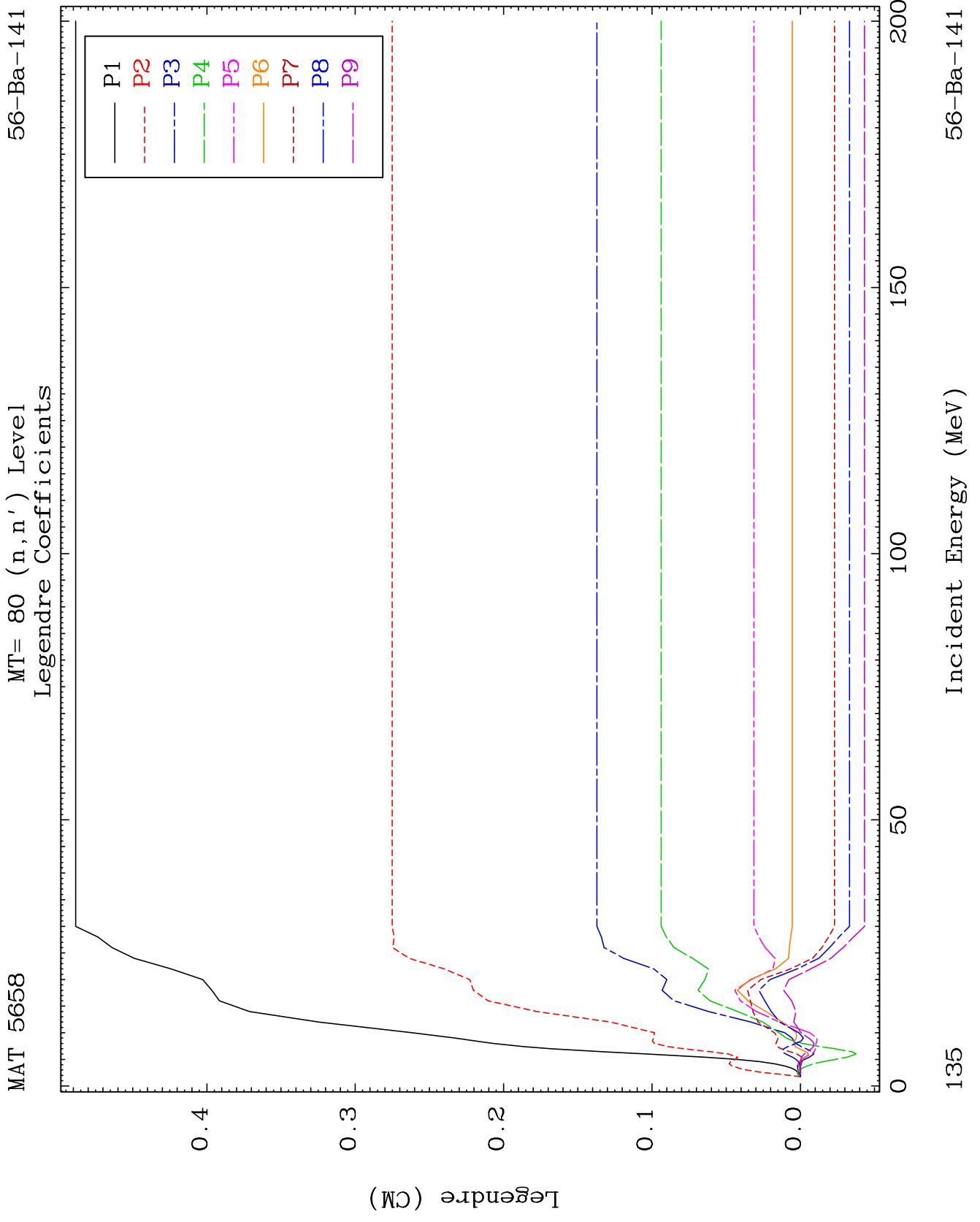

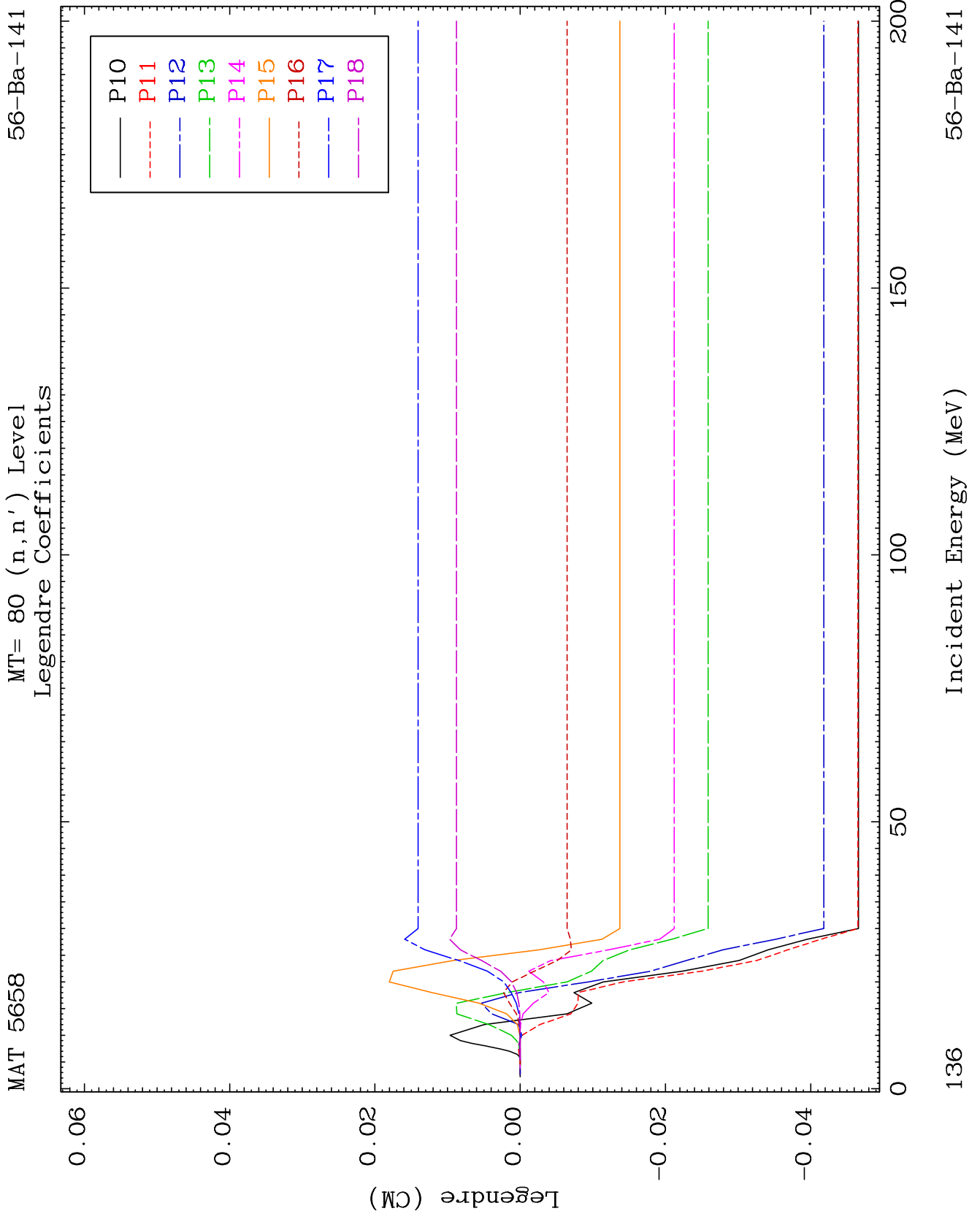

MAT 5658

MT= 80 (n,n') Level
Legendre Coefficients

56-Ba-141

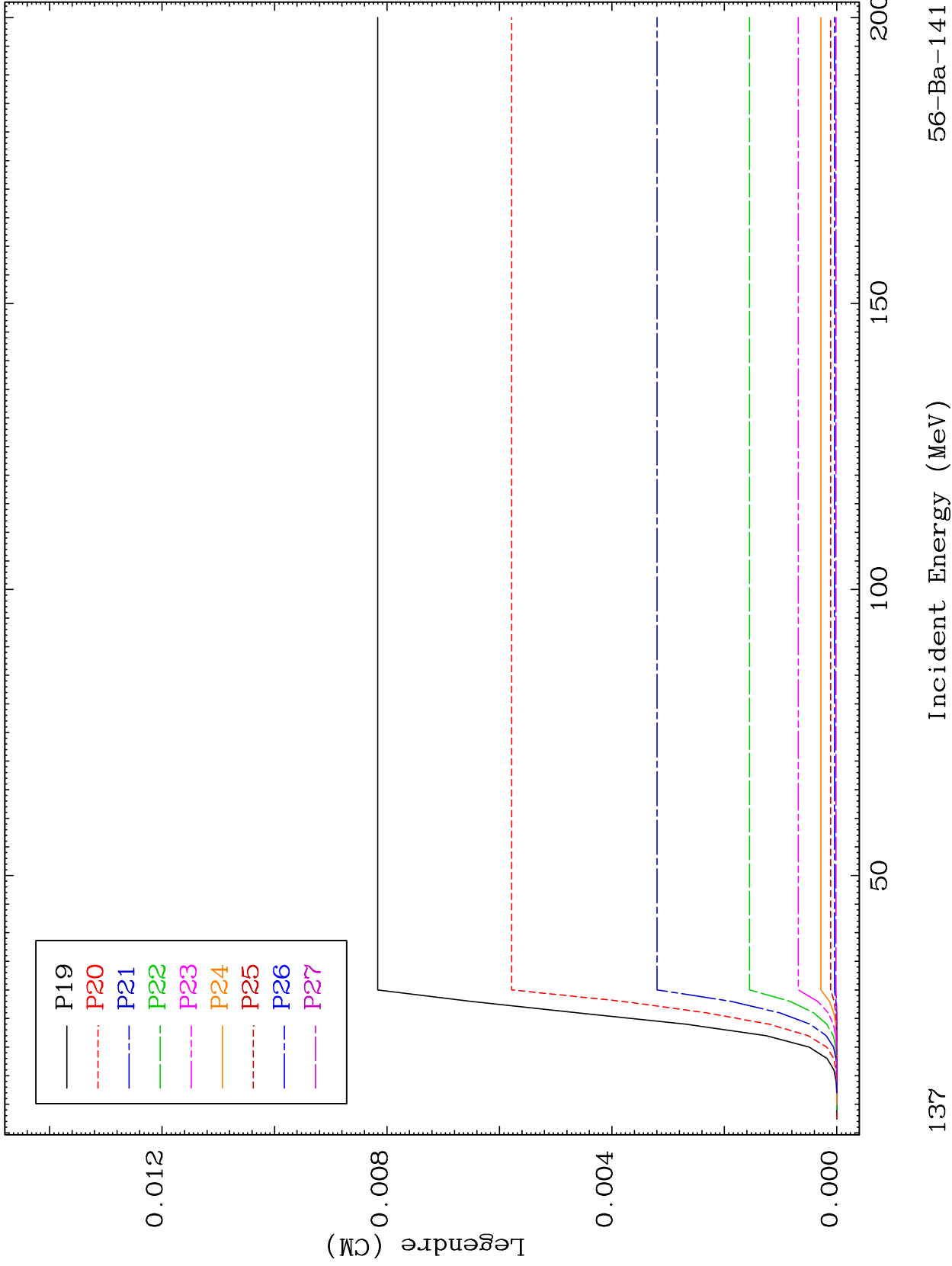

137

56-Ba-141

MAT 5658

MT= 80 (n,n') Level
Legendre Coefficients

56-Ba-141

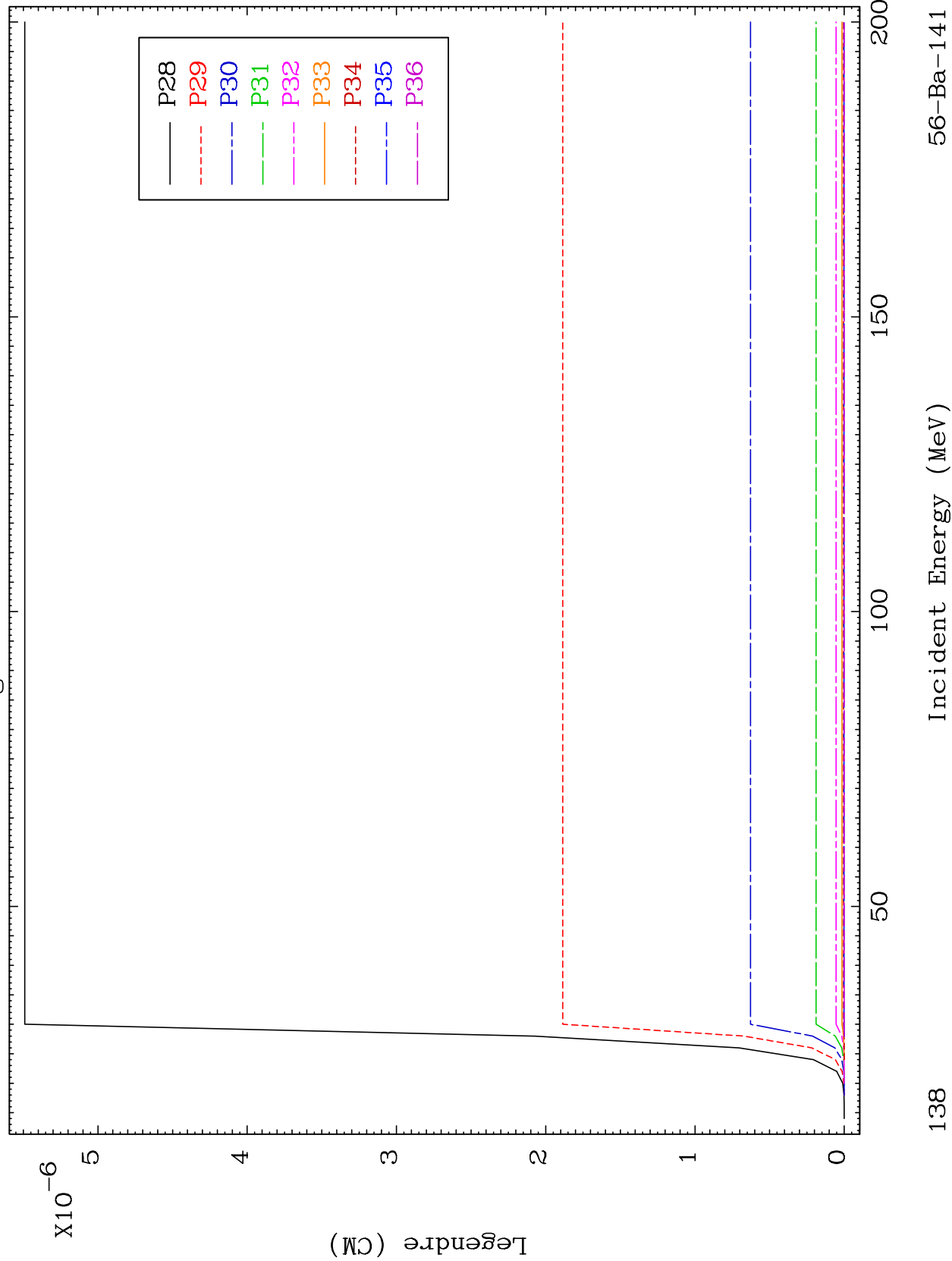

138

Incident Energy (MeV)

56-Ba-141

MAT 5658

(n,2n) d

56-Ba-141

Radionuclide Production Cross Section

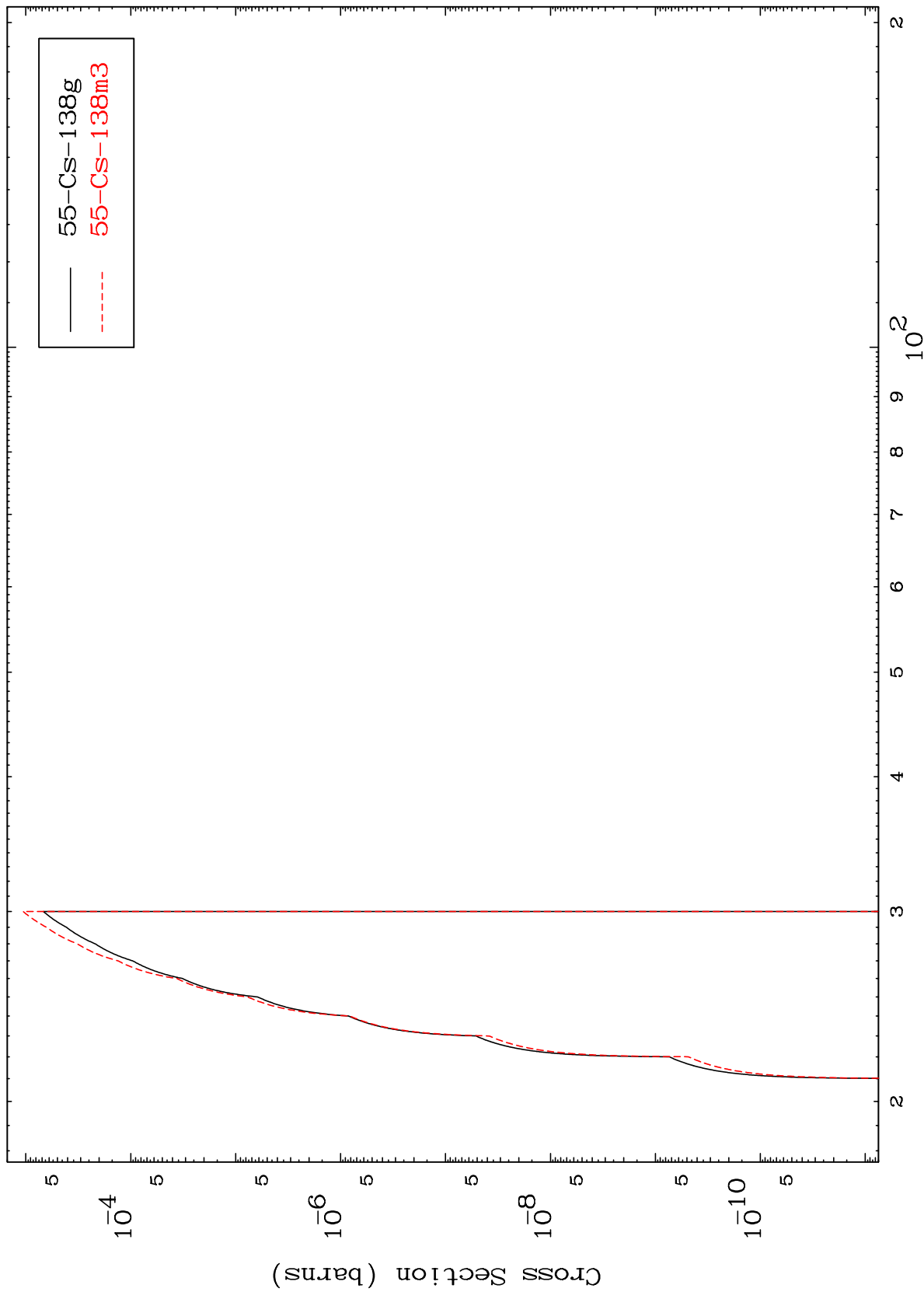

139

Incident Energy (MeV)

56-Ba-141

MAT 5658

(n,n') t

56-Ba-141

Radionuclide Production Cross Section

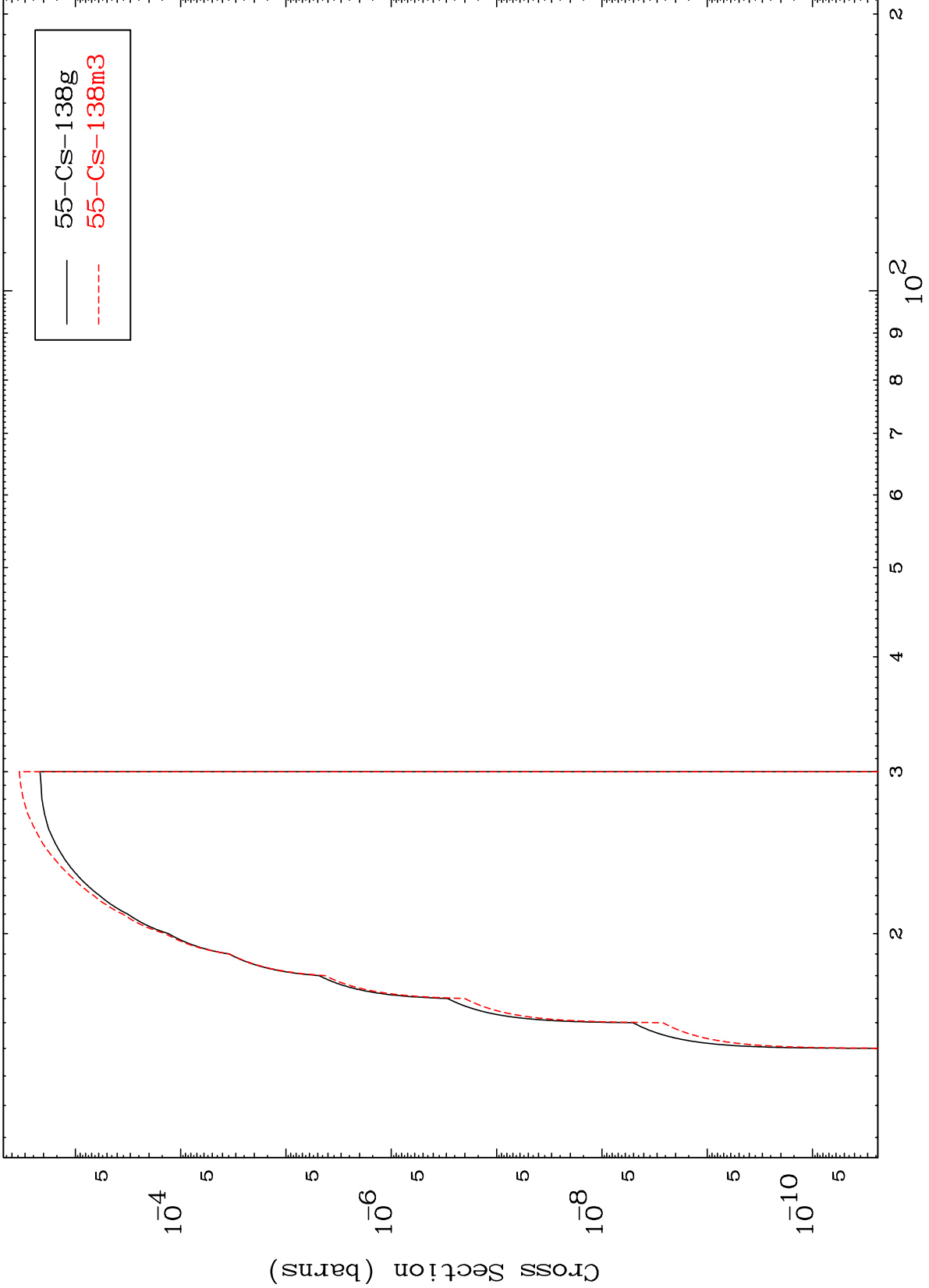

142

Incident Energy (MeV)

56-Ba-141

MAT 5658

(n,3n) p

56-Ba-141

Radionuclide Production Cross Section

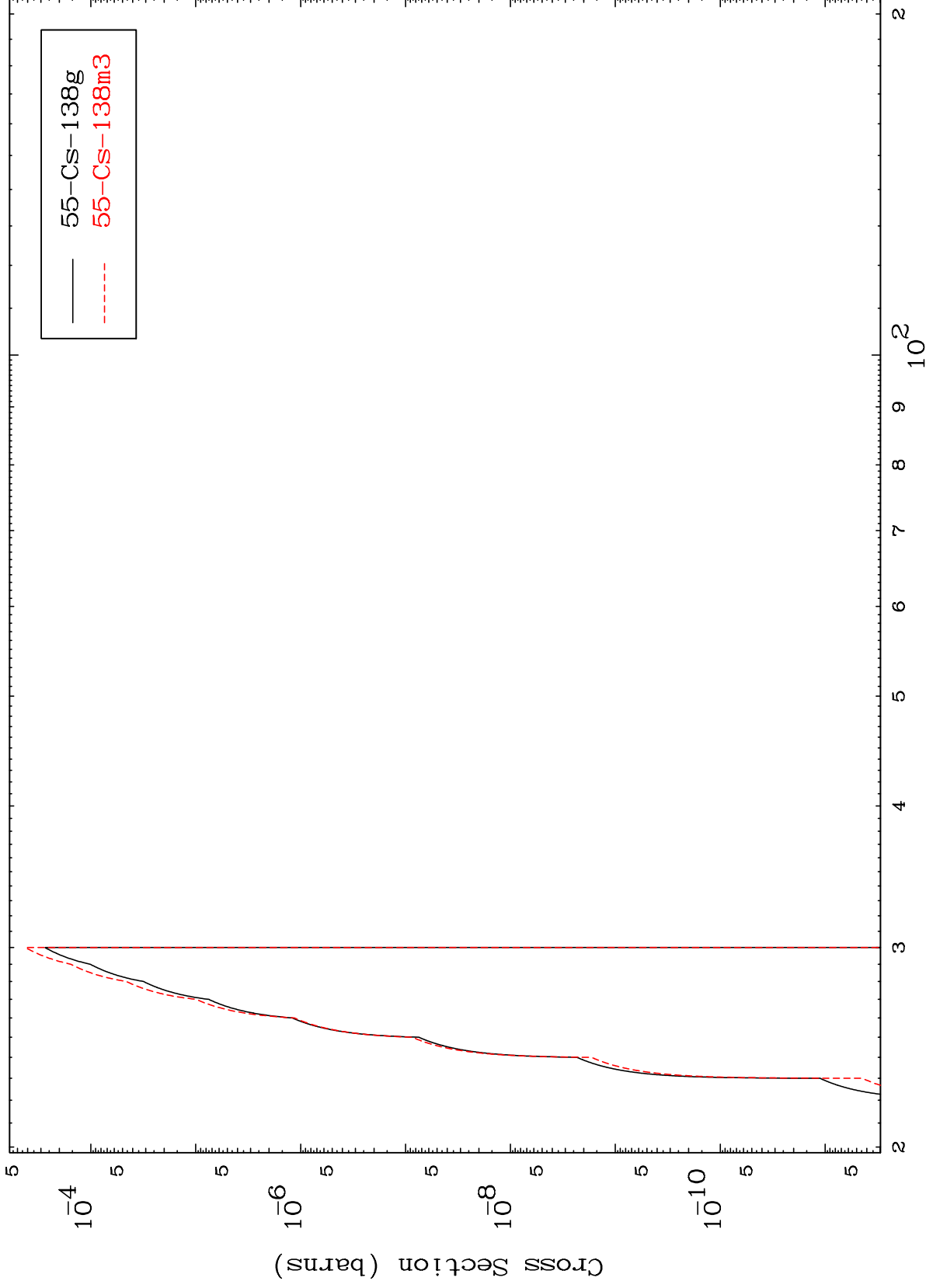

143

Incident Energy (MeV)

56-Ba-141

MAT 5658

(n,n') p α

56-Ba-141

Radionuclide Production Cross Section

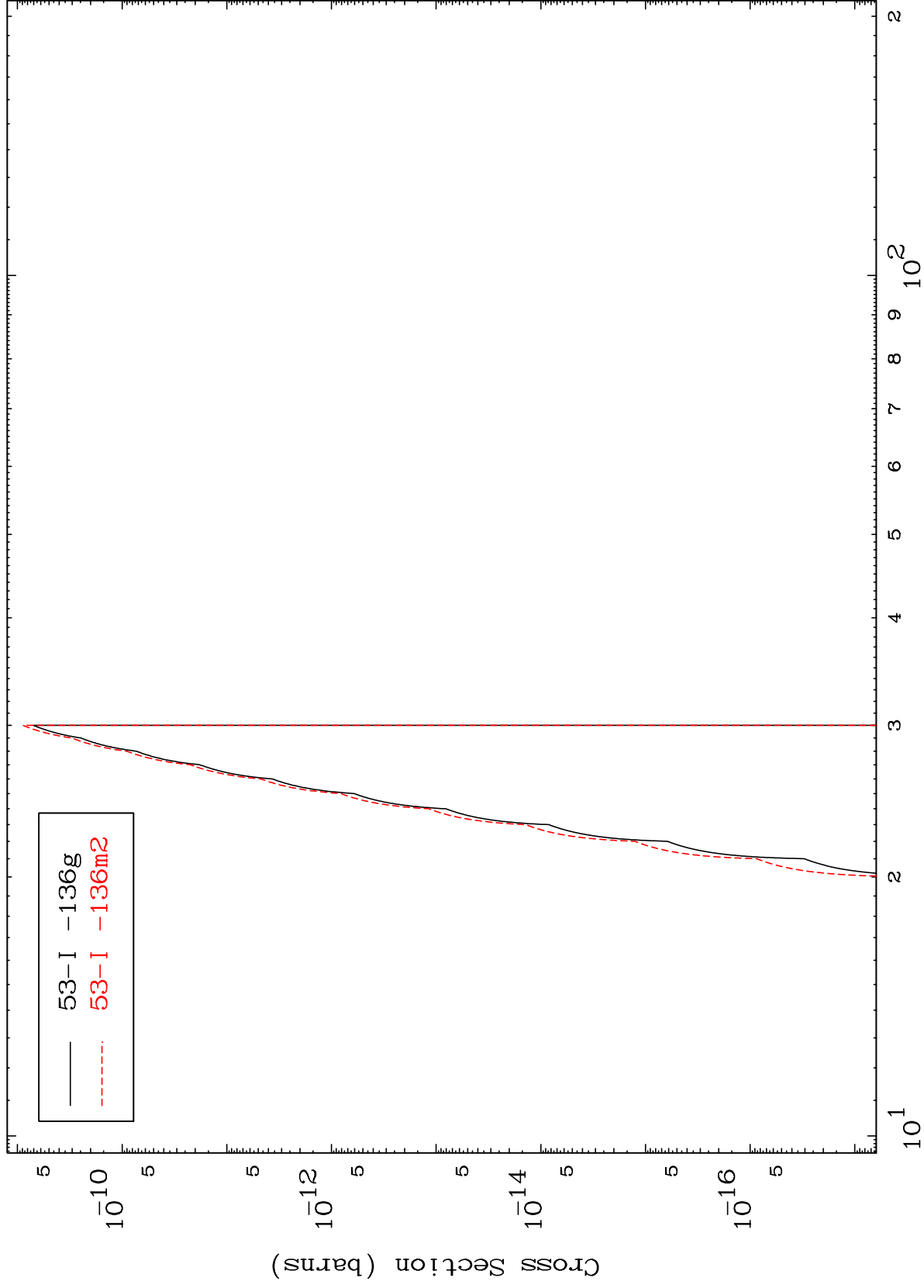

144

Incident Energy (MeV)

56-Ba-141

MAT 5658

(n,d) α

56-Ba-141

Radionuclide Production Cross Section

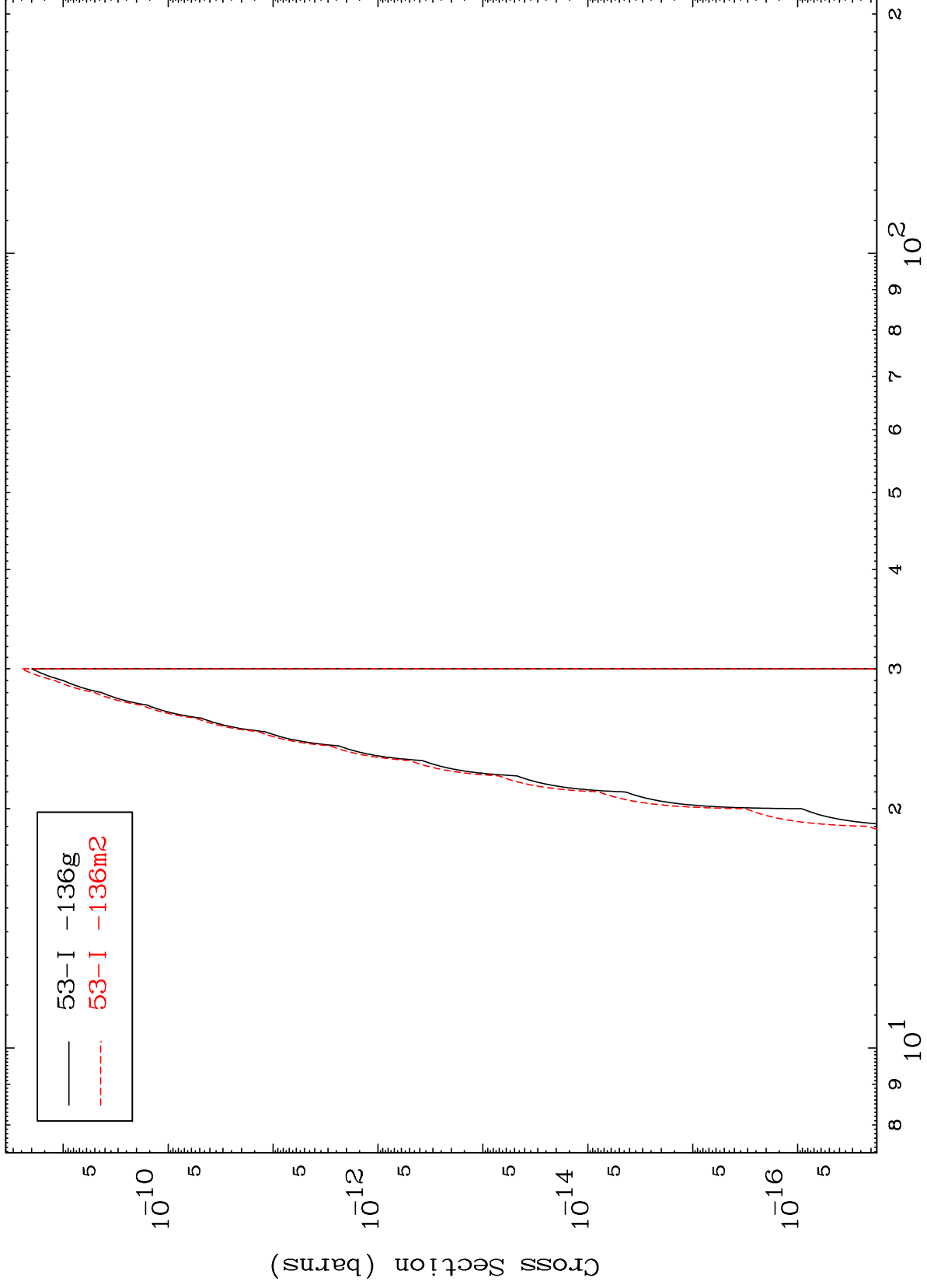

145

Incident Energy (MeV)

56-Ba-141