

# BH264 NEUTRON ACER TENDL-2024 LIBRARY; T=0.K

## Principal cross sections

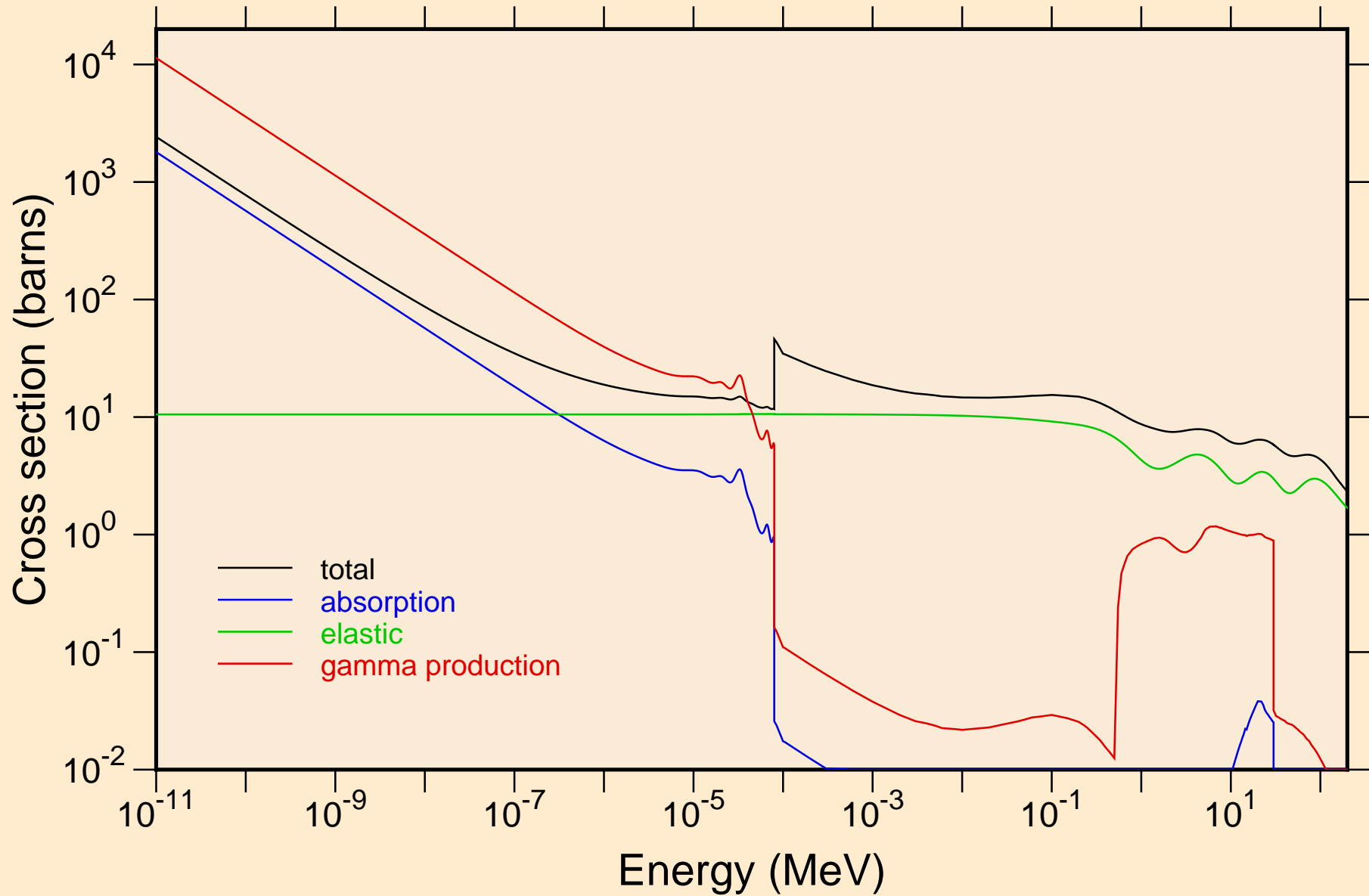

# BH264 NEUTRON ACER TENDL-2024 LIBRARY; T=0.K

## Heating

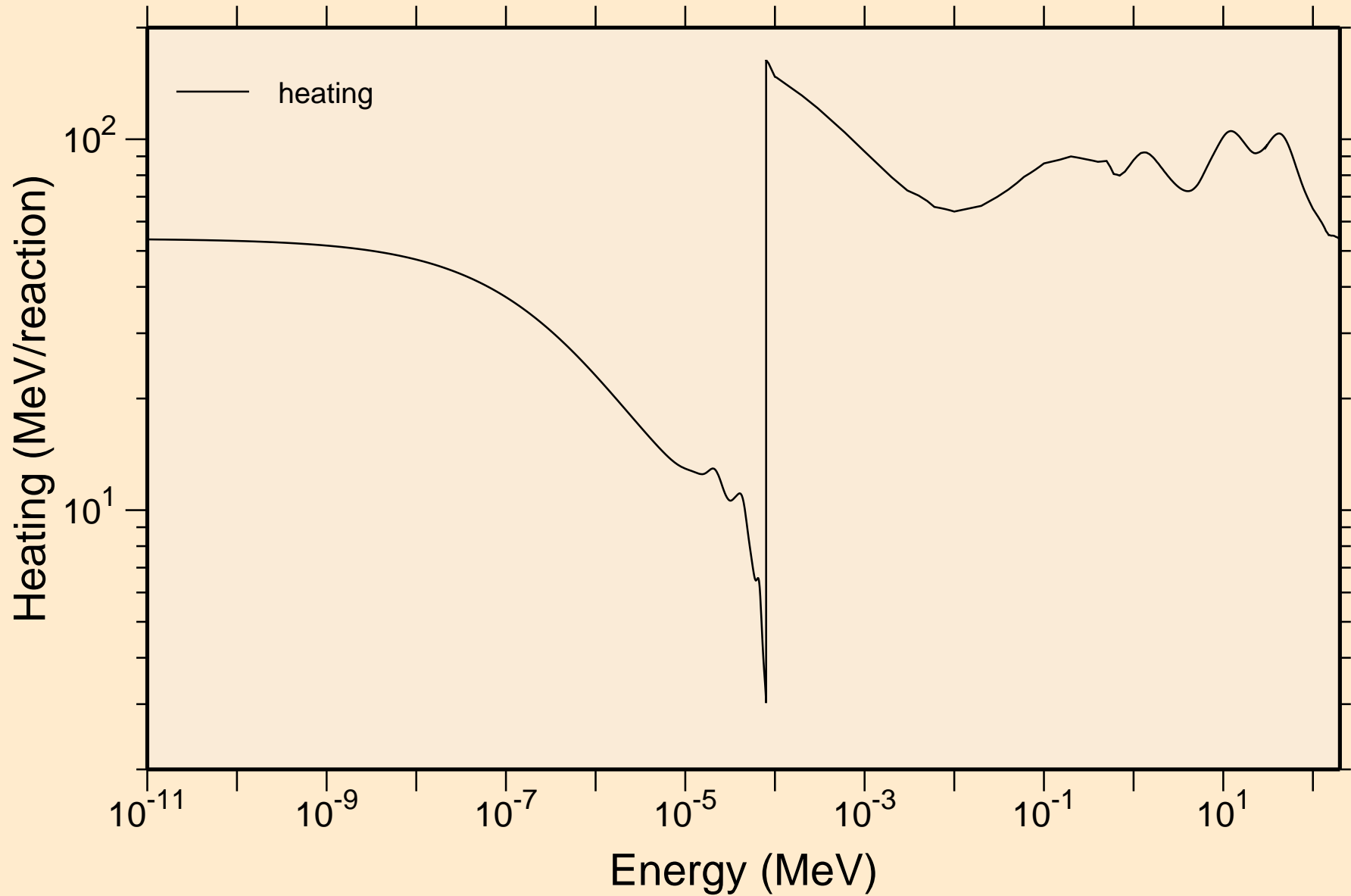

BH264 NEUTRON ACER TENDL-2024 LIBRARY; T=0.K  
Damage

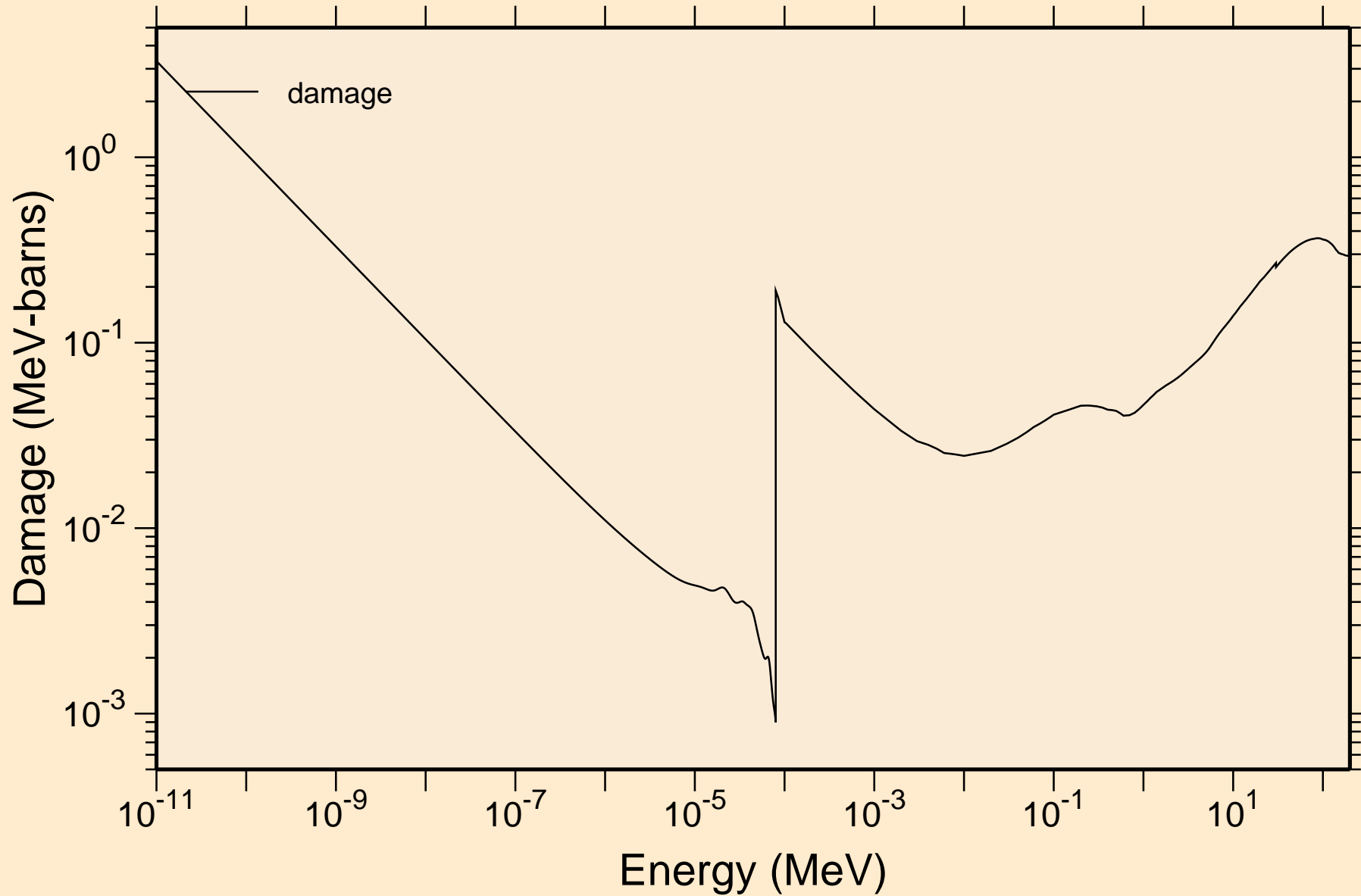

# BH264 NEUTRON ACER TENDL-2024 LIBRARY; T=0.K

## Non-threshold reactions

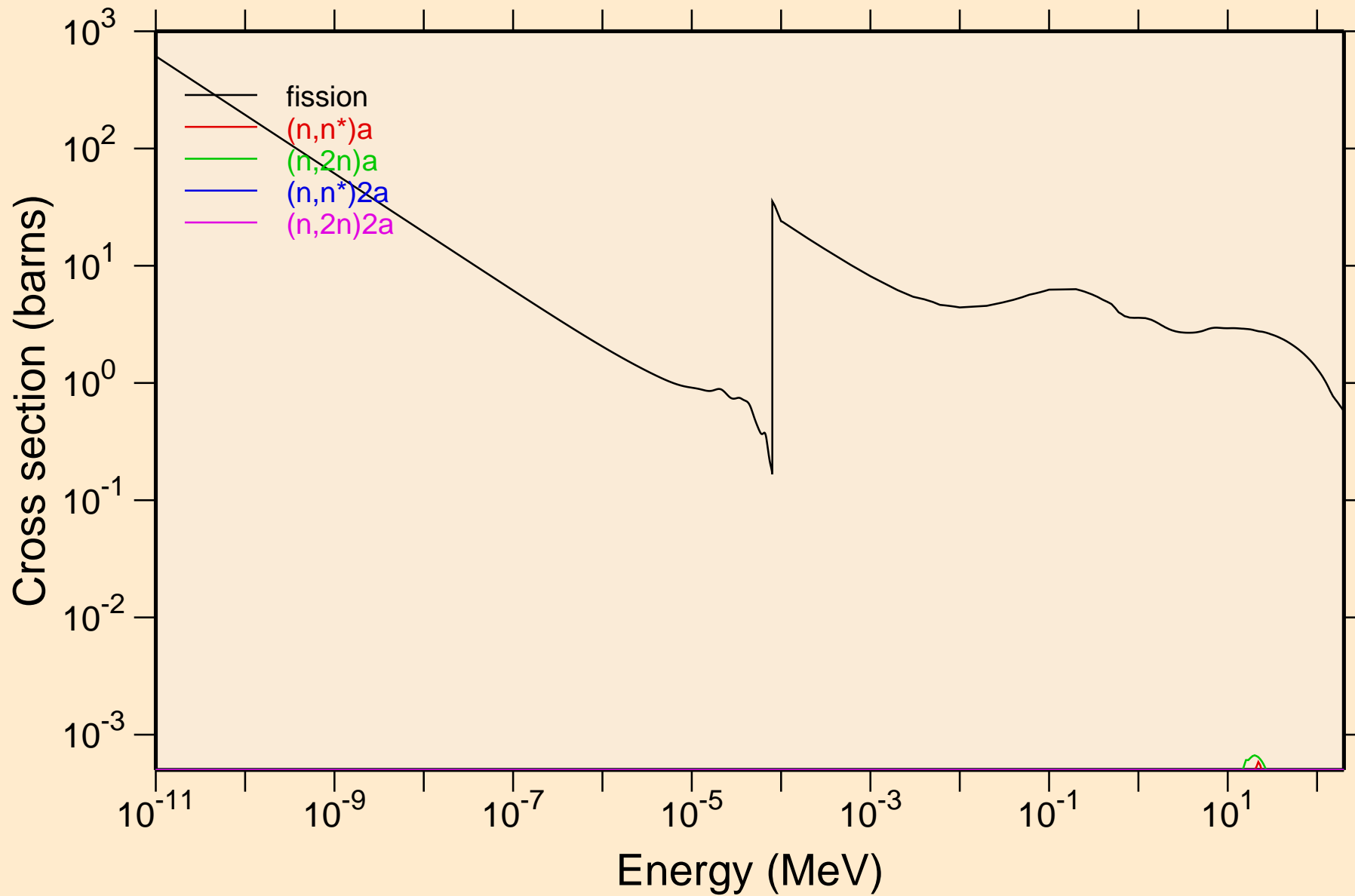

# BH264 NEUTRON ACER TENDL-2024 LIBRARY; T=0.K

## Non-threshold reactions

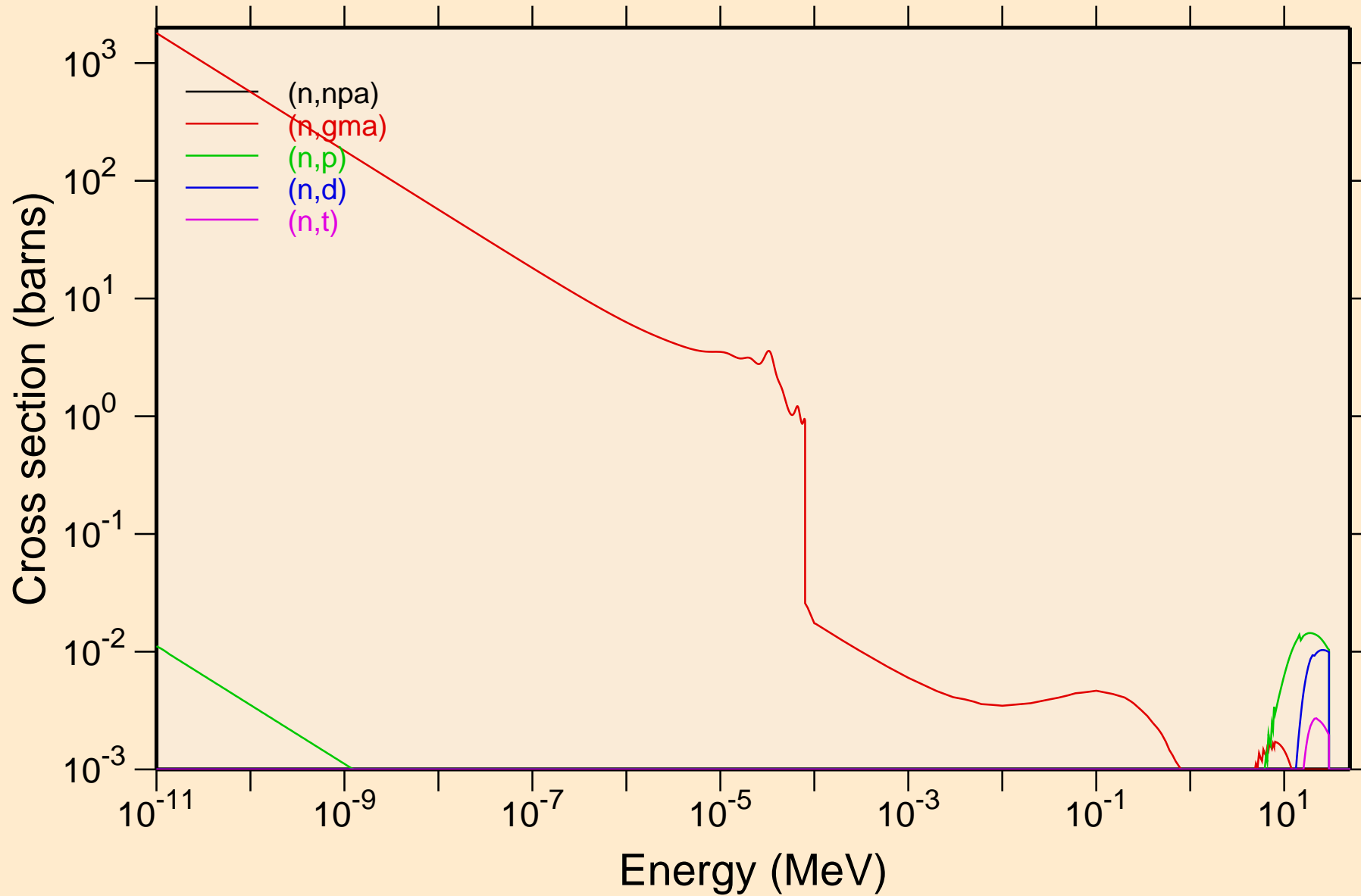

BH264 NEUTRON ACER TENDL-2024 LIBRARY; T=0.K  
Non-threshold reactions

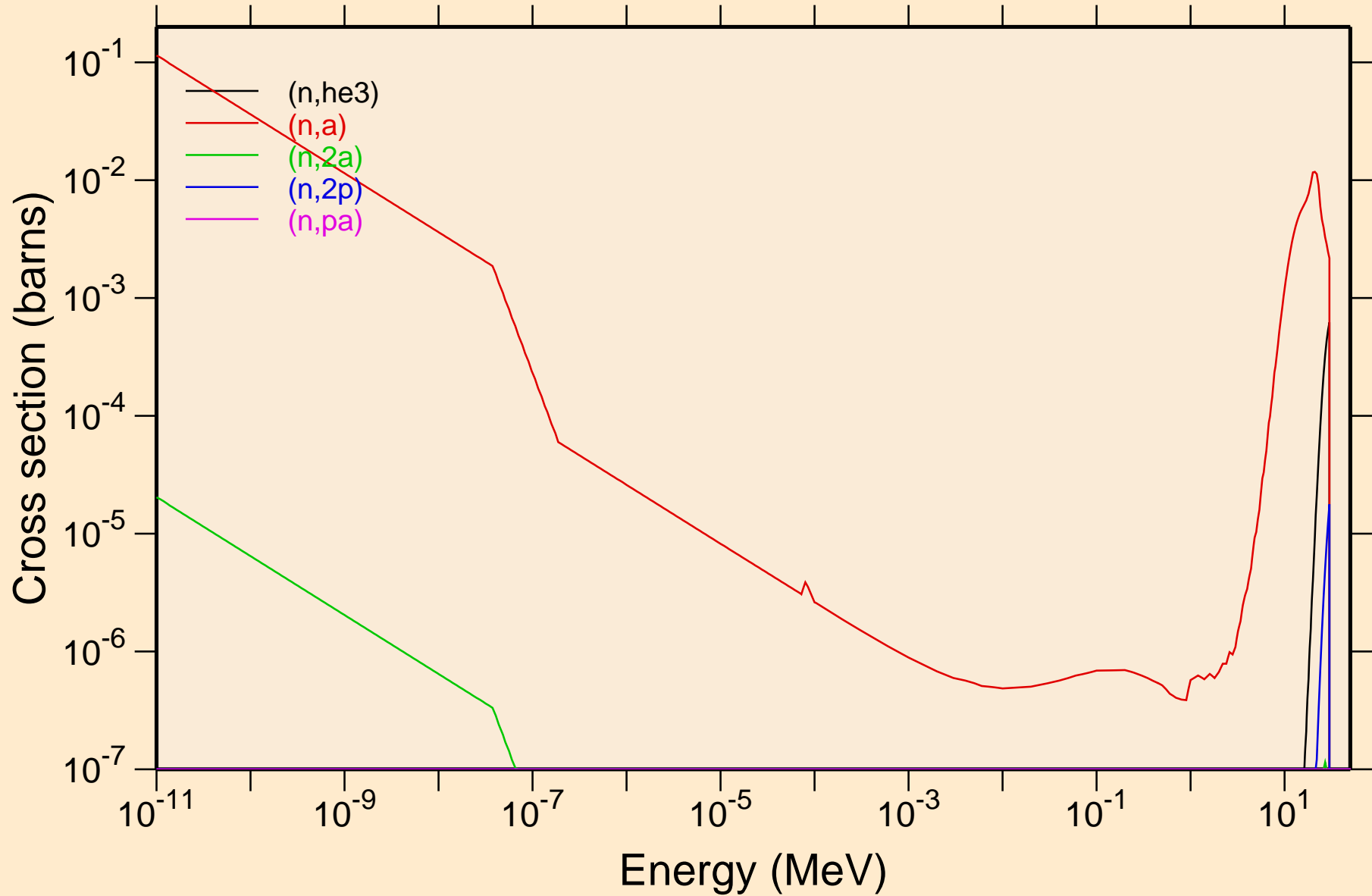

BH264 NEUTRON ACER TENDL-2024 LIBRARY; T=0.K  
Non-threshold reactions

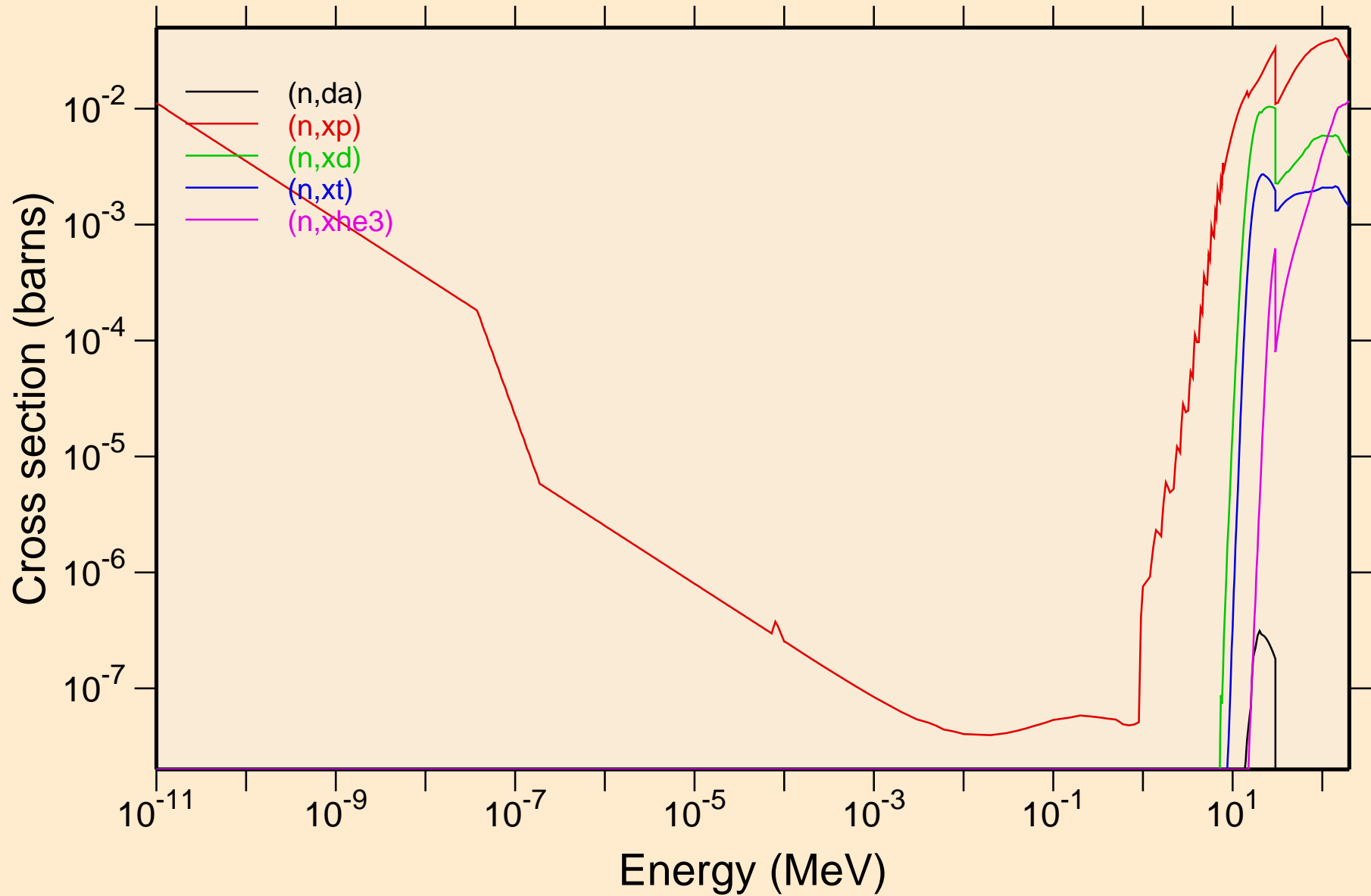

BH264 NEUTRON ACER TENDL-2024 LIBRARY; T=0.K  
Non-threshold reactions

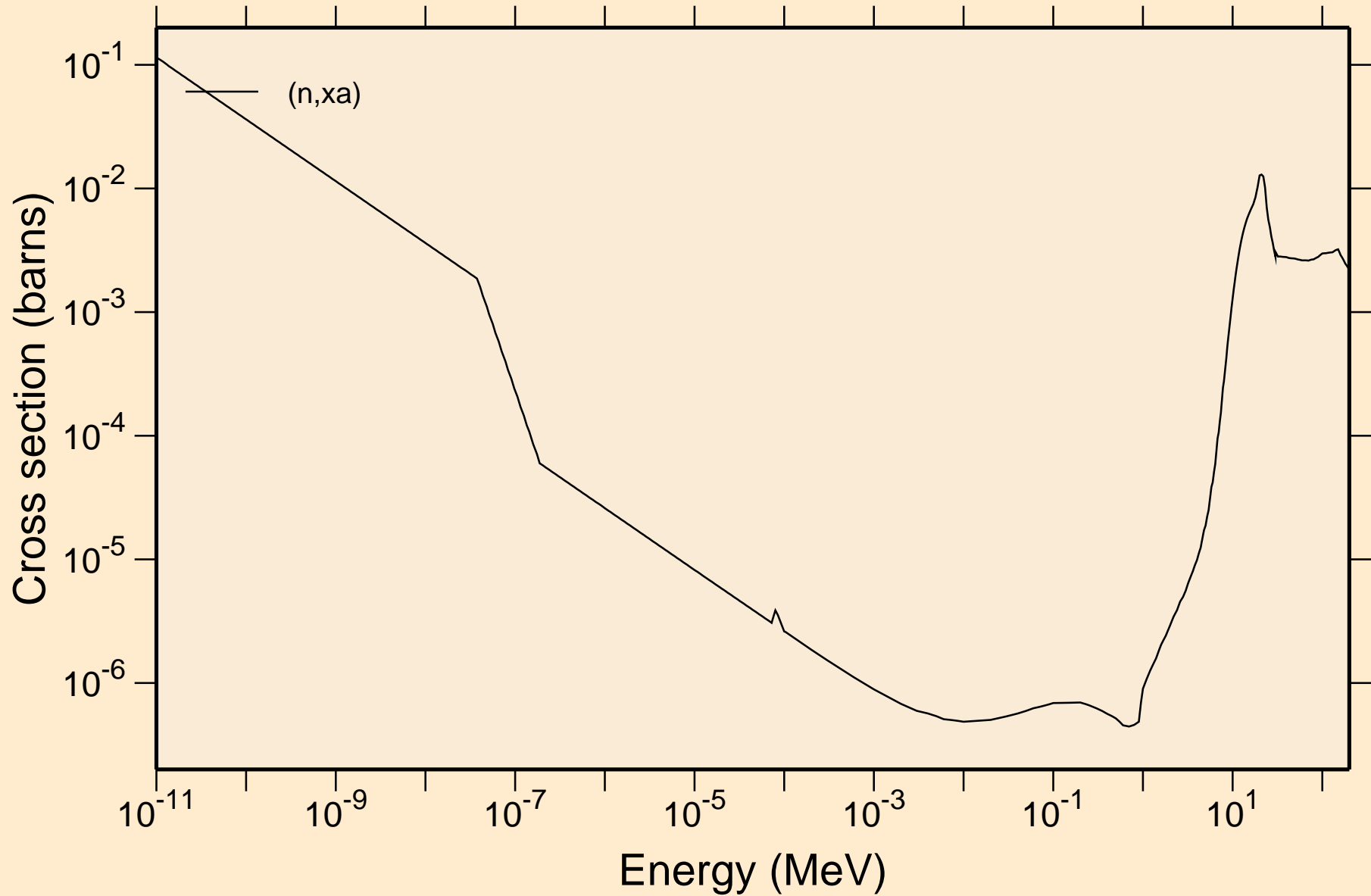



# BH264 NEUTRON ACER TENDL-2024 LIBRARY; T=0.K

## Principal cross sections

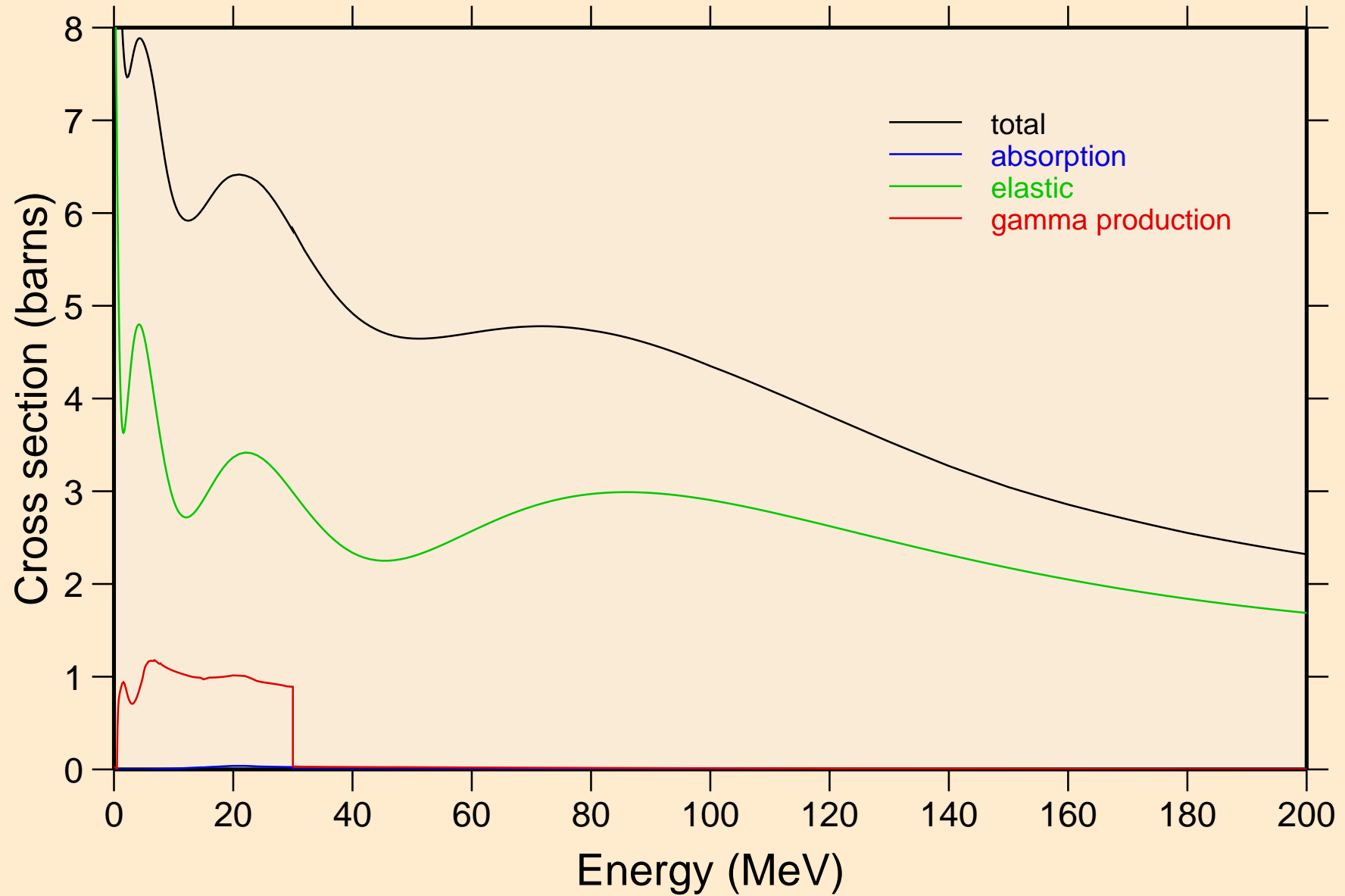

BH264 NEUTRON ACER TENDL-2024 LIBRARY; T=0.K  
Heating

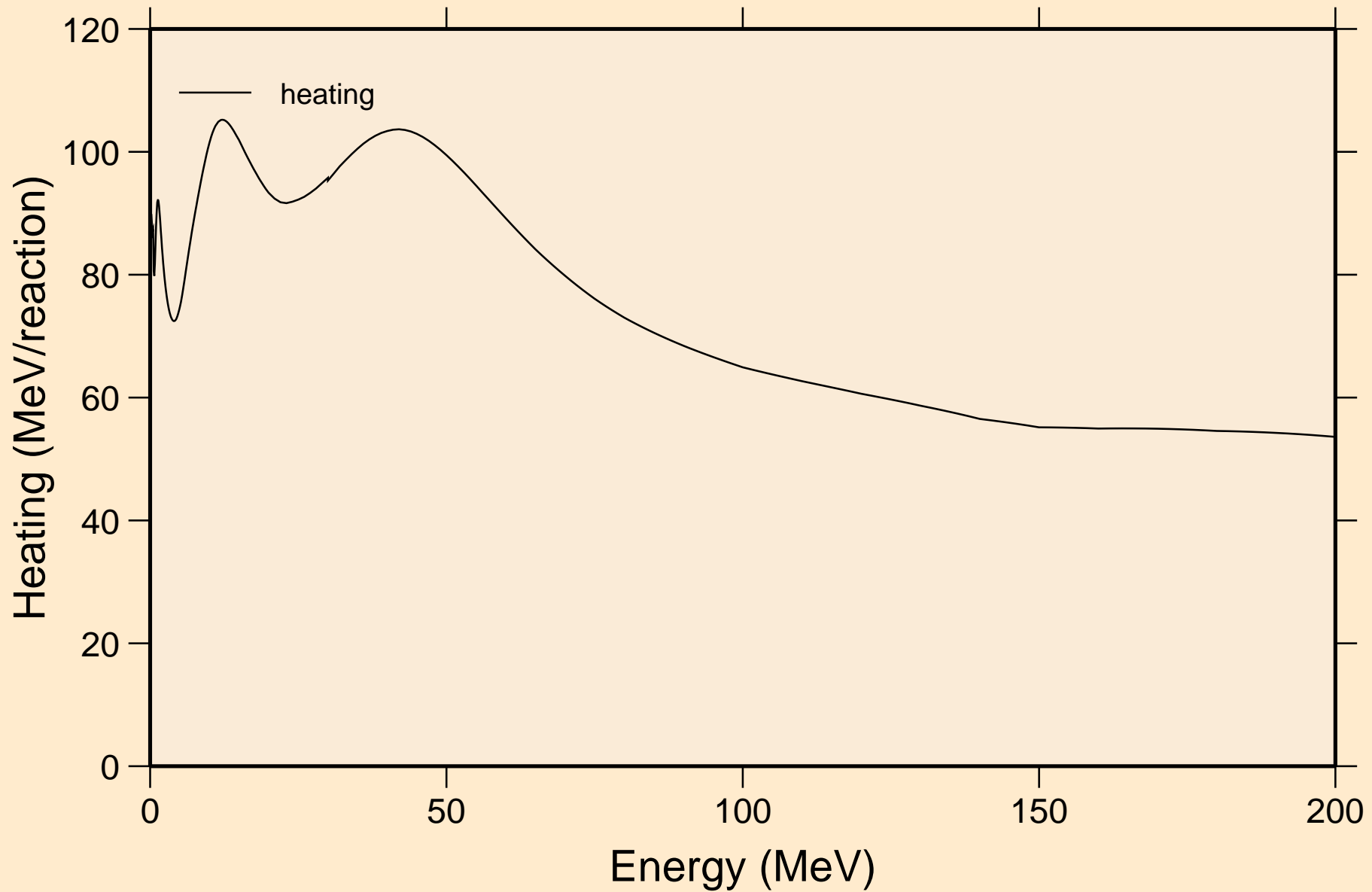

# BH264 NEUTRON ACER TENDL-2024 LIBRARY; T=0.K

## Damage

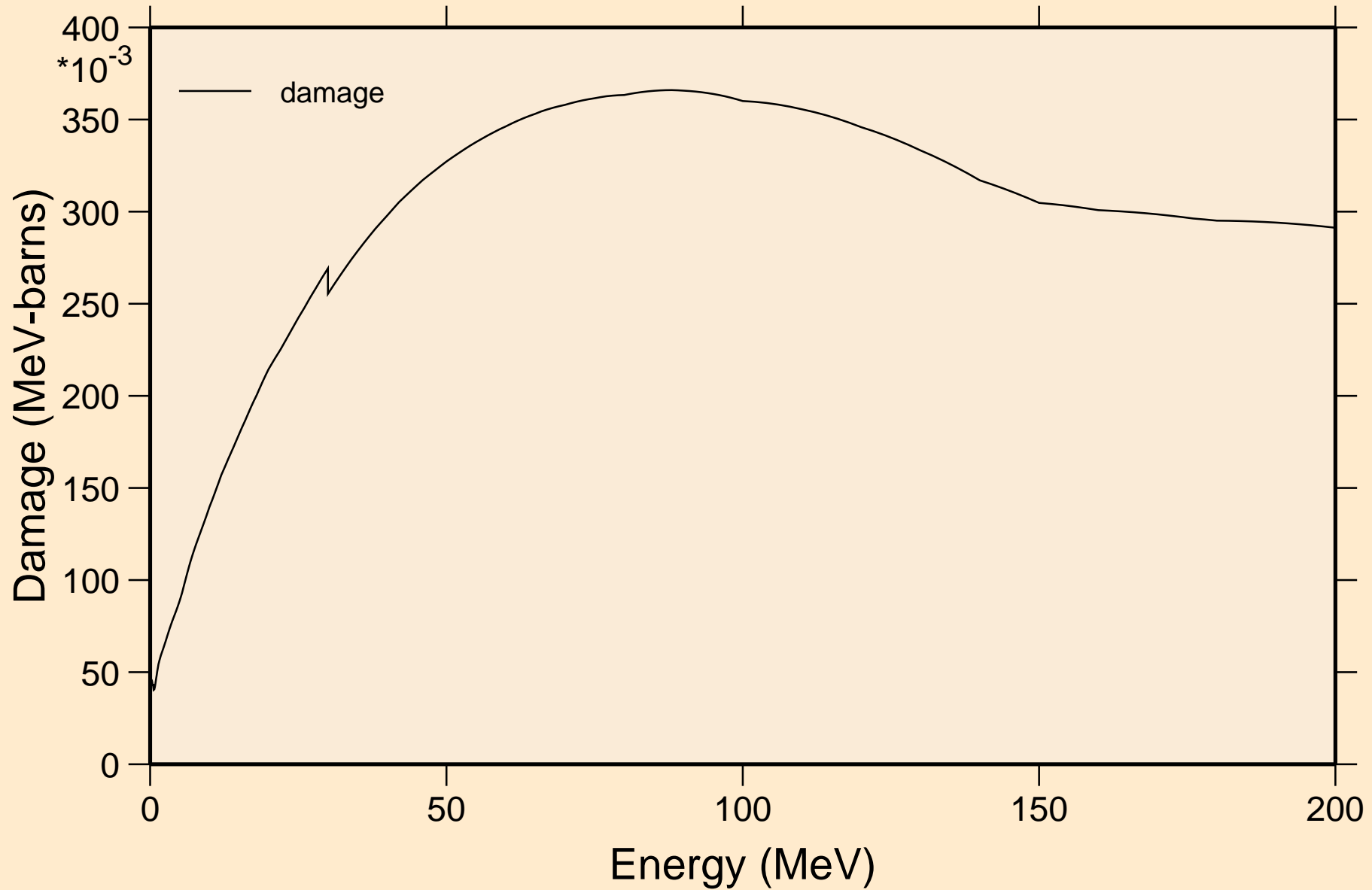

# BH264 NEUTRON ACER TENDL-2024 LIBRARY; T=0.K

## Non-threshold reactions

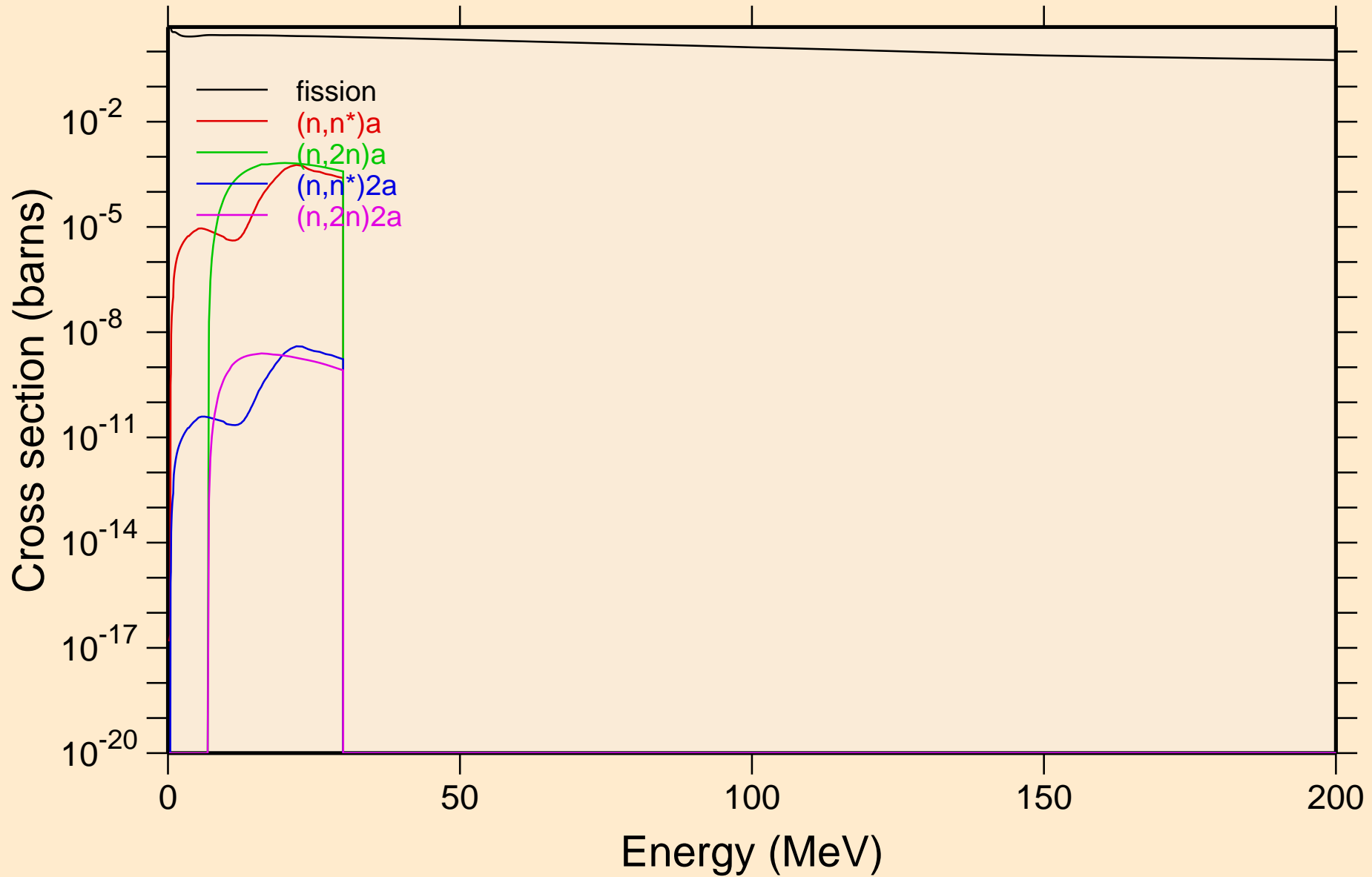

# BH264 NEUTRON ACER TENDL-2024 LIBRARY; T=0.K

## Non-threshold reactions

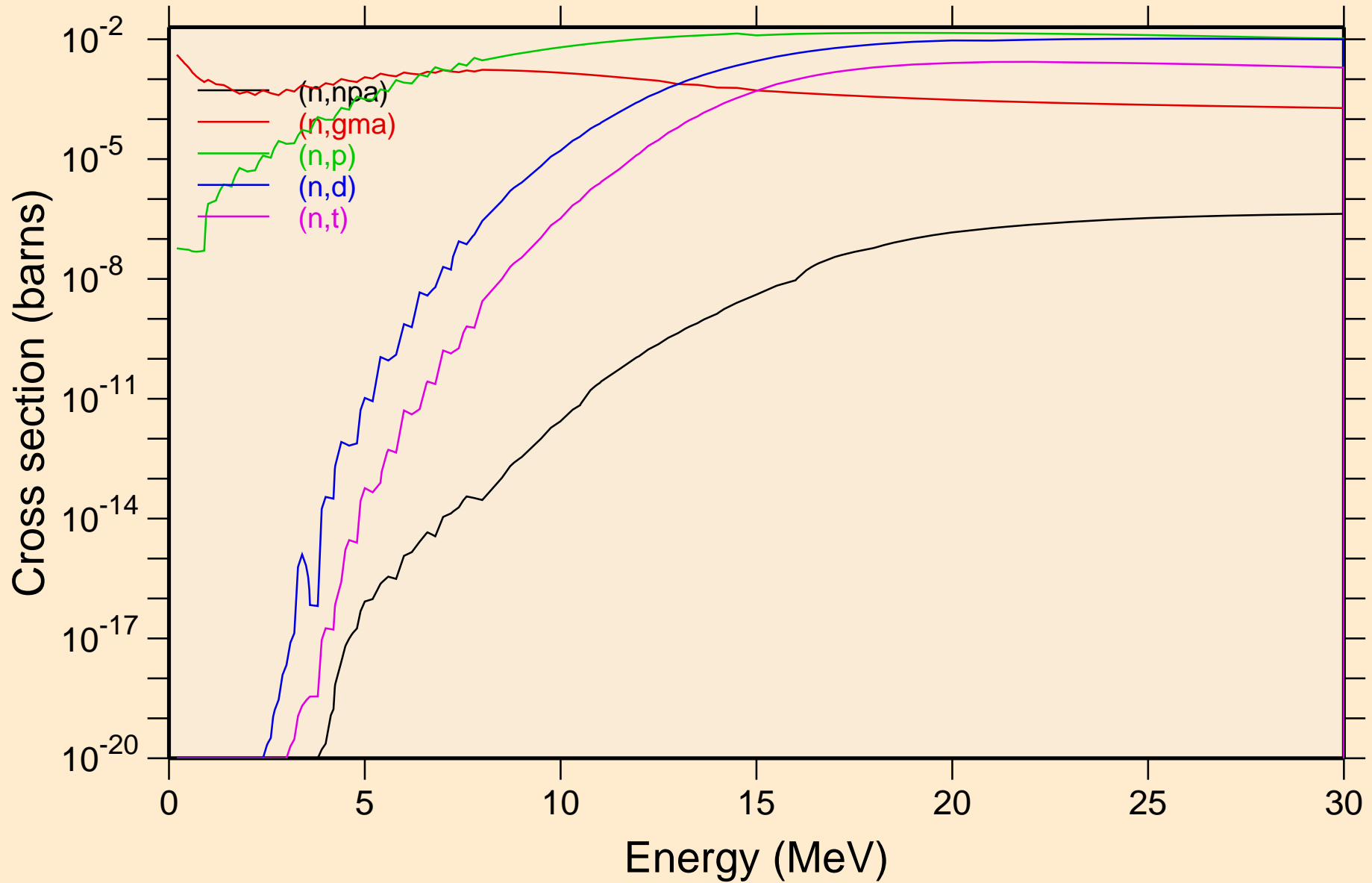

BH264 NEUTRON ACER TENDL-2024 LIBRARY; T=0.K  
Non-threshold reactions

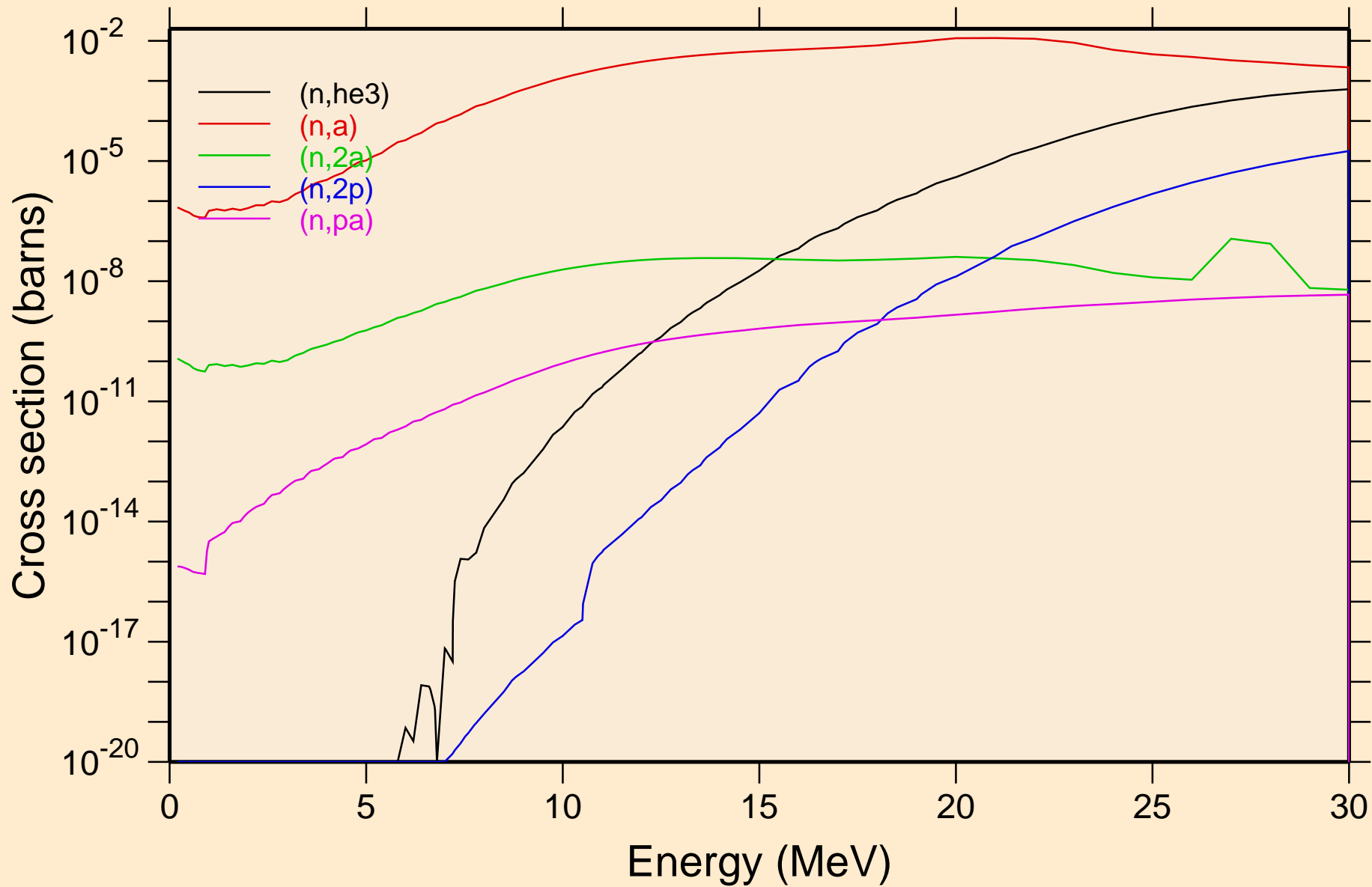

BH264 NEUTRON ACER TENDL-2024 LIBRARY; T=0.K  
Non-threshold reactions

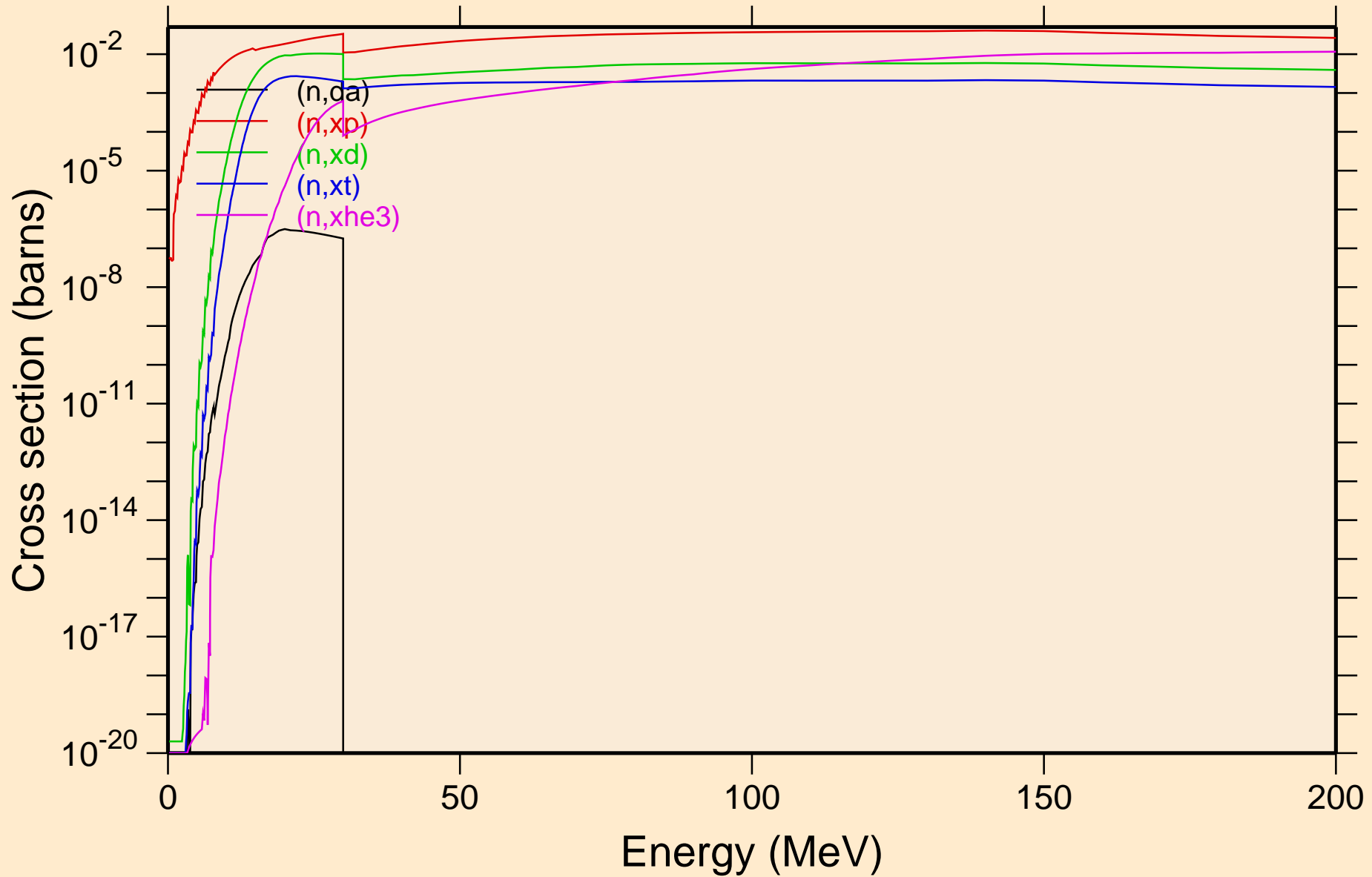

BH264 NEUTRON ACER TENDL-2024 LIBRARY; T=0.K  
Non-threshold reactions

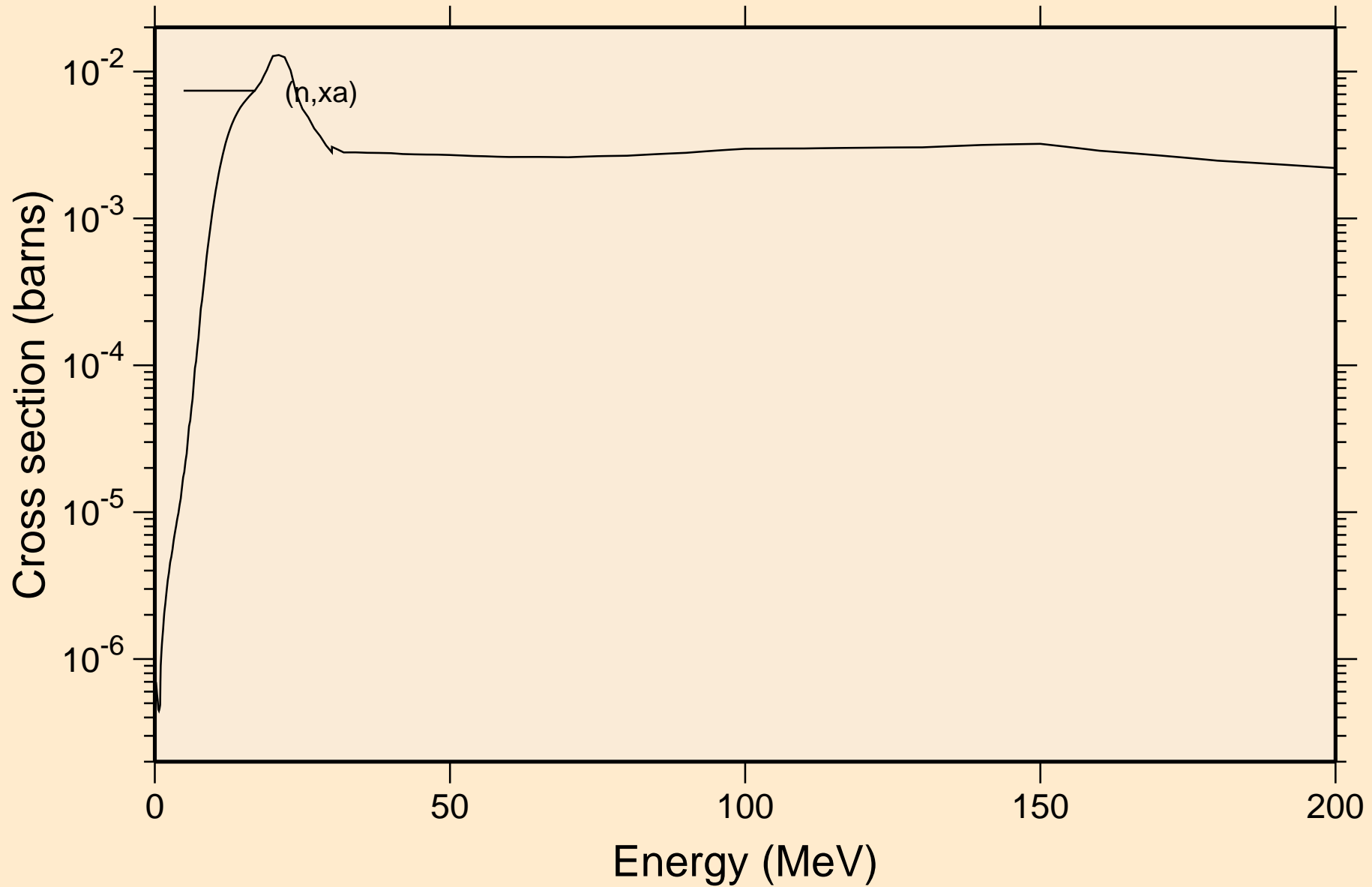



BH264 NEUTRON ACER TENDL-2024 LIBRARY; T=0.K  
Inelastic levels

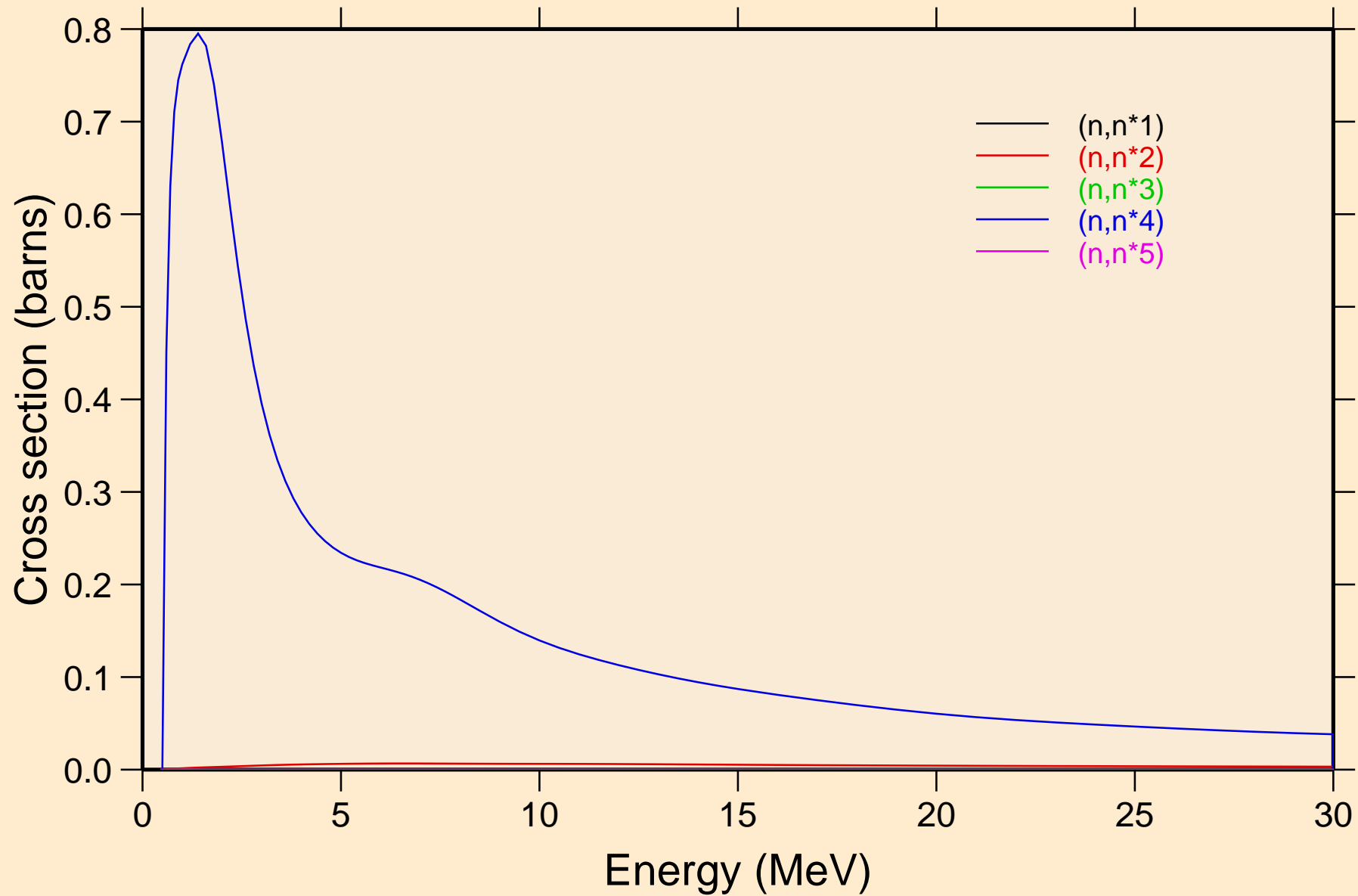

BH264 NEUTRON ACER TENDL-2024 LIBRARY; T=0.K  
Inelastic levels

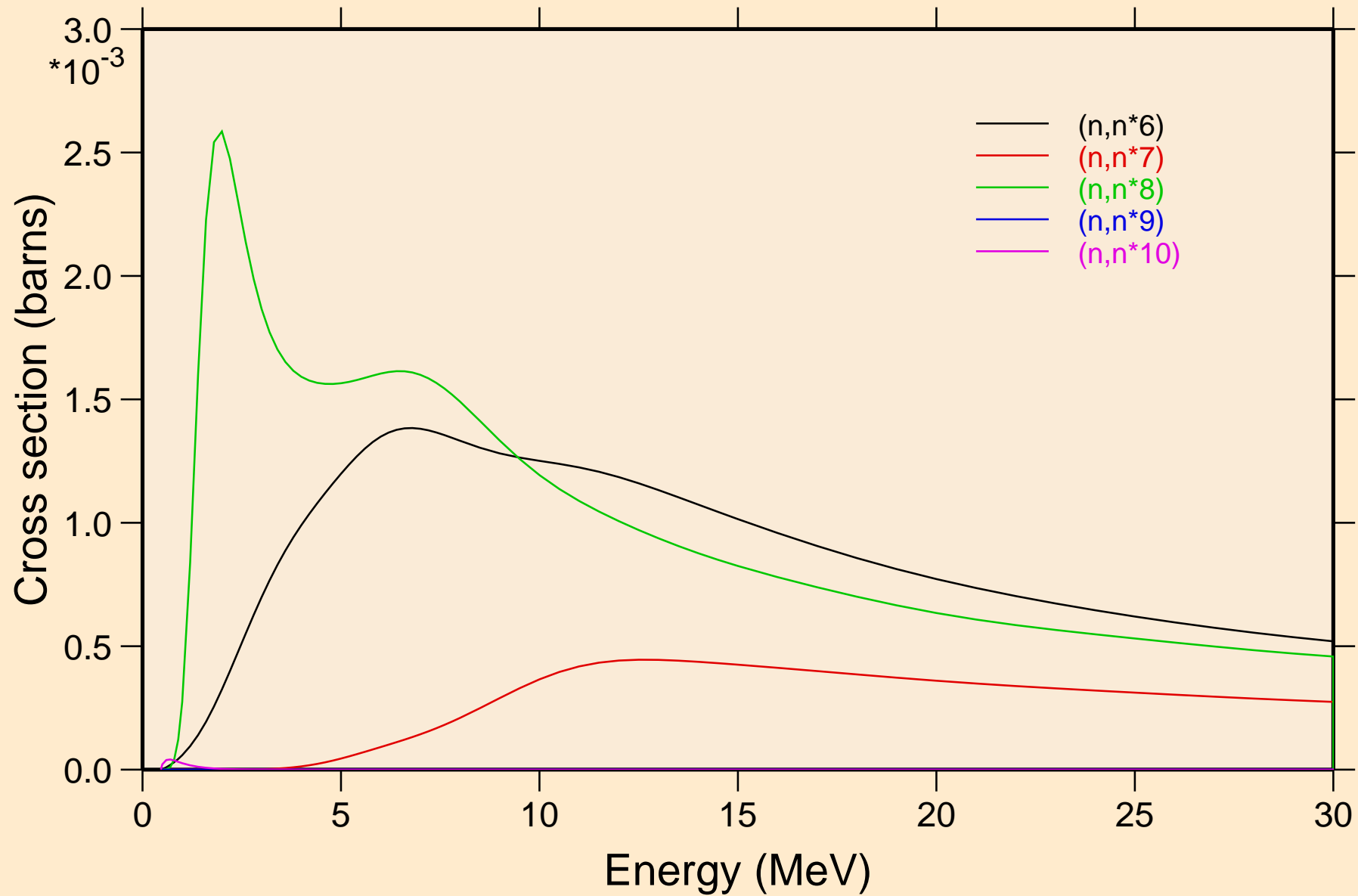

BH264 NEUTRON ACER TENDL-2024 LIBRARY; T=0.K  
Inelastic levels

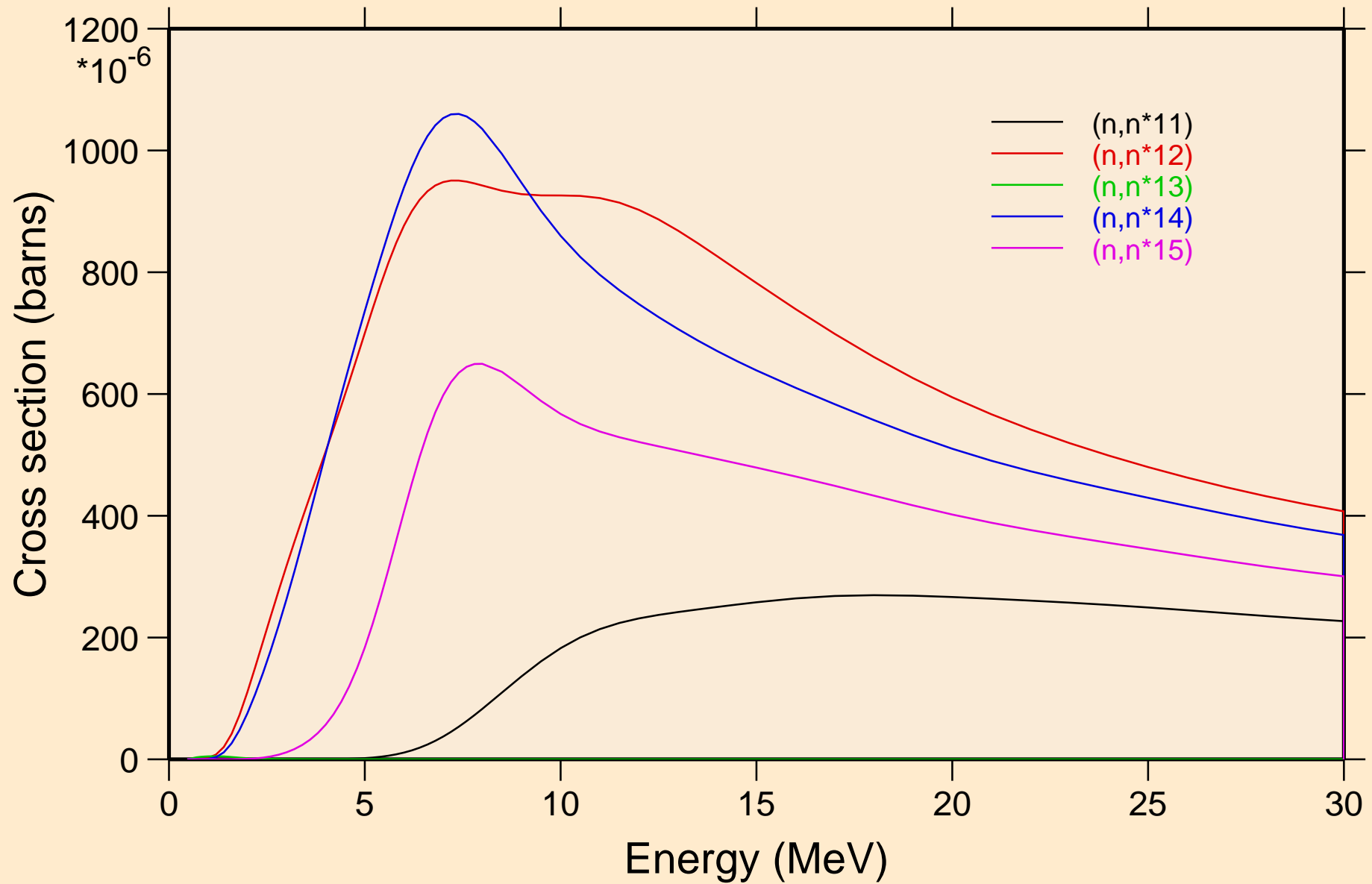

BH264 NEUTRON ACER TENDL-2024 LIBRARY; T=0.K  
Inelastic levels

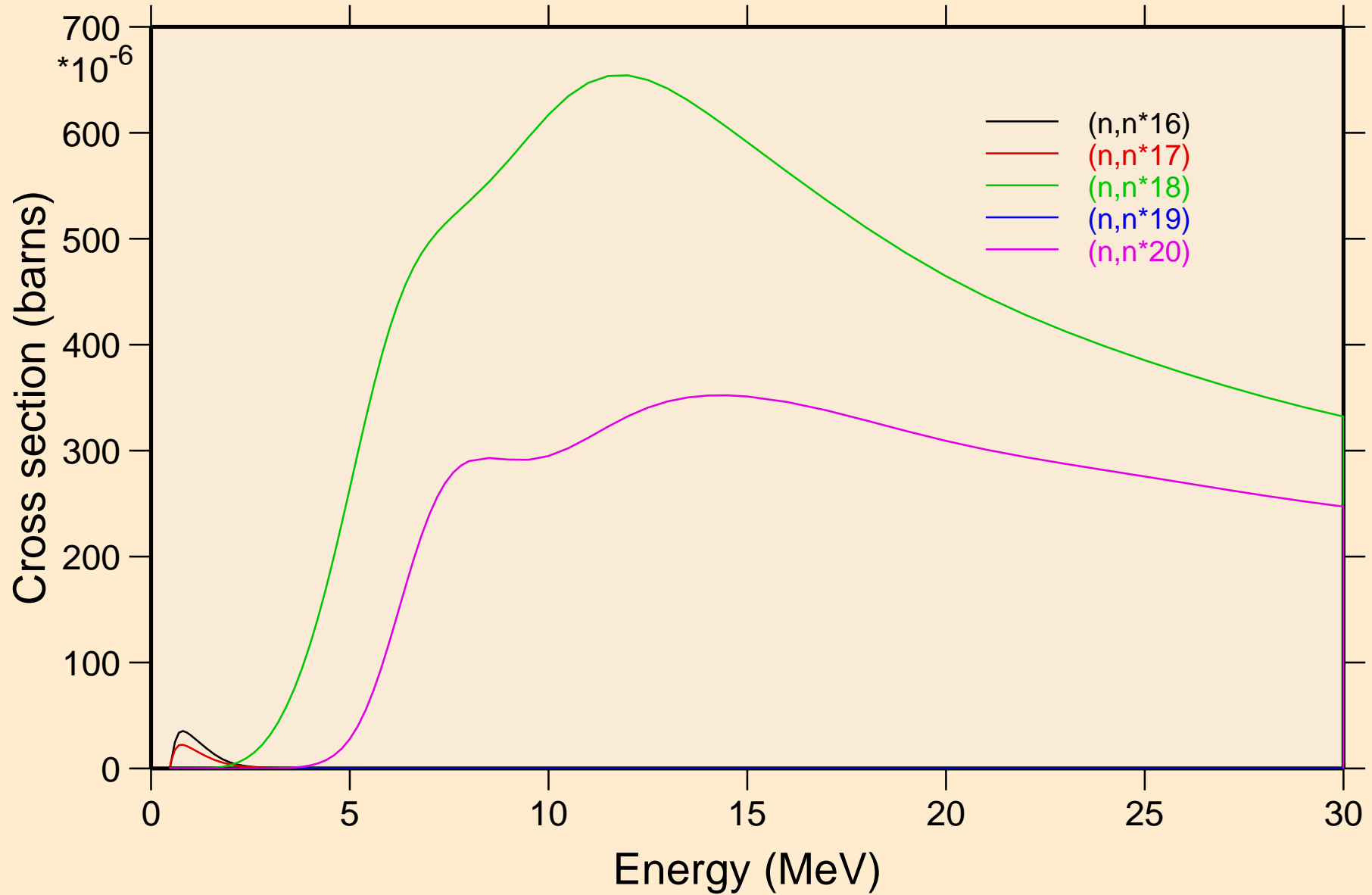

BH264 NEUTRON ACER TENDL-2024 LIBRARY; T=0.K  
Inelastic levels

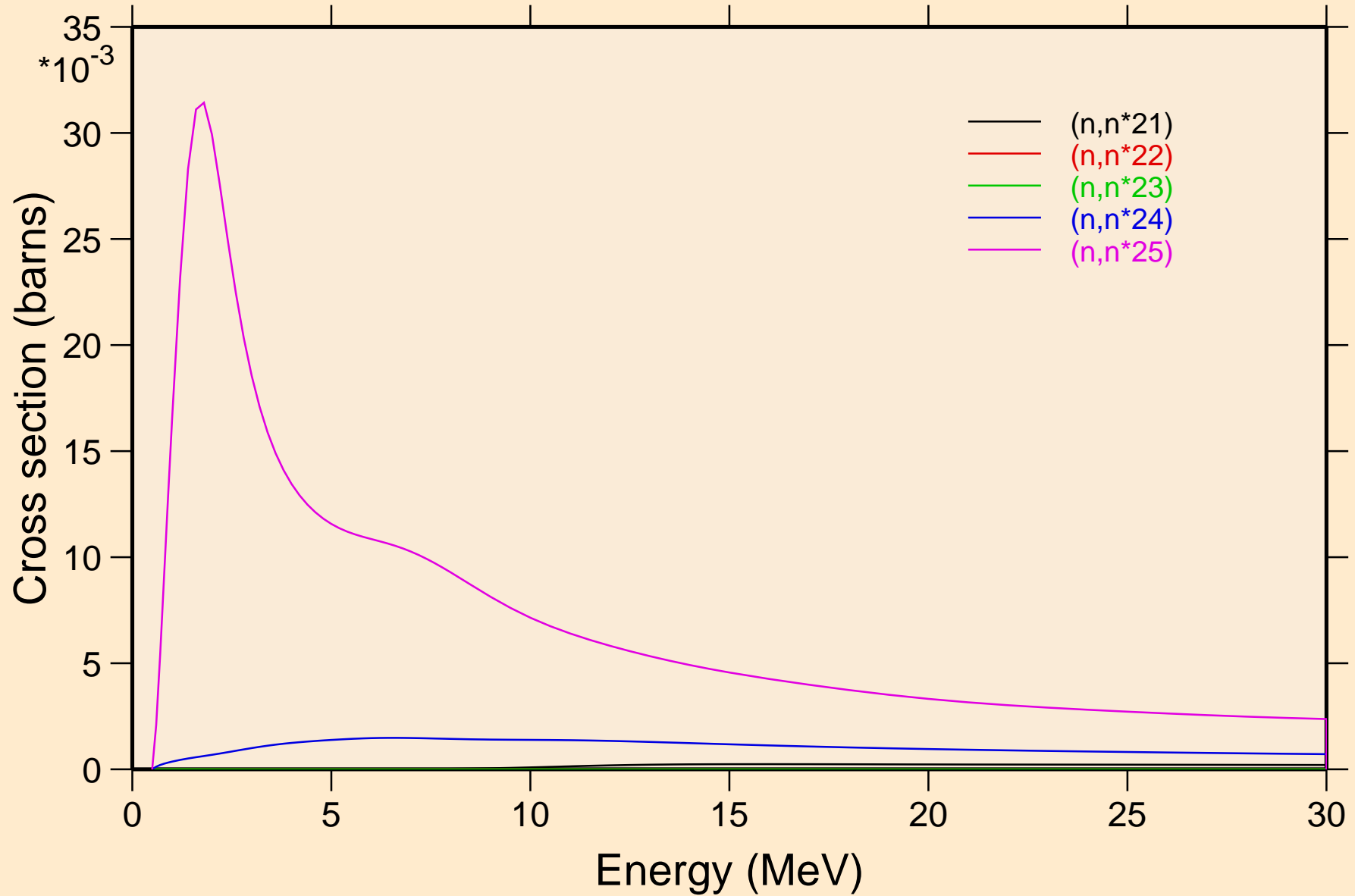

# BH264 NEUTRON ACER TENDL-2024 LIBRARY; T=0.K

## Threshold reactions

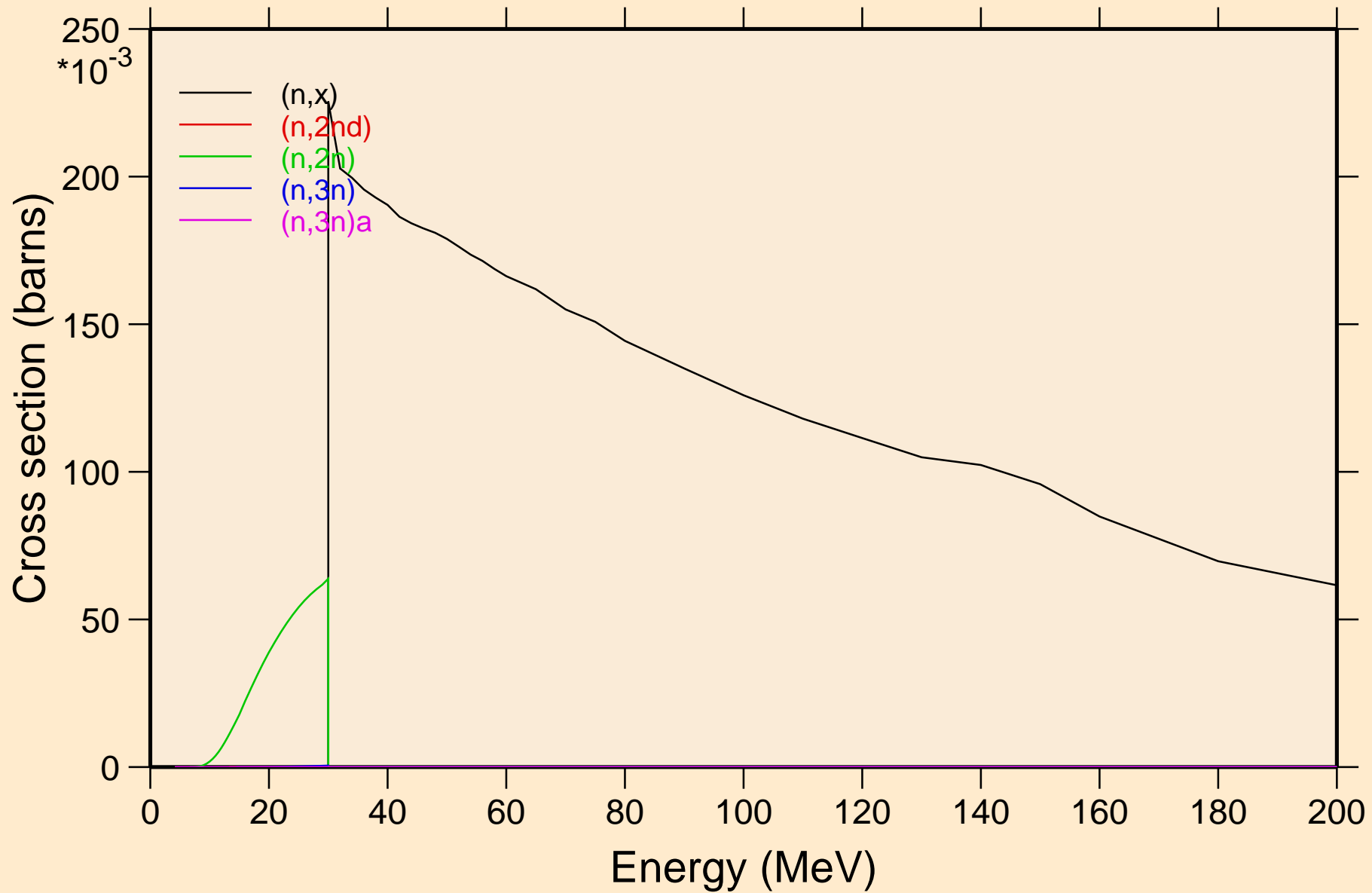

BH264 NEUTRON ACER TENDL-2024 LIBRARY; T=0.K  
Threshold reactions

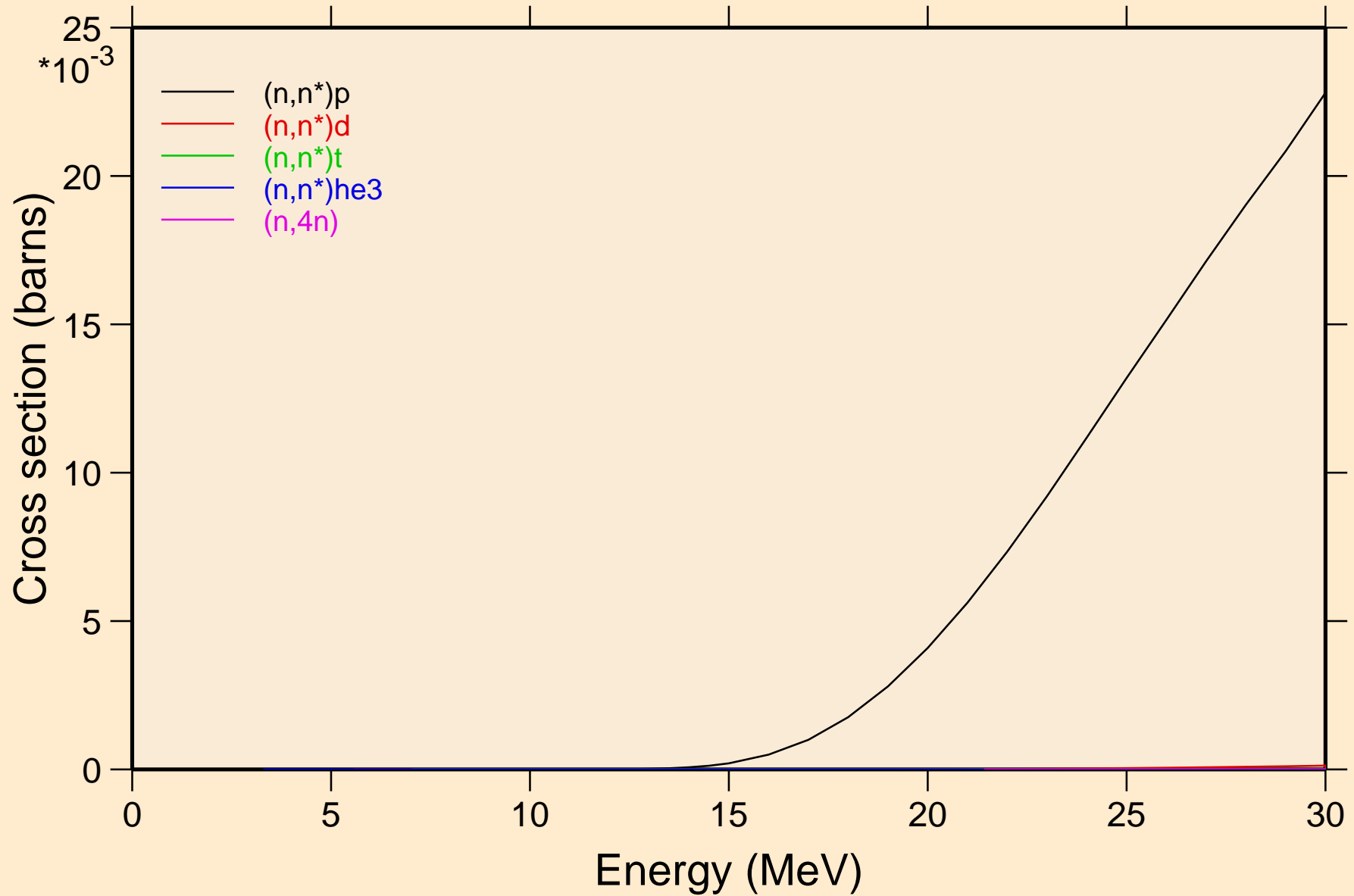

BH264 NEUTRON ACER TENDL-2024 LIBRARY; T=0.K  
Threshold reactions

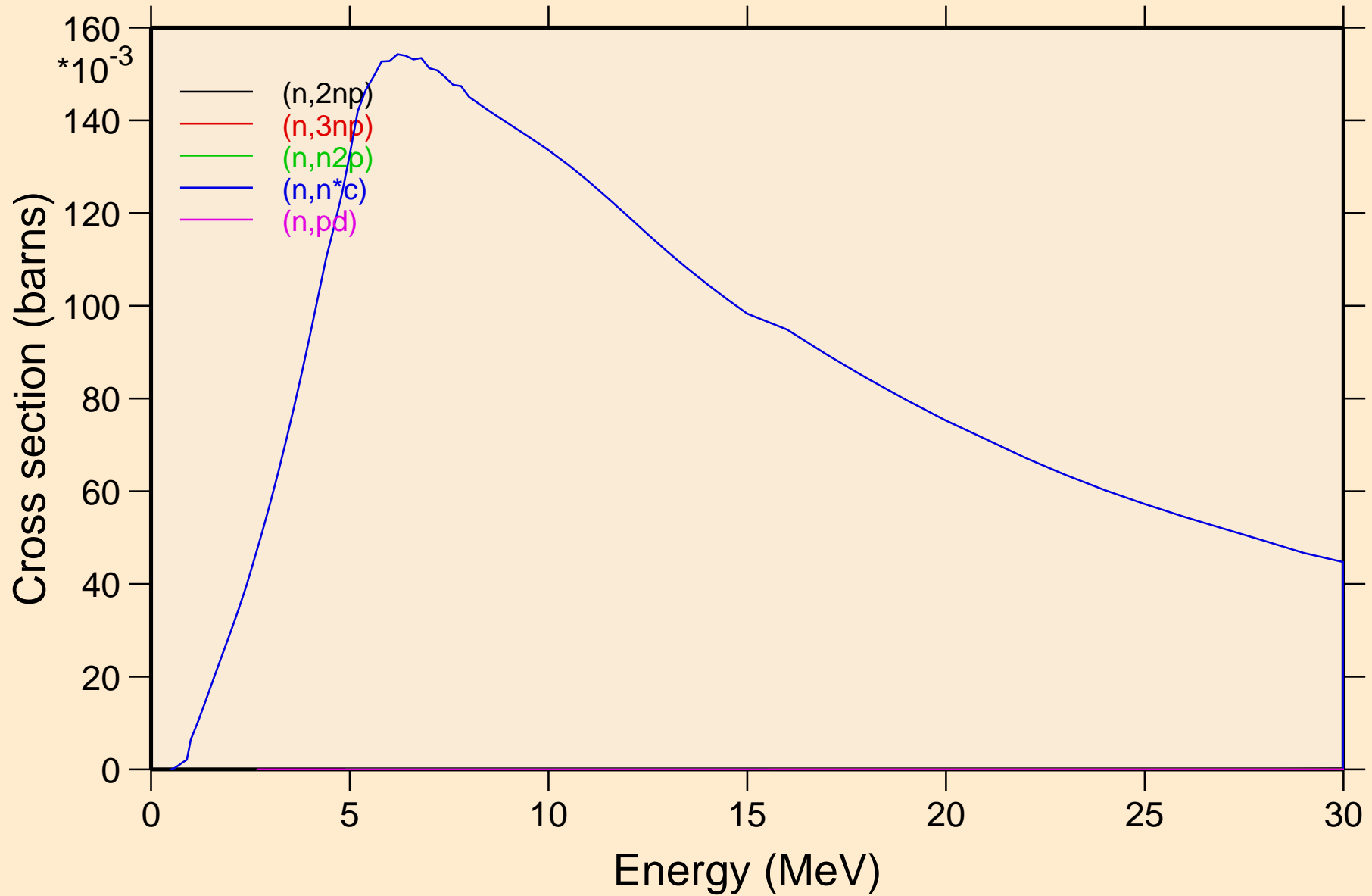



BH264 NEUTRON ACER TENDL-2024 LIBRARY; T=0.K  
angular distribution for elastic

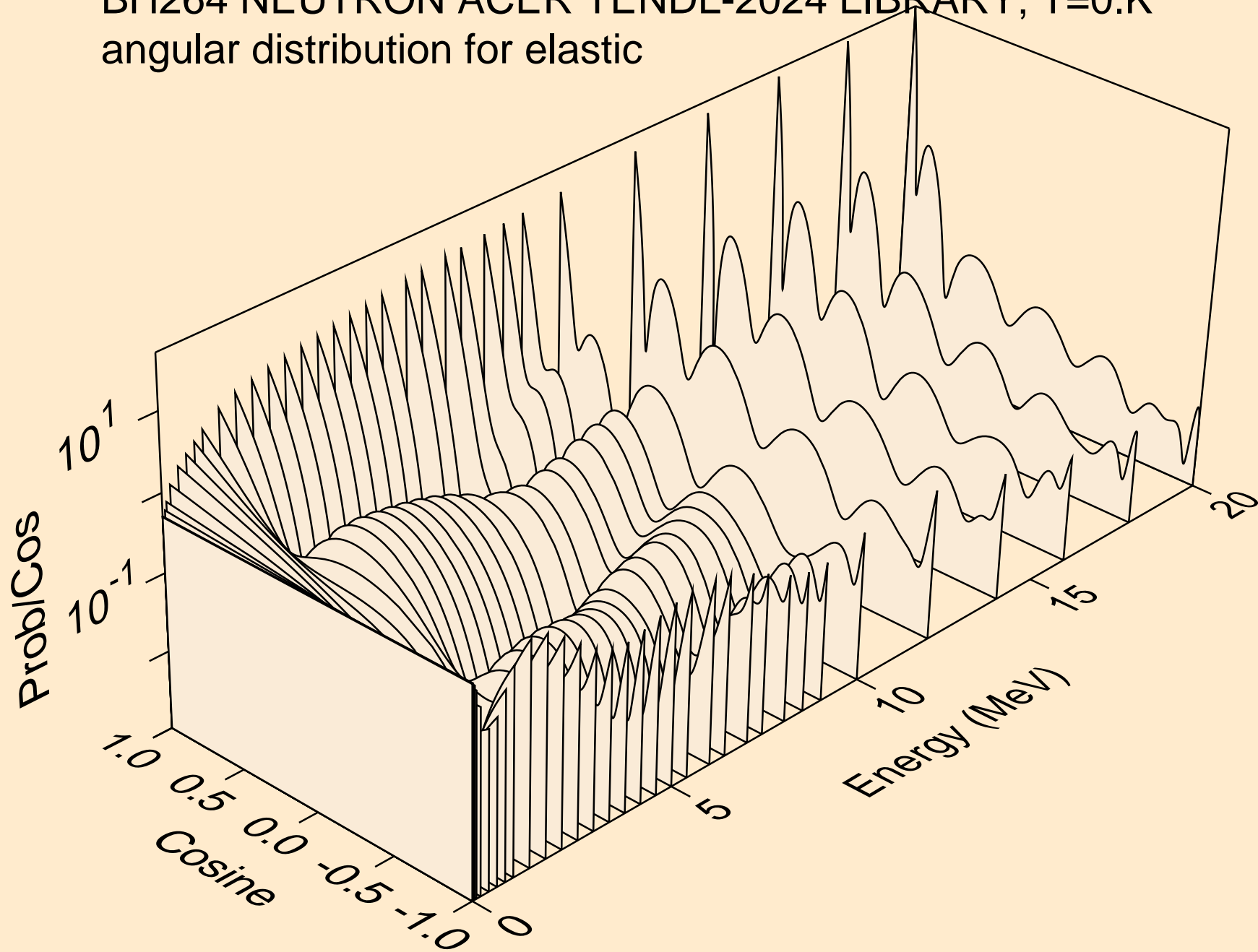

BH264 NEUTRON ACER TENDL-2024 LIBRARY; T=0.K  
angular distribution for elastic

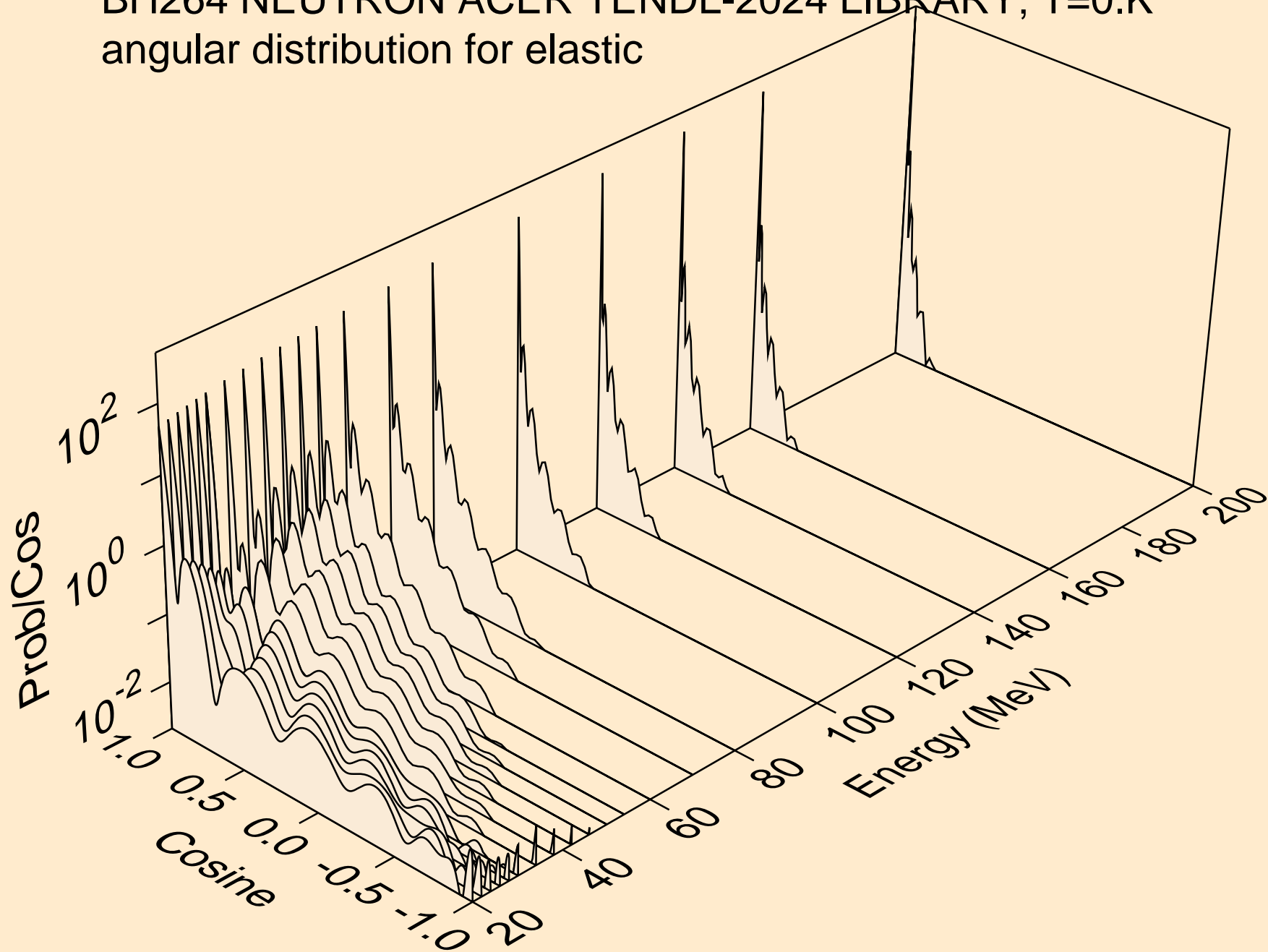

BH264 NEUTRON ACER TENDL-2024 LIBRARY; T=0.K  
angular distribution for (n,n\*1)

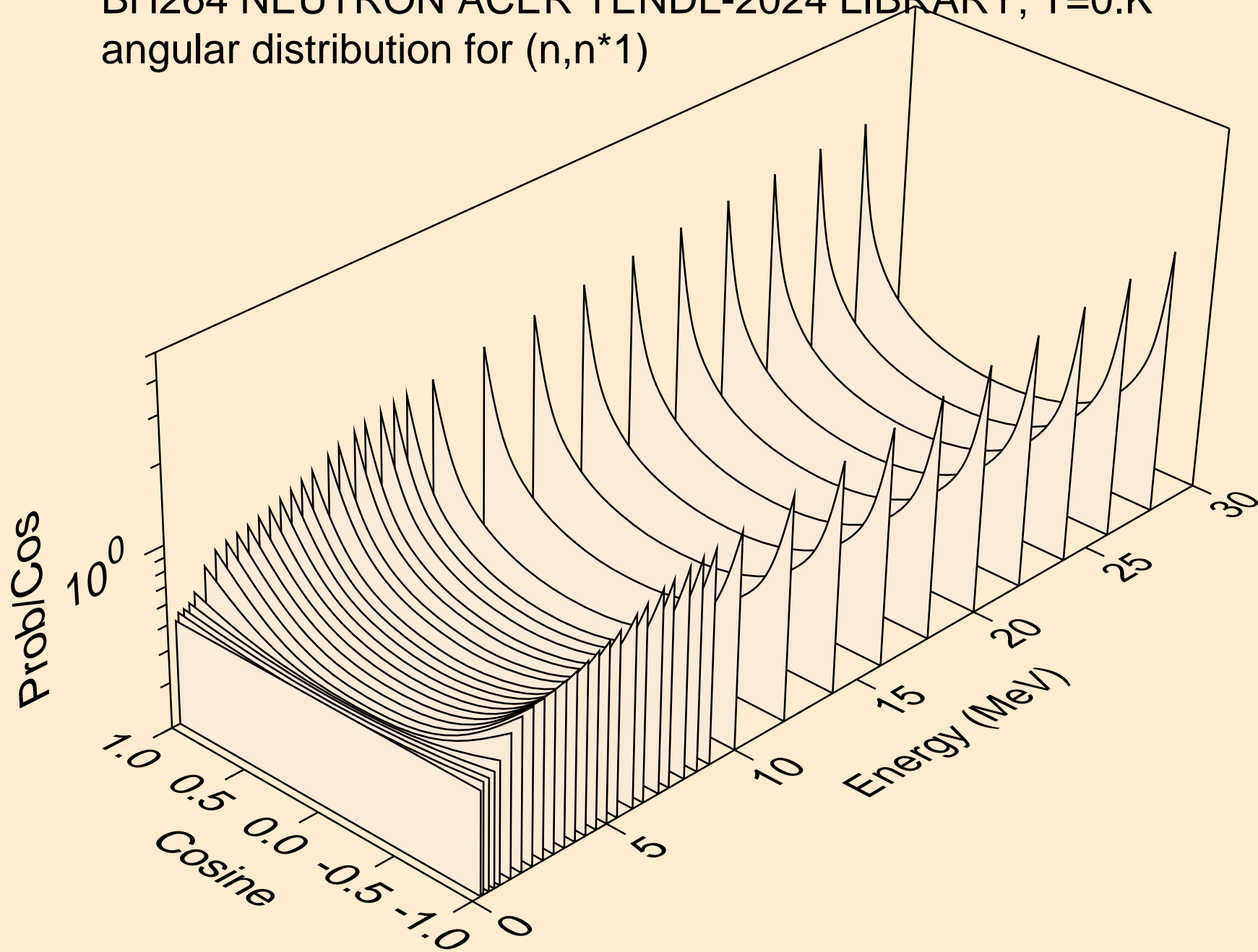

BH264 NEUTRON ACER TENDL-2024 LIBRARY; T=0.K  
angular distribution for (n,n\*2)

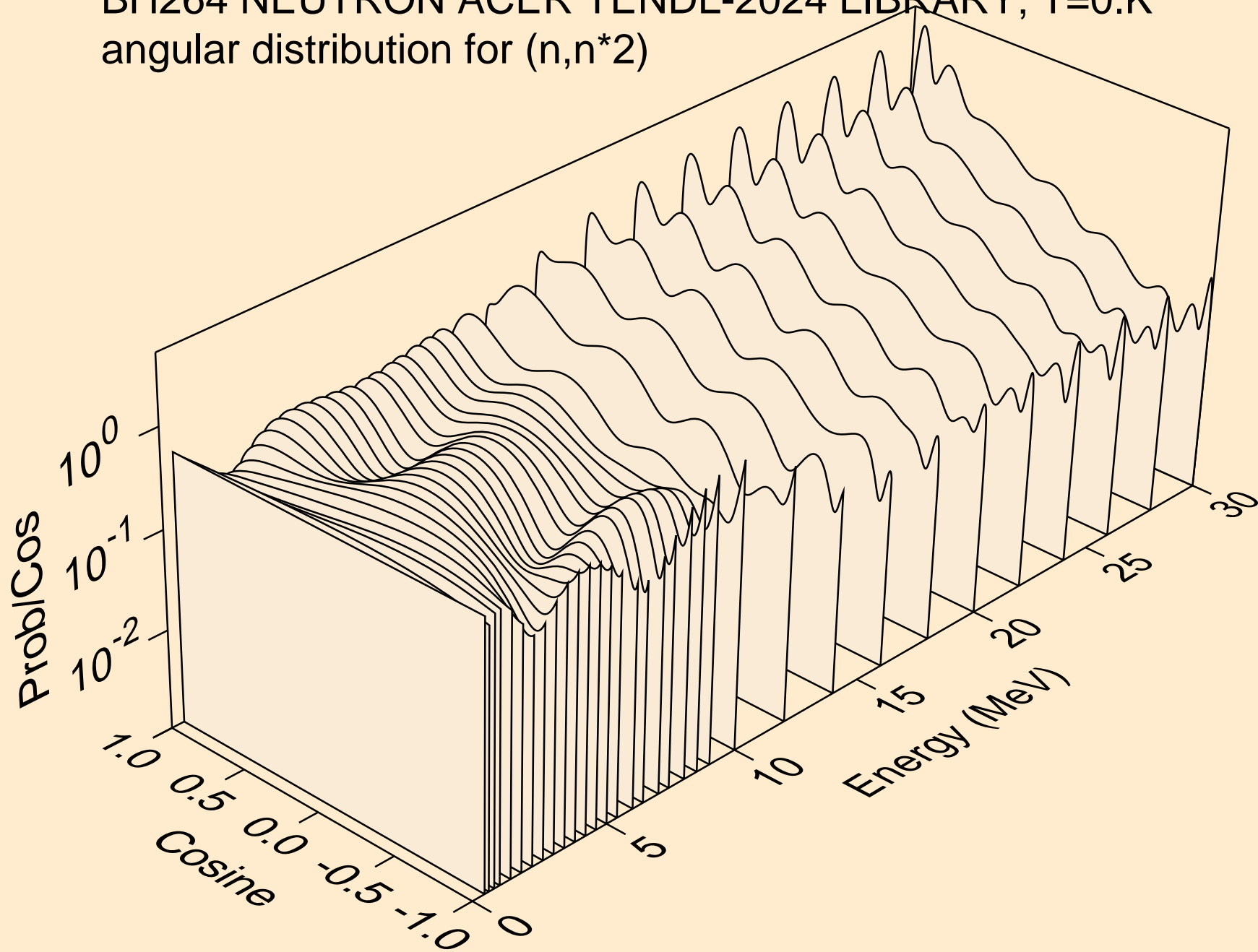

BH264 NEUTRON ACER TENDL-2024 LIBRARY; T=0.K  
angular distribution for (n,n\*3)

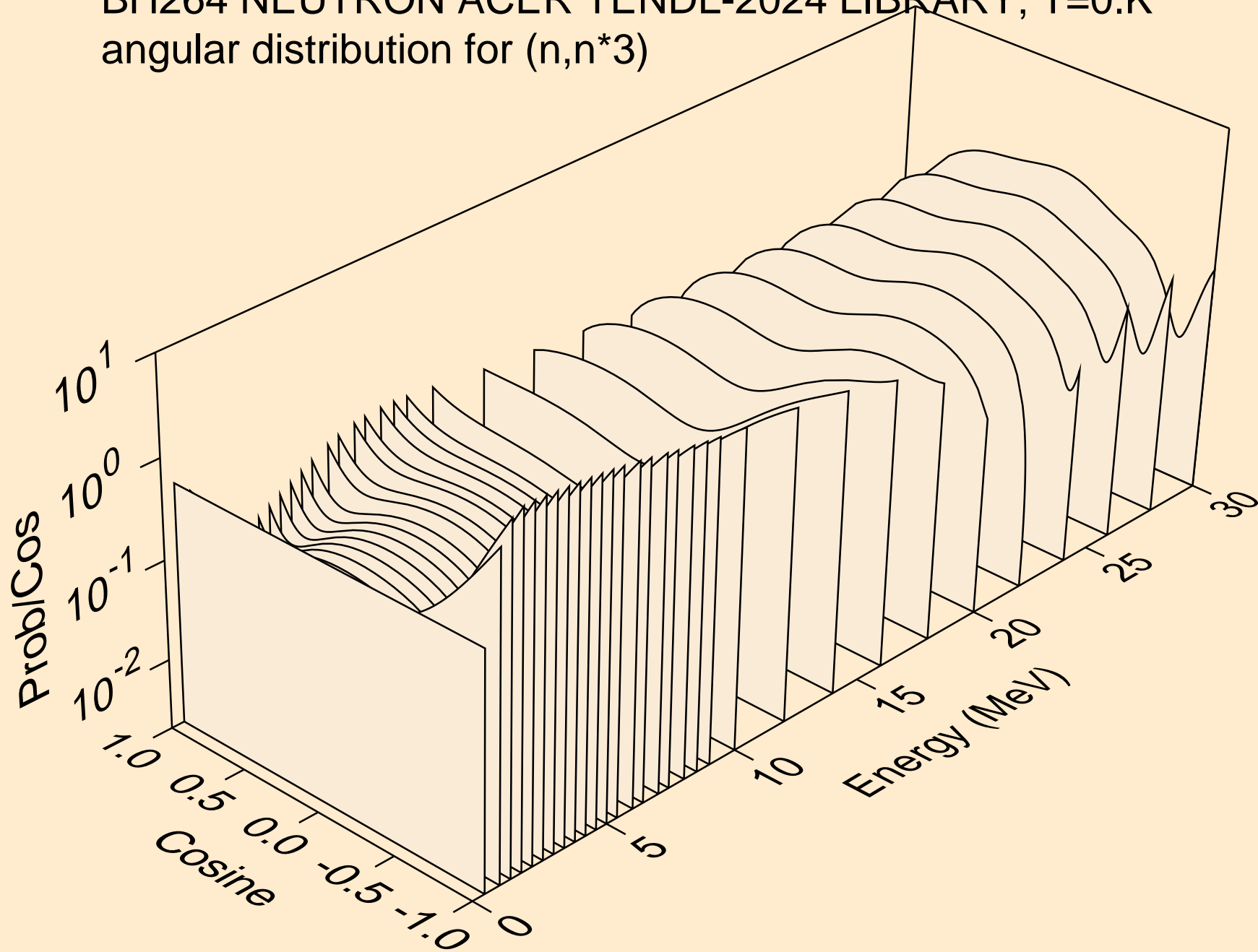

BH264 NEUTRON ACER TENDL-2024 LIBRARY; T=0.K  
angular distribution for (n,n\*4)

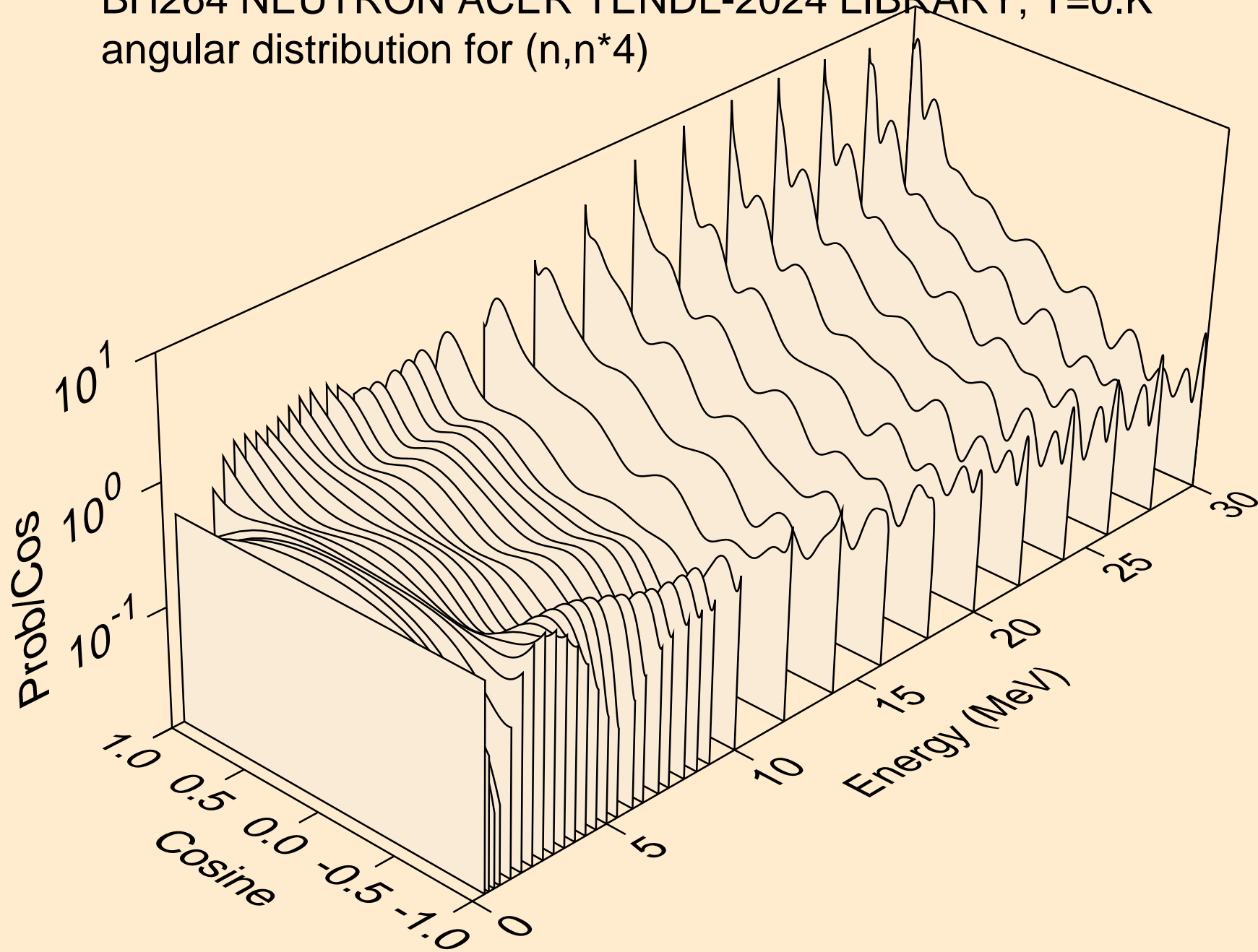

BH264 NEUTRON ACER TENDL-2024 LIBRARY; T=0.K  
angular distribution for (n,n\*5)

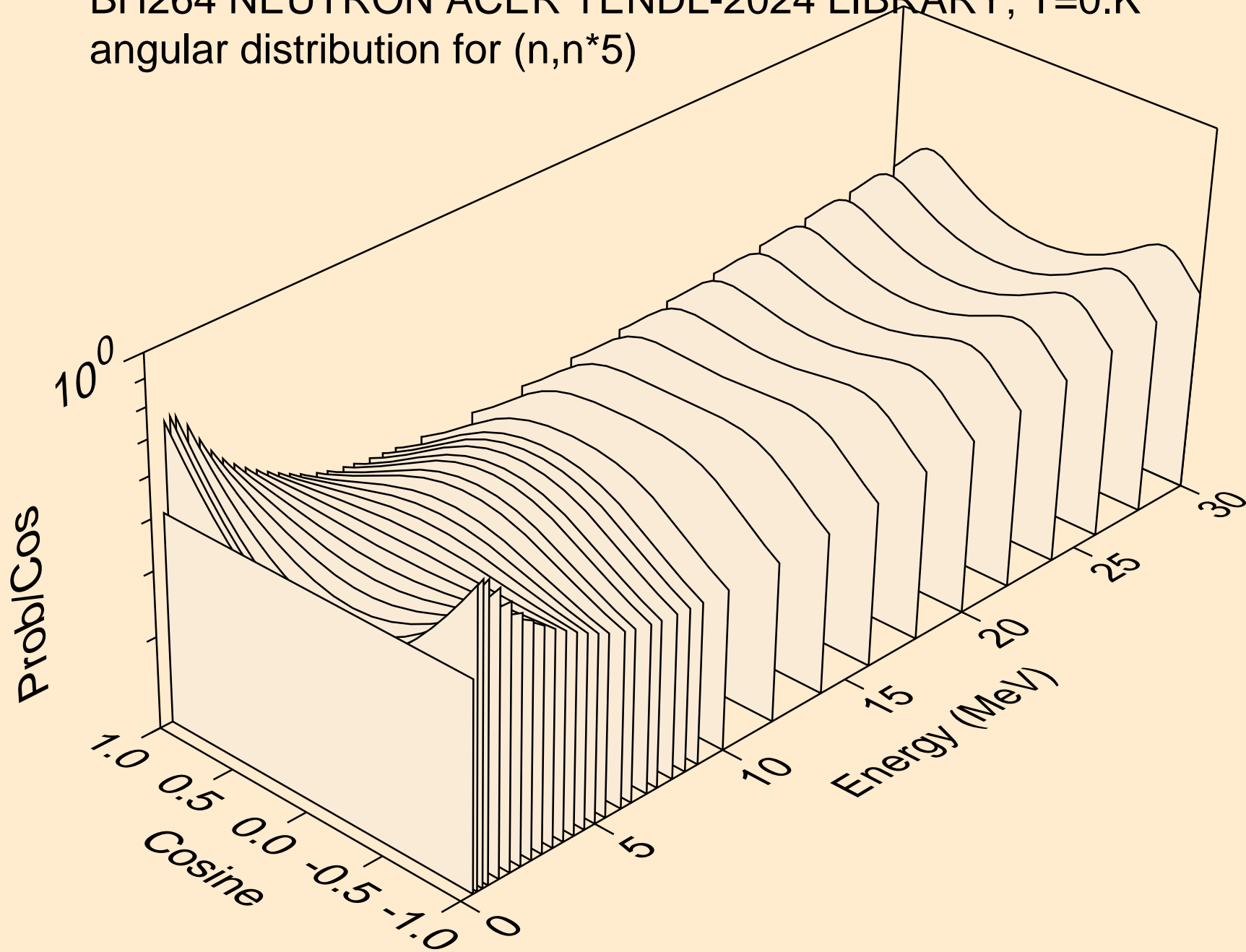

BH264 NEUTRON ACER TENDL-2024 LIBRARY; T=0.K  
angular distribution for (n,n\*6)

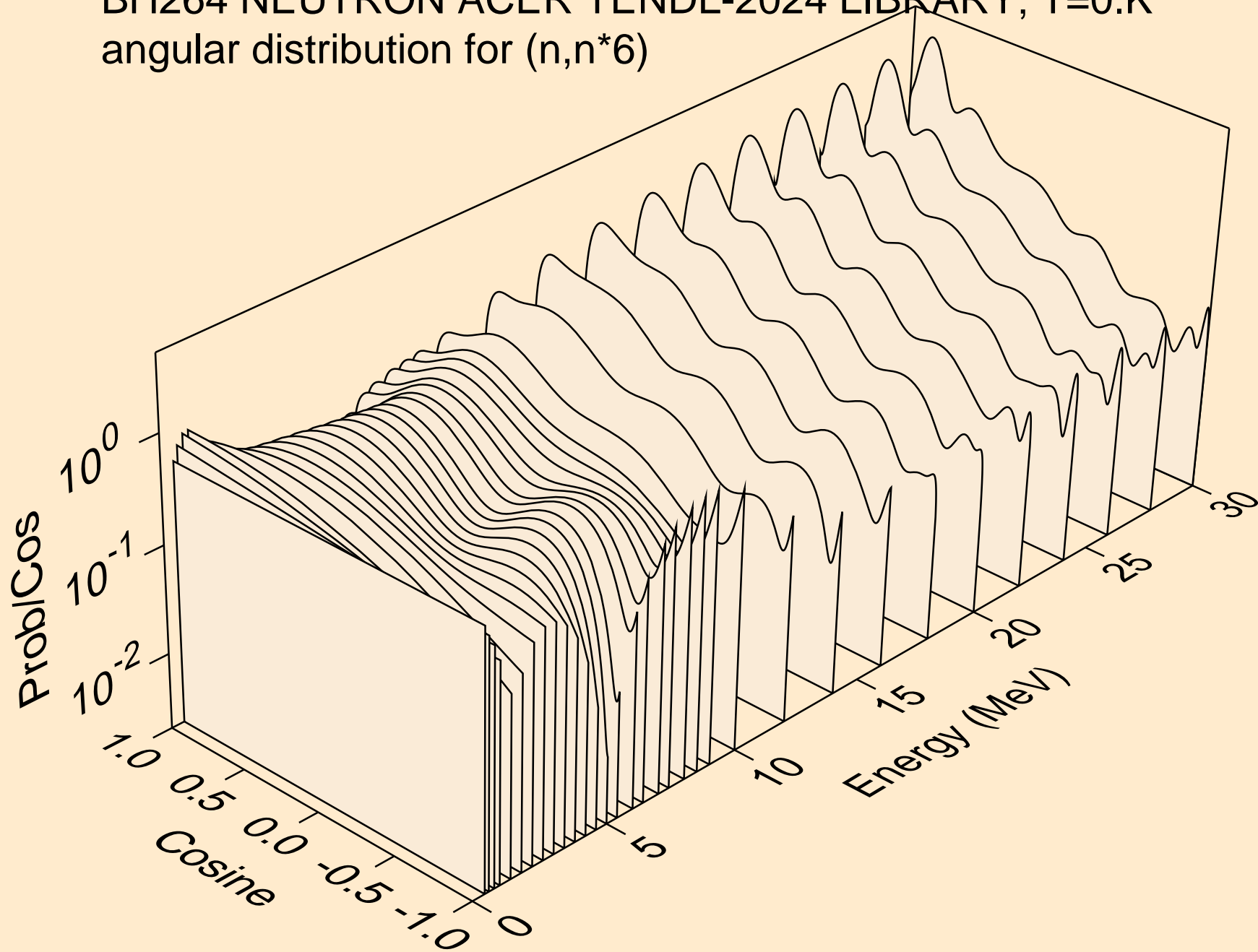



BH264 NEUTRON ACER TENDL-2024 LIBRARY; T=0.K  
angular distribution for (n,n\*7)

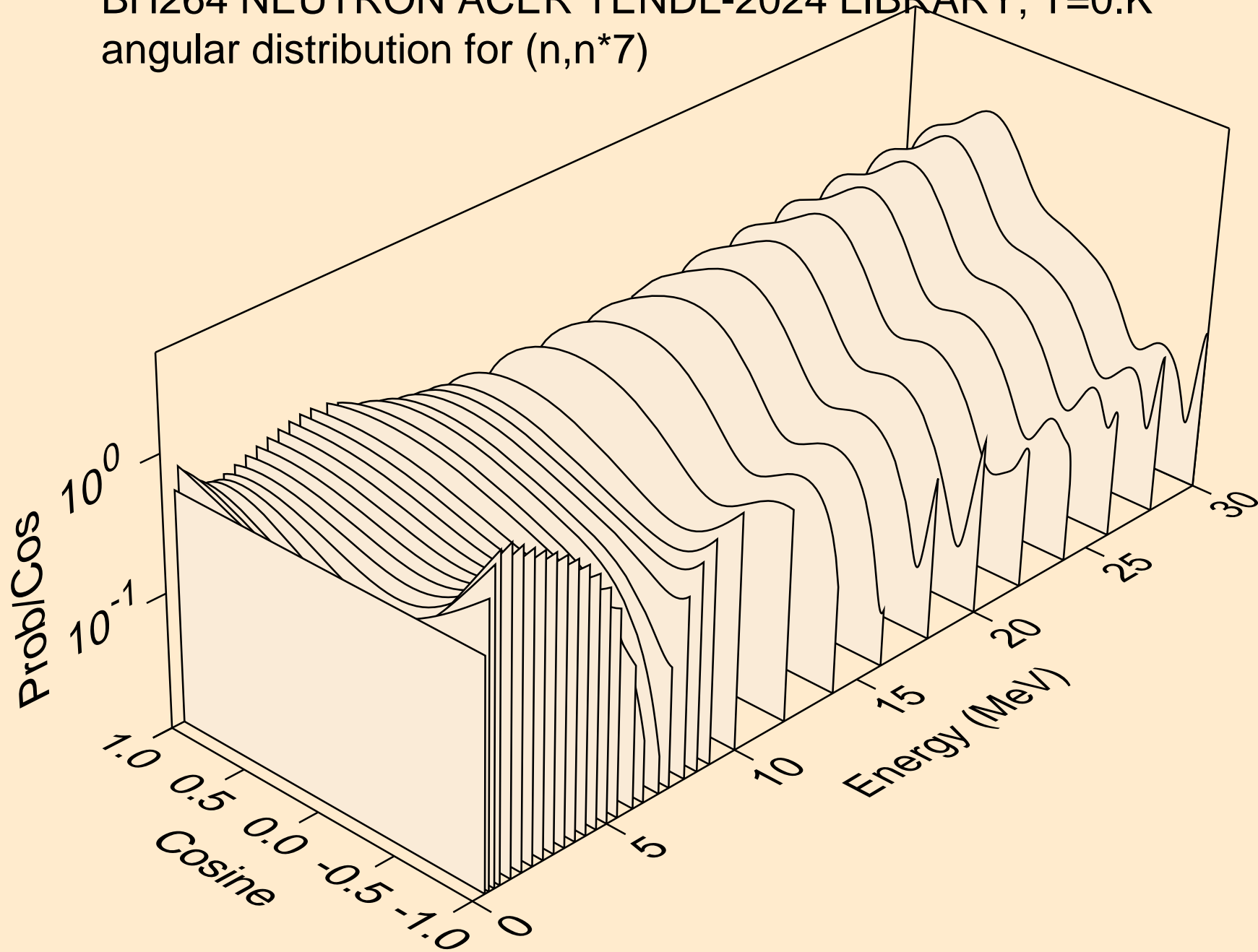

BH264 NEUTRON ACER TENDL-2024 LIBRARY; T=0.K  
angular distribution for (n,n\*8)

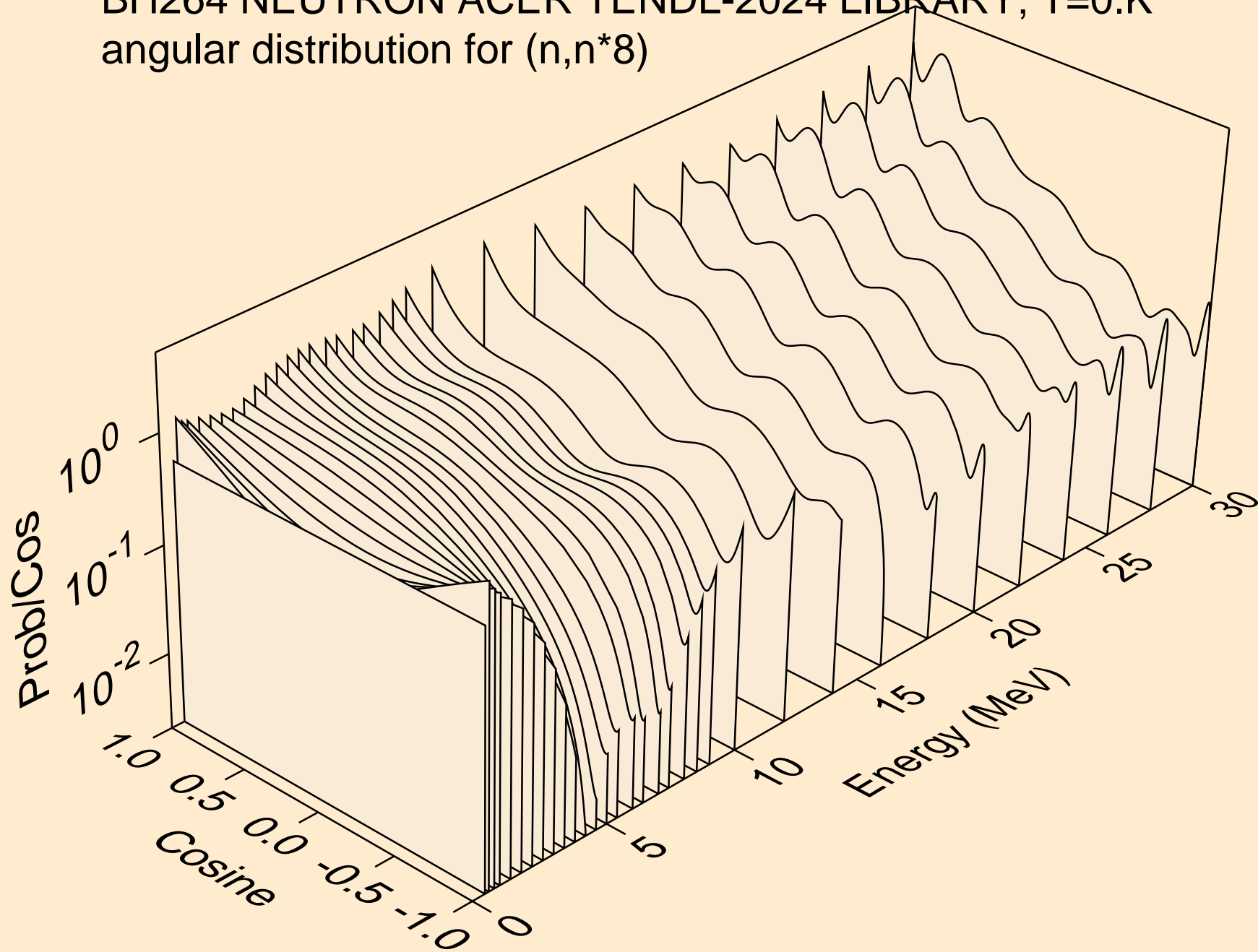

BH264 NEUTRON ACER TENDL-2024 LIBRARY; T=0.K  
angular distribution for (n,n\*9)

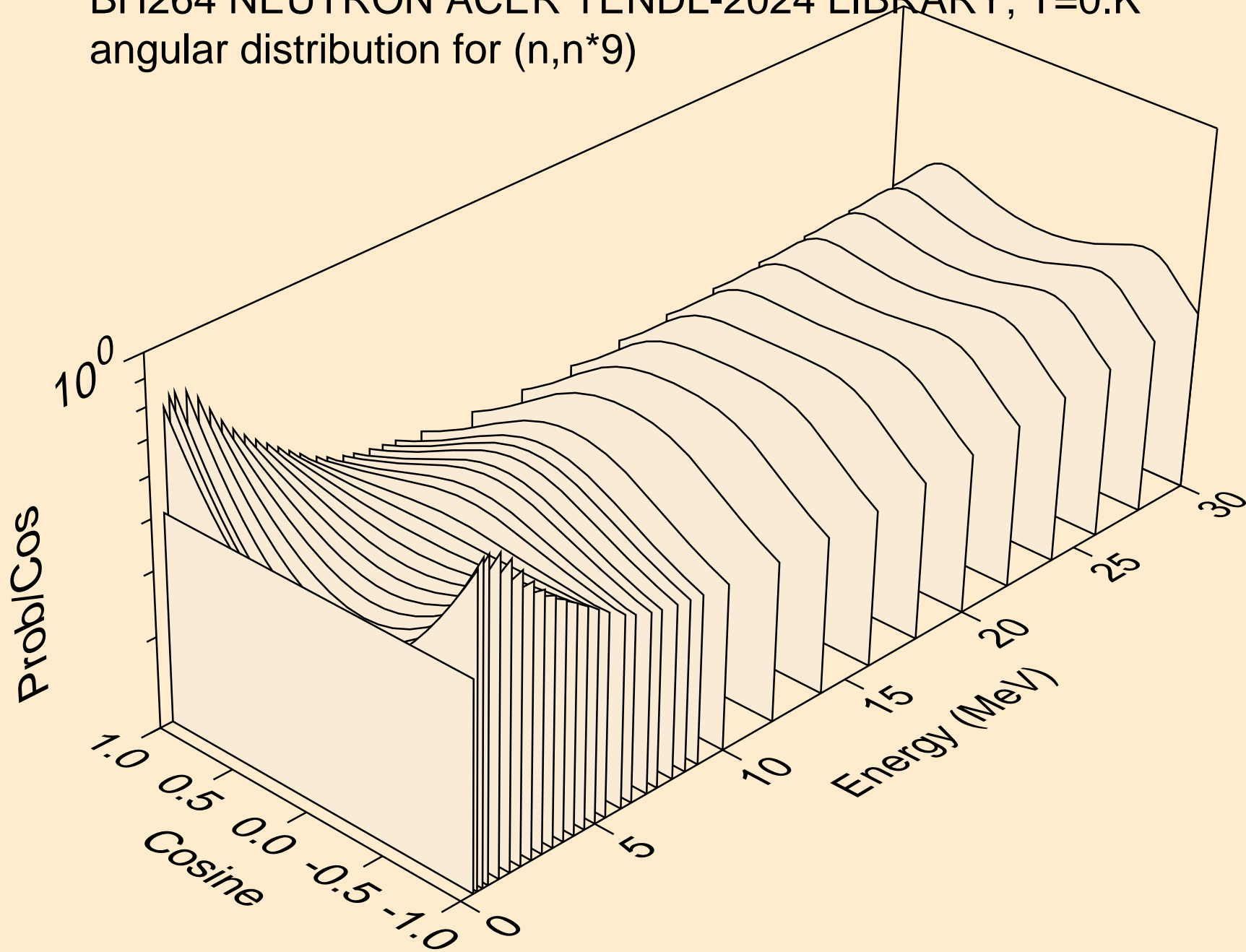

BH264 NEUTRON ACER TENDL-2024 LIBRARY; T=0.K  
angular distribution for (n,n\*10)

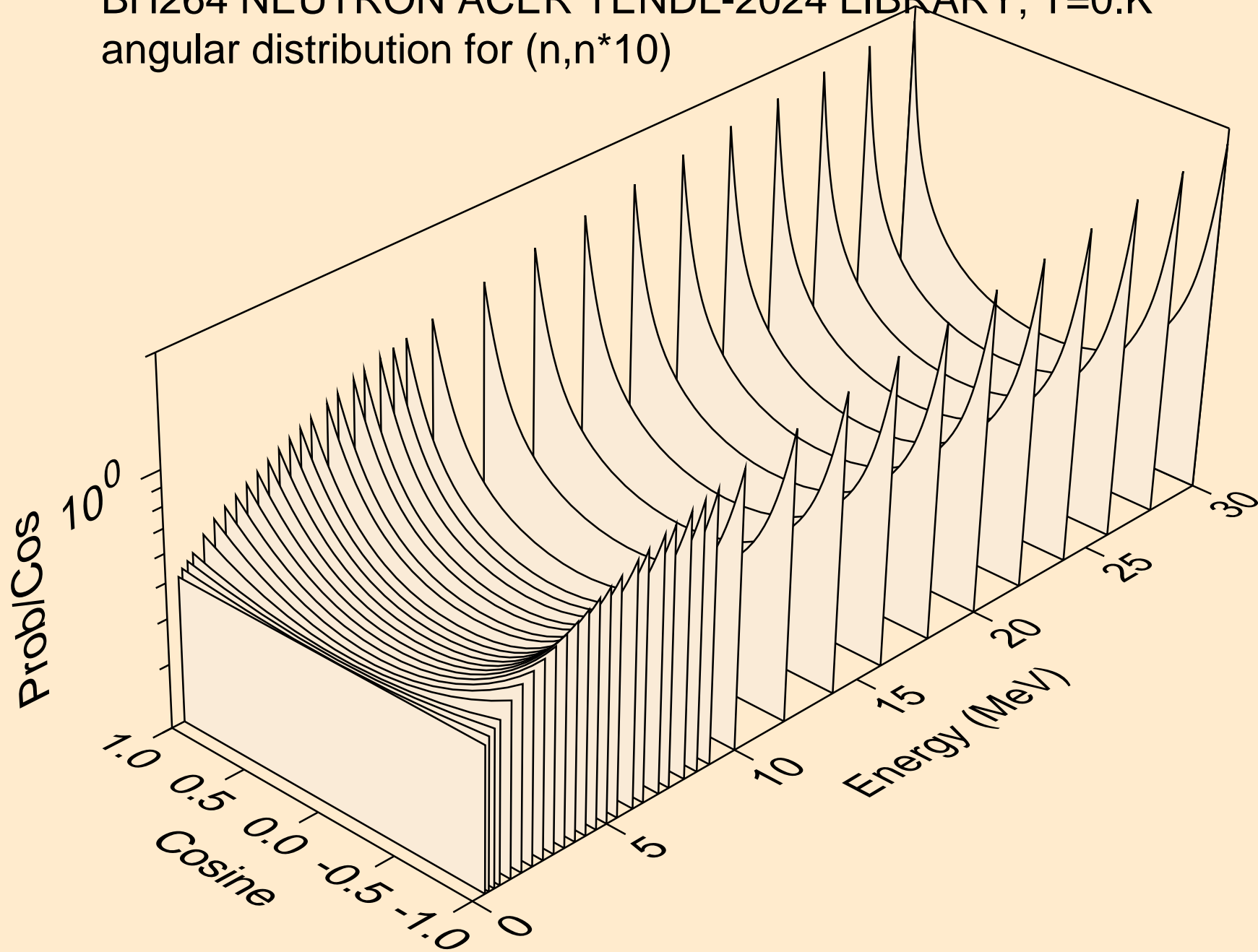

BH264 NEUTRON ACER TENDL-2024 LIBRARY; T=0.K  
angular distribution for (n,n\*11)

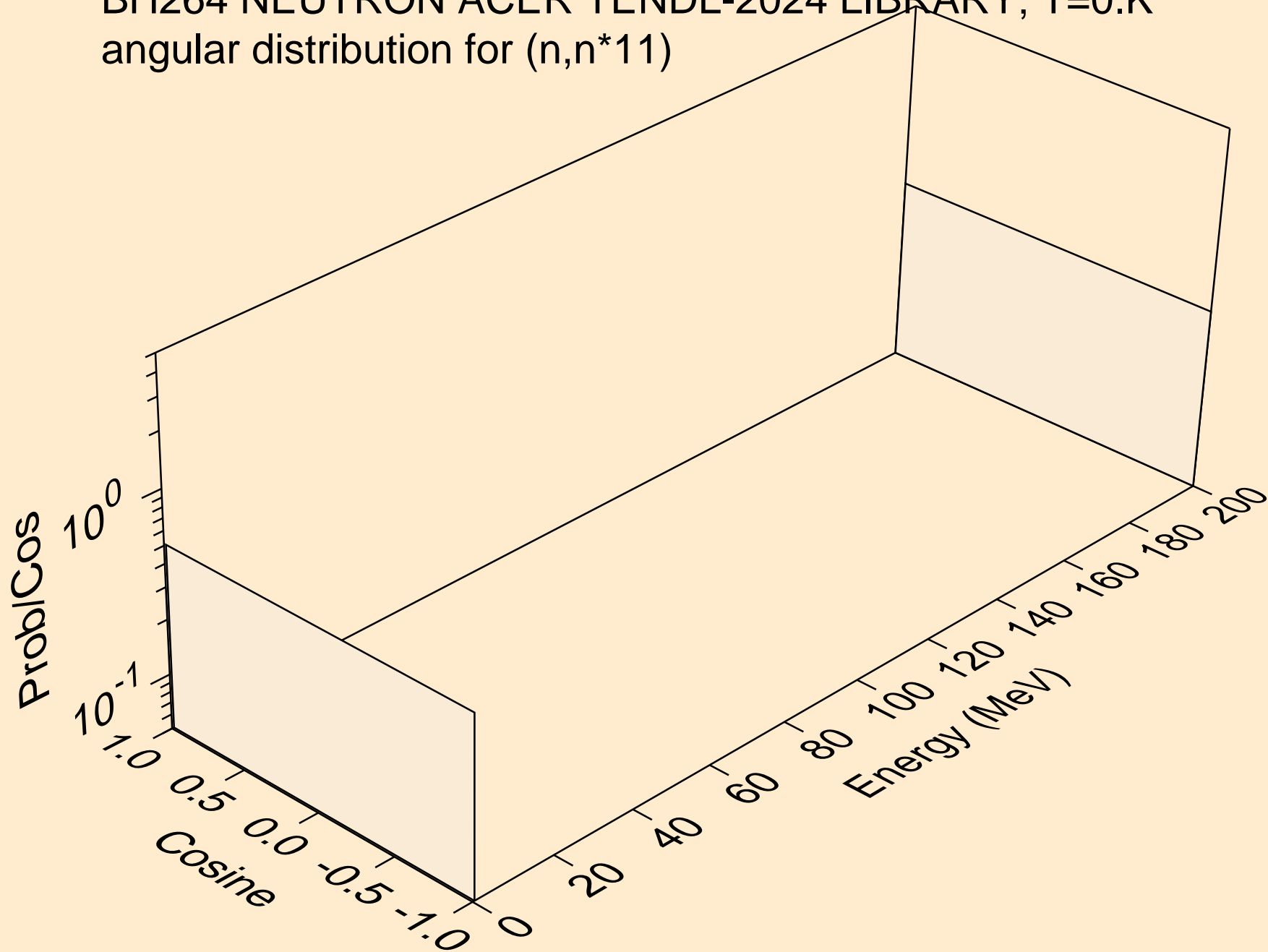

BH264 NEUTRON ACER TENDL-2024 LIBRARY; T=0.K  
angular distribution for (n,n\*12)

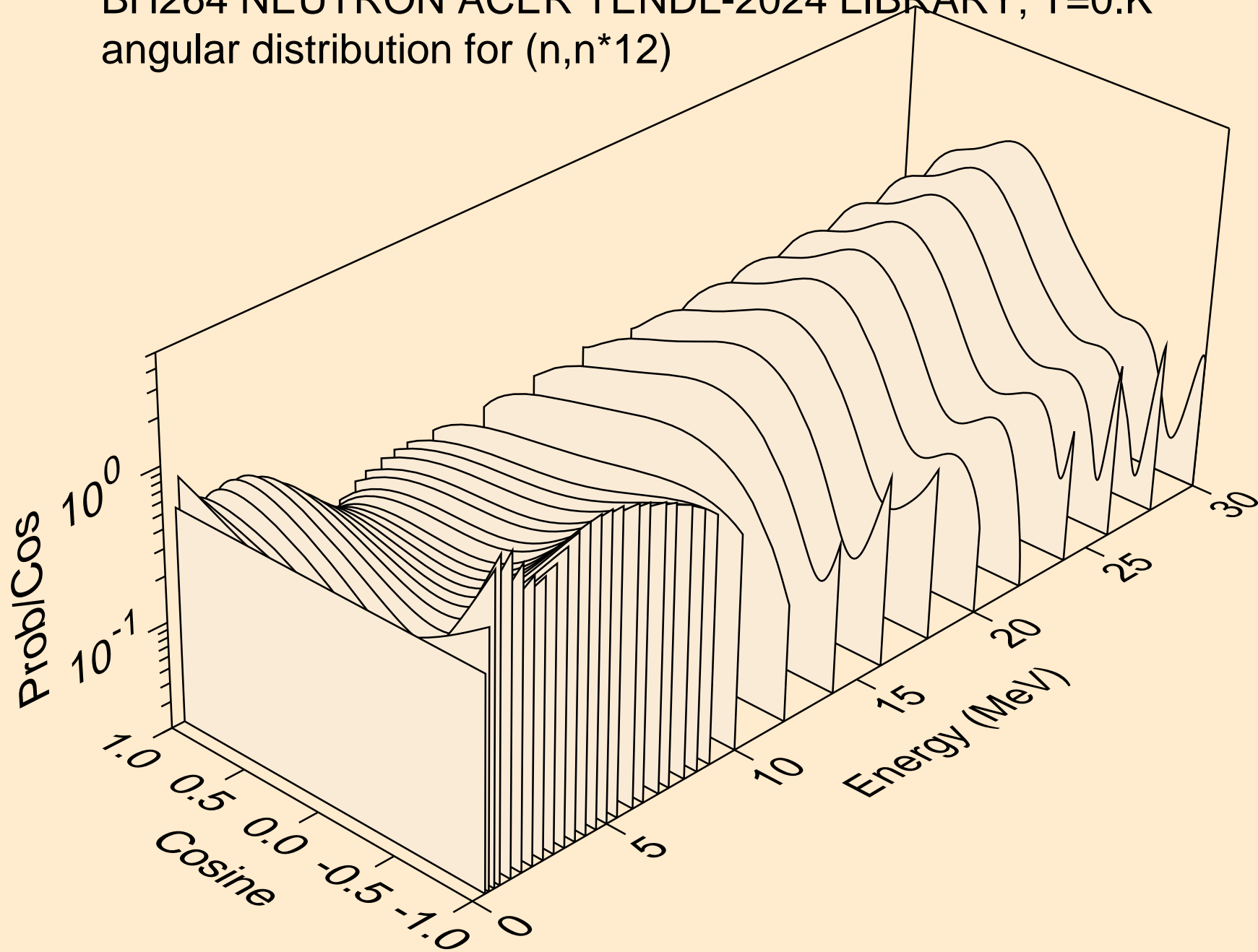

BH264 NEUTRON ACER TENDL-2024 LIBRARY; T=0.K  
angular distribution for (n,n\*13)

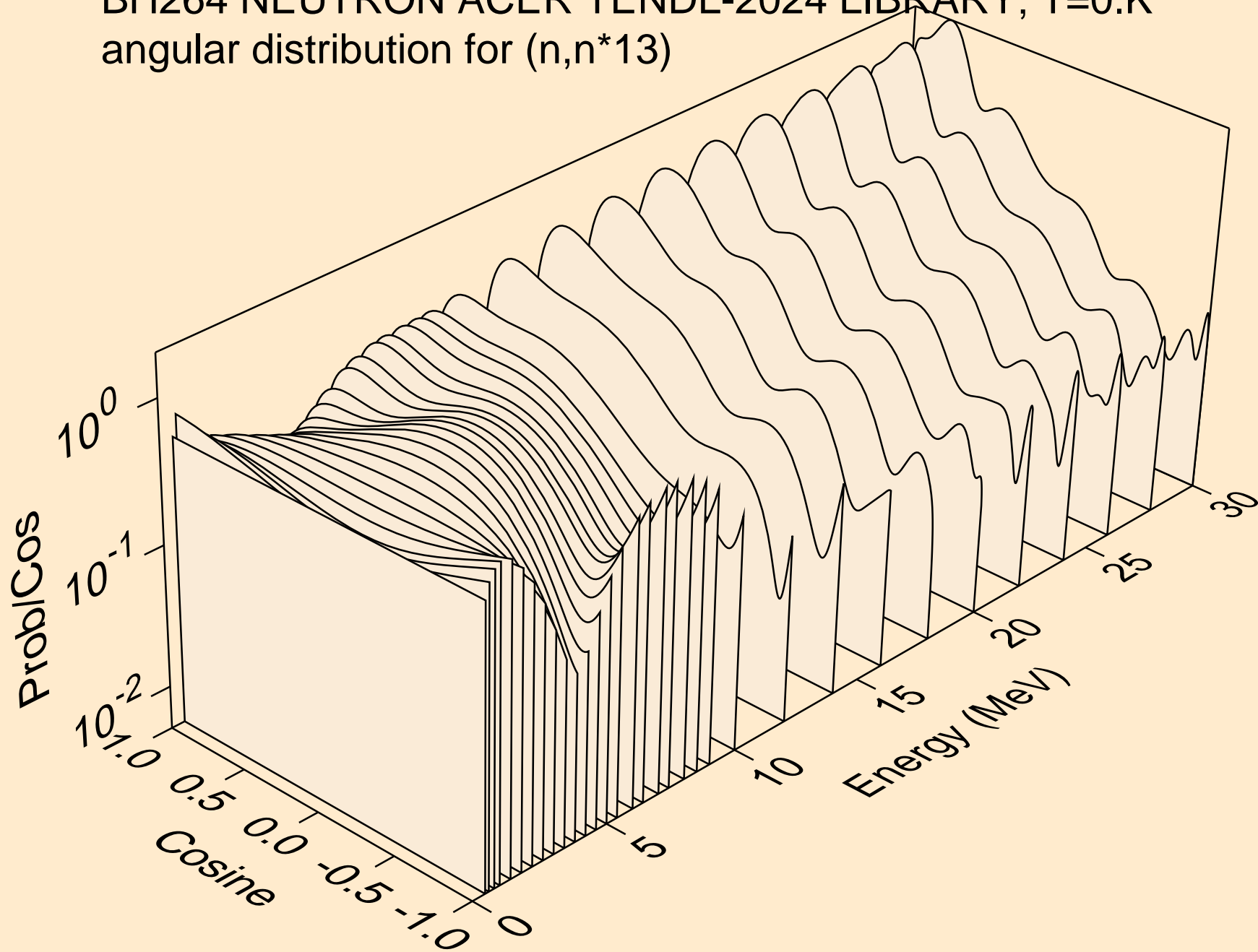

BH264 NEUTRON ACER TENDL-2024 LIBRARY; T=0.K  
angular distribution for (n,n\*14)

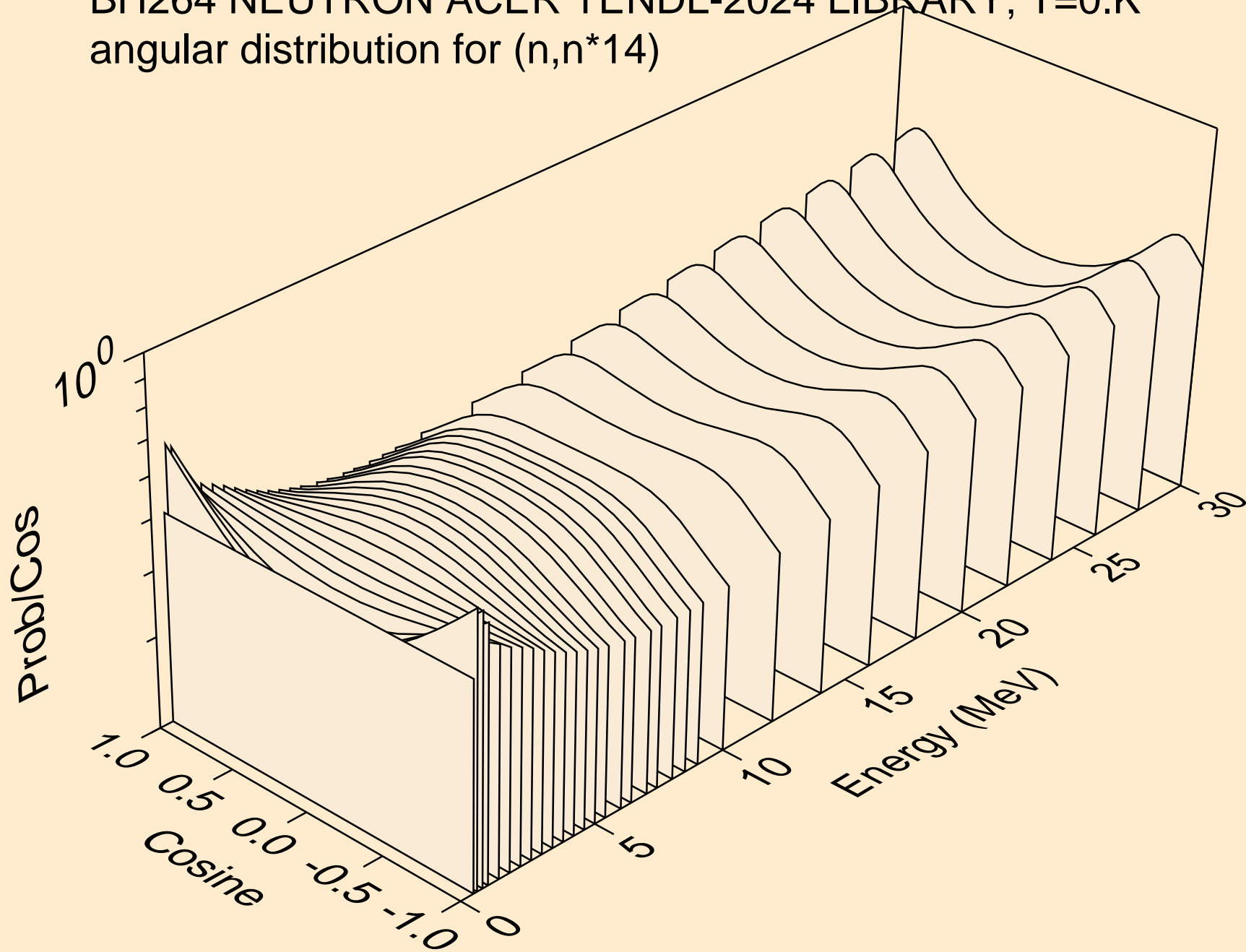



BH264 NEUTRON ACER TENDL-2024 LIBRARY; T=0.K  
angular distribution for (n,n\*15)

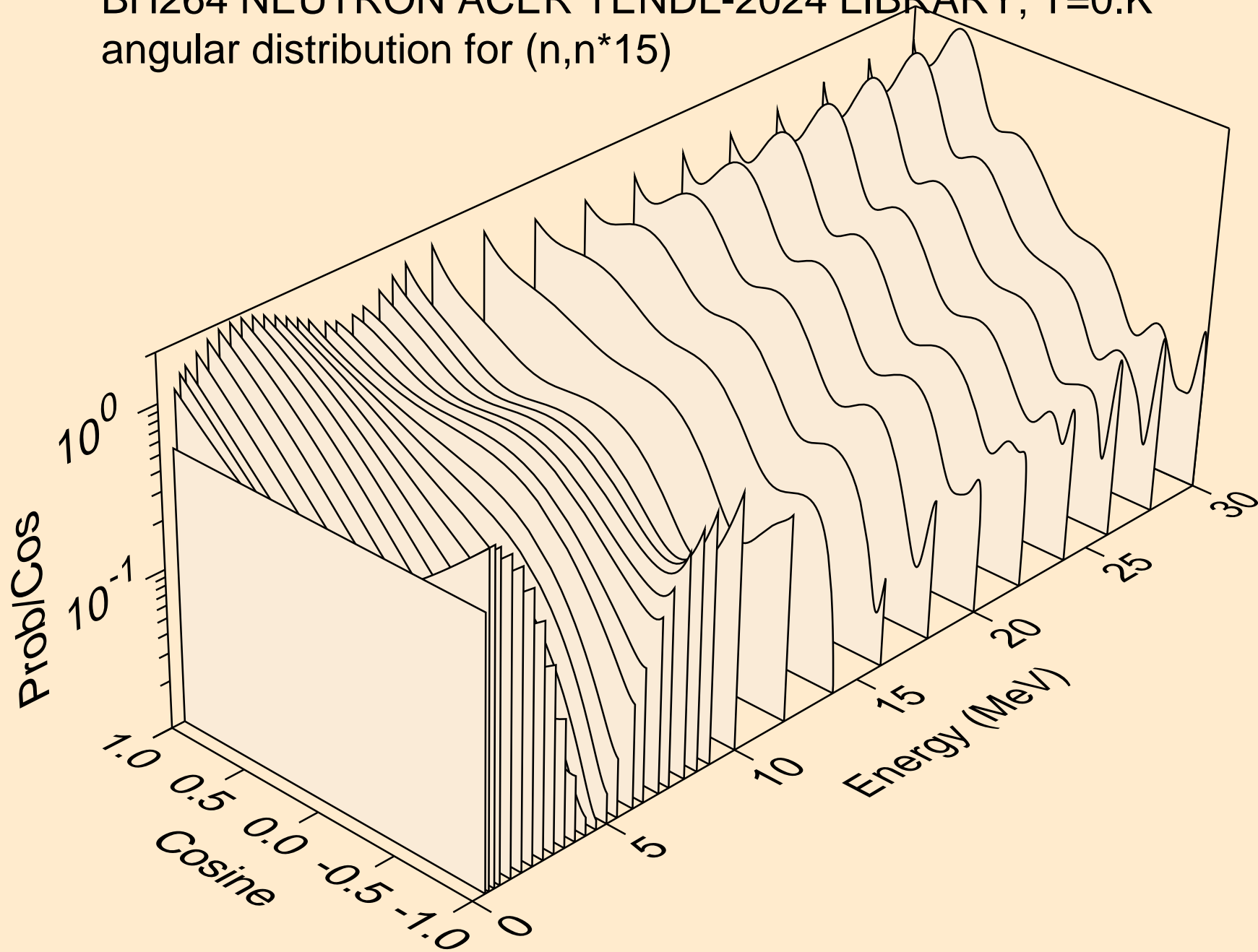

BH264 NEUTRON ACER TENDL-2024 LIBRARY; T=0.K  
angular distribution for (n,n\*16)

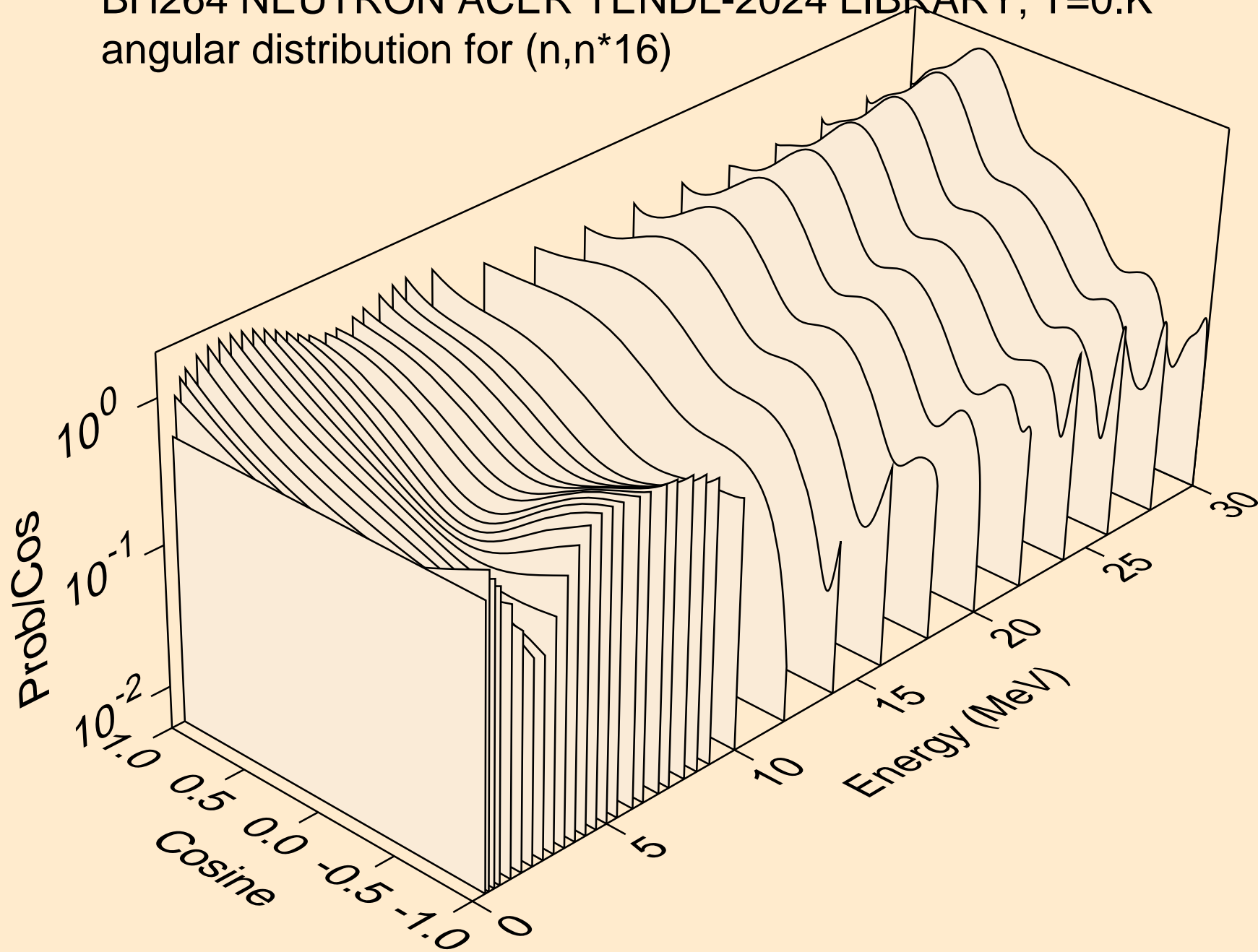

BH264 NEUTRON ACER TENDL-2024 LIBRARY; T=0.K  
angular distribution for (n,n\*17)

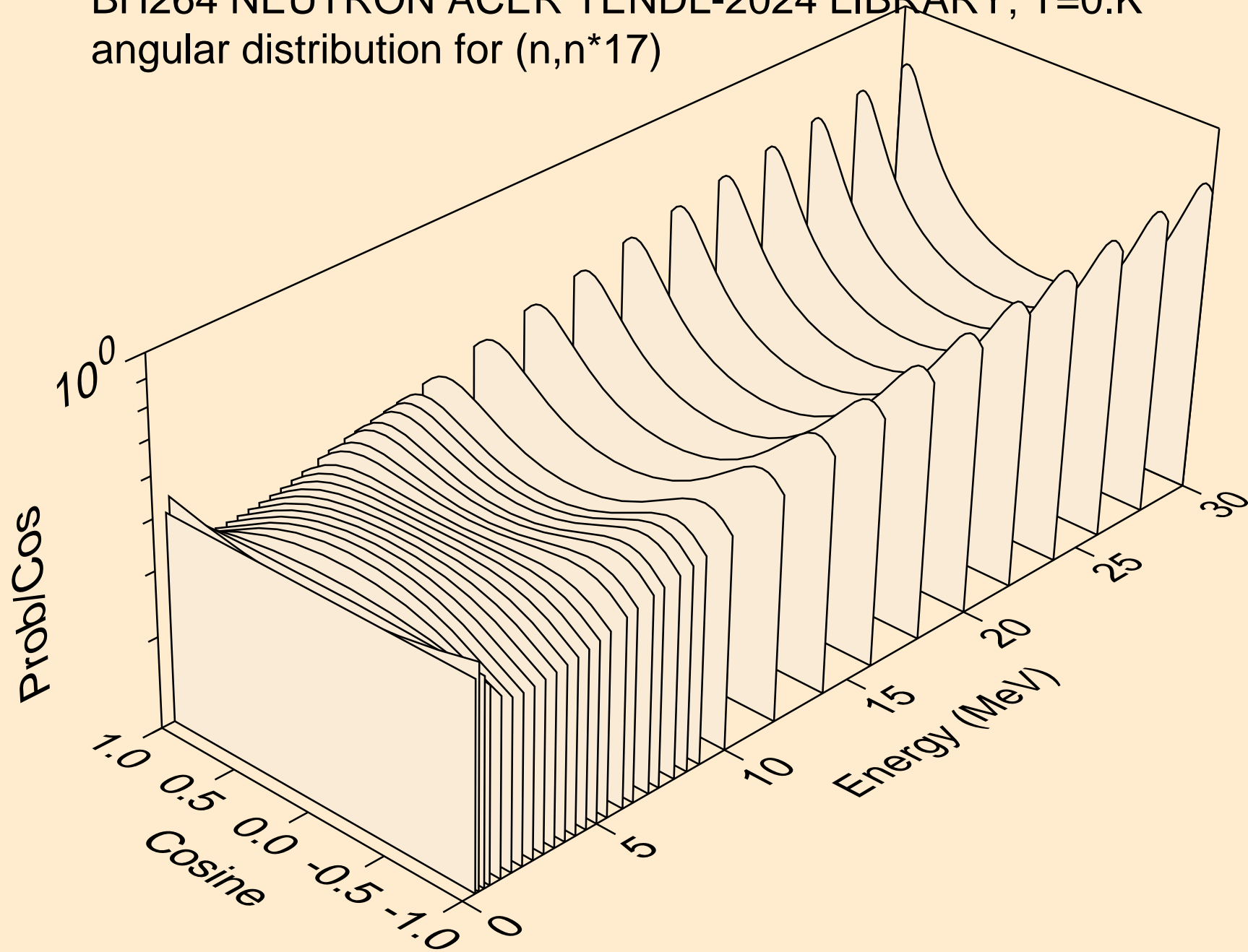

BH264 NEUTRON ACER TENDL-2024 LIBRARY; T=0.K  
angular distribution for (n,n\*18)

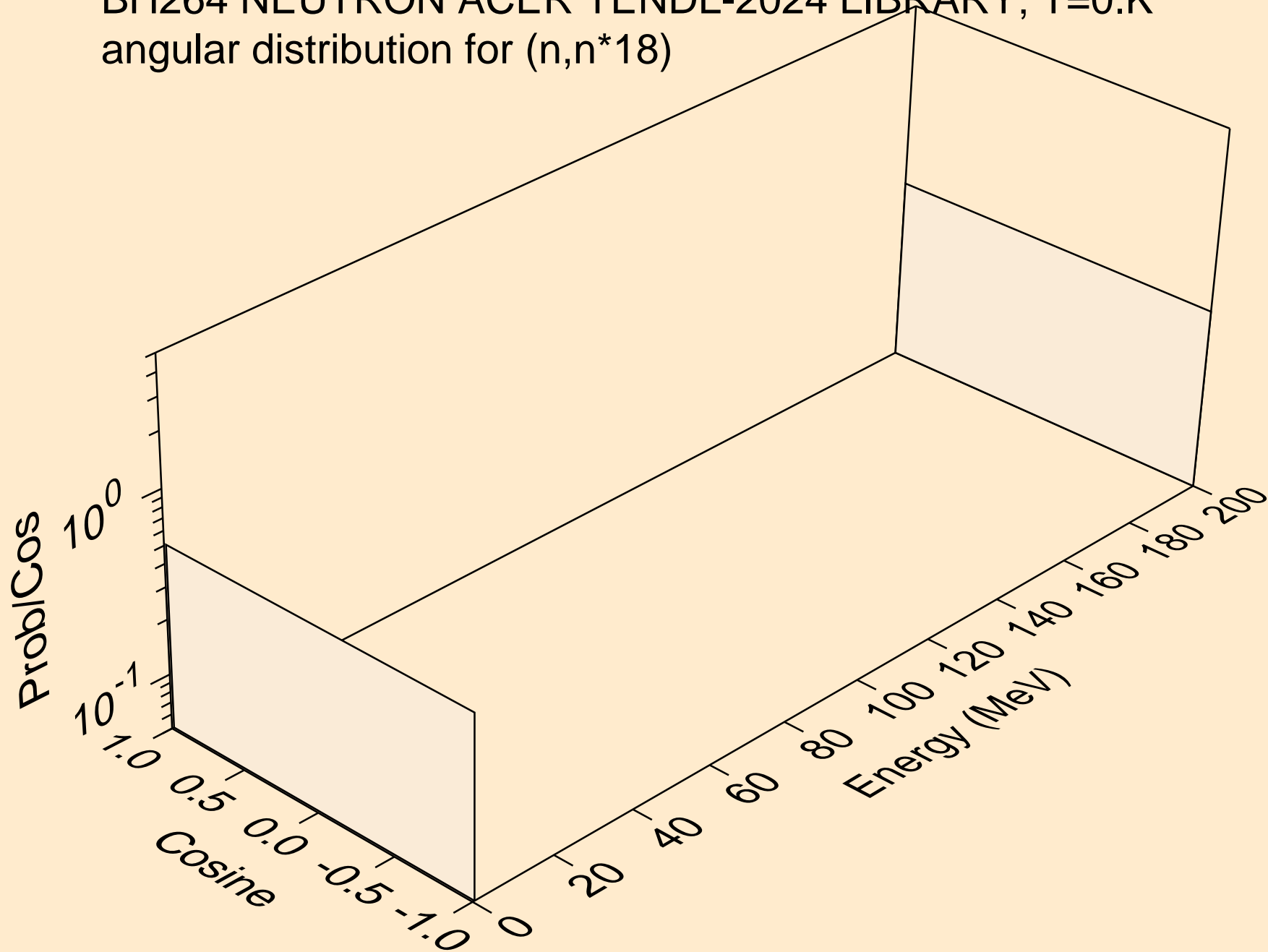

BH264 NEUTRON ACER TENDL-2024 LIBRARY; T=0.K  
angular distribution for (n,n\*19)

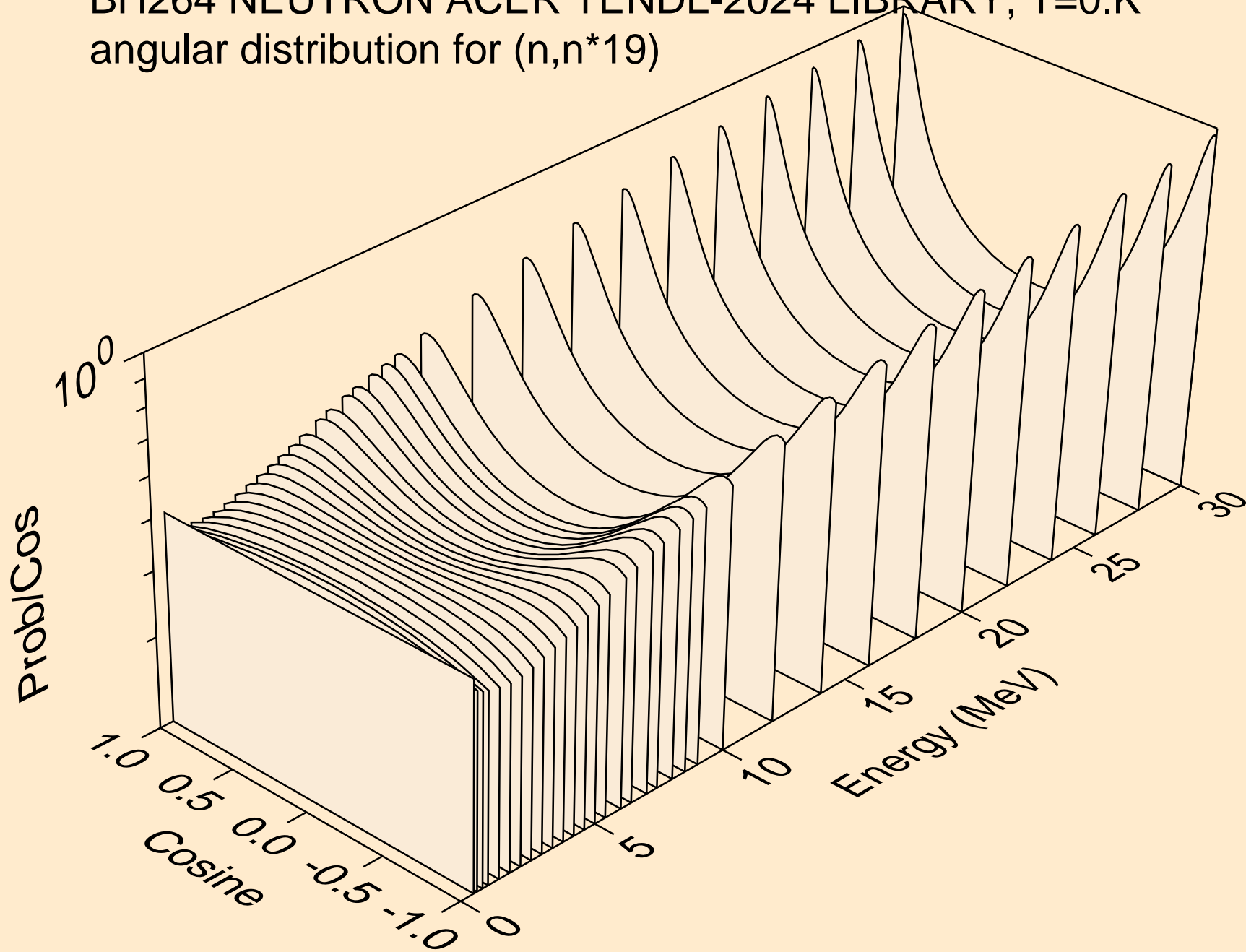

BH264 NEUTRON ACER TENDL-2024 LIBRARY; T=0.K  
angular distribution for (n,n\*20)

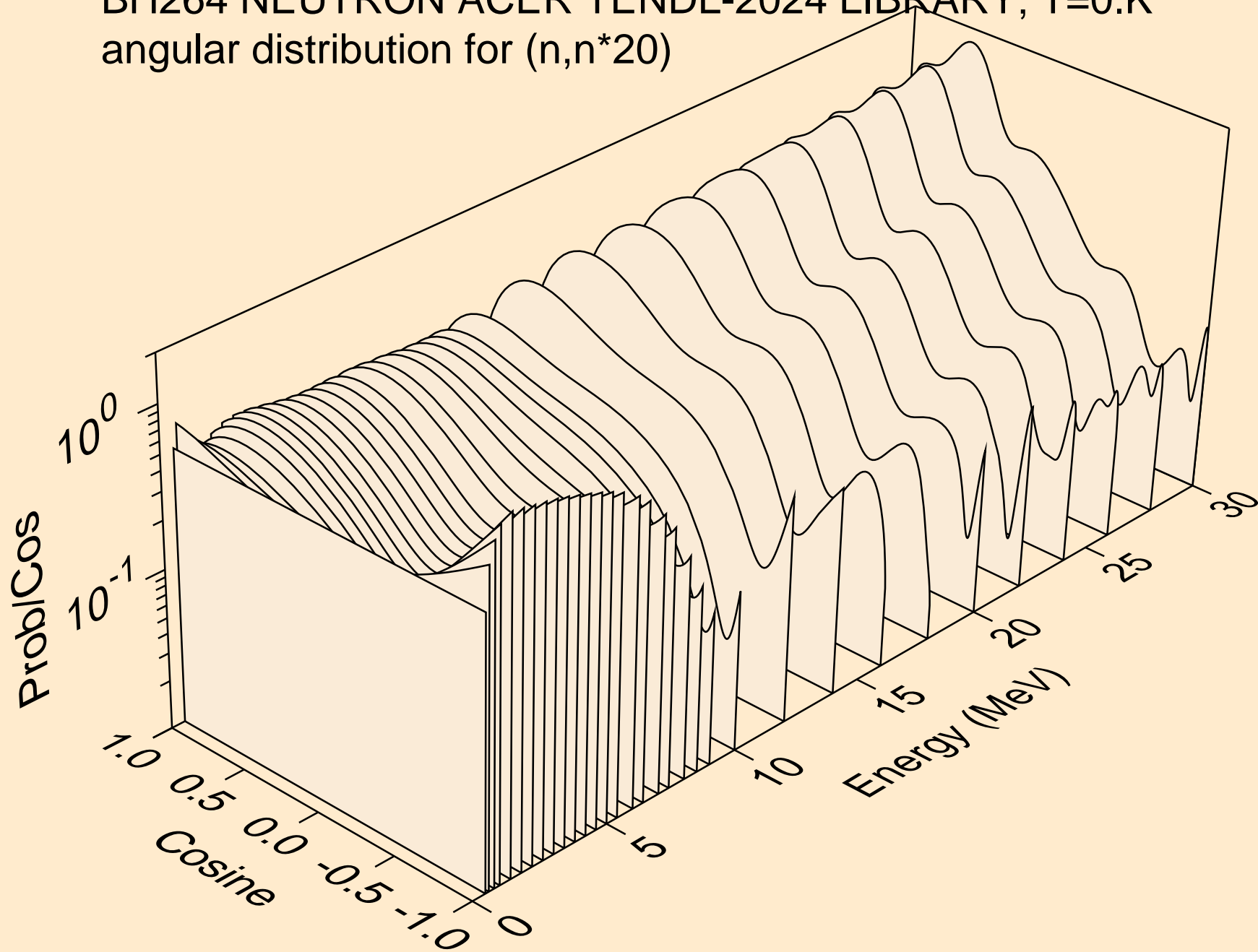

BH264 NEUTRON ACER TENDL-2024 LIBRARY; T=0.K  
angular distribution for (n,n\*21)

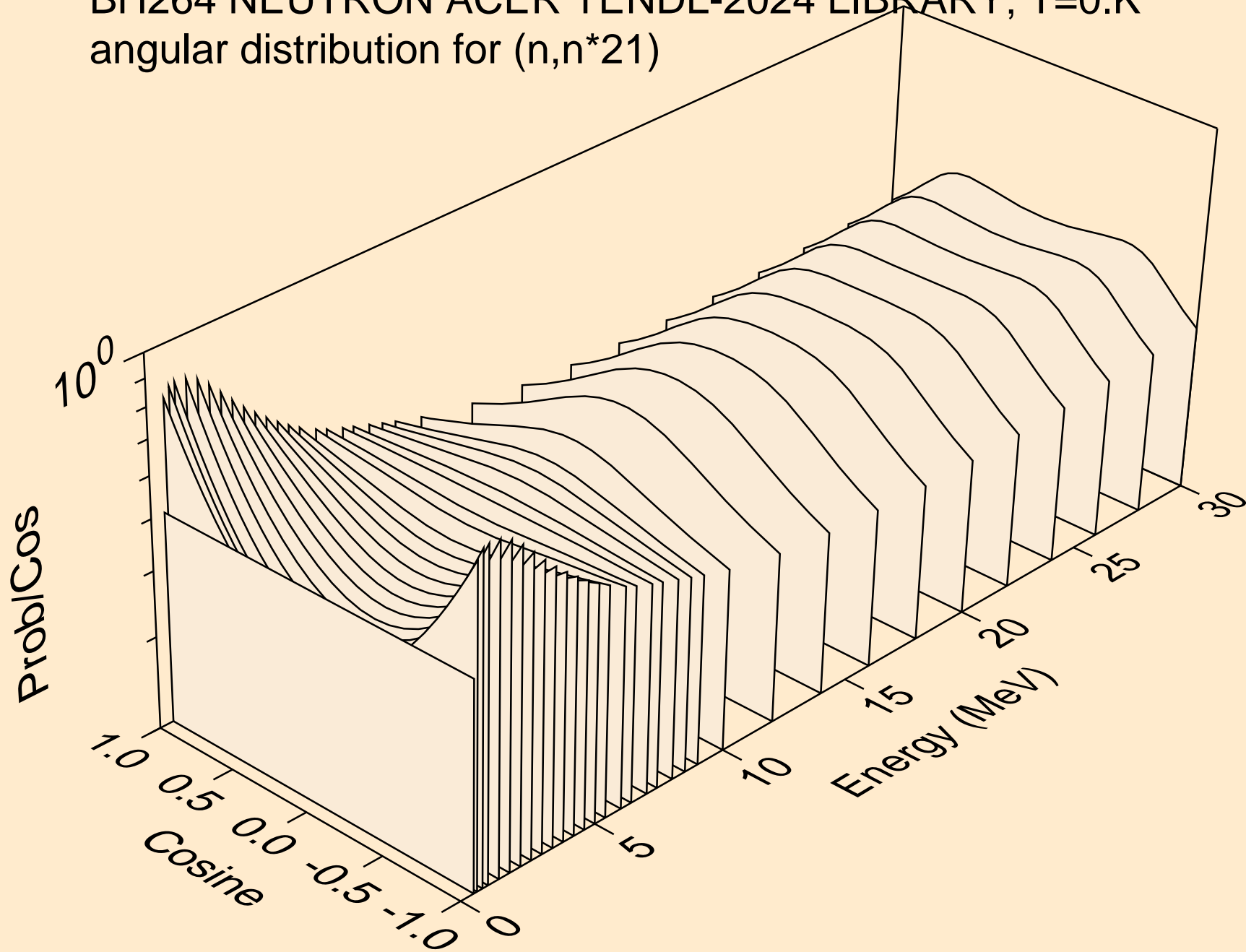

BH264 NEUTRON ACER TENDL-2024 LIBRARY; T=0.K  
angular distribution for (n,n\*22)

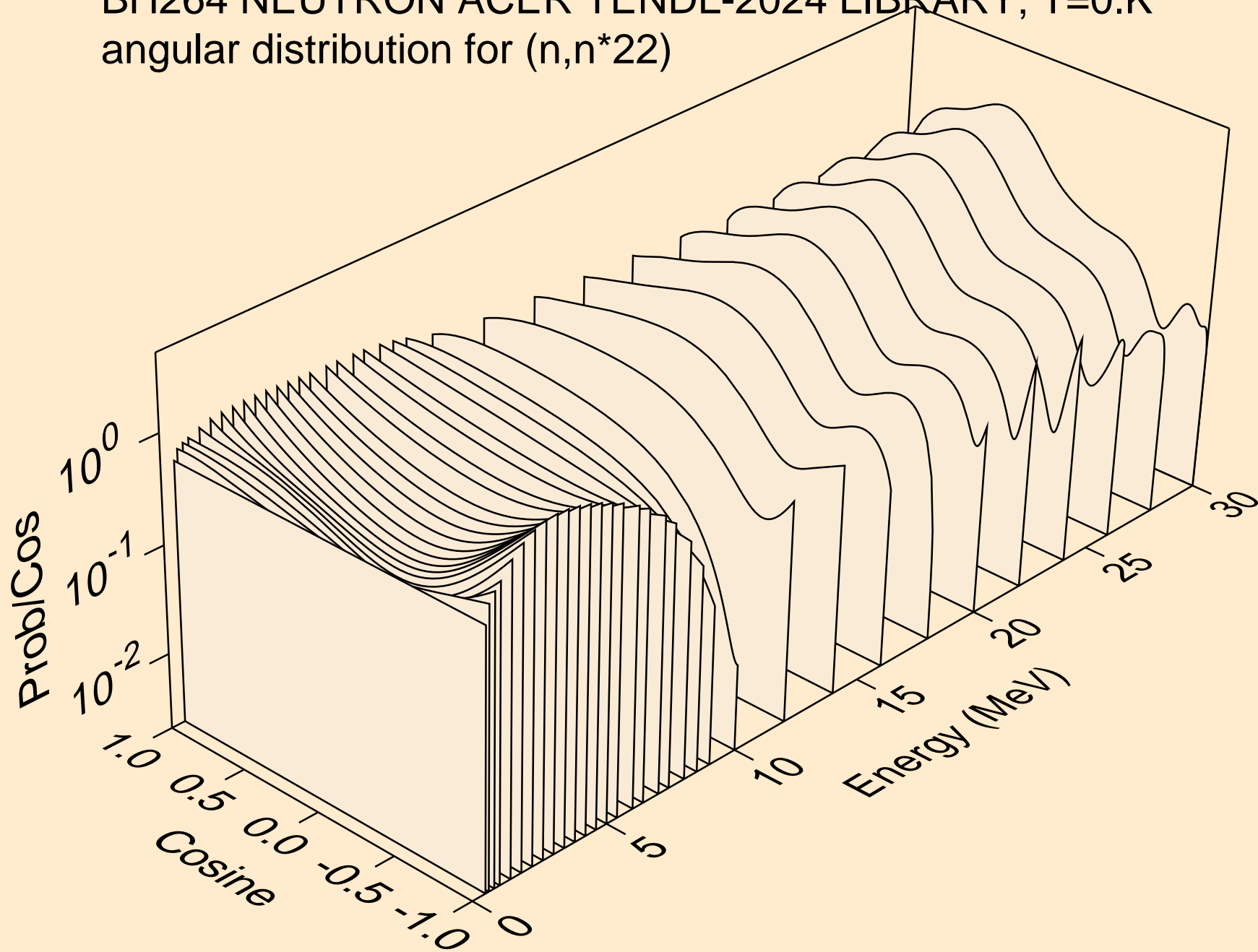



BH264 NEUTRON ACER TENDL-2024 LIBRARY; T=0.K  
angular distribution for (n,n\*23)

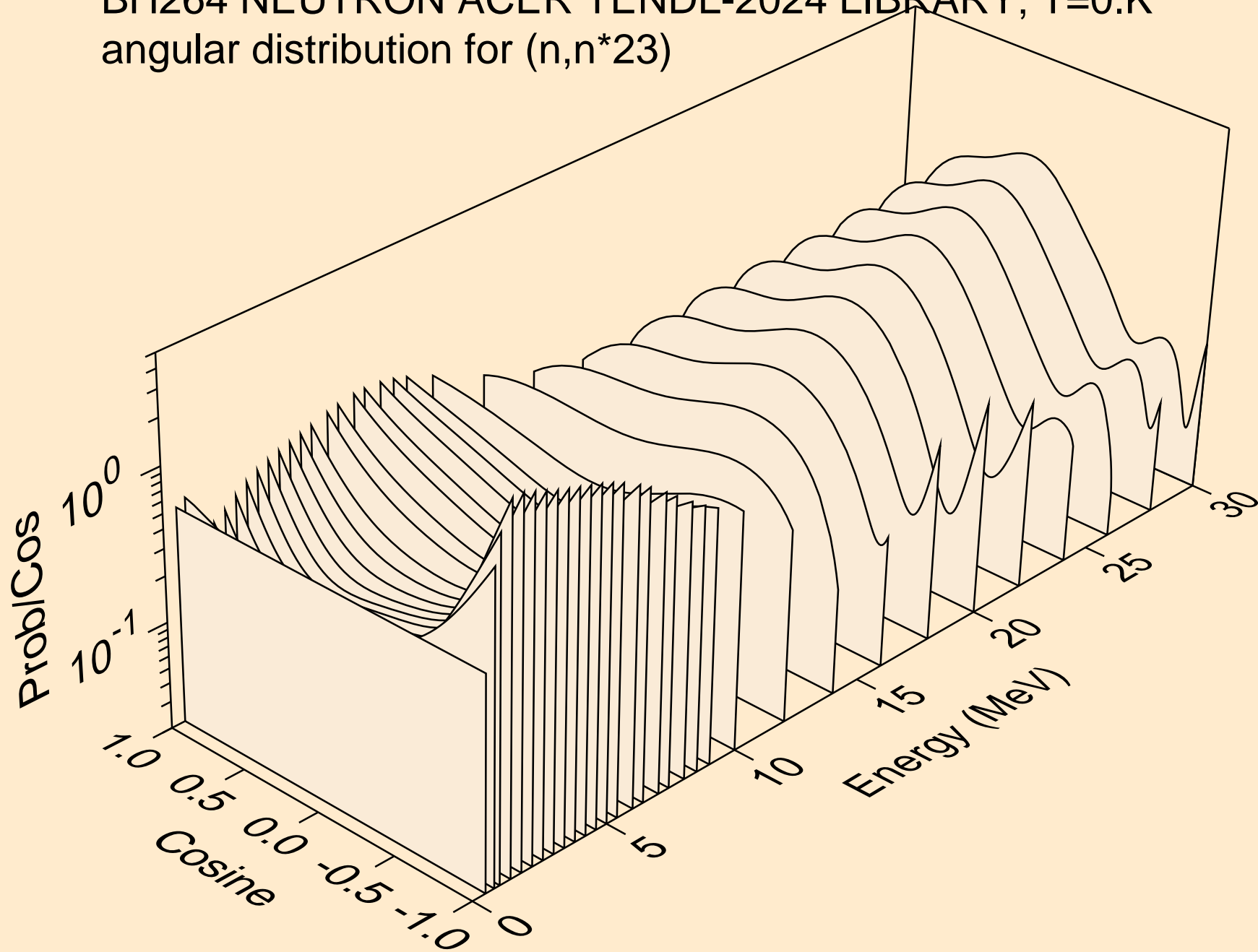

BH264 NEUTRON ACER TENDL-2024 LIBRARY; T=0.K  
angular distribution for (n,n\*24)

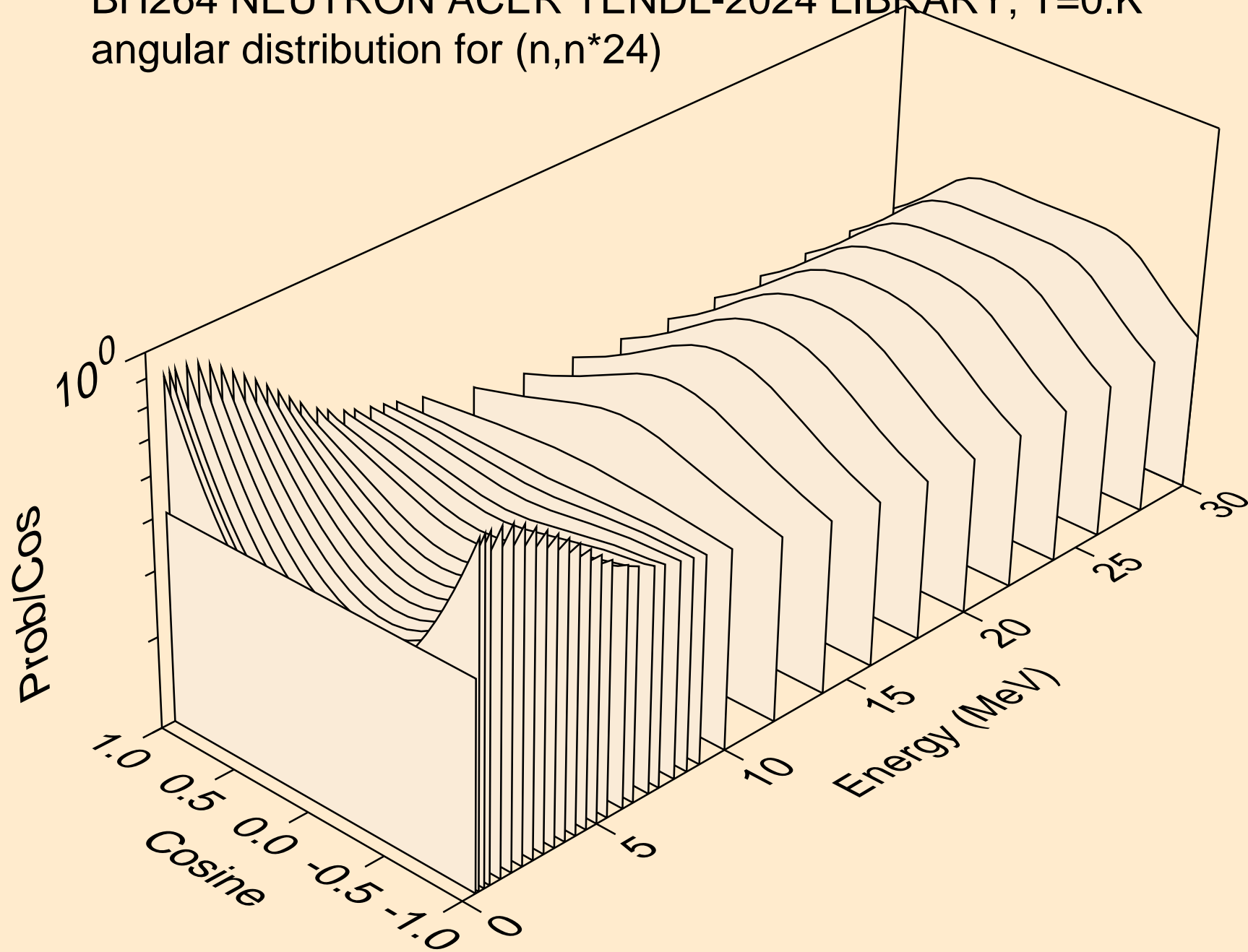

BH264 NEUTRON ACER TENDL-2024 LIBRARY; T=0.K  
angular distribution for (n,n\*25)

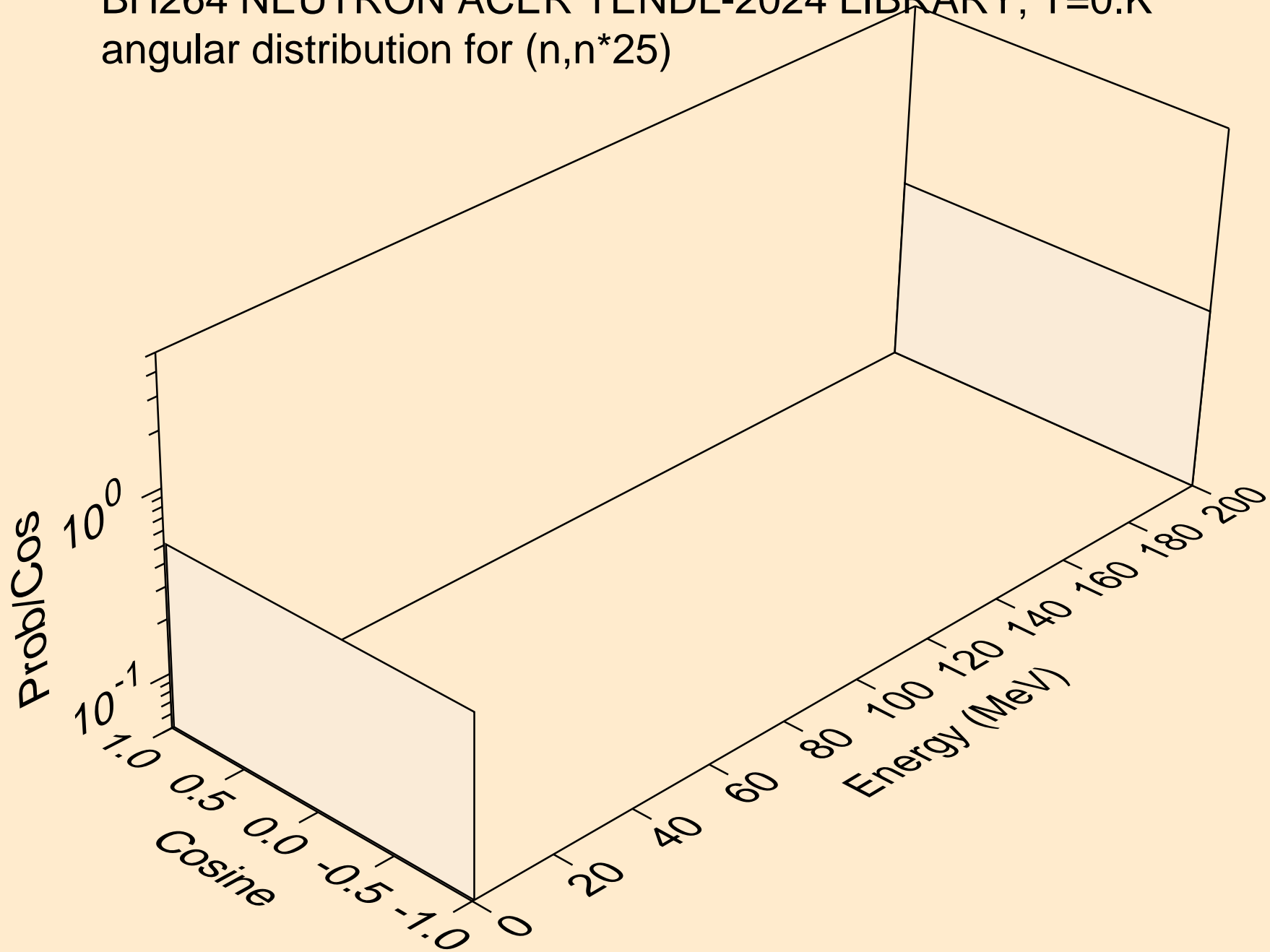

BH264 NEUTRON ACER TENDL-2024 LIBRARY; T=0.K

Total fission nubar

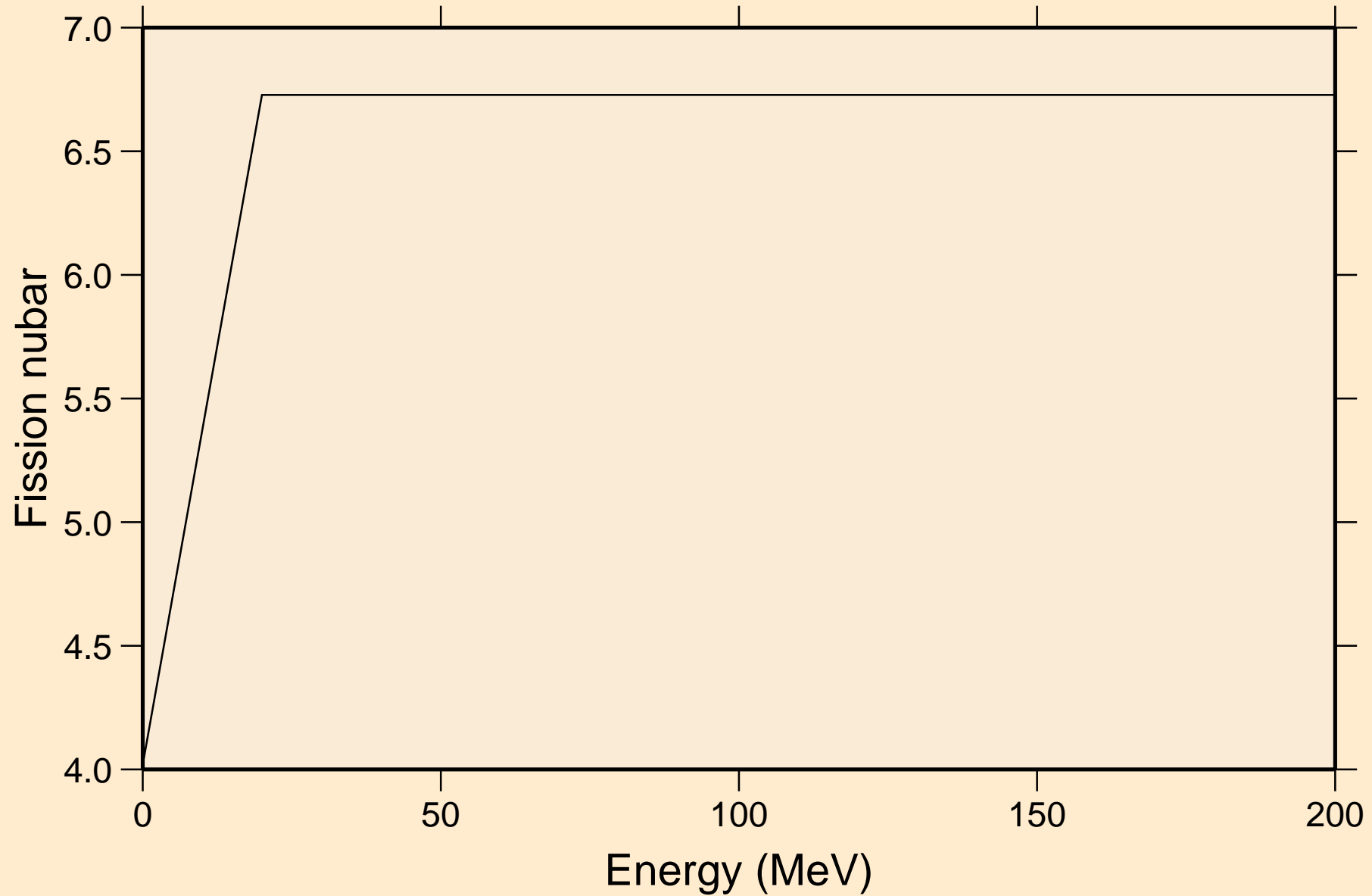

BH264 NEUTRON ACER TENDL-2024 LIBRARY; T=0.K  
Neutron emission for (n,x)

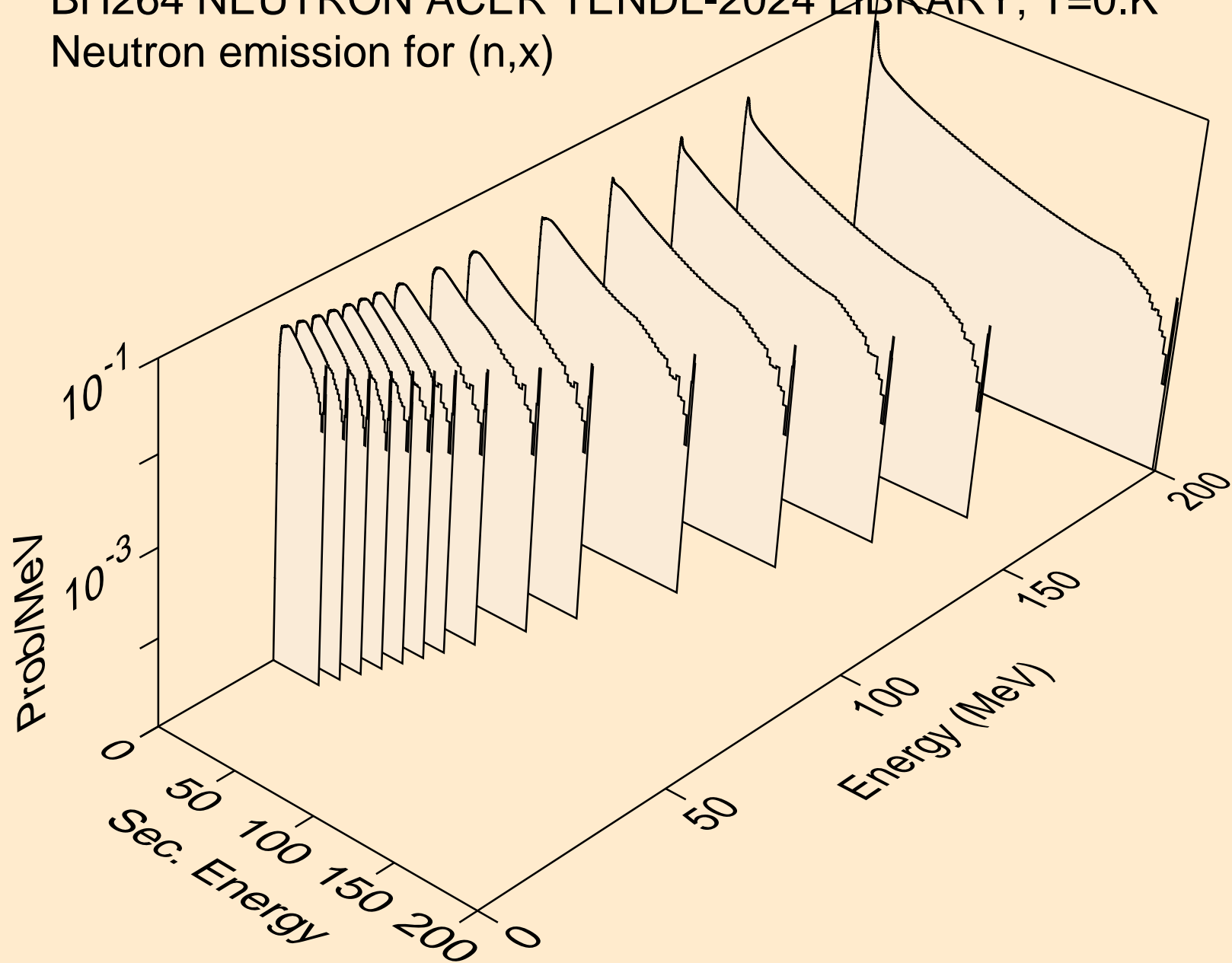

BH264 NEUTRON ACER TENDL-2024 LIBRARY; T=0.K  
Neutron emission for (n,2nd)

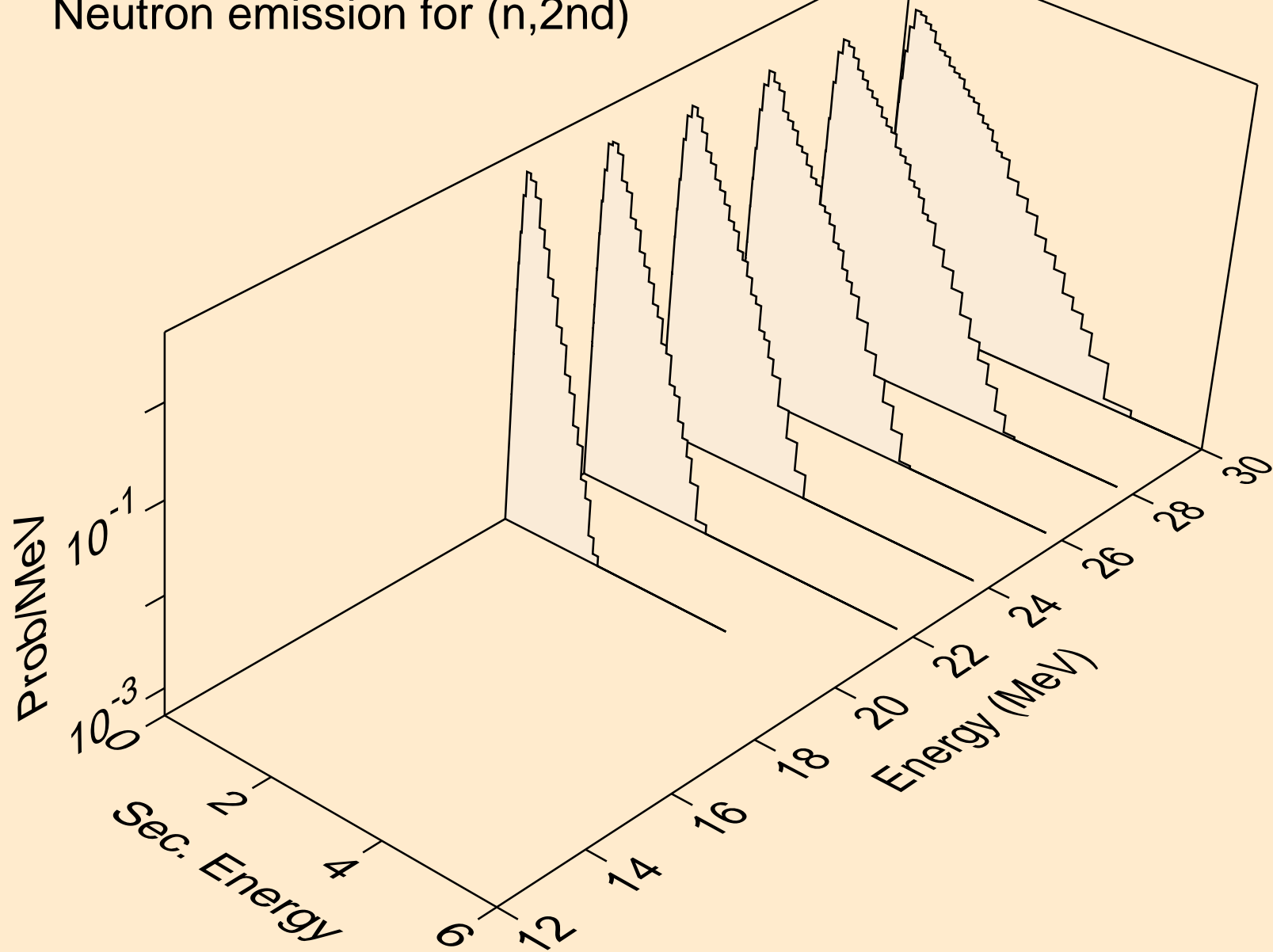

BH264 NEUTRON ACER TENDL-2024 LIBRARY; T=0.K  
Neutron emission for (n,2n)

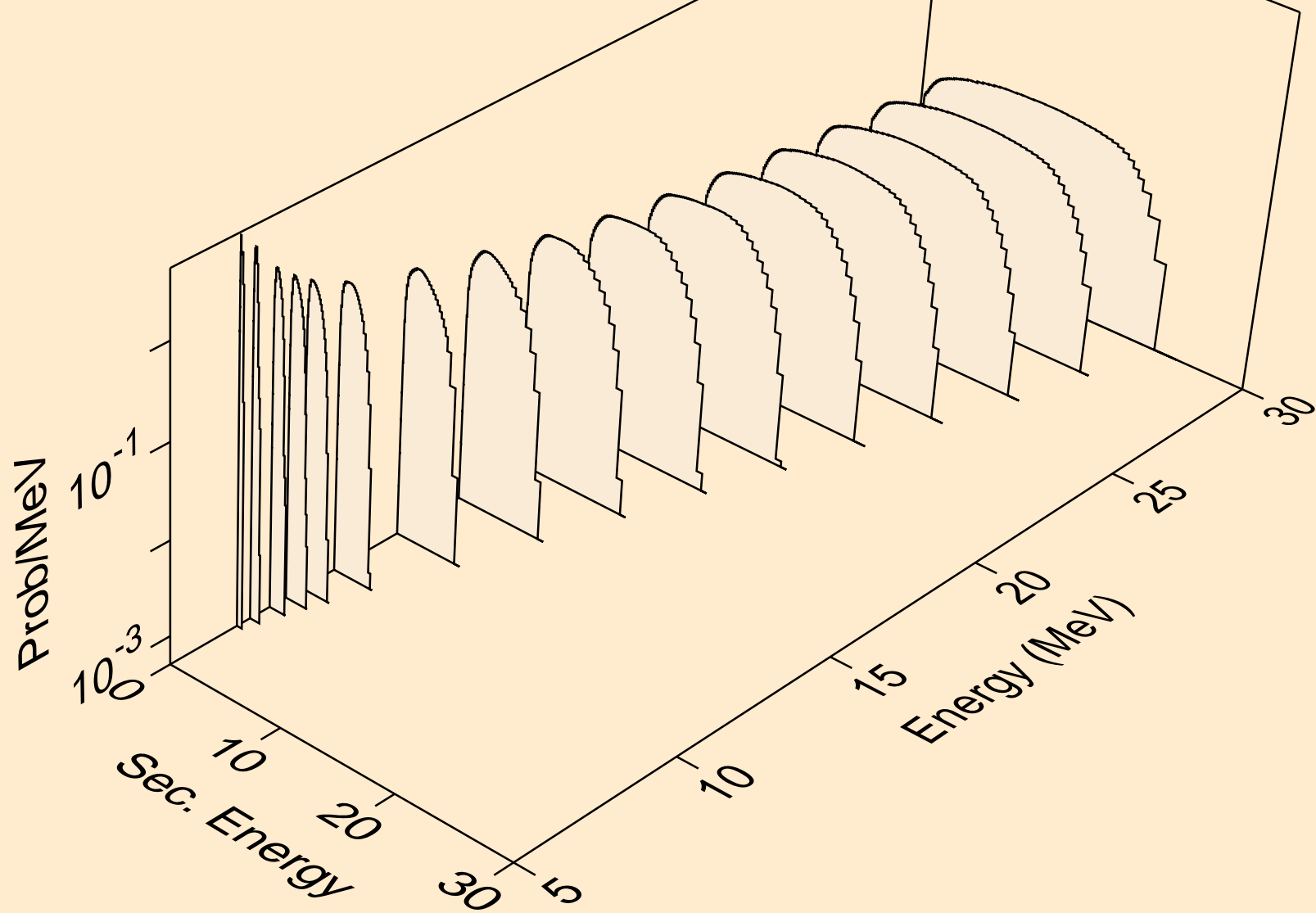

BH264 NEUTRON ACER TENDL-2024 LIBRARY; T=0.K  
Neutron emission for (n,3n)

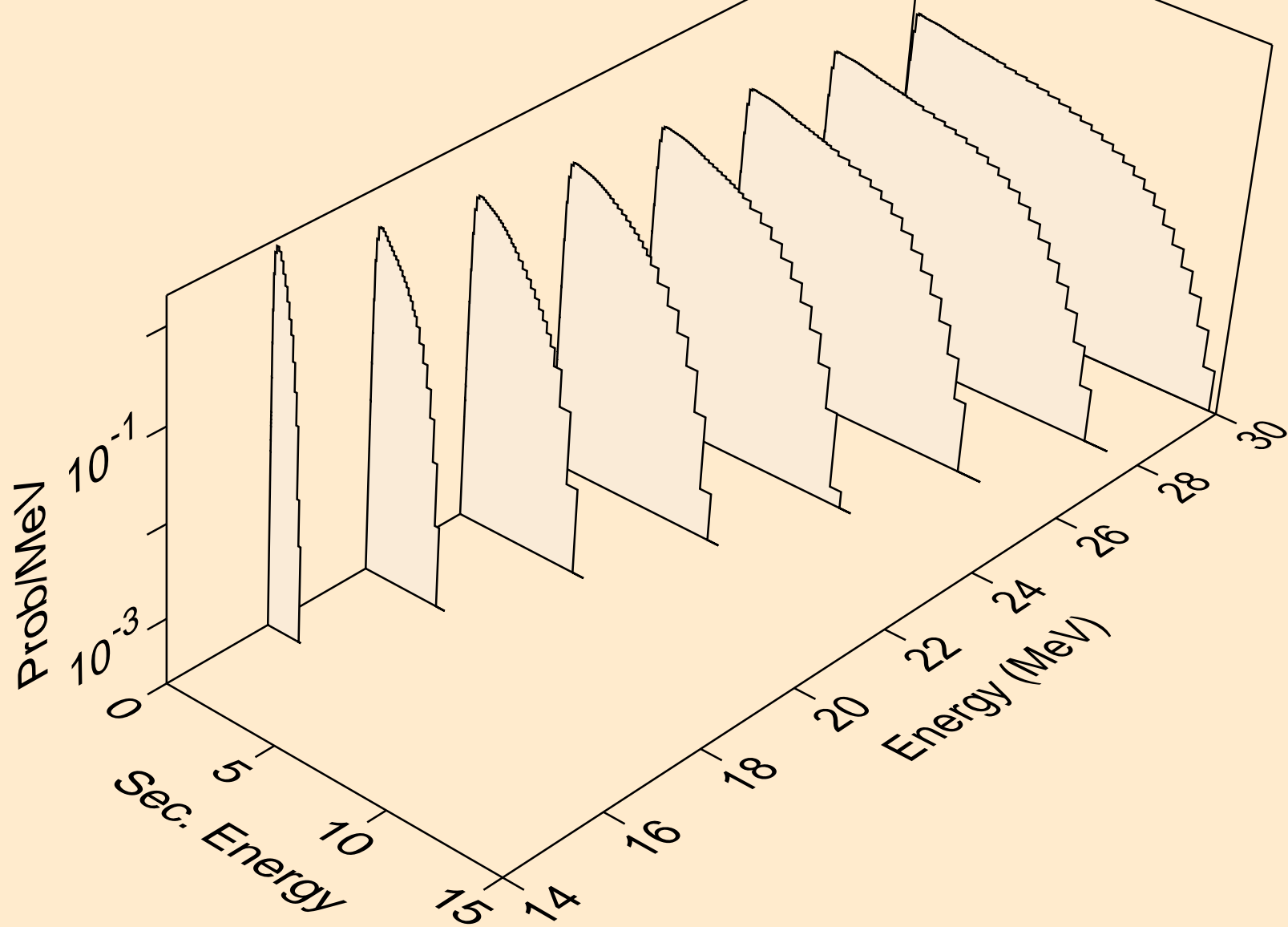



BH264 NEUTRON ACER TENDL-2024 LIBRARY; T=0.K  
Neutron emission for fission

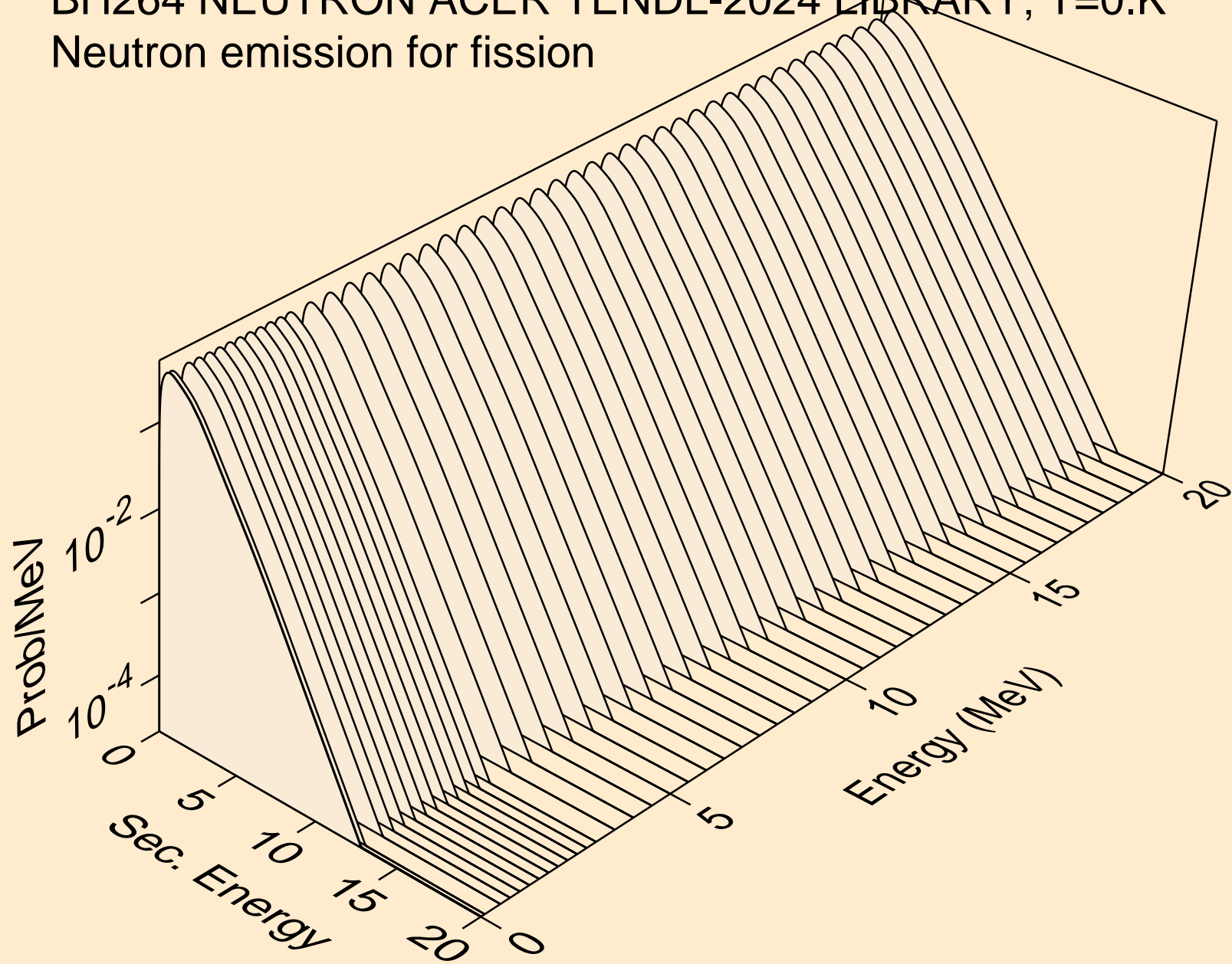

BH264 NEUTRON ACER TENDL-2024 LIBRARY; T=0.K  
Neutron emission for (n,n\*)a

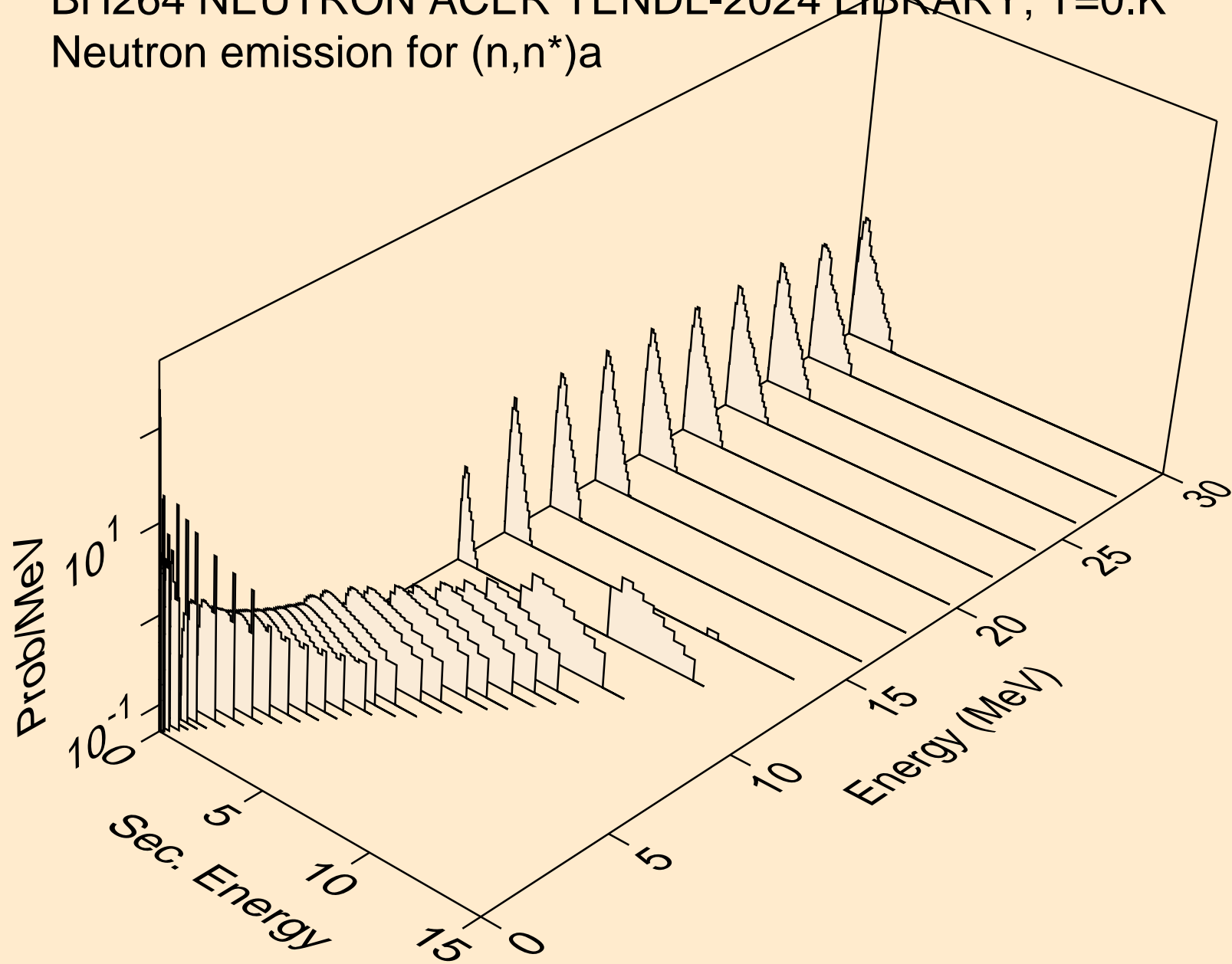

BH264 NEUTRON ACER TENDL-2024 LIBRARY; T=0.K  
Neutron emission for (n,2n)a

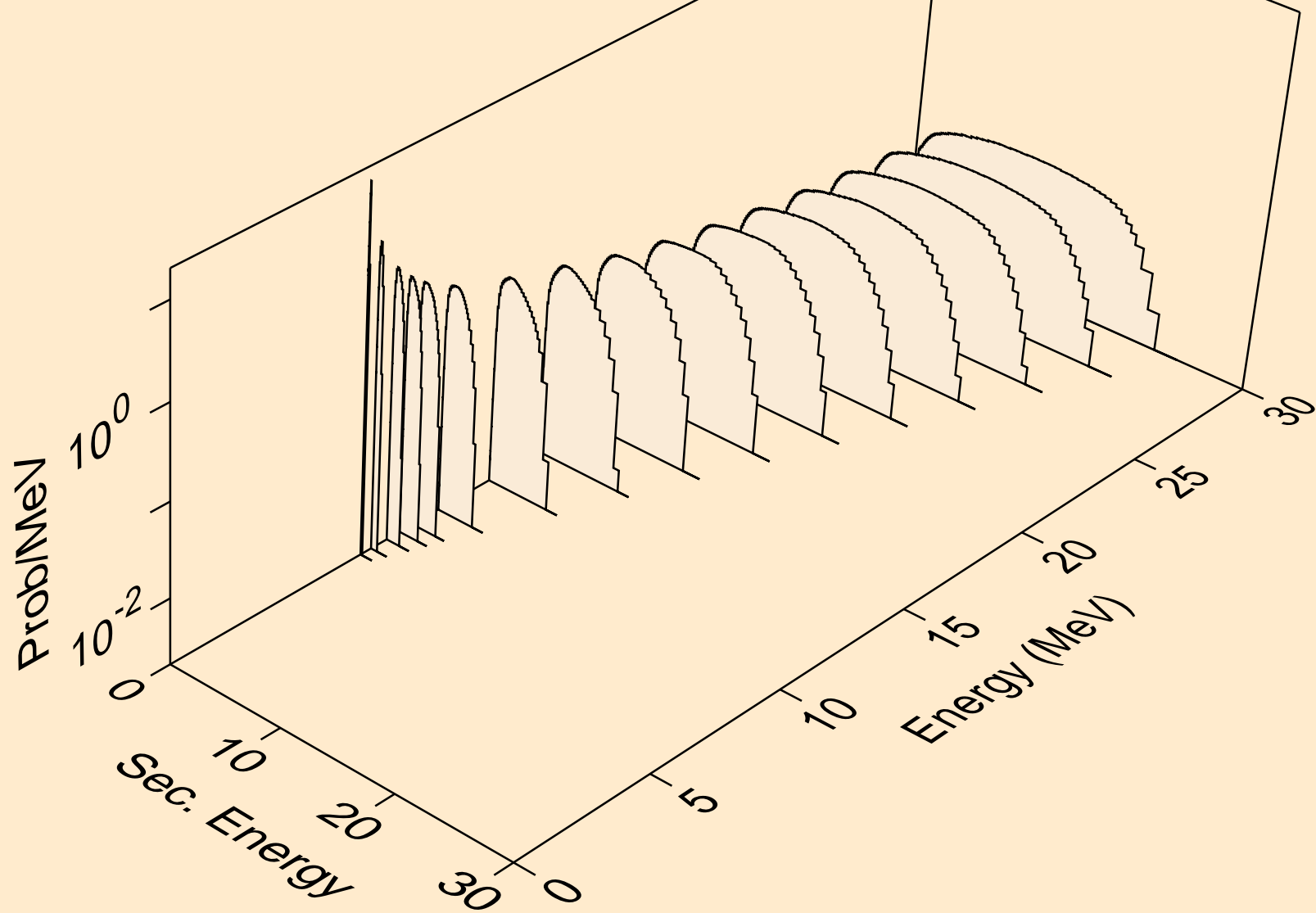

BH264 NEUTRON ACER TENDL-2024 LIBRARY; T=0.K  
Neutron emission for (n,3n)a

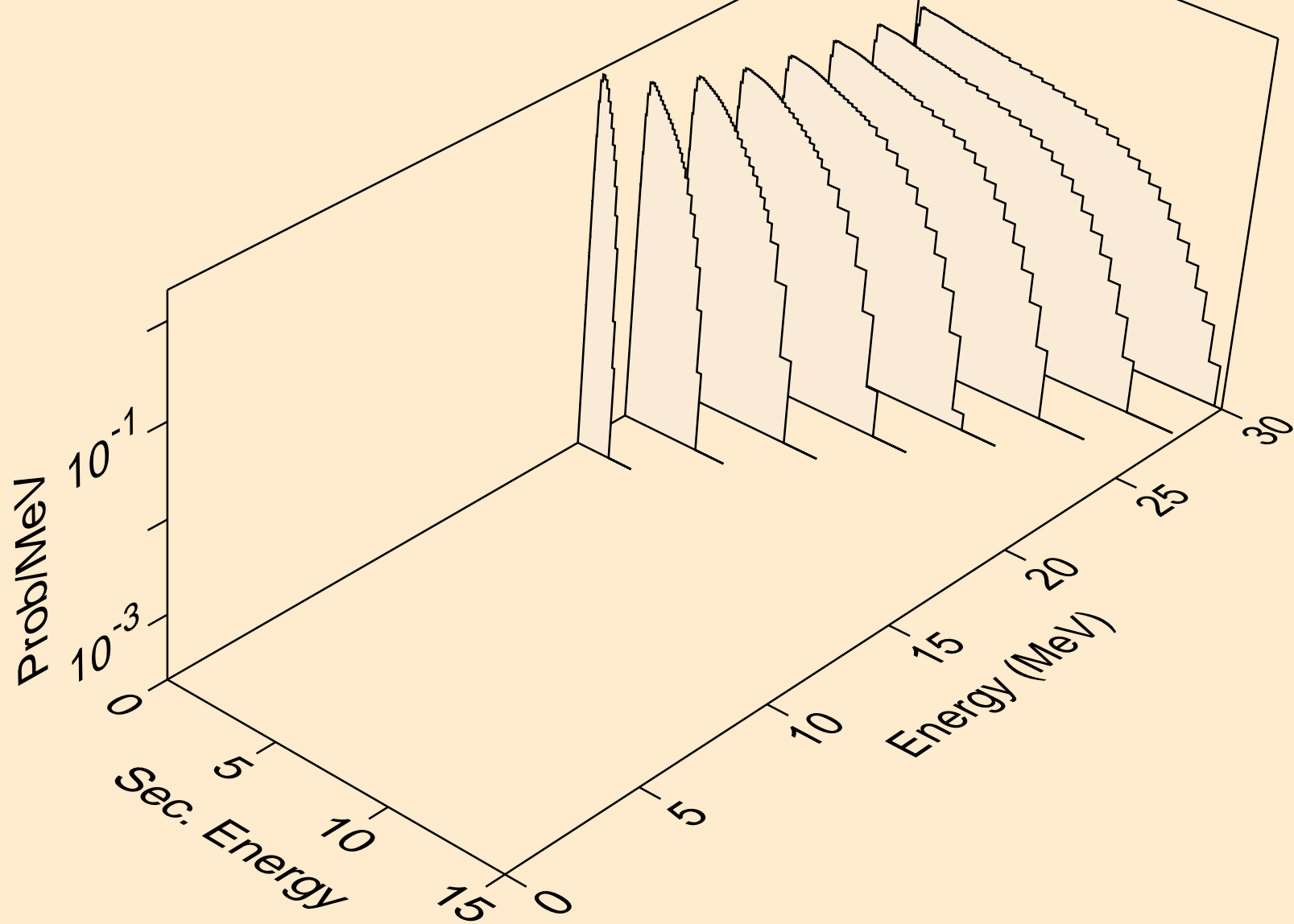

BH264 NEUTRON ACER TENDL-2024 LIBRARY; T=0.K  
Neutron emission for (n,n\*)p

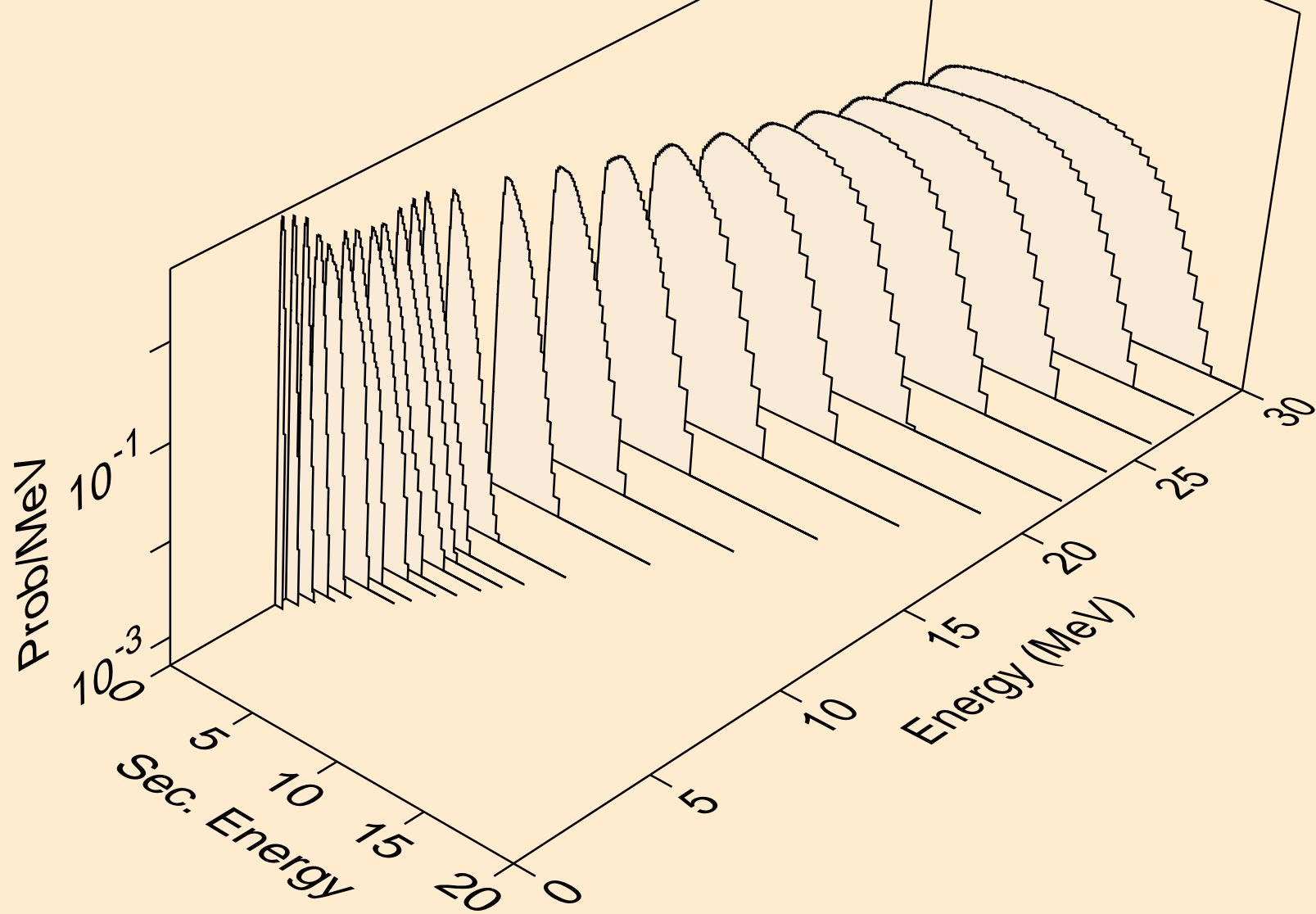

BH264 NEUTRON ACER TENDL-2024 LIBRARY; T=0.K  
Neutron emission for (n,n\*)2a

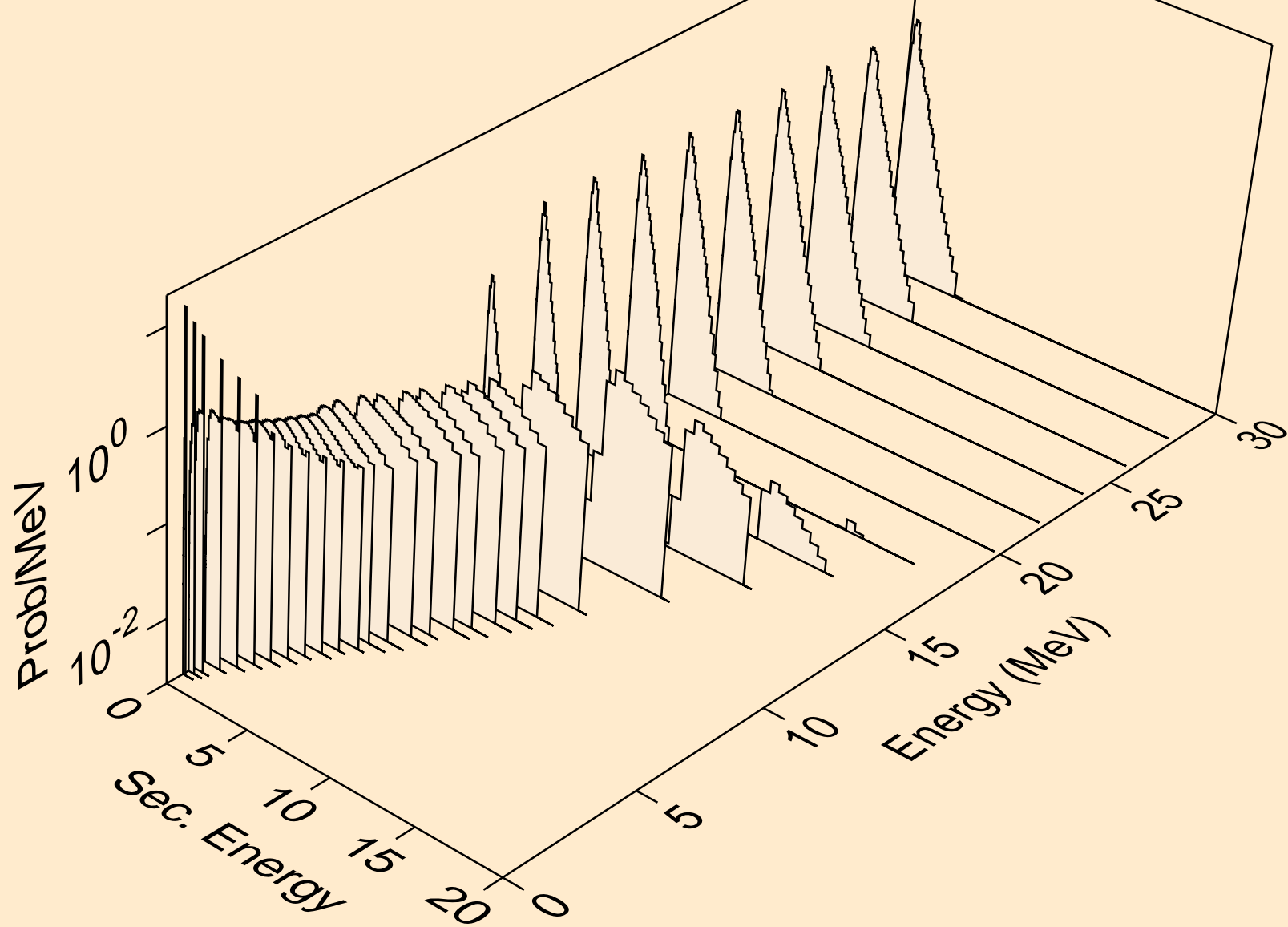

BH264 NEUTRON ACER TENDL-2024 LIBRARY; T=0.K  
Neutron emission for (n,2n)2a

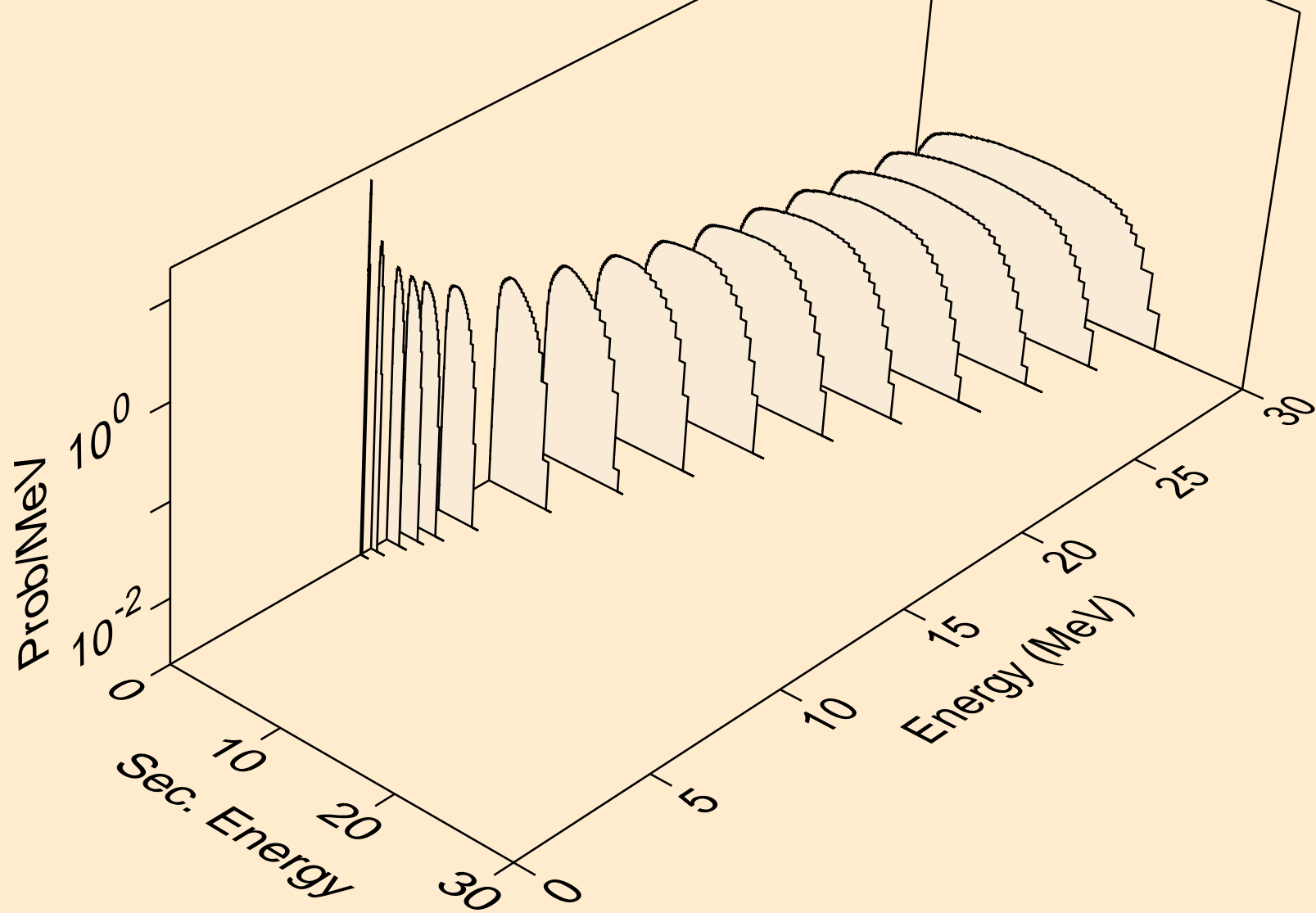

BH264 NEUTRON ACER TENDL-2024 LIBRARY; T=0.K  
Neutron emission for (n,n\*)d

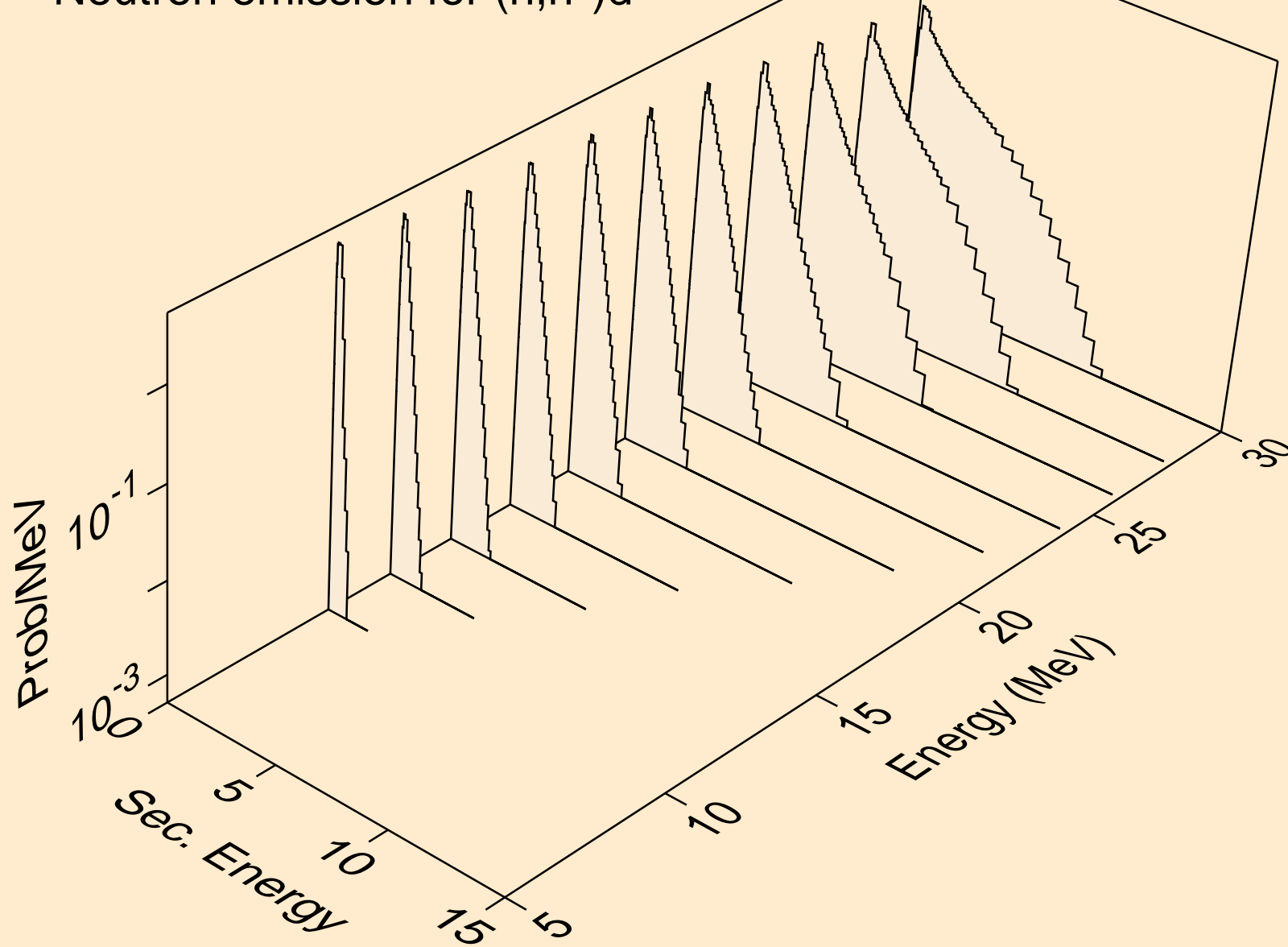



BH264 NEUTRON ACER TENDL-2024 LIBRARY; T=0.K  
Neutron emission for (n,n\*)t

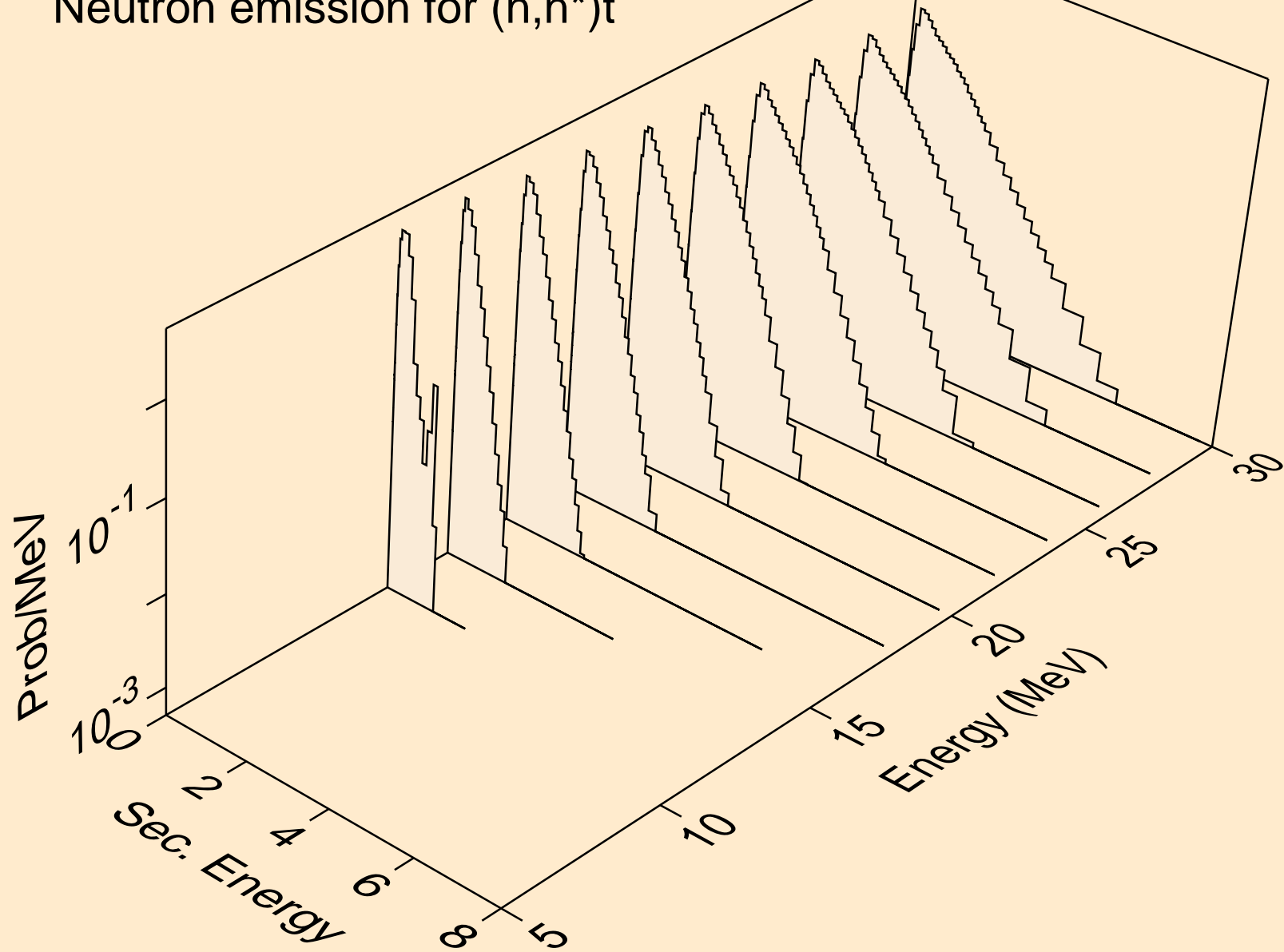

BH264 NEUTRON ACER TENDL-2024 LIBRARY; T=0.K  
Neutron emission for (n,n\*)he3

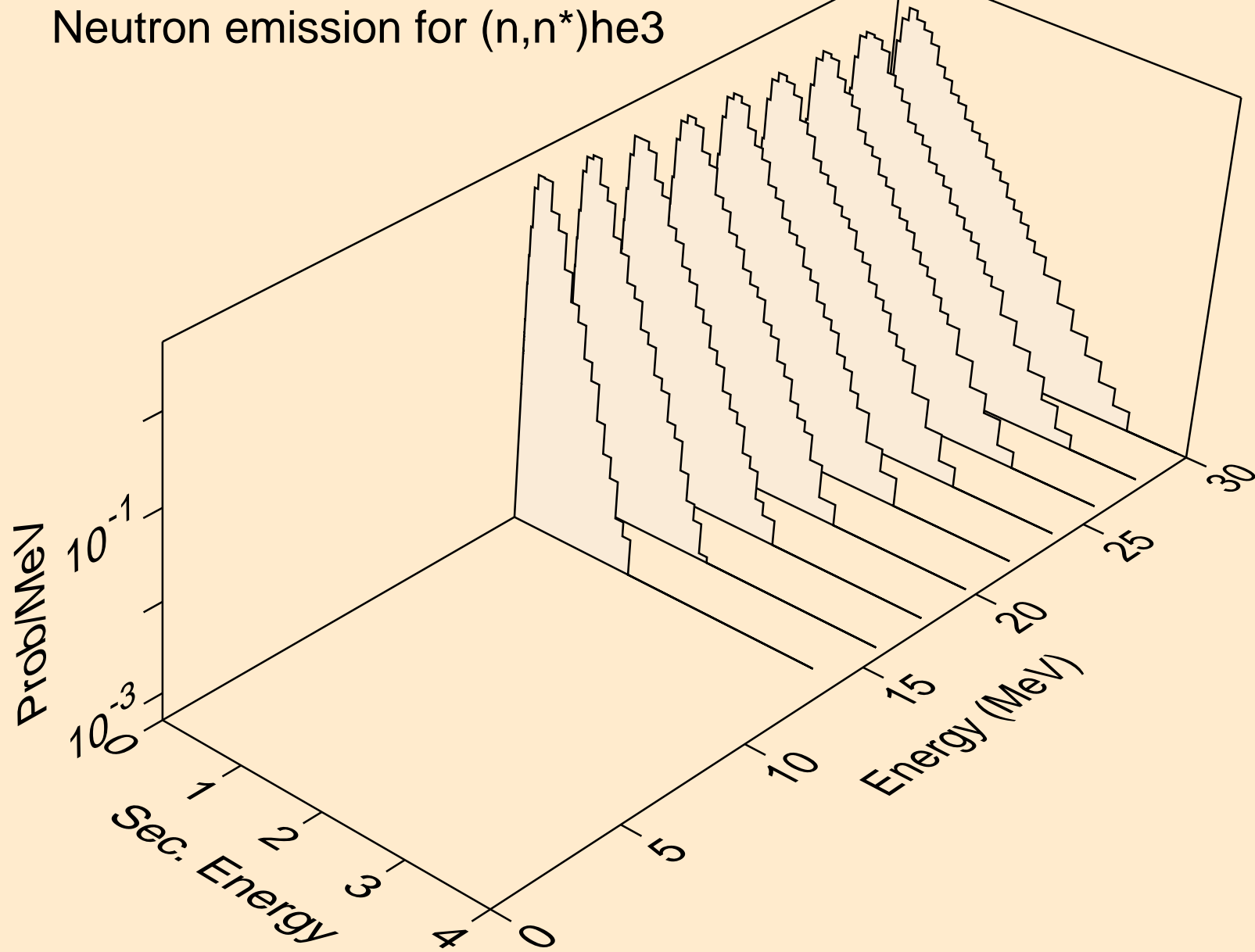

BH264 NEUTRON ACER TENDL-2024 LIBRARY; T=0.K  
Neutron emission for (n,4n)

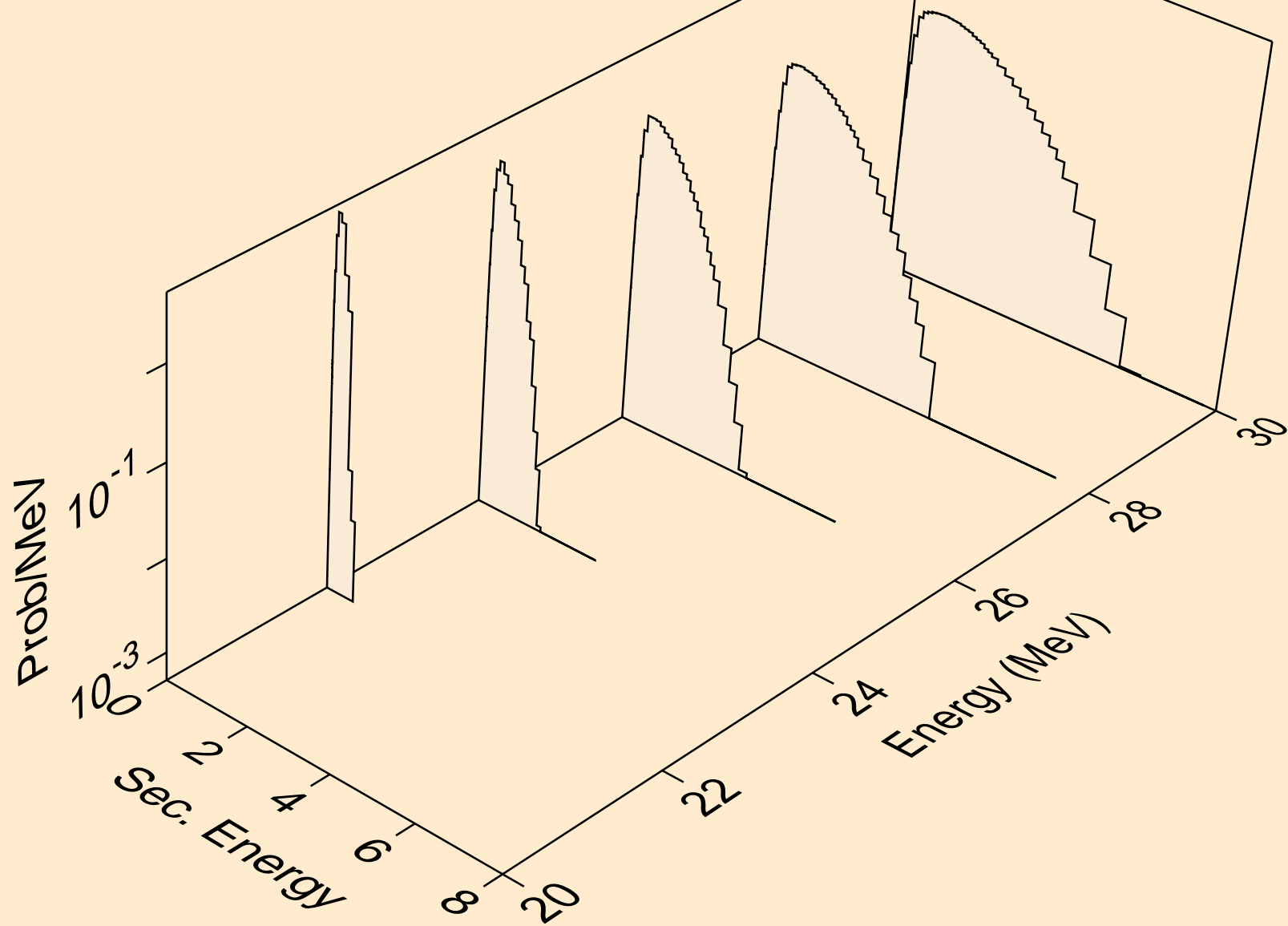

BH264 NEUTRON ACER TENDL-2024 LIBRARY; T=0.K  
Neutron emission for (n,2np)

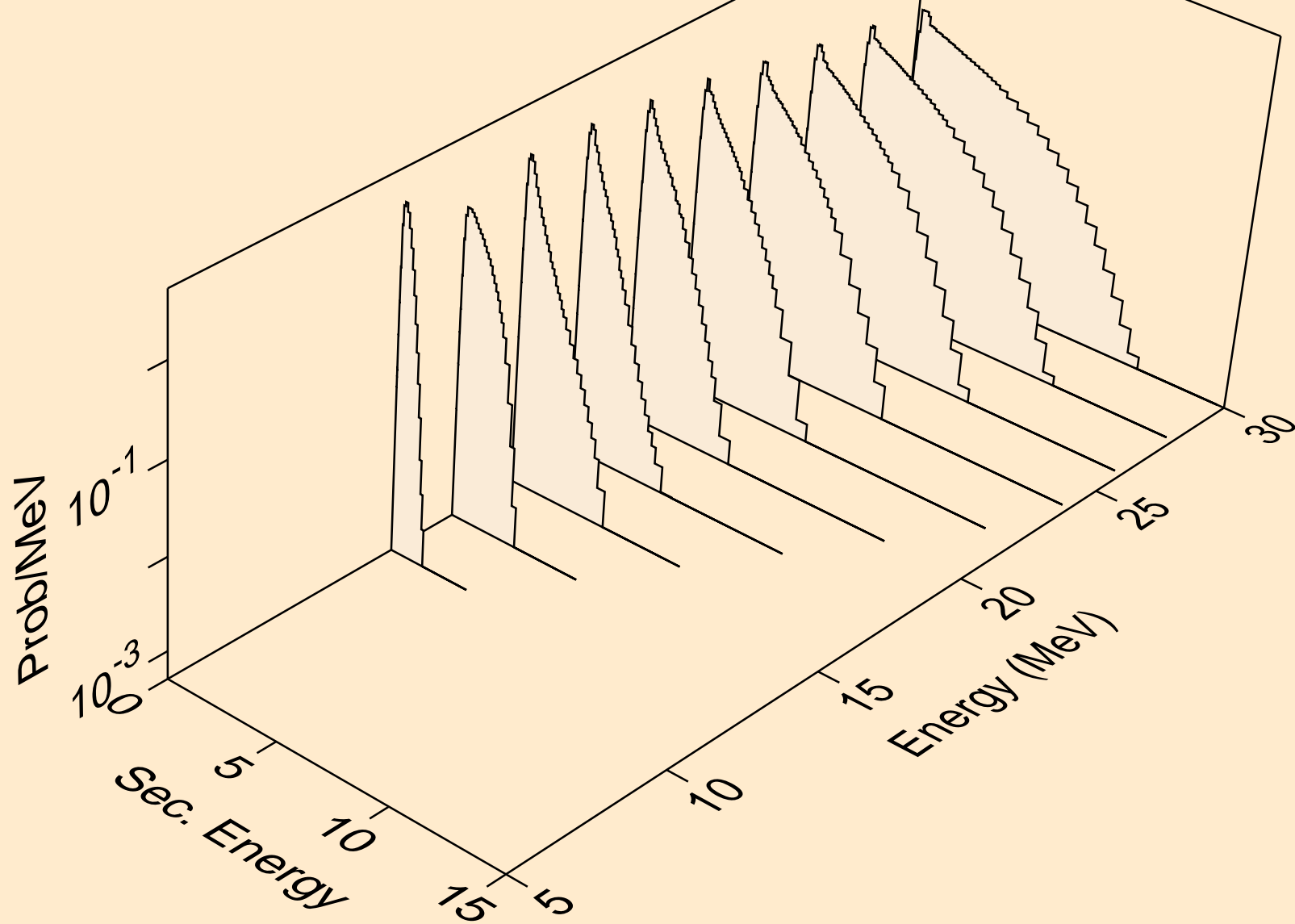

BH264 NEUTRON ACER TENDL-2024 LIBRARY; T=0.K  
Neutron emission for (n,3np)

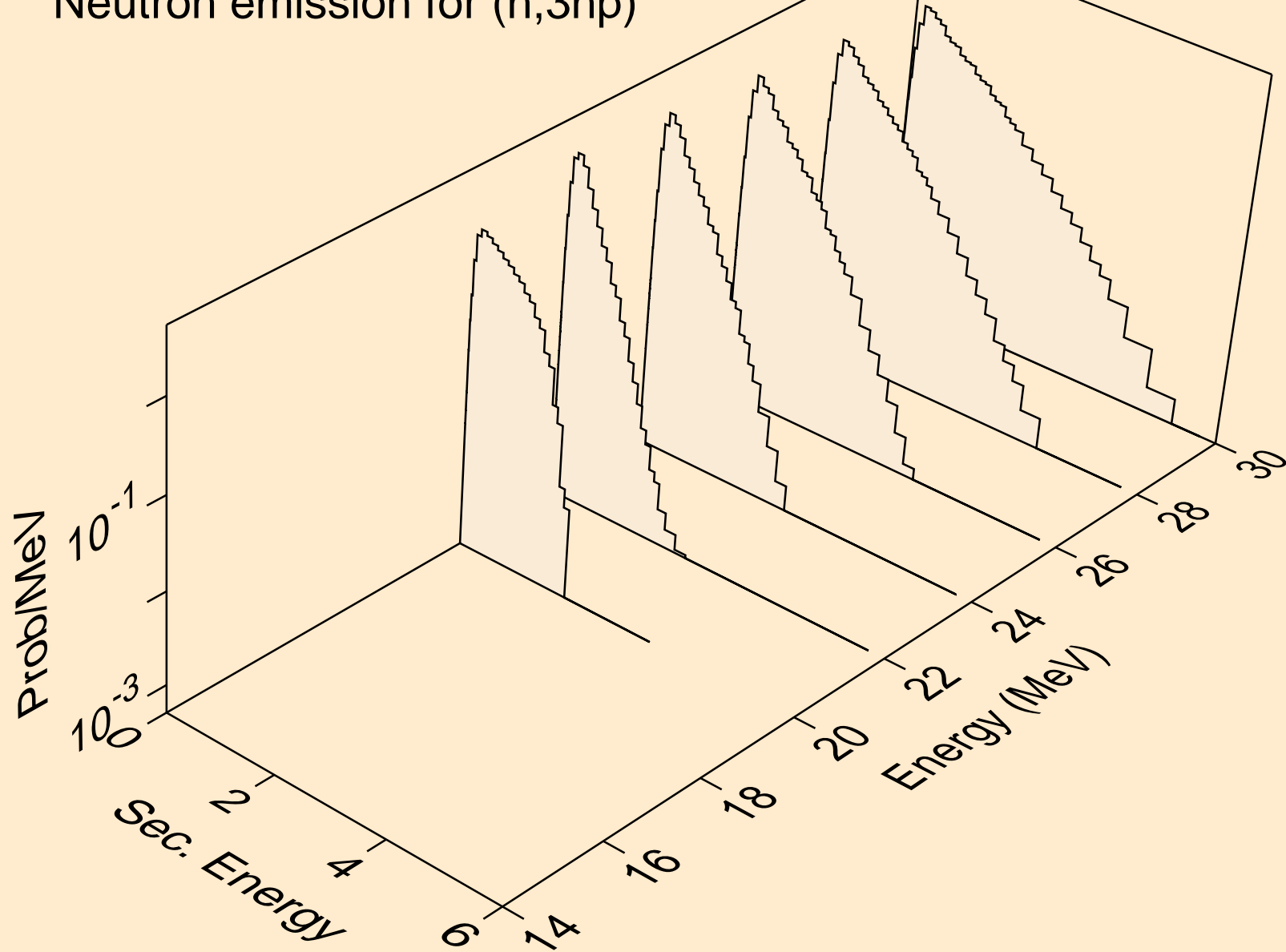

BH264 NEUTRON ACER TENDL-2024 LIBRARY; T=0.K  
Neutron emission for (n,n2p)

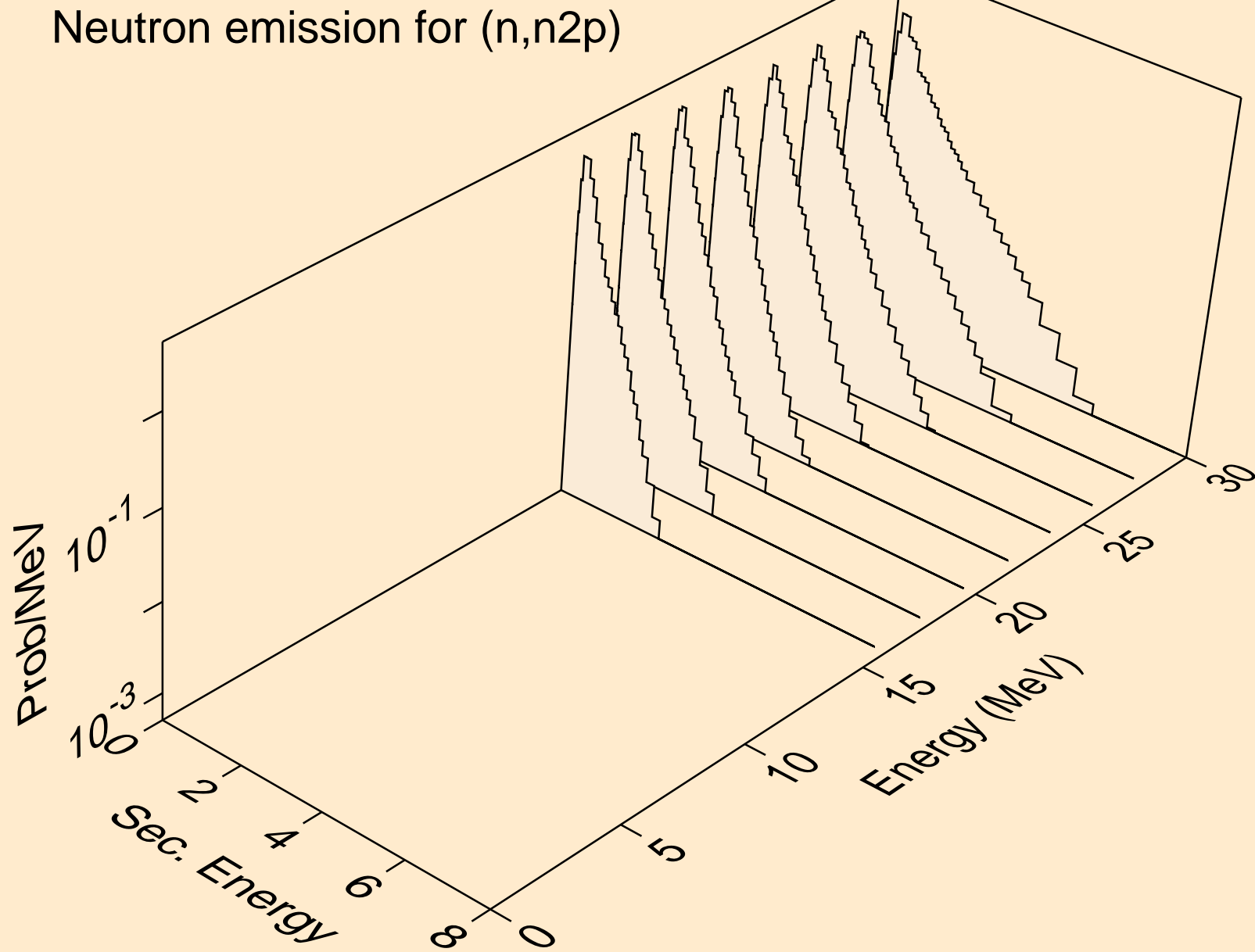

BH264 NEUTRON ACER TENDL-2024 LIBRARY; T=0.K  
Neutron emission for (n,npa)

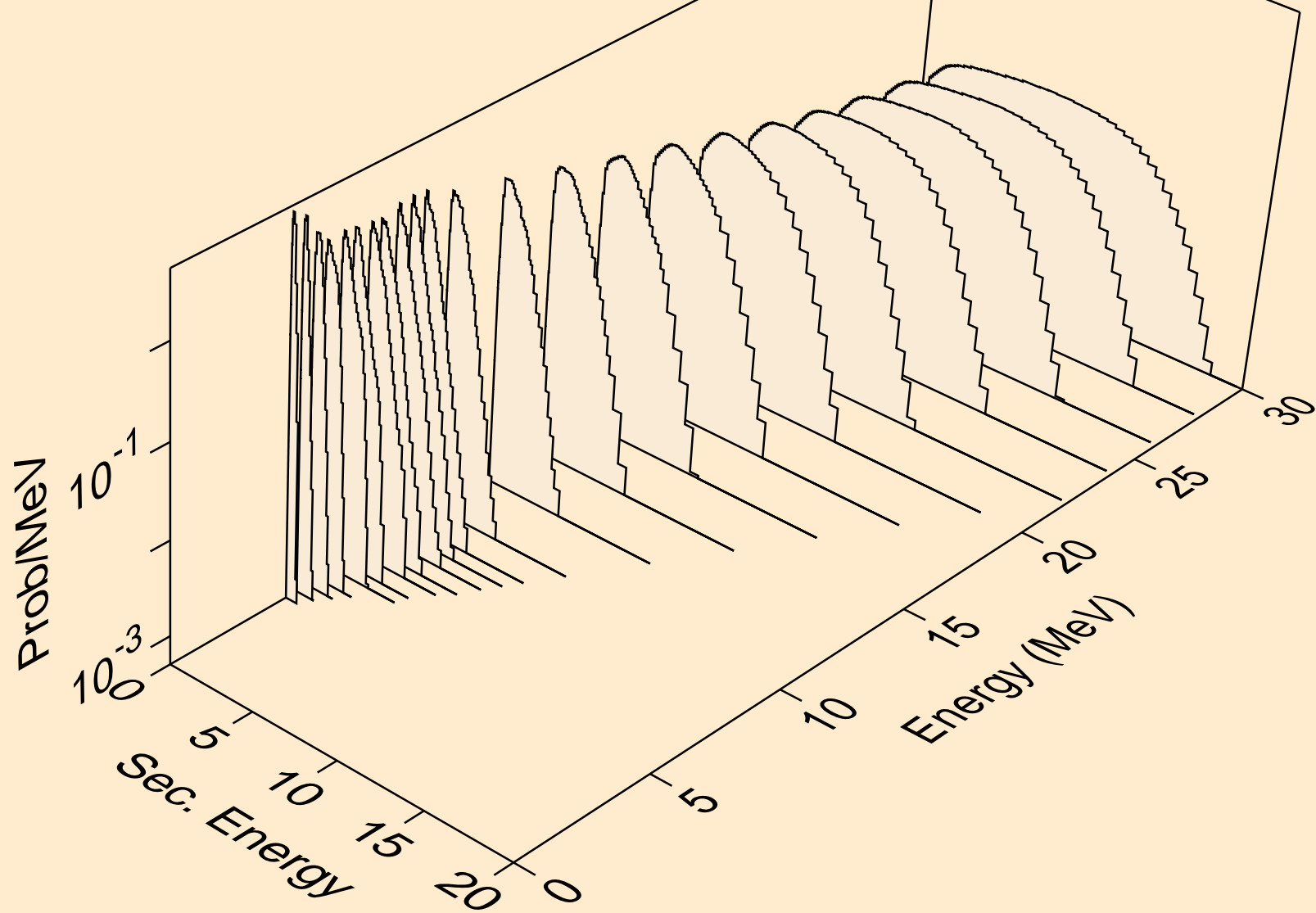

BH264 NEUTRON ACER TENDL-2024 LIBRARY; T=0.K  
Neutron emission for (n,n\*c)

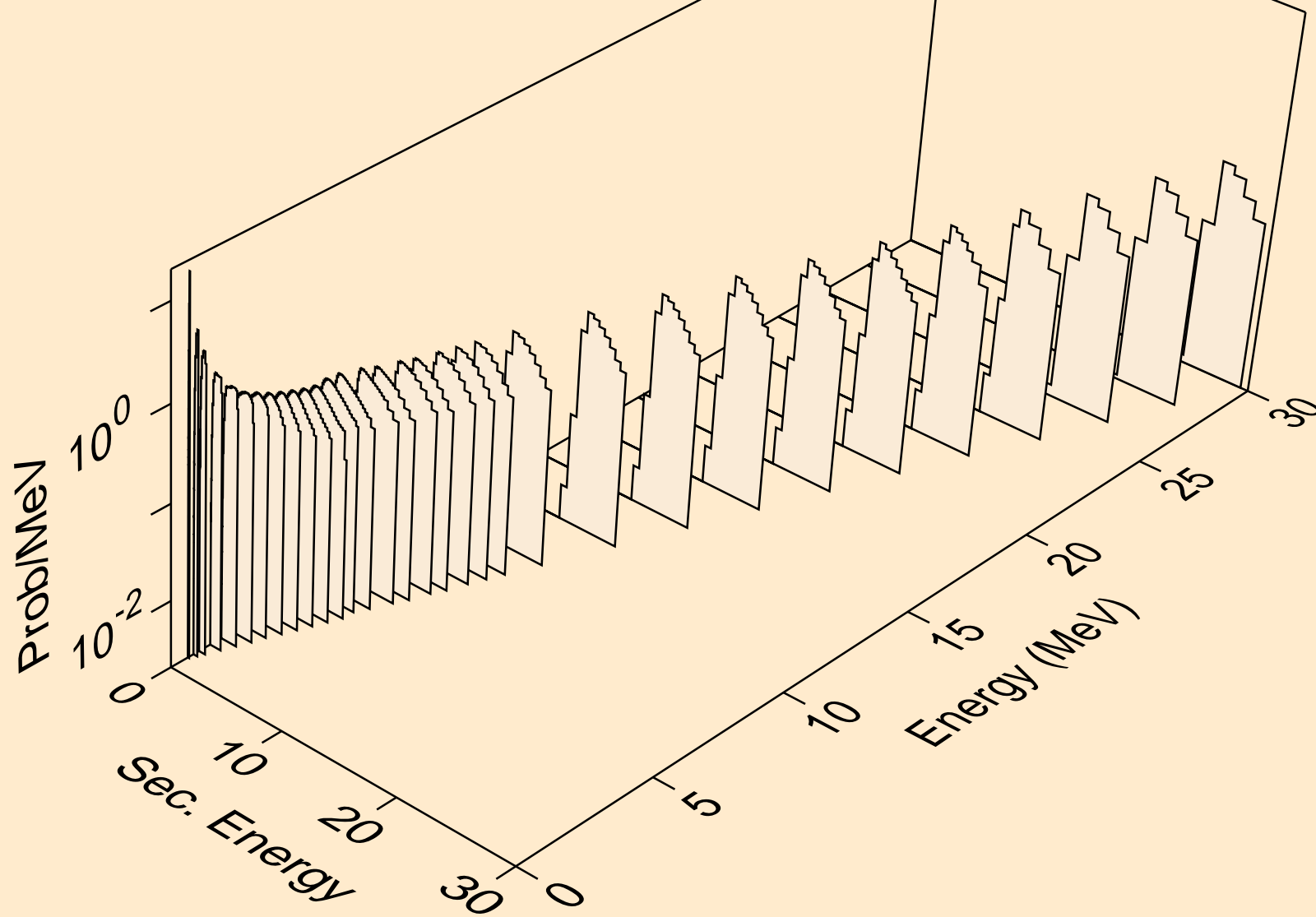



# BH264 NEUTRON ACER TENDL-2024 LIBRARY; T=0.K

## Delayed nubar

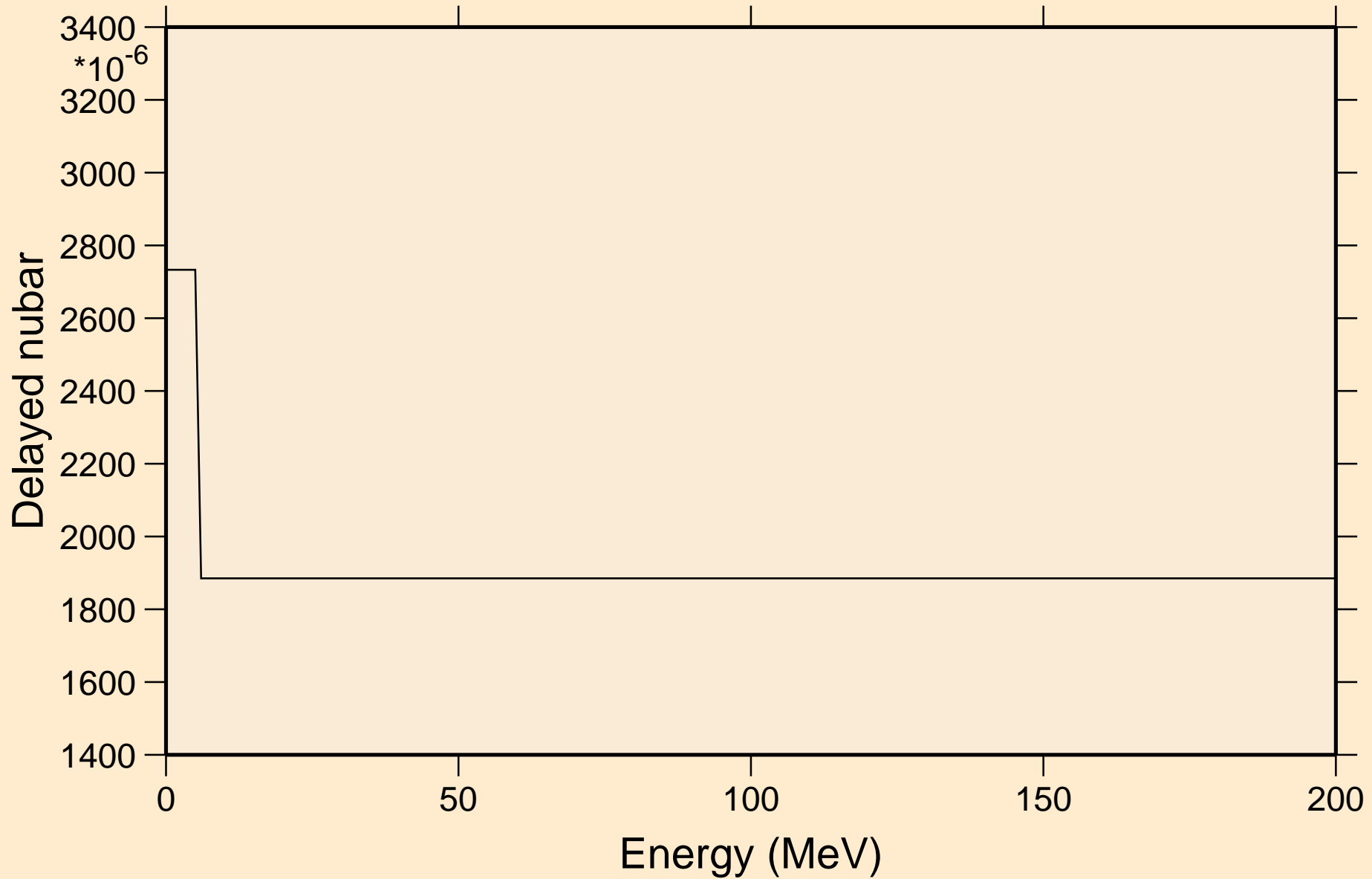

# BH264 NEUTRON ACER TENDL-2024 LIBRARY; T=0.K

## Delayed neutron spectra

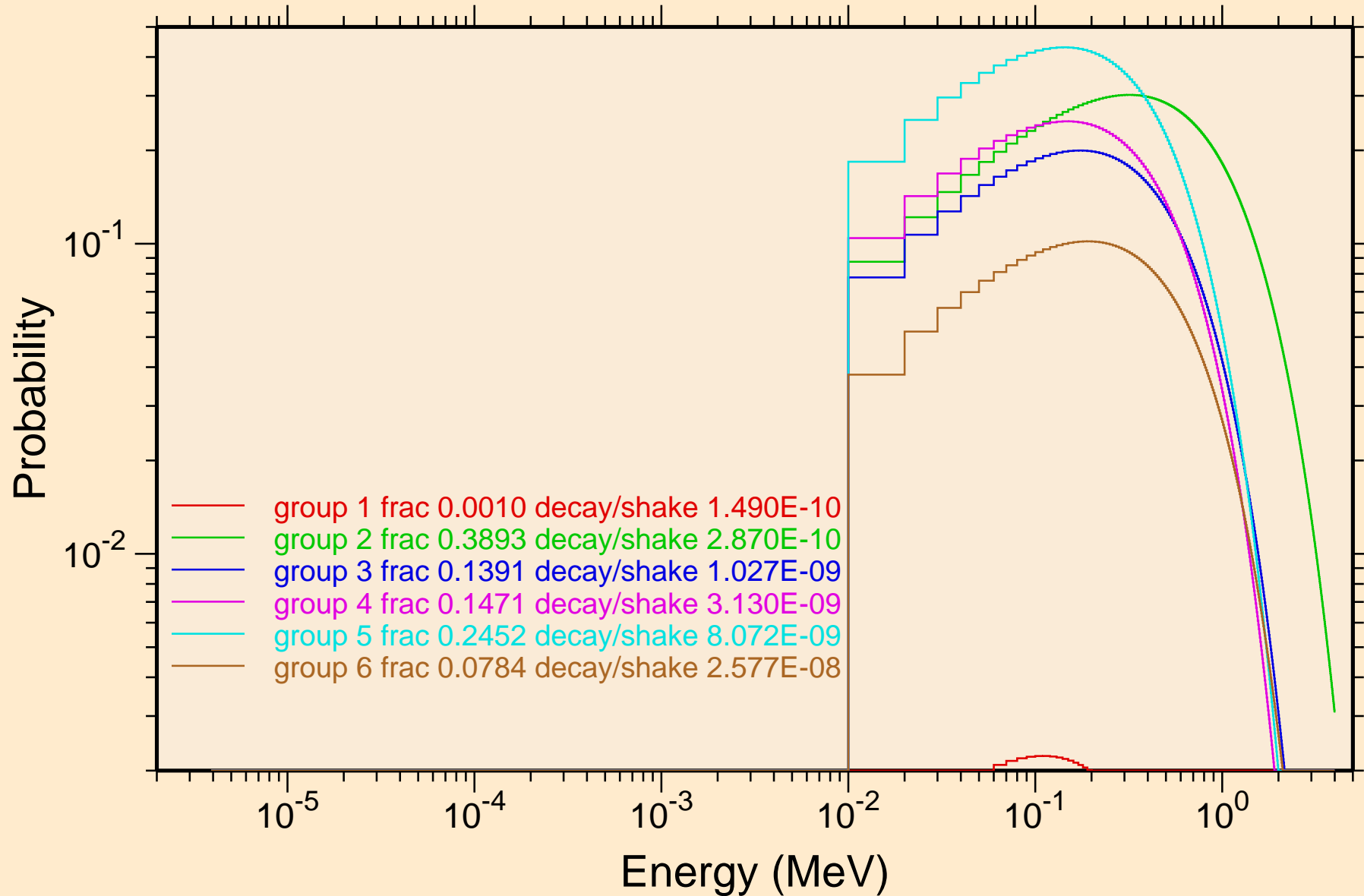

BH264 NEUTRON ACER TENDL-2024 LIBRARY; T=0.K  
Photon emission for (n,x)

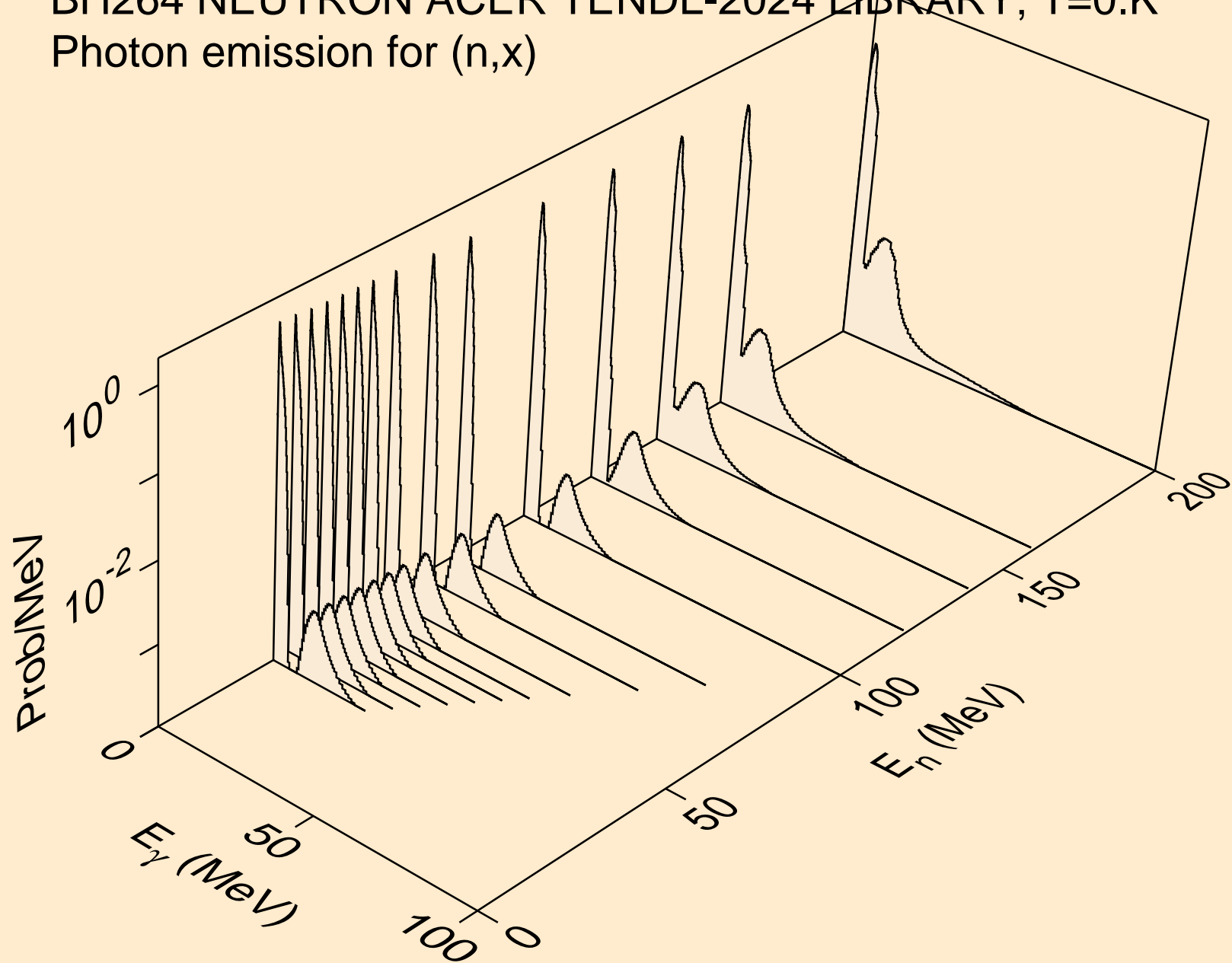

BH264 NEUTRON ACER TENDL-2024 LIBRARY; T=0.K  
Photon emission for (n,2nd)

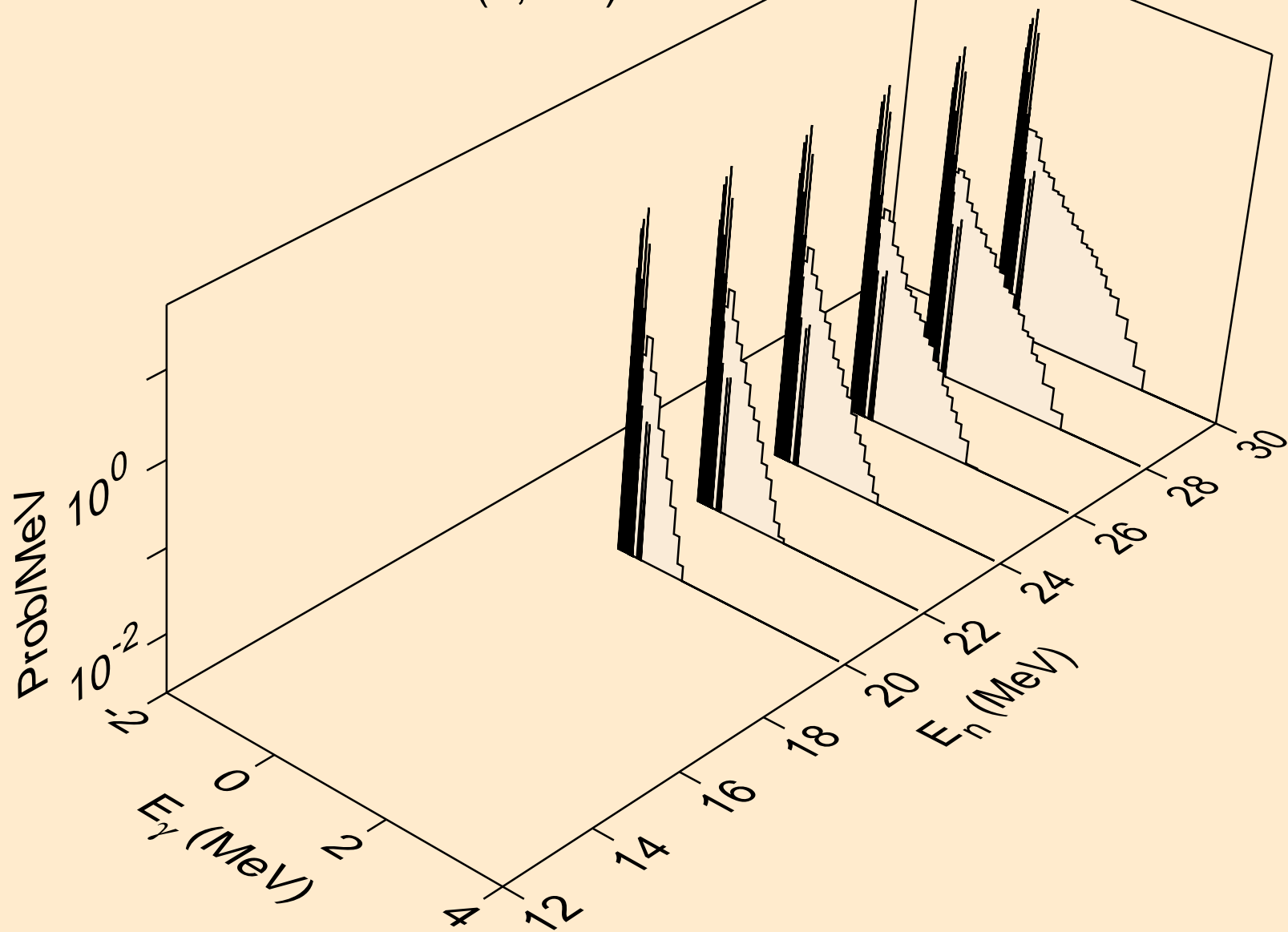

BH264 NEUTRON ACER TENDL-2024 LIBRARY; T=0.K  
Photon emission for (n,2n)

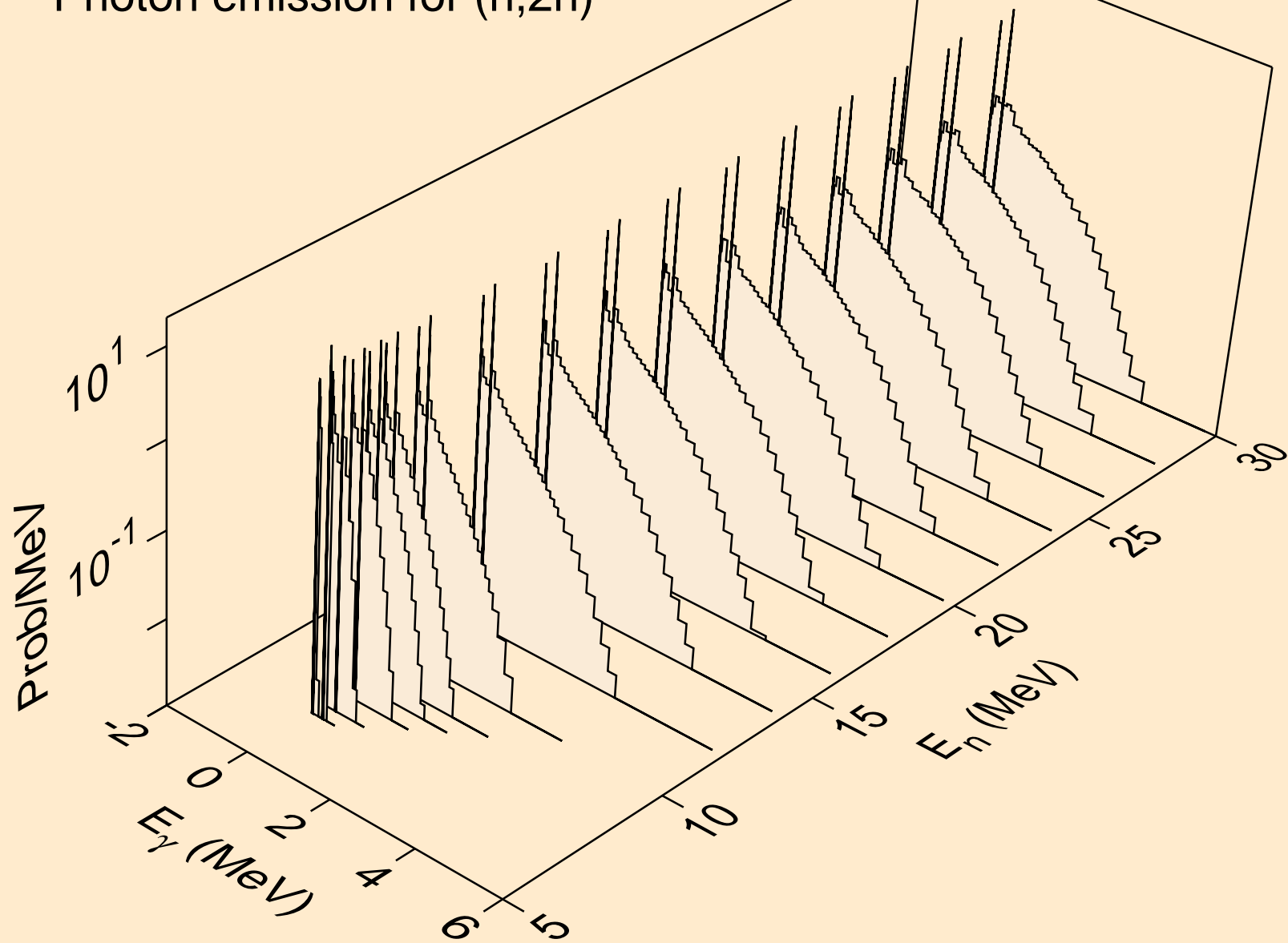

BH264 NEUTRON ACER TENDL-2024 LIBRARY; T=0.K  
Photon emission for (n,3n)

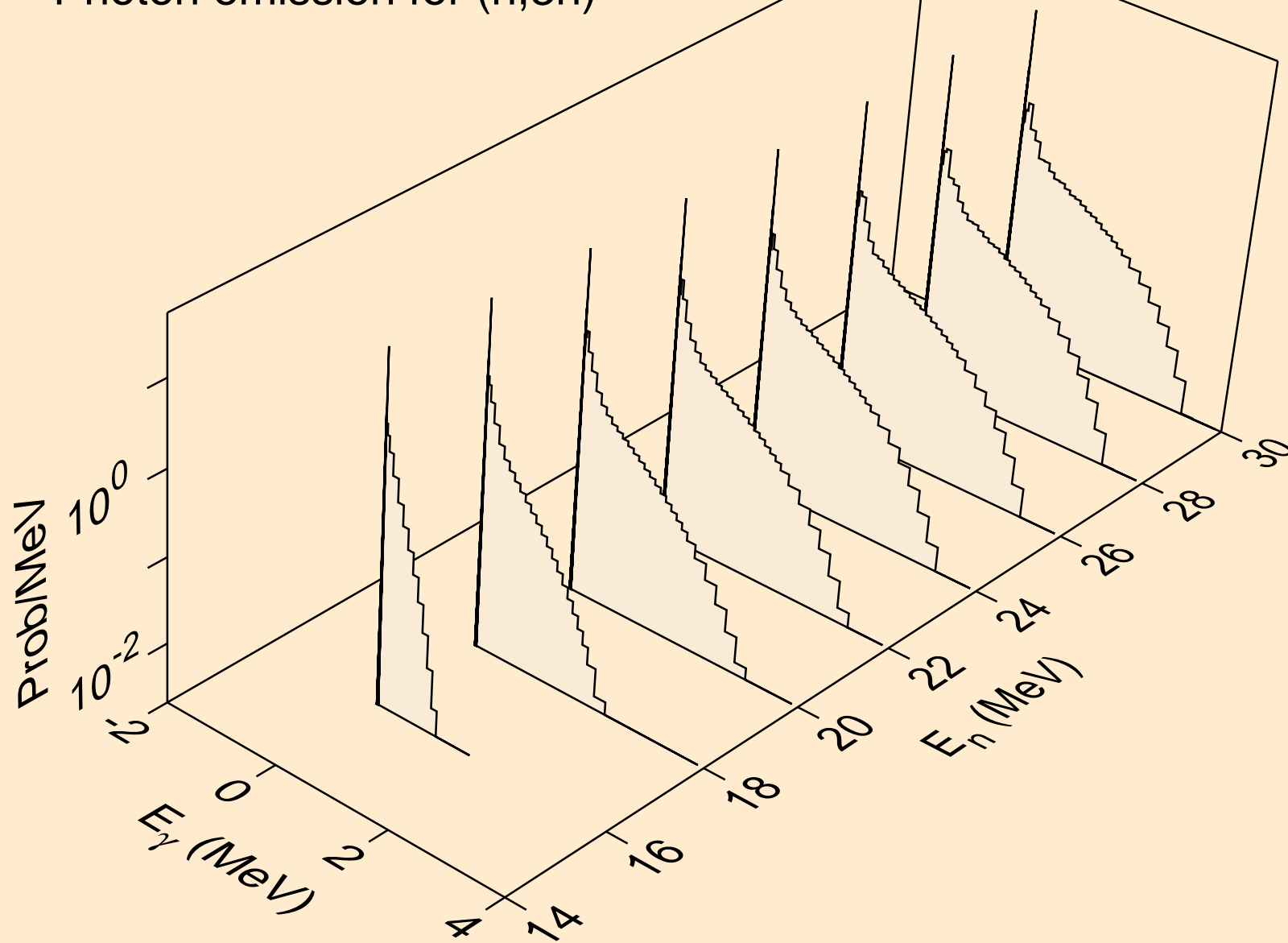

BH264 NEUTRON ACER TENDL-2024 LIBRARY; T=0.K  
Photon emission for (n,n\*)a

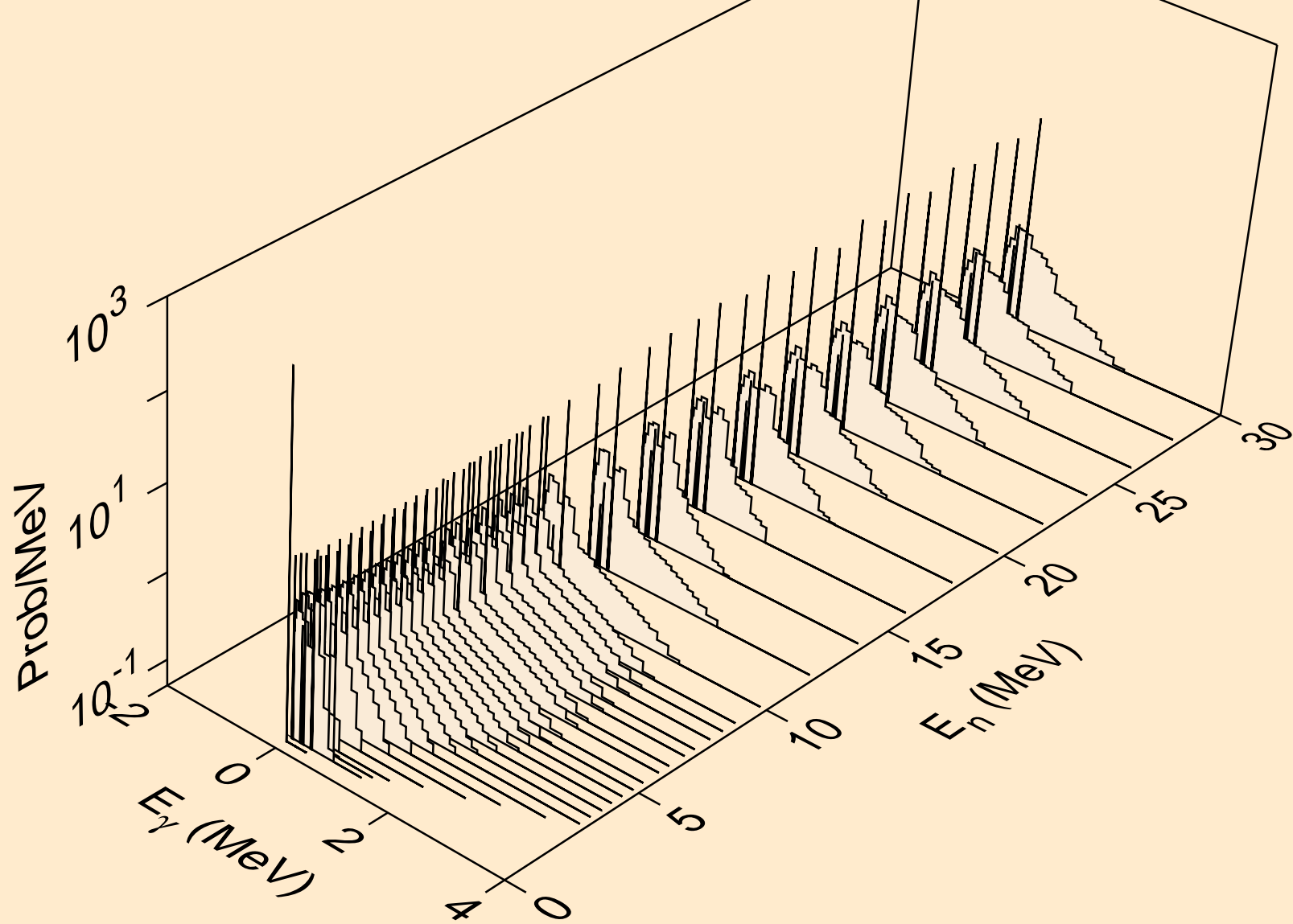

BH264 NEUTRON ACER TENDL-2024 LIBRARY; T=0.K  
Photon emission for (n,2n)a

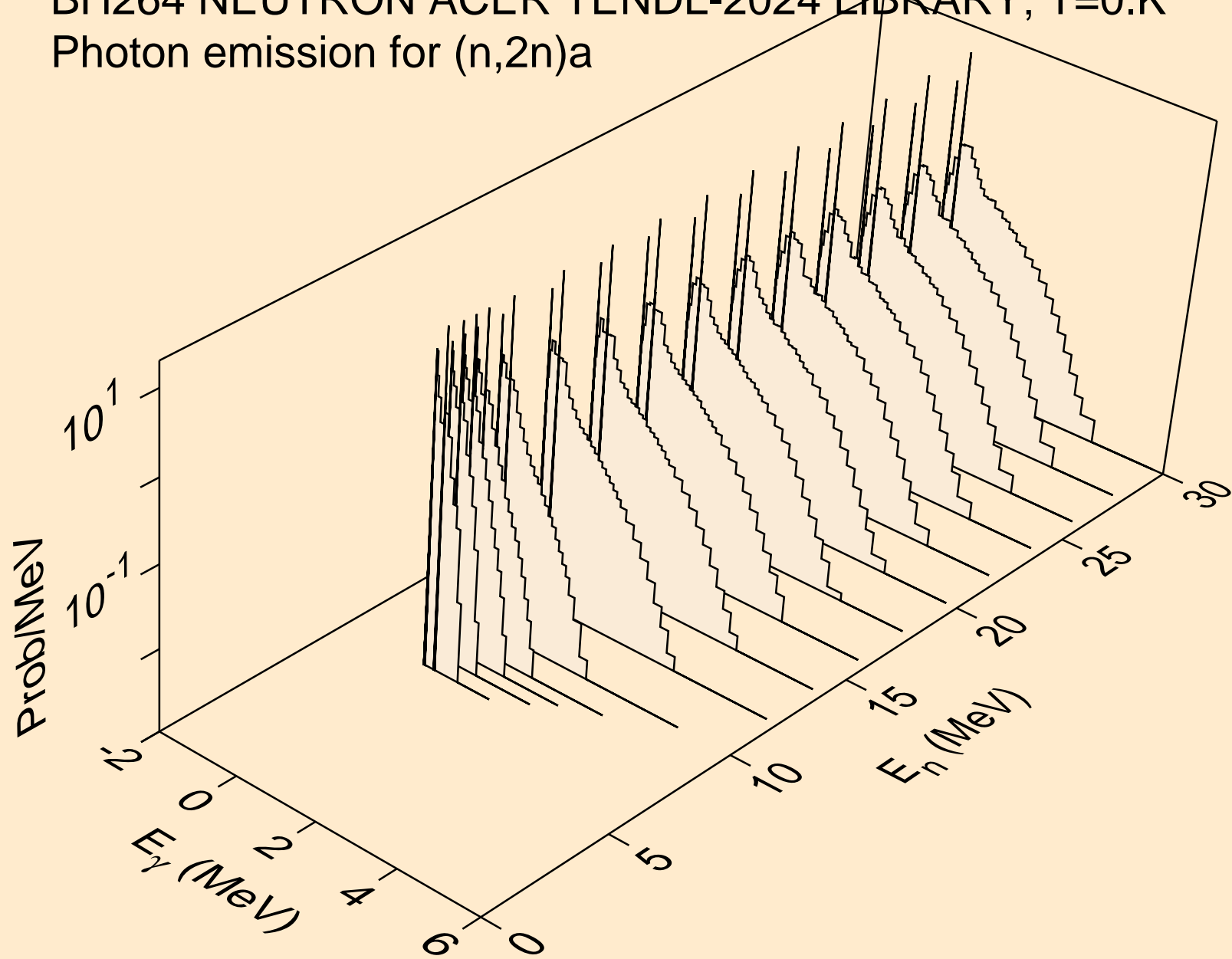



BH264 NEUTRON ACER TENDL-2024 LIBRARY; T=0.K  
Photon emission for (n,3n)a

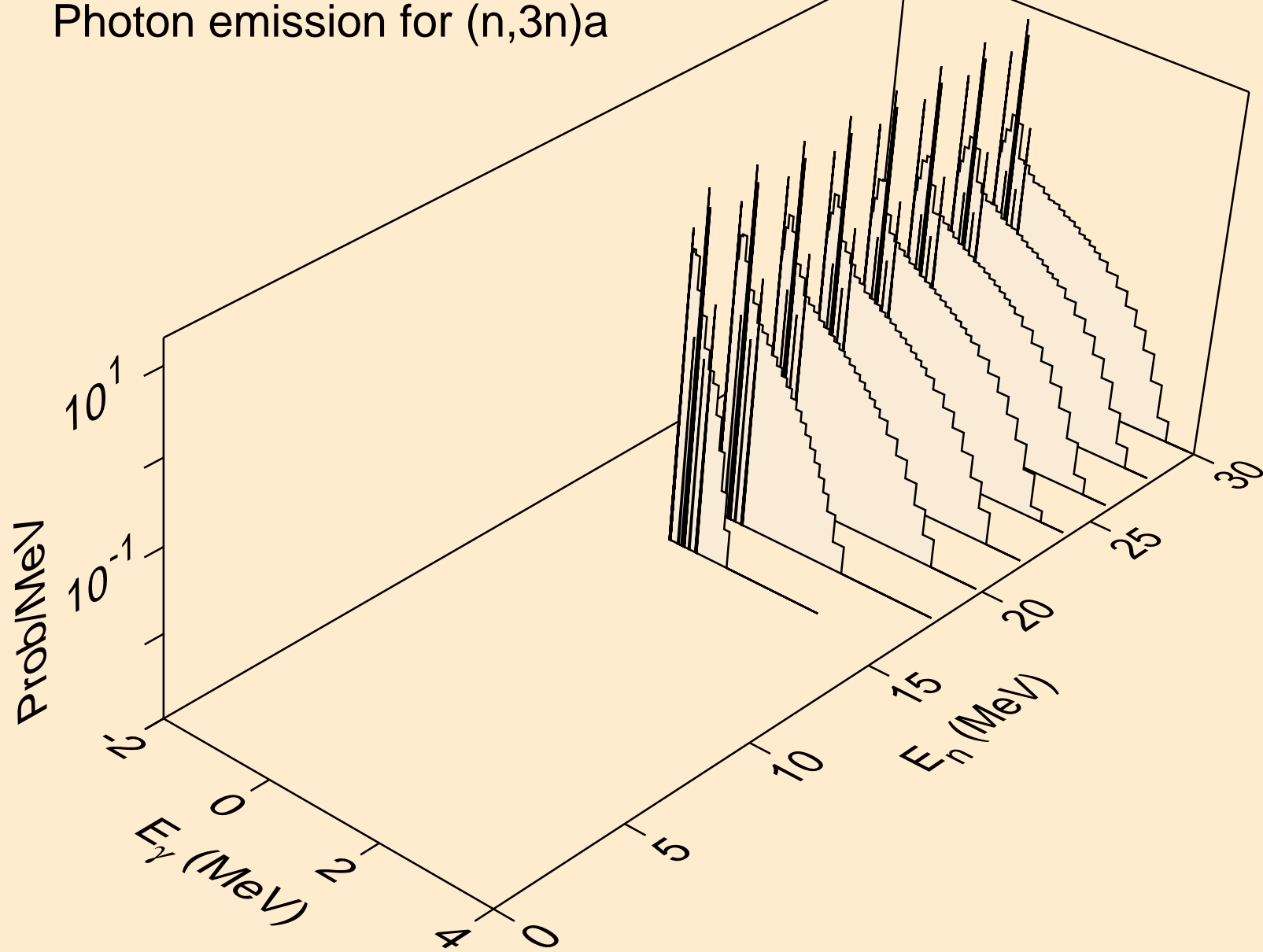

BH264 NEUTRON ACER TENDL-2024 LIBRARY; T=0.K  
Photon emission for (n,n\*)p

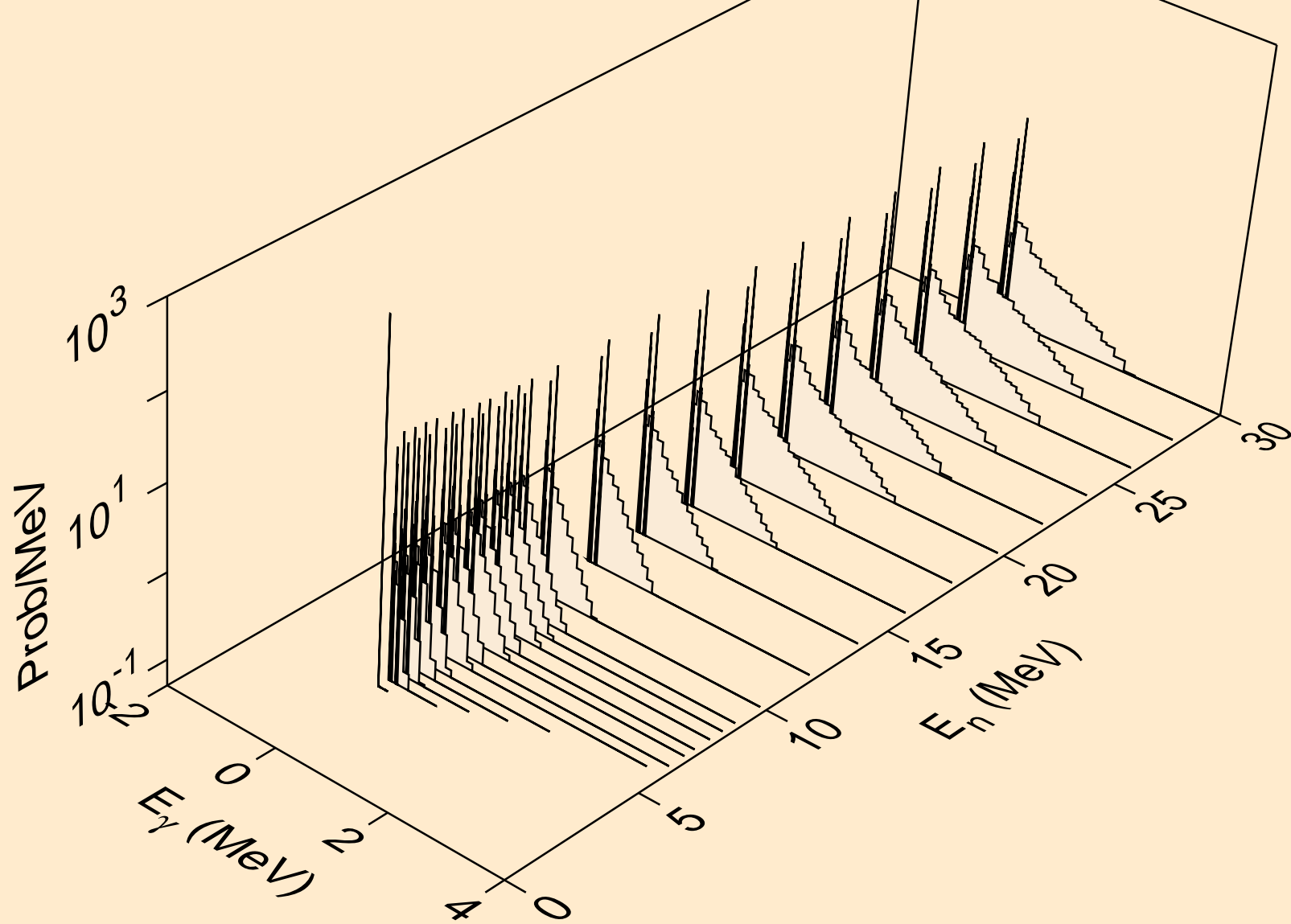

BH264 NEUTRON ACER TENDL-2024 LIBRARY; T=0.K  
Photon emission for (n,n\*)2a

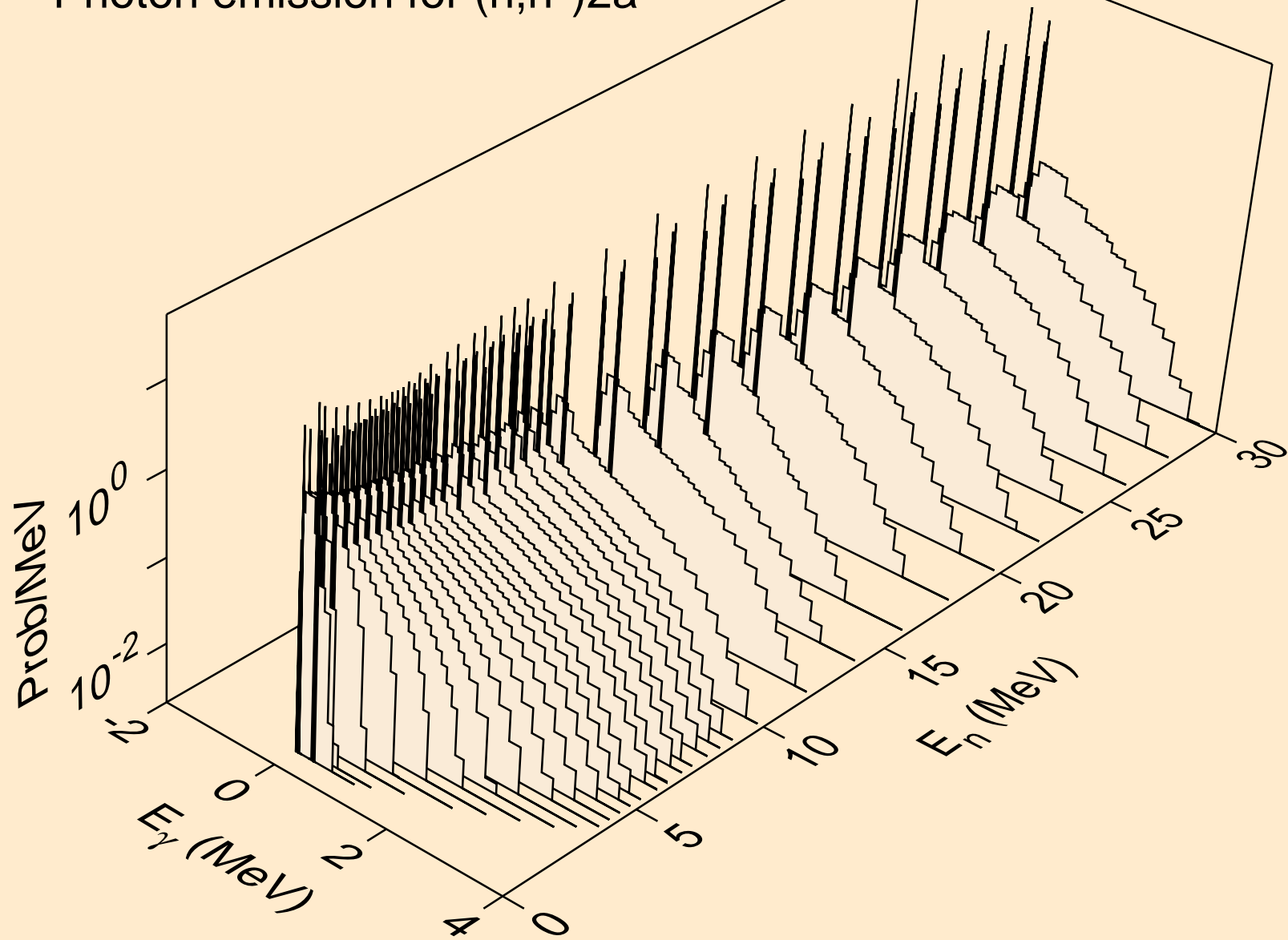

BH264 NEUTRON ACER TENDL-2024 LIBRARY; T=0.K  
Photon emission for (n,2n)2a

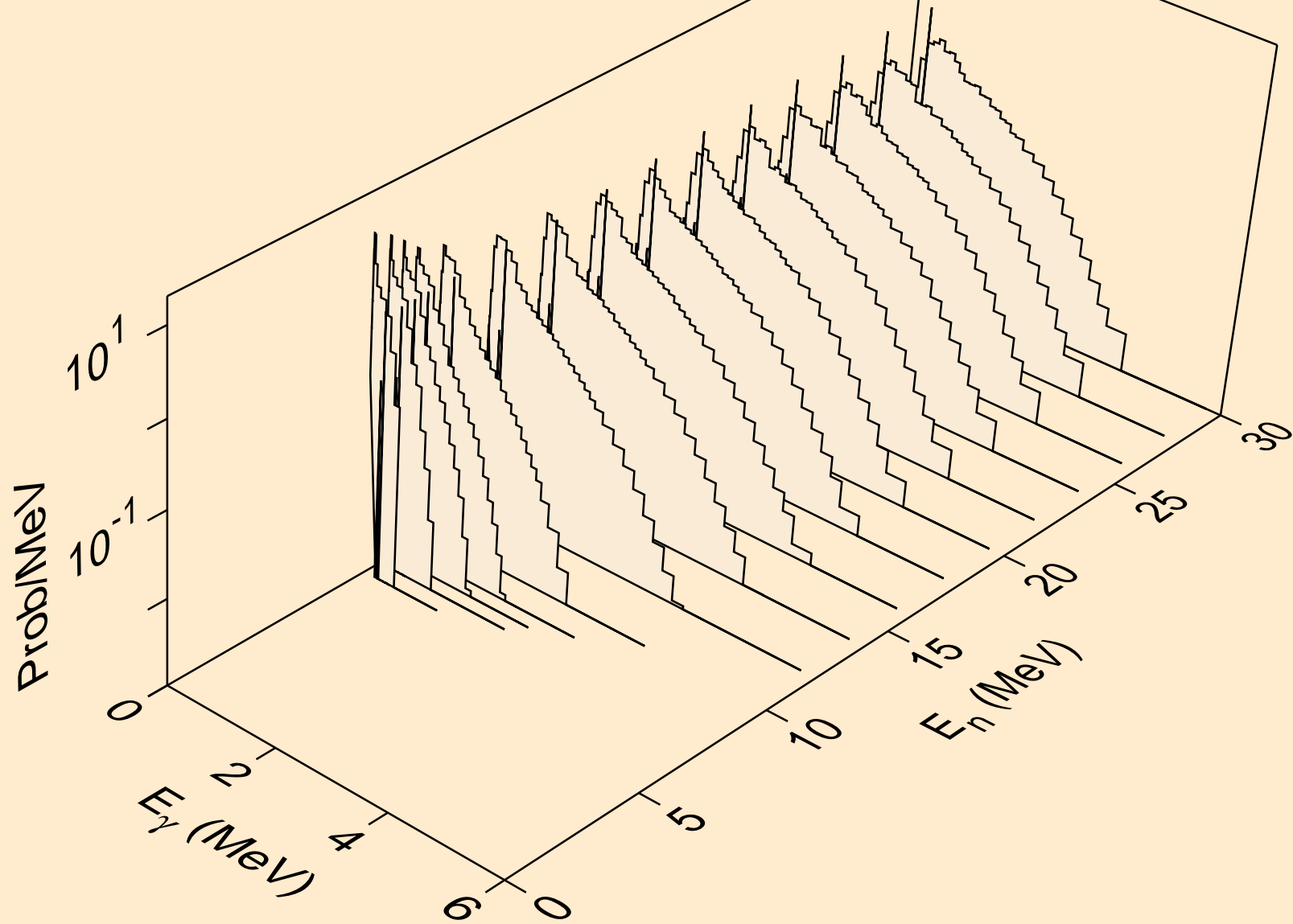

BH264 NEUTRON ACER TENDL-2024 LIBRARY; T=0.K  
Photon emission for (n,n\*)d

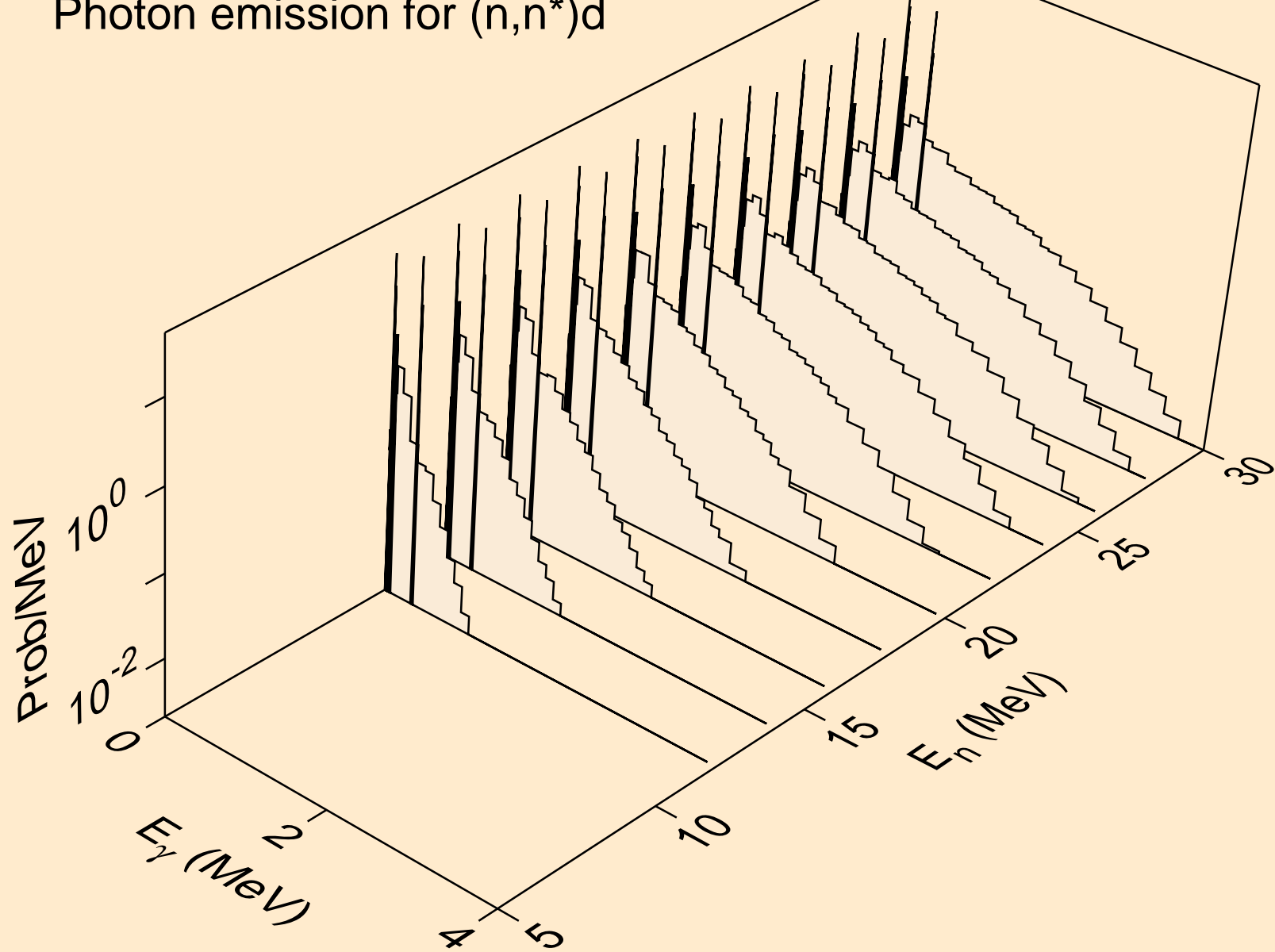

BH264 NEUTRON ACER TENDL-2024 LIBRARY; T=0.K  
Photon emission for (n,n\*)t

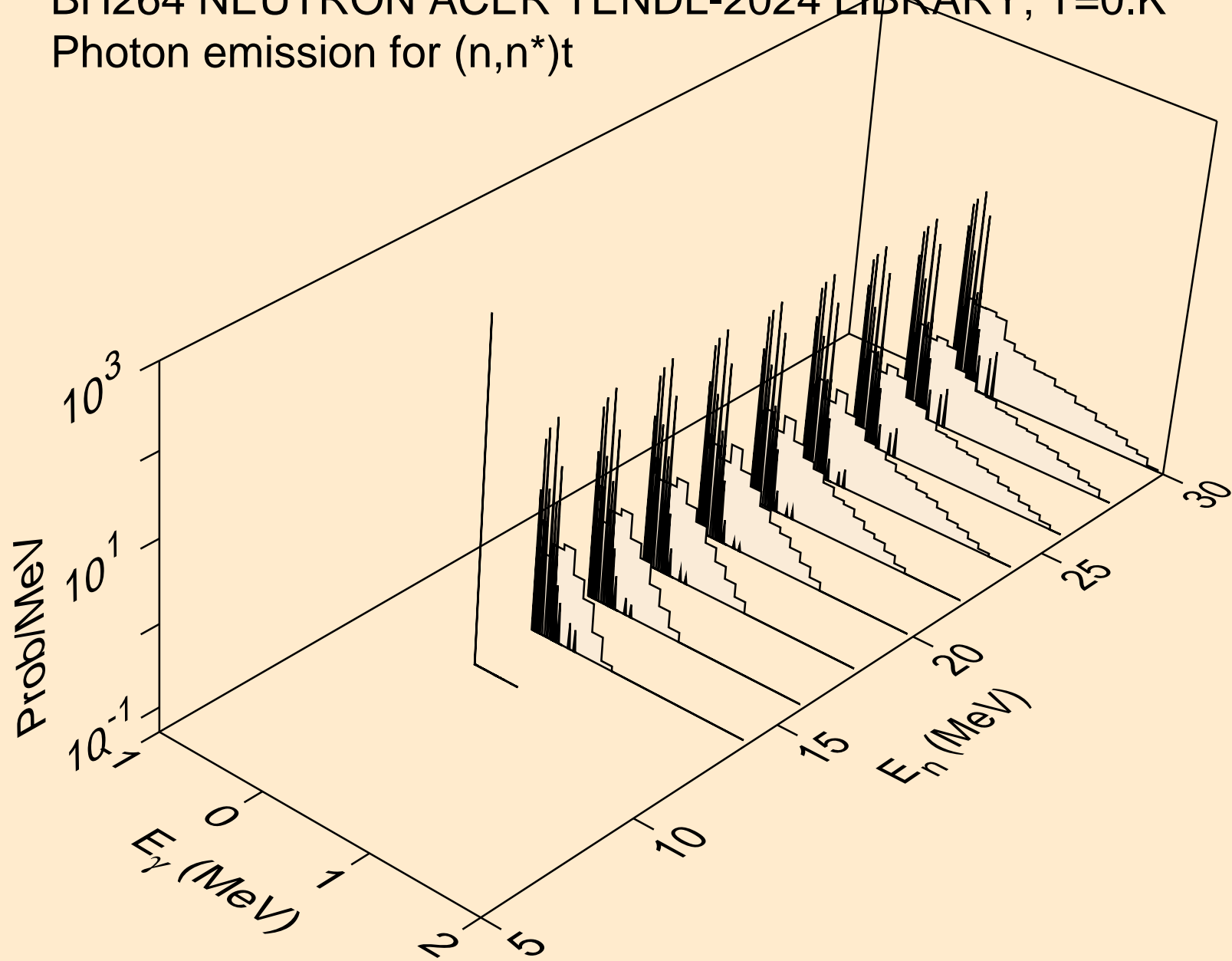

BH264 NEUTRON ACER TENDL-2024 LIBRARY; T=0.K  
Photon emission for (n,n\*)he3

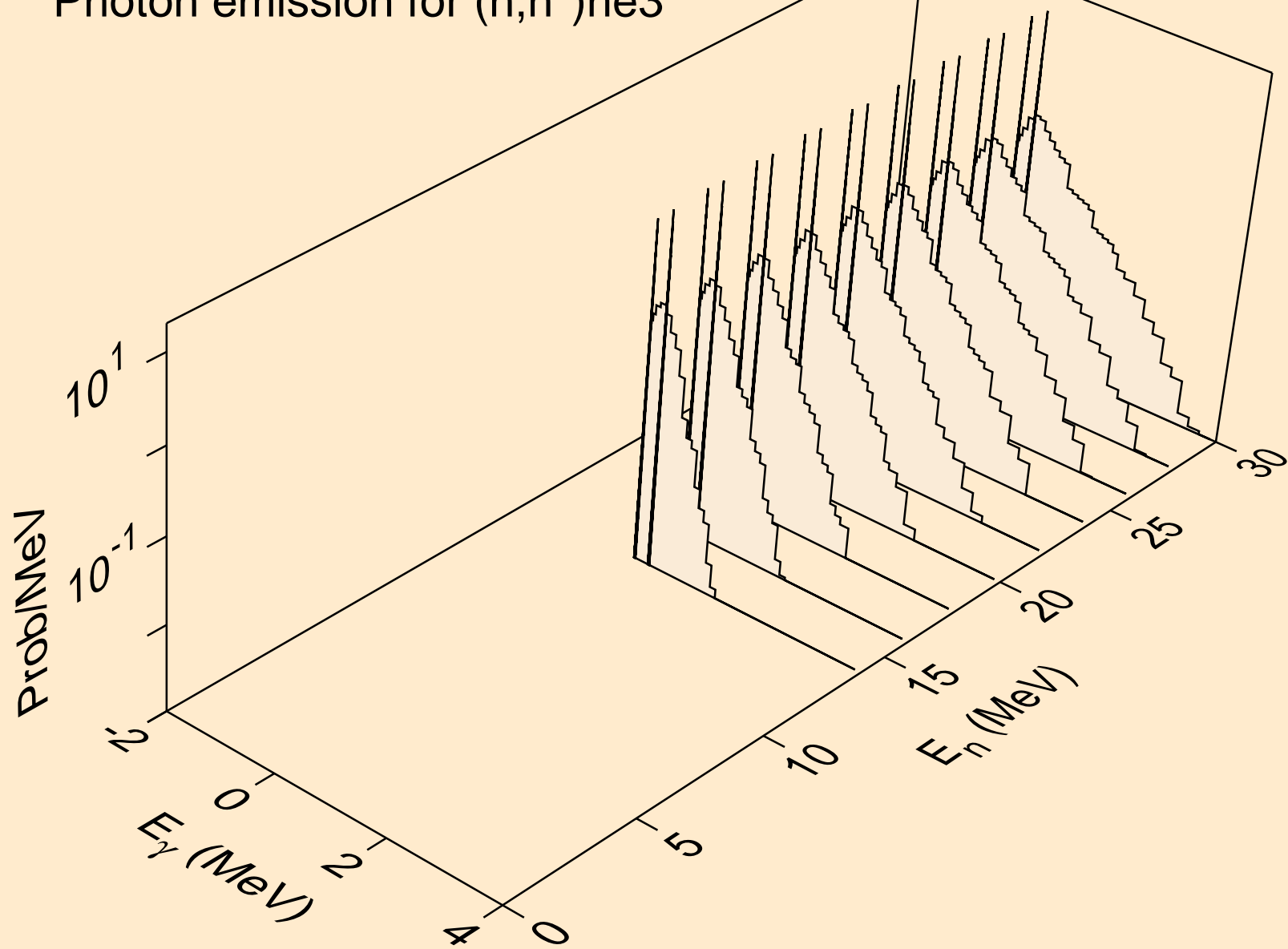

BH264 NEUTRON ACER TENDL-2024 LIBRARY; T=0.K  
Photon emission for (n,4n)

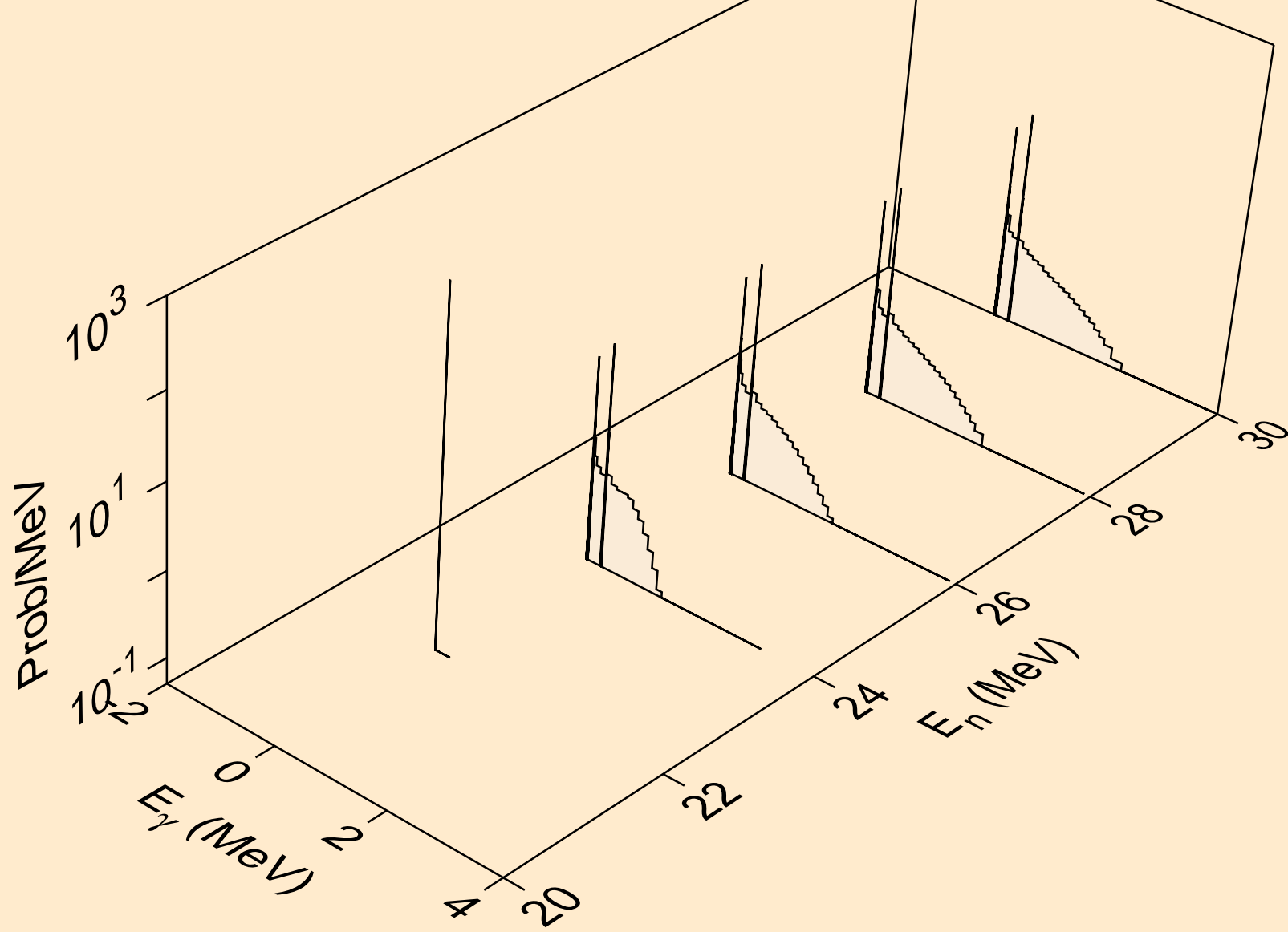



BH264 NEUTRON ACER TENDL-2024 LIBRARY; T=0.K  
Photon emission for (n,2np)

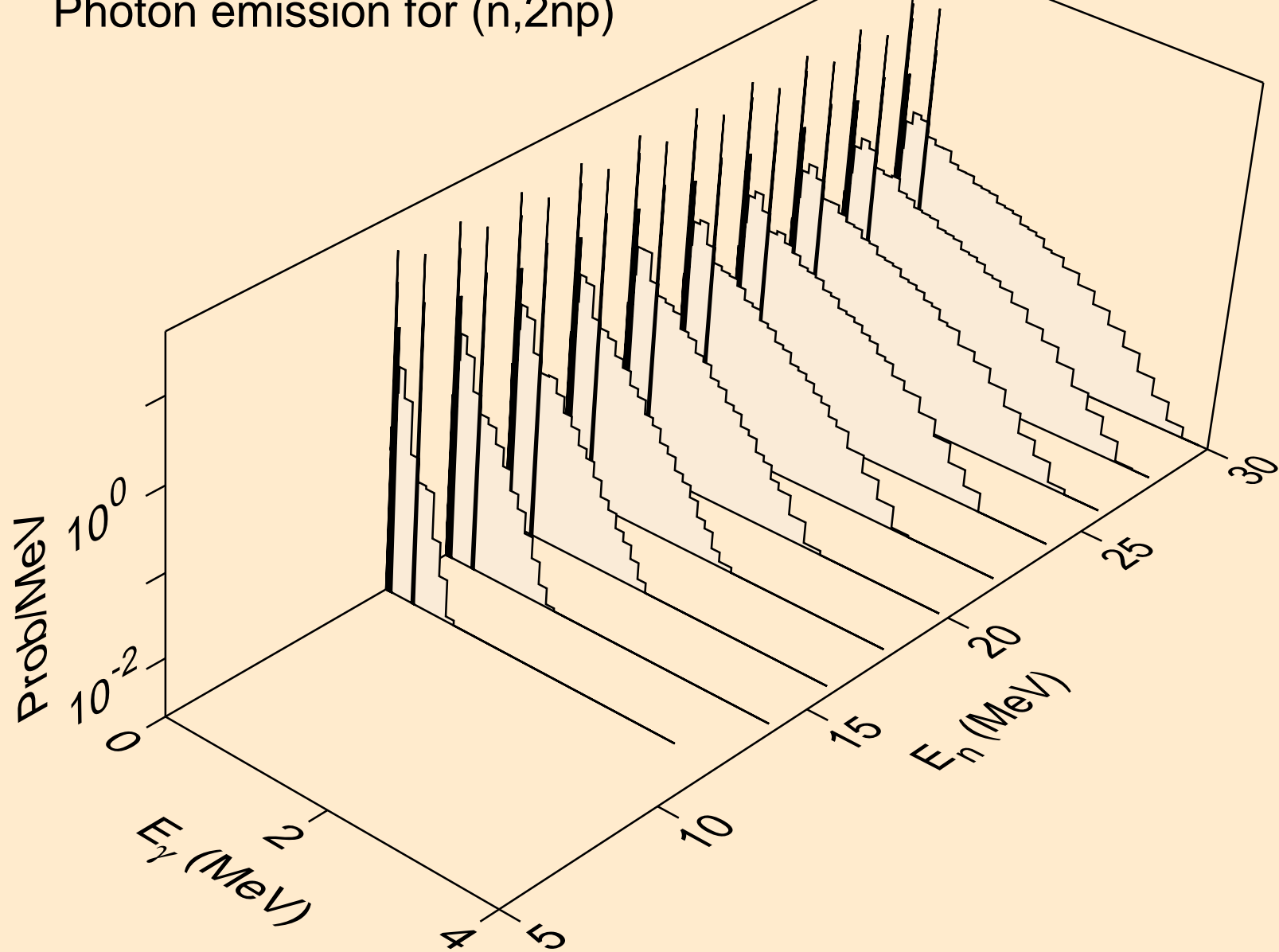

BH264 NEUTRON ACER TENDL-2024 LIBRARY; T=0.K  
Photon emission for (n,3np)

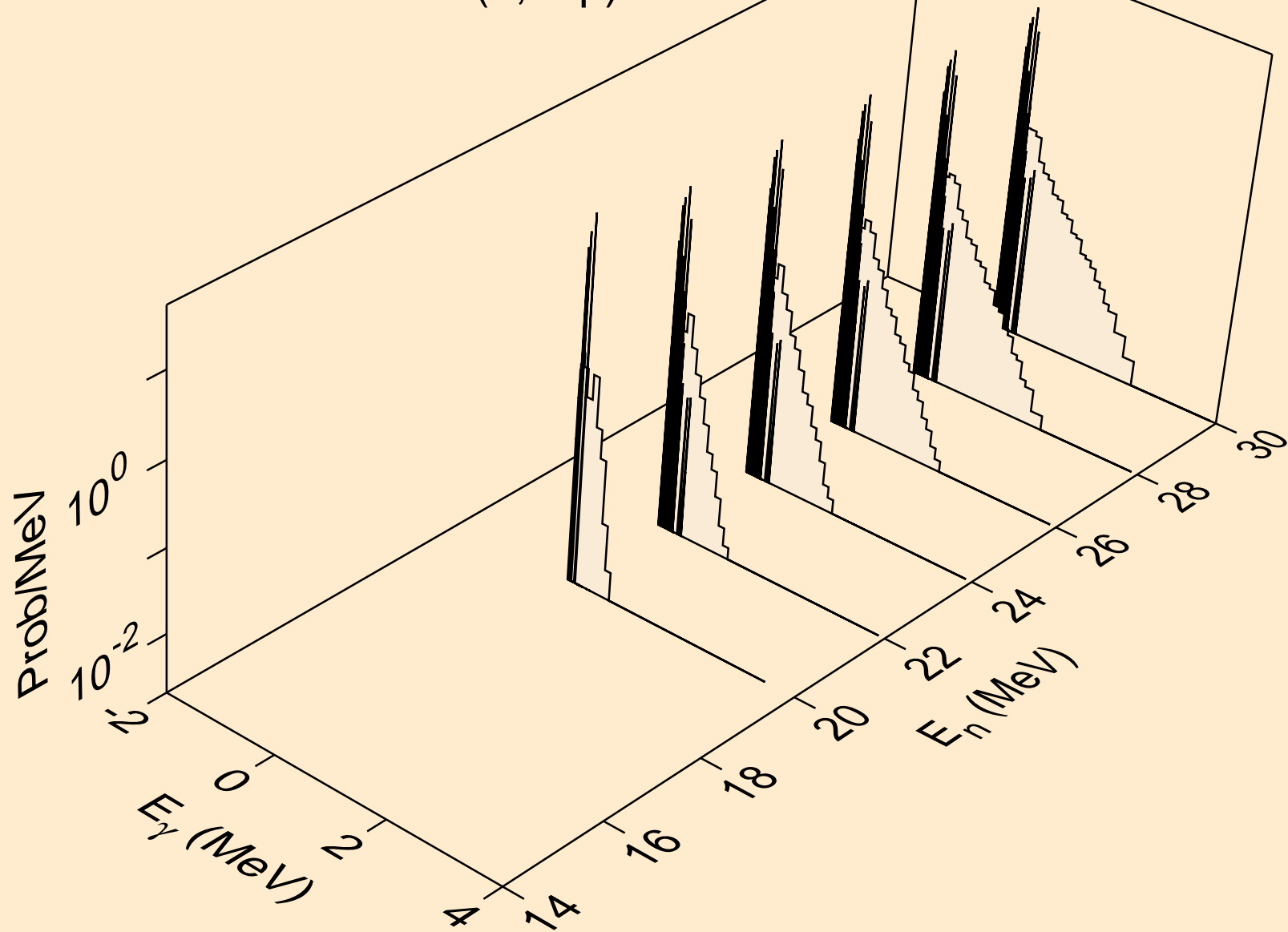

BH264 NEUTRON ACER TENDL-2024 LIBRARY; T=0.K  
Photon emission for (n,n2p)

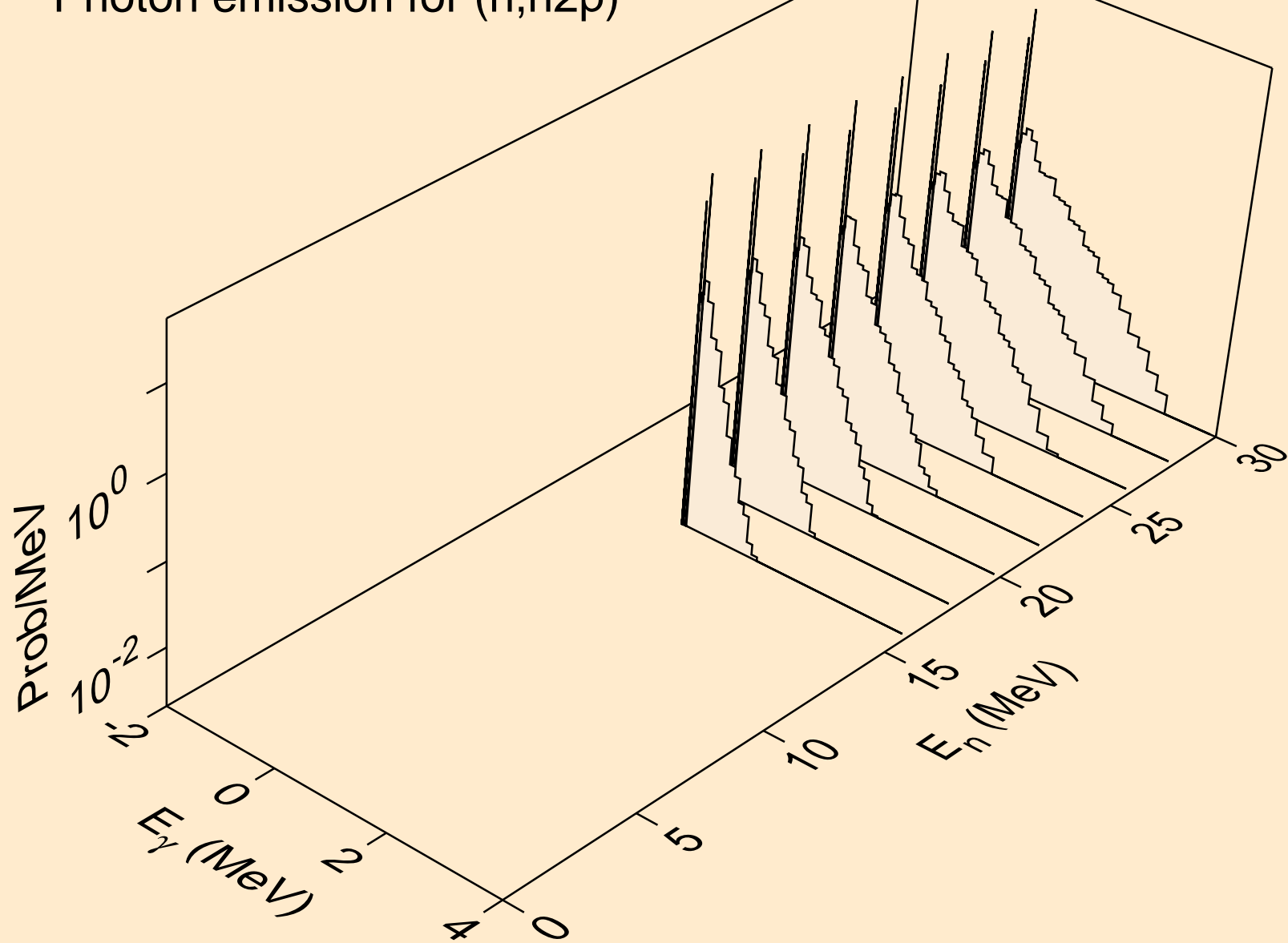

BH264 NEUTRON ACER TENDL-2024 LIBRARY; T=0.K  
Photon emission for (n,npa)

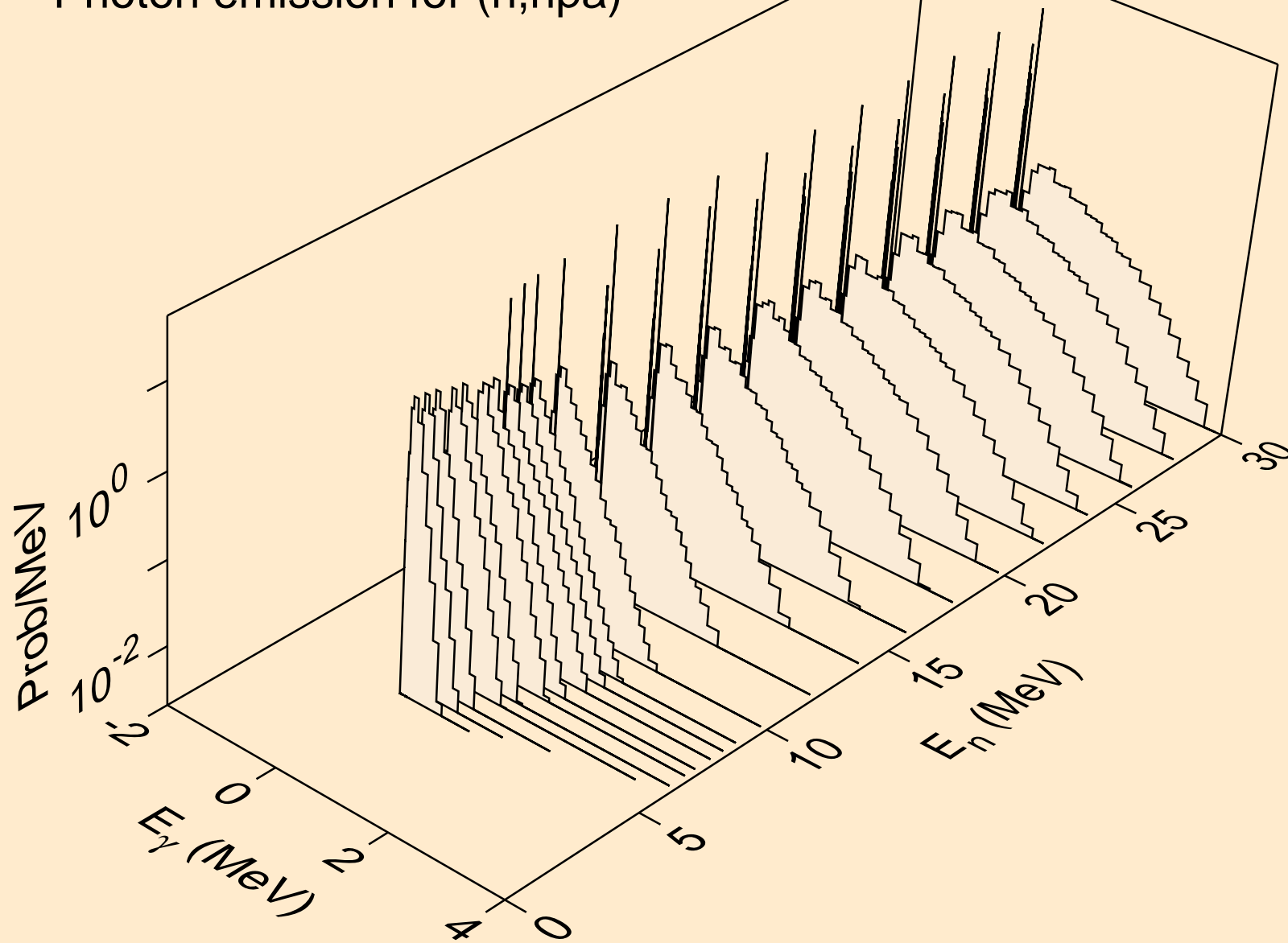

BH264 NEUTRON ACER TENDL-2024 LIBRARY; T=0.K  
Photon emission for (n,n\*c)

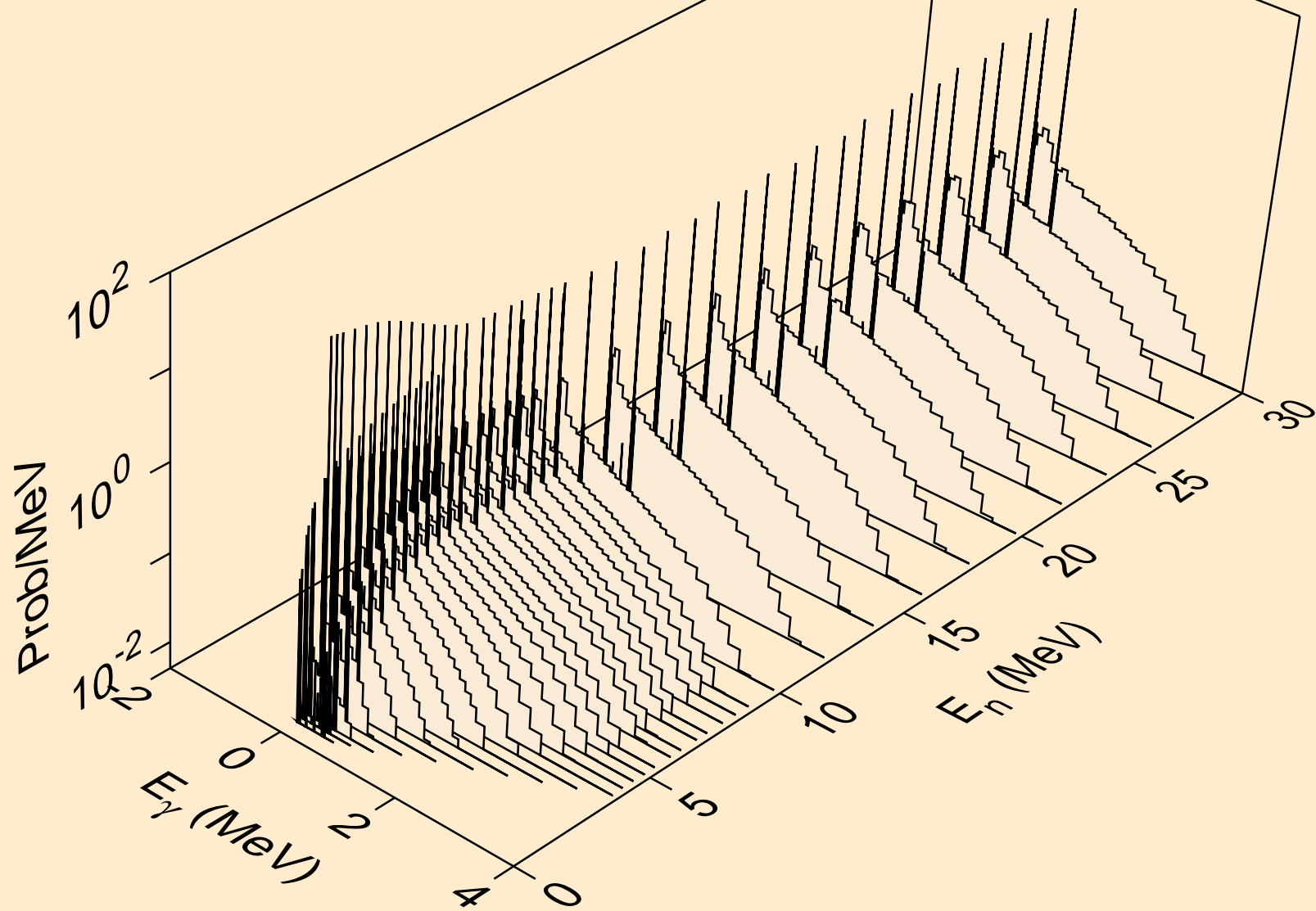

BH264 NEUTRON ACER TENDL-2024 LIBRARY; T=0.K  
Photon emission for (n,gma)

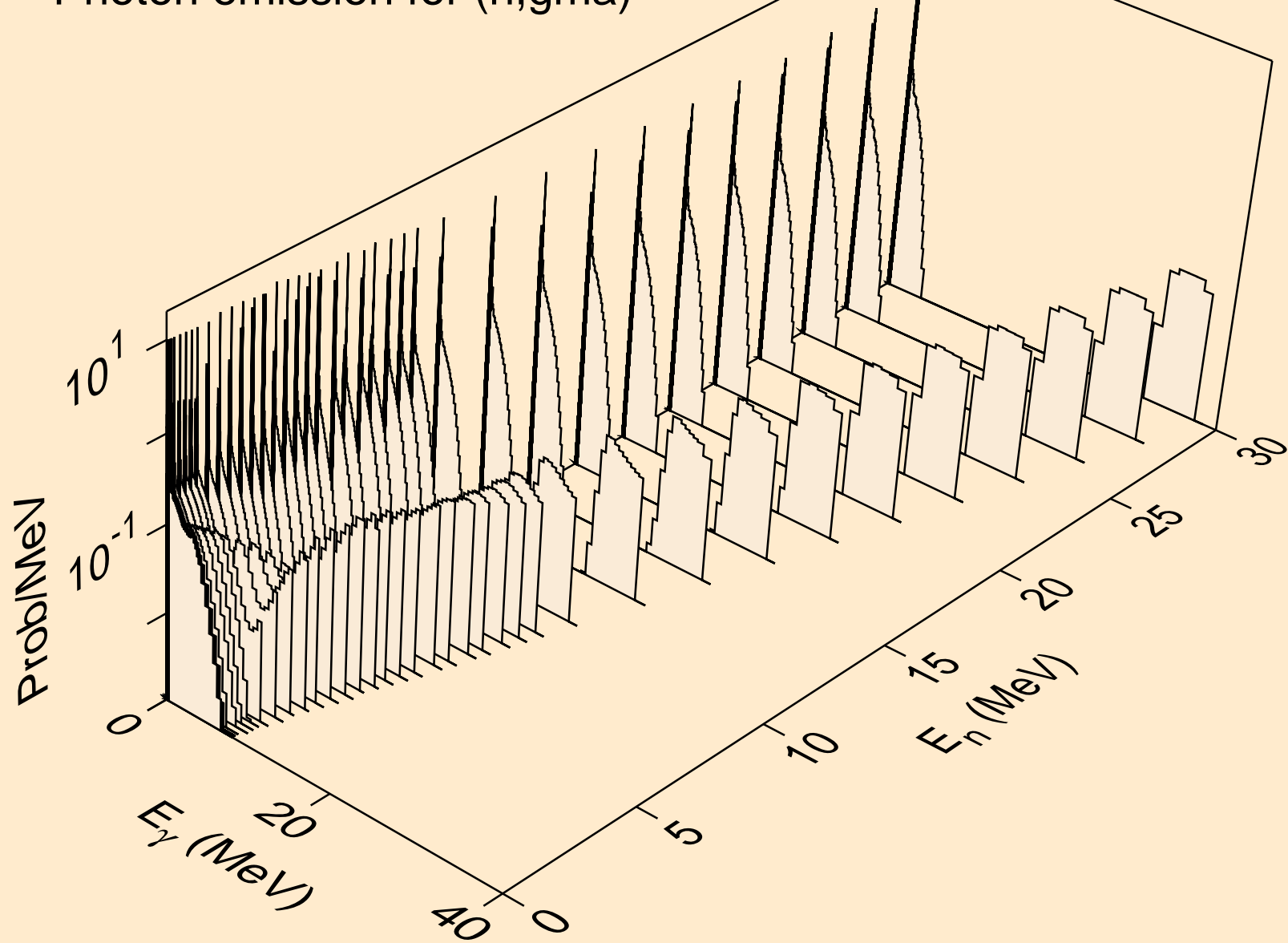

BH264 NEUTRON ACER TENDL-2024 LIBRARY; T=0.K  
Photon emission for (n,p)

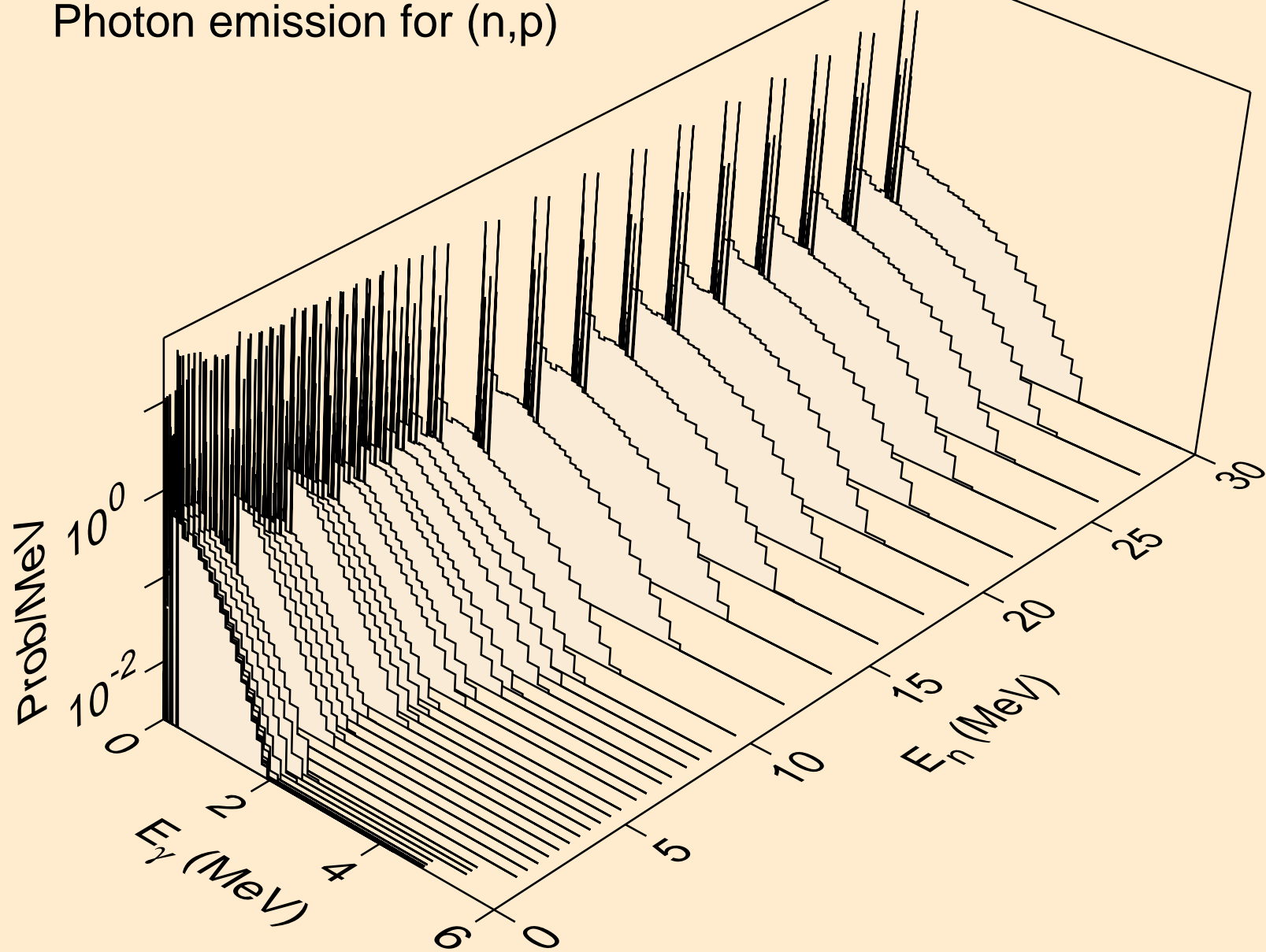

BH264 NEUTRON ACER TENDL-2024 LIBRARY; T=0.K  
Photon emission for (n,d)

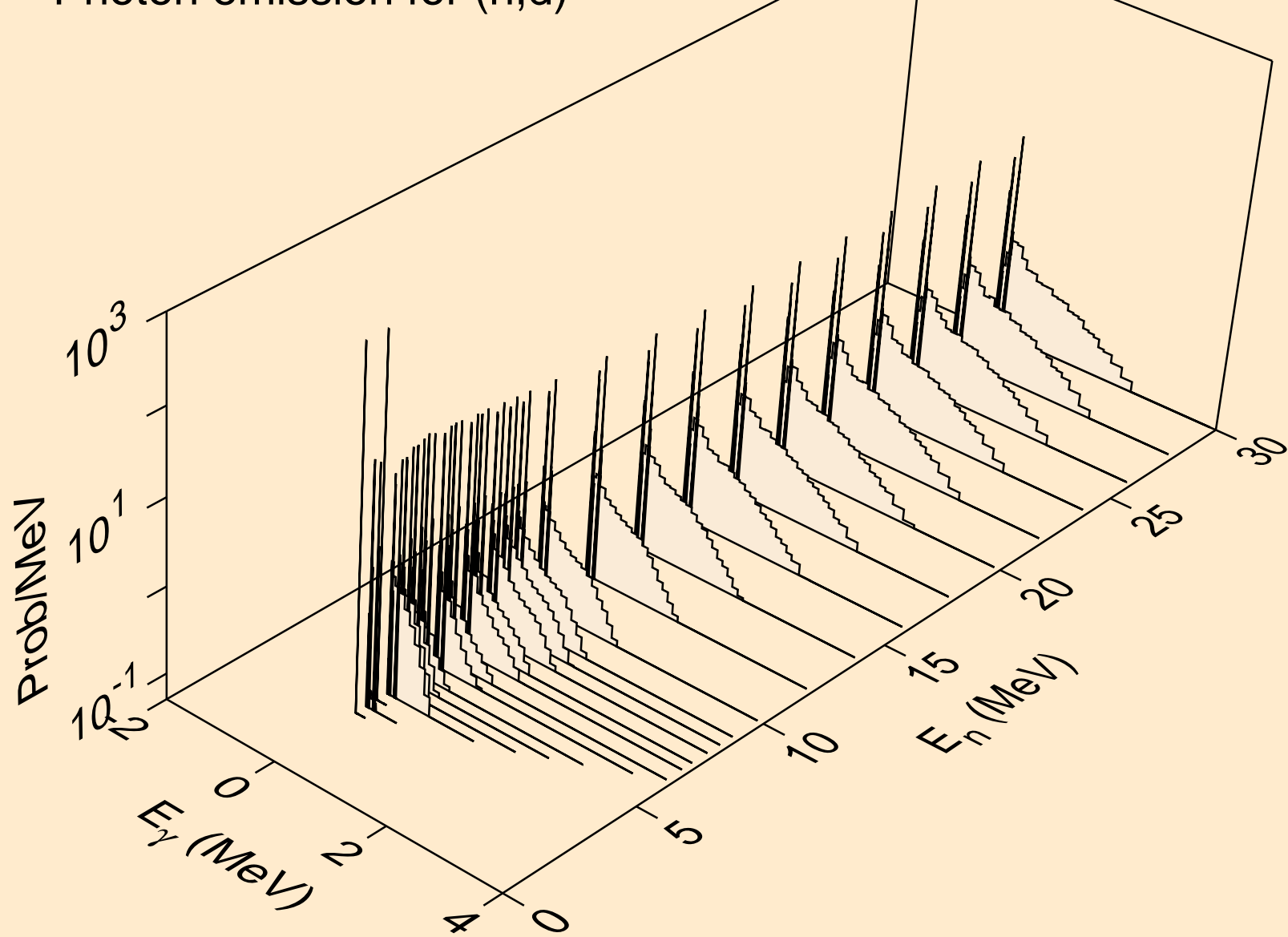



BH264 NEUTRON ACER TENDL-2024 LIBRARY; T=0.K  
Photon emission for (n,t)

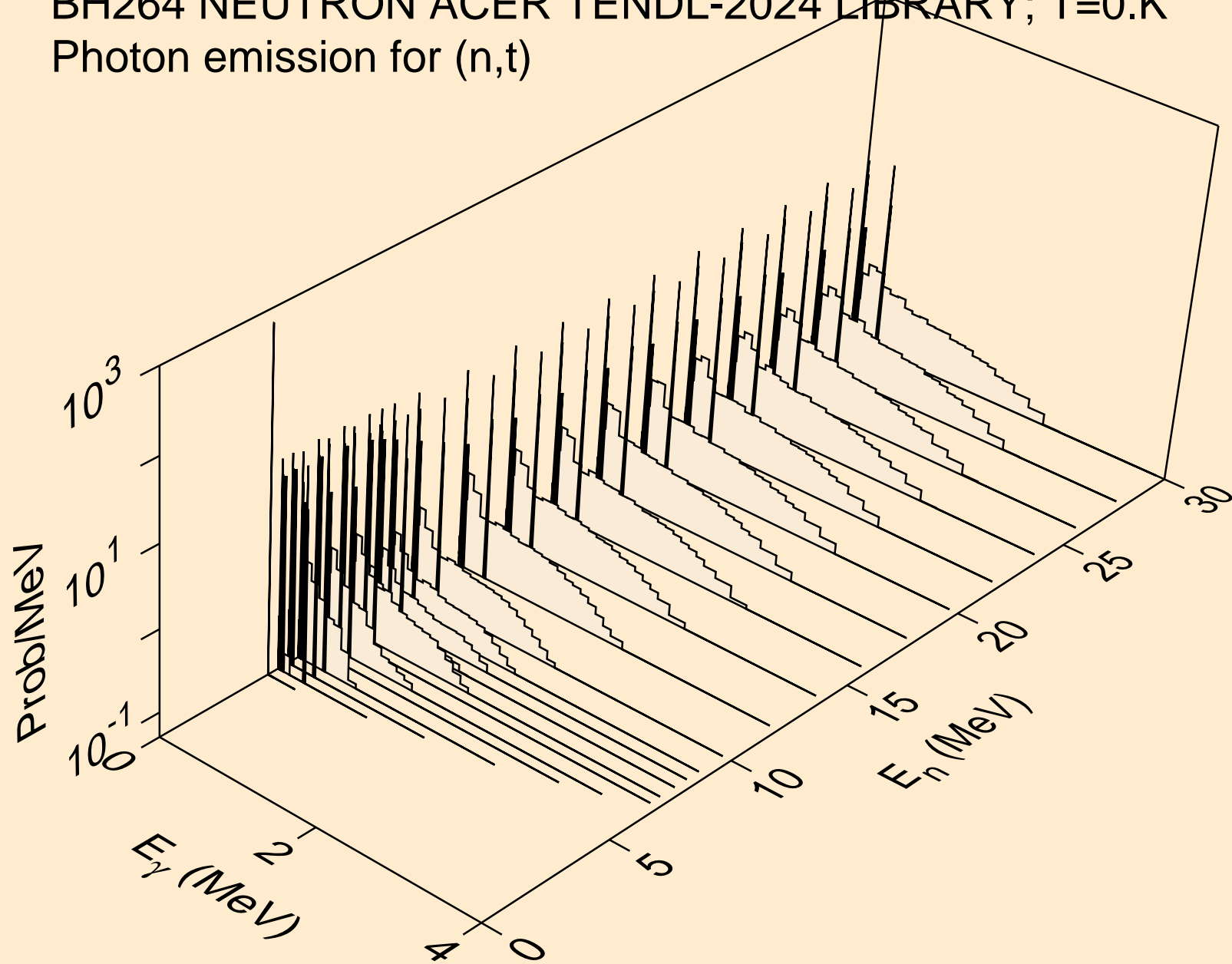

BH264 NEUTRON ACER TENDL-2024 LIBRARY; T=0.K  
Photon emission for (n,he3)

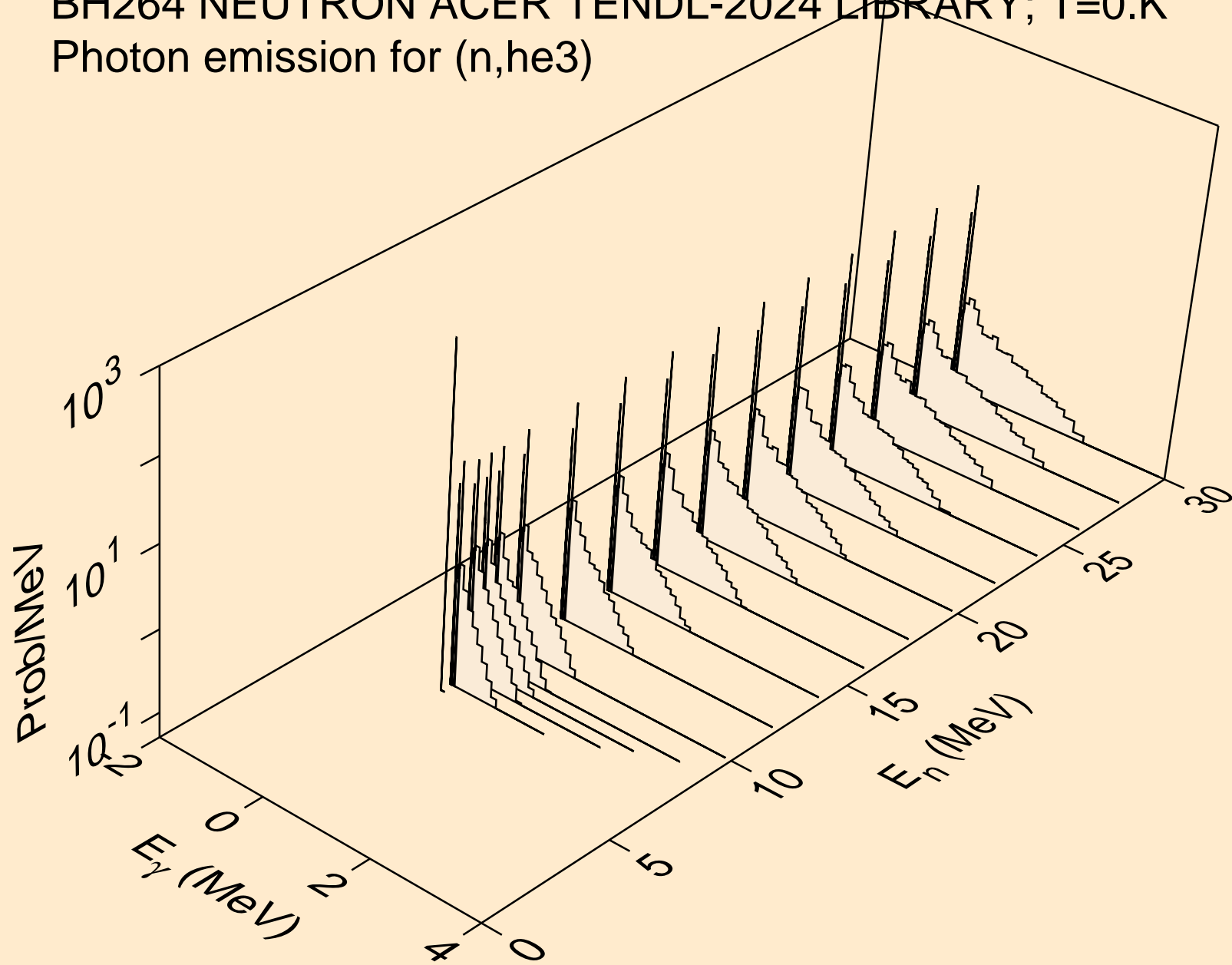

BH264 NEUTRON ACER TENDL-2024 LIBRARY; T=0.K  
Photon emission for (n,a)

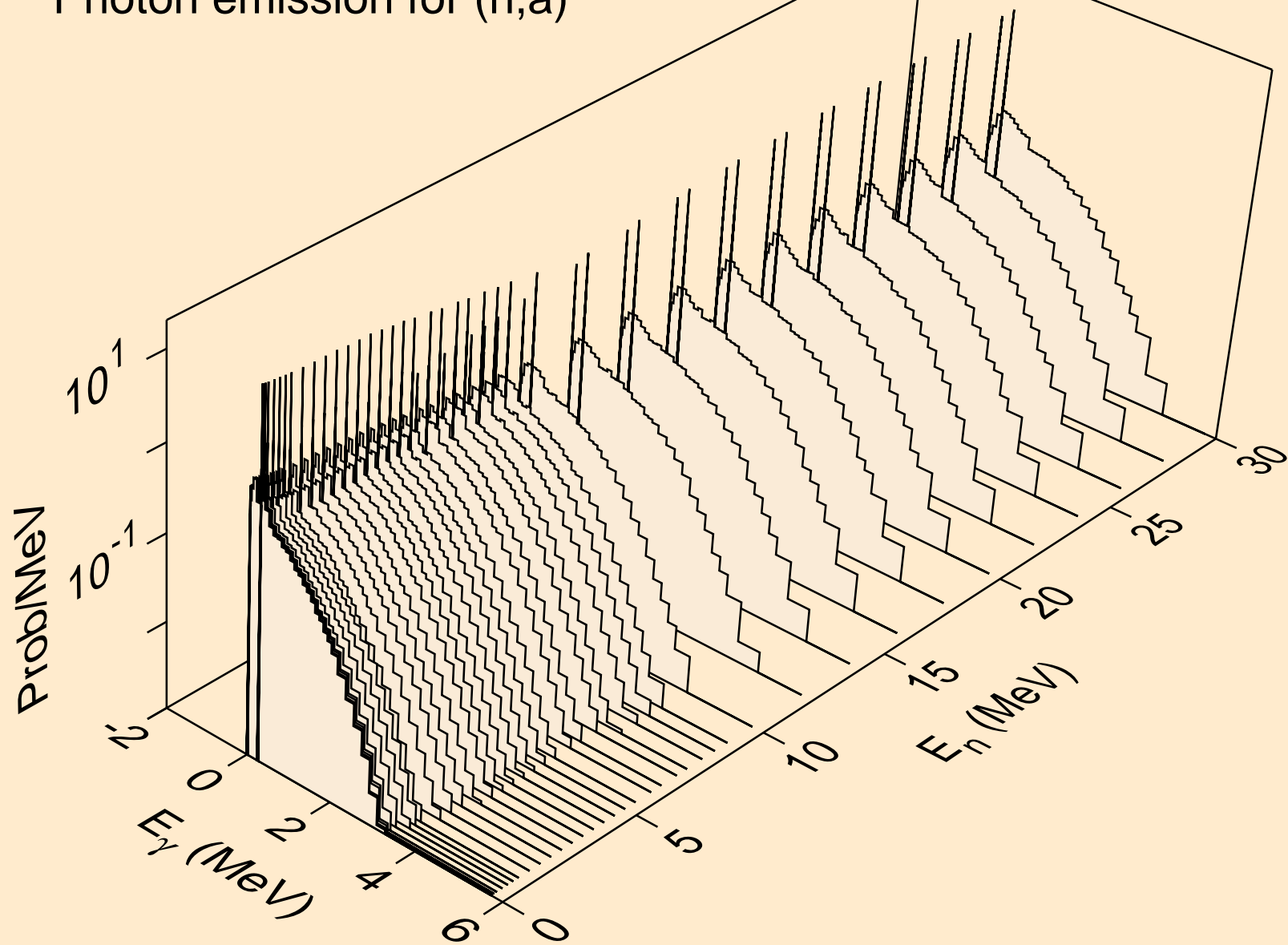

BH264 NEUTRON ACER TENDL-2024 LIBRARY; T=0.K  
Photon emission for (n,2a)

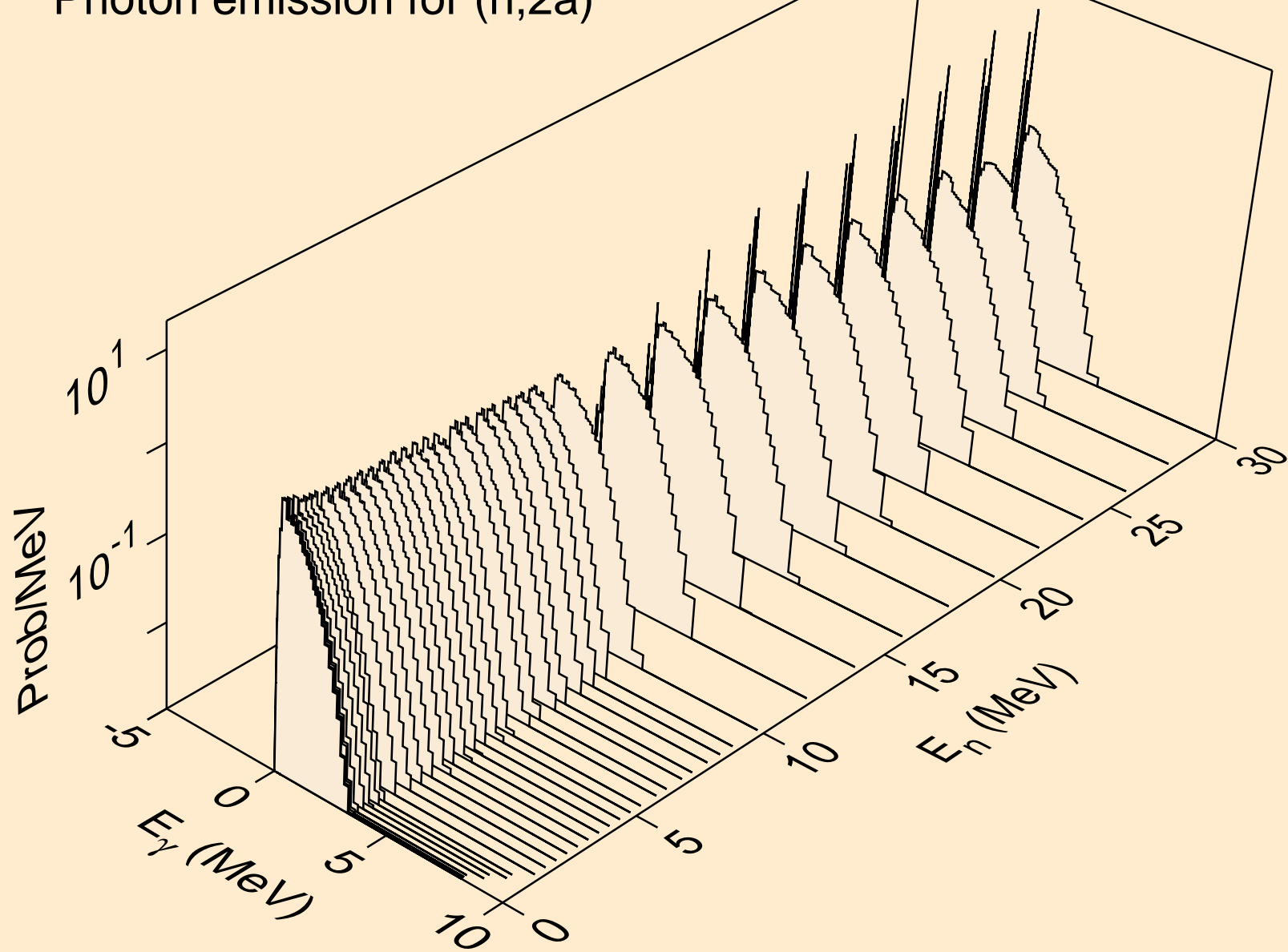

BH264 NEUTRON ACER TENDL-2024 LIBRARY; T=0.K  
Photon emission for (n,2p)

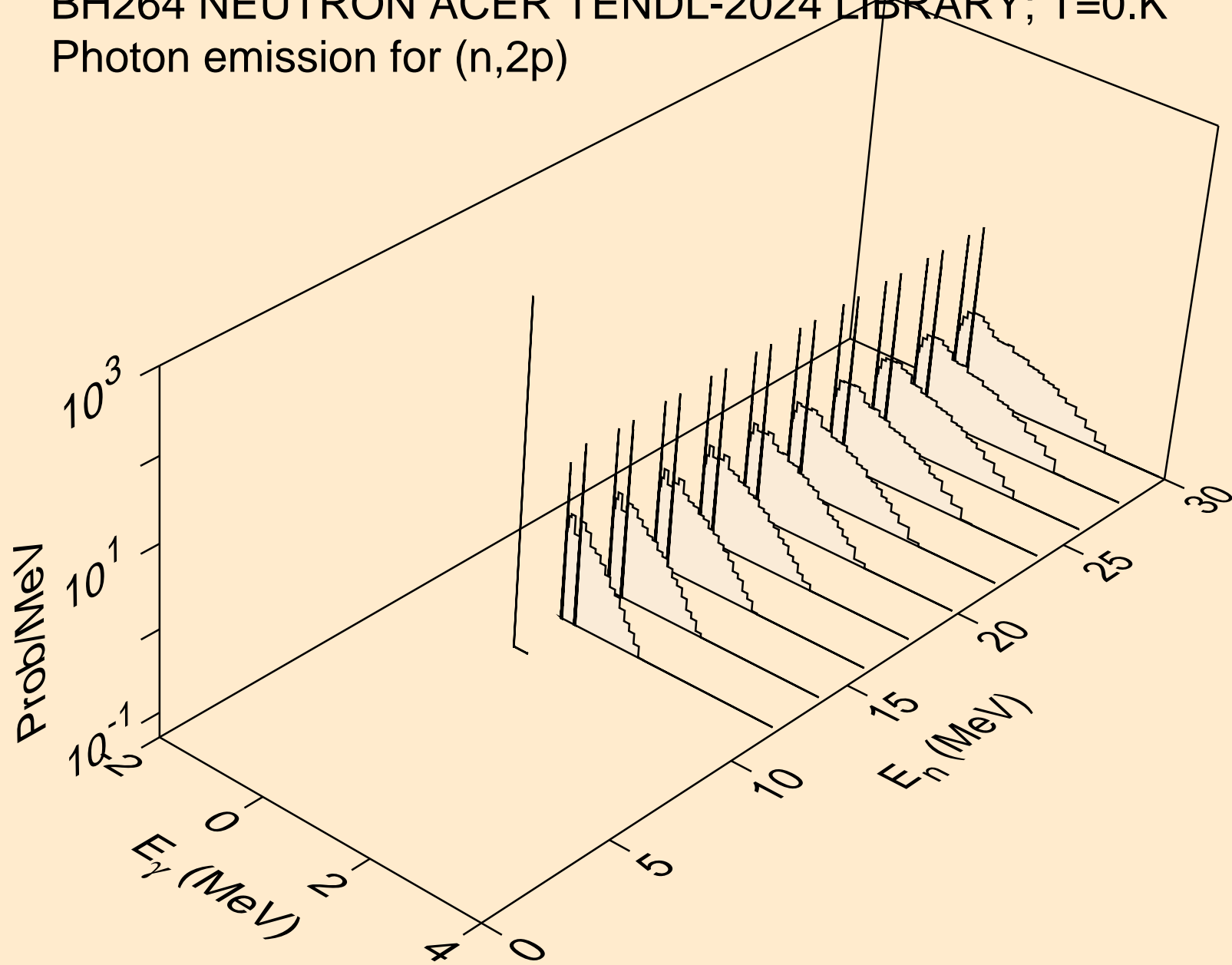

BH264 NEUTRON ACER TENDL-2024 LIBRARY; T=0.K  
Photon emission for (n,p $\alpha$ )

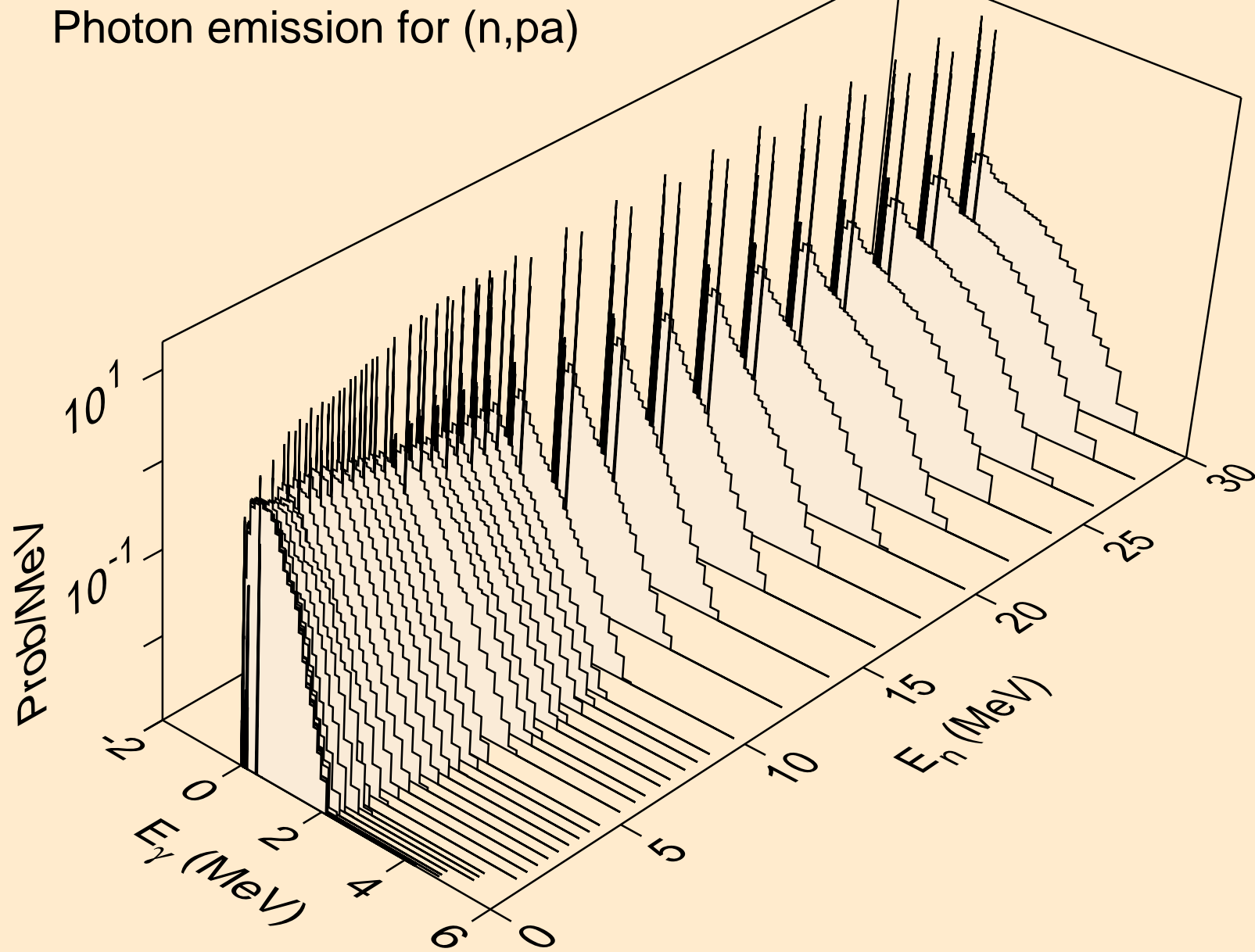

BH264 NEUTRON ACER TENDL-2024 LIBRARY; T=0.K  
Photon emission for (n,pd)

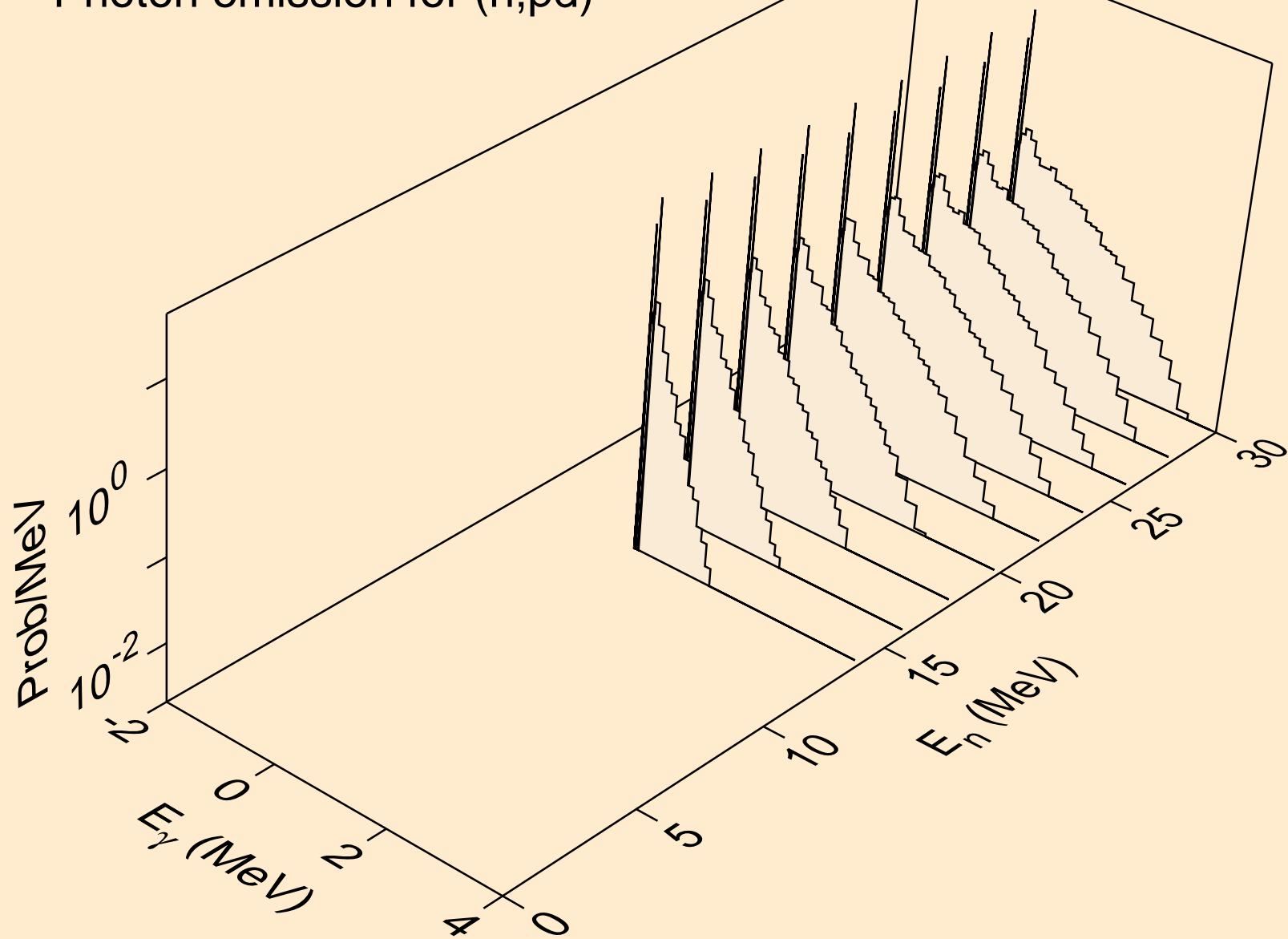

BH264 NEUTRON ACER TENDL-2024 LIBRARY; T=0.K  
Photon emission for (n,da)

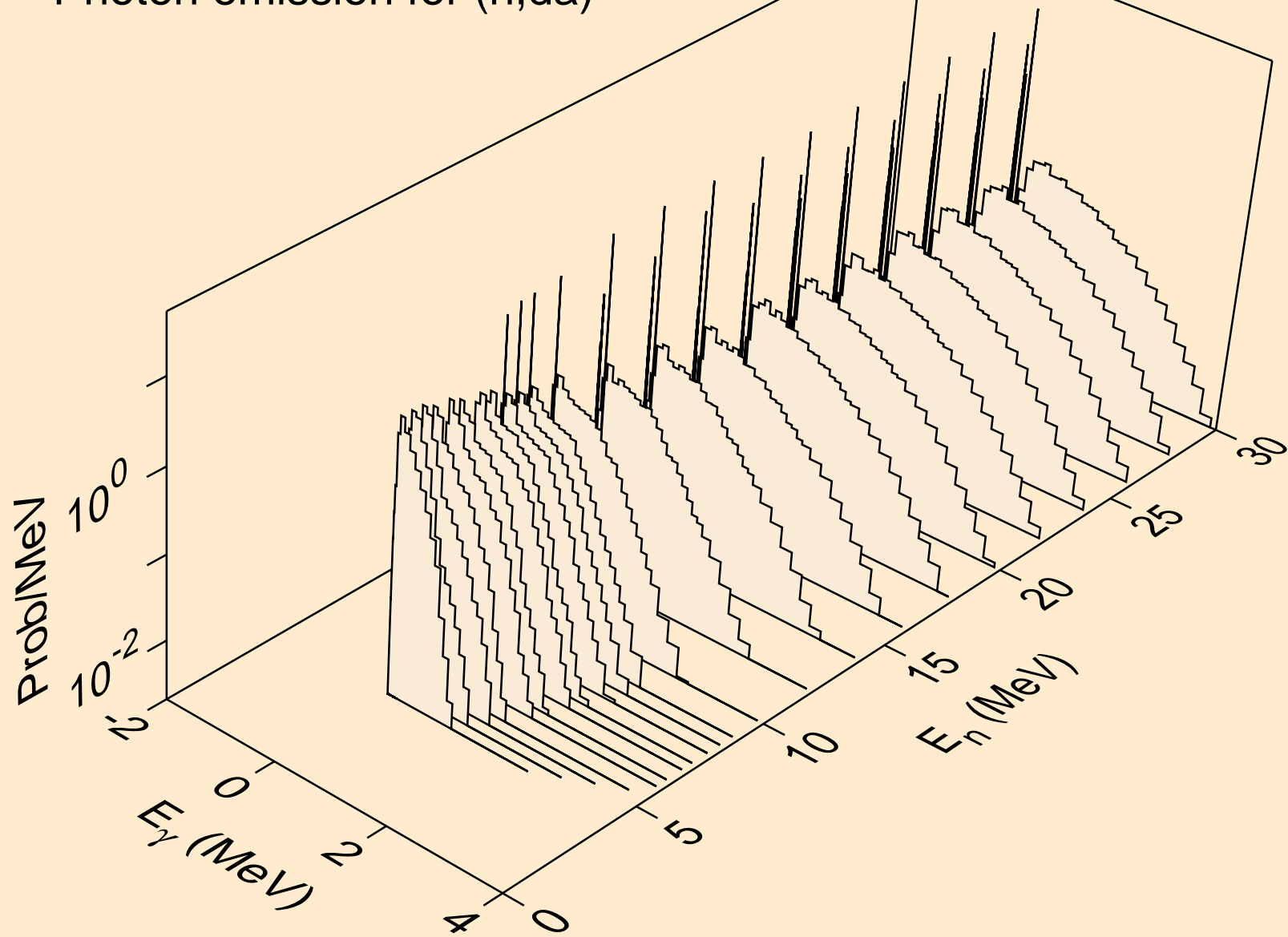



BH264 NEUTRON ACER TENDL-2024 LIBRARY; T=0.K  
thermal capture photon spectrum

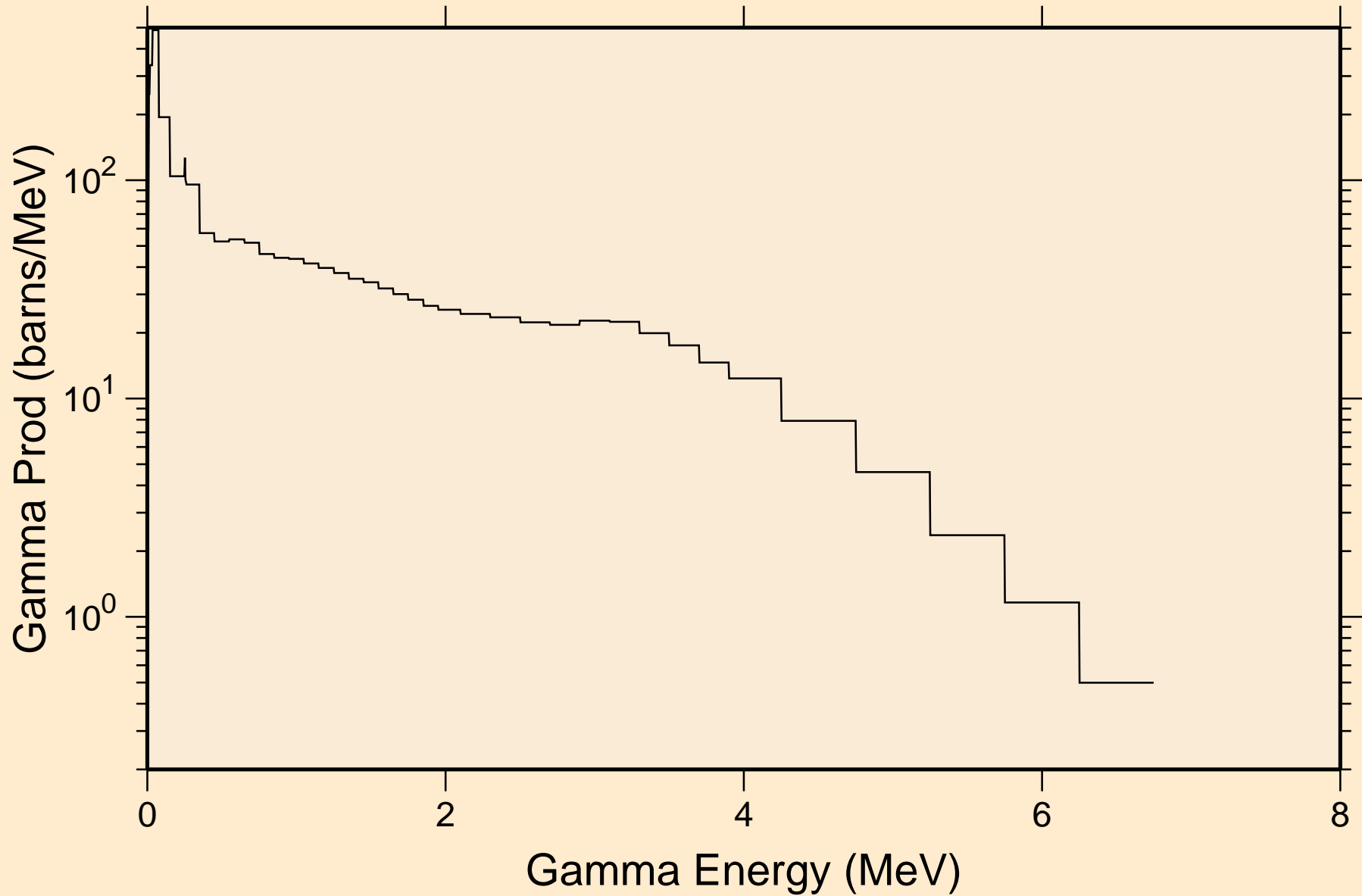

BH264 NEUTRON ACER TENDL-2024 LIBRARY; T=0.K  
14 MeV photon spectrum

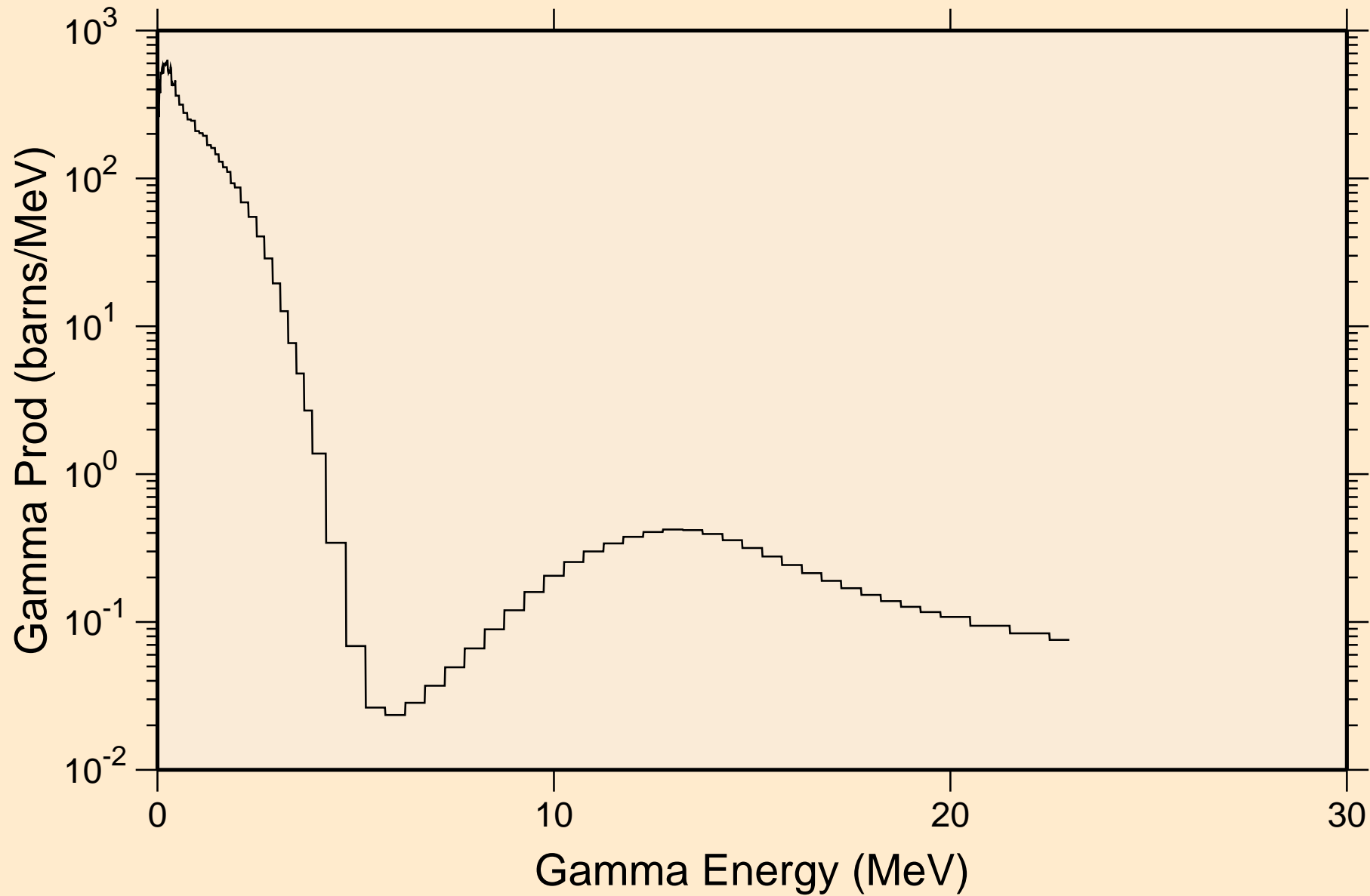

# BH264 NEUTRON ACER TENDL-2024 LIBRARY; T=0.K

## Particle heating contributions

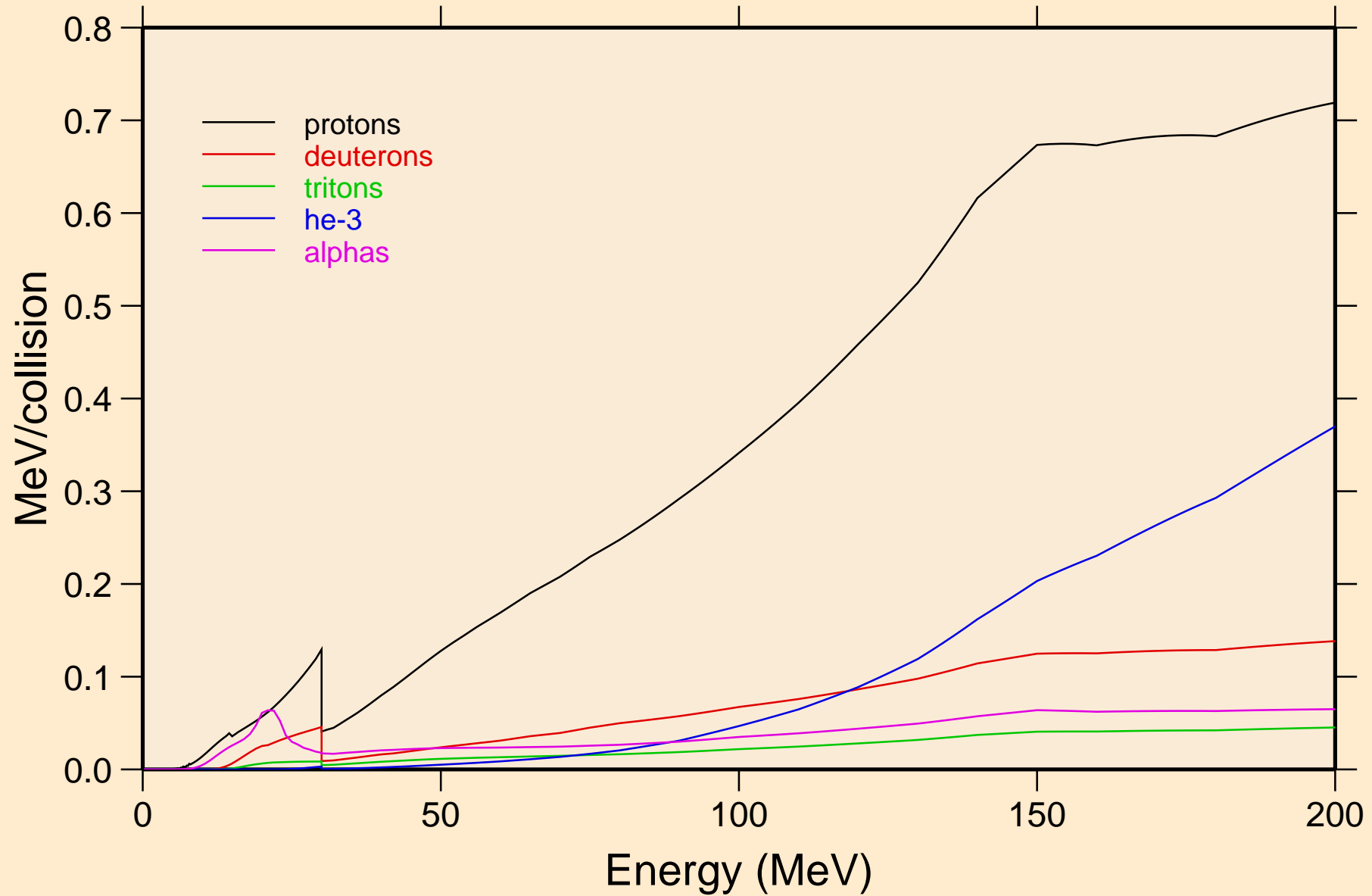

BH264 NEUTRON ACER TENDL-2024 LIBRARY; T=0.K  
Recoil Heating

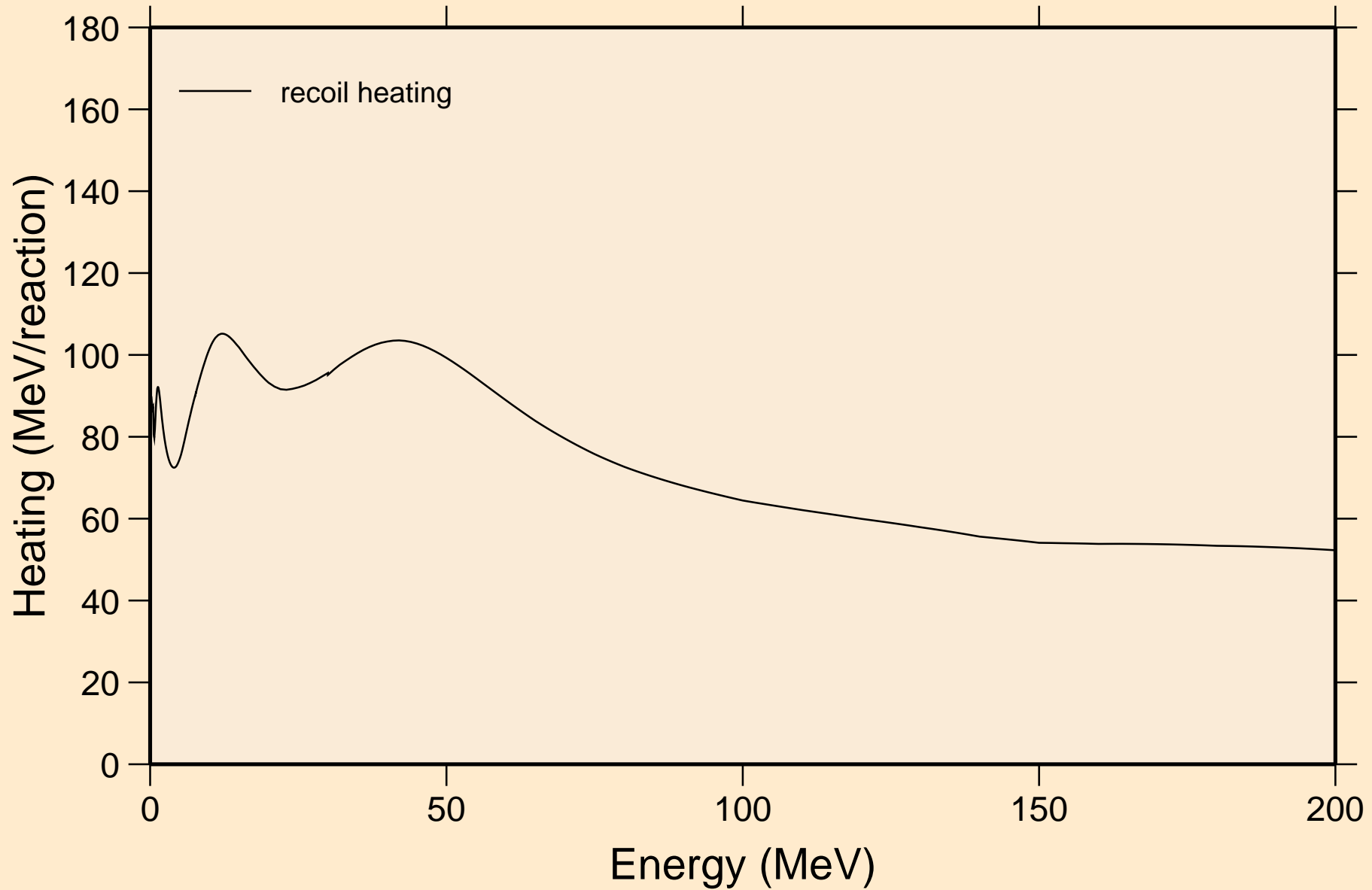

# BH264 NEUTRON ACER TENDL-2024 LIBRARY; T=0.K

## Particle production cross sections

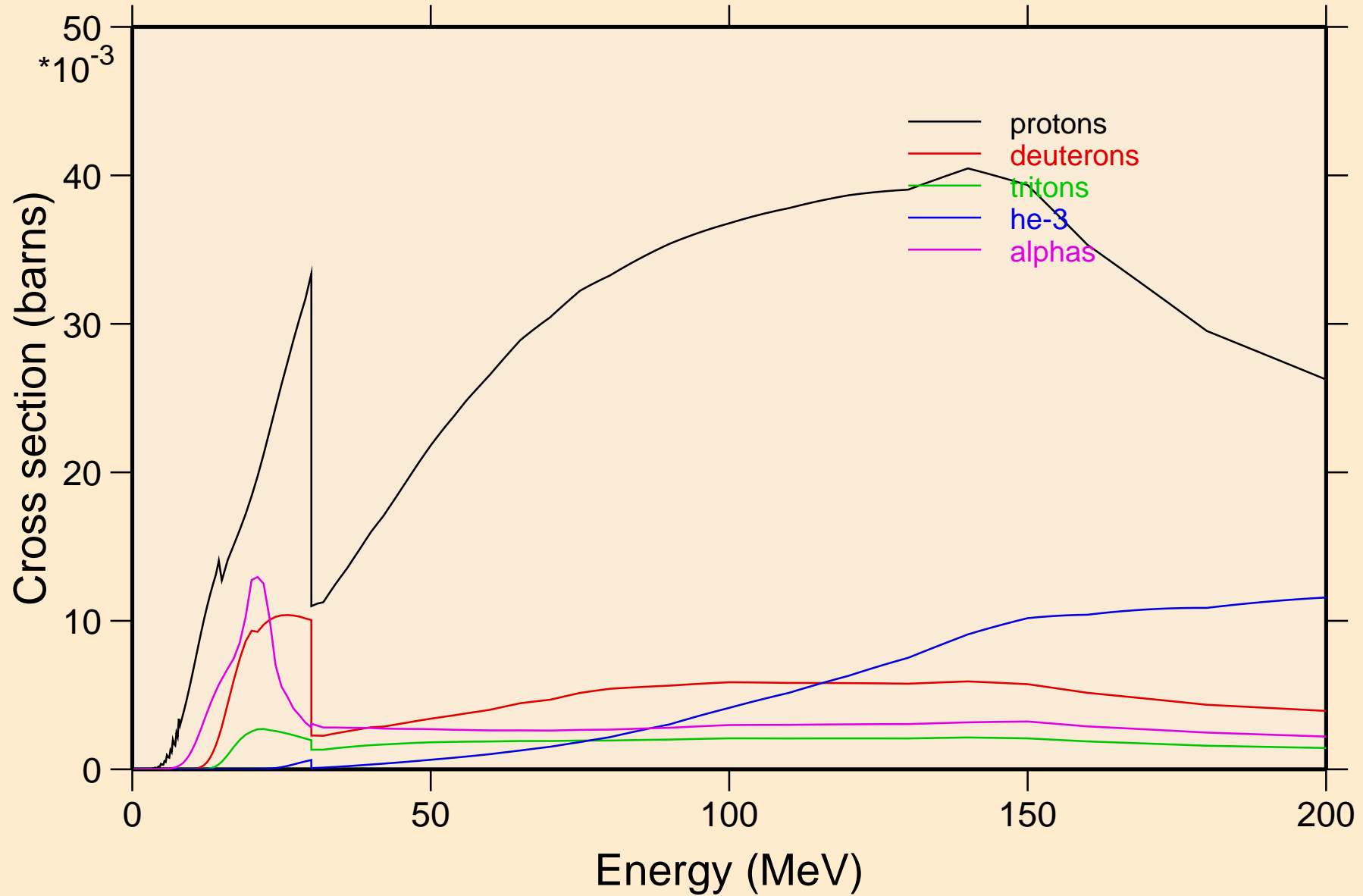

BH264 NEUTRON ACER TENDL-2024 LIBRARY; T=0.K  
protons from (n,x)

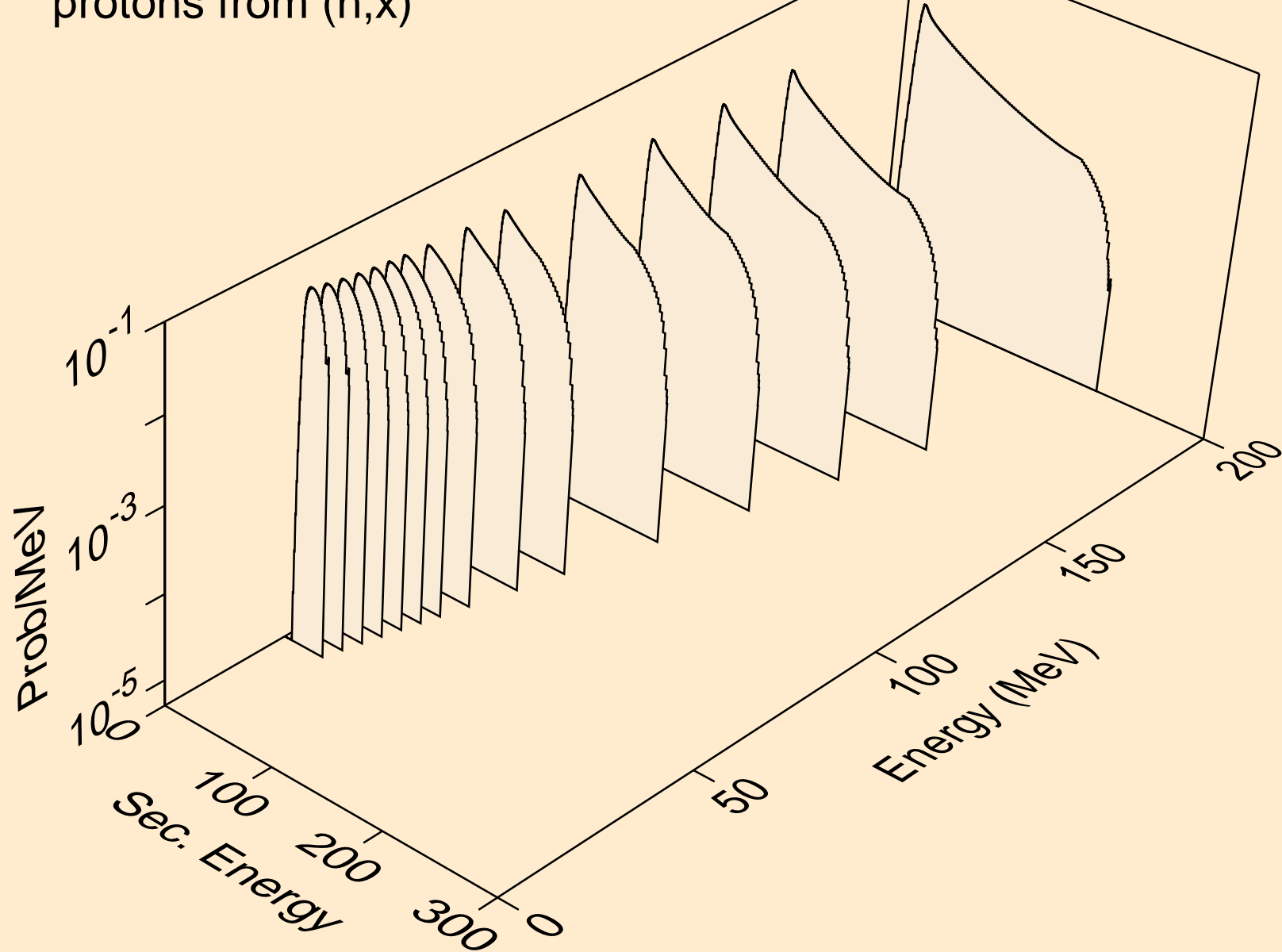

BH264 NEUTRON ACER TENDL-2024 LIBRARY; T=0.K  
protons from (n,n\*)p

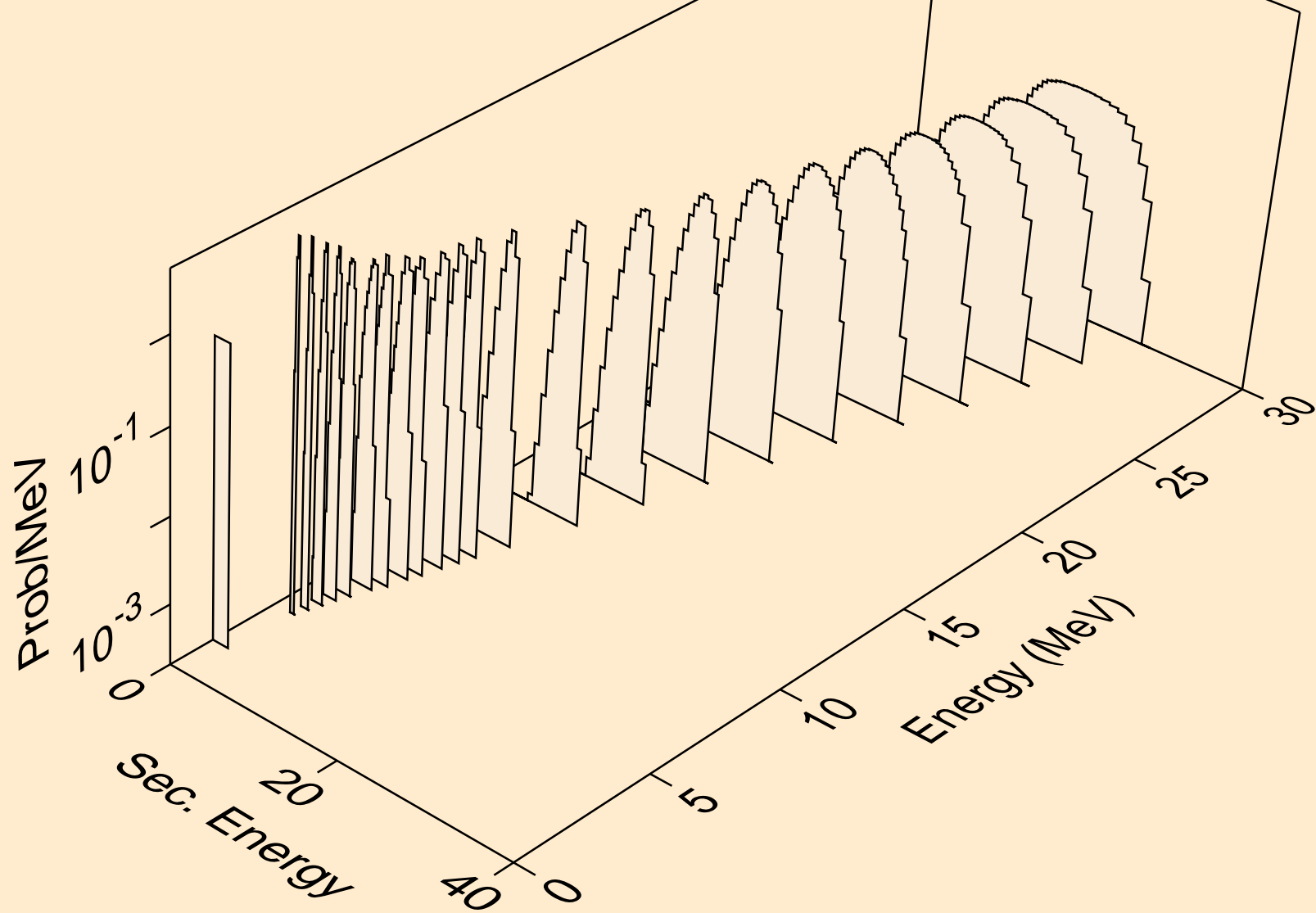

BH264 NEUTRON ACER TENDL-2024 LIBRARY; T=0.K  
protons from (n,2np)

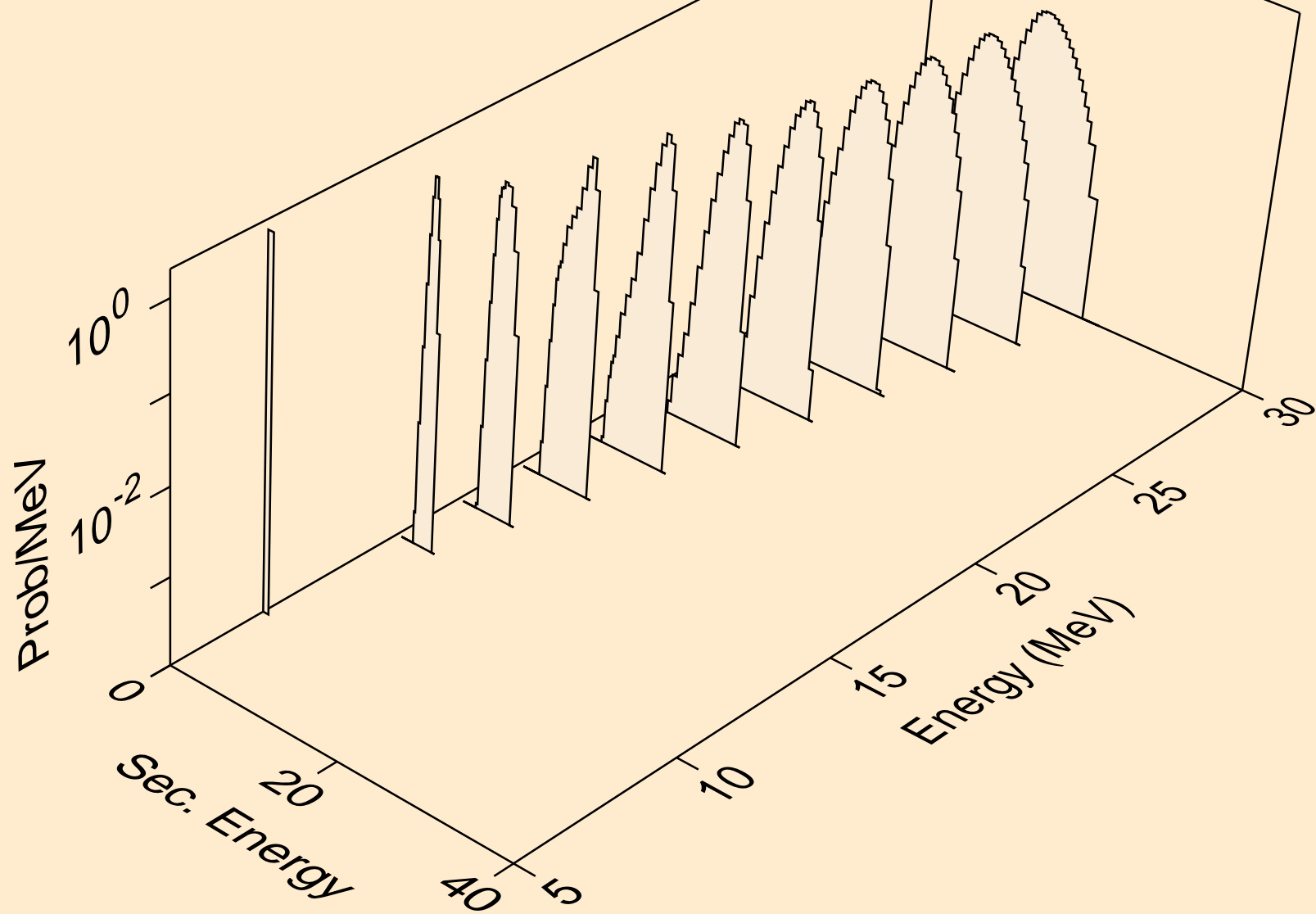



BH264 NEUTRON ACER TENDL-2024 LIBRARY; T=0.K  
protons from (n,3np)

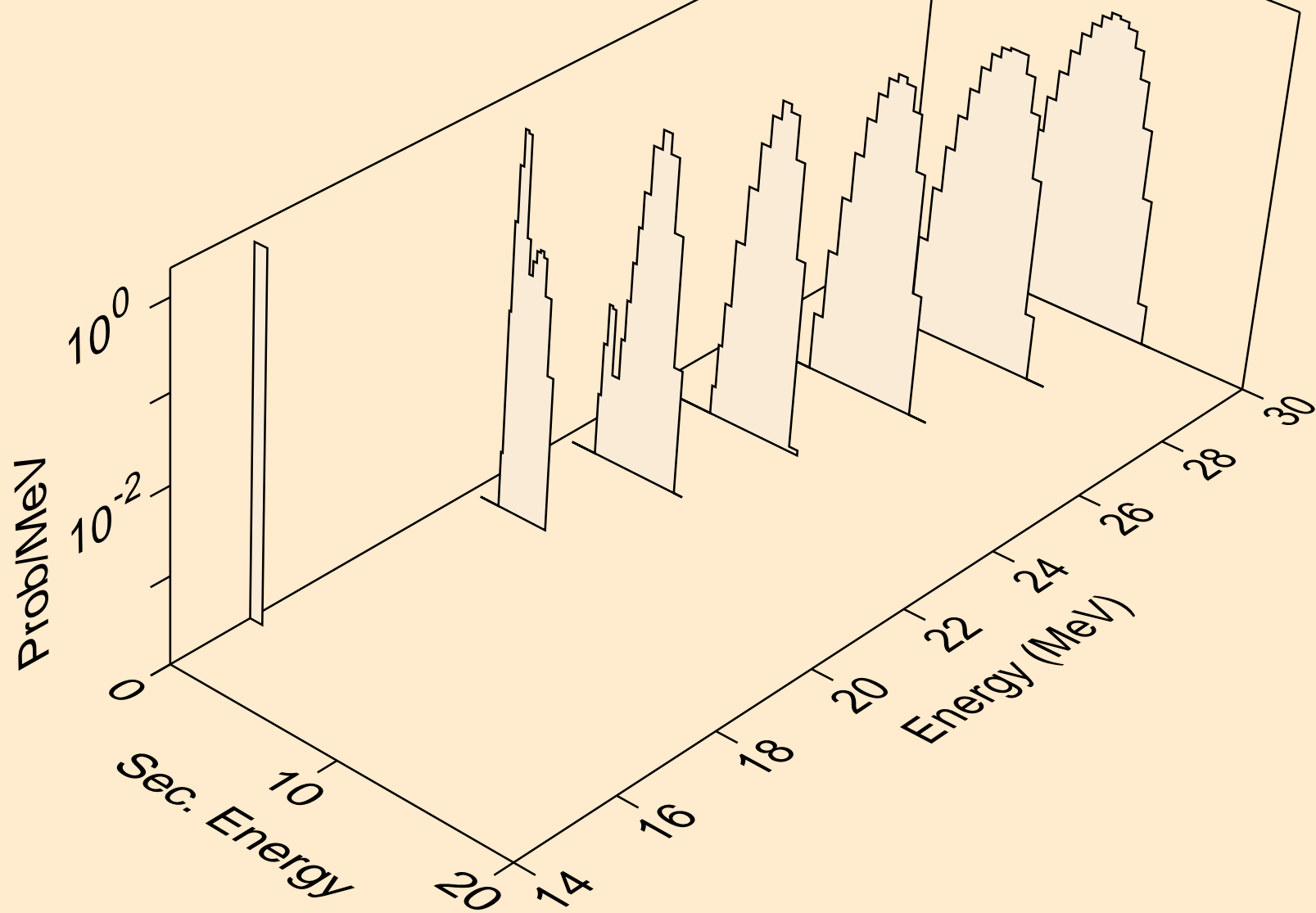

BH264 NEUTRON ACER TENDL-2024 LIBRARY; T=0.K  
protons from (n,n2p)

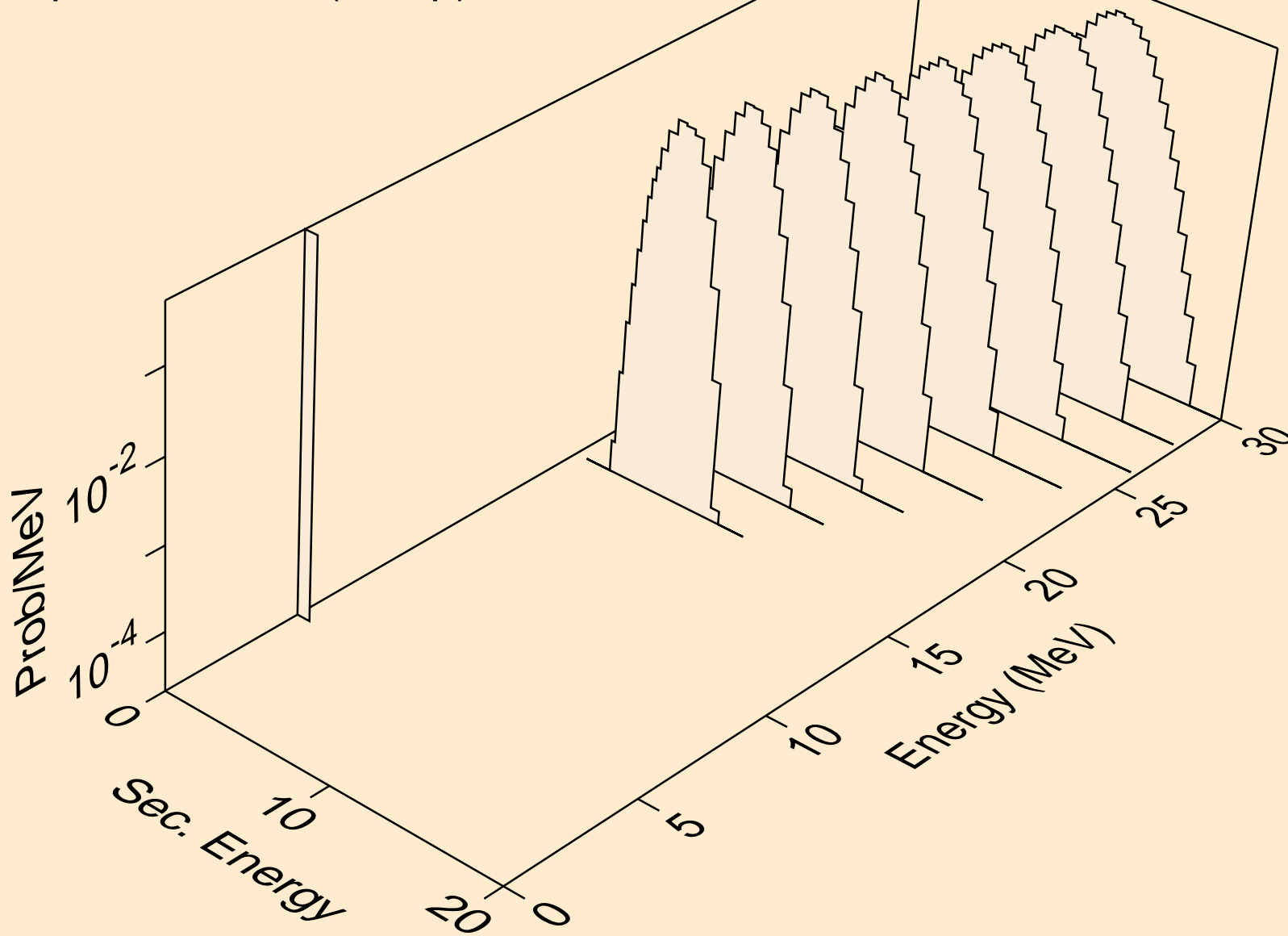

BH264 NEUTRON ACER TENDL-2024 LIBRARY; T=0.K  
protons from (n,npa)

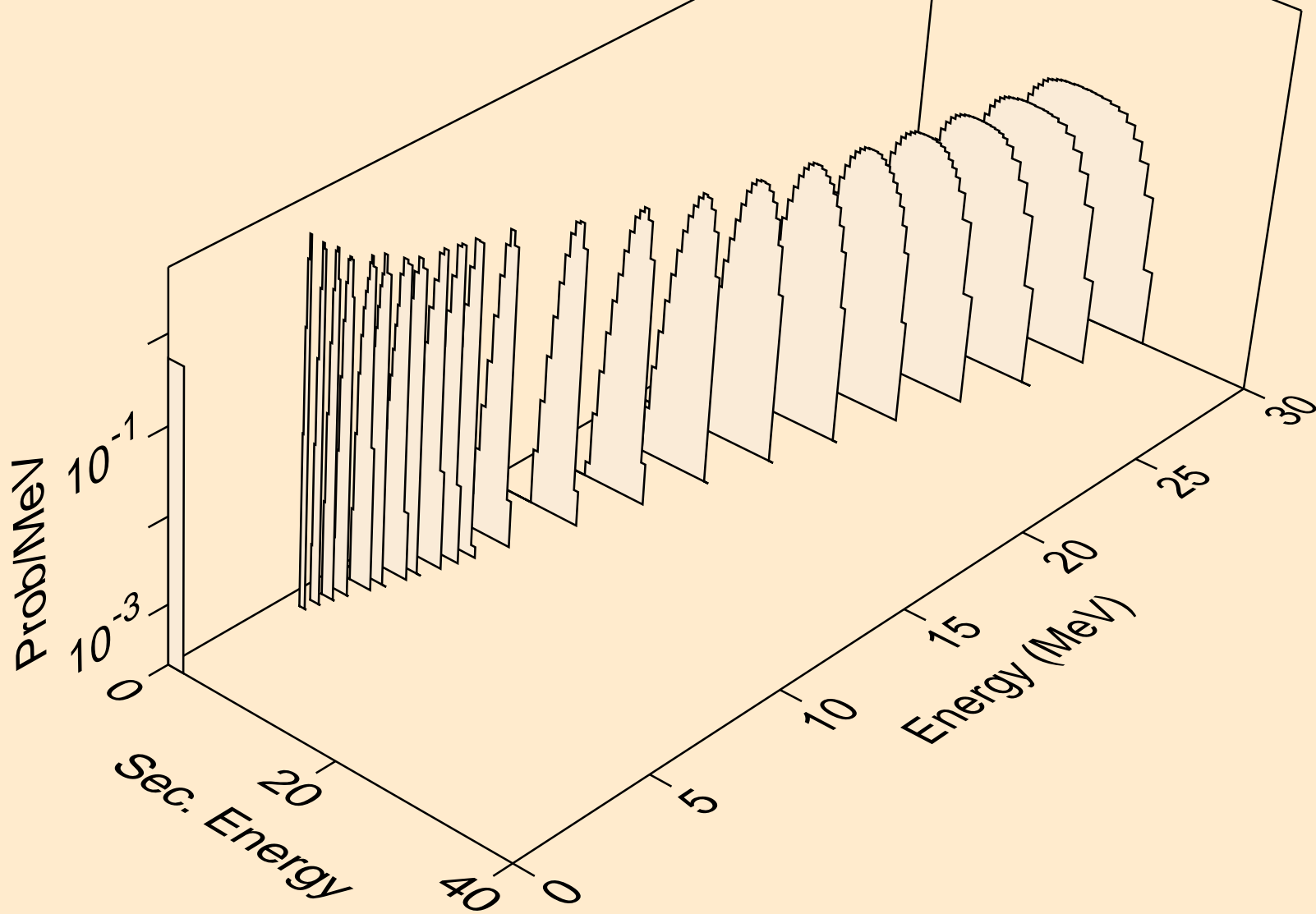

BH264 NEUTRON ACER TENDL-2024 LIBRARY; T=0.K  
protons from (n,p)

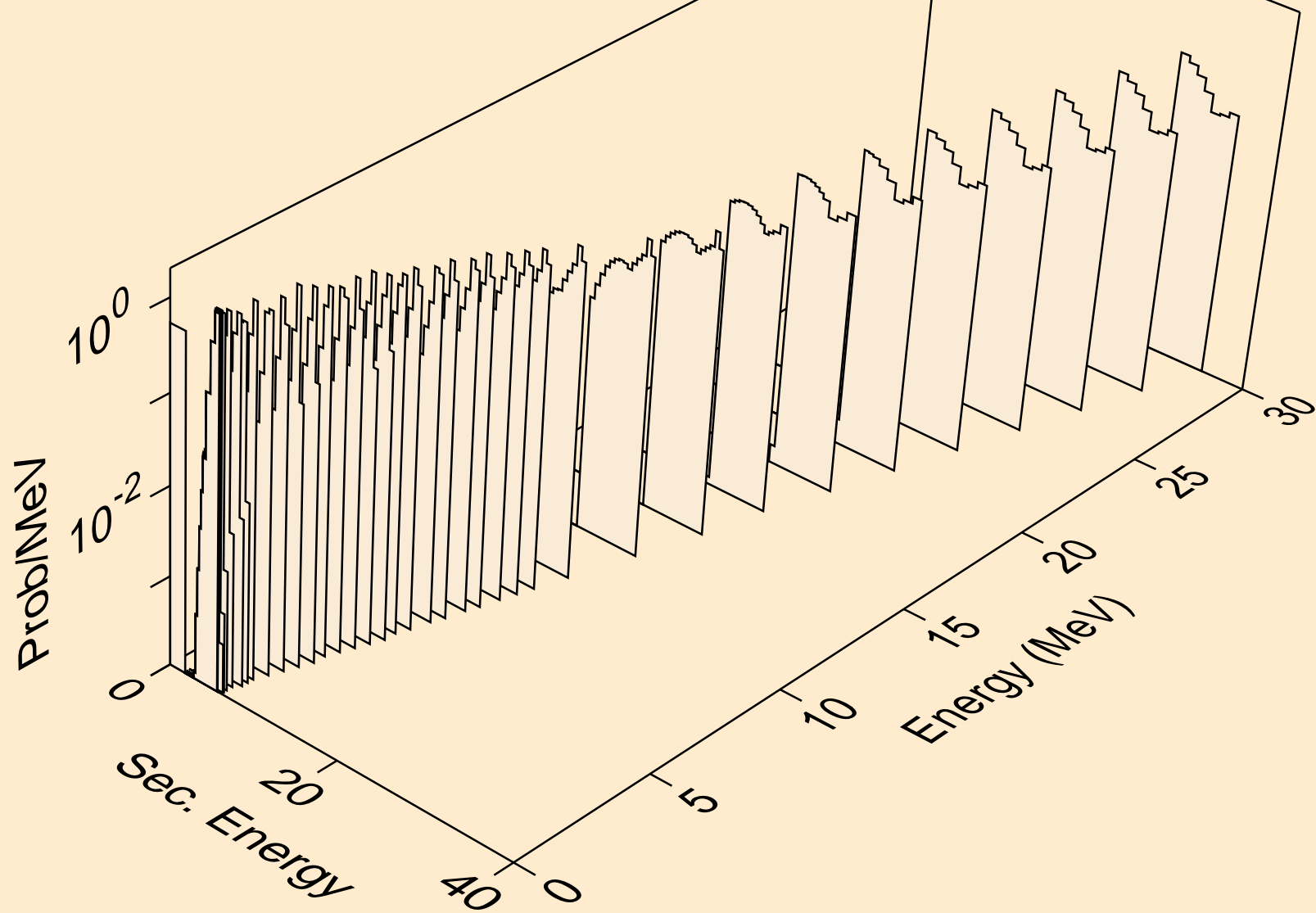

BH264 NEUTRON ACER TENDL-2024 LIBRARY; T=0.K  
protons from (n,2p)

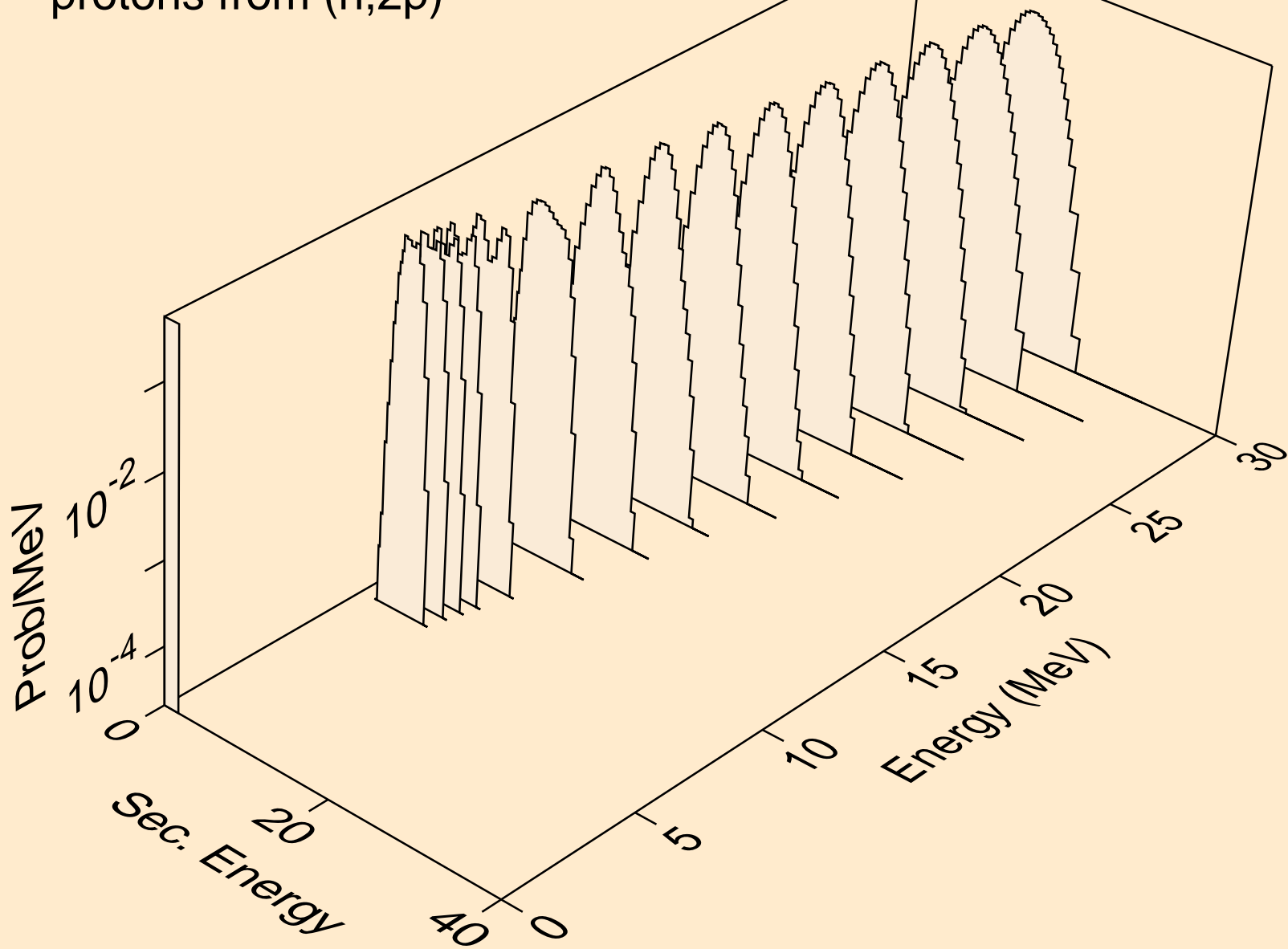

BH264 NEUTRON ACER TENDL-2024 LIBRARY; T=0.K  
protons from (n,p)

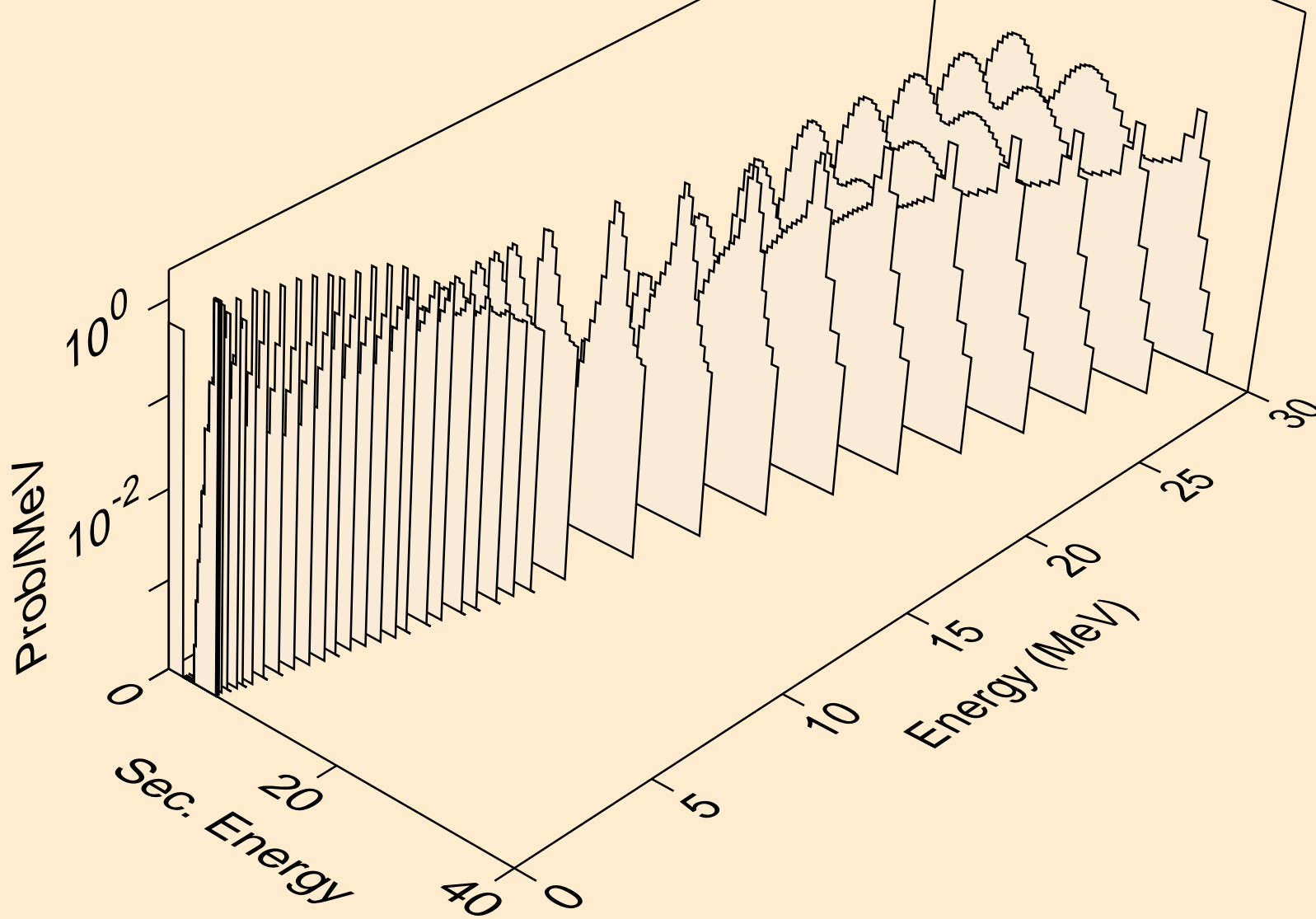

BH264 NEUTRON ACER TENDL-2024 LIBRARY; T=0.K  
protons from (n,pd)

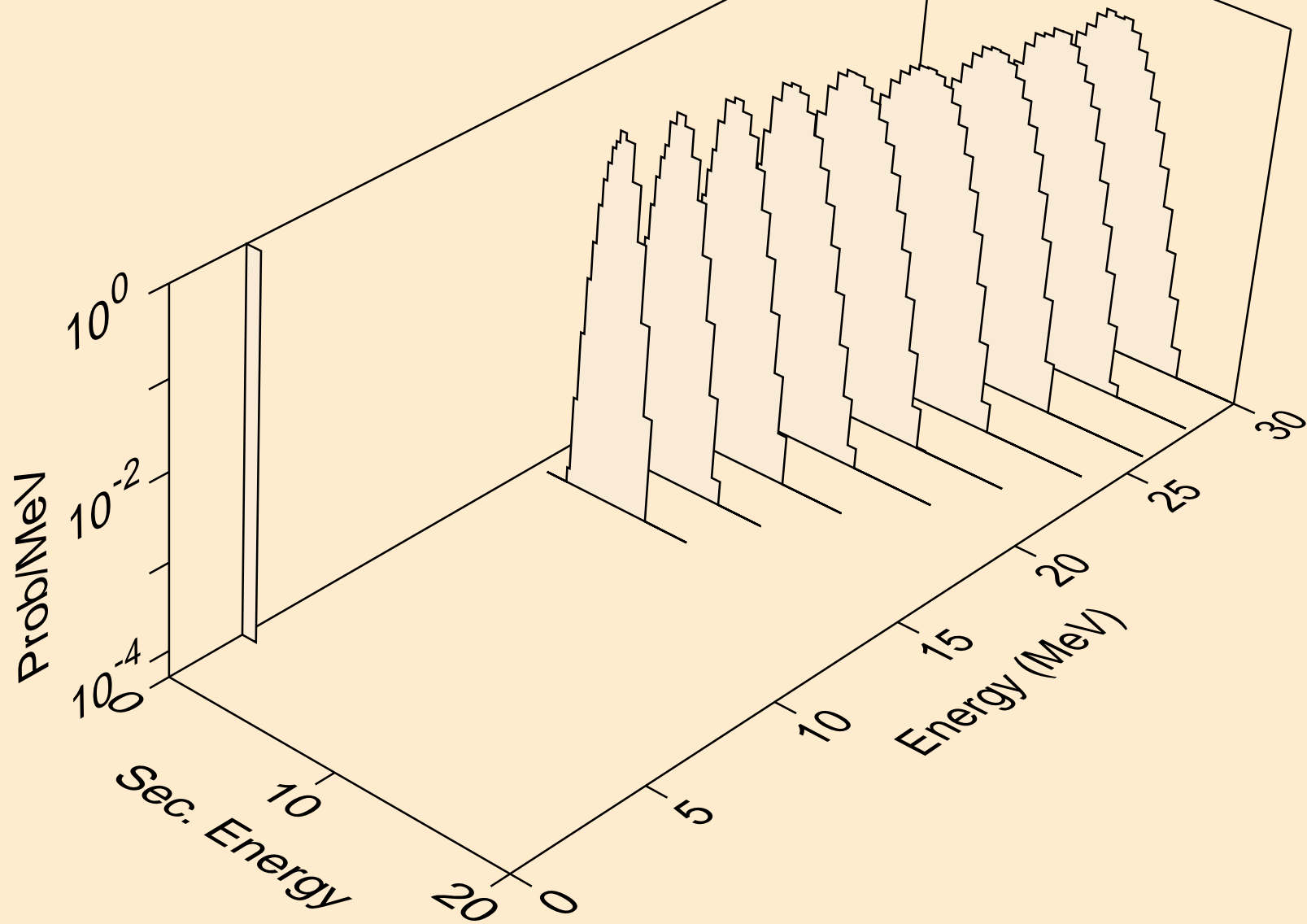

BH264 NEUTRON ACER TENDL-2024 LIBRARY; T=0.K  
deuterons from (n,x)

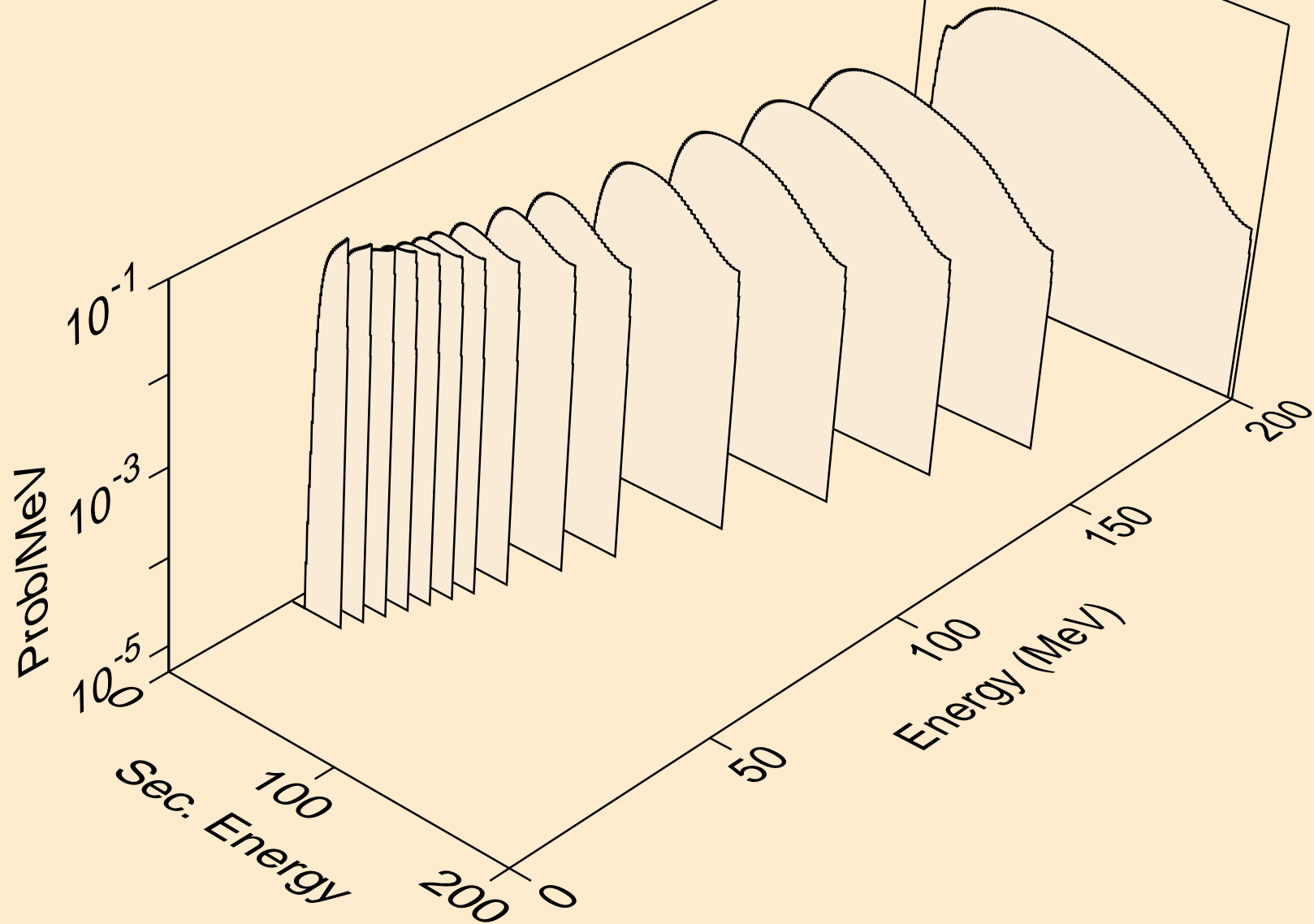



BH264 NEUTRON ACER TENDL-2024 LIBRARY; T=0.K  
deuterons from (n,2nd)

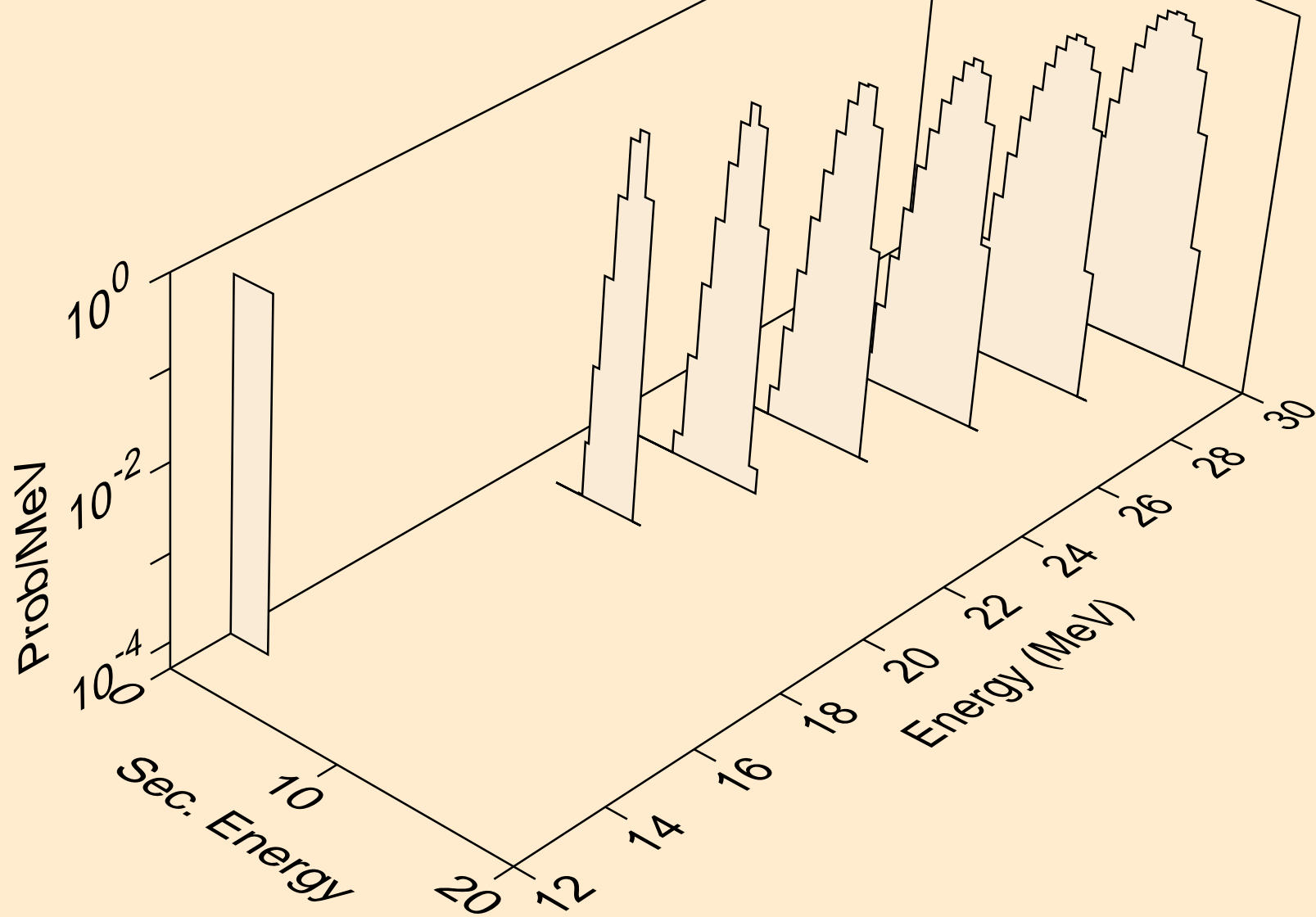

BH264 NEUTRON ACER TENDL-2024 LIBRARY; T=0.K  
deuterons from (n,n\*)d

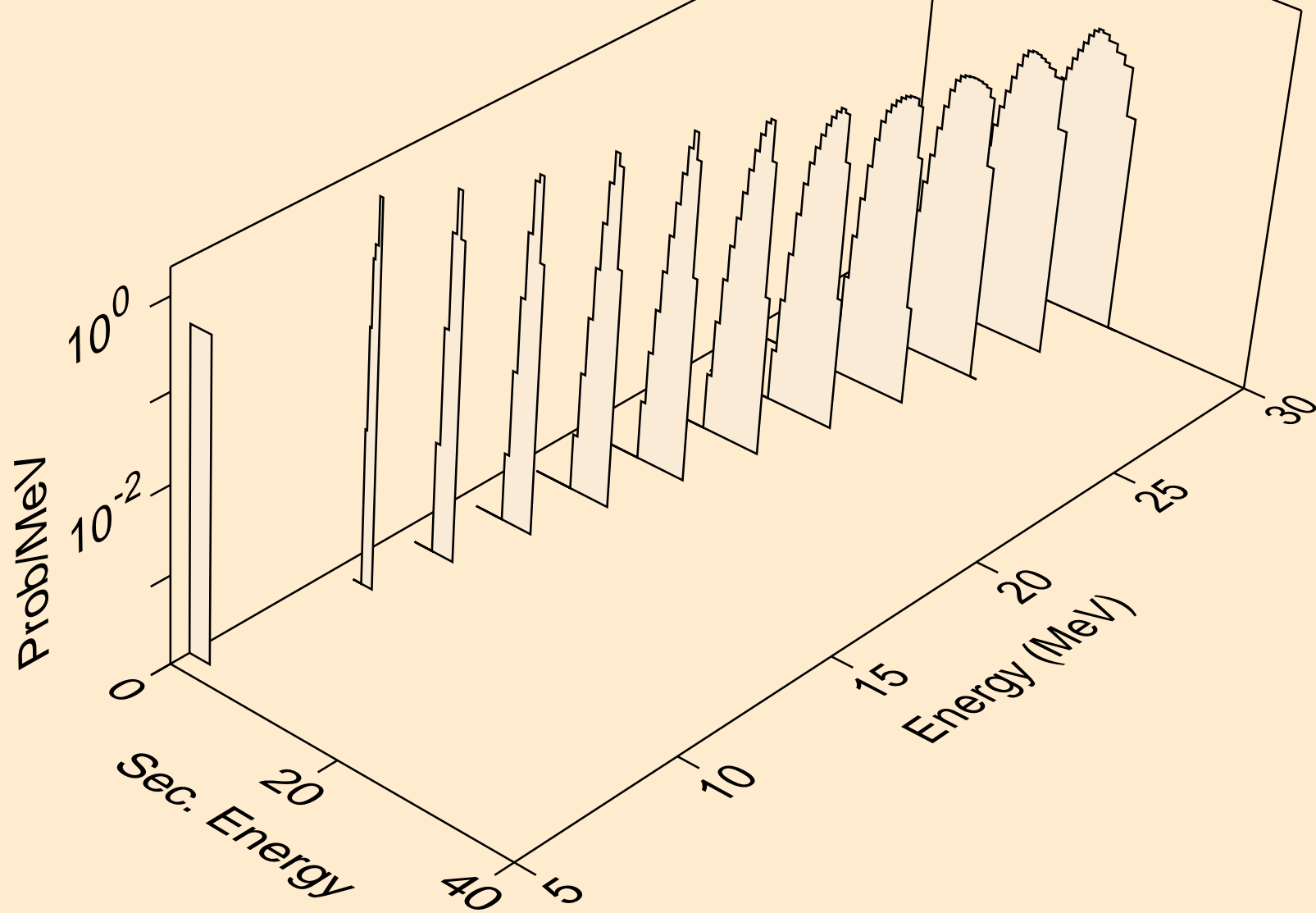

BH264 NEUTRON ACER TENDL-2024 LIBRARY; T=0.K  
deuterons from (n,d)

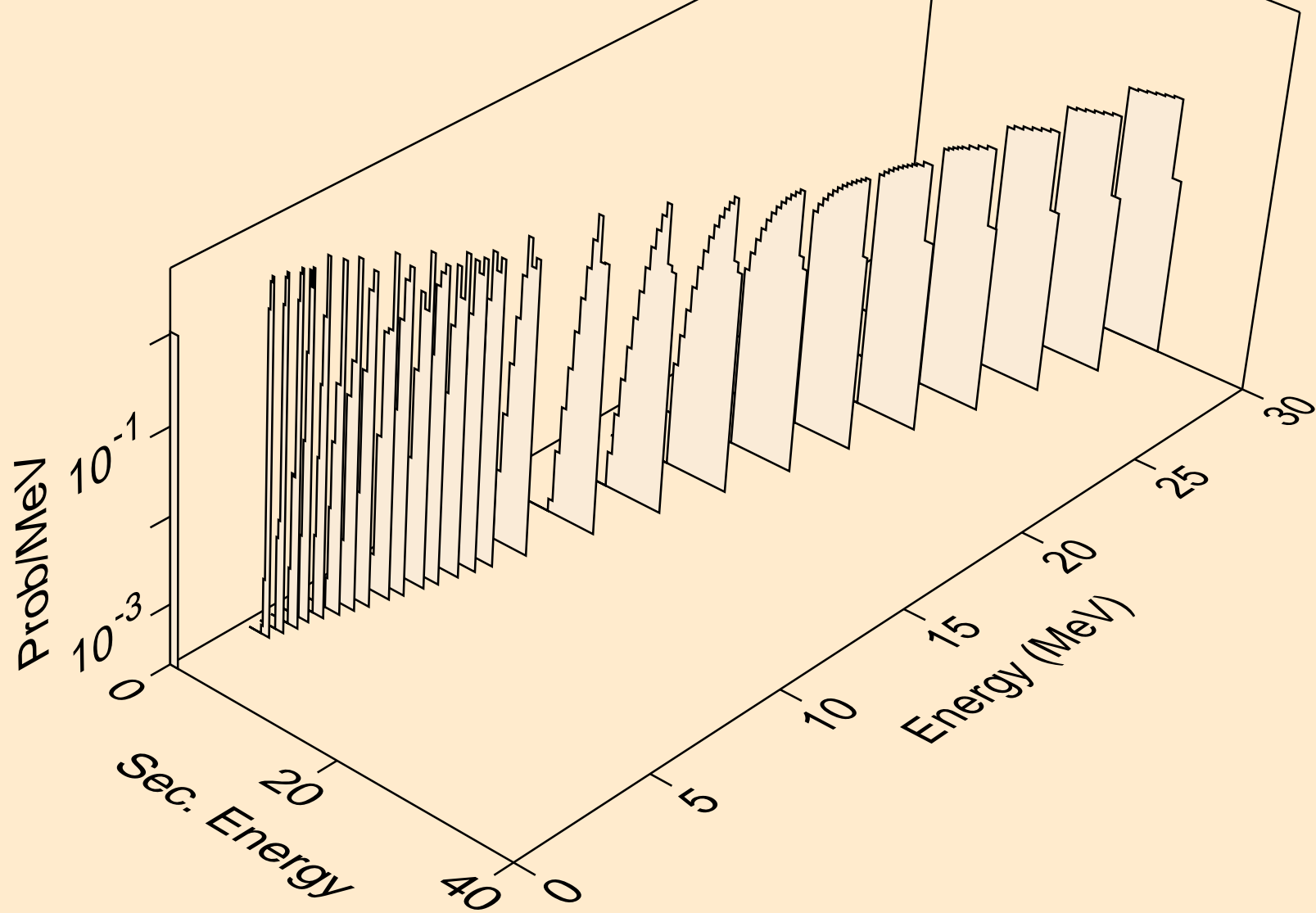

BH264 NEUTRON ACER TENDL-2024 LIBRARY; T=0.K  
deuterons from (n,pd)

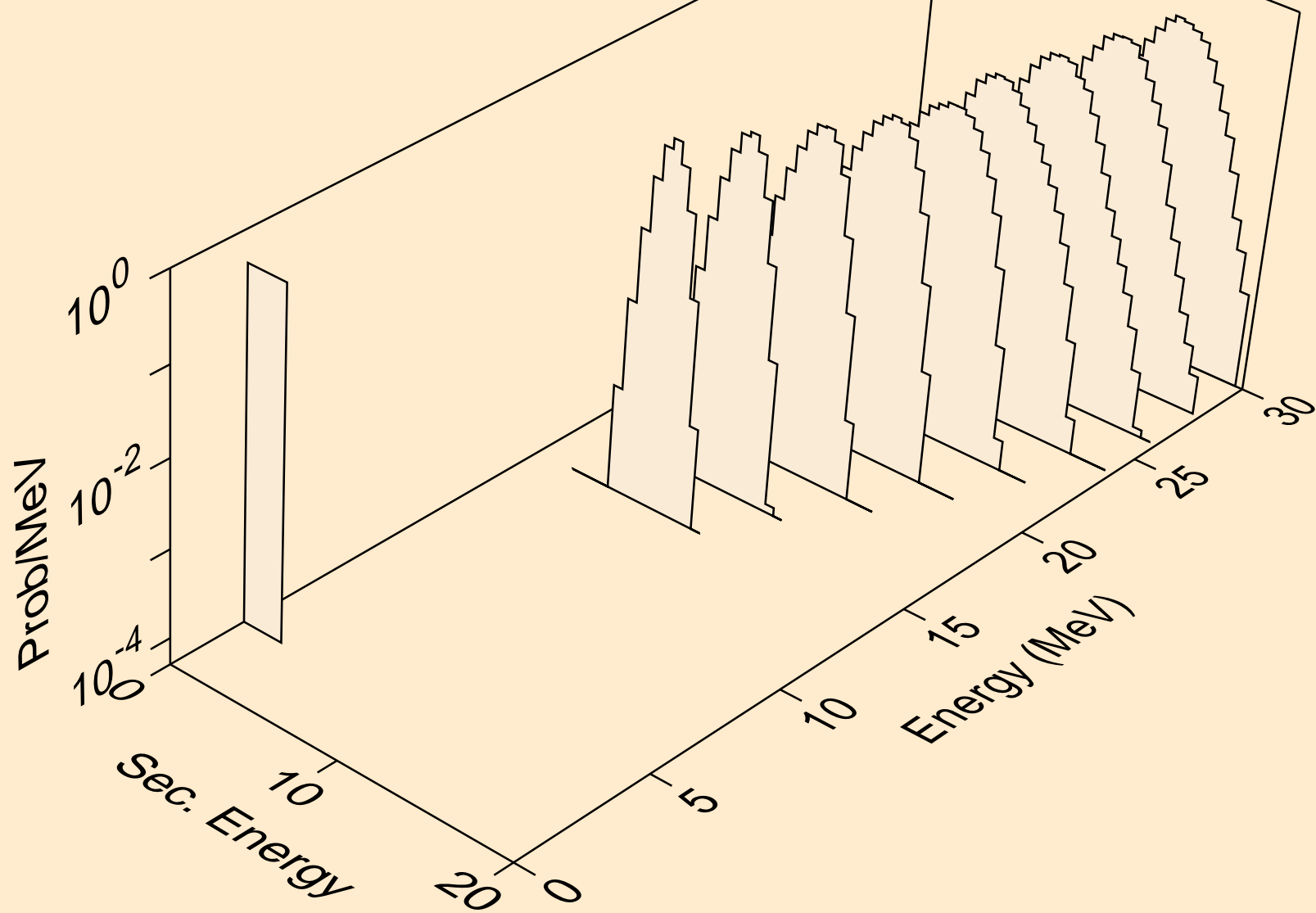

BH264 NEUTRON ACER TENDL-2024 LIBRARY; T=0.K  
deuterons from (n,da)

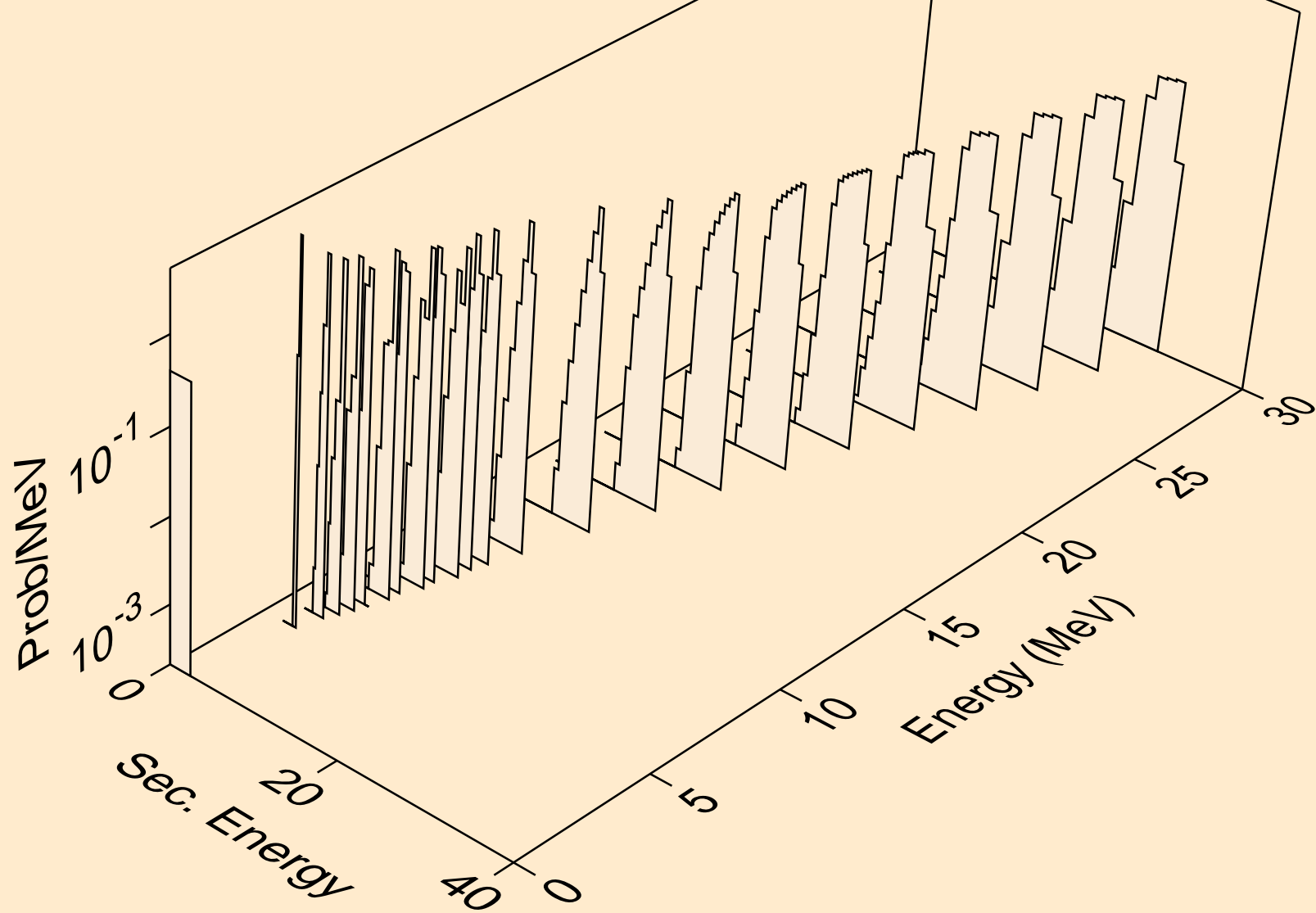

BH264 NEUTRON ACER TENDL-2024 LIBRARY; T=0.K  
tritons from (n,x)

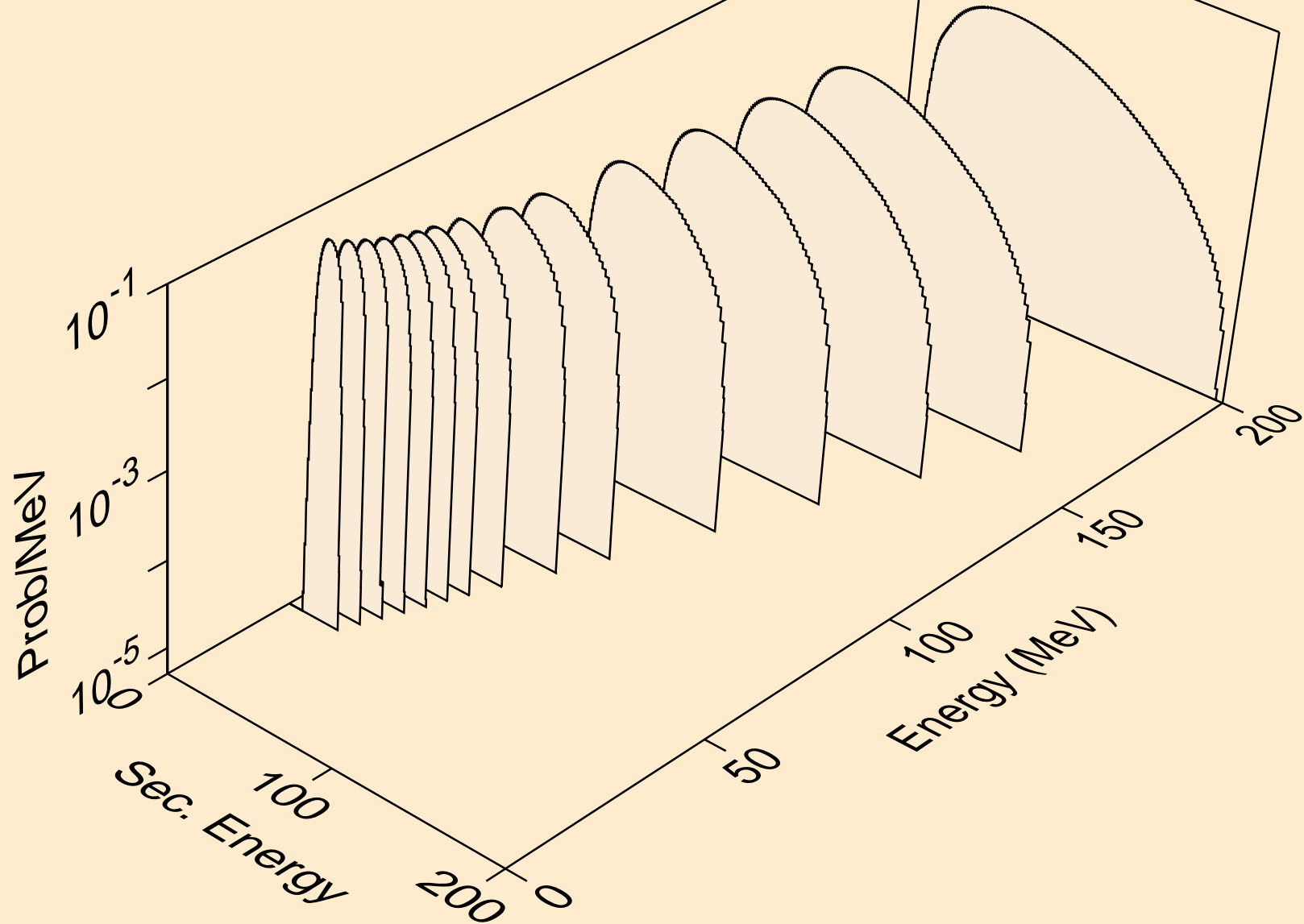

BH264 NEUTRON ACER TENDL-2024 LIBRARY; T=0.K  
tritons from (n,n\*)t

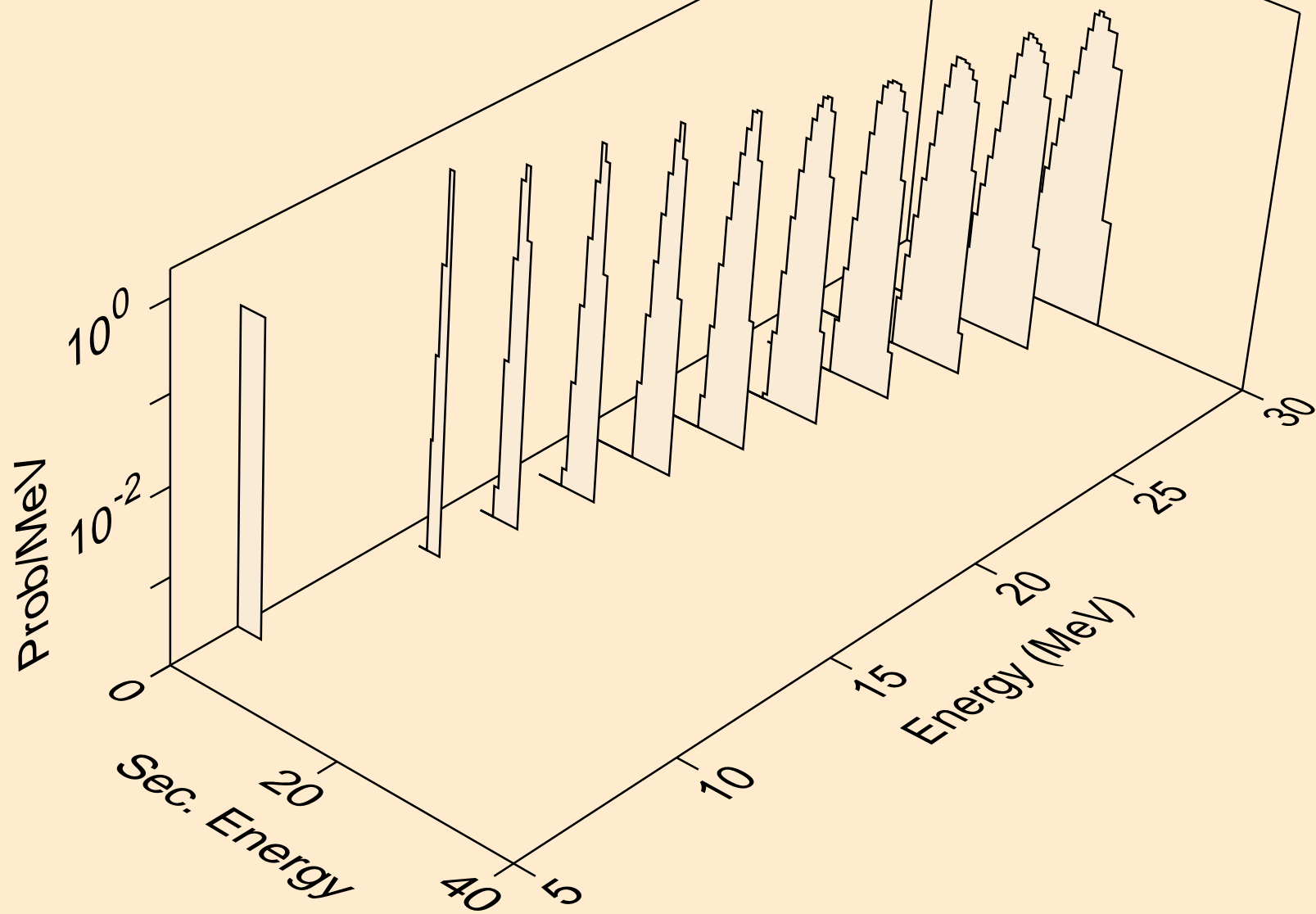

BH264 NEUTRON ACER TENDL-2024 LIBRARY; T=0.K  
tritons from (n,t)

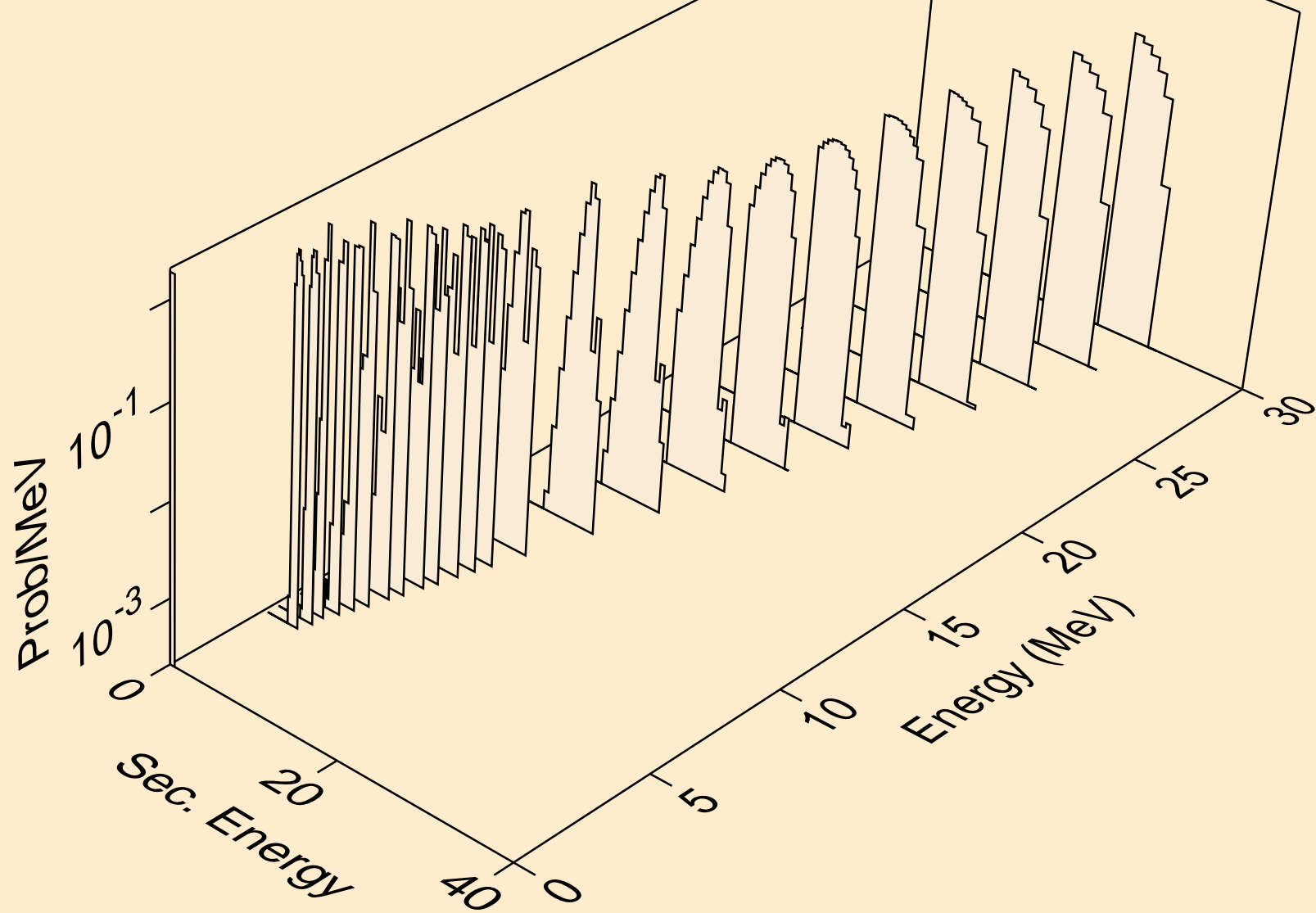



BH264 NEUTRON ACER TENDL-2024 LIBRARY; T=0.K  
he3s from (n,x)

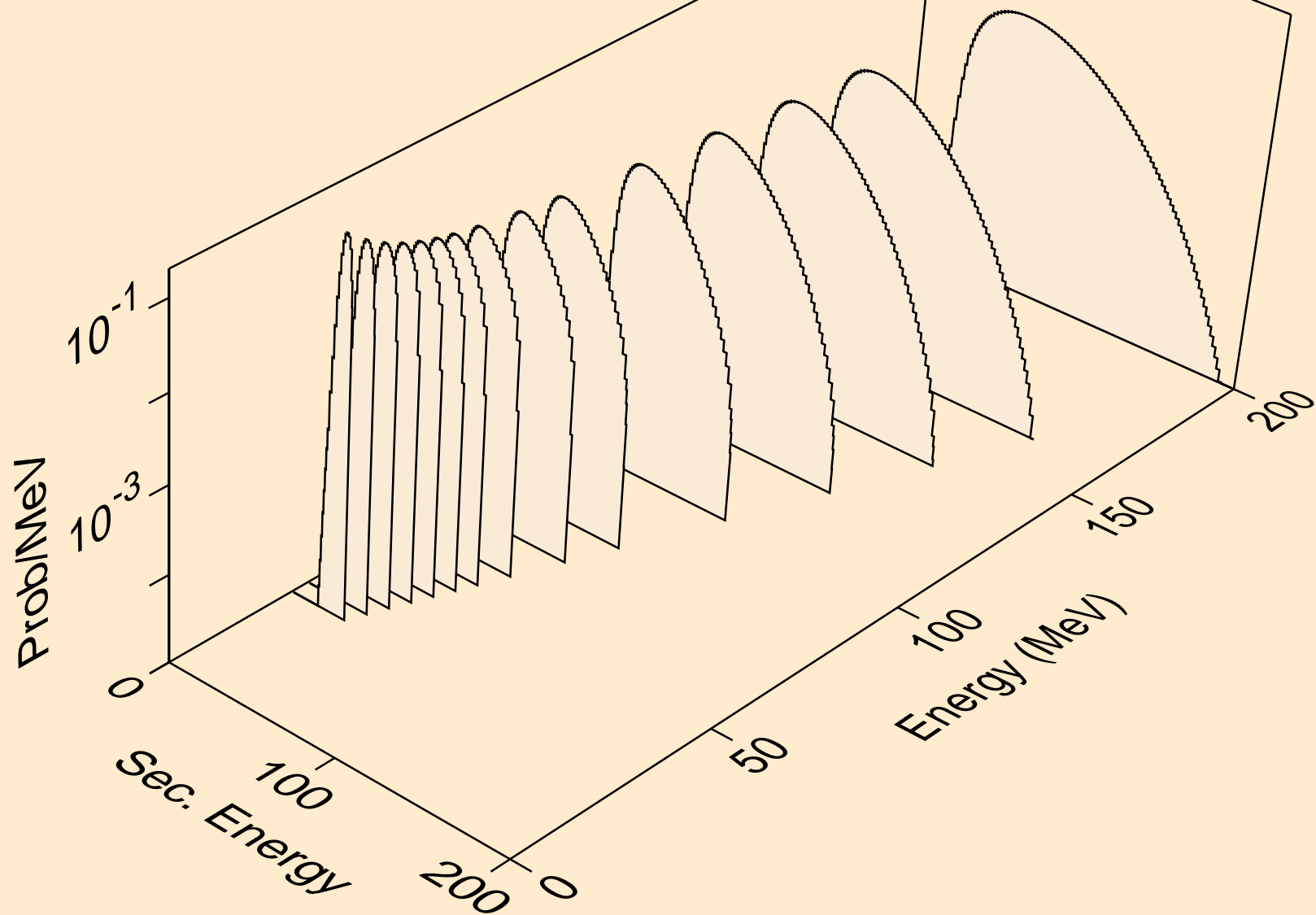

BH264 NEUTRON ACER TENDL-2024 LIBRARY; T=0.K  
he3s from (n,n\*)he3

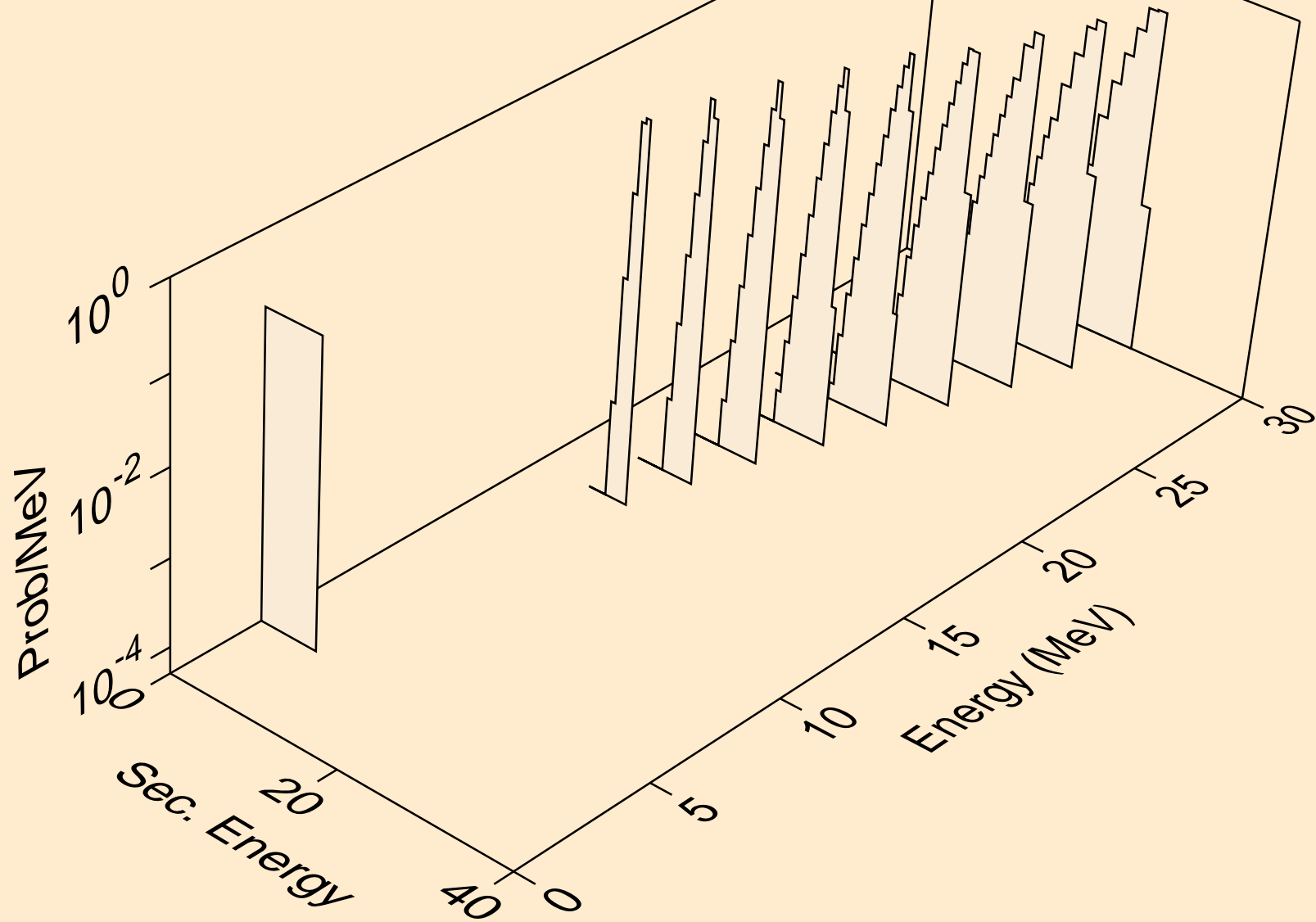

BH264 NEUTRON ACER TENDL-2024 LIBRARY; T=0.K  
he3s from (n,he3)

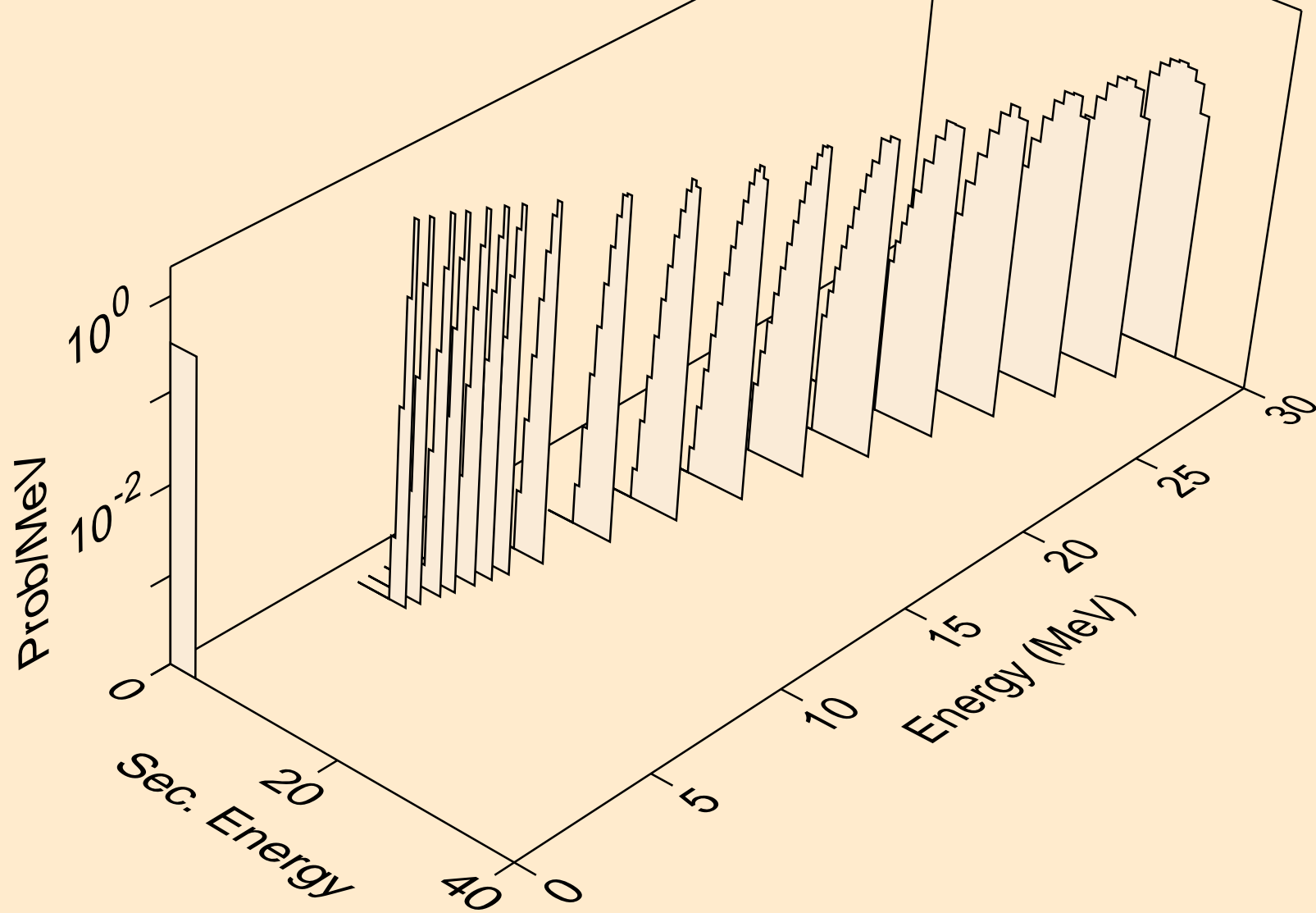

BH264 NEUTRON ACER TENDL-2024 LIBRARY; T=0.K  
alphas from (n,x)

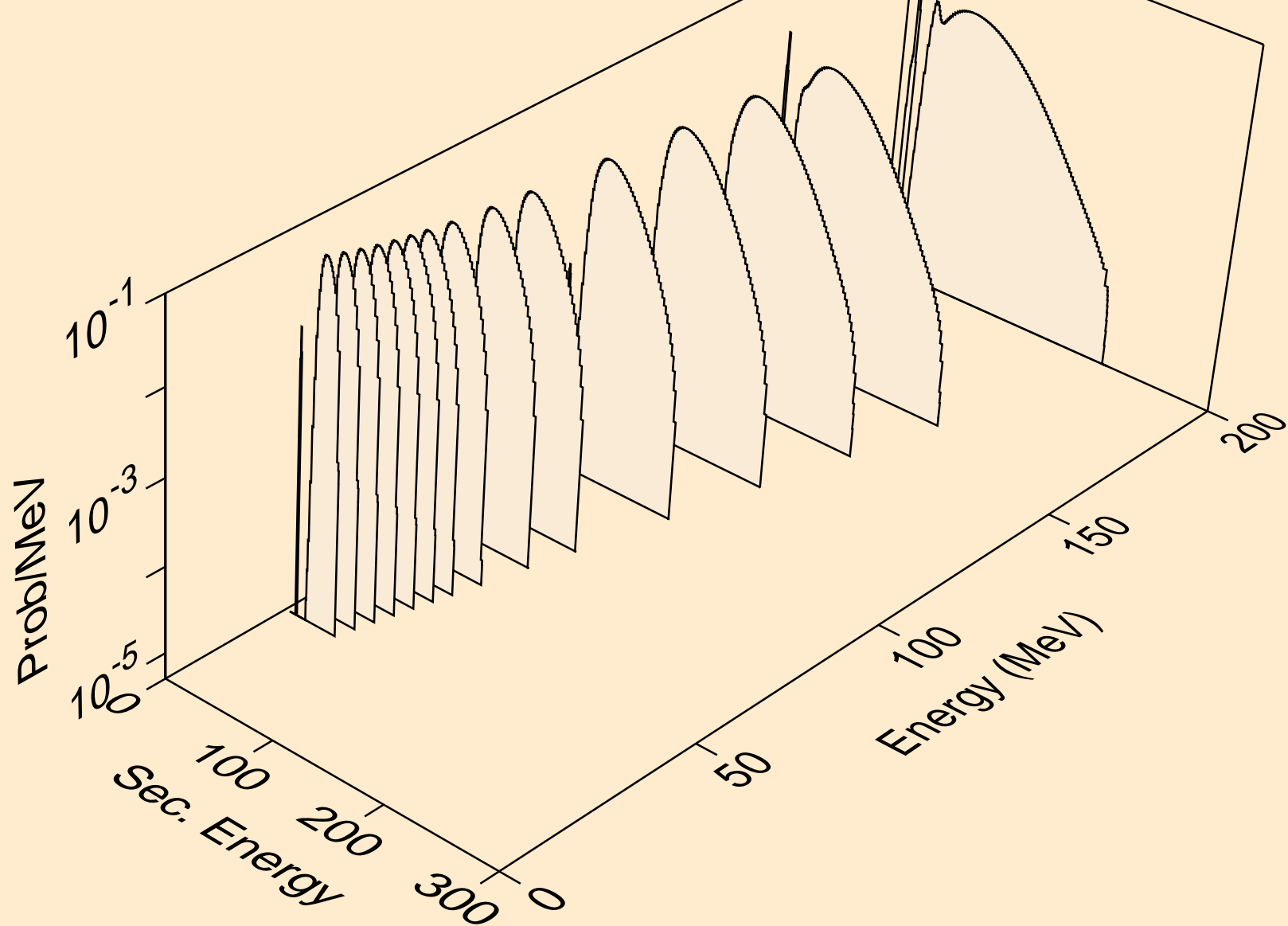

BH264 NEUTRON ACER TENDL-2024 LIBRARY; T=0.K  
alphas from (n,n\*)a

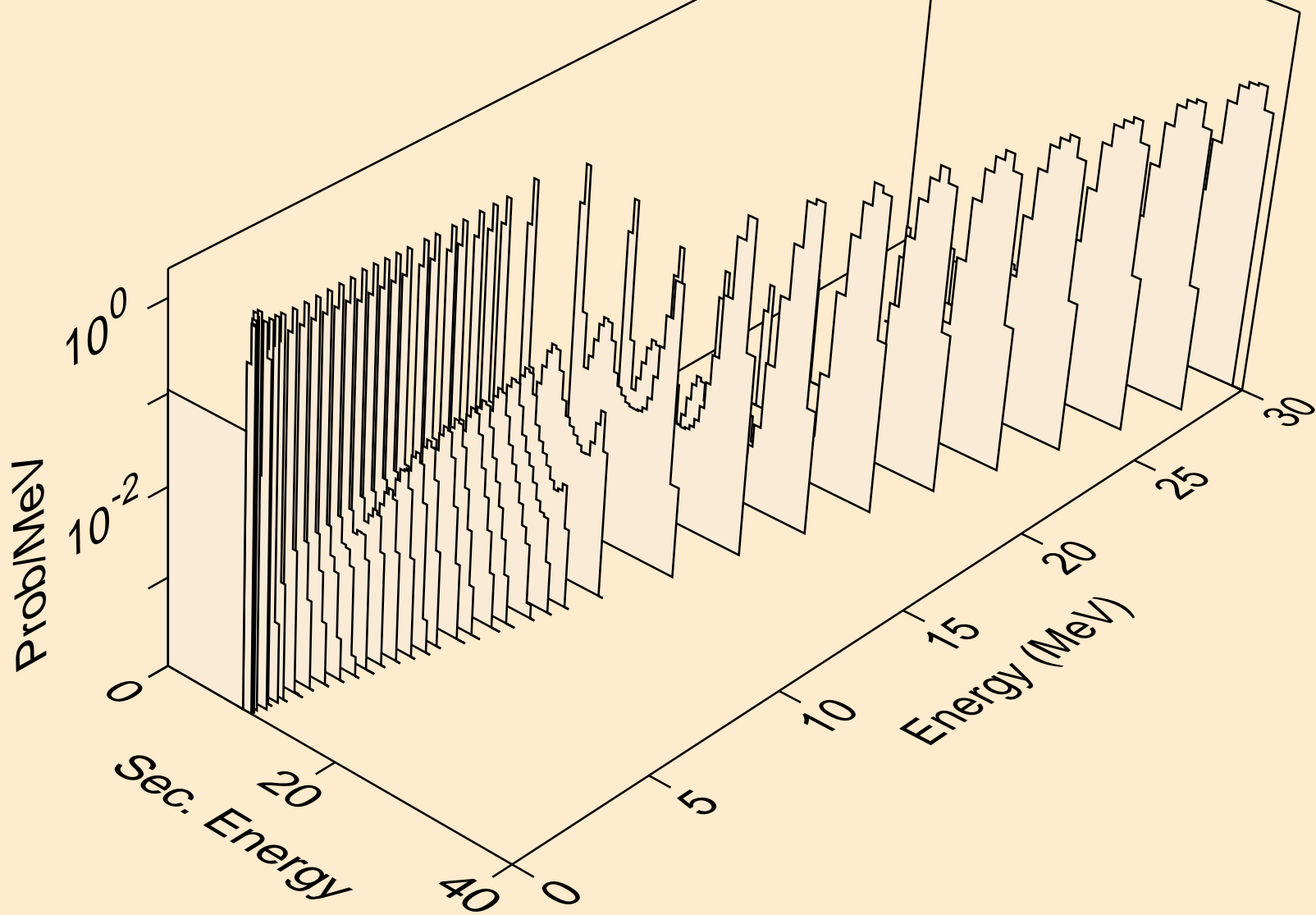

BH264 NEUTRON ACER TENDL-2024 LIBRARY; T=0.K  
alphas from (n,2n)a

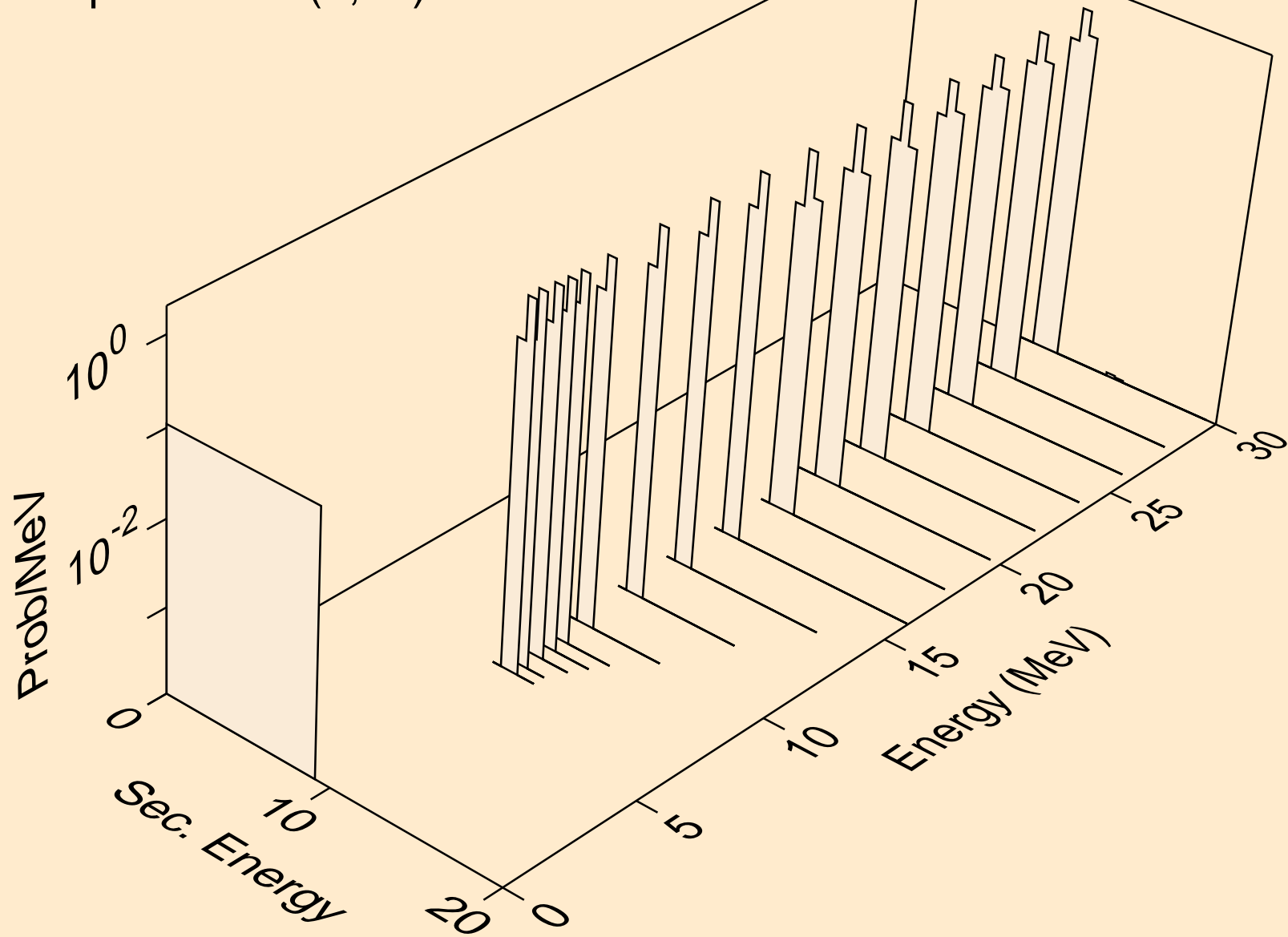

BH264 NEUTRON ACER TENDL-2024 LIBRARY; T=0.K  
alphas from (n,3n)a

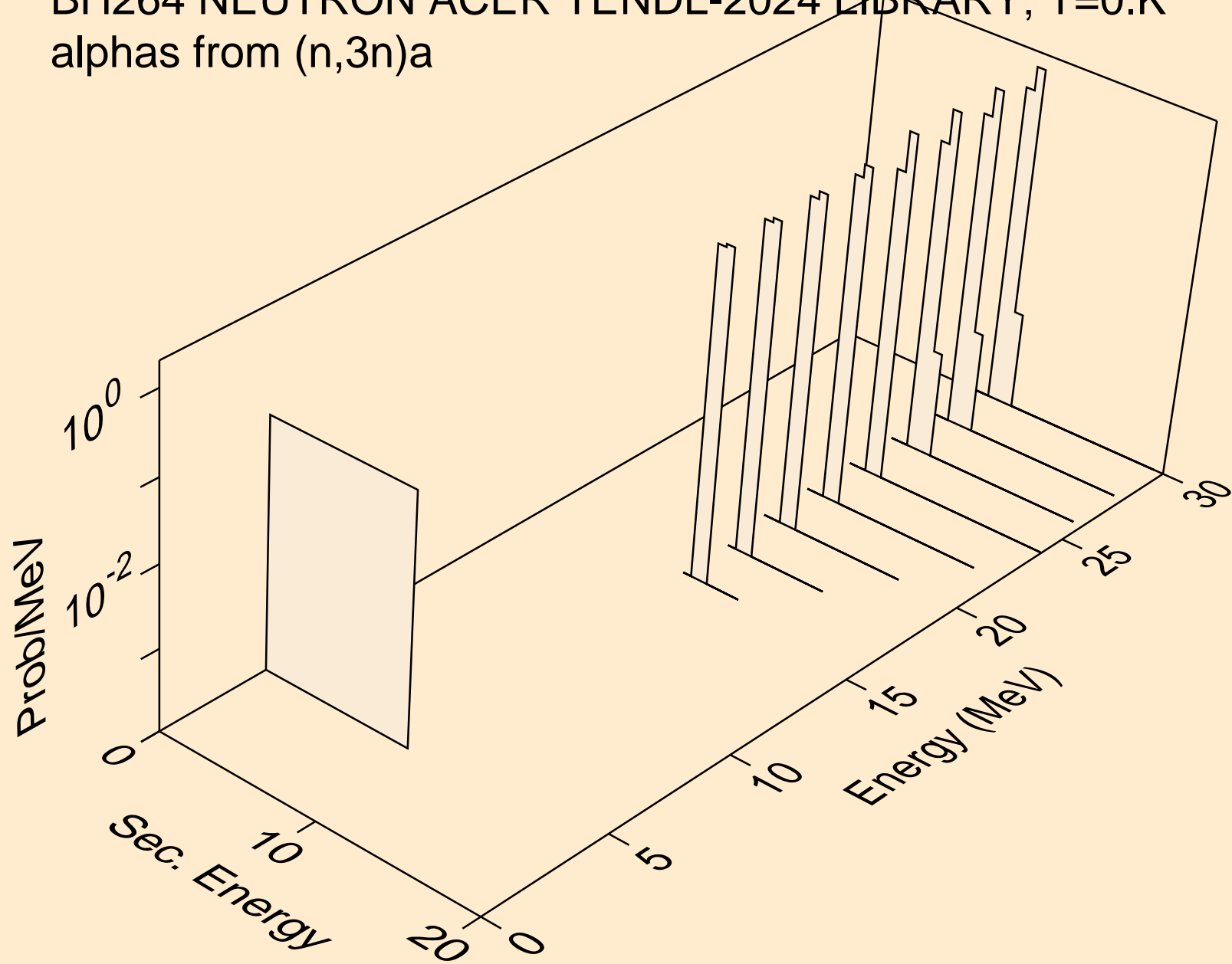

BH264 NEUTRON ACER TENDL-2024 LIBRARY; T=0.K  
alphas from (n,n\*)2a

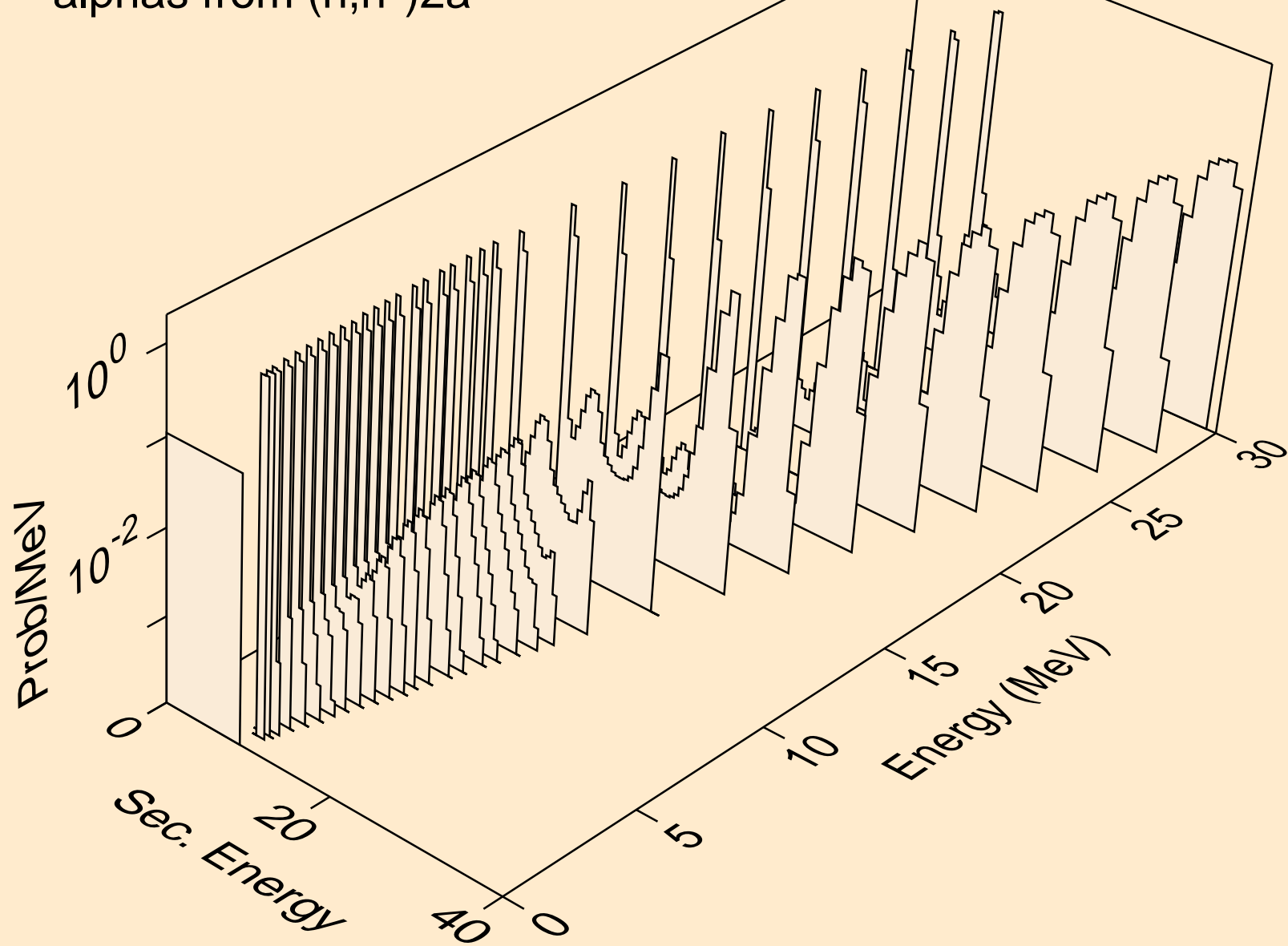



BH264 NEUTRON ACER TENDL-2024 LIBRARY; T=0.K  
alphas from (n,2n)2a

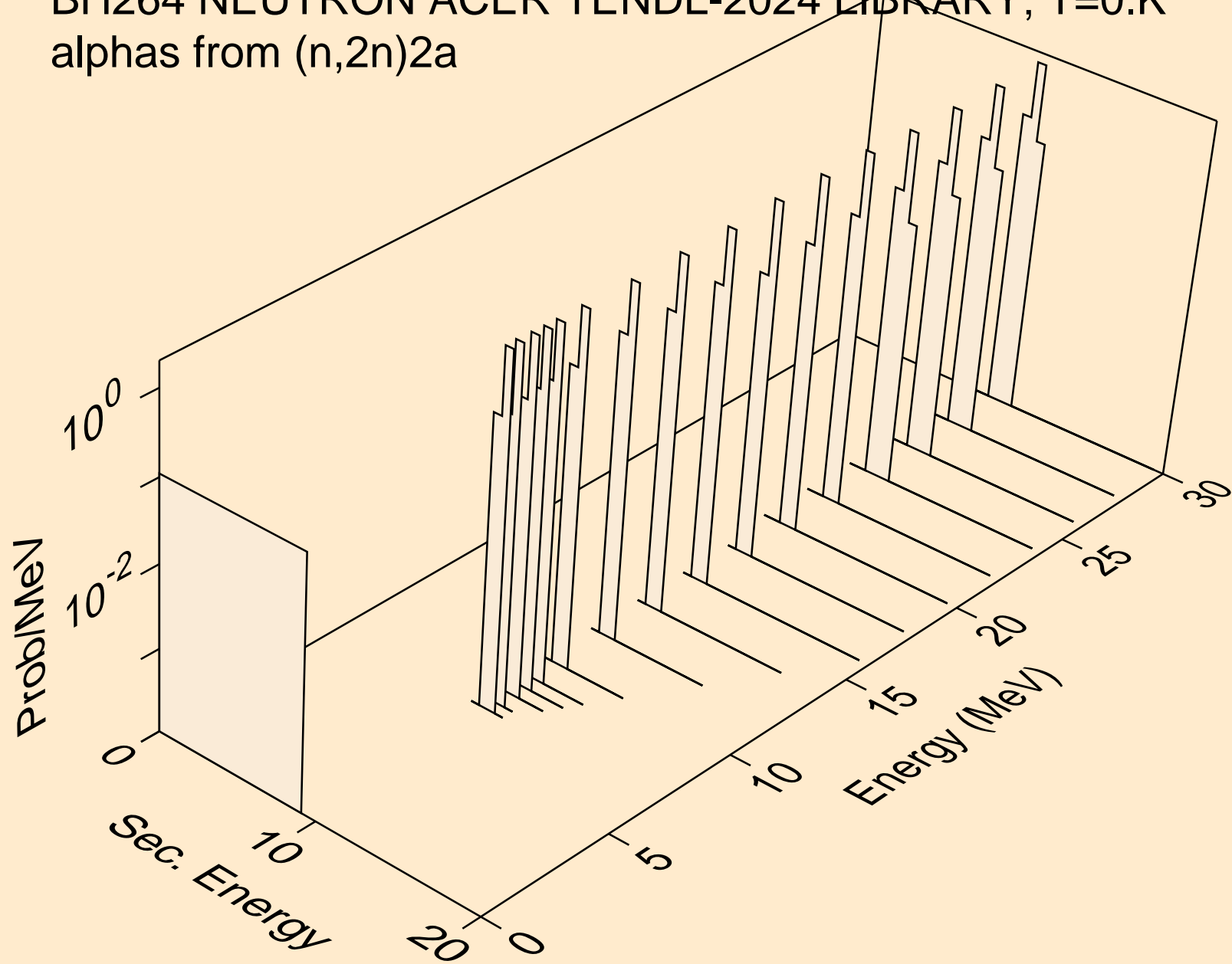

BH264 NEUTRON ACER TENDL-2024 LIBRARY; T=0.K  
alphas from (n,npa)

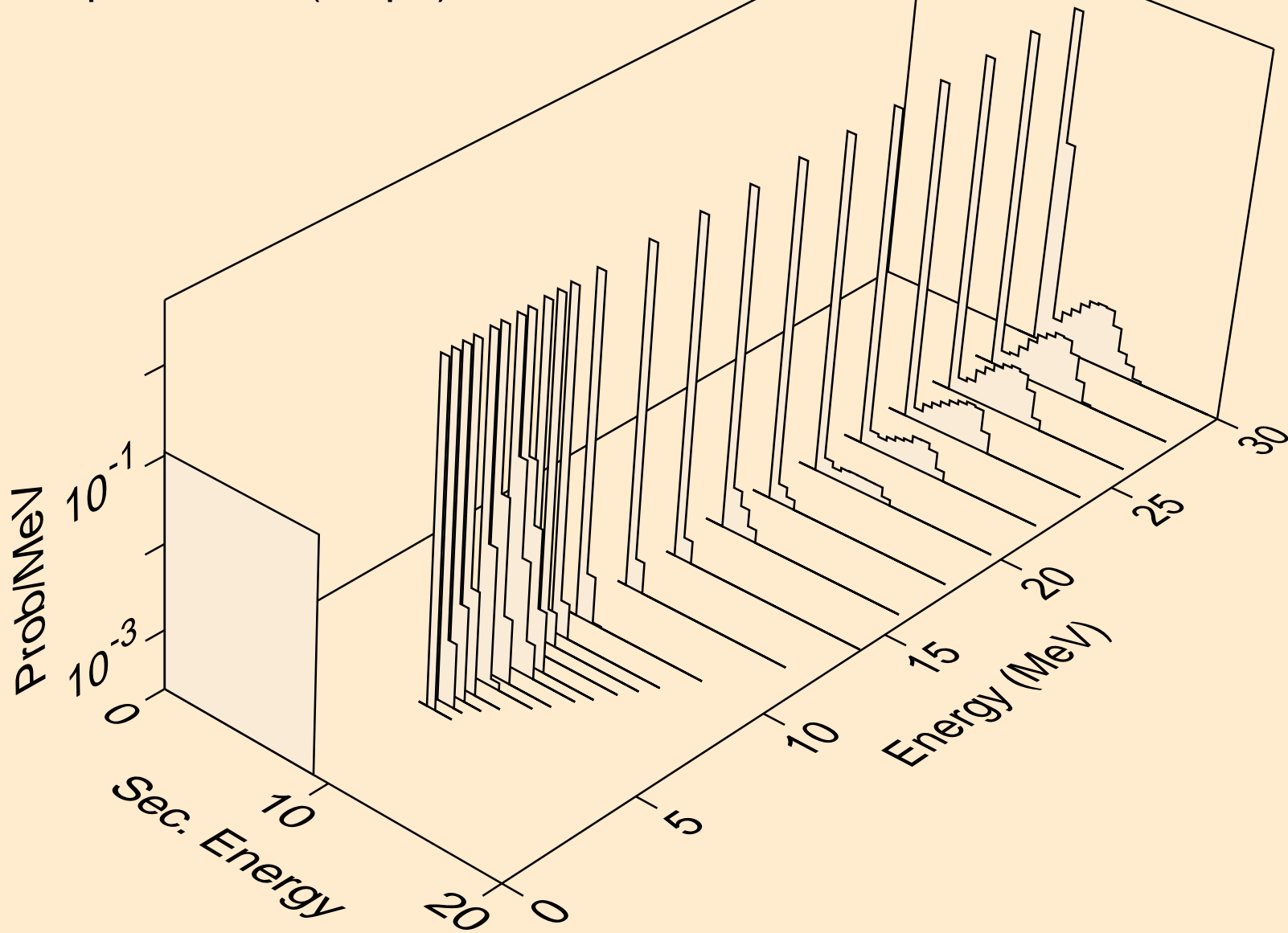

BH264 NEUTRON ACER TENDL-2024 LIBRARY; T=0.K  
alphas from (n,a)

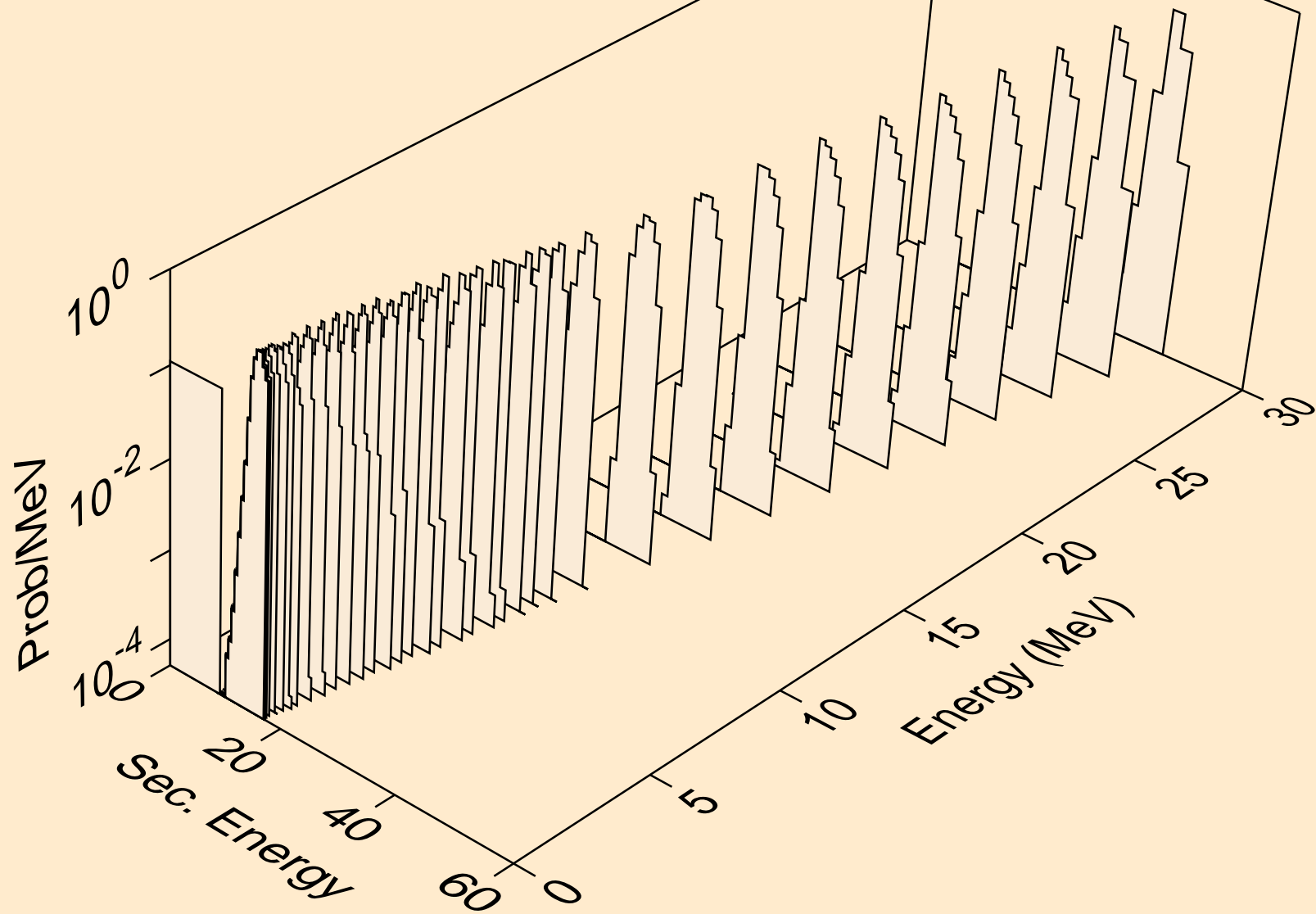

BH264 NEUTRON ACER TENDL-2024 LIBRARY; T=0.K  
alphas from (n,2a)

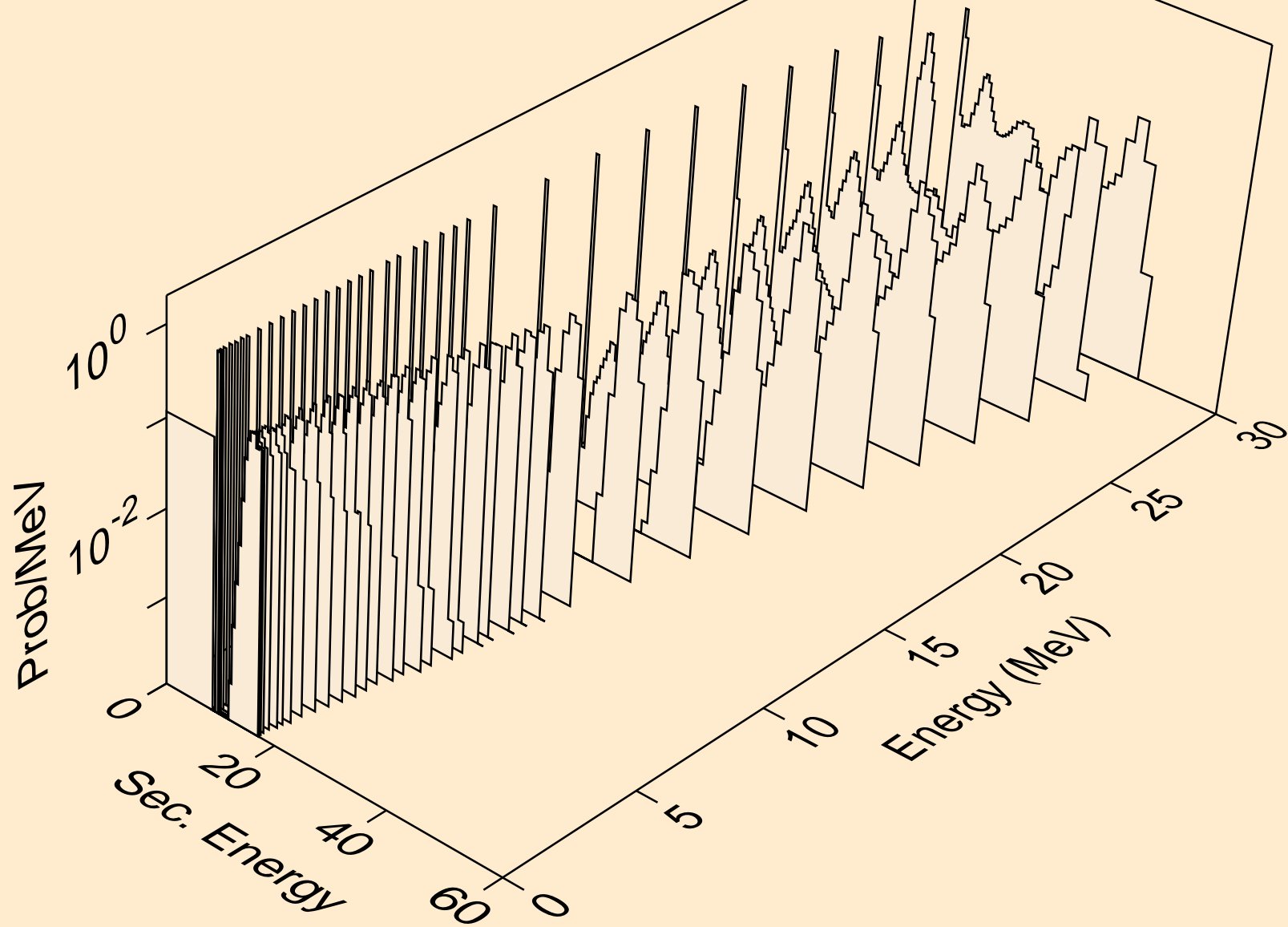

BH264 NEUTRON ACER TENDL-2024 LIBRARY; T=0.K  
alphas from (n,pa)

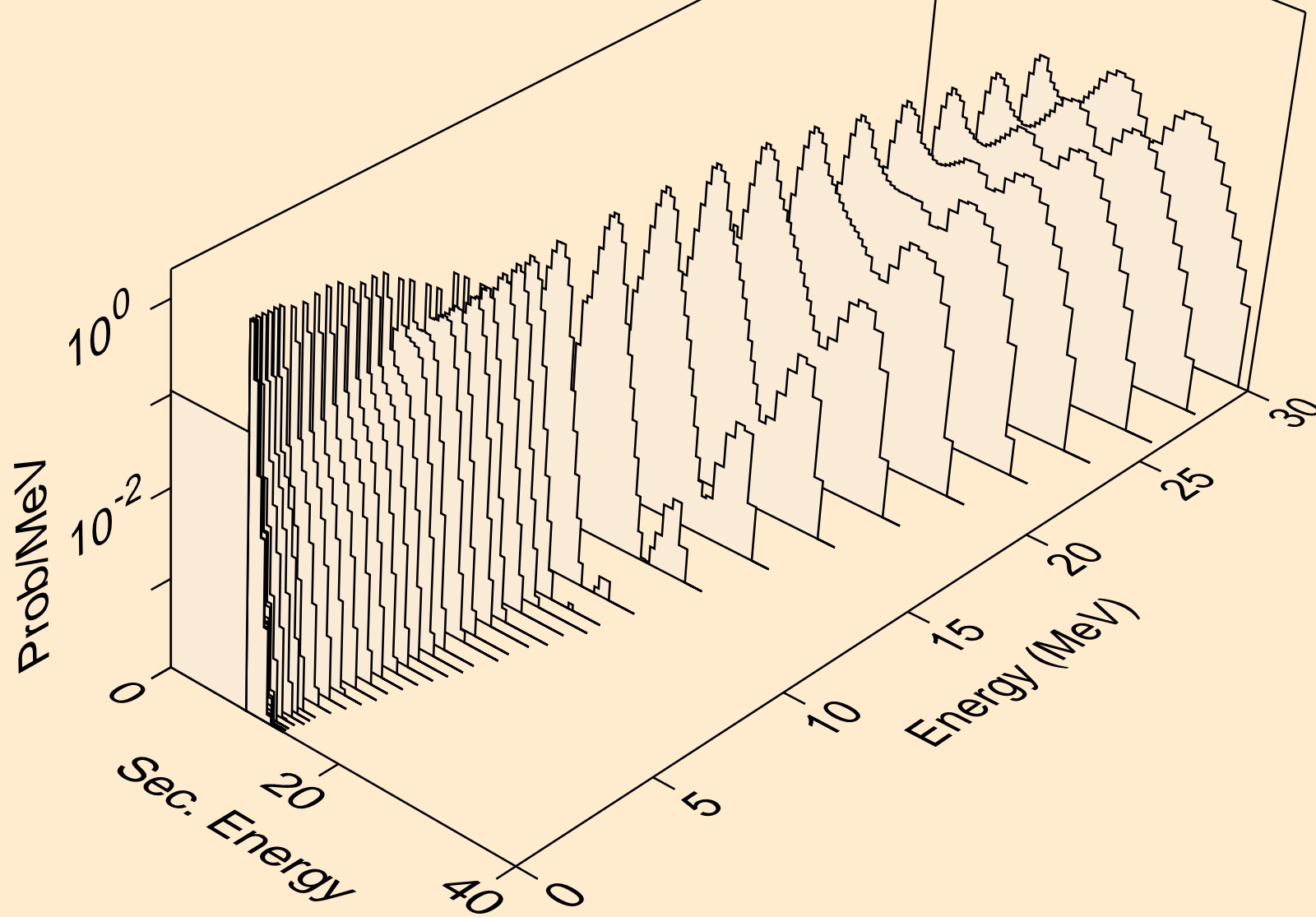

BH264 NEUTRON ACER TENDL-2024 LIBRARY; T=0.K  
alphas from (n,da)

