

BH276 NEUTRON ACER TENDL-2024 LIBRARY; T=0.K

Principal cross sections

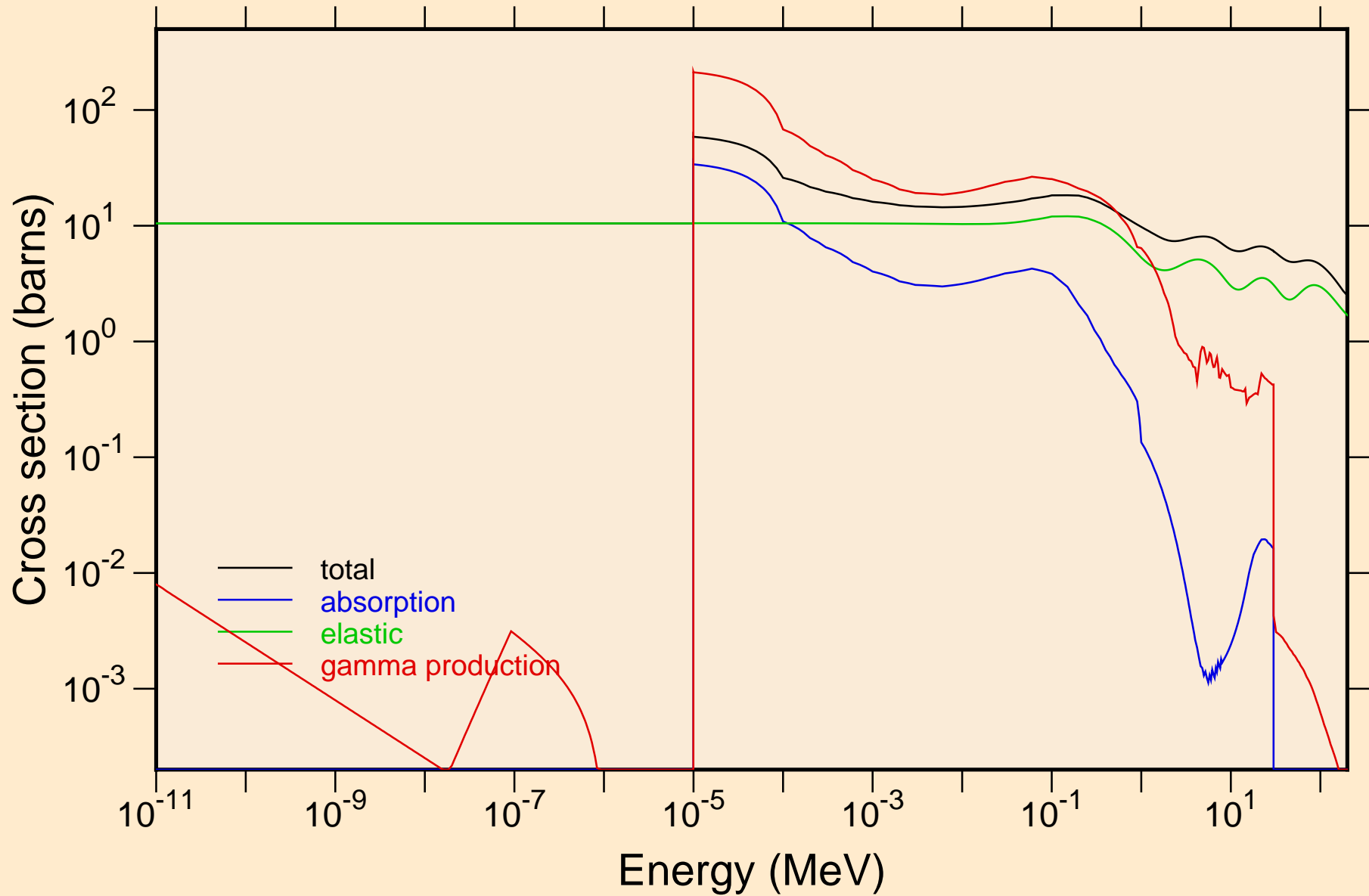

BH276 NEUTRON ACER TENDL-2024 LIBRARY; T=0.K

Heating

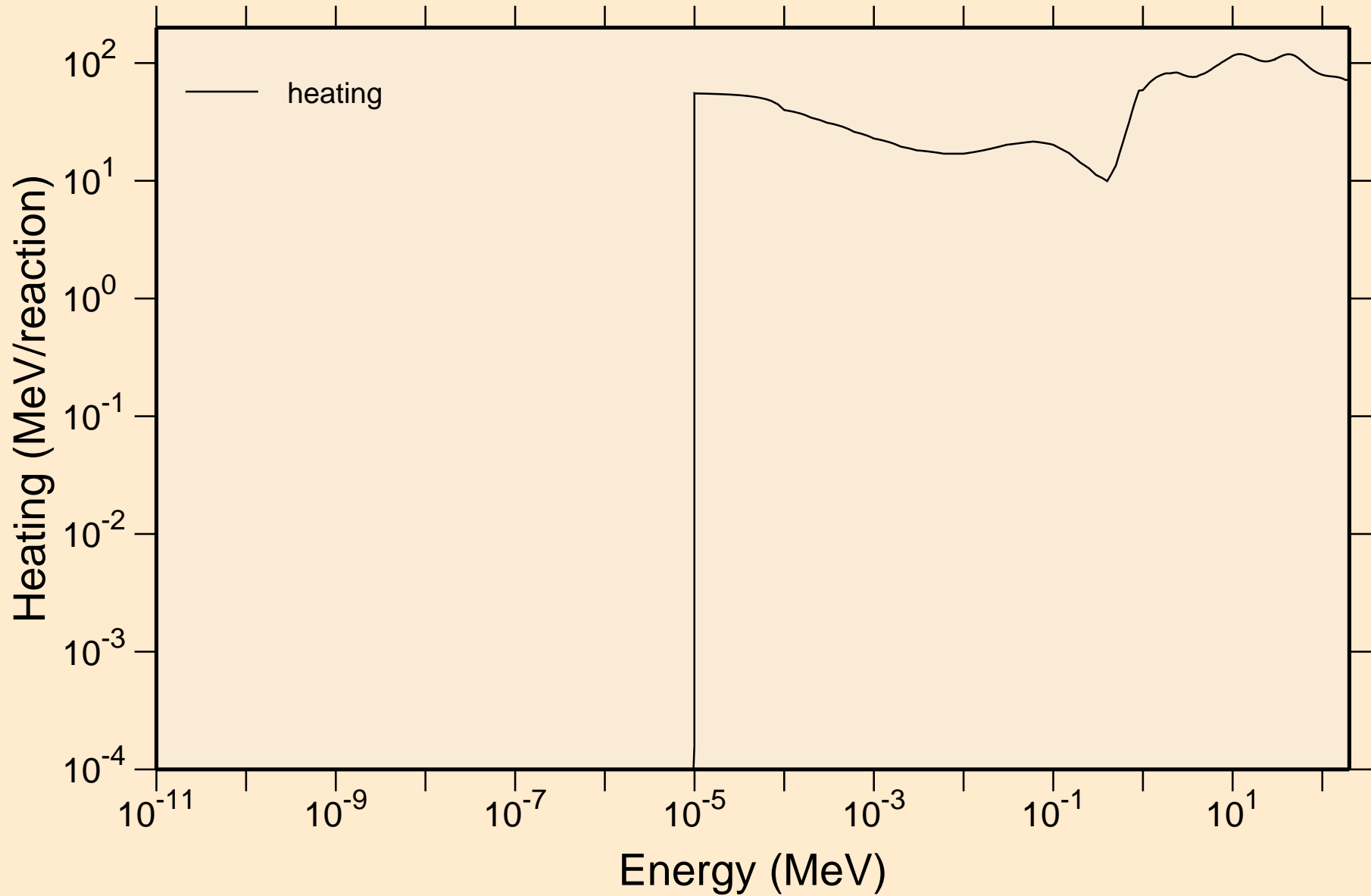

BH276 NEUTRON ACER TENDL-2024 LIBRARY; T=0.K

Damage

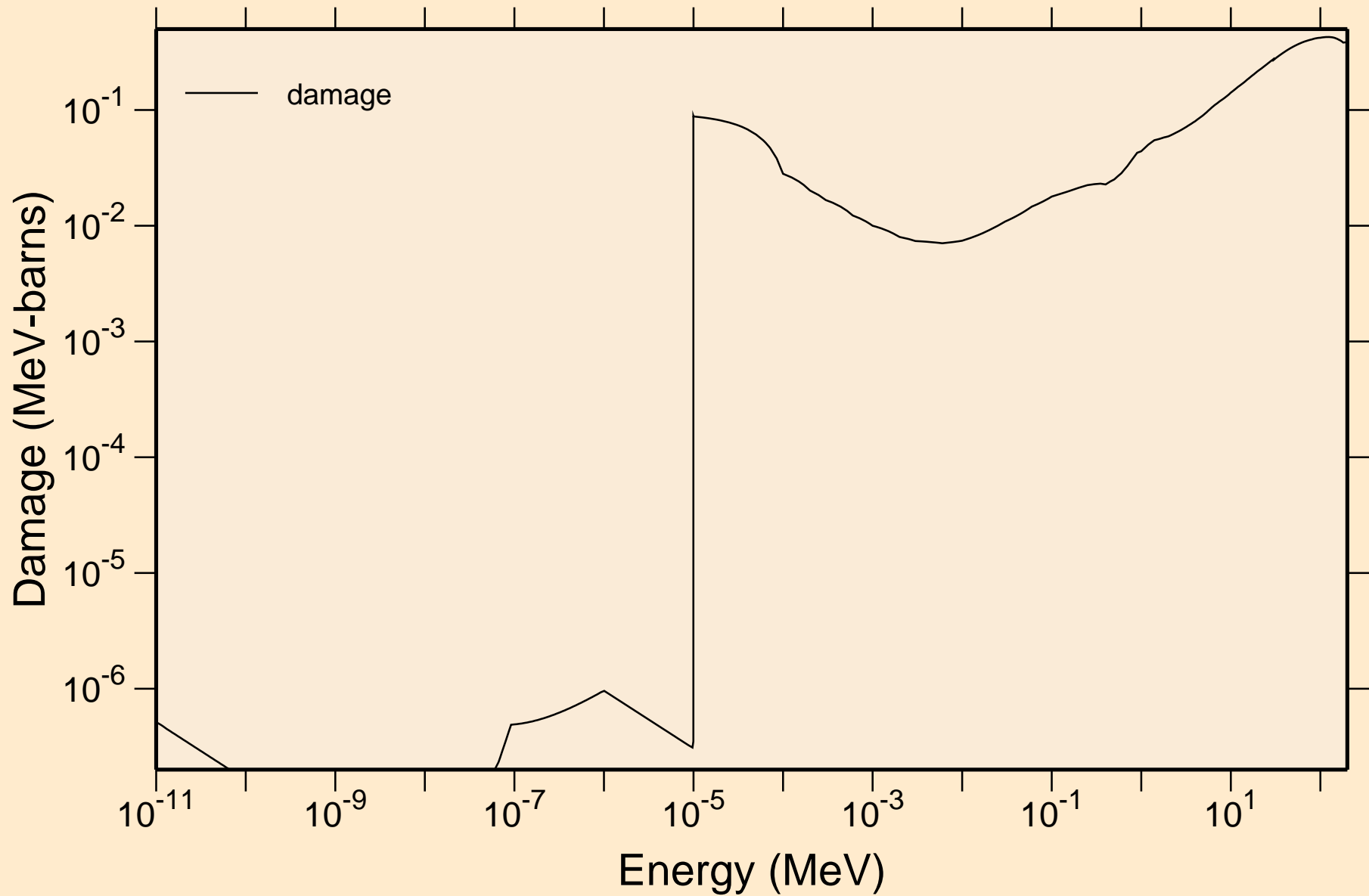

BH276 NEUTRON ACER TENDL-2024 LIBRARY; T=0.K

Non-threshold reactions

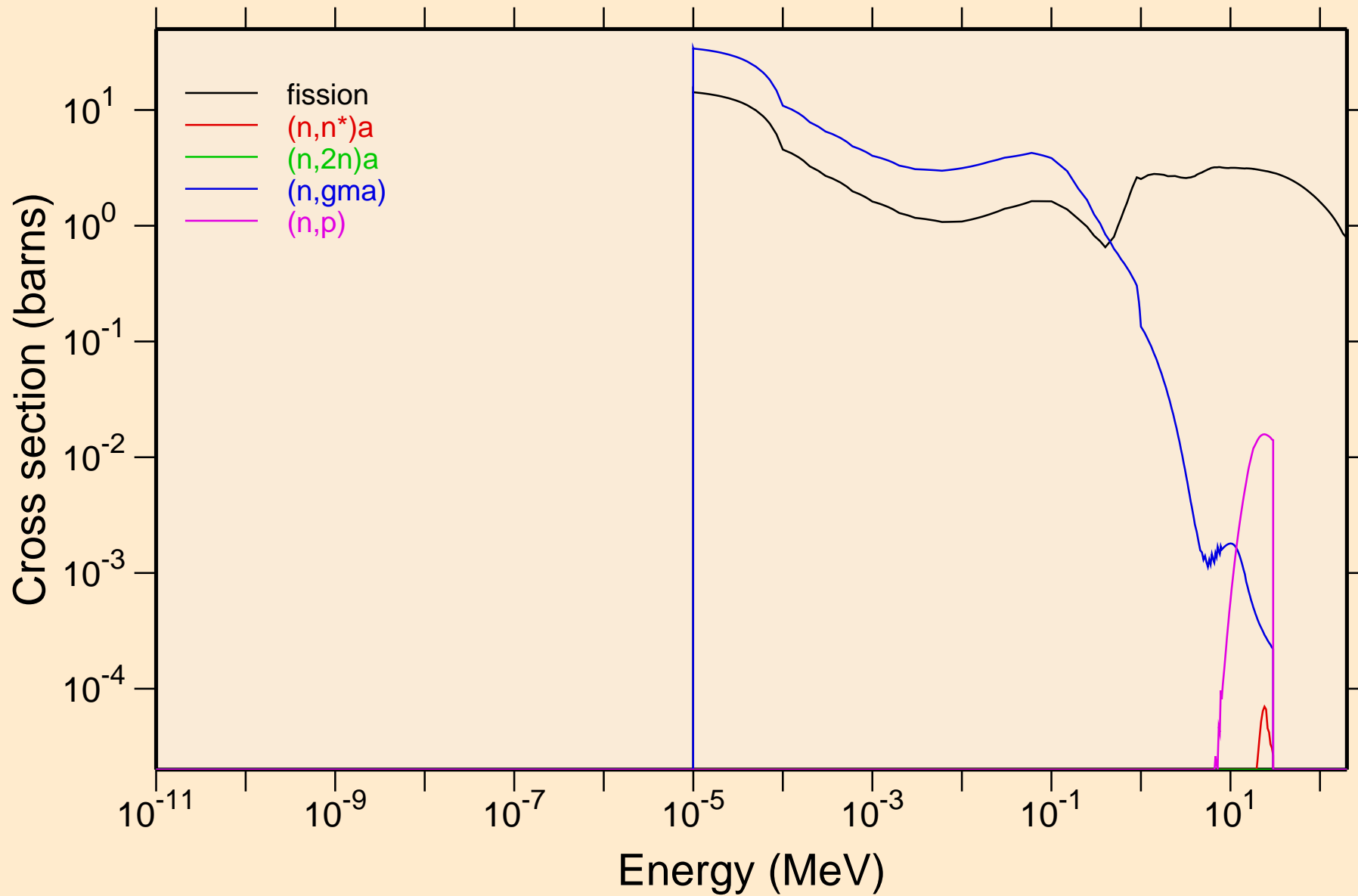

BH276 NEUTRON ACER TENDL-2024 LIBRARY; T=0.K
Non-threshold reactions

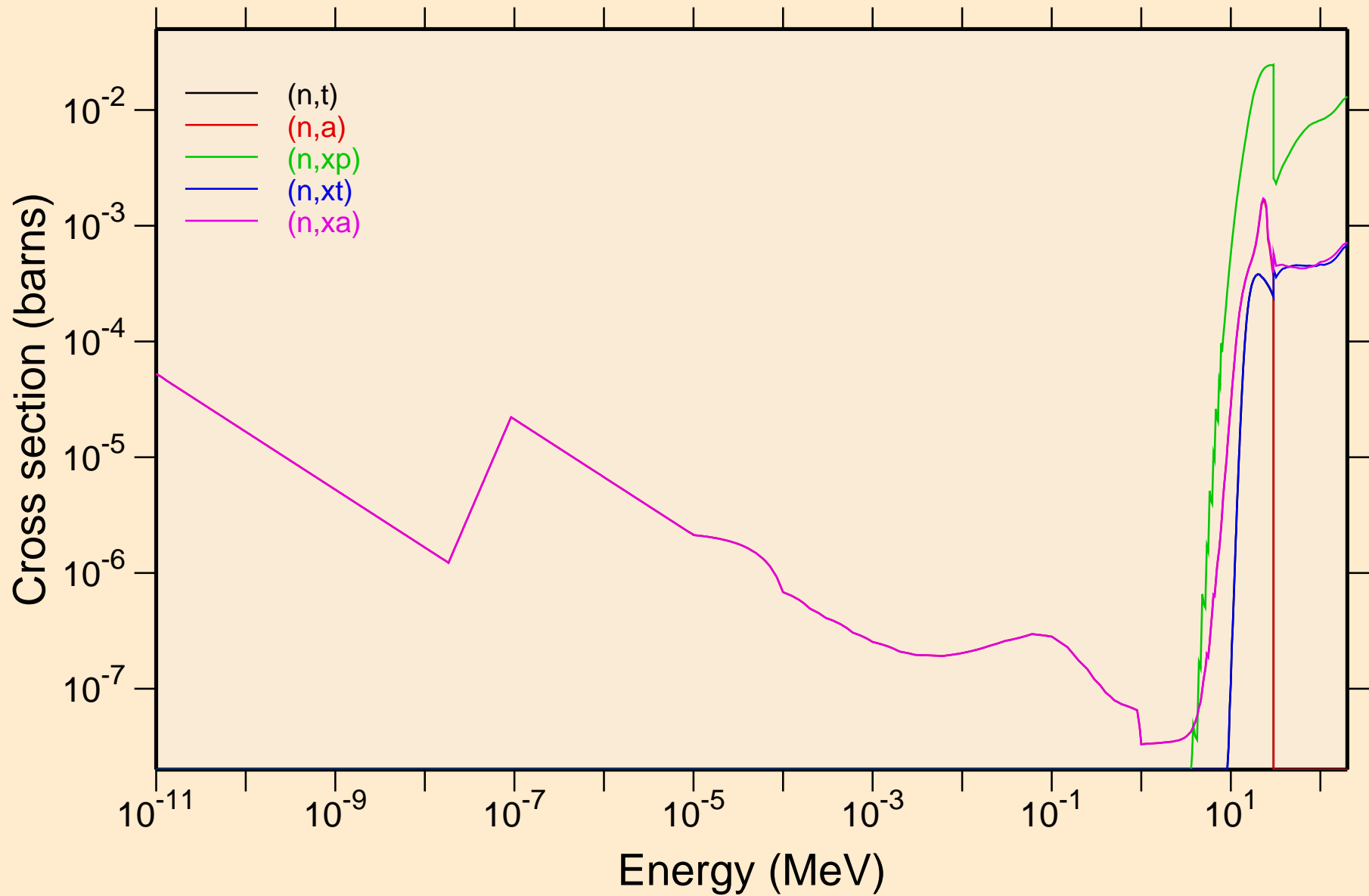

BH276 NEUTRON ACER TENDL-2024 LIBRARY; T=0.K

Principal cross sections

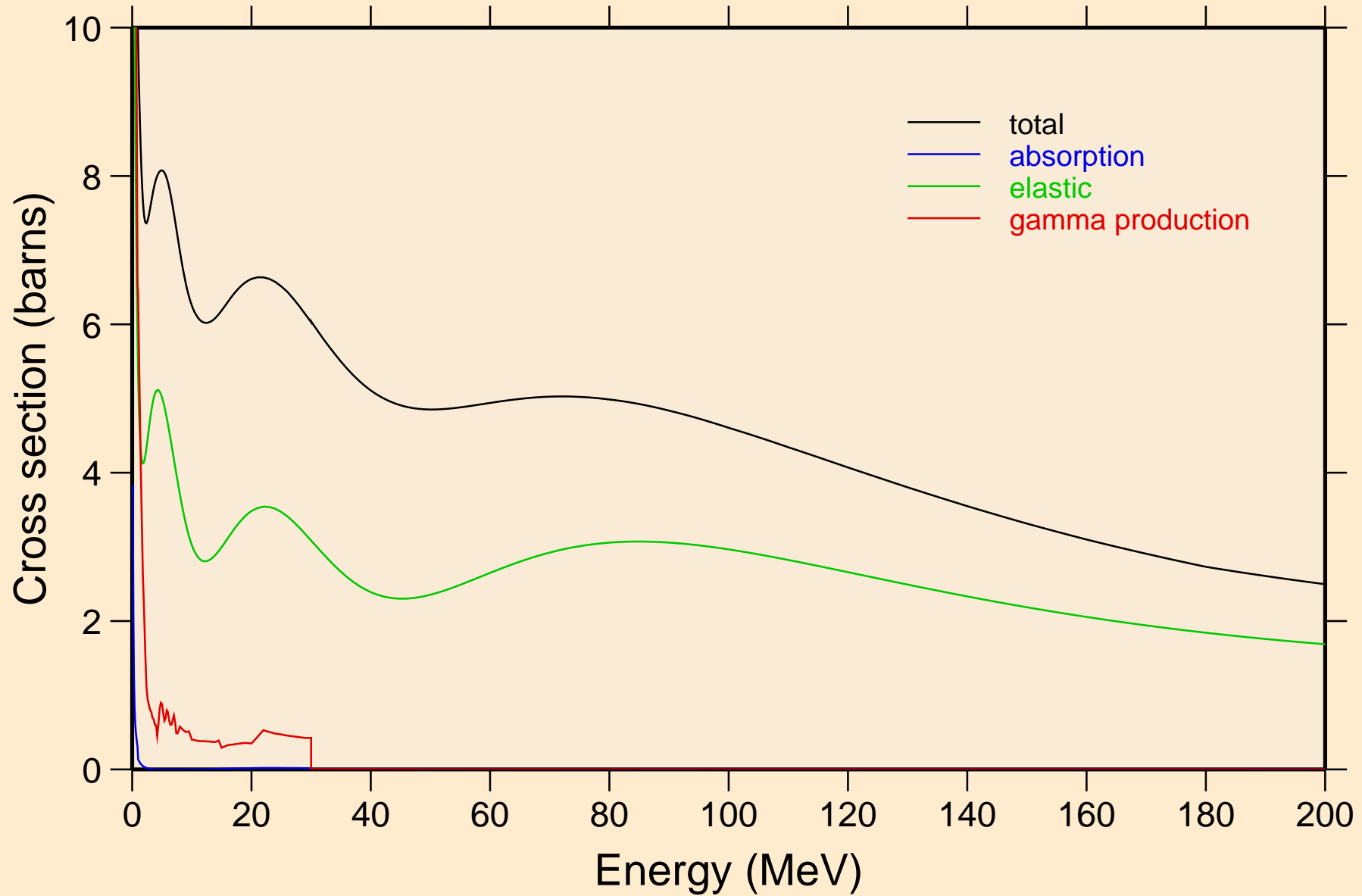

BH276 NEUTRON ACER TENDL-2024 LIBRARY; T=0.K

Heating

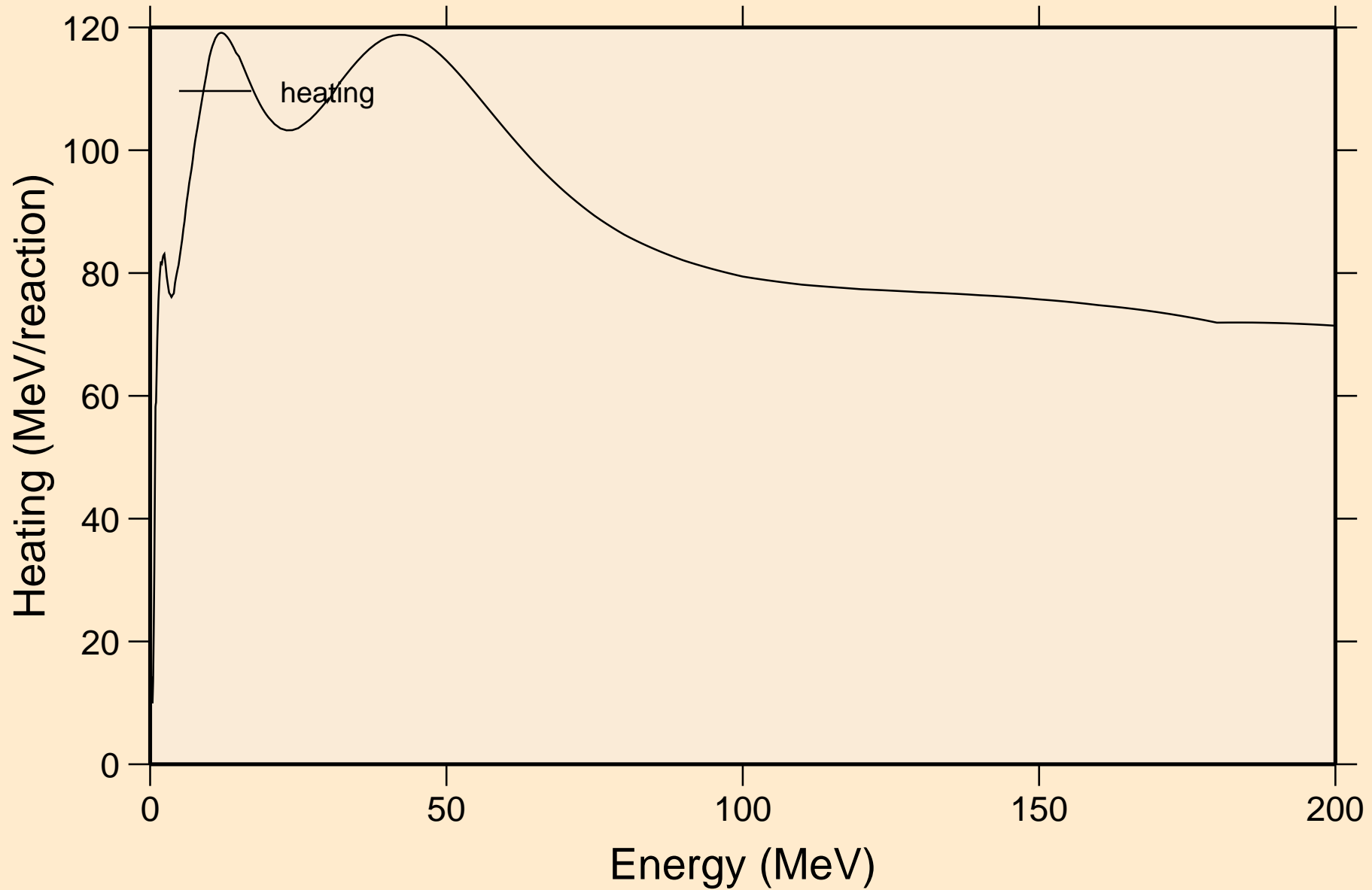

BH276 NEUTRON ACER TENDL-2024 LIBRARY; T=0.K
Damage

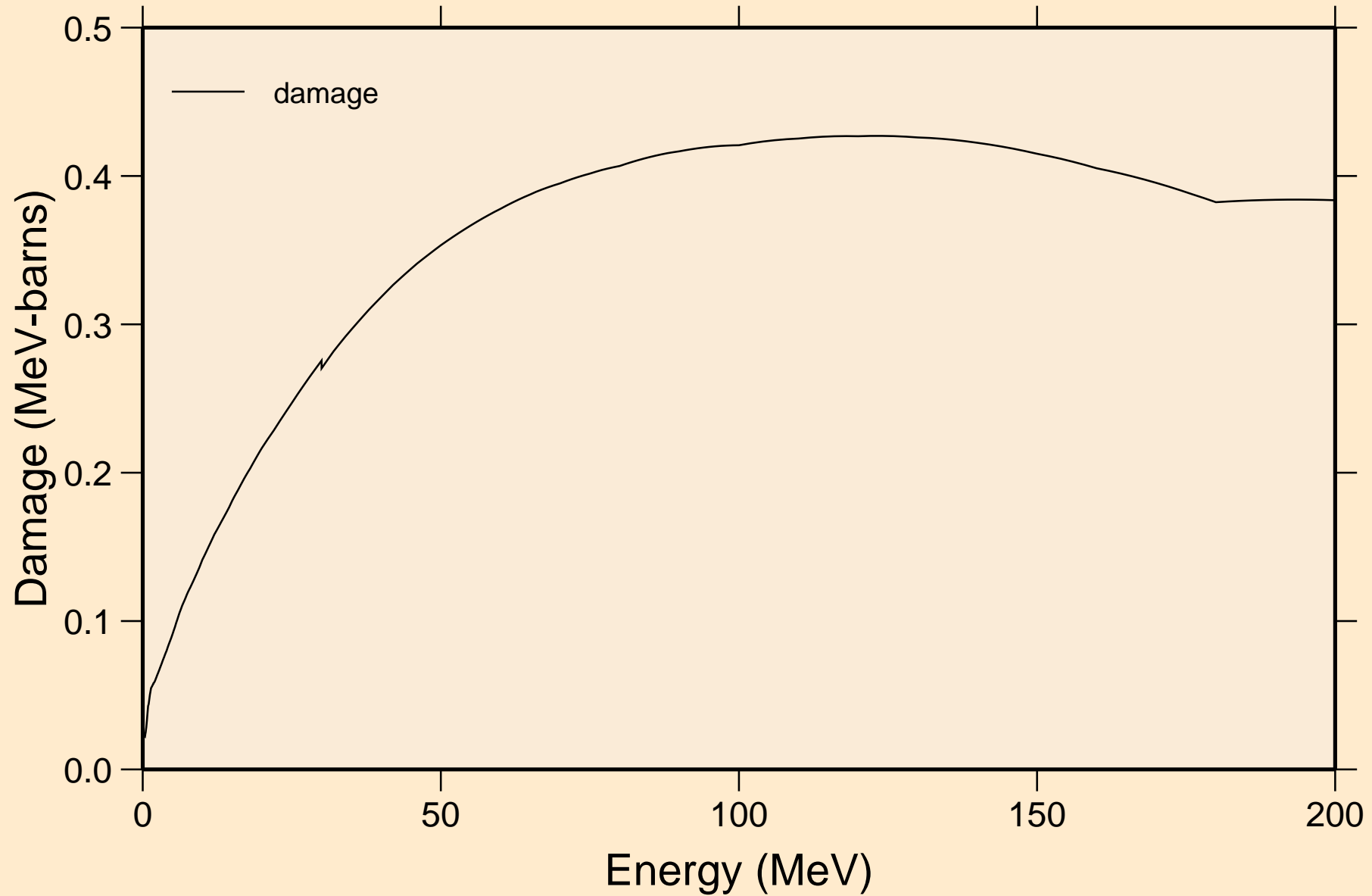

BH276 NEUTRON ACER TENDL-2024 LIBRARY; T=0.K

Non-threshold reactions

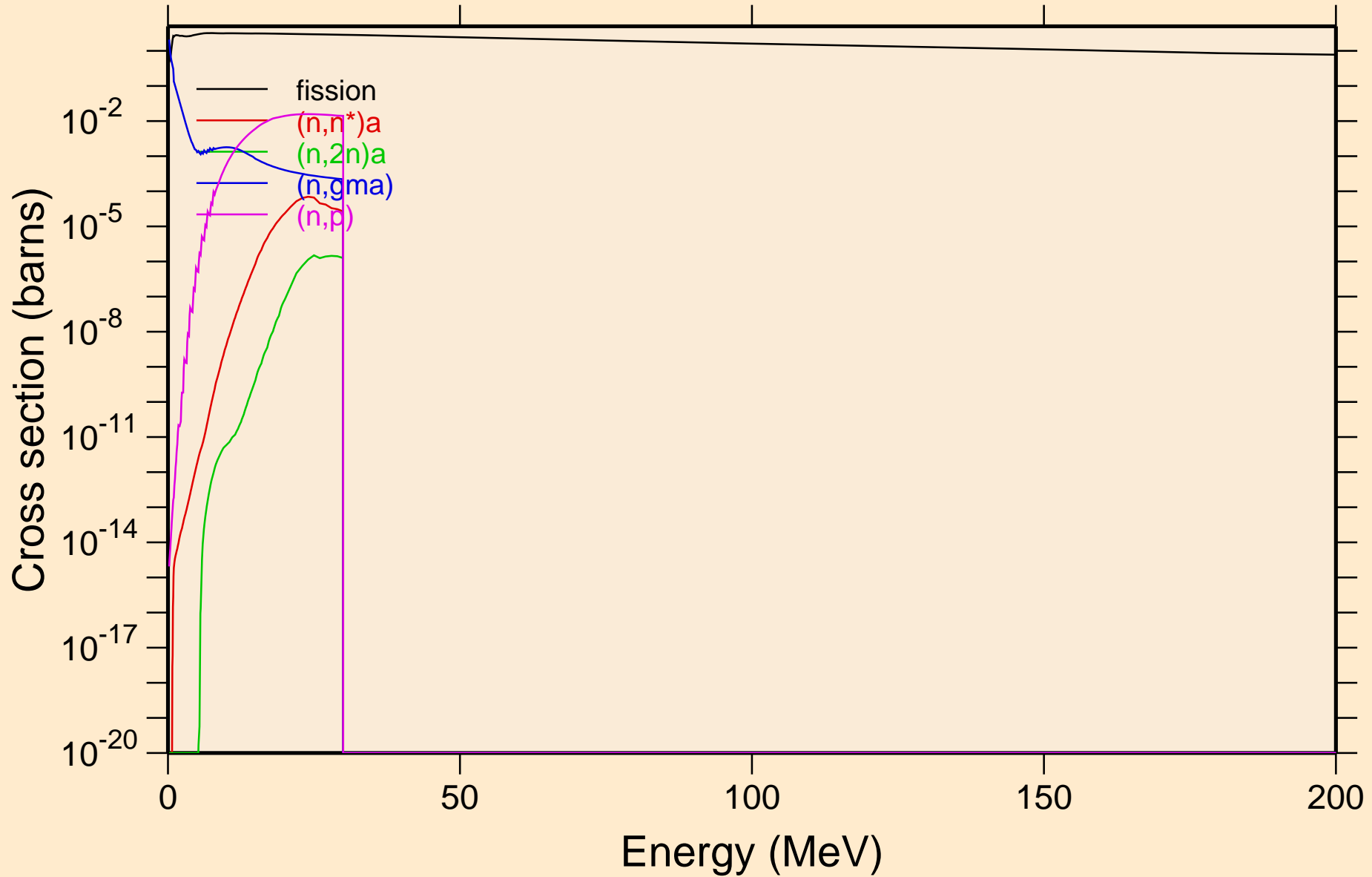

BH276 NEUTRON ACER TENDL-2024 LIBRARY; T=0.K
Non-threshold reactions

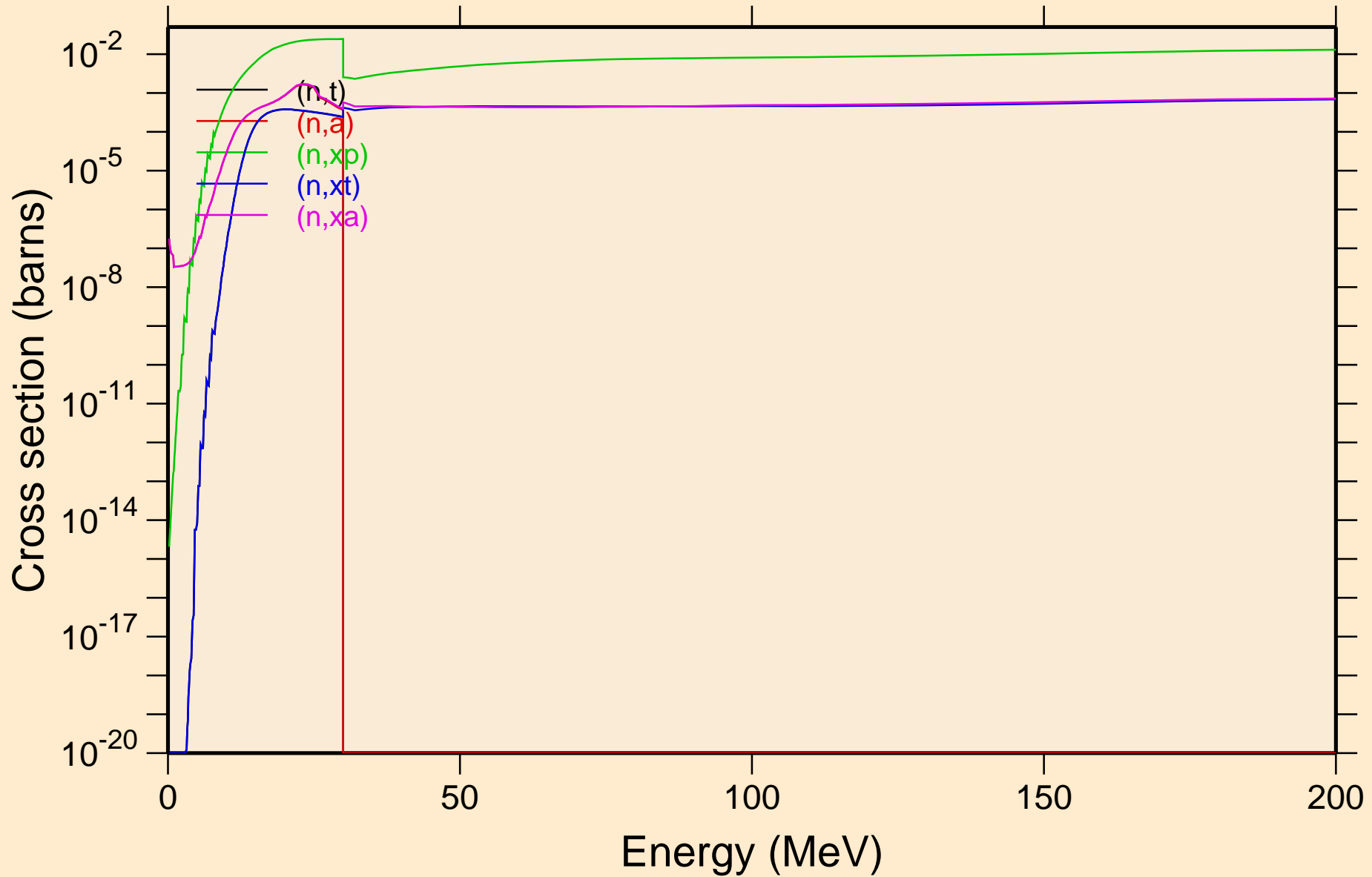

BH276 NEUTRON ACER TENDL-2024 LIBRARY; T=0.K
Inelastic levels

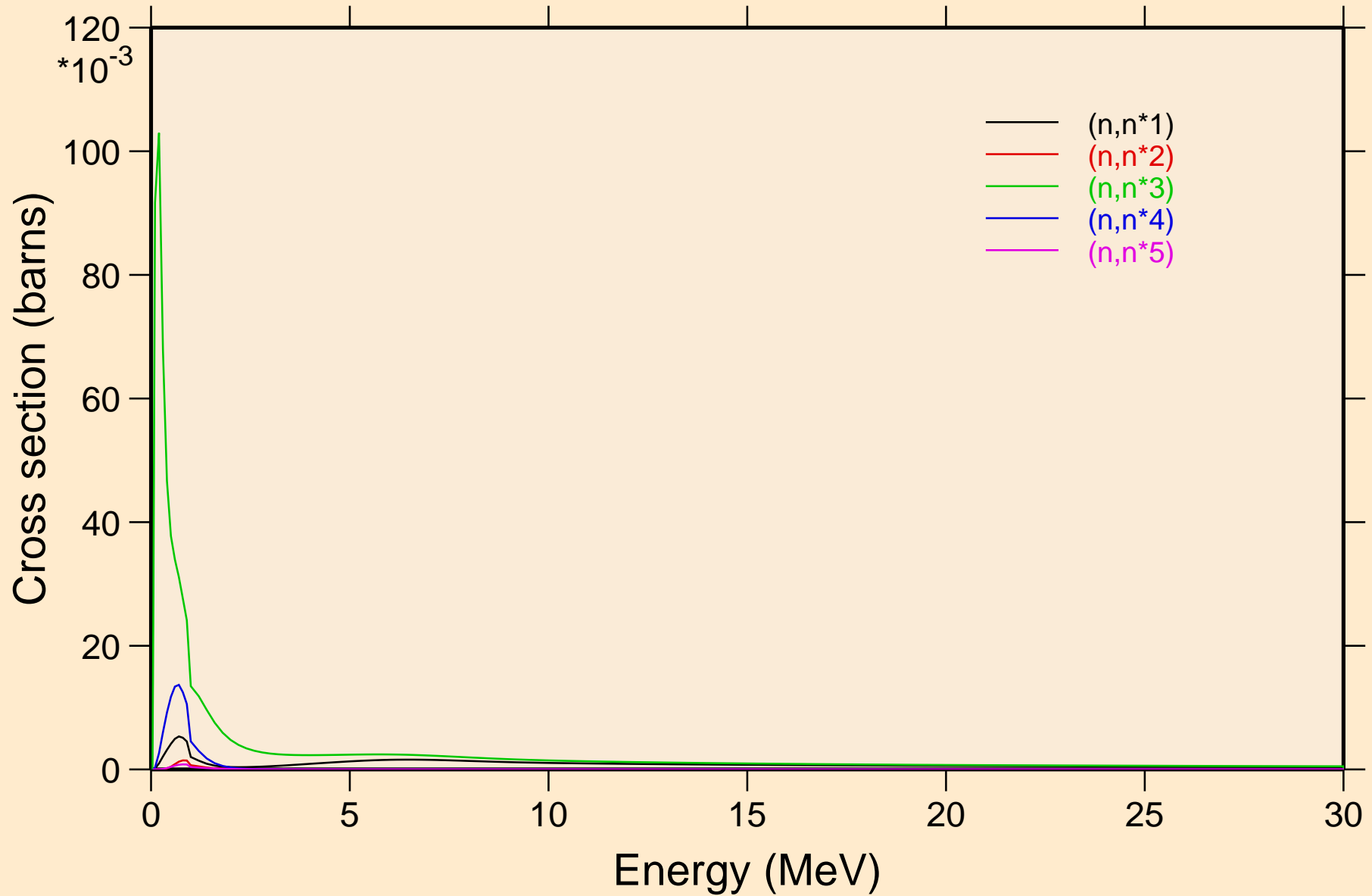

BH276 NEUTRON ACER TENDL-2024 LIBRARY; T=0.K
Inelastic levels

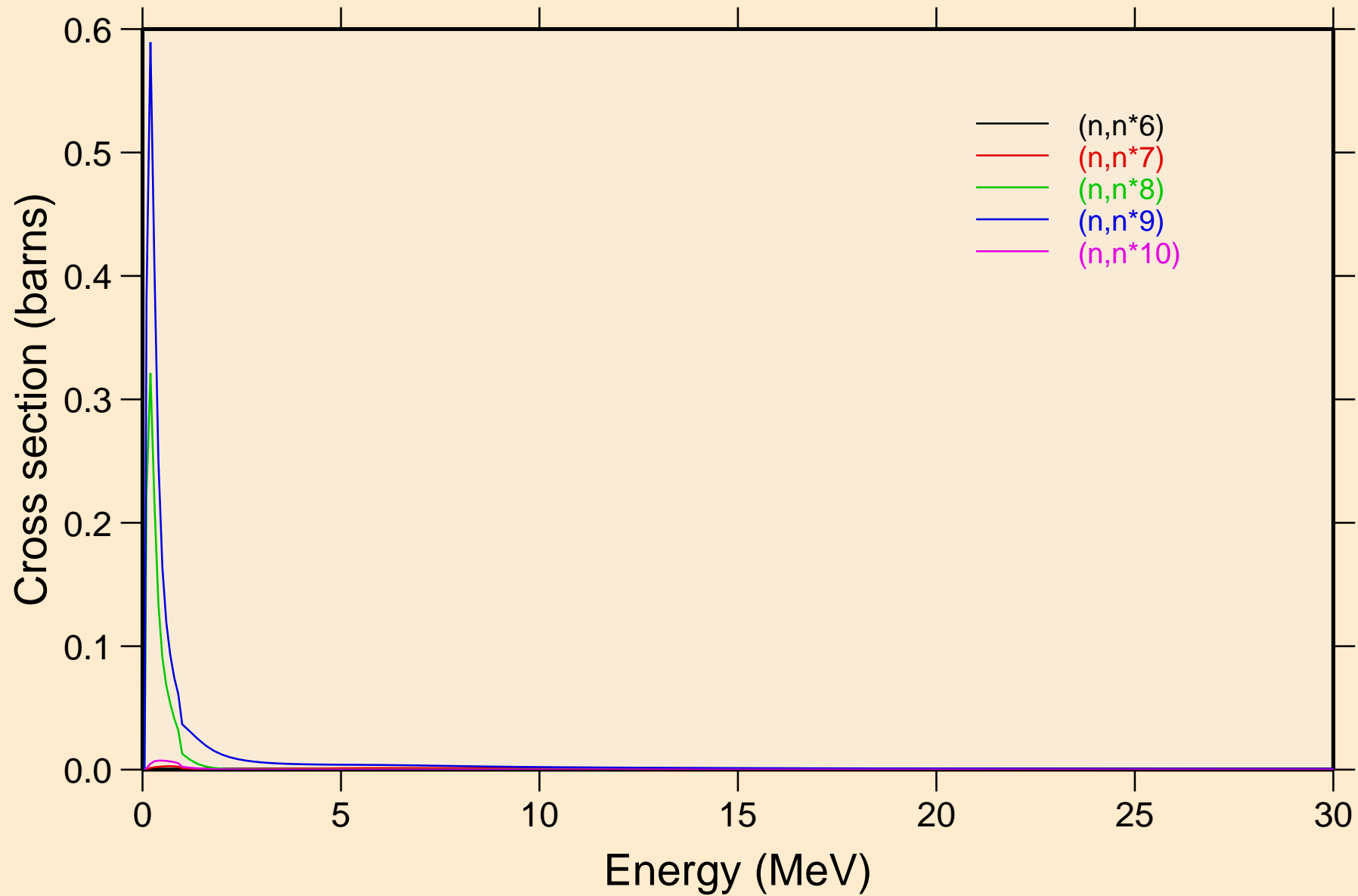

BH276 NEUTRON ACER TENDL-2024 LIBRARY; T=0.K
Inelastic levels

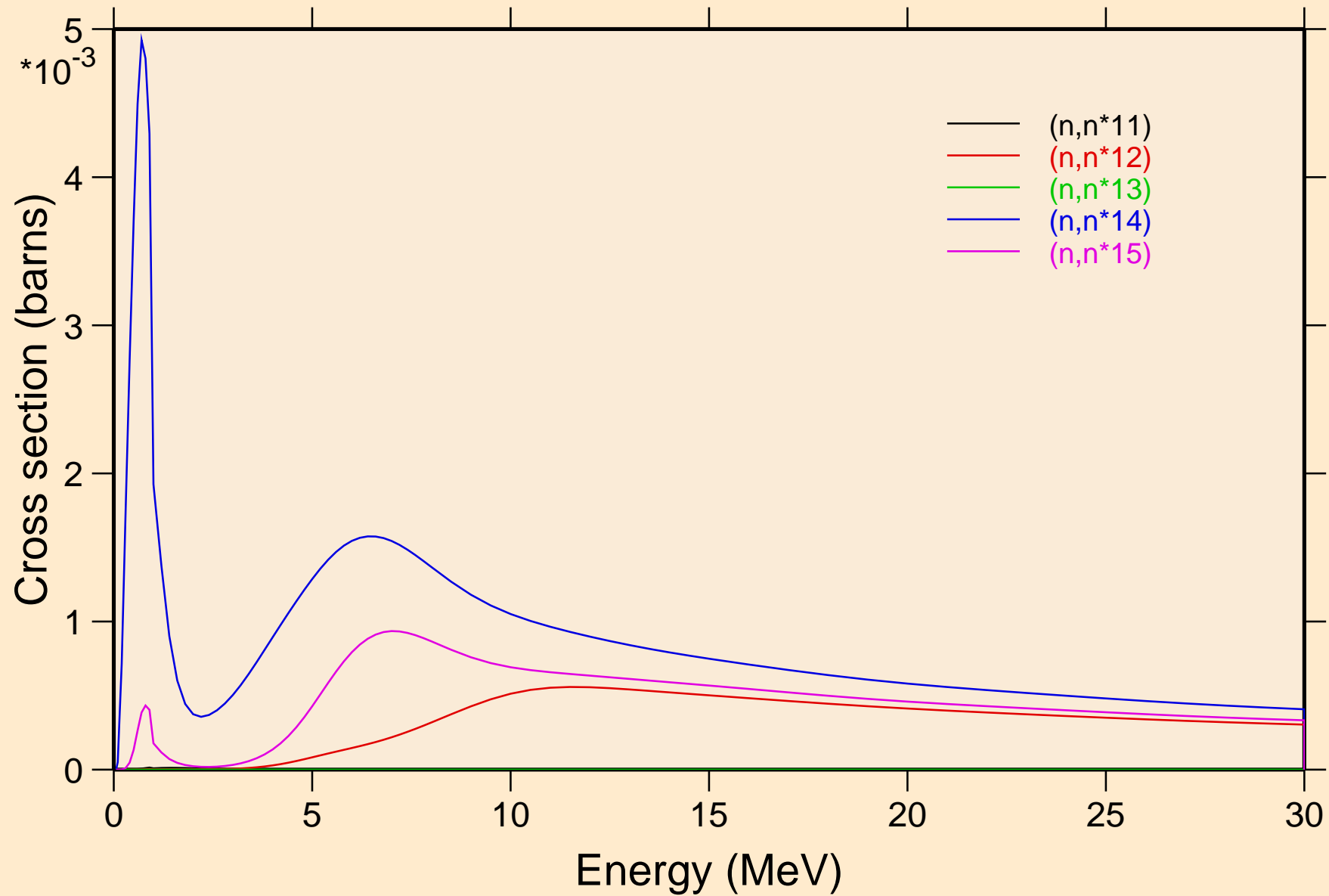

BH276 NEUTRON ACER TENDL-2024 LIBRARY; T=0.K
Inelastic levels

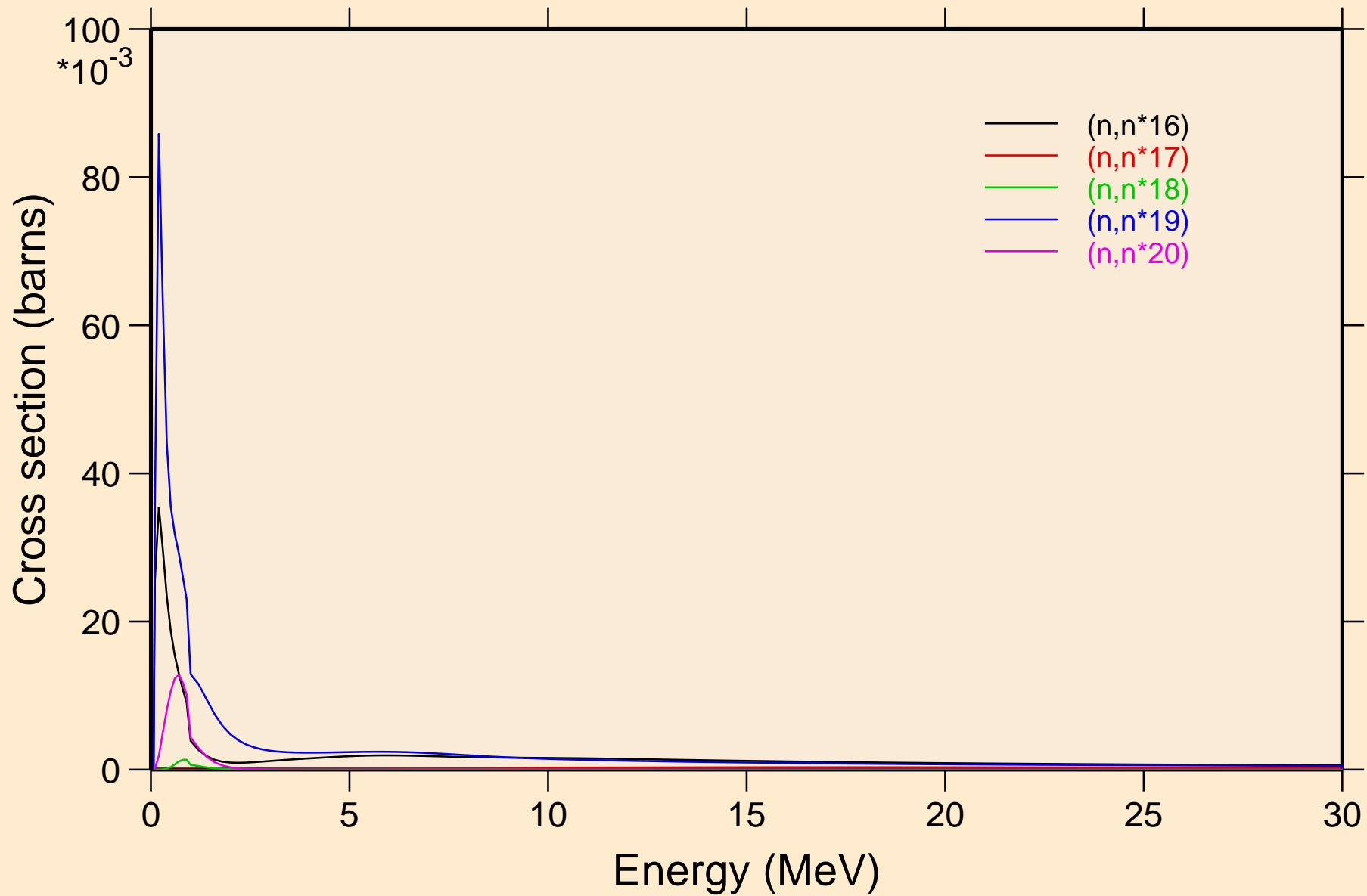

BH276 NEUTRON ACER TENDL-2024 LIBRARY; T=0.K
Inelastic levels

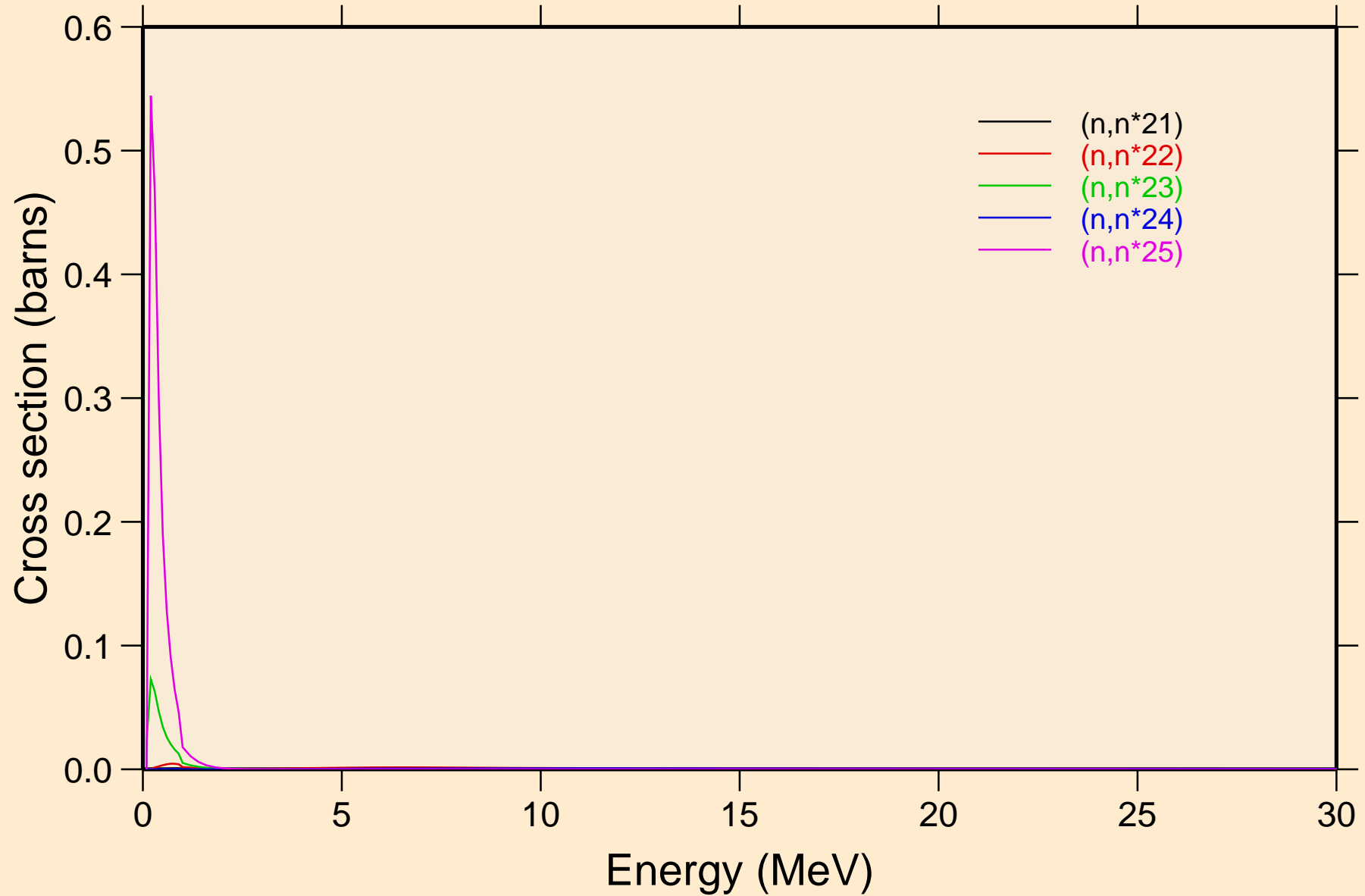

BH276 NEUTRON ACER TENDL-2024 LIBRARY; T=0.K
Inelastic levels

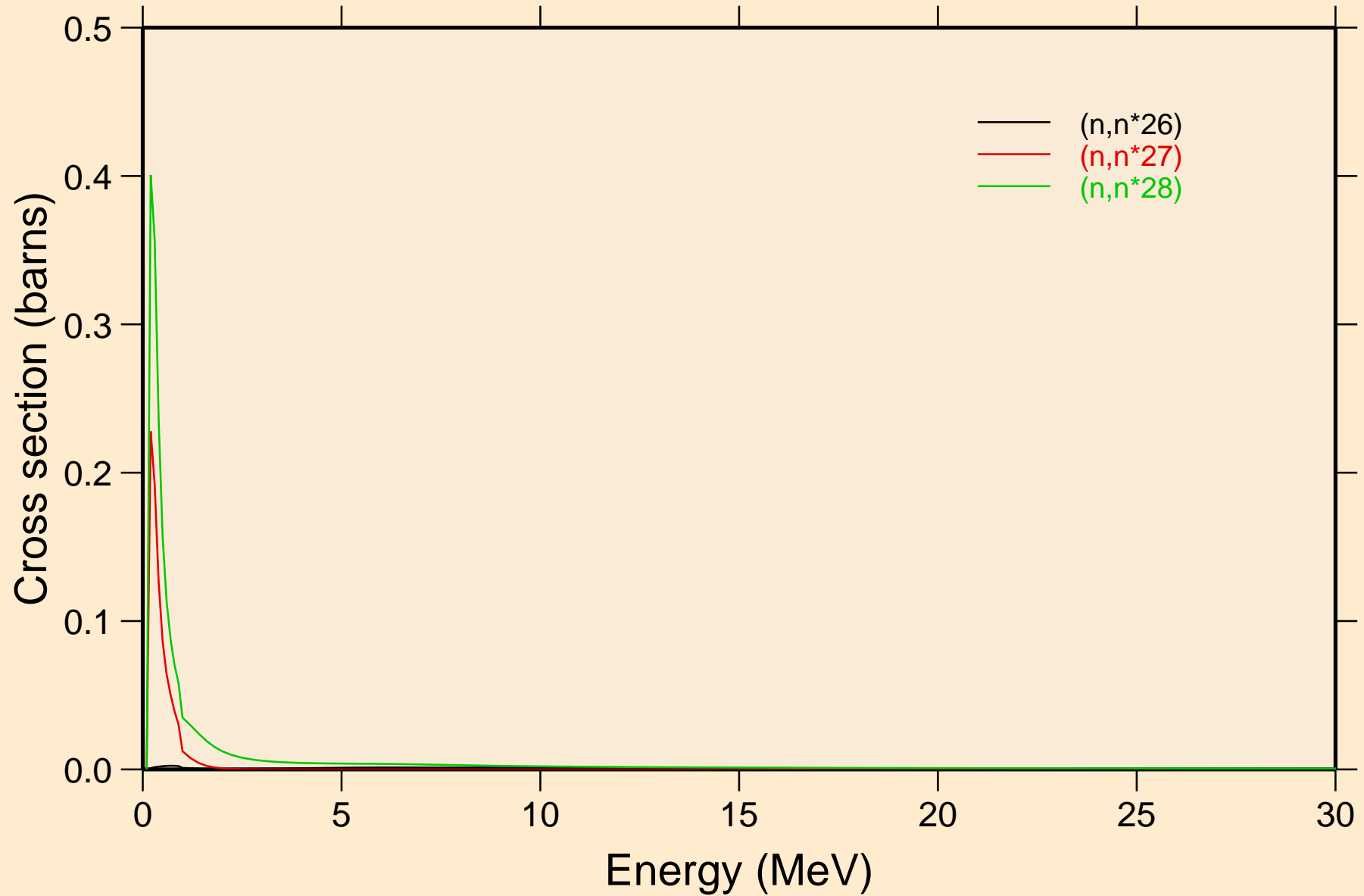

BH276 NEUTRON ACER TENDL-2024 LIBRARY; T=0.K
Threshold reactions

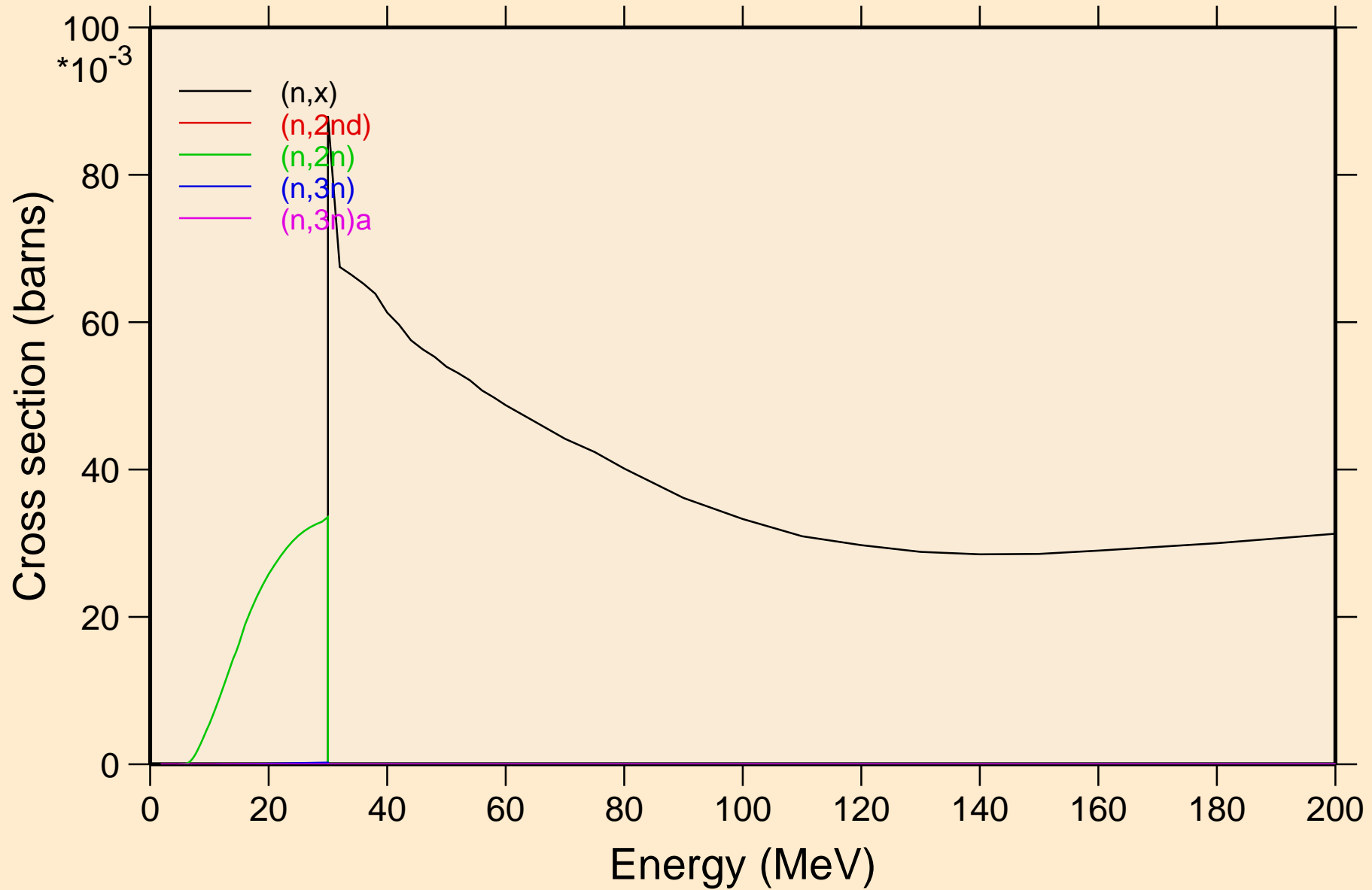

BH276 NEUTRON ACER TENDL-2024 LIBRARY; T=0.K
Threshold reactions

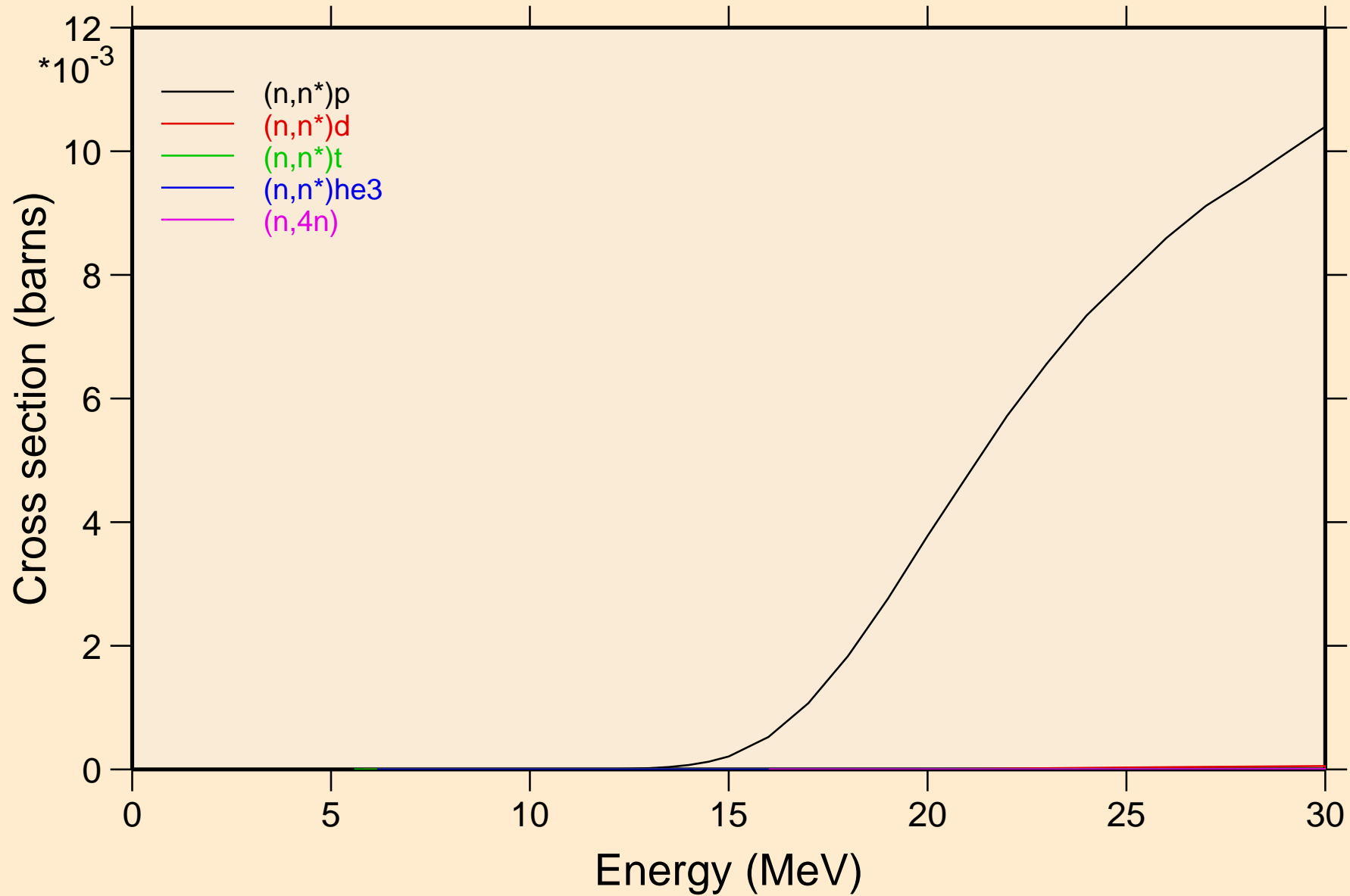

BH276 NEUTRON ACER TENDL-2024 LIBRARY; T=0.K
Threshold reactions

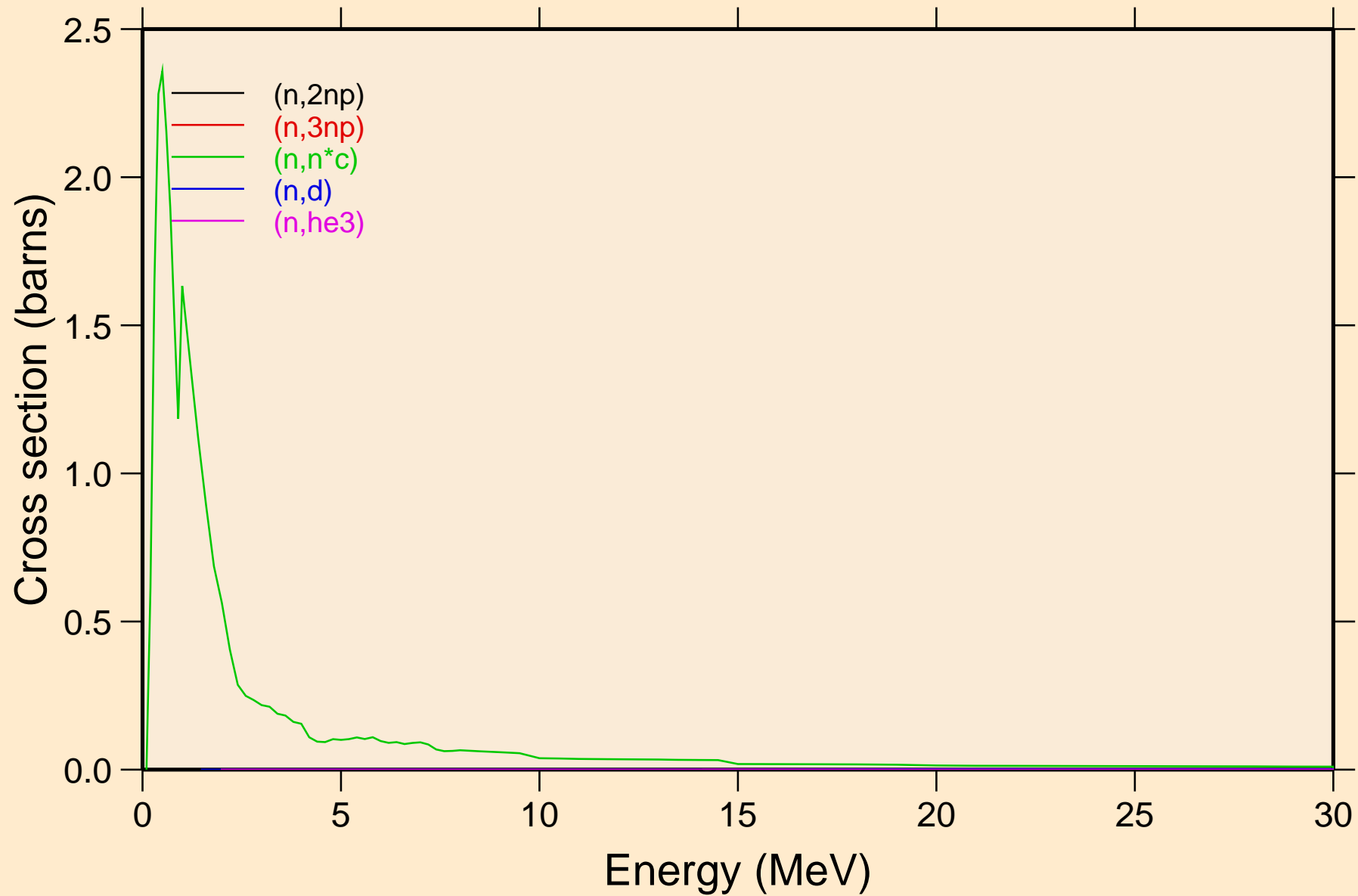

BH276 NEUTRON ACER TENDL-2024 LIBRARY; T=0.K

Threshold reactions

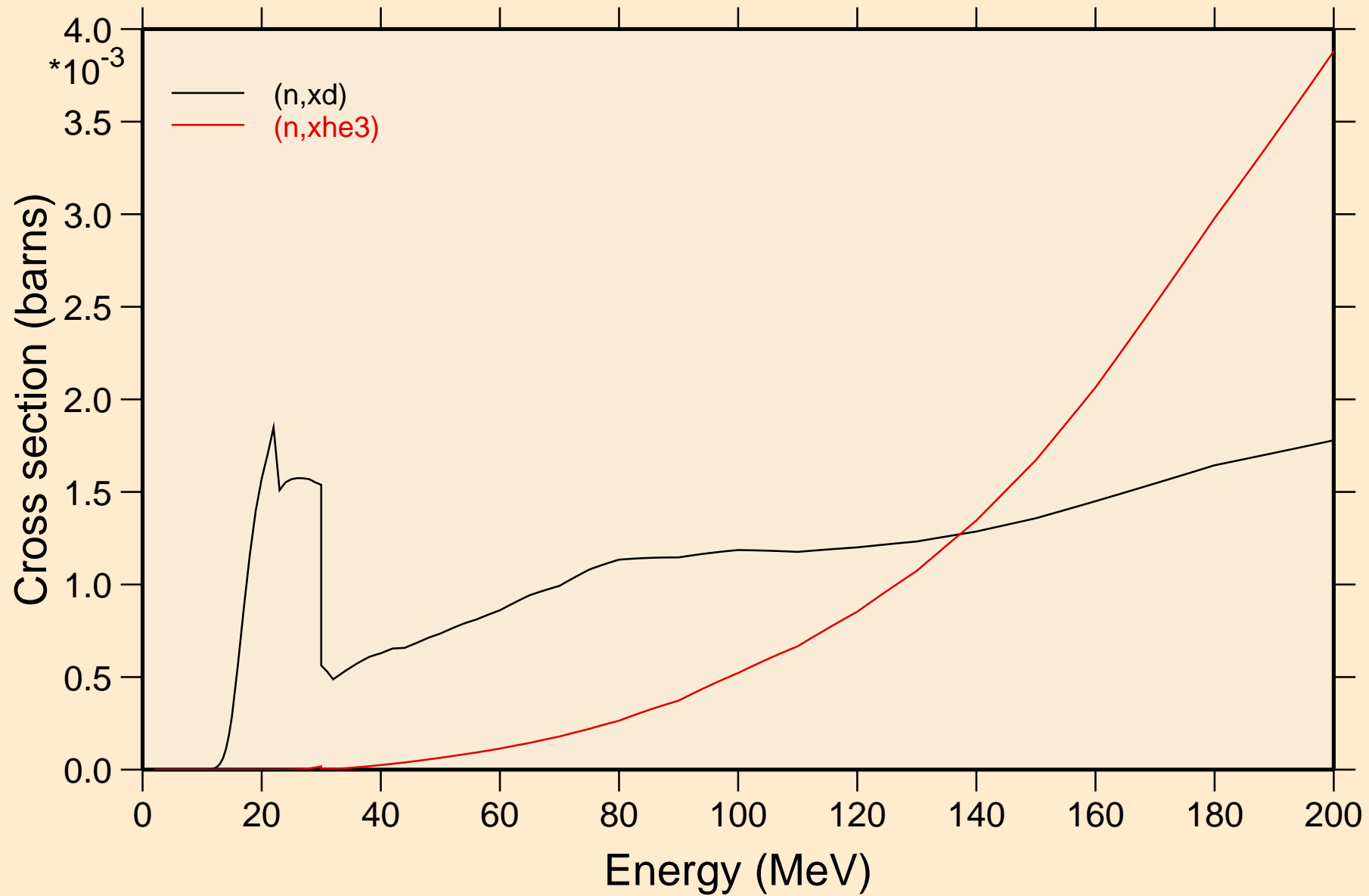

BH276 NEUTRON ACER TENDL-2024 LIBRARY; T=0.K
angular distribution for elastic

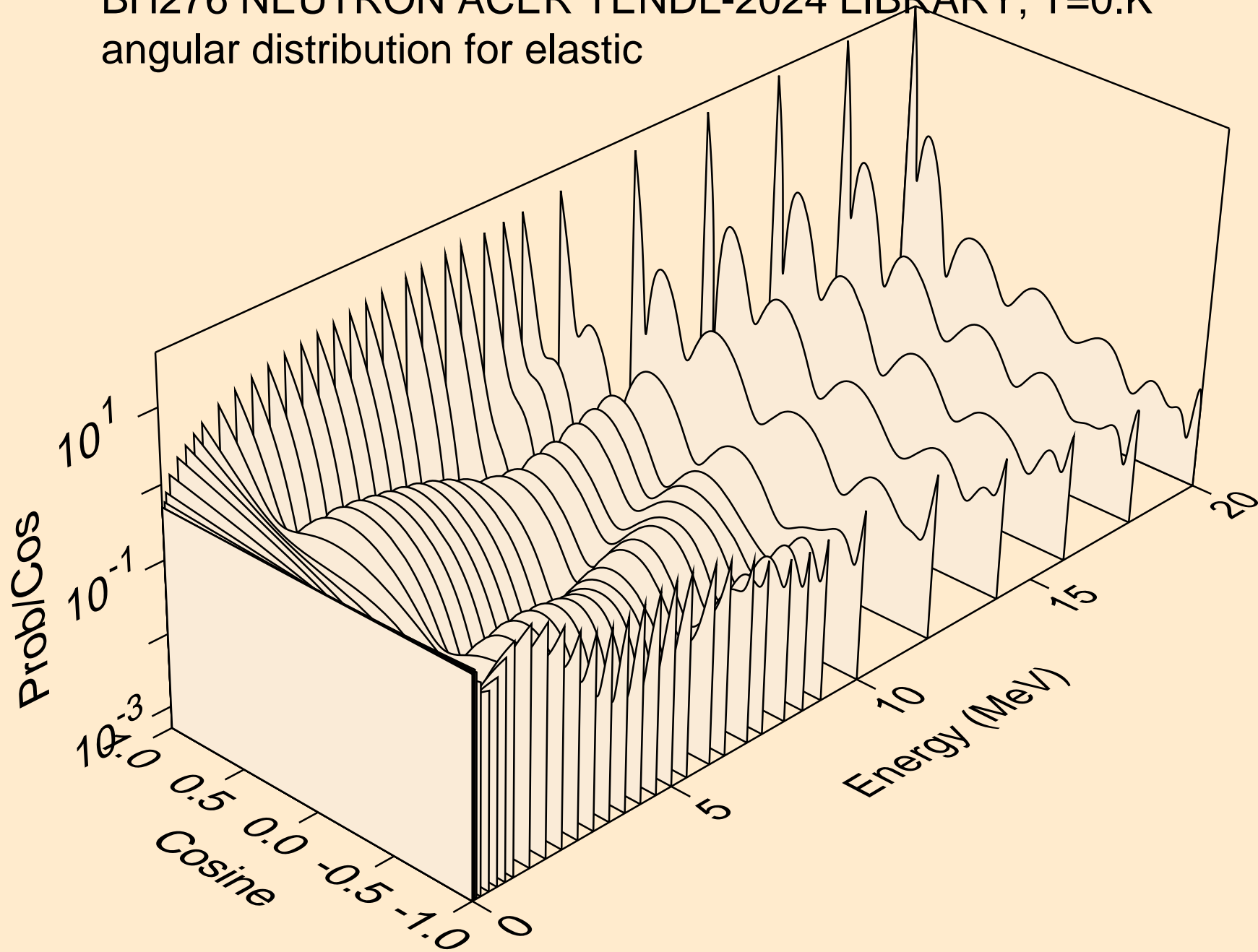

BH276 NEUTRON ACER TENDL-2024 LIBRARY; T=0.K
angular distribution for elastic

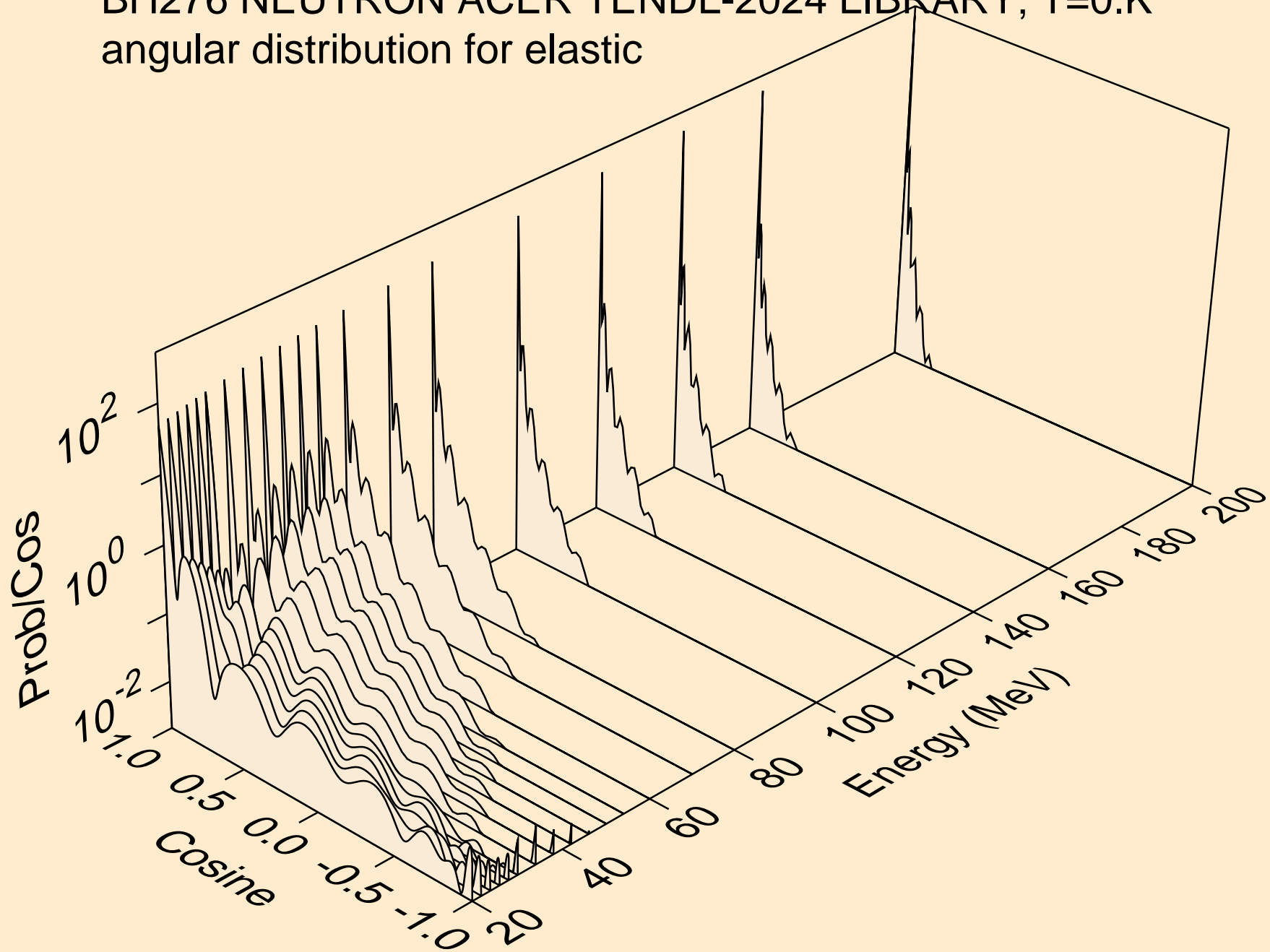

BH276 NEUTRON ACER TENDL-2024 LIBRARY; T=0.K
angular distribution for (n,n*1)

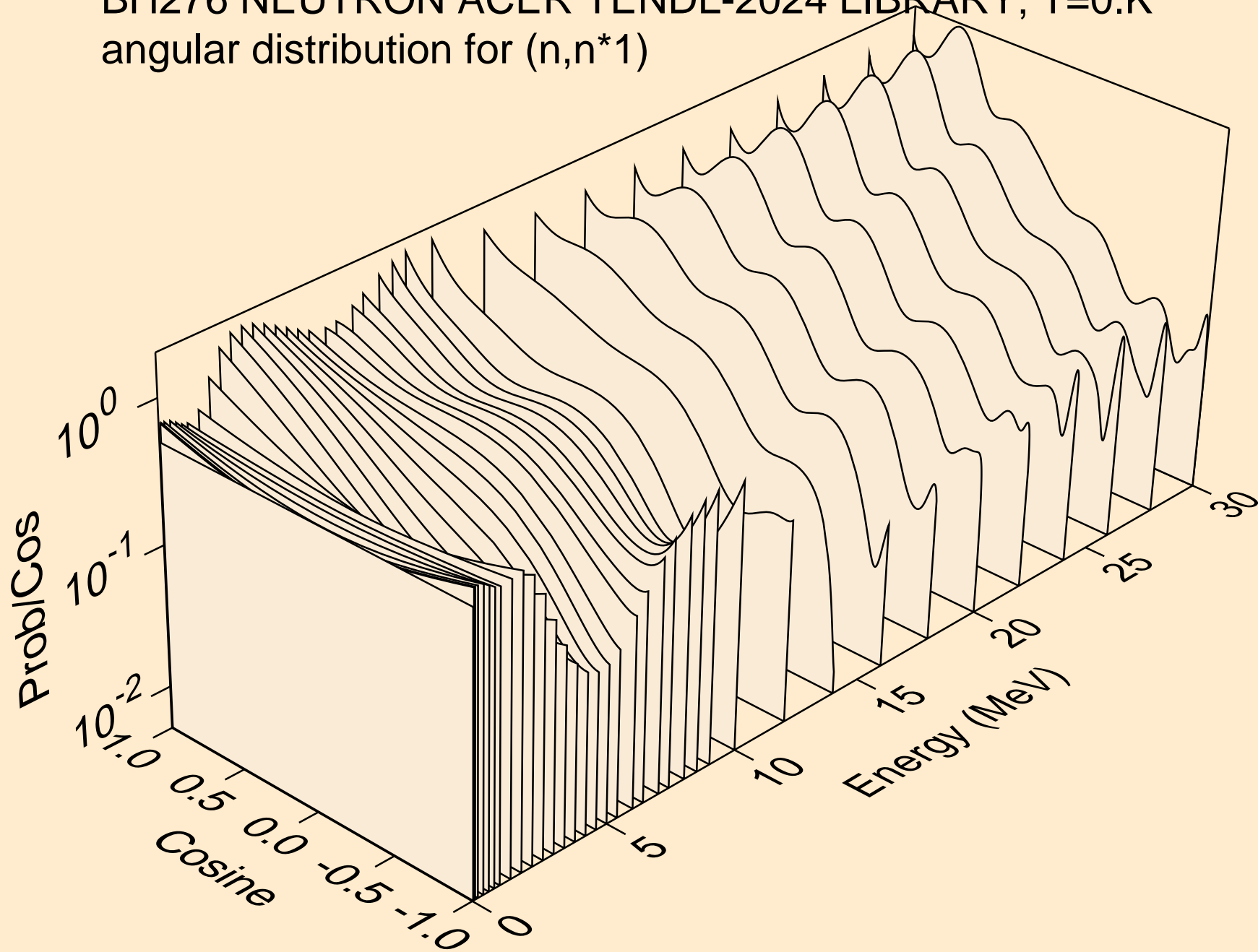

BH276 NEUTRON ACER TENDL-2024 LIBRARY; T=0.K
angular distribution for (n,n*2)

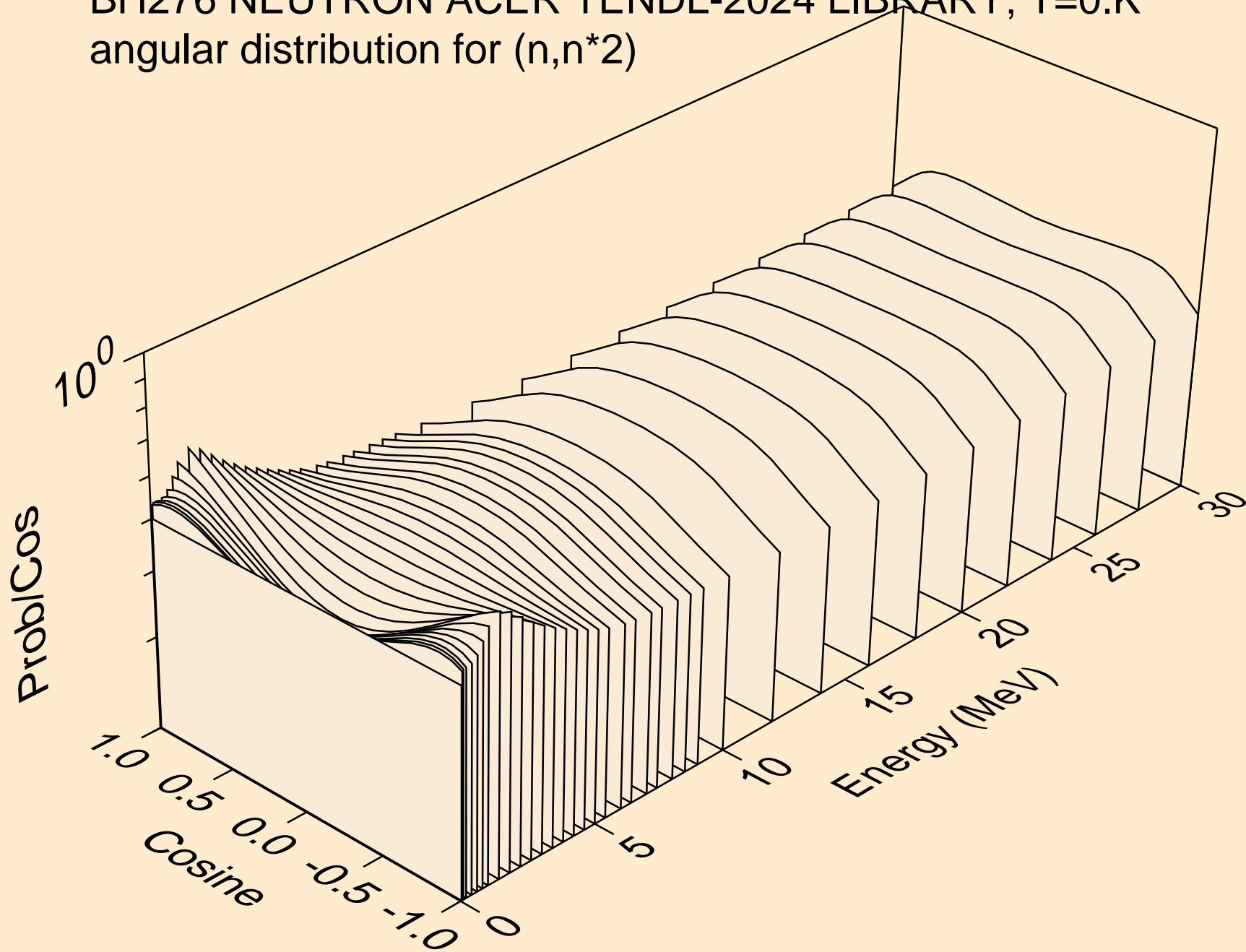

BH276 NEUTRON ACER TENDL-2024 LIBRARY; T=0.K
angular distribution for (n,n*3)

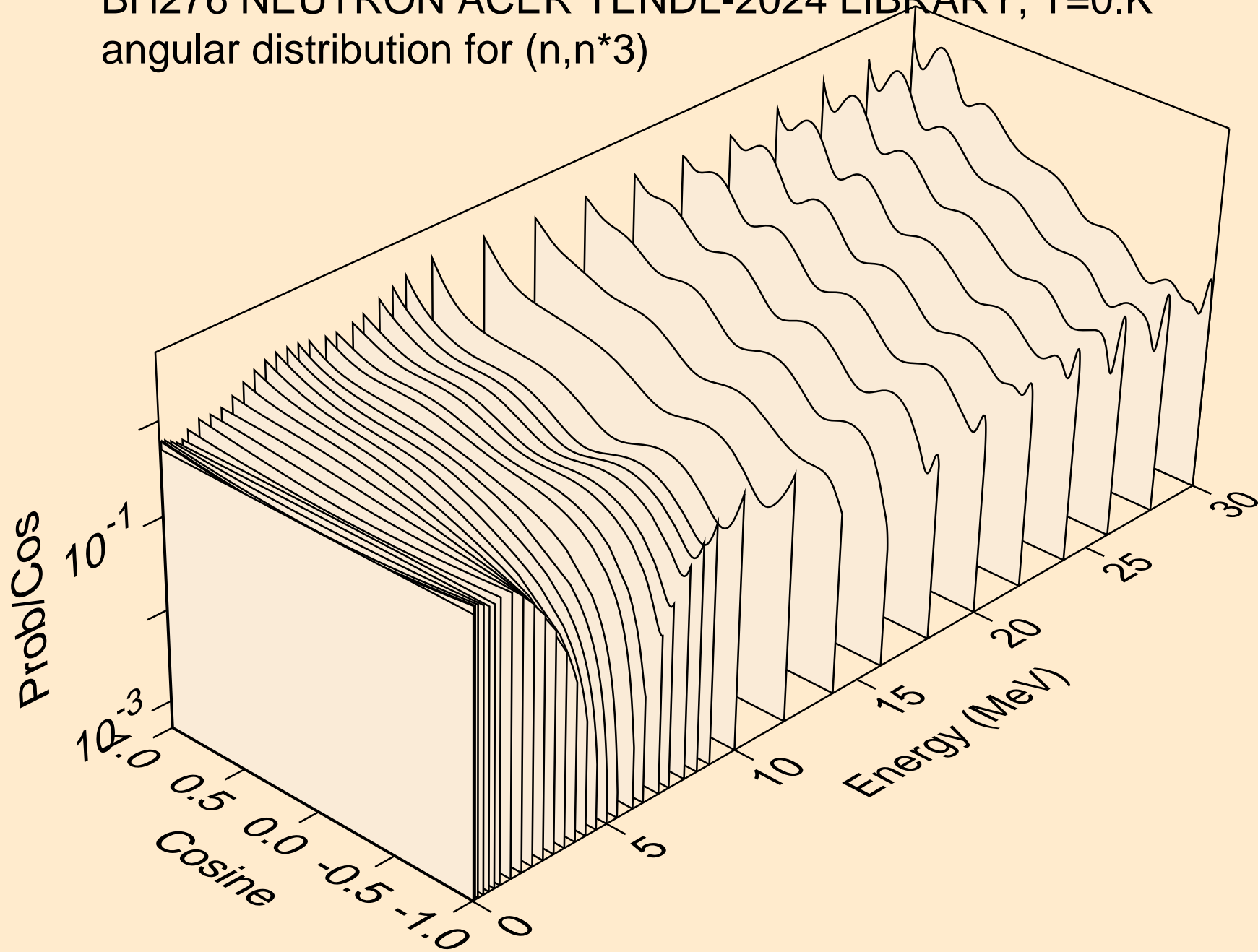

BH276 NEUTRON ACER TENDL-2024 LIBRARY; T=0.K
angular distribution for (n,n*4)

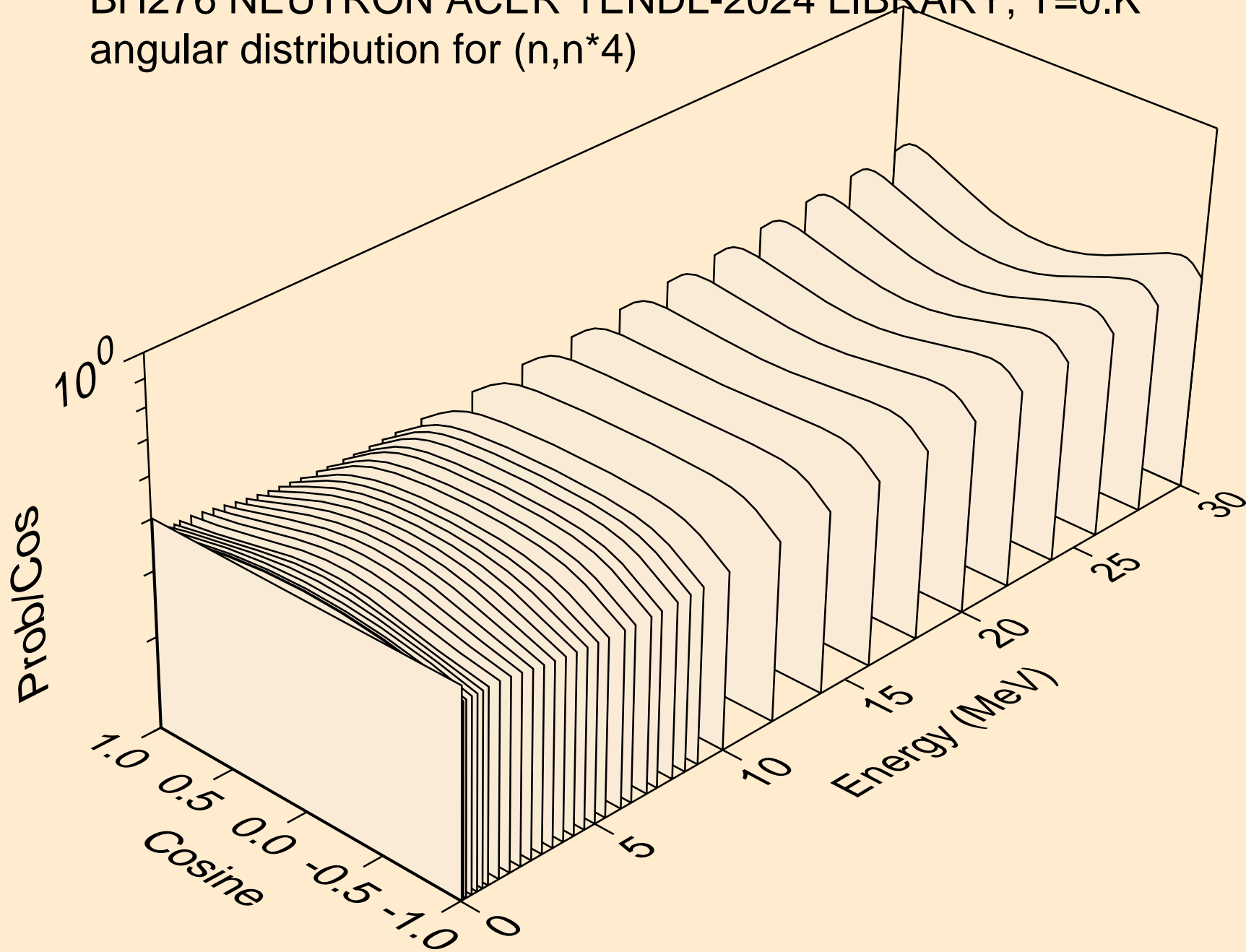

BH276 NEUTRON ACER TENDL-2024 LIBRARY; T=0.K
angular distribution for (n,n*5)

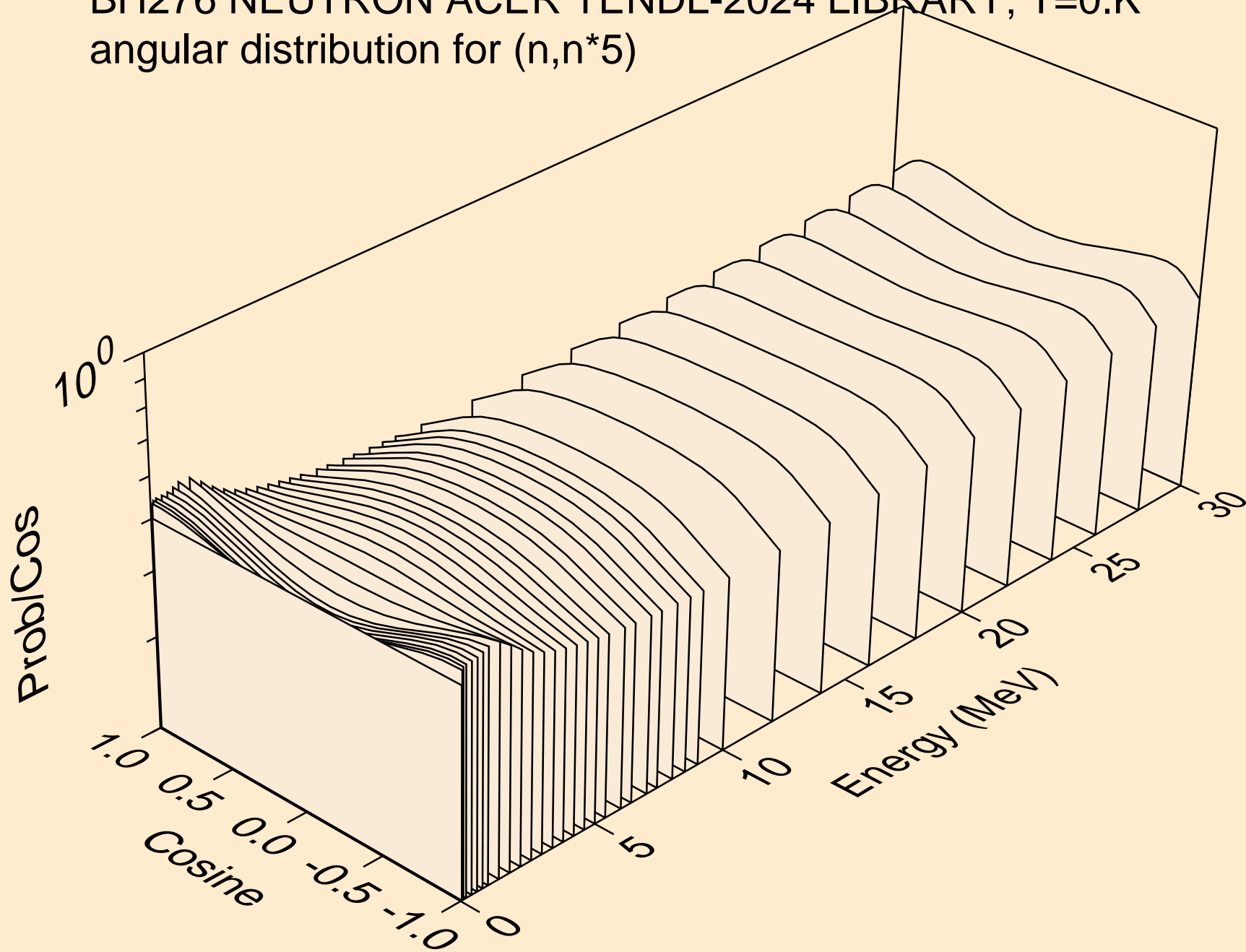

BH276 NEUTRON ACER TENDL-2024 LIBRARY; T=0.K
angular distribution for (n,n*6)

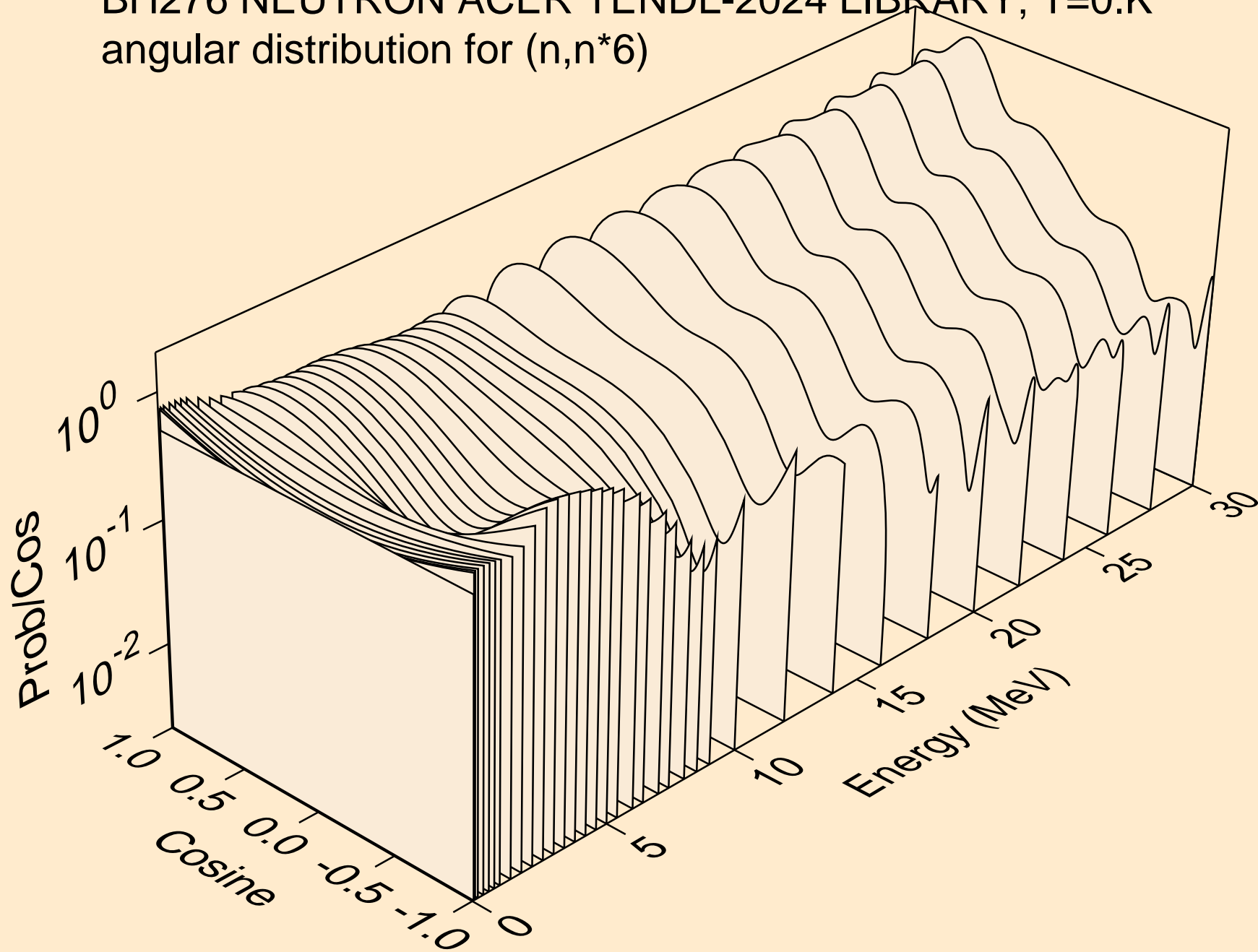

BH276 NEUTRON ACER TENDL-2024 LIBRARY; T=0.K
angular distribution for (n,n*7)

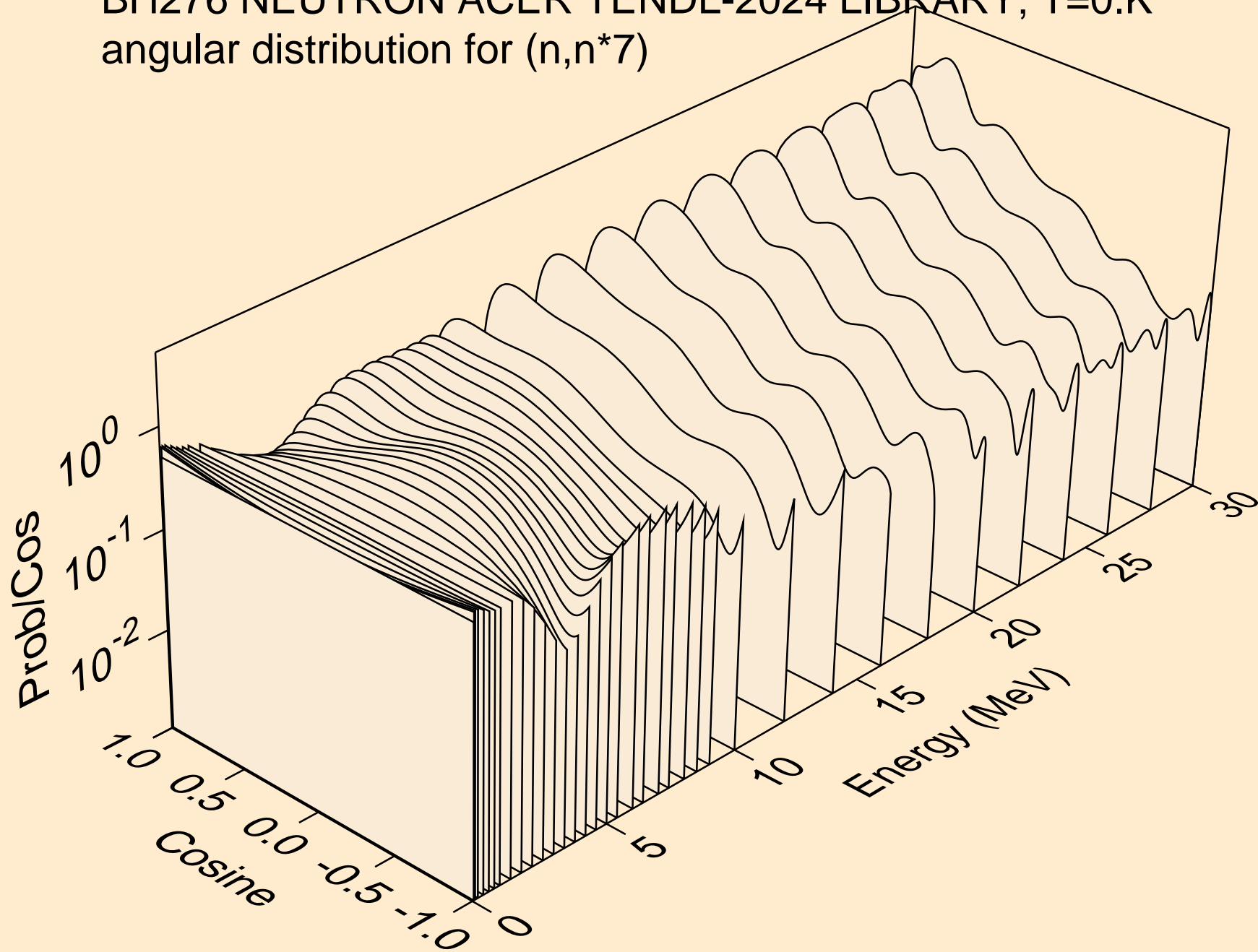

BH276 NEUTRON ACER TENDL-2024 LIBRARY; T=0.K
angular distribution for (n,n*8)

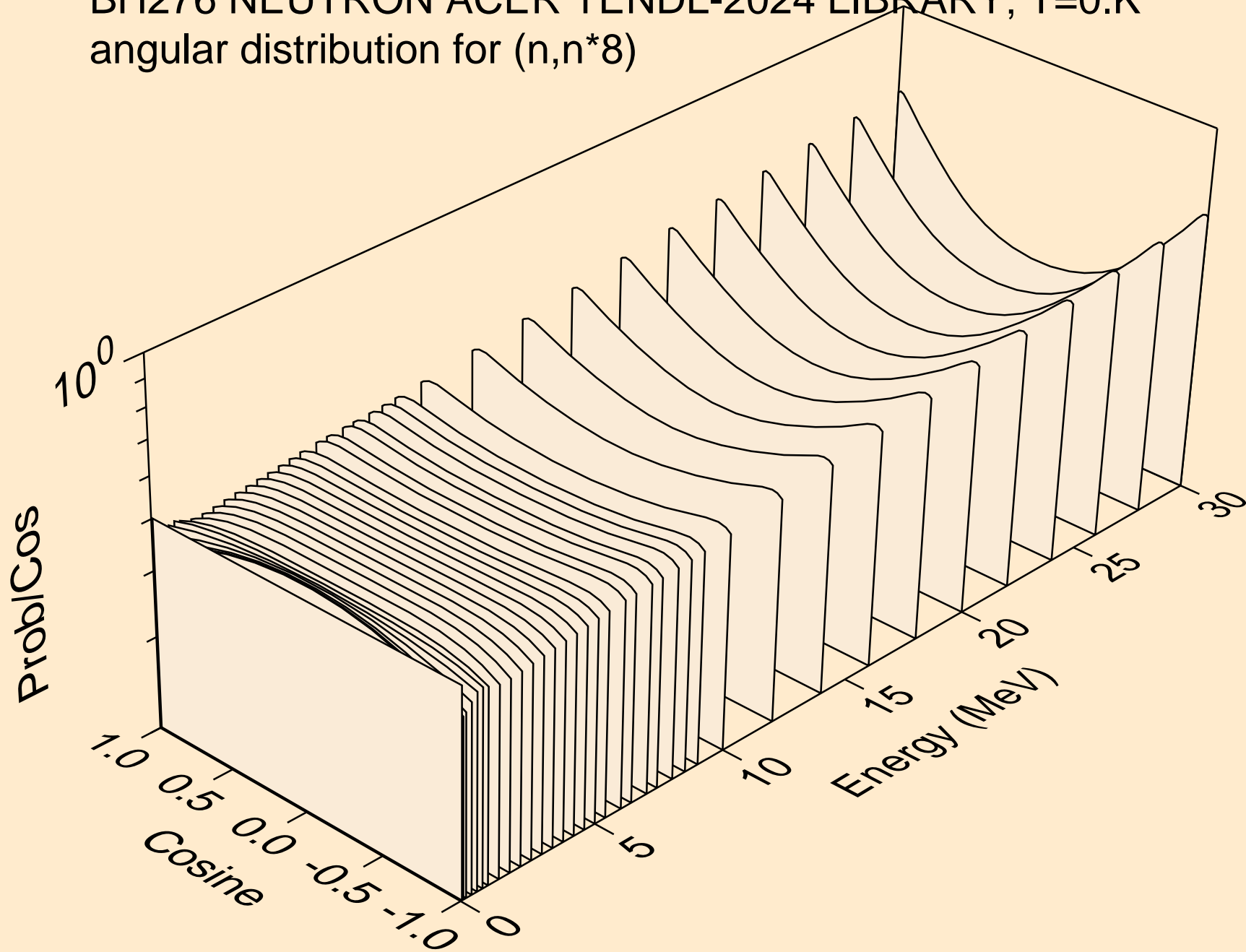

BH276 NEUTRON ACER TENDL-2024 LIBRARY; T=0.K
angular distribution for (n,n*9)

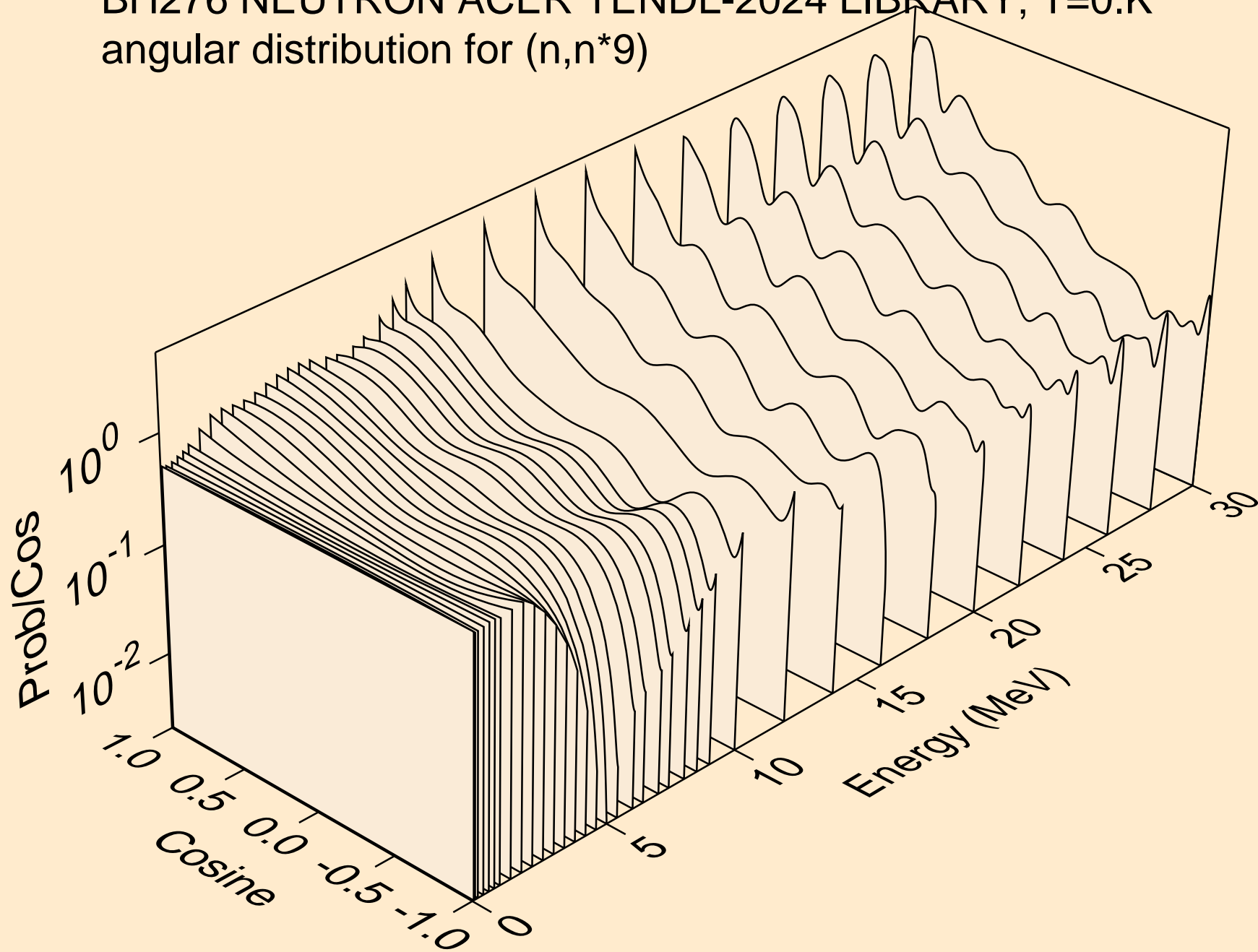

BH276 NEUTRON ACER TENDL-2024 LIBRARY; T=0.K
angular distribution for (n,n*10)

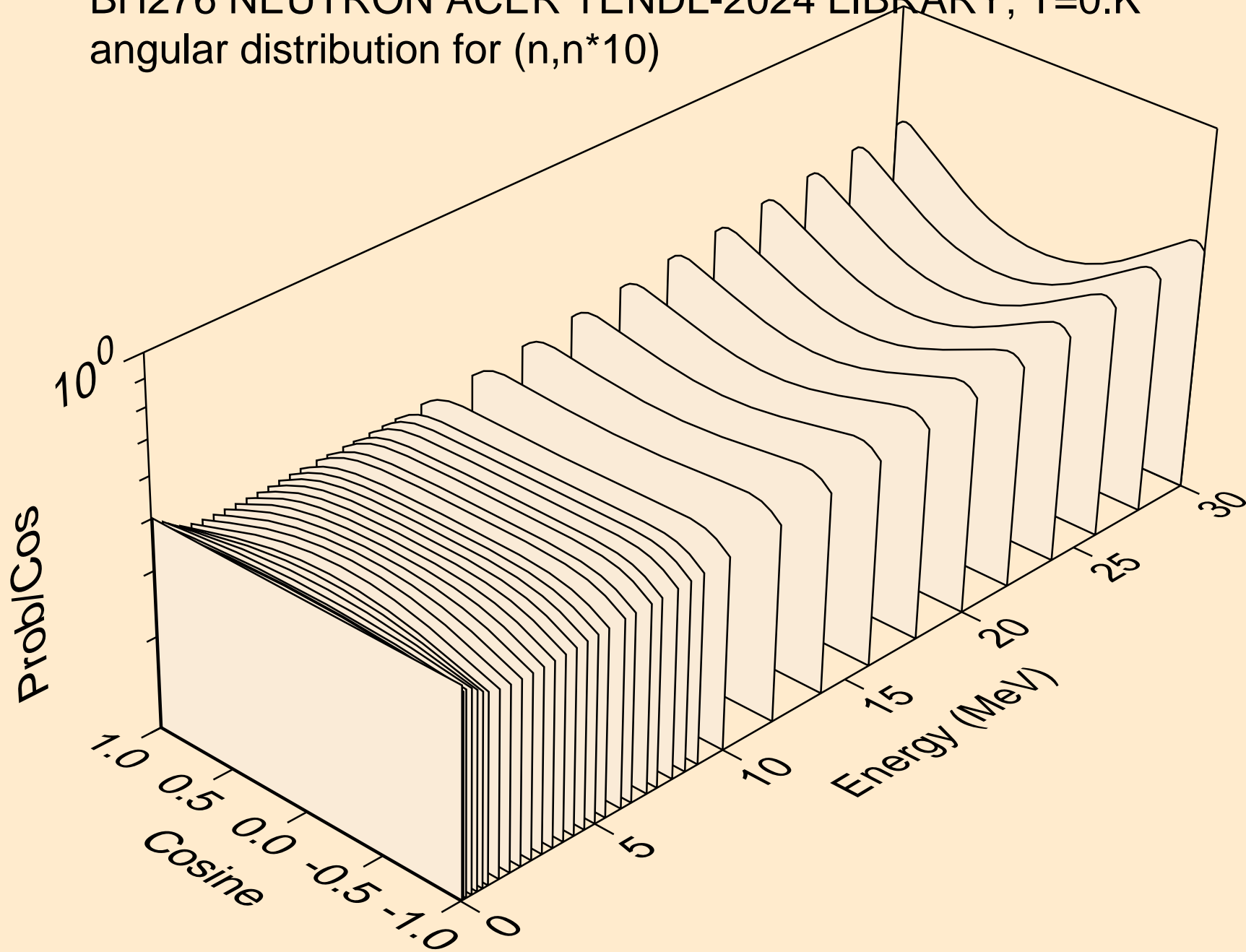

BH276 NEUTRON ACER TENDL-2024 LIBRARY; T=0.K
angular distribution for (n,n*11)

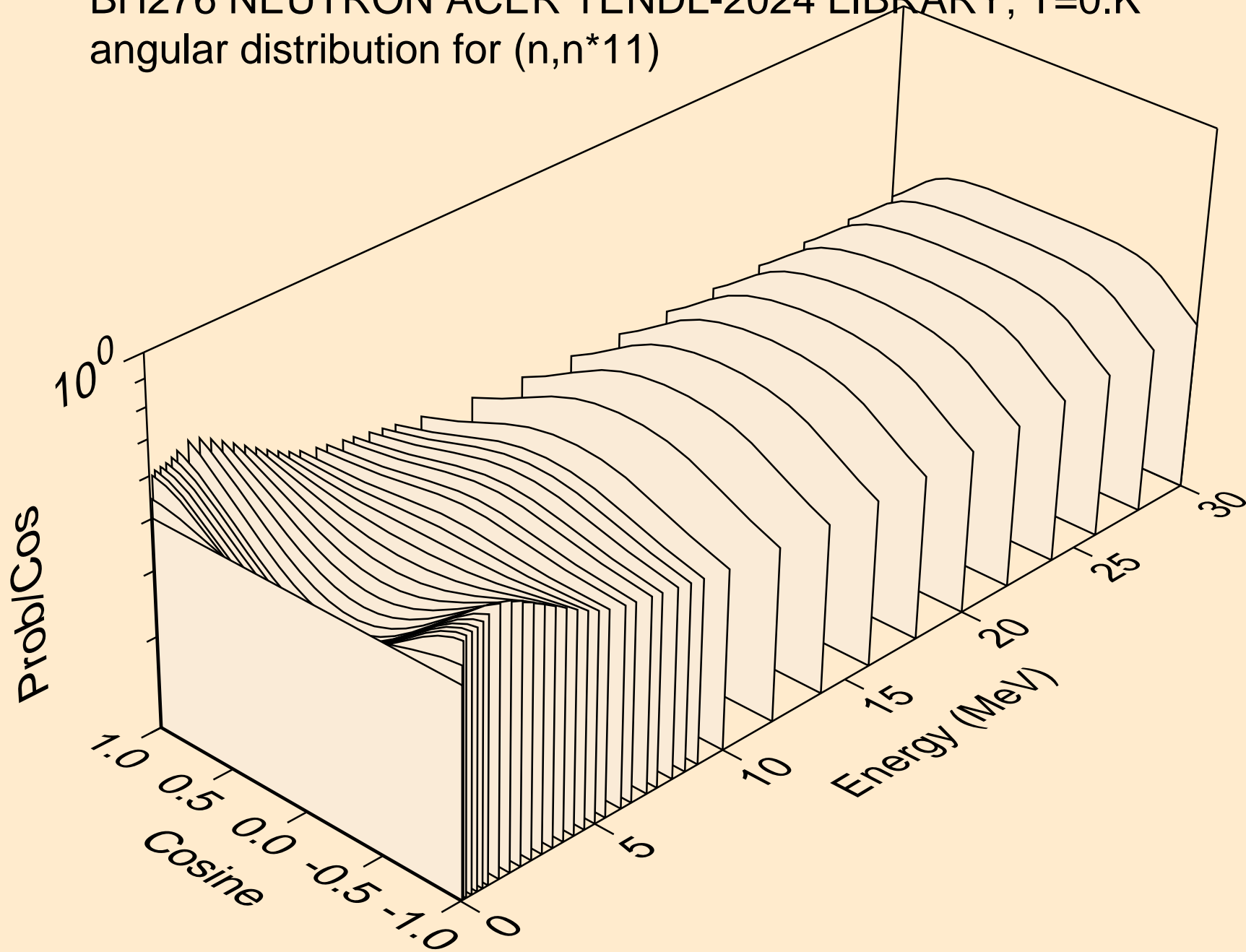

BH276 NEUTRON ACER TENDL-2024 LIBRARY; T=0.K
angular distribution for (n,n*12)

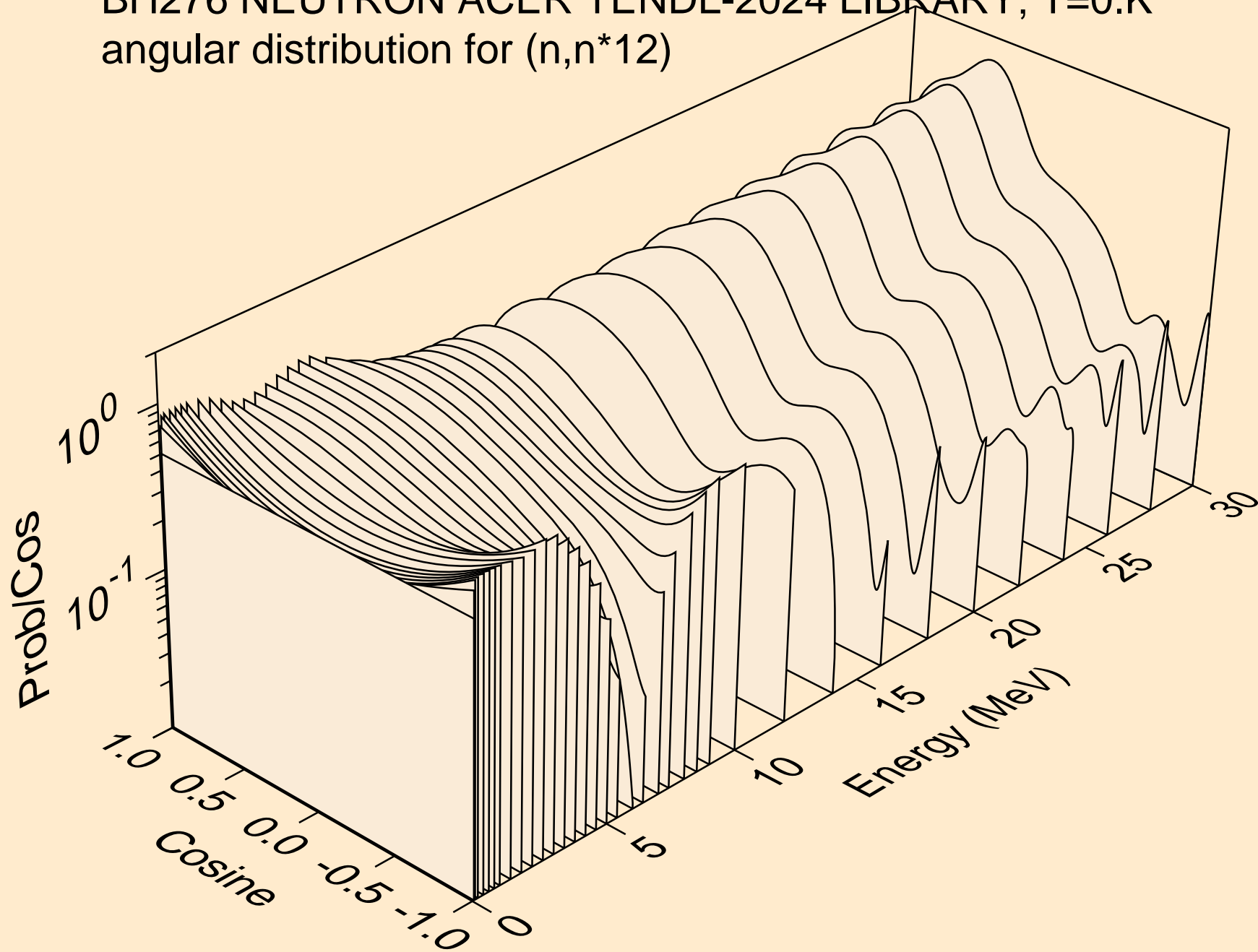

BH276 NEUTRON ACER TENDL-2024 LIBRARY; T=0.K
angular distribution for (n,n*13)

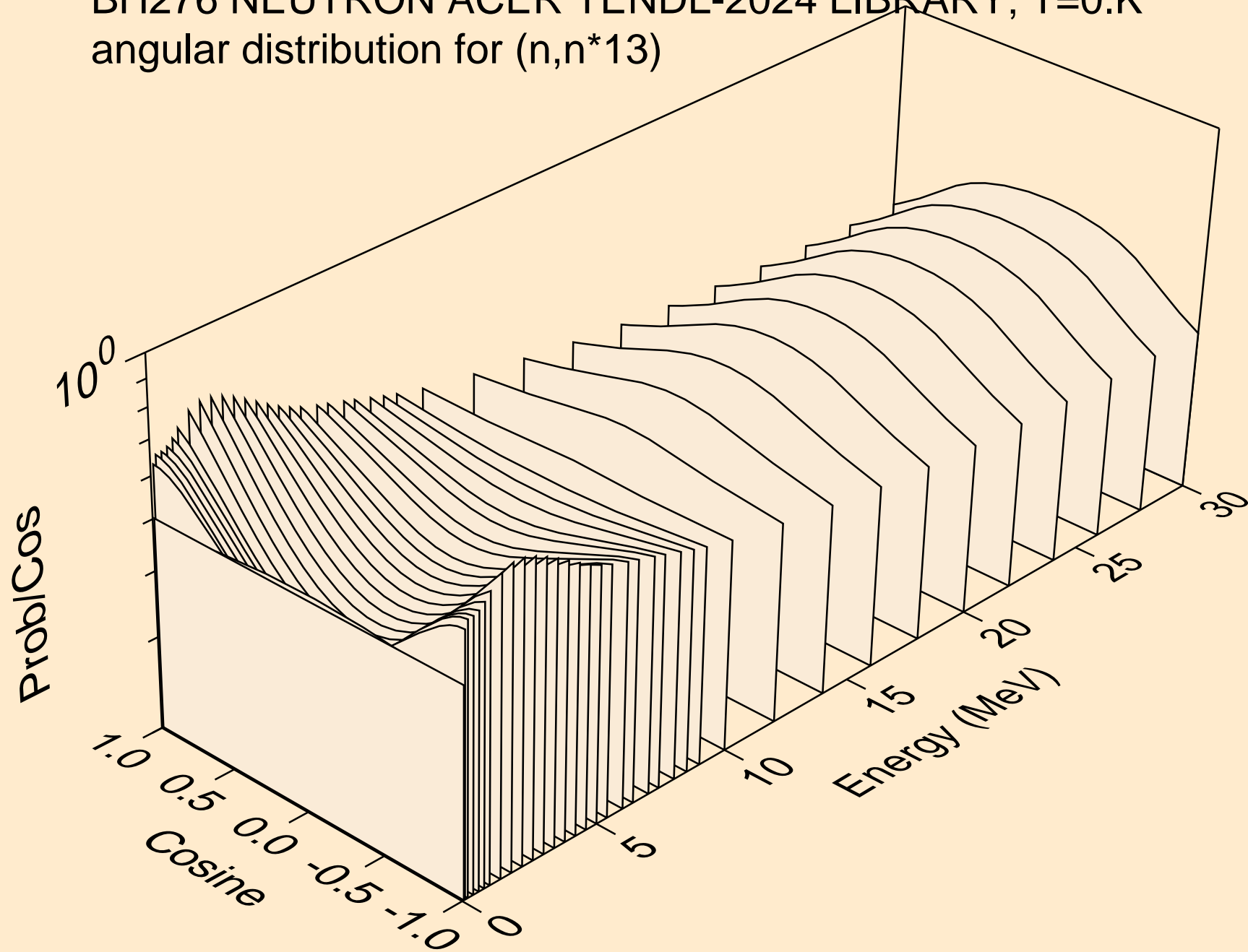

BH276 NEUTRON ACER TENDL-2024 LIBRARY; T=0.K
angular distribution for (n,n*14)

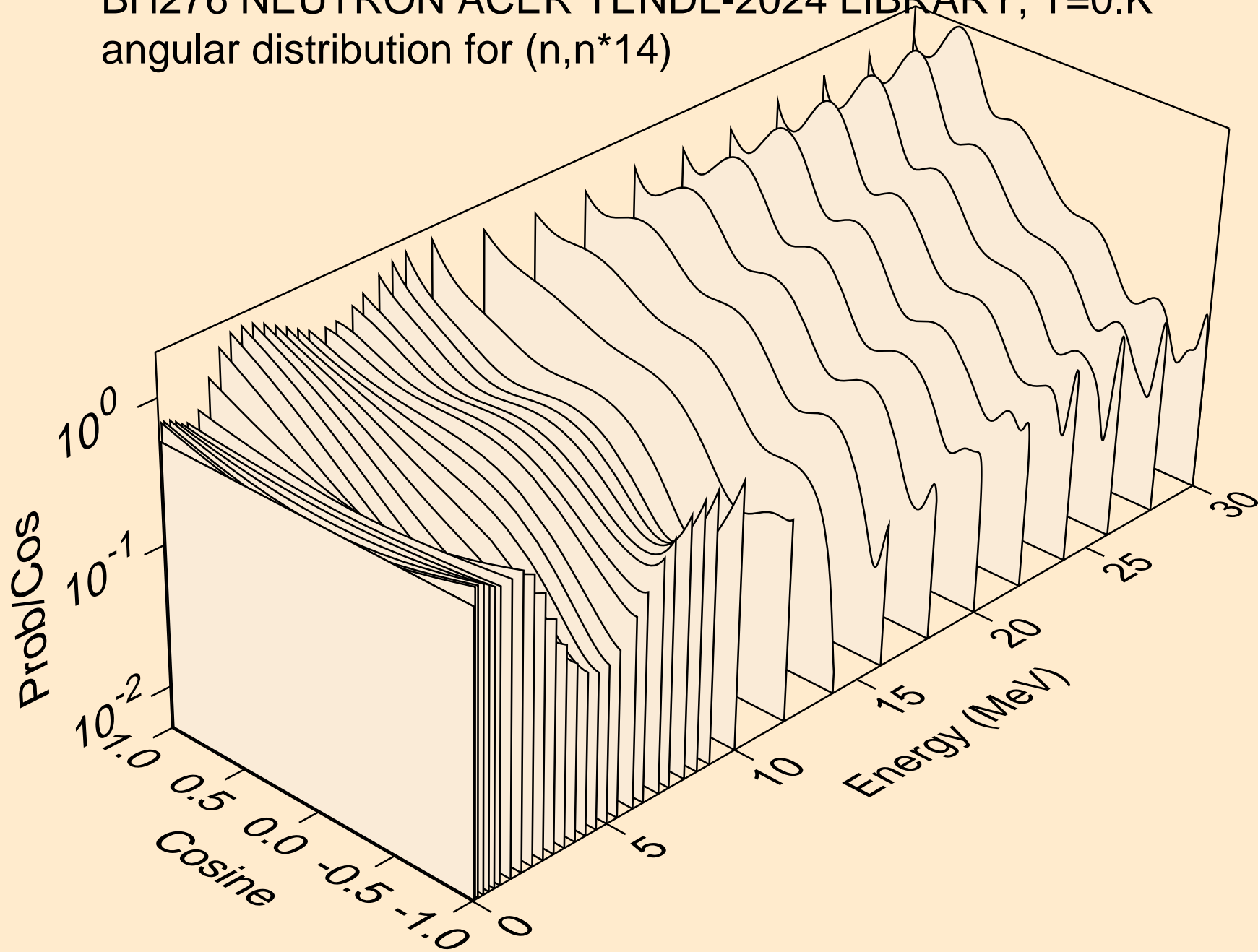

BH276 NEUTRON ACER TENDL-2024 LIBRARY; T=0.K
angular distribution for (n,n*15)

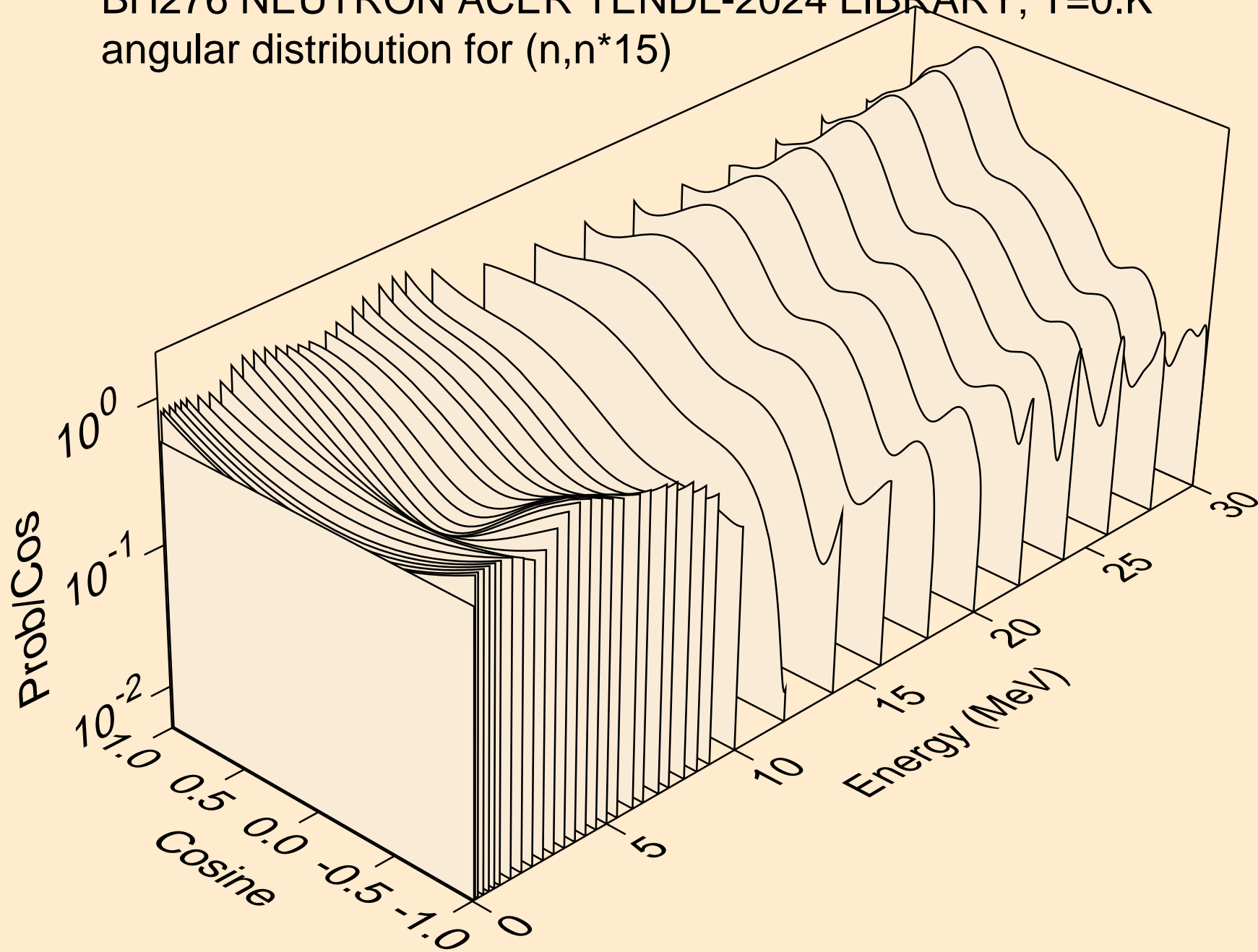

BH276 NEUTRON ACER TENDL-2024 LIBRARY; T=0.K
angular distribution for (n,n*16)

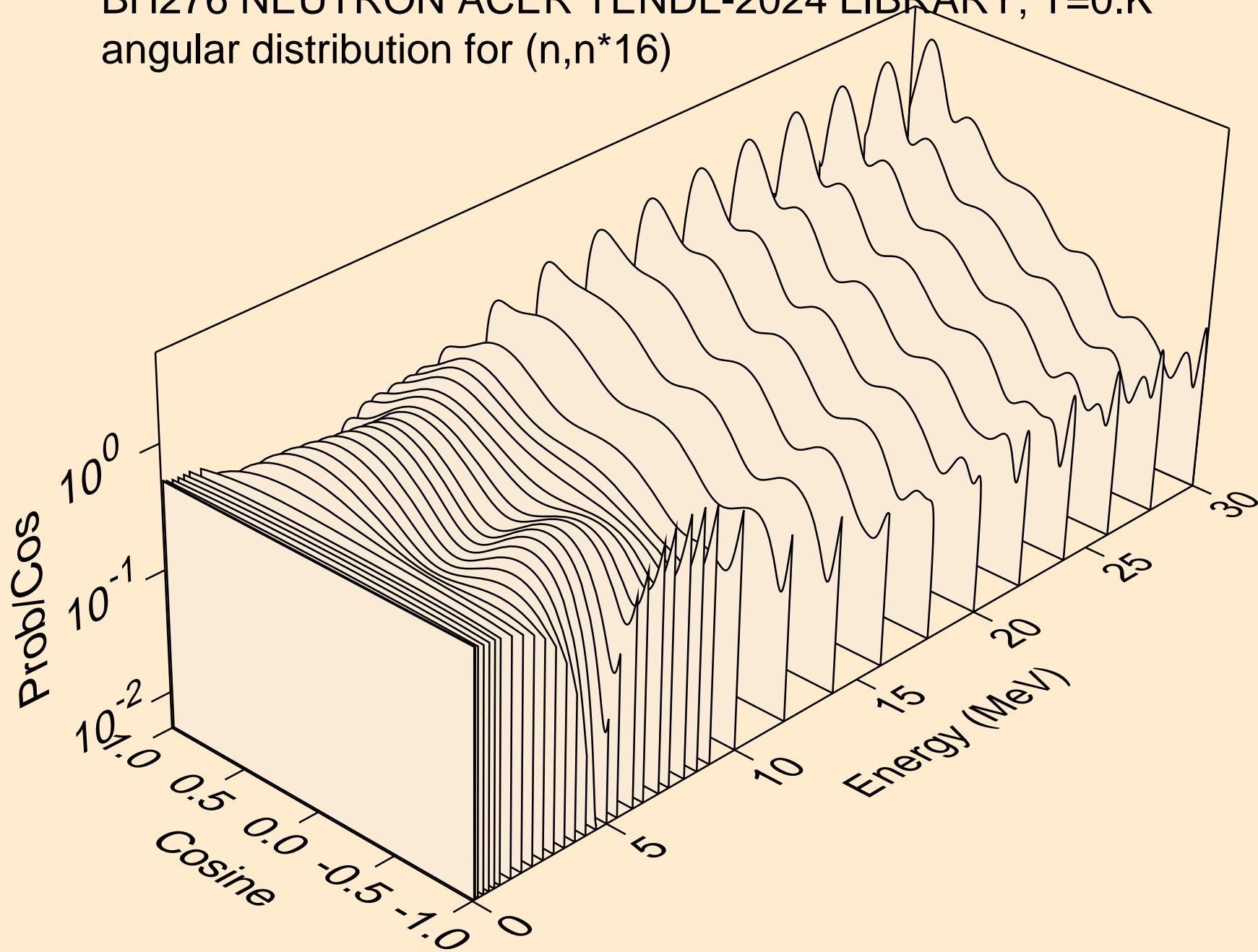

BH276 NEUTRON ACER TENDL-2024 LIBRARY; T=0.K
angular distribution for (n,n*17)

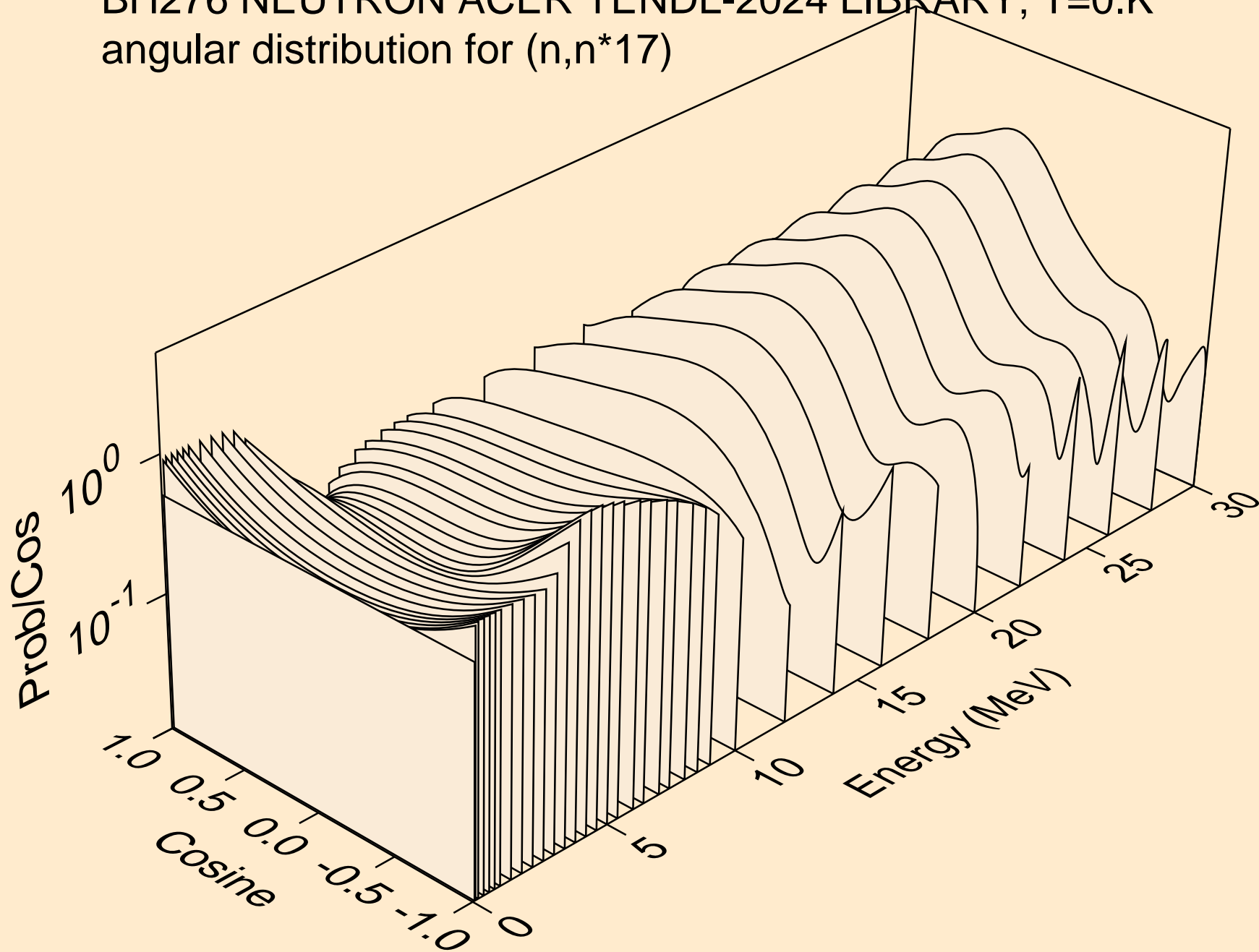

BH276 NEUTRON ACER TENDL-2024 LIBRARY; T=0.K
angular distribution for (n,n*18)

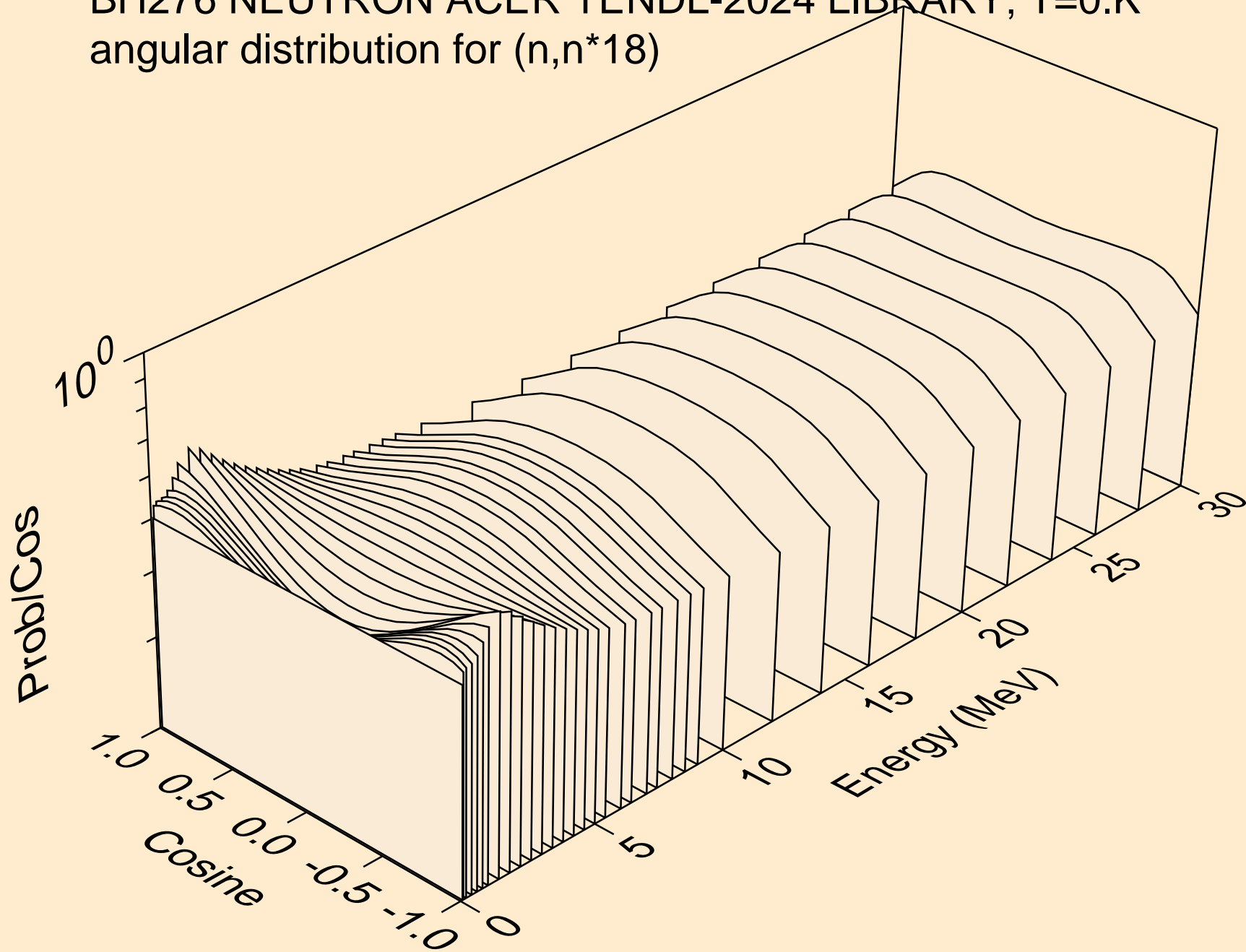

BH276 NEUTRON ACER TENDL-2024 LIBRARY; T=0.K
angular distribution for (n,n*19)

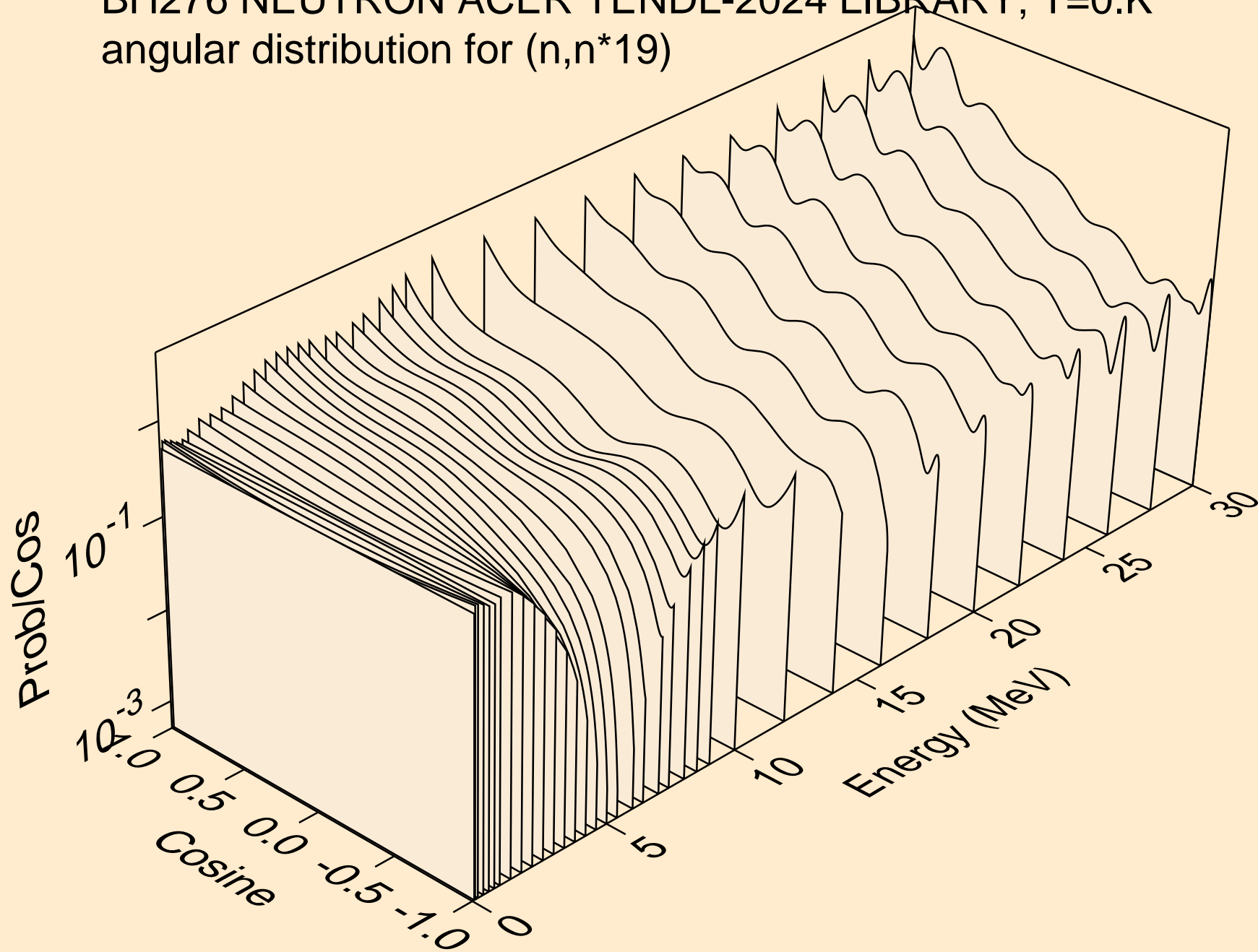

BH276 NEUTRON ACER TENDL-2024 LIBRARY; T=0.K
angular distribution for (n,n*20)

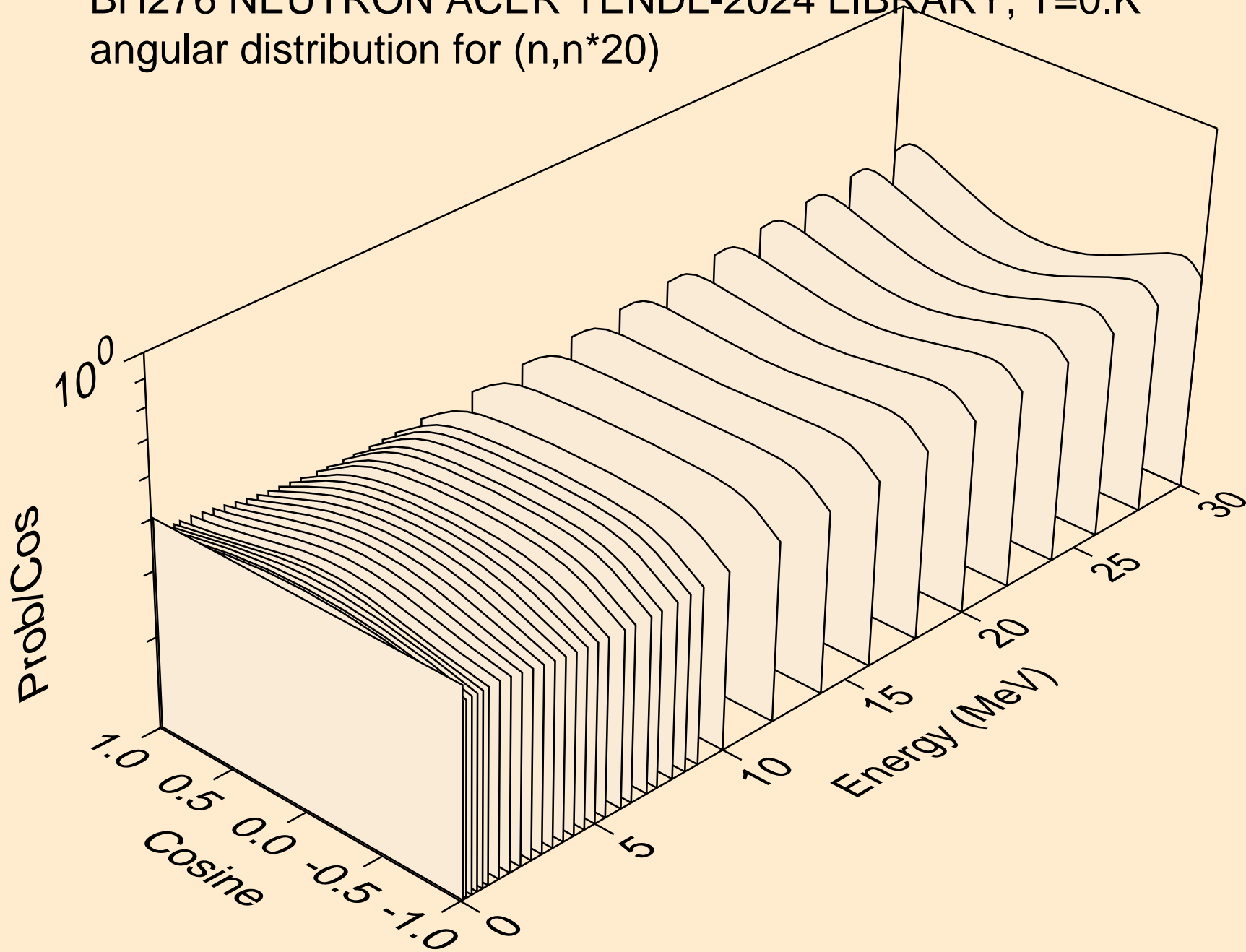

BH276 NEUTRON ACER TENDL-2024 LIBRARY; T=0.K
angular distribution for (n,n*21)

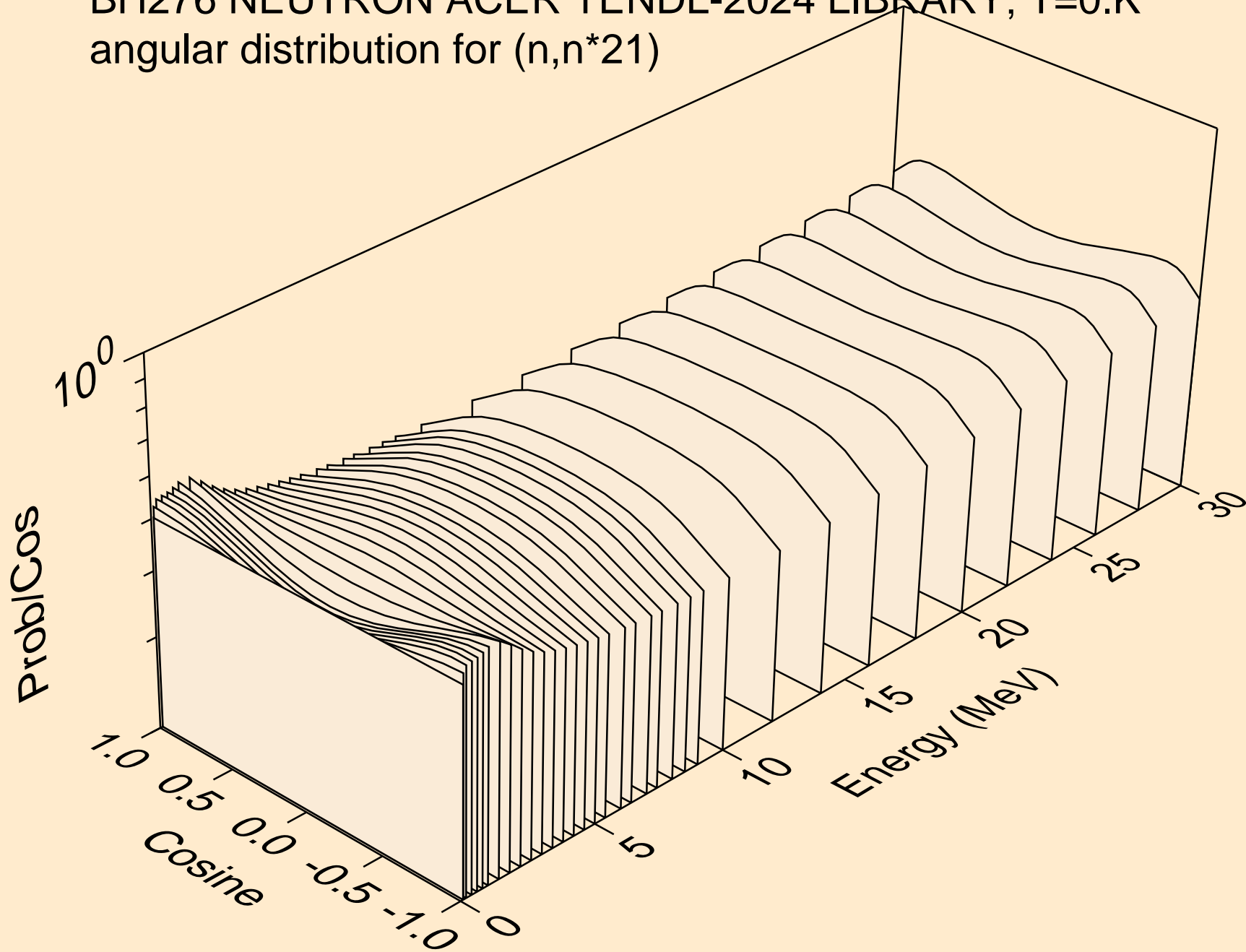

BH276 NEUTRON ACER TENDL-2024 LIBRARY; T=0.K
angular distribution for (n,n*22)

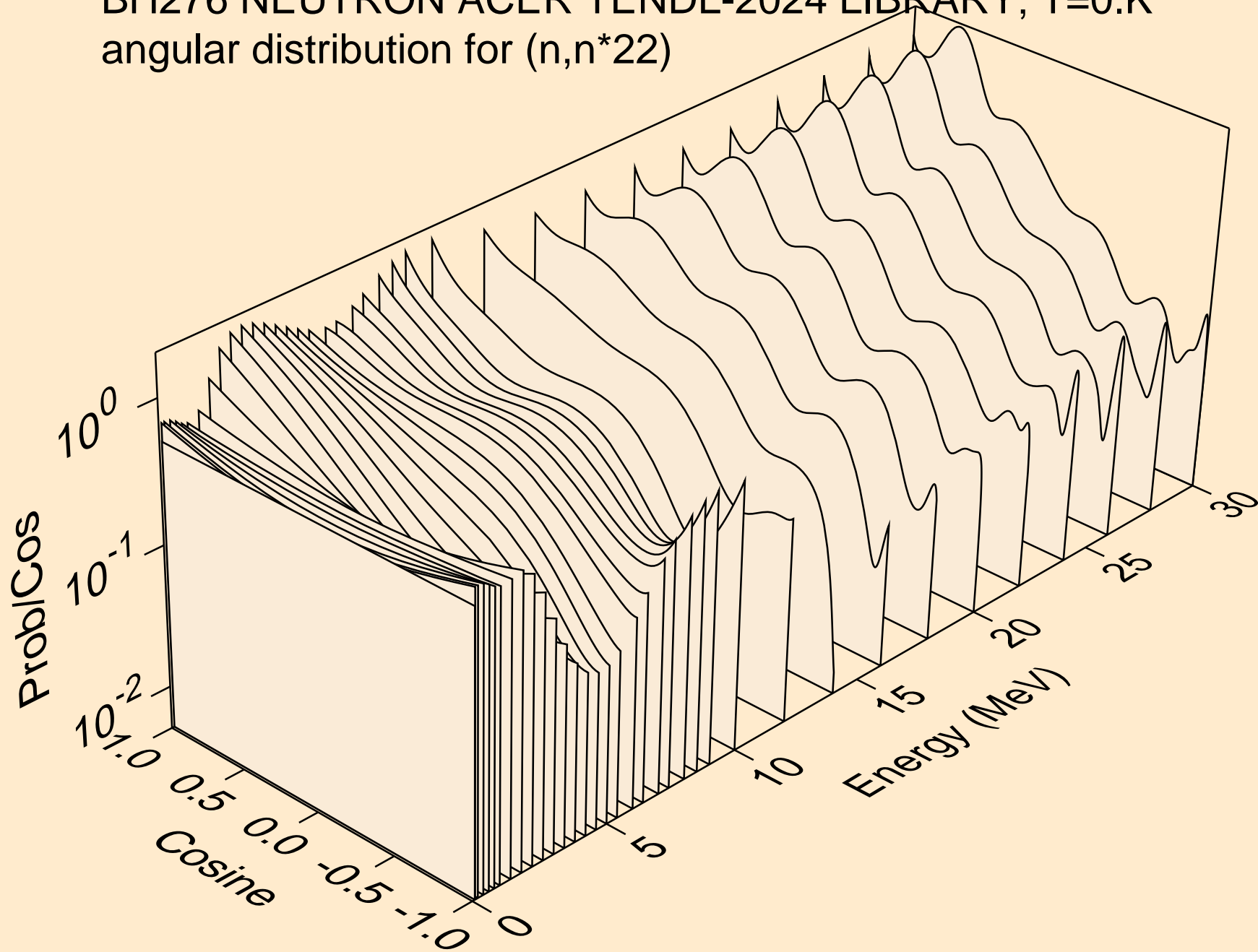

BH276 NEUTRON ACER TENDL-2024 LIBRARY; T=0.K
angular distribution for (n,n*23)

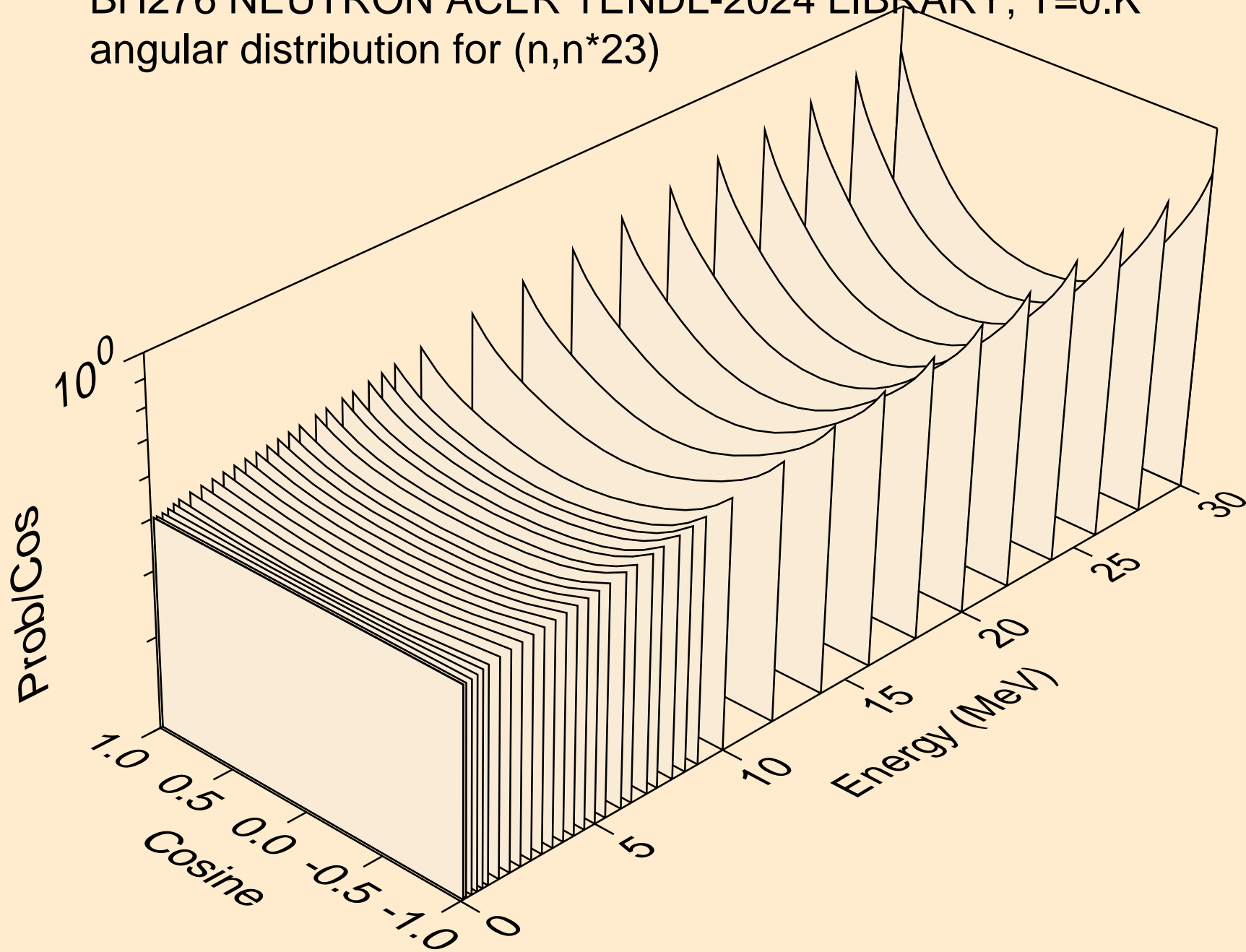

BH276 NEUTRON ACER TENDL-2024 LIBRARY; T=0.K
angular distribution for (n,n*24)

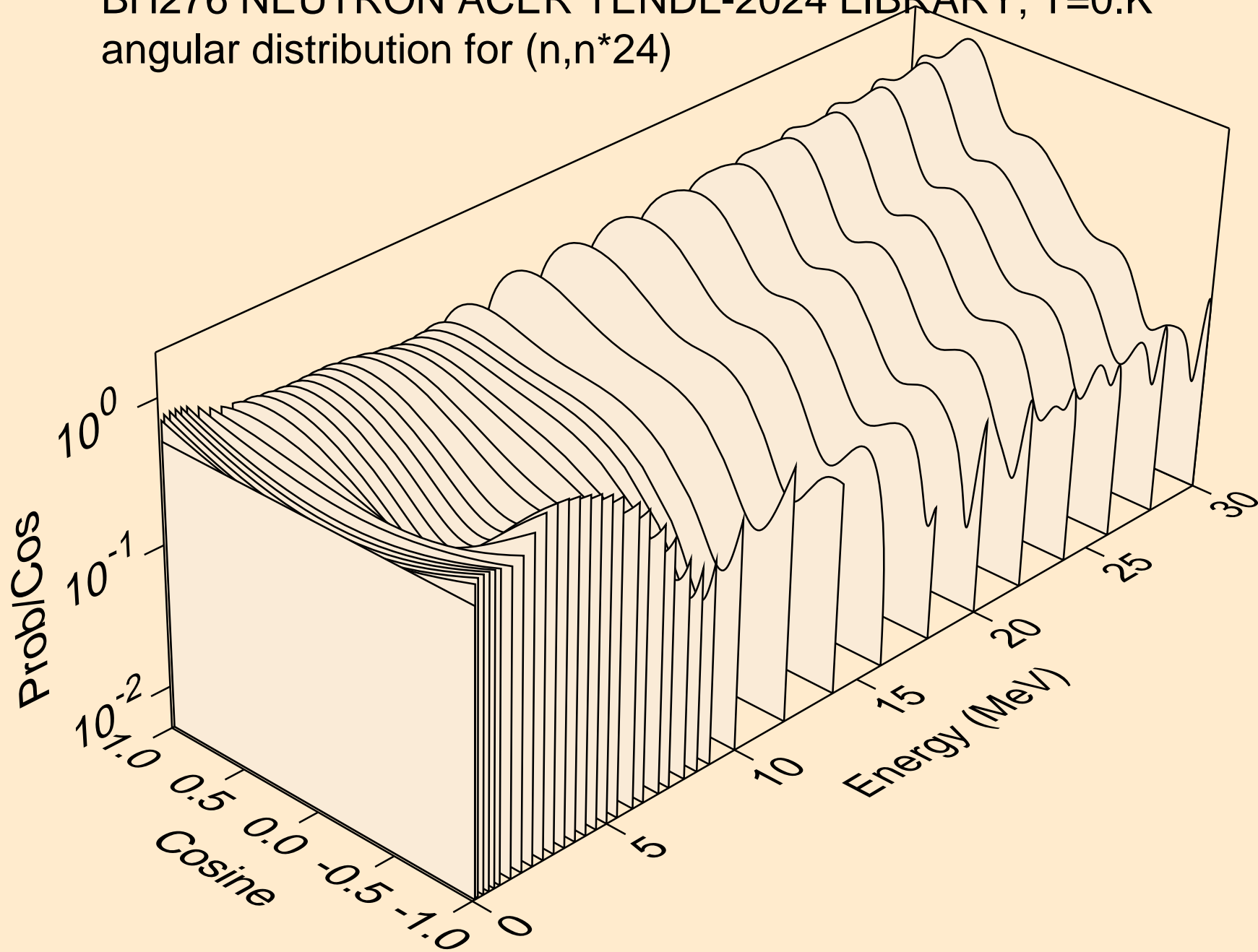

BH276 NEUTRON ACER TENDL-2024 LIBRARY; T=0.K
angular distribution for (n,n*25)

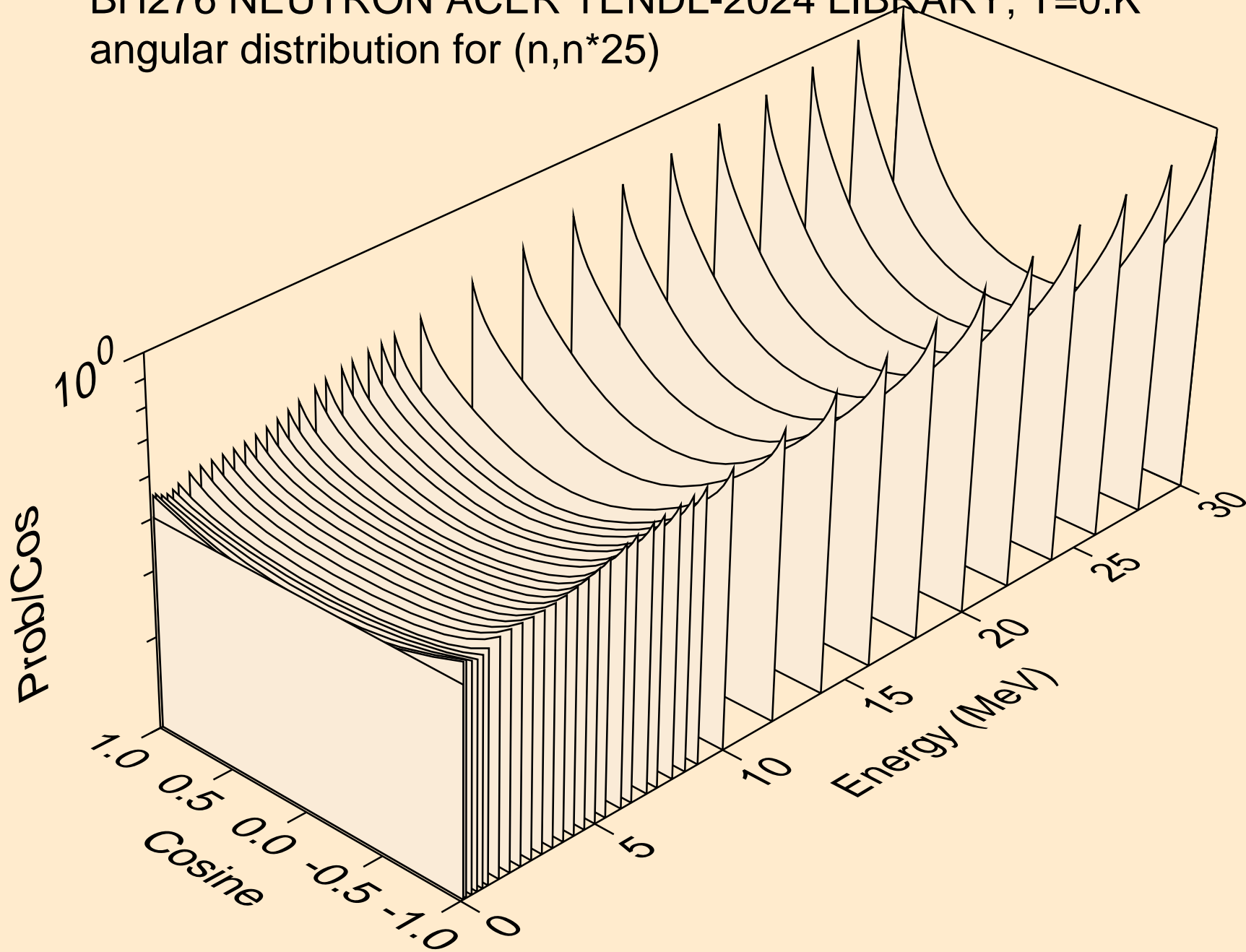

BH276 NEUTRON ACER TENDL-2024 LIBRARY; T=0.K
angular distribution for (n,n*26)

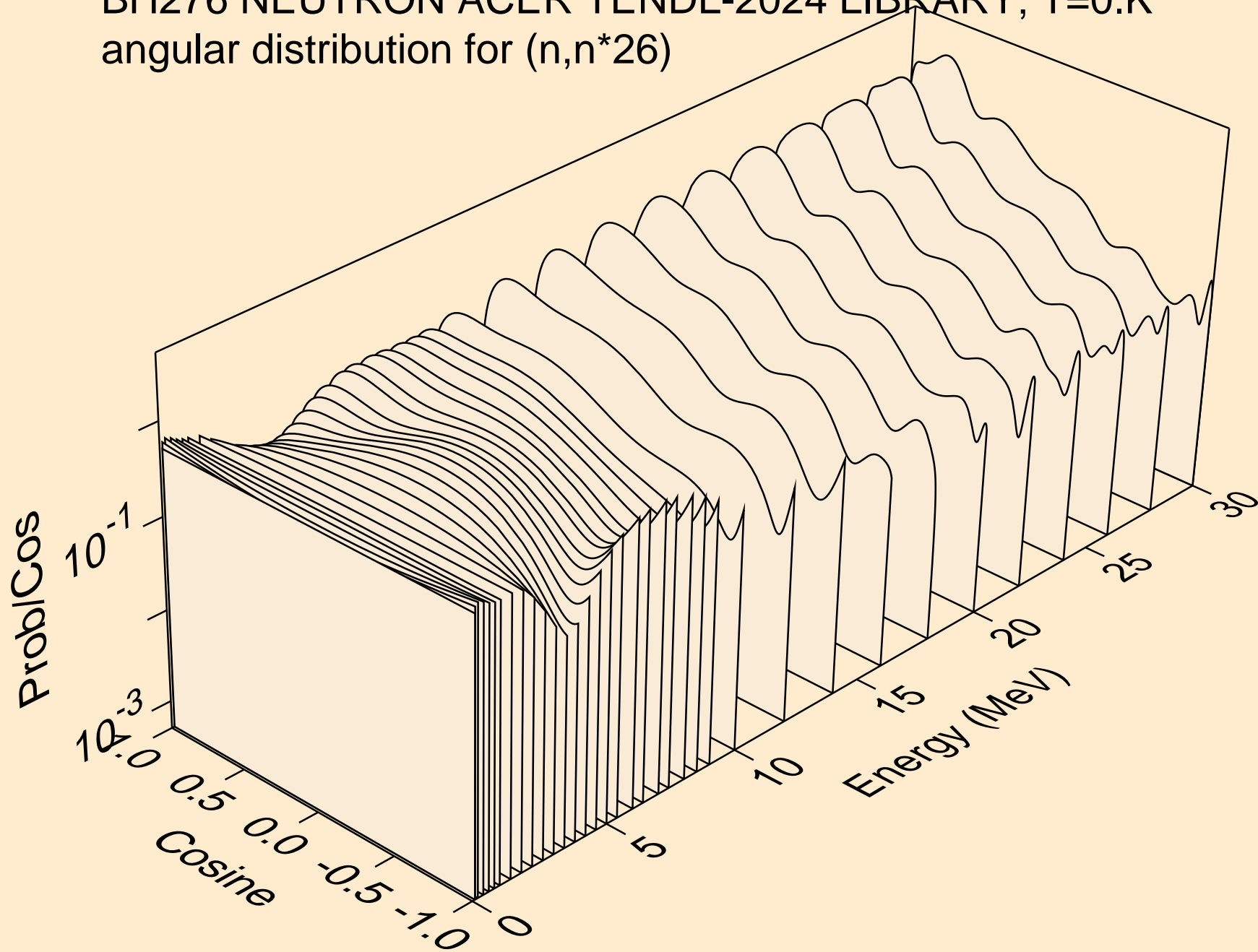

BH276 NEUTRON ACER TENDL-2024 LIBRARY; T=0.K
angular distribution for (n,n*27)

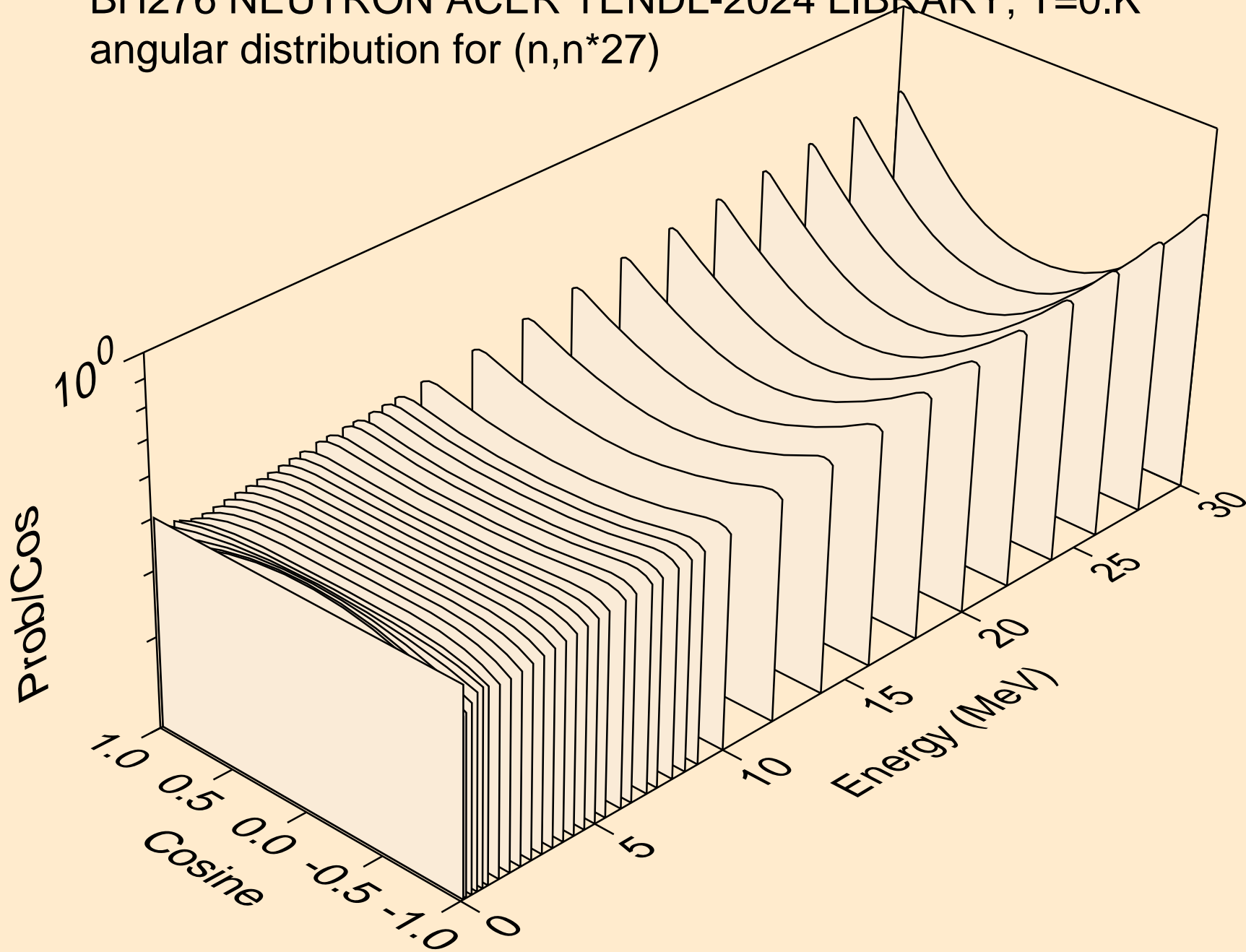

BH276 NEUTRON ACER TENDL-2024 LIBRARY; T=0.K
angular distribution for (n,n*28)

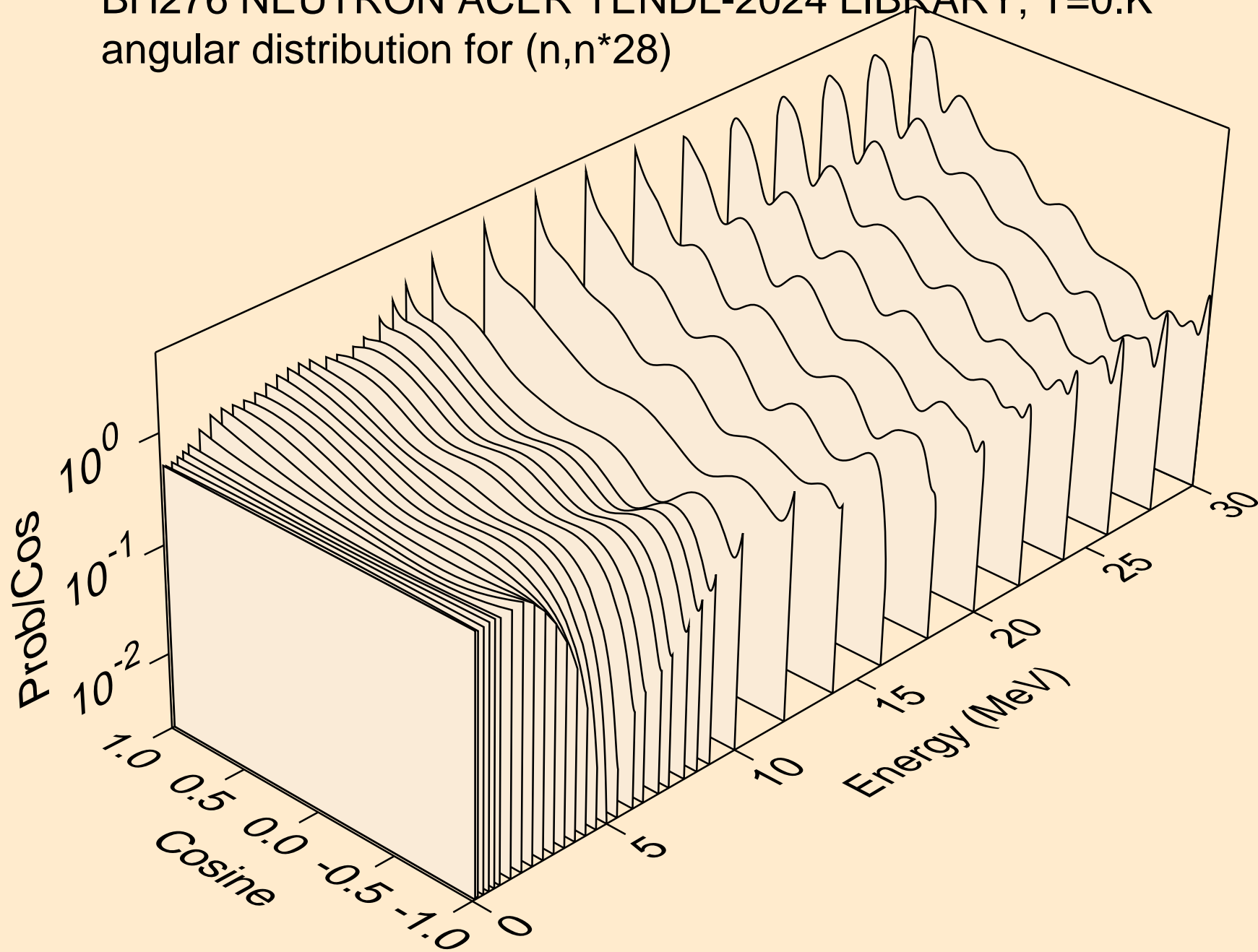

BH276 NEUTRON ACER TENDL-2024 LIBRARY; T=0.K

Total fission nubar

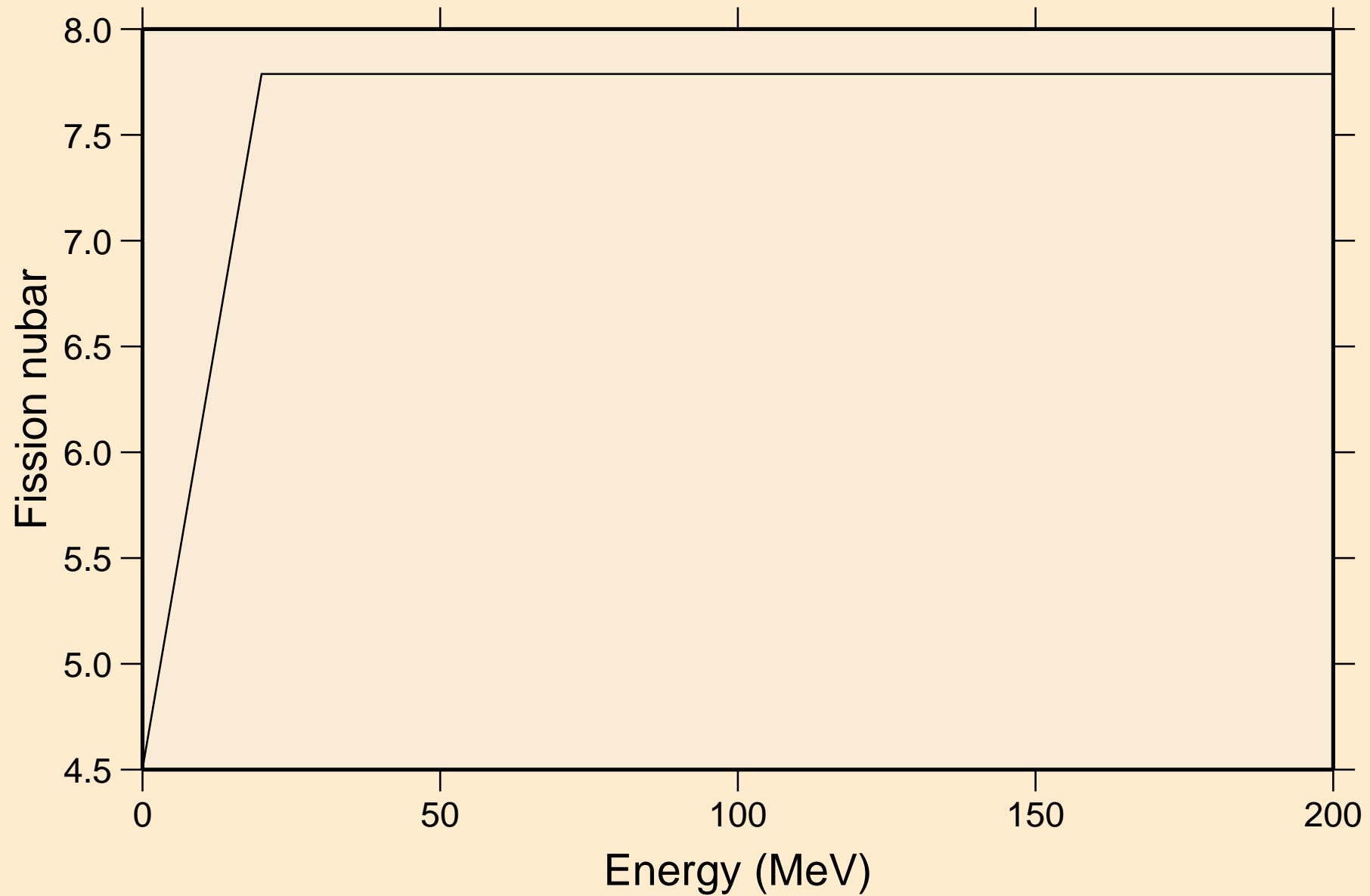

BH276 NEUTRON ACER TENDL-2024 LIBRARY; T=0.K
Neutron emission for (n,x)

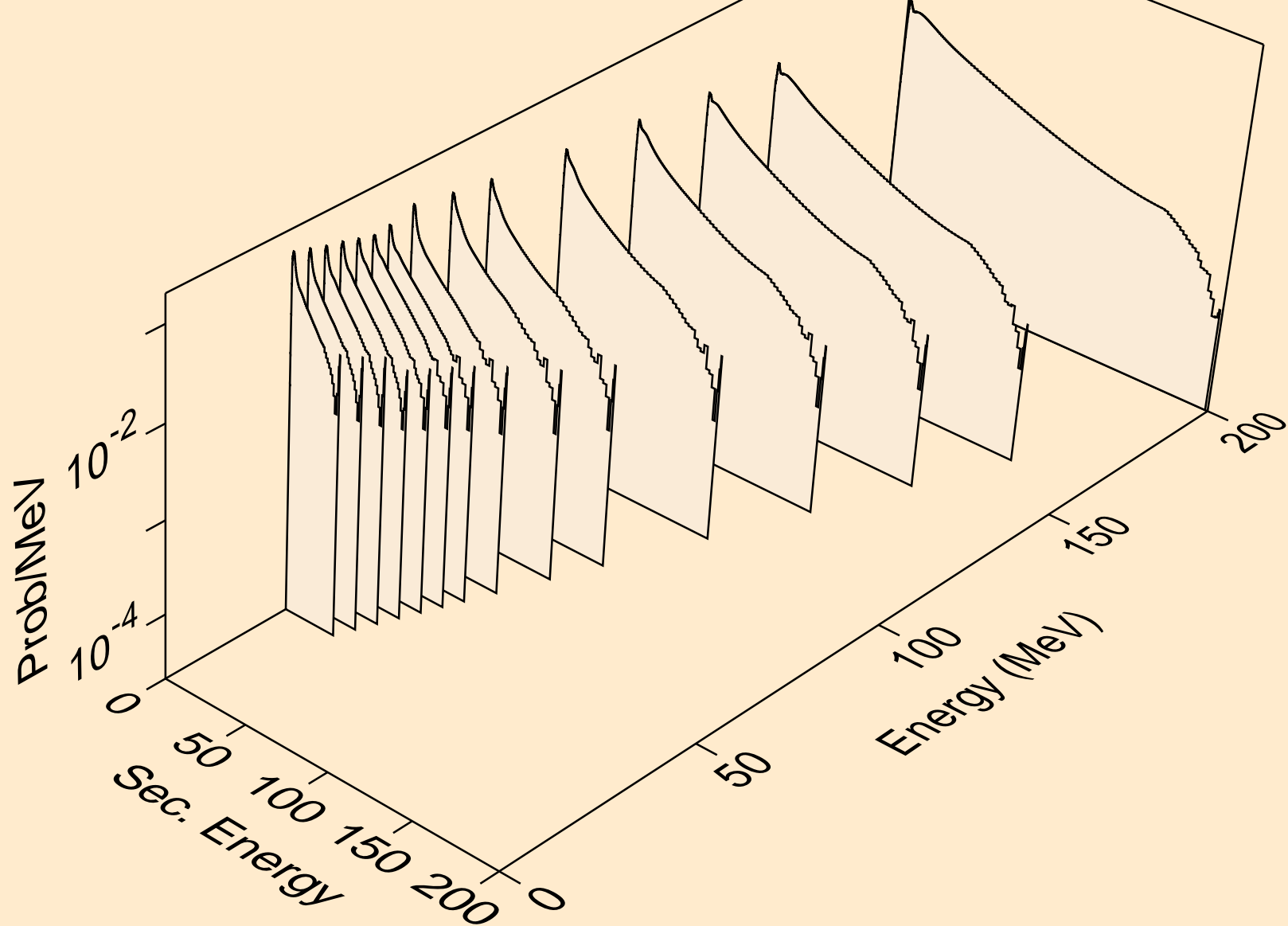

BH276 NEUTRON ACER TENDL-2024 LIBRARY; T=0.K
Neutron emission for (n,2nd)

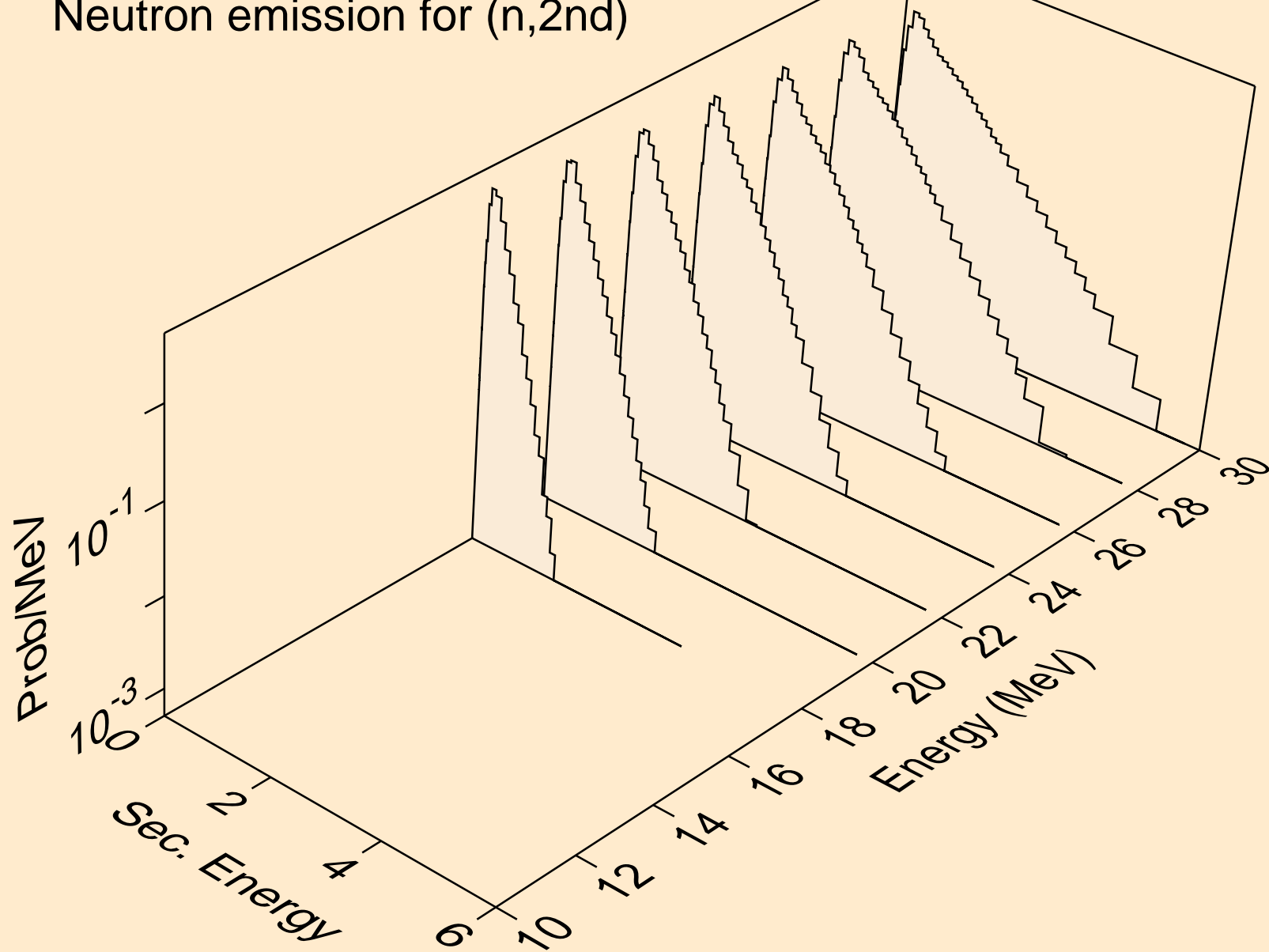

BH276 NEUTRON ACER TENDL-2024 LIBRARY; T=0.K
Neutron emission for (n,2n)

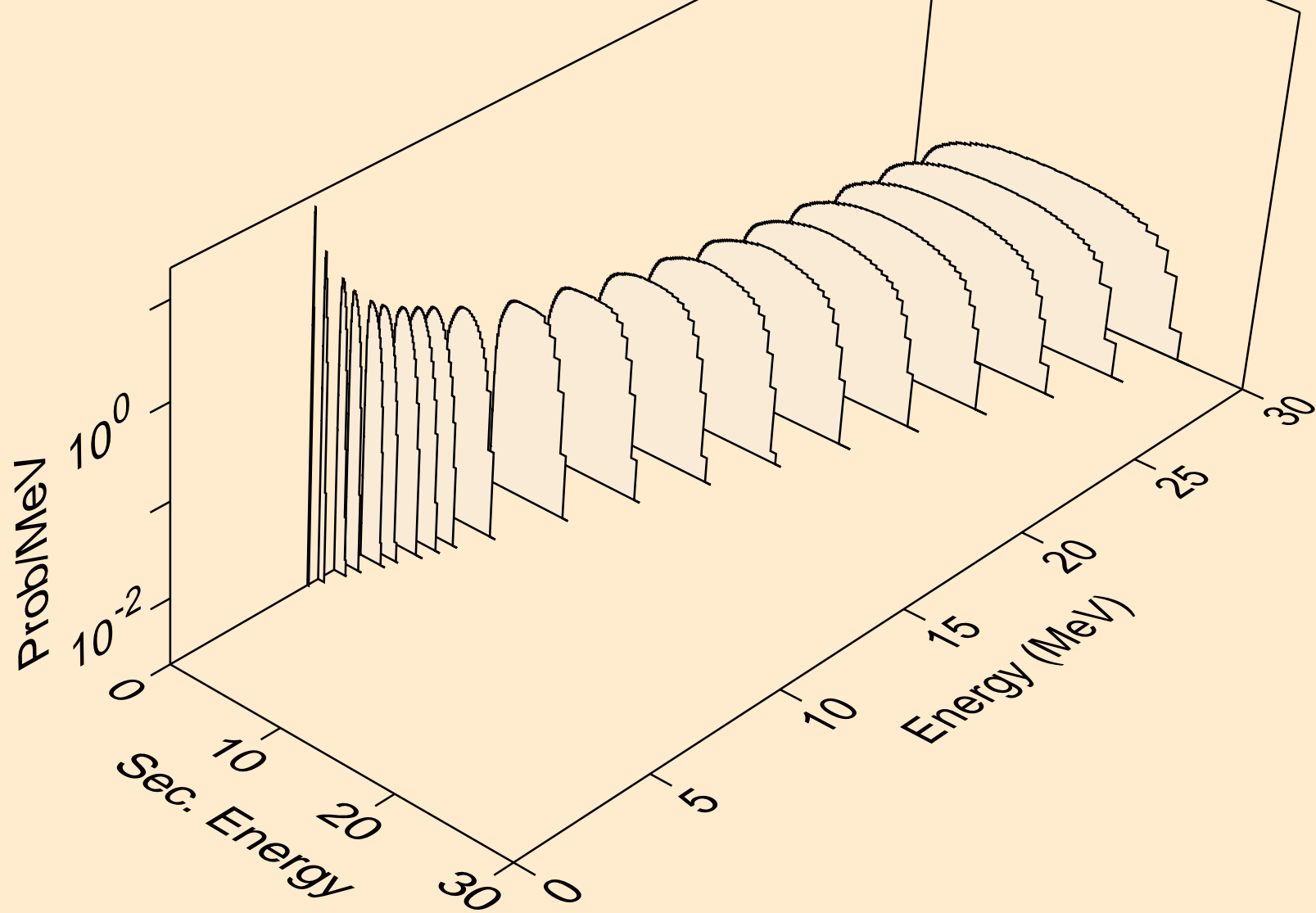

BH276 NEUTRON ACER TENDL-2024 LIBRARY; T=0.K
Neutron emission for (n,3n)

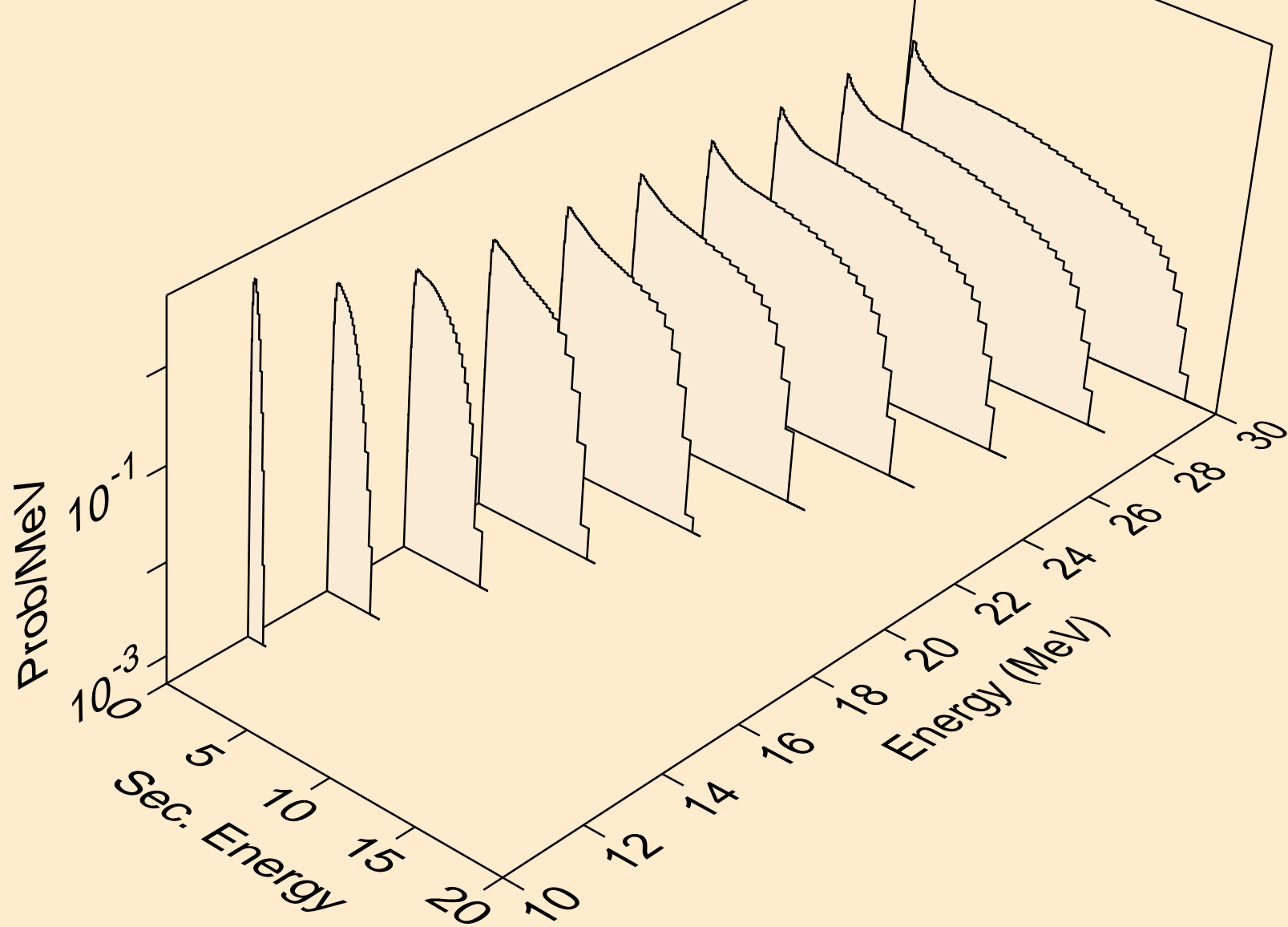

BH276 NEUTRON ACER TENDL-2024 LIBRARY; T=0.K
Neutron emission for fission

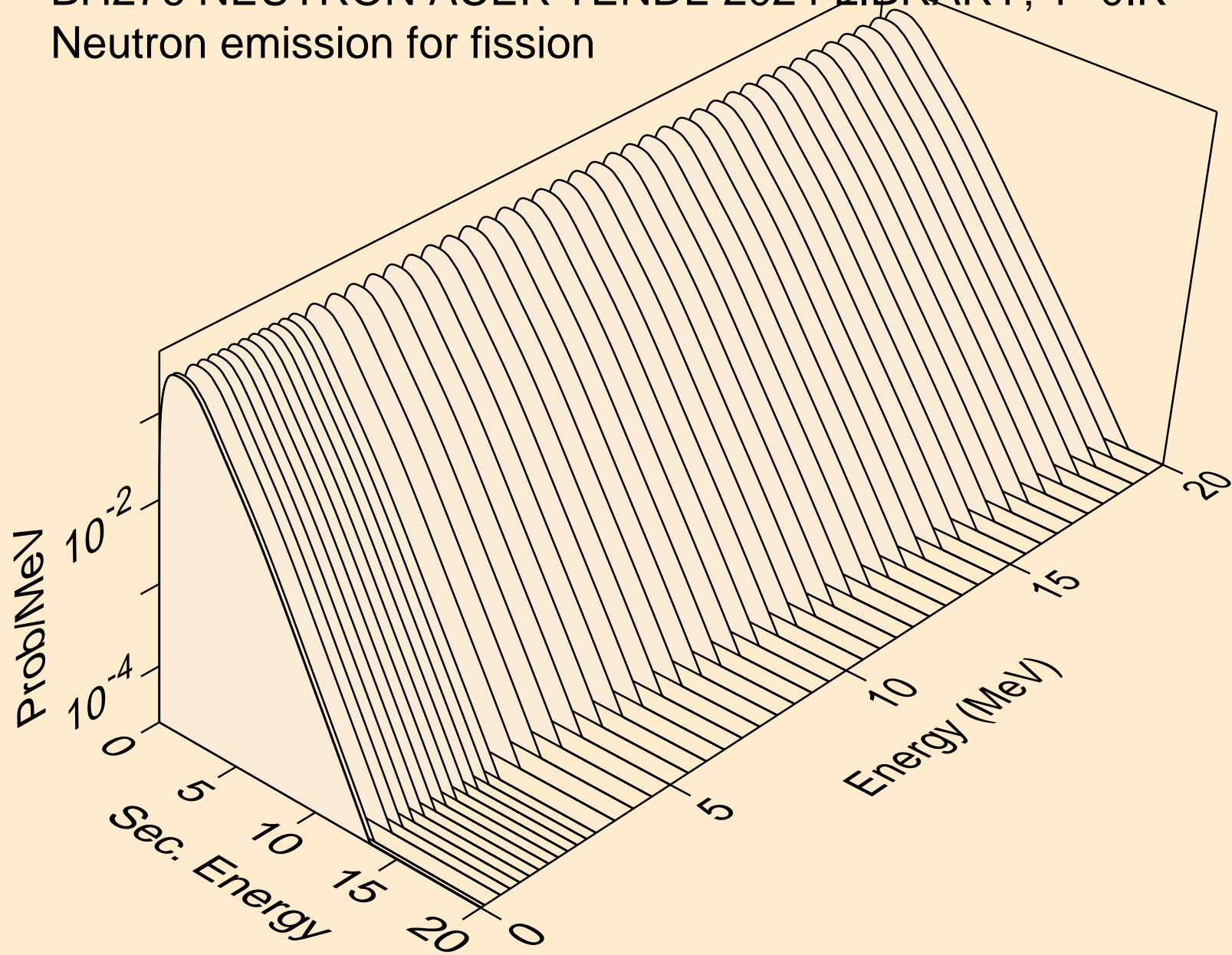

BH276 NEUTRON ACER TENDL-2024 LIBRARY; T=0.K
Neutron emission for (n,n*)a

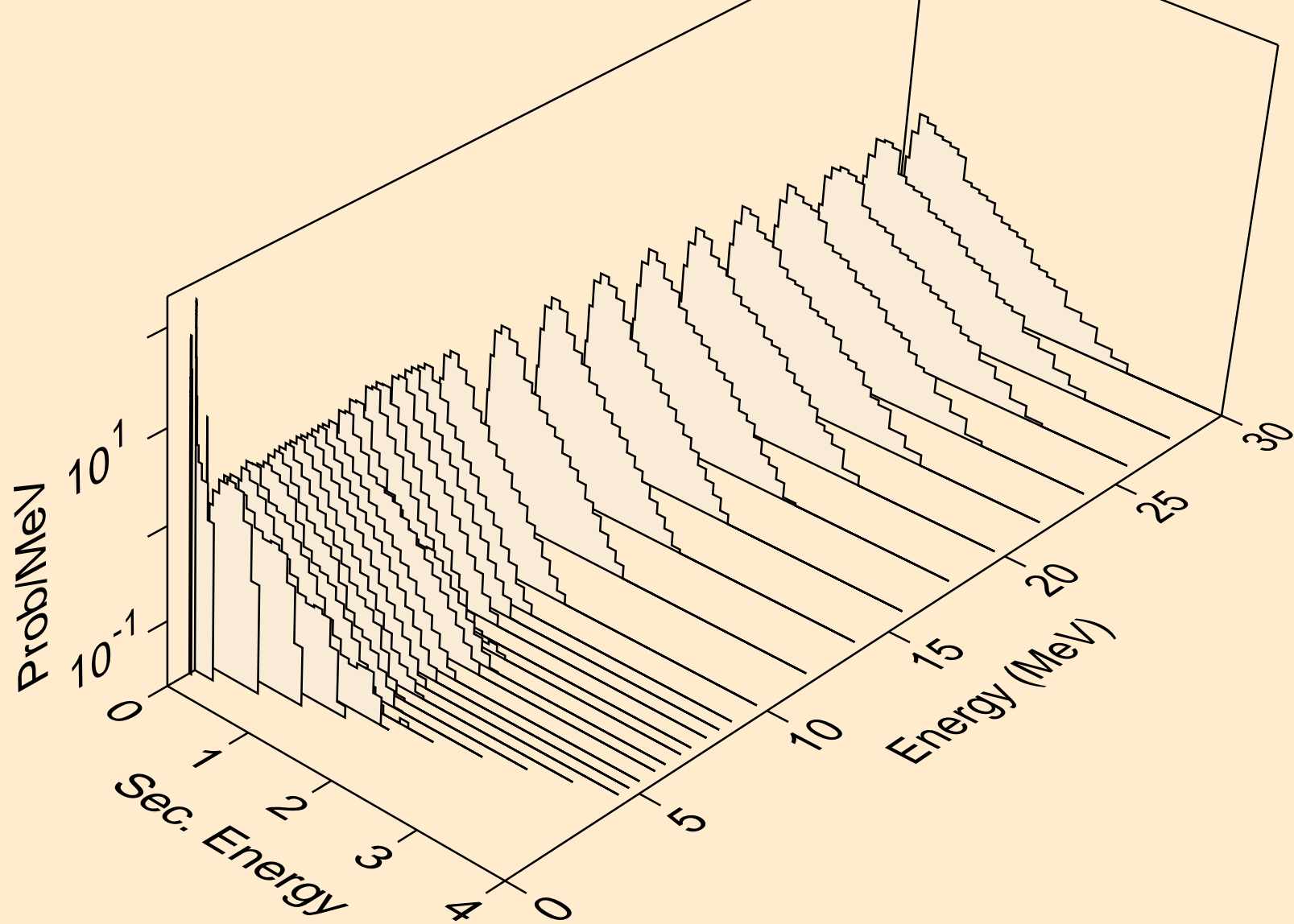

BH276 NEUTRON ACER TENDL-2024 LIBRARY; T=0.K
Neutron emission for (n,2n)a

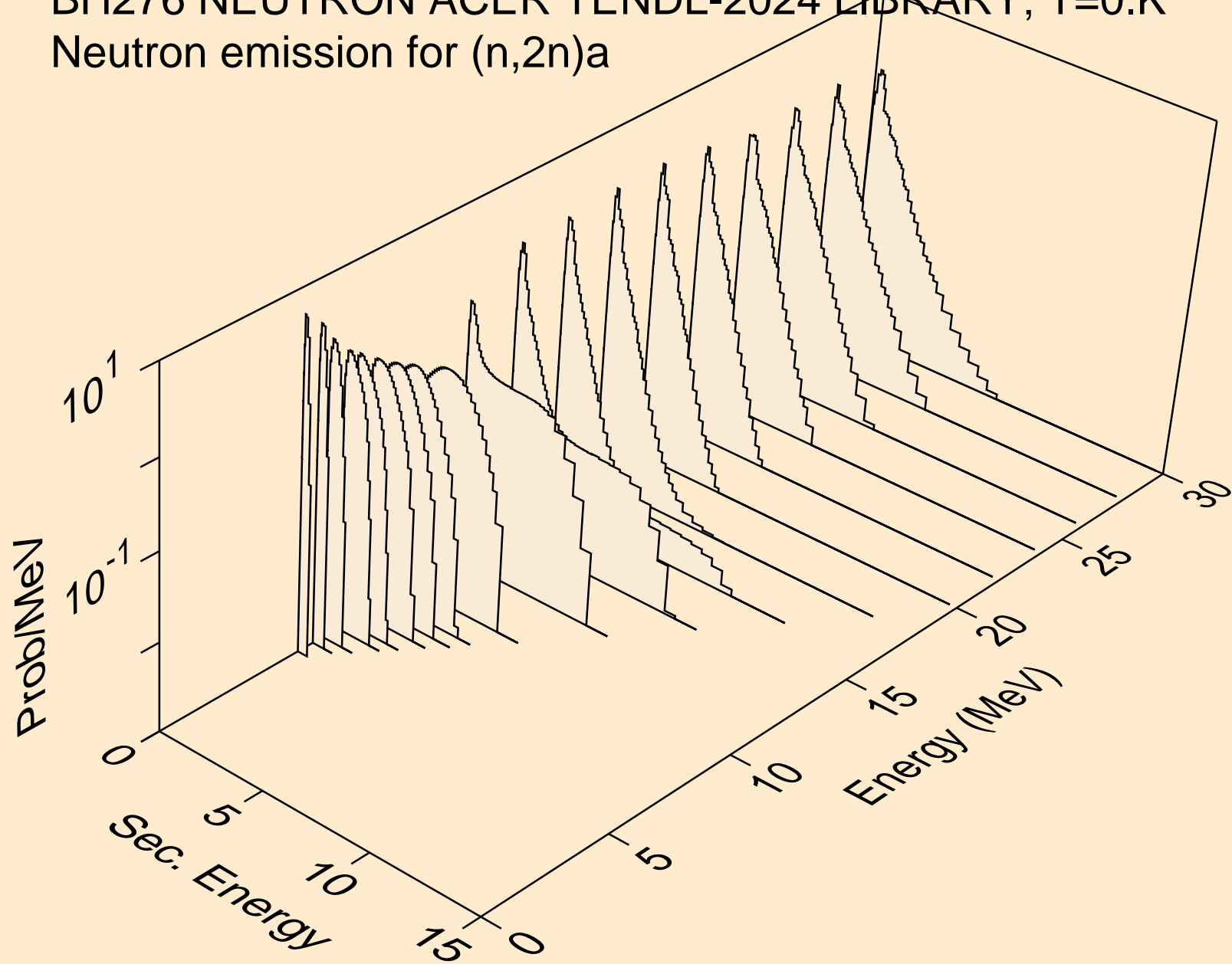

BH276 NEUTRON ACER TENDL-2024 LIBRARY; T=0.K
Neutron emission for (n,3n)a

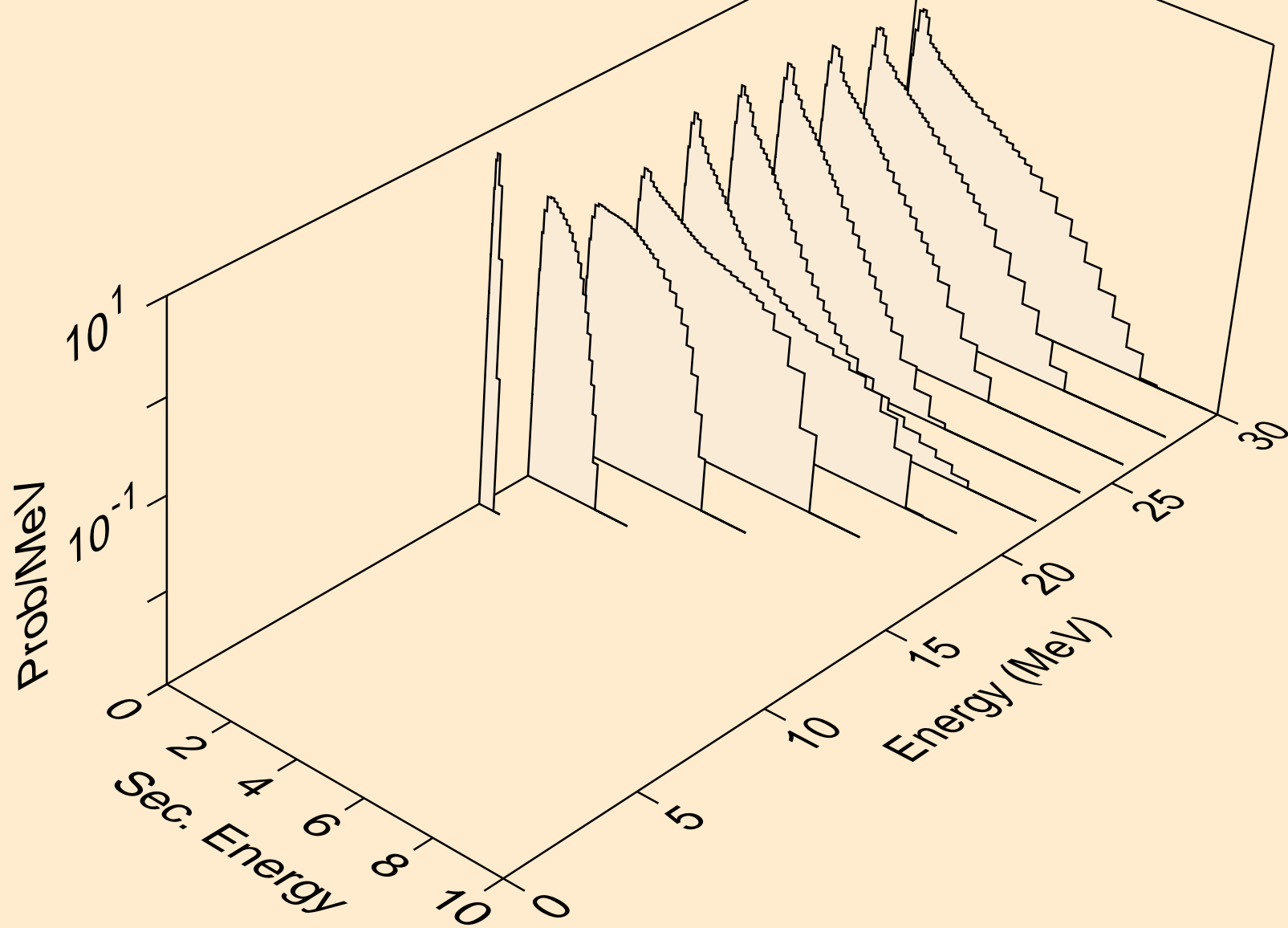

BH276 NEUTRON ACER TENDL-2024 LIBRARY; T=0.K
Neutron emission for (n,n*)p

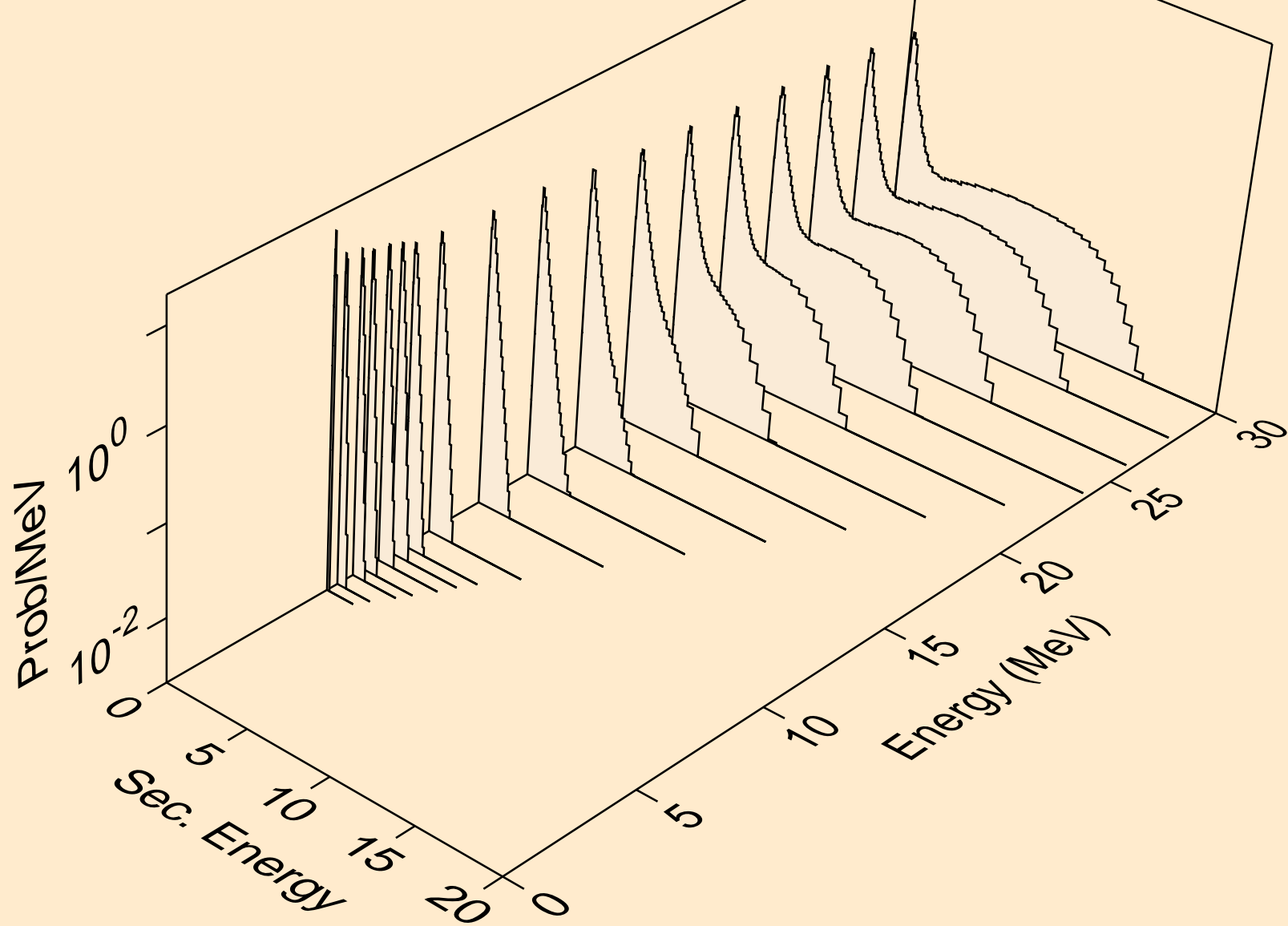

BH276 NEUTRON ACER TENDL-2024 LIBRARY; T=0.K
Neutron emission for (n,n*)d

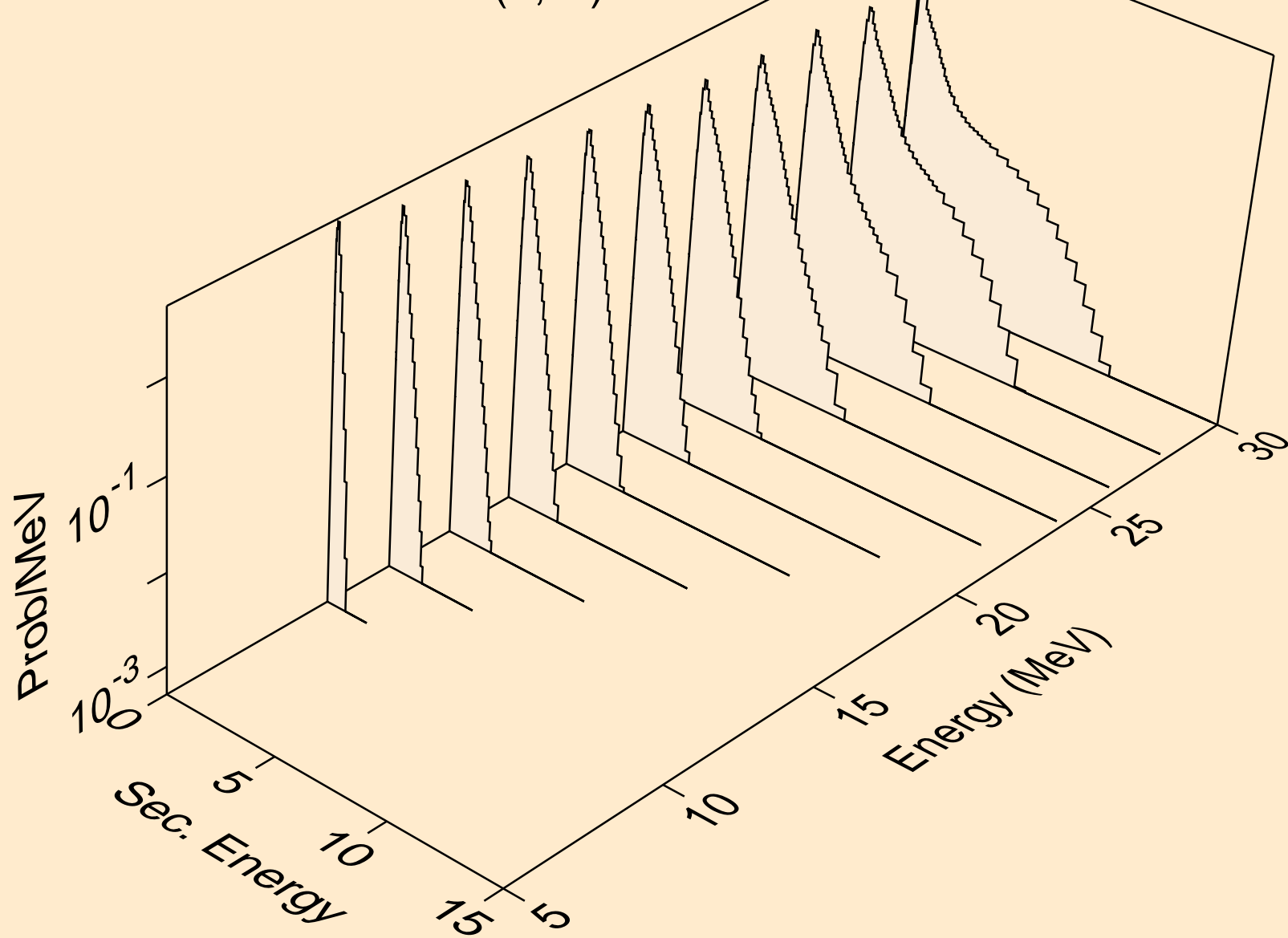

BH276 NEUTRON ACER TENDL-2024 LIBRARY; T=0.K
Neutron emission for (n,n*)t

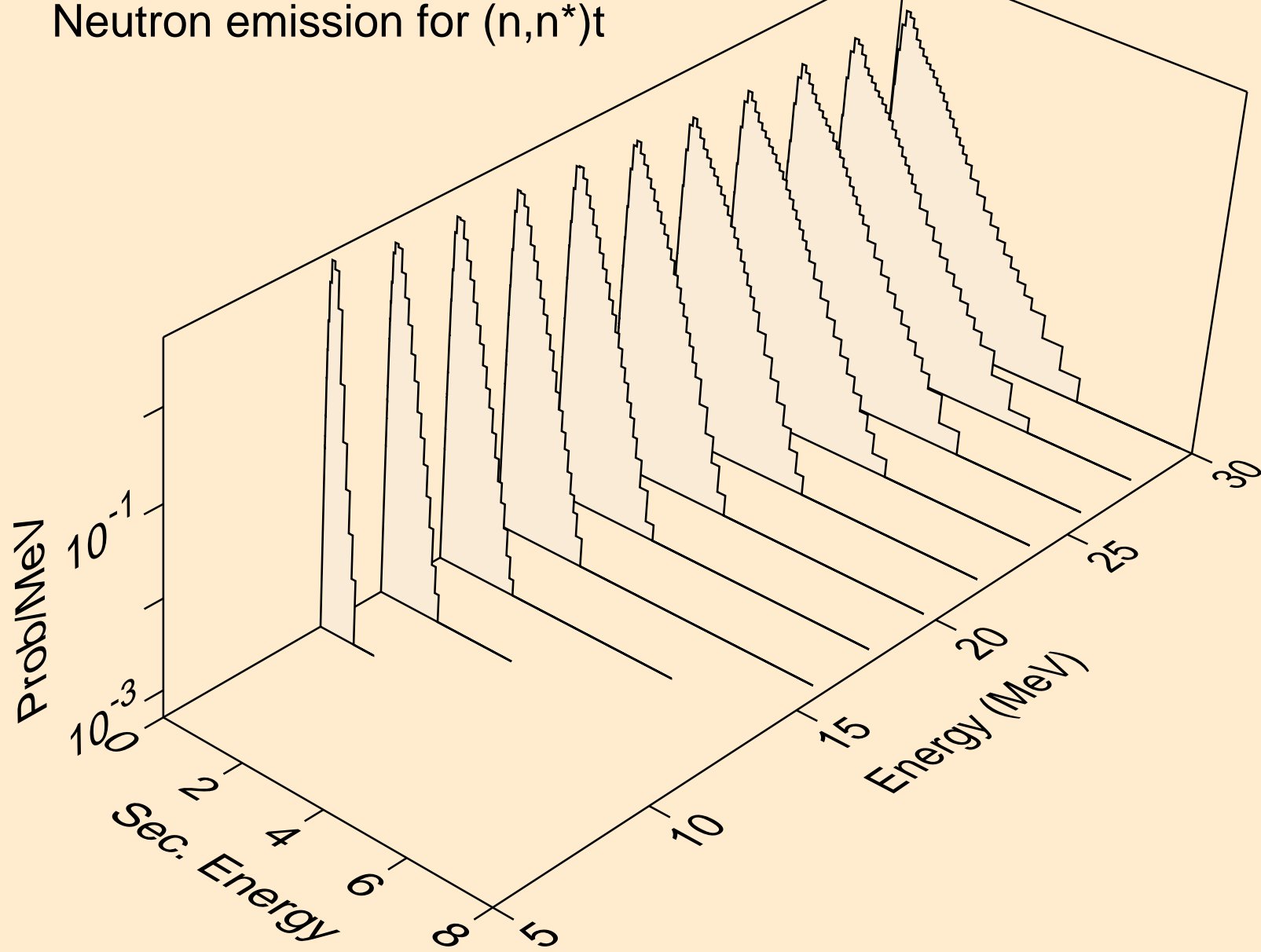

BH276 NEUTRON ACER TENDL-2024 LIBRARY; T=0.K
Neutron emission for (n,n*)he3

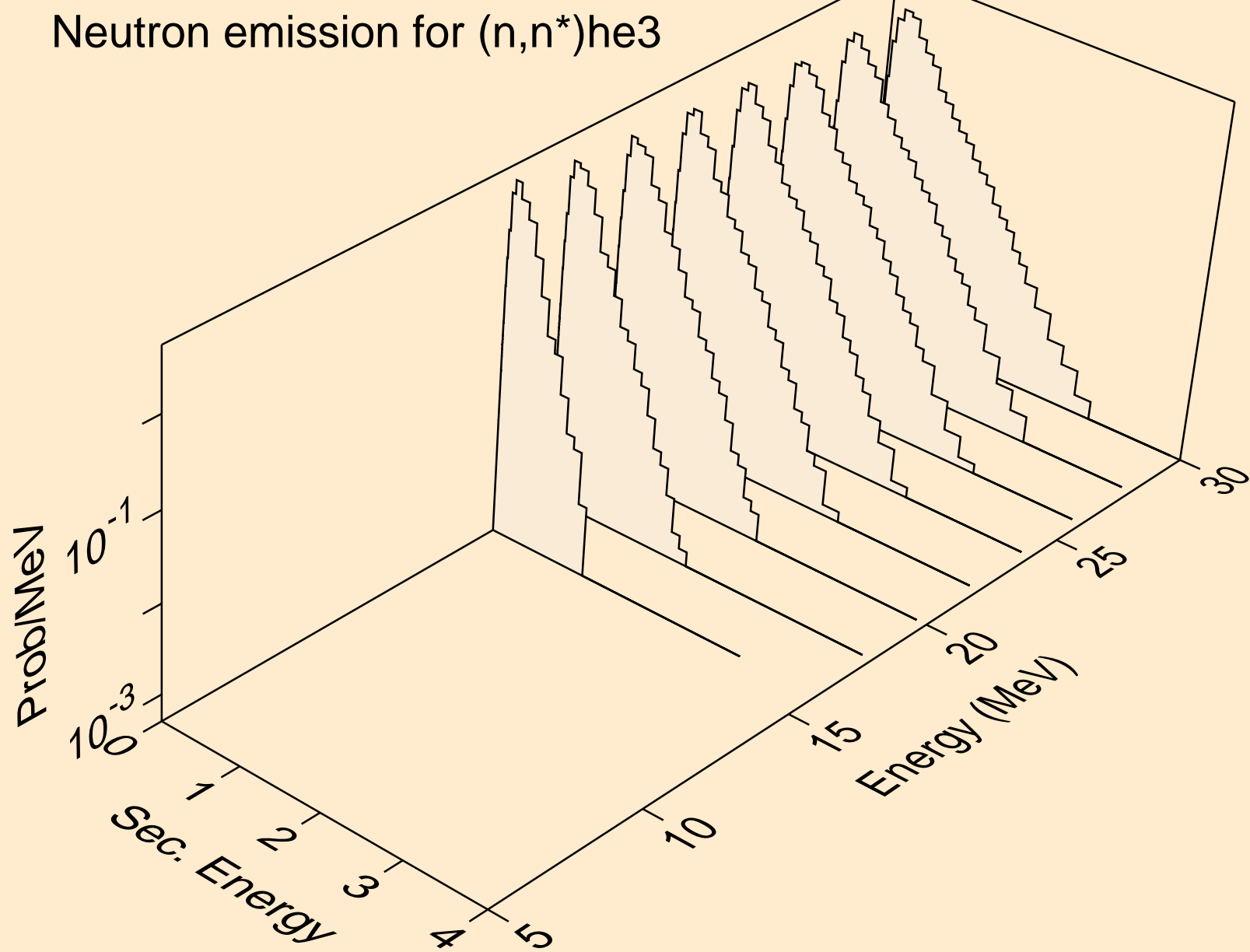

BH276 NEUTRON ACER TENDL-2024 LIBRARY; T=0.K
Neutron emission for (n,4n)

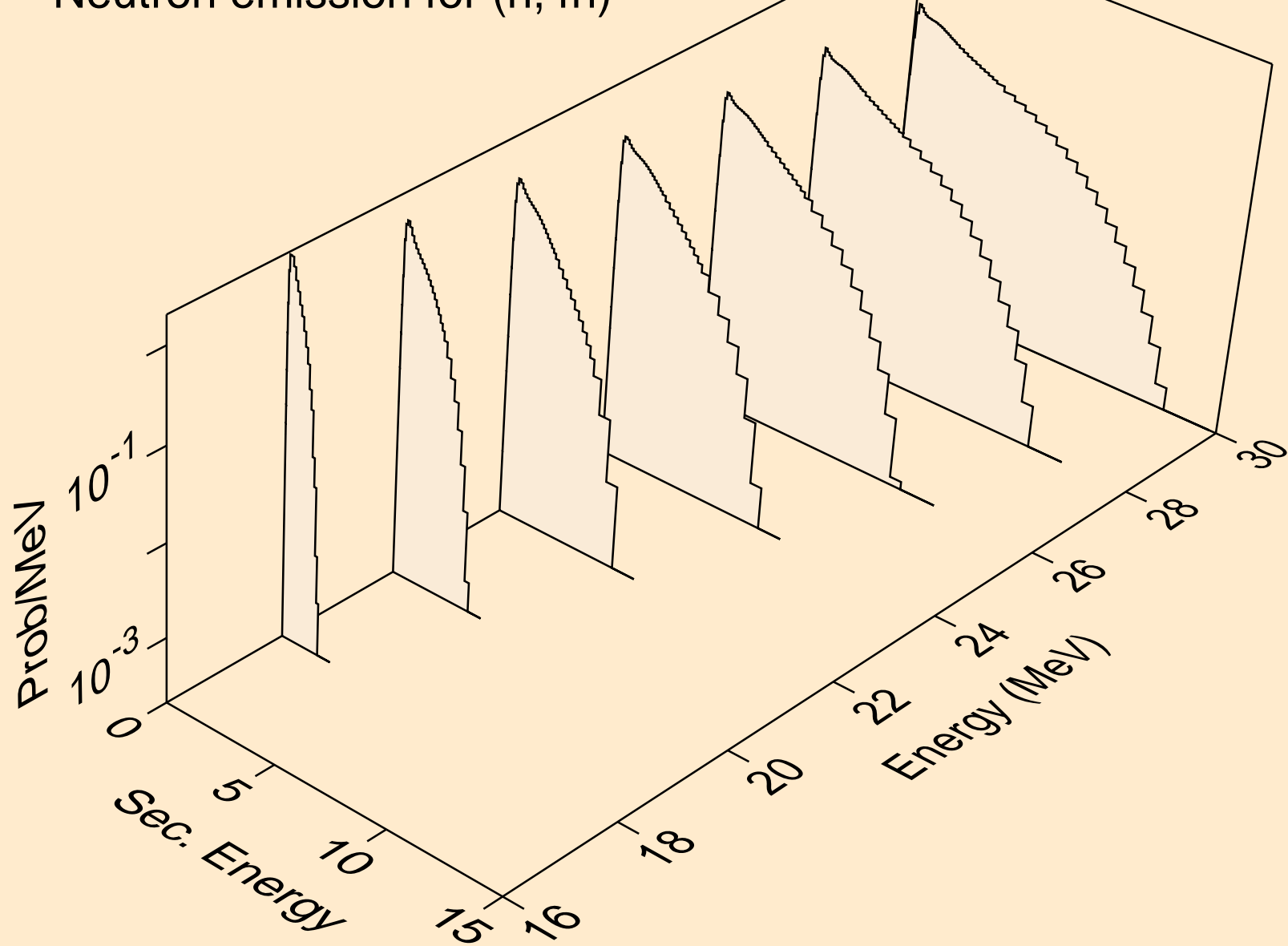

BH276 NEUTRON ACER TENDL-2024 LIBRARY; T=0.K
Neutron emission for (n,2np)

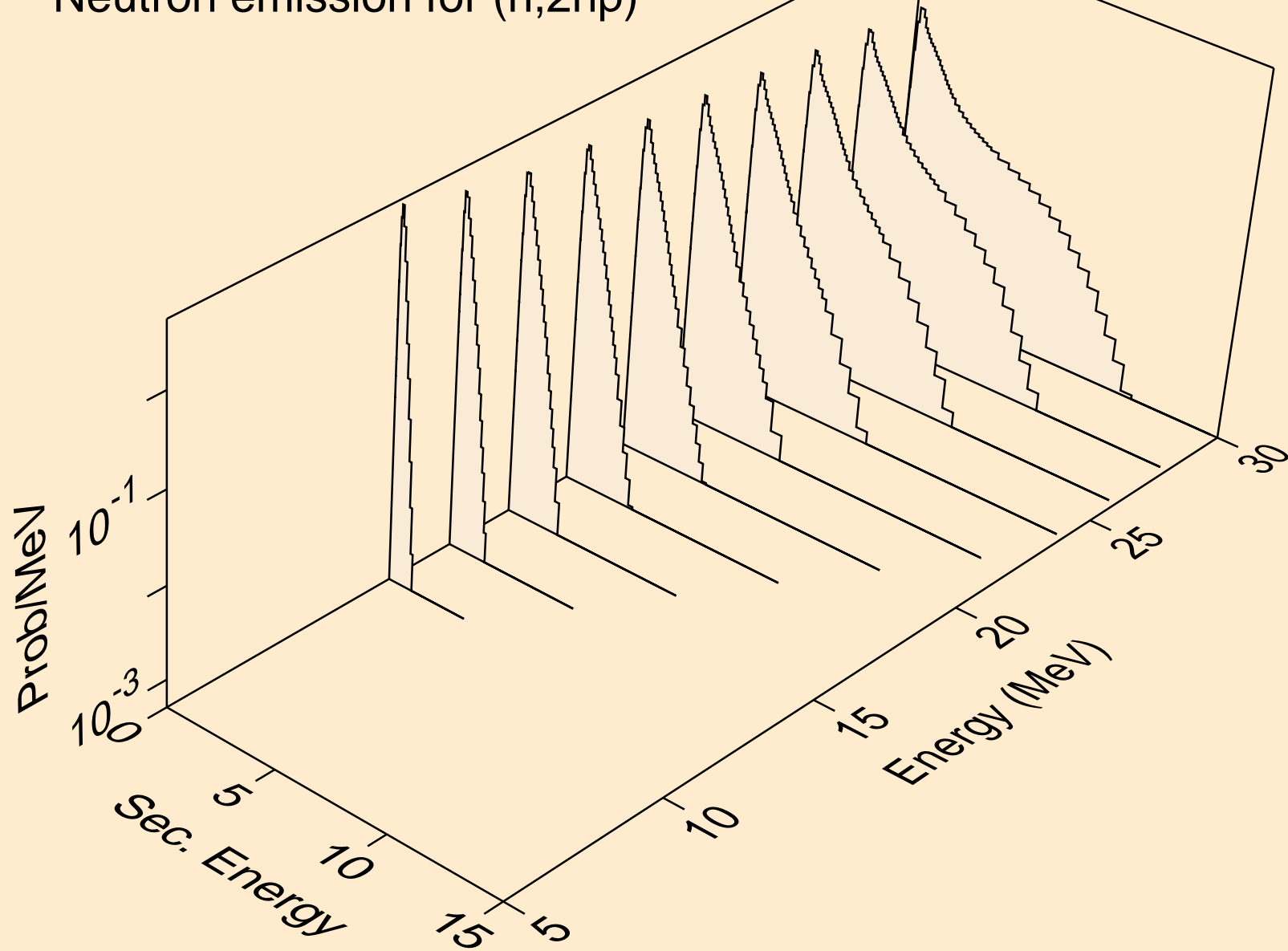

BH276 NEUTRON ACER TENDL-2024 LIBRARY; T=0.K
Neutron emission for (n,3np)

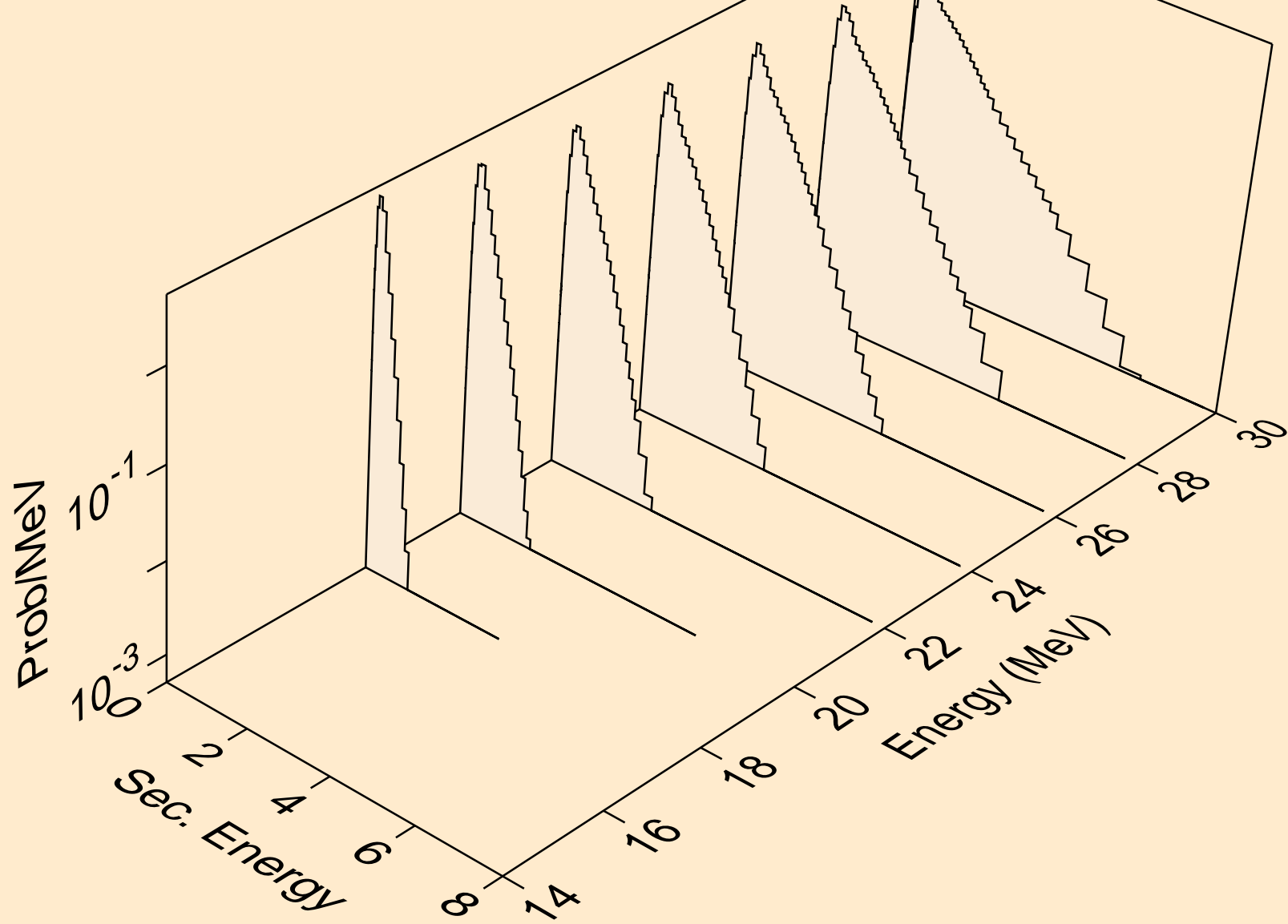

BH276 NEUTRON ACER TENDL-2024 LIBRARY; T=0.K
Neutron emission for (n,n*c)

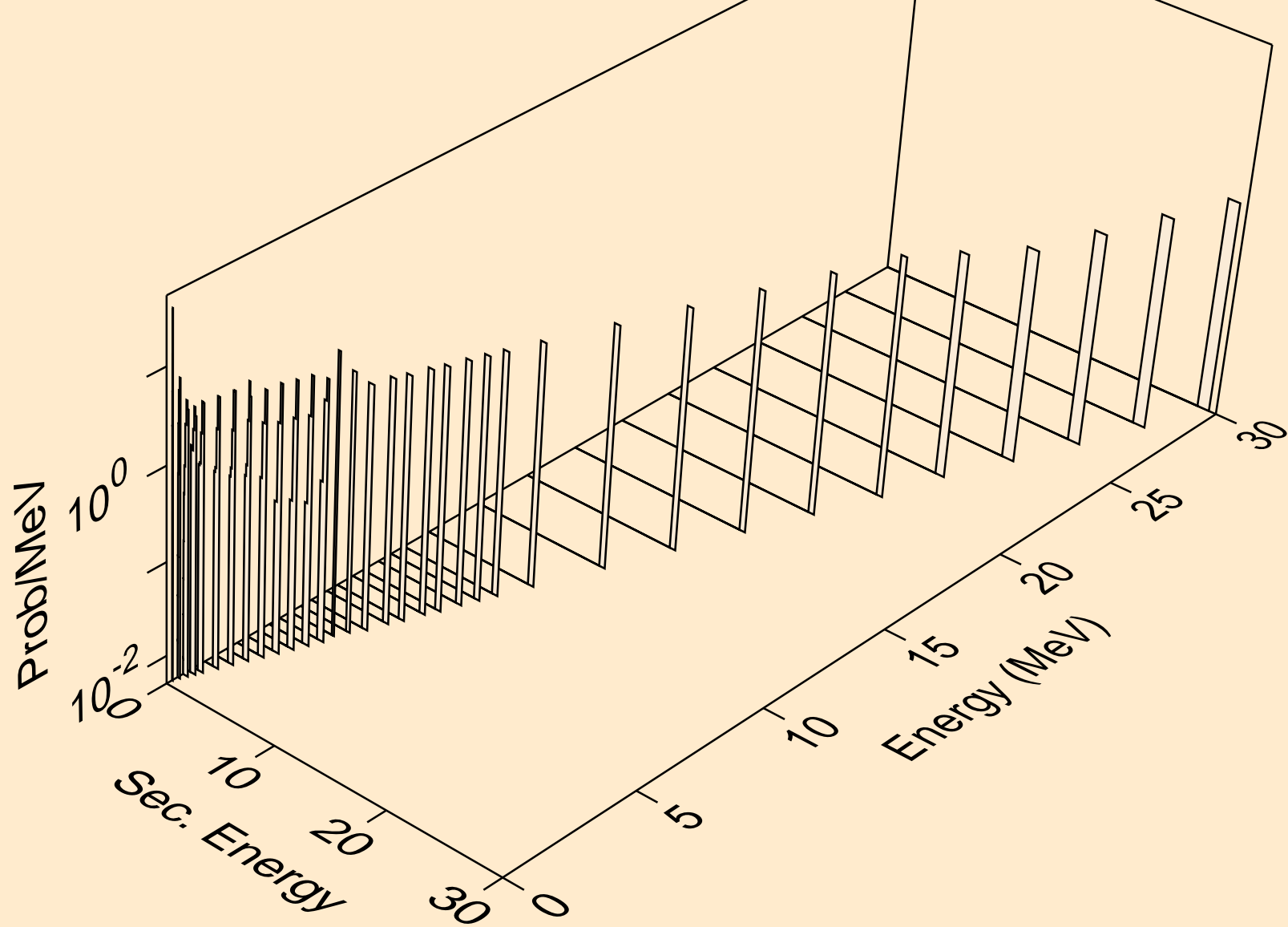

BH276 NEUTRON ACER TENDL-2024 LIBRARY; T=0.K

Delayed nubar

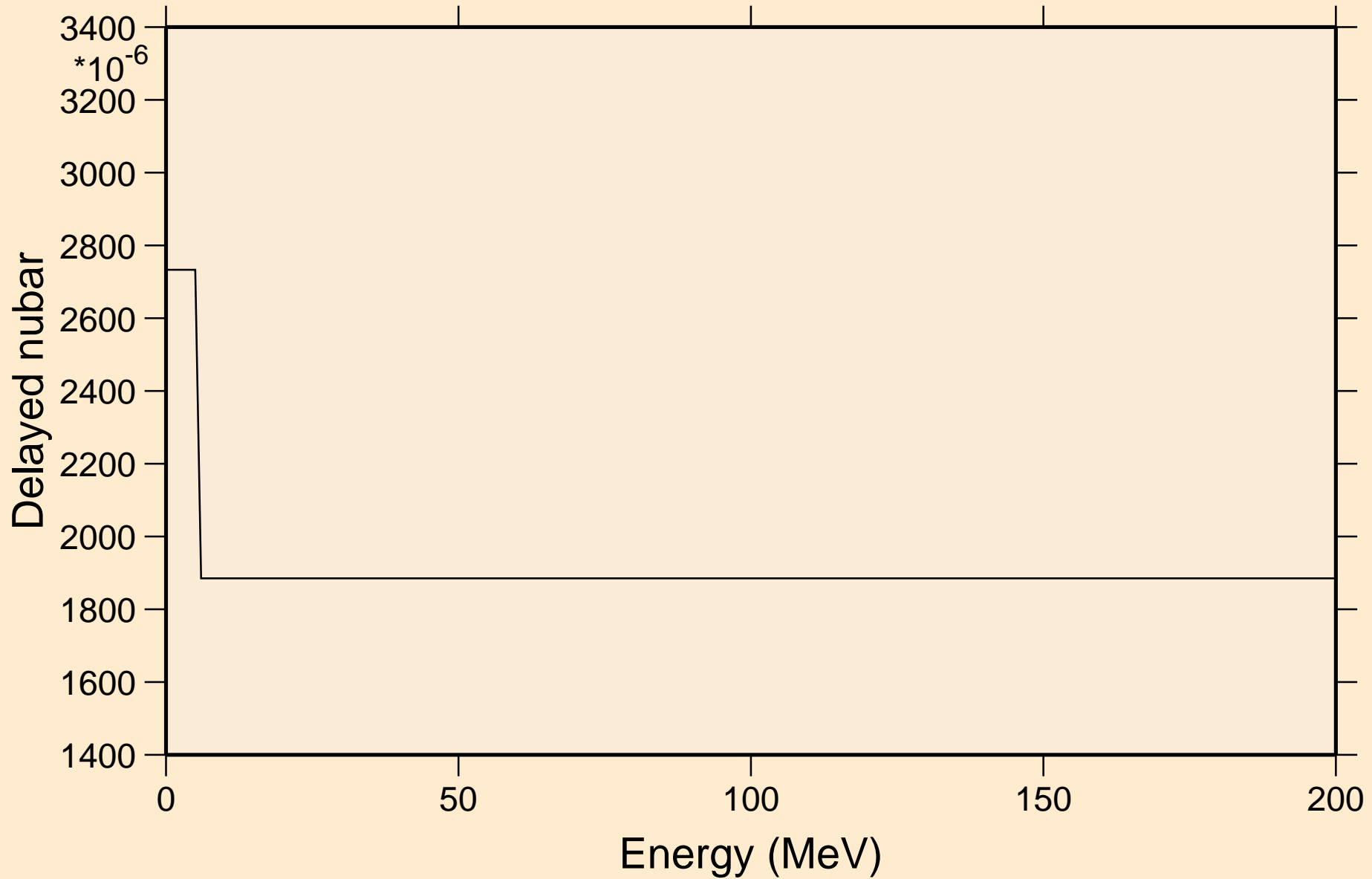

BH276 NEUTRON ACER TENDL-2024 LIBRARY; T=0.K

Delayed neutron spectra

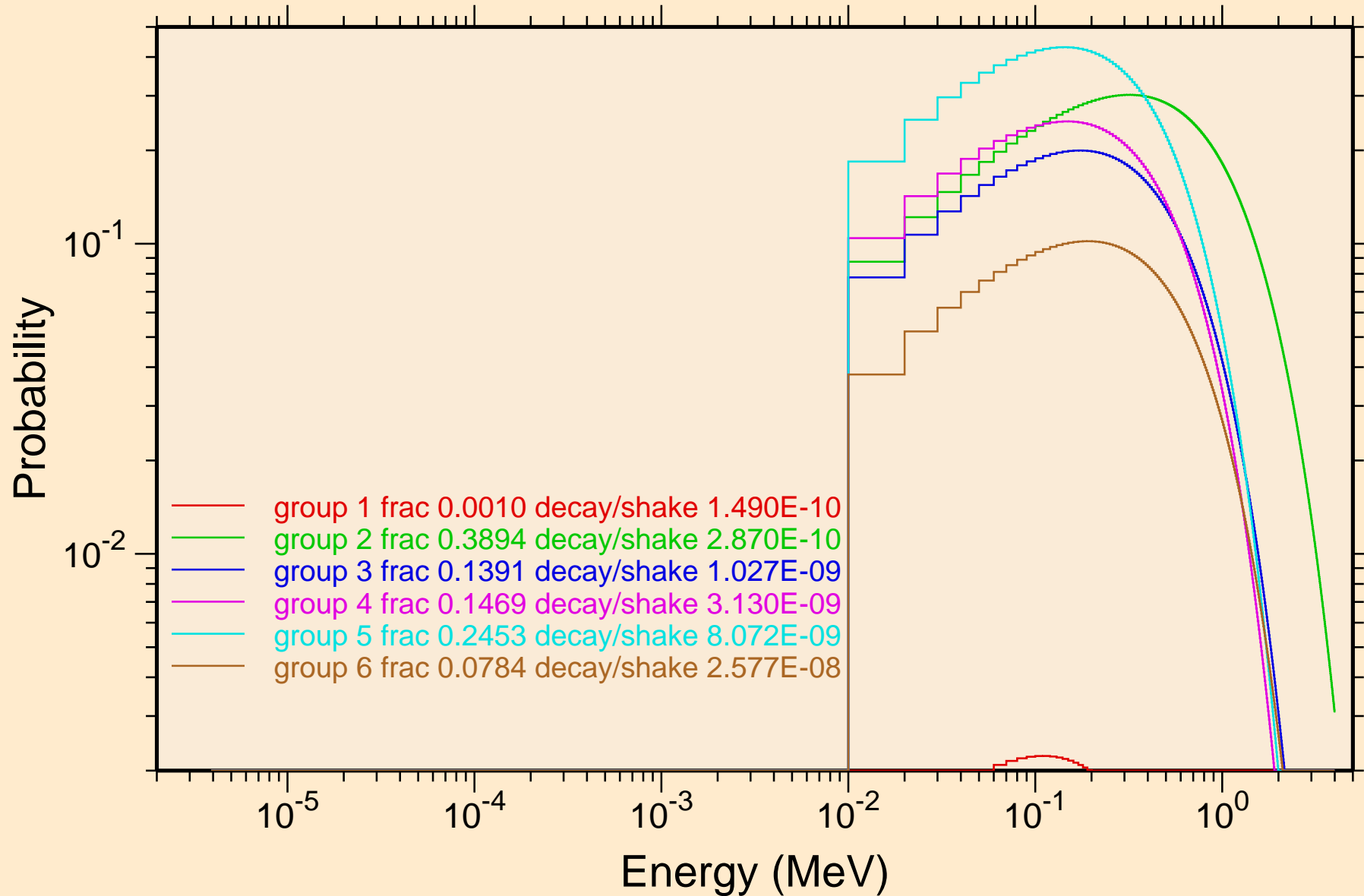

BH276 NEUTRON ACER TENDL-2024 LIBRARY; T=0.K
Photon emission for (n,x)

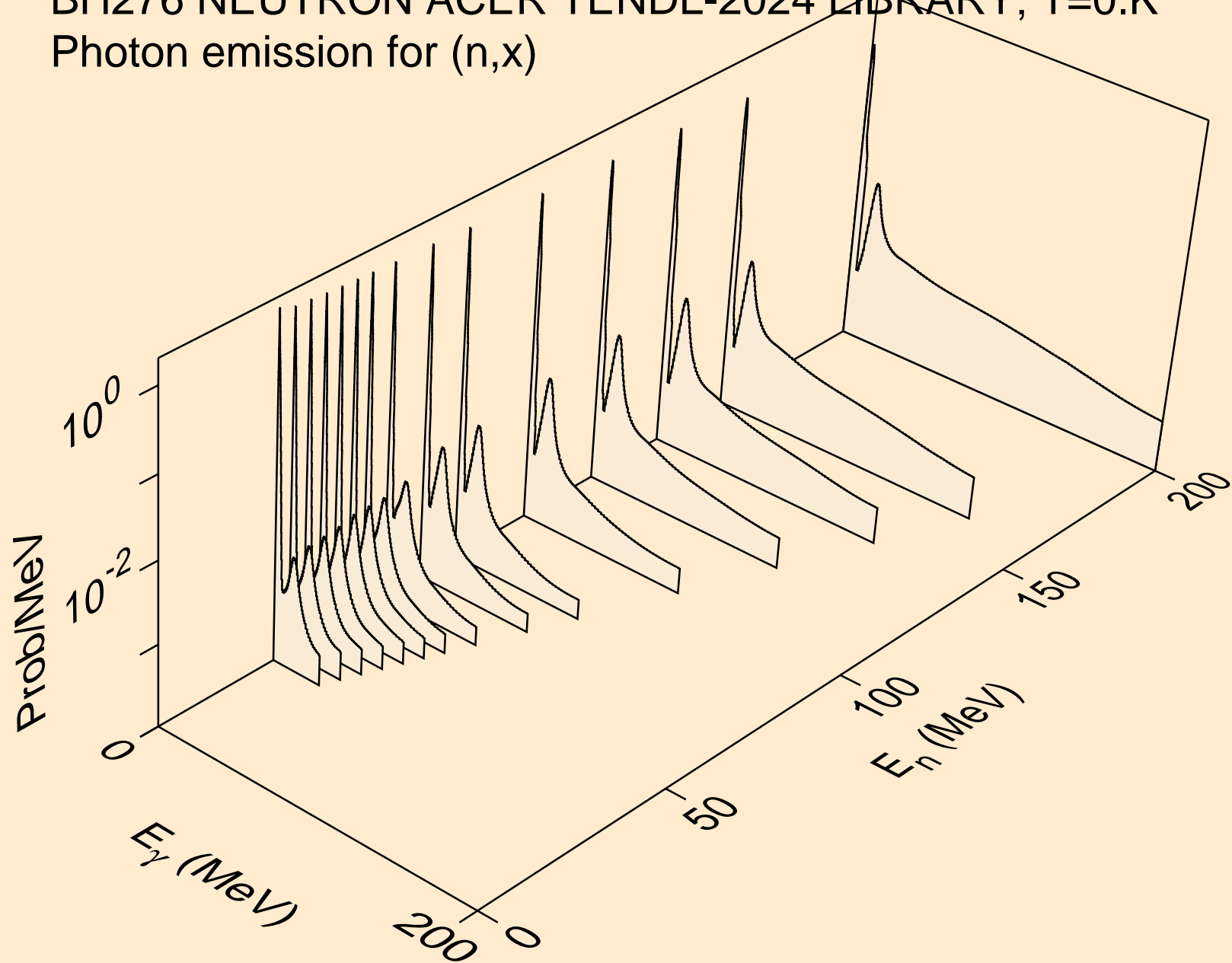

BH276 NEUTRON ACER TENDL-2024 LIBRARY; T=0.K
Photon emission for (n,2nd)

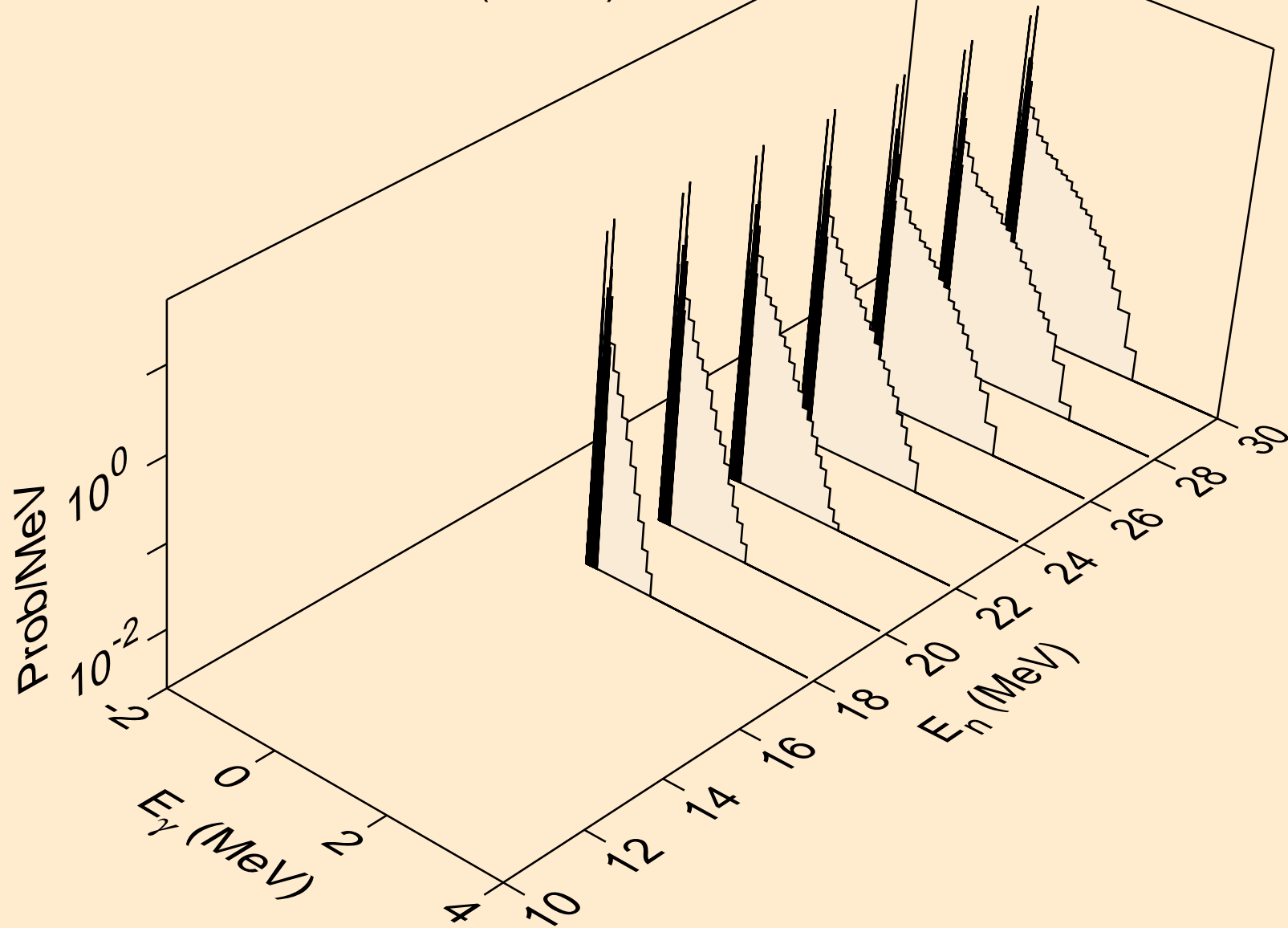

BH276 NEUTRON ACER TENDL-2024 LIBRARY; T=0.K
Photon emission for (n,2n)

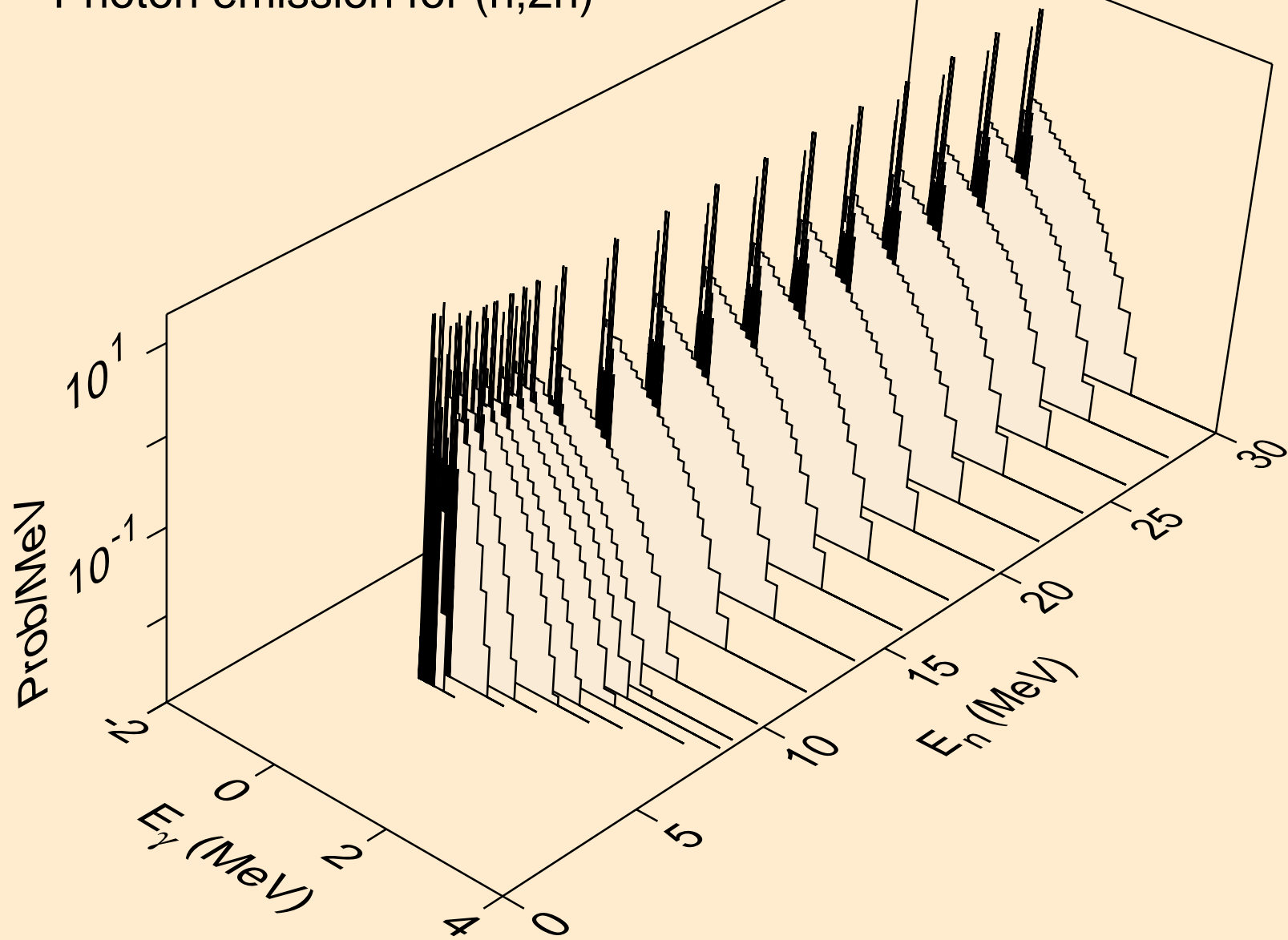

BH276 NEUTRON ACER TENDL-2024 LIBRARY; T=0.K
Photon emission for (n,3n)

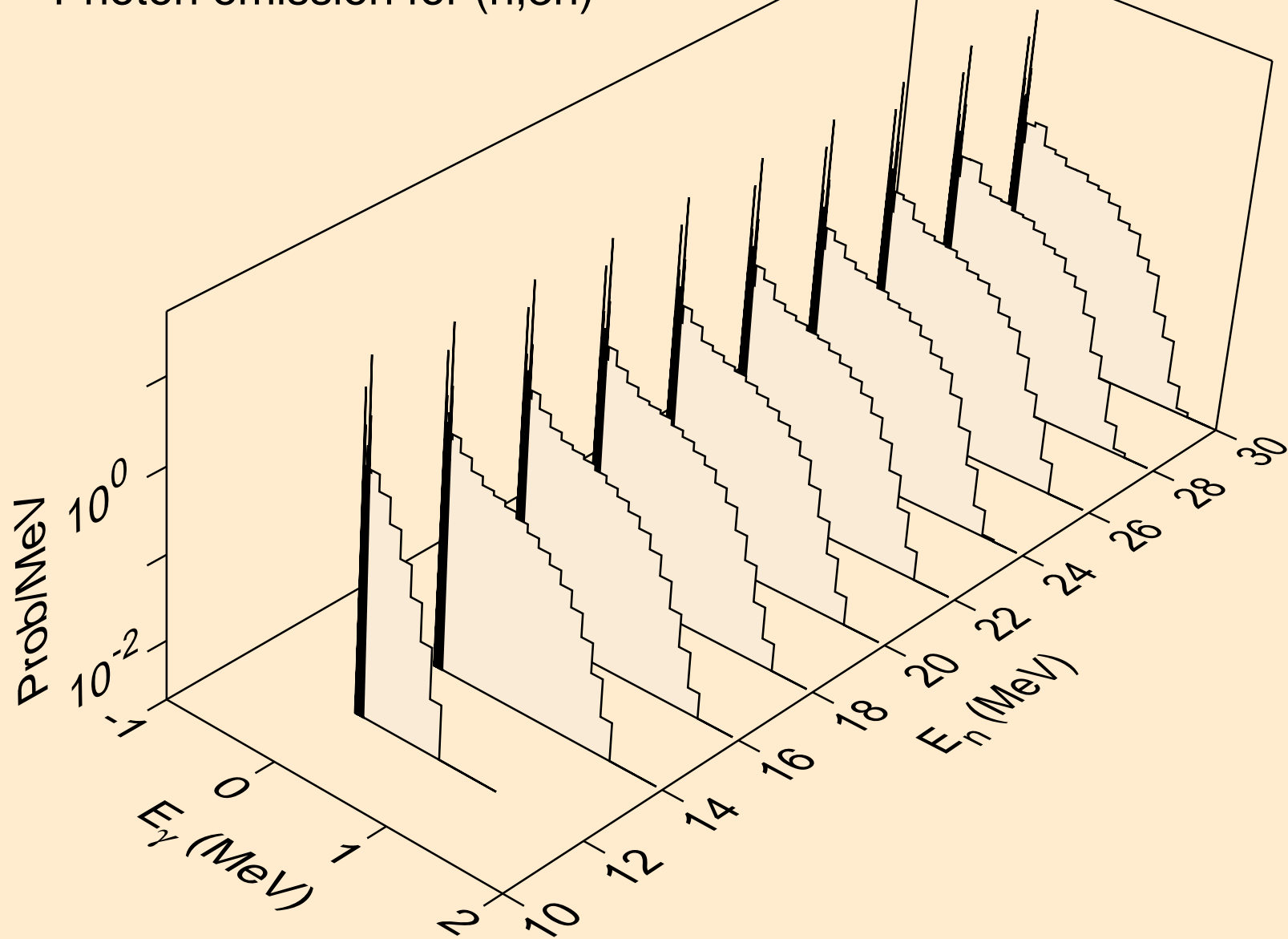

BH276 NEUTRON ACER TENDL-2024 LIBRARY; T=0.K
Photon emission for (n,n*)a

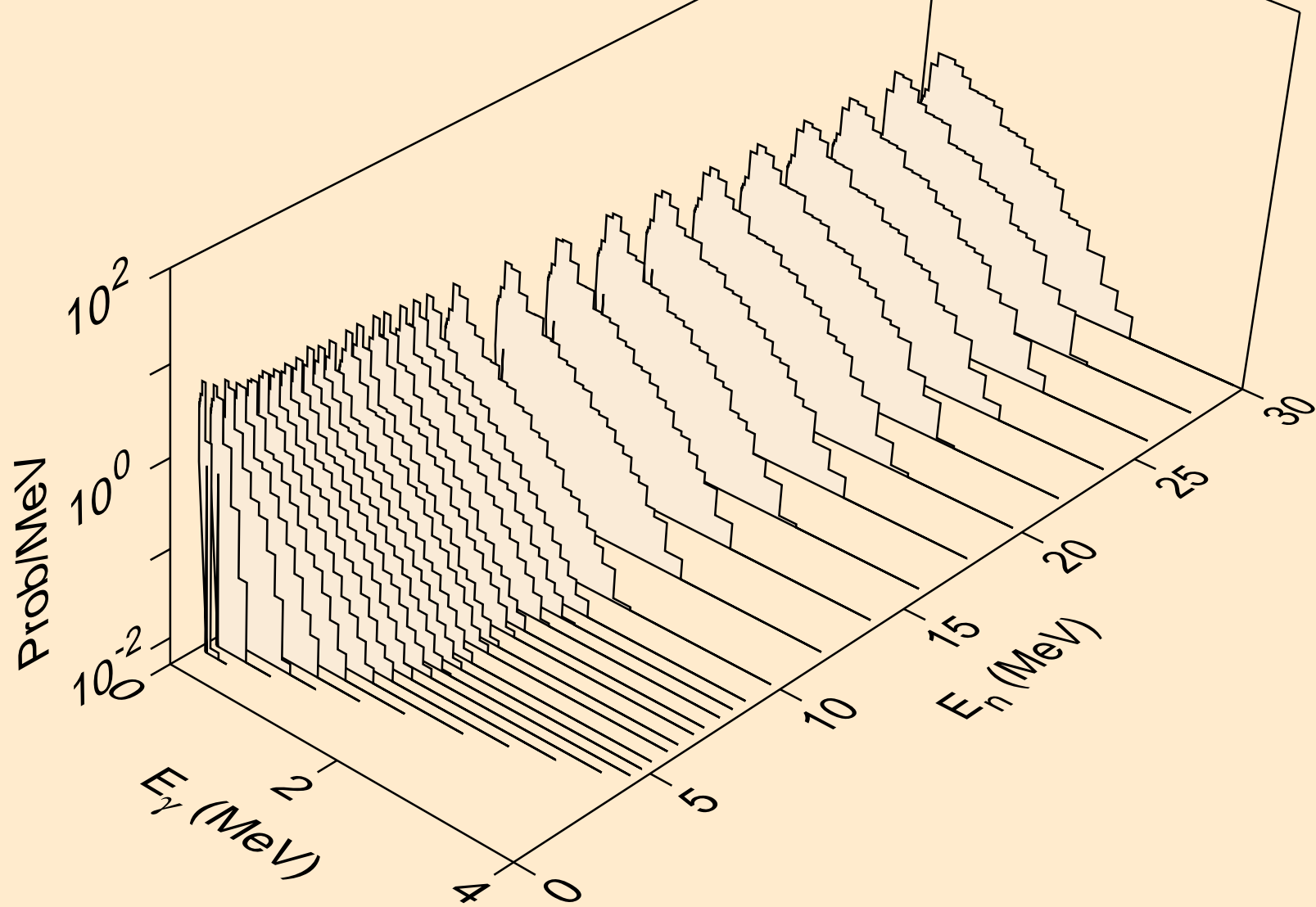

BH276 NEUTRON ACER TENDL-2024 LIBRARY; T=0.K
Photon emission for (n,2n)a

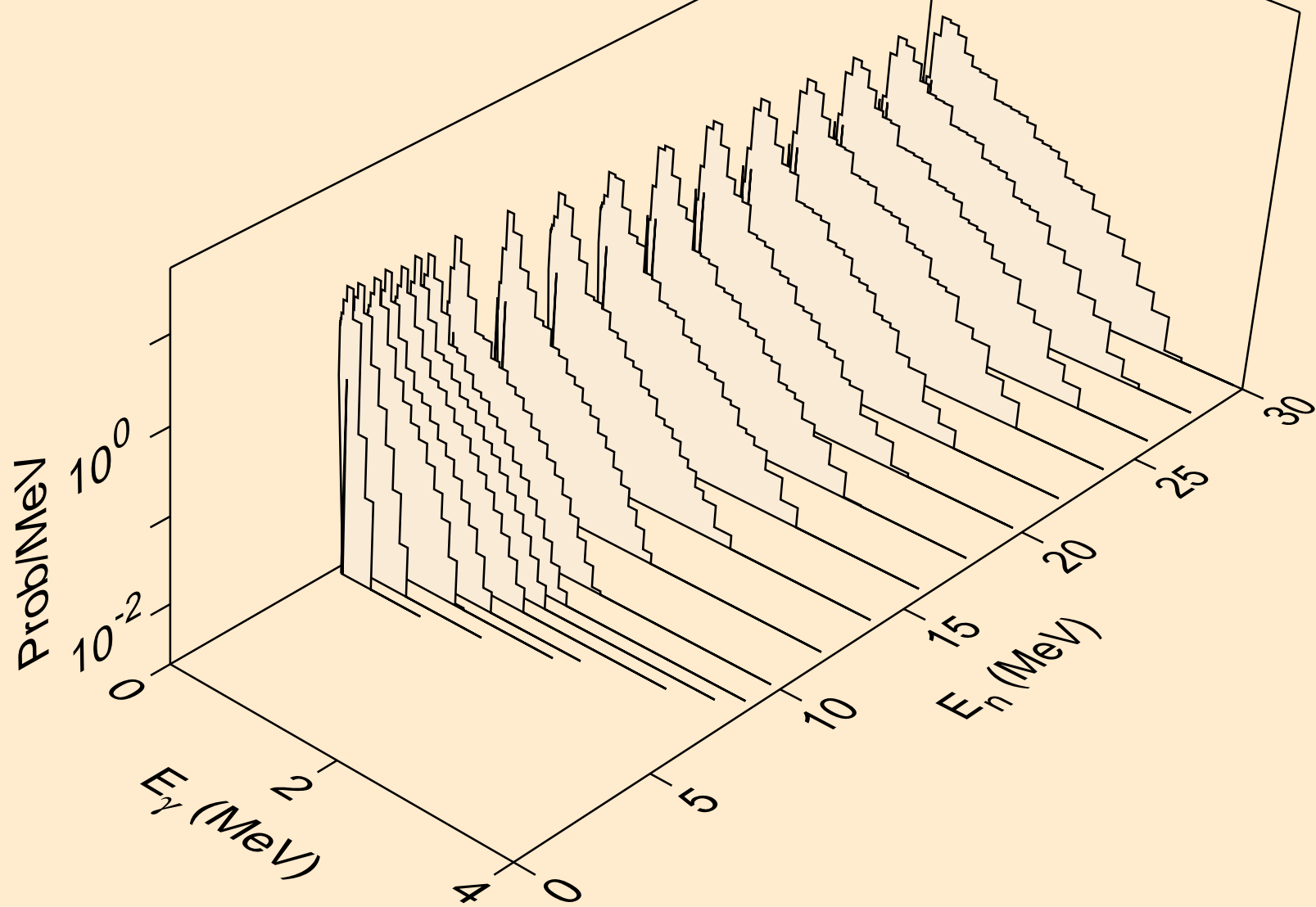

BH276 NEUTRON ACER TENDL-2024 LIBRARY; T=0.K
Photon emission for (n,3n)a

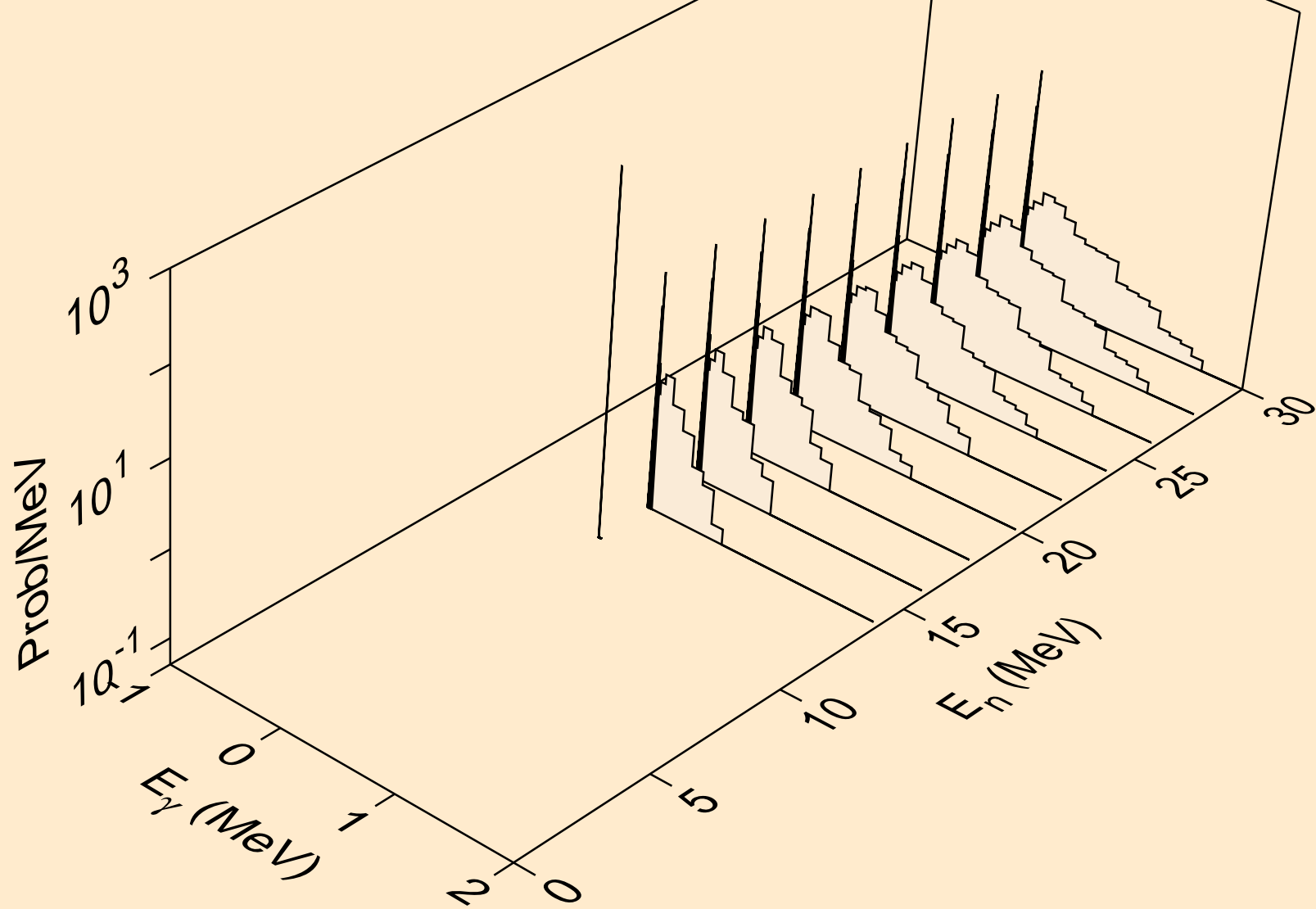

BH276 NEUTRON ACER TENDL-2024 LIBRARY; T=0.K
Photon emission for (n,n*)p

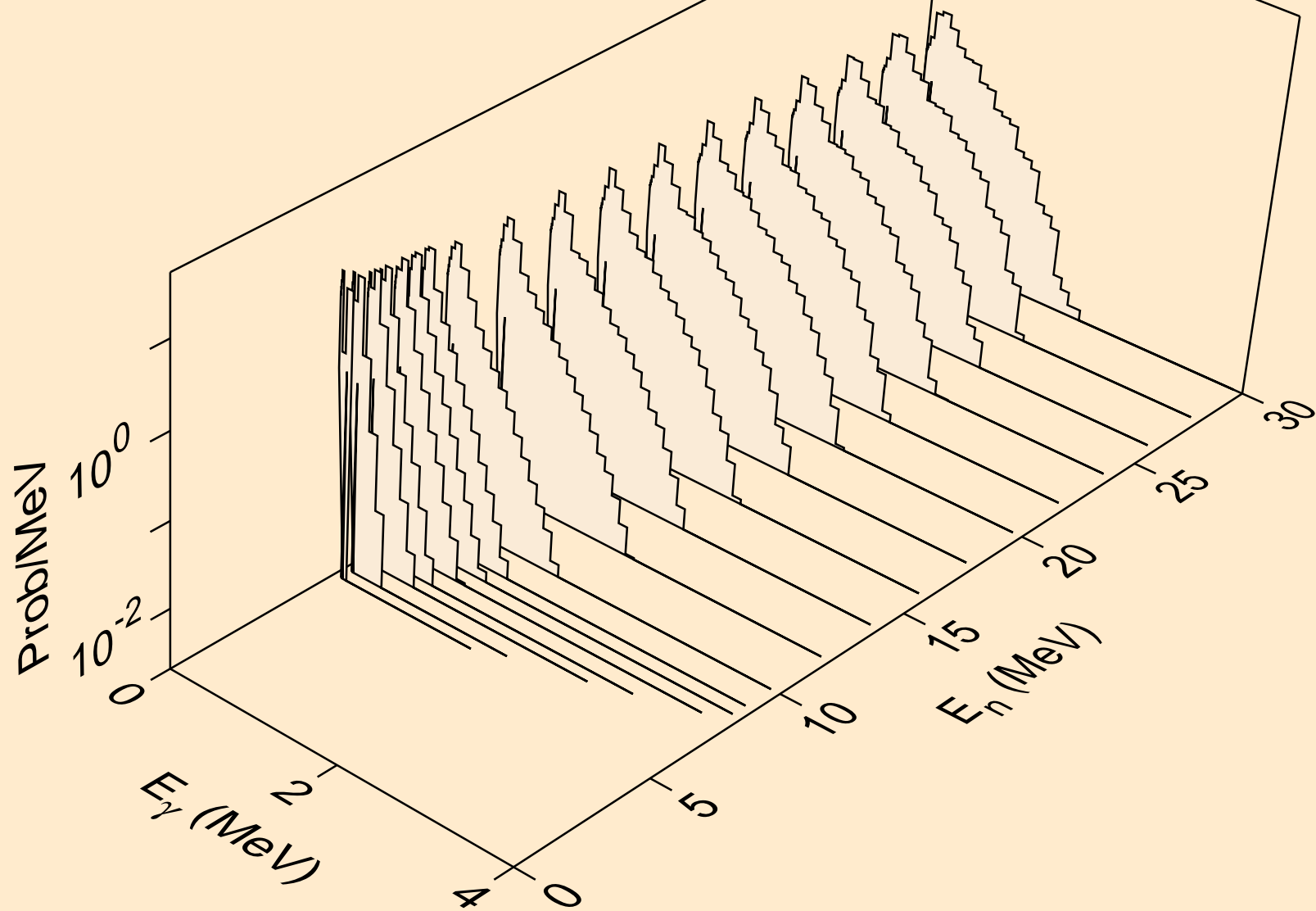

BH276 NEUTRON ACER TENDL-2024 LIBRARY; T=0.K
Photon emission for (n,n*)d

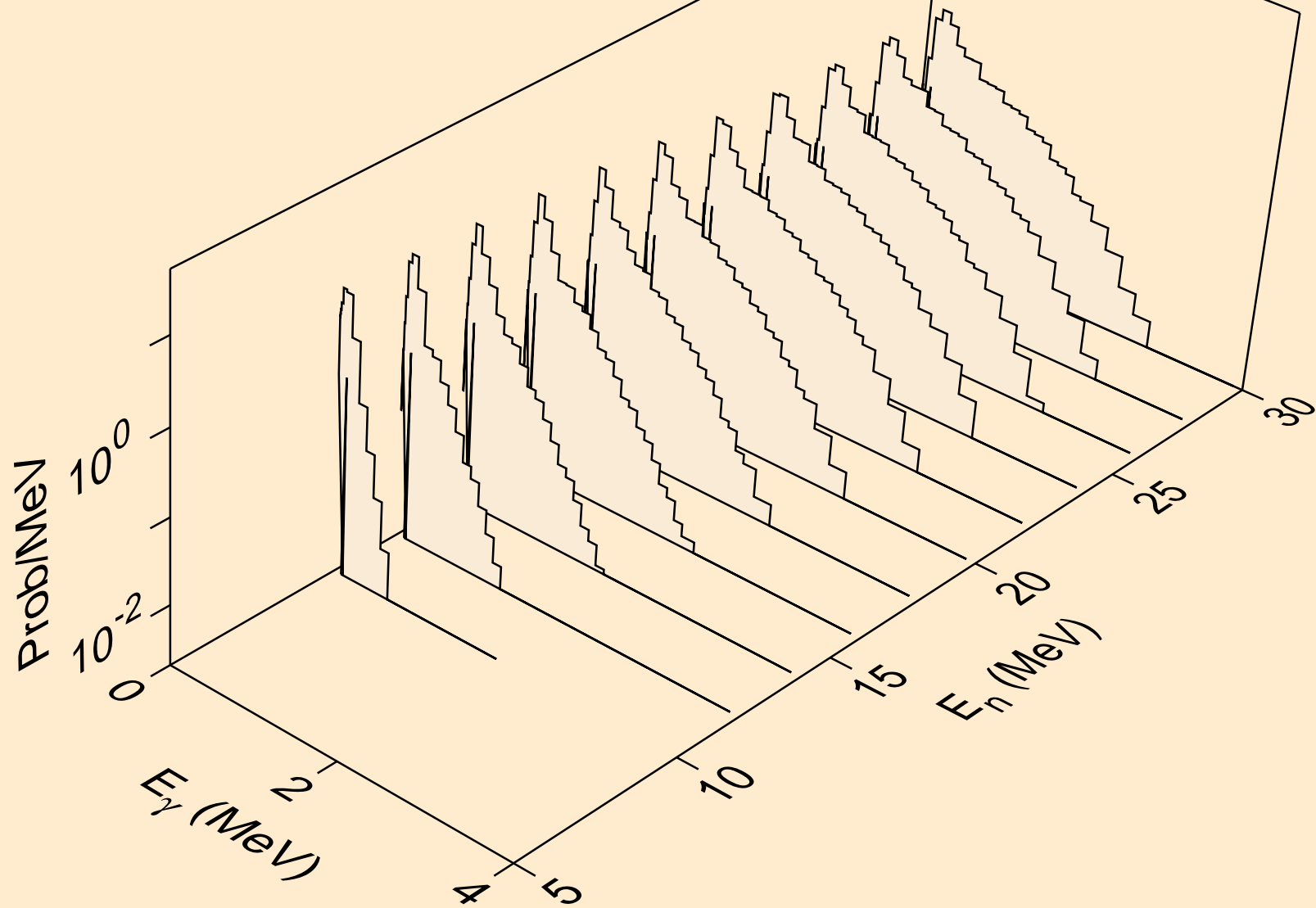

BH276 NEUTRON ACER TENDL-2024 LIBRARY; T=0.K
Photon emission for (n,n*)t

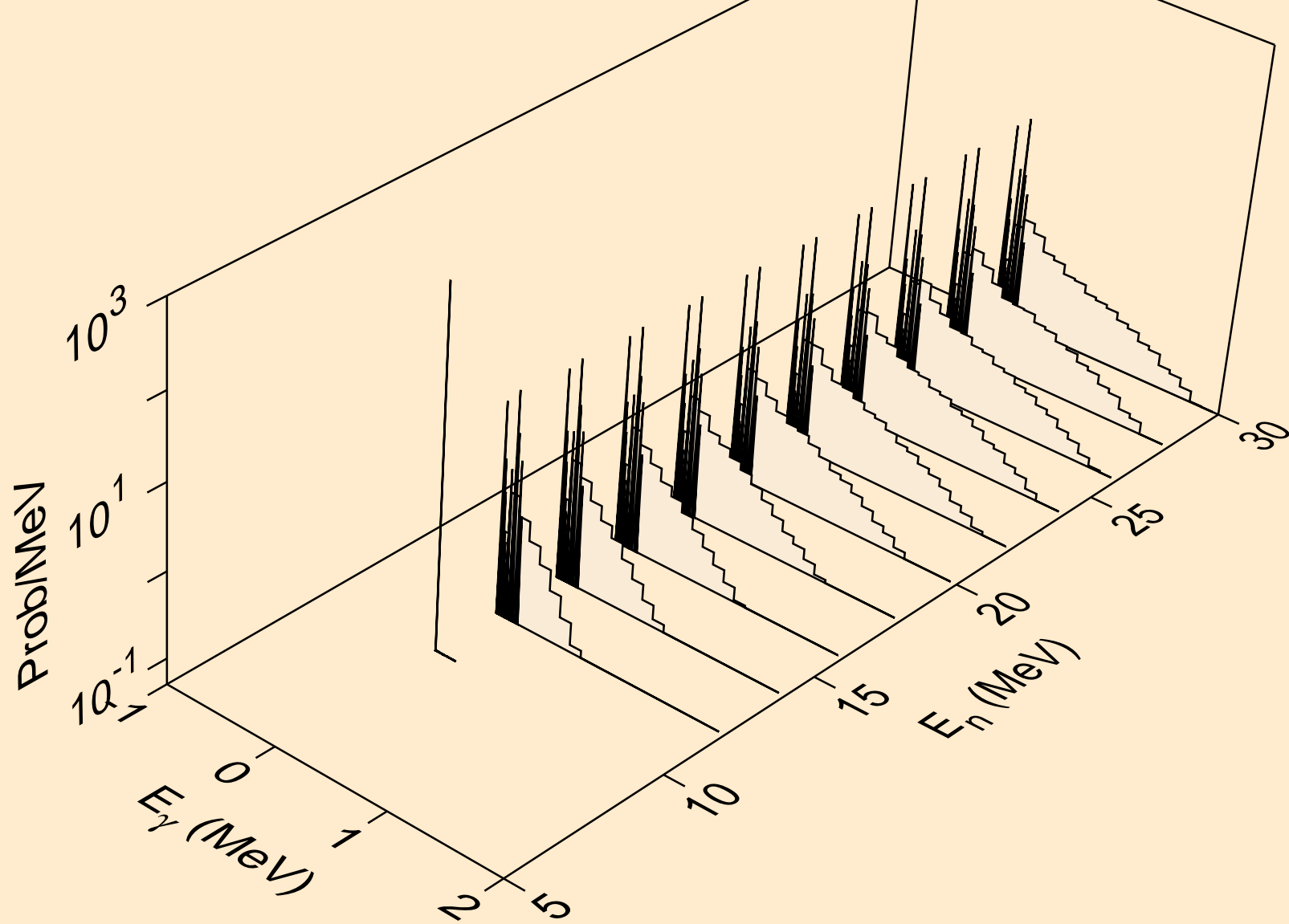

BH276 NEUTRON ACER TENDL-2024 LIBRARY; T=0.K
Photon emission for (n,n*)he3

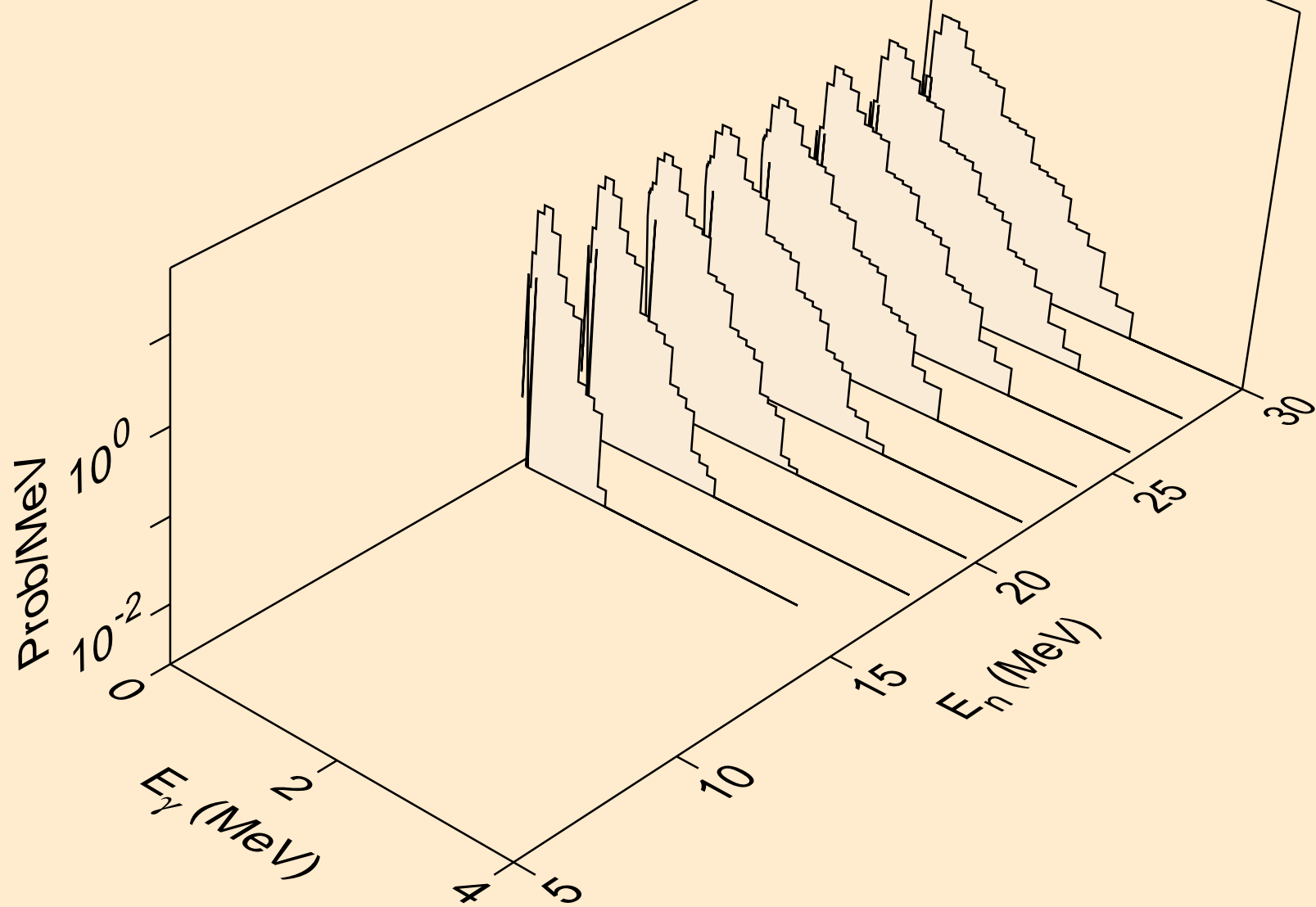

BH276 NEUTRON ACER TENDL-2024 LIBRARY; T=0.K
Photon emission for (n,4n)

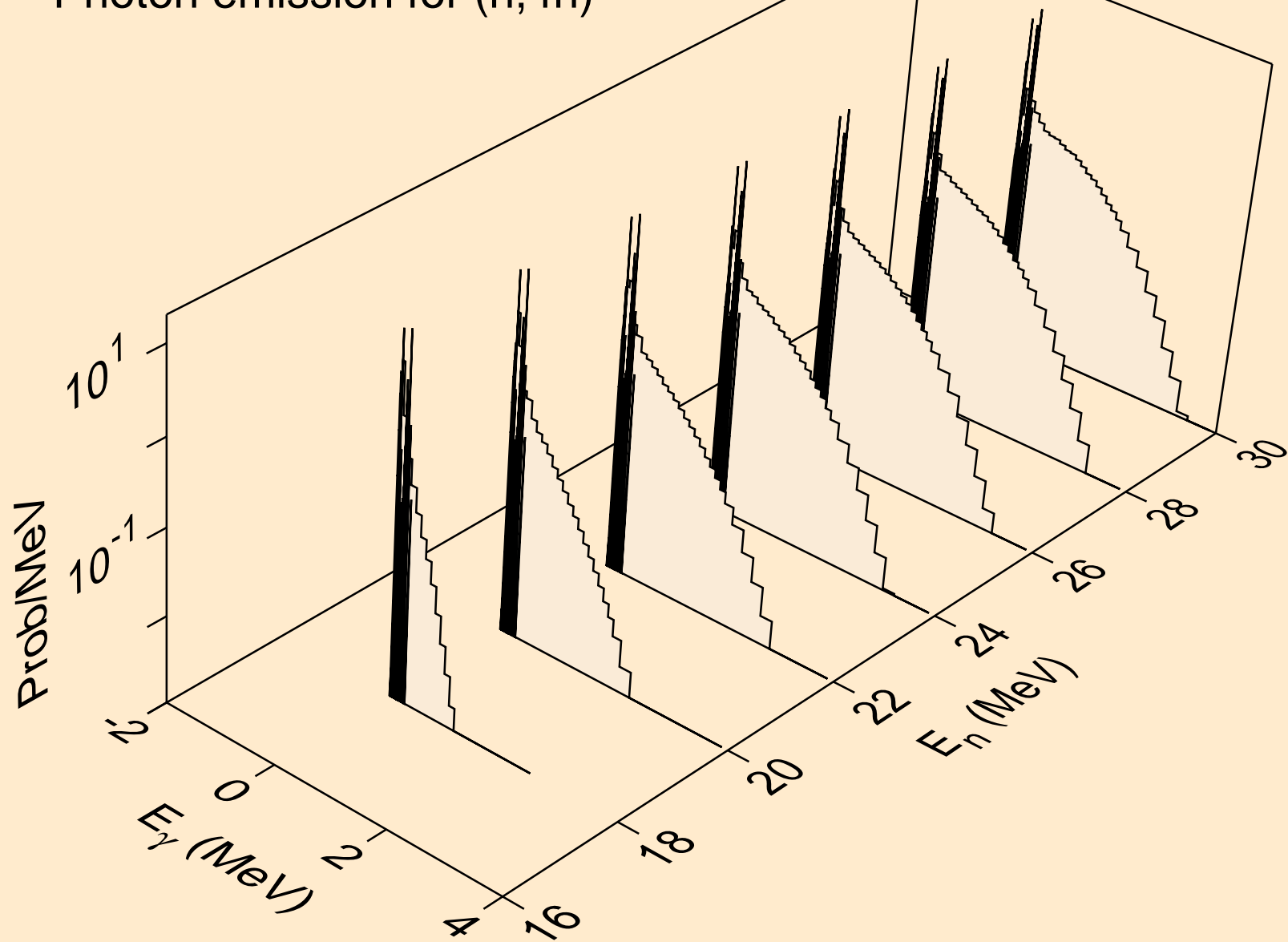

BH276 NEUTRON ACER TENDL-2024 LIBRARY; T=0.K
Photon emission for (n,2np)

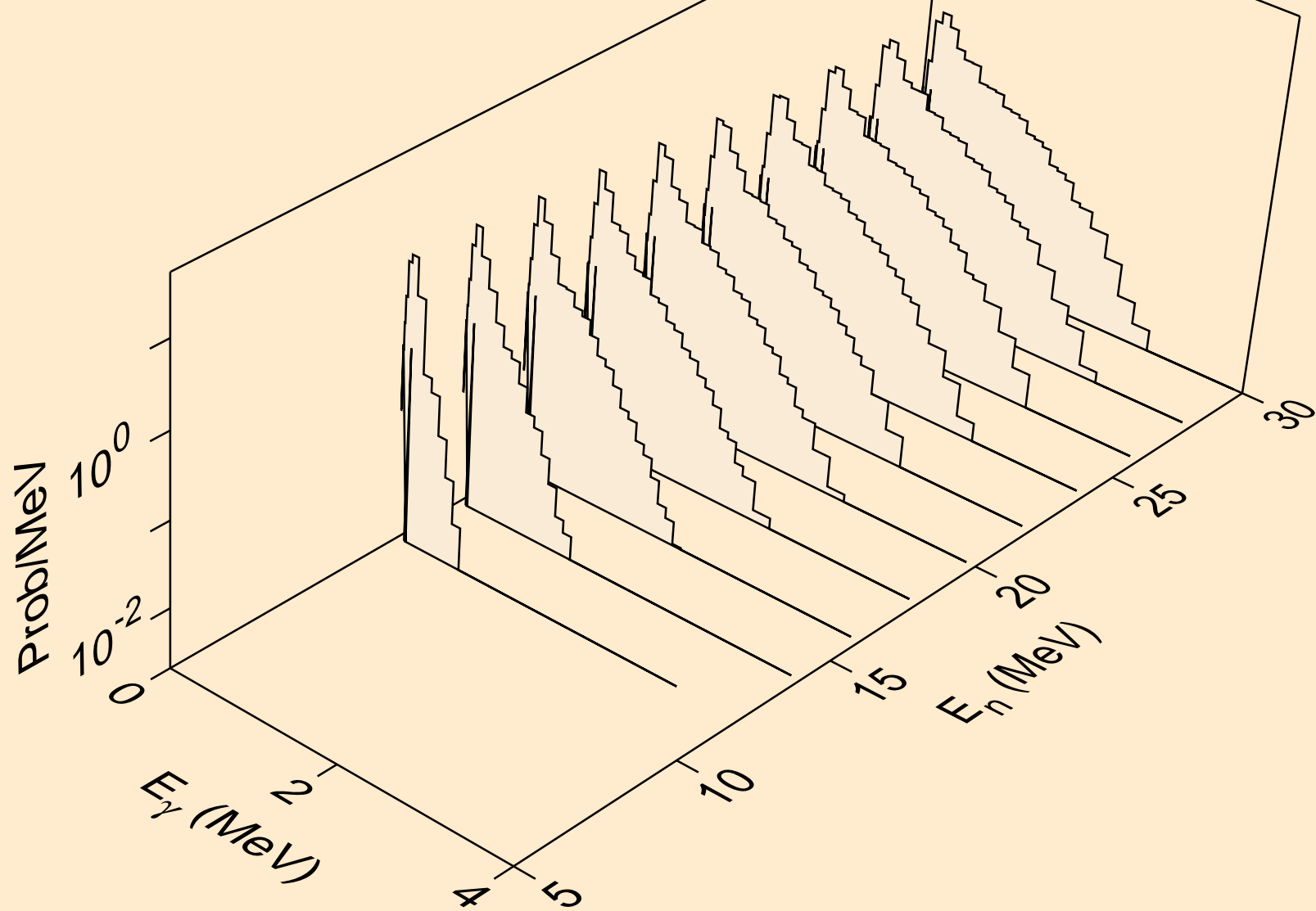

BH276 NEUTRON ACER TENDL-2024 LIBRARY; T=0.K
Photon emission for (n,3np)

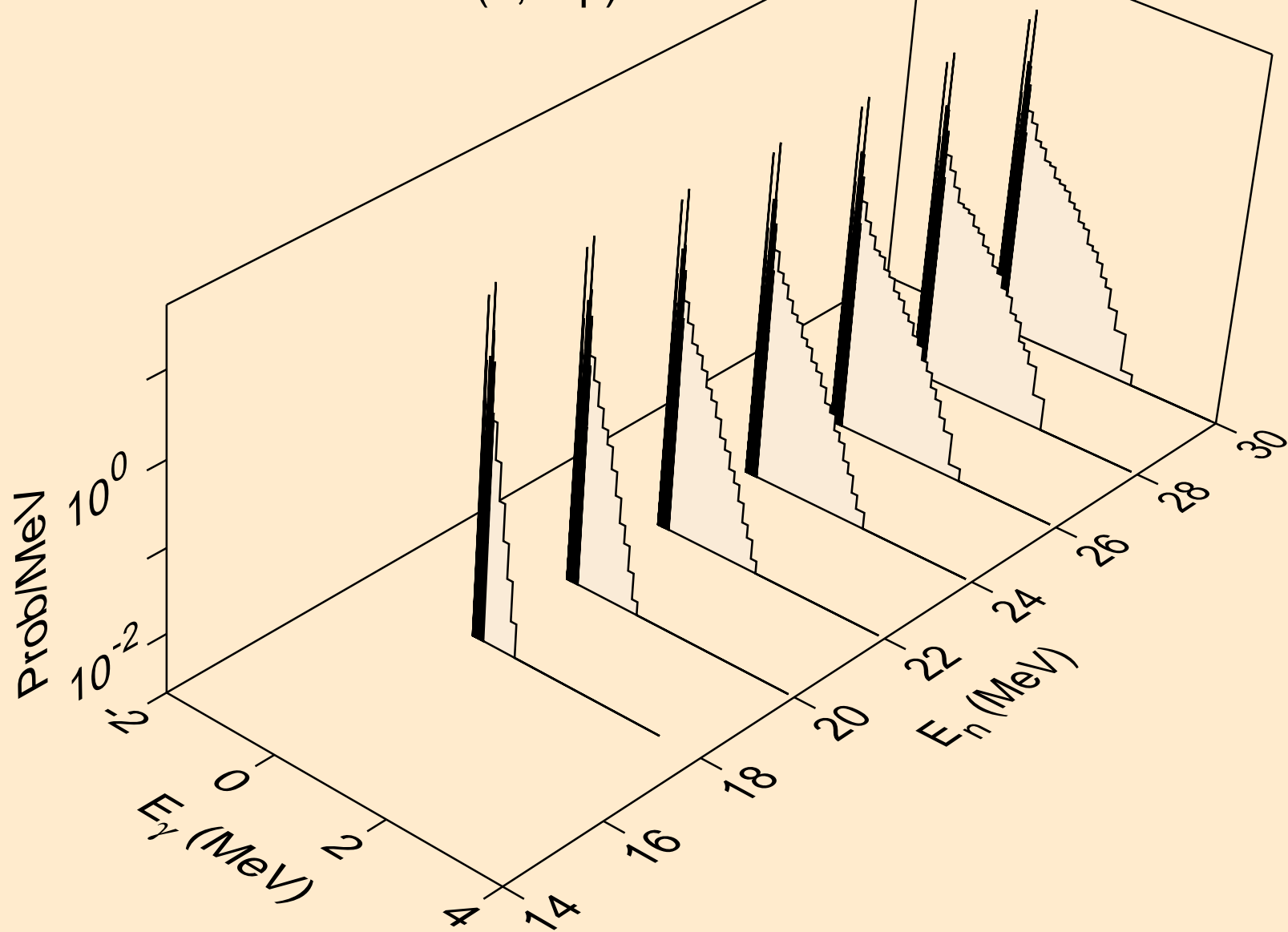

BH276 NEUTRON ACER TENDL-2024 LIBRARY; T=0.K
Photon emission for (n,n*c)

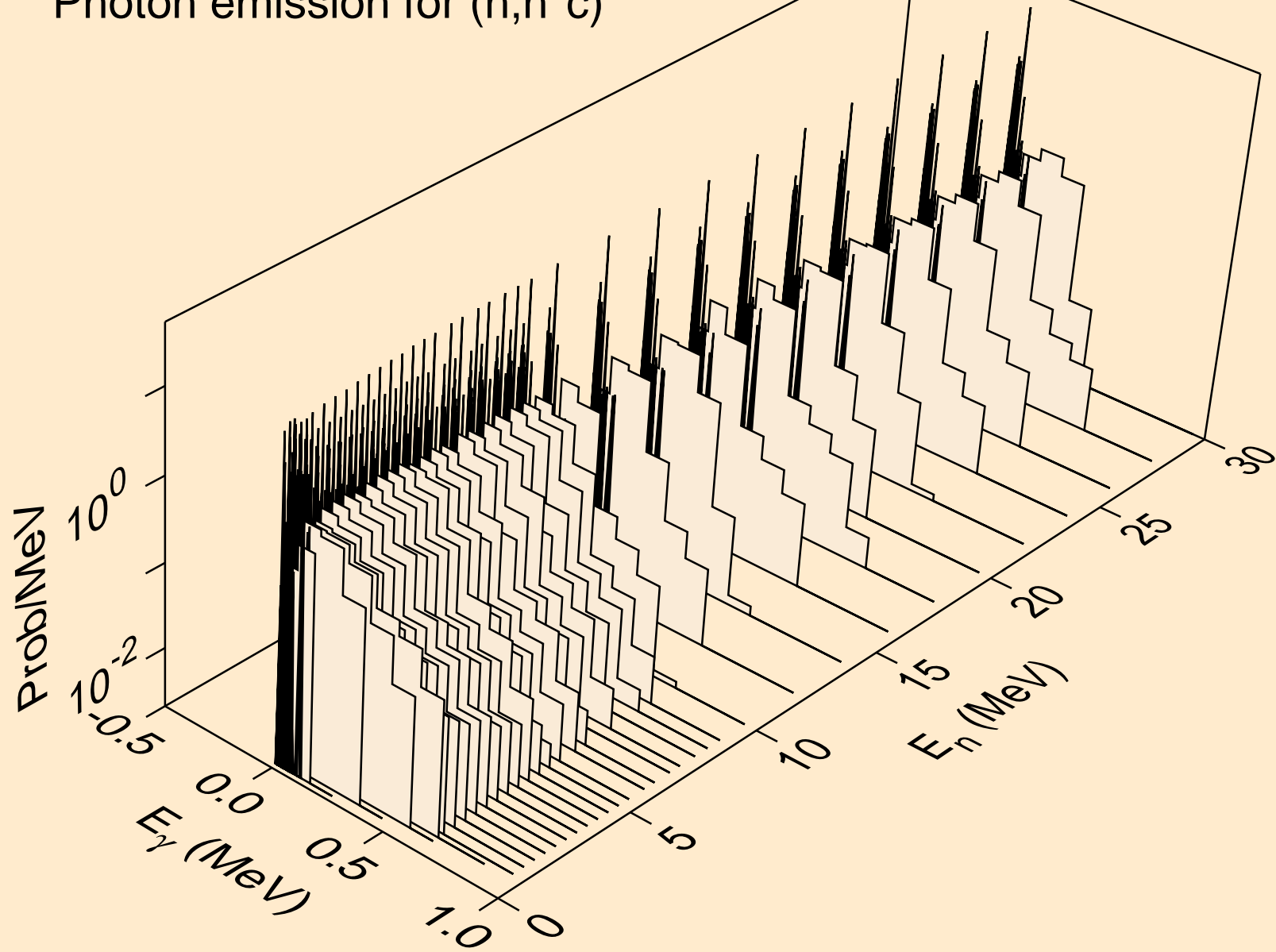

BH276 NEUTRON ACER TENDL-2024 LIBRARY; T=0.K
Photon emission for (n,gma)

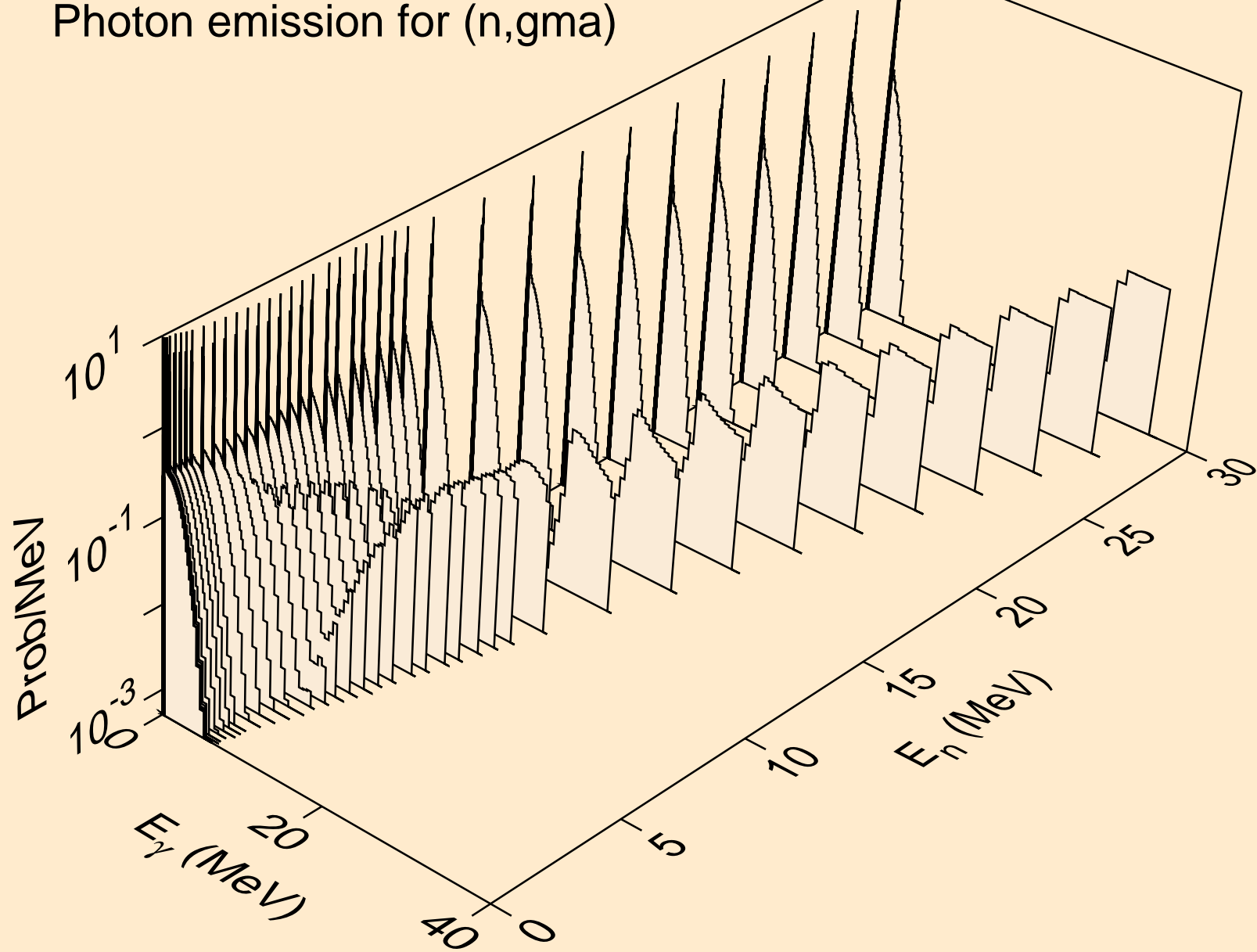

BH276 NEUTRON ACER TENDL-2024 LIBRARY; T=0.K
Photon emission for (n,p)

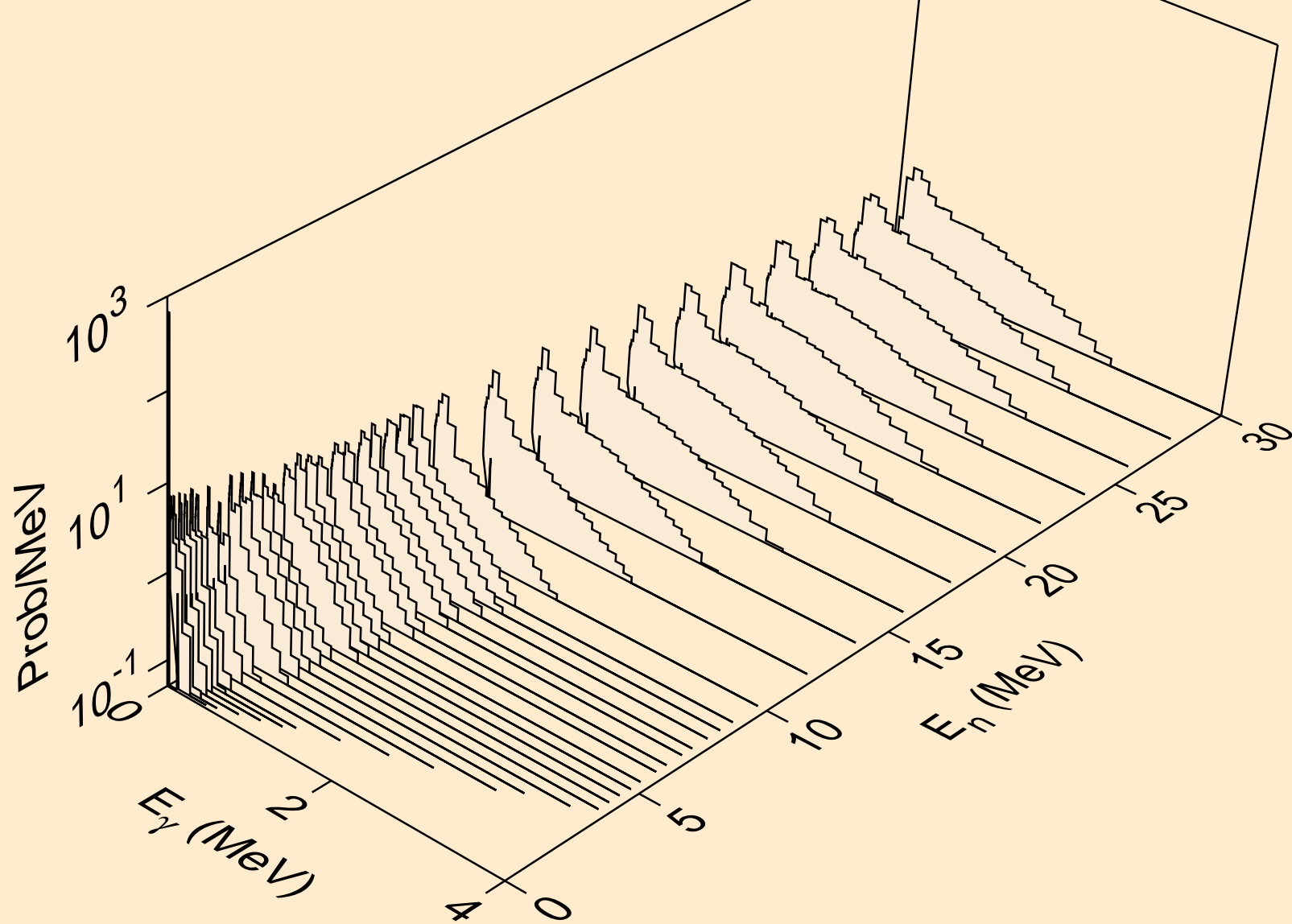

BH276 NEUTRON ACER TENDL-2024 LIBRARY; T=0.K
Photon emission for (n,d)

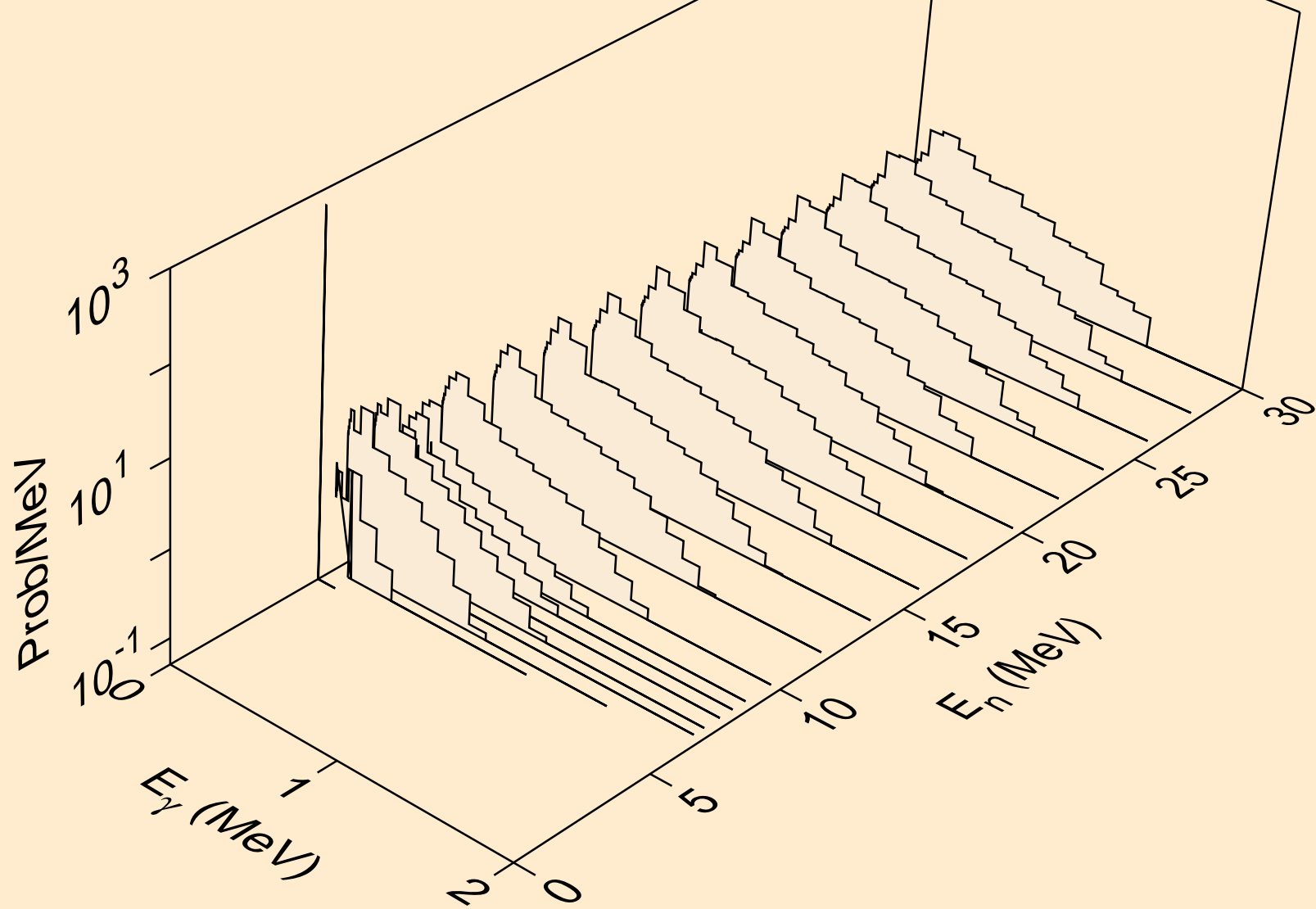

BH276 NEUTRON ACER TENDL-2024 LIBRARY; T=0.K
Photon emission for (n,t)

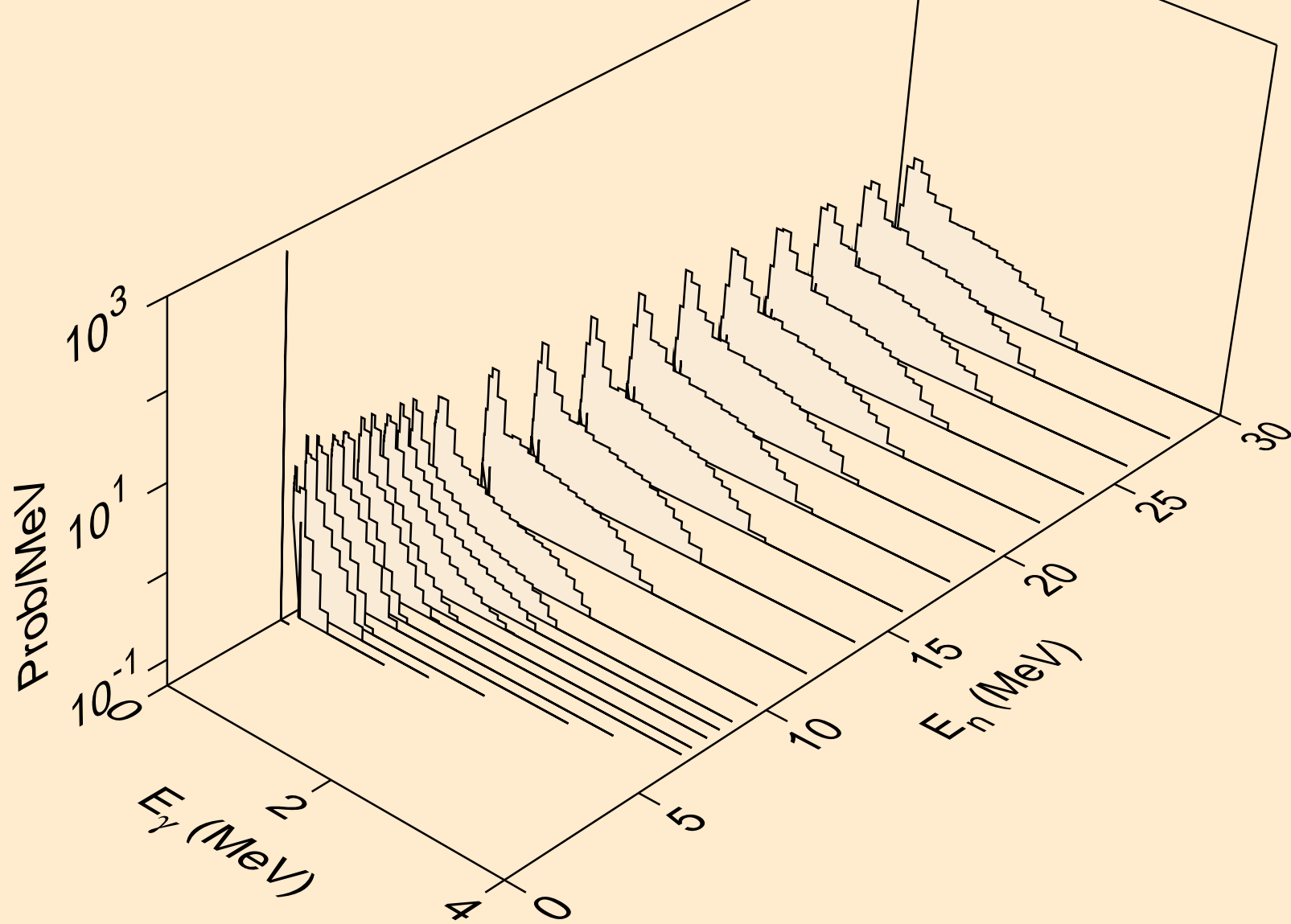

BH276 NEUTRON ACER TENDL-2024 LIBRARY; T=0.K
Photon emission for (n,he3)

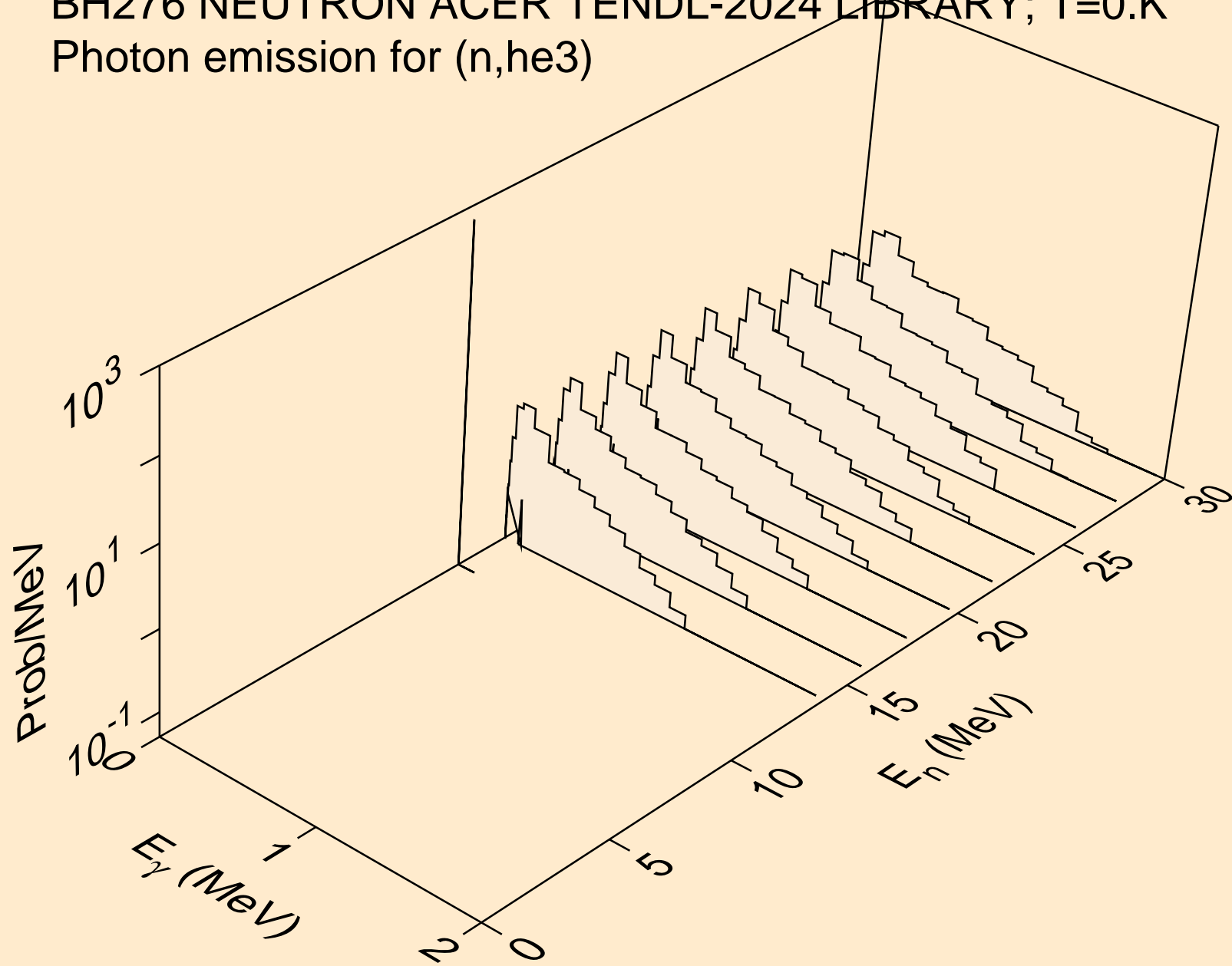

BH276 NEUTRON ACER TENDL-2024 LIBRARY; T=0.K
Photon emission for (n,a)

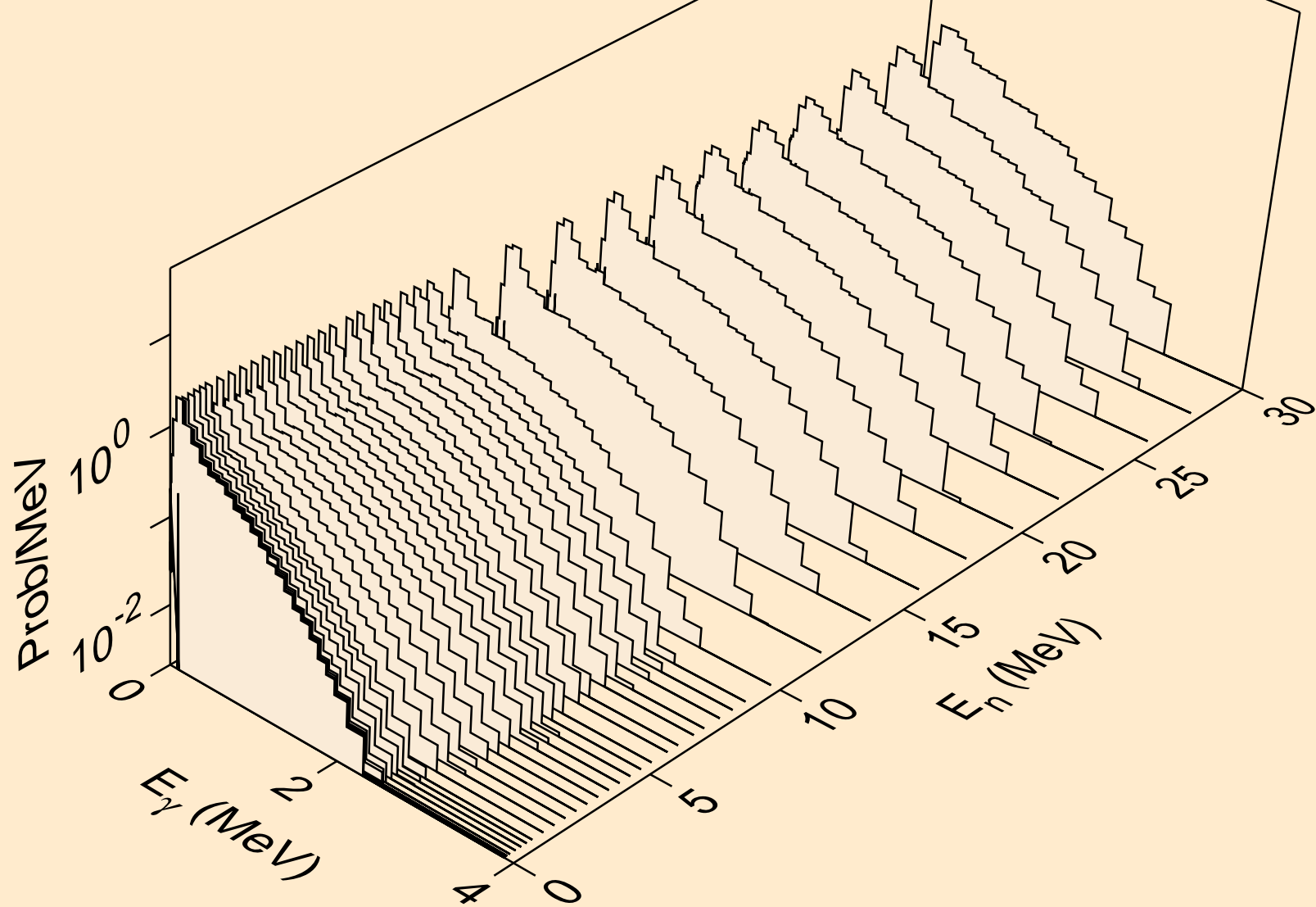

BH276 NEUTRON ACER TENDL-2024 LIBRARY; T=0.K
thermal capture photon spectrum

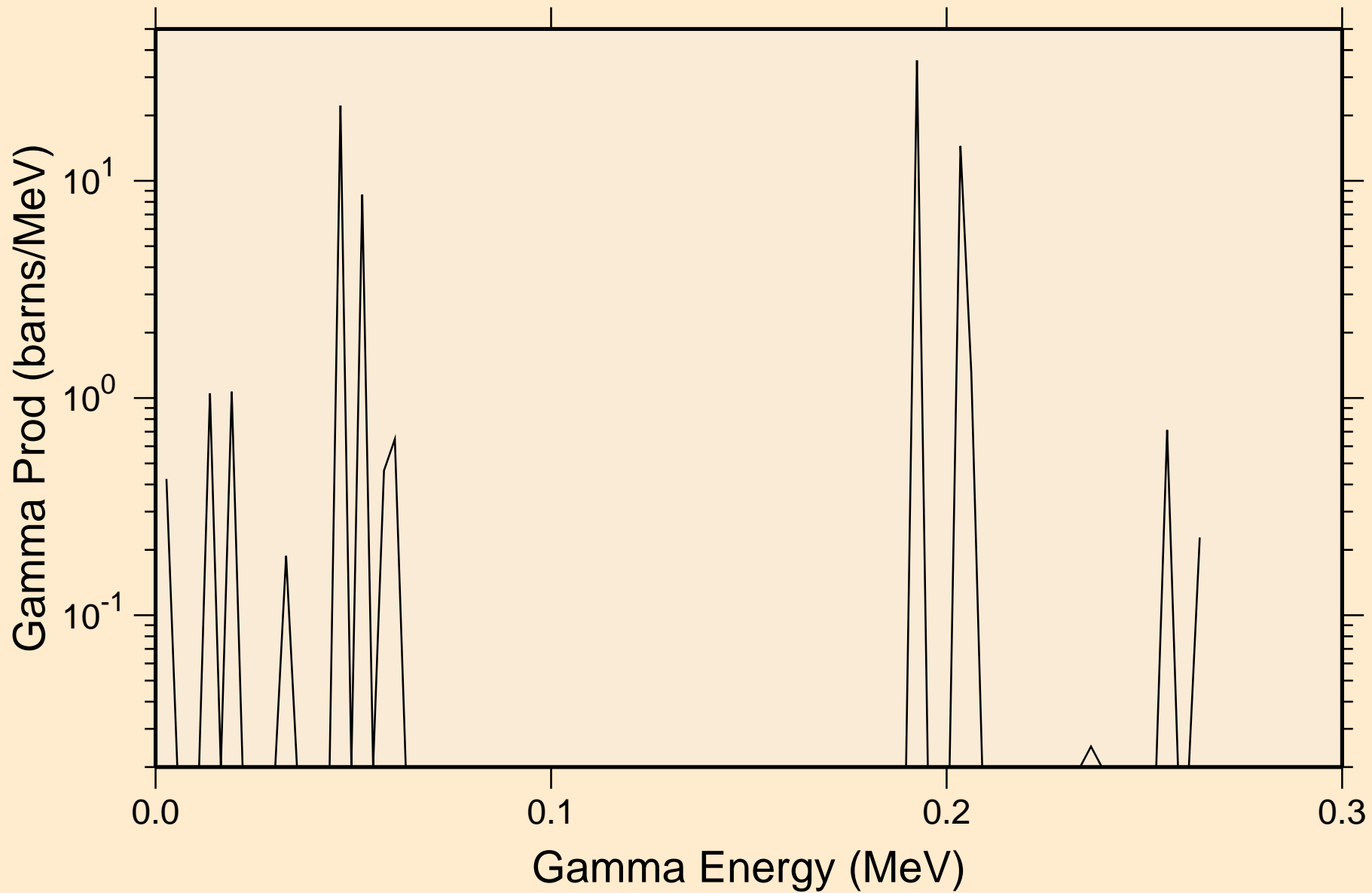

BH276 NEUTRON ACER TENDL-2024 LIBRARY; T=0.K
14 MeV photon spectrum

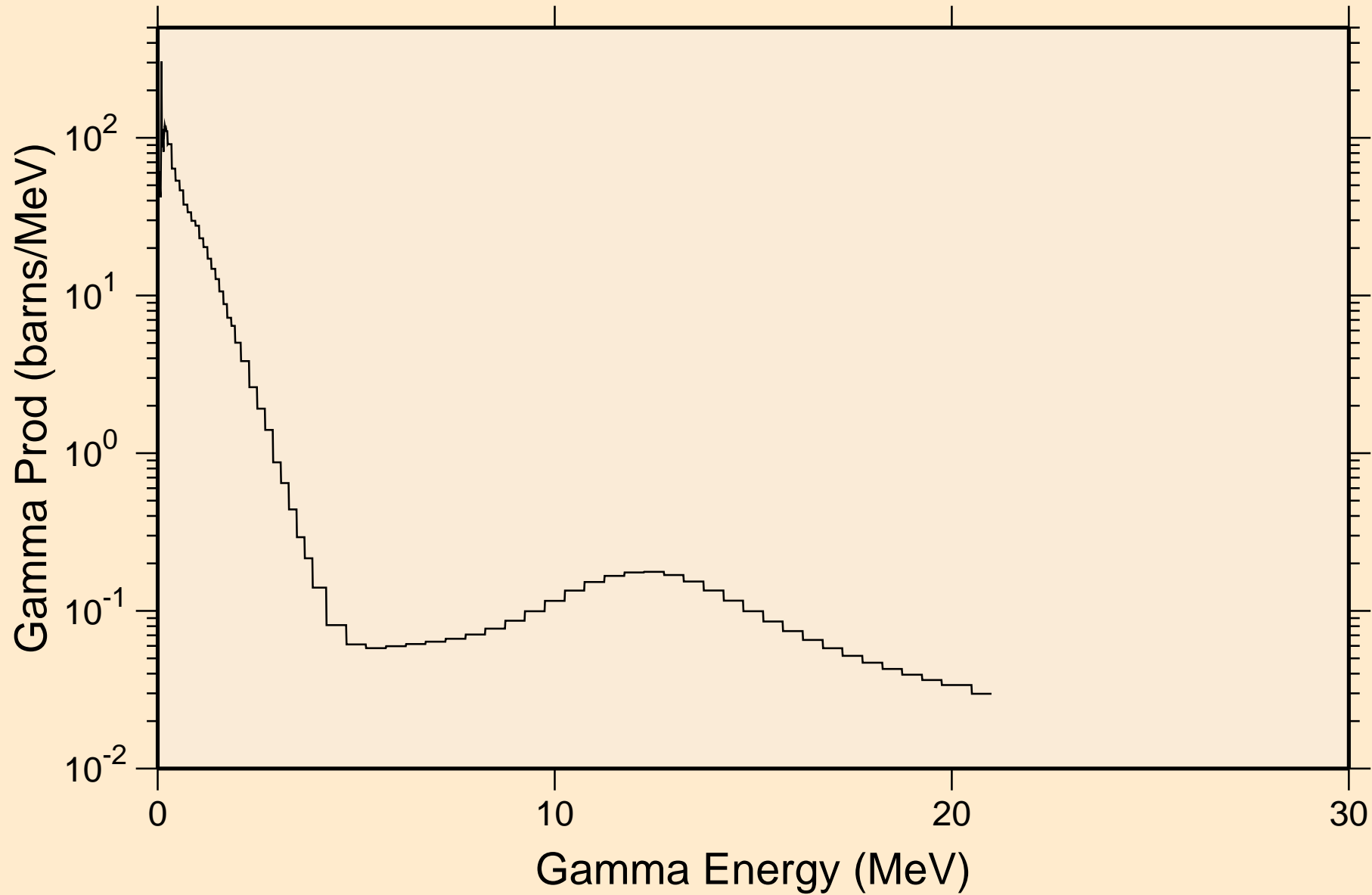

BH276 NEUTRON ACER TENDL-2024 LIBRARY; T=0.K

Particle heating contributions

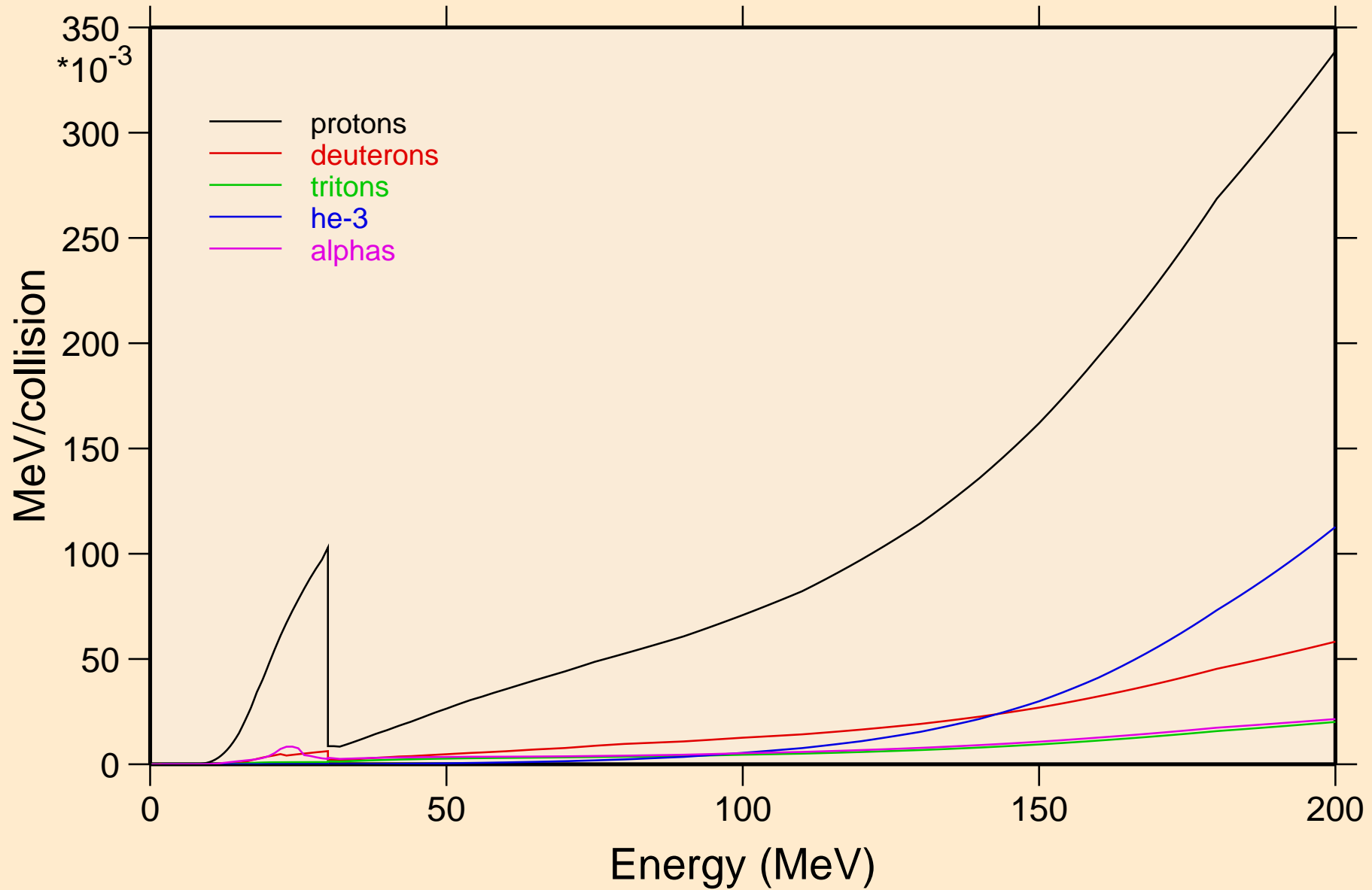

BH276 NEUTRON ACER TENDL-2024 LIBRARY; T=0.K
Recoil Heating

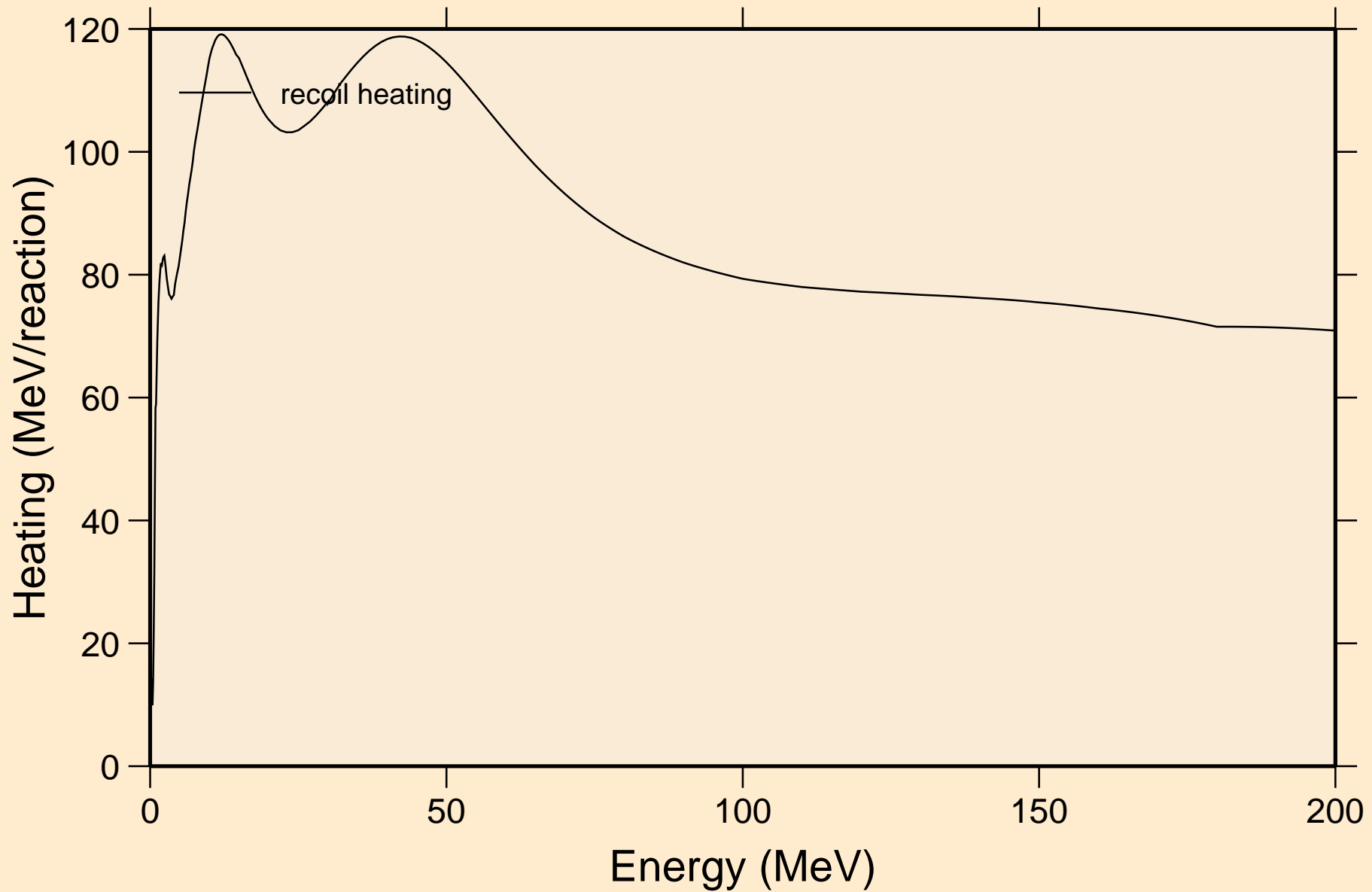

BH276 NEUTRON ACER TENDL-2024 LIBRARY; T=0.K

Particle production cross sections

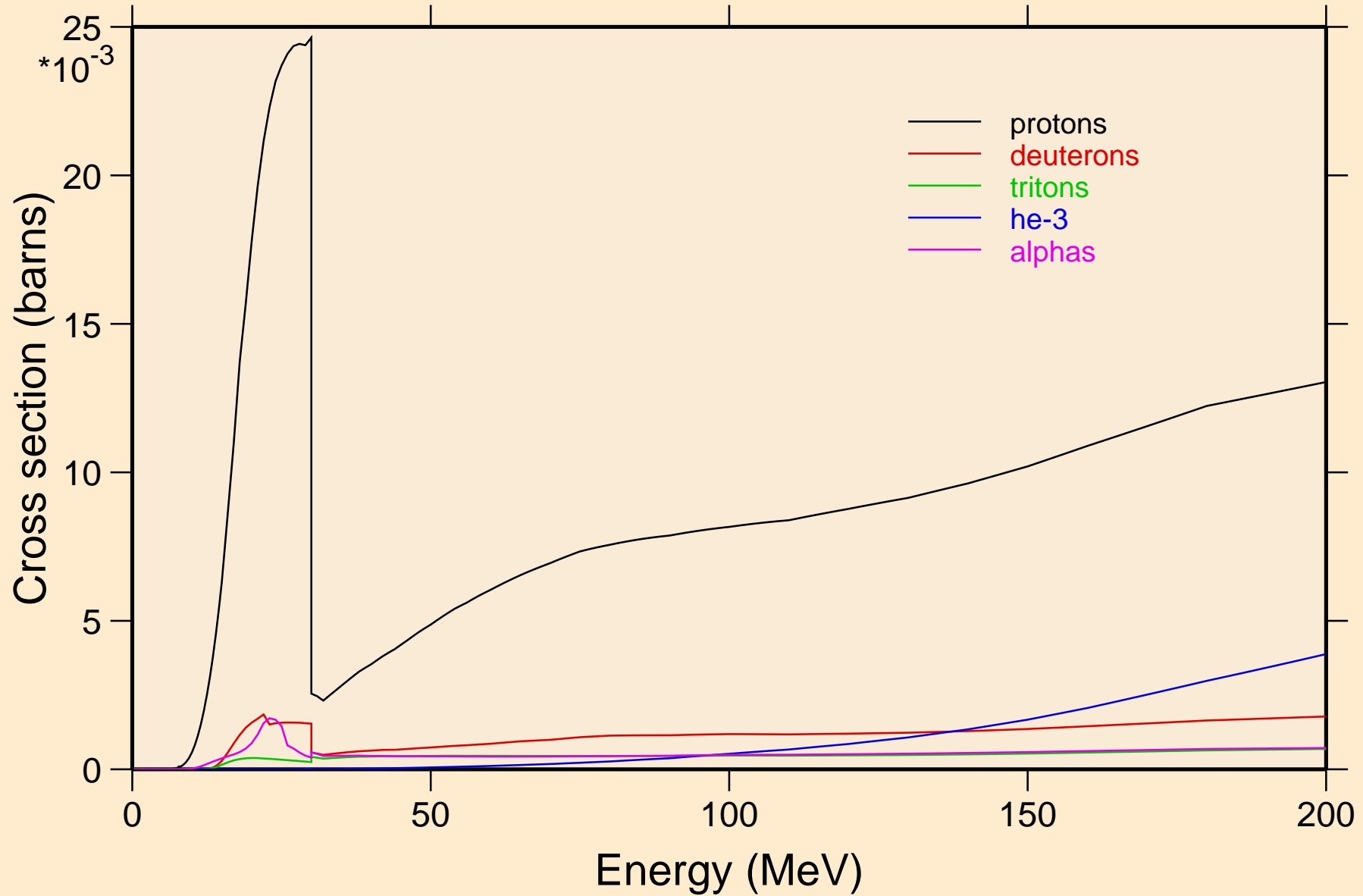

BH276 NEUTRON ACER TENDL-2024 LIBRARY; T=0.K
protons from (n,x)

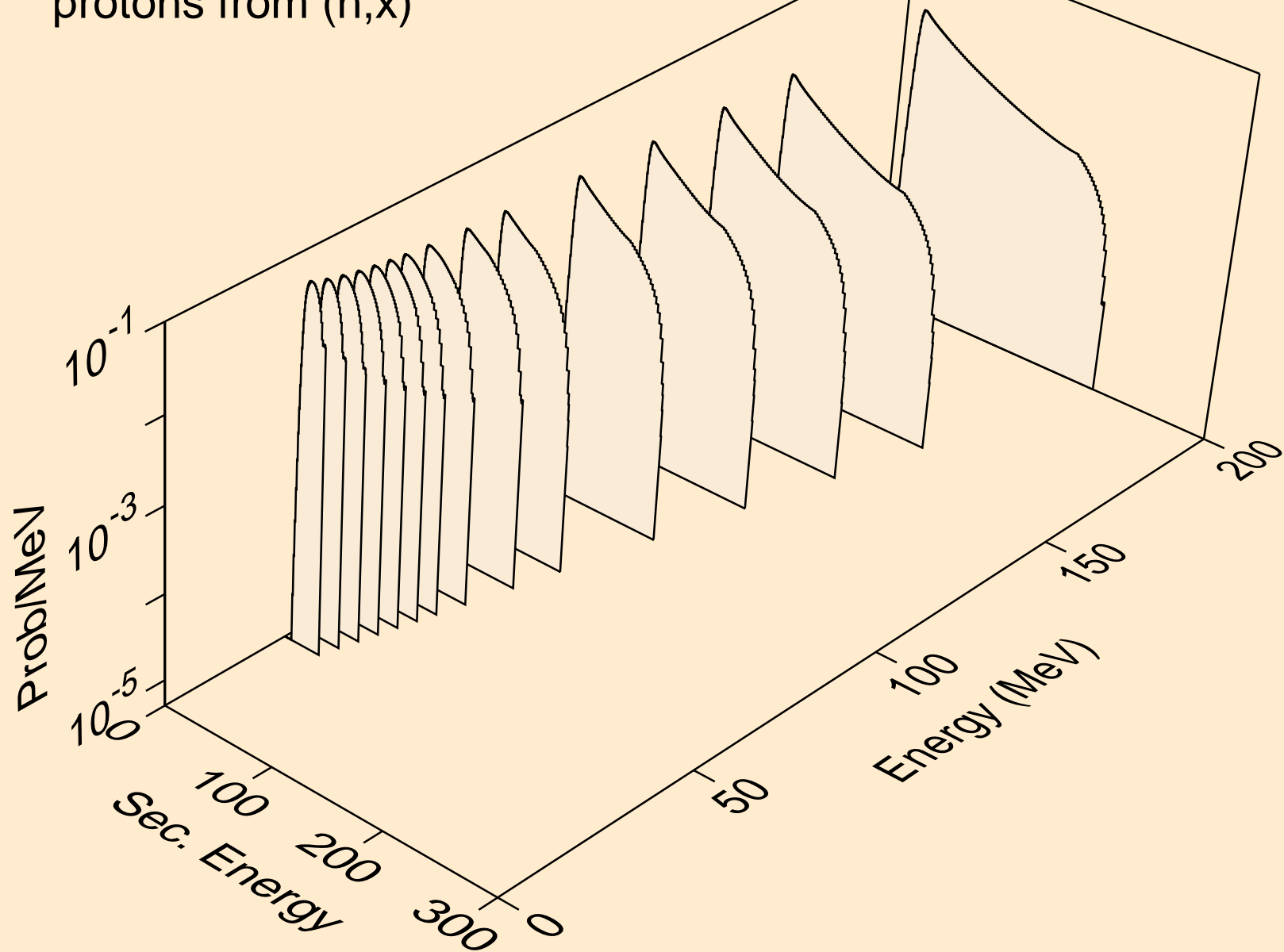

BH276 NEUTRON ACER TENDL-2024 LIBRARY; T=0.K
protons from (n,n*)p

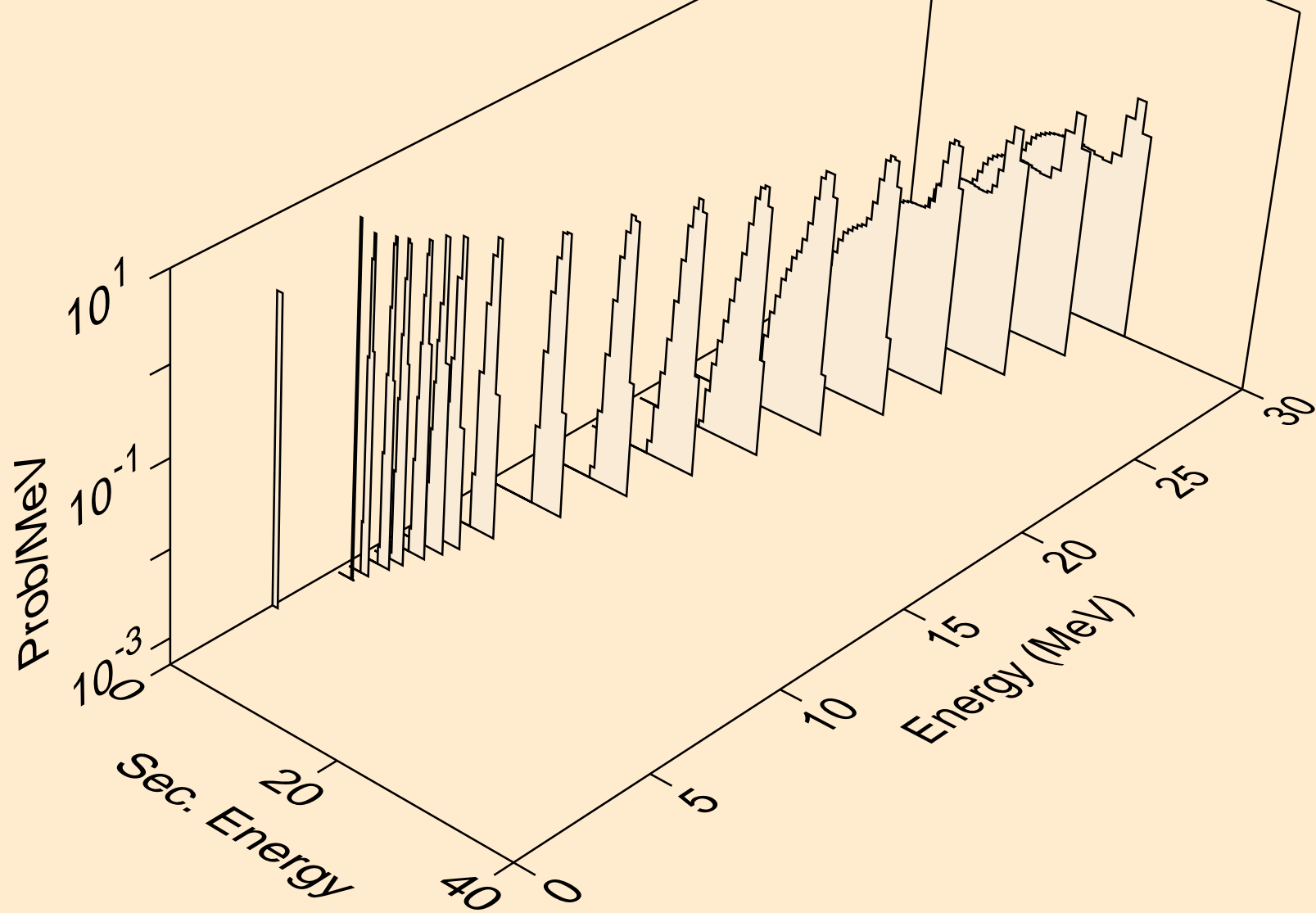

BH276 NEUTRON ACER TENDL-2024 LIBRARY; T=0.K
protons from (n,2np)

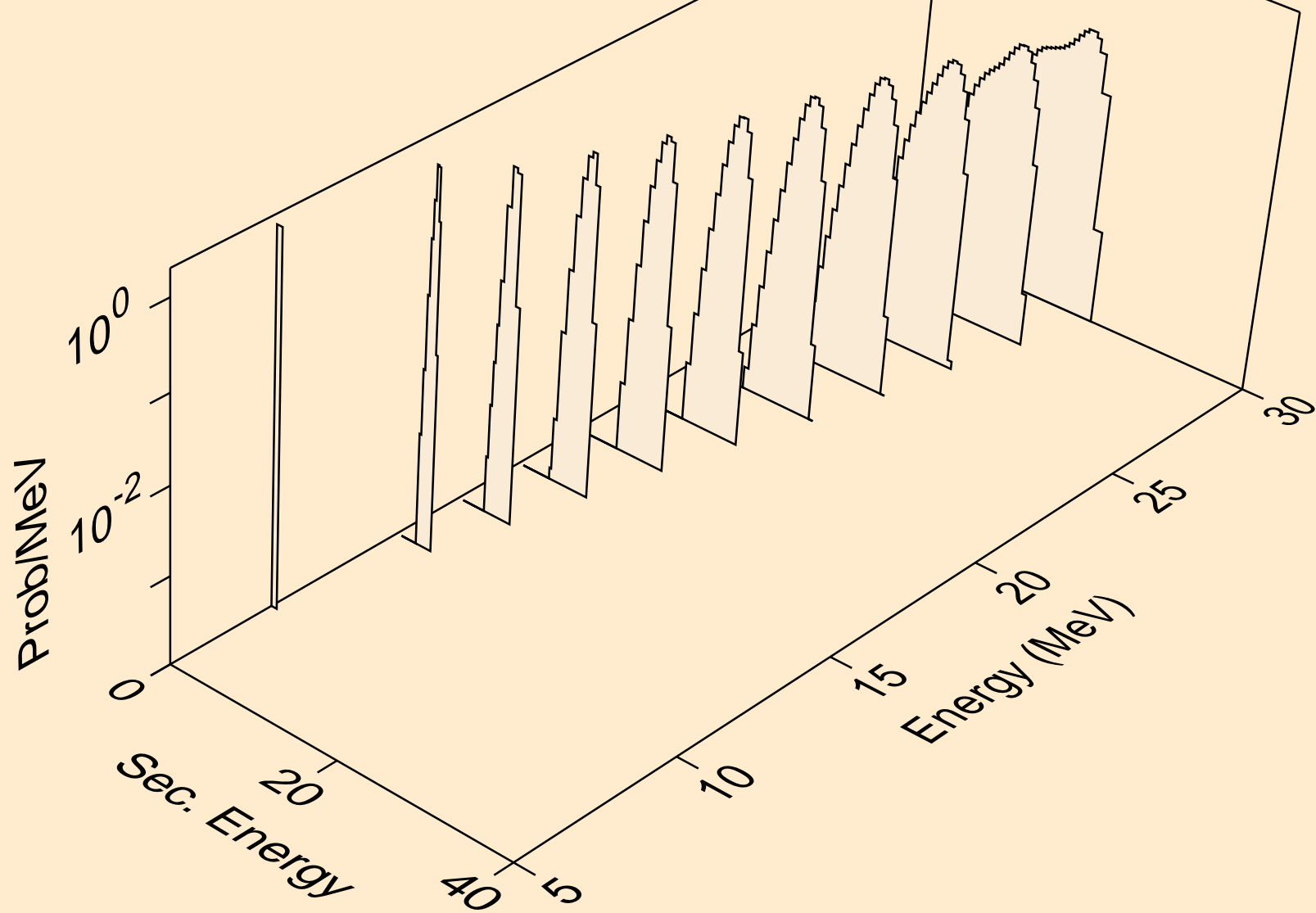

BH276 NEUTRON ACER TENDL-2024 LIBRARY; T=0.K
protons from (n,3np)

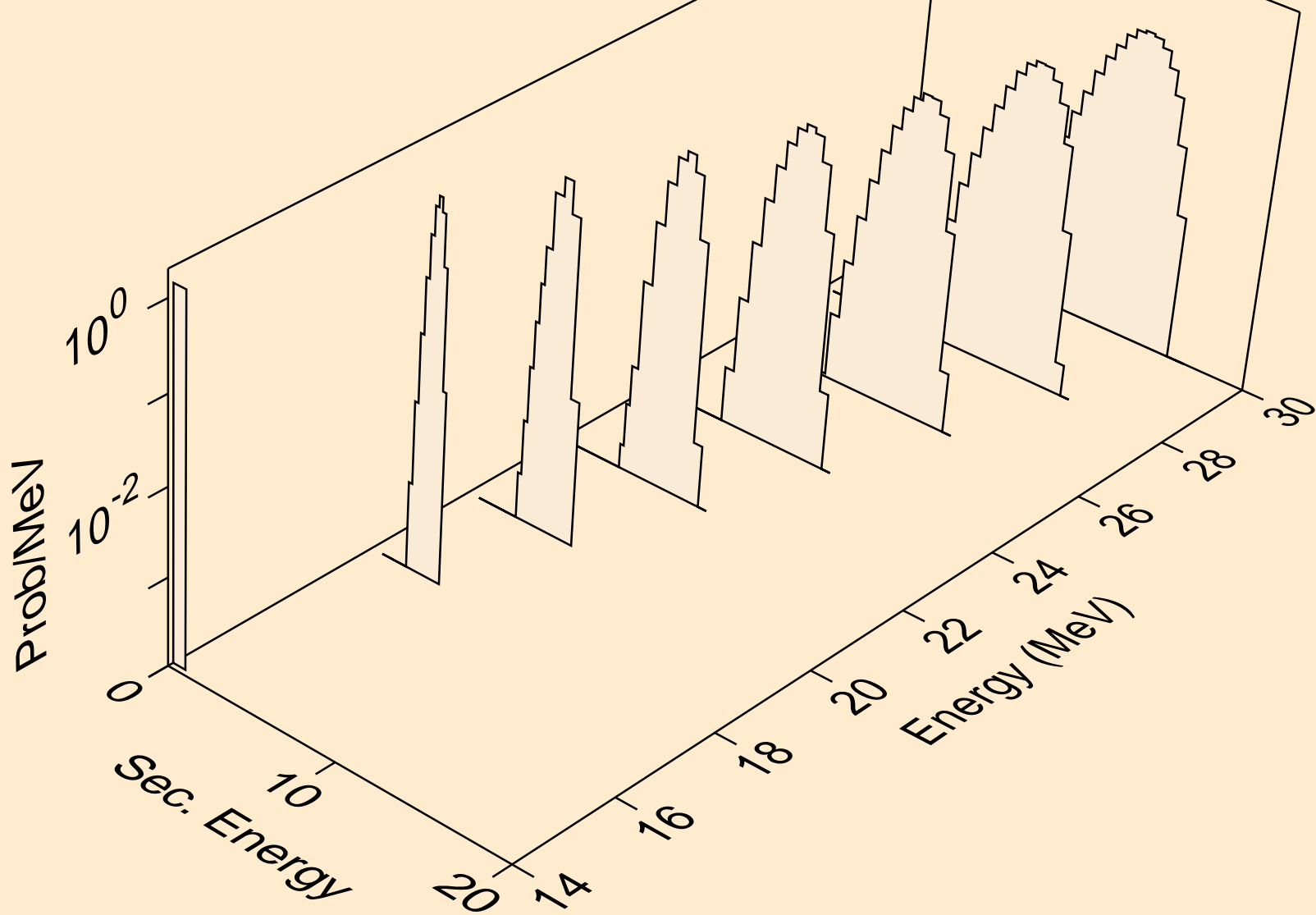

BH276 NEUTRON ACER TENDL-2024 LIBRARY; T=0.K
protons from (n,p)

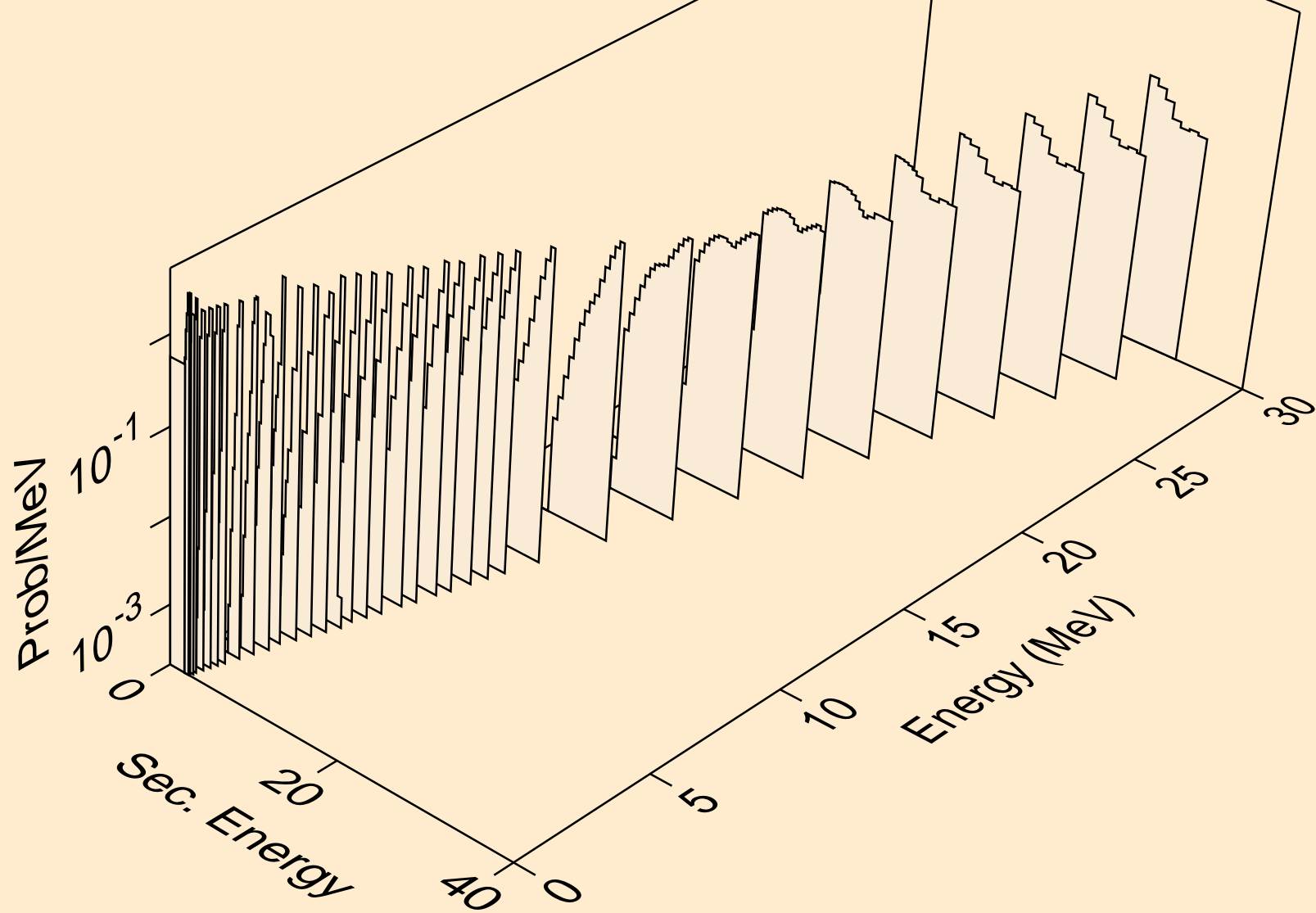

BH276 NEUTRON ACER TENDL-2024 LIBRARY; T=0.K
deuterons from (n,x)

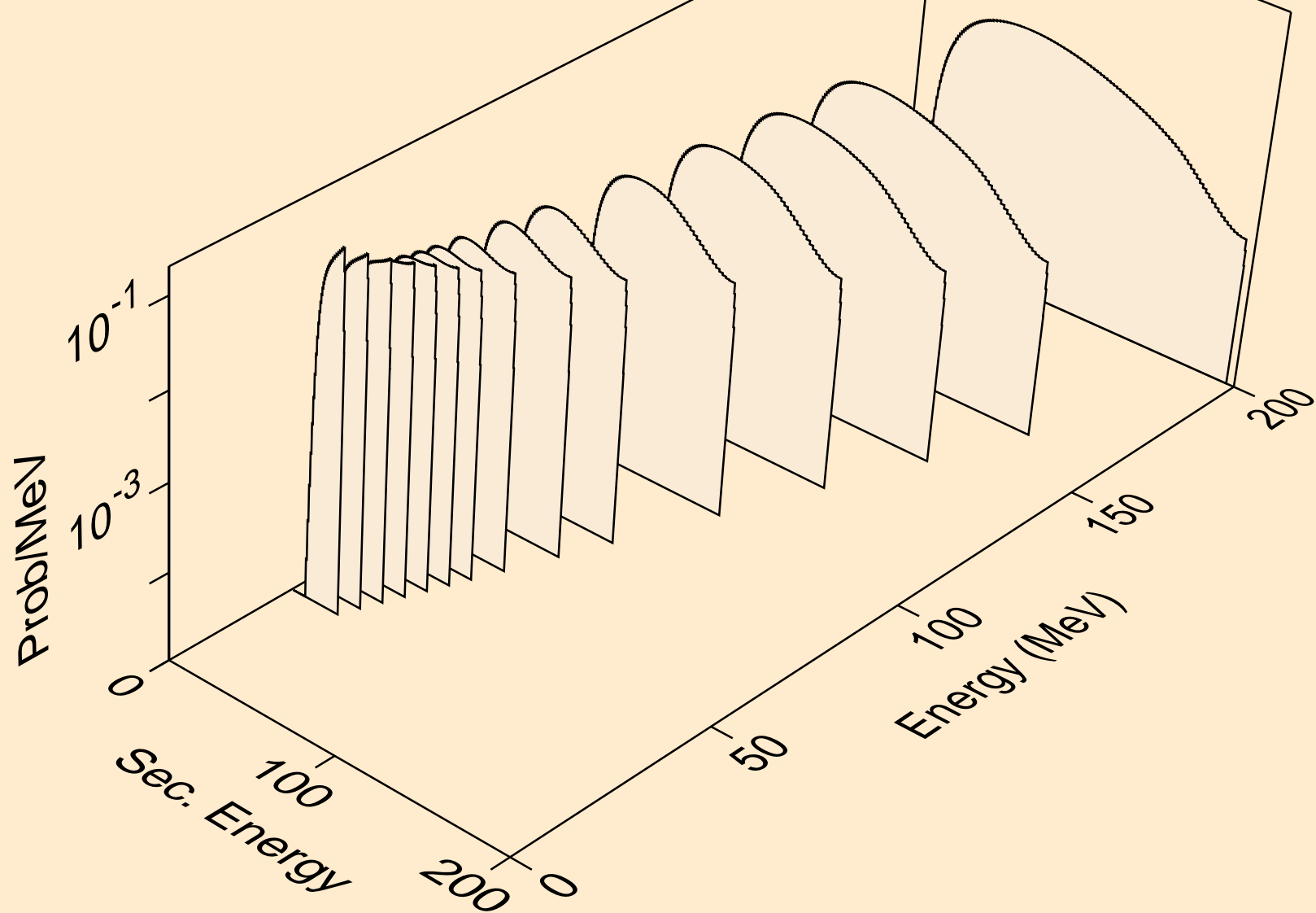

BH276 NEUTRON ACER TENDL-2024 LIBRARY; T=0.K
deuterons from (n,2nd)

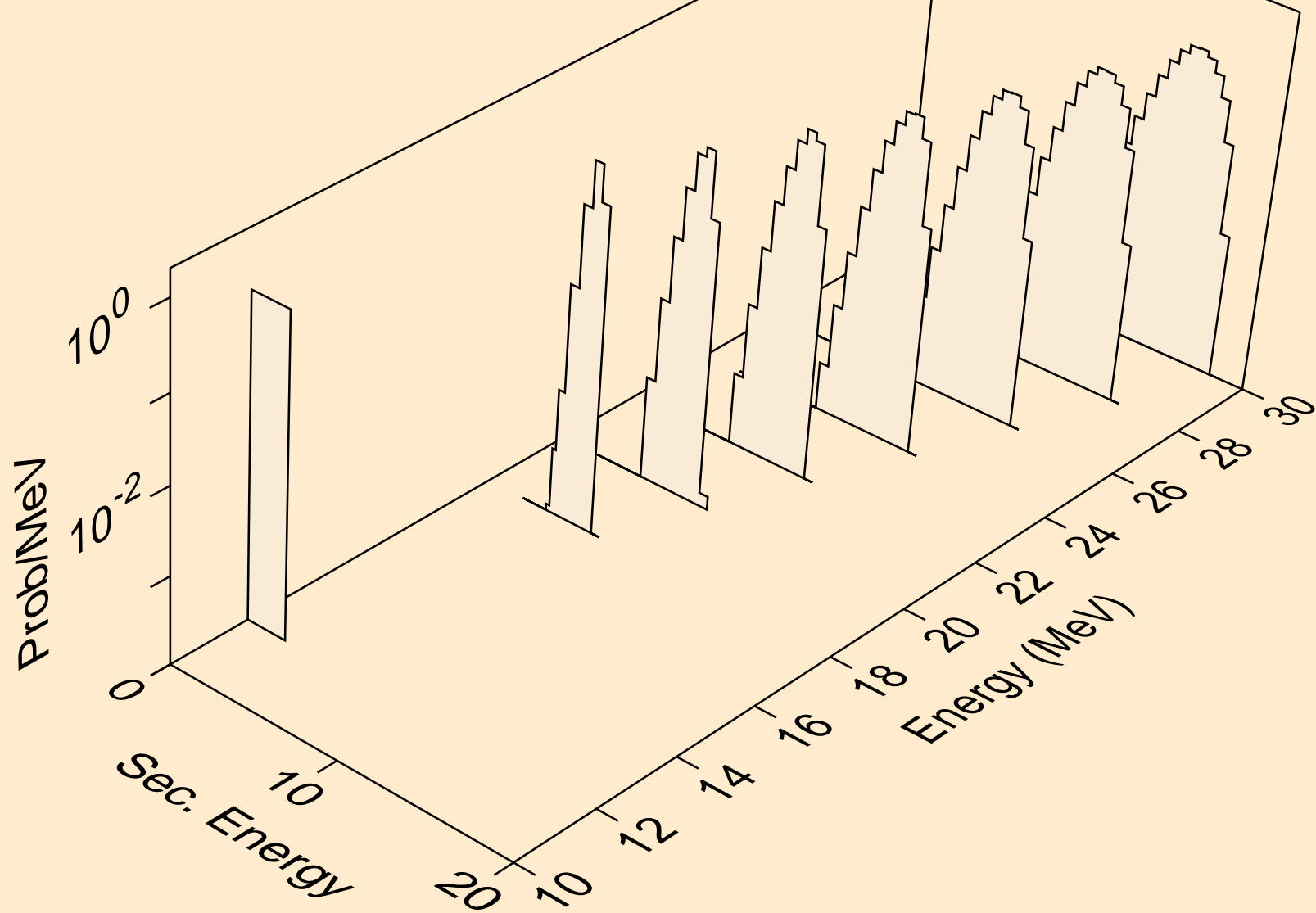

BH276 NEUTRON ACER TENDL-2024 LIBRARY; T=0.K
deuterons from (n,n*)d

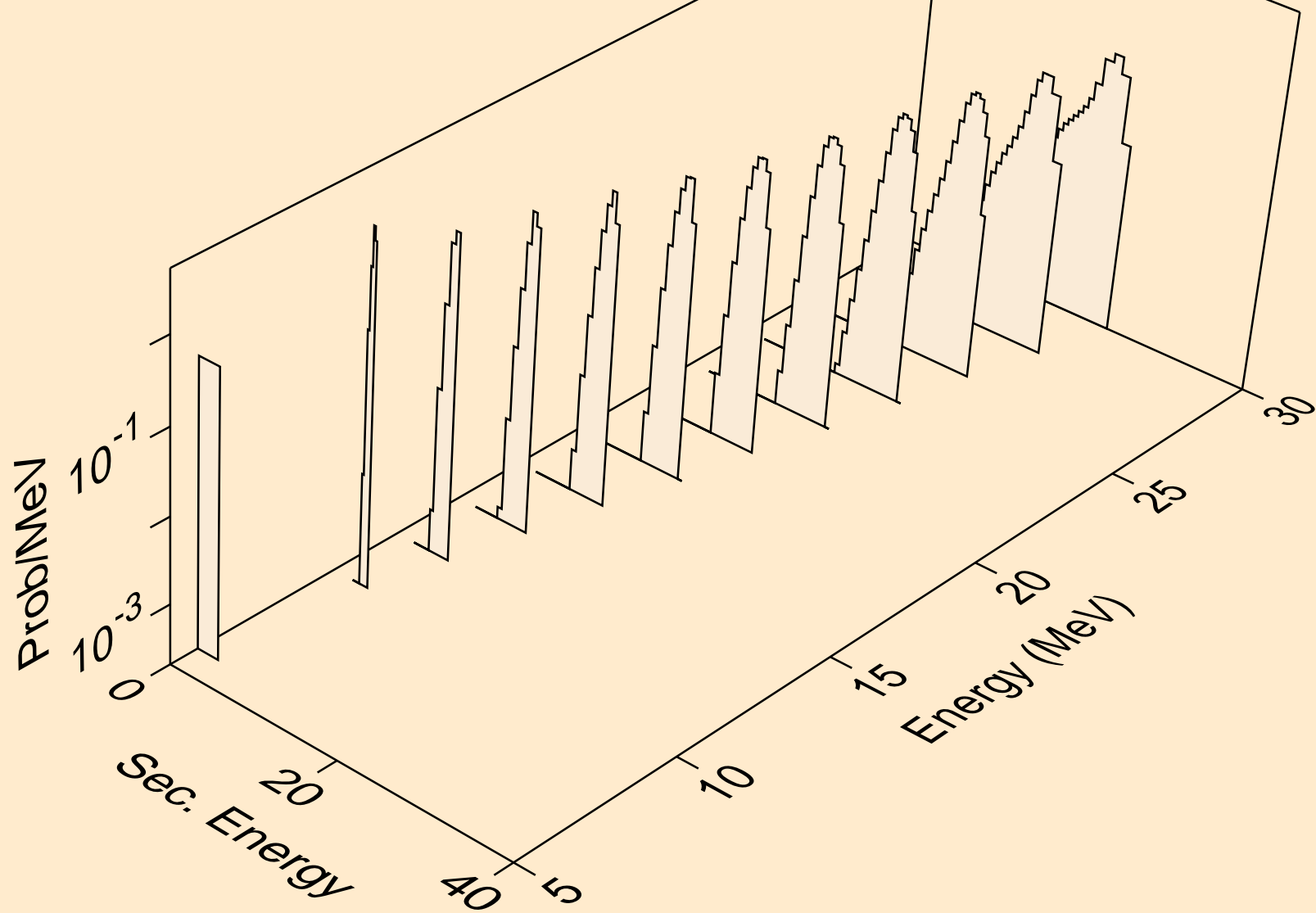

BH276 NEUTRON ACER TENDL-2024 LIBRARY; T=0.K
deuterons from (n,d)

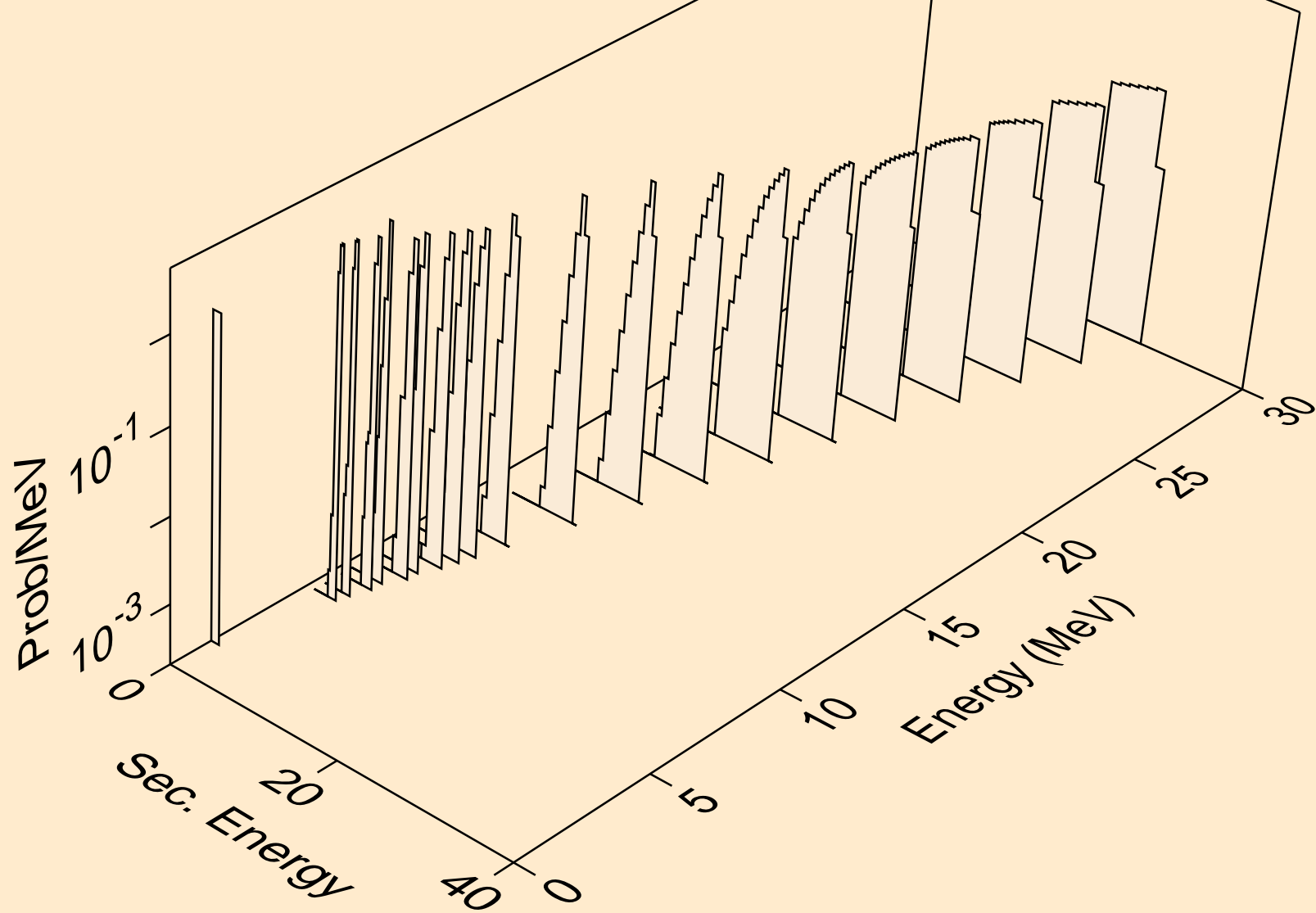

BH276 NEUTRON ACER TENDL-2024 LIBRARY; T=0.K
tritons from (n,x)

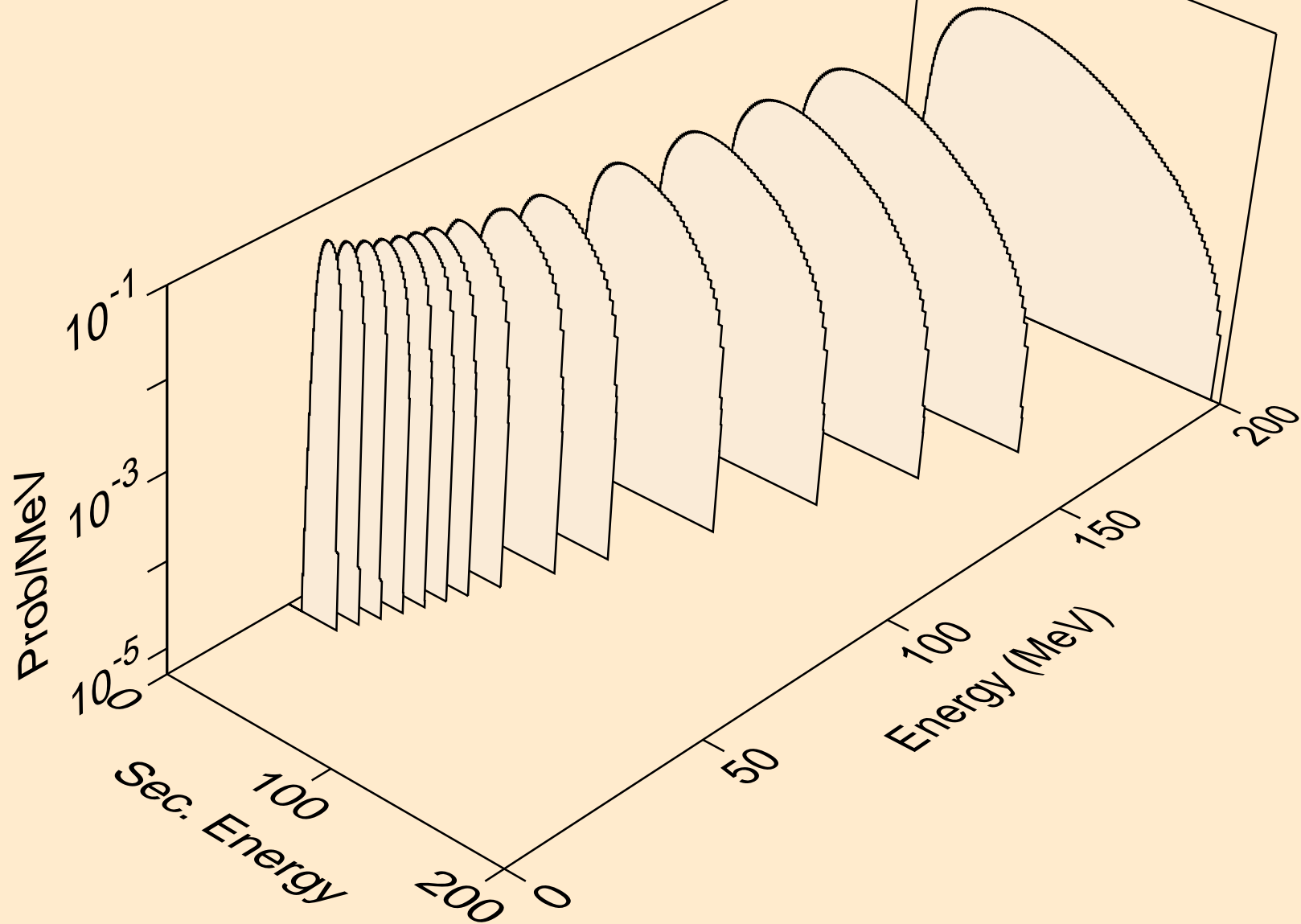

BH276 NEUTRON ACER TENDL-2024 LIBRARY; T=0.K
tritons from (n,n*)t

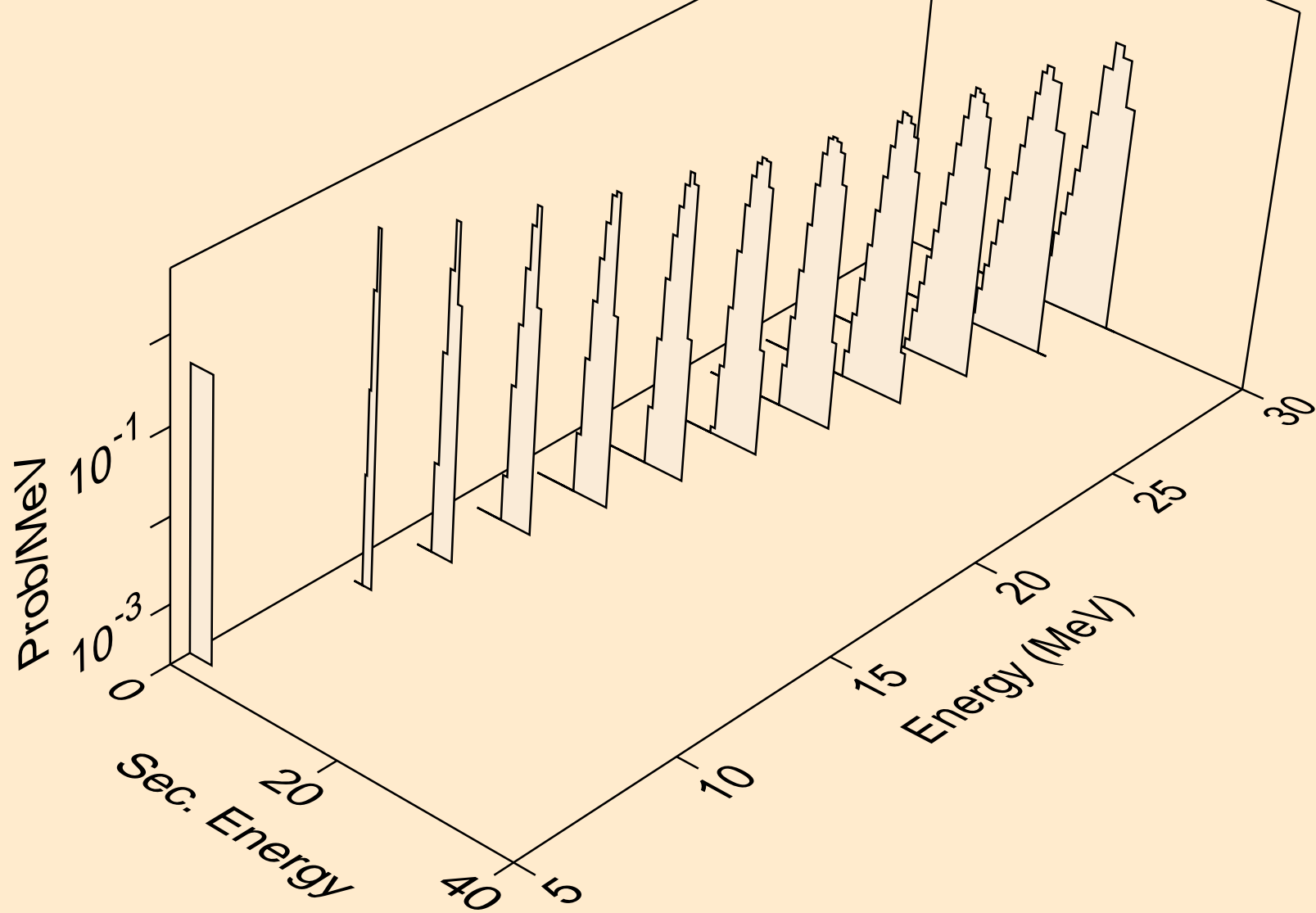

BH276 NEUTRON ACER TENDL-2024 LIBRARY; T=0.K
tritons from (n,t)

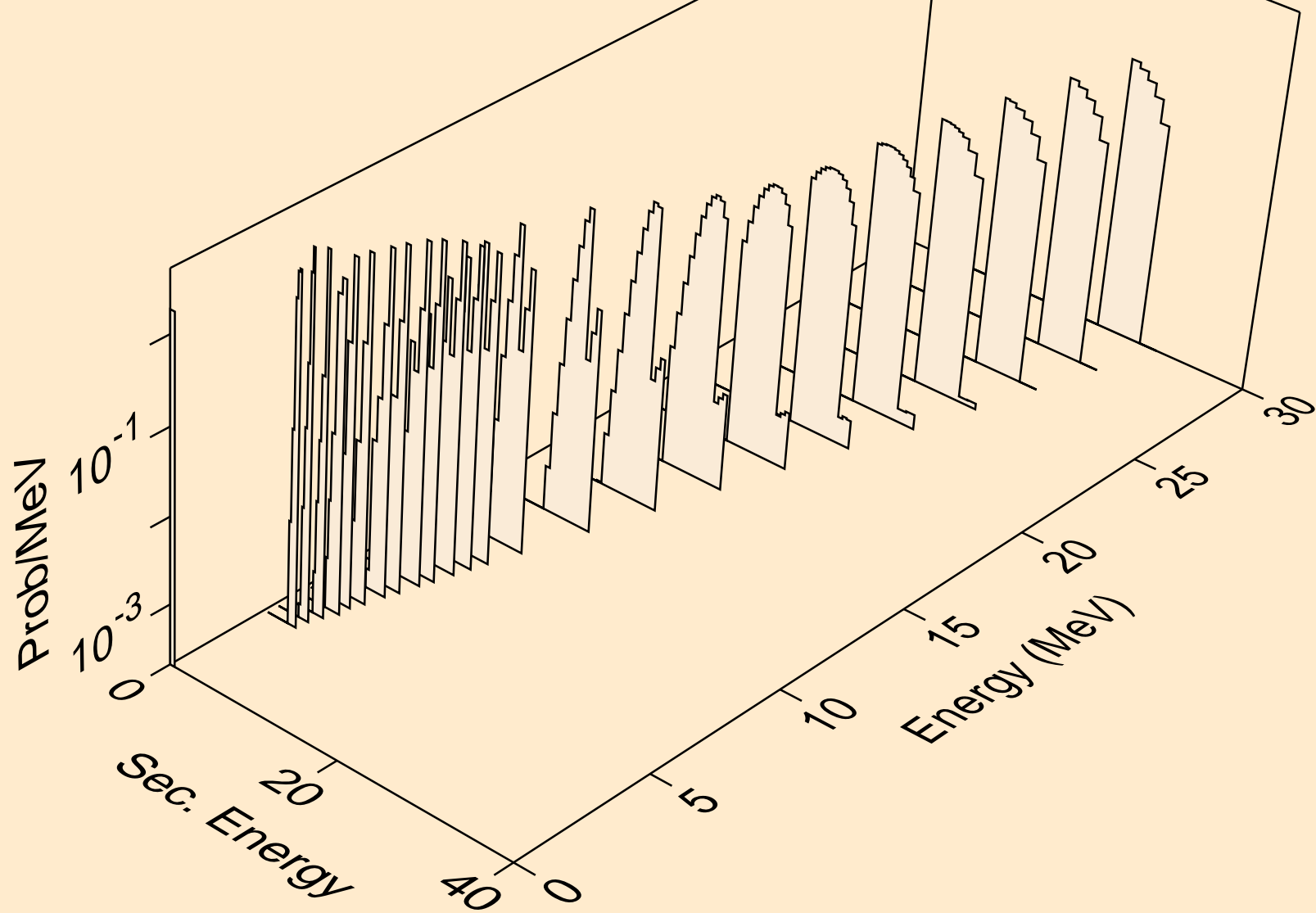

BH276 NEUTRON ACER TENDL-2024 LIBRARY; T=0.K
he3s from (n,x)

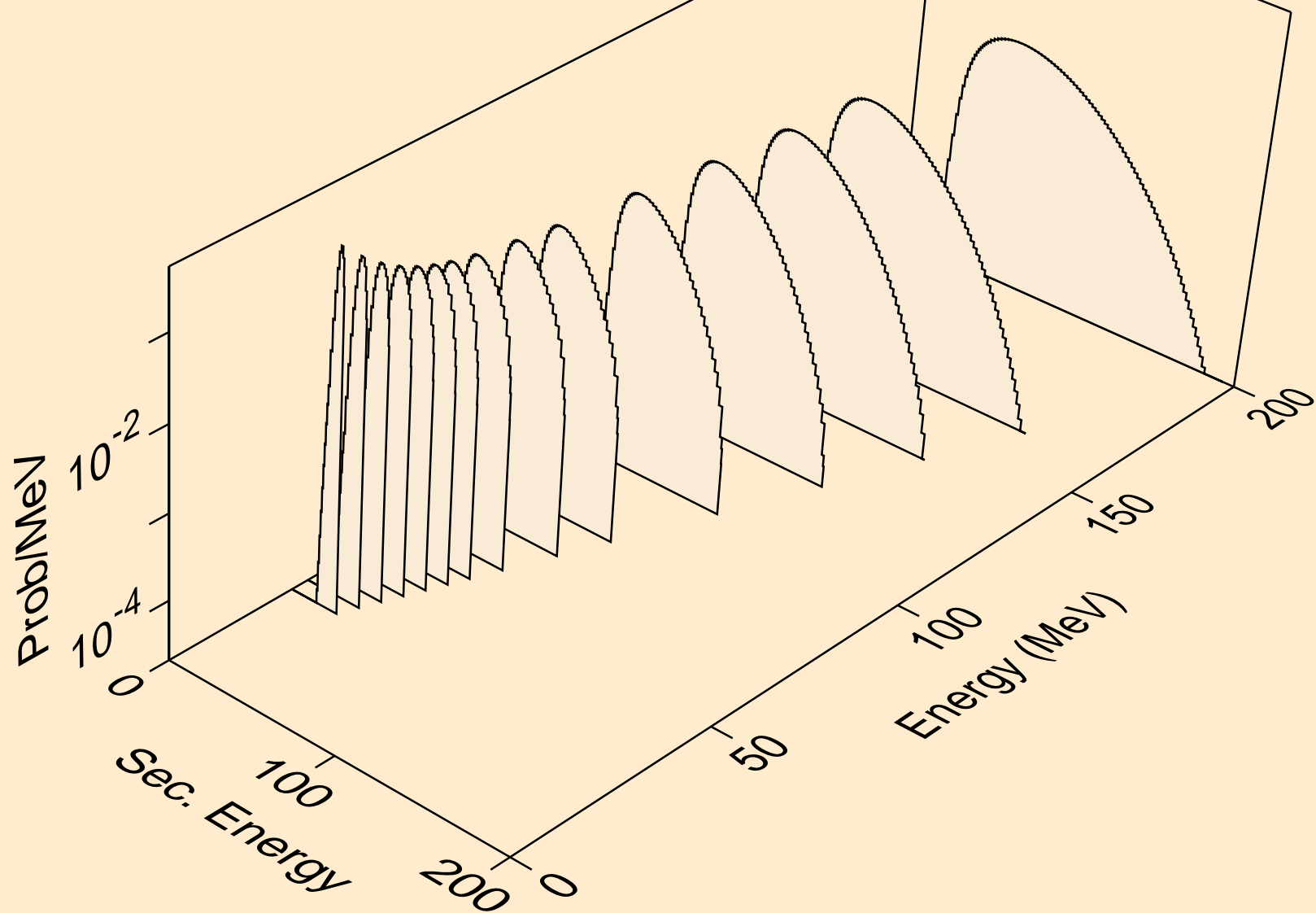

BH276 NEUTRON ACER TENDL-2024 LIBRARY; T=0.K
he3s from (n,n*)he3

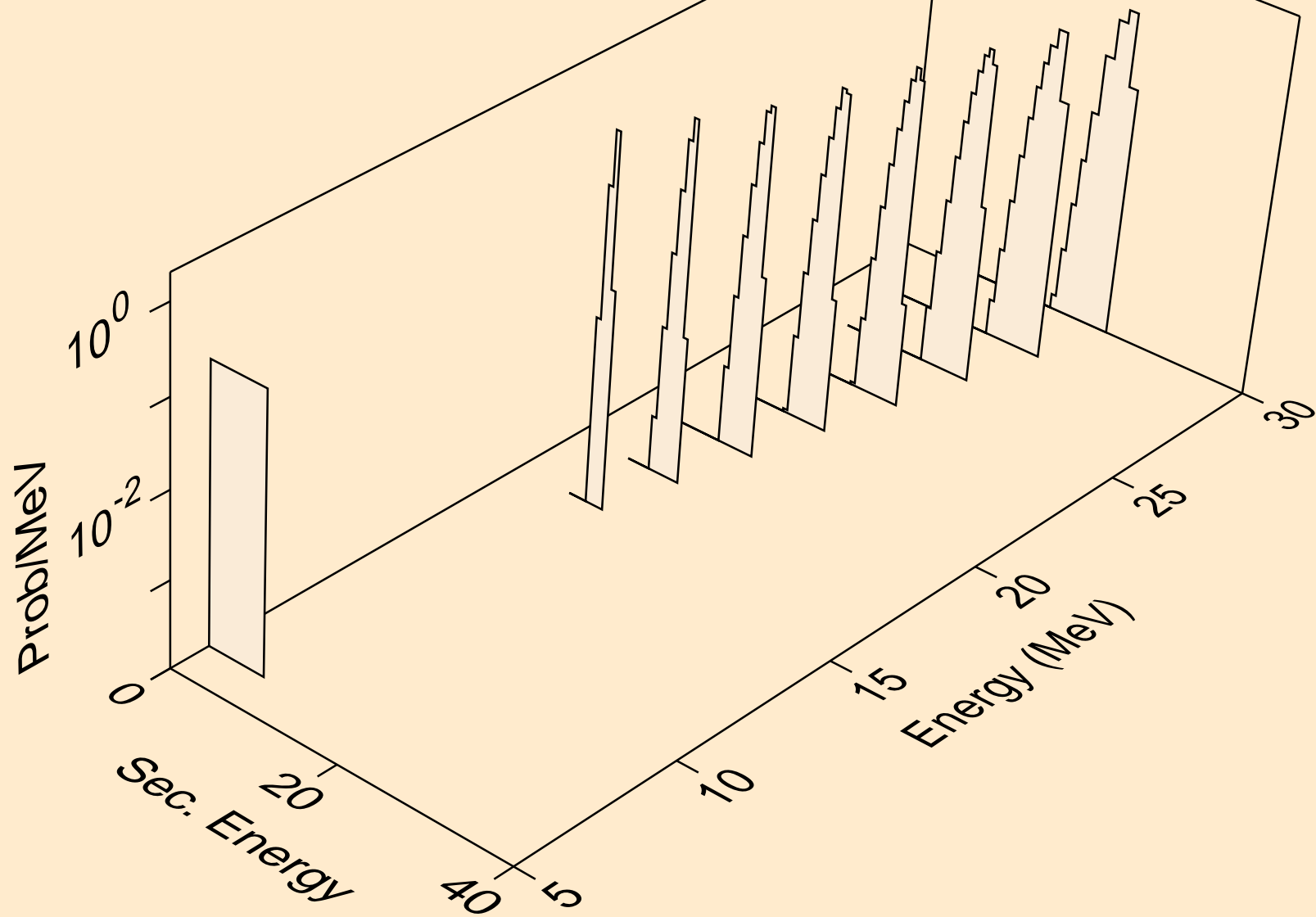

BH276 NEUTRON ACER TENDL-2024 LIBRARY; T=0.K
he3s from (n,he3)

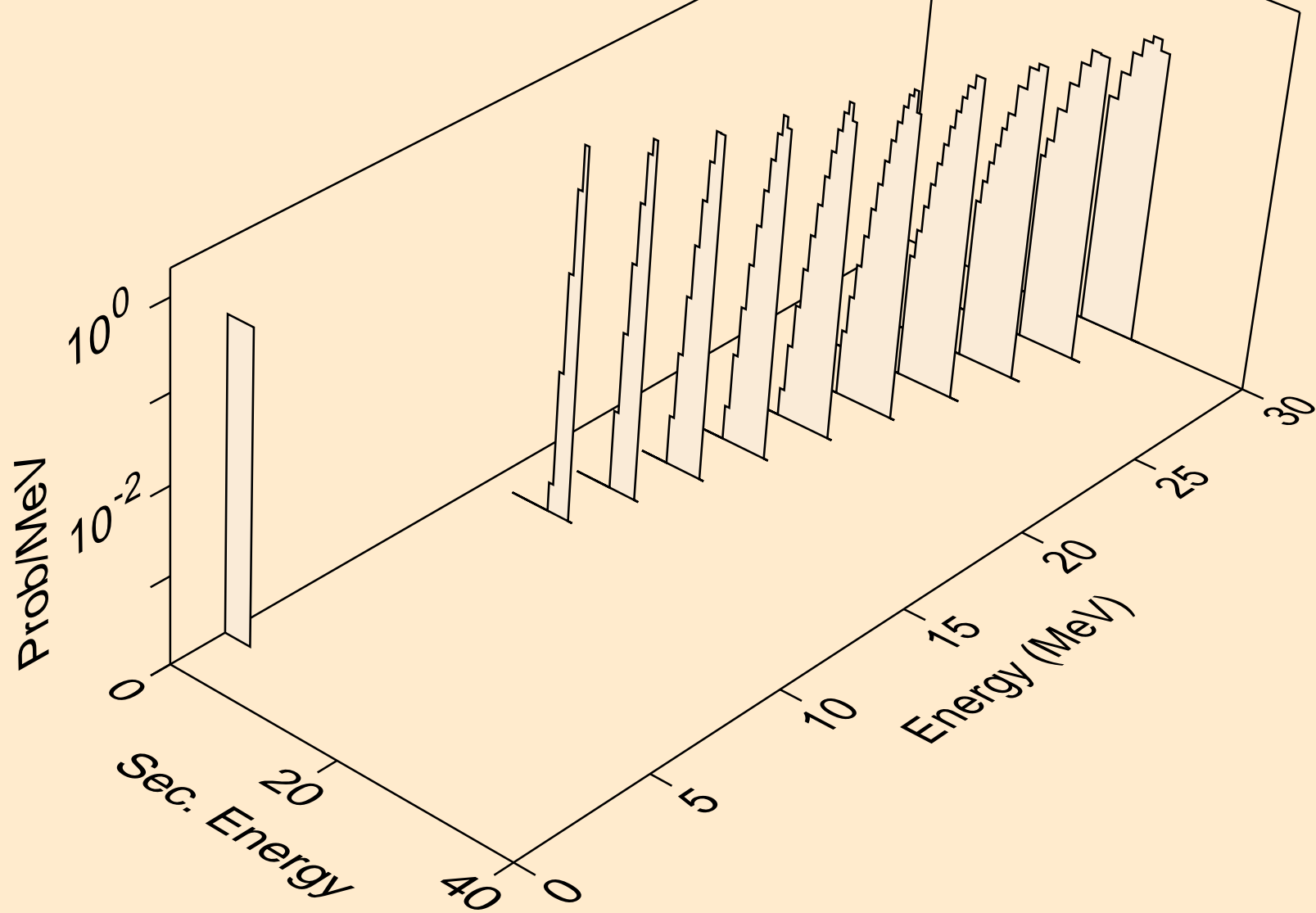

BH276 NEUTRON ACER TENDL-2024 LIBRARY; T=0.K
alphas from (n,x)

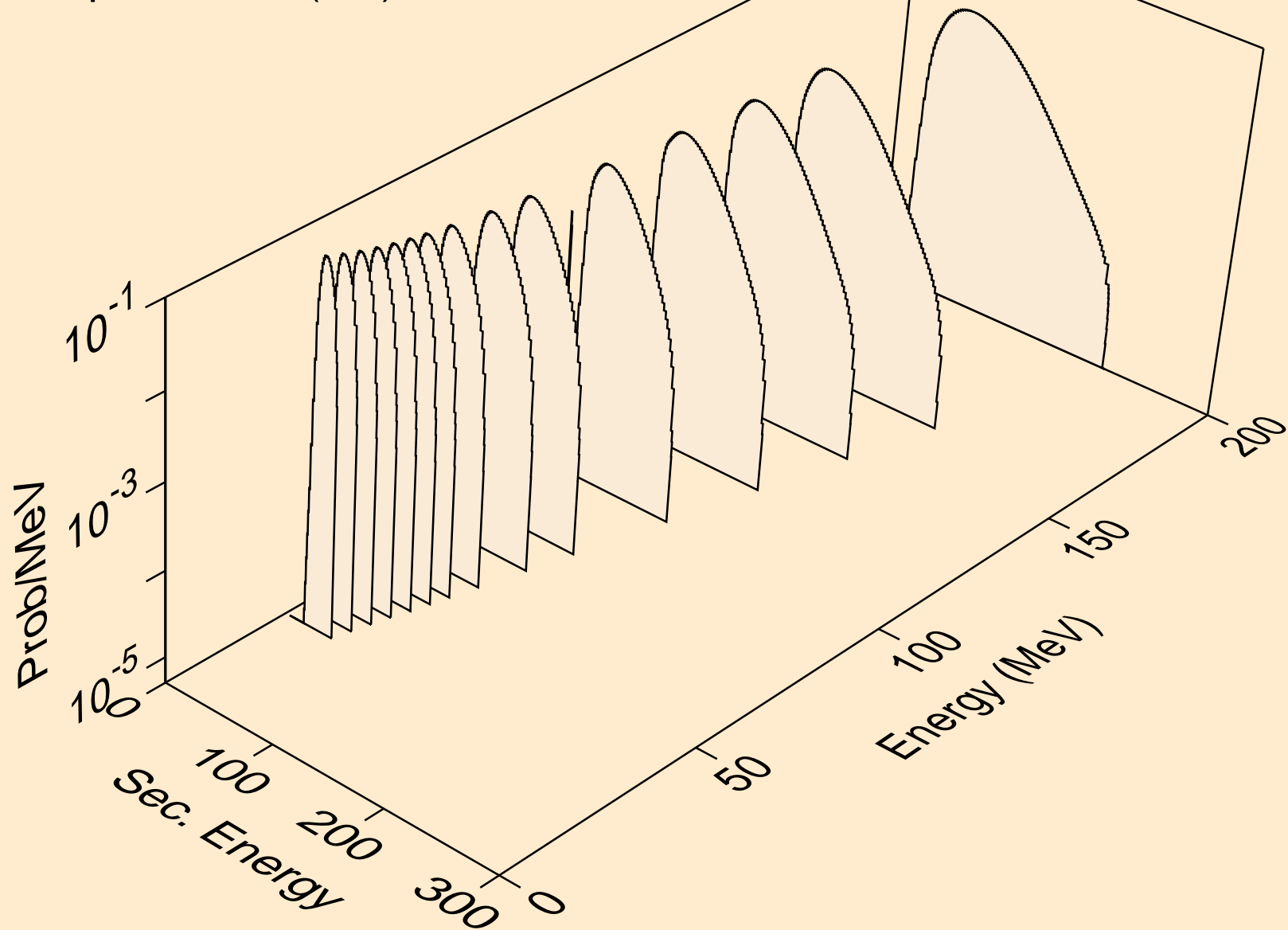

BH276 NEUTRON ACER TENDL-2024 LIBRARY; T=0.K
alphas from (n,n*)a

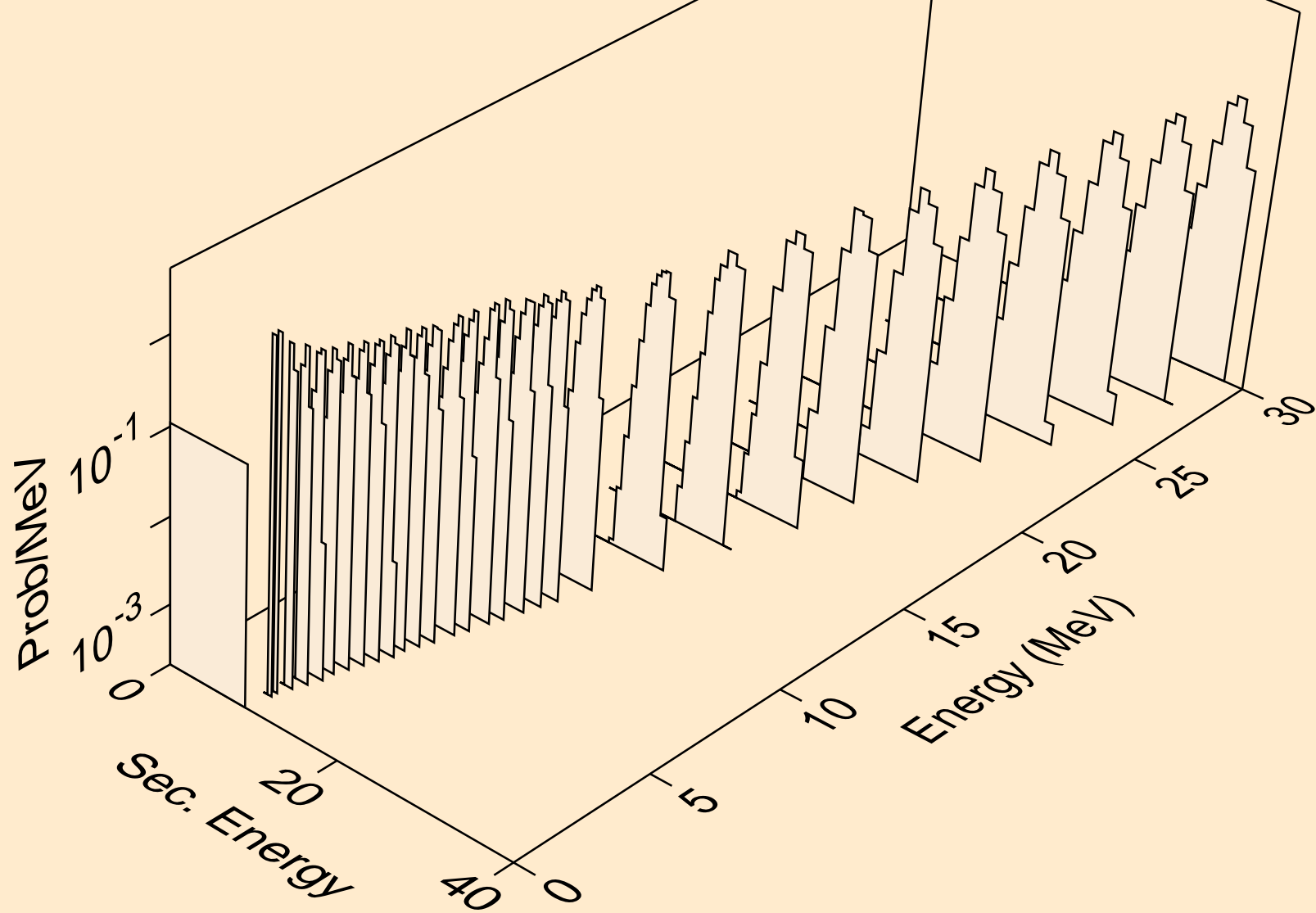

BH276 NEUTRON ACER TENDL-2024 LIBRARY; T=0.K
alphas from (n,2n)a

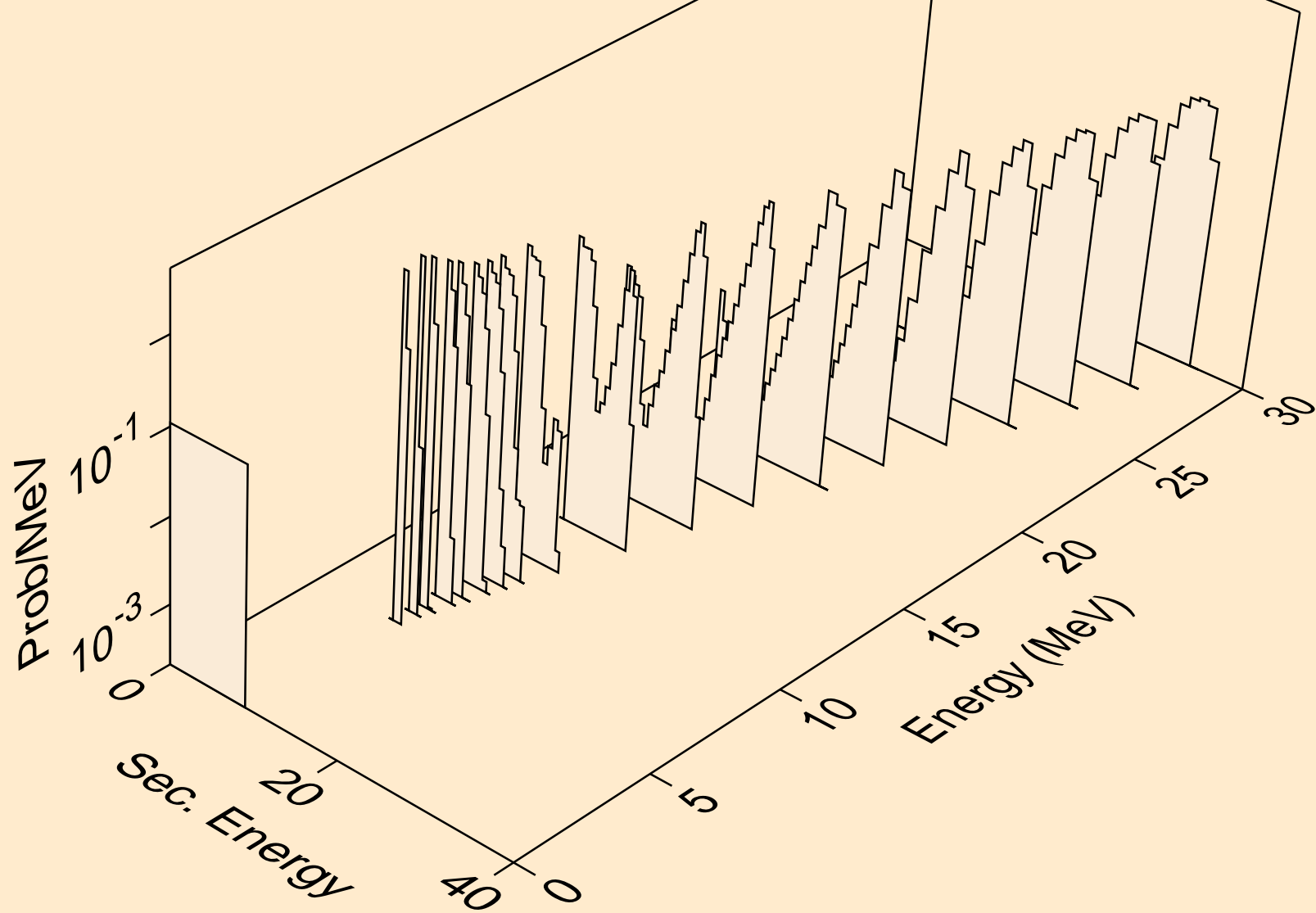

BH276 NEUTRON ACER TENDL-2024 LIBRARY; T=0.K
alphas from (n,3n)a

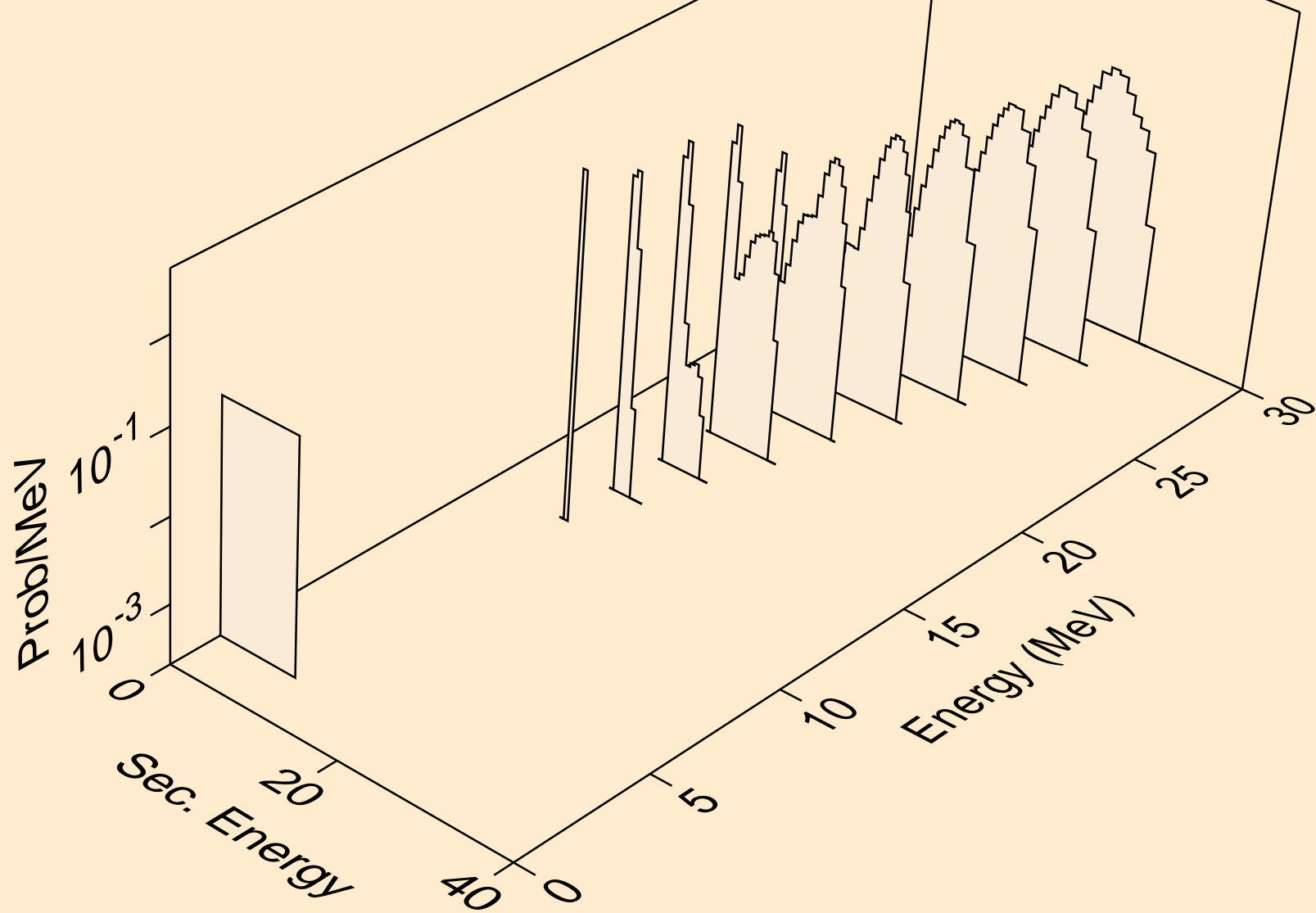

BH276 NEUTRON ACER TENDL-2024 LIBRARY; T=0.K
alphas from (n,a)

