

# BI192 NEUTRON ACER TENDL-2024 LIBRARY; T=0.K

## Principal cross sections

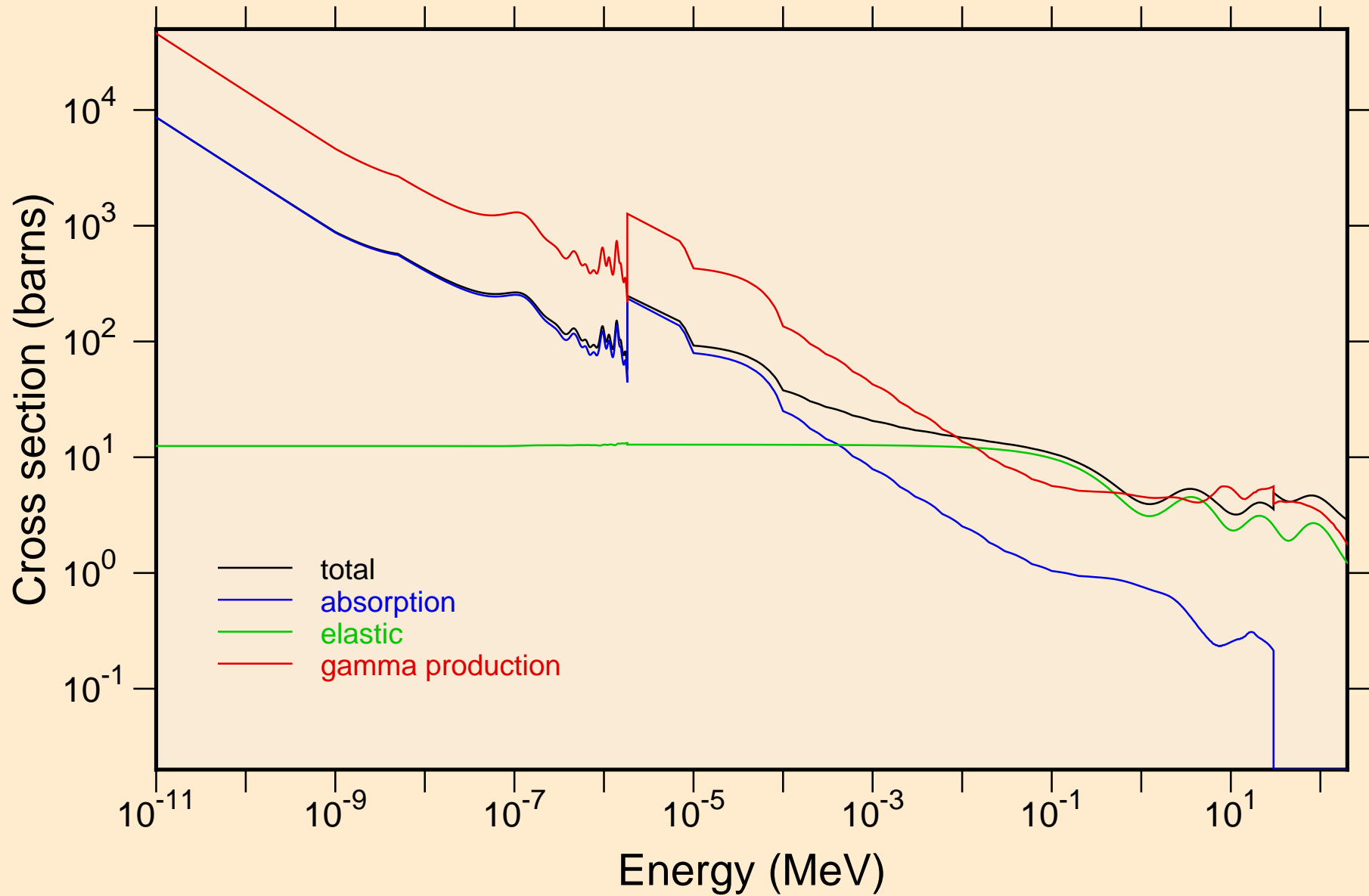

# BI192 NEUTRON ACER TENDL-2024 LIBRARY; T=0.K

## Heating

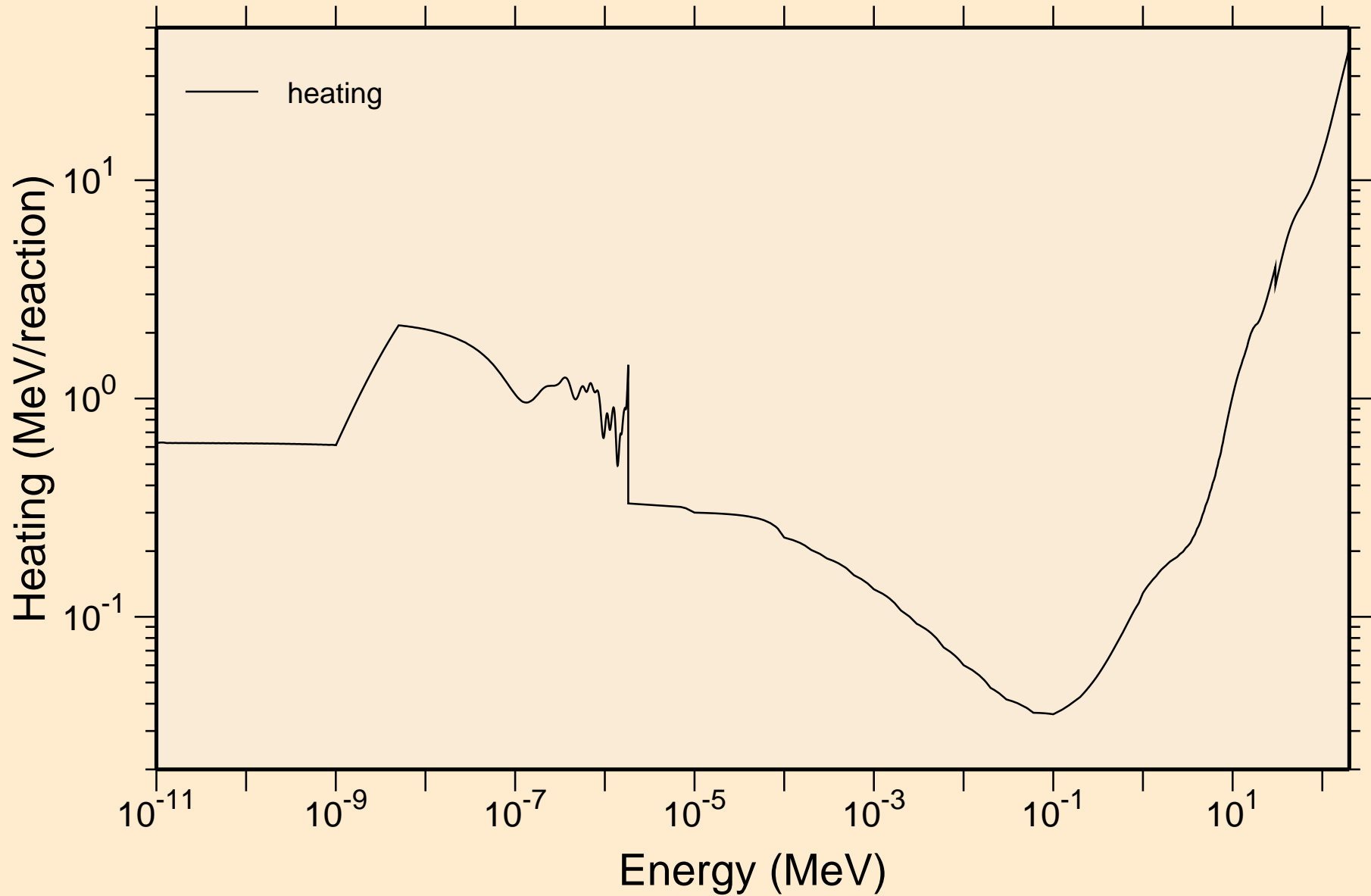

# BI192 NEUTRON ACER TENDL-2024 LIBRARY; T=0.K

## Damage

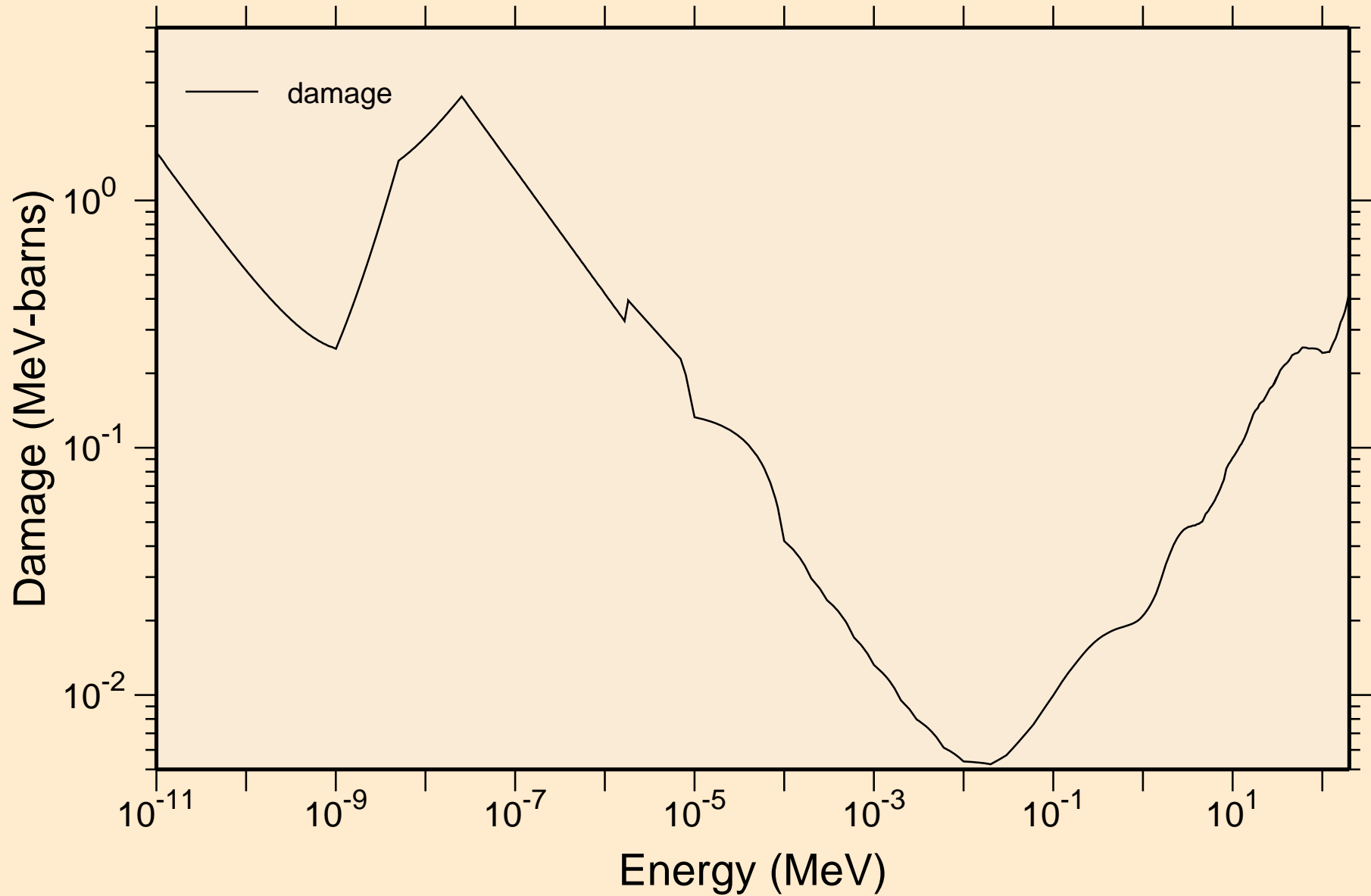

BI192 NEUTRON ACER TENDL-2024 LIBRARY; T=0.K  
Non-threshold reactions

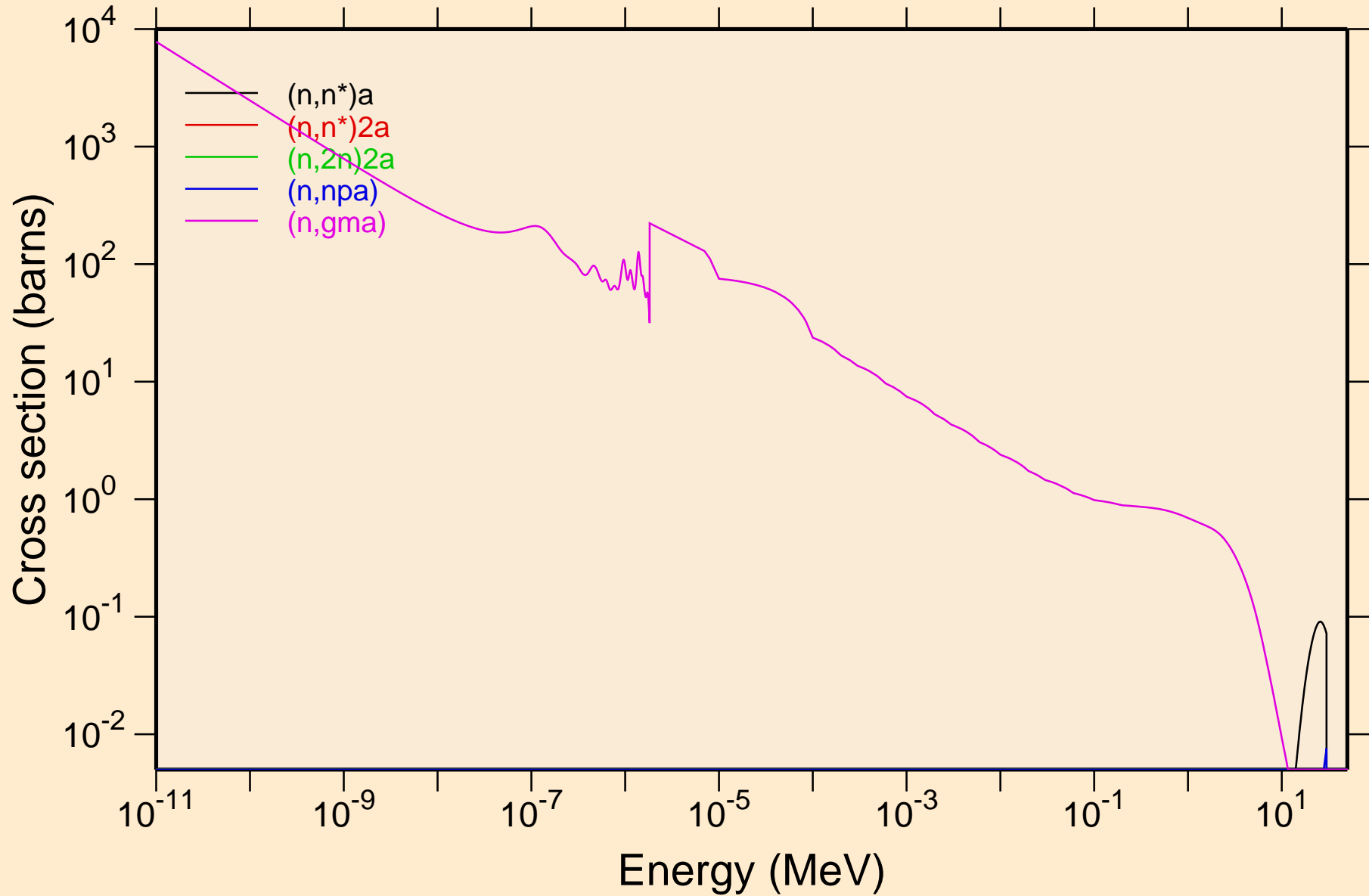

BI192 NEUTRON ACER TENDL-2024 LIBRARY; T=0.K  
Non-threshold reactions

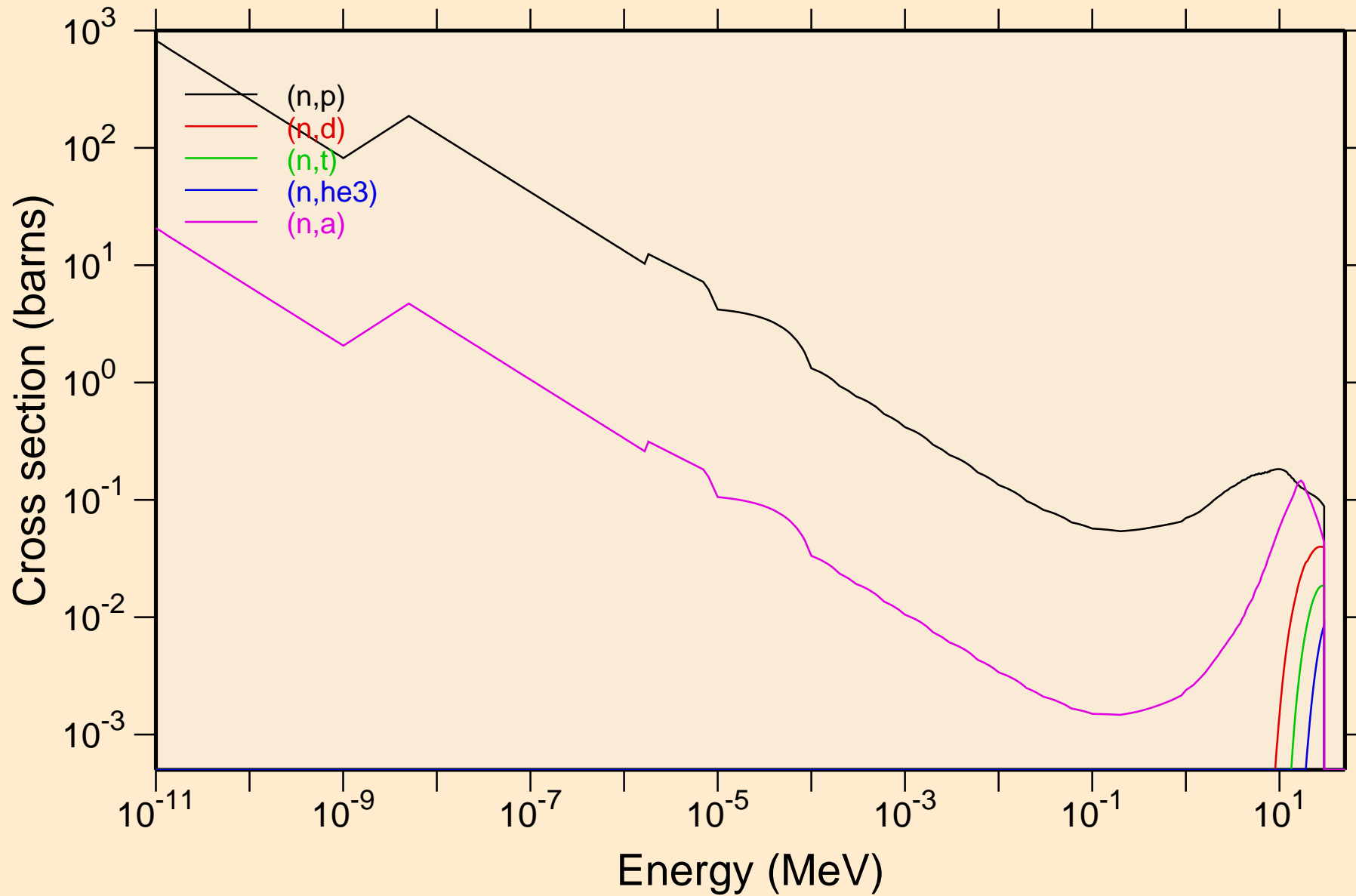

BI192 NEUTRON ACER TENDL-2024 LIBRARY; T=0.K  
Non-threshold reactions

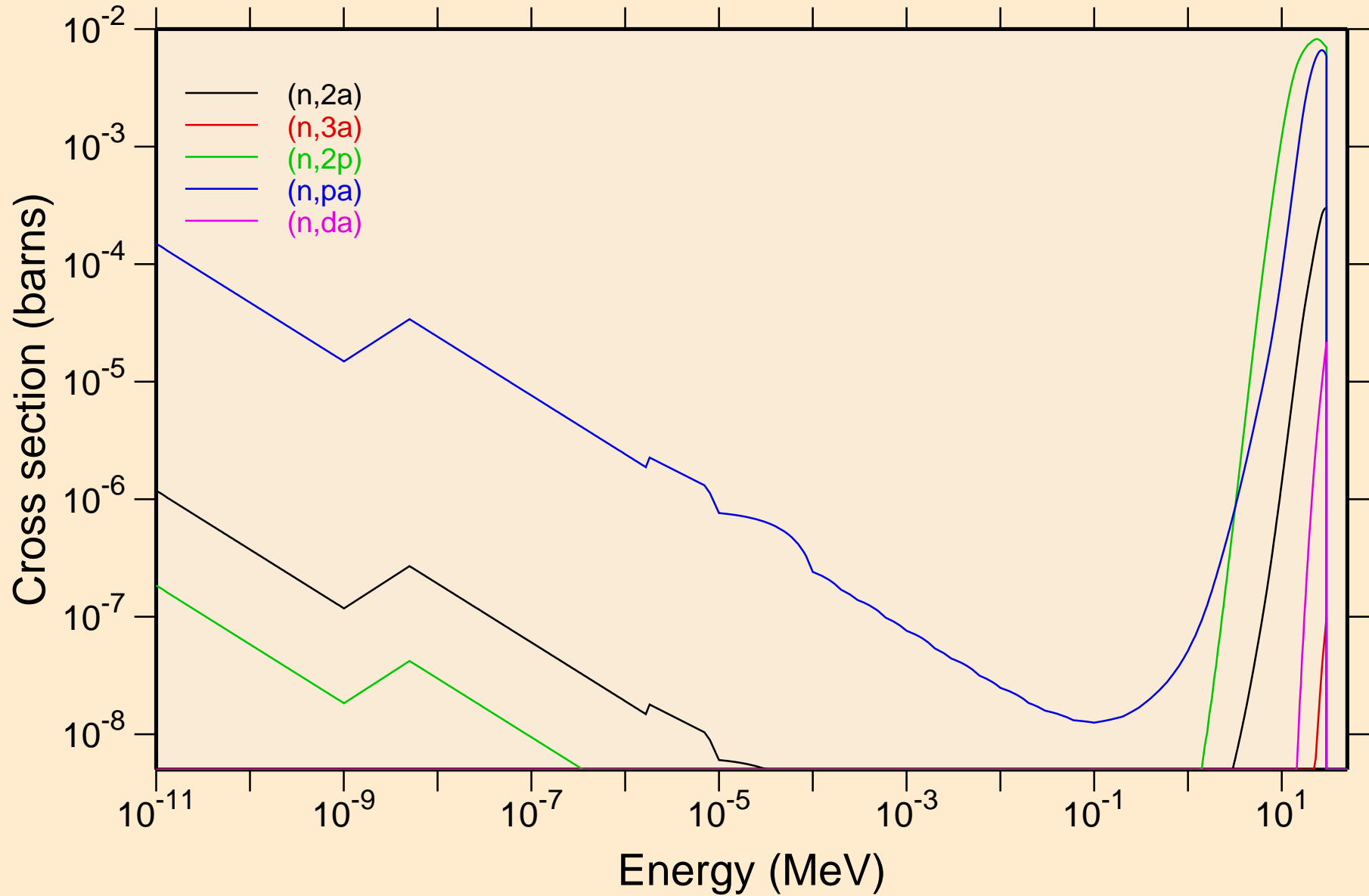

BI192 NEUTRON ACER TENDL-2024 LIBRARY; T=0.K  
Non-threshold reactions

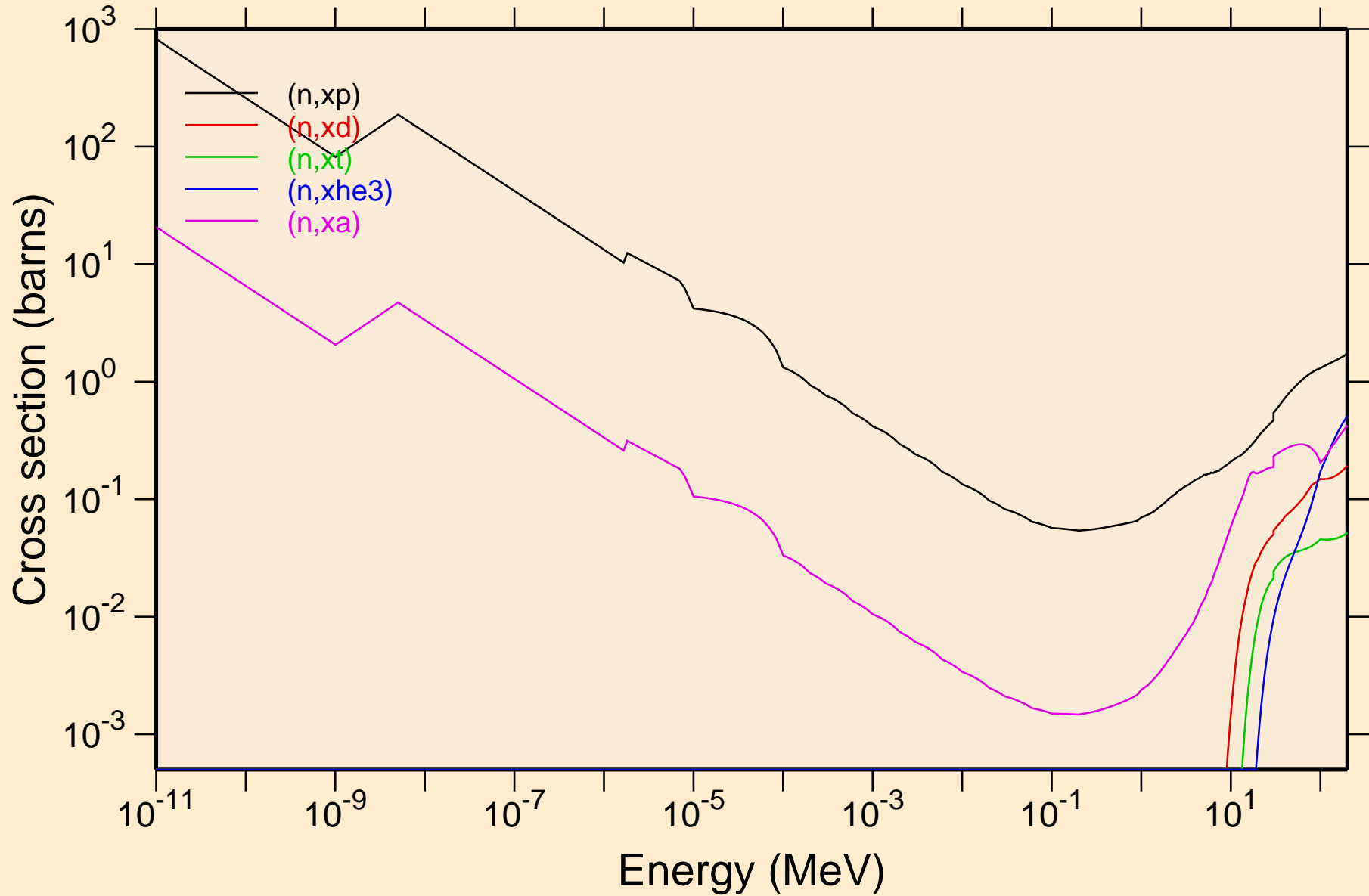

# BI192 NEUTRON ACER TENDL-2024 LIBRARY; T=0.K

## Principal cross sections

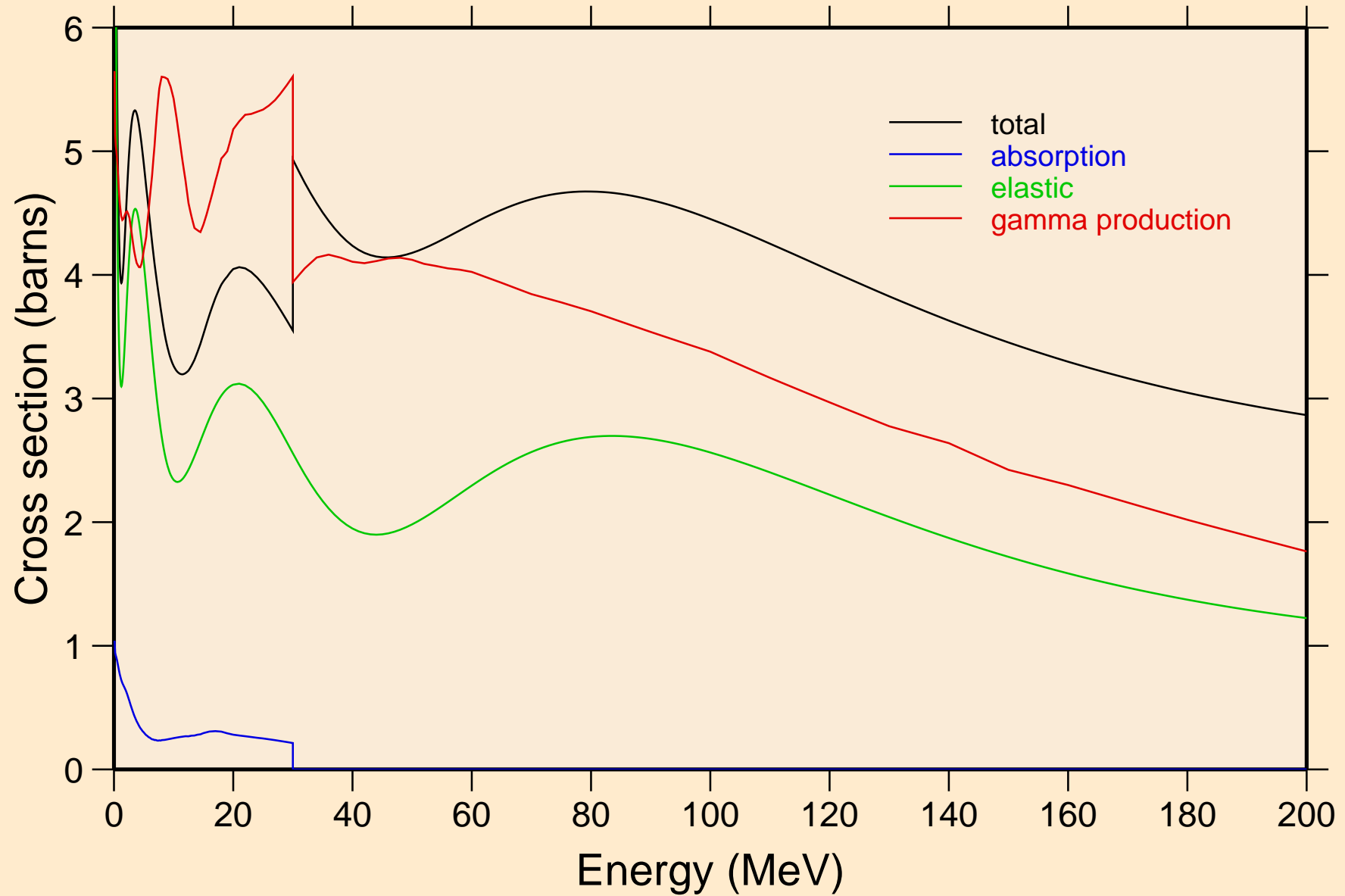



# BI192 NEUTRON ACER TENDL-2024 LIBRARY; T=0.K

## Heating

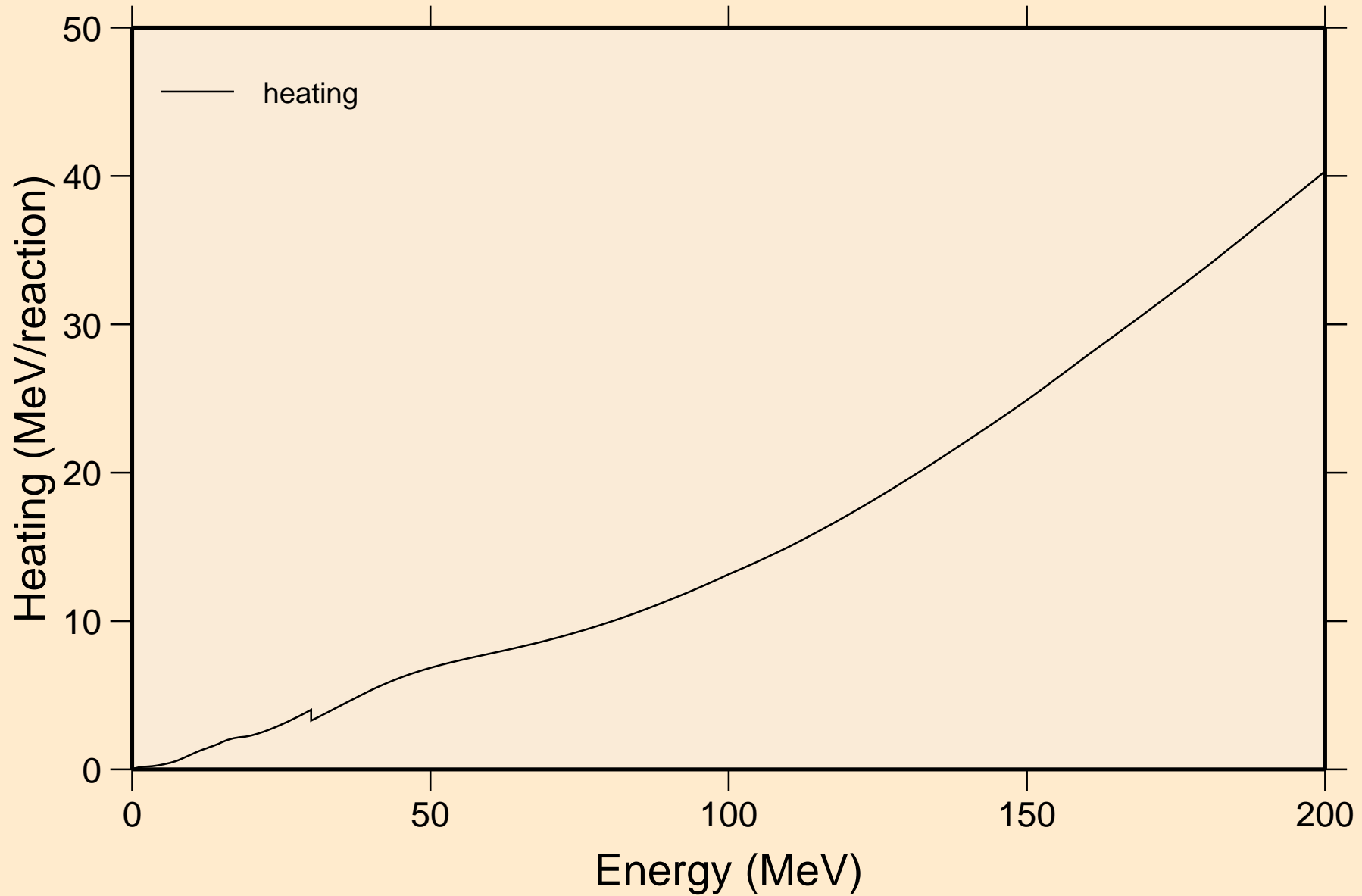

BI192 NEUTRON ACER TENDL-2024 LIBRARY; T=0.K  
Damage

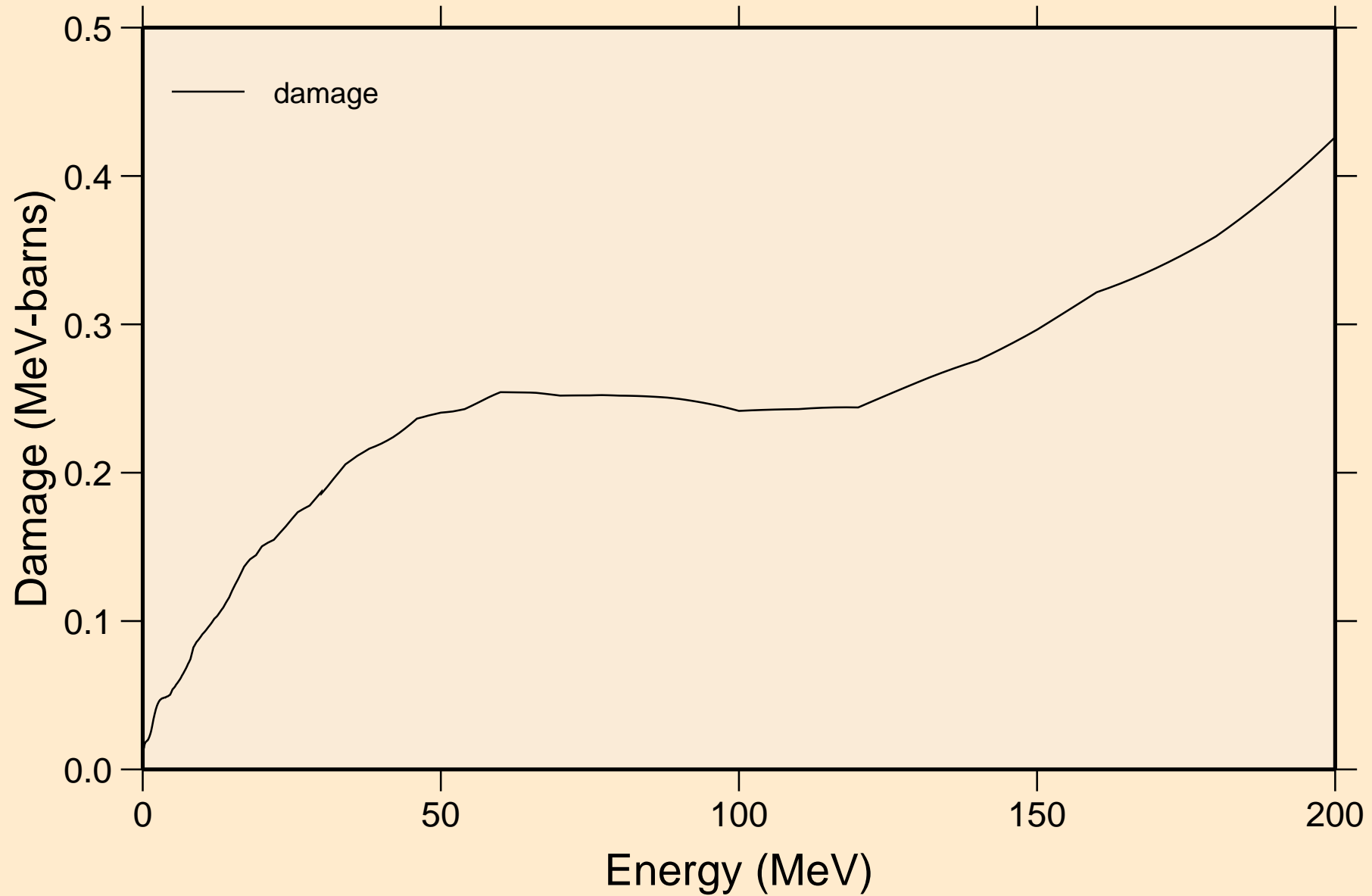

BI192 NEUTRON ACER TENDL-2024 LIBRARY; T=0.K  
Non-threshold reactions

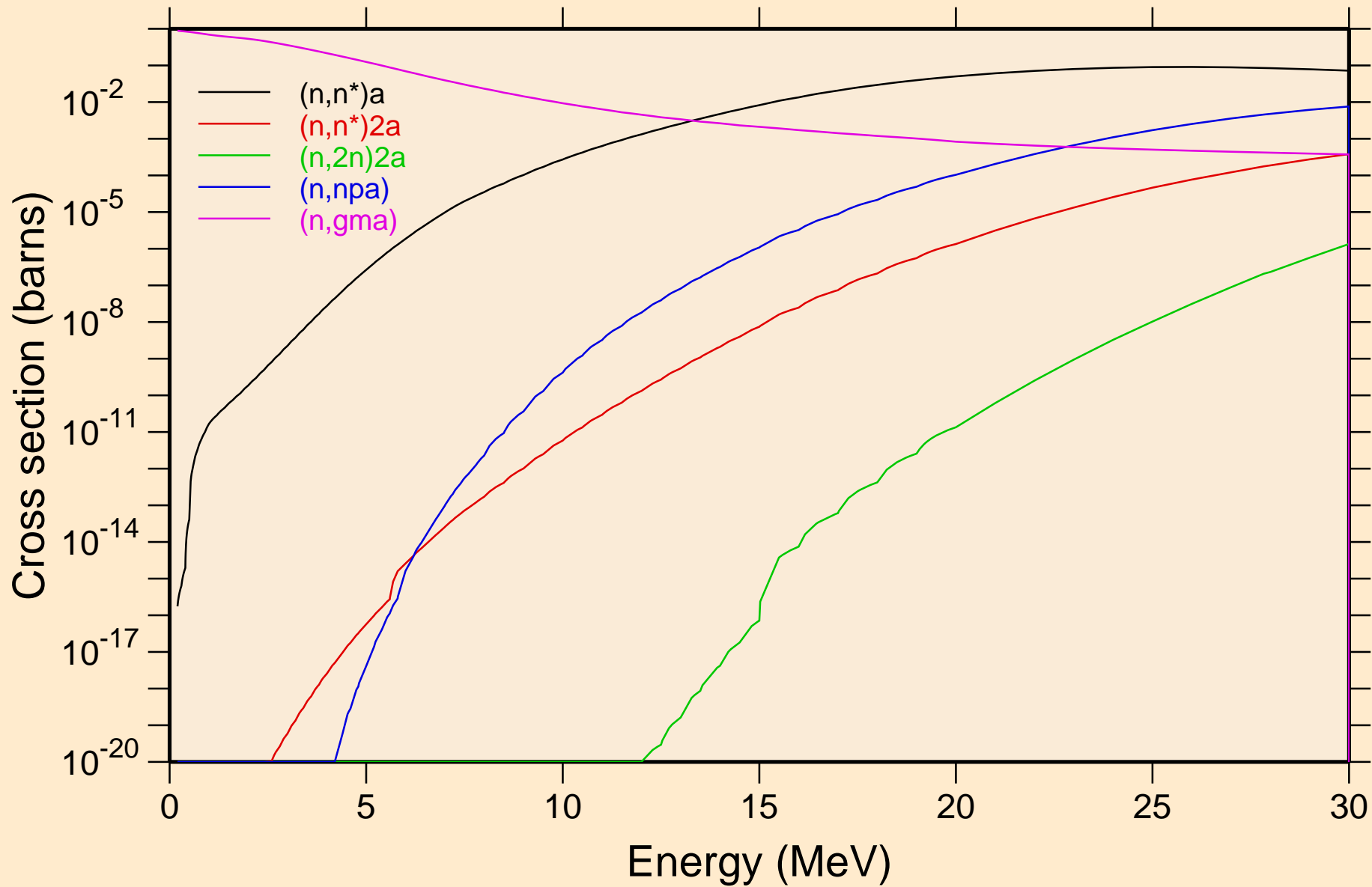

BI192 NEUTRON ACER TENDL-2024 LIBRARY; T=0.K  
Non-threshold reactions

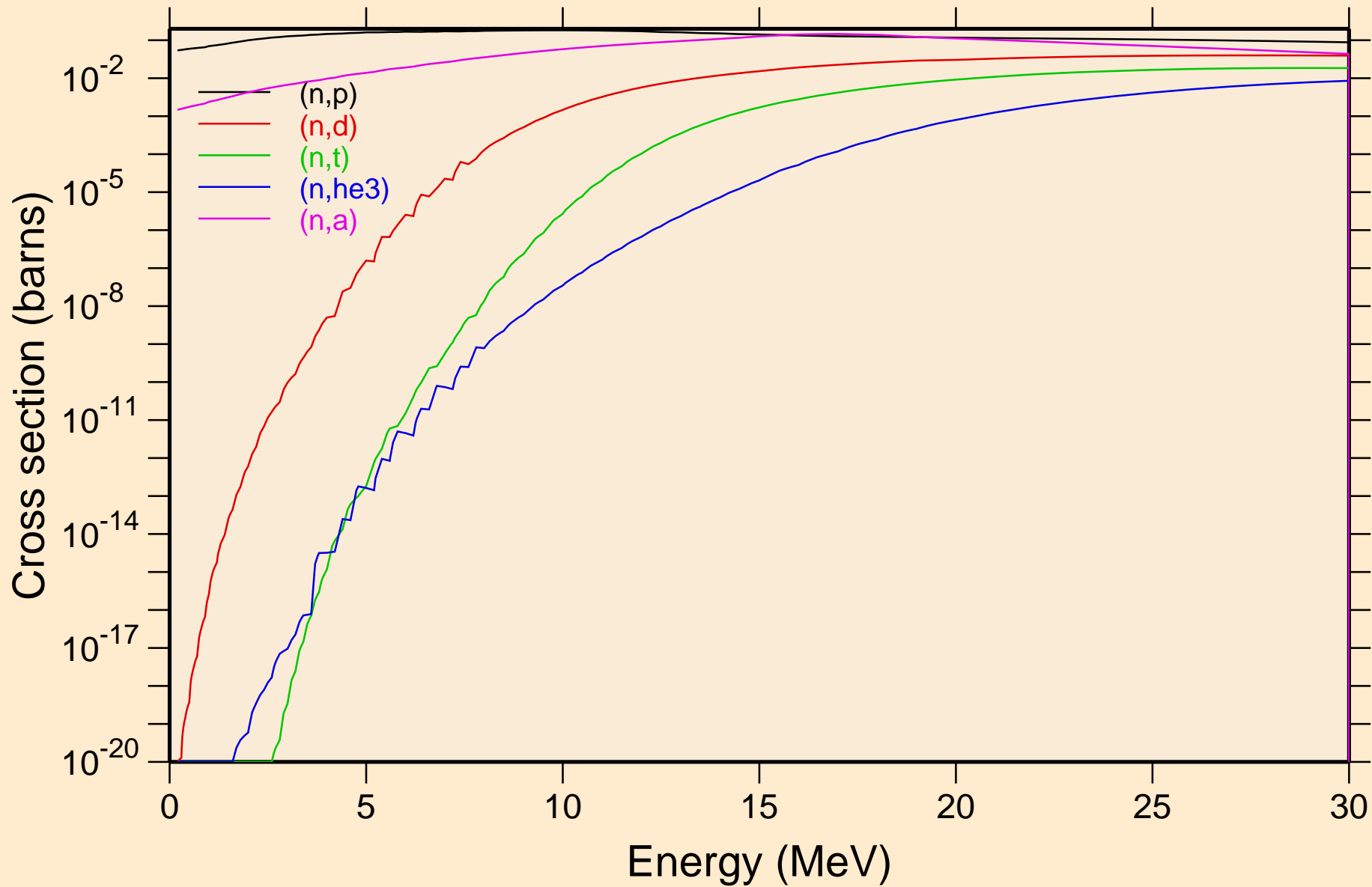

BI192 NEUTRON ACER TENDL-2024 LIBRARY; T=0.K  
Non-threshold reactions

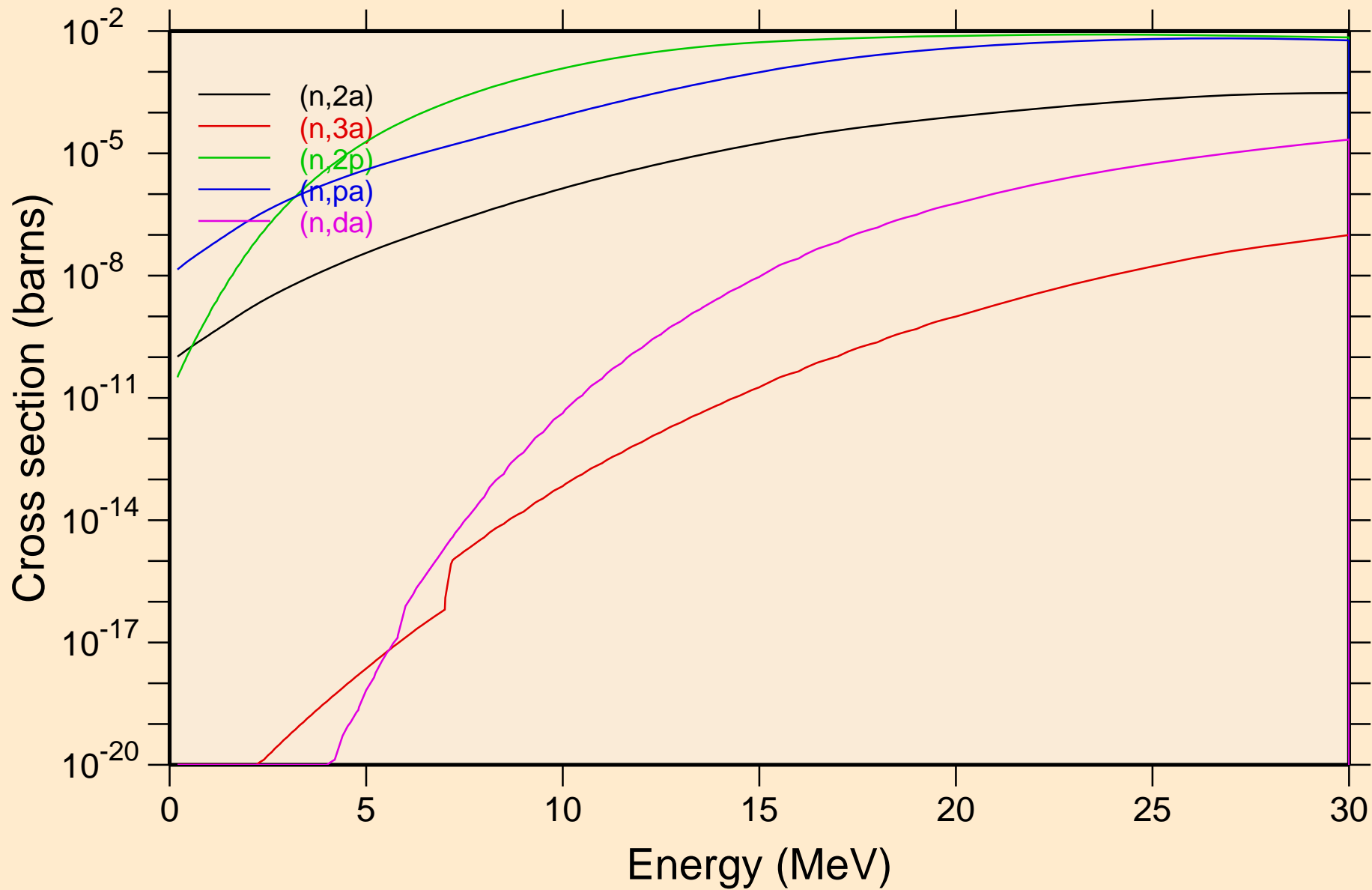

BI192 NEUTRON ACER TENDL-2024 LIBRARY; T=0.K  
Non-threshold reactions

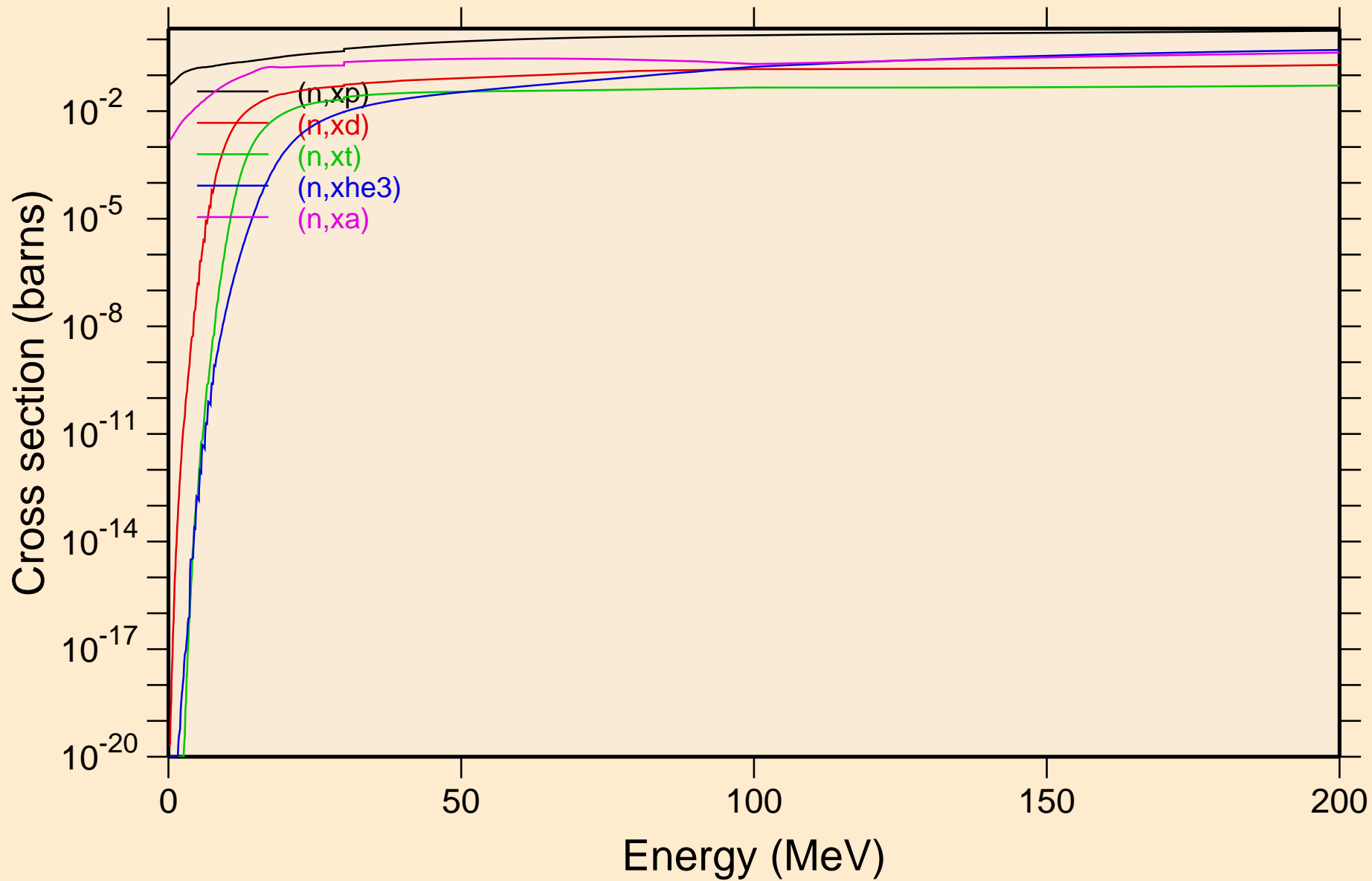

BI192 NEUTRON ACER TENDL-2024 LIBRARY; T=0.K  
Inelastic levels

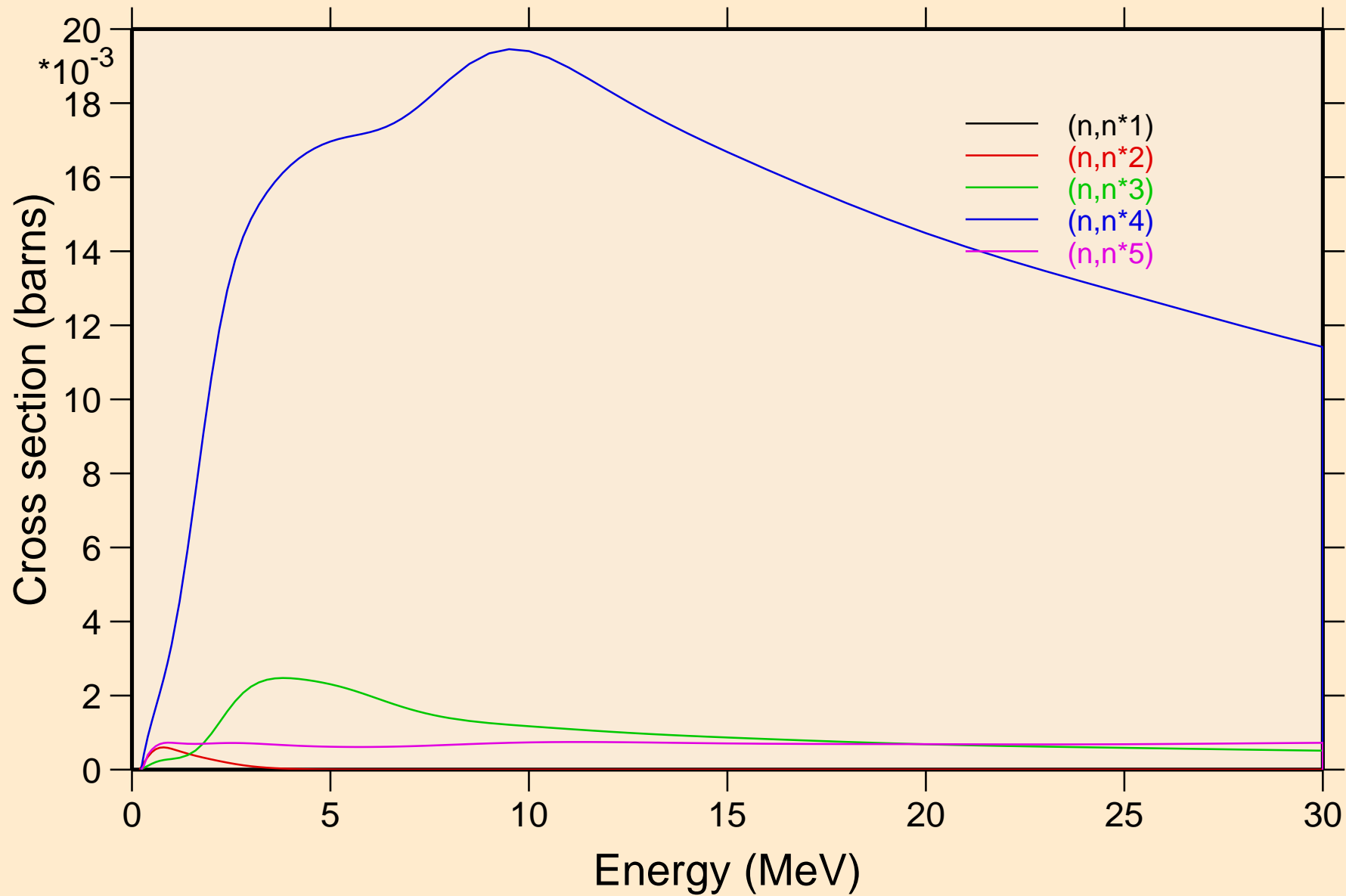

BI192 NEUTRON ACER TENDL-2024 LIBRARY; T=0.K  
Inelastic levels

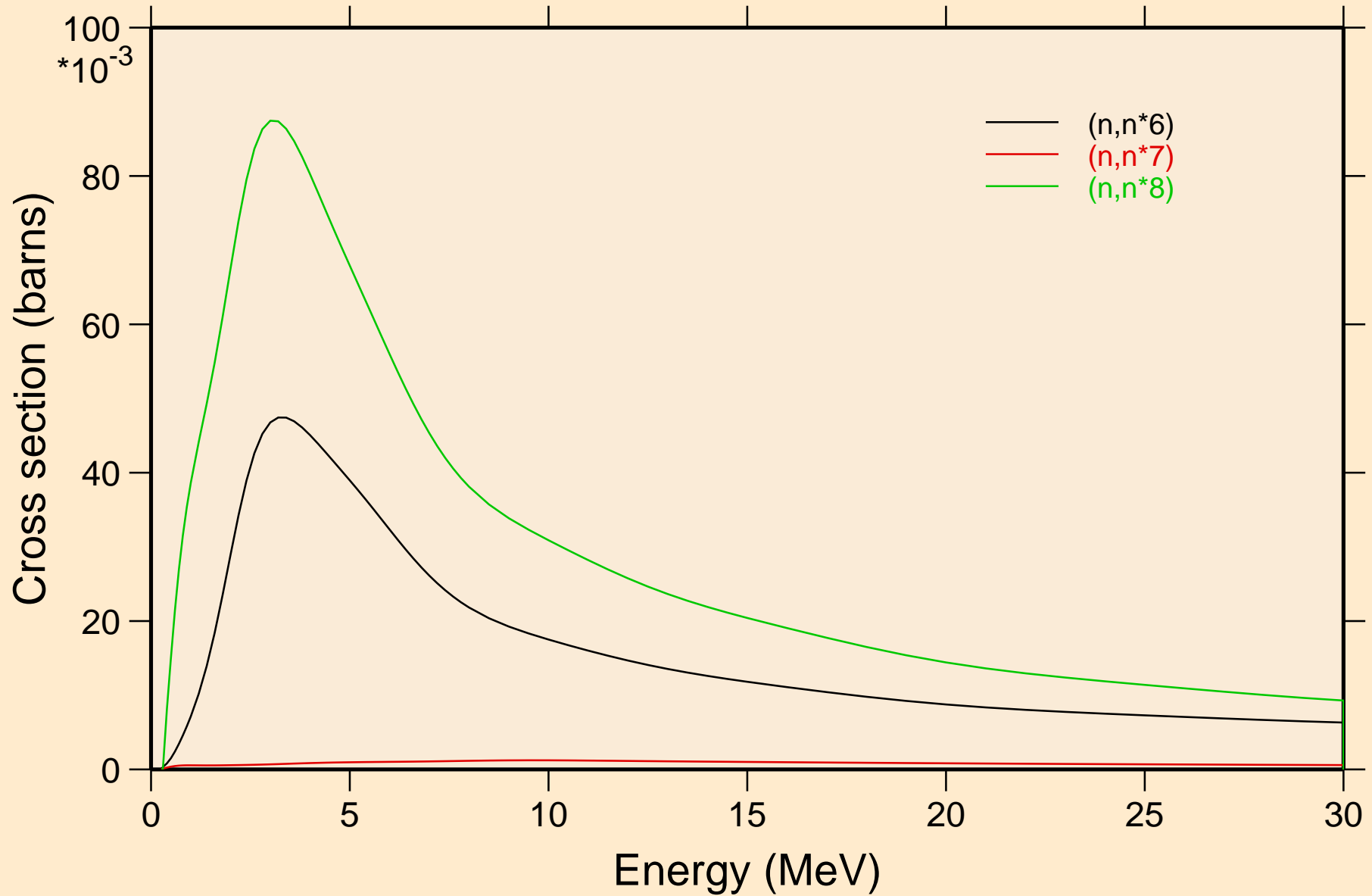



BI192 NEUTRON ACER TENDL-2024 LIBRARY; T=0.K  
Threshold reactions

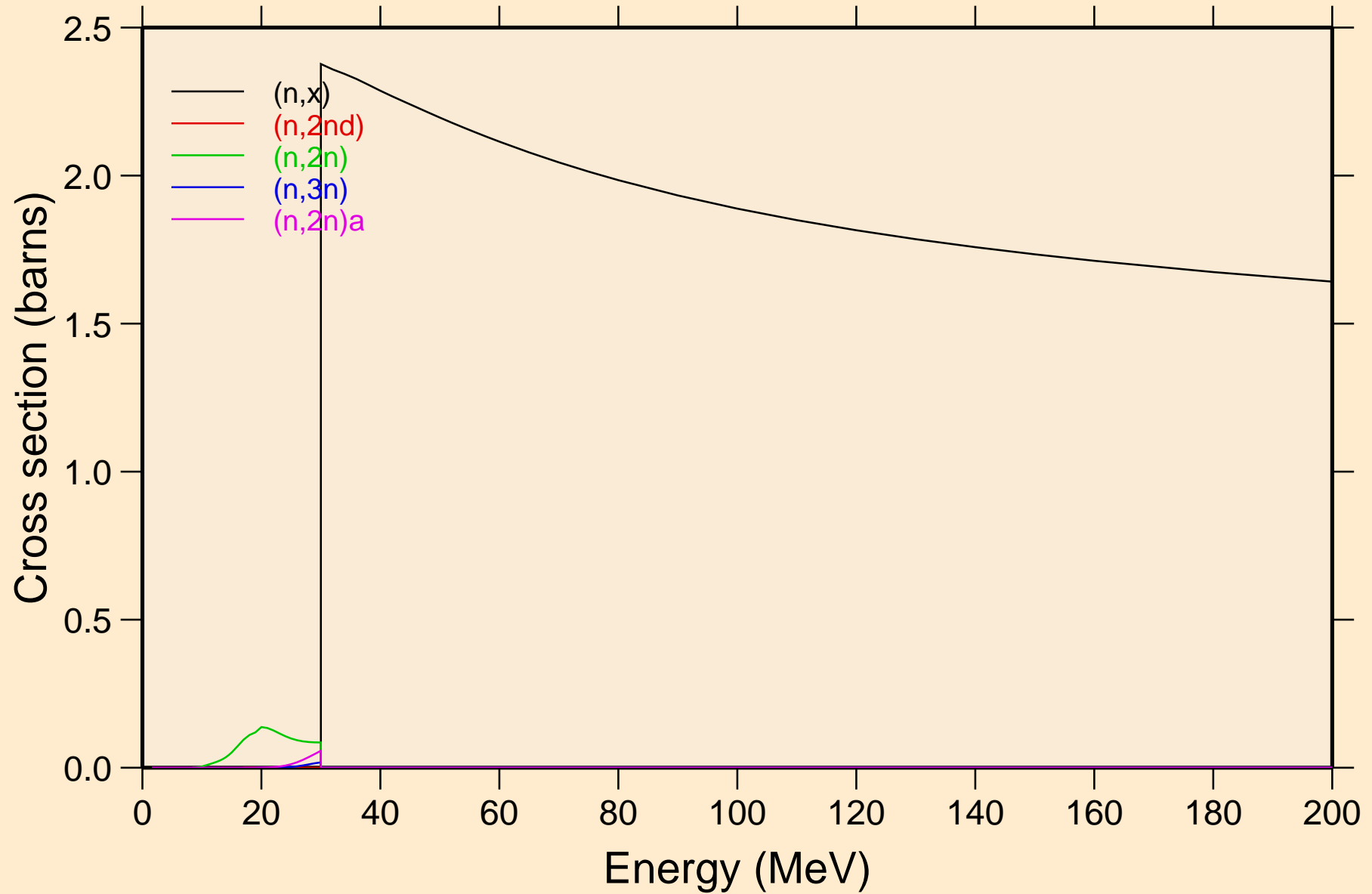

BI192 NEUTRON ACER TENDL-2024 LIBRARY; T=0.K  
Threshold reactions

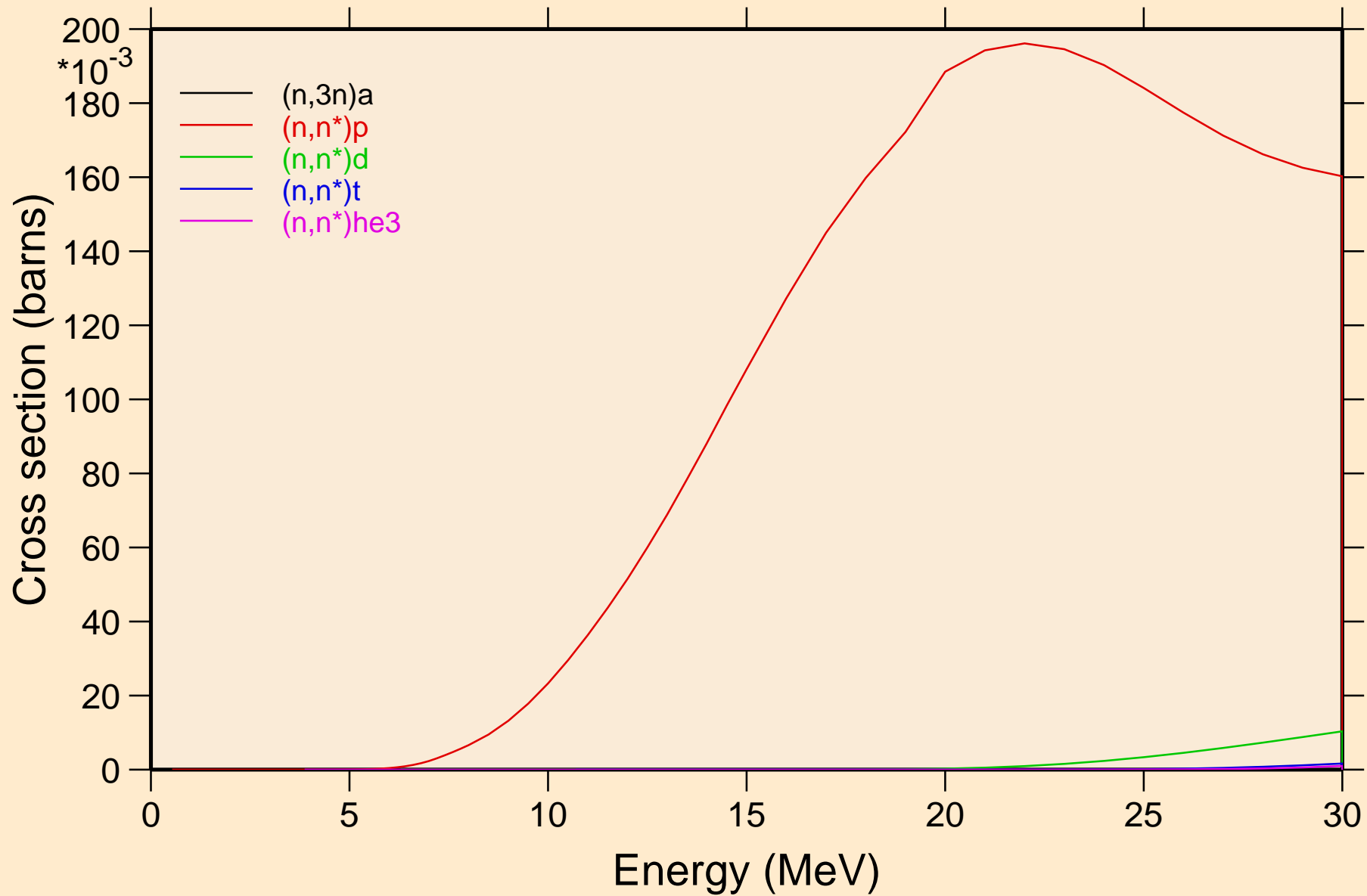

BI192 NEUTRON ACER TENDL-2024 LIBRARY; T=0.K  
Threshold reactions

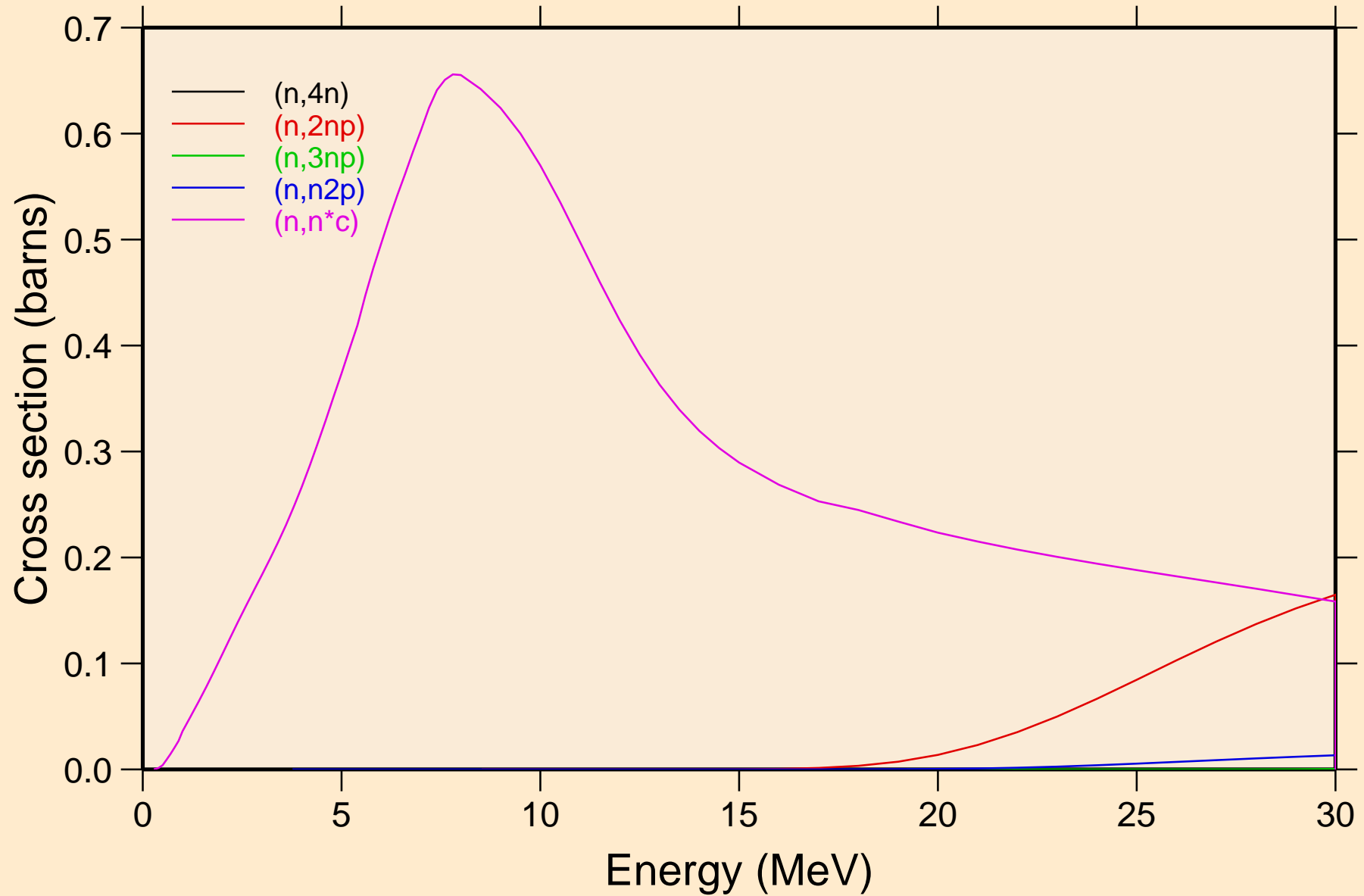

BI192 NEUTRON ACER TENDL-2024 LIBRARY; T=0.K  
Threshold reactions

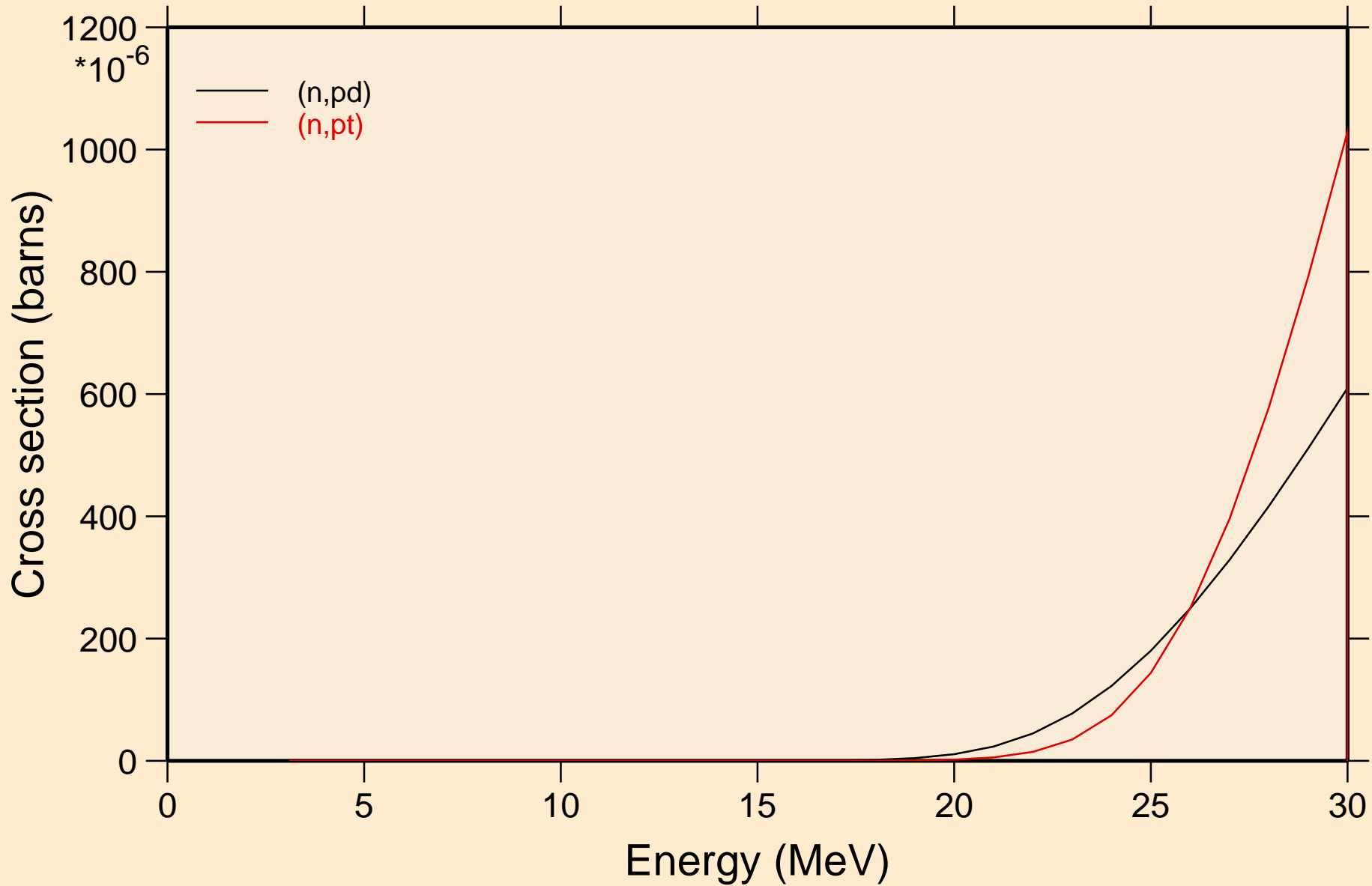

BI192 NEUTRON ACER TENDL-2024 LIBRARY; T=0.K  
angular distribution for elastic

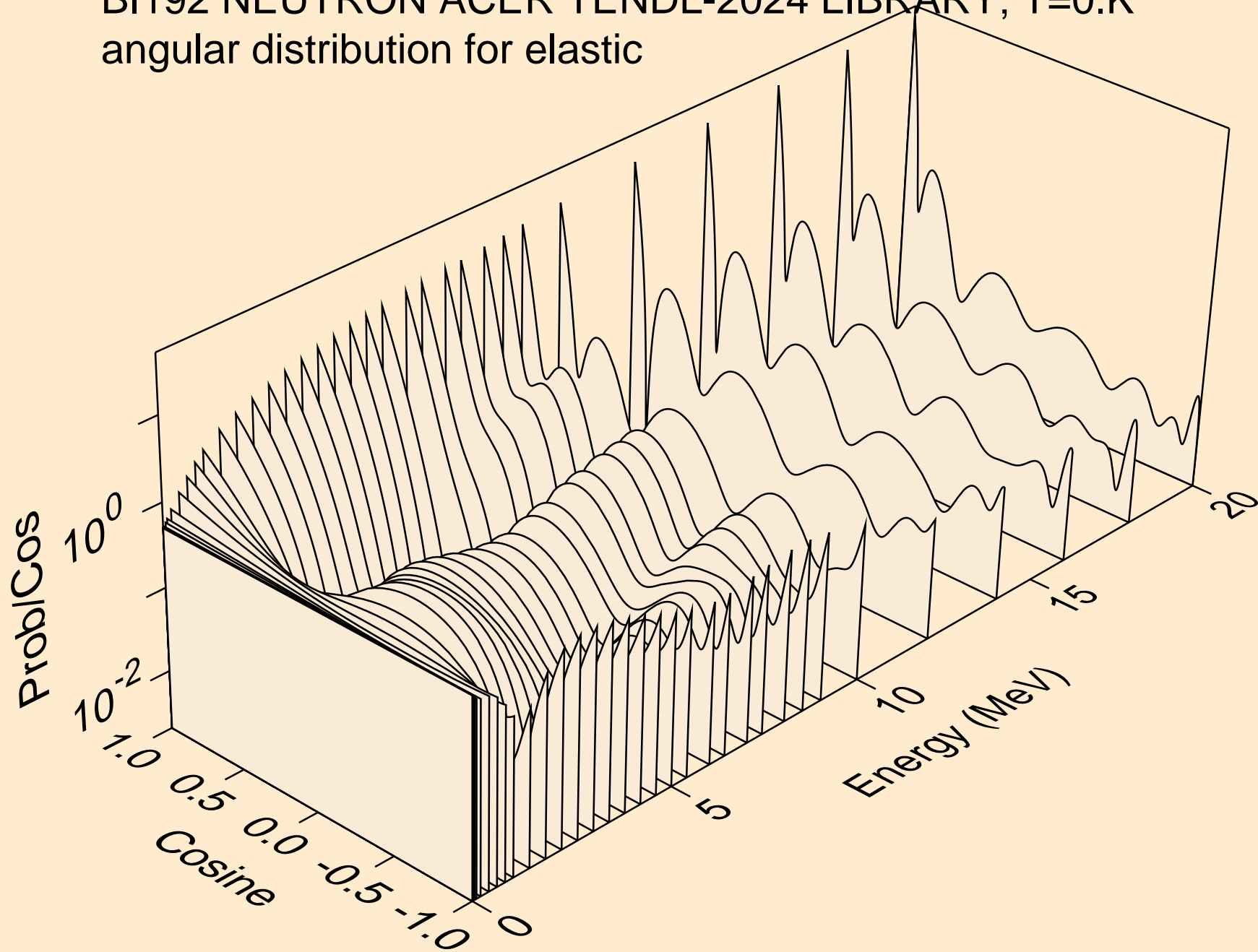

BI192 NEUTRON ACER TENDL-2024 LIBRARY; T=0.K  
angular distribution for elastic

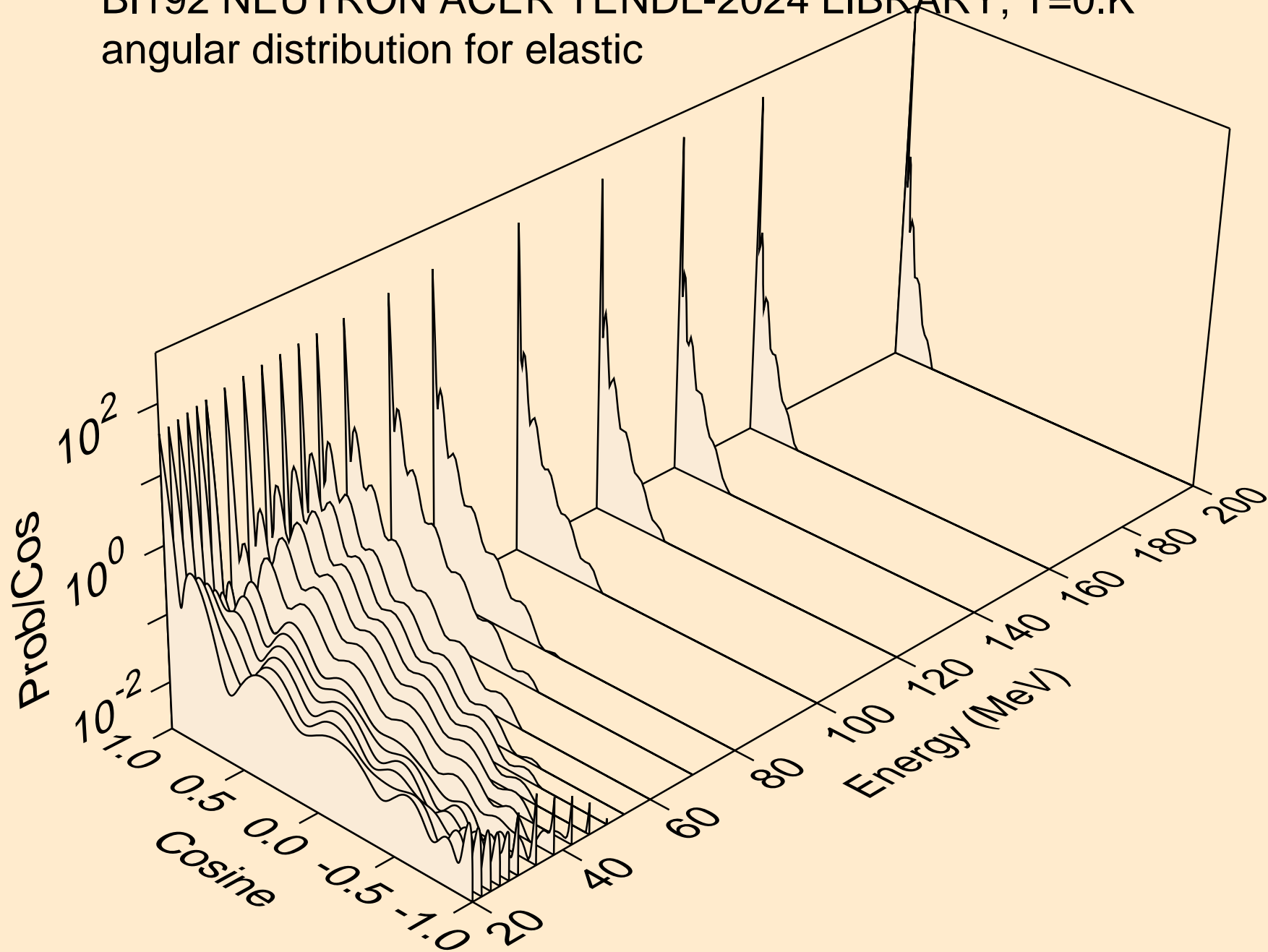

BI192 NEUTRON ACER TENDL-2024 LIBRARY; T=0.K  
angular distribution for (n,n\*1)

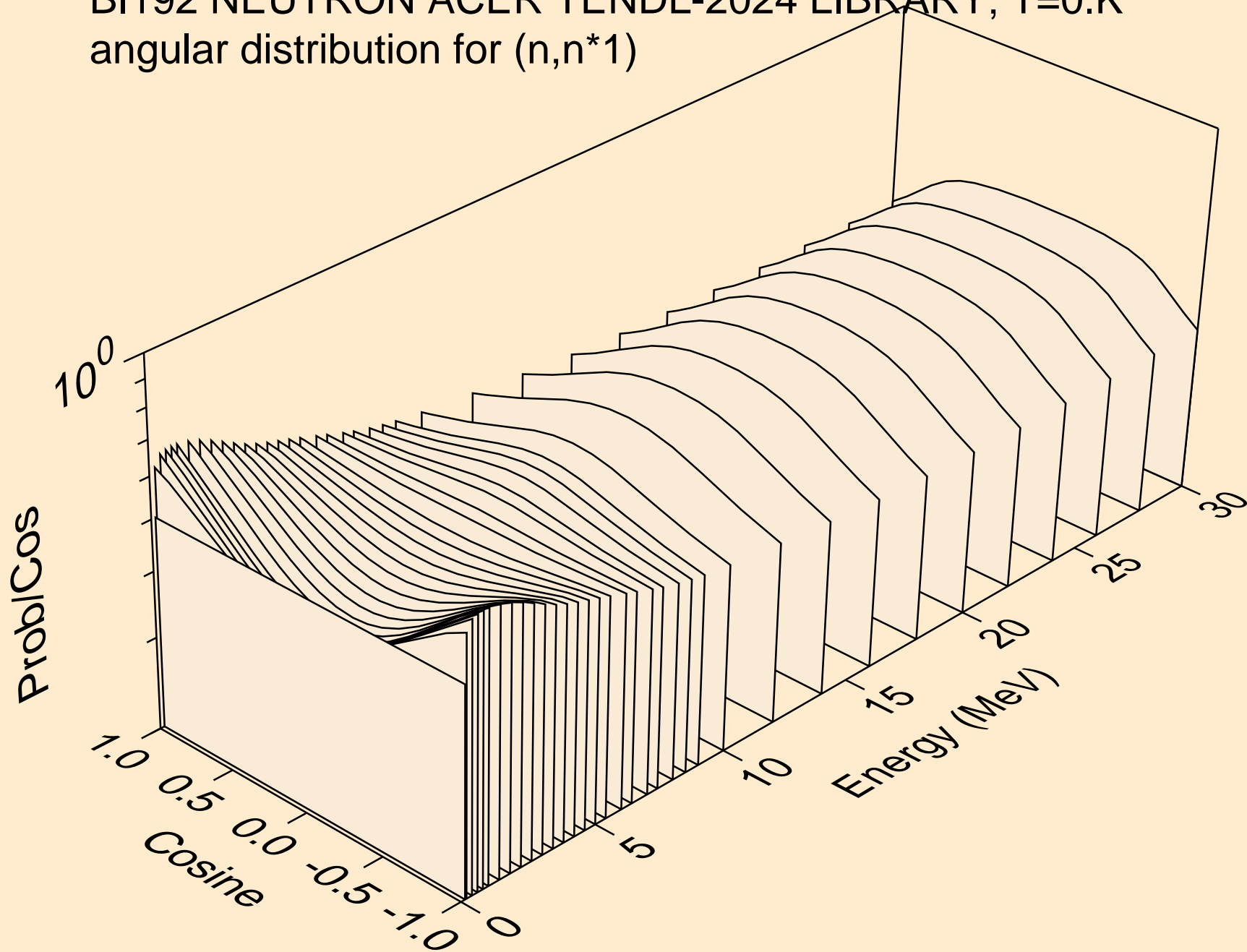

BI192 NEUTRON ACER TENDL-2024 LIBRARY; T=0.K  
angular distribution for (n,n\*2)

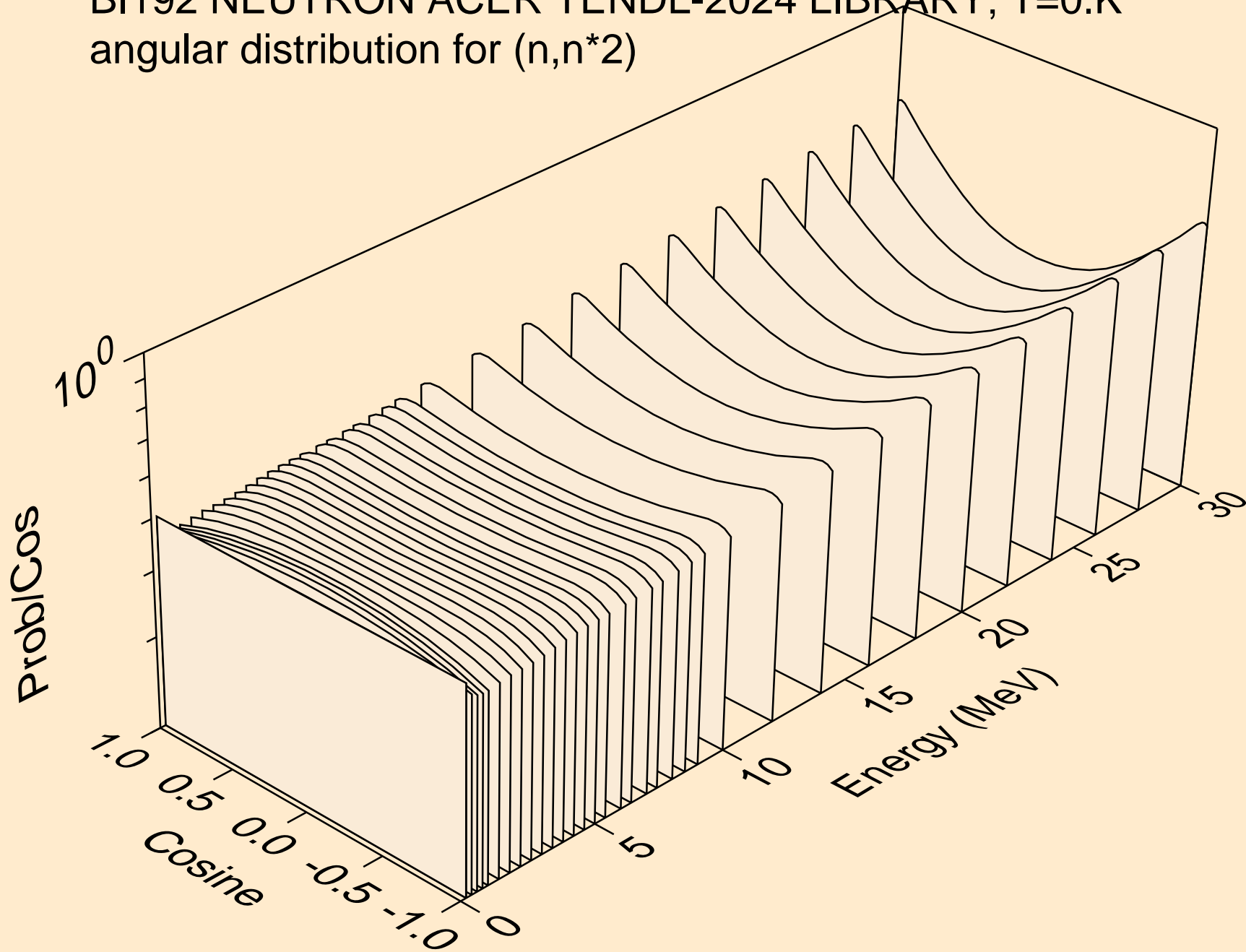



BI192 NEUTRON ACER TENDL-2024 LIBRARY; T=0.K  
angular distribution for (n,n\*3)

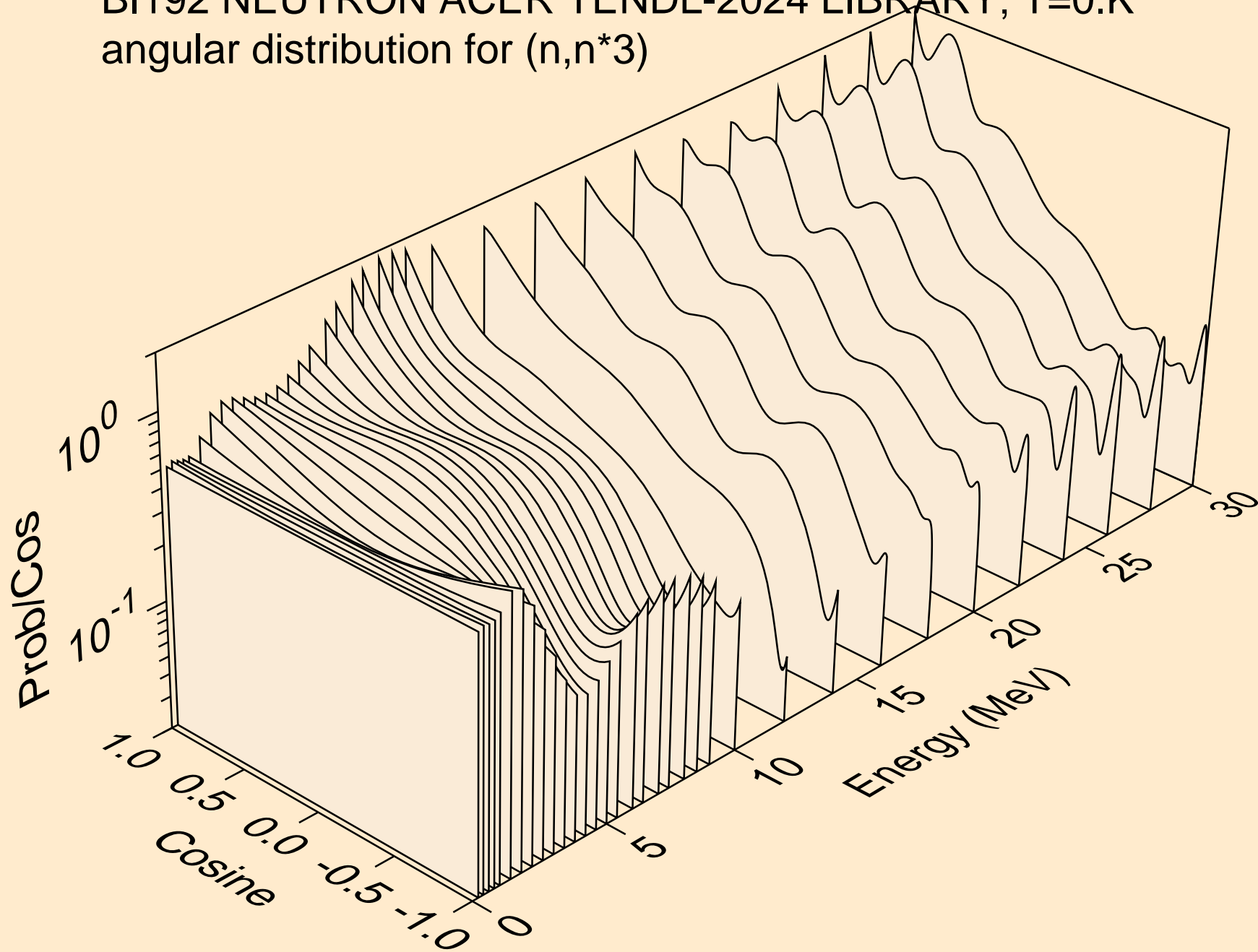

BI192 NEUTRON ACER TENDL-2024 LIBRARY; T=0.K  
angular distribution for (n,n\*4)

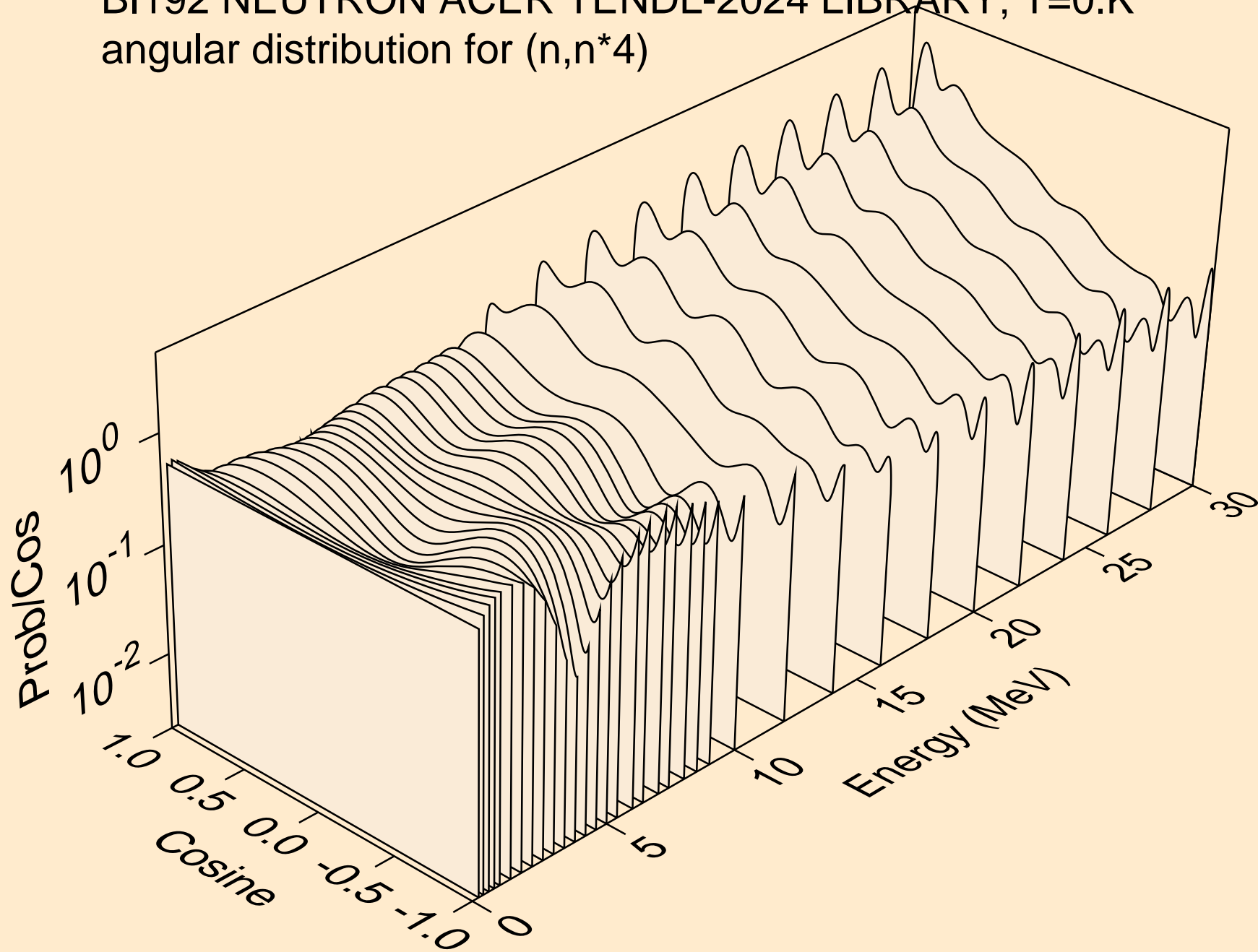

BI192 NEUTRON ACER TENDL-2024 LIBRARY; T=0.K  
angular distribution for (n,n\*5)

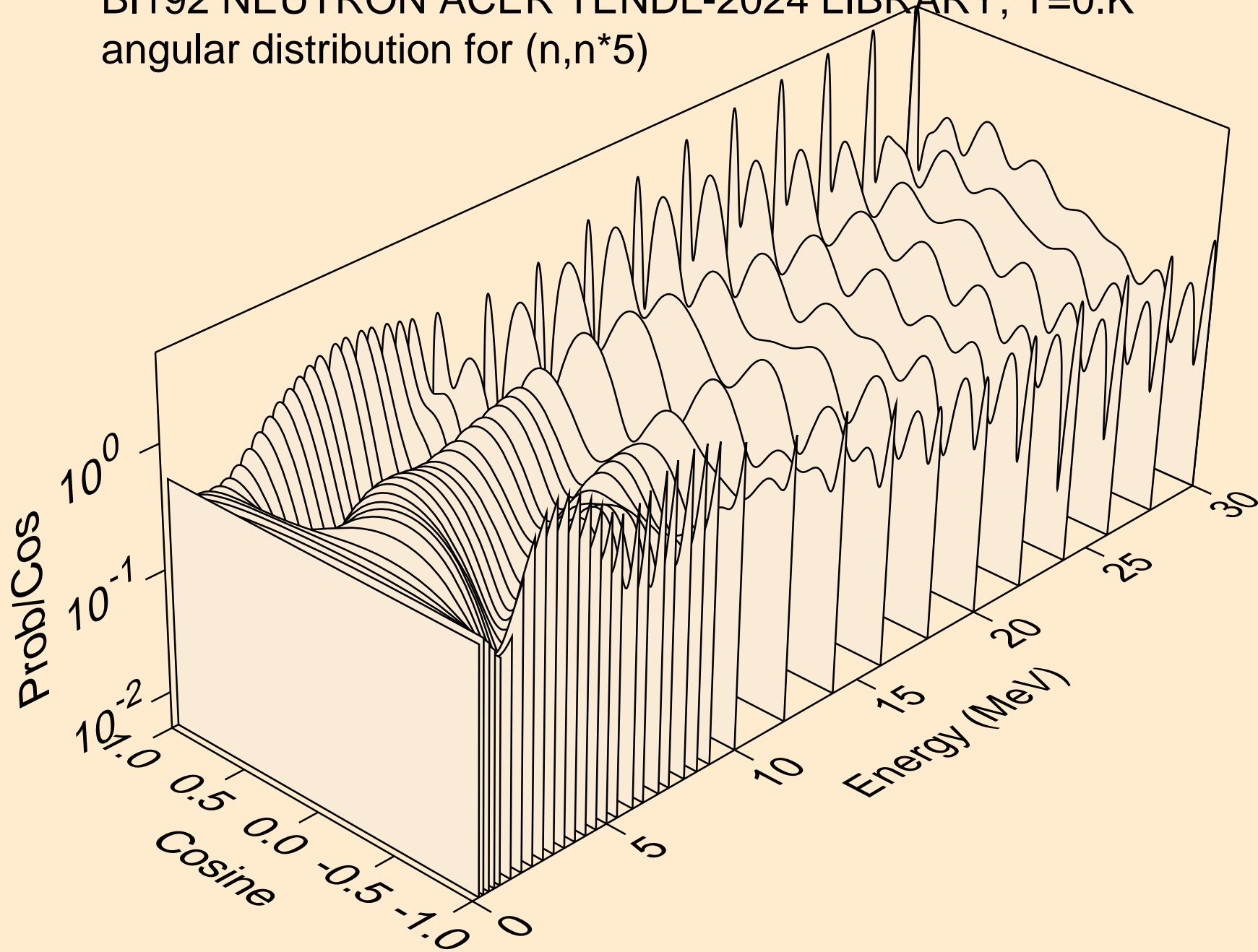

BI192 NEUTRON ACER TENDL-2024 LIBRARY; T=0.K  
angular distribution for (n,n\*6)

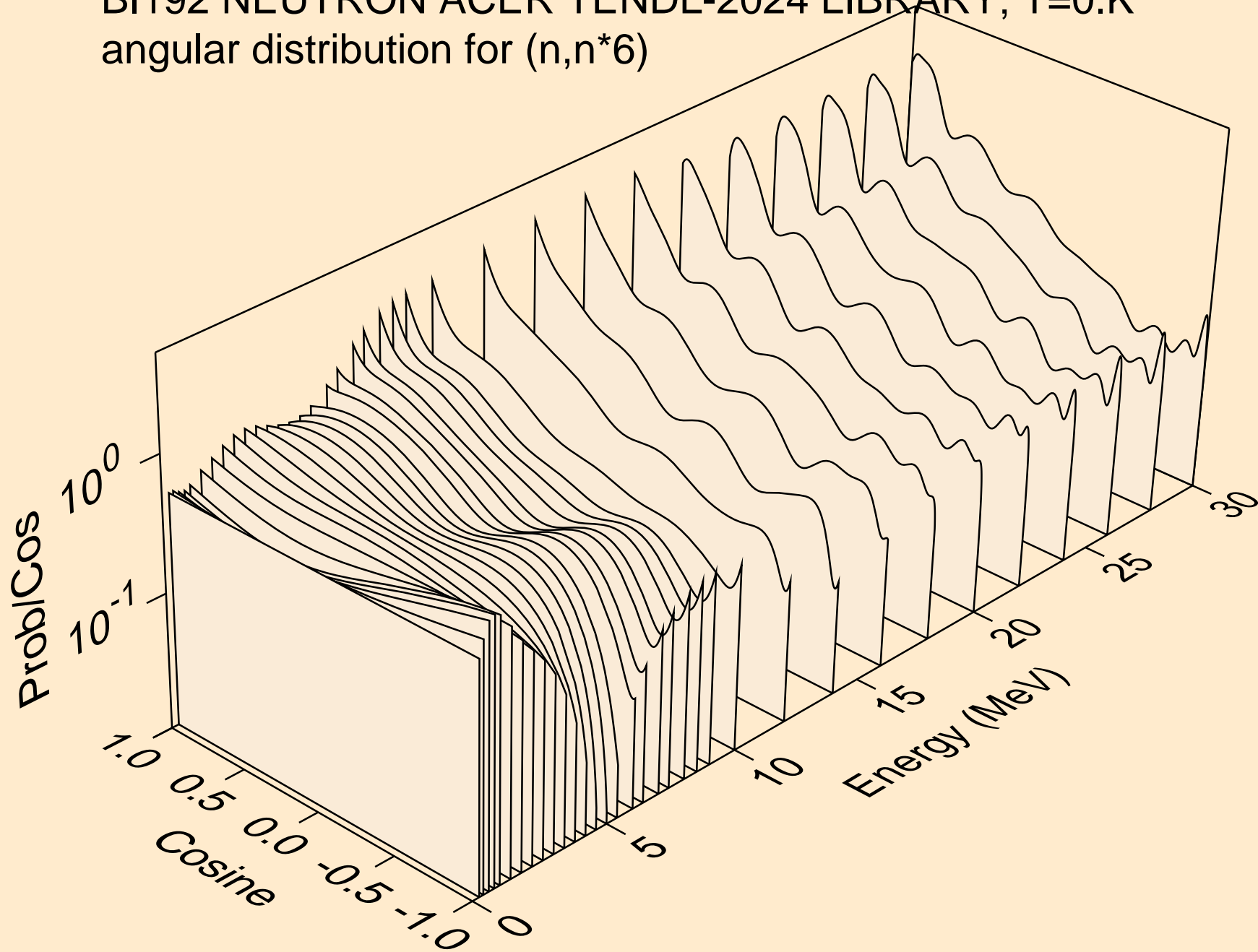

BI192 NEUTRON ACER TENDL-2024 LIBRARY; T=0.K  
angular distribution for (n,n\*7)

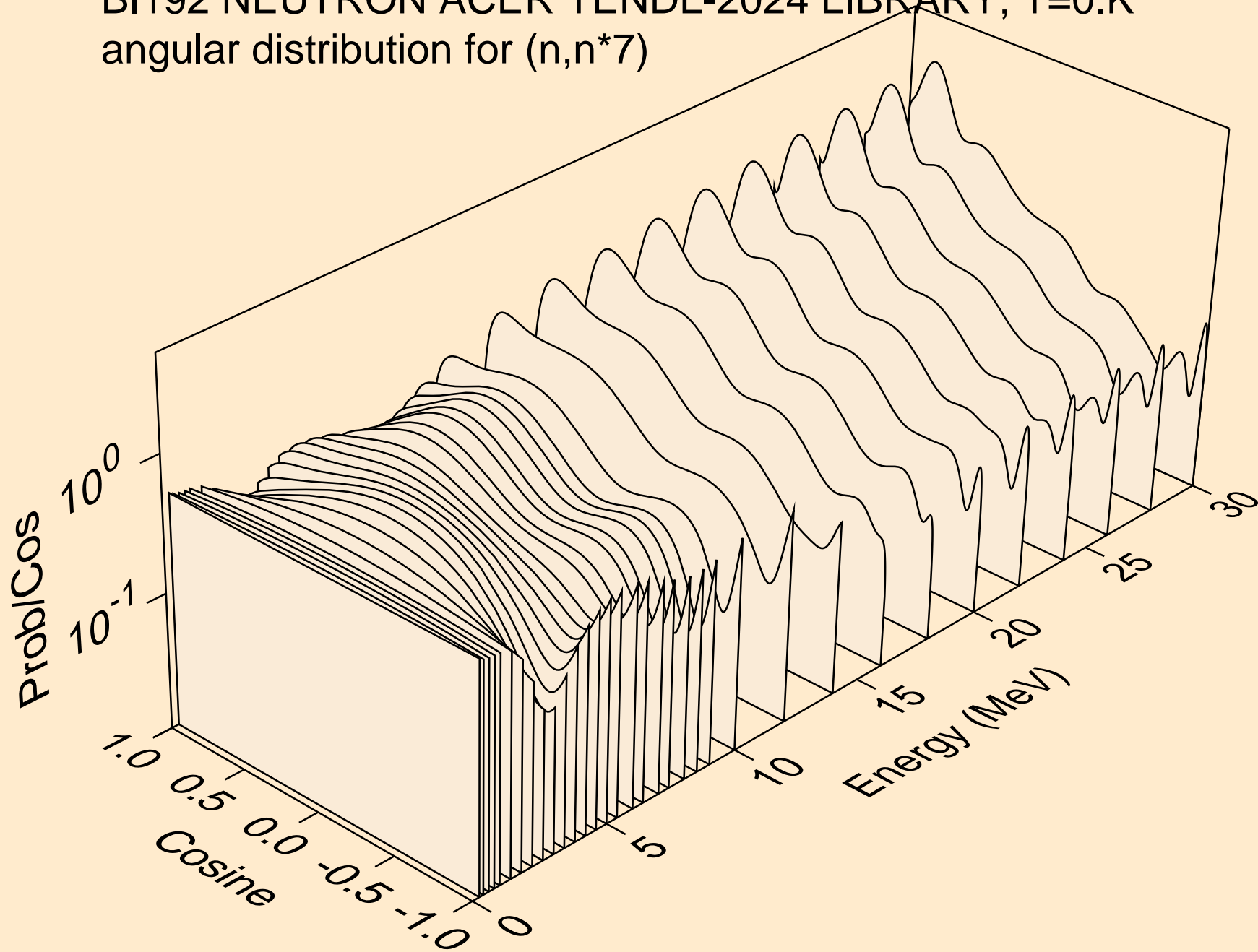

BI192 NEUTRON ACER TENDL-2024 LIBRARY; T=0.K  
angular distribution for (n,n\*8)

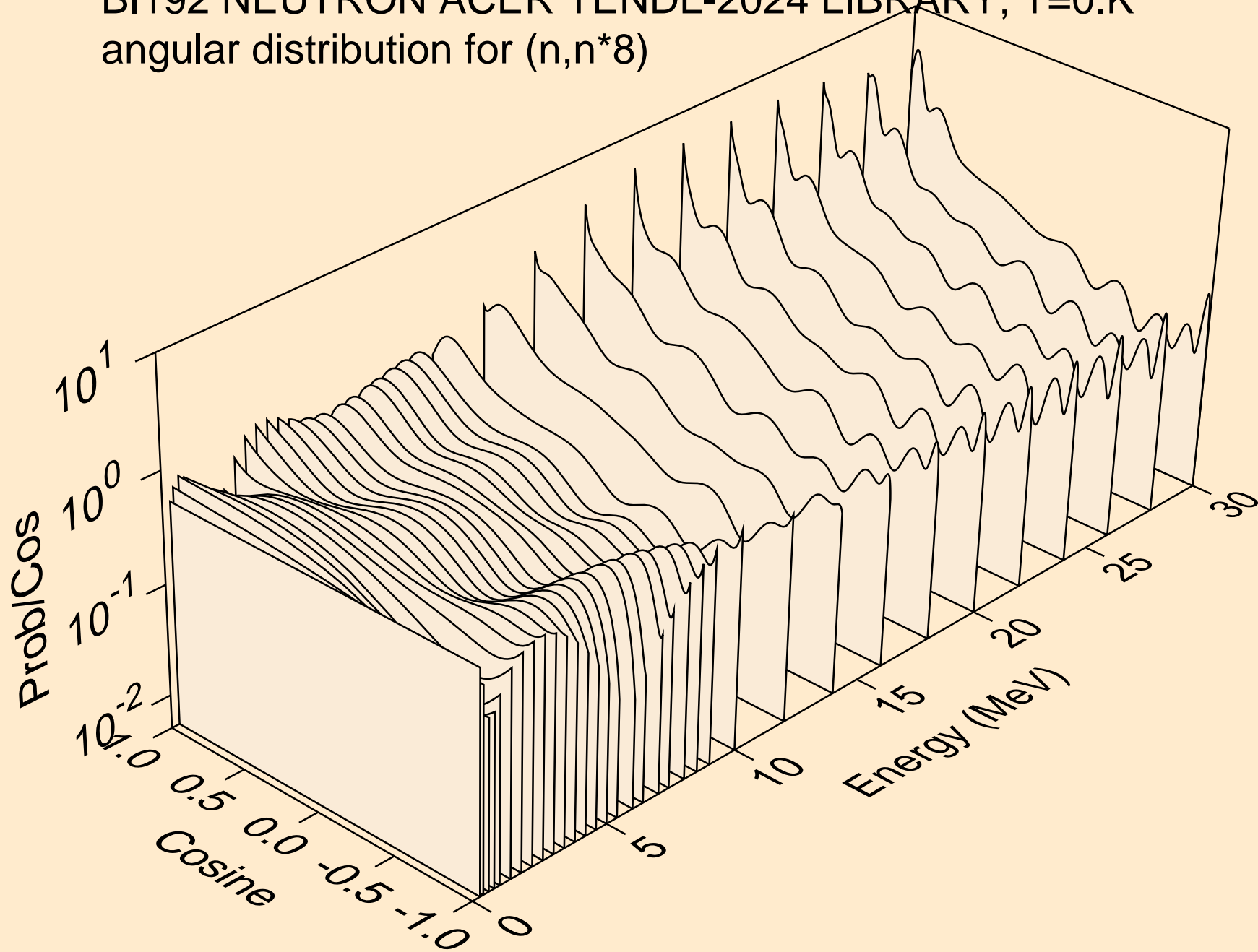

BI192 NEUTRON ACER TENDL-2024 LIBRARY; T=0.K  
Neutron emission for (n,x)

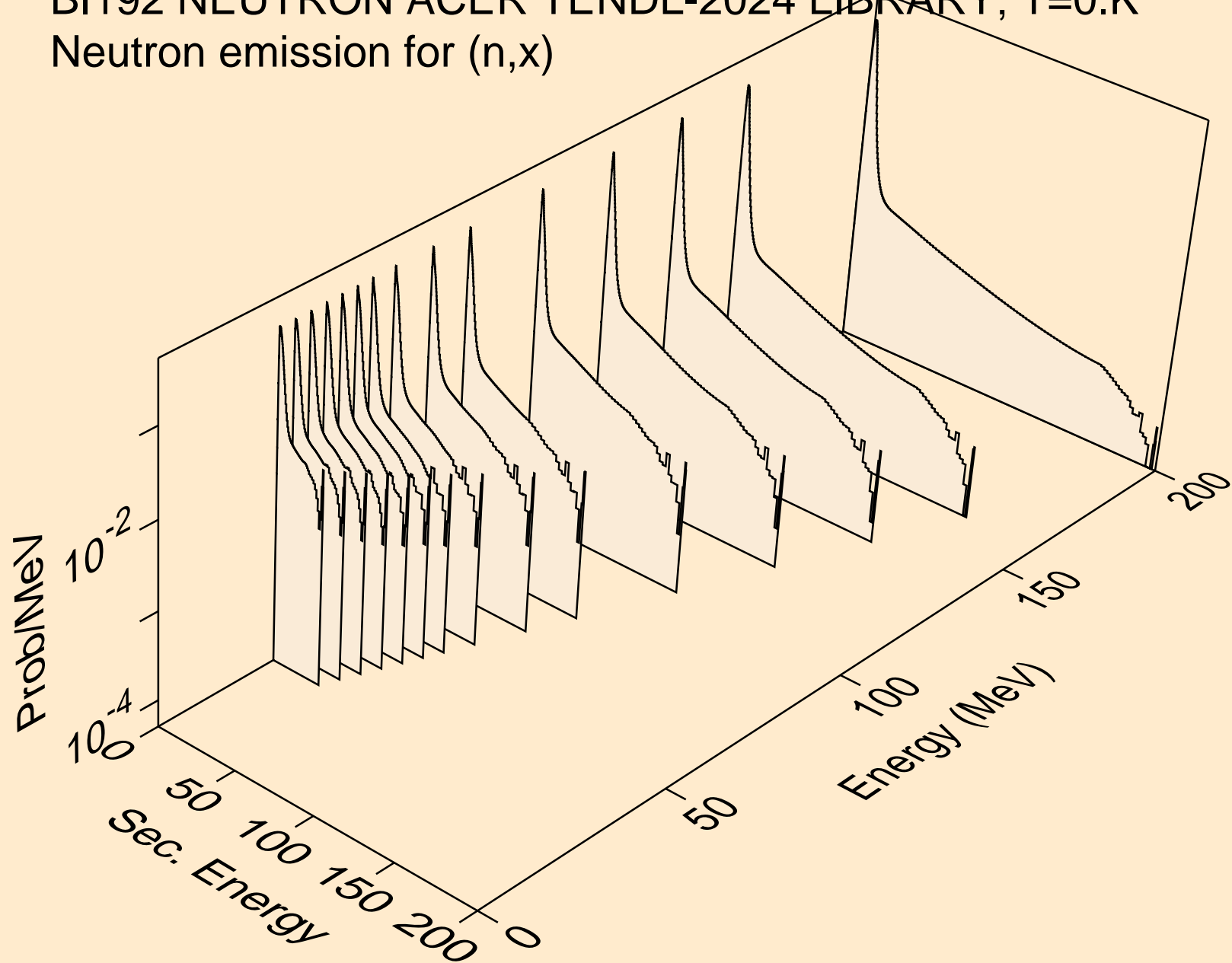

BI192 NEUTRON ACER TENDL-2024 LIBRARY; T=0.K  
Neutron emission for (n,2nd)

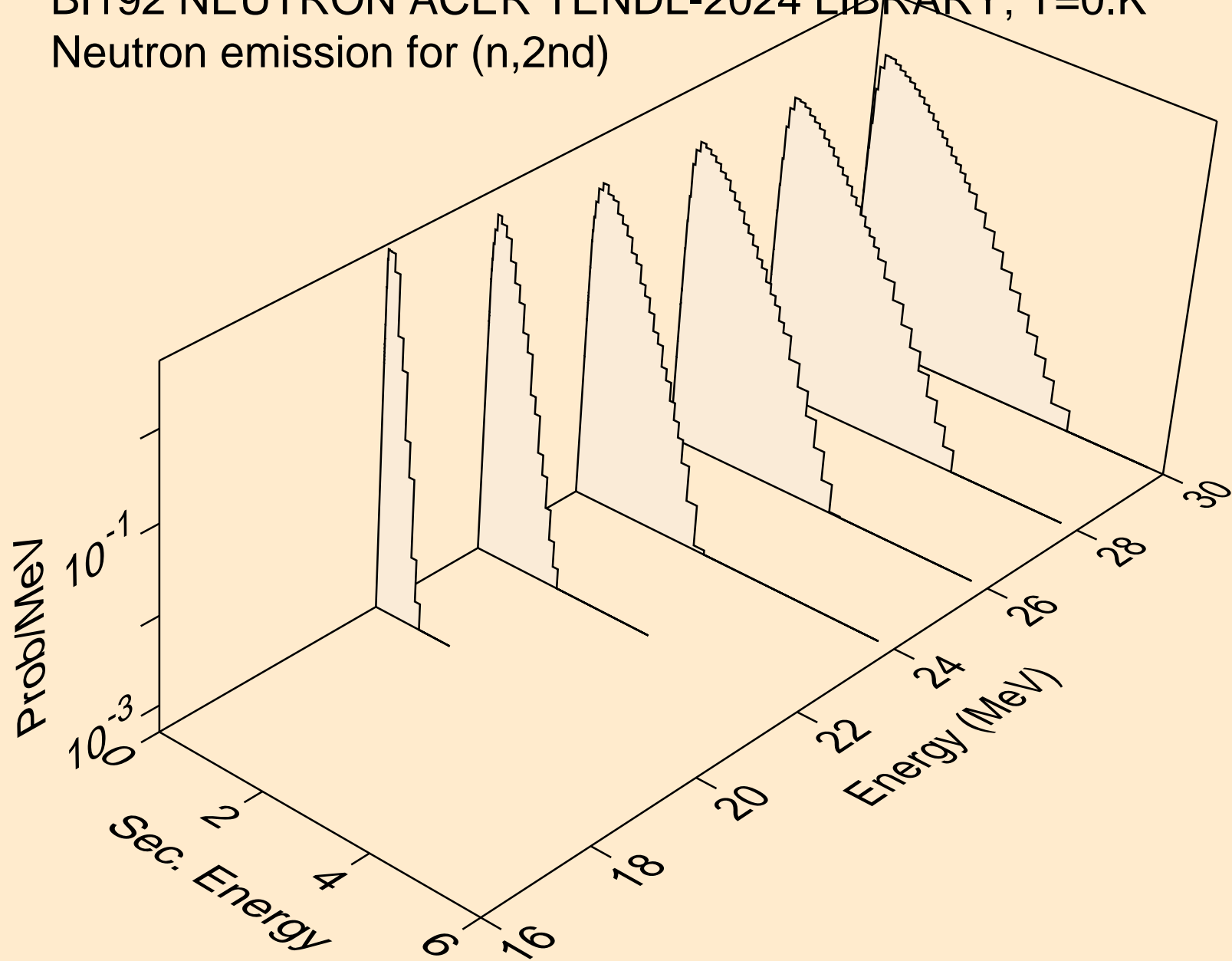



BI192 NEUTRON ACER TENDL-2024 LIBRARY; T=0.K  
Neutron emission for (n,2n)

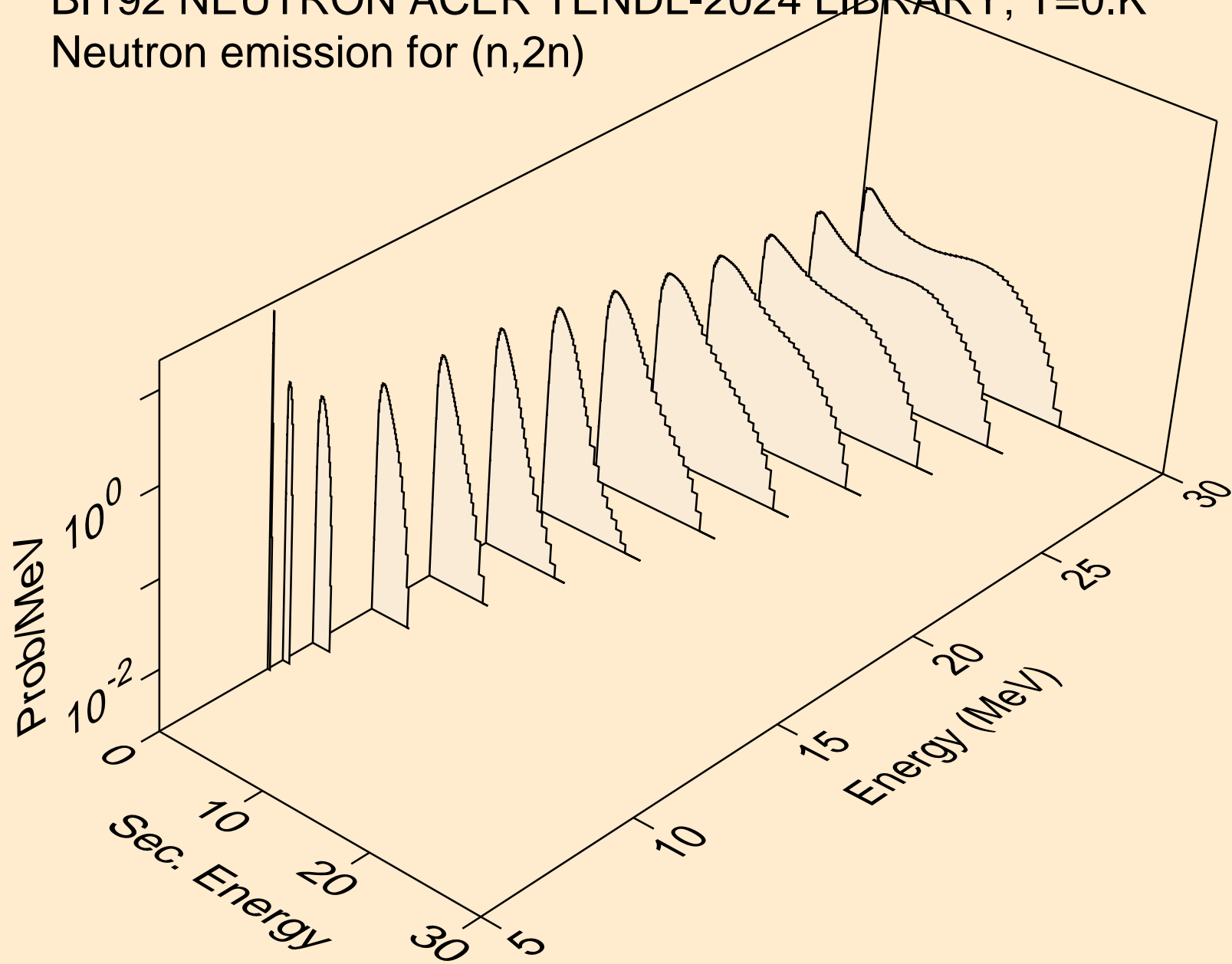

BI192 NEUTRON ACER TENDL-2024 LIBRARY; T=0.K  
Neutron emission for (n,3n)

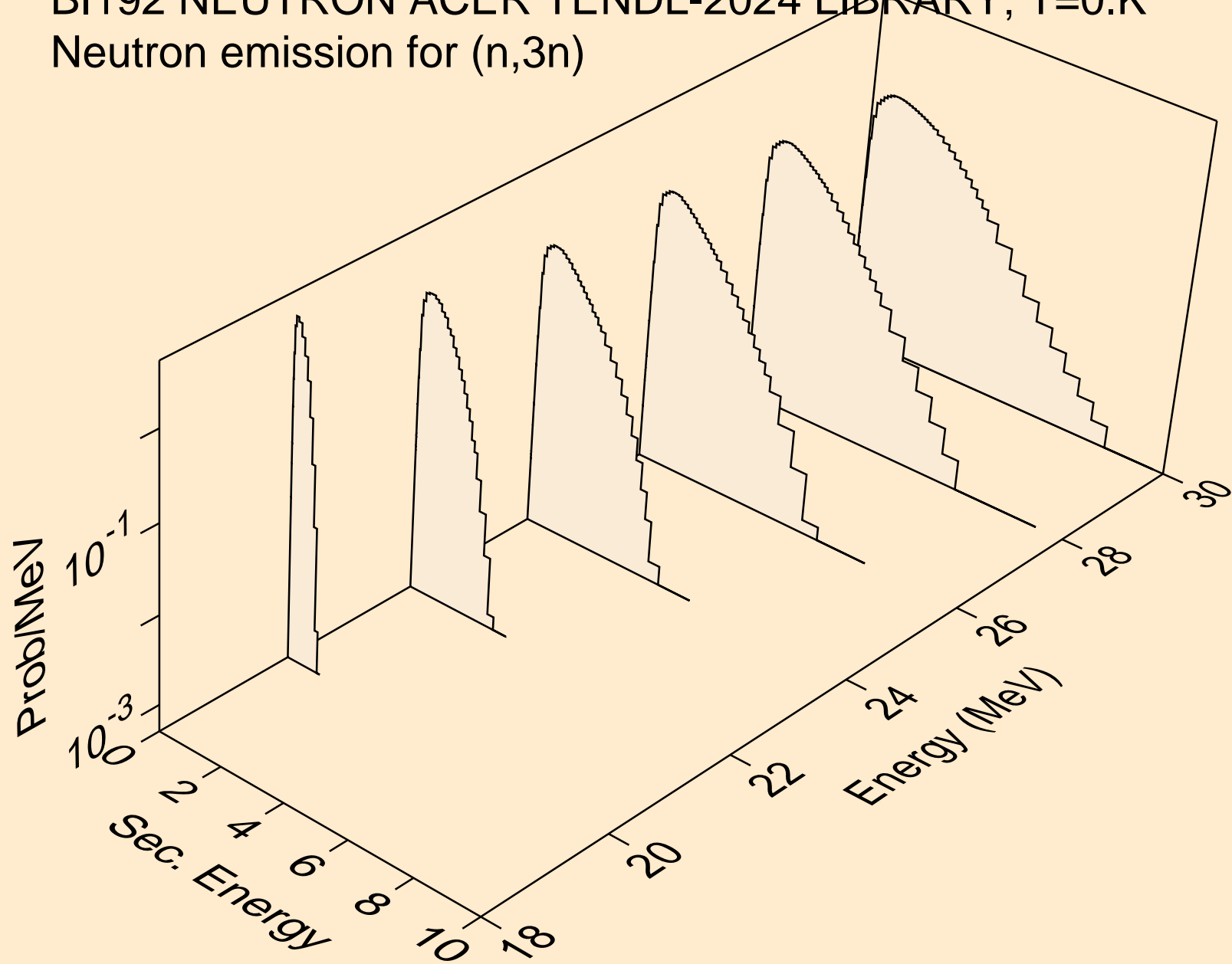

BI192 NEUTRON ACER TENDL-2024 LIBRARY; T=0.K  
Neutron emission for (n,n\*)a

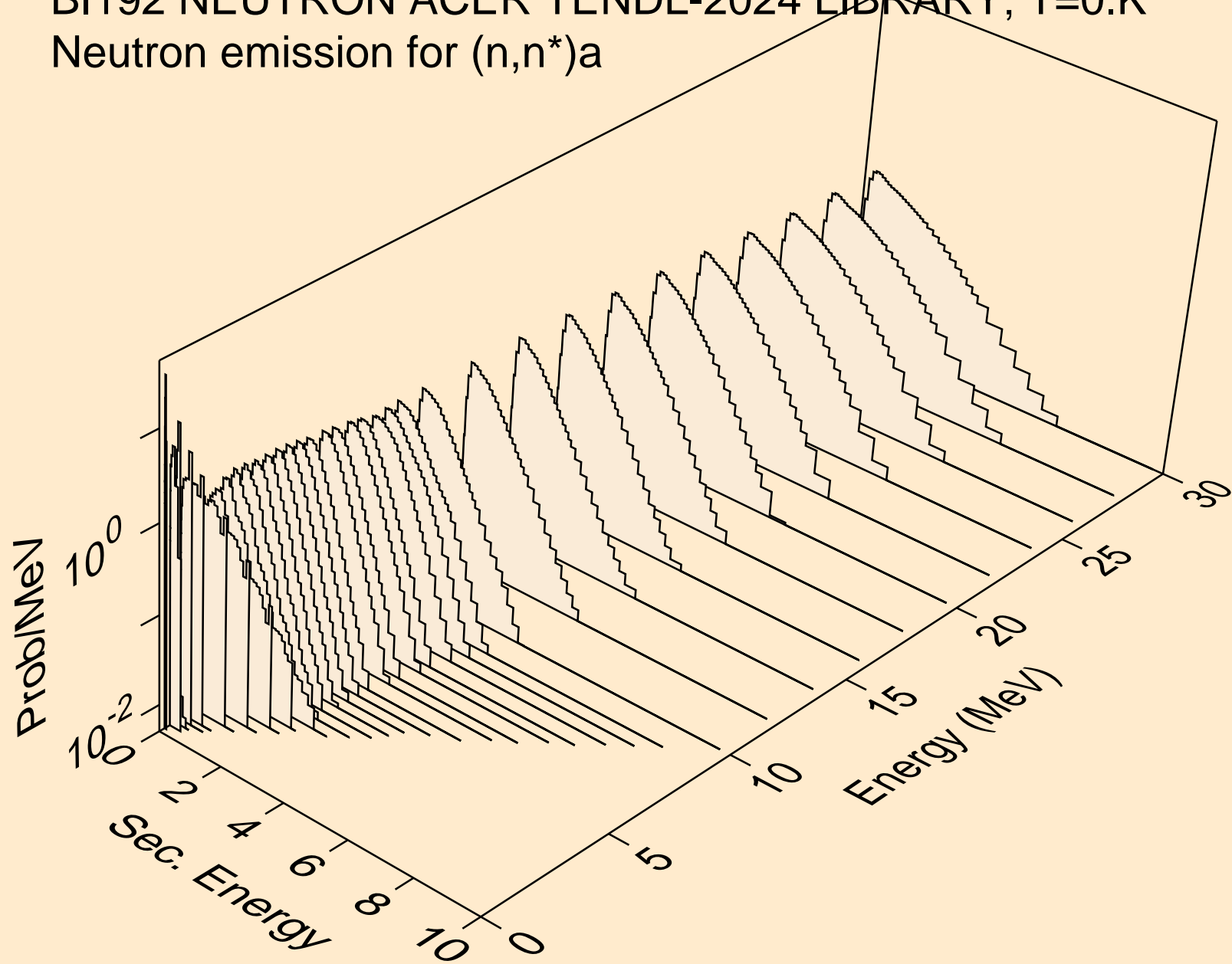

BI192 NEUTRON ACER TENDL-2024 LIBRARY; T=0.K  
Neutron emission for (n,2n)a

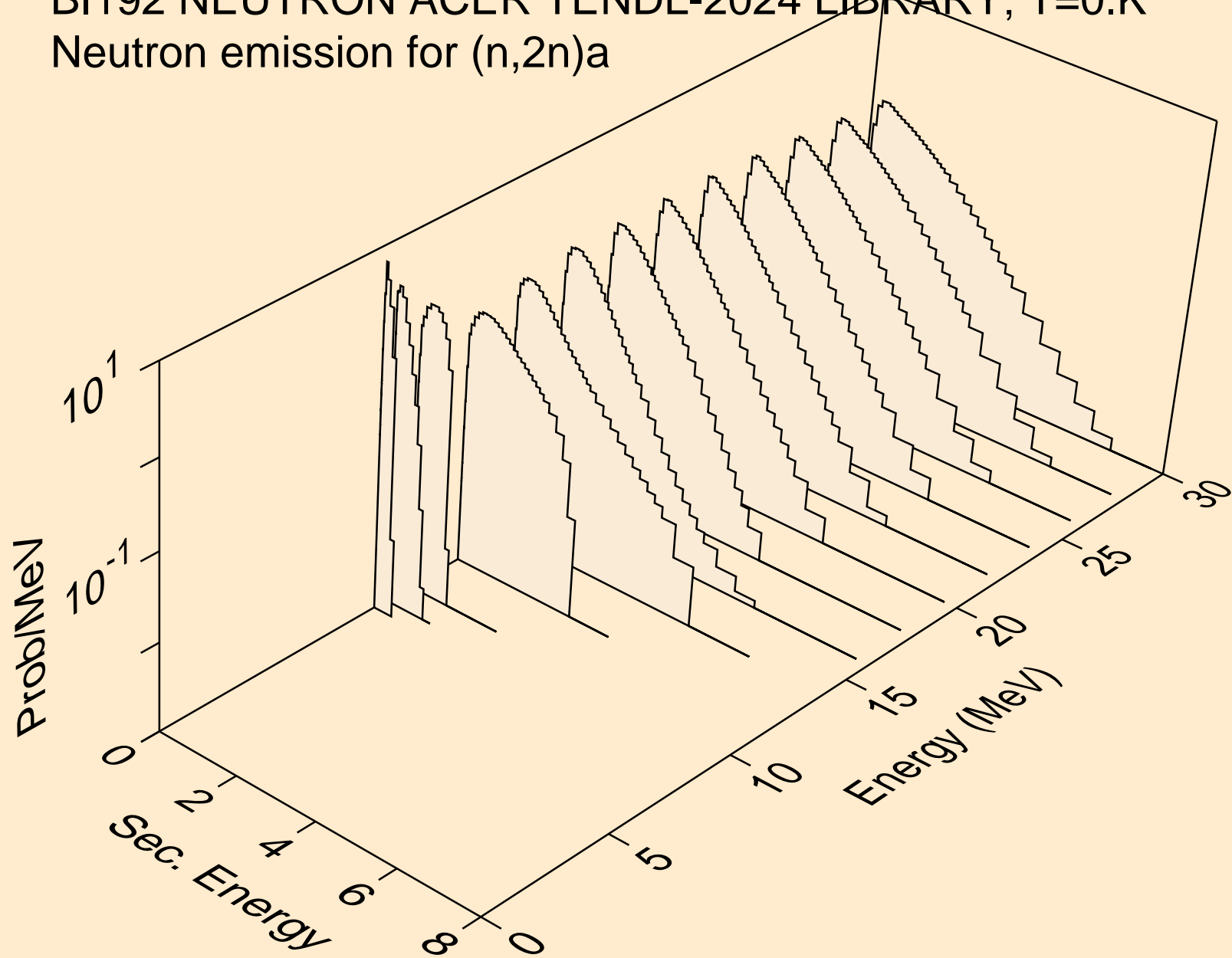

BI192 NEUTRON ACER TENDL-2024 LIBRARY; T=0.K  
Neutron emission for (n,3n)a

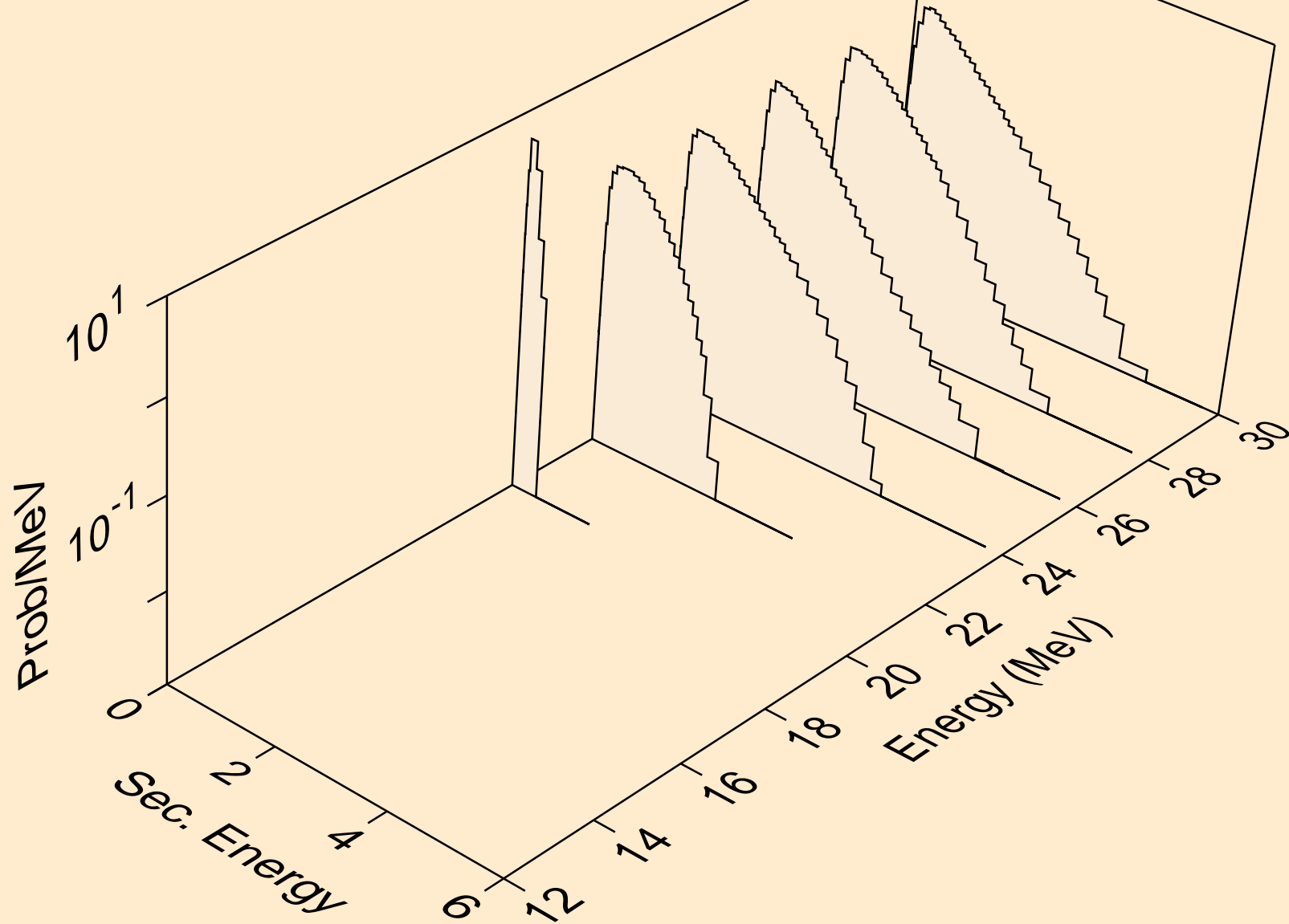

BI192 NEUTRON ACER TENDL-2024 LIBRARY; T=0.K  
Neutron emission for (n,n\*)p

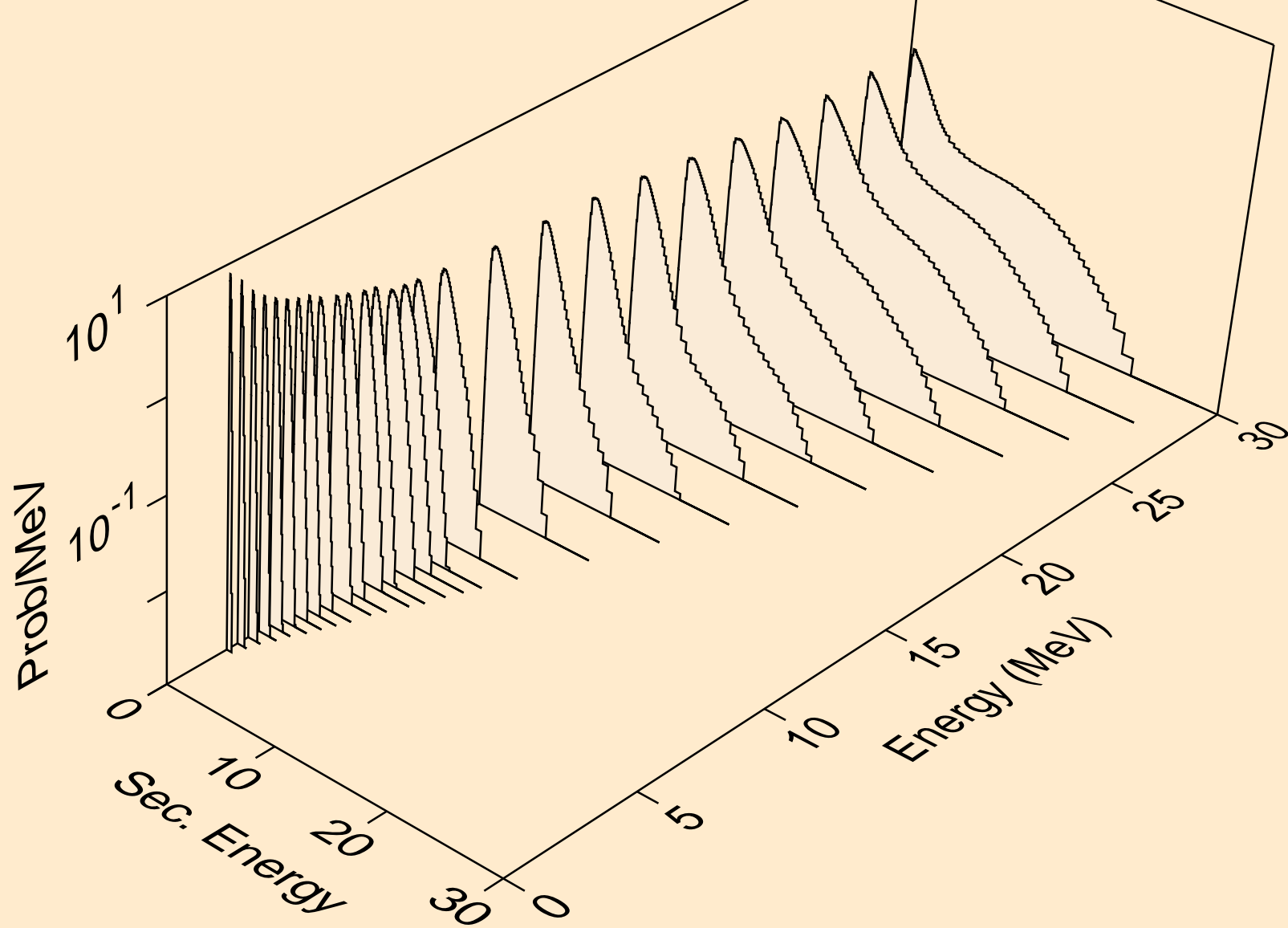

BI192 NEUTRON ACER TENDL-2024 LIBRARY; T=0.K  
Neutron emission for (n,n\*)2a

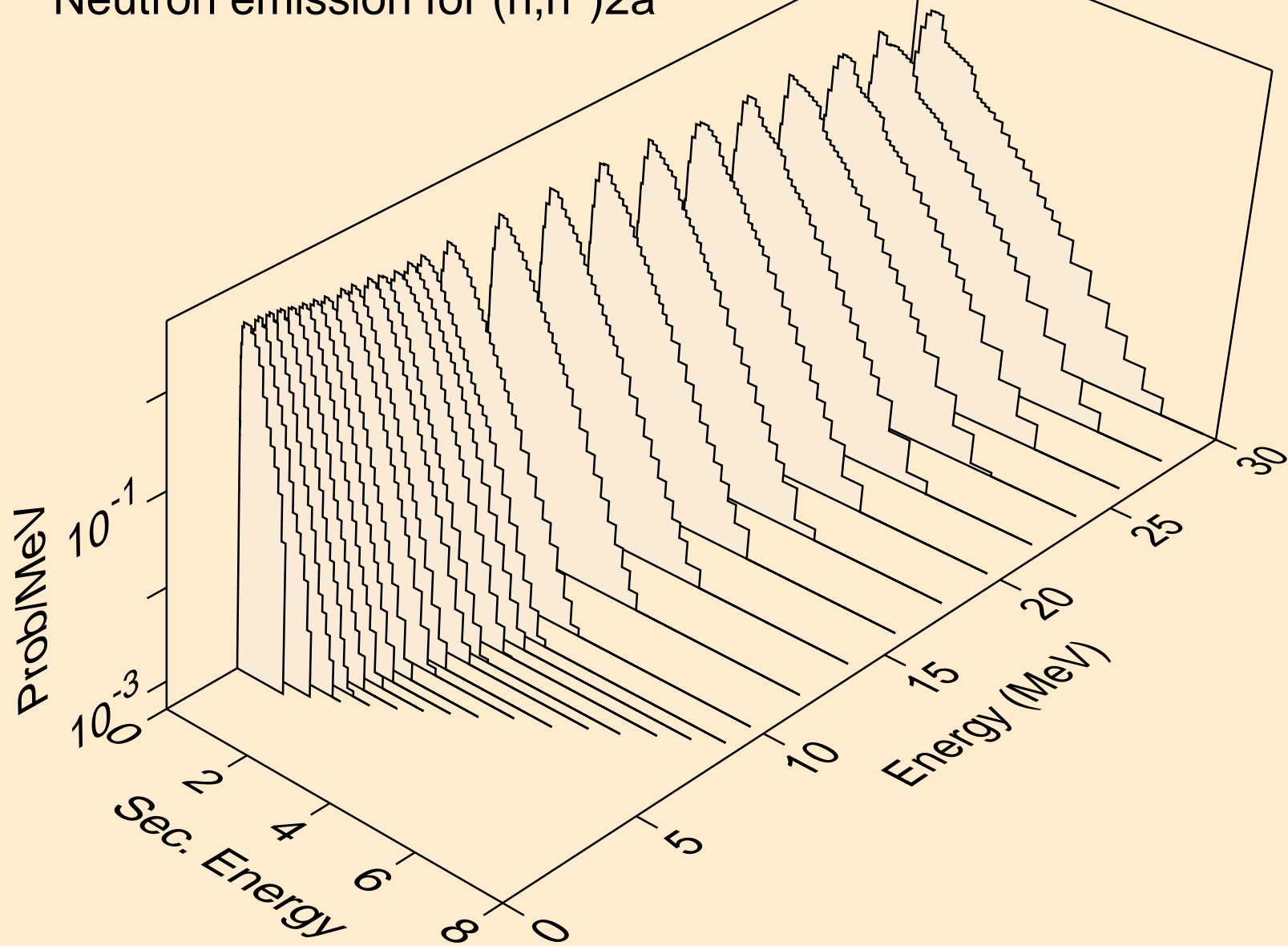

BI192 NEUTRON ACER TENDL-2024 LIBRARY; T=0.K  
Neutron emission for (n,2n)2a

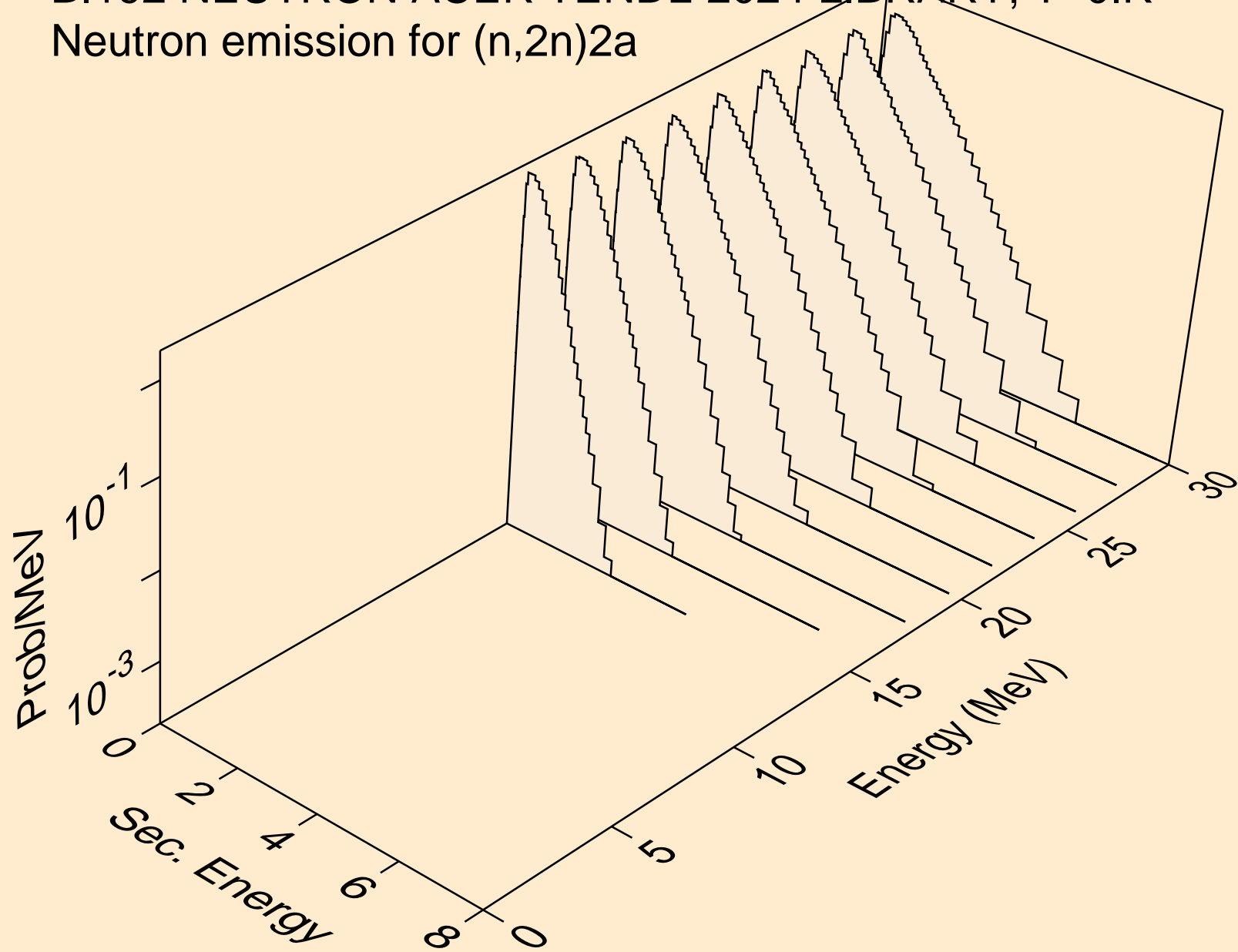



BI192 NEUTRON ACER TENDL-2024 LIBRARY; T=0.K  
Neutron emission for (n,n\*)d

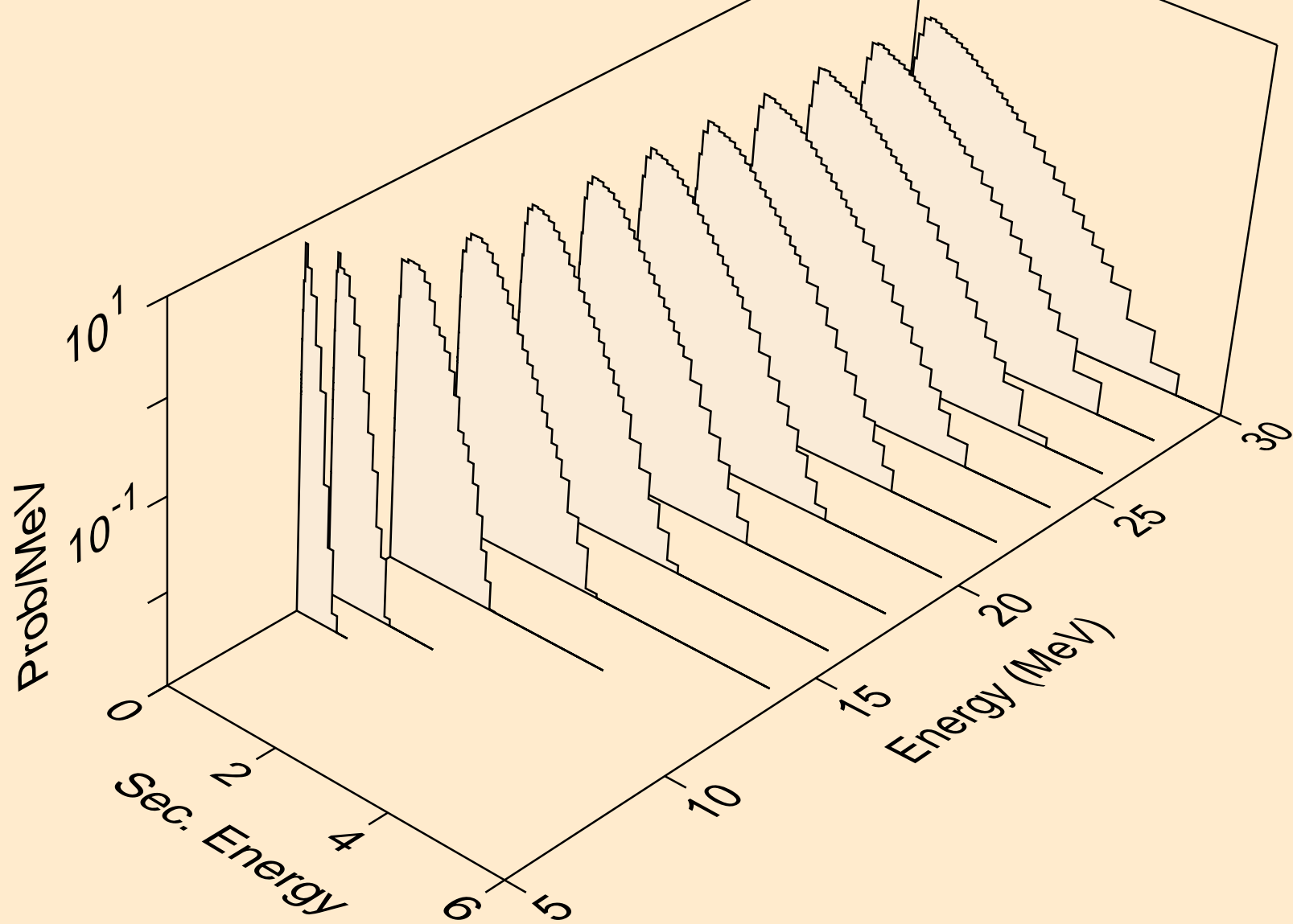

BI192 NEUTRON ACER TENDL-2024 LIBRARY; T=0.K  
Neutron emission for (n,n\*)t

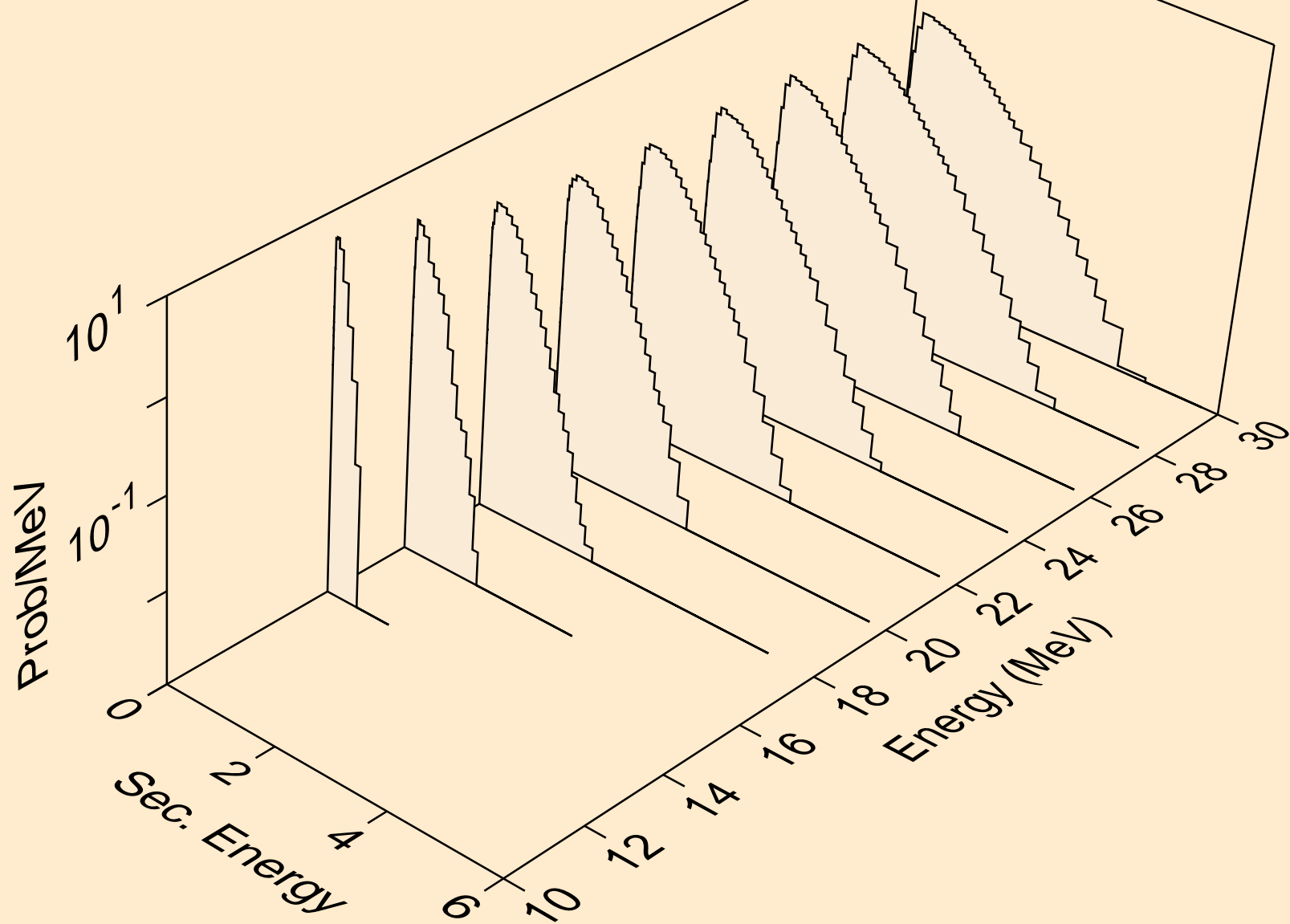

BI192 NEUTRON ACER TENDL-2024 LIBRARY; T=0.K  
Neutron emission for (n,n\*)he3

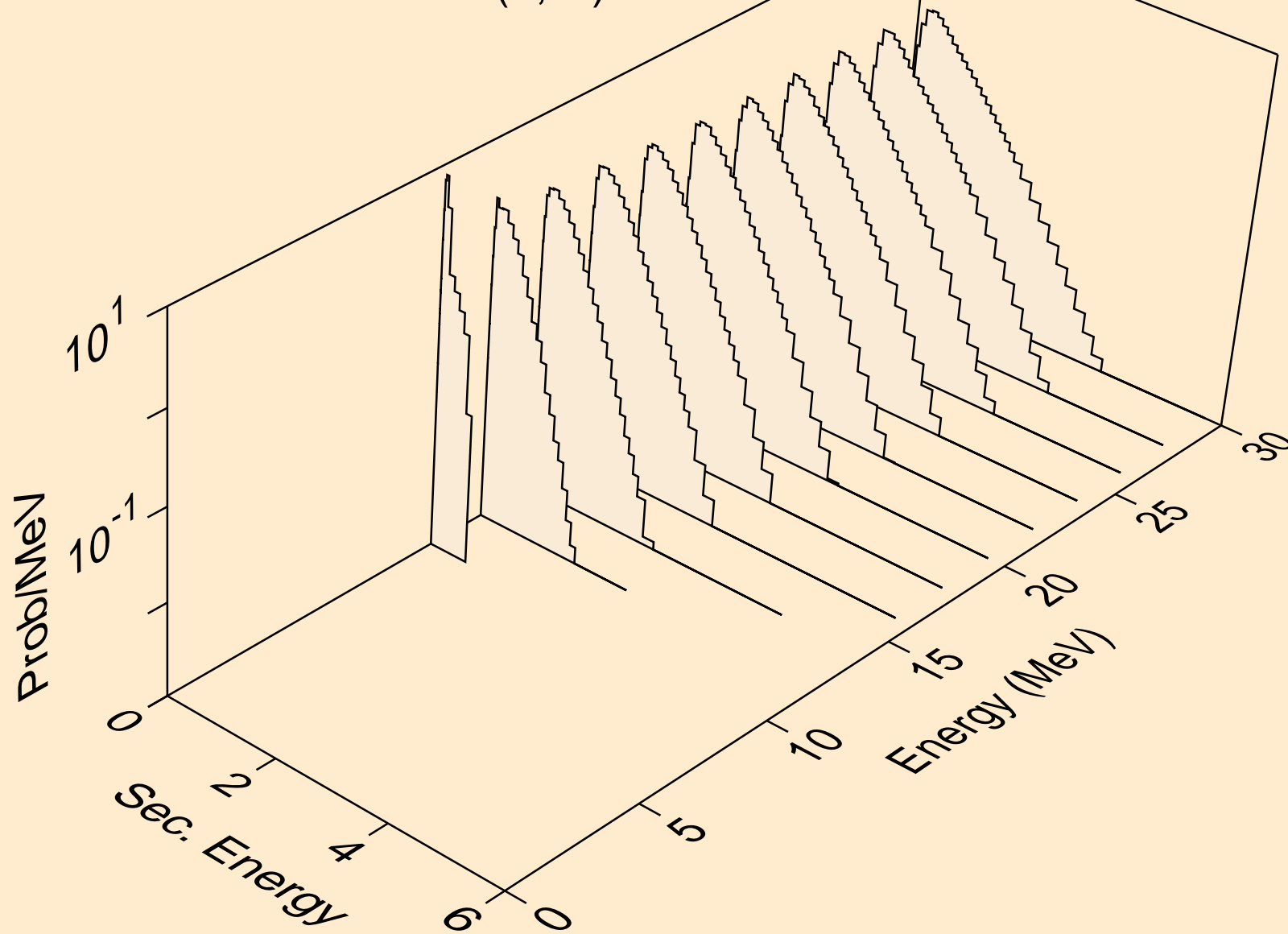

BI192 NEUTRON ACER TENDL-2024 LIBRARY; T=0.K  
Neutron emission for (n,4n)

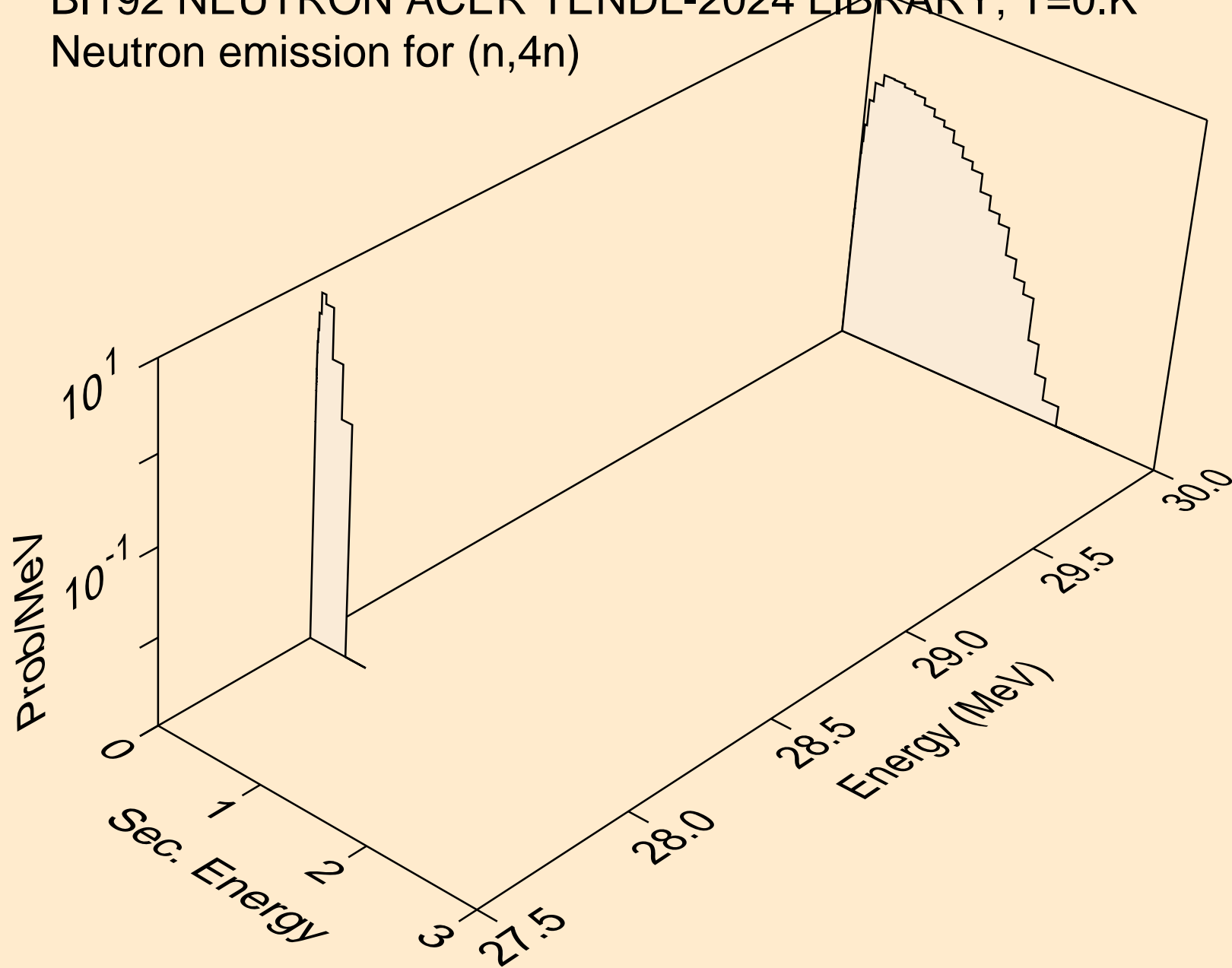

BI192 NEUTRON ACER TENDL-2024 LIBRARY; T=0.K  
Neutron emission for (n,2np)

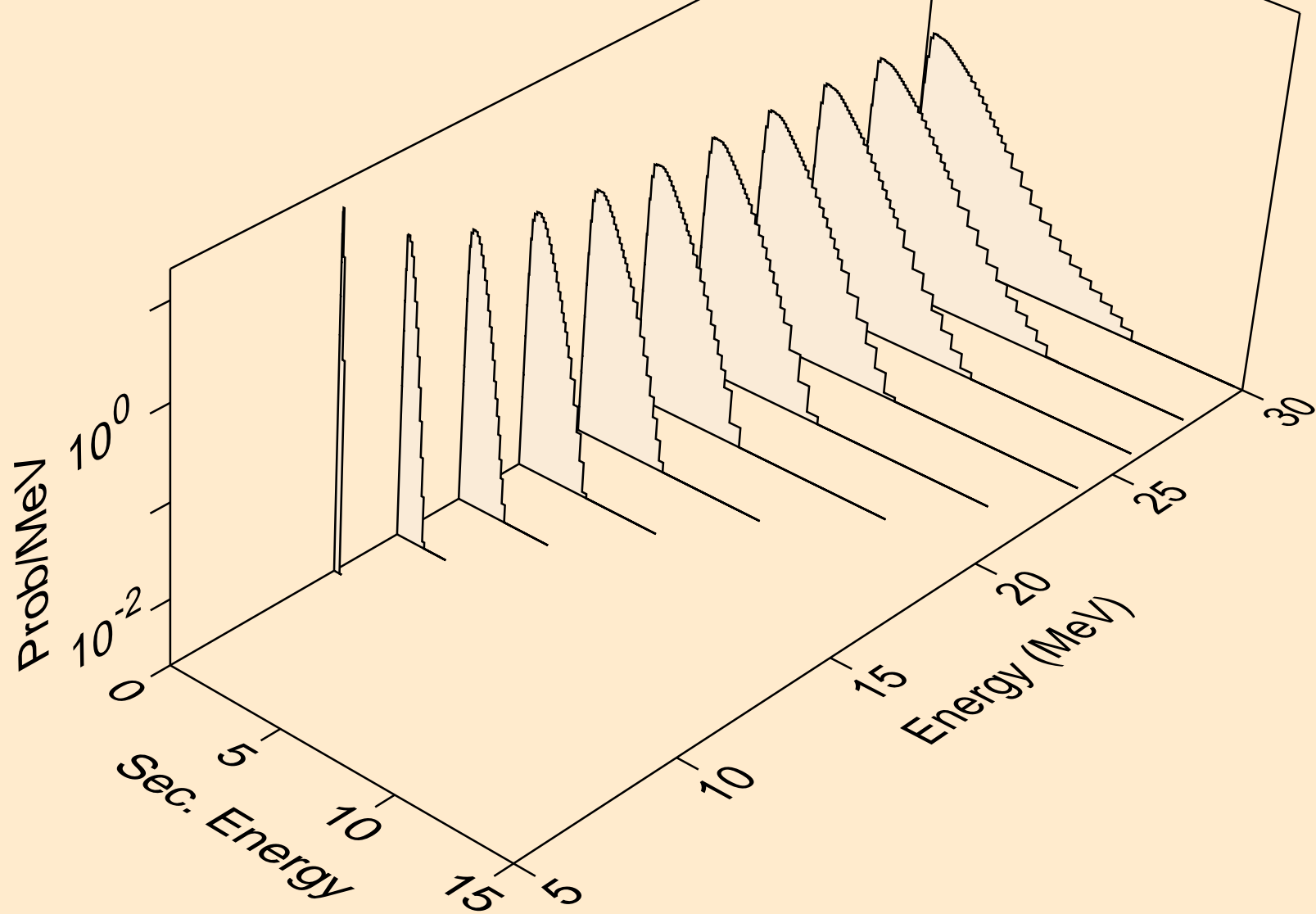

BI192 NEUTRON ACER TENDL-2024 LIBRARY; T=0.K  
Neutron emission for (n,3np)

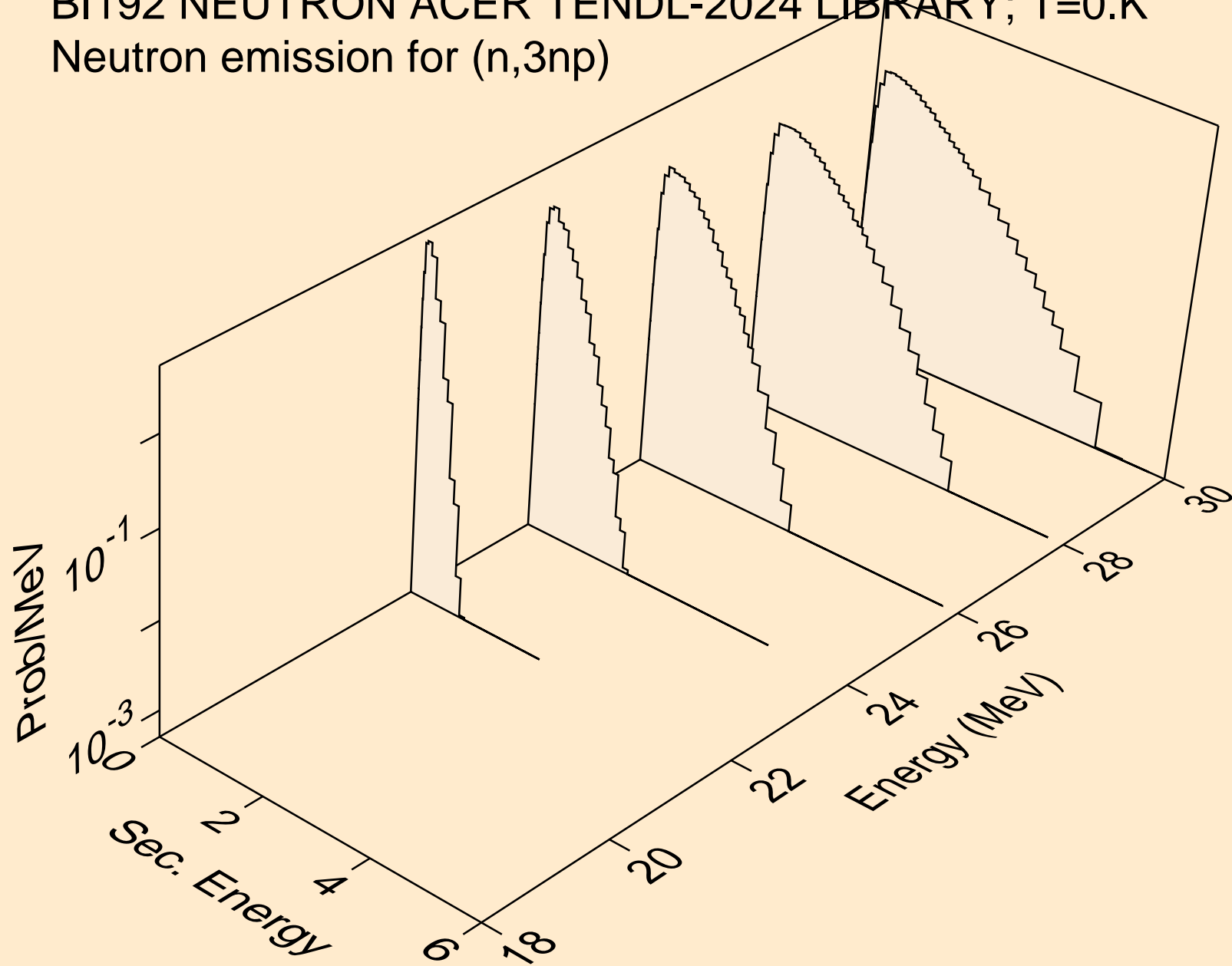

BI192 NEUTRON ACER TENDL-2024 LIBRARY; T=0.K  
Neutron emission for (n,n2p)

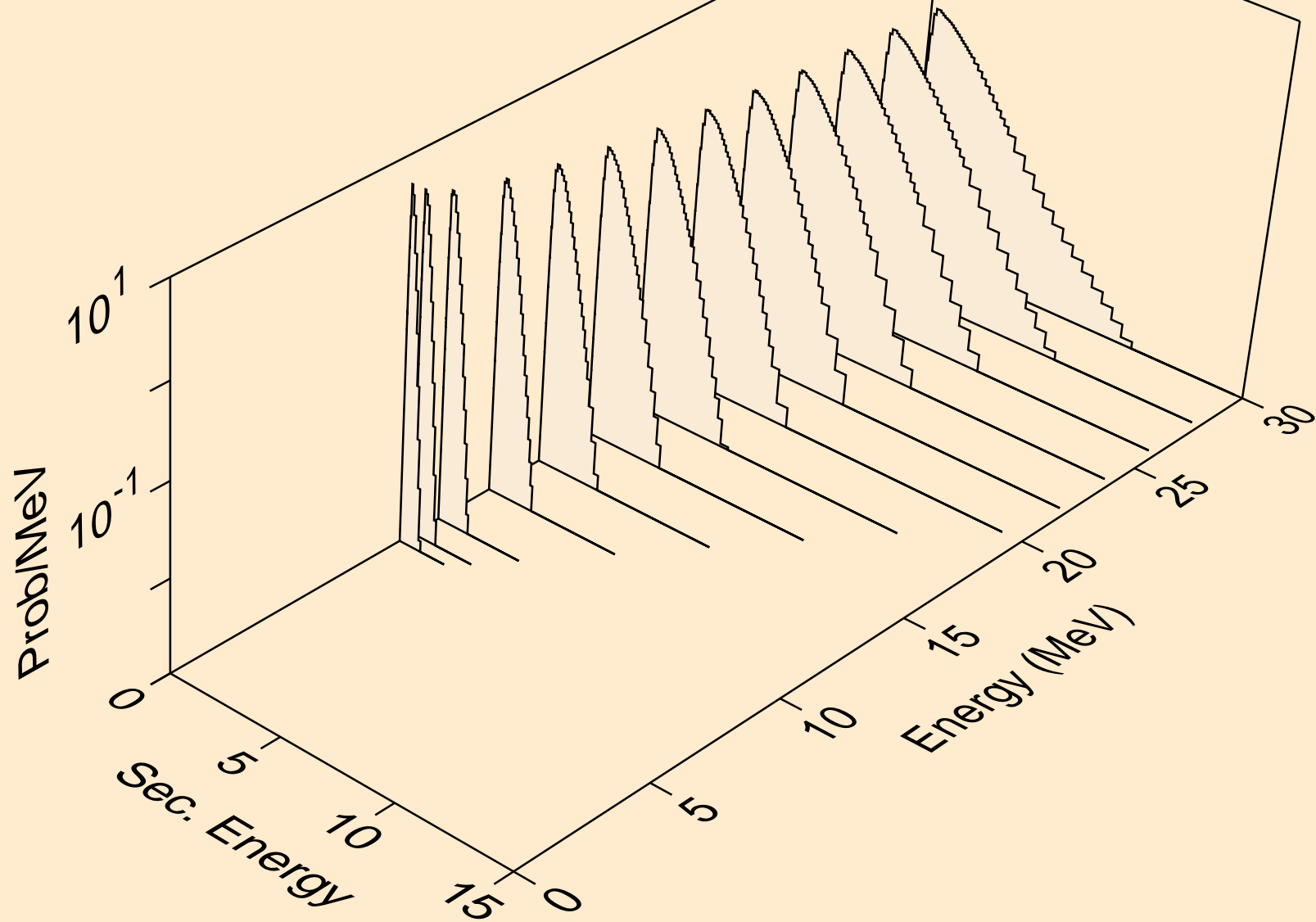

BI192 NEUTRON ACER TENDL-2024 LIBRARY; T=0.K  
Neutron emission for (n,npa)

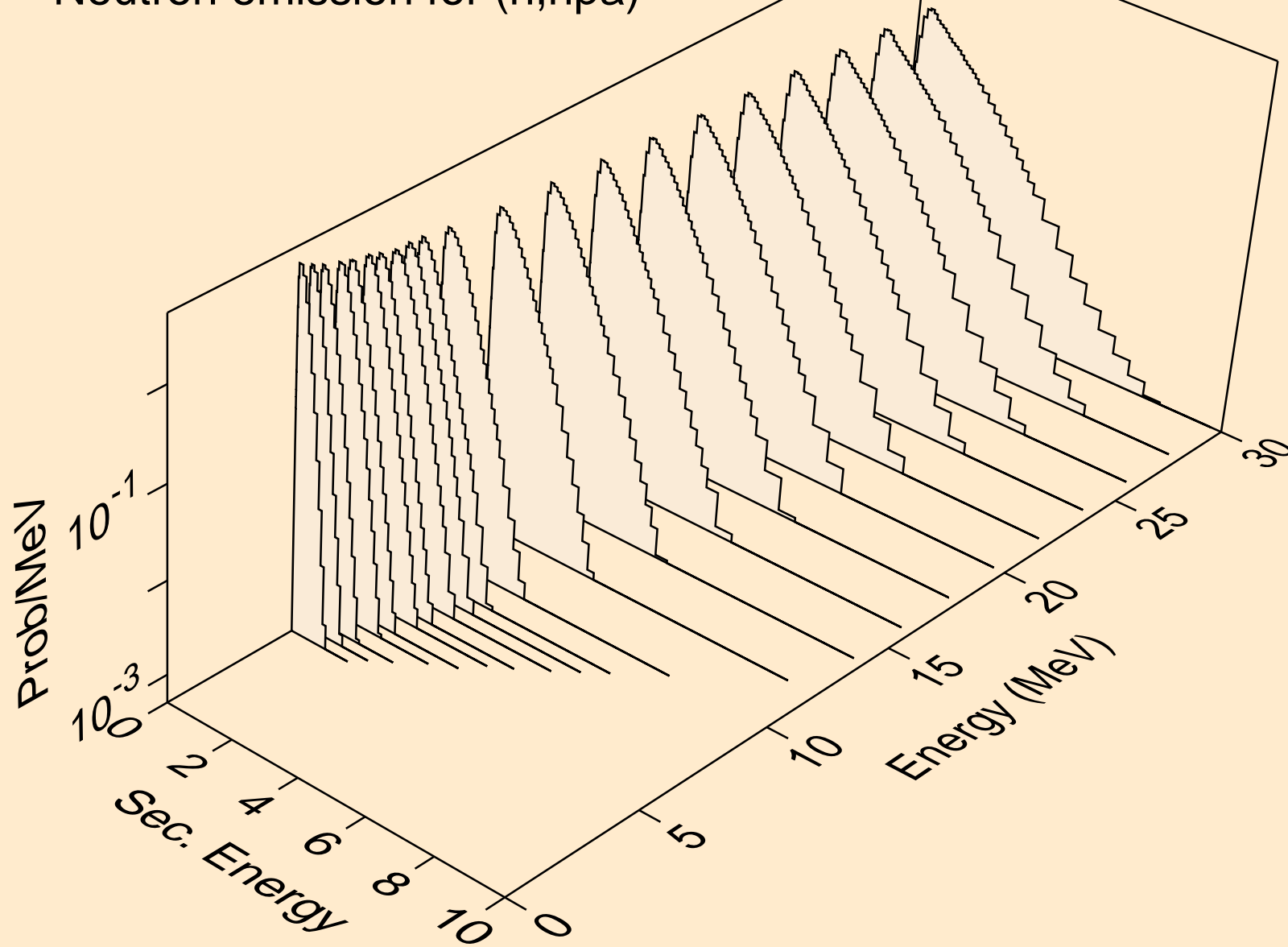



BI192 NEUTRON ACER TENDL-2024 LIBRARY; T=0.K  
Neutron emission for (n,n\*c)

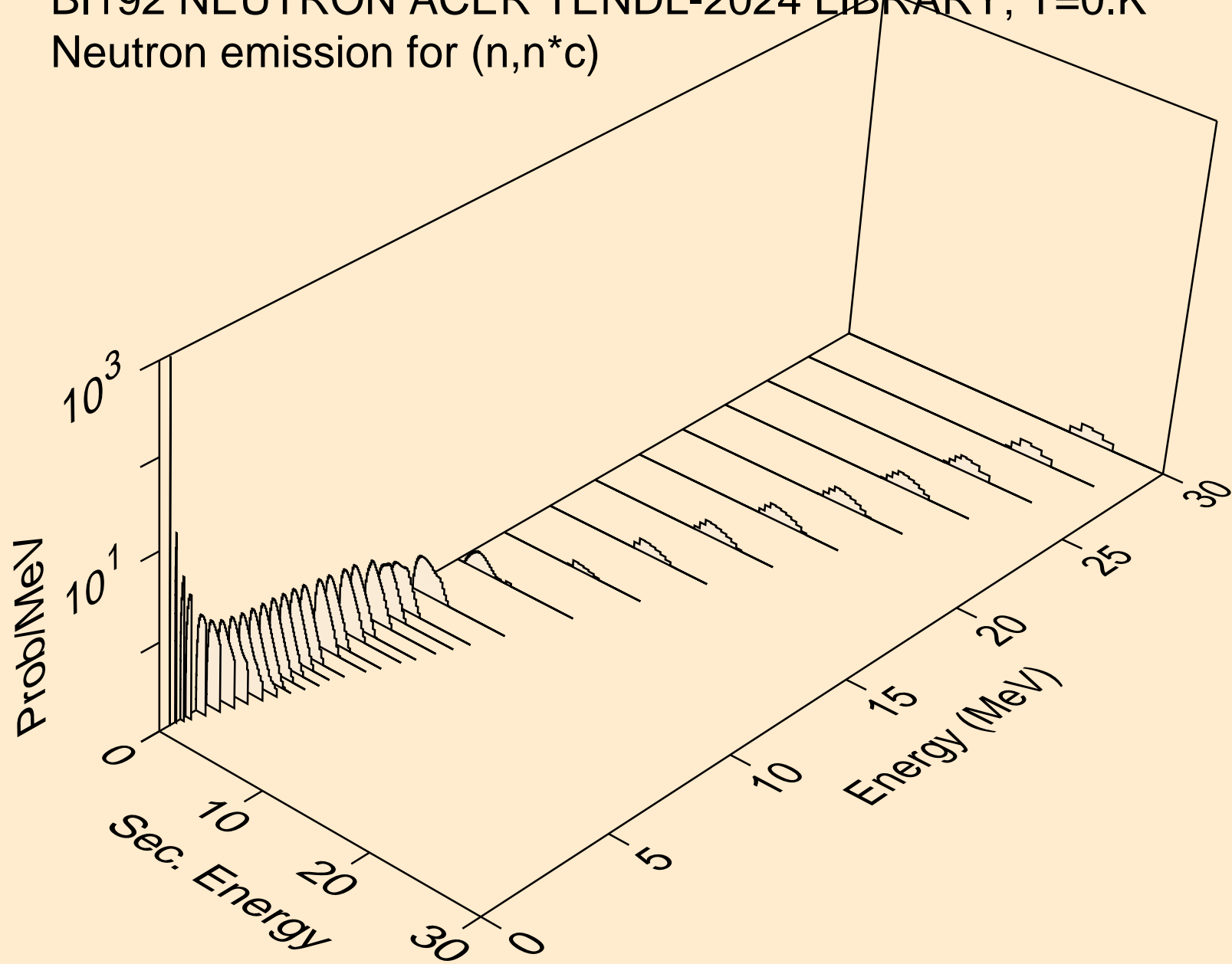

BI192 NEUTRON ACER TENDL-2024 LIBRARY; T=0.K  
Photon emission for (n,x)

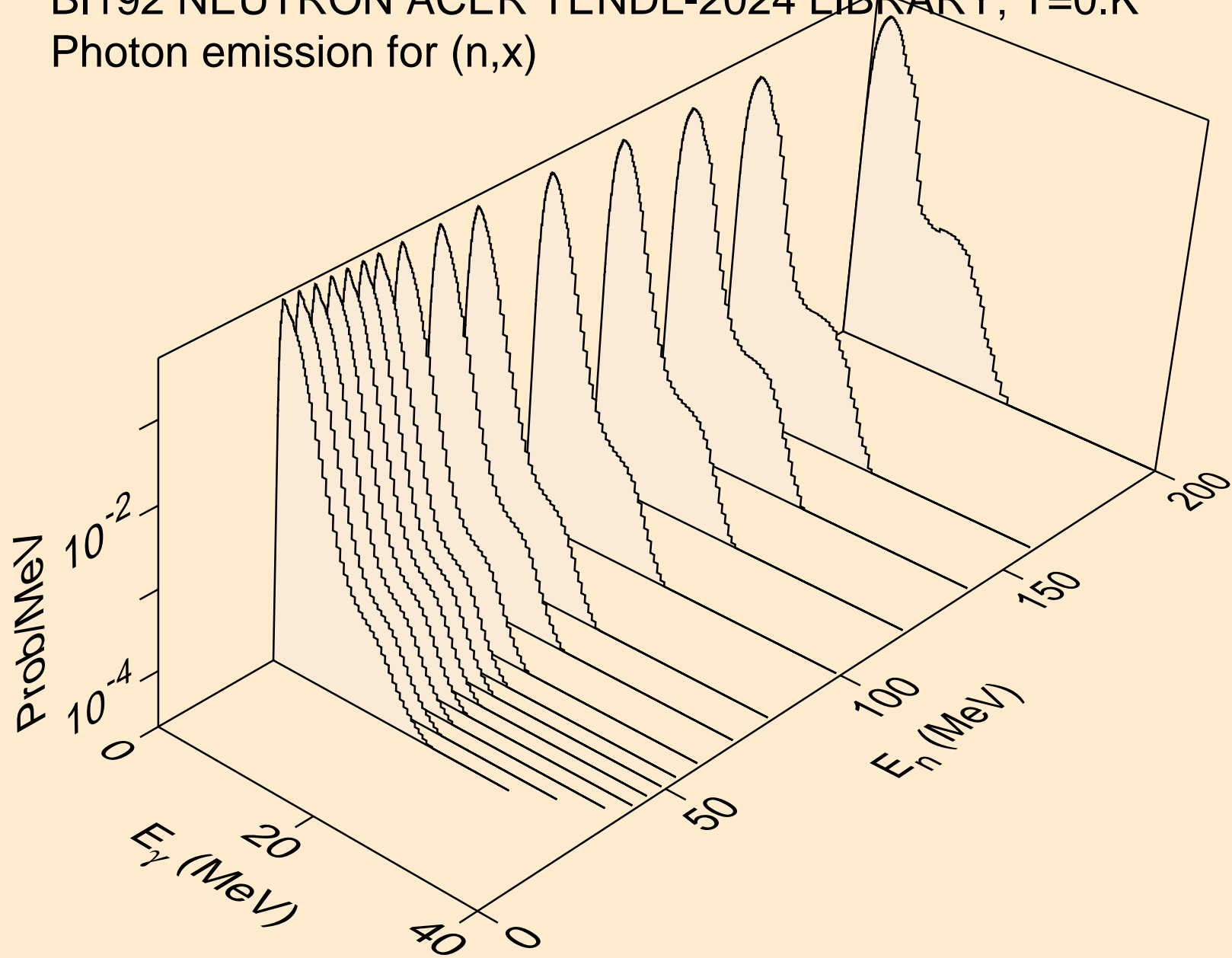

BI192 NEUTRON ACER TENDL-2024 LIBRARY; T=0.K  
Photon emission for (n,2nd)

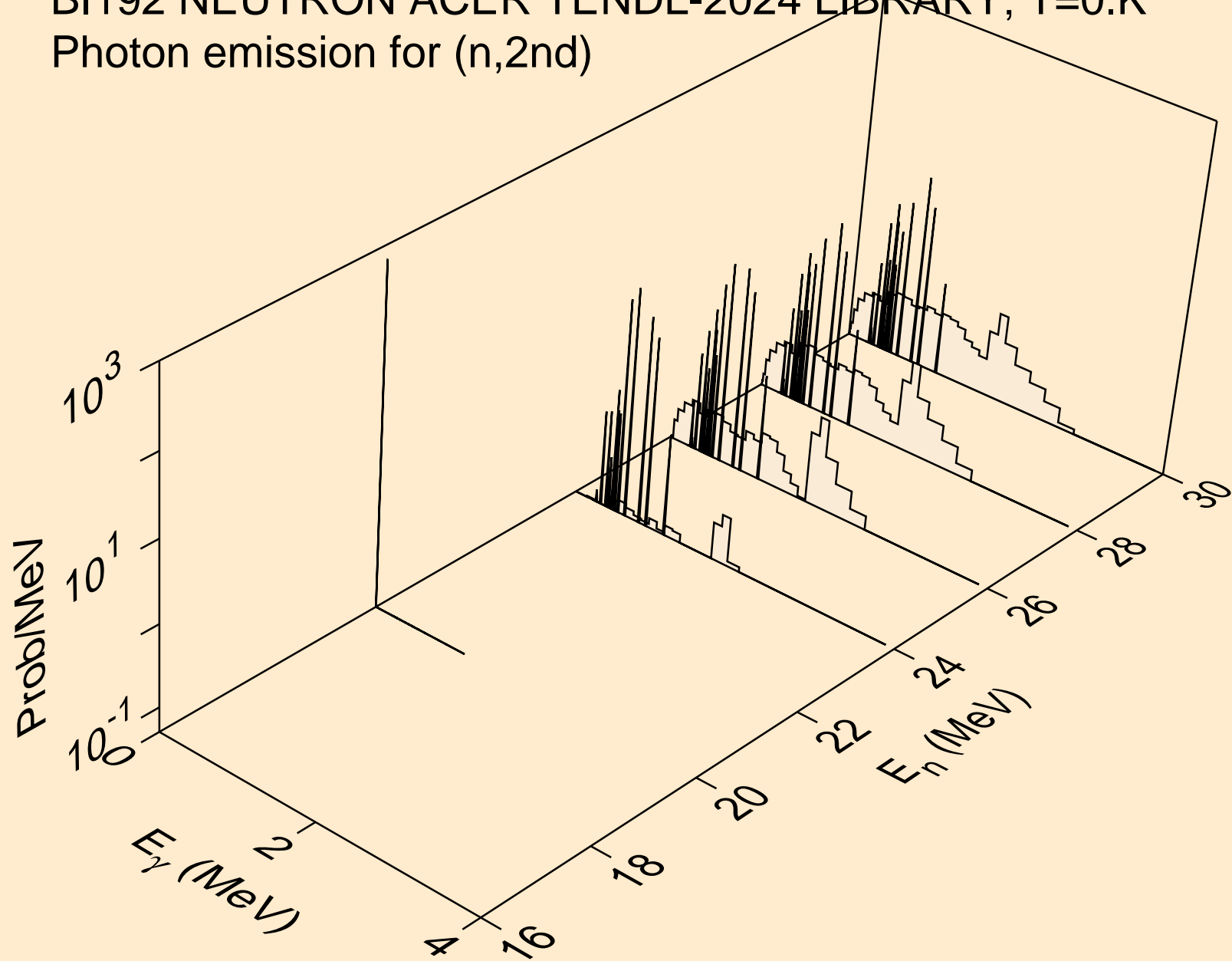

BI192 NEUTRON ACER TENDL-2024 LIBRARY; T=0.K  
Photon emission for (n,2n)

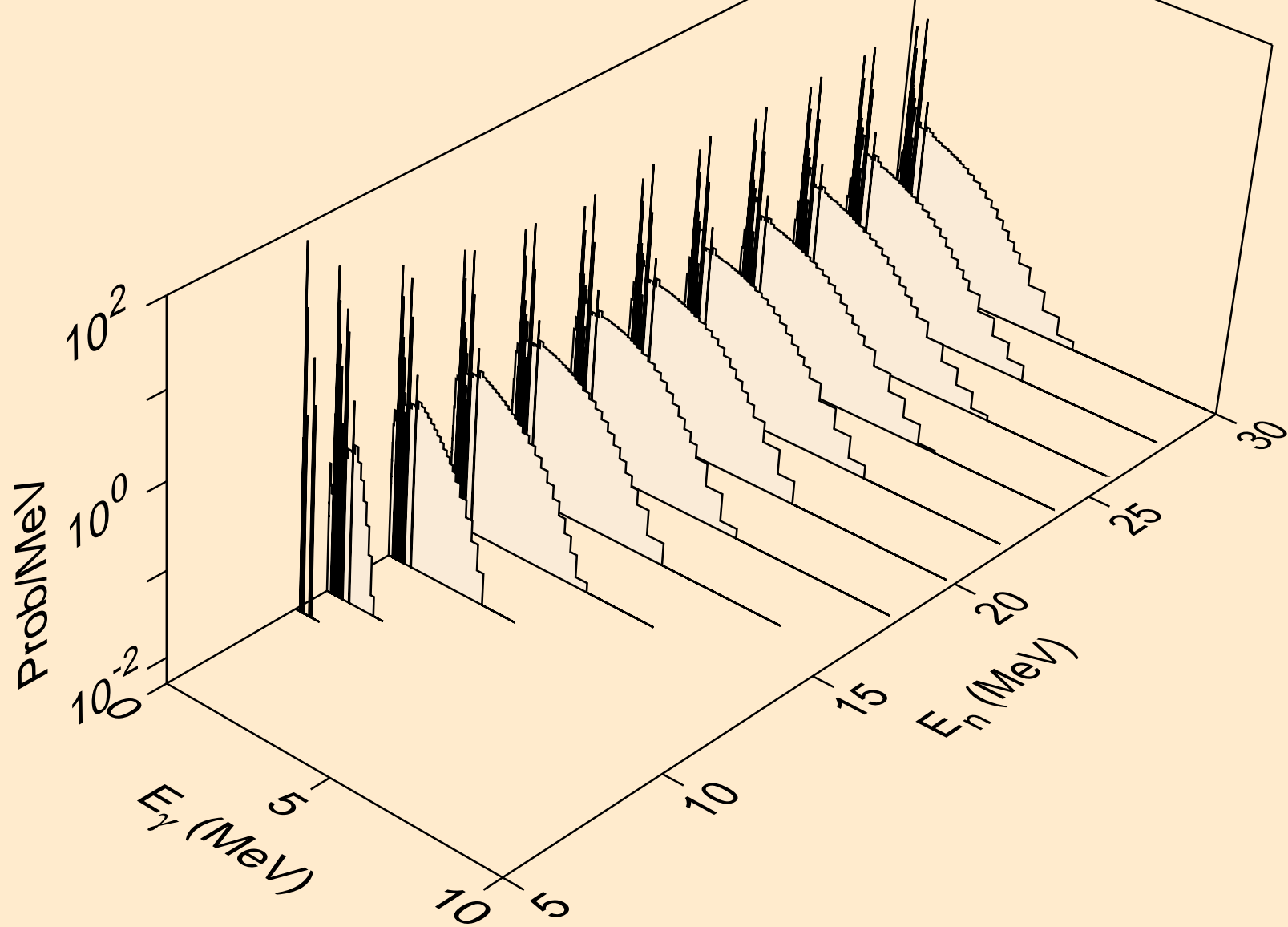

BI192 NEUTRON ACER TENDL-2024 LIBRARY; T=0.K  
Photon emission for (n,3n)

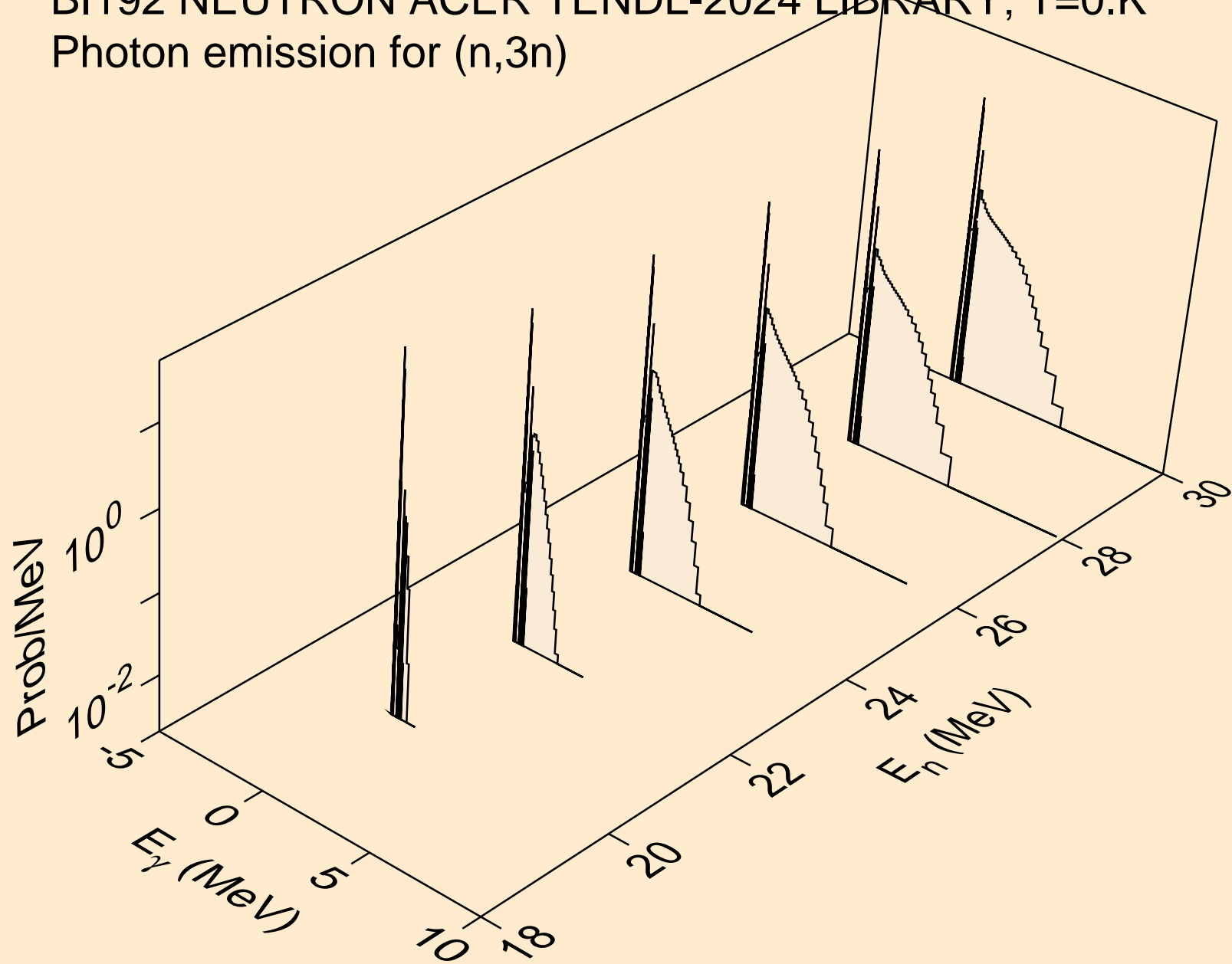

BI192 NEUTRON ACER TENDL-2024 LIBRARY; T=0.K  
Photon emission for (n,n\*)a

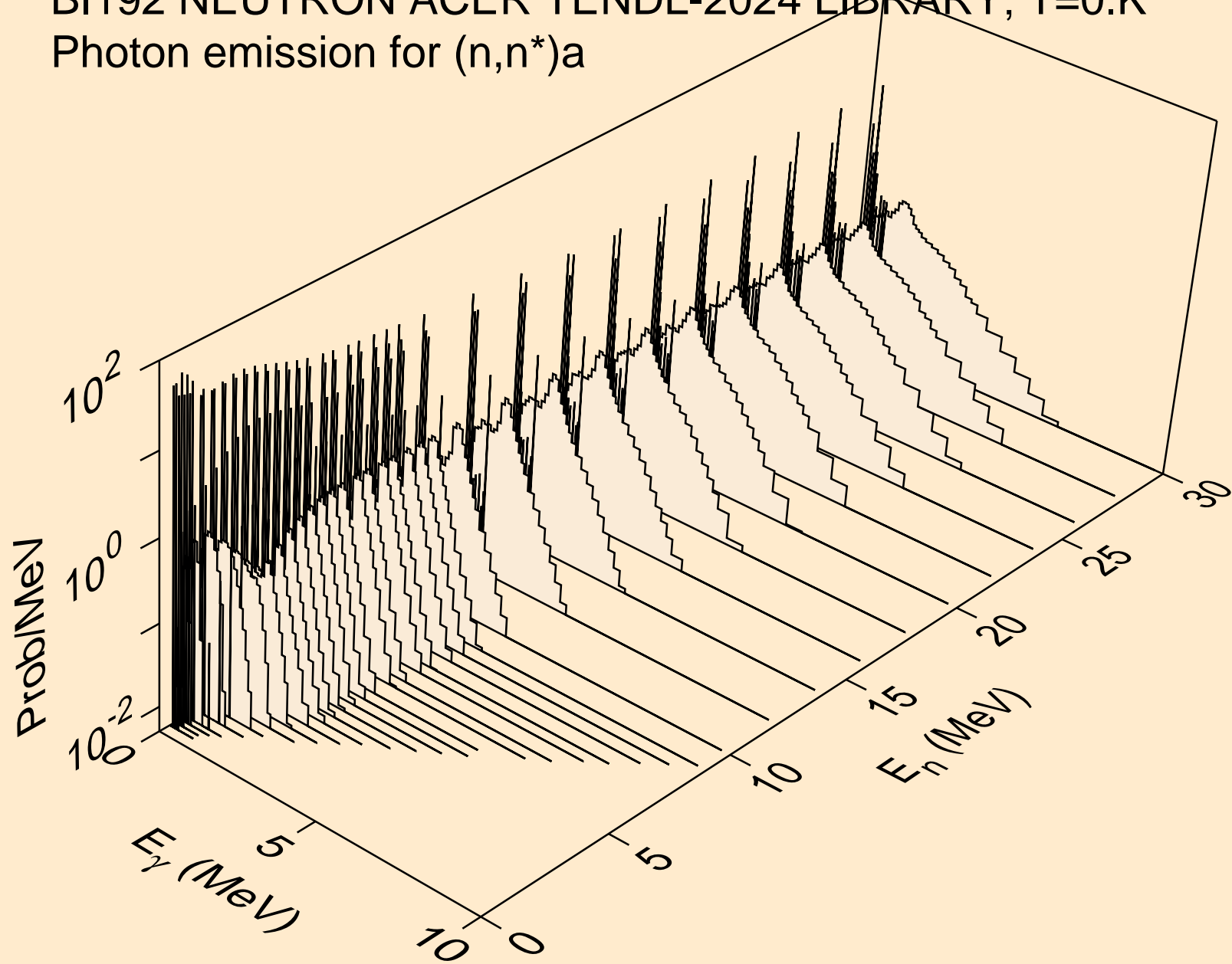

BI192 NEUTRON ACER TENDL-2024 LIBRARY; T=0.K  
Photon emission for (n,2n)a

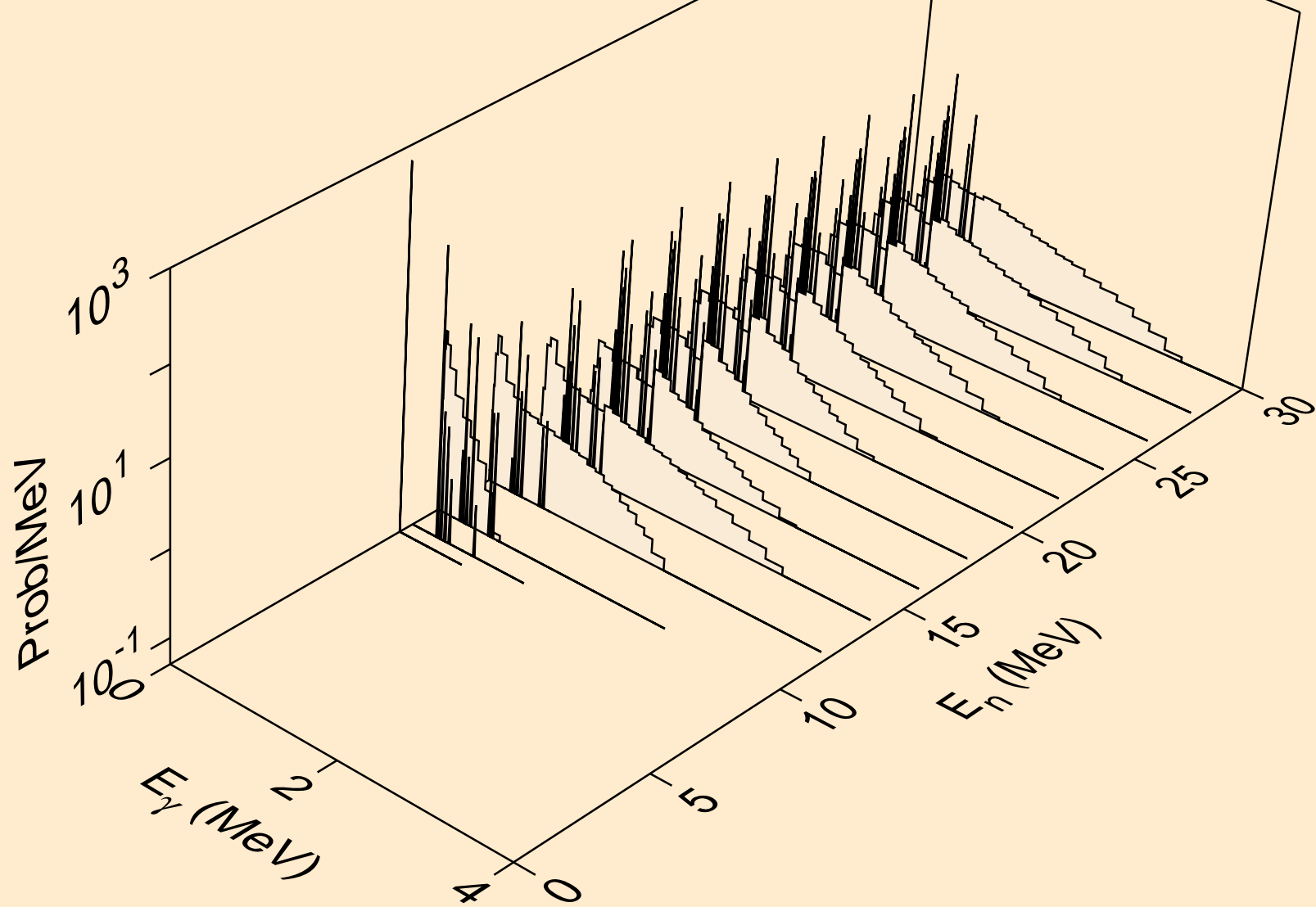

BI192 NEUTRON ACER TENDL-2024 LIBRARY; T=0.K  
Photon emission for (n,3n)a

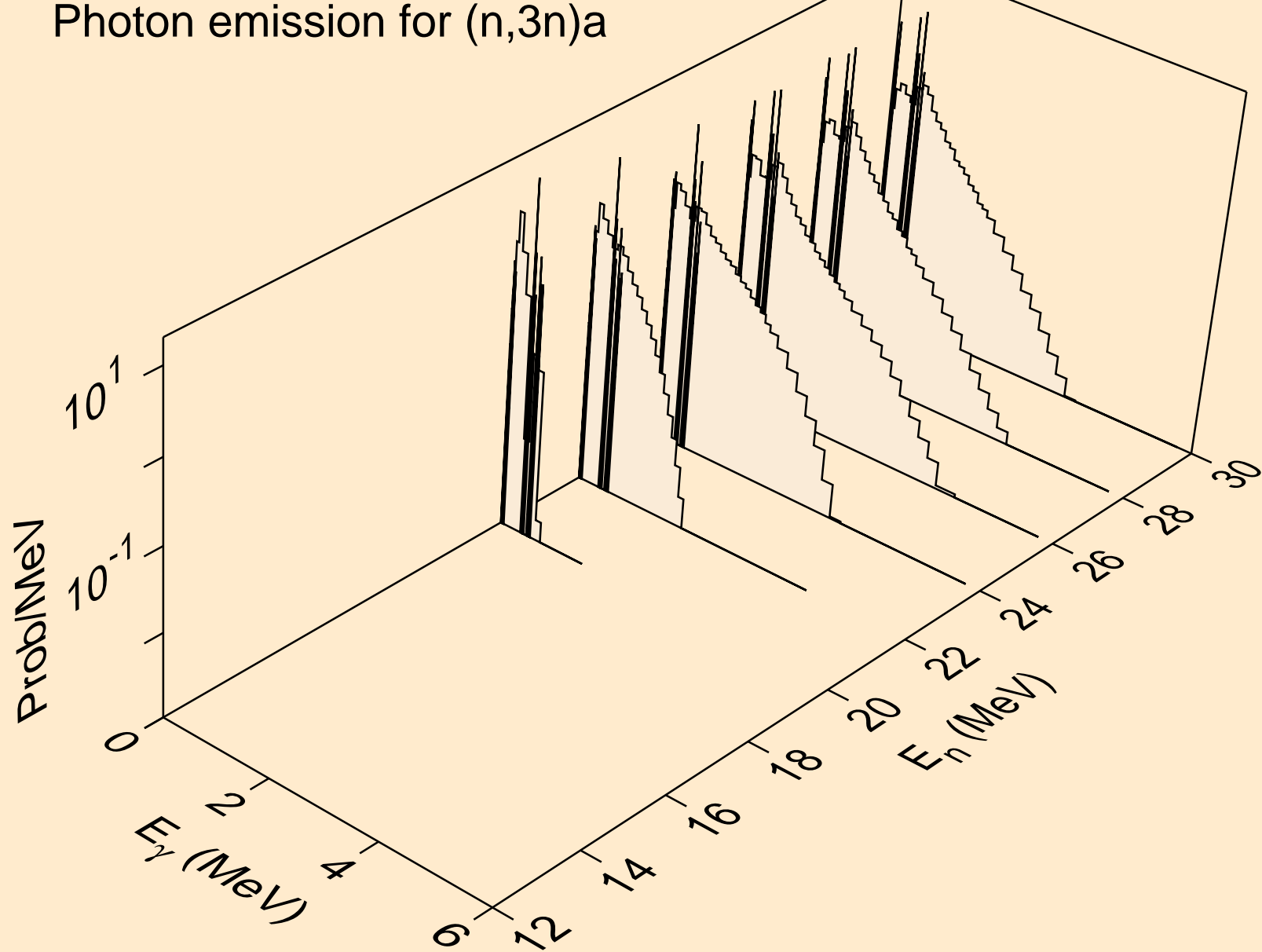



BI192 NEUTRON ACER TENDL-2024 LIBRARY; T=0.K  
Photon emission for (n,n\*)p

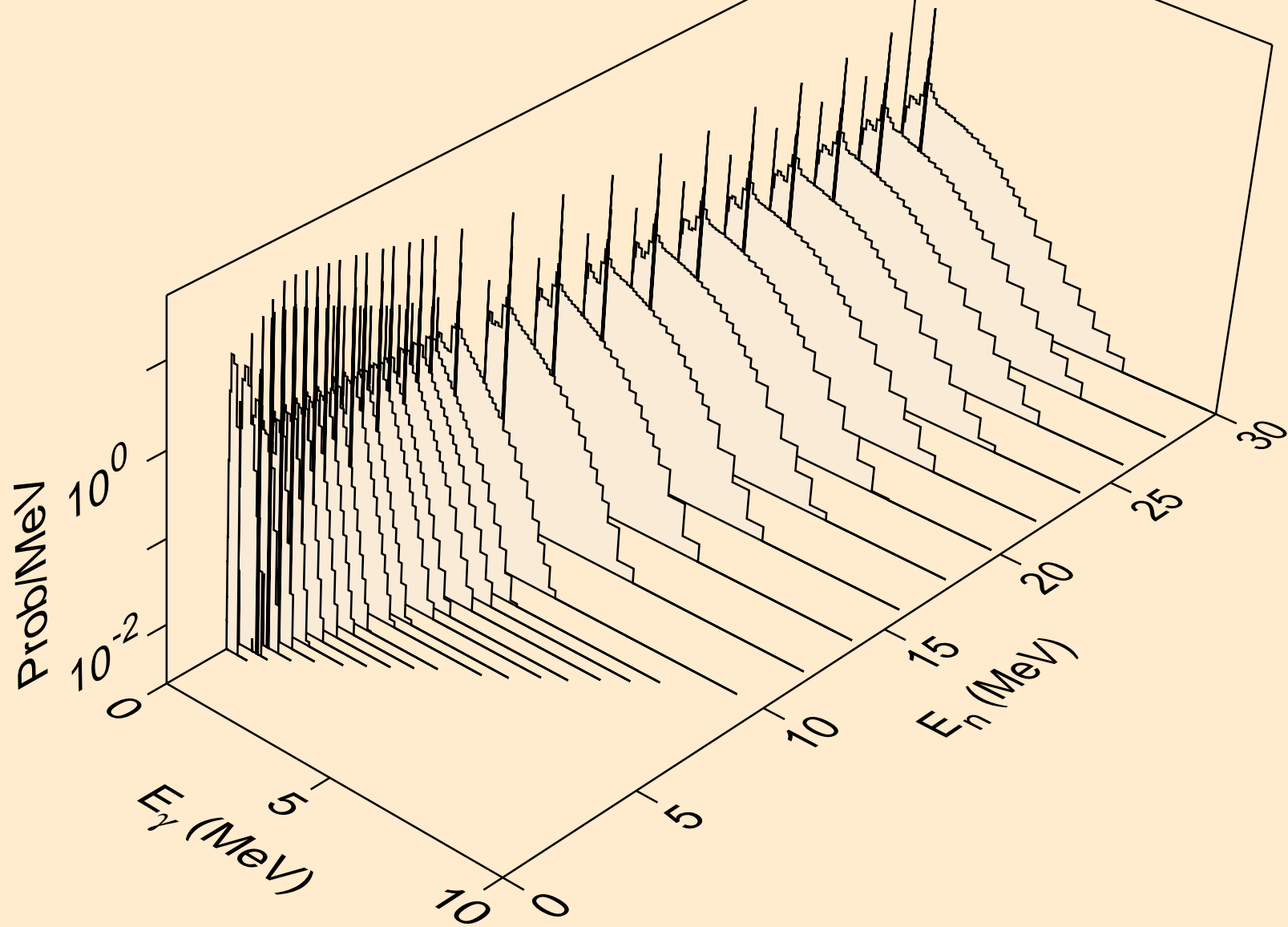

BI192 NEUTRON ACER TENDL-2024 LIBRARY; T=0.K  
Photon emission for (n,n\*)2a

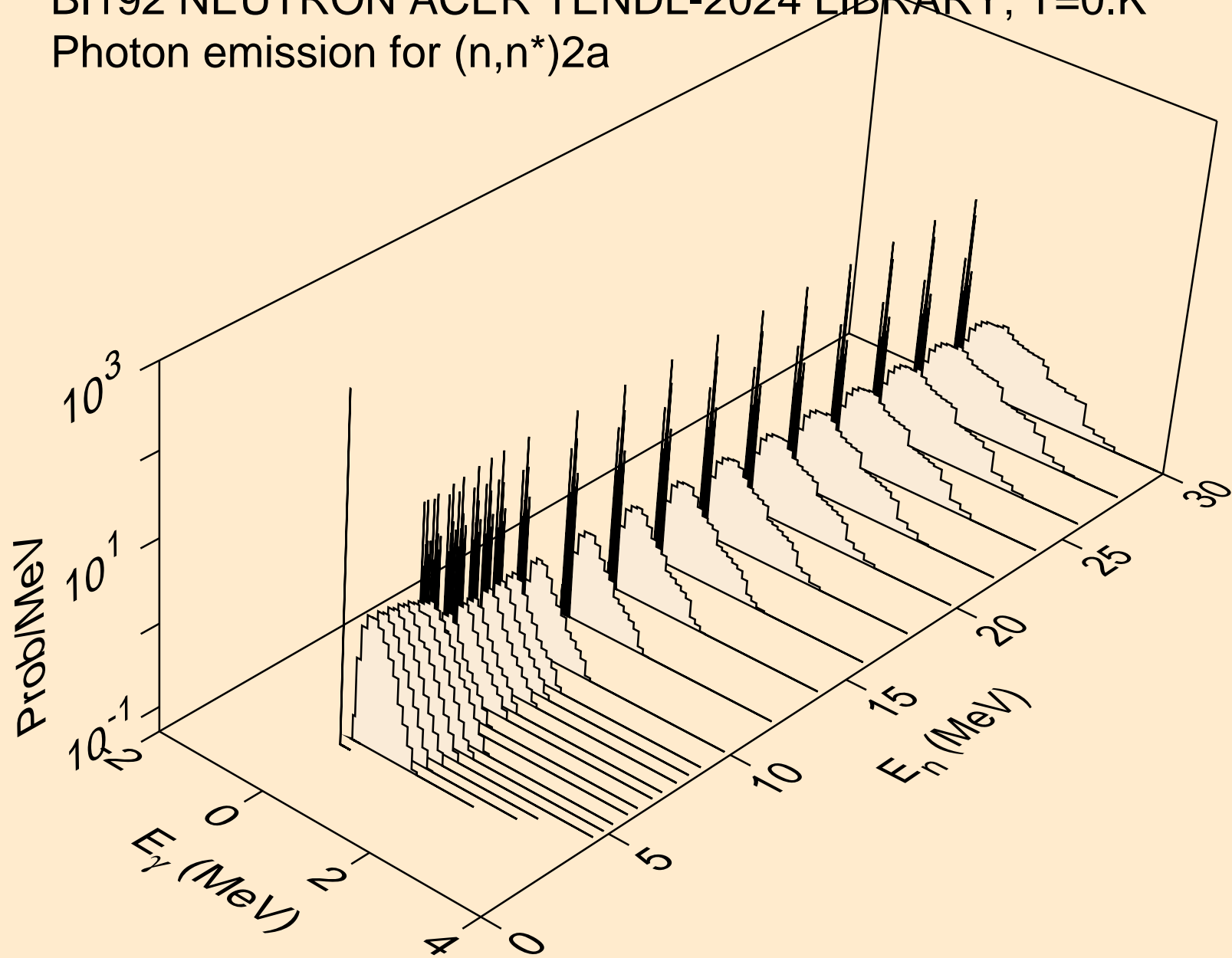

BI192 NEUTRON ACER TENDL-2024 LIBRARY; T=0.K  
Photon emission for (n,2n)2a

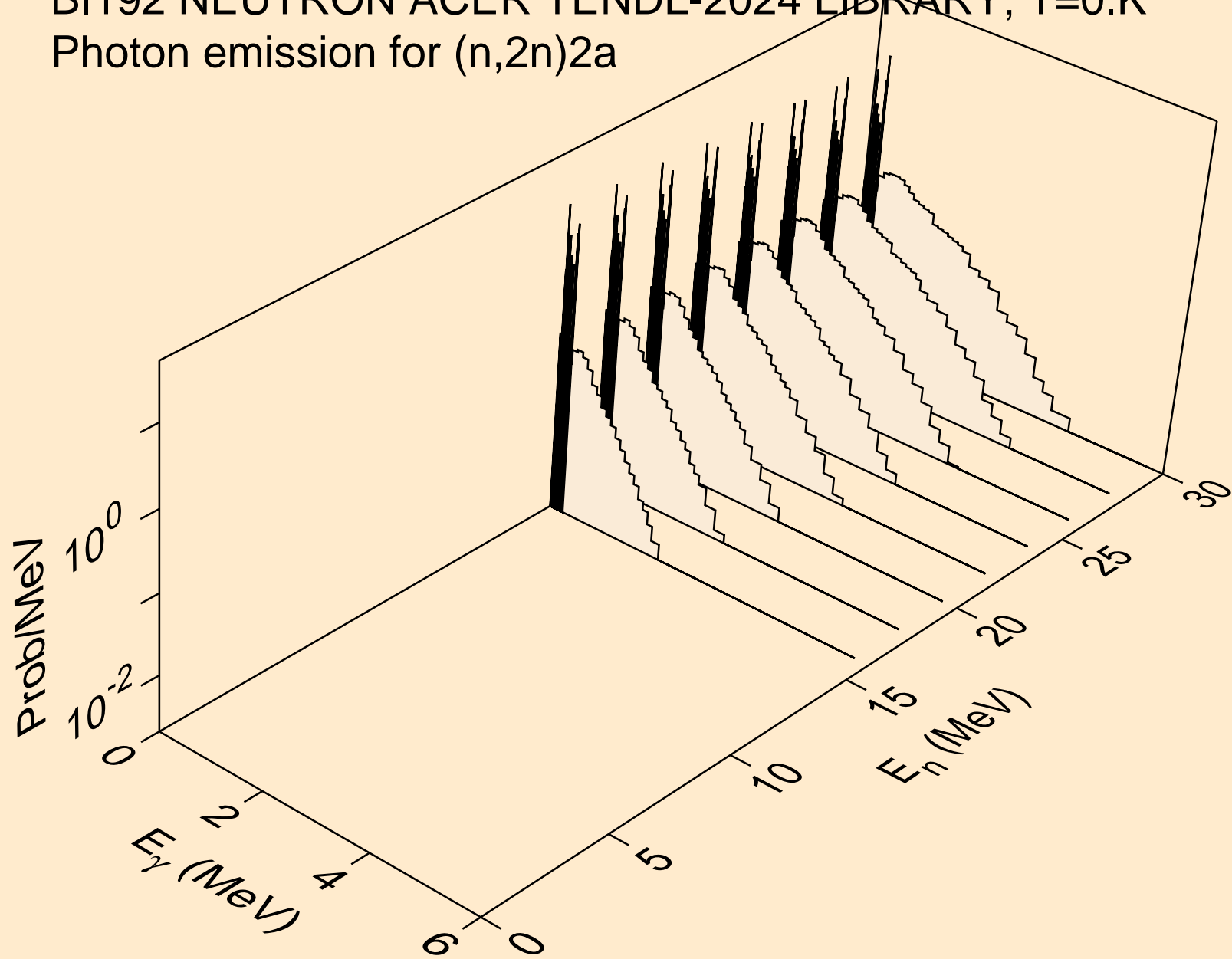

BI192 NEUTRON ACER TENDL-2024 LIBRARY; T=0.K  
Photon emission for (n,n\*)d

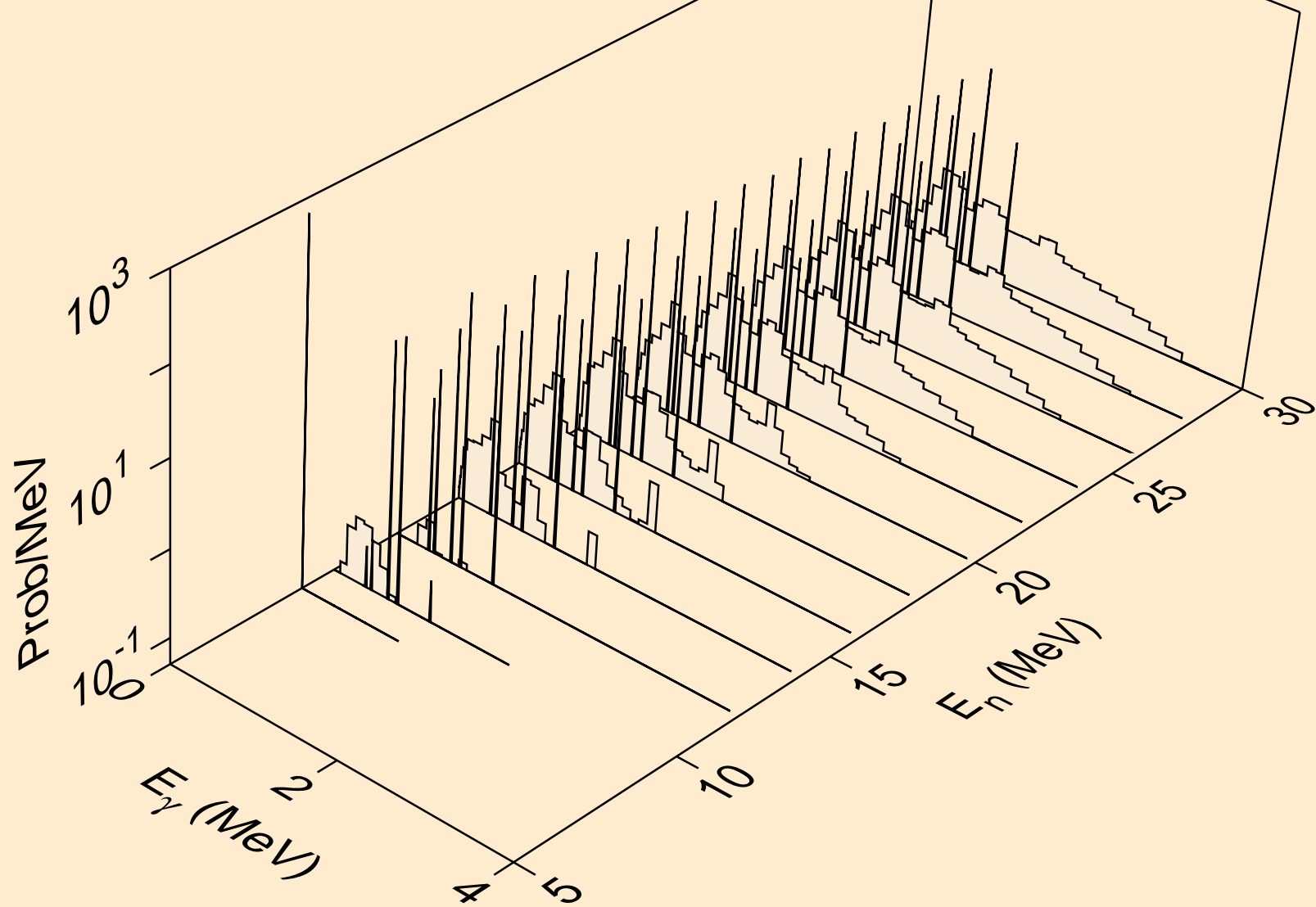

BI192 NEUTRON ACER TENDL-2024 LIBRARY; T=0.K  
Photon emission for (n,n\*)t

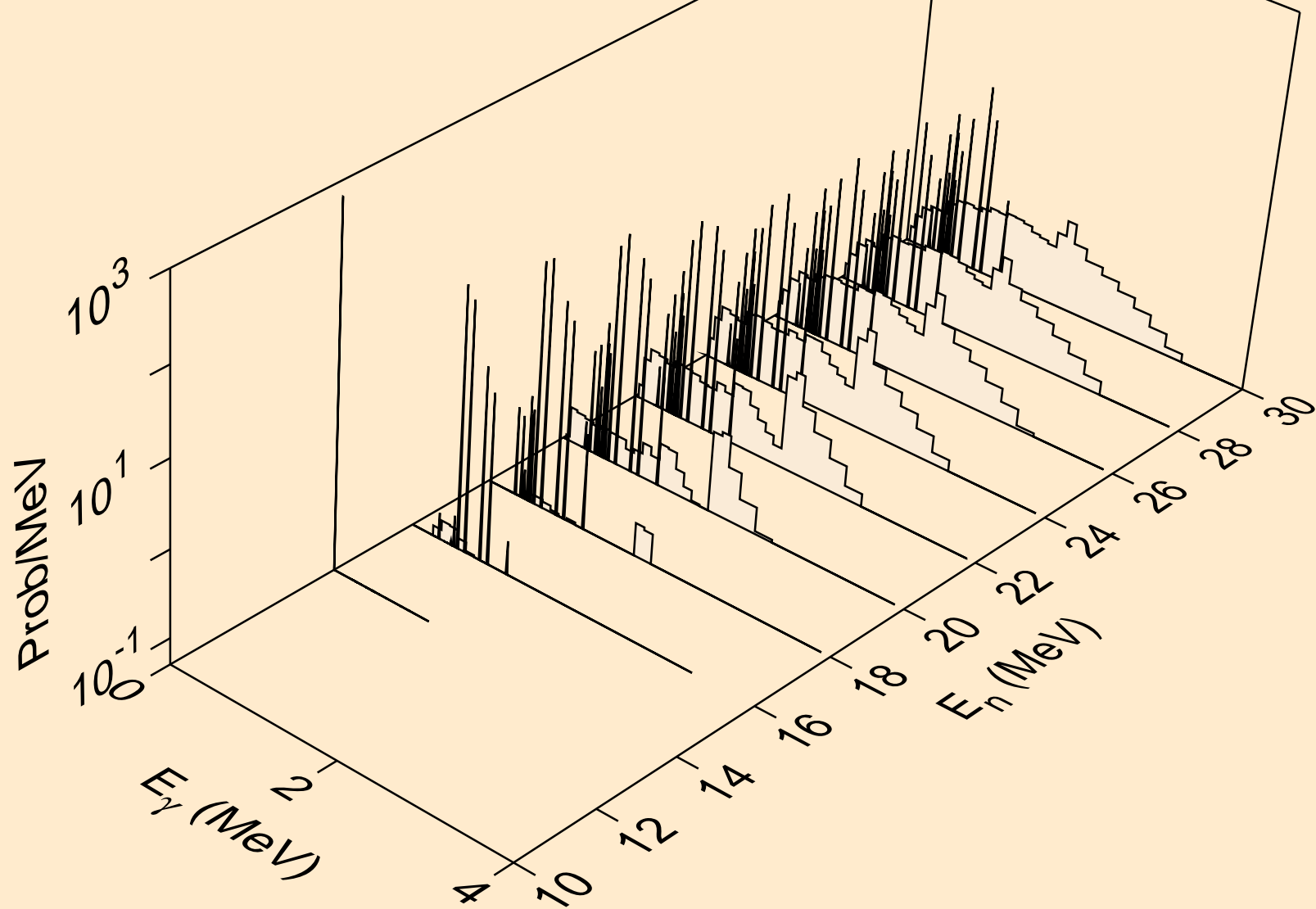

BI192 NEUTRON ACER TENDL-2024 LIBRARY; T=0.K  
Photon emission for (n,n\*)he3

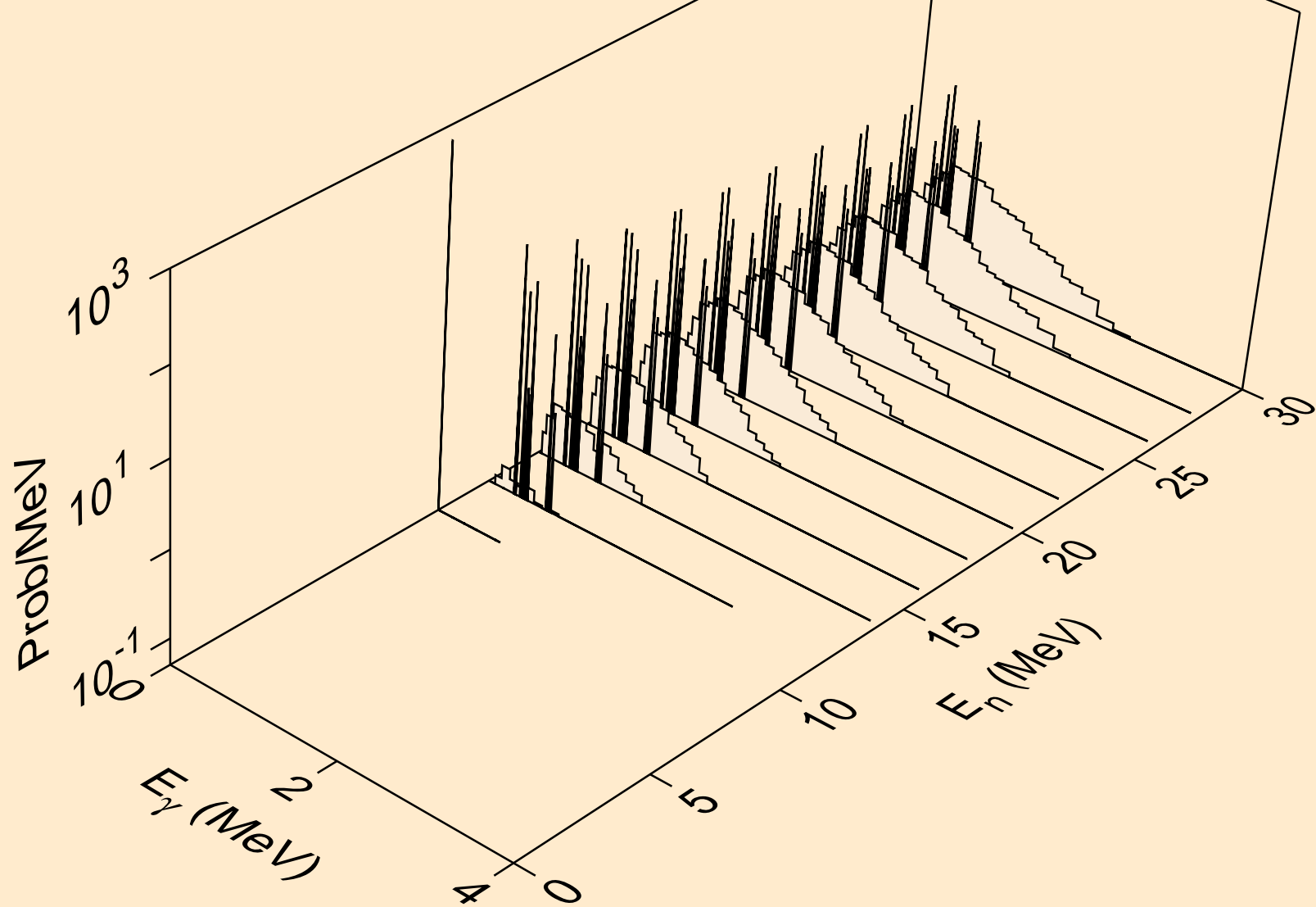

BI192 NEUTRON ACER TENDL-2024 LIBRARY; T=0.K  
Photon emission for (n,4n)

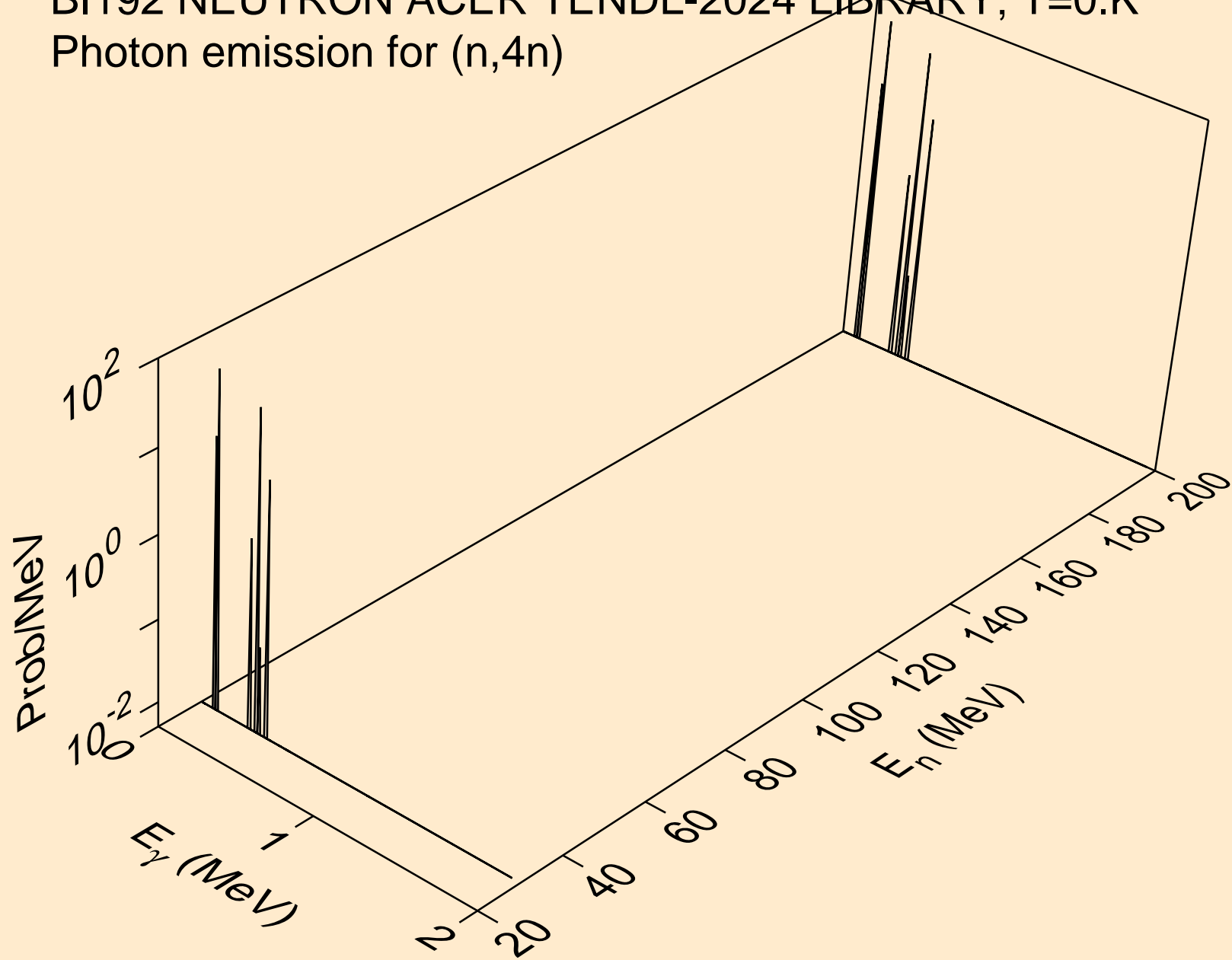

BI192 NEUTRON ACER TENDL-2024 LIBRARY; T=0.K  
Photon emission for (n,2np)

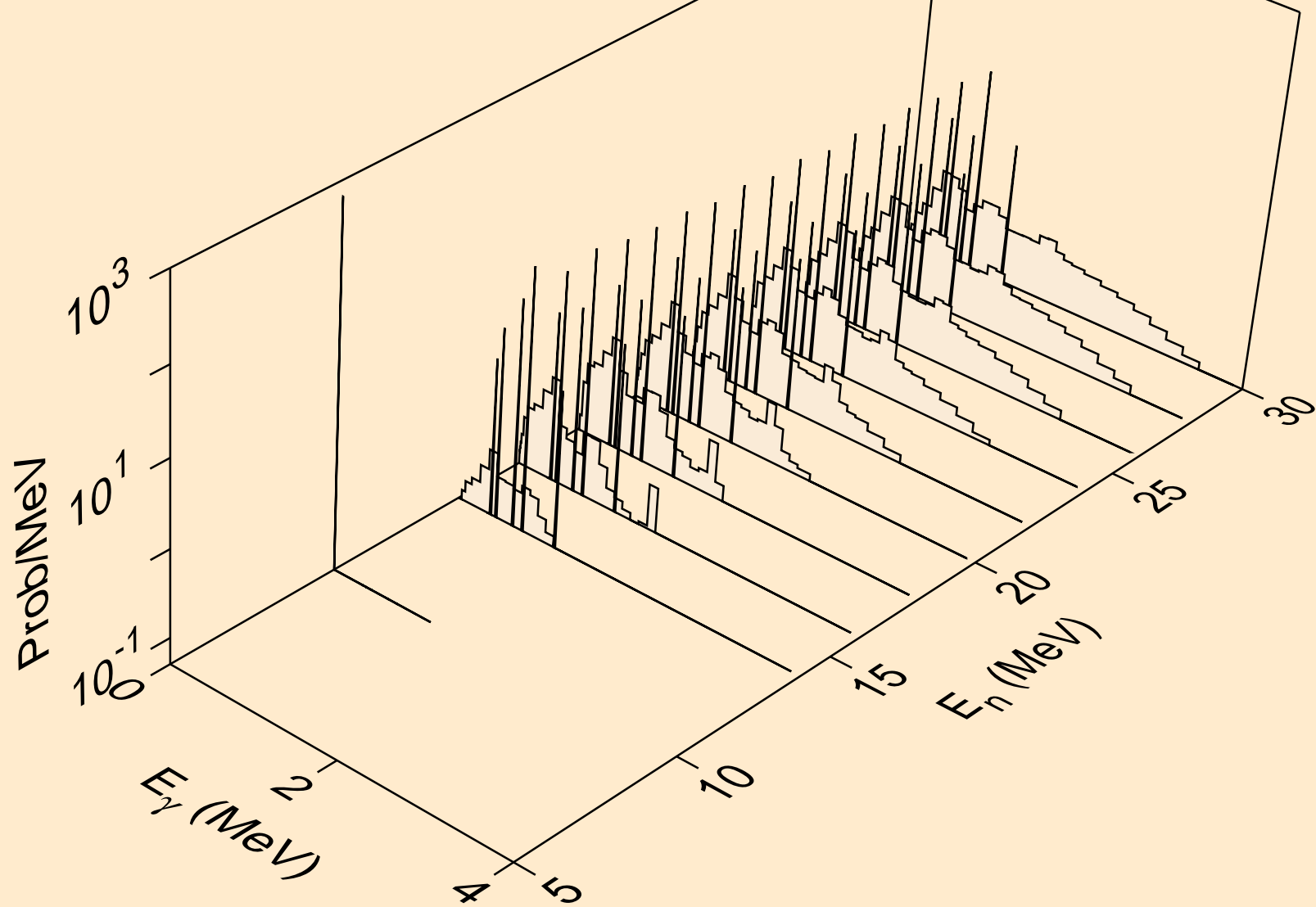



BI192 NEUTRON ACER TENDL-2024 LIBRARY; T=0.K  
Photon emission for (n,3np)

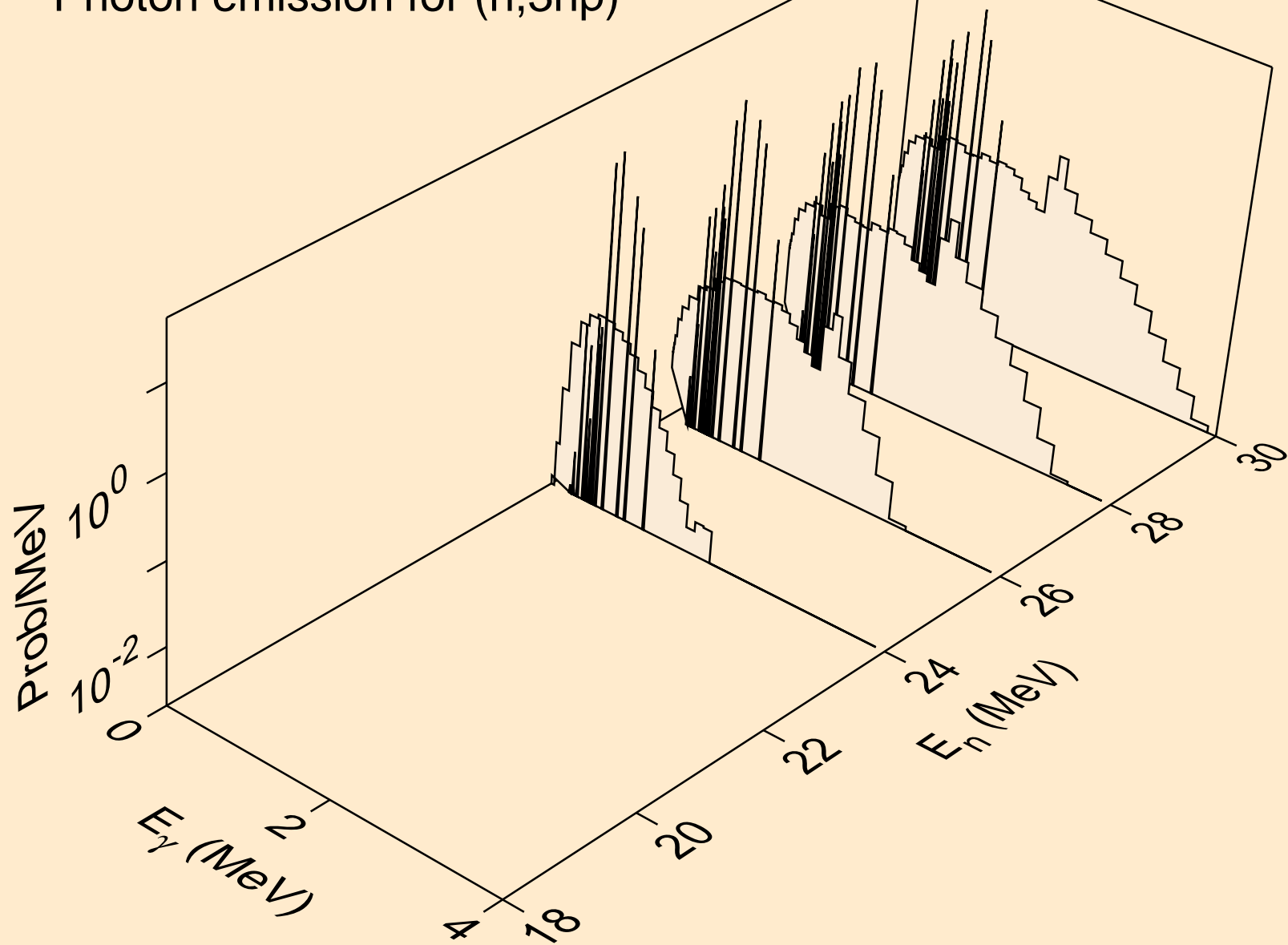

BI192 NEUTRON ACER TENDL-2024 LIBRARY; T=0.K  
Photon emission for (n,n2p)

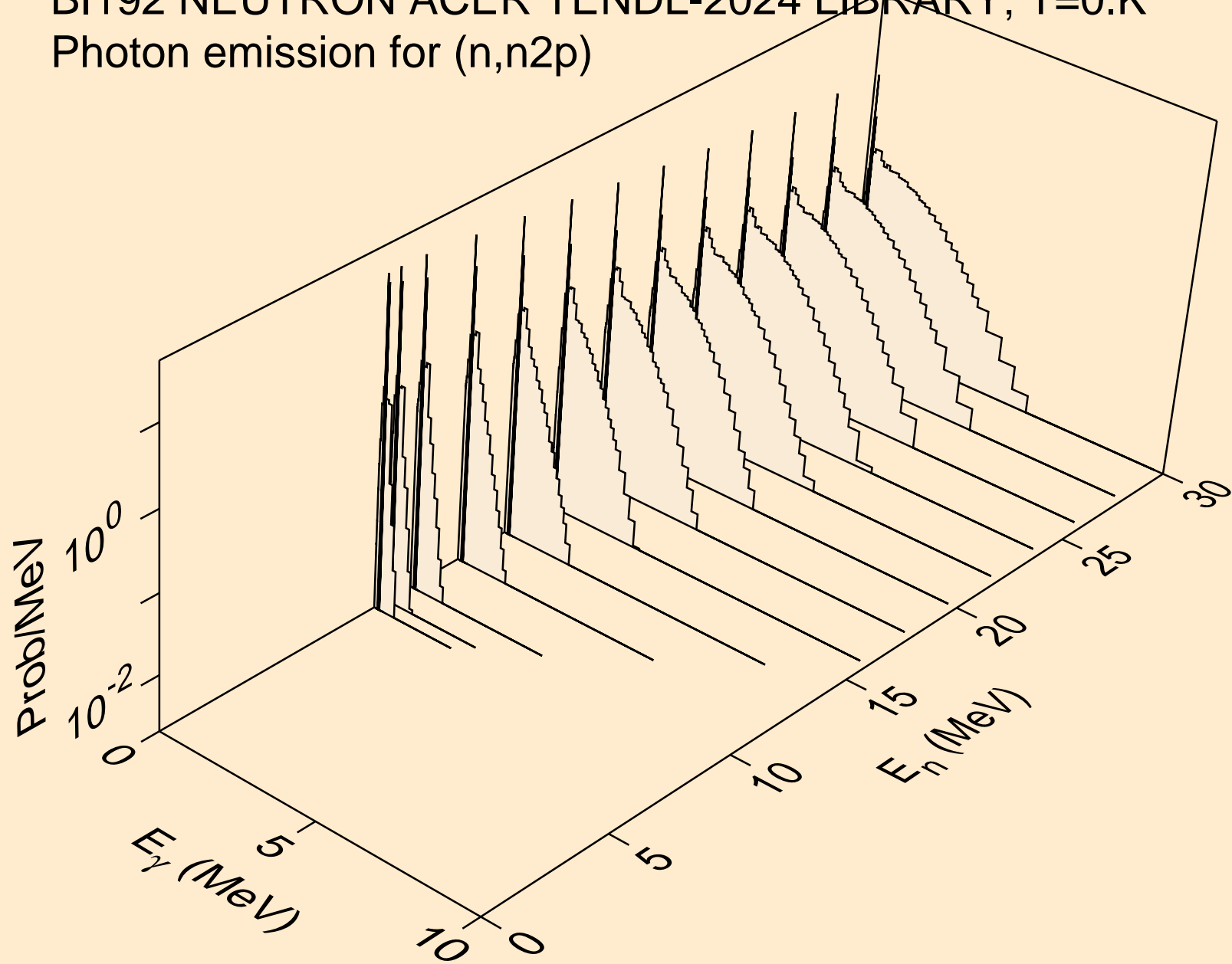

BI192 NEUTRON ACER TENDL-2024 LIBRARY; T=0.K  
Photon emission for (n,npa)

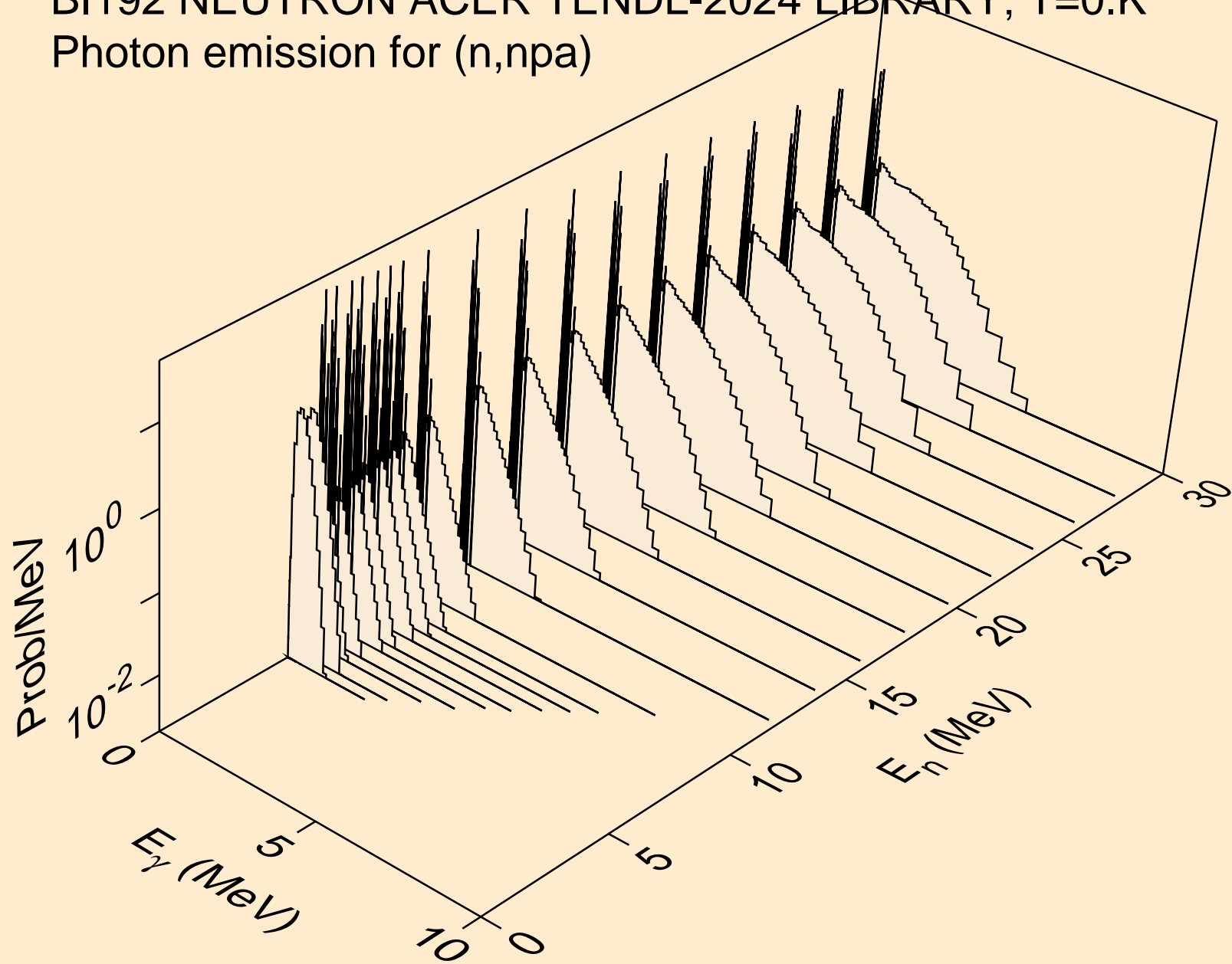

BI192 NEUTRON ACER TENDL-2024 LIBRARY; T=0.K  
Photon emission for (n,n\*c)

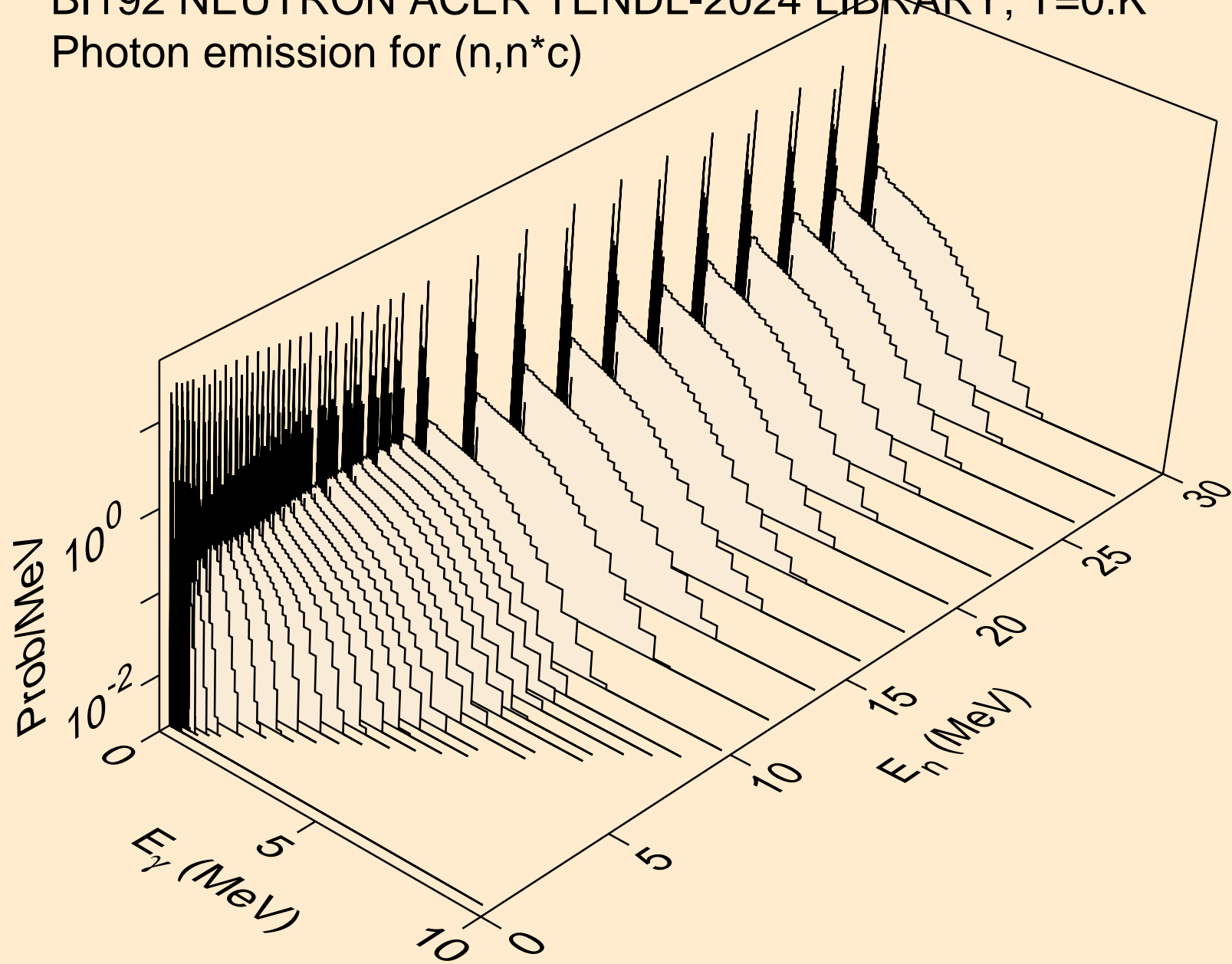

BI192 NEUTRON ACER TENDL-2024 LIBRARY; T=0.K  
Photon emission for (n,gma)

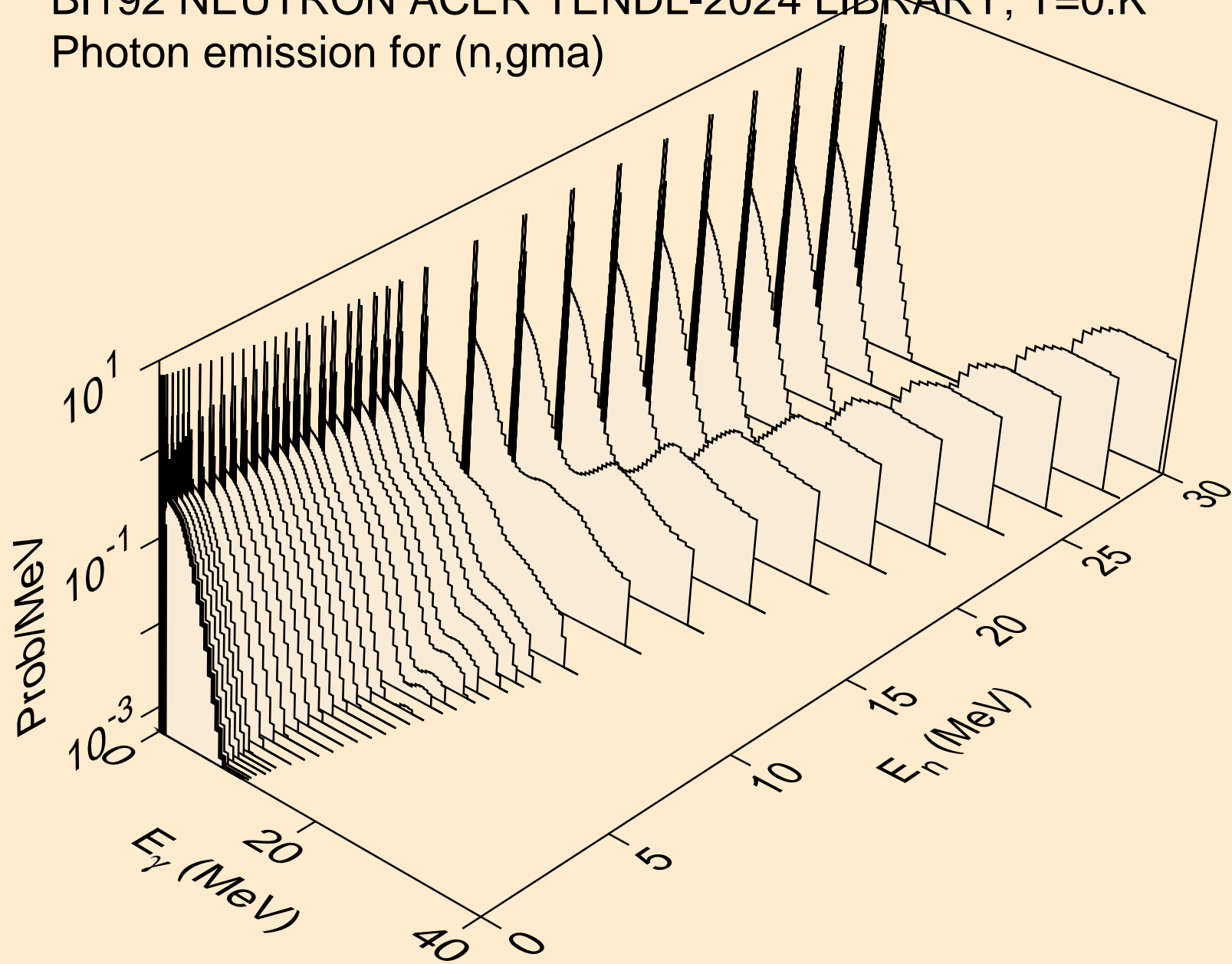

BI192 NEUTRON ACER TENDL-2024 LIBRARY; T=0.K  
Photon emission for (n,p)

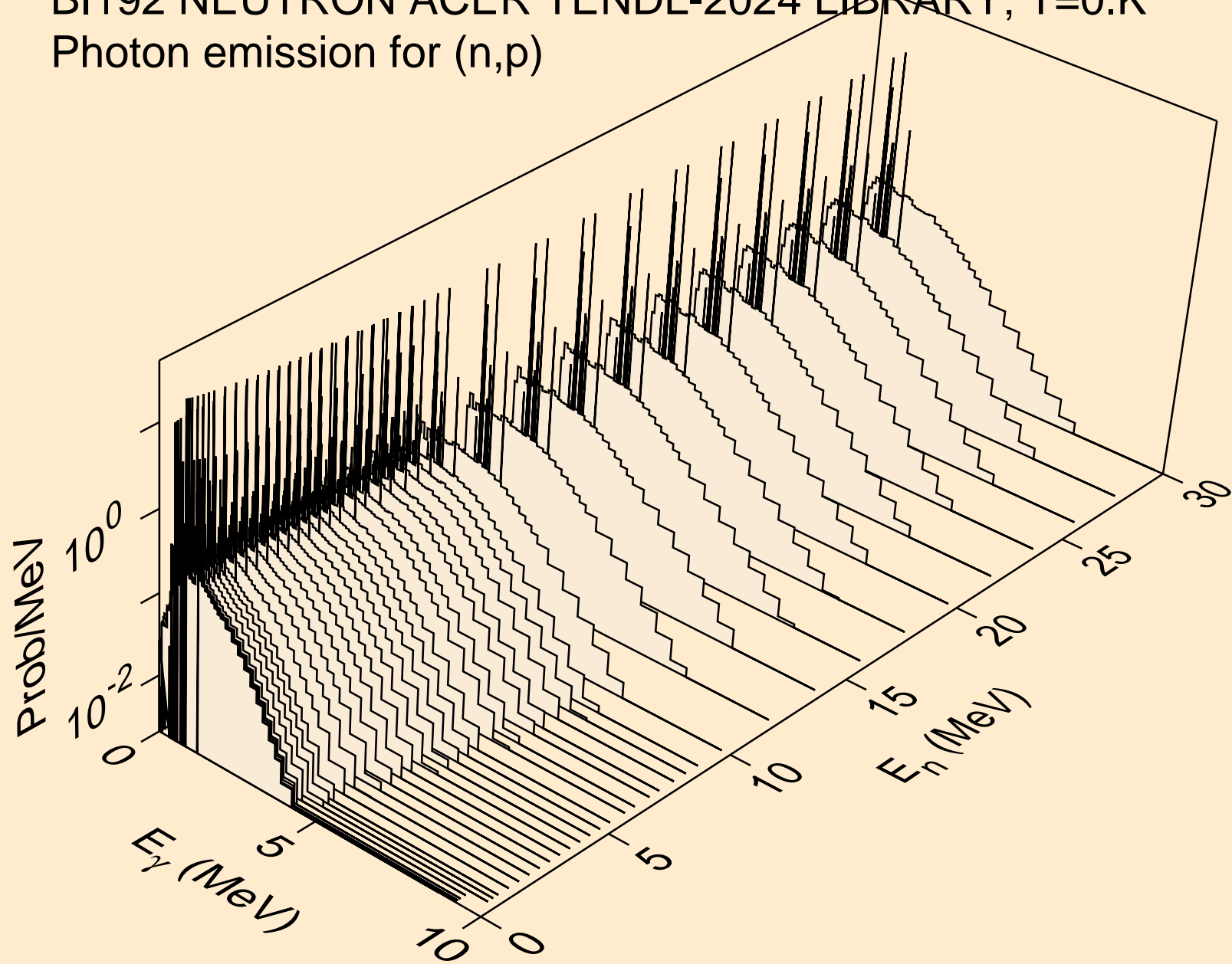

BI192 NEUTRON ACER TENDL-2024 LIBRARY; T=0.K  
Photon emission for (n,d)

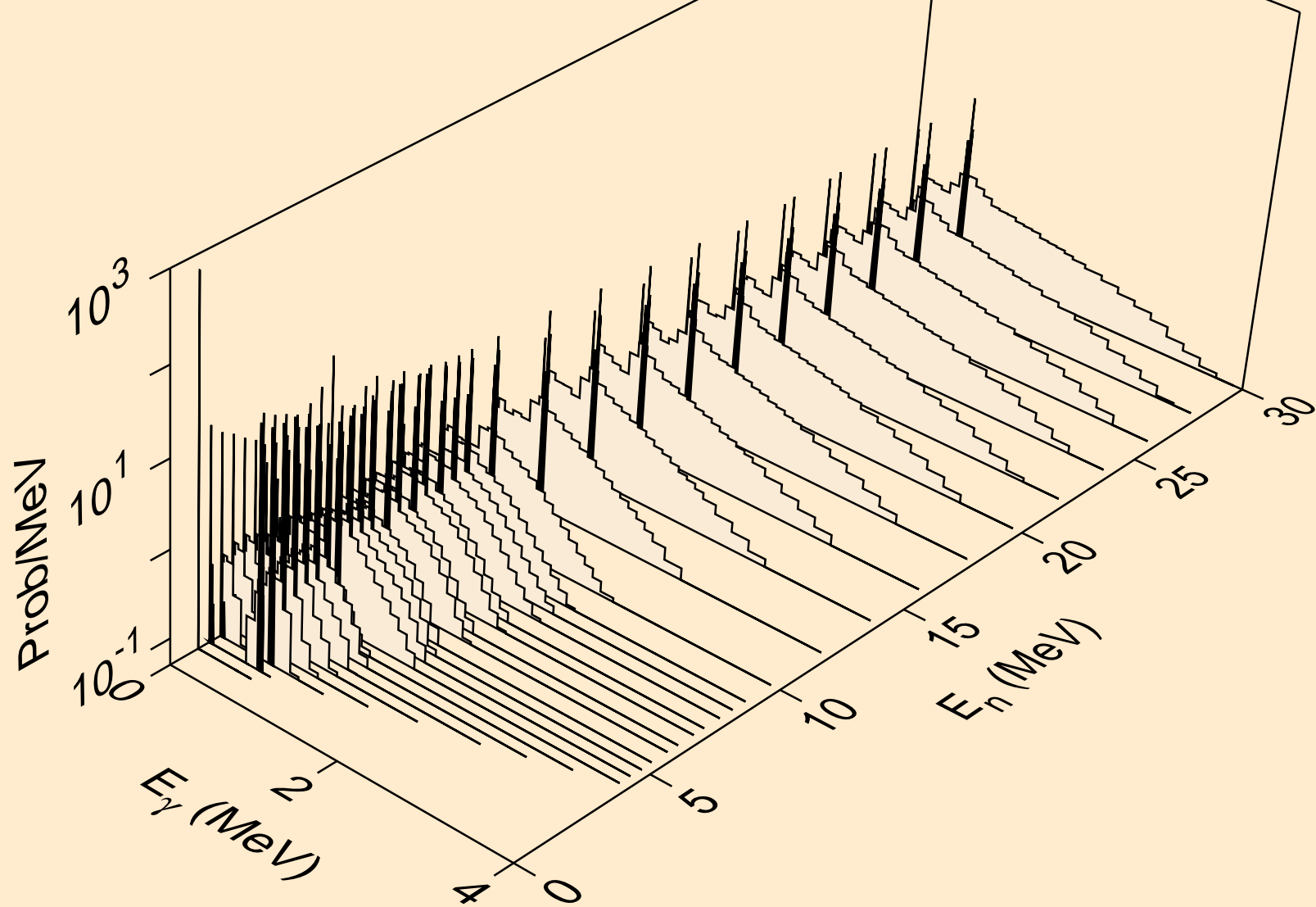

BI192 NEUTRON ACER TENDL-2024 LIBRARY; T=0.K  
Photon emission for (n,t)

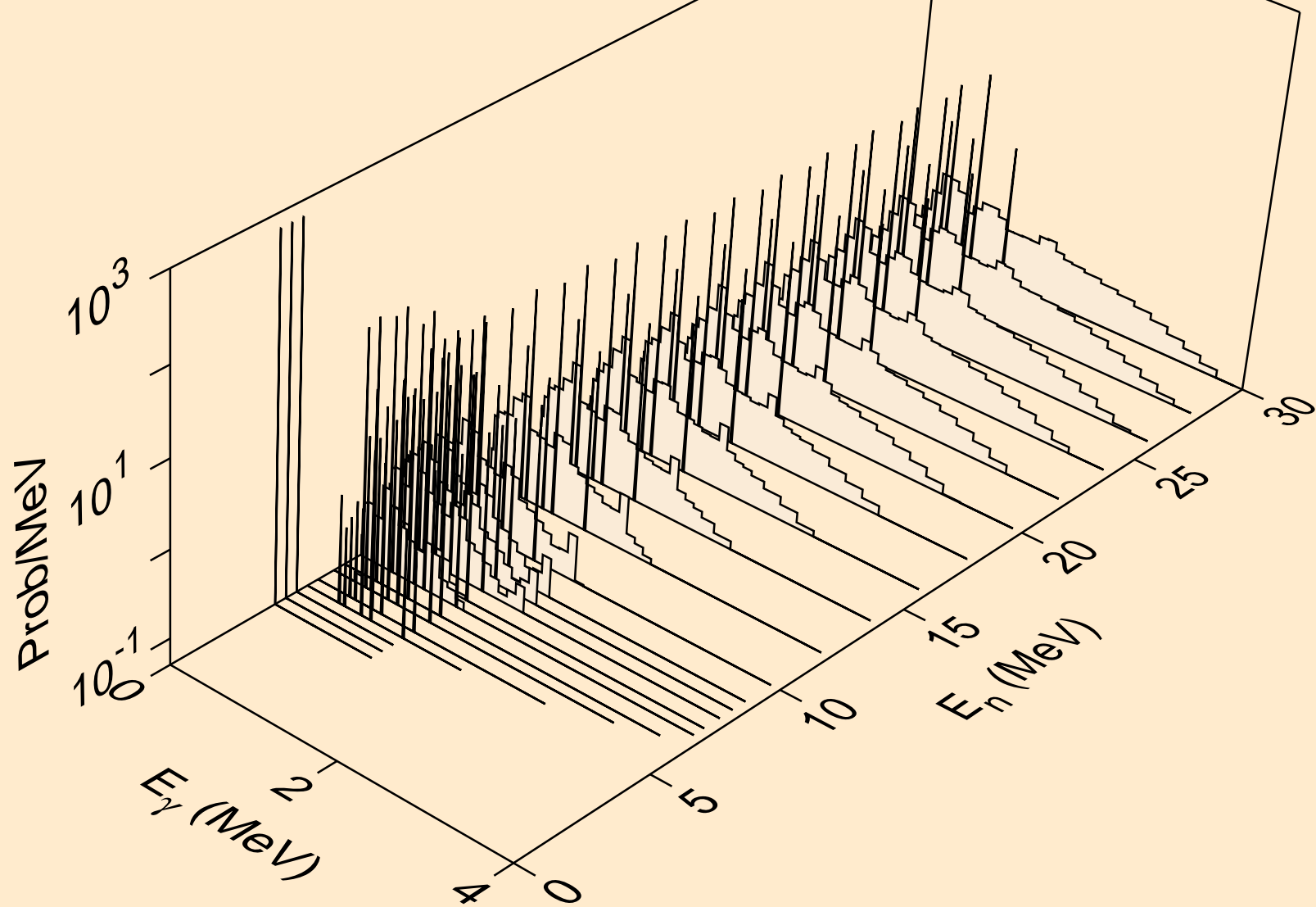



BI192 NEUTRON ACER TENDL-2024 LIBRARY; T=0.K  
Photon emission for (n,he3)

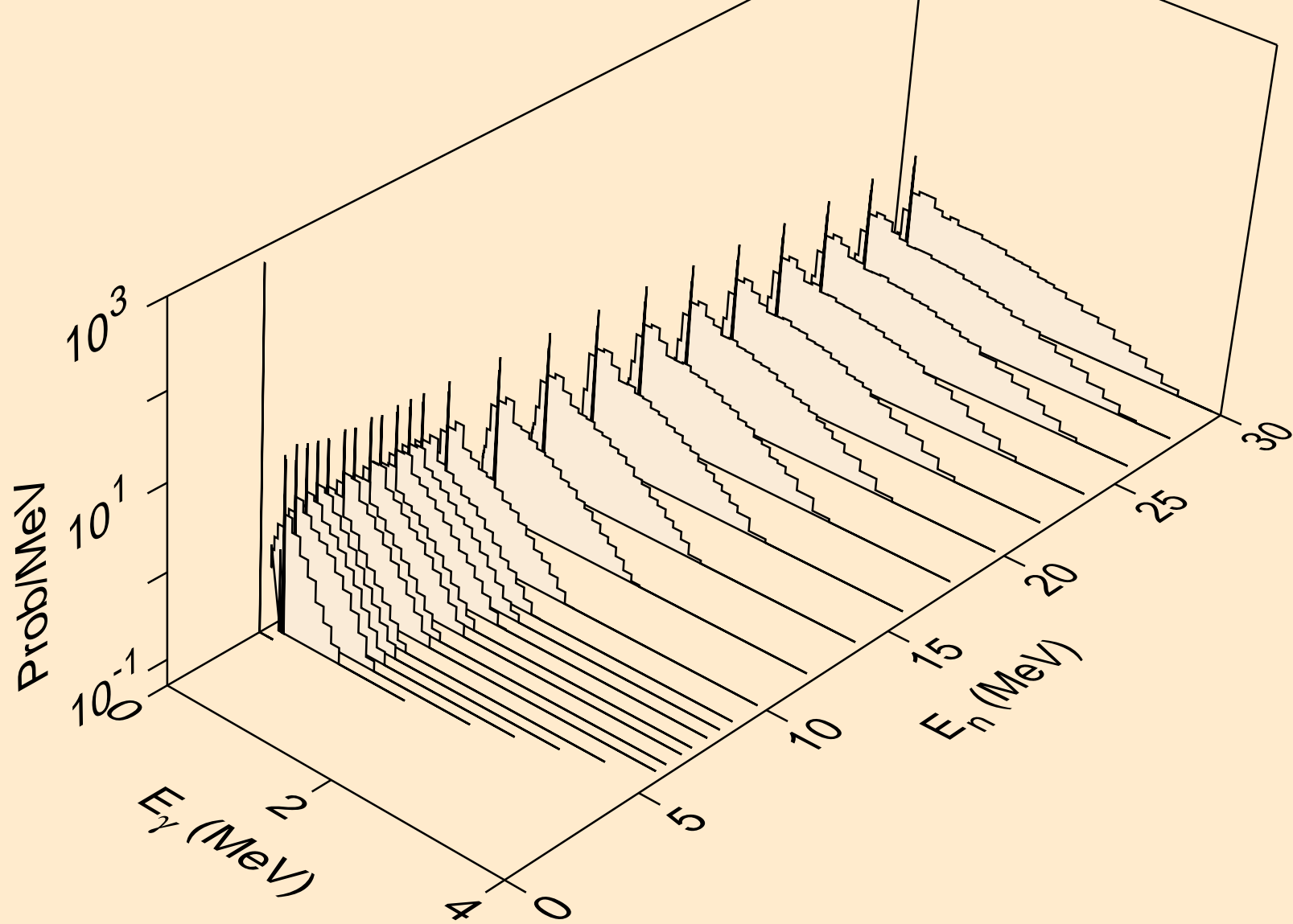

BI192 NEUTRON ACER TENDL-2024 LIBRARY; T=0.K  
Photon emission for (n,a)

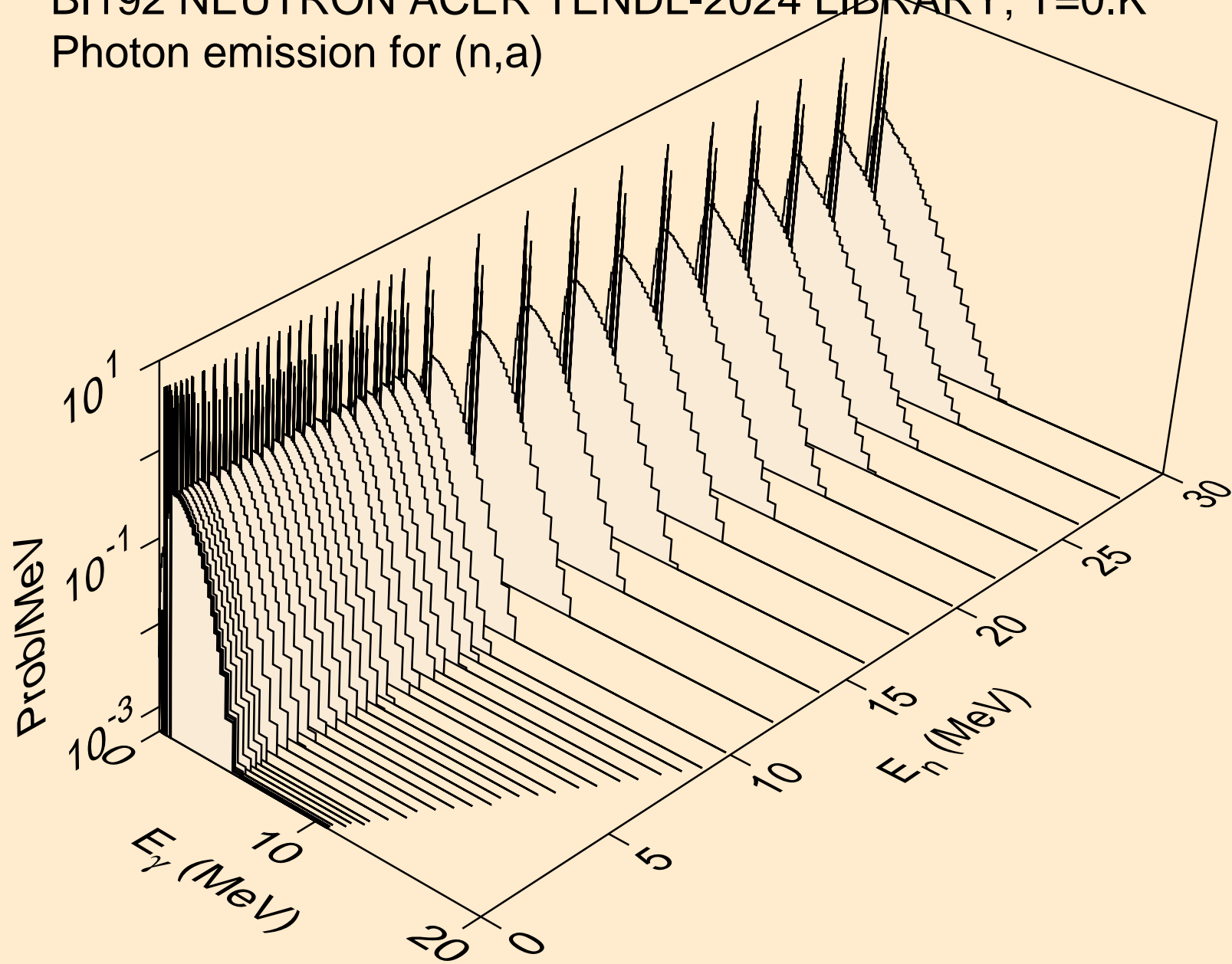

BI192 NEUTRON ACER TENDL-2024 LIBRARY; T=0.K  
Photon emission for (n,2a)

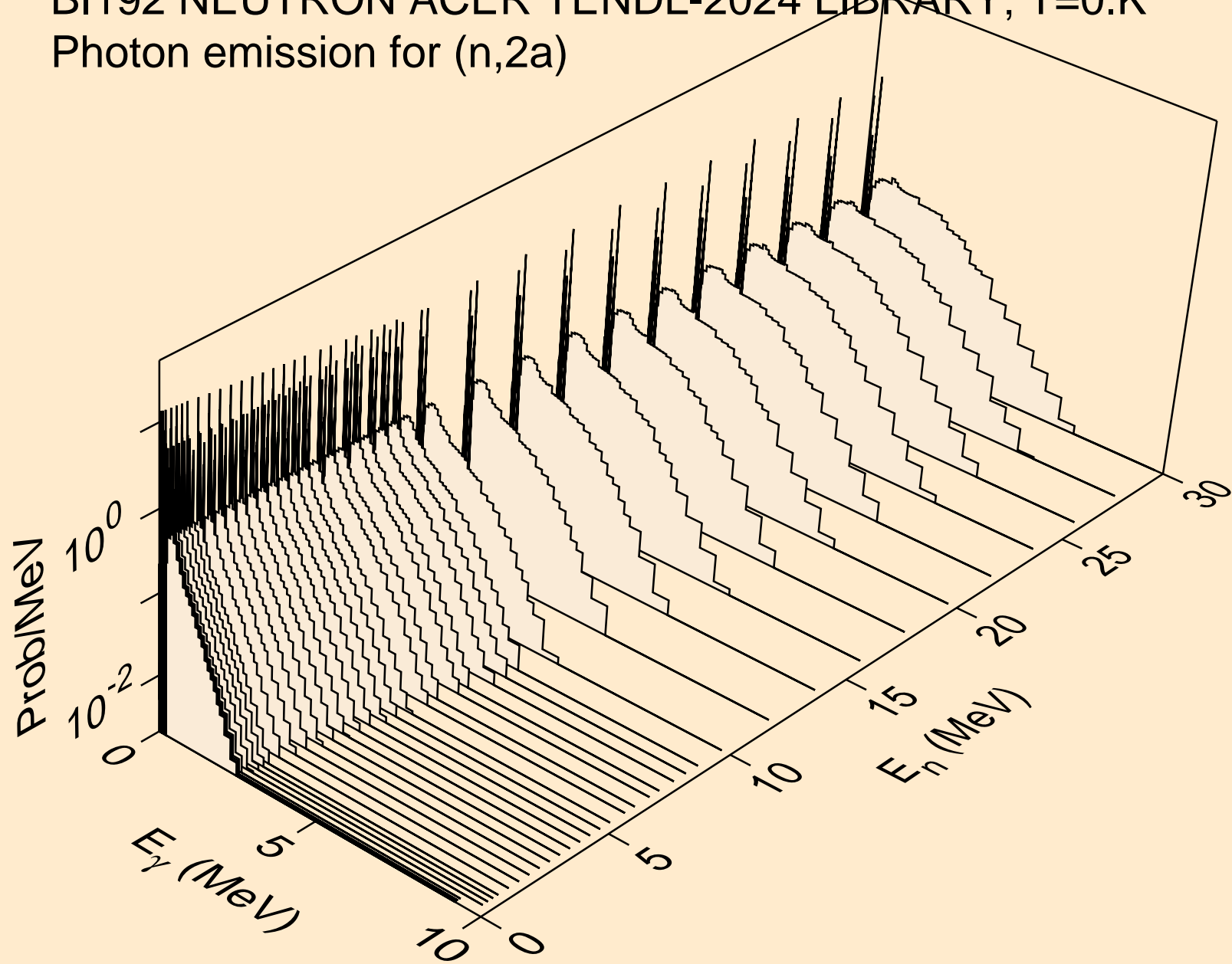

BI192 NEUTRON ACER TENDL-2024 LIBRARY; T=0.K  
Photon emission for (n,3a)

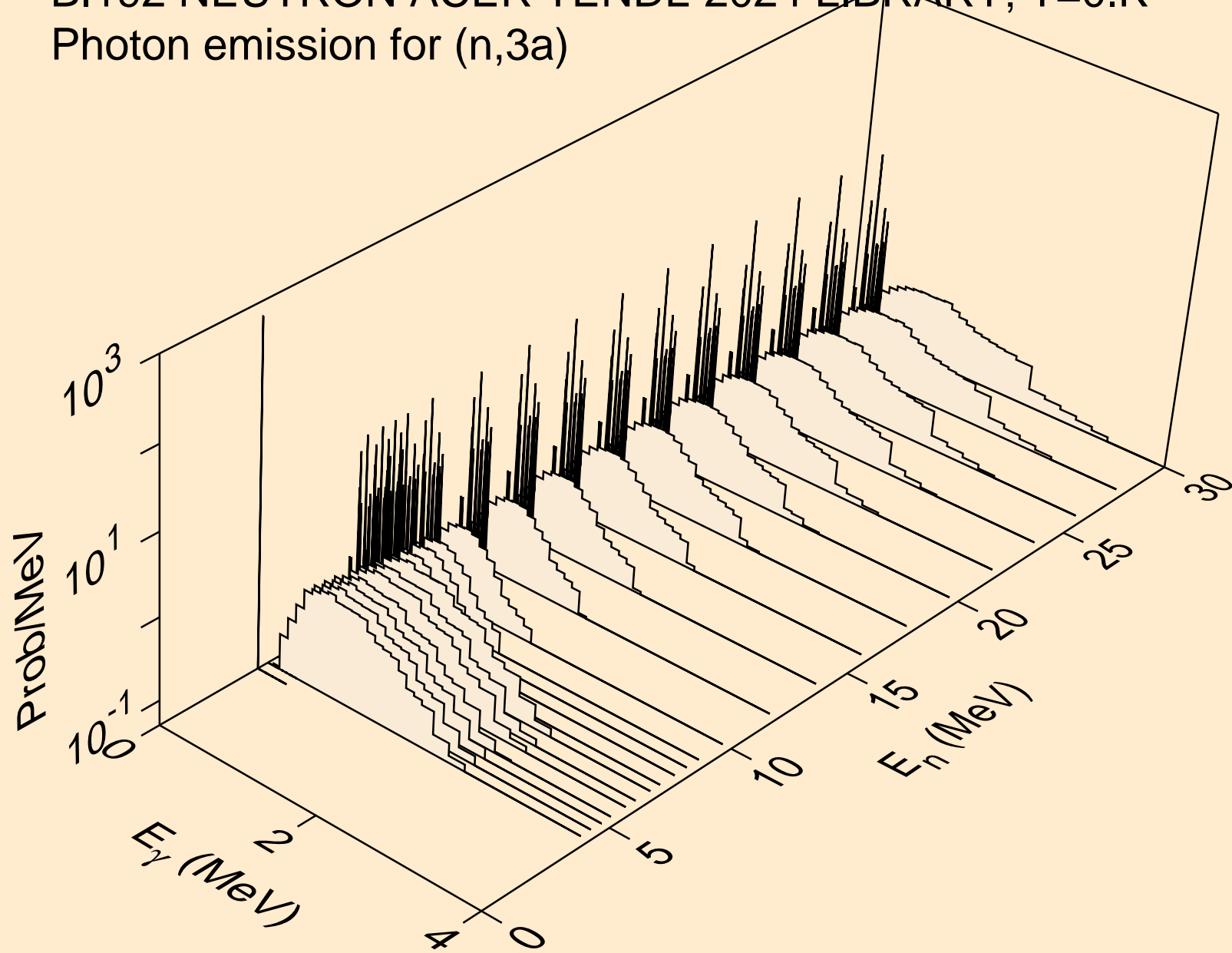

BI192 NEUTRON ACER TENDL-2024 LIBRARY; T=0.K  
Photon emission for (n,2p)

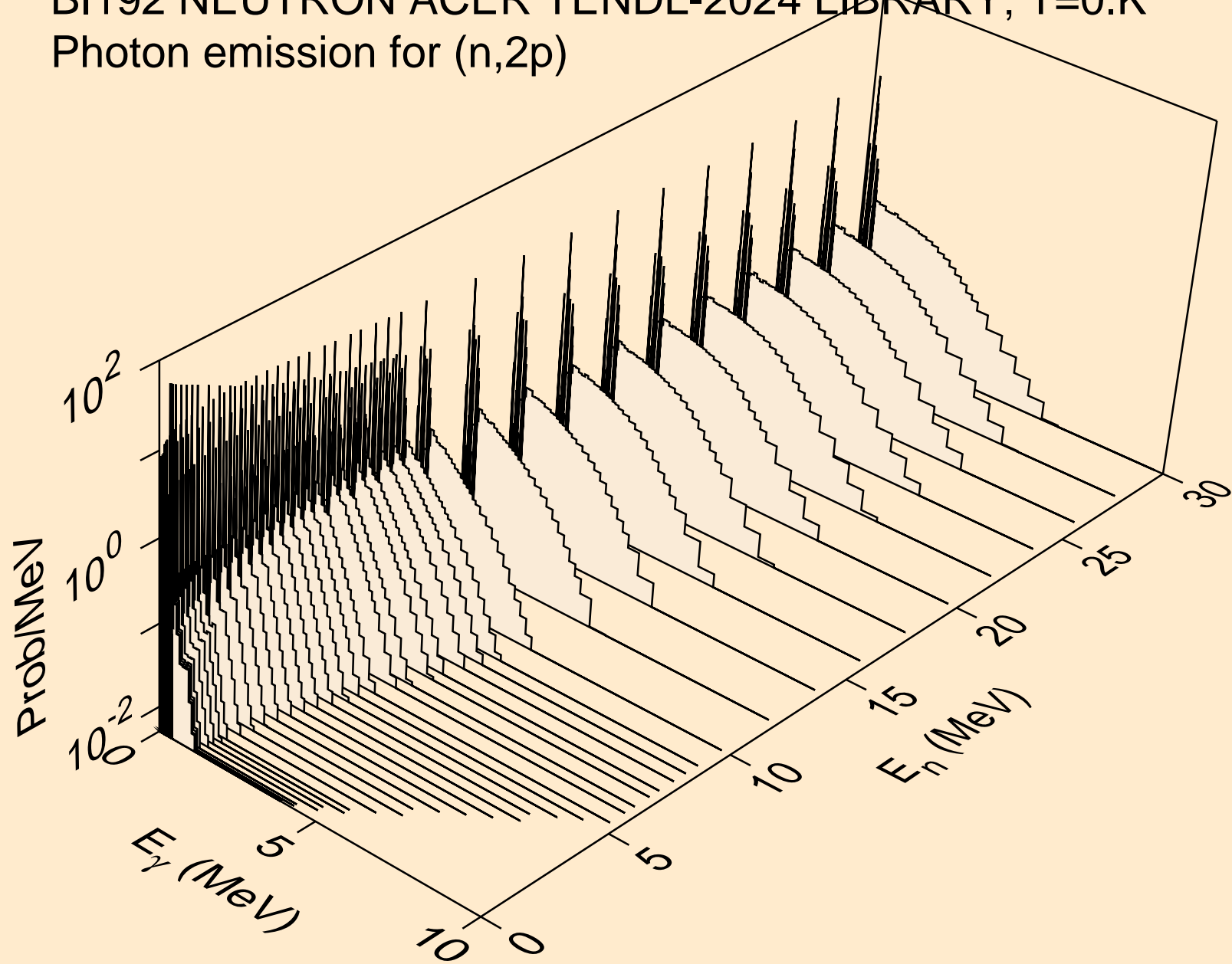

BI192 NEUTRON ACER TENDL-2024 LIBRARY; T=0.K  
Photon emission for (n,p $\alpha$ )

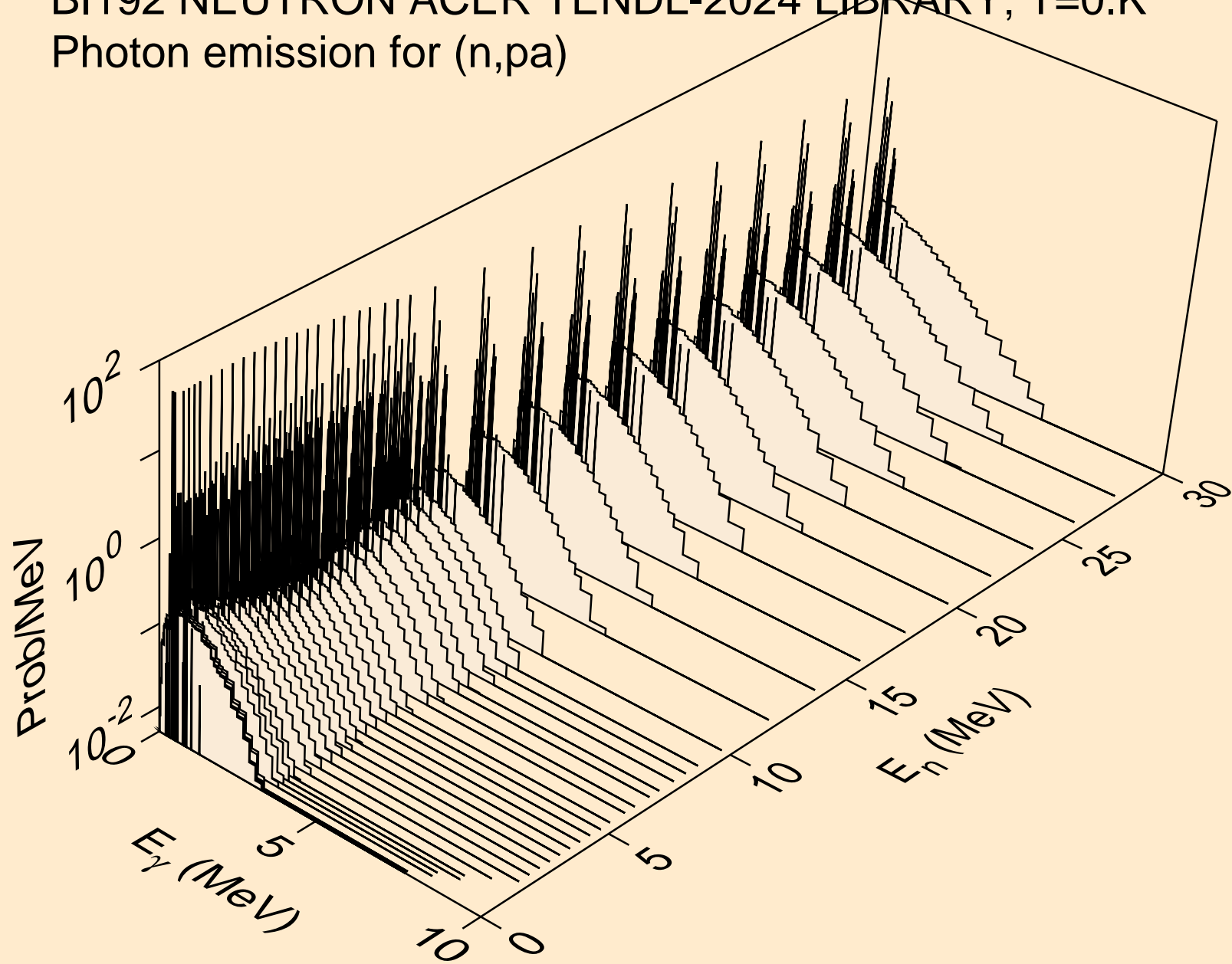

BI192 NEUTRON ACER TENDL-2024 LIBRARY; T=0.K  
Photon emission for (n,pd)

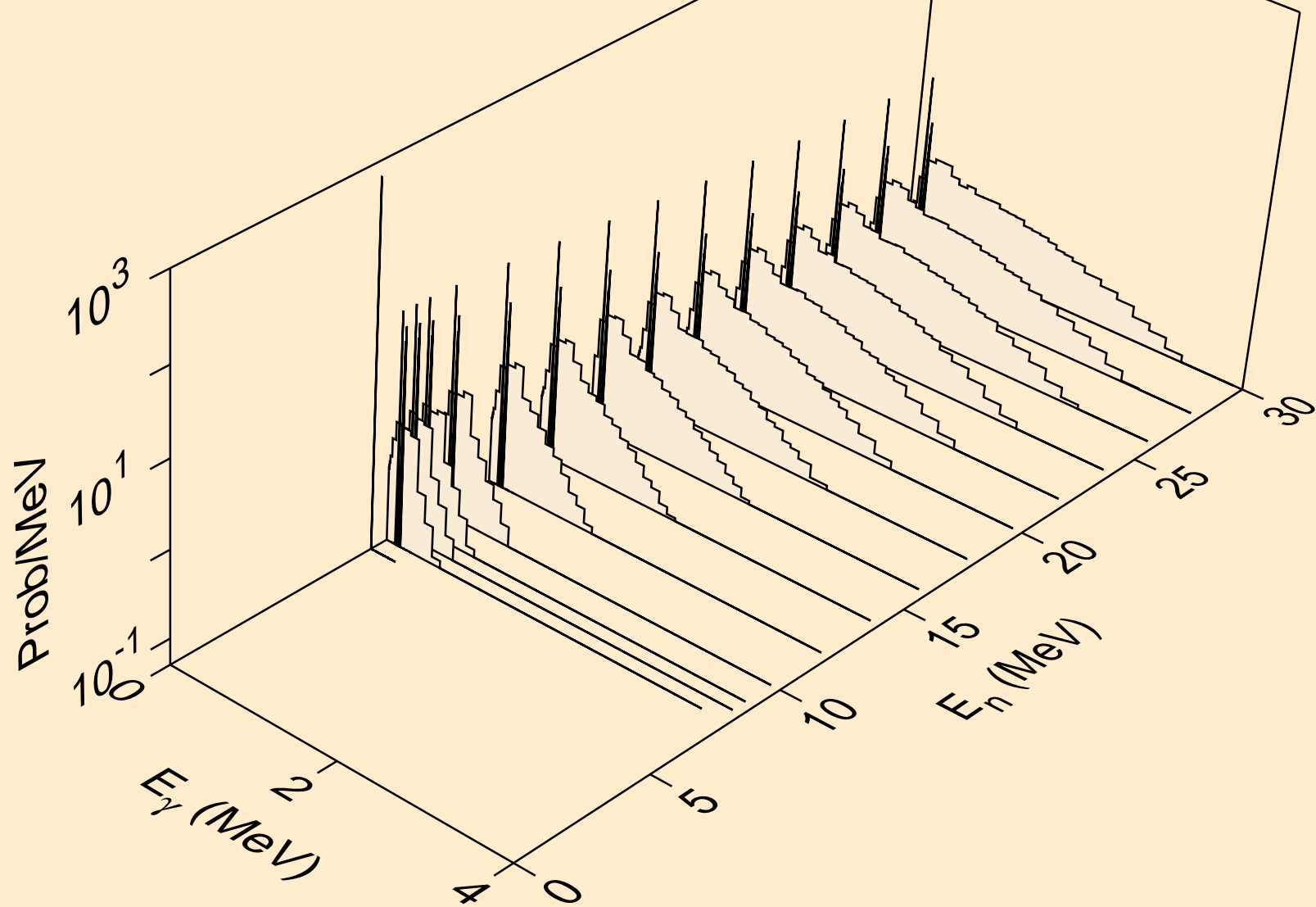

BI192 NEUTRON ACER TENDL-2024 LIBRARY; T=0.K  
Photon emission for (n,pt)

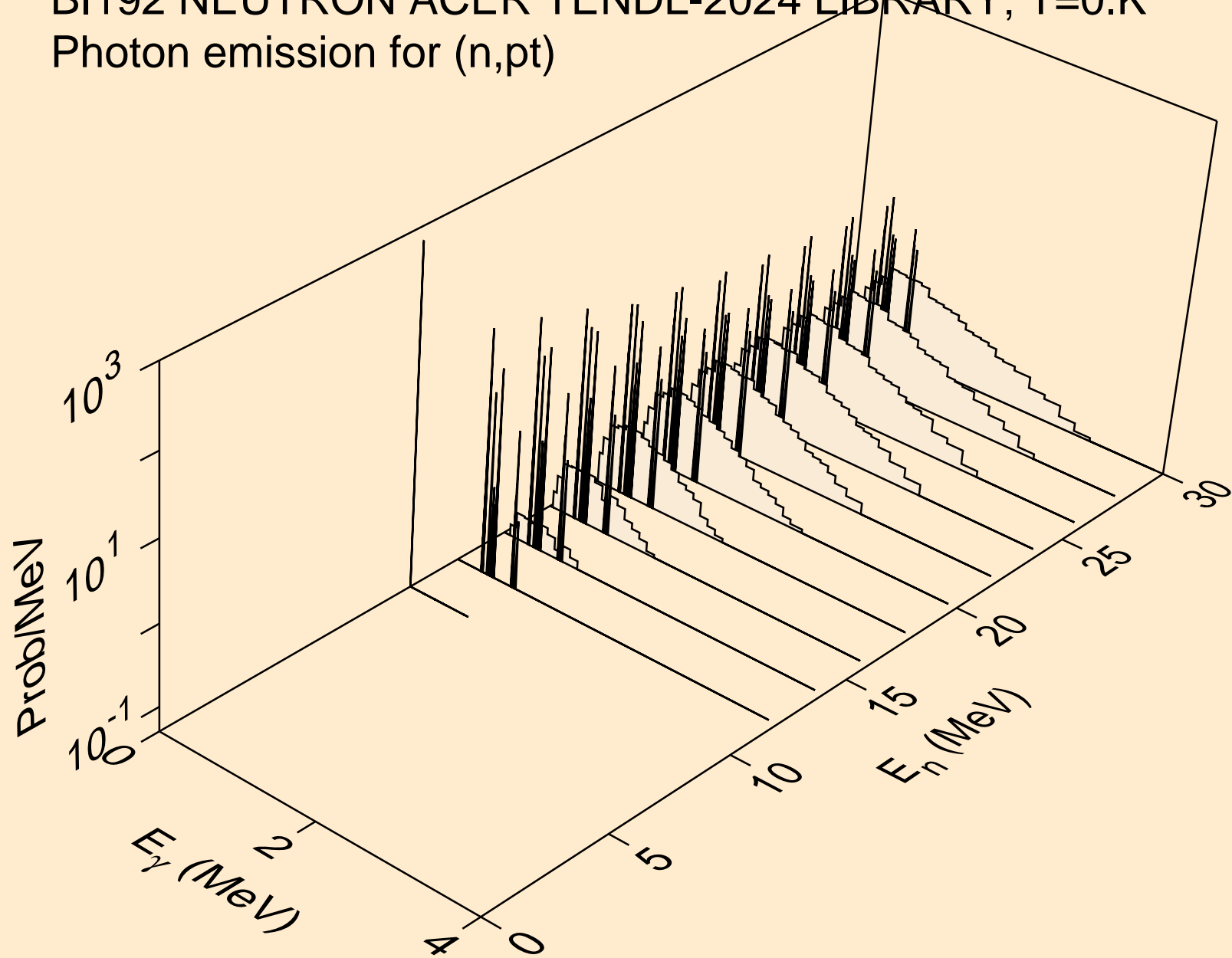



BI192 NEUTRON ACER TENDL-2024 LIBRARY; T=0.K  
Photon emission for (n,da)

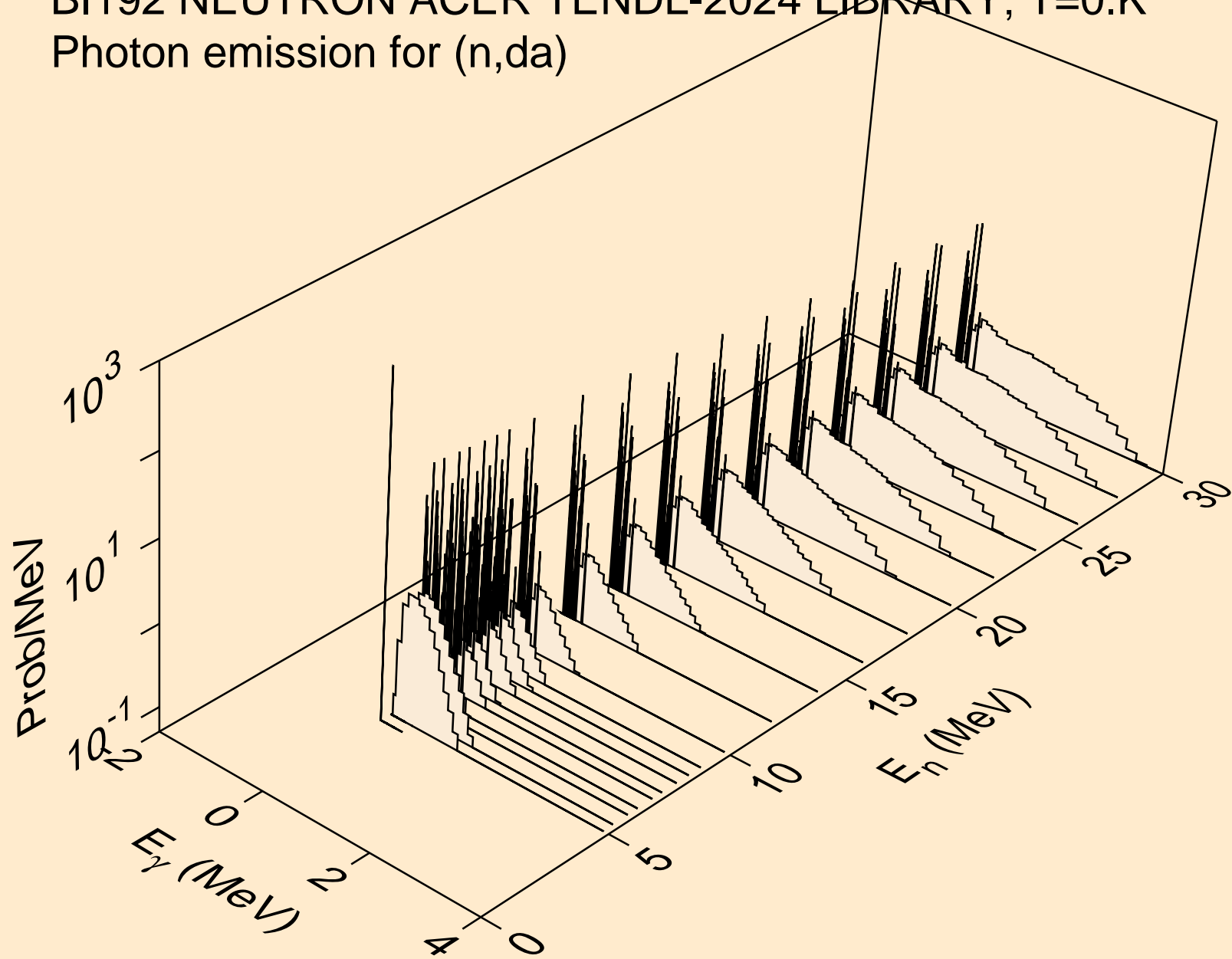

BI192 NEUTRON ACER TENDL-2024 LIBRARY; T=0.K  
thermal capture photon spectrum

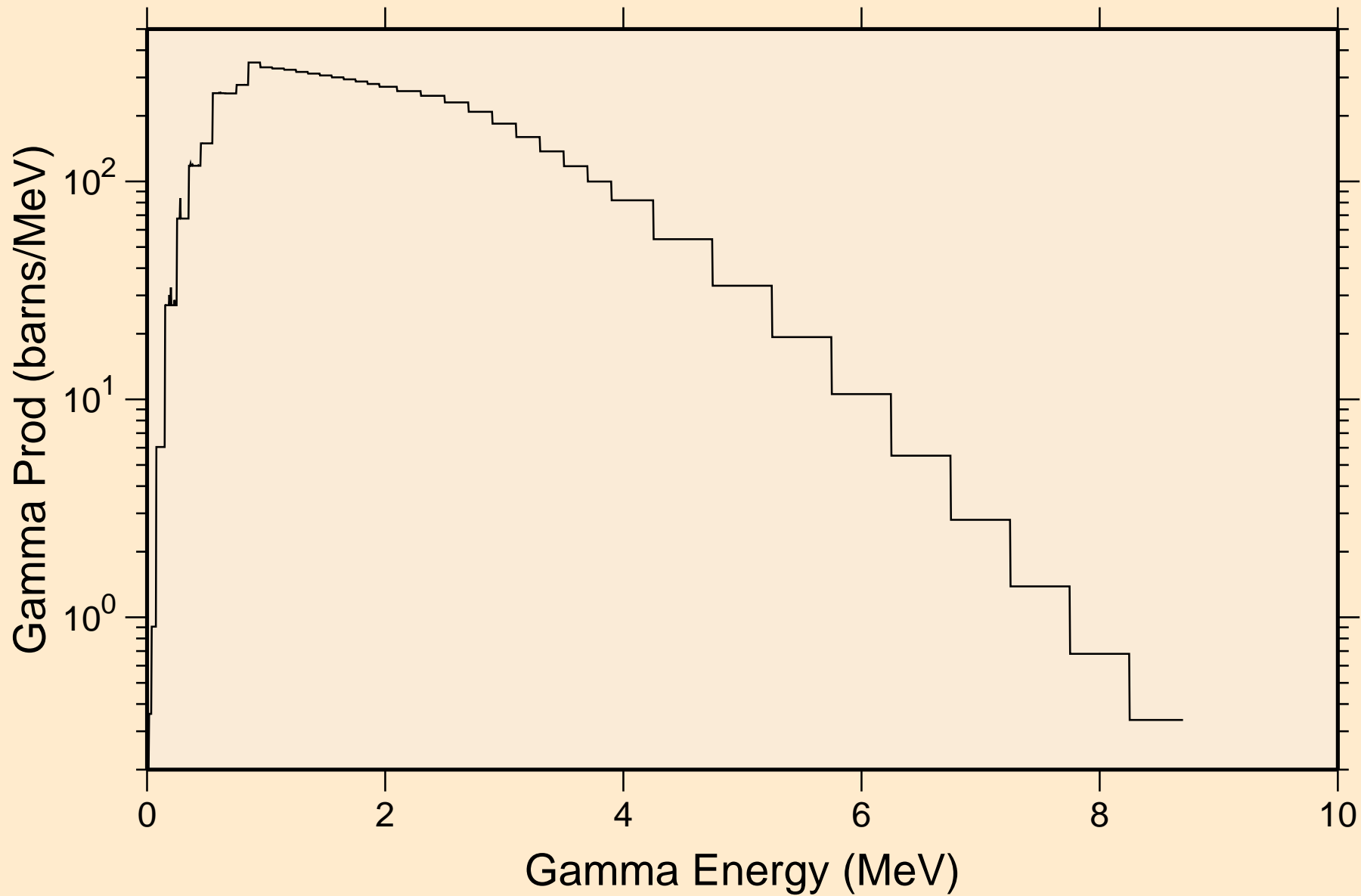

BI192 NEUTRON ACER TENDL-2024 LIBRARY; T=0.K  
14 MeV photon spectrum

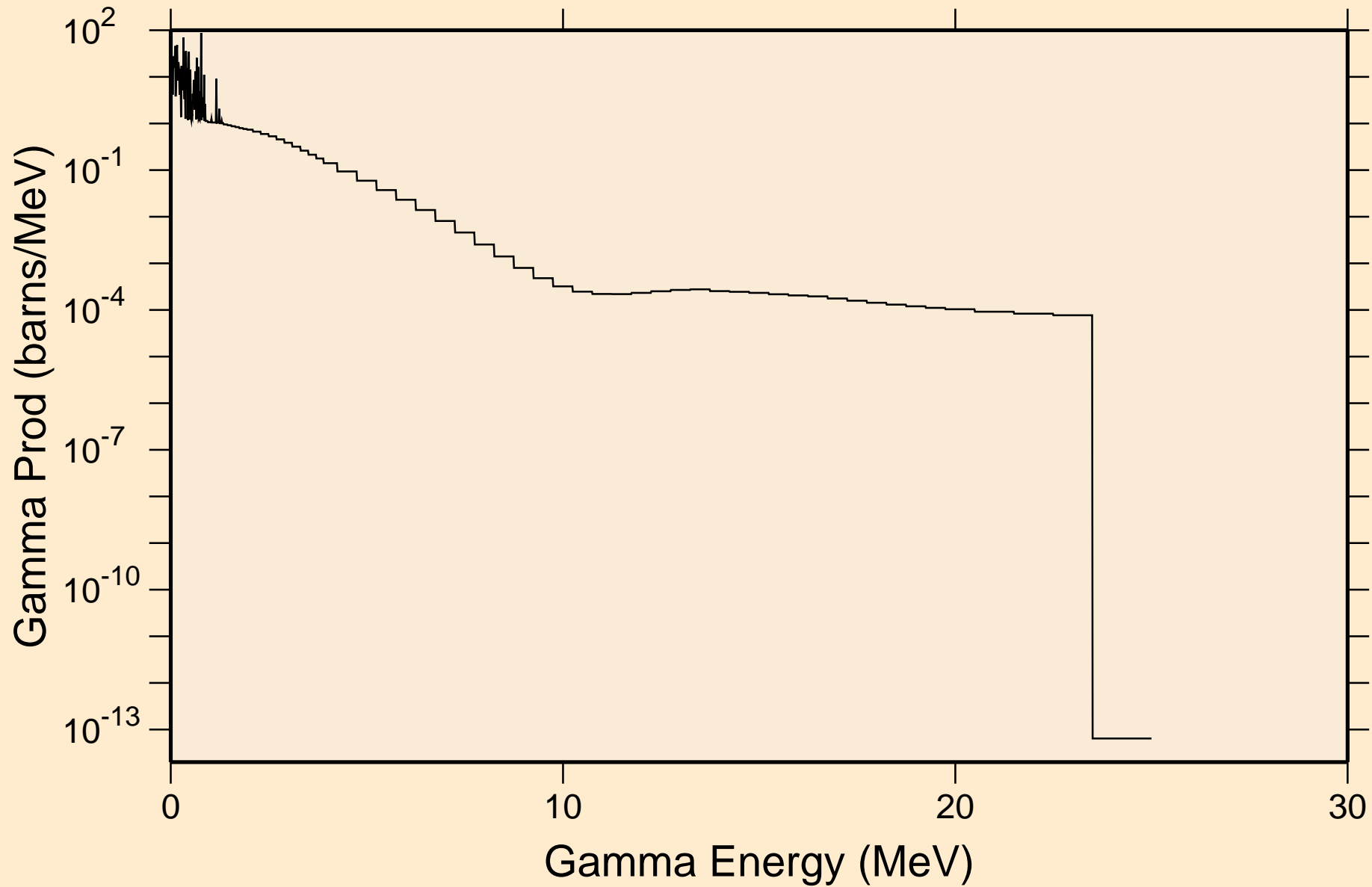

BI192 NEUTRON ACER TENDL-2024 LIBRARY; T=0.K  
Particle heating contributions

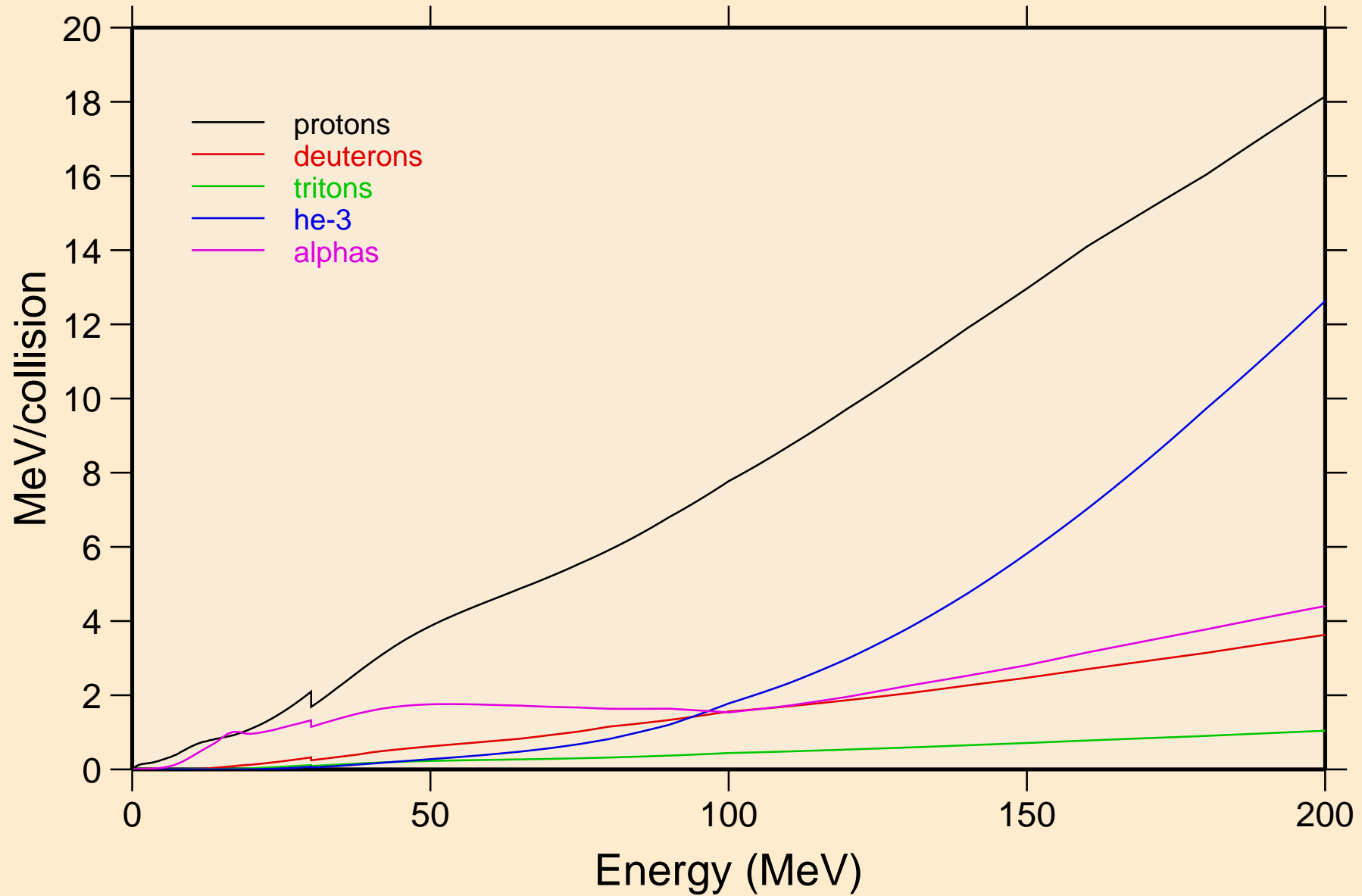

BI192 NEUTRON ACER TENDL-2024 LIBRARY; T=0.K  
Recoil Heating

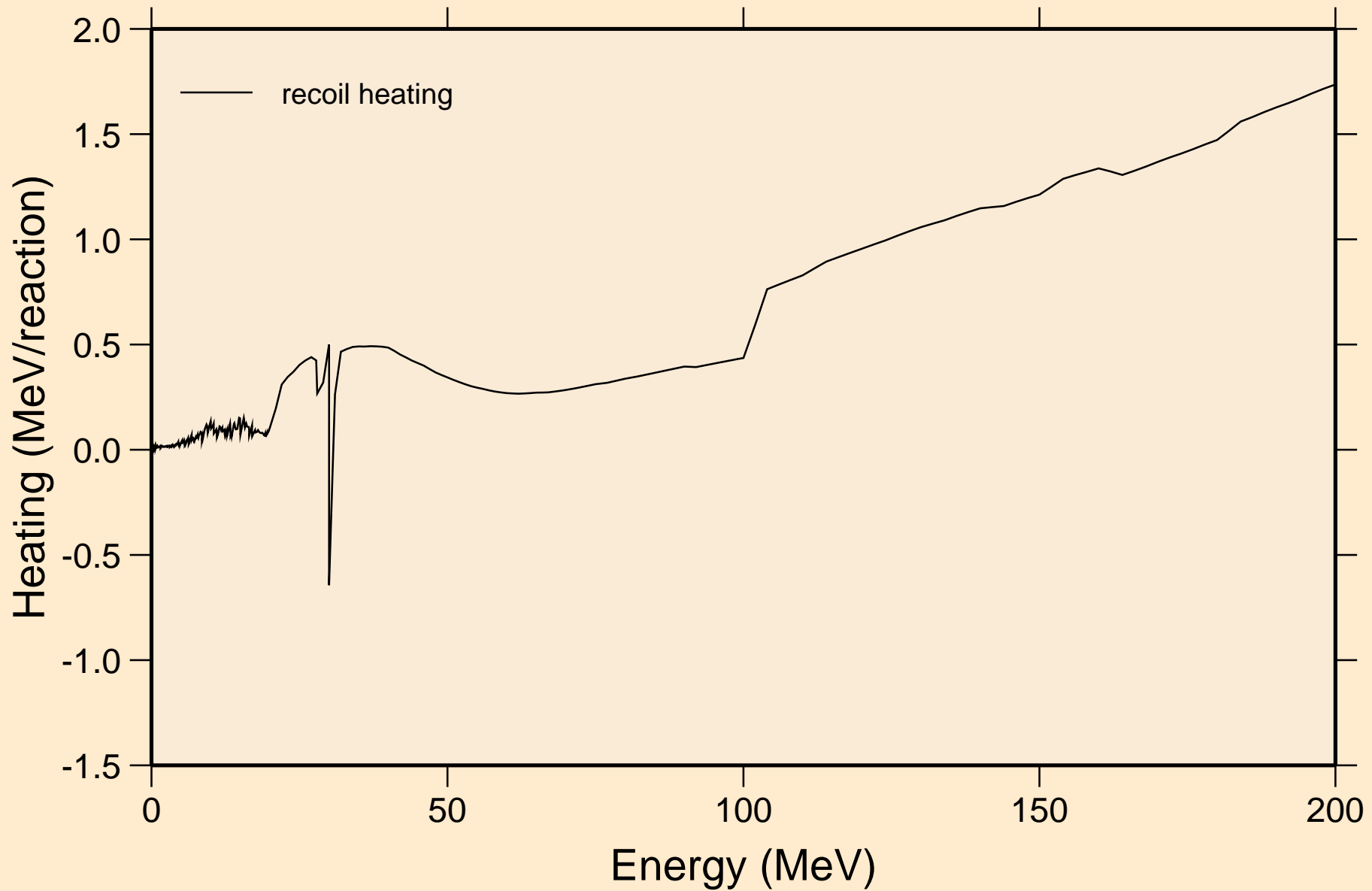

BI192 NEUTRON ACER TENDL-2024 LIBRARY; T=0.K  
Particle production cross sections

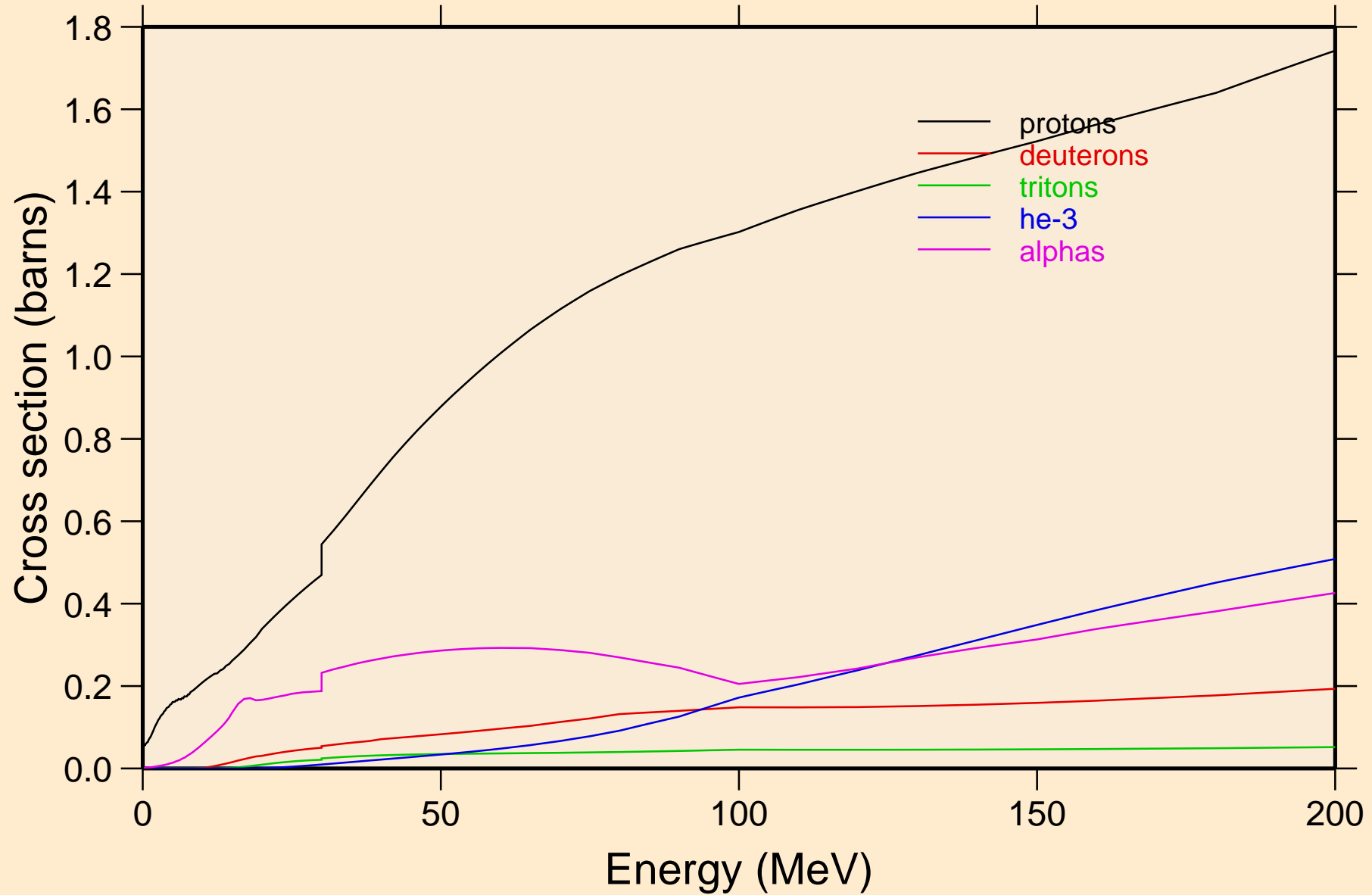

BI192 NEUTRON ACER TENDL-2024 LIBRARY; T=0.K  
protons from (n,x)

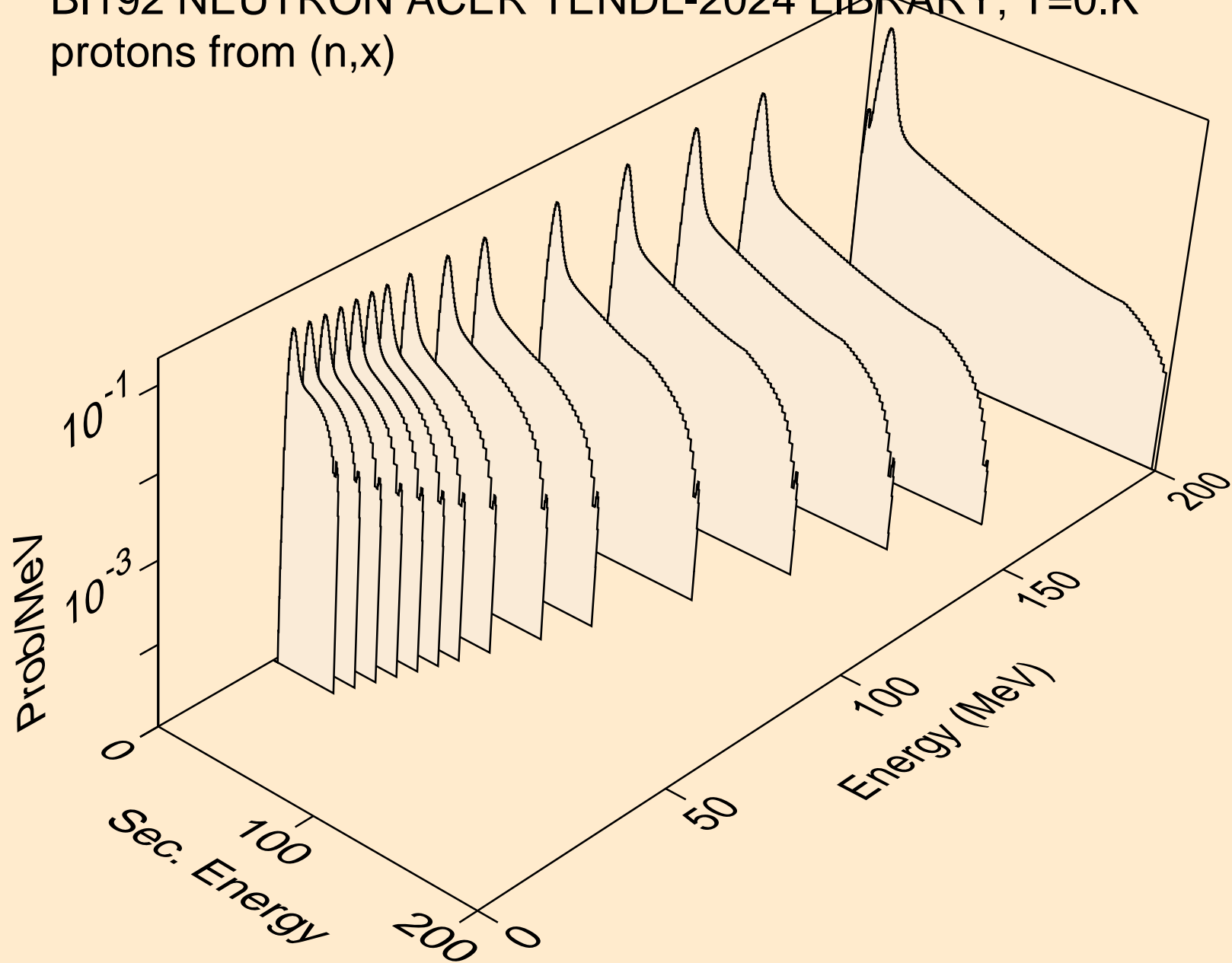

BI192 NEUTRON ACER TENDL-2024 LIBRARY; T=0.K  
protons from (n,n\*)p

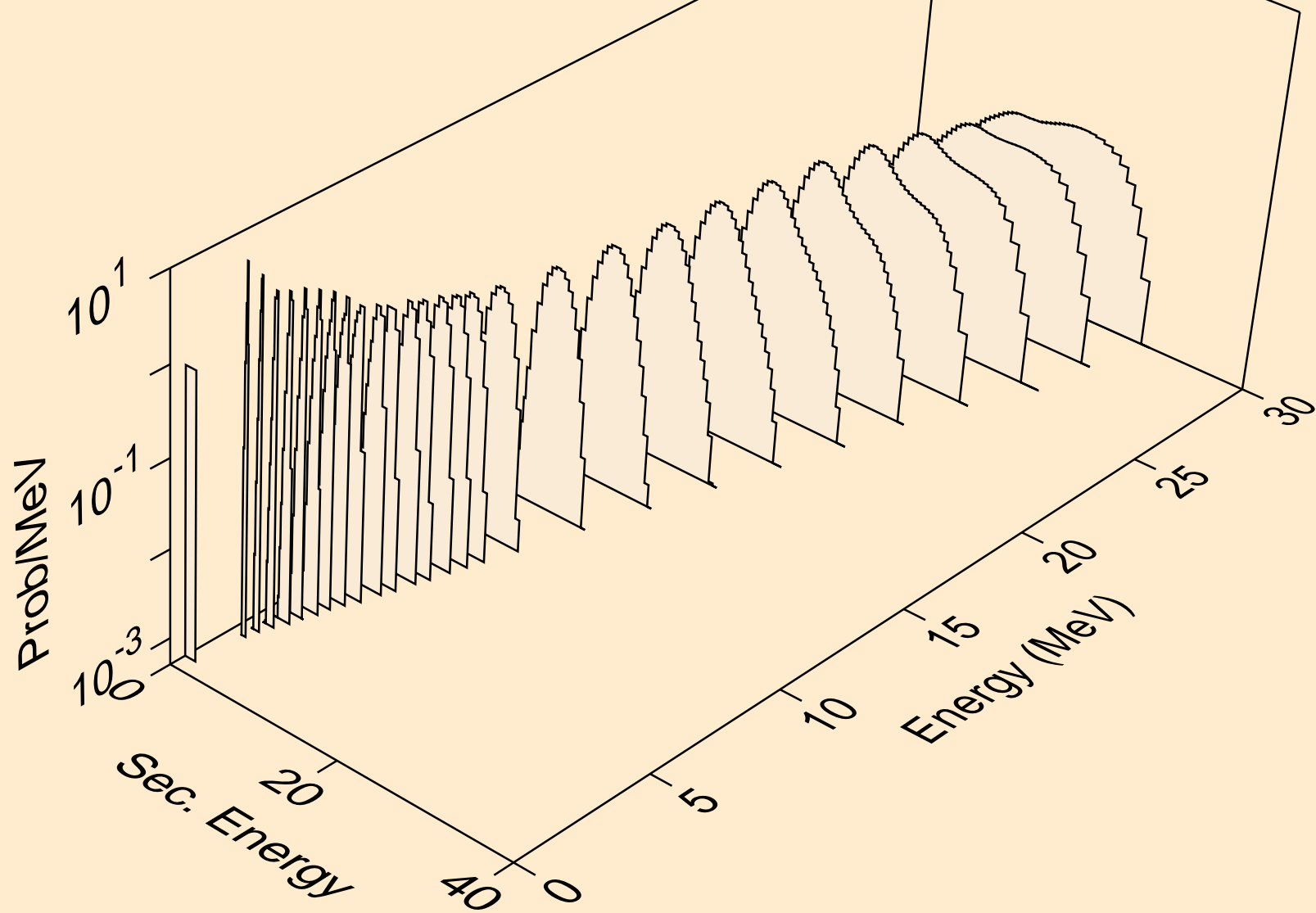



BI192 NEUTRON ACER TENDL-2024 LIBRARY; T=0.K  
protons from (n,2np)

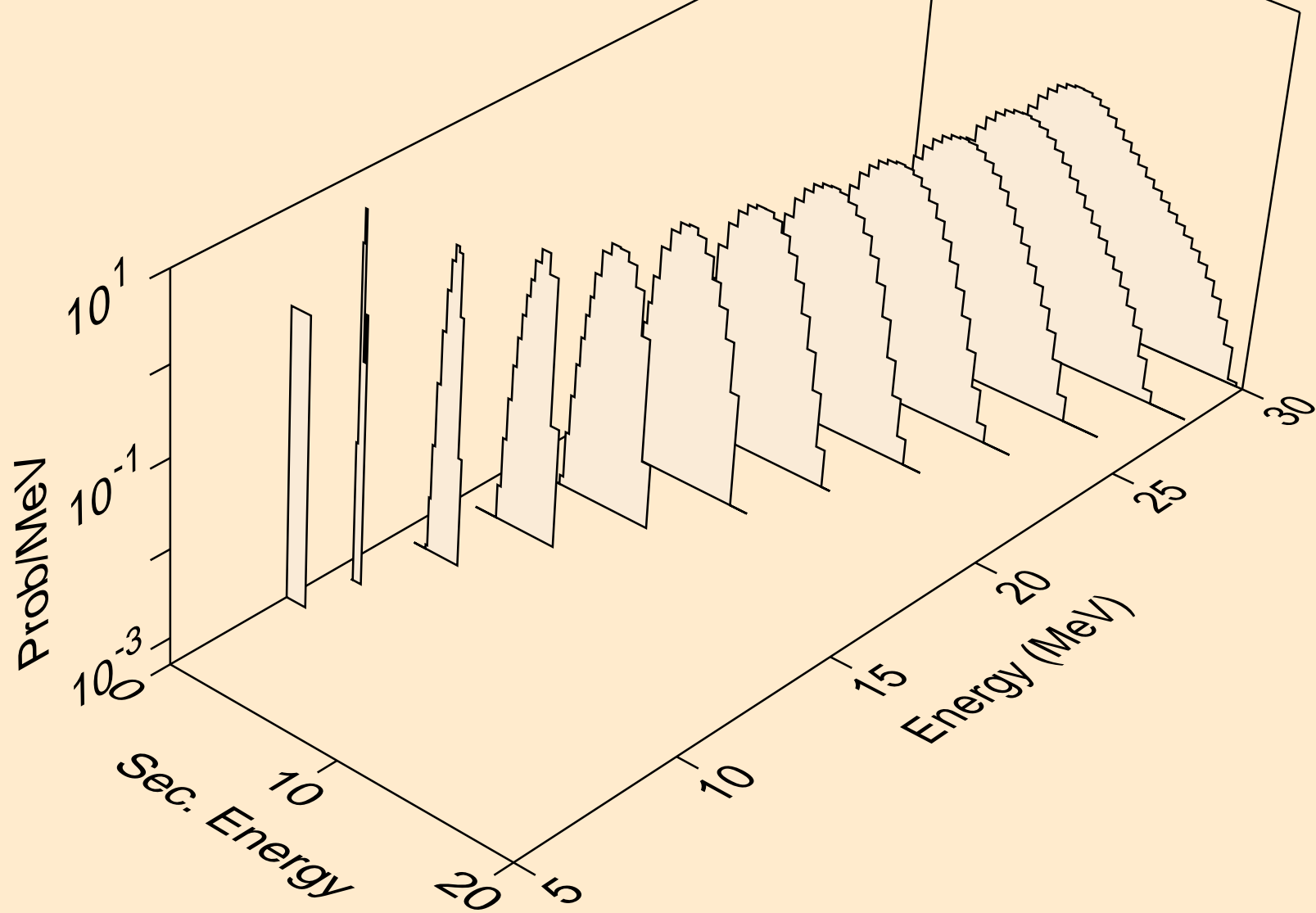

BI192 NEUTRON ACER TENDL-2024 LIBRARY; T=0.K  
protons from (n,3np)

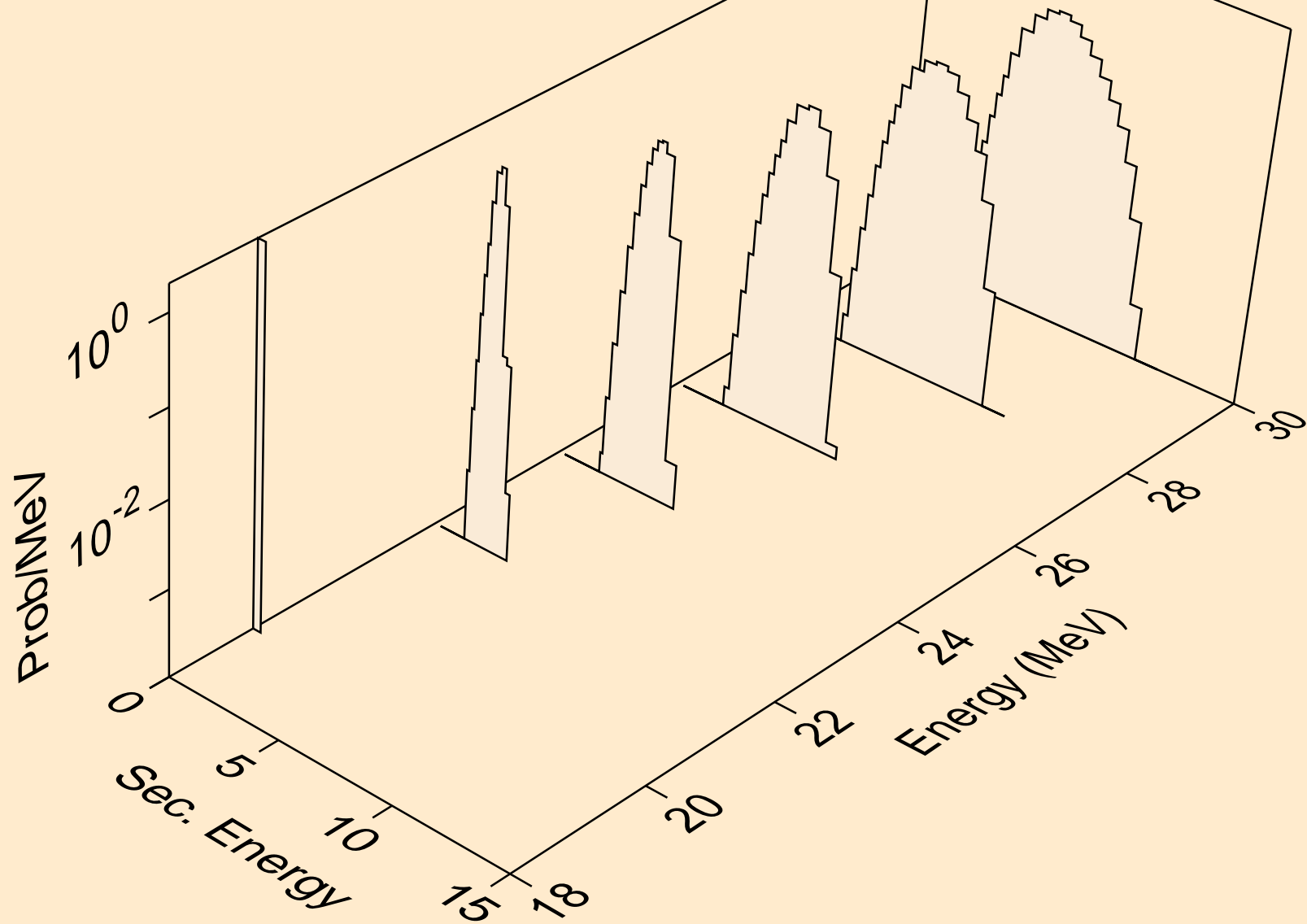

BI192 NEUTRON ACER TENDL-2024 LIBRARY; T=0.K  
protons from (n,n2p)

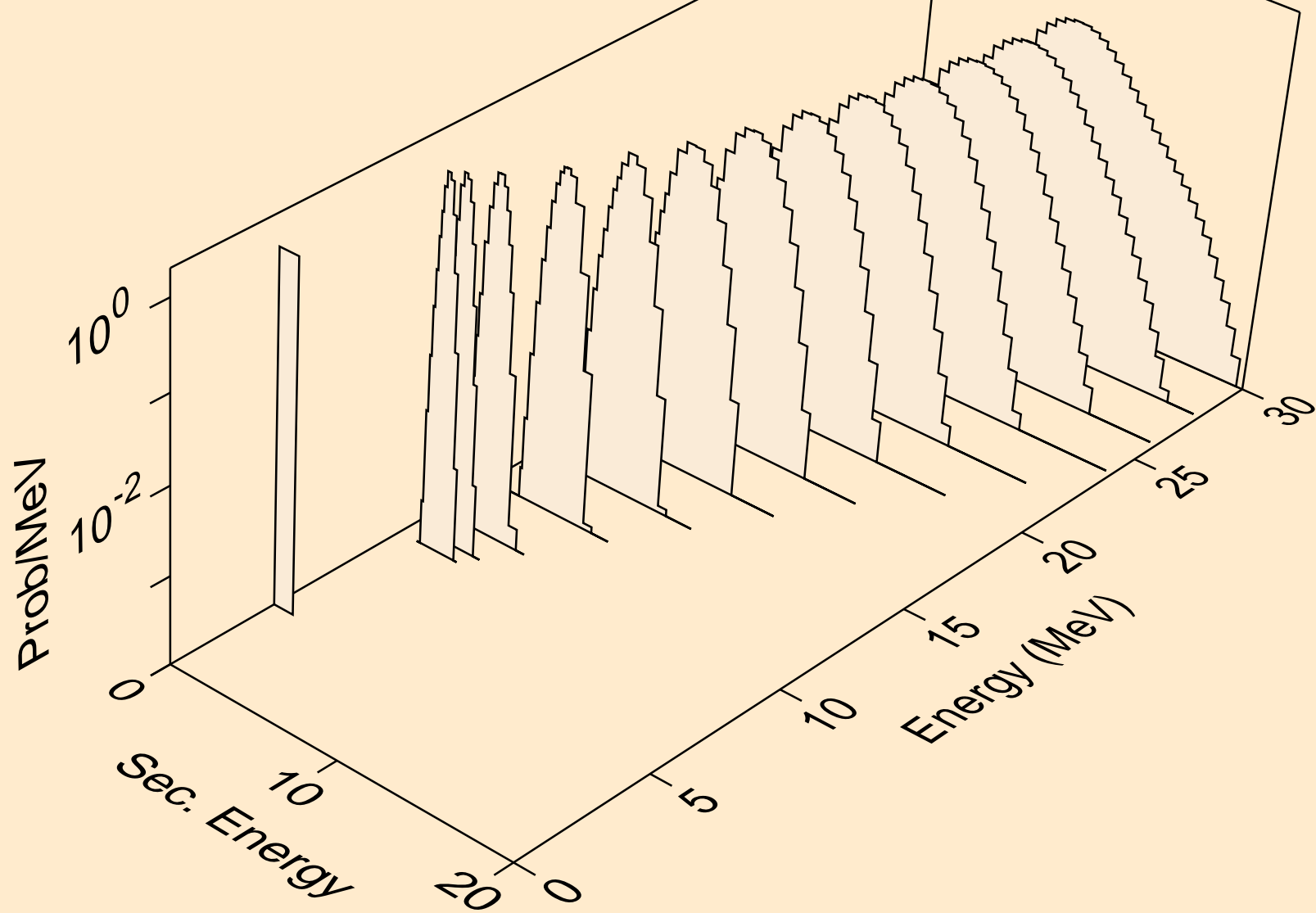

BI192 NEUTRON ACER TENDL-2024 LIBRARY; T=0.K  
protons from (n,npa)

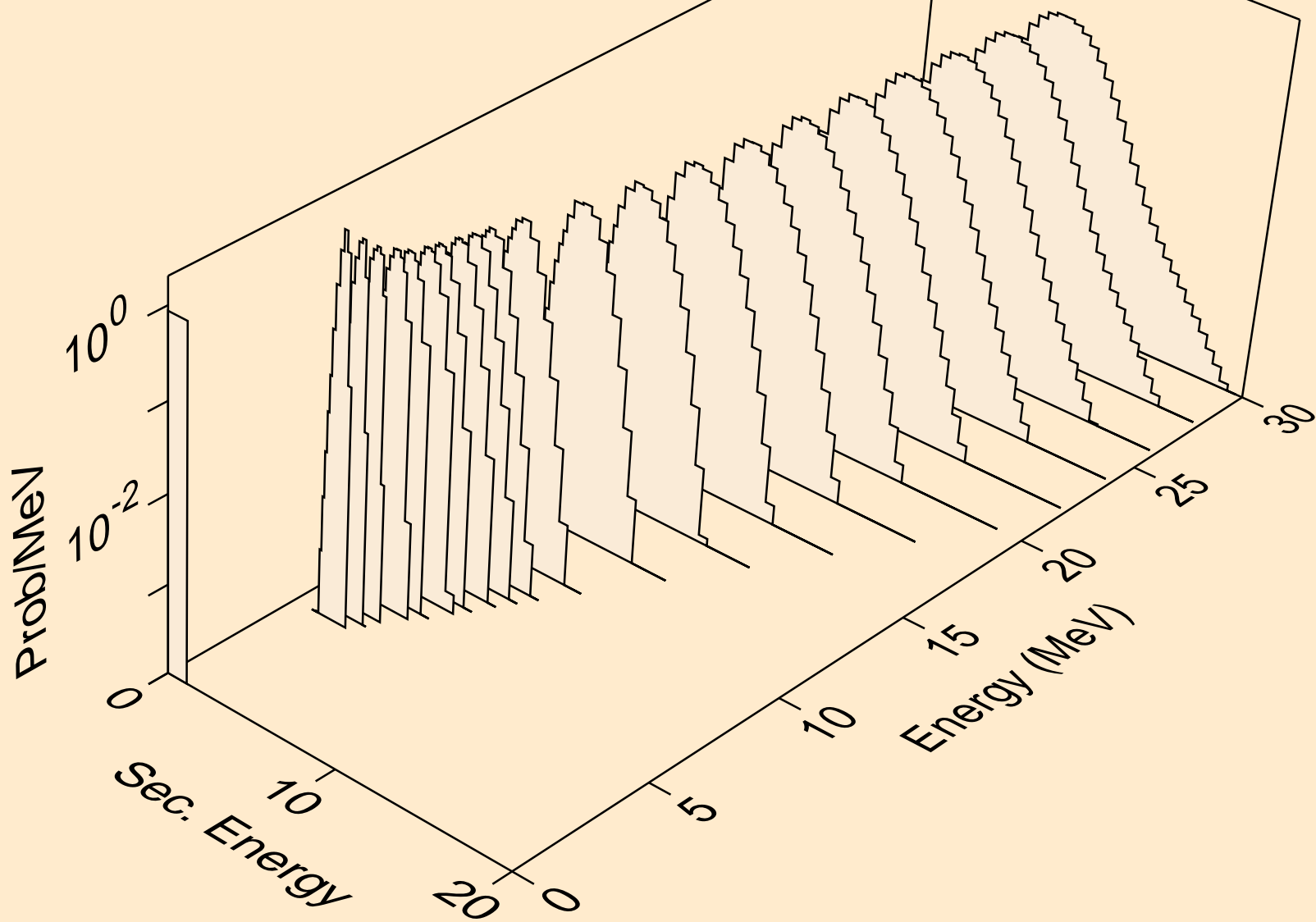

BI192 NEUTRON ACER TENDL-2024 LIBRARY; T=0.K  
protons from (n,p)

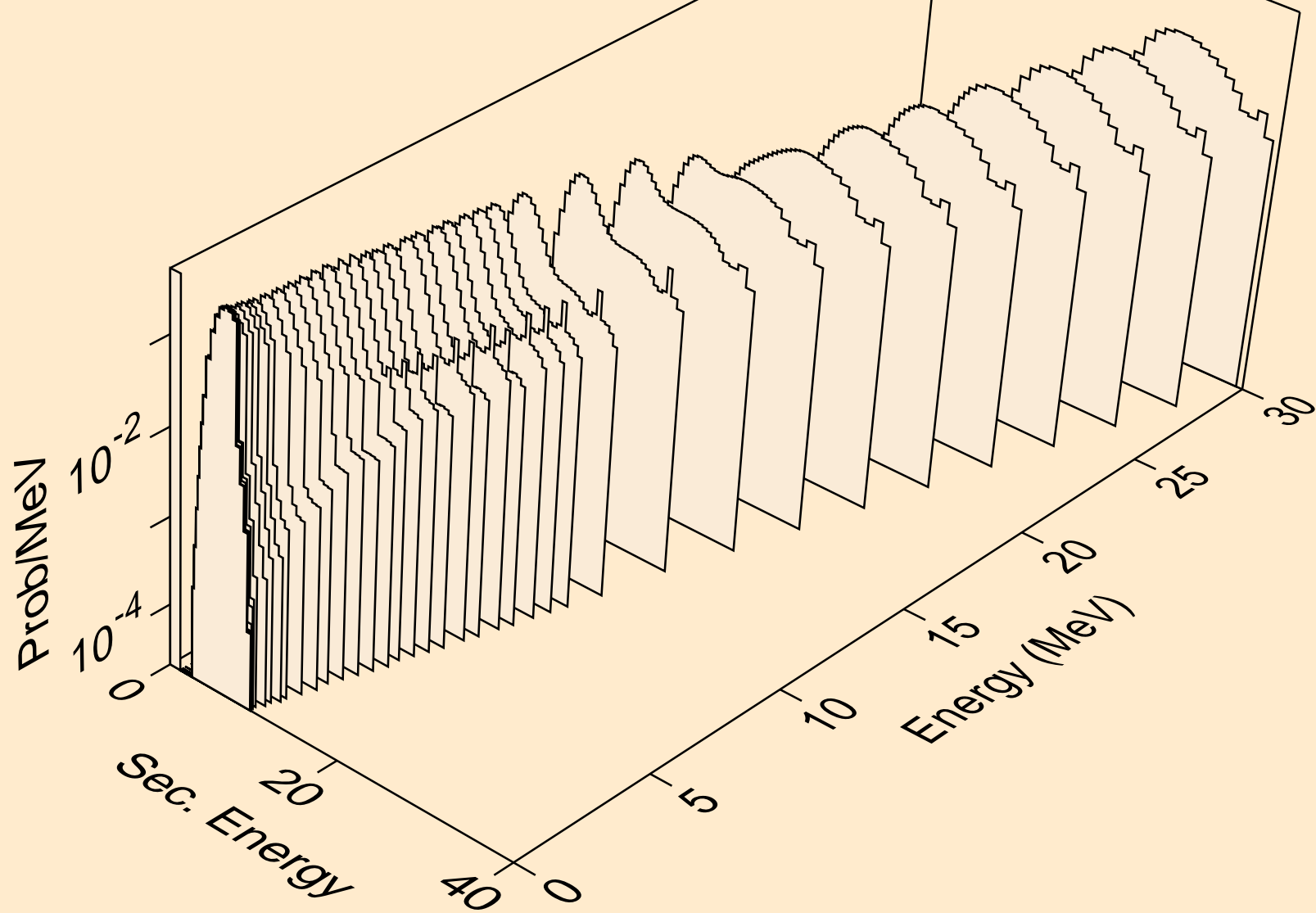

BI192 NEUTRON ACER TENDL-2024 LIBRARY; T=0.K  
protons from (n,2p)

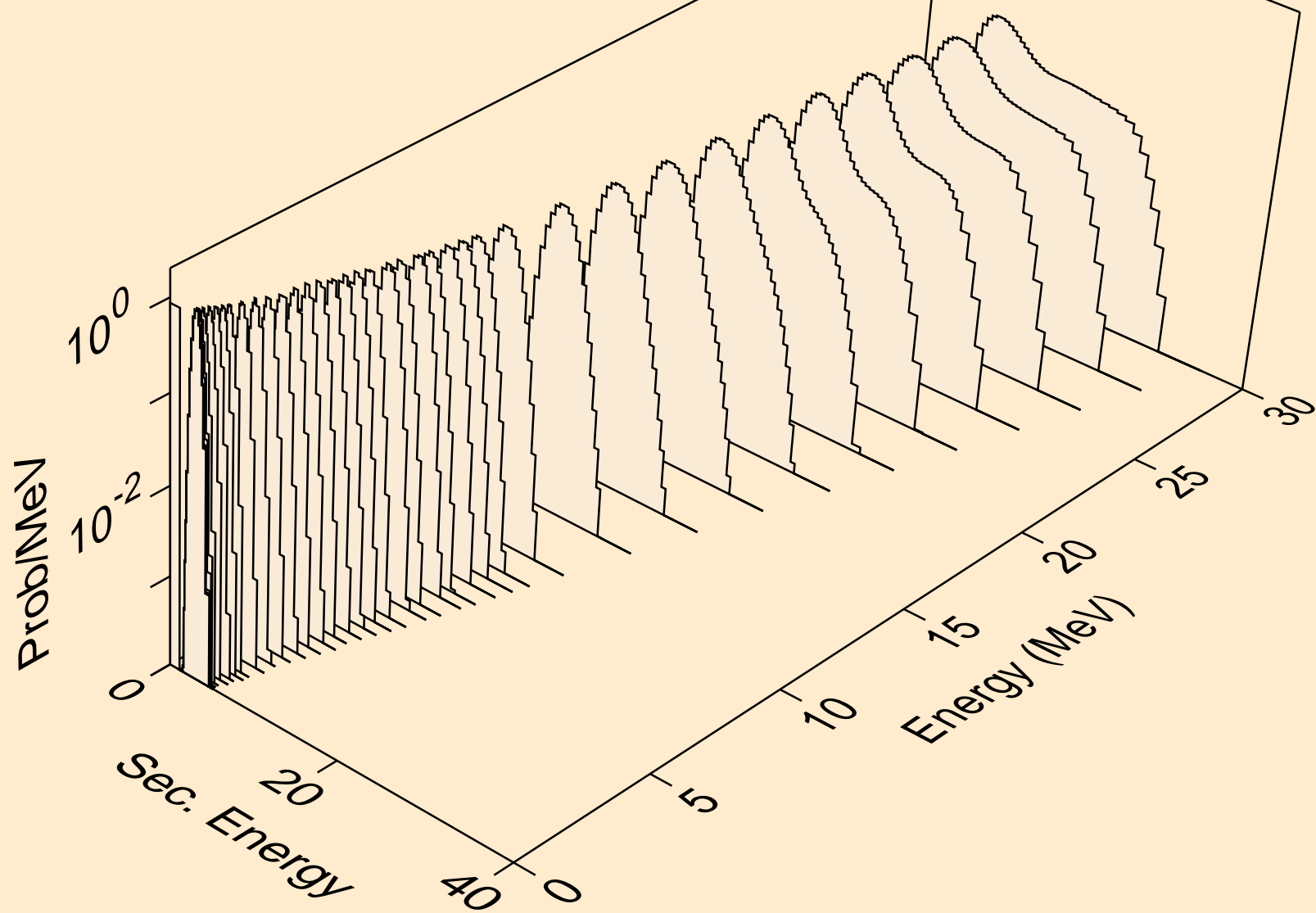

BI192 NEUTRON ACER TENDL-2024 LIBRARY; T=0.K  
protons from (n,p)

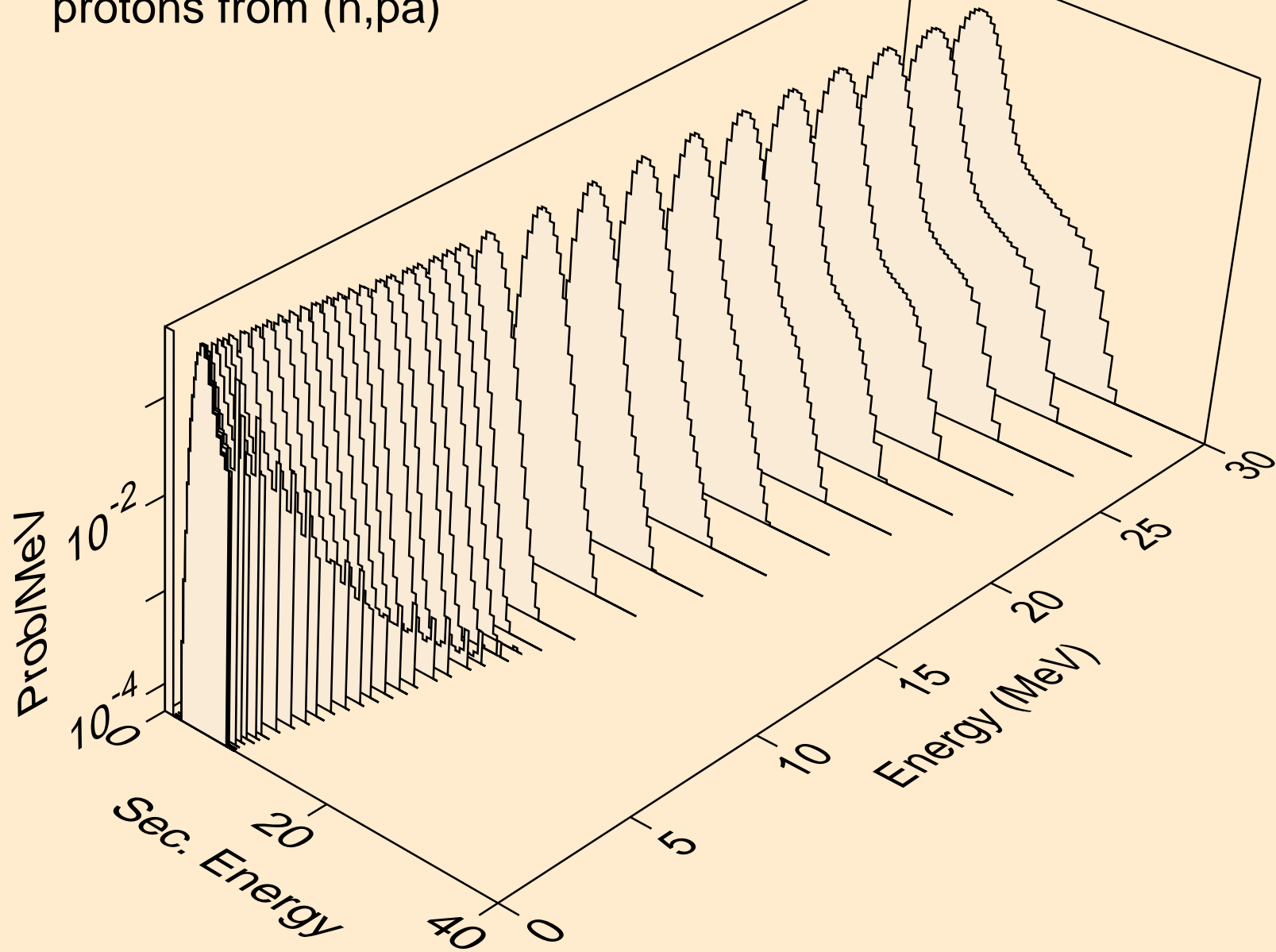

BI192 NEUTRON ACER TENDL-2024 LIBRARY; T=0.K  
protons from (n,pd)

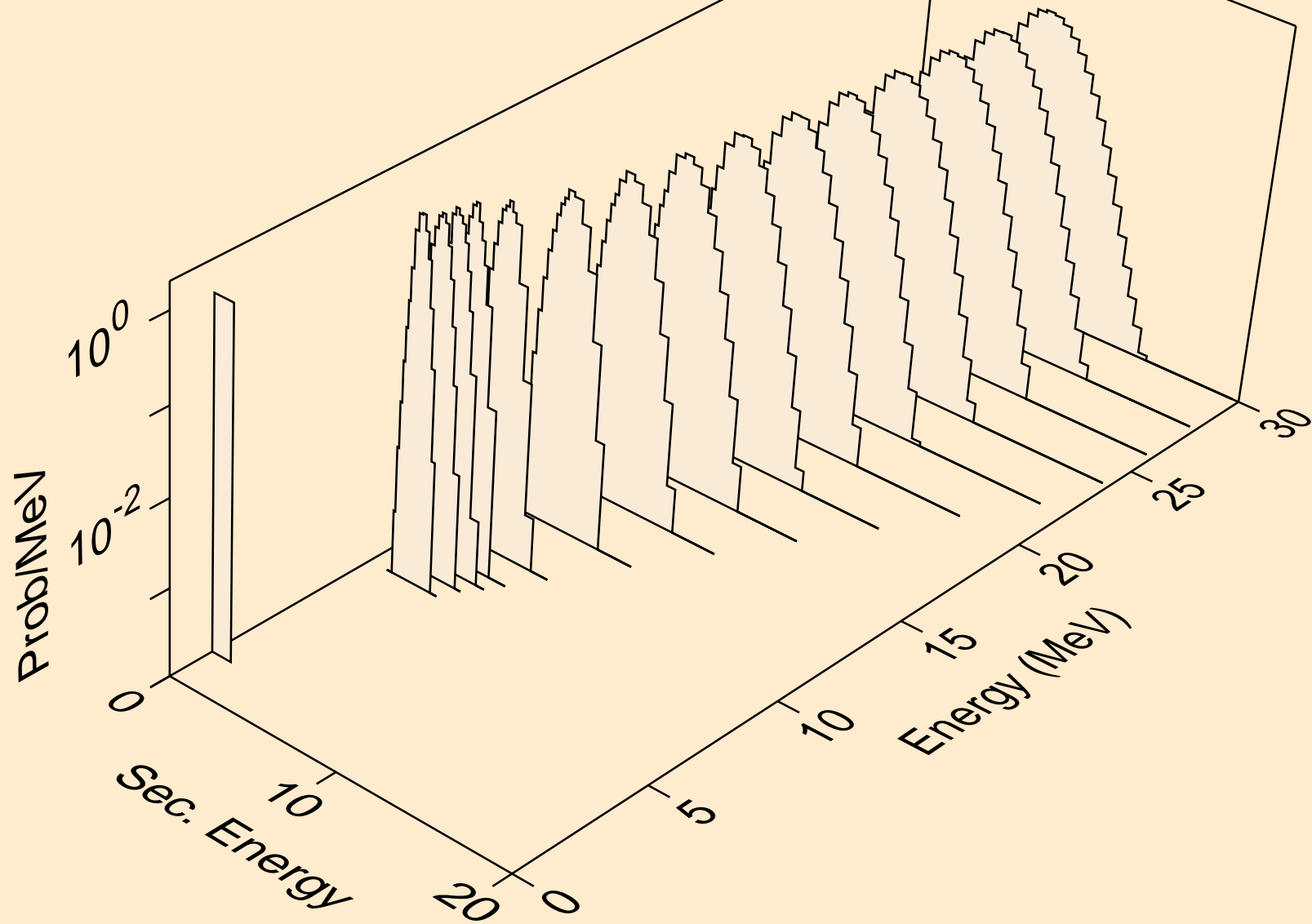



BI192 NEUTRON ACER TENDL-2024 LIBRARY; T=0.K  
protons from (n,pt)

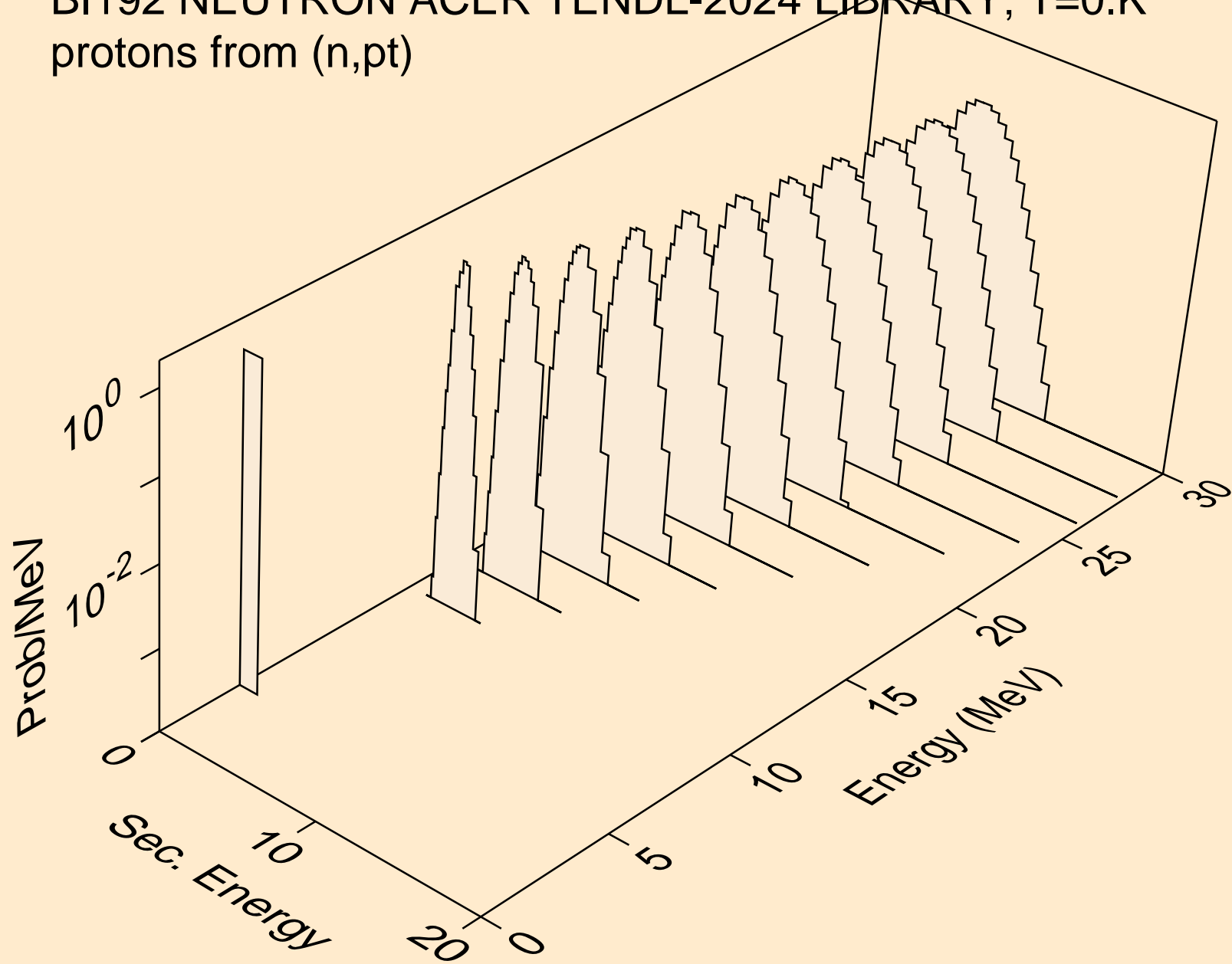

BI192 NEUTRON ACER TENDL-2024 LIBRARY; T=0.K  
deuterons from (n,x)

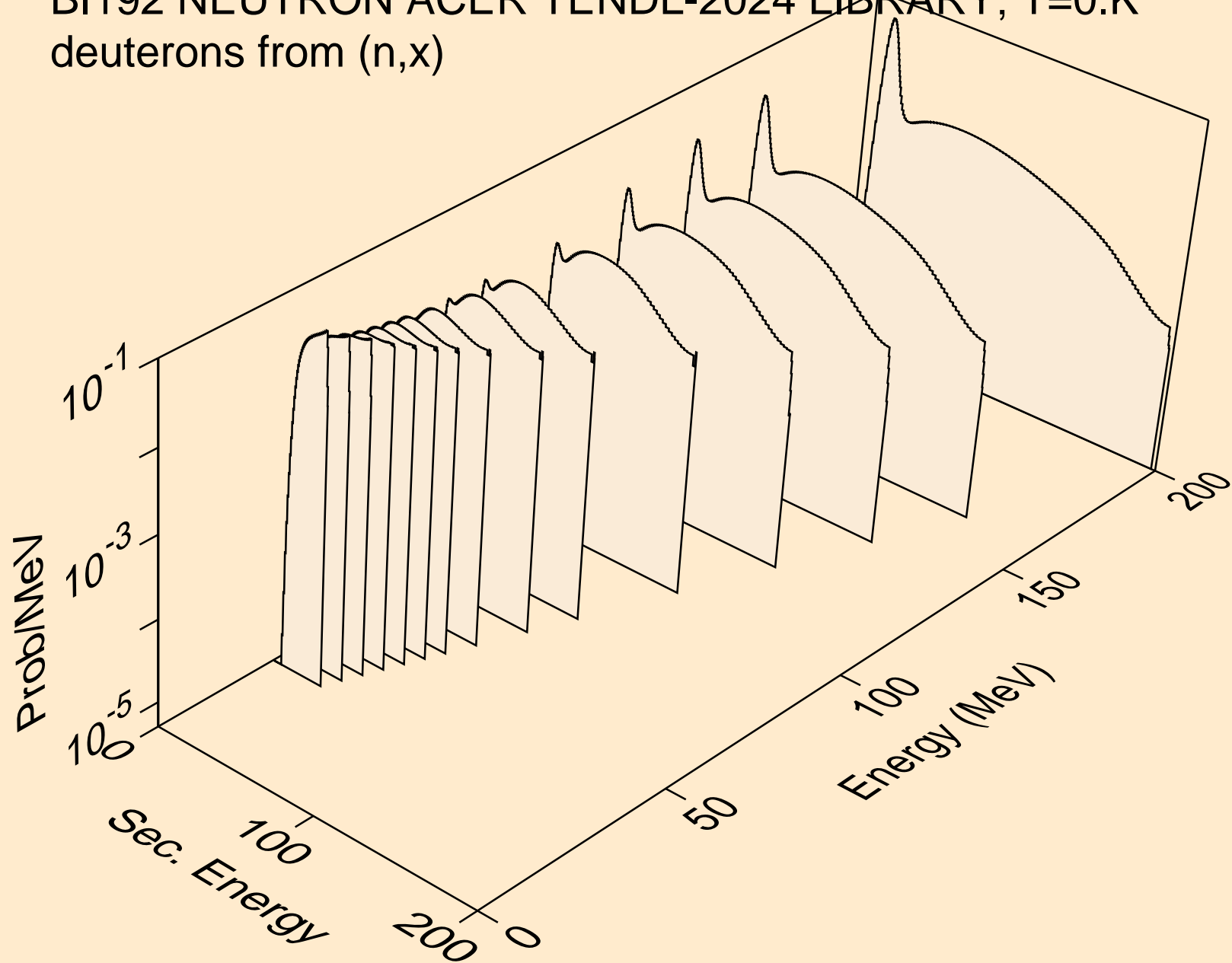

BI192 NEUTRON ACER TENDL-2024 LIBRARY; T=0.K  
deuterons from (n,2nd)

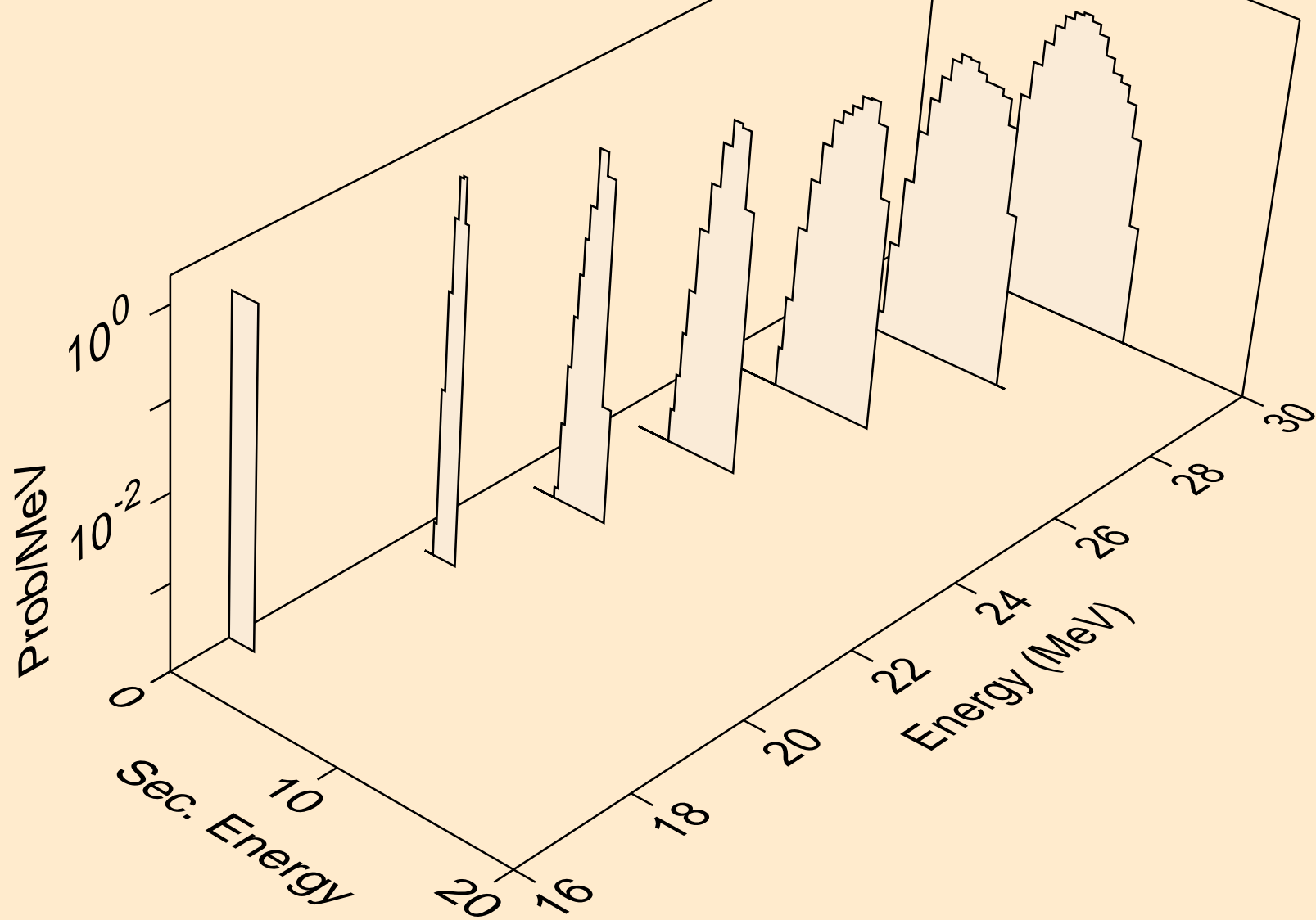

BI192 NEUTRON ACER TENDL-2024 LIBRARY; T=0.K  
deuterons from (n,n\*)d

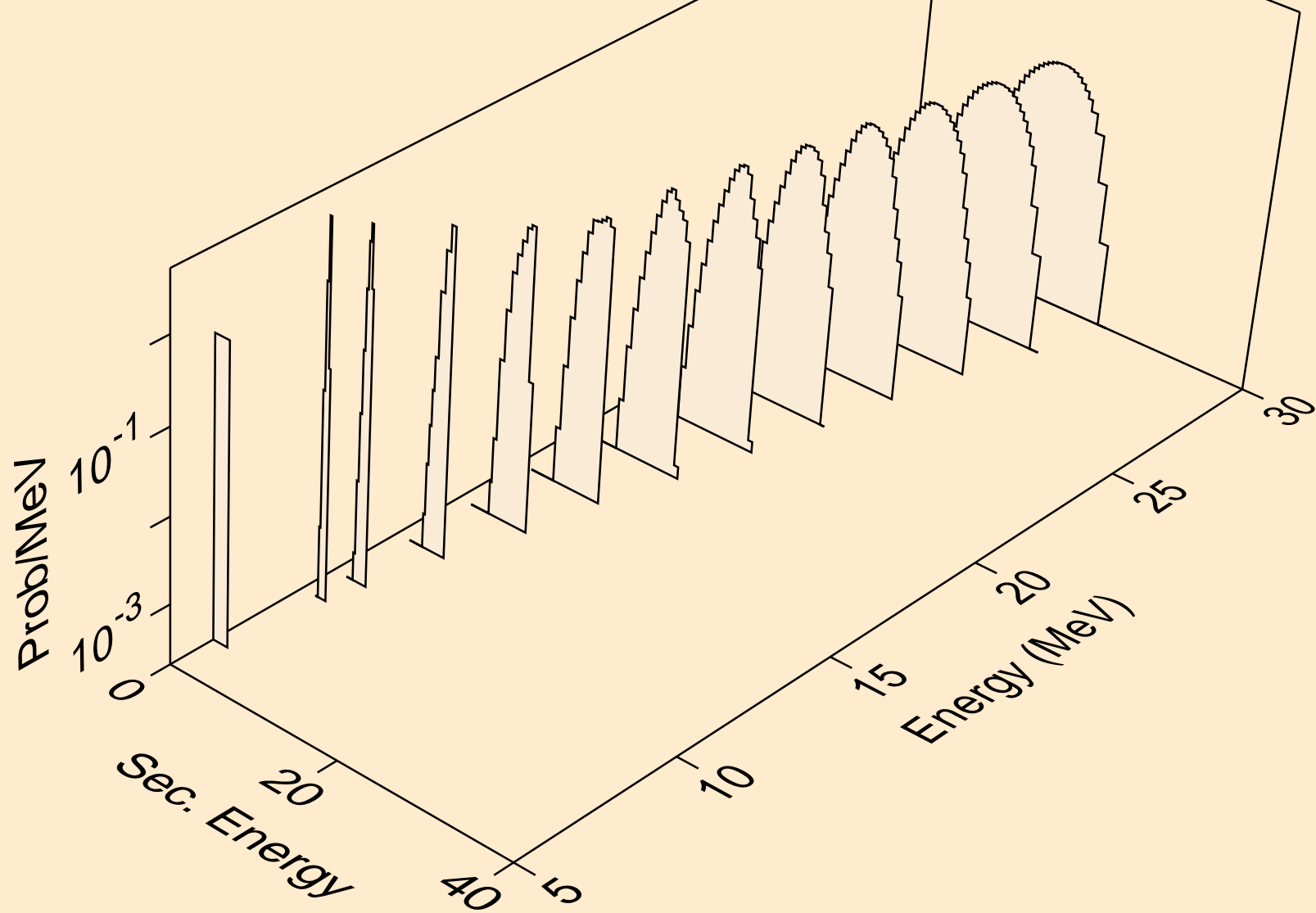

BI192 NEUTRON ACER TENDL-2024 LIBRARY; T=0.K  
deuterons from (n,d)

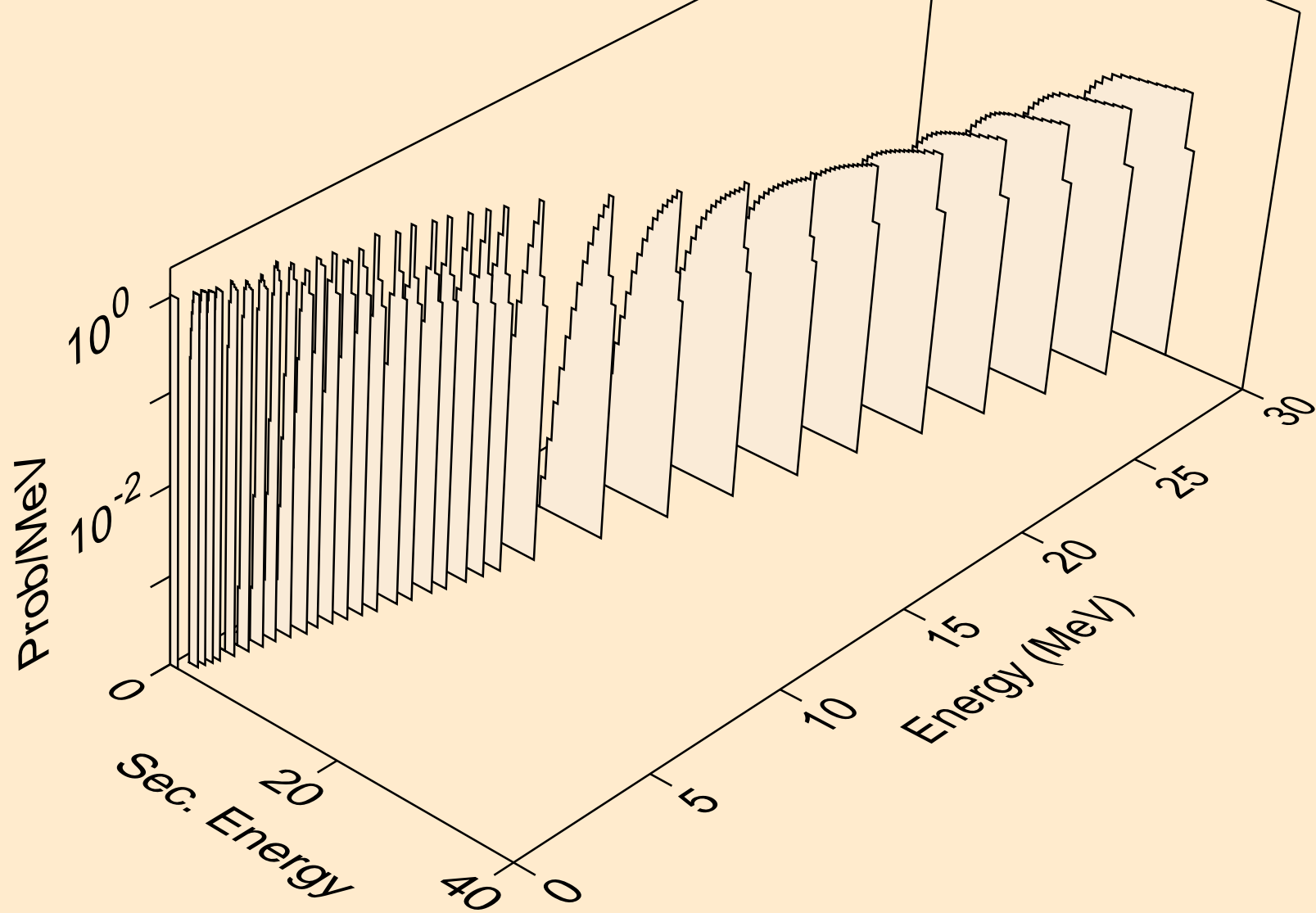

BI192 NEUTRON ACER TENDL-2024 LIBRARY; T=0.K  
deuterons from (n,pd)

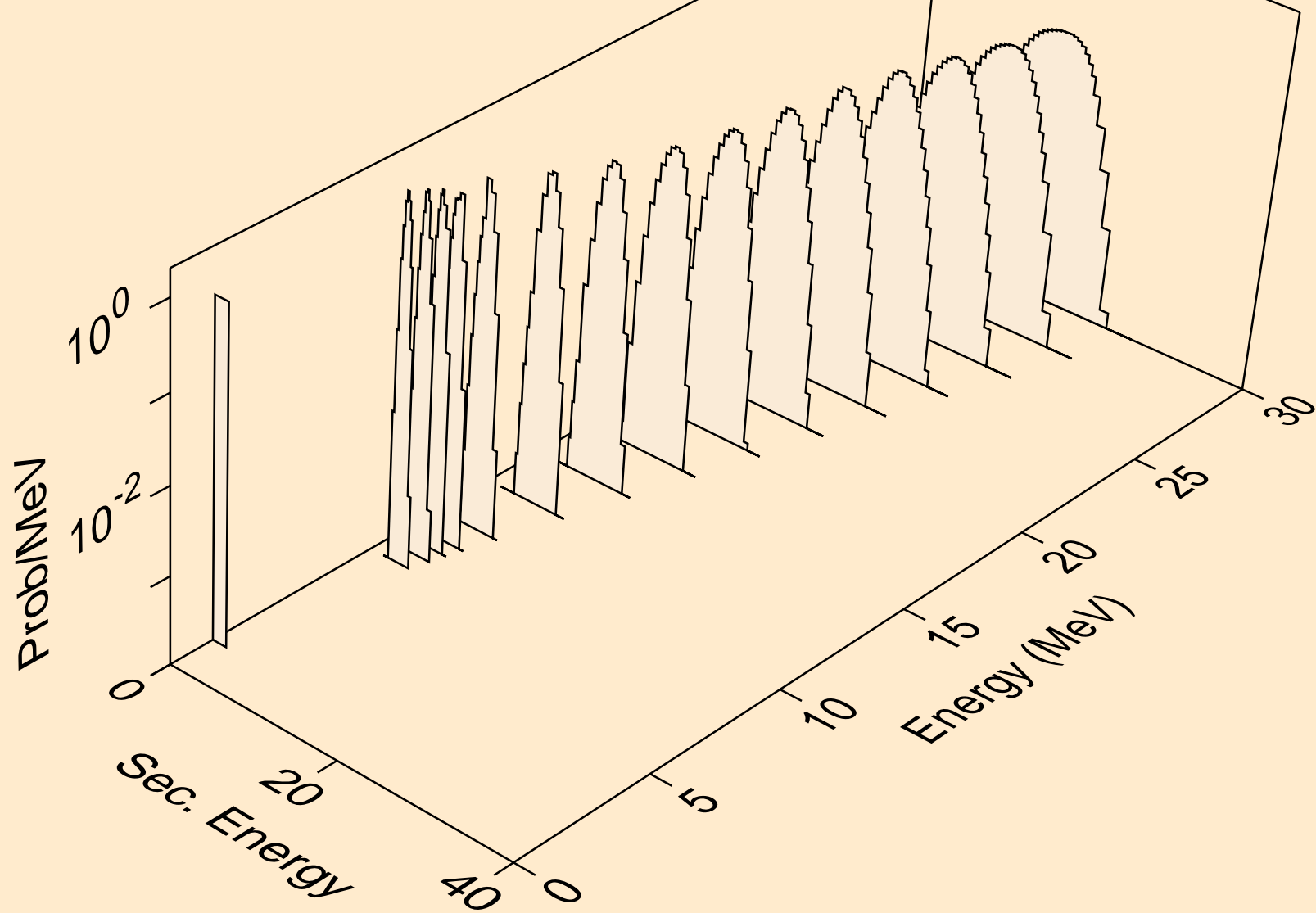

BI192 NEUTRON ACER TENDL-2024 LIBRARY; T=0.K  
deuterons from (n,da)

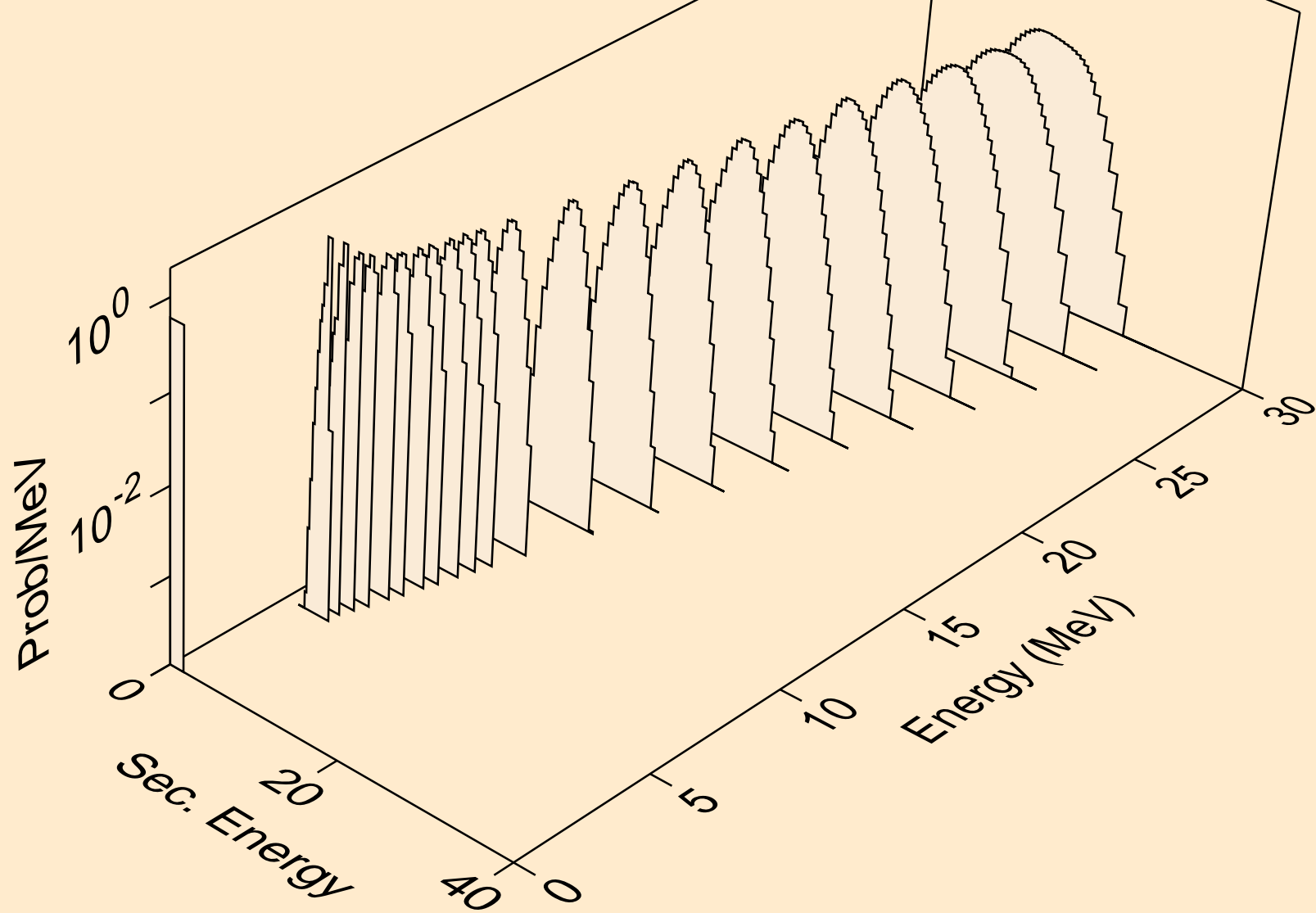

BI192 NEUTRON ACER TENDL-2024 LIBRARY; T=0.K  
tritons from (n,x)

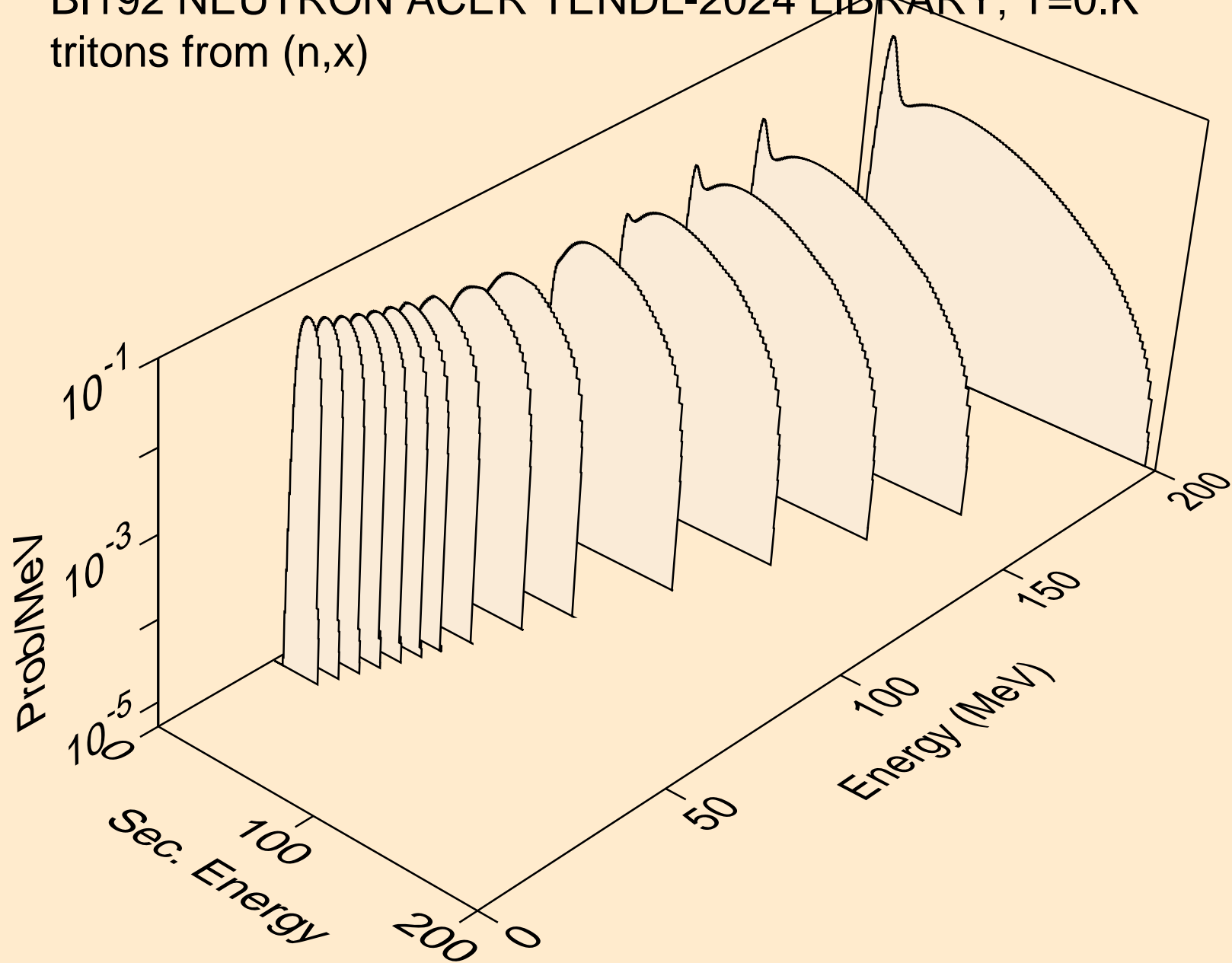



BI192 NEUTRON ACER TENDL-2024 LIBRARY; T=0.K  
tritons from (n,n\*)t

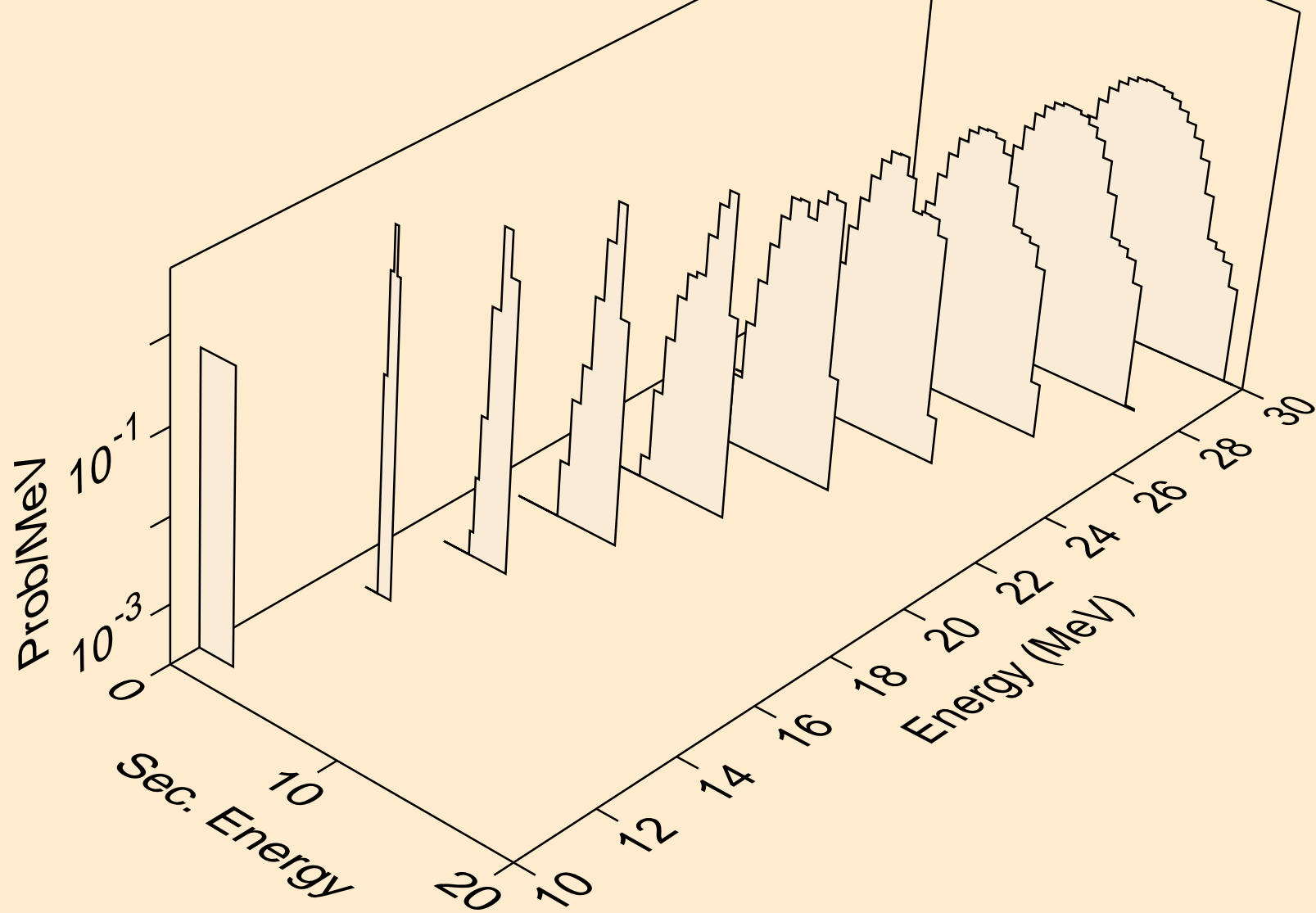

BI192 NEUTRON ACER TENDL-2024 LIBRARY; T=0.K  
tritons from (n,t)

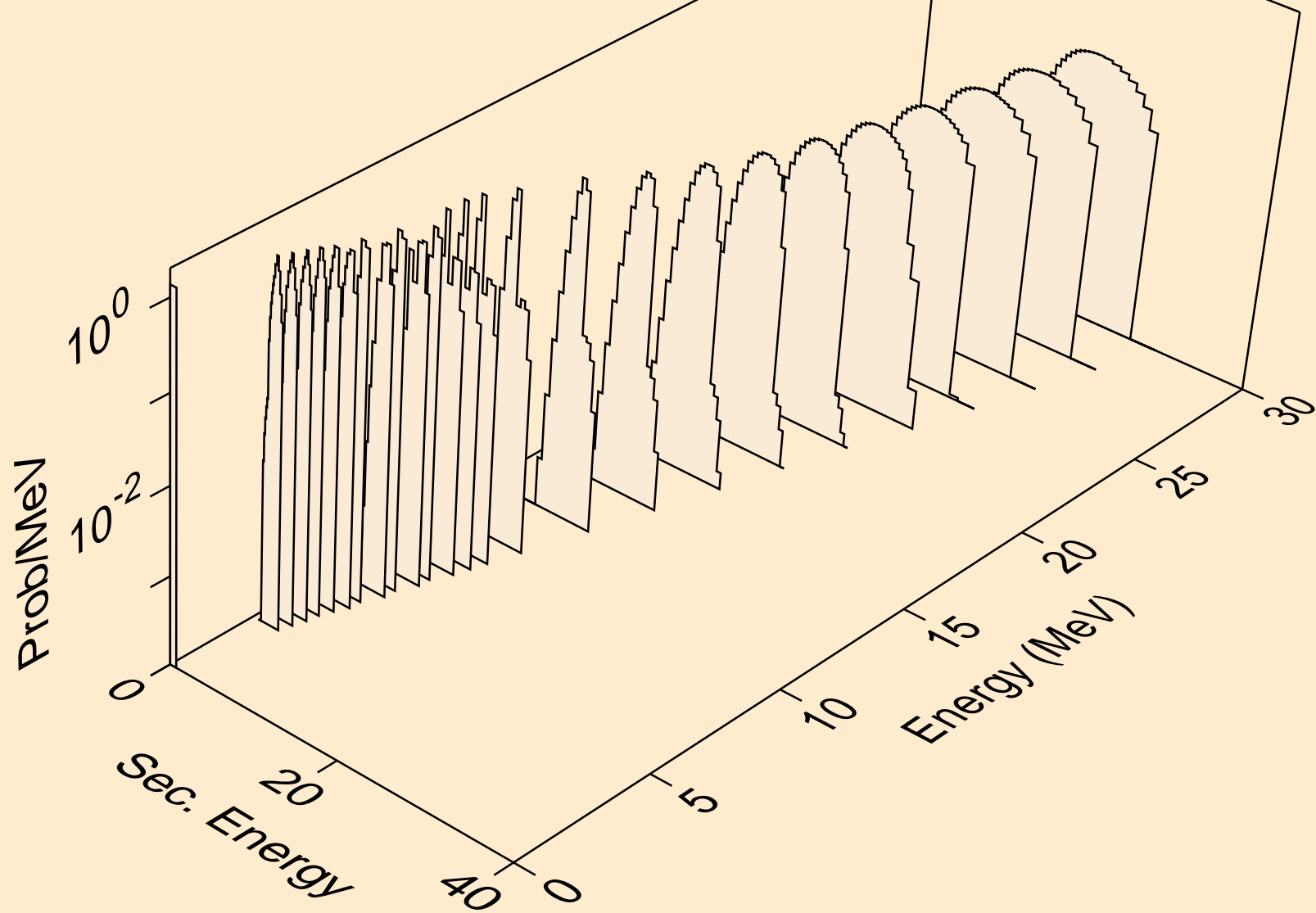

BI192 NEUTRON ACER TENDL-2024 LIBRARY; T=0.K  
tritons from (n,pt)

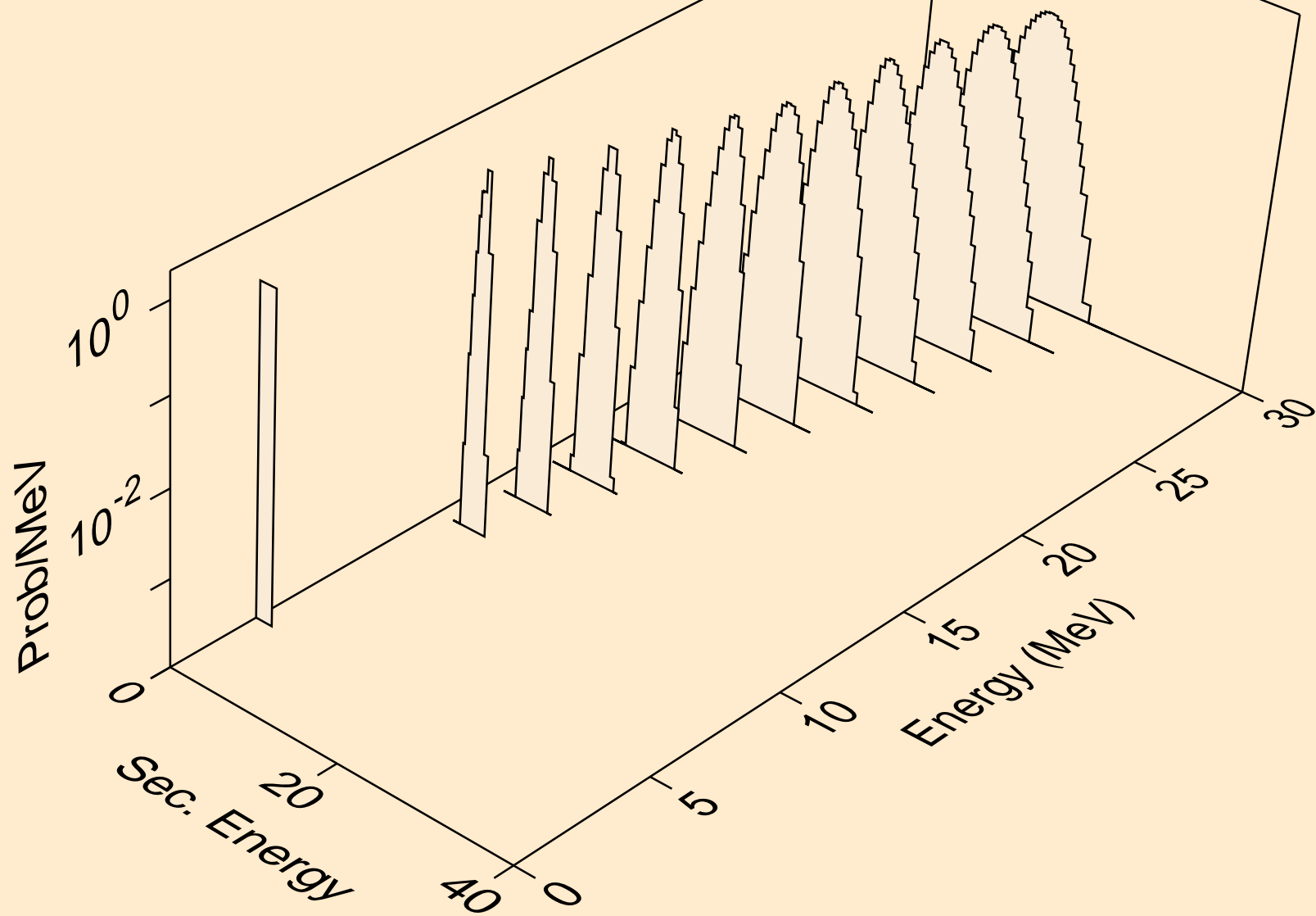

BI192 NEUTRON ACER TENDL-2024 LIBRARY; T=0.K  
he3s from (n,x)

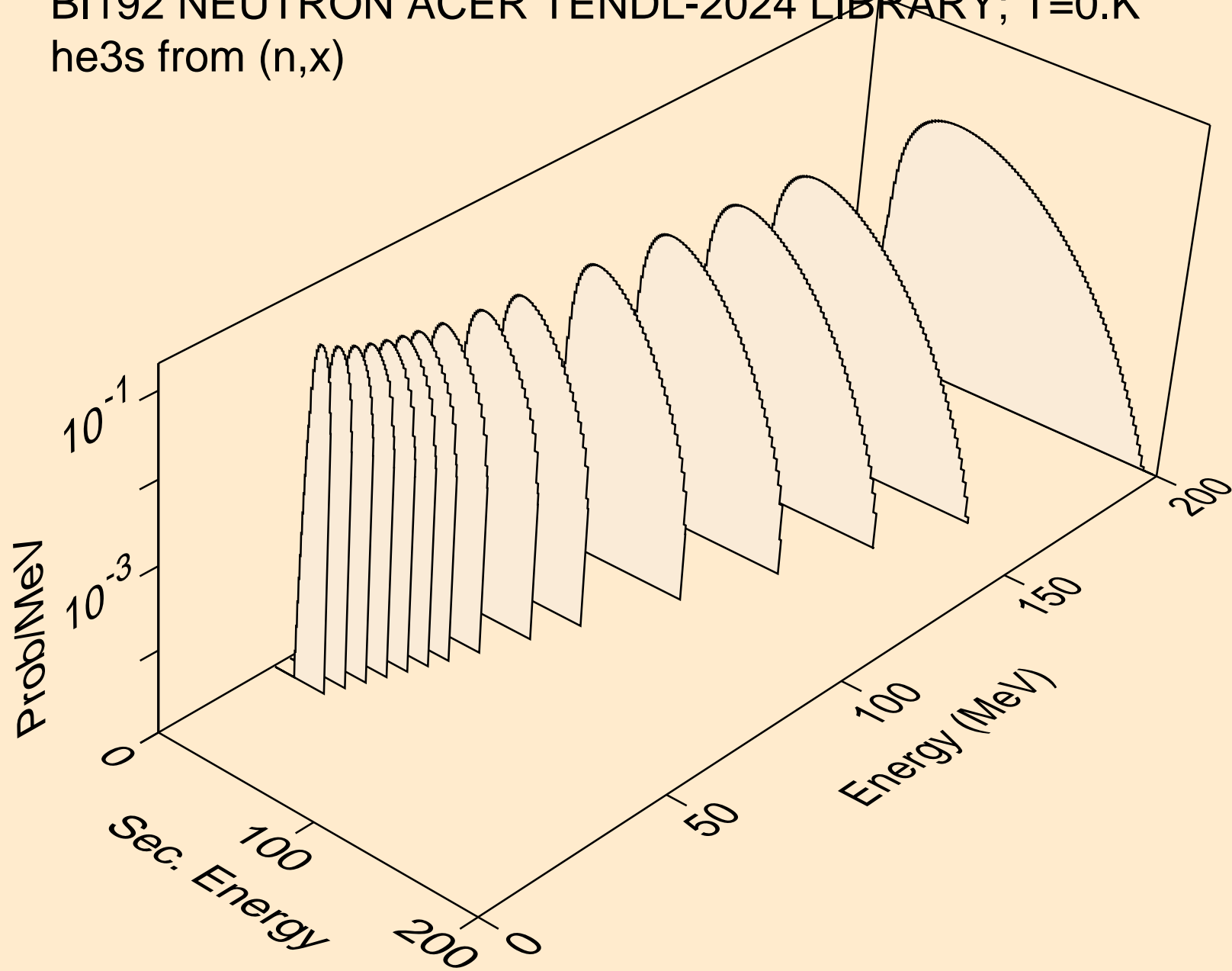

BI192 NEUTRON ACER TENDL-2024 LIBRARY; T=0.K  
he3s from (n,n\*)he3

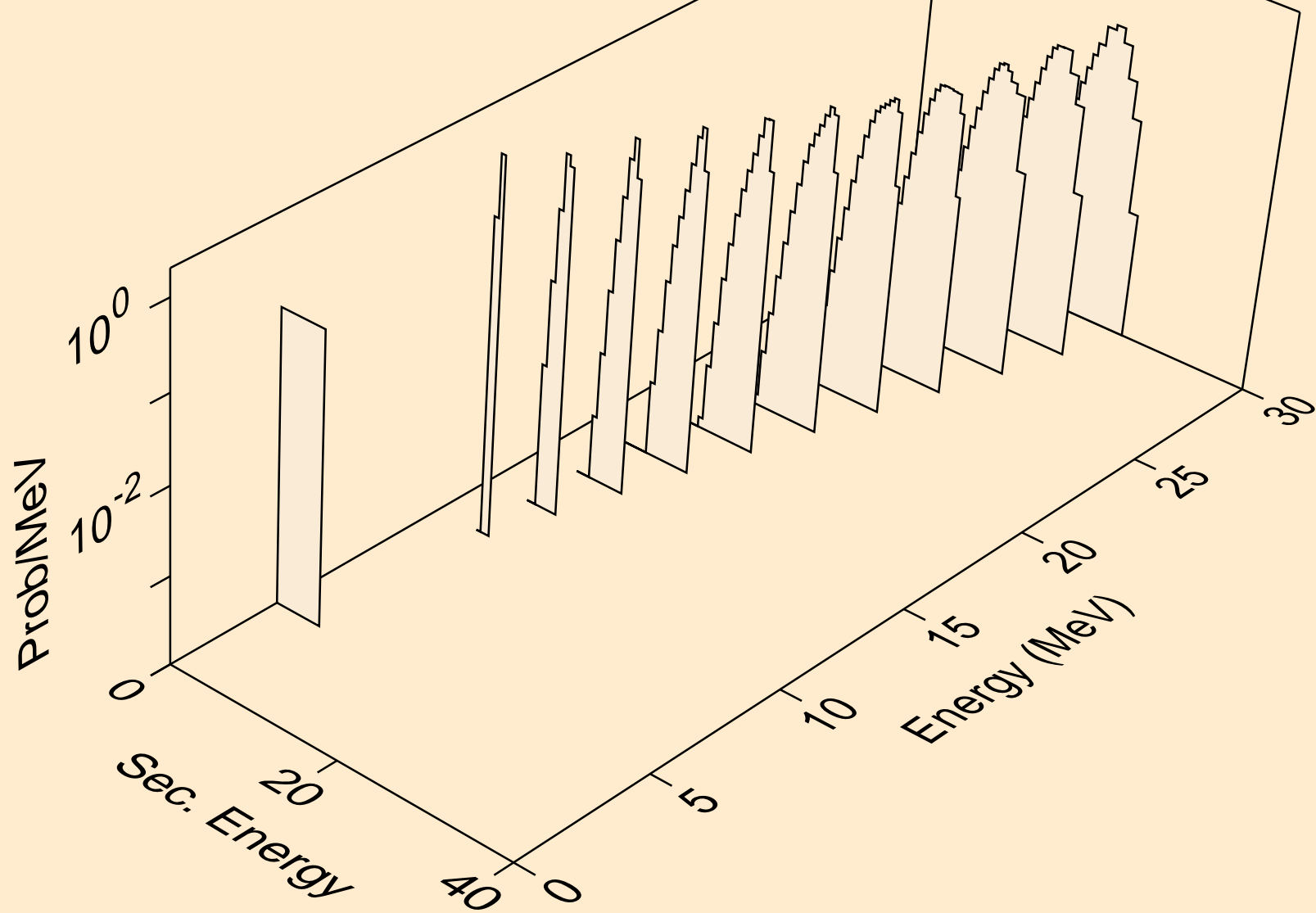

BI192 NEUTRON ACER TENDL-2024 LIBRARY; T=0.K  
he3s from (n,he3)

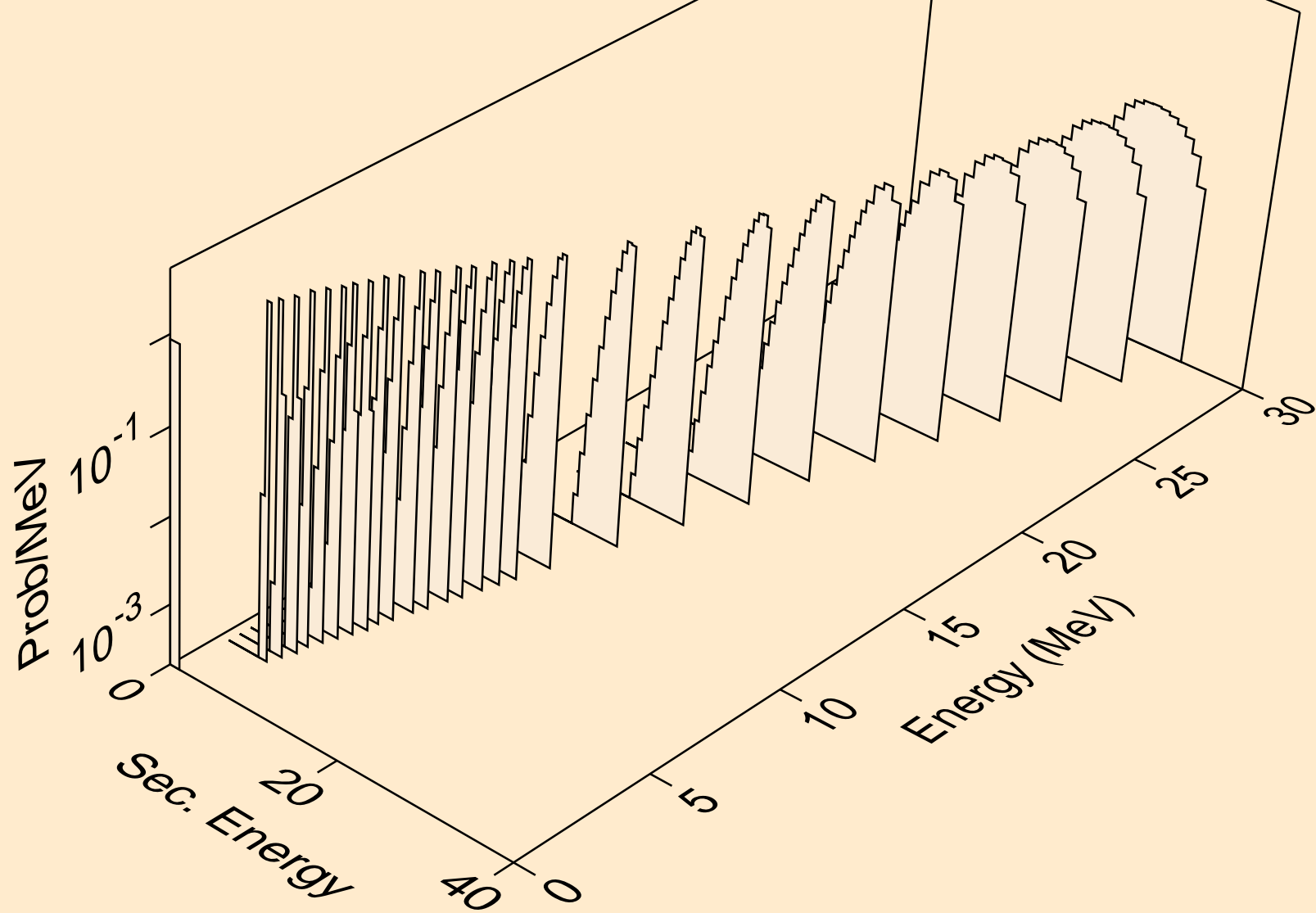

BI192 NEUTRON ACER TENDL-2024 LIBRARY; T=0.K  
alphas from (n,x)

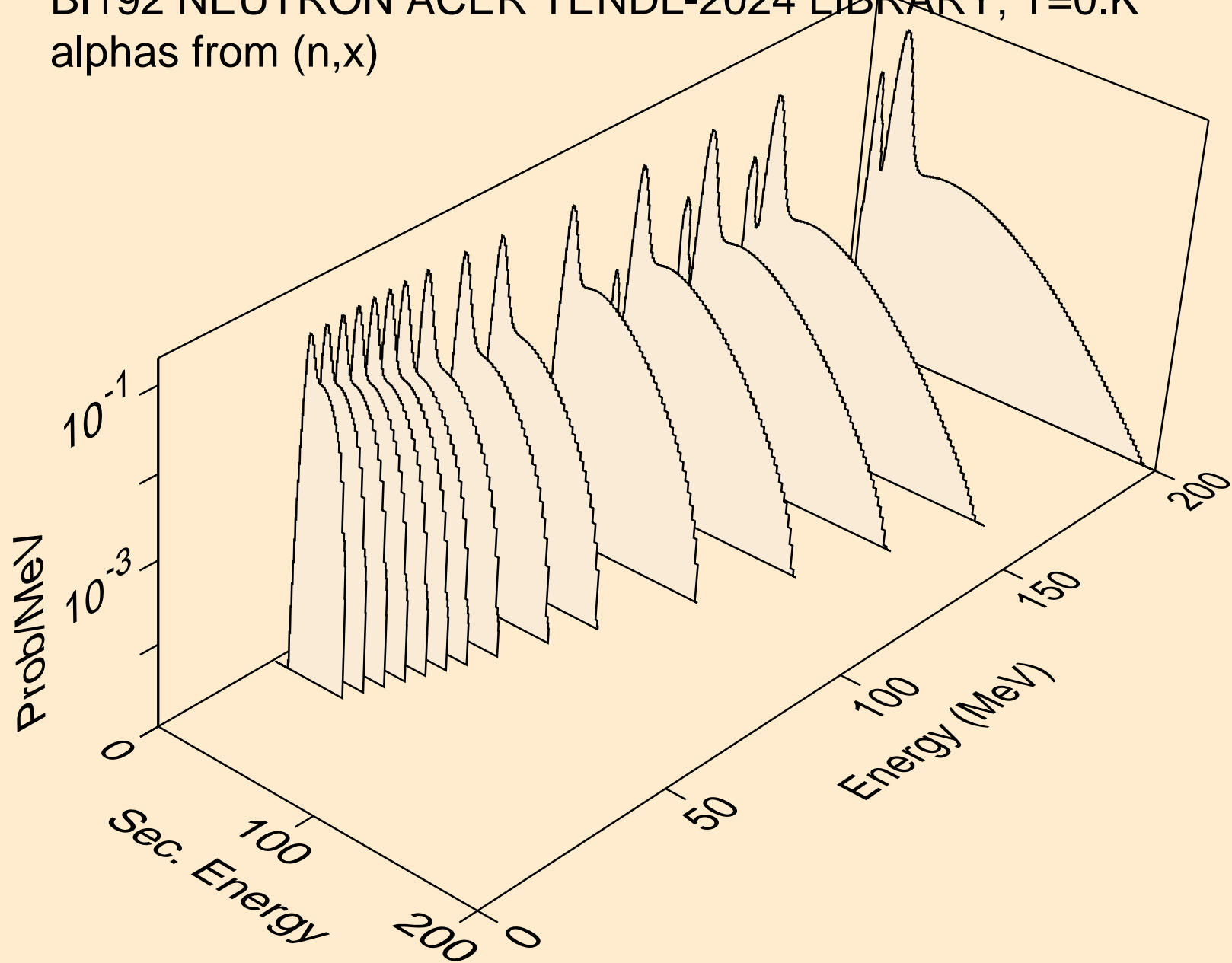

BI192 NEUTRON ACER TENDL-2024 LIBRARY; T=0.K  
alphas from (n,n\*)a

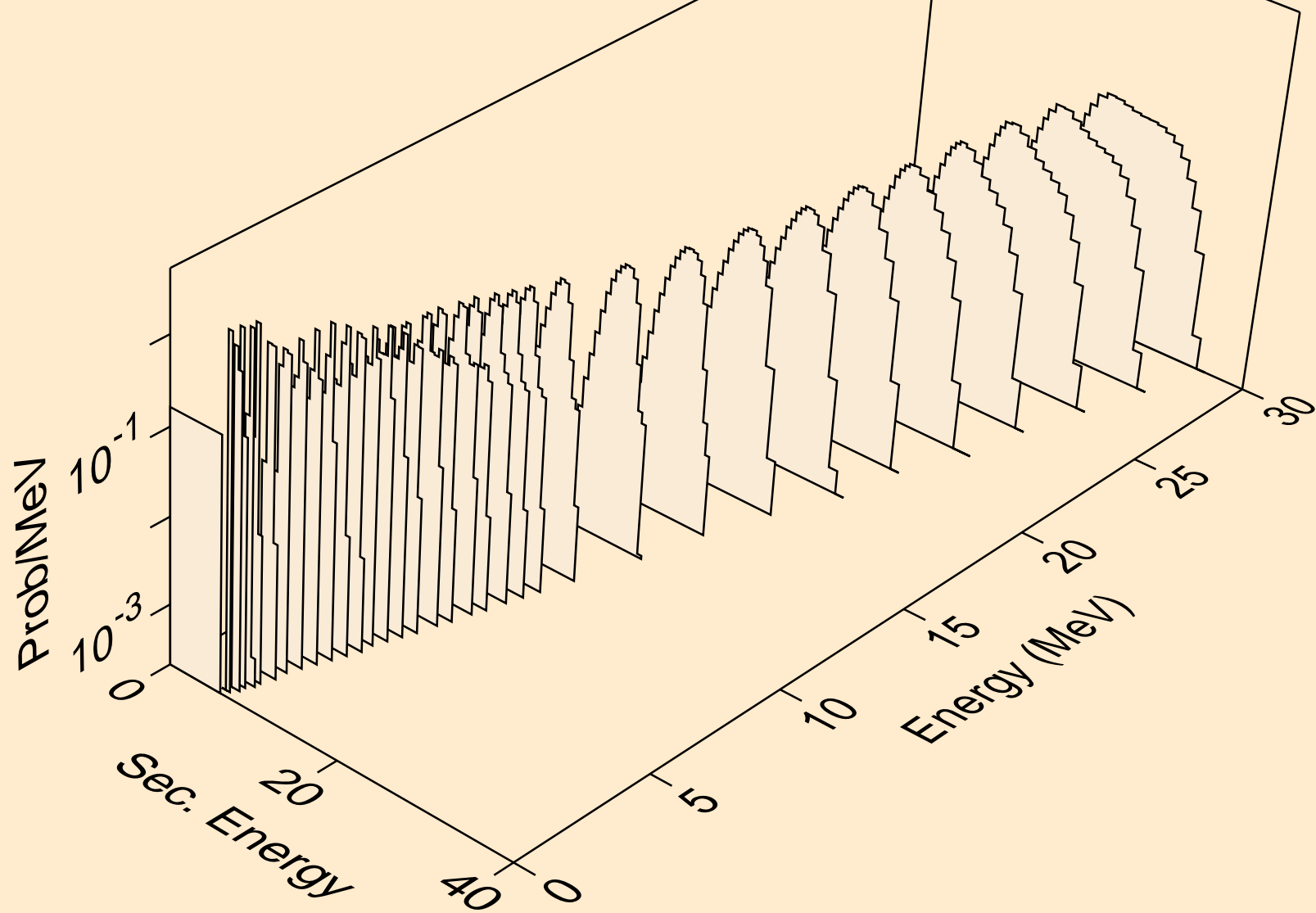



BI192 NEUTRON ACER TENDL-2024 LIBRARY; T=0.K  
alphas from (n,2n)a

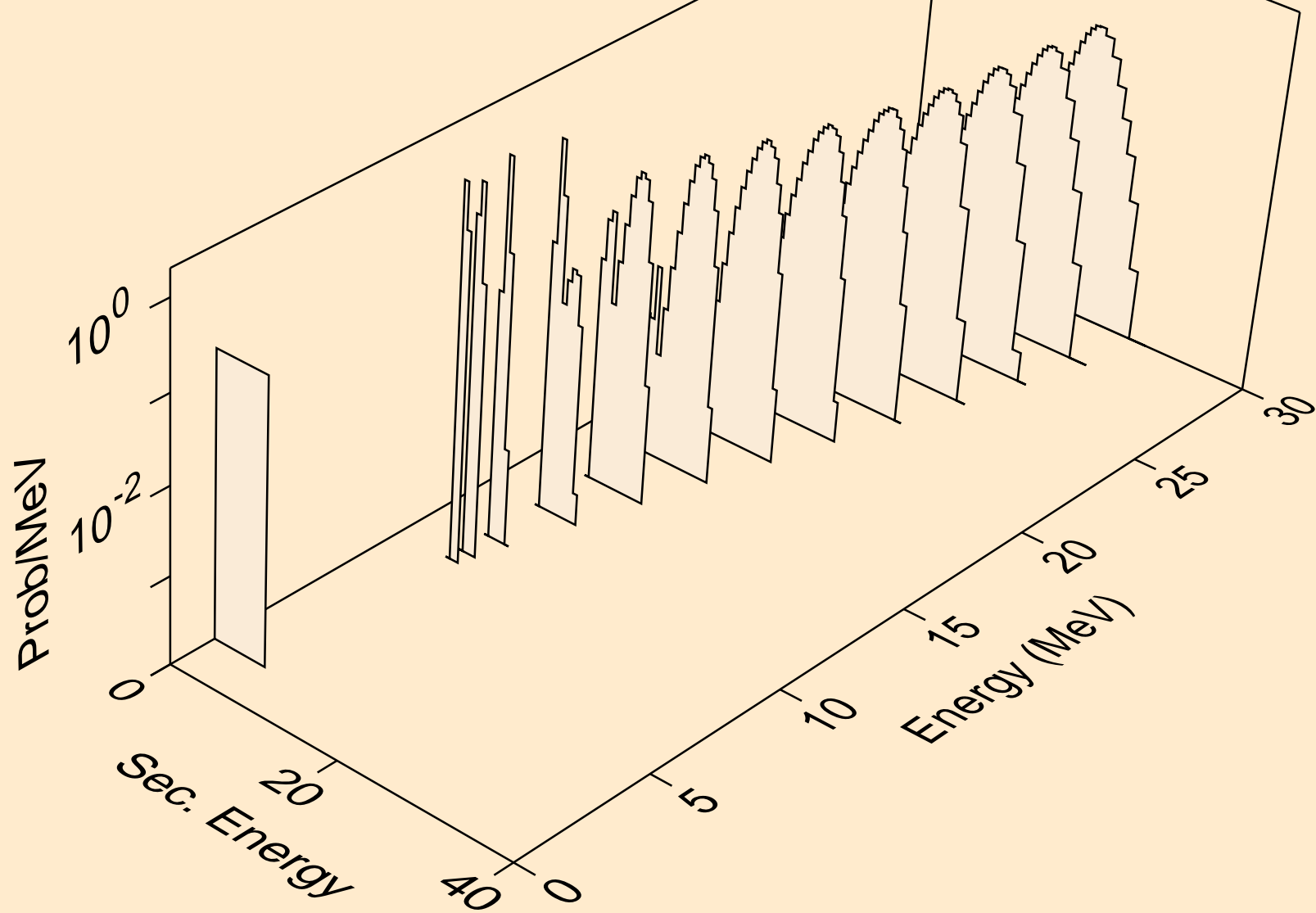

BI192 NEUTRON ACER TENDL-2024 LIBRARY; T=0.K  
alphas from (n,3n)a

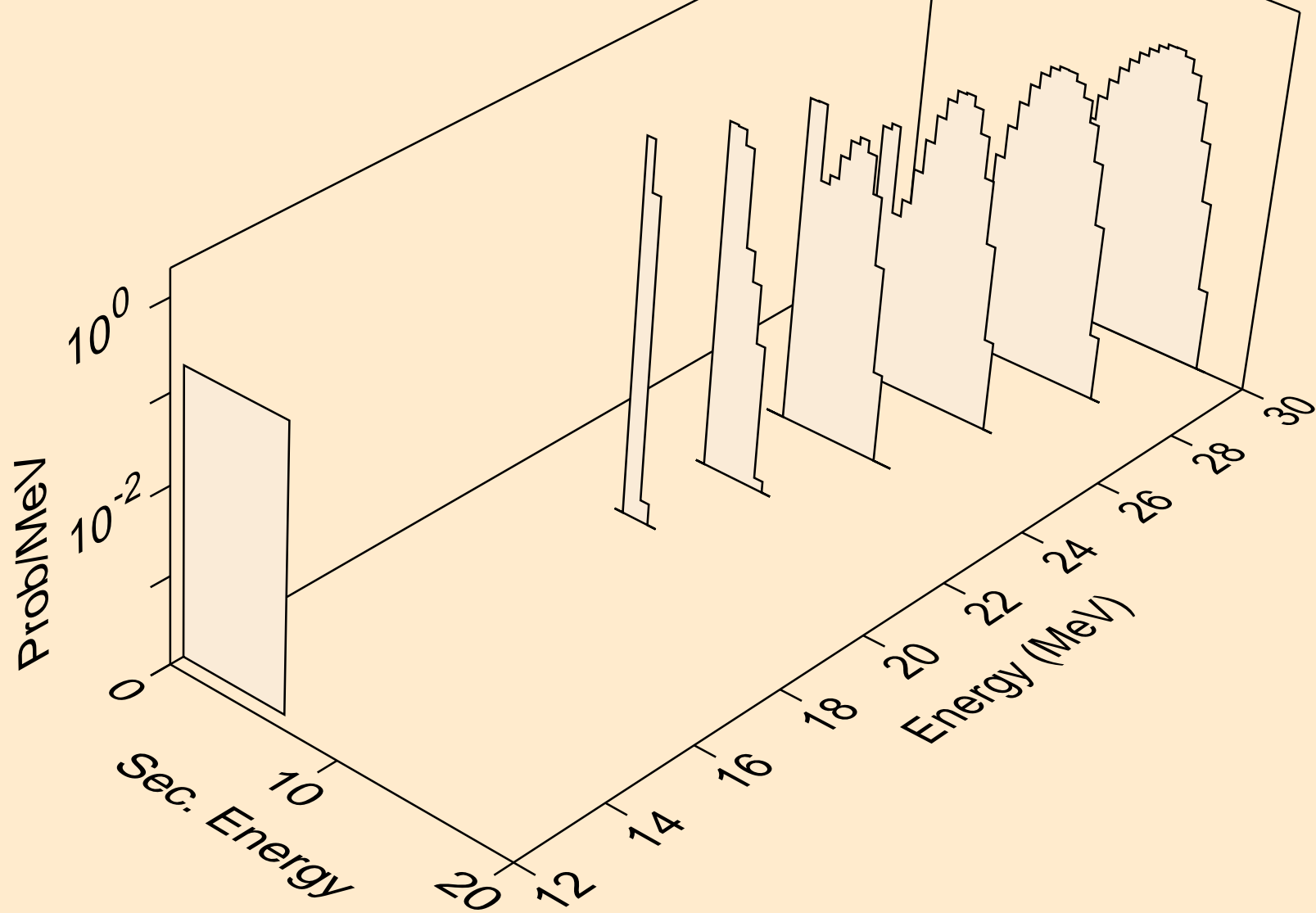

BI192 NEUTRON ACER TENDL-2024 LIBRARY; T=0.K  
alphas from (n,n\*)2a

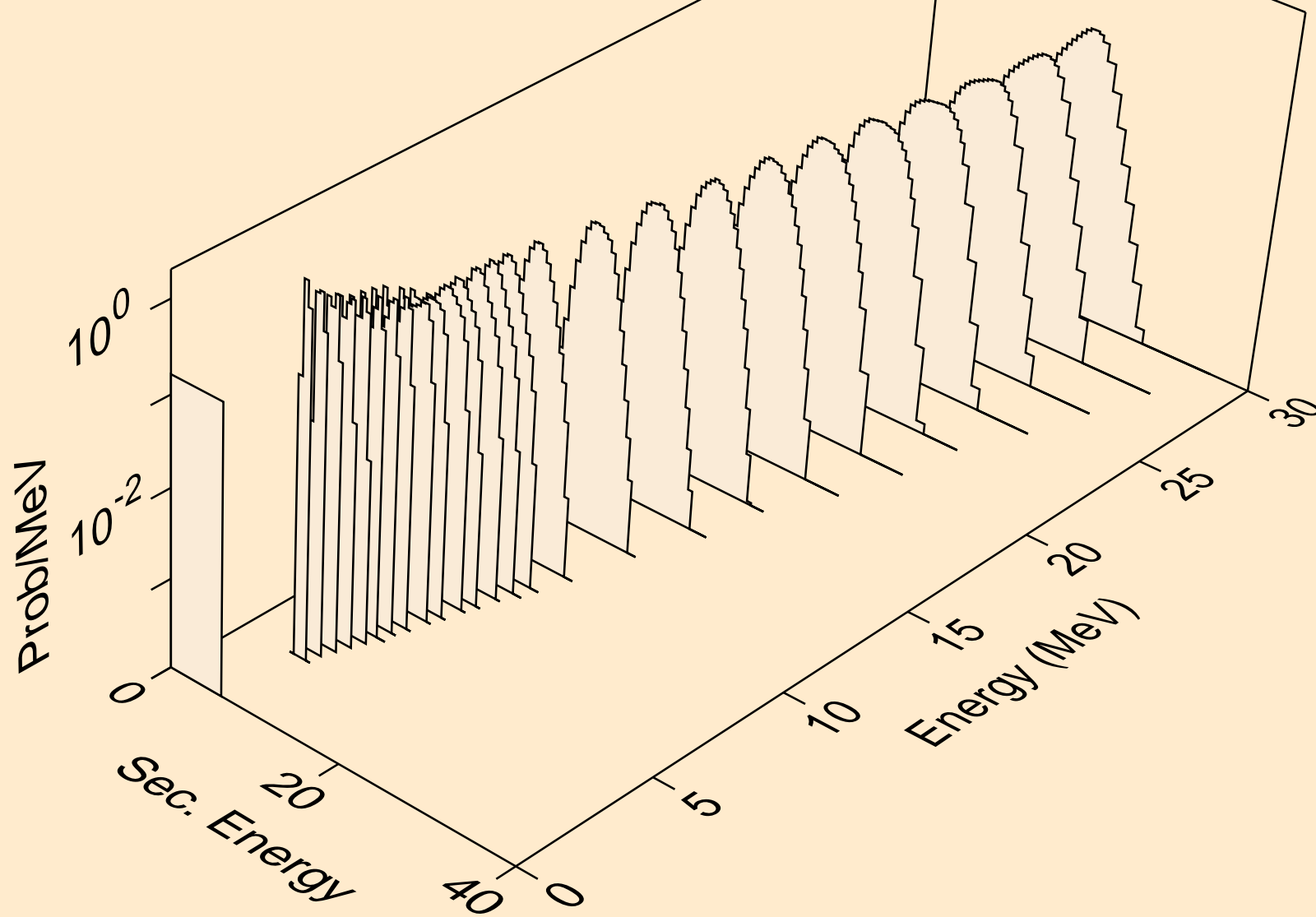

BI192 NEUTRON ACER TENDL-2024 LIBRARY; T=0.K  
alphas from (n,2n)2a

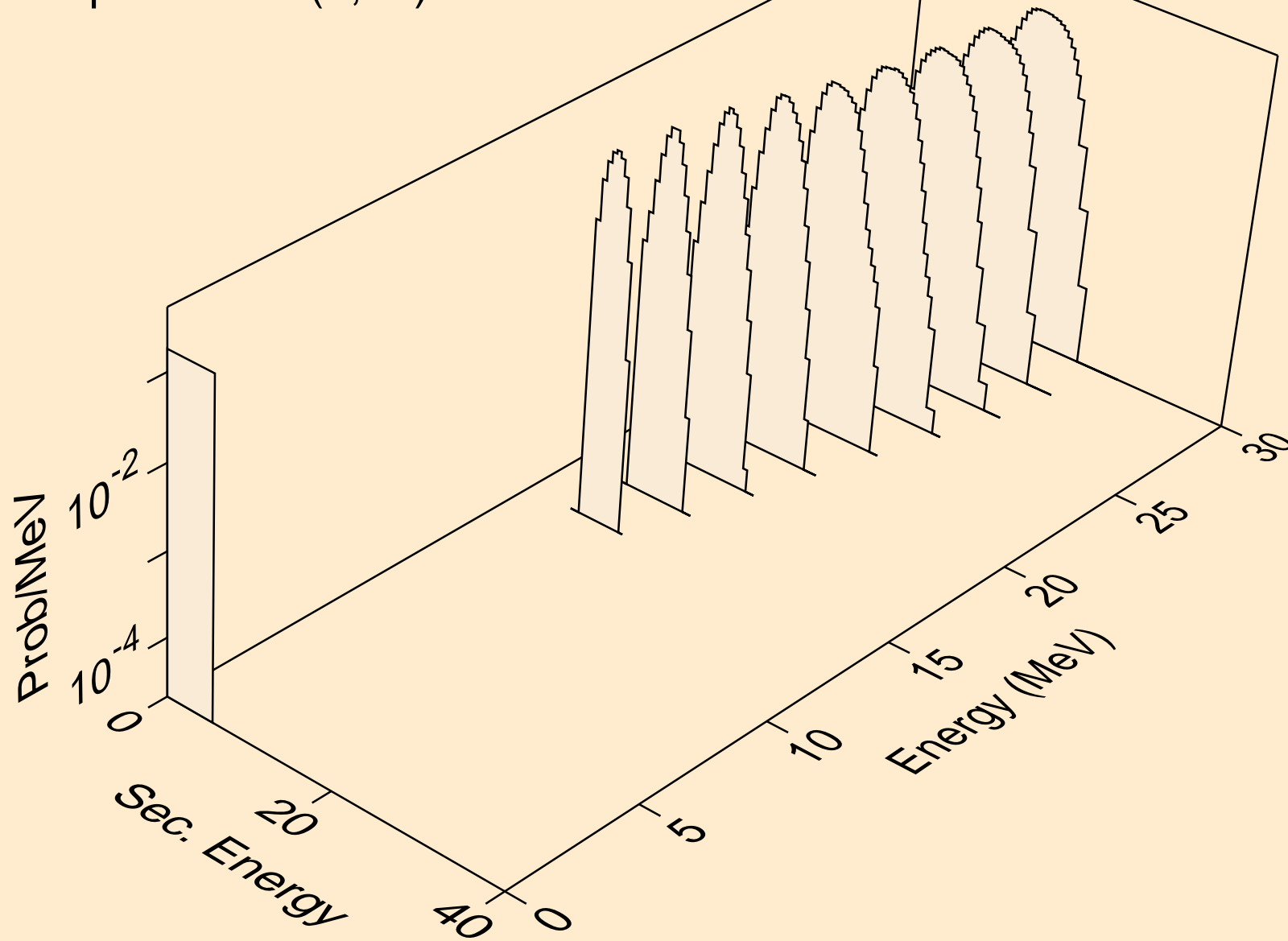

BI192 NEUTRON ACER TENDL-2024 LIBRARY; T=0.K  
alphas from (n,npa)

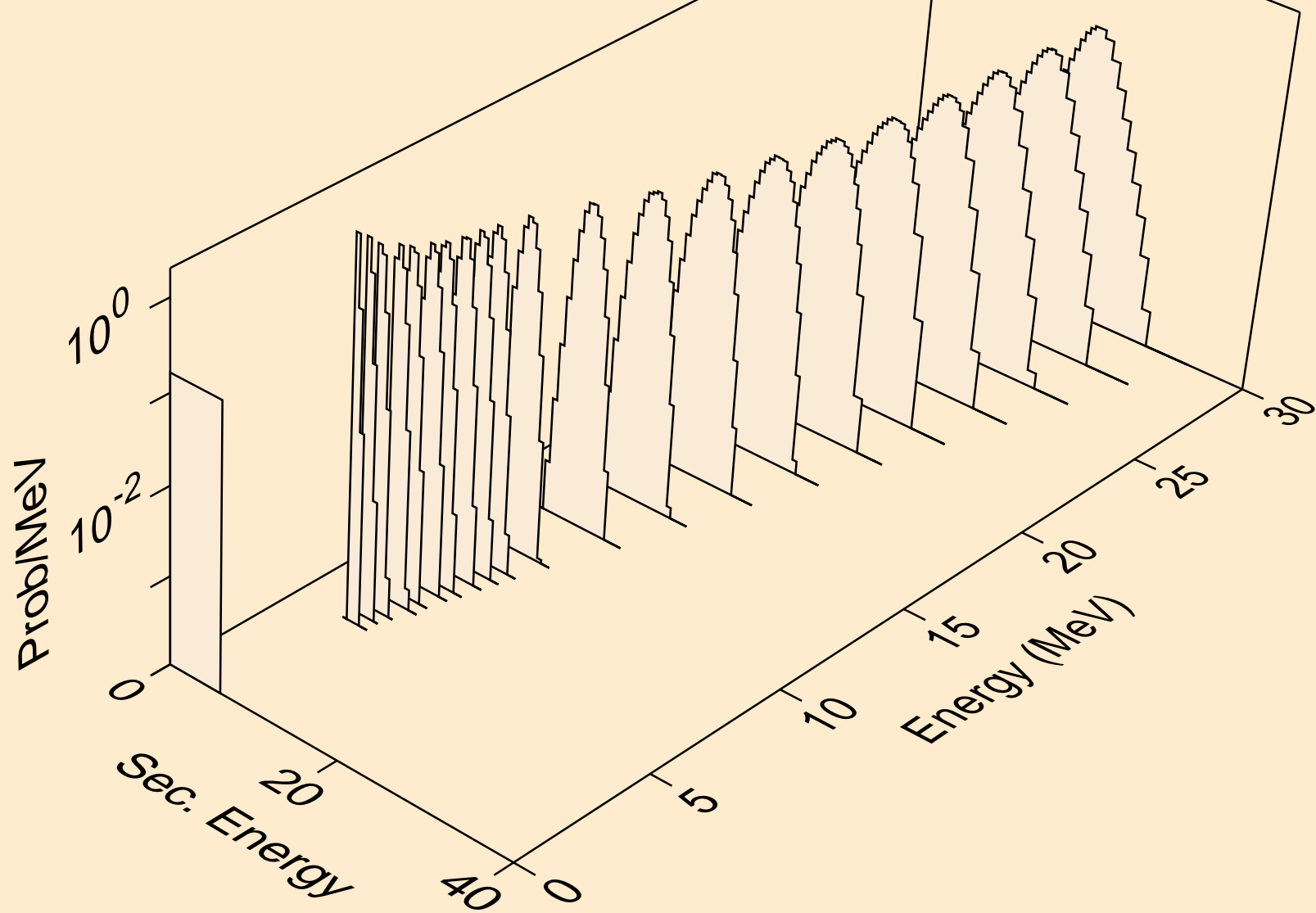

BI192 NEUTRON ACER TENDL-2024 LIBRARY; T=0.K  
alphas from (n,a)

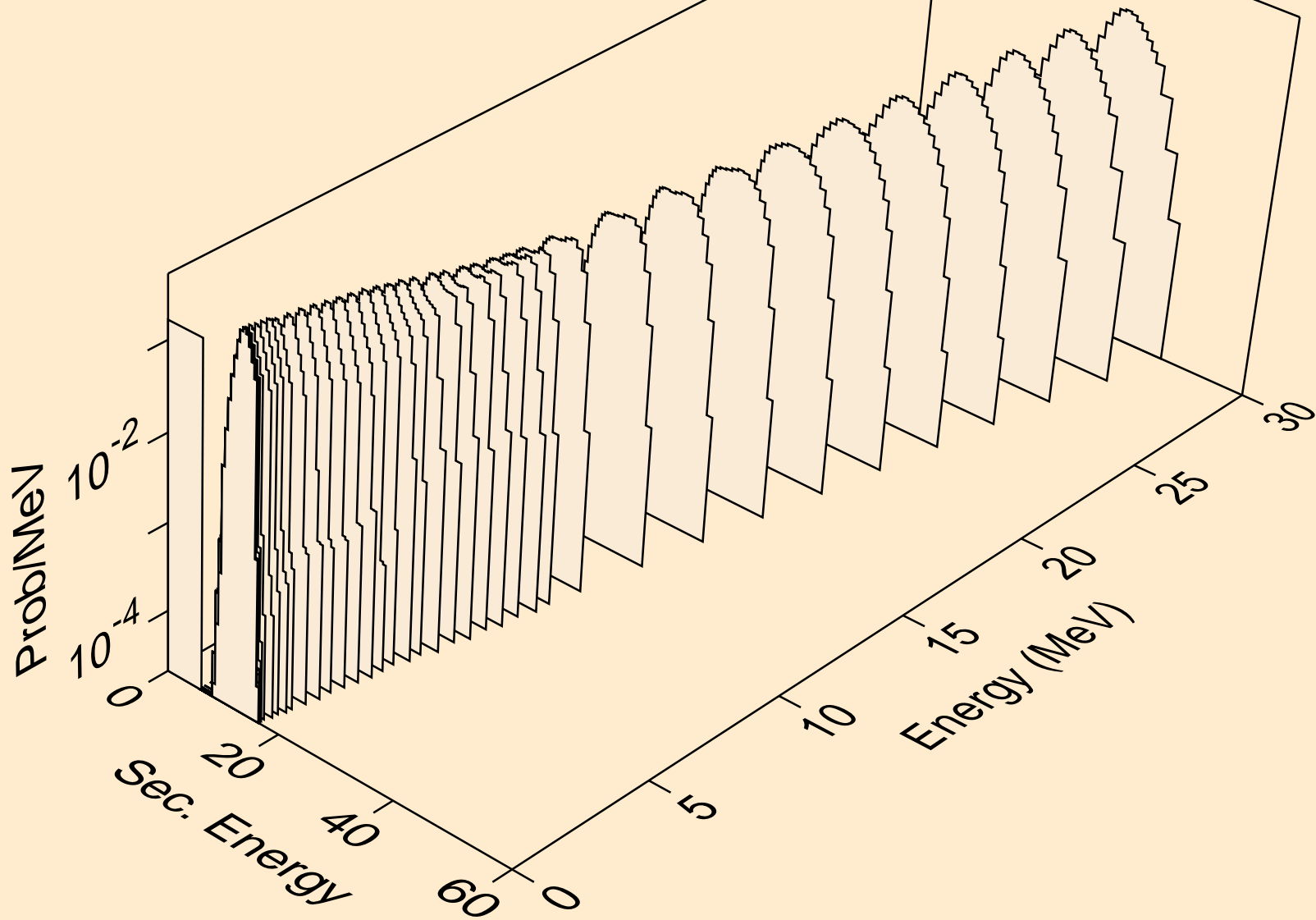

BI192 NEUTRON ACER TENDL-2024 LIBRARY; T=0.K  
alphas from (n,2a)

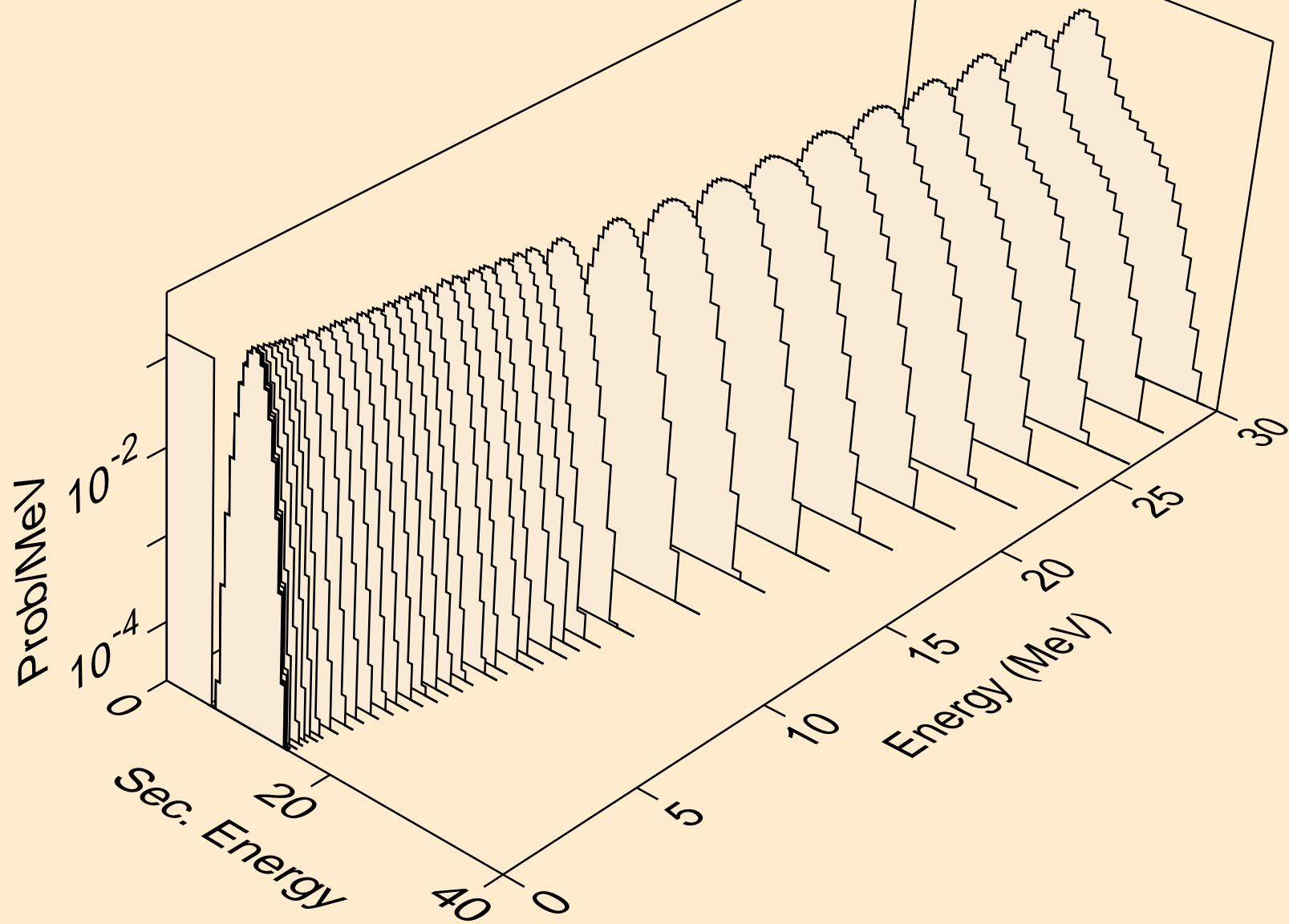

BI192 NEUTRON ACER TENDL-2024 LIBRARY; T=0.K  
alphas from (n,3a)

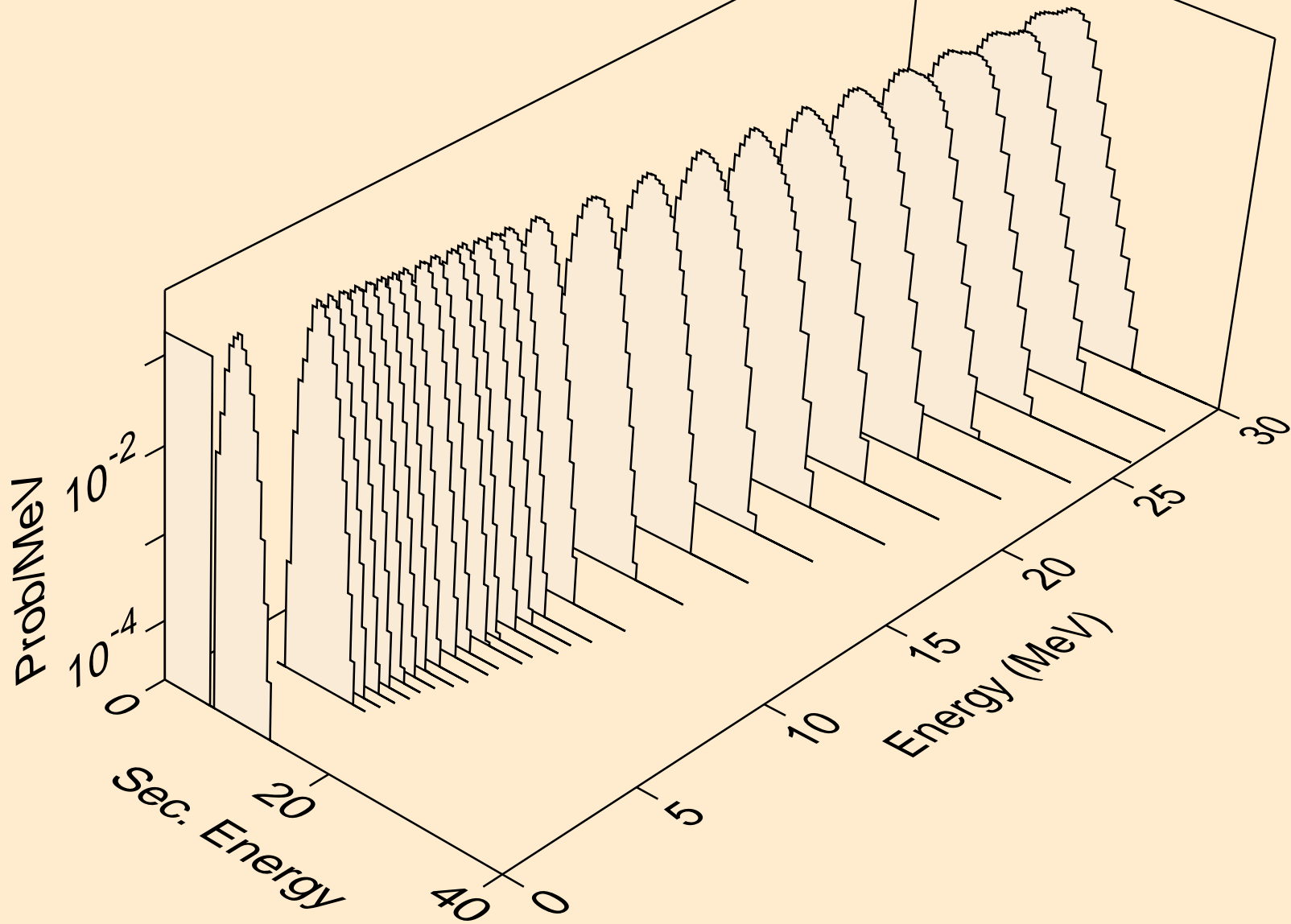



BI192 NEUTRON ACER TENDL-2024 LIBRARY; T=0.K  
alphas from (n,pa)

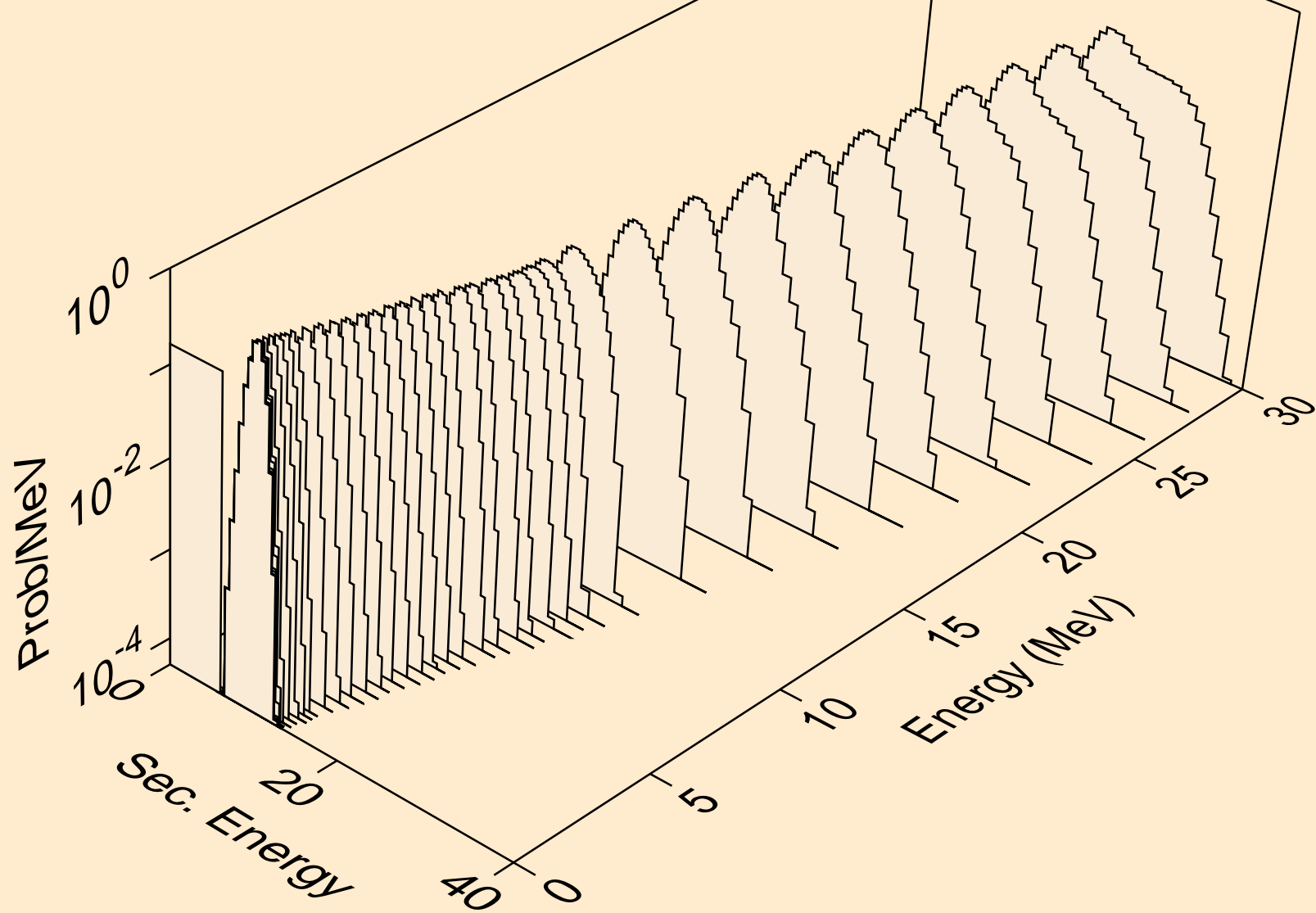

BI192 NEUTRON ACER TENDL-2024 LIBRARY; T=0.K  
alphas from (n,da)

