

# BI194M NEUTRON ACER TENDL-2024 LIBRARY; T=0.K

## Principal cross sections

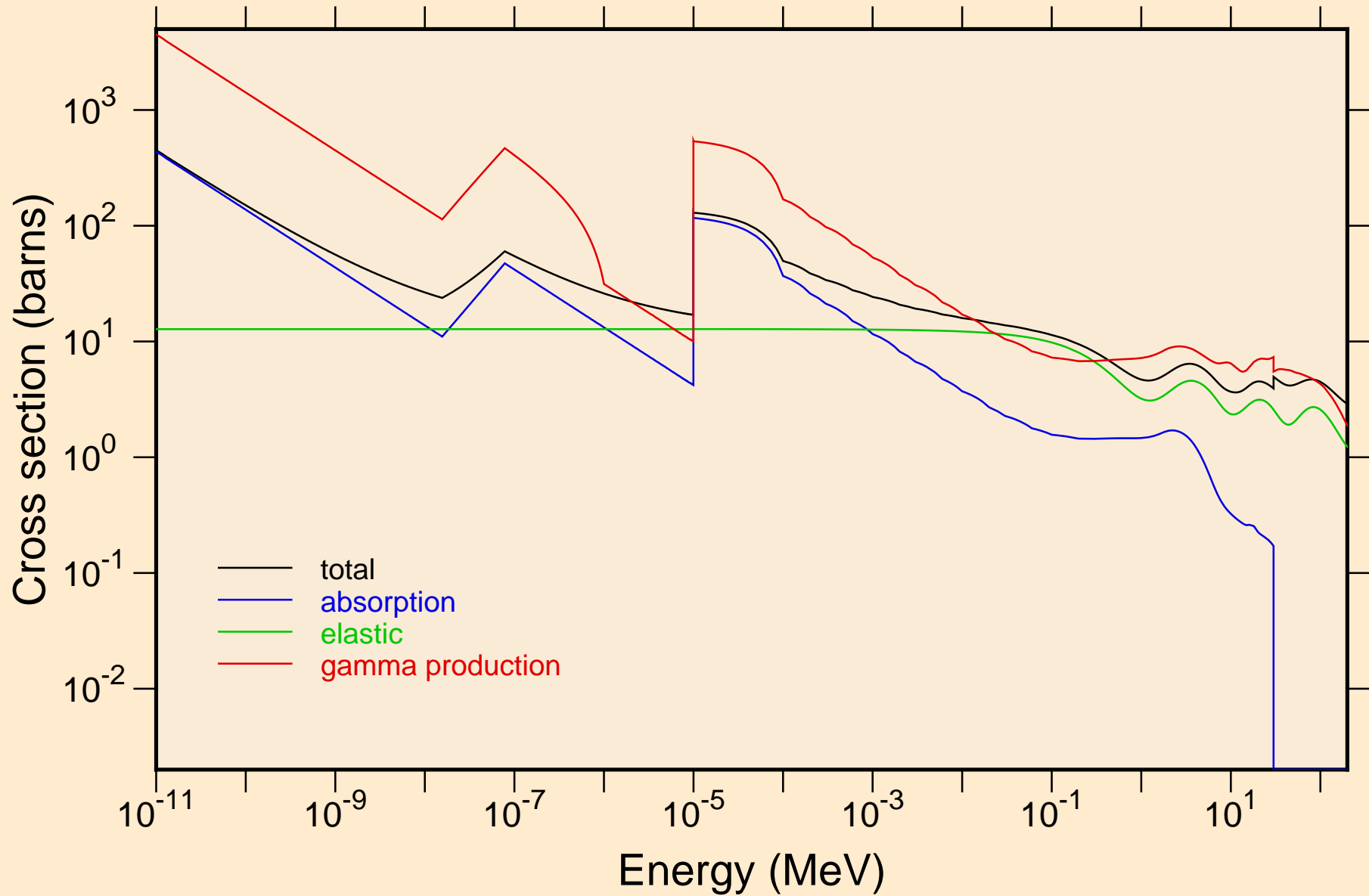

BI194M NEUTRON ACER TENDL-2024 LIBRARY; T=0.K  
Heating

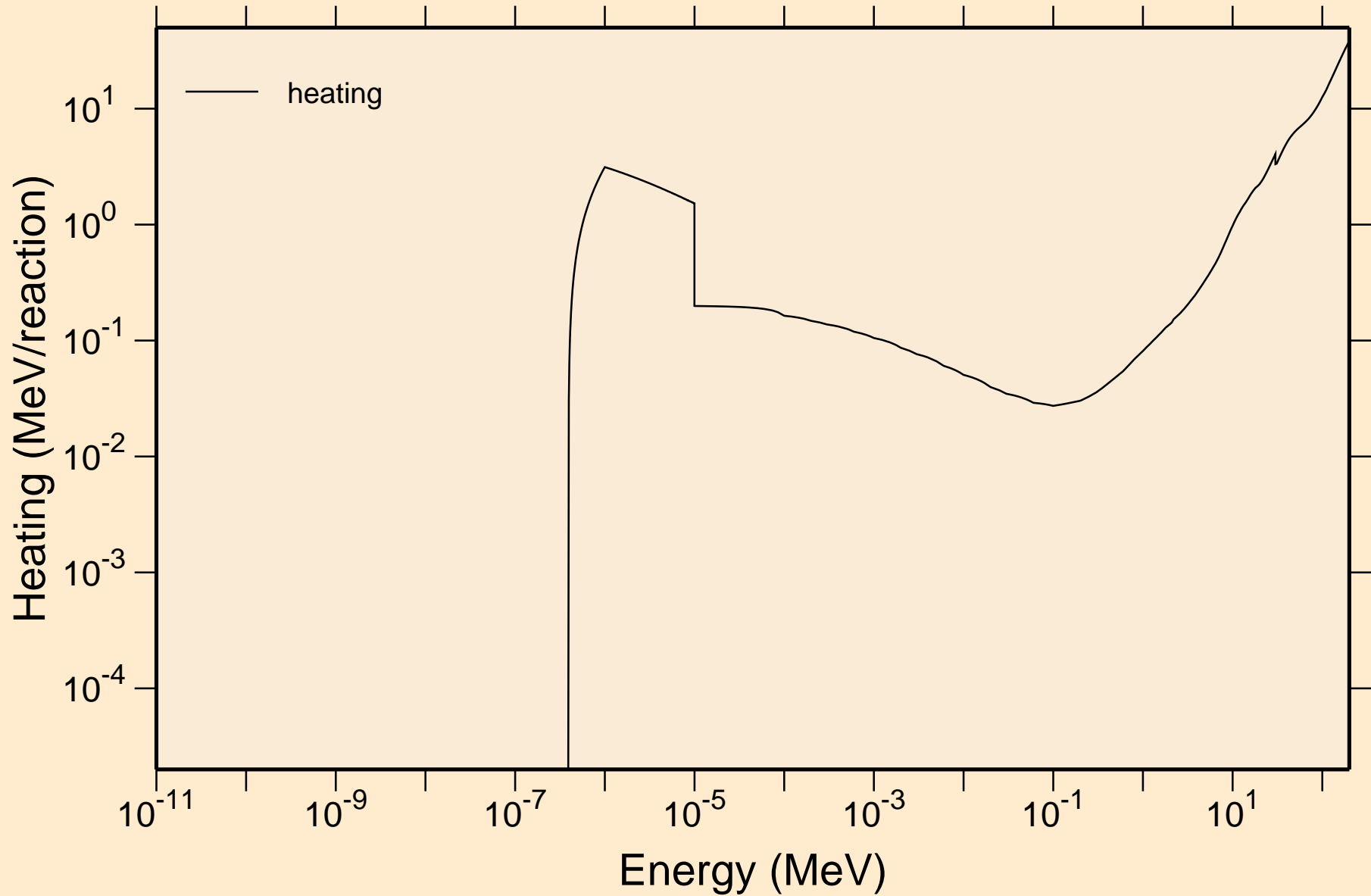

# BI194M NEUTRON ACER TENDL-2024 LIBRARY; T=0.K

## Damage

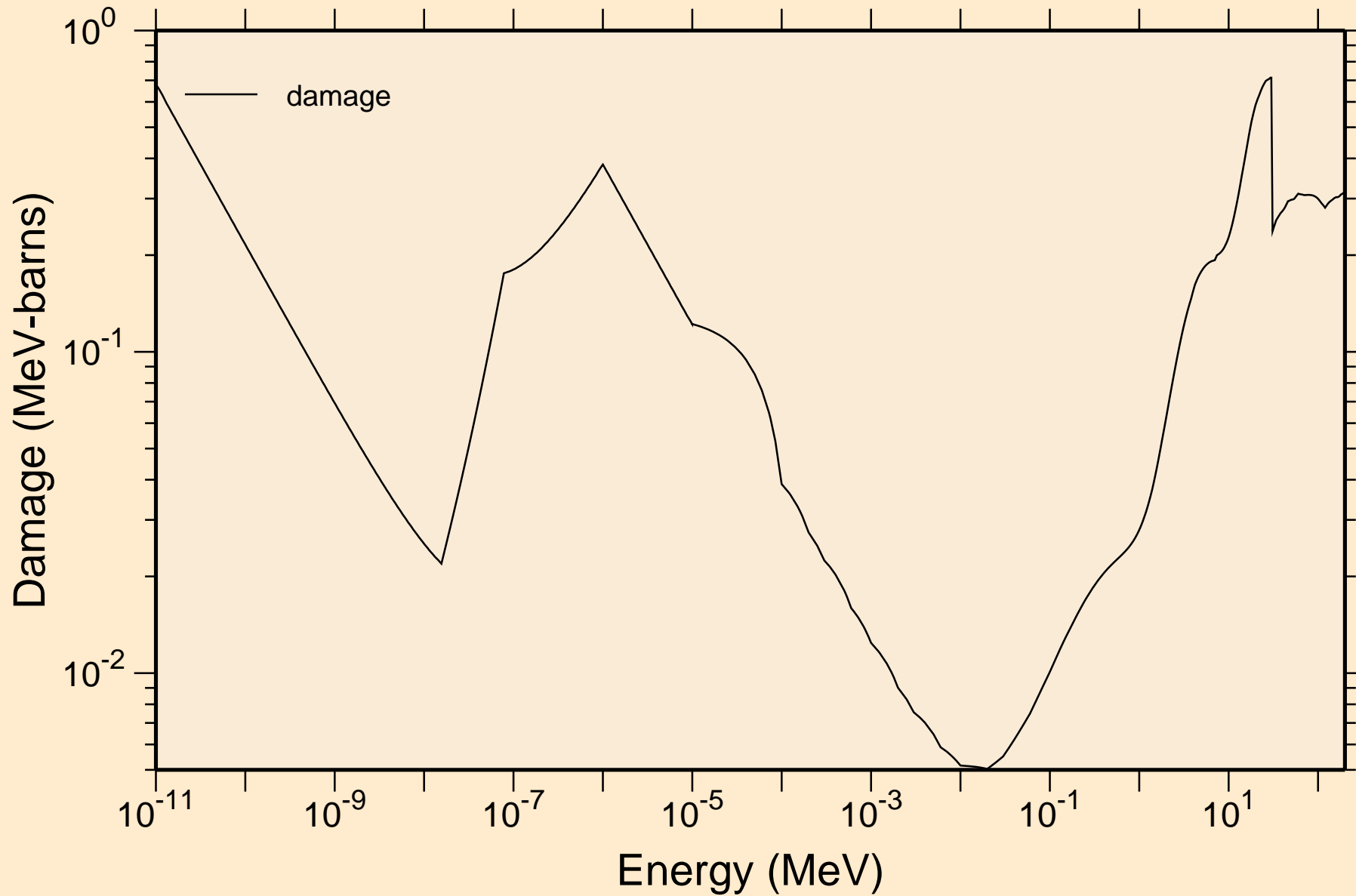

BI194M NEUTRON ACER TENDL-2024 LIBRARY; T=0.K  
Non-threshold reactions

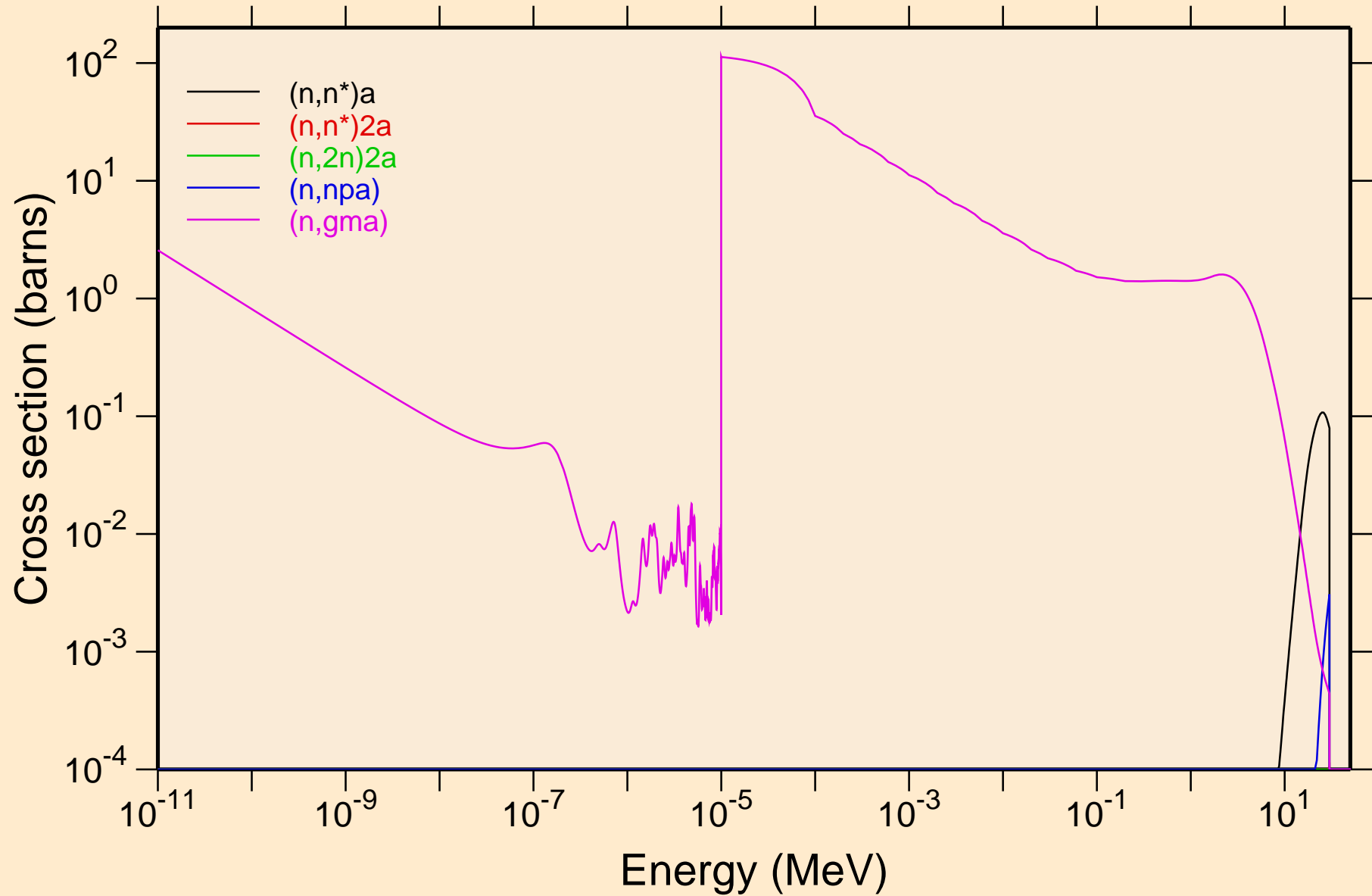

BI194M NEUTRON ACER TENDL-2024 LIBRARY; T=0.K  
Non-threshold reactions

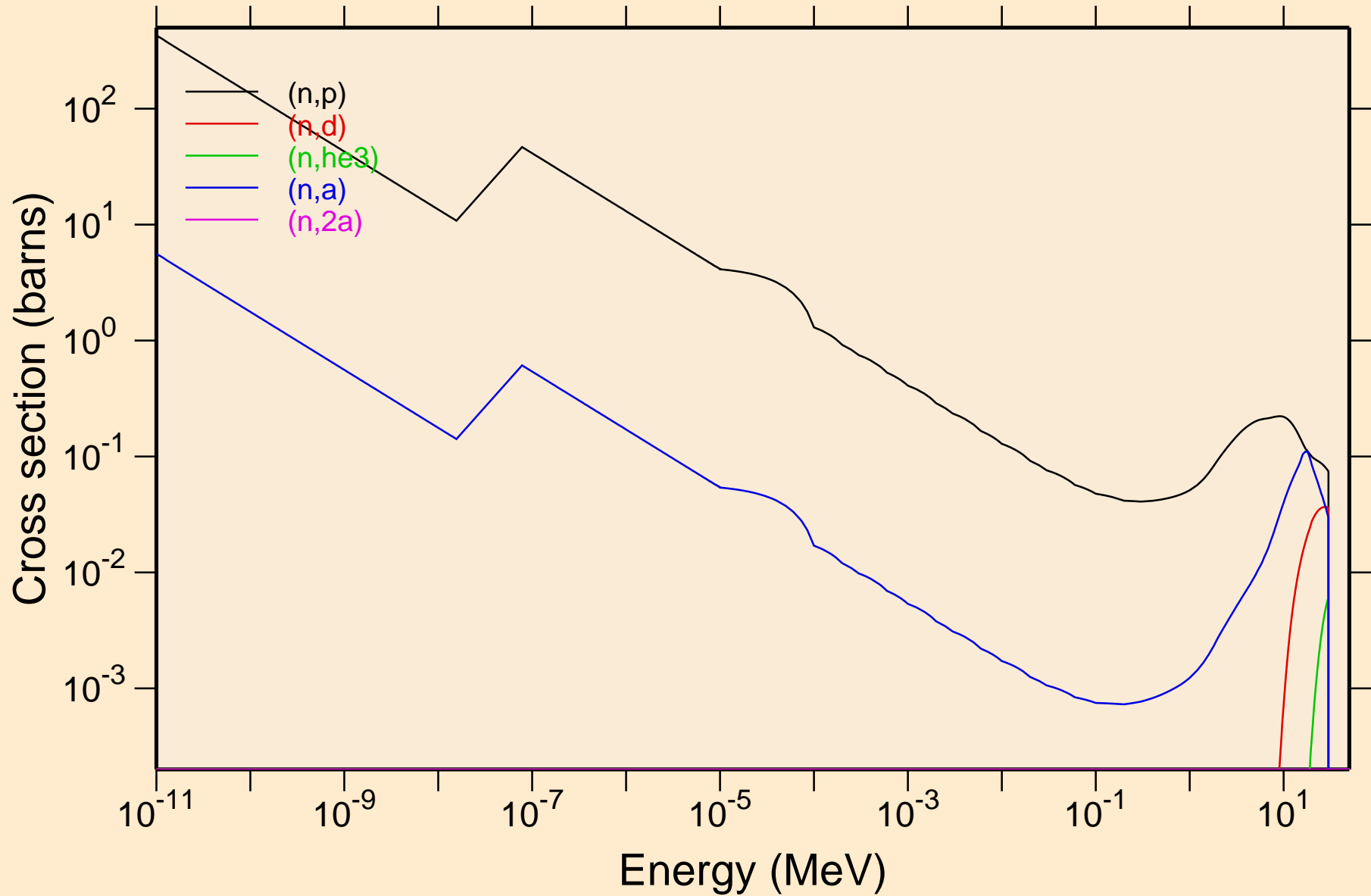

BI194M NEUTRON ACER TENDL-2024 LIBRARY; T=0.K  
Non-threshold reactions

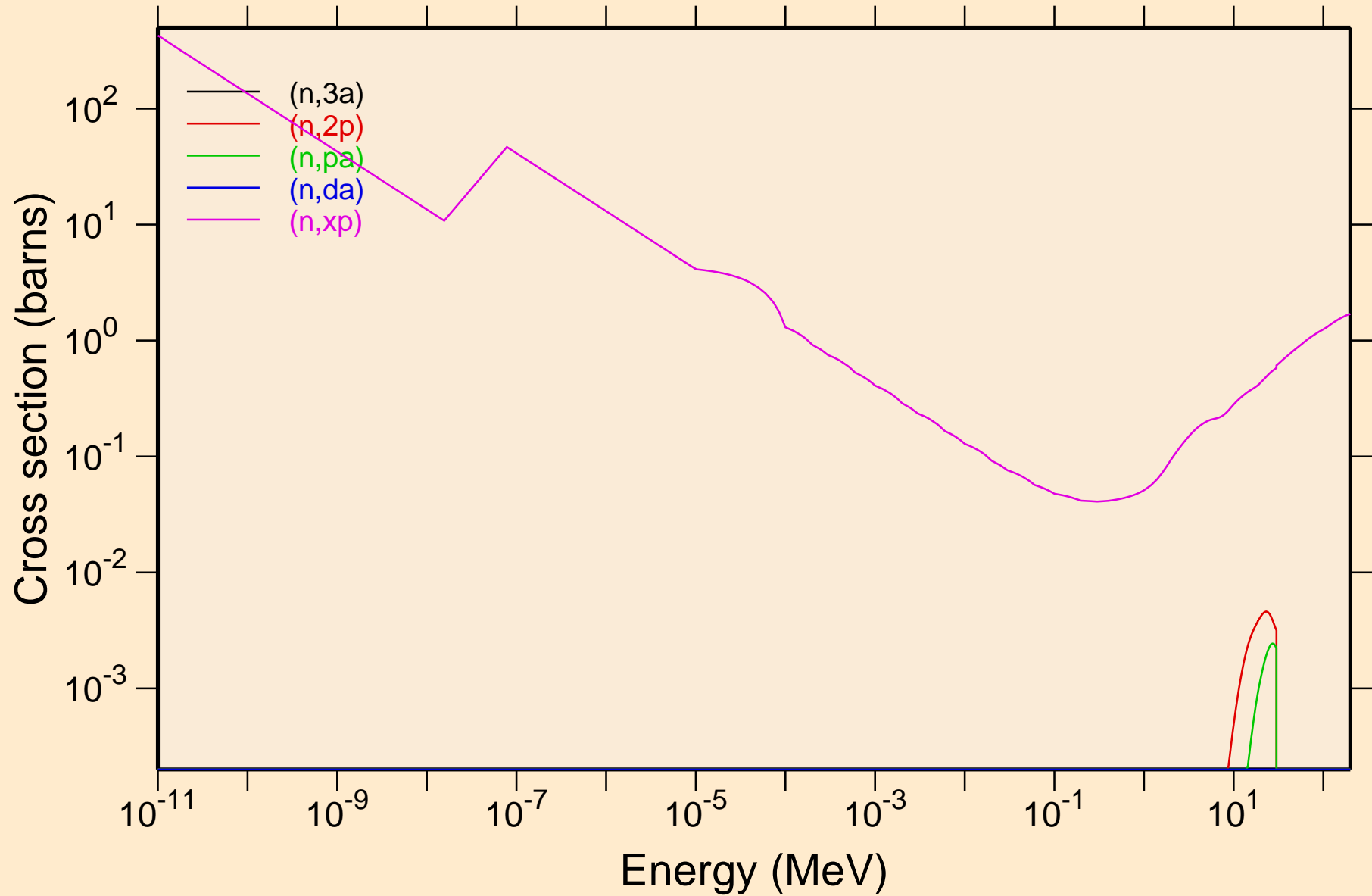

BI194M NEUTRON ACER TENDL-2024 LIBRARY; T=0.K  
Non-threshold reactions

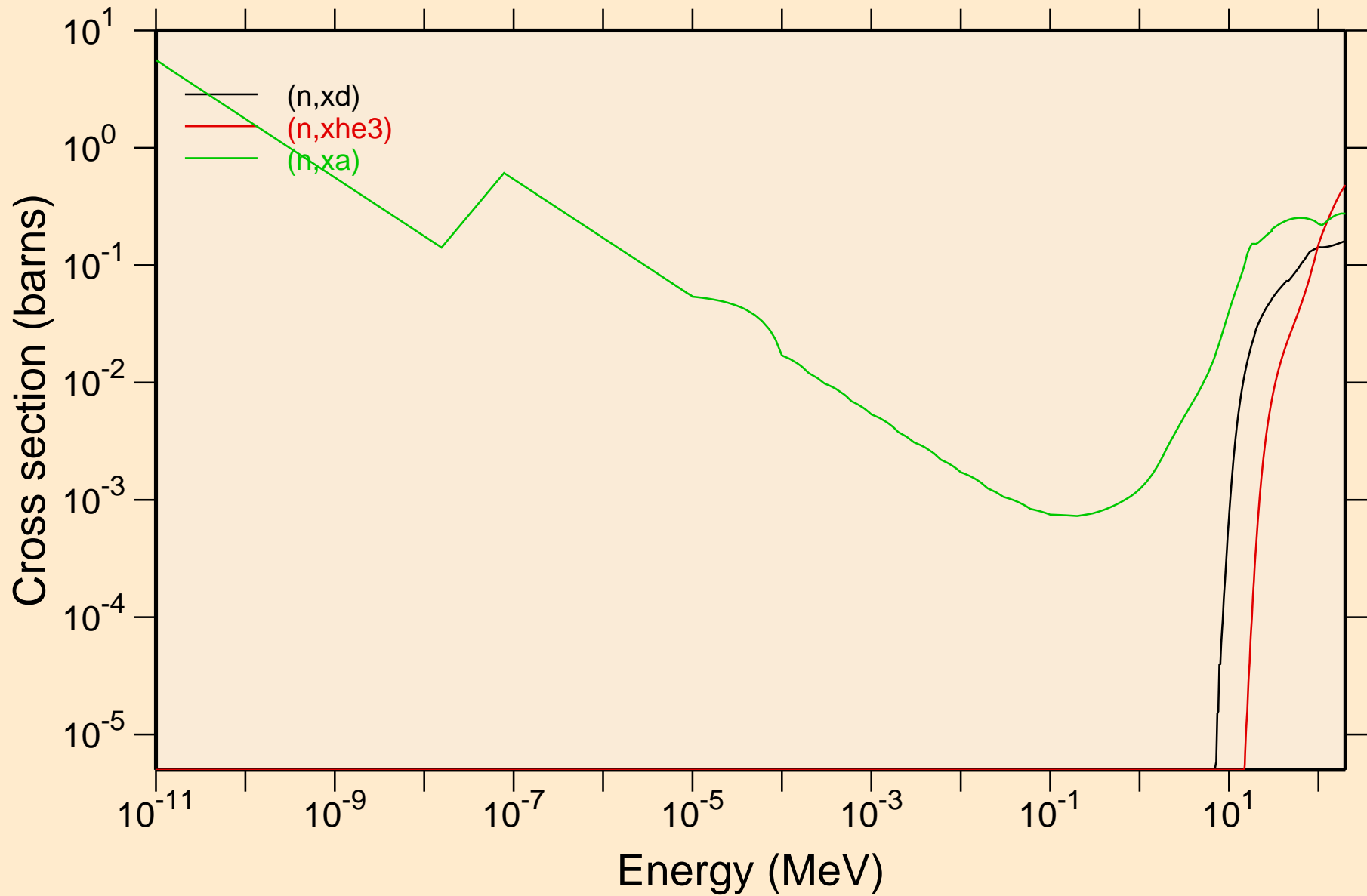

# BI194M NEUTRON ACER TENDL-2024 LIBRARY; T=0.K

## Principal cross sections

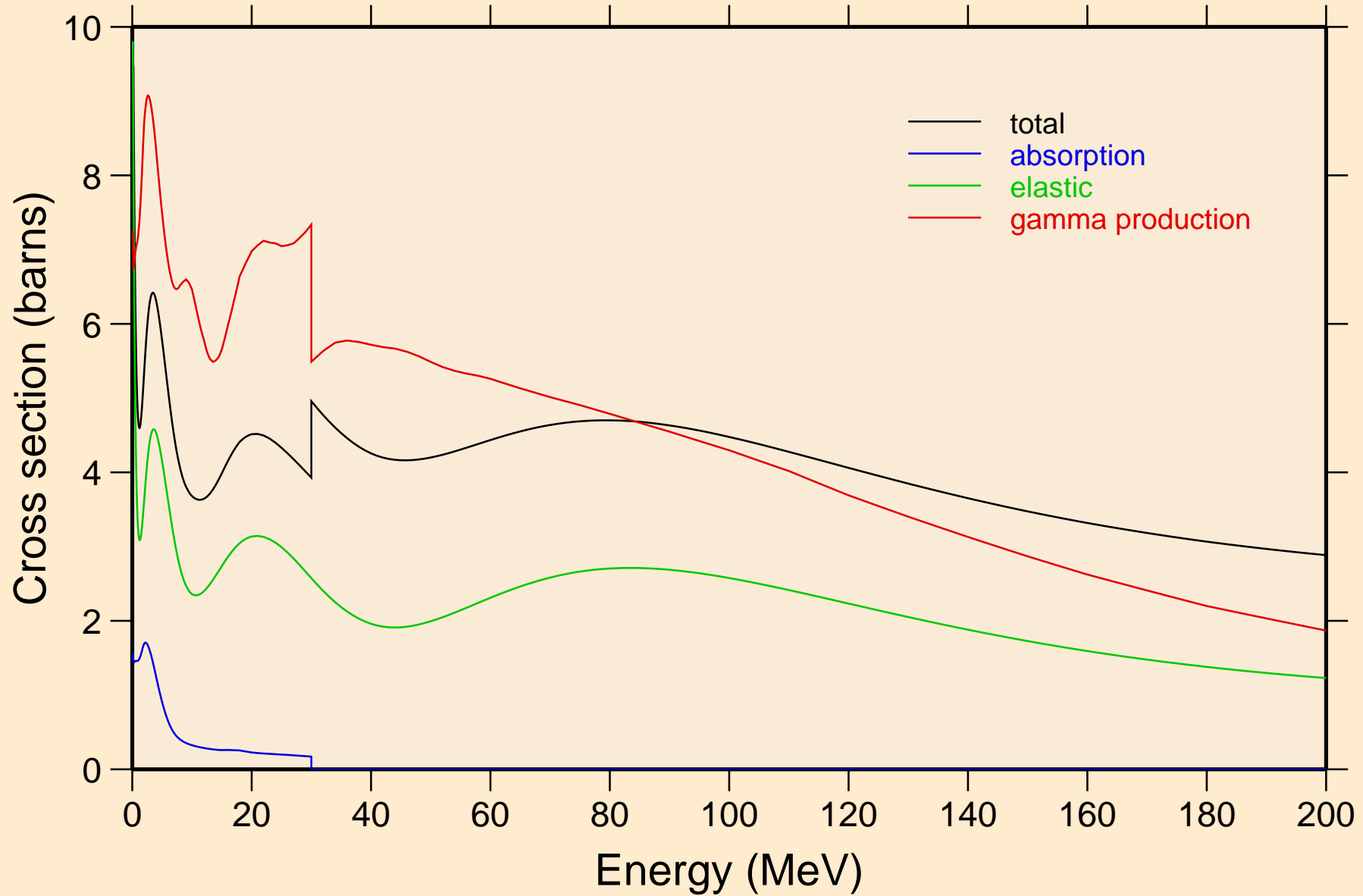



# BI194M NEUTRON ACER TENDL-2024 LIBRARY; T=0.K

## Heating

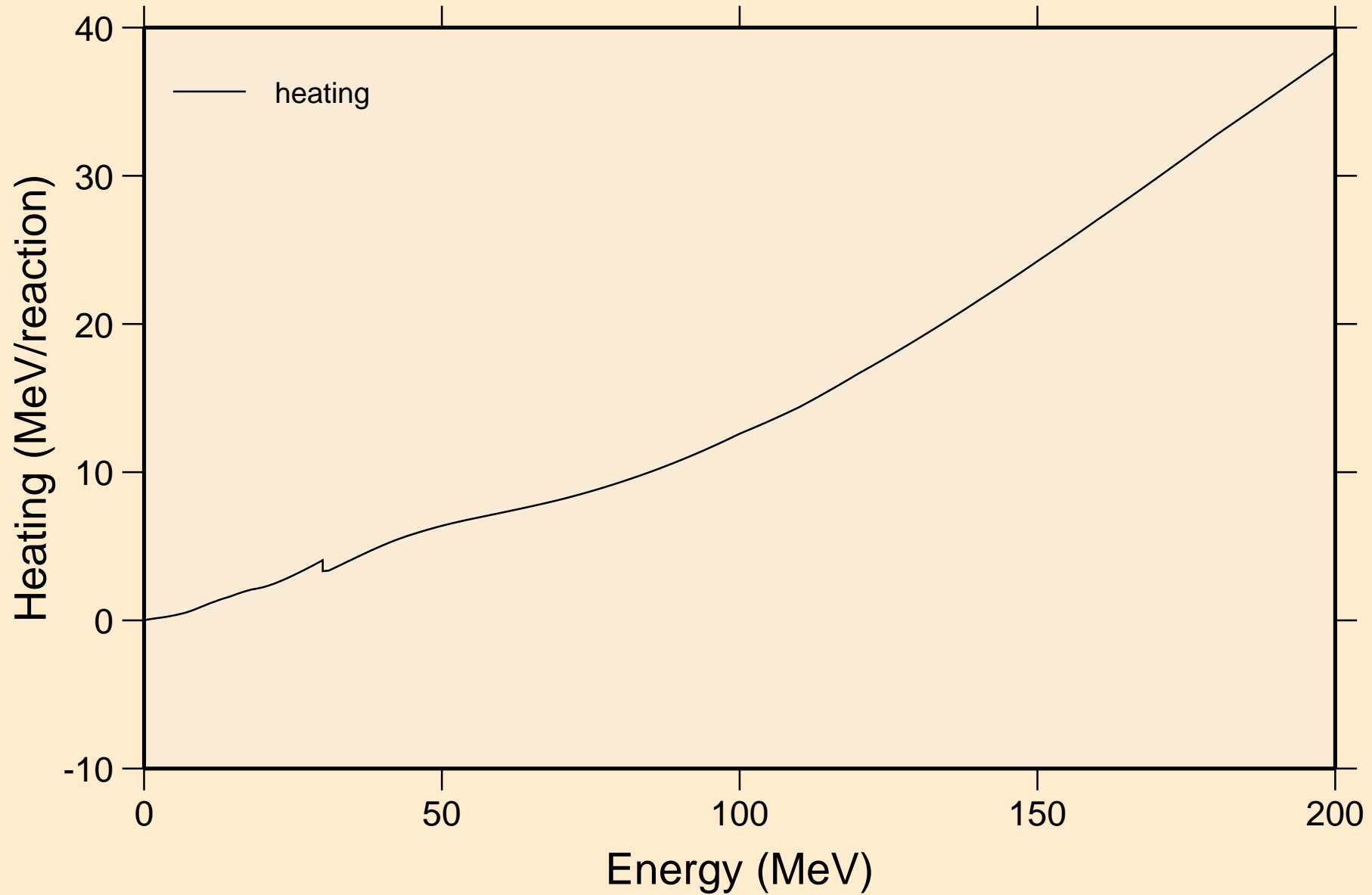

# BI194M NEUTRON ACER TENDL-2024 LIBRARY; T=0.K

## Damage

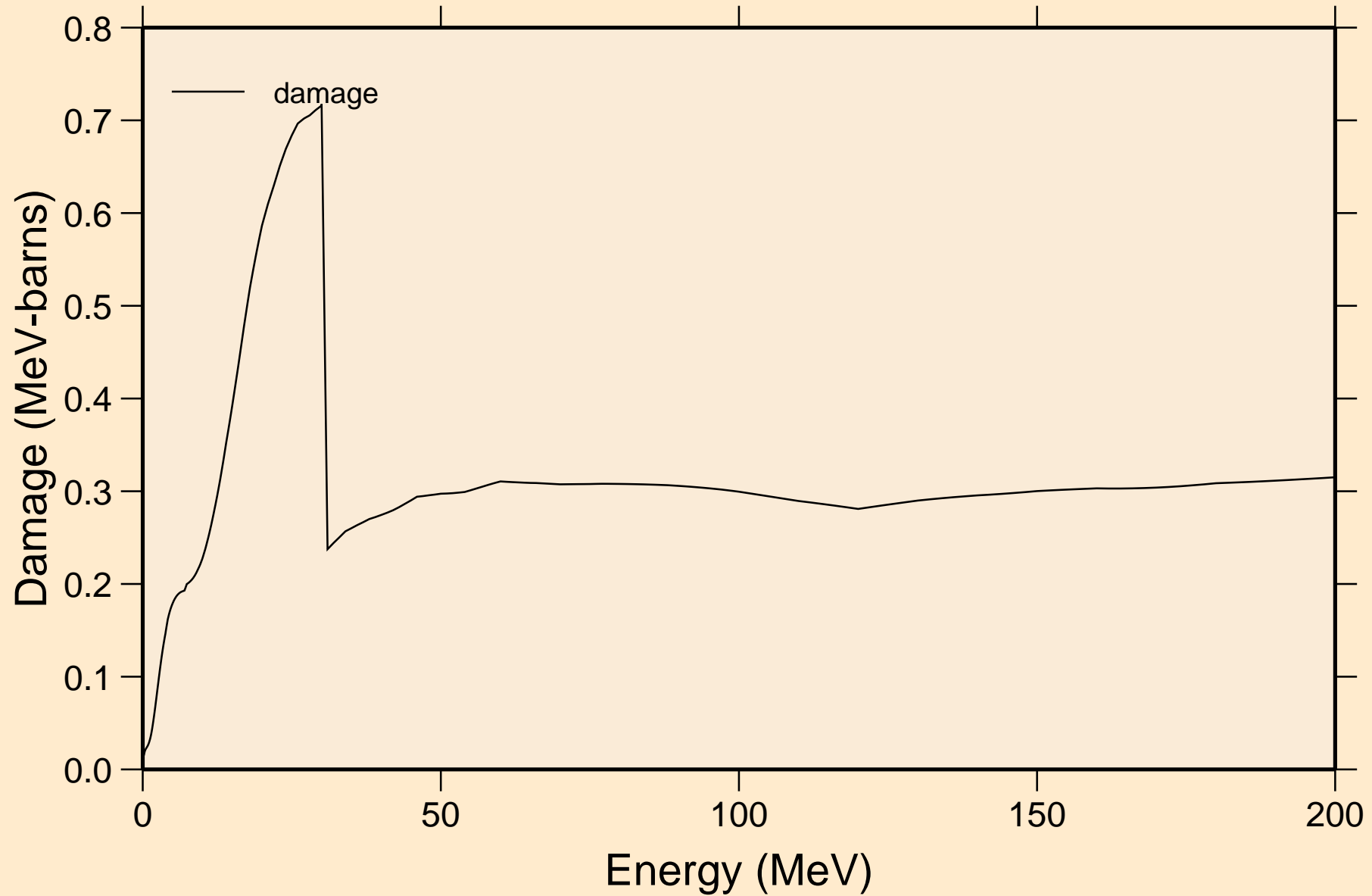

# BI194M NEUTRON ACER TENDL-2024 LIBRARY; T=0.K

## Non-threshold reactions

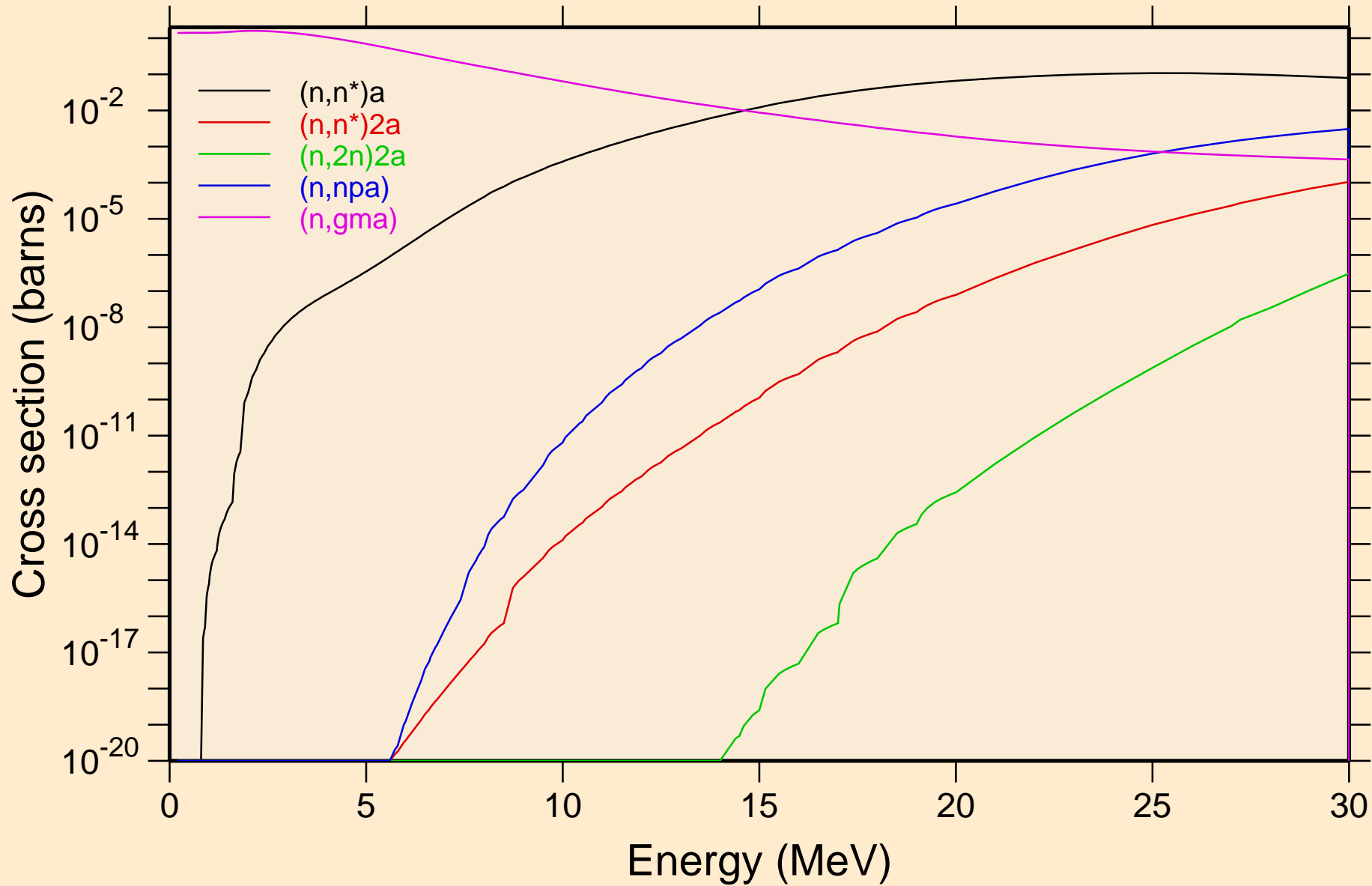

# BI194M NEUTRON ACER TENDL-2024 LIBRARY; T=0.K

## Non-threshold reactions

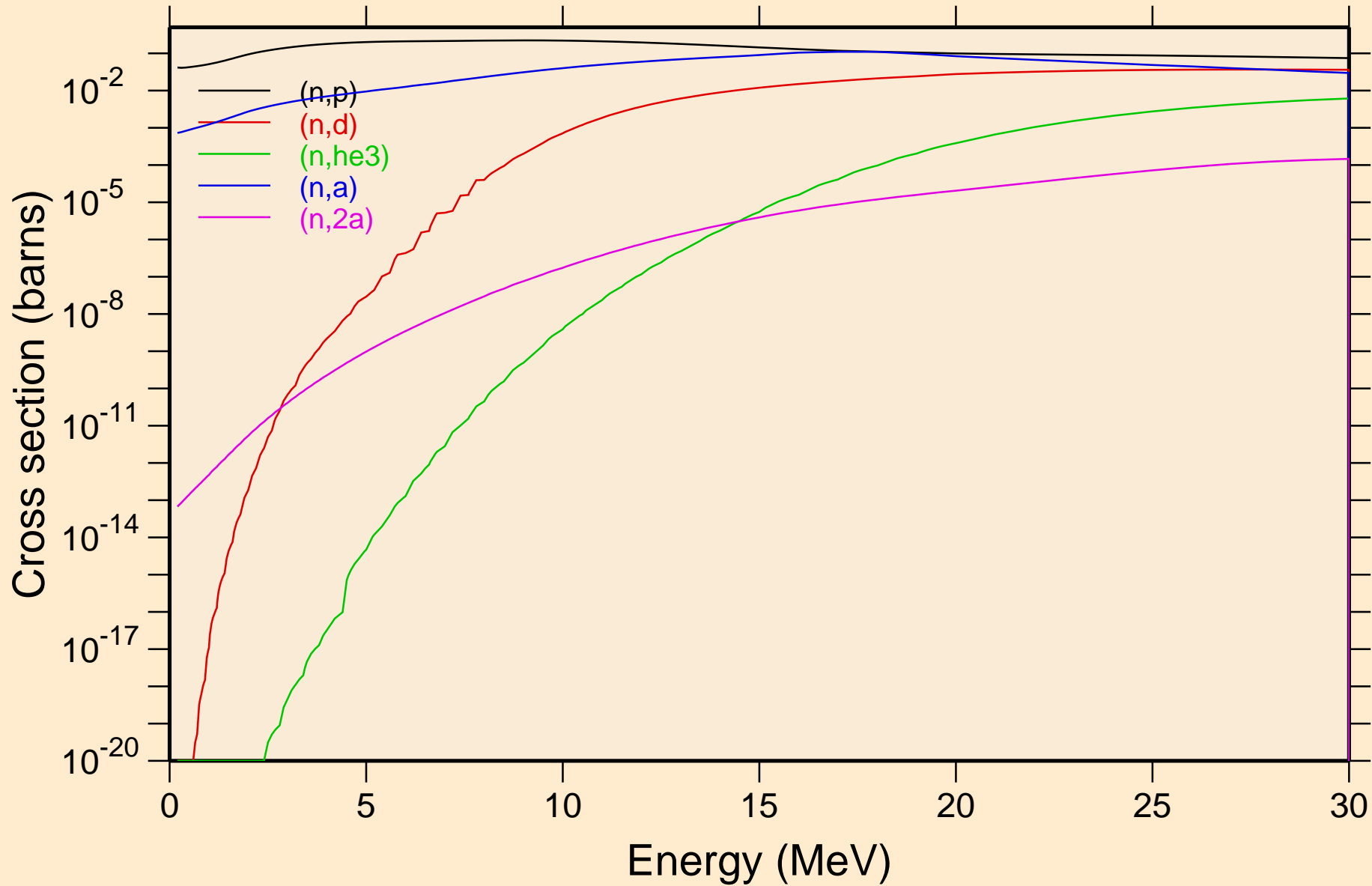

BI194M NEUTRON ACER TENDL-2024 LIBRARY; T=0.K  
Non-threshold reactions

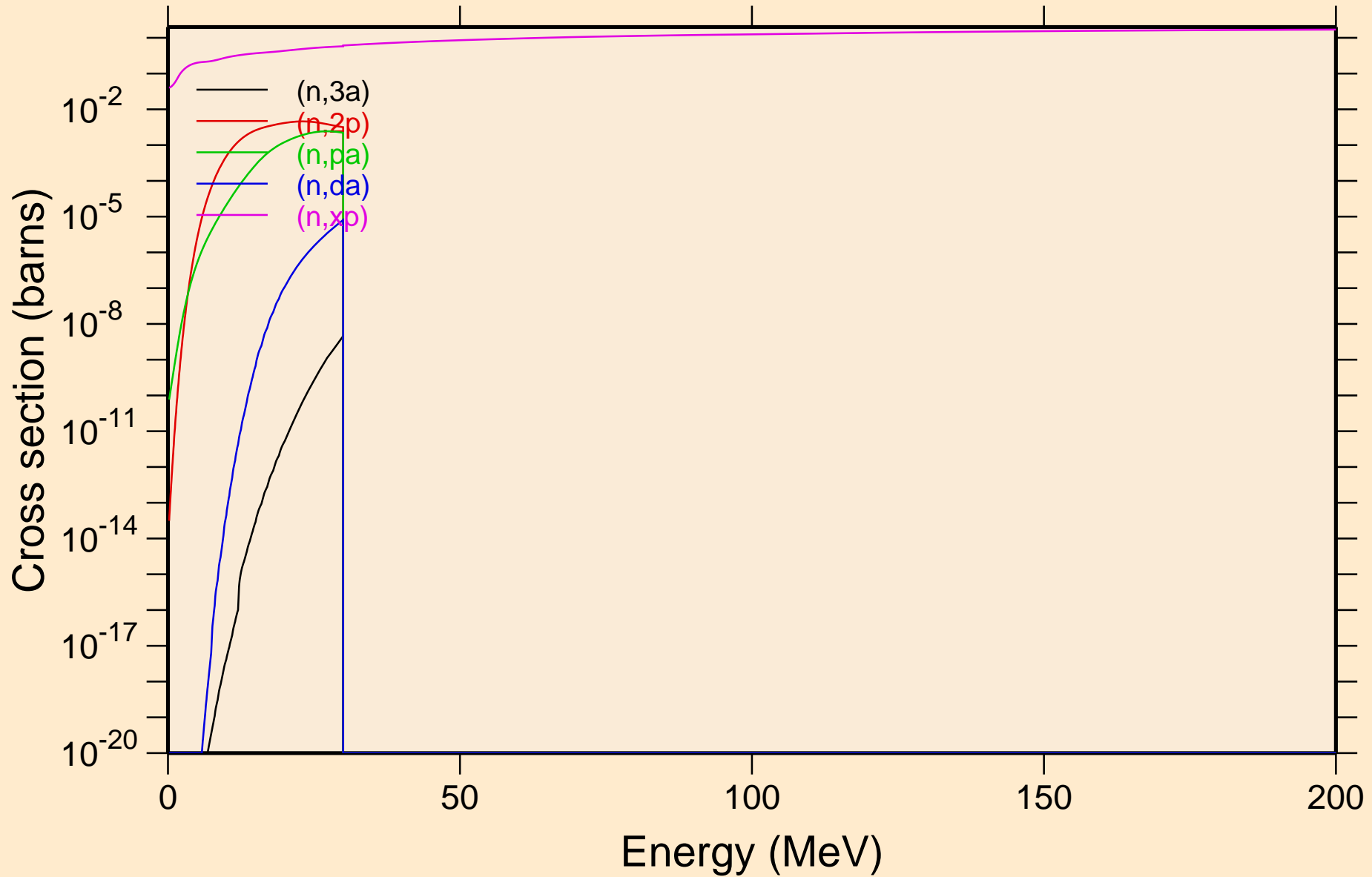

BI194M NEUTRON ACER TENDL-2024 LIBRARY; T=0.K  
Non-threshold reactions

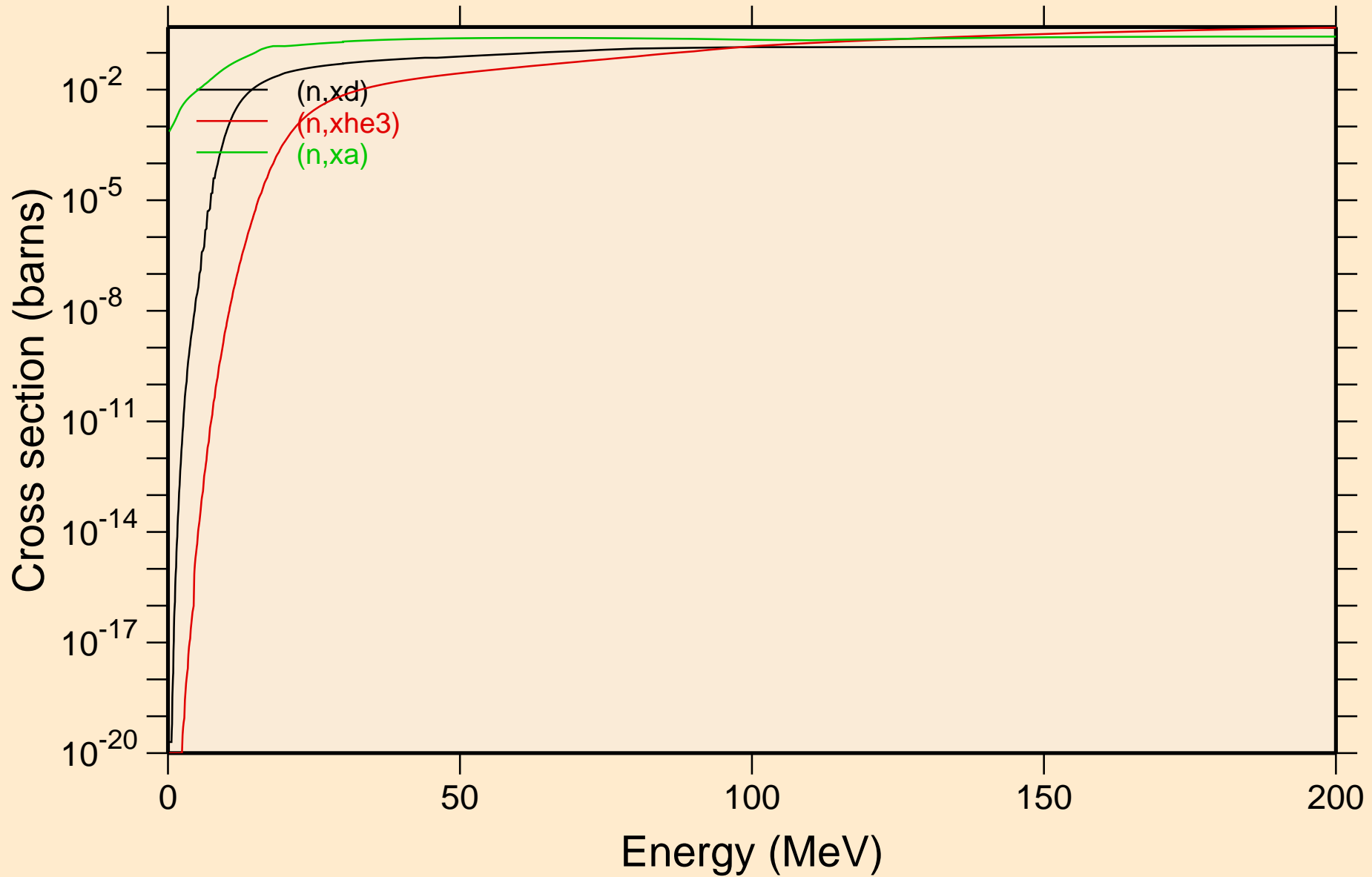

BI194M NEUTRON ACER TENDL-2024 LIBRARY; T=0.K  
Inelastic levels

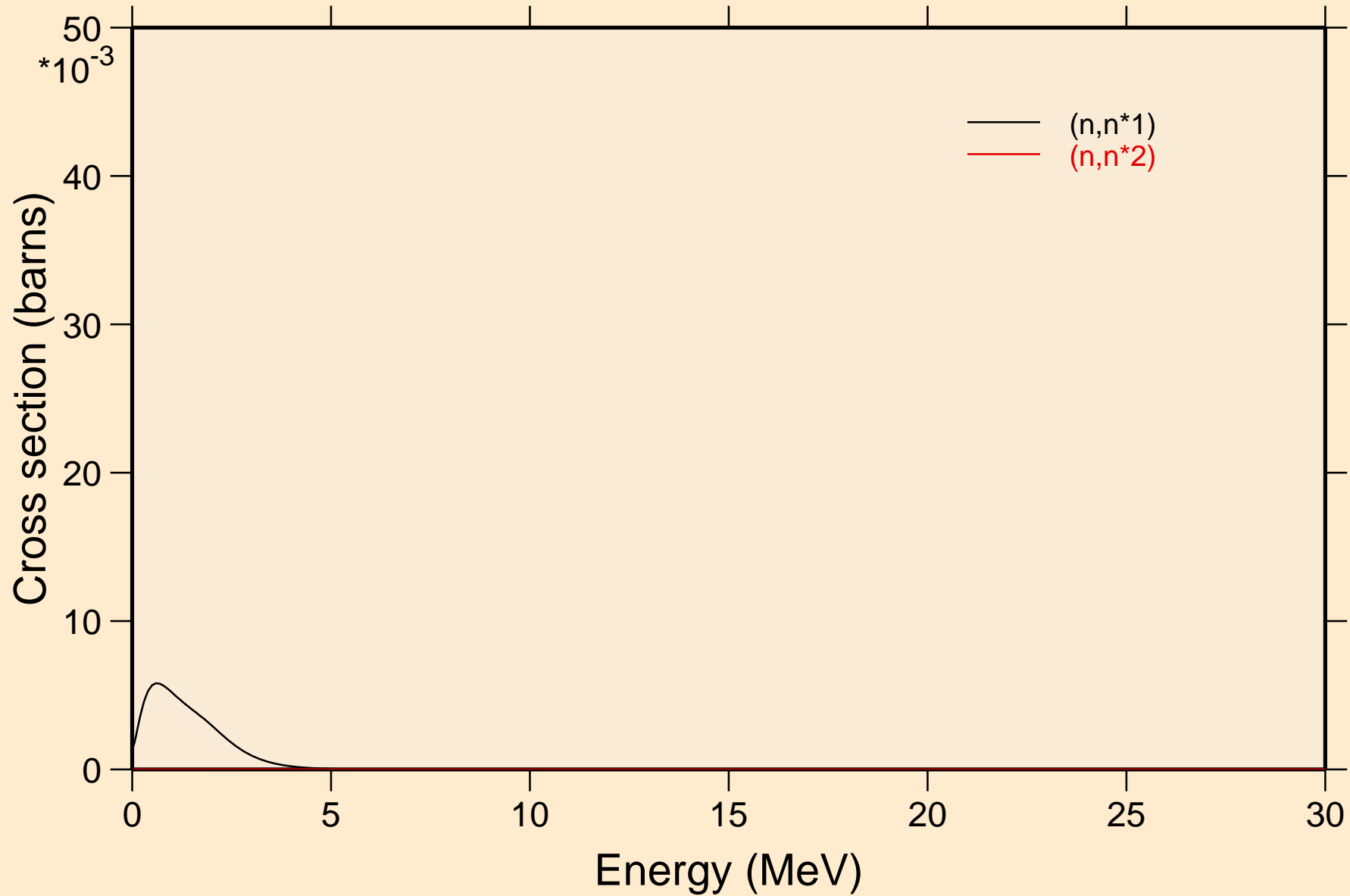

BI194M NEUTRON ACER TENDL-2024 LIBRARY; T=0.K  
Threshold reactions

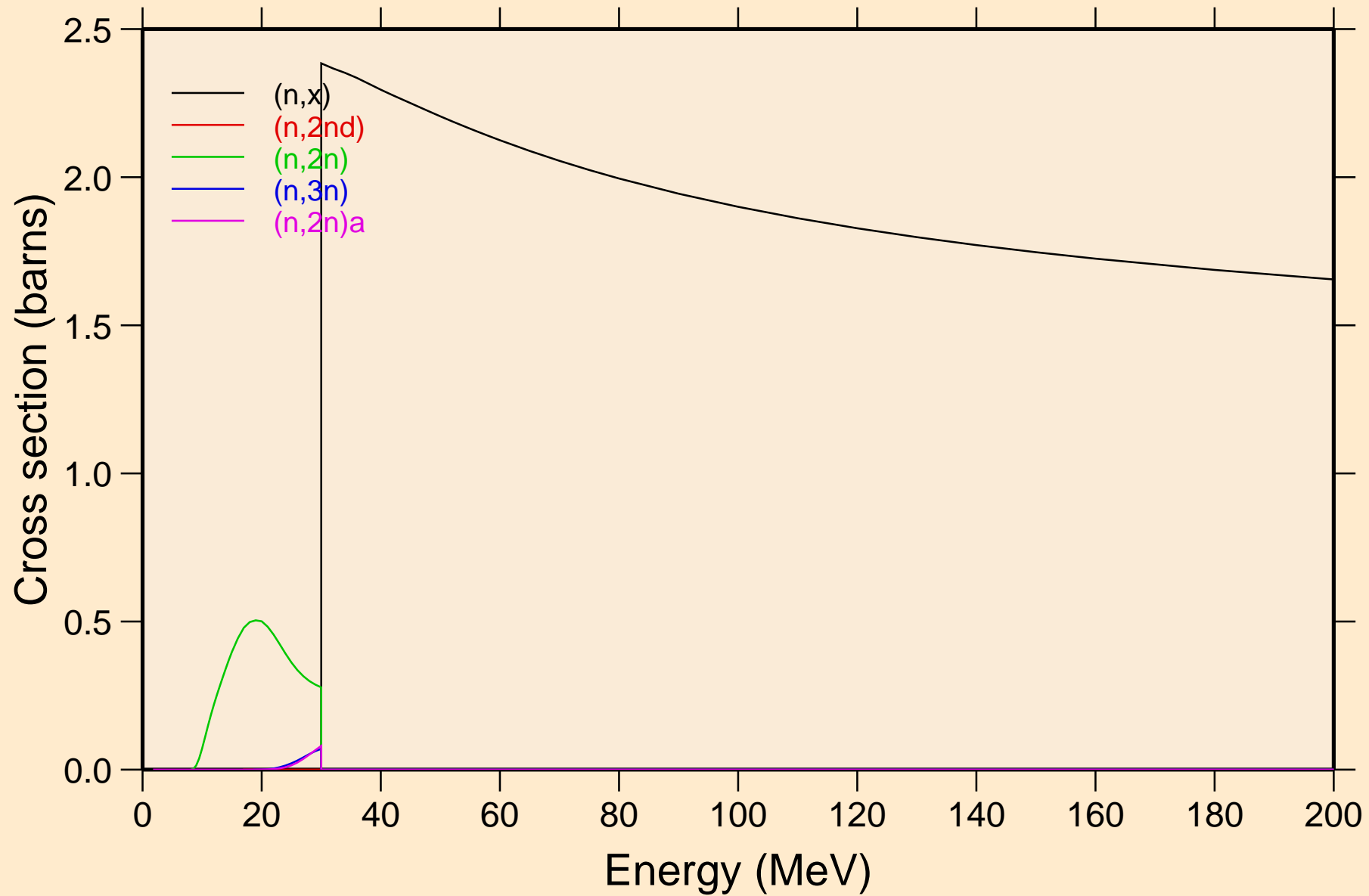



# BI194M NEUTRON ACER TENDL-2024 LIBRARY; T=0.K

## Threshold reactions

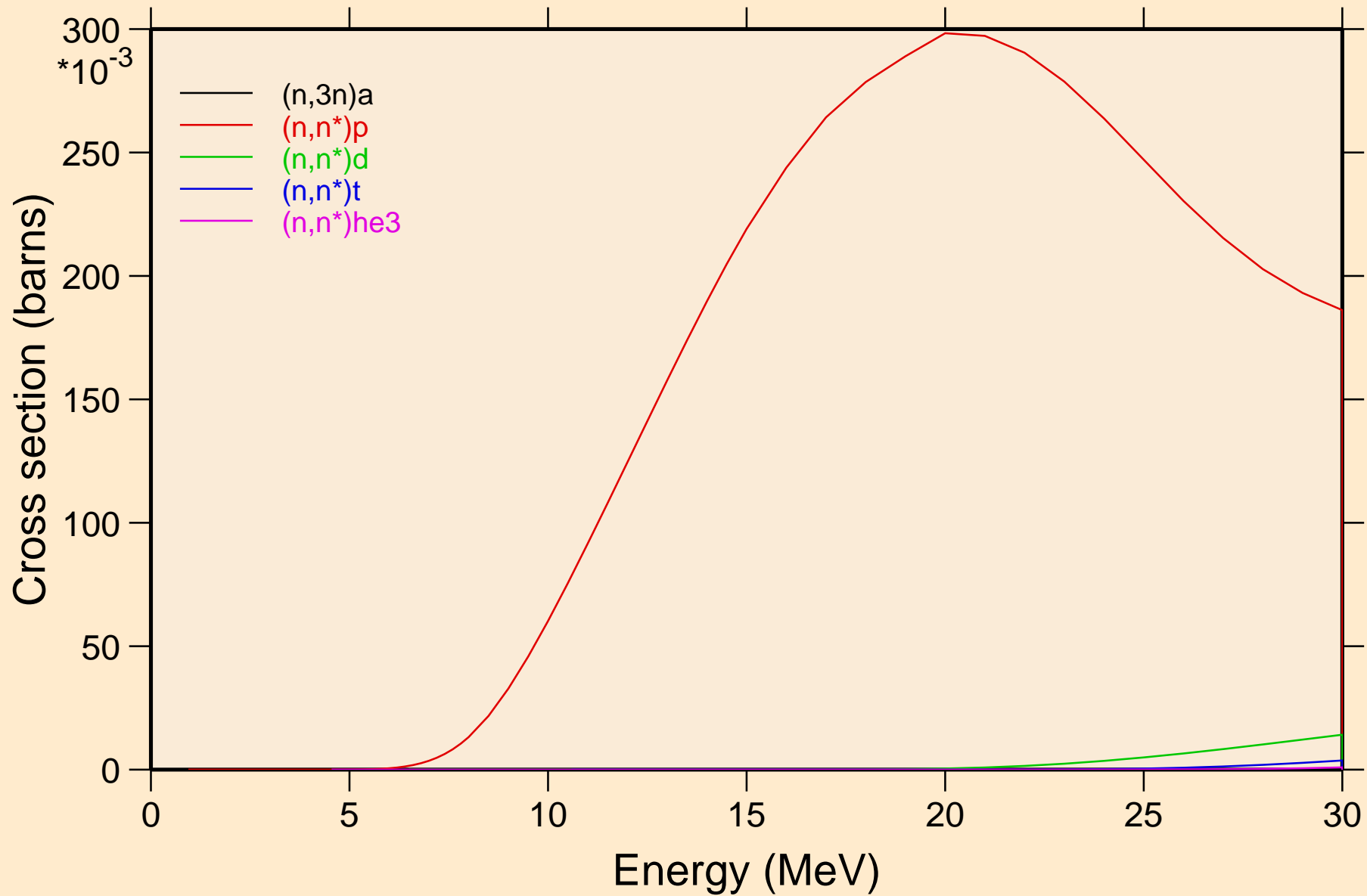

BI194M NEUTRON ACER TENDL-2024 LIBRARY; T=0.K  
Threshold reactions

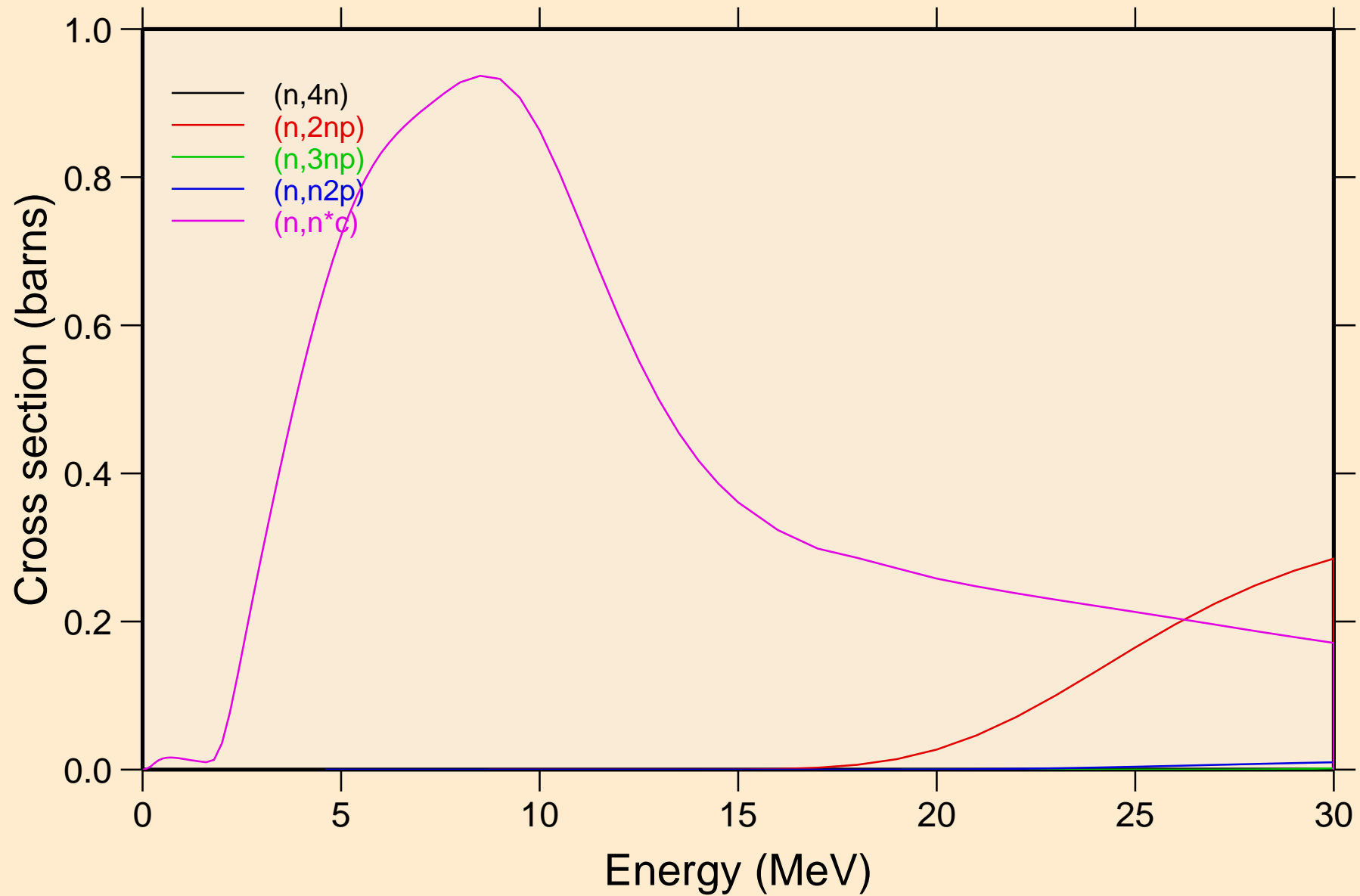

BI194M NEUTRON ACER TENDL-2024 LIBRARY; T=0.K  
Threshold reactions

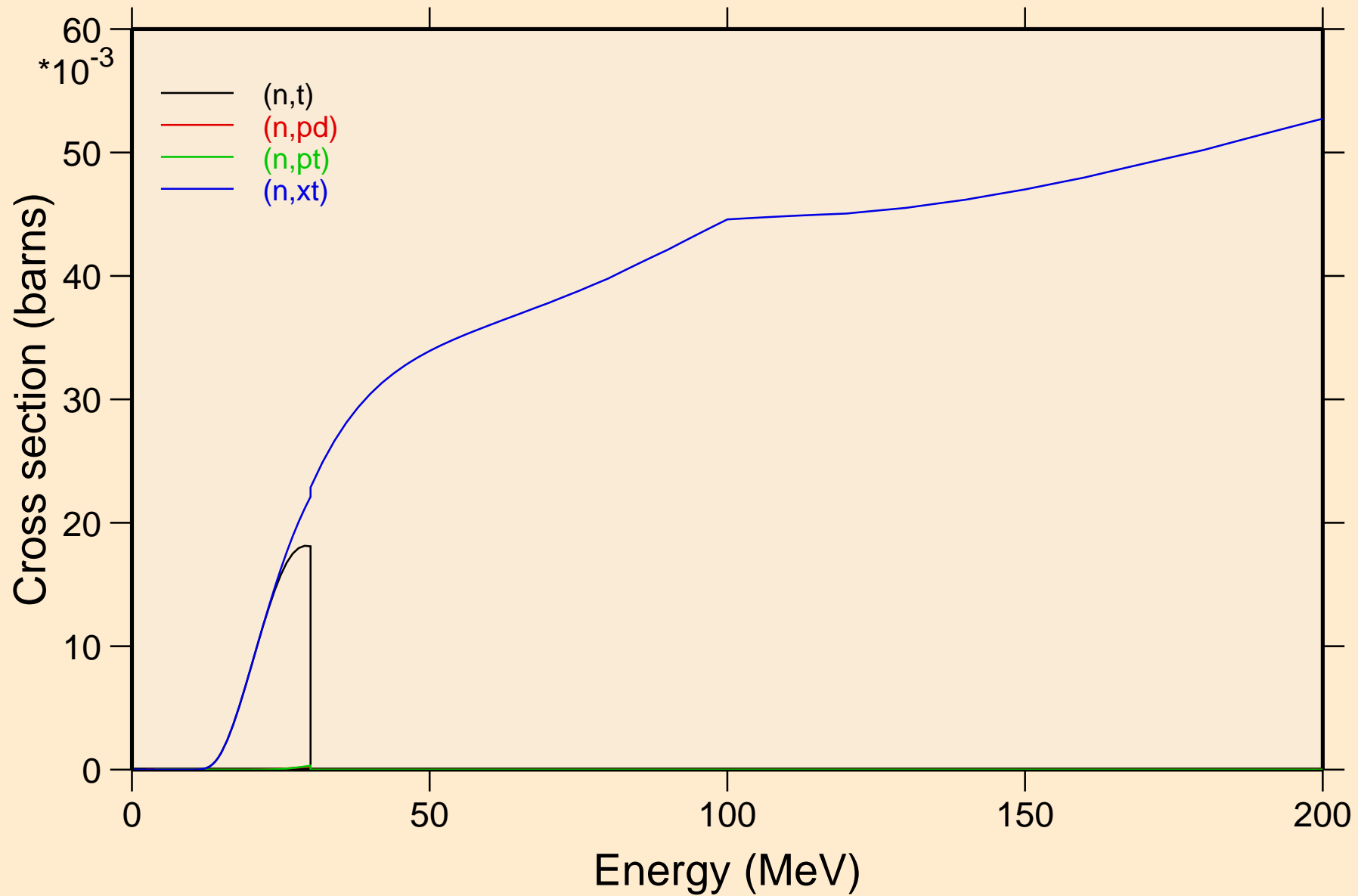

BI194M NEUTRON ACER TENDL-2024 LIBRARY; T=0.K  
angular distribution for elastic

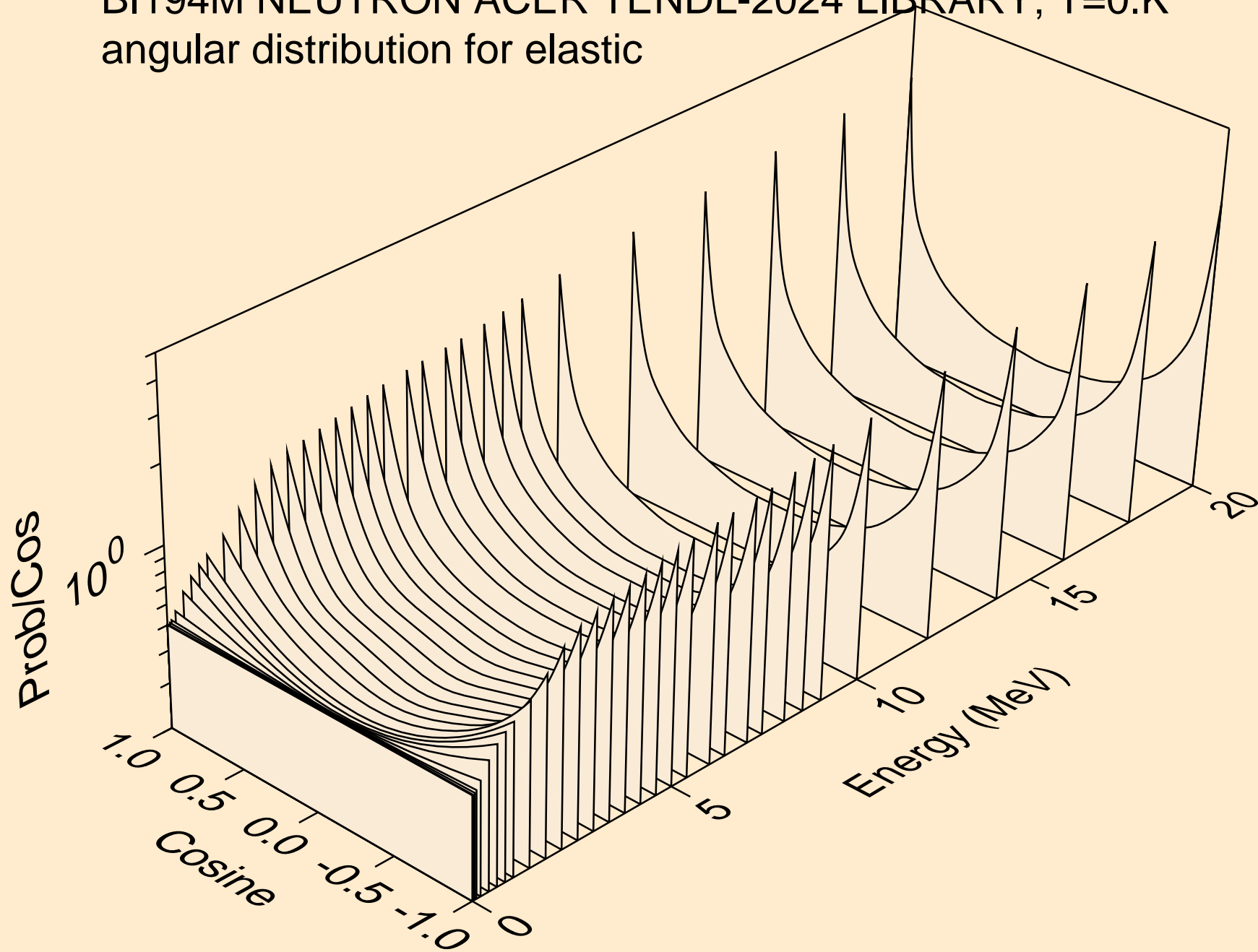

BI194M NEUTRON ACER TENDL-2024 LIBRARY; T=0.K  
angular distribution for elastic

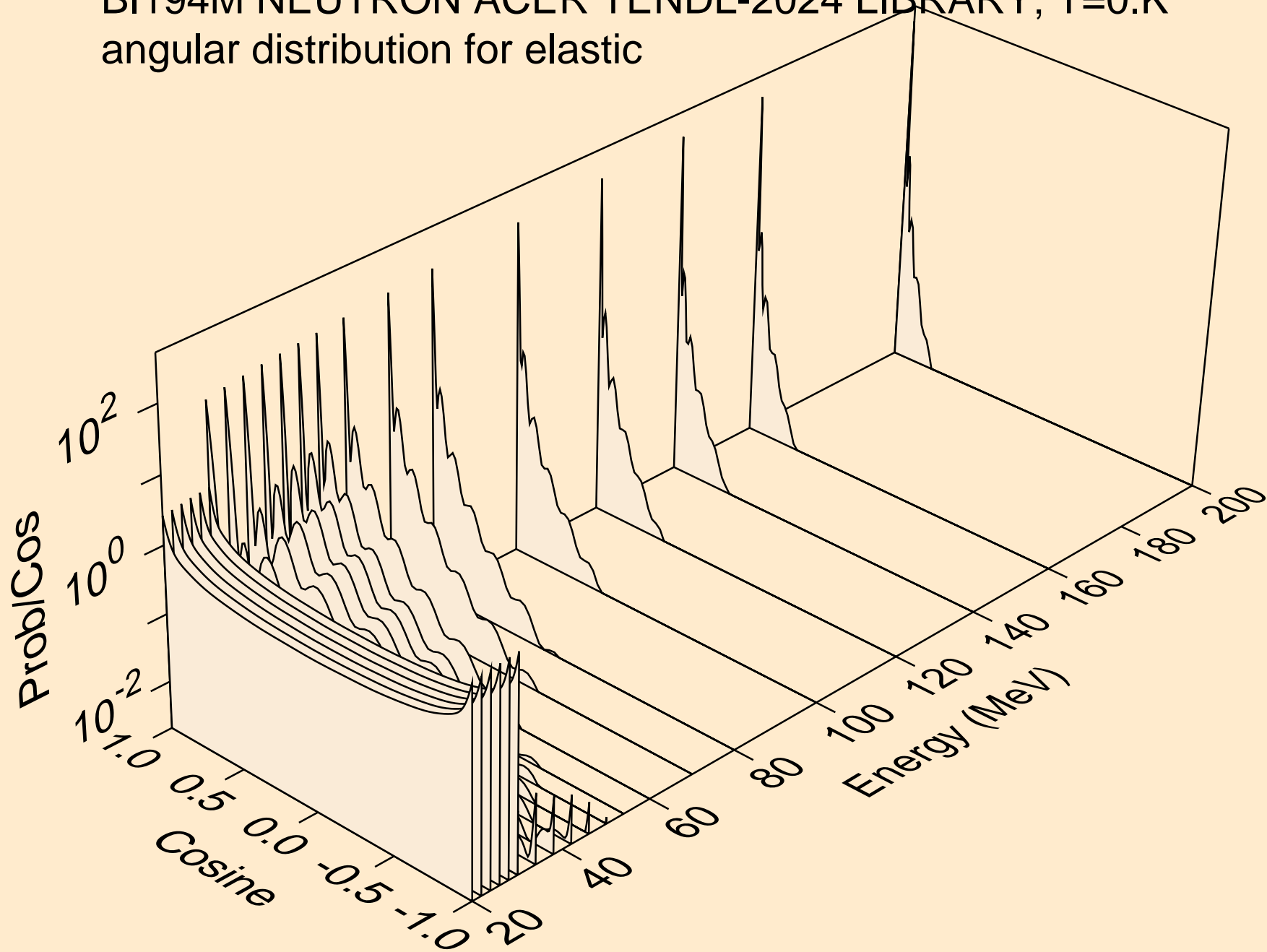

BI194M NEUTRON ACER TENDL-2024 LIBRARY; T=0.K  
angular distribution for (n,n\*1)

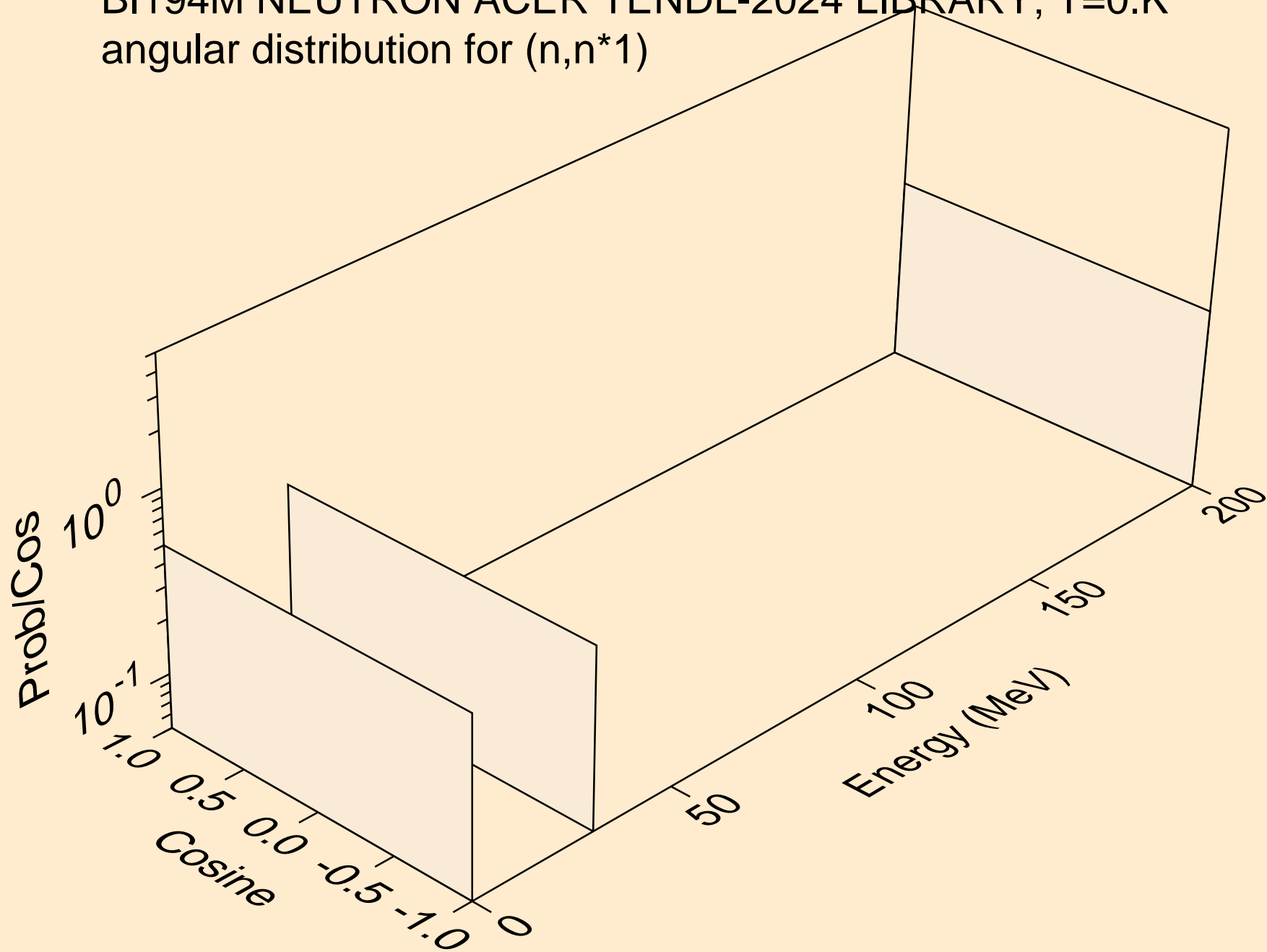

BI194M NEUTRON ACER TENDL-2024 LIBRARY; T=0.K  
angular distribution for (n,n\*2)

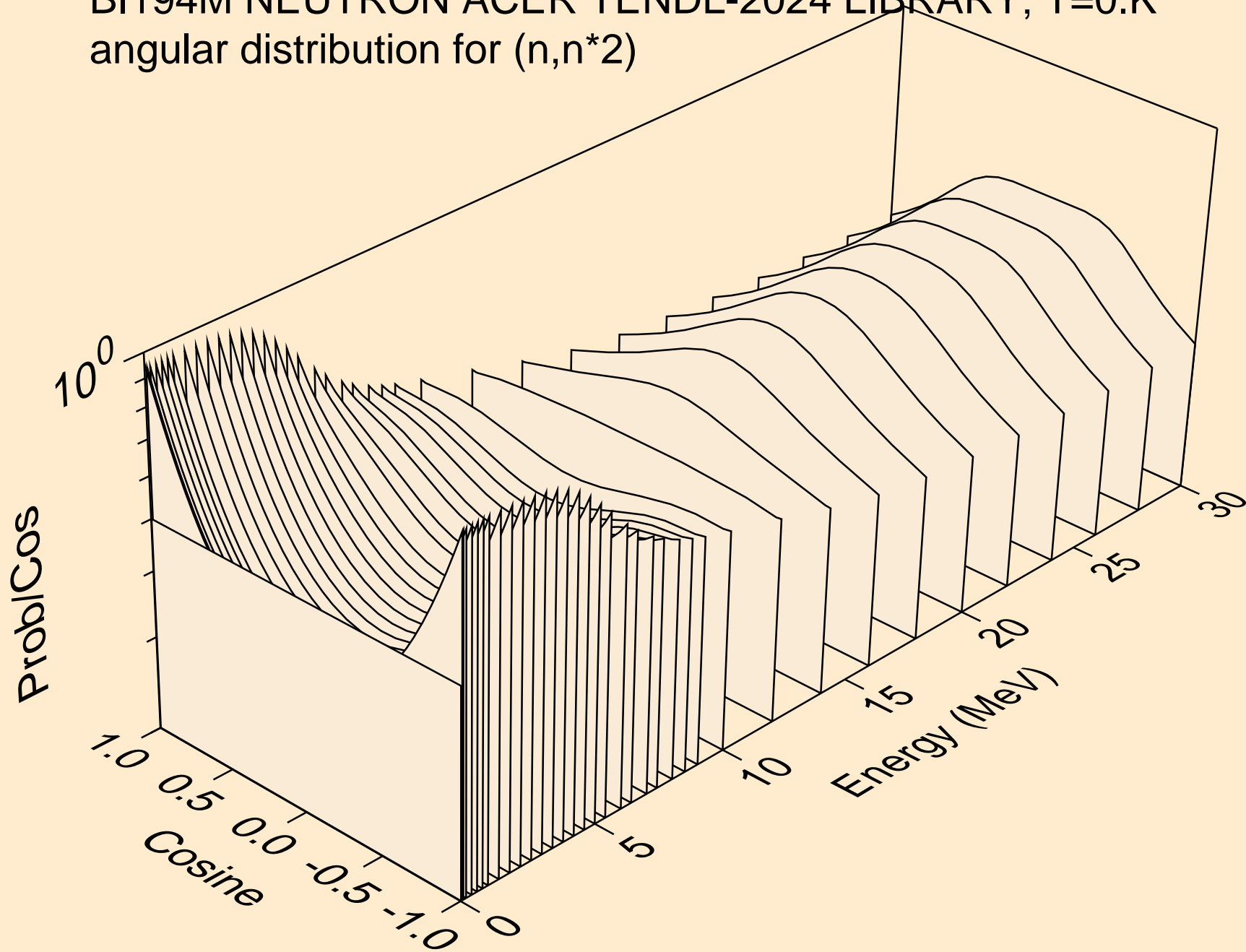

BI194M NEUTRON ACER TENDL-2024 LIBRARY; T=0.K  
Neutron emission for (n,x)

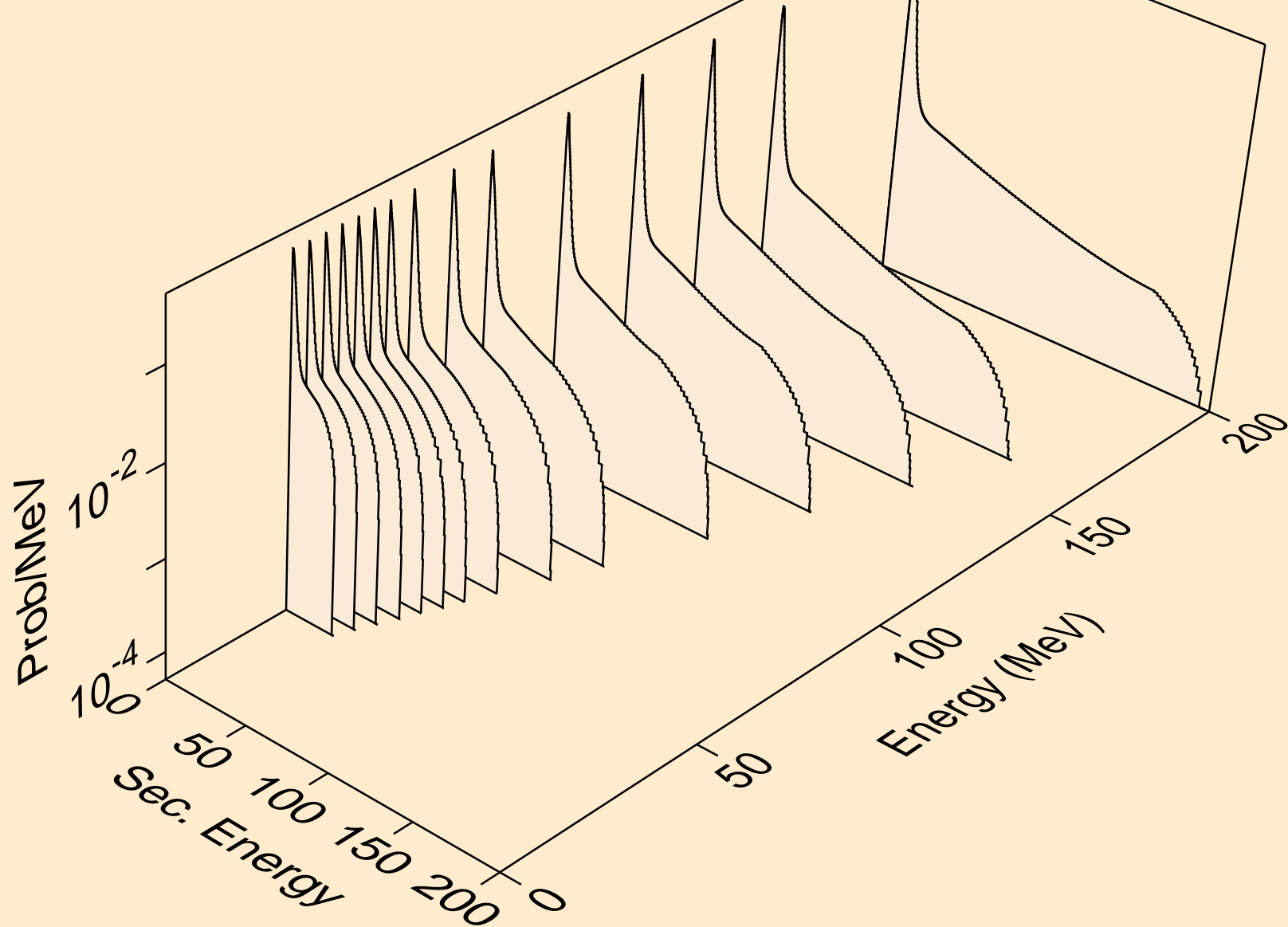



BI194M NEUTRON ACER TENDL-2024 LIBRARY; T=0.K  
Neutron emission for (n,2nd)

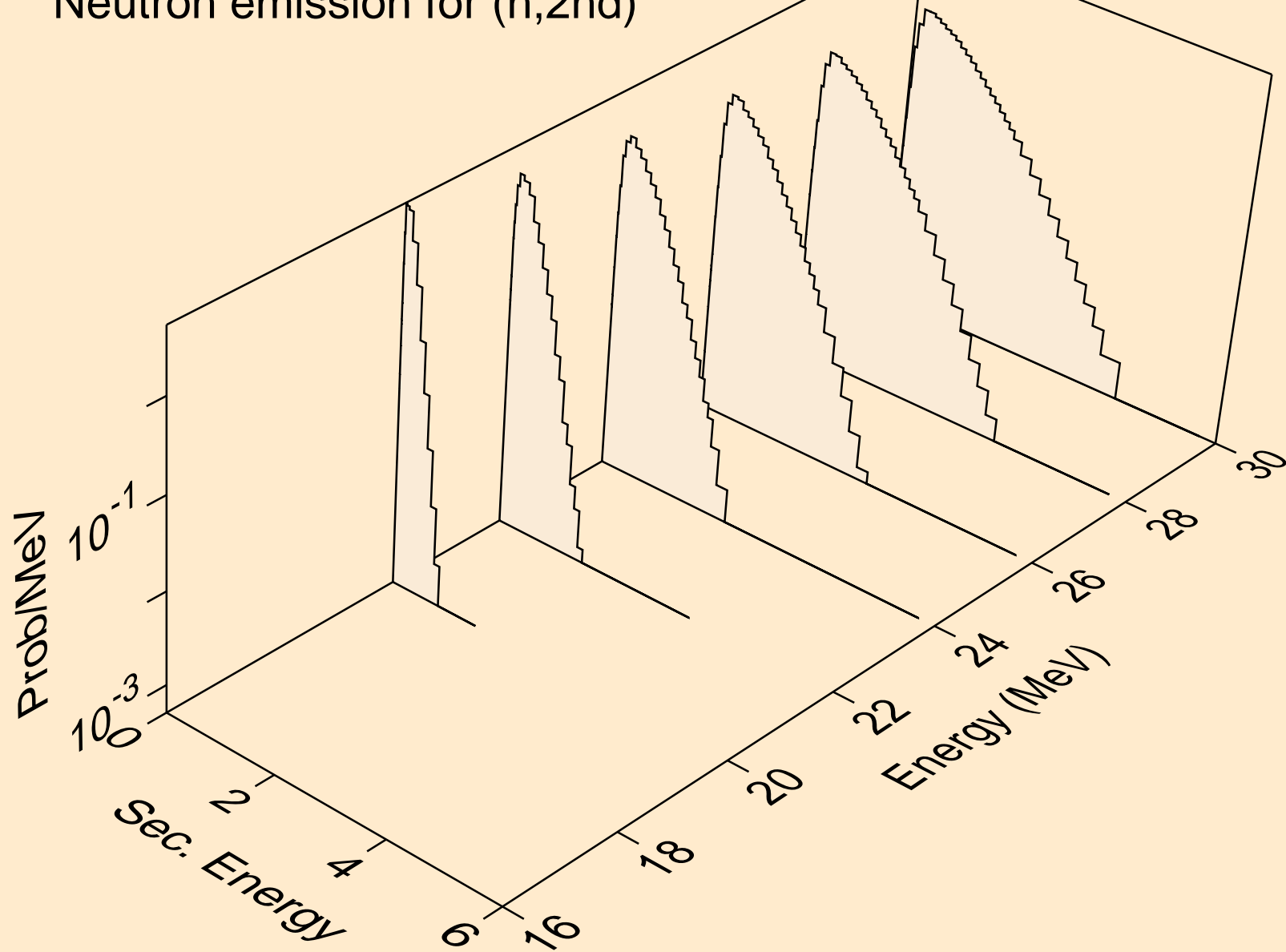

BI194M NEUTRON ACER TENDL-2024 LIBRARY; T=0.K  
Neutron emission for (n,2n)

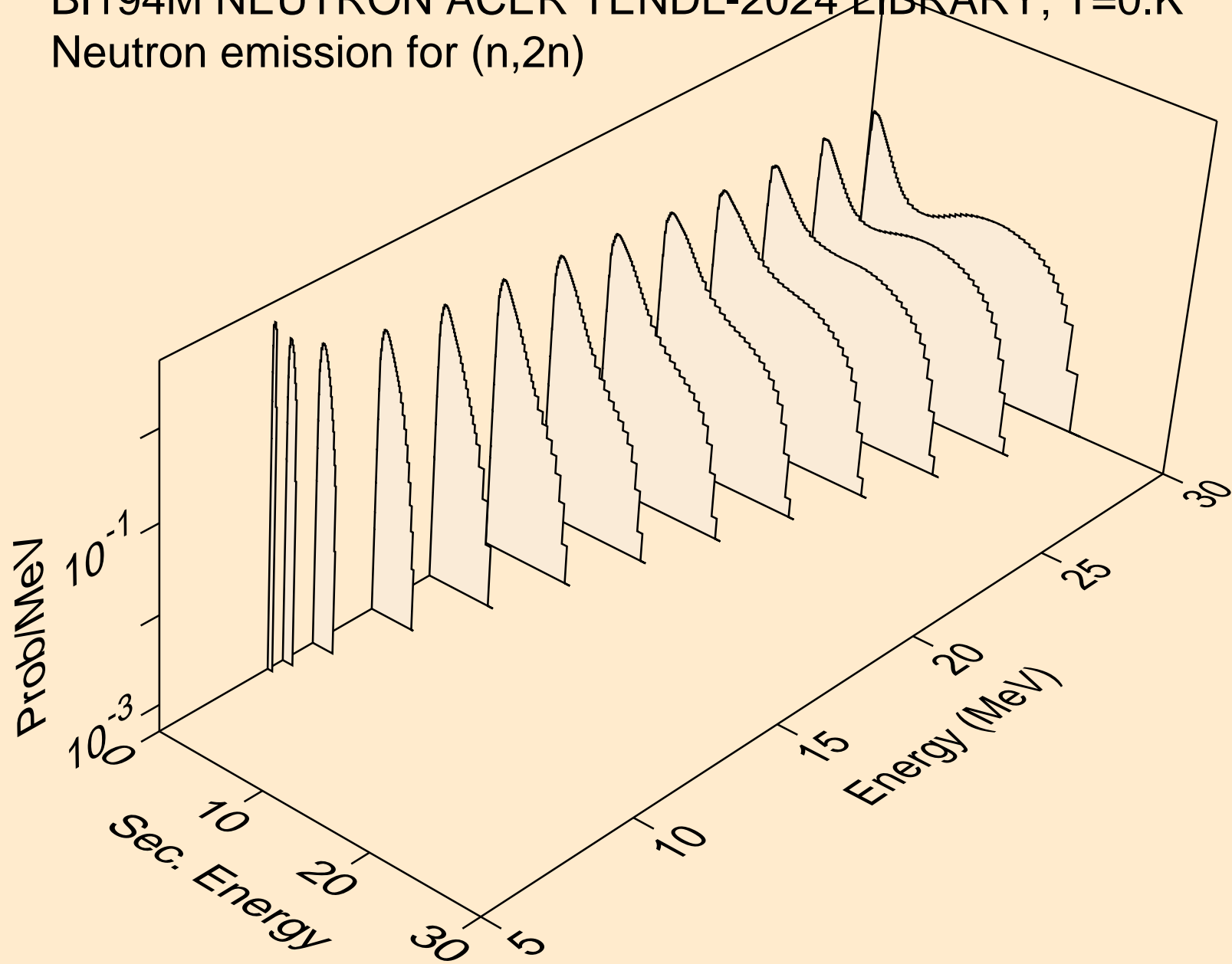

BI194M NEUTRON ACER TENDL-2024 LIBRARY; T=0.K  
Neutron emission for (n,3n)

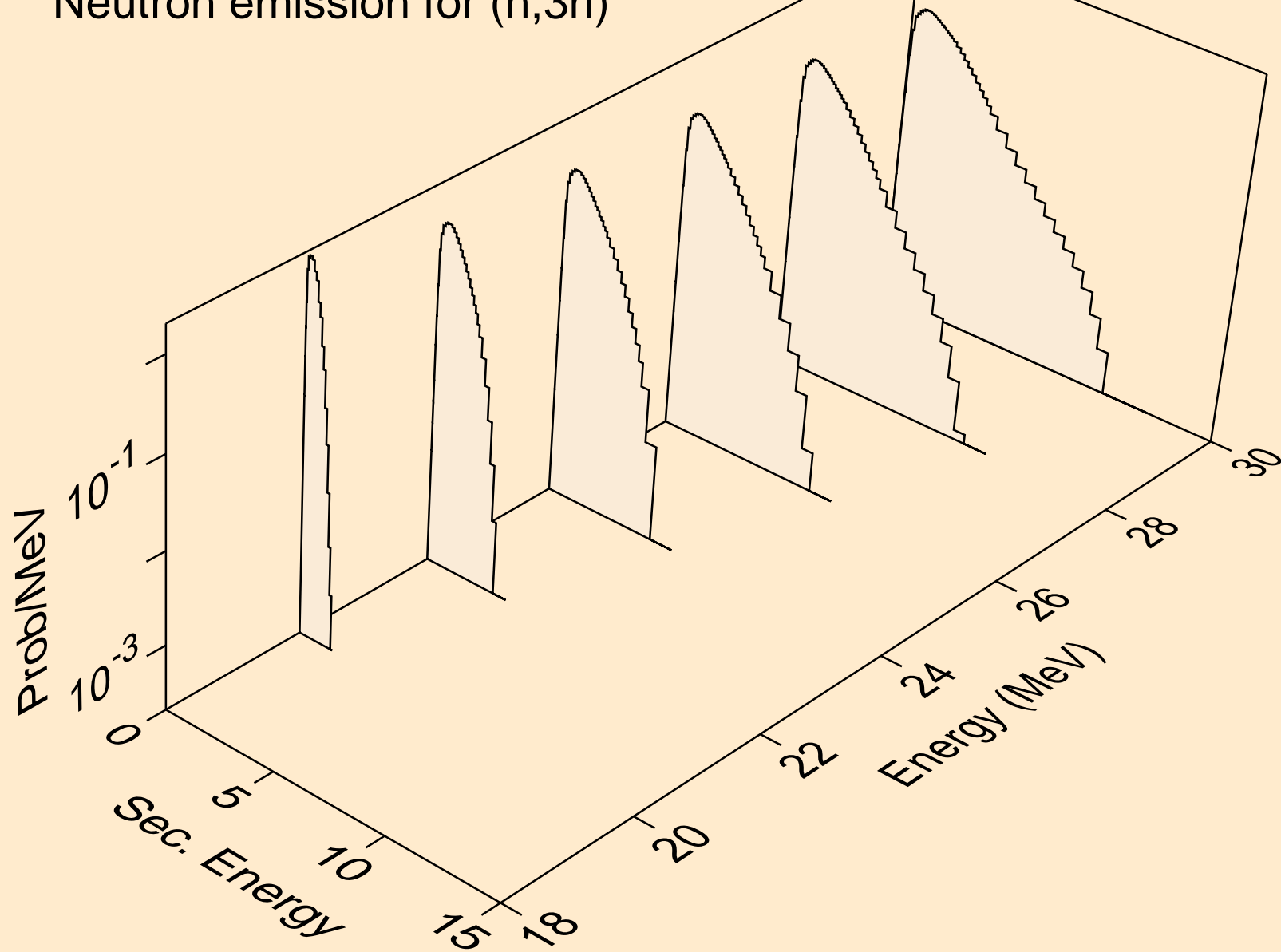

BI194M NEUTRON ACER TENDL-2024 LIBRARY; T=0.K  
Neutron emission for (n,n\*)a

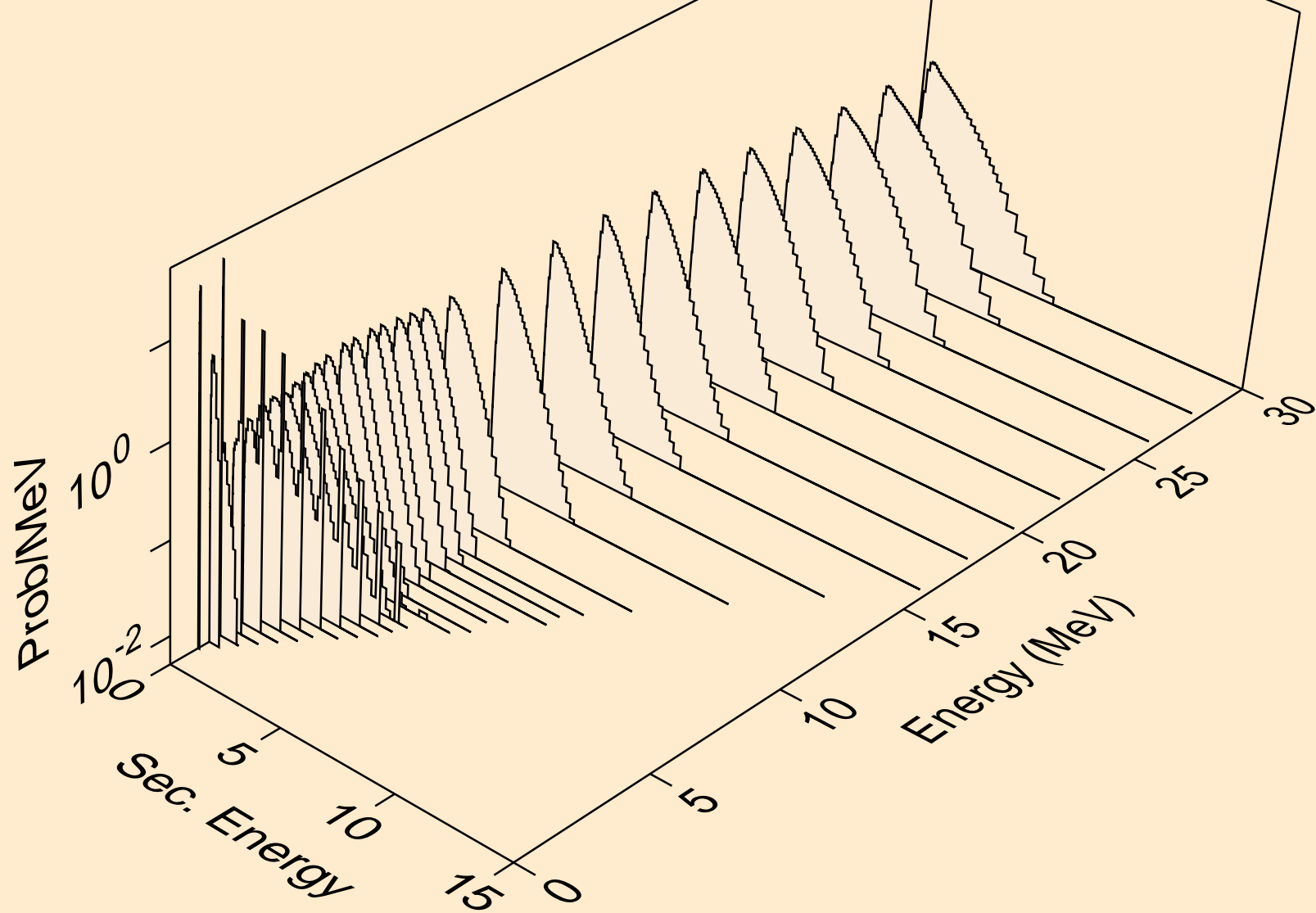

BI194M NEUTRON ACER TENDL-2024 LIBRARY; T=0.K  
Neutron emission for (n,2n)a

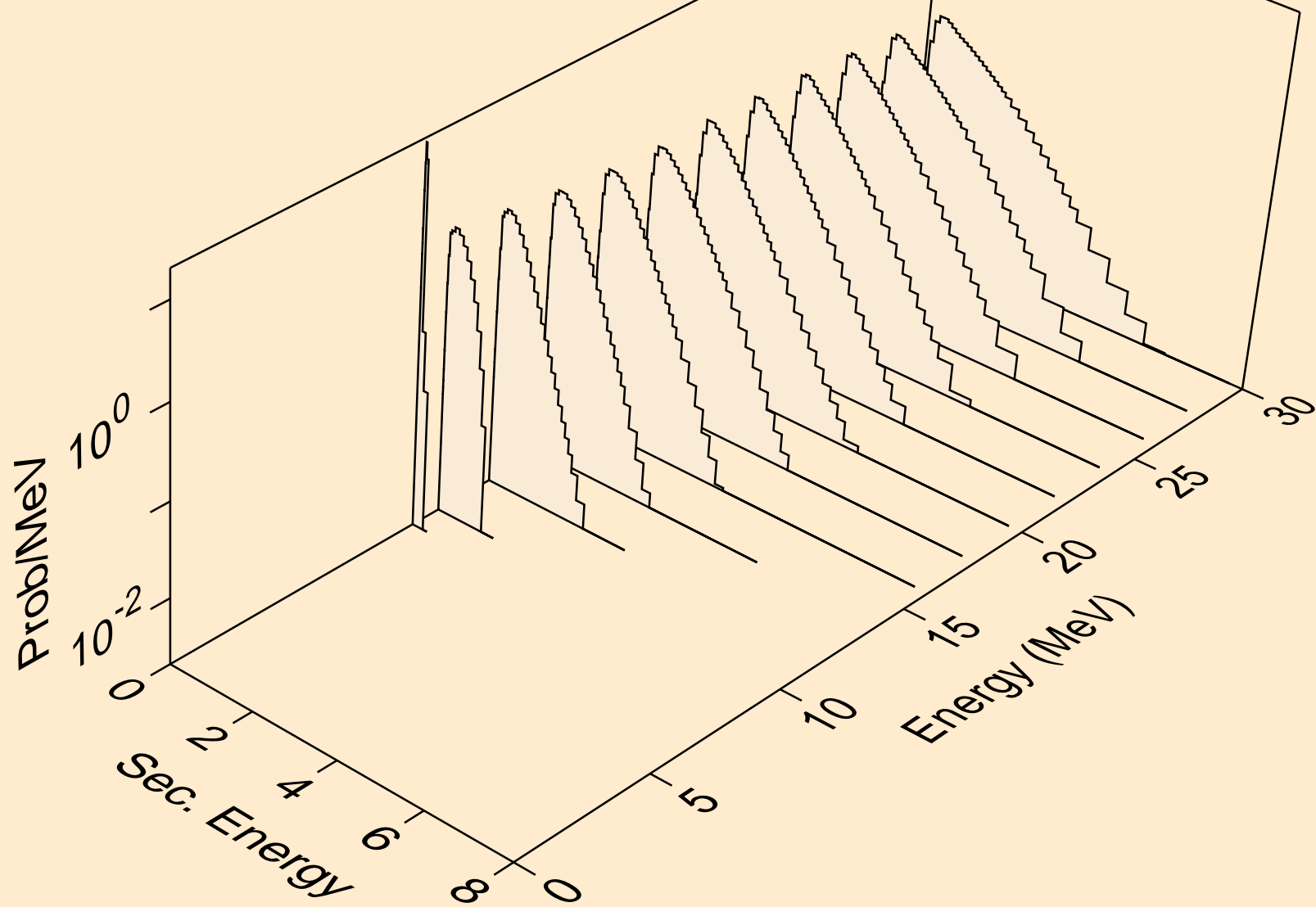

BI194M NEUTRON ACER TENDL-2024 LIBRARY; T=0.K  
Neutron emission for (n,3n)a

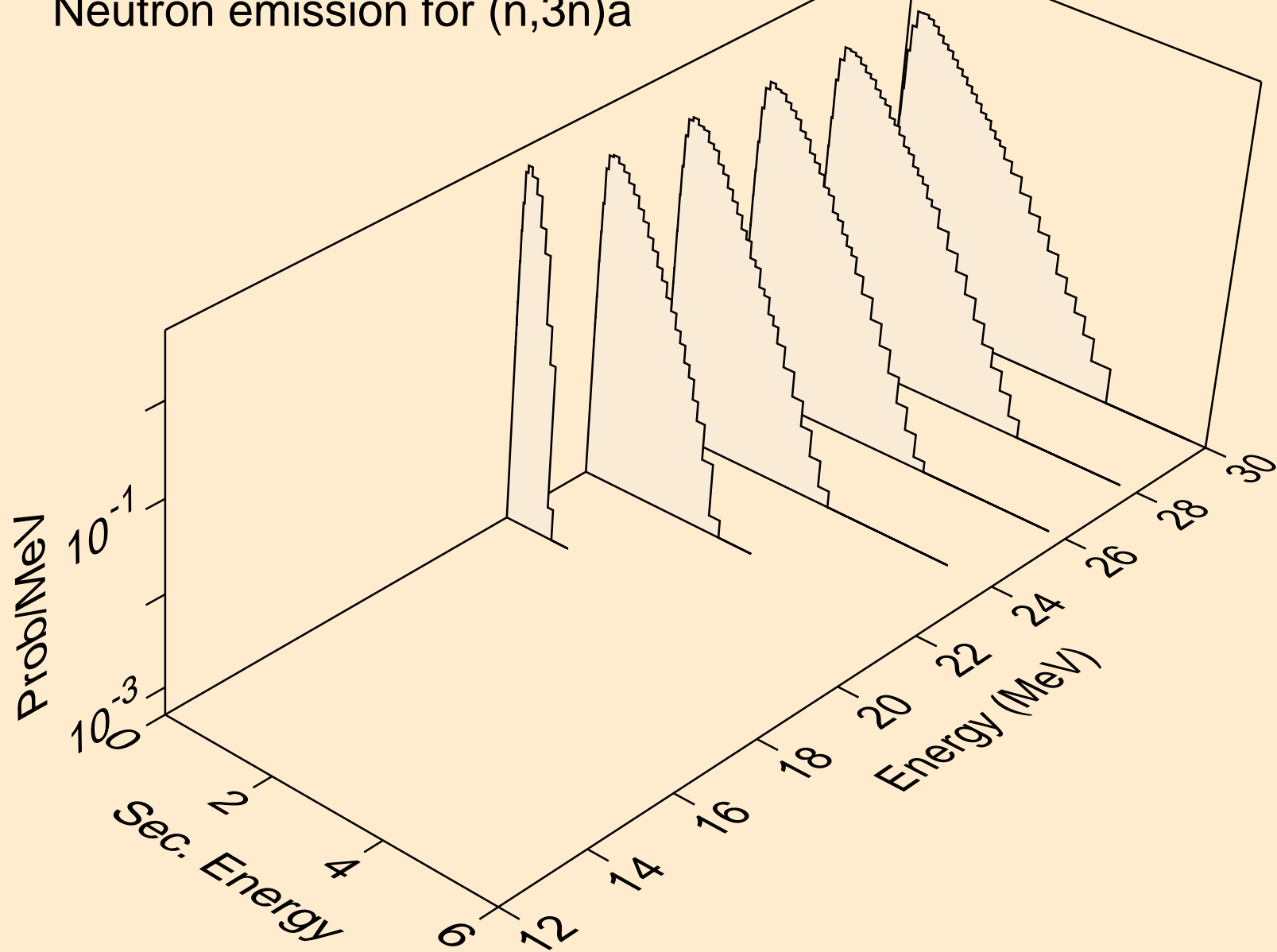

BI194M NEUTRON ACER TENDL-2024 LIBRARY; T=0.K  
Neutron emission for (n,n\*)p

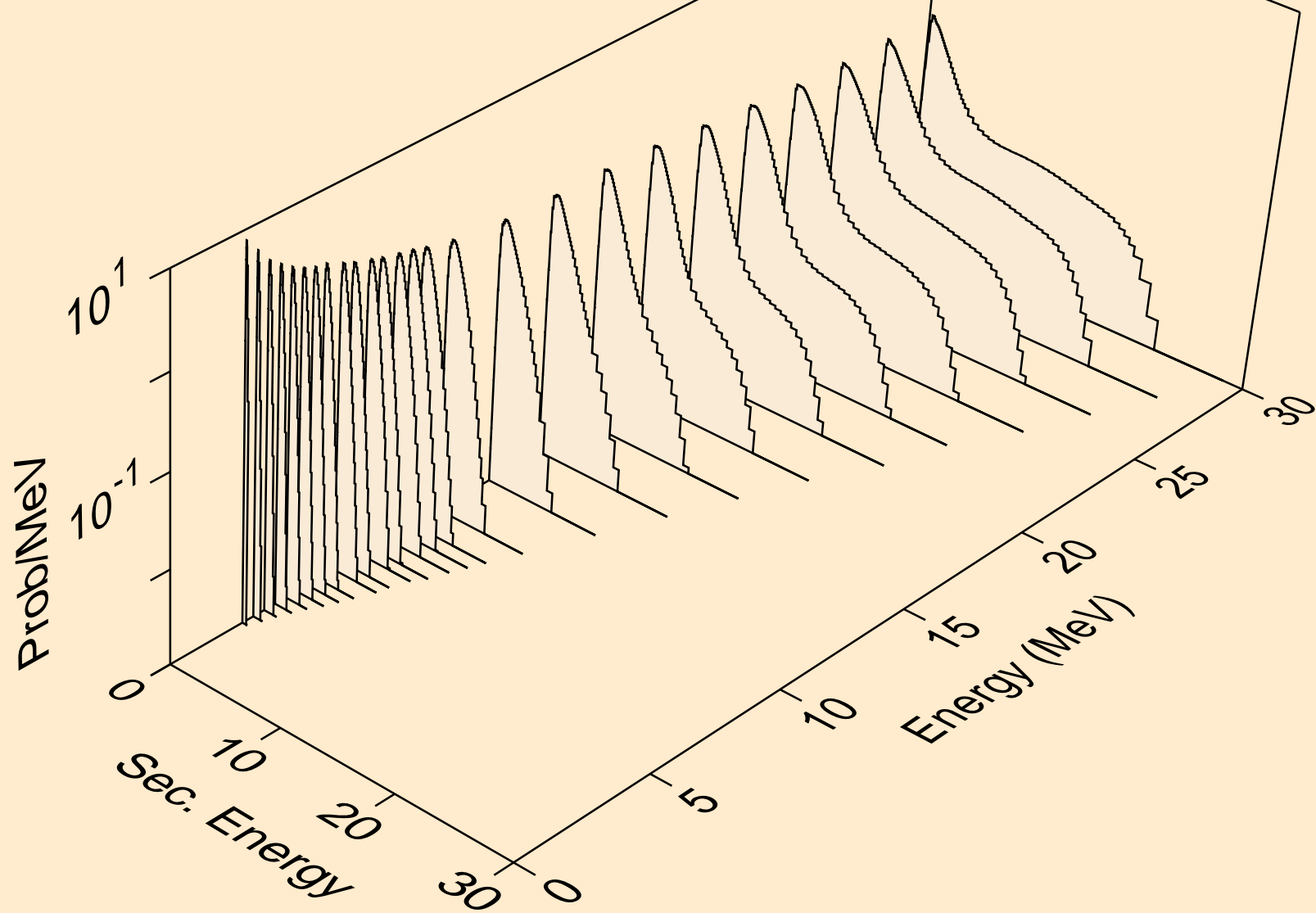

BI194M NEUTRON ACER TENDL-2024 LIBRARY; T=0.K  
Neutron emission for (n,n\*)2a

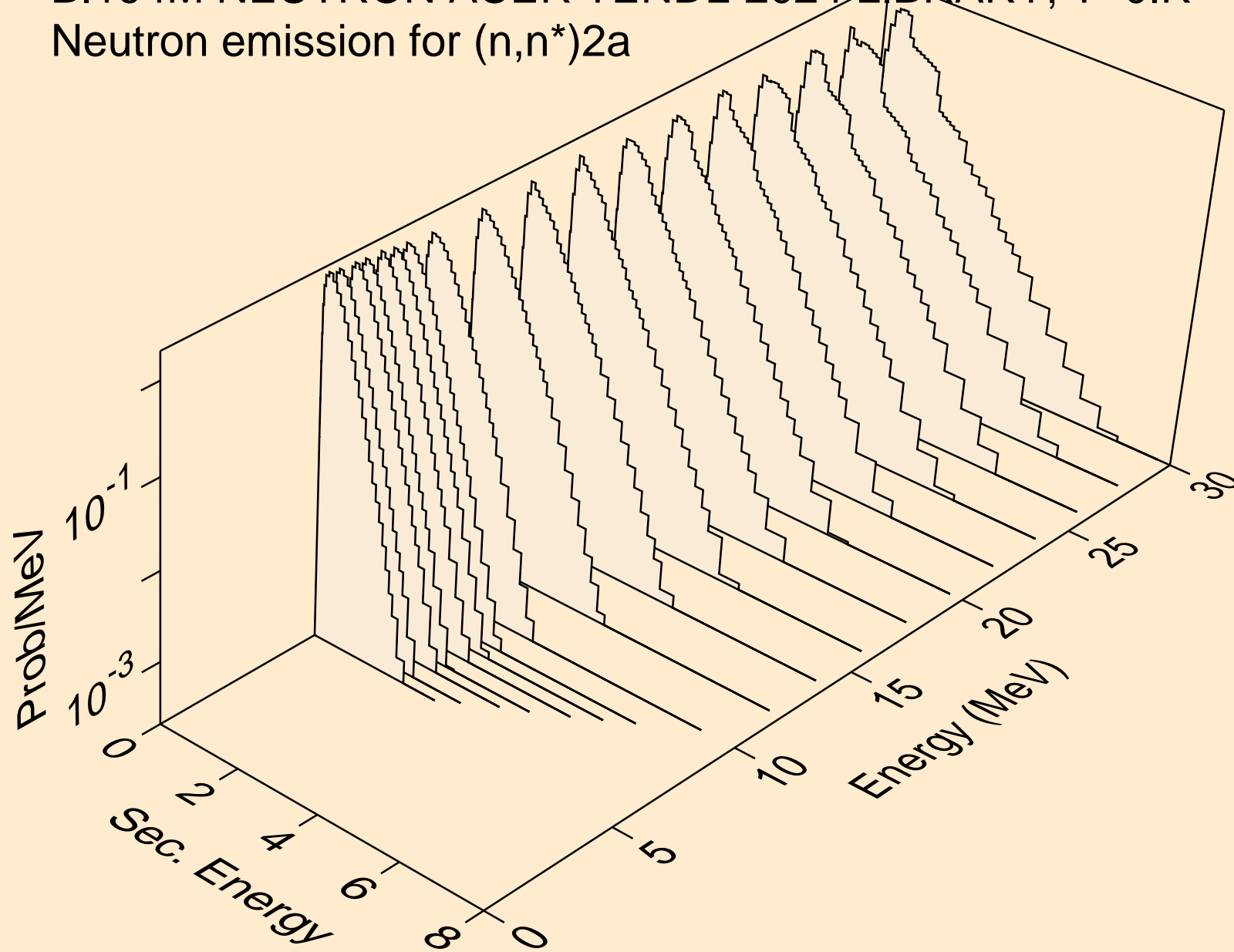



BI194M NEUTRON ACER TENDL-2024 LIBRARY; T=0.K  
Neutron emission for (n,2n)2a

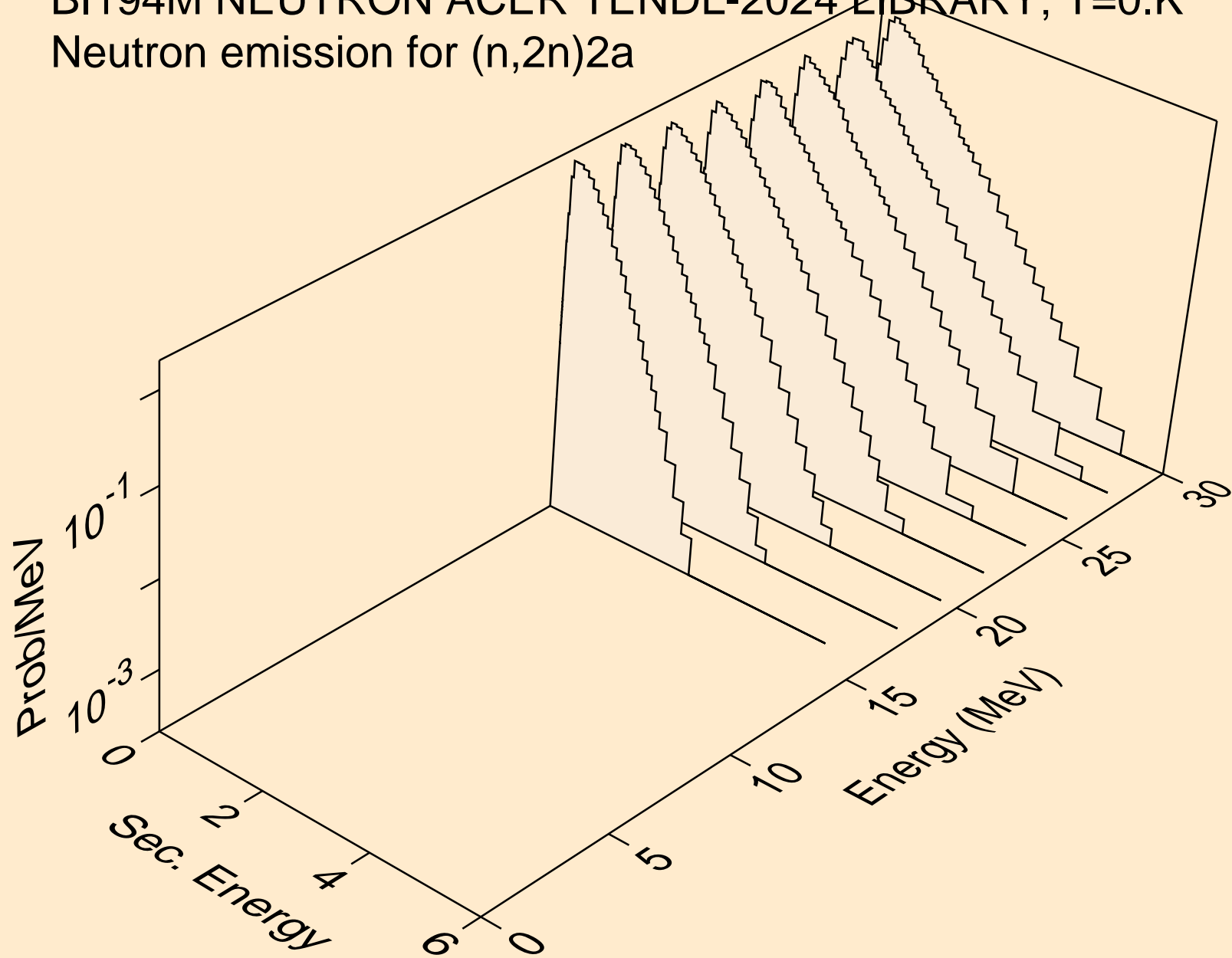

BI194M NEUTRON ACER TENDL-2024 LIBRARY; T=0.K  
Neutron emission for (n,n\*)d

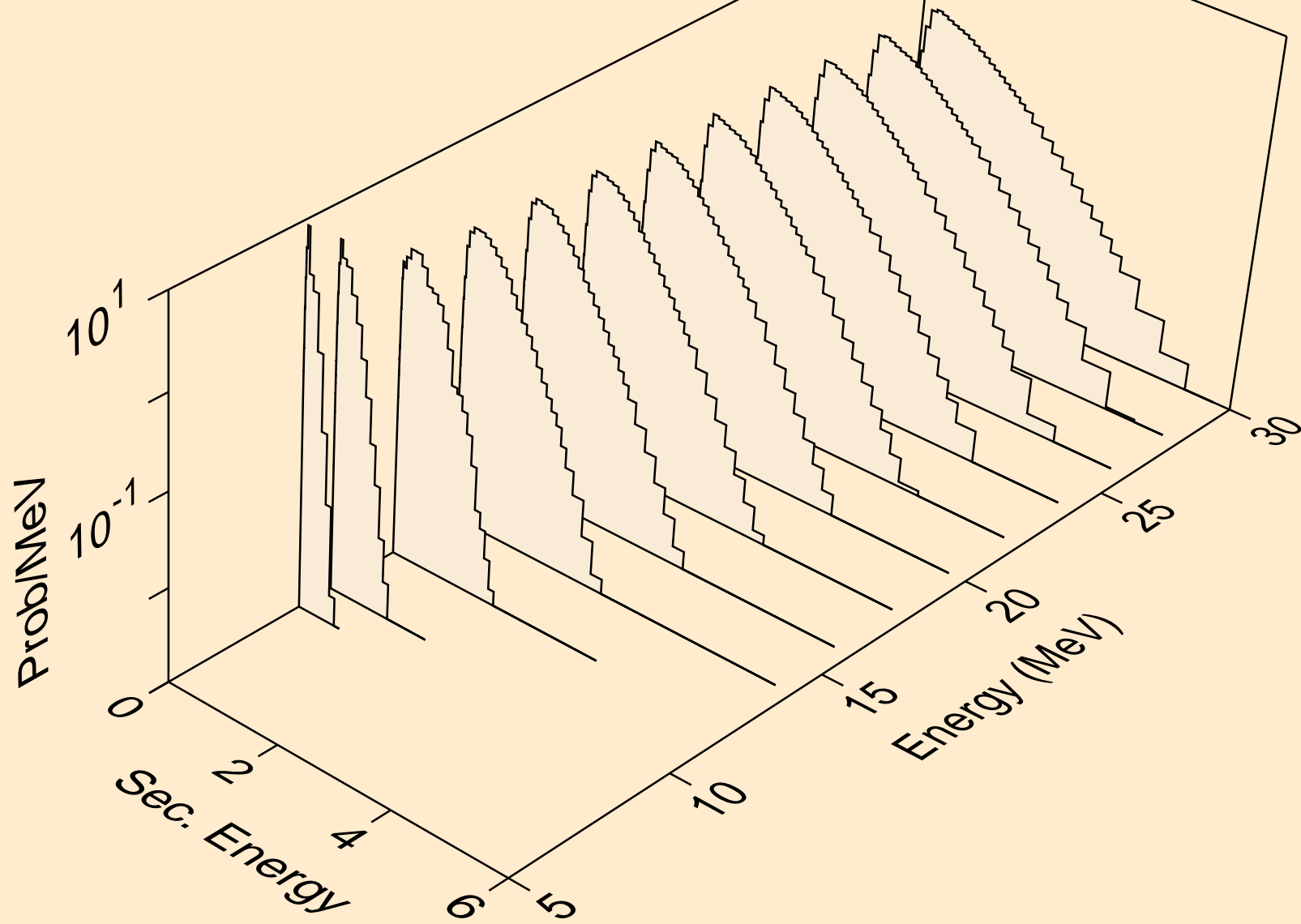

BI194M NEUTRON ACER TENDL-2024 LIBRARY; T=0.K  
Neutron emission for (n,n\*)t

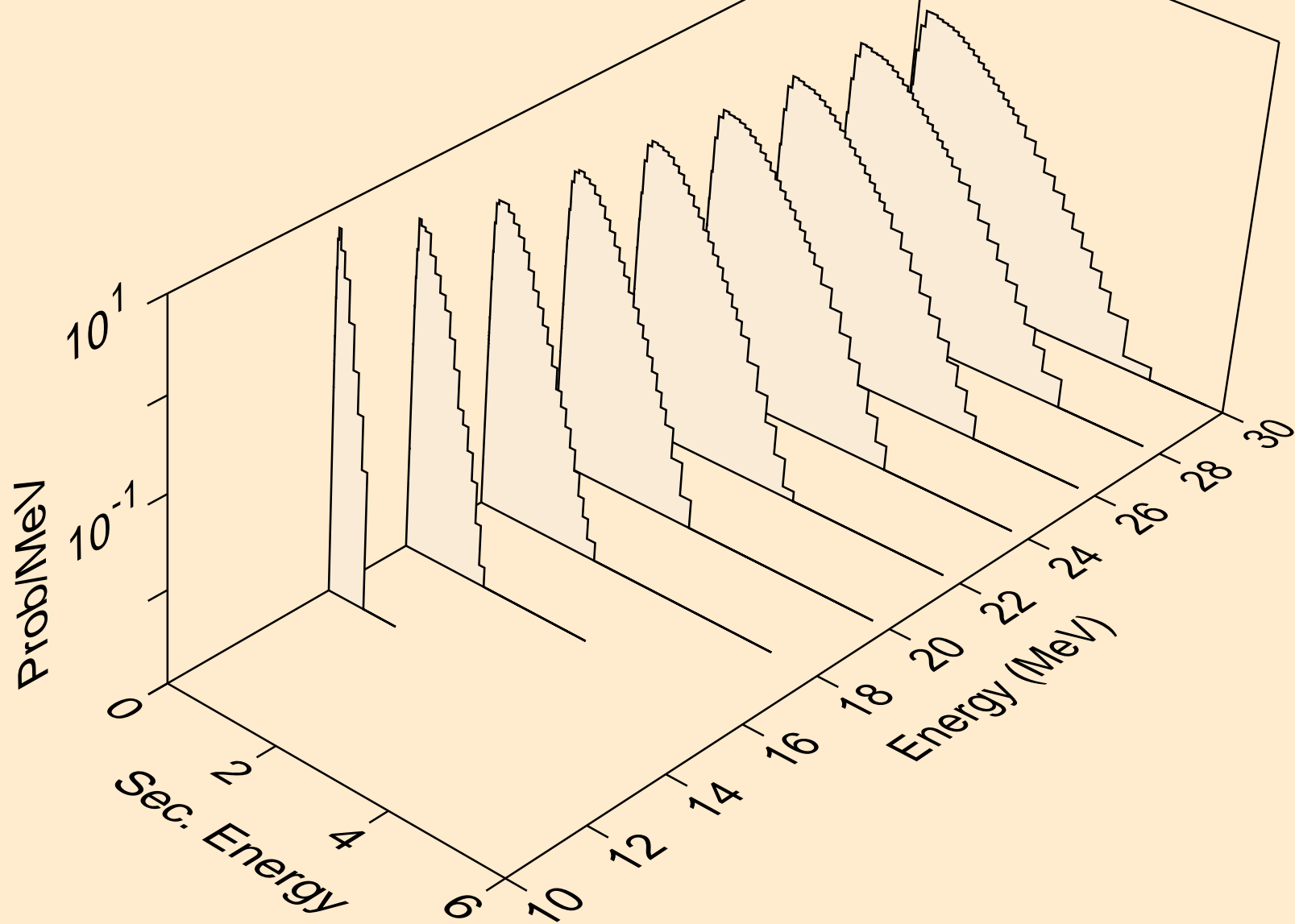

BI194M NEUTRON ACER TENDL-2024 LIBRARY; T=0.K  
Neutron emission for (n,n\*)he3

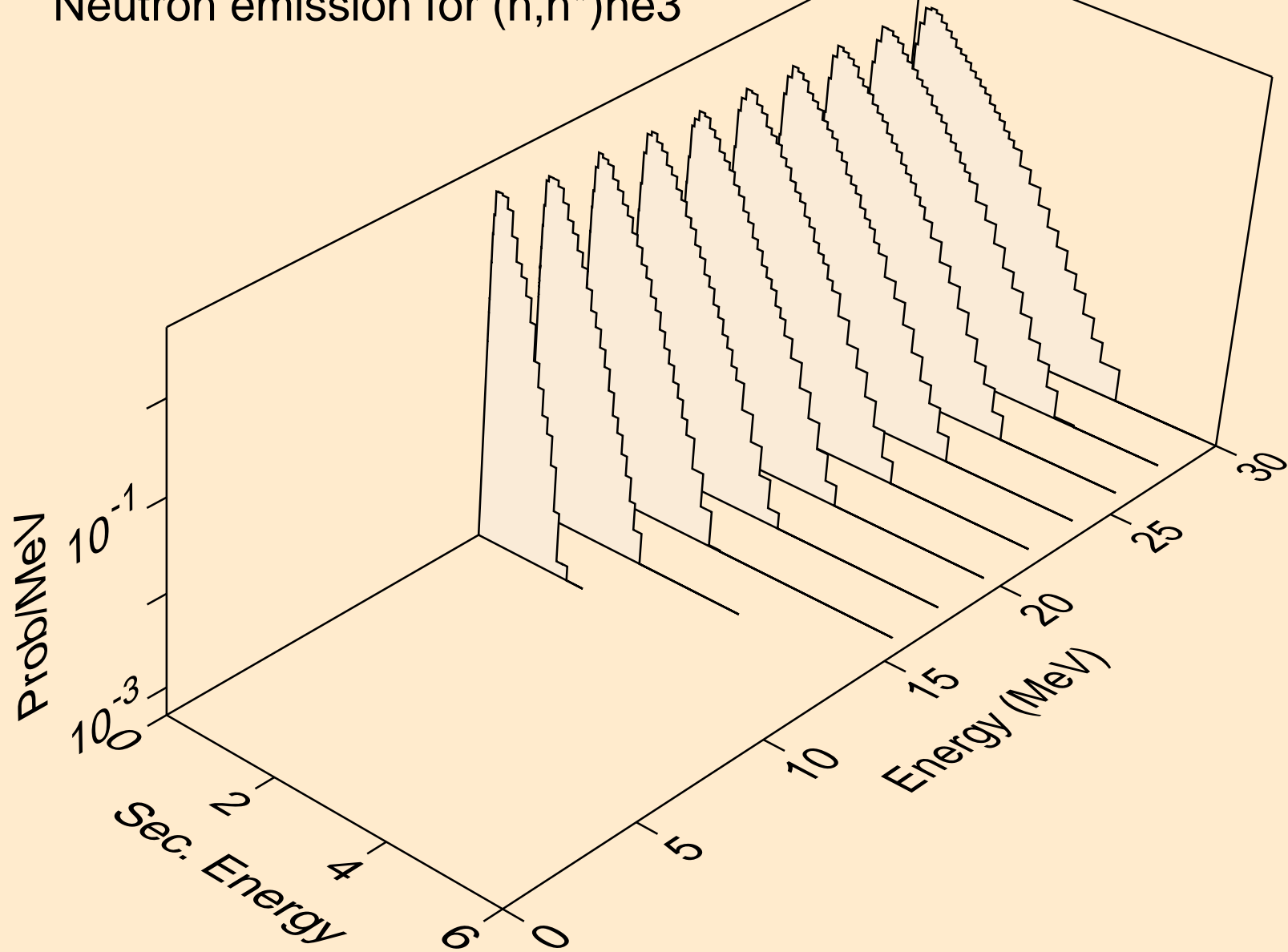

BI194M NEUTRON ACER TENDL-2024 LIBRARY; T=0.K  
Neutron emission for (n,4n)

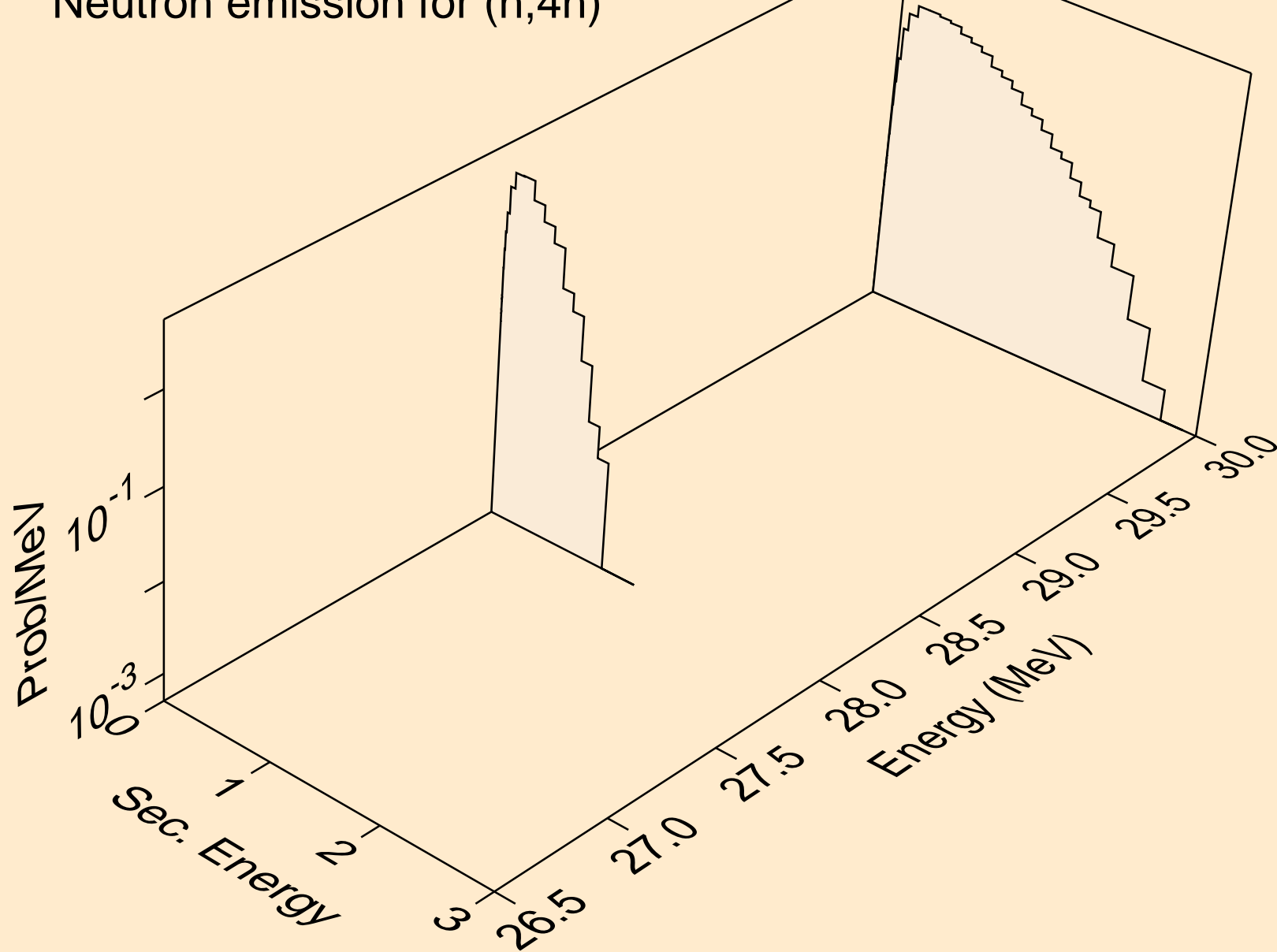

BI194M NEUTRON ACER TENDL-2024 LIBRARY; T=0.K  
Neutron emission for (n,2np)

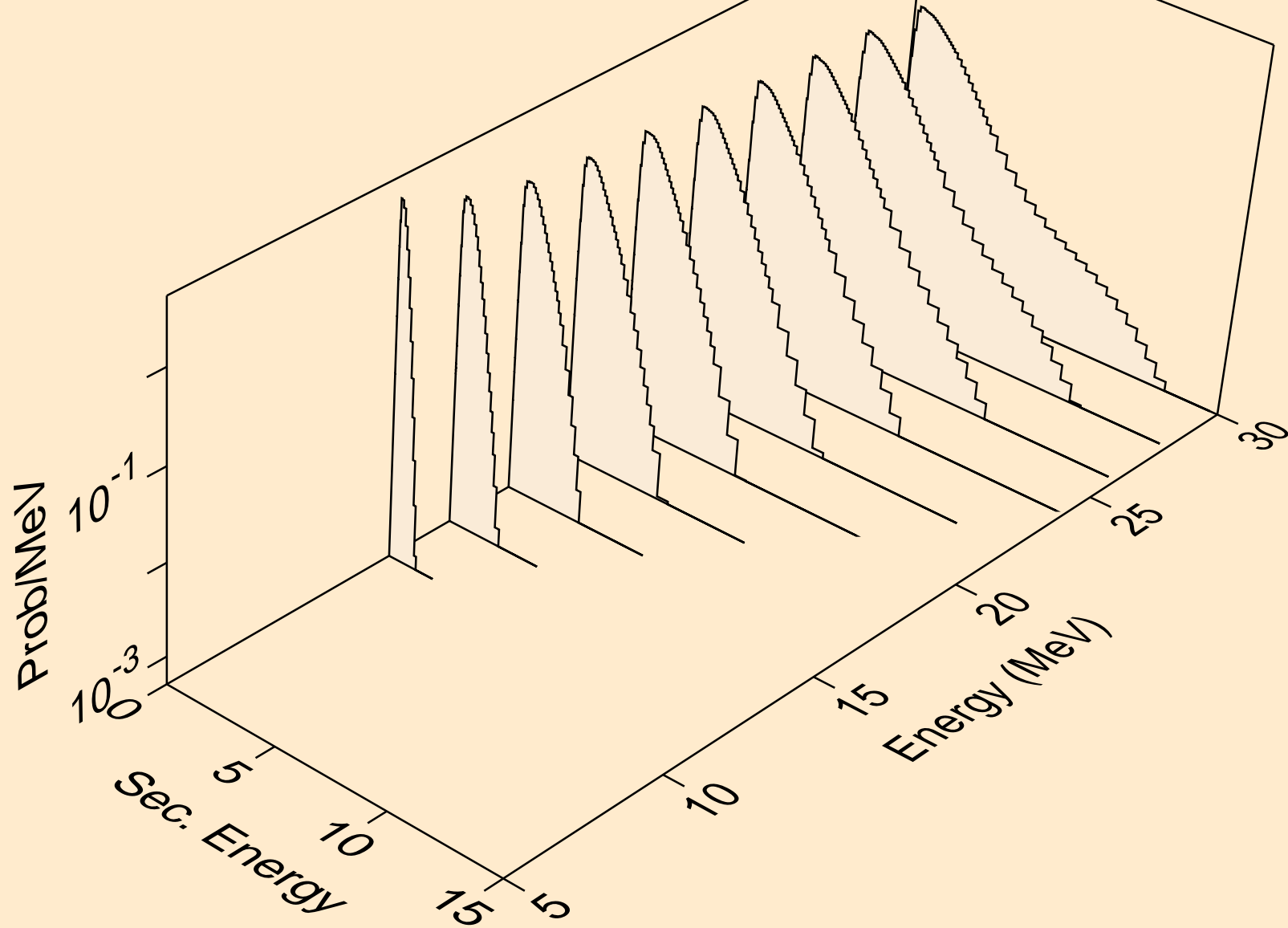

BI194M NEUTRON ACER TENDL-2024 LIBRARY; T=0.K  
Neutron emission for (n,3np)

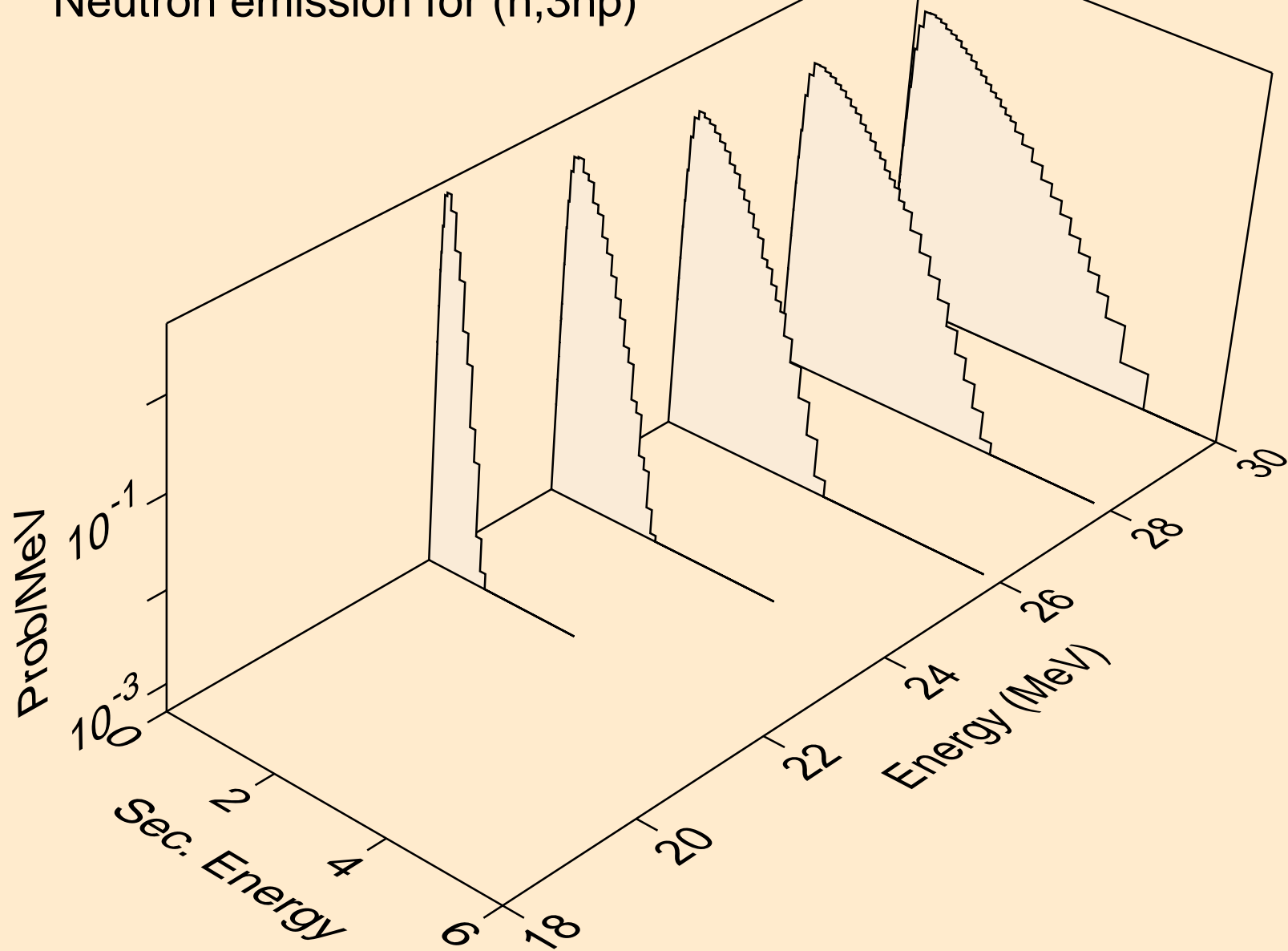

BI194M NEUTRON ACER TENDL-2024 LIBRARY; T=0.K  
Neutron emission for (n,n2p)

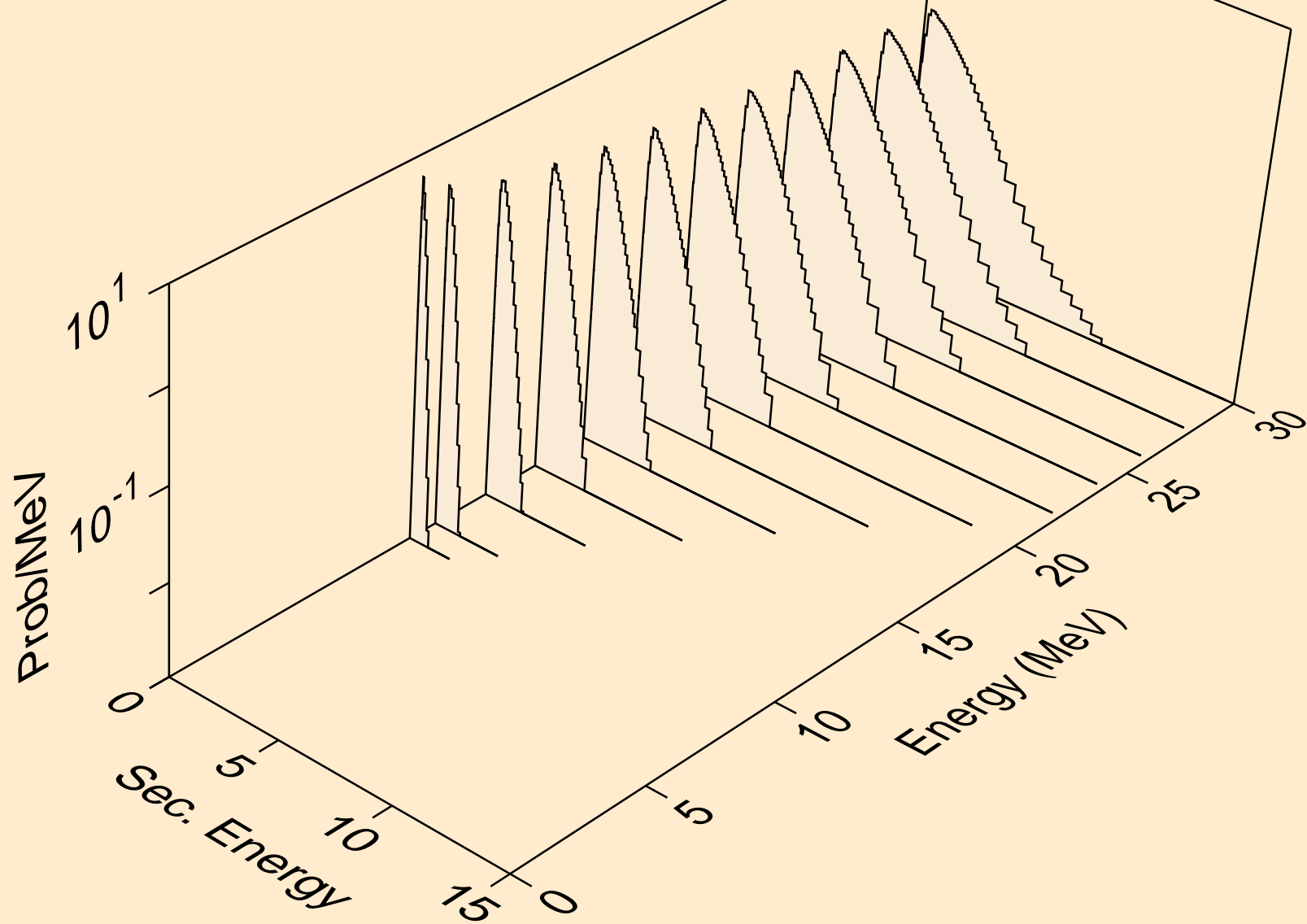



BI194M NEUTRON ACER TENDL-2024 LIBRARY; T=0.K  
Neutron emission for (n,npa)

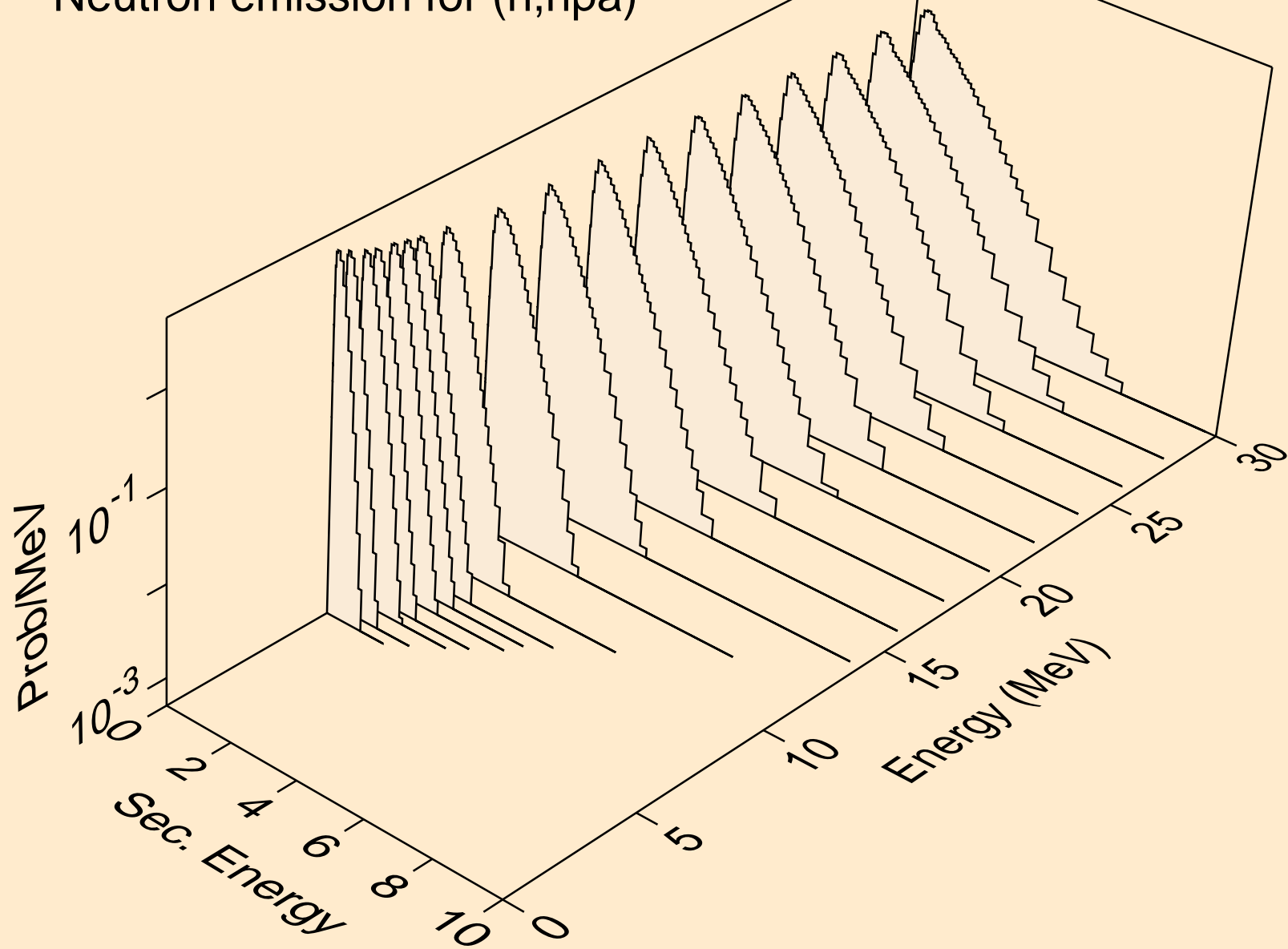

BI194M NEUTRON ACER TENDL-2024 LIBRARY; T=0.K  
Neutron emission for (n,n\*c)

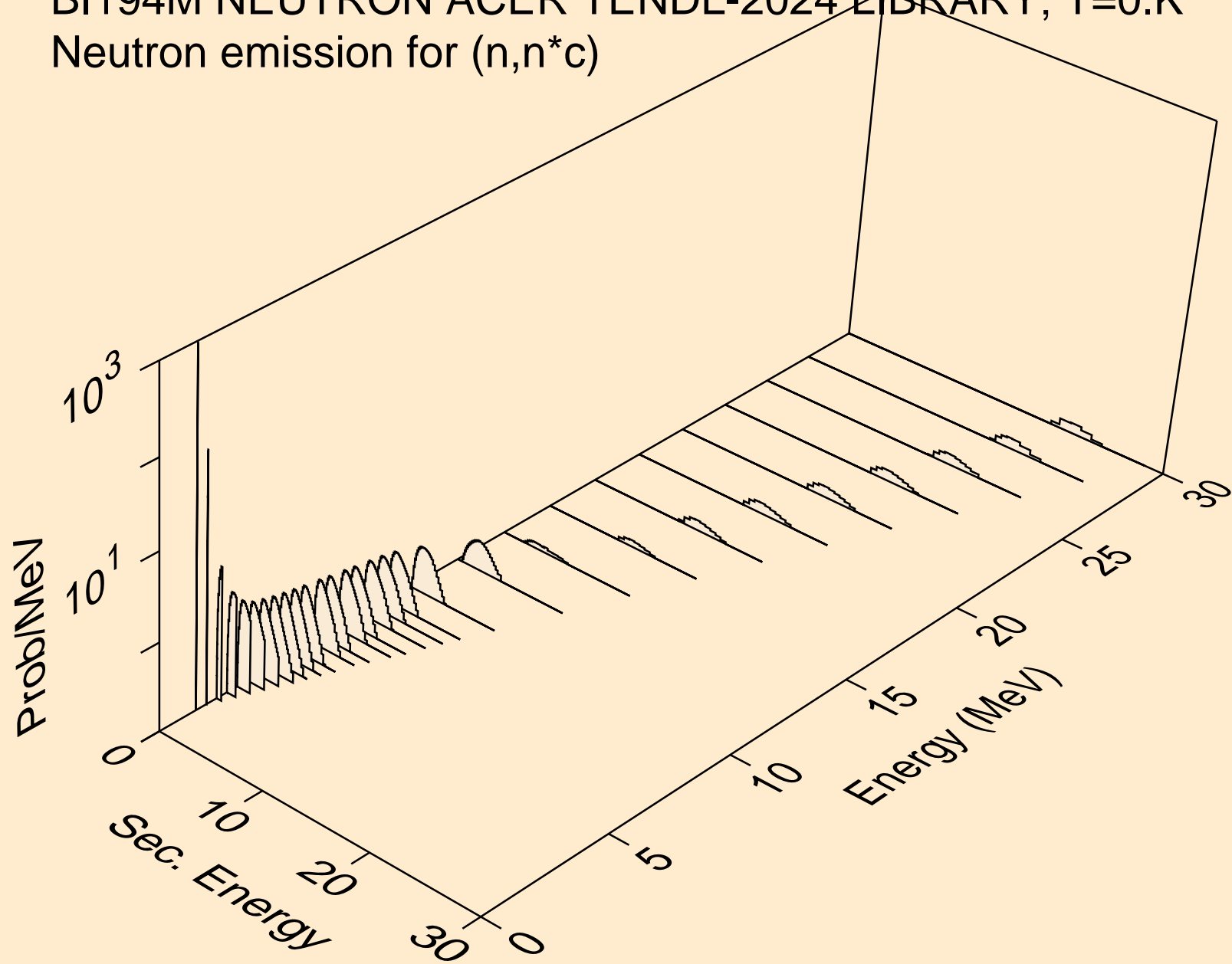

BI194M NEUTRON ACER TENDL-2024 LIBRARY; T=0.K  
Photon emission for (n,x)

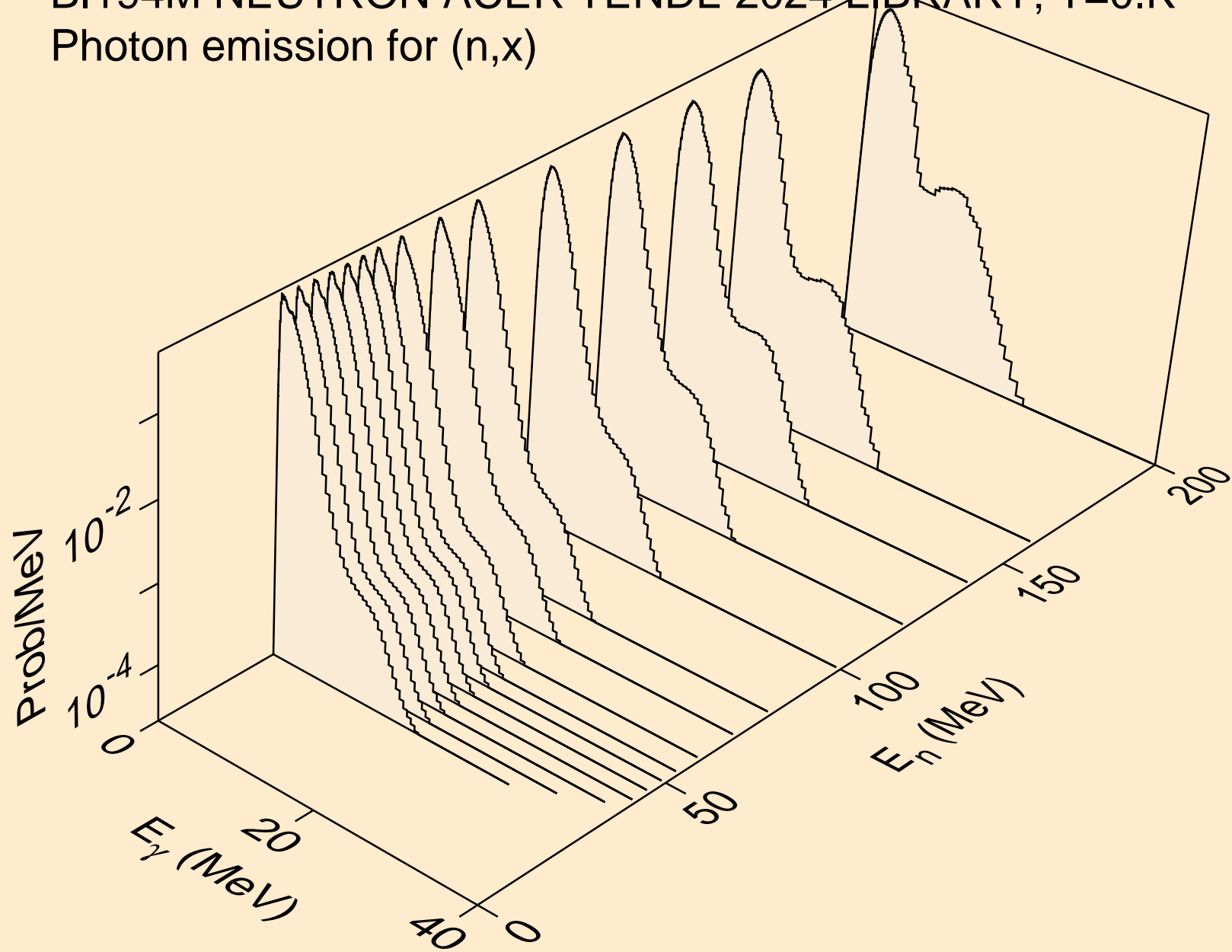

BI194M NEUTRON ACER TENDL-2024 LIBRARY; T=0.K  
Photon emission for (n,2nd)

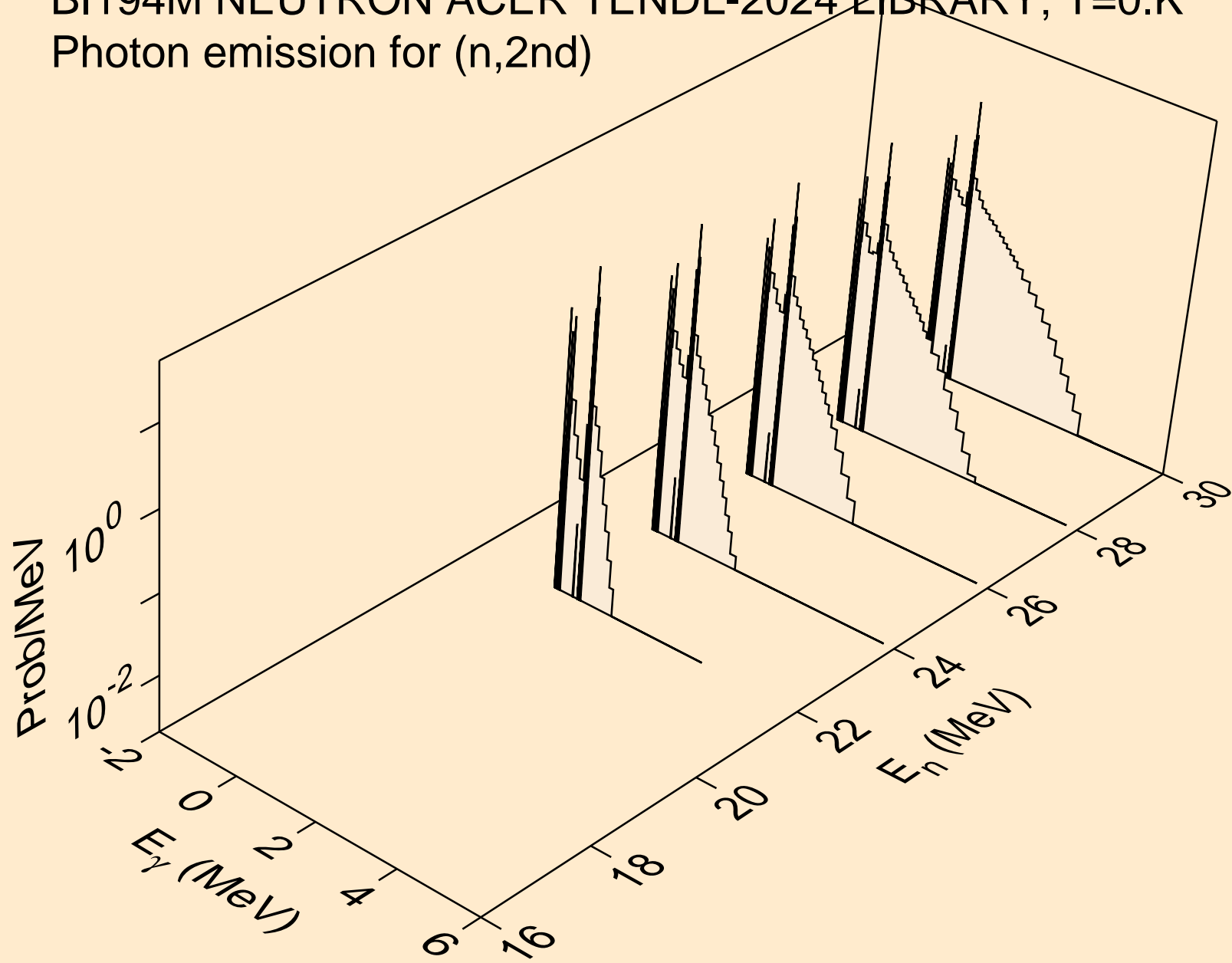

BI194M NEUTRON ACER TENDL-2024 LIBRARY; T=0.K  
Photon emission for (n,2n)

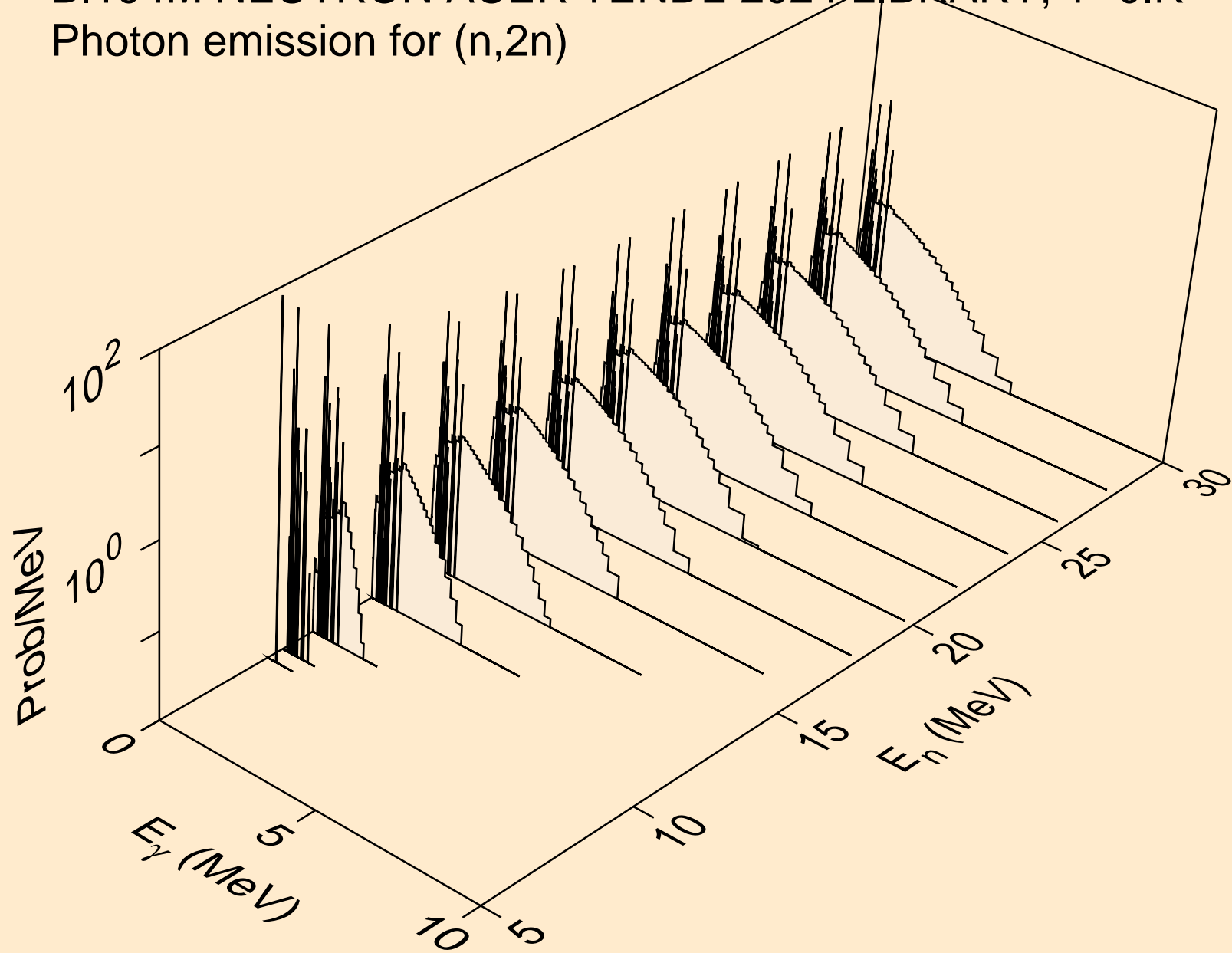

BI194M NEUTRON ACER TENDL-2024 LIBRARY; T=0.K  
Photon emission for (n,3n)

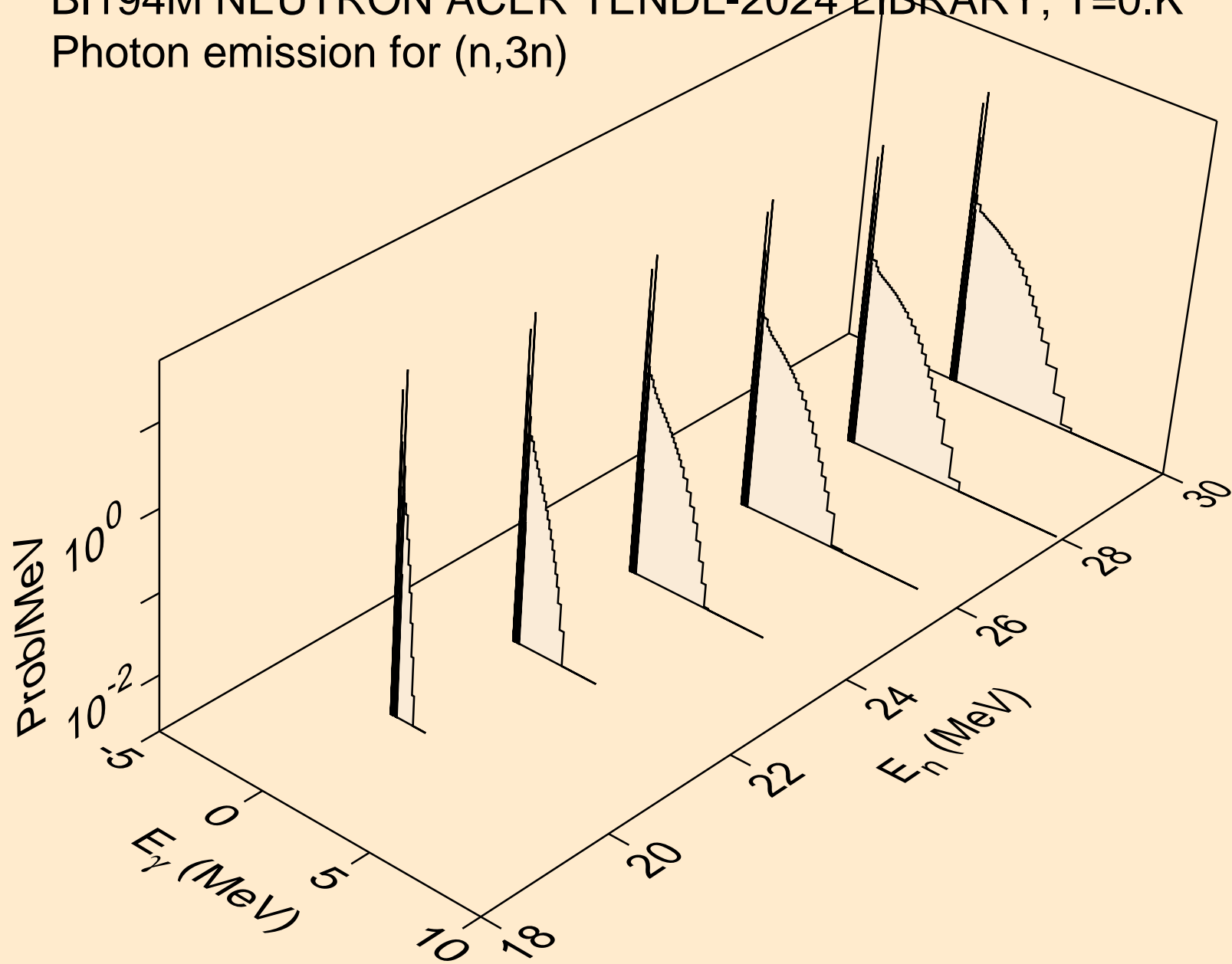

BI194M NEUTRON ACER TENDL-2024 LIBRARY; T=0.K  
Photon emission for (n,n\*)a

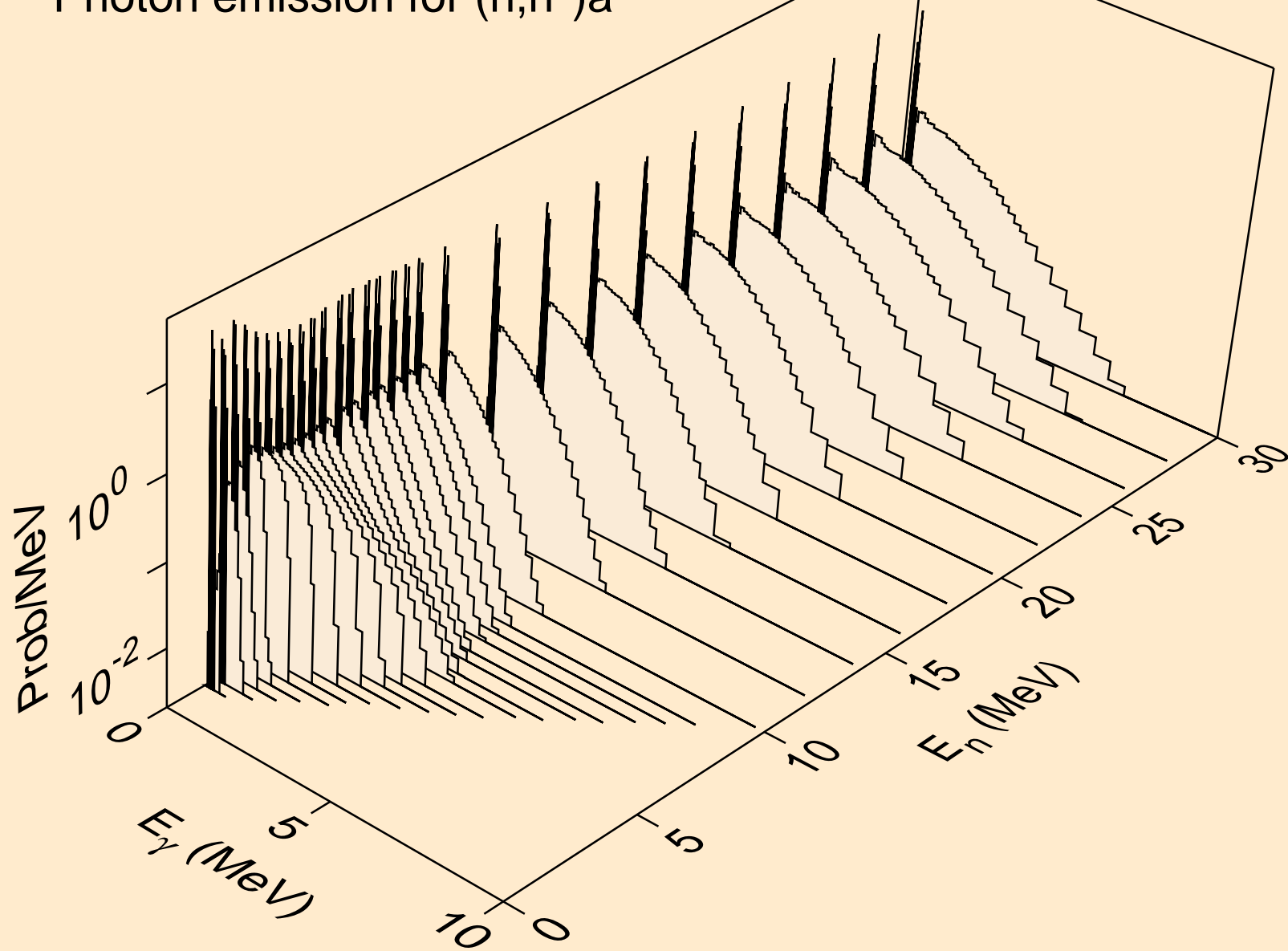

BI194M NEUTRON ACER TENDL-2024 LIBRARY; T=0.K  
Photon emission for (n,2n)a

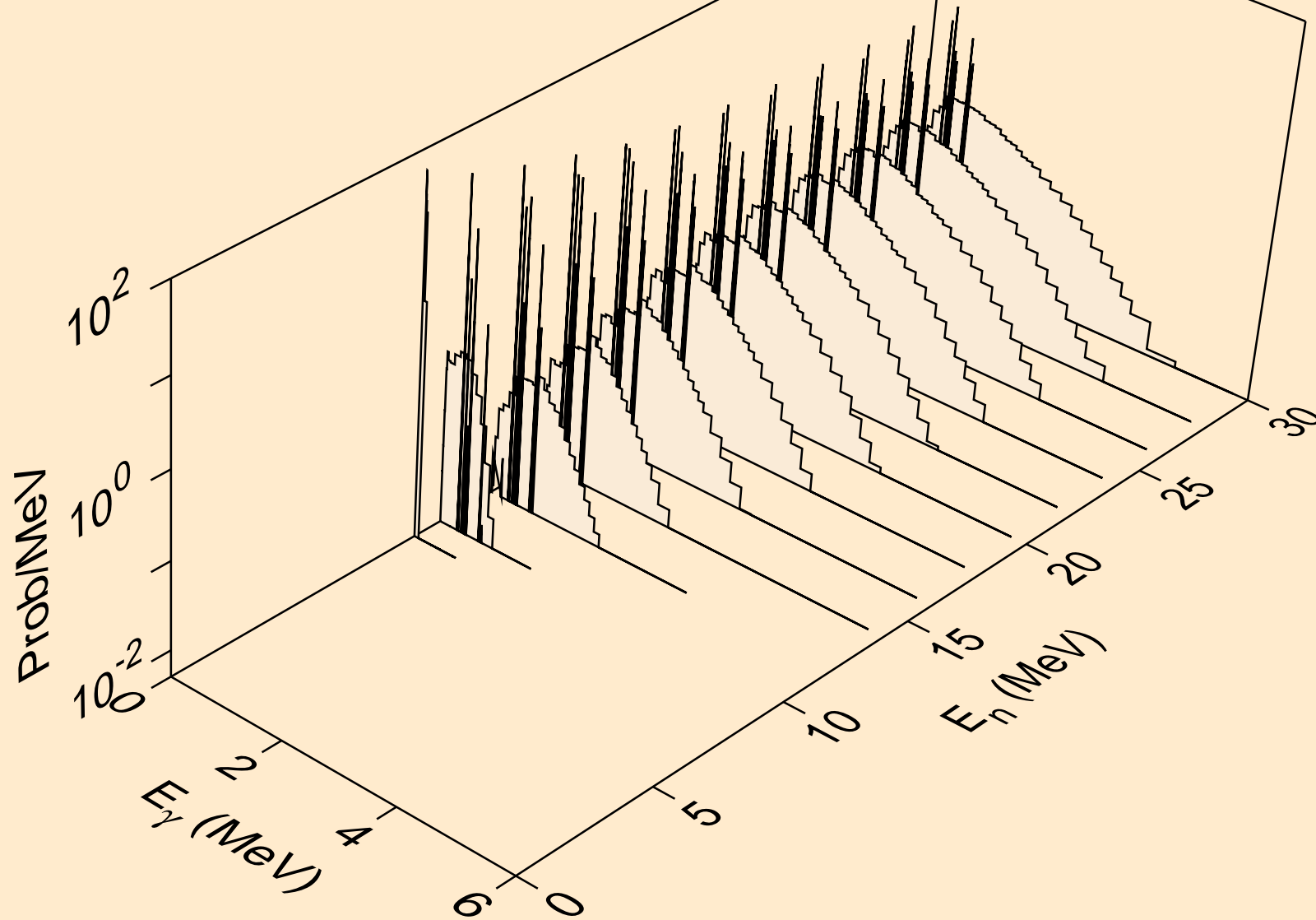



BI194M NEUTRON ACER TENDL-2024 LIBRARY; T=0.K  
Photon emission for (n,3n)a

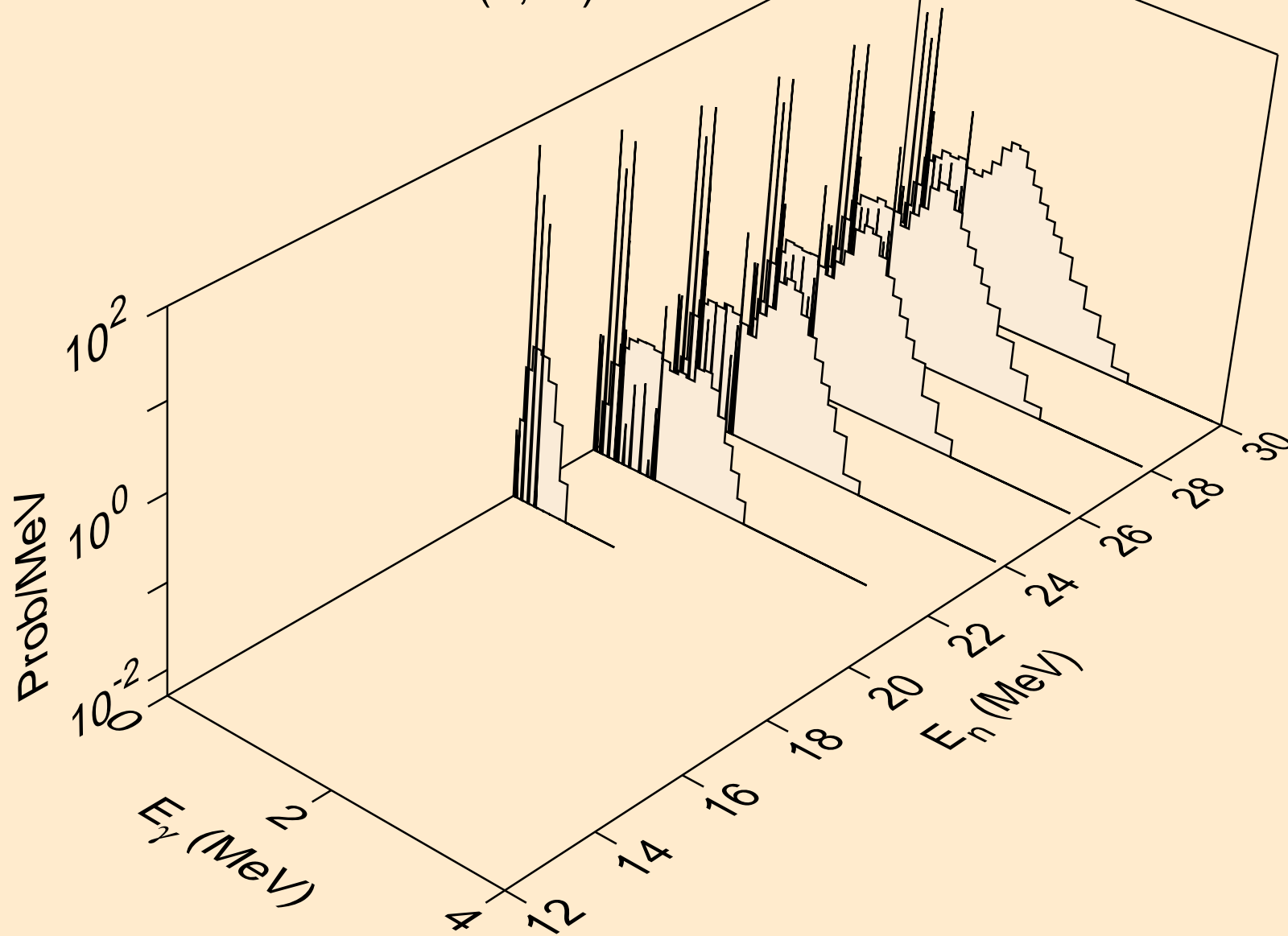

BI194M NEUTRON ACER TENDL-2024 LIBRARY; T=0.K  
Photon emission for (n,n\*)p

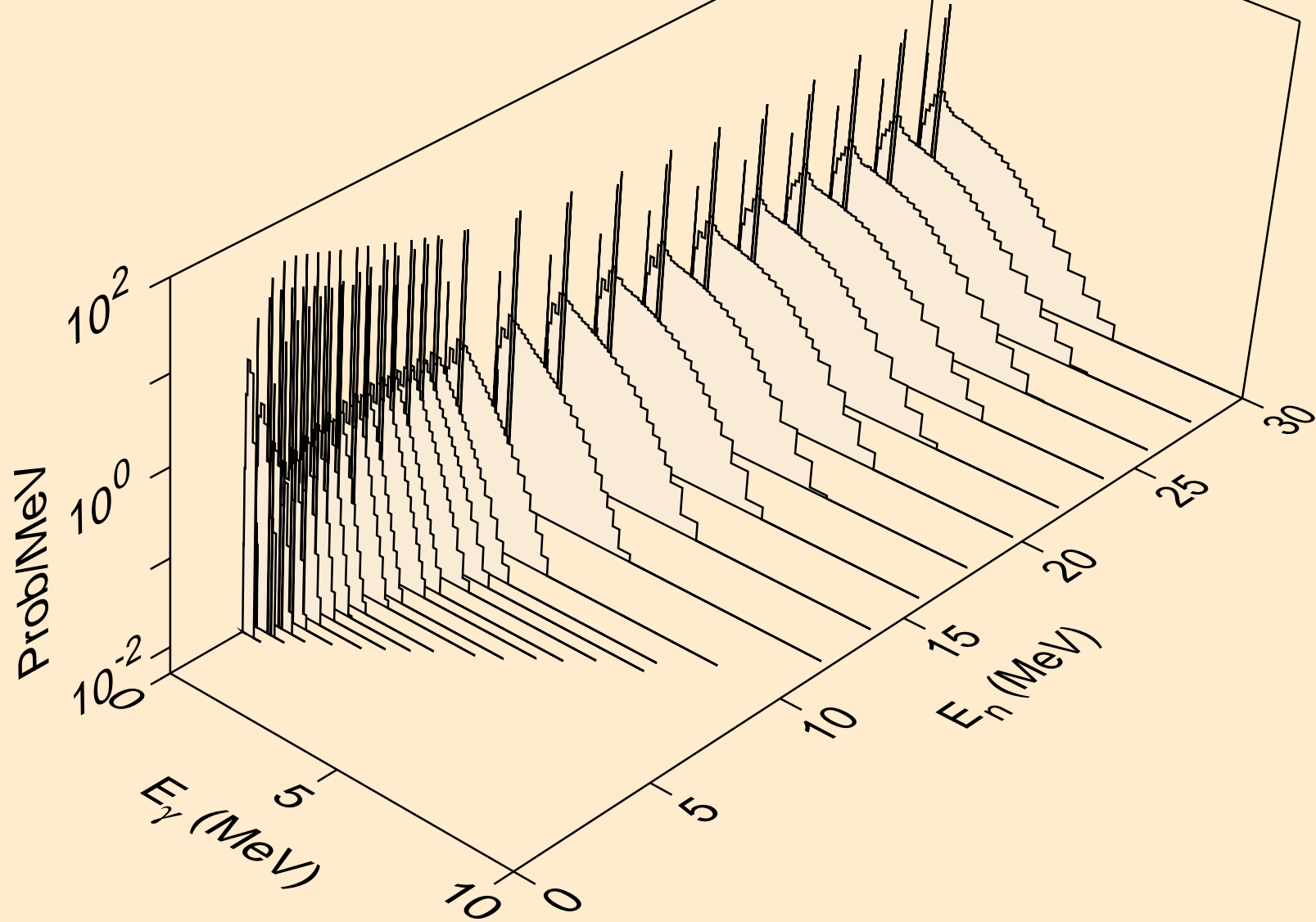

BI194M NEUTRON ACER TENDL-2024 LIBRARY; T=0.K  
Photon emission for (n,n\*)2a

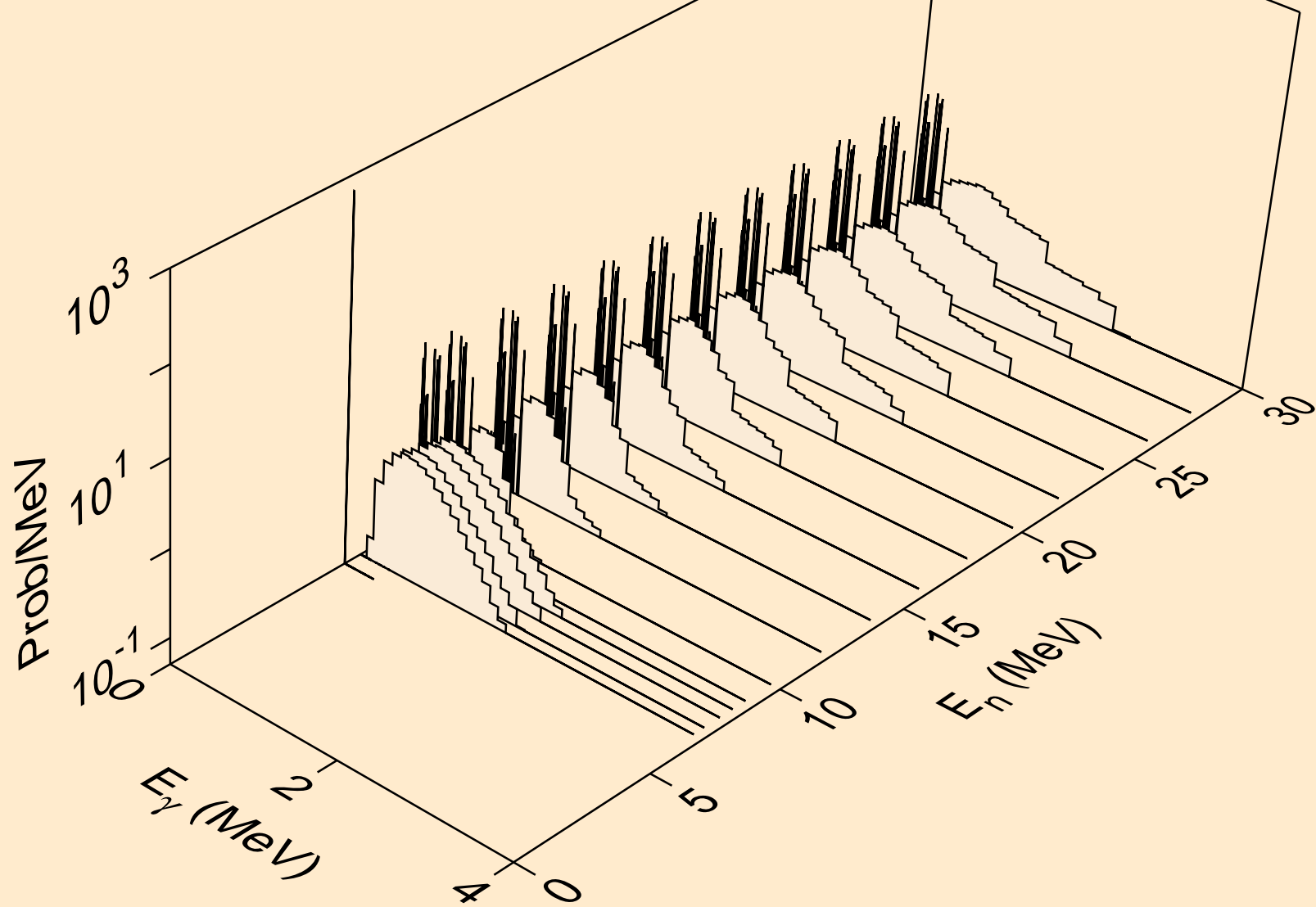

BI194M NEUTRON ACER TENDL-2024 LIBRARY; T=0.K  
Photon emission for (n,2n)2a

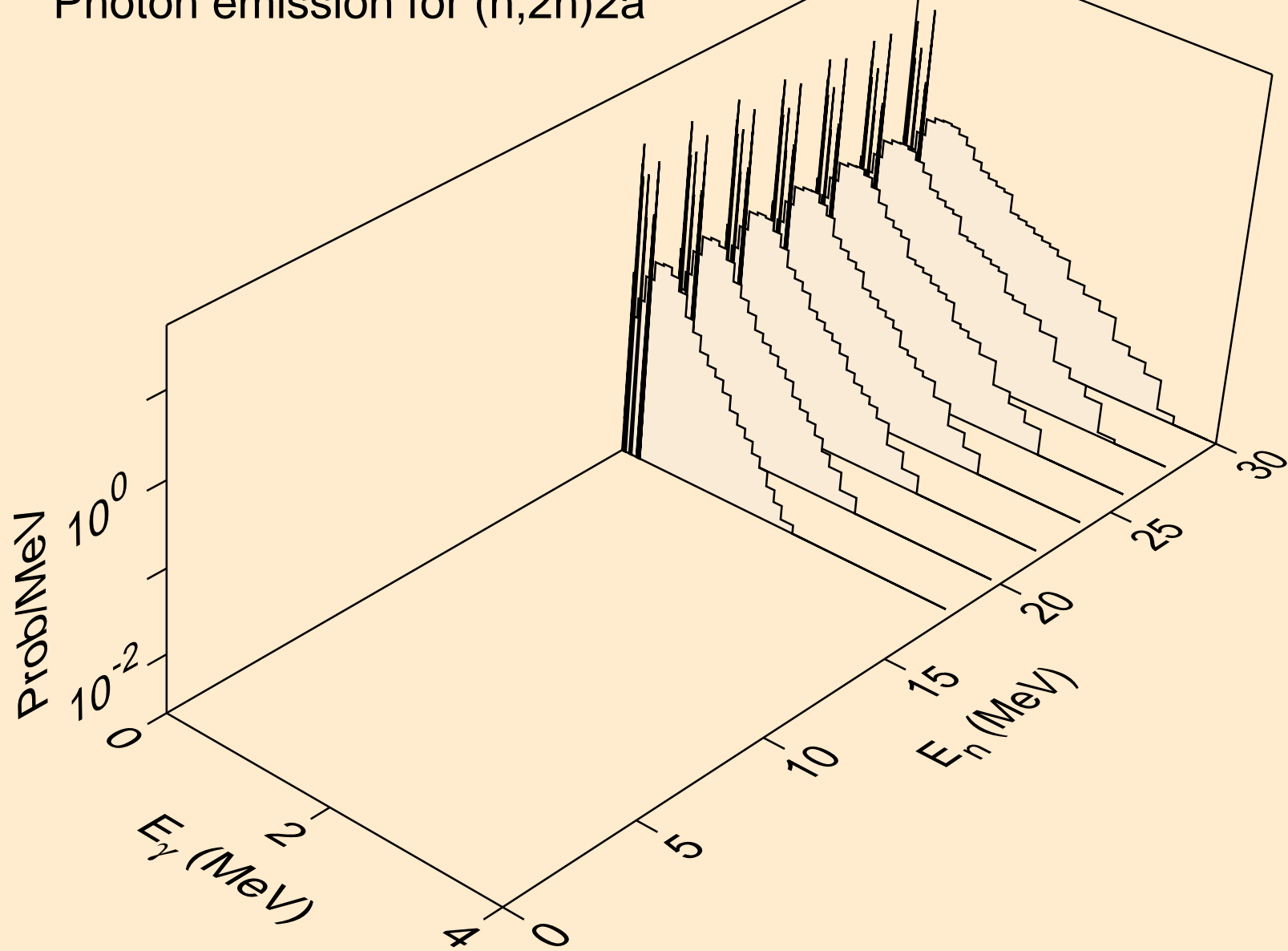

BI194M NEUTRON ACER TENDL-2024 LIBRARY; T=0.K  
Photon emission for (n,n\*)d

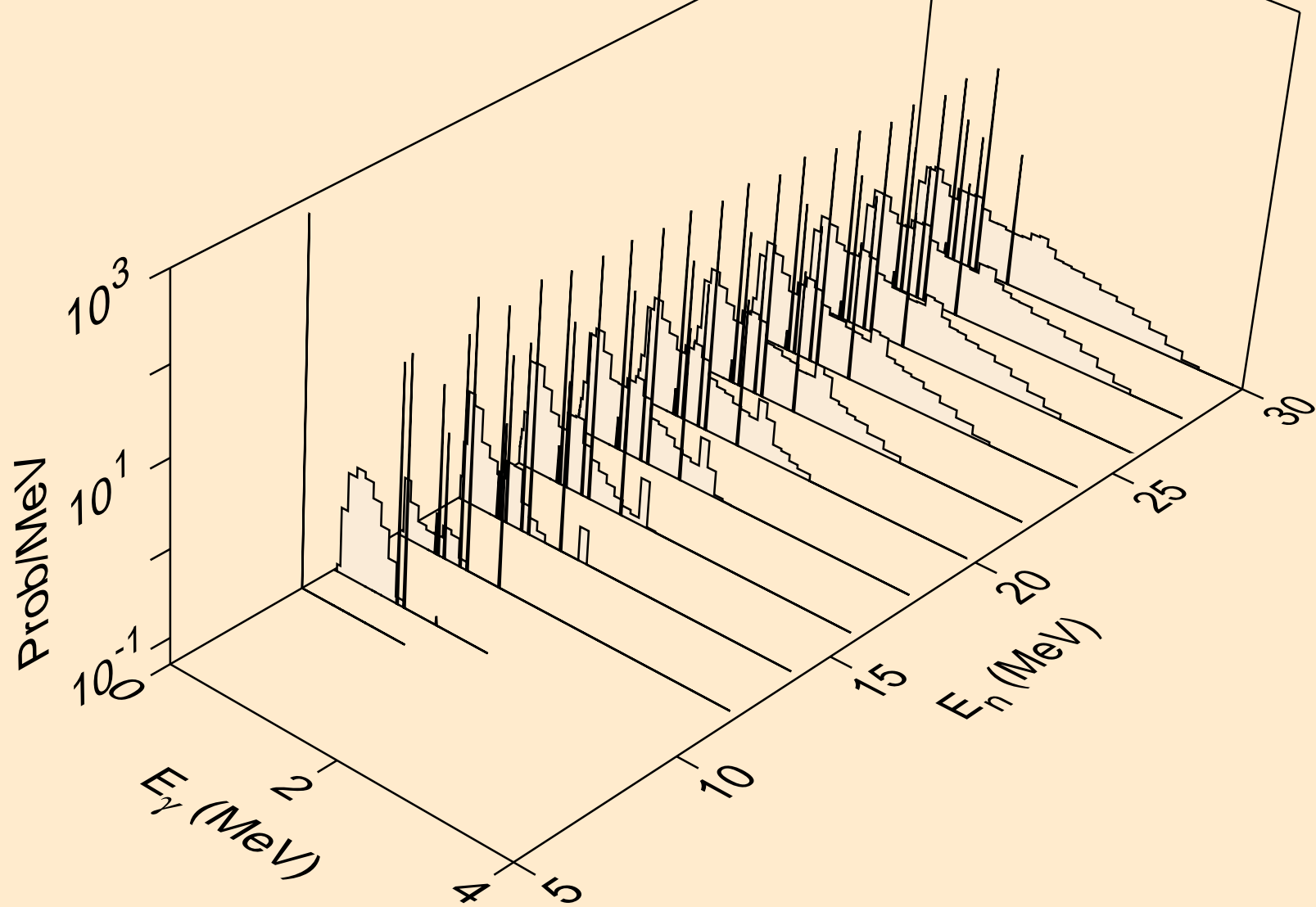

BI194M NEUTRON ACER TENDL-2024 LIBRARY; T=0.K  
Photon emission for (n,n\*)t

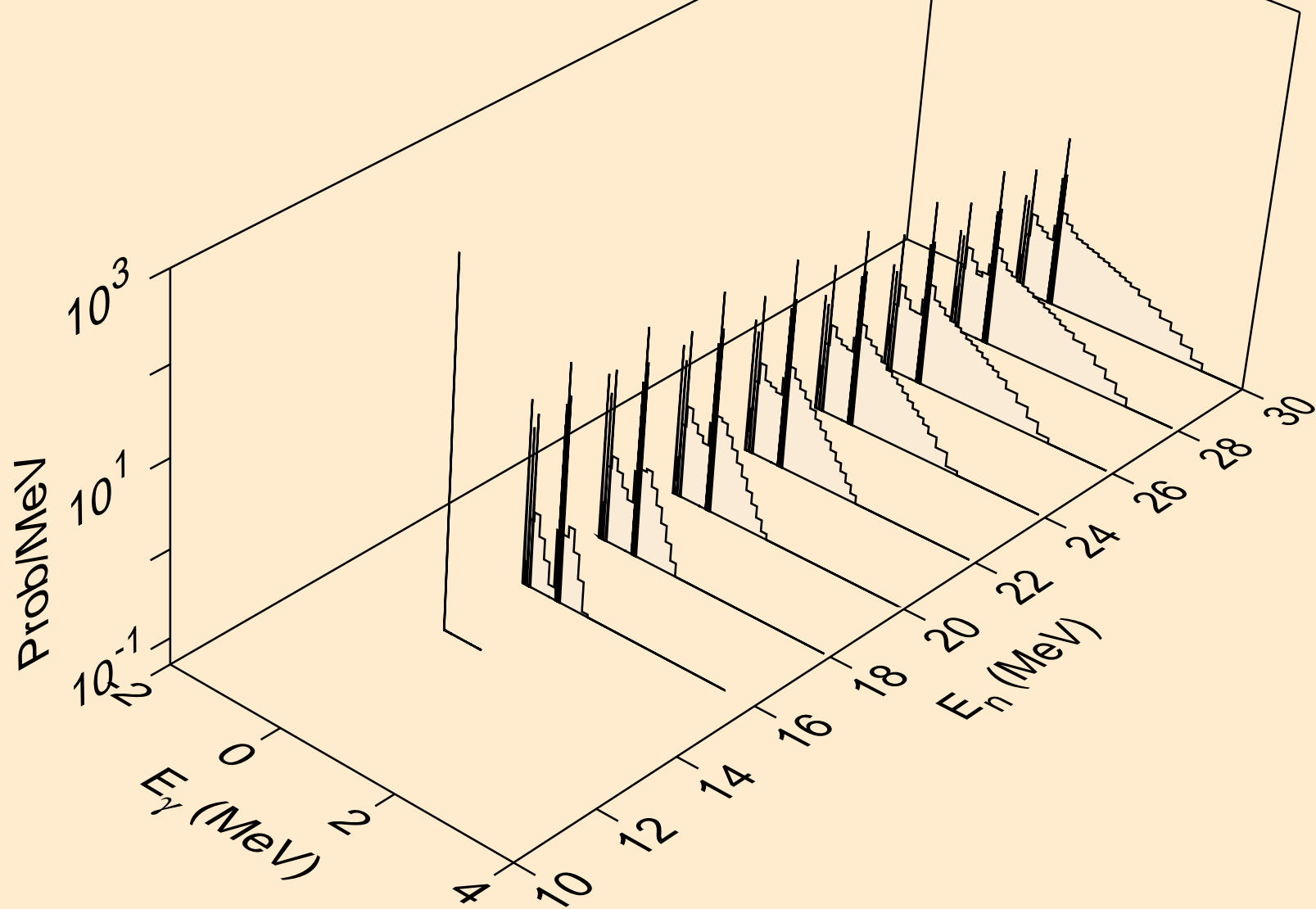

BI194M NEUTRON ACER TENDL-2024 LIBRARY; T=0.K  
Photon emission for (n,n\*)he3

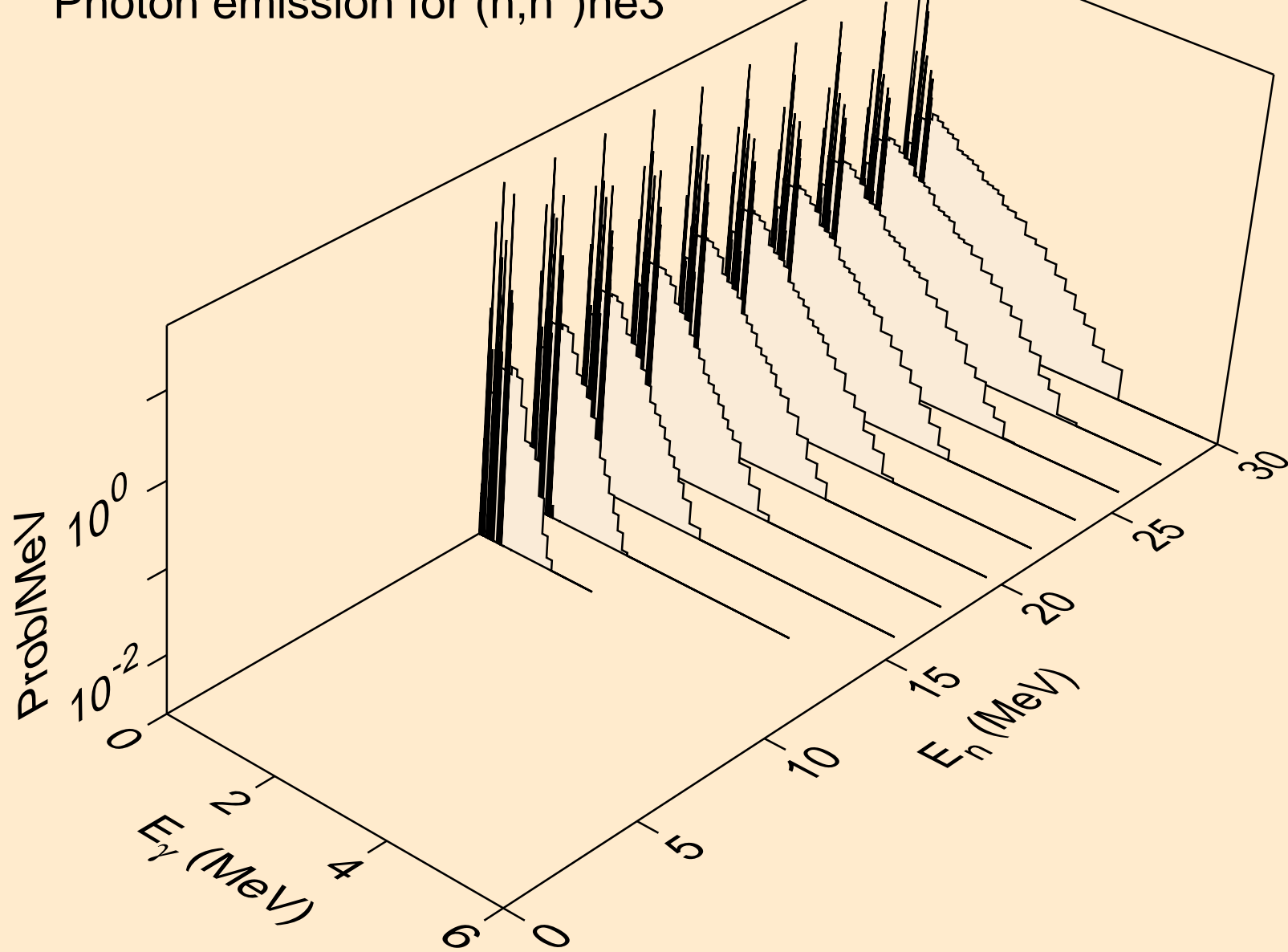

BI194M NEUTRON ACER TENDL-2024 LIBRARY; T=0.K  
Photon emission for (n,4n)

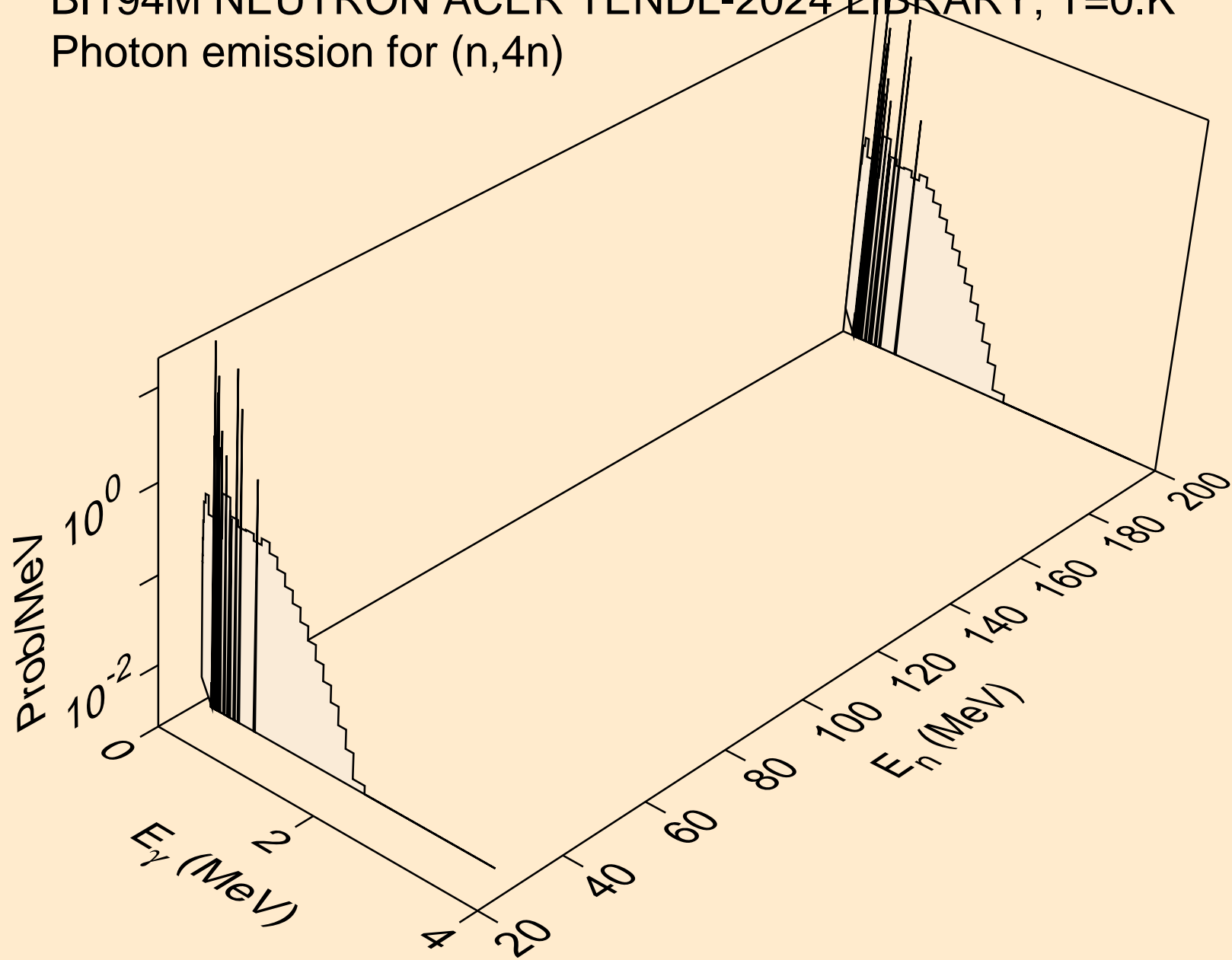



BI194M NEUTRON ACER TENDL-2024 LIBRARY; T=0.K  
Photon emission for (n,2np)

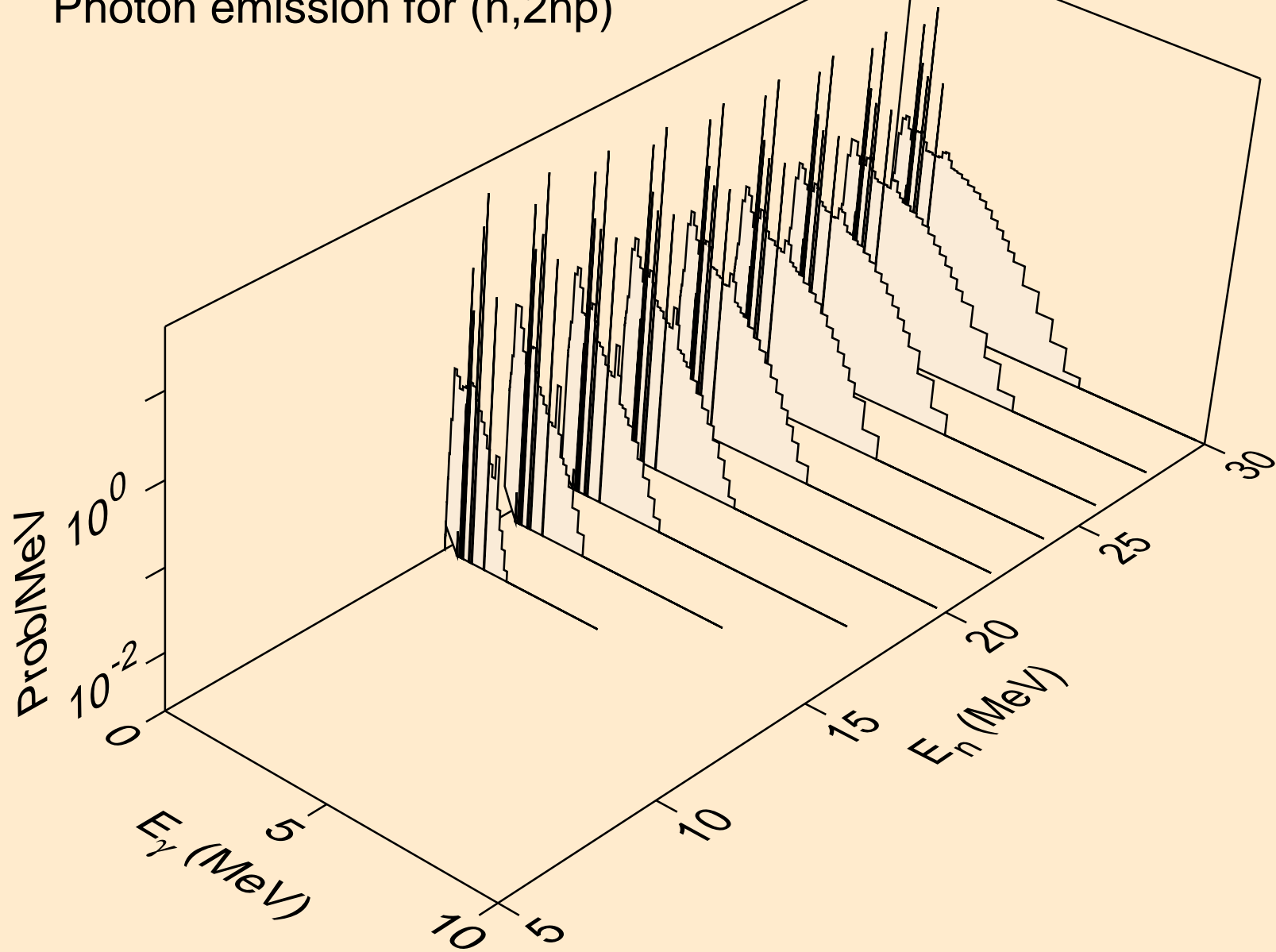

BI194M NEUTRON ACER TENDL-2024 LIBRARY; T=0.K  
Photon emission for (n,3np)

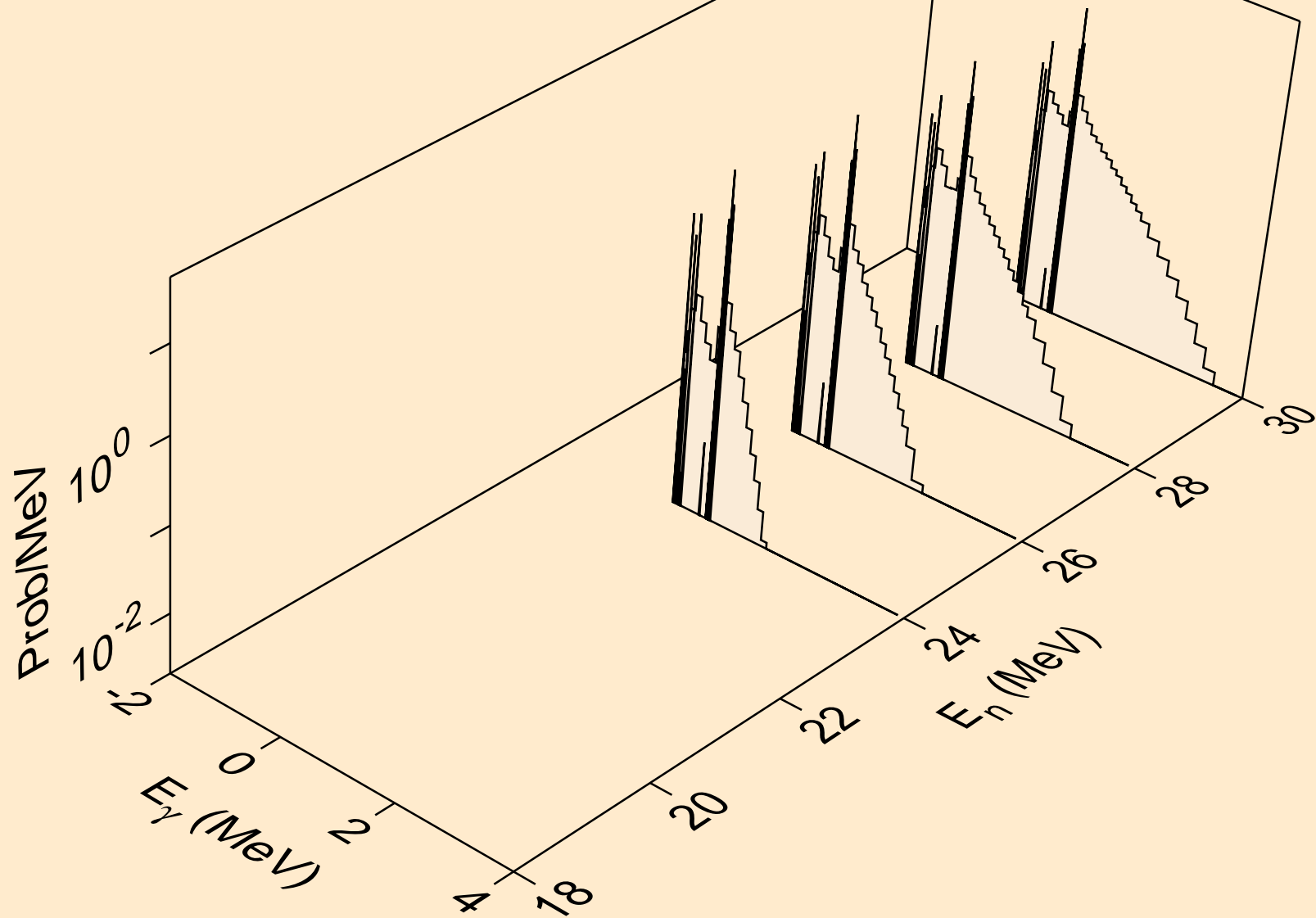

BI194M NEUTRON ACER TENDL-2024 LIBRARY; T=0.K  
Photon emission for (n,n2p)

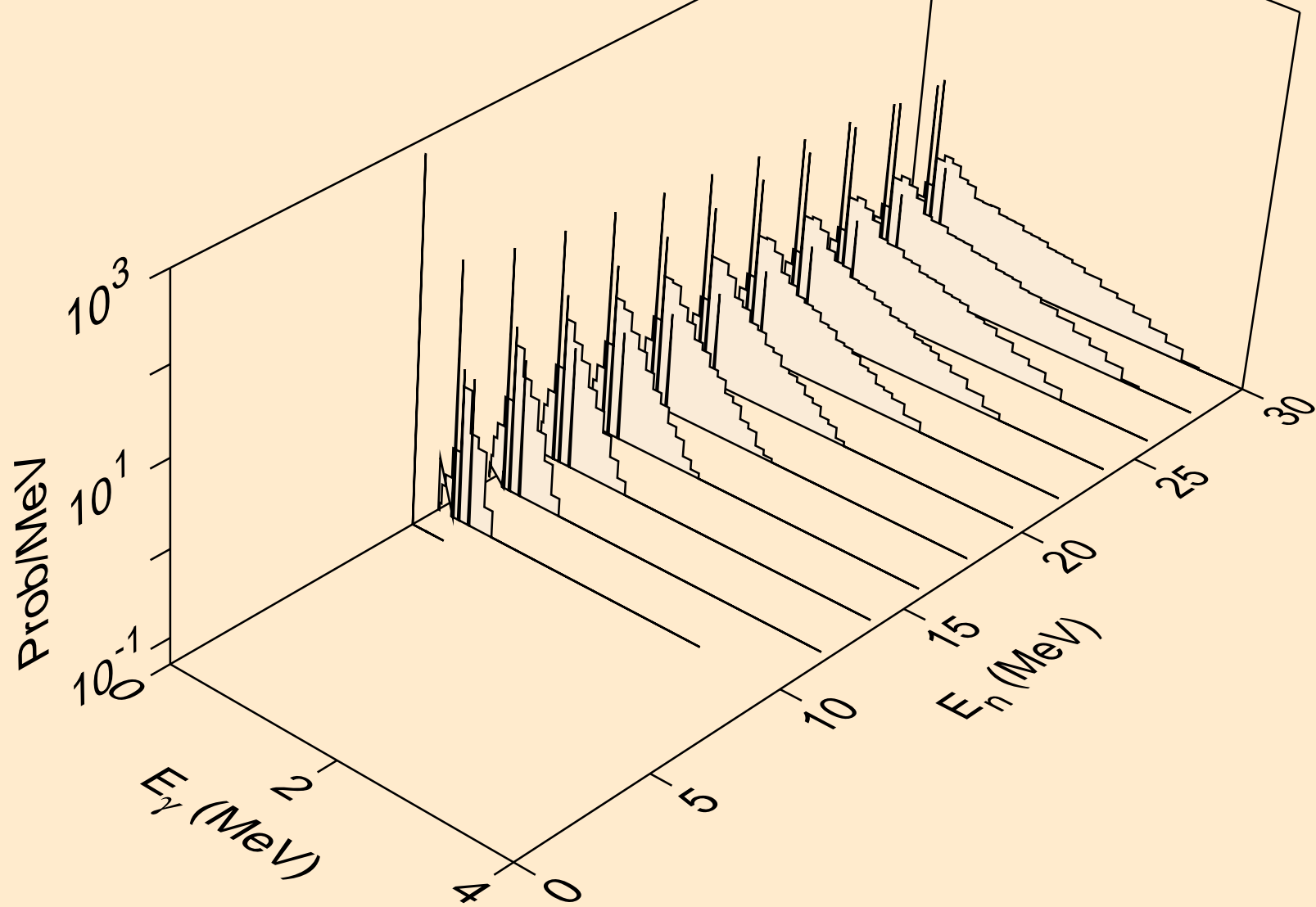

BI194M NEUTRON ACER TENDL-2024 LIBRARY; T=0.K  
Photon emission for (n,npa)

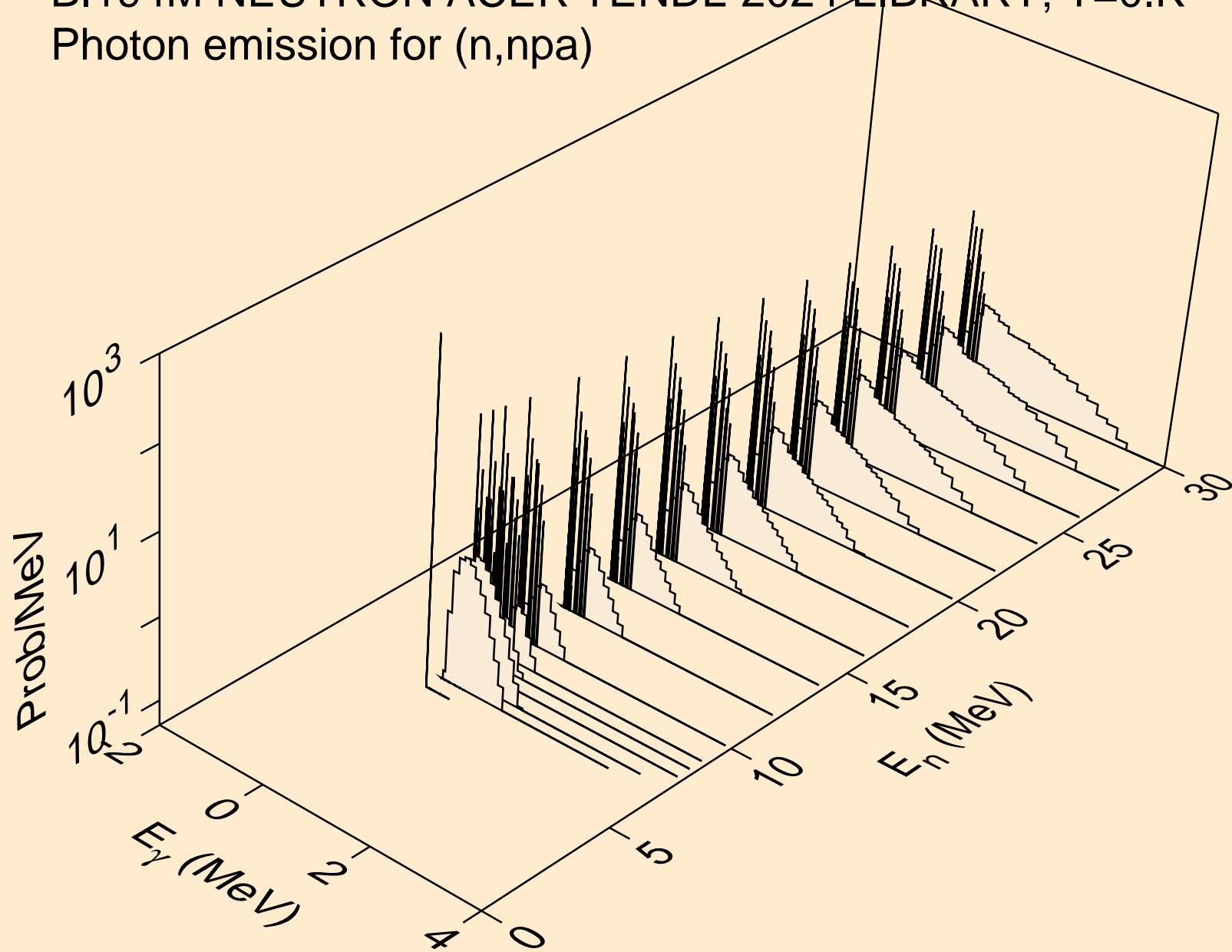

BI194M NEUTRON ACER TENDL-2024 LIBRARY; T=0.K  
Photon emission for (n,n\*c)

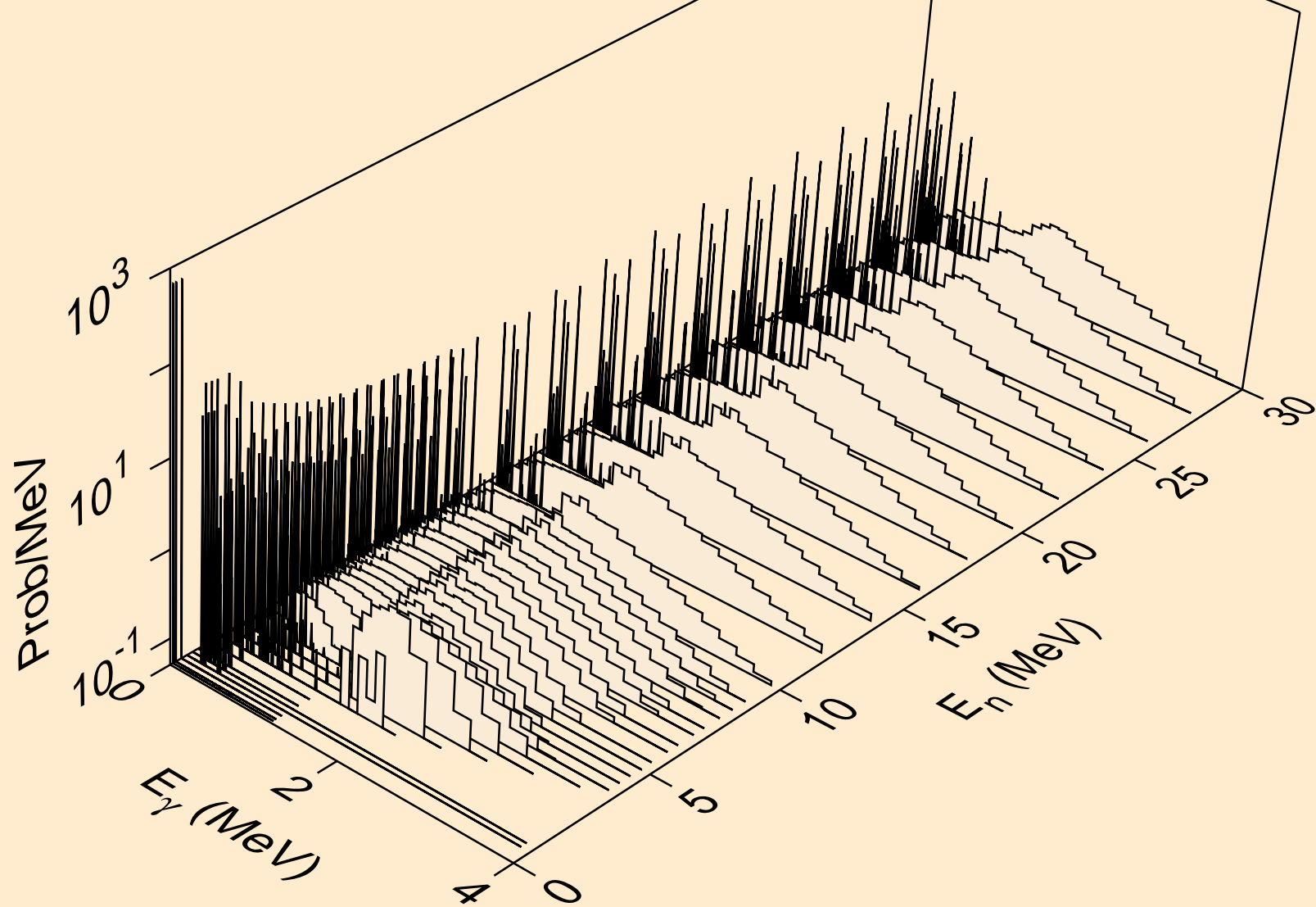

BI194M NEUTRON ACER TENDL-2024 LIBRARY; T=0.K  
Photon emission for (n,gma)

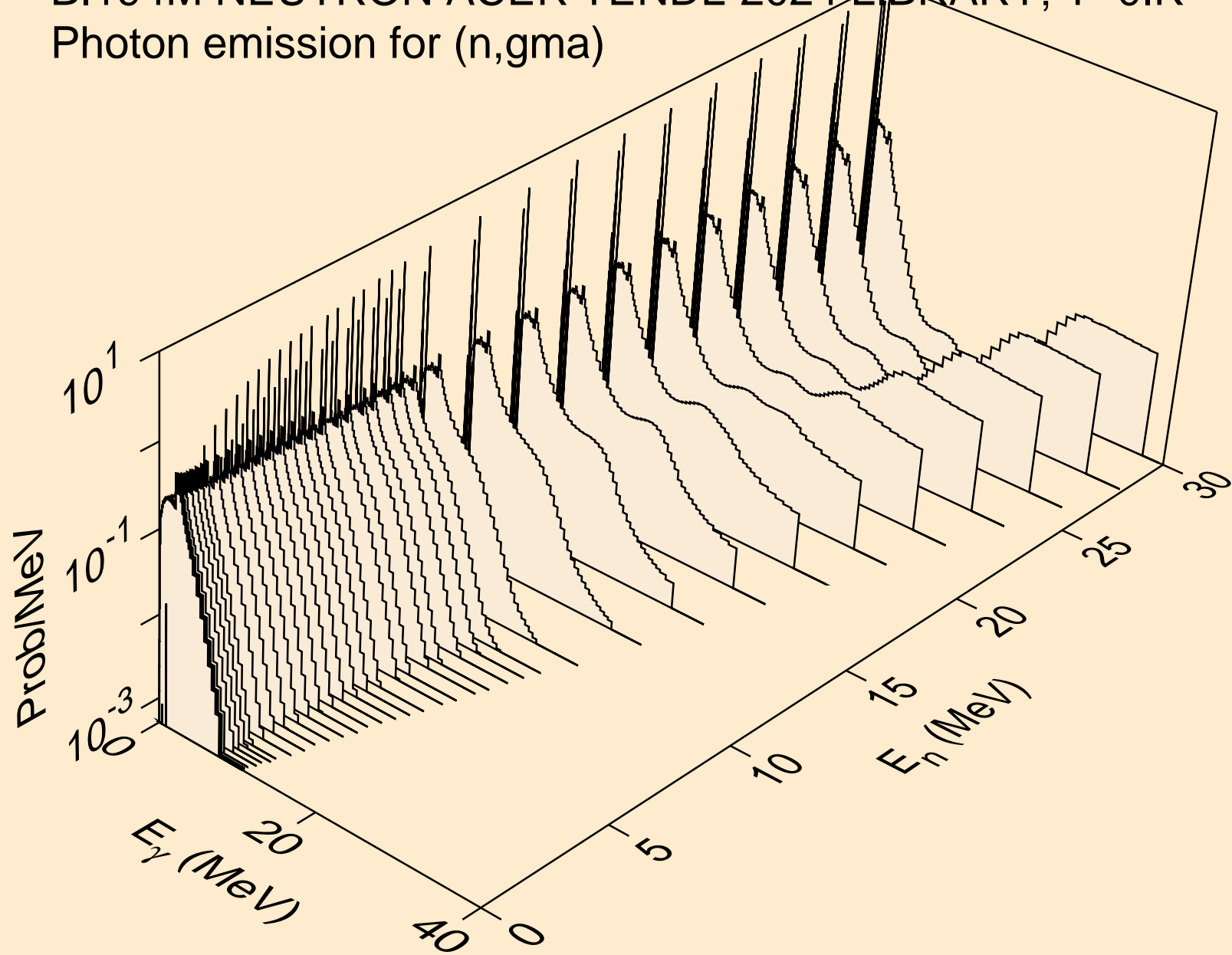

BI194M NEUTRON ACER TENDL-2024 LIBRARY; T=0.K  
Photon emission for (n,p)

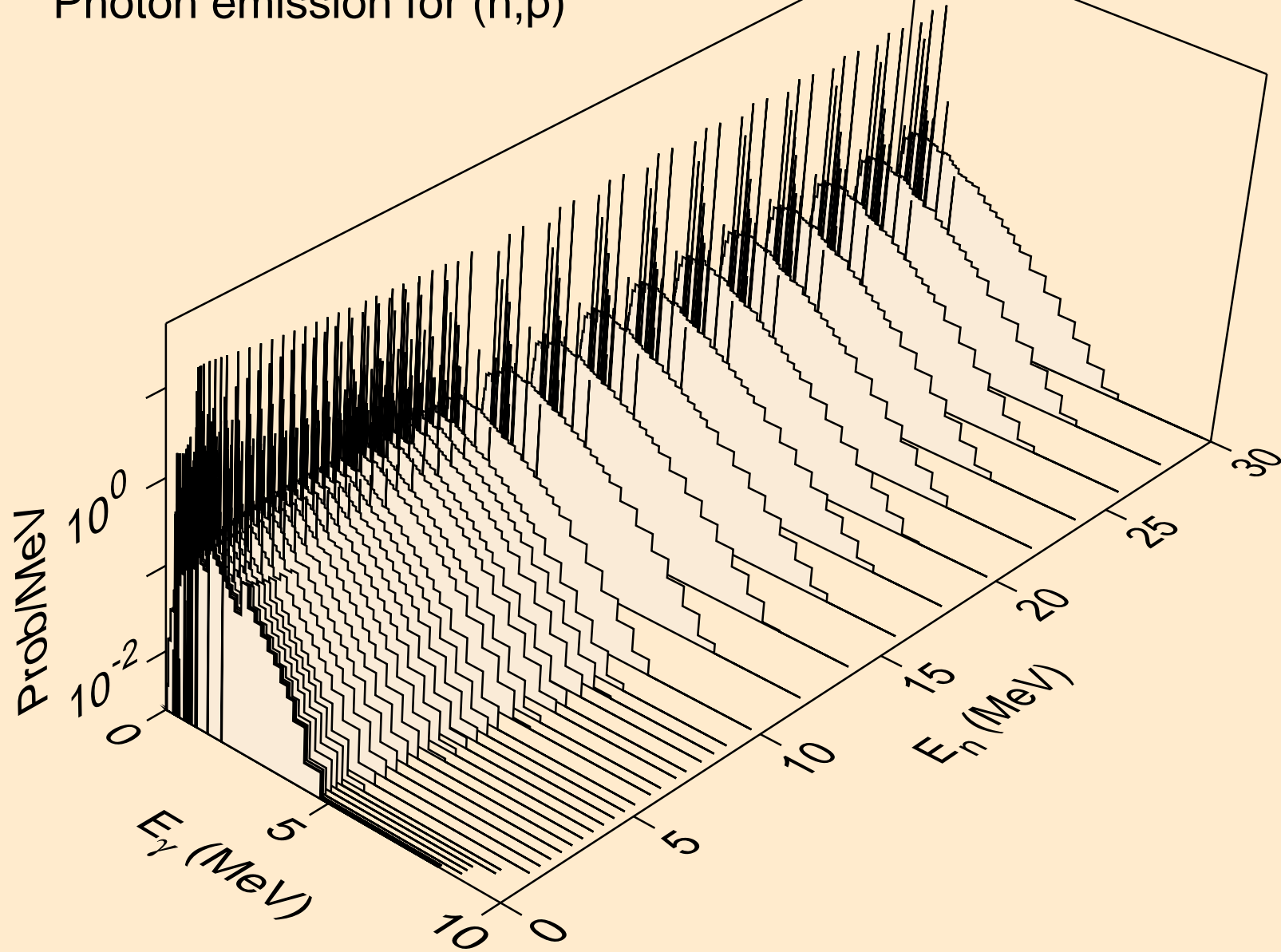

BI194M NEUTRON ACER TENDL-2024 LIBRARY; T=0.K  
Photon emission for (n,d)

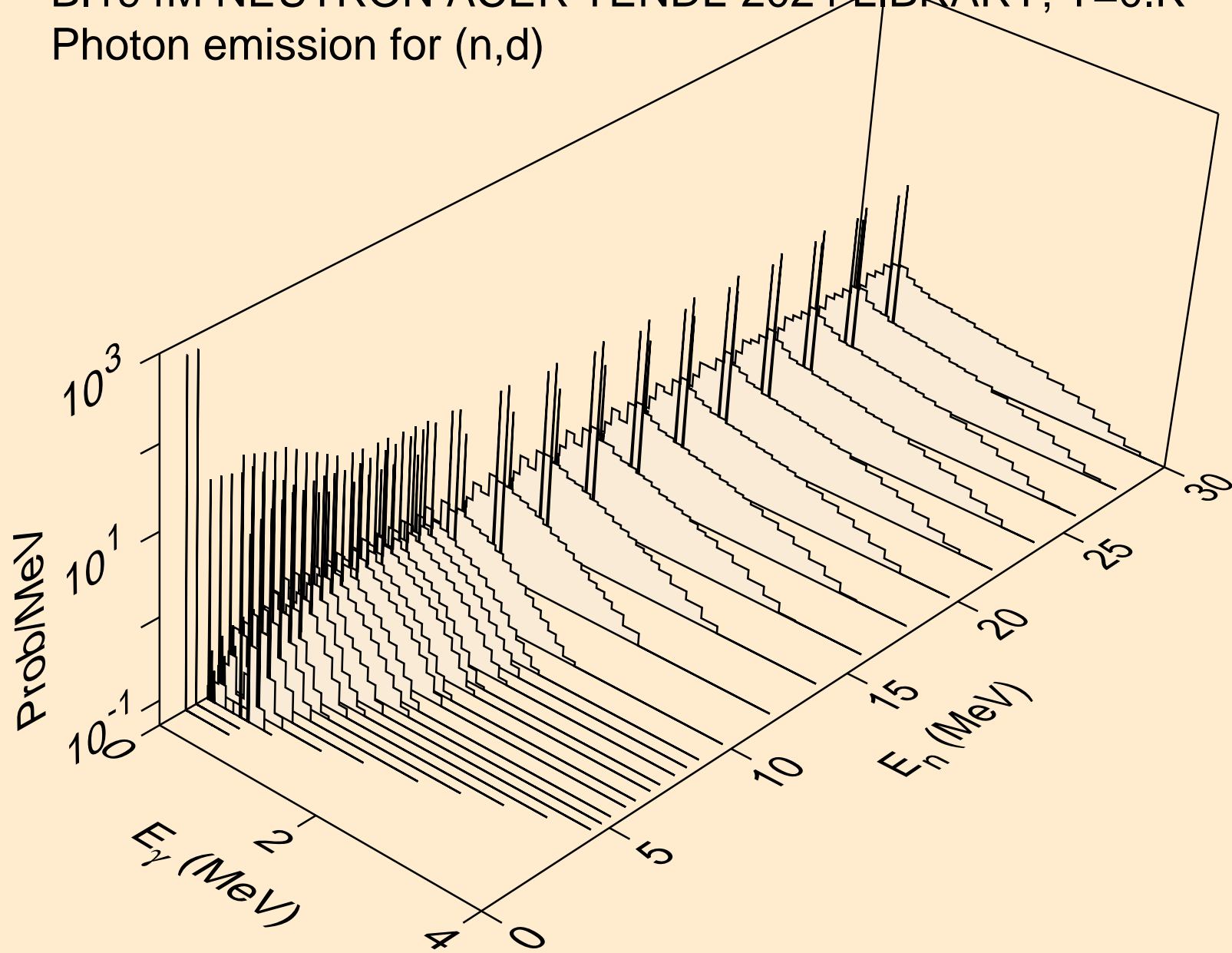



BI194M NEUTRON ACER TENDL-2024 LIBRARY; T=0.K  
Photon emission for (n,t)

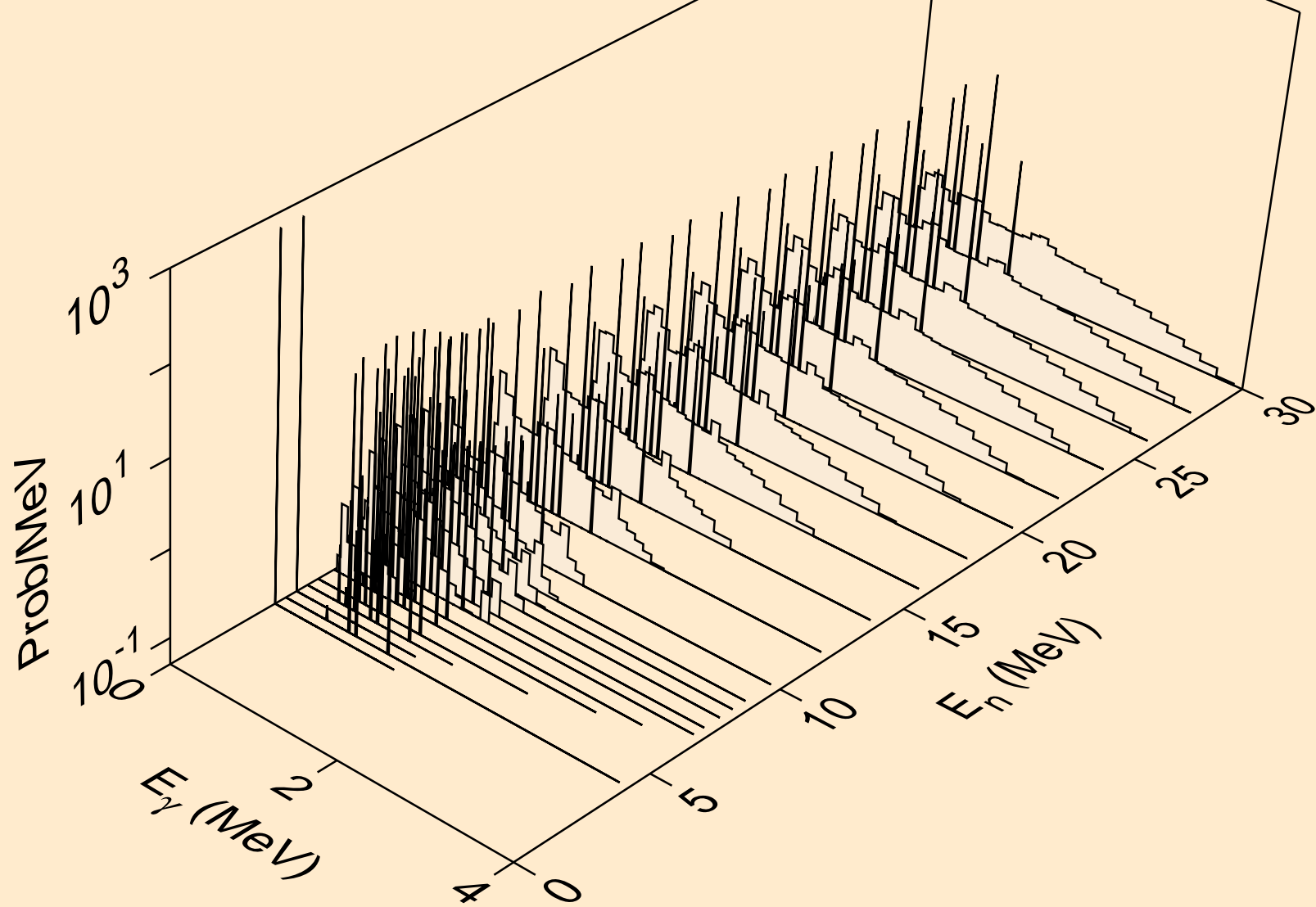

BI194M NEUTRON ACER TENDL-2024 LIBRARY; T=0.K  
Photon emission for (n,he3)

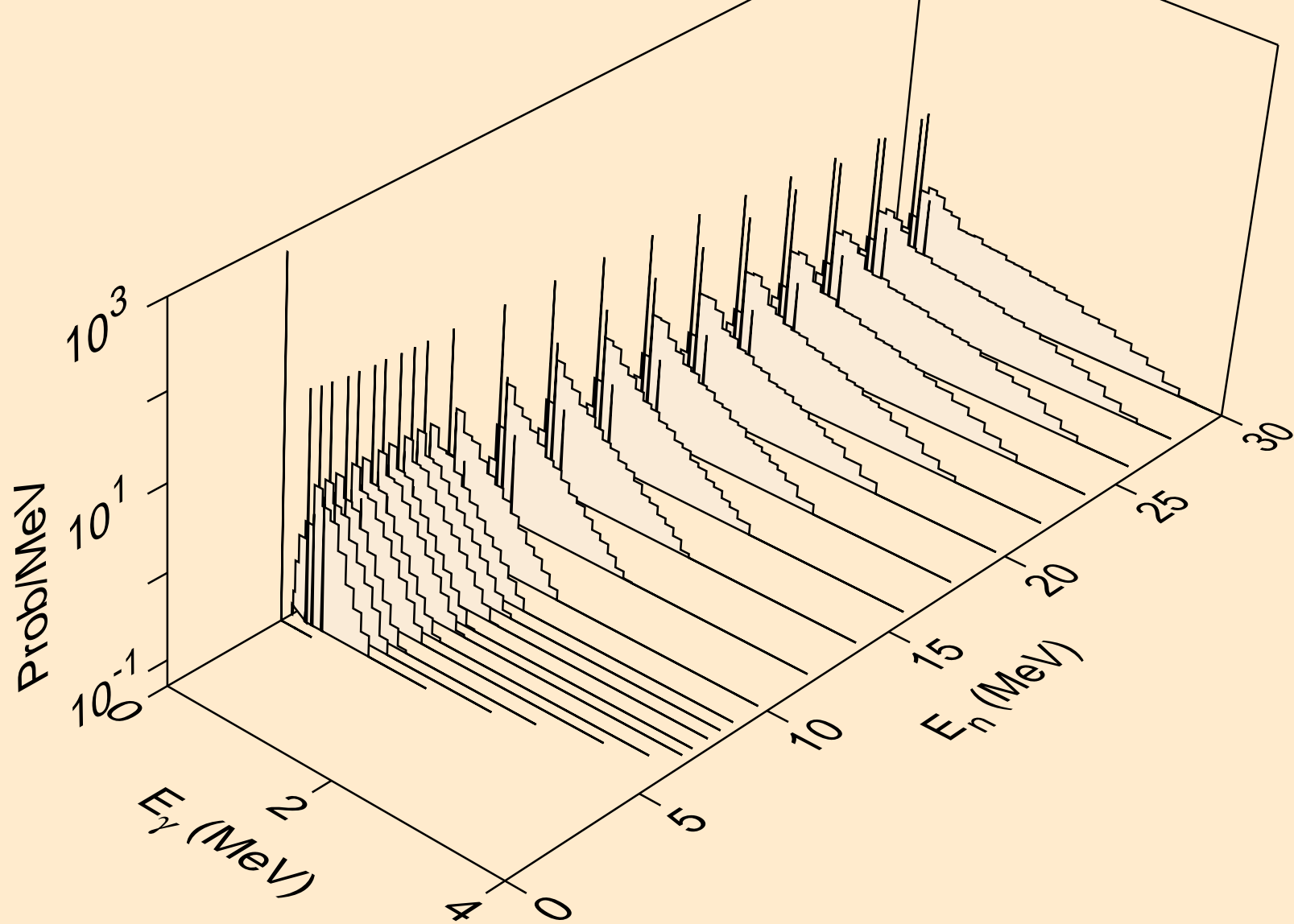

BI194M NEUTRON ACER TENDL-2024 LIBRARY; T=0.K  
Photon emission for (n,a)

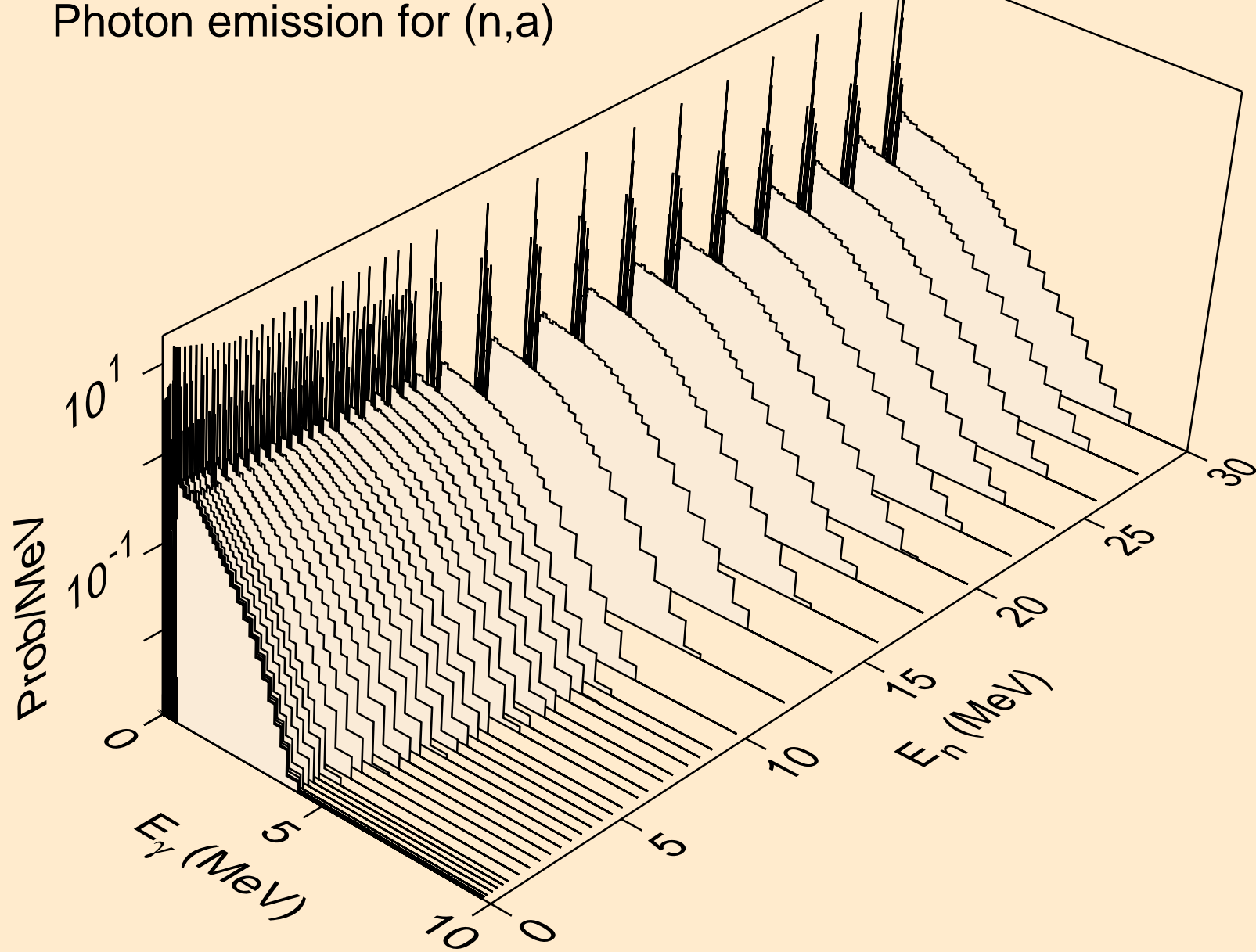

BI194M NEUTRON ACER TENDL-2024 LIBRARY; T=0.K  
Photon emission for (n,2a)

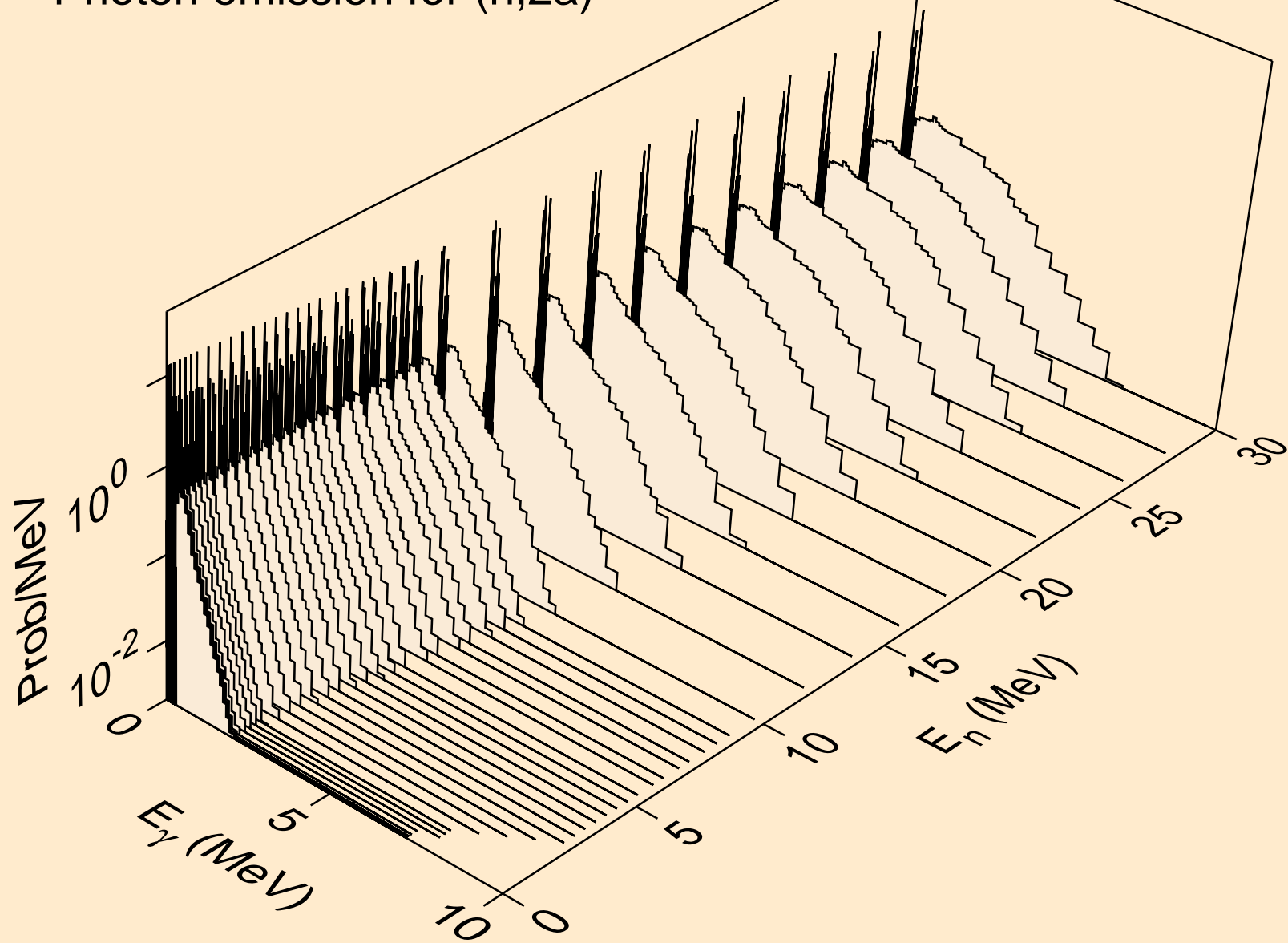

BI194M NEUTRON ACER TENDL-2024 LIBRARY; T=0.K  
Photon emission for (n,3a)

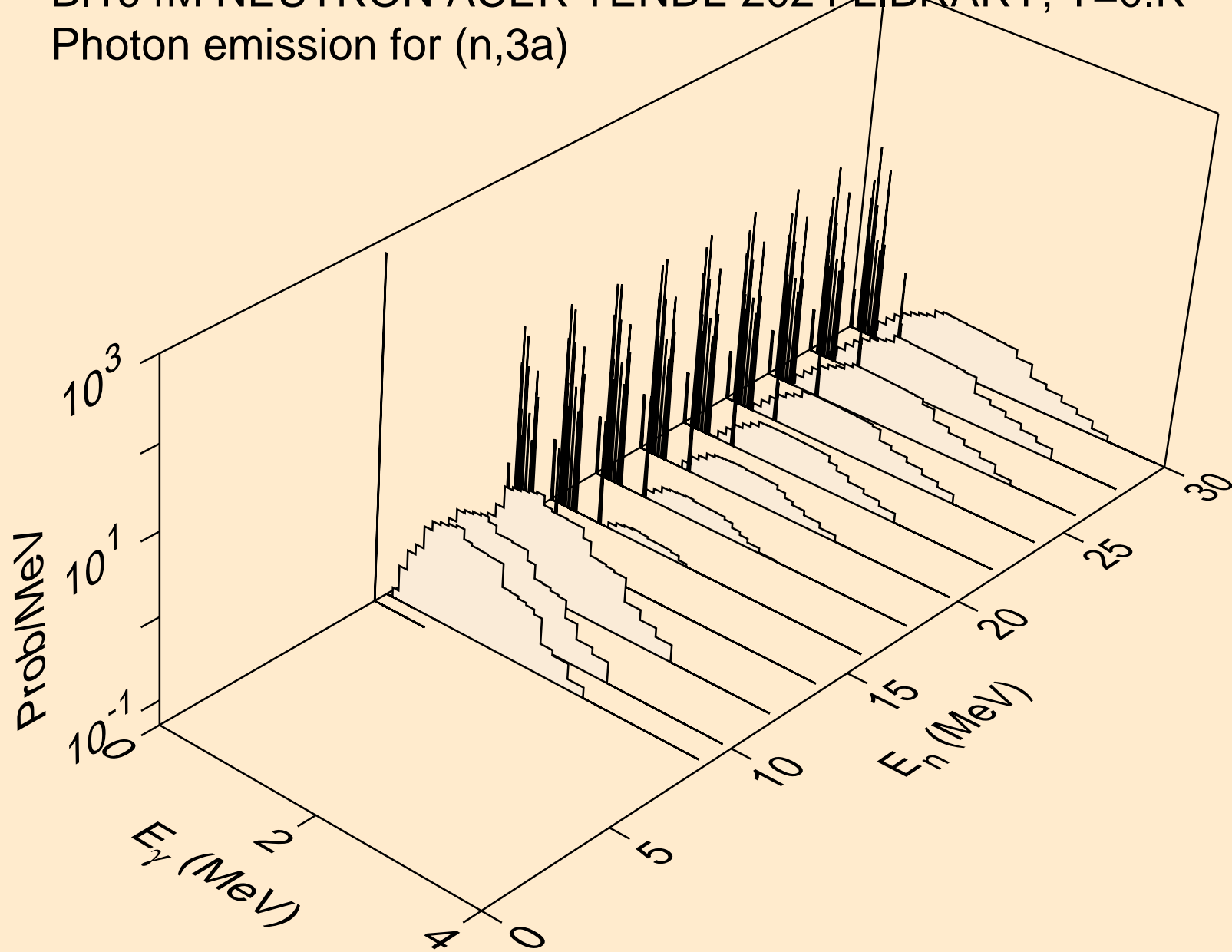

BI194M NEUTRON ACER TENDL-2024 LIBRARY; T=0.K  
Photon emission for (n,2p)

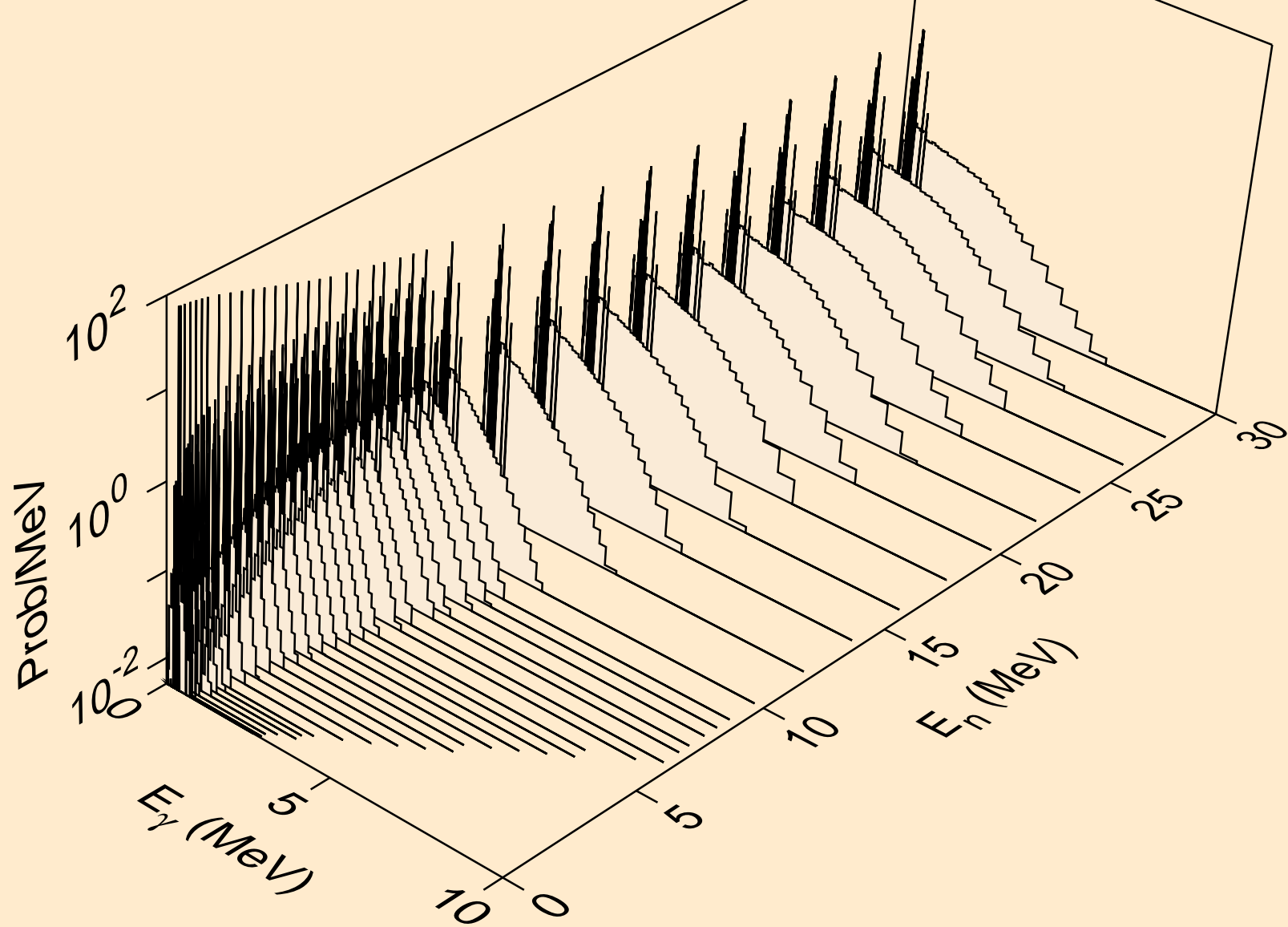

BI194M NEUTRON ACER TENDL-2024 LIBRARY; T=0.K  
Photon emission for (n,pa)

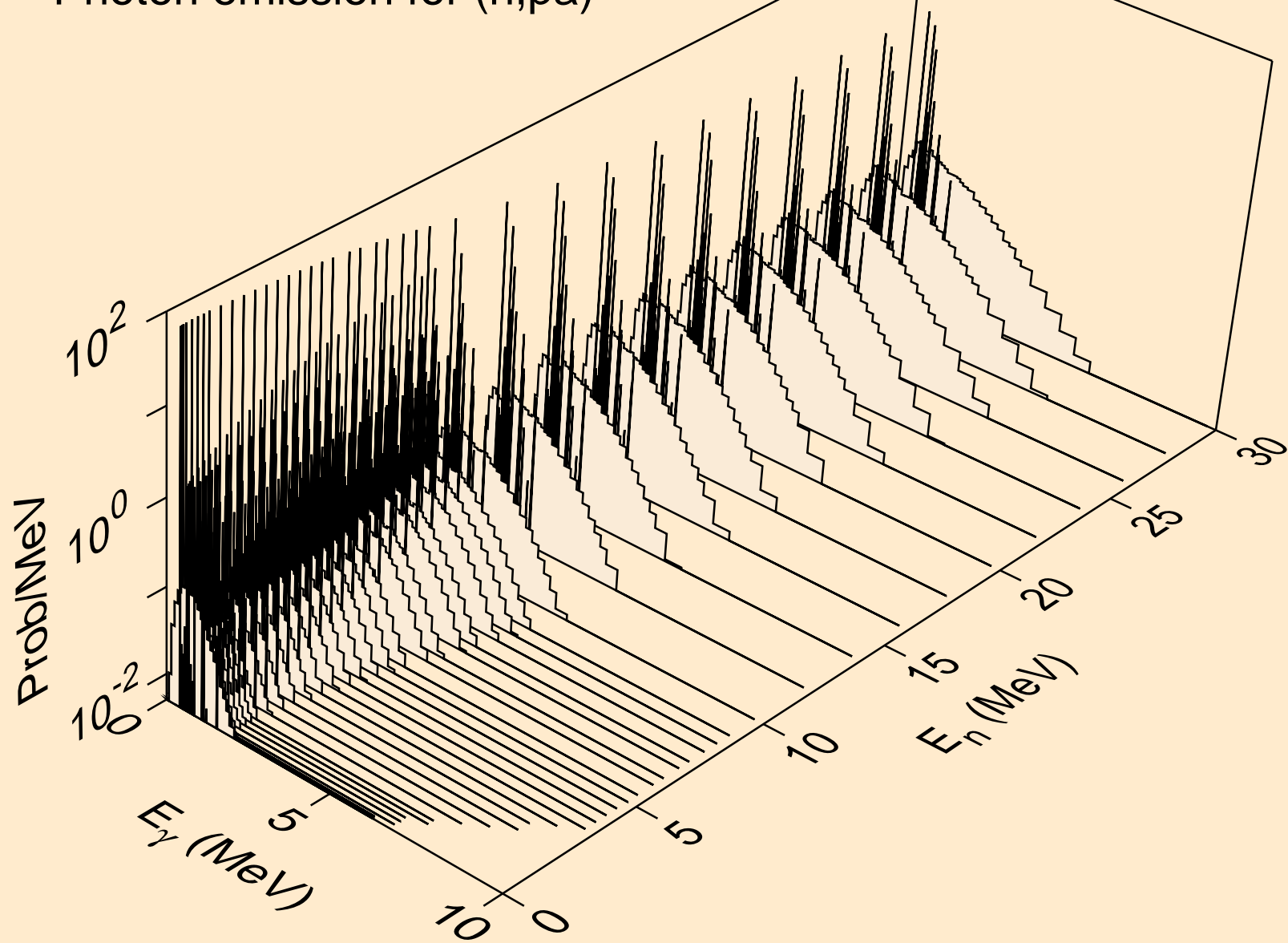

BI194M NEUTRON ACER TENDL-2024 LIBRARY; T=0.K  
Photon emission for (n,pd)

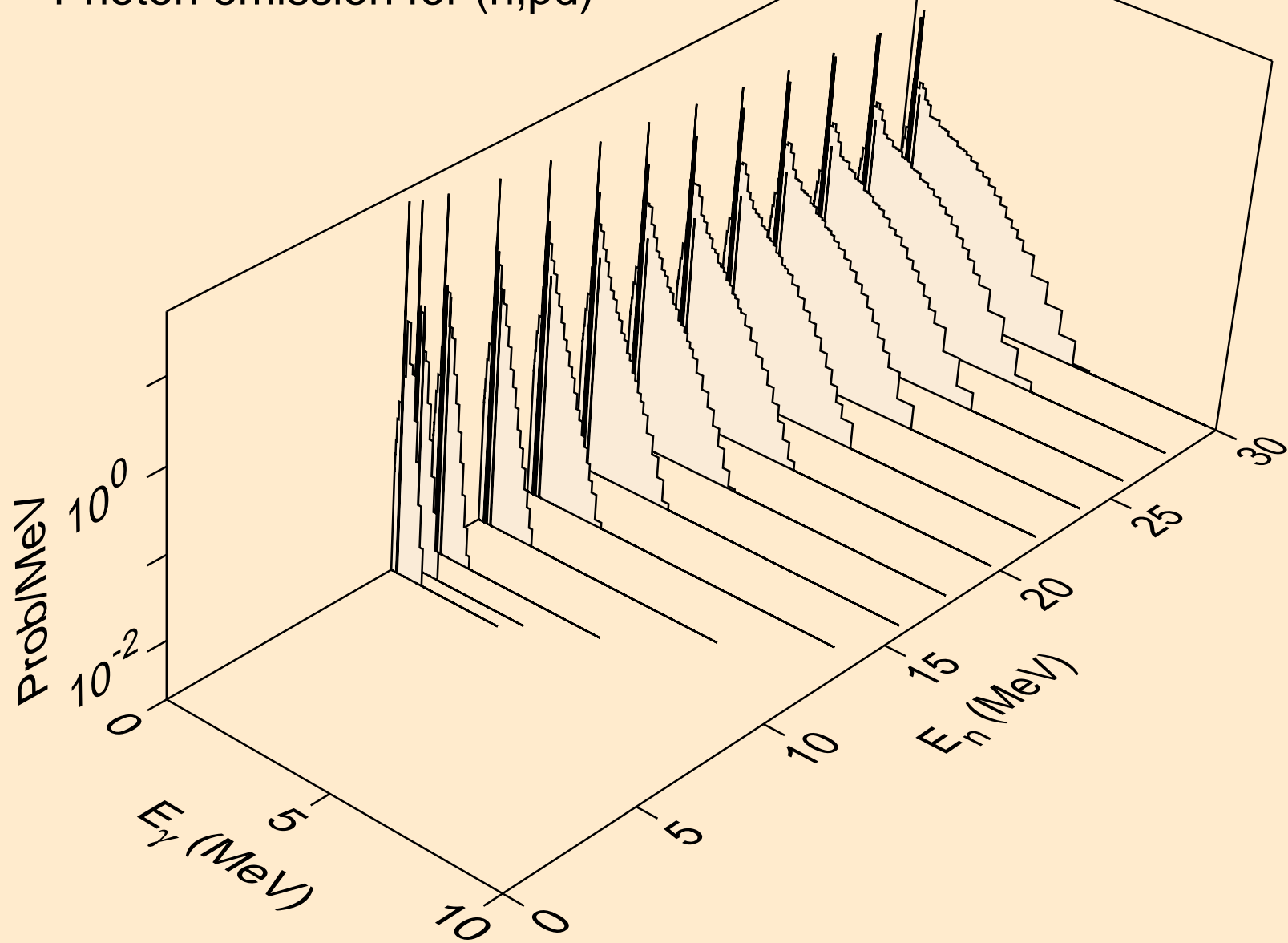



BI194M NEUTRON ACER TENDL-2024 LIBRARY; T=0.K  
Photon emission for (n,pt)

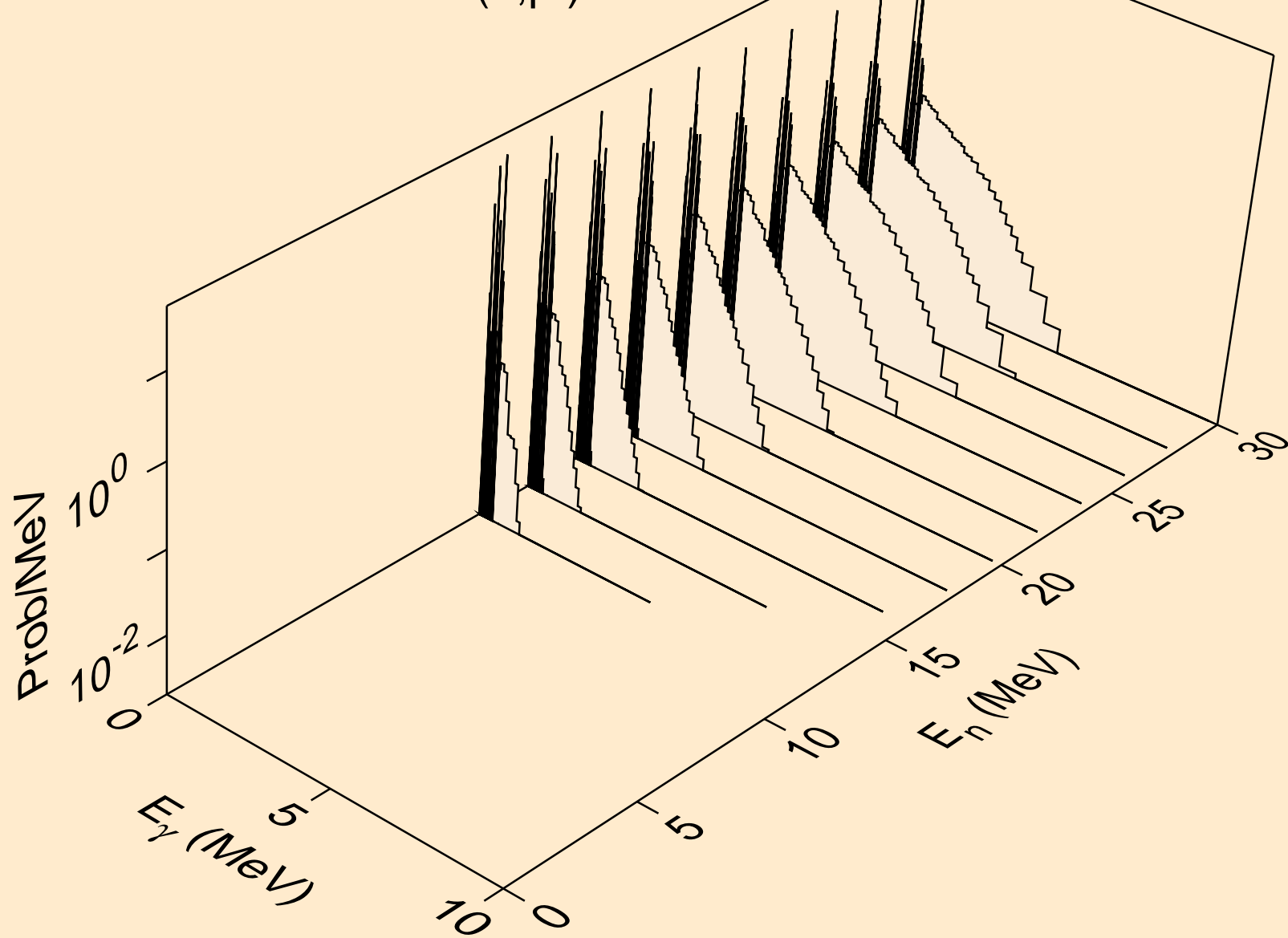

BI194M NEUTRON ACER TENDL-2024 LIBRARY; T=0.K  
Photon emission for (n,da)

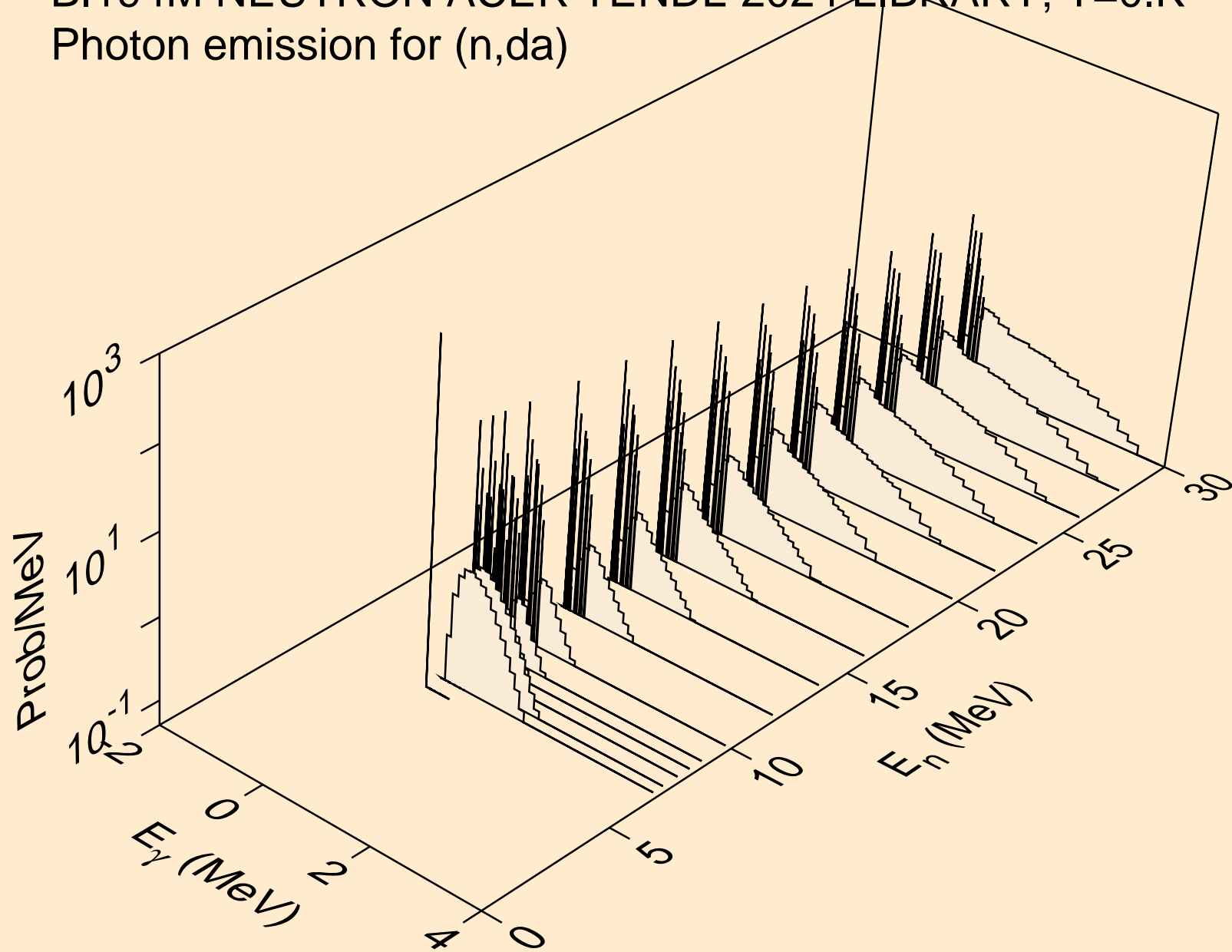

BI194M NEUTRON ACER TENDL-2024 LIBRARY; T=0.K  
thermal capture photon spectrum

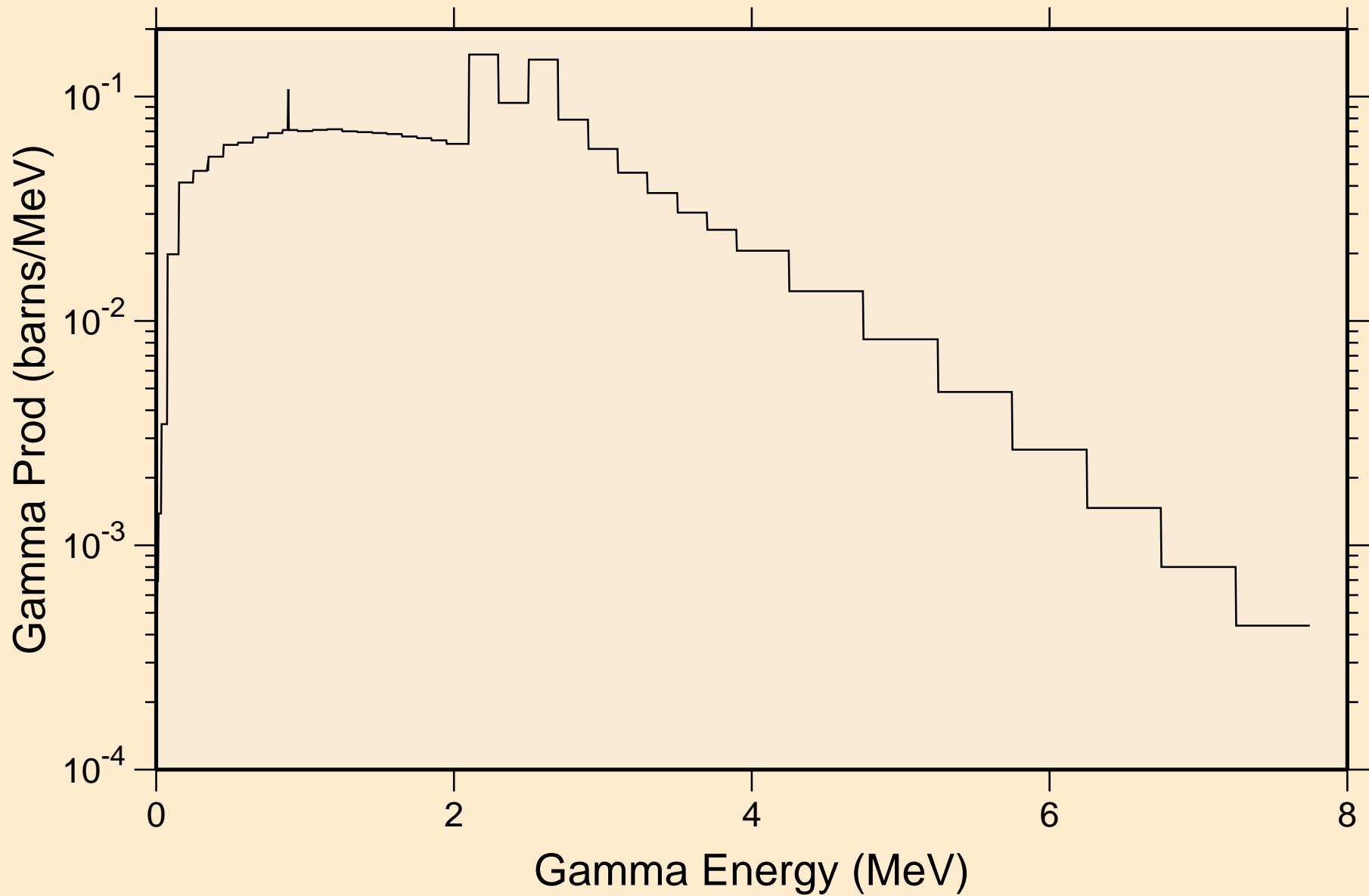

BI194M NEUTRON ACER TENDL-2024 LIBRARY; T=0.K  
14 MeV photon spectrum

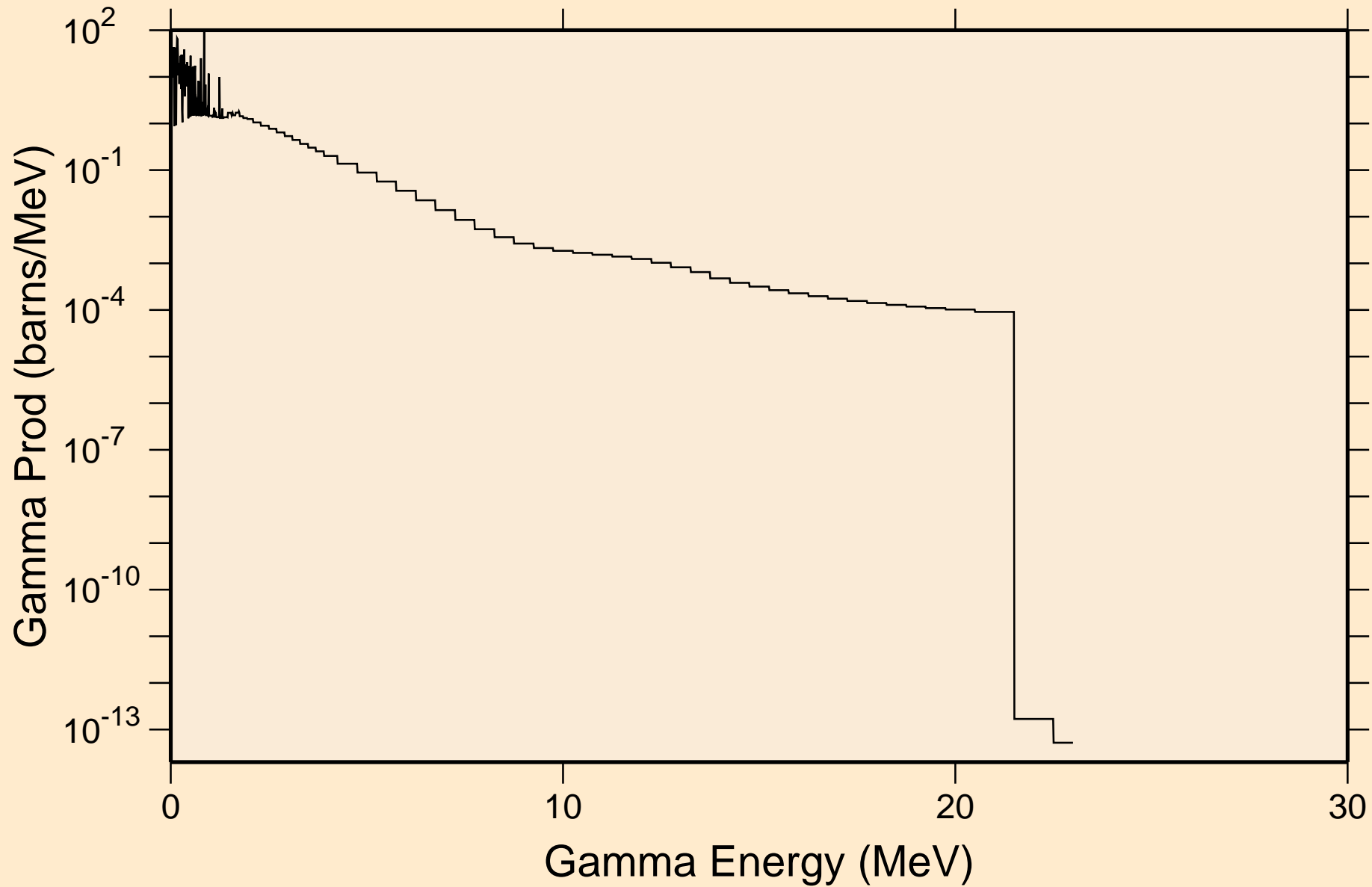

BI194M NEUTRON ACER TENDL-2024 LIBRARY; T=0.K  
Particle heating contributions

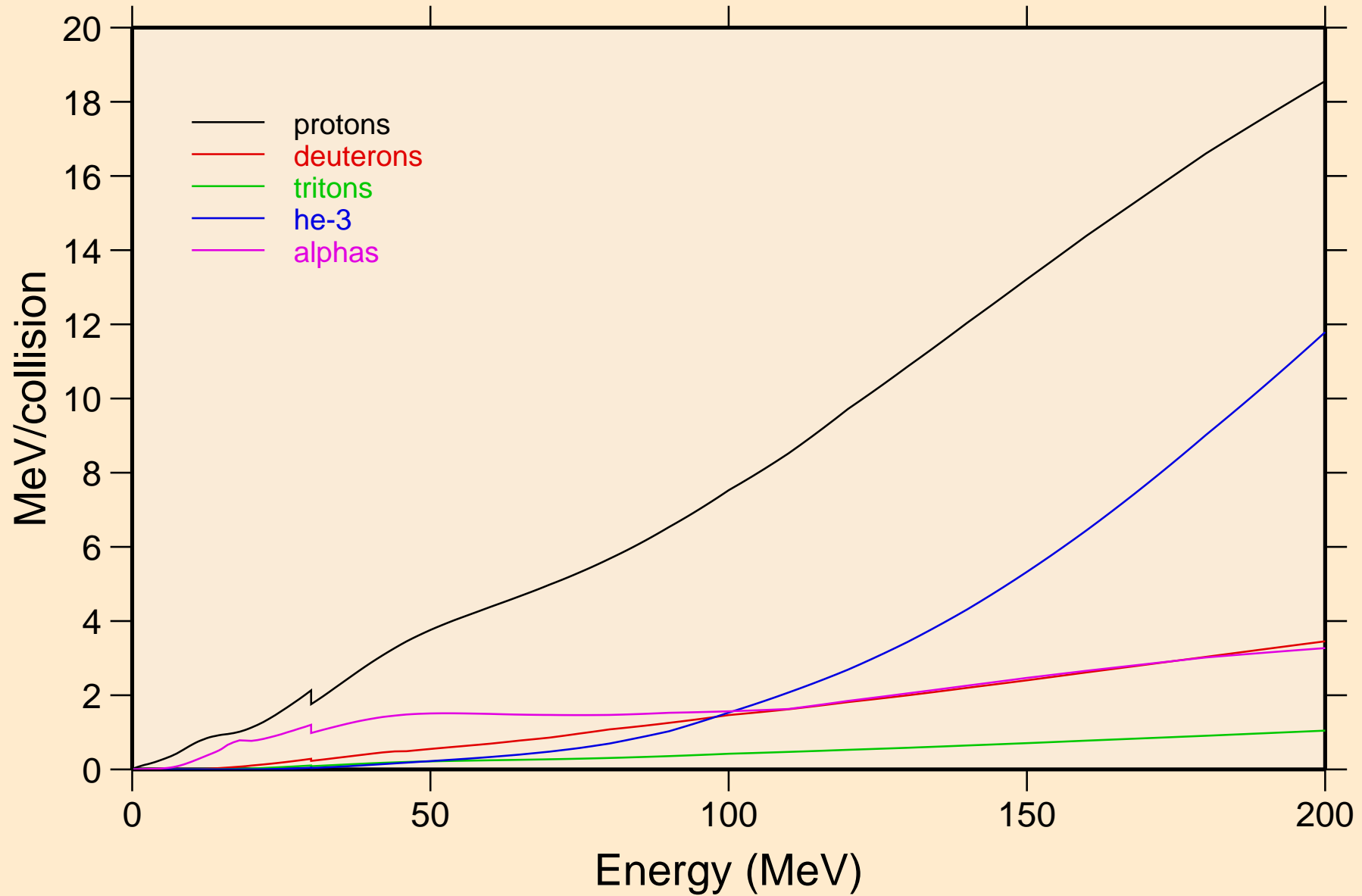

BI194M NEUTRON ACER TENDL-2024 LIBRARY; T=0.K  
Recoil Heating

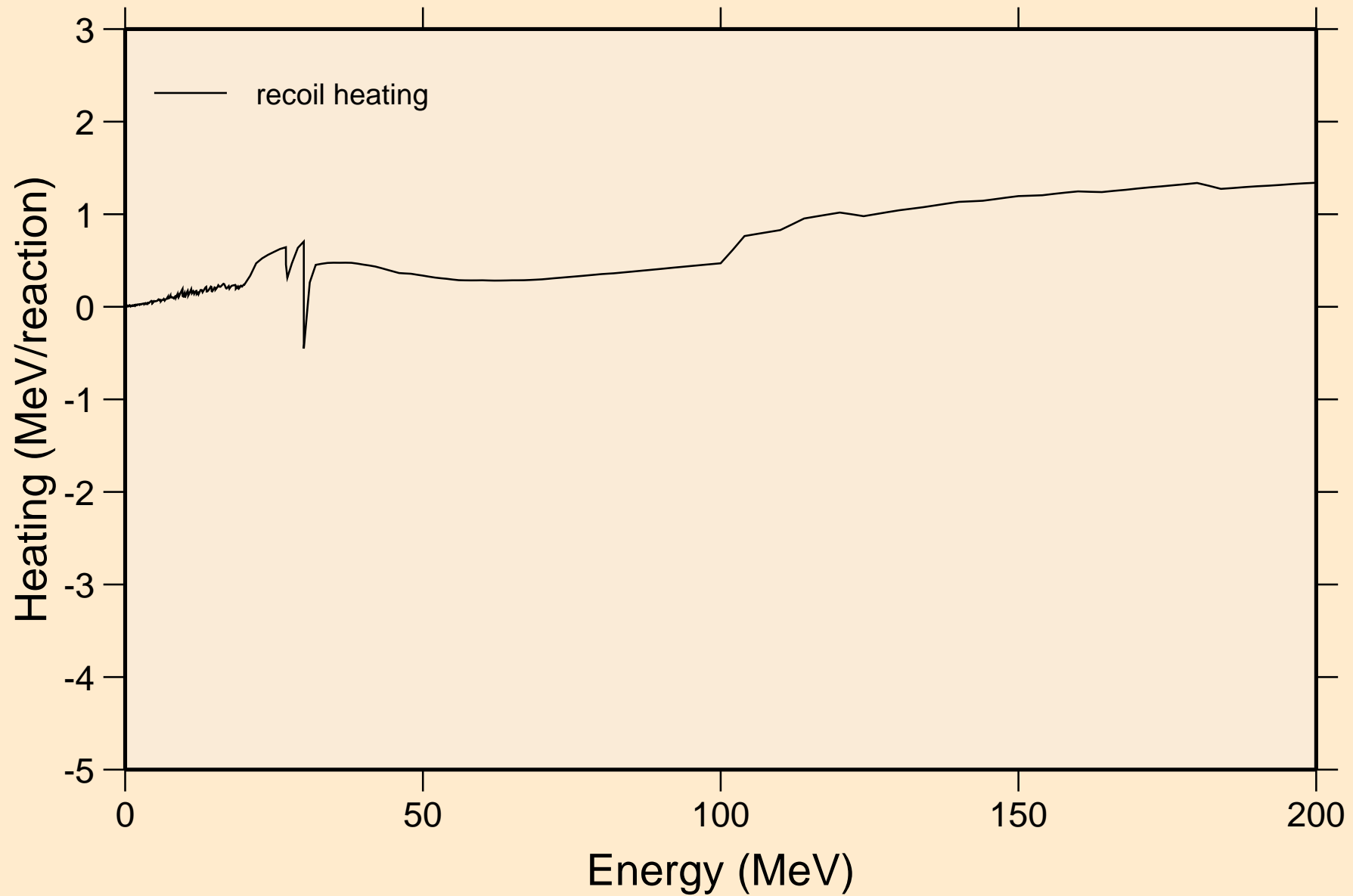

# BI194M NEUTRON ACER TENDL-2024 LIBRARY; T=0.K

## Particle production cross sections

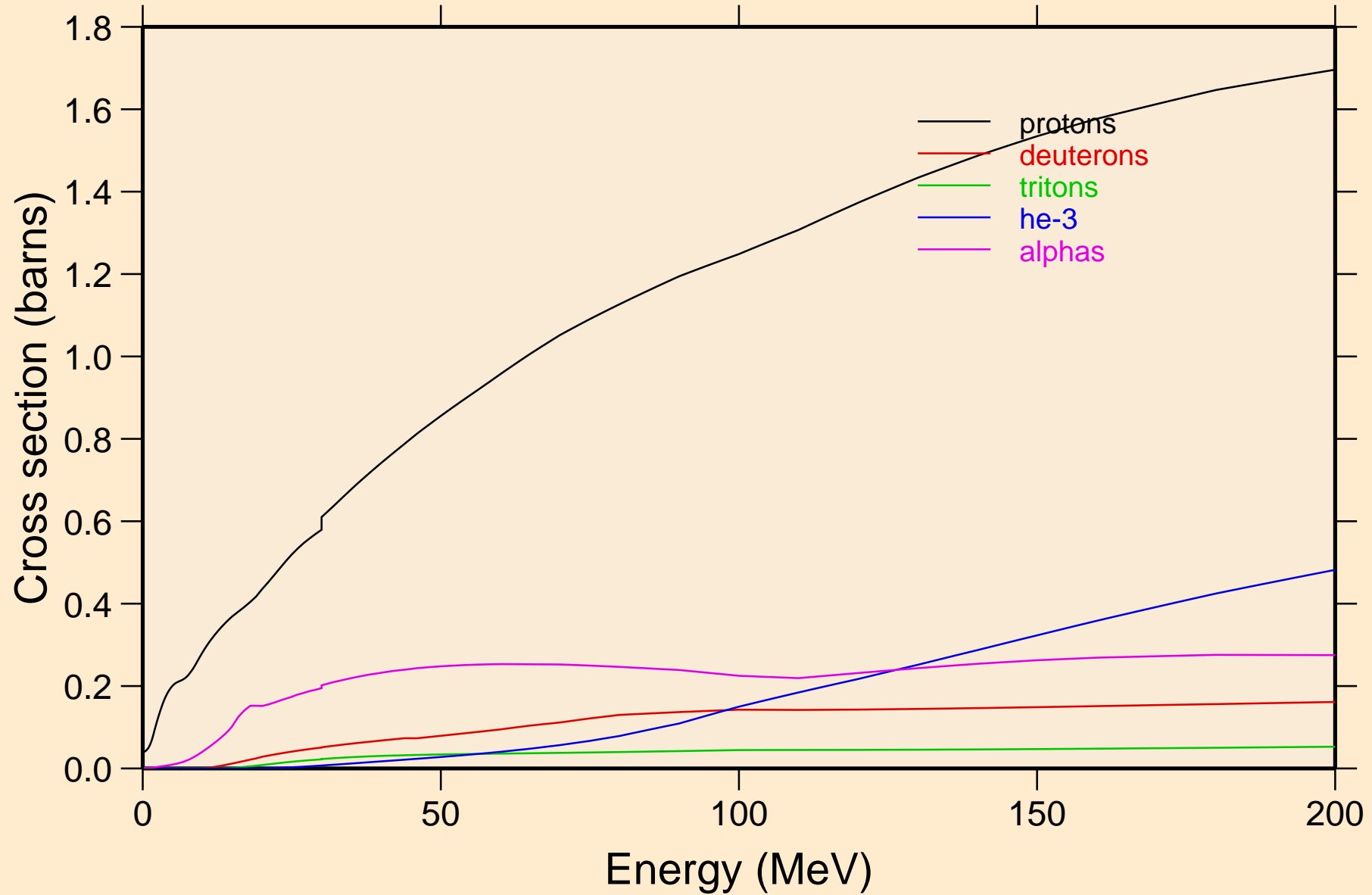

BI194M NEUTRON ACER TENDL-2024 LIBRARY; T=0.K  
protons from (n,x)

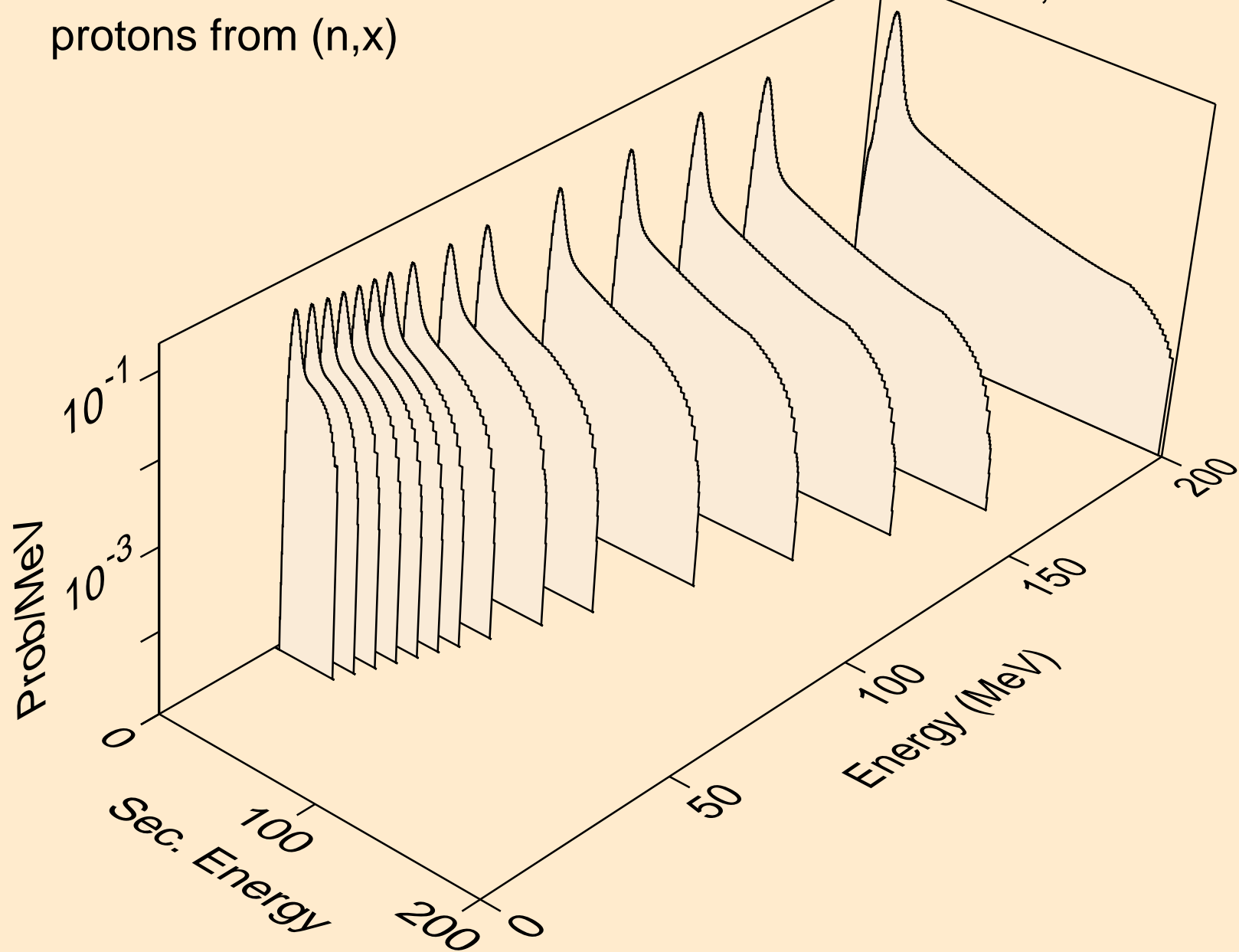



BI194M NEUTRON ACER TENDL-2024 LIBRARY; T=0.K  
protons from (n,n\*)p

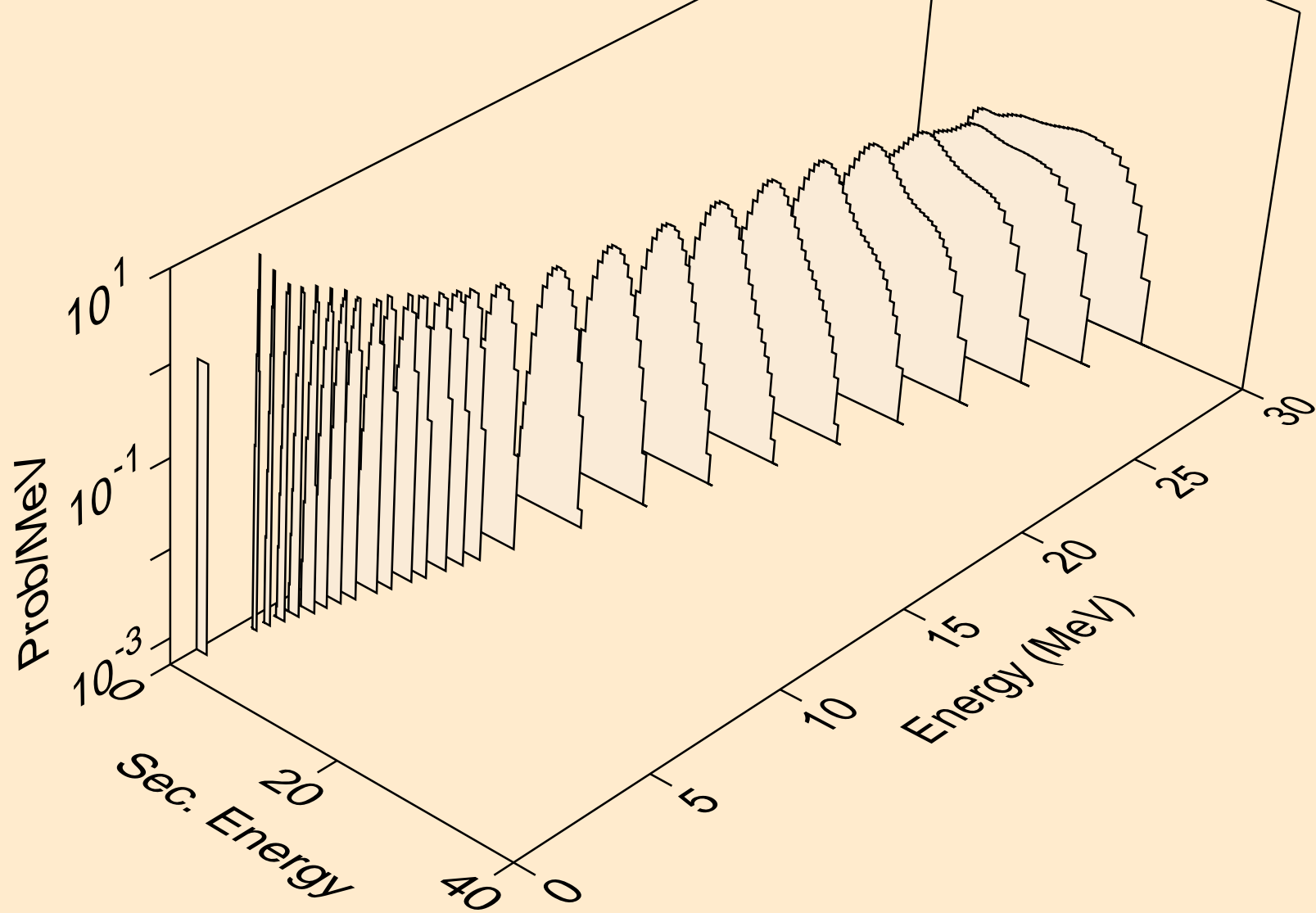

BI194M NEUTRON ACER TENDL-2024 LIBRARY; T=0.K  
protons from (n,2np)

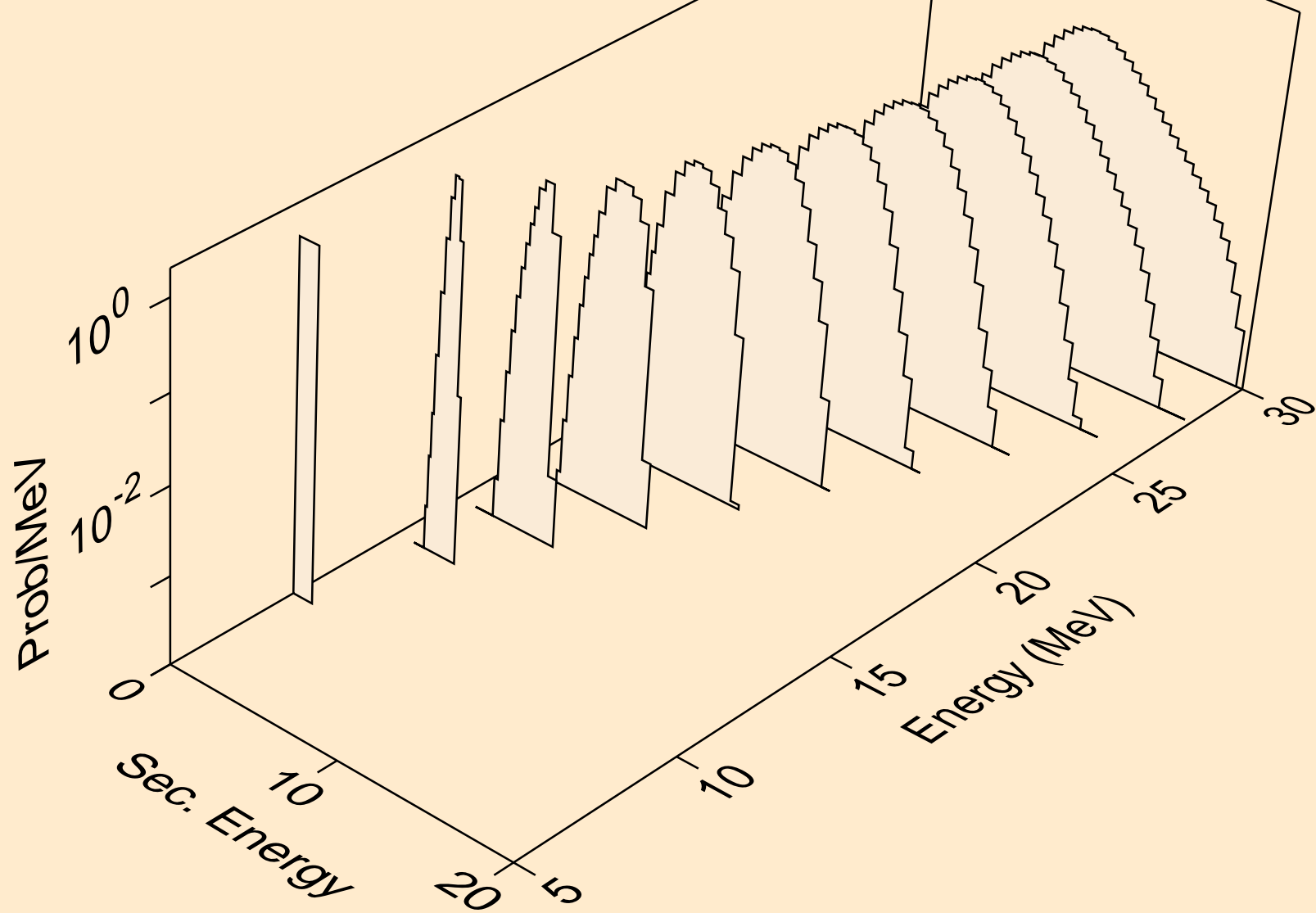

BI194M NEUTRON ACER TENDL-2024 LIBRARY; T=0.K  
protons from (n,3np)

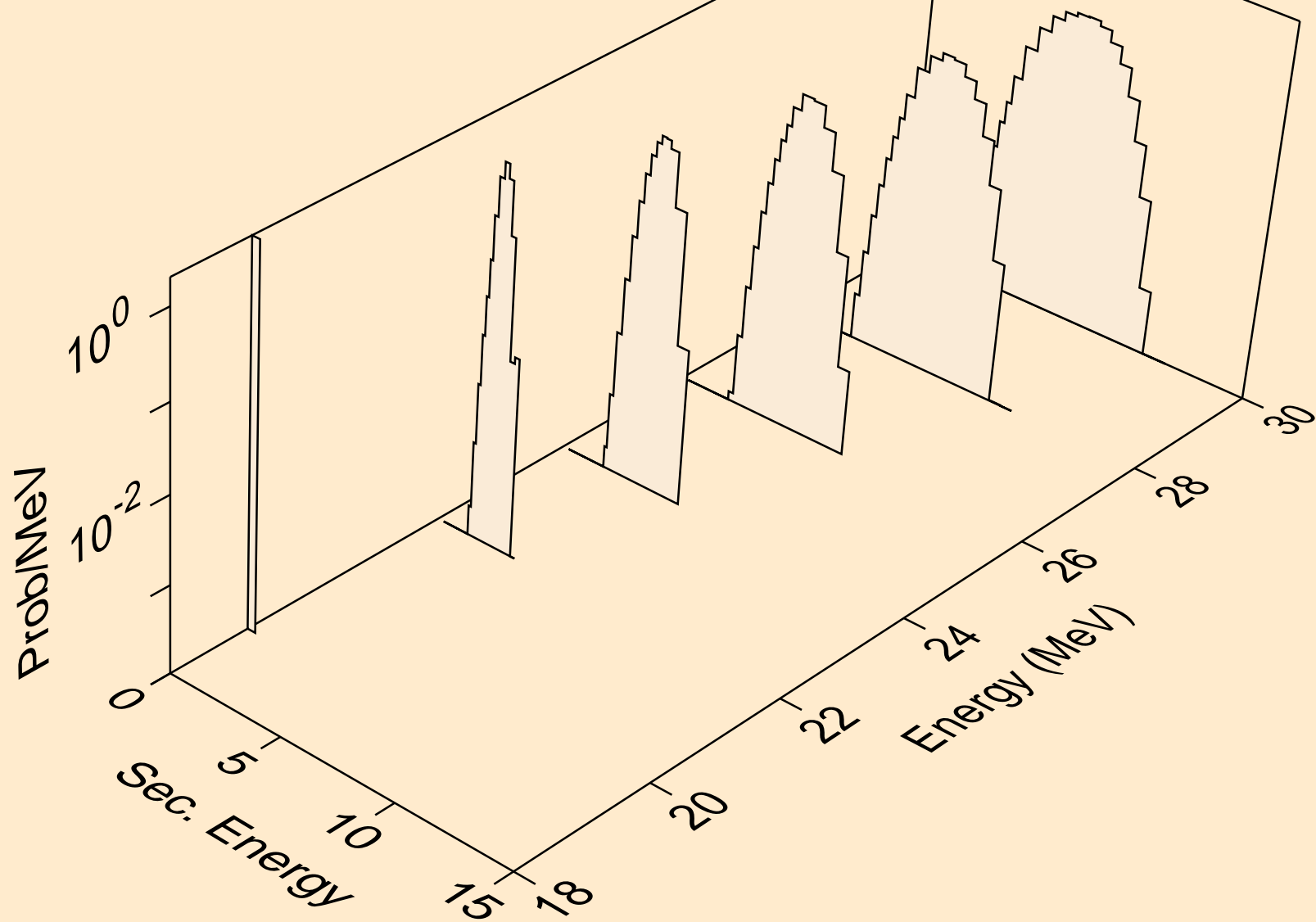

BI194M NEUTRON ACER TENDL-2024 LIBRARY; T=0.K  
protons from (n,n2p)

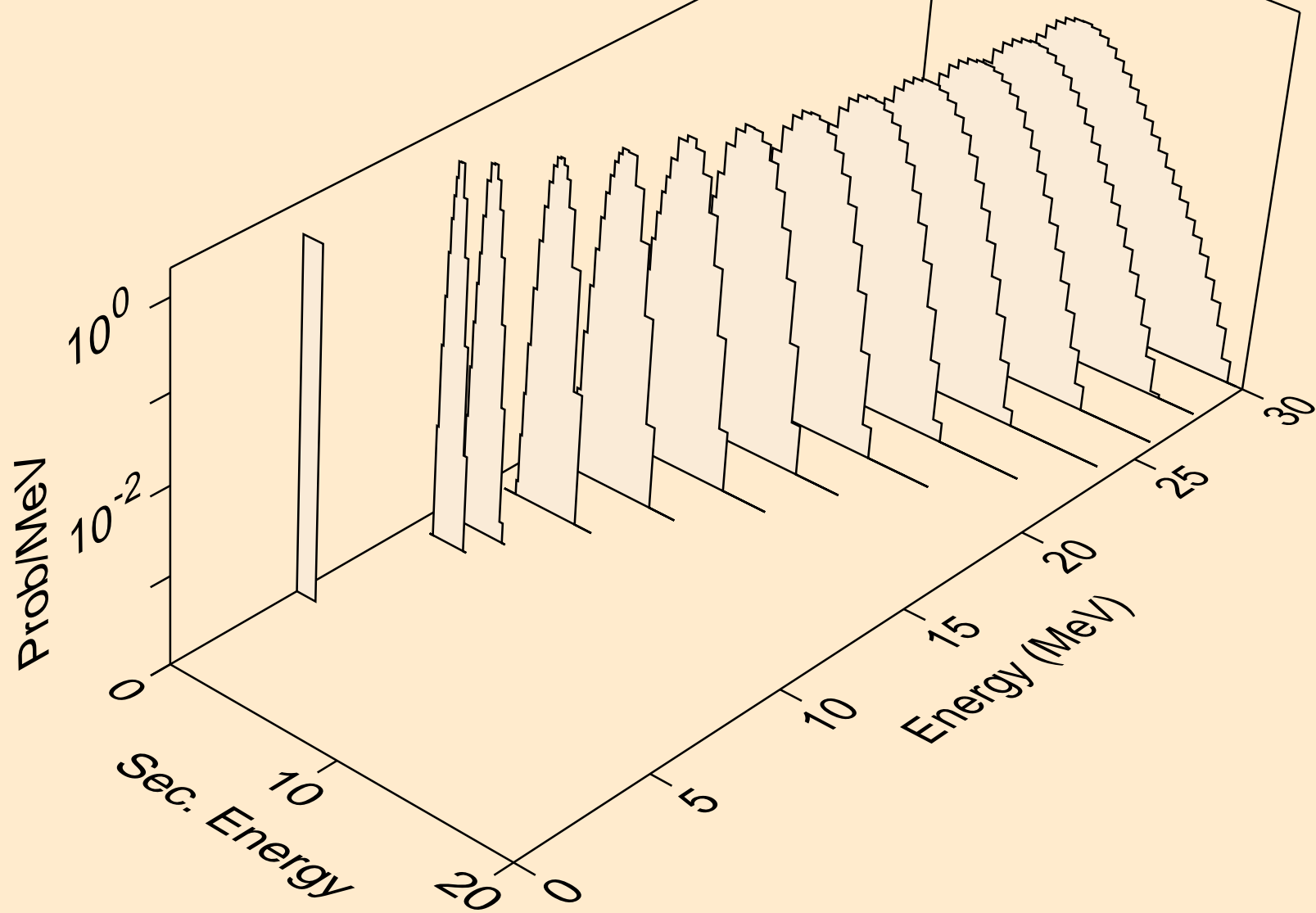

BI194M NEUTRON ACER TENDL-2024 LIBRARY; T=0.K  
protons from (n,npa)

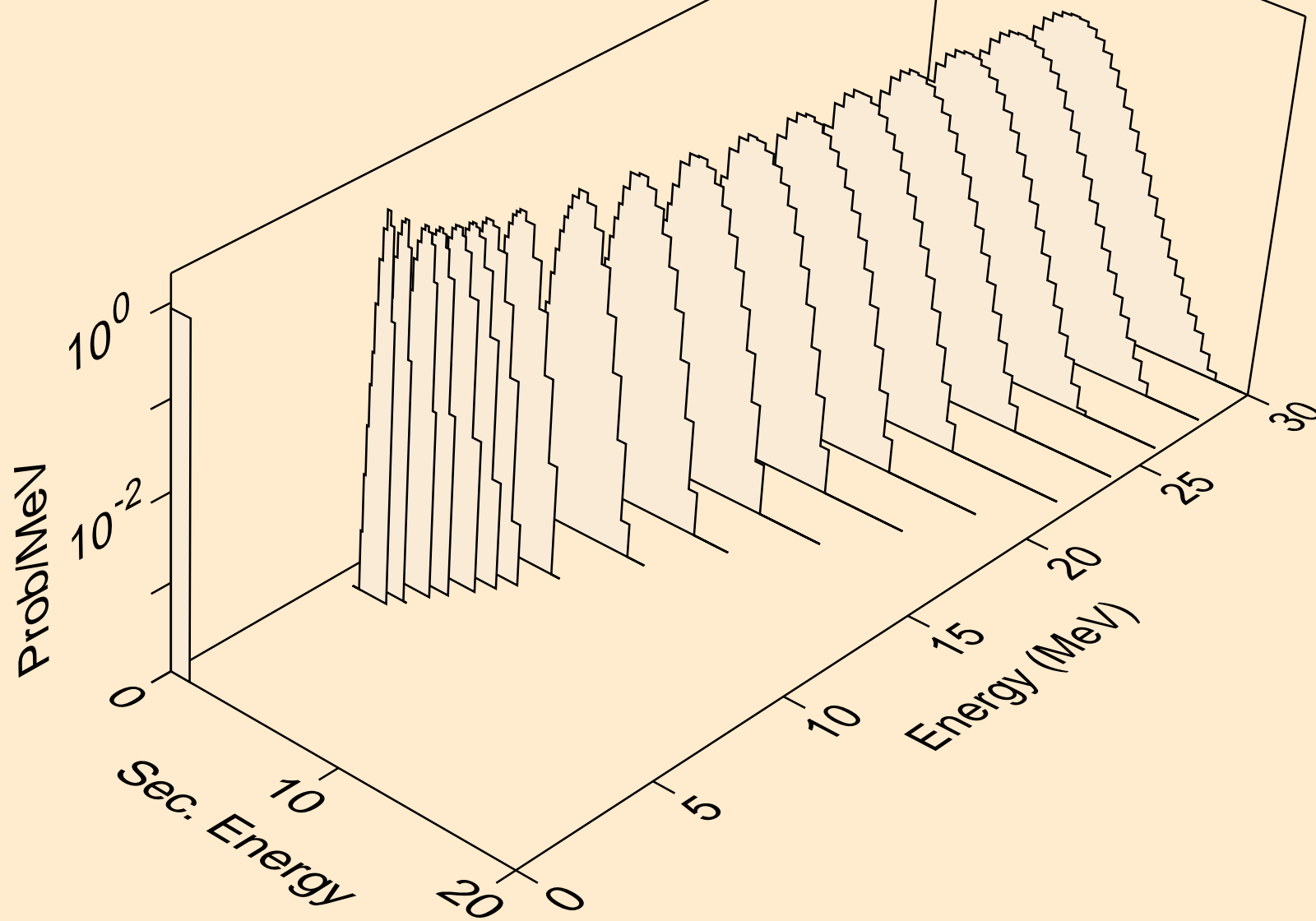

BI194M NEUTRON ACER TENDL-2024 LIBRARY; T=0.K  
protons from (n,p)

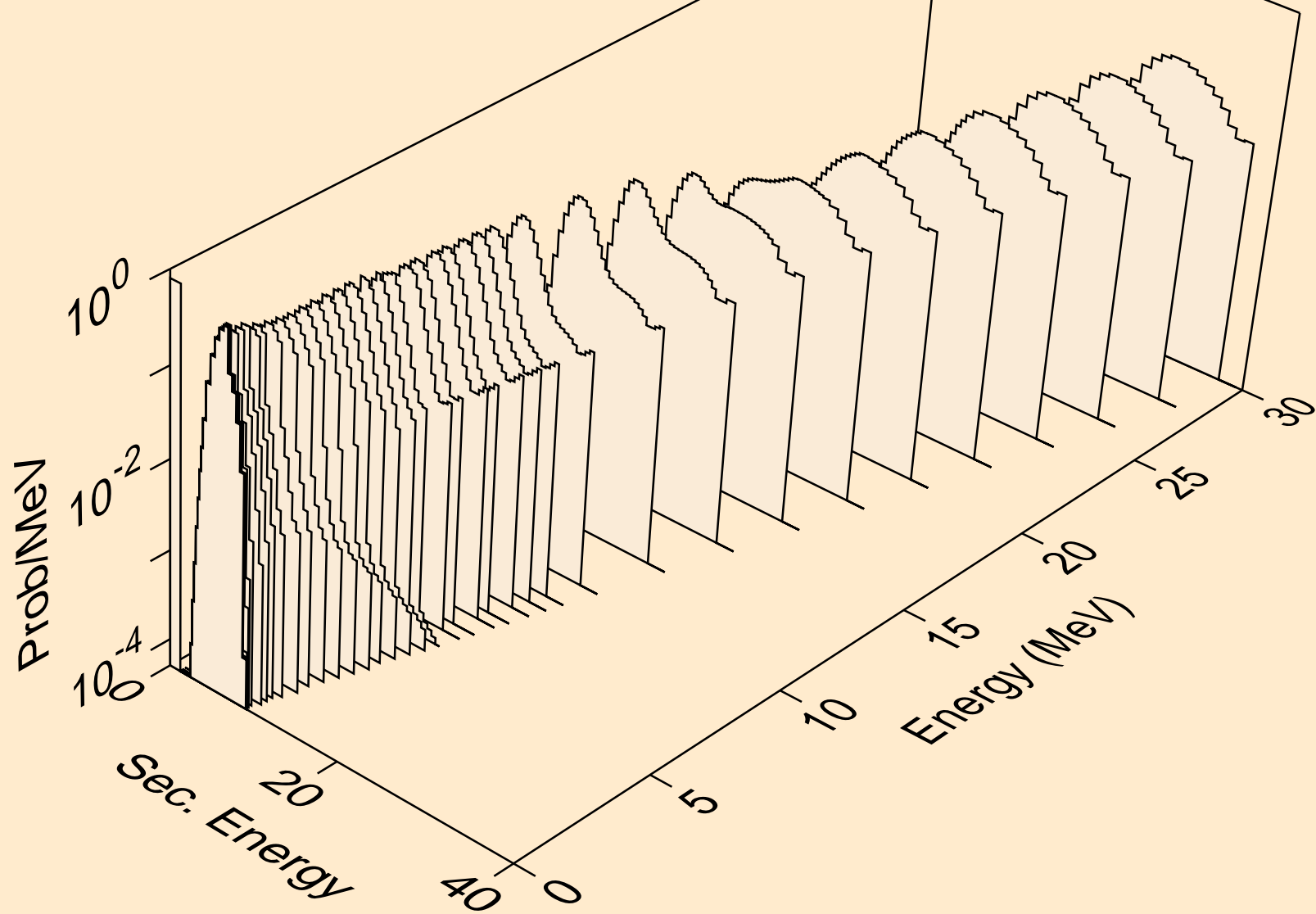

BI194M NEUTRON ACER TENDL-2024 LIBRARY; T=0.K  
protons from (n,2p)

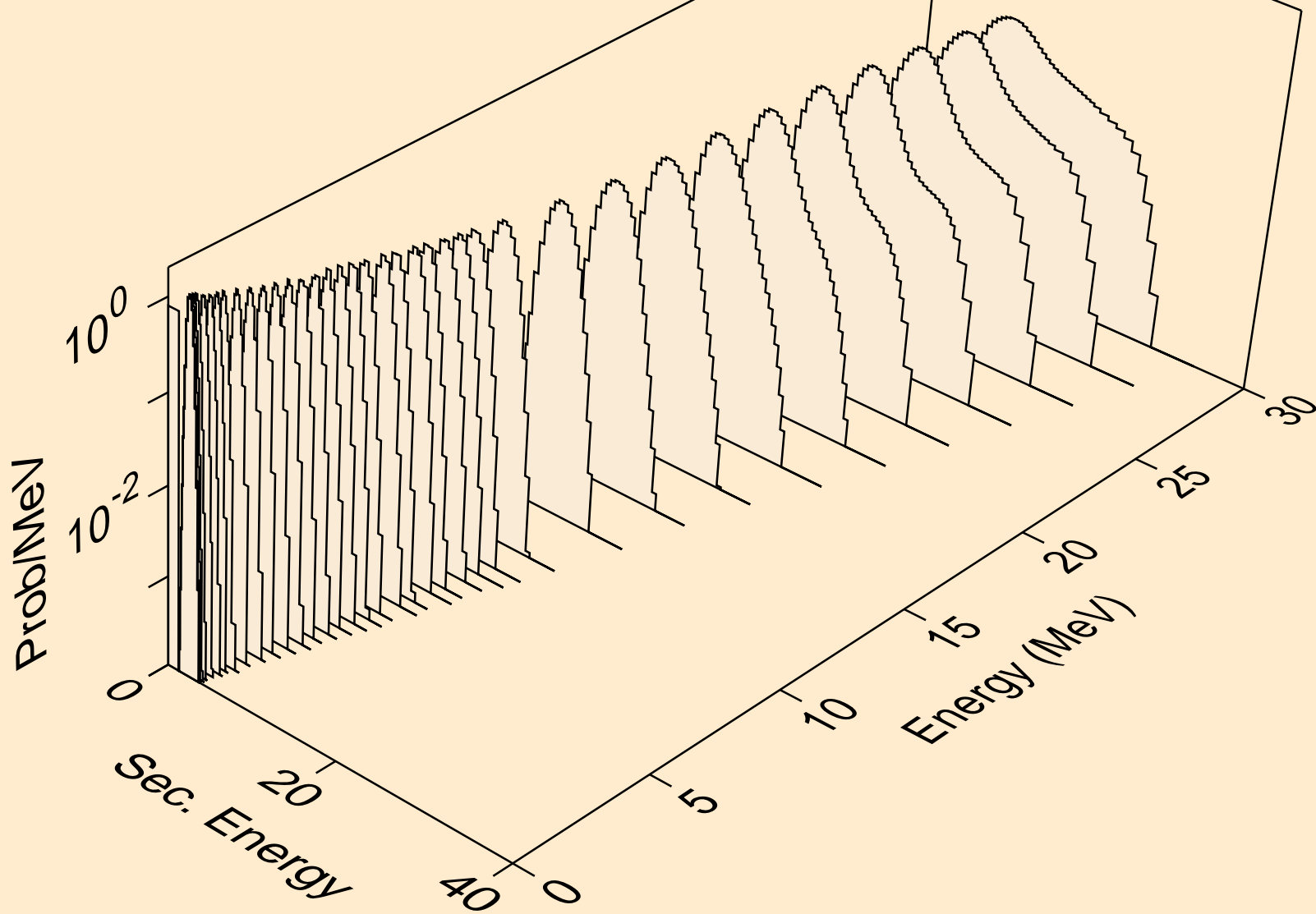

BI194M NEUTRON ACER TENDL-2024 LIBRARY; T=0.K  
protons from (n,p)

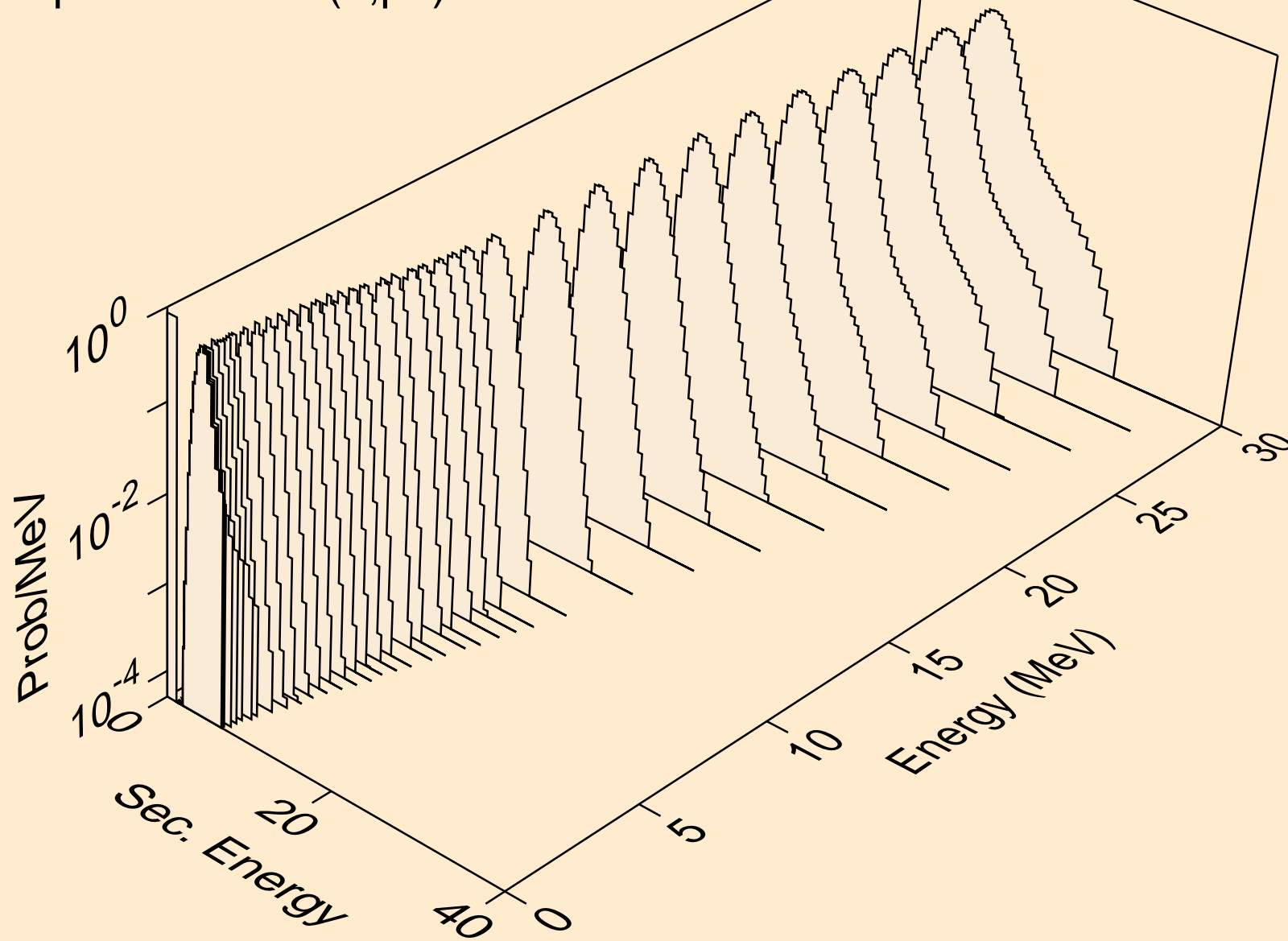



BI194M NEUTRON ACER TENDL-2024 LIBRARY; T=0.K  
protons from (n,pd)

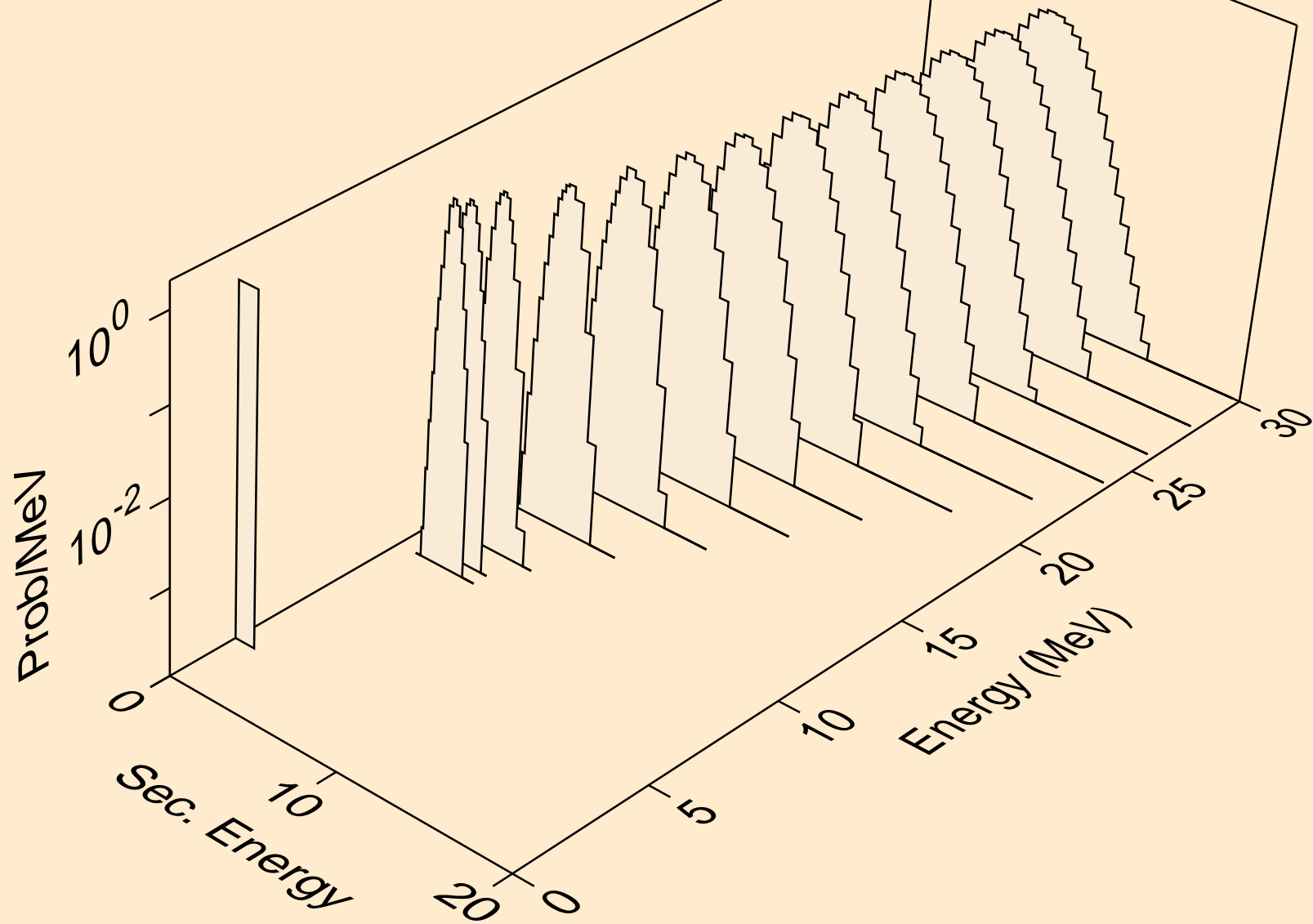

BI194M NEUTRON ACER TENDL-2024 LIBRARY; T=0.K  
protons from (n,pt)

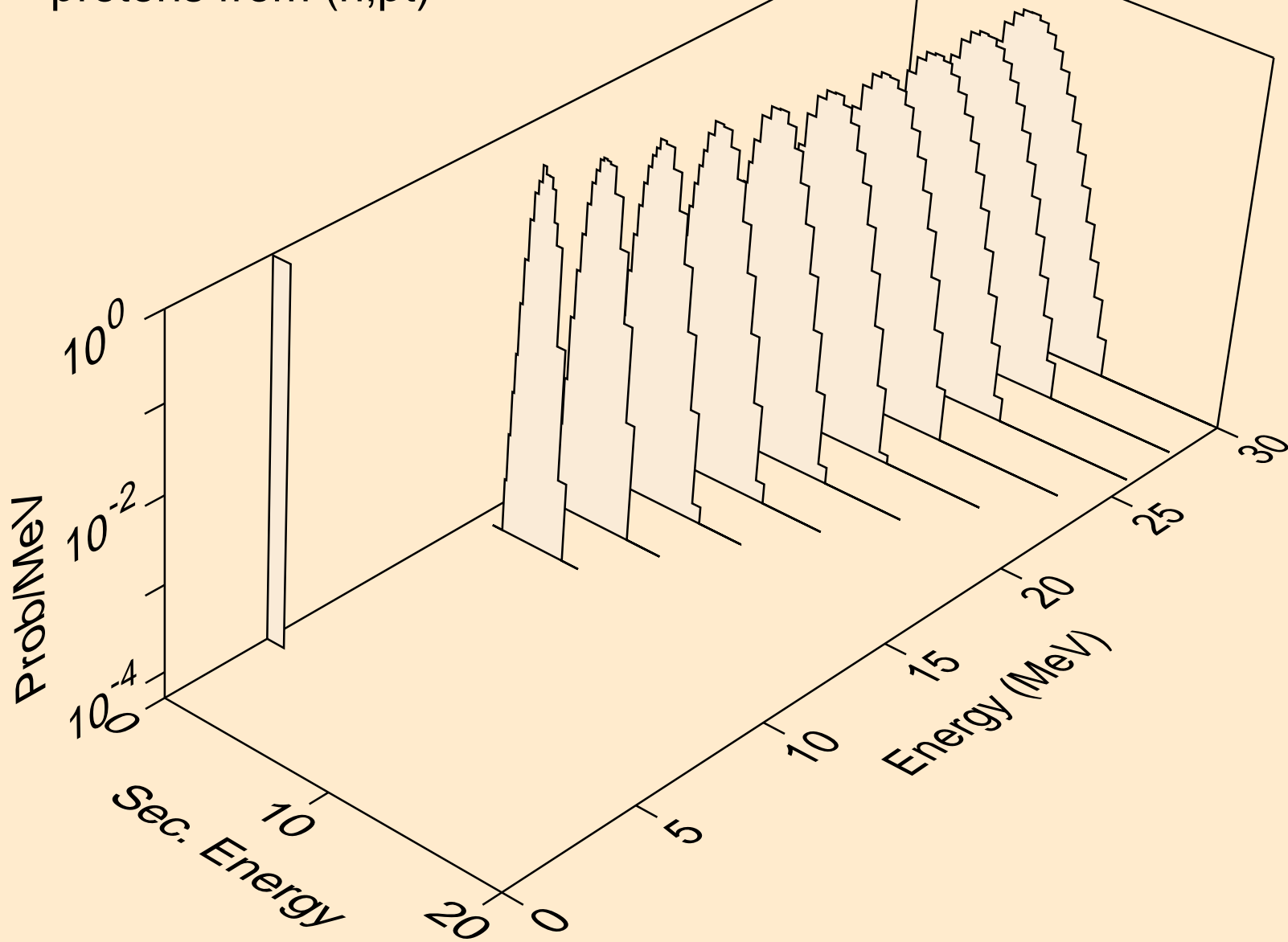

BI194M NEUTRON ACER TENDL-2024 LIBRARY; T=0.K  
deuterons from (n,x)

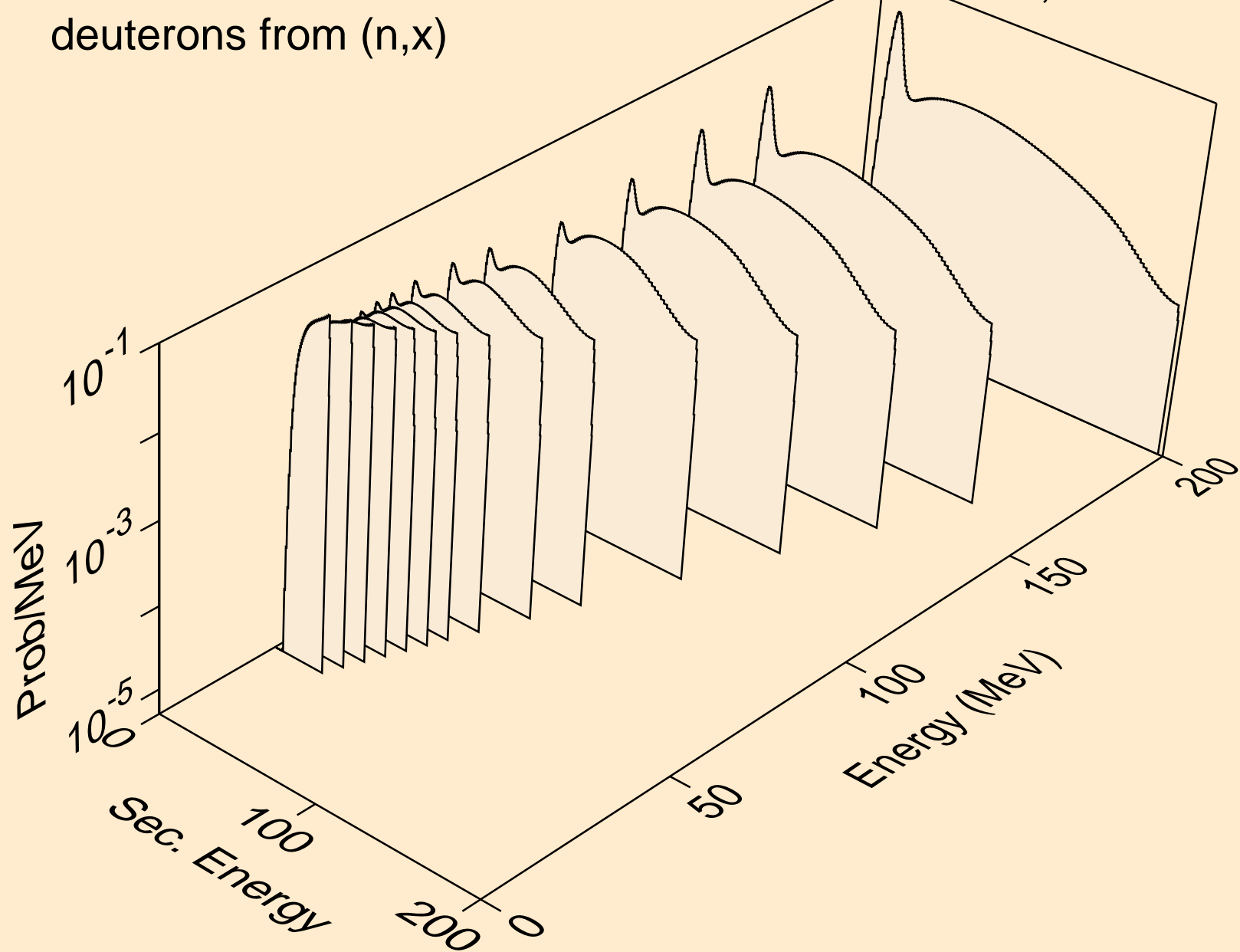

BI194M NEUTRON ACER TENDL-2024 LIBRARY; T=0.K  
deuterons from (n,2nd)

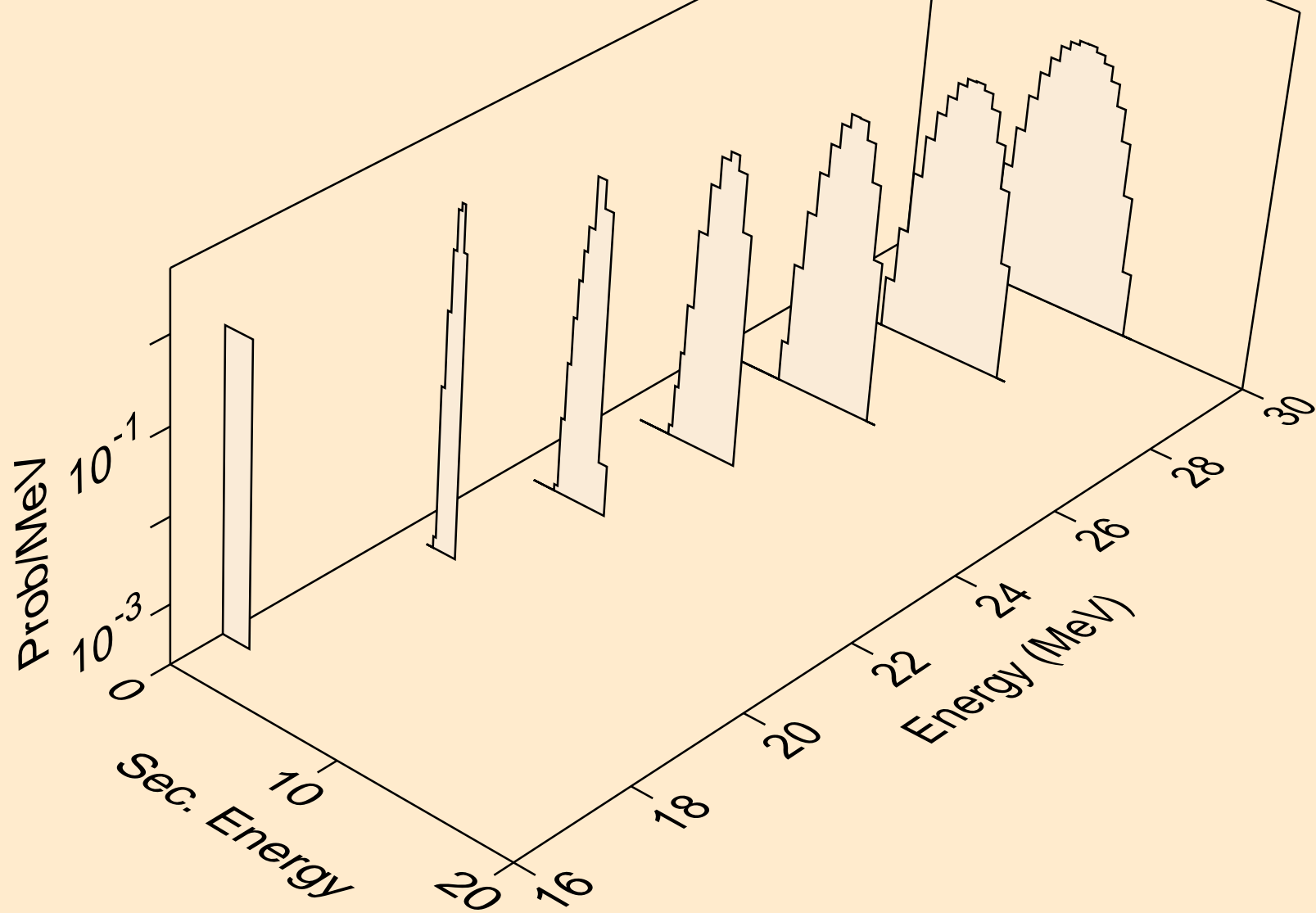

BI194M NEUTRON ACER TENDL-2024 LIBRARY; T=0.K  
deuterons from (n,n\*)d

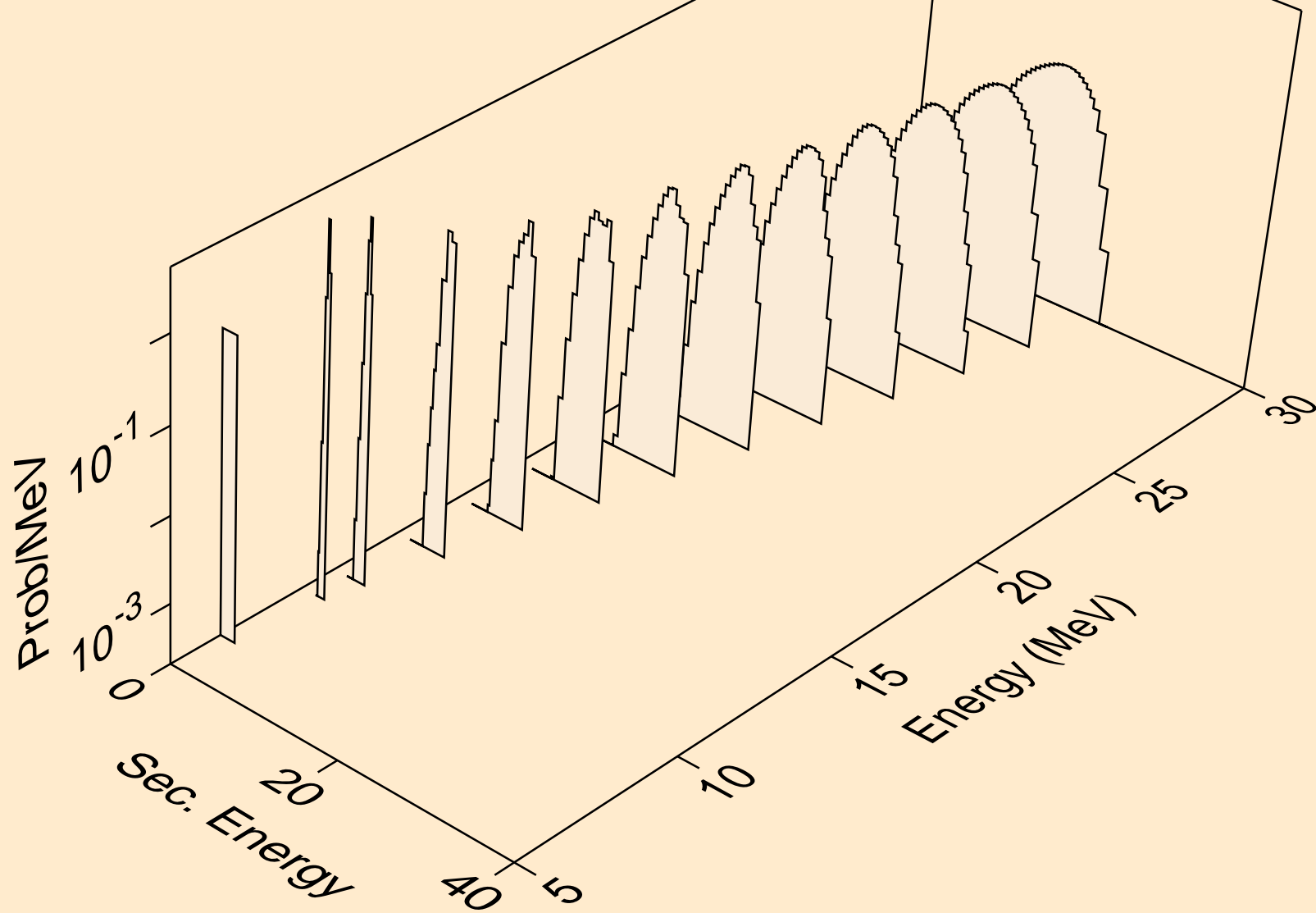

BI194M NEUTRON ACER TENDL-2024 LIBRARY; T=0.K  
deuterons from (n,d)

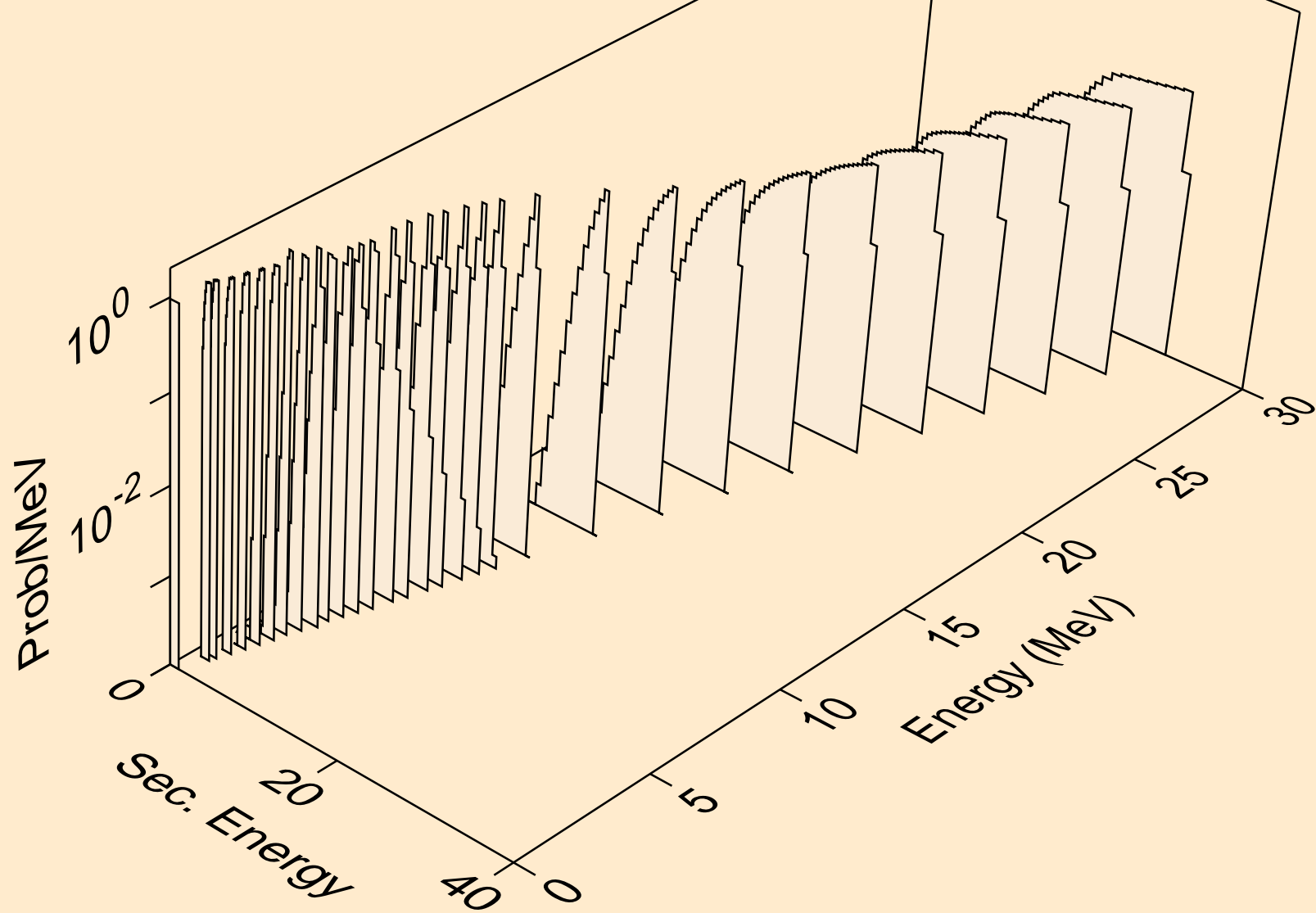

BI194M NEUTRON ACER TENDL-2024 LIBRARY; T=0.K  
deuterons from (n,pd)

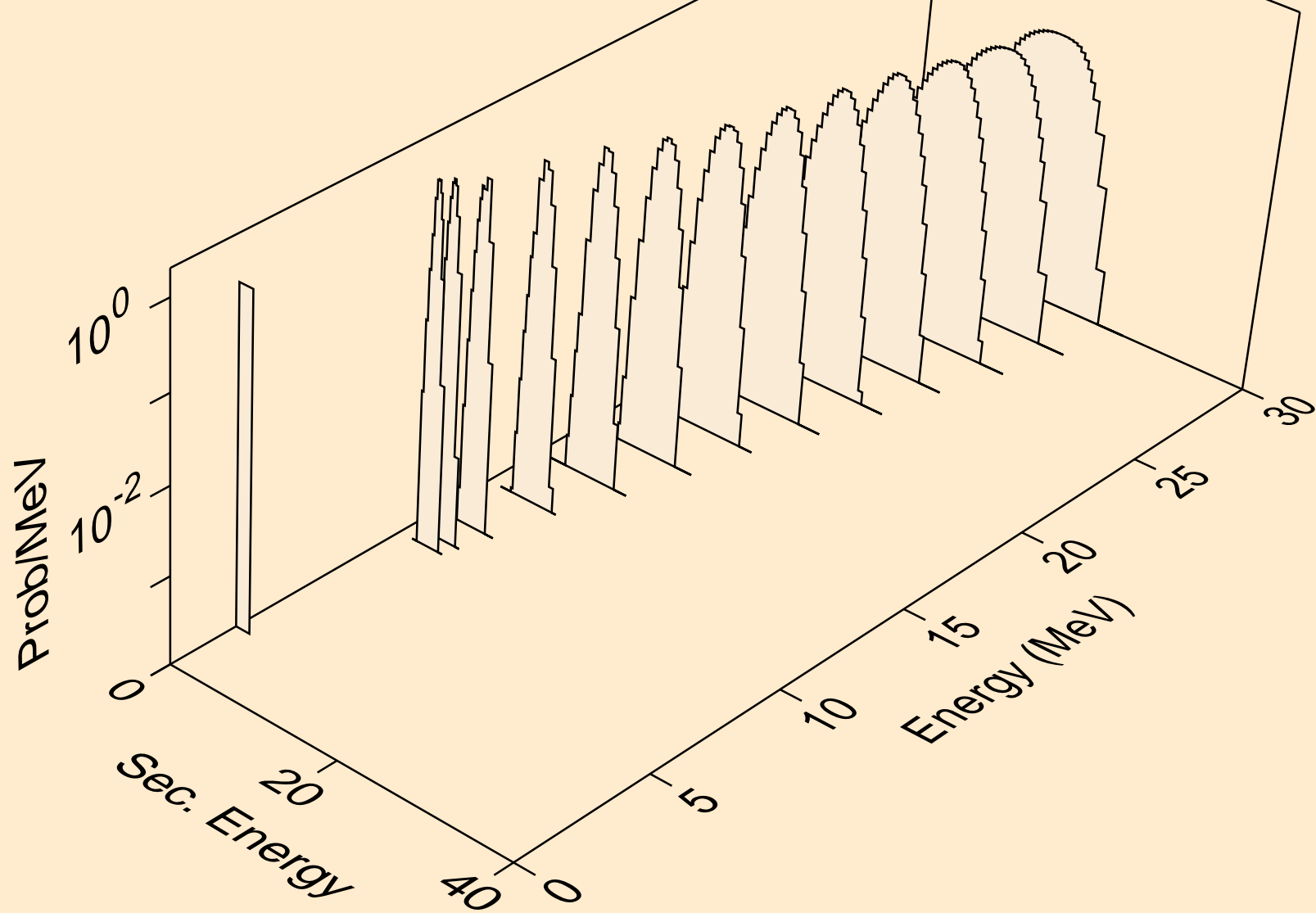

BI194M NEUTRON ACER TENDL-2024 LIBRARY; T=0.K  
deuterons from (n,da)

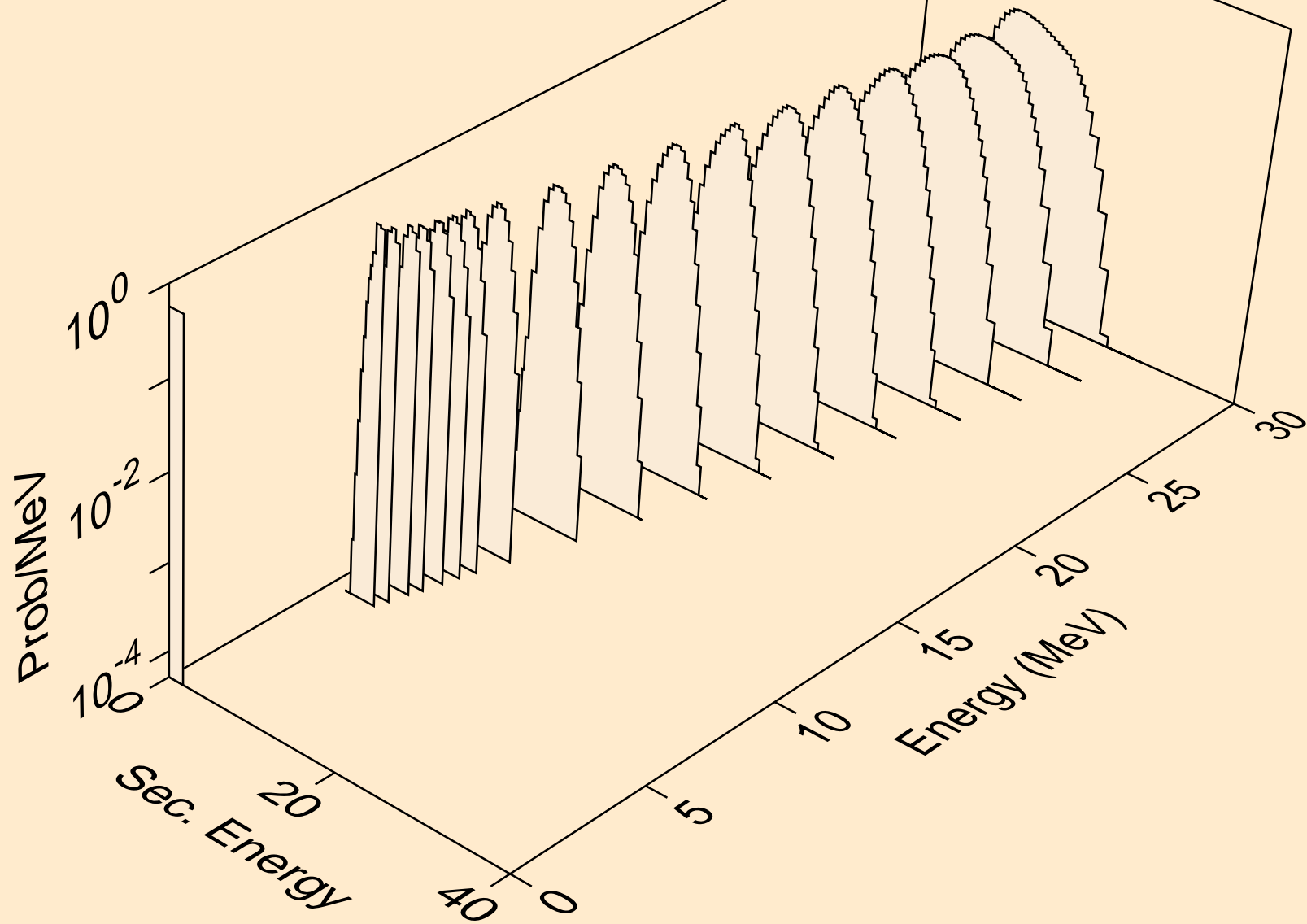



BI194M NEUTRON ACER TENDL-2024 LIBRARY; T=0.K  
tritons from (n,x)

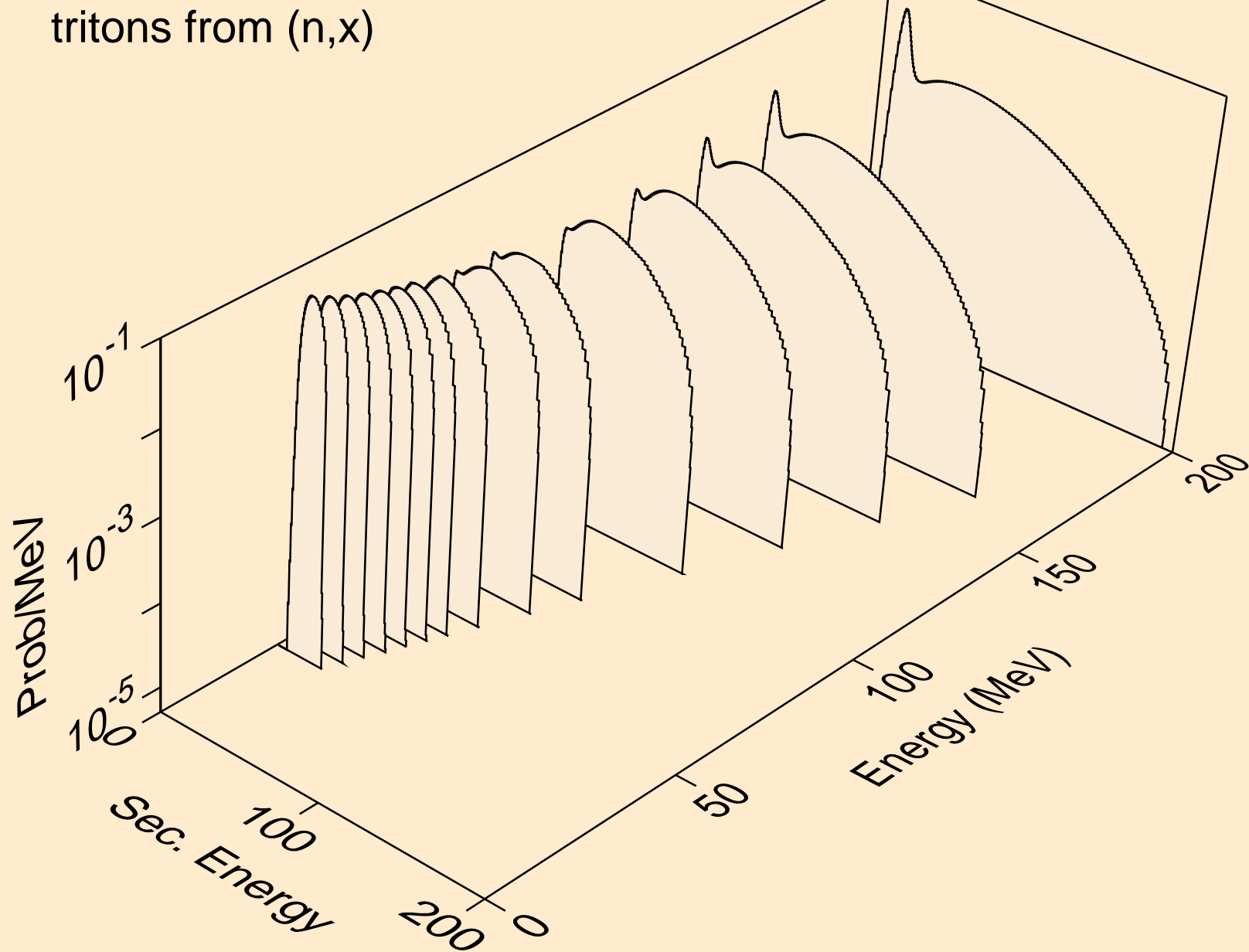

BI194M NEUTRON ACER TENDL-2024 LIBRARY; T=0.K  
tritons from (n,n\*)t

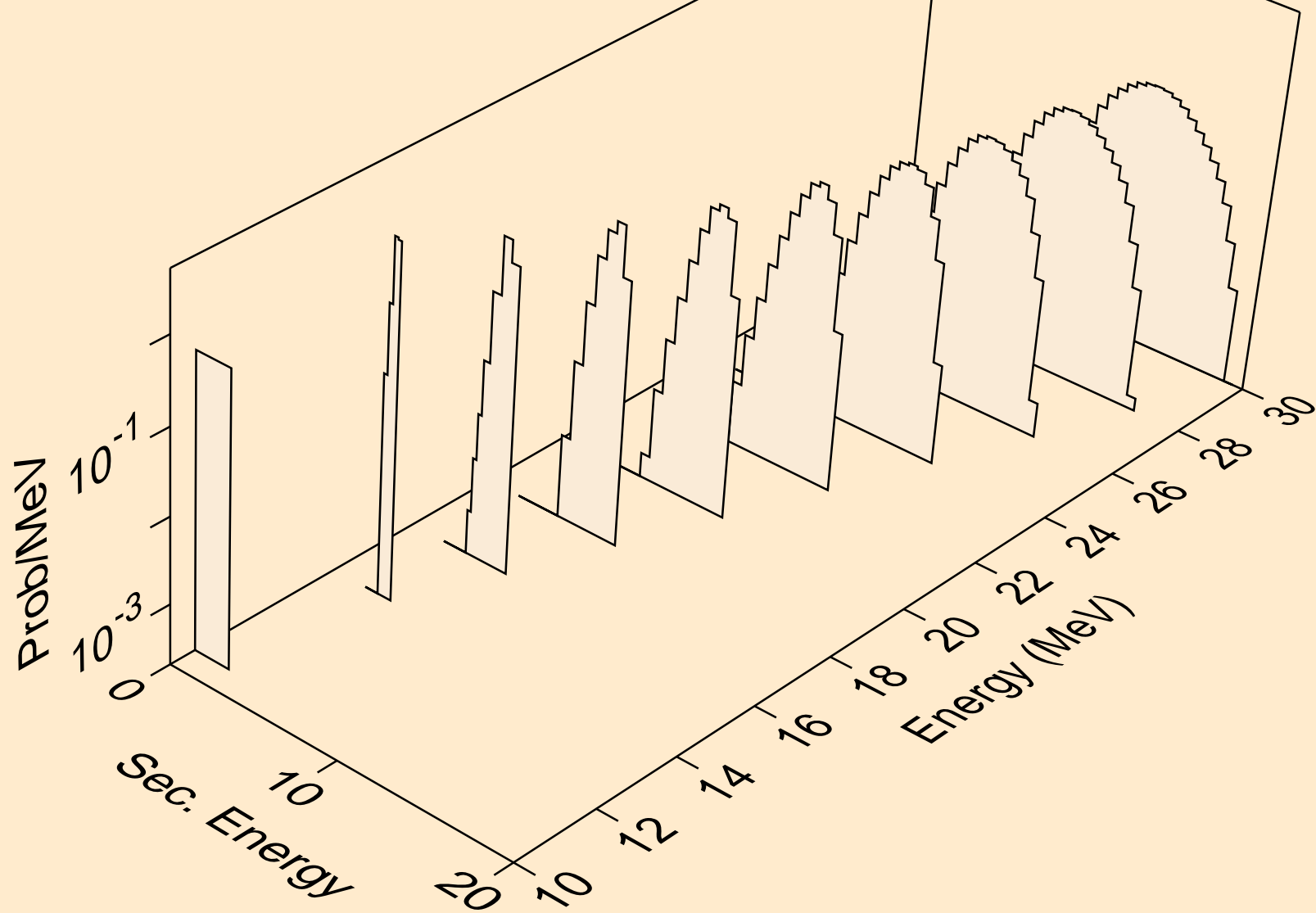

BI194M NEUTRON ACER TENDL-2024 LIBRARY; T=0.K  
tritons from (n,t)

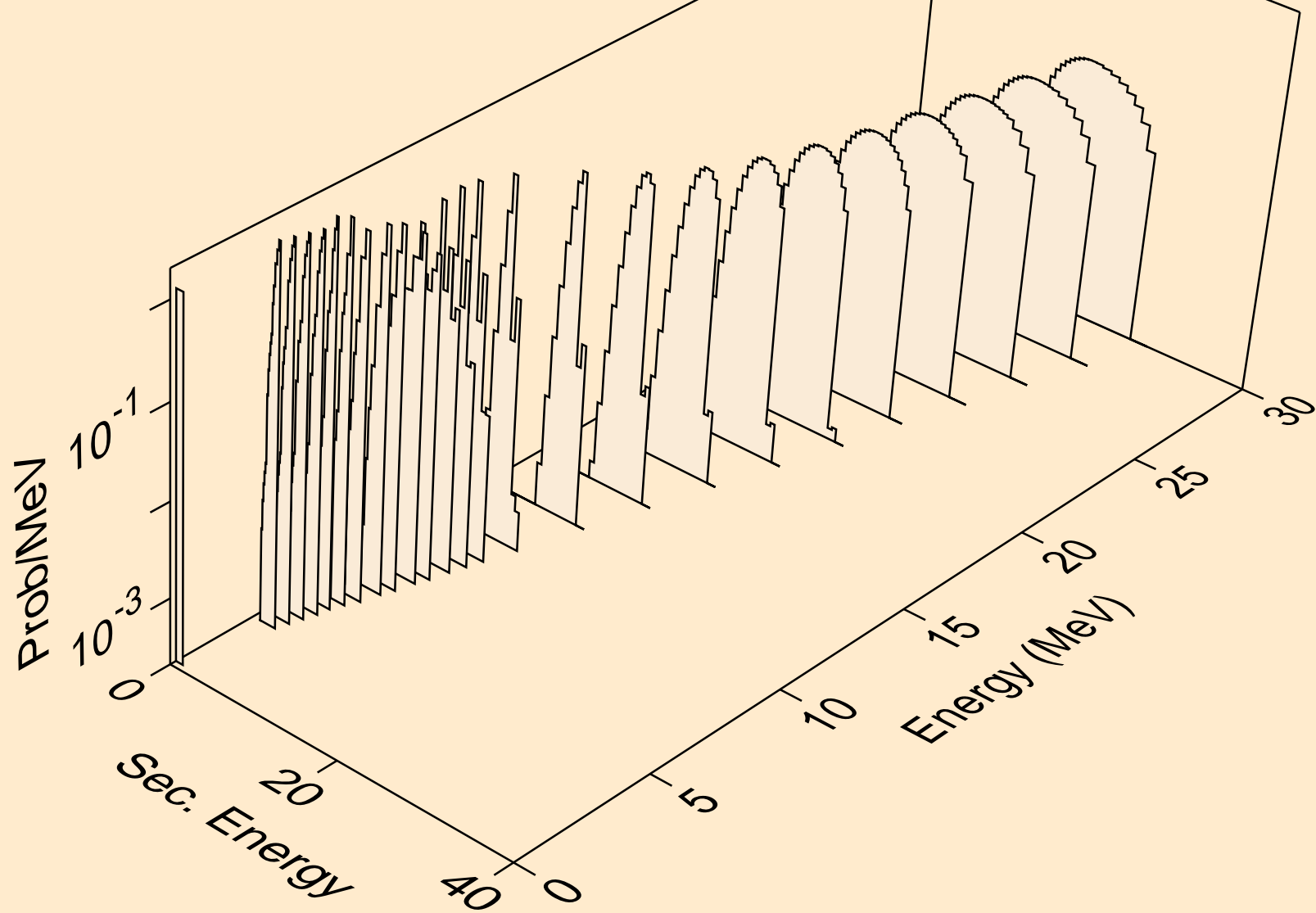

BI194M NEUTRON ACER TENDL-2024 LIBRARY; T=0.K  
tritons from (n,pt)

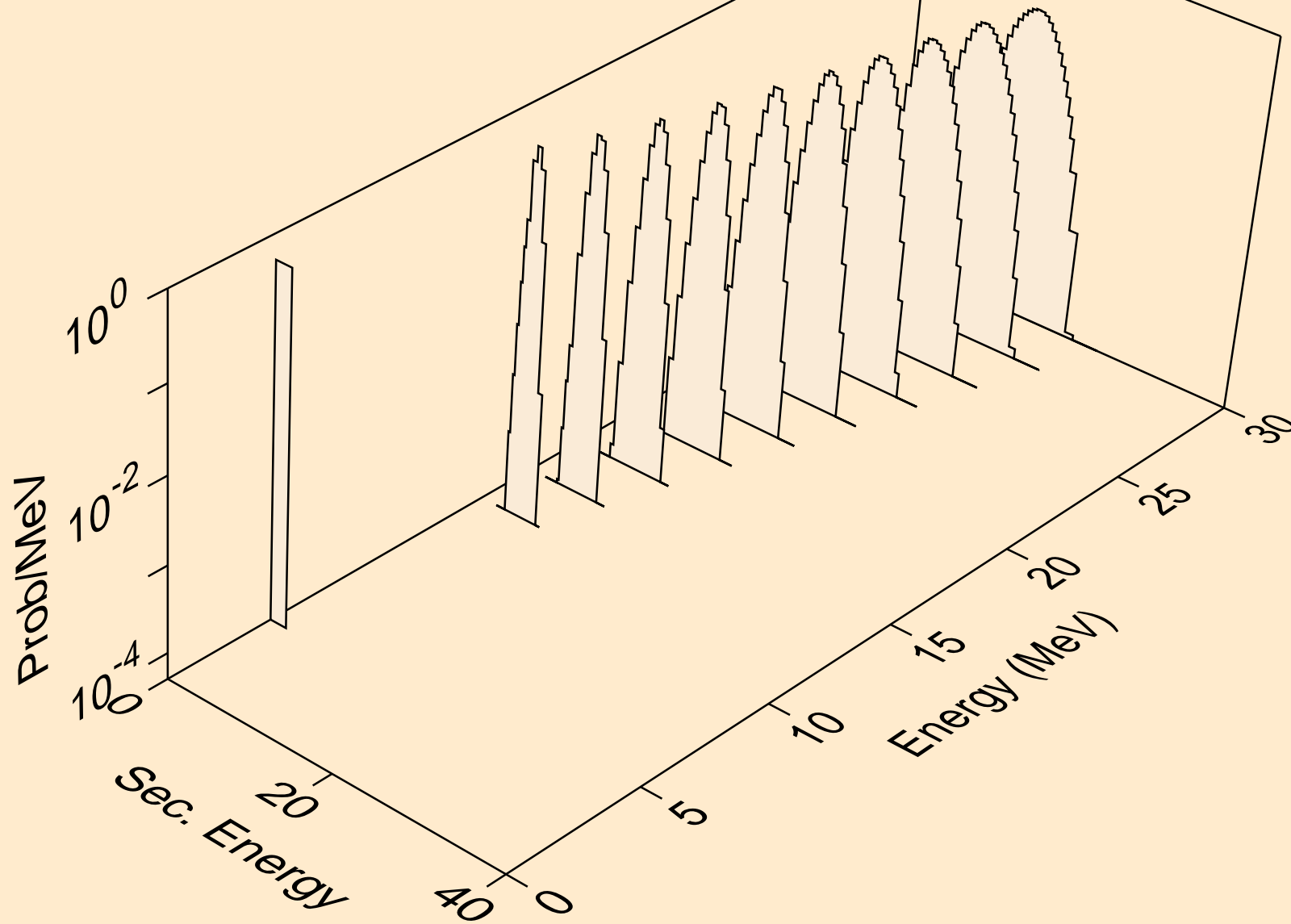

BI194M NEUTRON ACER TENDL-2024 LIBRARY; T=0.K  
he3s from (n,x)

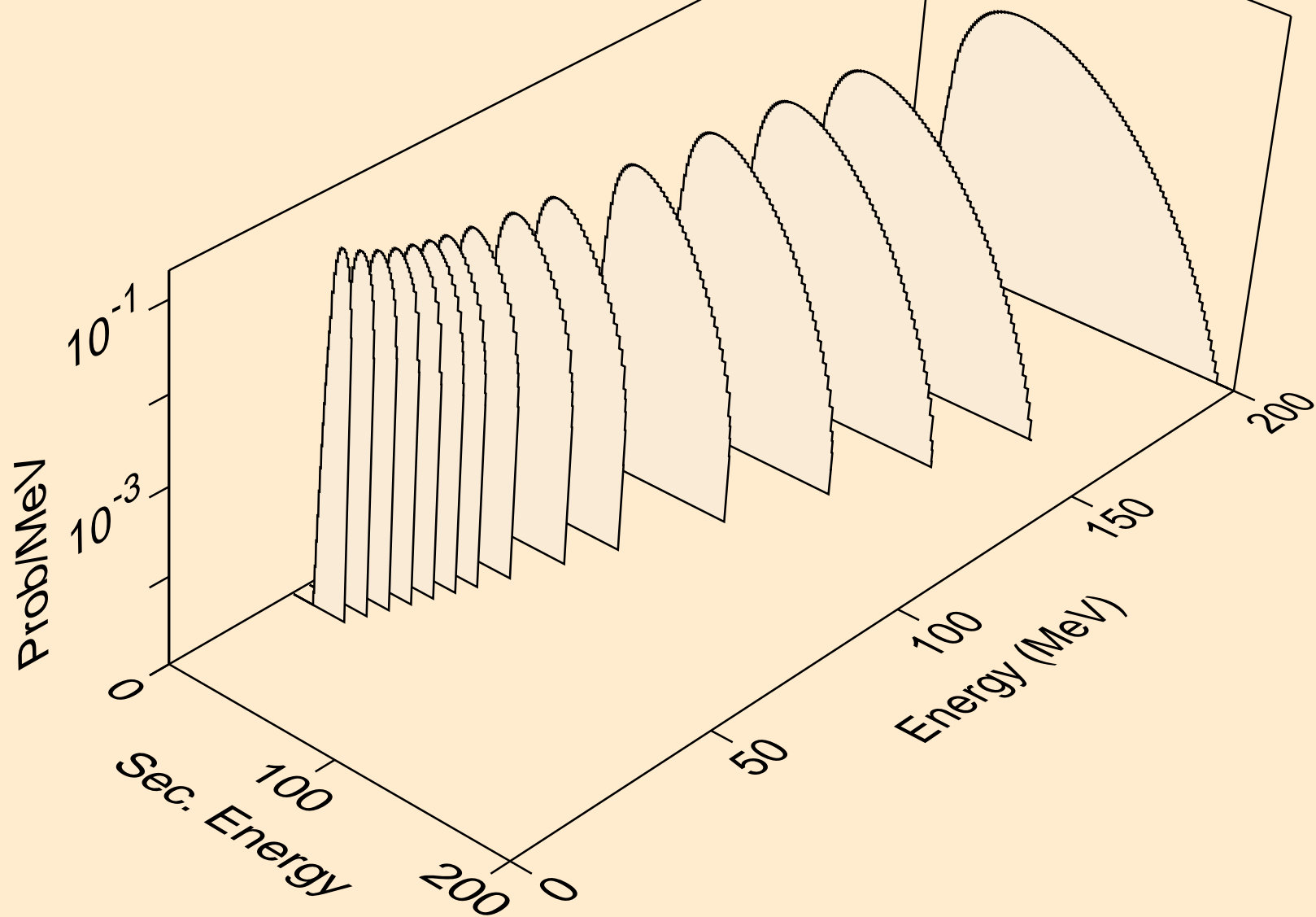

BI194M NEUTRON ACER TENDL-2024 LIBRARY; T=0.K  
he3s from (n,n\*)he3

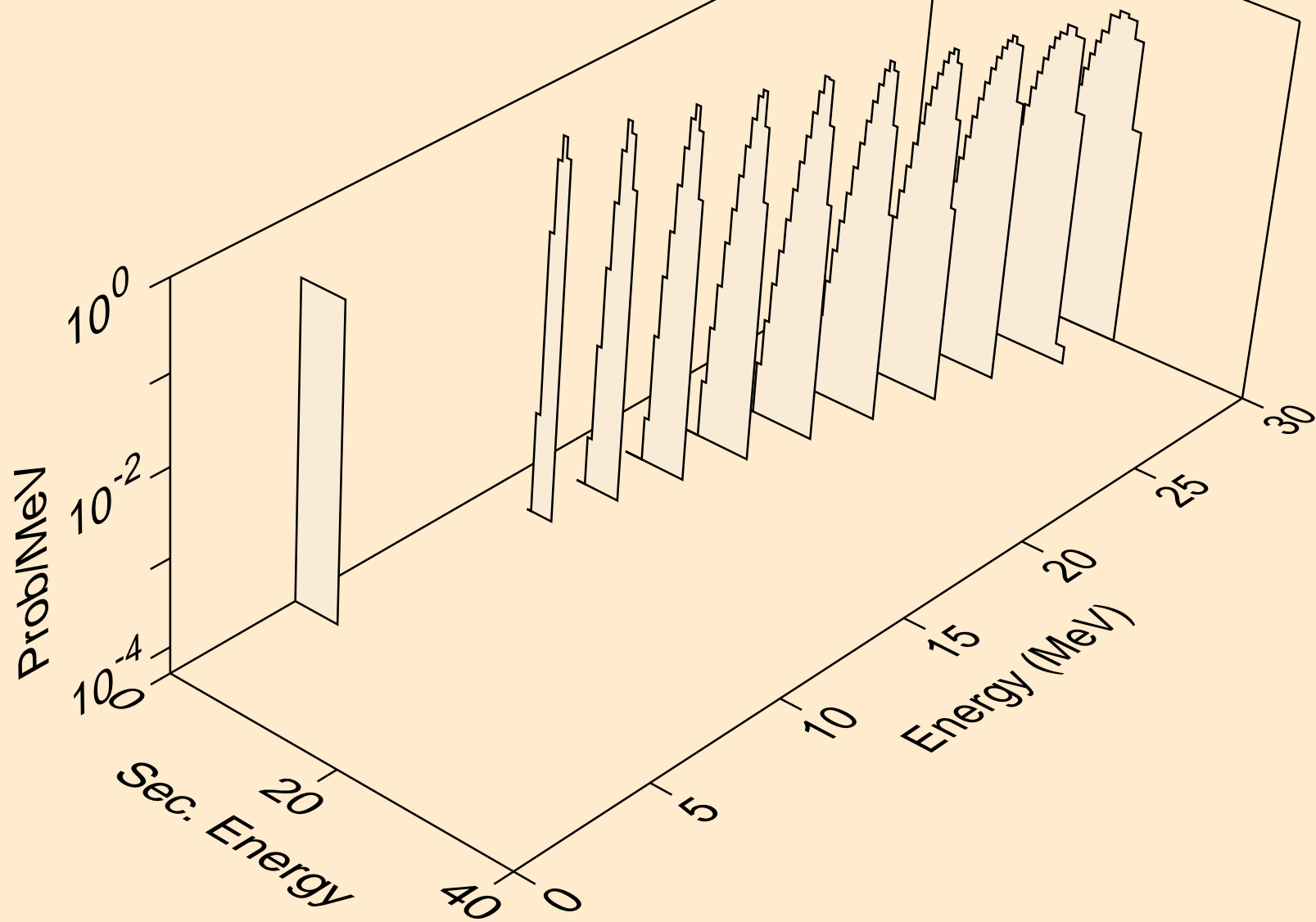

BI194M NEUTRON ACER TENDL-2024 LIBRARY; T=0.K  
he3s from (n,he3)

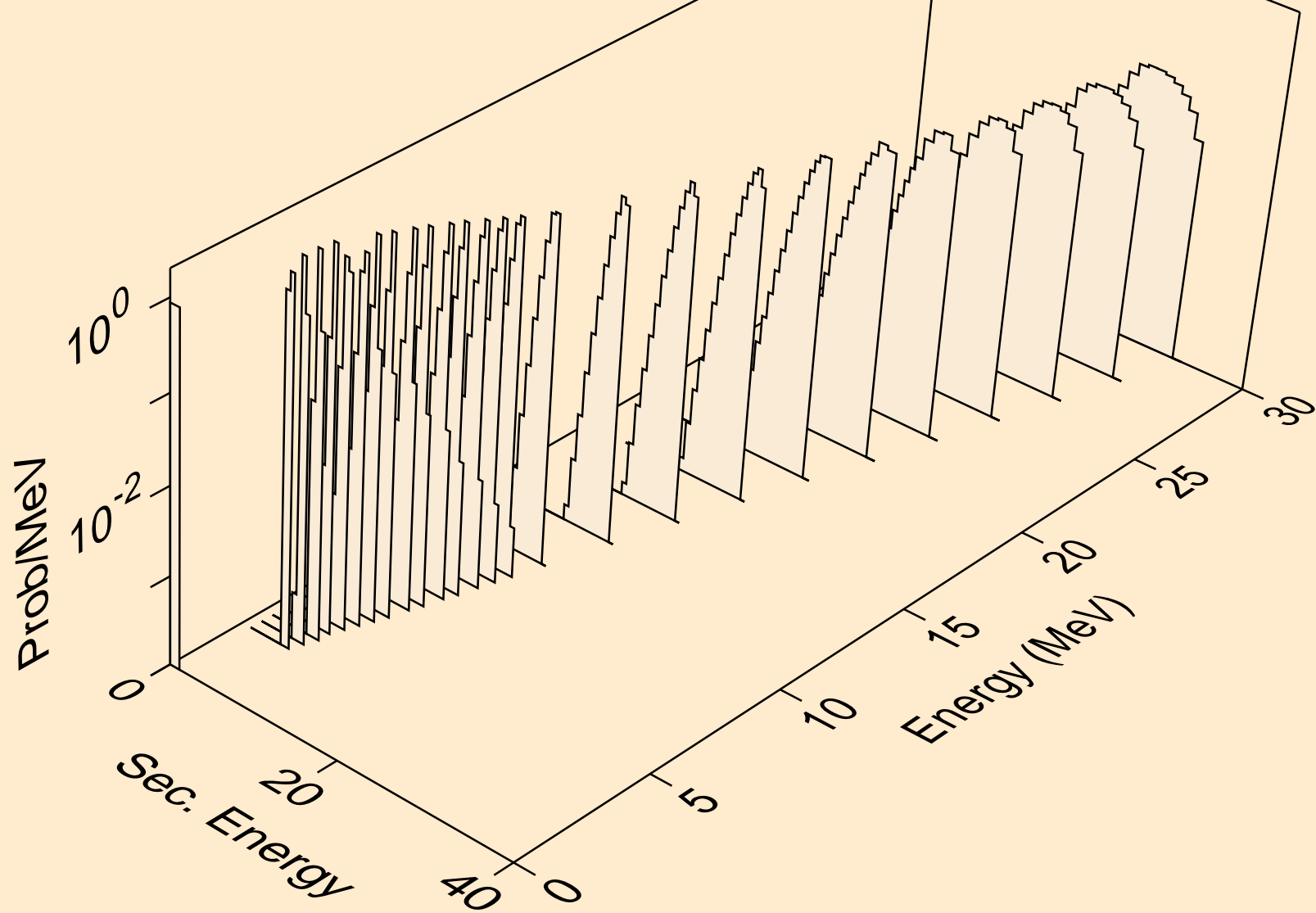

BI194M NEUTRON ACER TENDL-2024 LIBRARY; T=0.K  
alphas from (n,x)

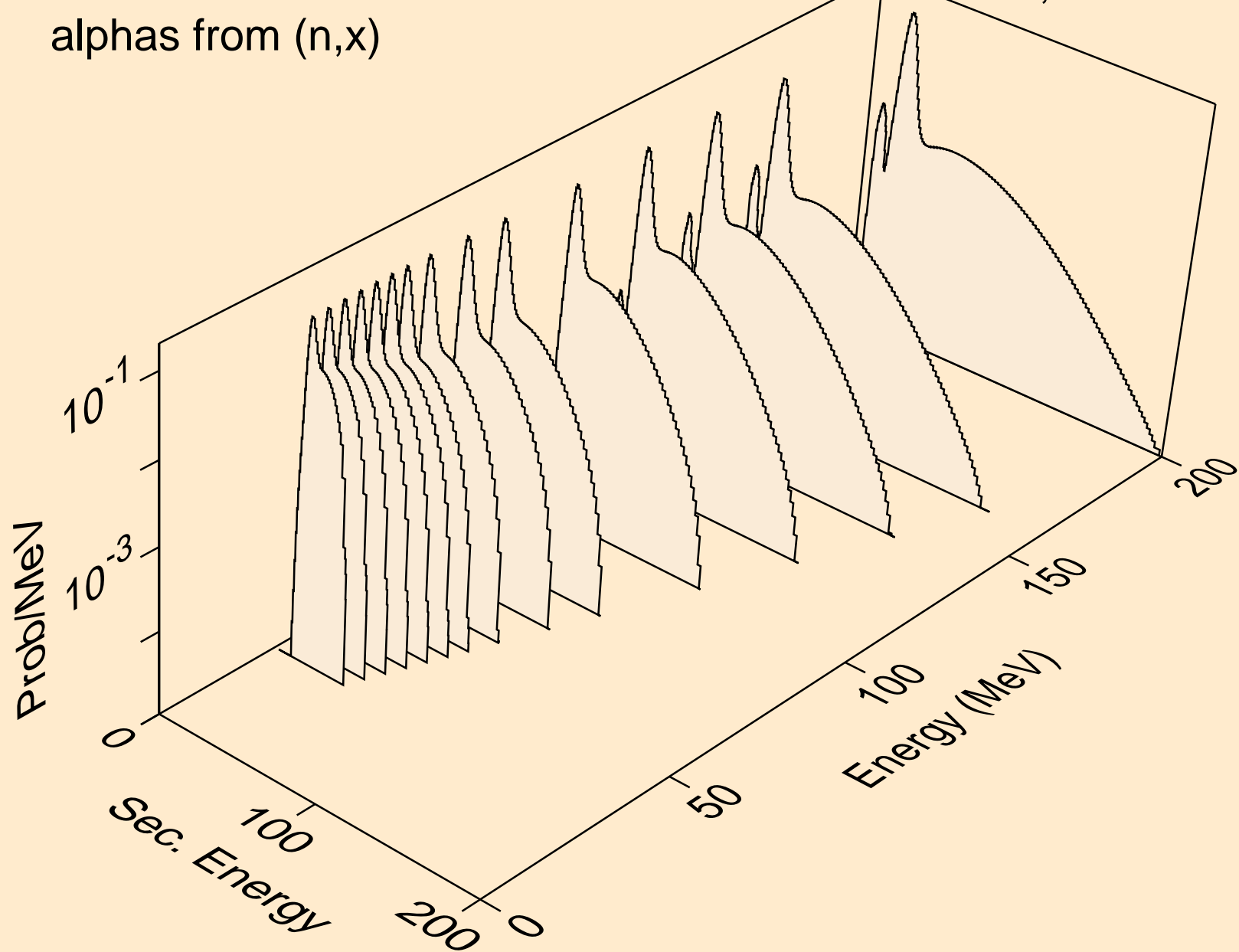



BI194M NEUTRON ACER TENDL-2024 LIBRARY; T=0.K  
alphas from (n,n\*)a

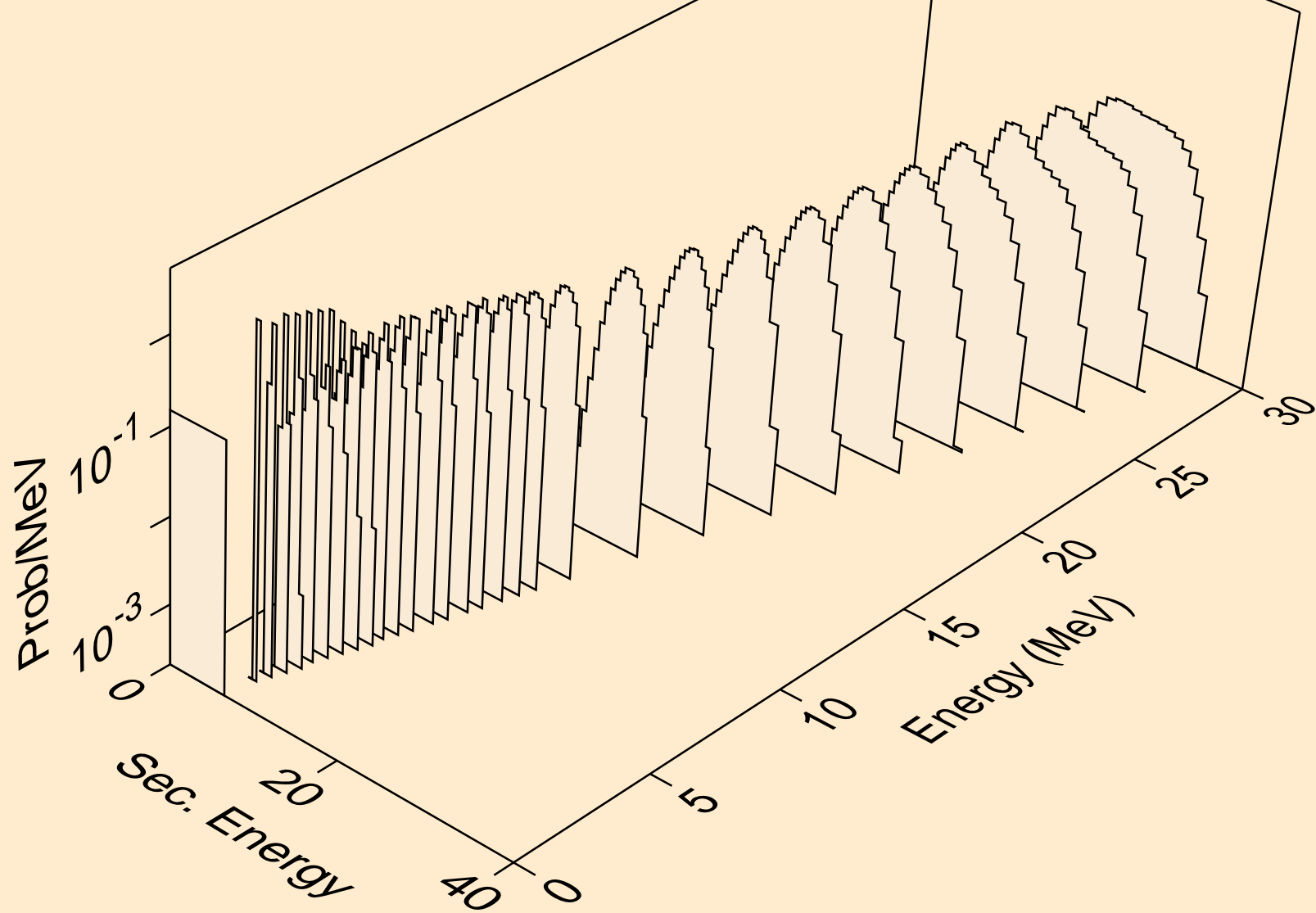

BI194M NEUTRON ACER TENDL-2024 LIBRARY; T=0.K  
alphas from (n,2n)a

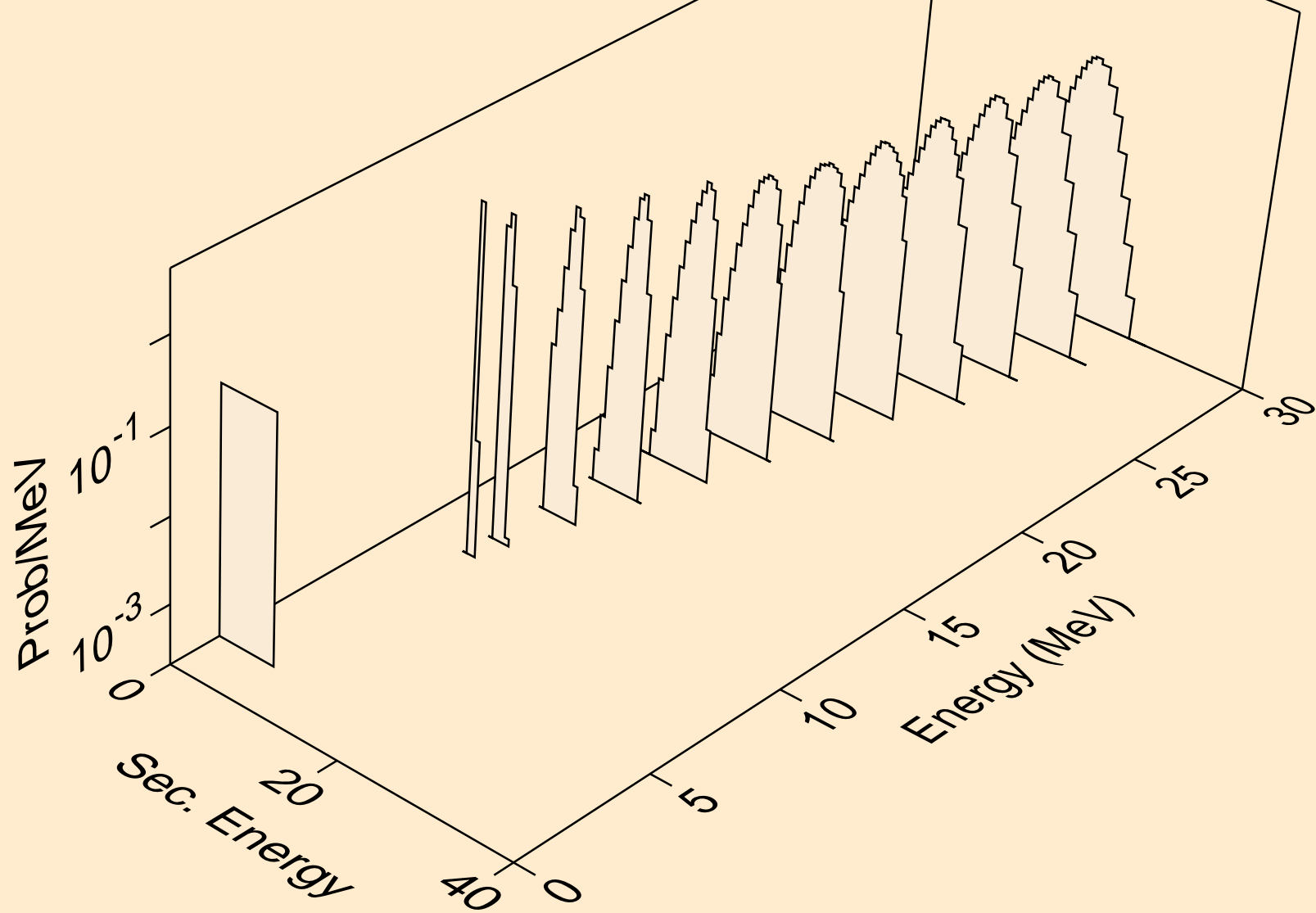

BI194M NEUTRON ACER TENDL-2024 LIBRARY; T=0.K  
alphas from (n,3n)a

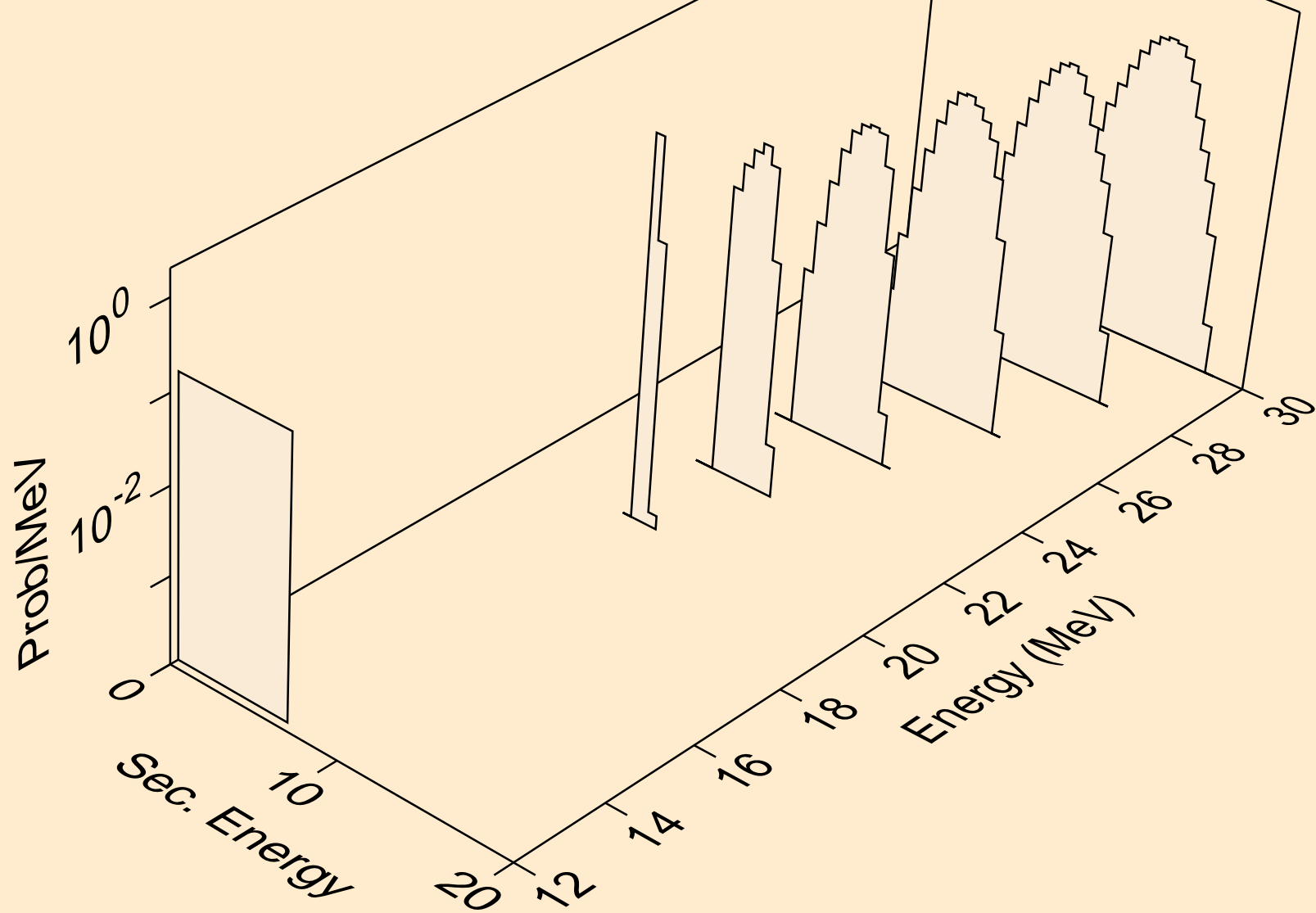

BI194M NEUTRON ACER TENDL-2024 LIBRARY; T=0.K  
alphas from (n,n\*)2a

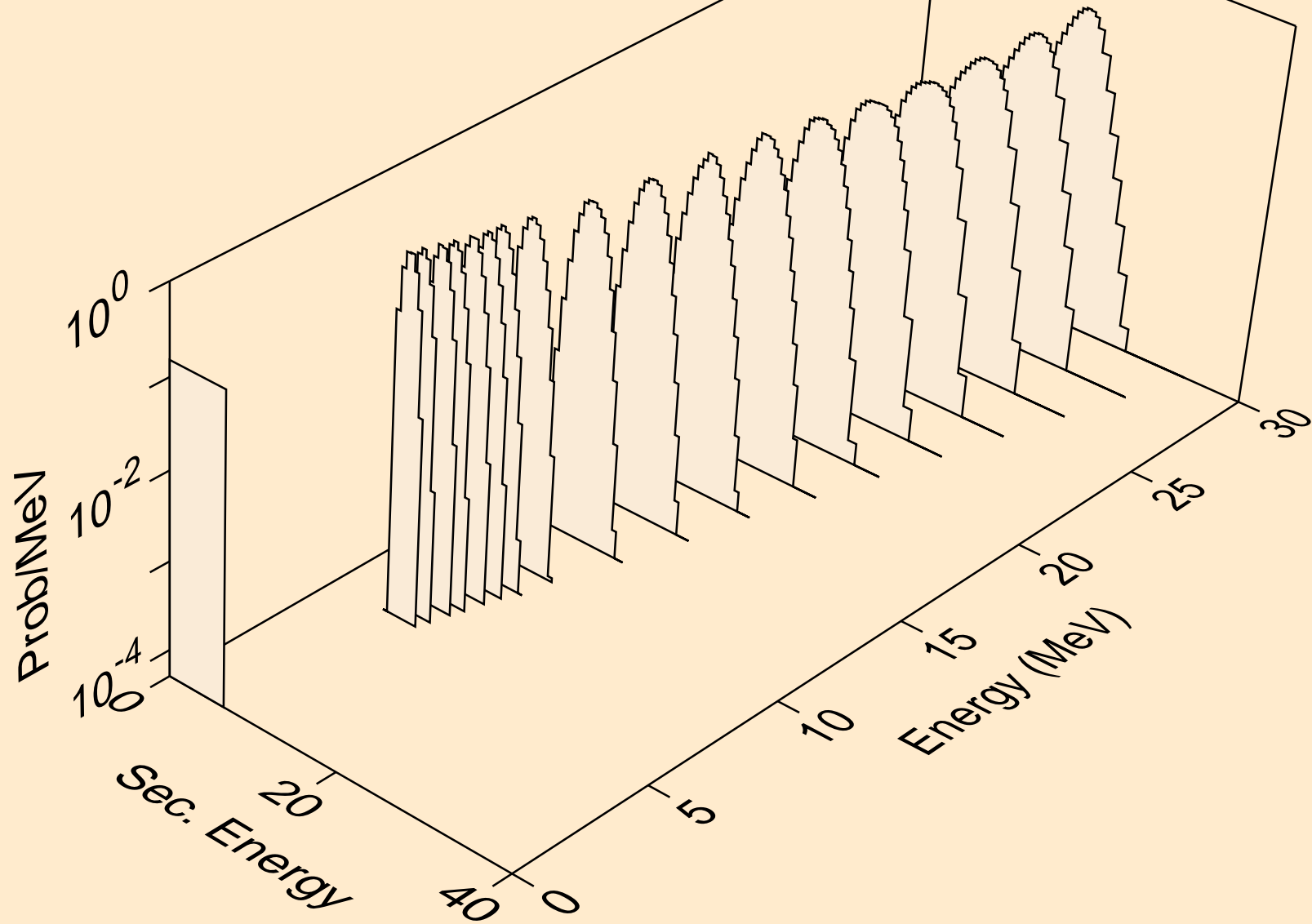

BI194M NEUTRON ACER TENDL-2024 LIBRARY; T=0.K  
alphas from (n,2n)2a

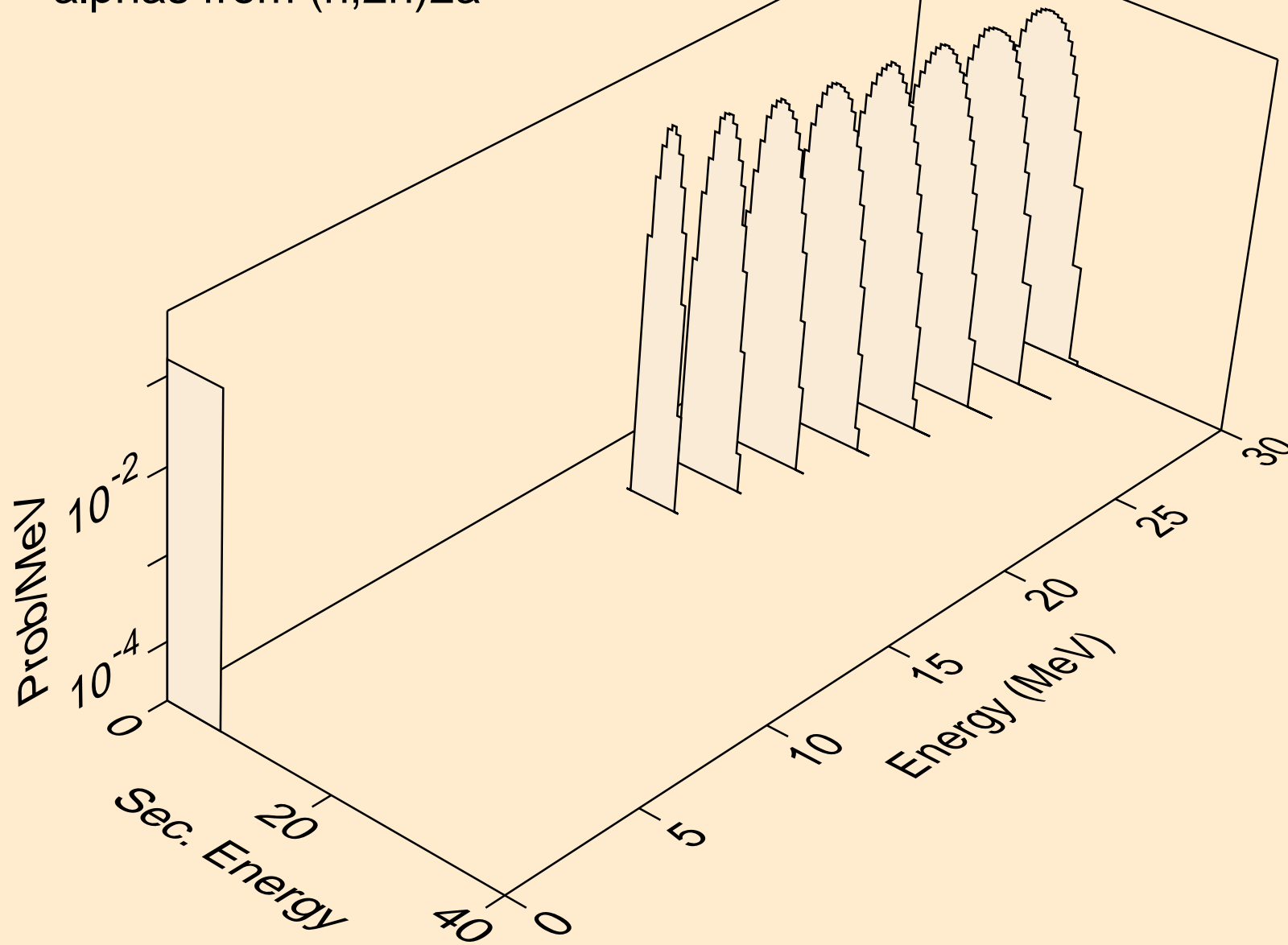

BI194M NEUTRON ACER TENDL-2024 LIBRARY; T=0.K  
alphas from (n,npa)

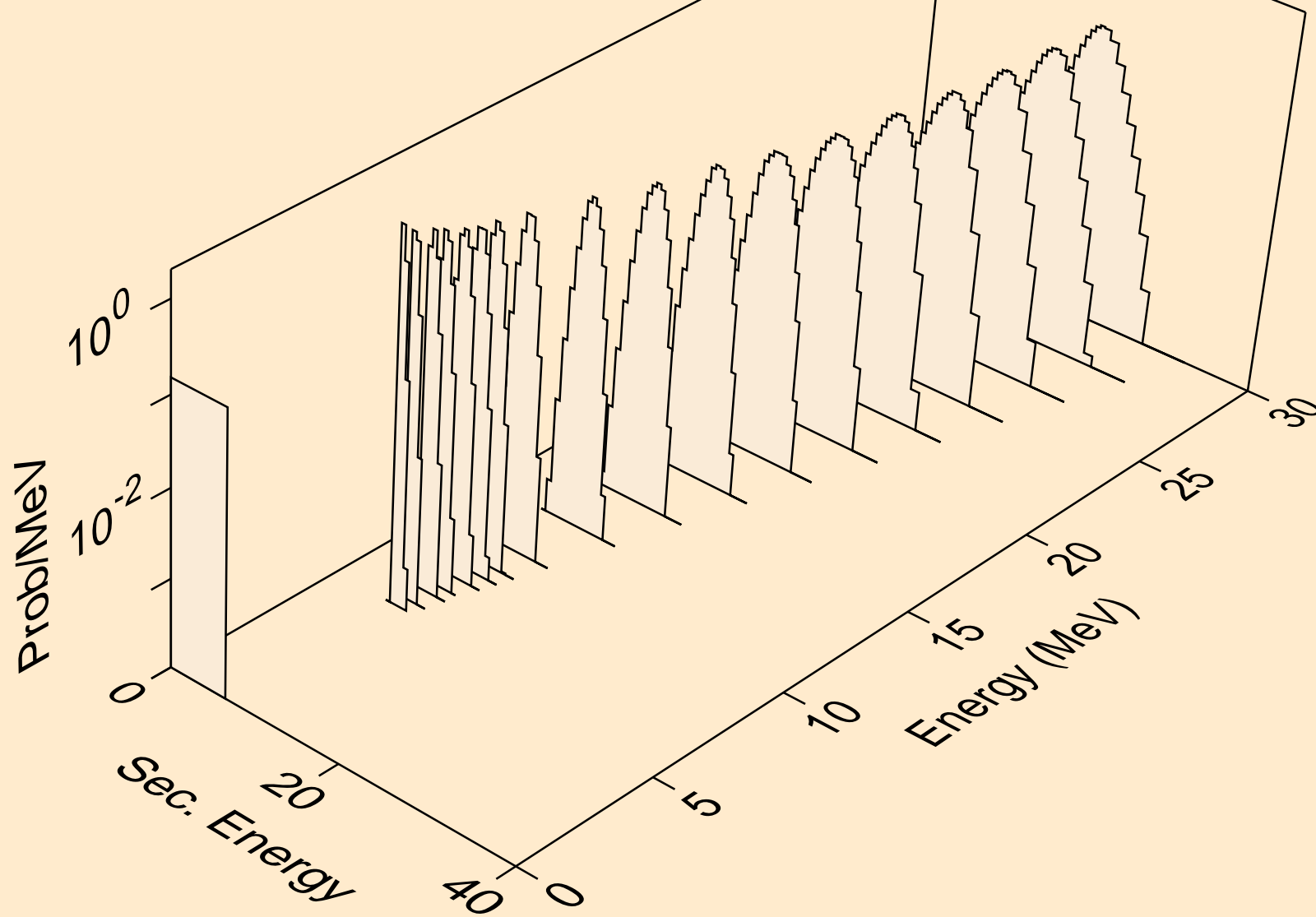

BI194M NEUTRON ACER TENDL-2024 LIBRARY; T=0.K  
alphas from (n,a)

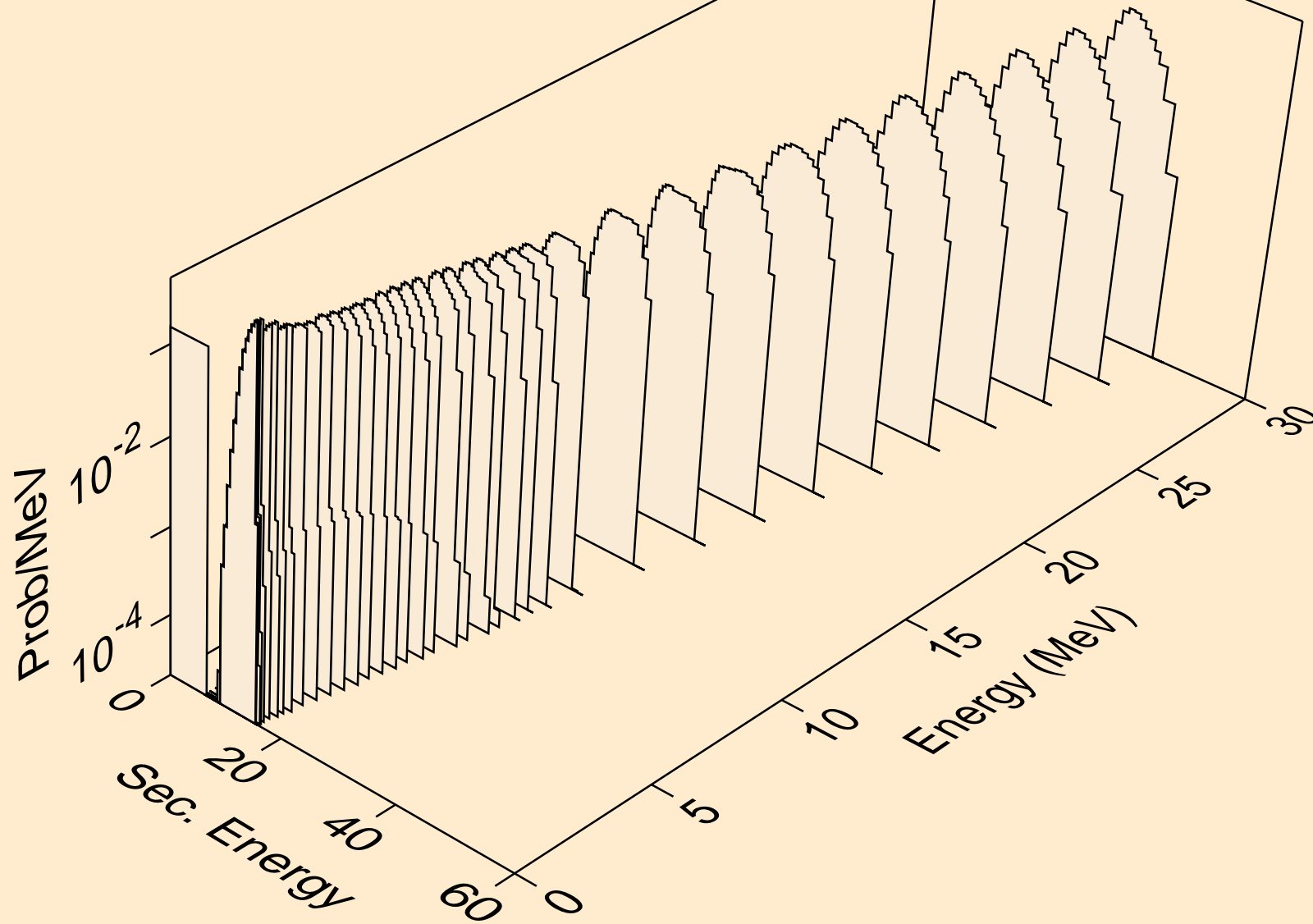

BI194M NEUTRON ACER TENDL-2024 LIBRARY; T=0.K  
alphas from (n,2a)

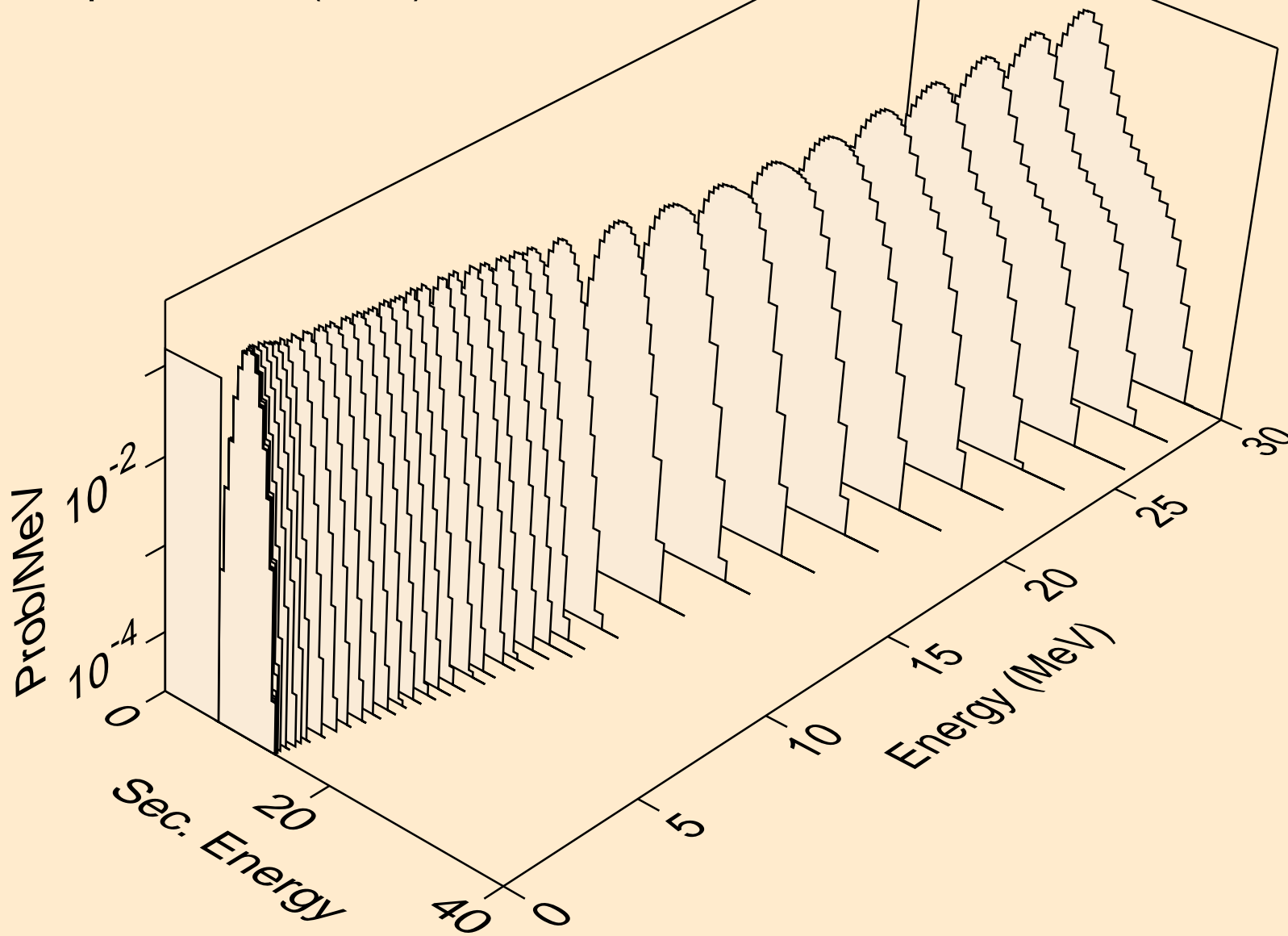



BI194M NEUTRON ACER TENDL-2024 LIBRARY; T=0.K  
alphas from (n,3a)

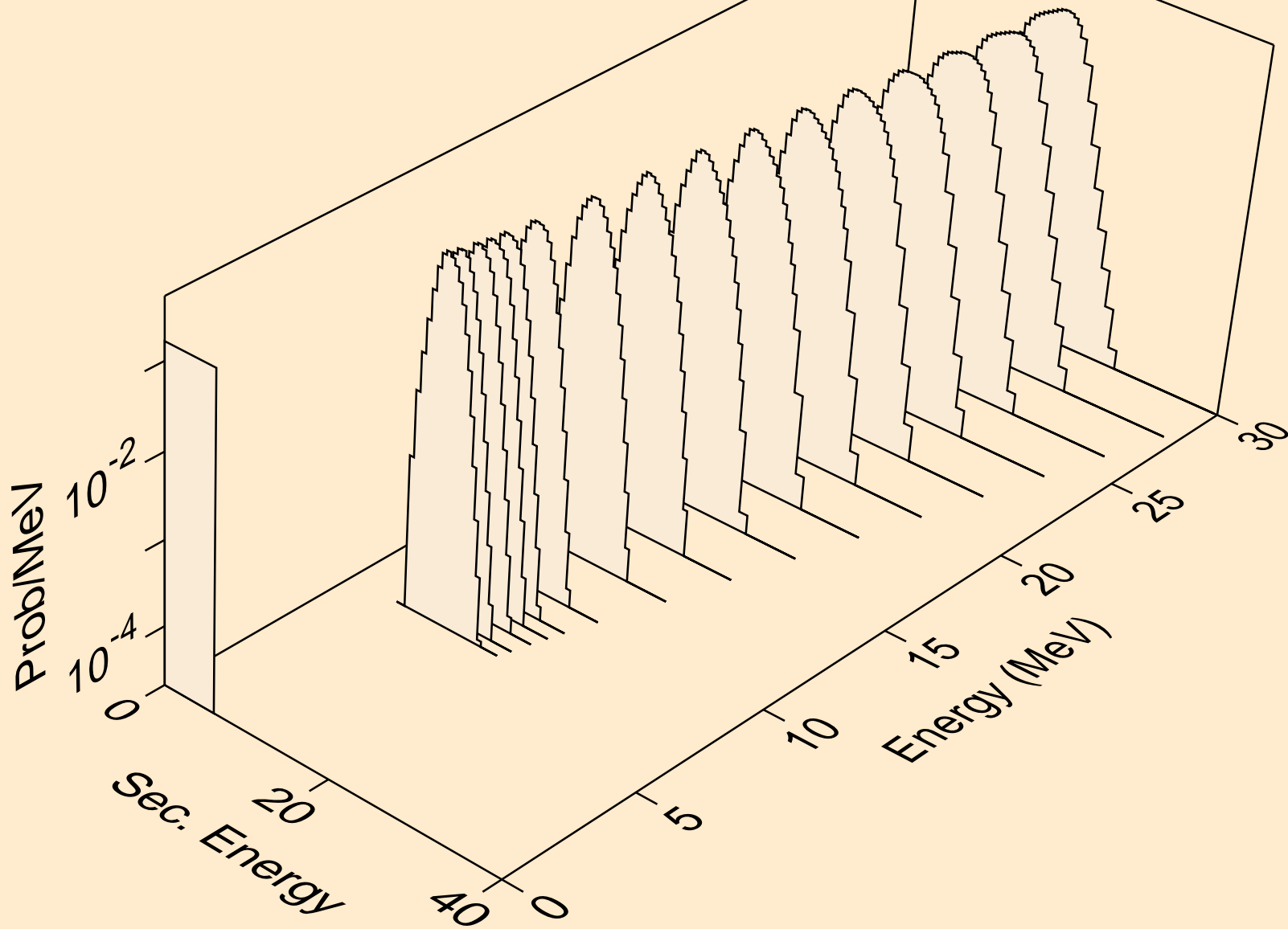

BI194M NEUTRON ACER TENDL-2024 LIBRARY; T=0.K  
alphas from (n,pa)

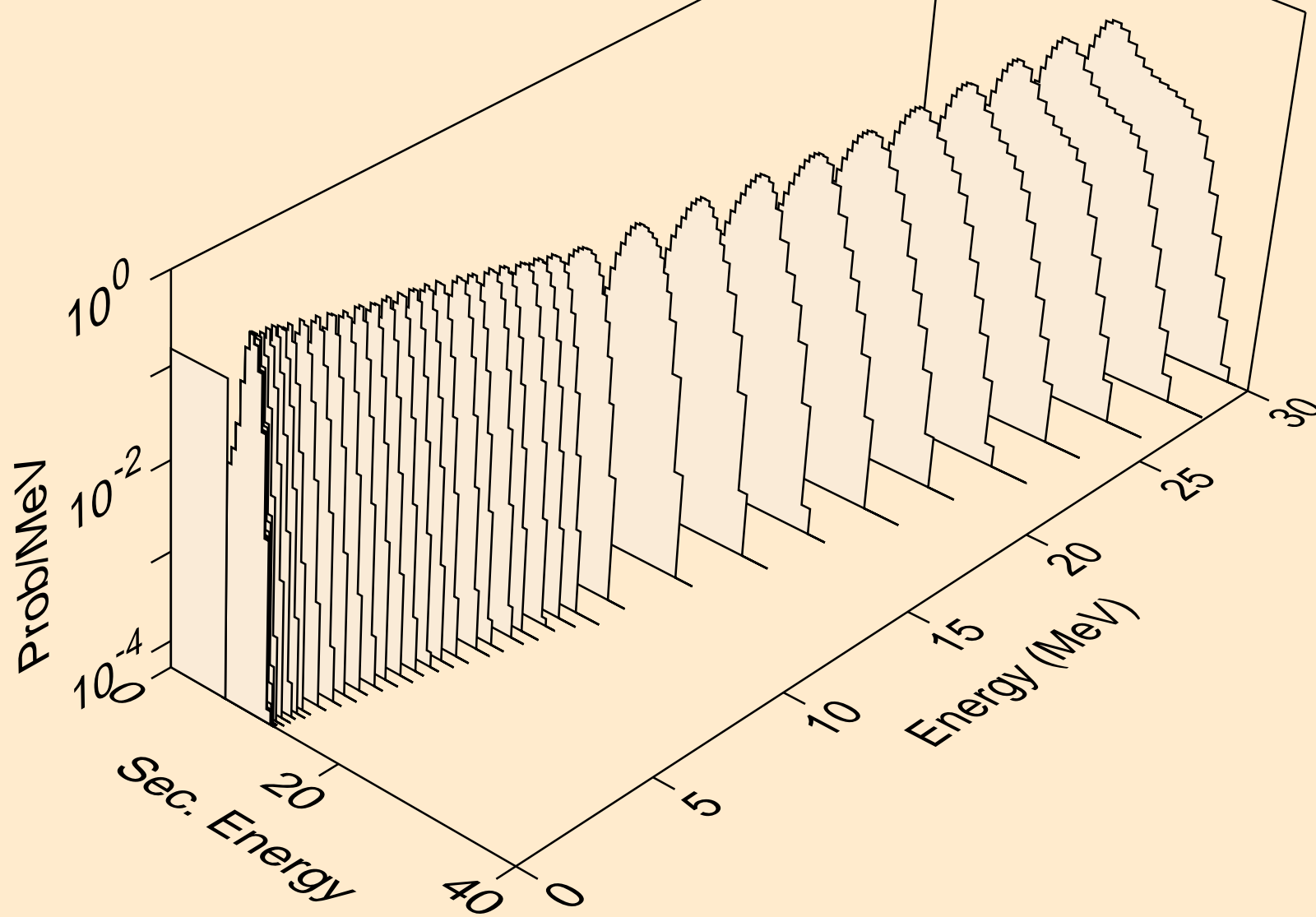

BI194M NEUTRON ACER TENDL-2024 LIBRARY; T=0.K  
alphas from (n,da)

