

BI224 NEUTRON ACER TENDL-2024 LIBRARY; T=0.K

Principal cross sections

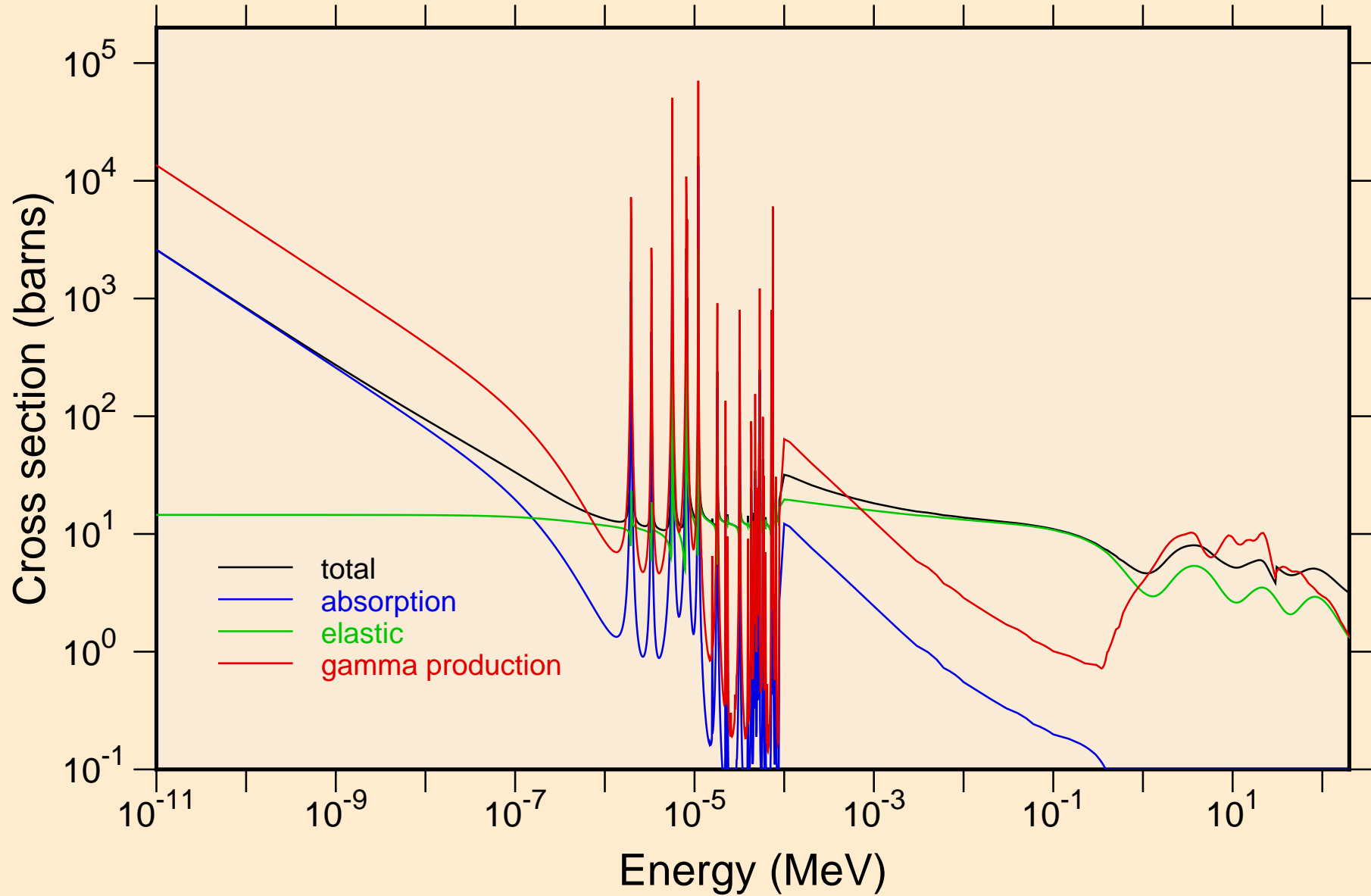

BI224 NEUTRON ACER TENDL-2024 LIBRARY; T=0.K
resonance total cross section

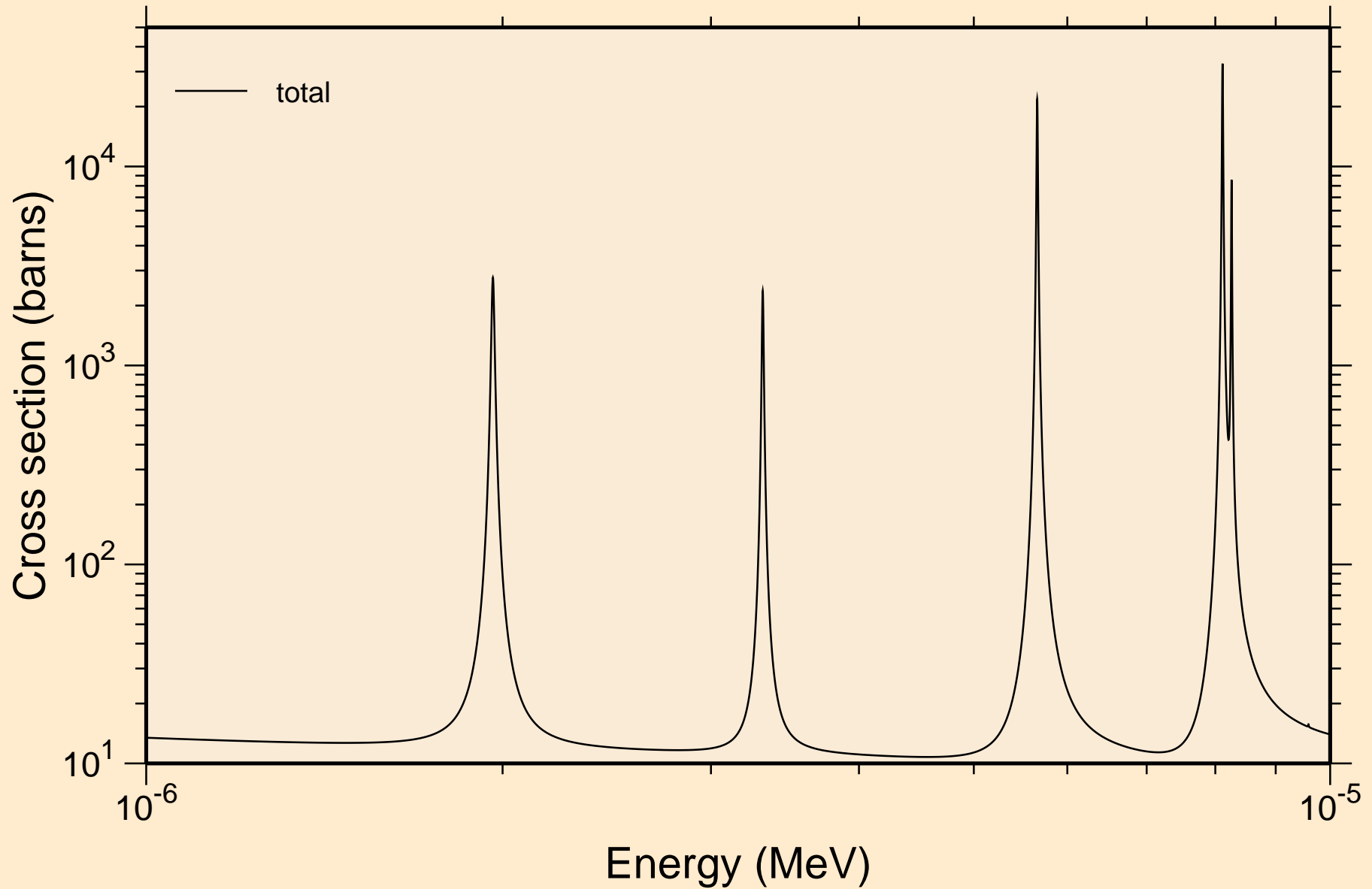

BI224 NEUTRON ACER TENDL-2024 LIBRARY; T=0.K
resonance total cross section

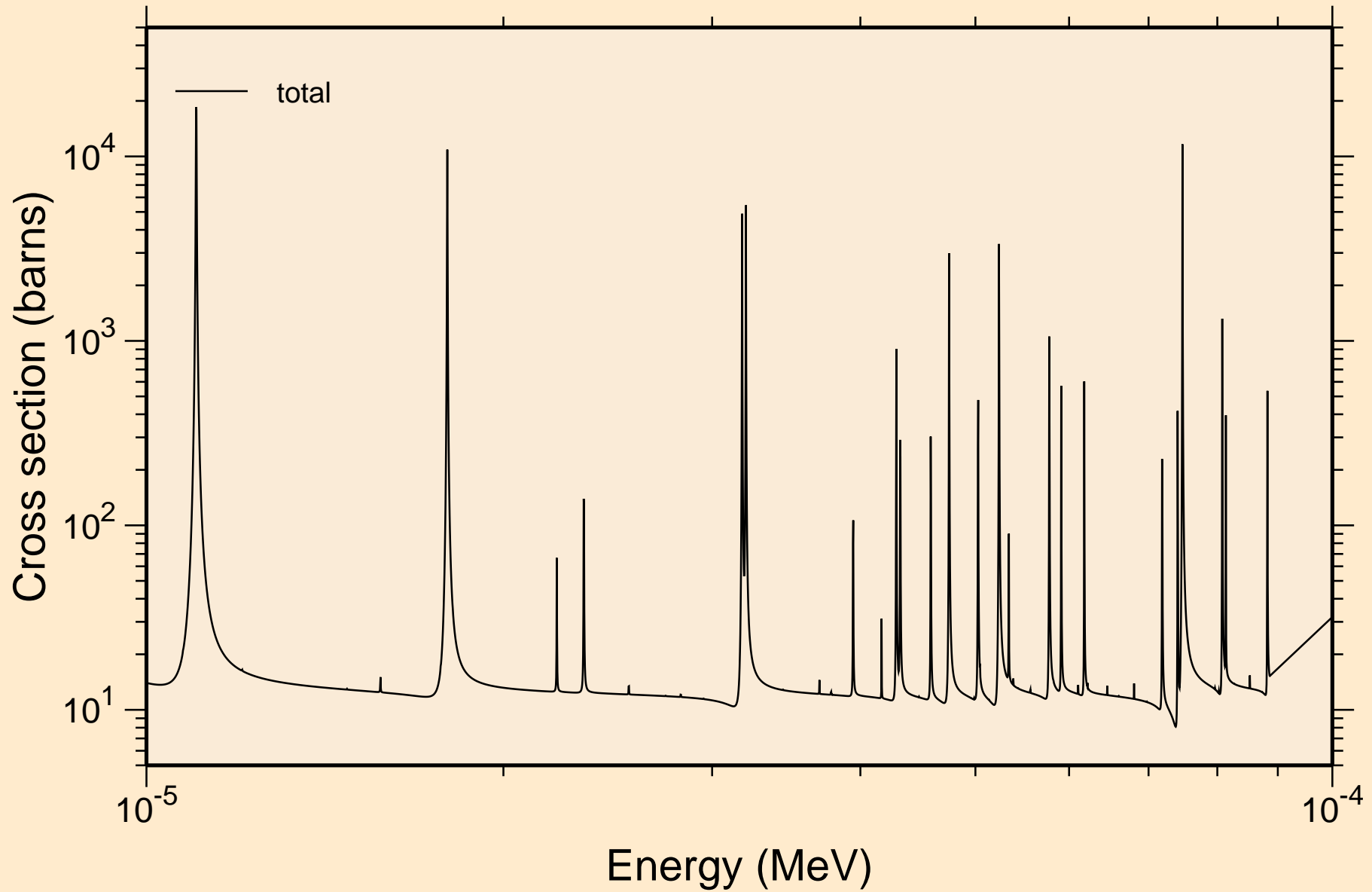

BI224 NEUTRON ACER TENDL-2024 LIBRARY; T=0.K
resonance total cross section

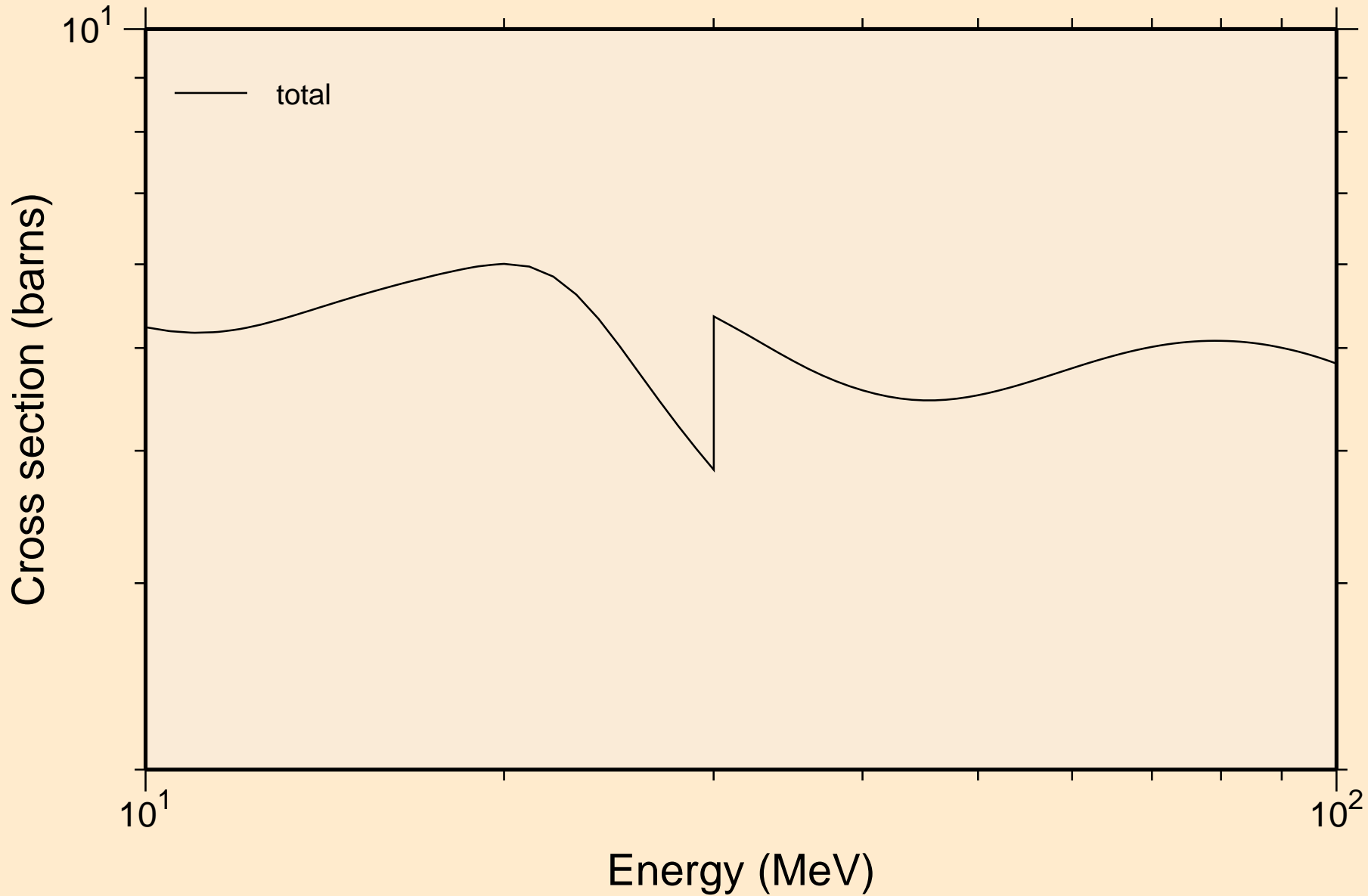

BI224 NEUTRON ACER TENDL-2024 LIBRARY; T=0.K
resonance absorption cross sections

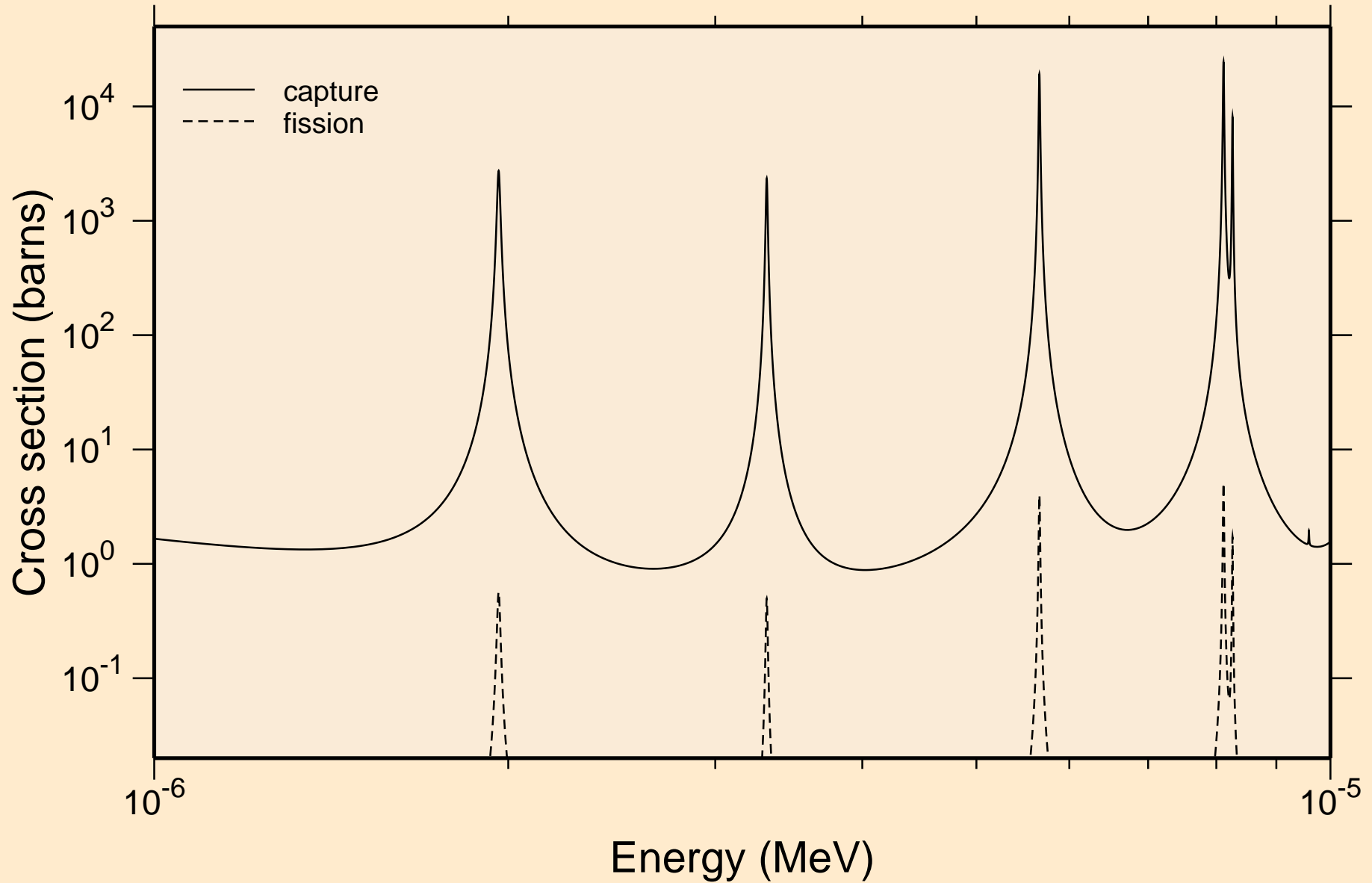

BI224 NEUTRON ACER TENDL-2024 LIBRARY; T=0.K

resonance absorption cross sections

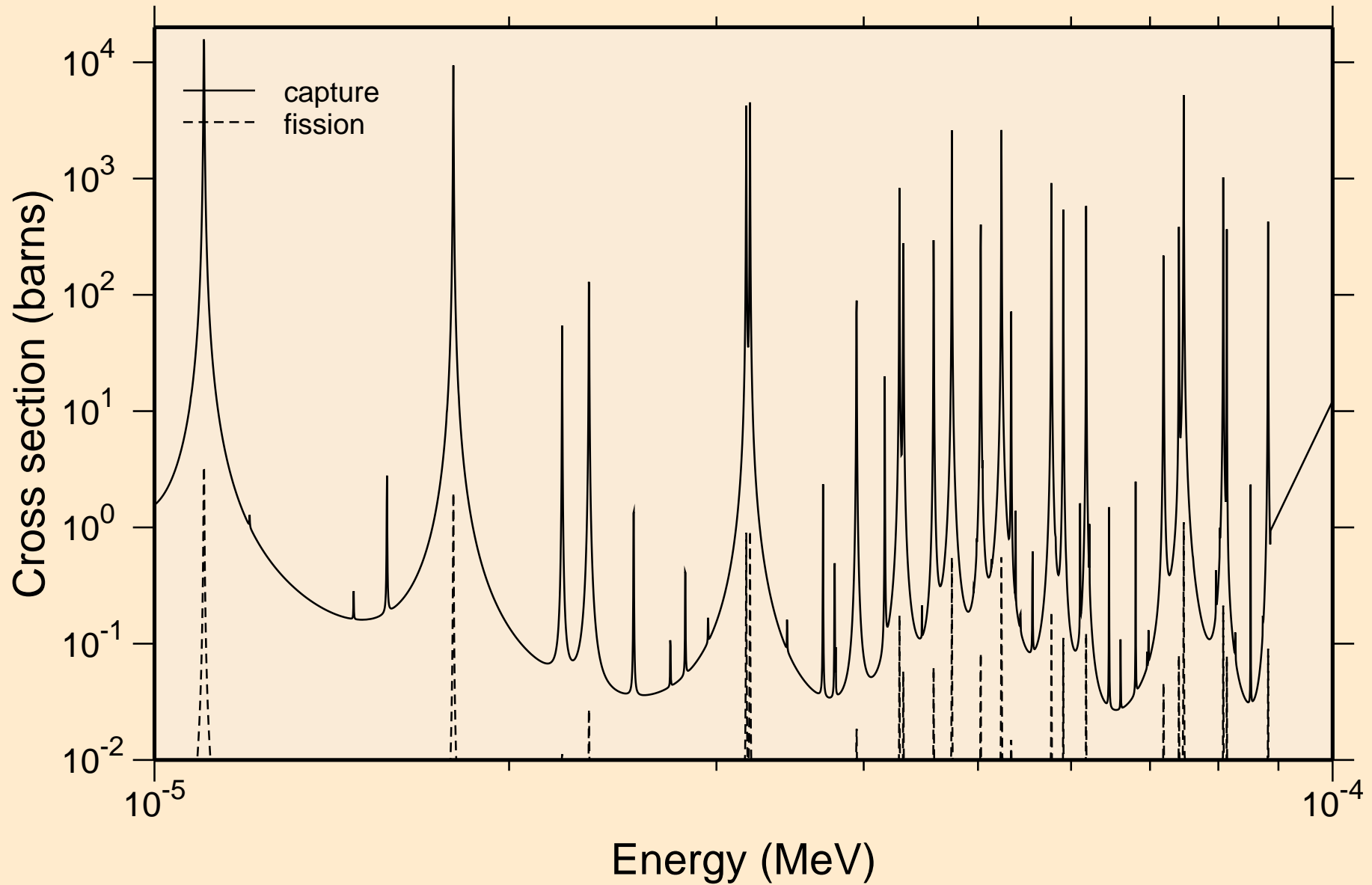

BI224 NEUTRON ACER TENDL-2024 LIBRARY; T=0.K
resonance absorption cross sections

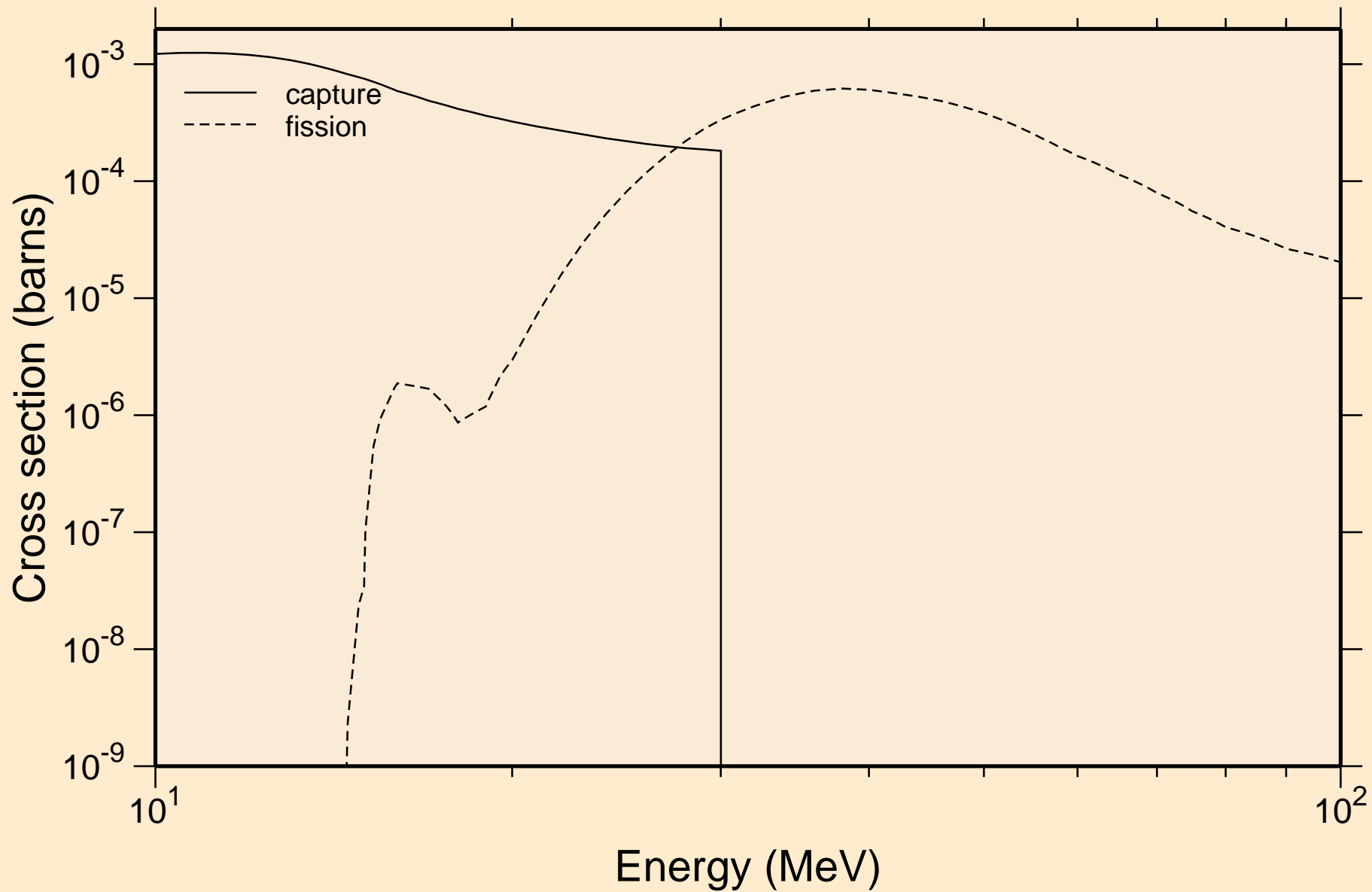

BI224 NEUTRON ACER TENDL-2024 LIBRARY; T=0.K

Heating

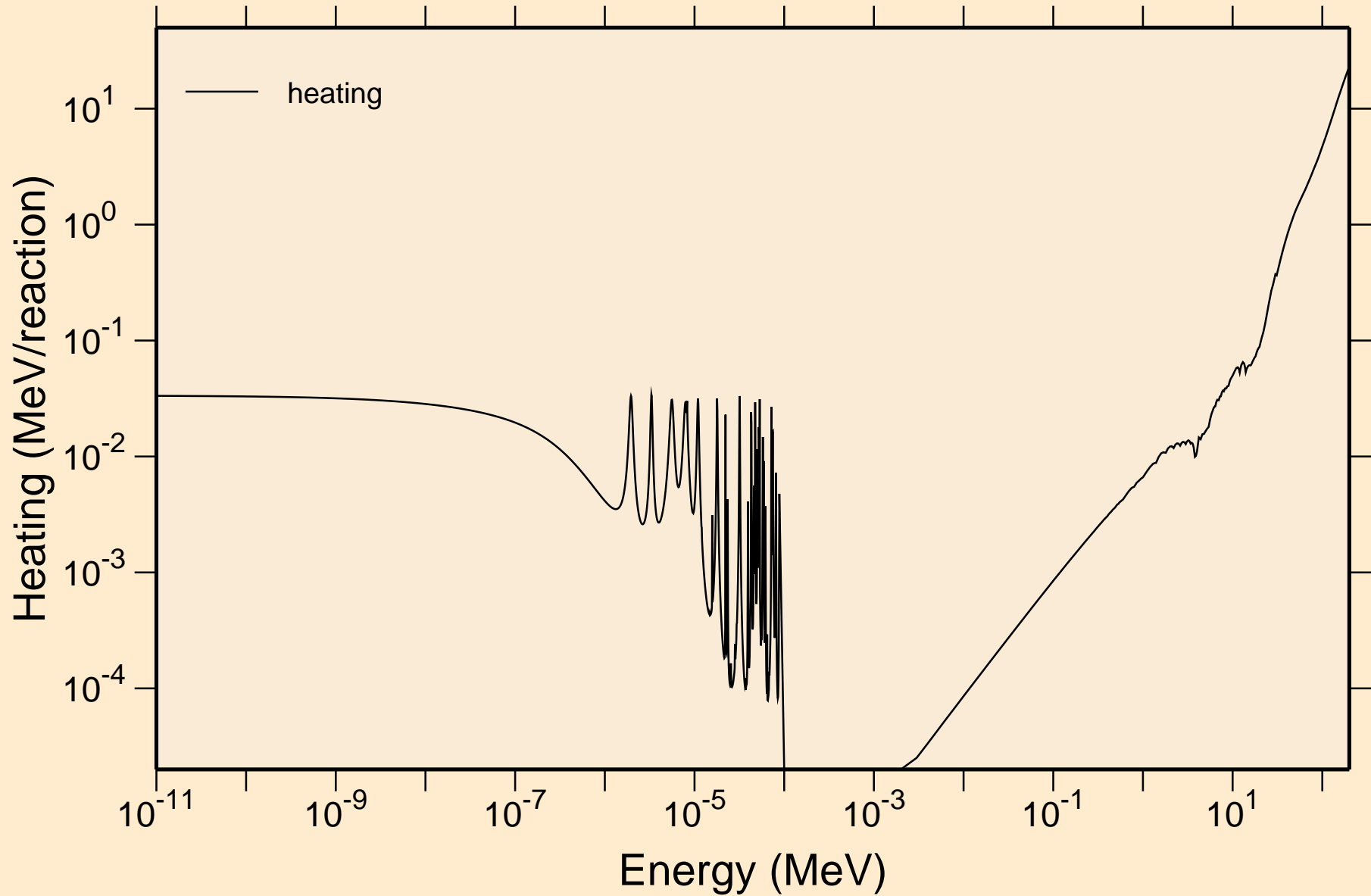

BI224 NEUTRON ACER TENDL-2024 LIBRARY; T=0.K

Damage

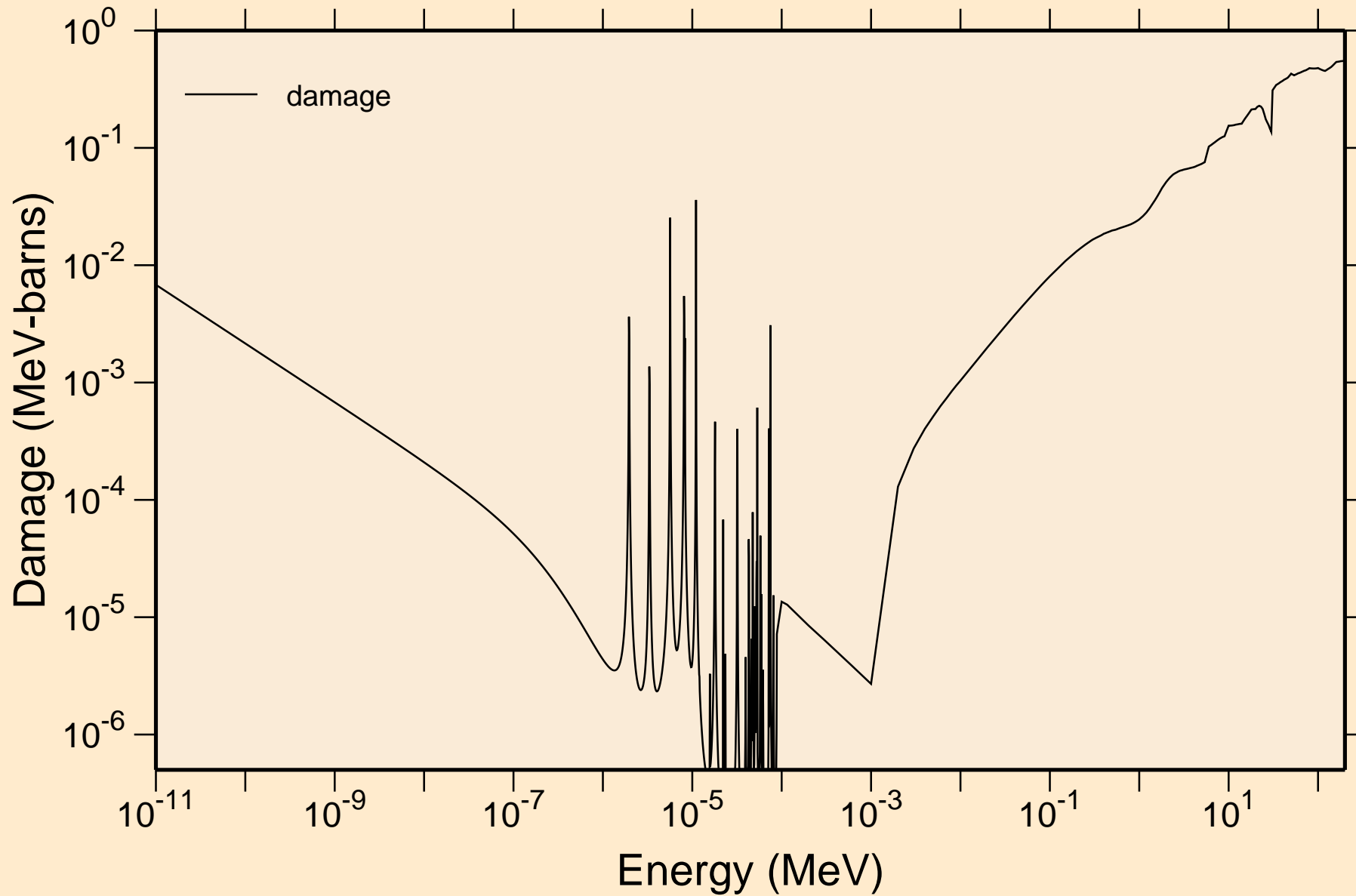

BI224 NEUTRON ACER TENDL-2024 LIBRARY; T=0.K

Non-threshold reactions

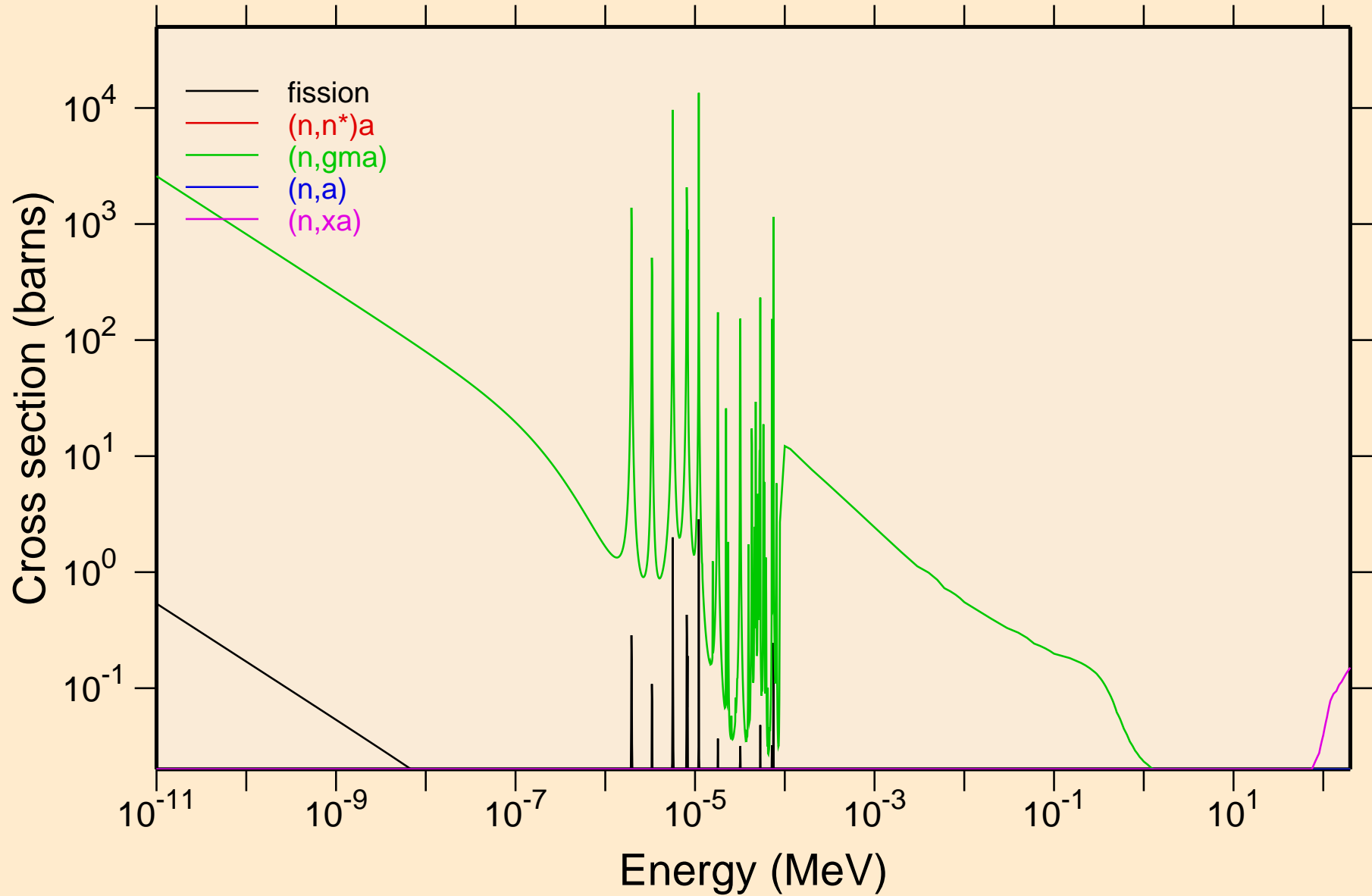

BI224 NEUTRON ACER TENDL-2024 LIBRARY; T=0.K

Principal cross sections

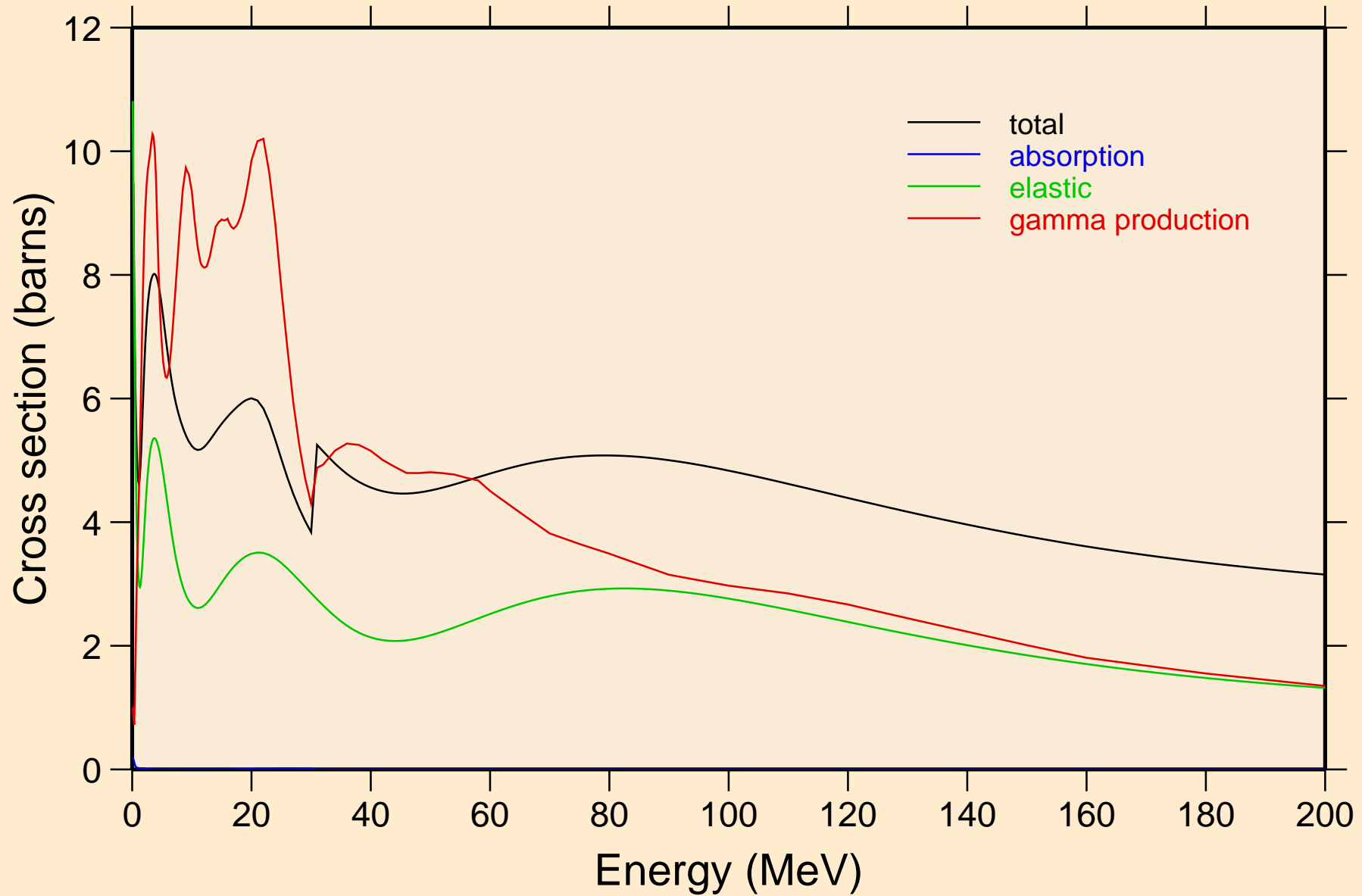

BI224 NEUTRON ACER TENDL-2024 LIBRARY; T=0.K

Heating

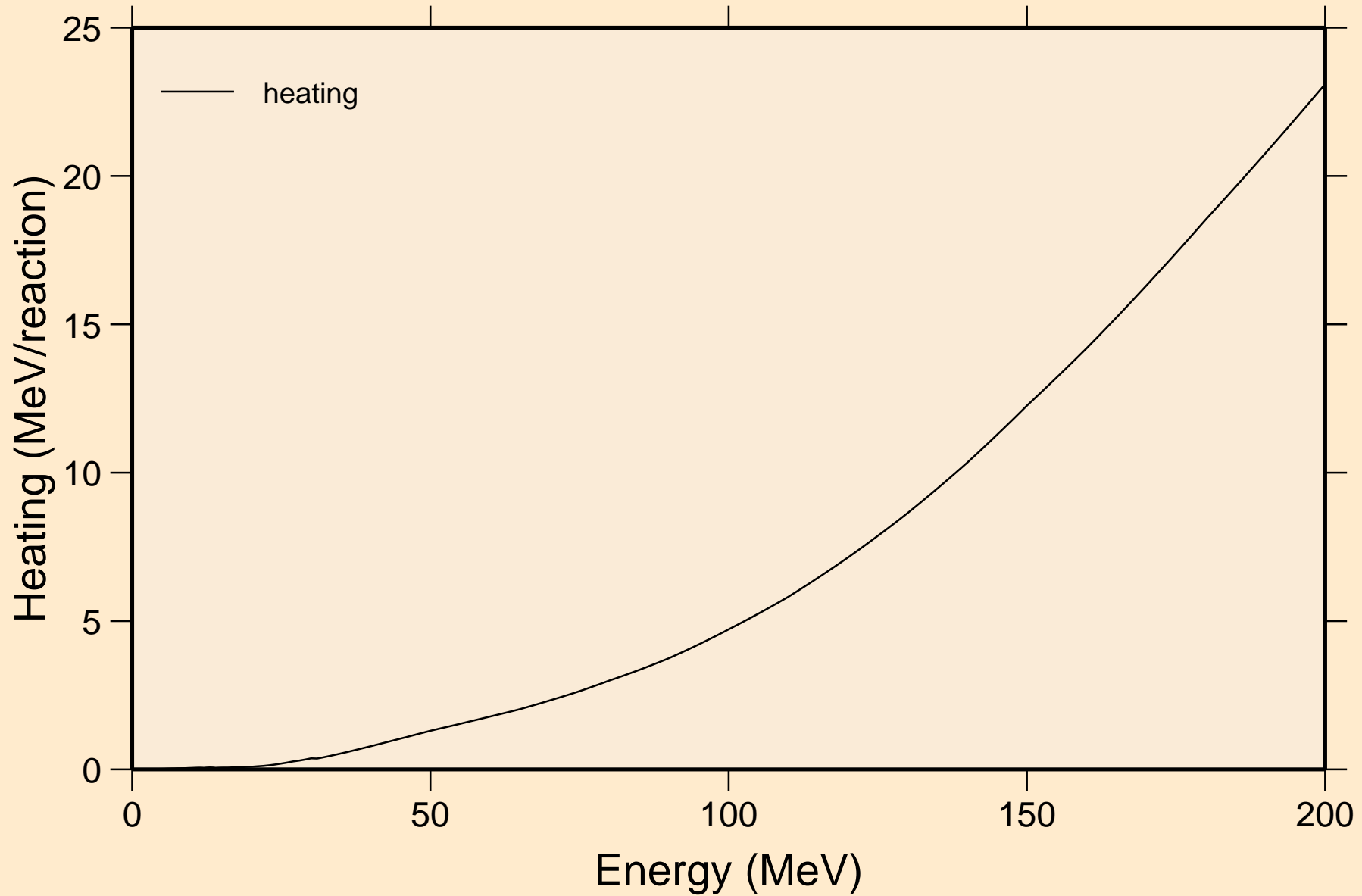

BI224 NEUTRON ACER TENDL-2024 LIBRARY; T=0.K
Damage

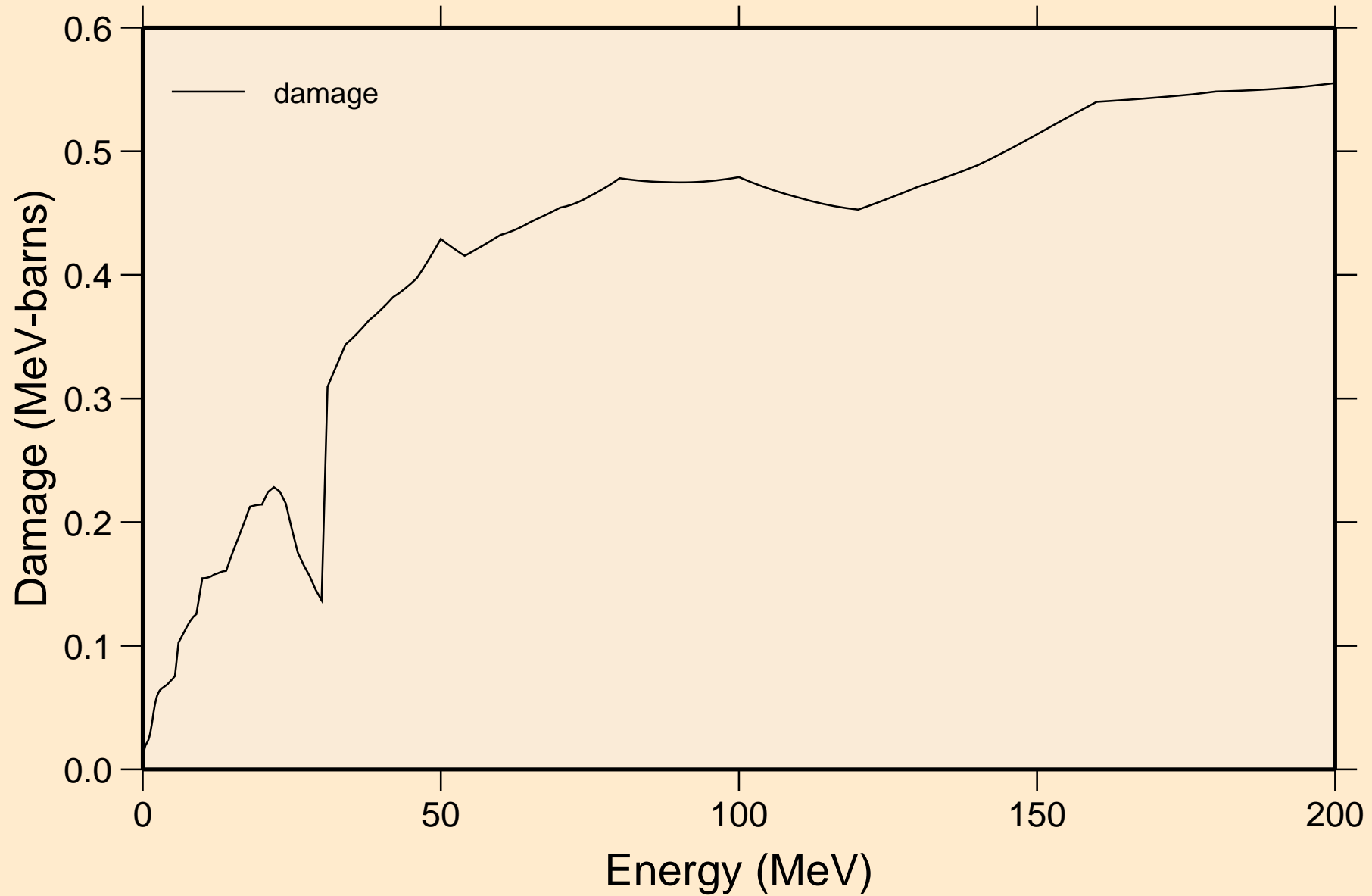

BI224 NEUTRON ACER TENDL-2024 LIBRARY; T=0.K

Non-threshold reactions

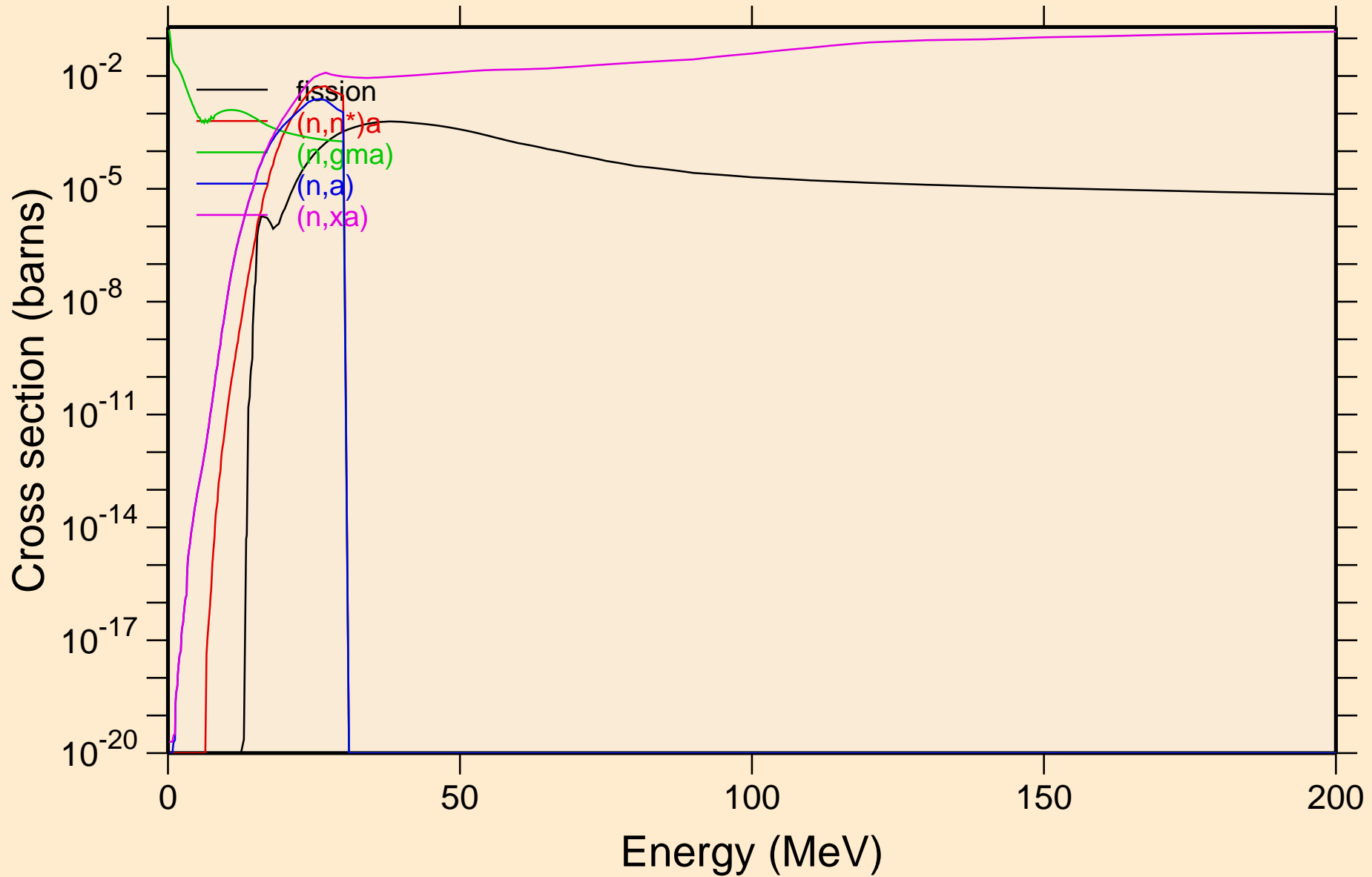

BI224 NEUTRON ACER TENDL-2024 LIBRARY; T=0.K
Inelastic levels

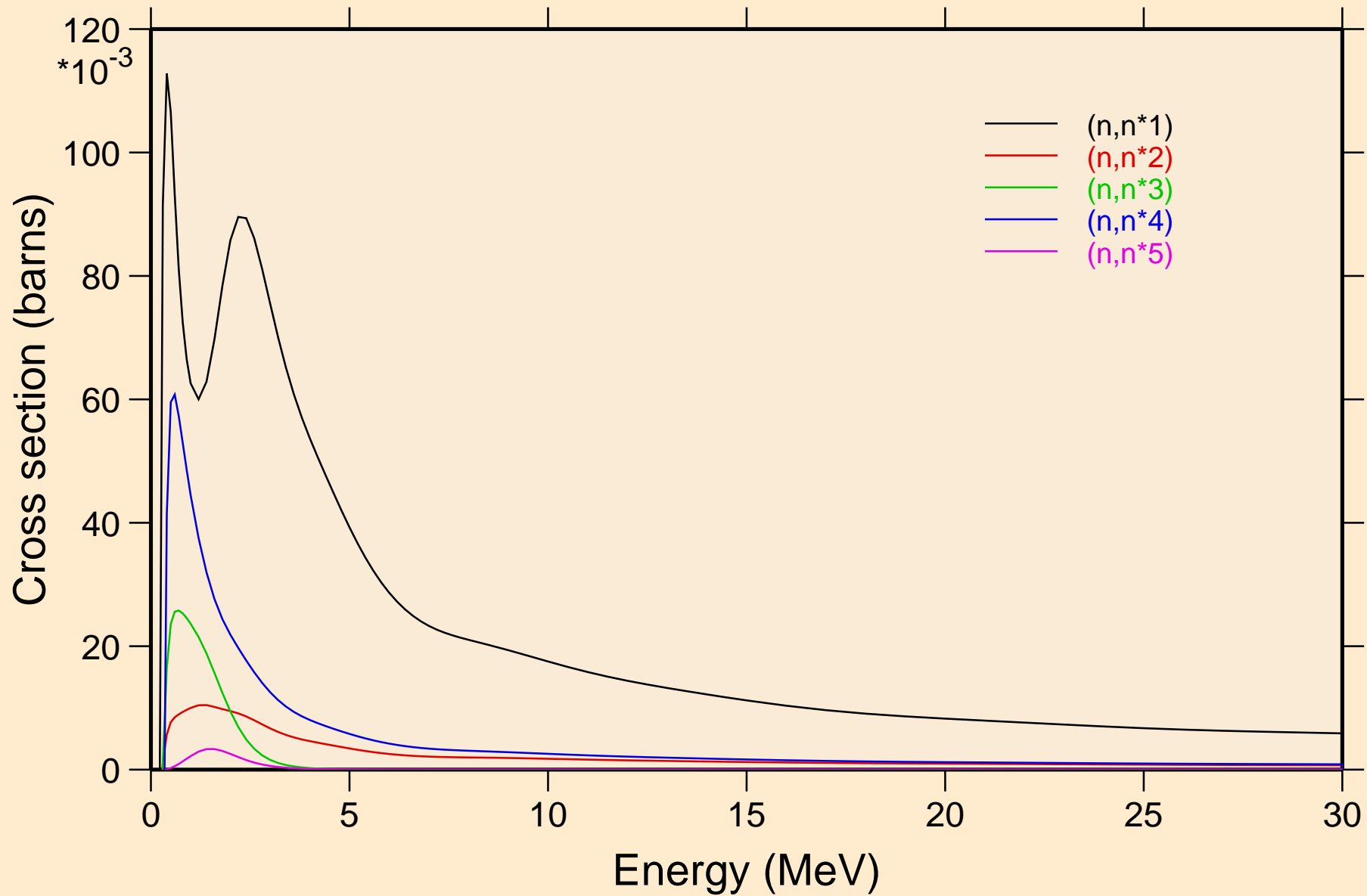

BI224 NEUTRON ACER TENDL-2024 LIBRARY; T=0.K
Inelastic levels

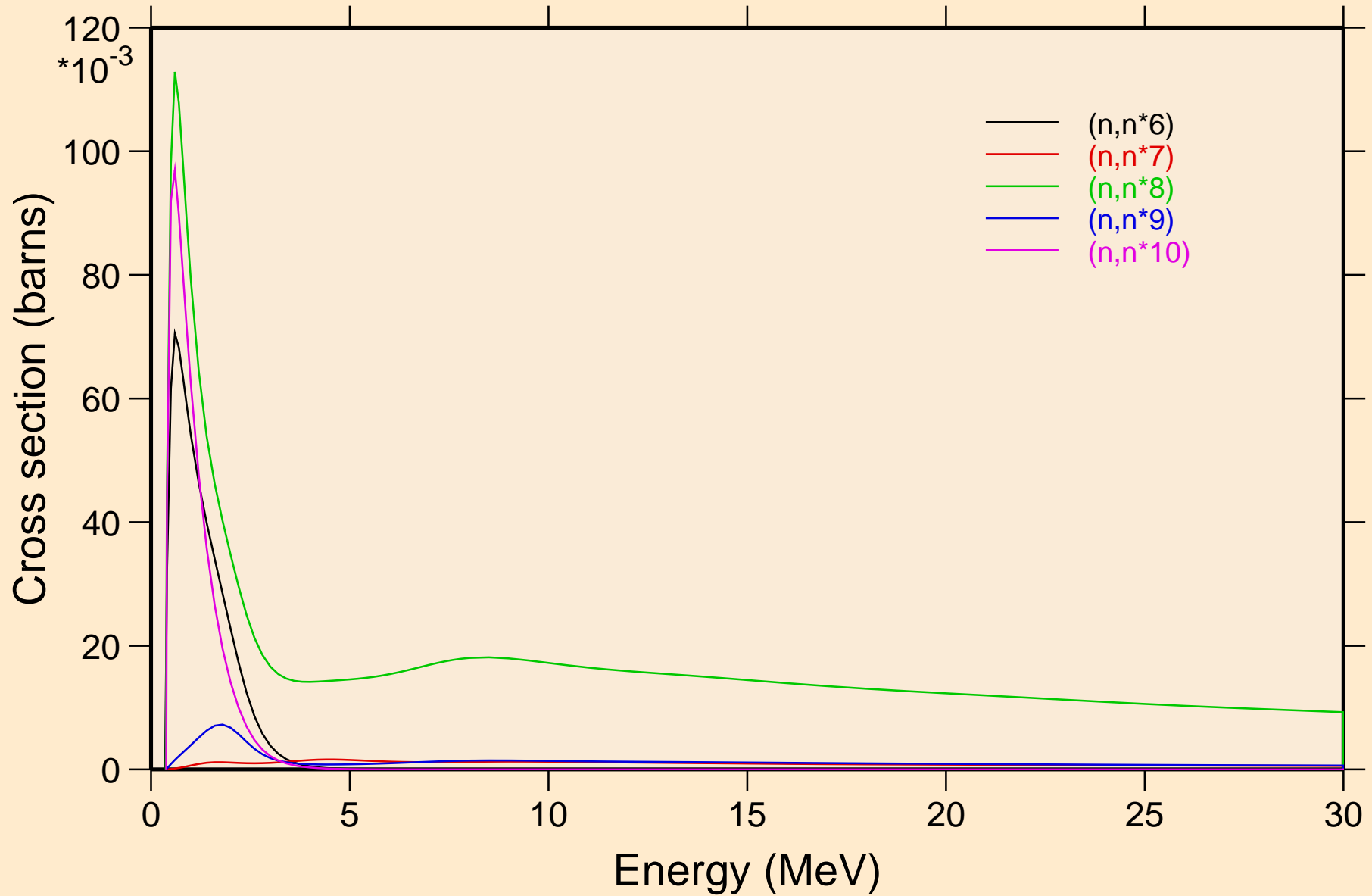

BI224 NEUTRON ACER TENDL-2024 LIBRARY; T=0.K
Inelastic levels

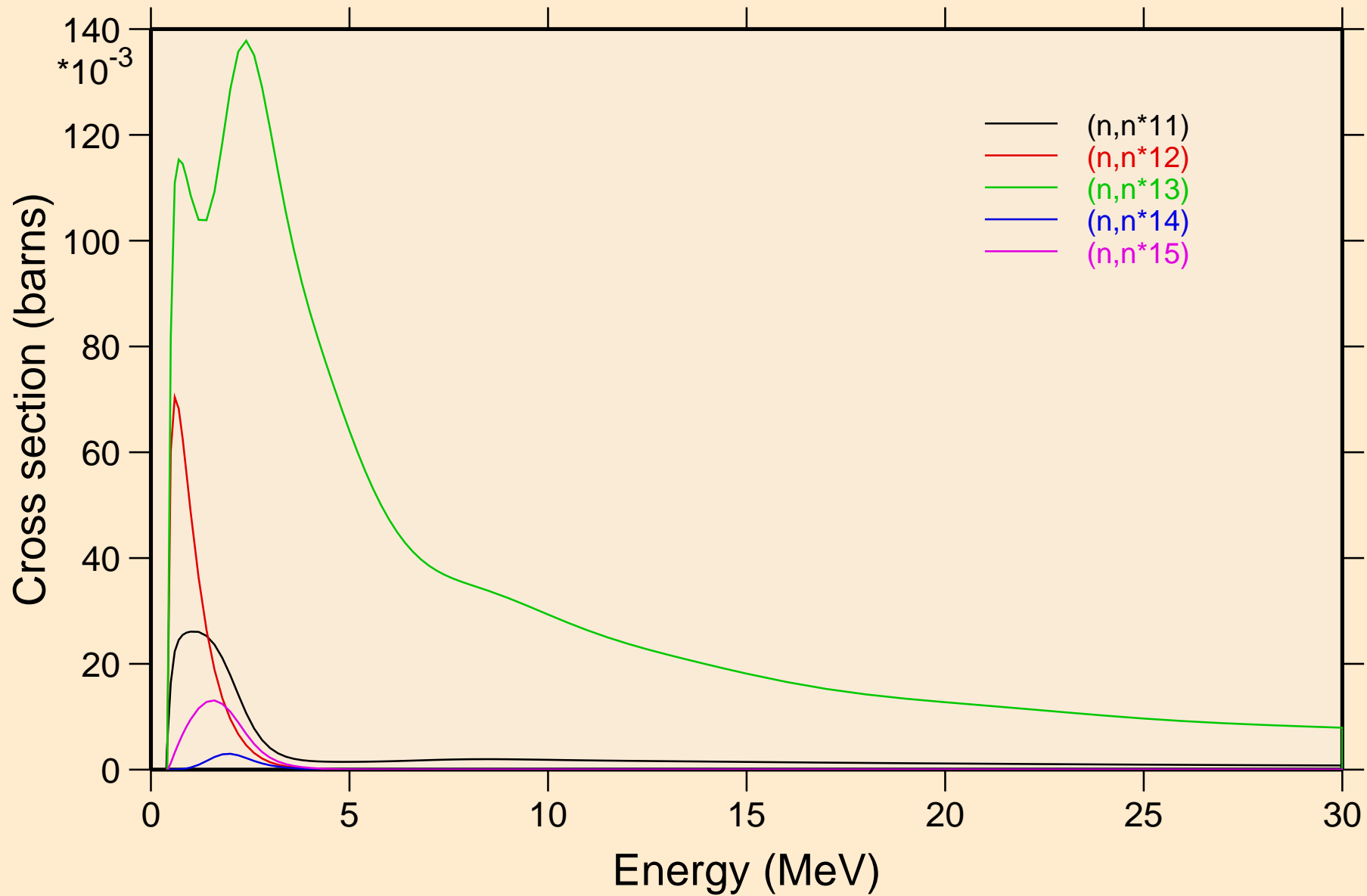

BI224 NEUTRON ACER TENDL-2024 LIBRARY; T=0.K
Inelastic levels

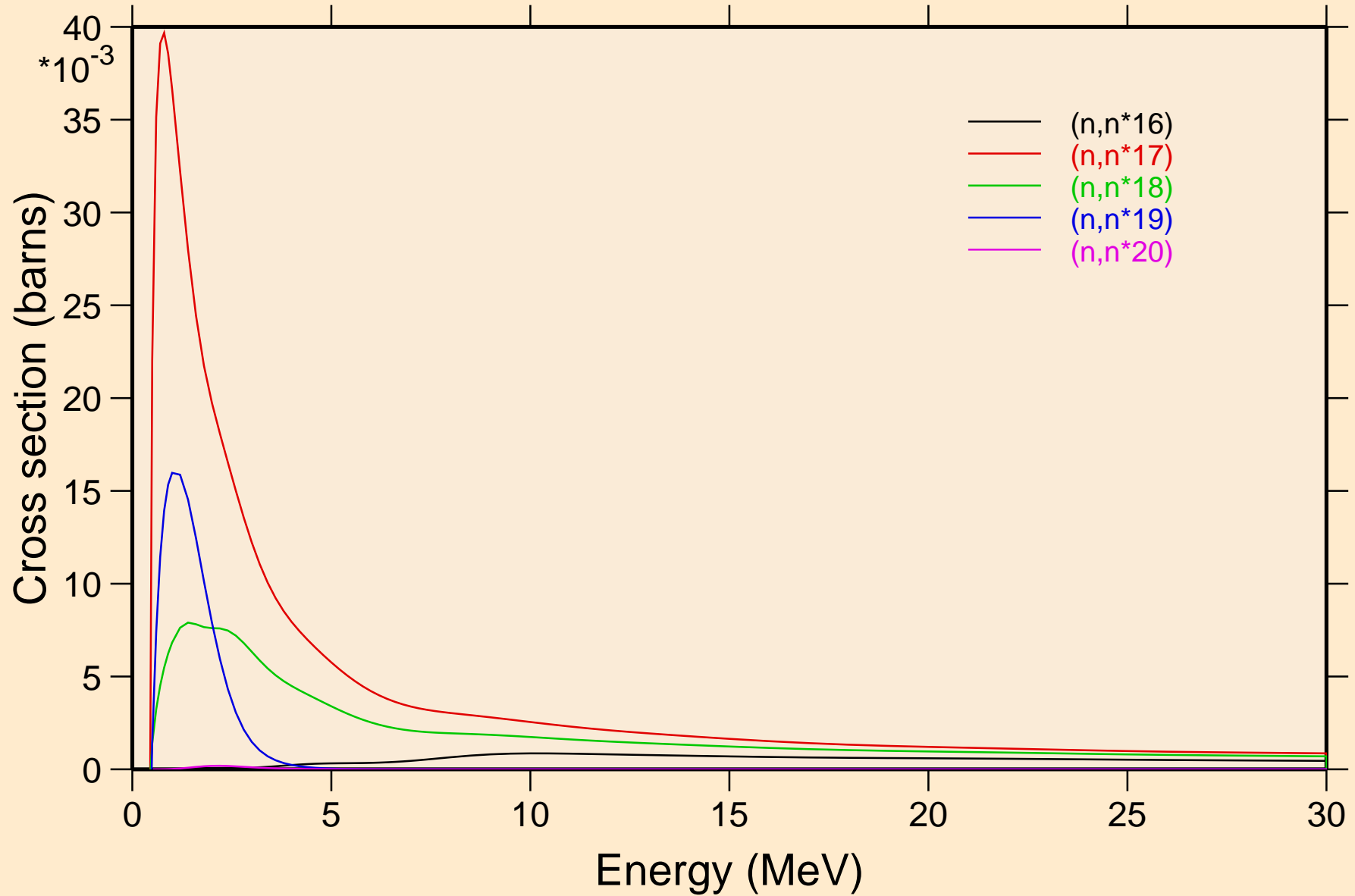

BI224 NEUTRON ACER TENDL-2024 LIBRARY; T=0.K
Inelastic levels

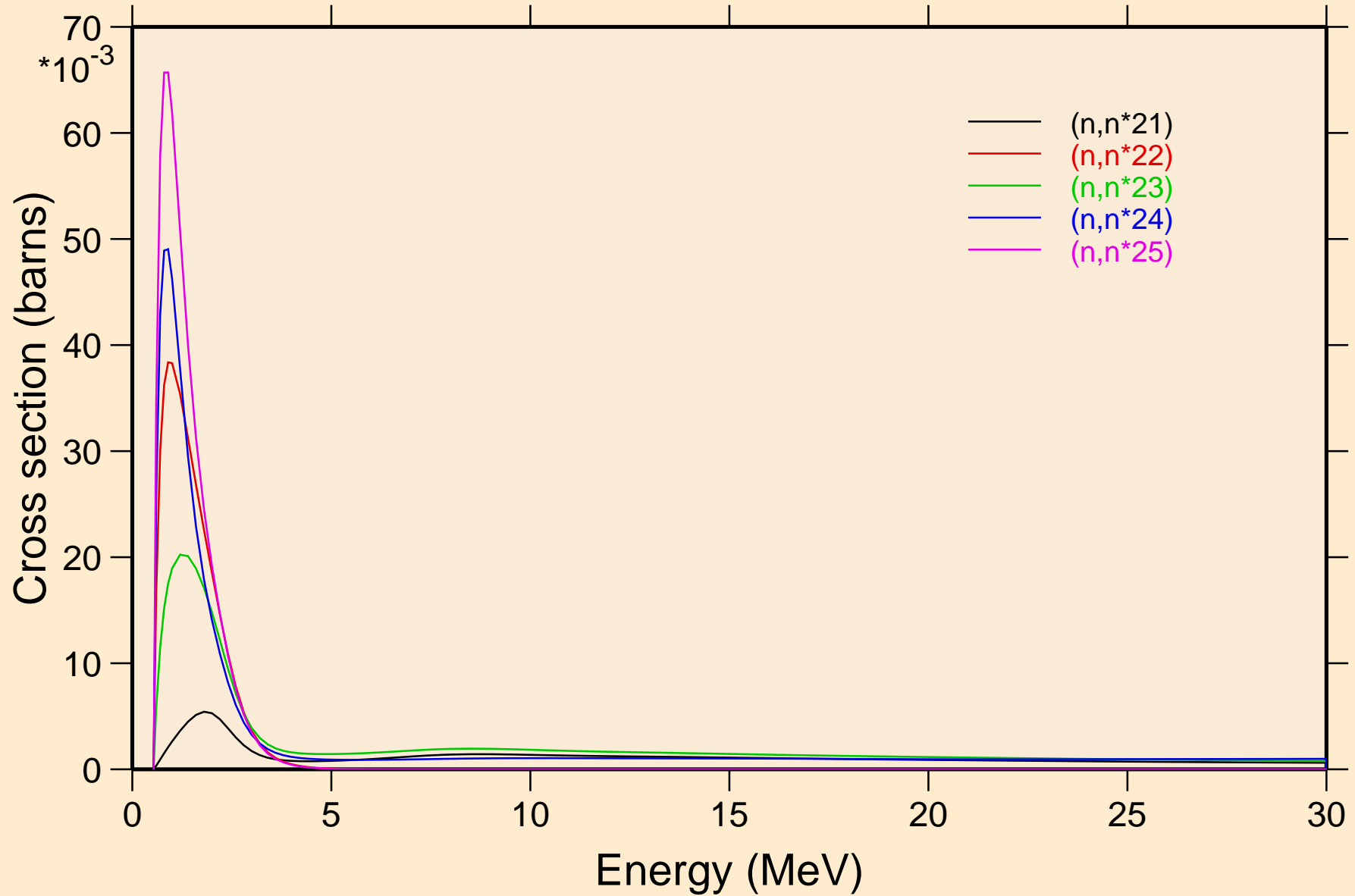

BI224 NEUTRON ACER TENDL-2024 LIBRARY; T=0.K
Inelastic levels

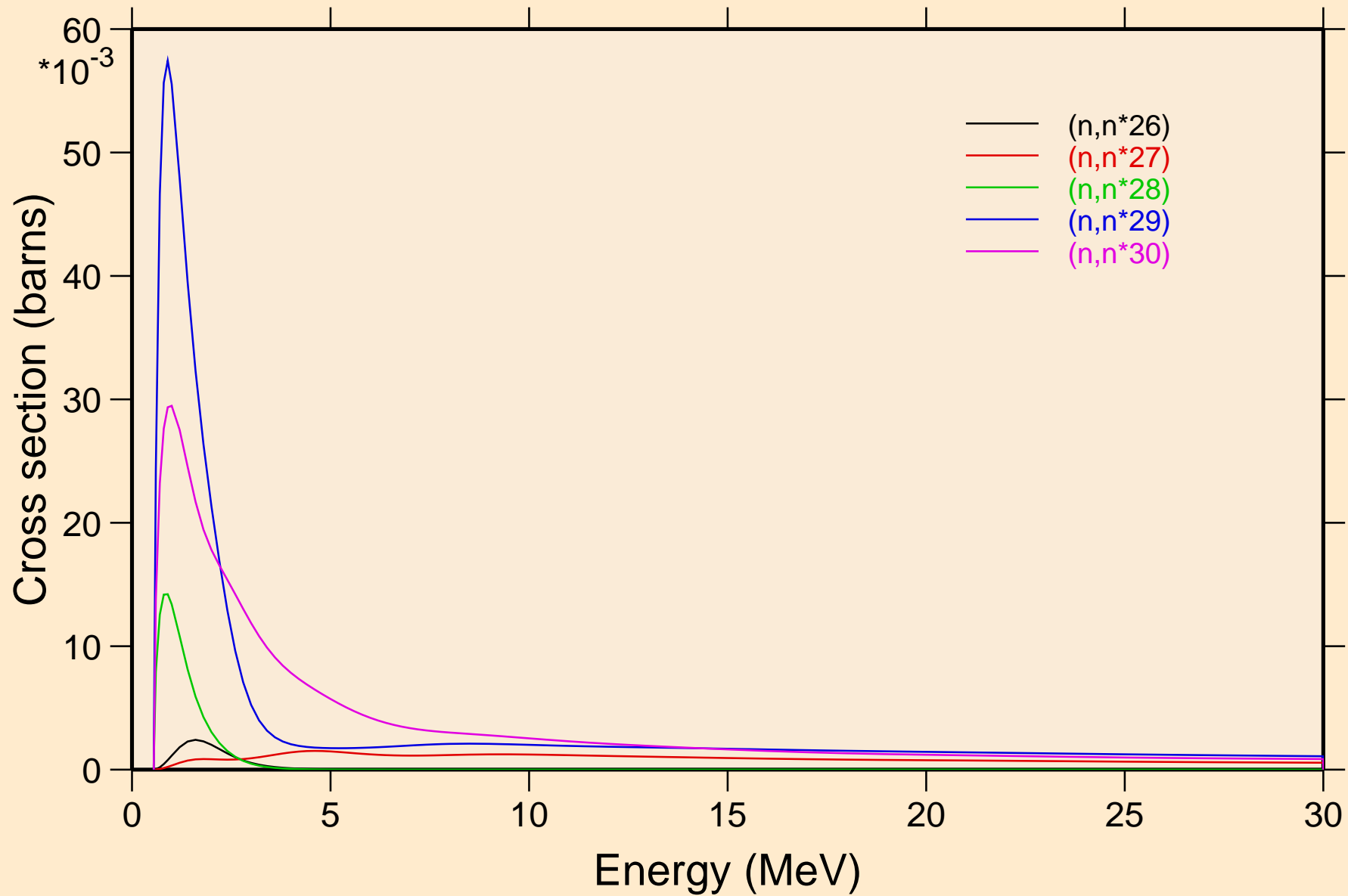

BI224 NEUTRON ACER TENDL-2024 LIBRARY; T=0.K

Threshold reactions

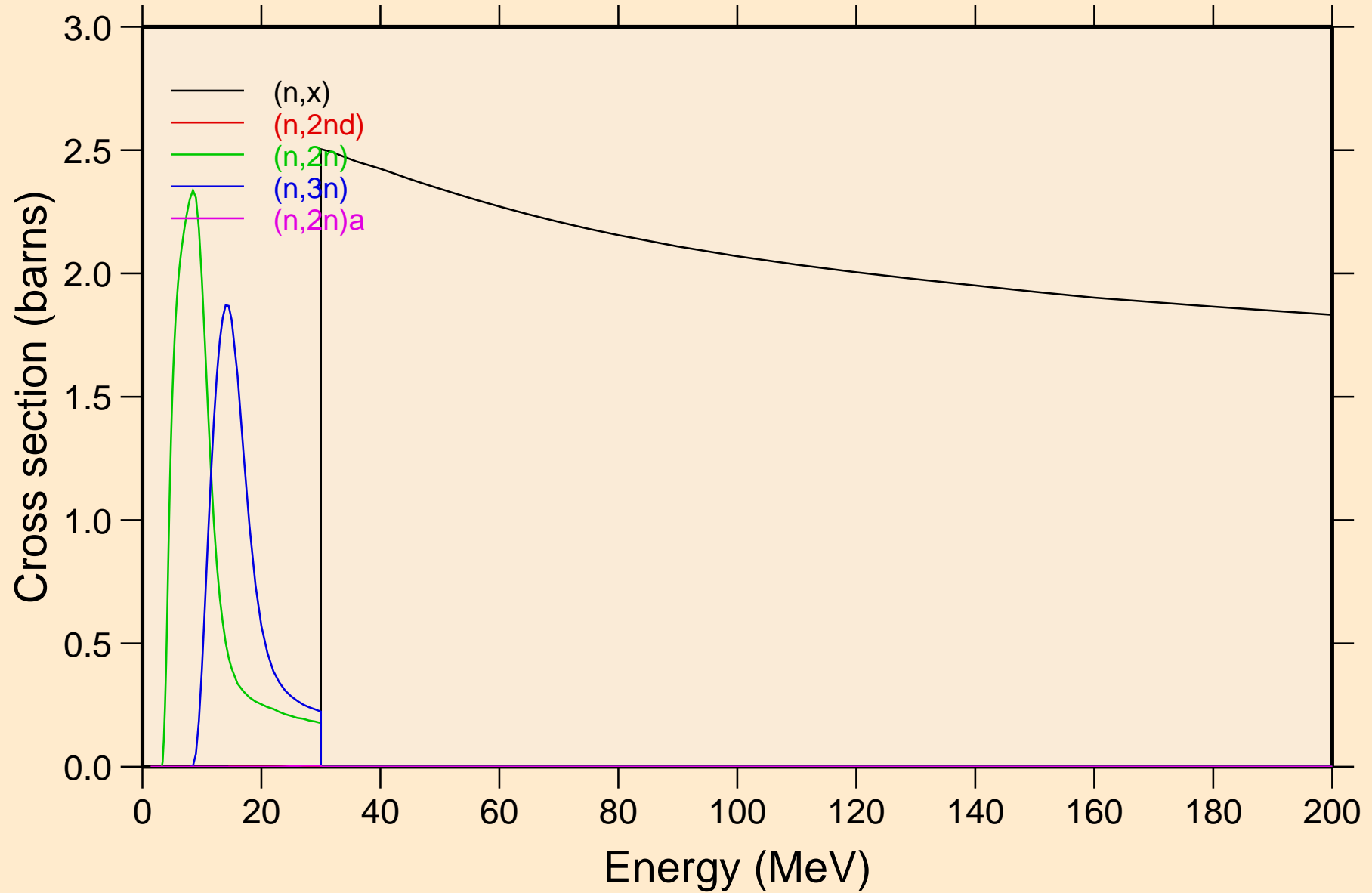

BI224 NEUTRON ACER TENDL-2024 LIBRARY; T=0.K
Threshold reactions

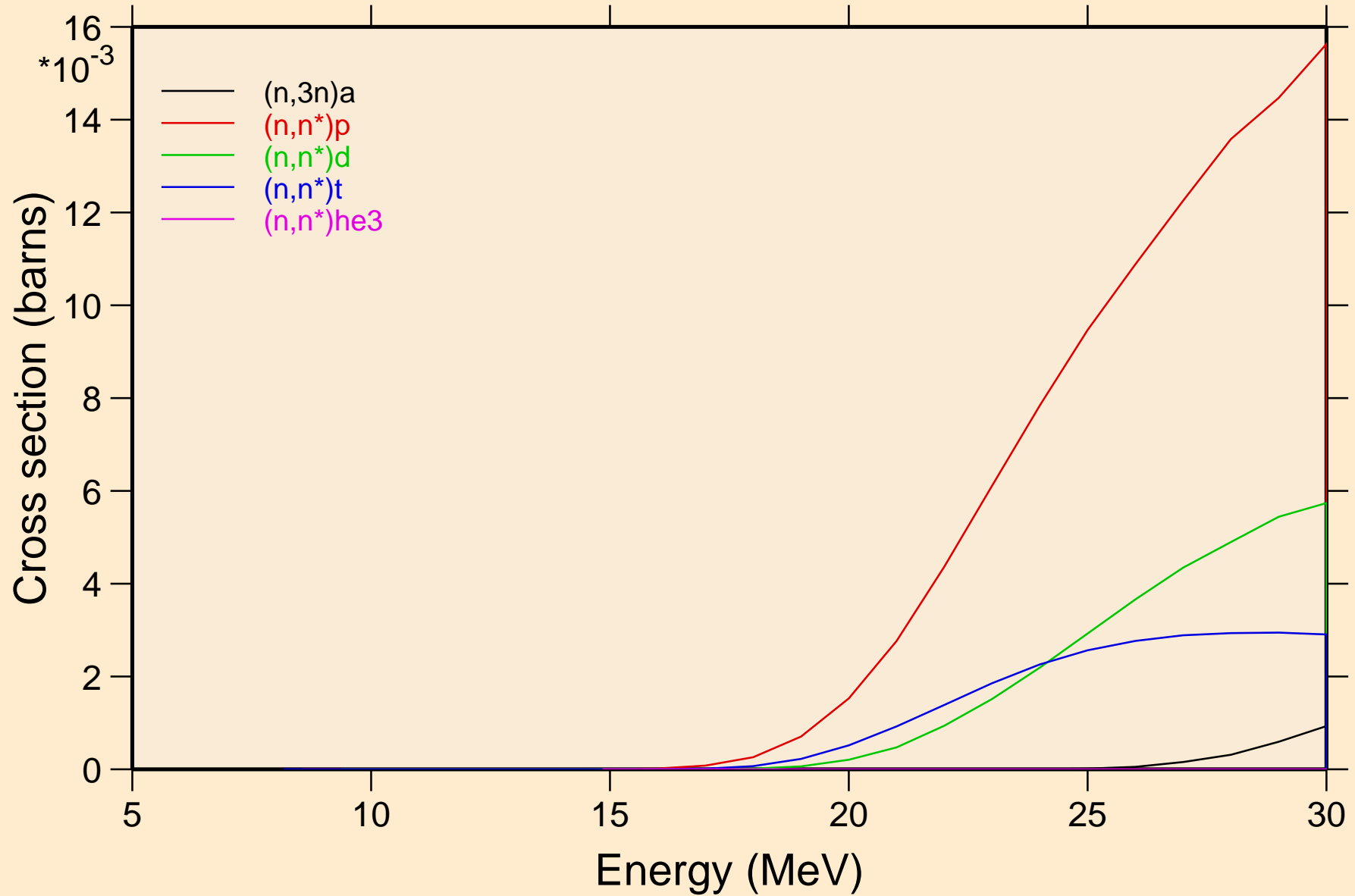

BI224 NEUTRON ACER TENDL-2024 LIBRARY; T=0.K
Threshold reactions

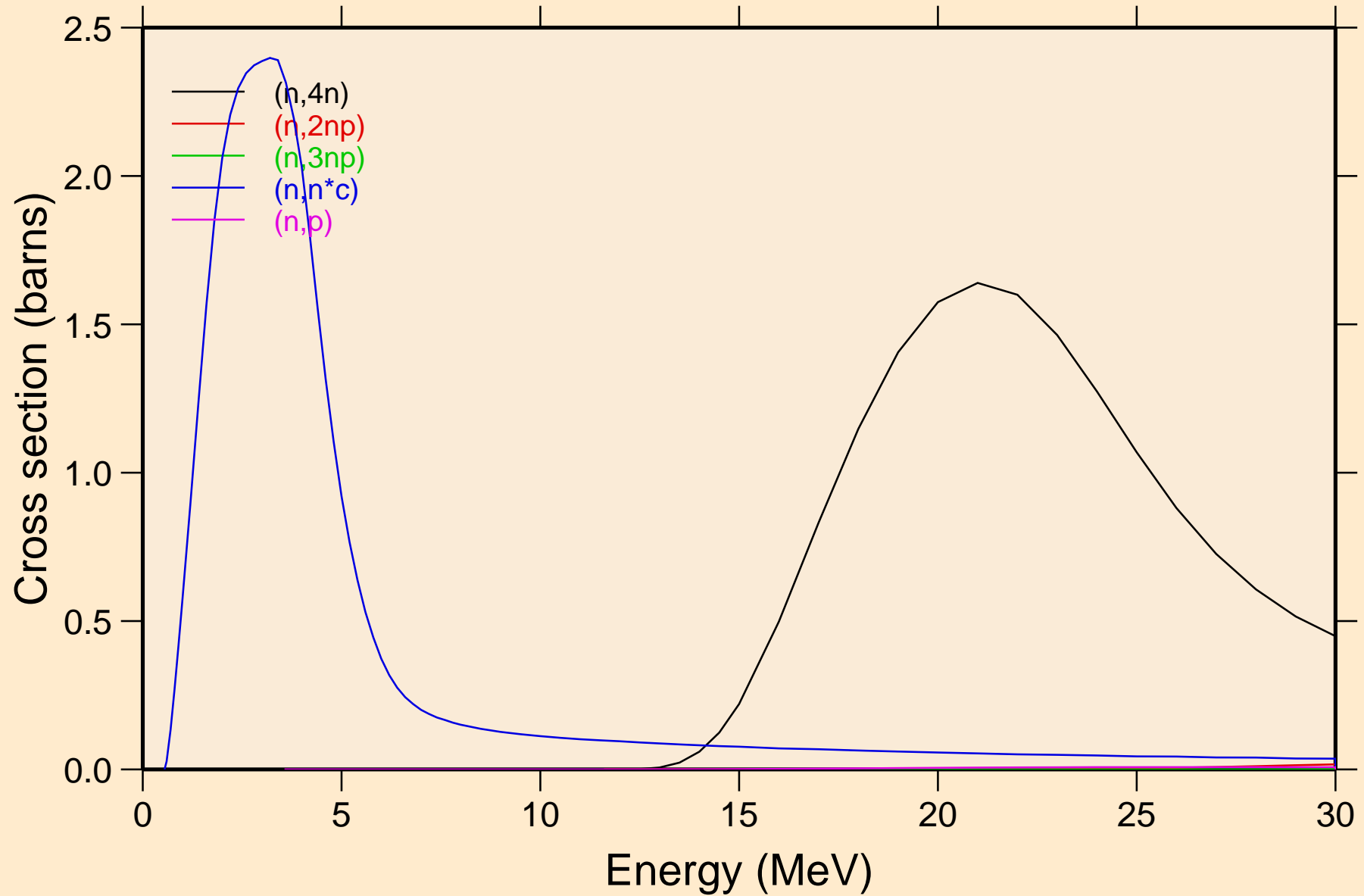

BI224 NEUTRON ACER TENDL-2024 LIBRARY; T=0.K
Threshold reactions

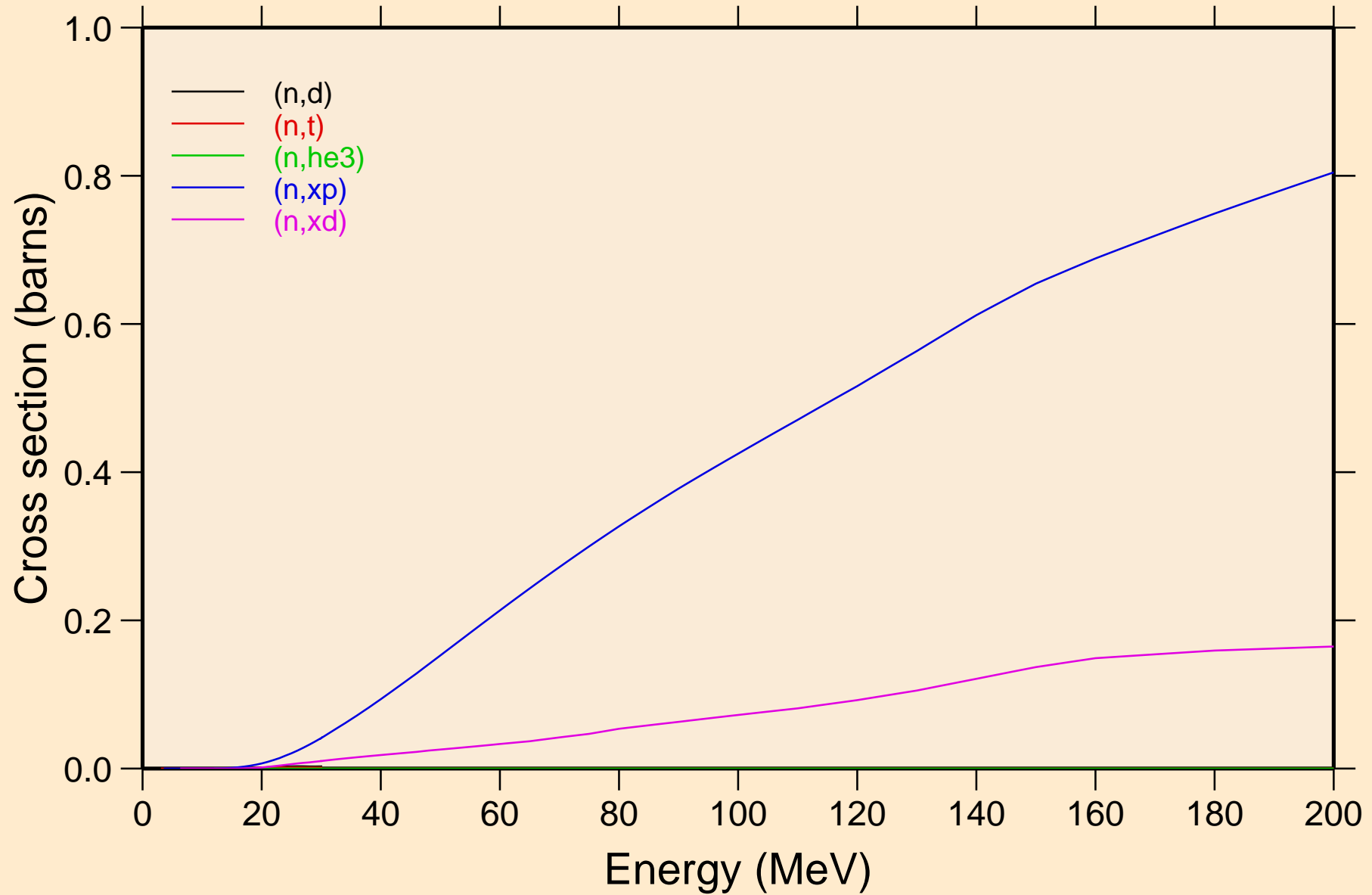

BI224 NEUTRON ACER TENDL-2024 LIBRARY; T=0.K
Threshold reactions

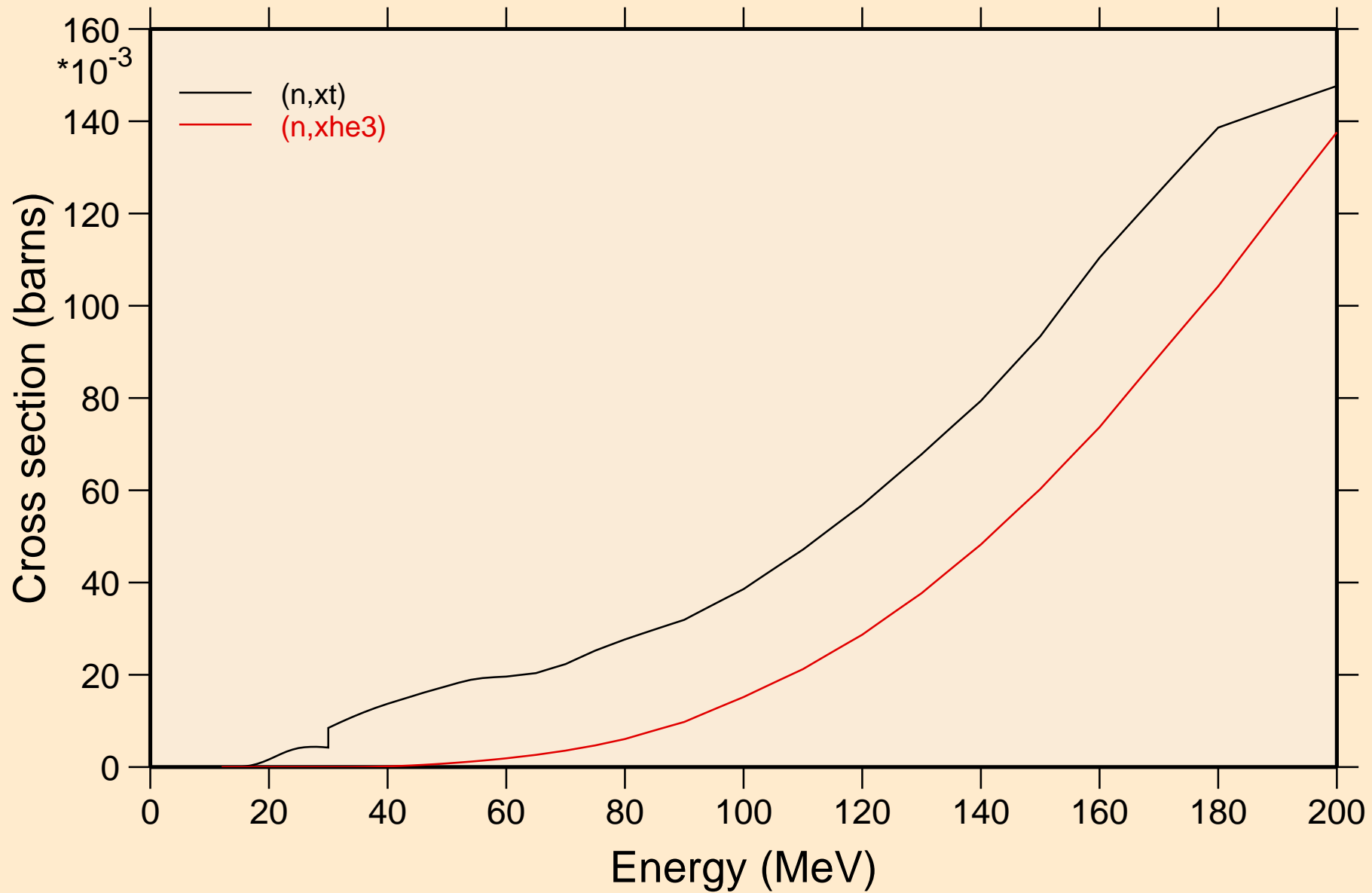

BI224 NEUTRON ACER TENDL-2024 LIBRARY; T=0.K
angular distribution for elastic

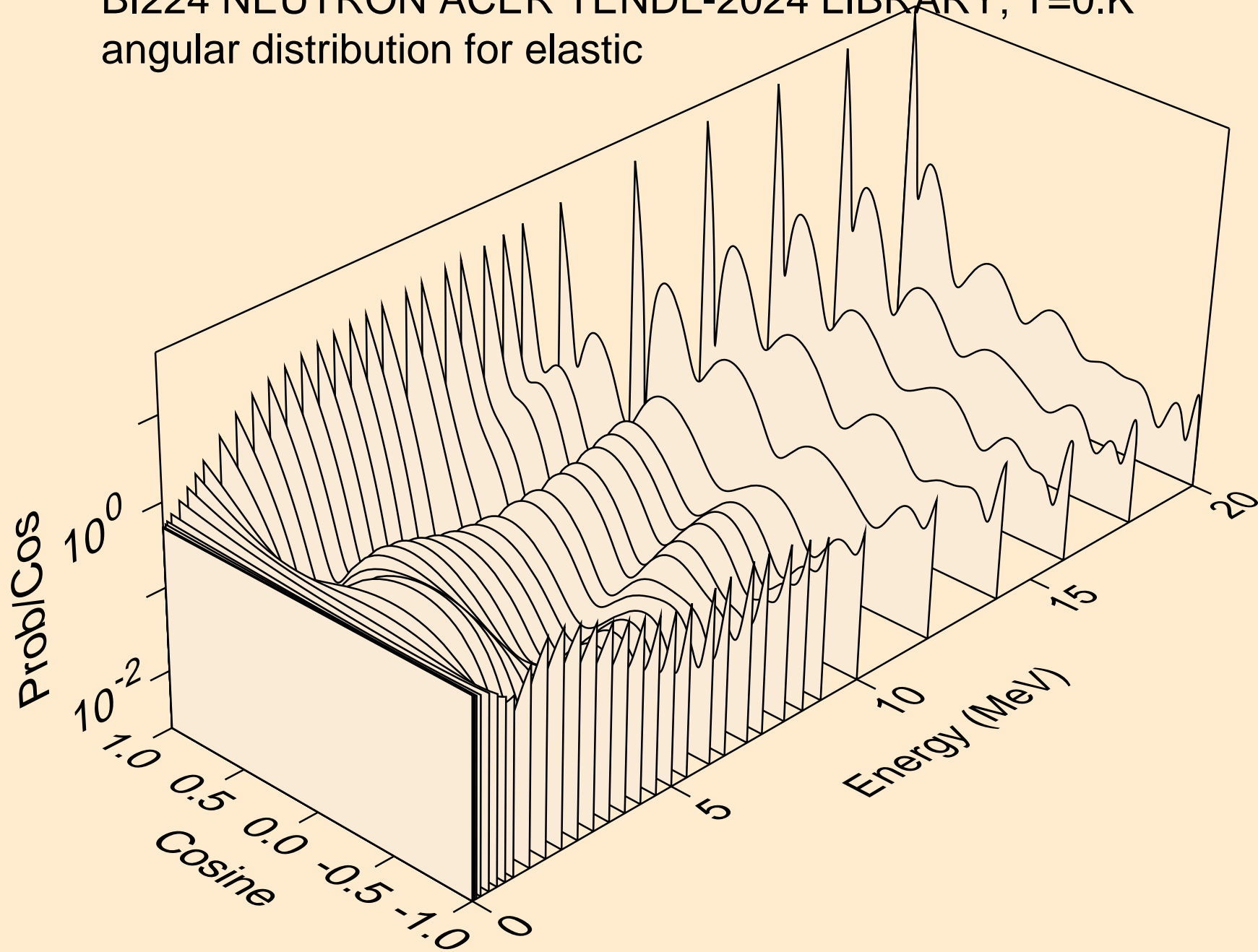

BI224 NEUTRON ACER TENDL-2024 LIBRARY; T=0.K
angular distribution for elastic

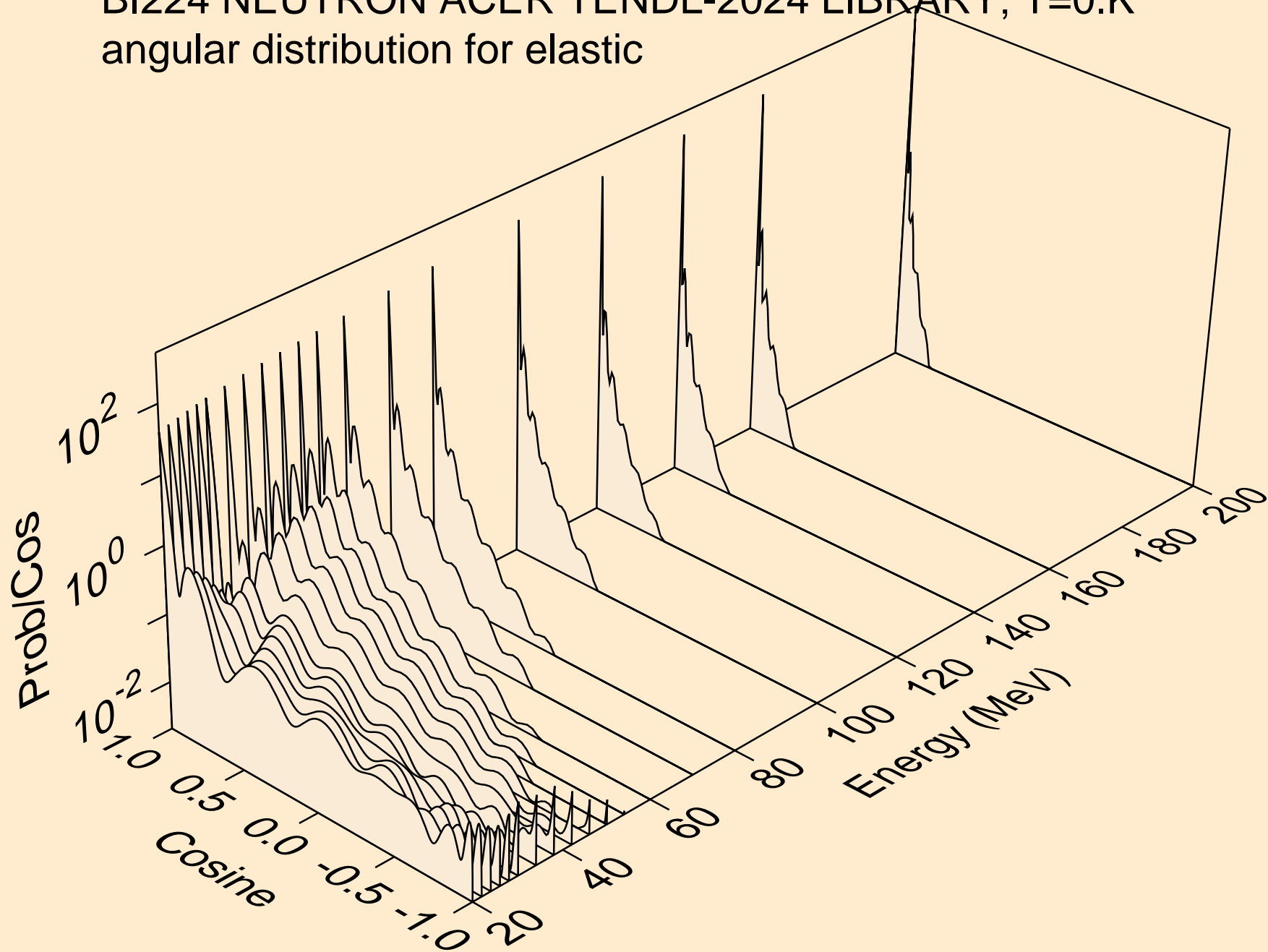

BI224 NEUTRON ACER TENDL-2024 LIBRARY; T=0.K
angular distribution for (n,n*1)

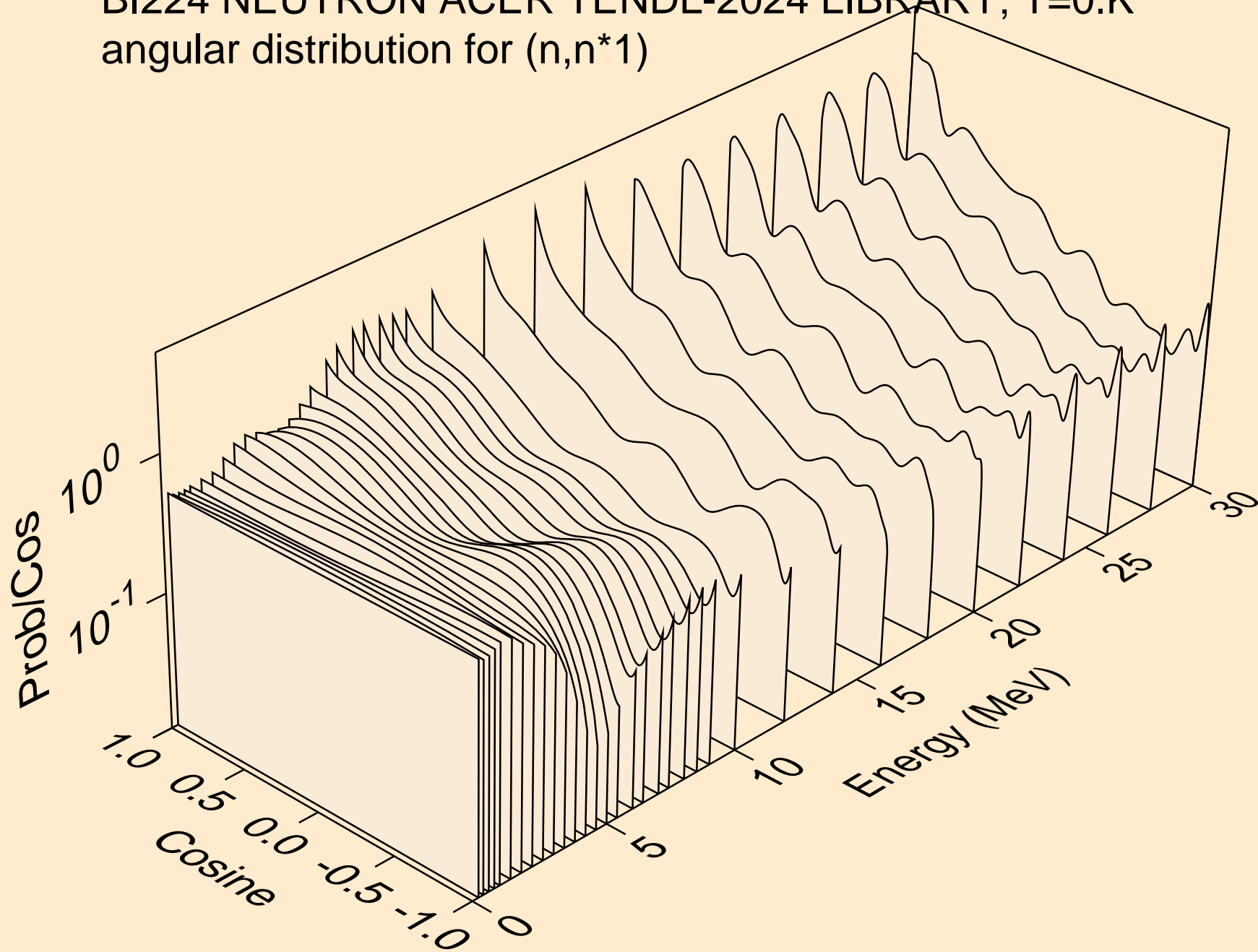

BI224 NEUTRON ACER TENDL-2024 LIBRARY; T=0.K
angular distribution for (n,n*2)

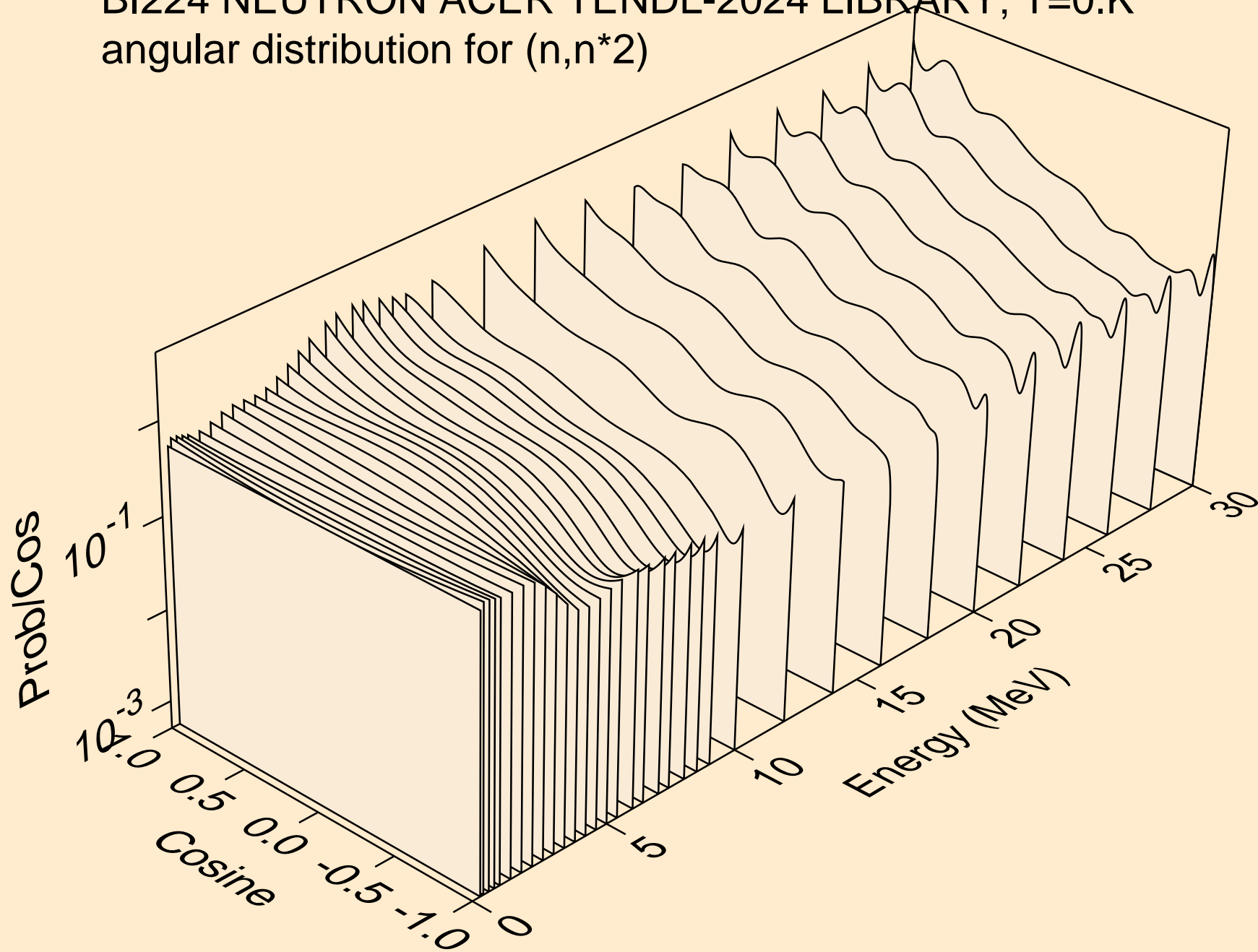

BI224 NEUTRON ACER TENDL-2024 LIBRARY; T=0.K
angular distribution for (n,n*3)

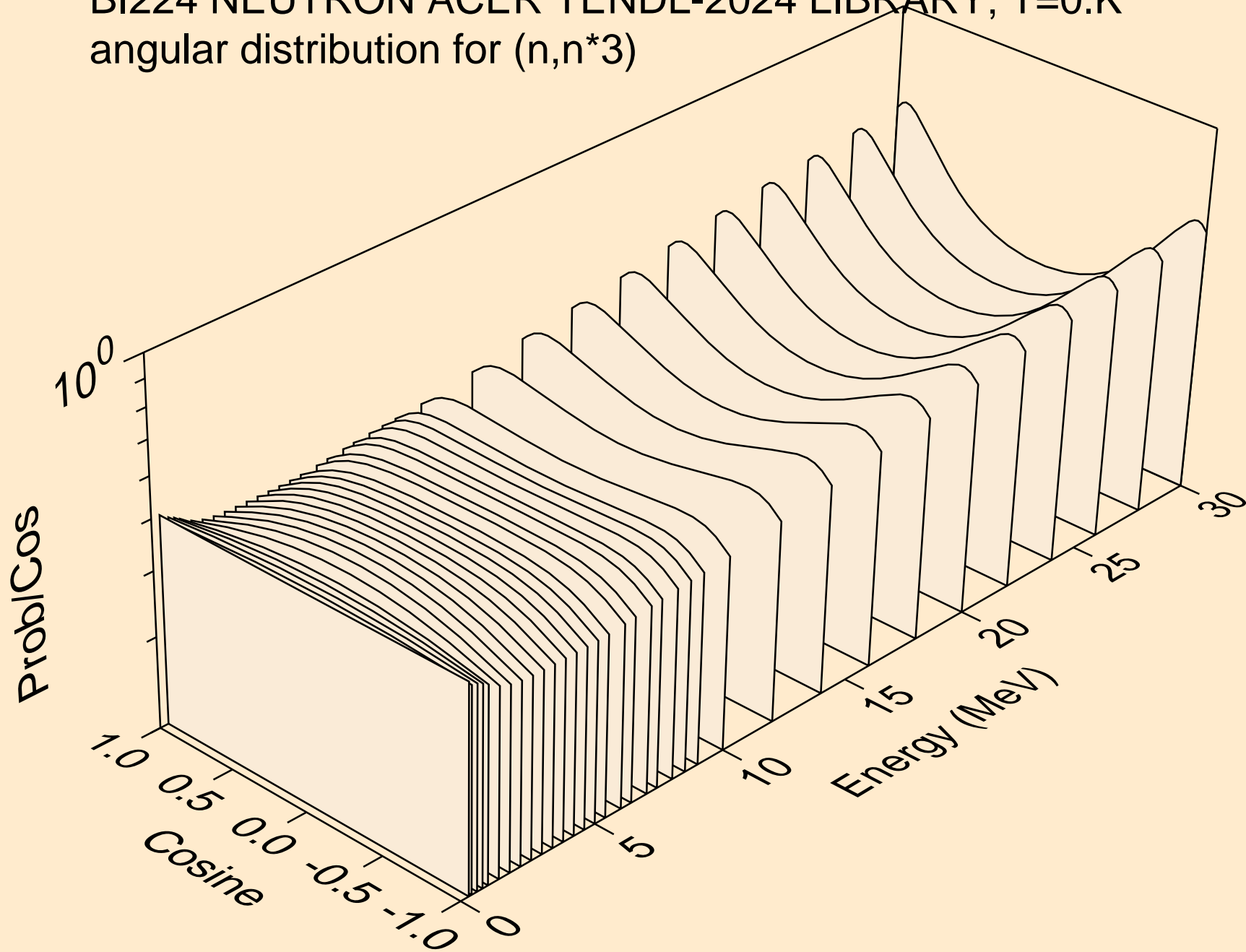

BI224 NEUTRON ACER TENDL-2024 LIBRARY; T=0.K
angular distribution for (n,n*4)

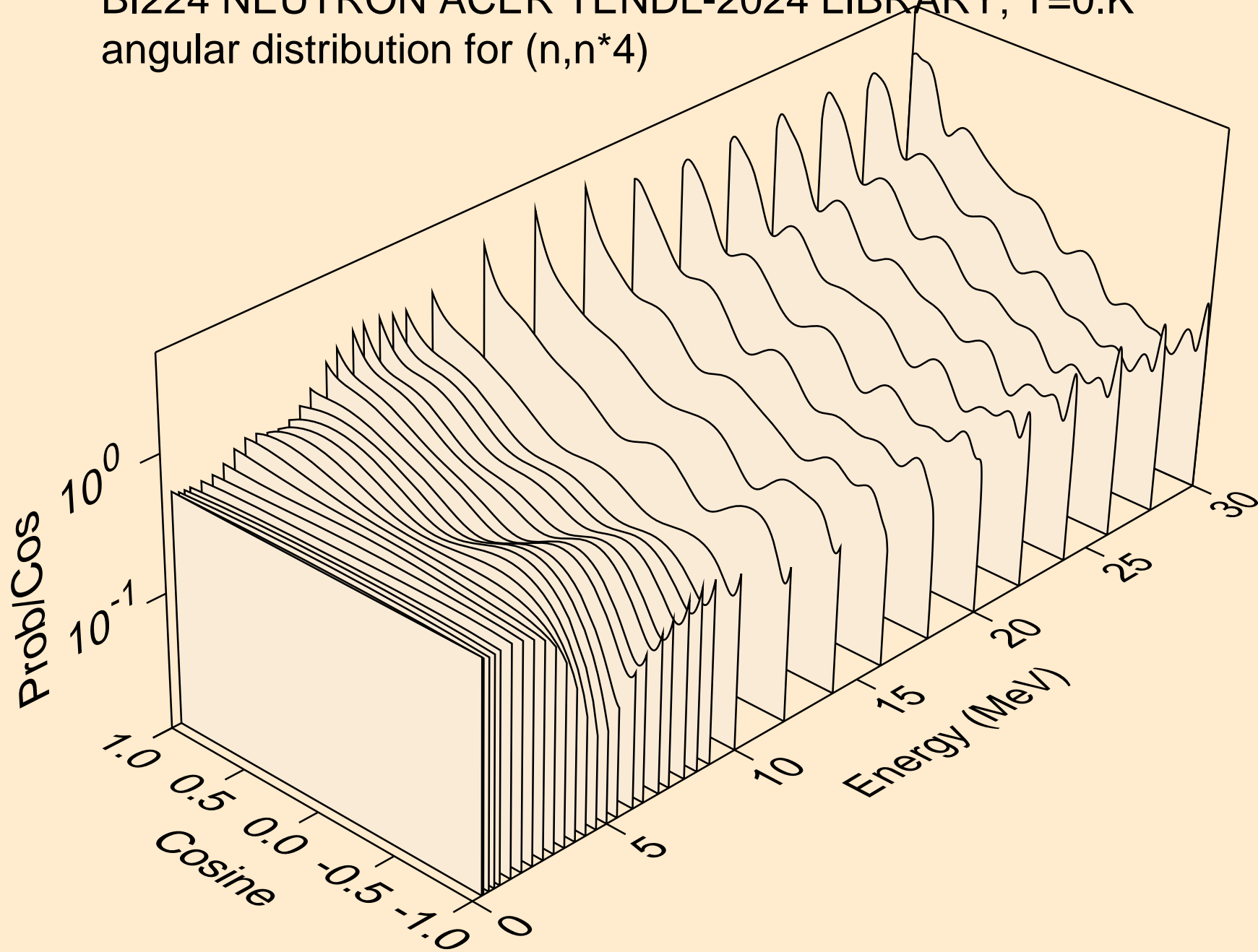

BI224 NEUTRON ACER TENDL-2024 LIBRARY; T=0.K
angular distribution for (n,n*5)

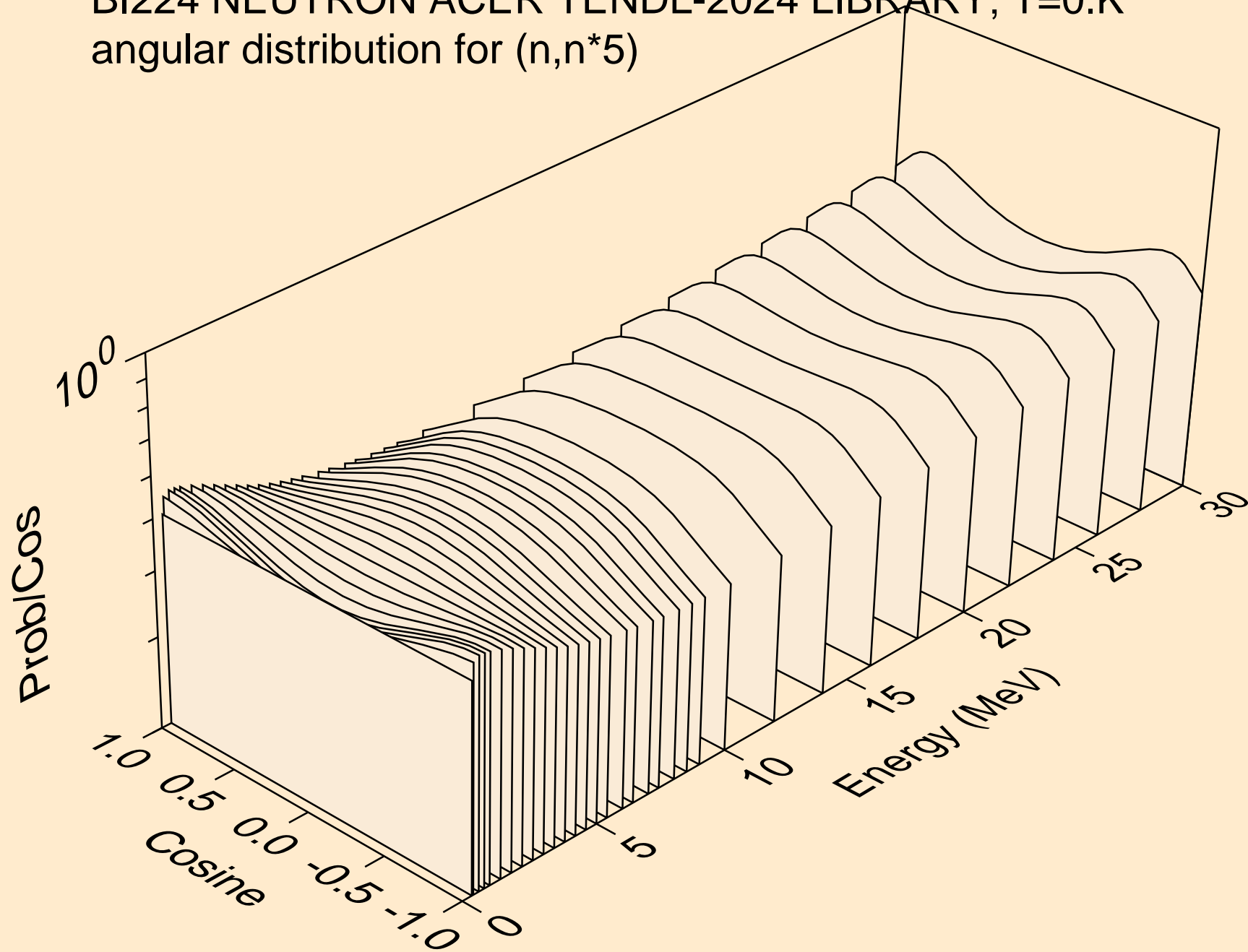

BI224 NEUTRON ACER TENDL-2024 LIBRARY; T=0.K
angular distribution for (n,n*6)

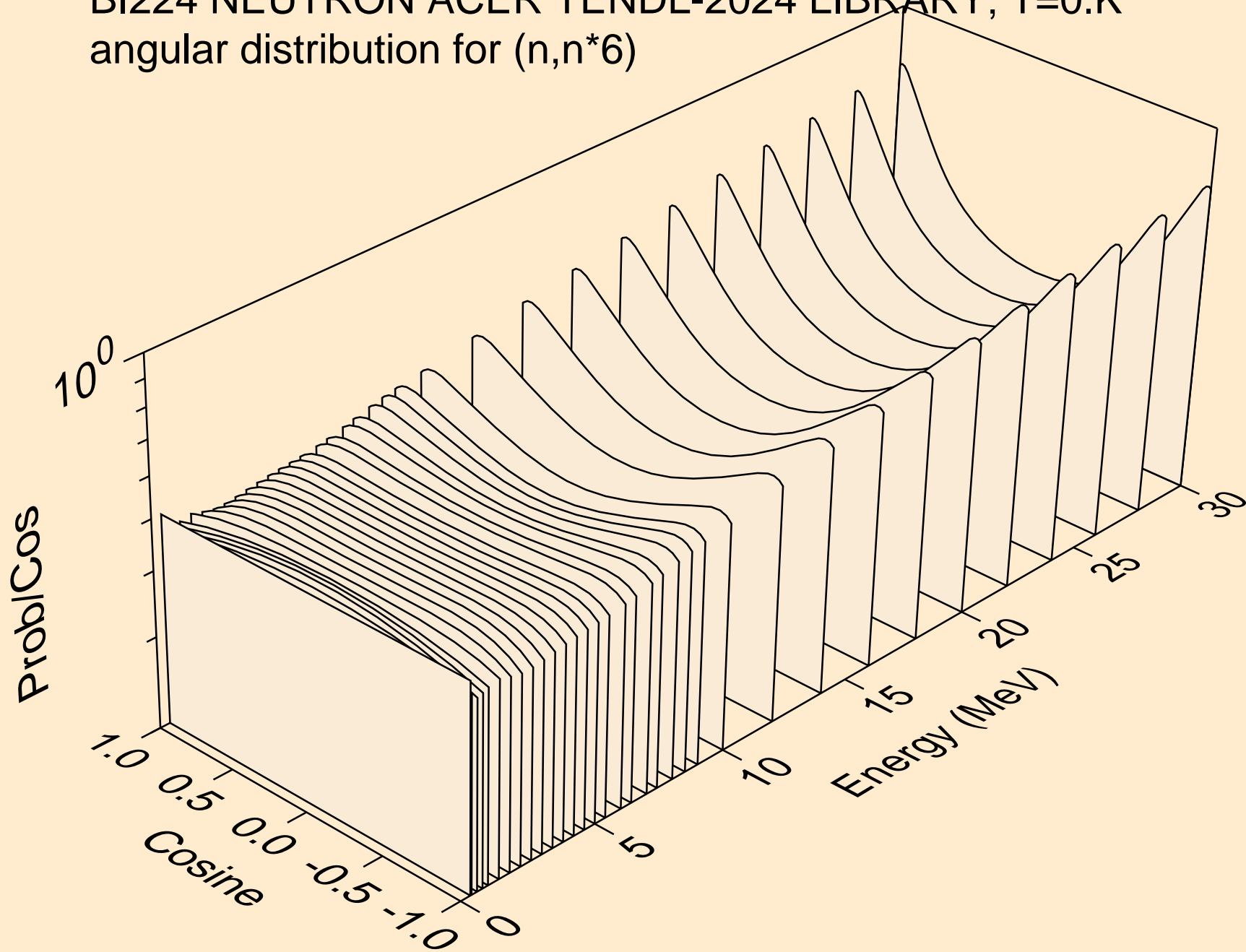

BI224 NEUTRON ACER TENDL-2024 LIBRARY; T=0.K
angular distribution for (n,n*7)

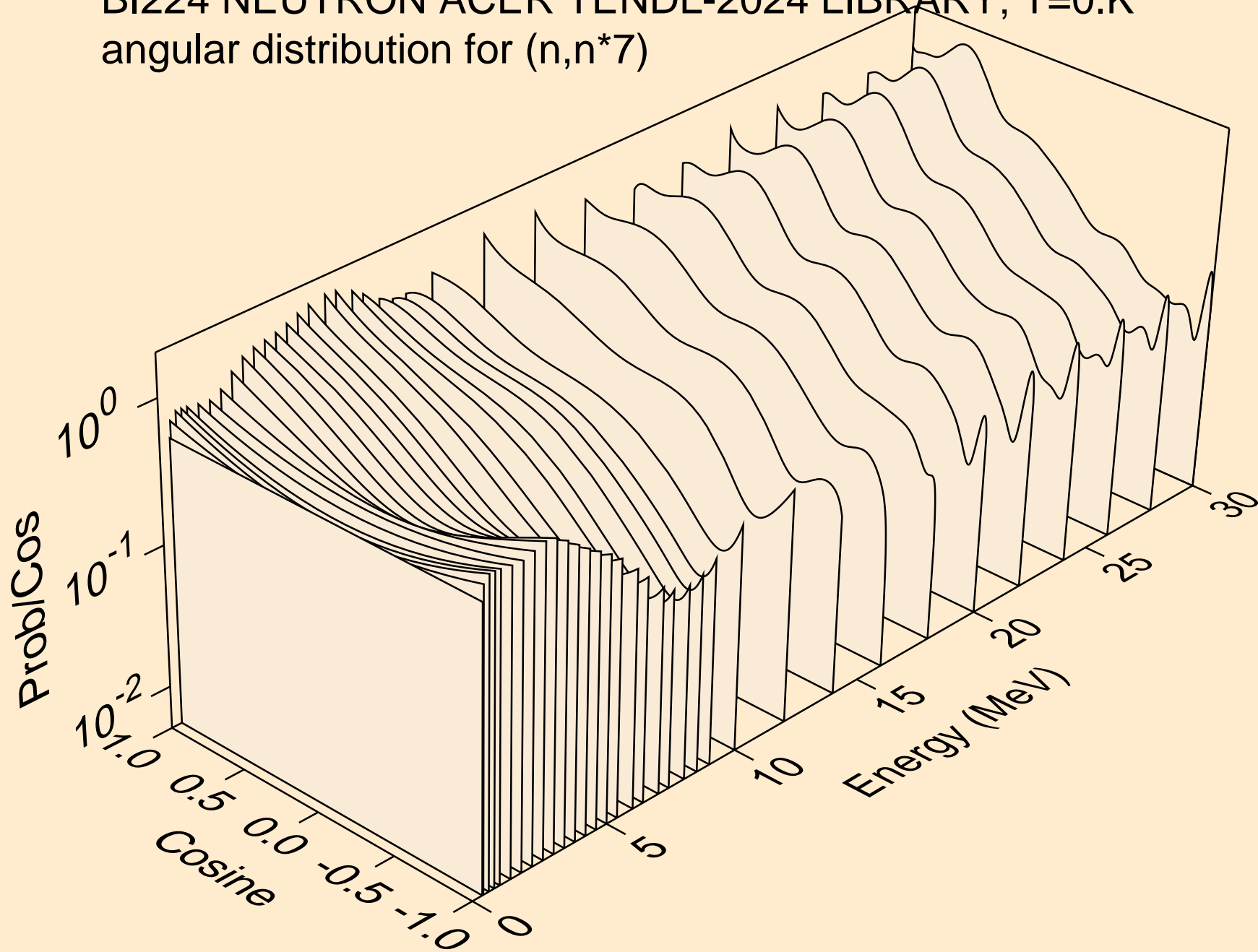

BI224 NEUTRON ACER TENDL-2024 LIBRARY; T=0.K
angular distribution for (n,n*8)

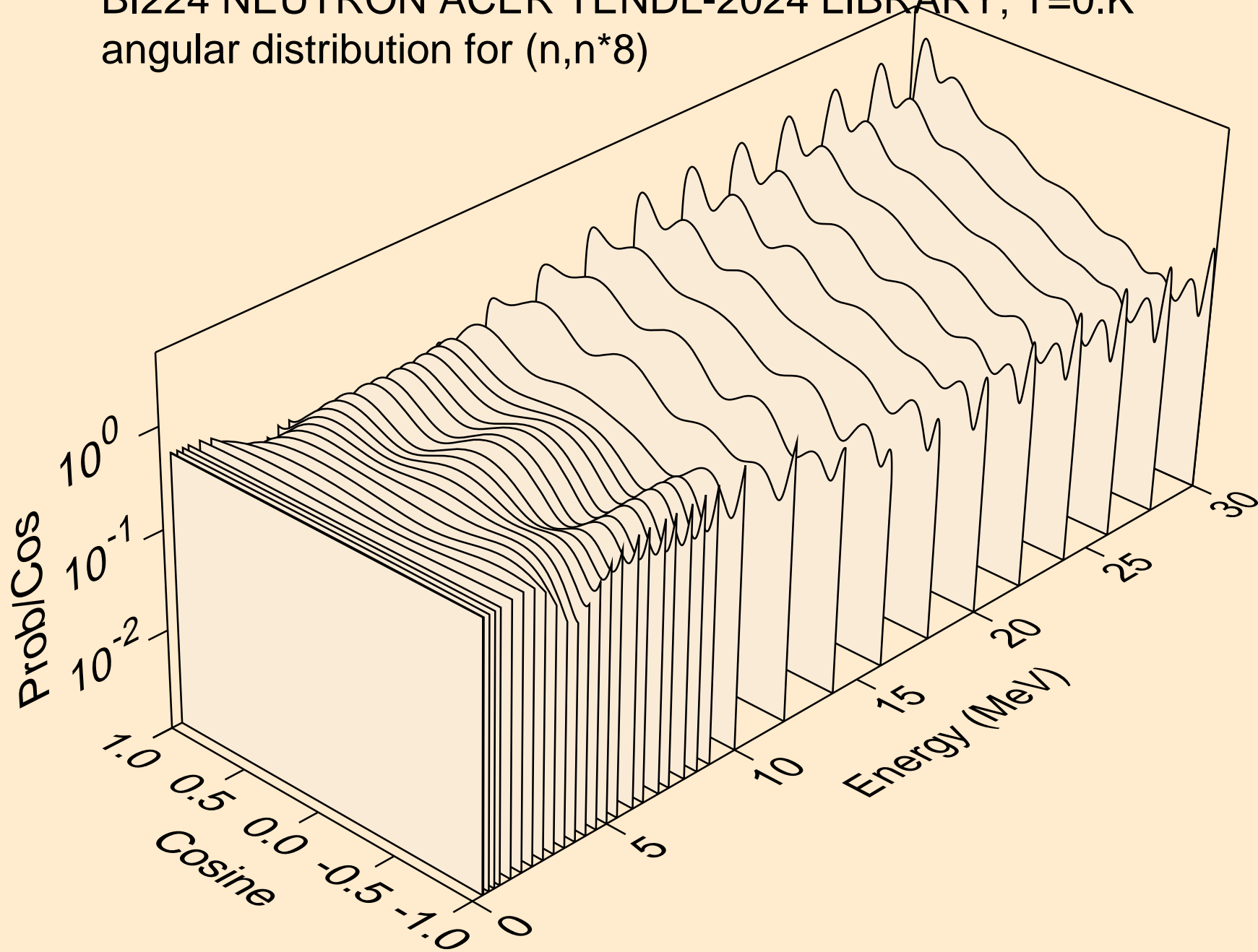

BI224 NEUTRON ACER TENDL-2024 LIBRARY; T=0.K
angular distribution for (n,n*9)

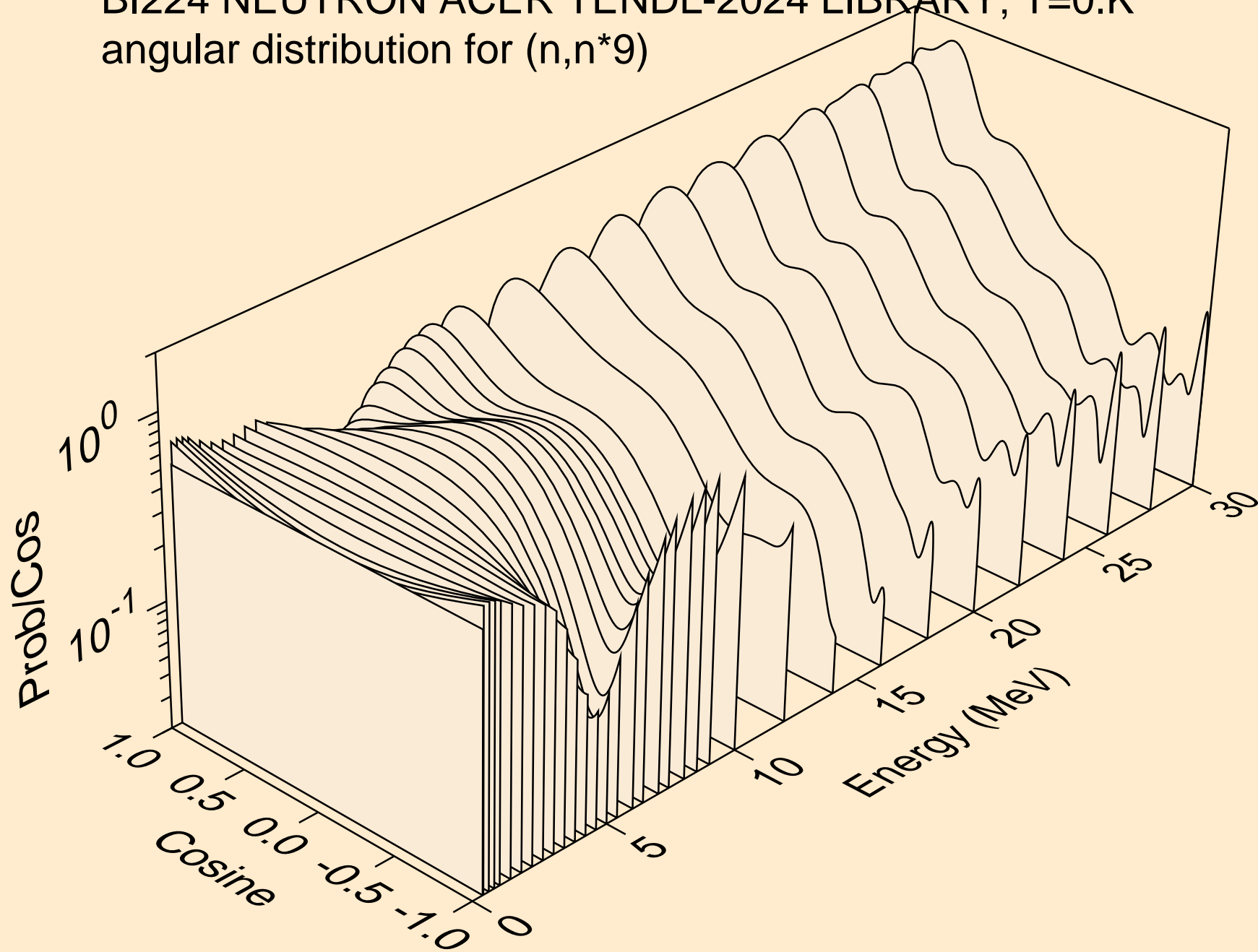

BI224 NEUTRON ACER TENDL-2024 LIBRARY; T=0.K
angular distribution for (n,n*10)

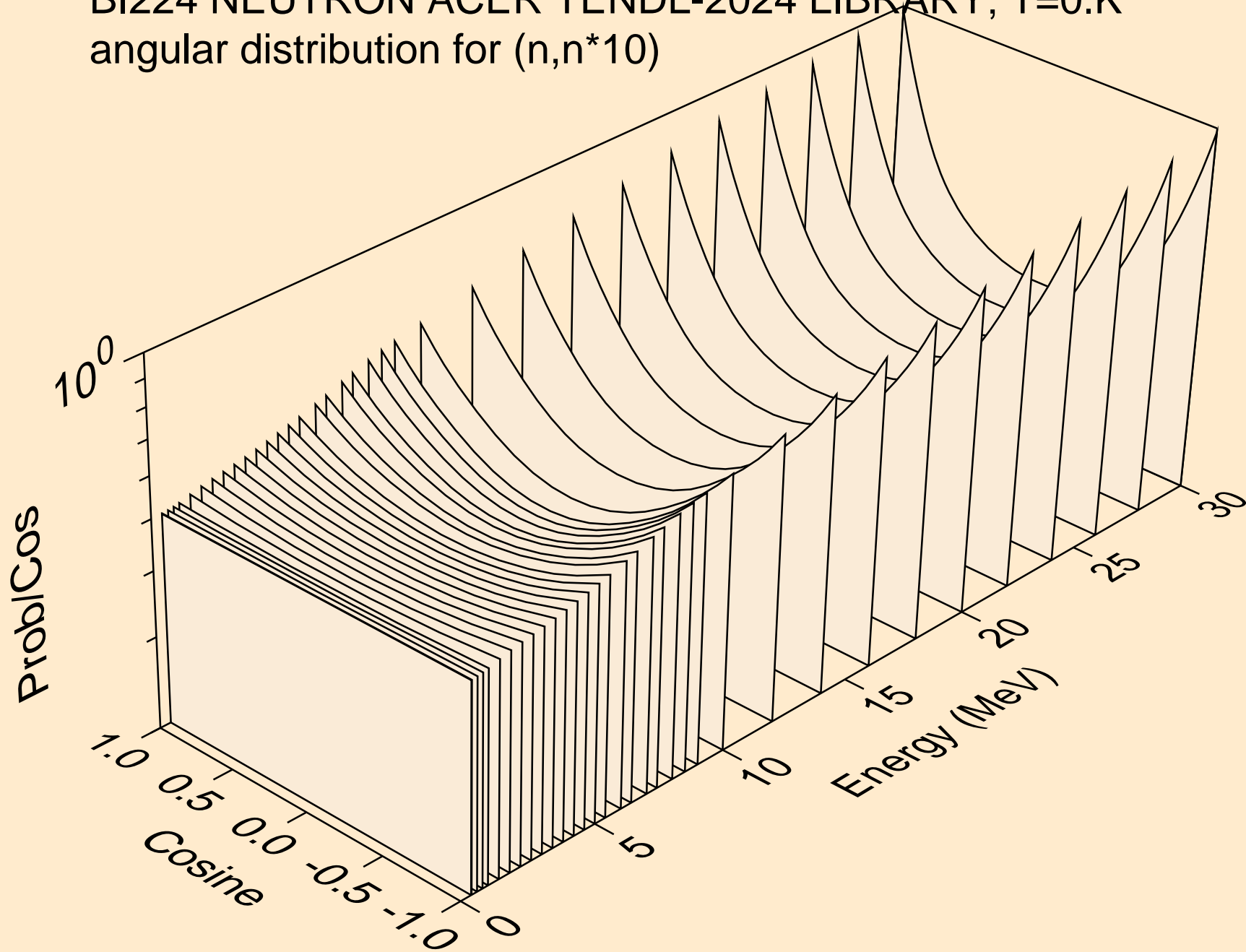

BI224 NEUTRON ACER TENDL-2024 LIBRARY; T=0.K
angular distribution for (n,n*11)

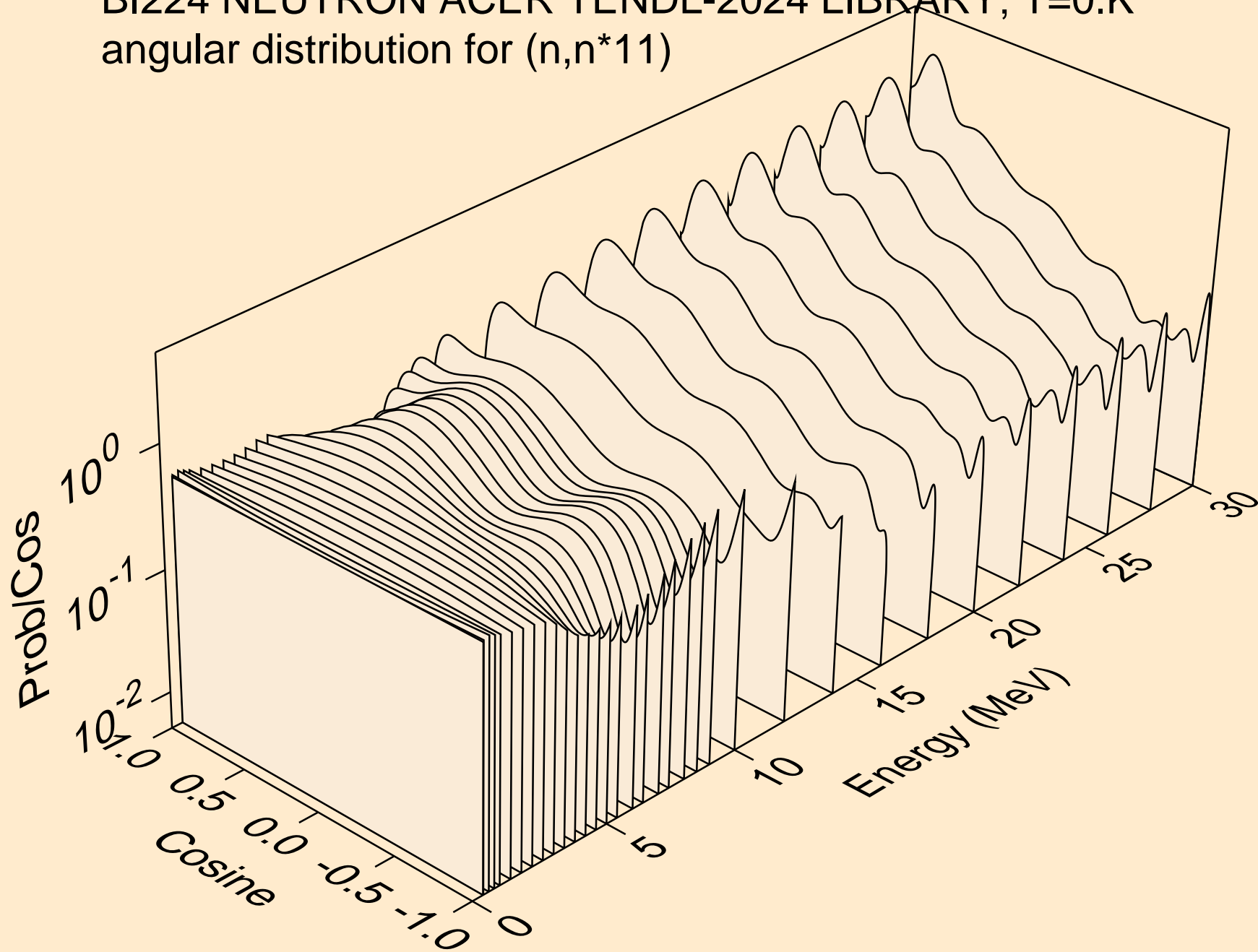

BI224 NEUTRON ACER TENDL-2024 LIBRARY; T=0.K
angular distribution for (n,n*12)

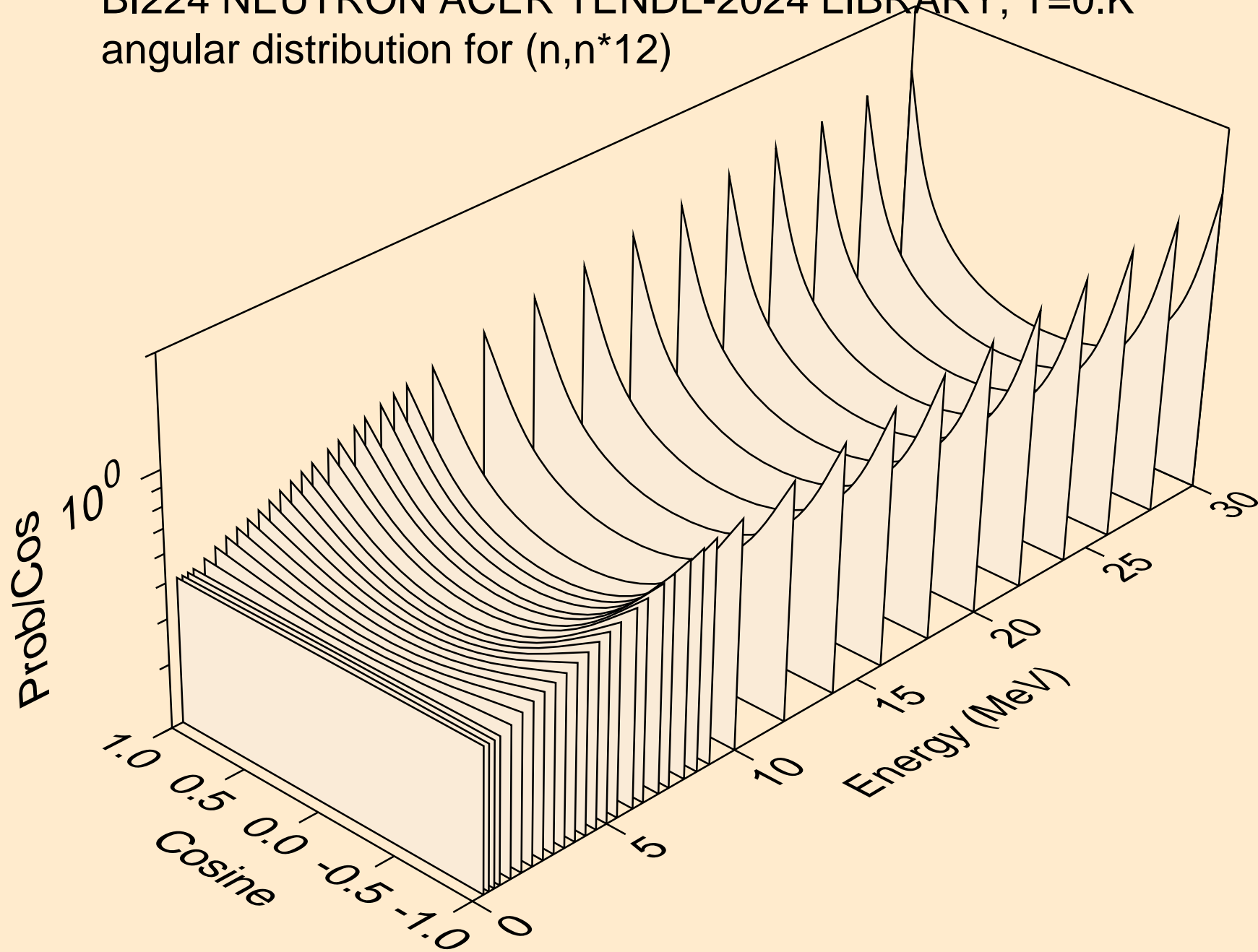

BI224 NEUTRON ACER TENDL-2024 LIBRARY; T=0.K
angular distribution for (n,n*13)

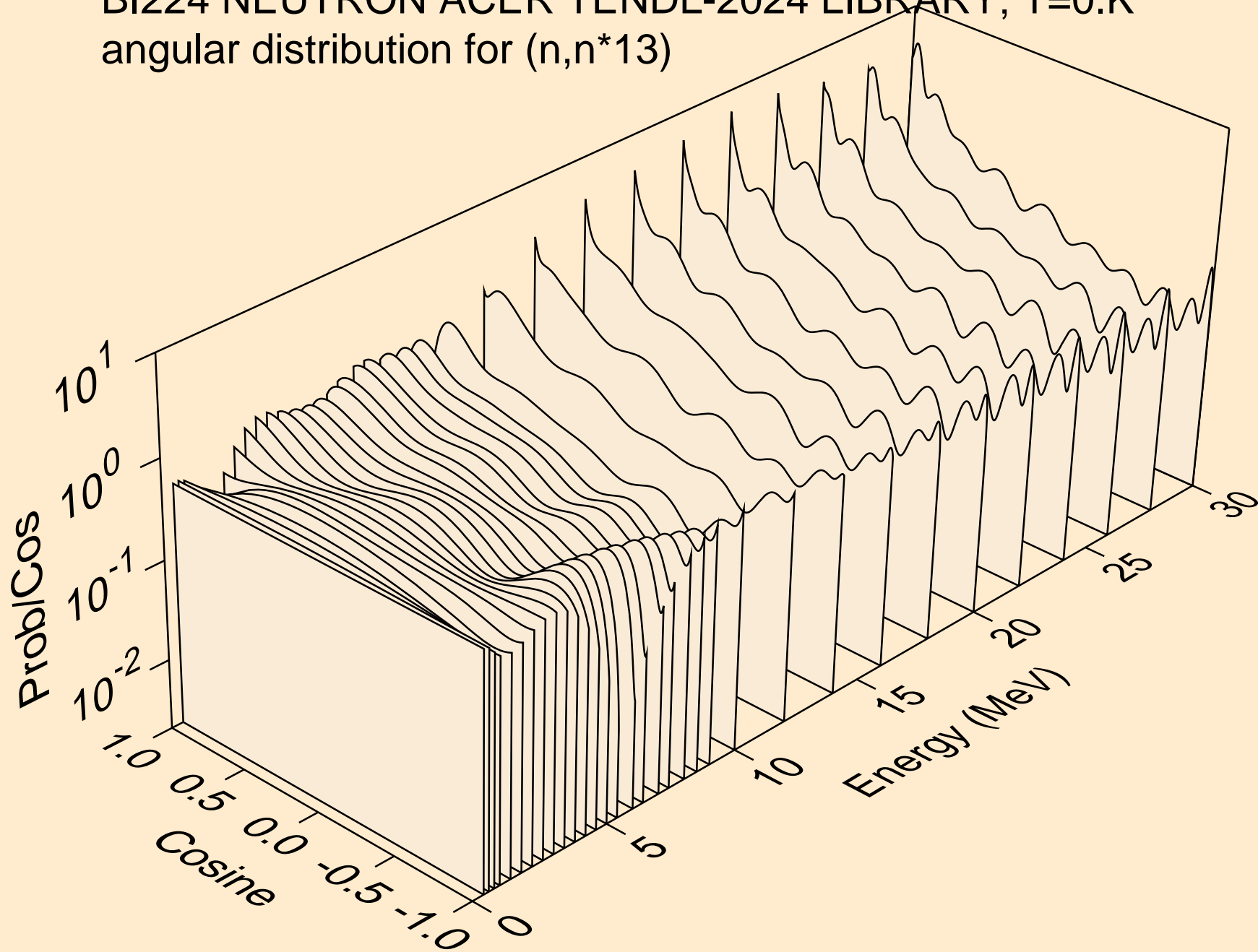

BI224 NEUTRON ACER TENDL-2024 LIBRARY; T=0.K
angular distribution for (n,n*14)

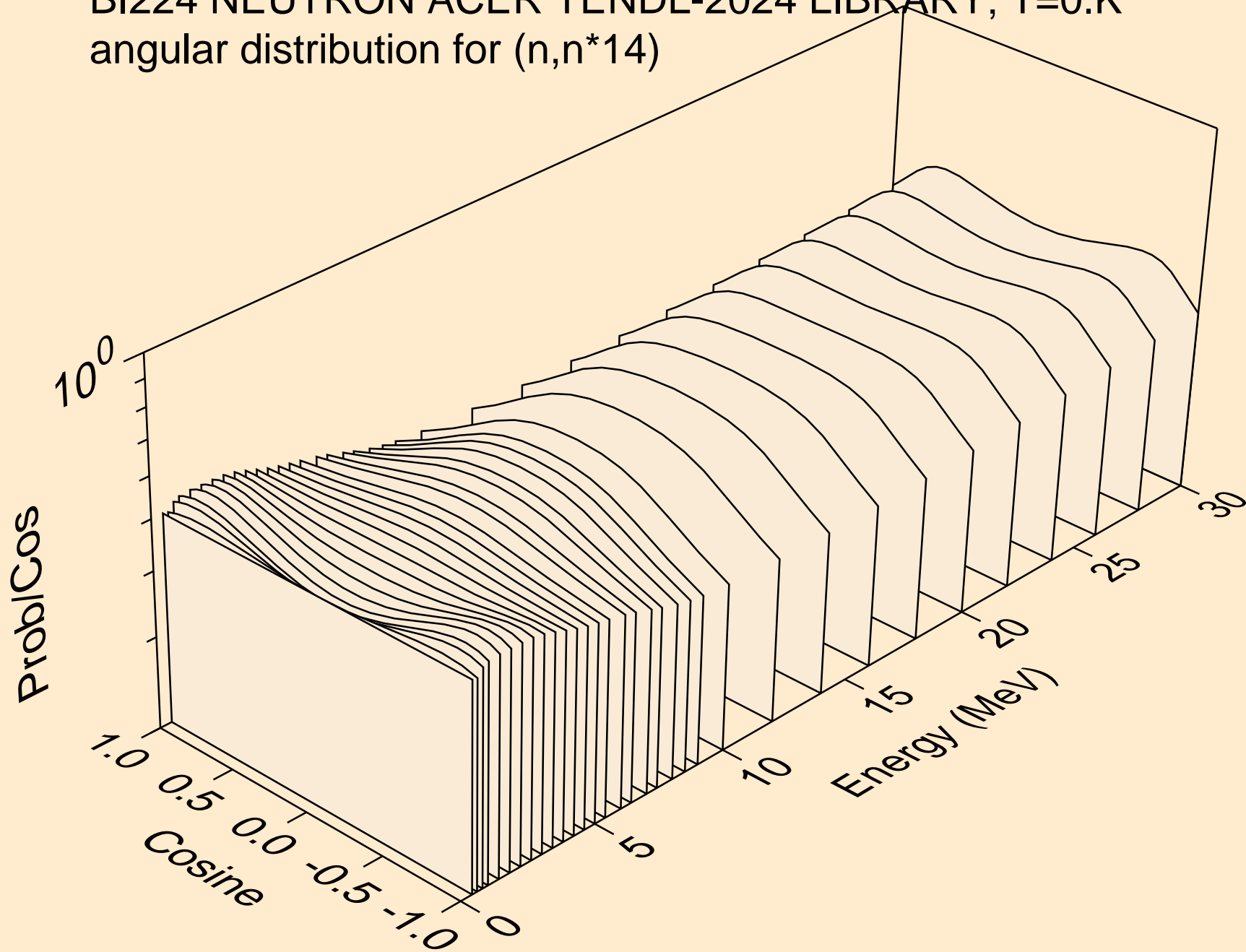

BI224 NEUTRON ACER TENDL-2024 LIBRARY; T=0.K
angular distribution for (n,n*15)

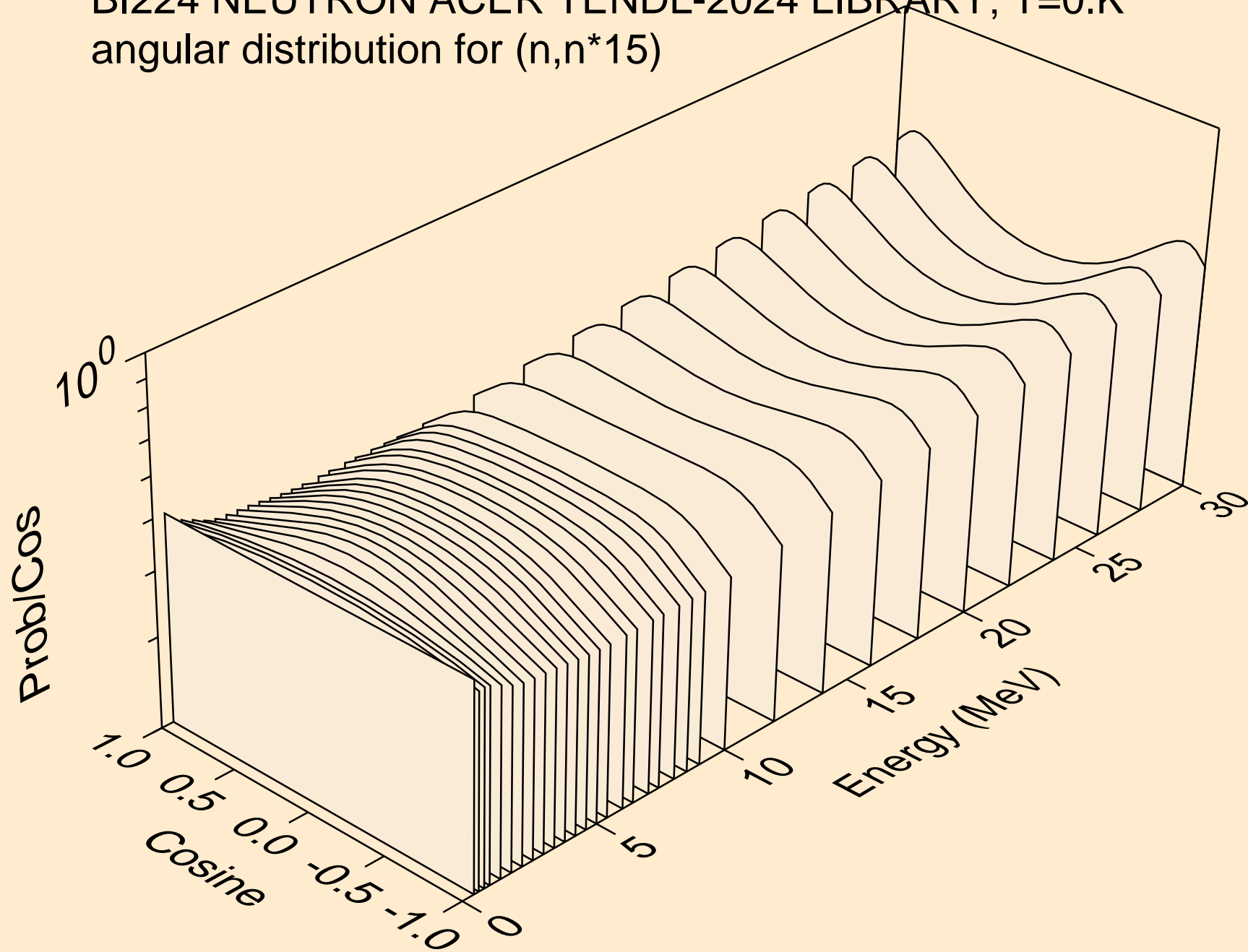

BI224 NEUTRON ACER TENDL-2024 LIBRARY; T=0.K
angular distribution for (n,n*16)

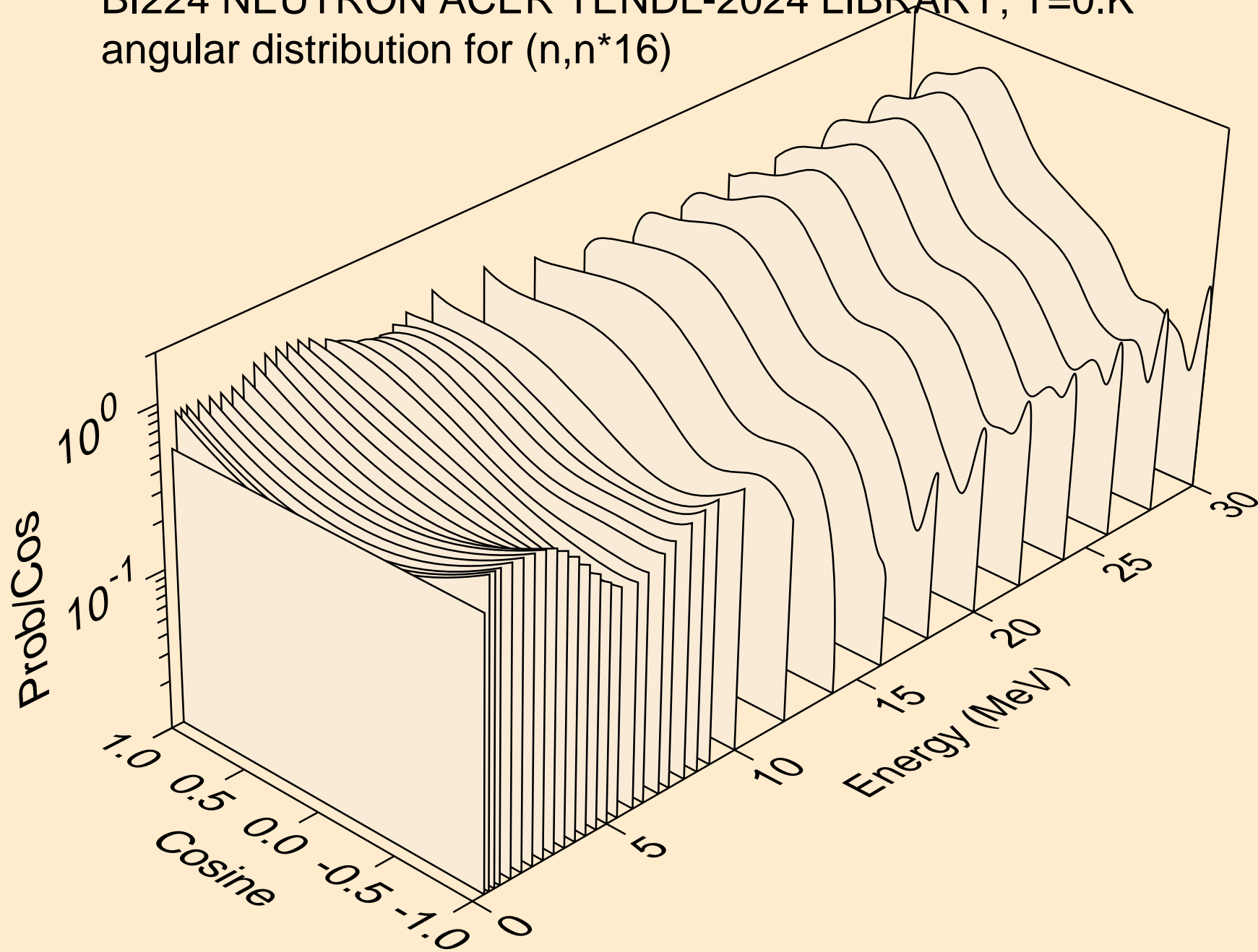

BI224 NEUTRON ACER TENDL-2024 LIBRARY; T=0.K
angular distribution for (n,n*17)

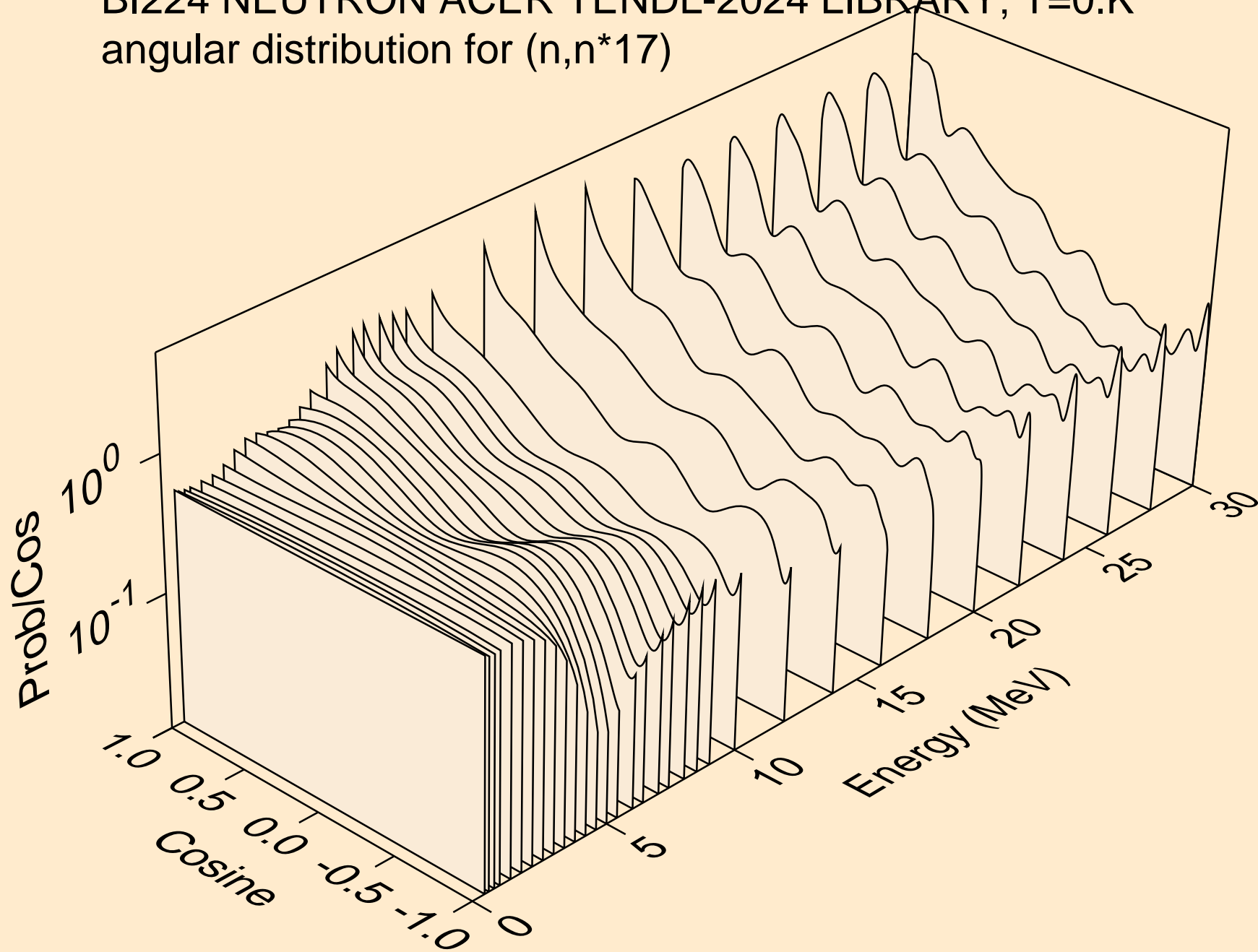

BI224 NEUTRON ACER TENDL-2024 LIBRARY; T=0.K
angular distribution for (n,n*18)

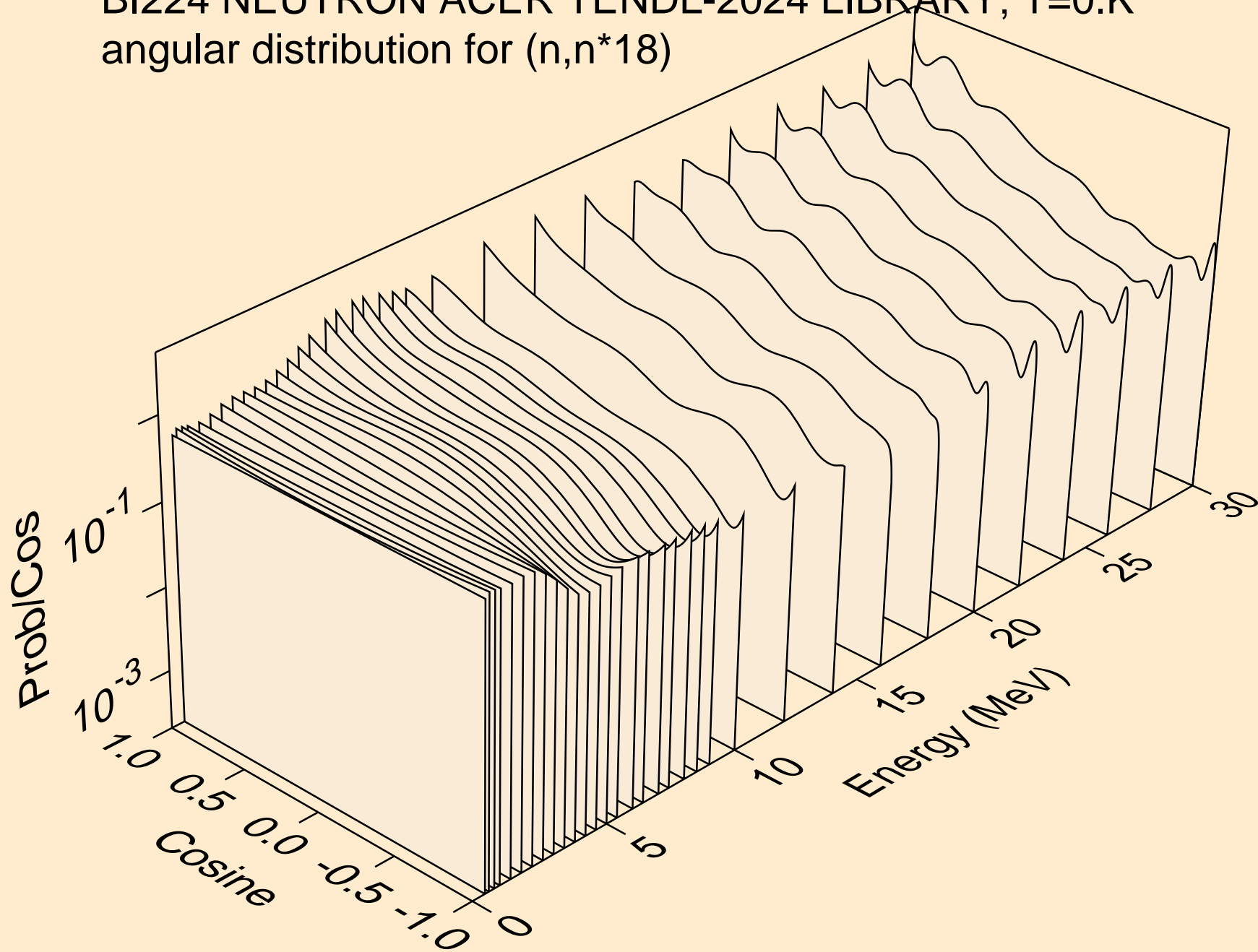

BI224 NEUTRON ACER TENDL-2024 LIBRARY; T=0.K
angular distribution for (n,n*19)

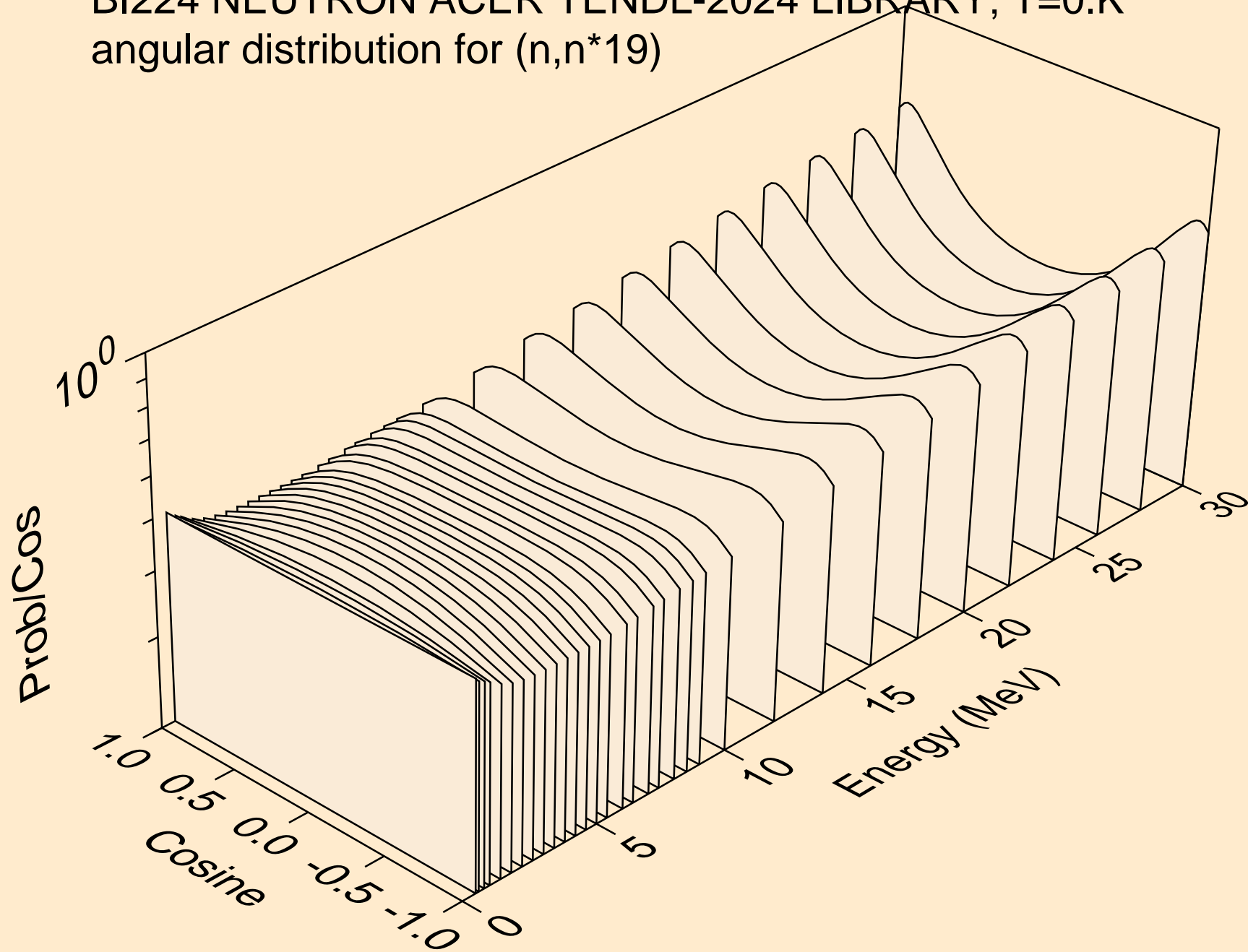

BI224 NEUTRON ACER TENDL-2024 LIBRARY; T=0.K
angular distribution for (n,n*20)

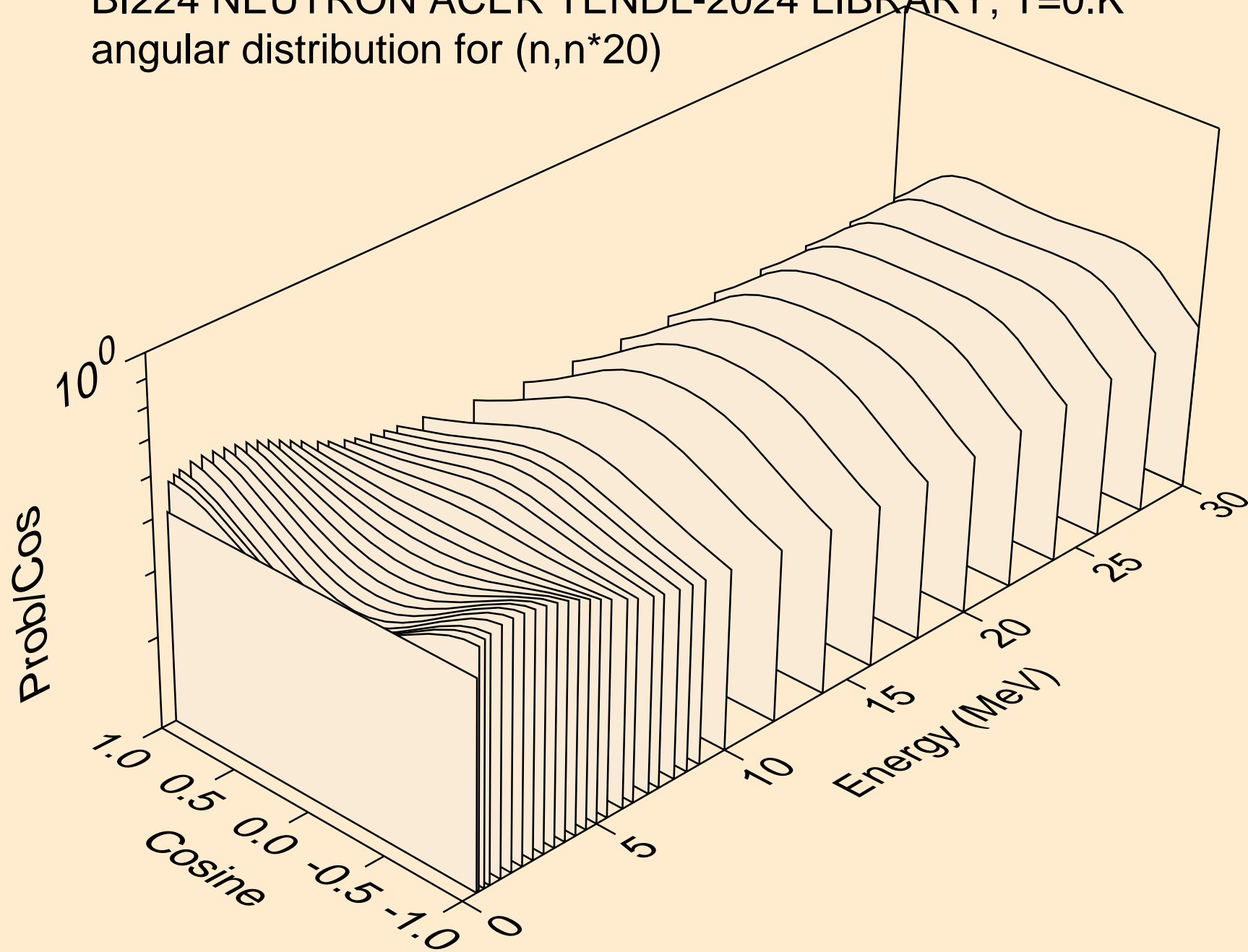

BI224 NEUTRON ACER TENDL-2024 LIBRARY; T=0.K
angular distribution for (n,n*21)

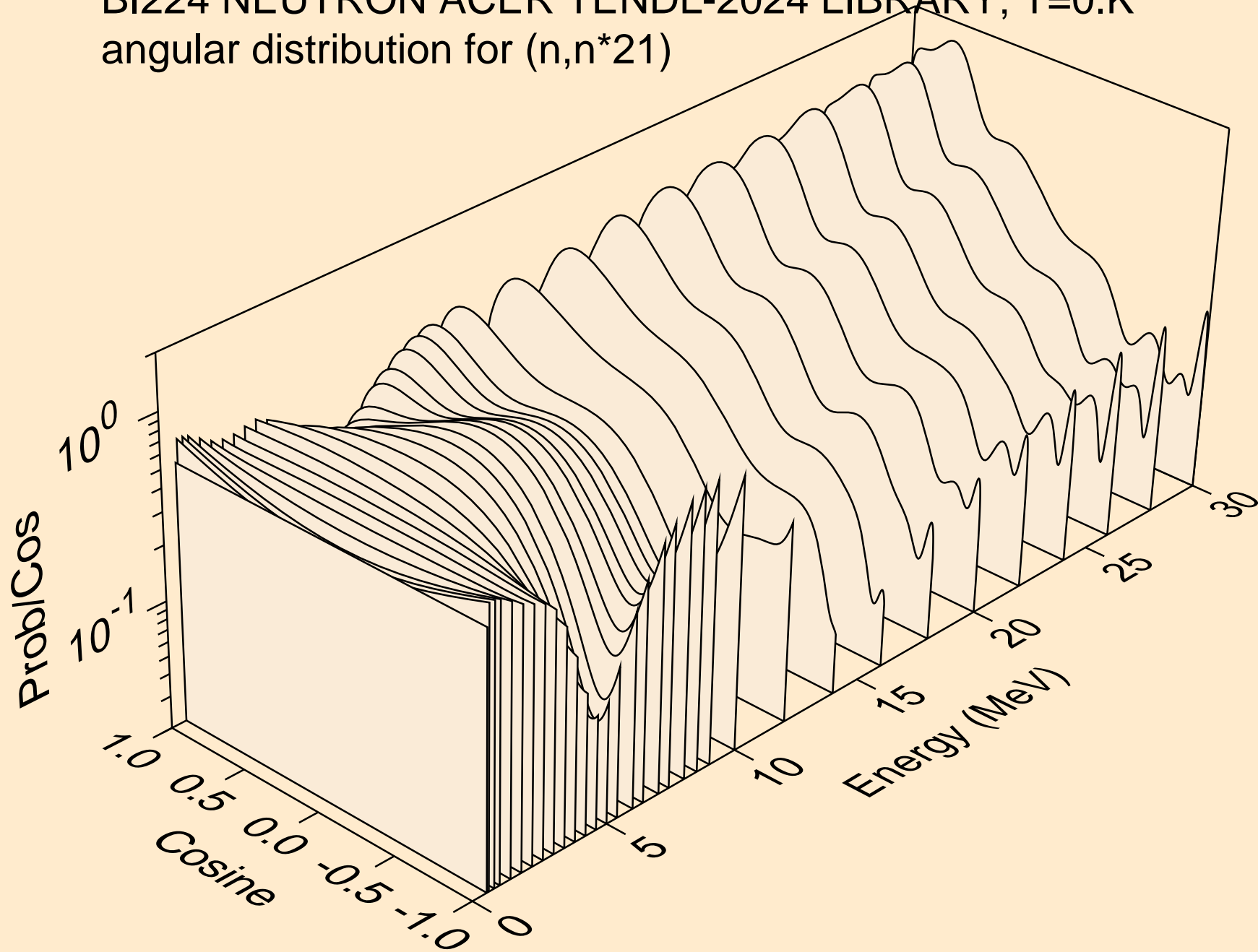

BI224 NEUTRON ACER TENDL-2024 LIBRARY; T=0.K
angular distribution for (n,n*22)

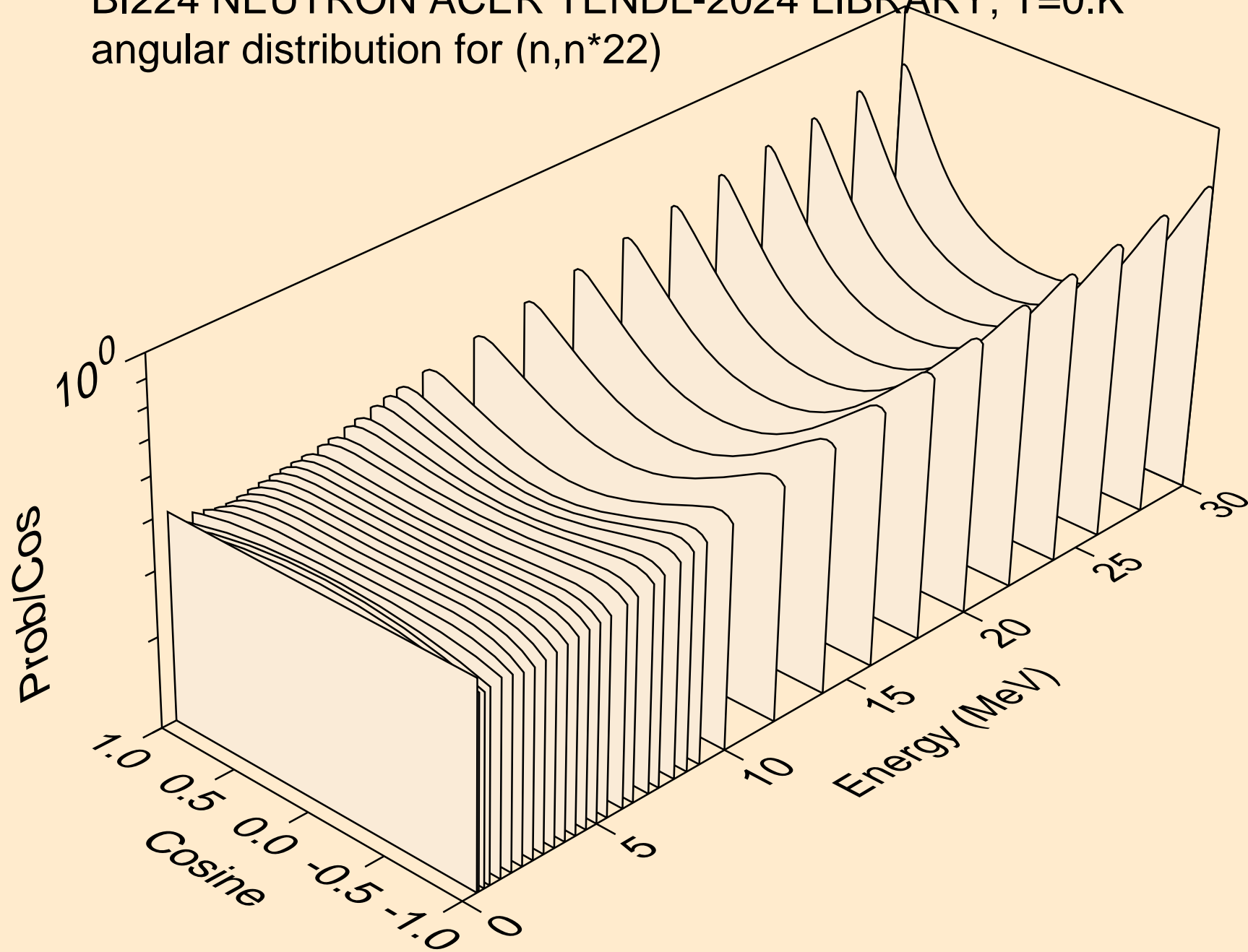

BI224 NEUTRON ACER TENDL-2024 LIBRARY; T=0.K
angular distribution for (n,n*23)

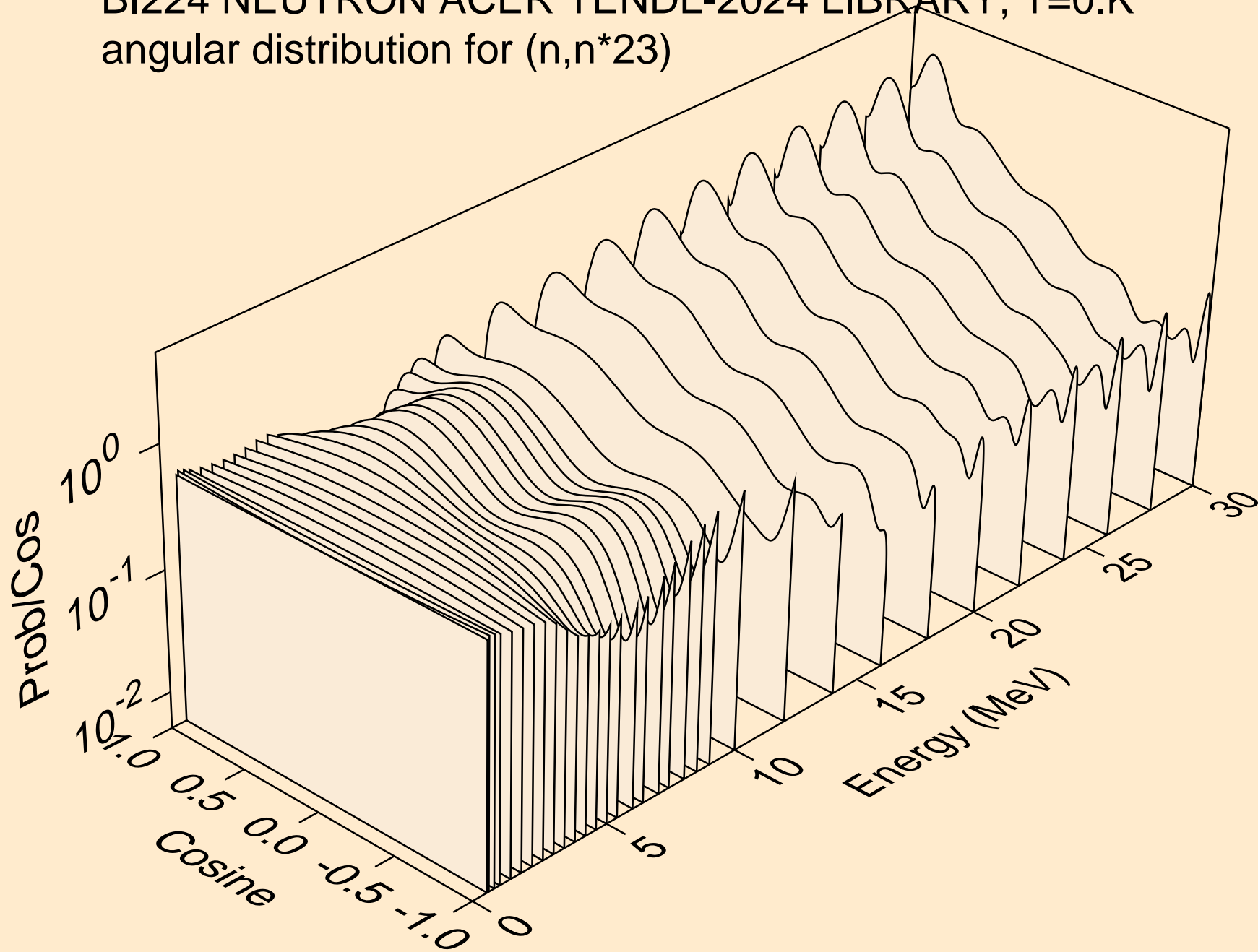

BI224 NEUTRON ACER TENDL-2024 LIBRARY; T=0.K
angular distribution for (n,n*24)

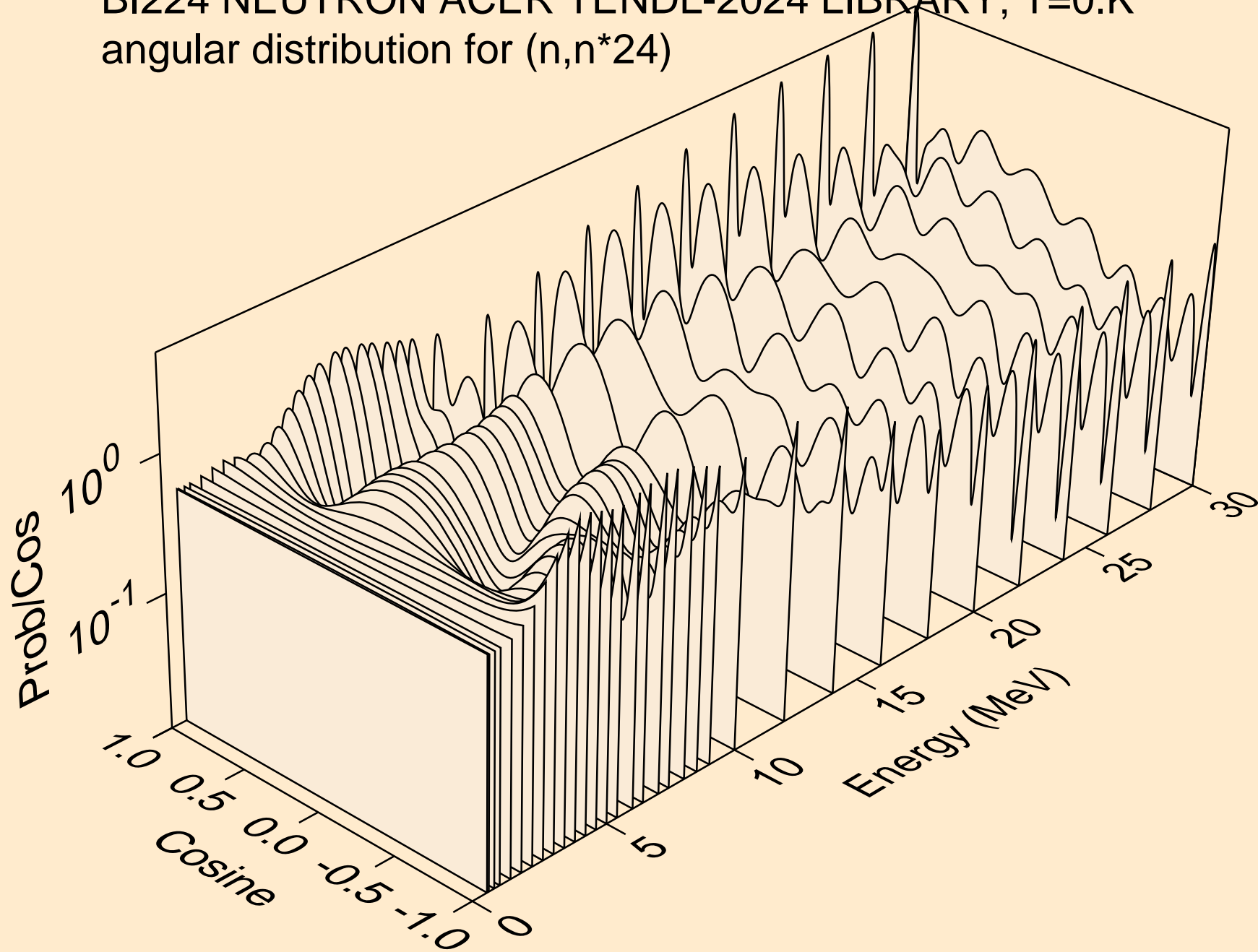

BI224 NEUTRON ACER TENDL-2024 LIBRARY; T=0.K
angular distribution for (n,n*25)

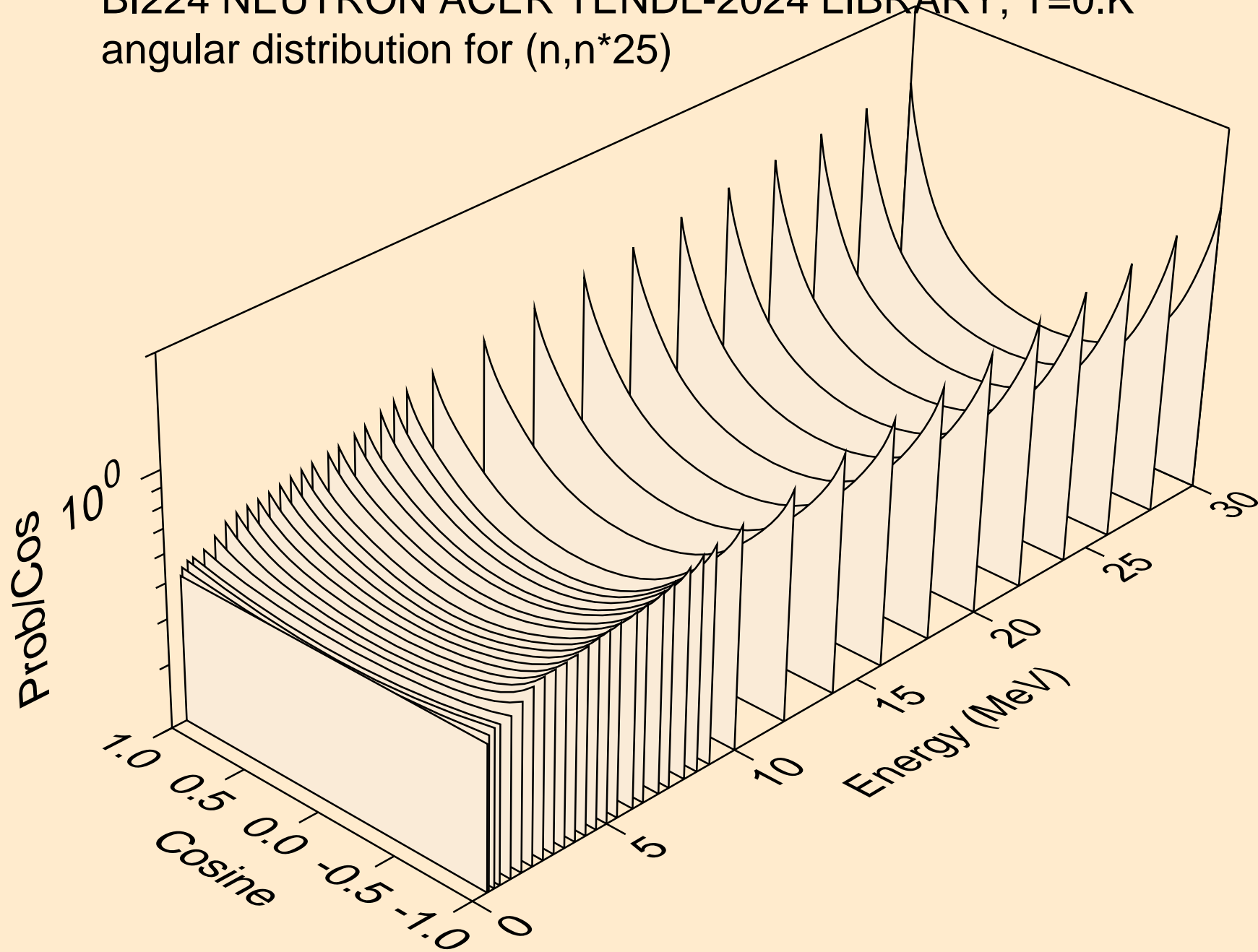

BI224 NEUTRON ACER TENDL-2024 LIBRARY; T=0.K
angular distribution for (n,n*26)

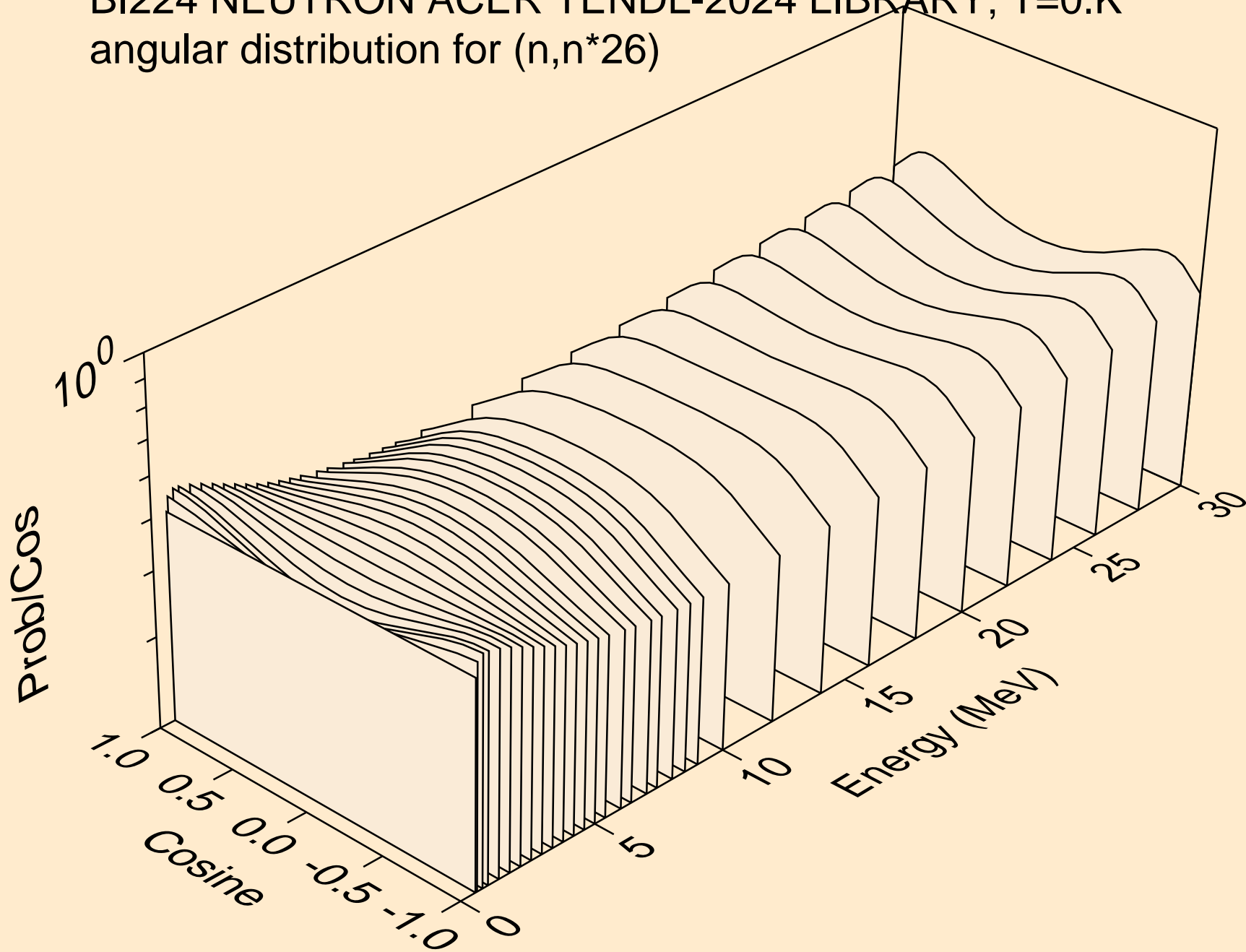

BI224 NEUTRON ACER TENDL-2024 LIBRARY; T=0.K
angular distribution for (n,n*27)

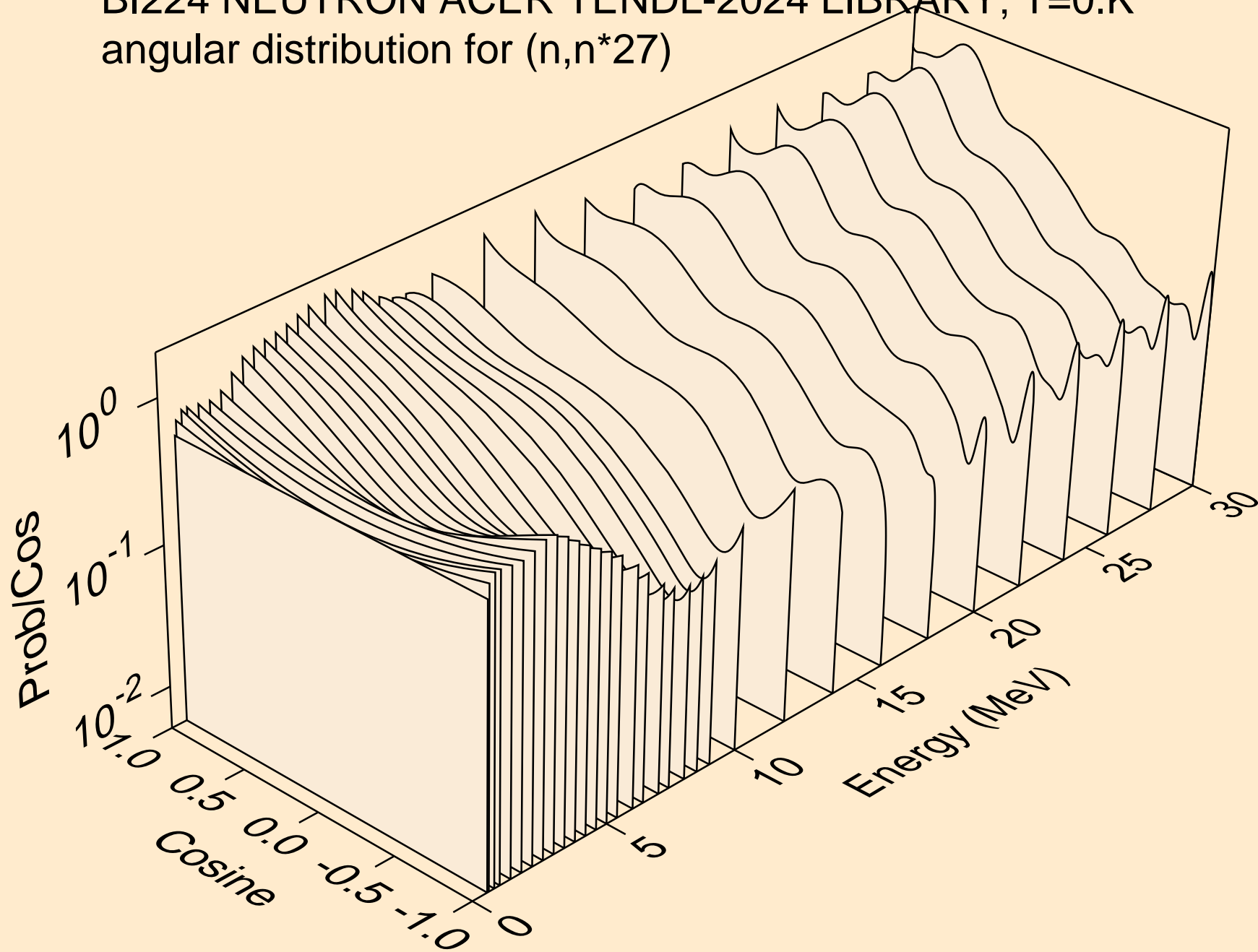

BI224 NEUTRON ACER TENDL-2024 LIBRARY; T=0.K
angular distribution for (n,n*28)

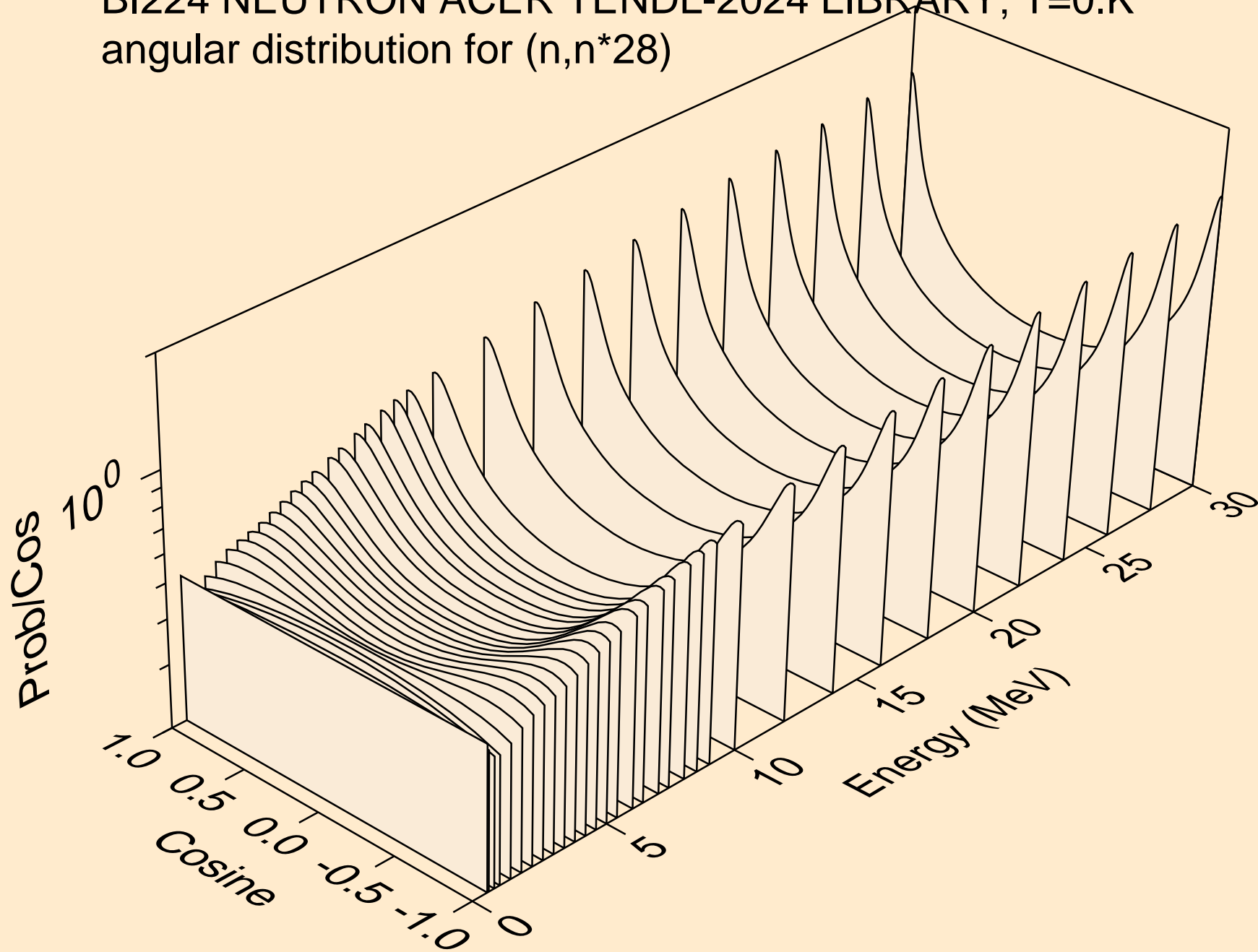

BI224 NEUTRON ACER TENDL-2024 LIBRARY; T=0.K
angular distribution for (n,n*29)

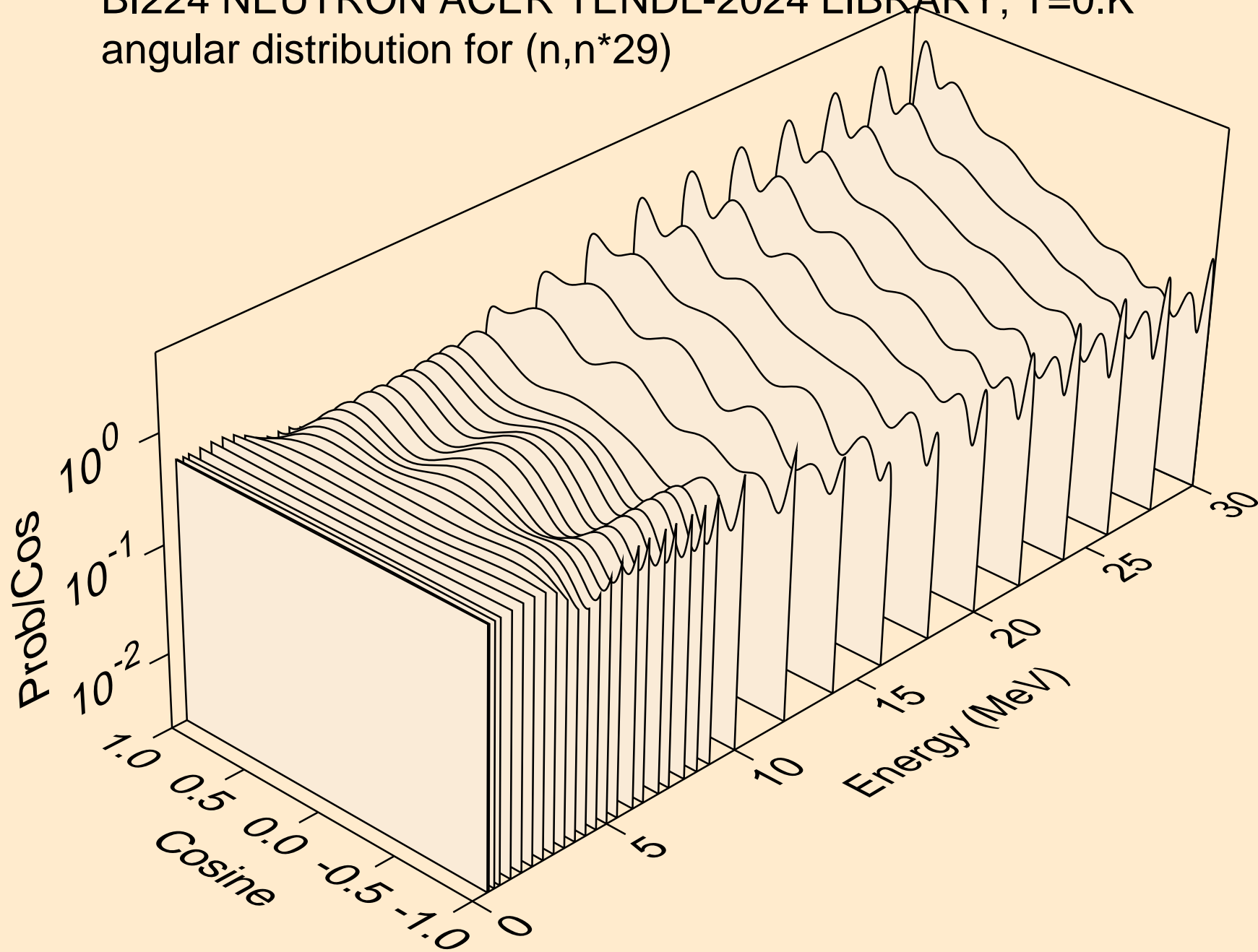

BI224 NEUTRON ACER TENDL-2024 LIBRARY; T=0.K
angular distribution for (n,n*30)

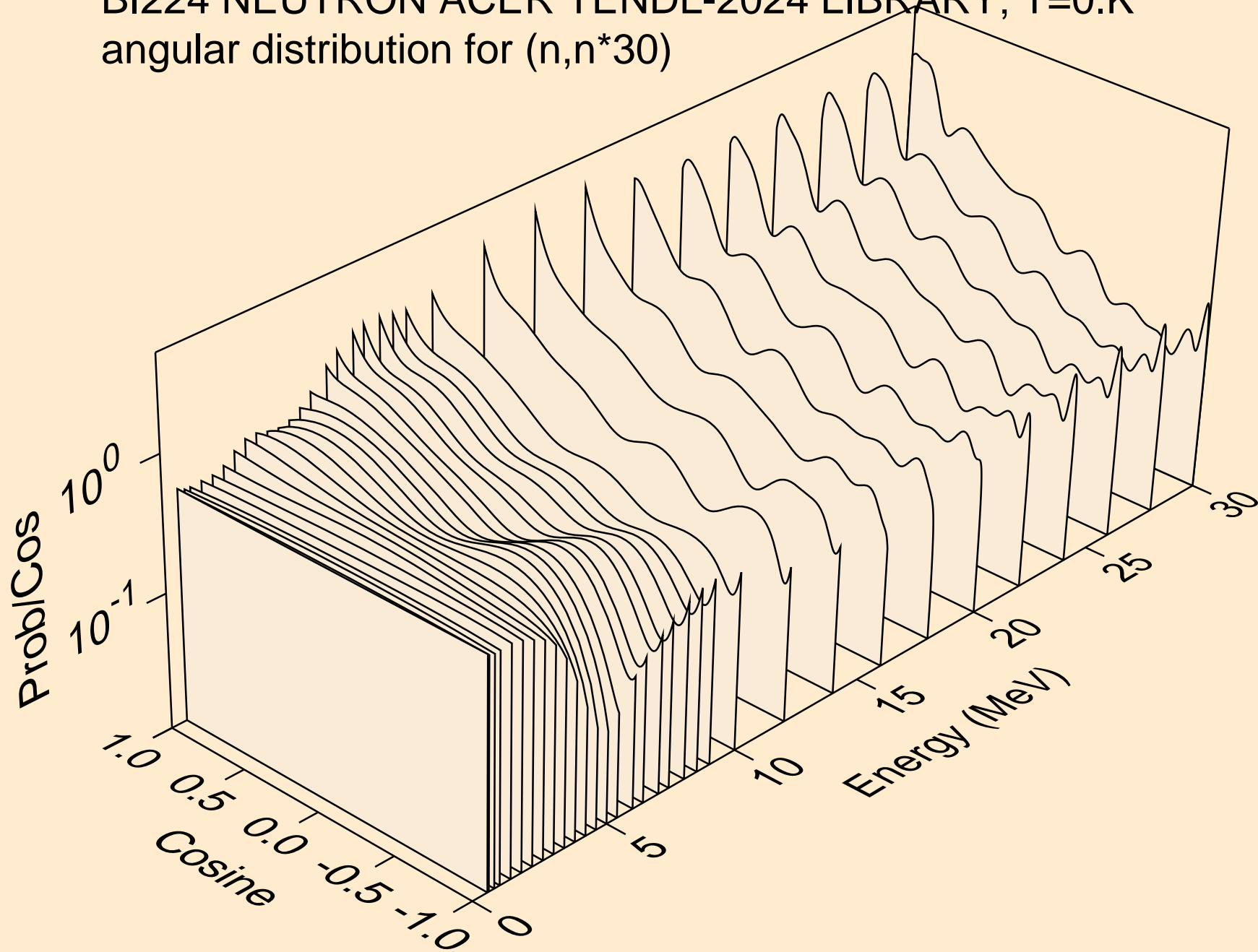

BI224 NEUTRON ACER TENDL-2024 LIBRARY; T=0.K

Total fission nubar

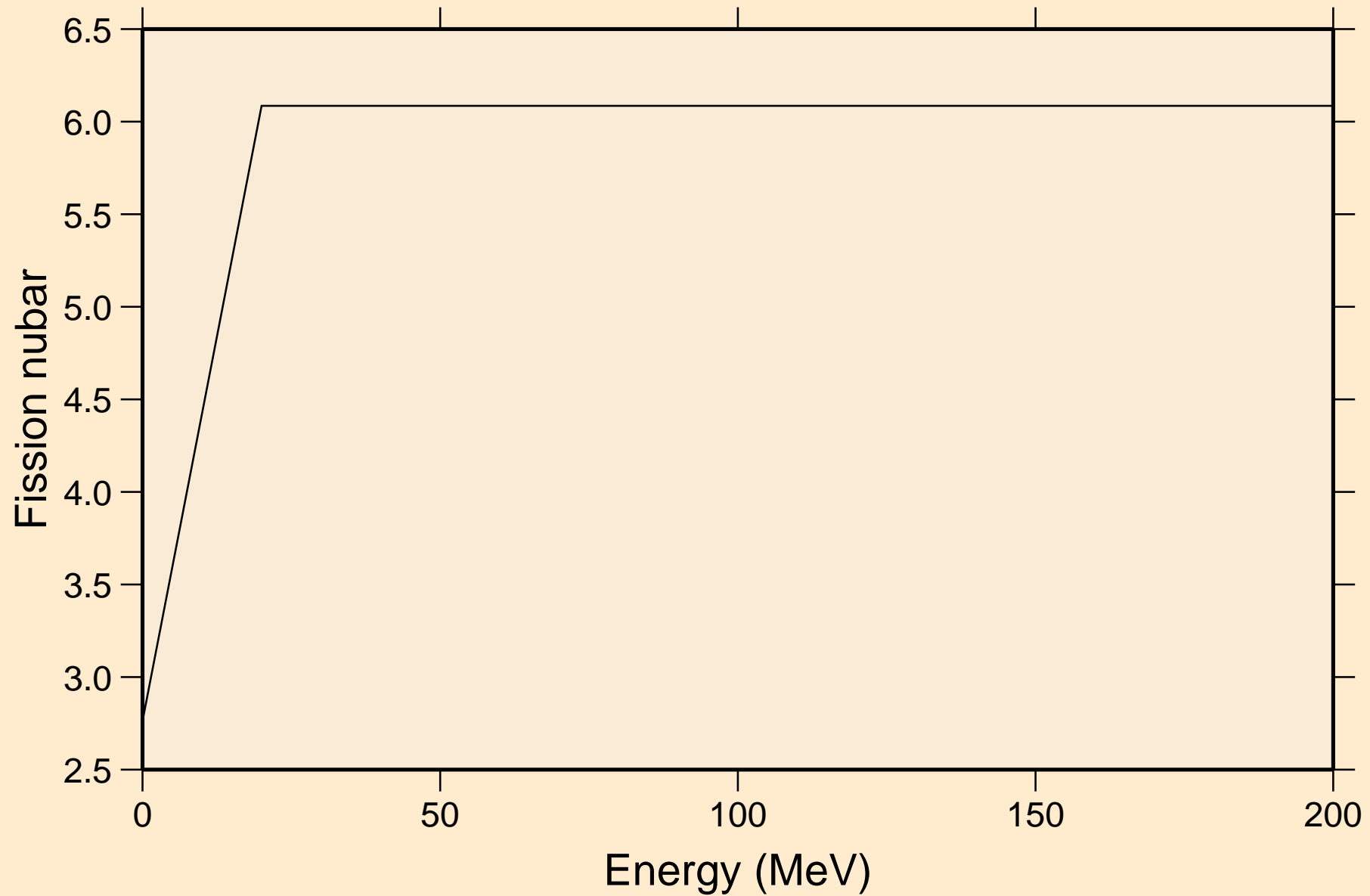

BI224 NEUTRON ACER TENDL-2024 LIBRARY; T=0.K
Neutron emission for (n,x)

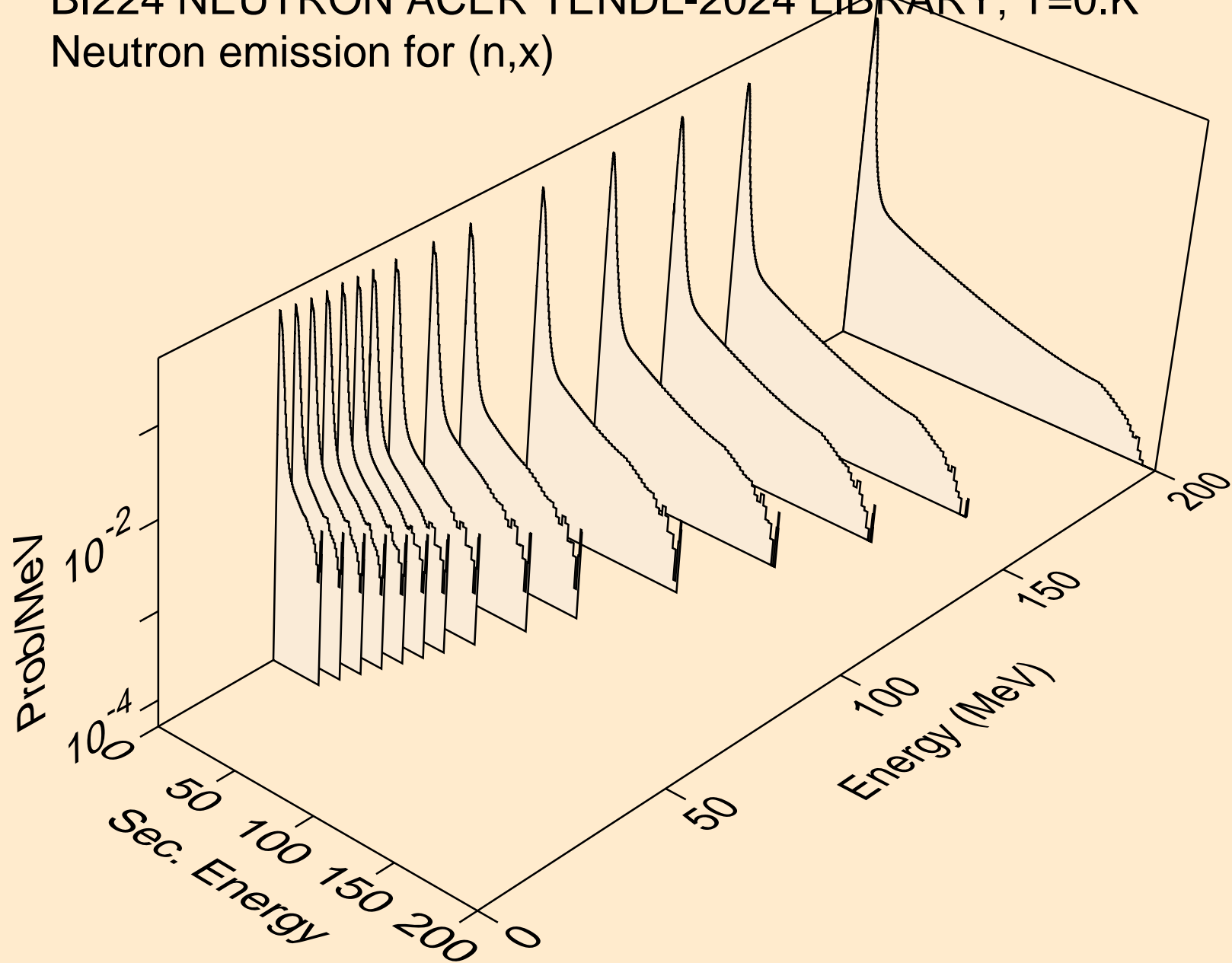

BI224 NEUTRON ACER TENDL-2024 LIBRARY; T=0.K
Neutron emission for (n,2nd)

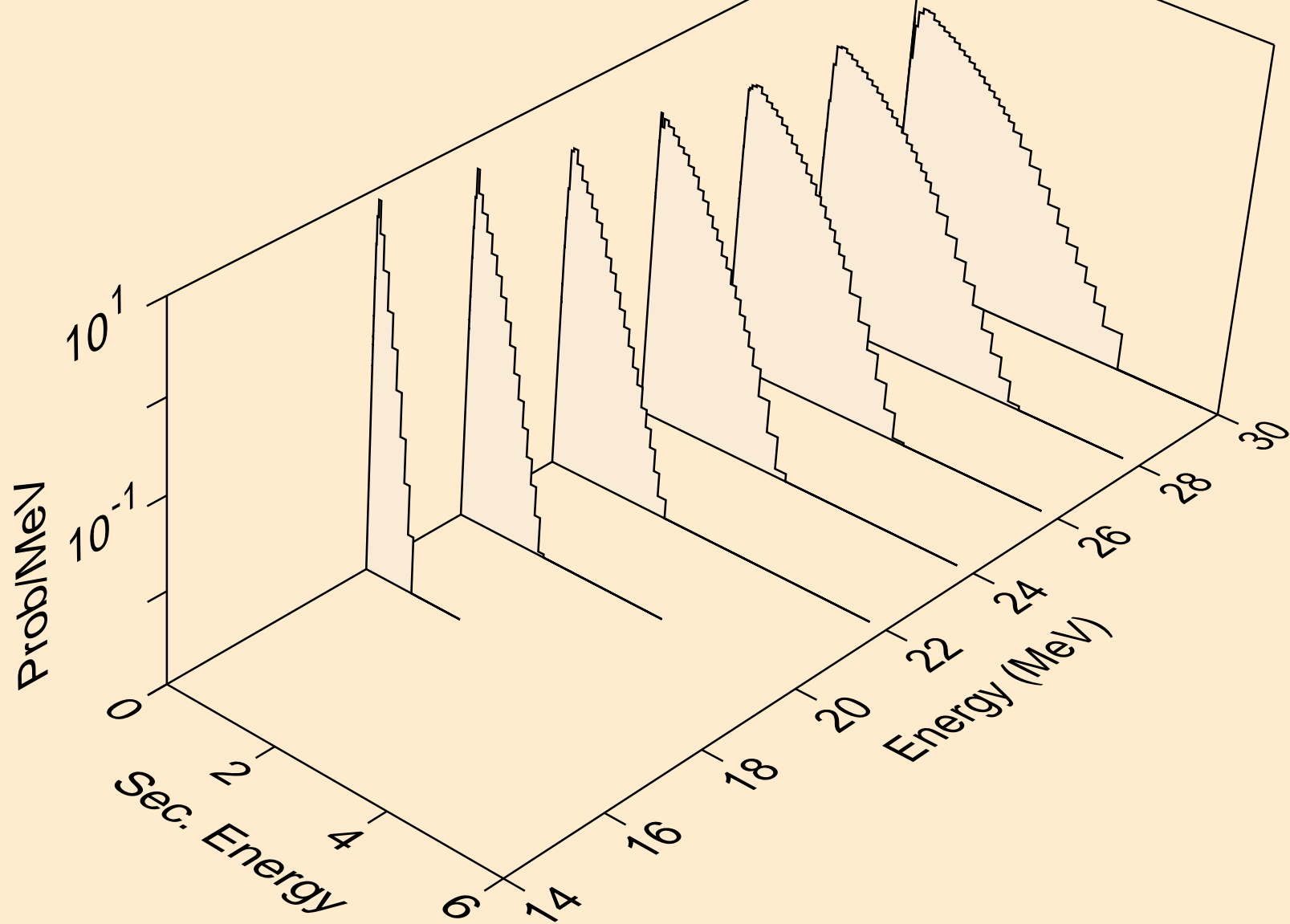

BI224 NEUTRON ACER TENDL-2024 LIBRARY; T=0.K
Neutron emission for (n,2n)

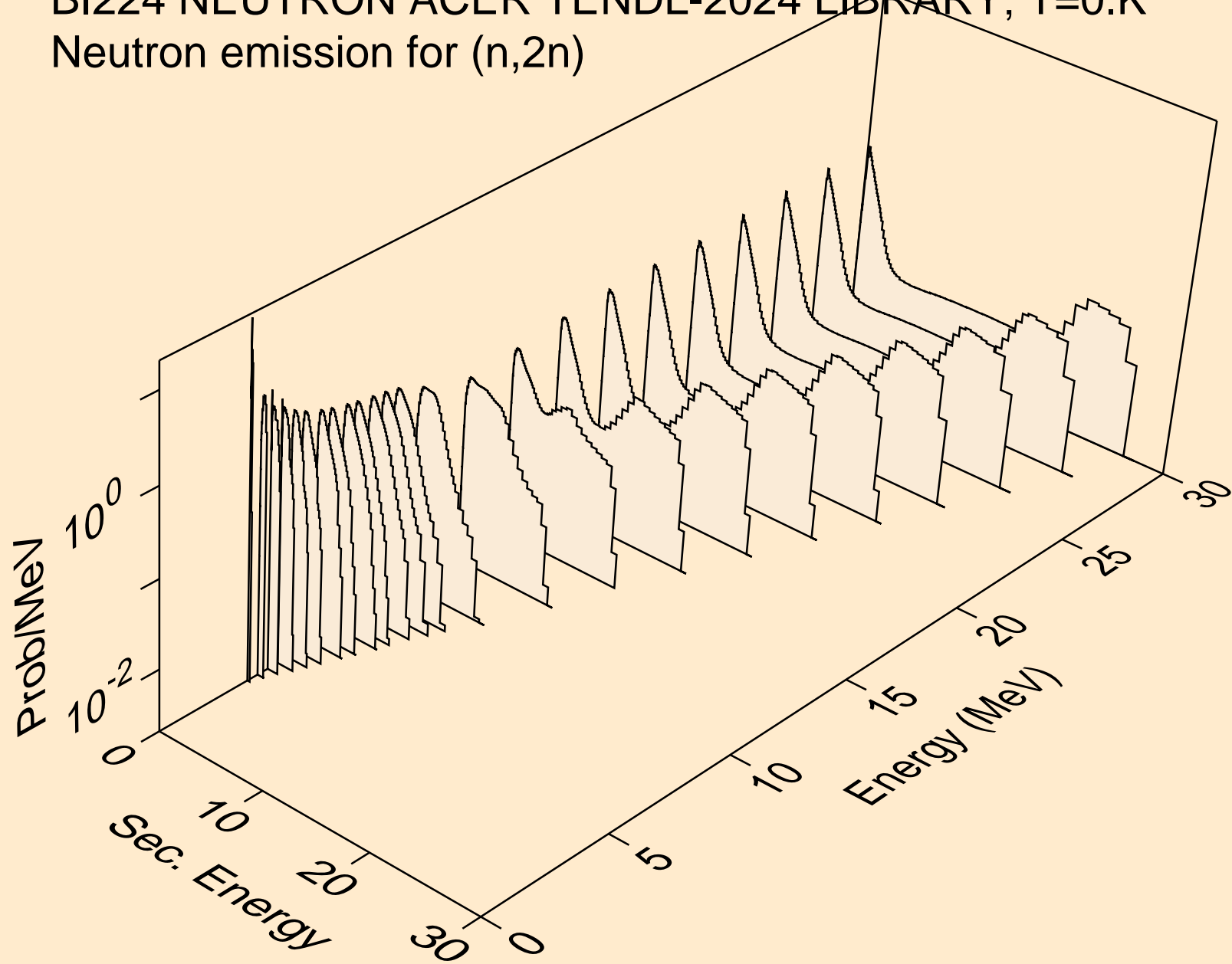

BI224 NEUTRON ACER TENDL-2024 LIBRARY; T=0.K
Neutron emission for (n,3n)

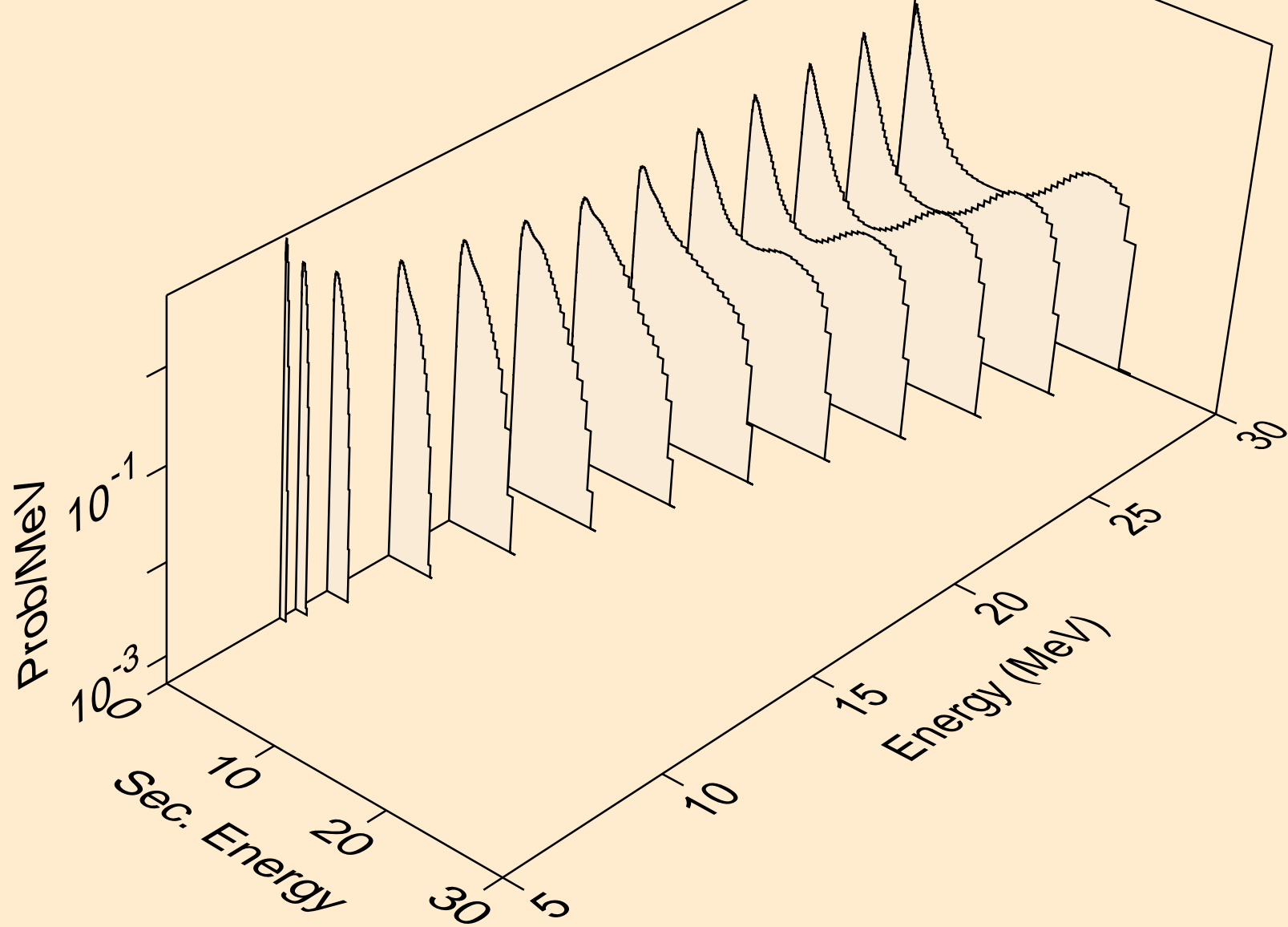

BI224 NEUTRON ACER TENDL-2024 LIBRARY; T=0.K
Neutron emission for fission

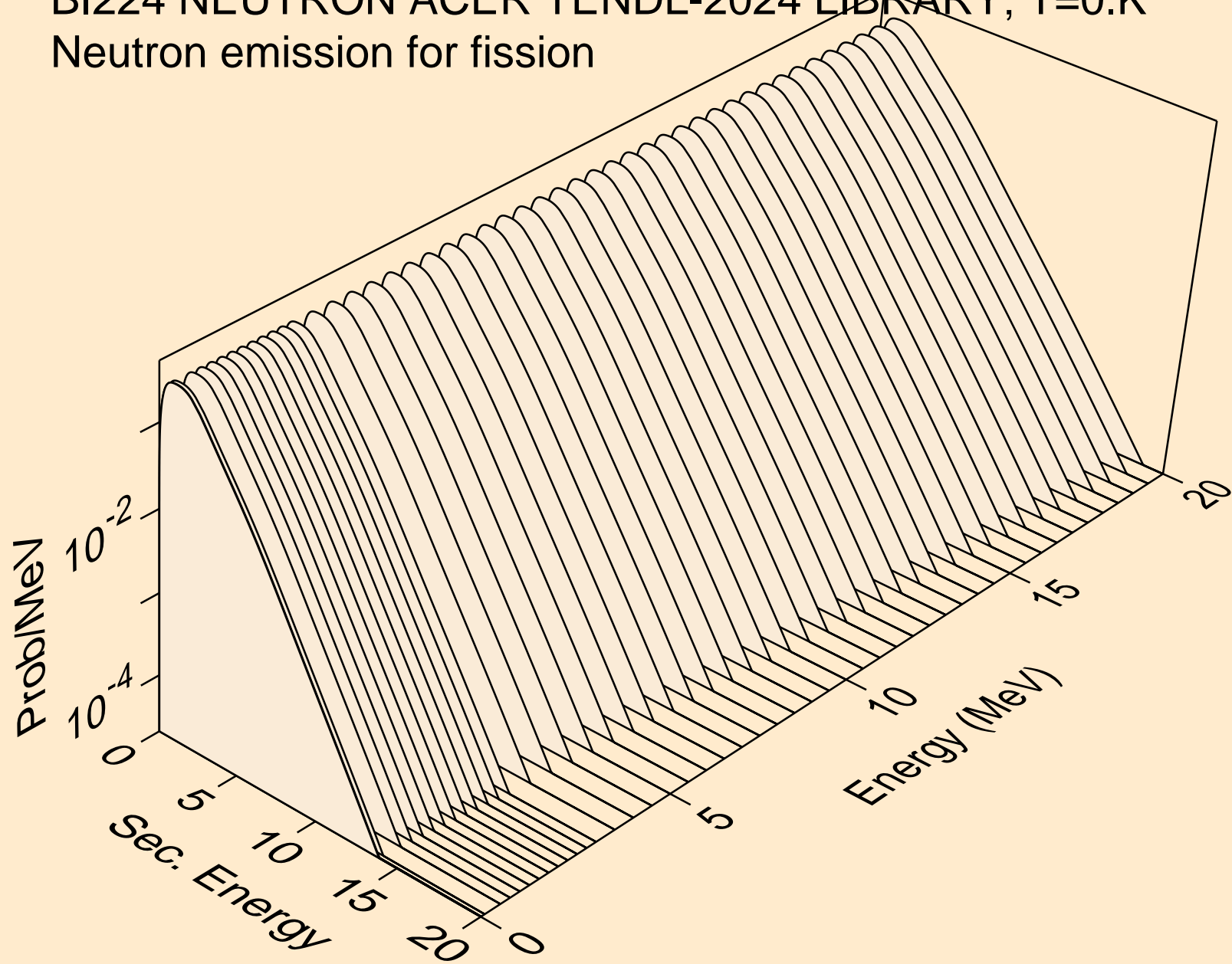

BI224 NEUTRON ACER TENDL-2024 LIBRARY; T=0.K
Neutron emission for (n,n*)a

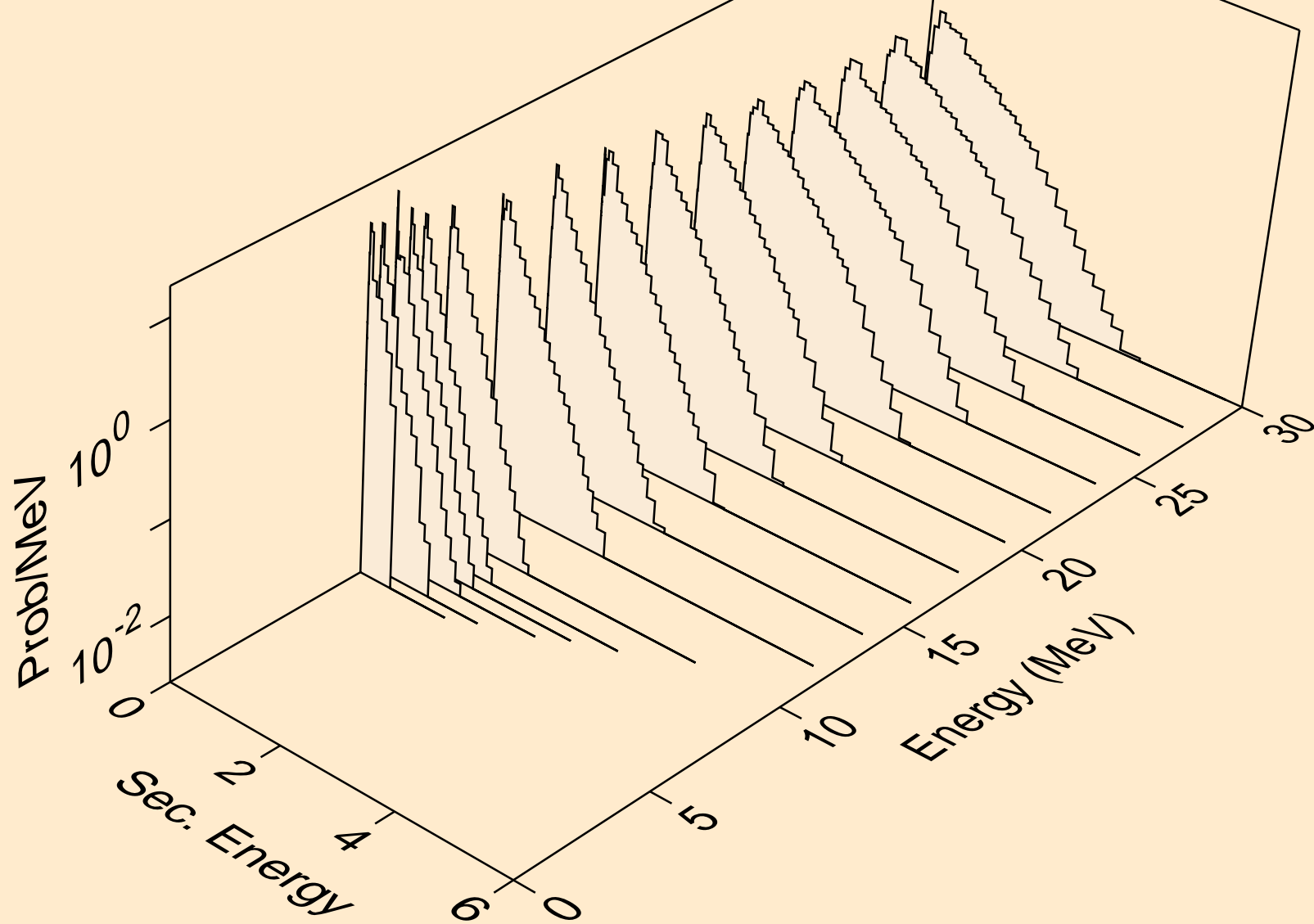

BI224 NEUTRON ACER TENDL-2024 LIBRARY; T=0.K
Neutron emission for (n,2n)a

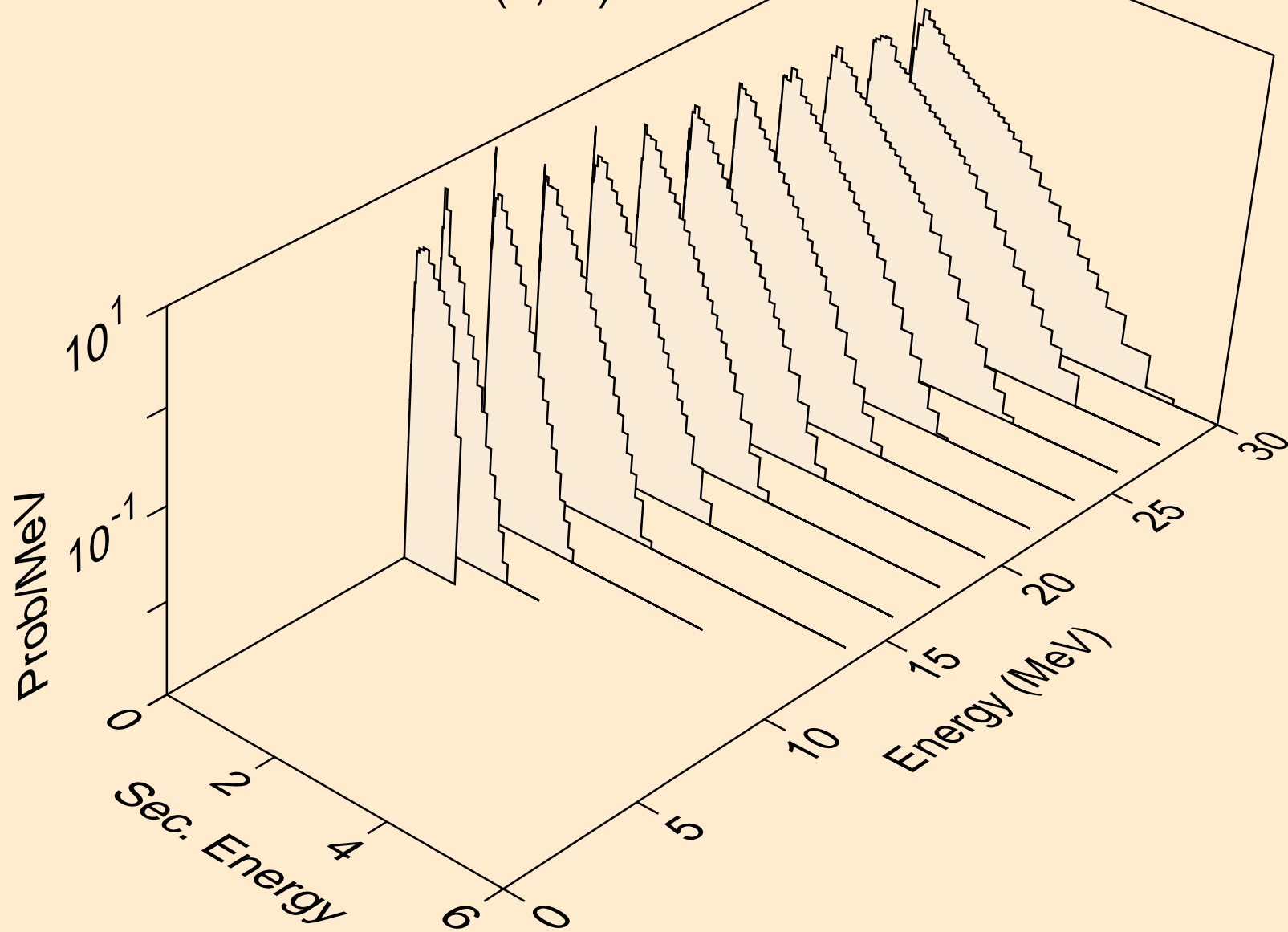

BI224 NEUTRON ACER TENDL-2024 LIBRARY; T=0.K
Neutron emission for (n,3n)a

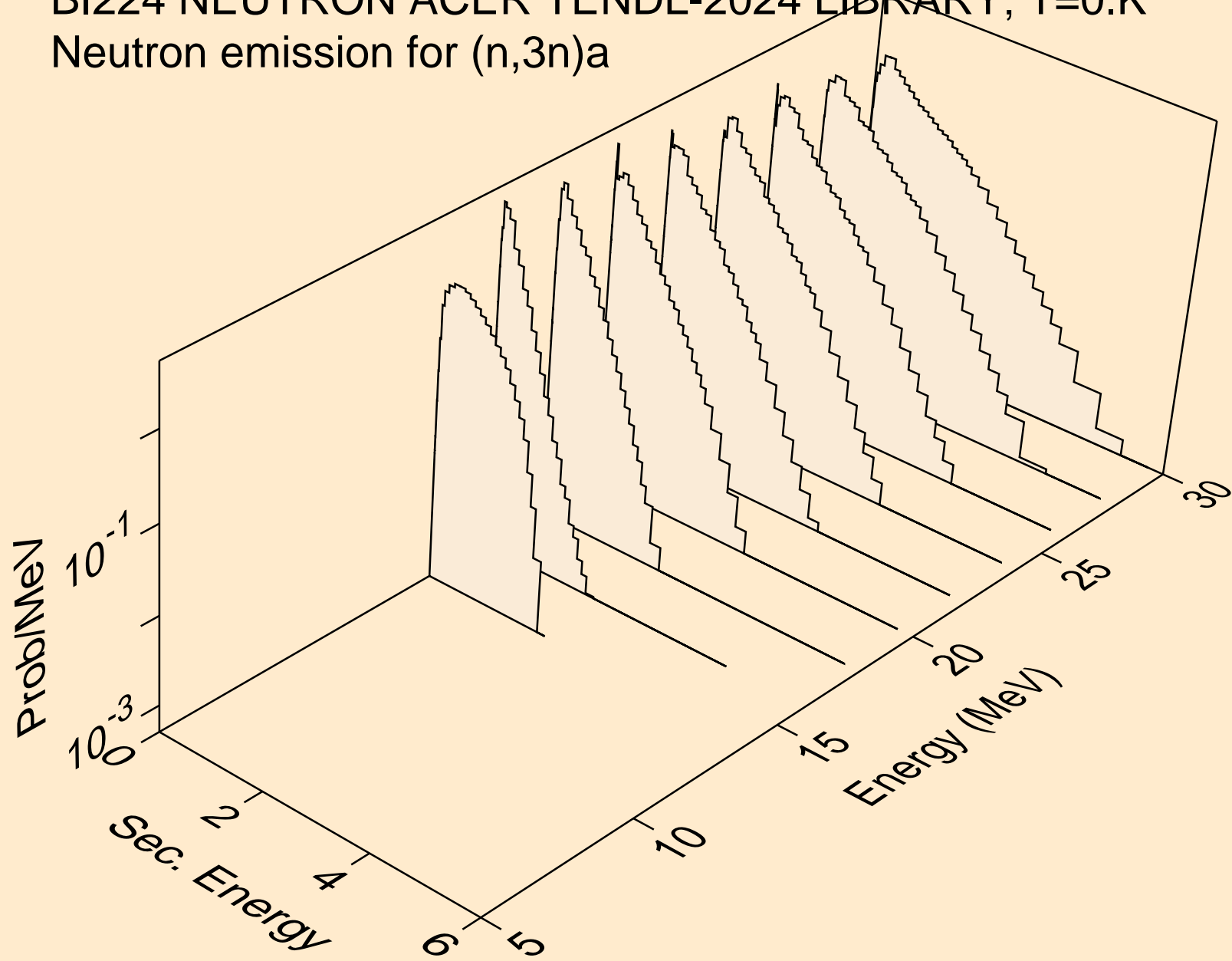

BI224 NEUTRON ACER TENDL-2024 LIBRARY; T=0.K
Neutron emission for (n,n*)p

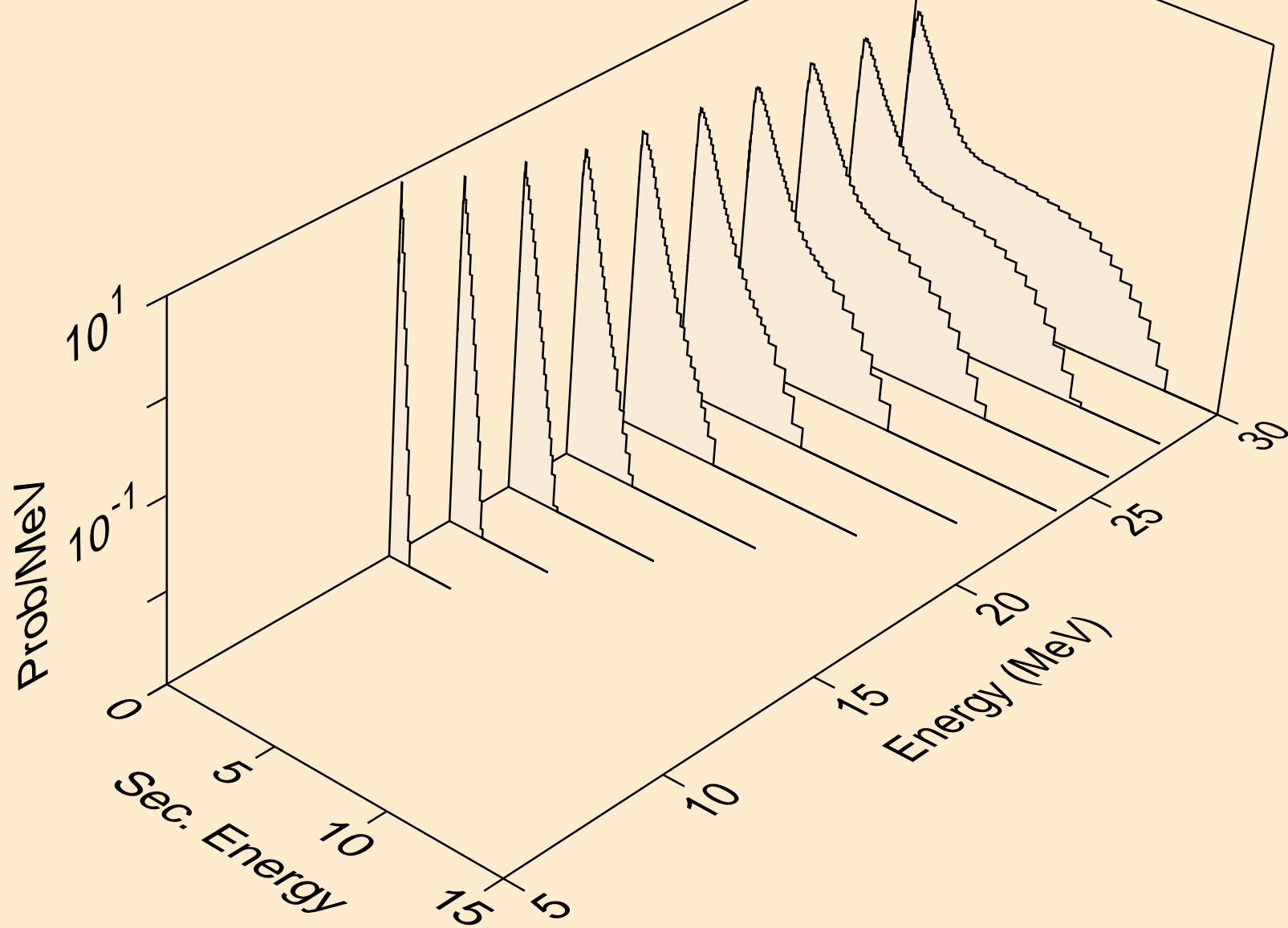

BI224 NEUTRON ACER TENDL-2024 LIBRARY; T=0.K
Neutron emission for (n,n*)d

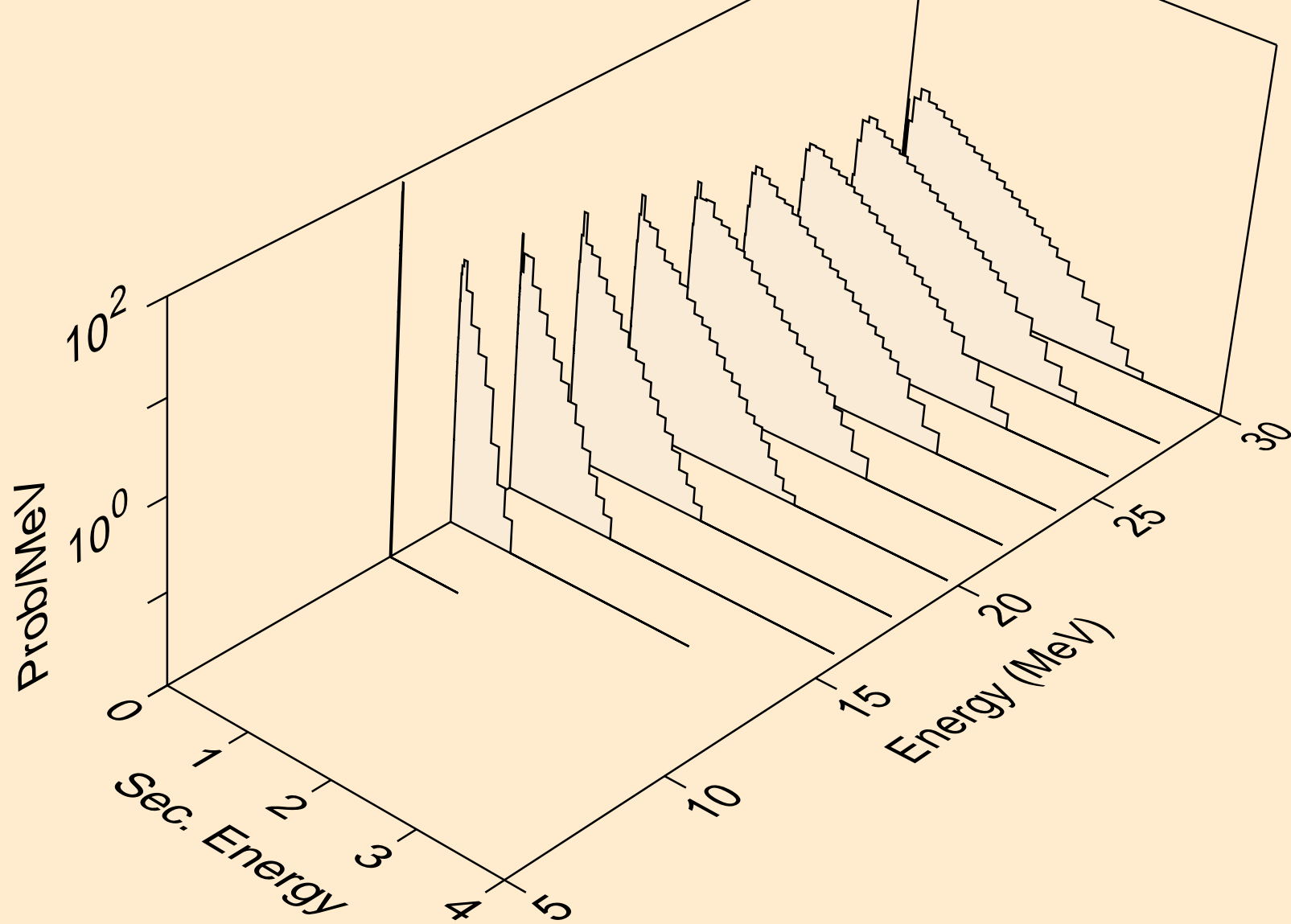

BI224 NEUTRON ACER TENDL-2024 LIBRARY; T=0.K
Neutron emission for (n,n*)t

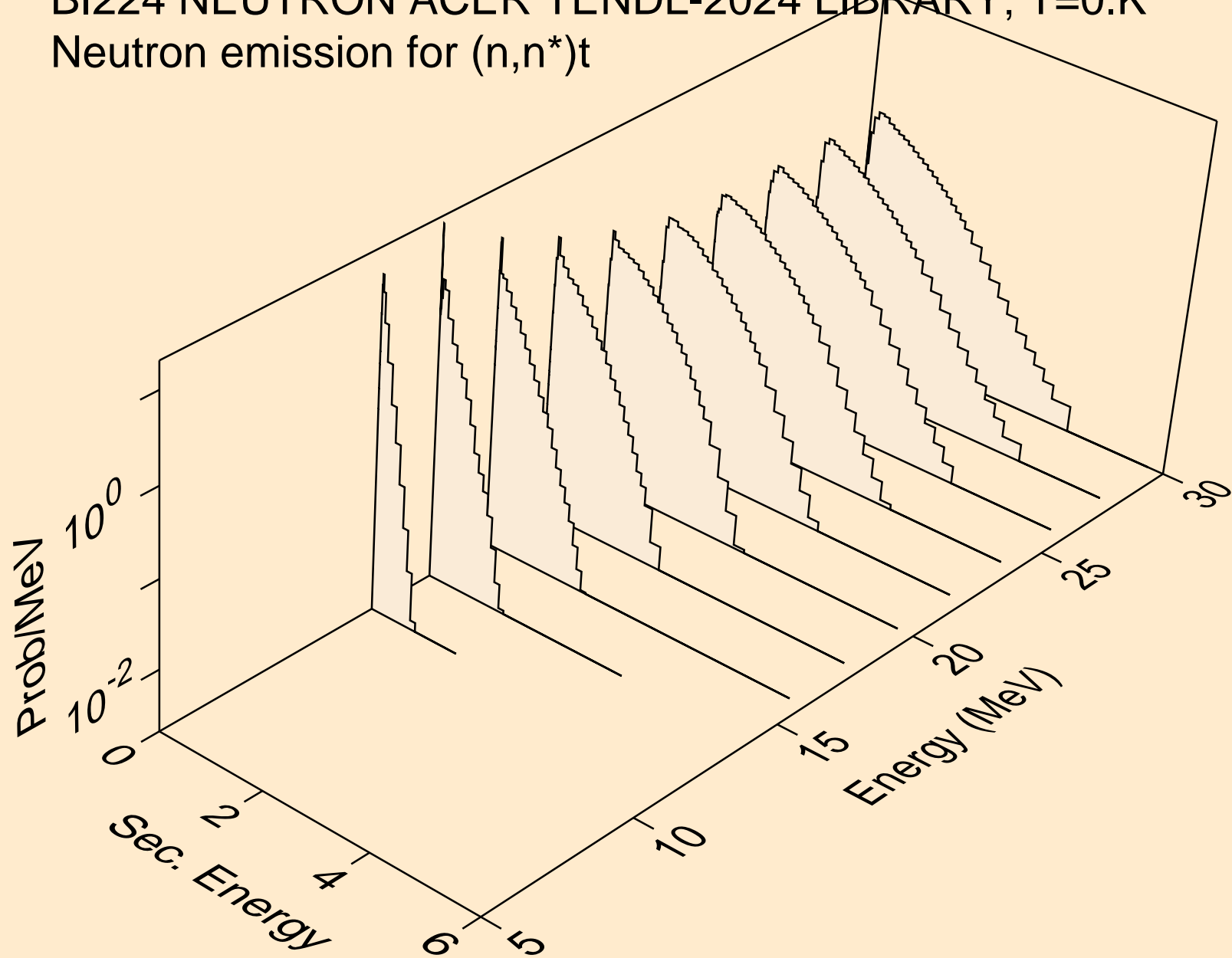

BI224 NEUTRON ACER TENDL-2024 LIBRARY; T=0.K
Neutron emission for (n,n*)he3

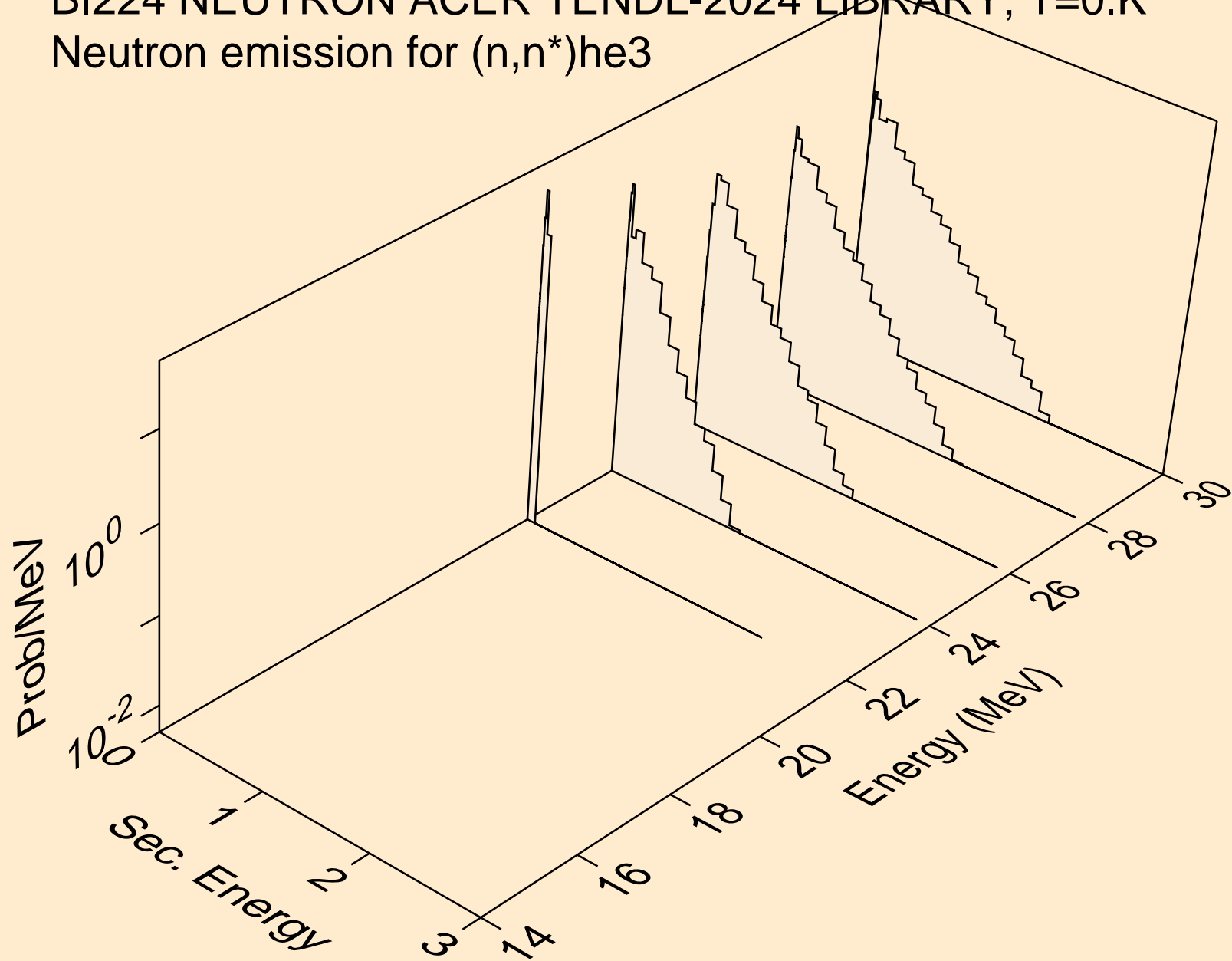

BI224 NEUTRON ACER TENDL-2024 LIBRARY; T=0.K
Neutron emission for (n,4n)

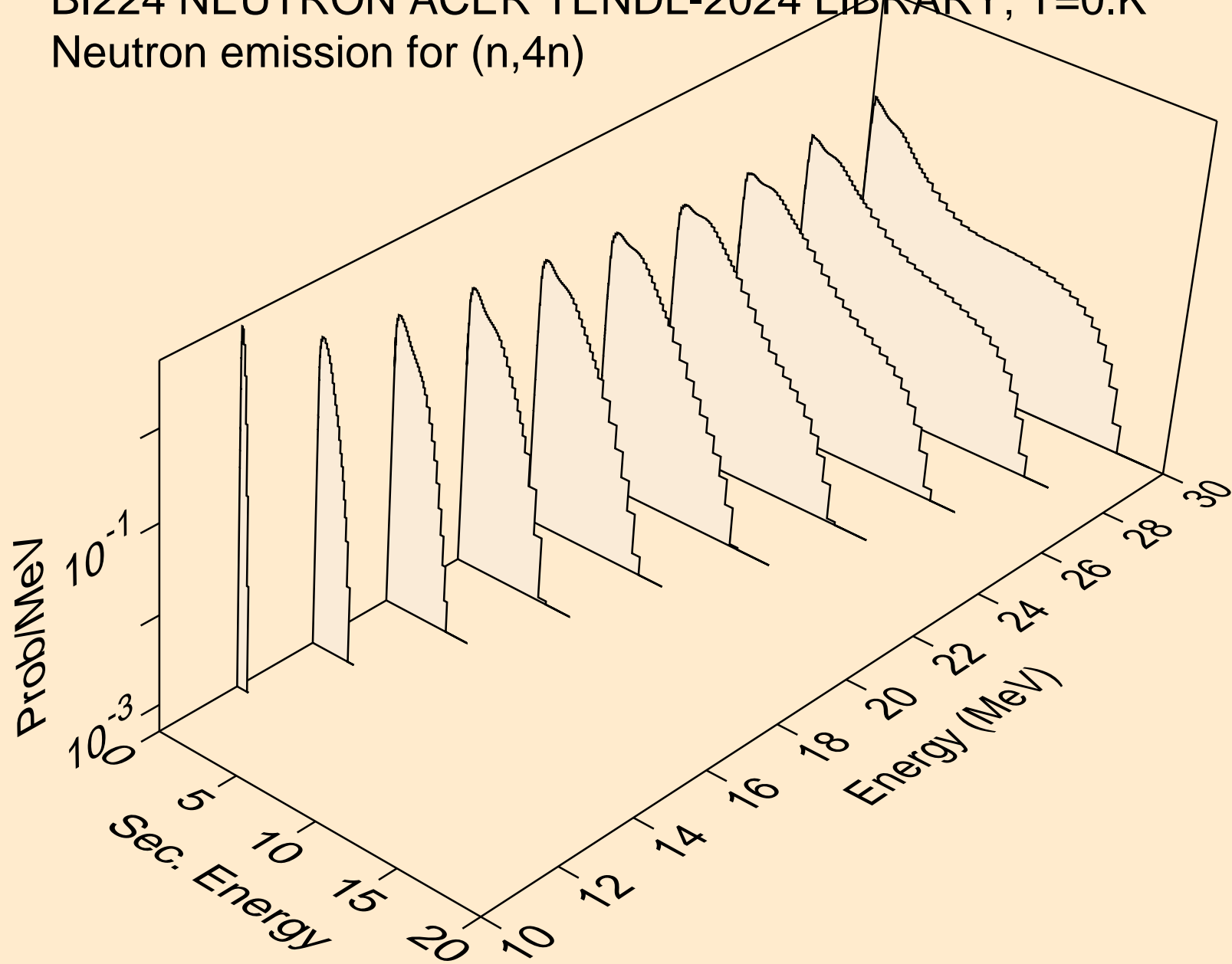

BI224 NEUTRON ACER TENDL-2024 LIBRARY; T=0.K
Neutron emission for (n,2np)

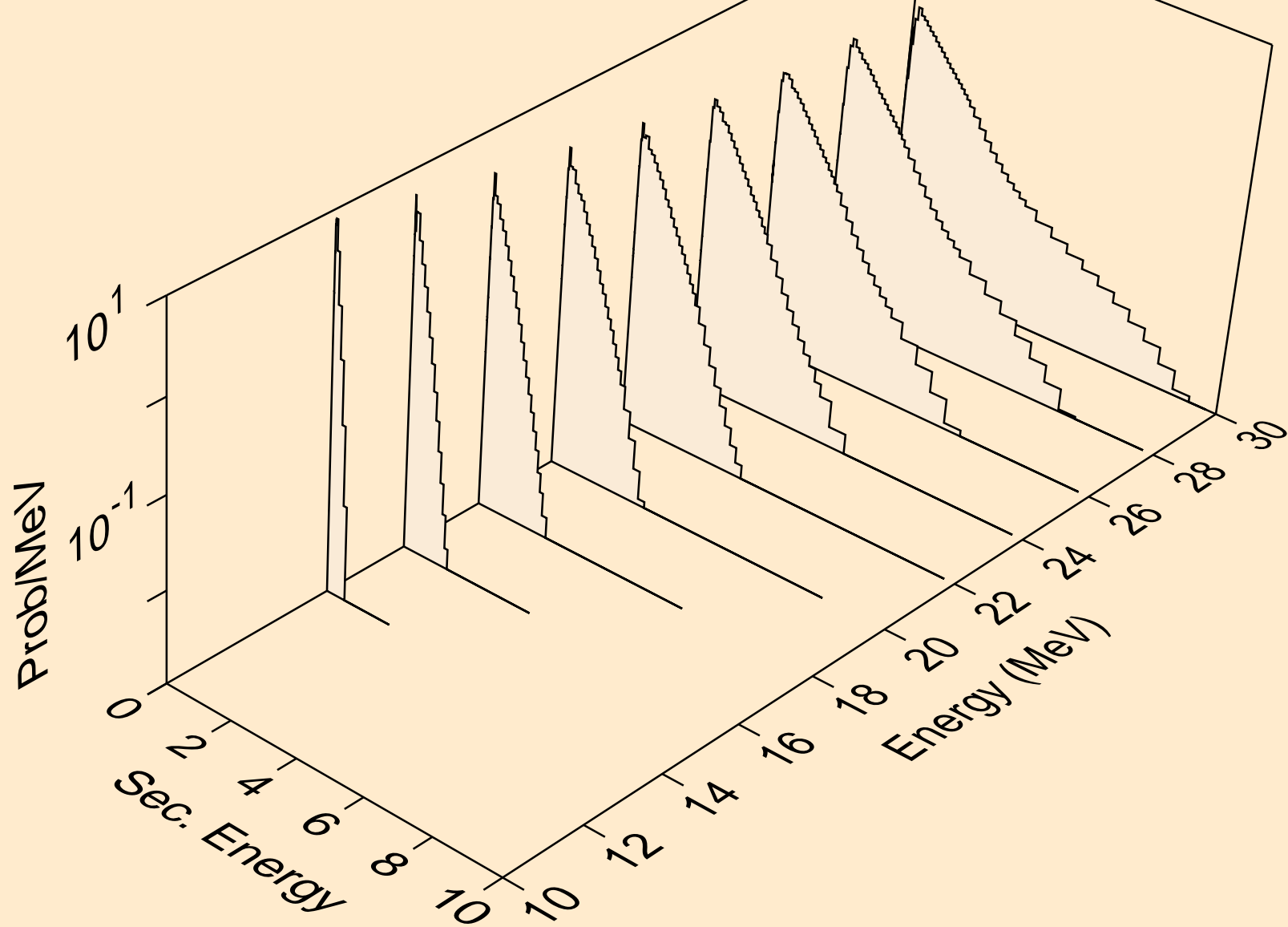

BI224 NEUTRON ACER TENDL-2024 LIBRARY; T=0.K
Neutron emission for (n,3np)

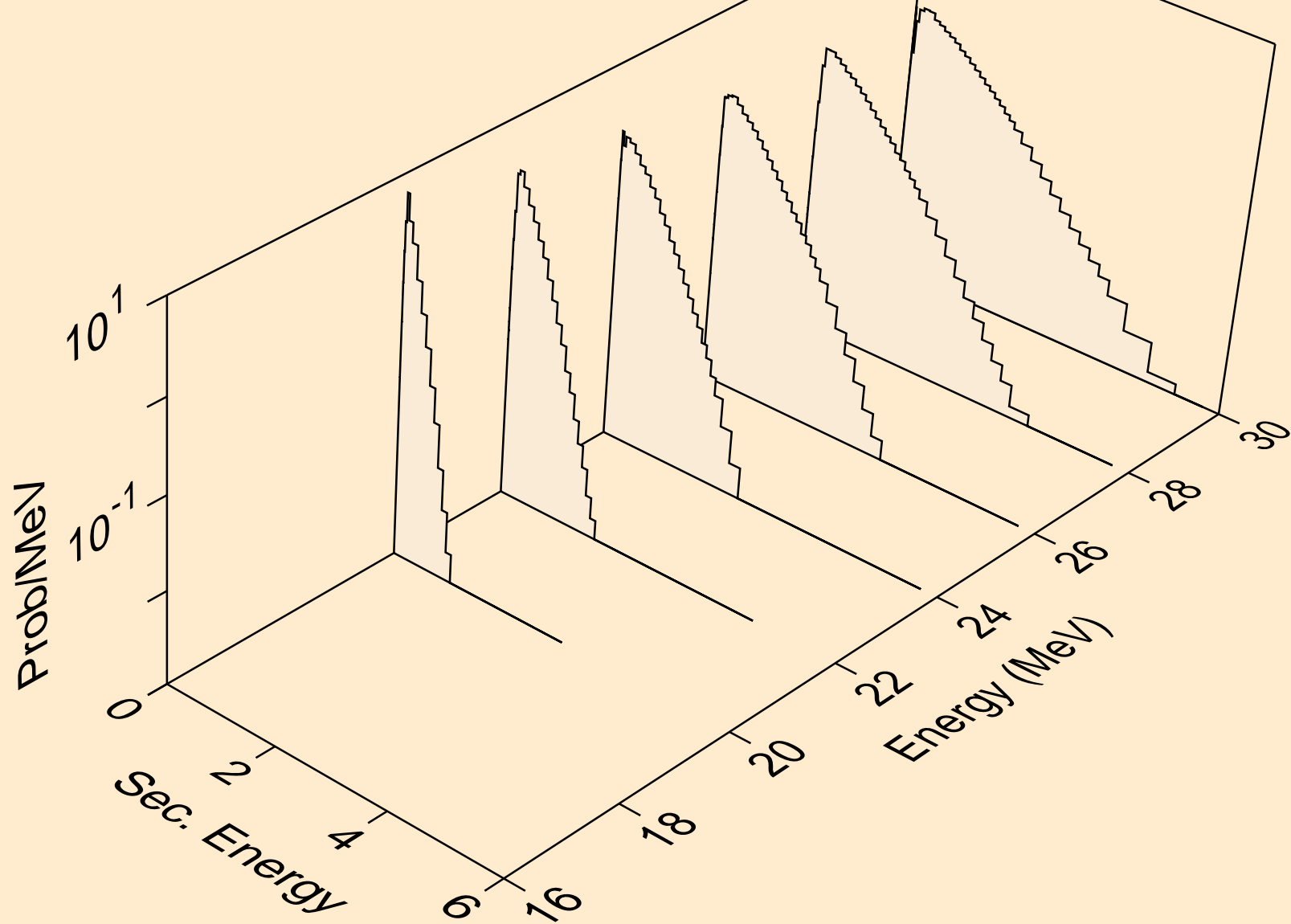

BI224 NEUTRON ACER TENDL-2024 LIBRARY; T=0.K
Neutron emission for (n,n*c)

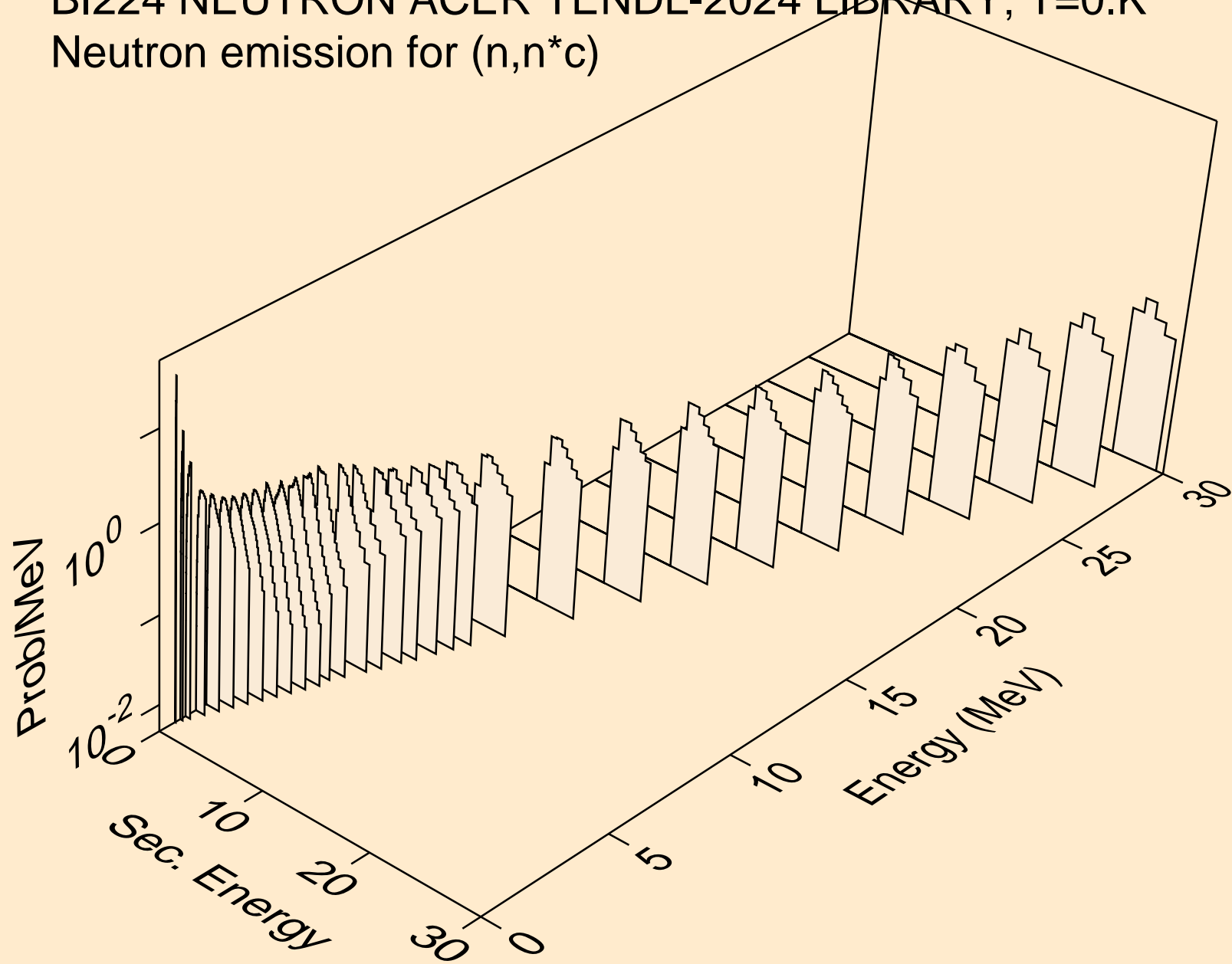

BI224 NEUTRON ACER TENDL-2024 LIBRARY; T=0.K

Delayed nubar

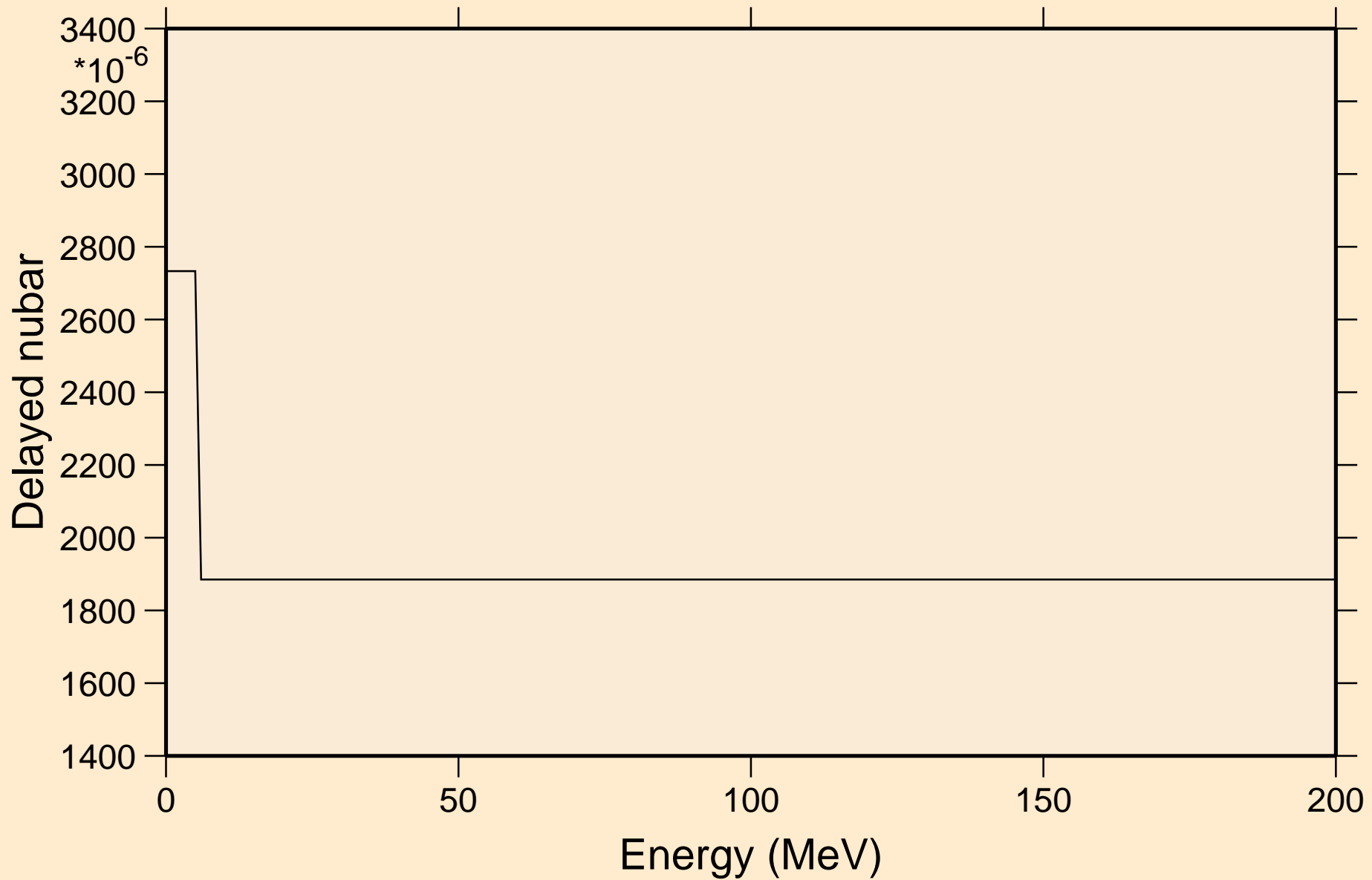

BI224 NEUTRON ACER TENDL-2024 LIBRARY; T=0.K

Delayed neutron spectra

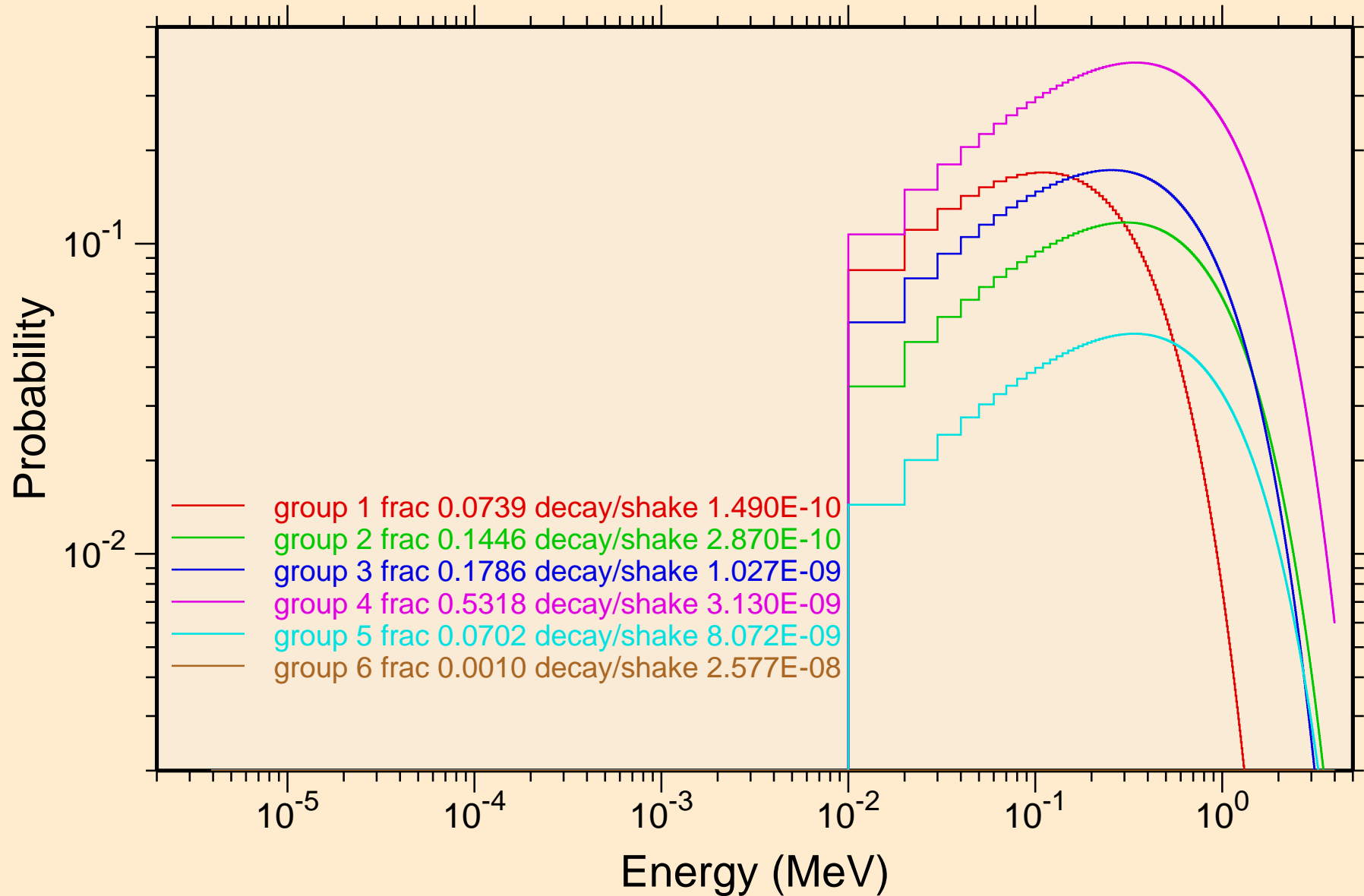

BI224 NEUTRON ACER TENDL-2024 LIBRARY; T=0.K
Photon emission for (n,x)

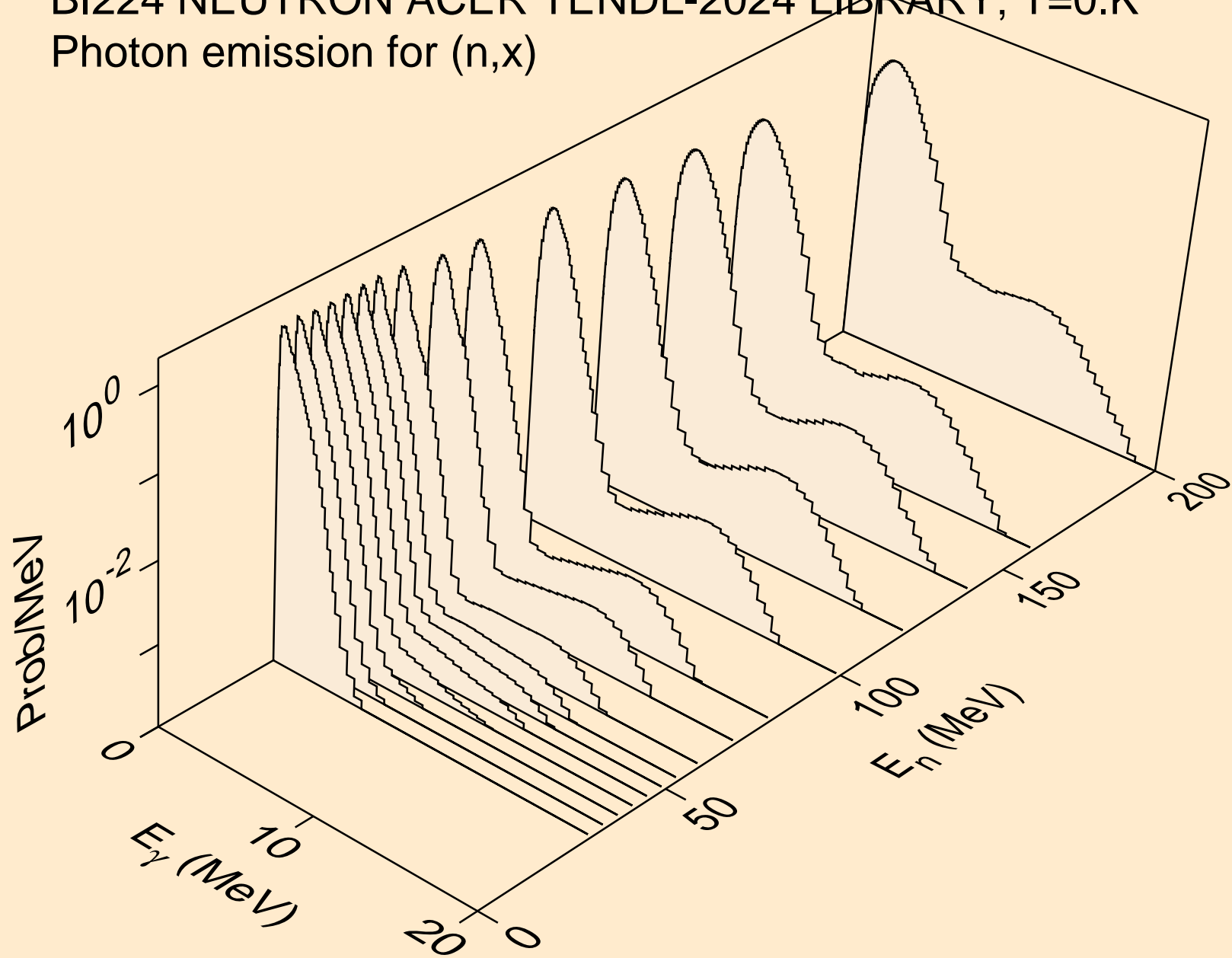

BI224 NEUTRON ACER TENDL-2024 LIBRARY; T=0.K
Photon emission for (n,2nd)

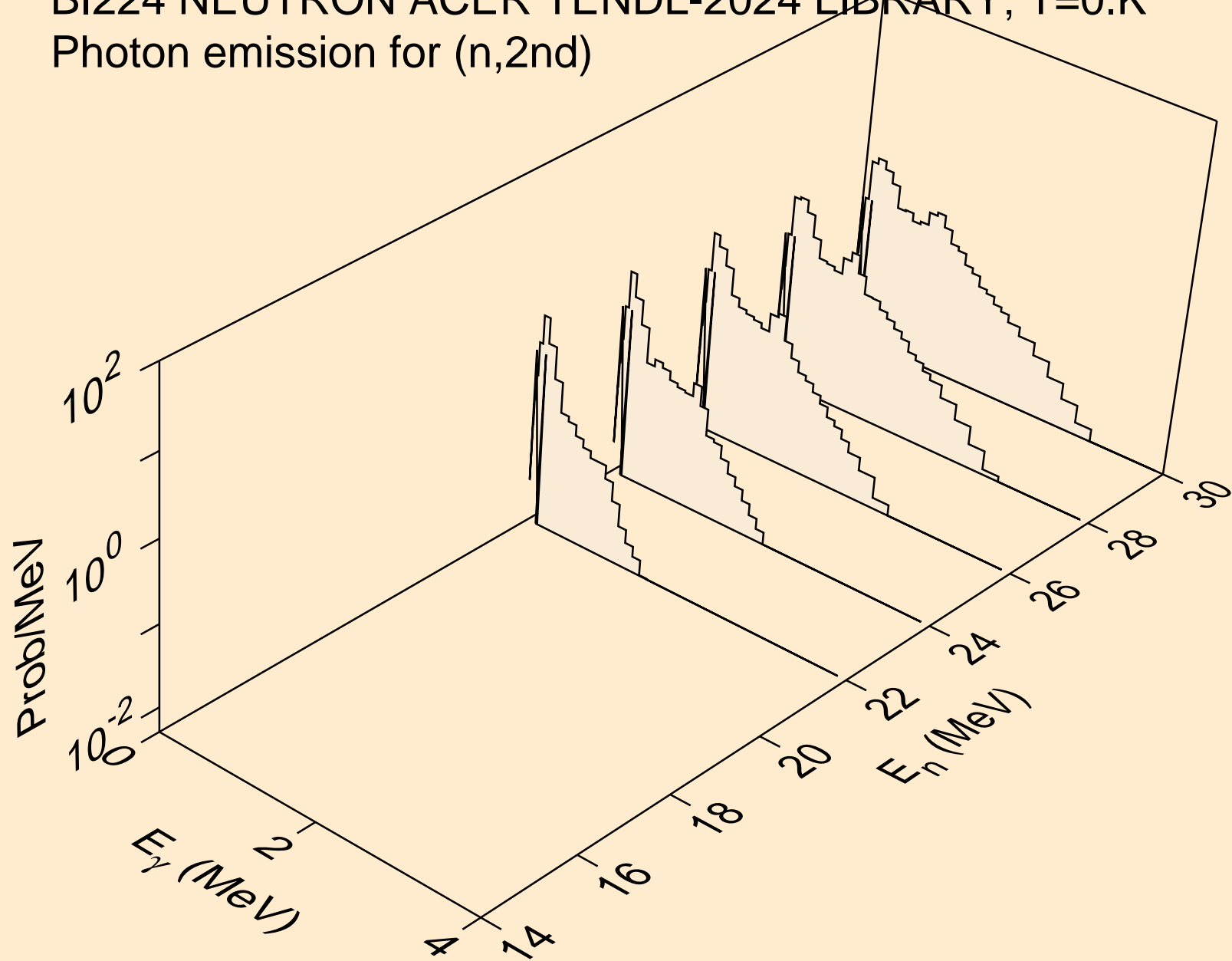

BI224 NEUTRON ACER TENDL-2024 LIBRARY; T=0.K
Photon emission for (n,2n)

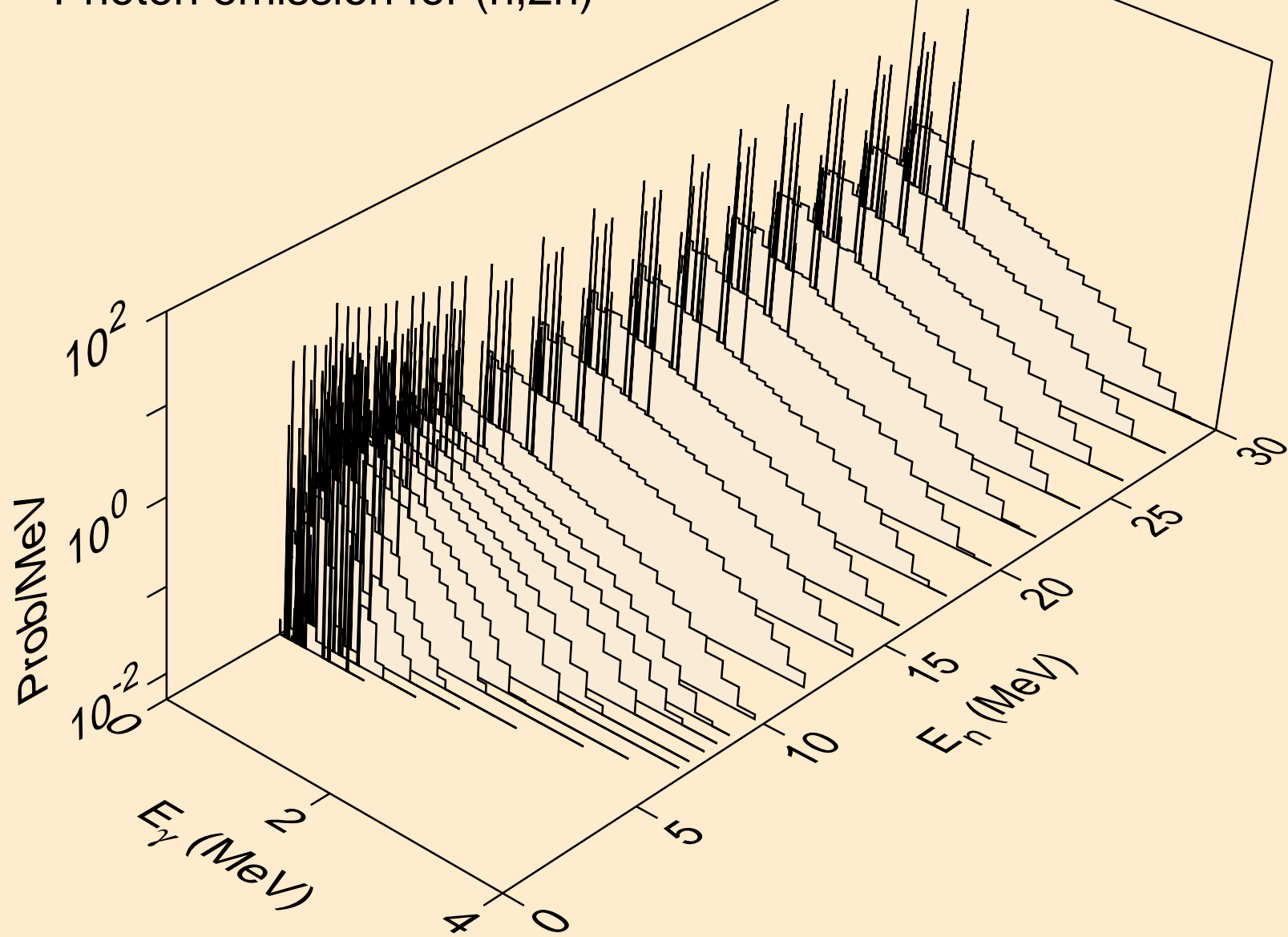

BI224 NEUTRON ACER TENDL-2024 LIBRARY; T=0.K
Photon emission for (n,3n)

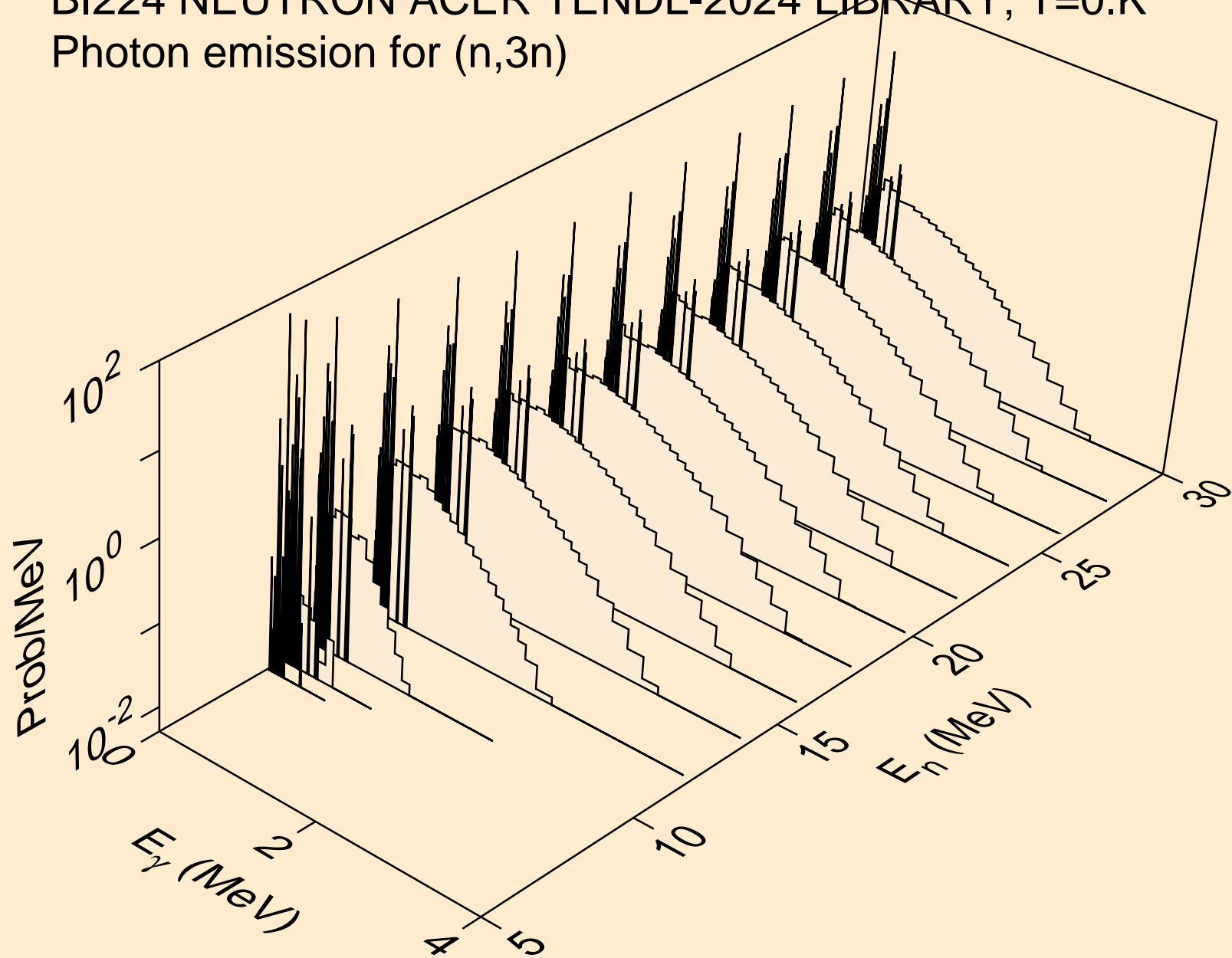

BI224 NEUTRON ACER TENDL-2024 LIBRARY; T=0.K
Photon emission for (n,n*)a

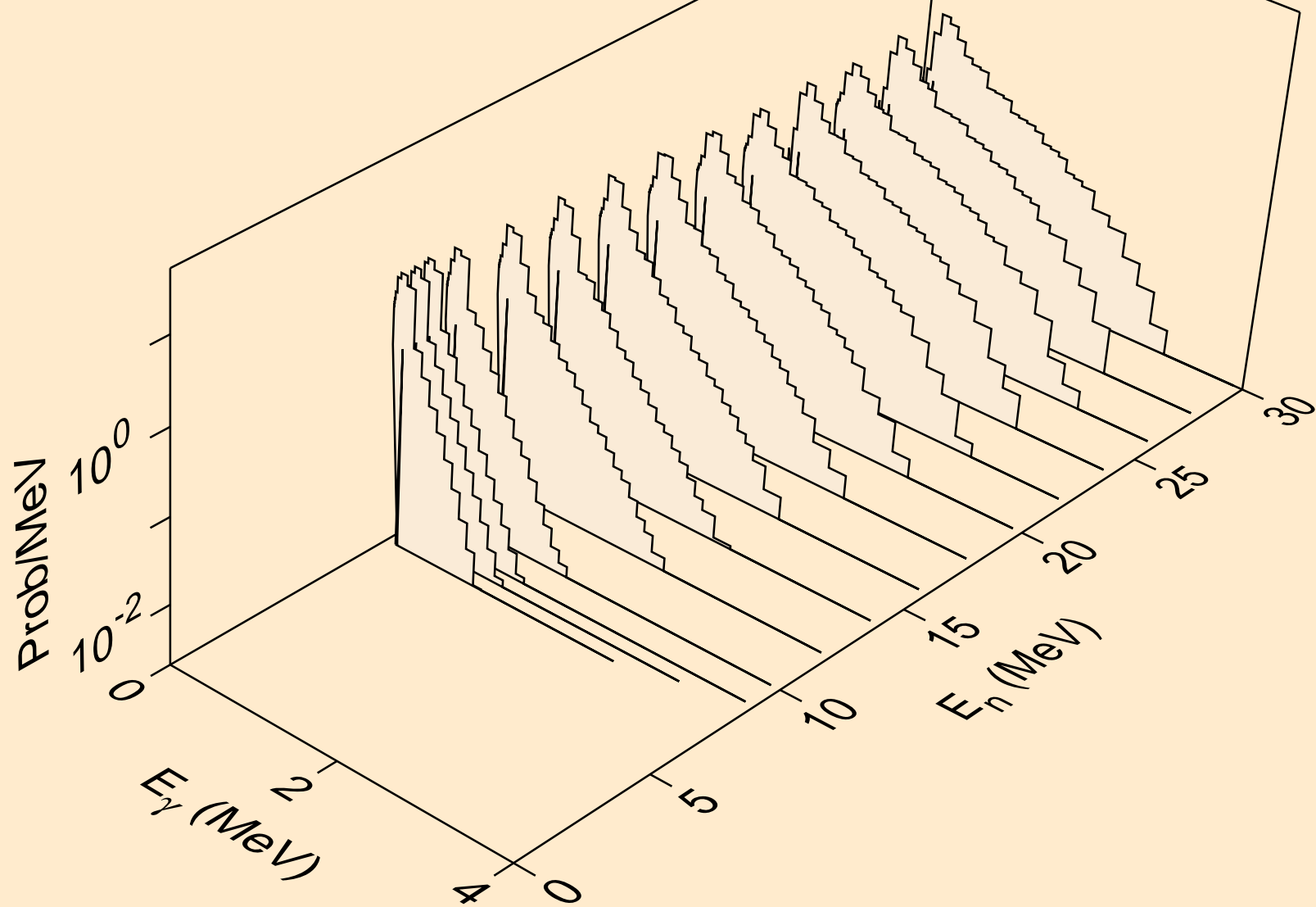

BI224 NEUTRON ACER TENDL-2024 LIBRARY; T=0.K
Photon emission for (n,2n)a

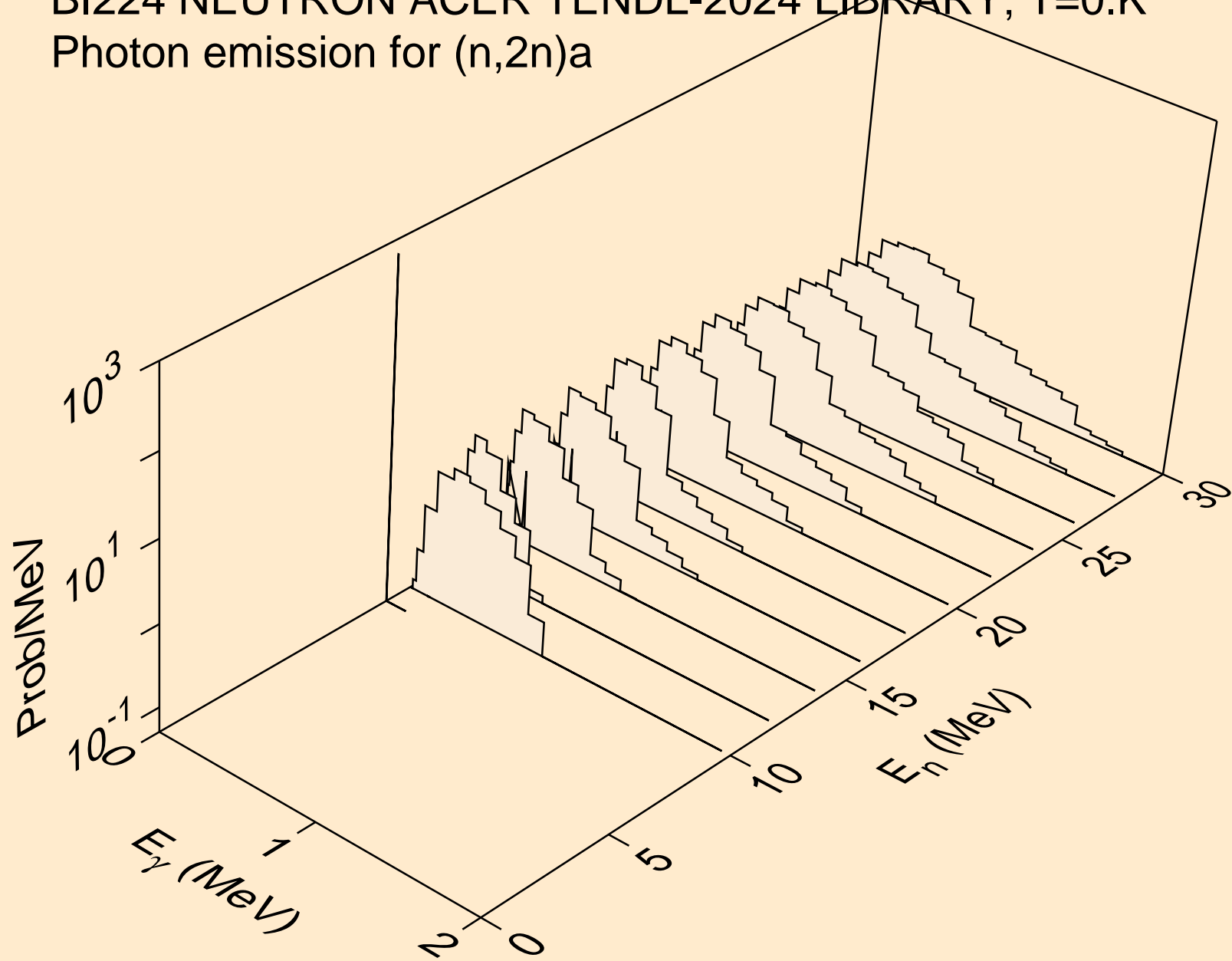

BI224 NEUTRON ACER TENDL-2024 LIBRARY; T=0.K
Photon emission for (n,3n)a

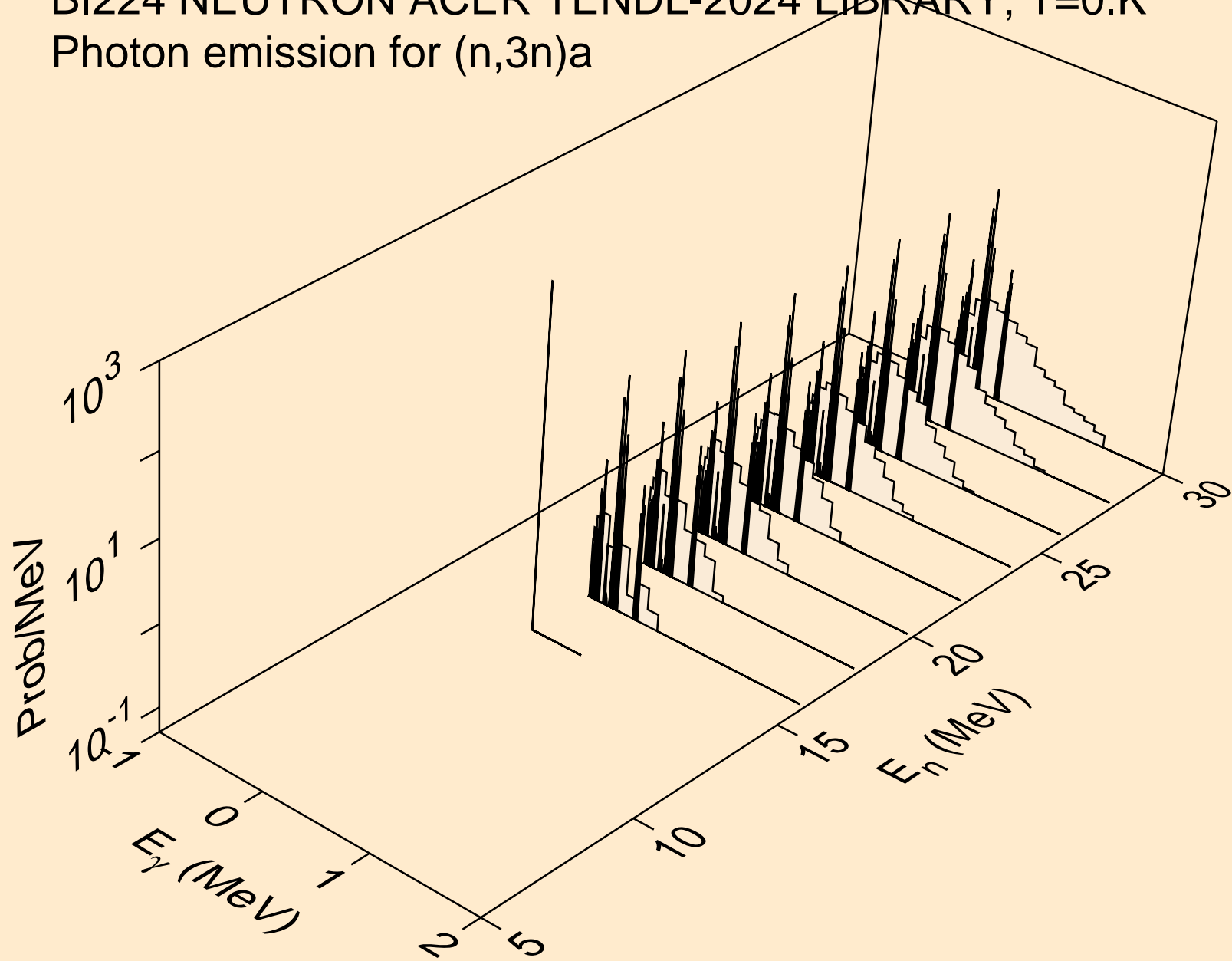

BI224 NEUTRON ACER TENDL-2024 LIBRARY; T=0.K
Photon emission for (n,n*)p

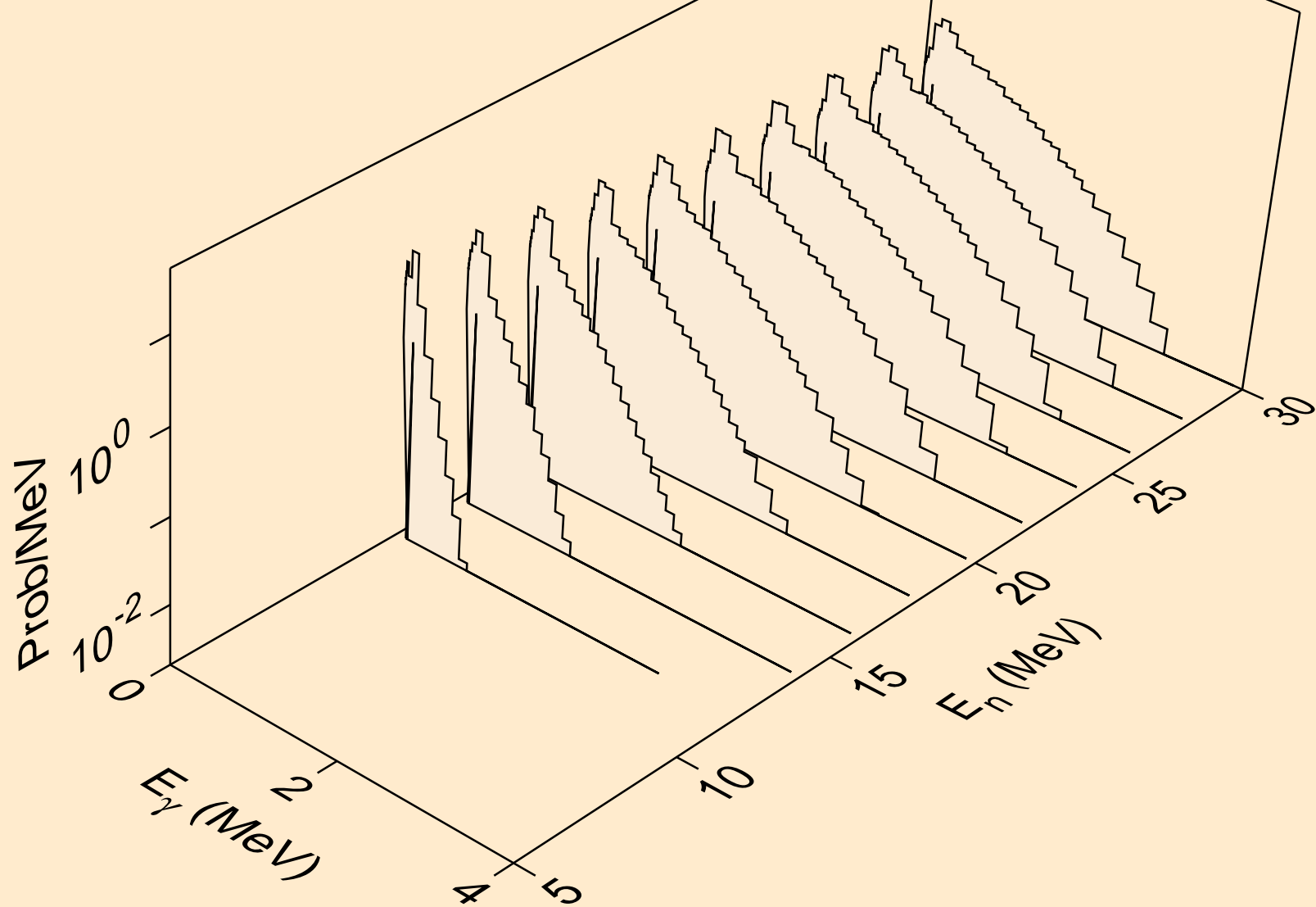

BI224 NEUTRON ACER TENDL-2024 LIBRARY; T=0.K
Photon emission for (n,n*)d

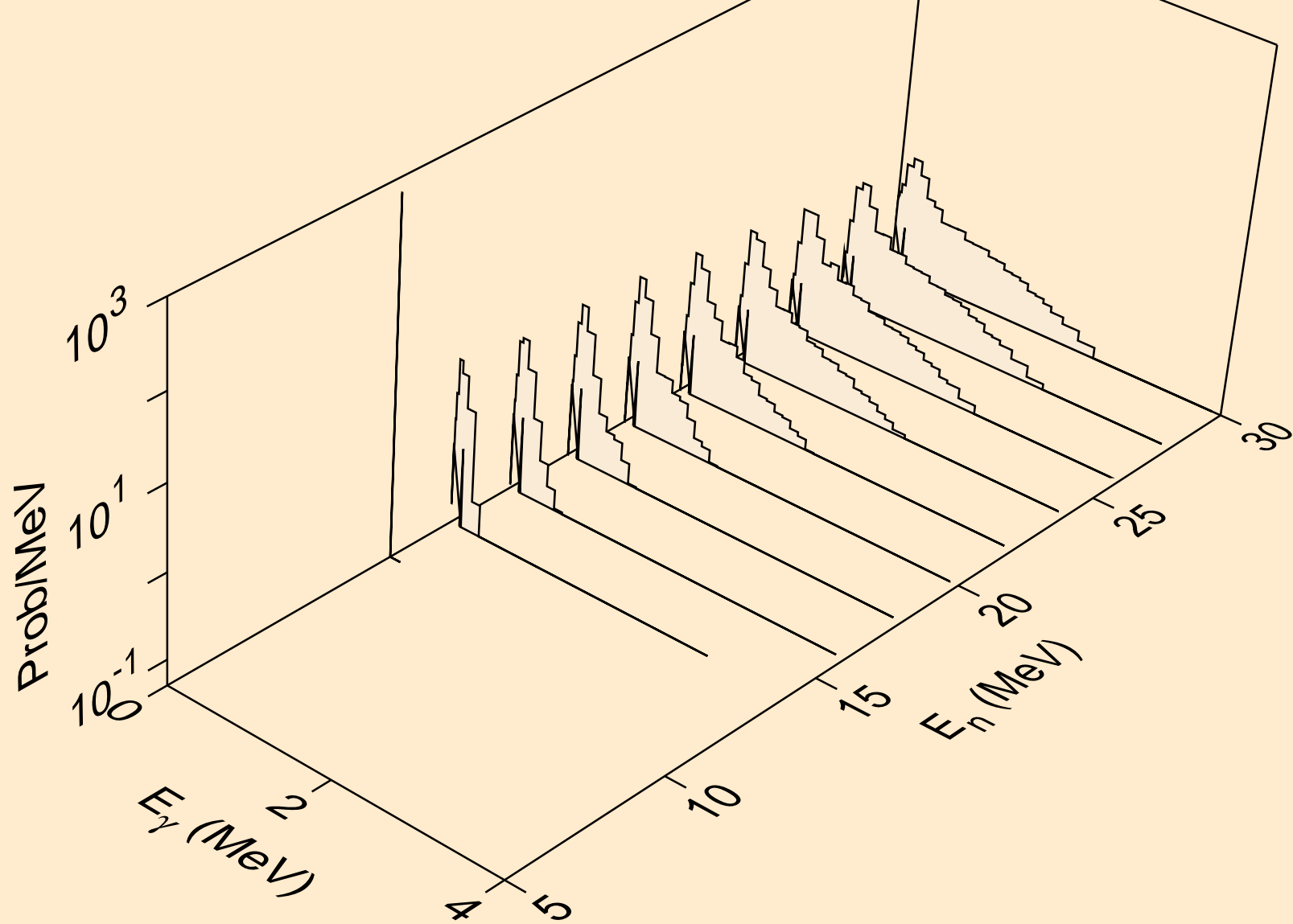

BI224 NEUTRON ACER TENDL-2024 LIBRARY; T=0.K
Photon emission for (n,n*)t

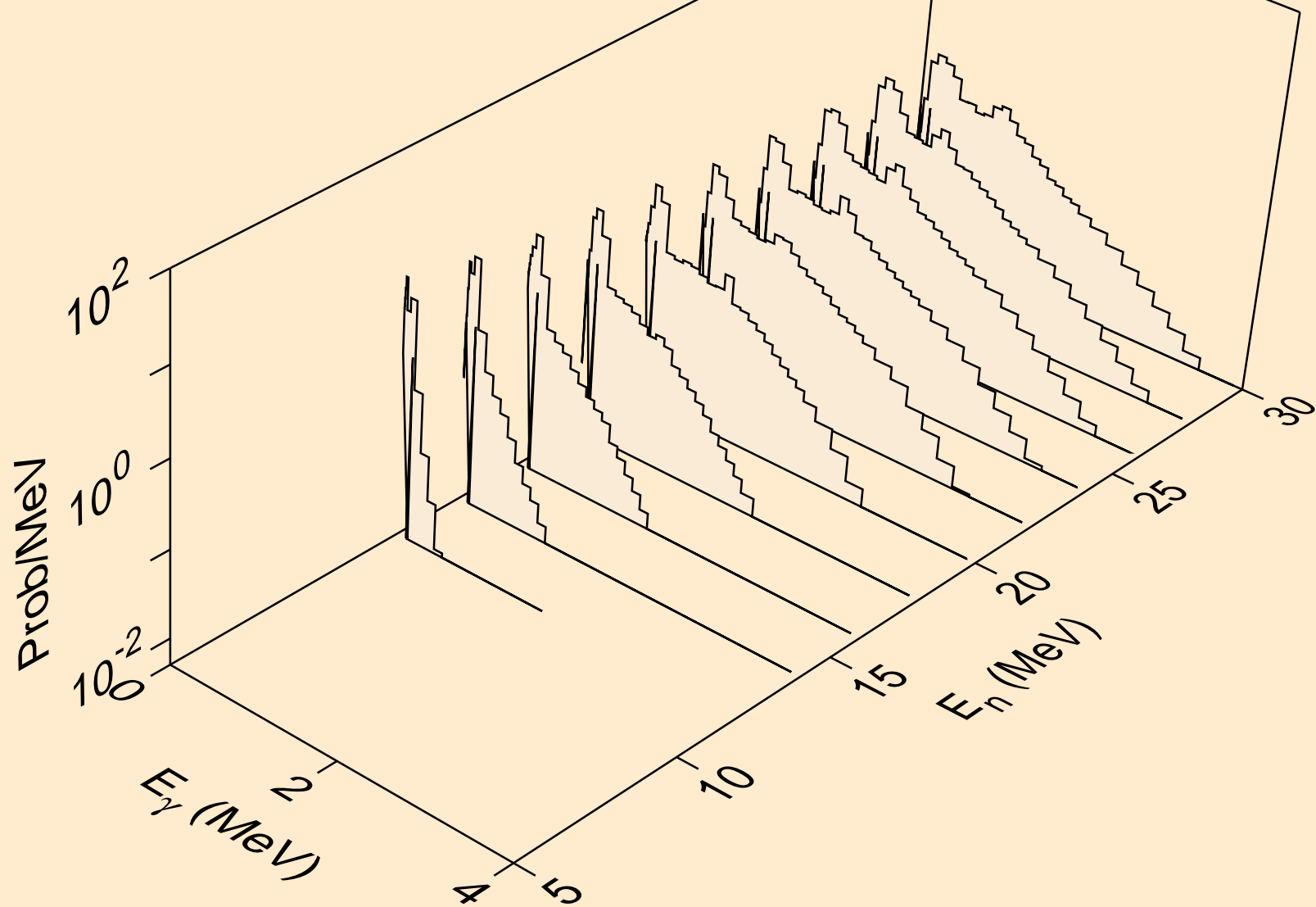

BI224 NEUTRON ACER TENDL-2024 LIBRARY; T=0.K
Photon emission for (n,n*)he3

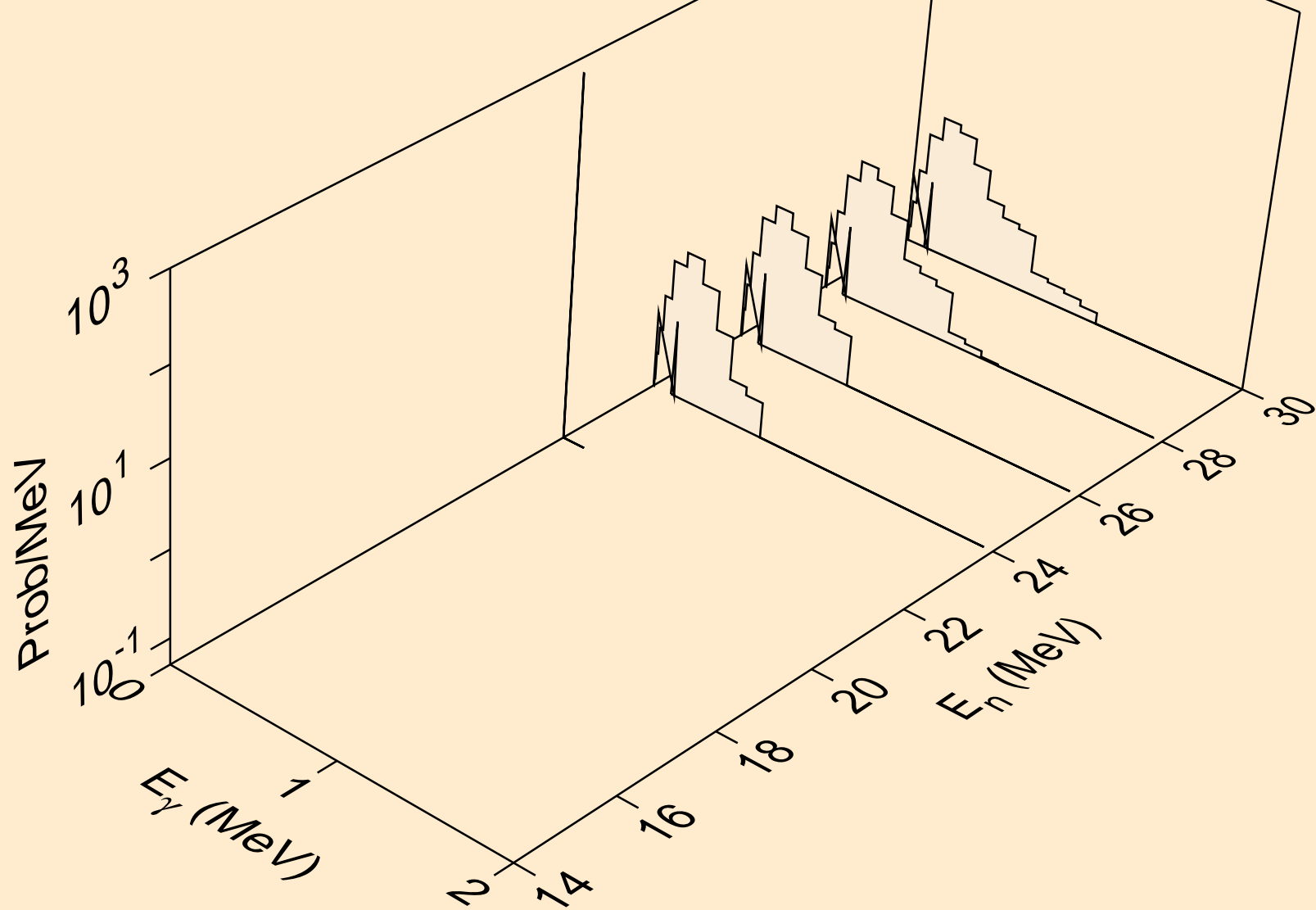

BI224 NEUTRON ACER TENDL-2024 LIBRARY; T=0.K
Photon emission for (n,4n)

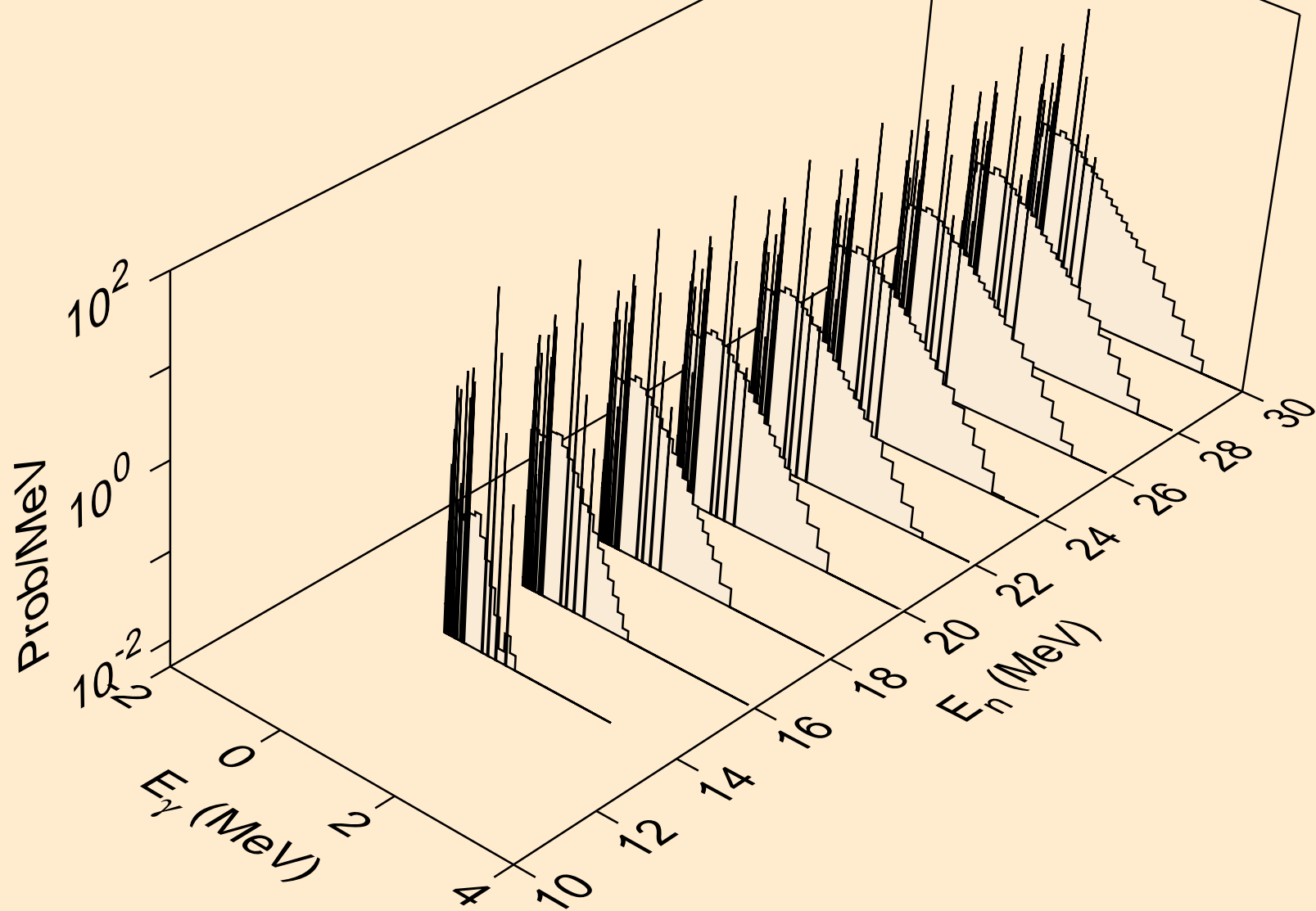

BI224 NEUTRON ACER TENDL-2024 LIBRARY; T=0.K
Photon emission for (n,2np)

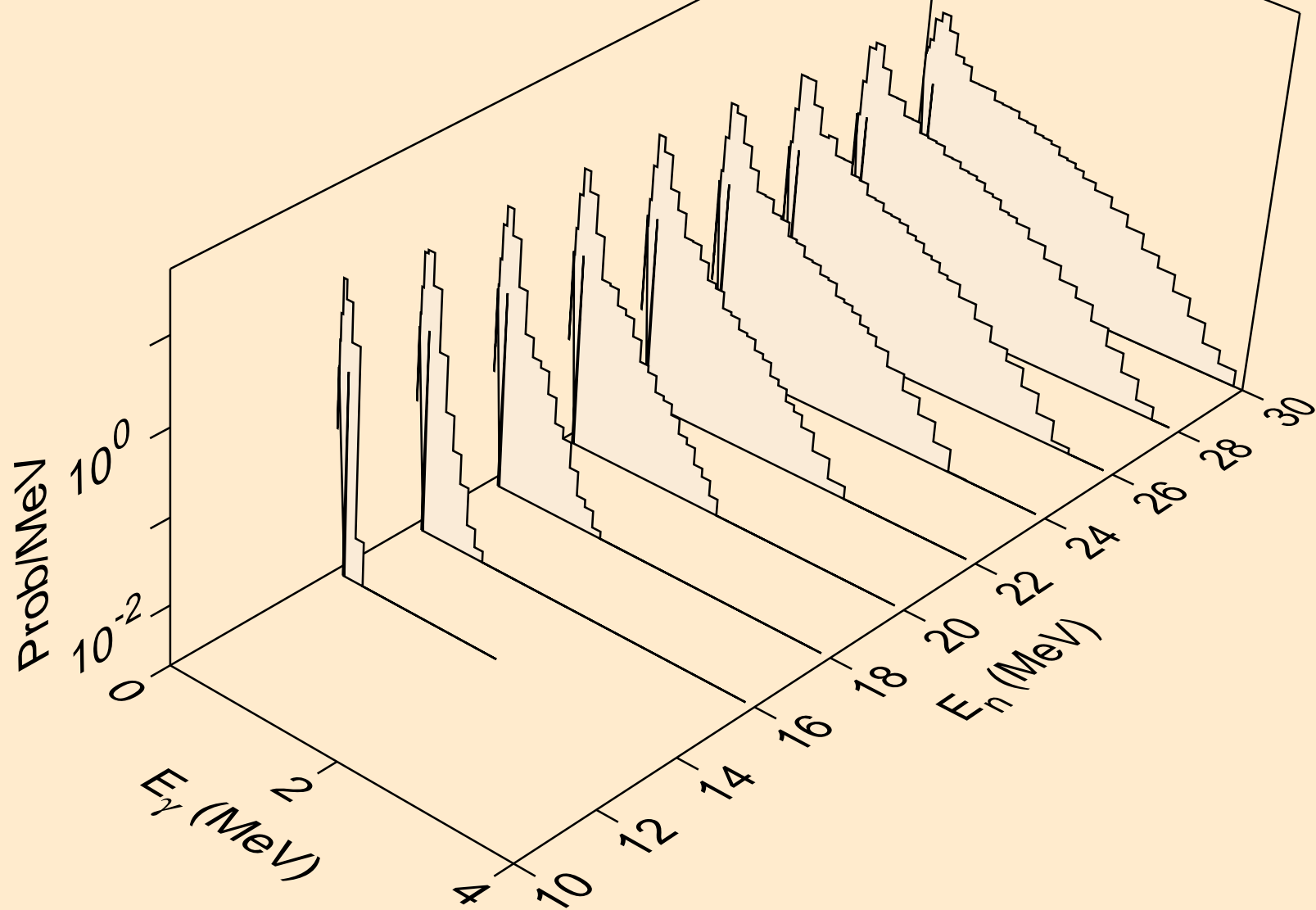

BI224 NEUTRON ACER TENDL-2024 LIBRARY; T=0.K
Photon emission for (n,3np)

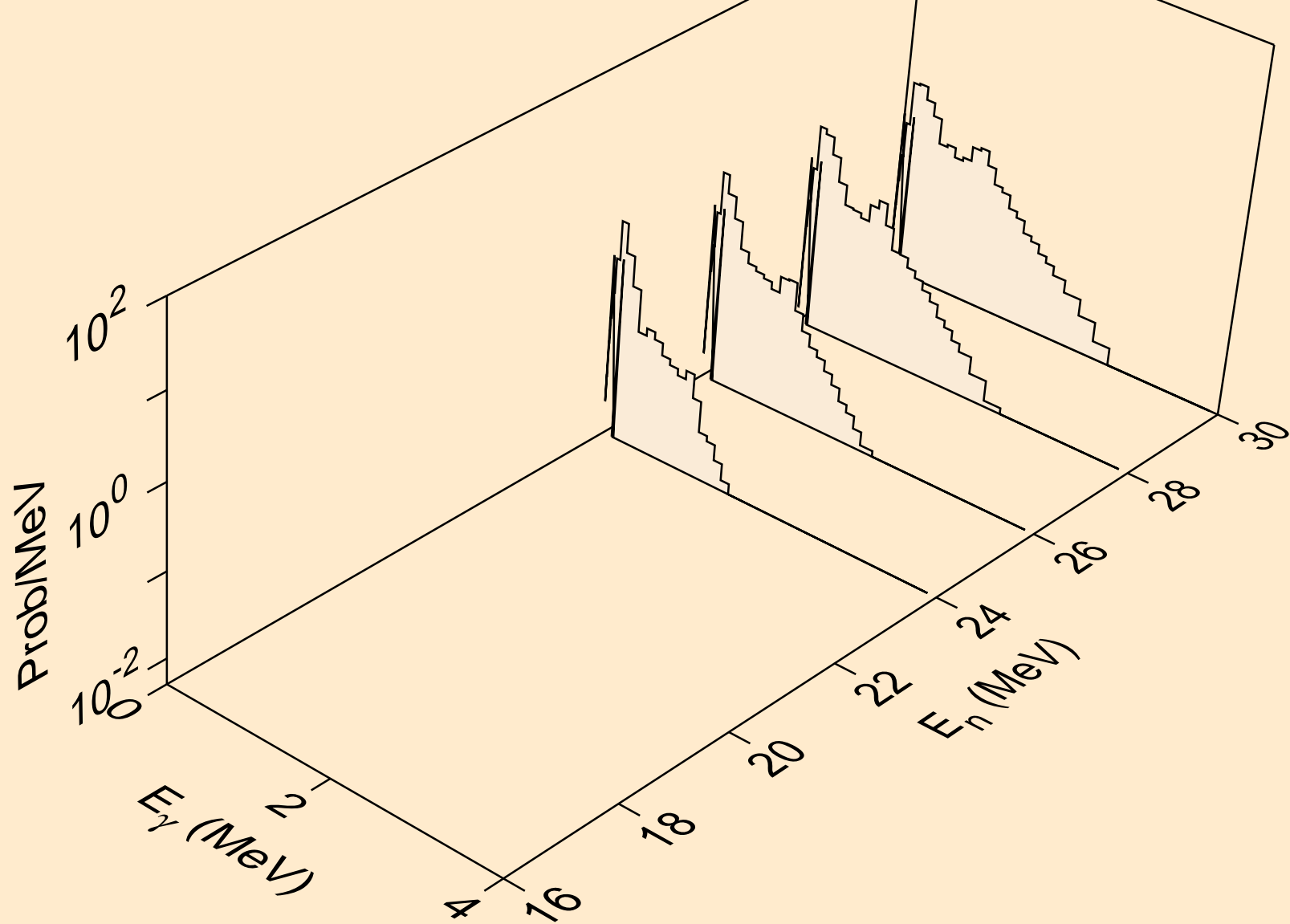

BI224 NEUTRON ACER TENDL-2024 LIBRARY; T=0.K
Photon emission for (n,n*c)

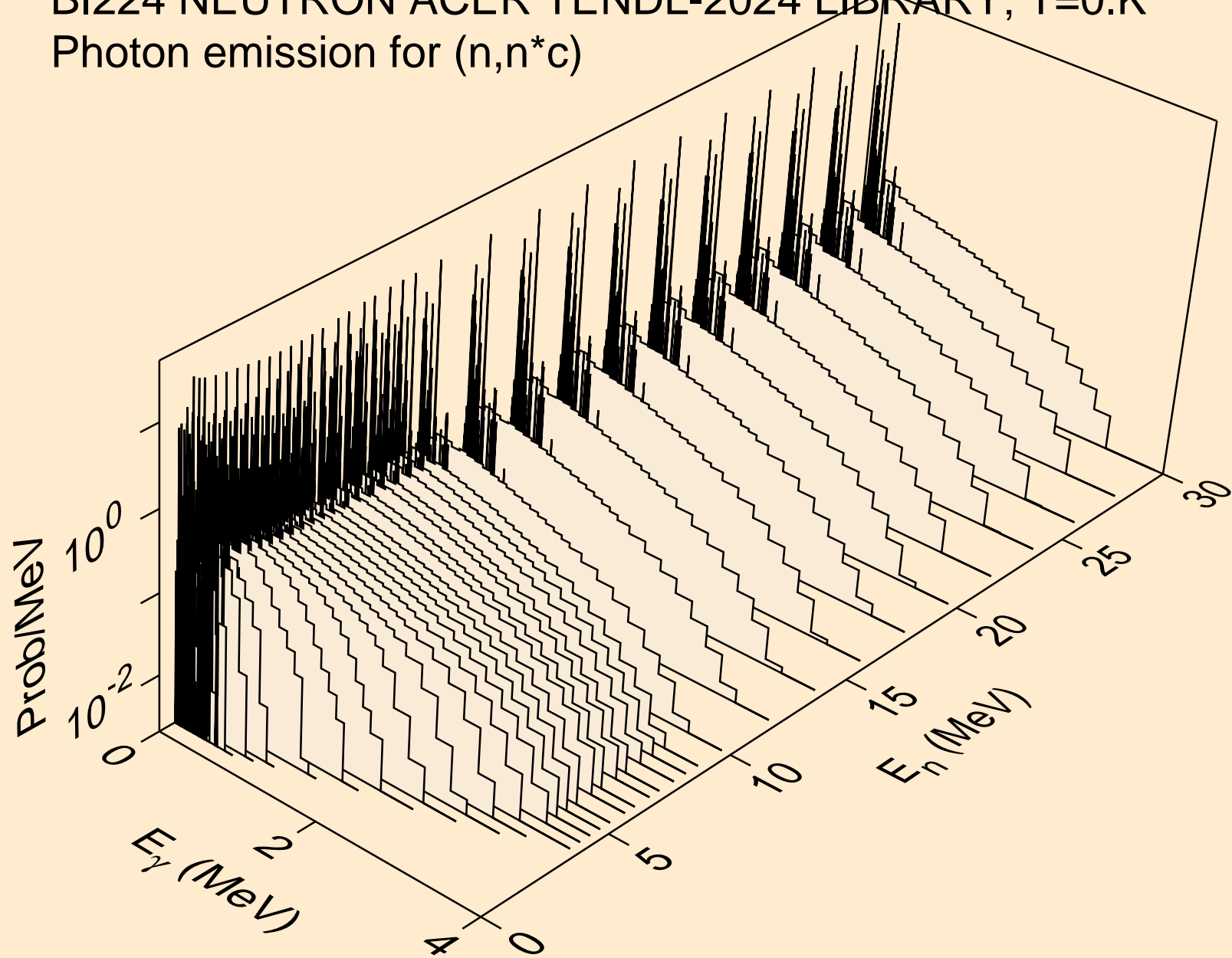

BI224 NEUTRON ACER TENDL-2024 LIBRARY; T=0.K
Photon emission for (n,gma)

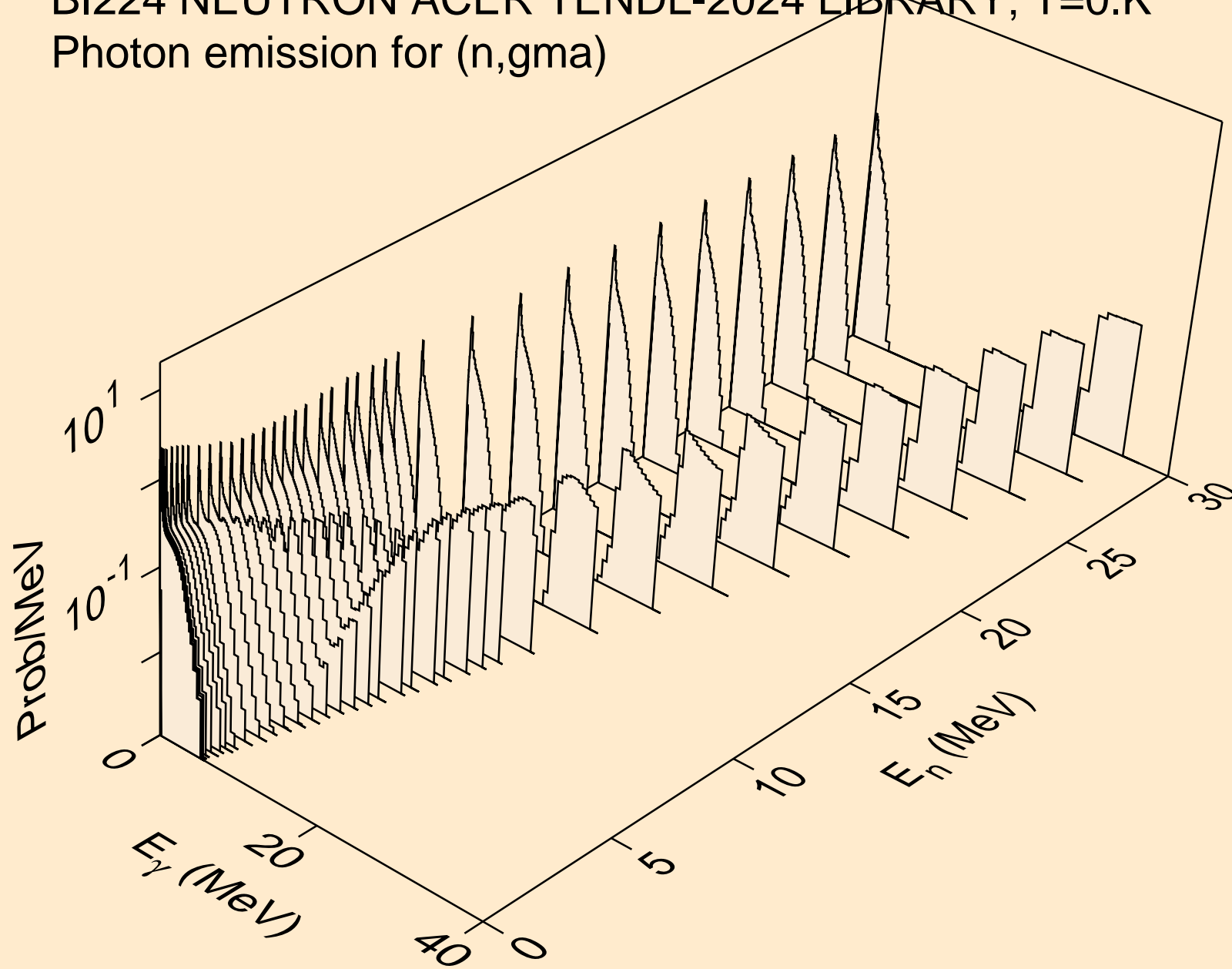

BI224 NEUTRON ACER TENDL-2024 LIBRARY; T=0.K
Photon emission for (n,p)

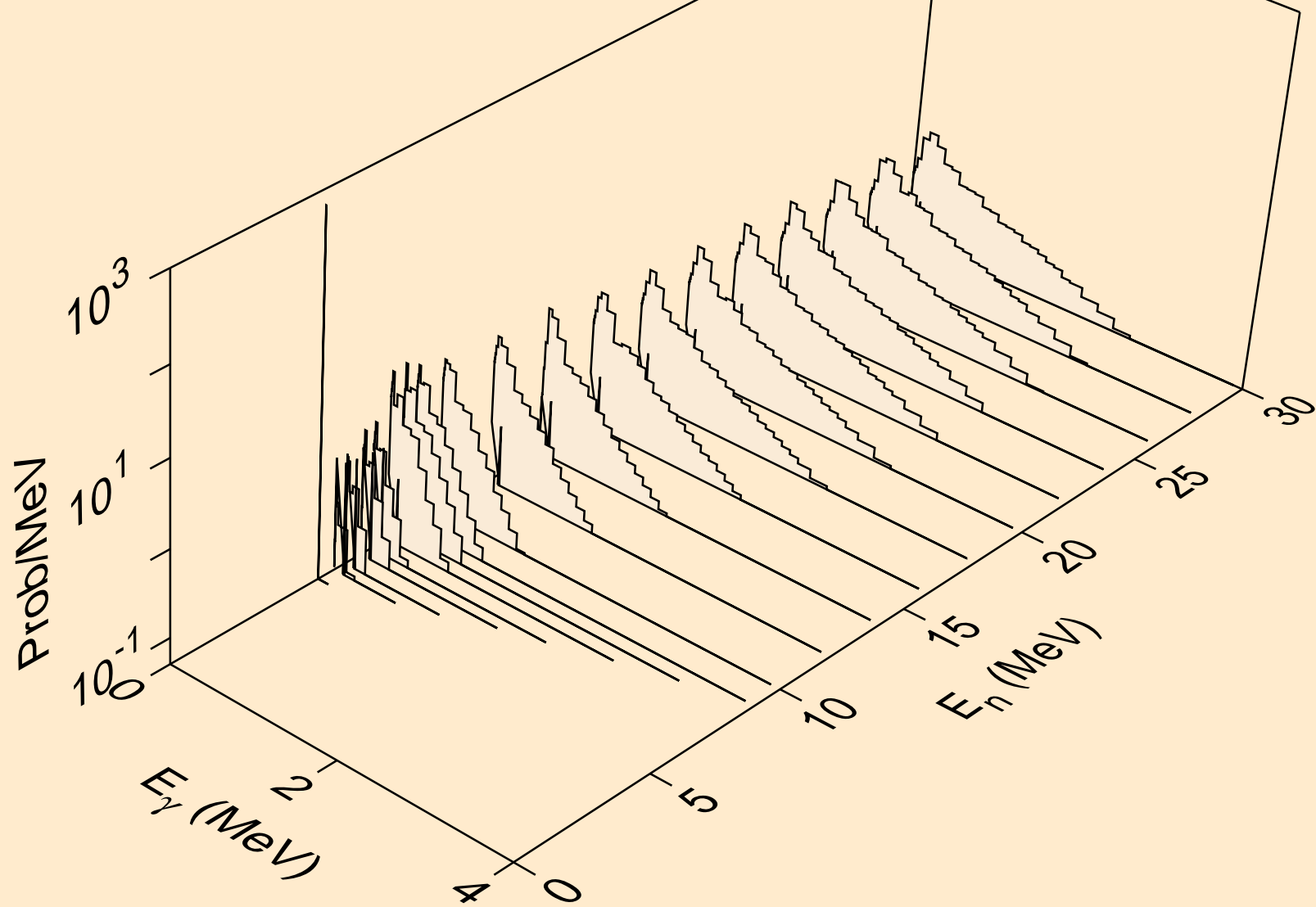

BI224 NEUTRON ACER TENDL-2024 LIBRARY; T=0.K
Photon emission for (n,d)

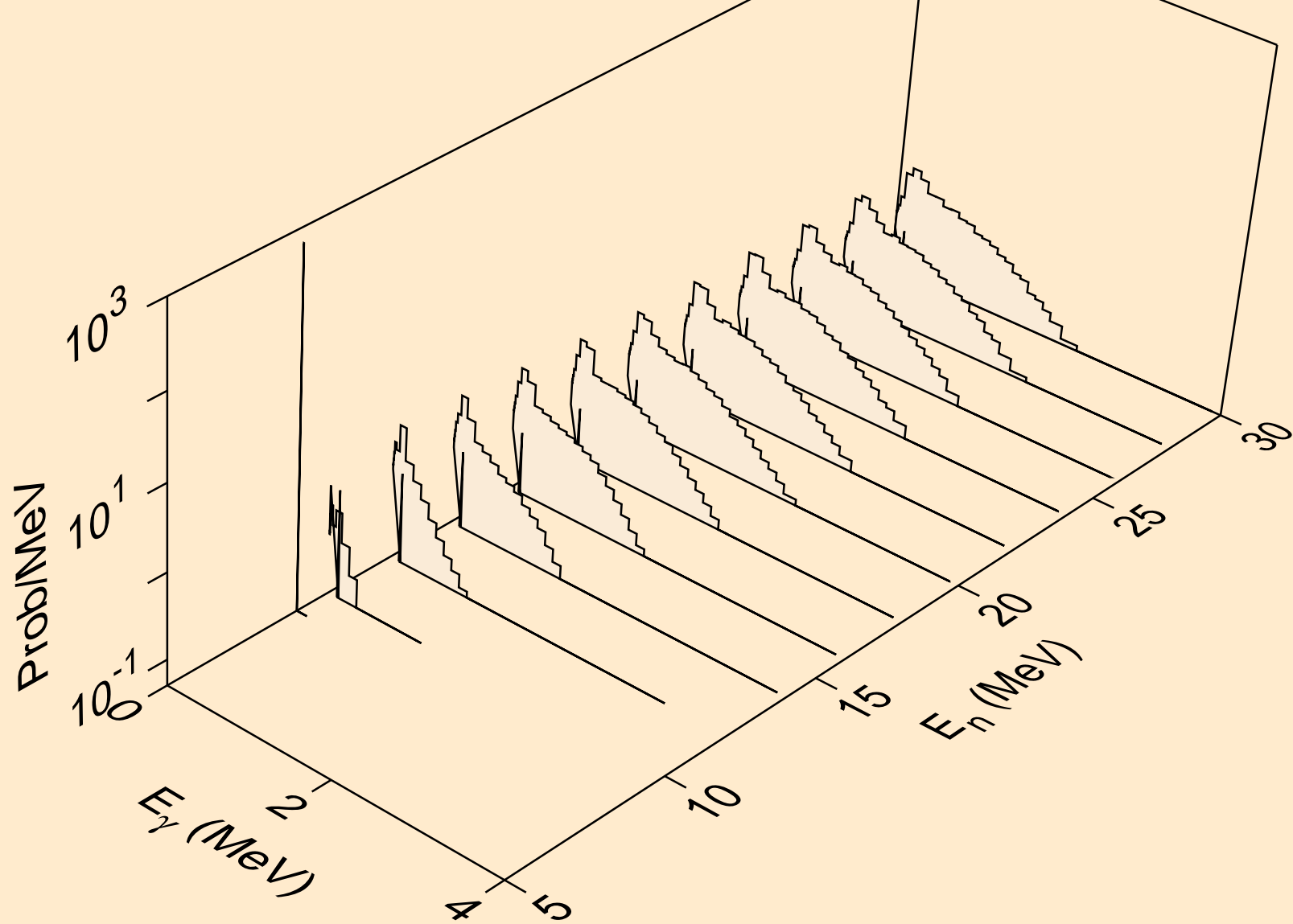

BI224 NEUTRON ACER TENDL-2024 LIBRARY; T=0.K
Photon emission for (n,t)

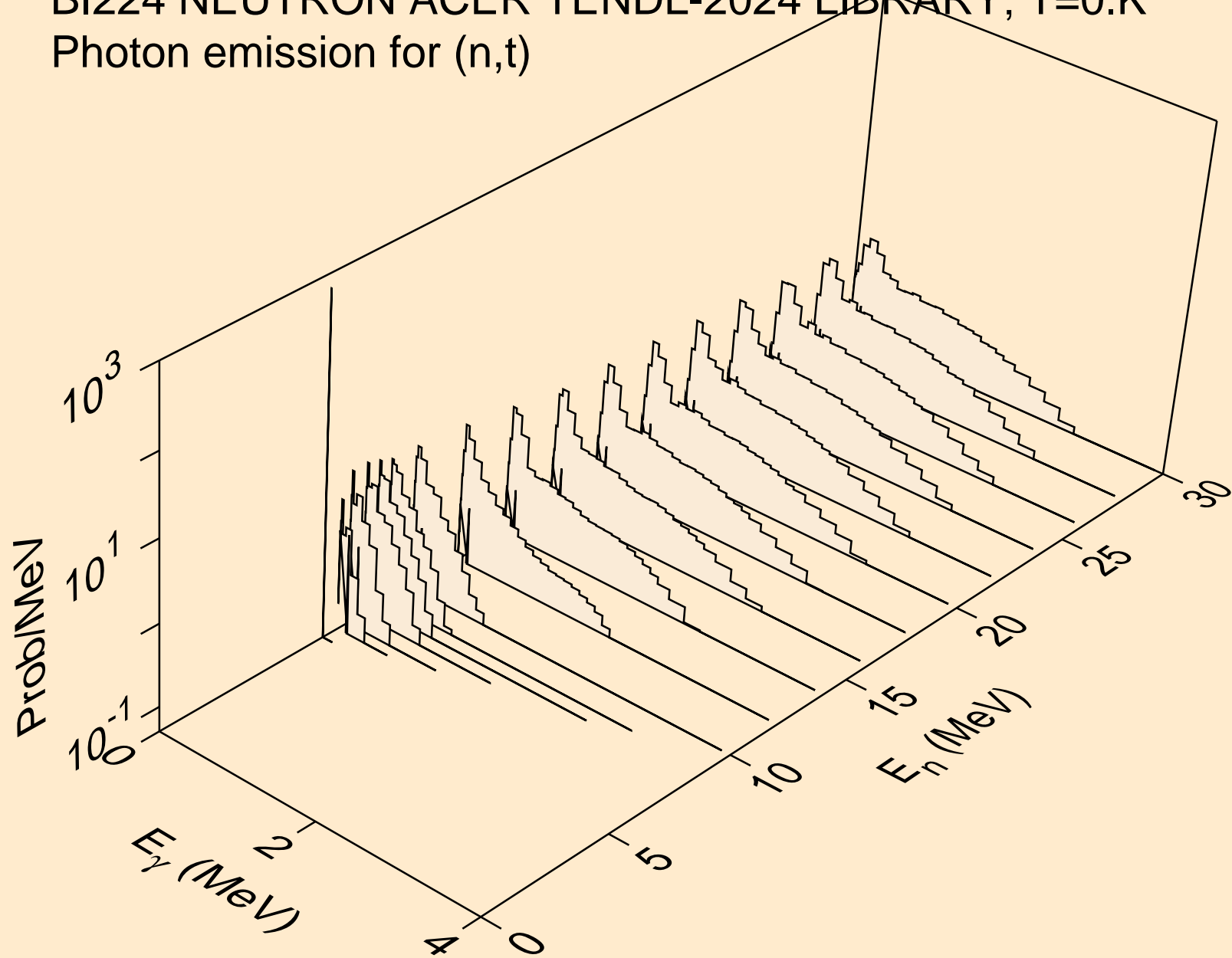

BI224 NEUTRON ACER TENDL-2024 LIBRARY; T=0.K
Photon emission for (n,he3)

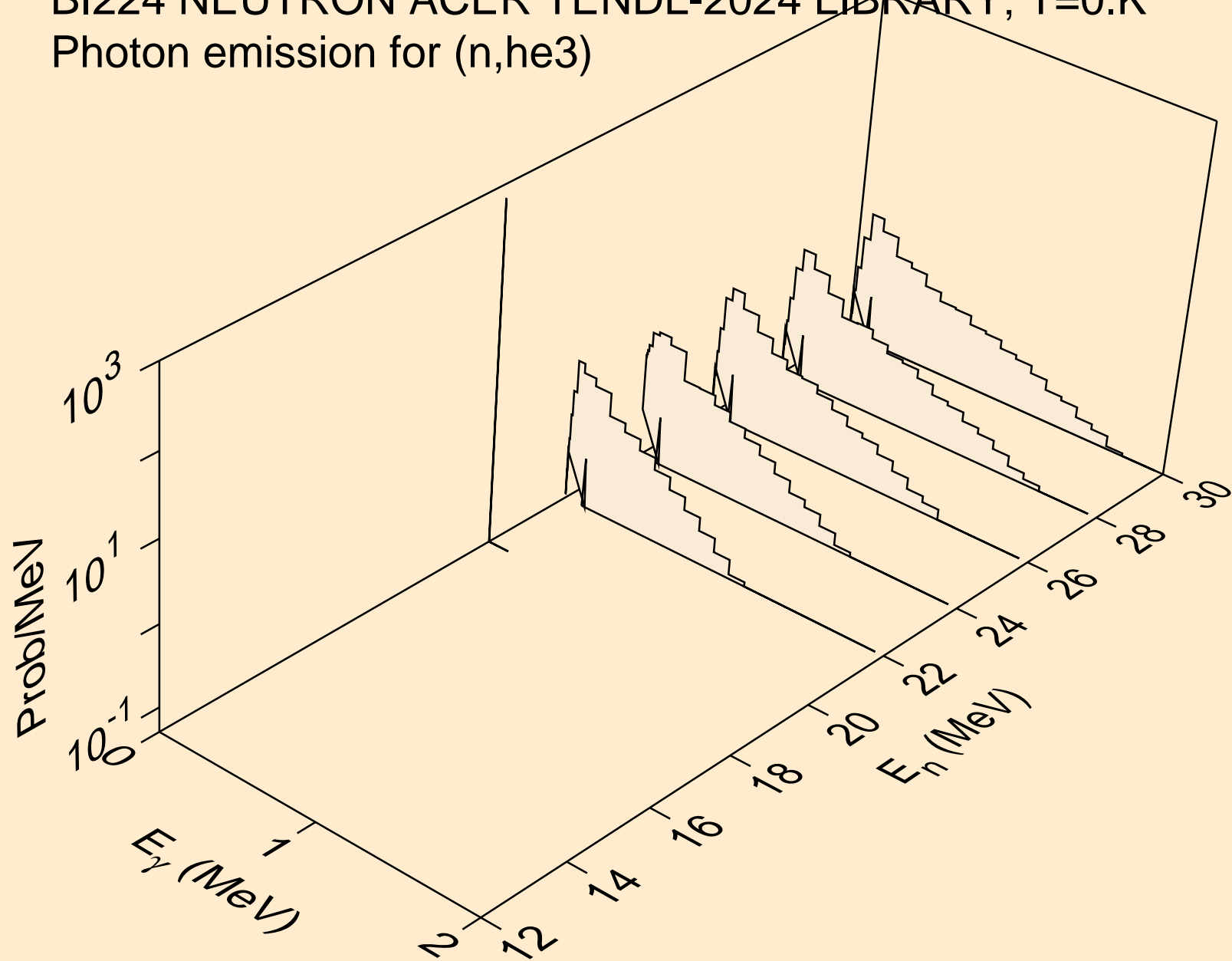

BI224 NEUTRON ACER TENDL-2024 LIBRARY; T=0.K
Photon emission for (n,a)

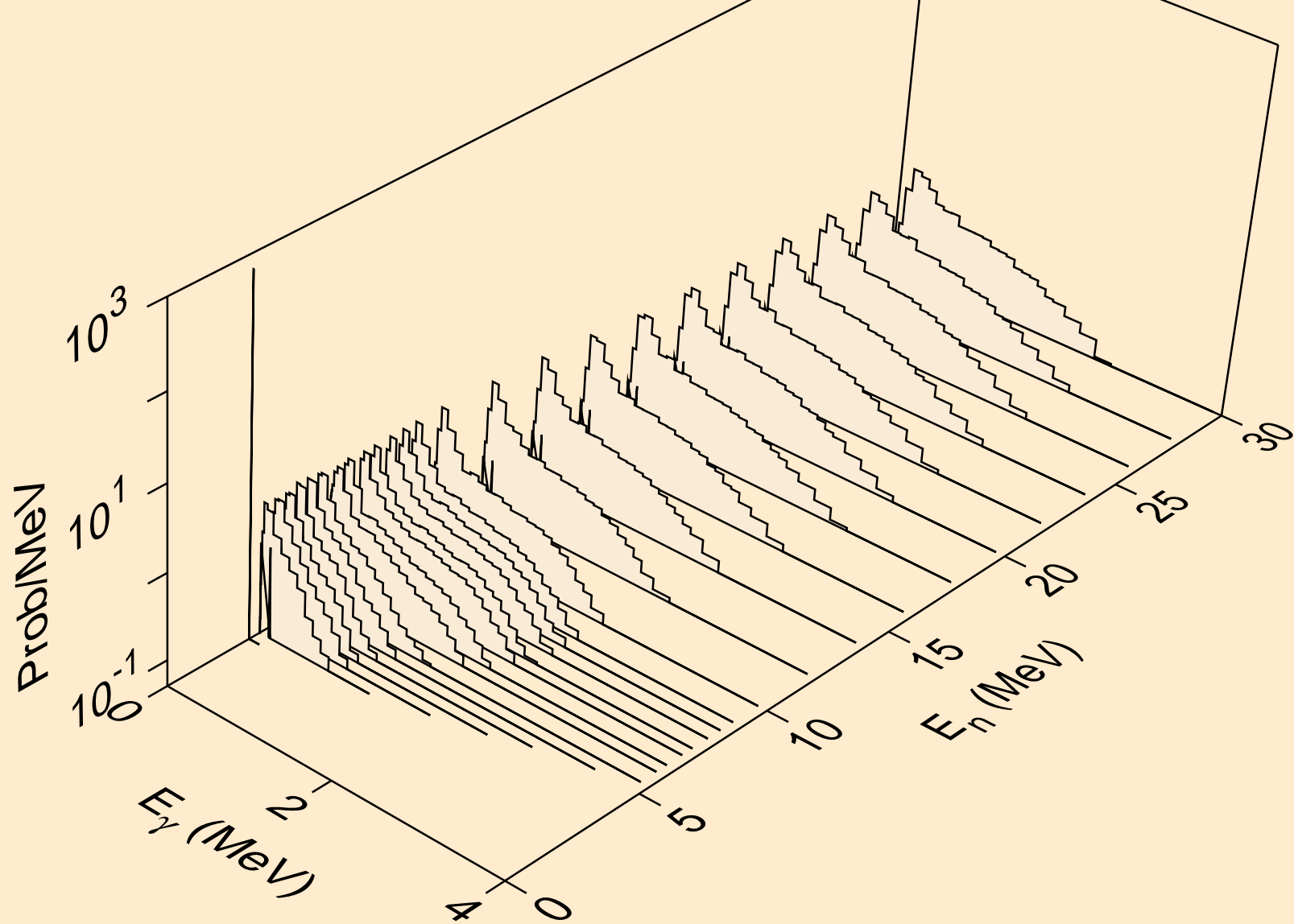

BI224 NEUTRON ACER TENDL-2024 LIBRARY; T=0.K
thermal capture photon spectrum

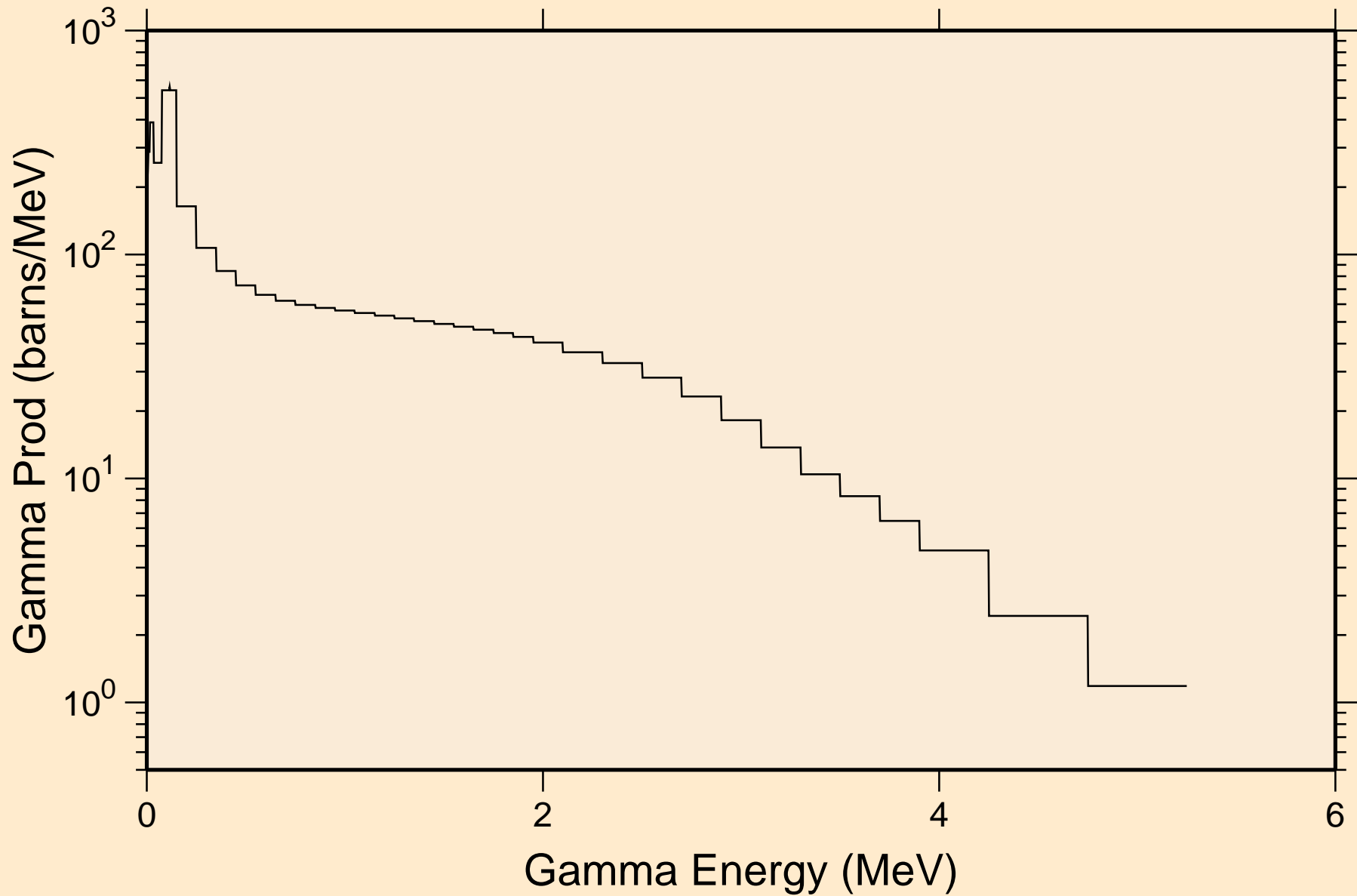

BI224 NEUTRON ACER TENDL-2024 LIBRARY; T=0.K
14 MeV photon spectrum

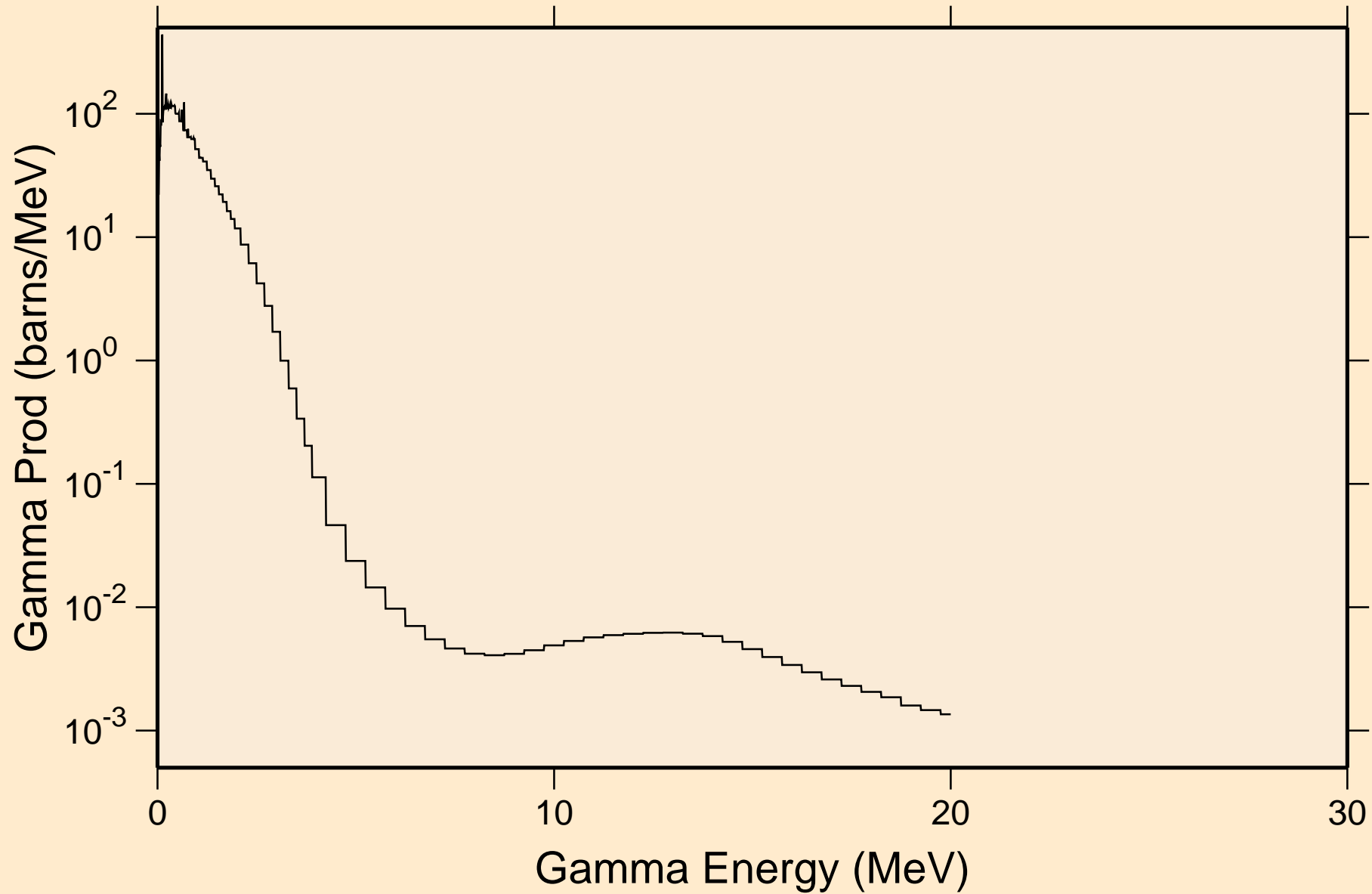

BI224 NEUTRON ACER TENDL-2024 LIBRARY; T=0.K
Particle heating contributions

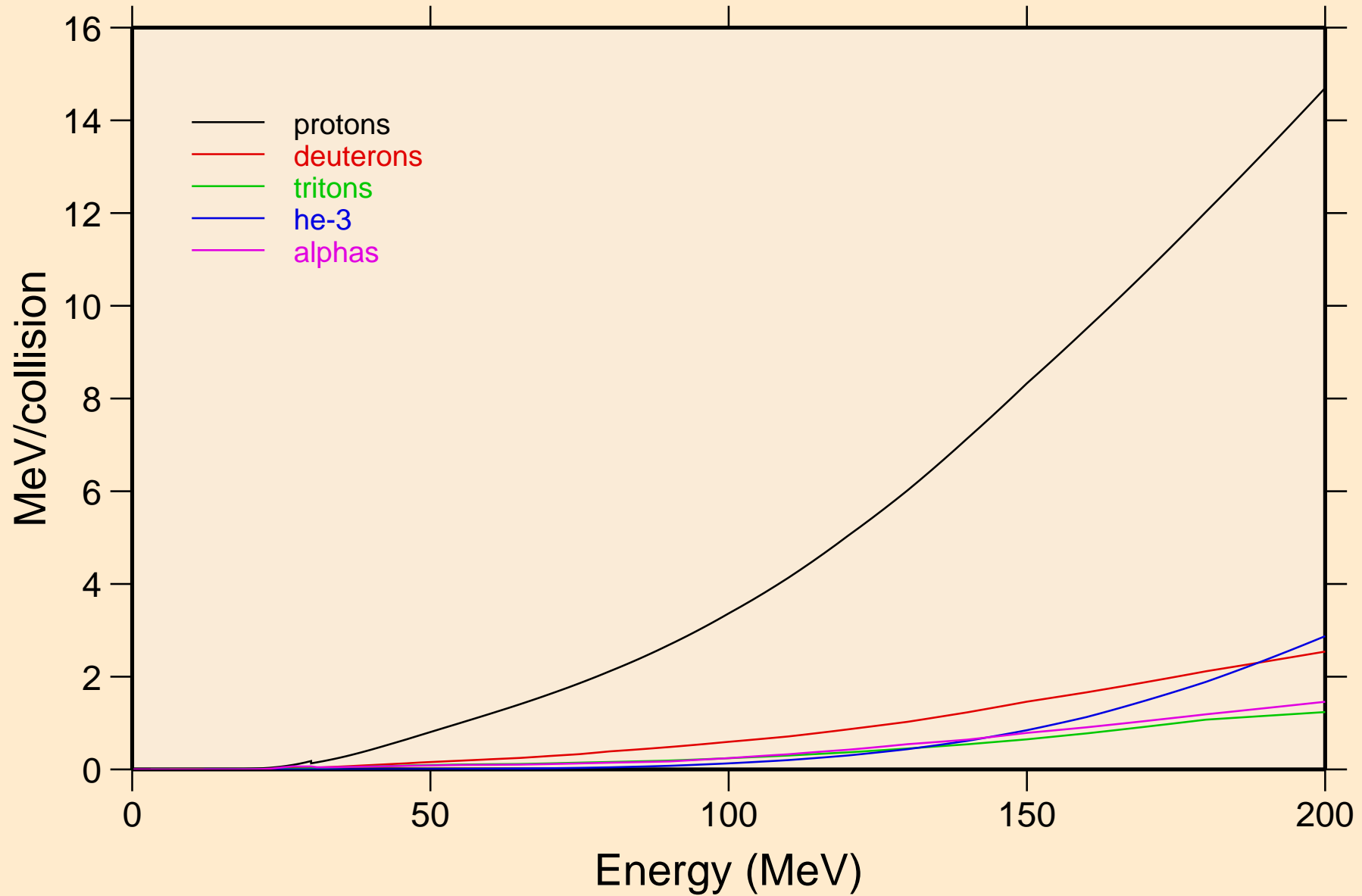

BI224 NEUTRON ACER TENDL-2024 LIBRARY; T=0.K
Recoil Heating

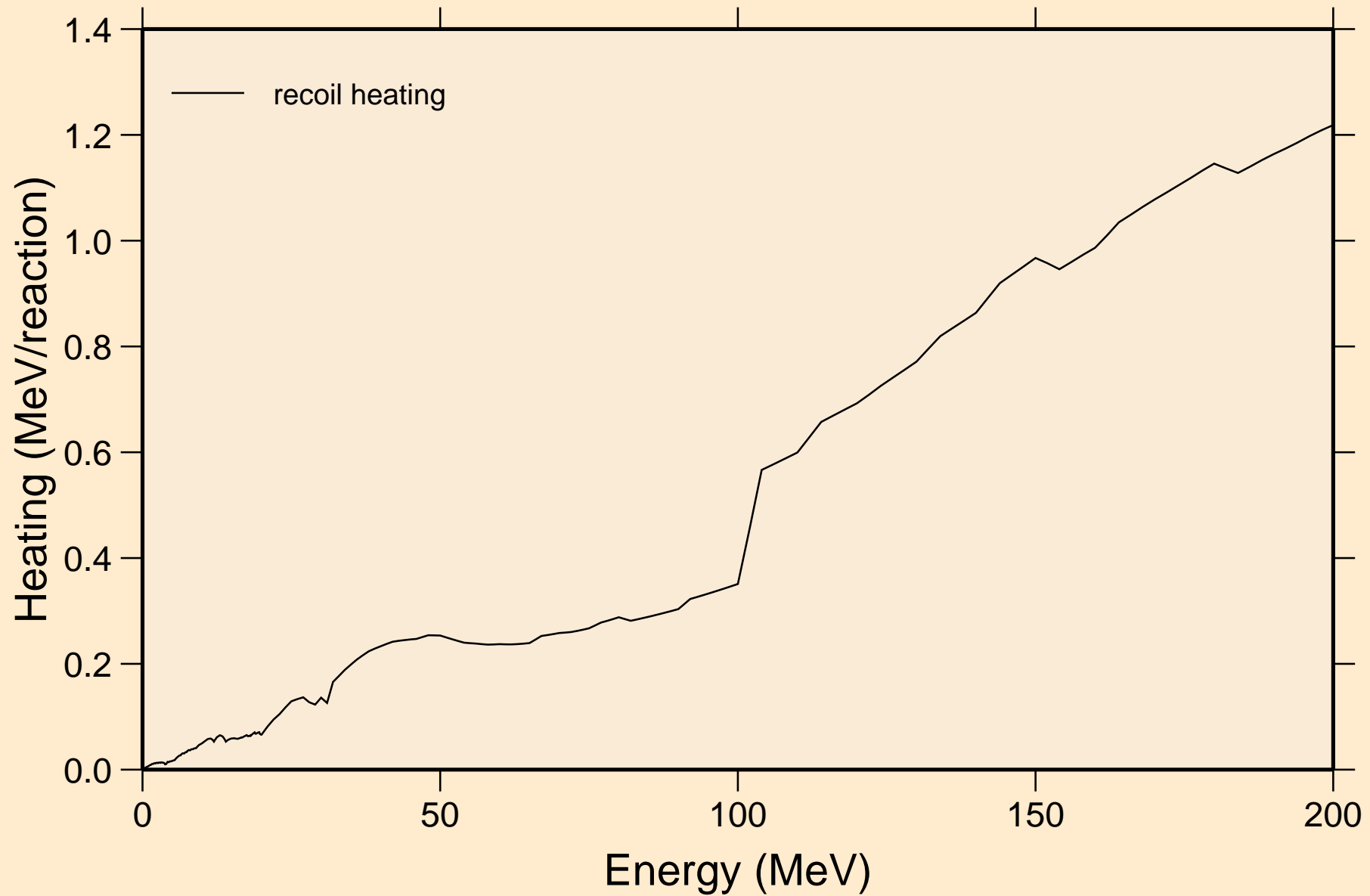

BI224 NEUTRON ACER TENDL-2024 LIBRARY; T=0.K
Particle production cross sections

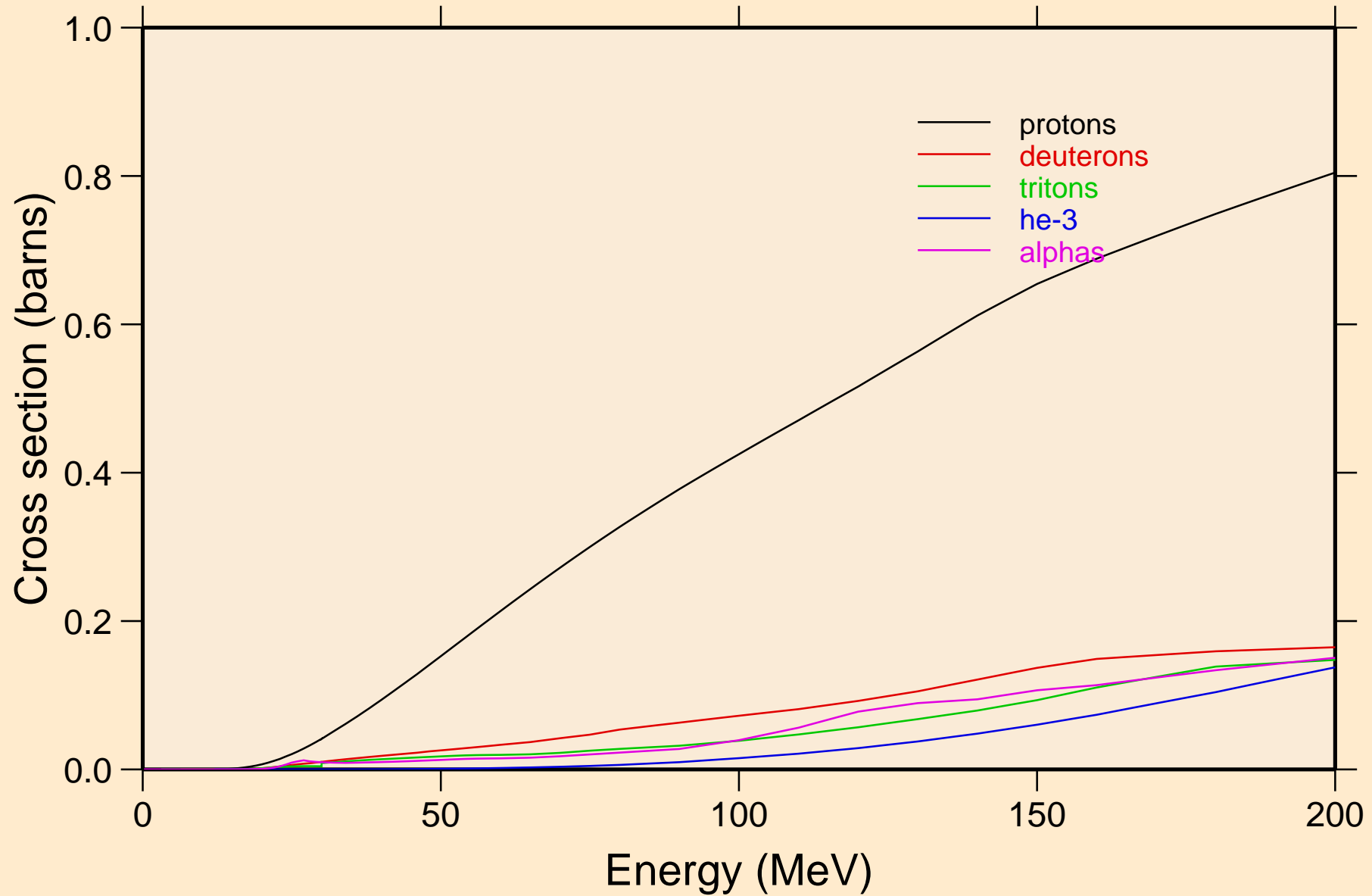

BI224 NEUTRON ACER TENDL-2024 LIBRARY; T=0.K
protons from (n,x)

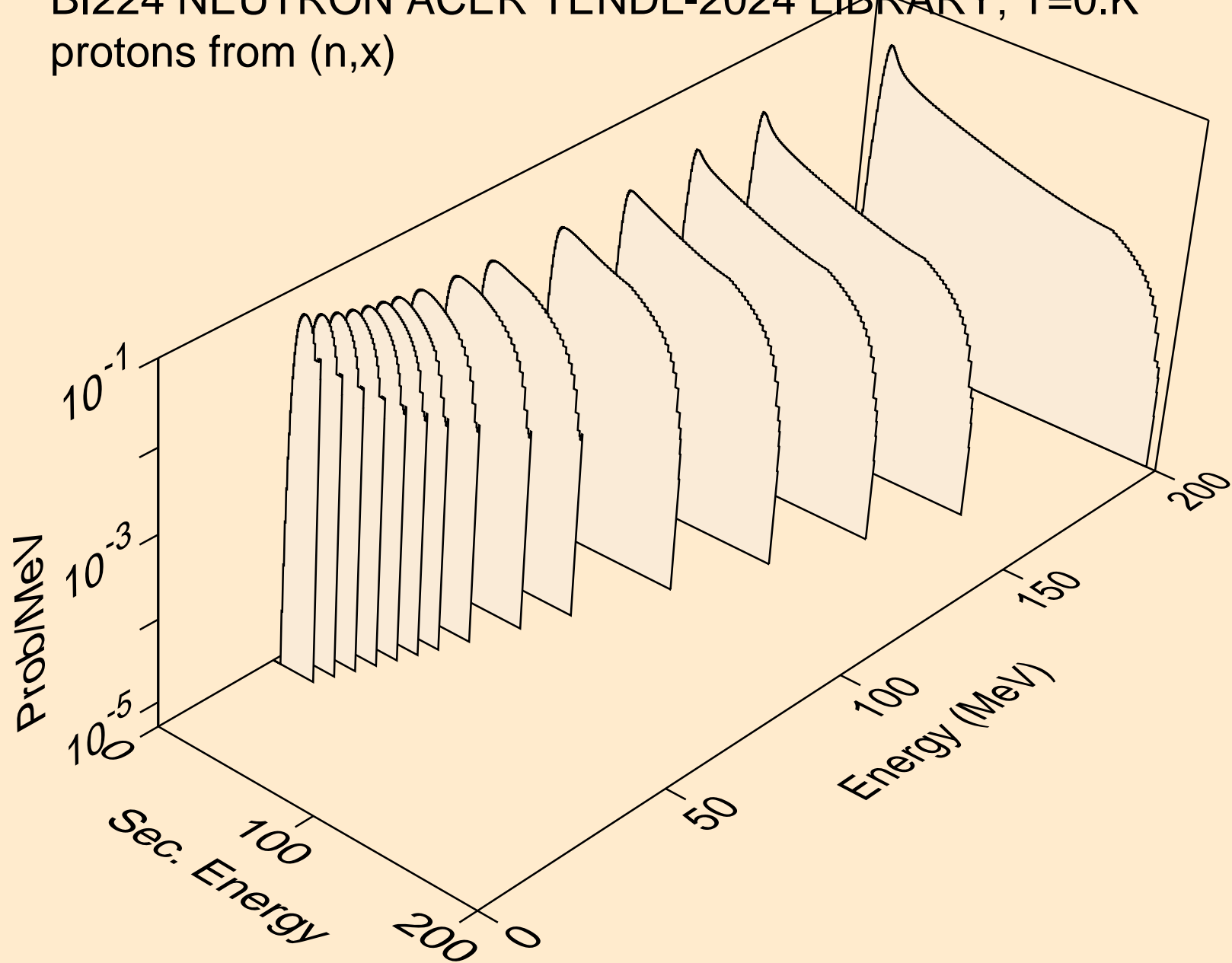

BI224 NEUTRON ACER TENDL-2024 LIBRARY; T=0.K
protons from (n,n*)p

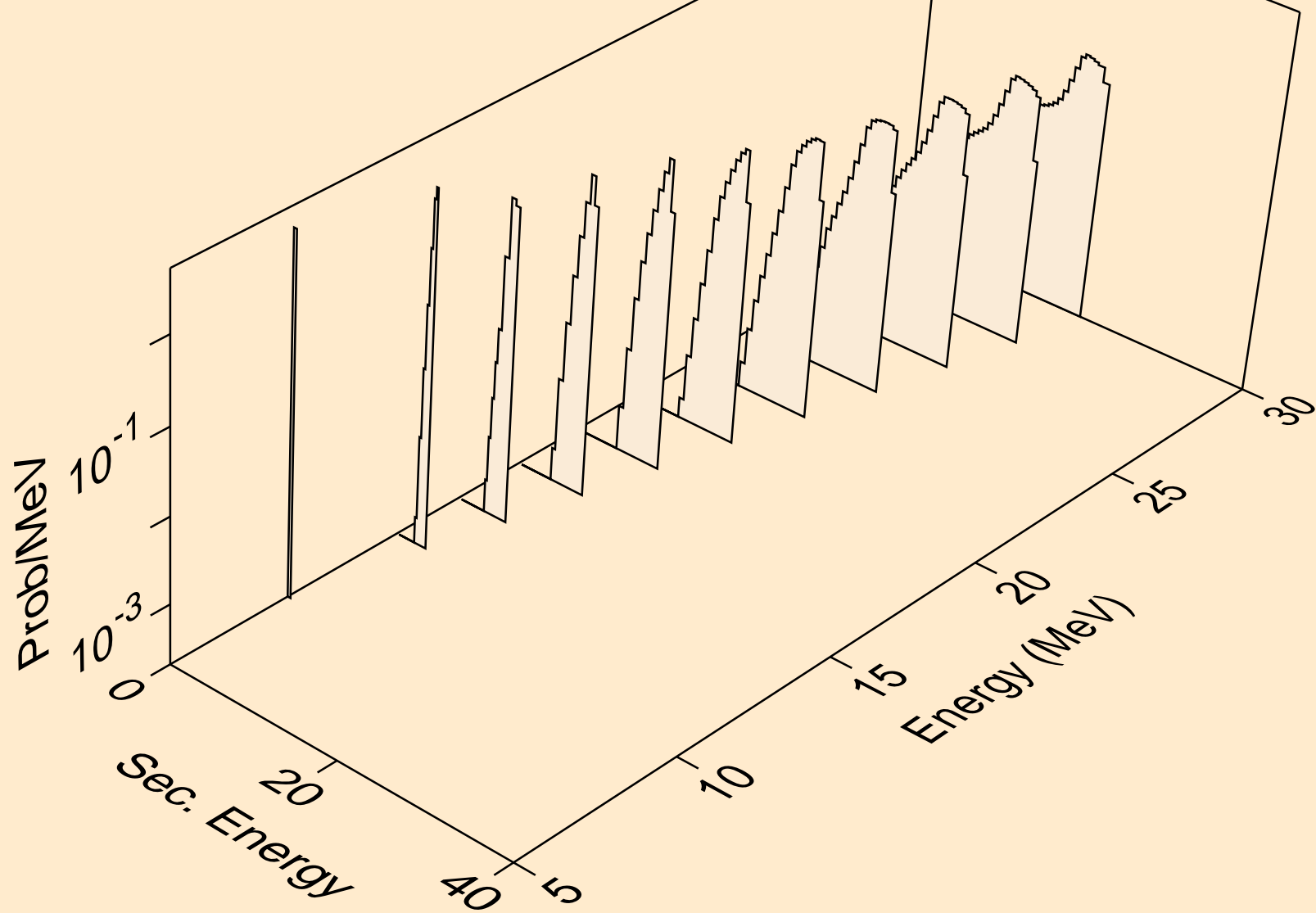

BI224 NEUTRON ACER TENDL-2024 LIBRARY; T=0.K
protons from (n,2np)

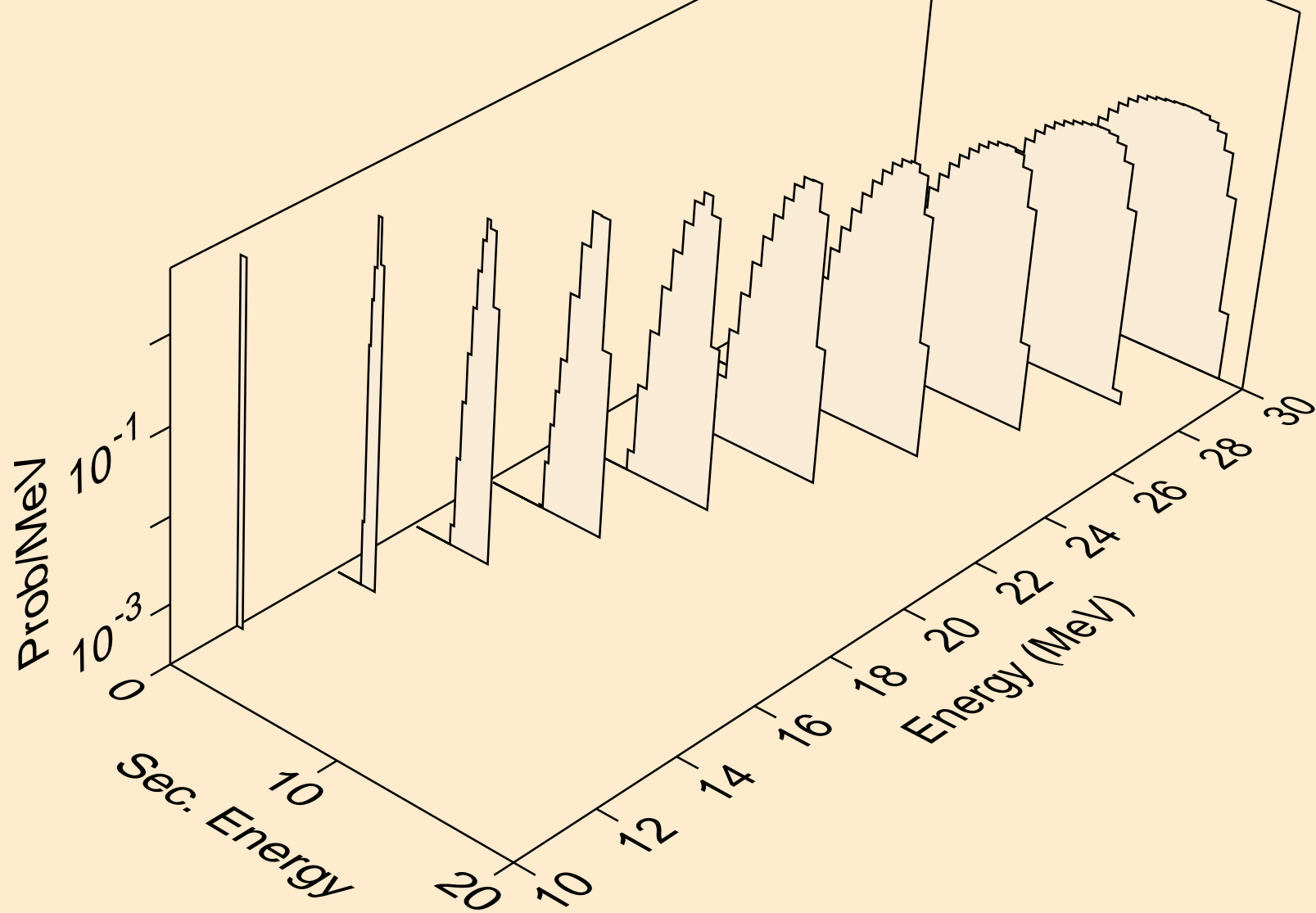

BI224 NEUTRON ACER TENDL-2024 LIBRARY; T=0.K
protons from (n,3np)

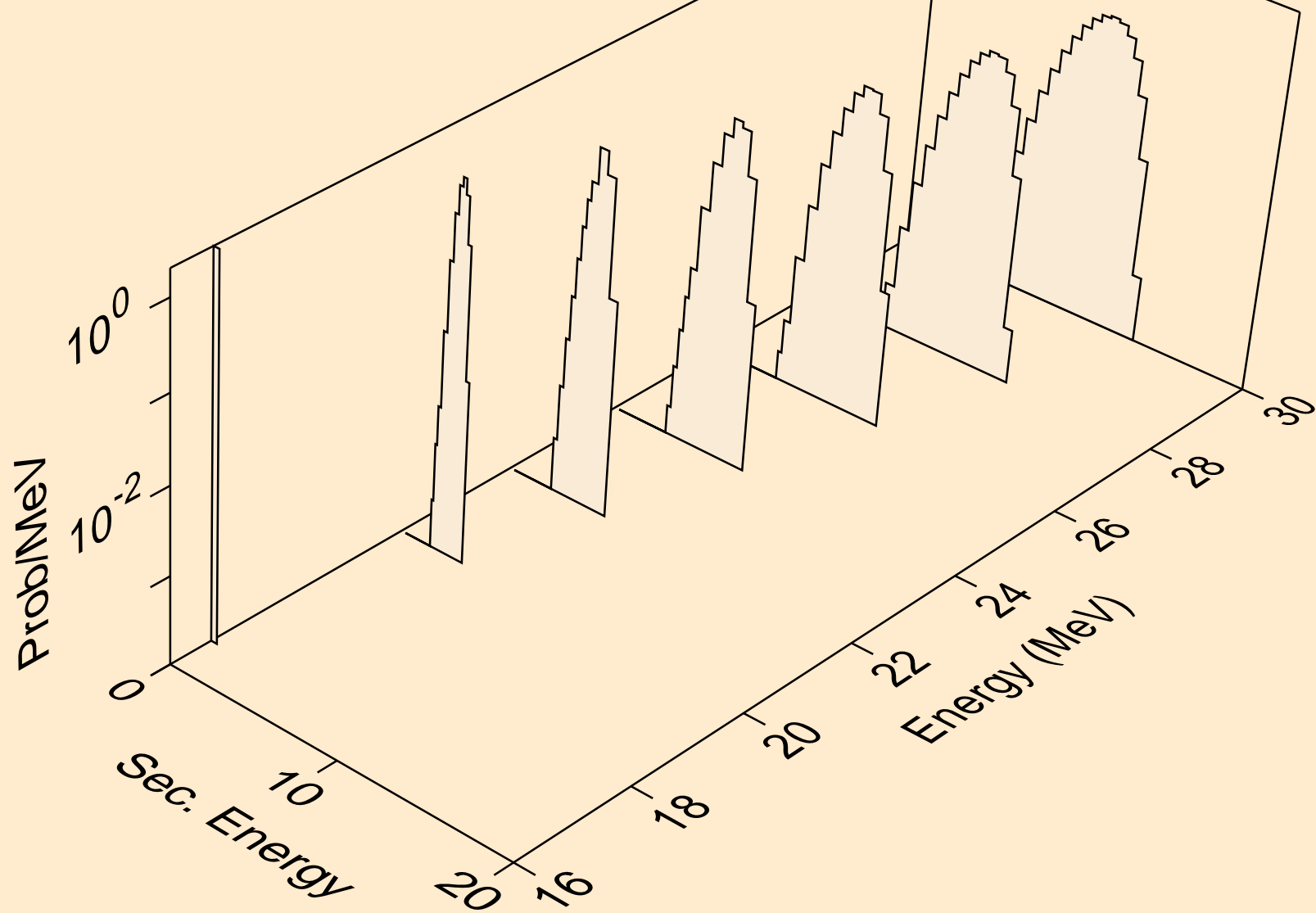

BI224 NEUTRON ACER TENDL-2024 LIBRARY; T=0.K
protons from (n,p)

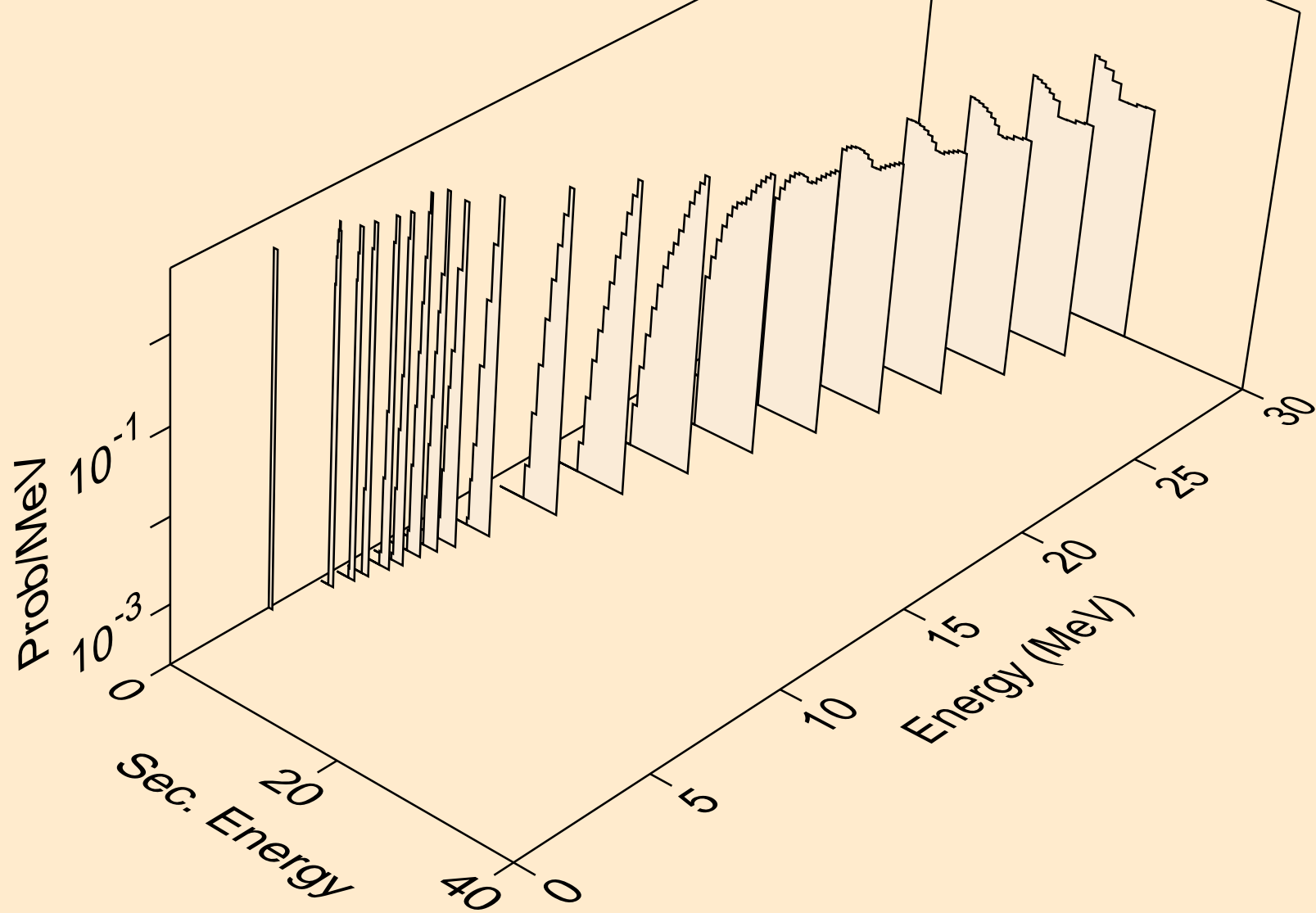

BI224 NEUTRON ACER TENDL-2024 LIBRARY; T=0.K
deuterons from (n,x)

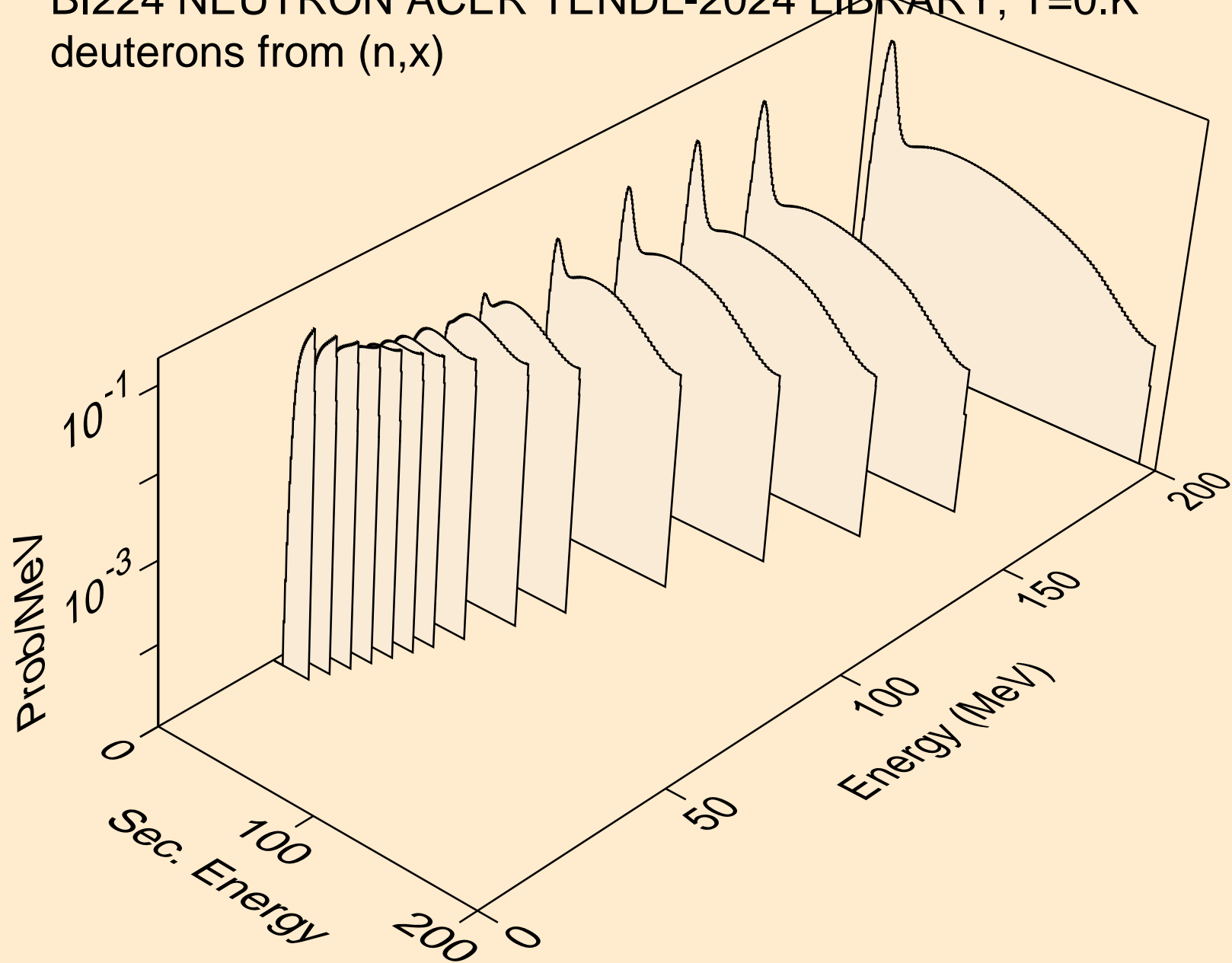

BI224 NEUTRON ACER TENDL-2024 LIBRARY; T=0.K
deuterons from (n,2nd)

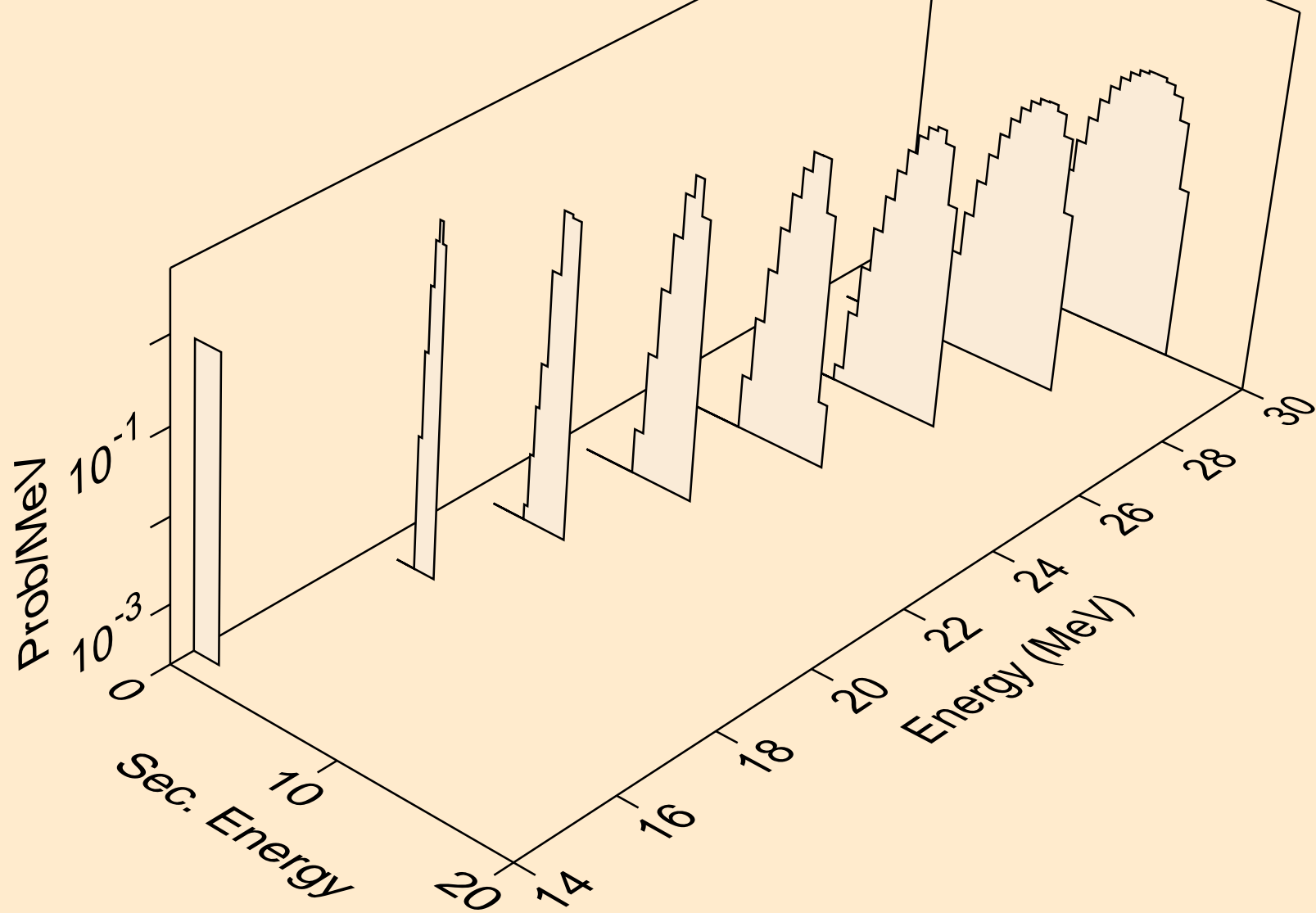

BI224 NEUTRON ACER TENDL-2024 LIBRARY; T=0.K
deuterons from (n,n*)d

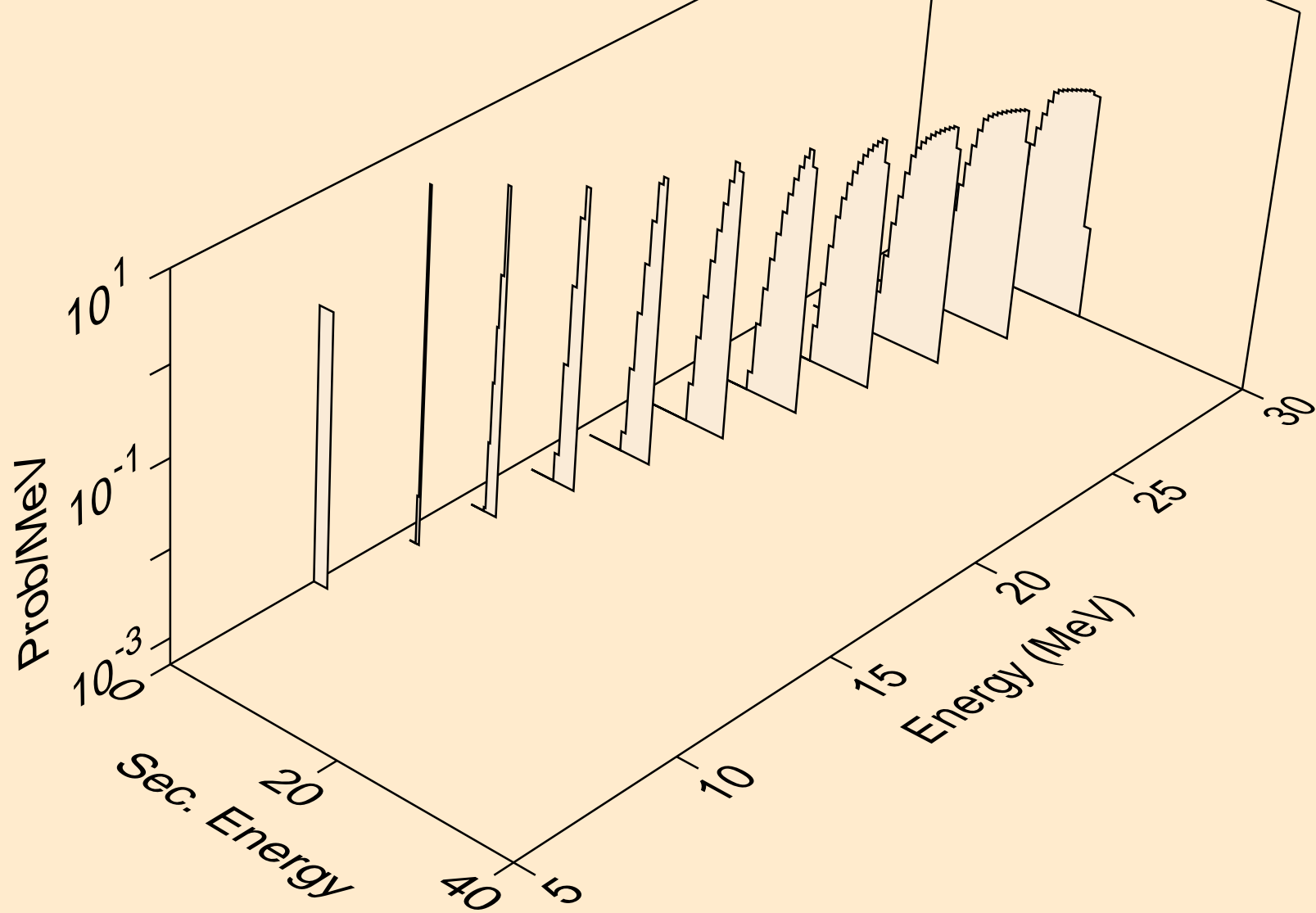

BI224 NEUTRON ACER TENDL-2024 LIBRARY; T=0.K
deuterons from (n,d)

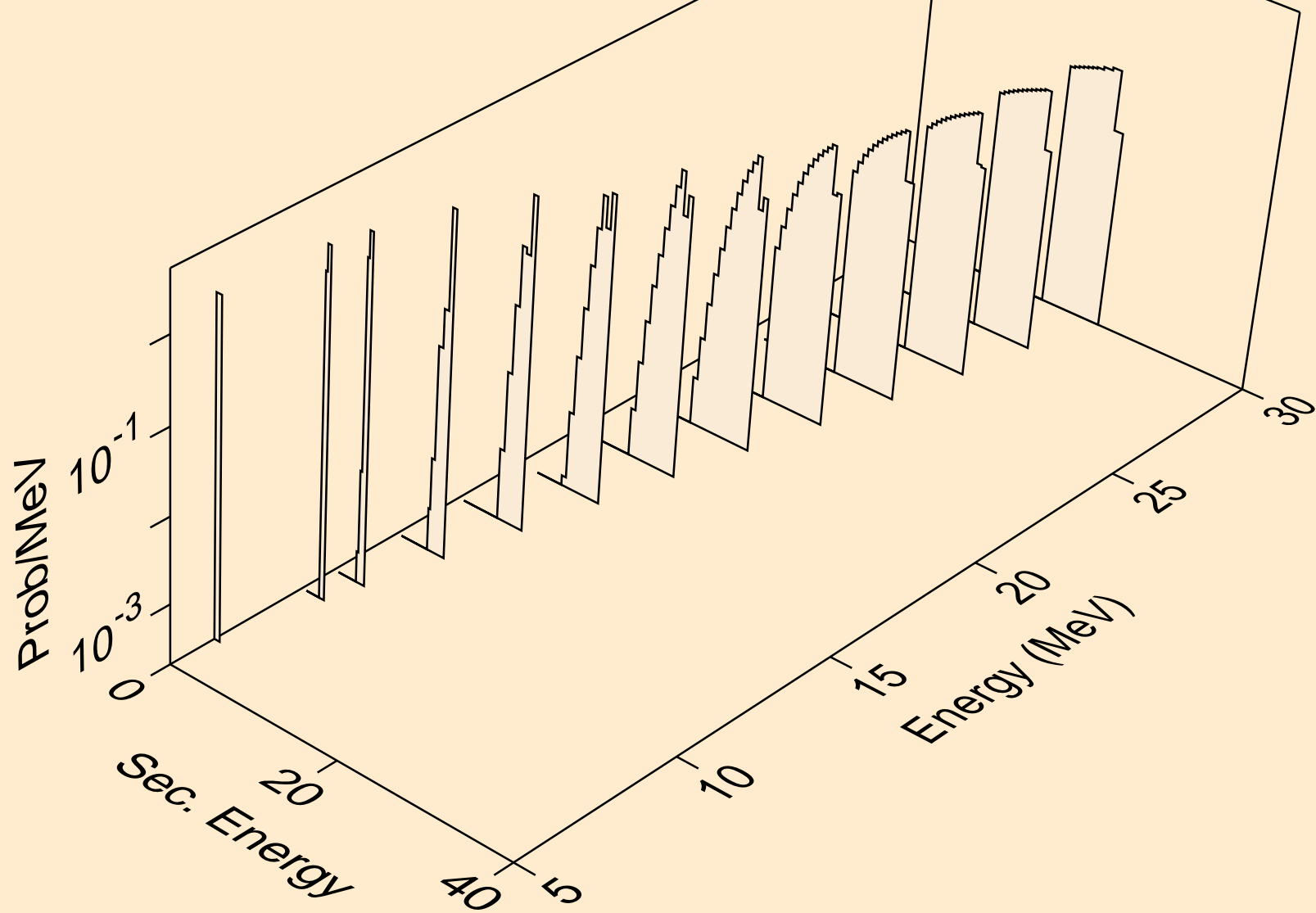

BI224 NEUTRON ACER TENDL-2024 LIBRARY; T=0.K
tritons from (n,x)

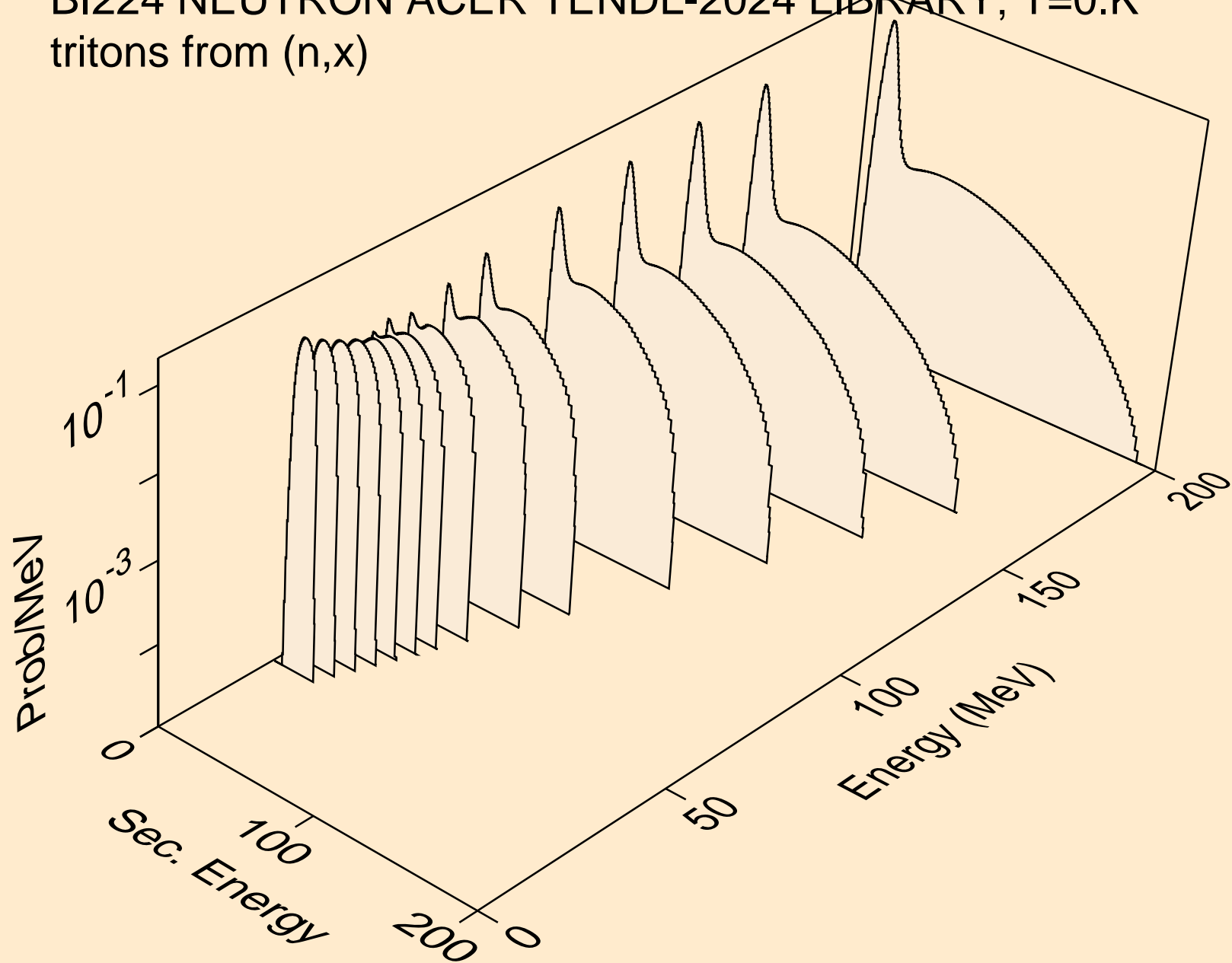

BI224 NEUTRON ACER TENDL-2024 LIBRARY; T=0.K
tritons from (n,n*)t

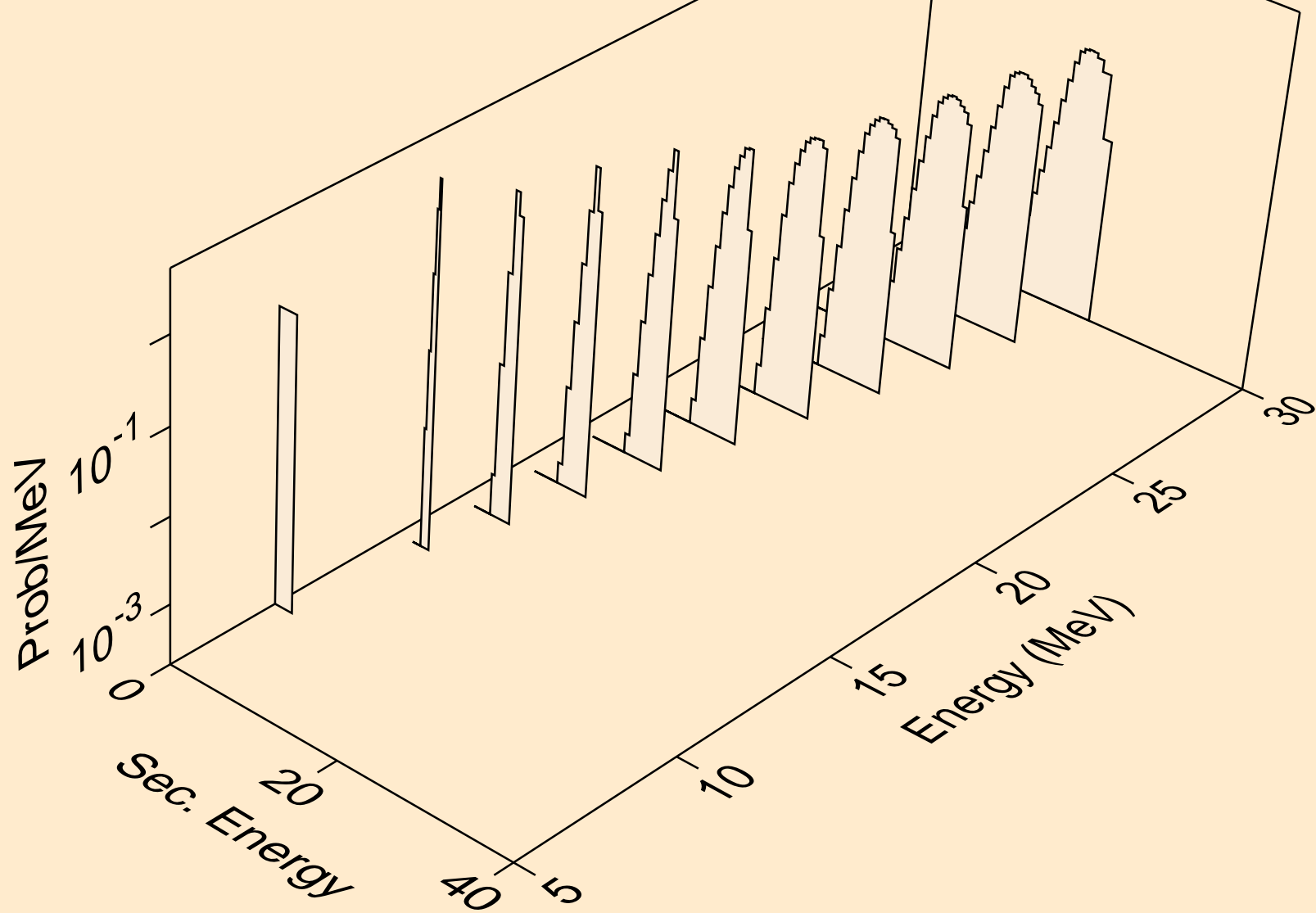

BI224 NEUTRON ACER TENDL-2024 LIBRARY; T=0.K
tritons from (n,t)

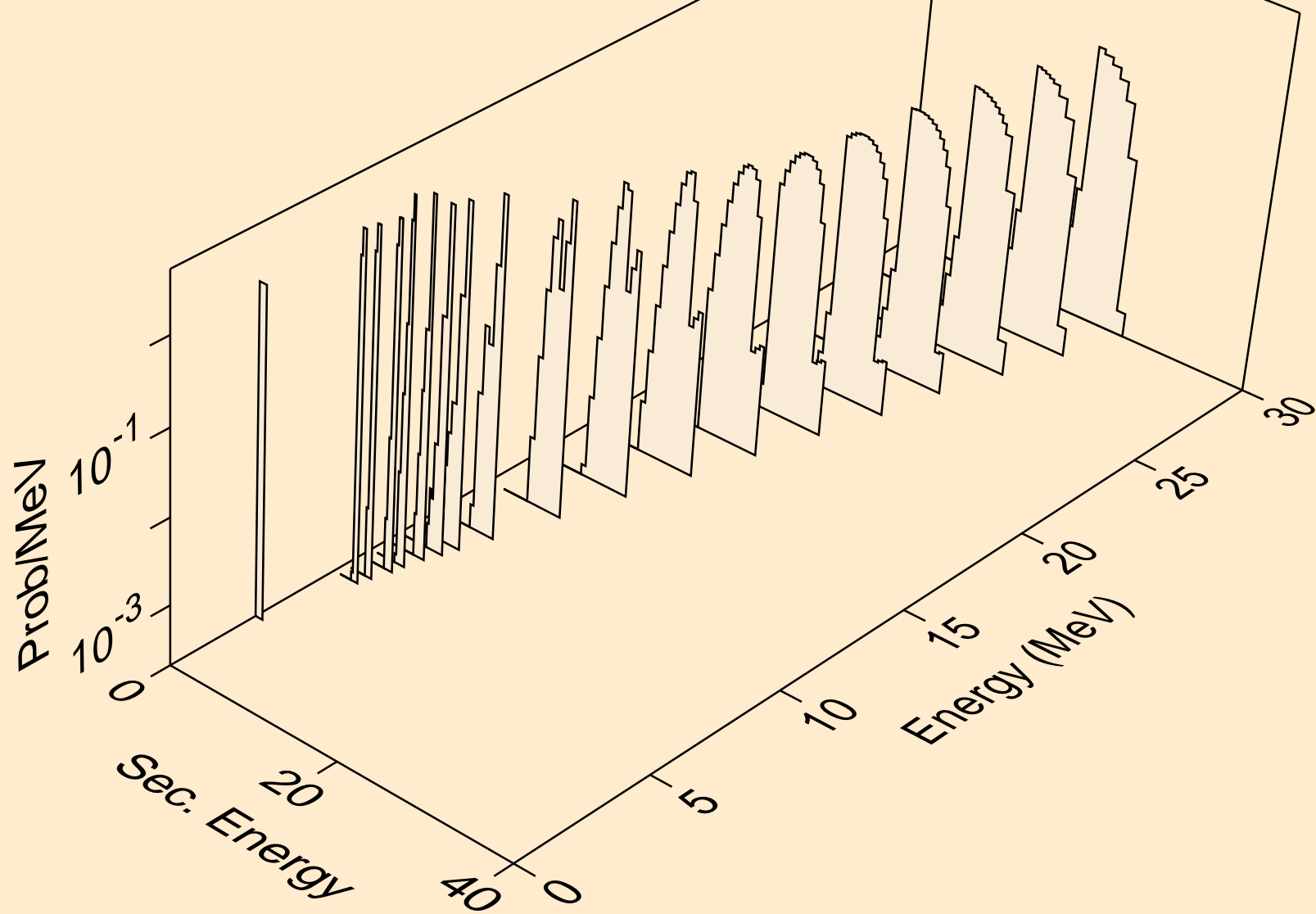

BI224 NEUTRON ACER TENDL-2024 LIBRARY; T=0.K
he3s from (n,x)

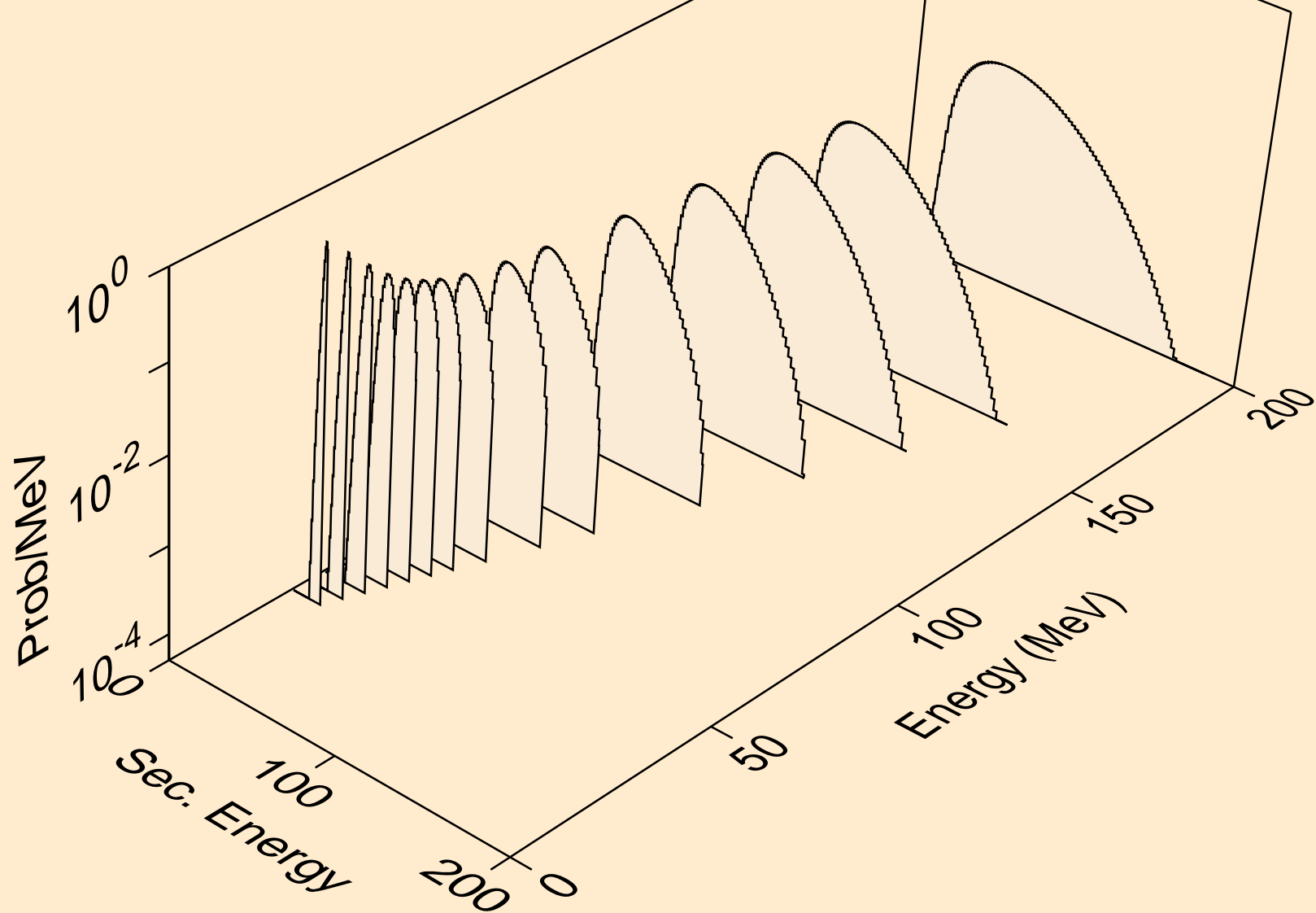

BI224 NEUTRON ACER TENDL-2024 LIBRARY; T=0.K
he3s from (n,n*)he3

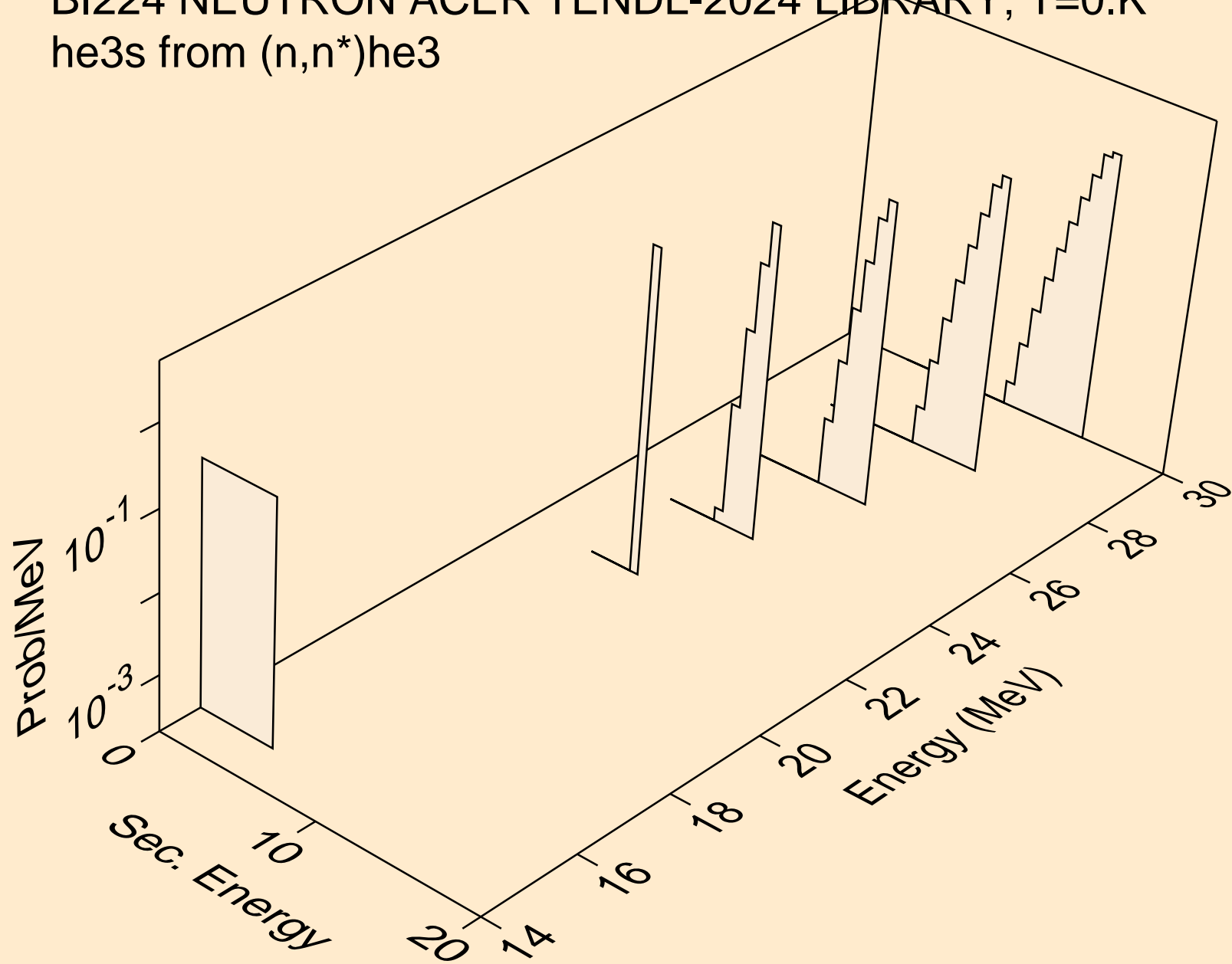

BI224 NEUTRON ACER TENDL-2024 LIBRARY; T=0.K
he3s from (n,he3)

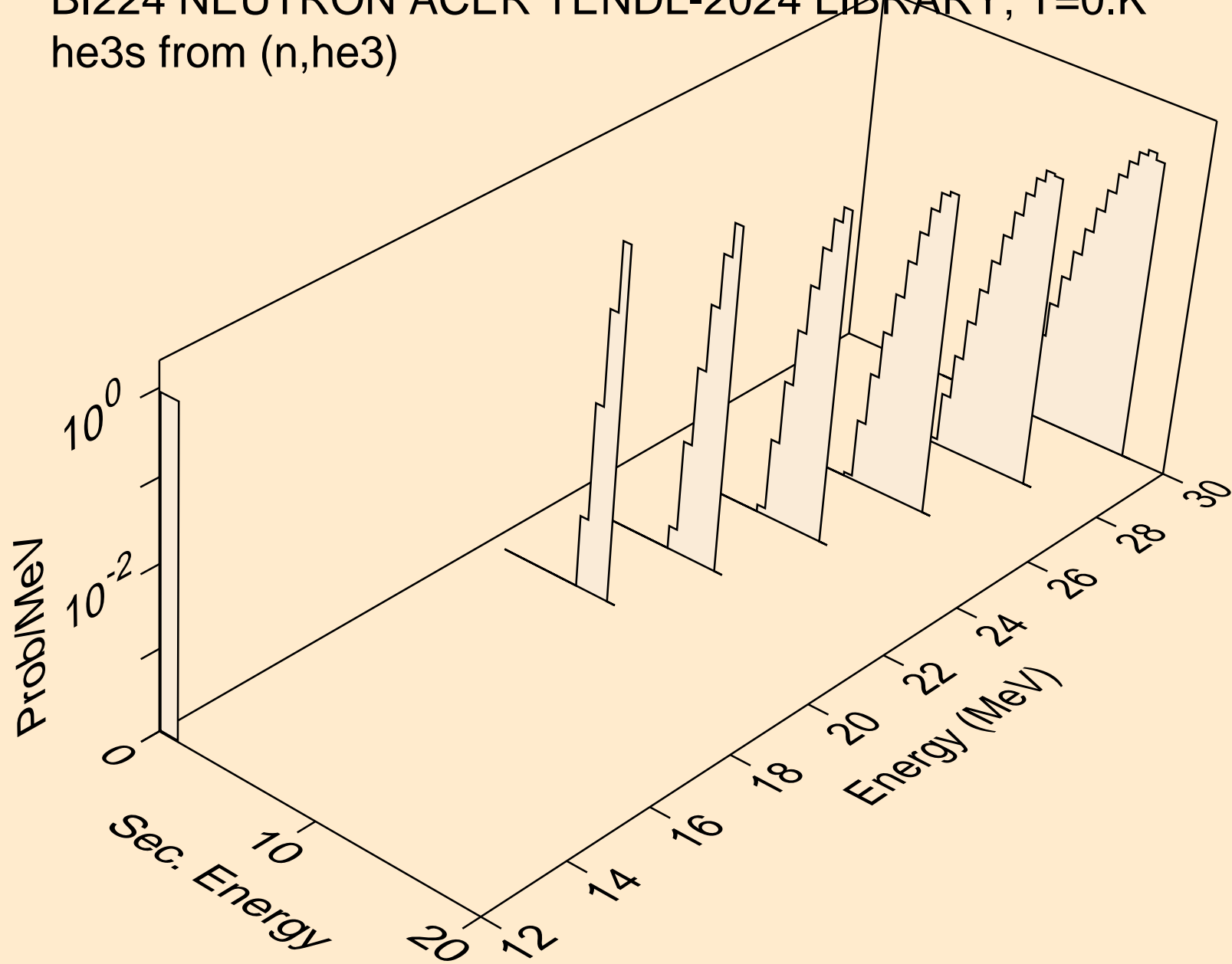

BI224 NEUTRON ACER TENDL-2024 LIBRARY; T=0.K
alphas from (n,x)

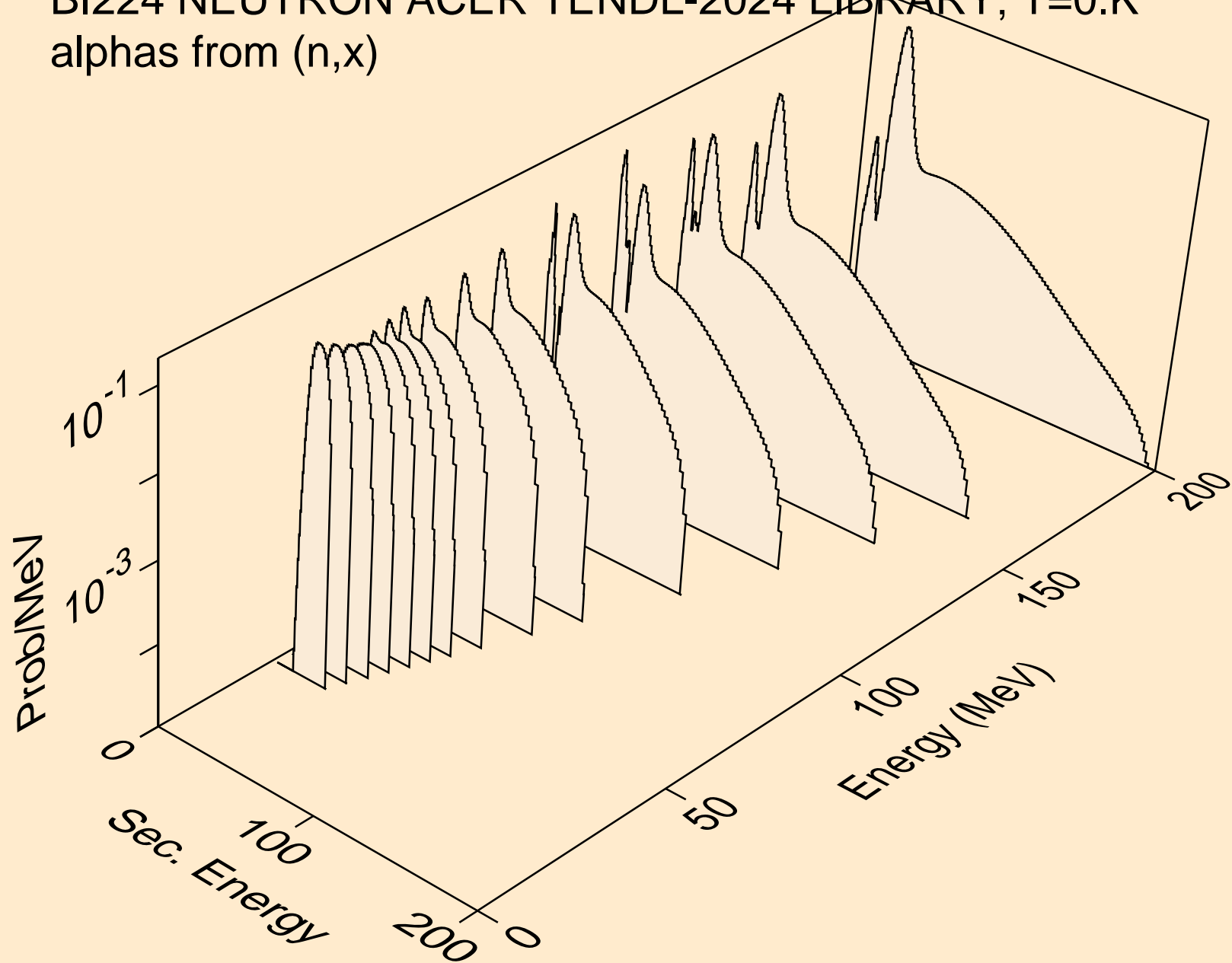

BI224 NEUTRON ACER TENDL-2024 LIBRARY; T=0.K
alphas from (n,n*)a

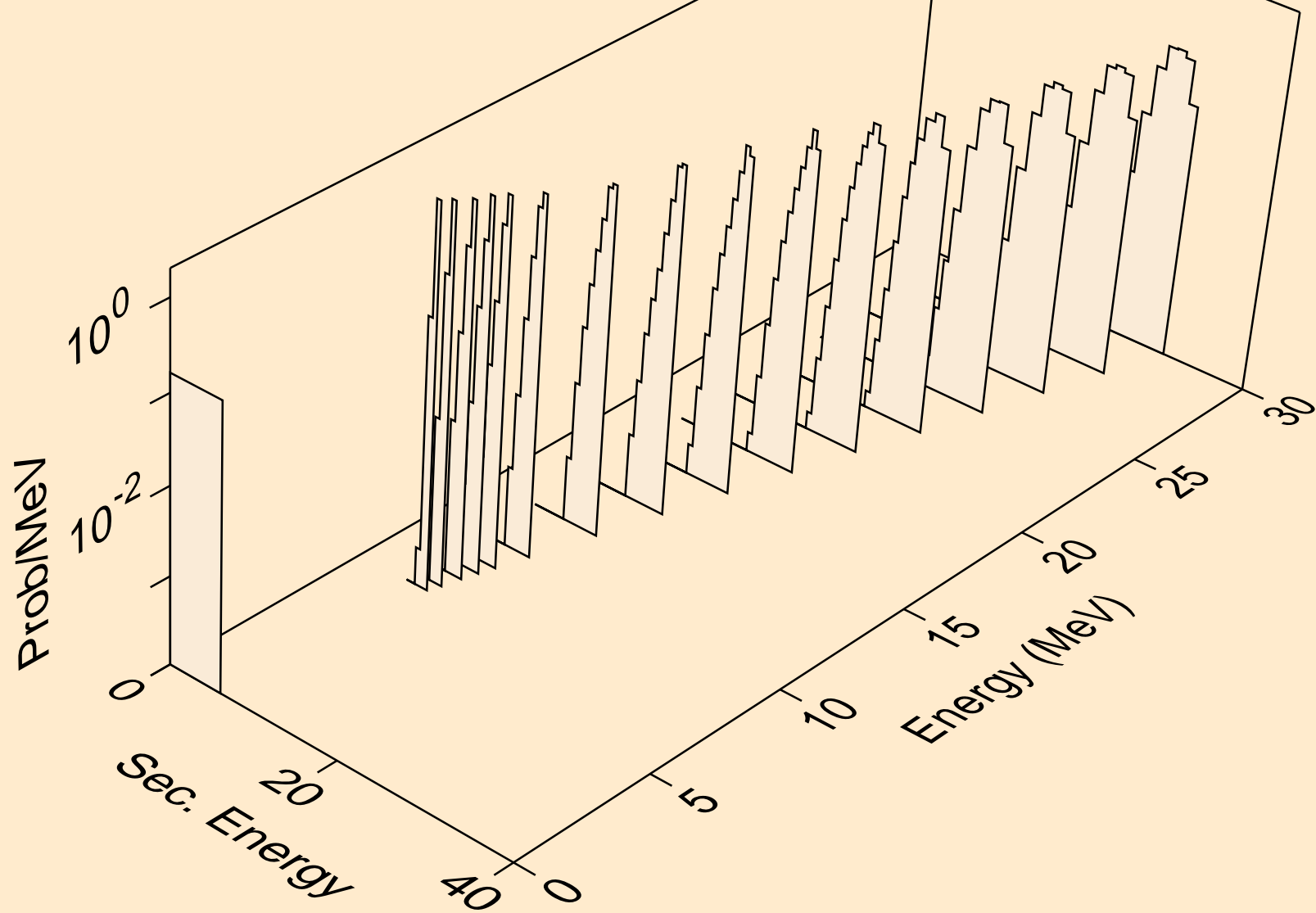

BI224 NEUTRON ACER TENDL-2024 LIBRARY; T=0.K
alphas from (n,2n)a

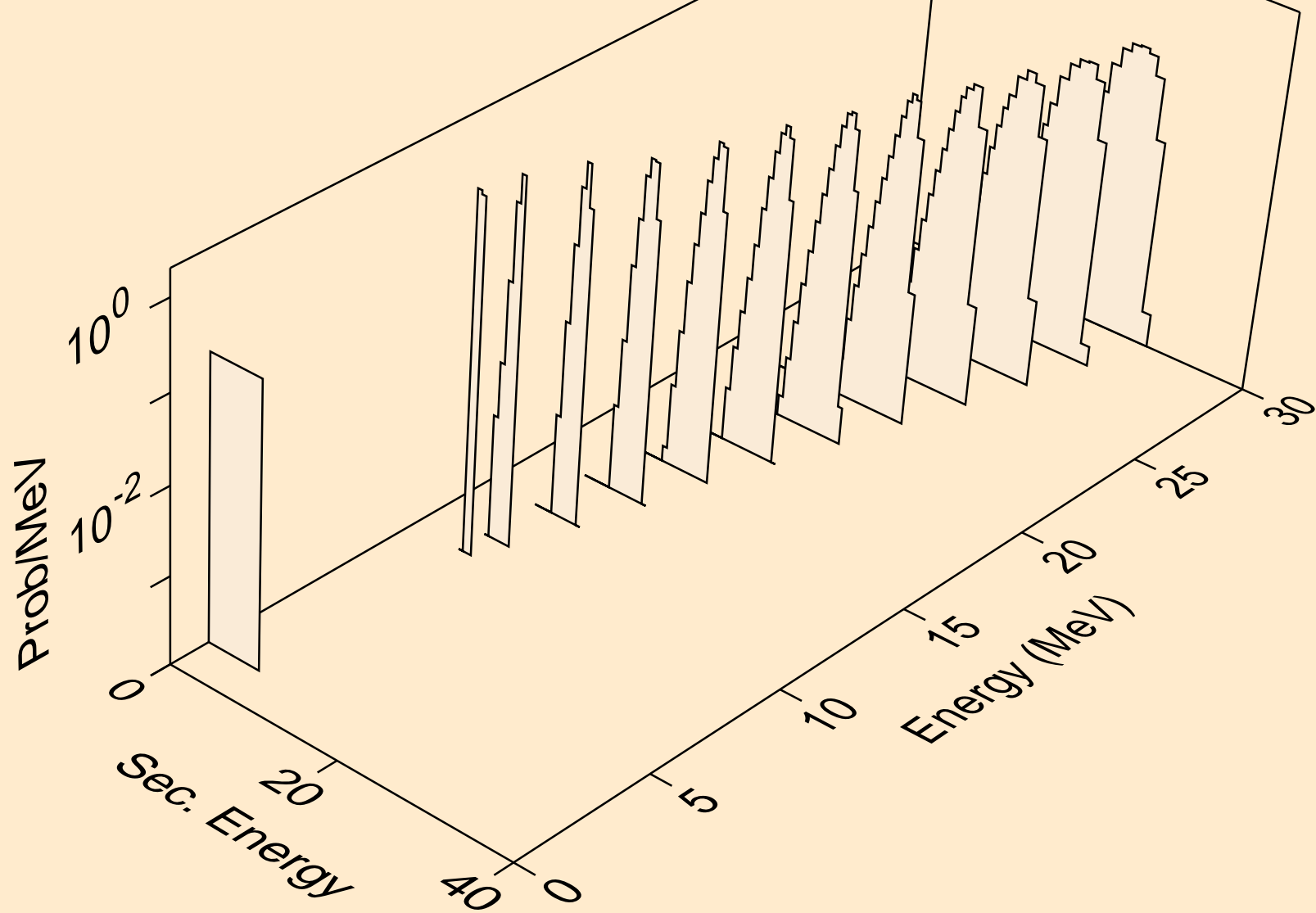

BI224 NEUTRON ACER TENDL-2024 LIBRARY; T=0.K
alphas from (n,3n)a

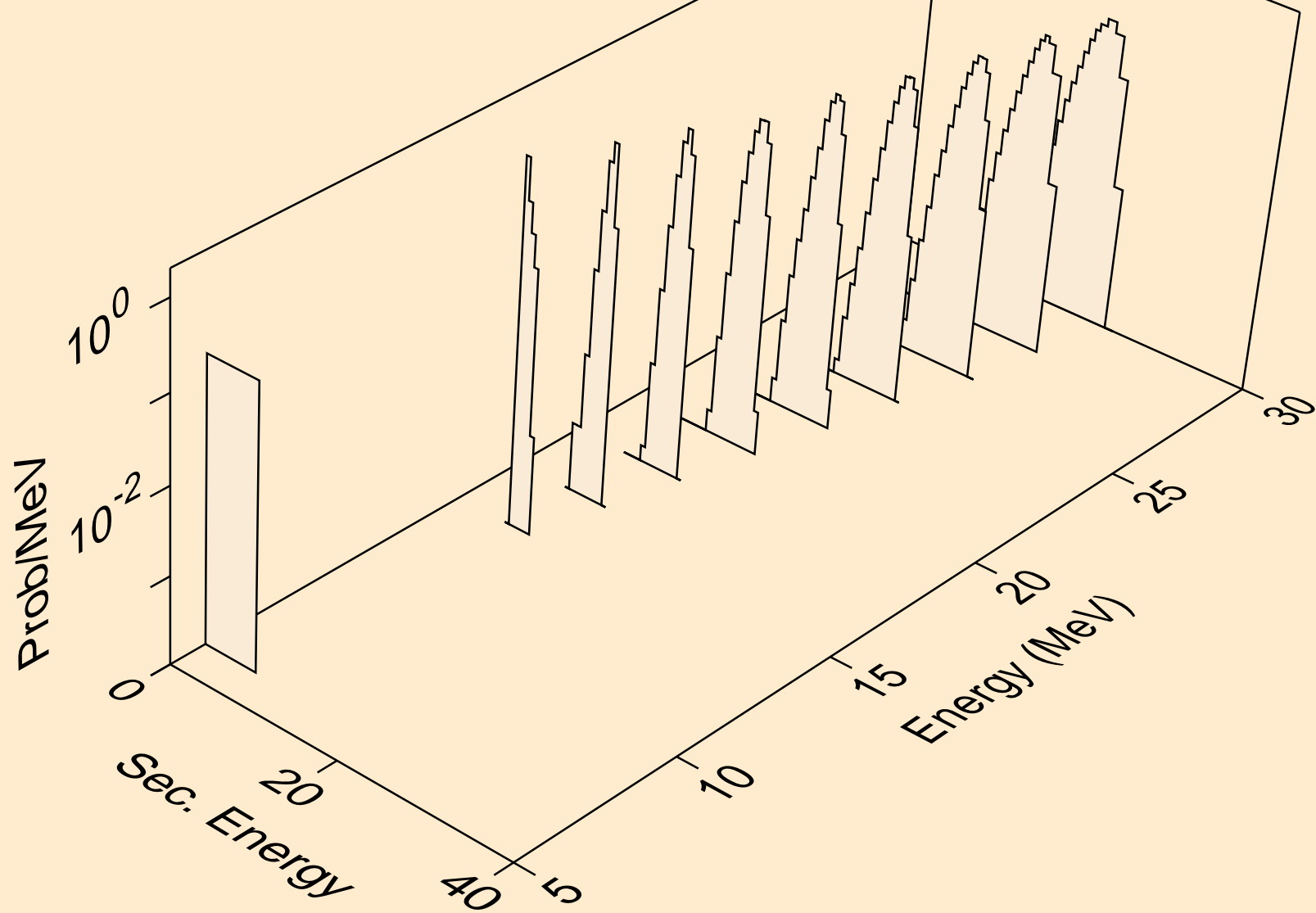

BI224 NEUTRON ACER TENDL-2024 LIBRARY; T=0.K
alphas from (n,a)

