

BR073 NEUTRON ACER TENDL-2024 LIBRARY; T=0.K

Principal cross sections

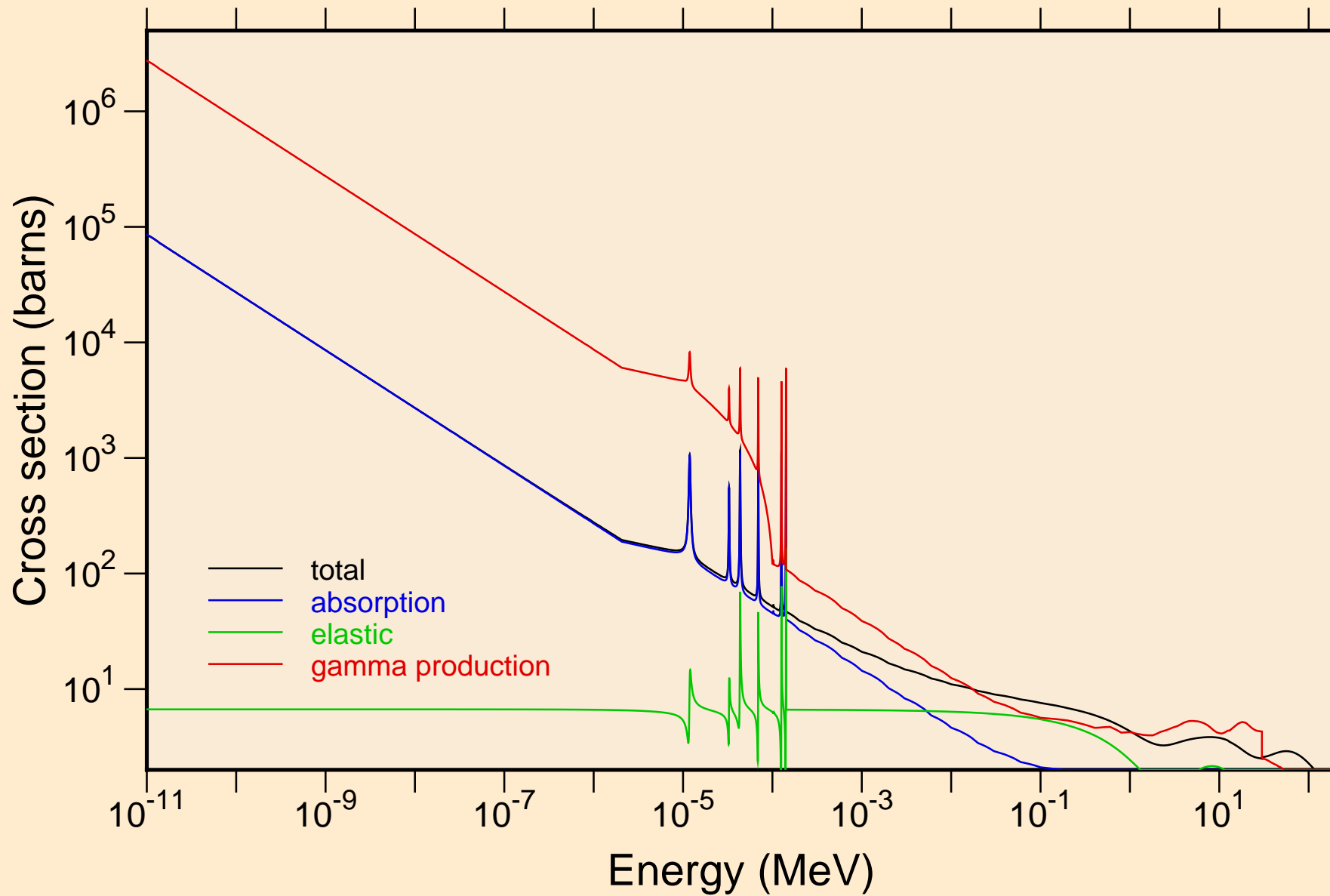

BR073 NEUTRON ACER TENDL-2024 LIBRARY; T=0.K
resonance total cross section

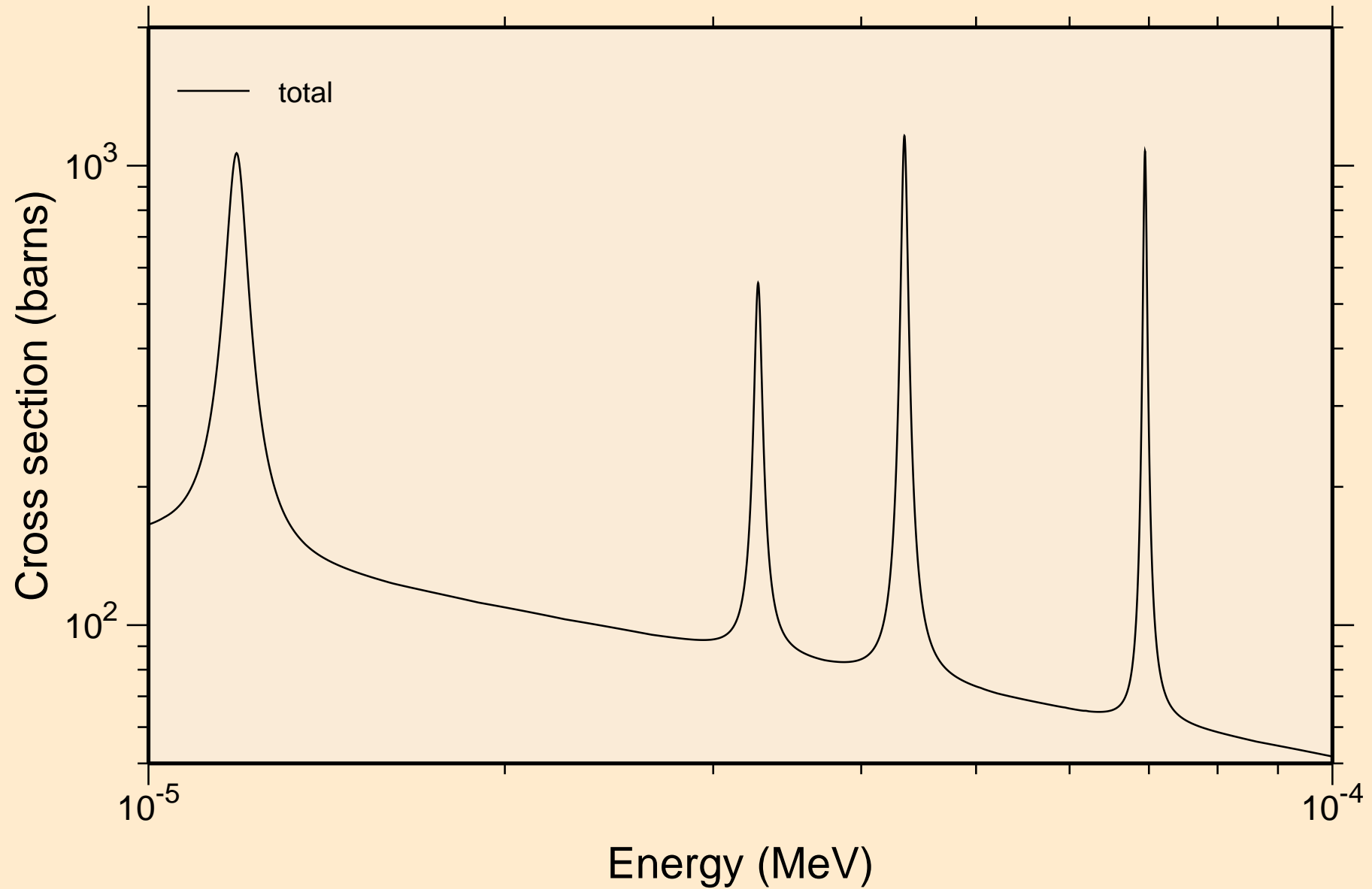

BR073 NEUTRON ACER TENDL-2024 LIBRARY; T=0.K
resonance total cross section

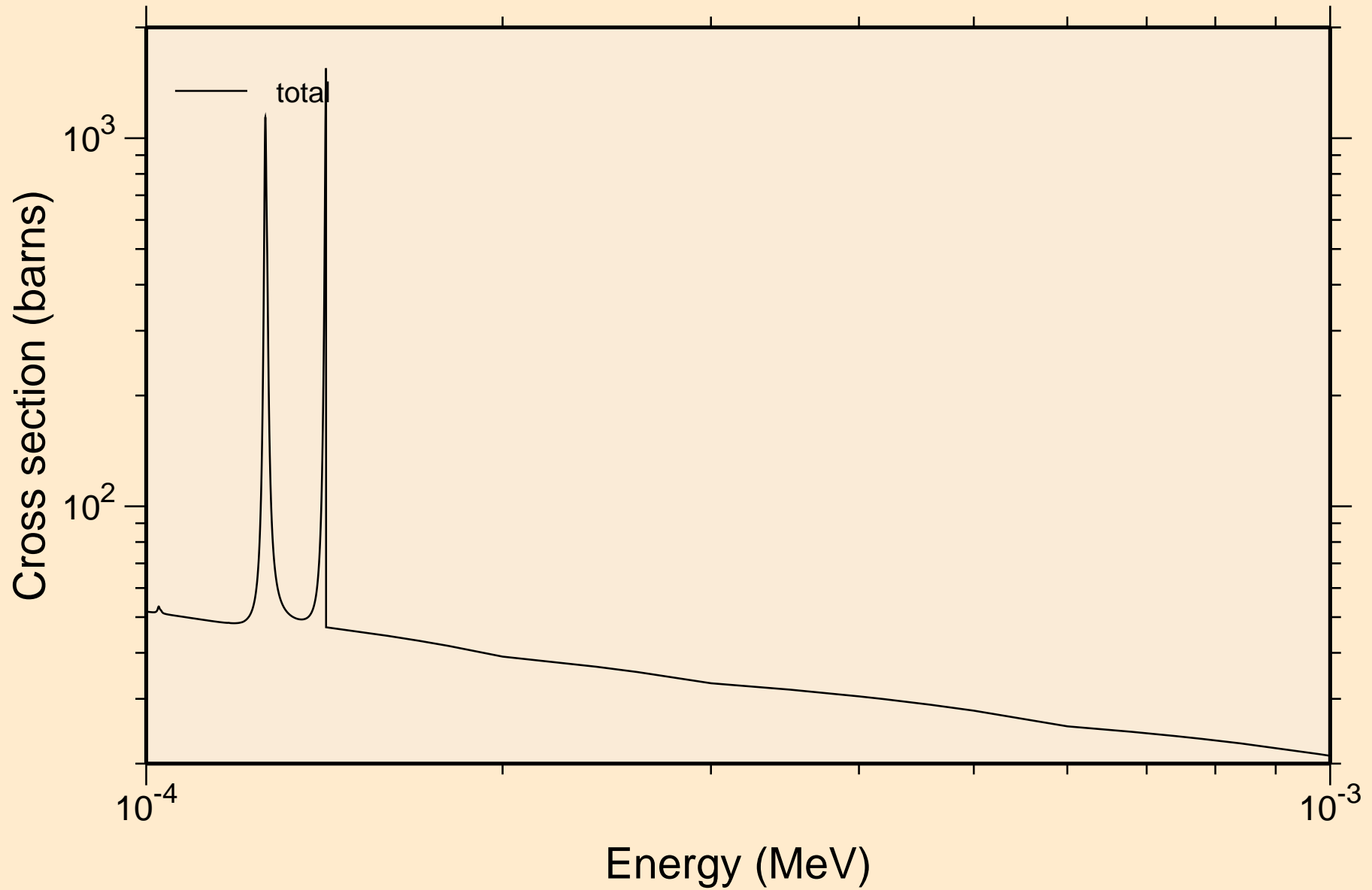

BR073 NEUTRON ACER TENDL-2024 LIBRARY; T=0.K
resonance total cross section

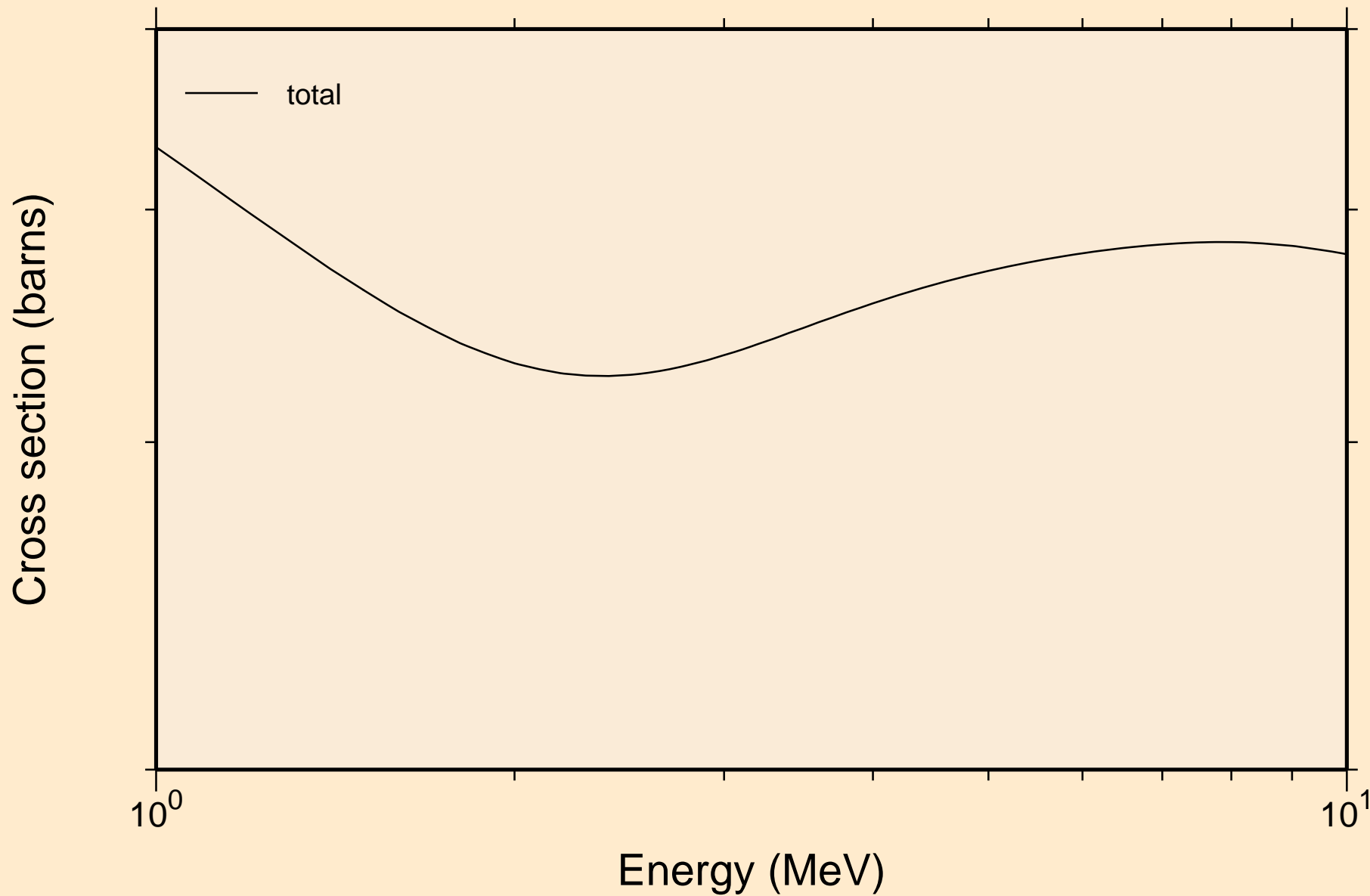

BR073 NEUTRON ACER TENDL-2024 LIBRARY; T=0.K
resonance absorption cross sections

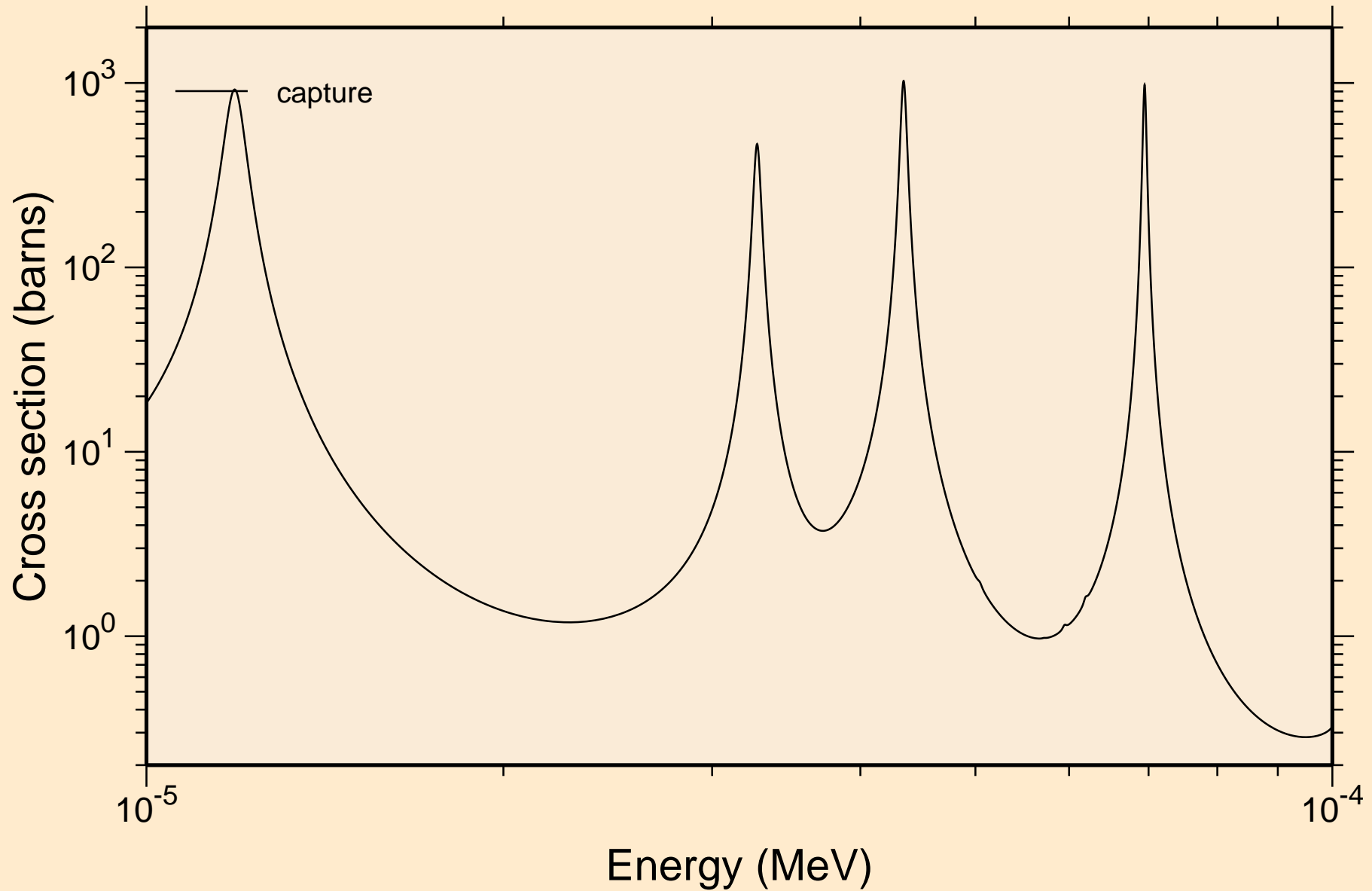

BR073 NEUTRON ACER TENDL-2024 LIBRARY; T=0.K
resonance absorption cross sections

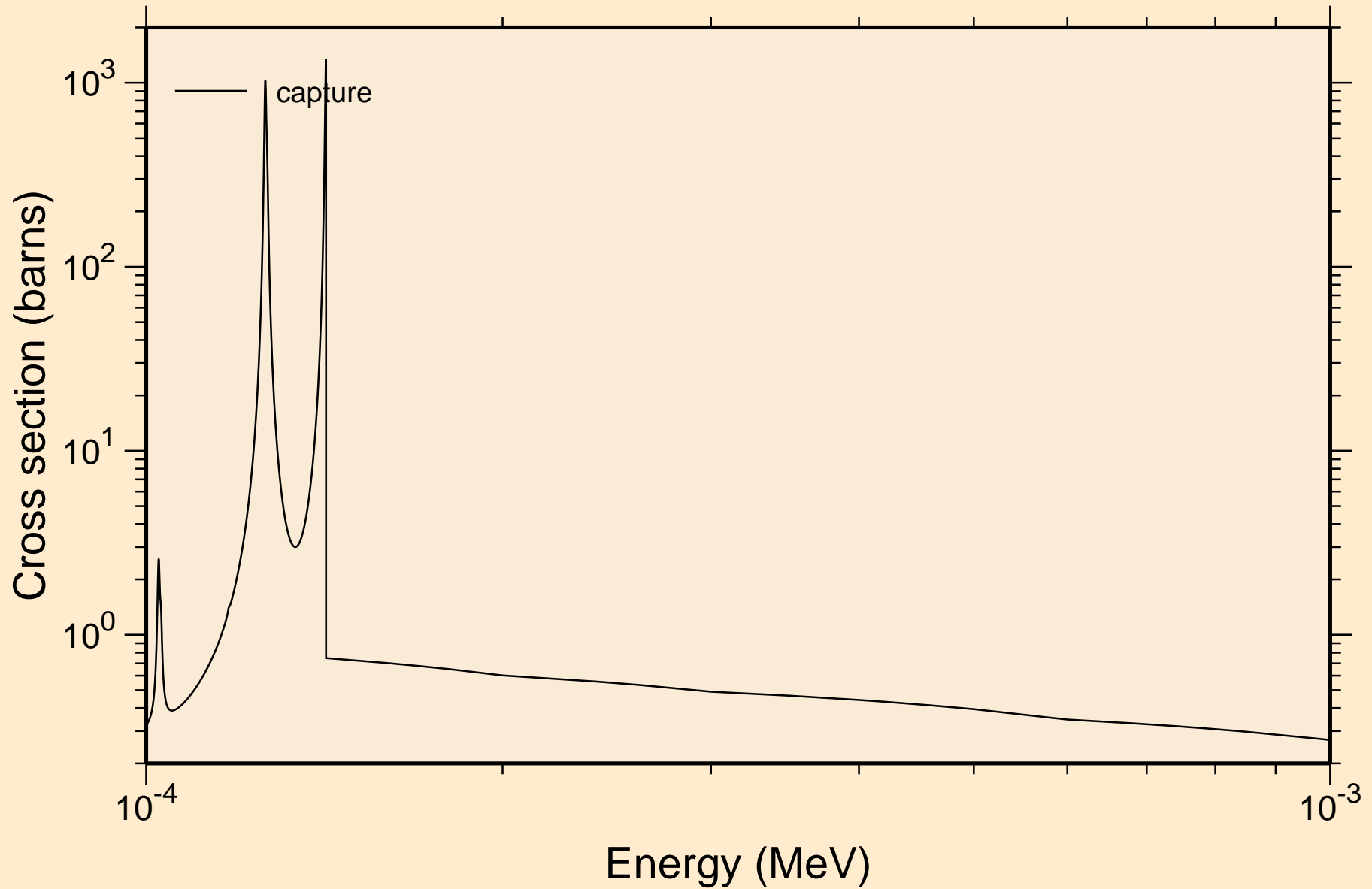

BR073 NEUTRON ACER TENDL-2024 LIBRARY; T=0.K
resonance absorption cross sections

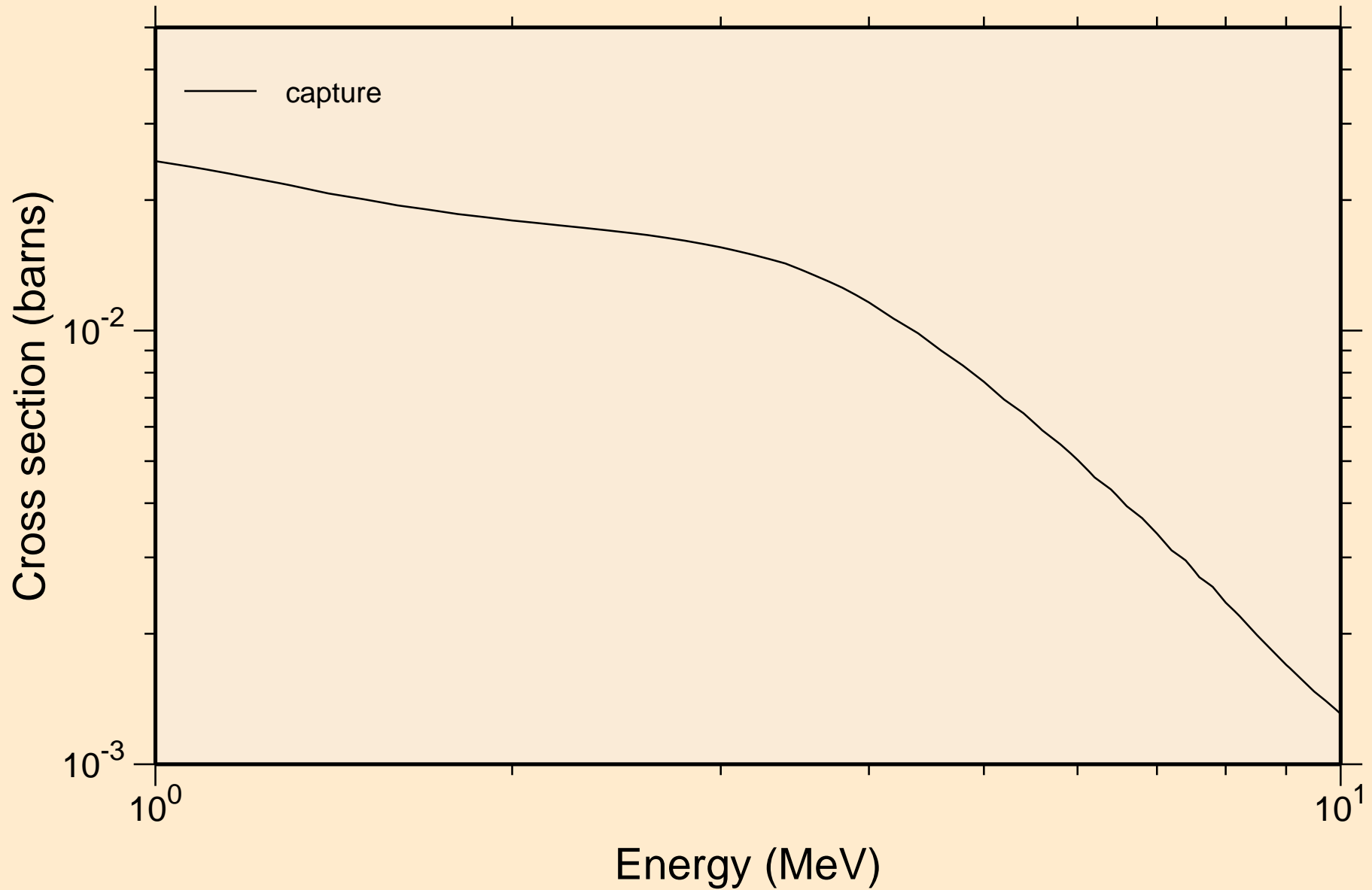

BR073 NEUTRON ACER TENDL-2024 LIBRARY; T=0.K

Heating

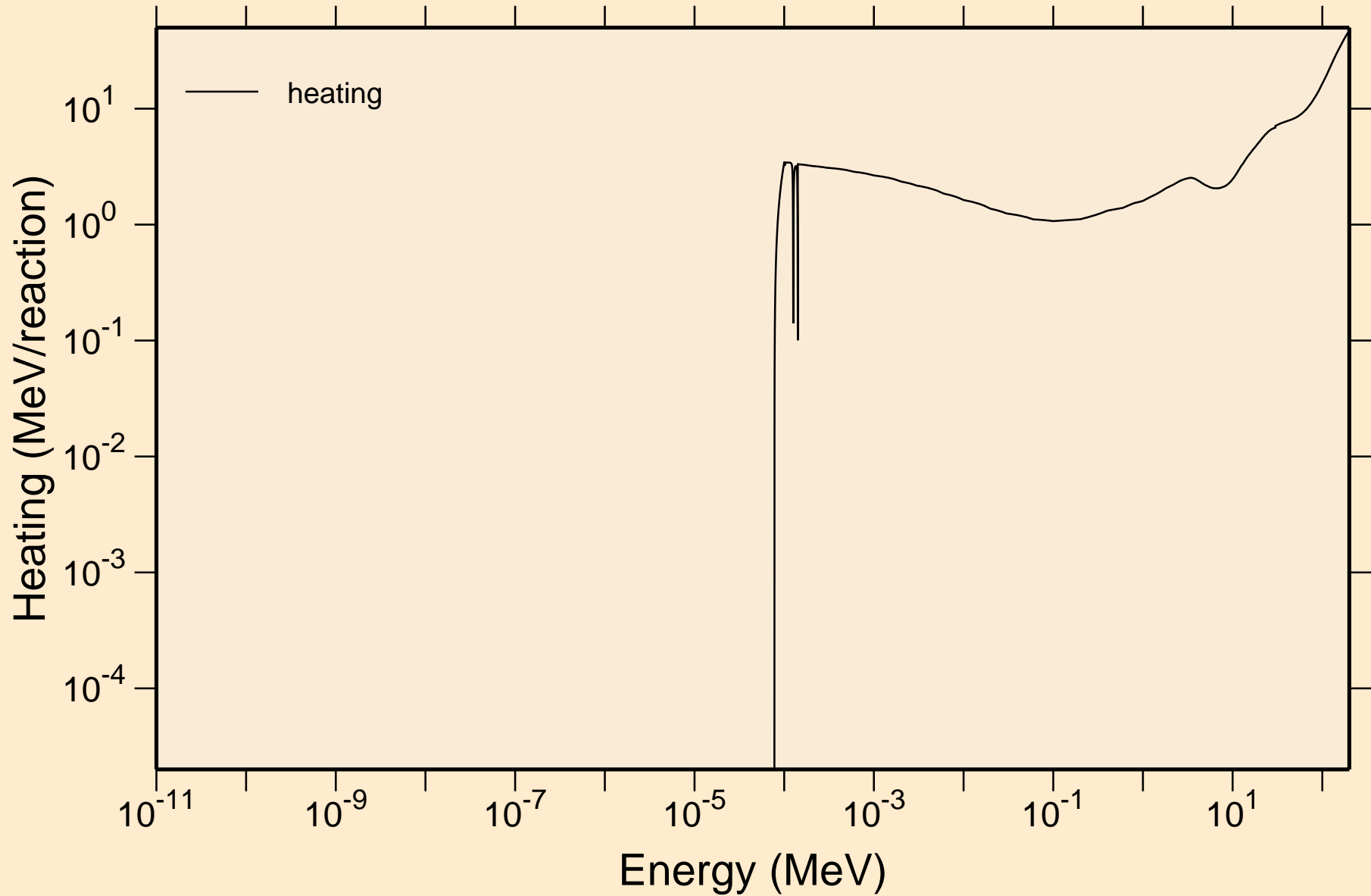

BR073 NEUTRON ACER TENDL-2024 LIBRARY; T=0.K
Damage

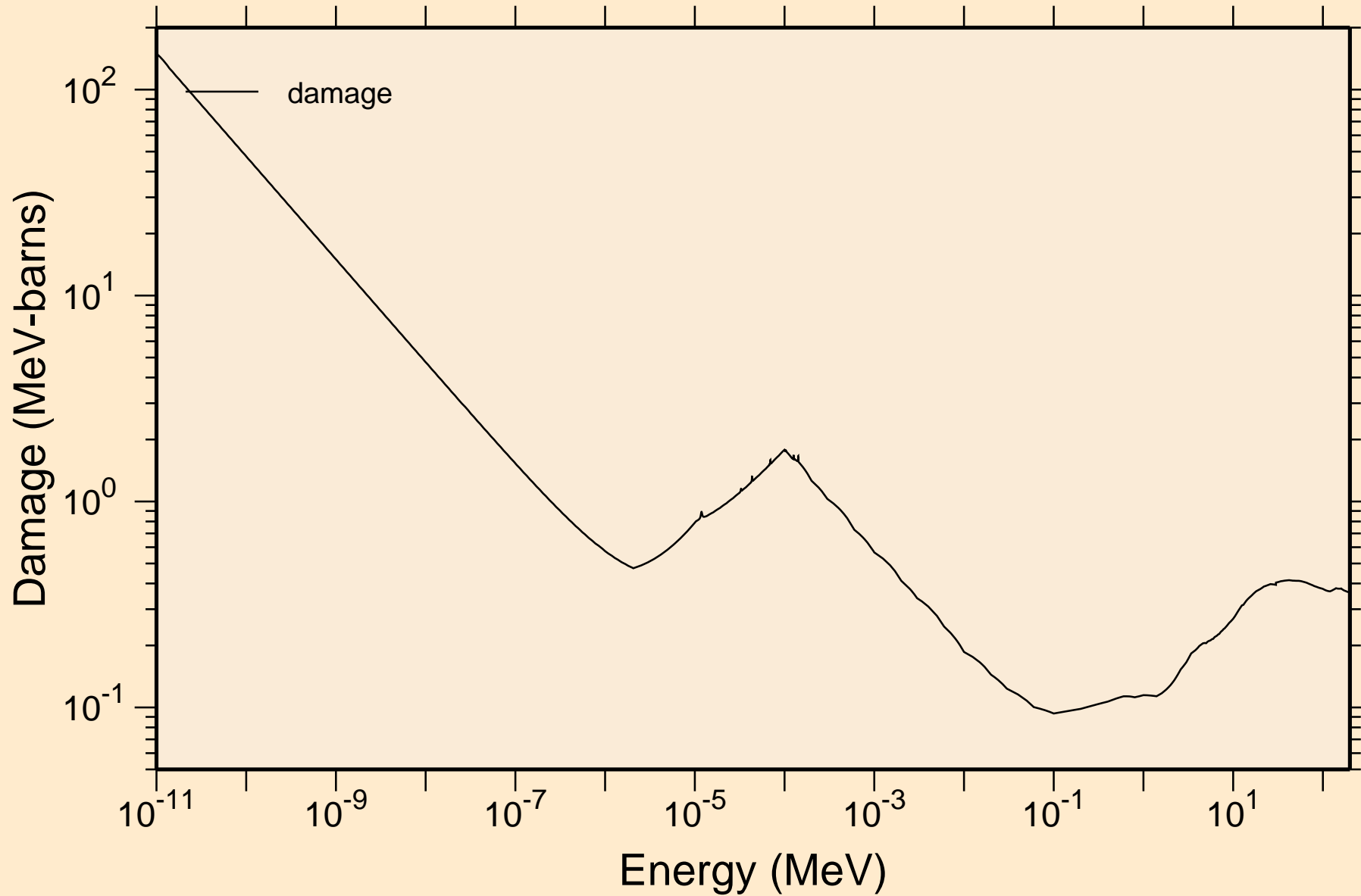

BR073 NEUTRON ACER TENDL-2024 LIBRARY; T=0.K

Non-threshold reactions

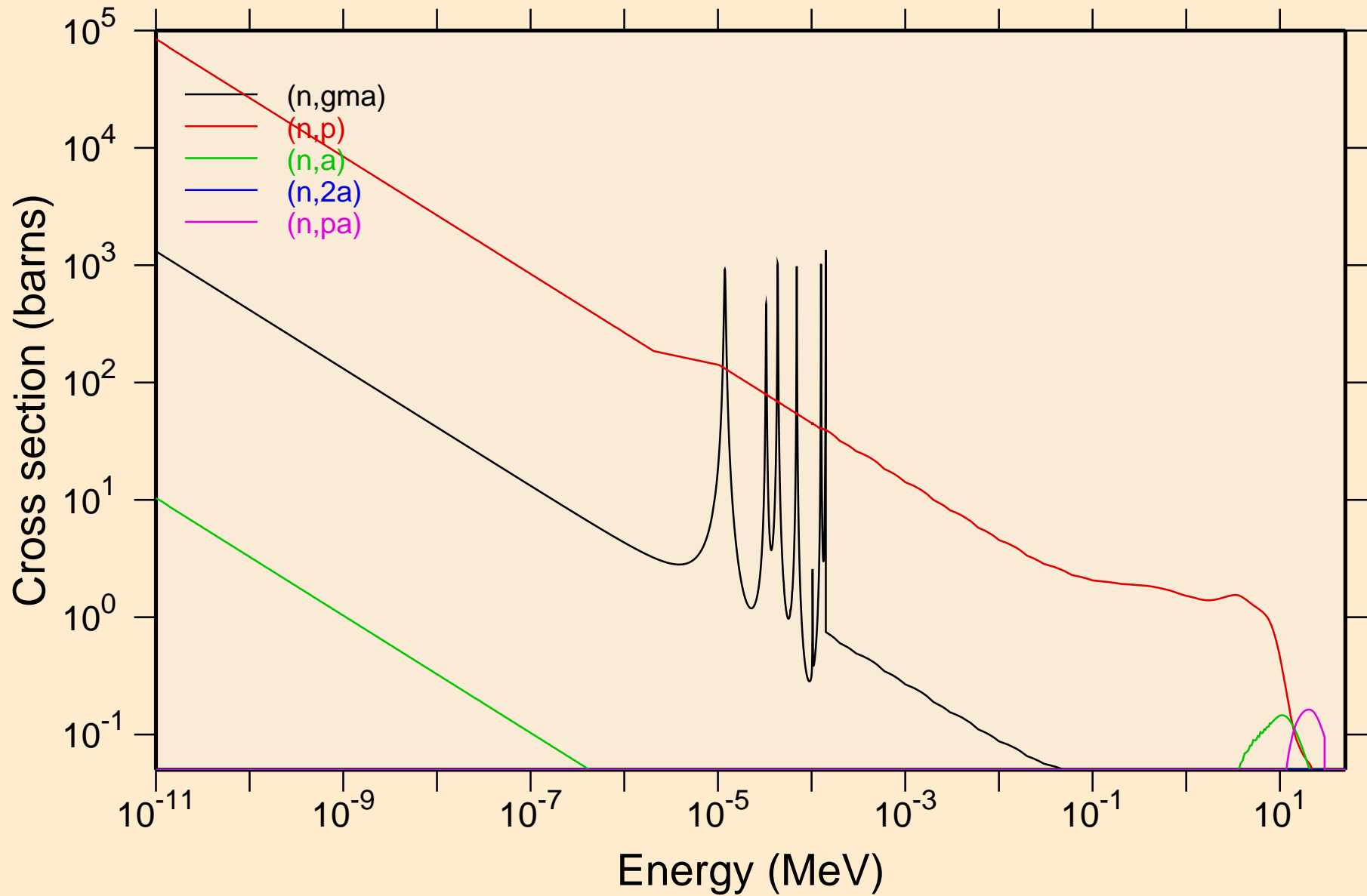

BR073 NEUTRON ACER TENDL-2024 LIBRARY; T=0.K
Non-threshold reactions

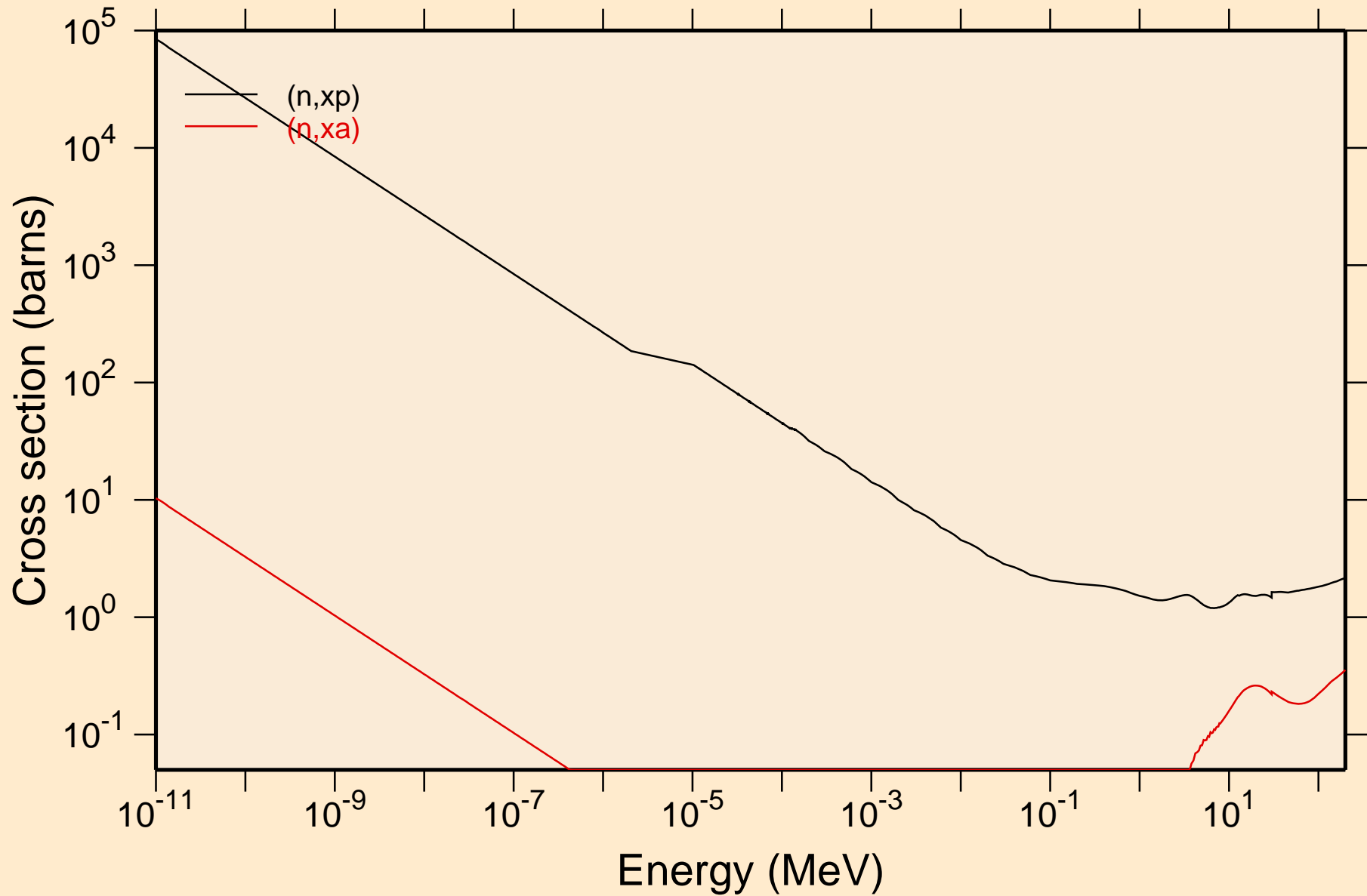

BR073 NEUTRON ACER TENDL-2024 LIBRARY; T=0.K

Principal cross sections

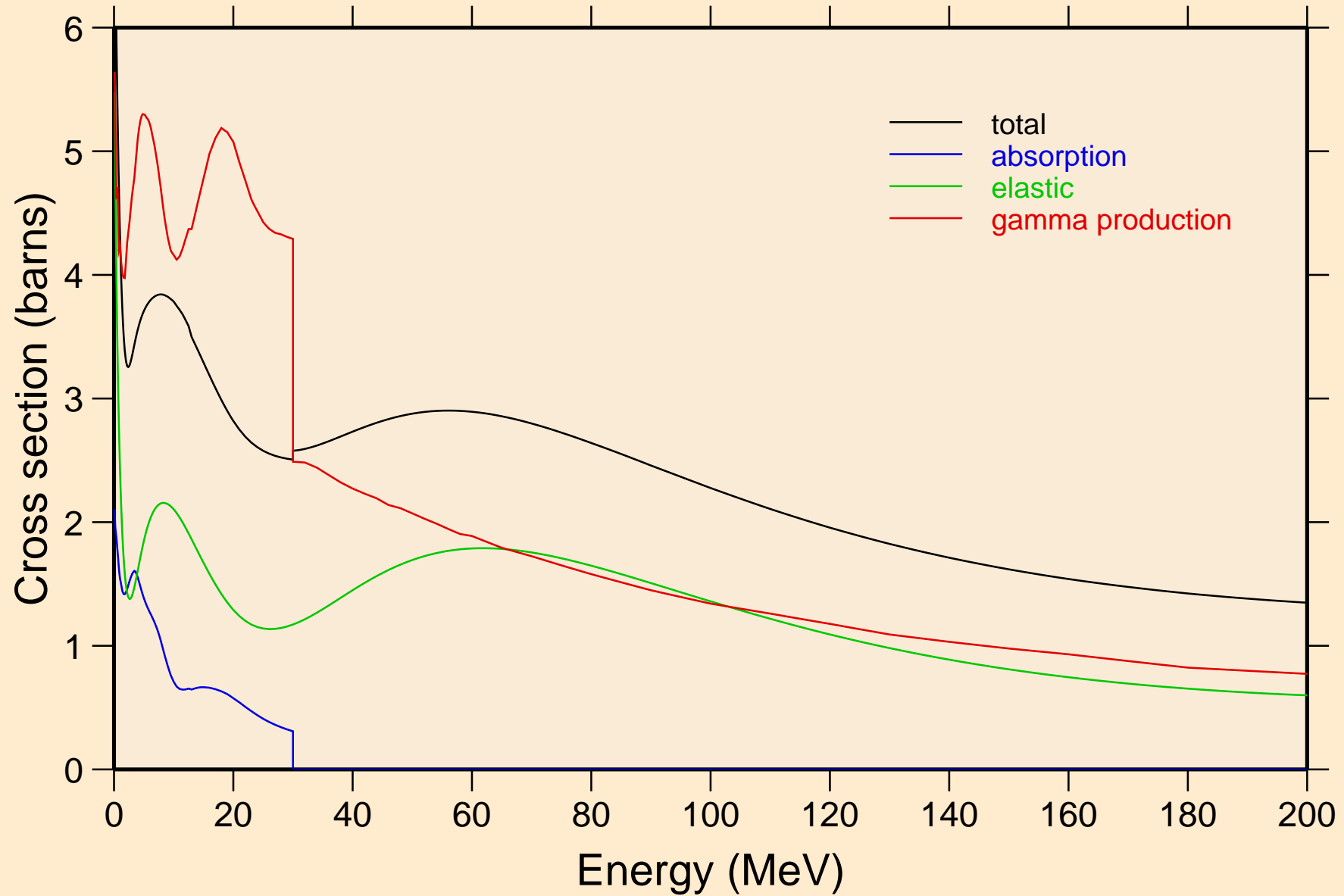

BR073 NEUTRON ACER TENDL-2024 LIBRARY; T=0.K

Heating

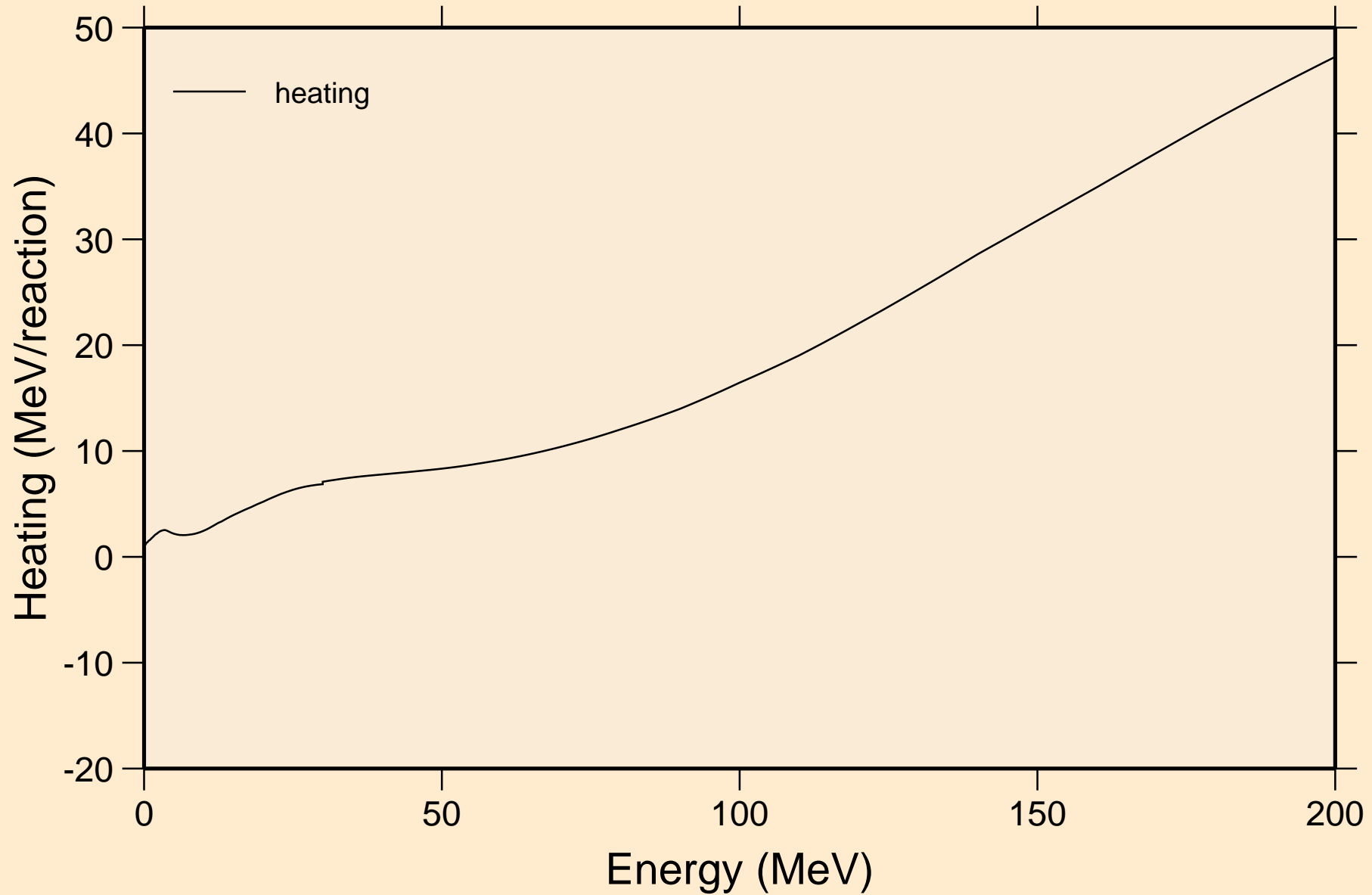

BR073 NEUTRON ACER TENDL-2024 LIBRARY; T=0.K

Damage

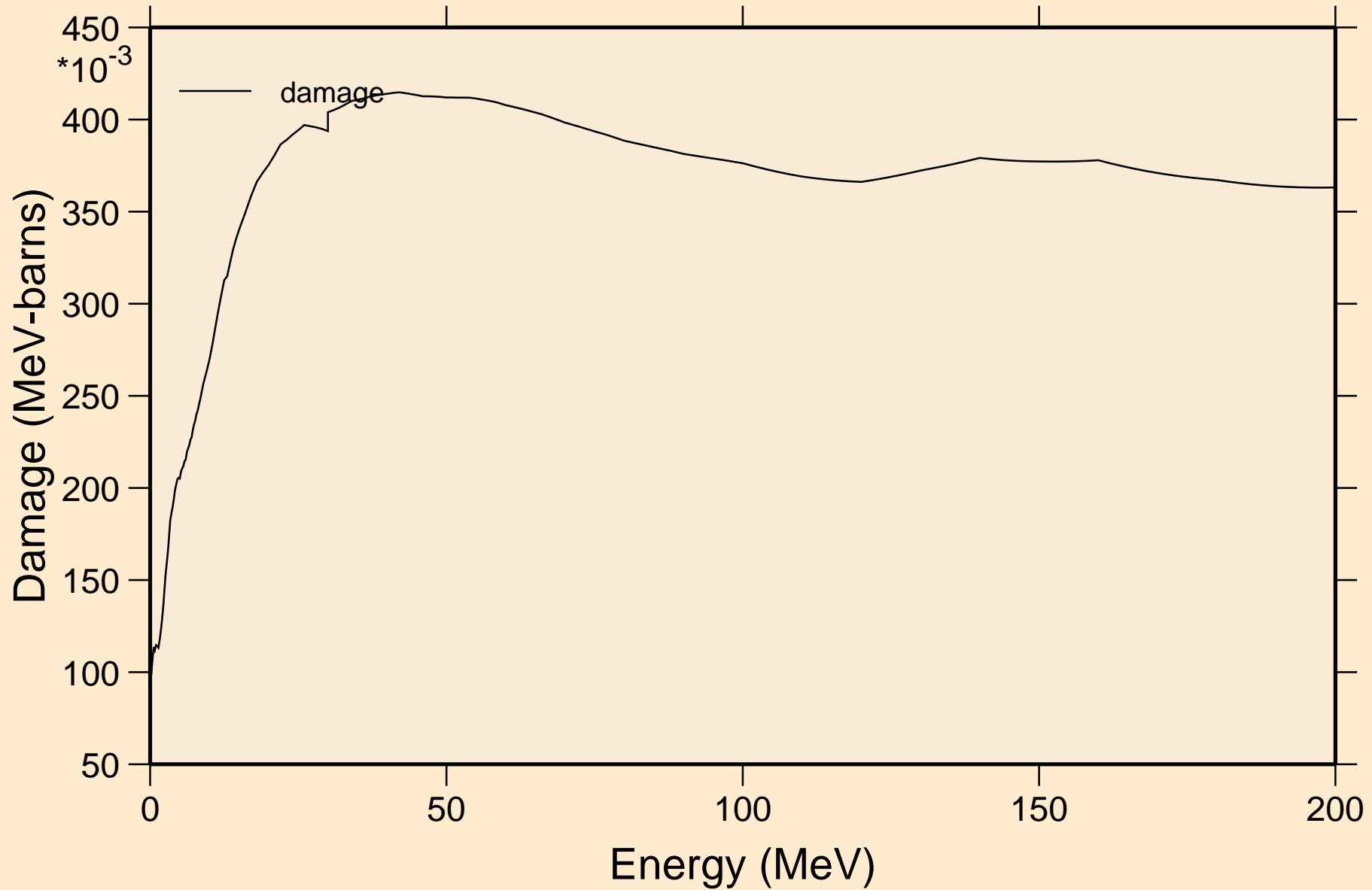

BR073 NEUTRON ACER TENDL-2024 LIBRARY; T=0.K
Non-threshold reactions

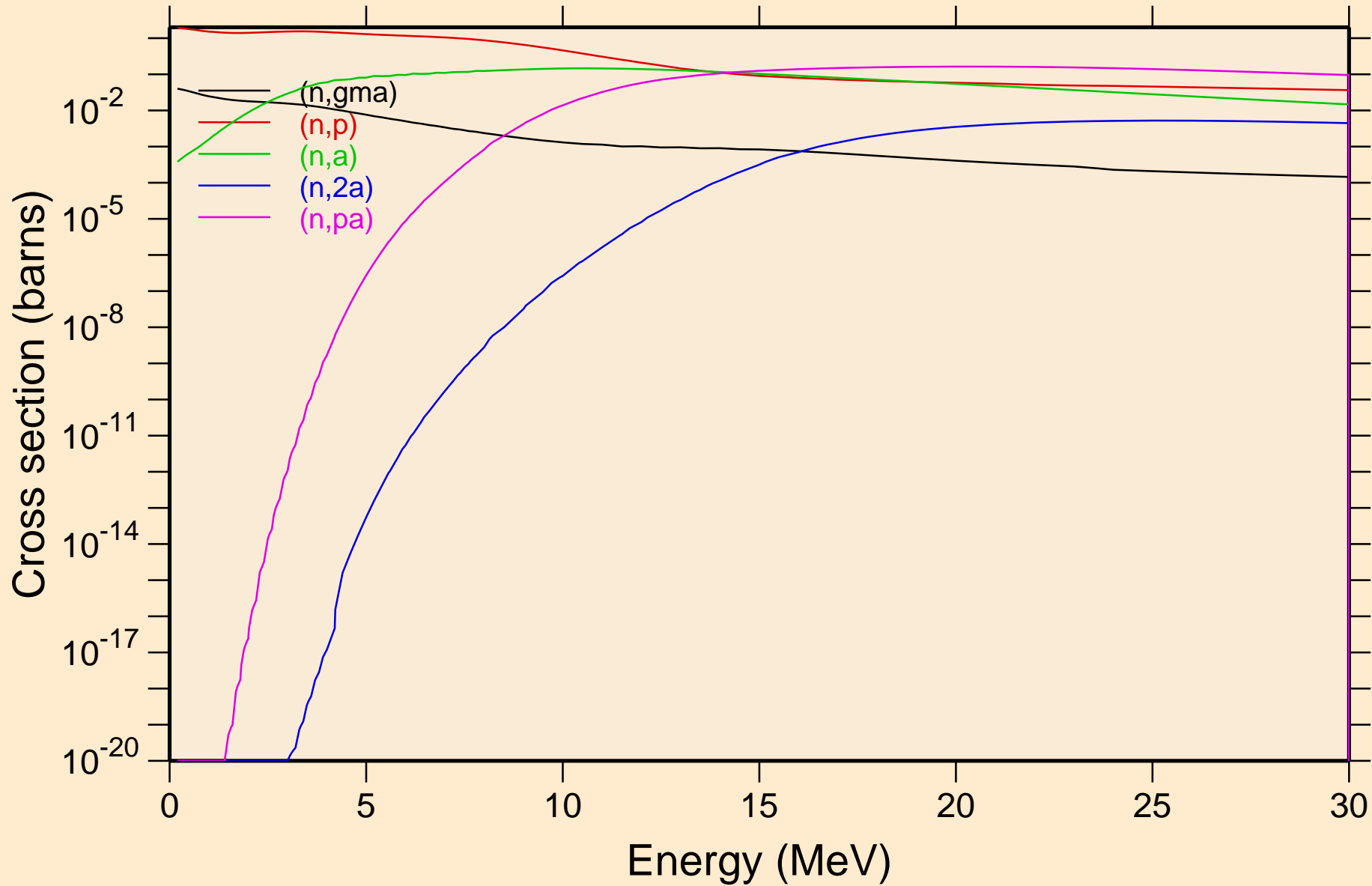

BR073 NEUTRON ACER TENDL-2024 LIBRARY; T=0.K
Non-threshold reactions

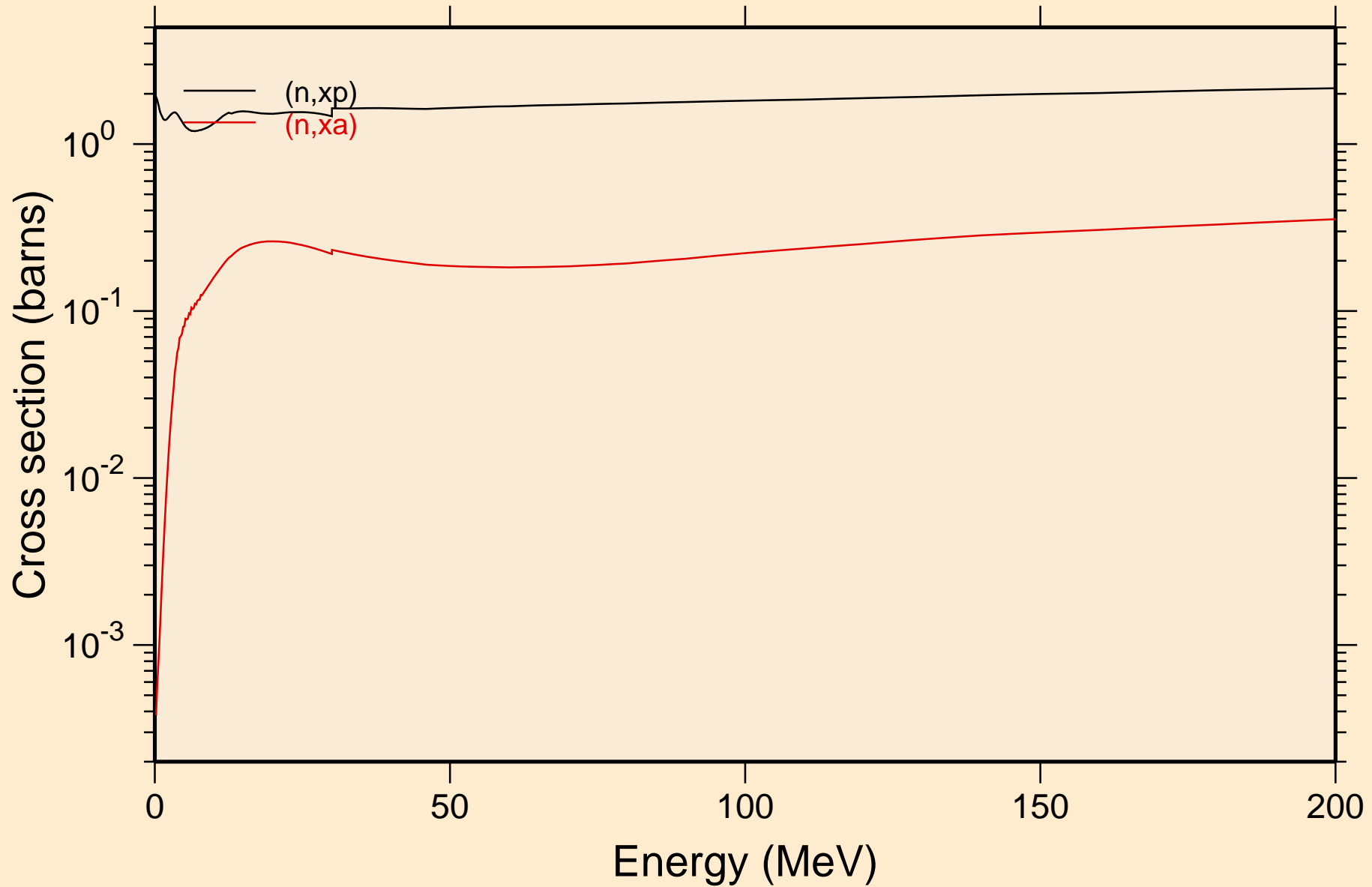

BR073 NEUTRON ACER TENDL-2024 LIBRARY; T=0.K
Inelastic levels

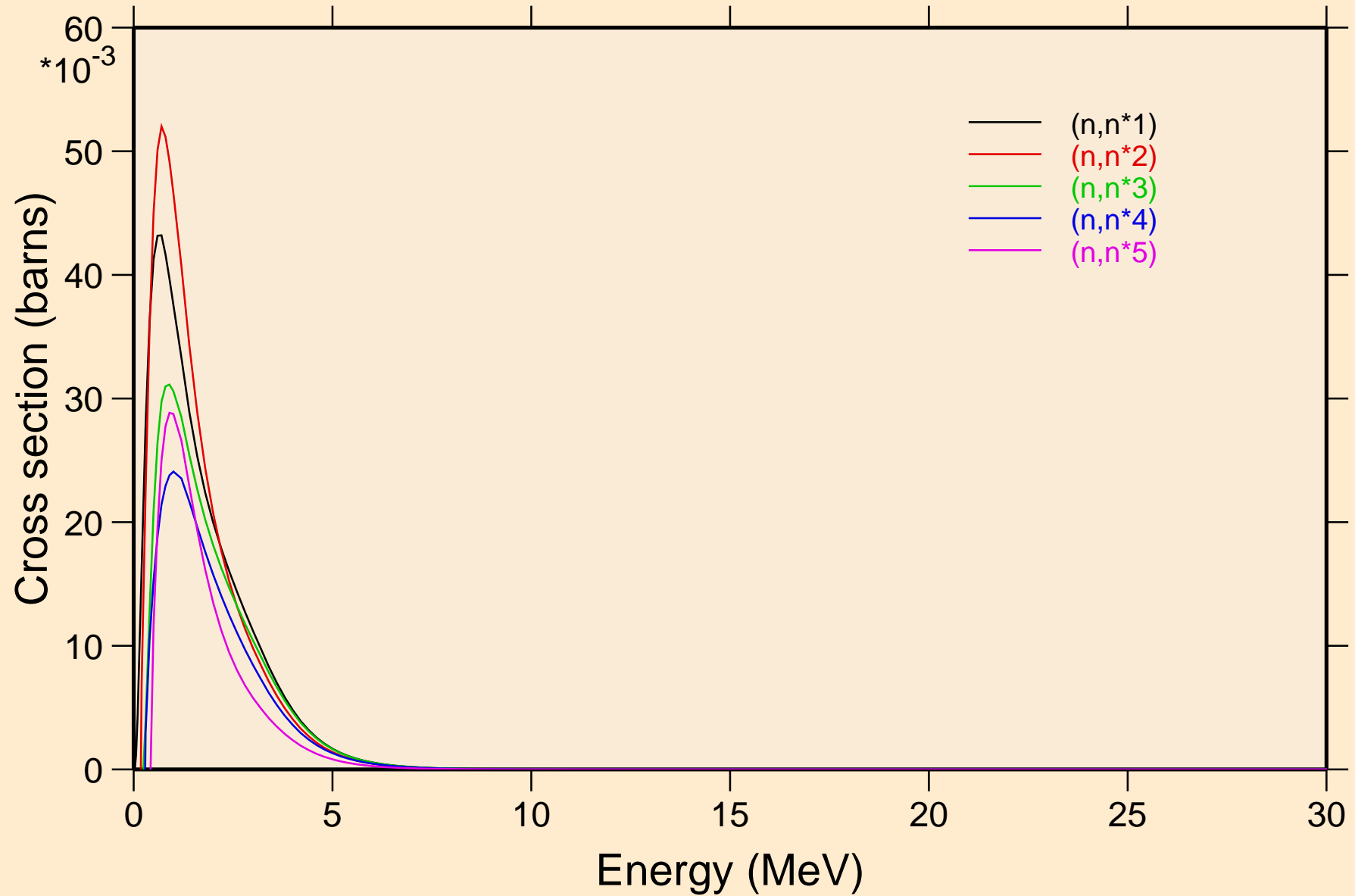

BR073 NEUTRON ACER TENDL-2024 LIBRARY; T=0.K
Inelastic levels

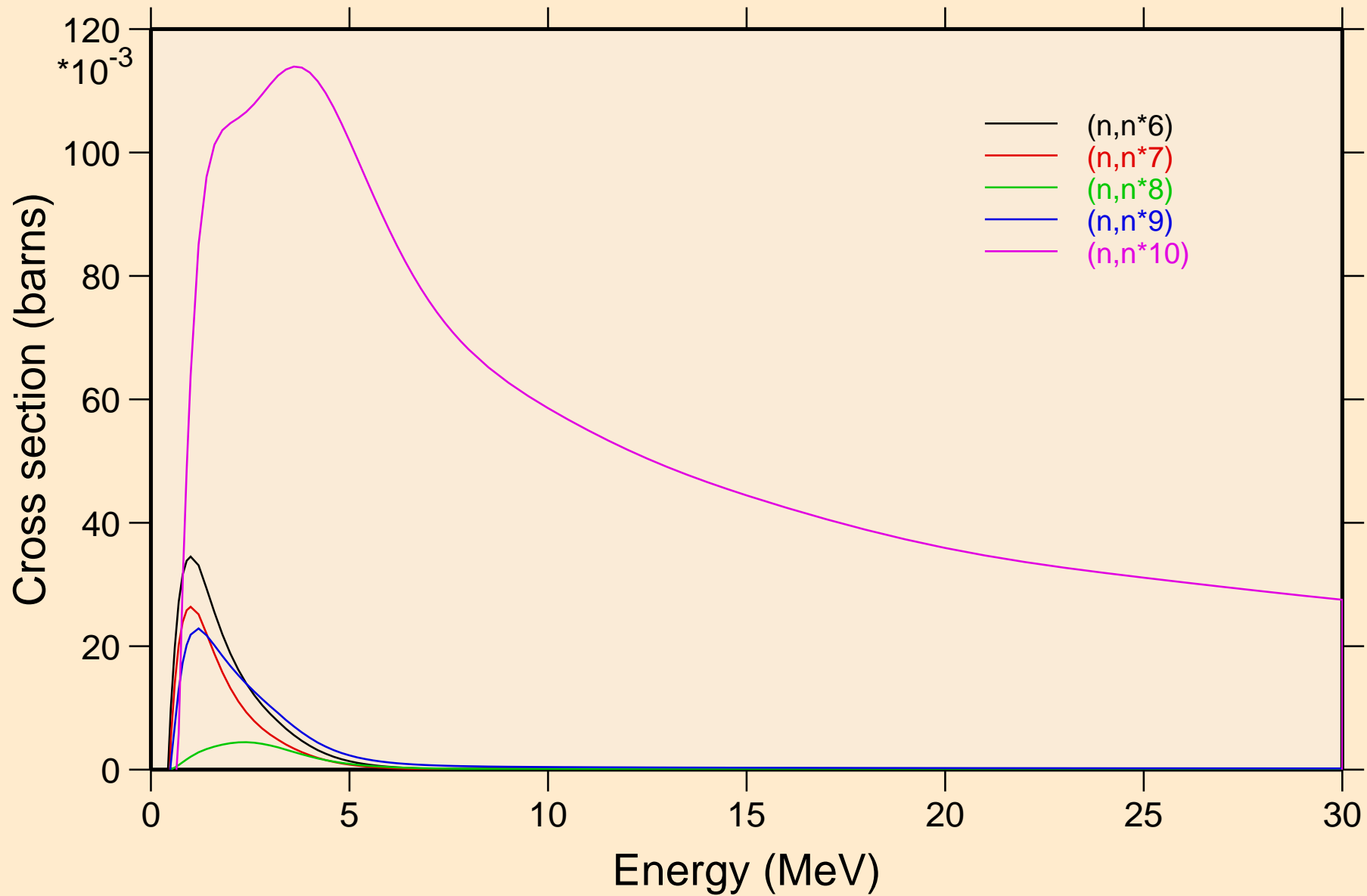

BR073 NEUTRON ACER TENDL-2024 LIBRARY; T=0.K
Inelastic levels

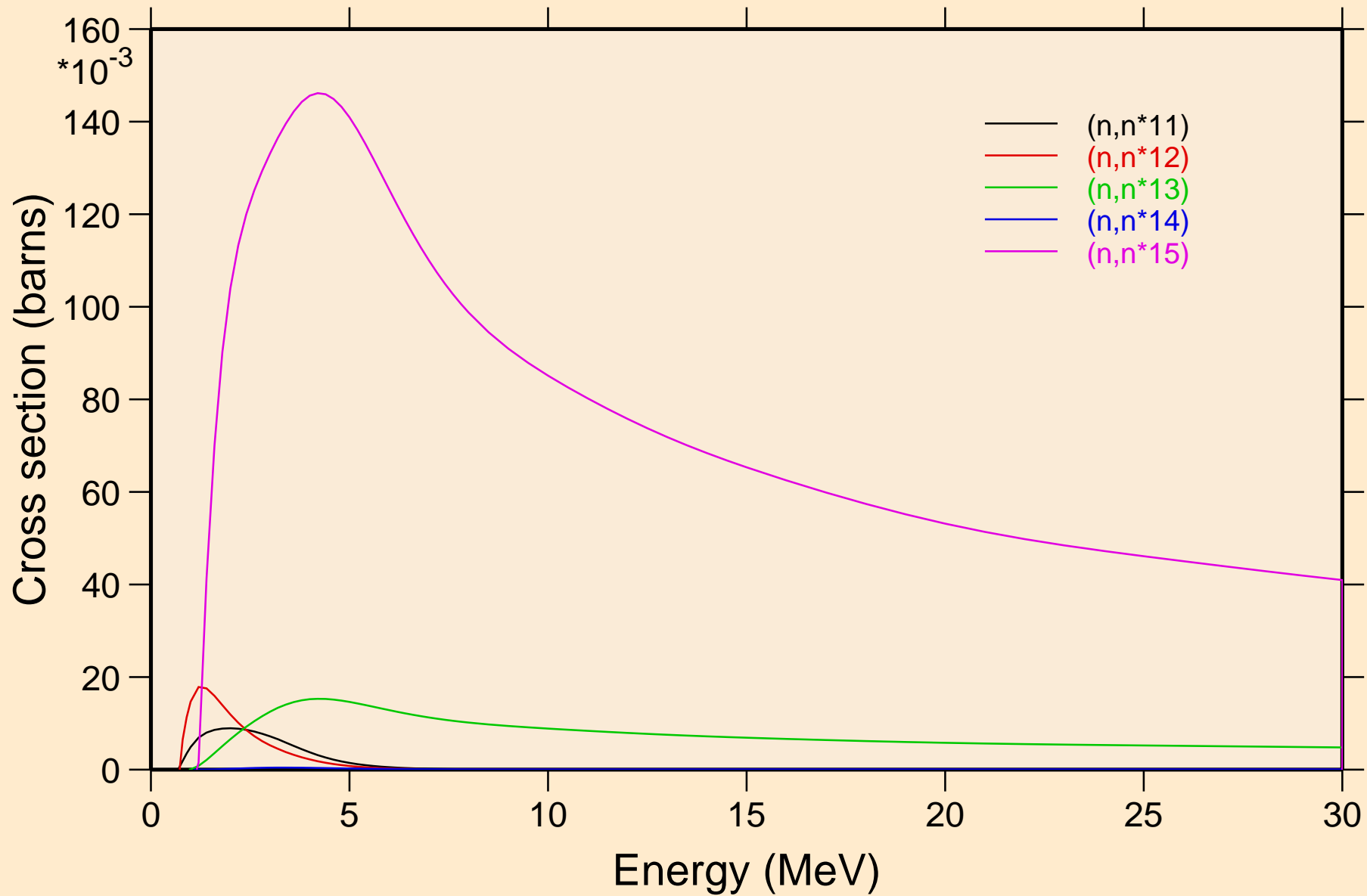

BR073 NEUTRON ACER TENDL-2024 LIBRARY; T=0.K
Inelastic levels

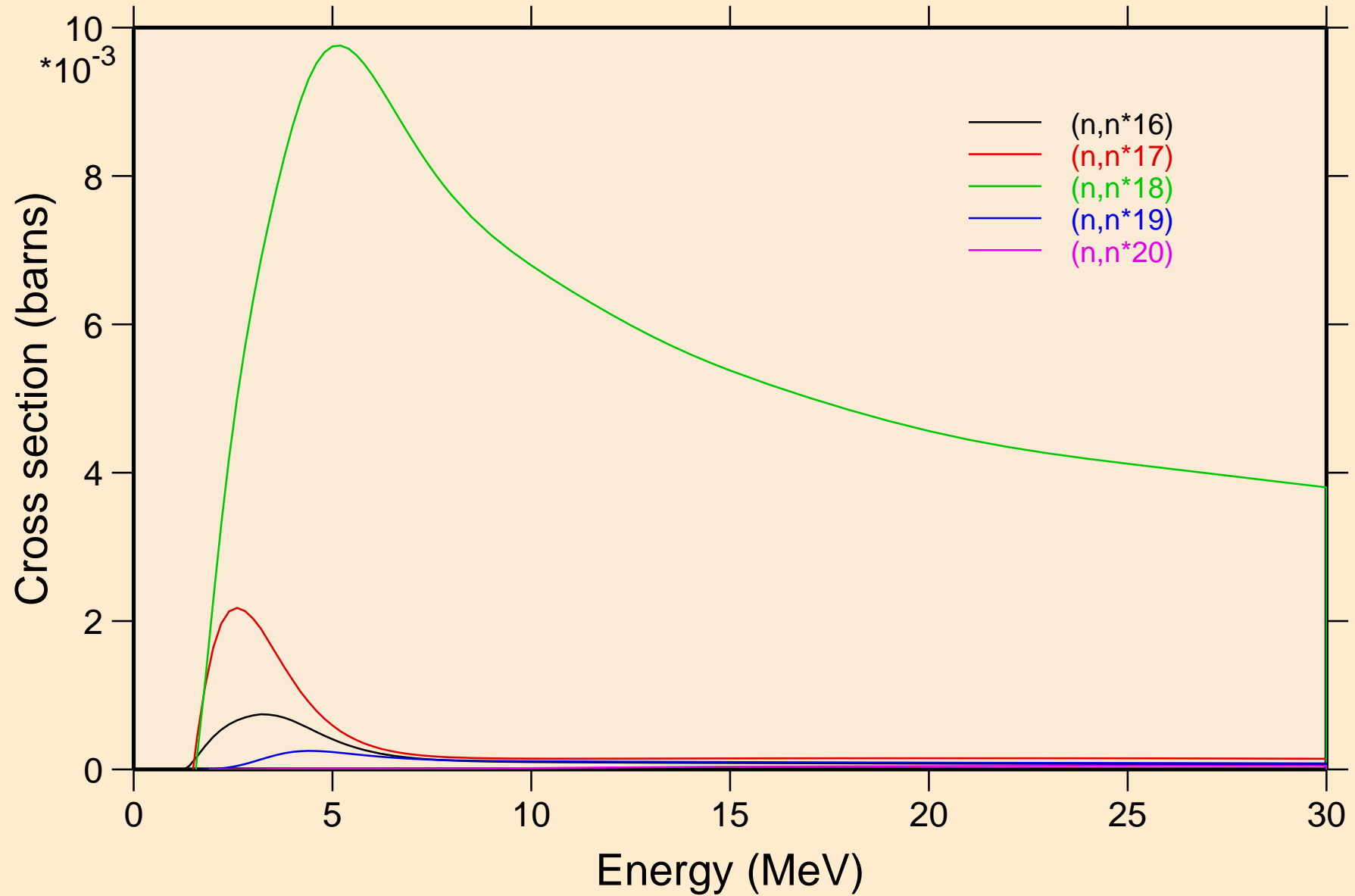

BR073 NEUTRON ACER TENDL-2024 LIBRARY; T=0.K
Inelastic levels

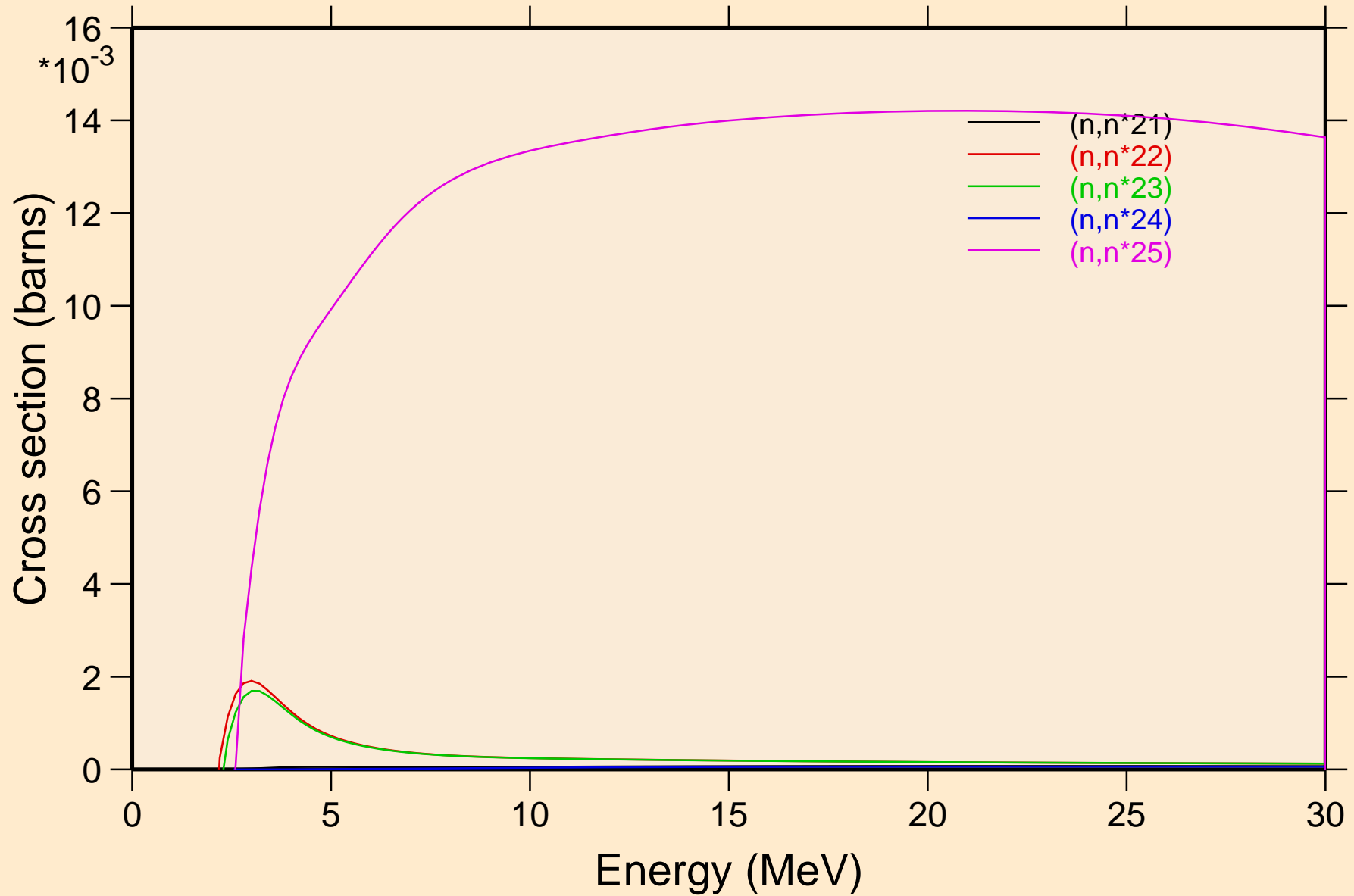

BR073 NEUTRON ACER TENDL-2024 LIBRARY; T=0.K
Threshold reactions

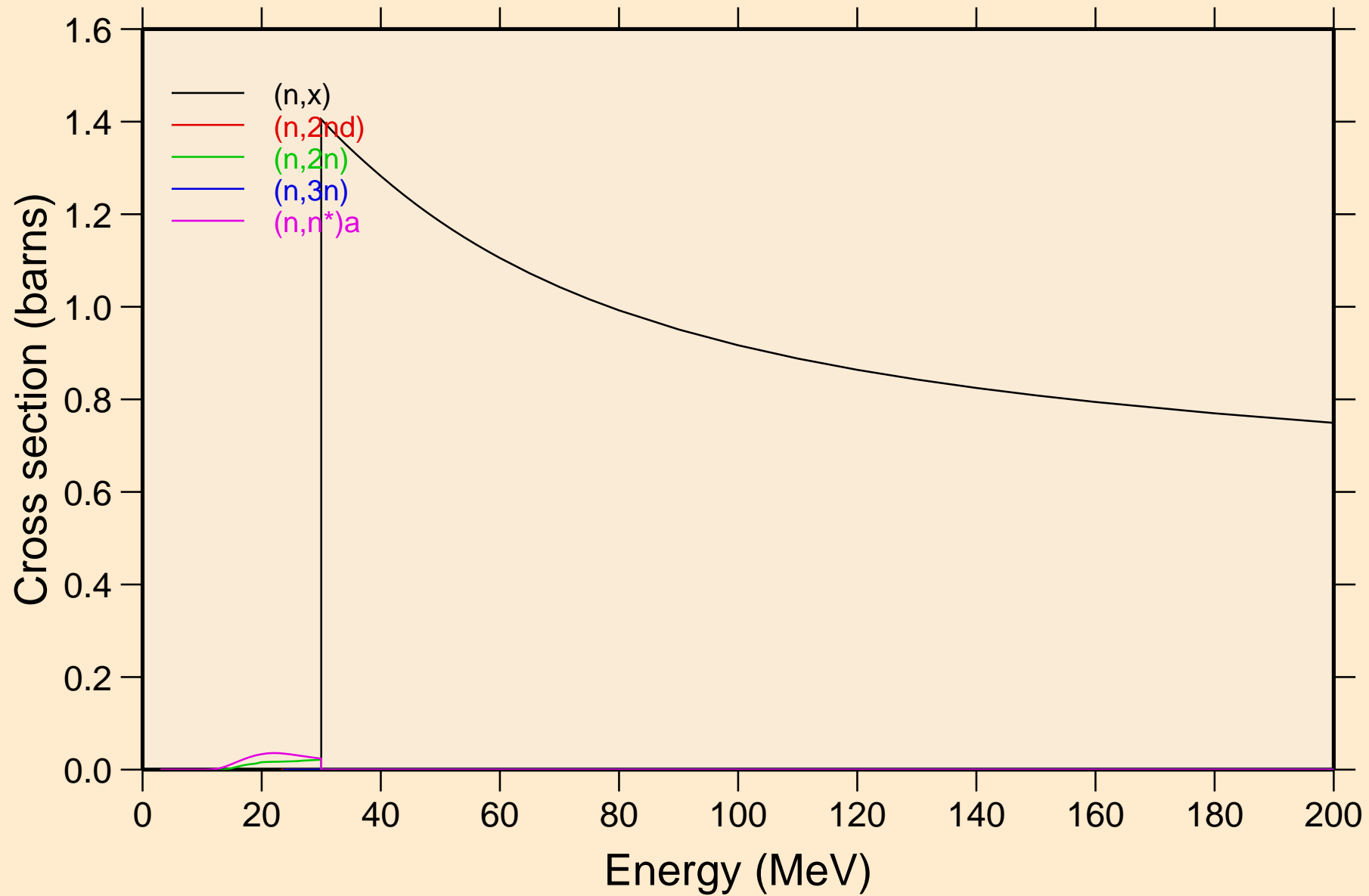

BR073 NEUTRON ACER TENDL-2024 LIBRARY; T=0.K
Threshold reactions

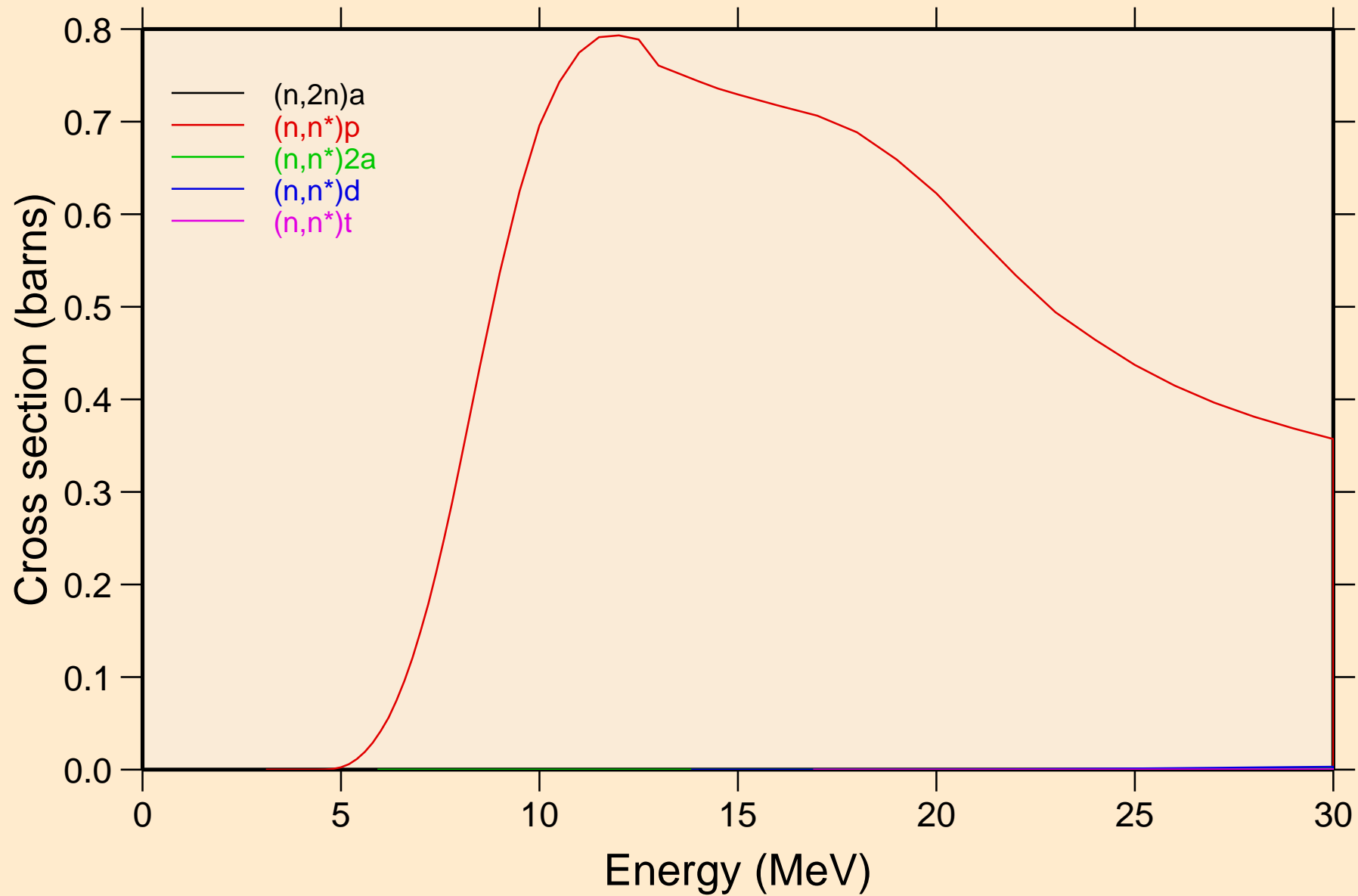

BR073 NEUTRON ACER TENDL-2024 LIBRARY; T=0.K
Threshold reactions

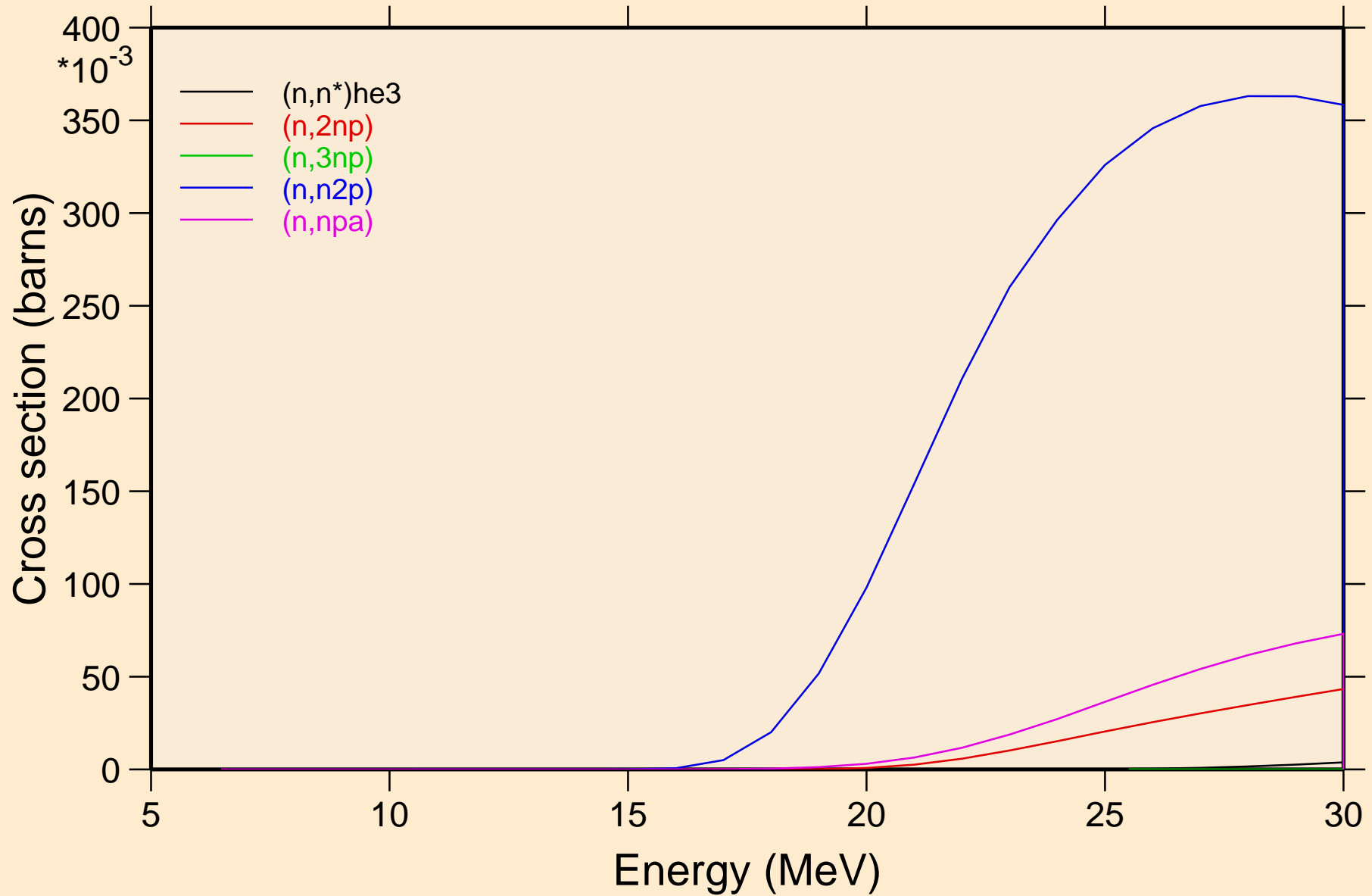

BR073 NEUTRON ACER TENDL-2024 LIBRARY; T=0.K

Threshold reactions

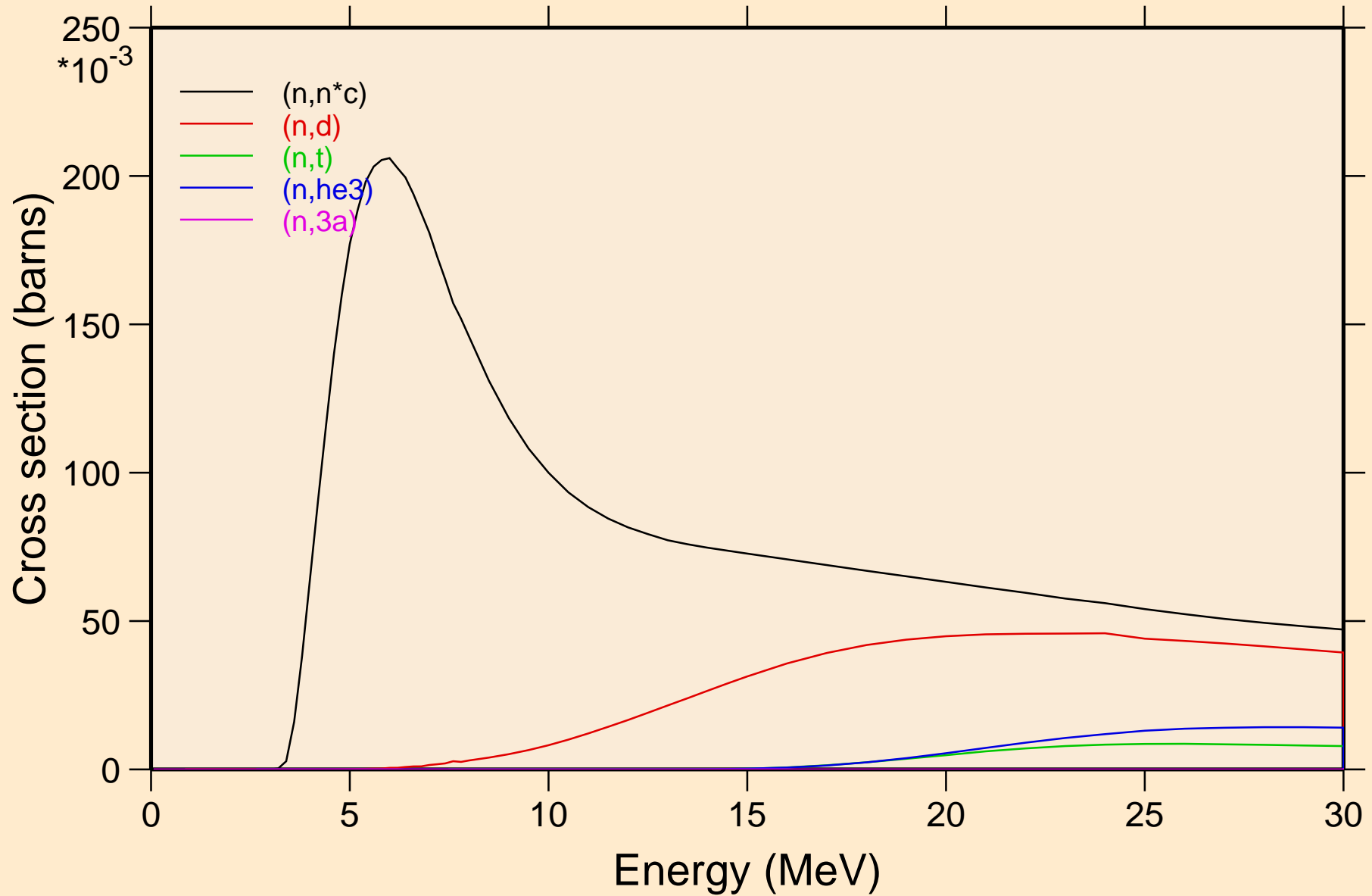

BR073 NEUTRON ACER TENDL-2024 LIBRARY; T=0.K
Threshold reactions

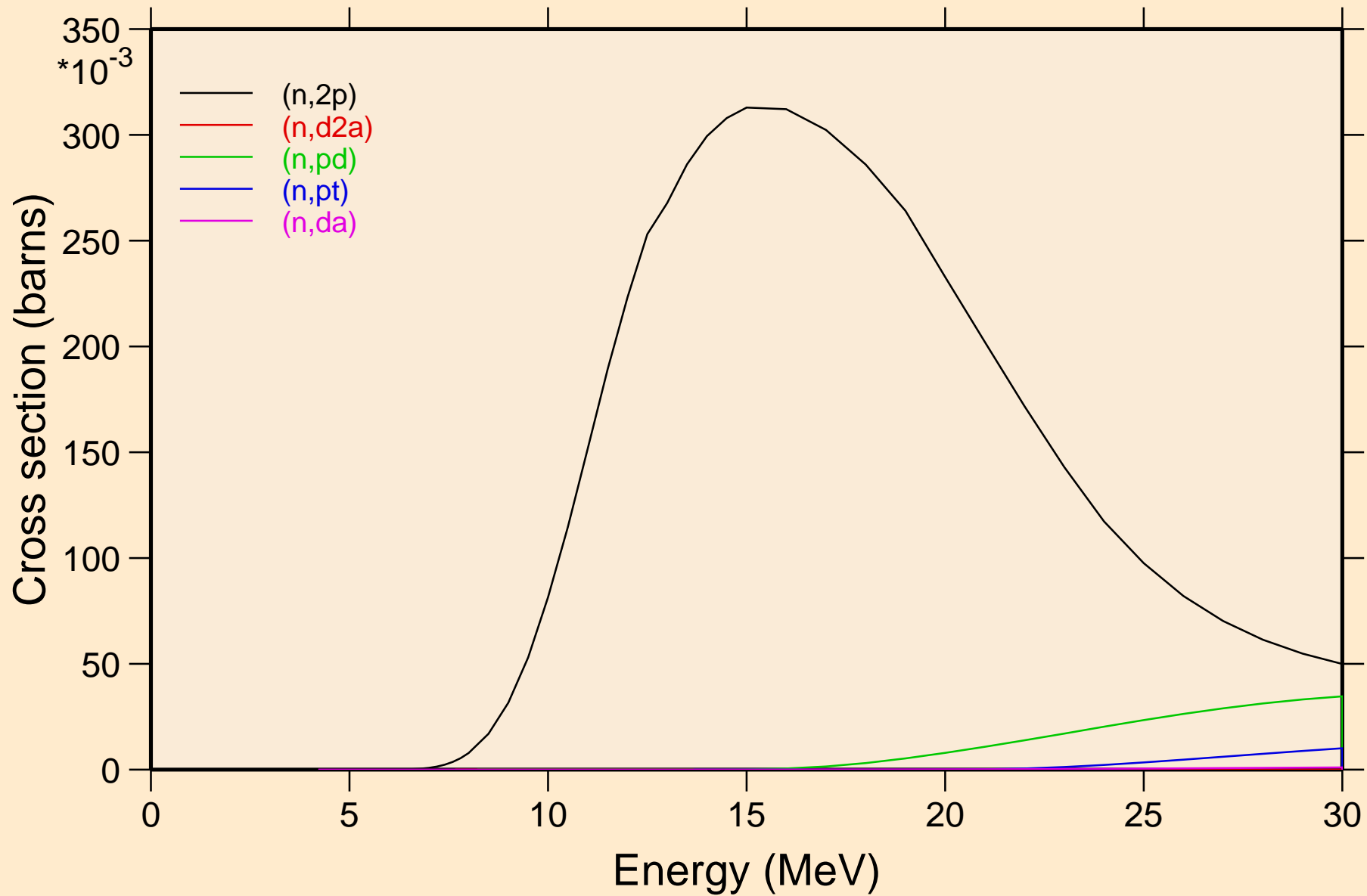

BR073 NEUTRON ACER TENDL-2024 LIBRARY; T=0.K
Threshold reactions

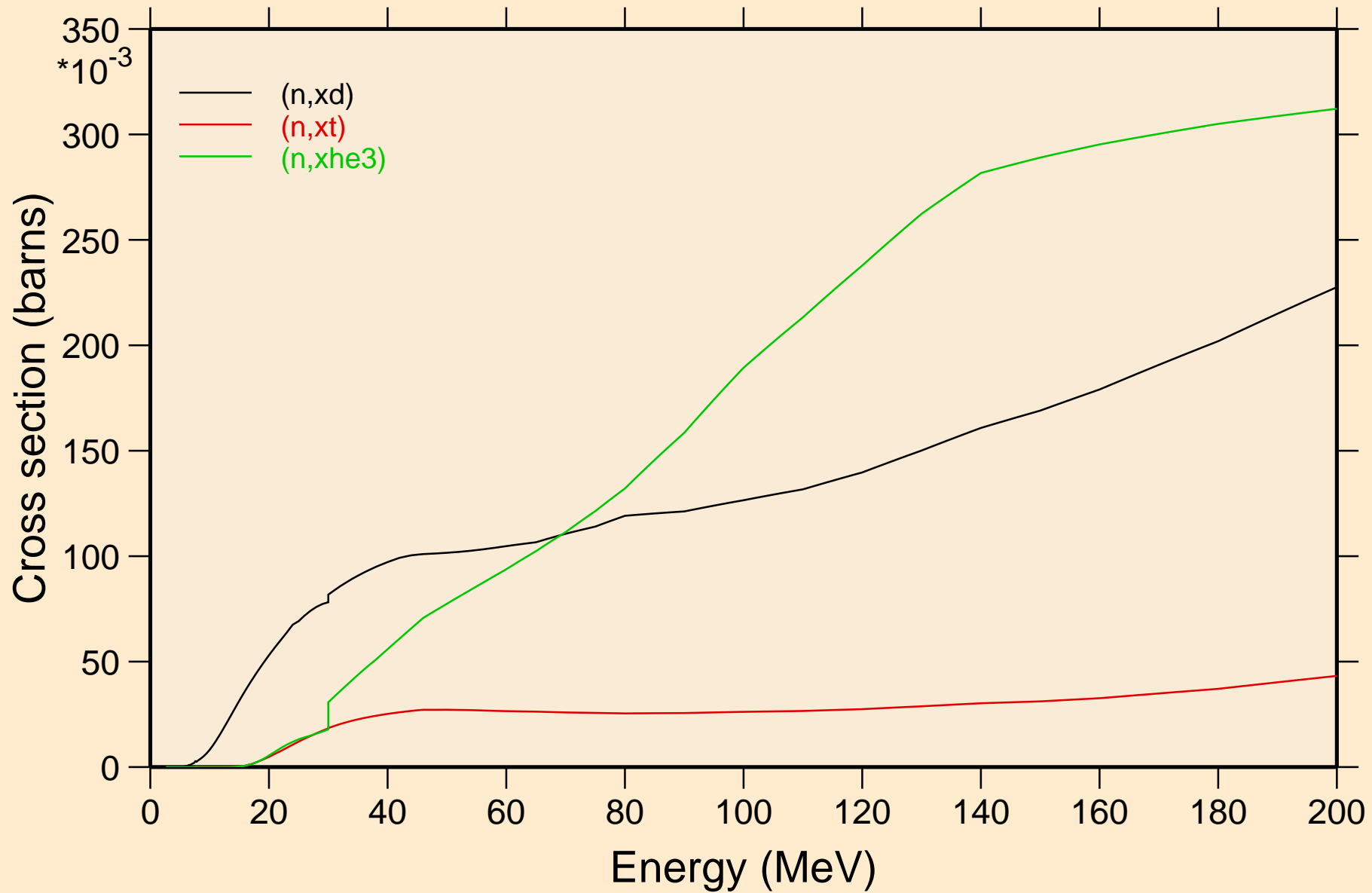

BR073 NEUTRON ACER TENDL-2024 LIBRARY; T=0.K
angular distribution for elastic

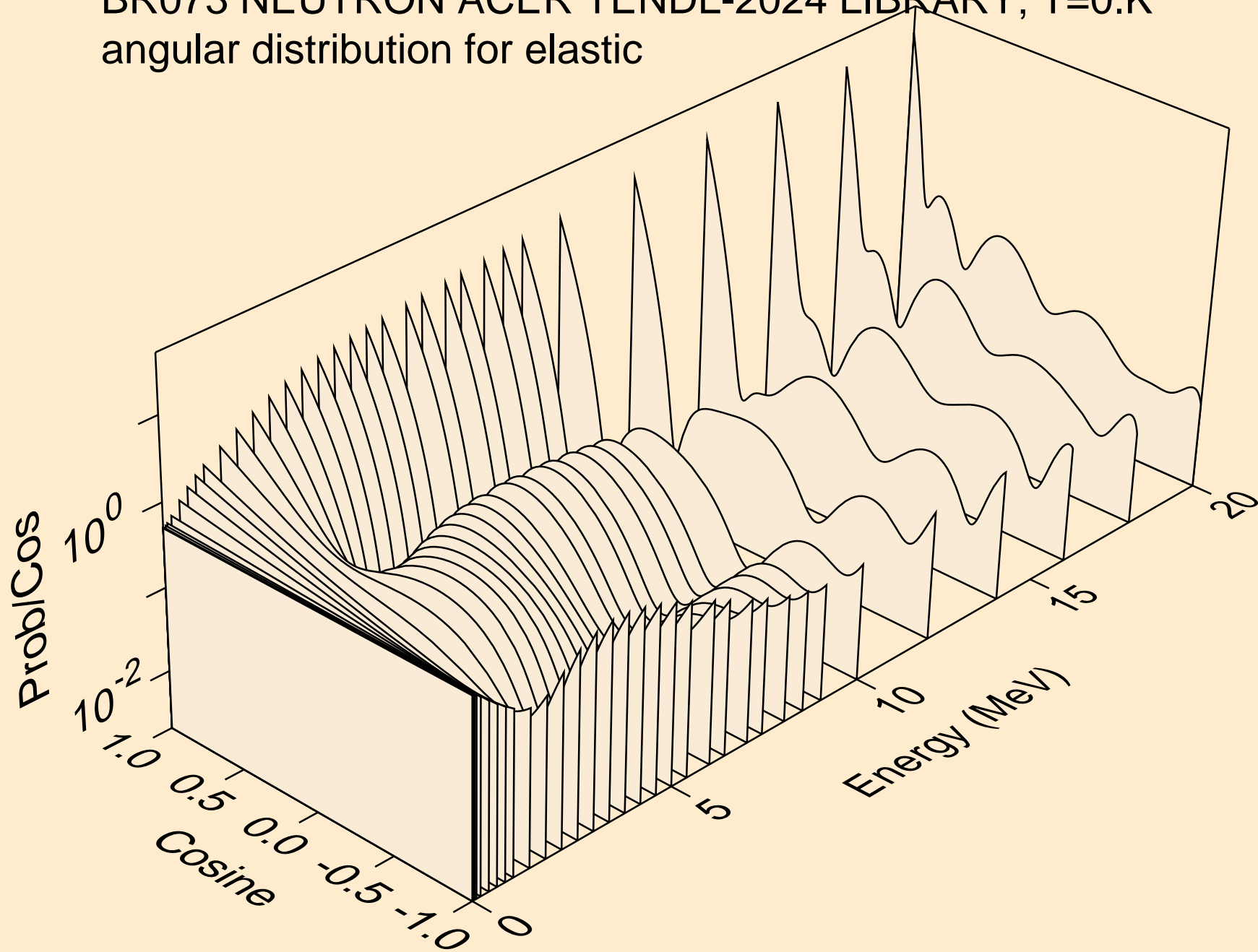

BR073 NEUTRON ACER TENDL-2024 LIBRARY; T=0.K
angular distribution for elastic

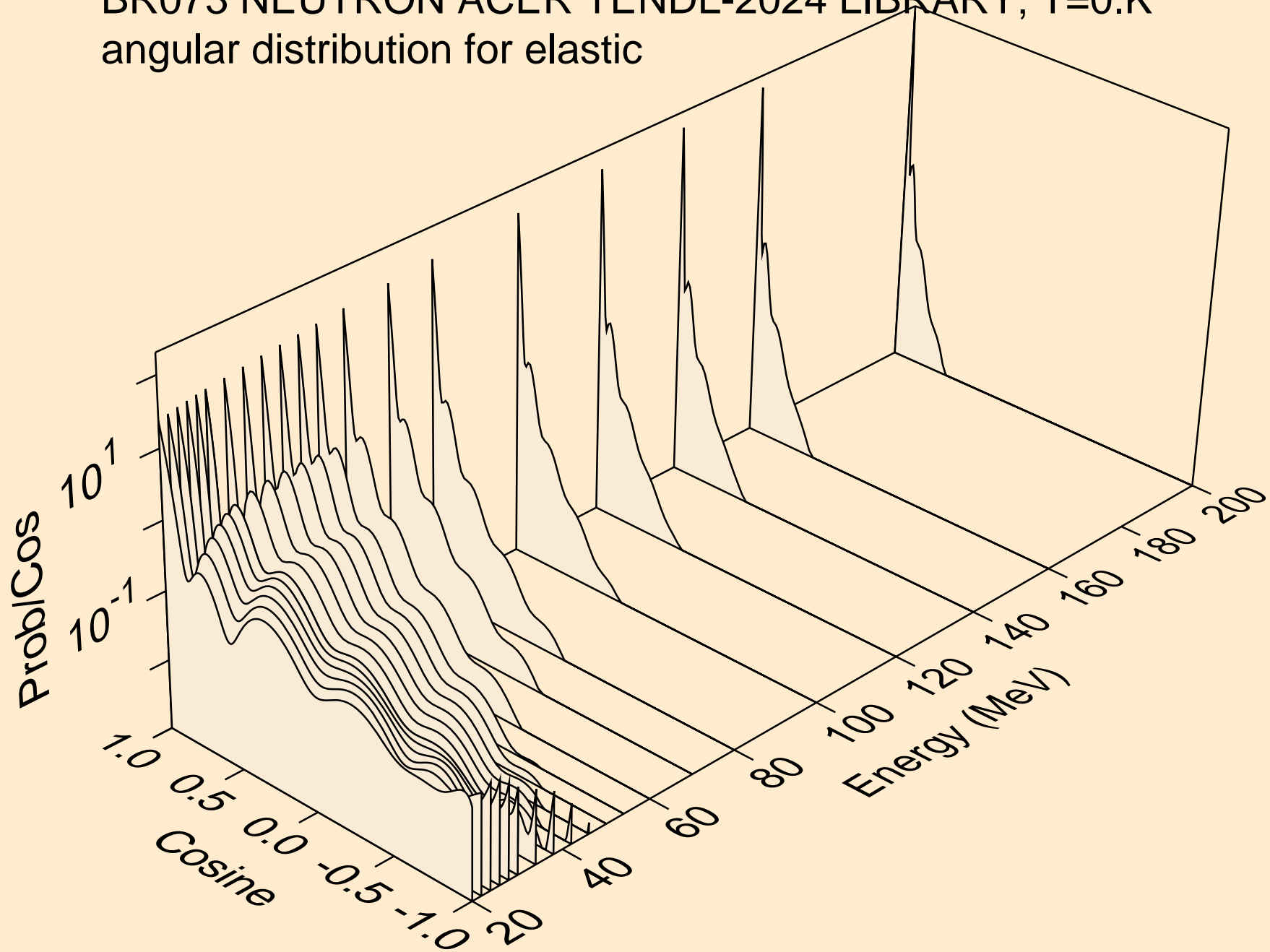

BR073 NEUTRON ACER TENDL-2024 LIBRARY; T=0.K
angular distribution for (n,n*1)

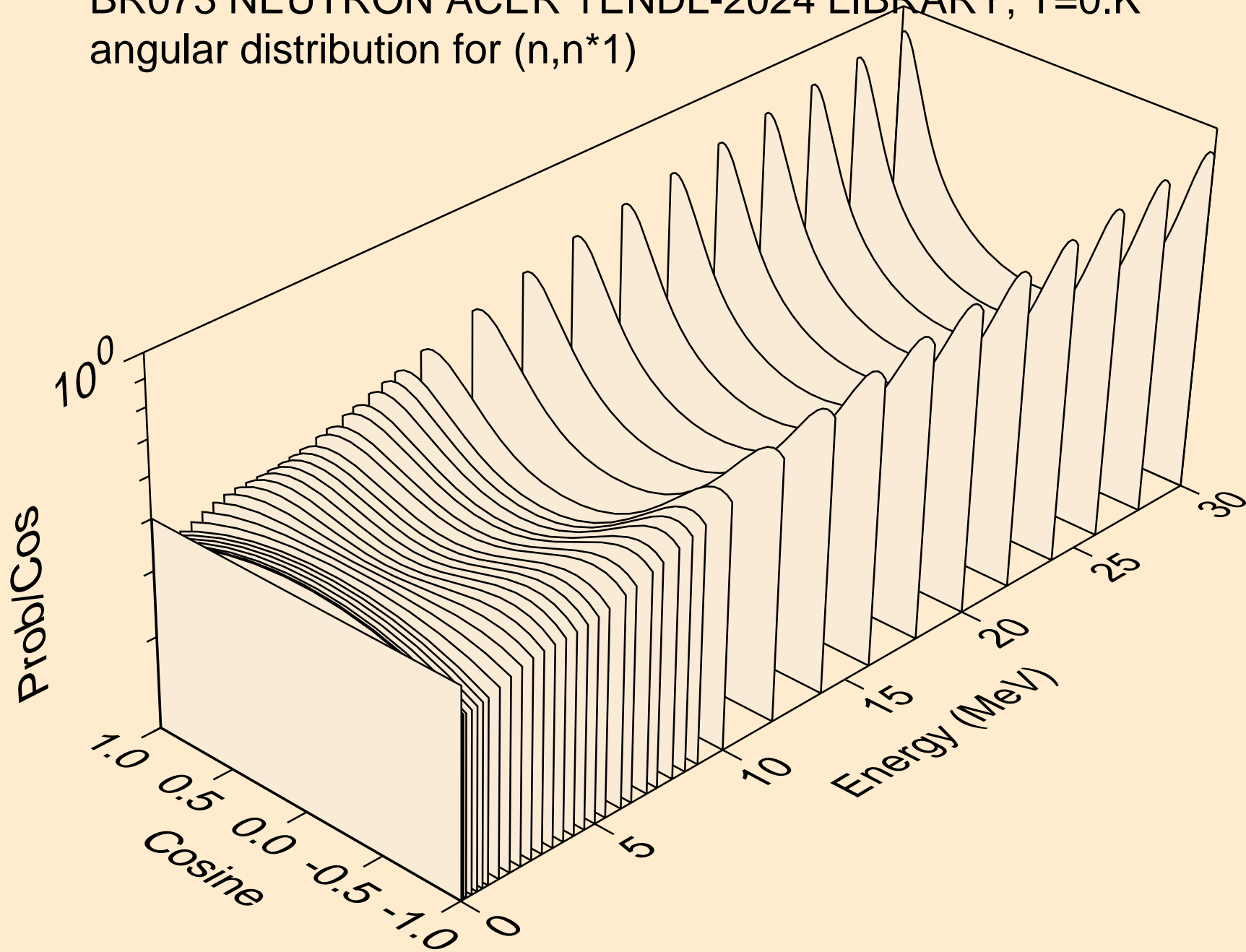

BR073 NEUTRON ACER TENDL-2024 LIBRARY; T=0.K
angular distribution for (n,n*2)

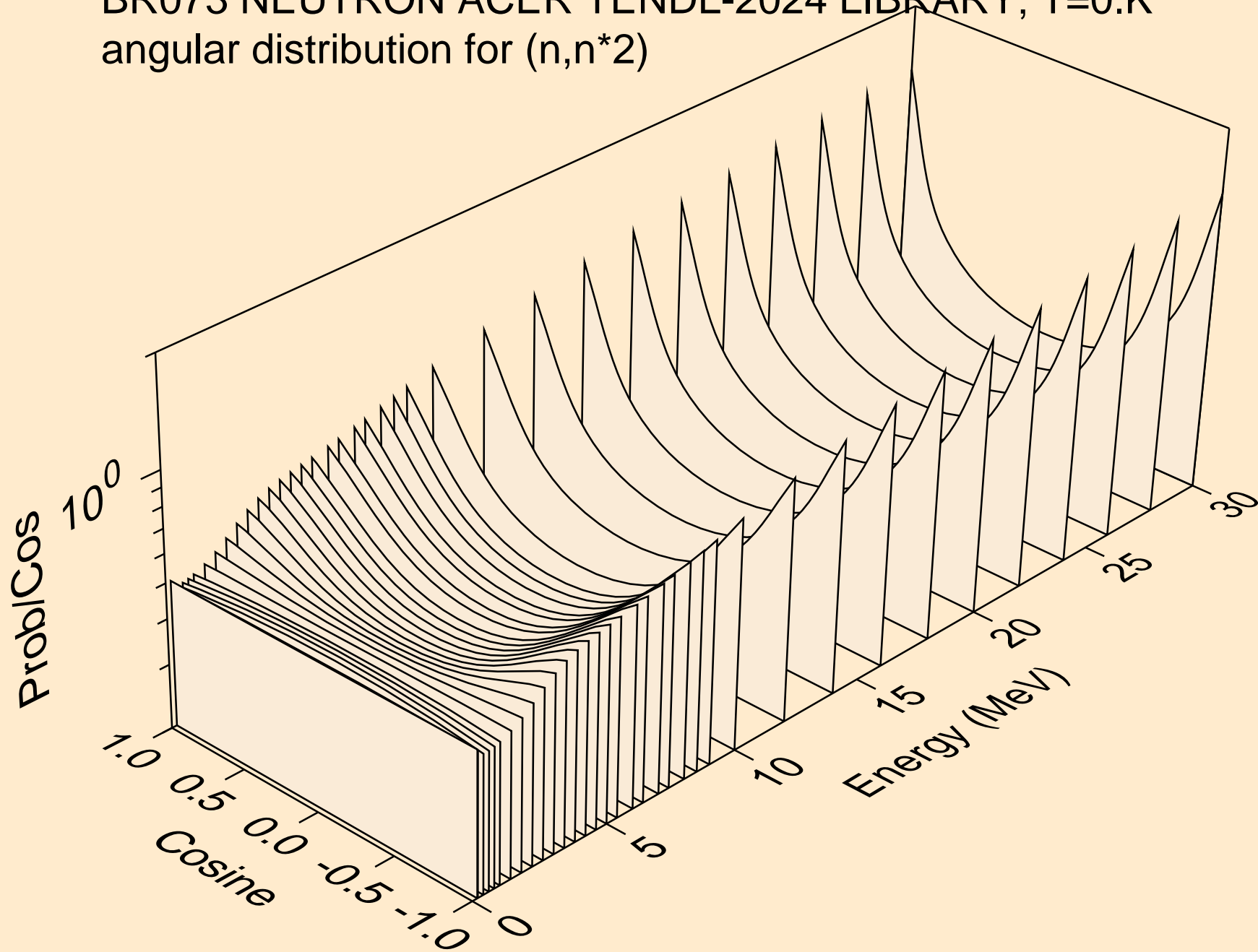

BR073 NEUTRON ACER TENDL-2024 LIBRARY; T=0.K
angular distribution for (n,n*3)

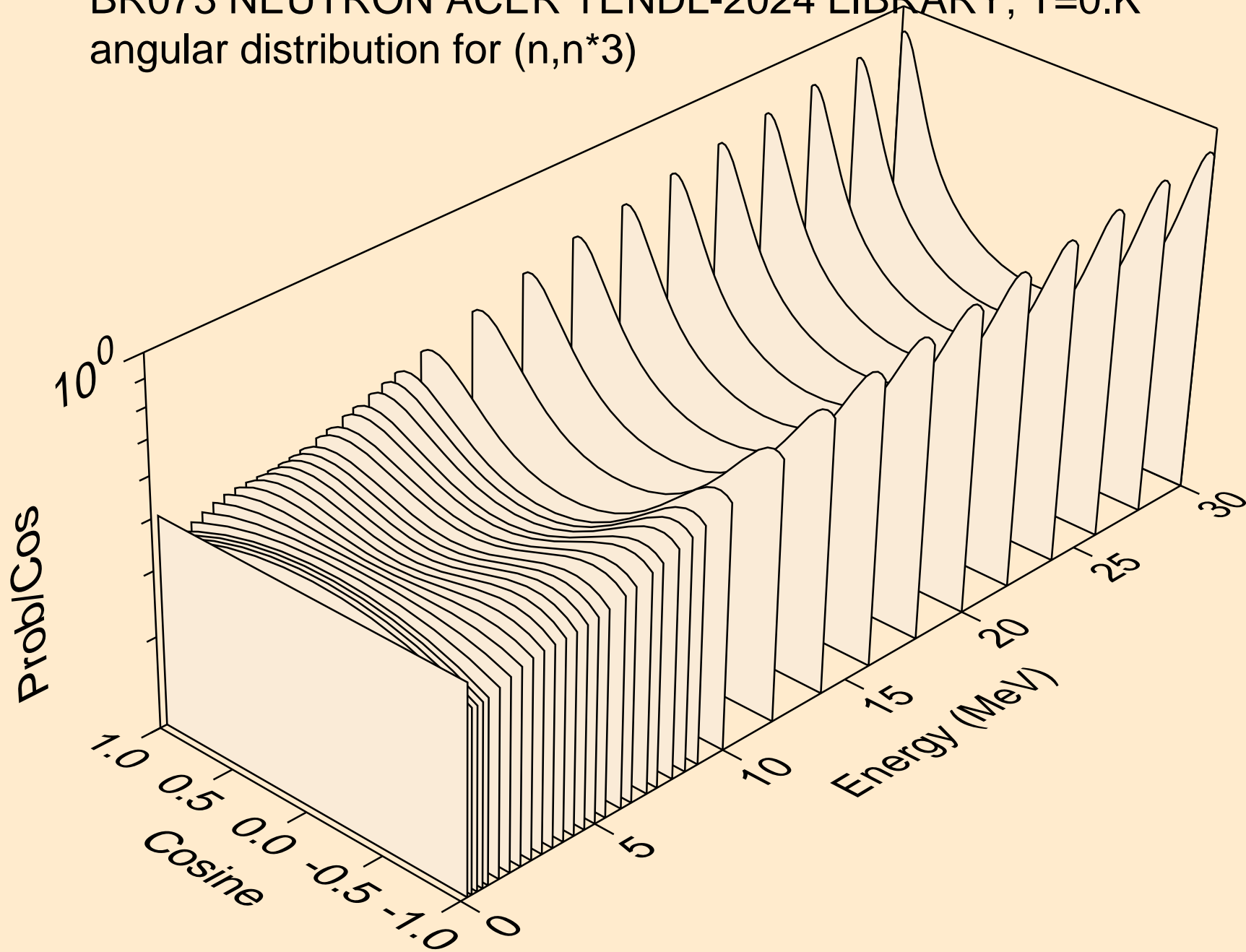

BR073 NEUTRON ACER TENDL-2024 LIBRARY; T=0.K
angular distribution for (n,n*4)

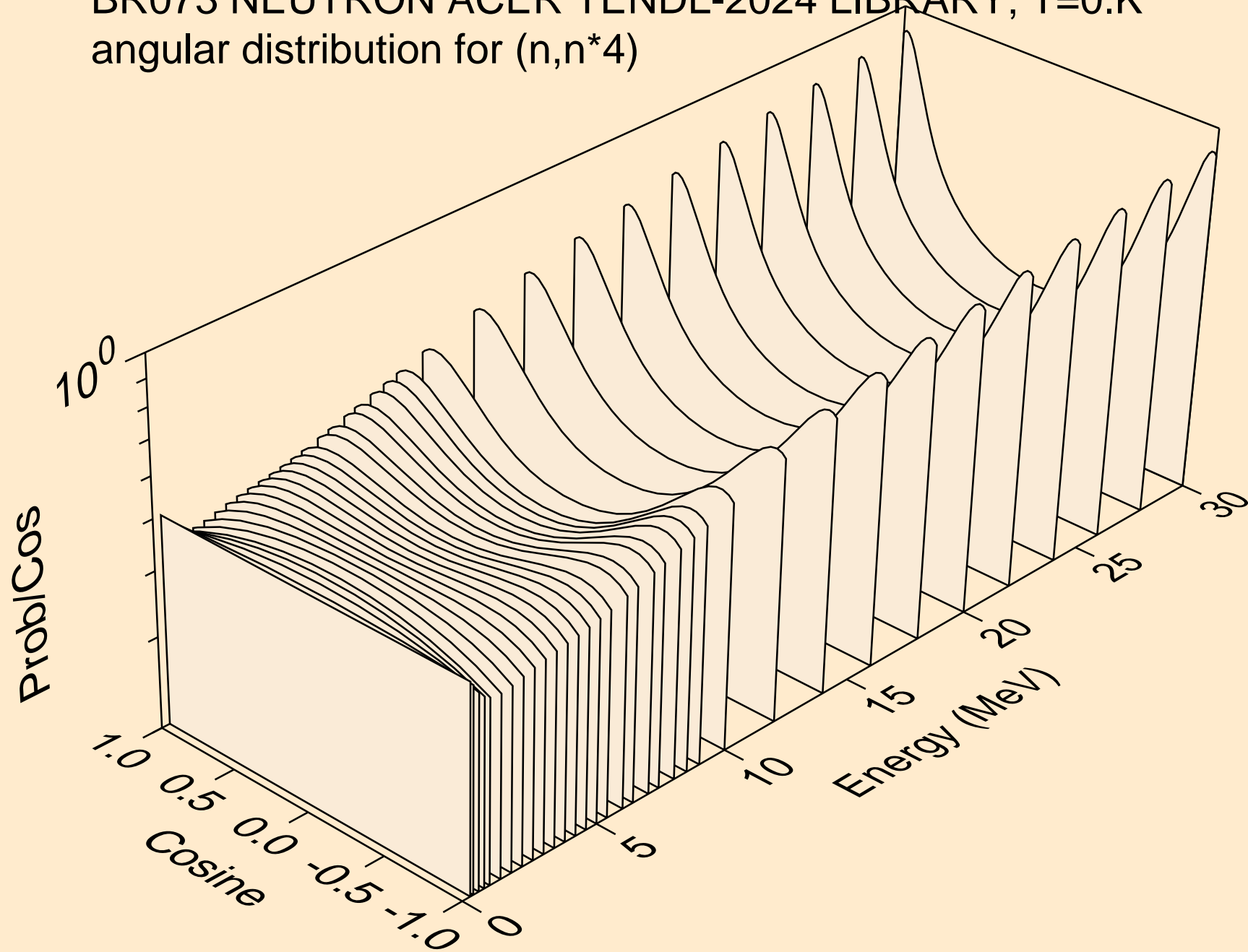

BR073 NEUTRON ACER TENDL-2024 LIBRARY; T=0.K
angular distribution for (n,n*5)

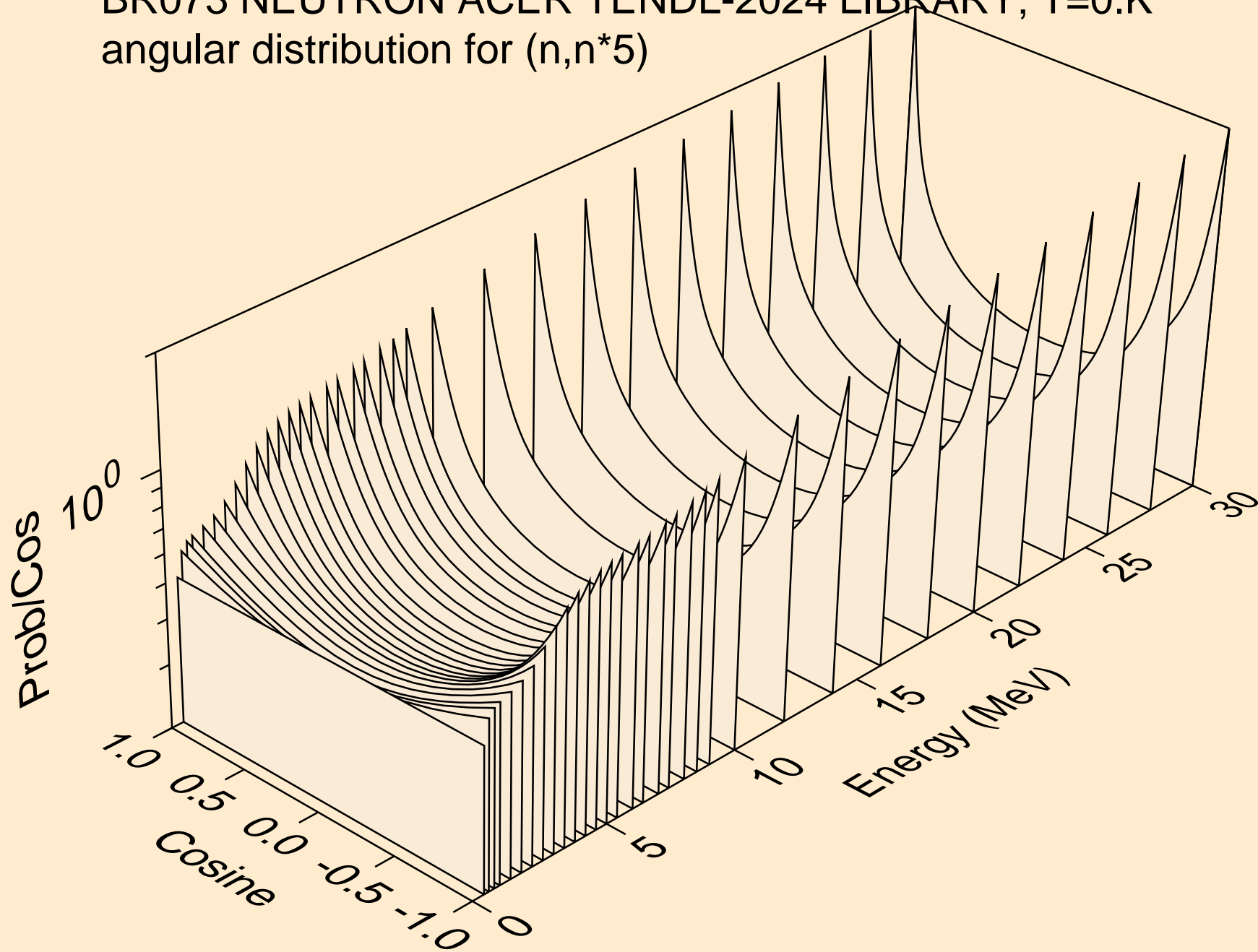

BR073 NEUTRON ACER TENDL-2024 LIBRARY; T=0.K
angular distribution for (n,n*6)

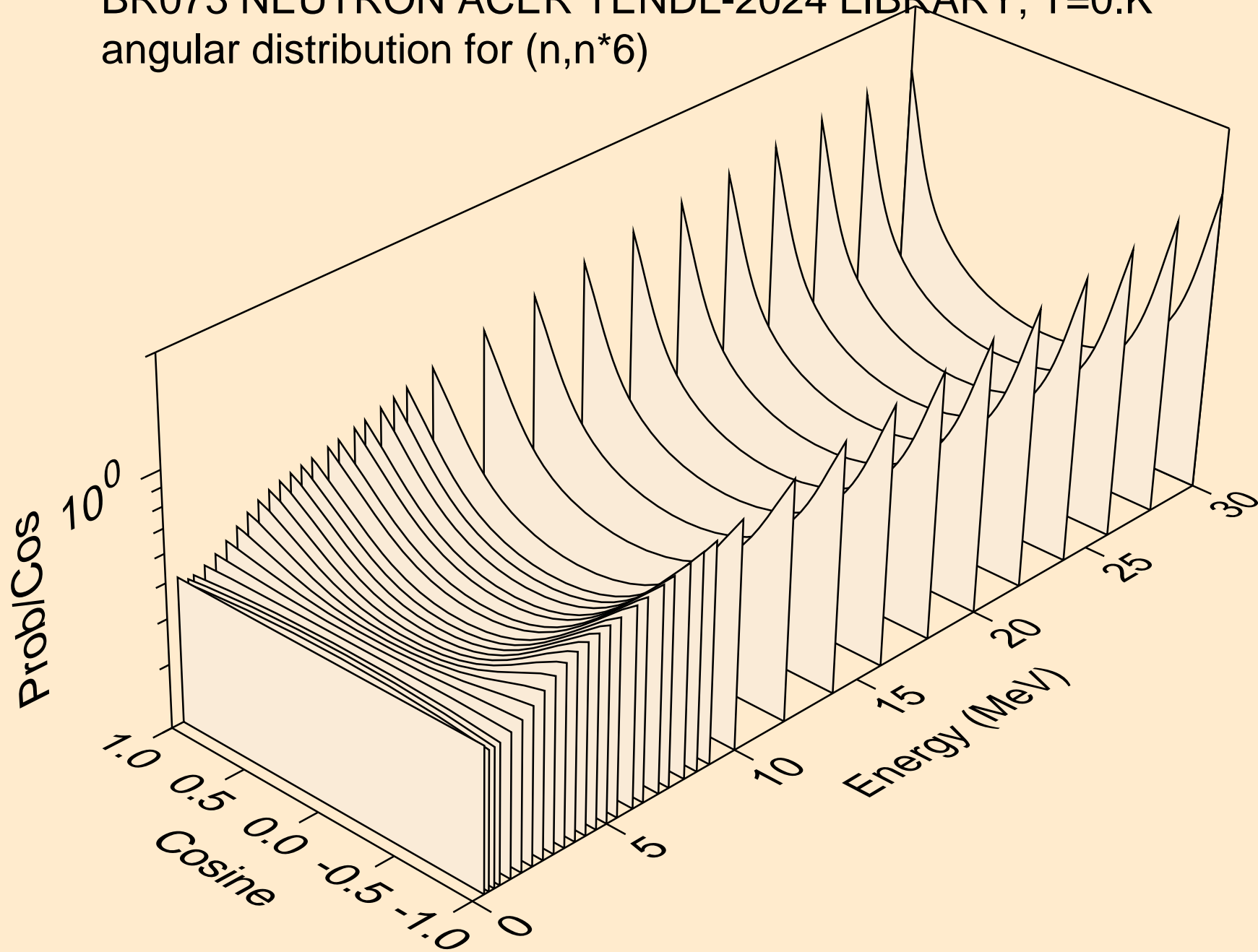

BR073 NEUTRON ACER TENDL-2024 LIBRARY; T=0.K
angular distribution for (n,n*7)

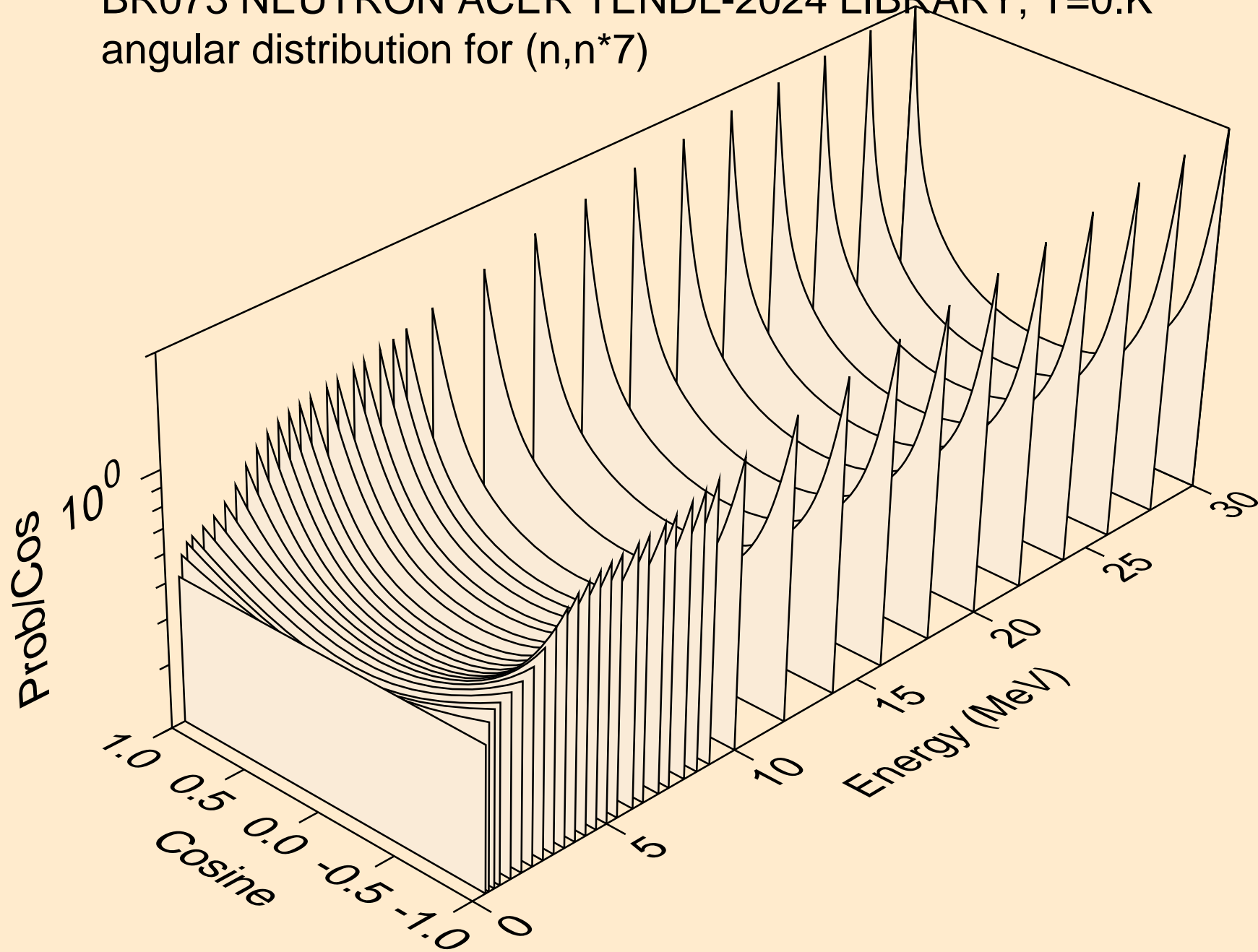

BR073 NEUTRON ACER TENDL-2024 LIBRARY; T=0.K
angular distribution for (n,n*8)

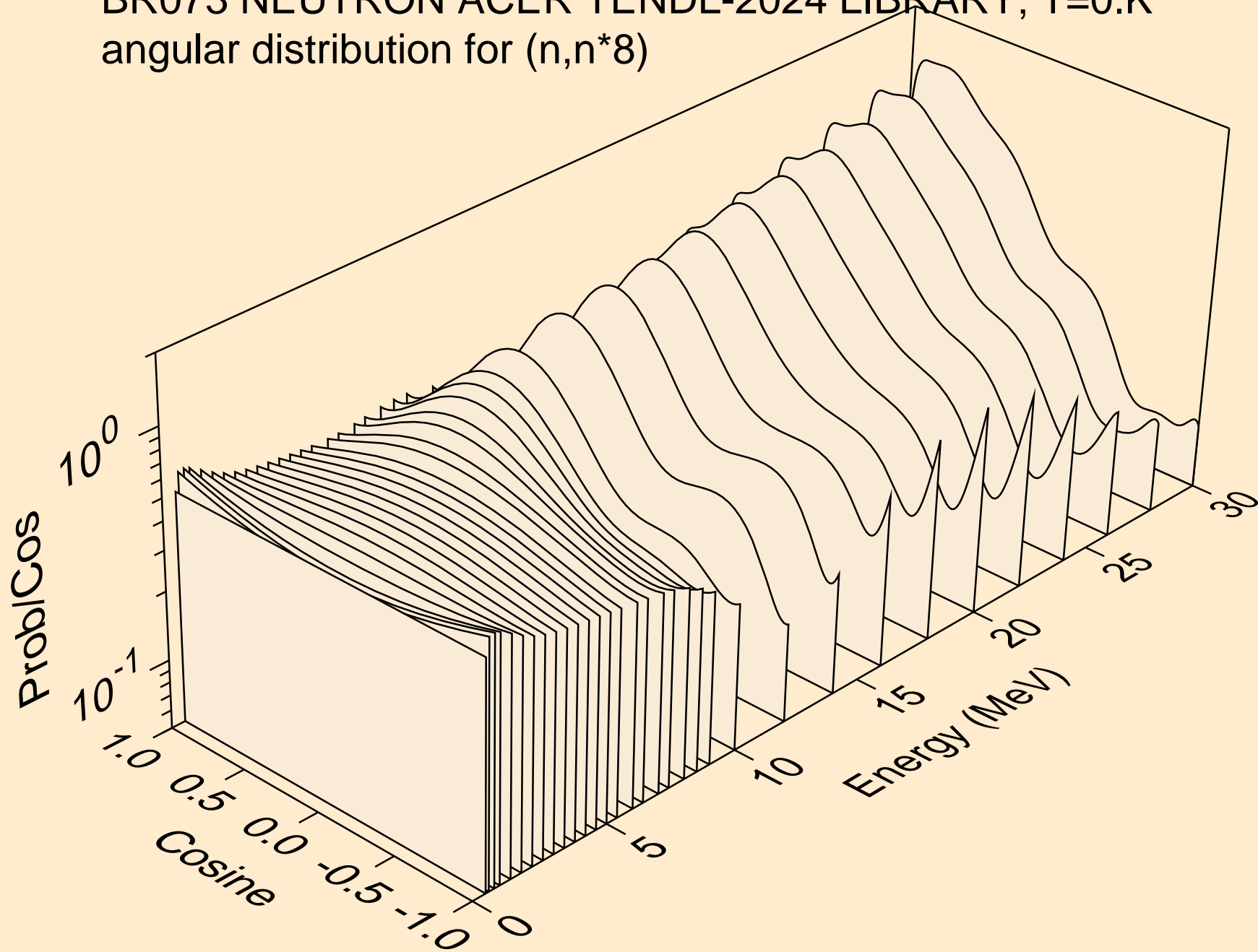

BR073 NEUTRON ACER TENDL-2024 LIBRARY; T=0.K
angular distribution for (n,n*9)

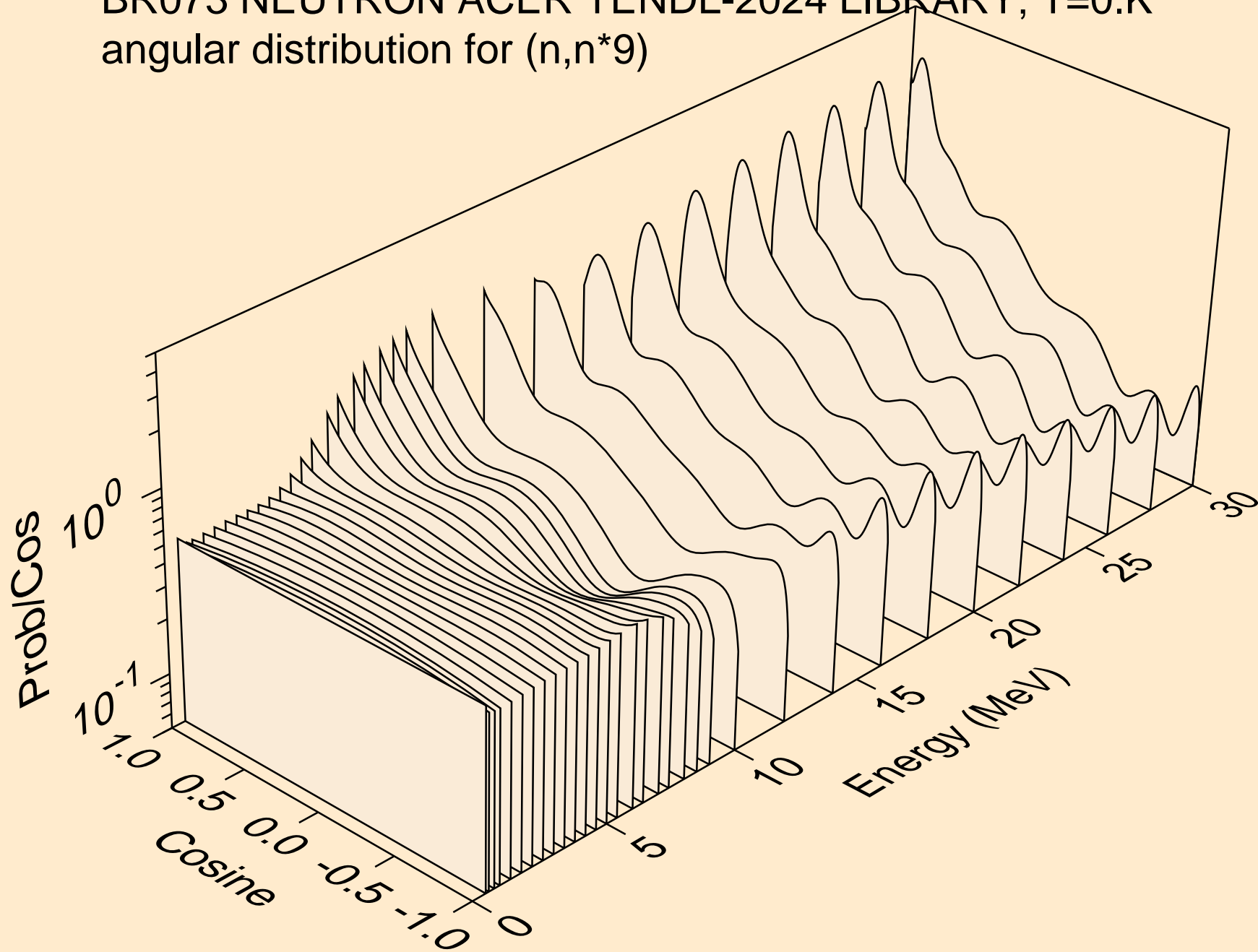

BR073 NEUTRON ACER TENDL-2024 LIBRARY; T=0.K
angular distribution for (n,n*10)

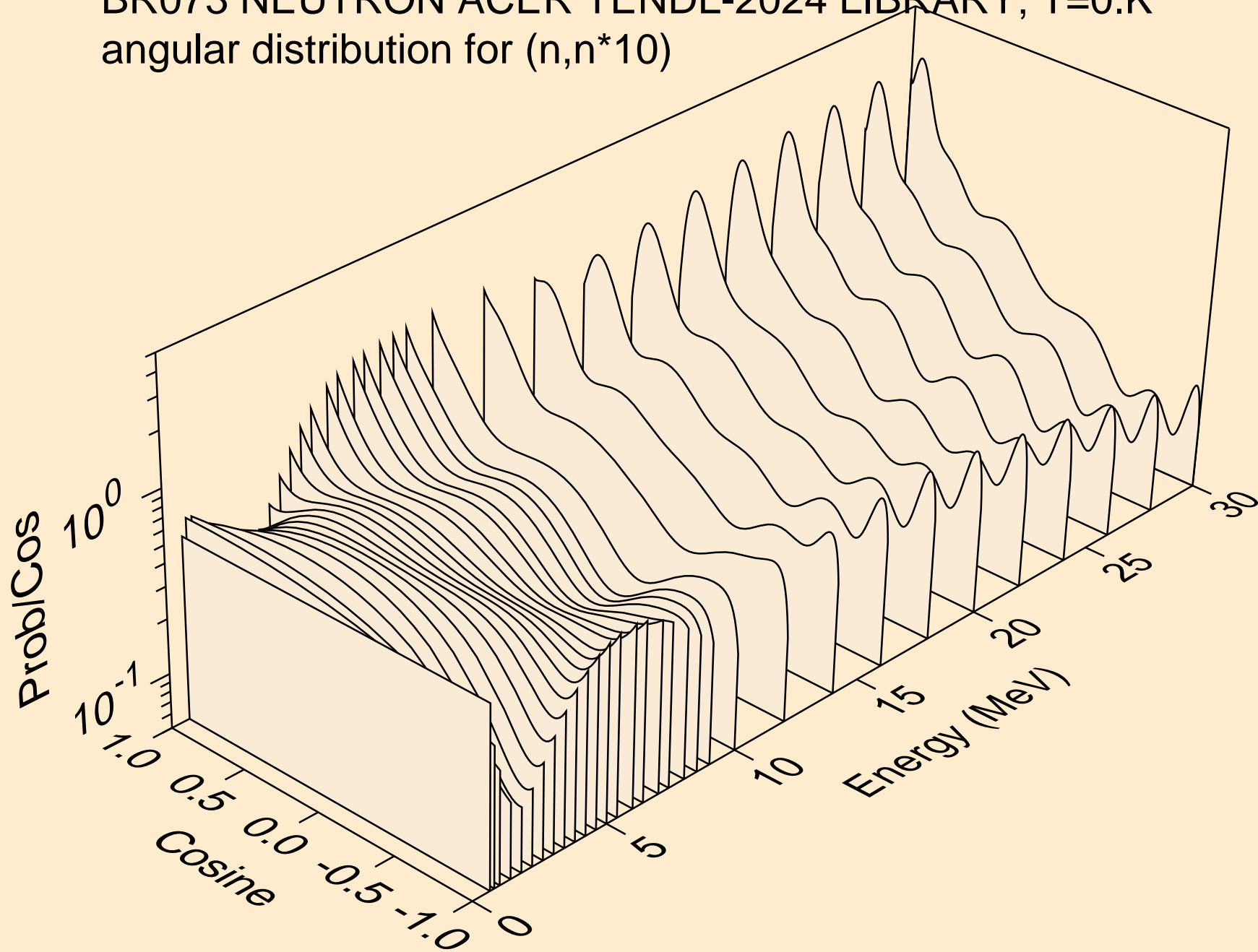

BR073 NEUTRON ACER TENDL-2024 LIBRARY; T=0.K
angular distribution for (n,n*11)

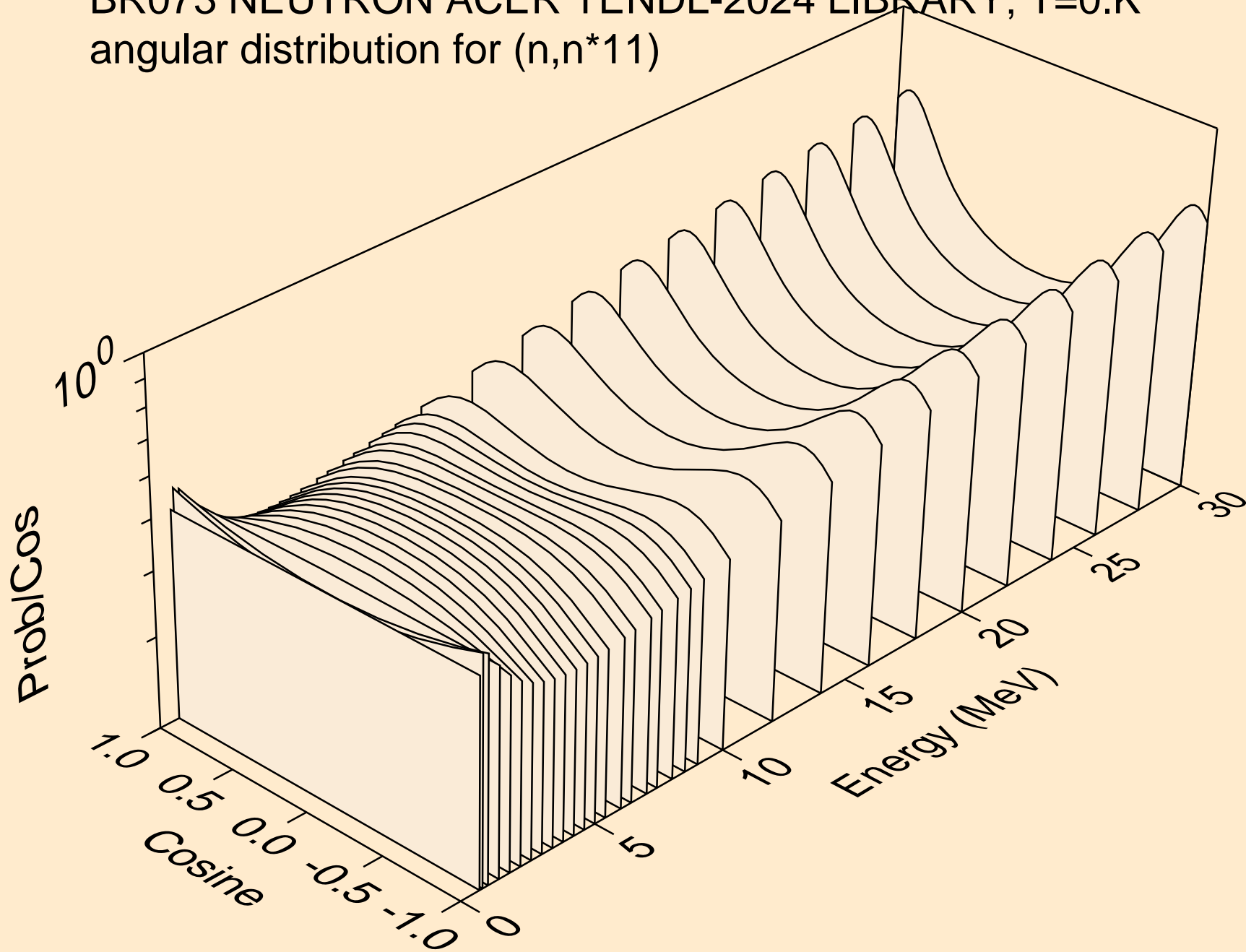

BR073 NEUTRON ACER TENDL-2024 LIBRARY; T=0.K
angular distribution for (n,n*12)

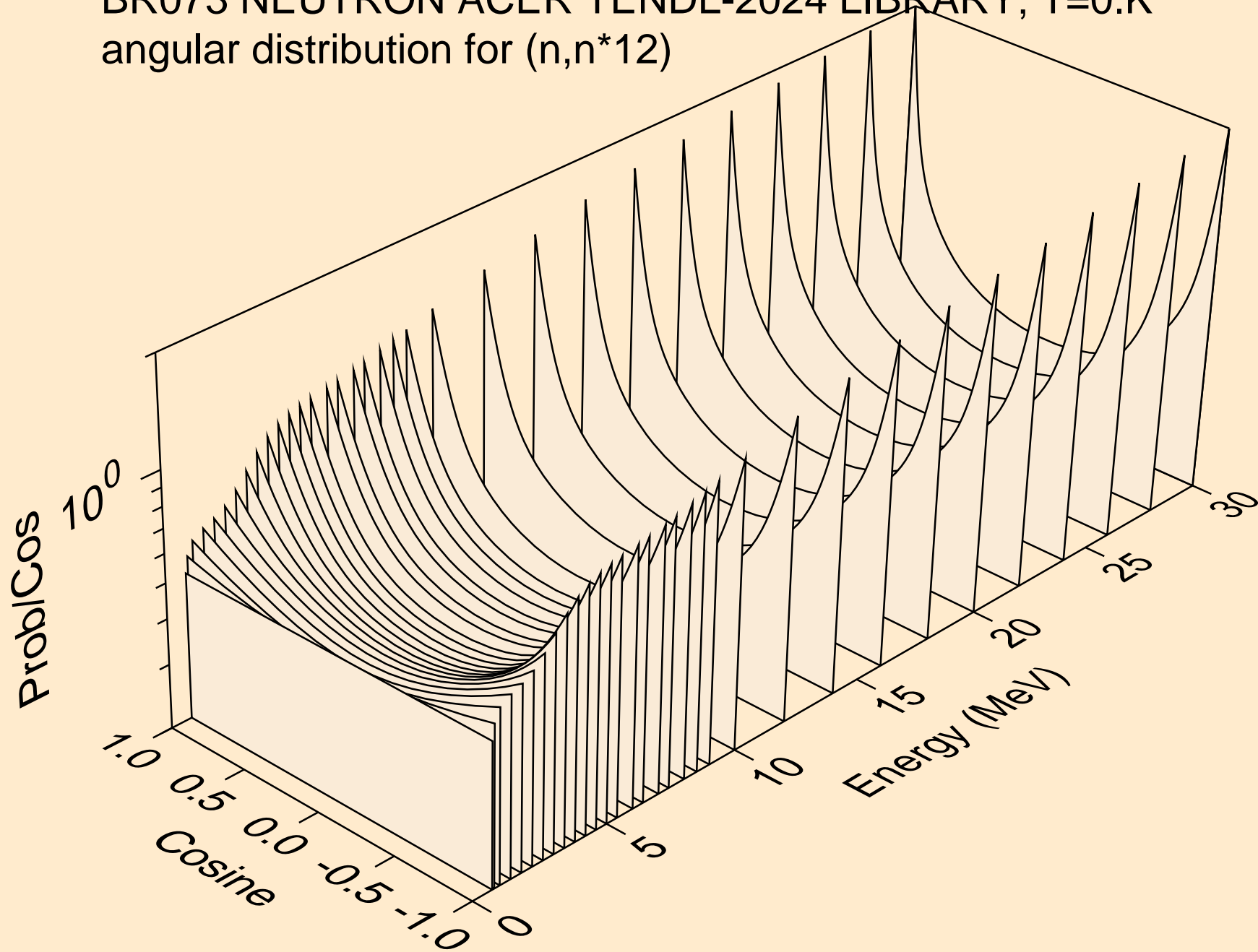

BR073 NEUTRON ACER TENDL-2024 LIBRARY; T=0.K
angular distribution for (n,n*13)

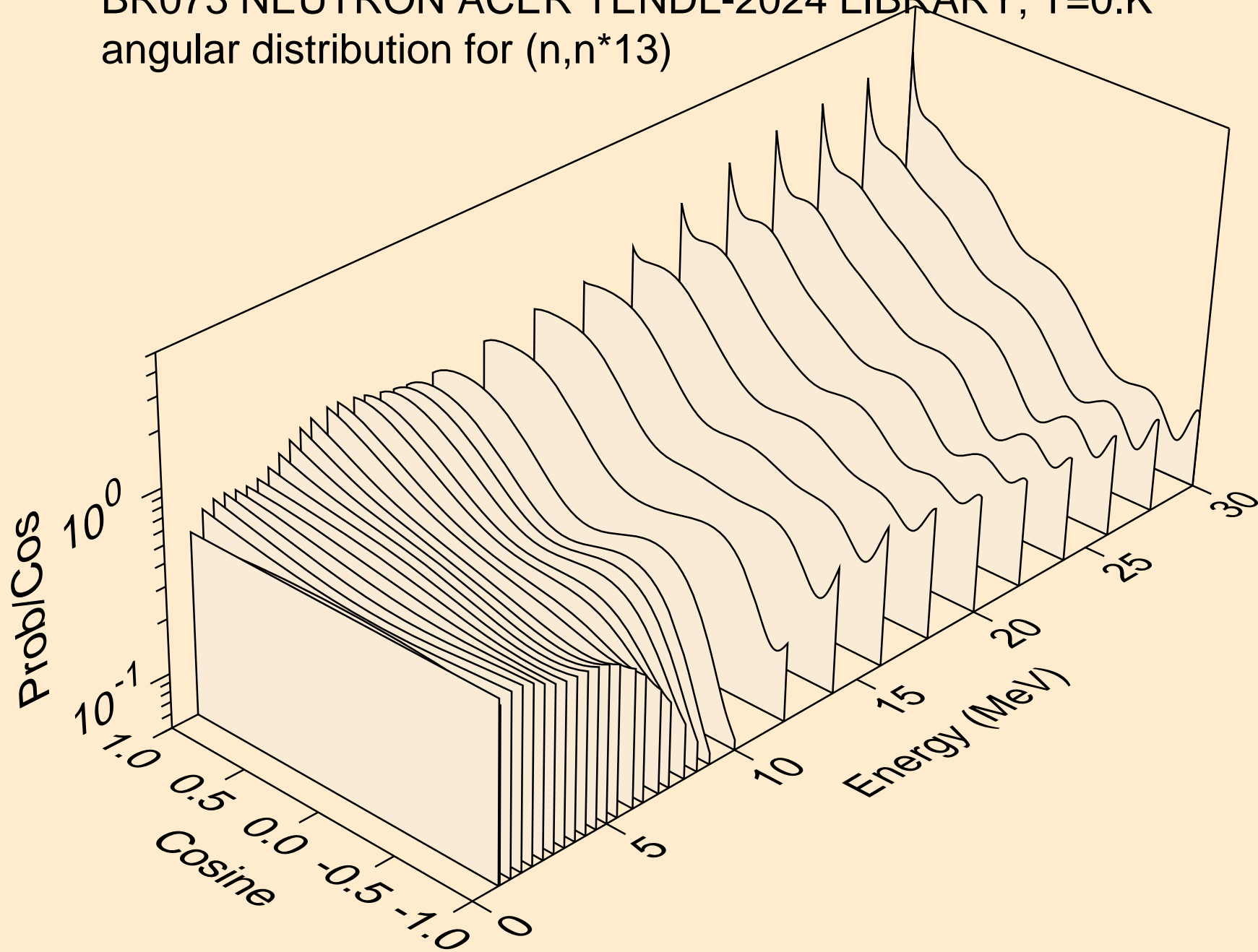

BR073 NEUTRON ACER TENDL-2024 LIBRARY; T=0.K
angular distribution for (n,n*14)

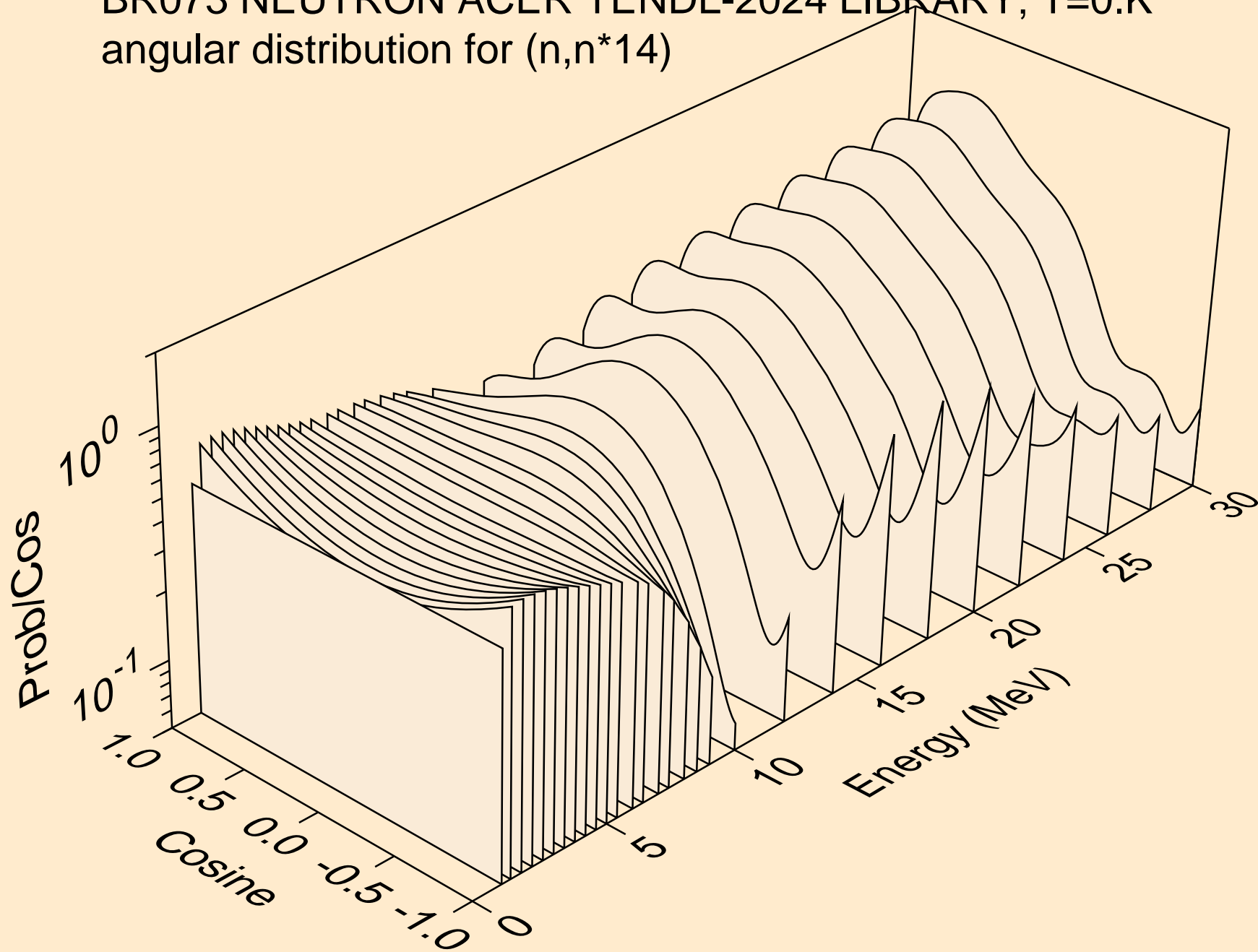

BR073 NEUTRON ACER TENDL-2024 LIBRARY; T=0.K
angular distribution for (n,n*15)

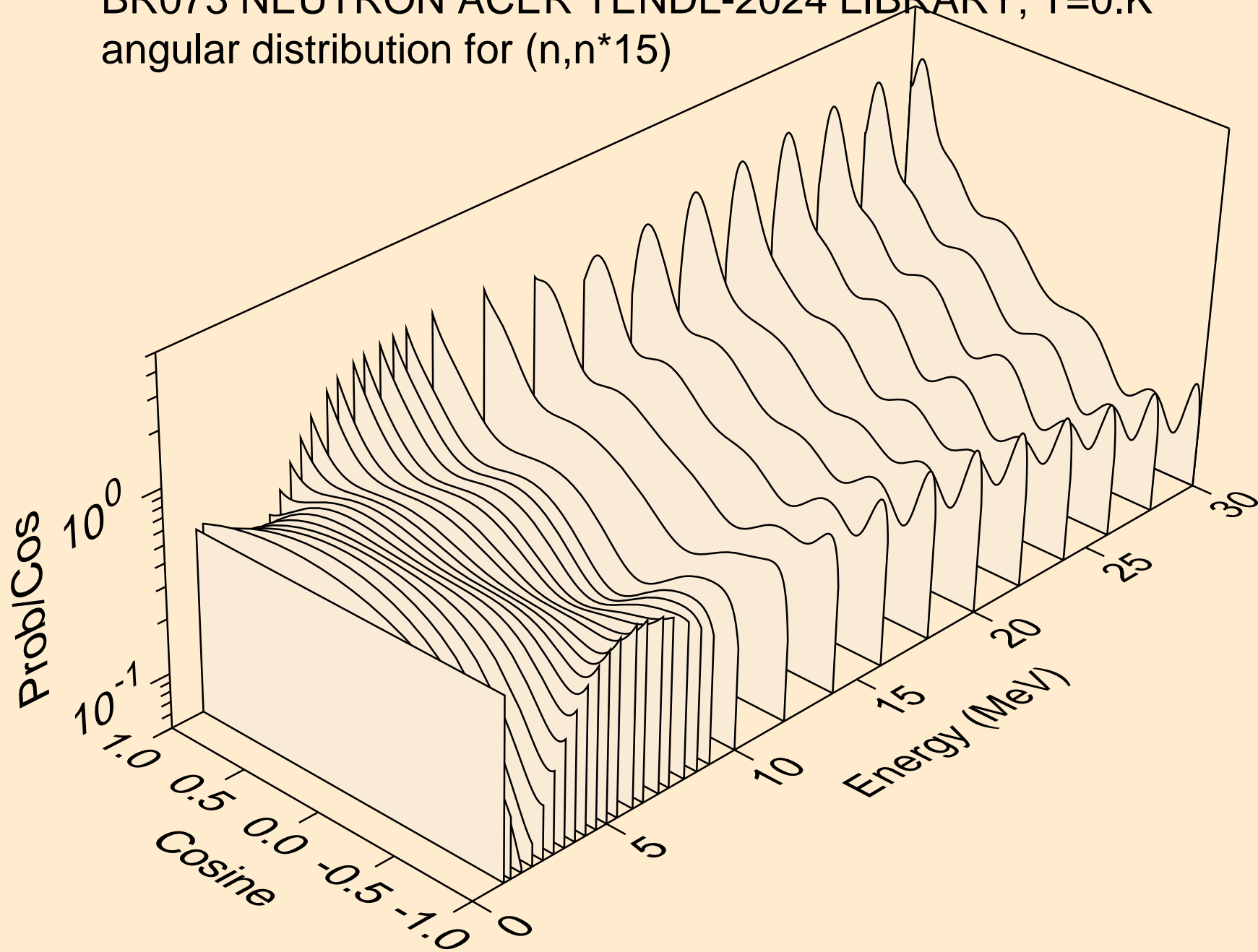

BR073 NEUTRON ACER TENDL-2024 LIBRARY; T=0.K
angular distribution for (n,n*16)

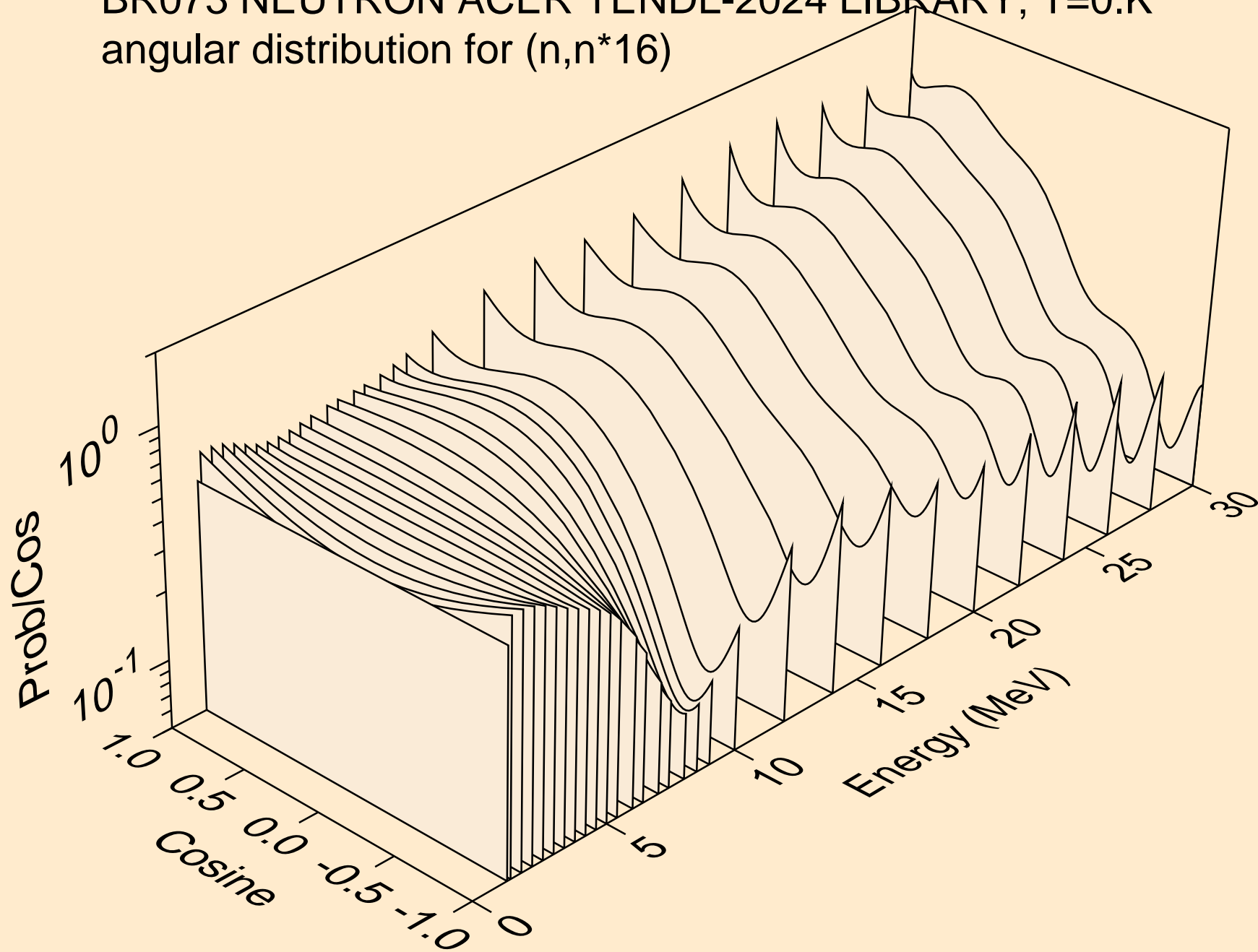

BR073 NEUTRON ACER TENDL-2024 LIBRARY; T=0.K
angular distribution for (n,n*17)

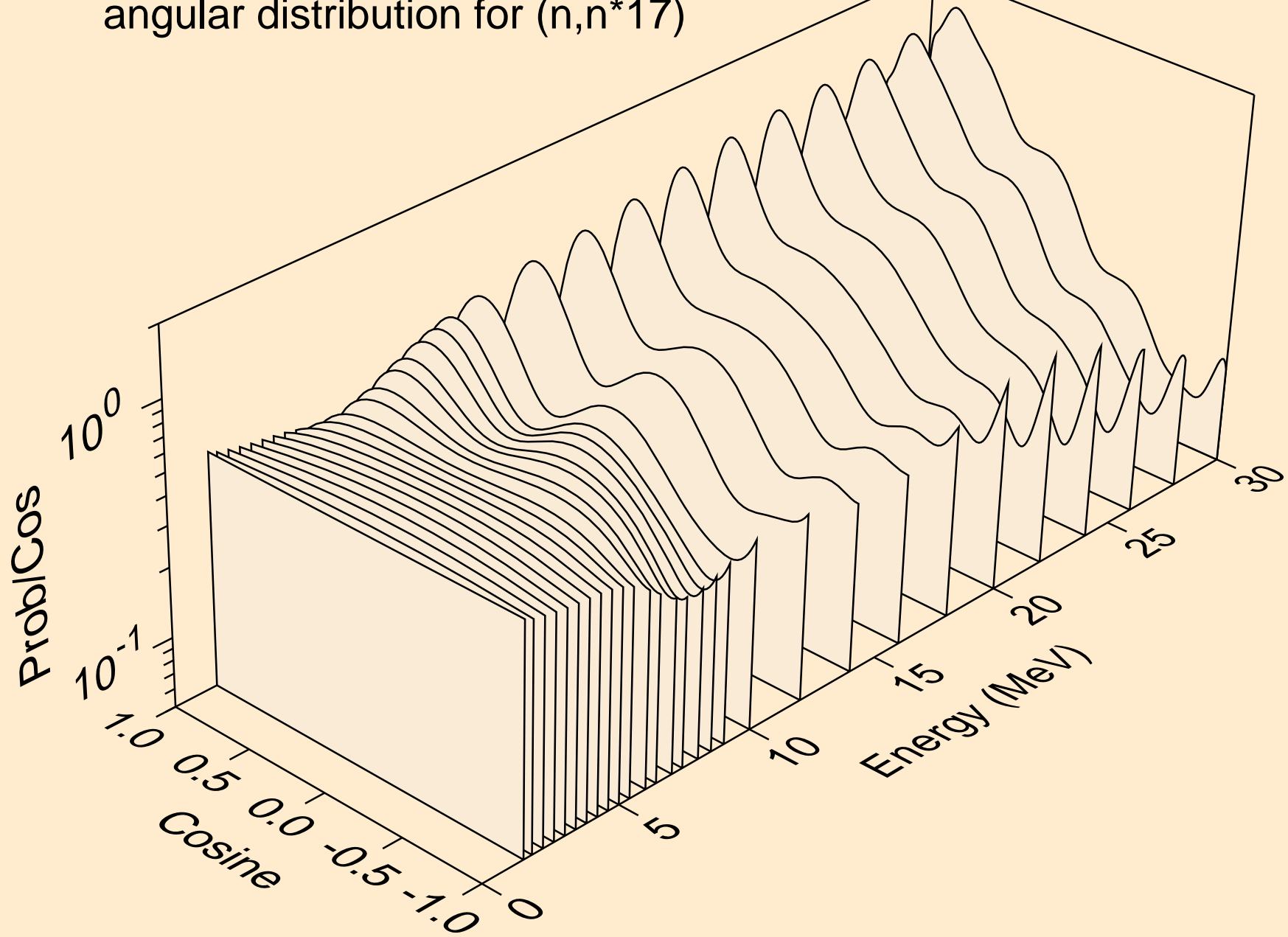

BR073 NEUTRON ACER TENDL-2024 LIBRARY; T=0.K
angular distribution for (n,n*18)

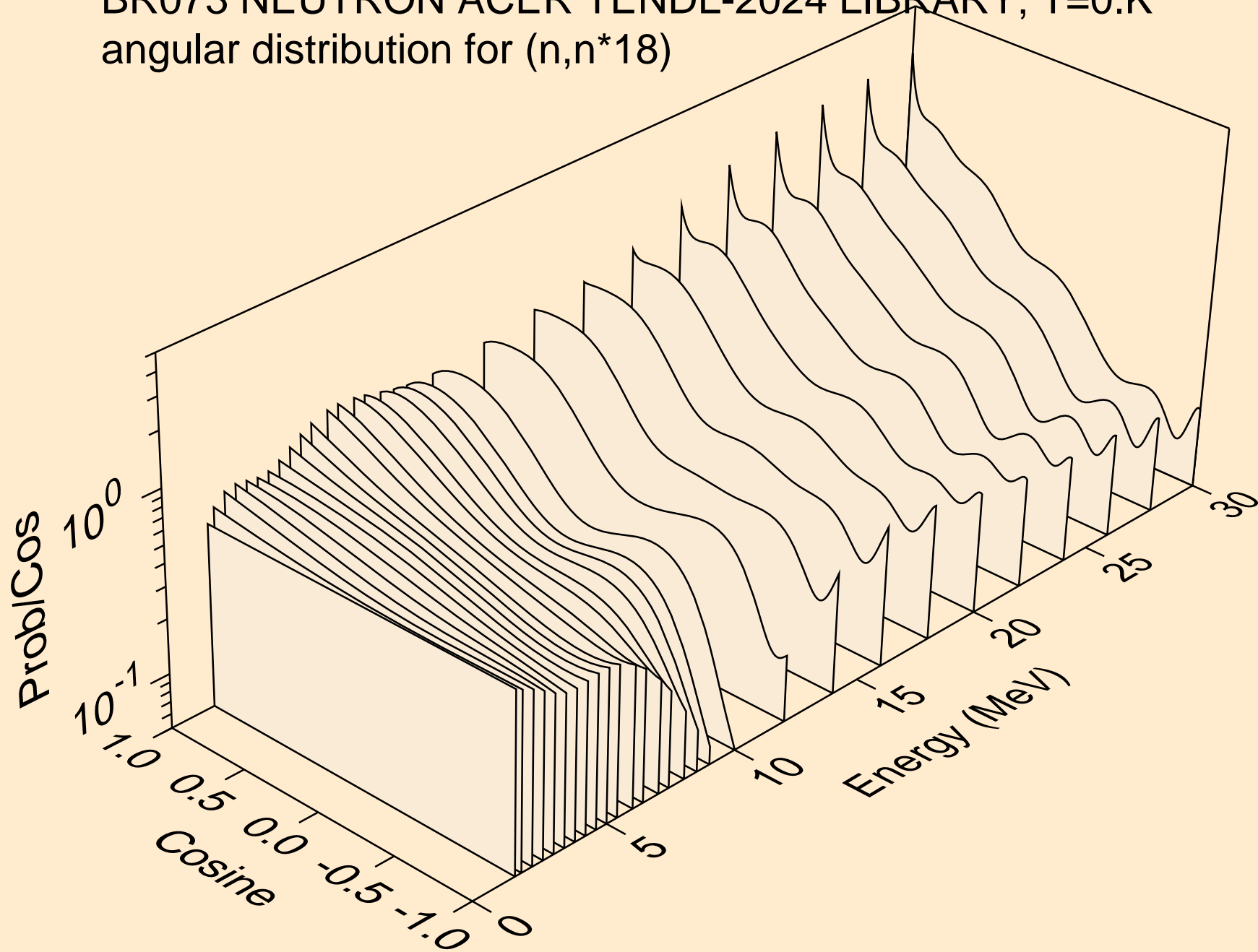

BR073 NEUTRON ACER TENDL-2024 LIBRARY; T=0.K
angular distribution for (n,n*19)

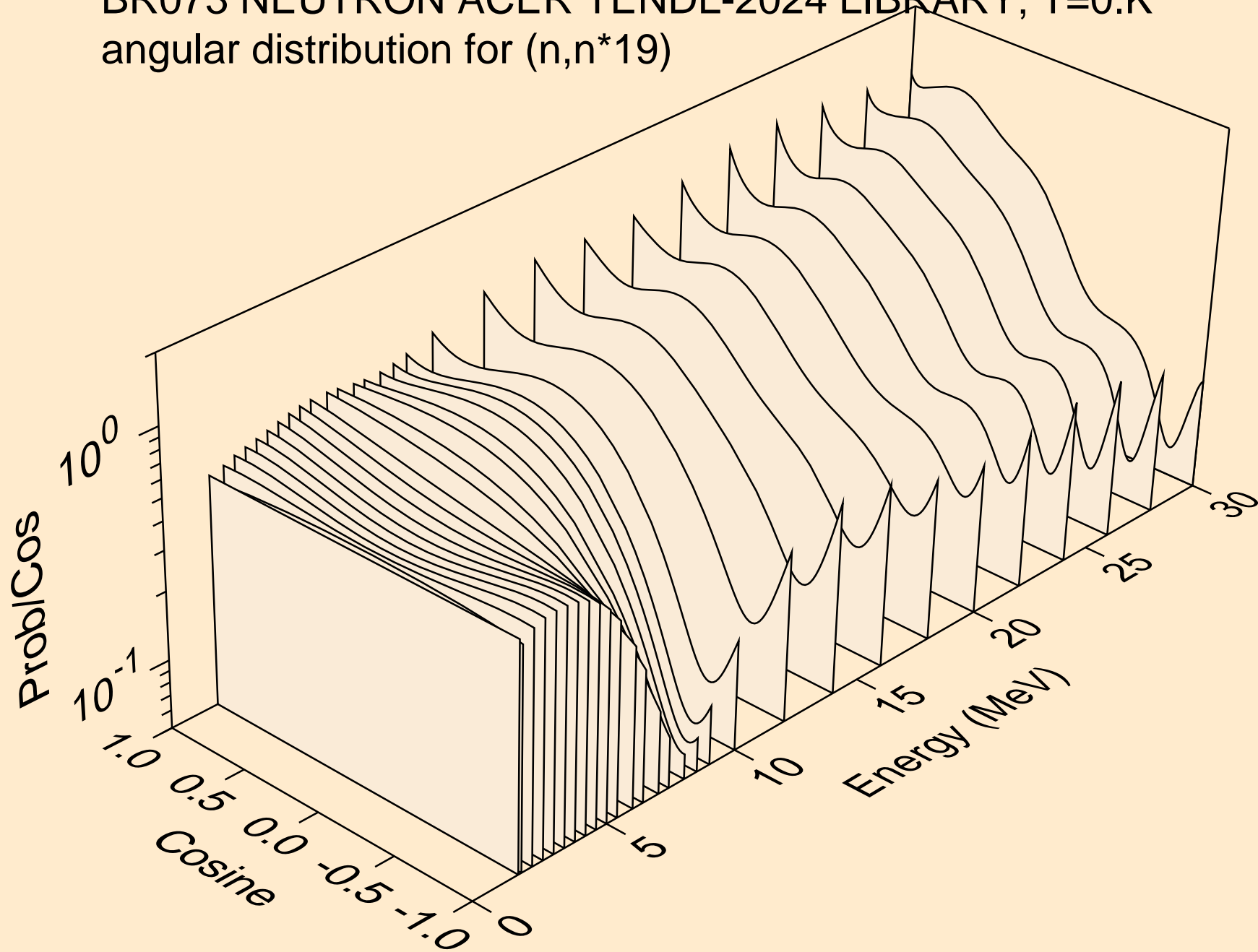

BR073 NEUTRON ACER TENDL-2024 LIBRARY; T=0.K
angular distribution for (n,n*20)

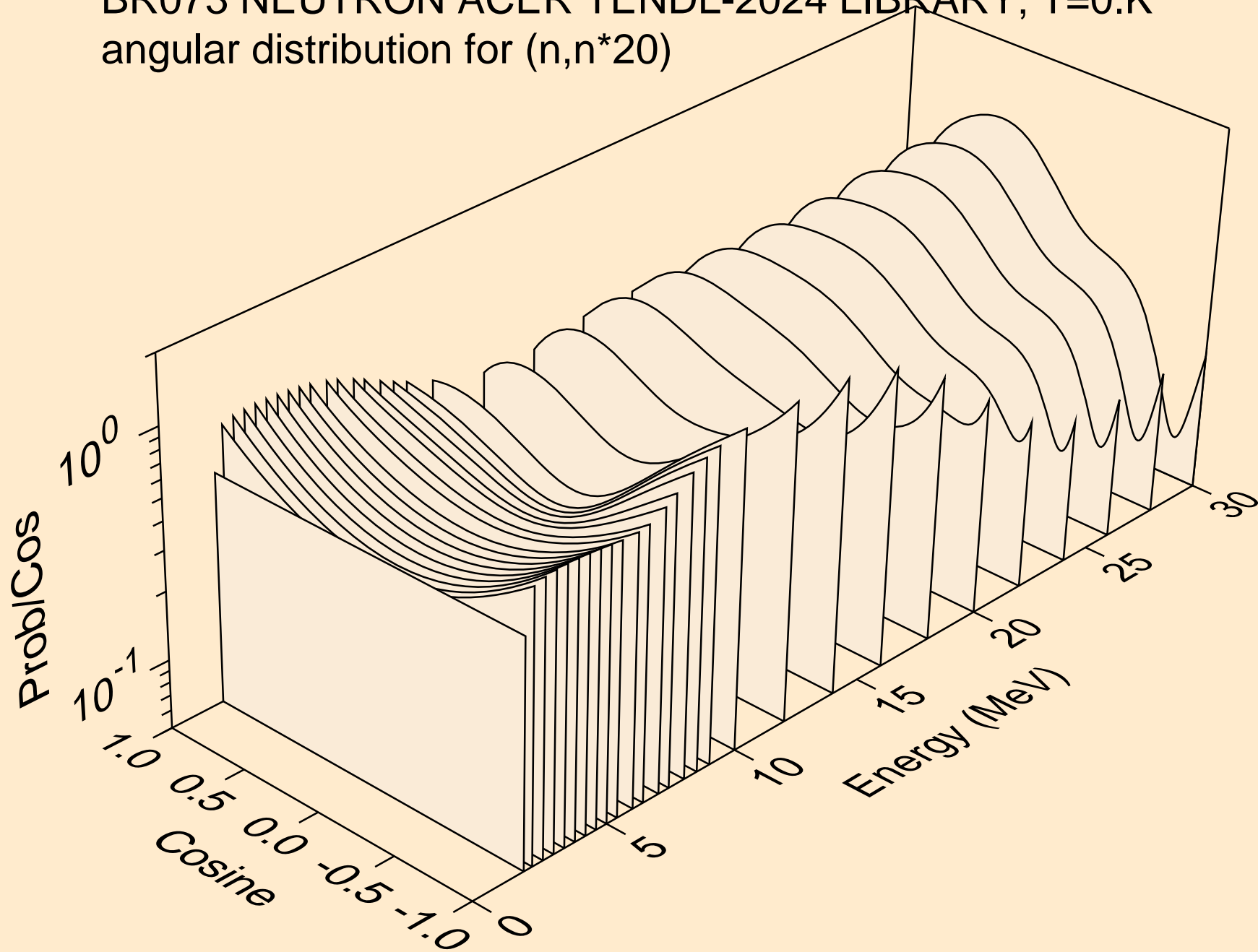

BR073 NEUTRON ACER TENDL-2024 LIBRARY; T=0.K
angular distribution for (n,n*21)

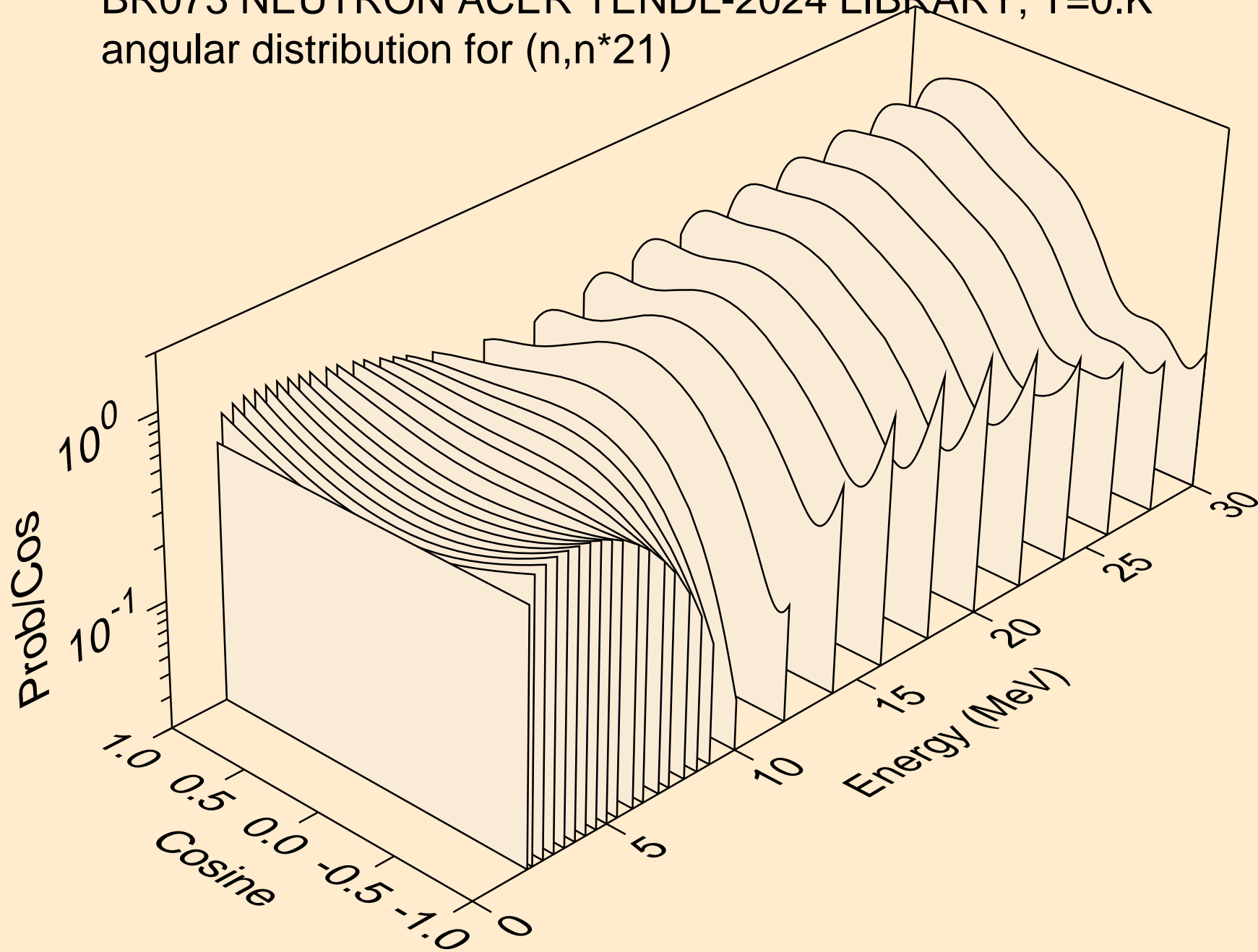

BR073 NEUTRON ACER TENDL-2024 LIBRARY; T=0.K
angular distribution for (n,n*22)

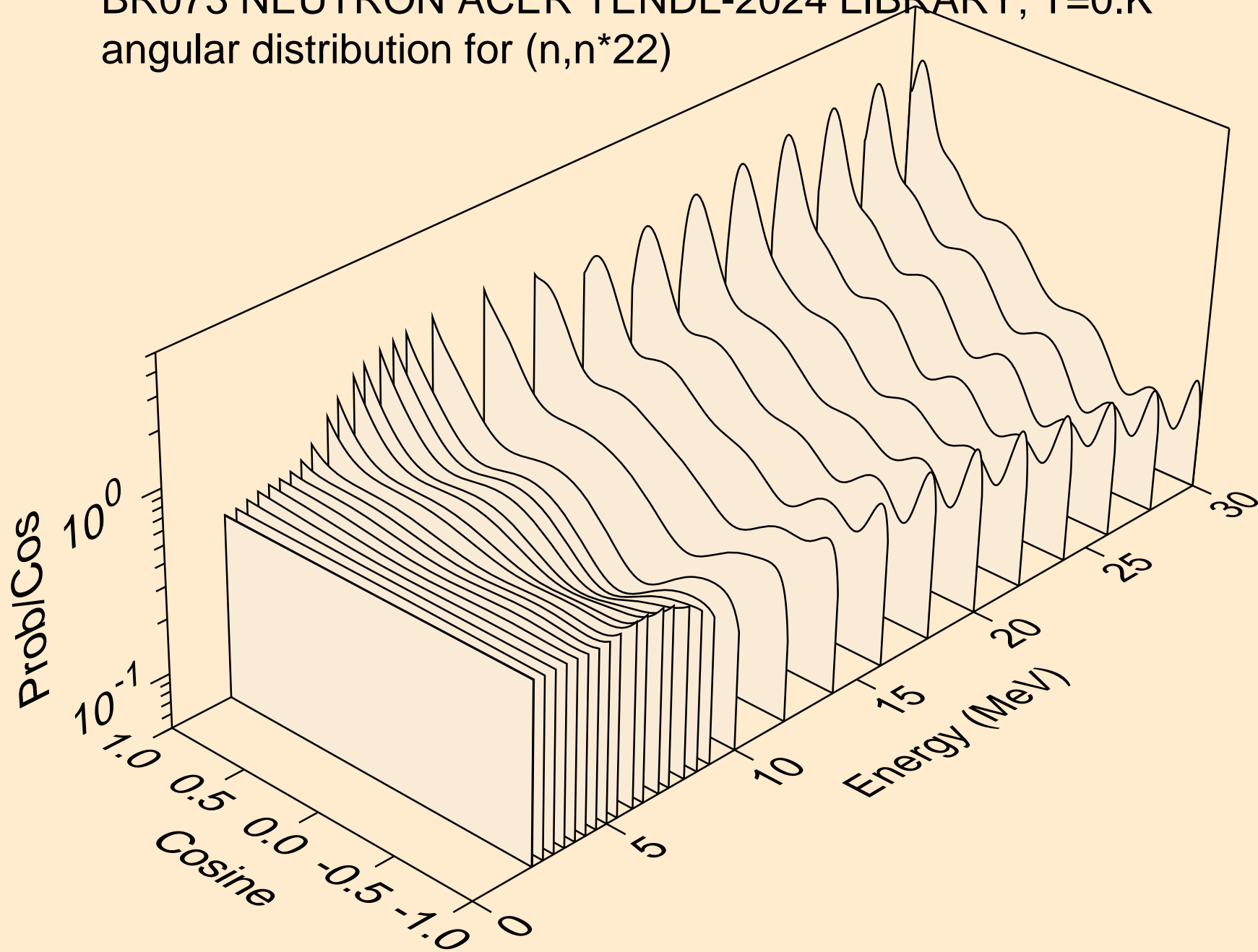

BR073 NEUTRON ACER TENDL-2024 LIBRARY; T=0.K
angular distribution for (n,n*23)

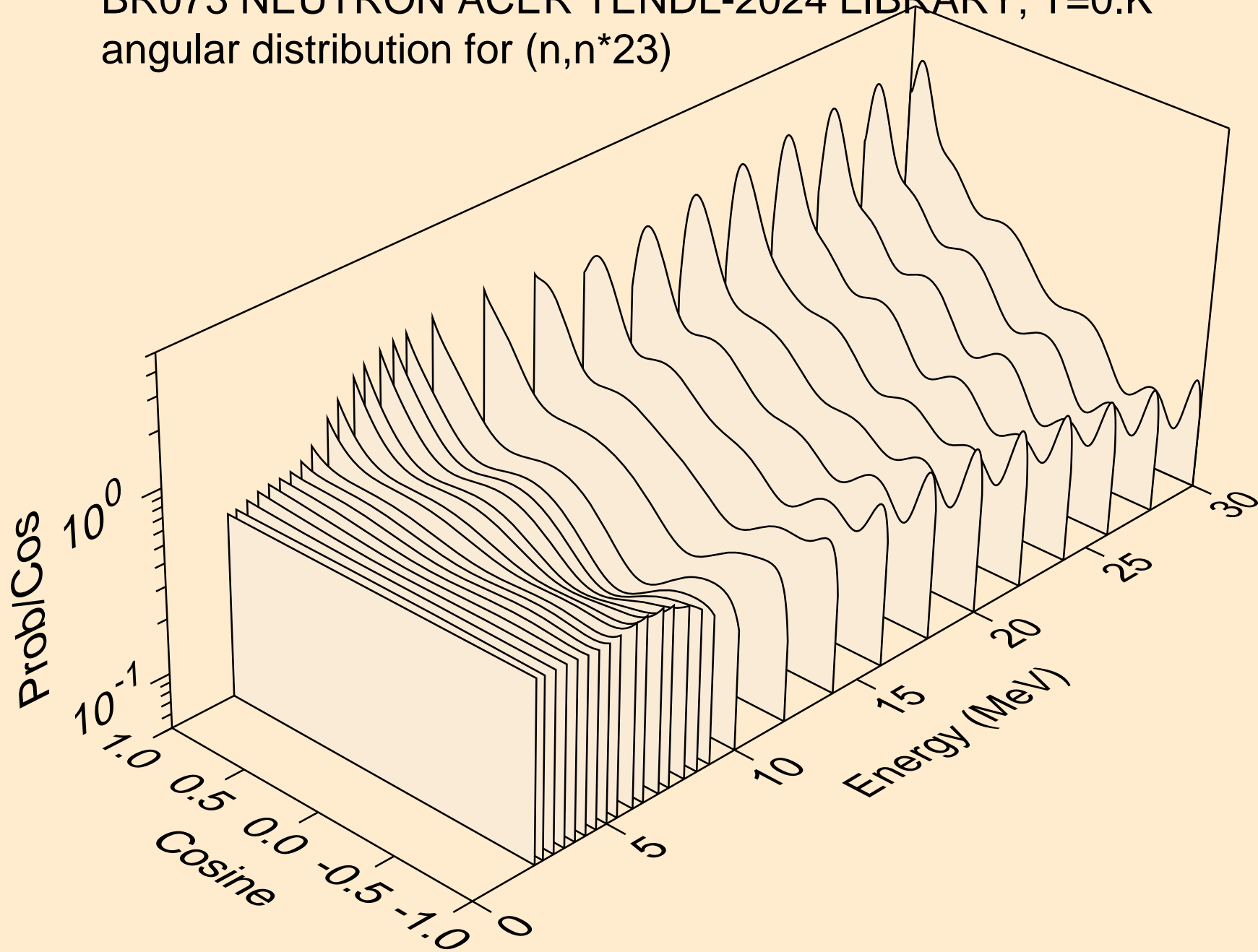

BR073 NEUTRON ACER TENDL-2024 LIBRARY; T=0.K
angular distribution for (n,n*24)

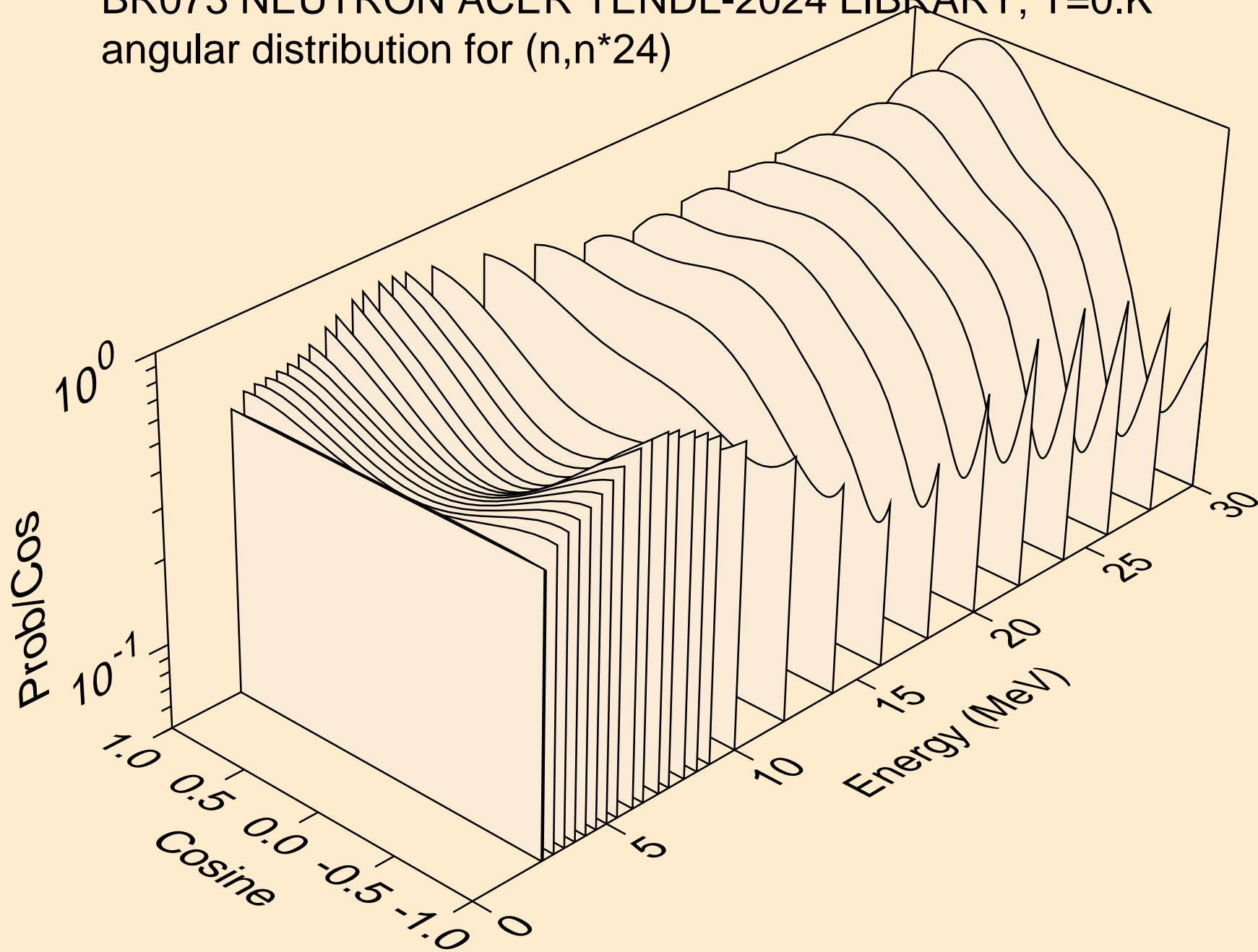

BR073 NEUTRON ACER TENDL-2024 LIBRARY; T=0.K
angular distribution for (n,n*25)

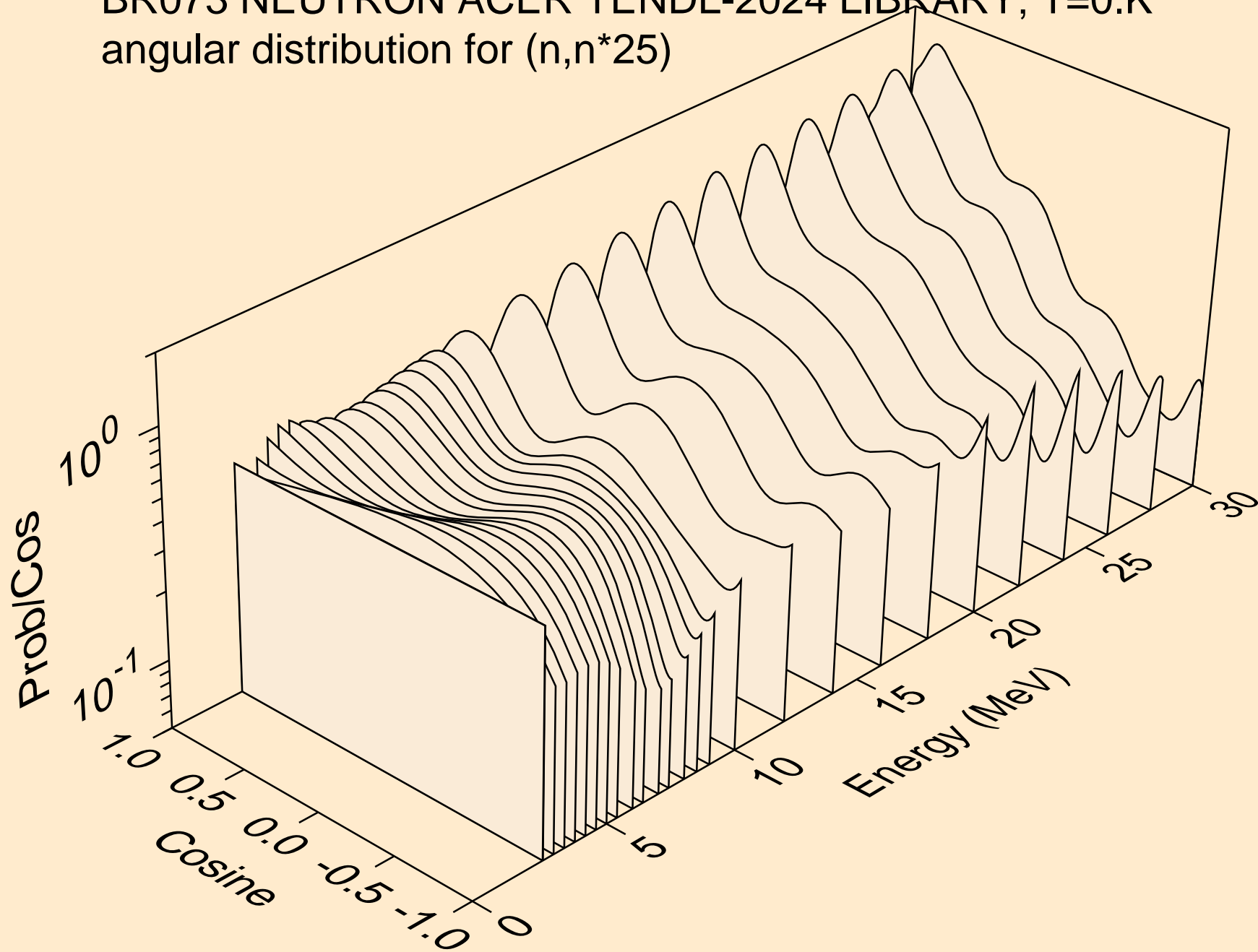

BR073 NEUTRON ACER TENDL-2024 LIBRARY; T=0.K
Neutron emission for (n,x)

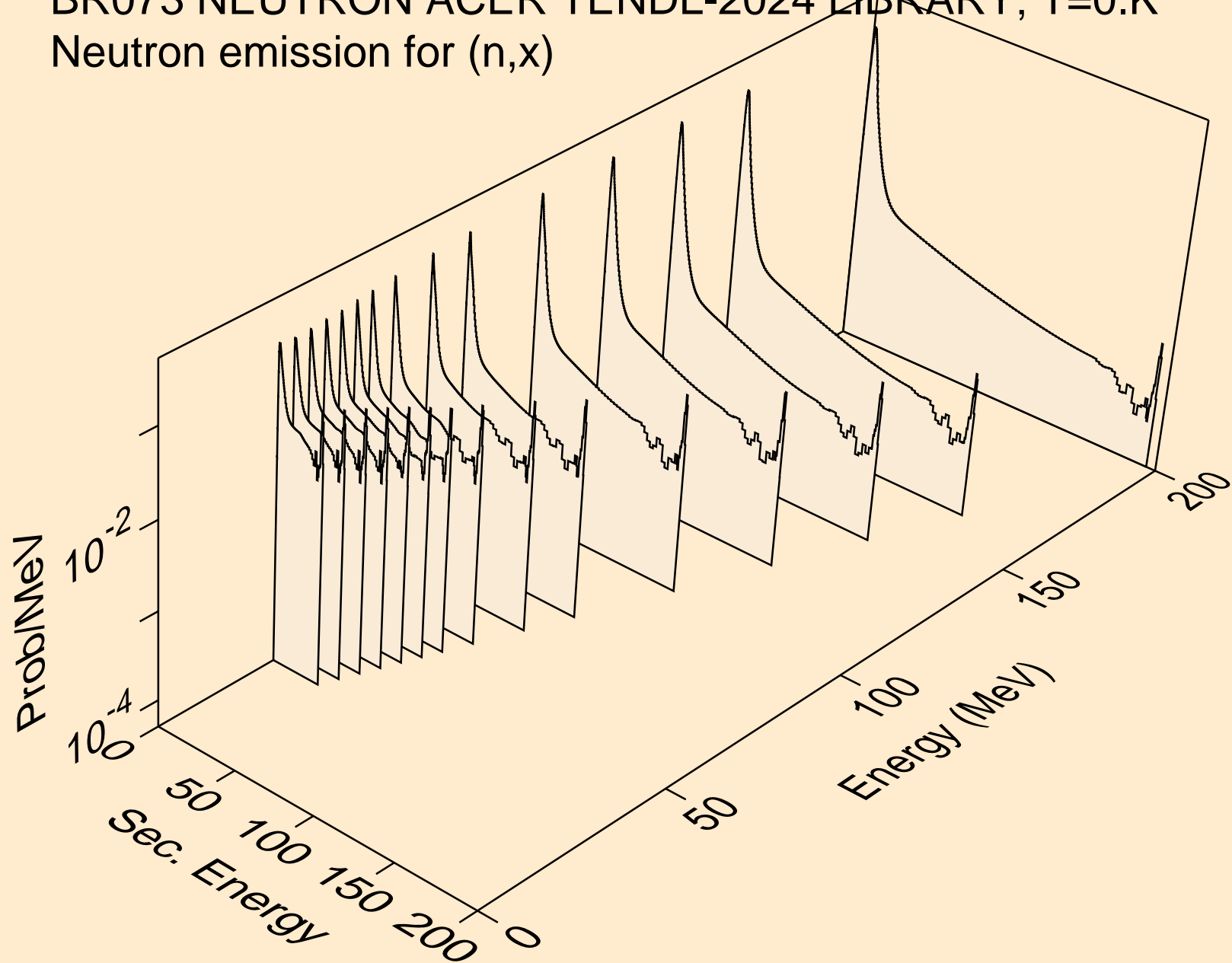

BR073 NEUTRON ACER TENDL-2024 LIBRARY; T=0.K
Neutron emission for (n,2nd)

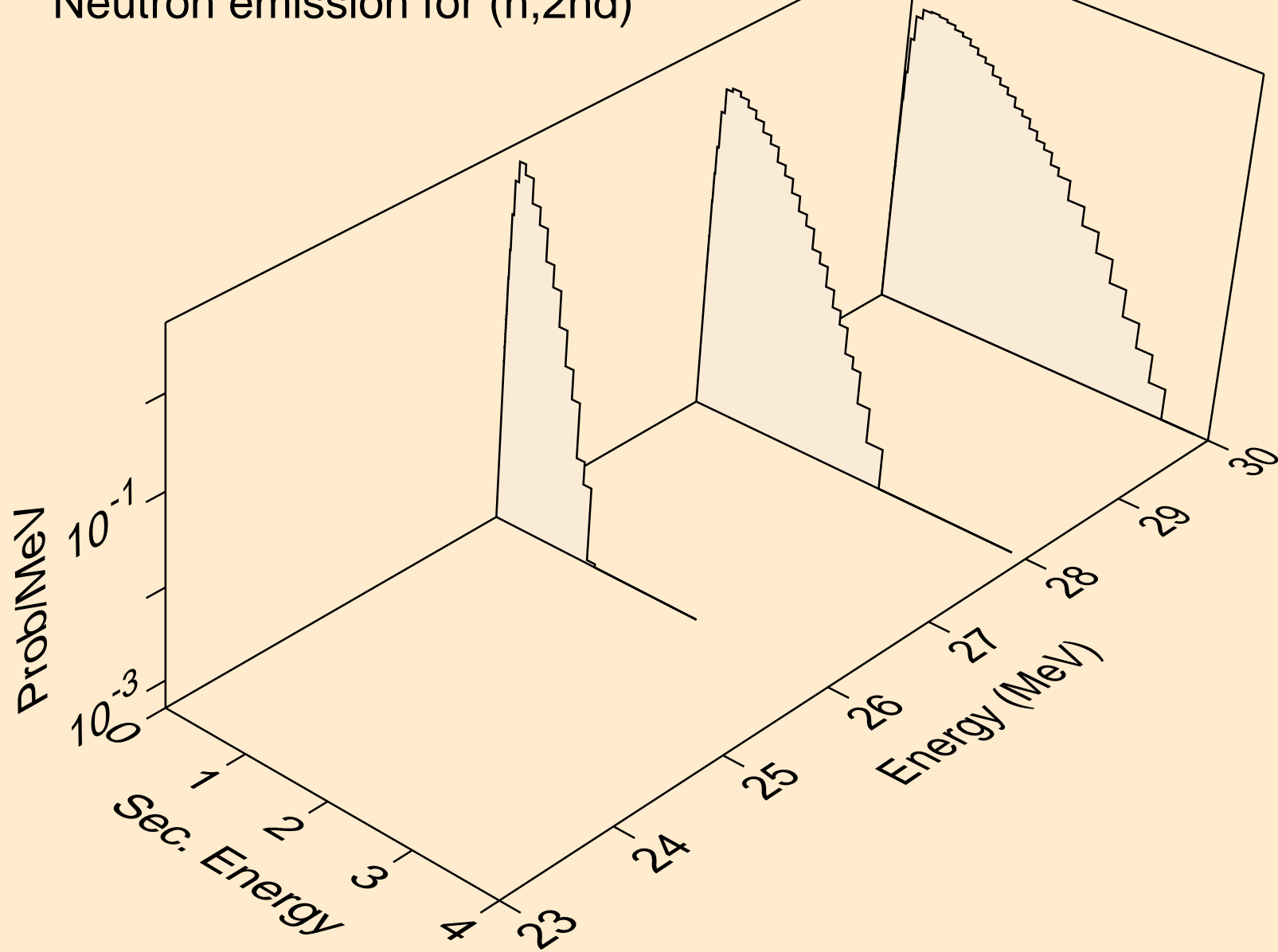

BR073 NEUTRON ACER TENDL-2024 LIBRARY; T=0.K
Neutron emission for (n,2n)

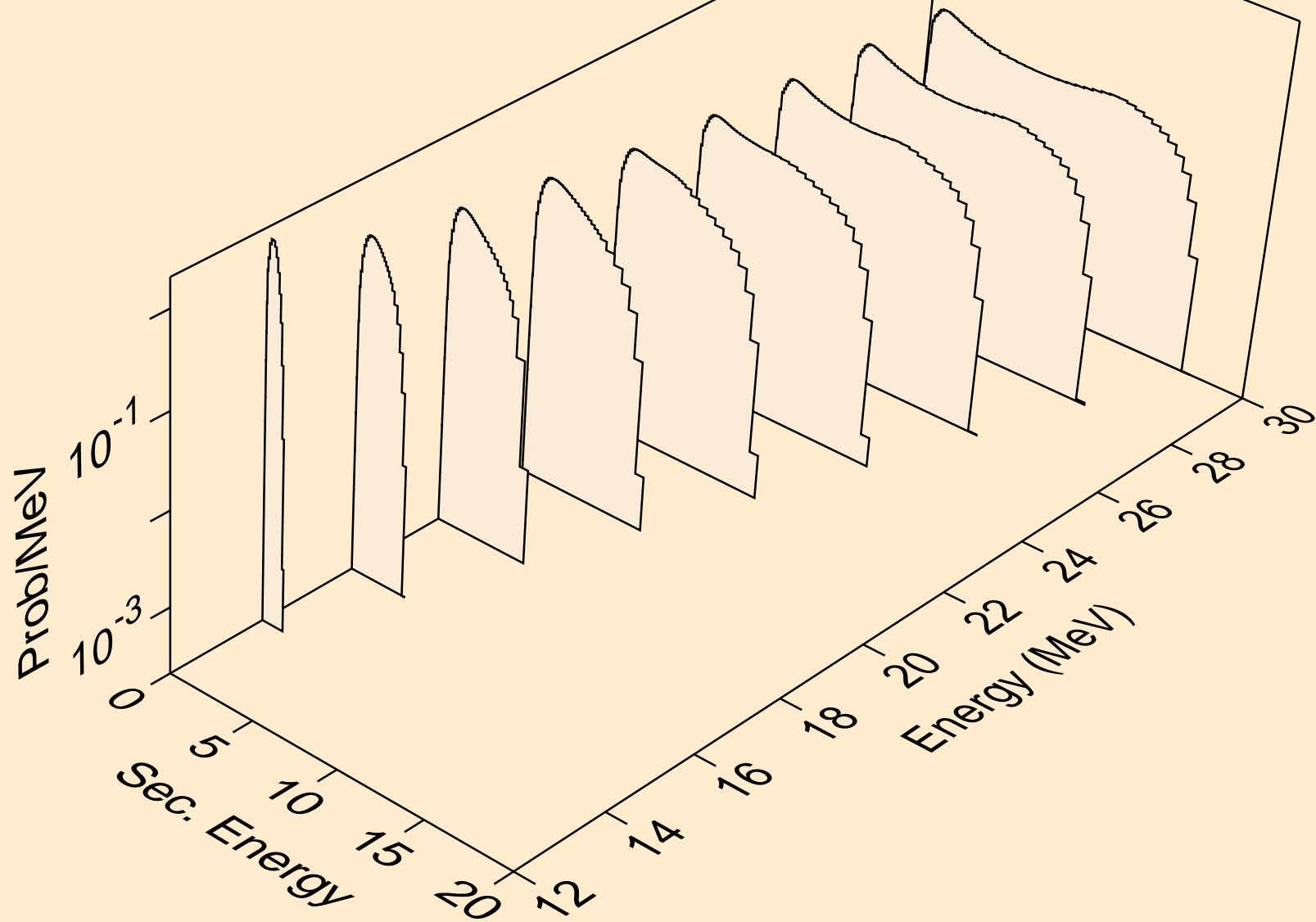

BR073 NEUTRON ACER TENDL-2024 LIBRARY; T=0.K
Neutron emission for (n,3n)

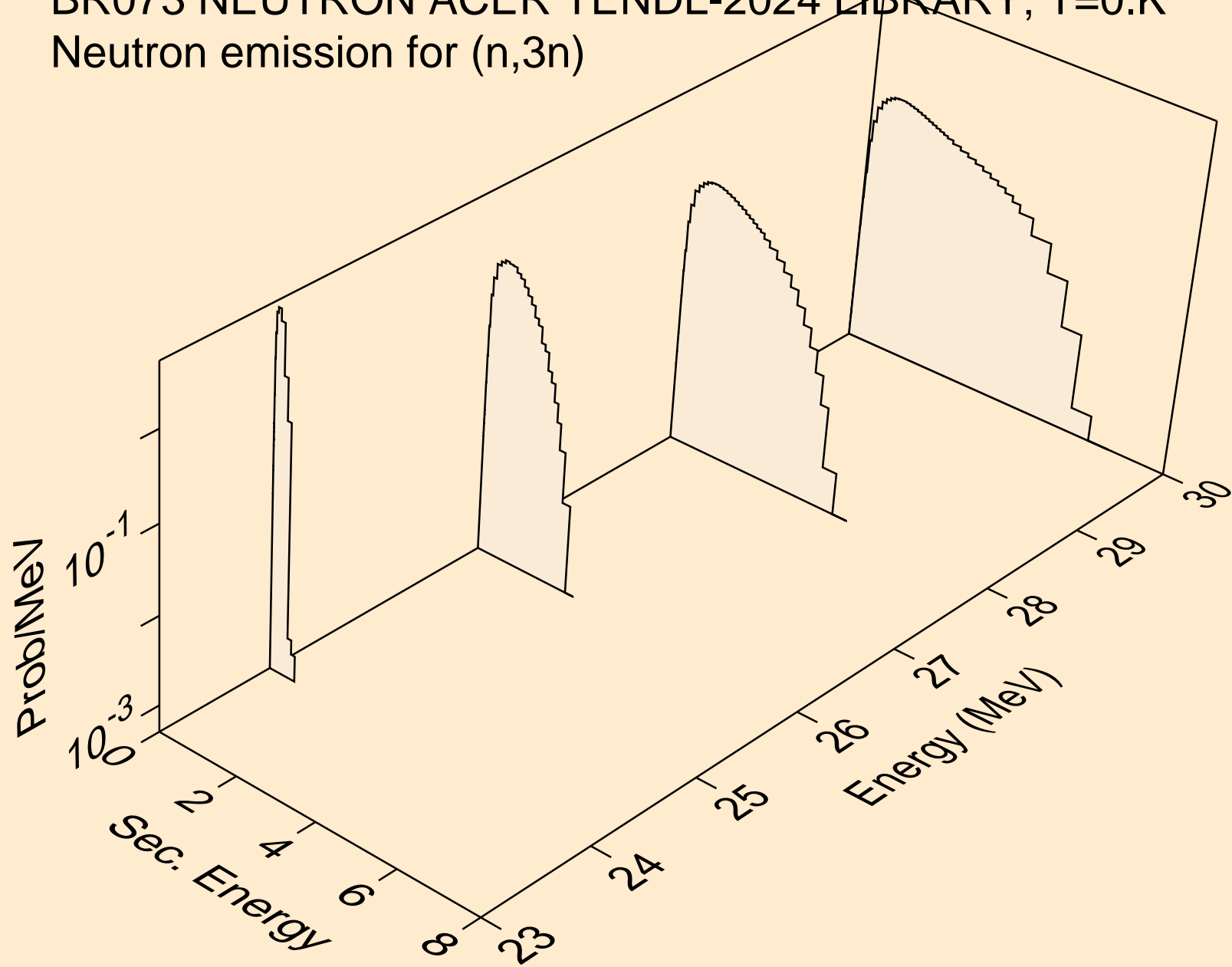

BR073 NEUTRON ACER TENDL-2024 LIBRARY; T=0.K
Neutron emission for (n,n*)a

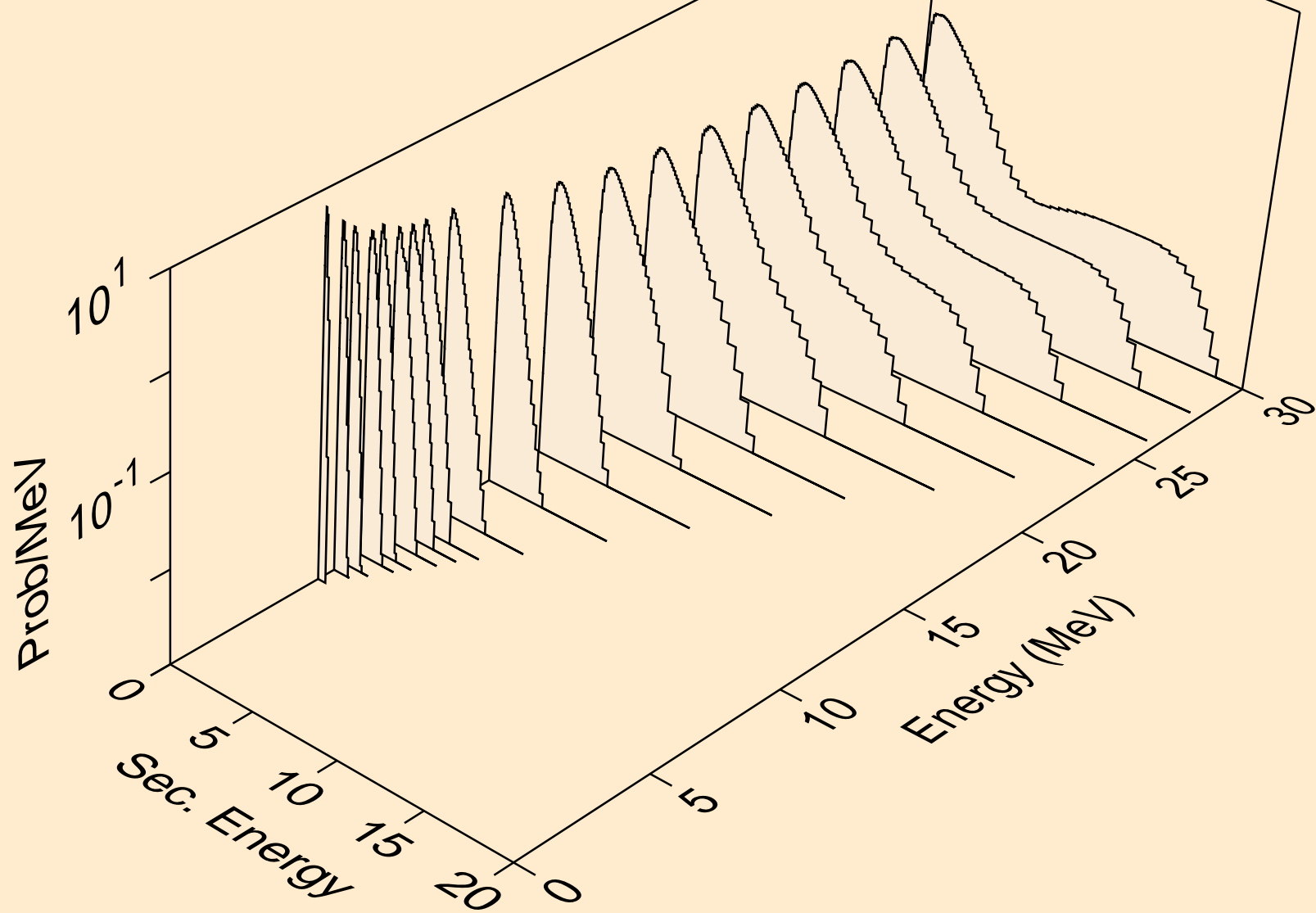

BR073 NEUTRON ACER TENDL-2024 LIBRARY; T=0.K
Neutron emission for (n,2n)a

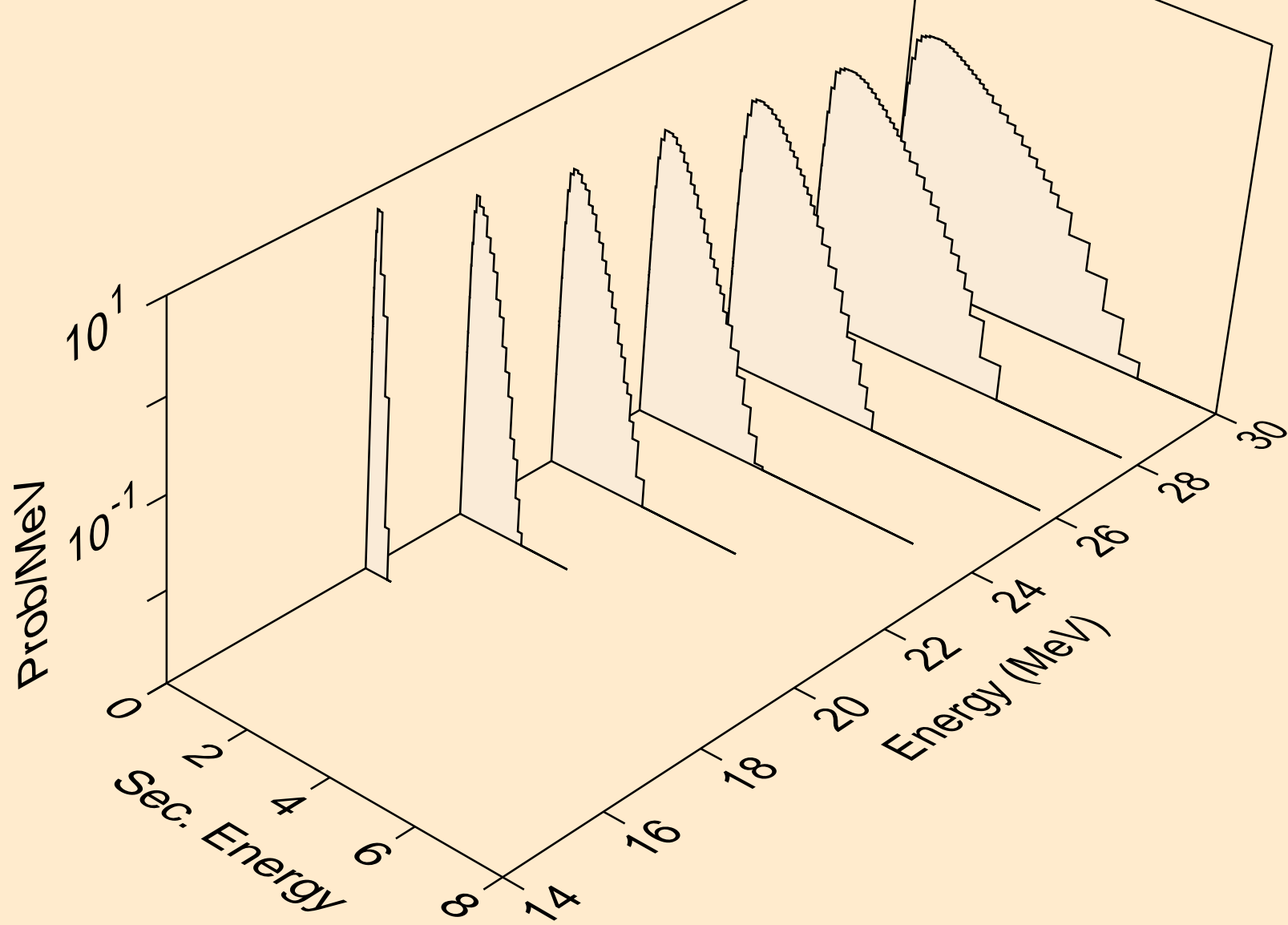

BR073 NEUTRON ACER TENDL-2024 LIBRARY; T=0.K
Neutron emission for (n,n*)p

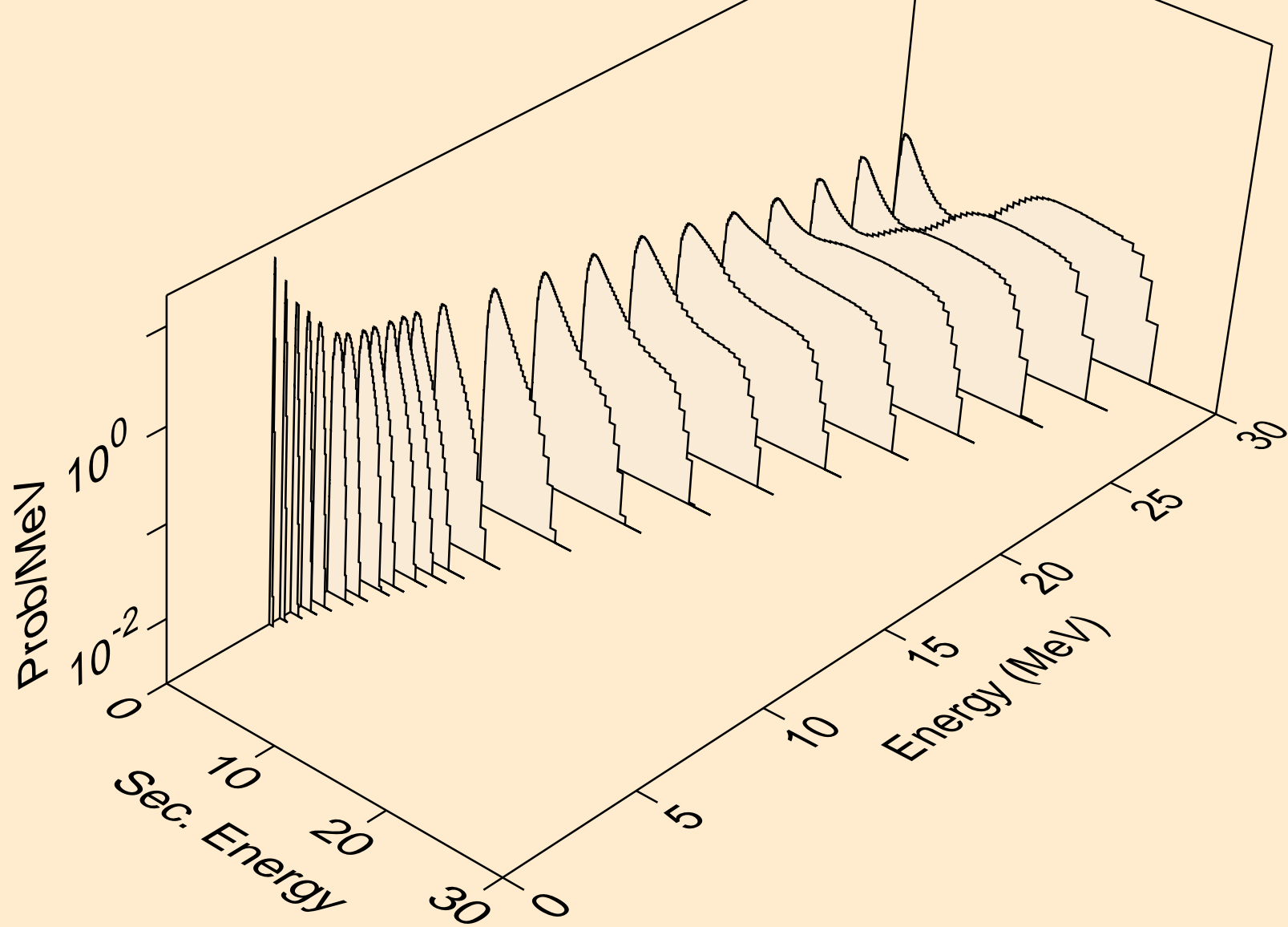

BR073 NEUTRON ACER TENDL-2024 LIBRARY; T=0.K
Neutron emission for (n,n*)2a

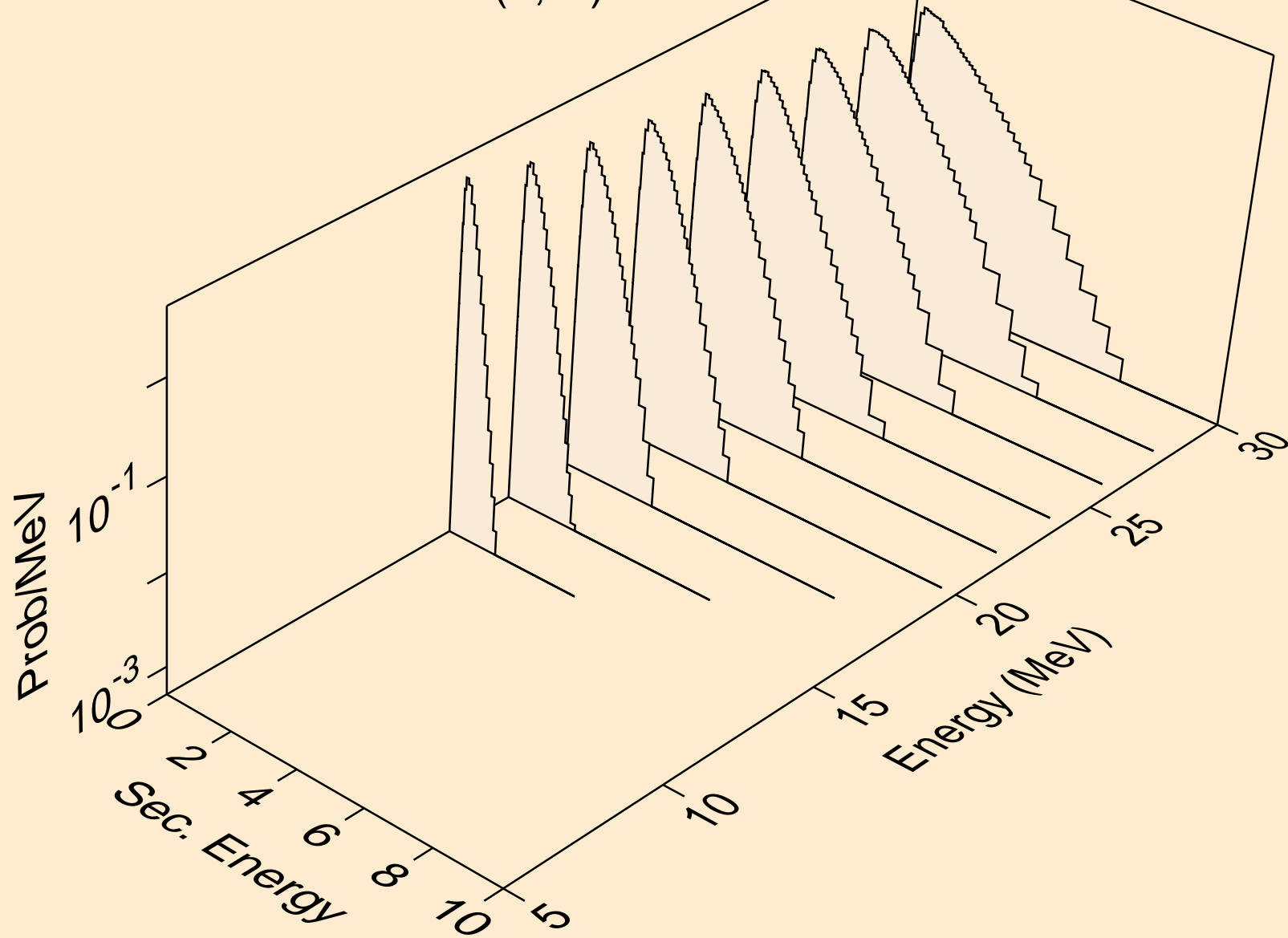

BR073 NEUTRON ACER TENDL-2024 LIBRARY; T=0.K
Neutron emission for (n,n*)d

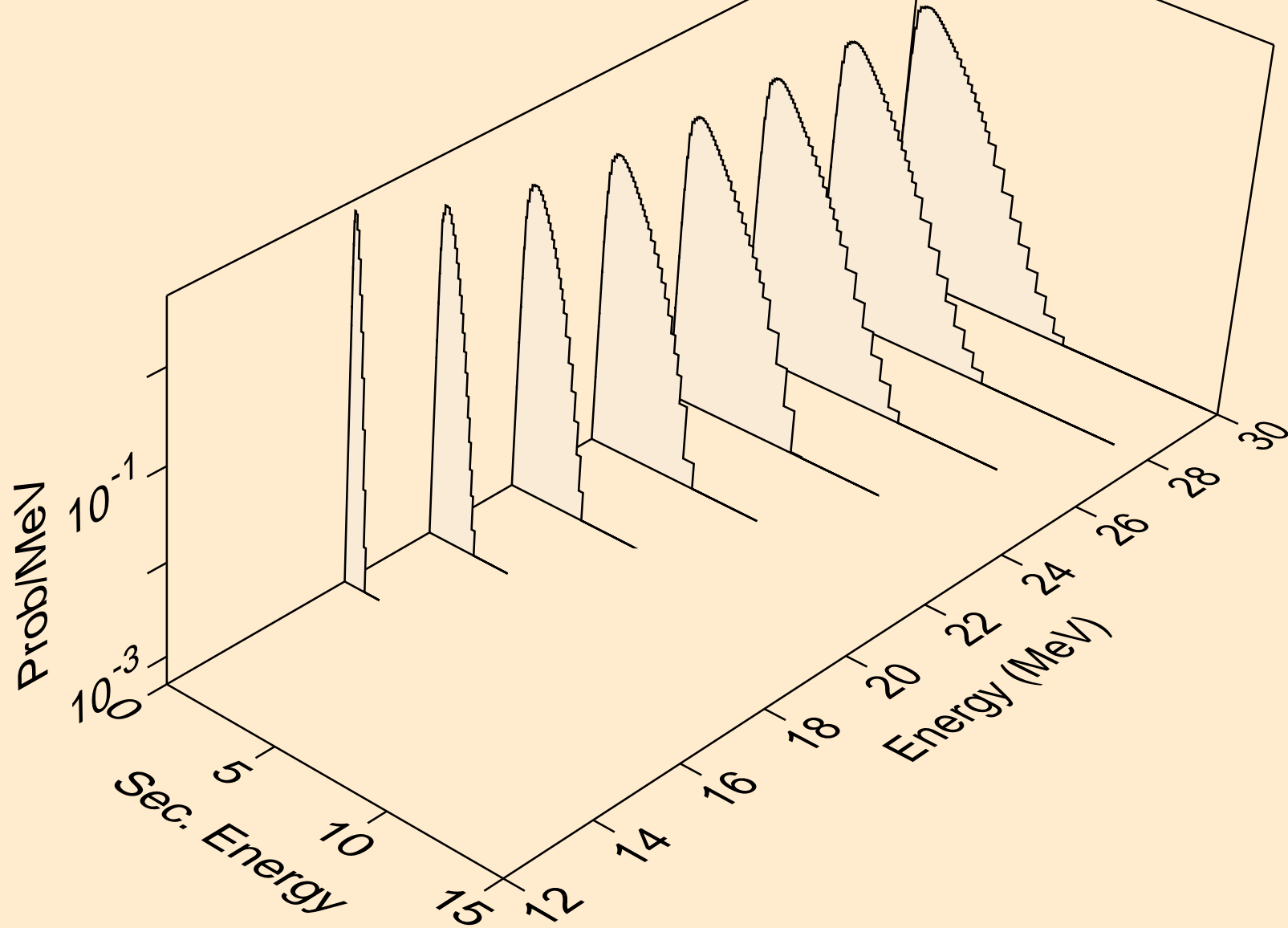

BR073 NEUTRON ACER TENDL-2024 LIBRARY; T=0.K
Neutron emission for (n,n*)t

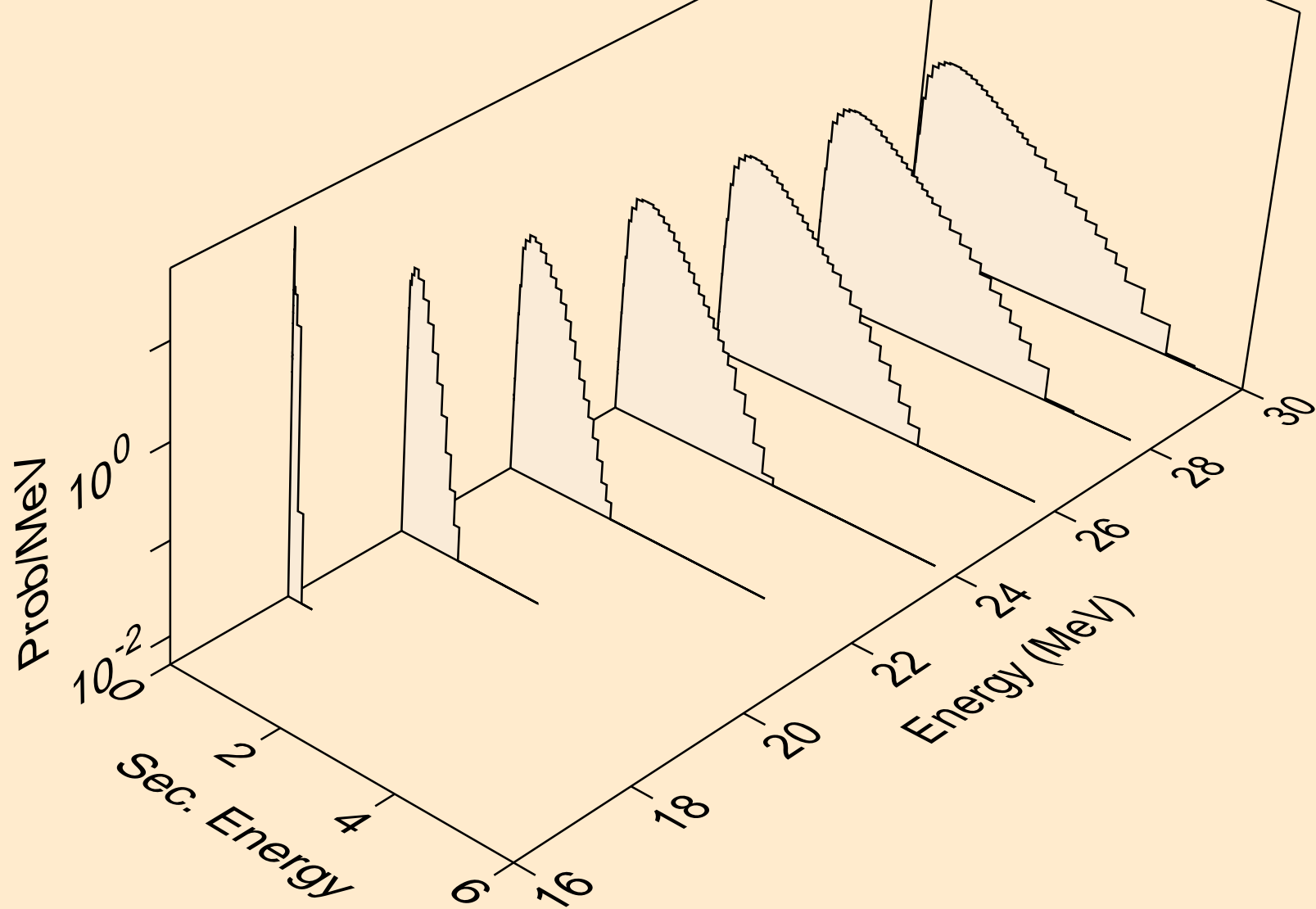

BR073 NEUTRON ACER TENDL-2024 LIBRARY; T=0.K
Neutron emission for (n,n*)he3

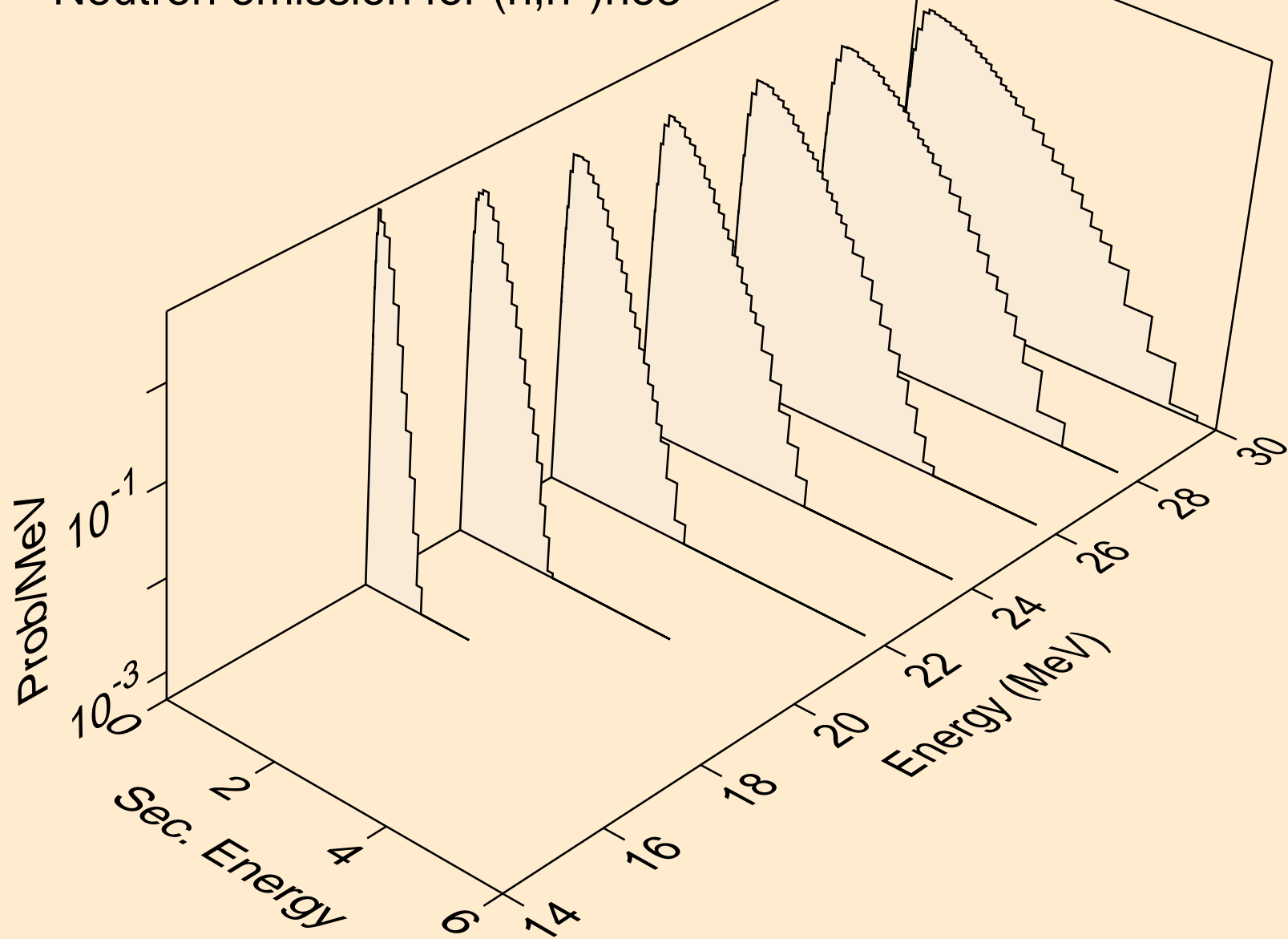

BR073 NEUTRON ACER TENDL-2024 LIBRARY; T=0.K
Neutron emission for (n,2np)

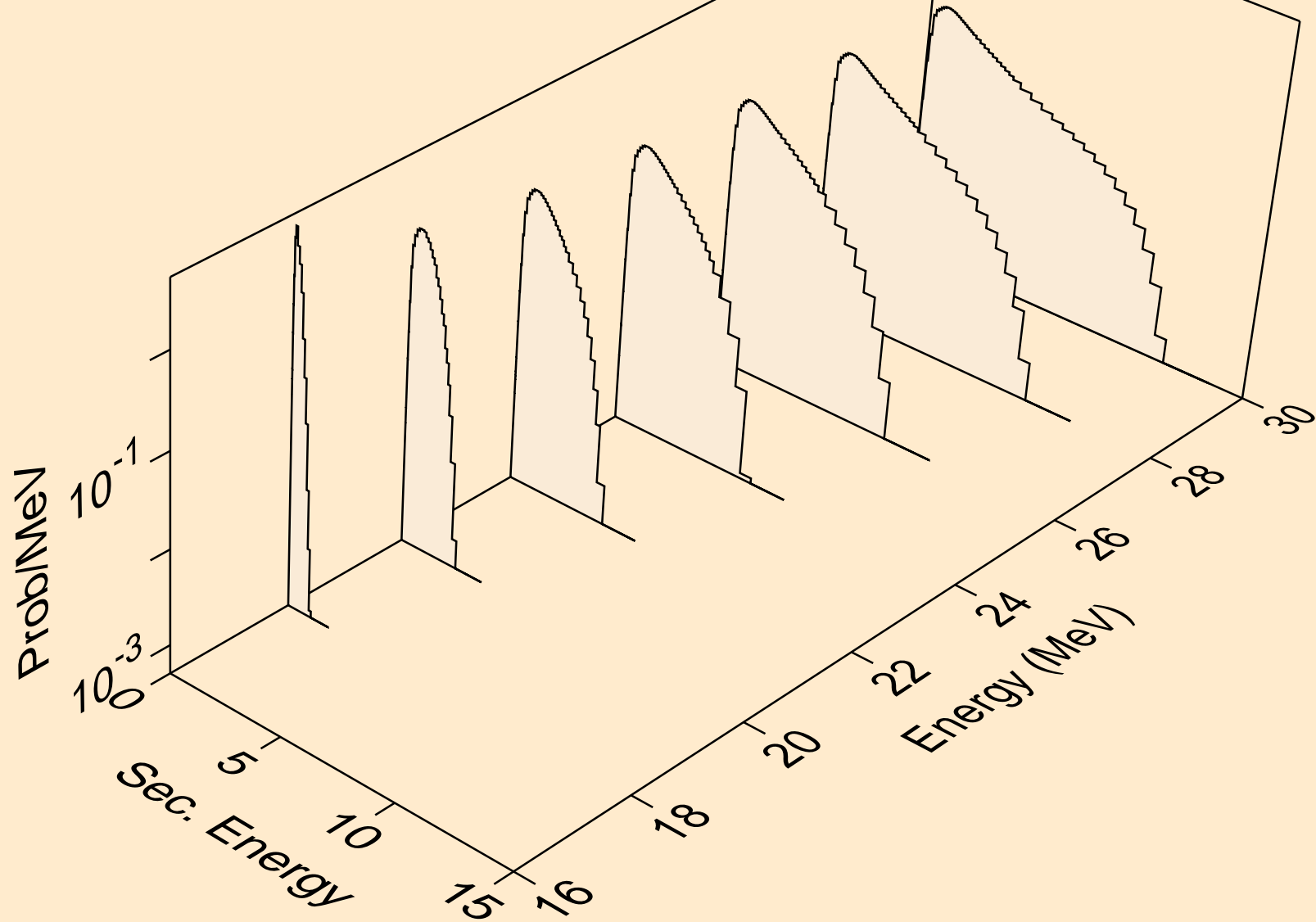

BR073 NEUTRON ACER TENDL-2024 LIBRARY; T=0.K
Neutron emission for (n,3np)

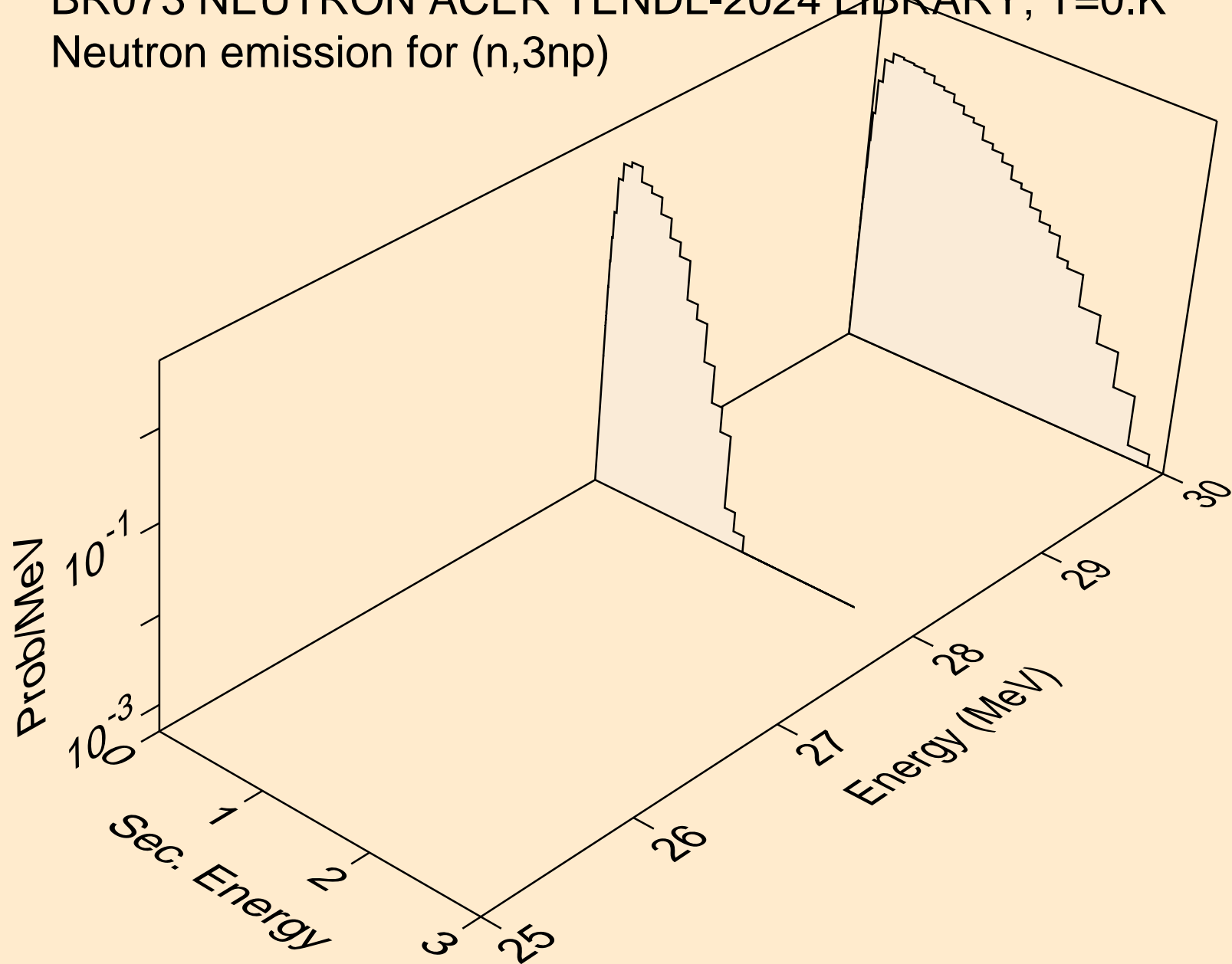

BR073 NEUTRON ACER TENDL-2024 LIBRARY; T=0.K
Neutron emission for (n,n2p)

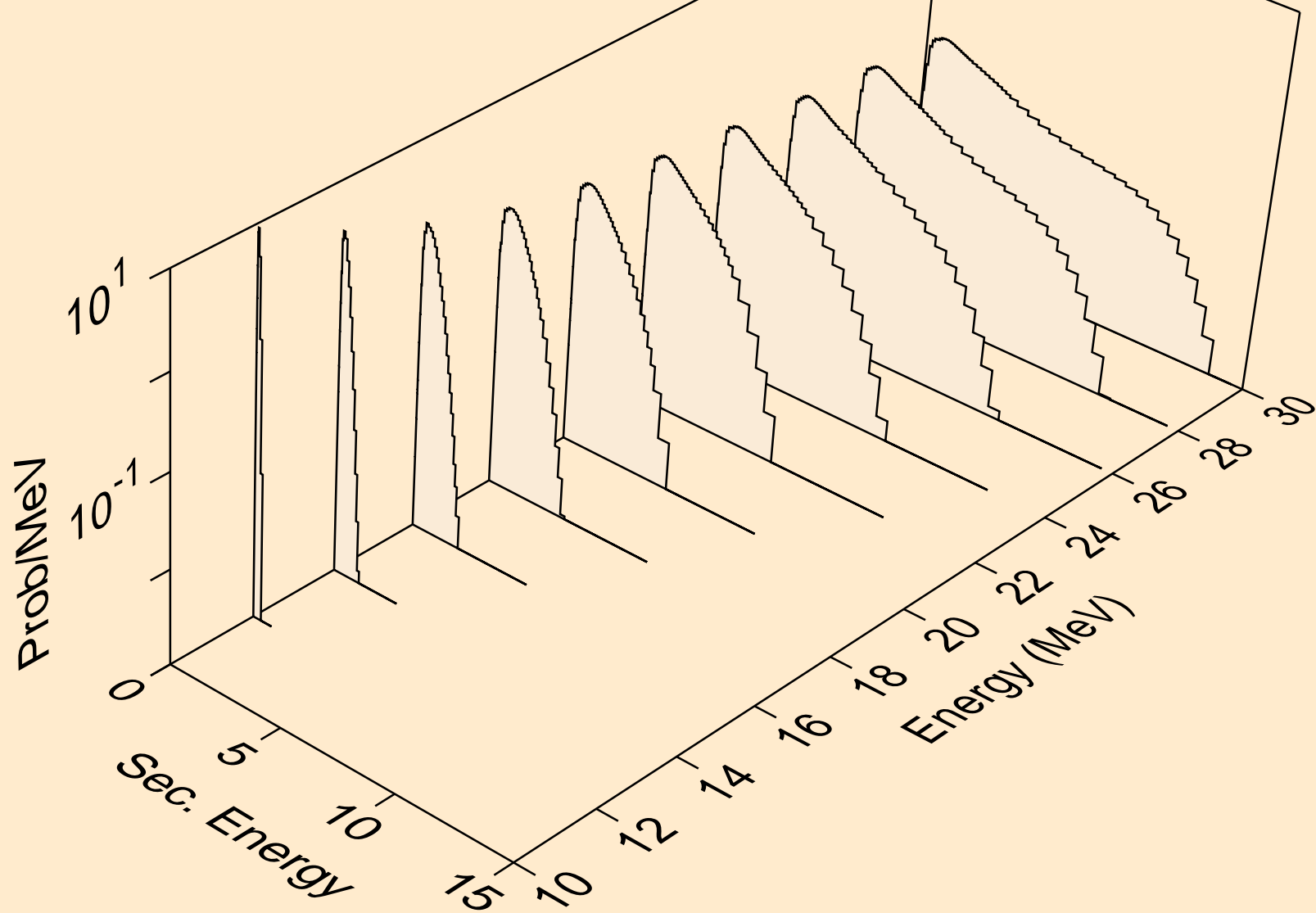

BR073 NEUTRON ACER TENDL-2024 LIBRARY; T=0.K
Neutron emission for (n,npa)

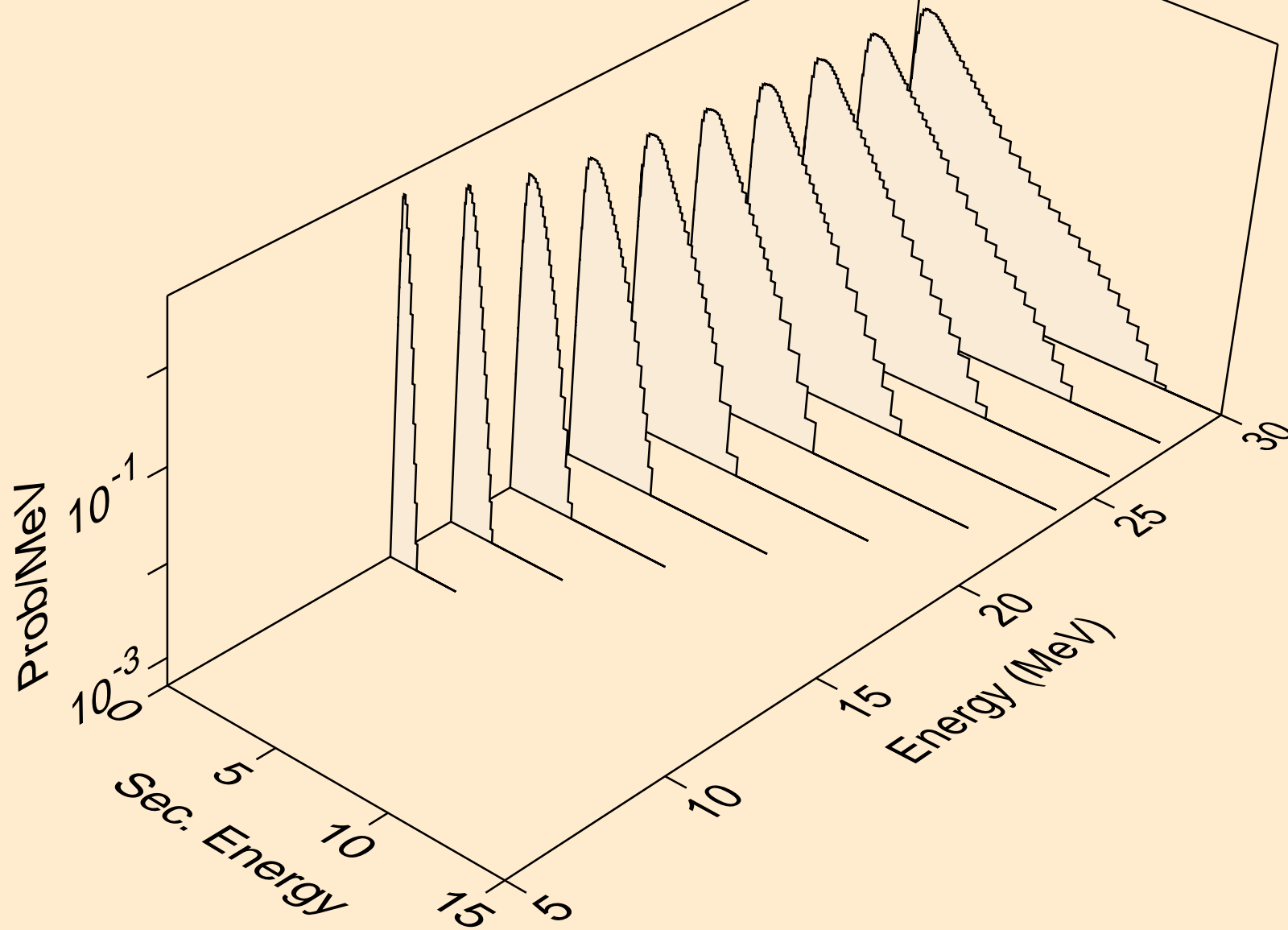

BR073 NEUTRON ACER TENDL-2024 LIBRARY; T=0.K
Neutron emission for (n,n*c)

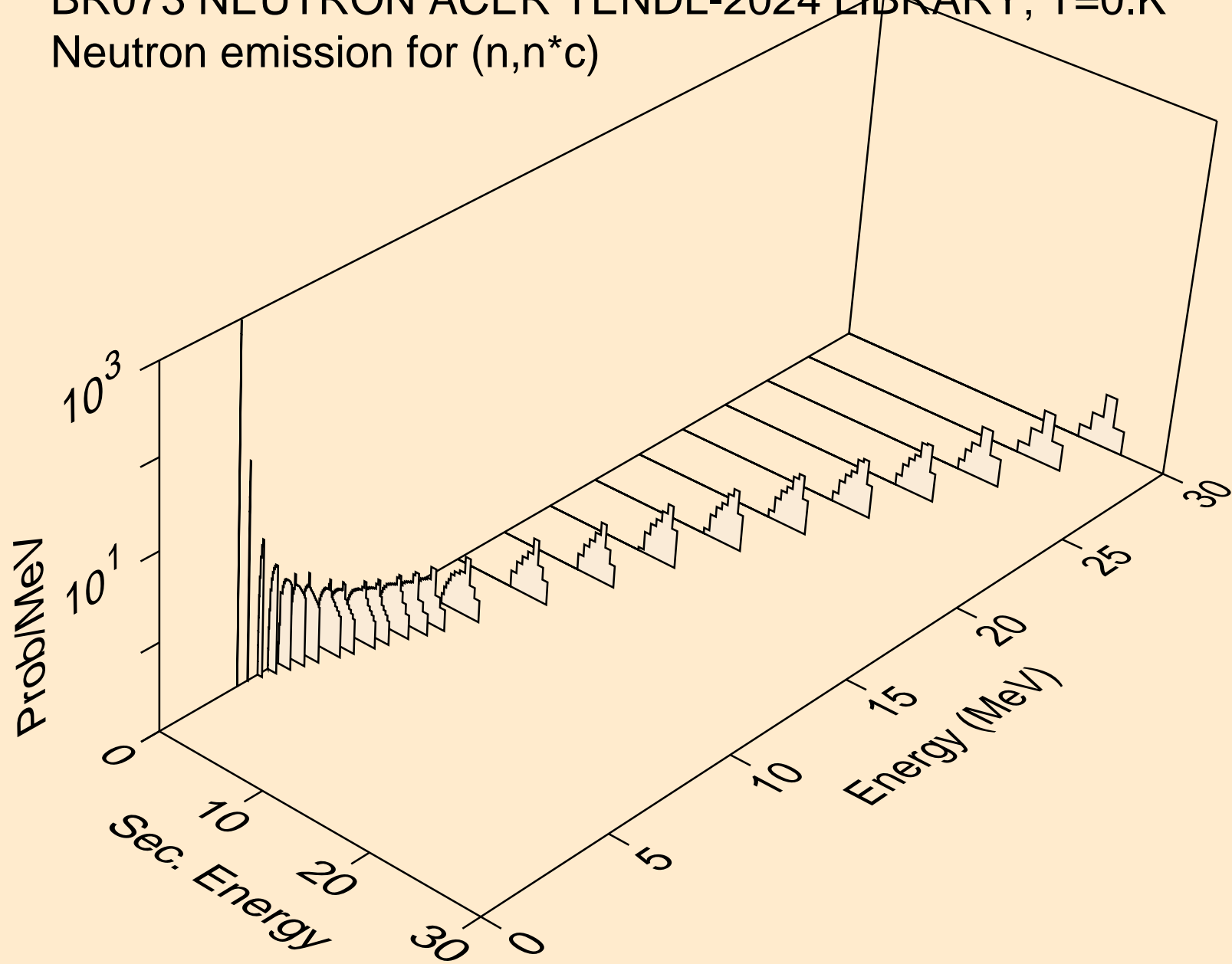

BR073 NEUTRON ACER TENDL-2024 LIBRARY; T=0.K
Photon emission for (n,x)

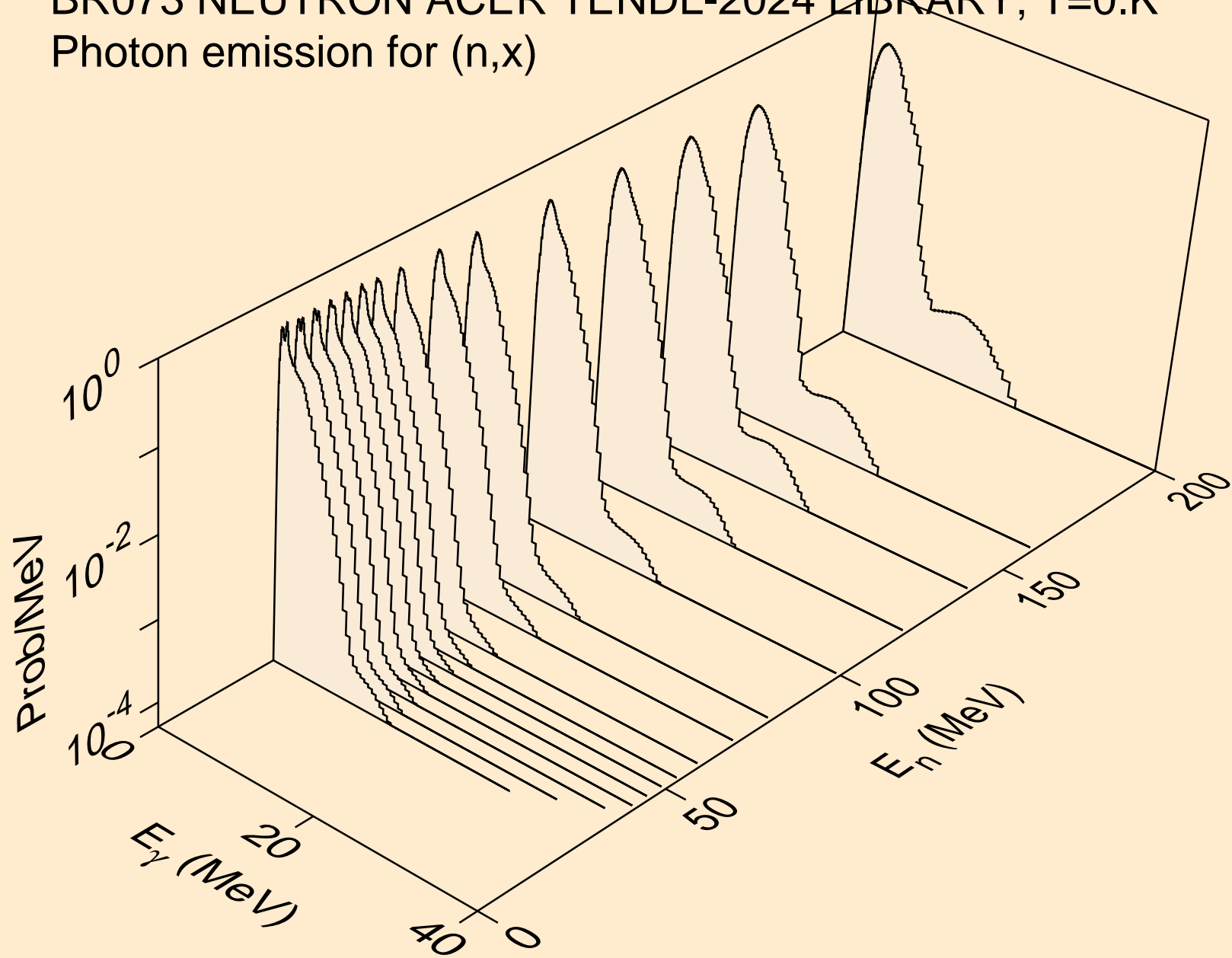

BR073 NEUTRON ACER TENDL-2024 LIBRARY; T=0.K
Photon emission for (n,2nd)

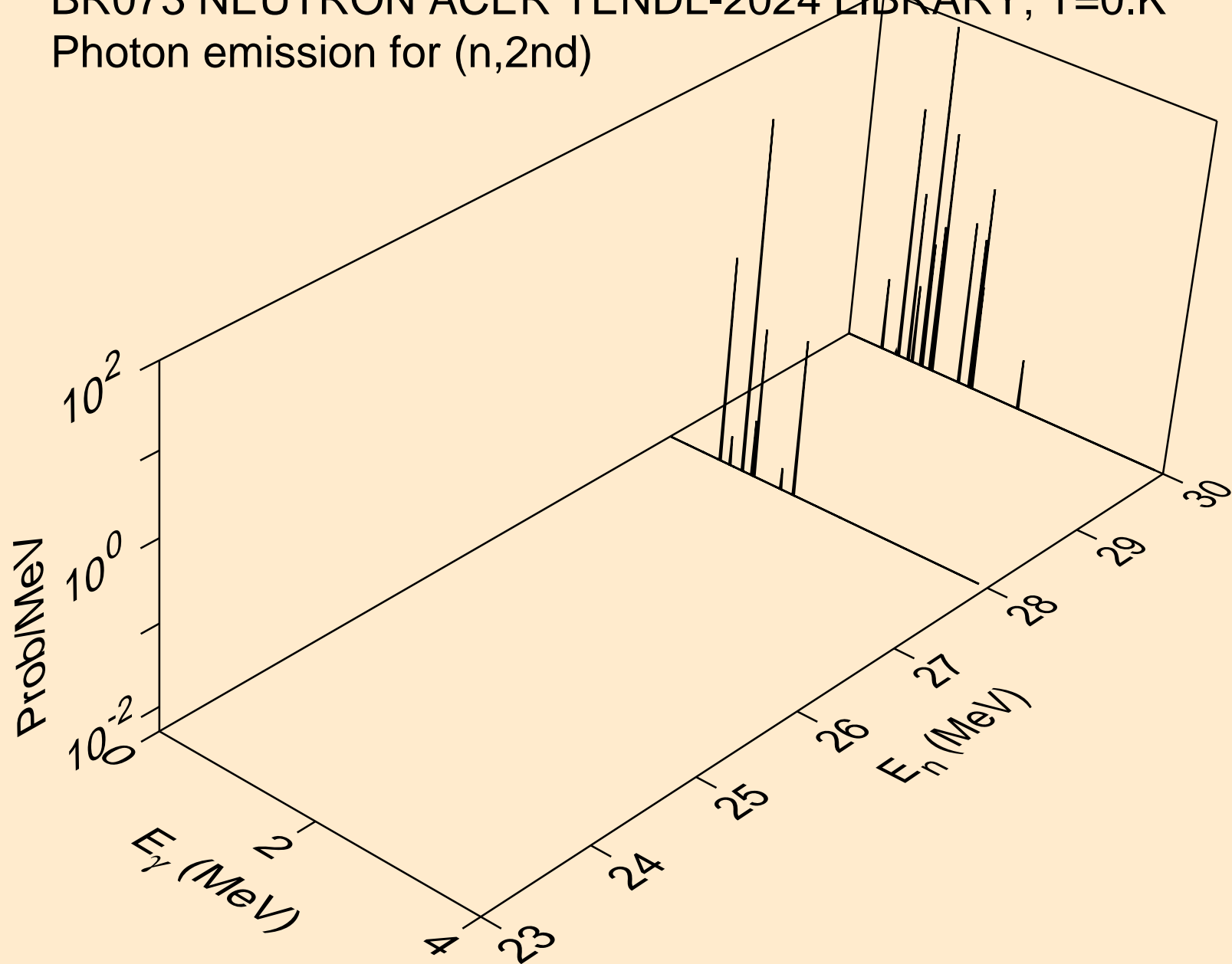

BR073 NEUTRON ACER TENDL-2024 LIBRARY; T=0.K
Photon emission for (n,2n)

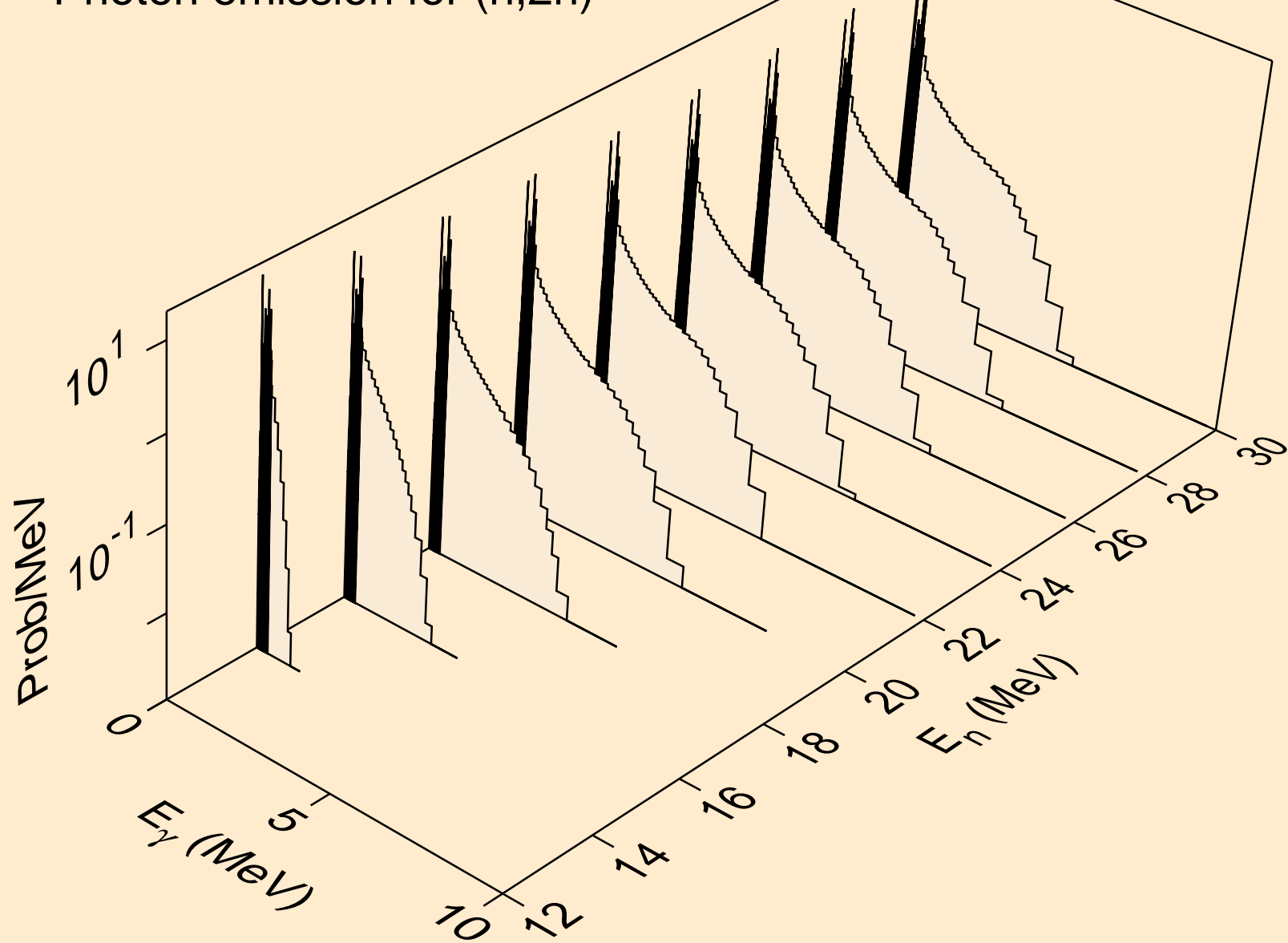

BR073 NEUTRON ACER TENDL-2024 LIBRARY; T=0.K
Photon emission for (n,3n)

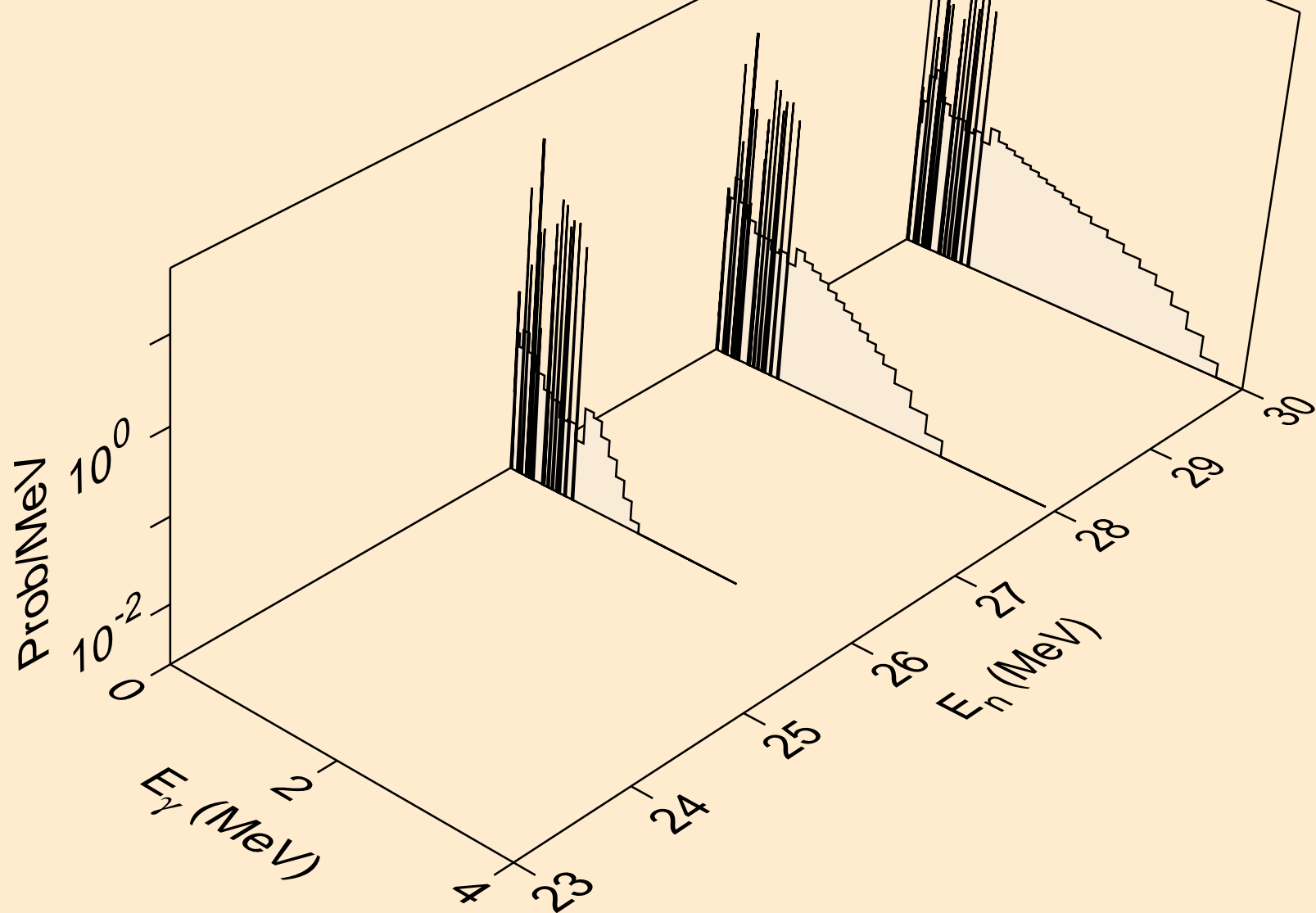

BR073 NEUTRON ACER TENDL-2024 LIBRARY; T=0.K
Photon emission for (n,n*)a

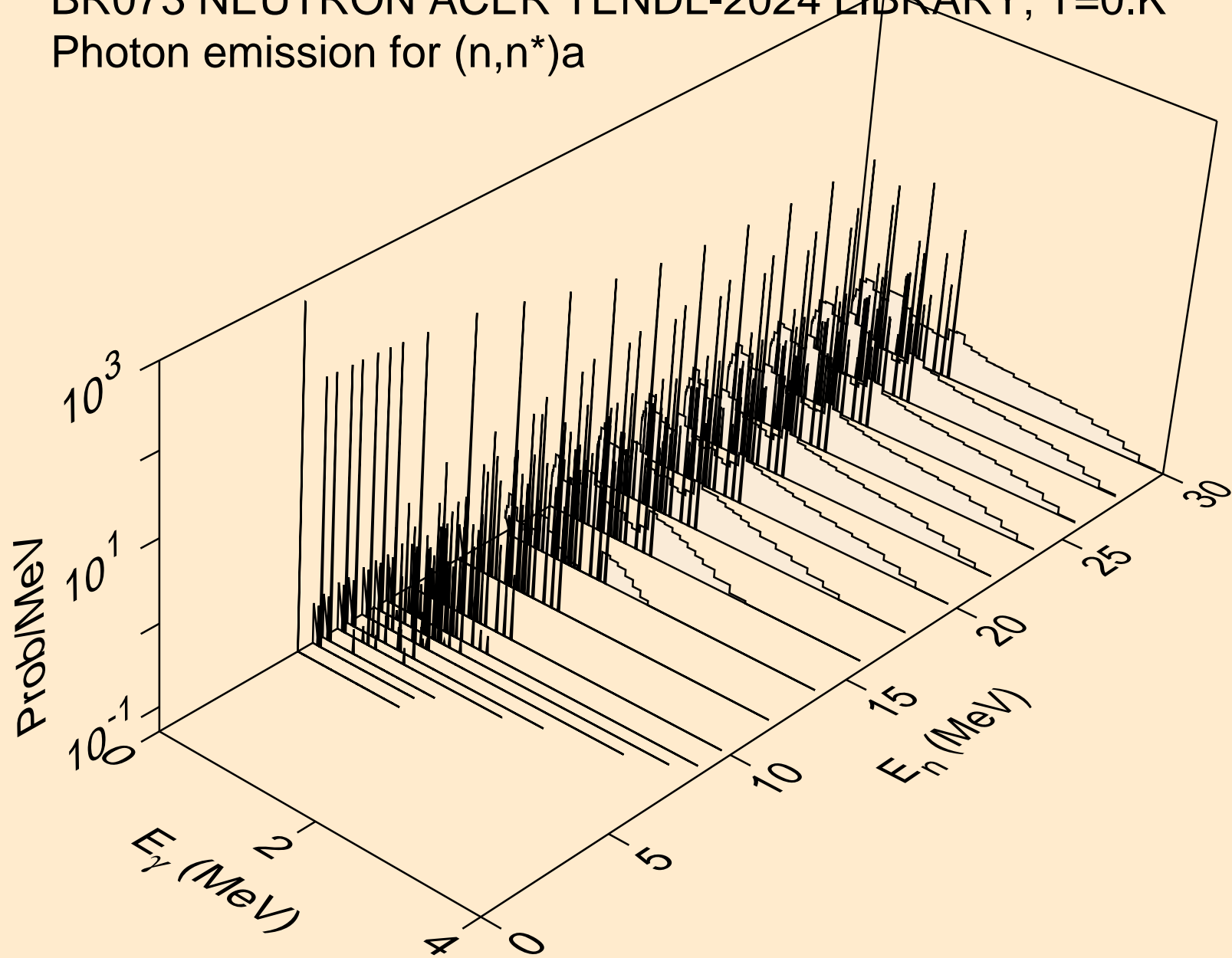

BR073 NEUTRON ACER TENDL-2024 LIBRARY; T=0.K
Photon emission for (n,2n)a

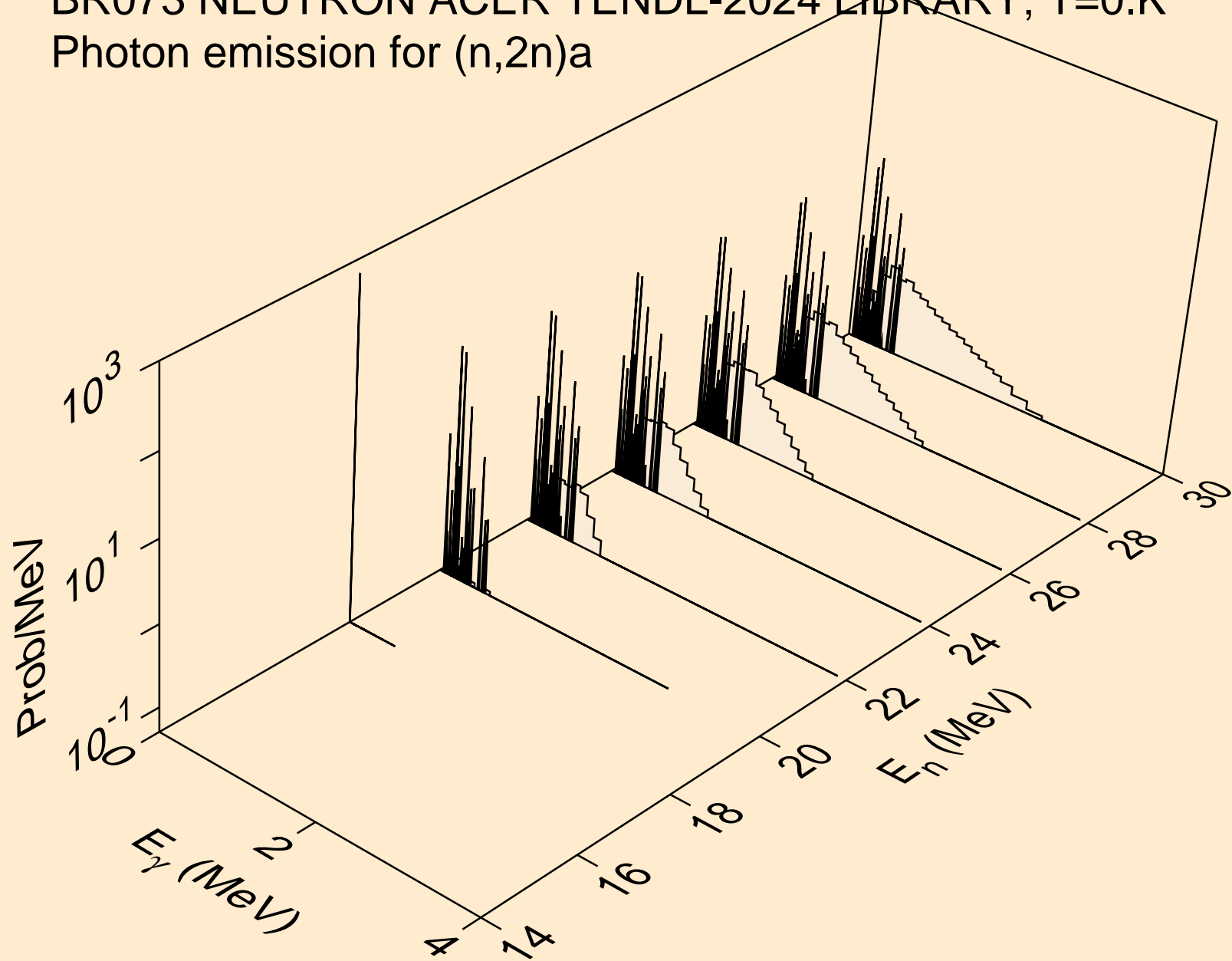

BR073 NEUTRON ACER TENDL-2024 LIBRARY; T=0.K
Photon emission for (n,n*)p

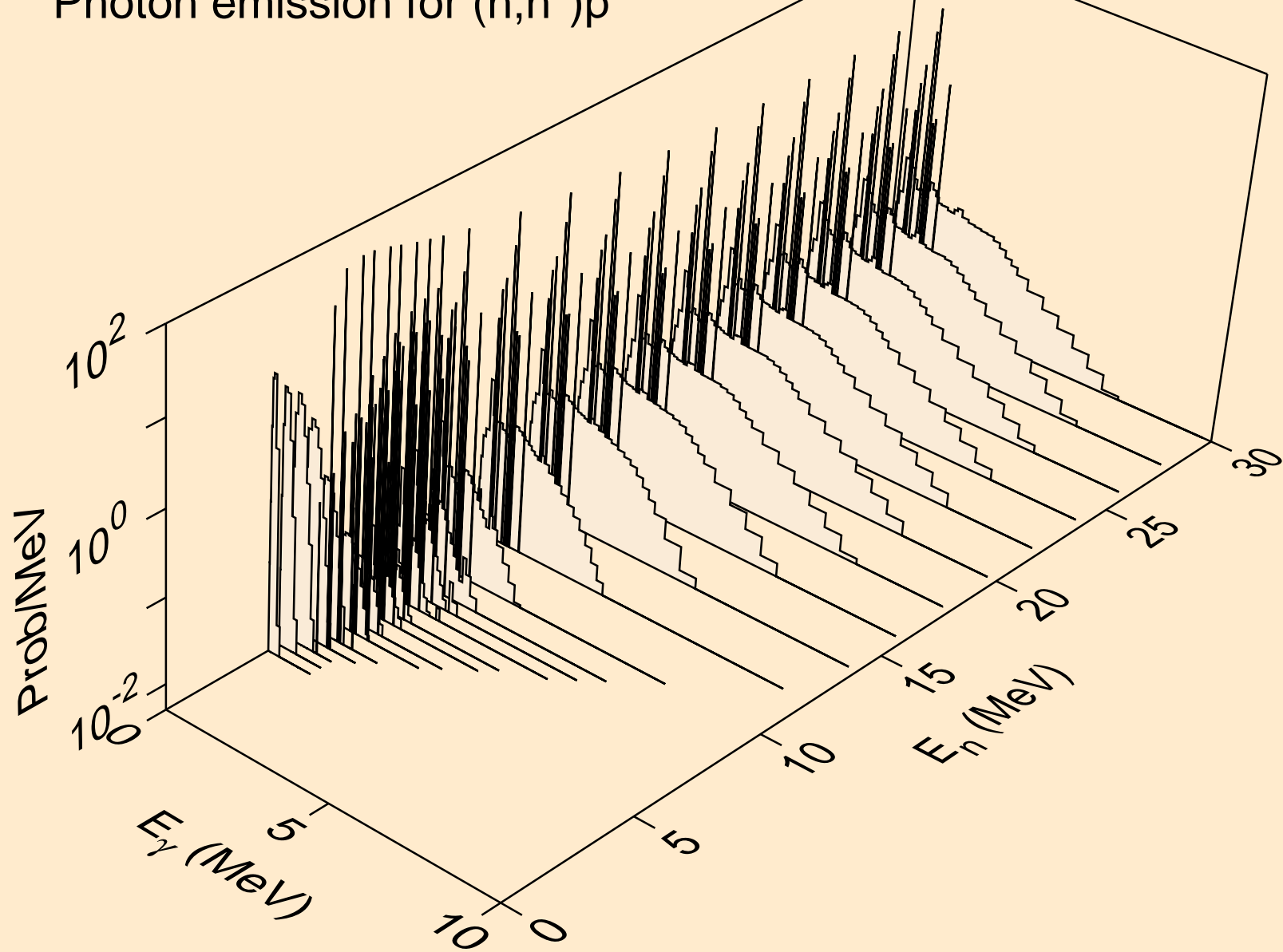

BR073 NEUTRON ACER TENDL-2024 LIBRARY; T=0.K
Photon emission for (n,n*)2a

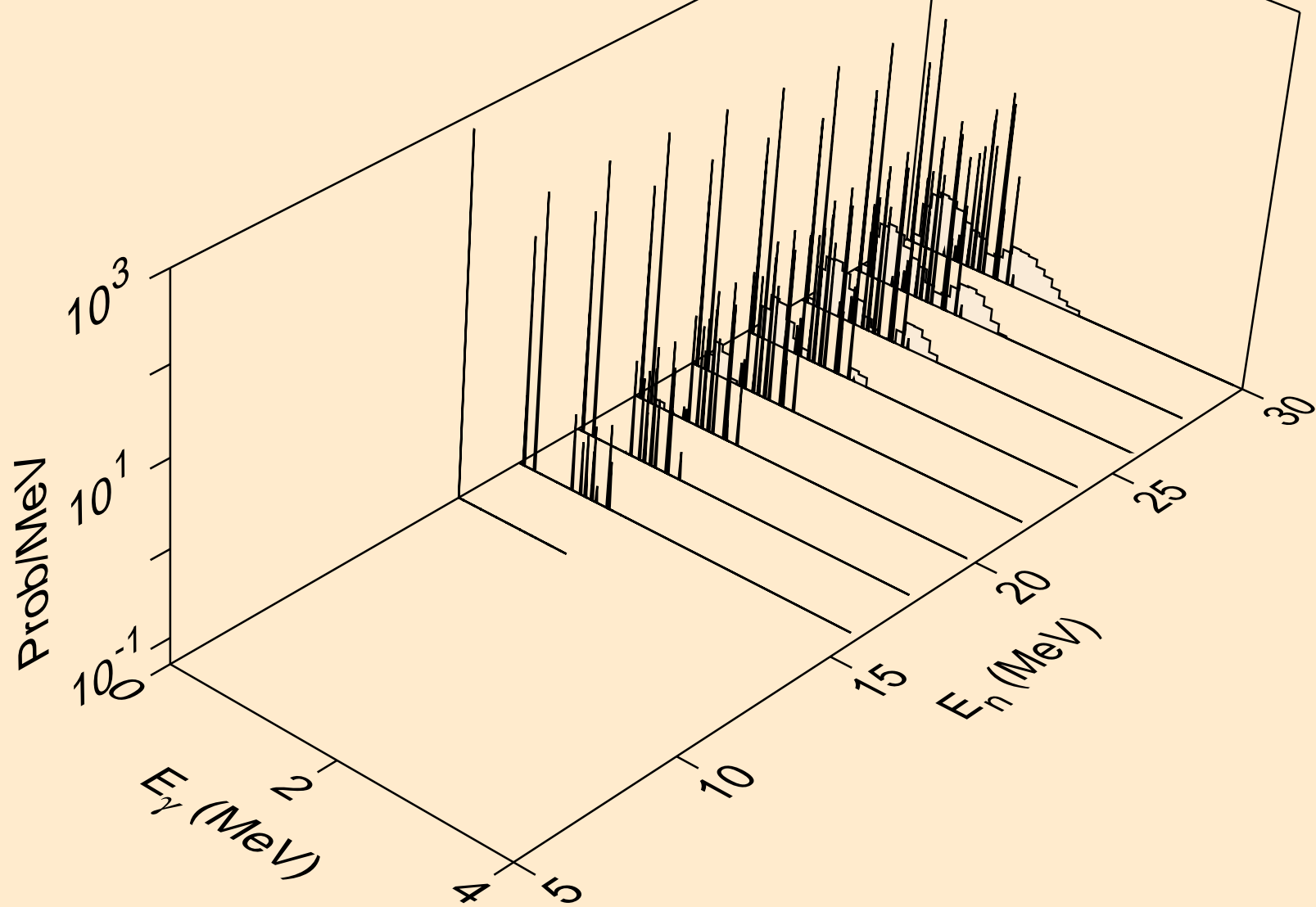

BR073 NEUTRON ACER TENDL-2024 LIBRARY; T=0.K
Photon emission for (n,n*)d

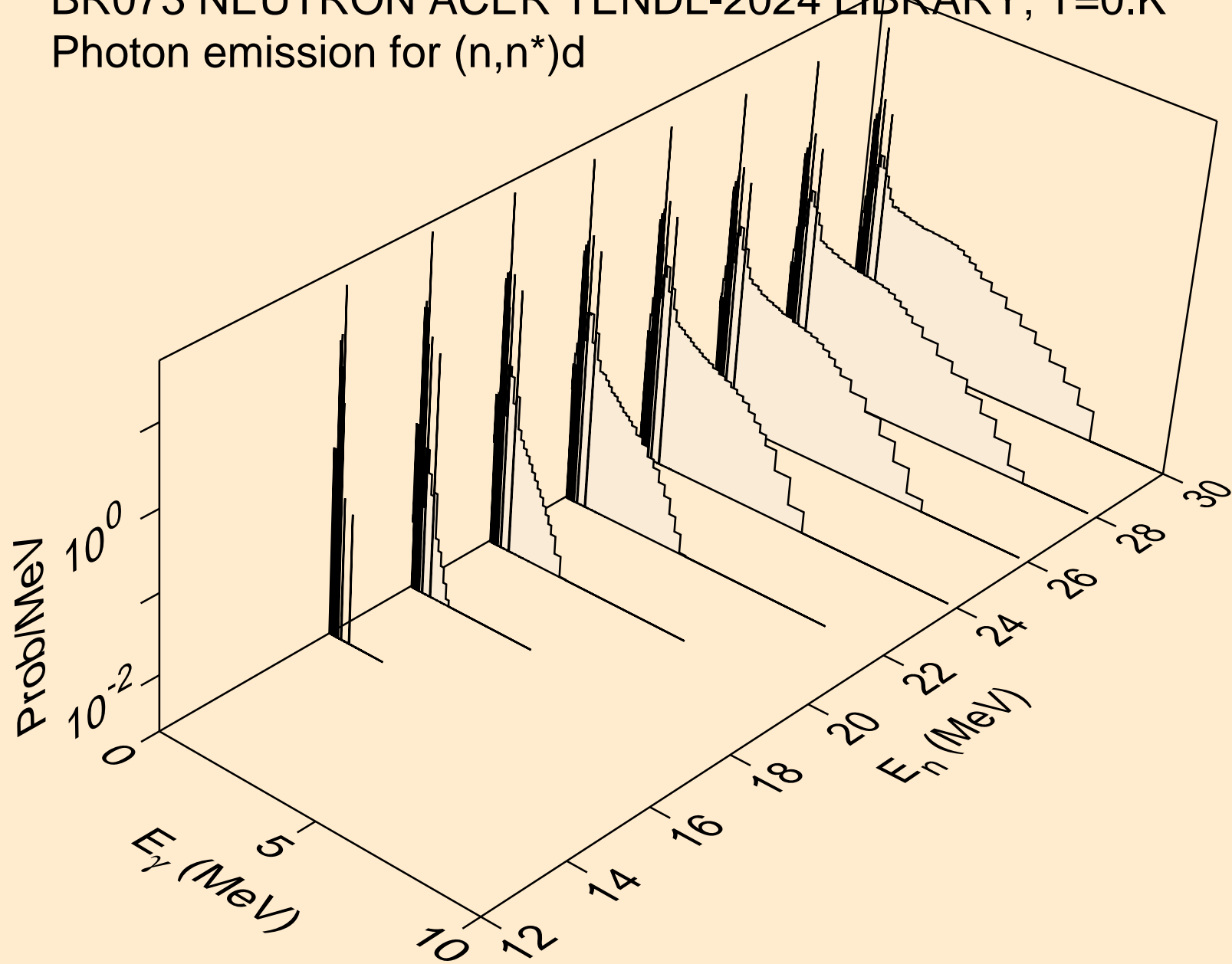

BR073 NEUTRON ACER TENDL-2024 LIBRARY; T=0.K
Photon emission for (n,n*)t

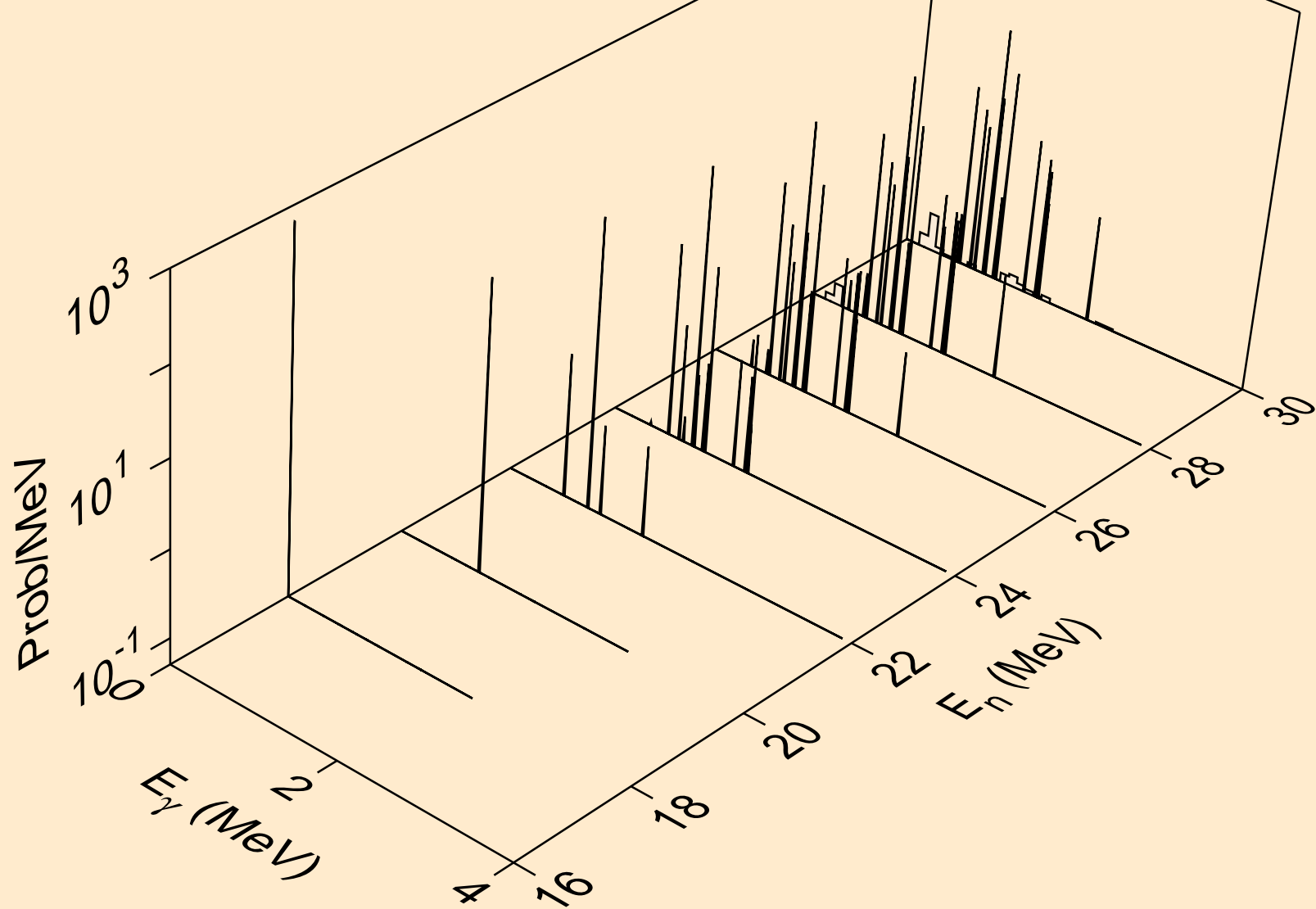

BR073 NEUTRON ACER TENDL-2024 LIBRARY; T=0.K
Photon emission for (n,n*)he3

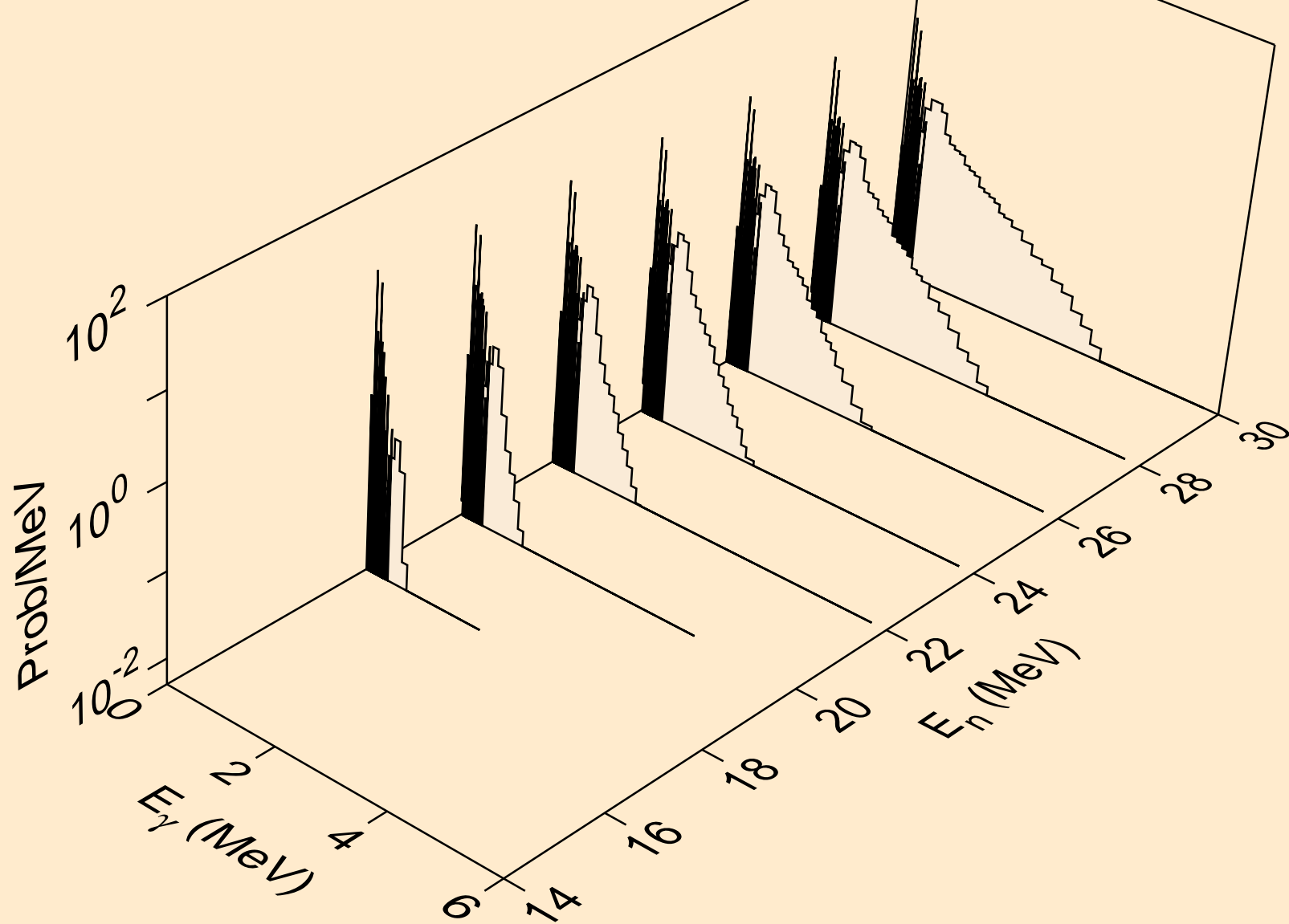

BR073 NEUTRON ACER TENDL-2024 LIBRARY; T=0.K
Photon emission for (n,2np)

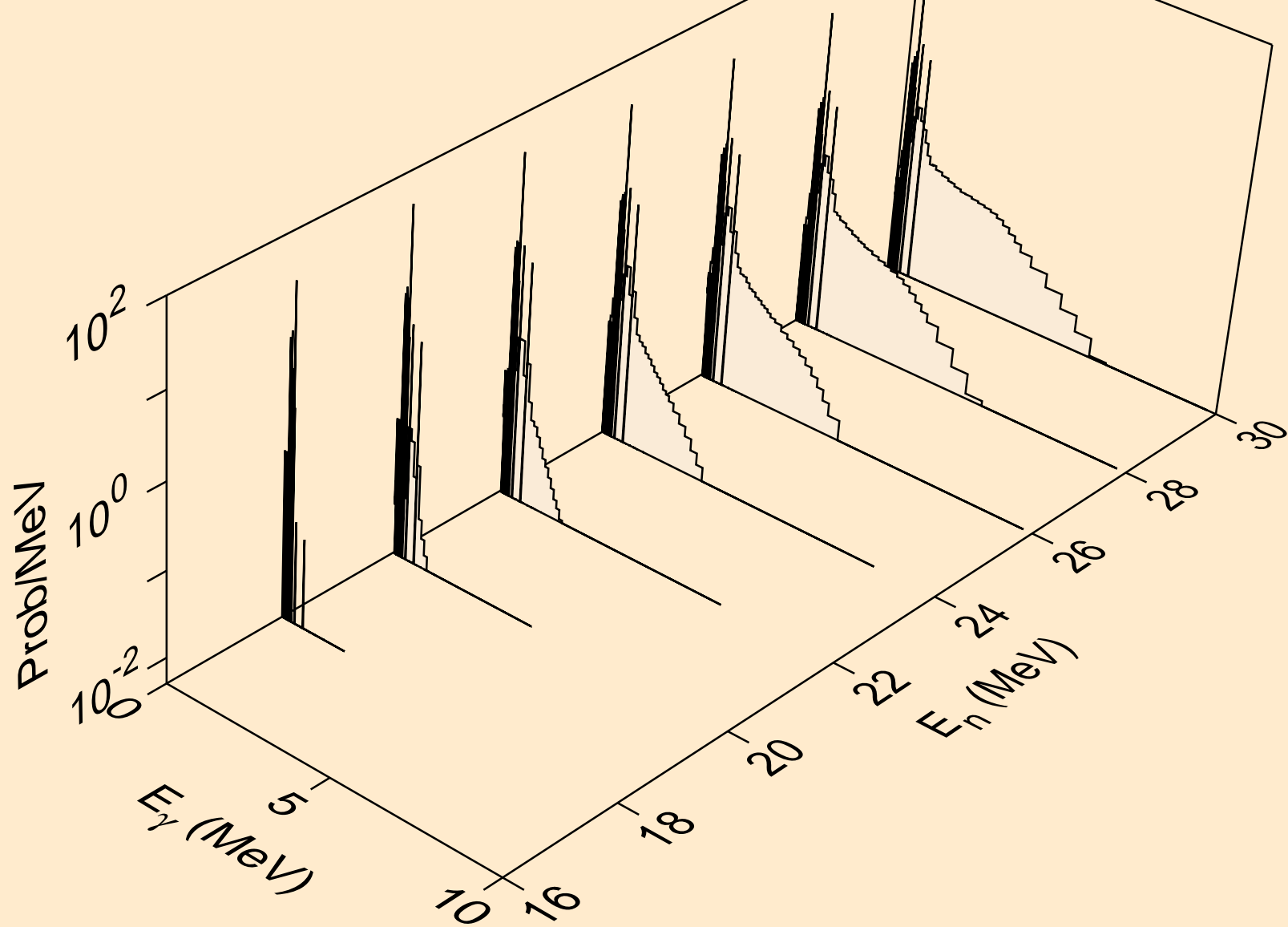

BR073 NEUTRON ACER TENDL-2024 LIBRARY; T=0.K
Photon emission for (n,3np)

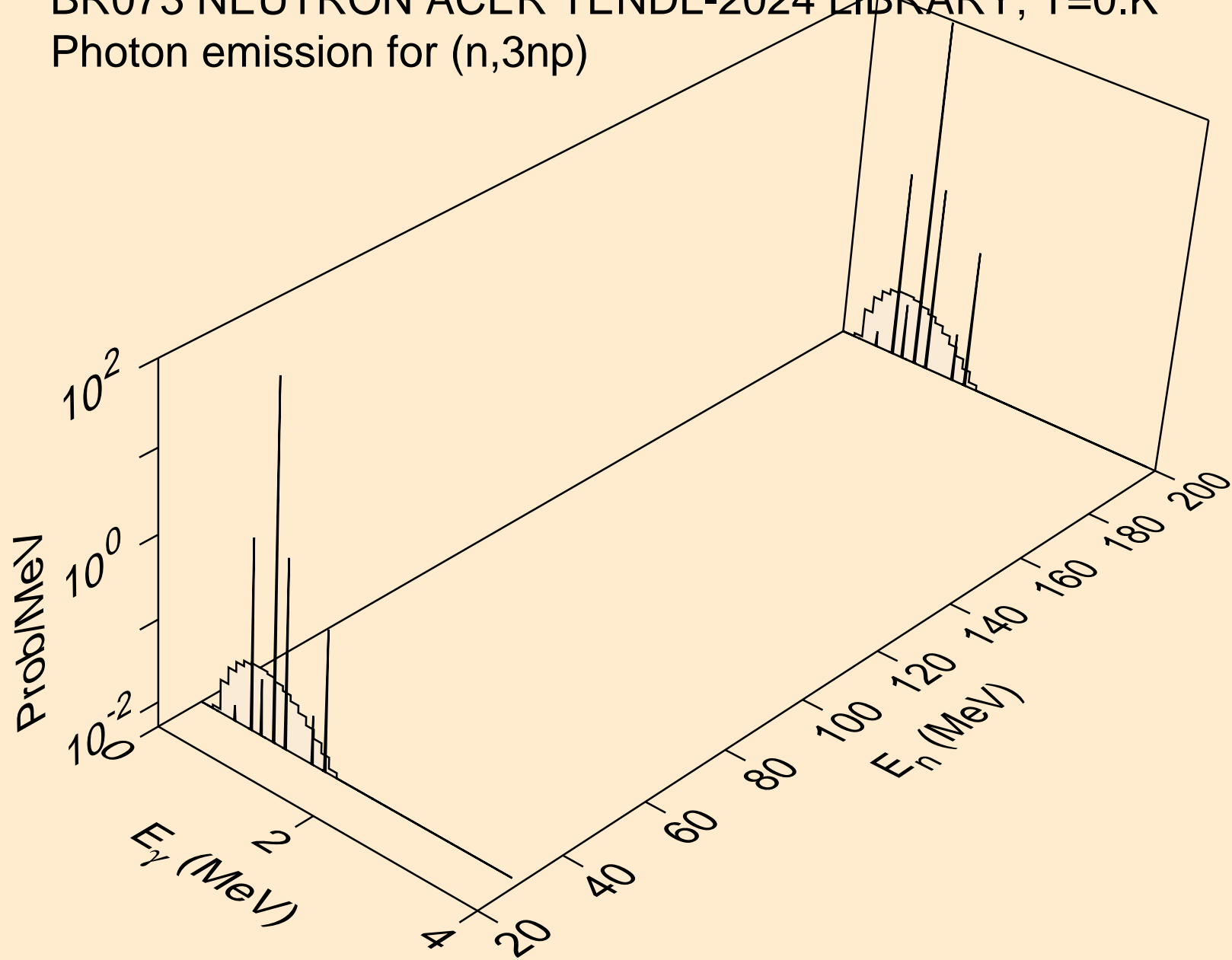

BR073 NEUTRON ACER TENDL-2024 LIBRARY; T=0.K
Photon emission for (n,n2p)

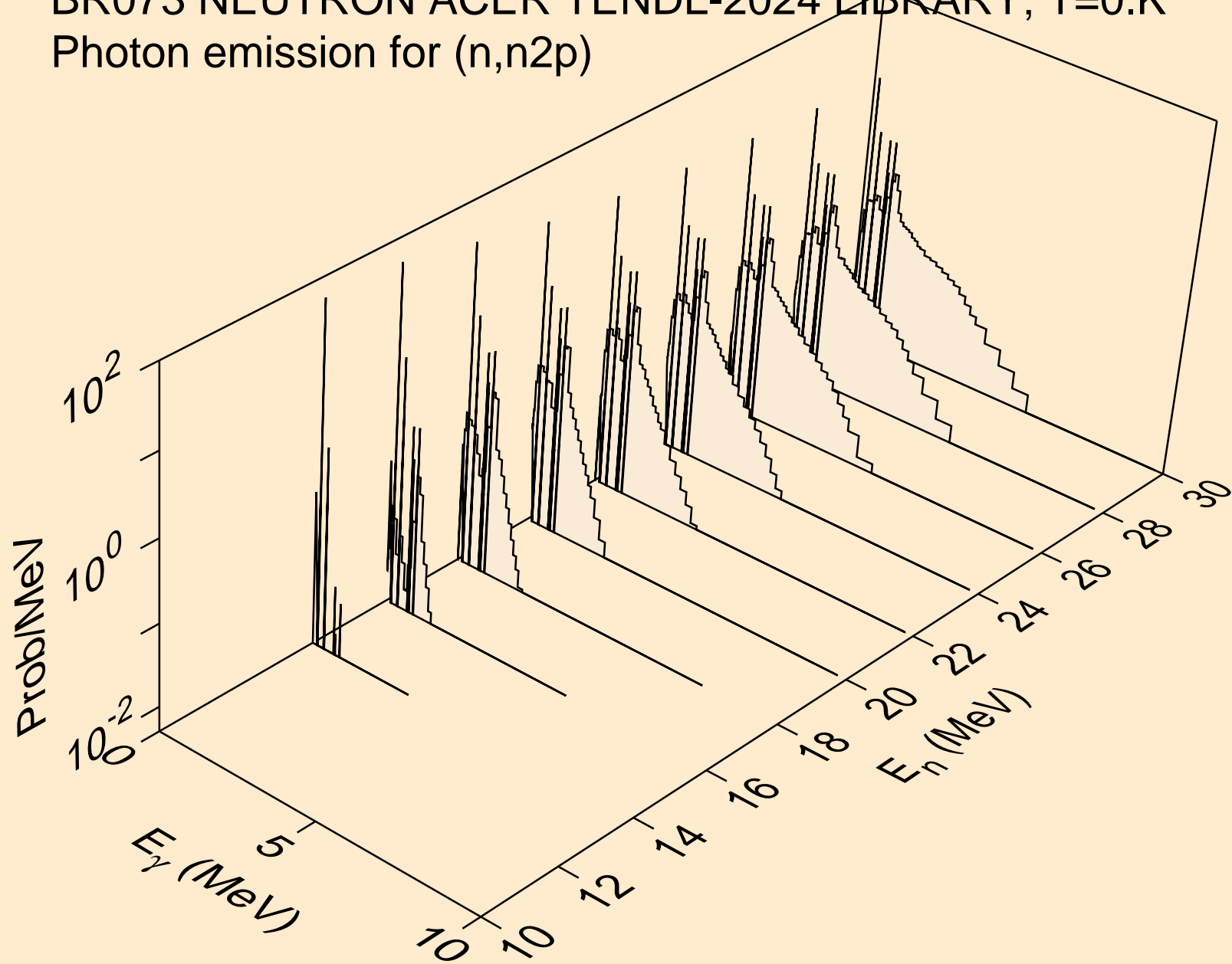

BR073 NEUTRON ACER TENDL-2024 LIBRARY; T=0.K
Photon emission for (n,npa)

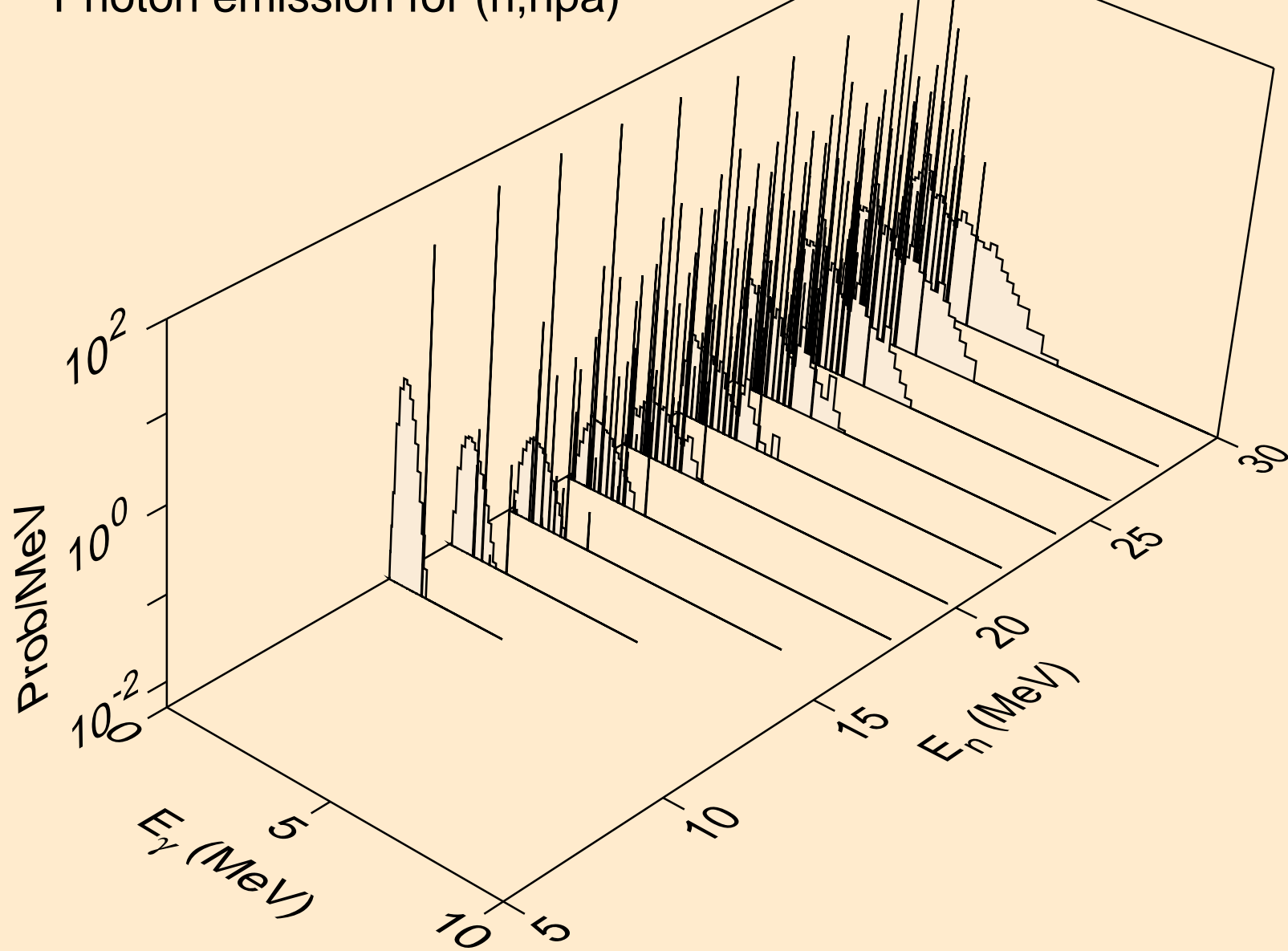

BR073 NEUTRON ACER TENDL-2024 LIBRARY; T=0.K
Photon emission for (n,n*c)

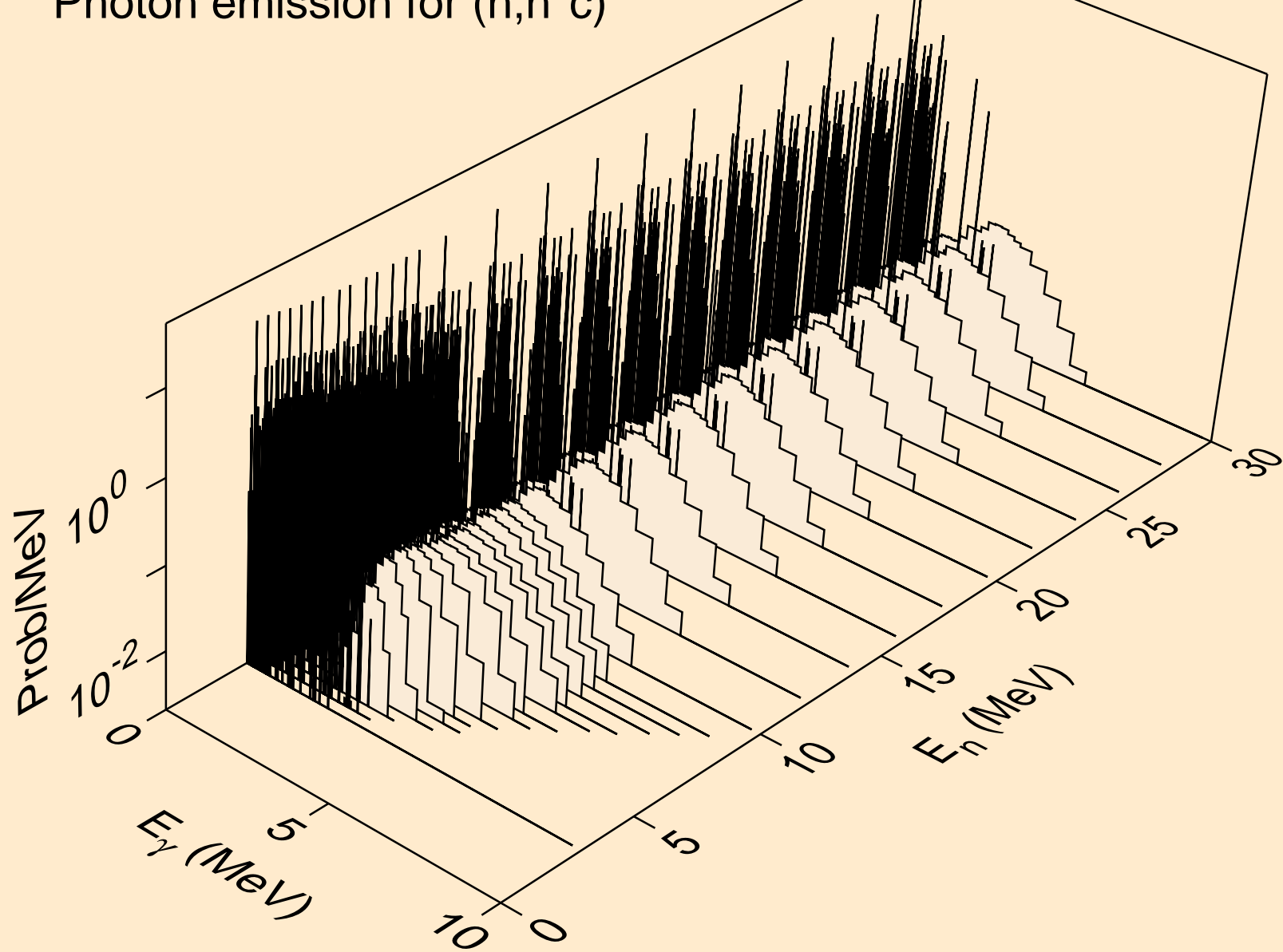

BR073 NEUTRON ACER TENDL-2024 LIBRARY; T=0.K
Photon emission for (n,gma)

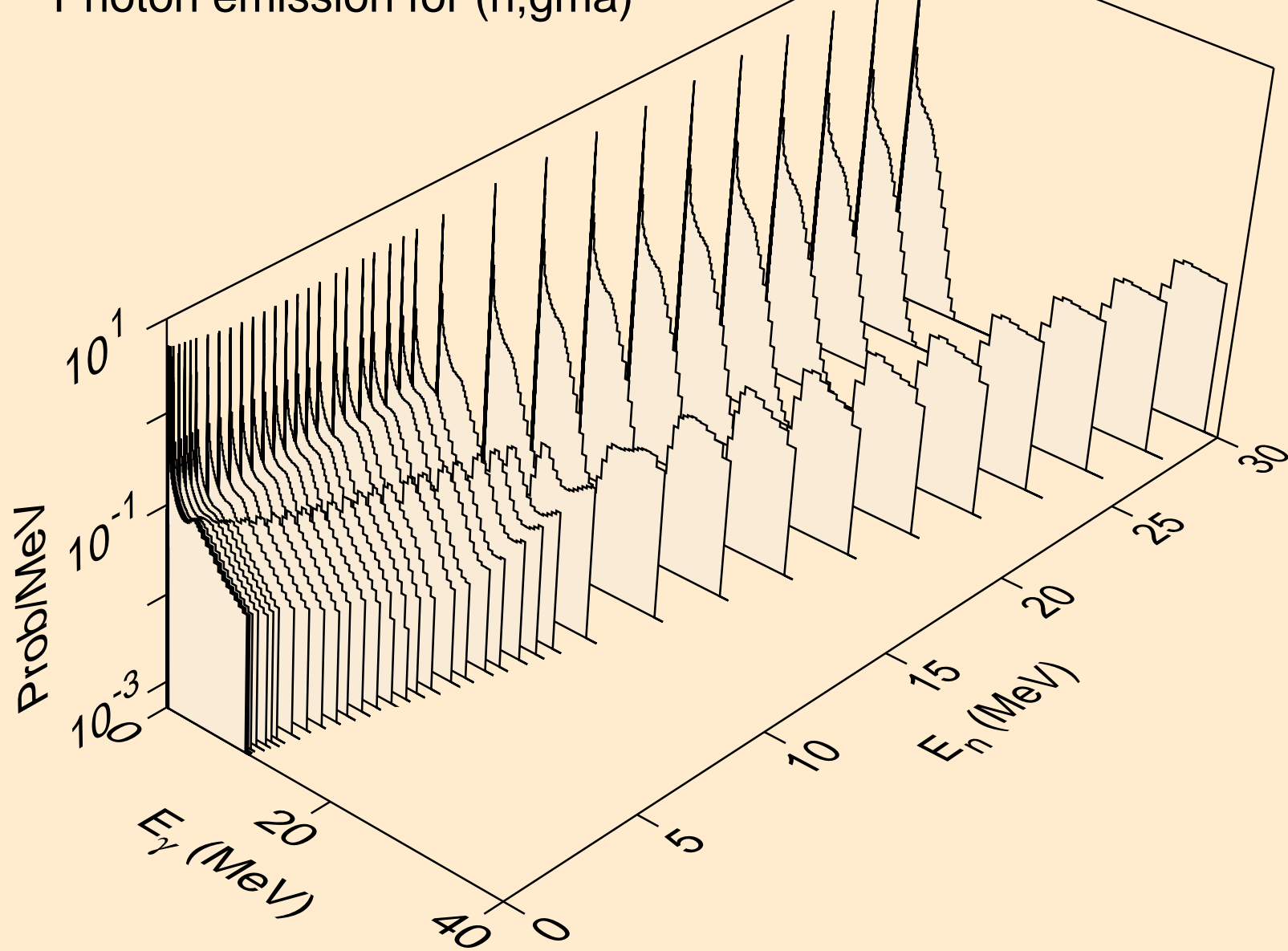

BR073 NEUTRON ACER TENDL-2024 LIBRARY; T=0.K
Photon emission for (n,p)

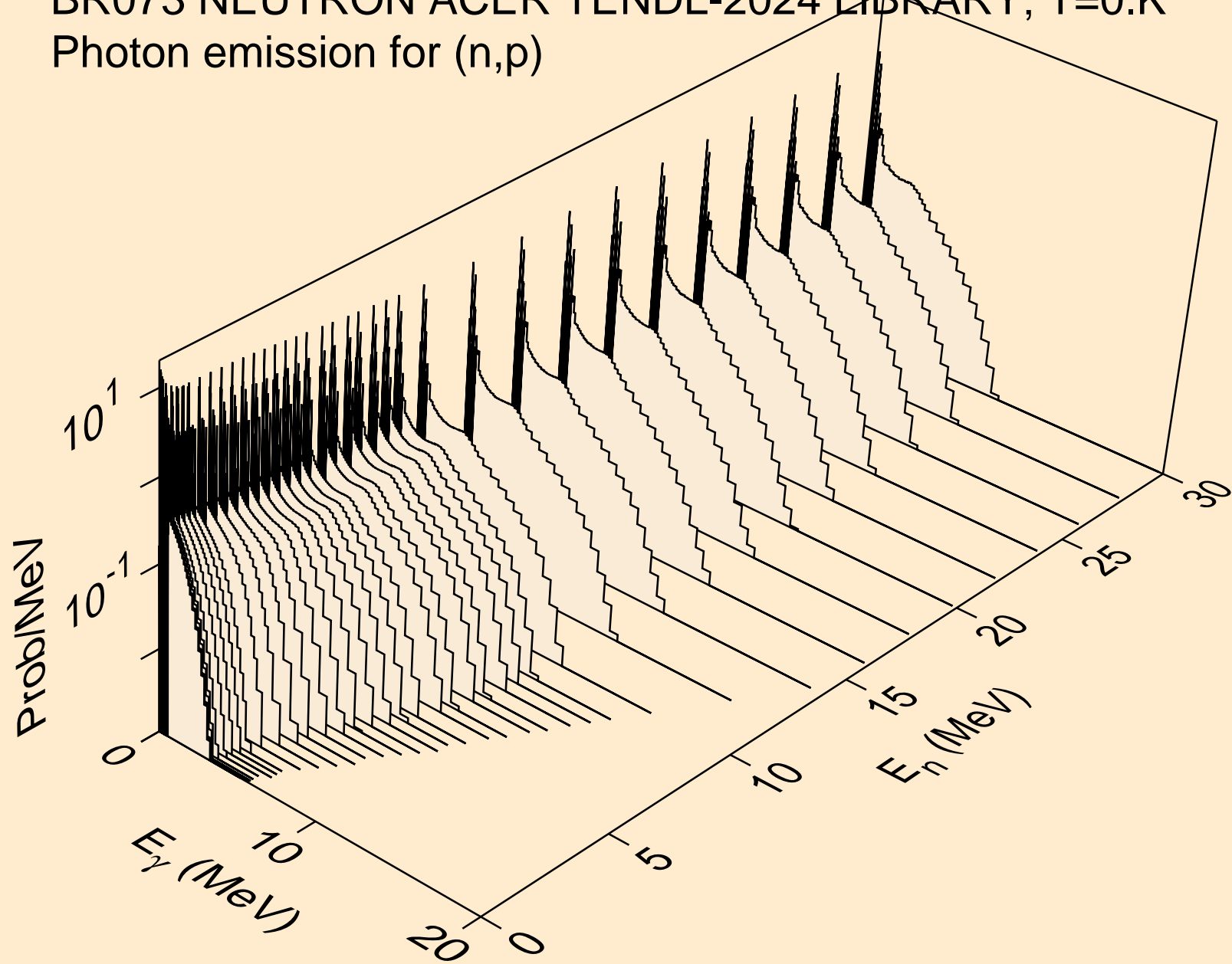

BR073 NEUTRON ACER TENDL-2024 LIBRARY; T=0.K
Photon emission for (n,d)

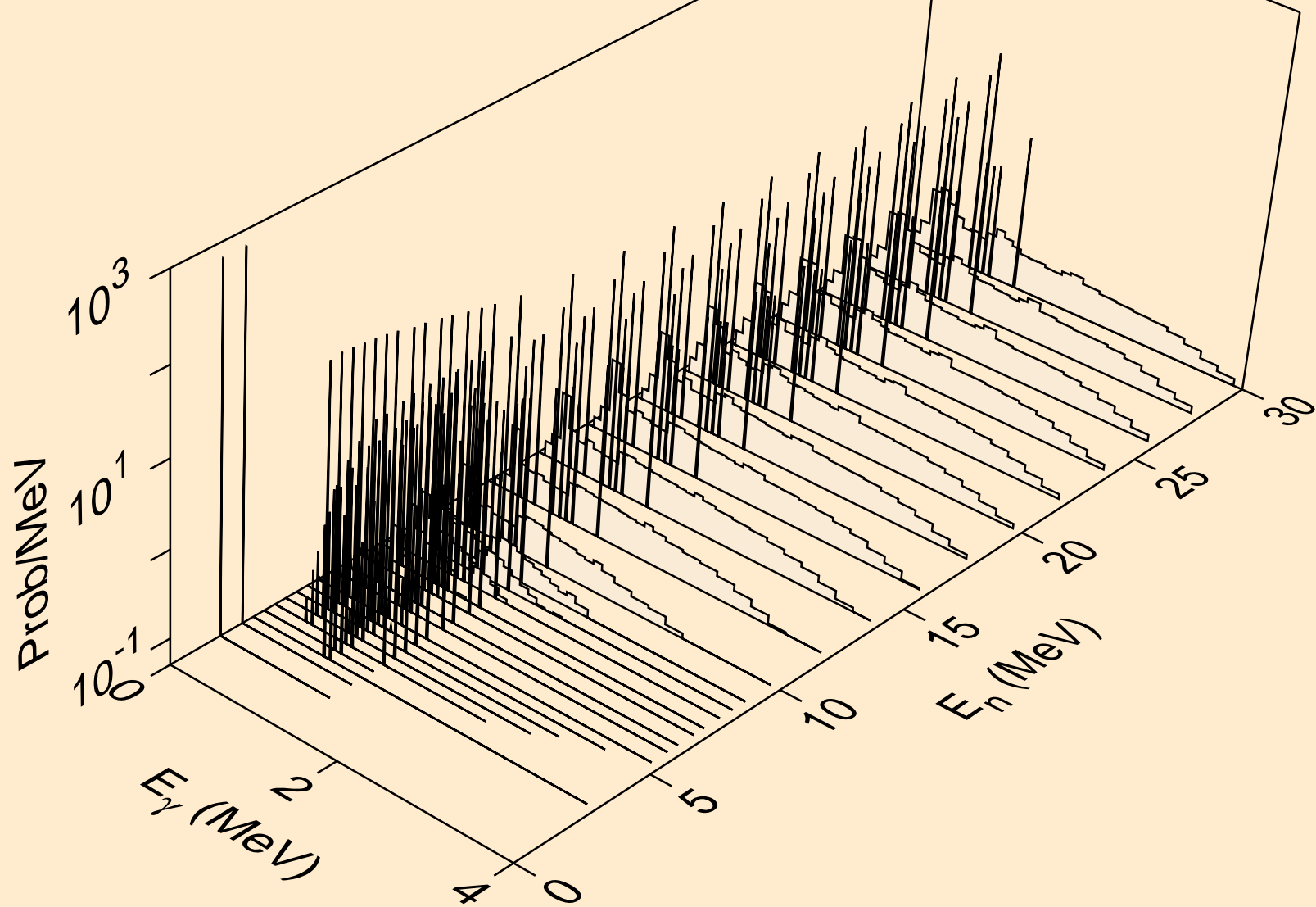

BR073 NEUTRON ACER TENDL-2024 LIBRARY; T=0.K
Photon emission for (n,t)

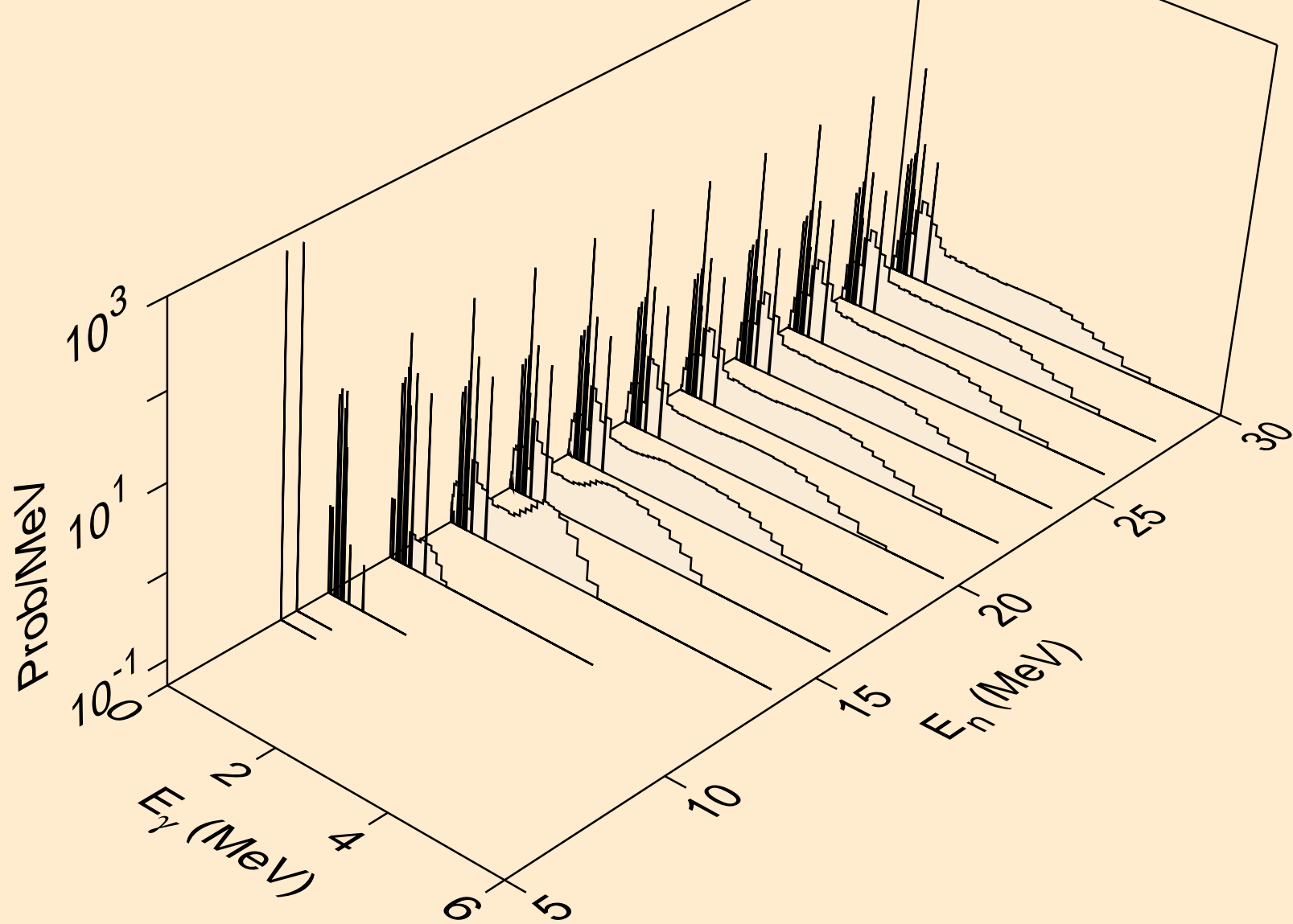

BR073 NEUTRON ACER TENDL-2024 LIBRARY; T=0.K
Photon emission for (n,he3)

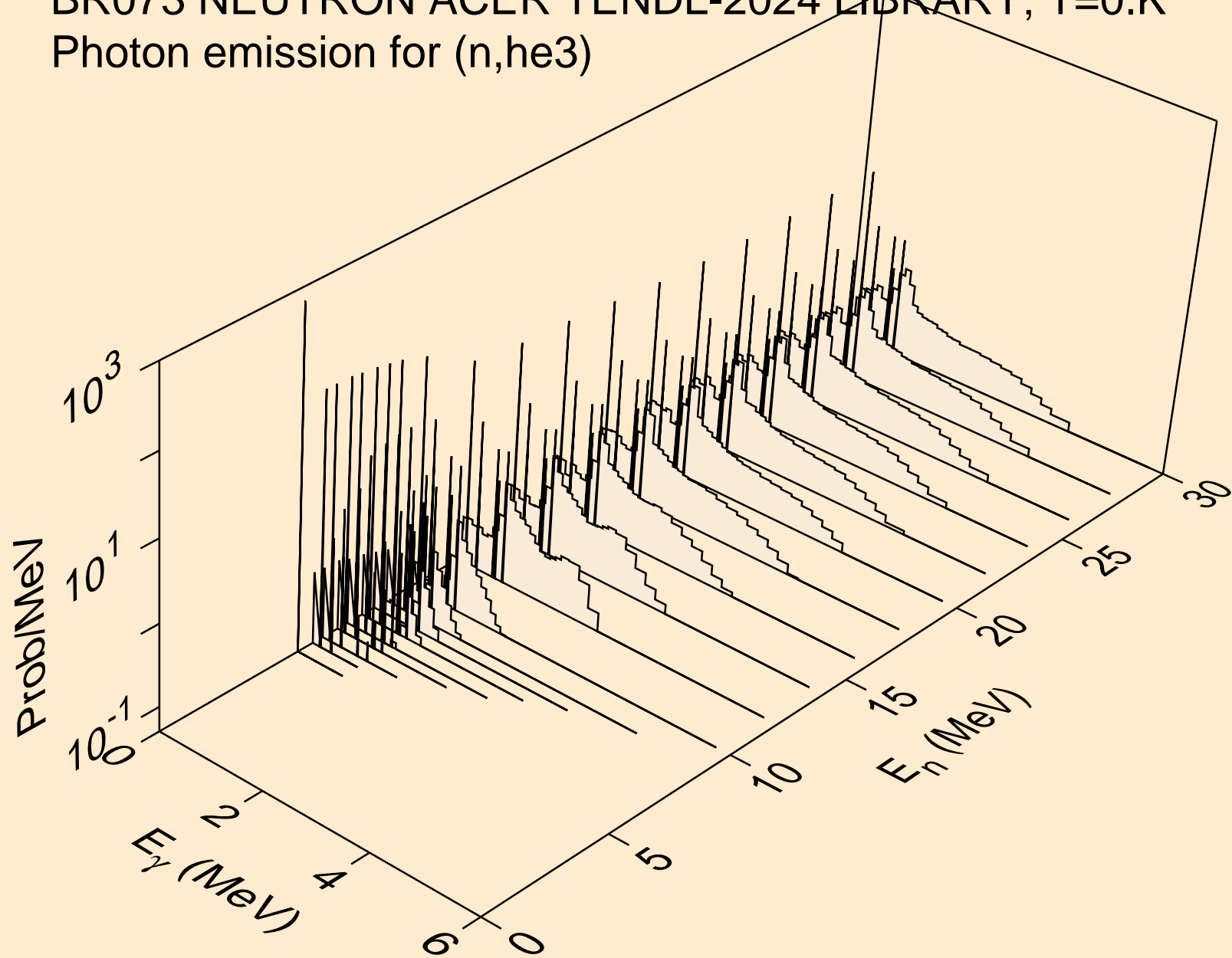

BR073 NEUTRON ACER TENDL-2024 LIBRARY; T=0.K
Photon emission for (n,a)

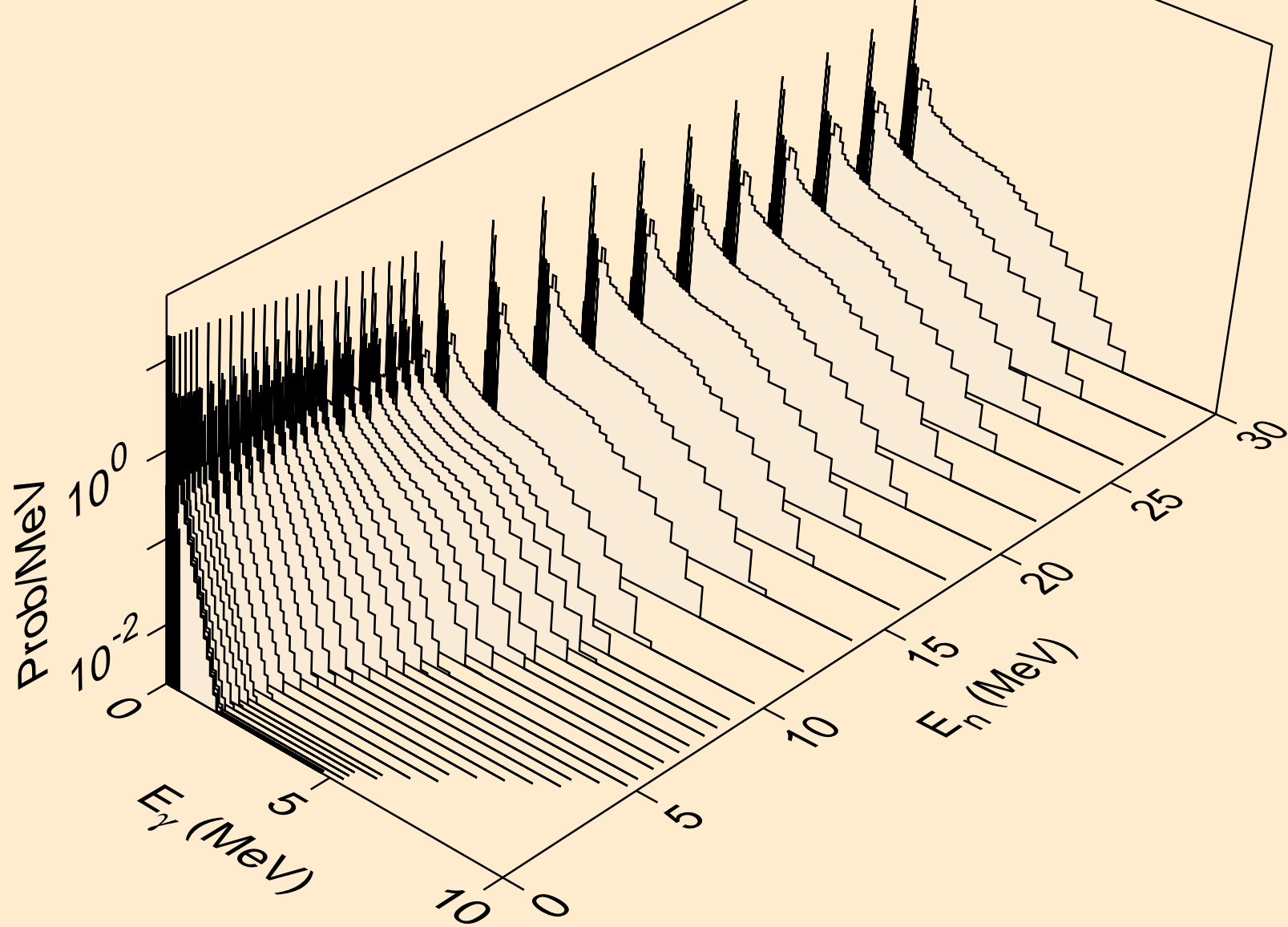

BR073 NEUTRON ACER TENDL-2024 LIBRARY; T=0.K
Photon emission for (n,2a)

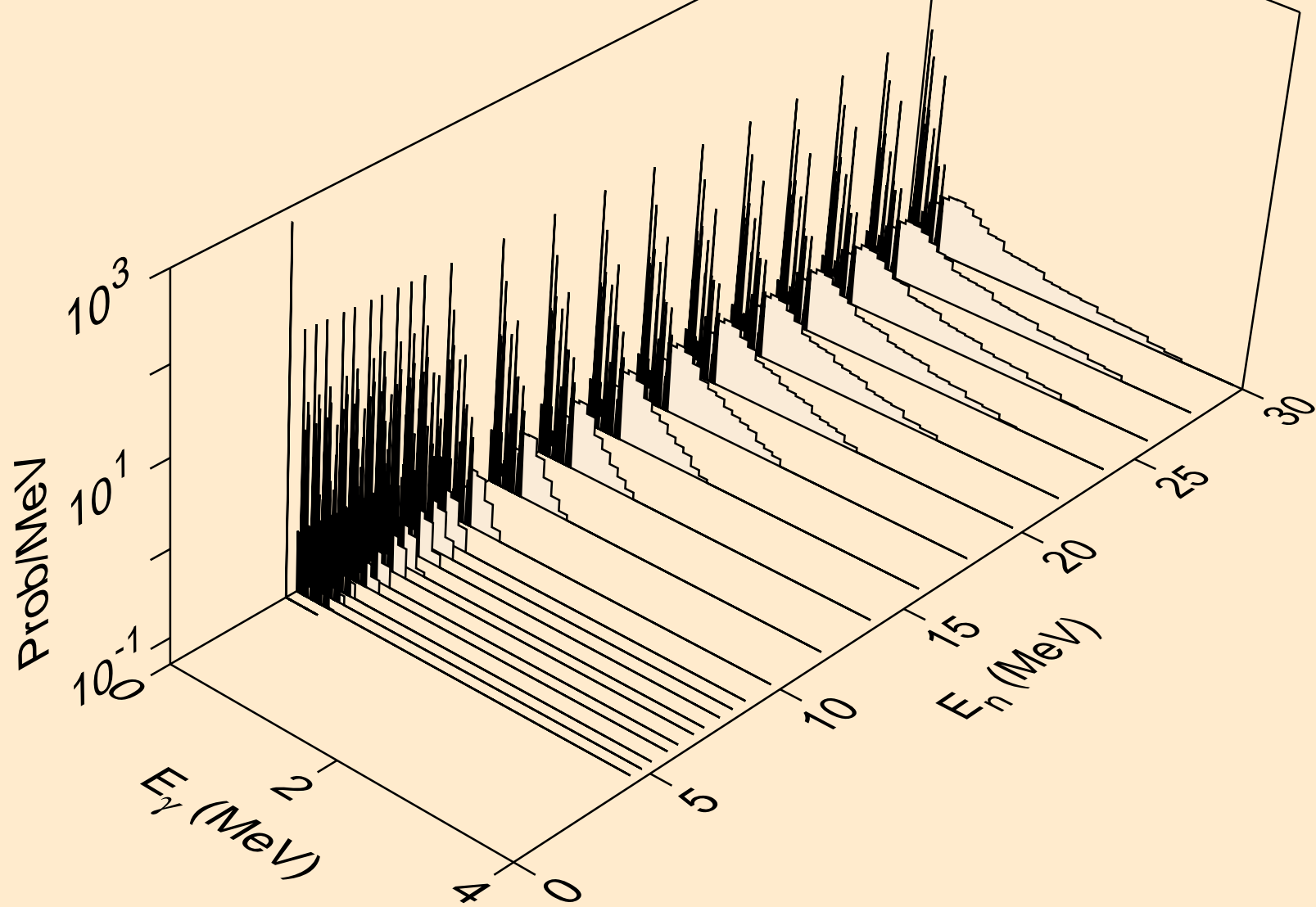

BR073 NEUTRON ACER TENDL-2024 LIBRARY; T=0.K
Photon emission for (n,3a)

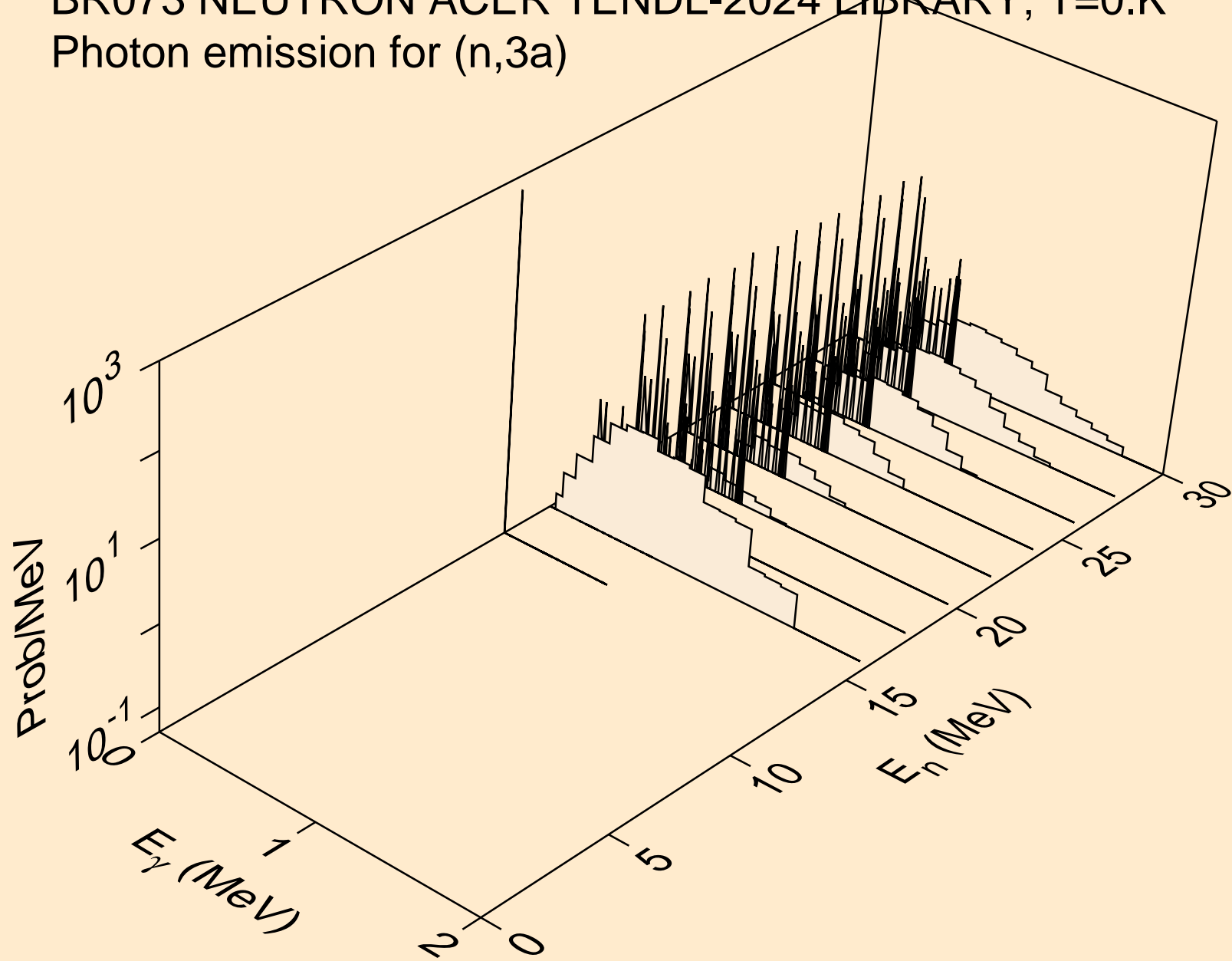

BR073 NEUTRON ACER TENDL-2024 LIBRARY; T=0.K
Photon emission for (n,2p)

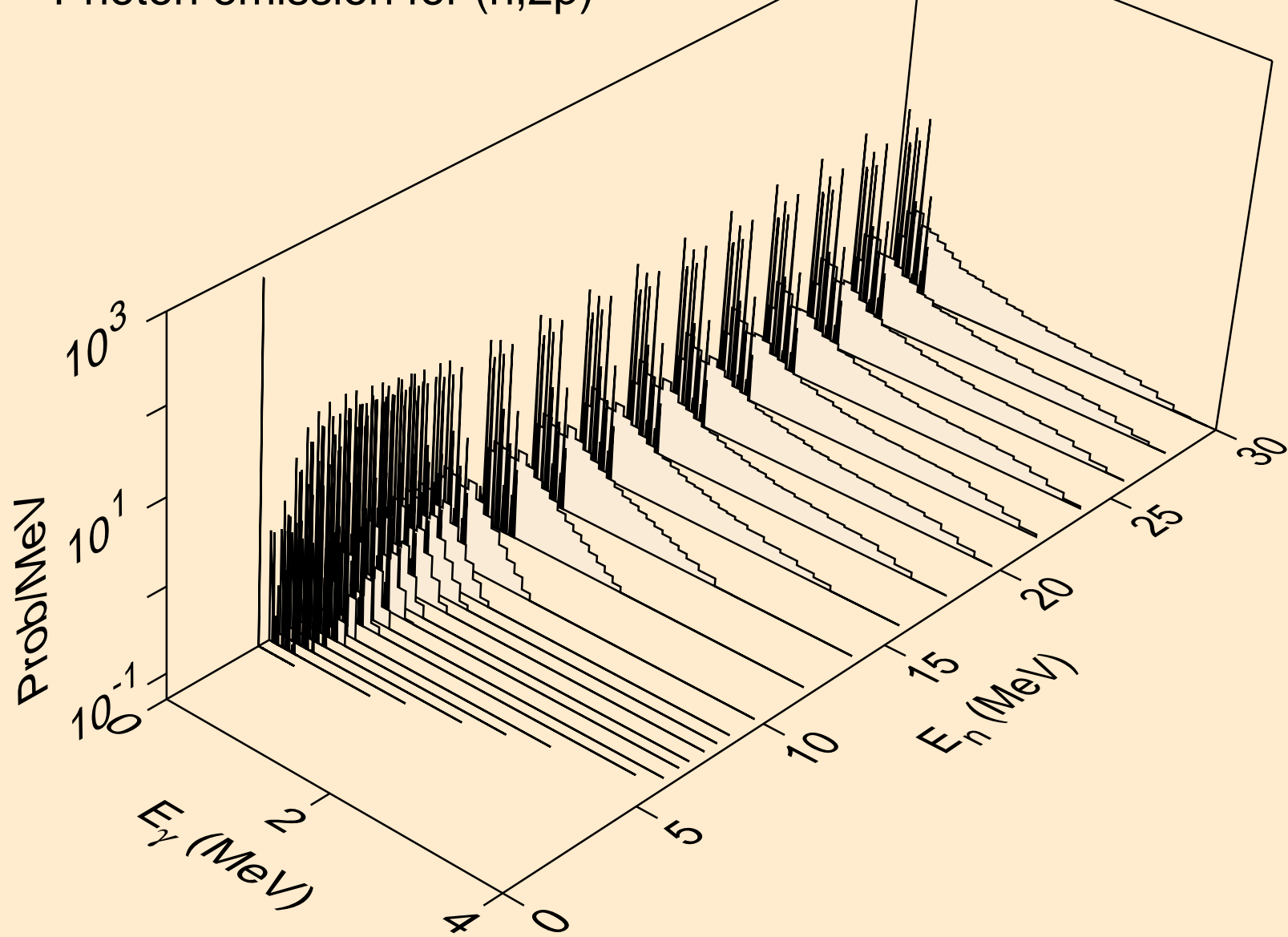

BR073 NEUTRON ACER TENDL-2024 LIBRARY; T=0.K
Photon emission for (n,p α)

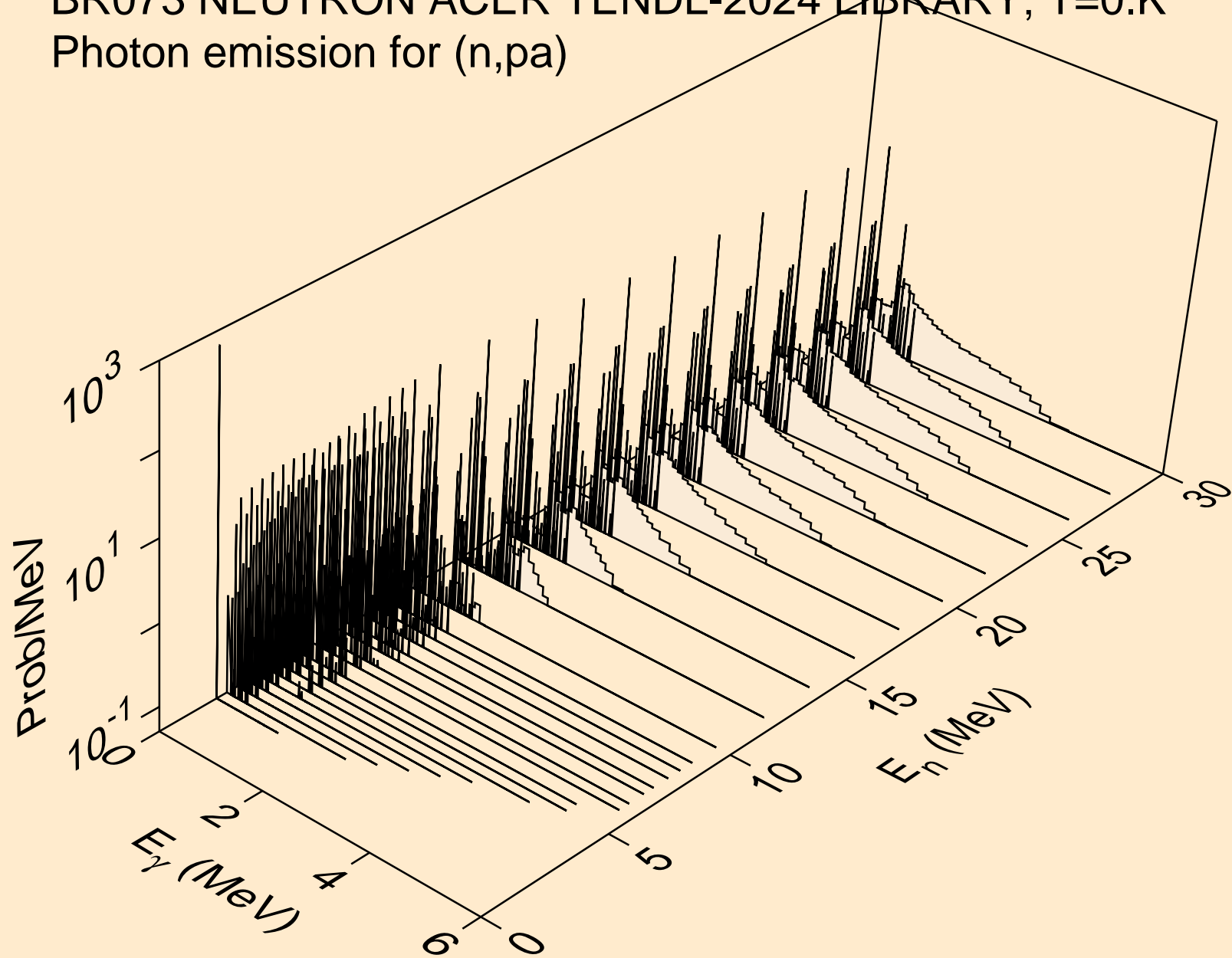

BR073 NEUTRON ACER TENDL-2024 LIBRARY; T=0.K
Photon emission for (n,d2a)

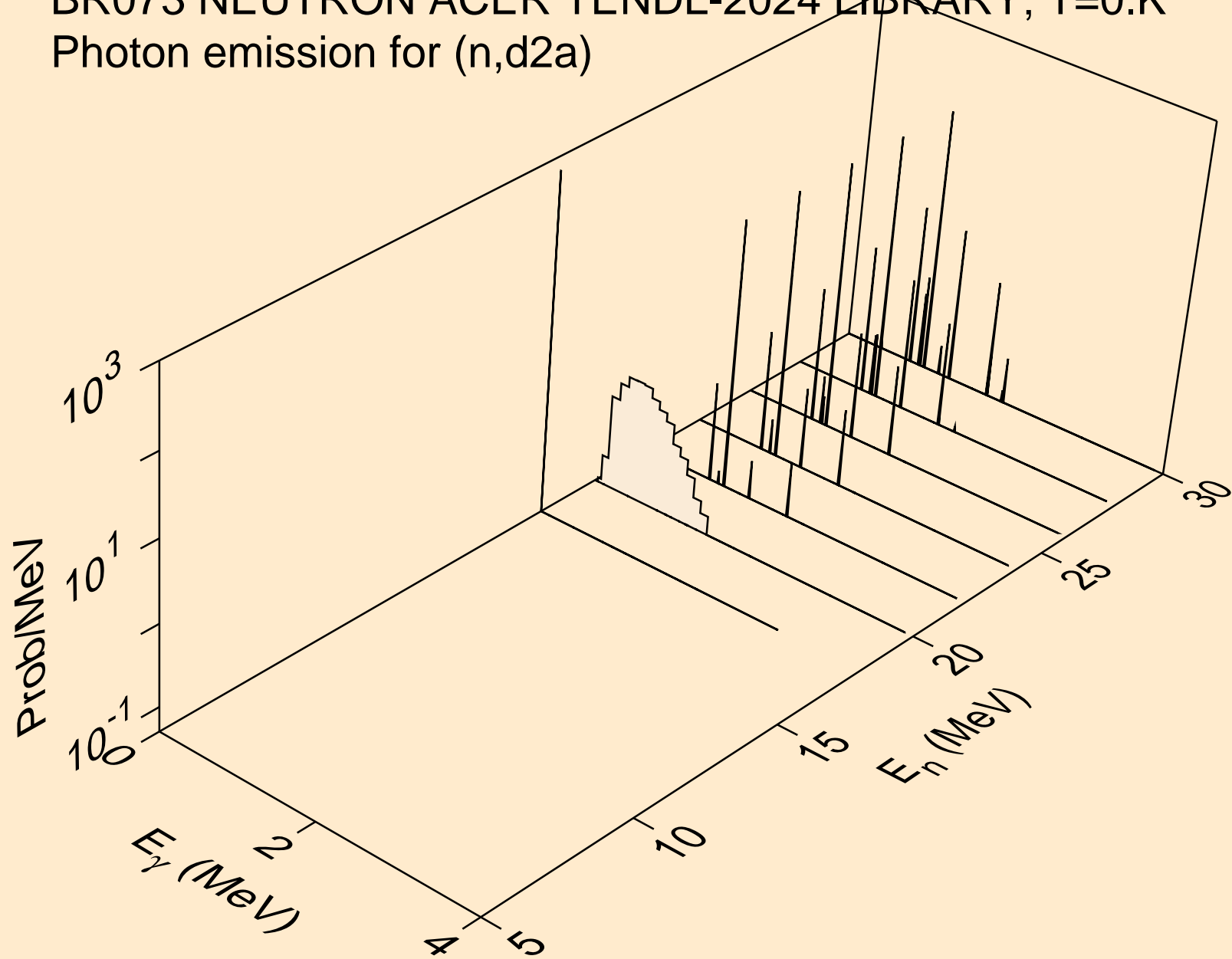

BR073 NEUTRON ACER TENDL-2024 LIBRARY; T=0.K
Photon emission for (n,pd)

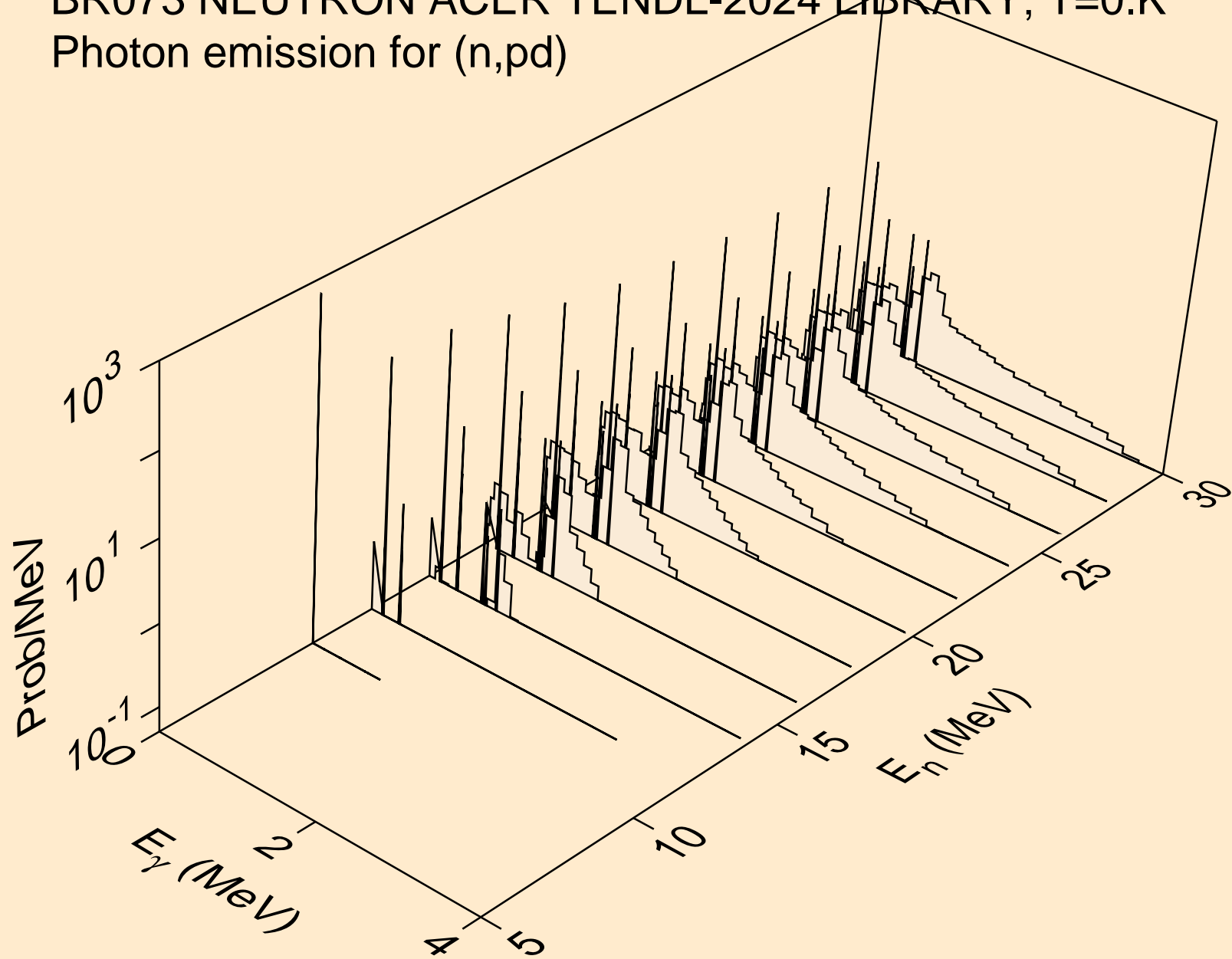

BR073 NEUTRON ACER TENDL-2024 LIBRARY; T=0.K
Photon emission for (n,pt)

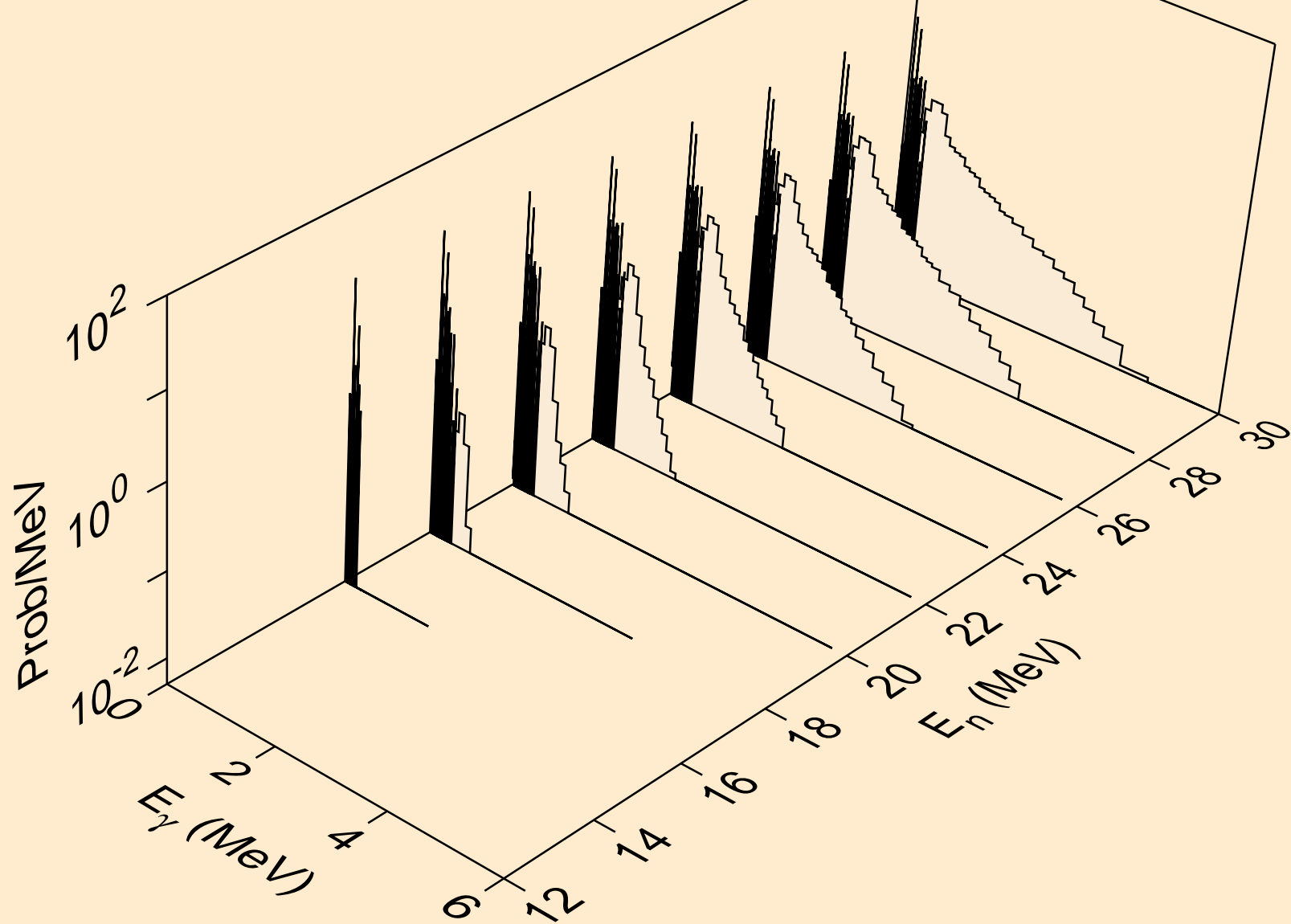

BR073 NEUTRON ACER TENDL-2024 LIBRARY; T=0.K
Photon emission for (n,da)

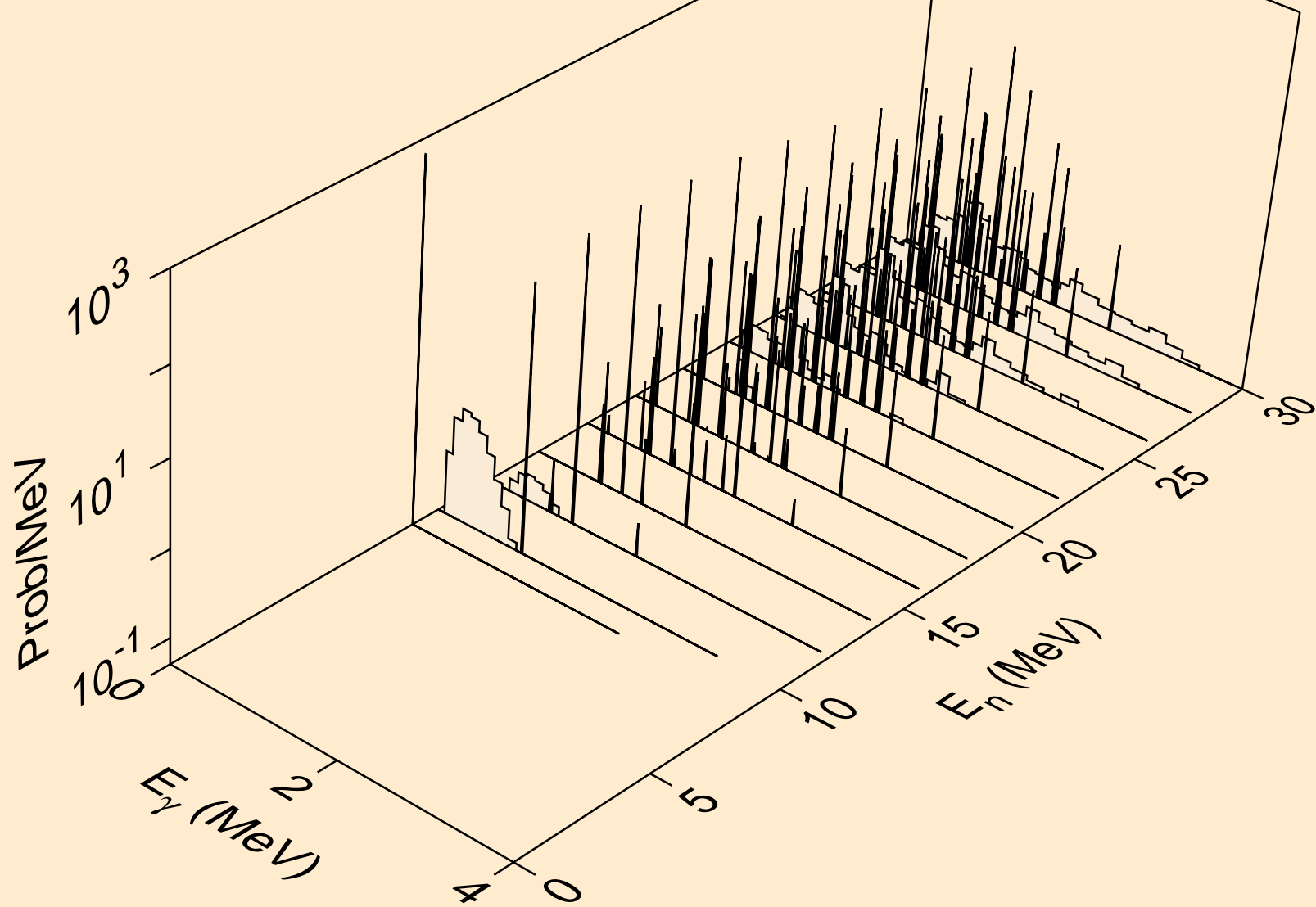

BR073 NEUTRON ACER TENDL-2024 LIBRARY; T=0.K
thermal capture photon spectrum

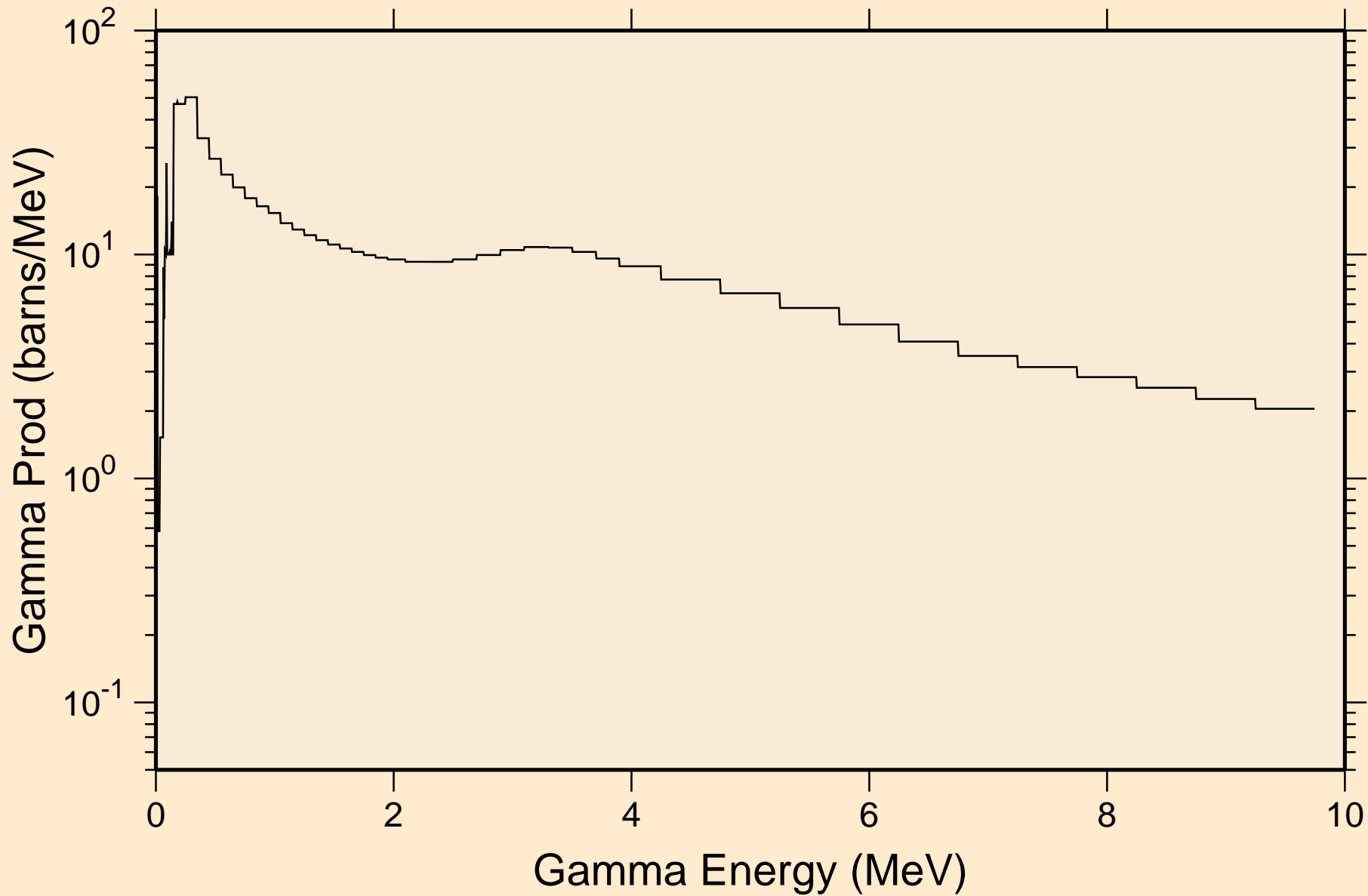

BR073 NEUTRON ACER TENDL-2024 LIBRARY; T=0.K
14 MeV photon spectrum

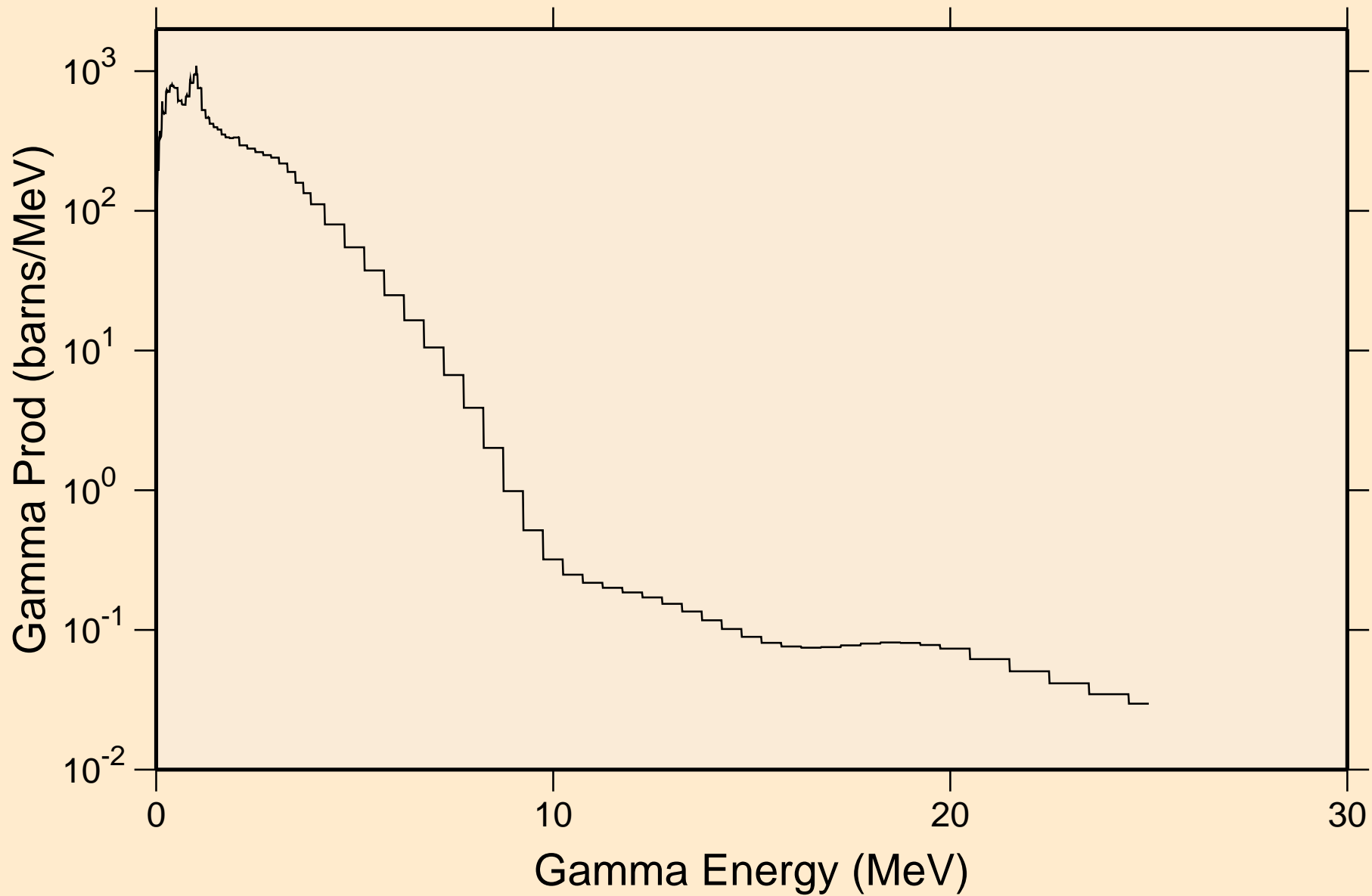

BR073 NEUTRON ACER TENDL-2024 LIBRARY; T=0.K
Particle heating contributions

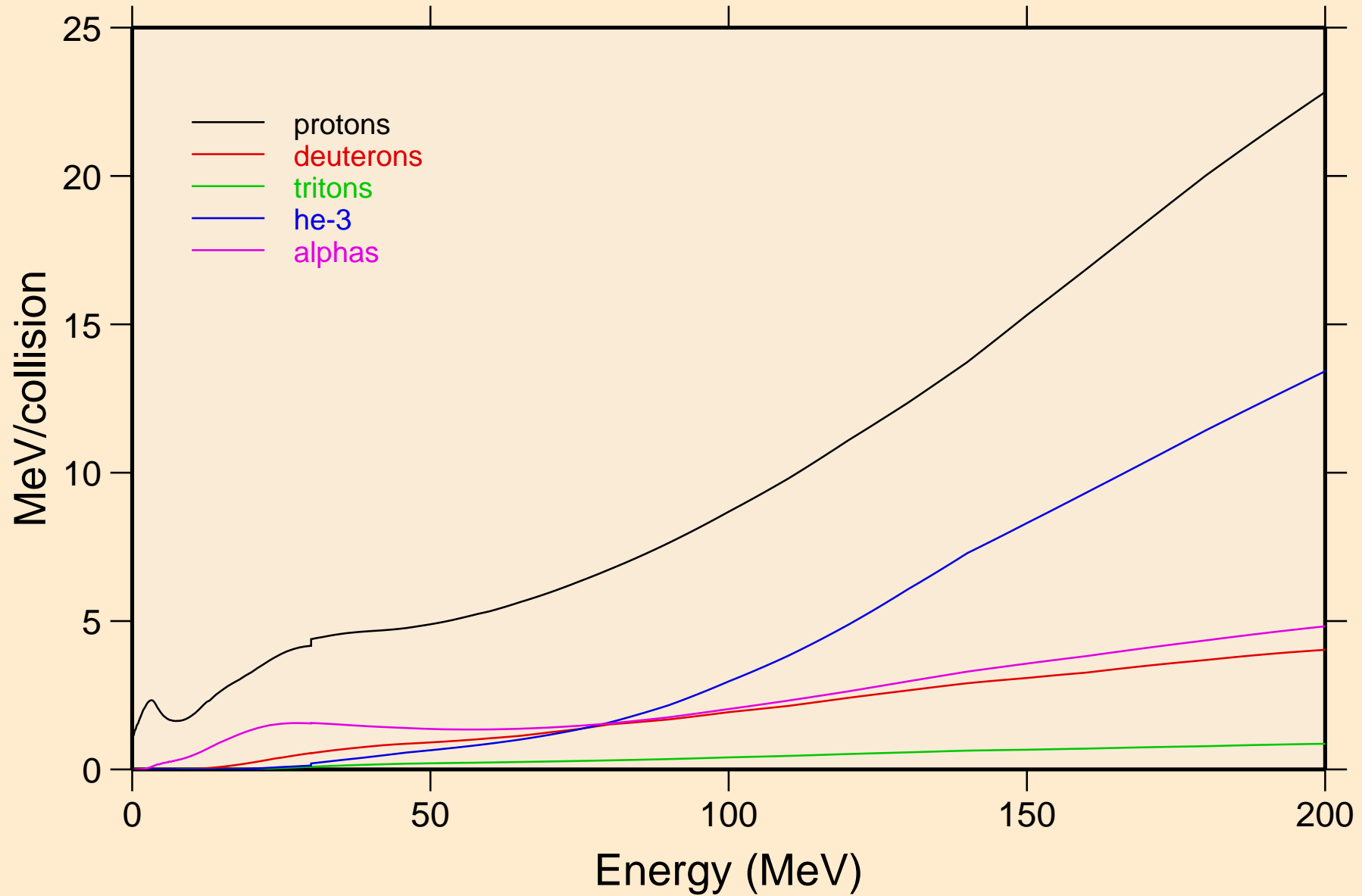

BR073 NEUTRON ACER TENDL-2024 LIBRARY; T=0.K
Recoil Heating

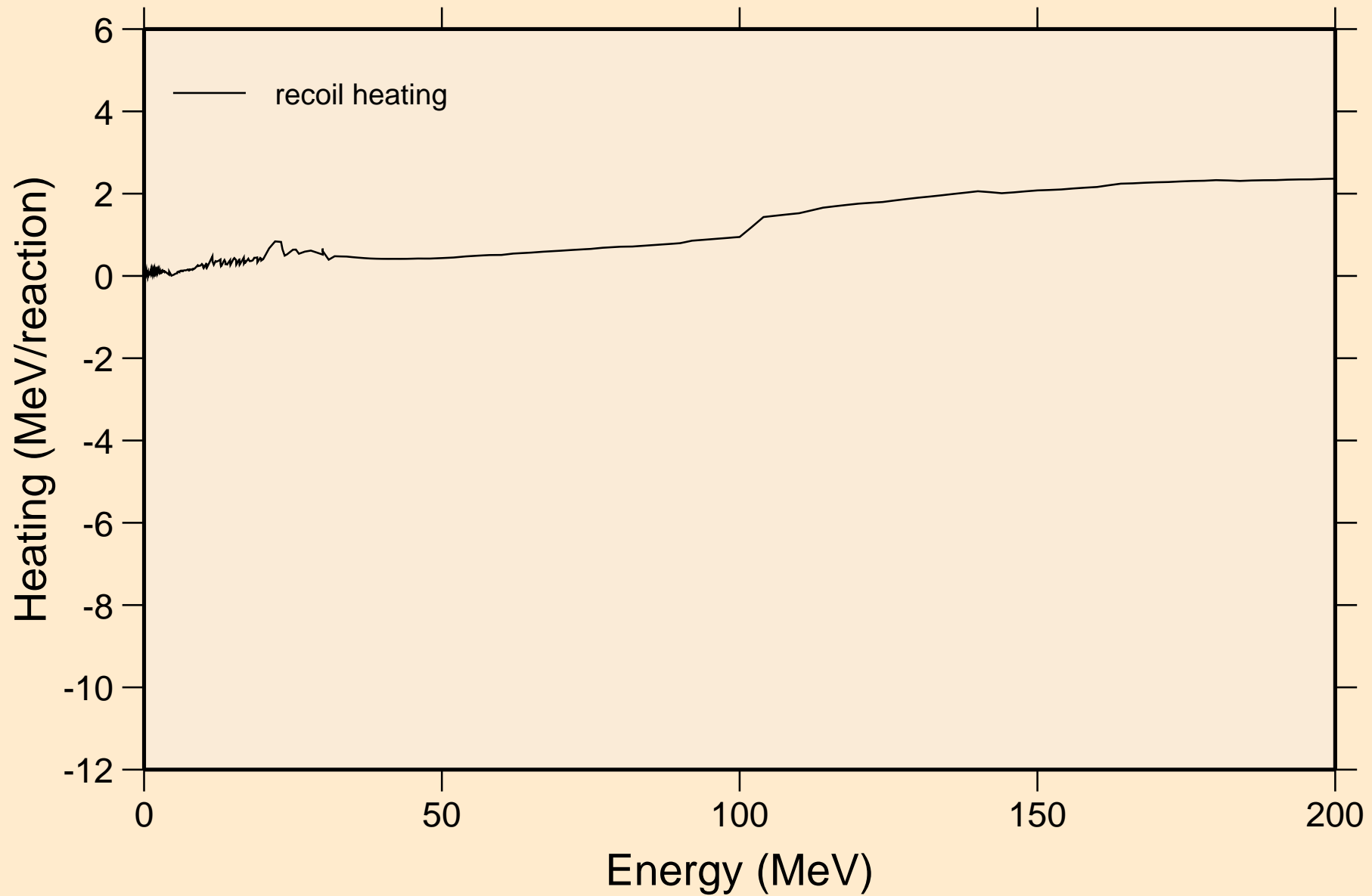

BR073 NEUTRON ACER TENDL-2024 LIBRARY; T=0.K

Particle production cross sections

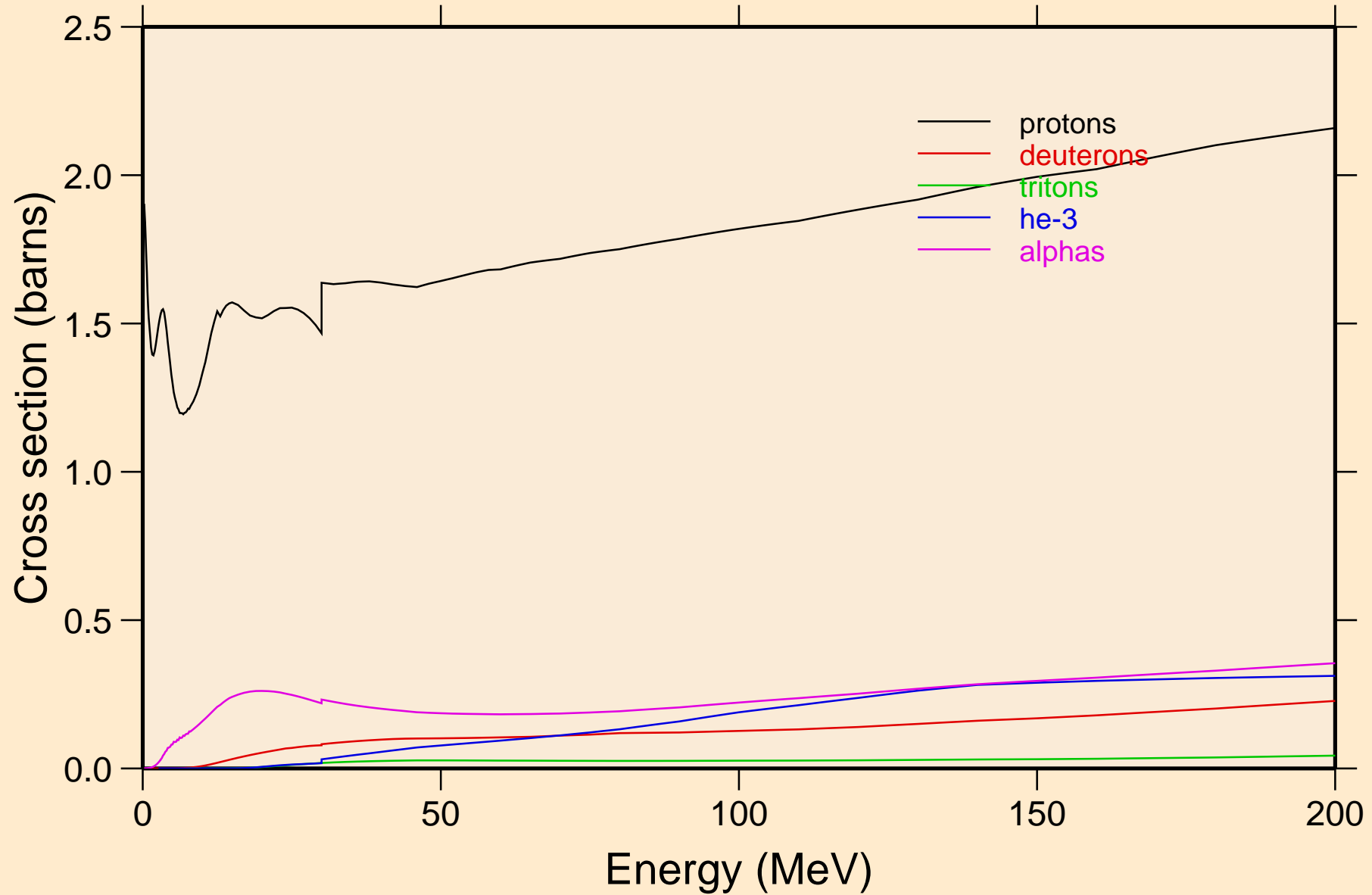

BR073 NEUTRON ACER TENDL-2024 LIBRARY; T=0.K
protons from (n,x)

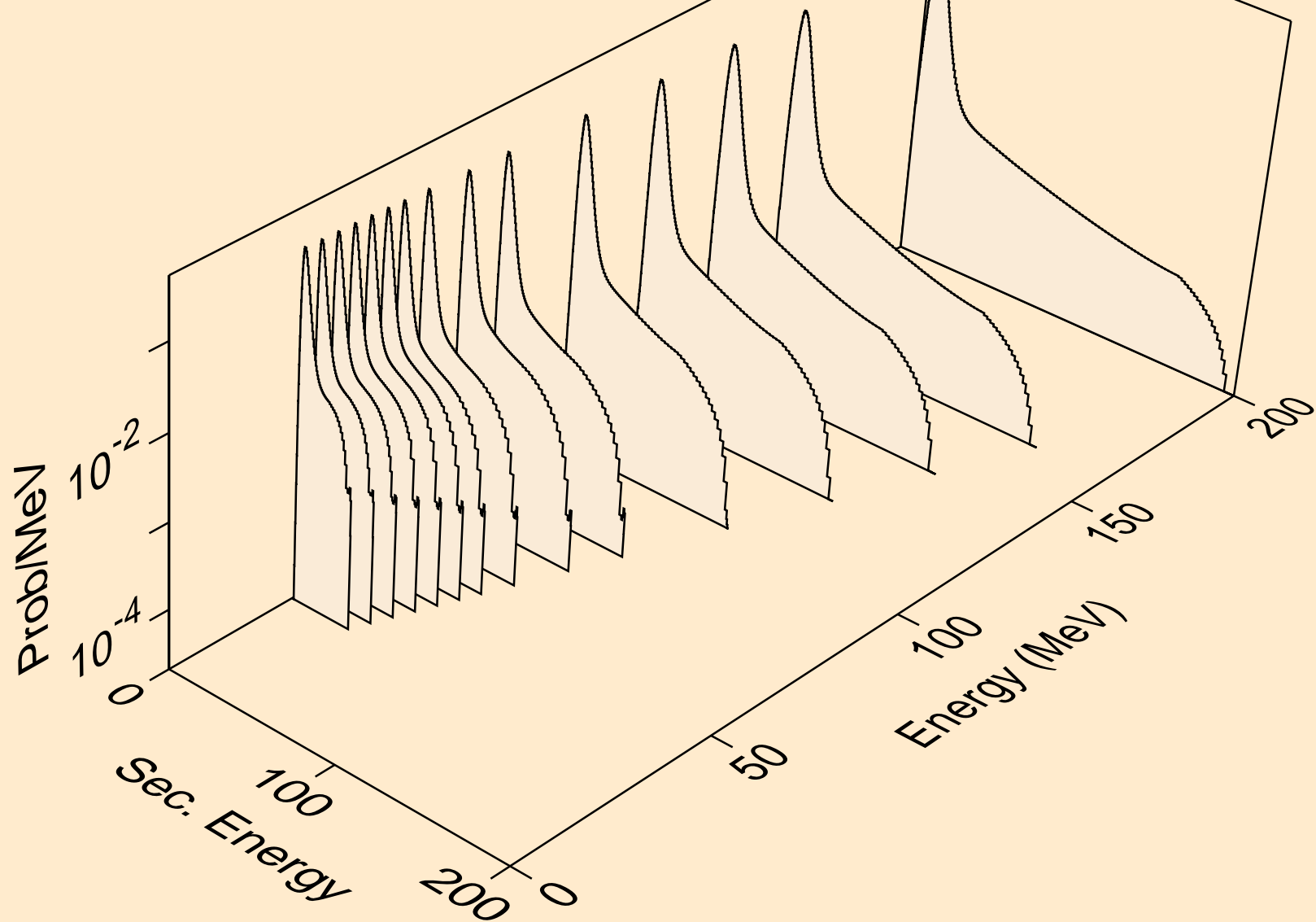

BR073 NEUTRON ACER TENDL-2024 LIBRARY; T=0.K
protons from (n,n*)p

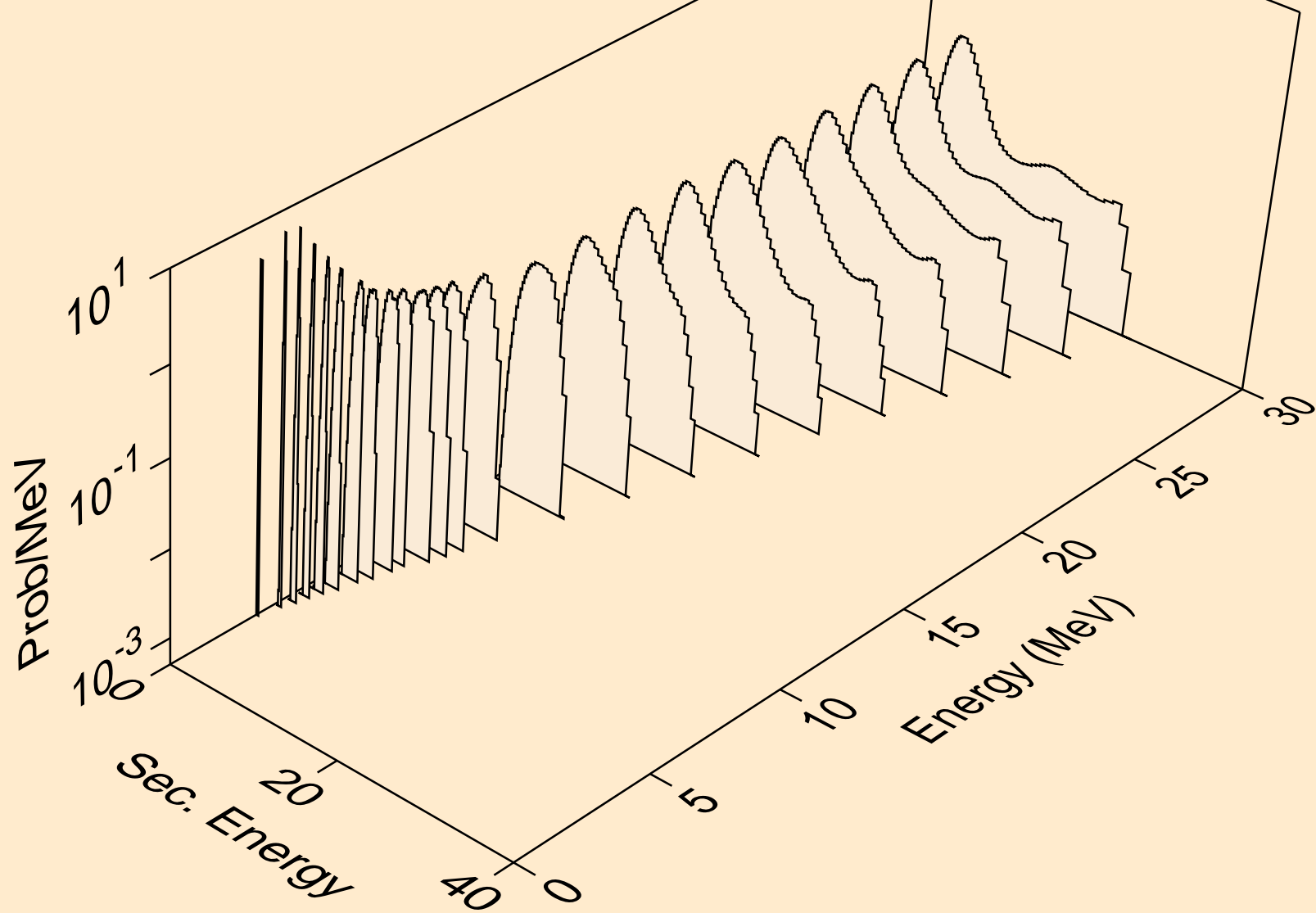

BR073 NEUTRON ACER TENDL-2024 LIBRARY; T=0.K
protons from (n,2np)

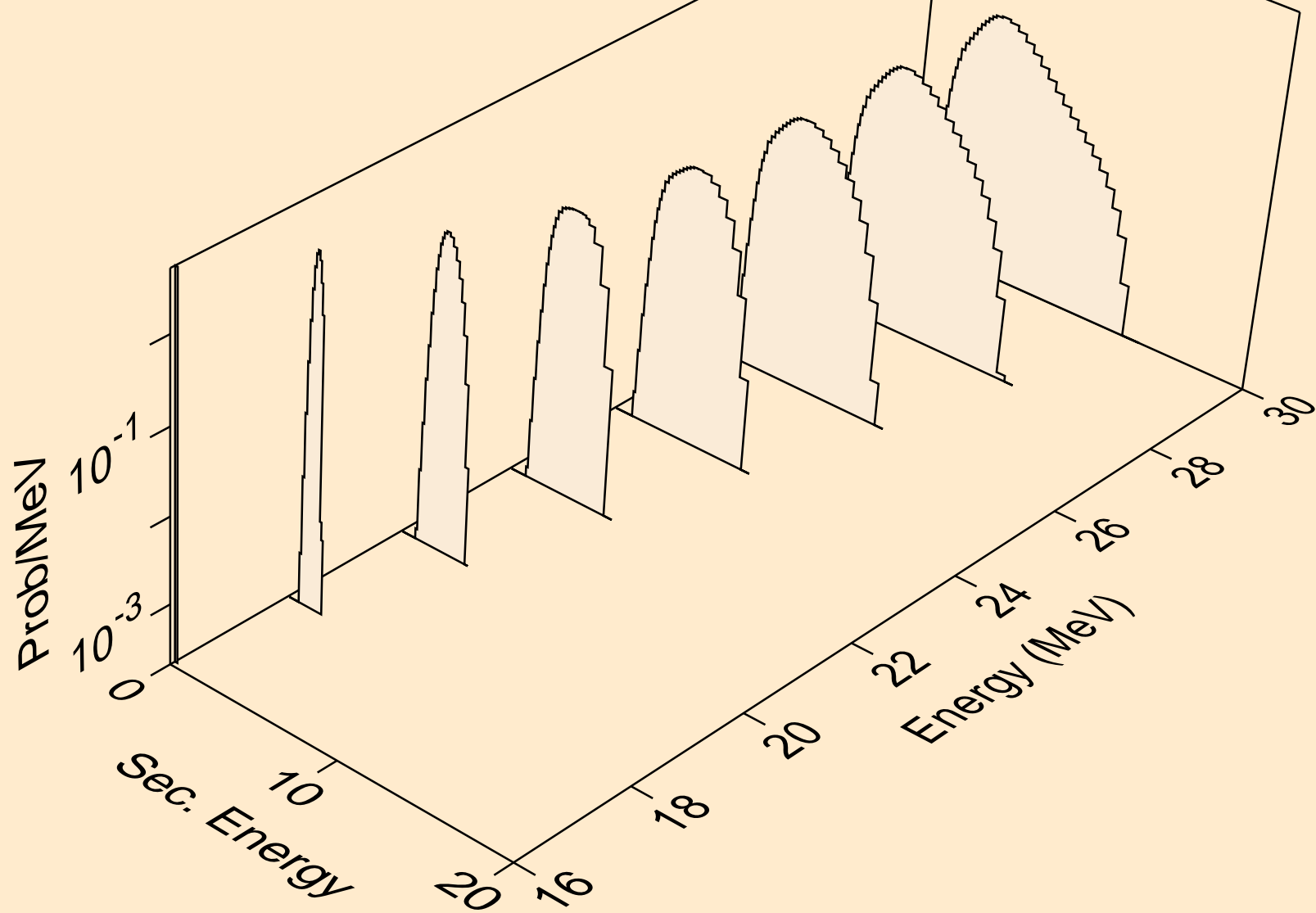

BR073 NEUTRON ACER TENDL-2024 LIBRARY; T=0.K
protons from (n,3np)

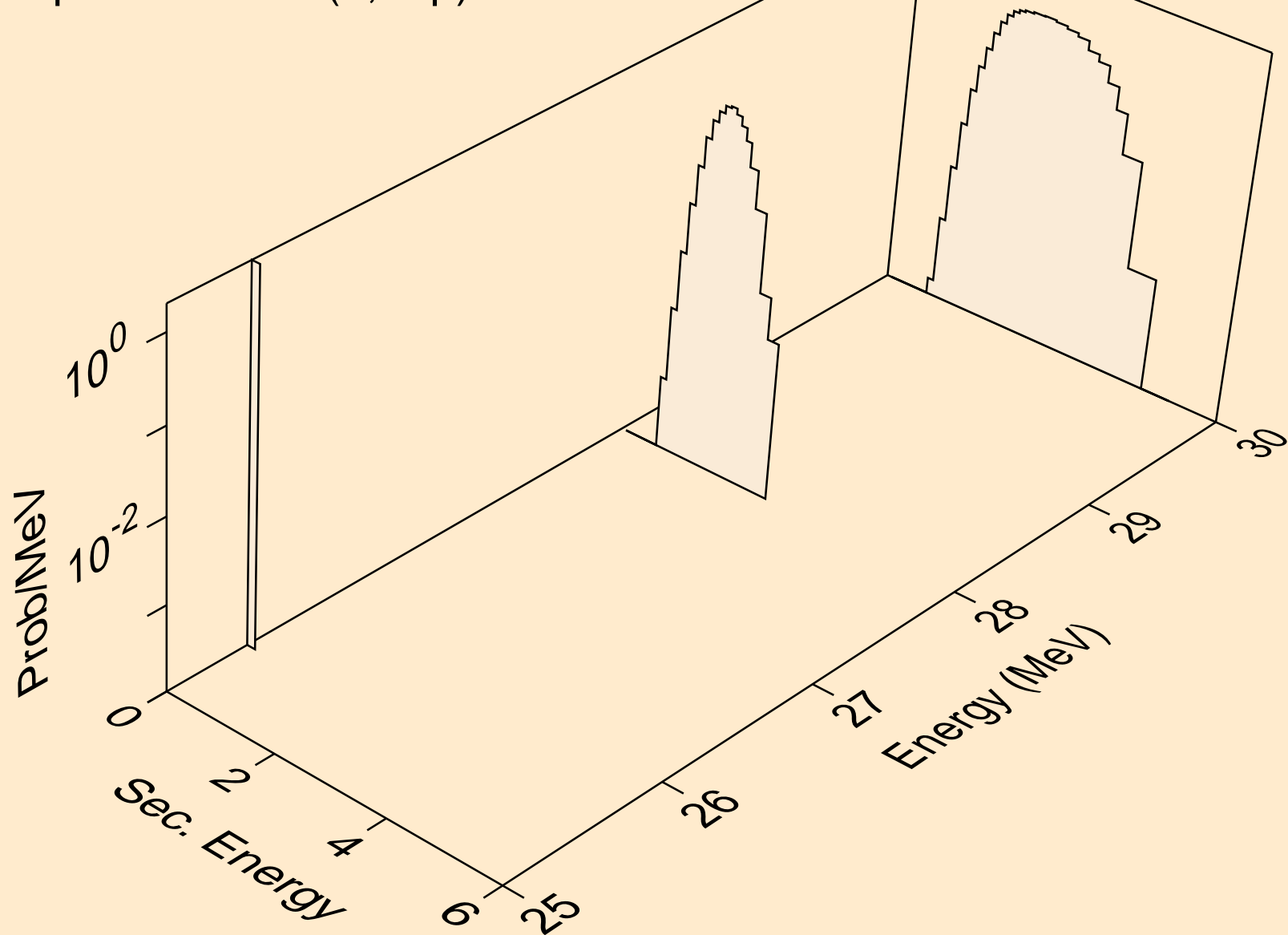

BR073 NEUTRON ACER TENDL-2024 LIBRARY; T=0.K
protons from (n,n2p)

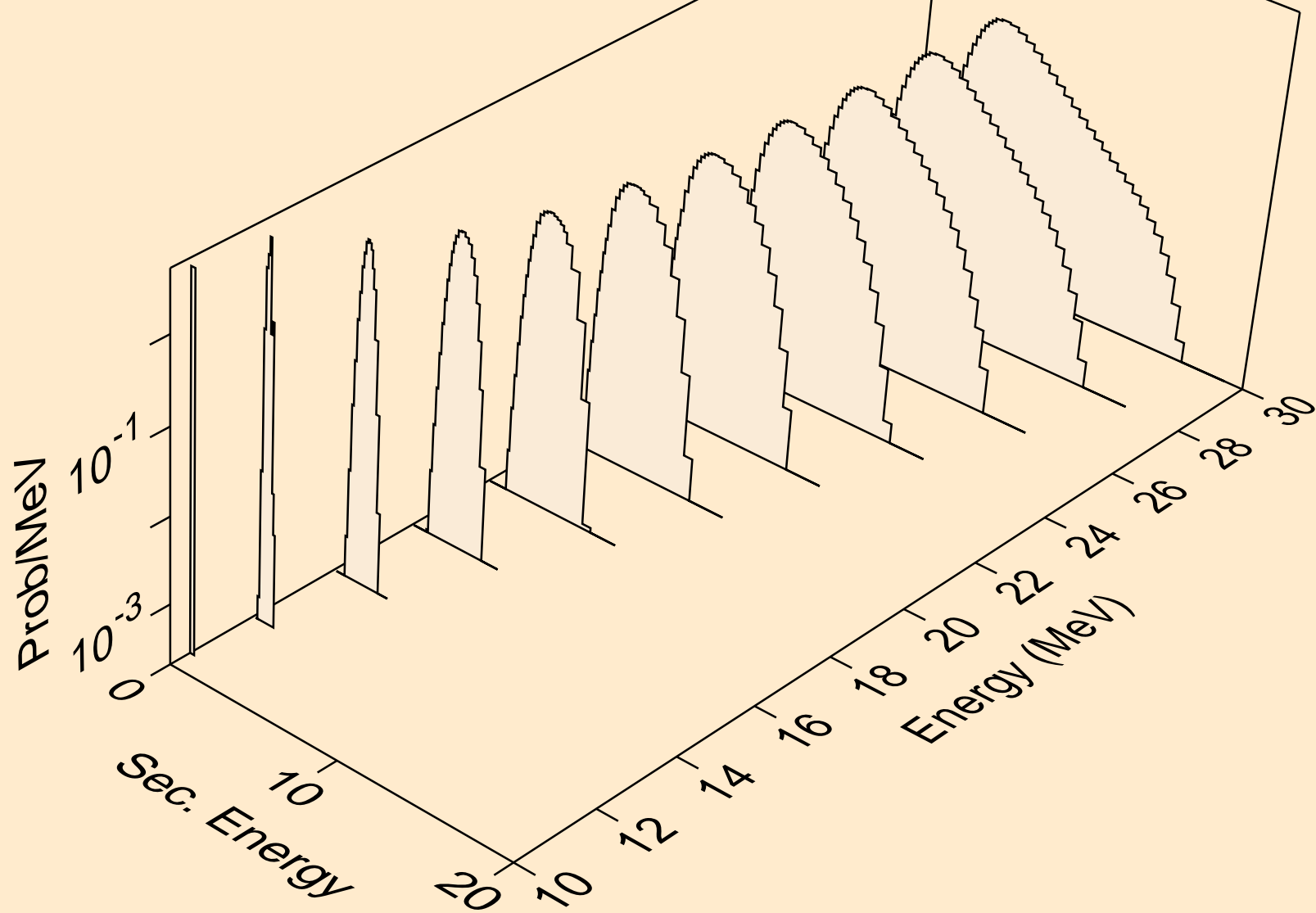

BR073 NEUTRON ACER TENDL-2024 LIBRARY; T=0.K
protons from (n,npa)

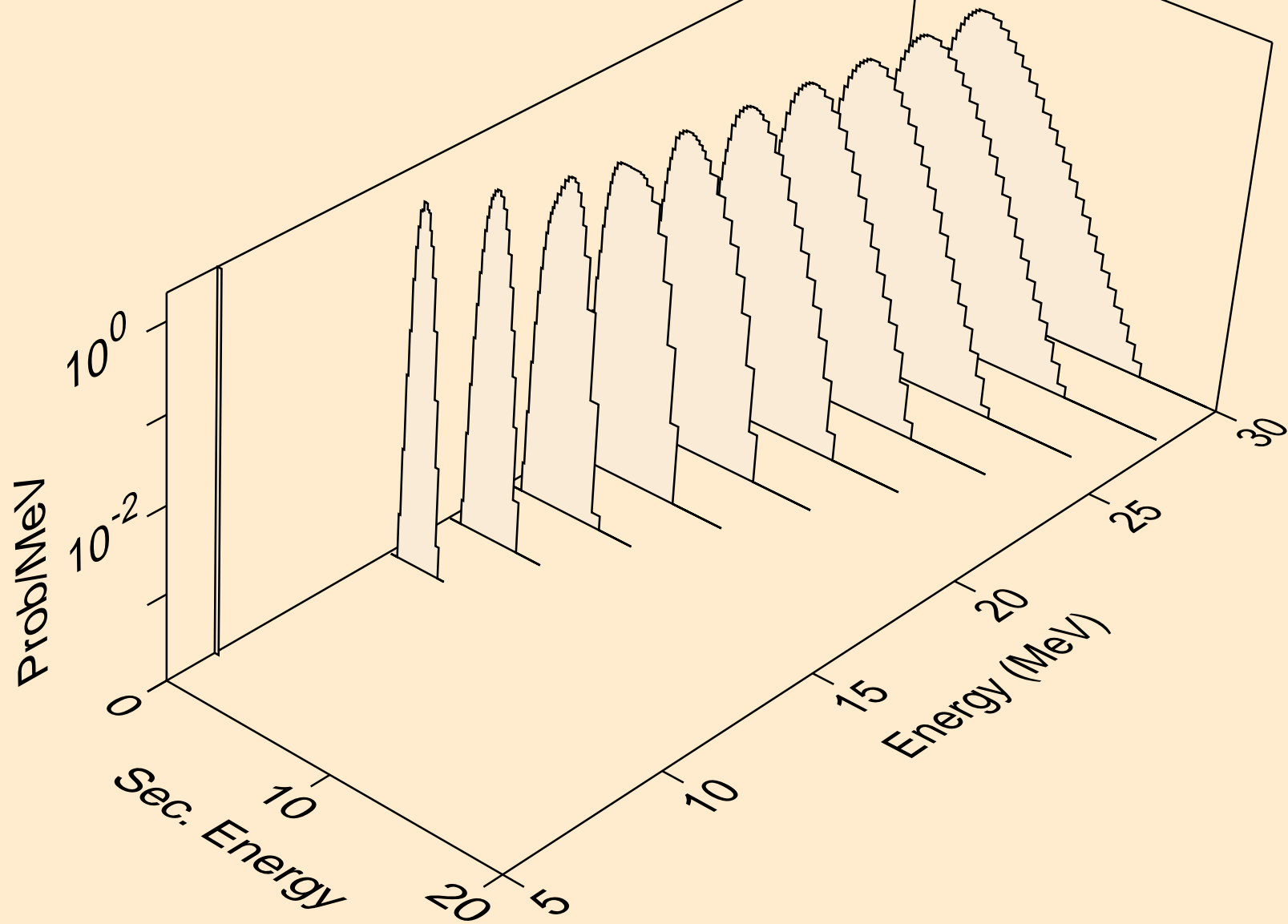

BR073 NEUTRON ACER TENDL-2024 LIBRARY; T=0.K
protons from (n,p)

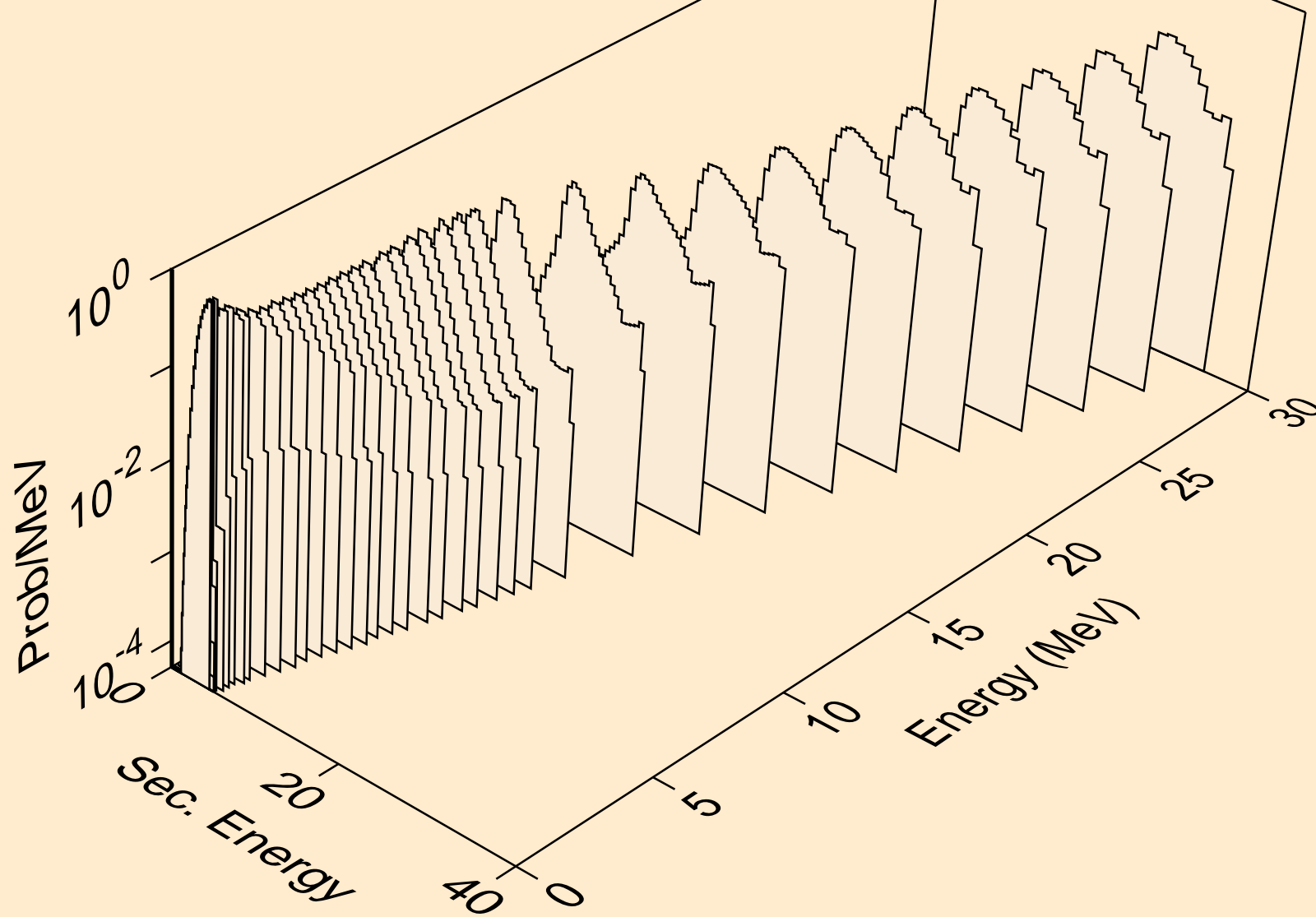

BR073 NEUTRON ACER TENDL-2024 LIBRARY; T=0.K
protons from (n,2p)

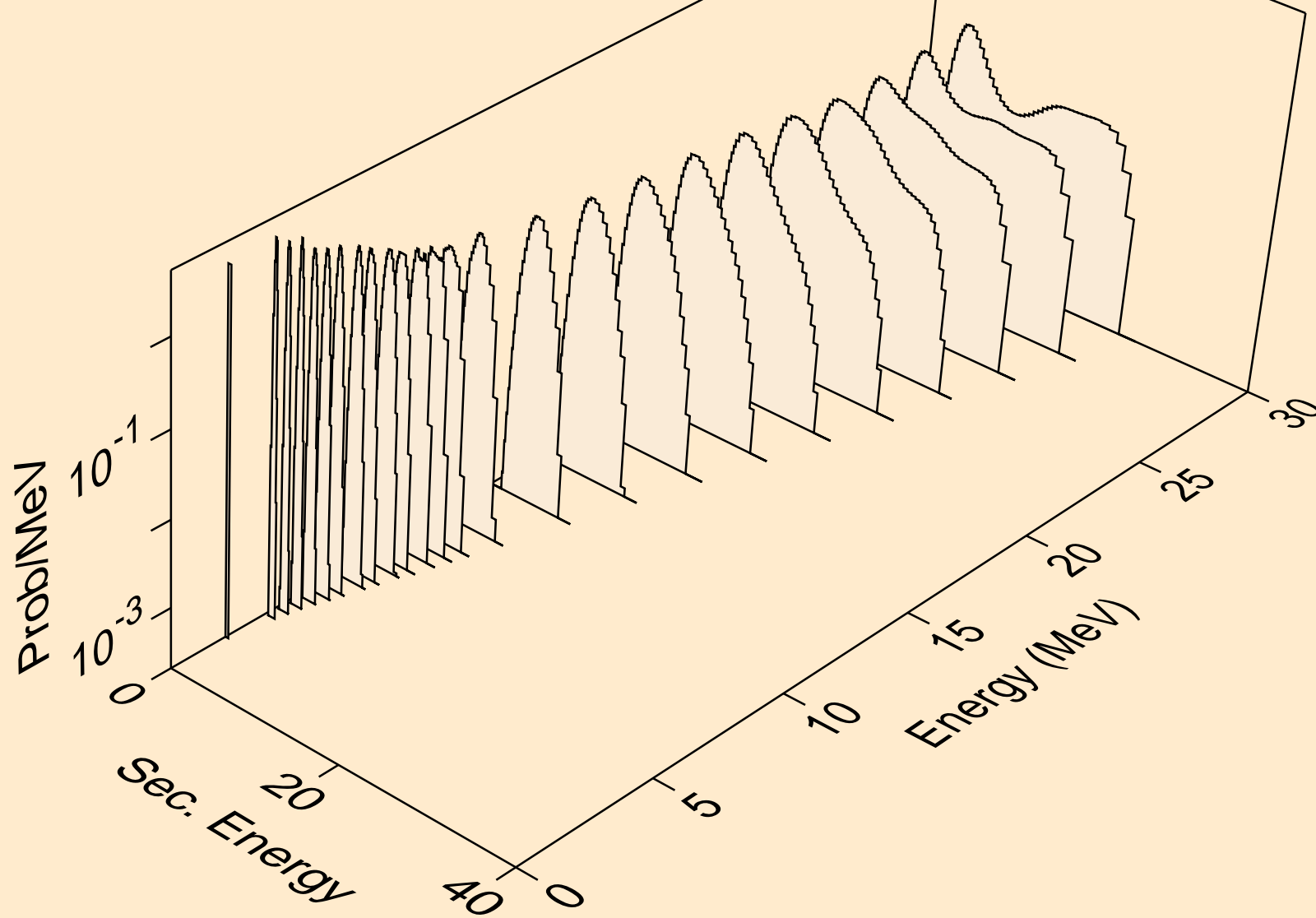

BR073 NEUTRON ACER TENDL-2024 LIBRARY; T=0.K
protons from (n,p)

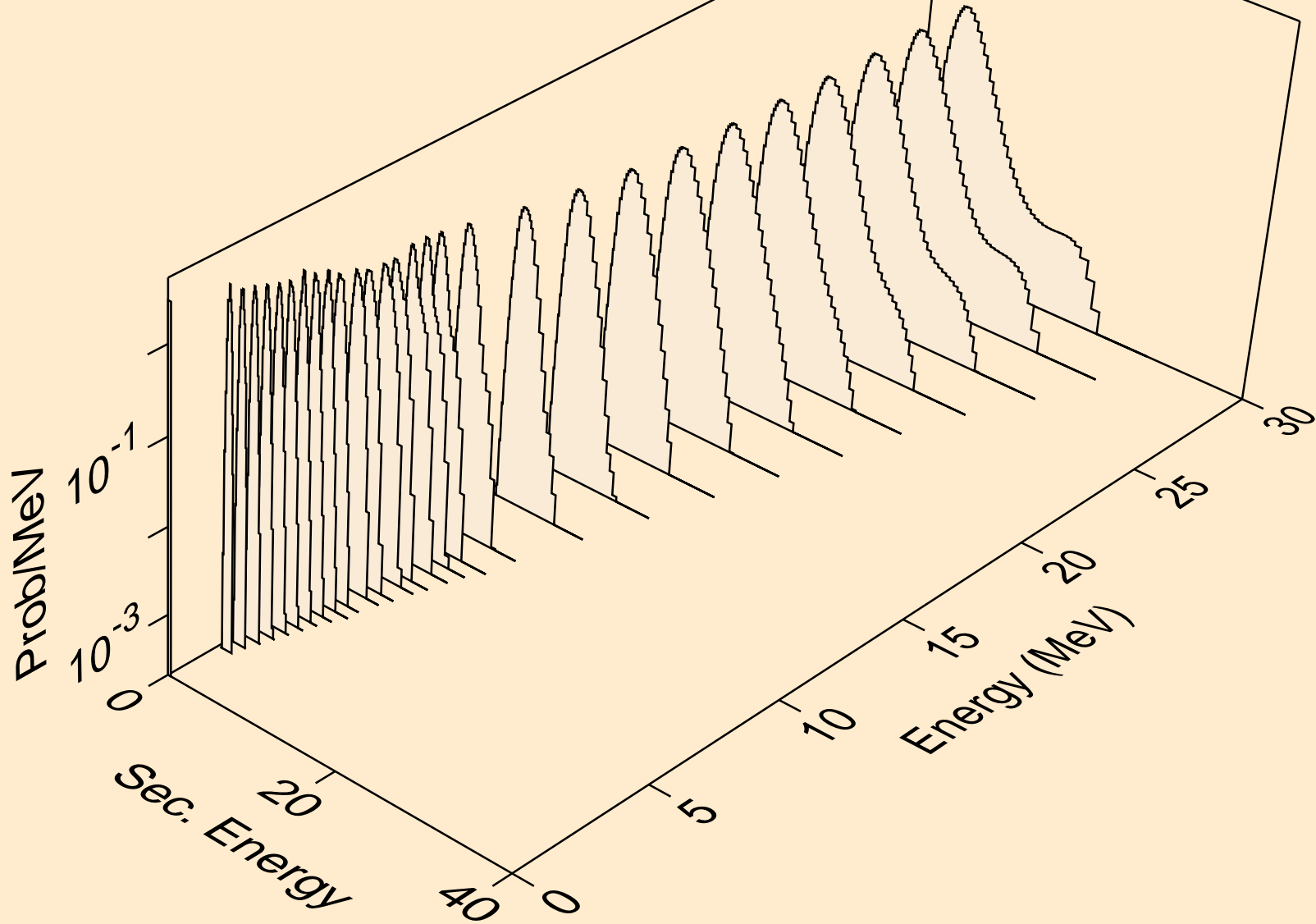

BR073 NEUTRON ACER TENDL-2024 LIBRARY; T=0.K
protons from (n,pd)

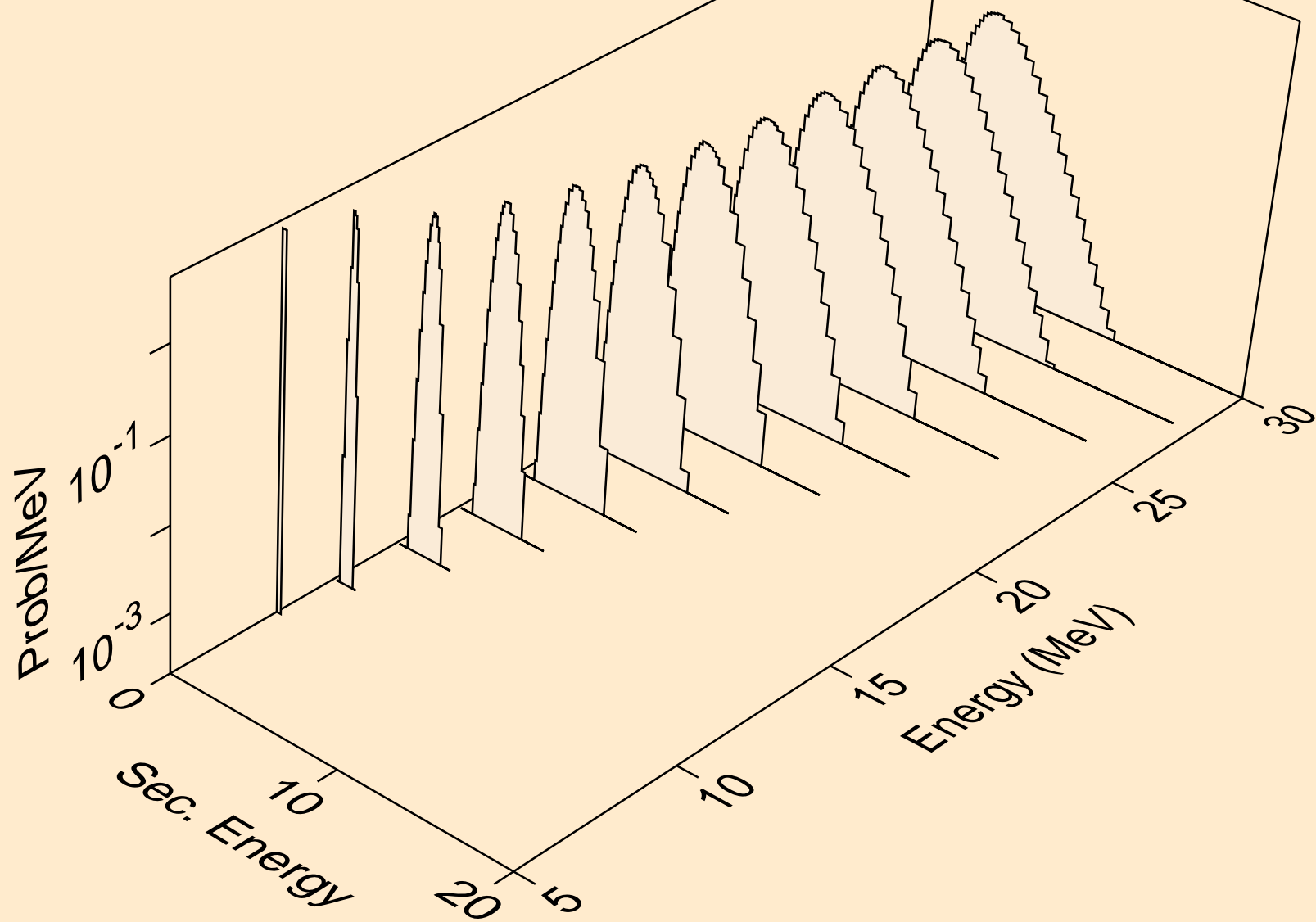

BR073 NEUTRON ACER TENDL-2024 LIBRARY; T=0.K
protons from (n,pt)

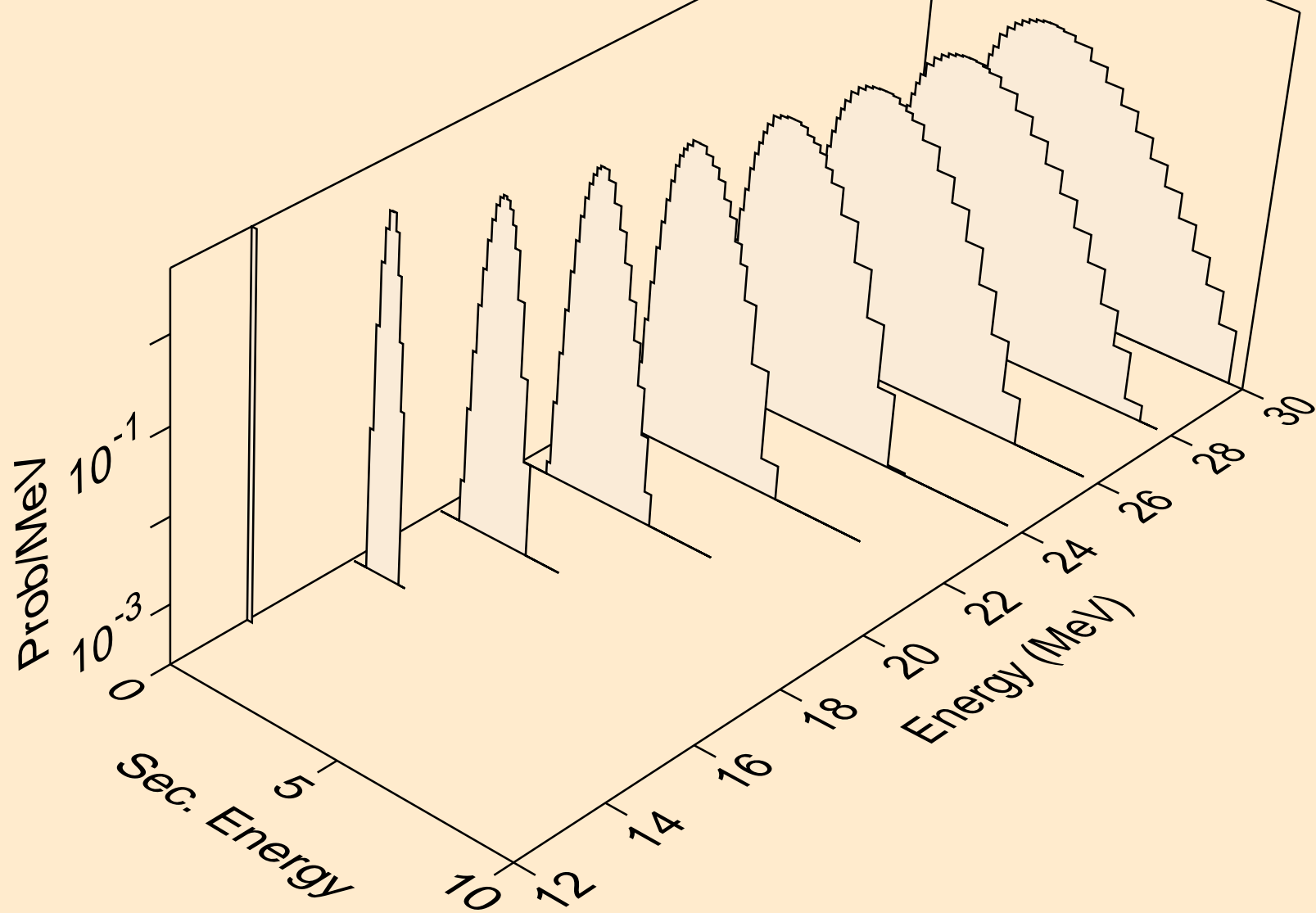

BR073 NEUTRON ACER TENDL-2024 LIBRARY; T=0.K
deuterons from (n,x)

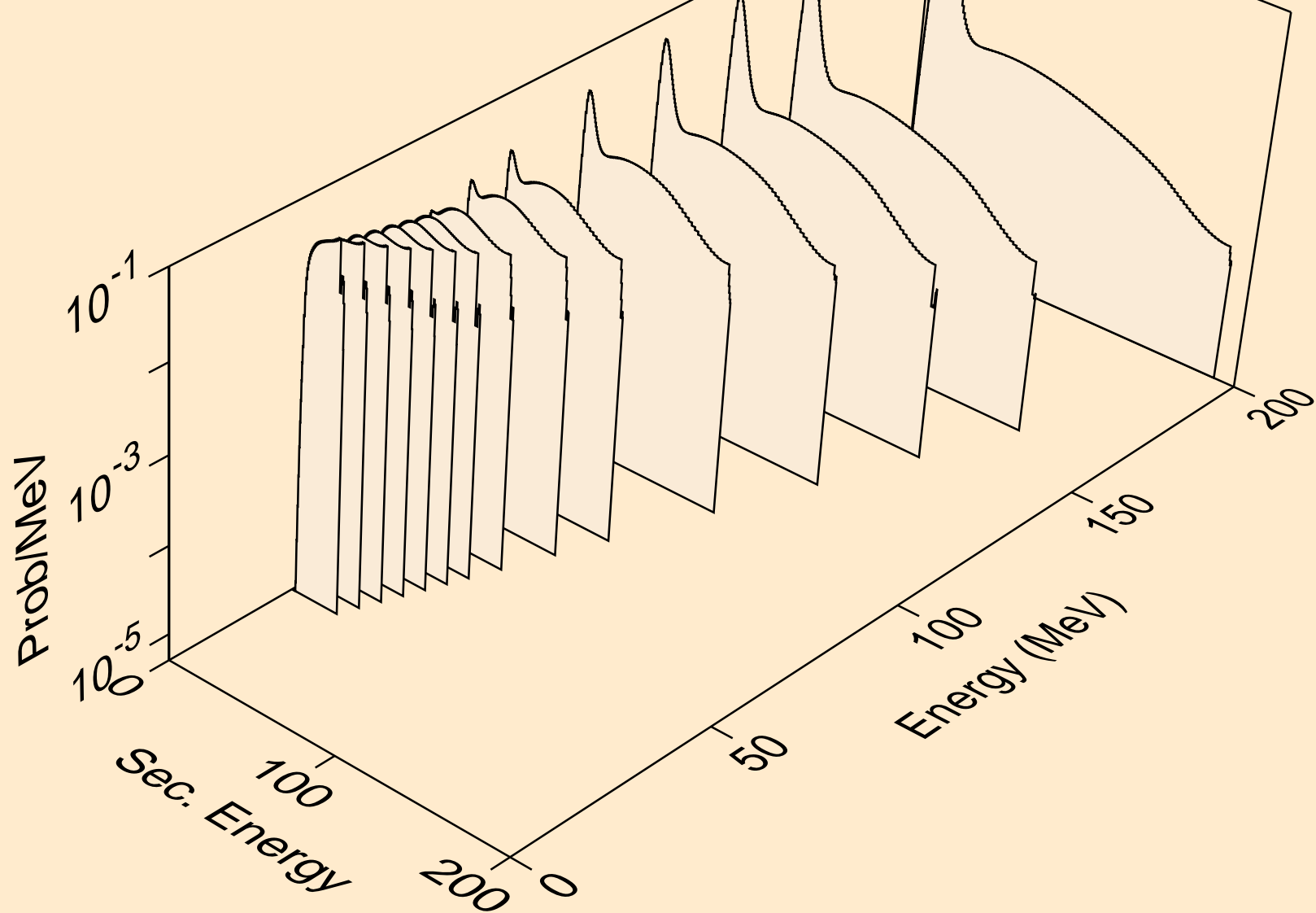

BR073 NEUTRON ACER TENDL-2024 LIBRARY; T=0.K
deuterons from (n,2nd)

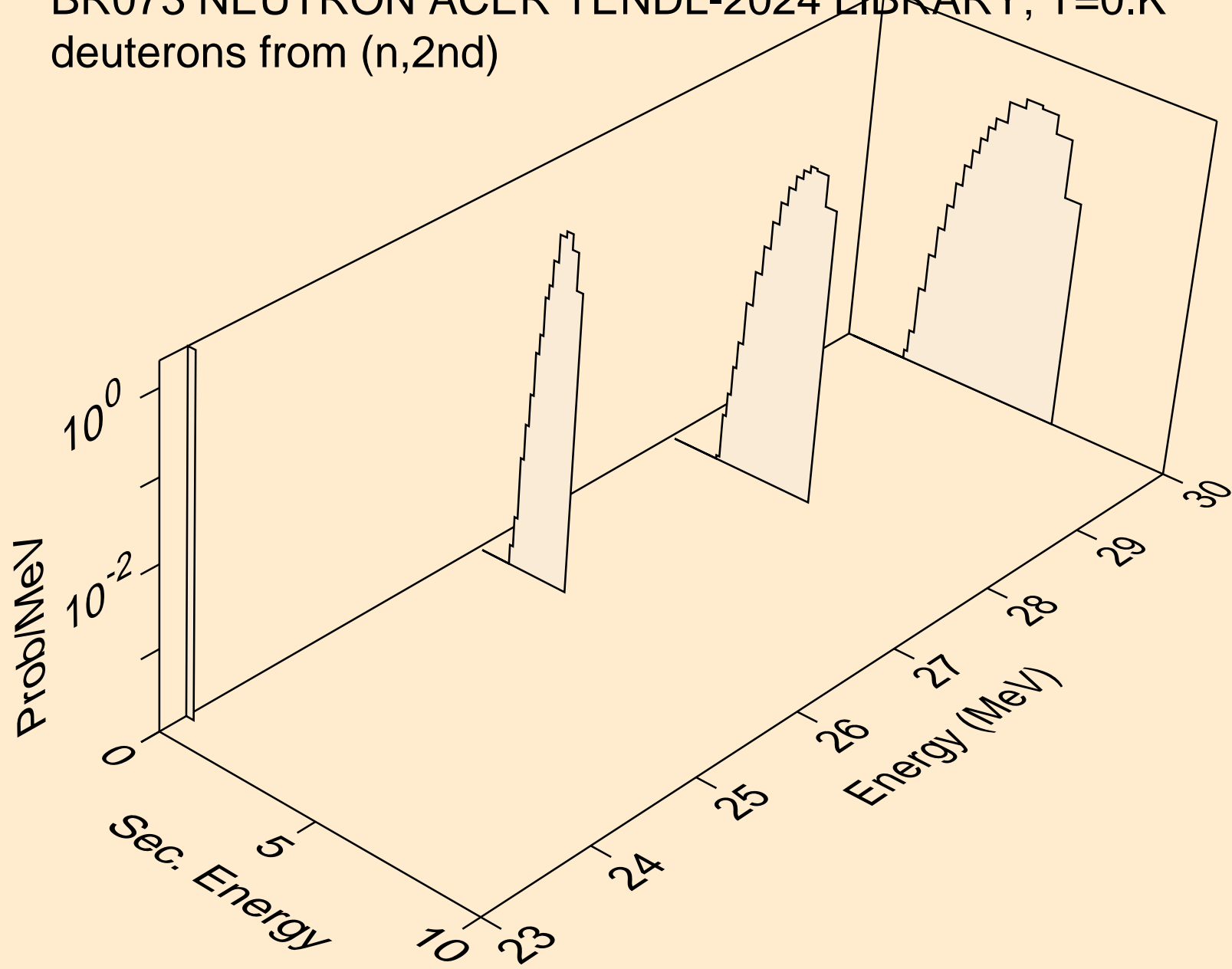

BR073 NEUTRON ACER TENDL-2024 LIBRARY; T=0.K
deuterons from (n,n*)d

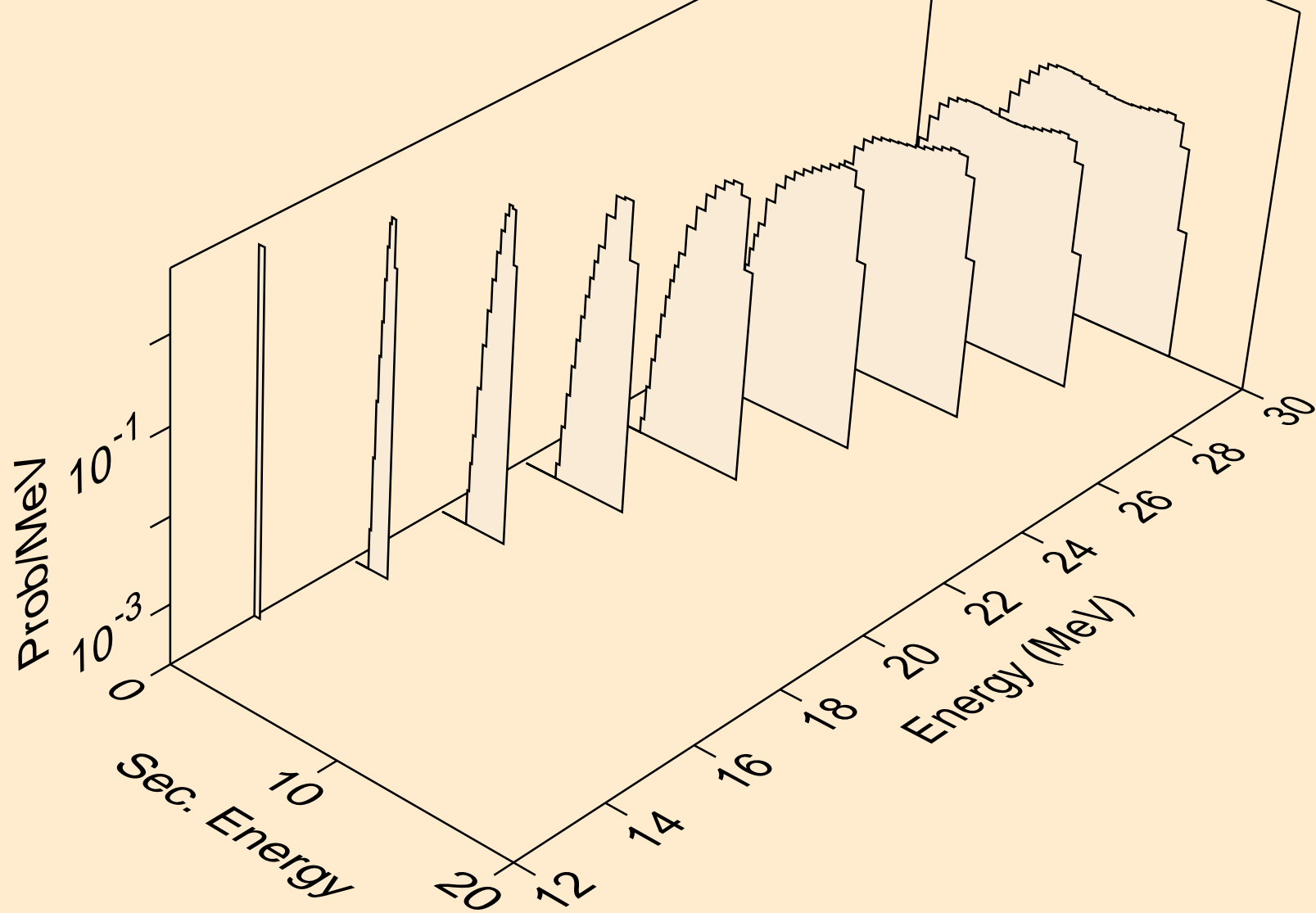

BR073 NEUTRON ACER TENDL-2024 LIBRARY; T=0.K
deuterons from (n,d)

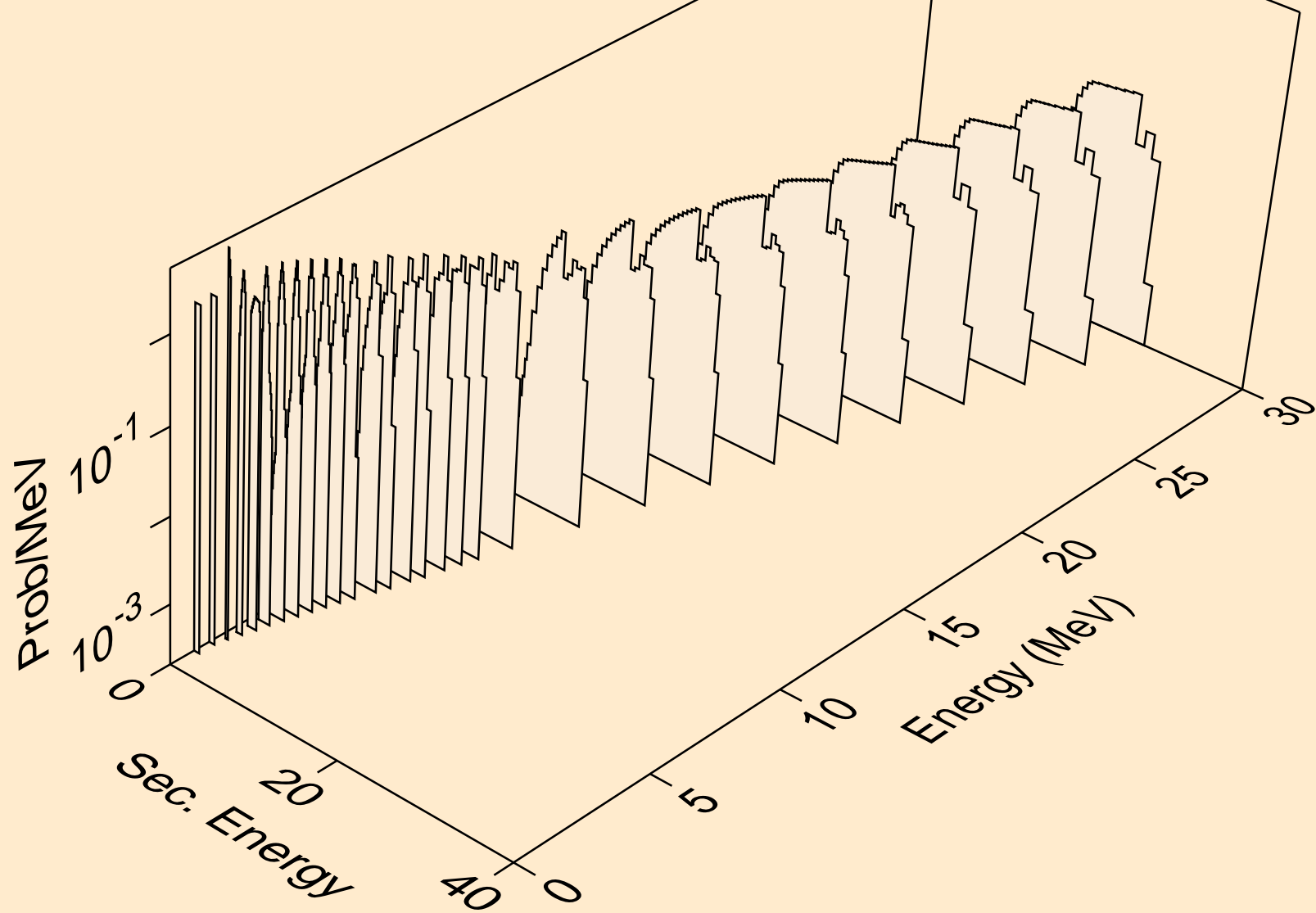

BR073 NEUTRON ACER TENDL-2024 LIBRARY; T=0.K
deuterons from (n,d2a)

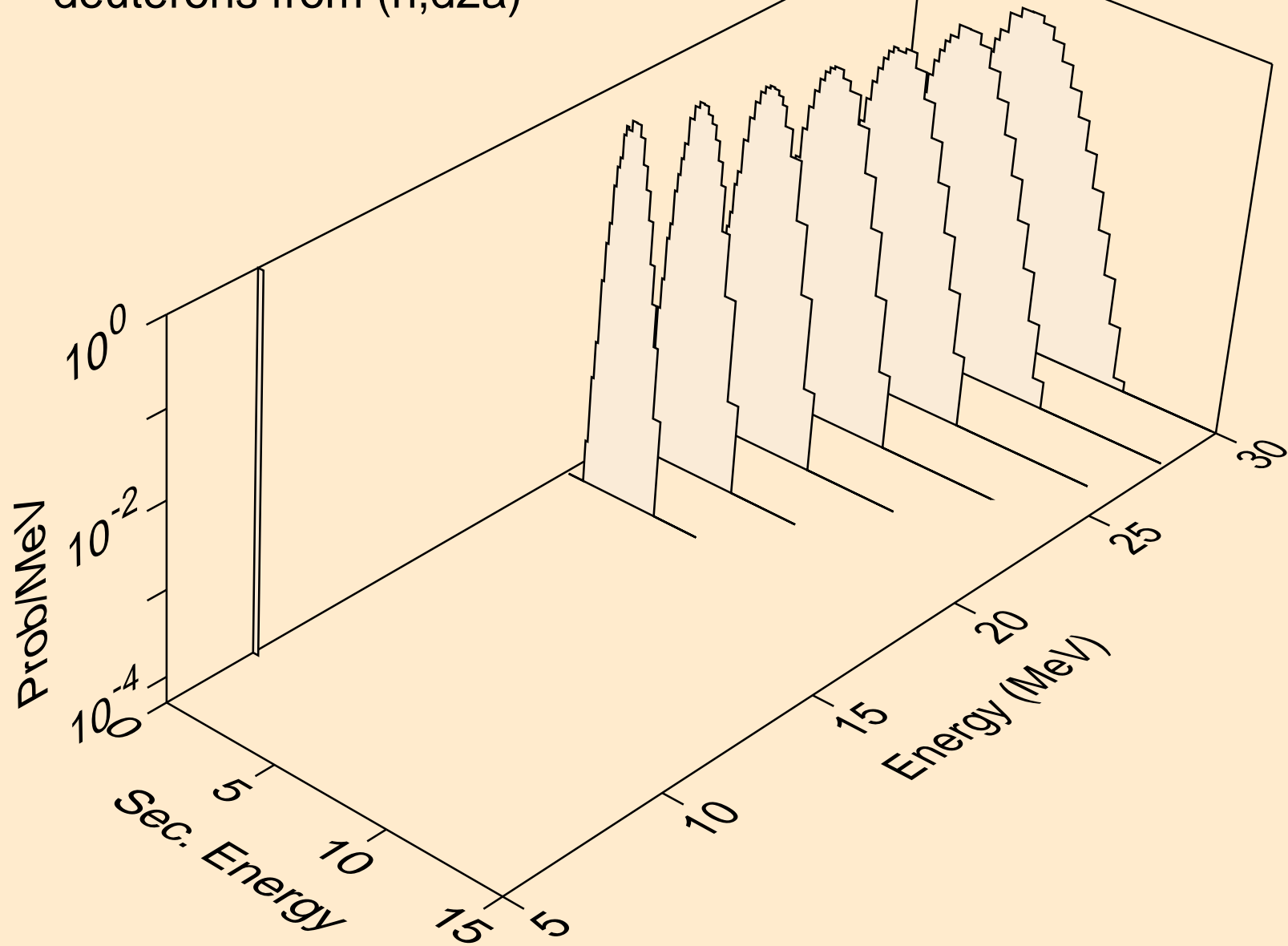

BR073 NEUTRON ACER TENDL-2024 LIBRARY; T=0.K
deuterons from (n,pd)

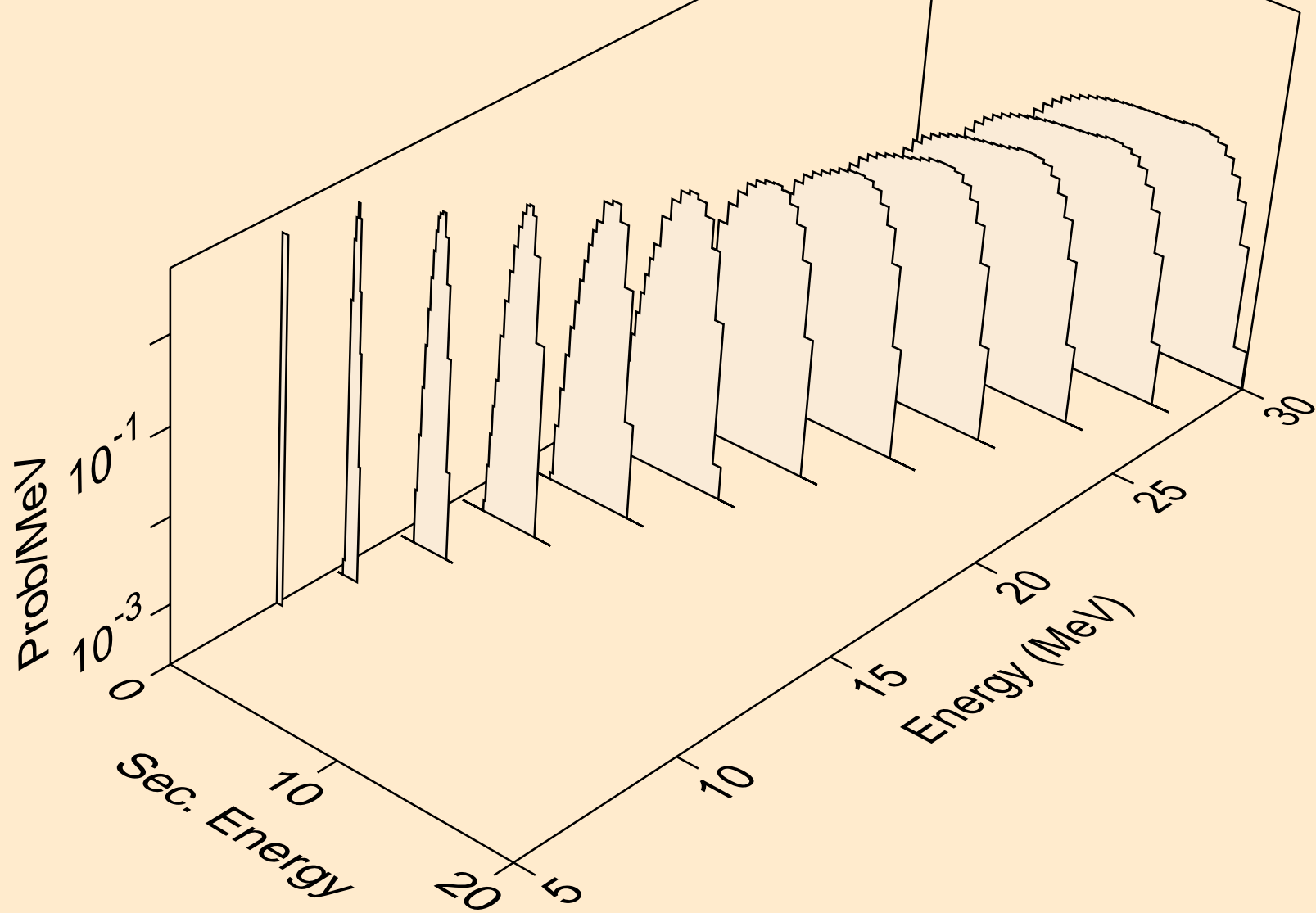

BR073 NEUTRON ACER TENDL-2024 LIBRARY; T=0.K
deuterons from (n,da)

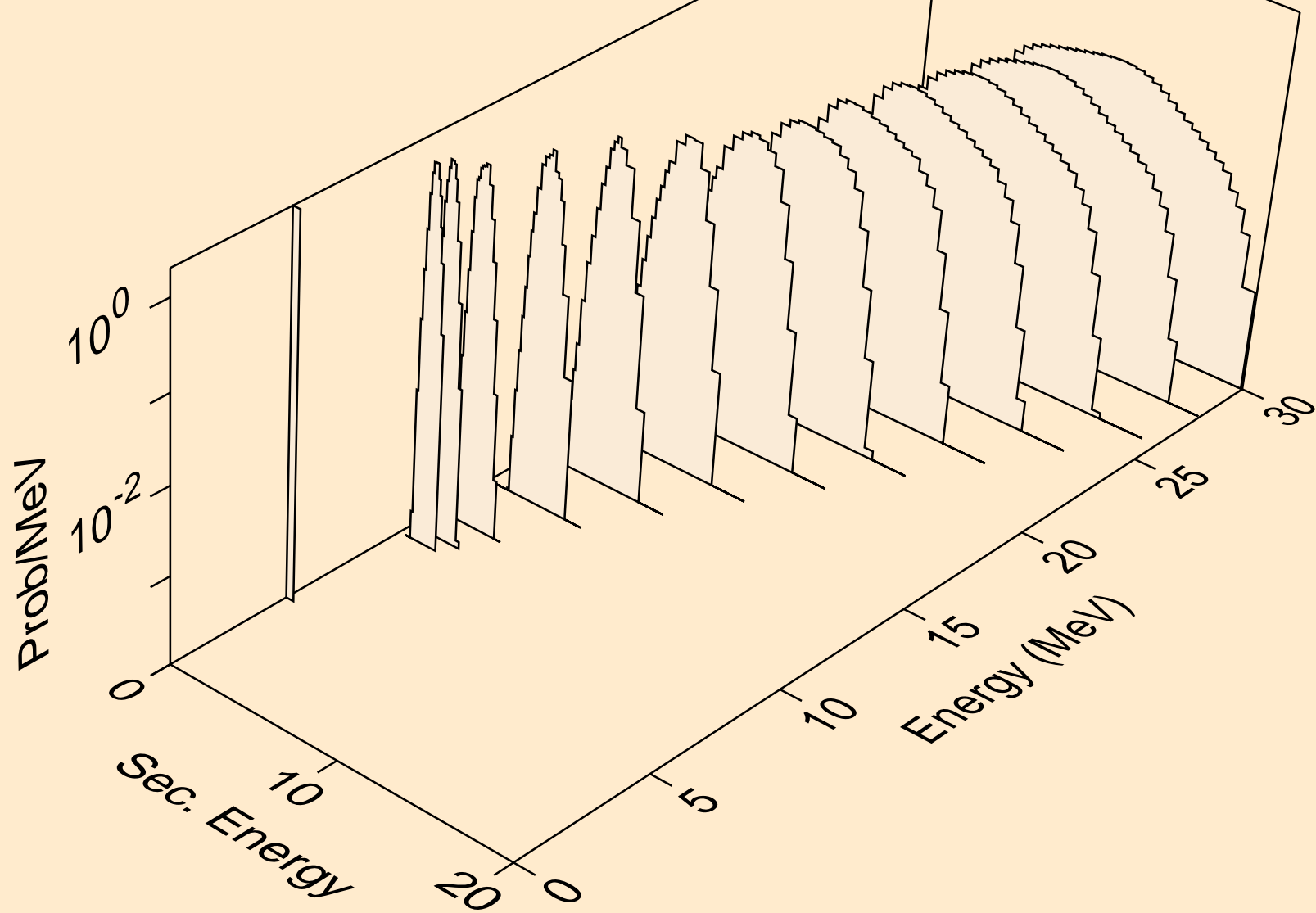

BR073 NEUTRON ACER TENDL-2024 LIBRARY; T=0.K
tritons from (n,x)

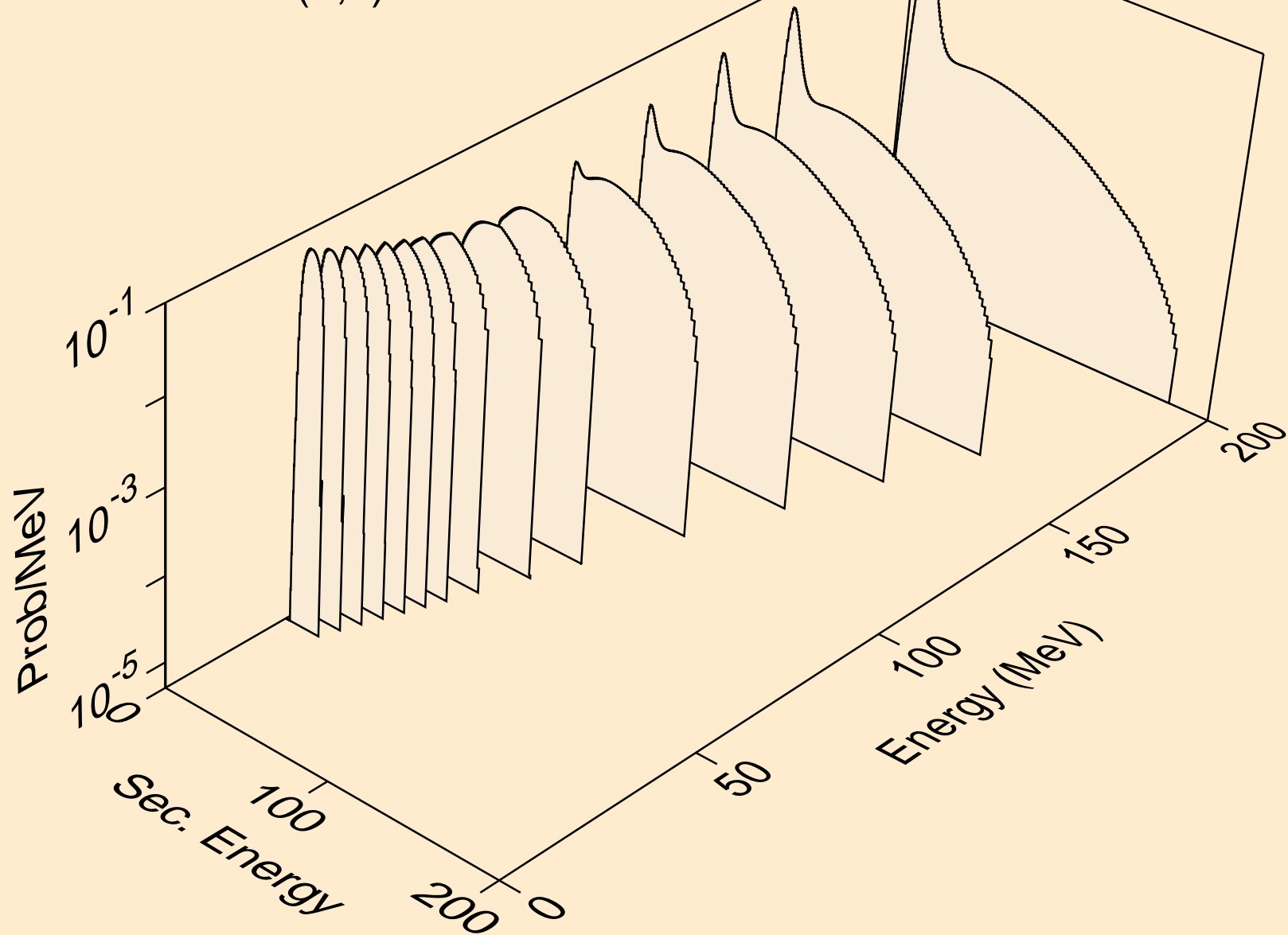

BR073 NEUTRON ACER TENDL-2024 LIBRARY; T=0.K
tritons from (n,n*)t

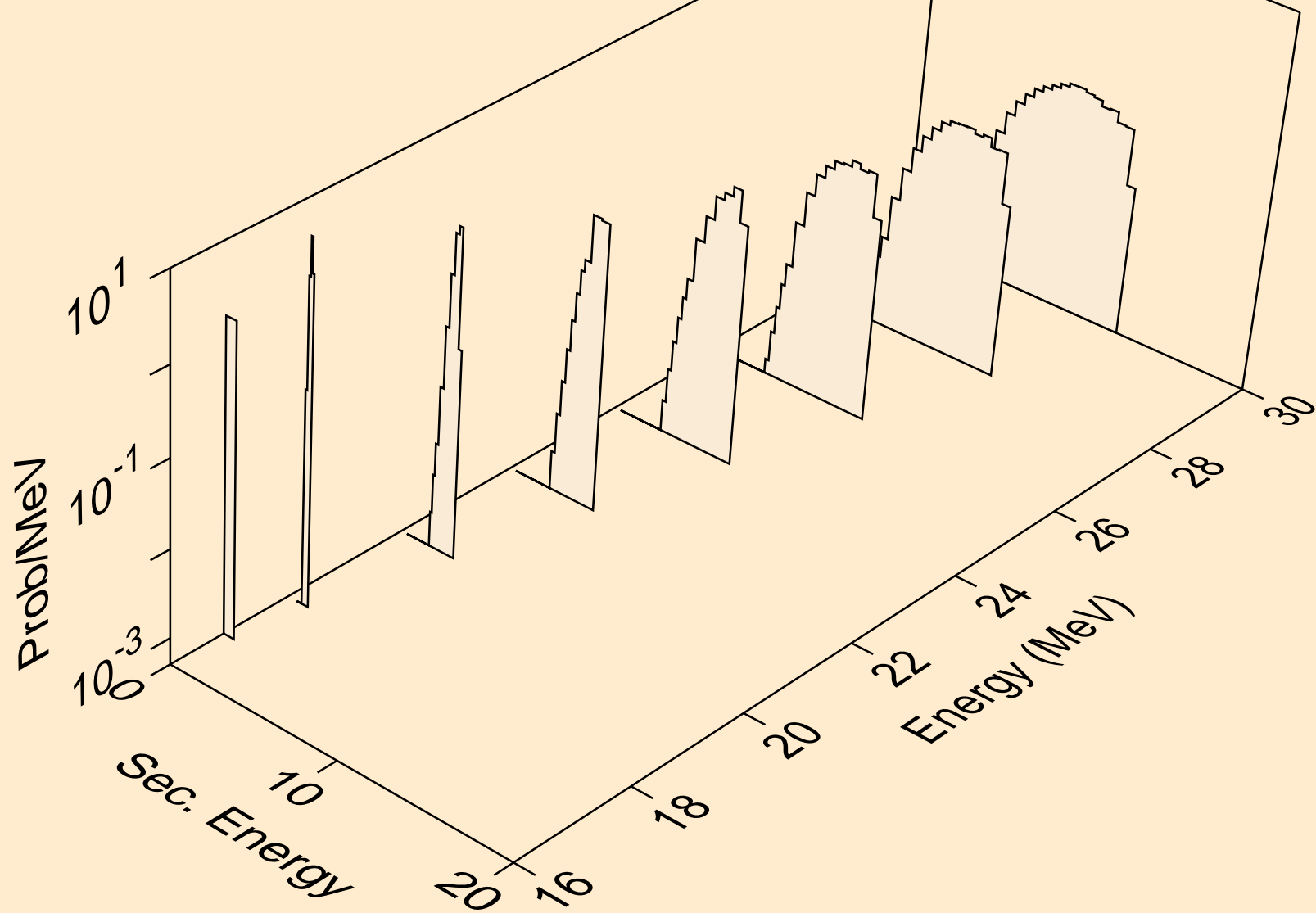

BR073 NEUTRON ACER TENDL-2024 LIBRARY; T=0.K
tritons from (n,t)

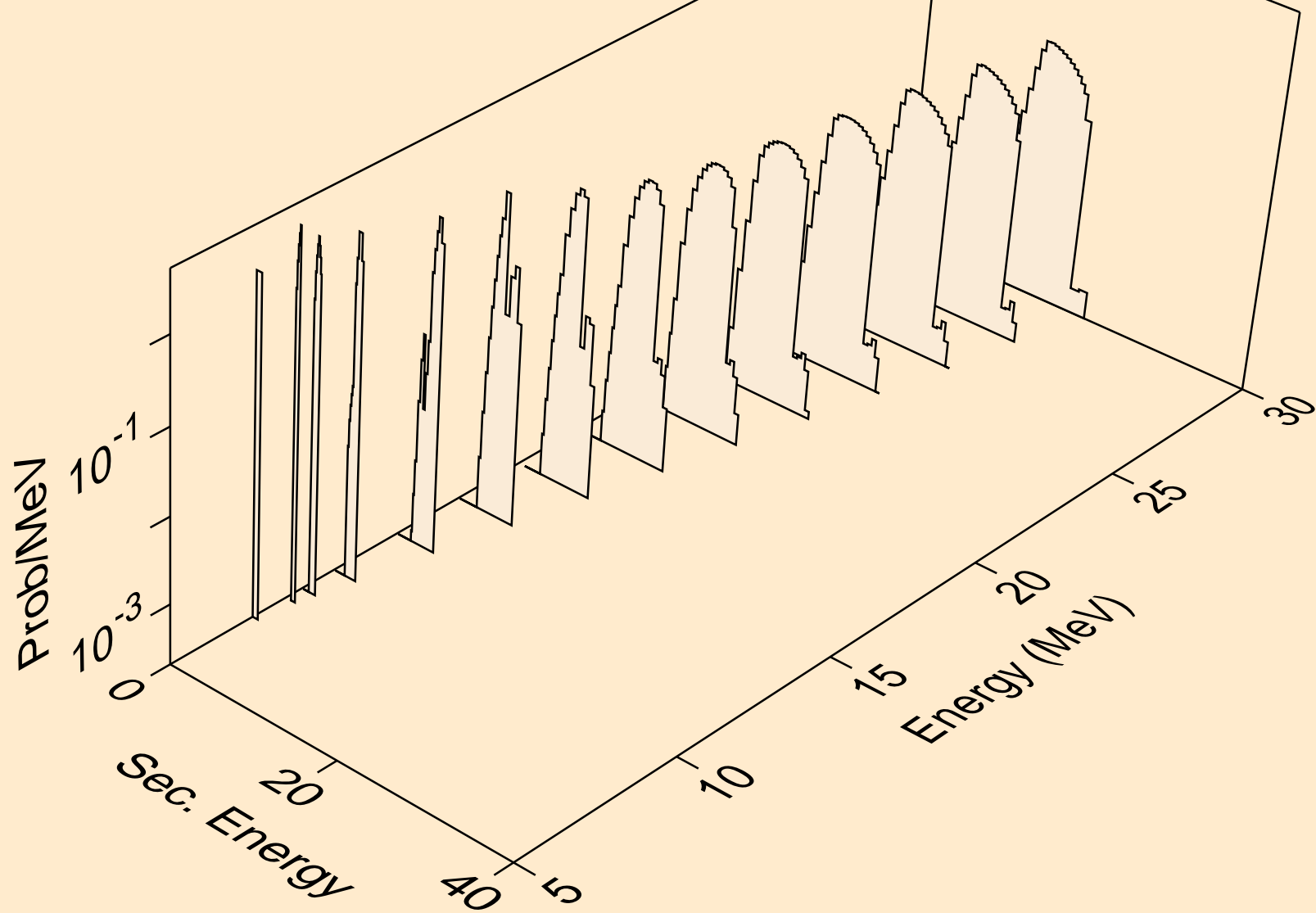

BR073 NEUTRON ACER TENDL-2024 LIBRARY; T=0.K
tritons from (n,pt)

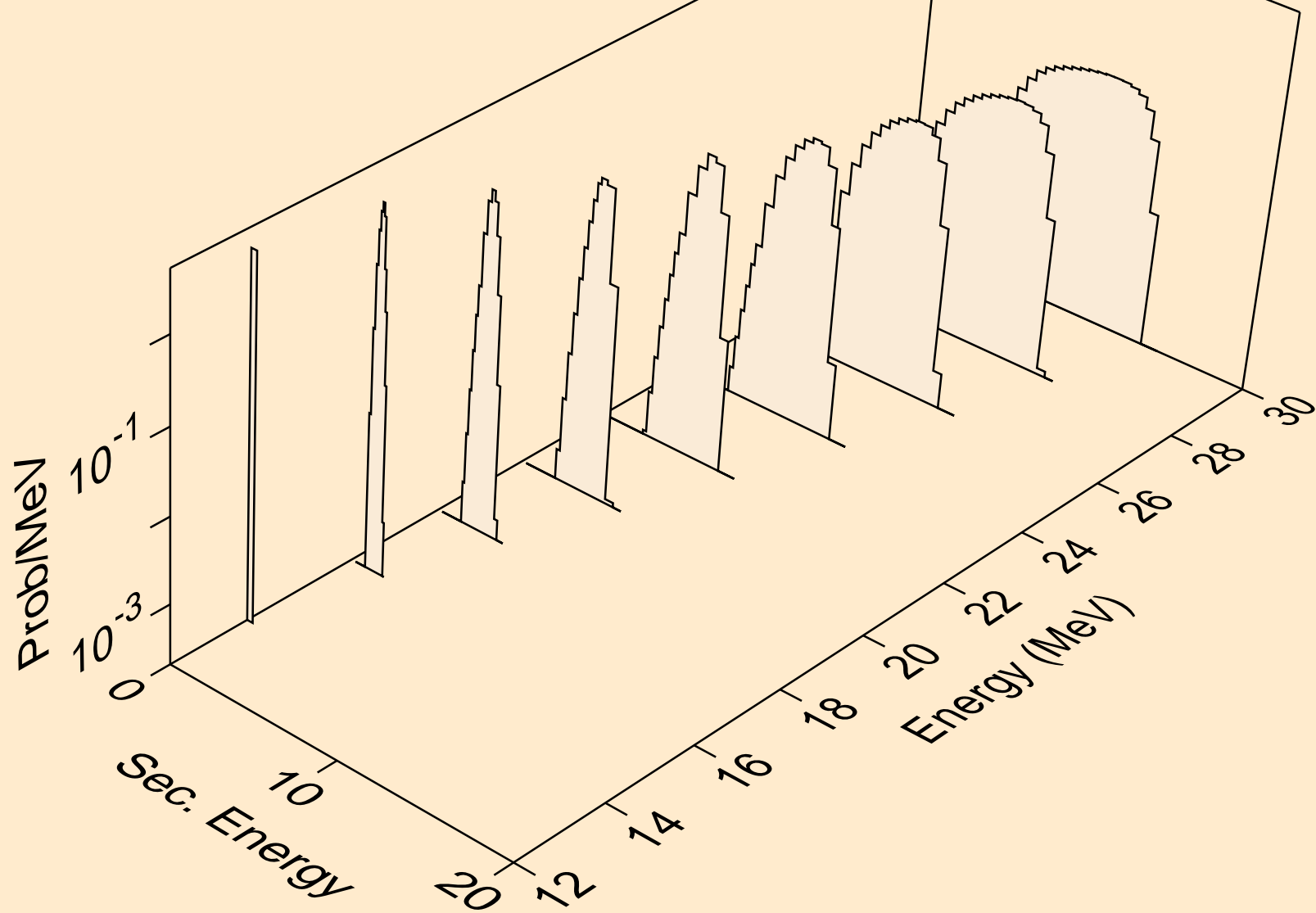

BR073 NEUTRON ACER TENDL-2024 LIBRARY; T=0.K
he3s from (n,x)

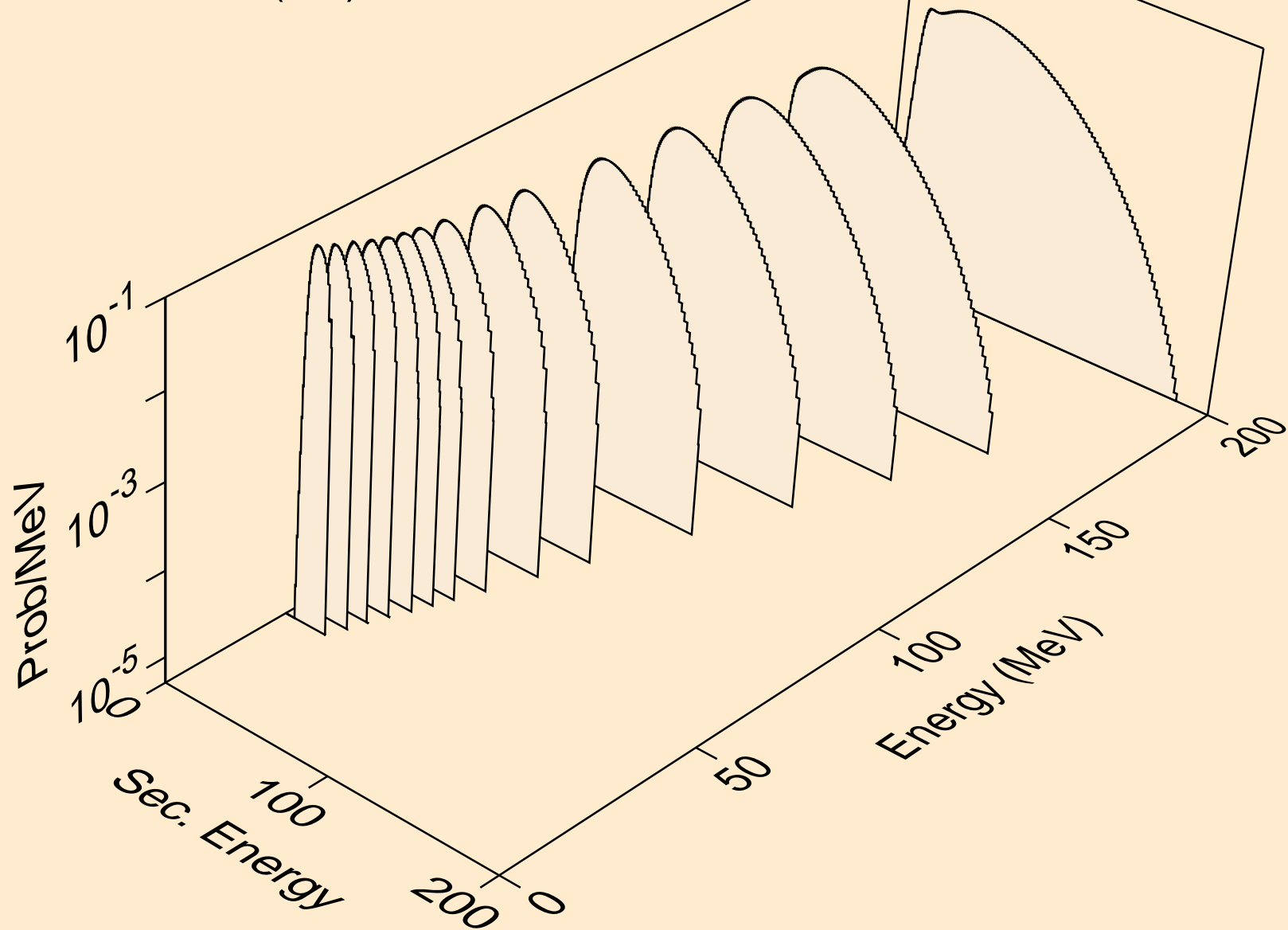

BR073 NEUTRON ACER TENDL-2024 LIBRARY; T=0.K
he3s from (n,n*)he3

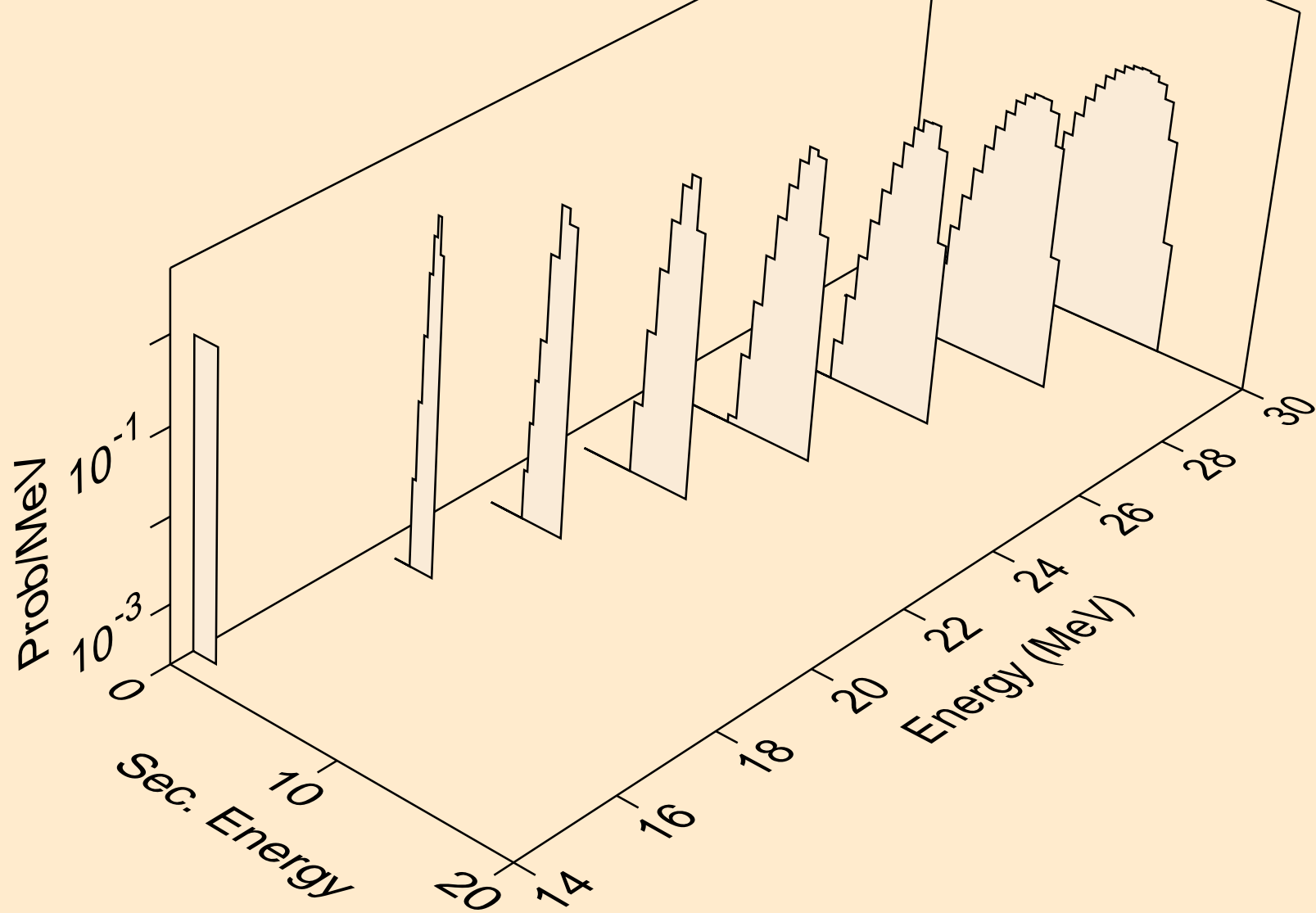

BR073 NEUTRON ACER TENDL-2024 LIBRARY; T=0.K
he3s from (n,he3)

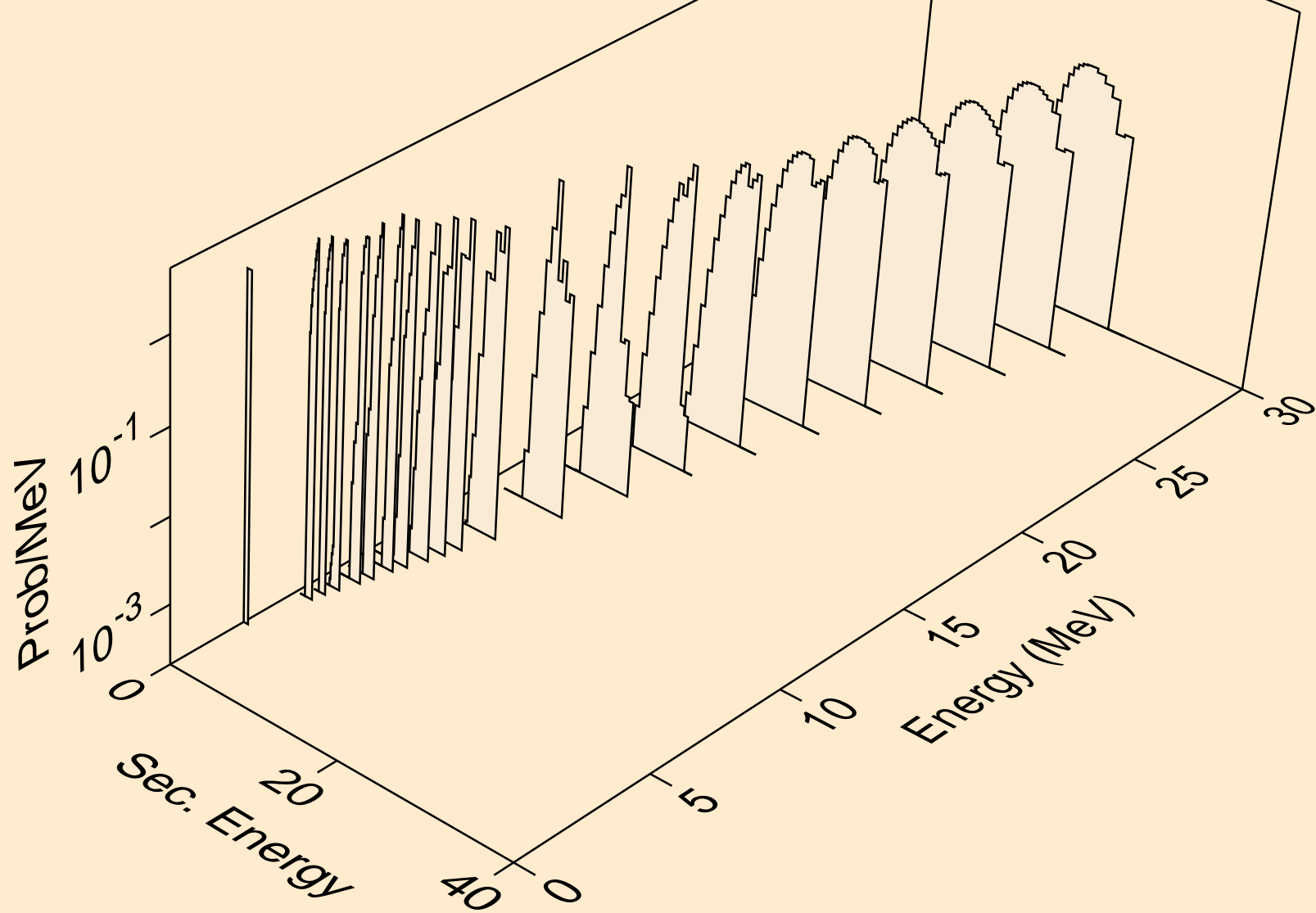

BR073 NEUTRON ACER TENDL-2024 LIBRARY; T=0.K
alphas from (n,x)

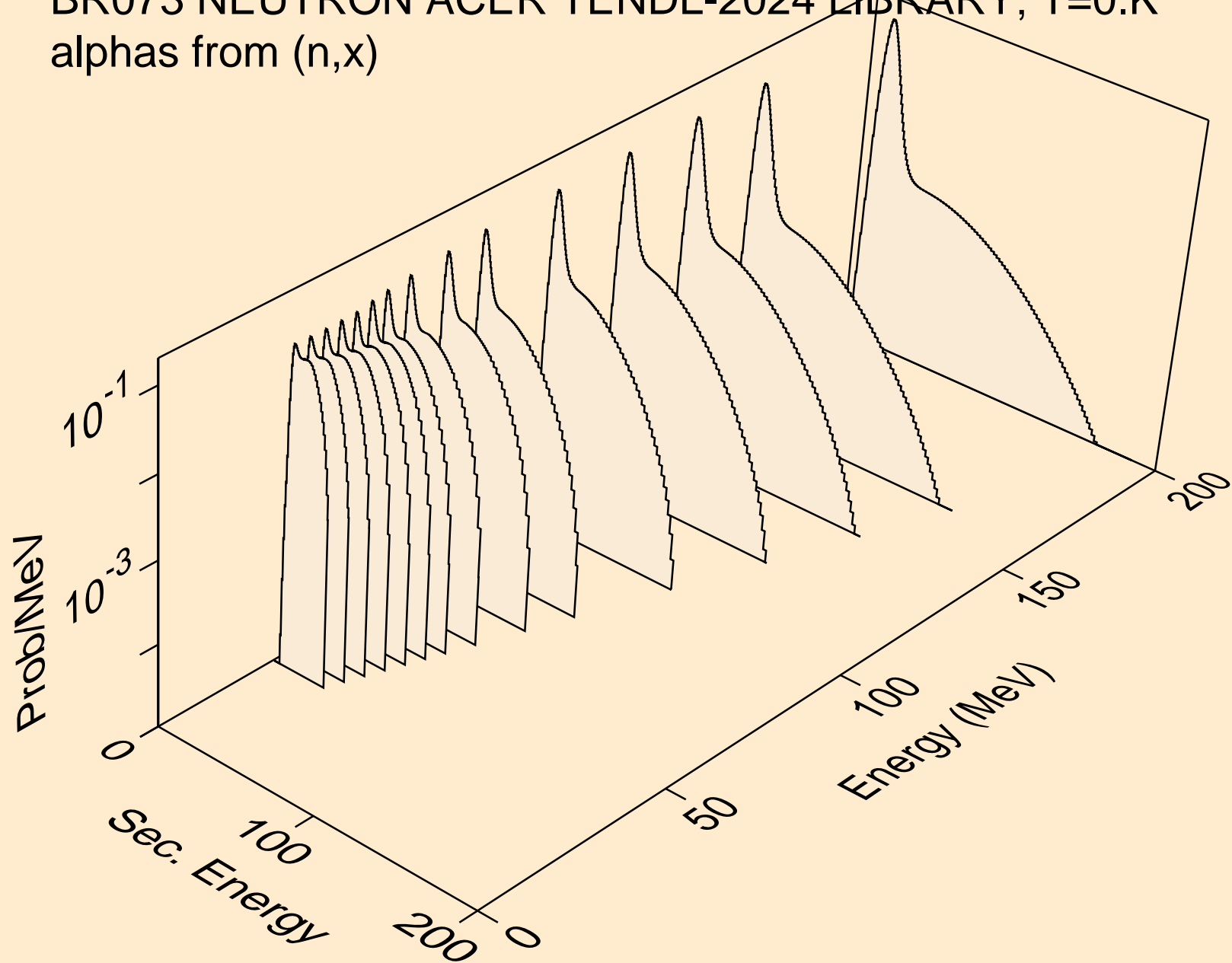

BR073 NEUTRON ACER TENDL-2024 LIBRARY; T=0.K
alphas from (n,n*)a

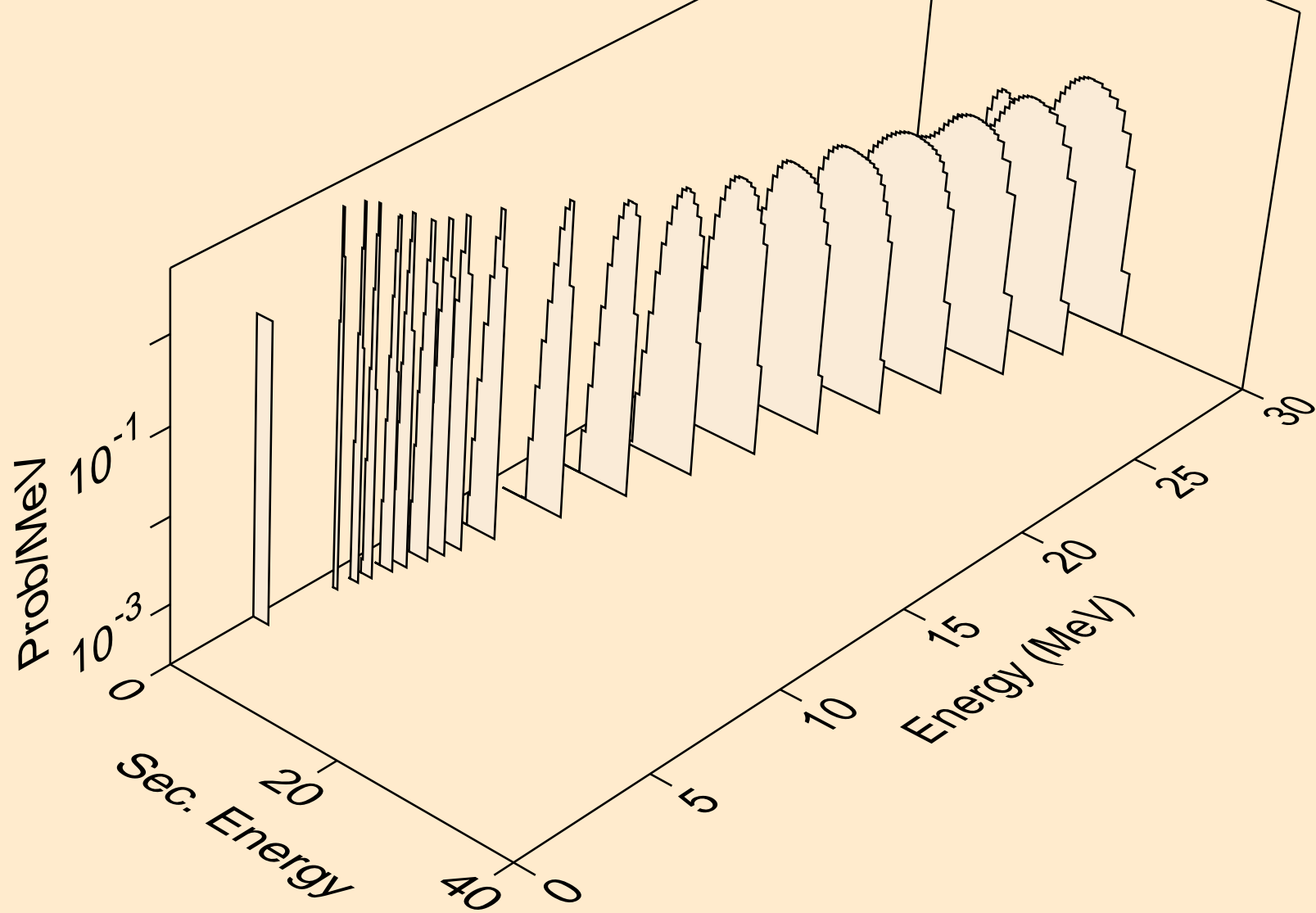

BR073 NEUTRON ACER TENDL-2024 LIBRARY; T=0.K
alphas from (n,2n)a

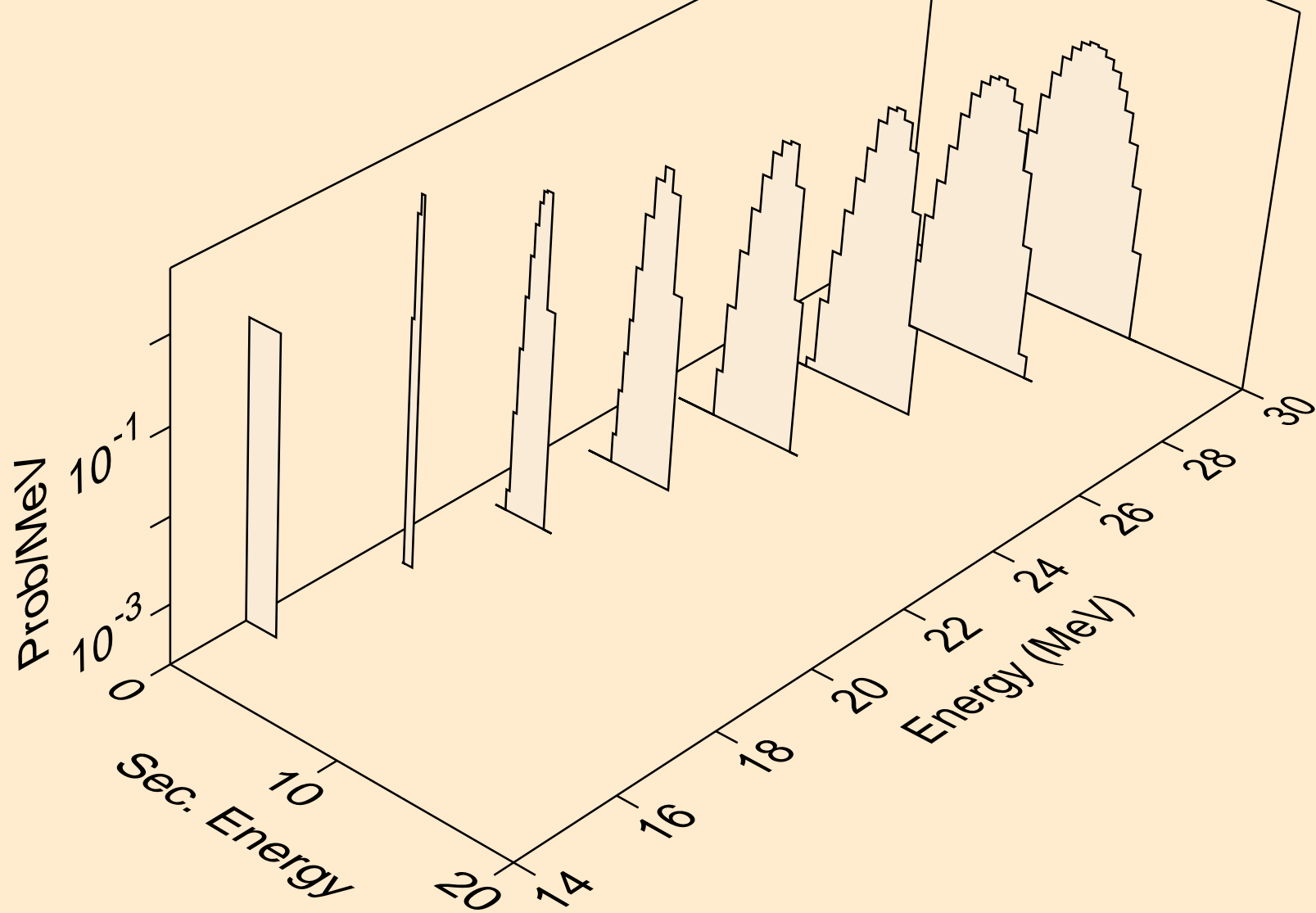

BR073 NEUTRON ACER TENDL-2024 LIBRARY; T=0.K
alphas from (n,n*)2a

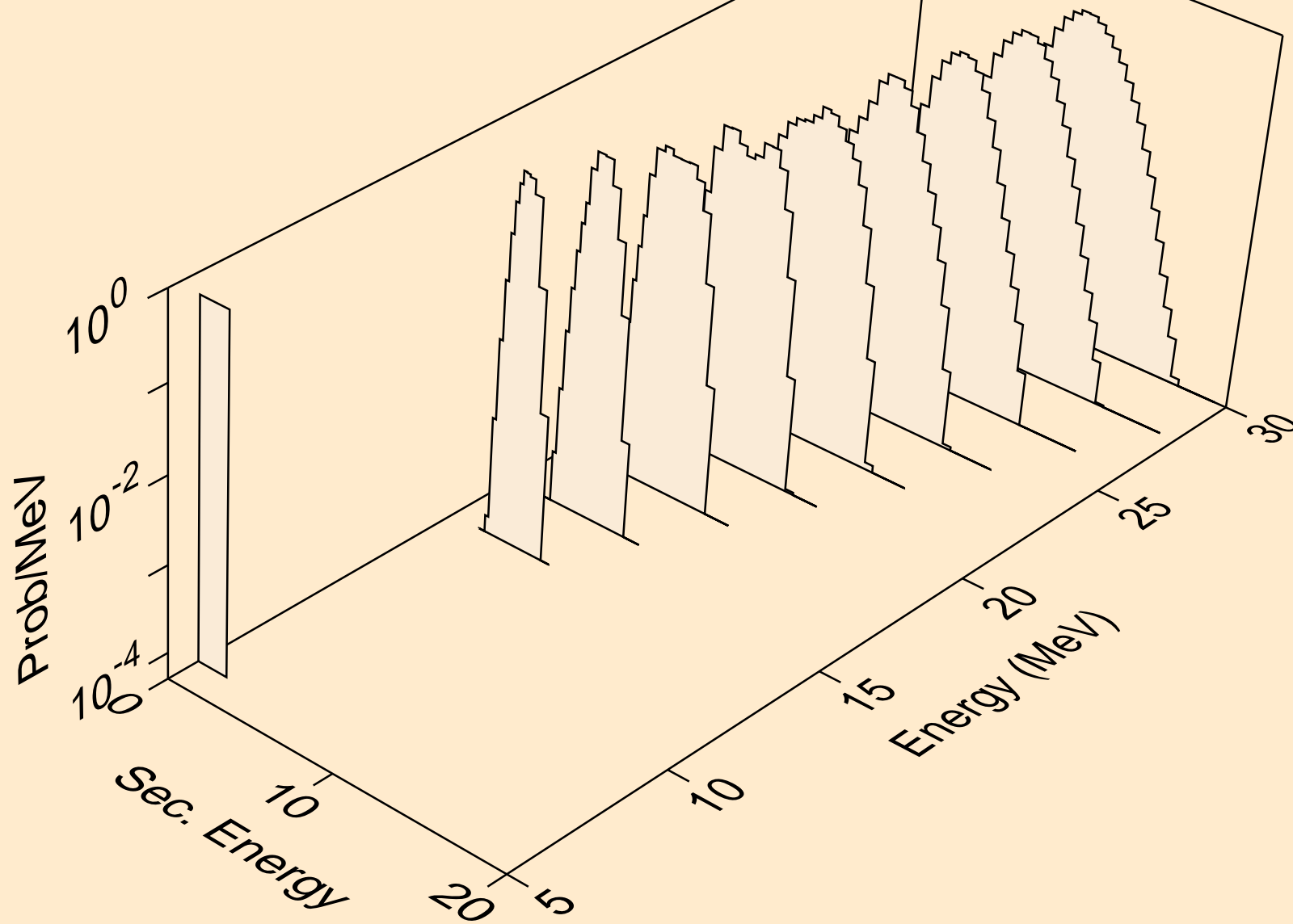

BR073 NEUTRON ACER TENDL-2024 LIBRARY; T=0.K
alphas from (n,npa)

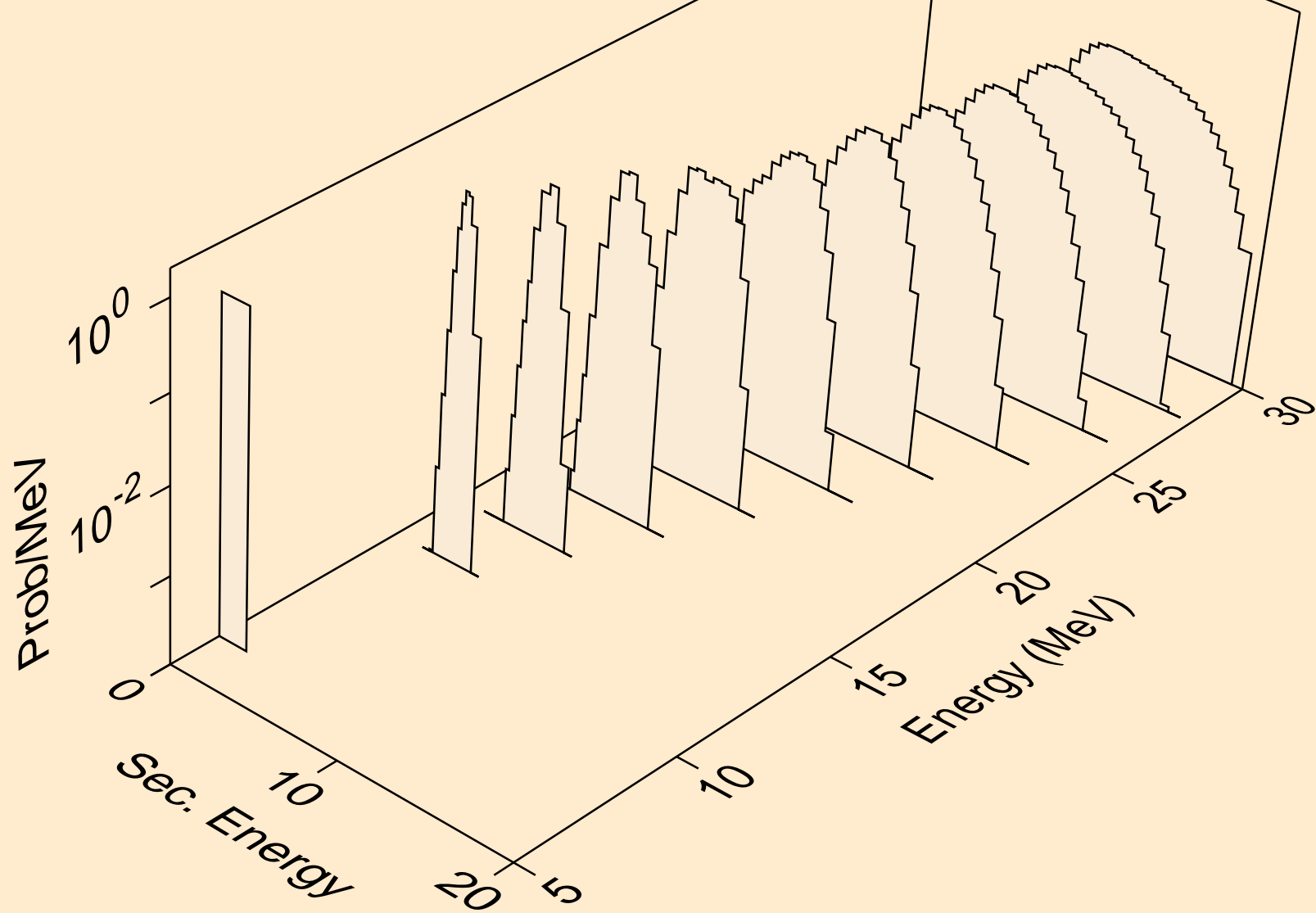

BR073 NEUTRON ACER TENDL-2024 LIBRARY; T=0.K
alphas from (n,a)

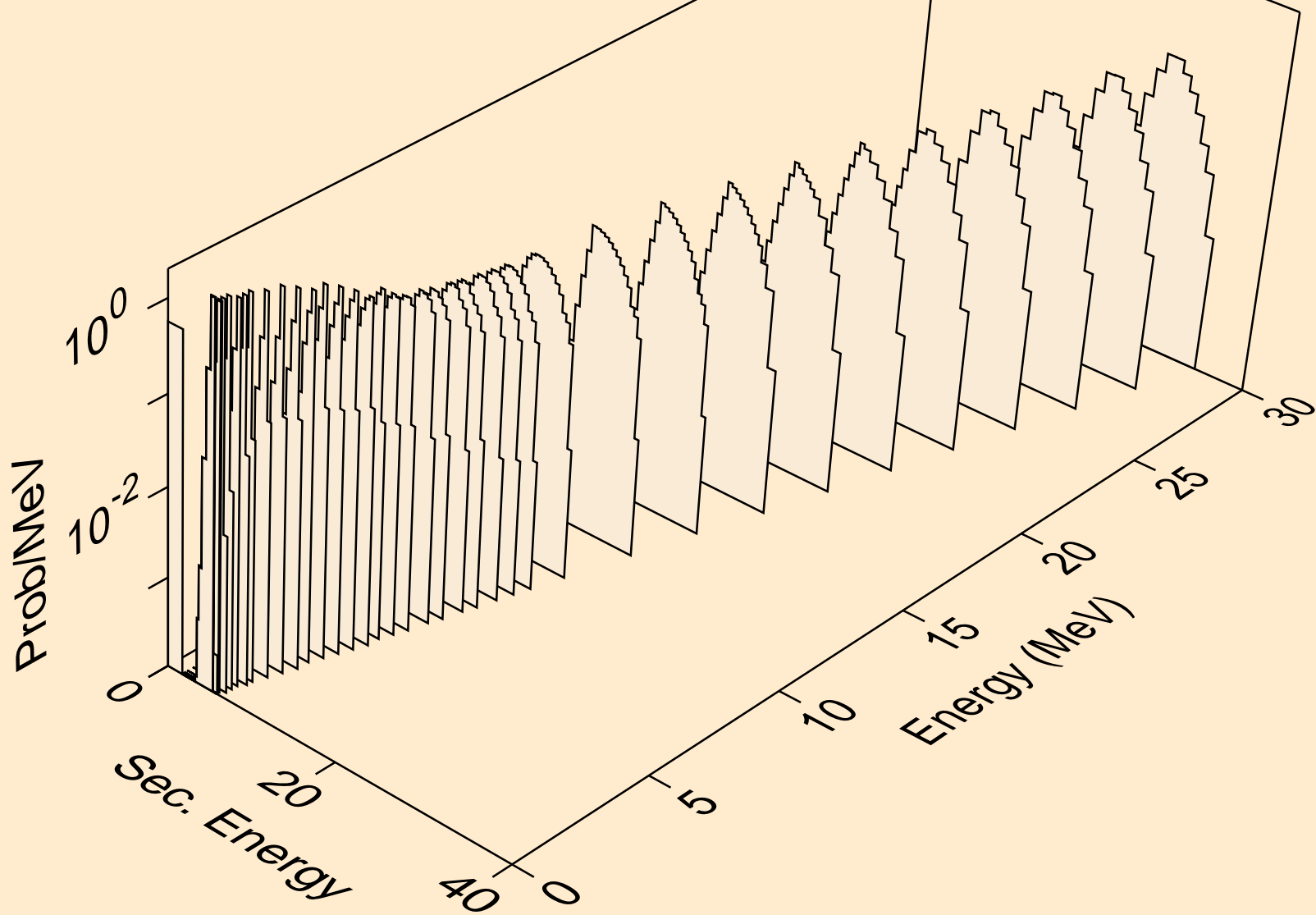

BR073 NEUTRON ACER TENDL-2024 LIBRARY; T=0.K
alphas from (n,2a)

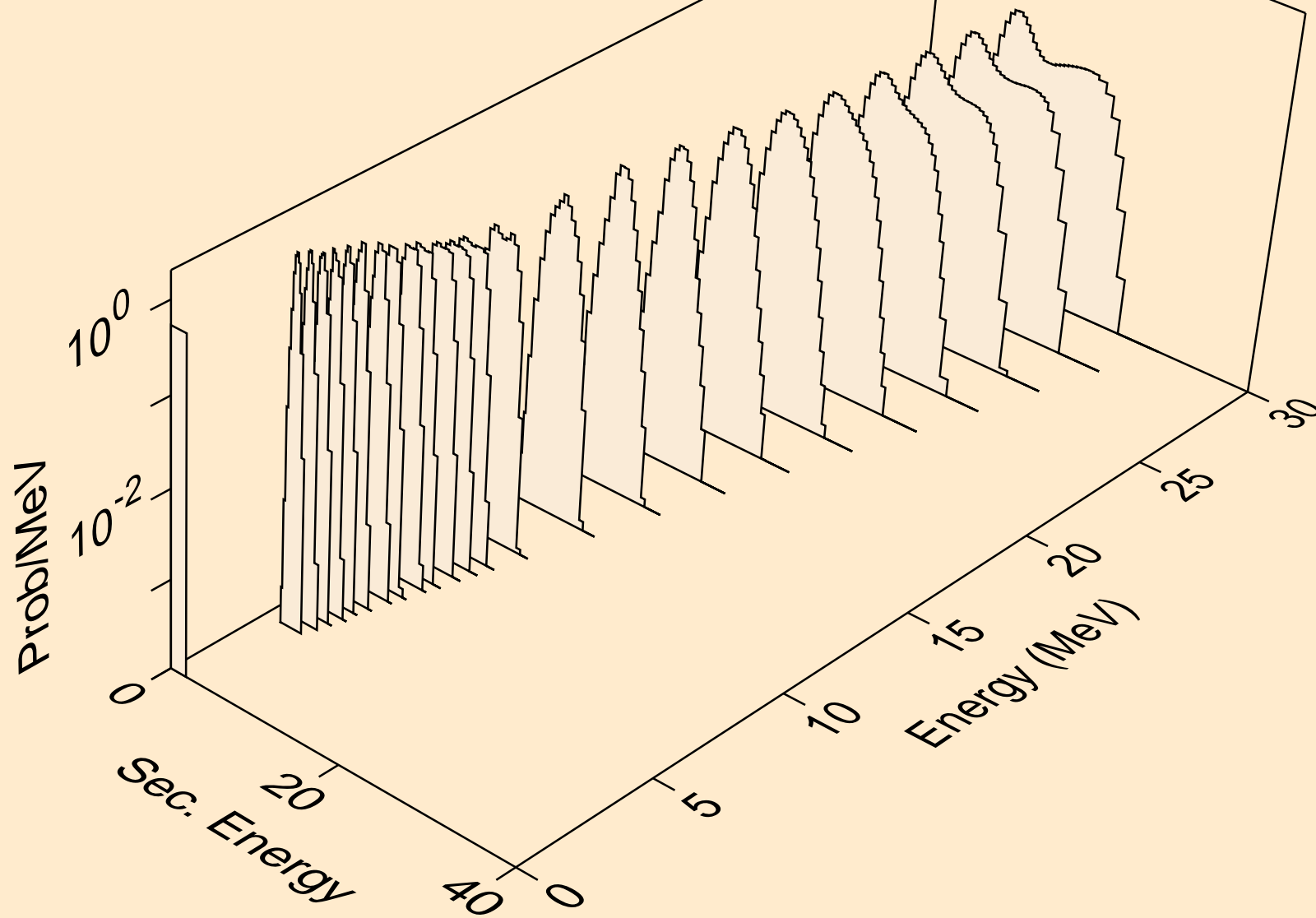

BR073 NEUTRON ACER TENDL-2024 LIBRARY; T=0.K
alphas from (n,3a)

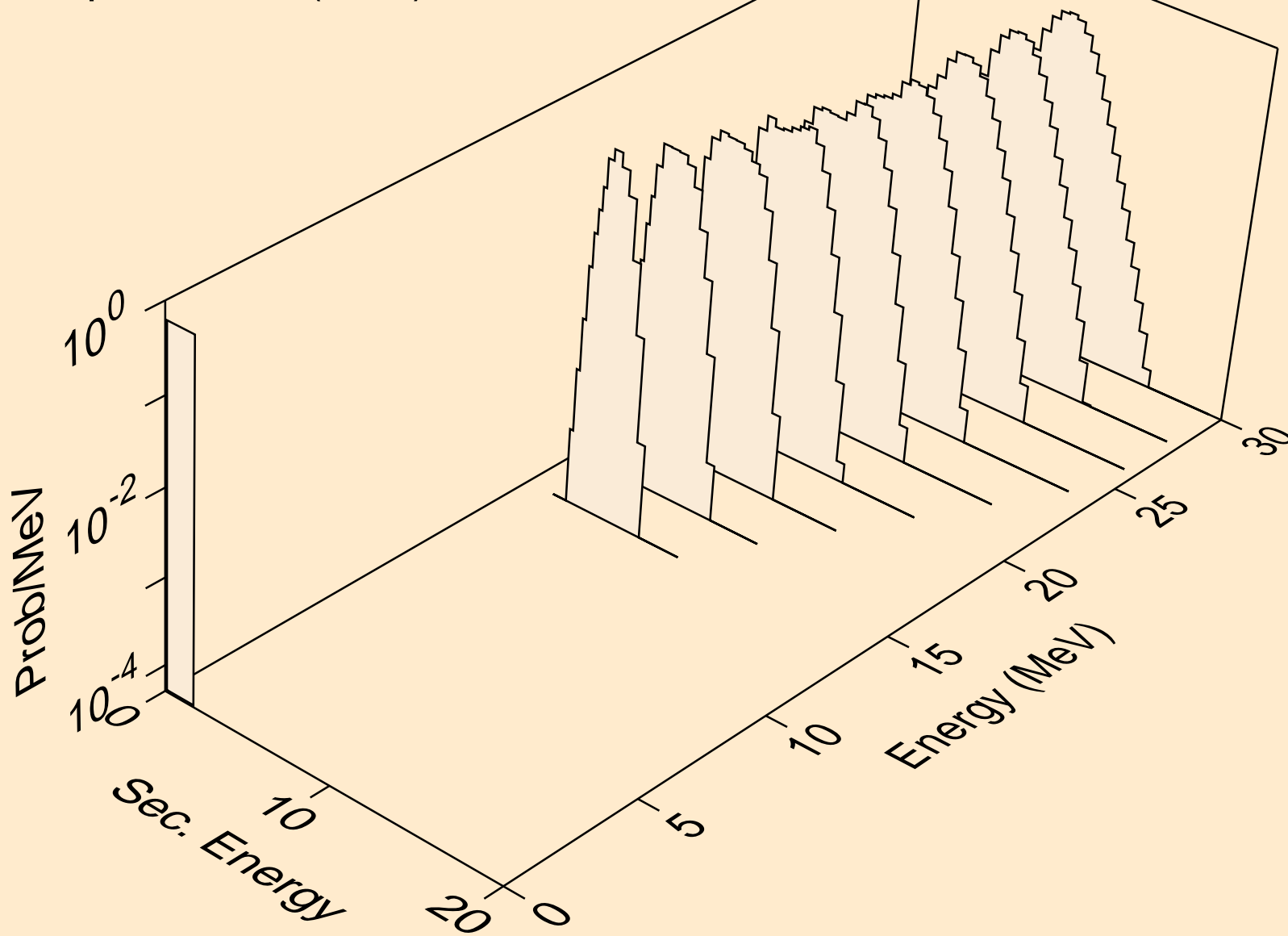

BR073 NEUTRON ACER TENDL-2024 LIBRARY; T=0.K
alphas from (n,pa)

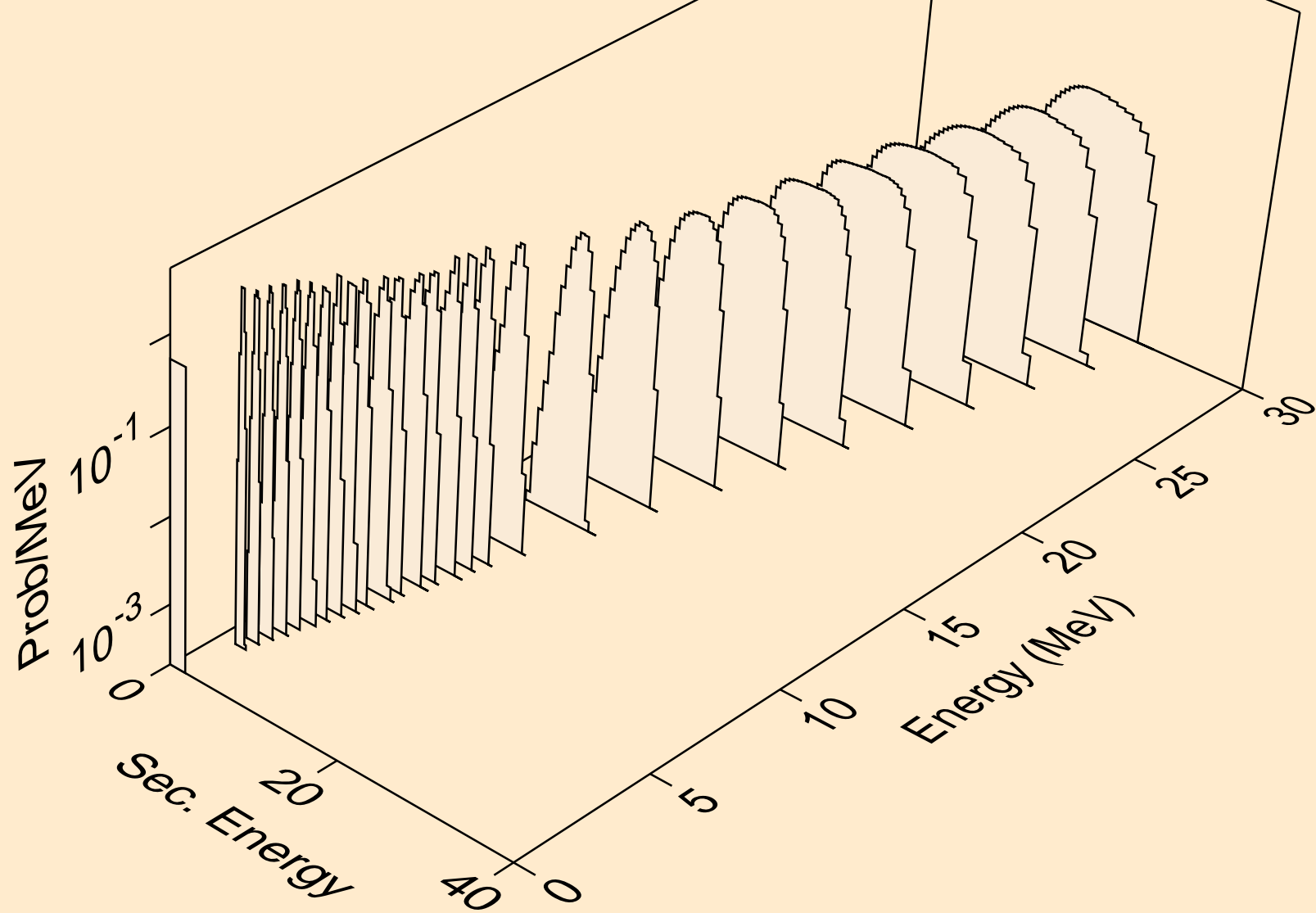

BR073 NEUTRON ACER TENDL-2024 LIBRARY; T=0.K
alphas from (n,d2a)

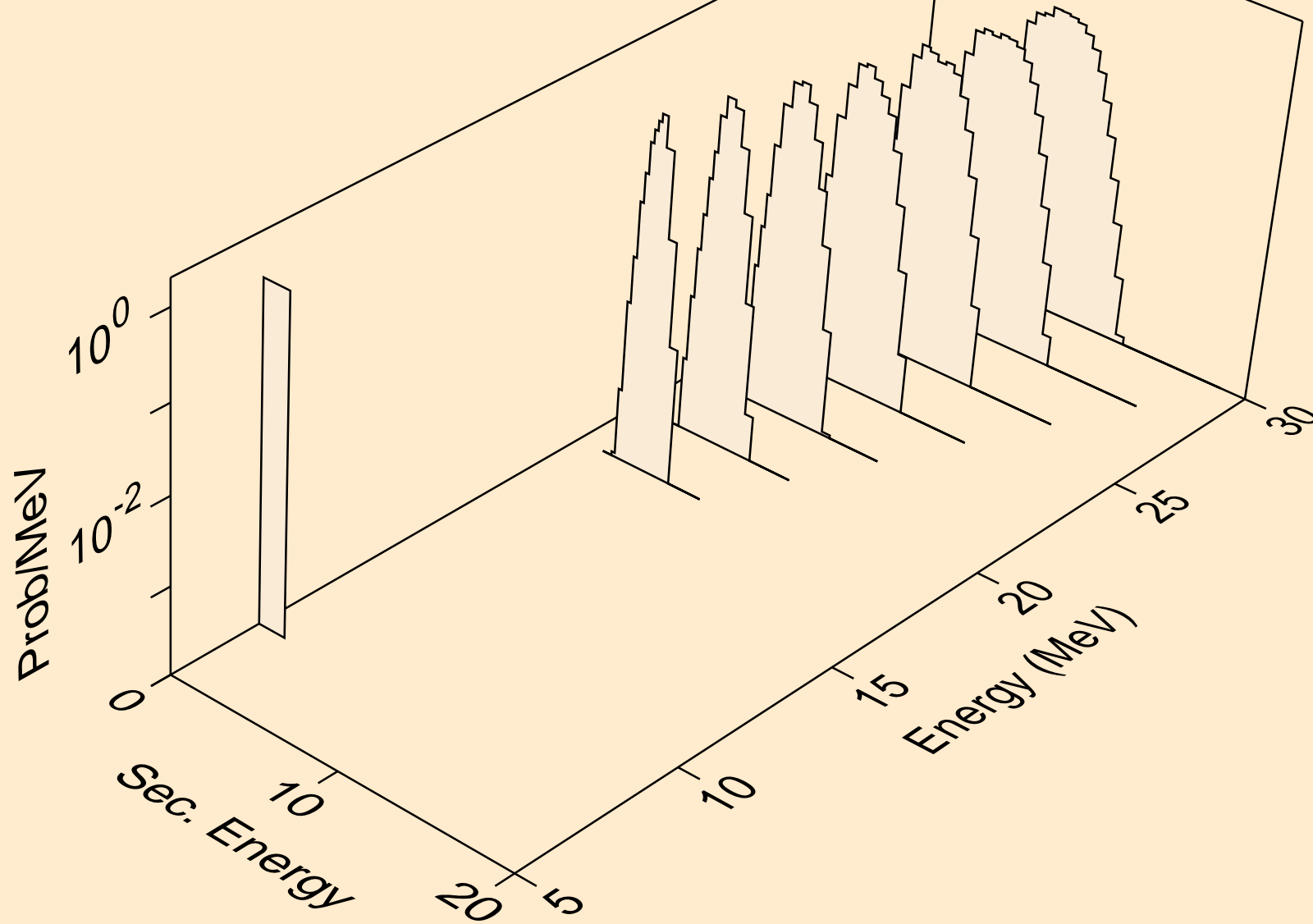

BR073 NEUTRON ACER TENDL-2024 LIBRARY; T=0.K
alphas from (n,da)

