

BR084 NEUTRON ACER TENDL-2024 LIBRARY; T=0.K  
Principal cross sections

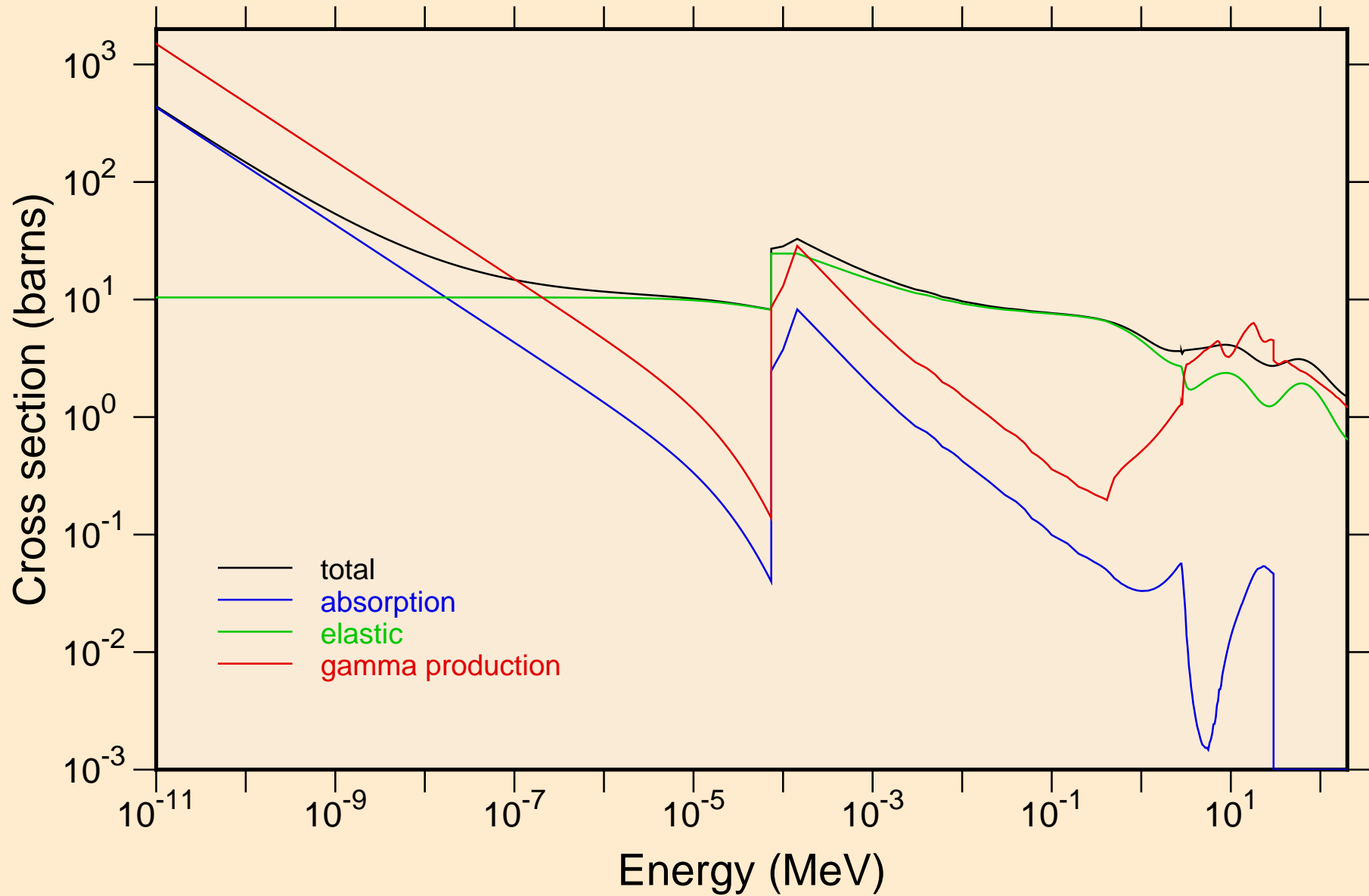

# BR084 NEUTRON ACER TENDL-2024 LIBRARY; T=0.K

## Heating

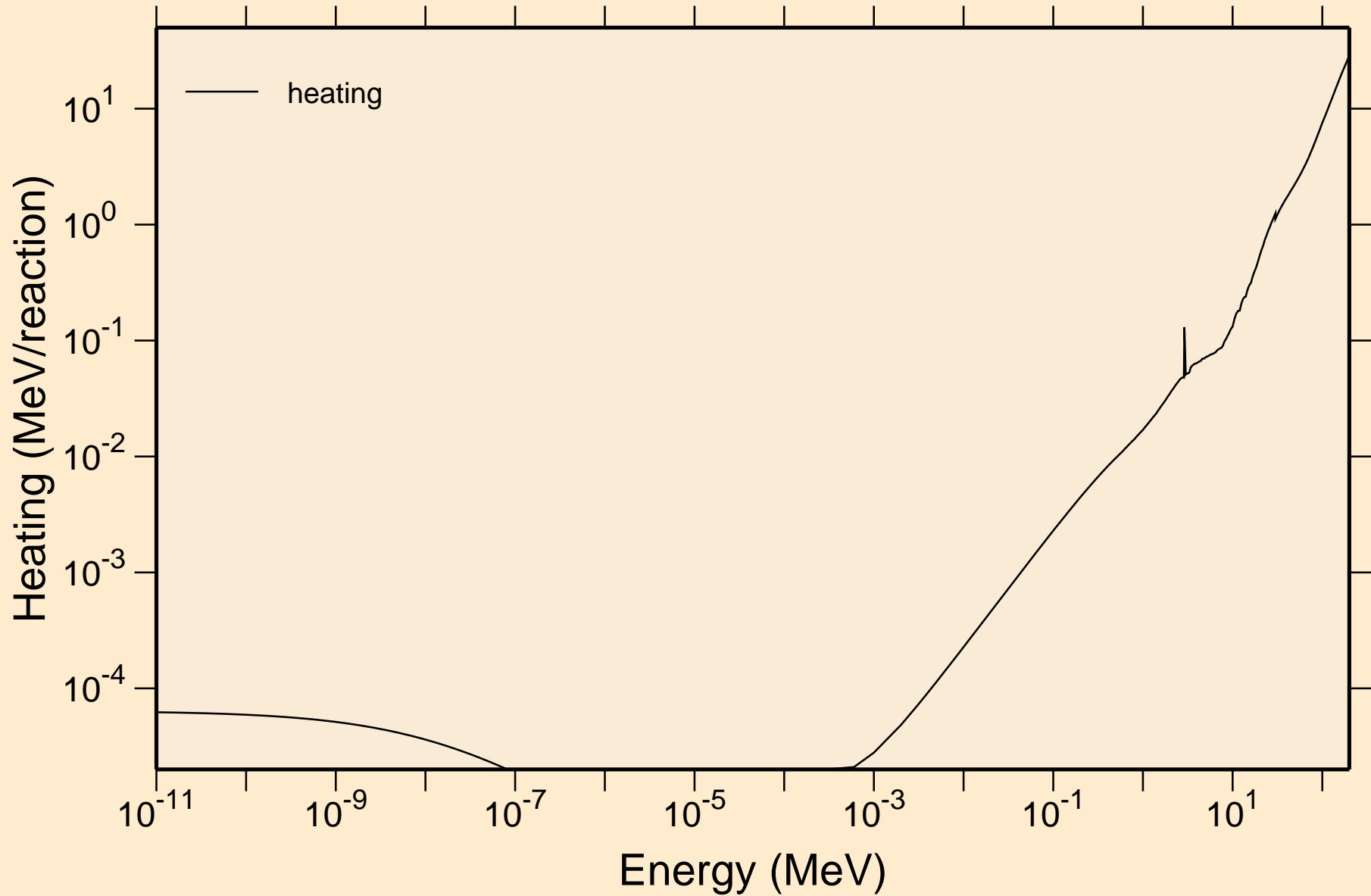

BR084 NEUTRON ACER TENDL-2024 LIBRARY; T=0.K  
Damage

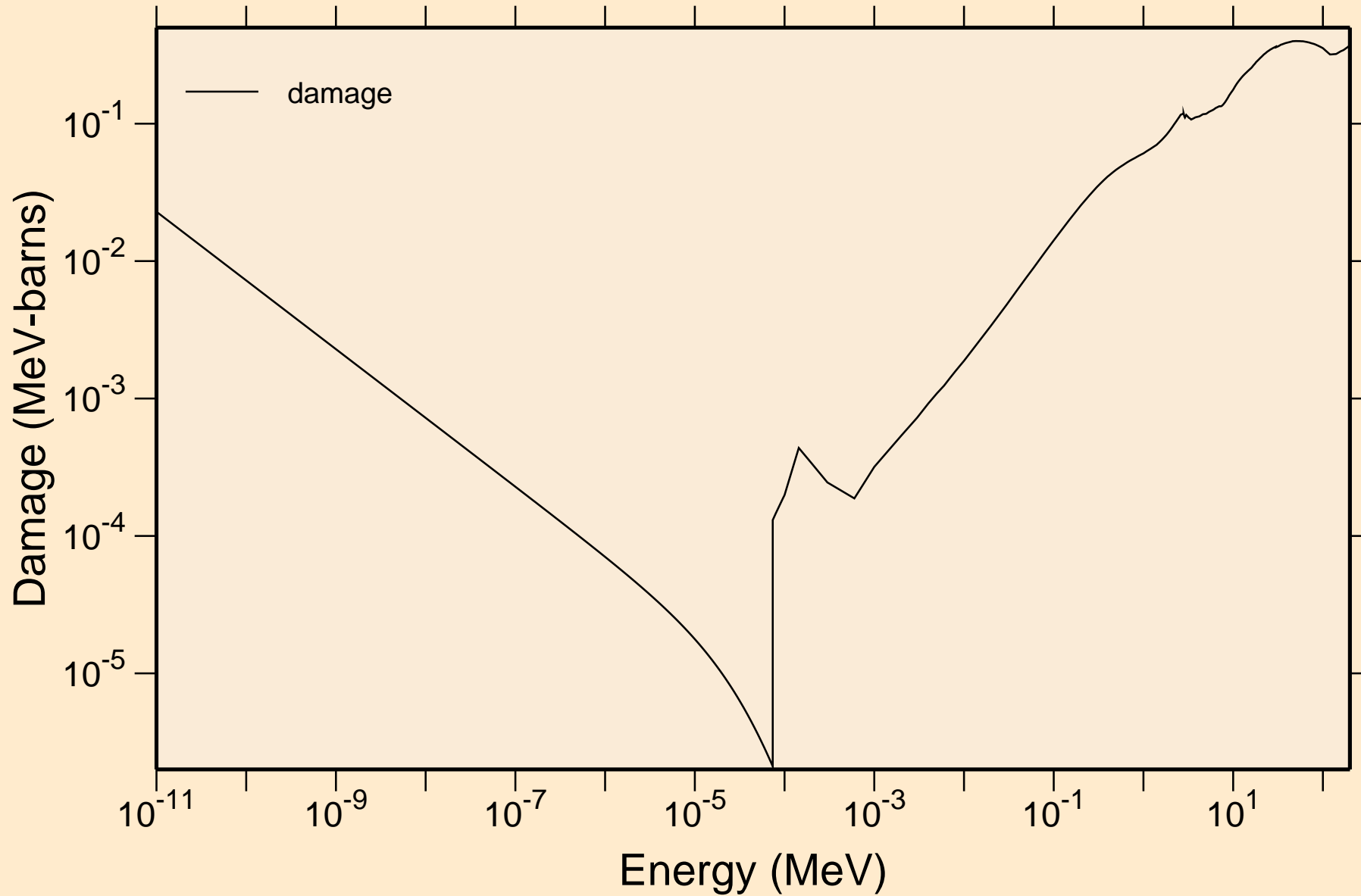

BR084 NEUTRON ACER TENDL-2024 LIBRARY; T=0.K  
Non-threshold reactions

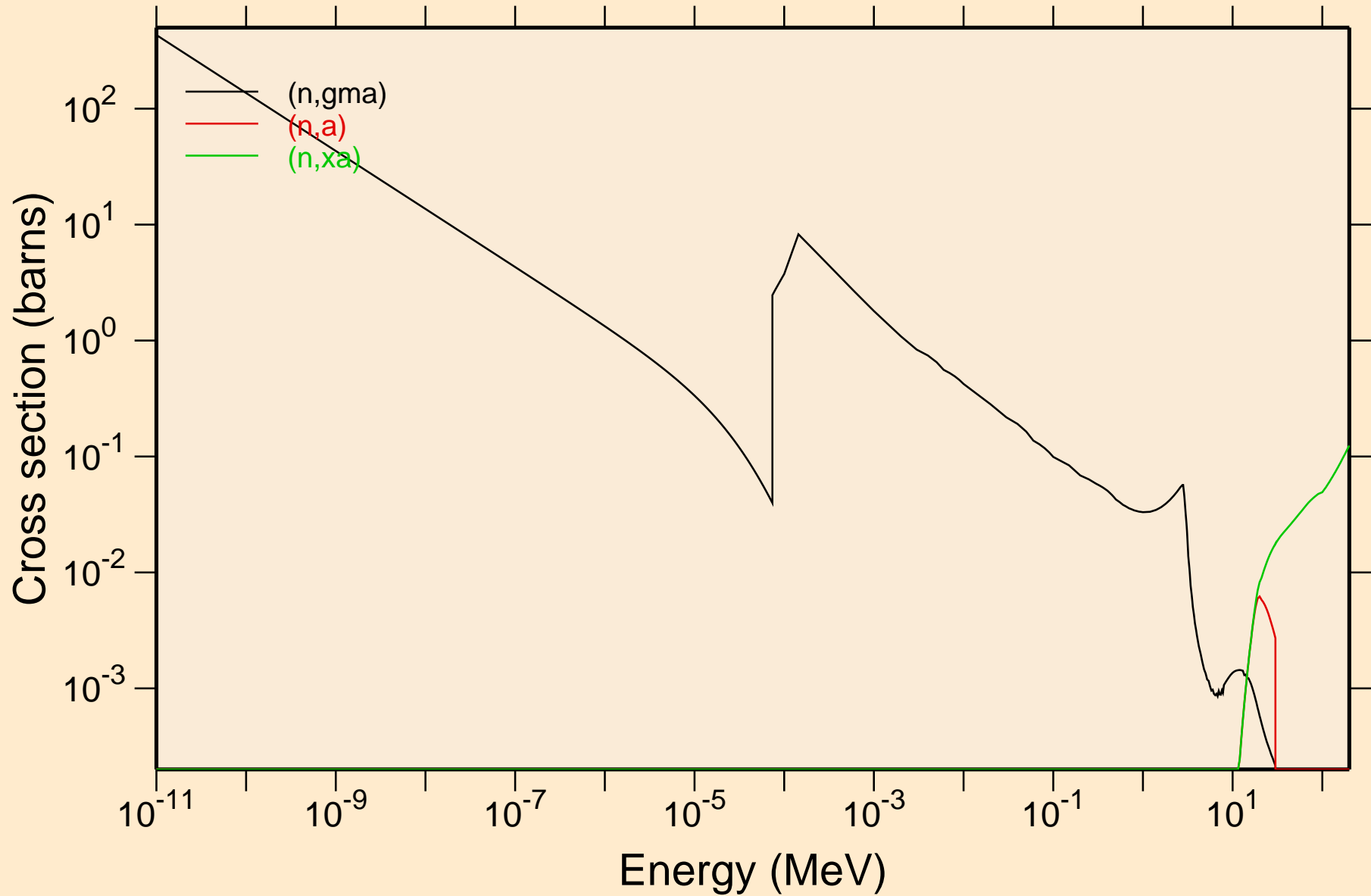

# BR084 NEUTRON ACER TENDL-2024 LIBRARY; T=0.K

## Principal cross sections

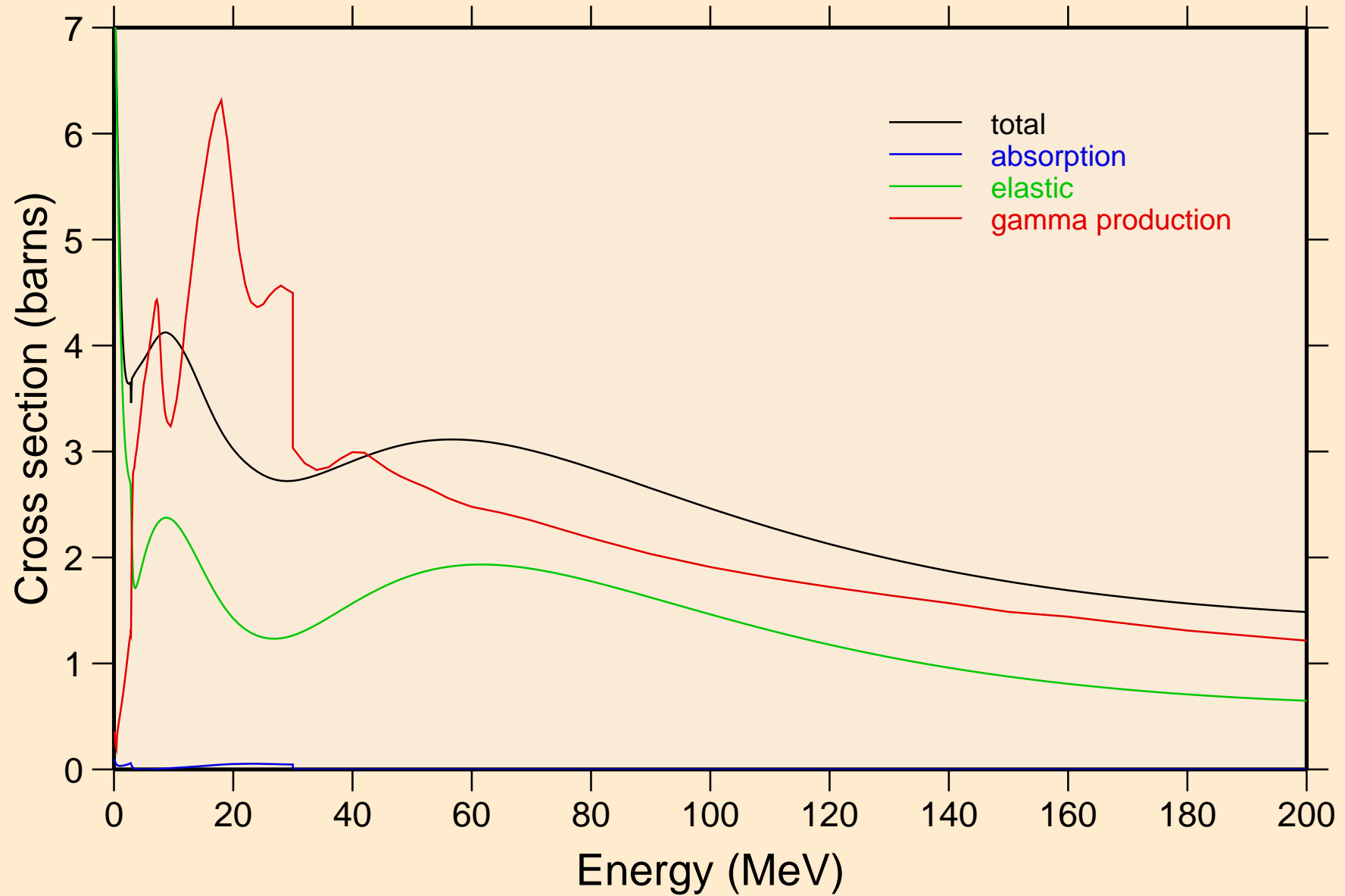

# BR084 NEUTRON ACER TENDL-2024 LIBRARY; T=0.K

## Heating

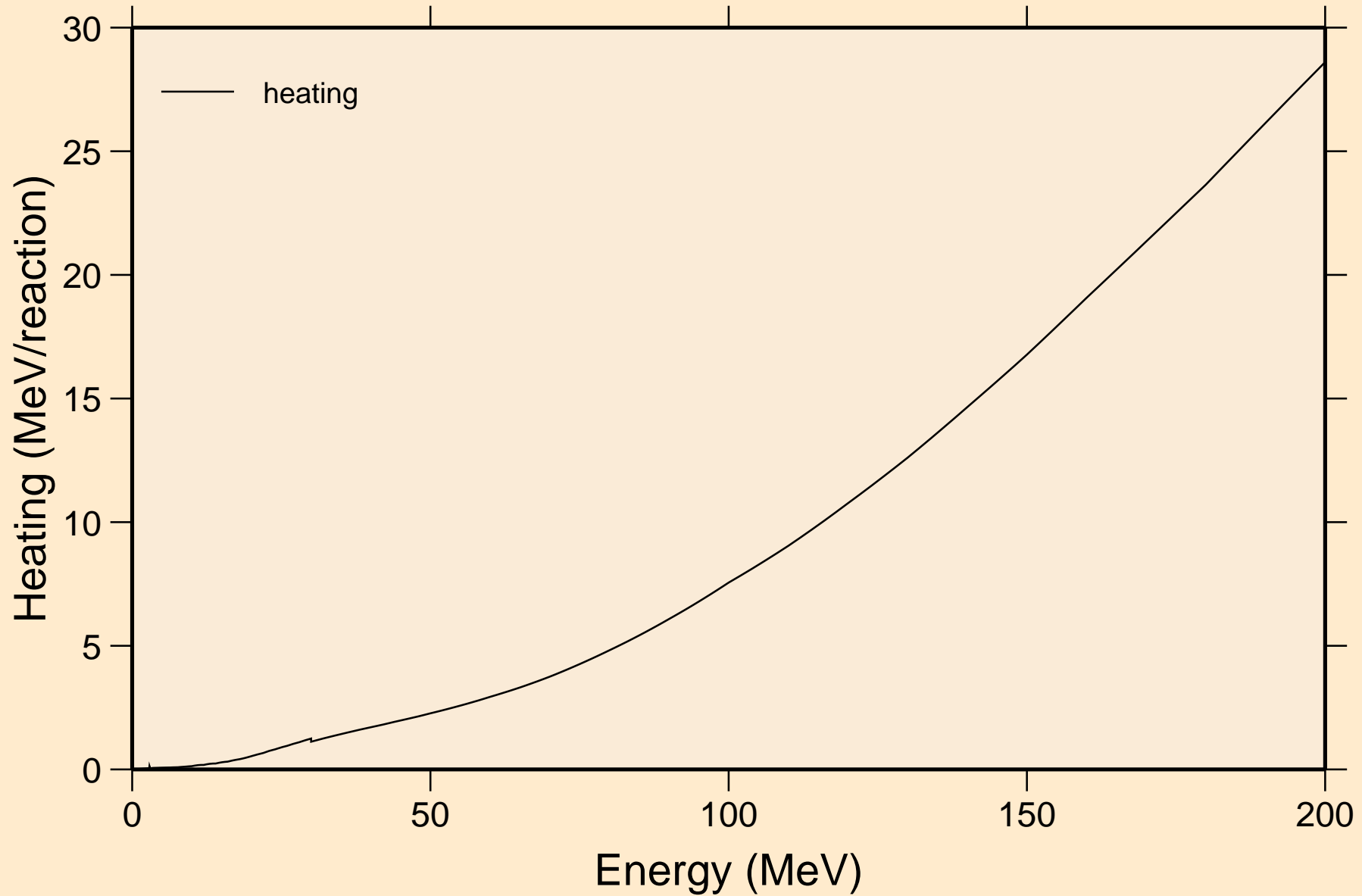

# BR084 NEUTRON ACER TENDL-2024 LIBRARY; T=0.K

## Damage

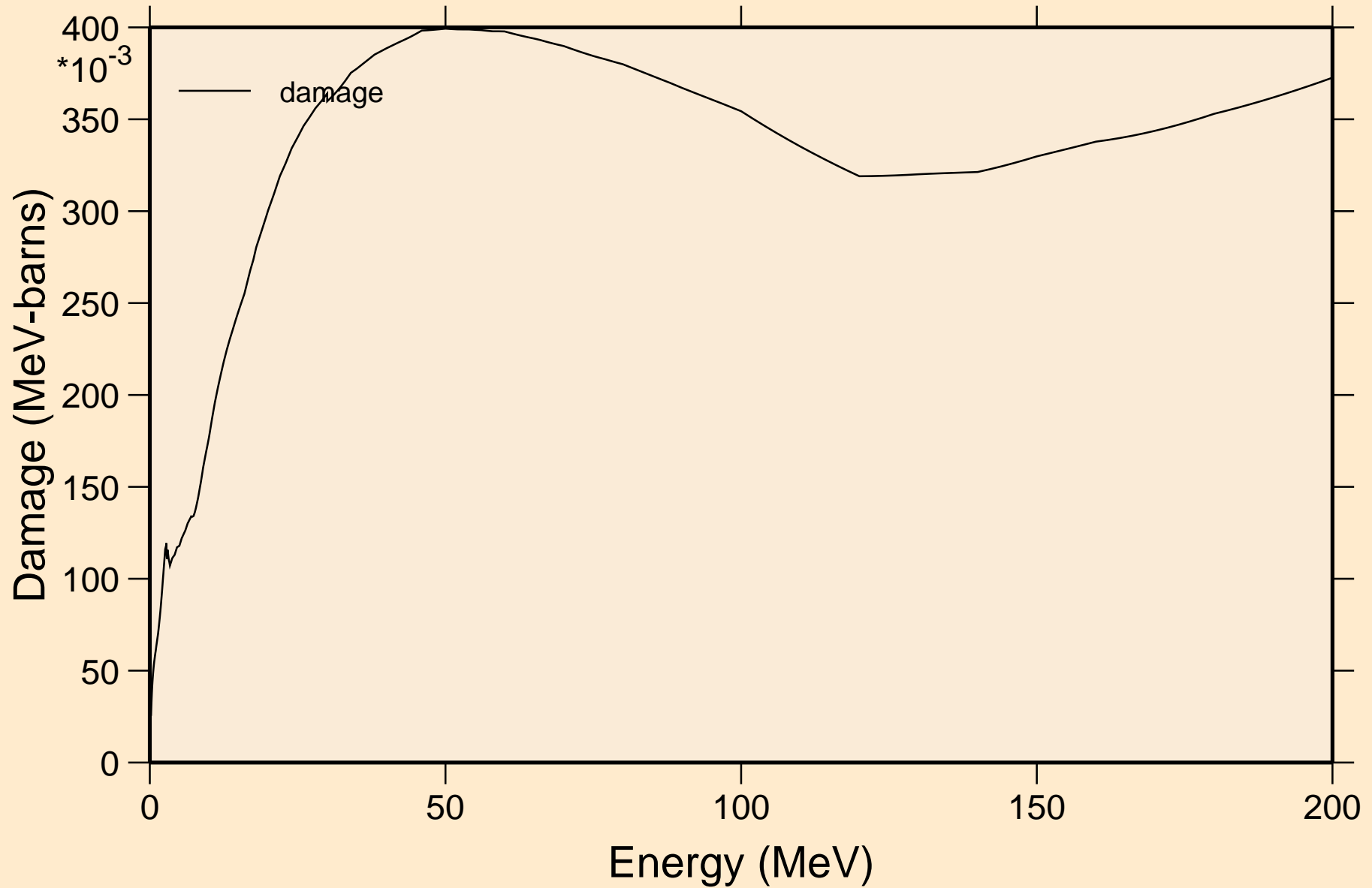

BR084 NEUTRON ACER TENDL-2024 LIBRARY; T=0.K  
Non-threshold reactions

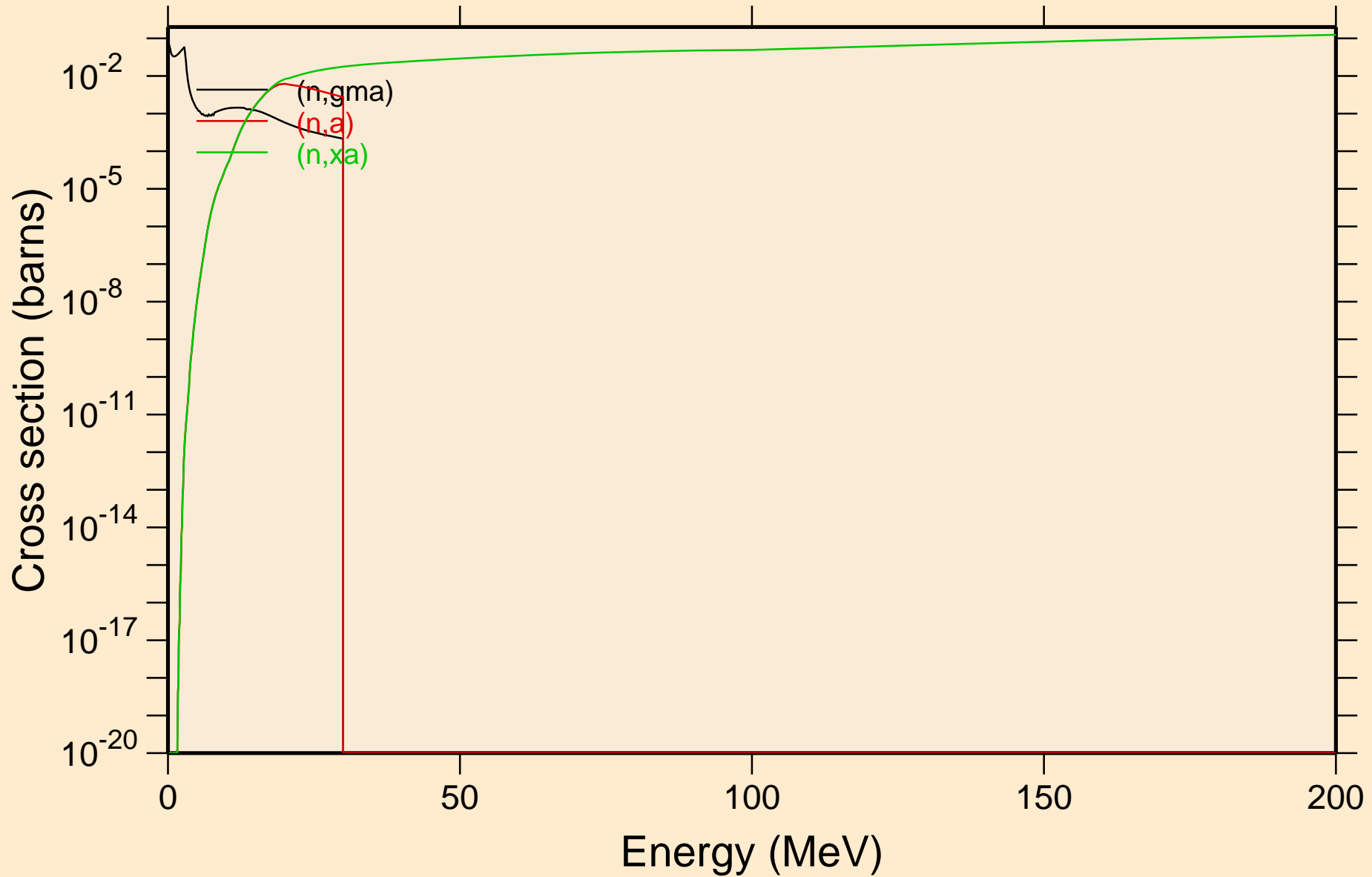



BR084 NEUTRON ACER TENDL-2024 LIBRARY; T=0.K  
Inelastic levels

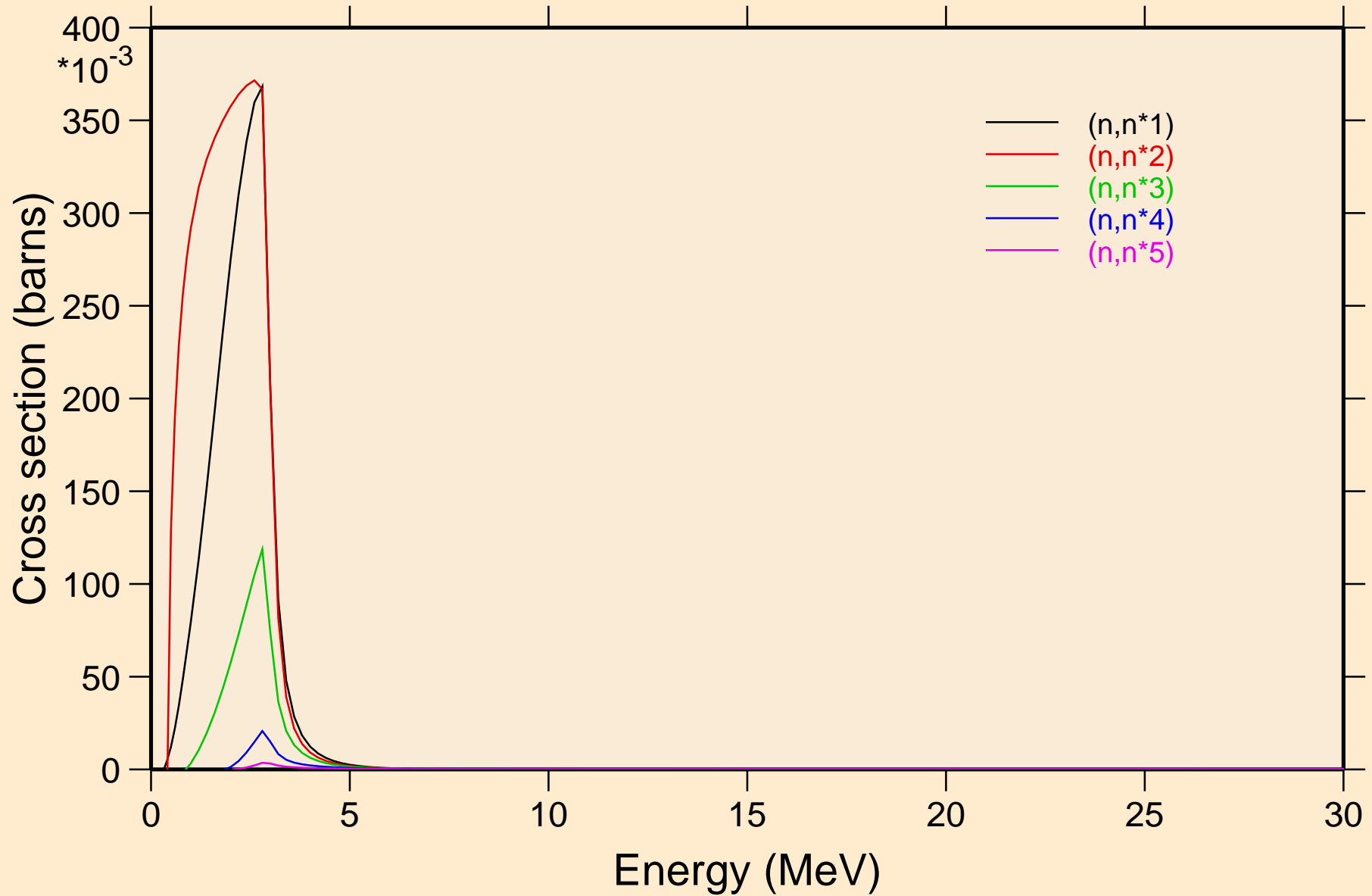

BR084 NEUTRON ACER TENDL-2024 LIBRARY; T=0.K  
Inelastic levels

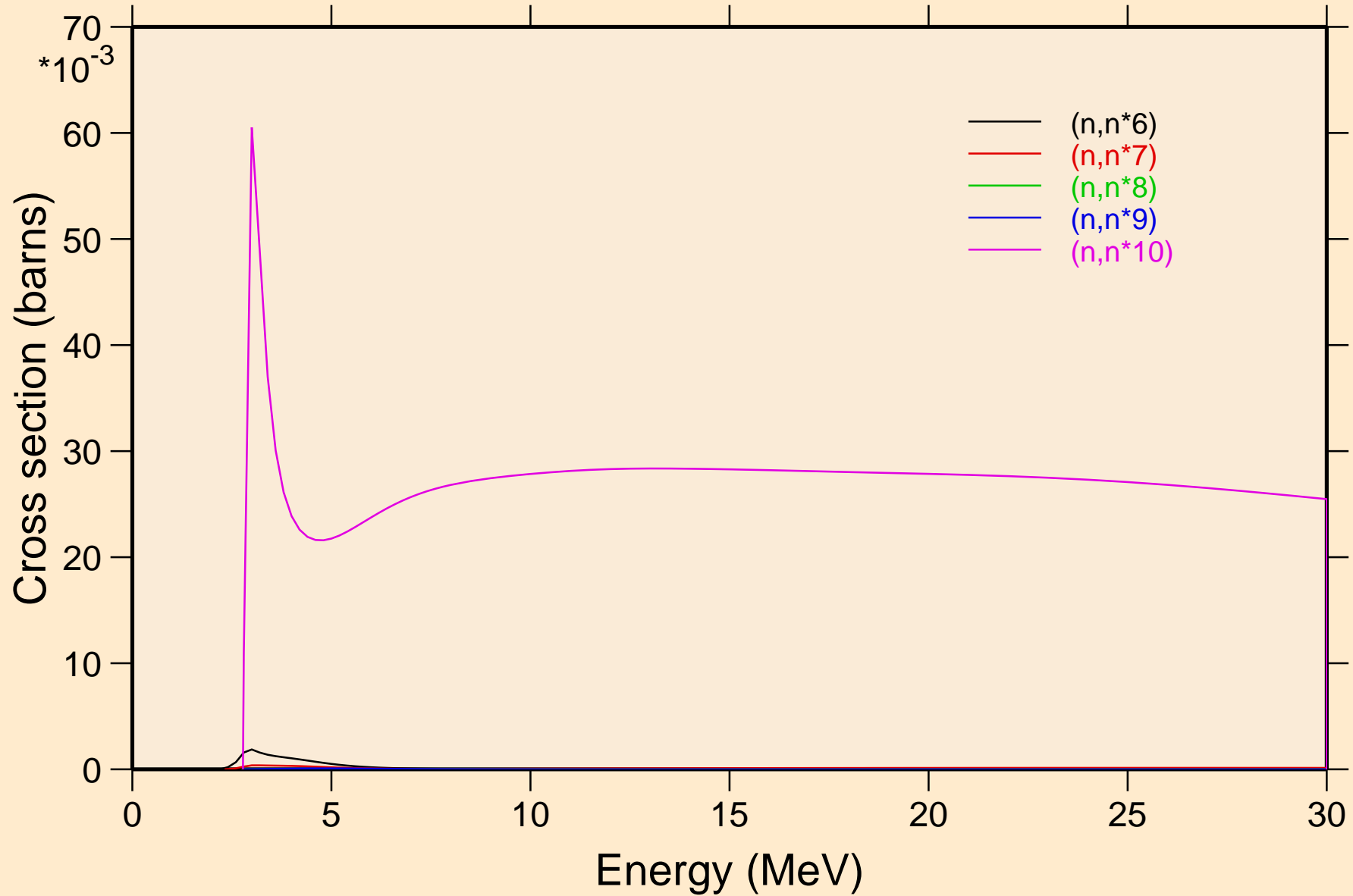

BR084 NEUTRON ACER TENDL-2024 LIBRARY; T=0.K  
Inelastic levels

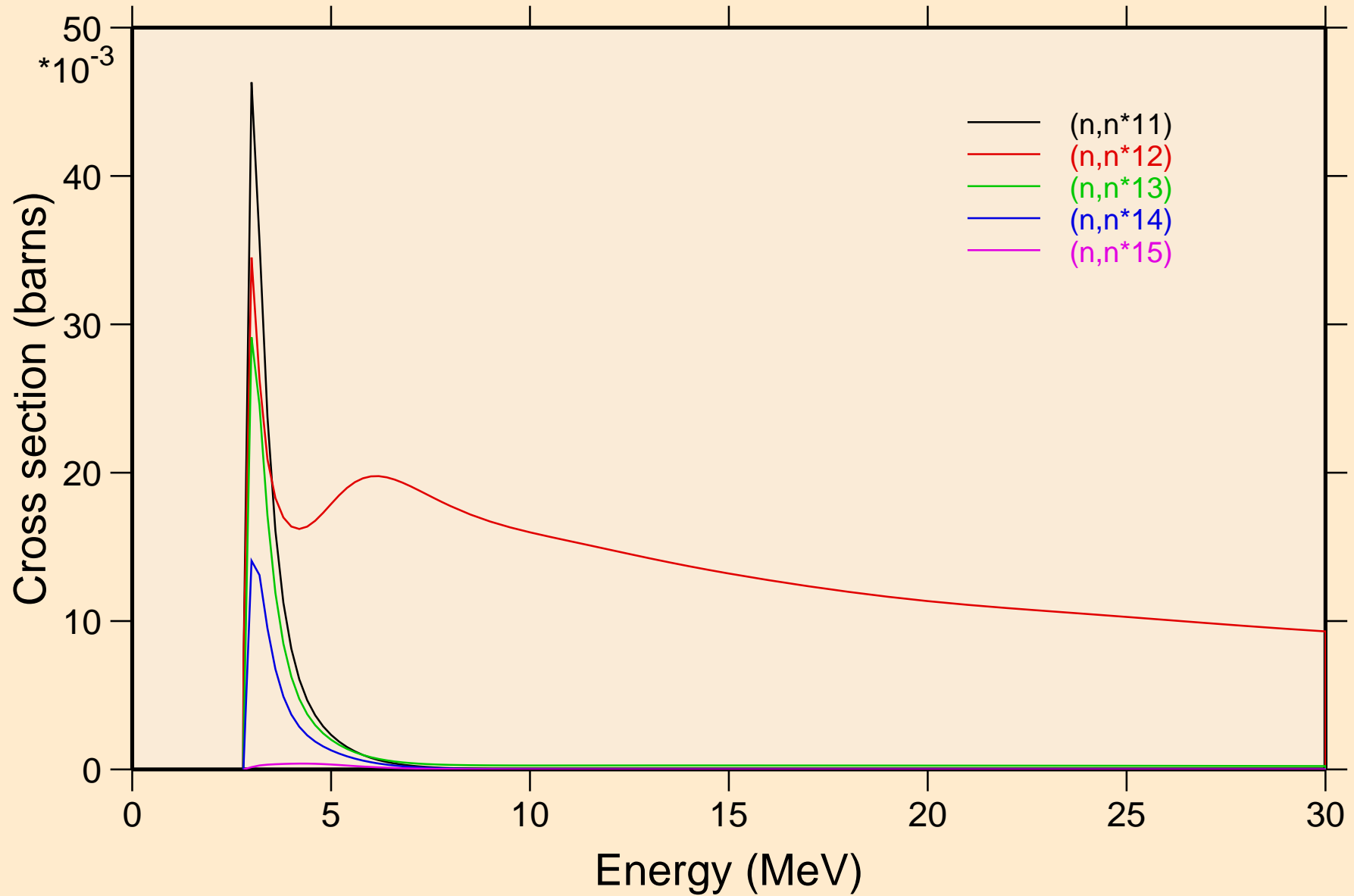

BR084 NEUTRON ACER TENDL-2024 LIBRARY; T=0.K  
Inelastic levels

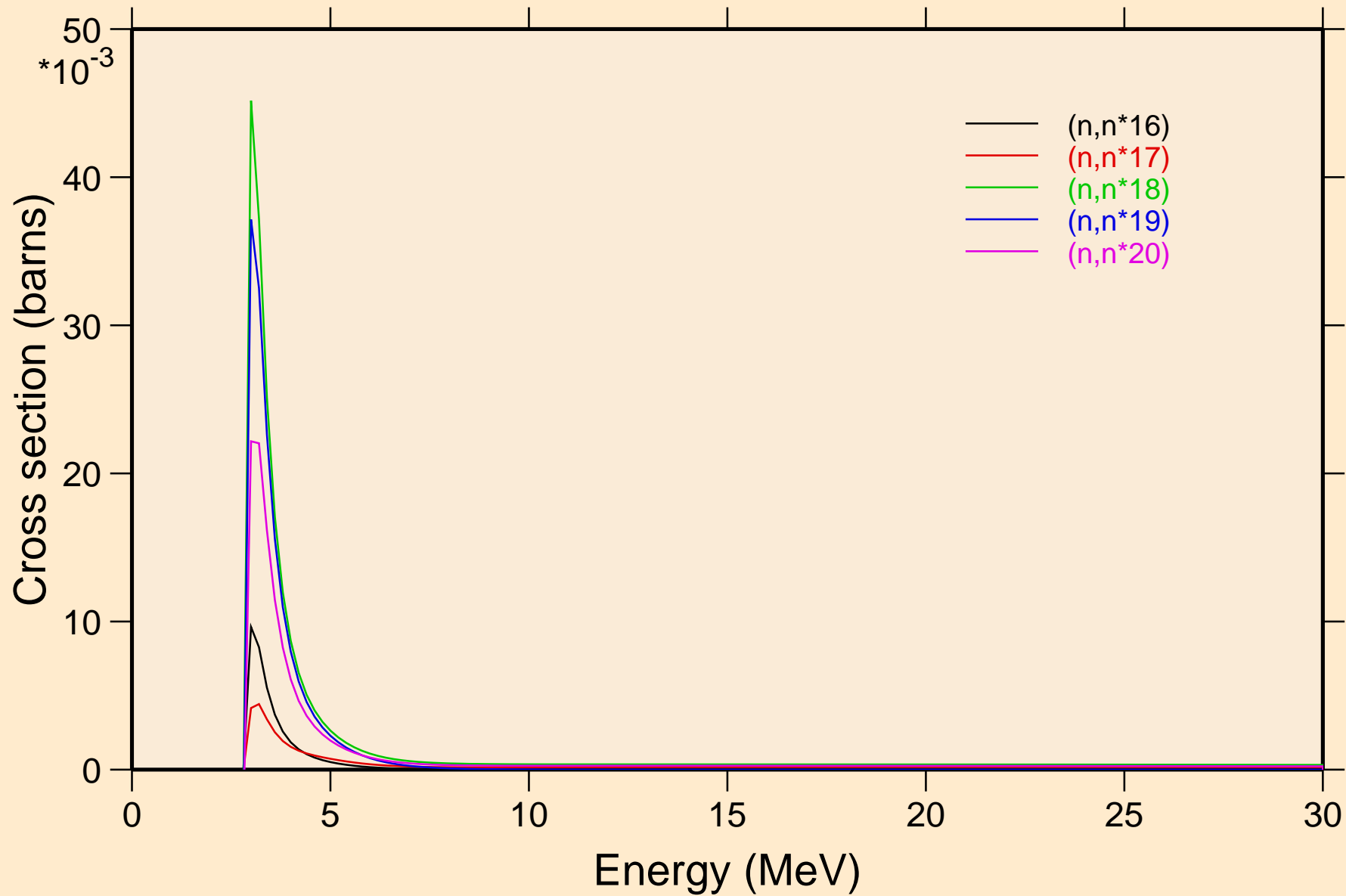

BR084 NEUTRON ACER TENDL-2024 LIBRARY; T=0.K  
Inelastic levels

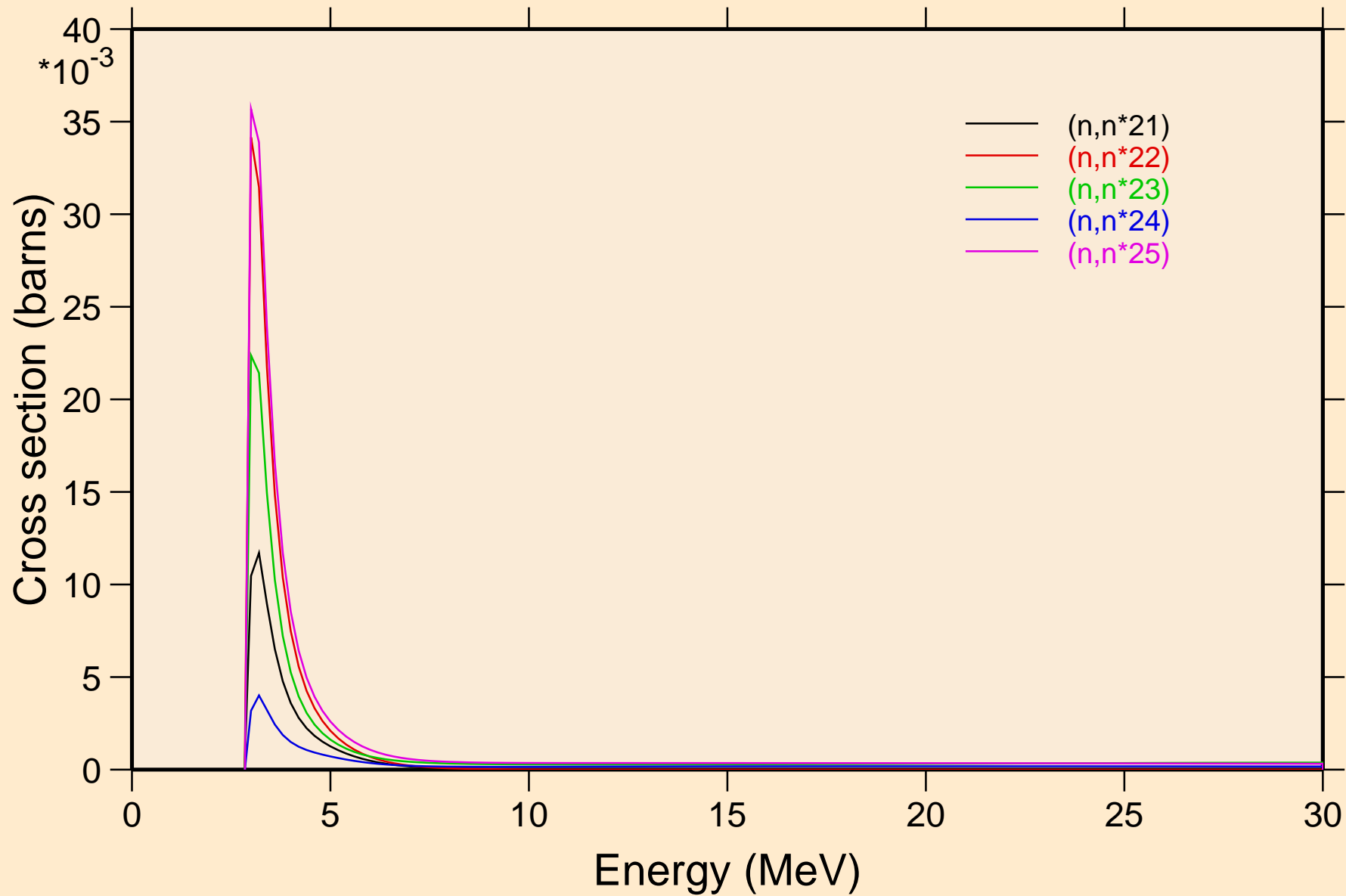

BR084 NEUTRON ACER TENDL-2024 LIBRARY; T=0.K  
Inelastic levels

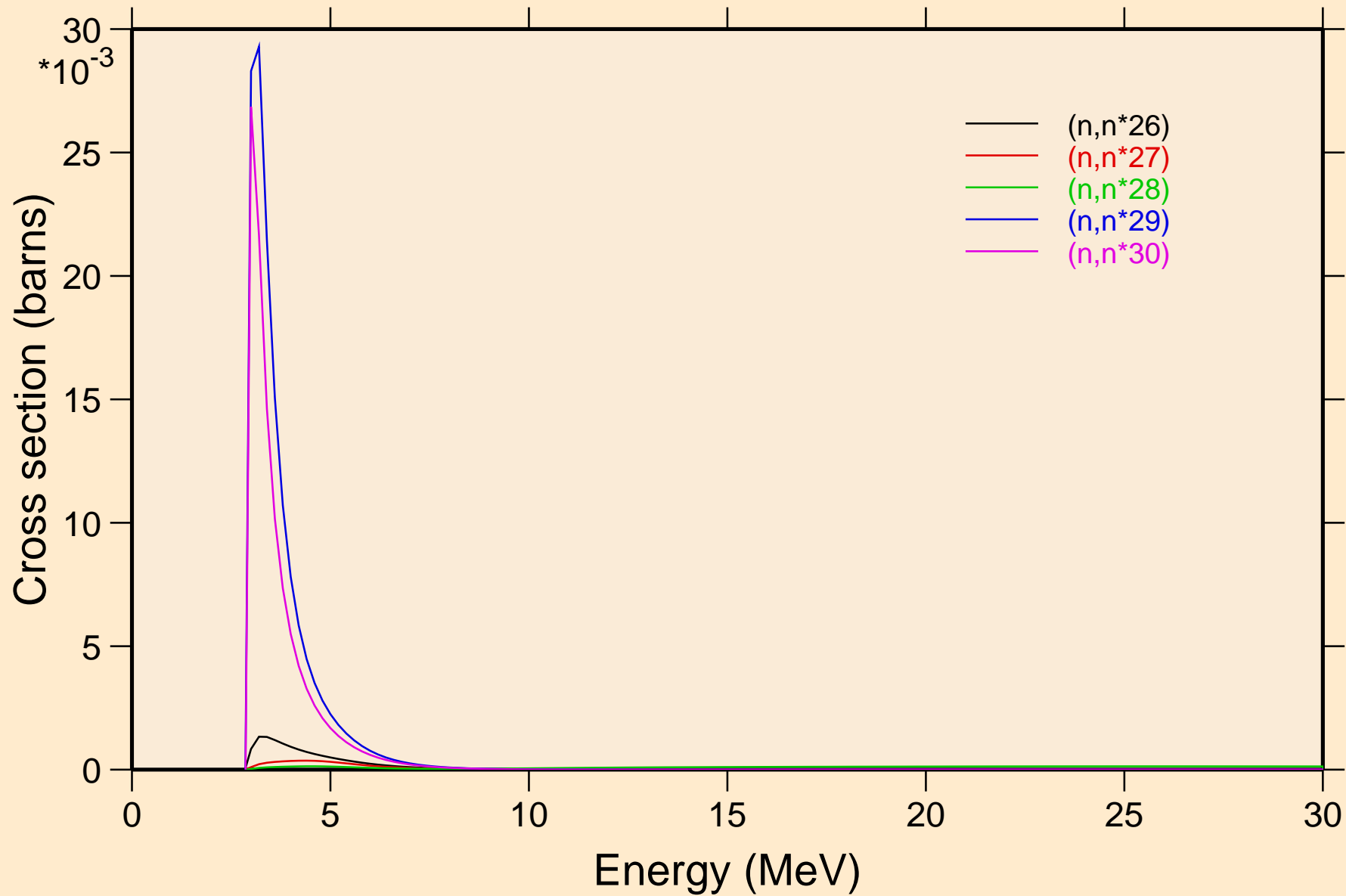

BR084 NEUTRON ACER TENDL-2024 LIBRARY; T=0.K  
Threshold reactions

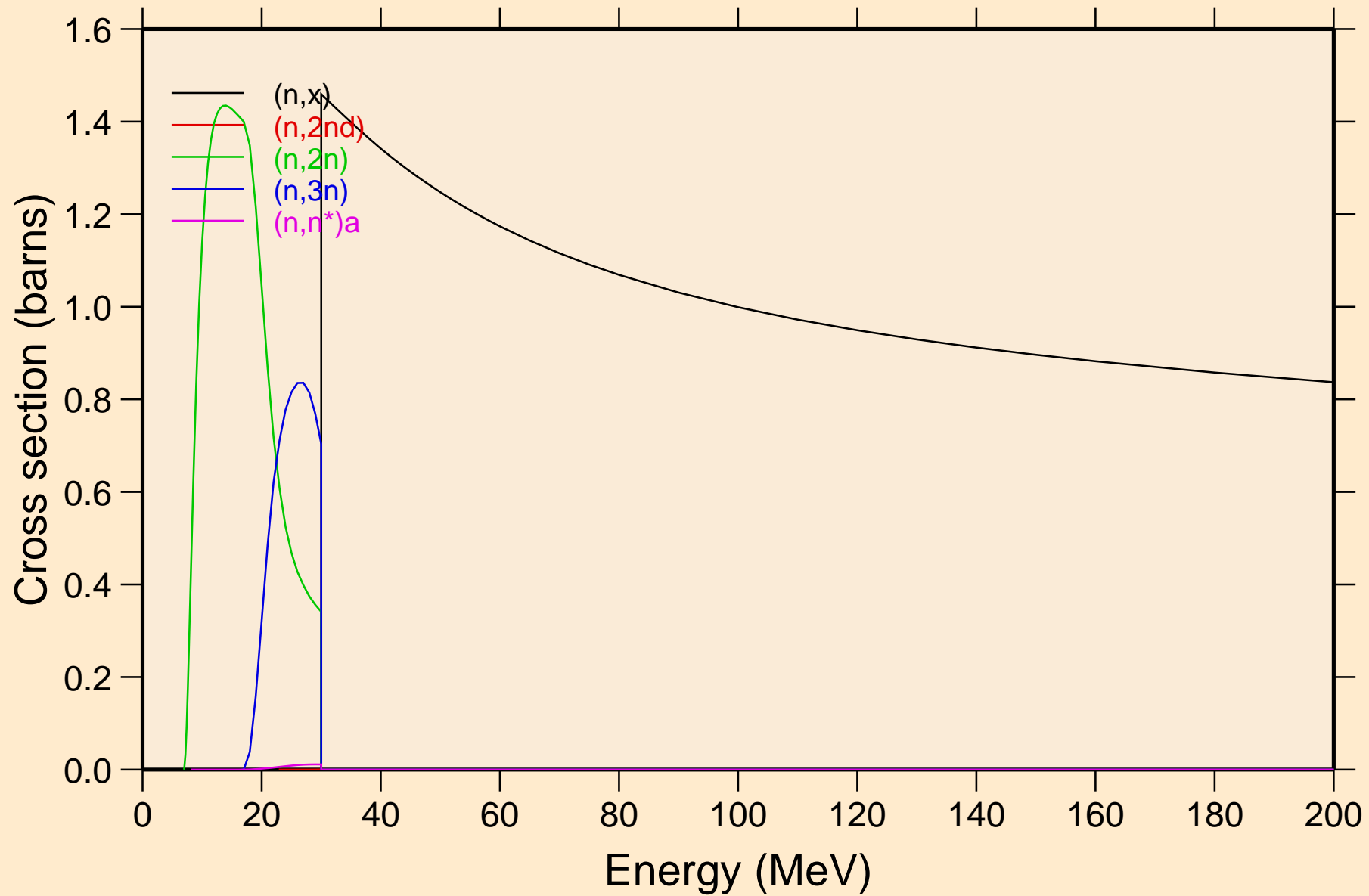

BR084 NEUTRON ACER TENDL-2024 LIBRARY; T=0.K  
Threshold reactions

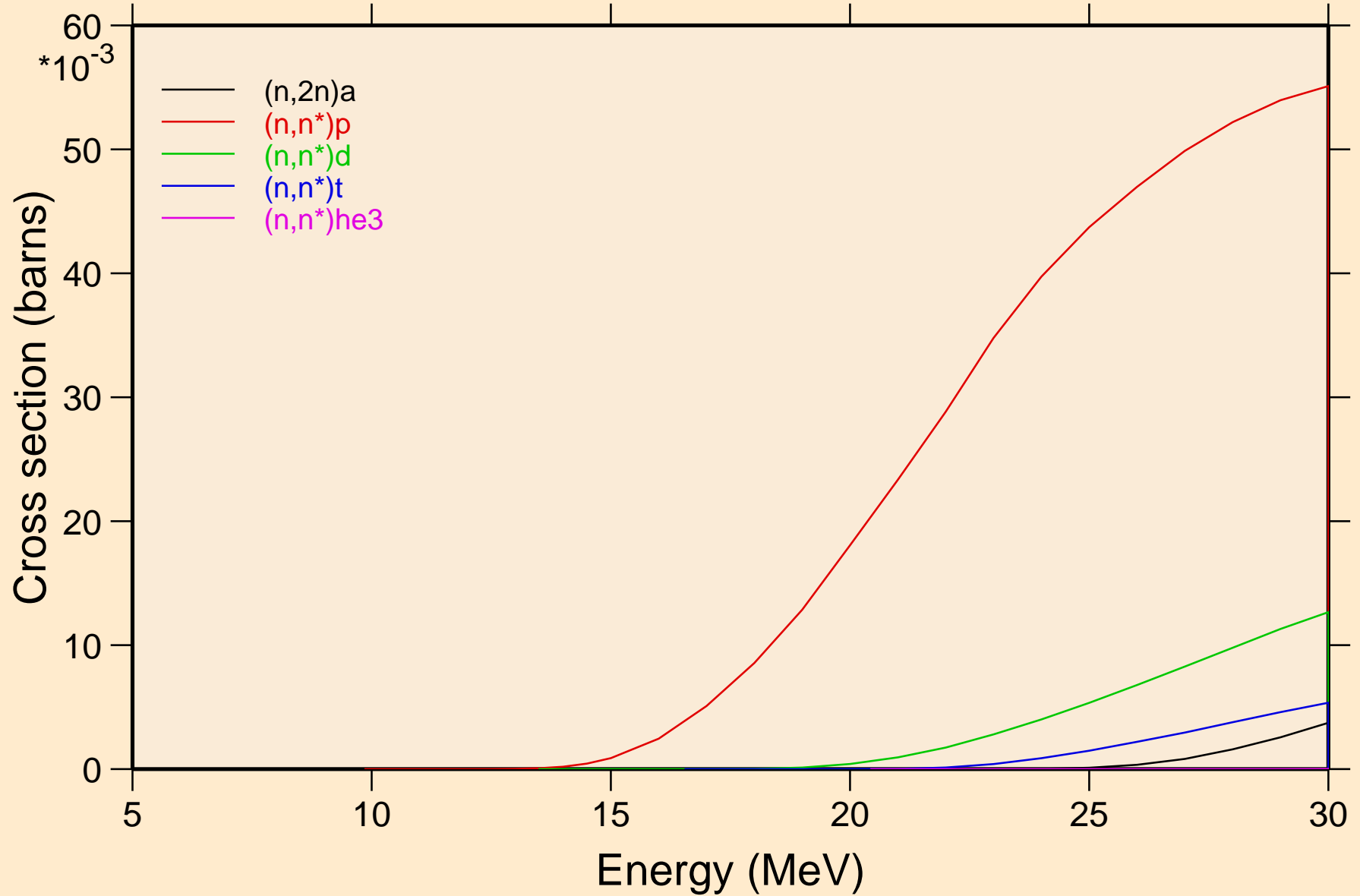



BR084 NEUTRON ACER TENDL-2024 LIBRARY; T=0.K  
Threshold reactions

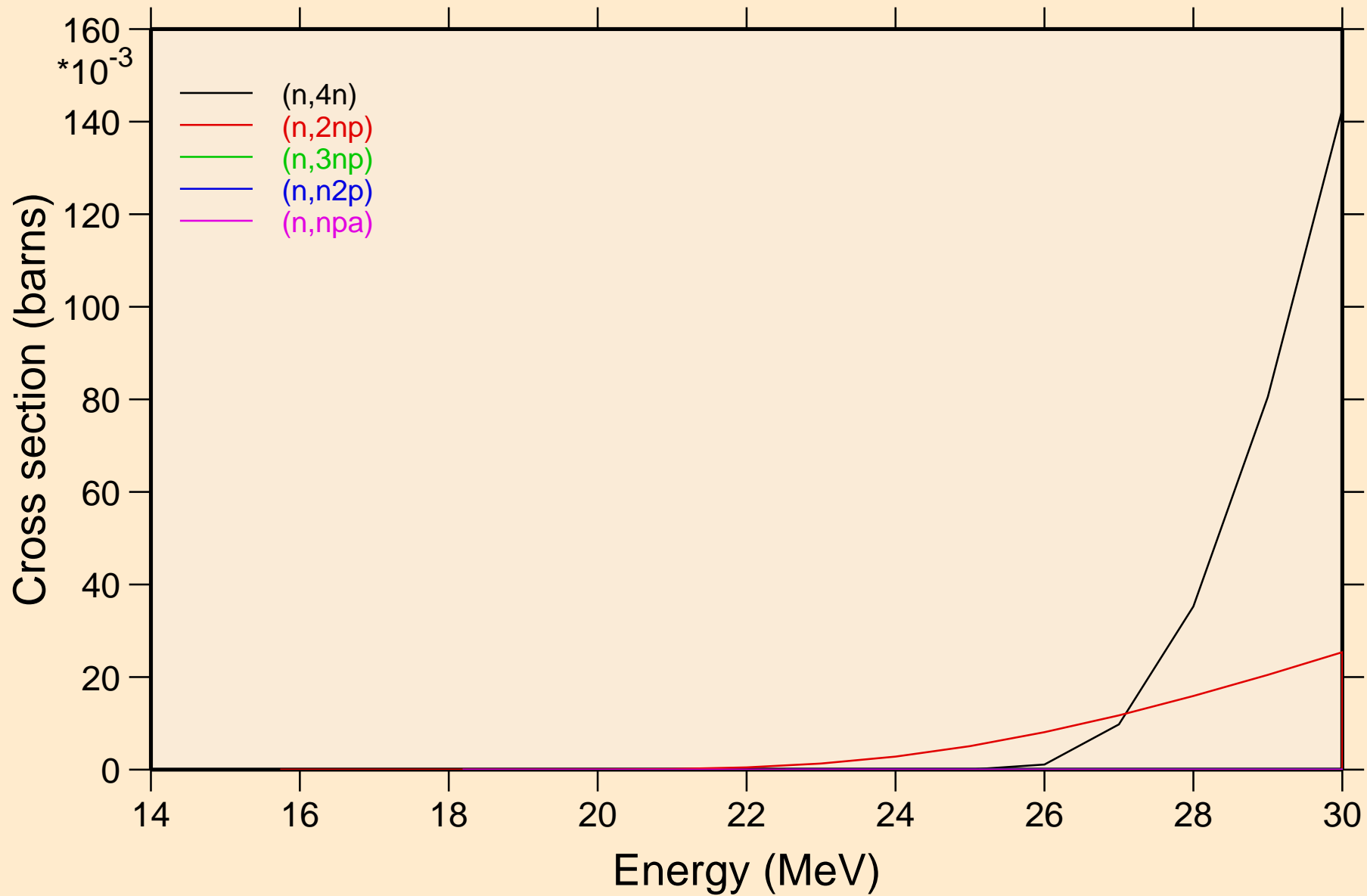

BR084 NEUTRON ACER TENDL-2024 LIBRARY; T=0.K  
Threshold reactions

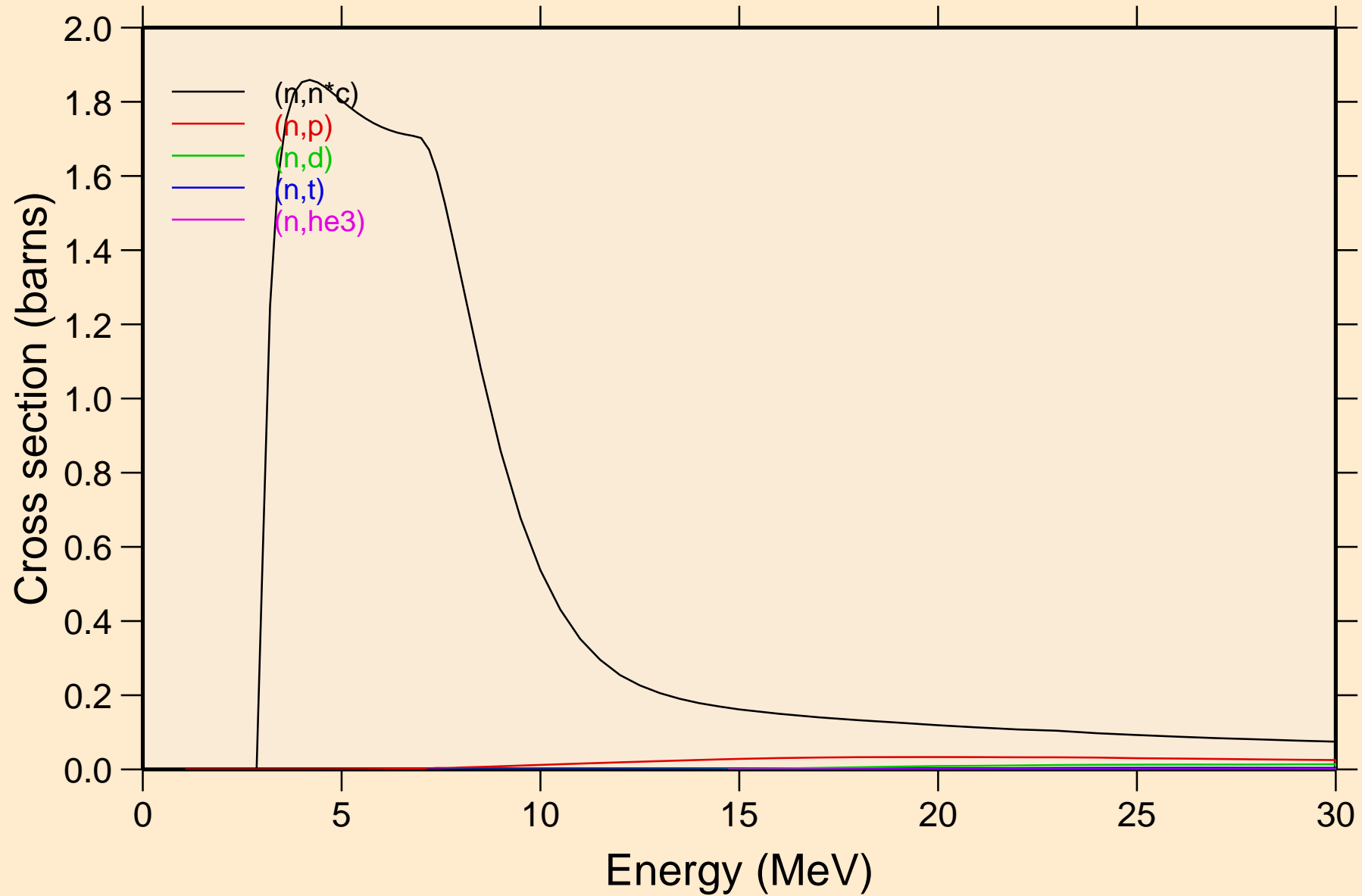

# BR084 NEUTRON ACER TENDL-2024 LIBRARY; T=0.K

## Threshold reactions

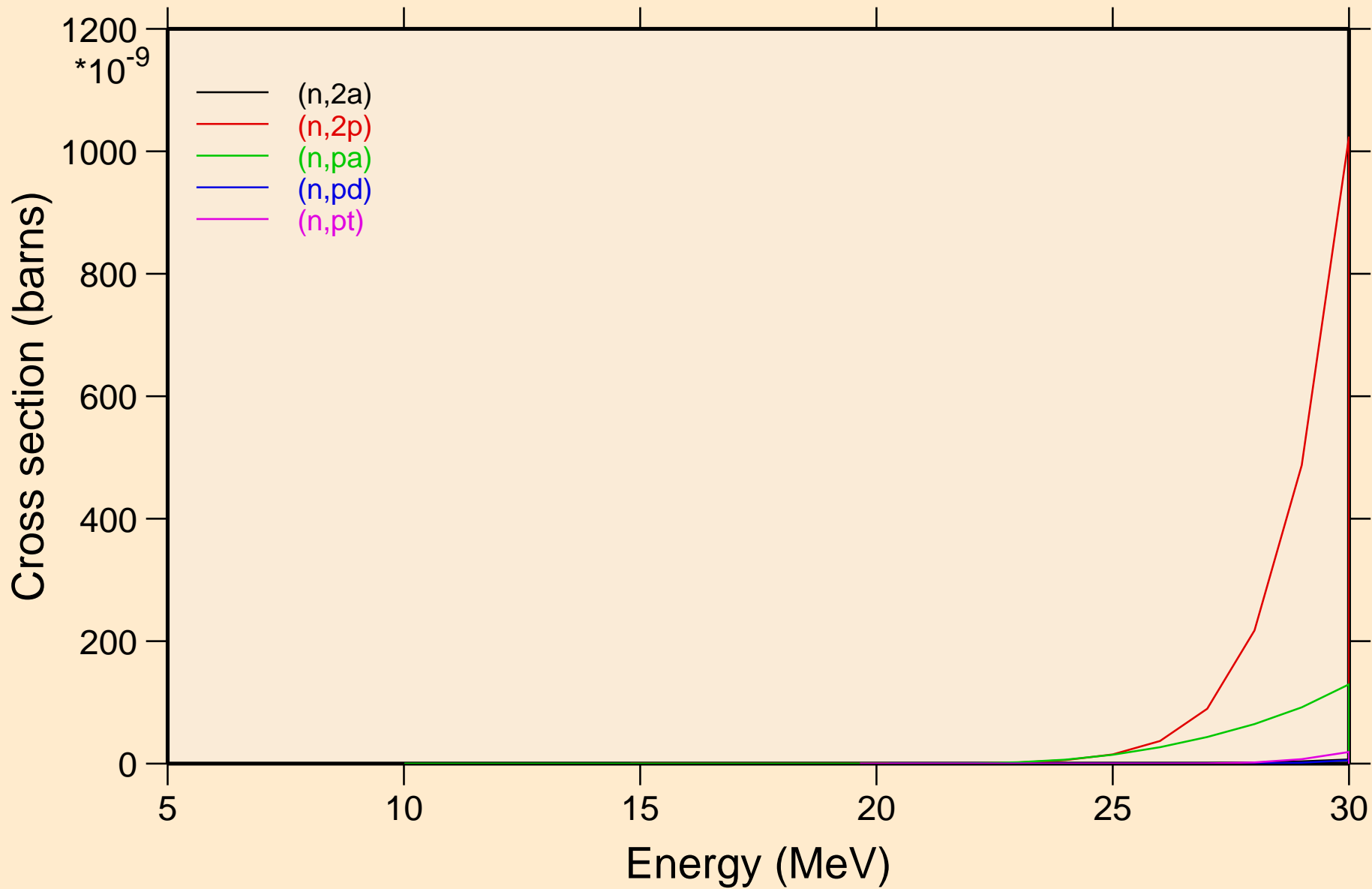

BR084 NEUTRON ACER TENDL-2024 LIBRARY; T=0.K  
Threshold reactions

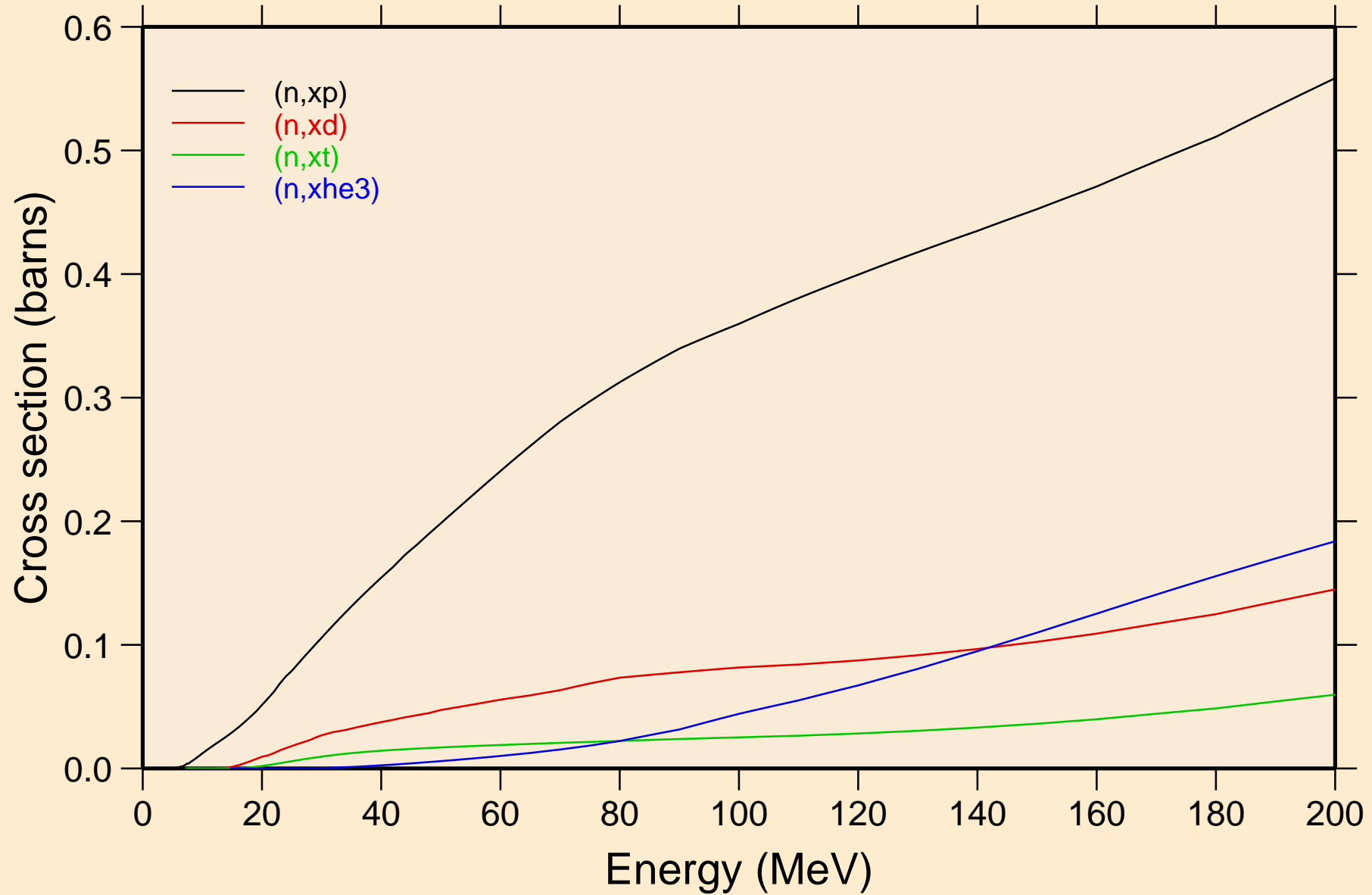

BR084 NEUTRON ACER TENDL-2024 LIBRARY; T=0.K  
angular distribution for elastic

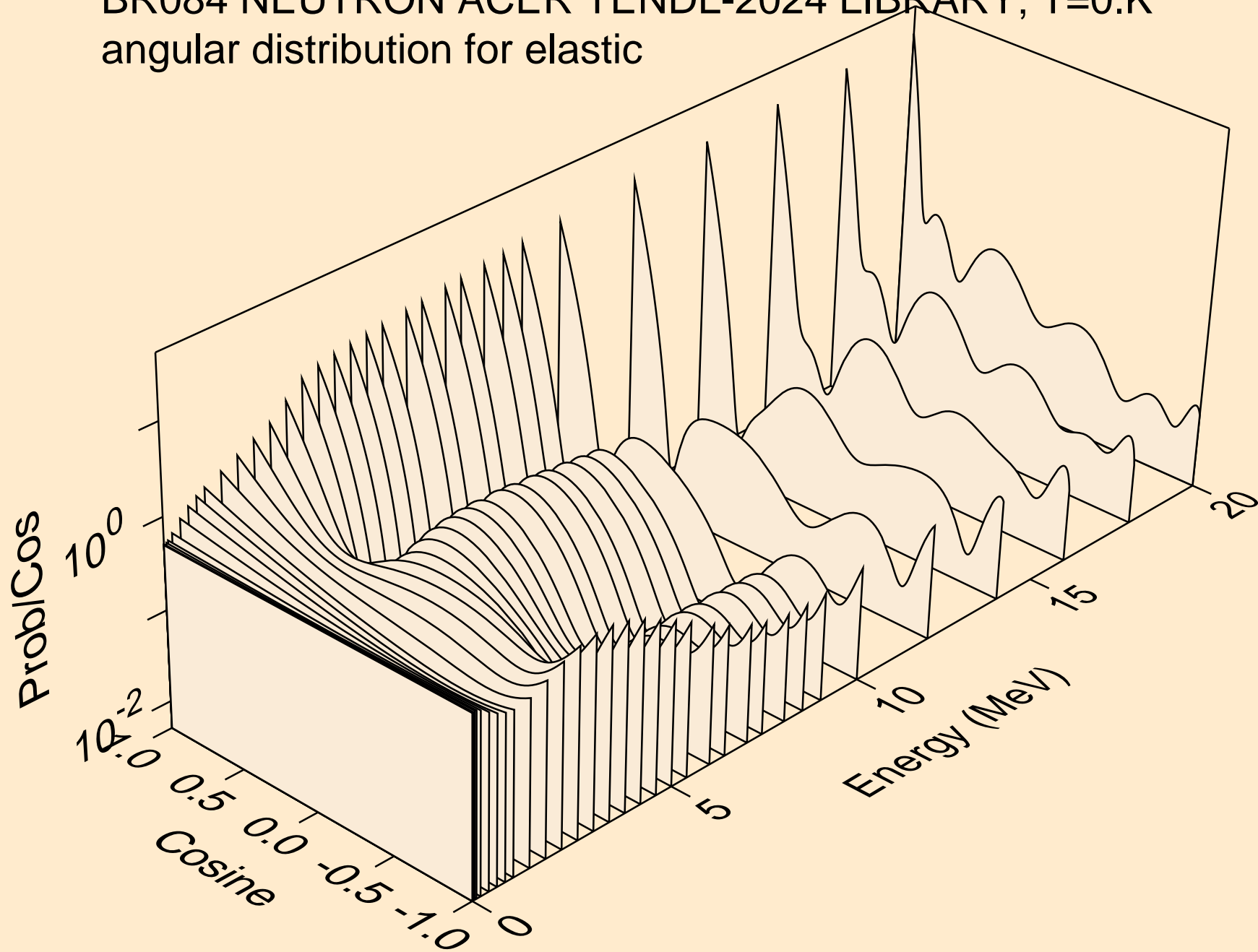

BR084 NEUTRON ACER TENDL-2024 LIBRARY; T=0.K  
angular distribution for elastic

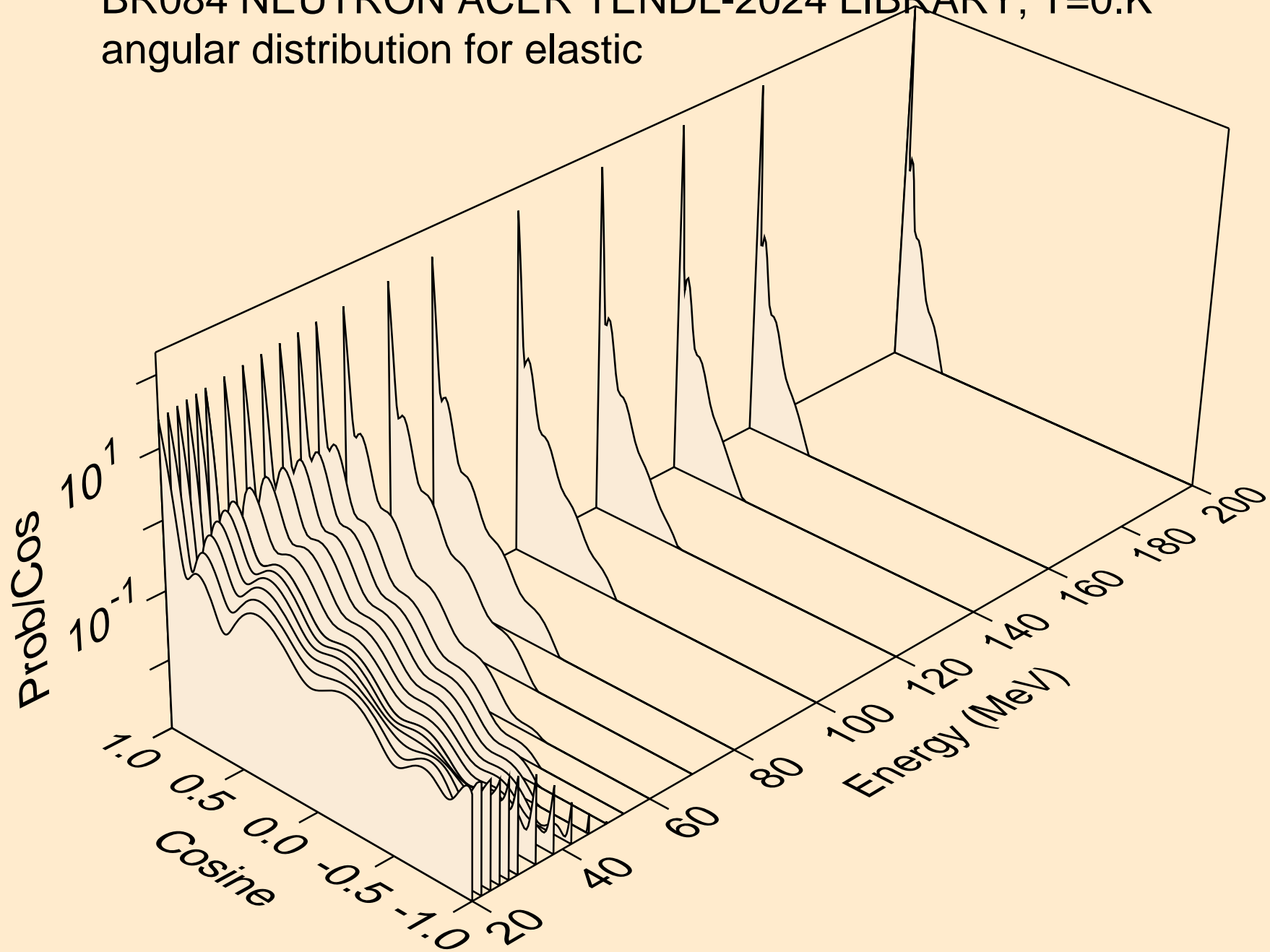

BR084 NEUTRON ACER TENDL-2024 LIBRARY; T=0.K  
angular distribution for (n,n\*1)

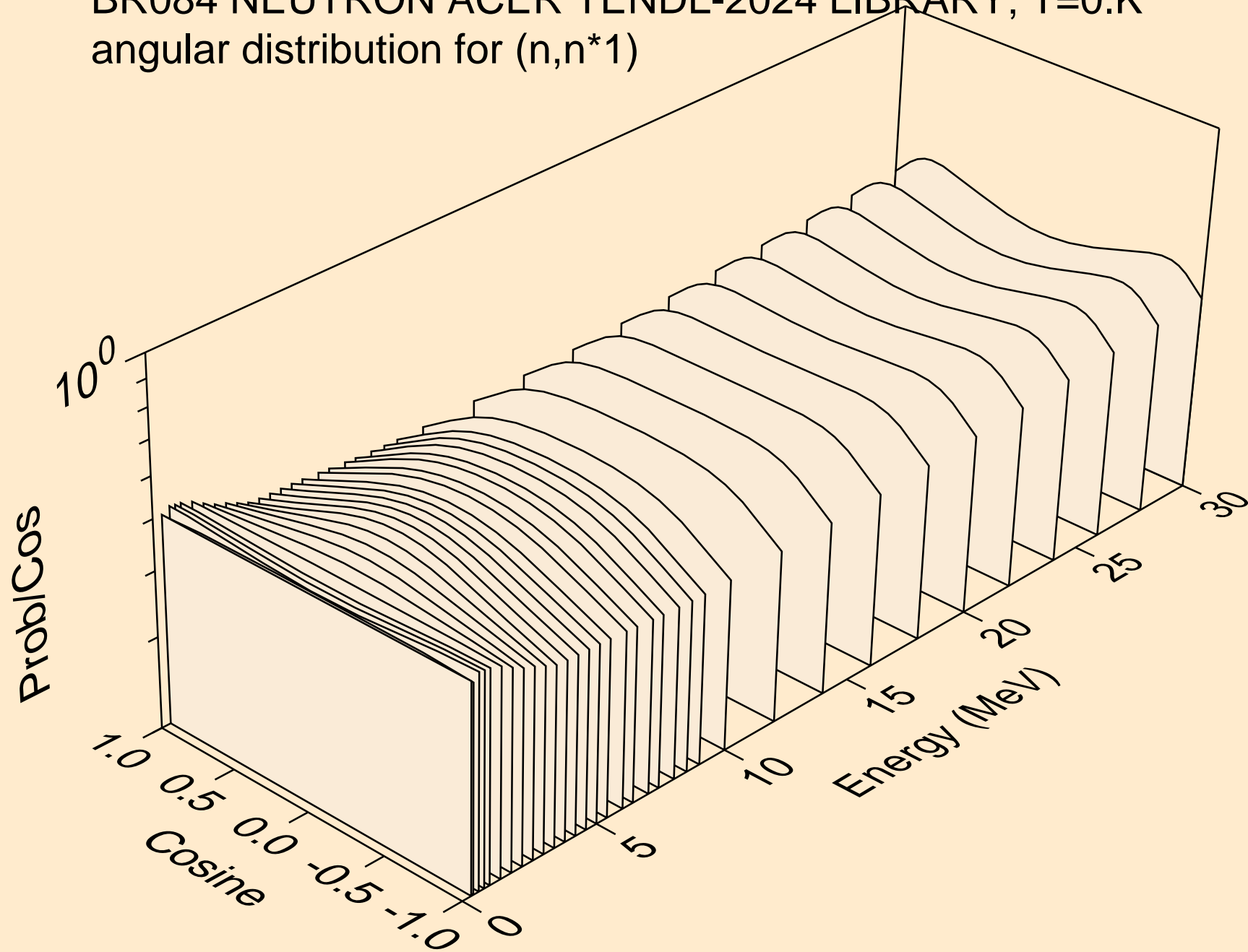

BR084 NEUTRON ACER TENDL-2024 LIBRARY; T=0.K  
angular distribution for (n,n\*2)

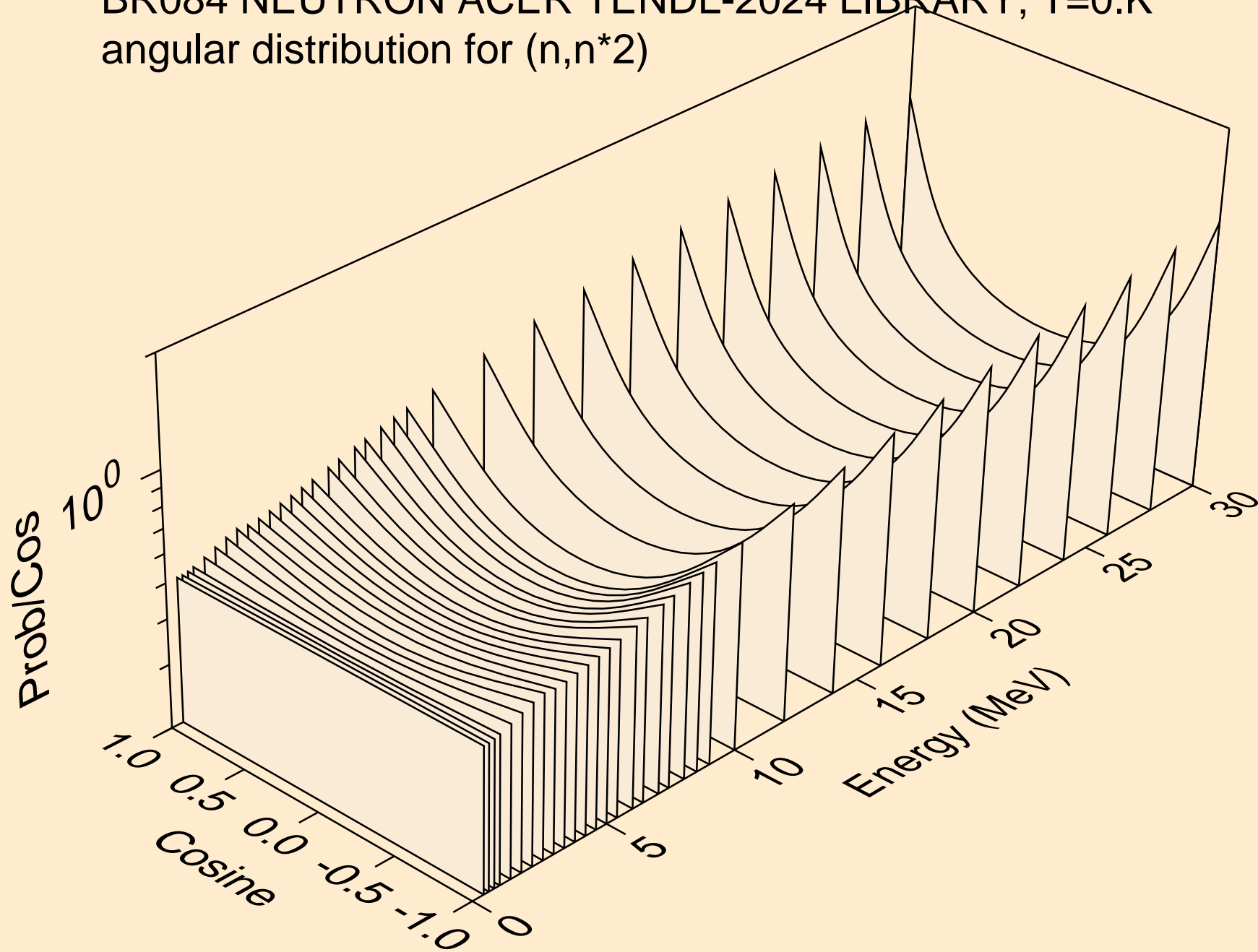



BR084 NEUTRON ACER TENDL-2024 LIBRARY; T=0.K  
angular distribution for (n,n\*3)

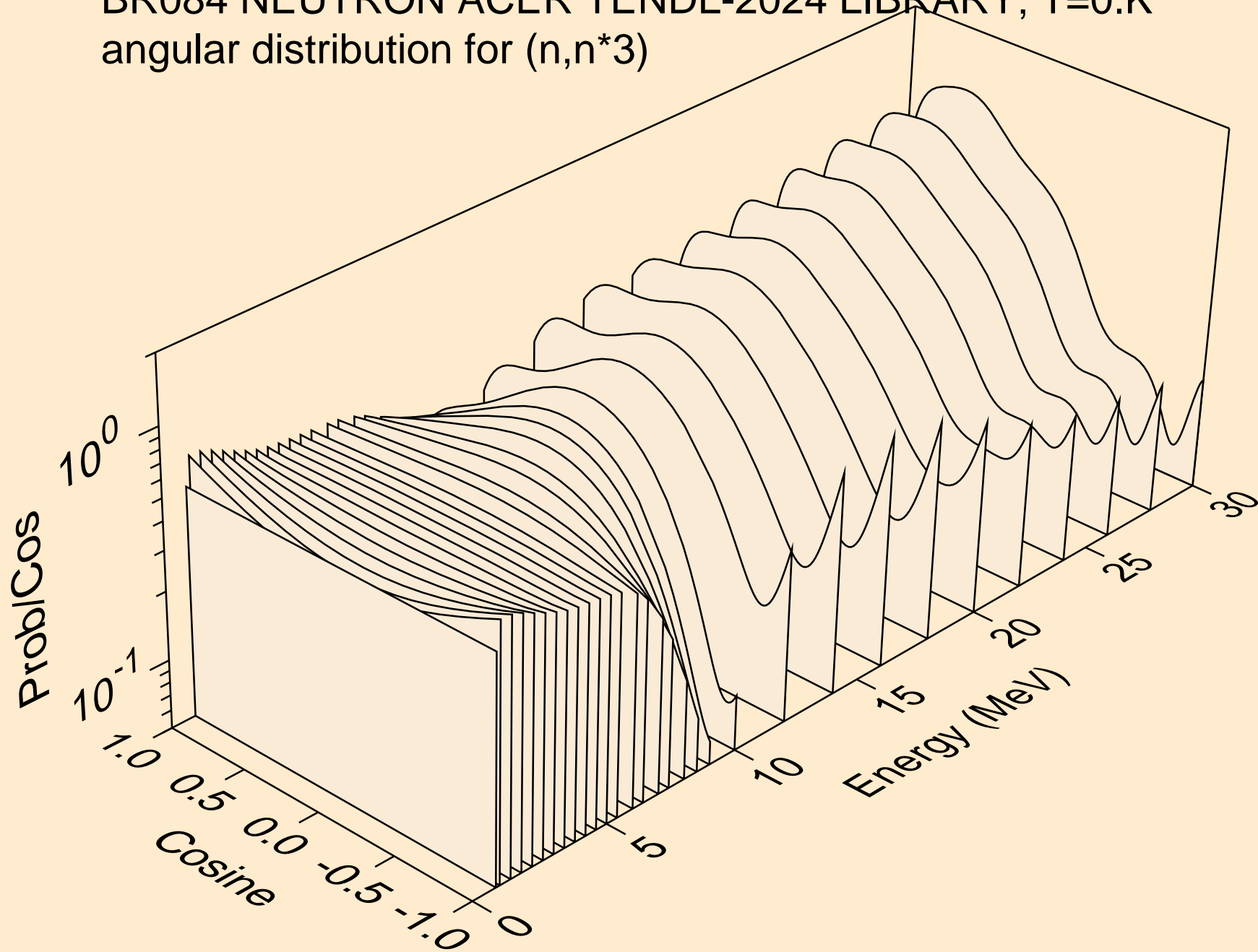

BR084 NEUTRON ACER TENDL-2024 LIBRARY; T=0.K  
angular distribution for (n,n\*4)

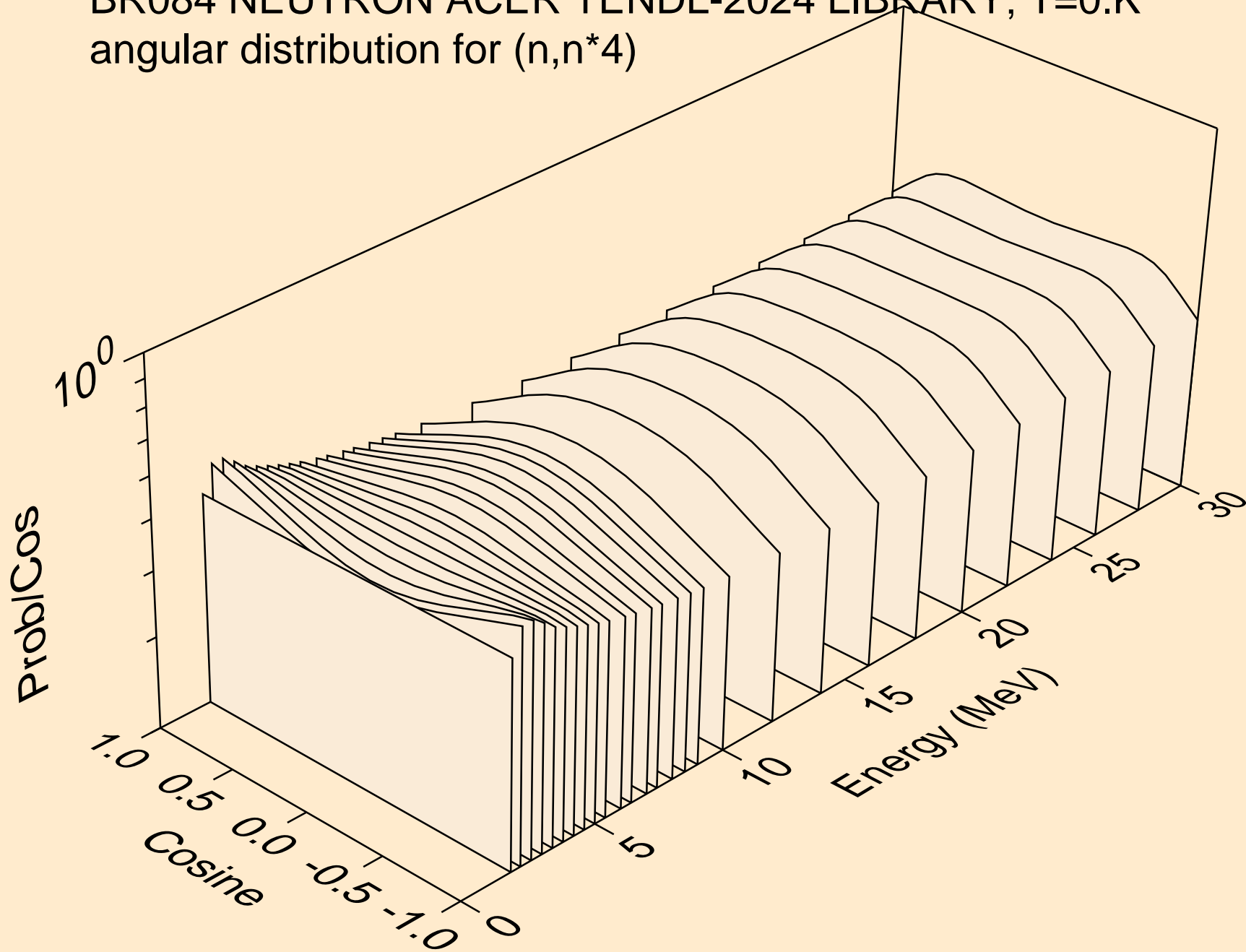

BR084 NEUTRON ACER TENDL-2024 LIBRARY; T=0.K  
angular distribution for (n,n\*5)

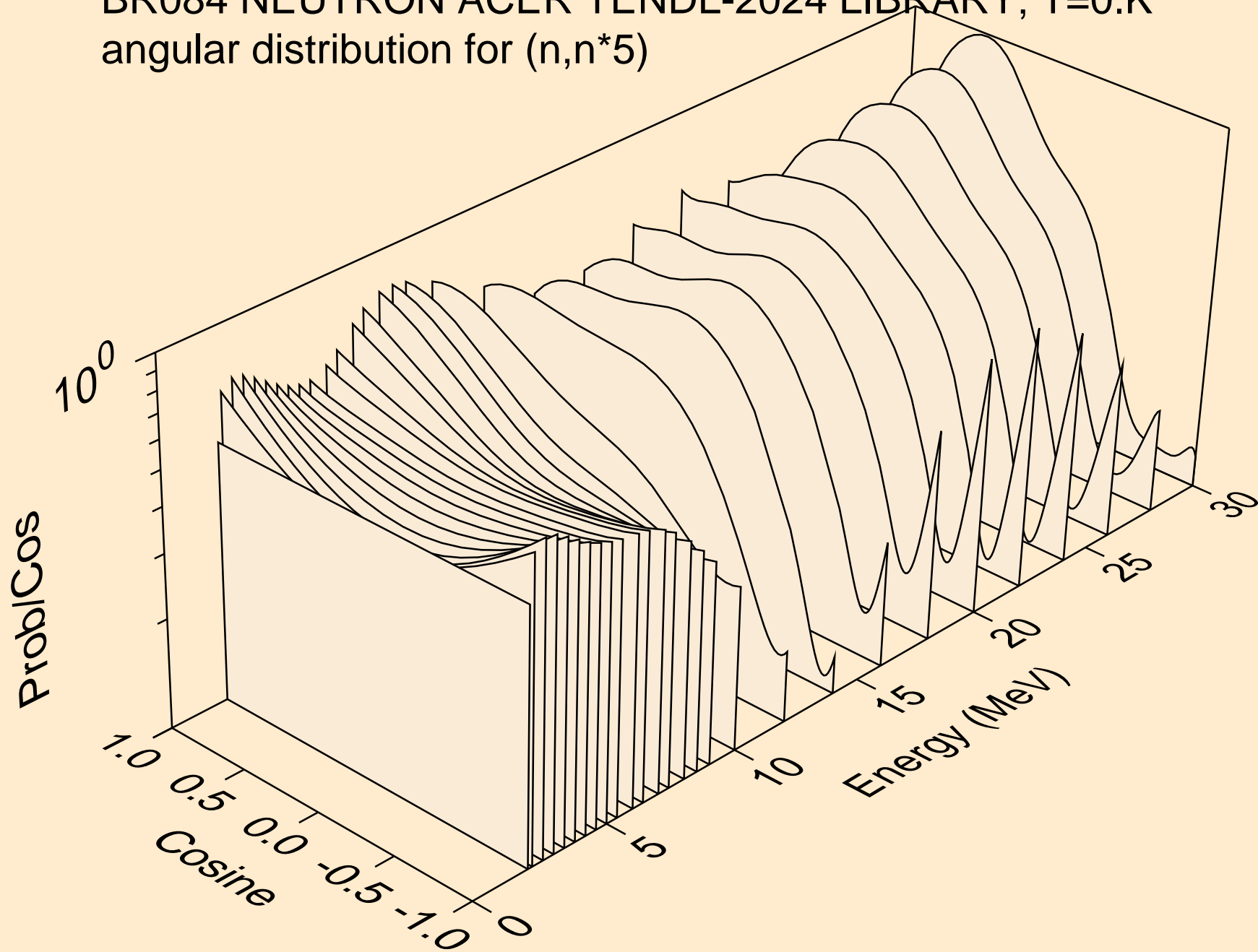

BR084 NEUTRON ACER TENDL-2024 LIBRARY; T=0.K  
angular distribution for (n,n\*6)

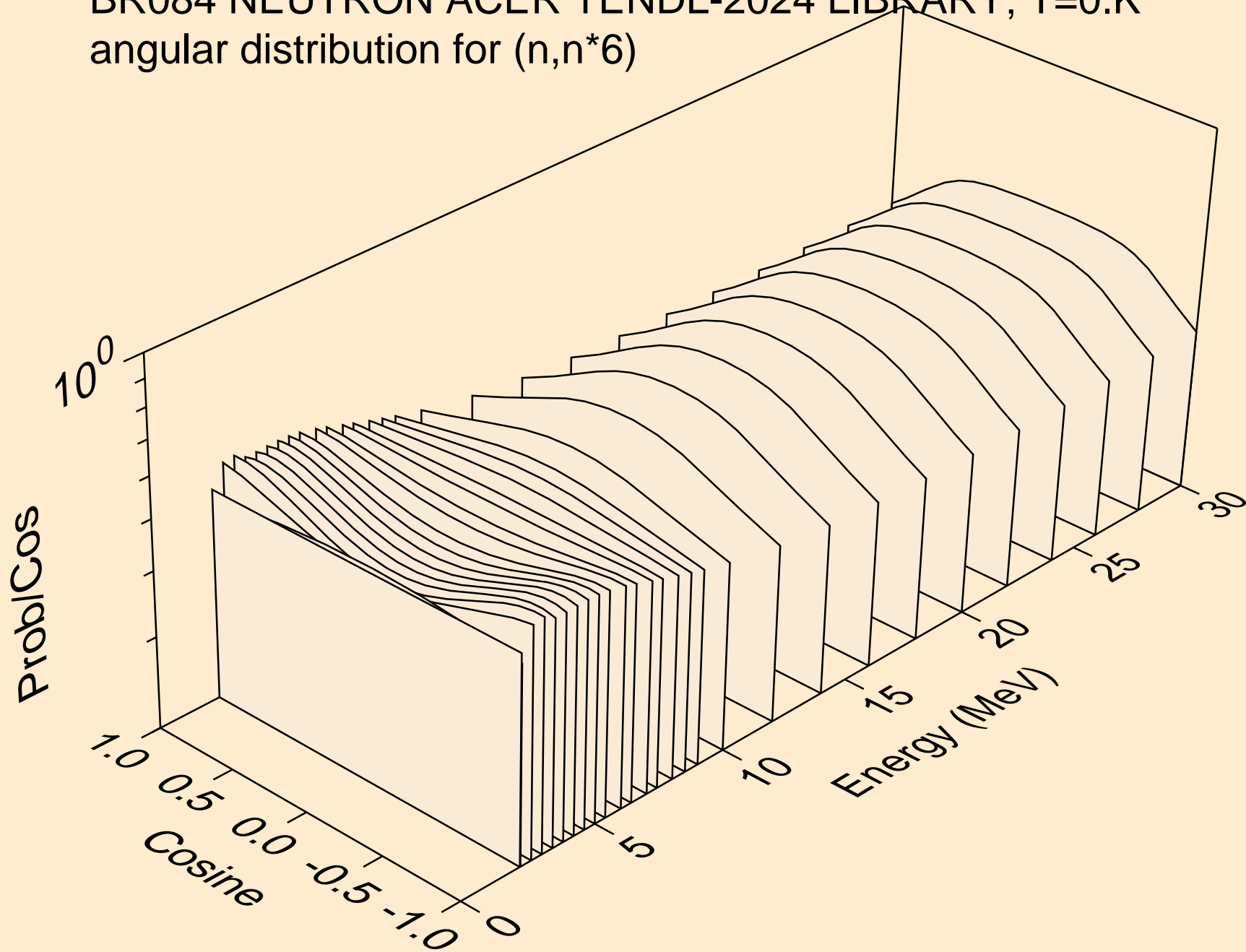

BR084 NEUTRON ACER TENDL-2024 LIBRARY; T=0.K  
angular distribution for (n,n\*7)

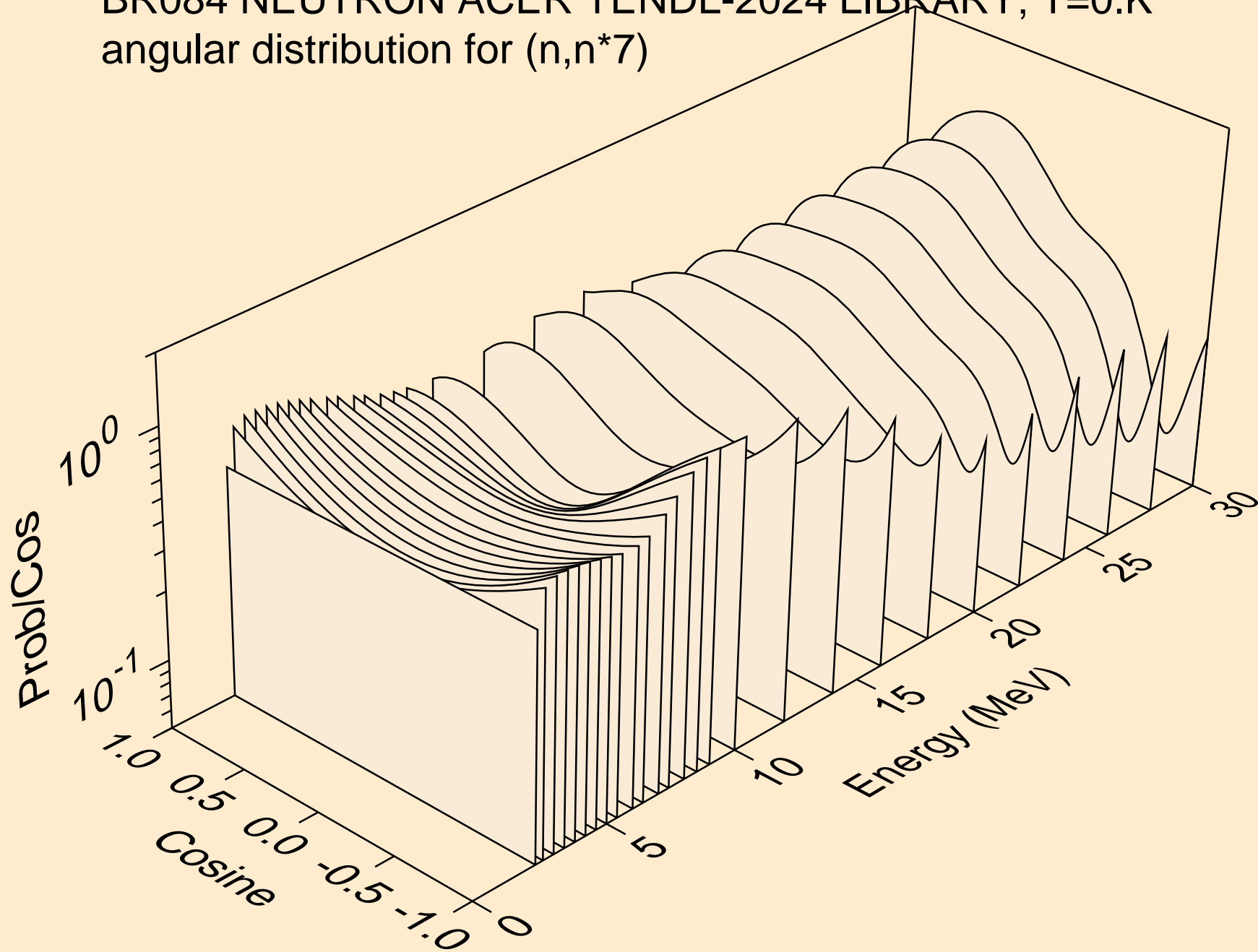

BR084 NEUTRON ACER TENDL-2024 LIBRARY; T=0.K  
angular distribution for (n,n\*8)

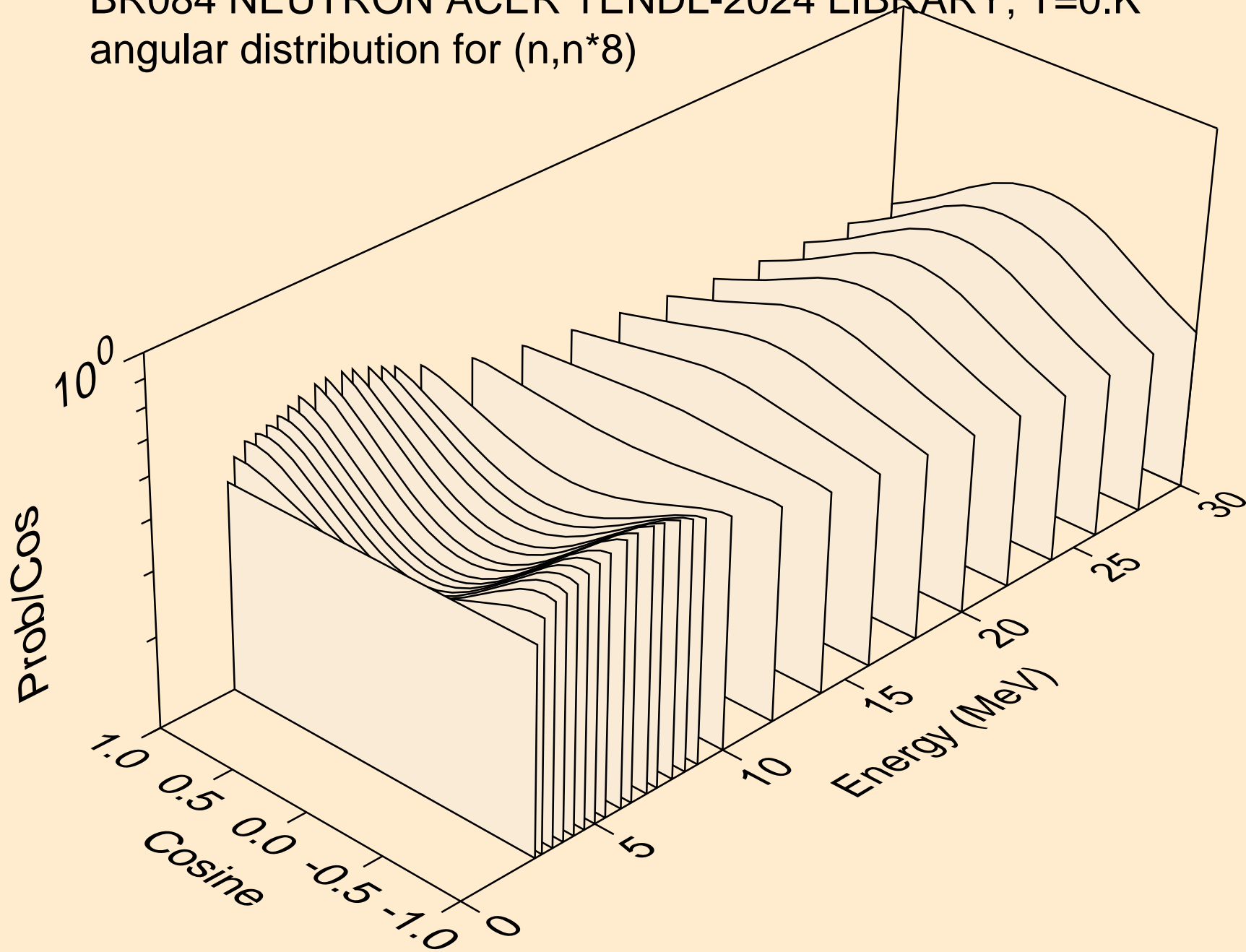

BR084 NEUTRON ACER TENDL-2024 LIBRARY; T=0.K  
angular distribution for (n,n\*9)

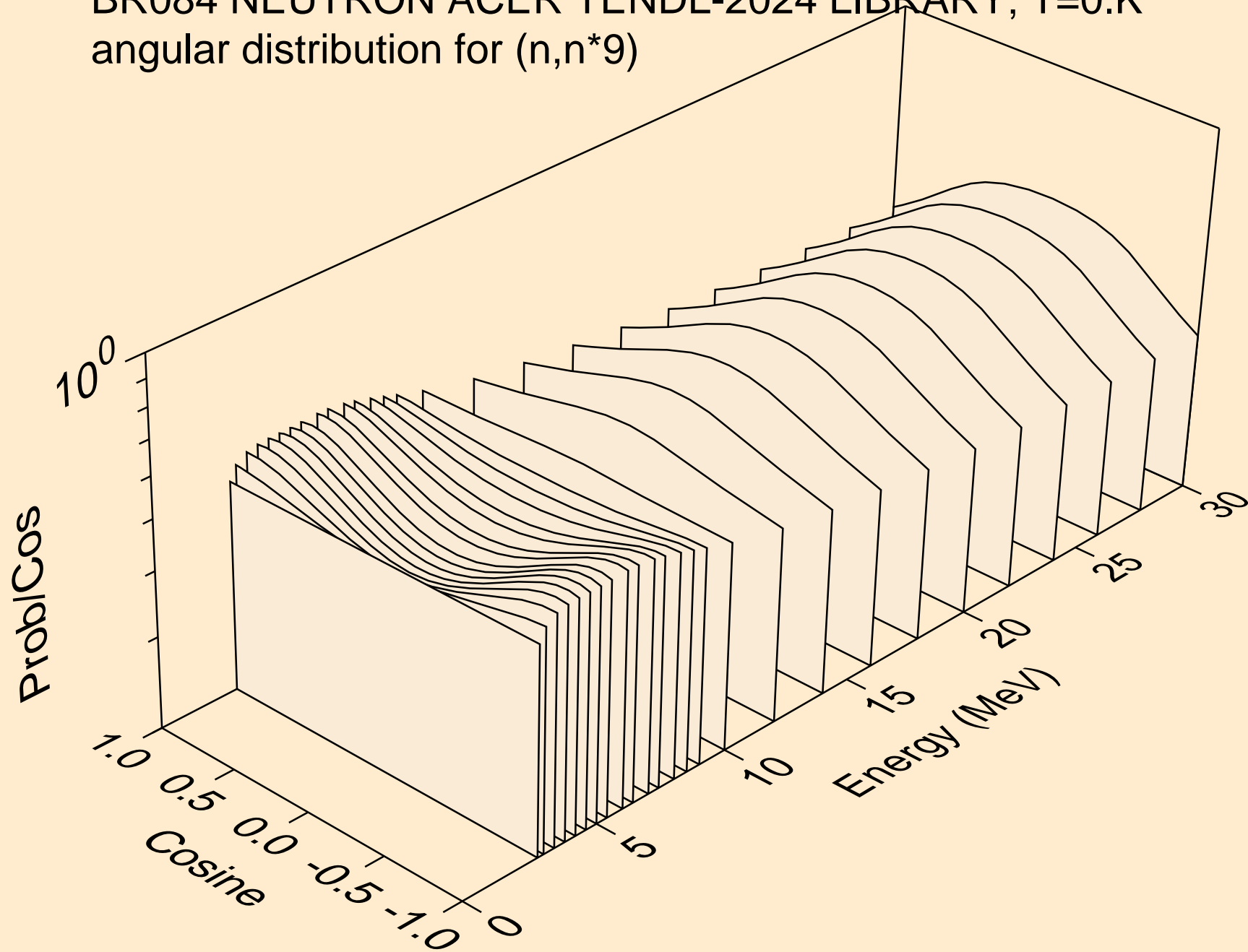

BR084 NEUTRON ACER TENDL-2024 LIBRARY; T=0.K  
angular distribution for (n,n\*10)

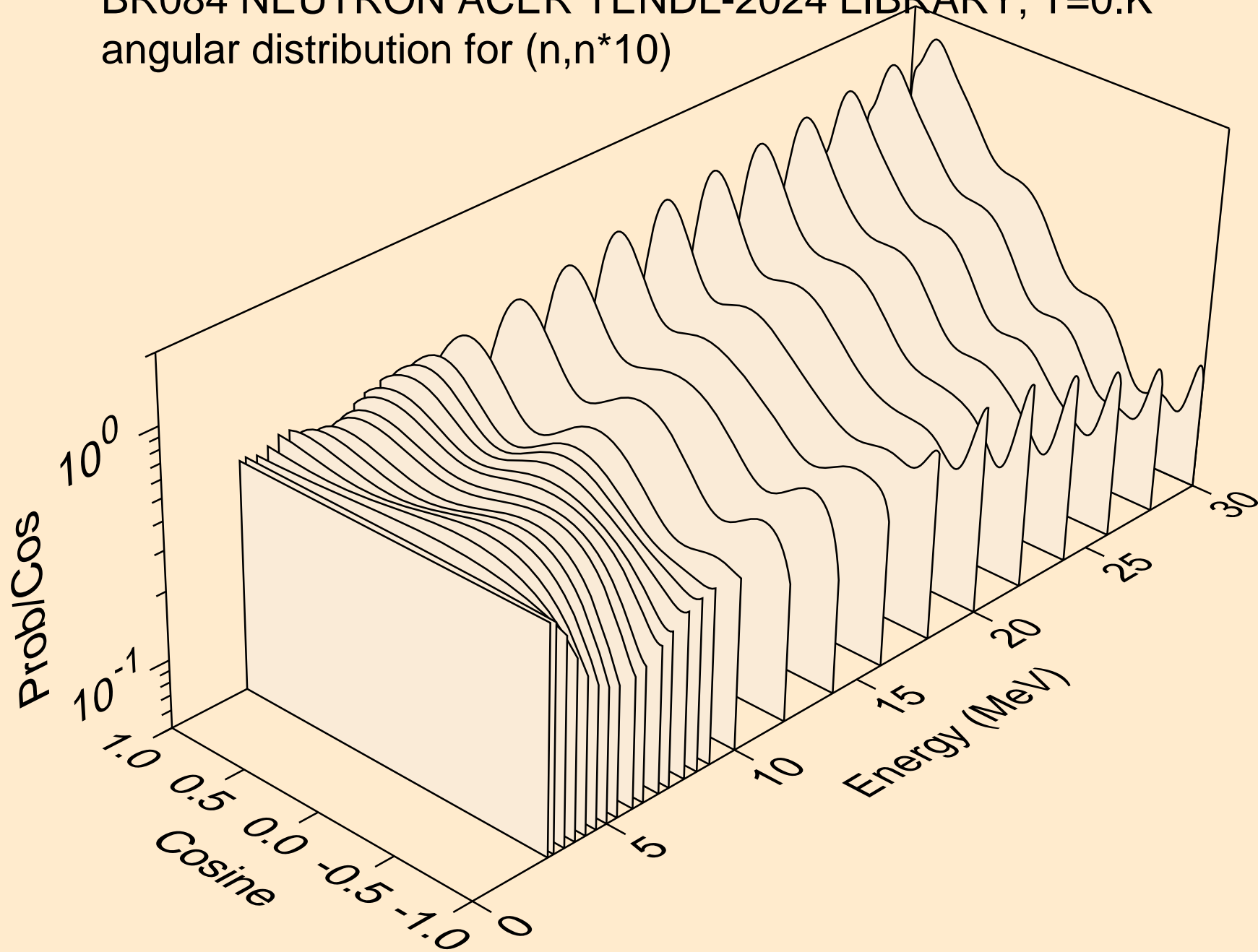



BR084 NEUTRON ACER TENDL-2024 LIBRARY; T=0.K  
angular distribution for (n,n\*11)

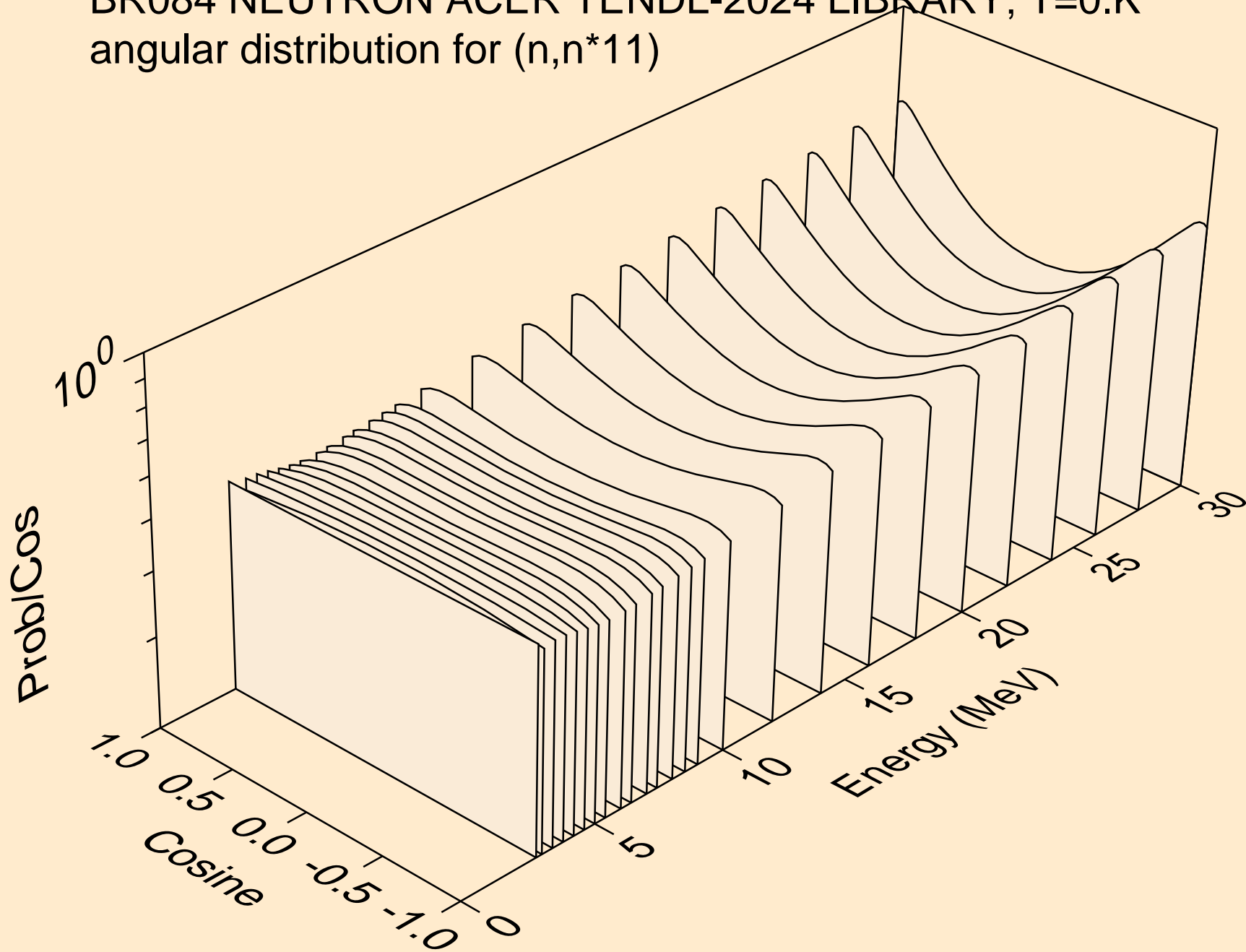

BR084 NEUTRON ACER TENDL-2024 LIBRARY; T=0.K  
angular distribution for (n,n\*12)

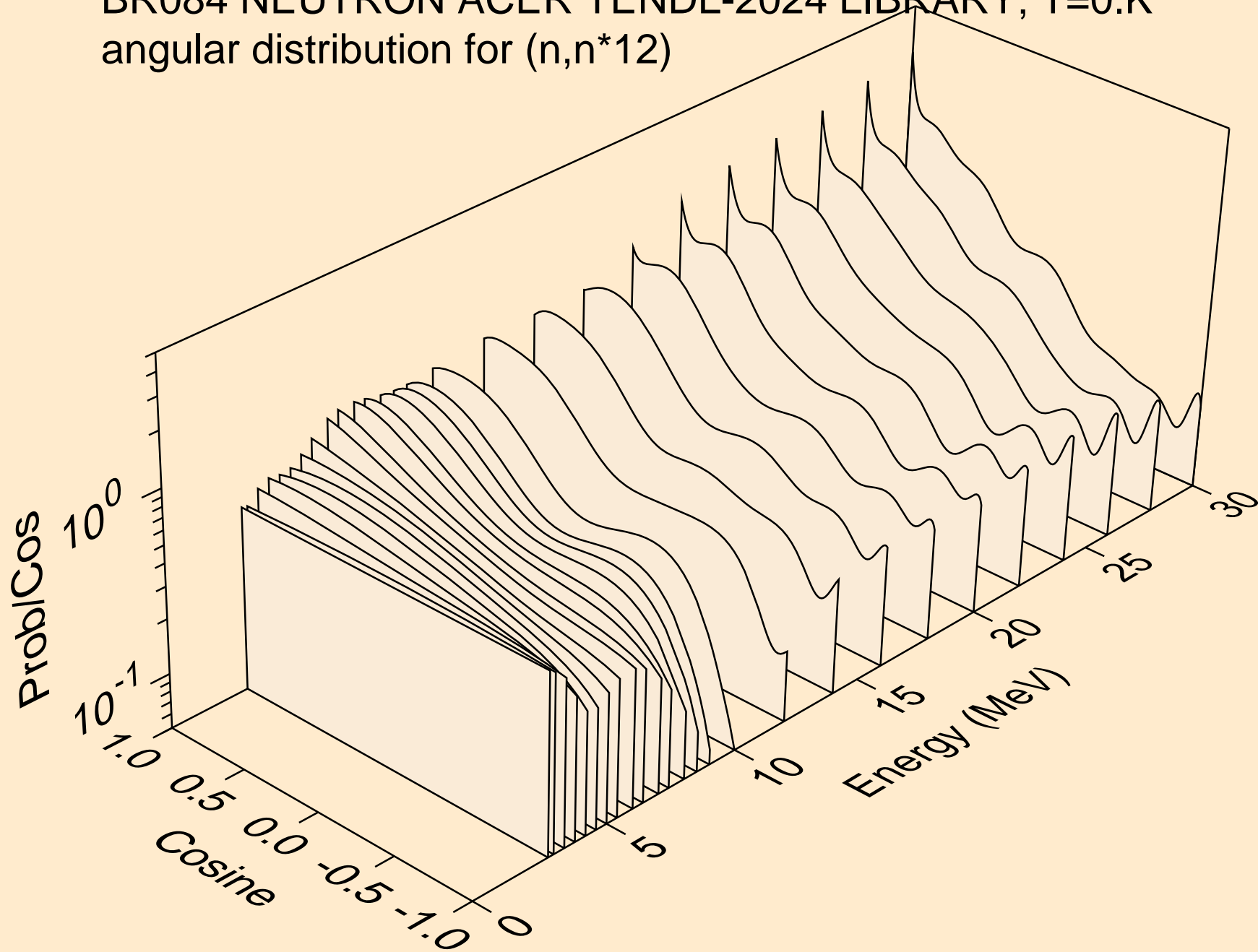

BR084 NEUTRON ACER TENDL-2024 LIBRARY; T=0.K  
angular distribution for (n,n\*13)

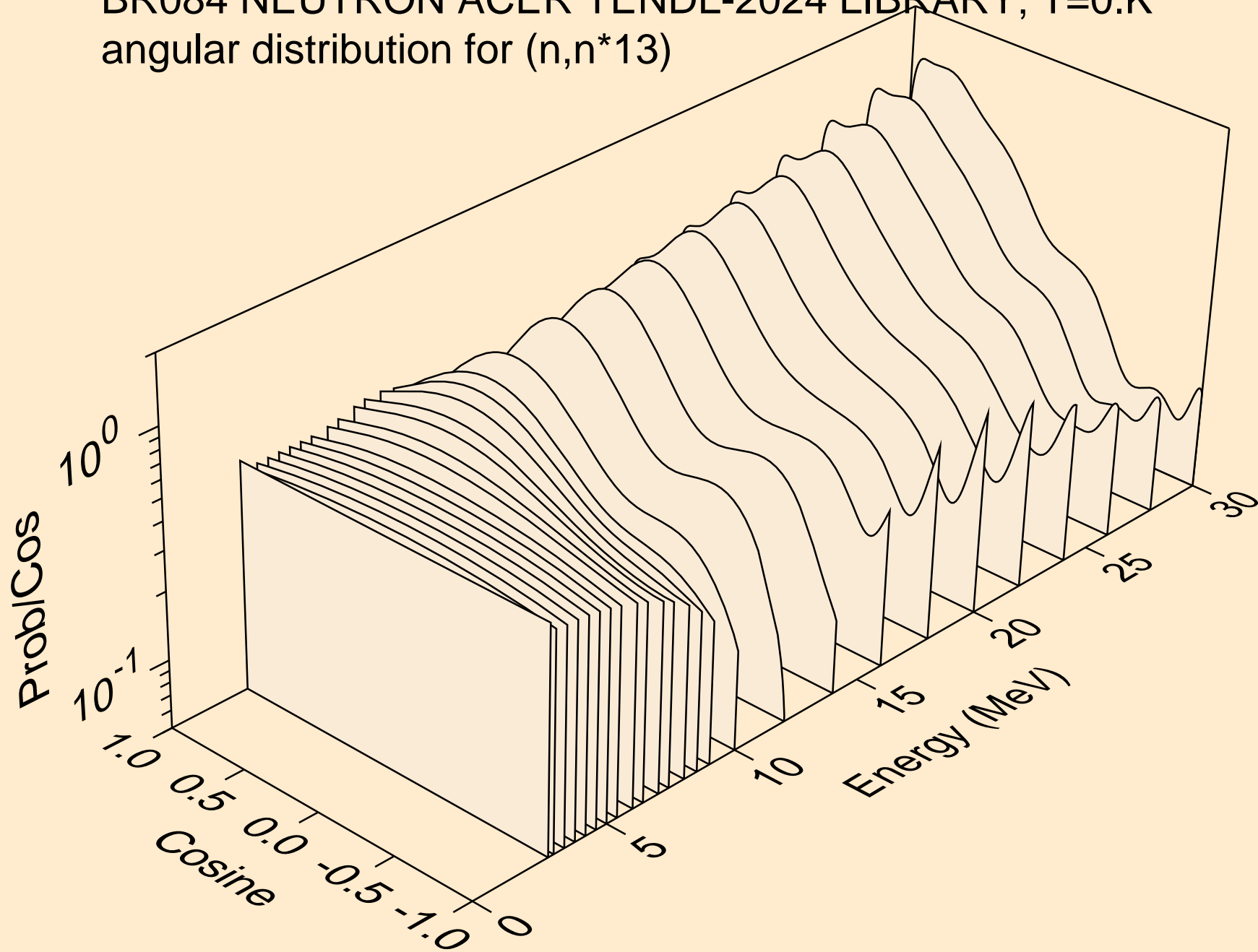

BR084 NEUTRON ACER TENDL-2024 LIBRARY; T=0.K  
angular distribution for (n,n\*14)

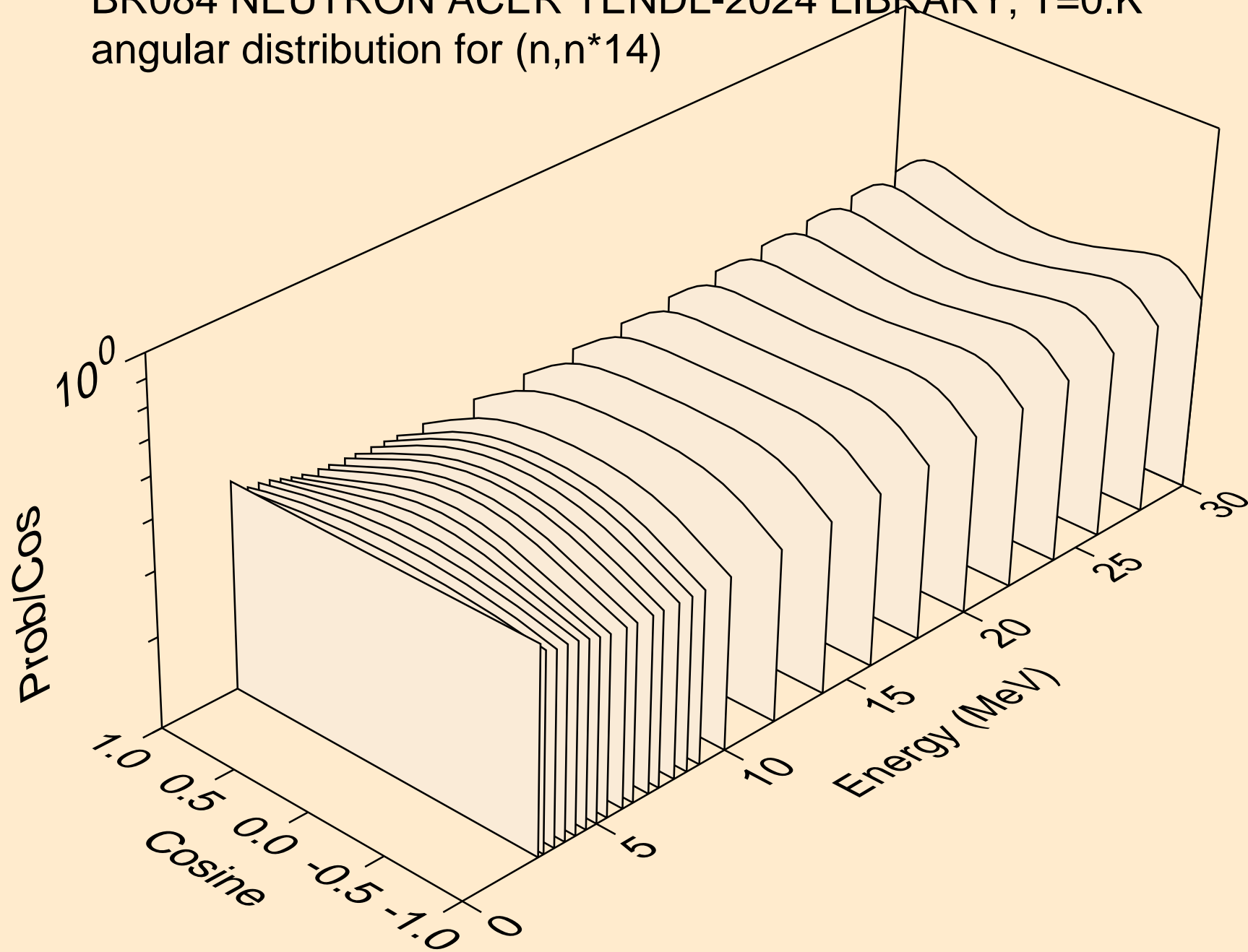

BR084 NEUTRON ACER TENDL-2024 LIBRARY; T=0.K  
angular distribution for (n,n\*15)

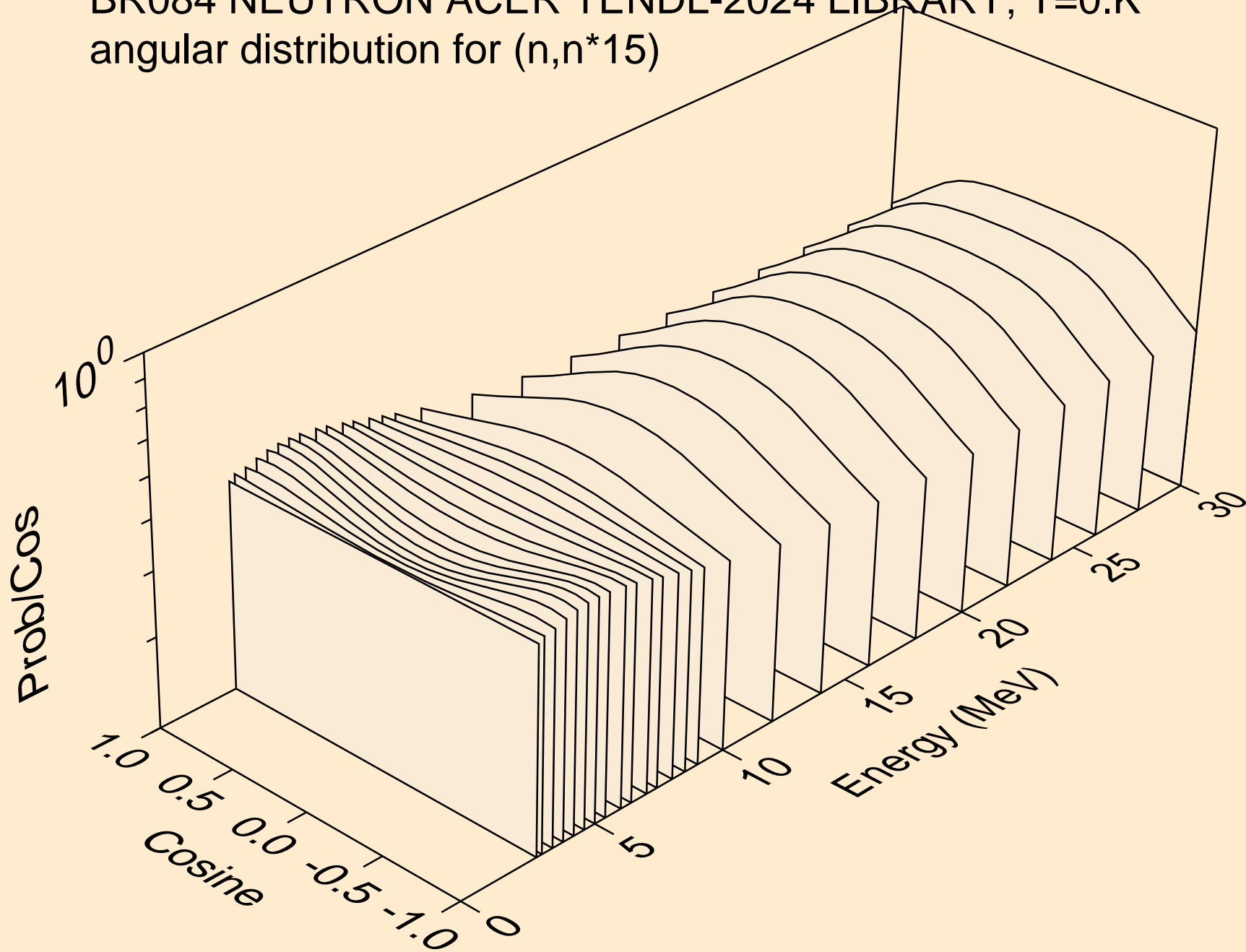

BR084 NEUTRON ACER TENDL-2024 LIBRARY; T=0.K  
angular distribution for (n,n\*16)

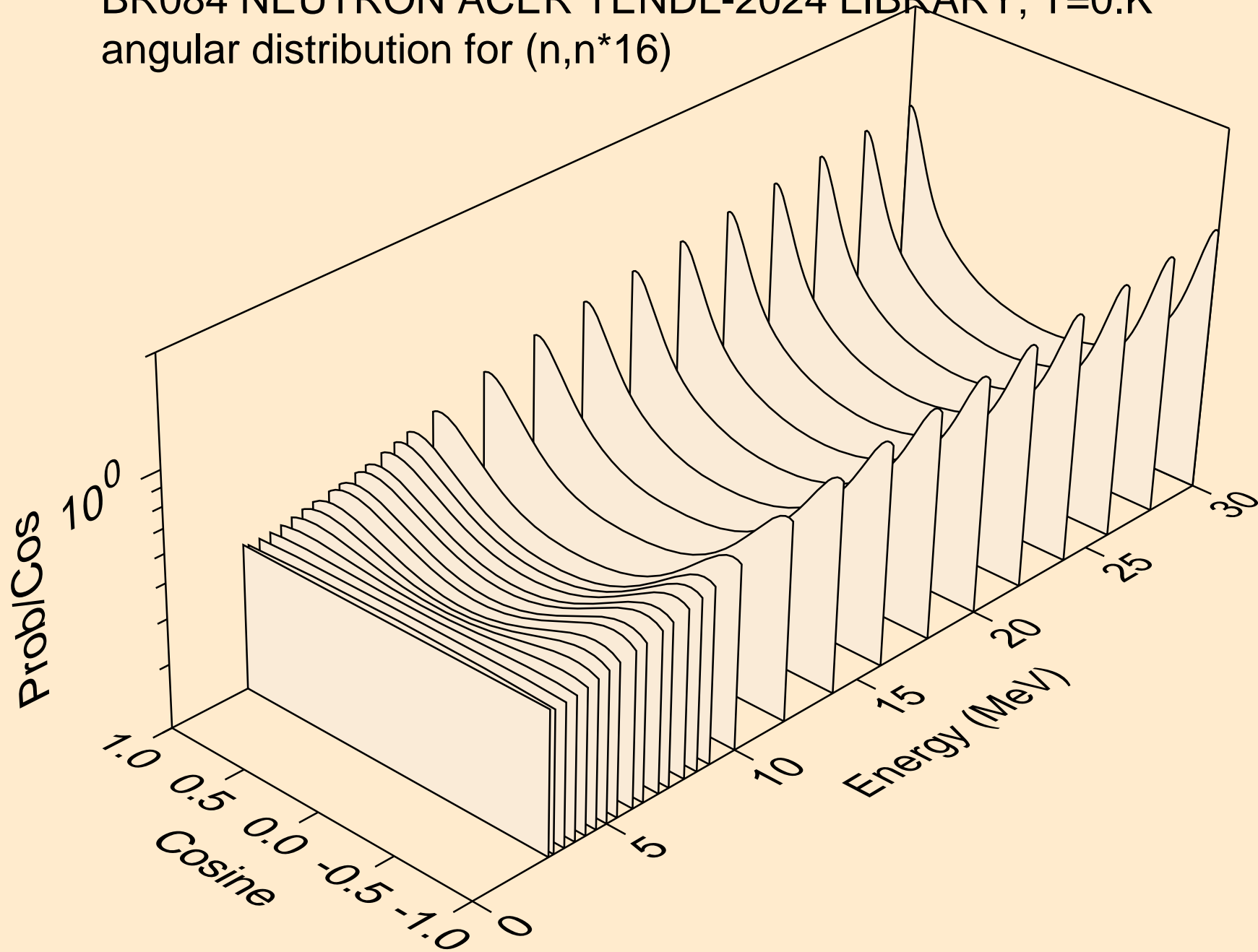

BR084 NEUTRON ACER TENDL-2024 LIBRARY; T=0.K  
angular distribution for (n,n\*17)

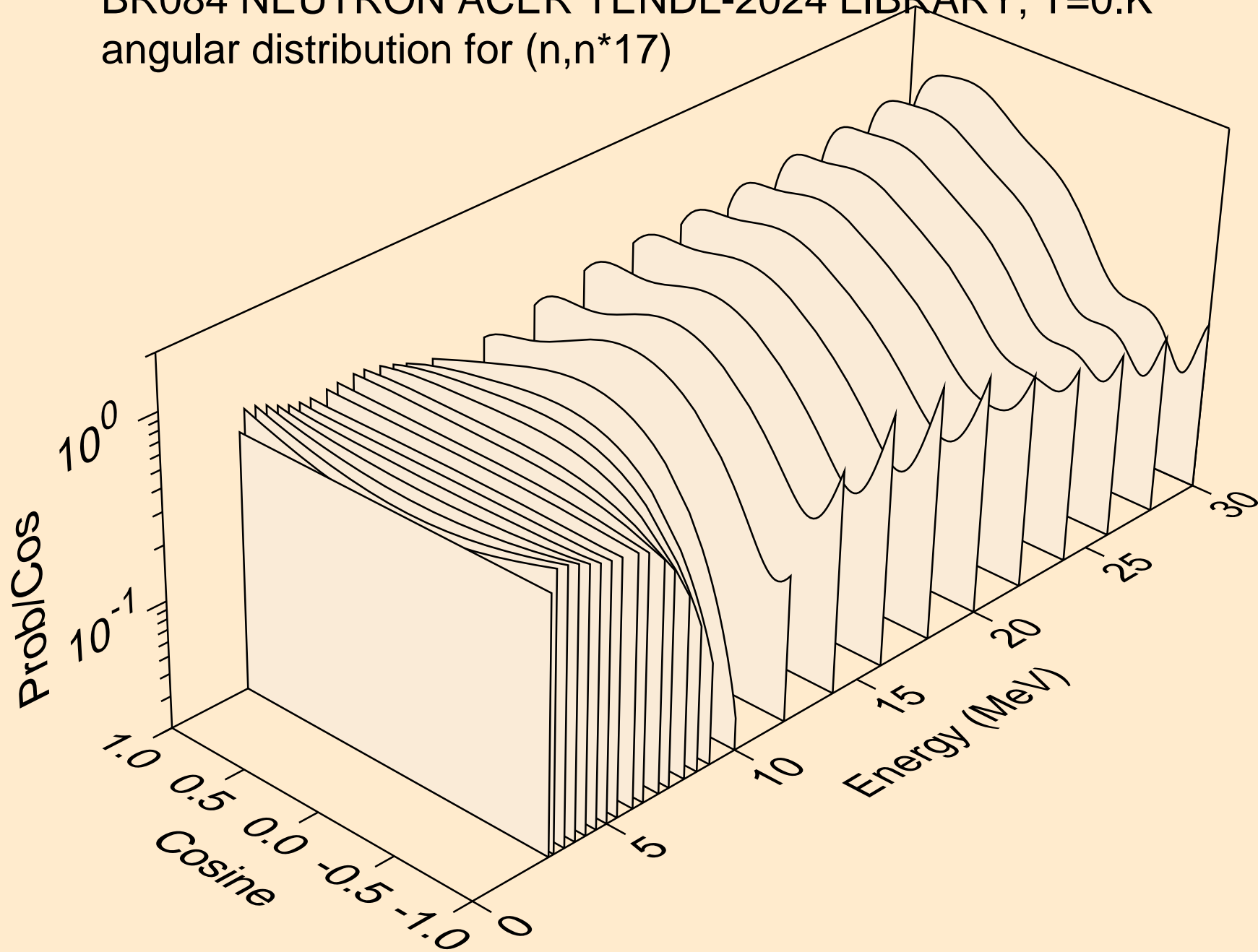

BR084 NEUTRON ACER TENDL-2024 LIBRARY; T=0.K  
angular distribution for (n,n\*18)

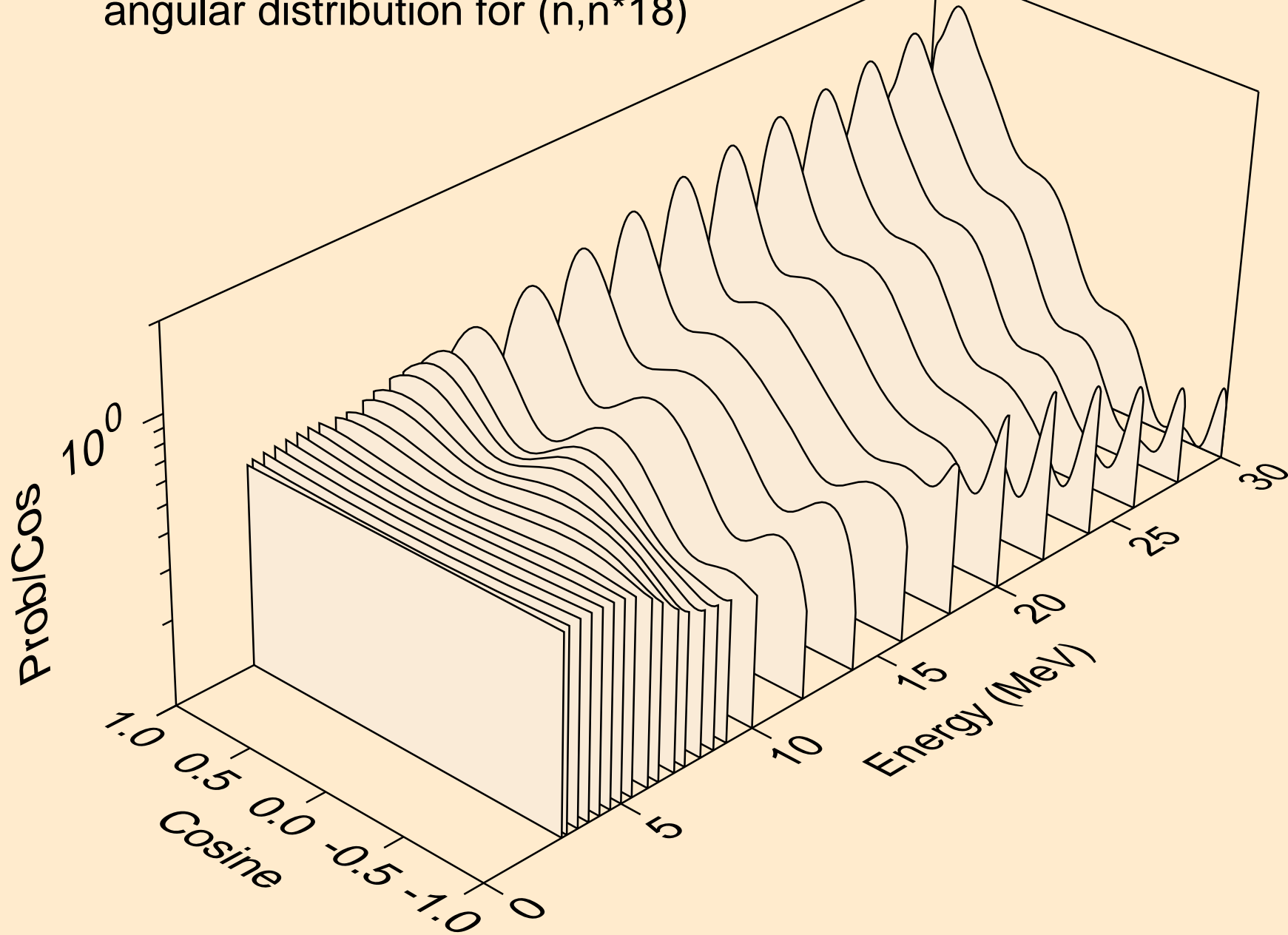



BR084 NEUTRON ACER TENDL-2024 LIBRARY; T=0.K  
angular distribution for (n,n\*19)

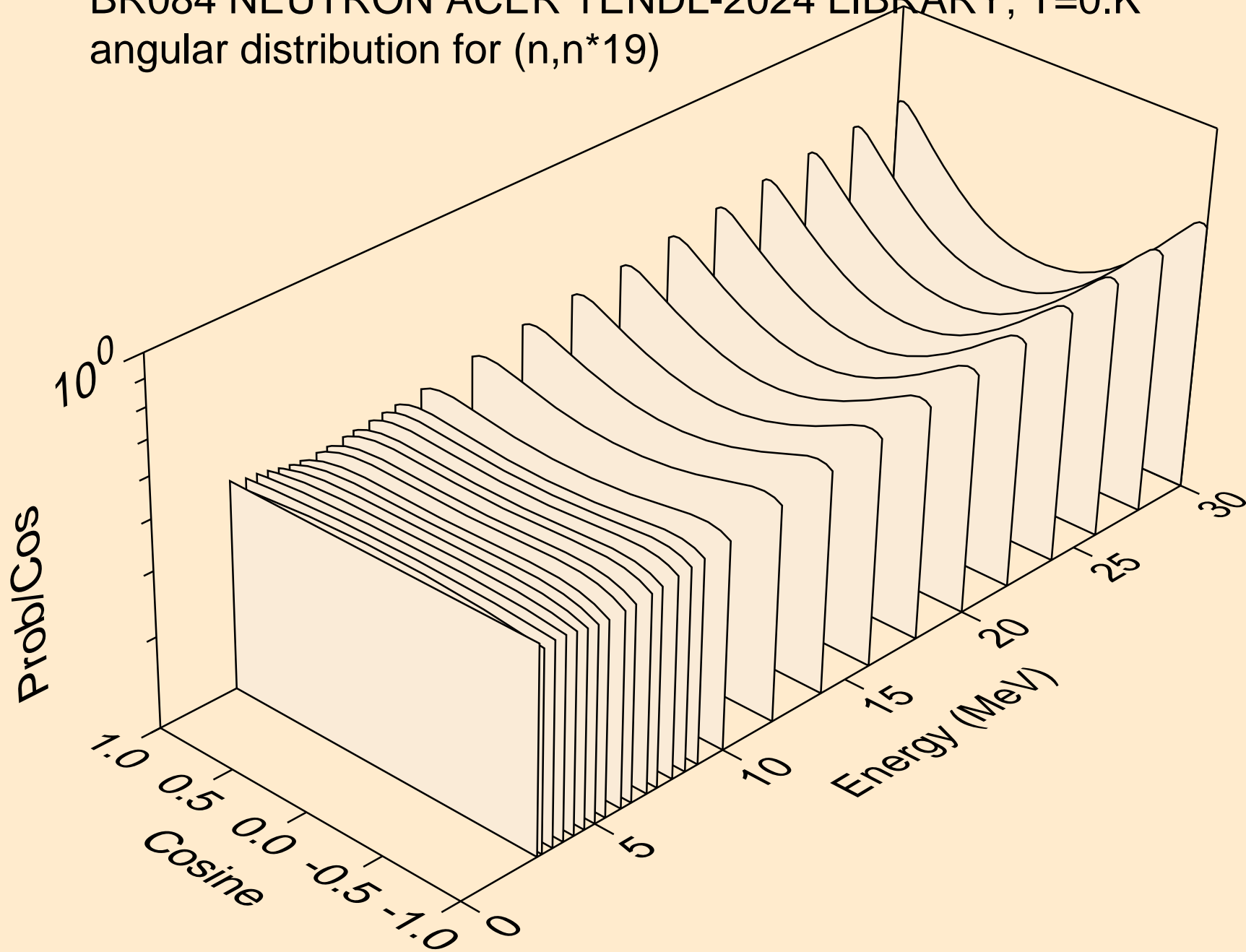

BR084 NEUTRON ACER TENDL-2024 LIBRARY; T=0.K  
angular distribution for (n,n\*20)

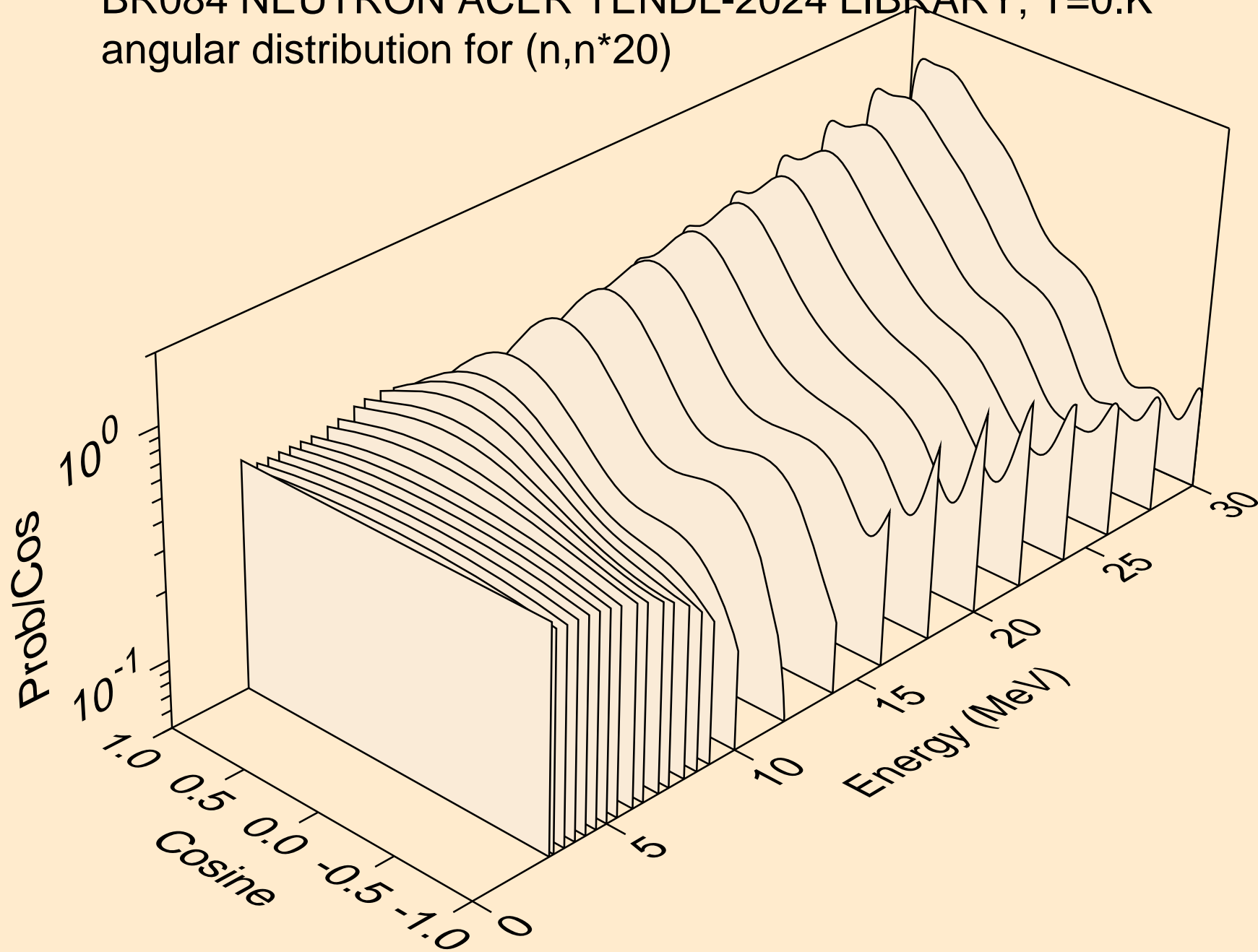

BR084 NEUTRON ACER TENDL-2024 LIBRARY; T=0.K  
angular distribution for (n,n\*21)

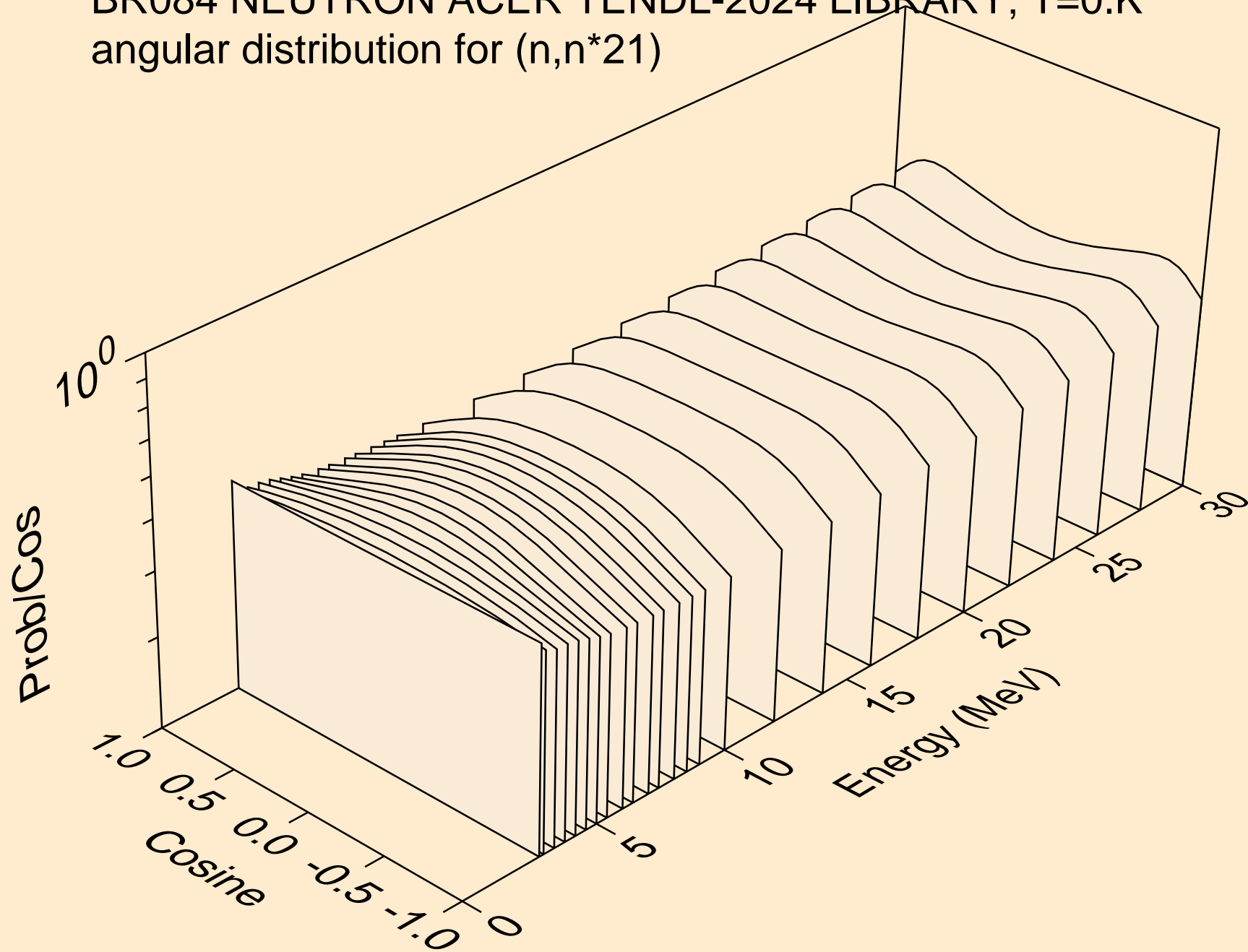

BR084 NEUTRON ACER TENDL-2024 LIBRARY; T=0.K  
angular distribution for (n,n\*22)

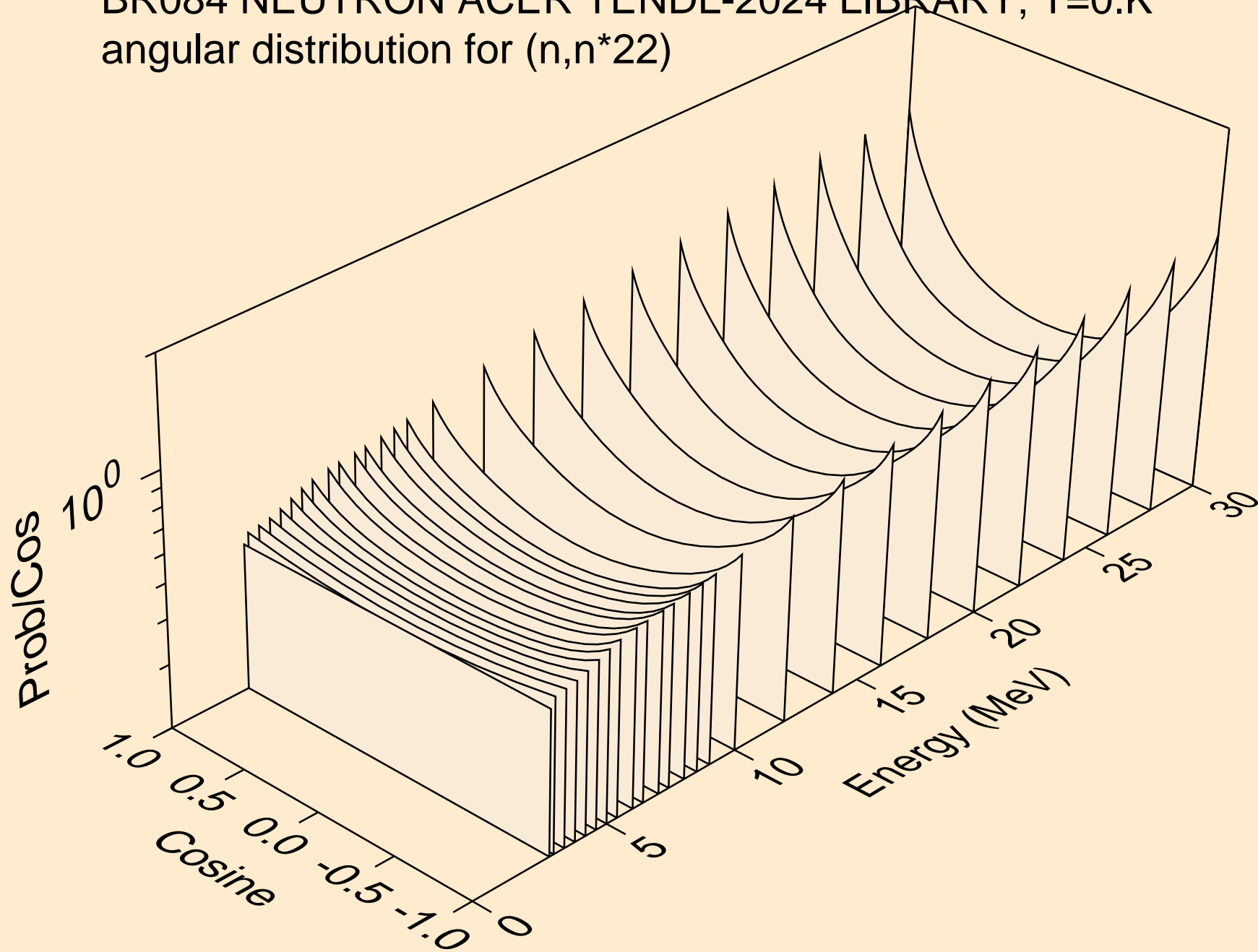

BR084 NEUTRON ACER TENDL-2024 LIBRARY; T=0.K  
angular distribution for (n,n\*23)

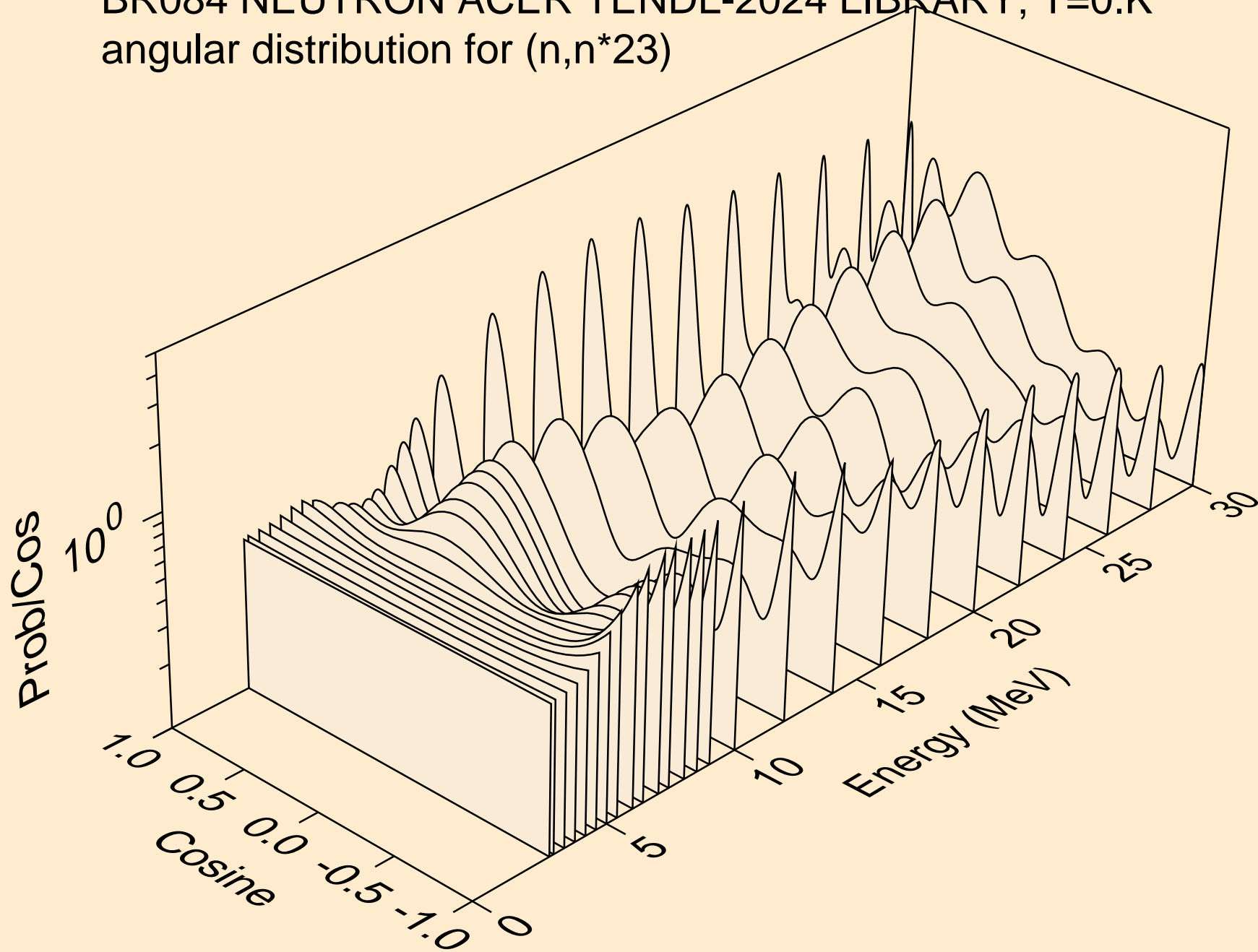

BR084 NEUTRON ACER TENDL-2024 LIBRARY; T=0.K  
angular distribution for (n,n\*24)

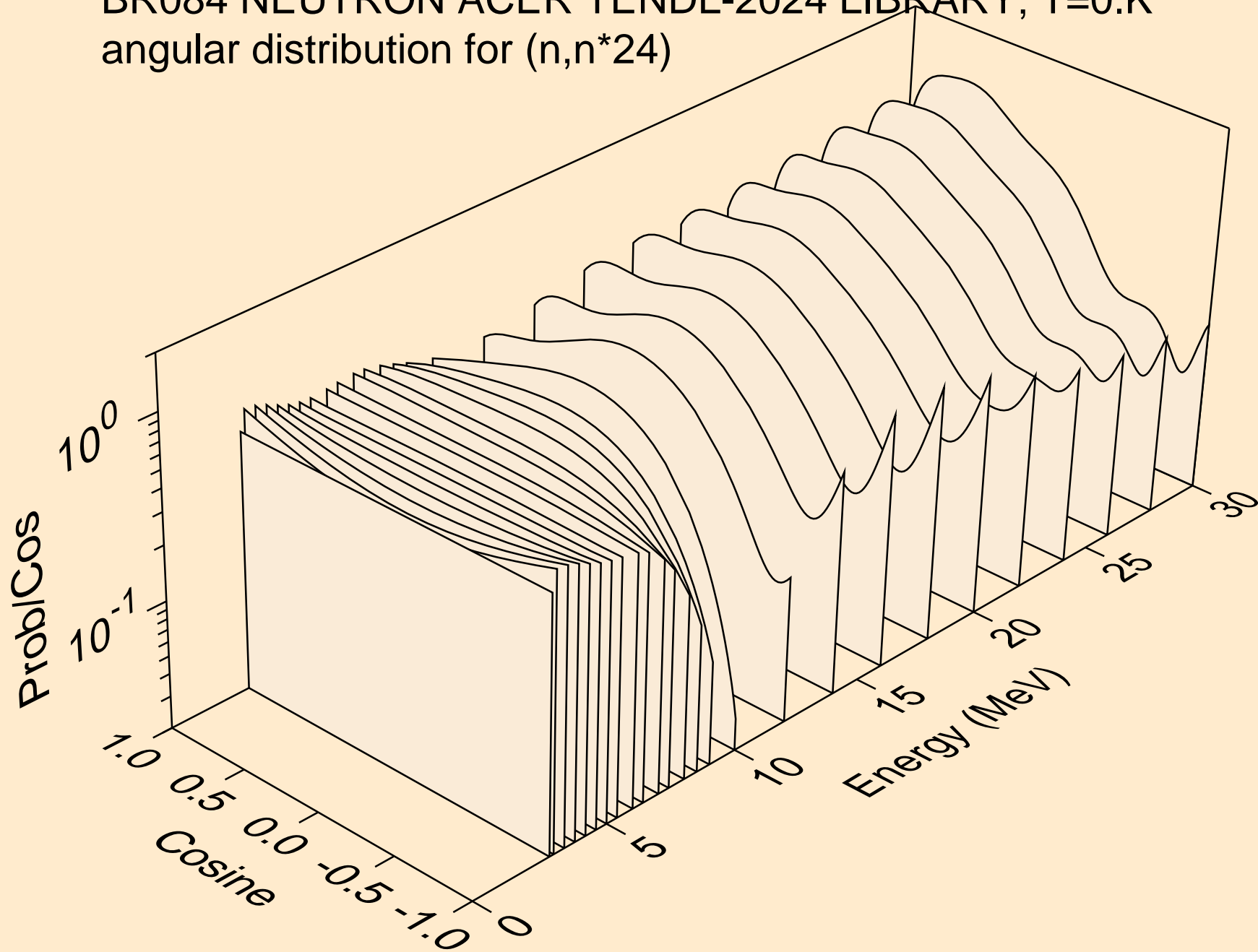

BR084 NEUTRON ACER TENDL-2024 LIBRARY; T=0.K  
angular distribution for (n,n\*25)

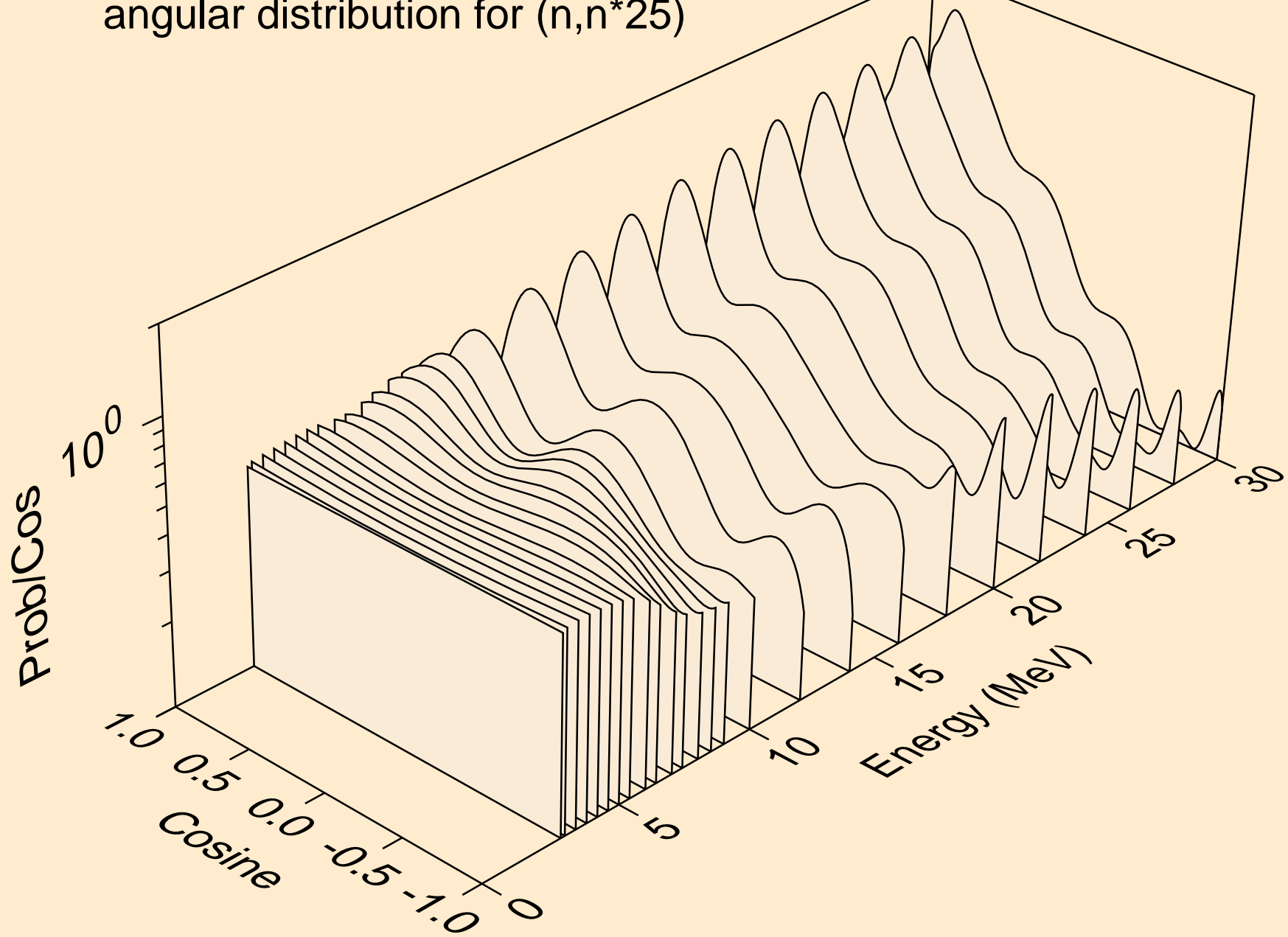

BR084 NEUTRON ACER TENDL-2024 LIBRARY; T=0.K  
angular distribution for (n,n\*26)

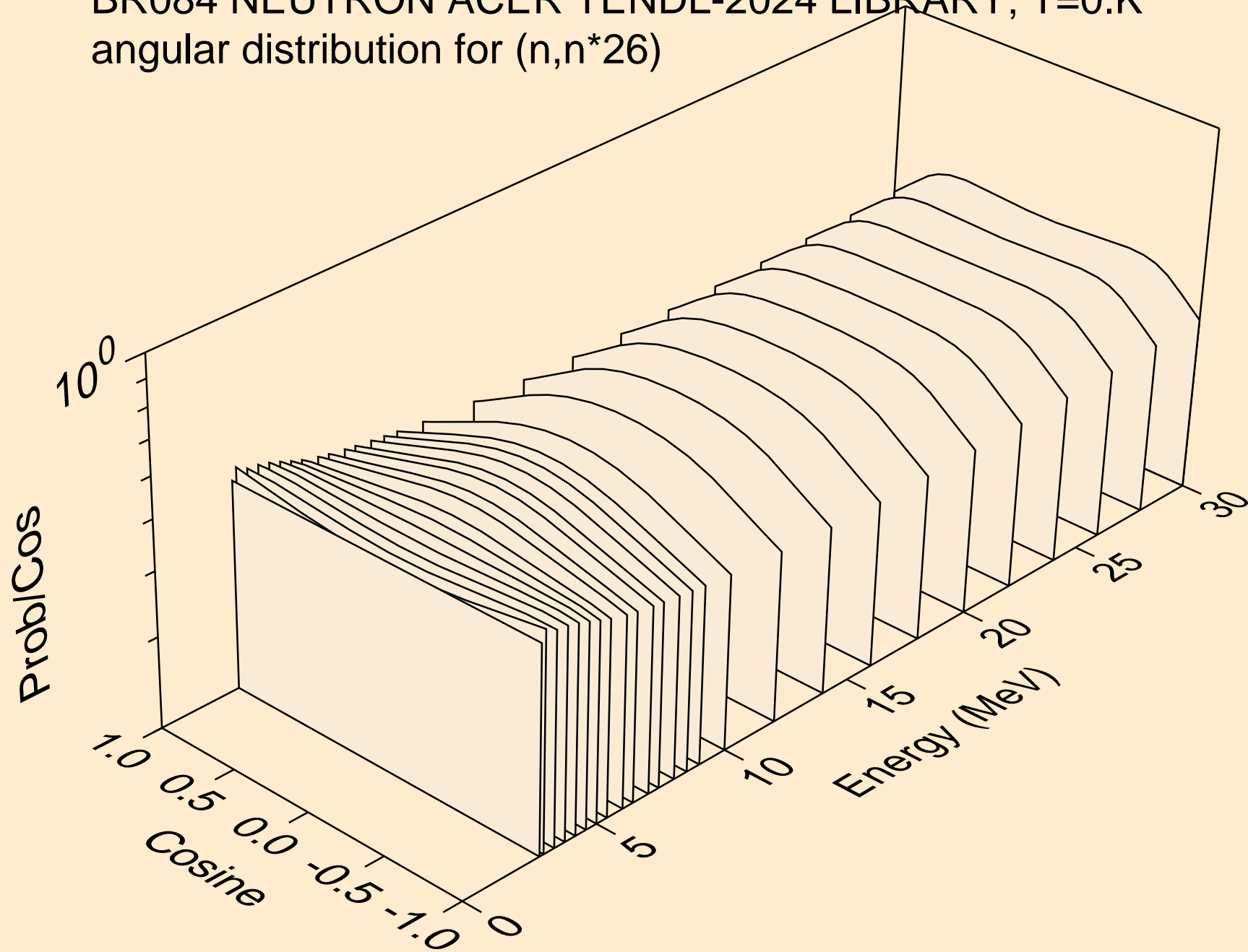



BR084 NEUTRON ACER TENDL-2024 LIBRARY; T=0.K  
angular distribution for (n,n\*27)

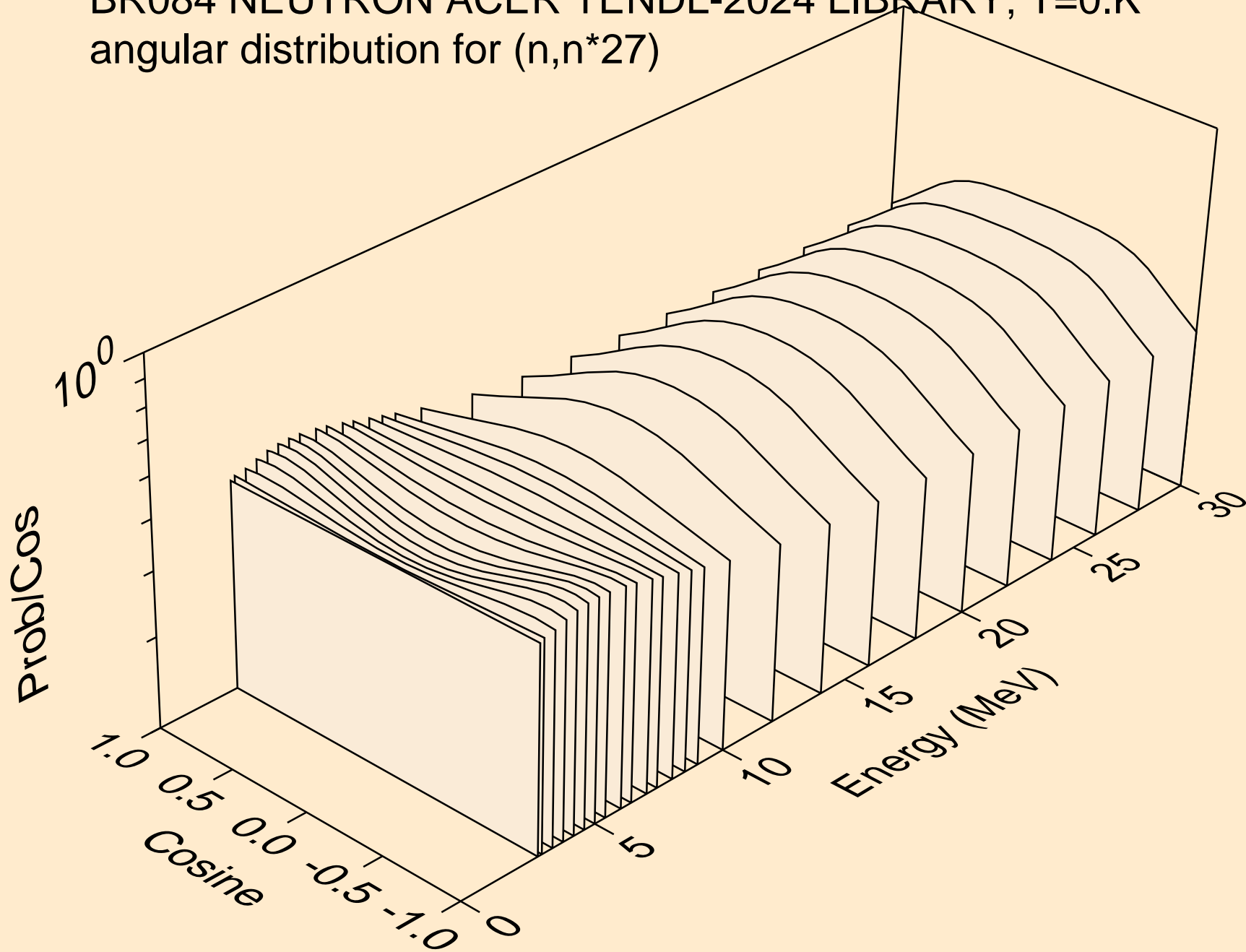

BR084 NEUTRON ACER TENDL-2024 LIBRARY; T=0.K  
angular distribution for (n,n\*28)

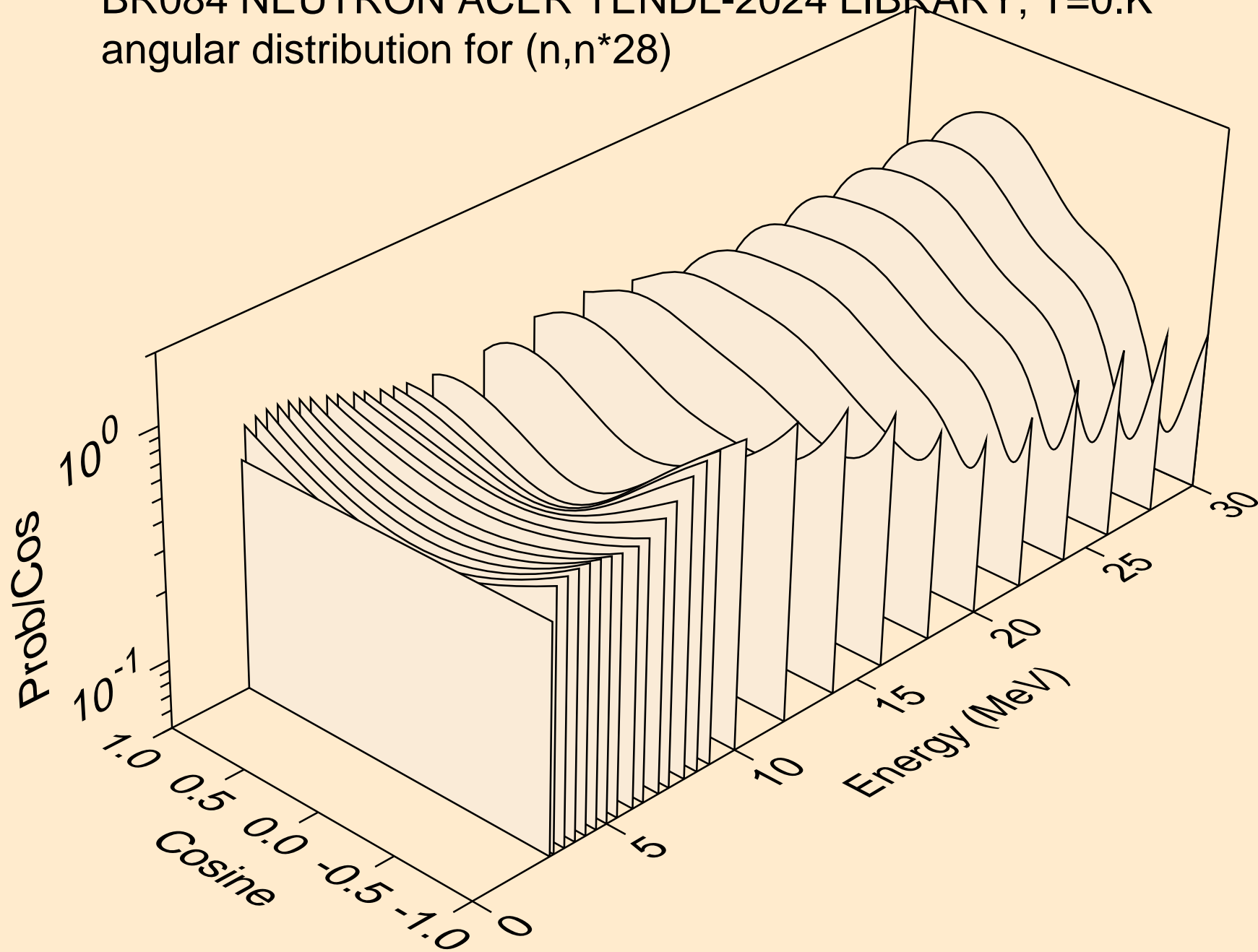

BR084 NEUTRON ACER TENDL-2024 LIBRARY; T=0.K  
angular distribution for (n,n\*29)

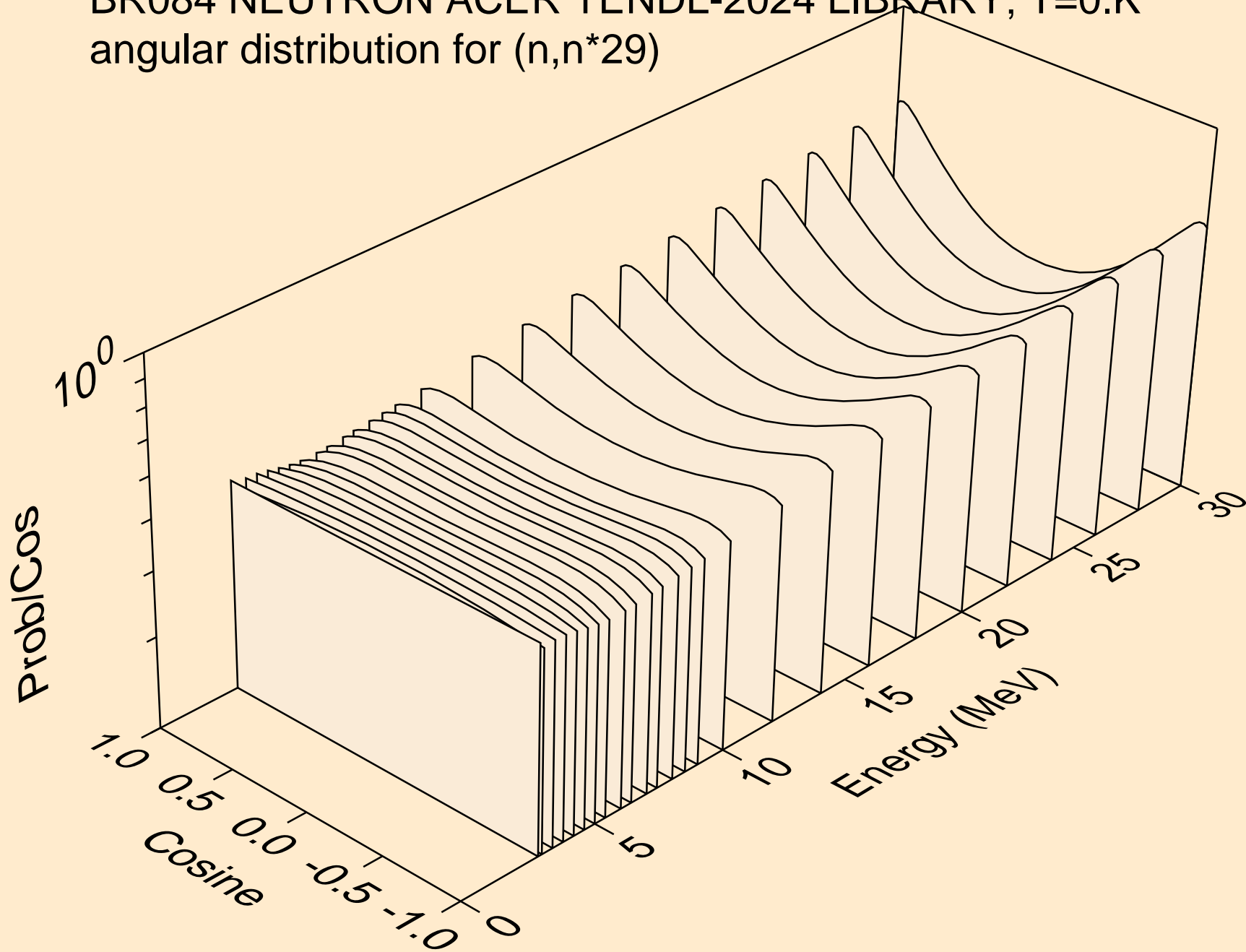

BR084 NEUTRON ACER TENDL-2024 LIBRARY; T=0.K  
angular distribution for (n,n\*30)

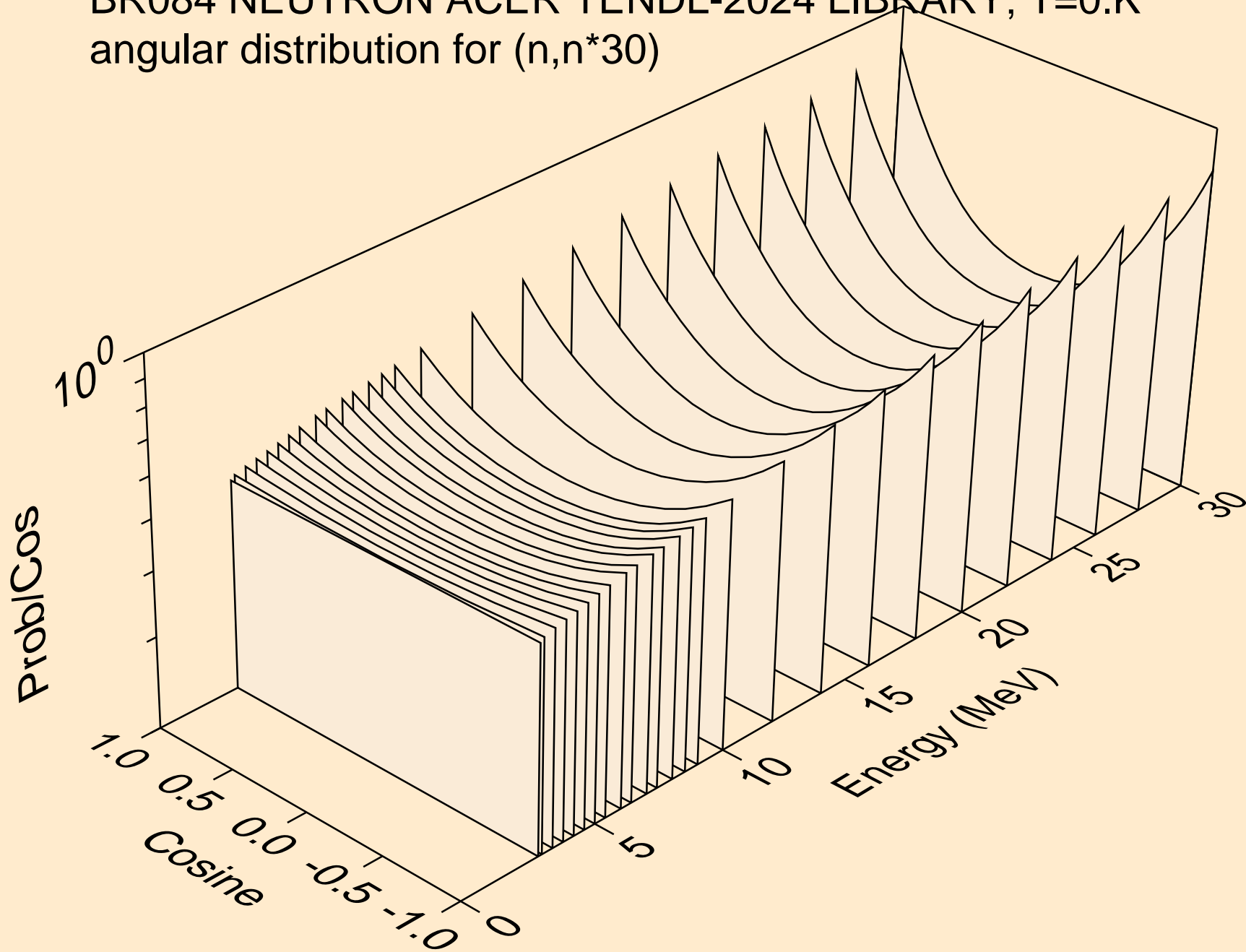

BR084 NEUTRON ACER TENDL-2024 LIBRARY; T=0.K  
Neutron emission for (n,x)

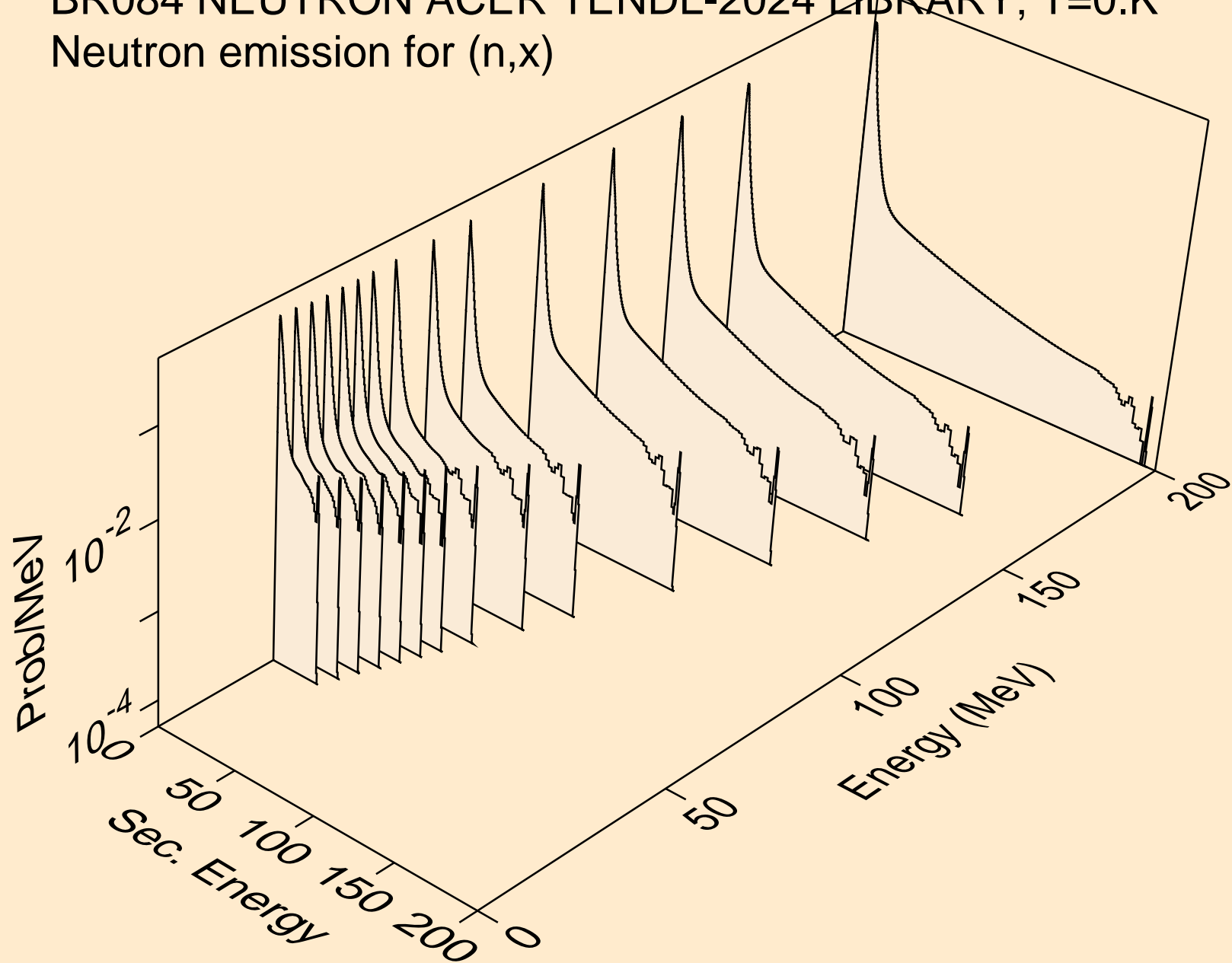

BR084 NEUTRON ACER TENDL-2024 LIBRARY; T=0.K  
Neutron emission for (n,2nd)

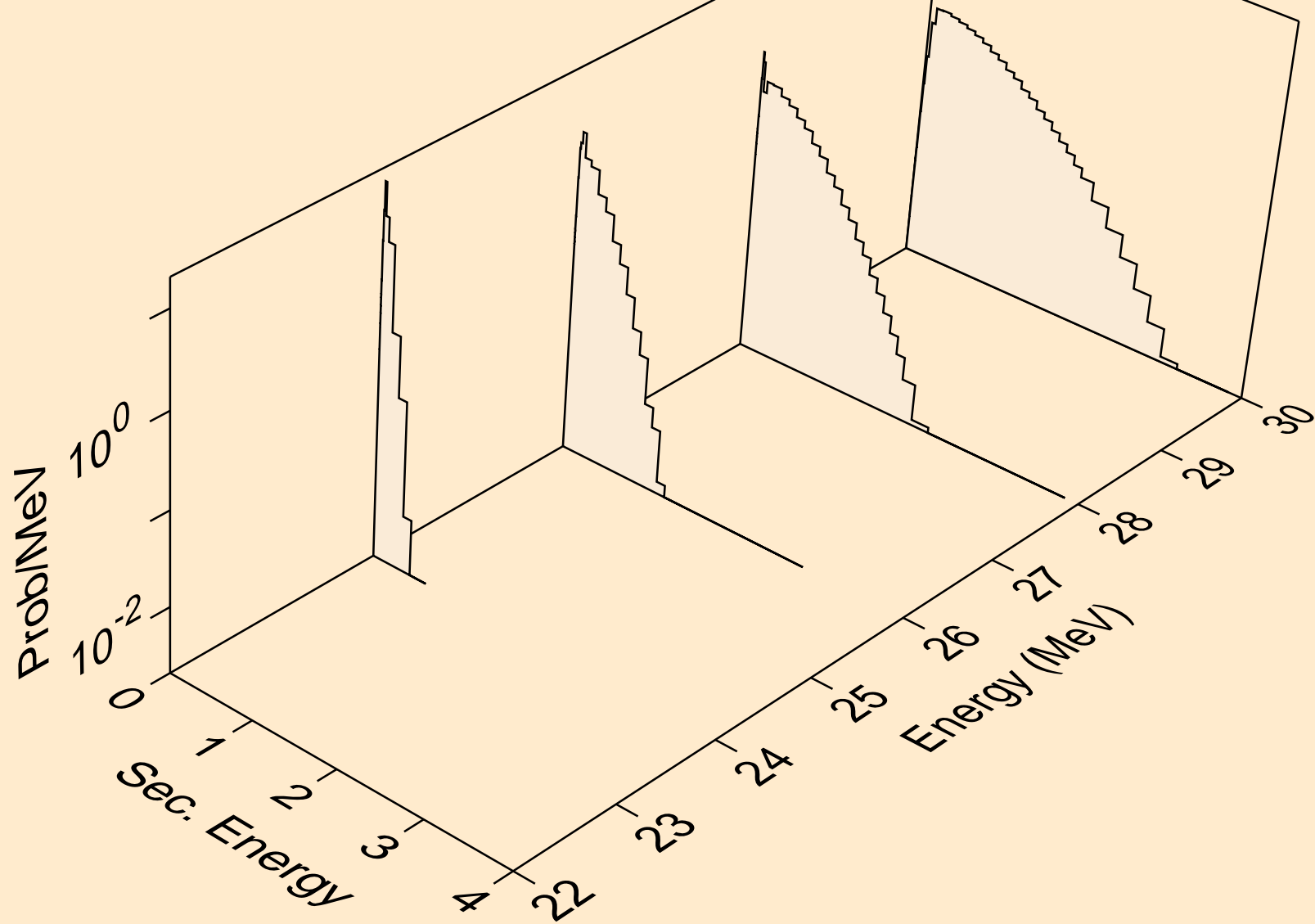

BR084 NEUTRON ACER TENDL-2024 LIBRARY; T=0.K  
Neutron emission for (n,2n)

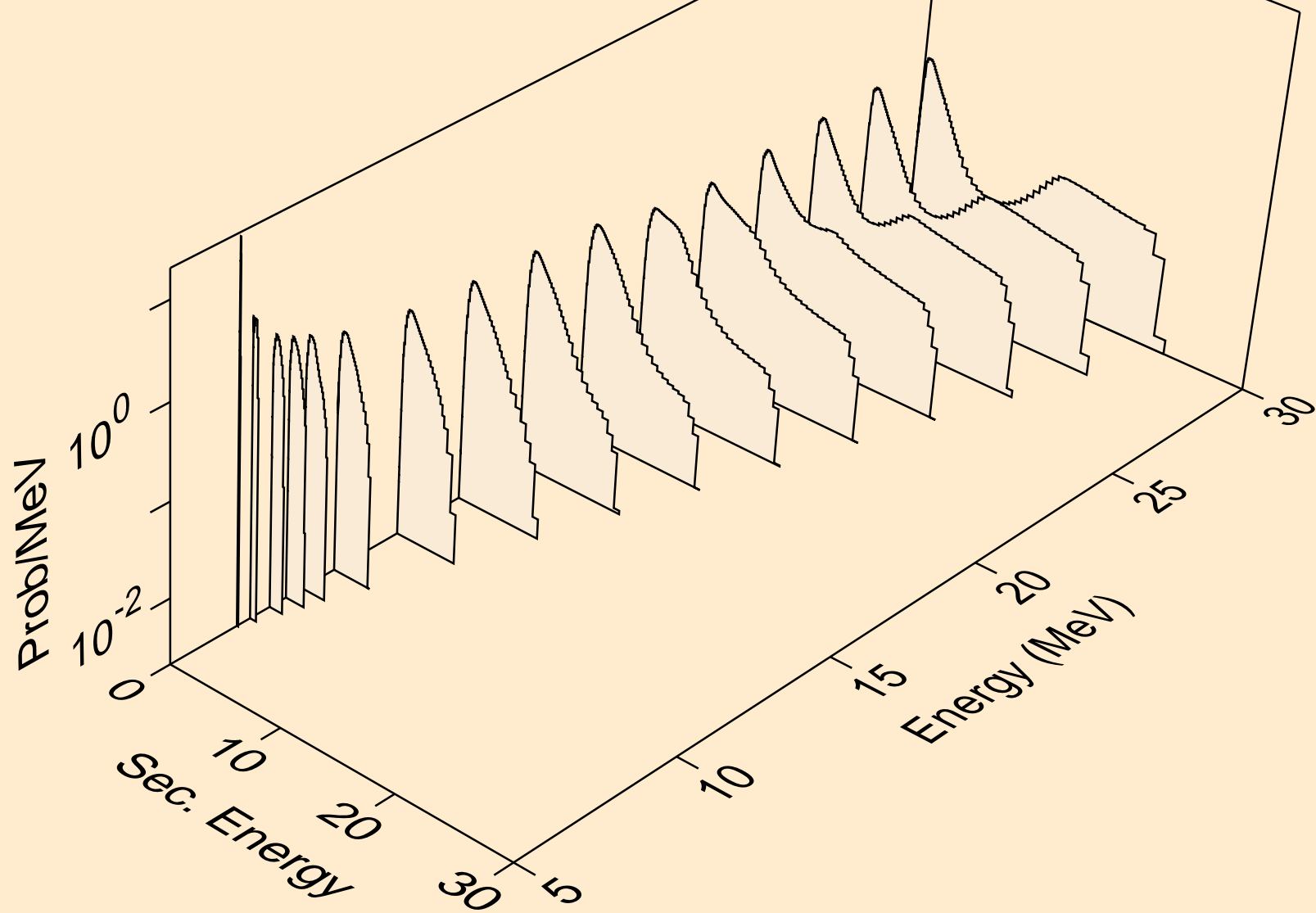

BR084 NEUTRON ACER TENDL-2024 LIBRARY; T=0.K  
Neutron emission for (n,3n)

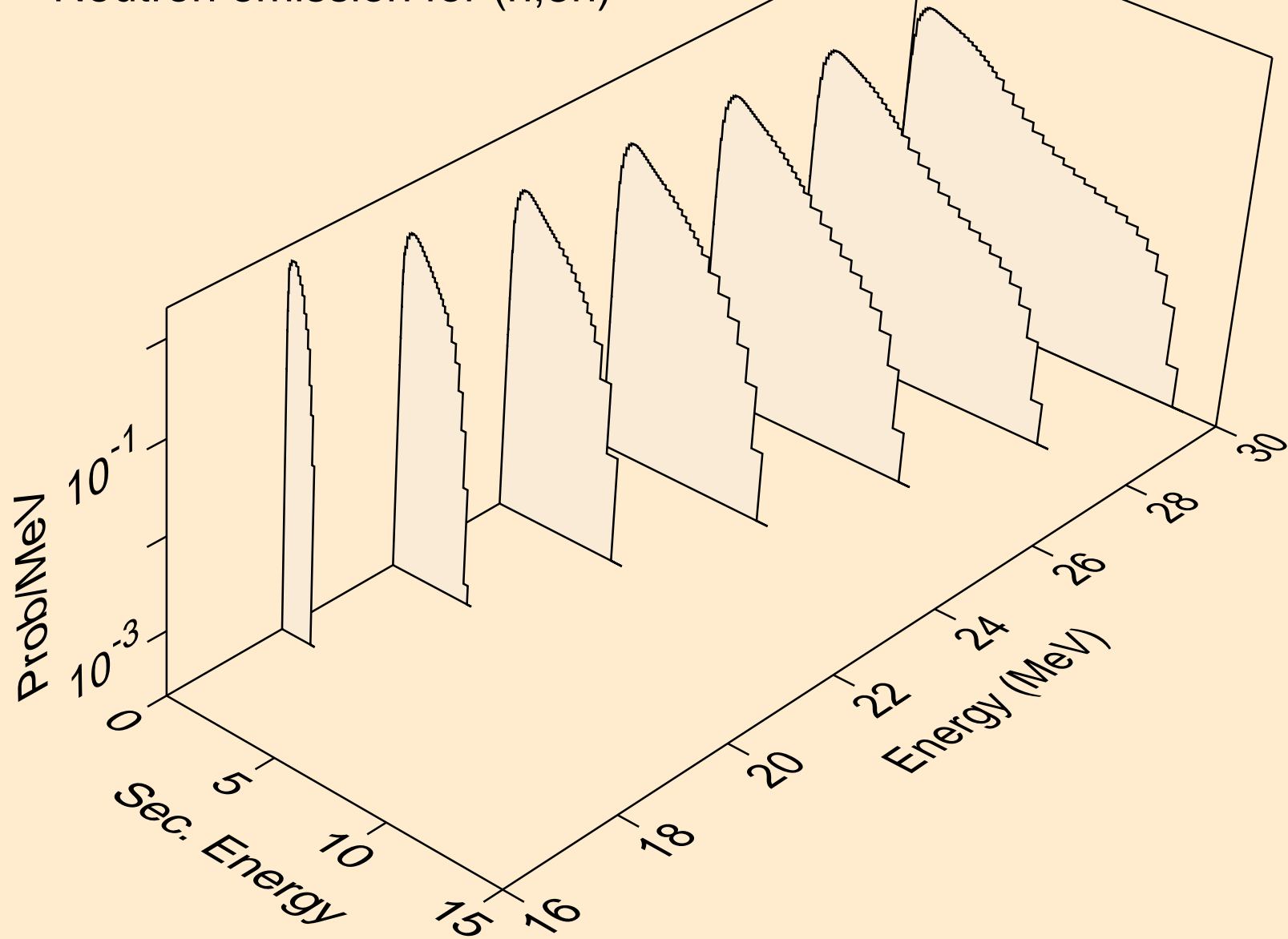



BR084 NEUTRON ACER TENDL-2024 LIBRARY; T=0.K  
Neutron emission for (n,n\*)a

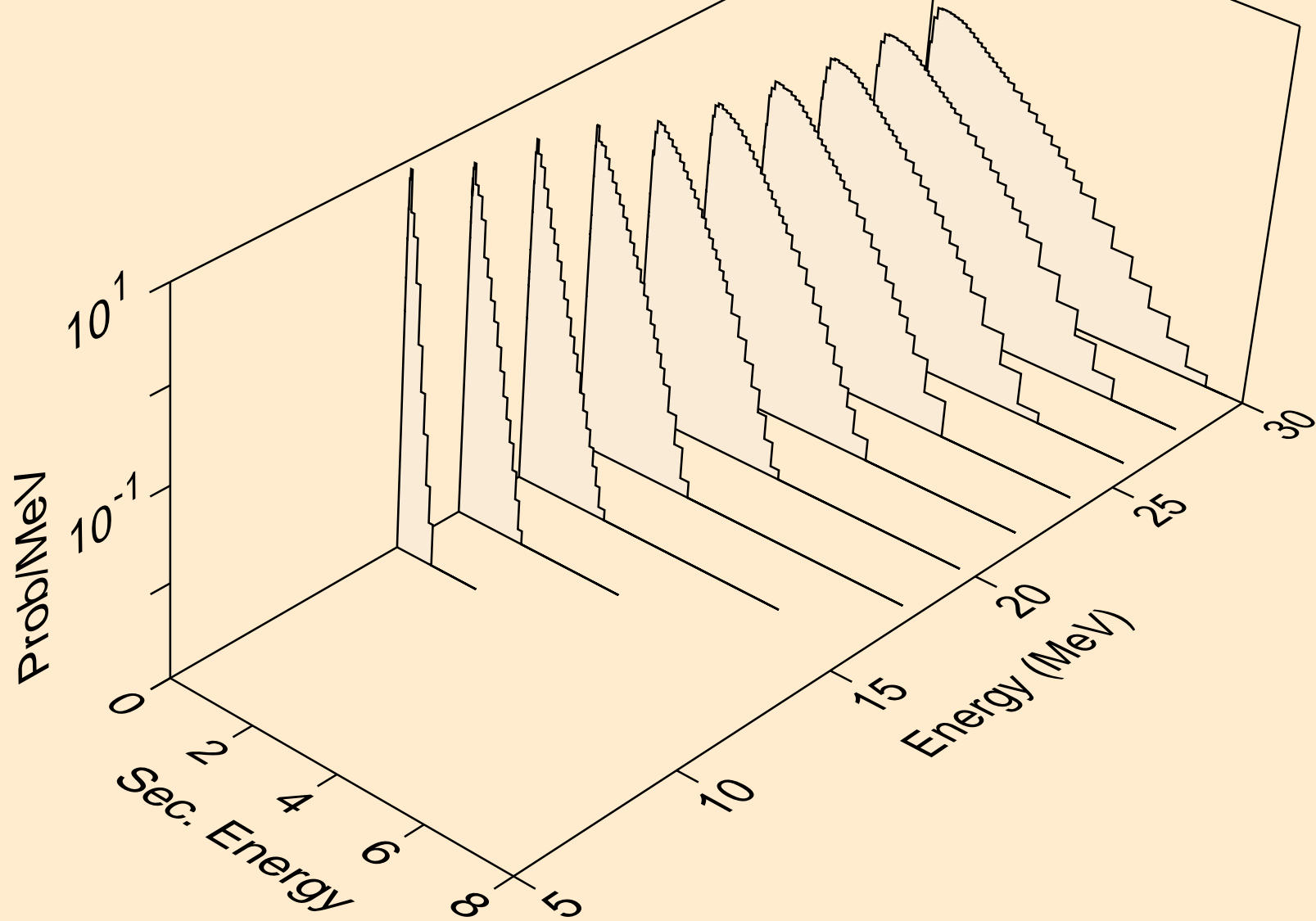

BR084 NEUTRON ACER TENDL-2024 LIBRARY; T=0.K  
Neutron emission for (n,2n)a

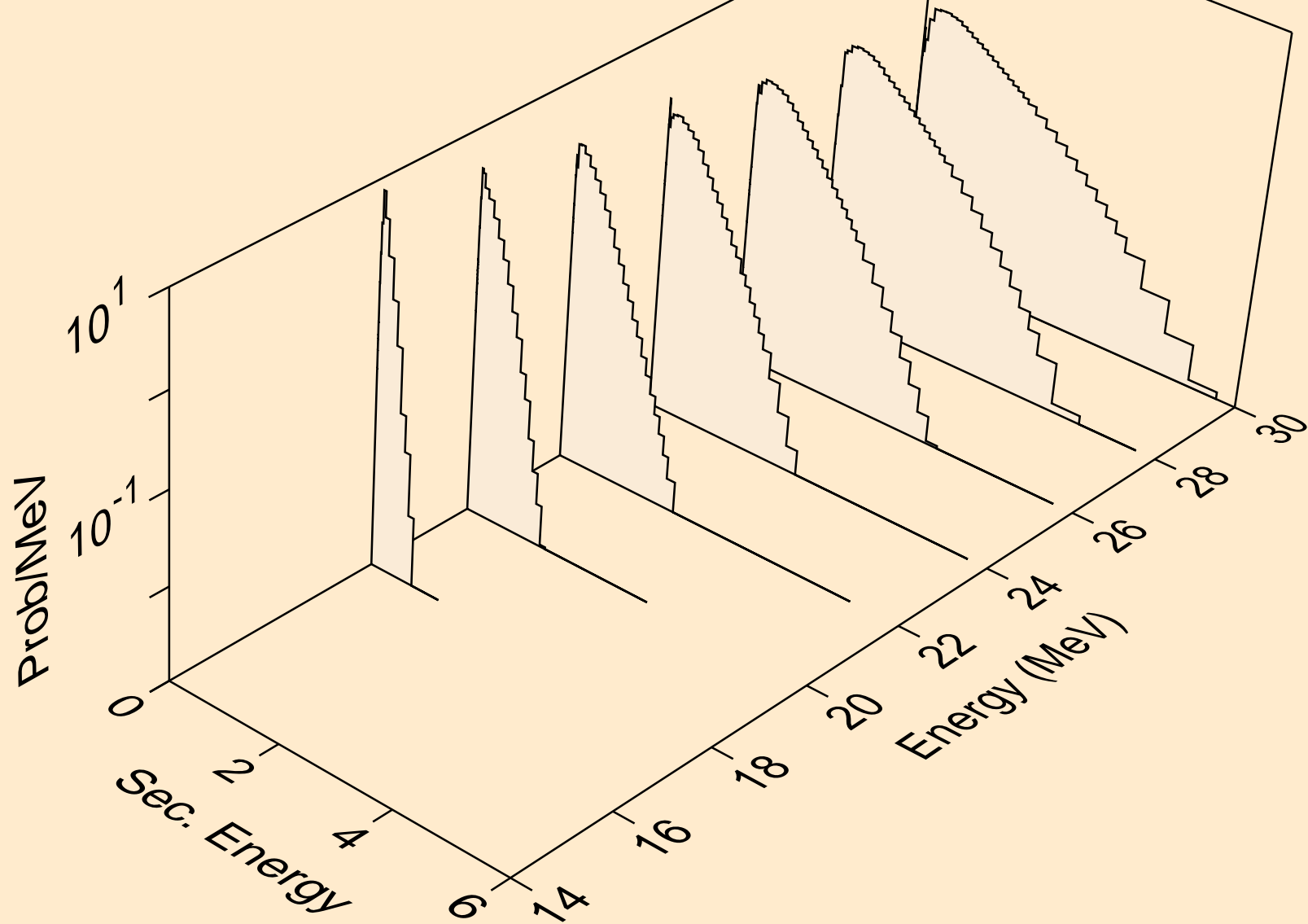

BR084 NEUTRON ACER TENDL-2024 LIBRARY; T=0.K  
Neutron emission for (n,n\*)p

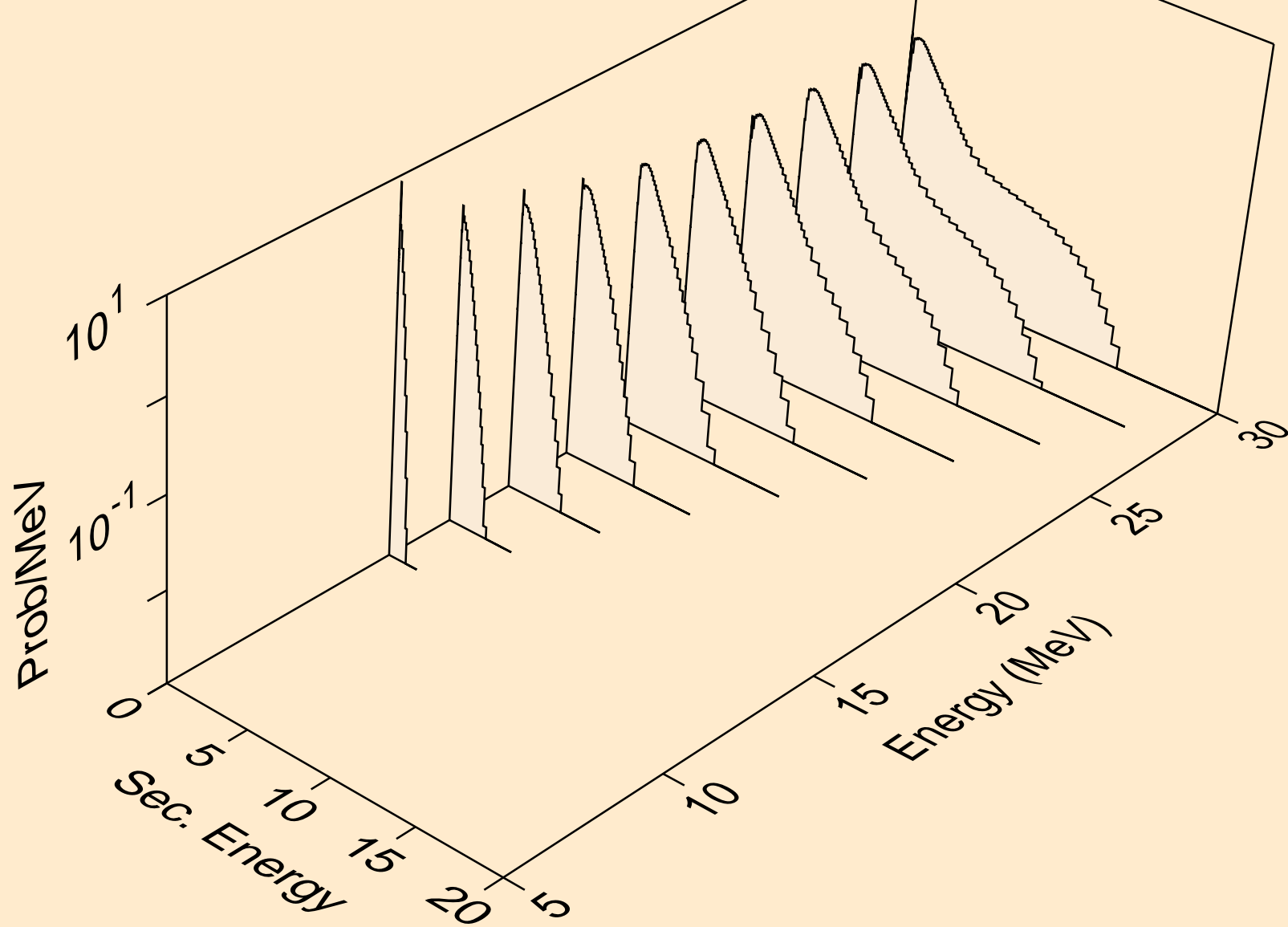

BR084 NEUTRON ACER TENDL-2024 LIBRARY; T=0.K  
Neutron emission for (n,n\*)d

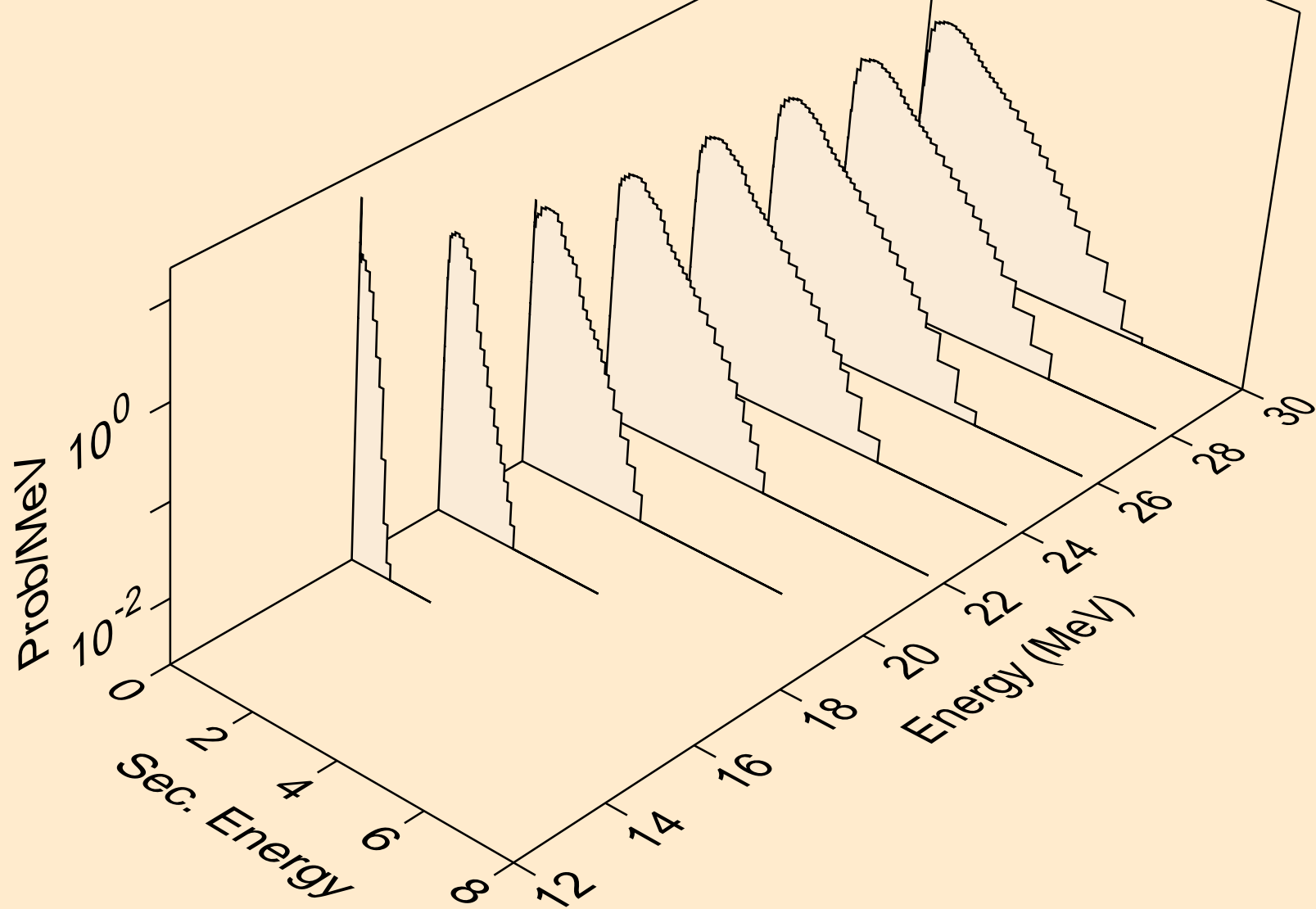

BR084 NEUTRON ACER TENDL-2024 LIBRARY; T=0.K  
Neutron emission for (n,n\*)t

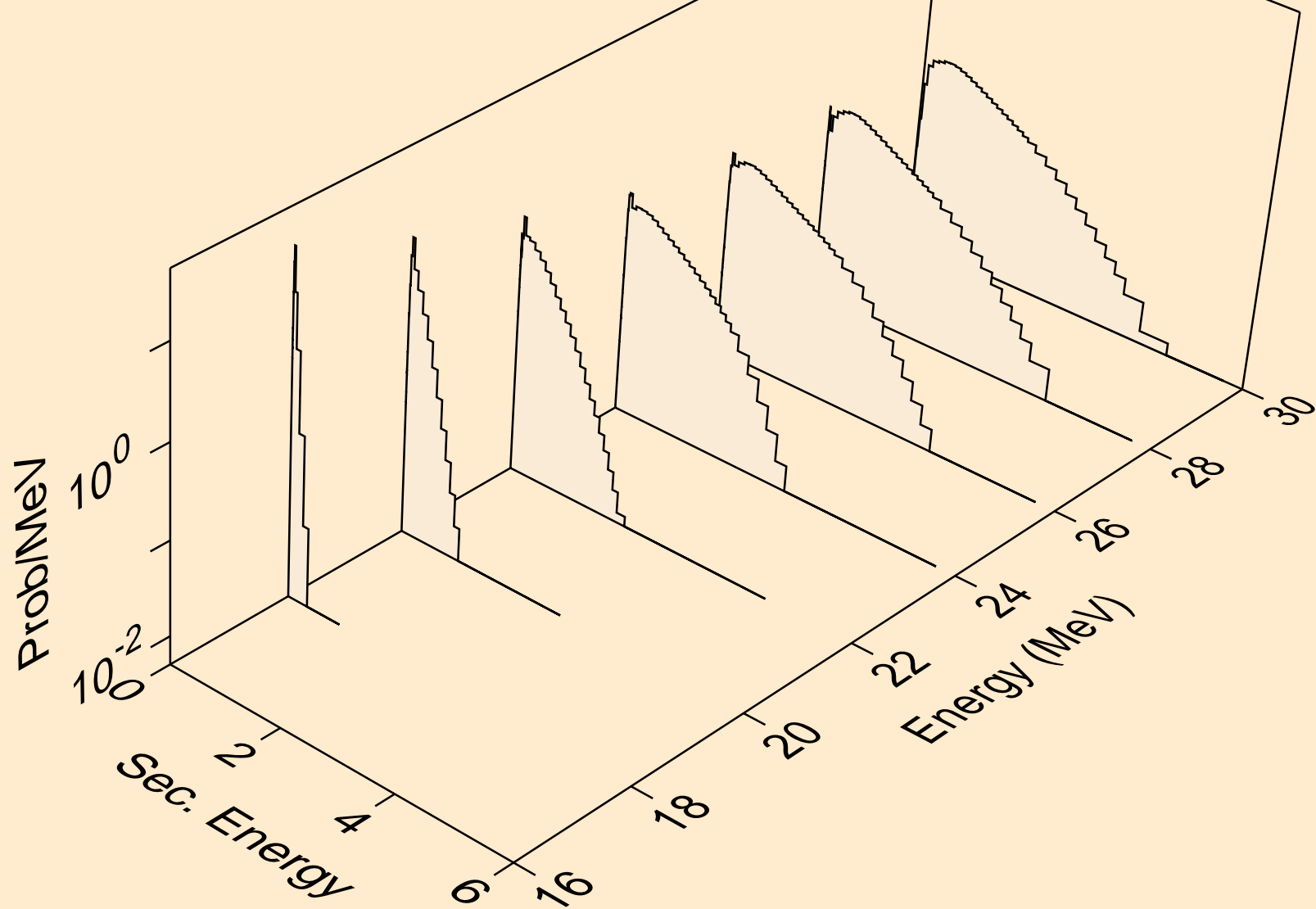

BR084 NEUTRON ACER TENDL-2024 LIBRARY; T=0.K  
Neutron emission for (n,n\*)he3

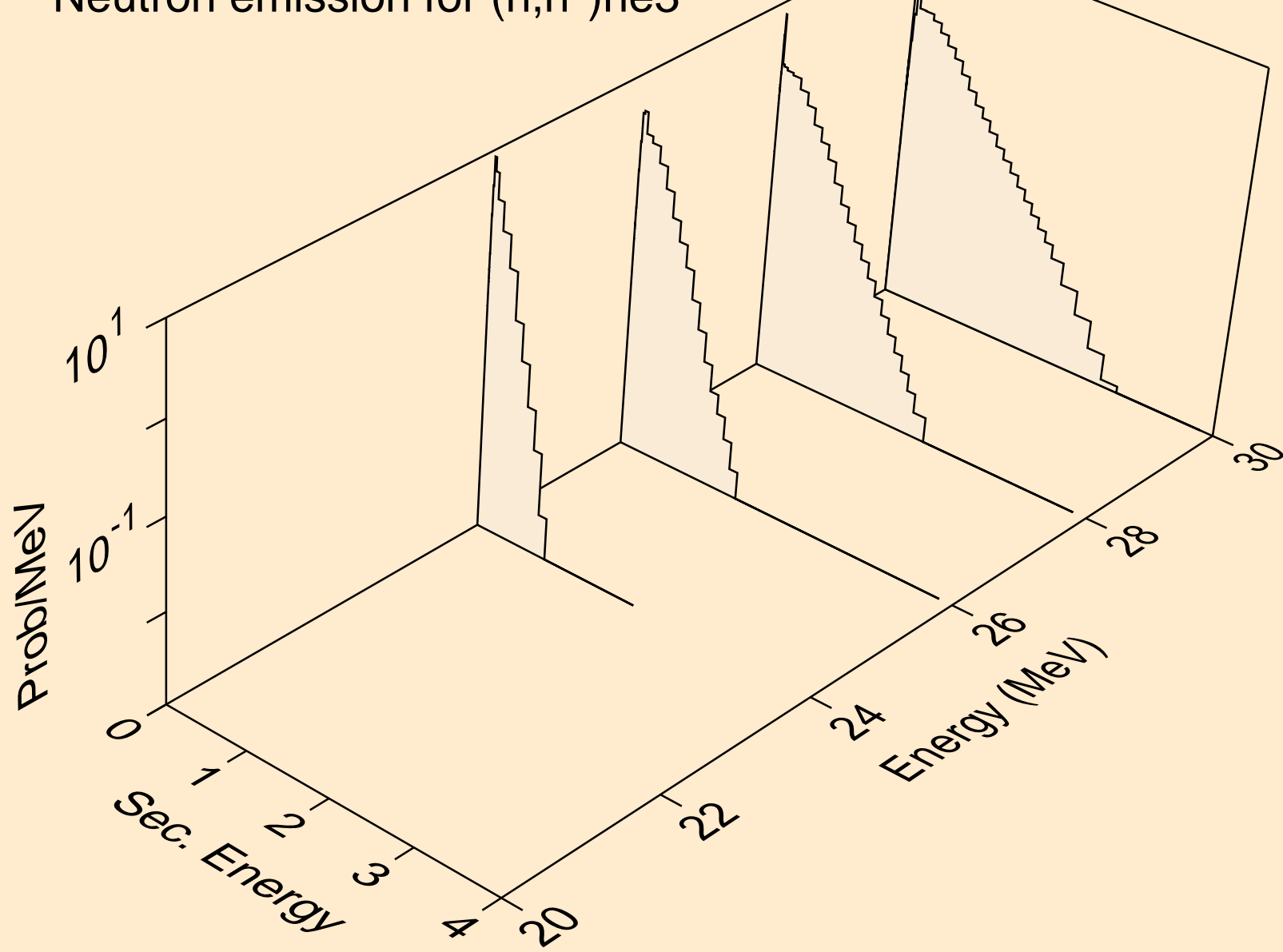

BR084 NEUTRON ACER TENDL-2024 LIBRARY; T=0.K  
Neutron emission for (n,4n)

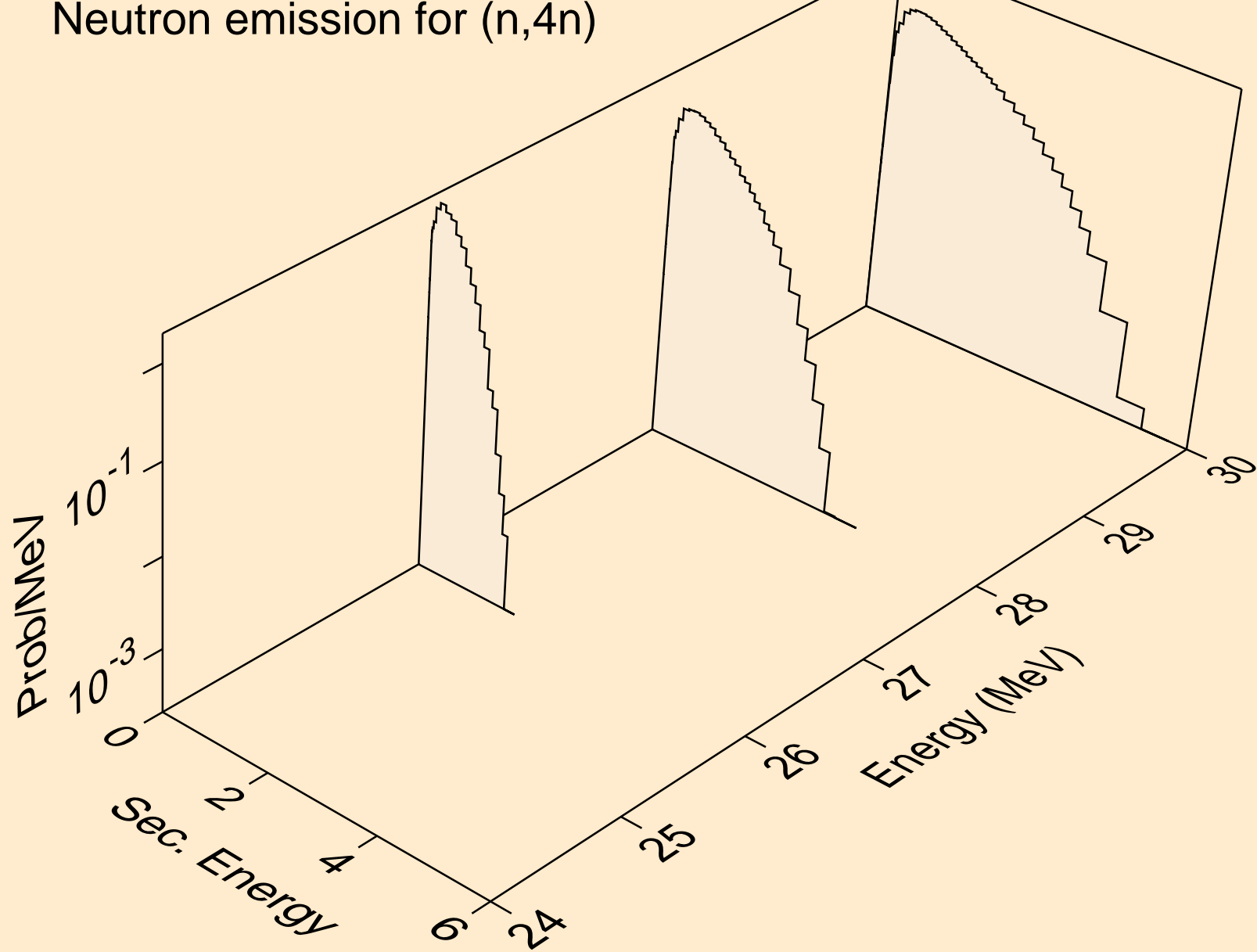

BR084 NEUTRON ACER TENDL-2024 LIBRARY; T=0.K  
Neutron emission for (n,2np)

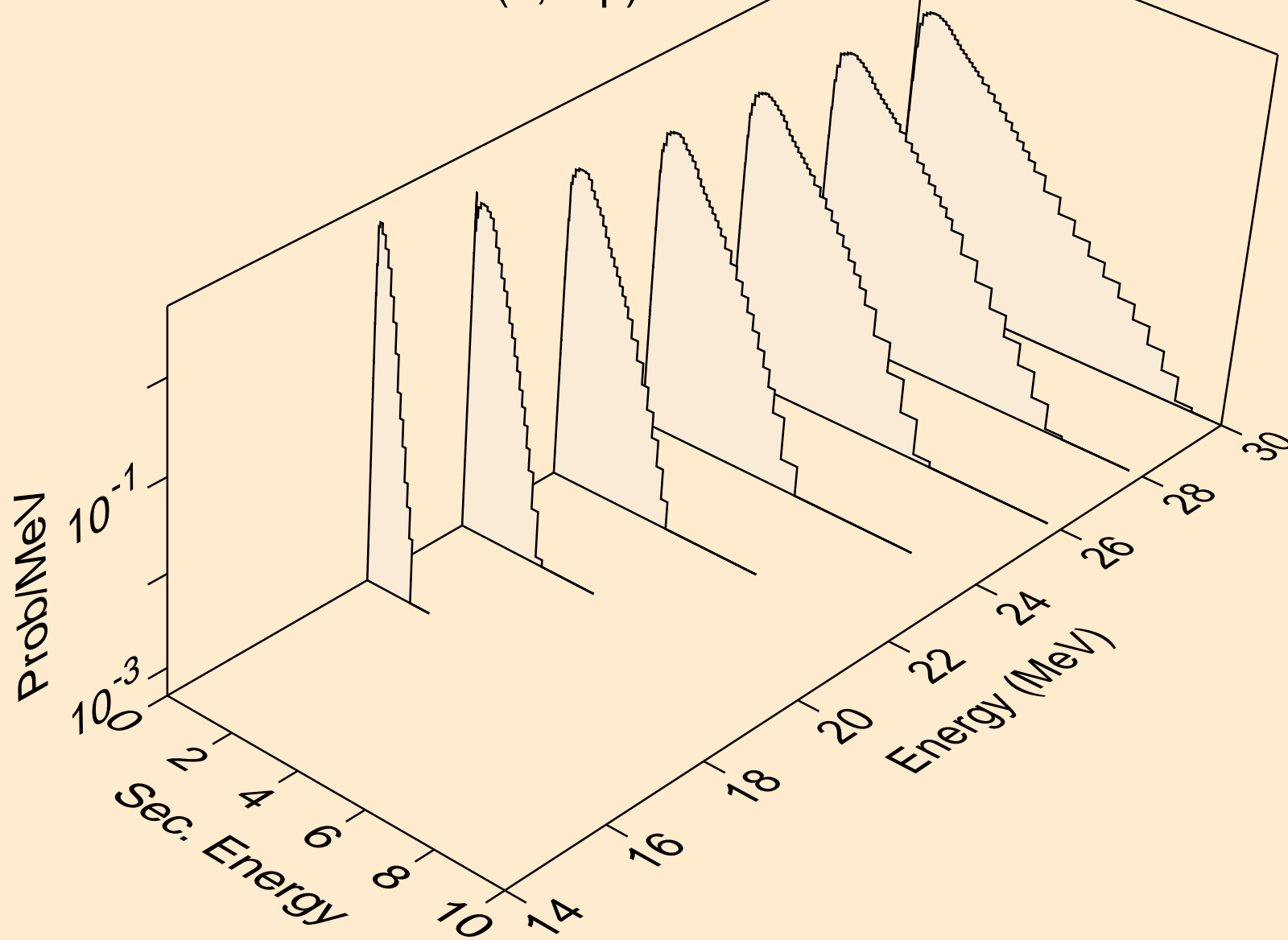



BR084 NEUTRON ACER TENDL-2024 LIBRARY; T=0.K  
Neutron emission for (n,3np)

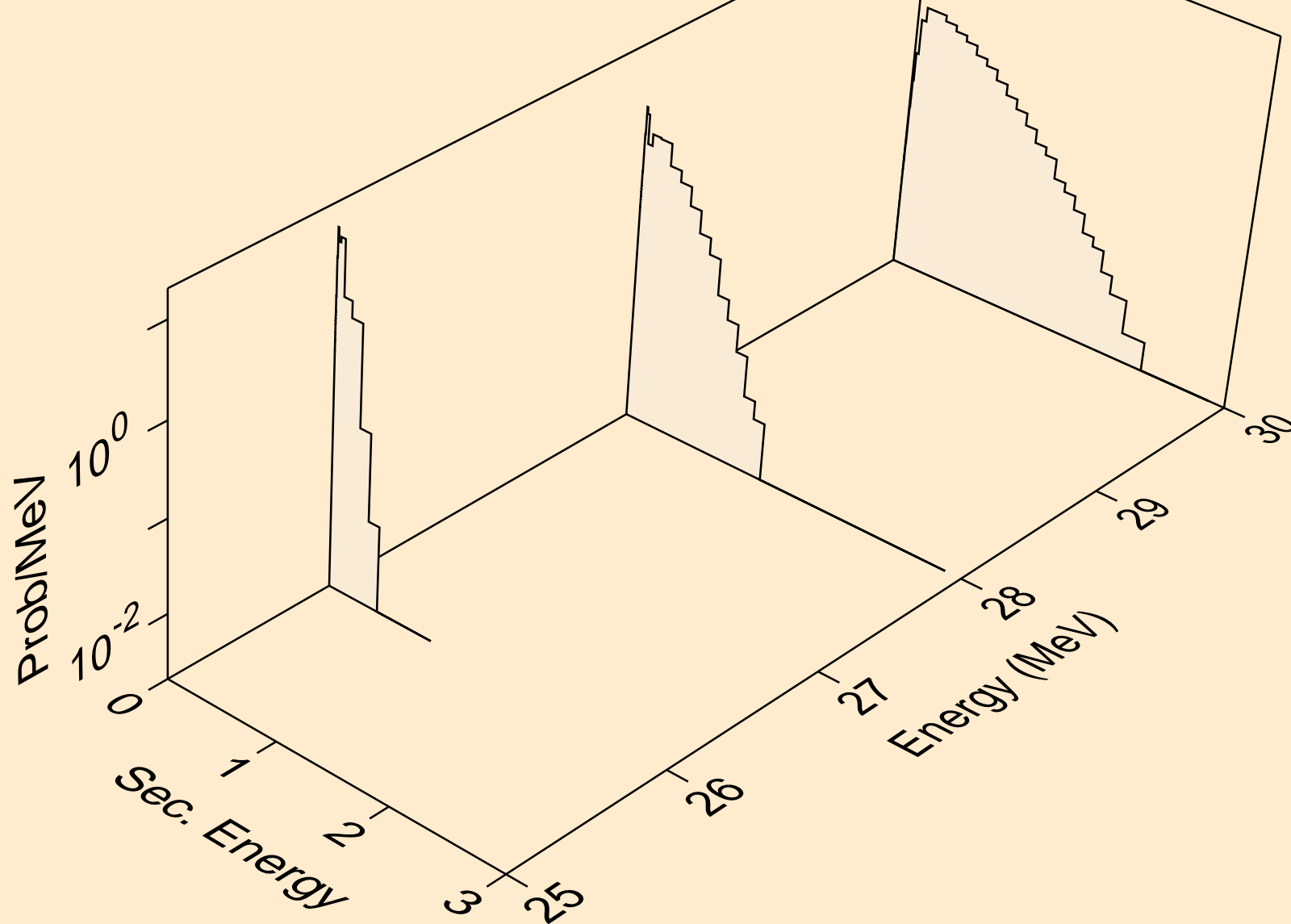

BR084 NEUTRON ACER TENDL-2024 LIBRARY; T=0.K  
Neutron emission for (n,n2p)

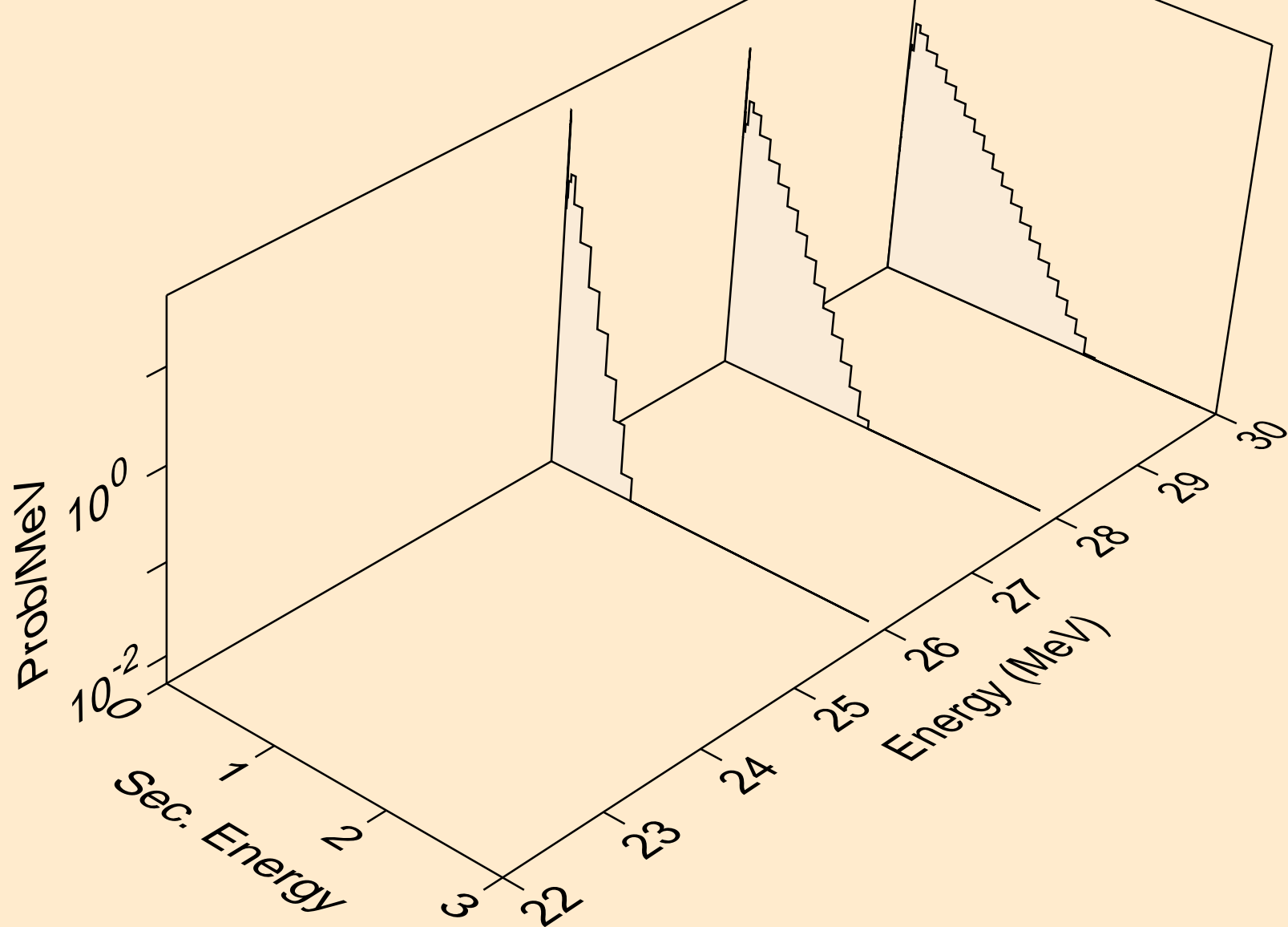

BR084 NEUTRON ACER TENDL-2024 LIBRARY; T=0.K  
Neutron emission for (n,npa)

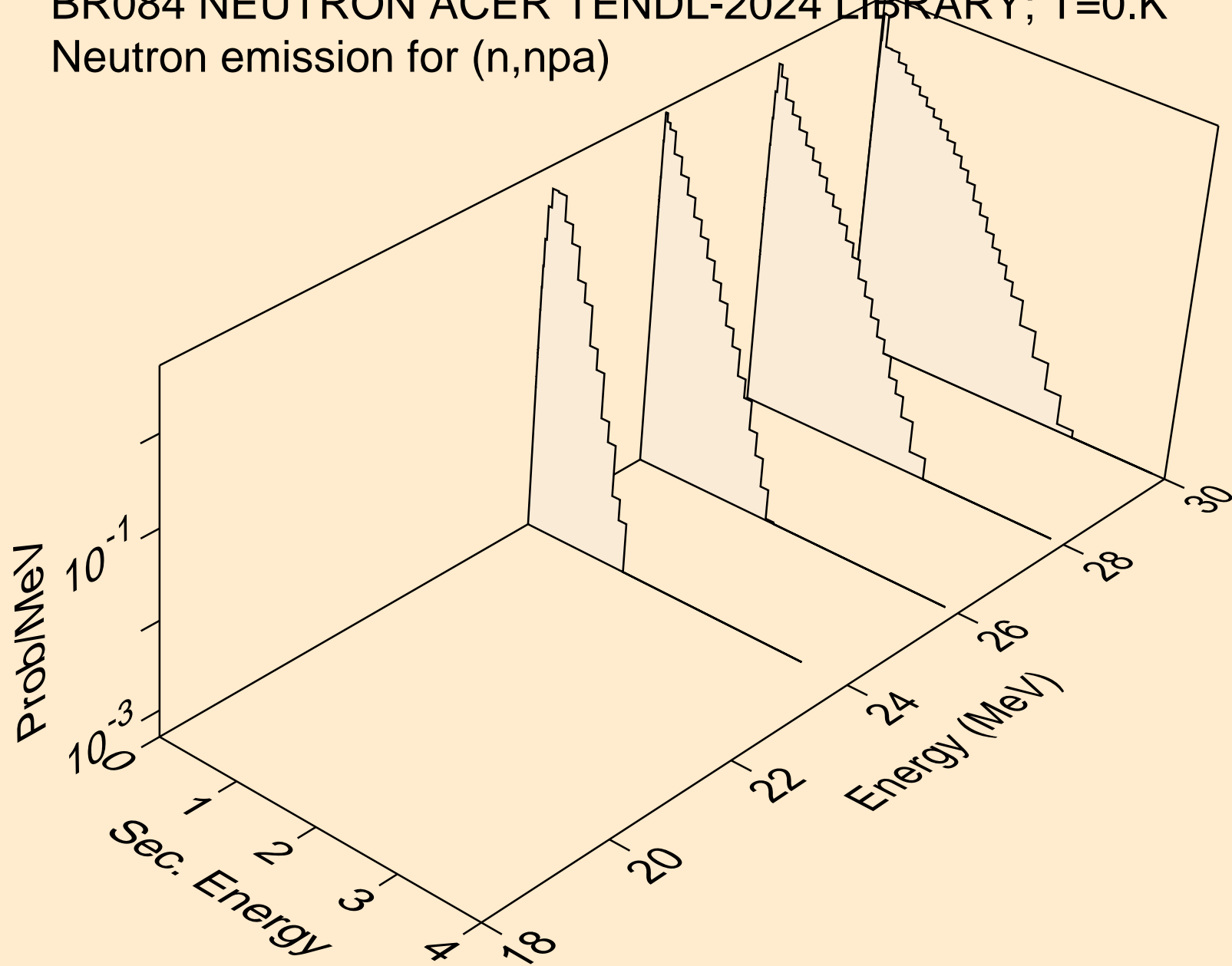

BR084 NEUTRON ACER TENDL-2024 LIBRARY; T=0.K  
Neutron emission for (n,n\*c)

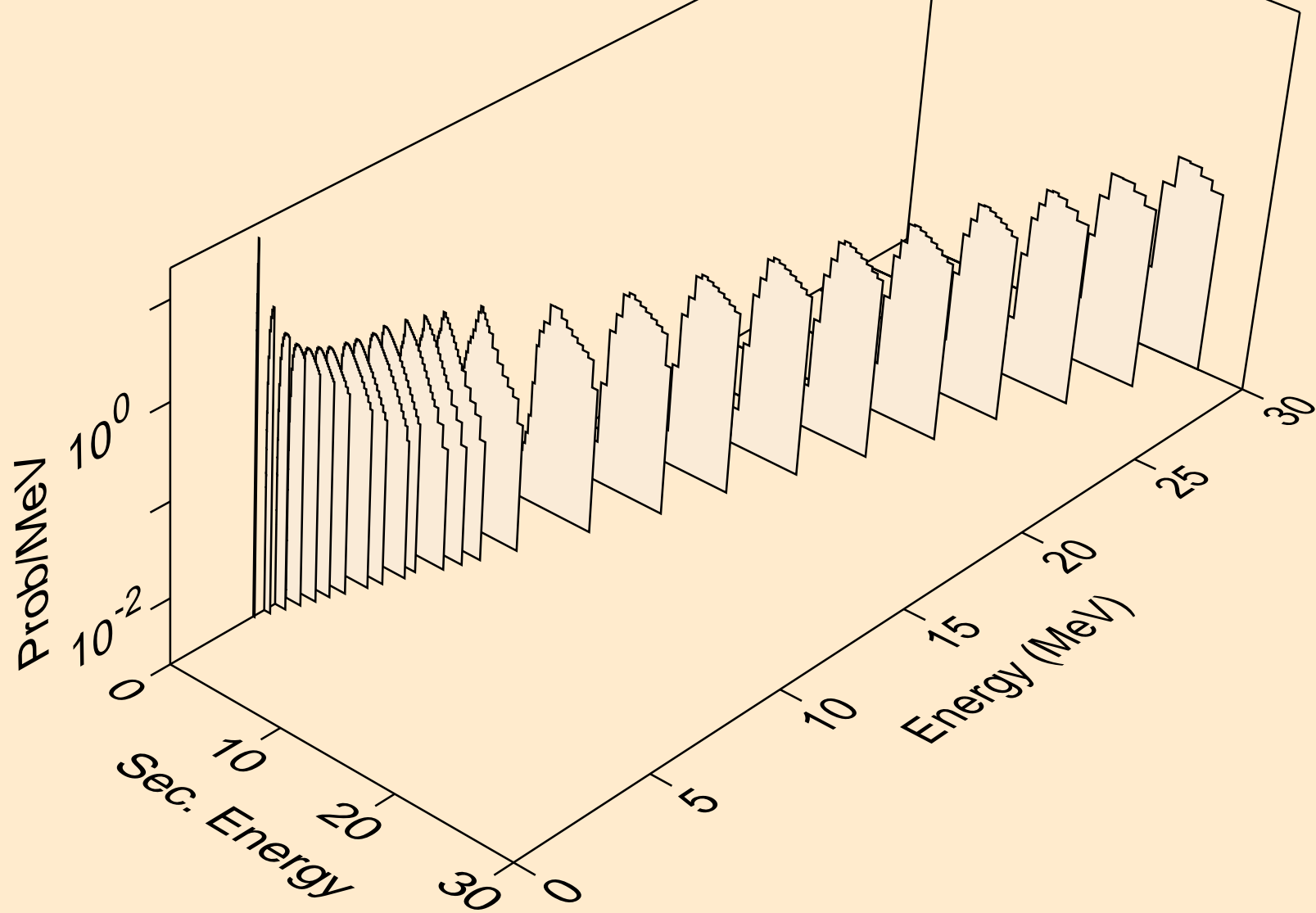

BR084 NEUTRON ACER TENDL-2024 LIBRARY; T=0.K  
Photon emission for (n,x)

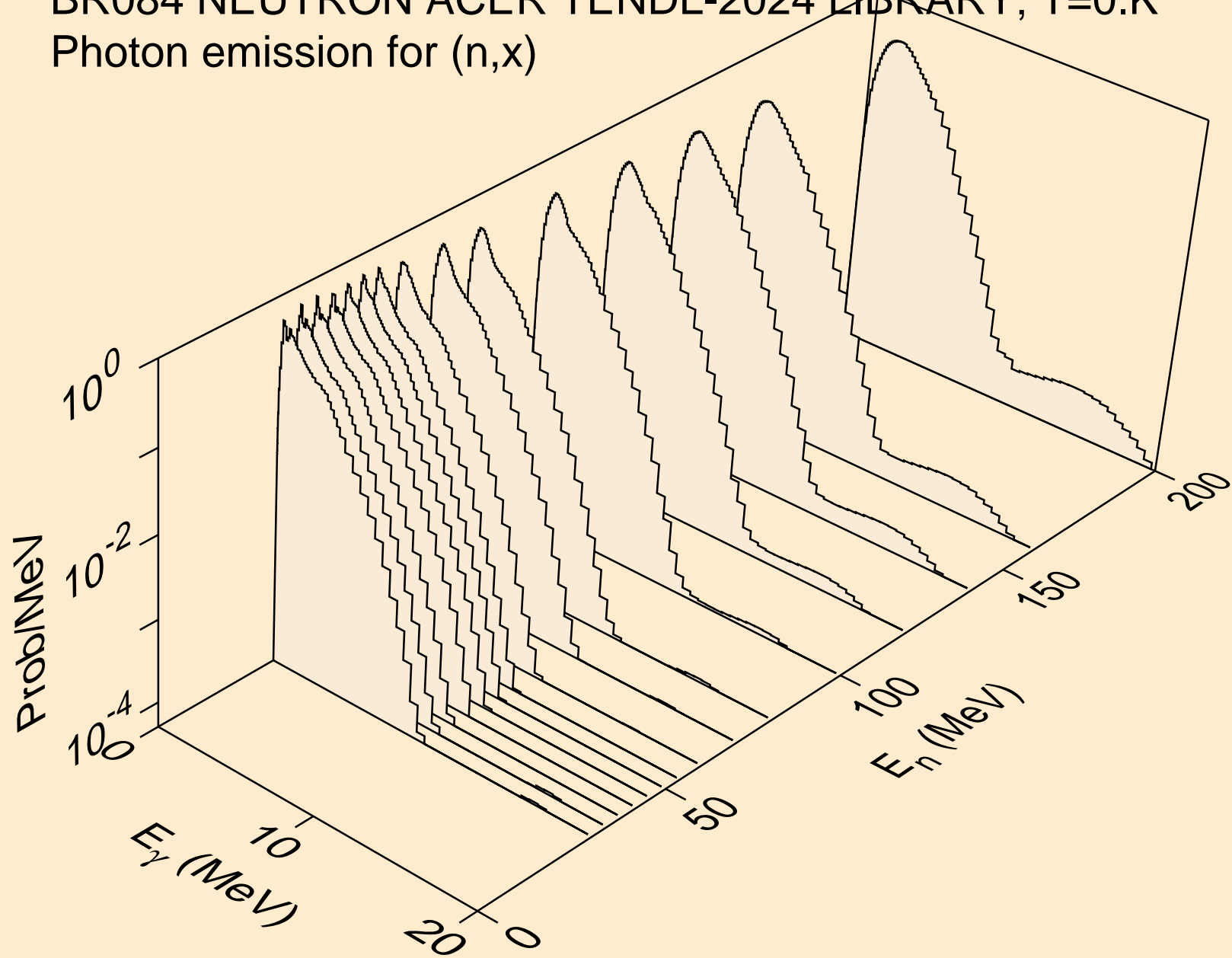

BR084 NEUTRON ACER TENDL-2024 LIBRARY; T=0.K  
Photon emission for (n,2nd)

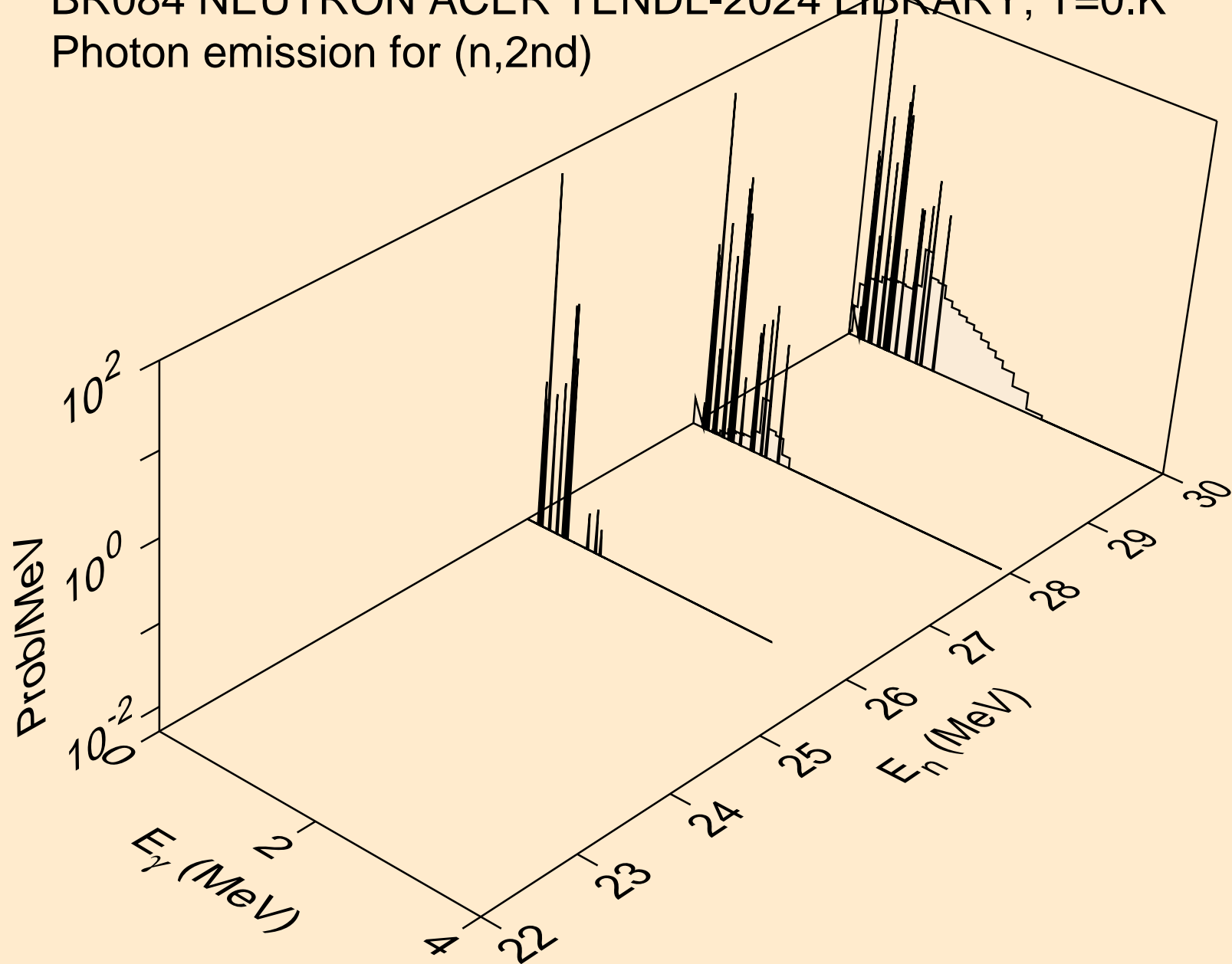

BR084 NEUTRON ACER TENDL-2024 LIBRARY; T=0.K  
Photon emission for (n,2n)

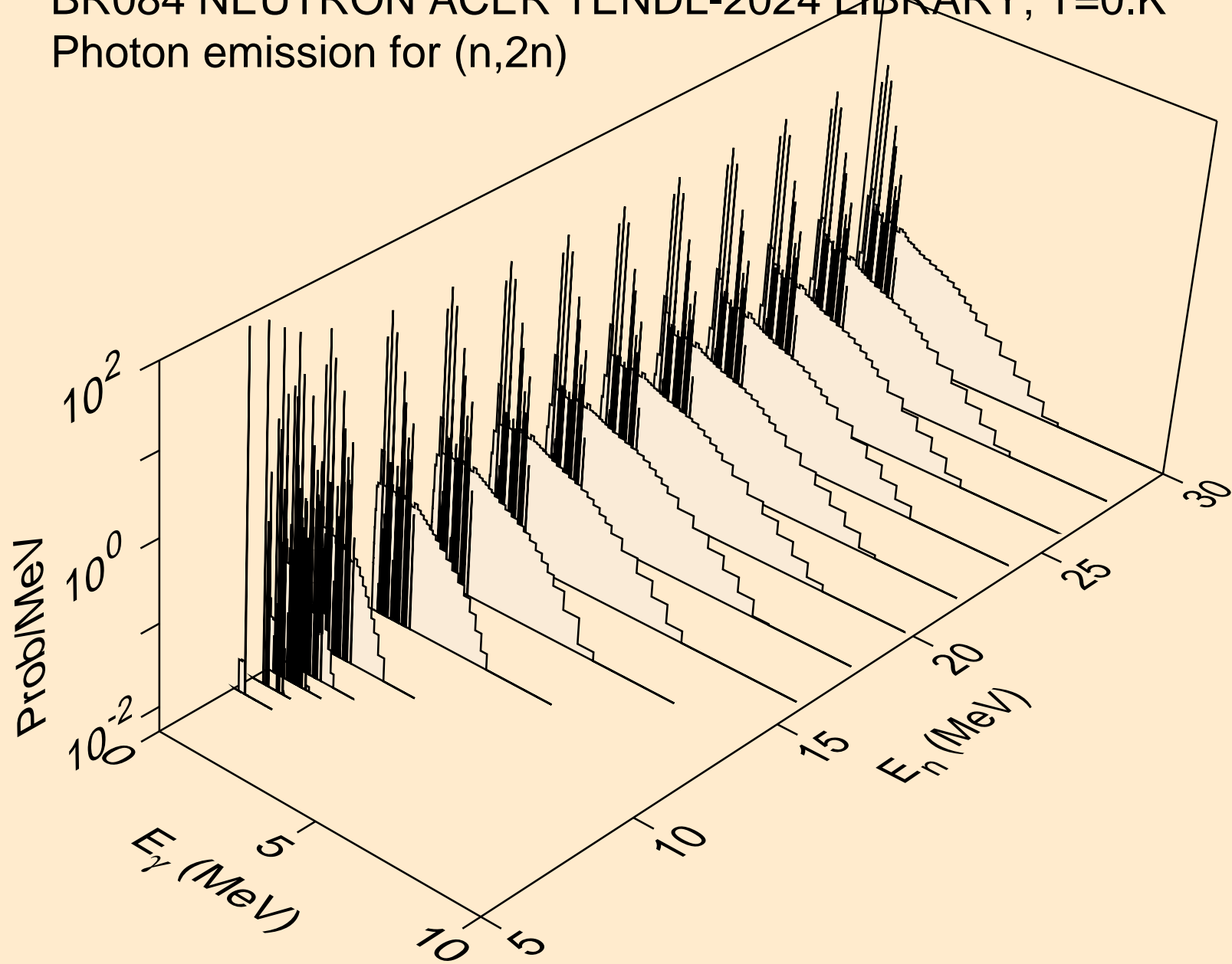

BR084 NEUTRON ACER TENDL-2024 LIBRARY; T=0.K  
Photon emission for (n,3n)

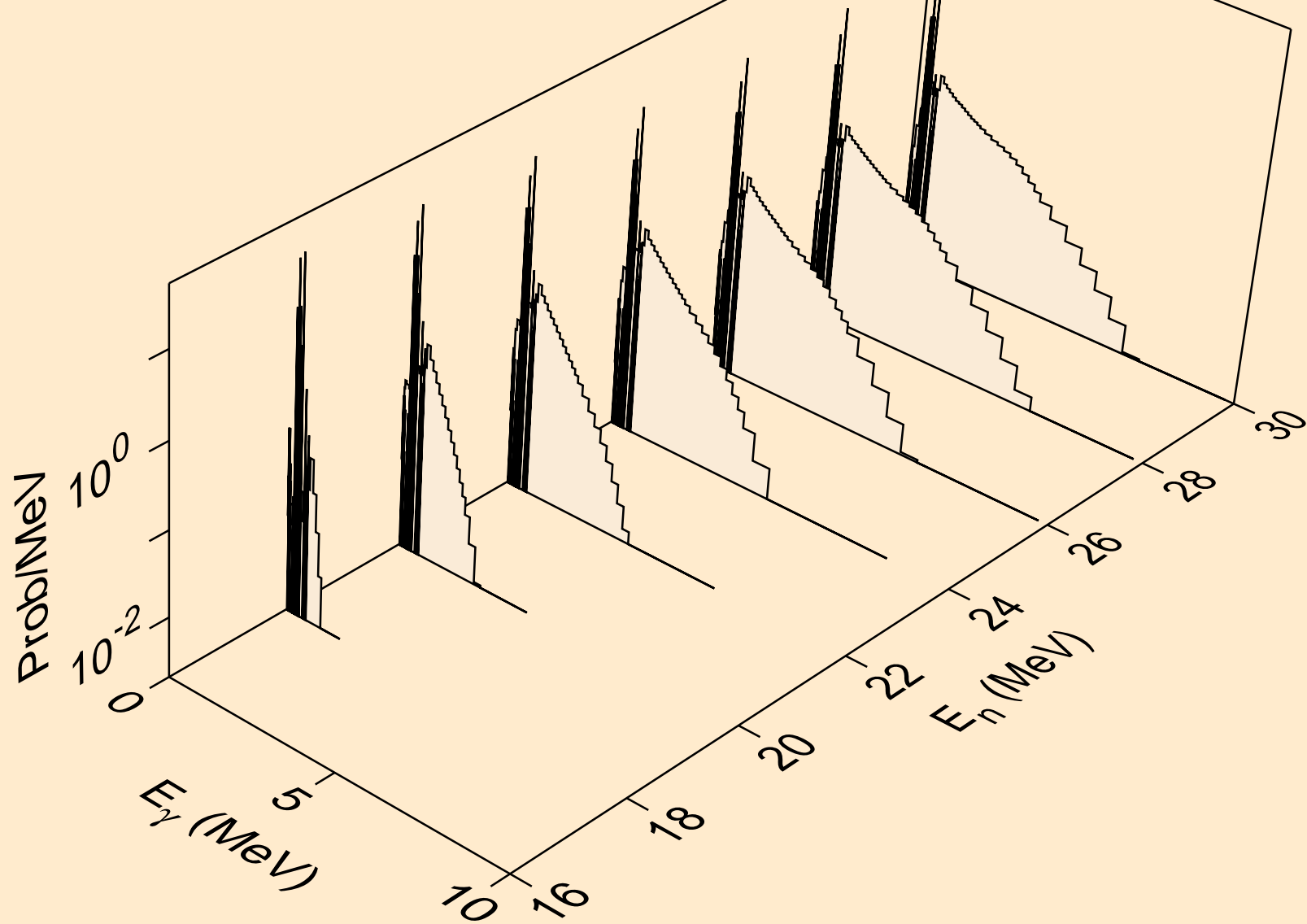



BR084 NEUTRON ACER TENDL-2024 LIBRARY; T=0.K  
Photon emission for (n,n\*)a

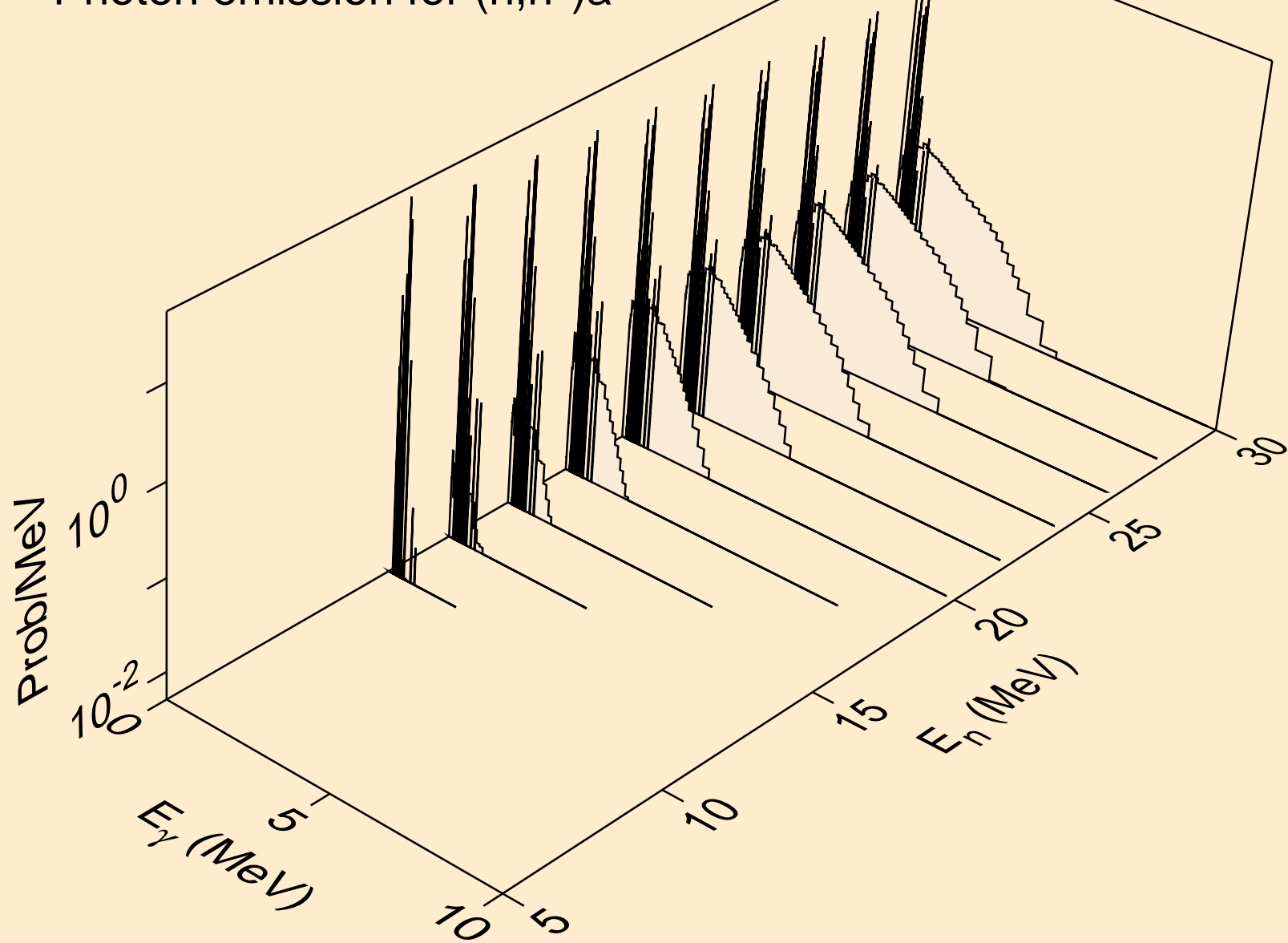

BR084 NEUTRON ACER TENDL-2024 LIBRARY; T=0.K  
Photon emission for (n,2n)a

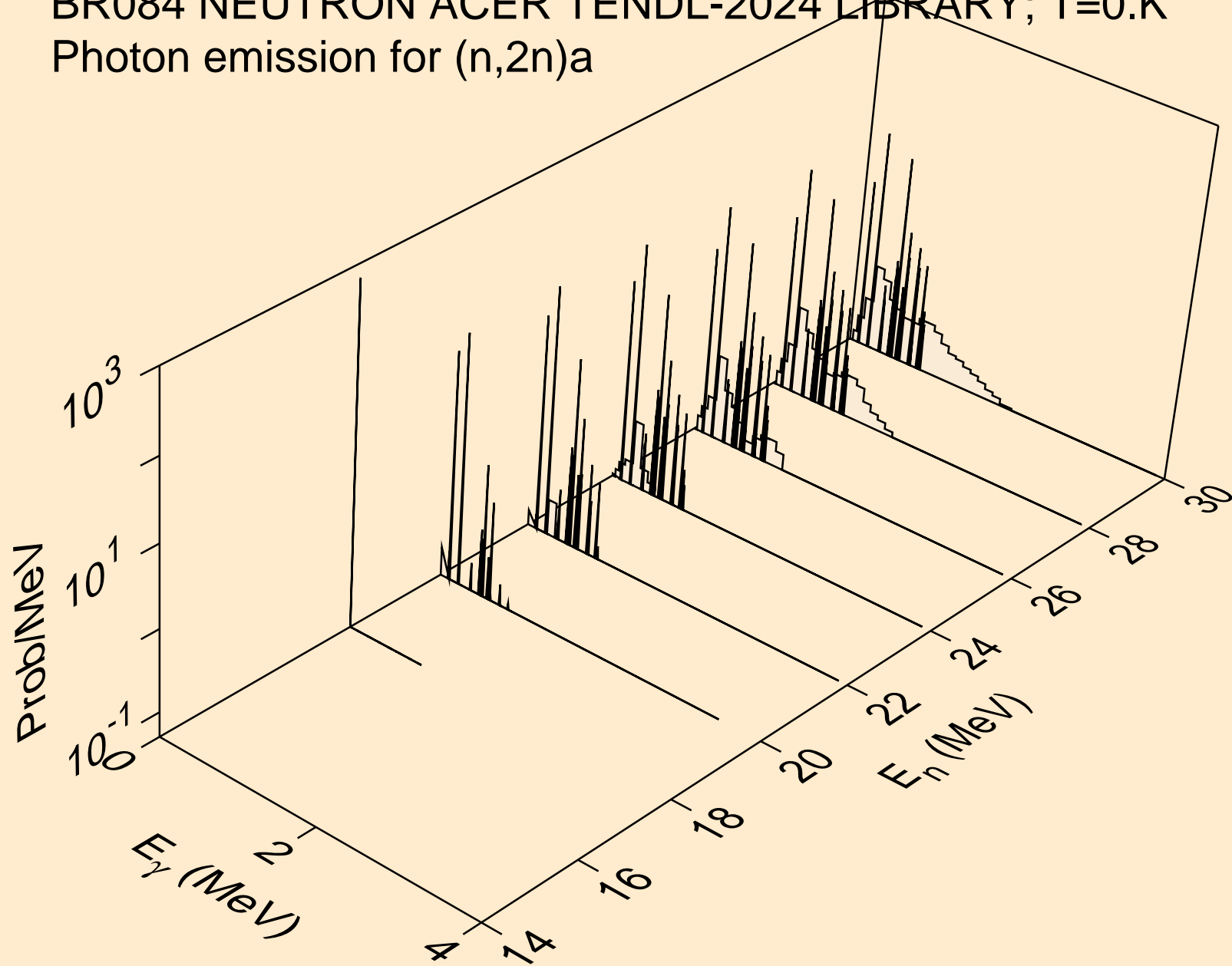

BR084 NEUTRON ACER TENDL-2024 LIBRARY; T=0.K  
Photon emission for (n,n\*)p

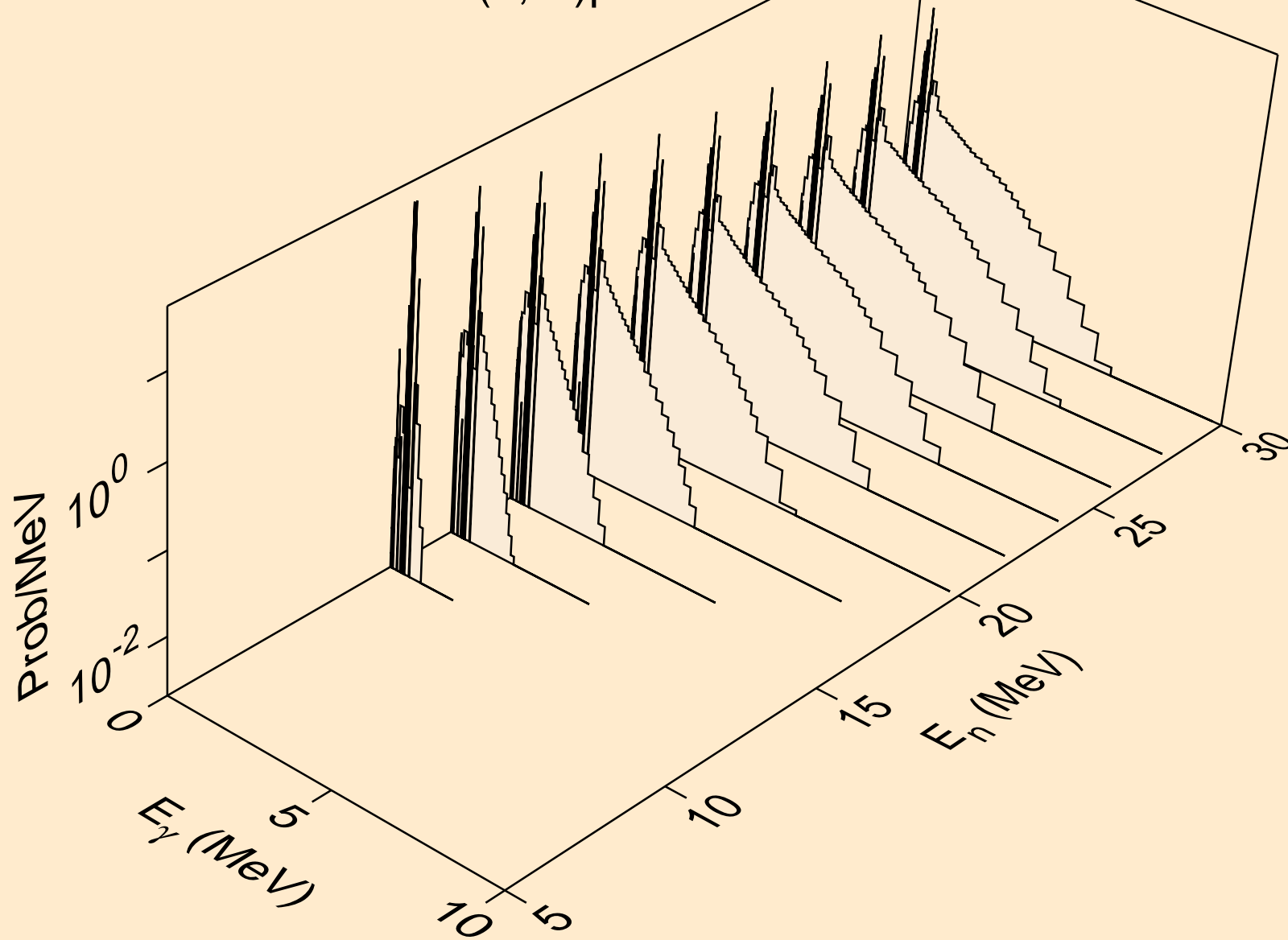

BR084 NEUTRON ACER TENDL-2024 LIBRARY; T=0.K  
Photon emission for (n,n\*)d

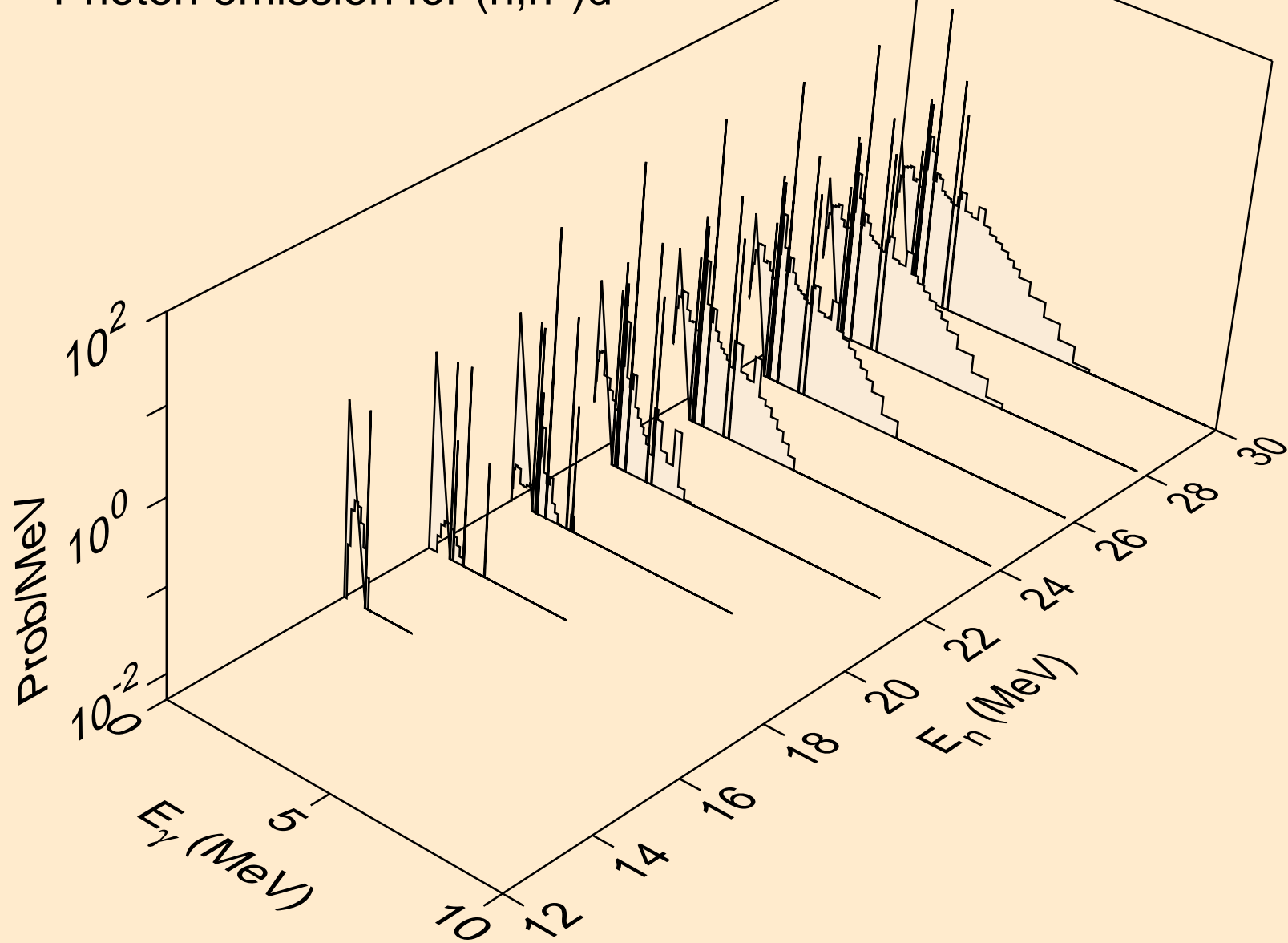

BR084 NEUTRON ACER TENDL-2024 LIBRARY; T=0.K  
Photon emission for (n,n\*)t

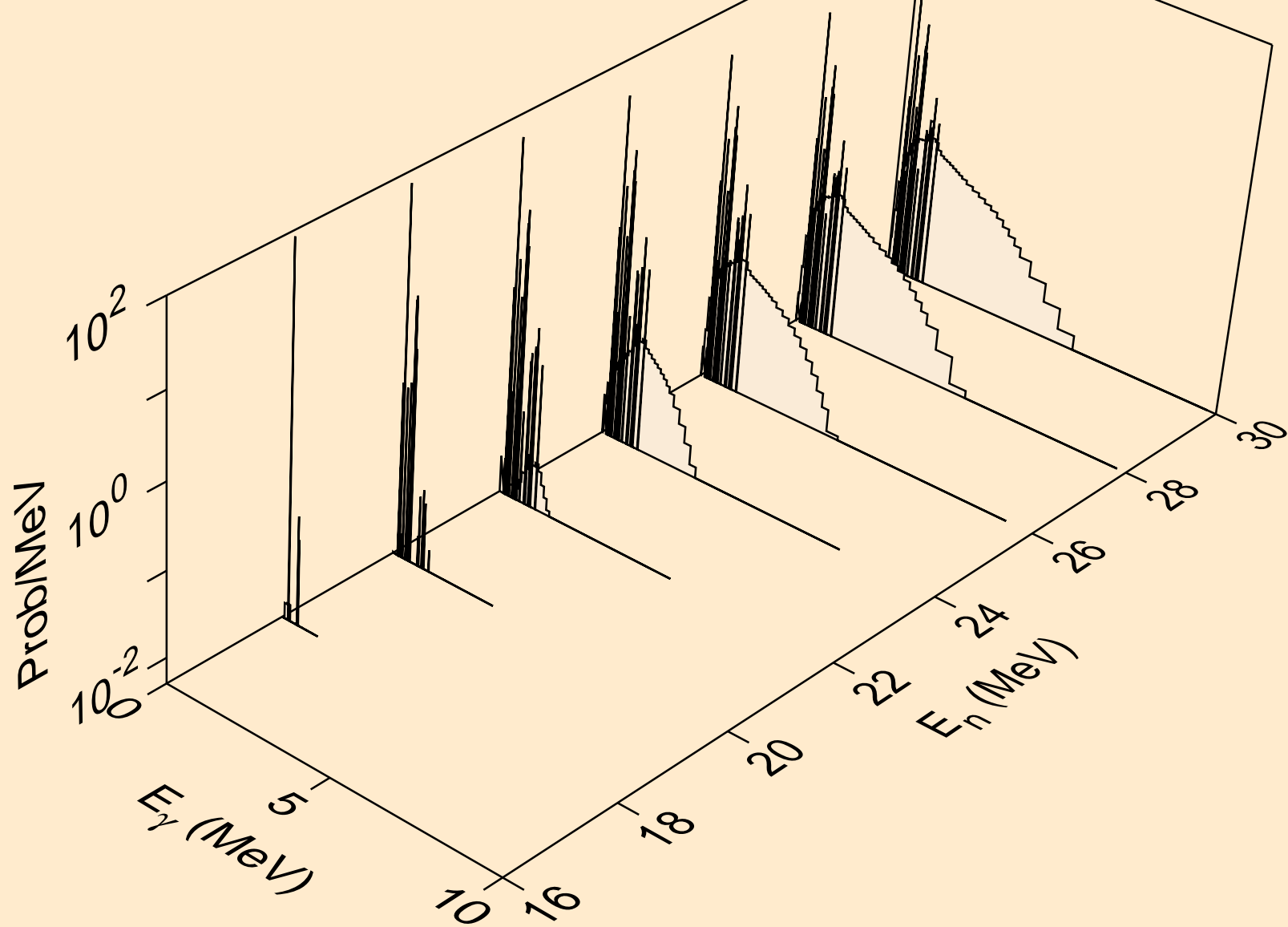

BR084 NEUTRON ACER TENDL-2024 LIBRARY; T=0.K  
Photon emission for (n,n\*)he3

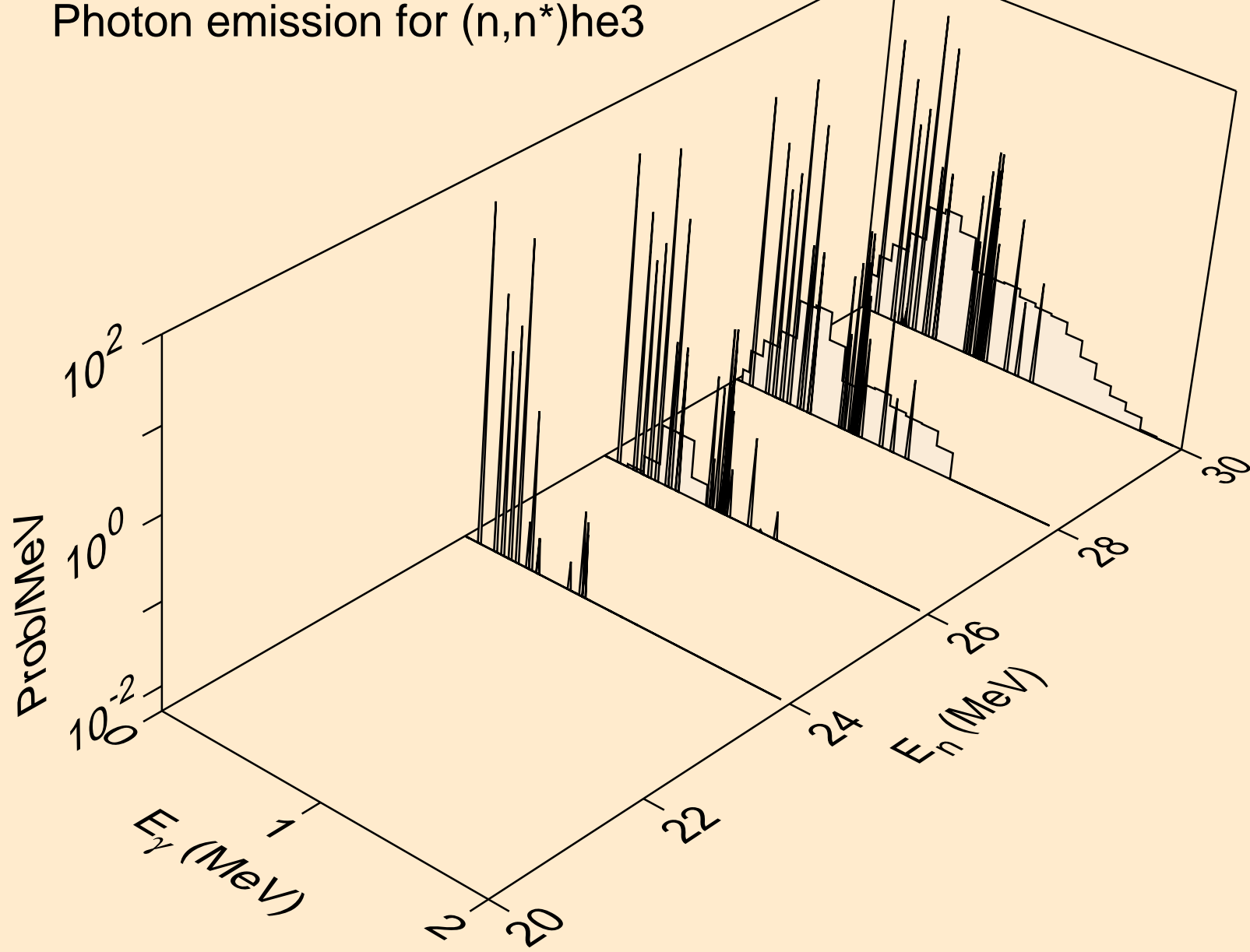

BR084 NEUTRON ACER TENDL-2024 LIBRARY; T=0.K  
Photon emission for (n,4n)

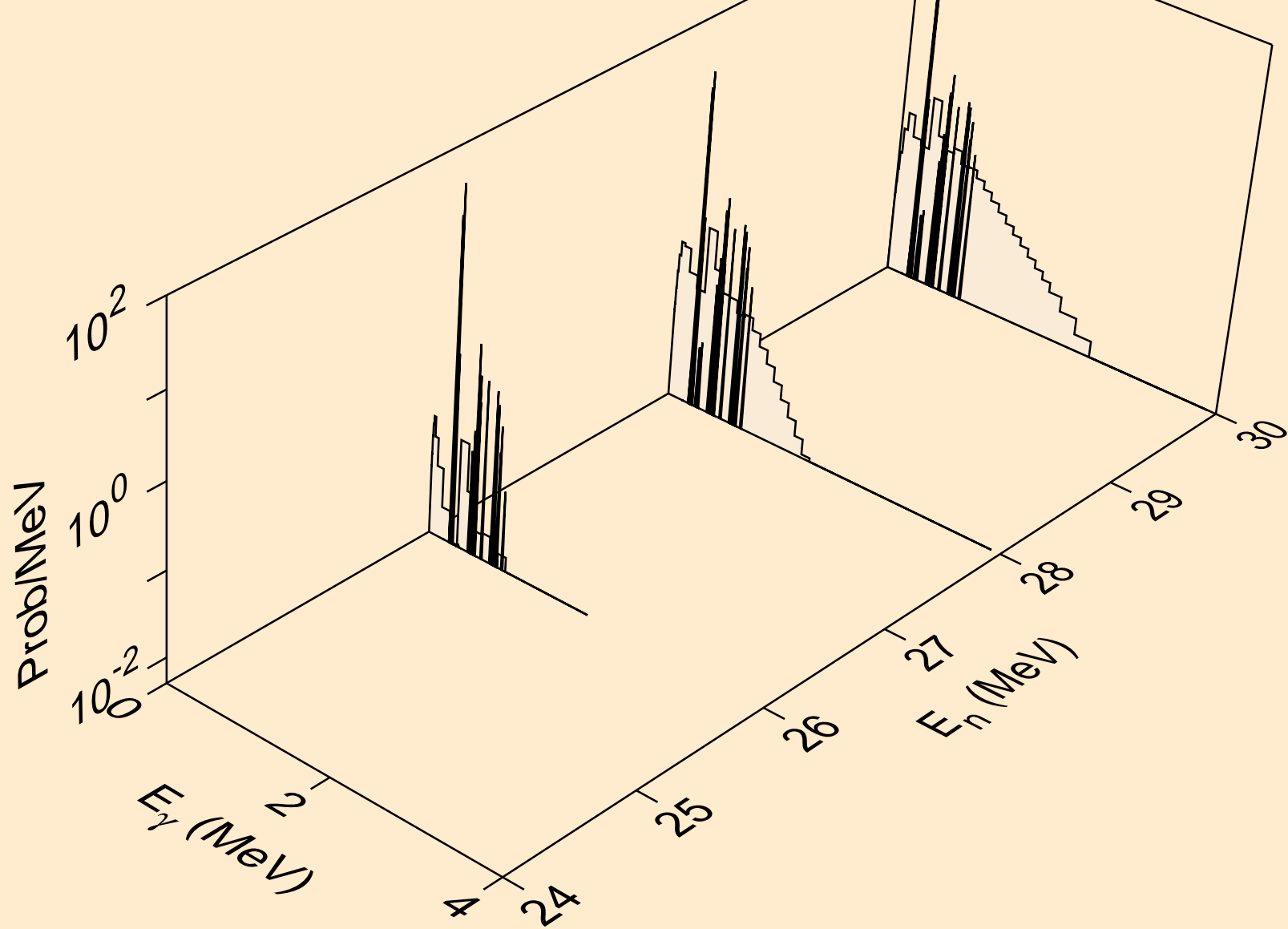

BR084 NEUTRON ACER TENDL-2024 LIBRARY; T=0.K  
Photon emission for (n,2np)

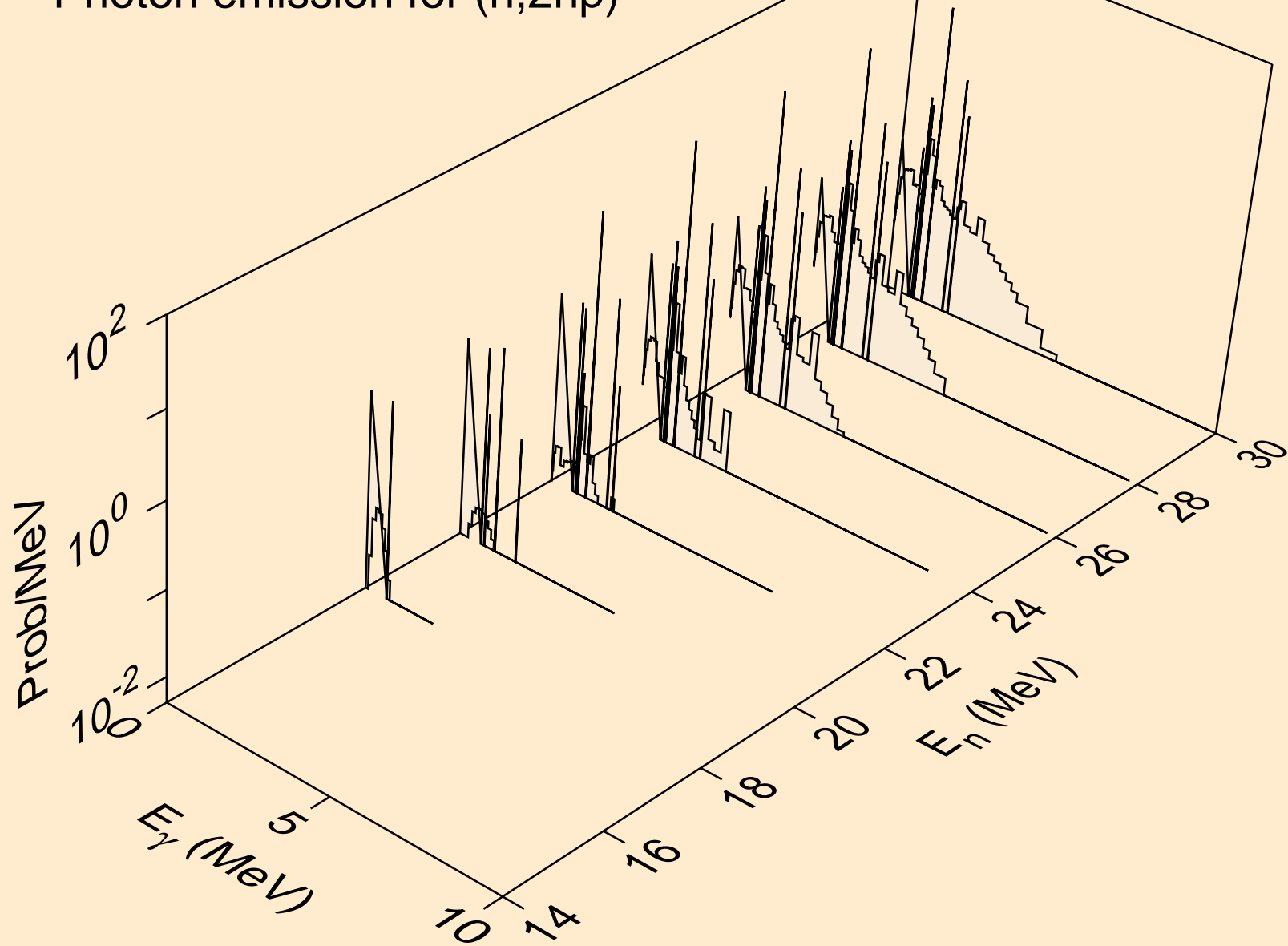



BR084 NEUTRON ACER TENDL-2024 LIBRARY; T=0.K  
Photon emission for (n,3np)

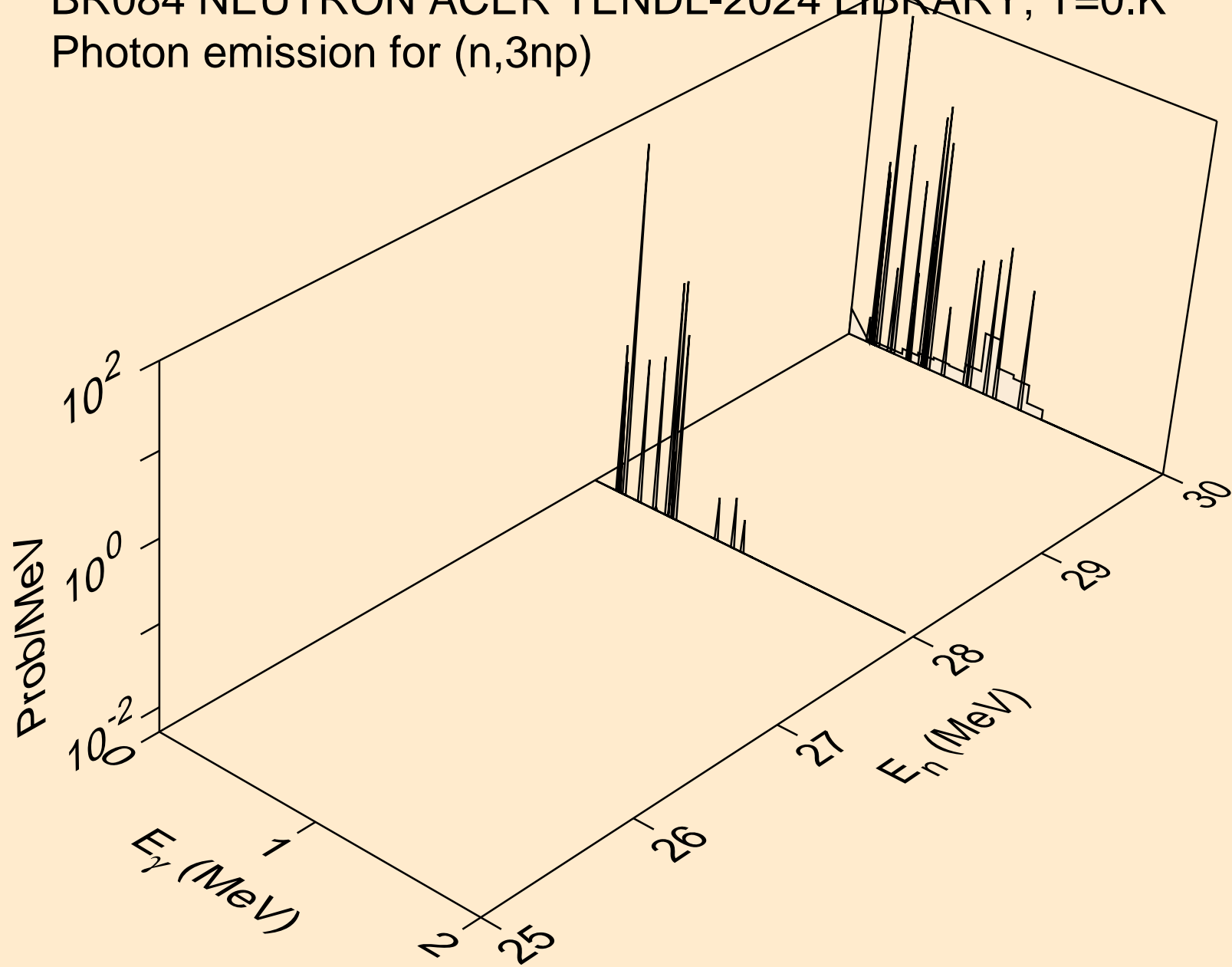

BR084 NEUTRON ACER TENDL-2024 LIBRARY; T=0.K  
Photon emission for (n,n2p)

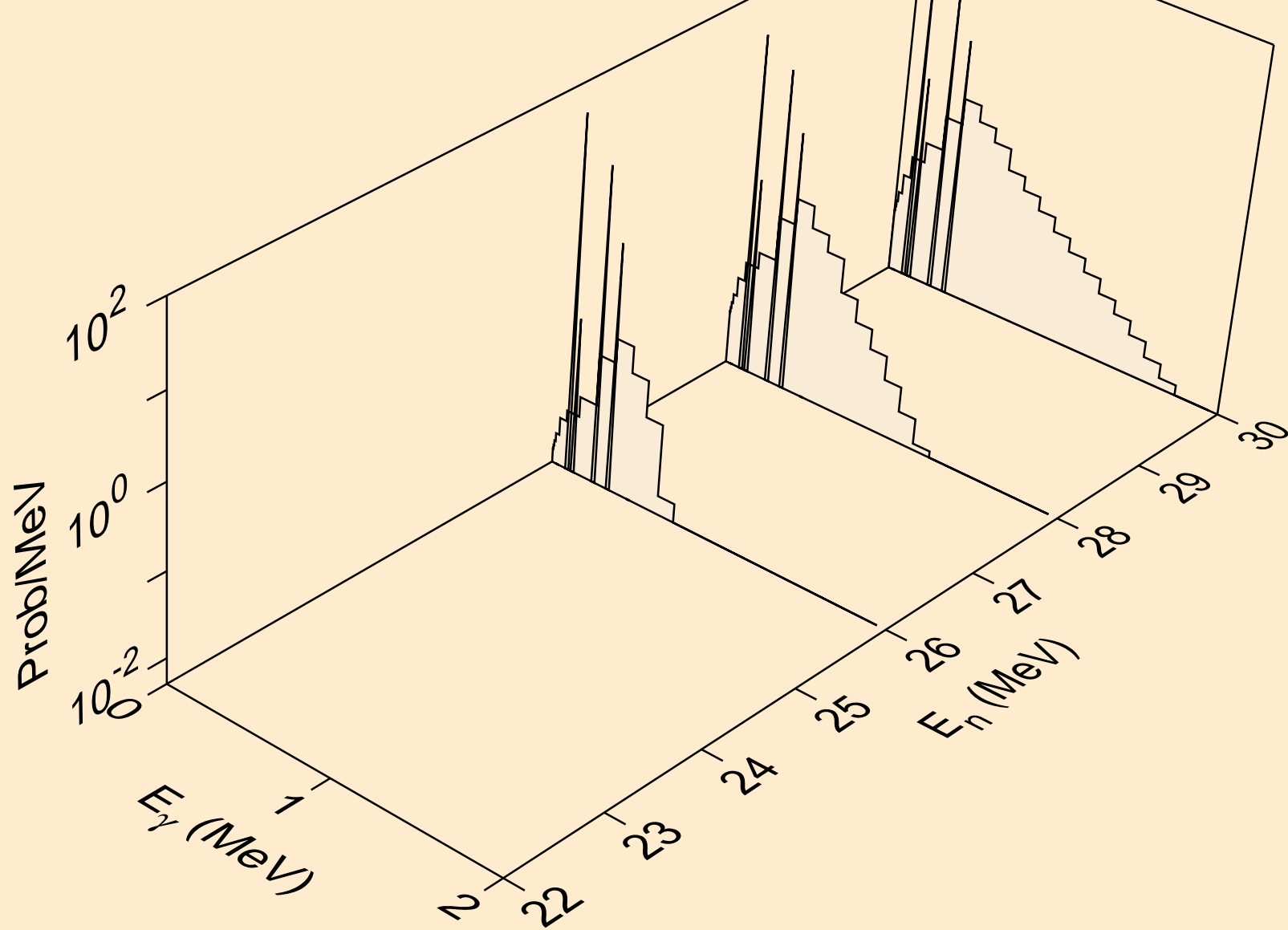

BR084 NEUTRON ACER TENDL-2024 LIBRARY; T=0.K  
Photon emission for (n,npa)

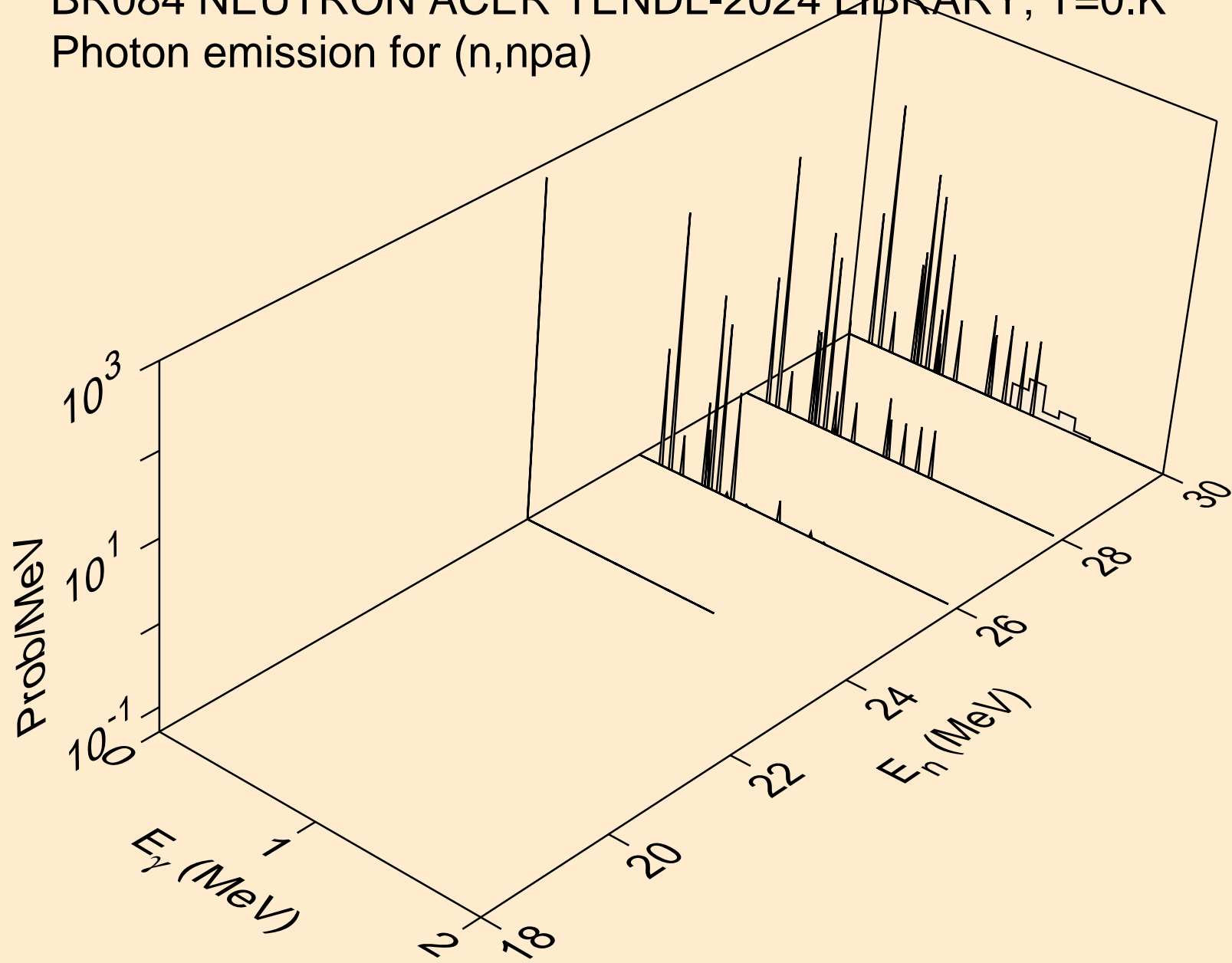

BR084 NEUTRON ACER TENDL-2024 LIBRARY; T=0.K  
Photon emission for (n,n\*c)

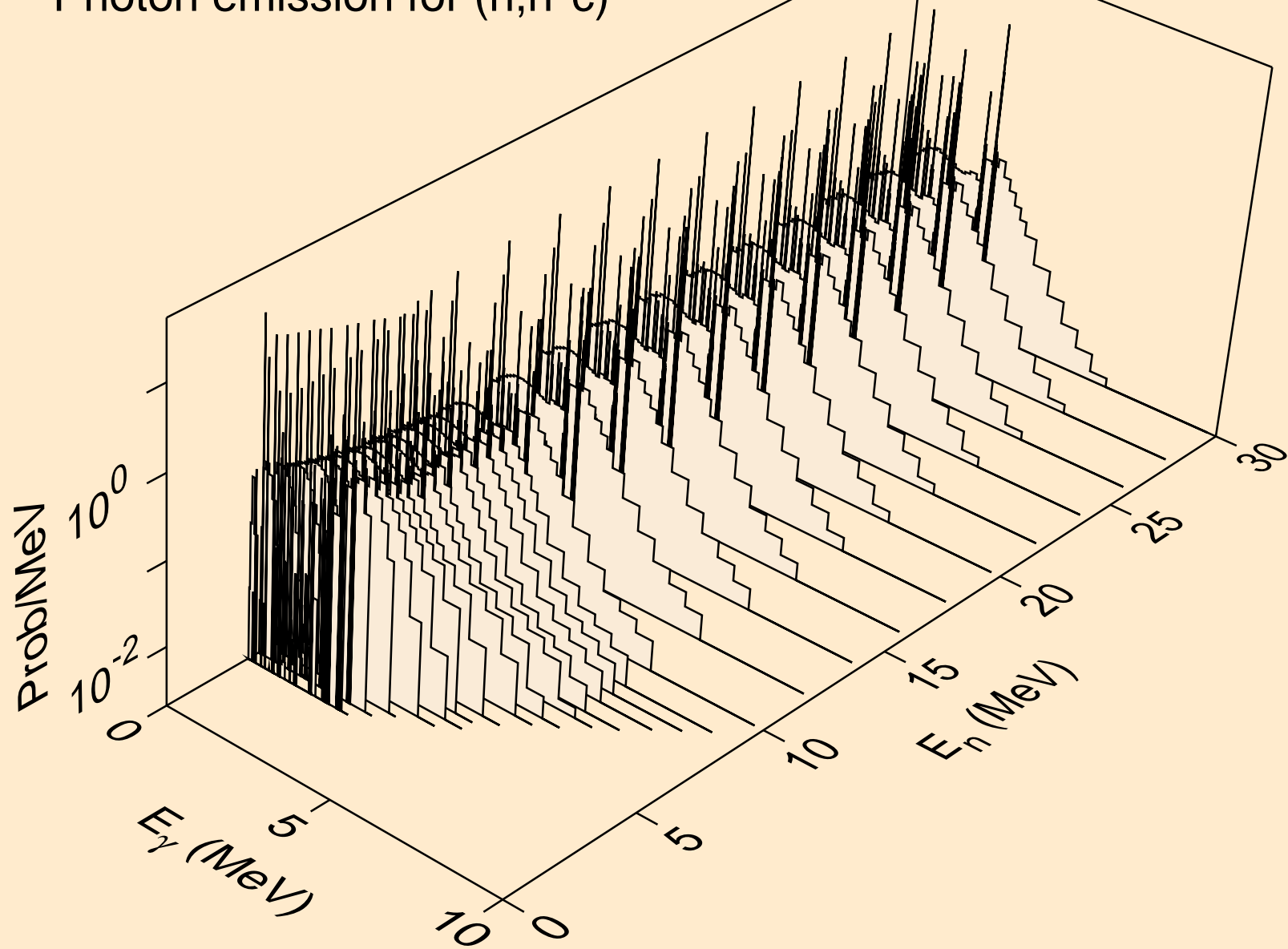

BR084 NEUTRON ACER TENDL-2024 LIBRARY; T=0.K  
Photon emission for (n,gma)

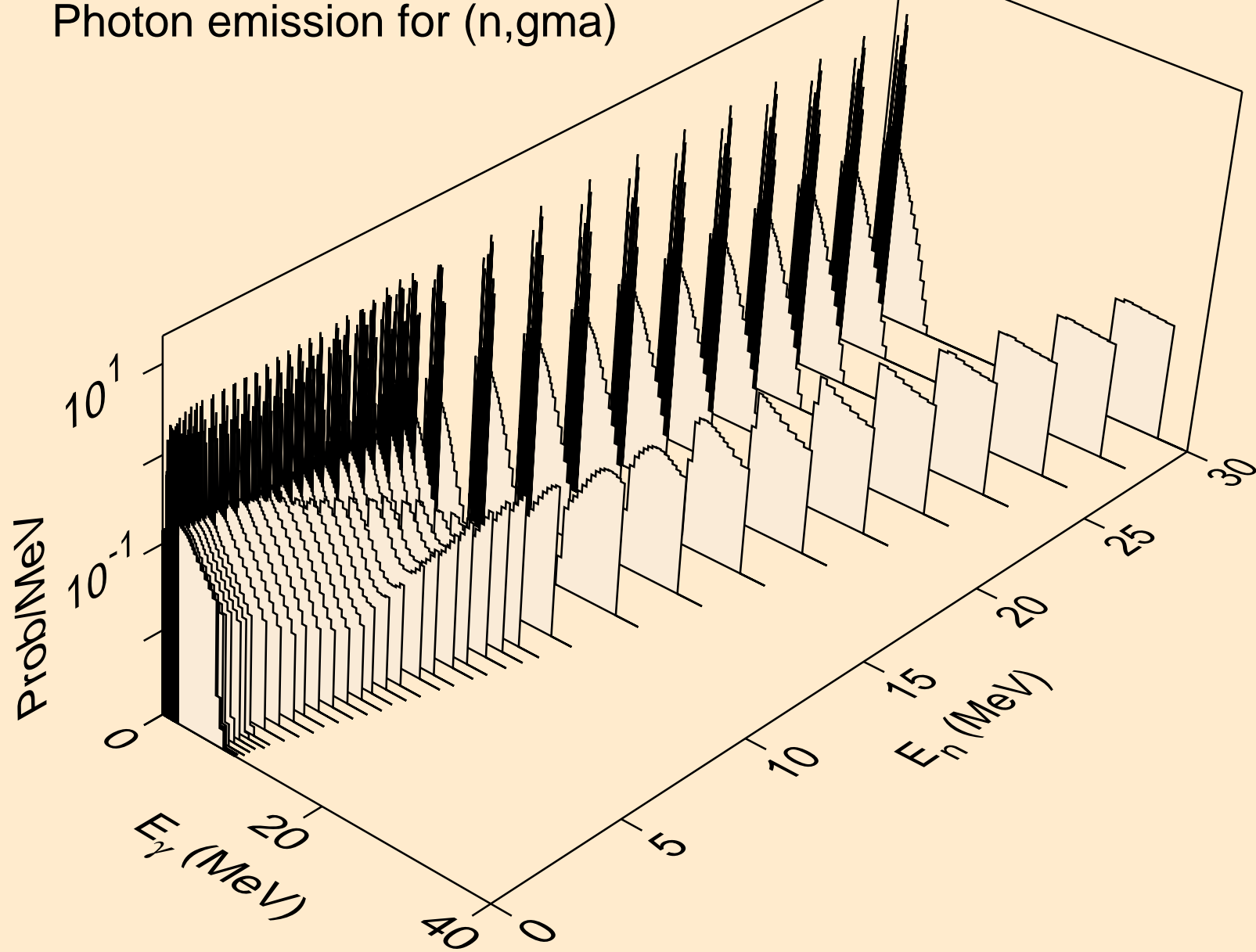

BR084 NEUTRON ACER TENDL-2024 LIBRARY; T=0.K  
Photon emission for (n,p)

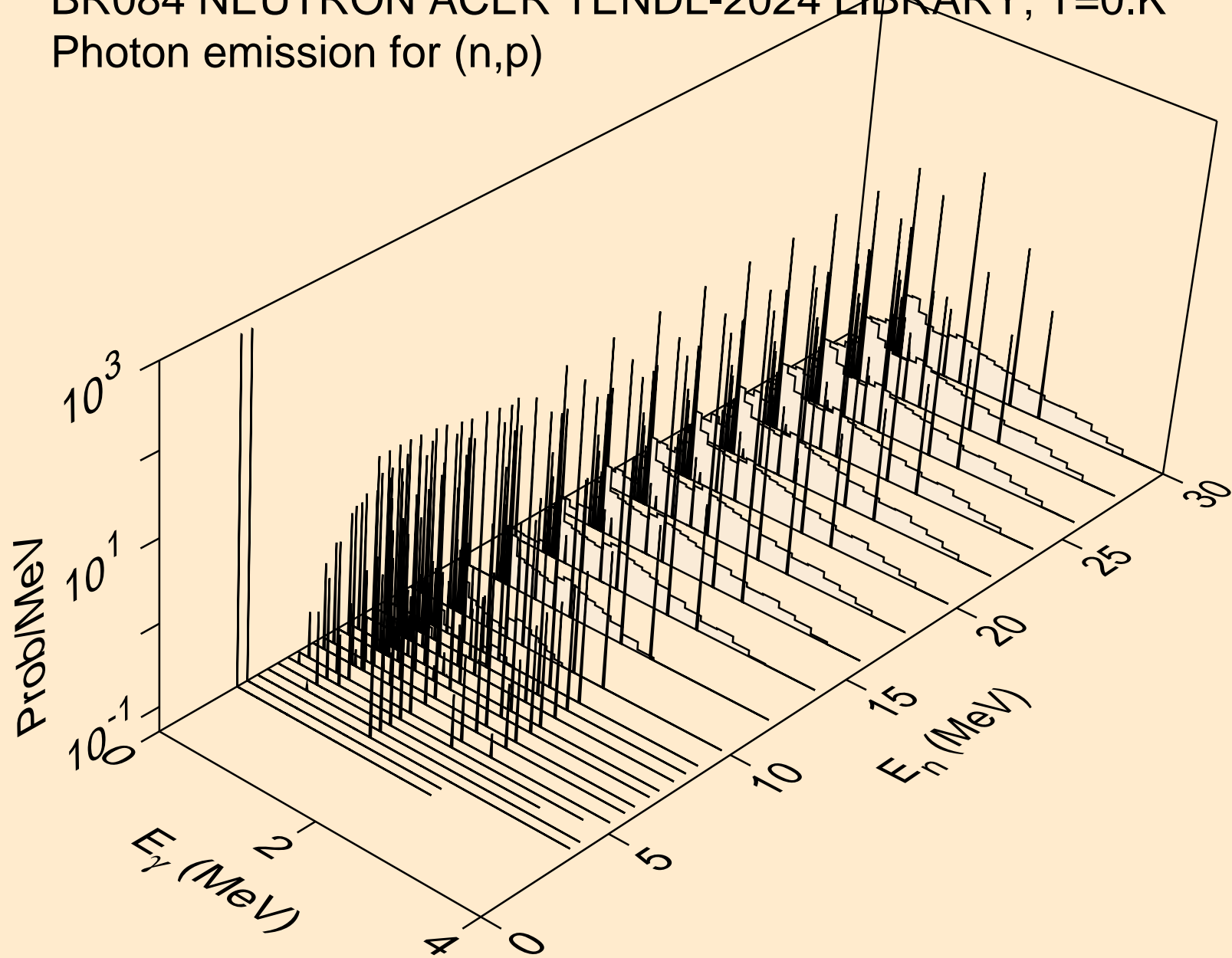

BR084 NEUTRON ACER TENDL-2024 LIBRARY; T=0.K  
Photon emission for (n,d)

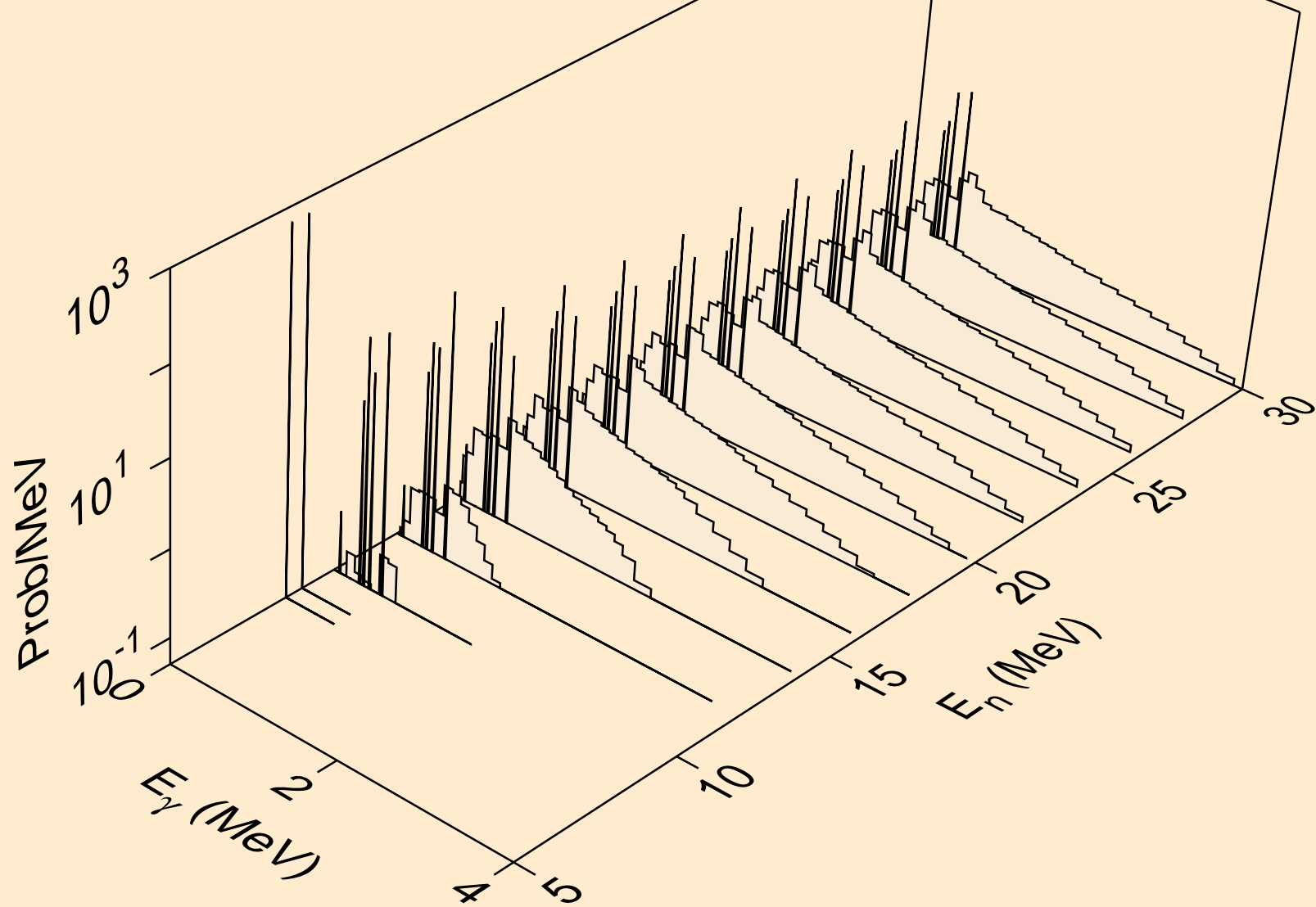

BR084 NEUTRON ACER TENDL-2024 LIBRARY; T=0.K  
Photon emission for (n,t)

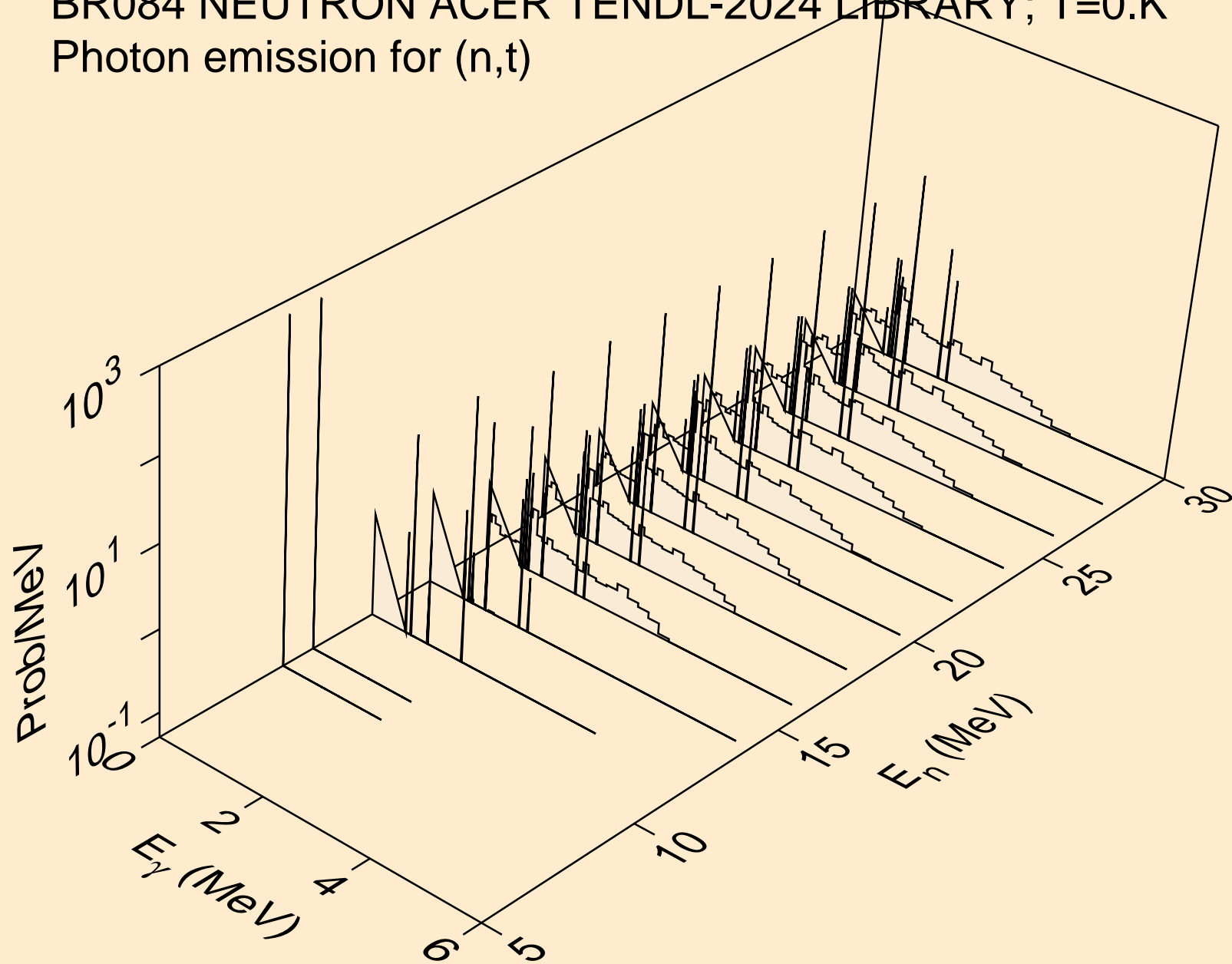



BR084 NEUTRON ACER TENDL-2024 LIBRARY; T=0.K  
Photon emission for (n,he3)

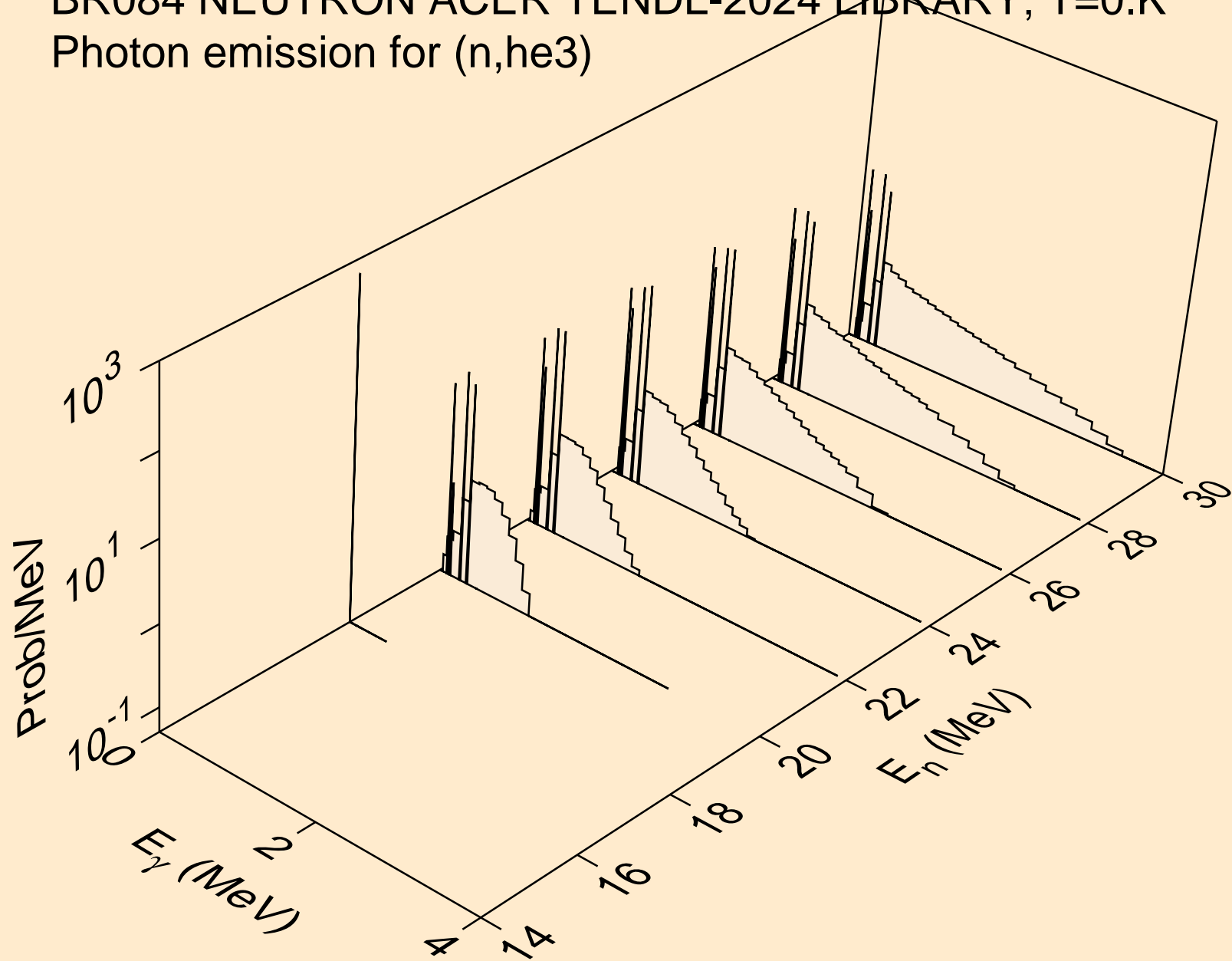

BR084 NEUTRON ACER TENDL-2024 LIBRARY; T=0.K  
Photon emission for (n,a)

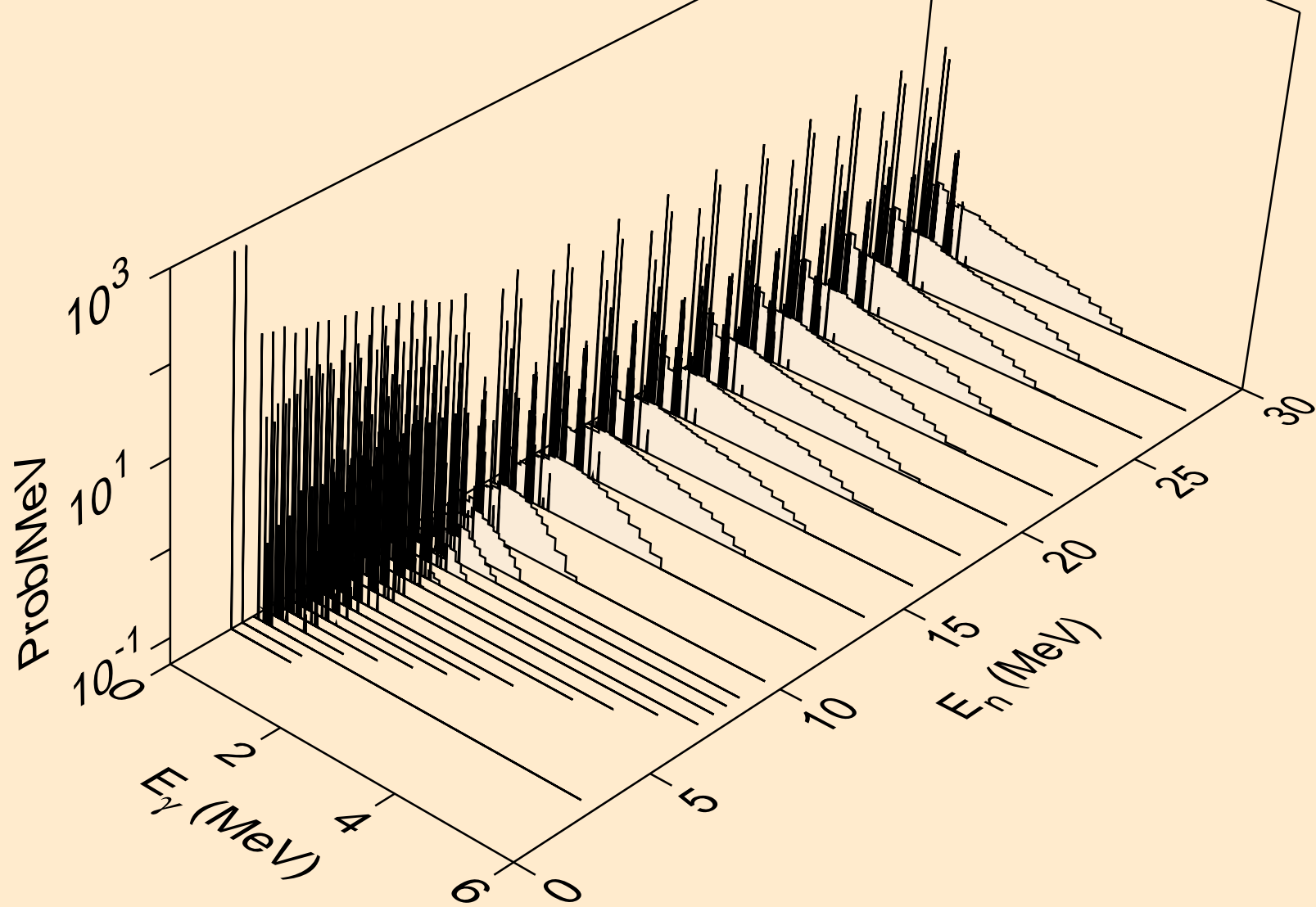

BR084 NEUTRON ACER TENDL-2024 LIBRARY; T=0.K  
Photon emission for (n,2a)

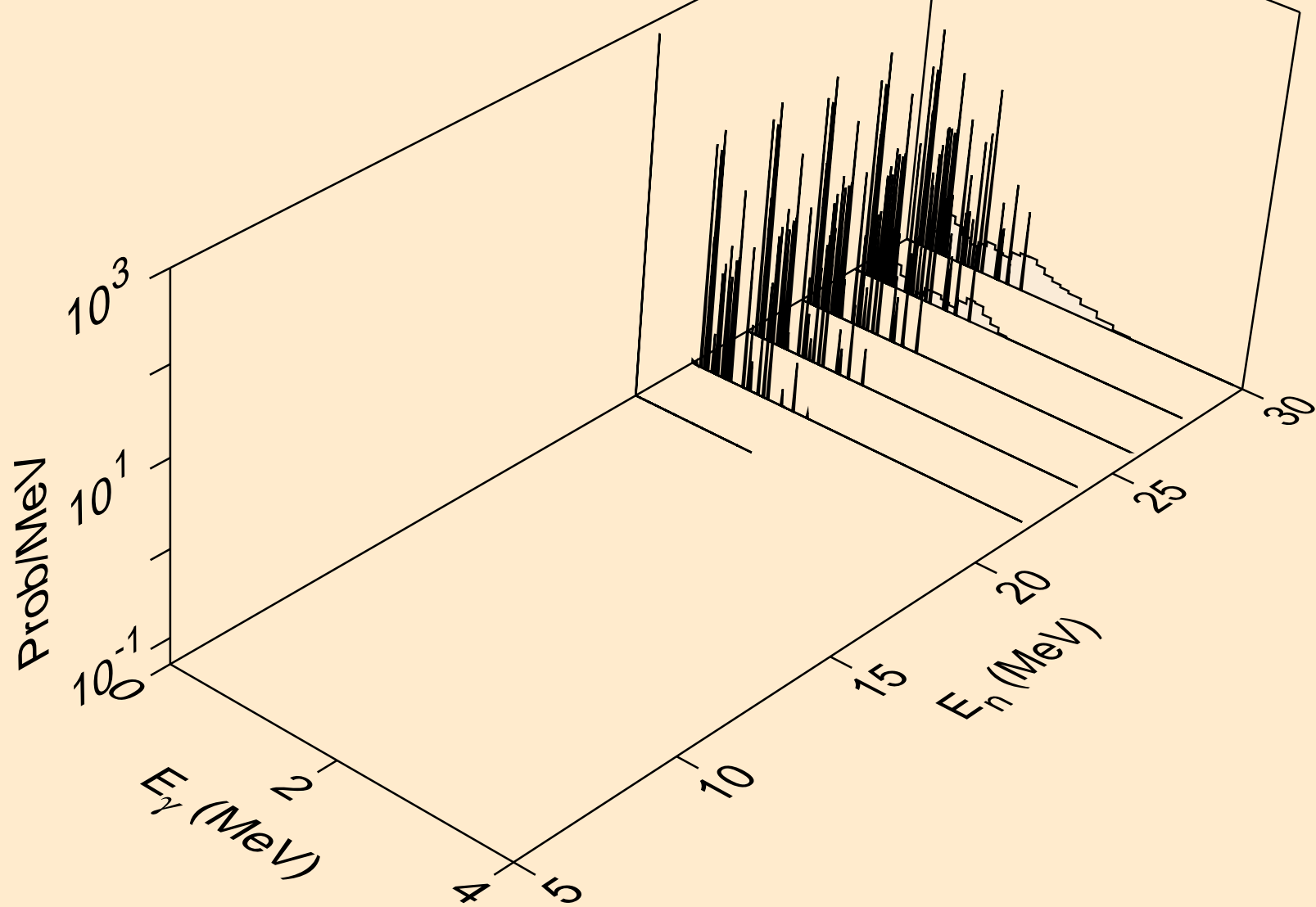

BR084 NEUTRON ACER TENDL-2024 LIBRARY; T=0.K  
Photon emission for (n,2p)

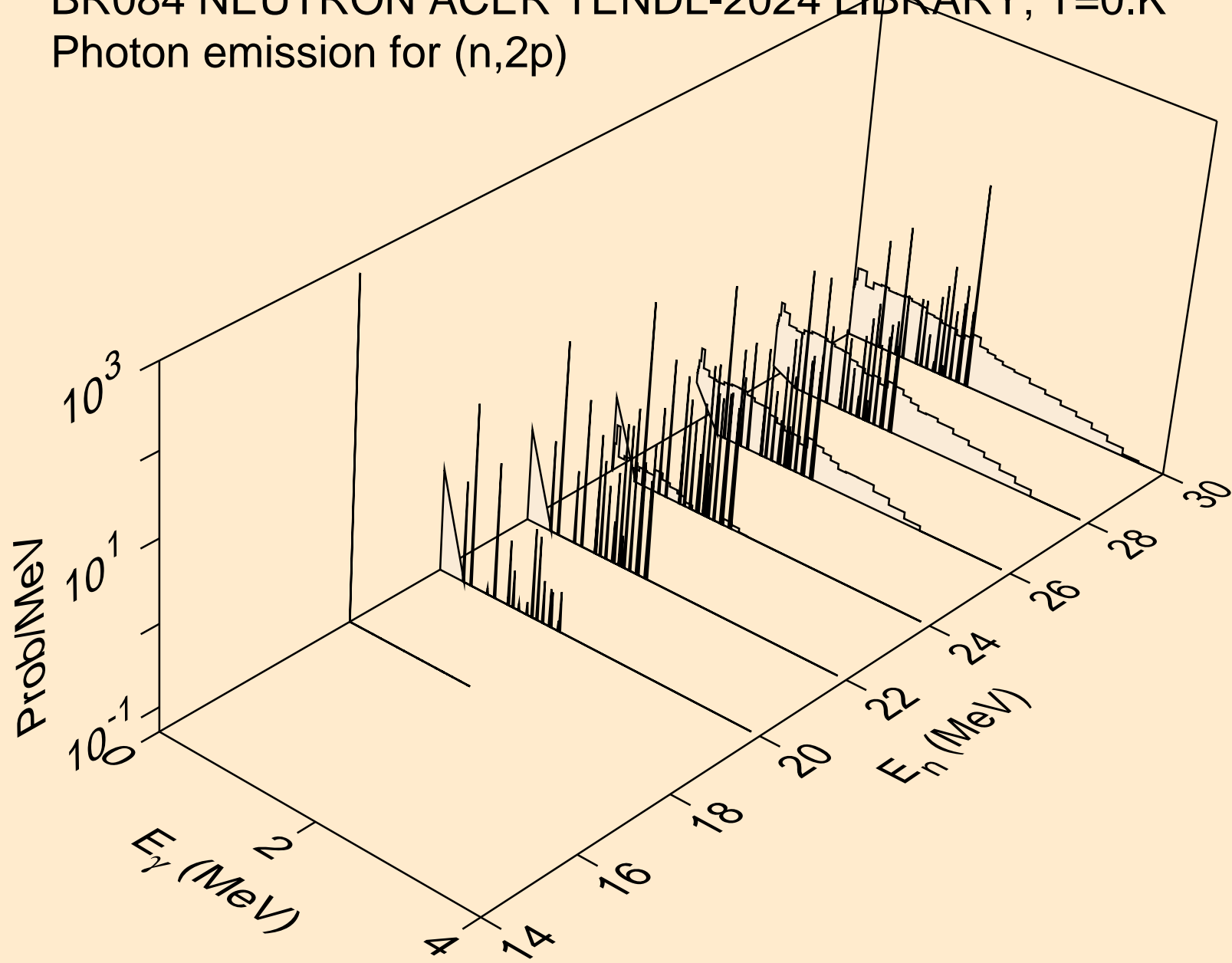

BR084 NEUTRON ACER TENDL-2024 LIBRARY; T=0.K  
Photon emission for (n,p $\alpha$ )

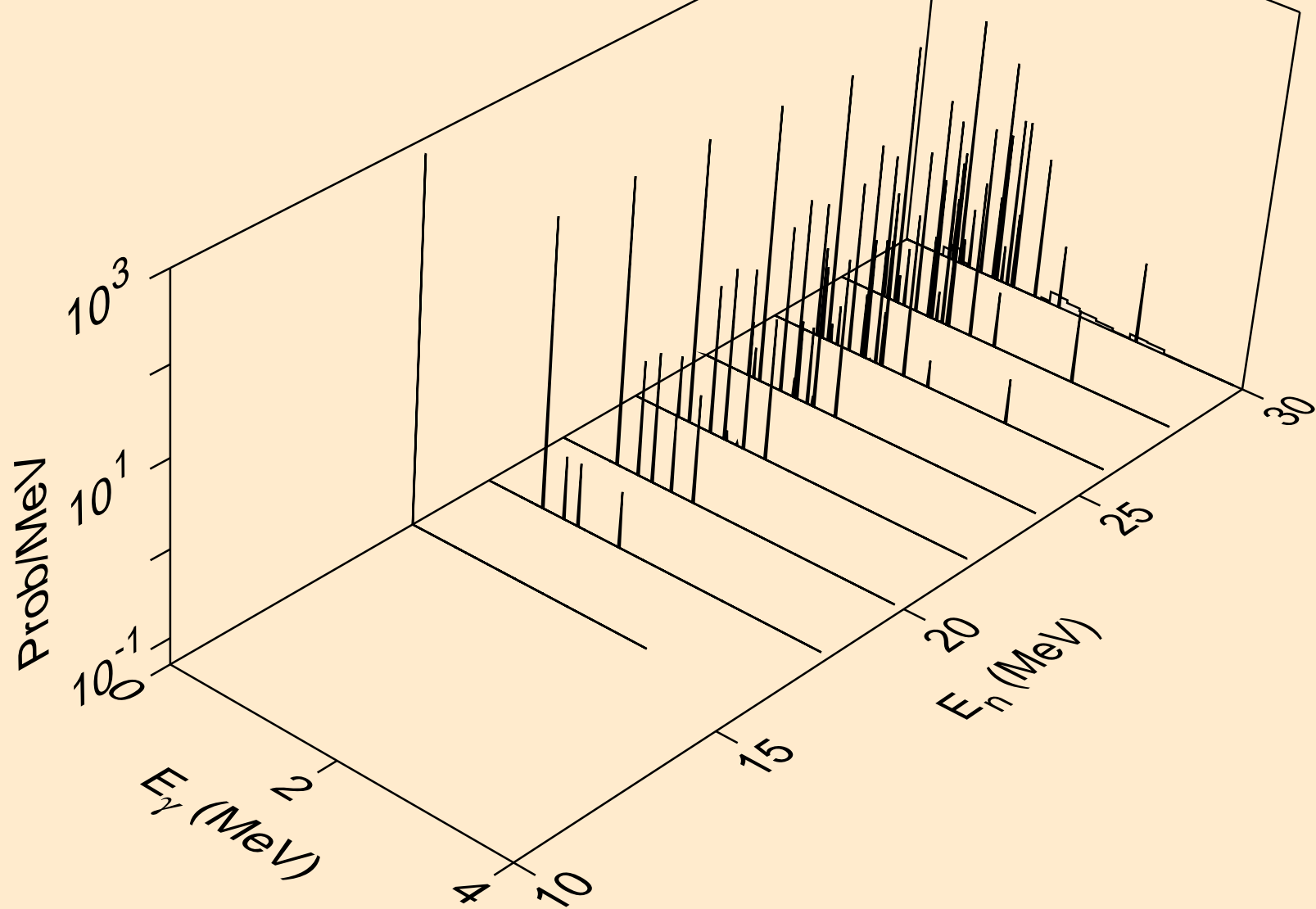

BR084 NEUTRON ACER TENDL-2024 LIBRARY; T=0.K  
Photon emission for (n,pd)

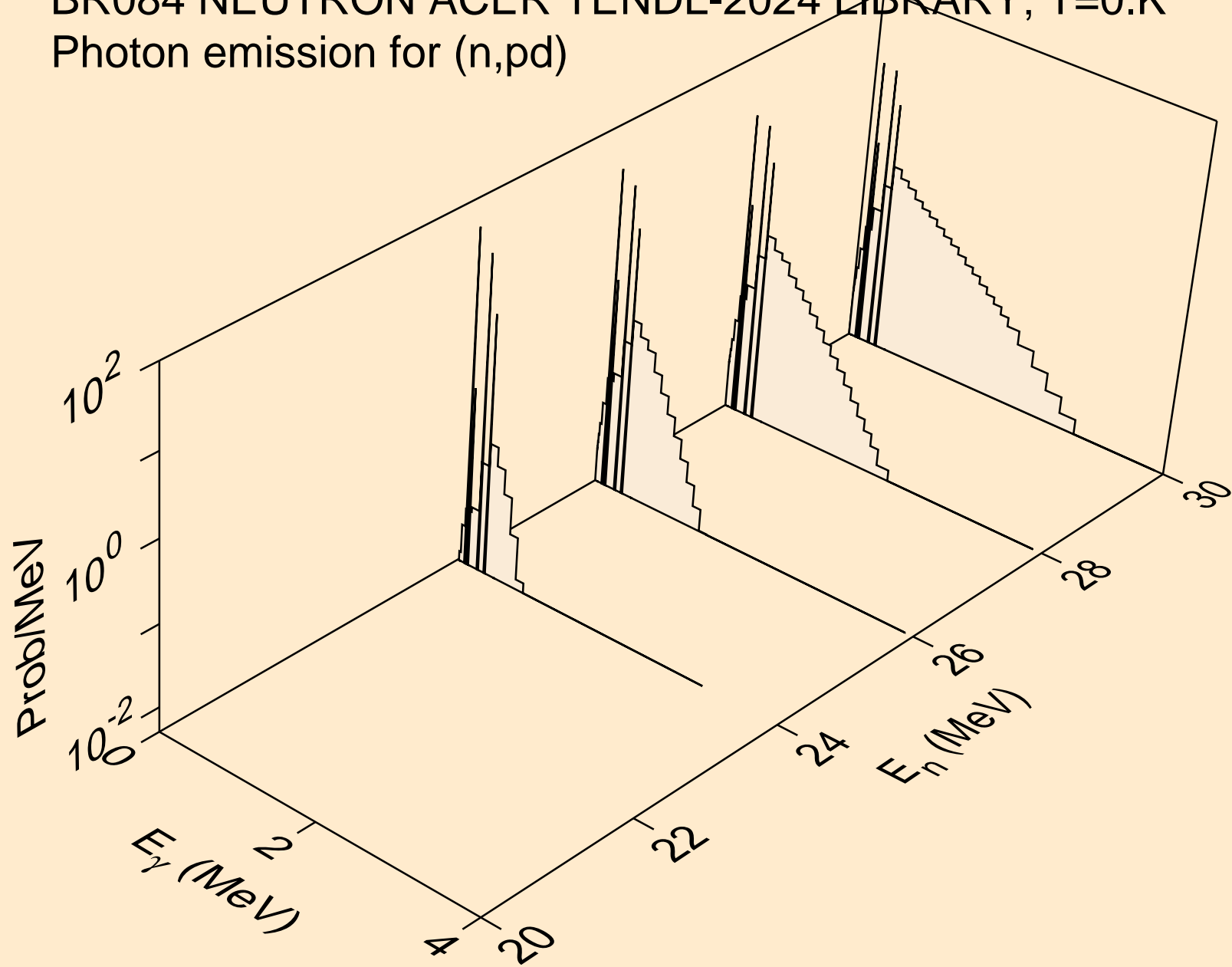

BR084 NEUTRON ACER TENDL-2024 LIBRARY; T=0.K  
Photon emission for (n,pt)

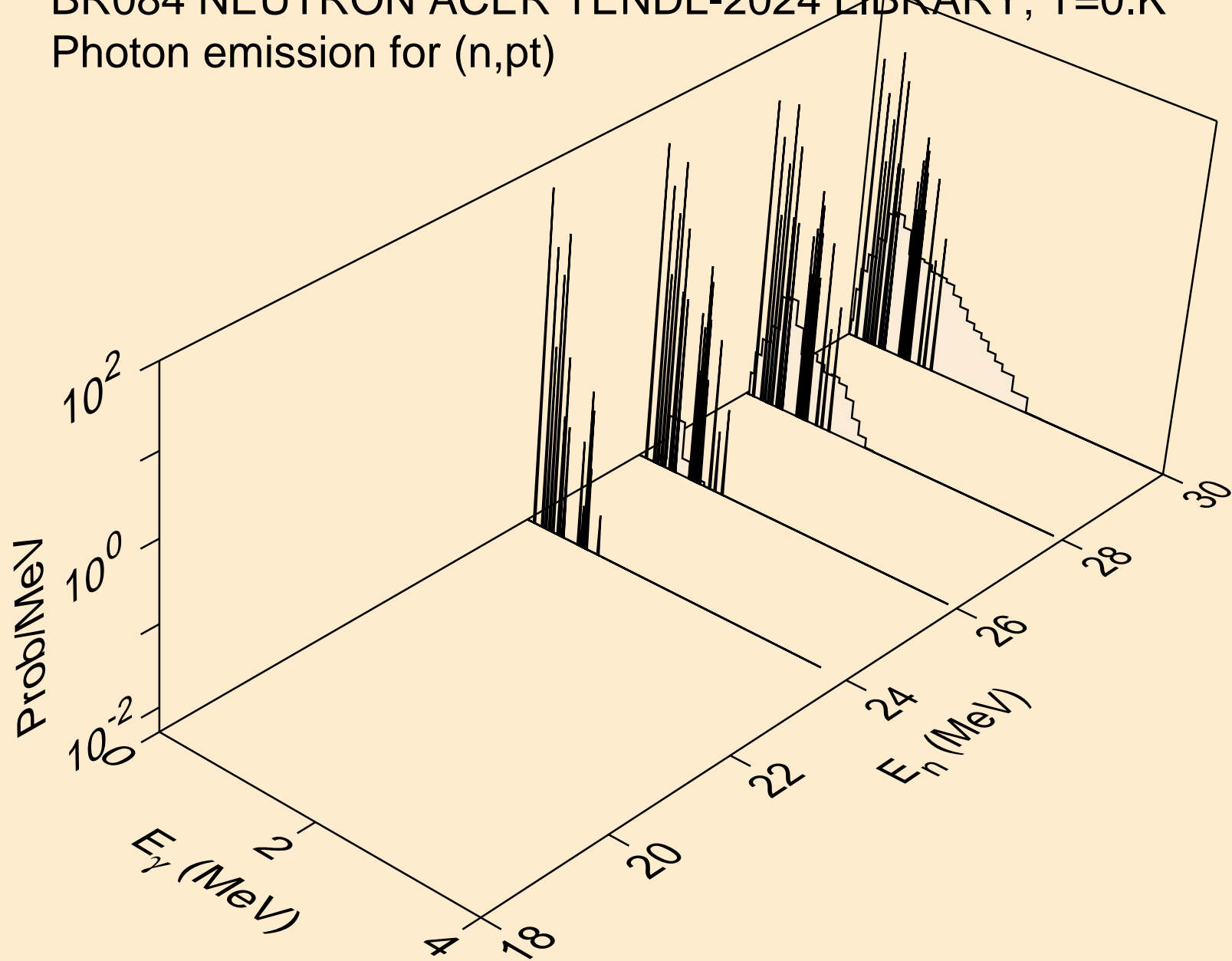

BR084 NEUTRON ACER TENDL-2024 LIBRARY; T=0.K  
thermal capture photon spectrum

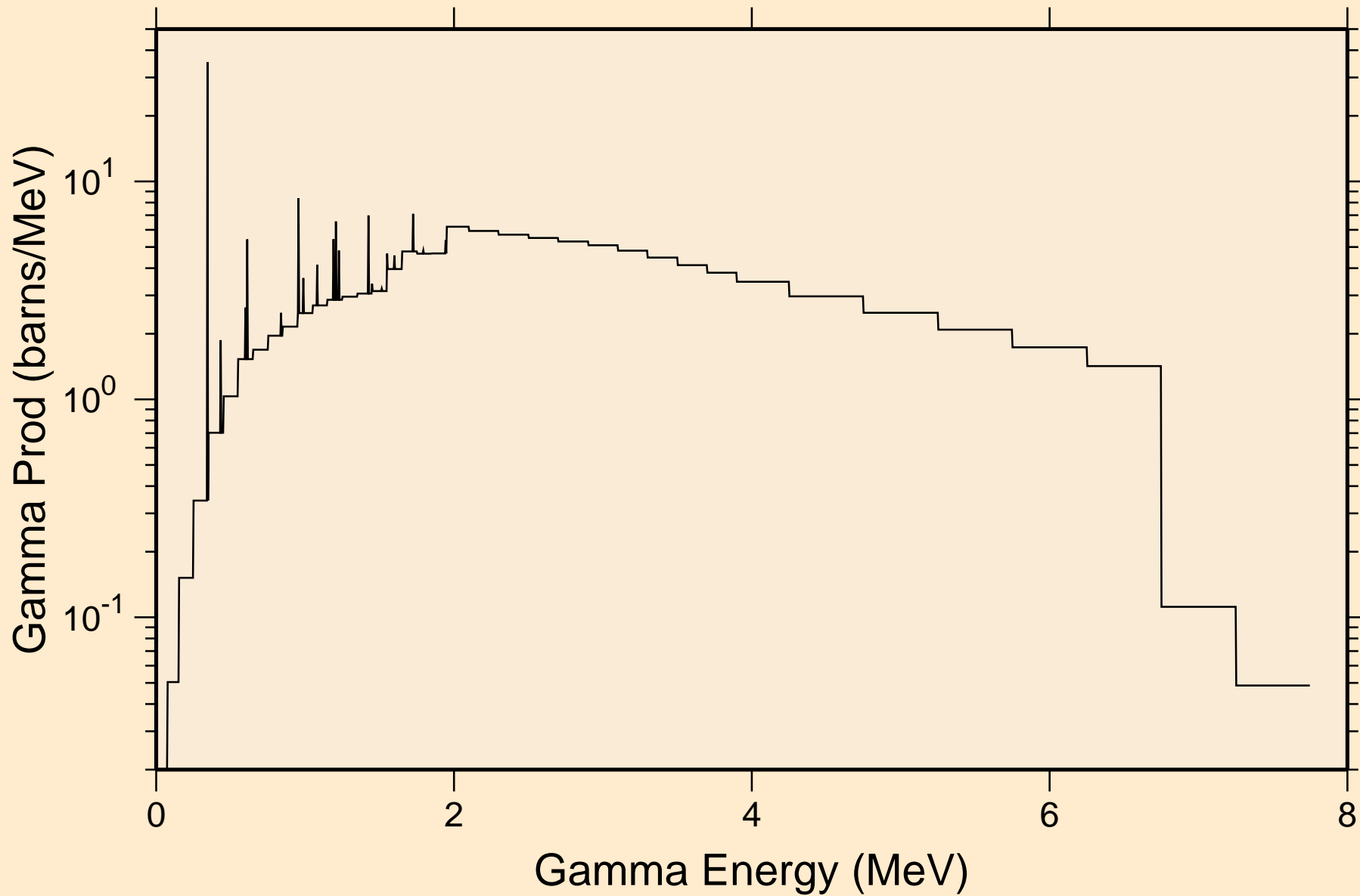



BR084 NEUTRON ACER TENDL-2024 LIBRARY; T=0.K  
14 MeV photon spectrum

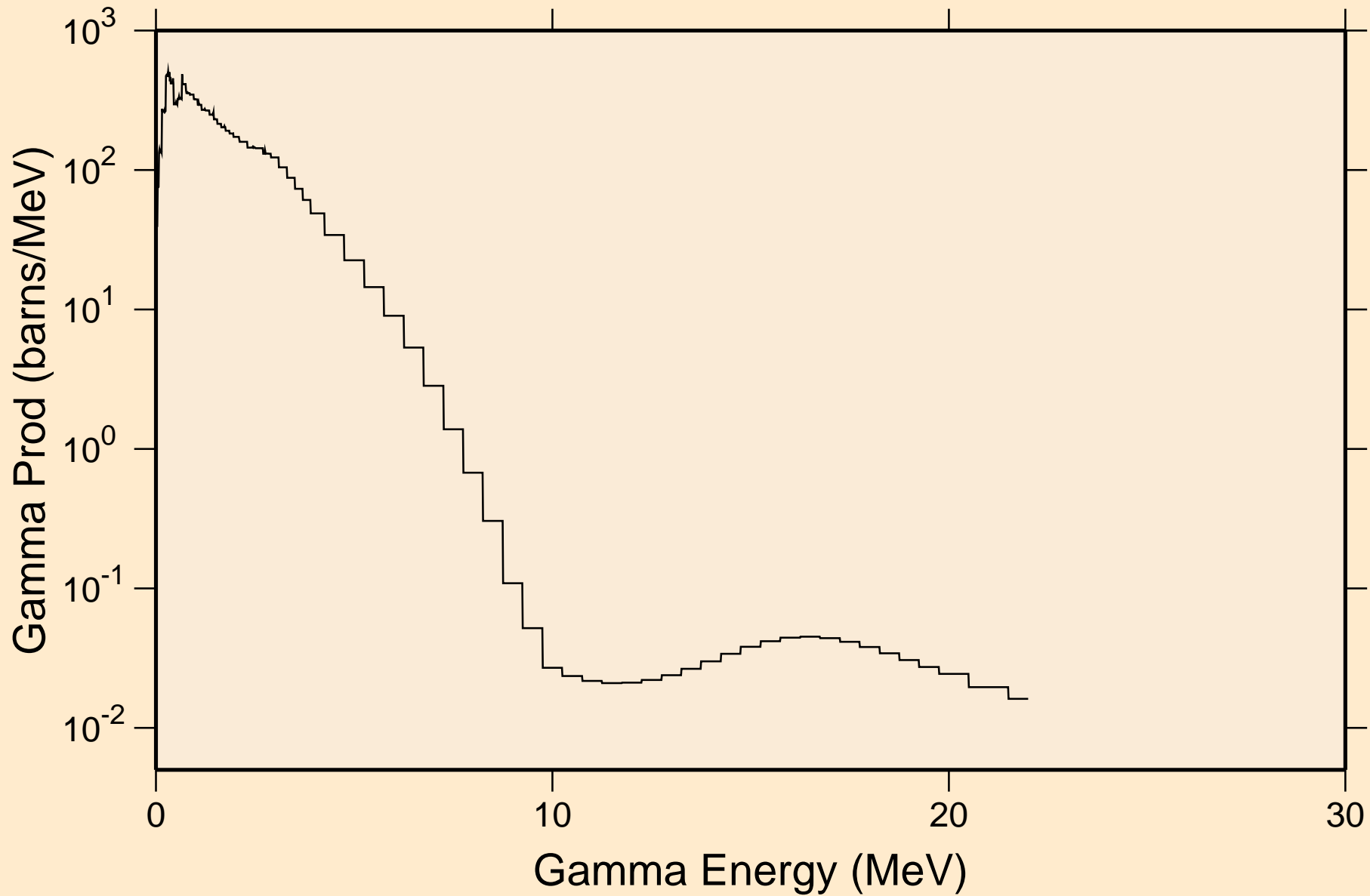

# BR084 NEUTRON ACER TENDL-2024 LIBRARY; T=0.K

## Particle heating contributions

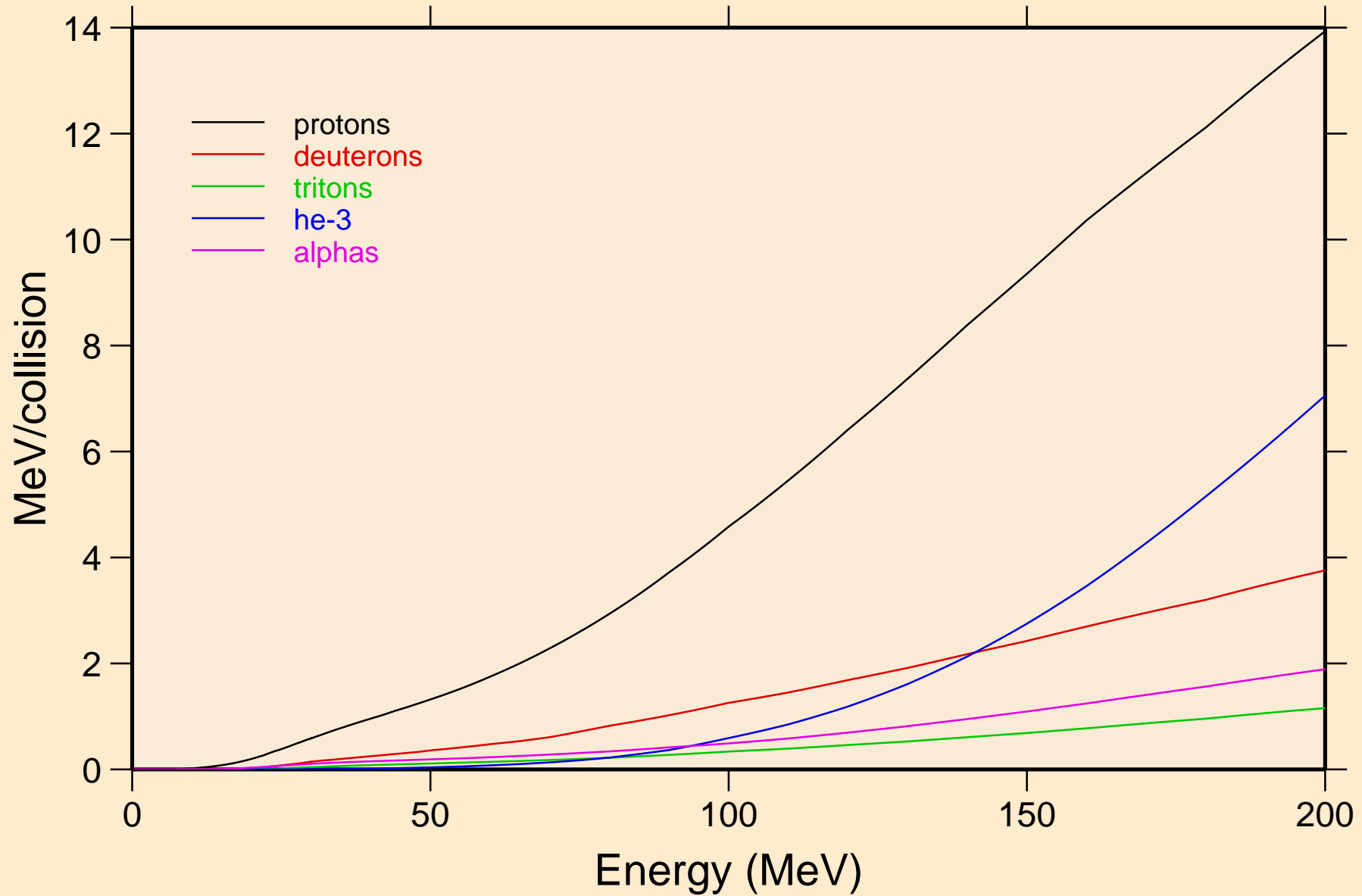

BR084 NEUTRON ACER TENDL-2024 LIBRARY; T=0.K  
Recoil Heating

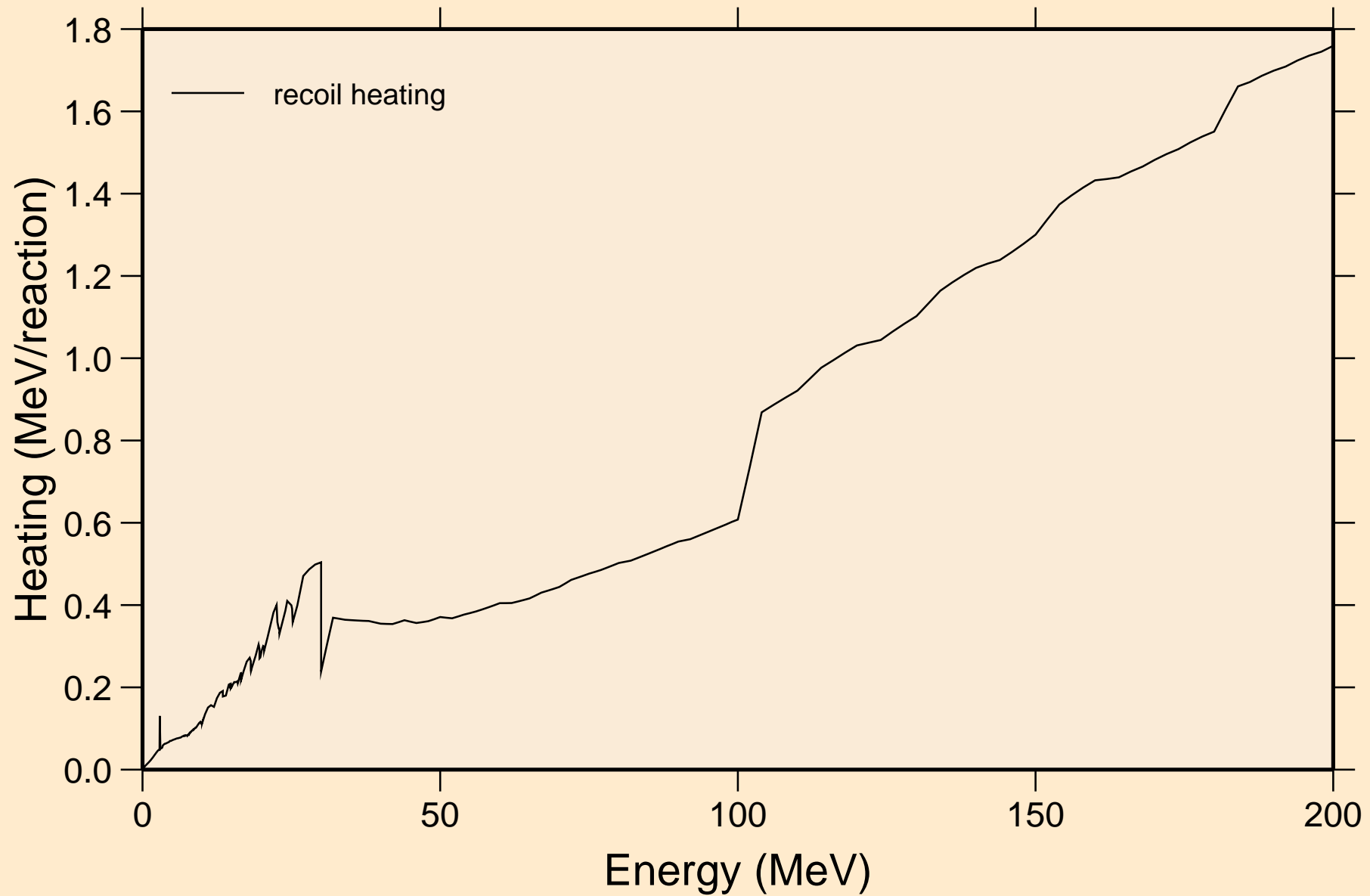

BR084 NEUTRON ACER TENDL-2024 LIBRARY; T=0.K  
Particle production cross sections

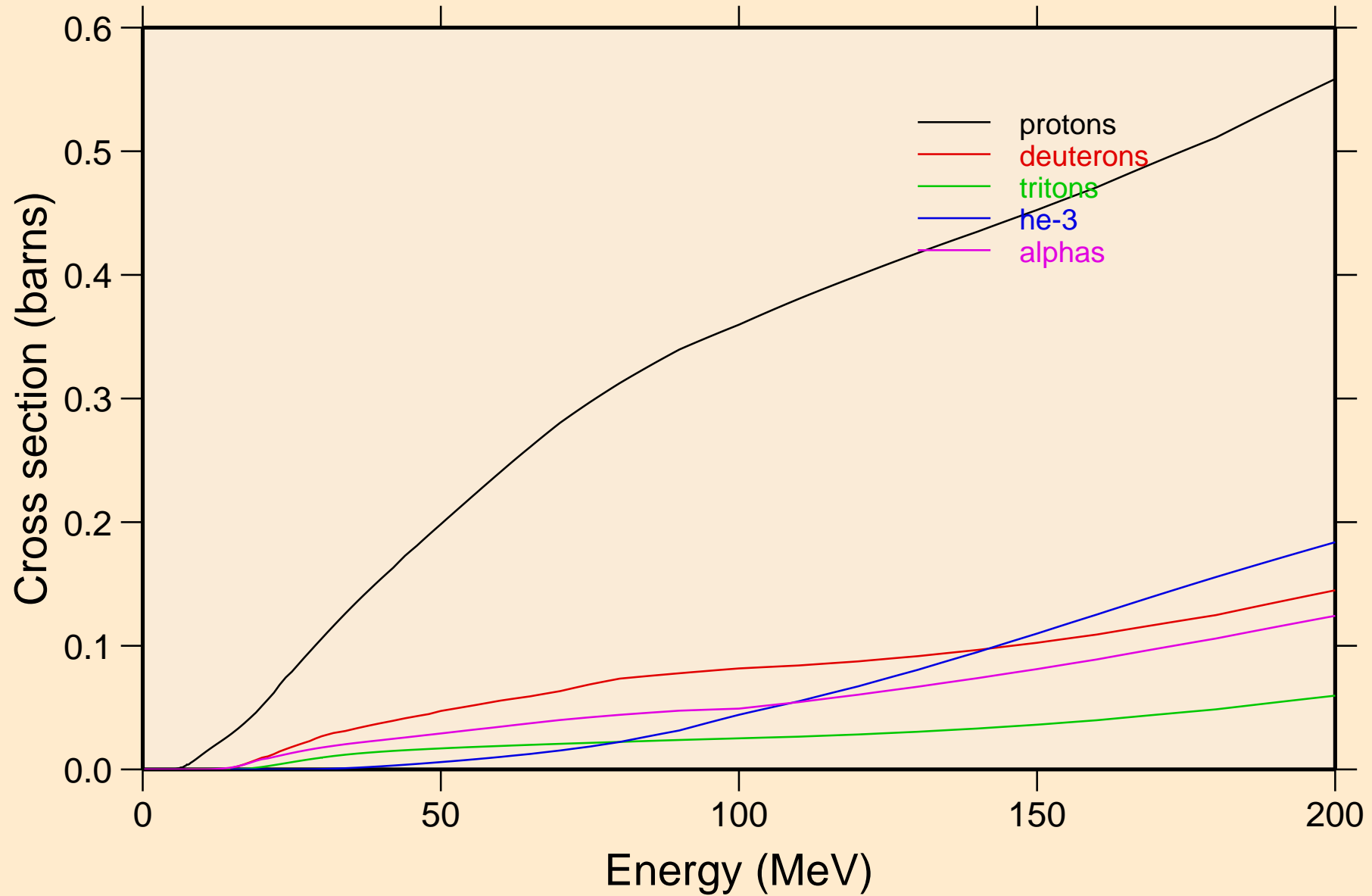

BR084 NEUTRON ACER TENDL-2024 LIBRARY; T=0.K  
protons from (n,x)

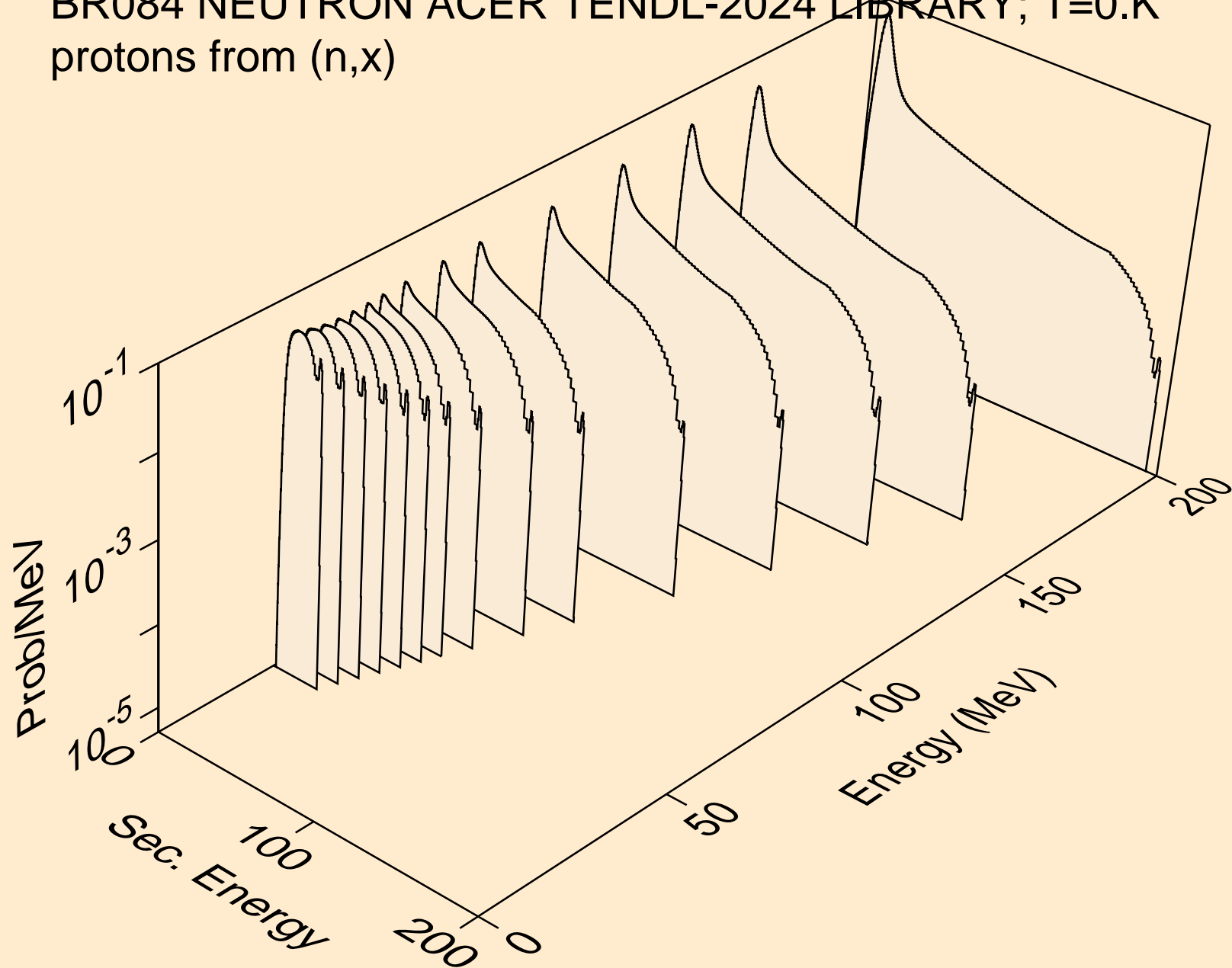

BR084 NEUTRON ACER TENDL-2024 LIBRARY; T=0.K  
protons from (n,n\*)p

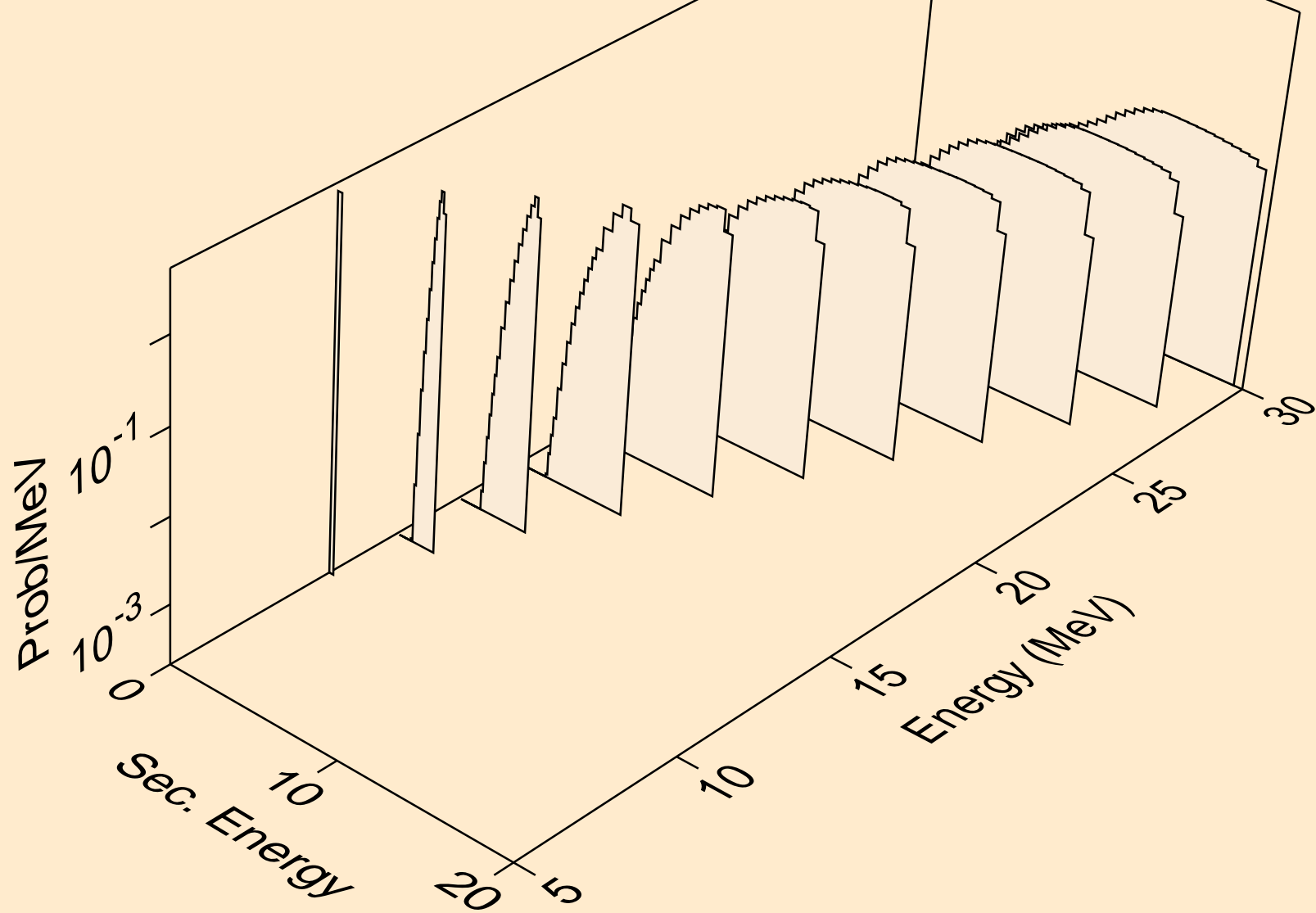

BR084 NEUTRON ACER TENDL-2024 LIBRARY; T=0.K  
protons from (n,2np)

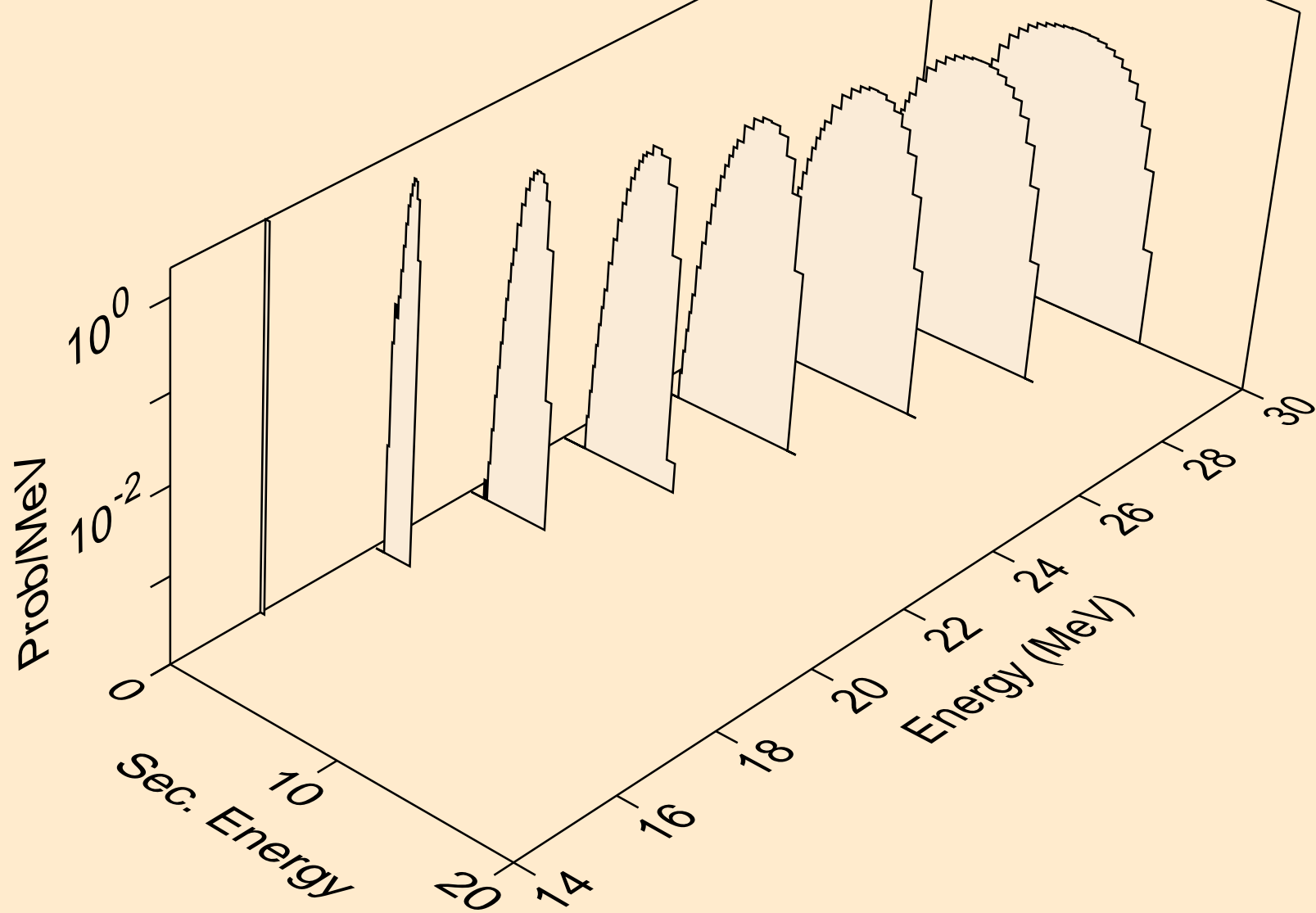

BR084 NEUTRON ACER TENDL-2024 LIBRARY; T=0.K  
protons from (n,3np)

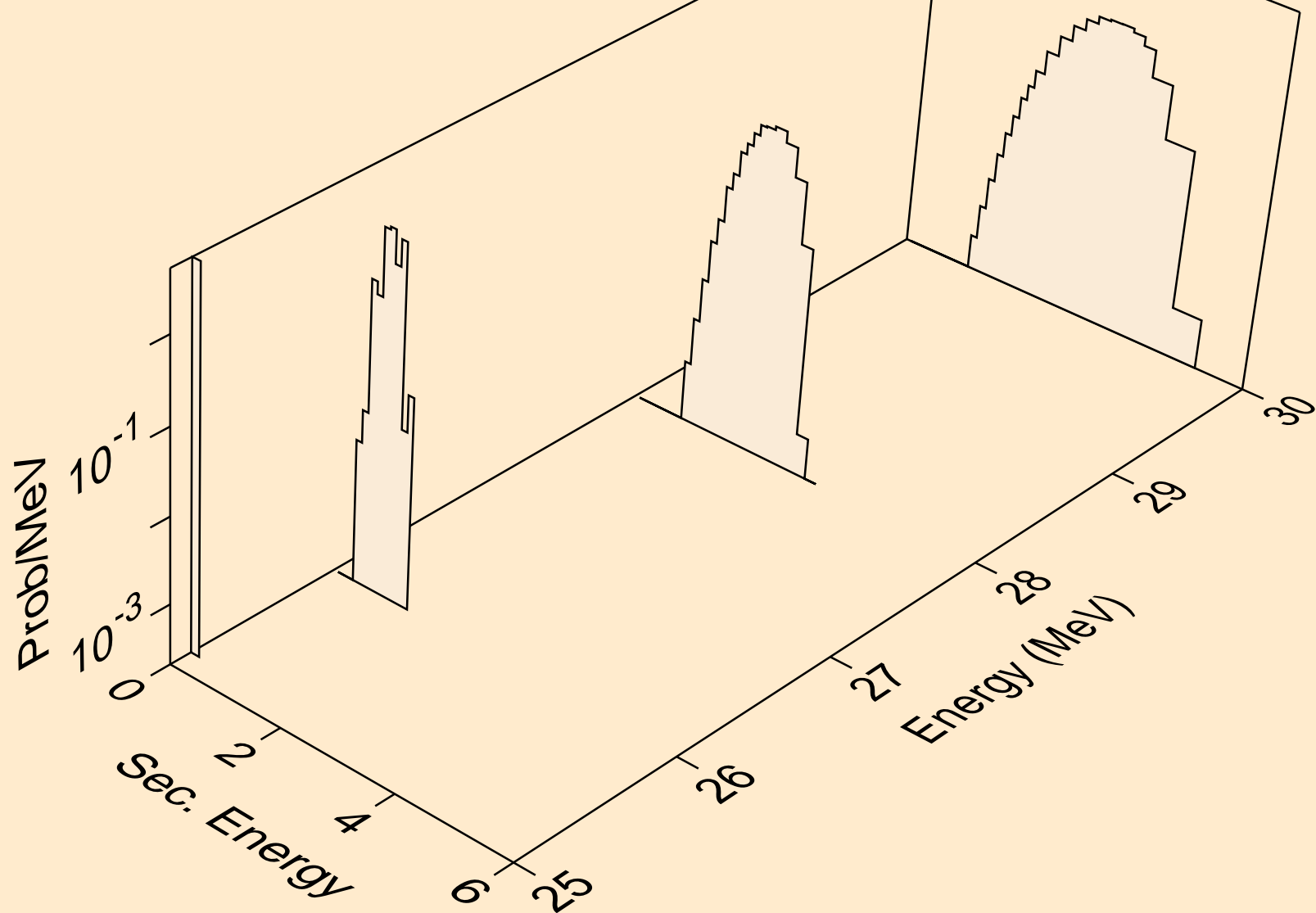



BR084 NEUTRON ACER TENDL-2024 LIBRARY; T=0.K  
protons from (n,n2p)

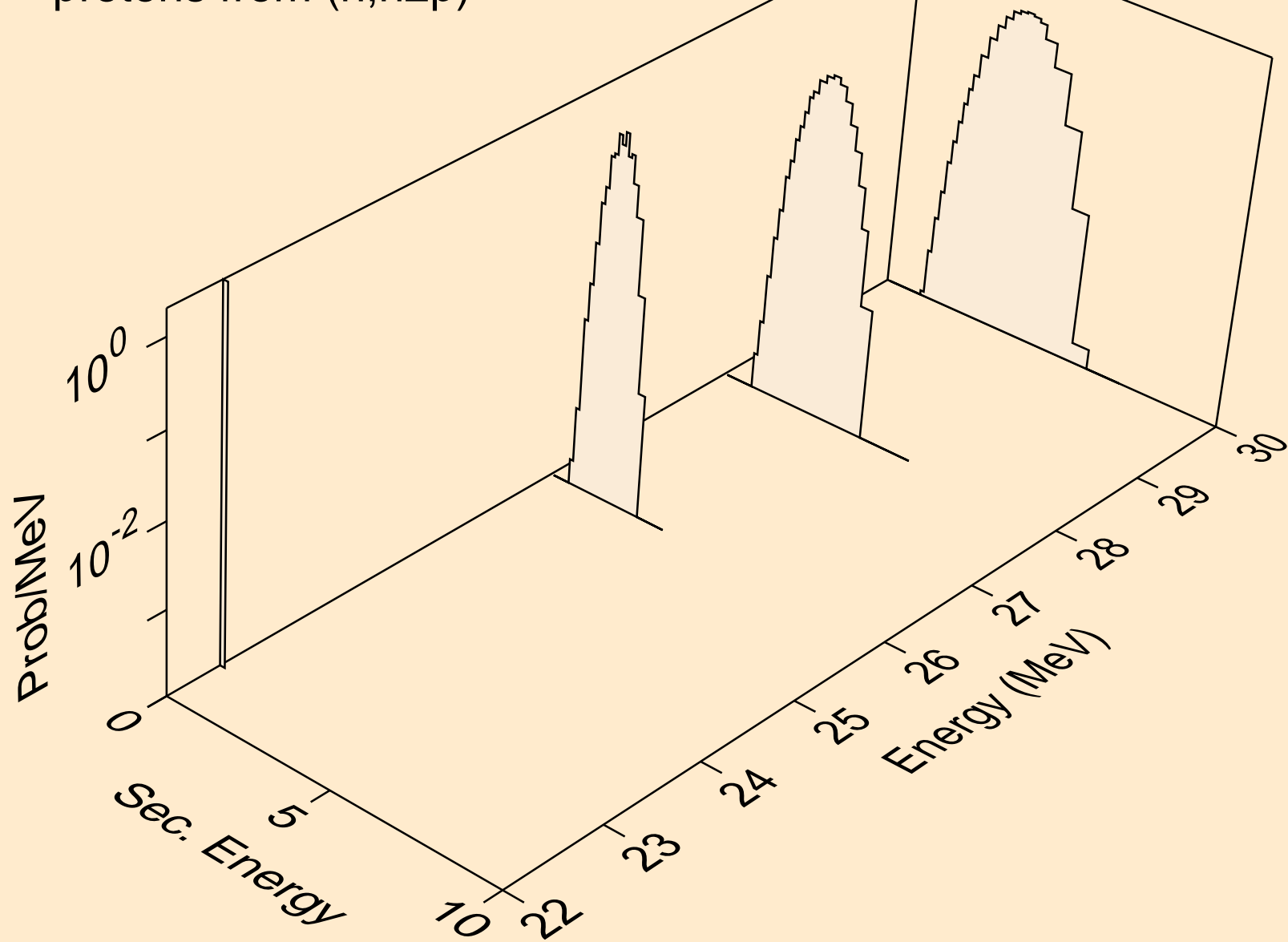

BR084 NEUTRON ACER TENDL-2024 LIBRARY; T=0.K  
protons from (n,npa)

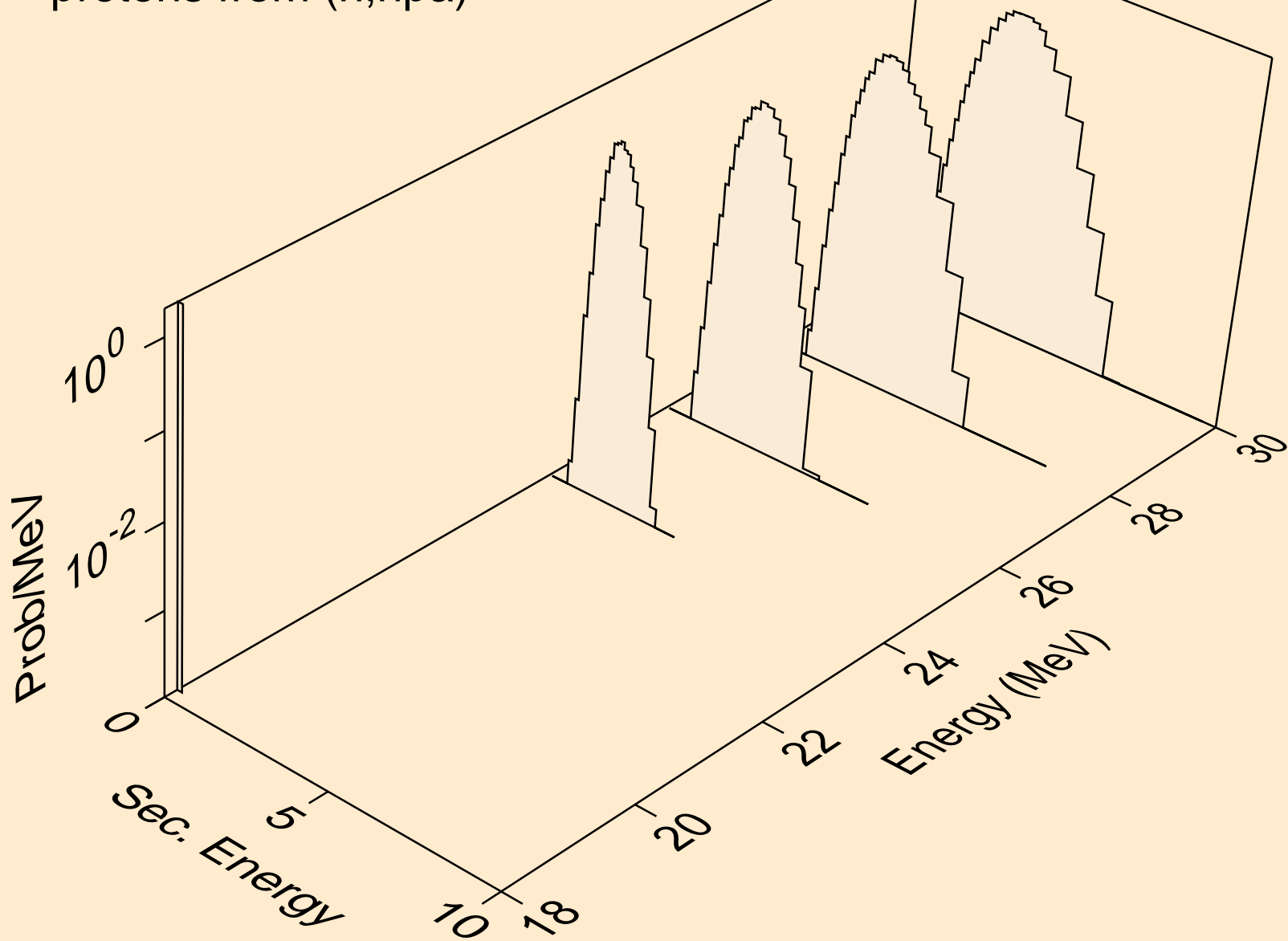

BR084 NEUTRON ACER TENDL-2024 LIBRARY; T=0.K  
protons from (n,p)

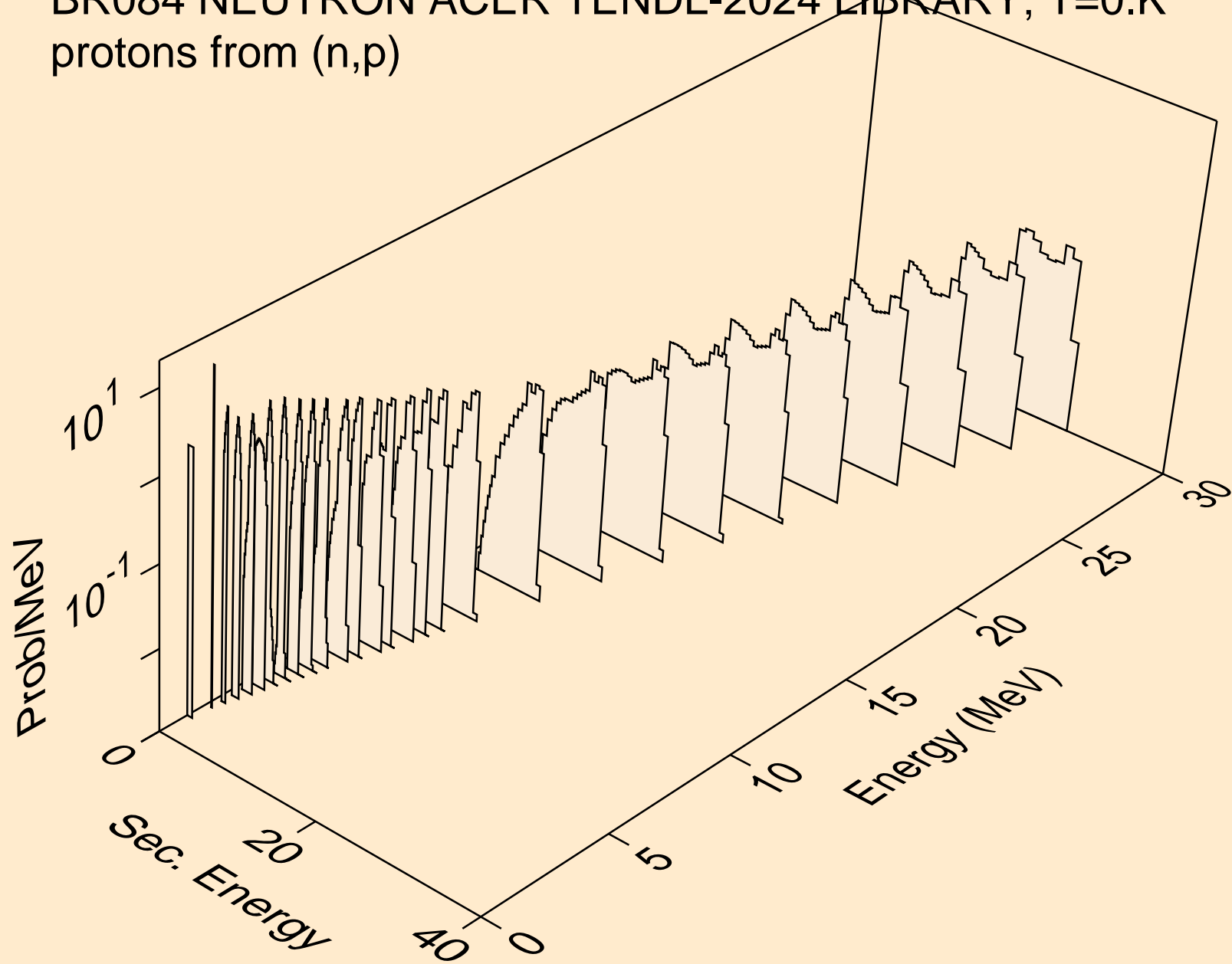

BR084 NEUTRON ACER TENDL-2024 LIBRARY; T=0.K  
protons from (n,2p)

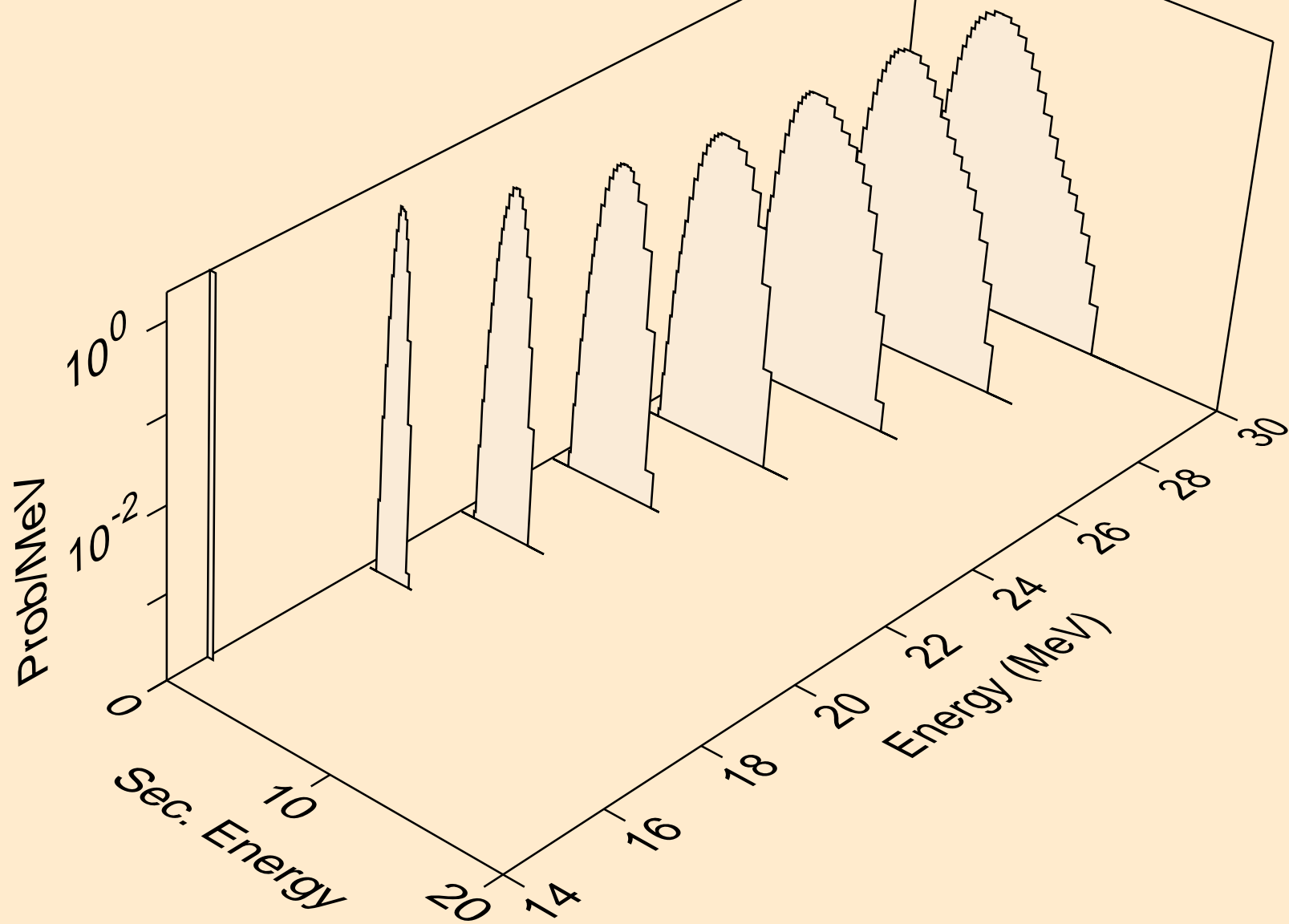

BR084 NEUTRON ACER TENDL-2024 LIBRARY; T=0.K  
protons from (n,p)

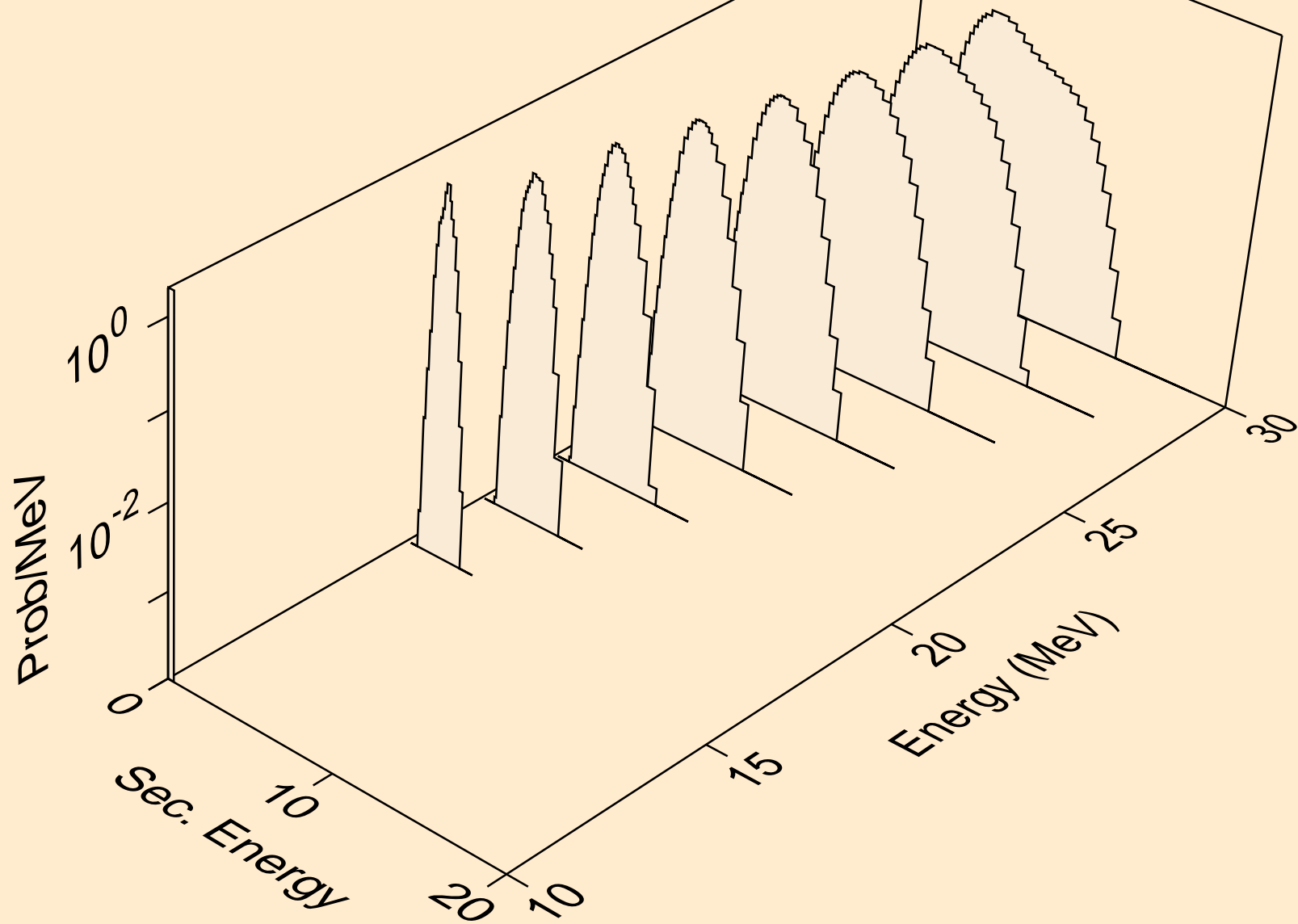

BR084 NEUTRON ACER TENDL-2024 LIBRARY; T=0.K  
protons from (n,pd)

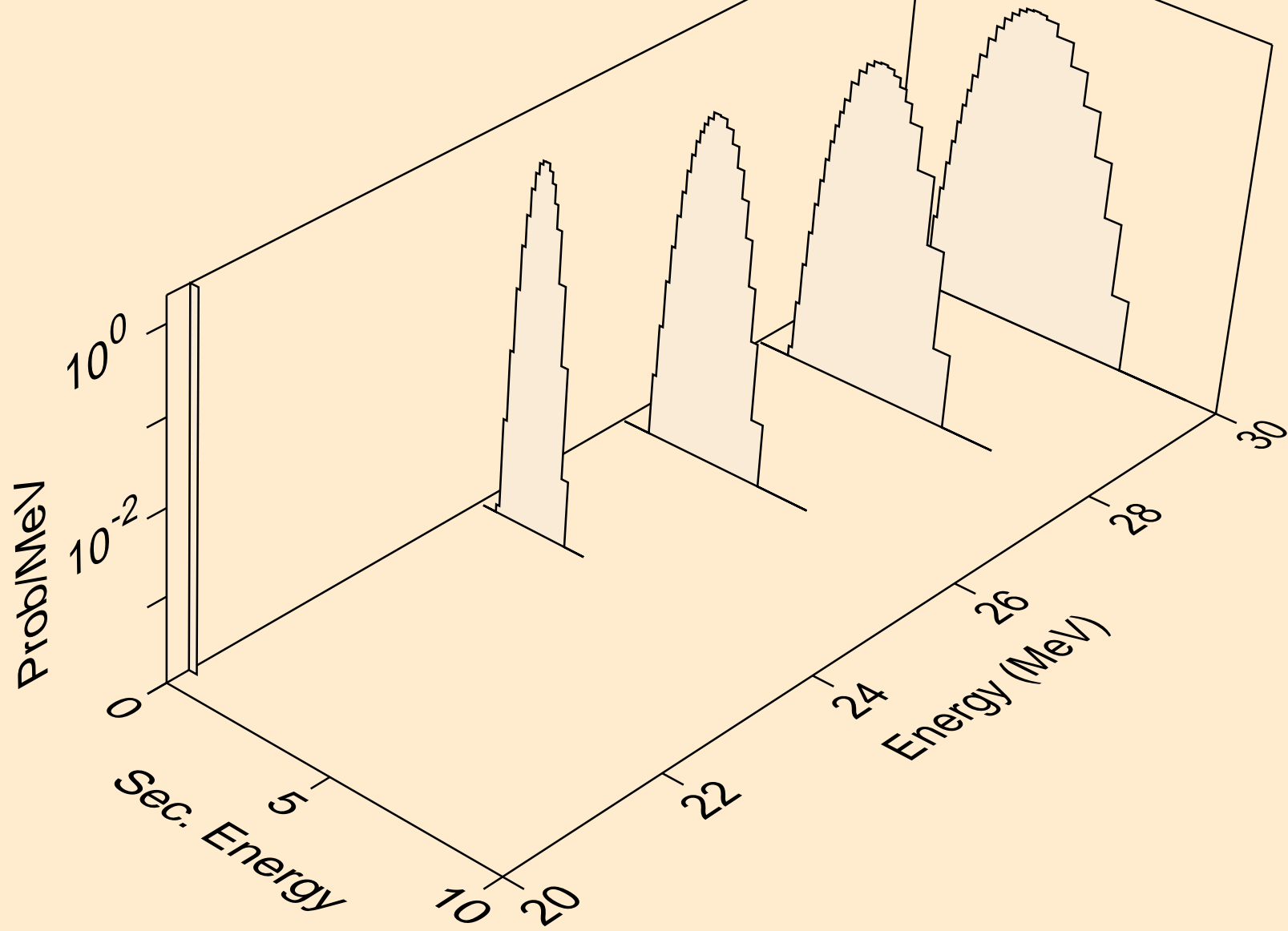

BR084 NEUTRON ACER TENDL-2024 LIBRARY; T=0.K  
protons from (n,pt)

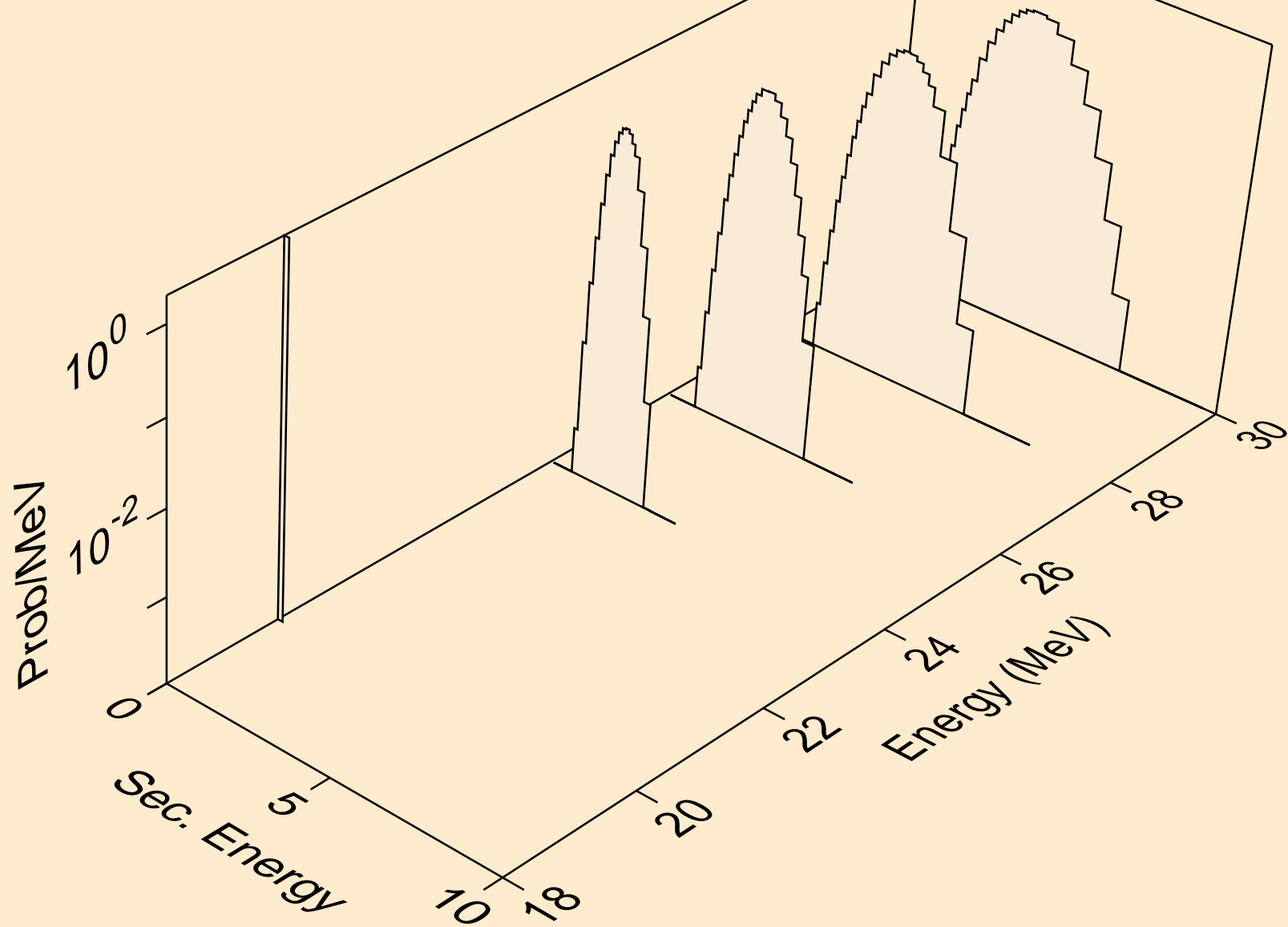

BR084 NEUTRON ACER TENDL-2024 LIBRARY; T=0.K  
deuterons from (n,x)

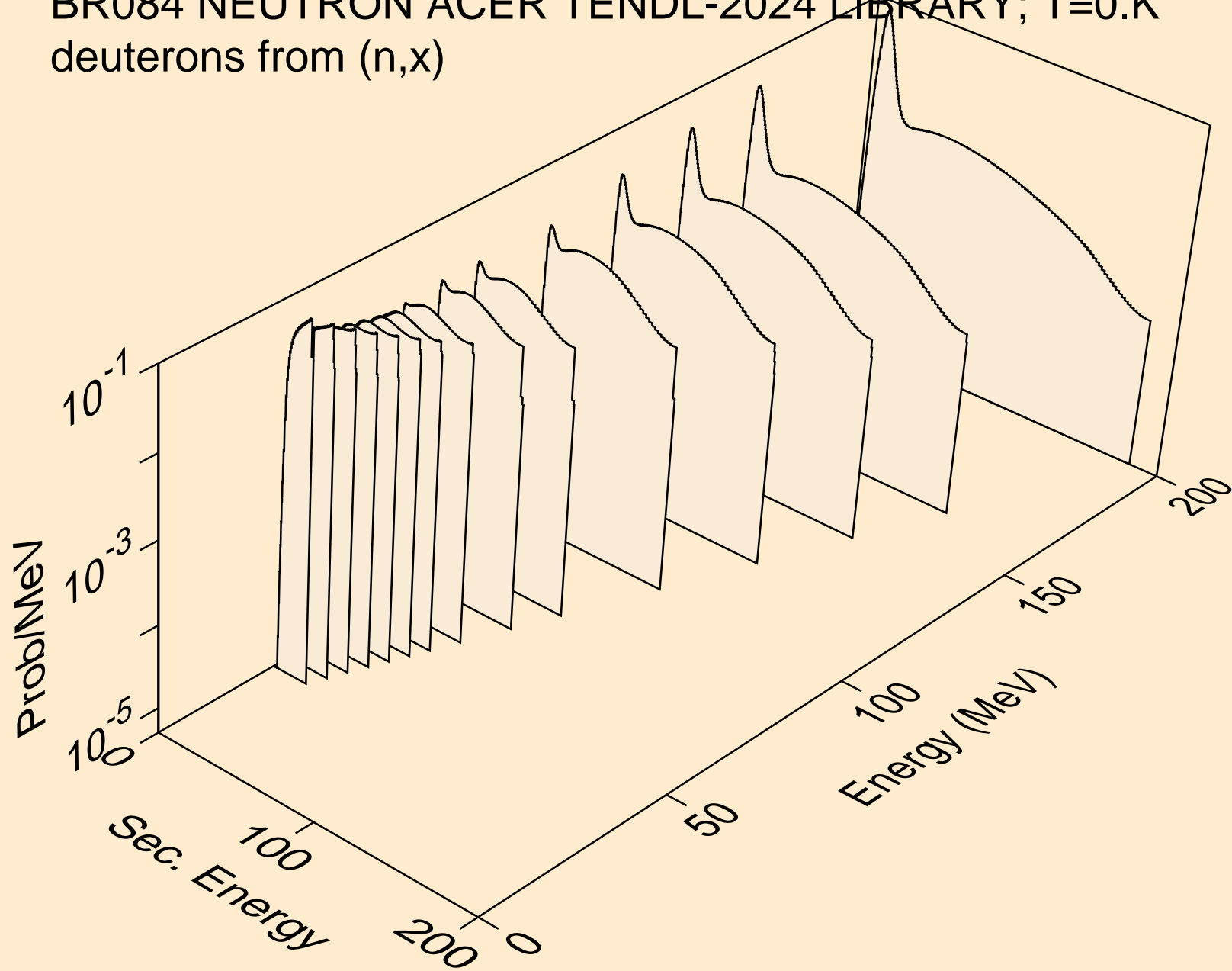



BR084 NEUTRON ACER TENDL-2024 LIBRARY; T=0.K  
deuterons from (n,2nd)

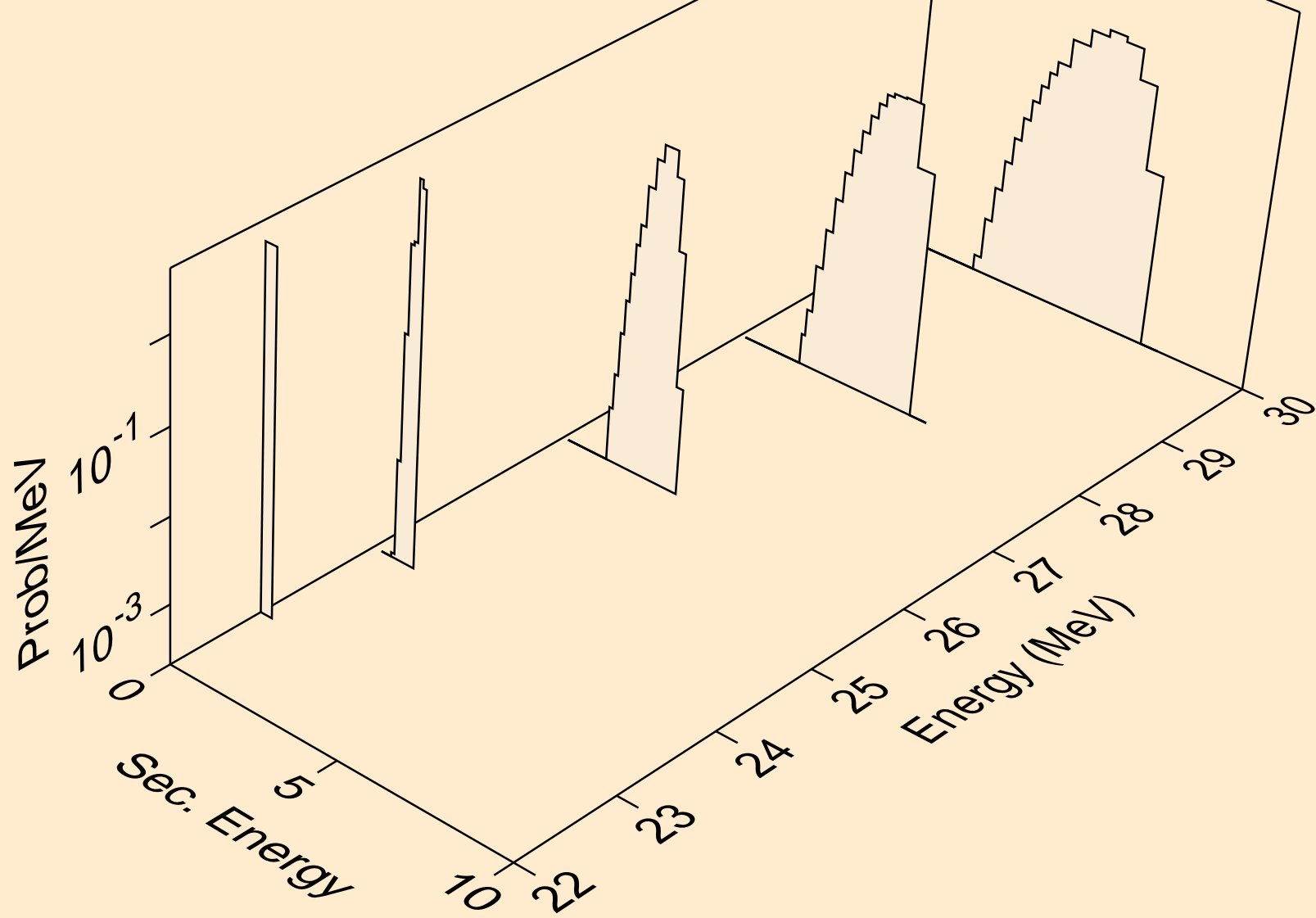

BR084 NEUTRON ACER TENDL-2024 LIBRARY; T=0.K  
deuterons from (n,n\*)d

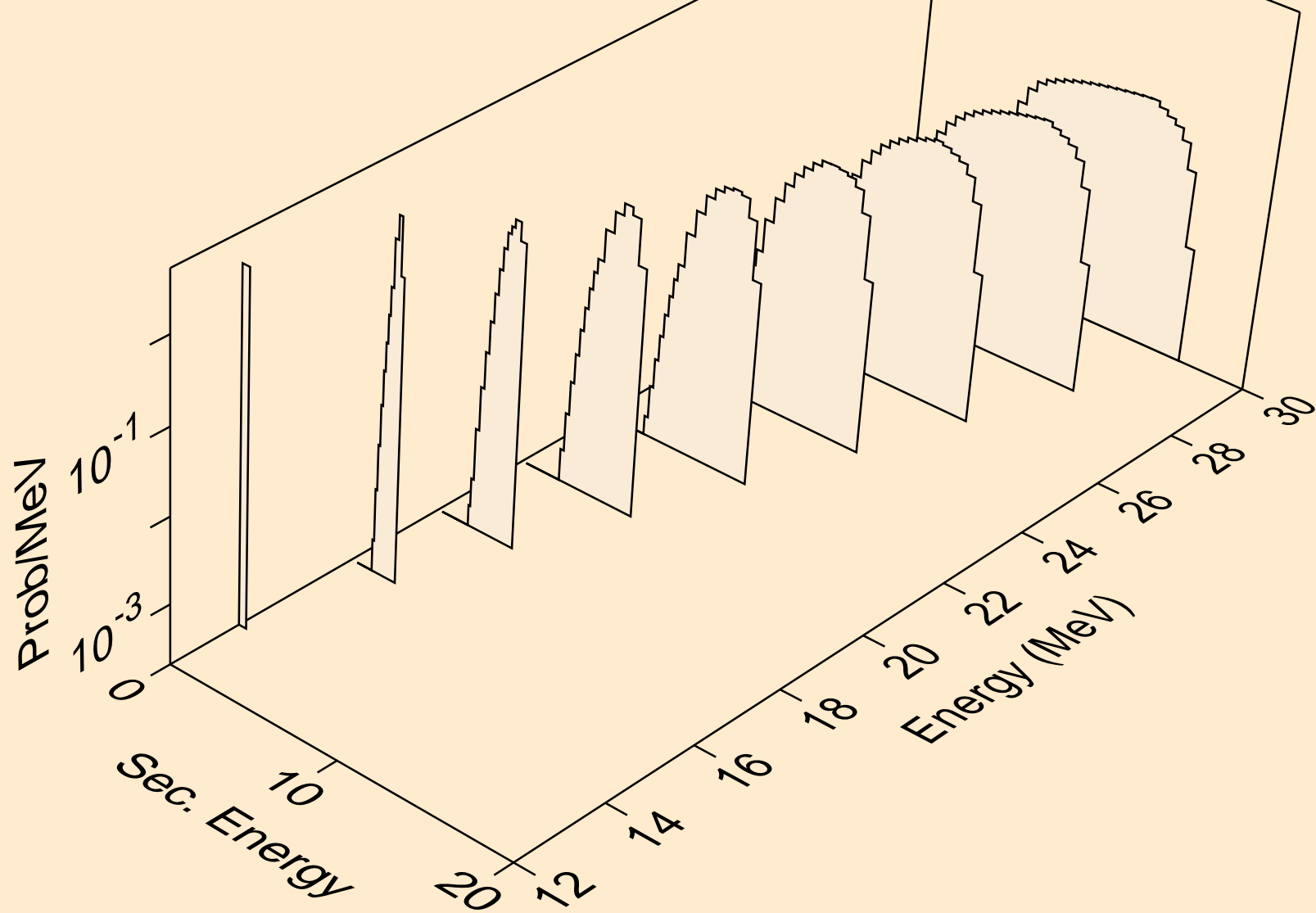

BR084 NEUTRON ACER TENDL-2024 LIBRARY; T=0.K  
deuterons from (n,d)

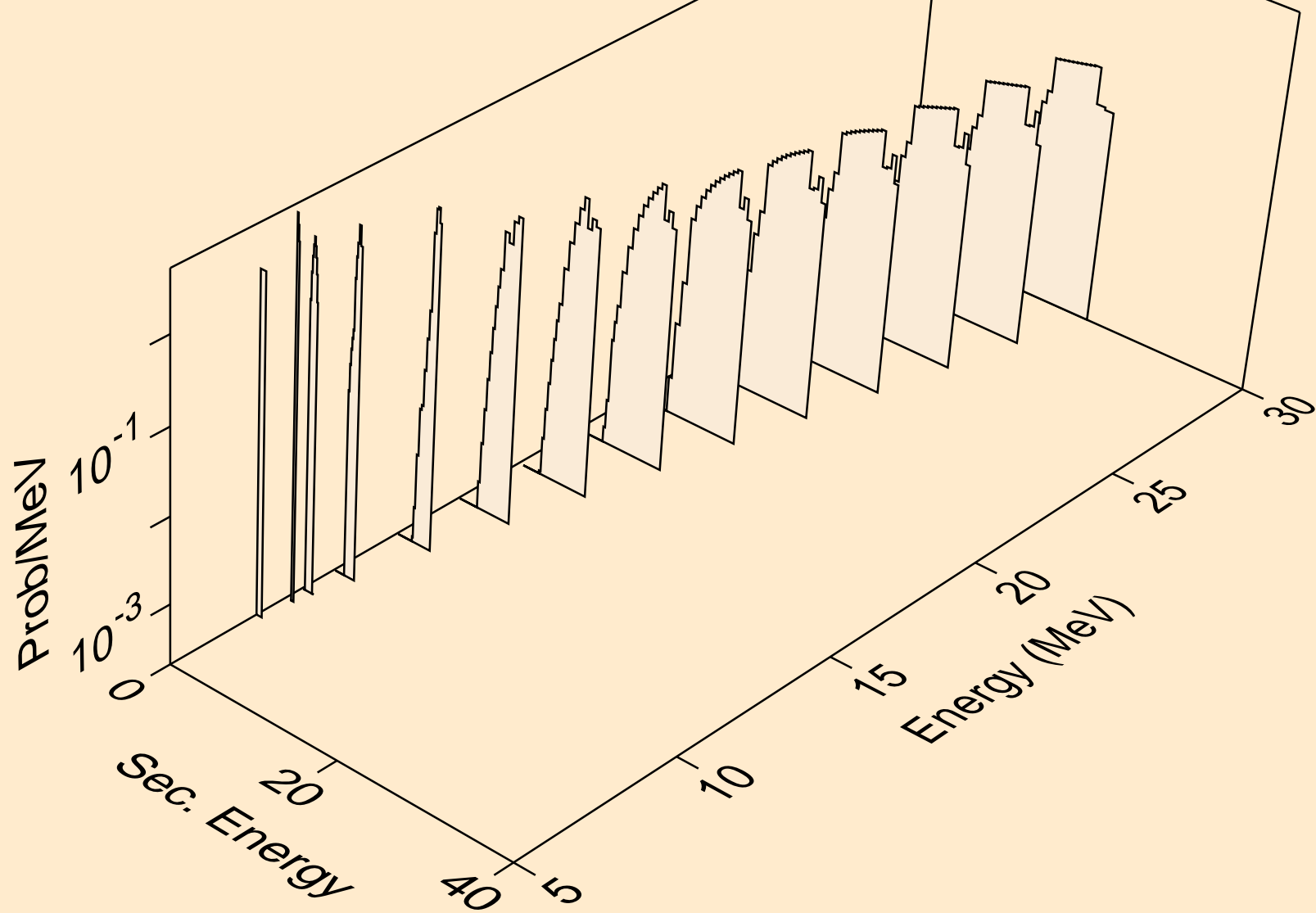

BR084 NEUTRON ACER TENDL-2024 LIBRARY; T=0.K  
deuterons from (n,pd)

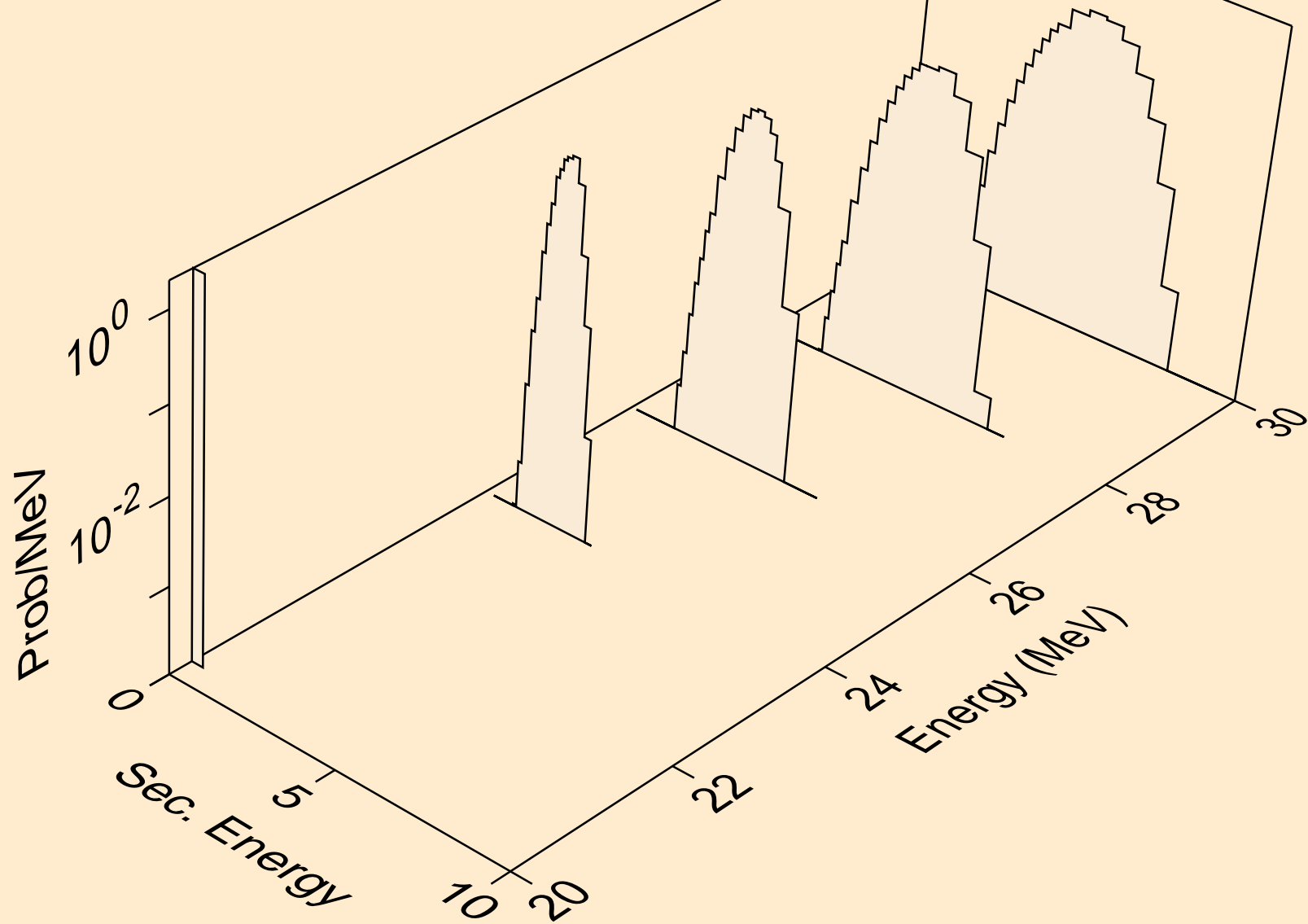

BR084 NEUTRON ACER TENDL-2024 LIBRARY; T=0.K  
tritons from (n,x)

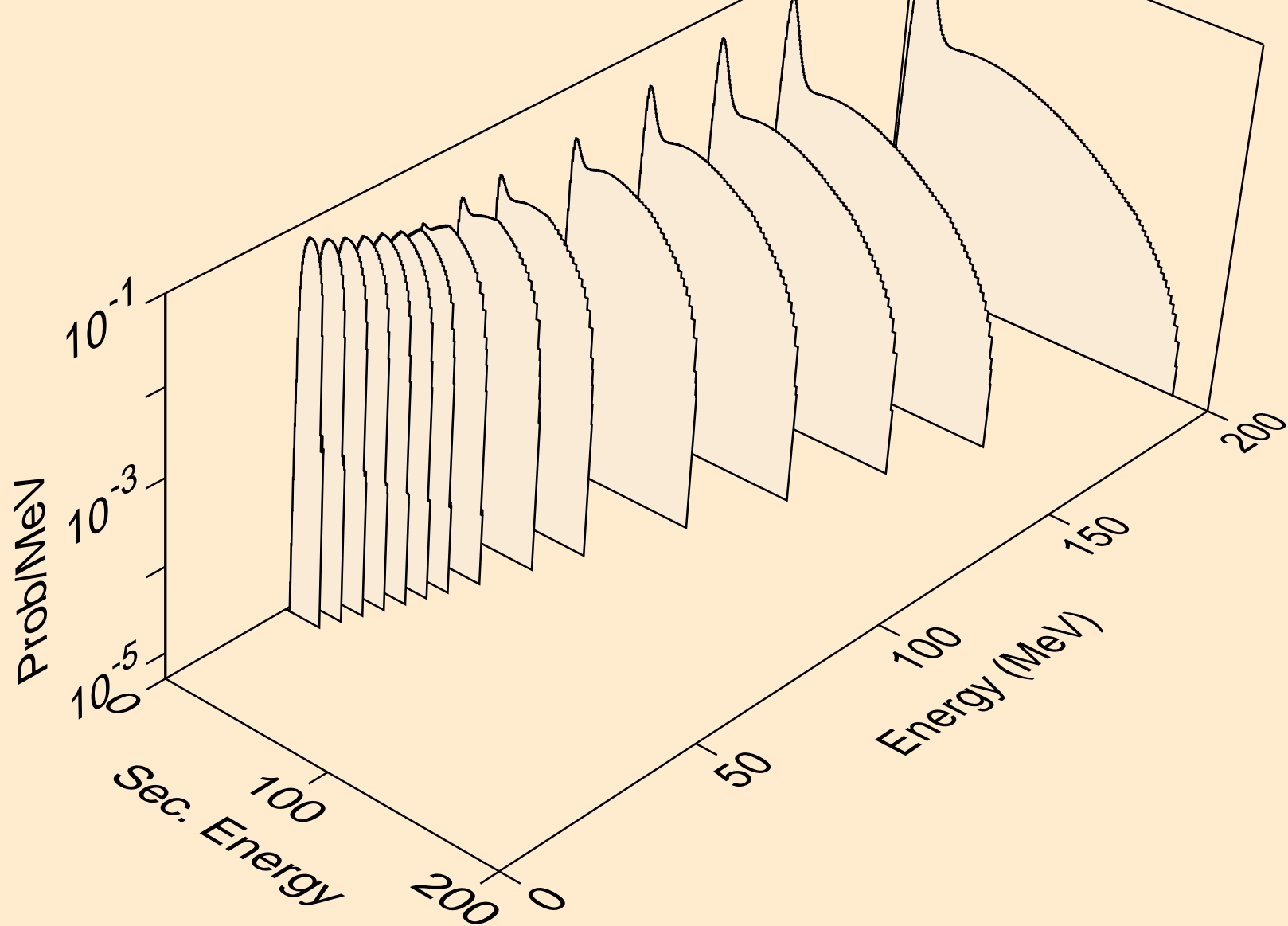

BR084 NEUTRON ACER TENDL-2024 LIBRARY; T=0.K  
tritons from (n,n\*)t

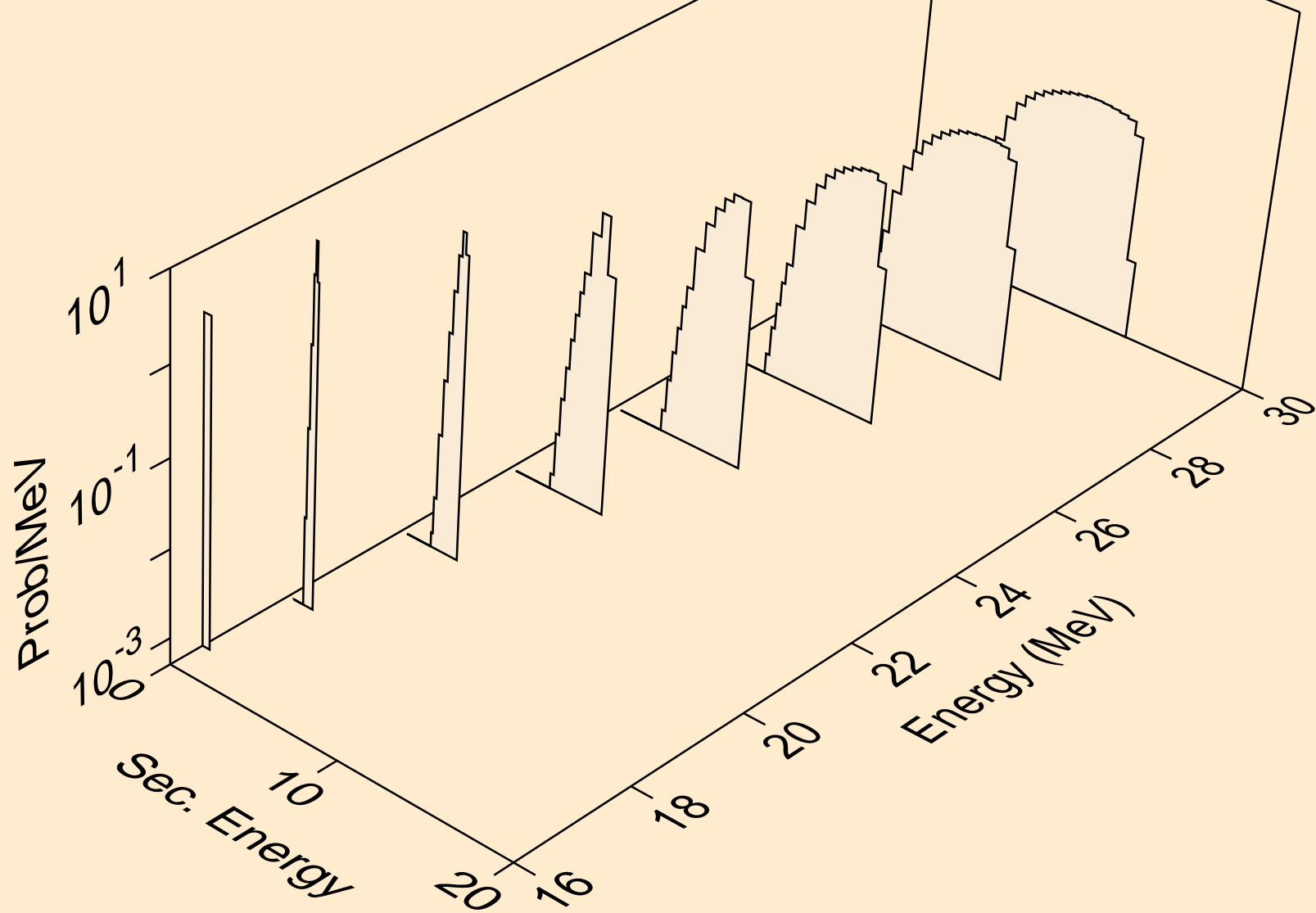

BR084 NEUTRON ACER TENDL-2024 LIBRARY; T=0.K  
tritons from (n,t)

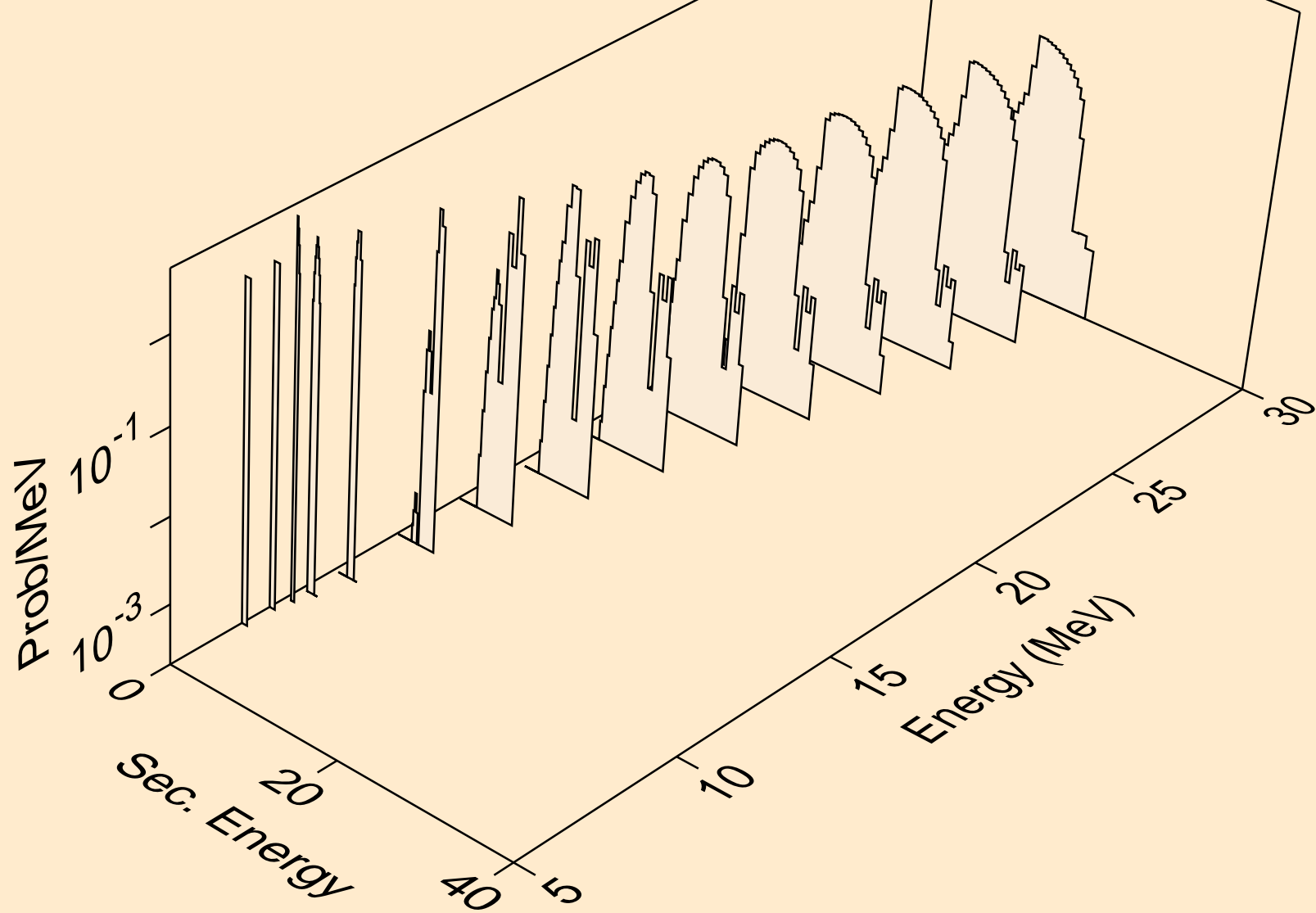

BR084 NEUTRON ACER TENDL-2024 LIBRARY; T=0.K  
tritons from (n,pt)

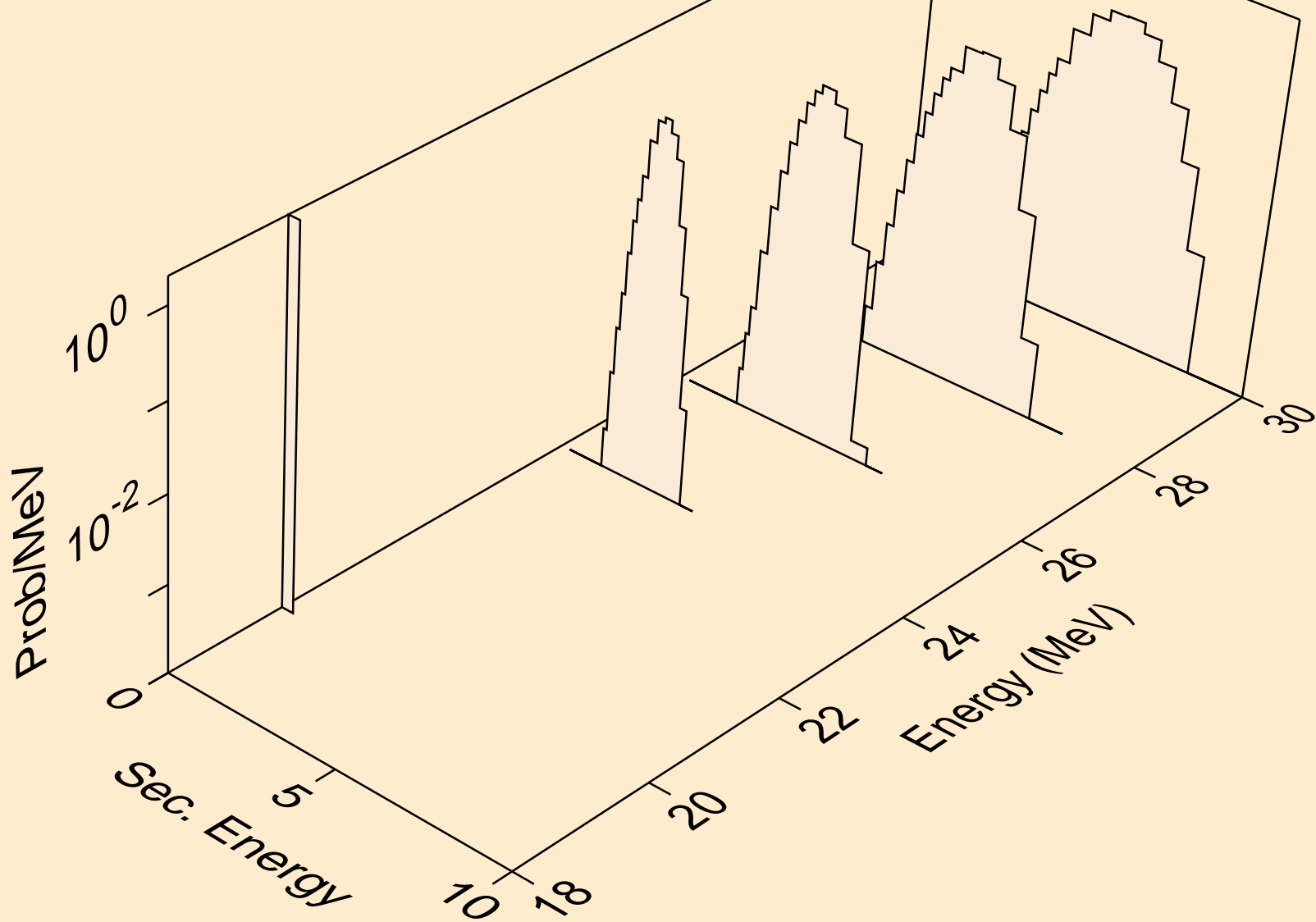



BR084 NEUTRON ACER TENDL-2024 LIBRARY; T=0.K  
he3s from (n,x)

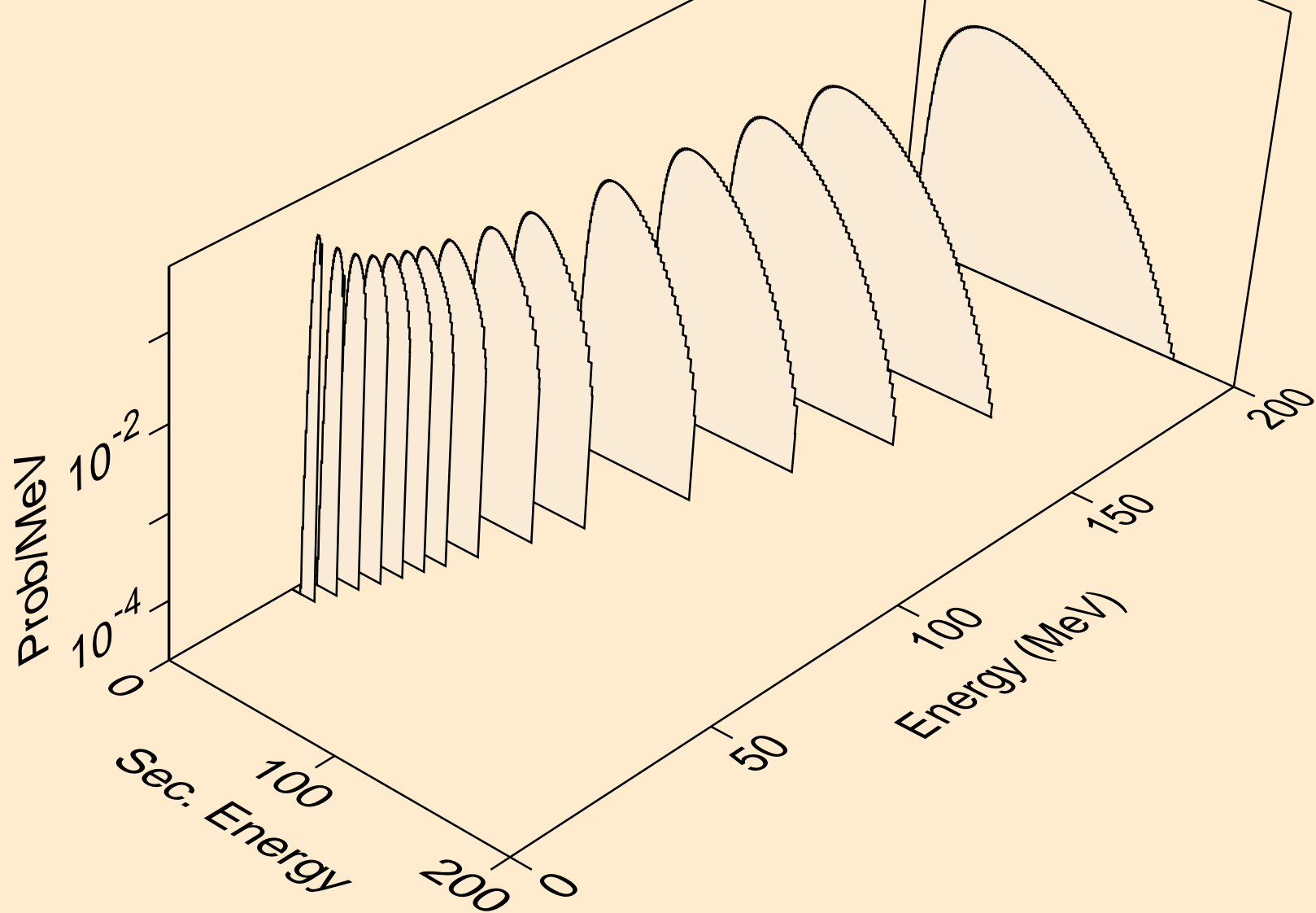

BR084 NEUTRON ACER TENDL-2024 LIBRARY; T=0.K  
he3s from (n,n\*)he3

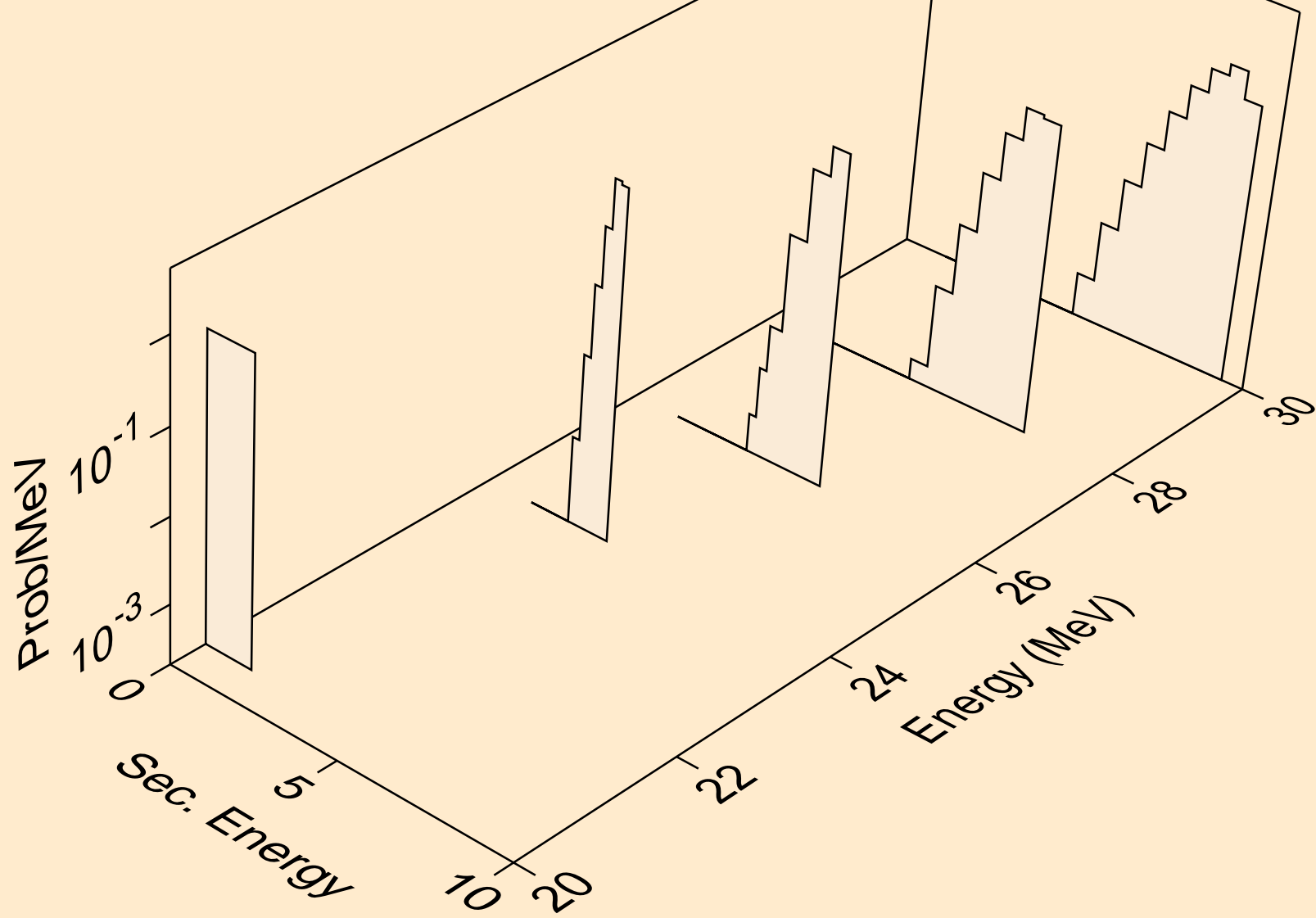

BR084 NEUTRON ACER TENDL-2024 LIBRARY; T=0.K  
he3s from (n,he3)

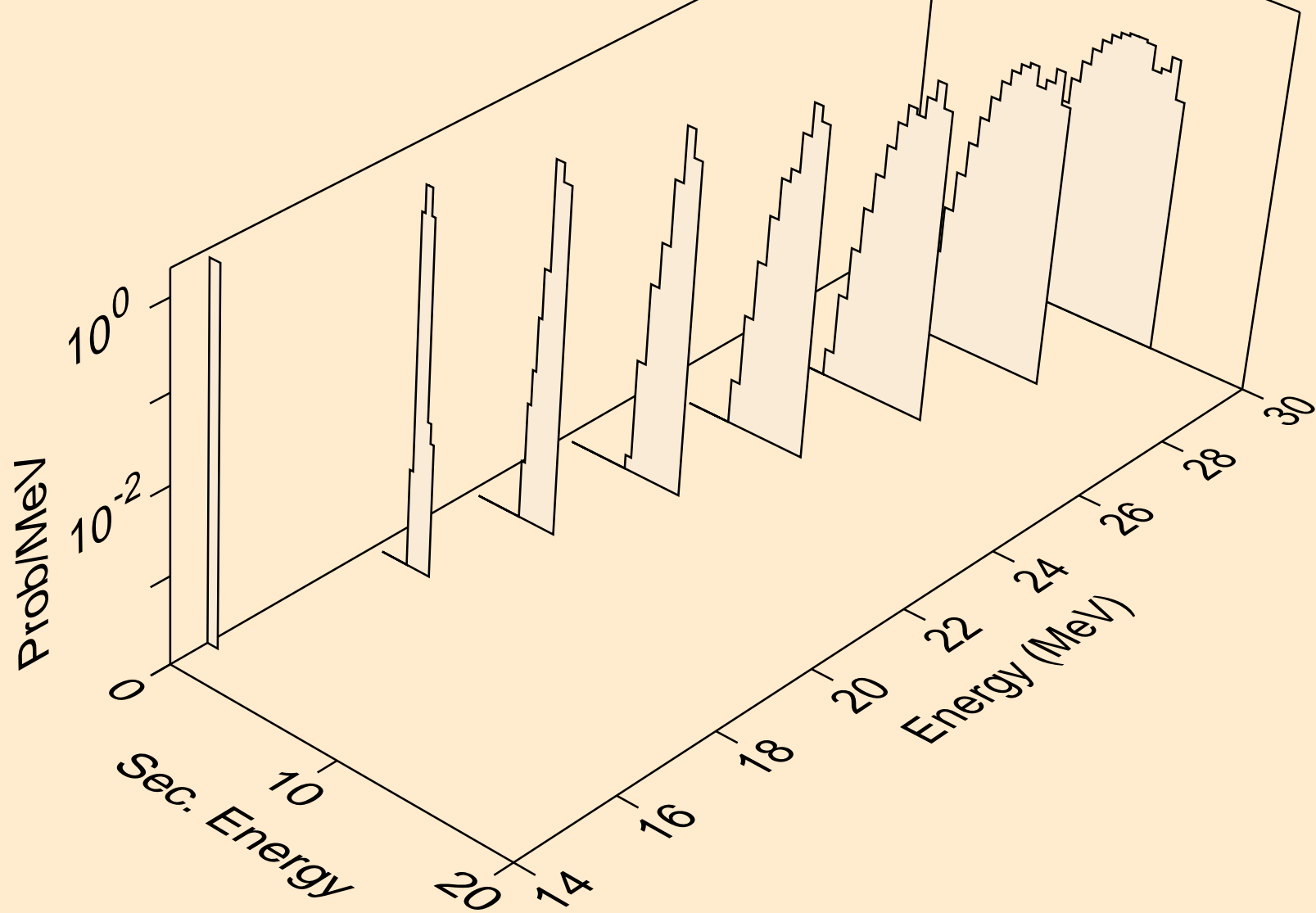

BR084 NEUTRON ACER TENDL-2024 LIBRARY; T=0.K  
alphas from (n,x)

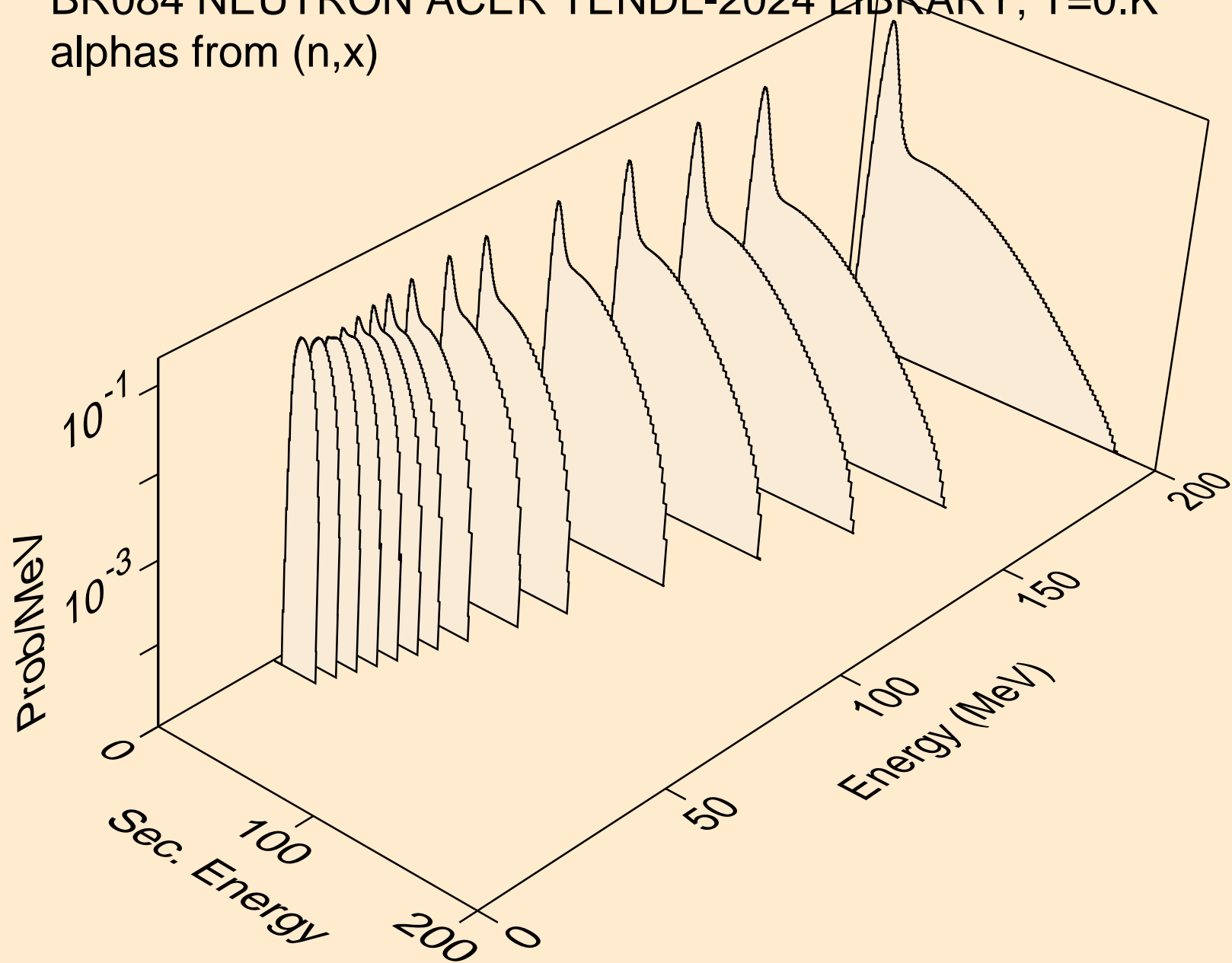

BR084 NEUTRON ACER TENDL-2024 LIBRARY; T=0.K  
alphas from (n,n\*)a

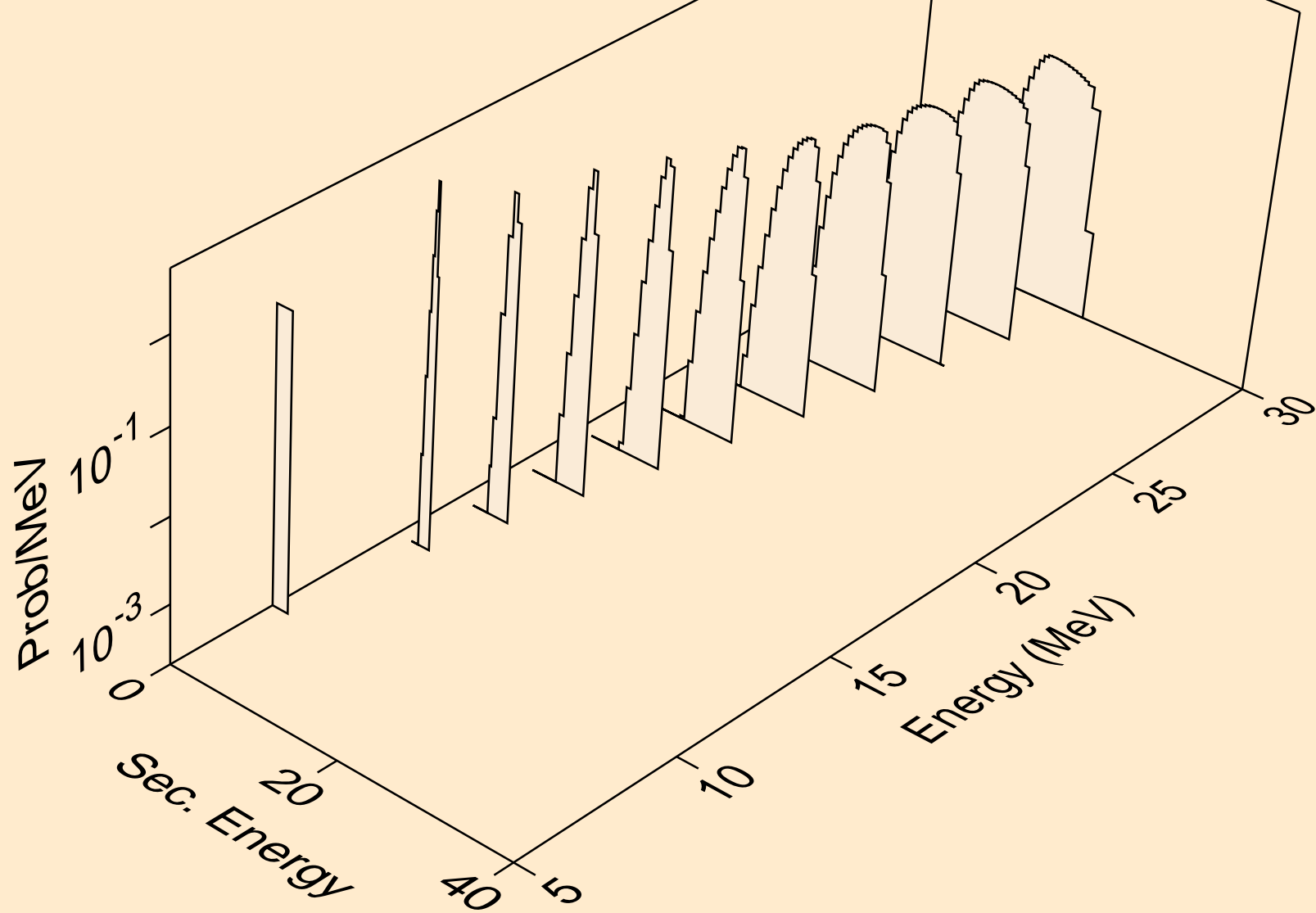

BR084 NEUTRON ACER TENDL-2024 LIBRARY; T=0.K  
alphas from (n,2n)a

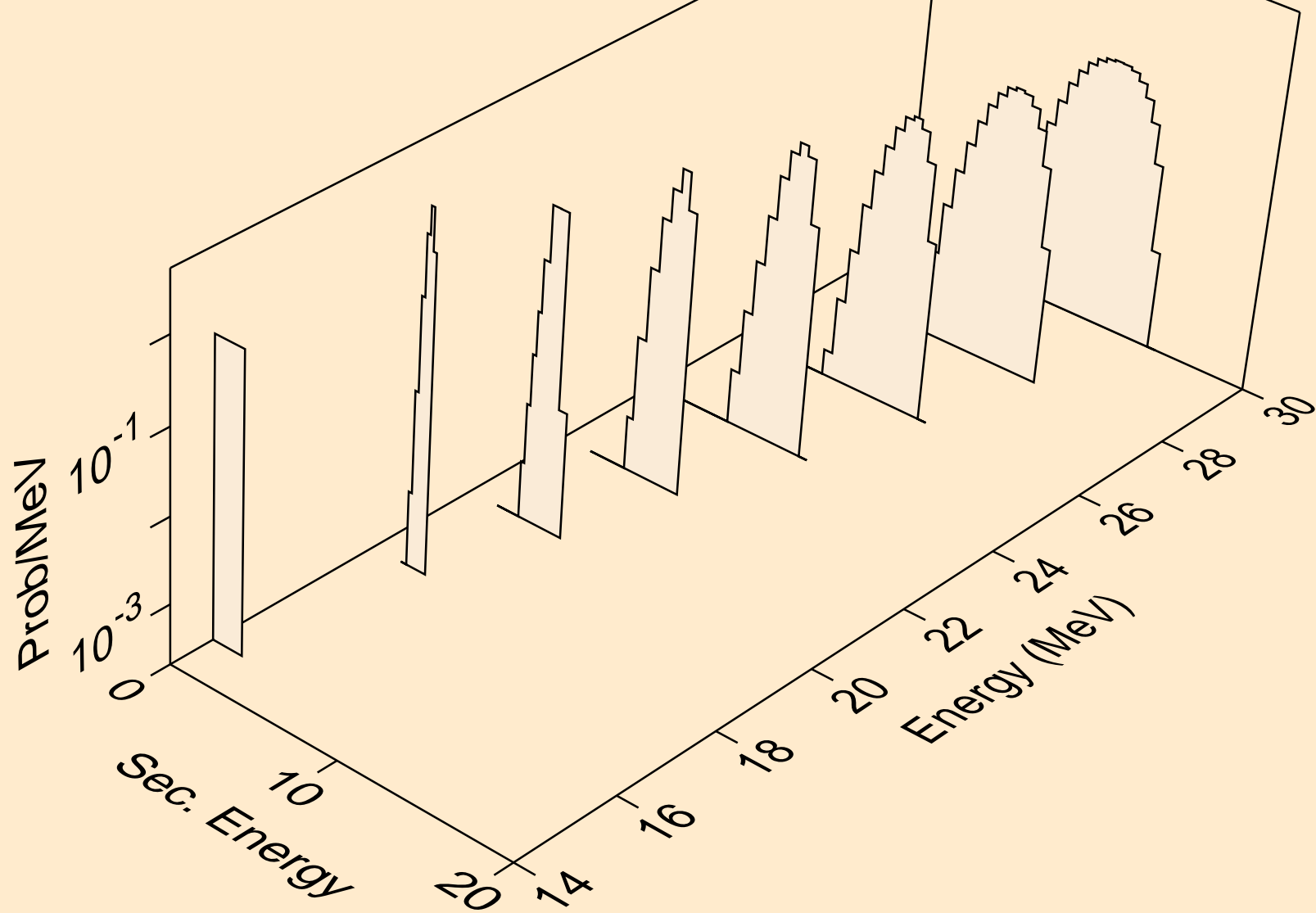

BR084 NEUTRON ACER TENDL-2024 LIBRARY; T=0.K  
alphas from (n,npa)

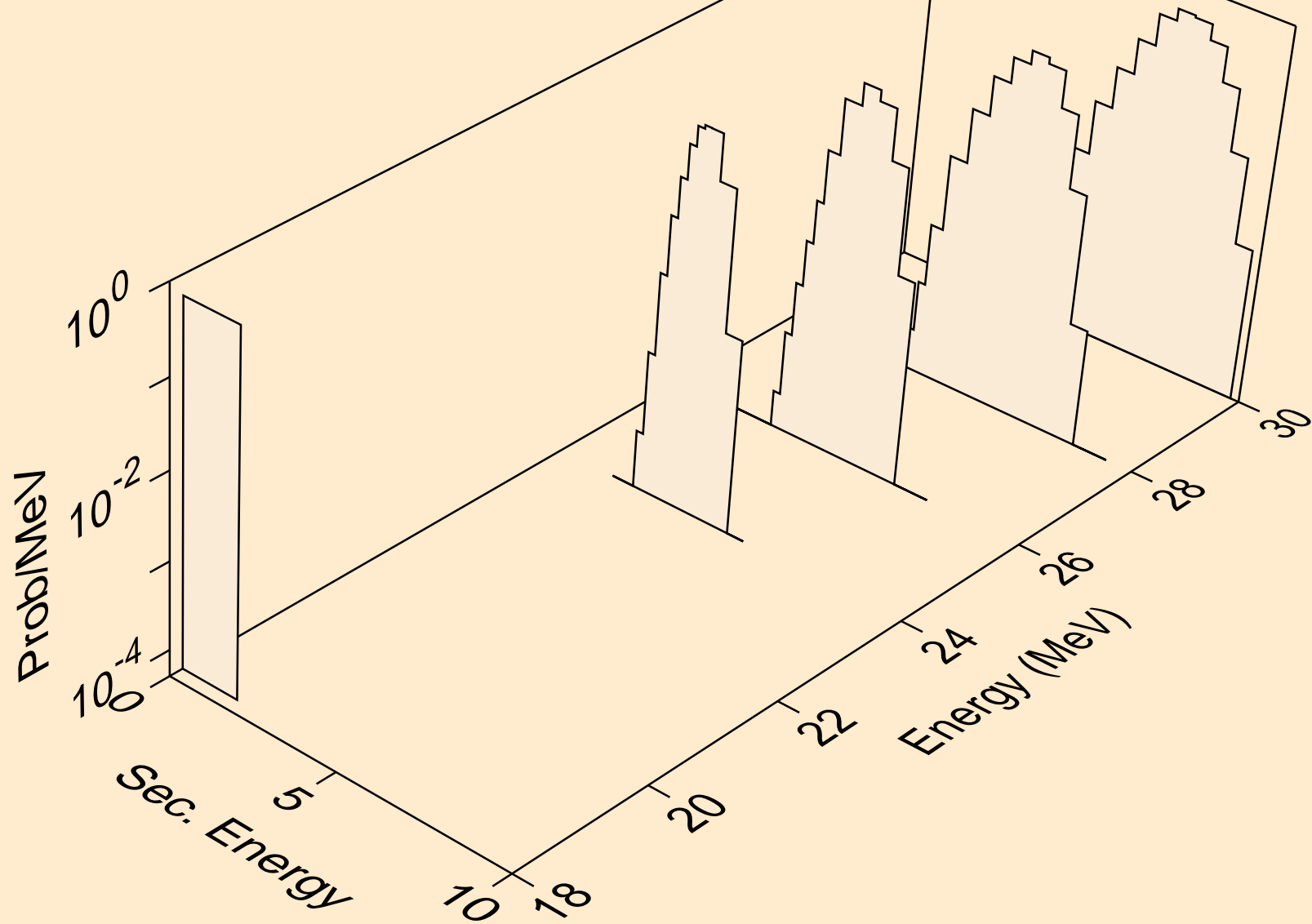

BR084 NEUTRON ACER TENDL-2024 LIBRARY; T=0.K  
alphas from (n,a)

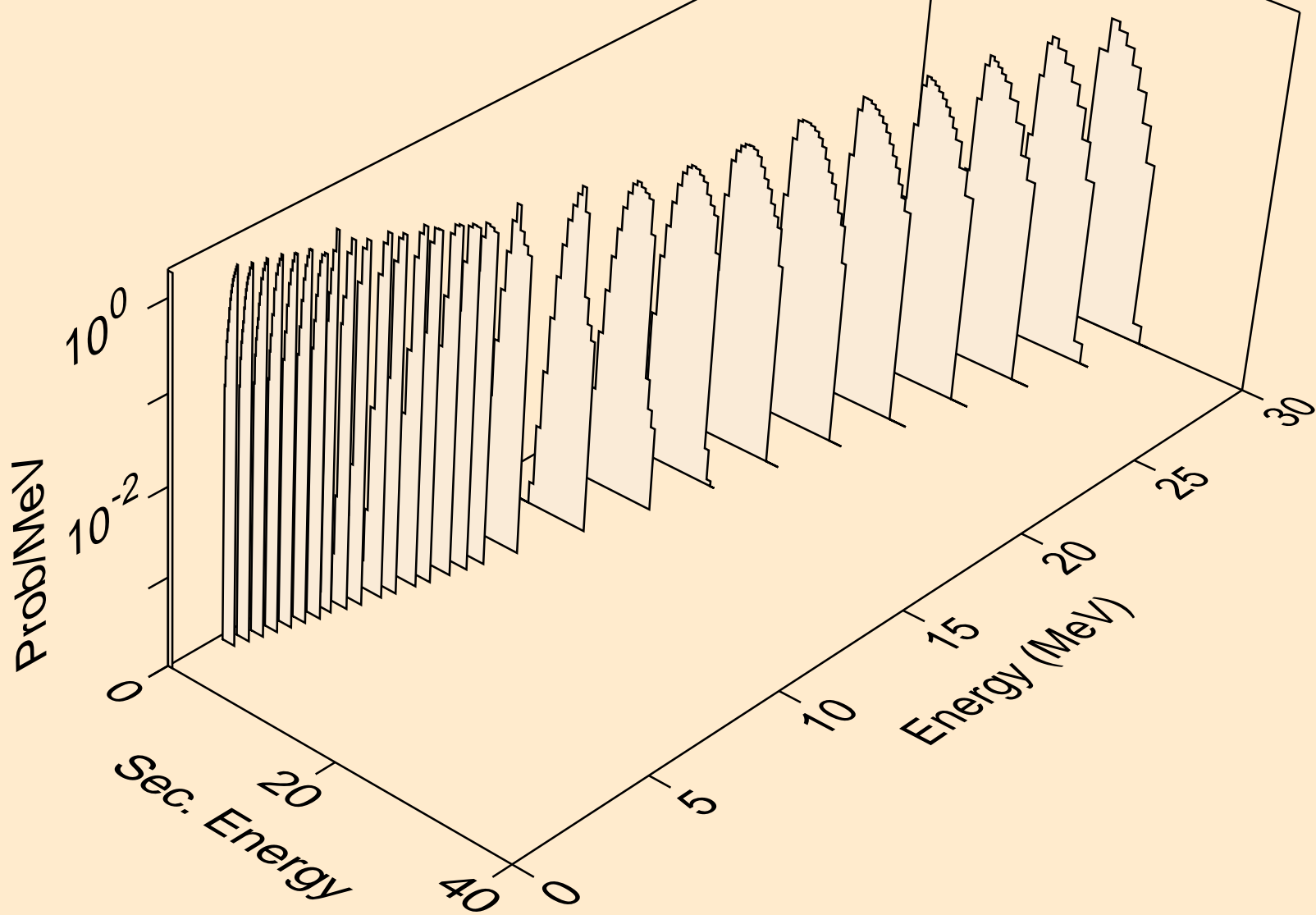



BR084 NEUTRON ACER TENDL-2024 LIBRARY; T=0.K  
alphas from (n,2a)

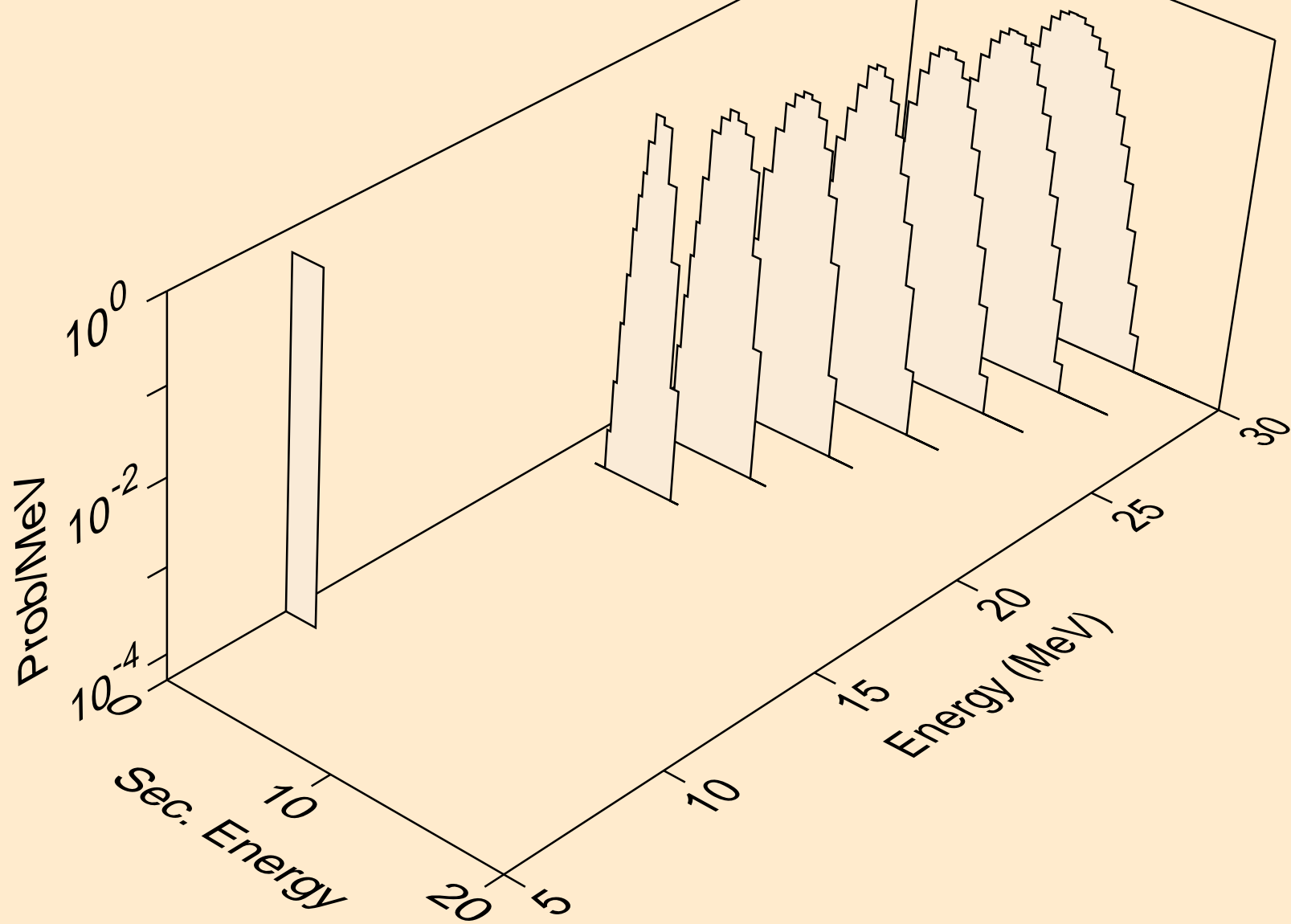

BR084 NEUTRON ACER TENDL-2024 LIBRARY; T=0.K  
alphas from (n,pa)

