

C015 NEUTRON ACER TENDL-2024 LIBRARY; T=0.K

Principal cross sections

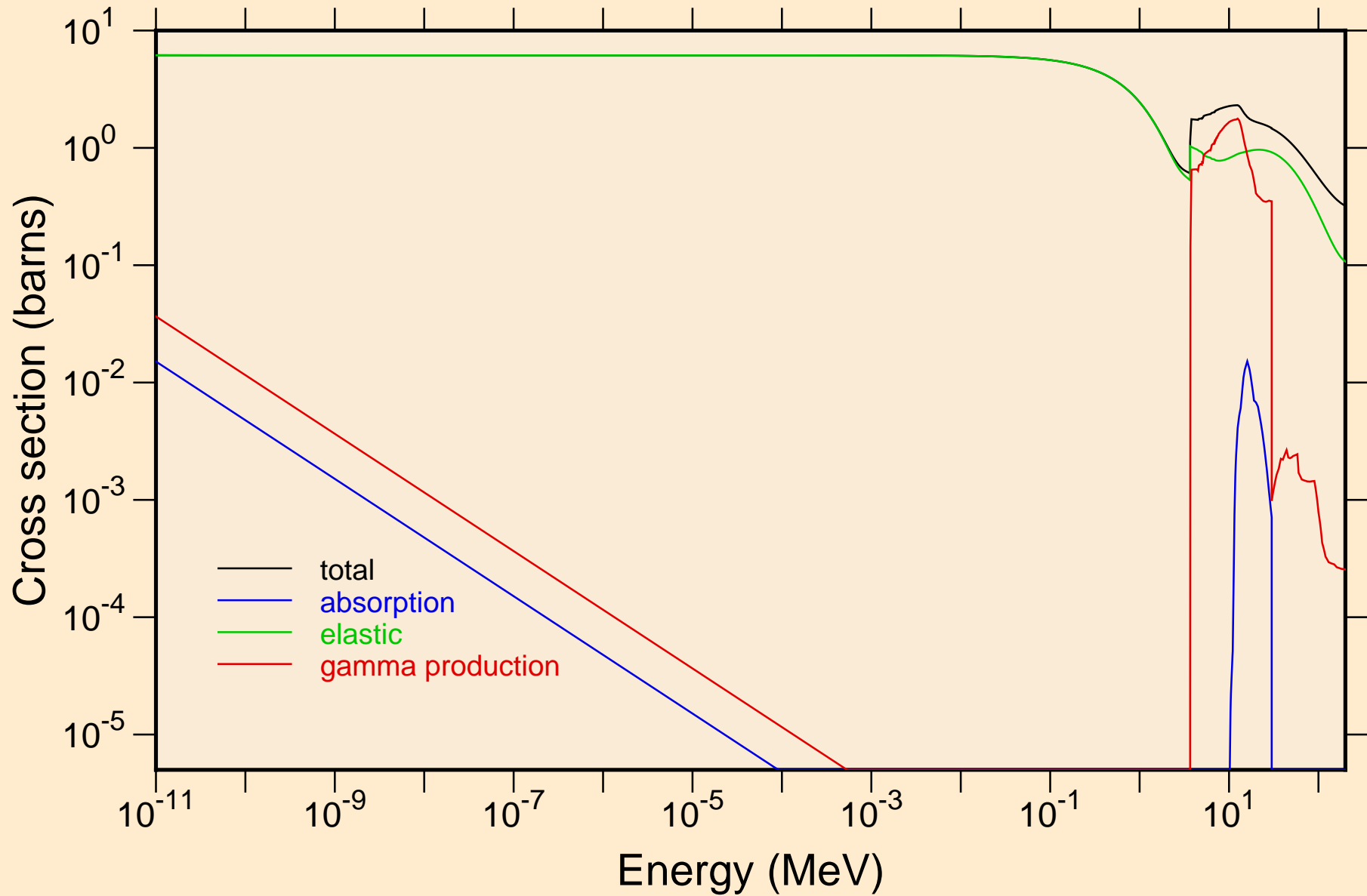

C015 NEUTRON ACER TENDL-2024 LIBRARY; T=0.K

Heating

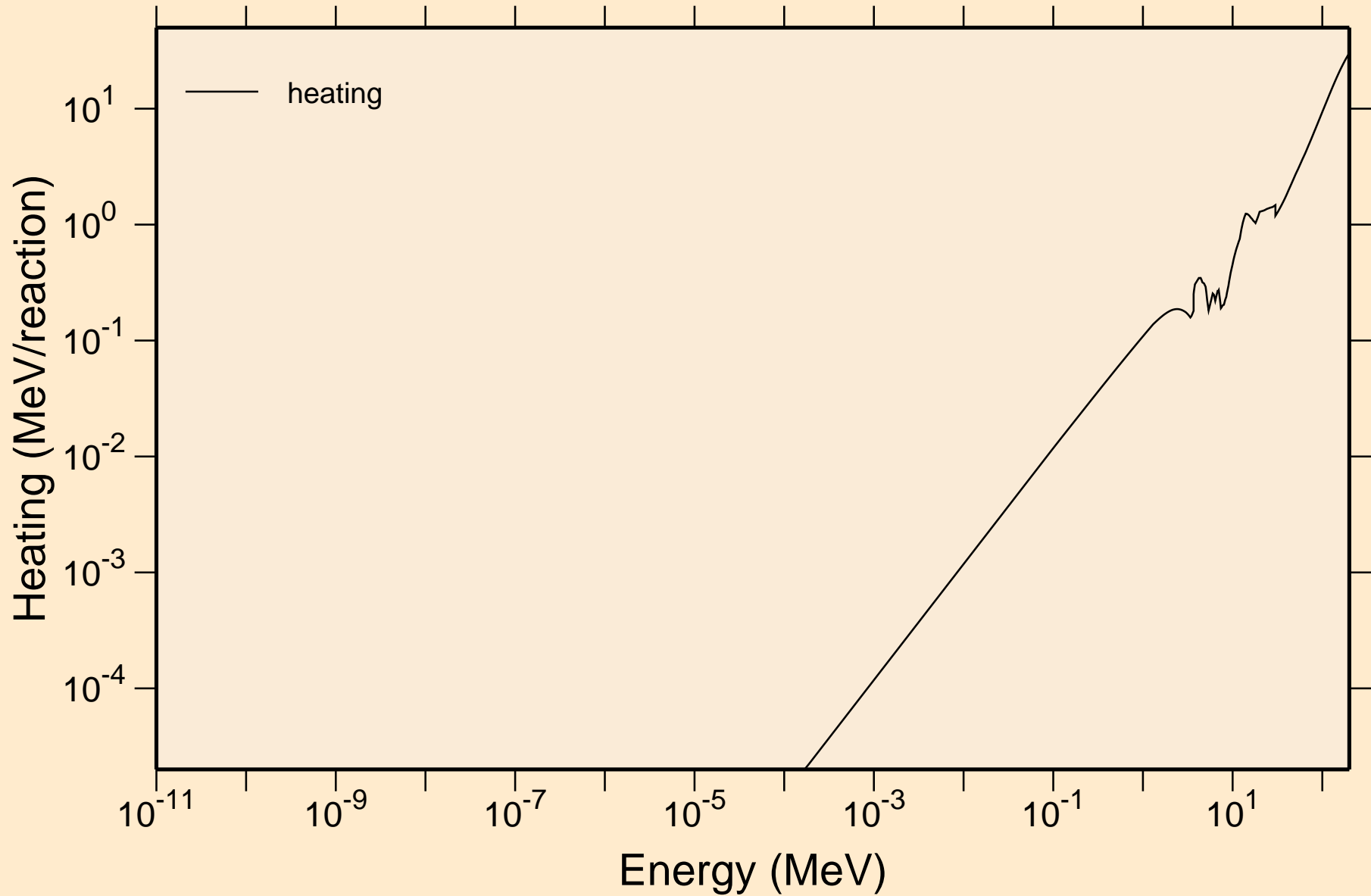

C015 NEUTRON ACER TENDL-2024 LIBRARY; T=0.K

Damage

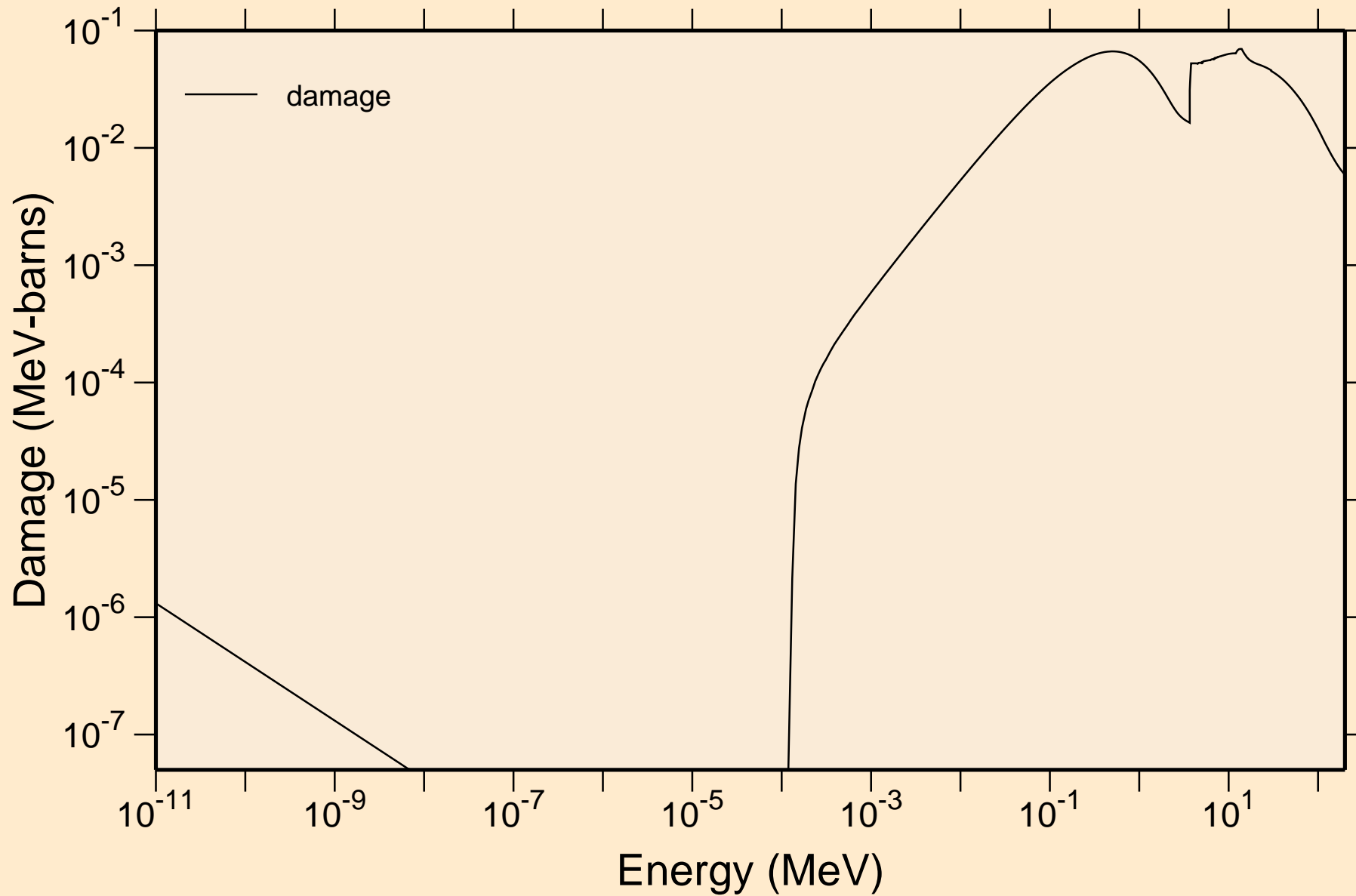

C015 NEUTRON ACER TENDL-2024 LIBRARY; T=0.K
Non-threshold reactions

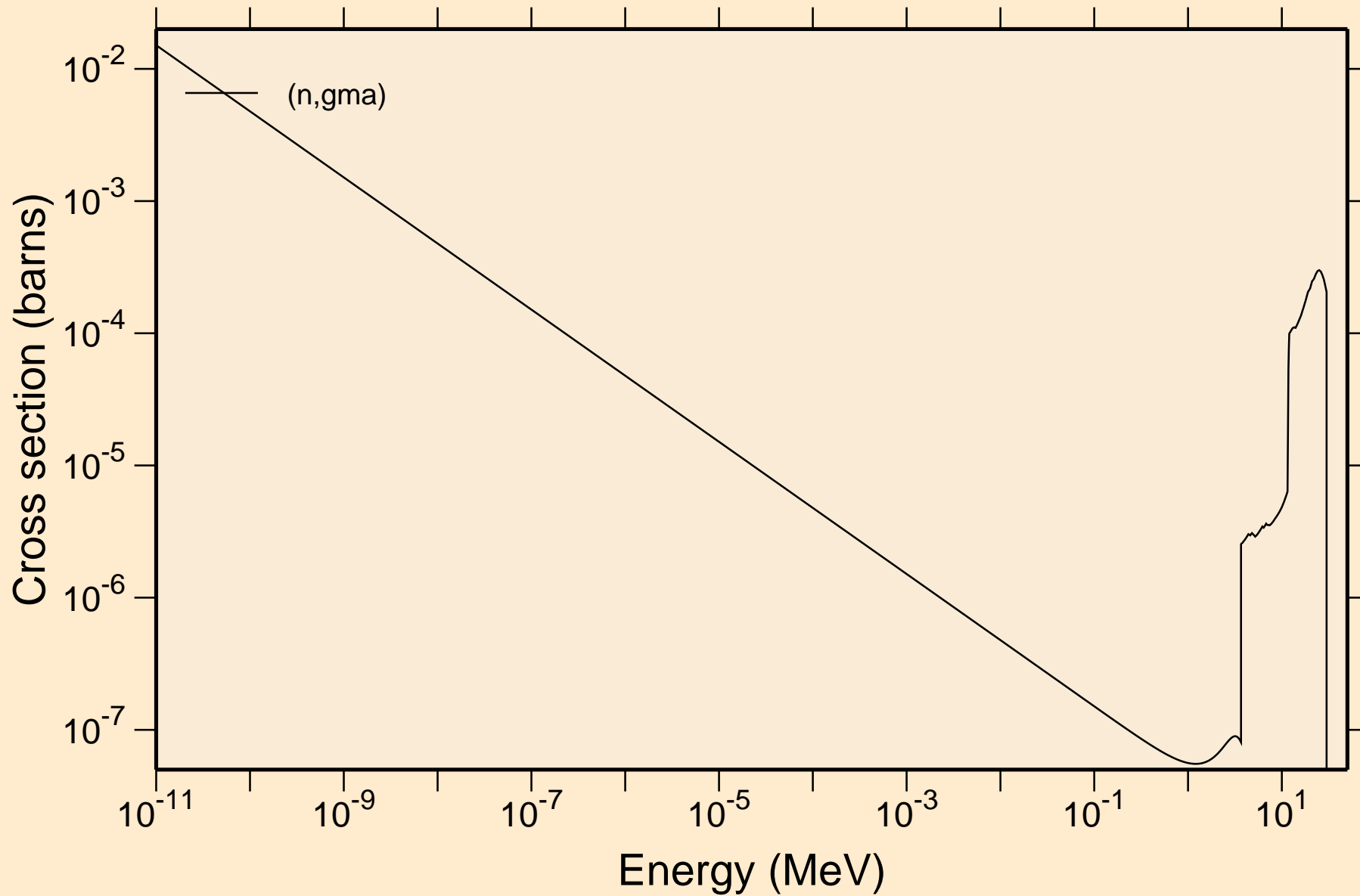

C015 NEUTRON ACER TENDL-2024 LIBRARY; T=0.K

Principal cross sections

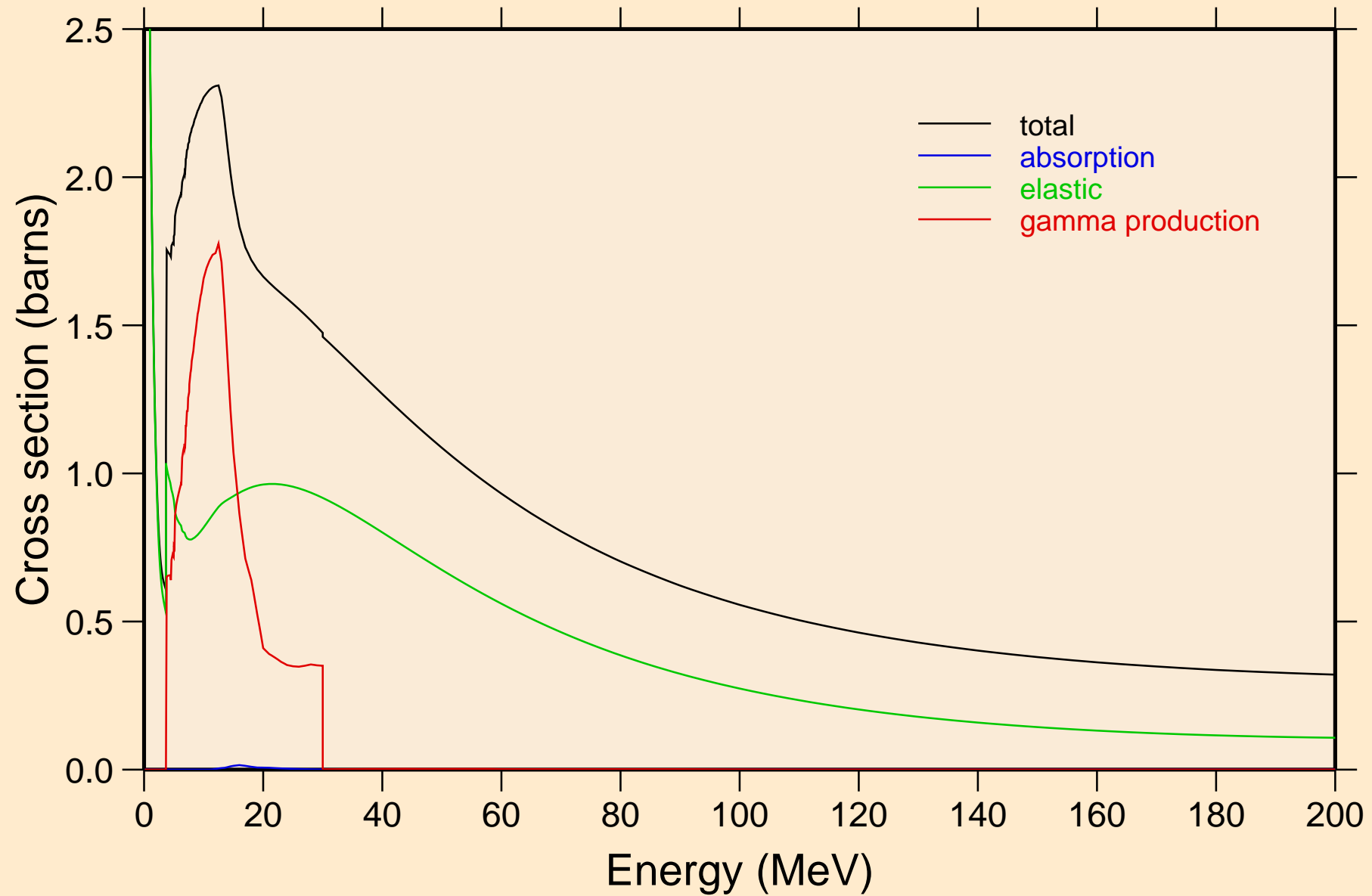

C015 NEUTRON ACER TENDL-2024 LIBRARY; T=0.K

Heating

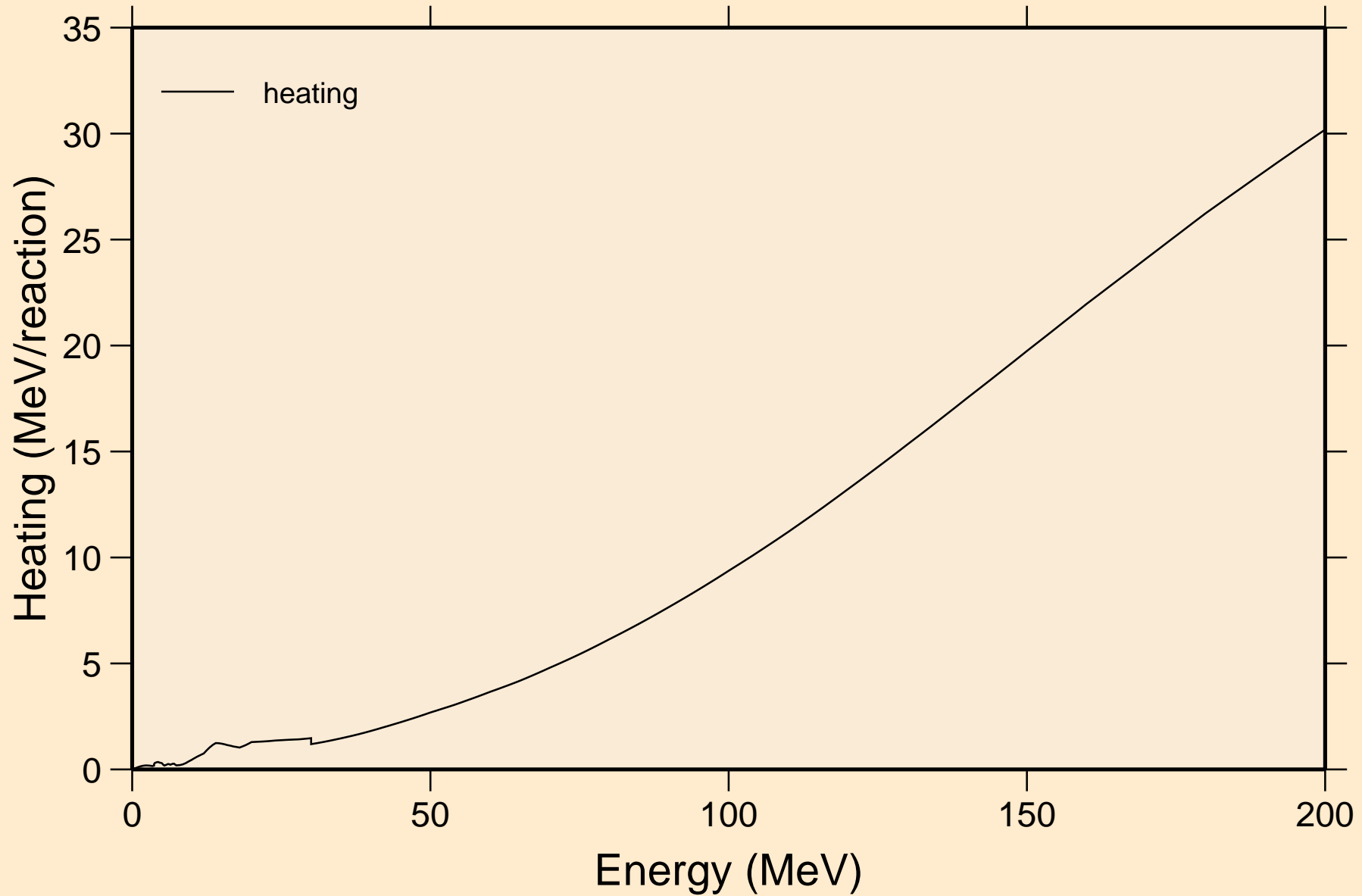

C015 NEUTRON ACER TENDL-2024 LIBRARY; T=0.K

Damage

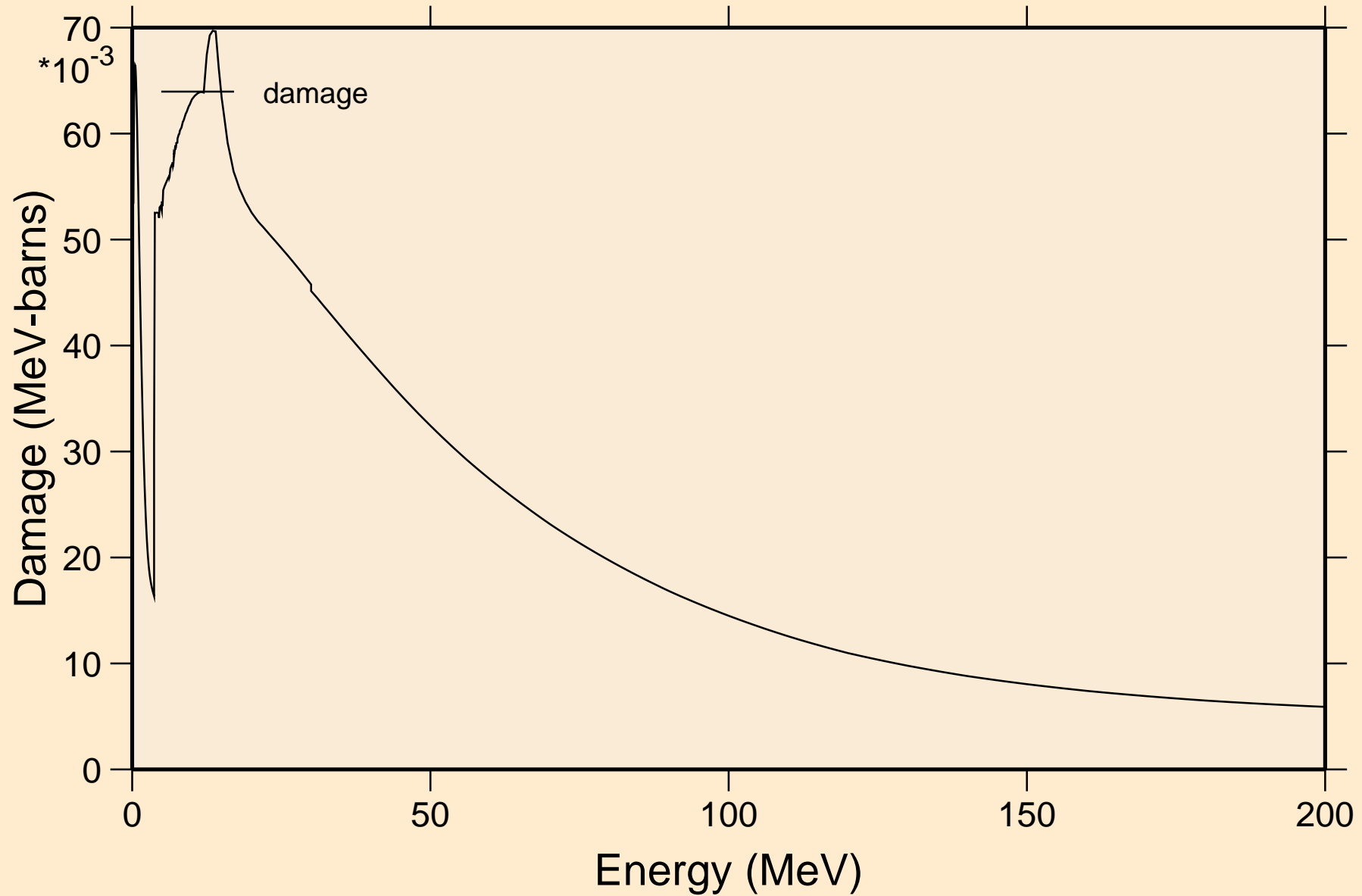

C015 NEUTRON ACER TENDL-2024 LIBRARY; T=0.K
Non-threshold reactions

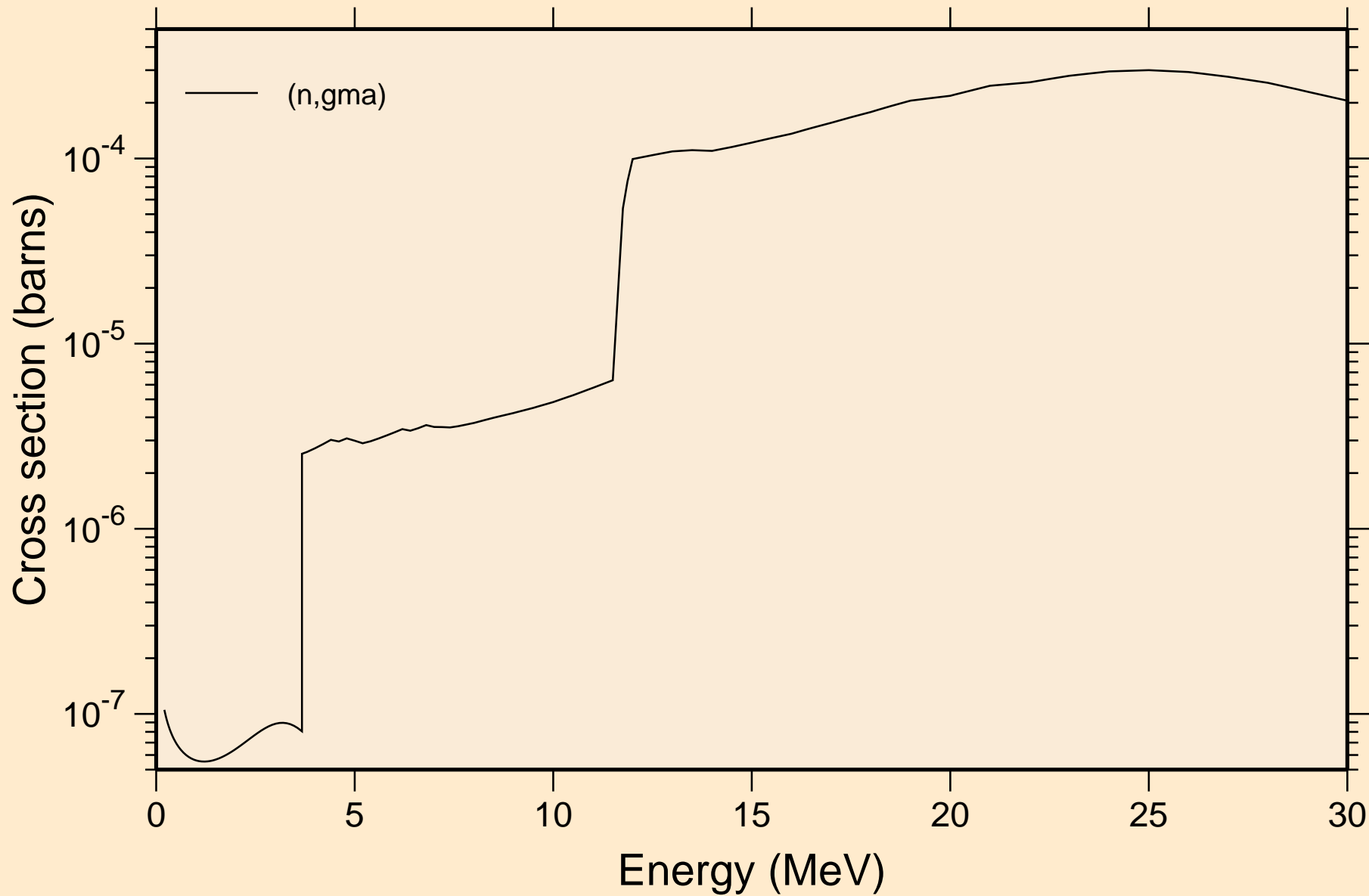

C015 NEUTRON ACER TENDL-2024 LIBRARY; T=0.K
Inelastic levels

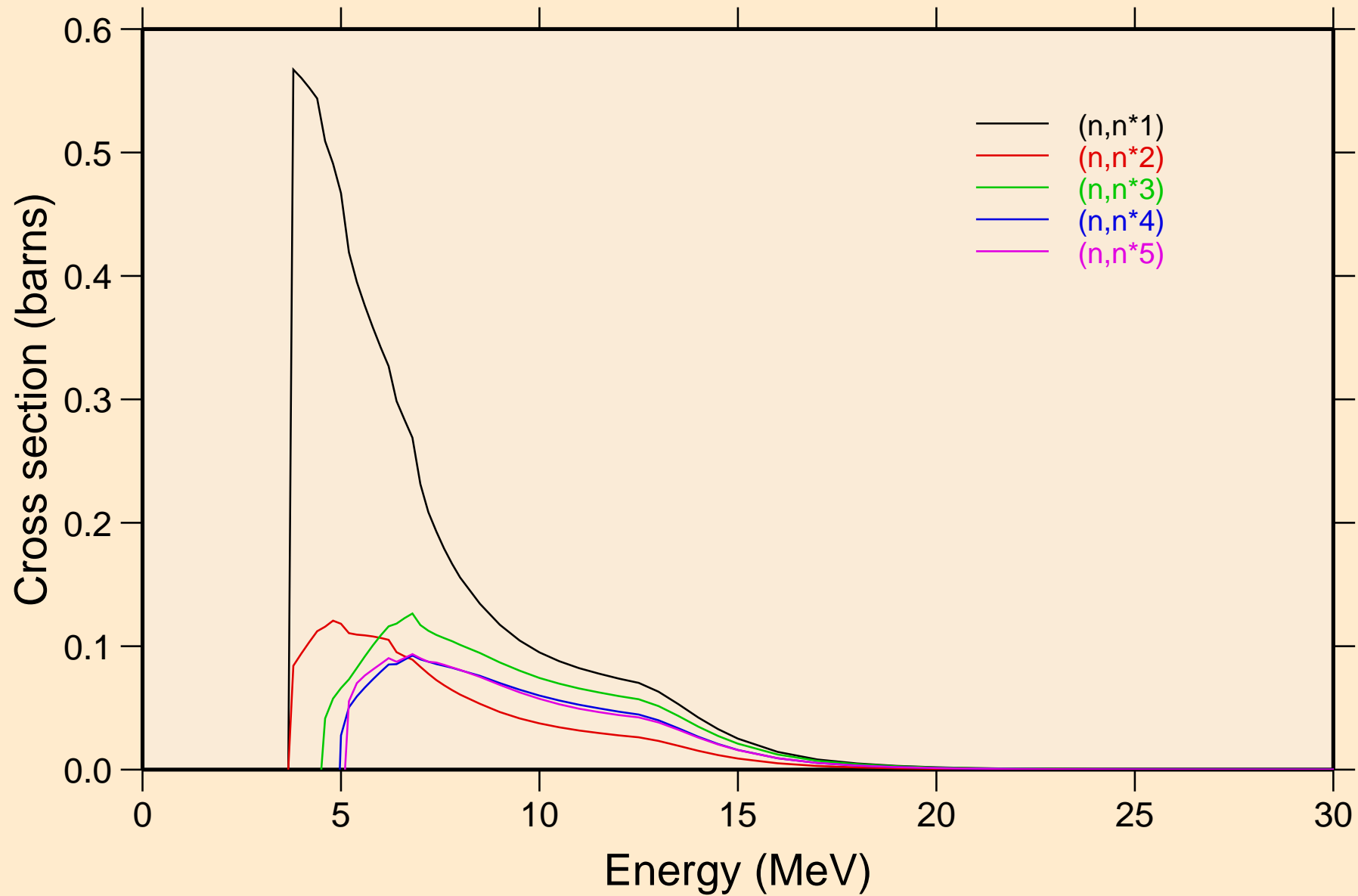

C015 NEUTRON ACER TENDL-2024 LIBRARY; T=0.K
Inelastic levels

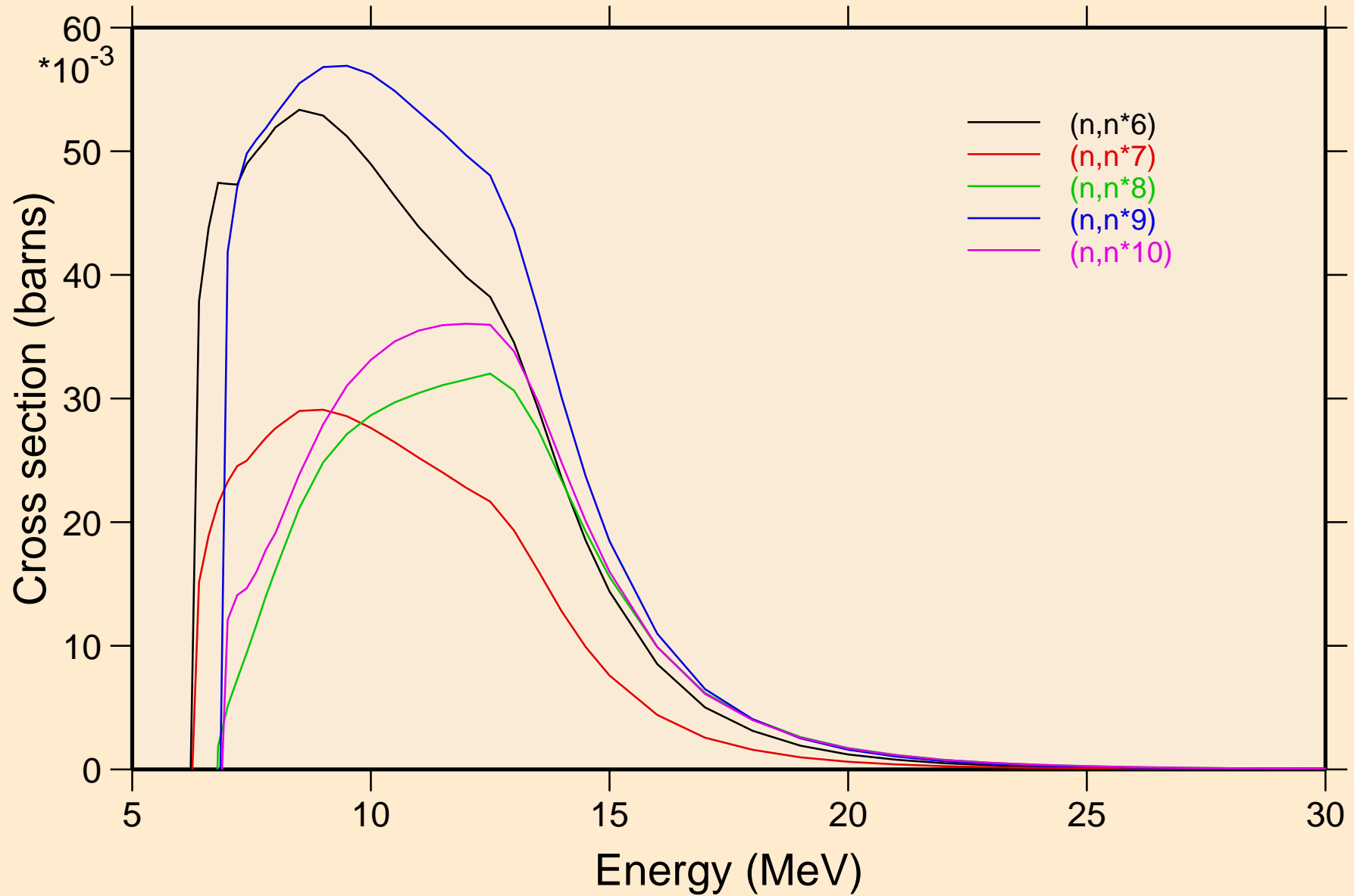

C015 NEUTRON ACER TENDL-2024 LIBRARY; T=0.K
Inelastic levels

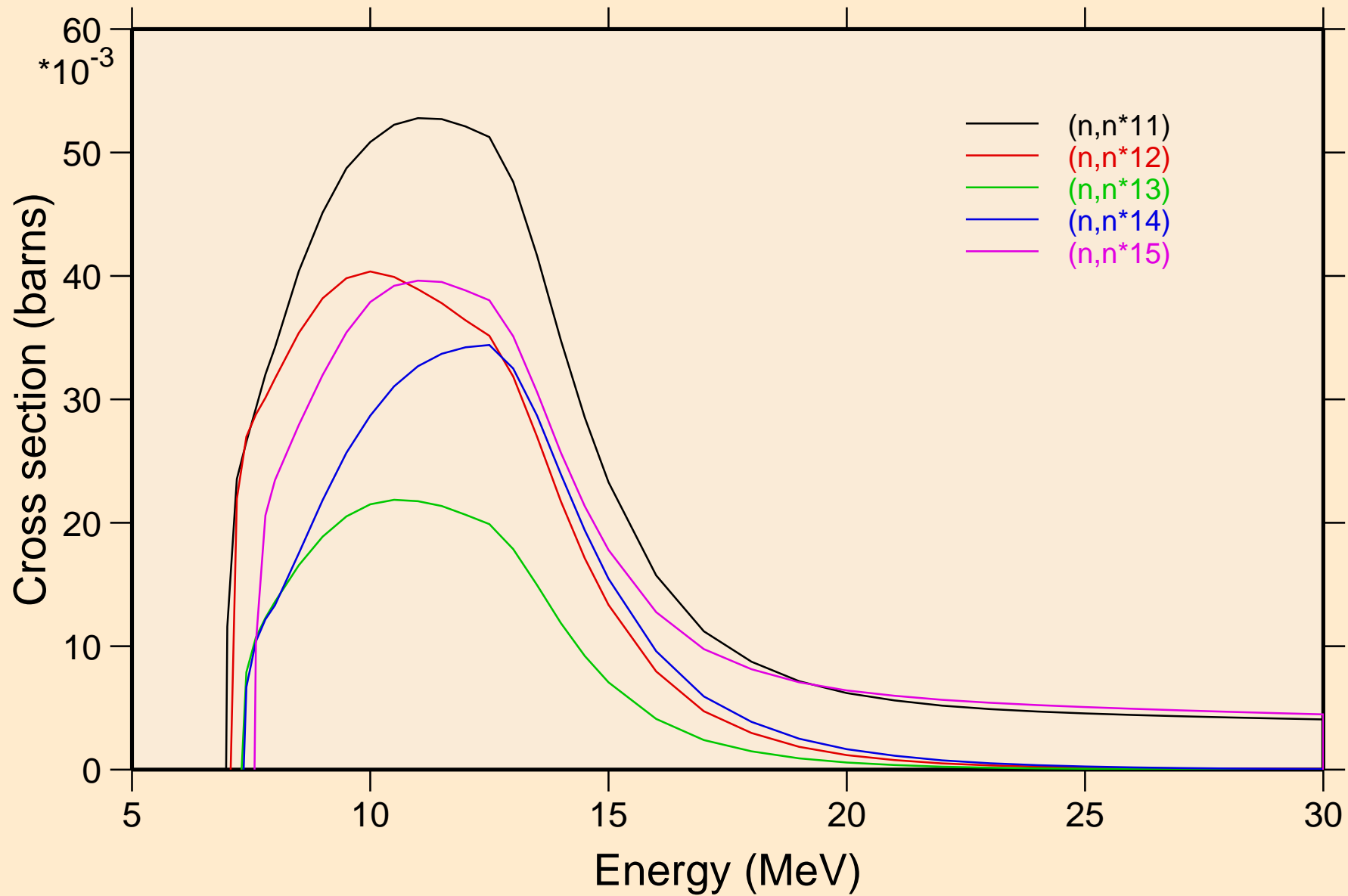

C015 NEUTRON ACER TENDL-2024 LIBRARY; T=0.K
Inelastic levels

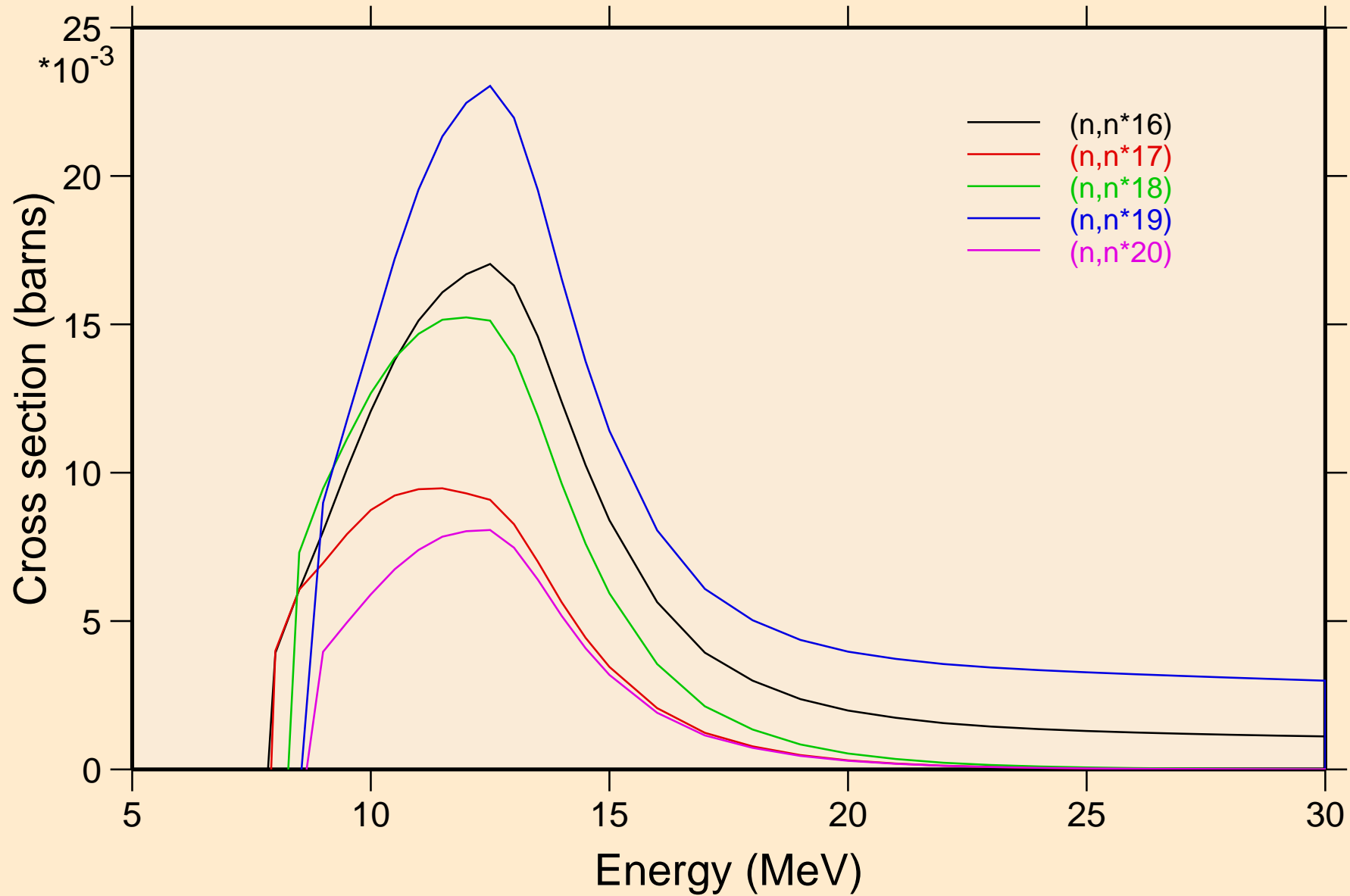

C015 NEUTRON ACER TENDL-2024 LIBRARY; T=0.K
Inelastic levels

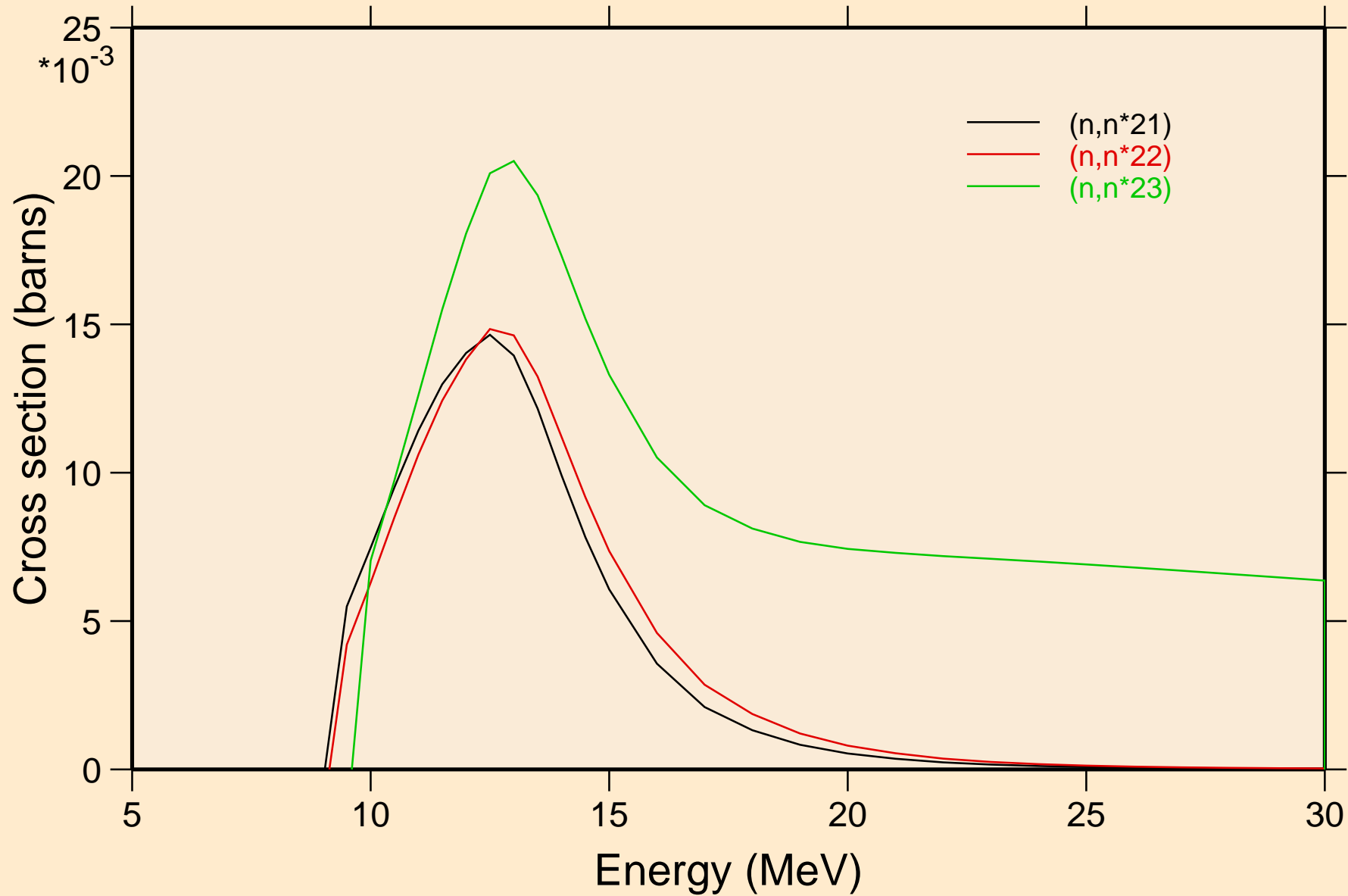

C015 NEUTRON ACER TENDL-2024 LIBRARY; T=0.K

Threshold reactions

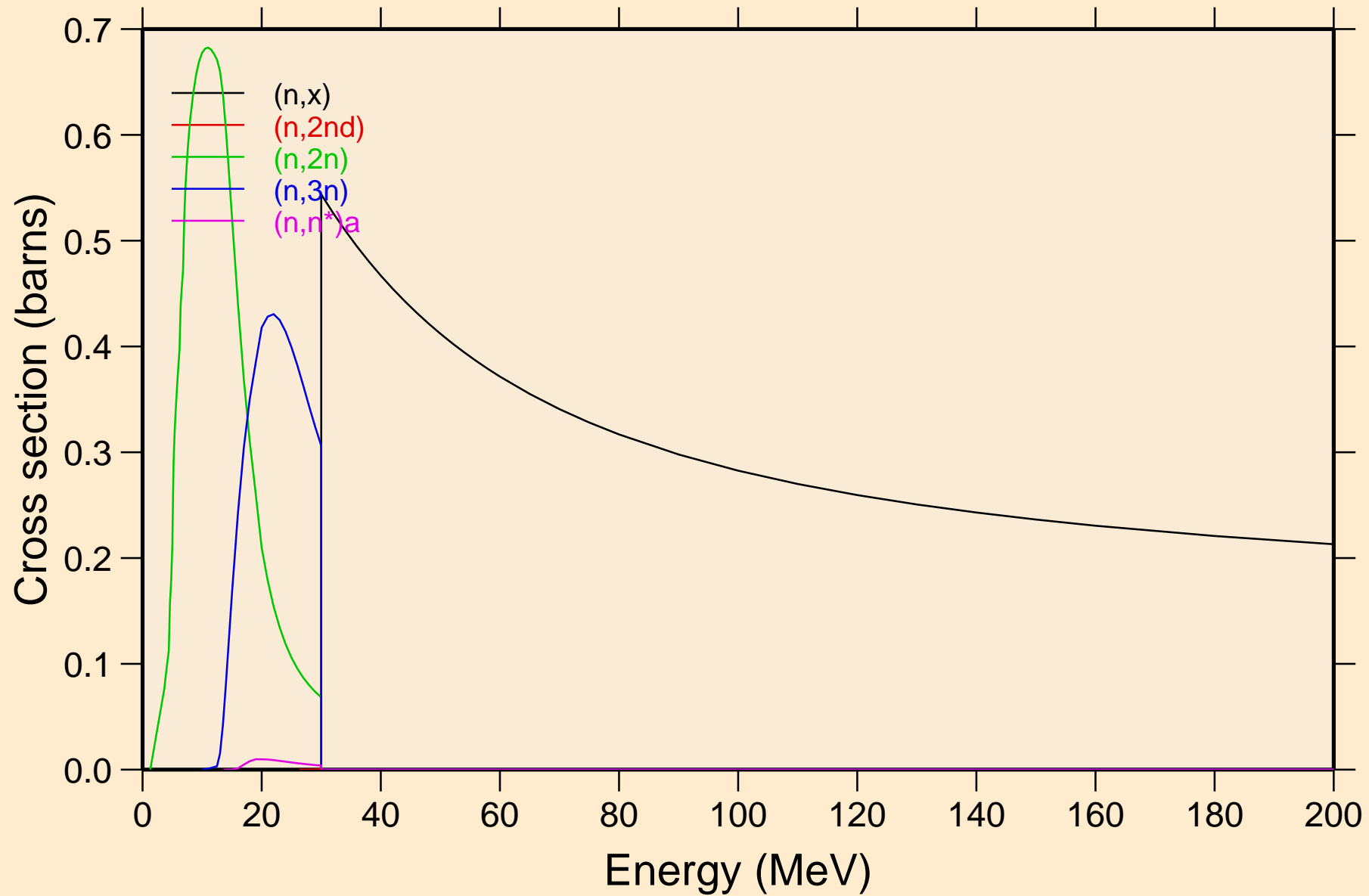

C015 NEUTRON ACER TENDL-2024 LIBRARY; T=0.K

Threshold reactions

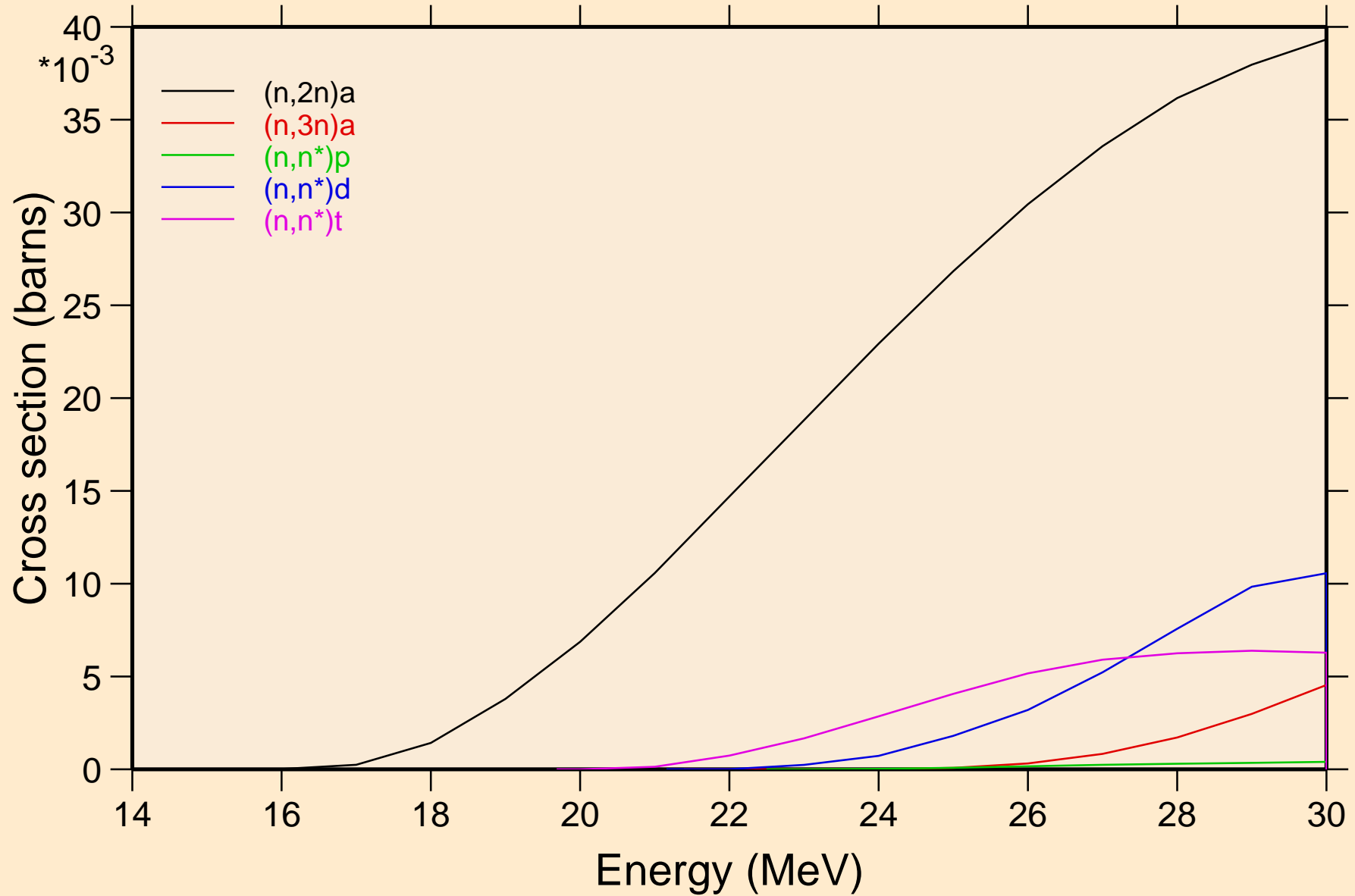

C015 NEUTRON ACER TENDL-2024 LIBRARY; T=0.K

Threshold reactions

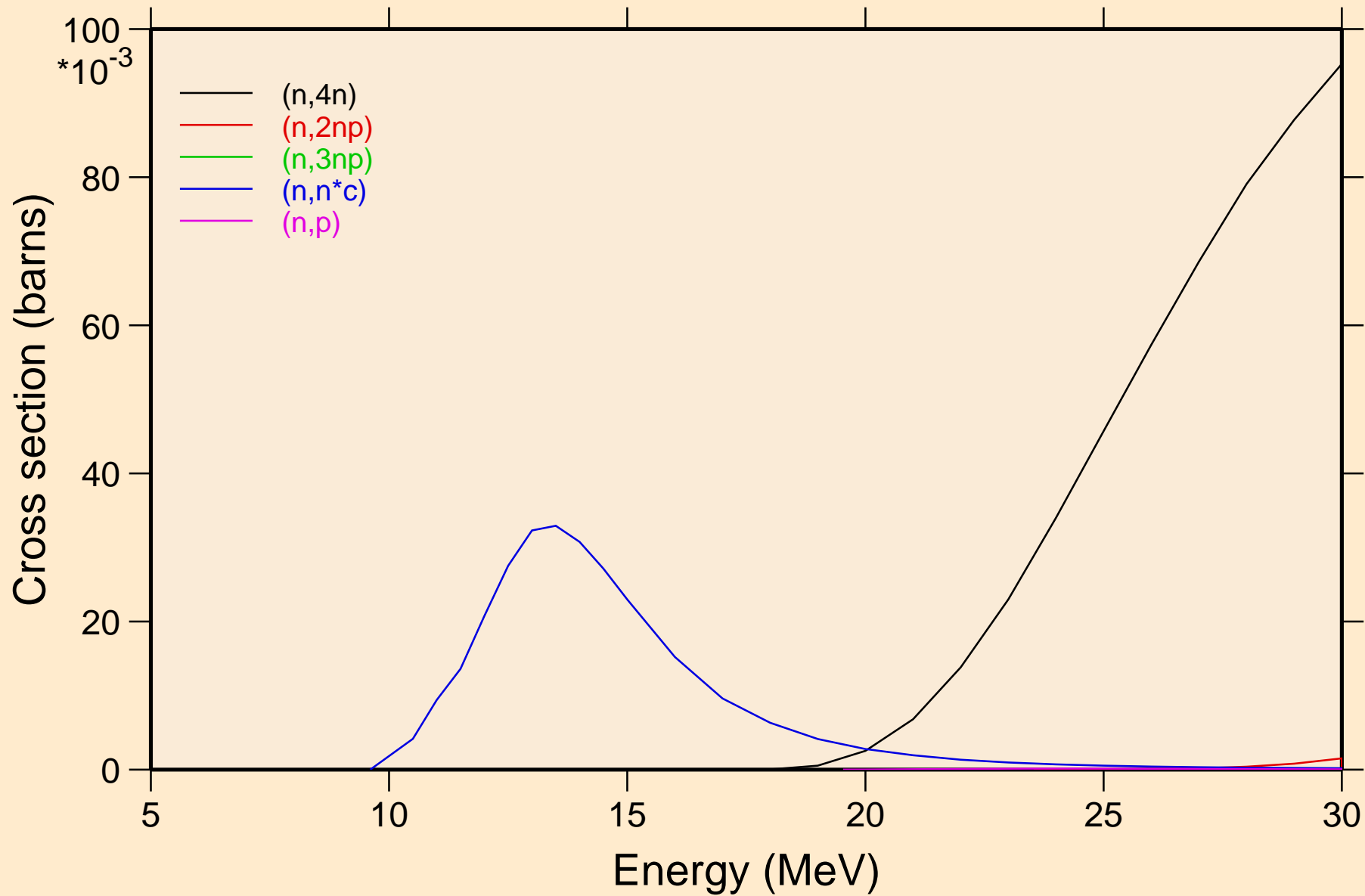

C015 NEUTRON ACER TENDL-2024 LIBRARY; T=0.K
Threshold reactions

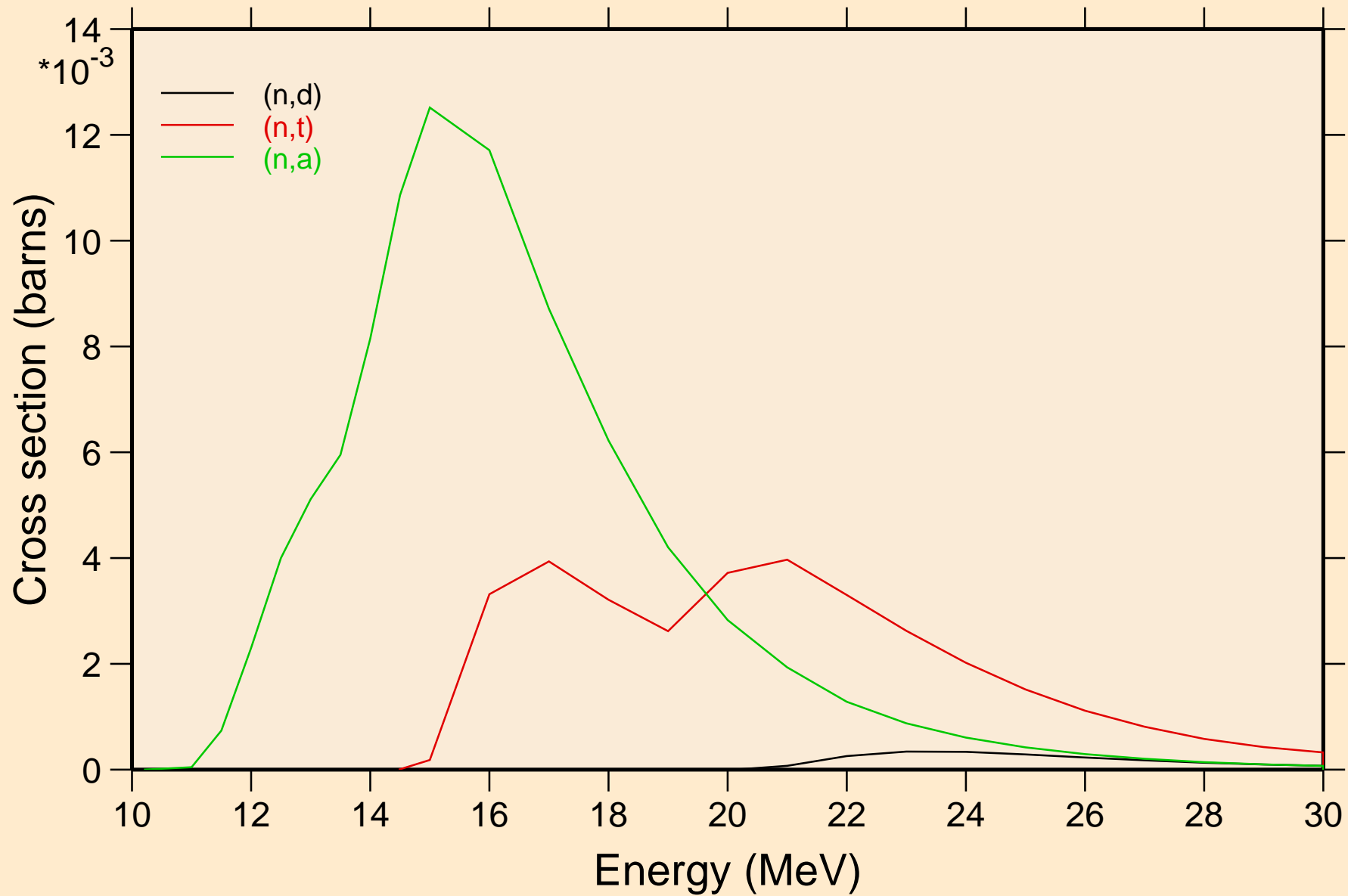

C015 NEUTRON ACER TENDL-2024 LIBRARY; T=0.K

Threshold reactions

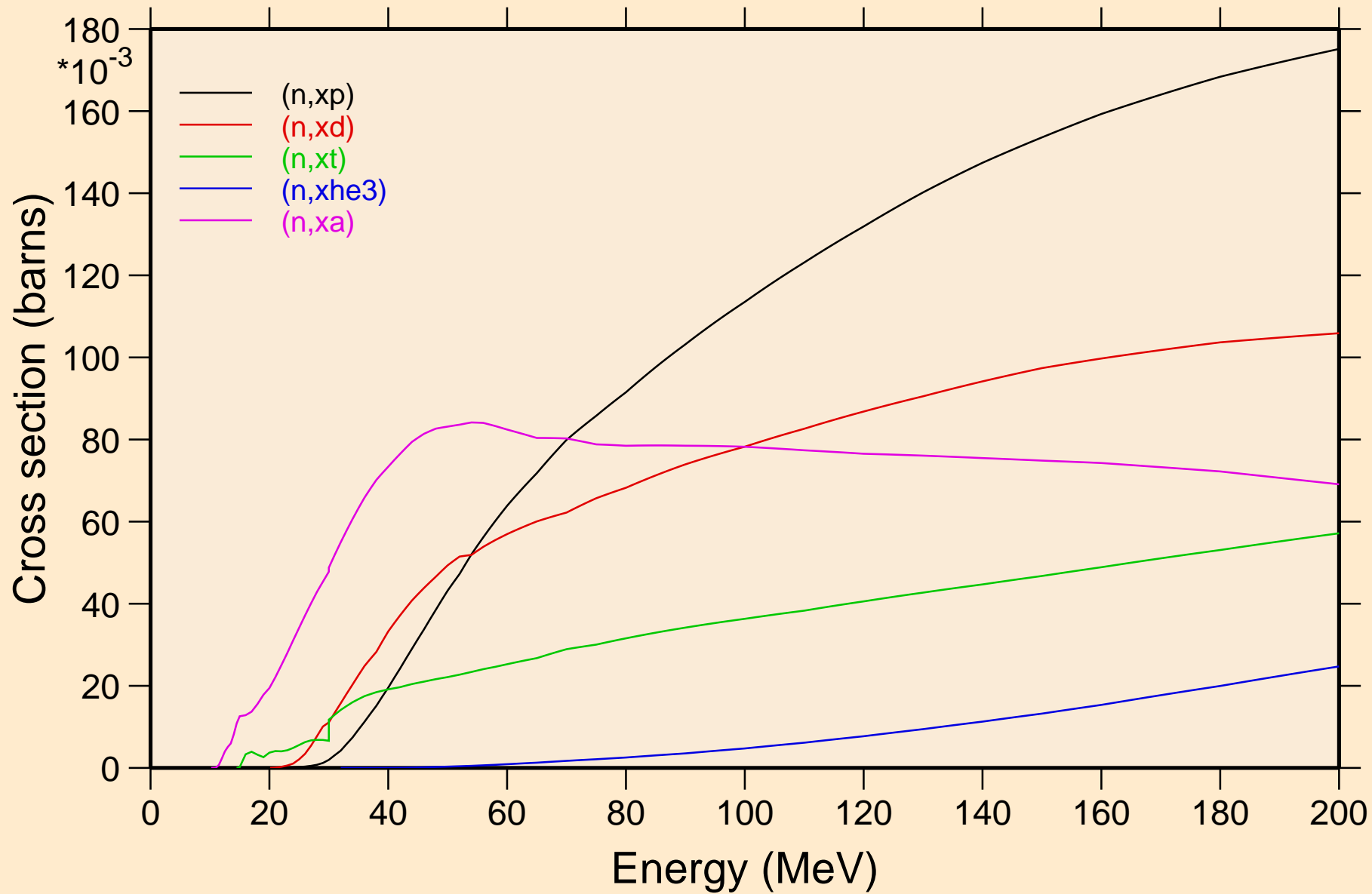

C015 NEUTRON ACER TENDL-2024 LIBRARY; T=0.K
angular distribution for elastic

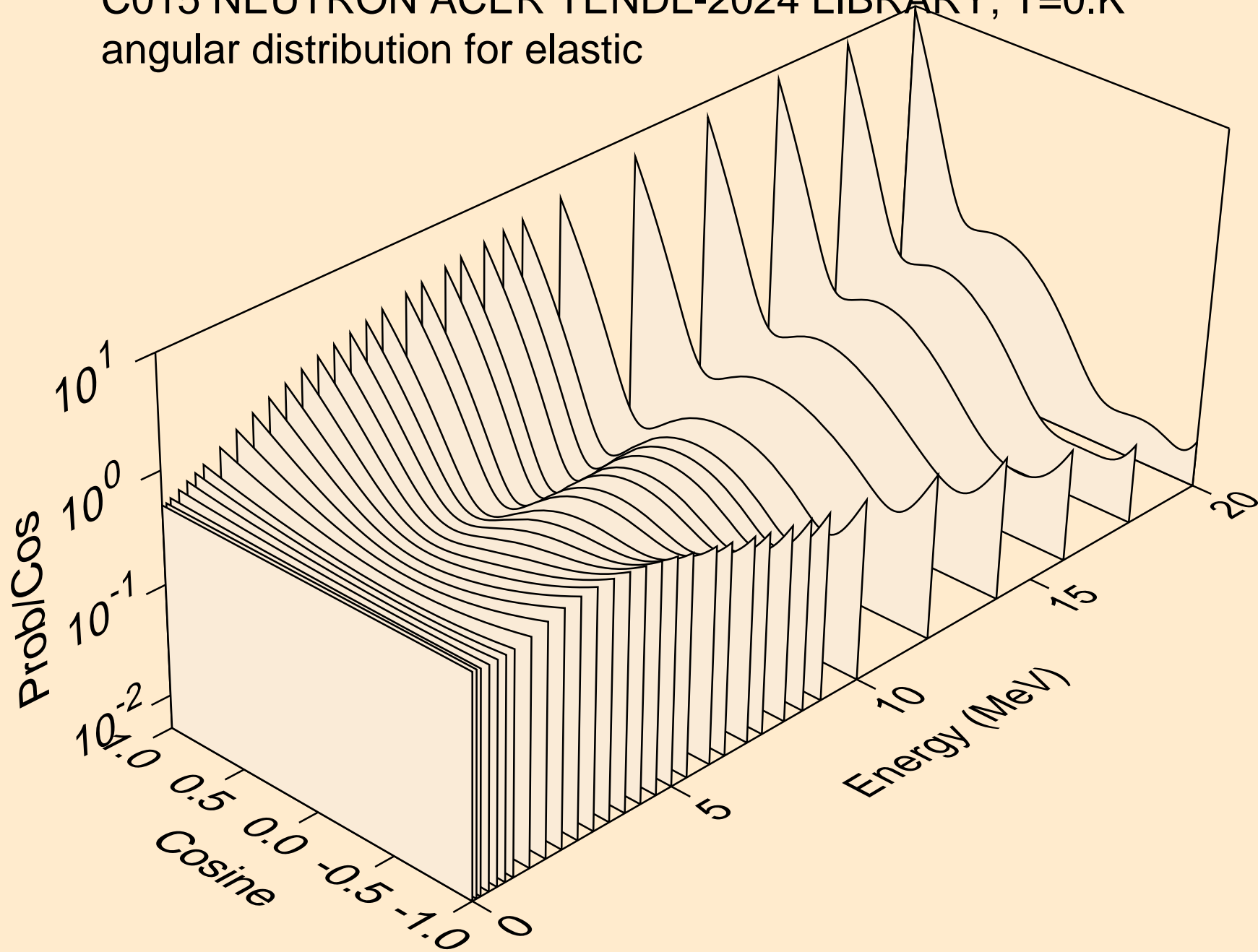

C015 NEUTRON ACER TENDL-2024 LIBRARY; T=0.K
angular distribution for elastic

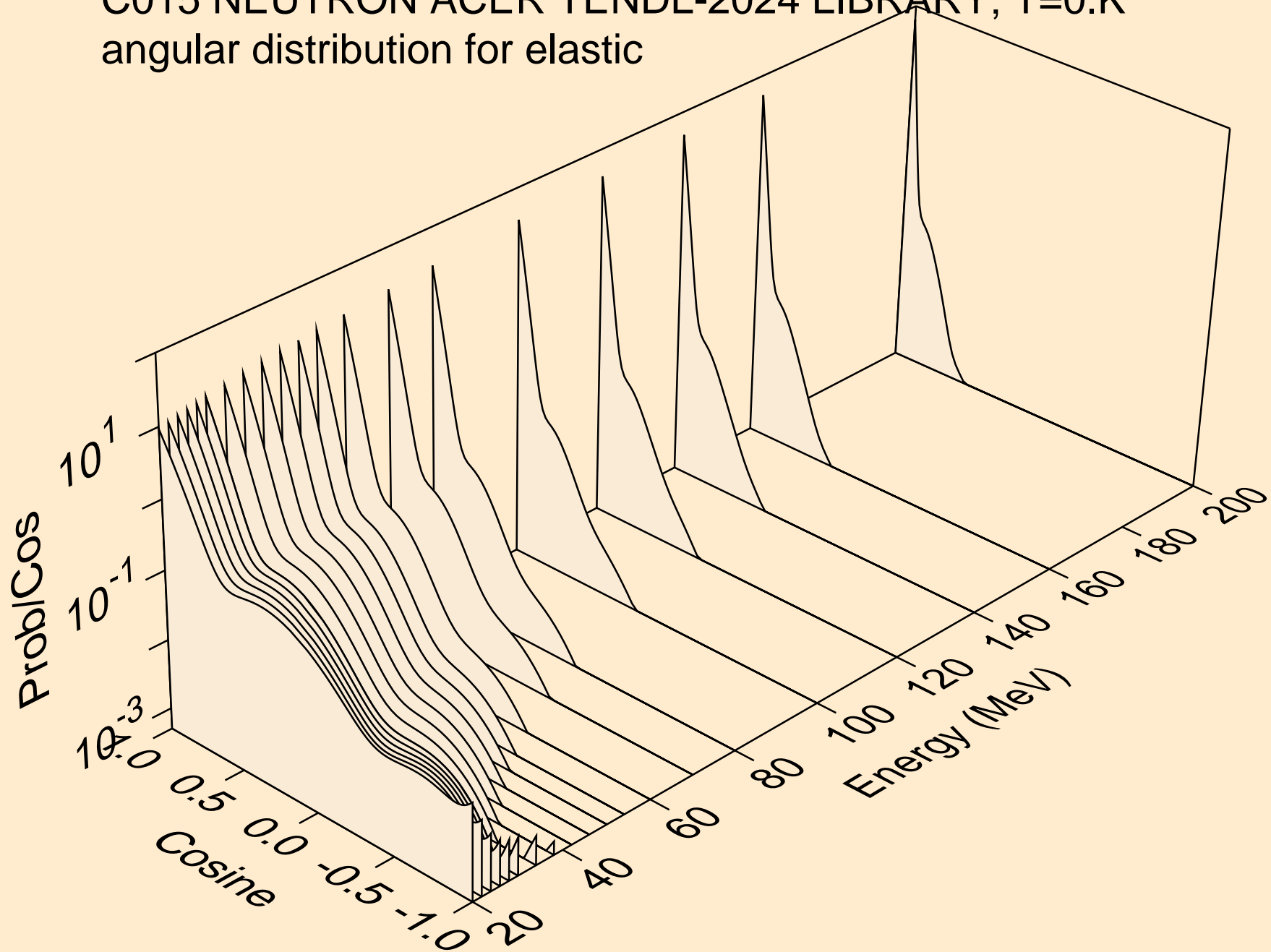

C015 NEUTRON ACER TENDL-2024 LIBRARY; T=0.K
angular distribution for (n,n*1)

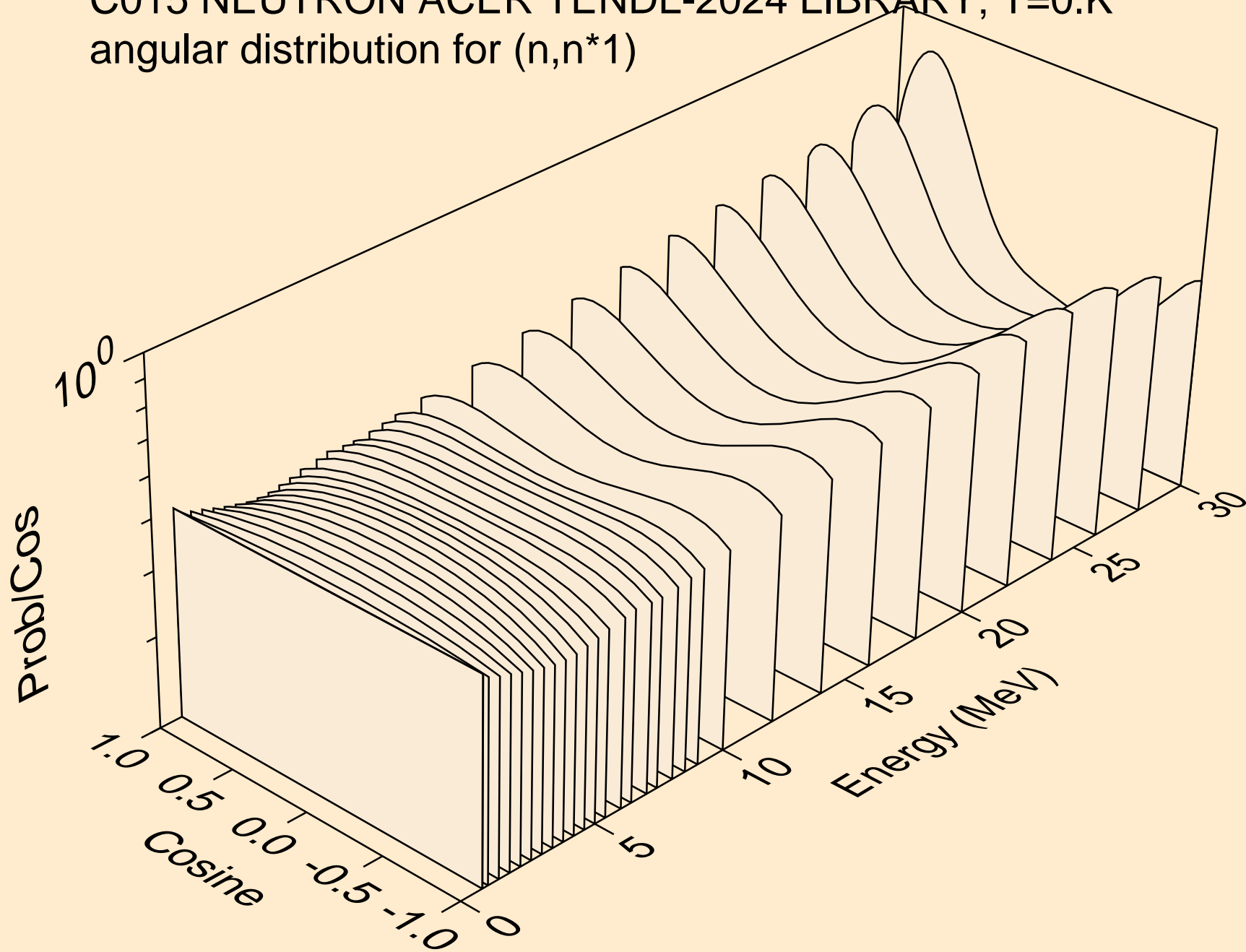

C015 NEUTRON ACER TENDL-2024 LIBRARY; T=0.K
angular distribution for (n,n*2)

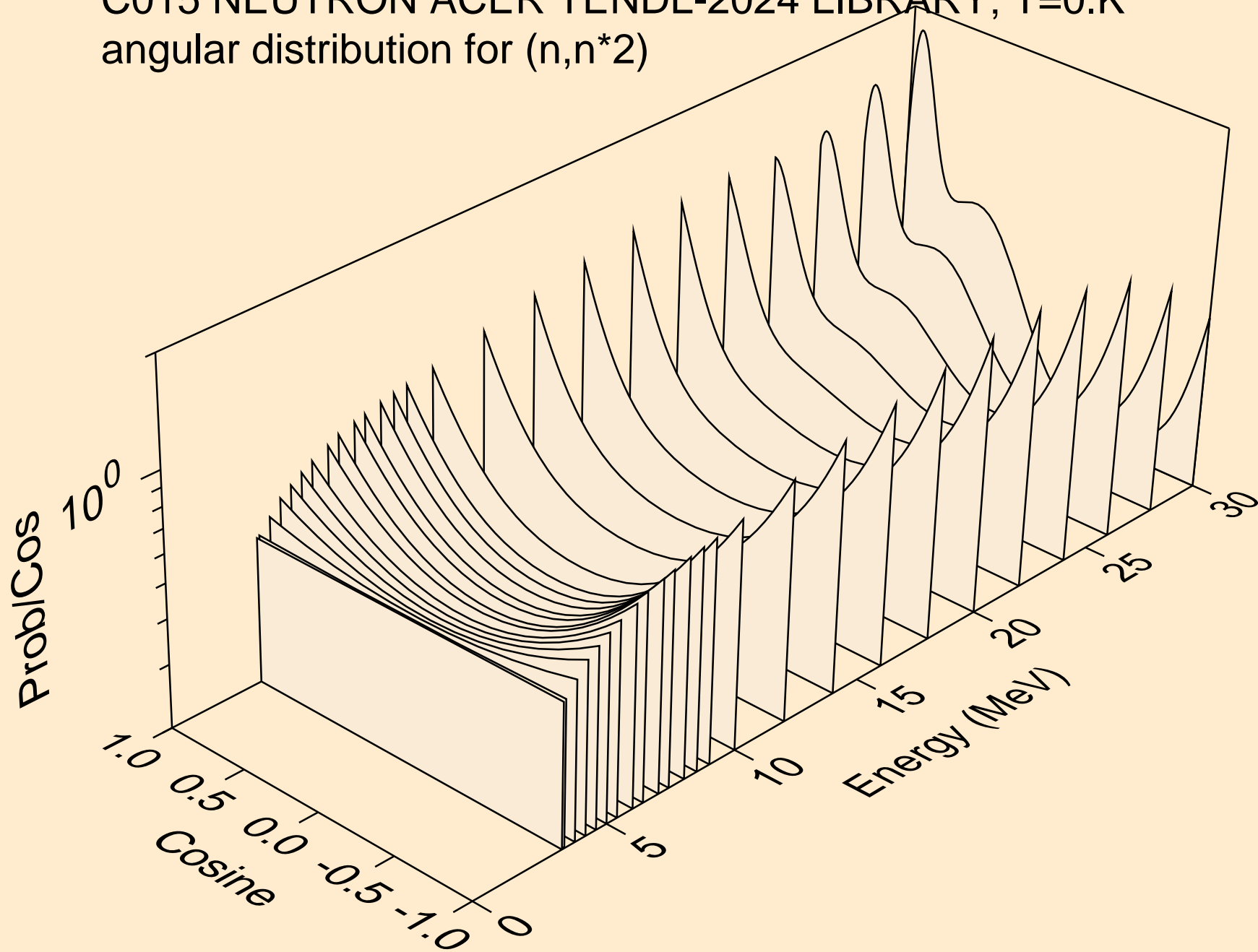

C015 NEUTRON ACER TENDL-2024 LIBRARY; T=0.K
angular distribution for (n,n*3)

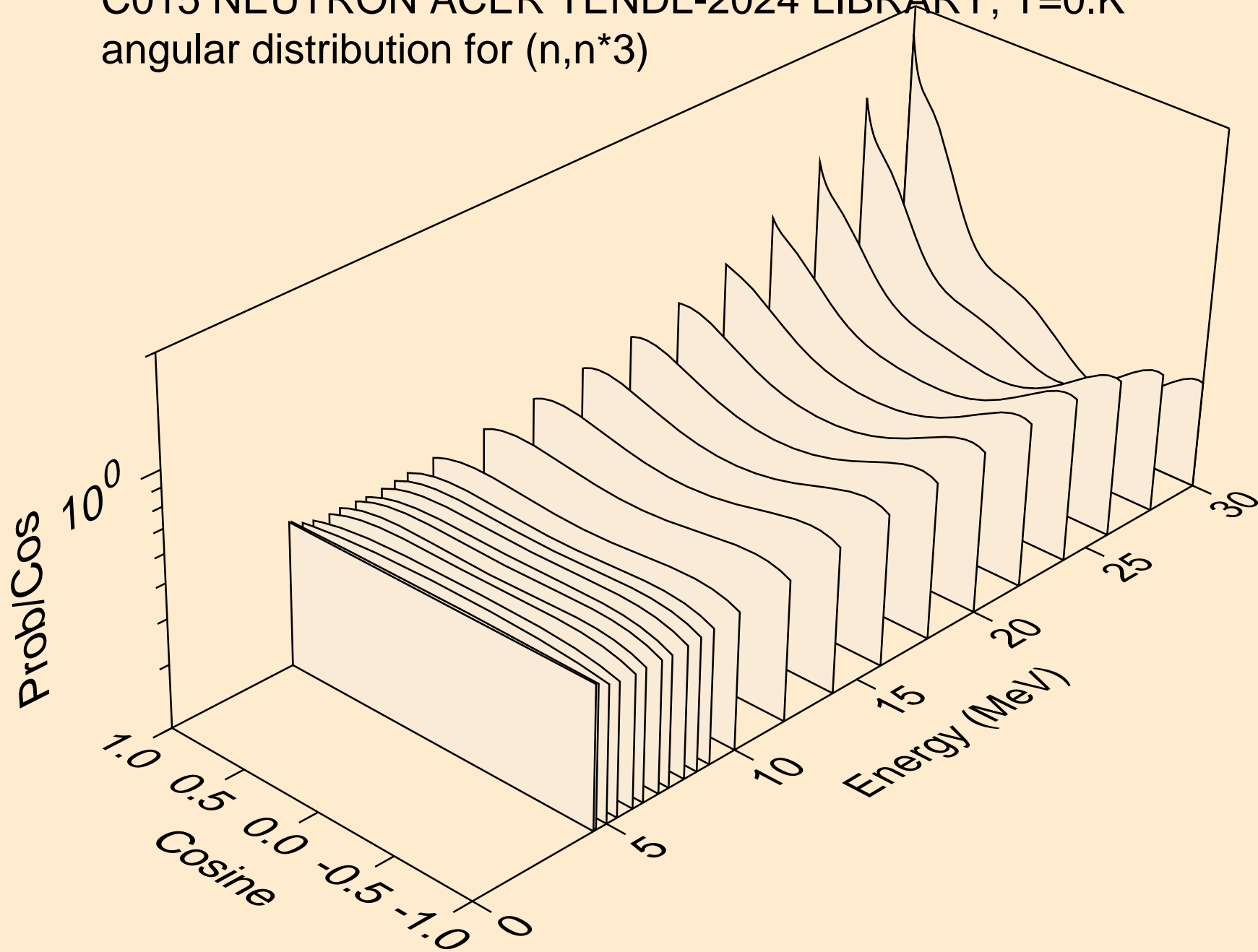

C015 NEUTRON ACER TENDL-2024 LIBRARY; T=0.K
angular distribution for (n,n*4)

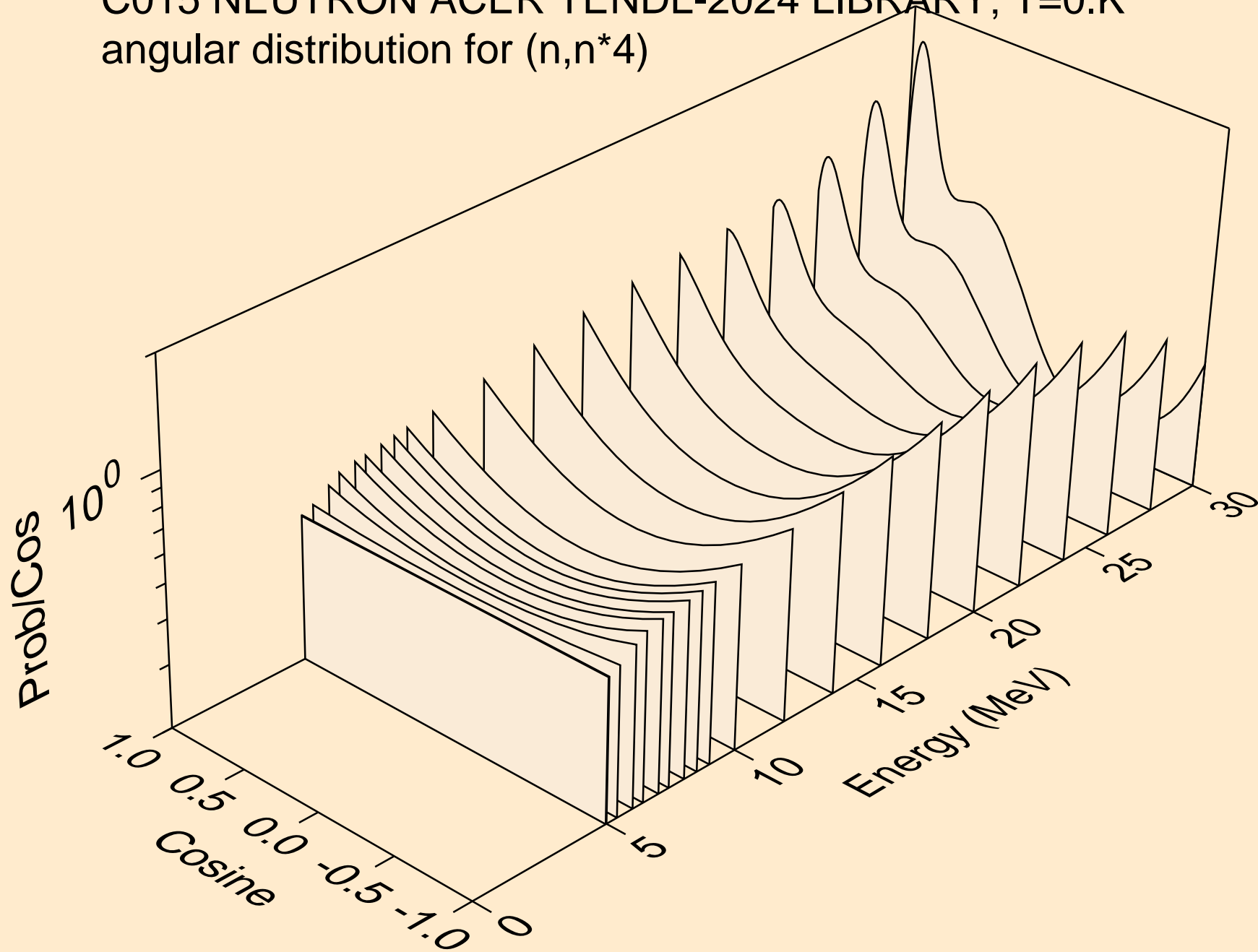

C015 NEUTRON ACER TENDL-2024 LIBRARY; T=0.K
angular distribution for (n,n*5)

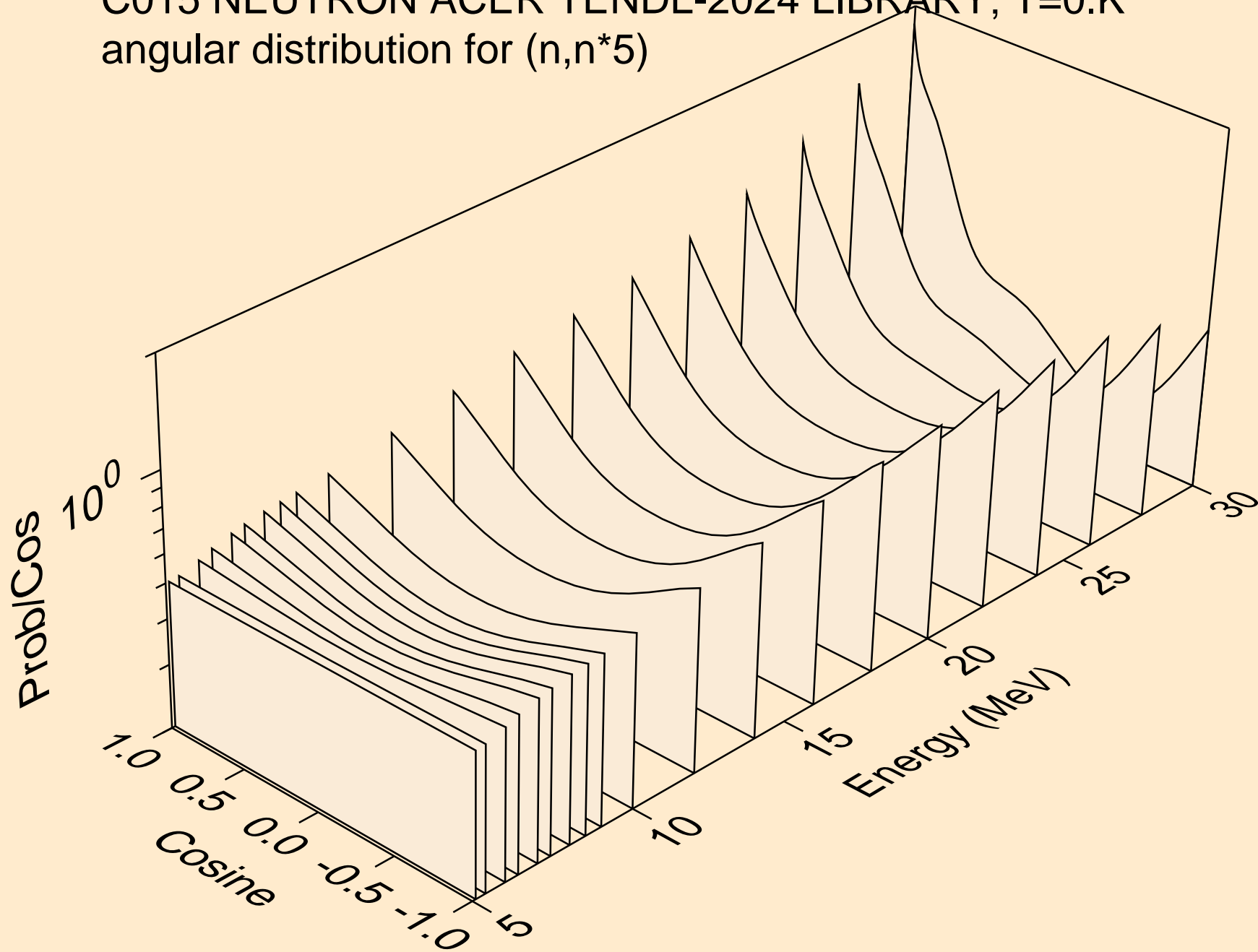

C015 NEUTRON ACER TENDL-2024 LIBRARY; T=0.K
angular distribution for (n,n*6)

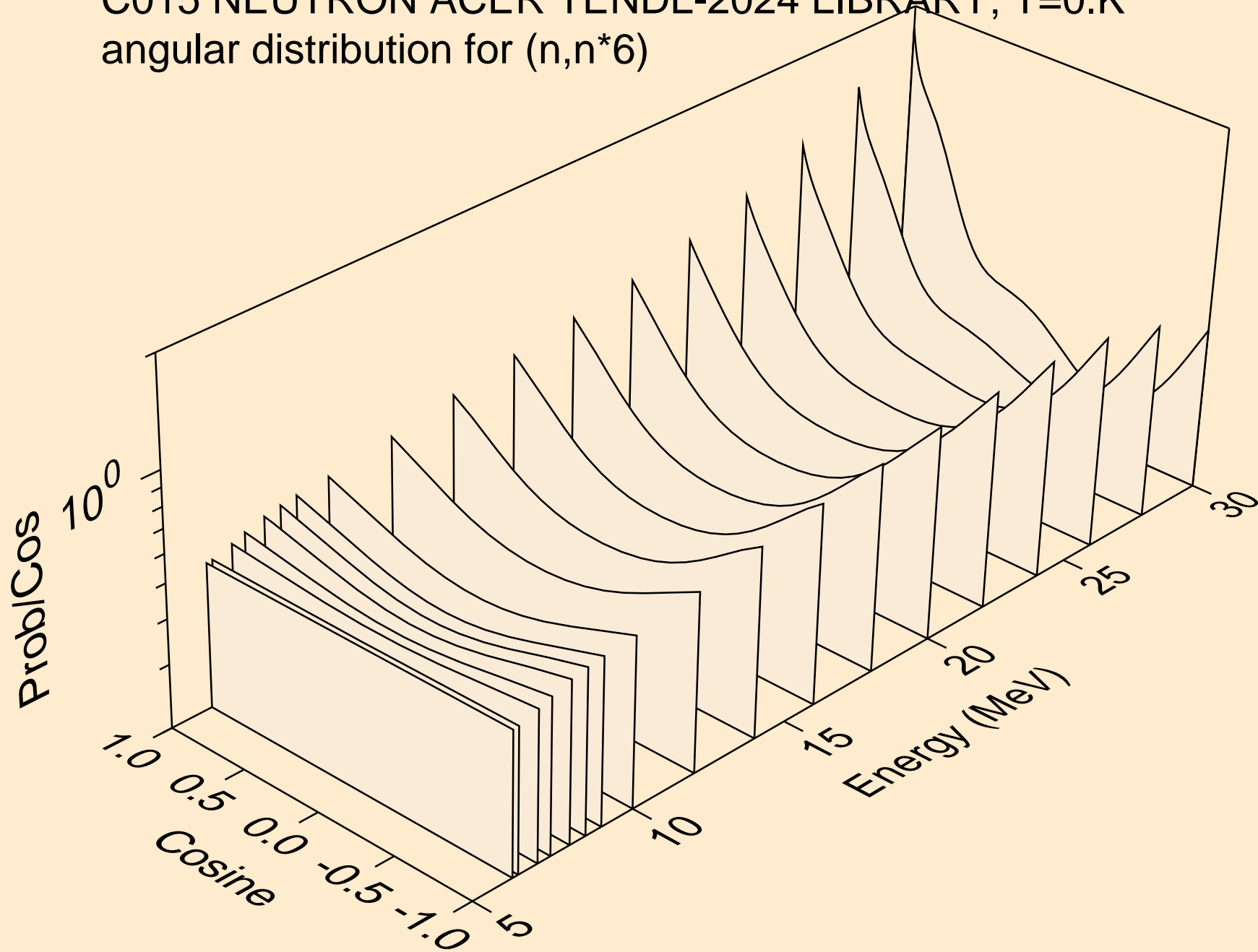

C015 NEUTRON ACER TENDL-2024 LIBRARY; T=0.K
angular distribution for (n,n*7)

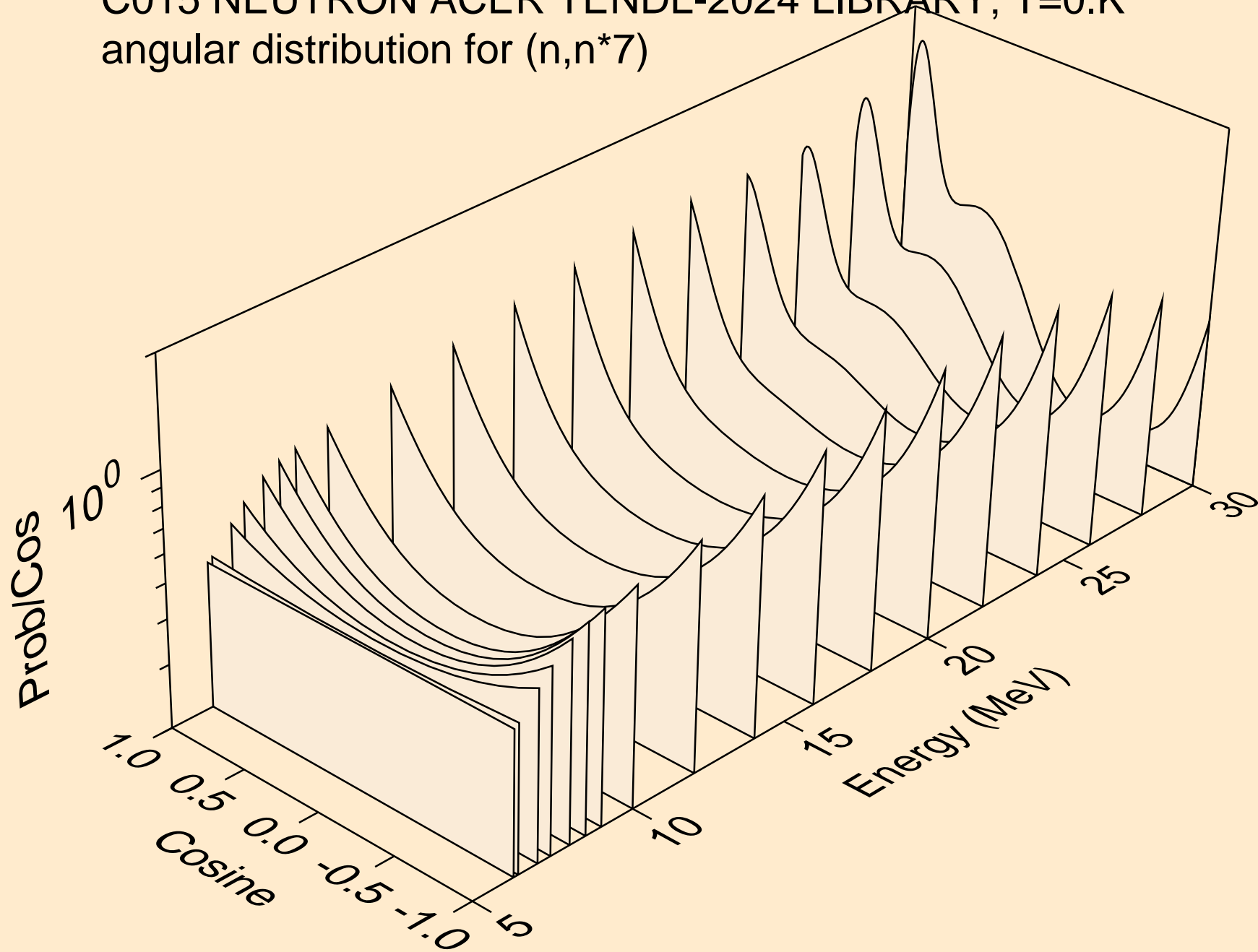

C015 NEUTRON ACER TENDL-2024 LIBRARY; T=0.K
angular distribution for (n,n*8)

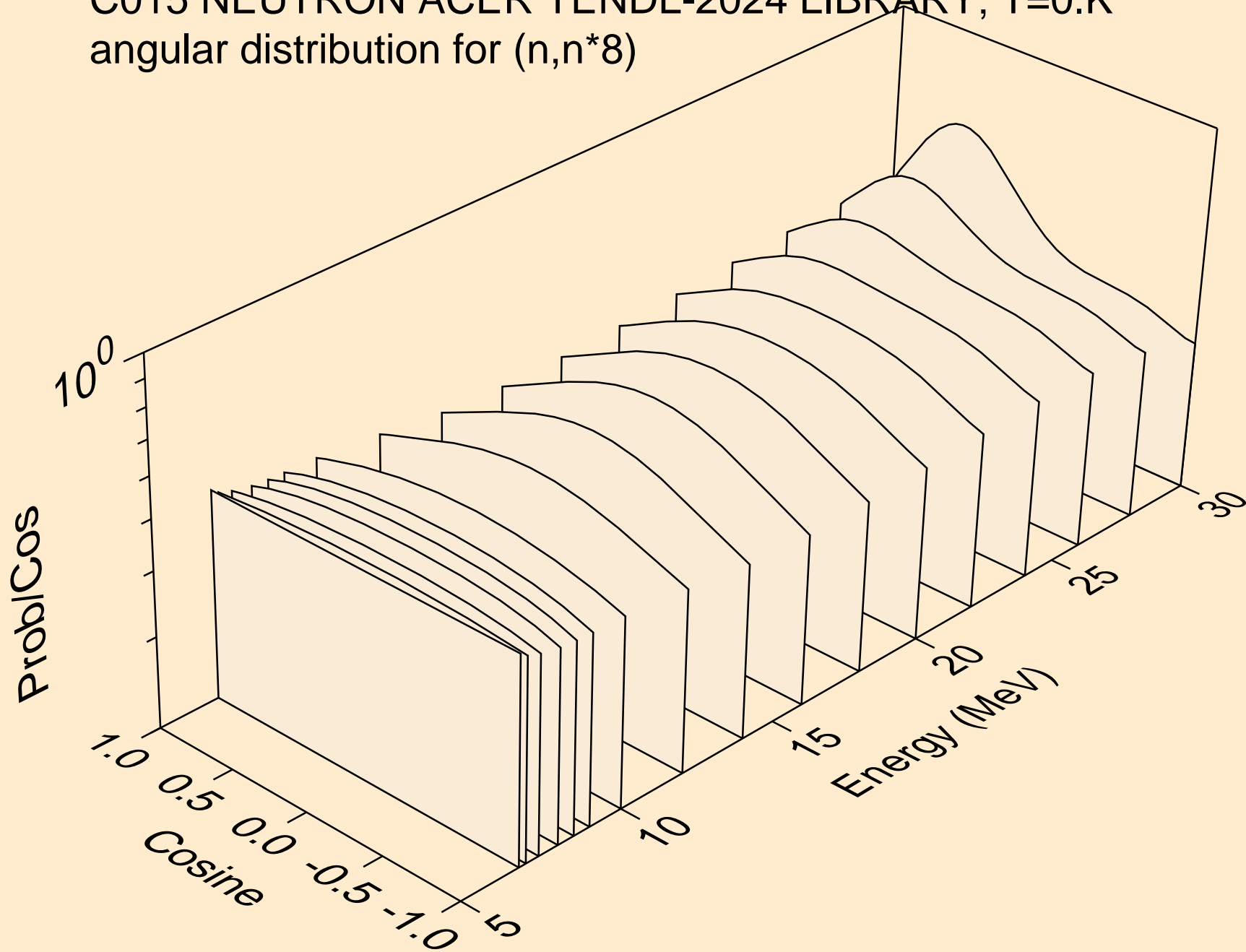

C015 NEUTRON ACER TENDL-2024 LIBRARY; T=0.K
angular distribution for (n,n*9)

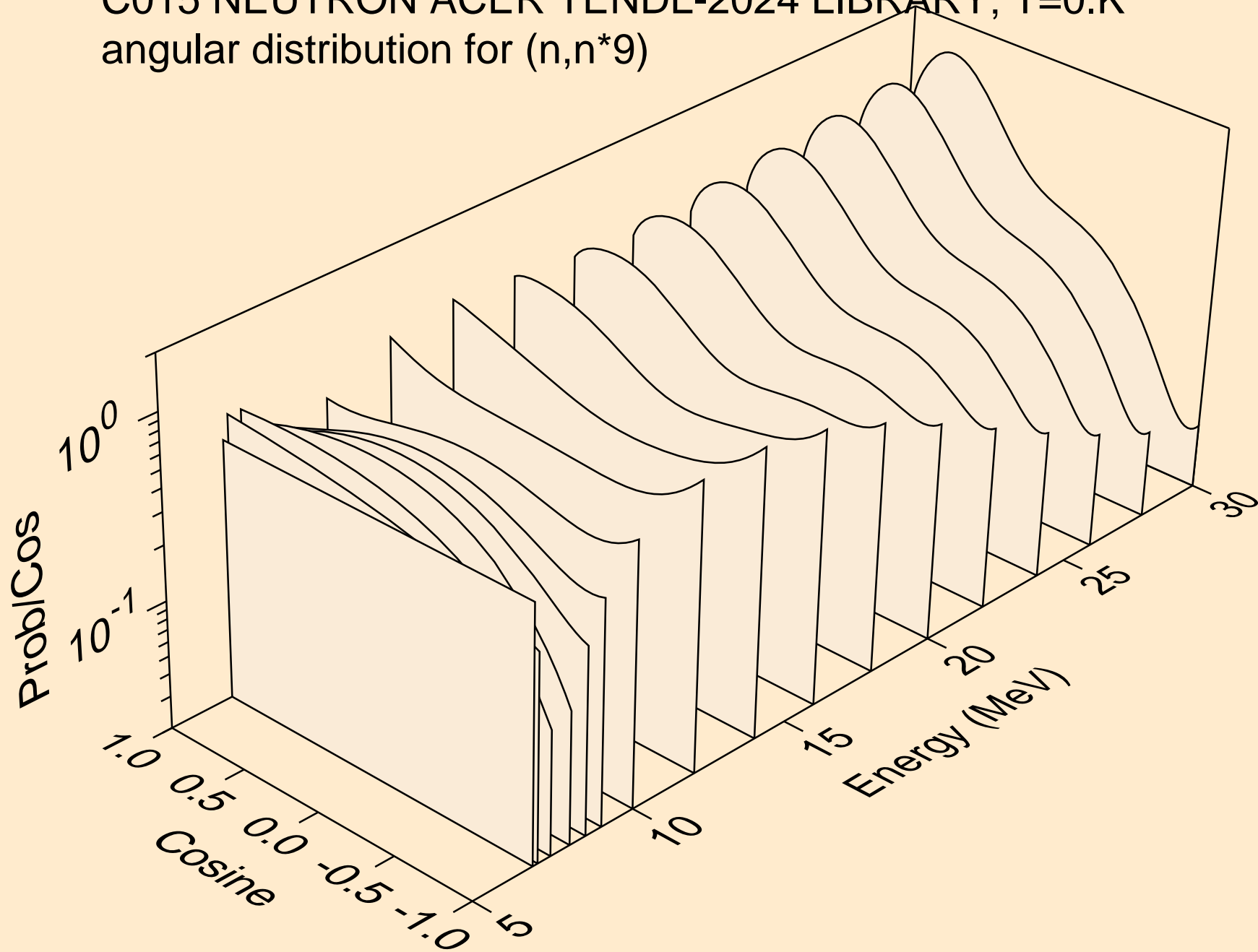

C015 NEUTRON ACER TENDL-2024 LIBRARY; T=0.K
angular distribution for (n,n*10)

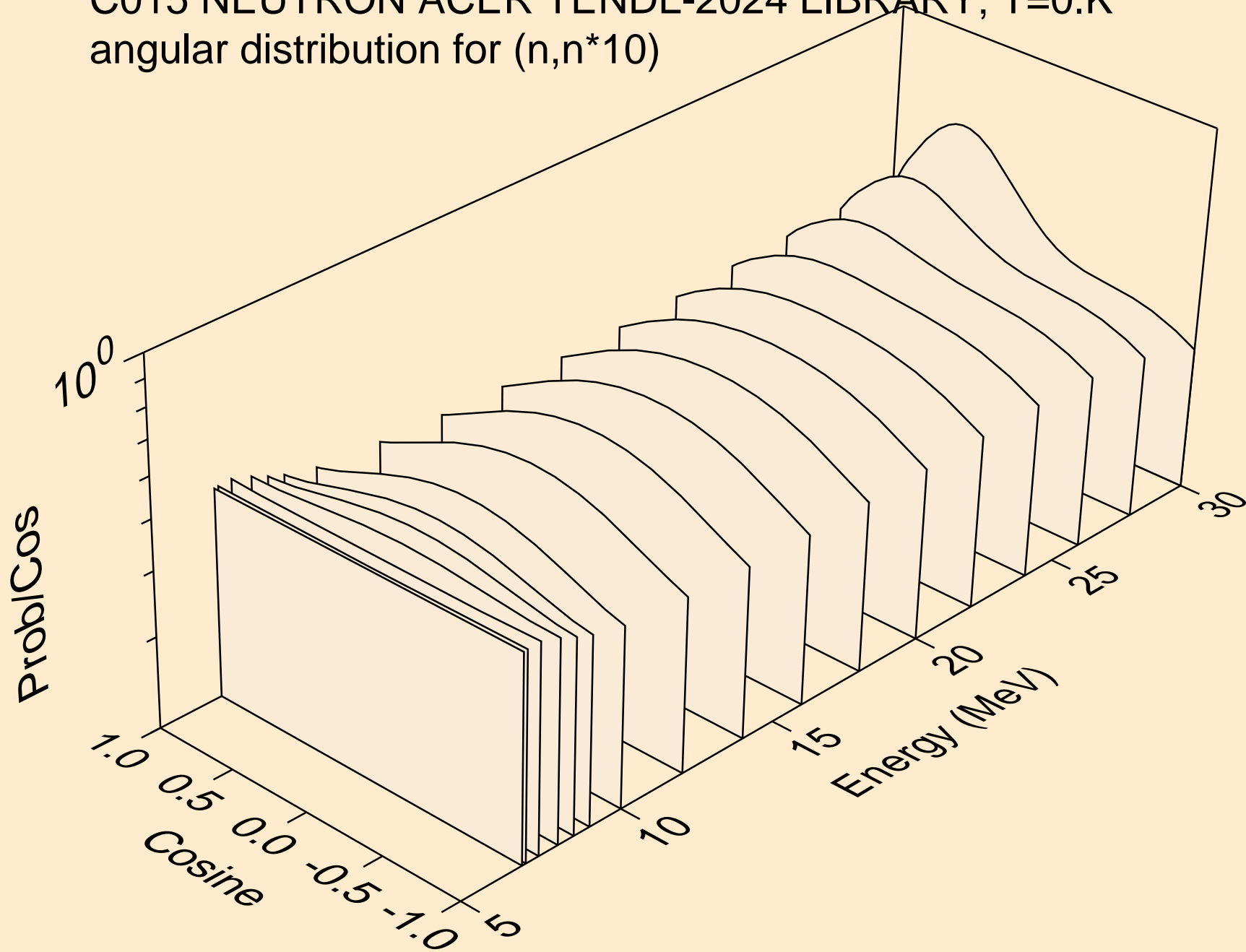

C015 NEUTRON ACER TENDL-2024 LIBRARY; T=0.K
angular distribution for (n,n*11)

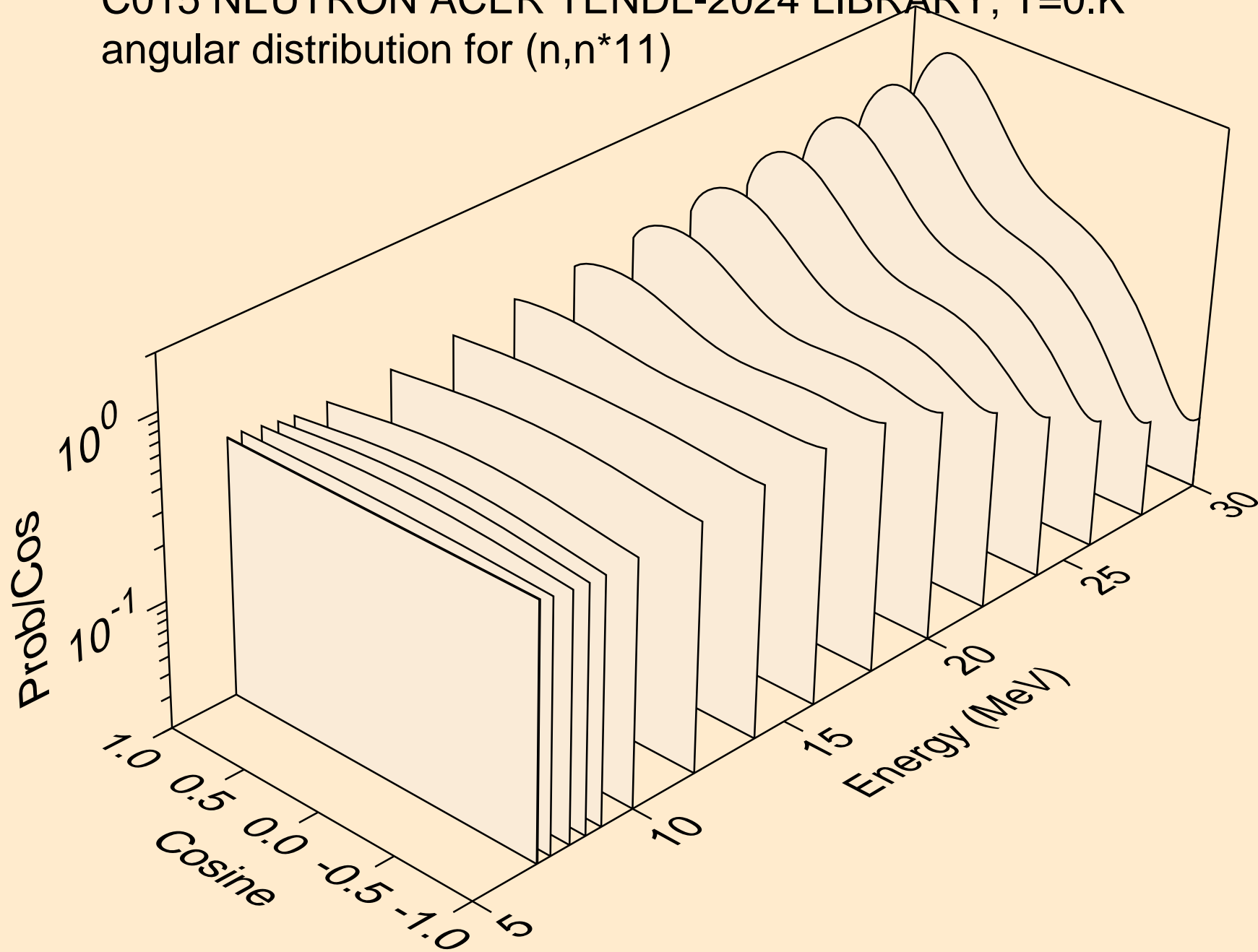

C015 NEUTRON ACER TENDL-2024 LIBRARY; T=0.K
angular distribution for (n,n*12)

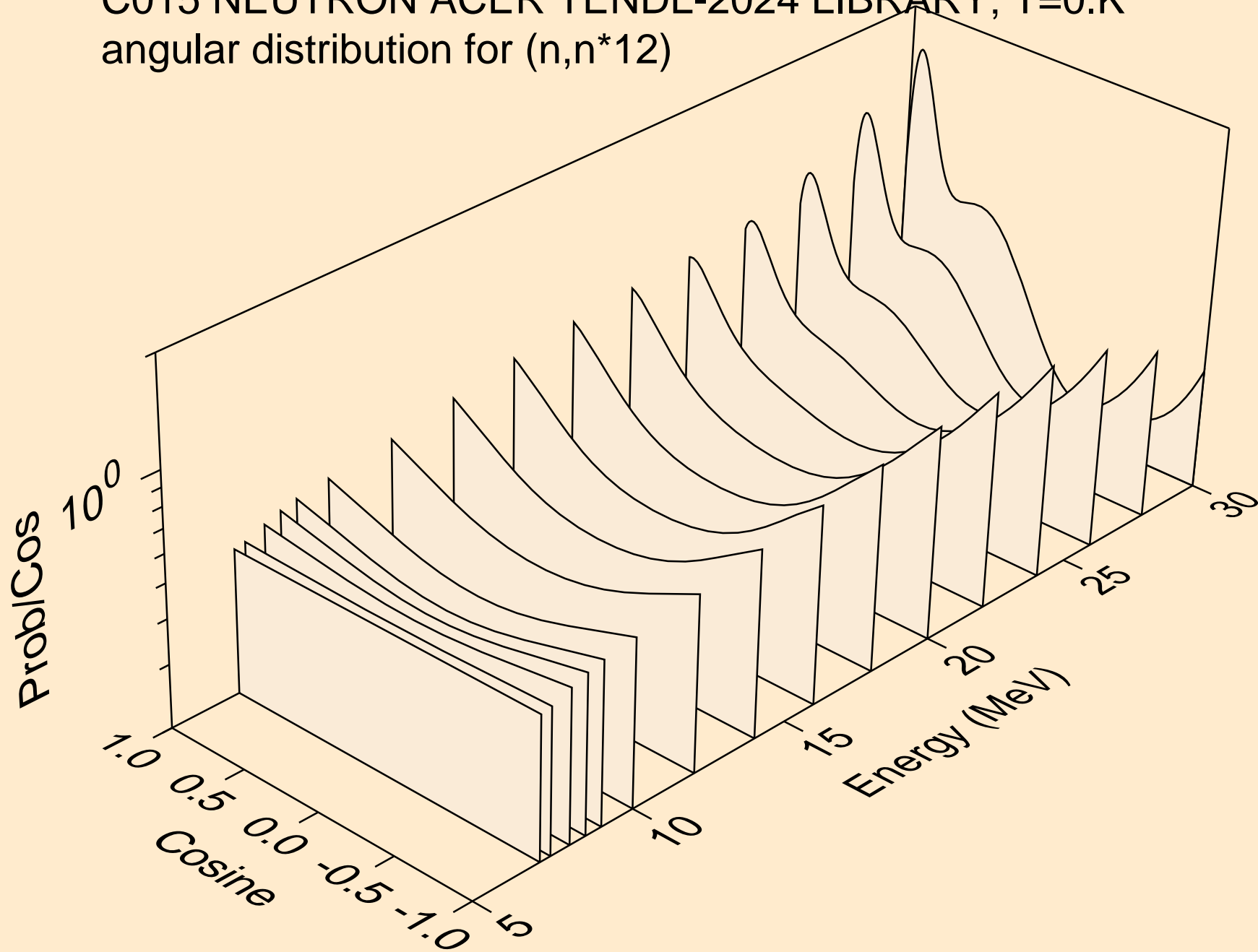

C015 NEUTRON ACER TENDL-2024 LIBRARY; T=0.K
angular distribution for (n,n*13)

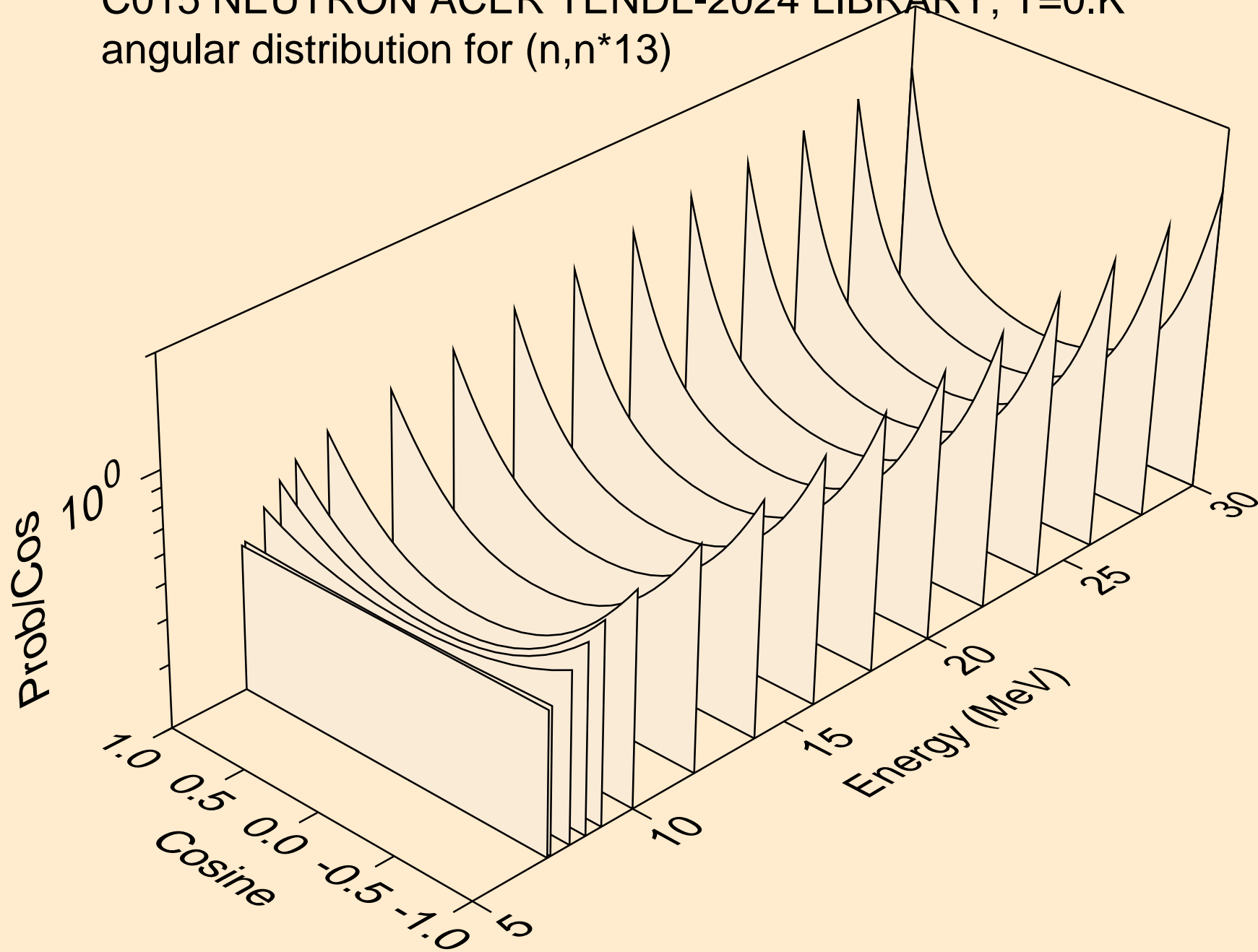

C015 NEUTRON ACER TENDL-2024 LIBRARY; T=0.K
angular distribution for (n,n*14)

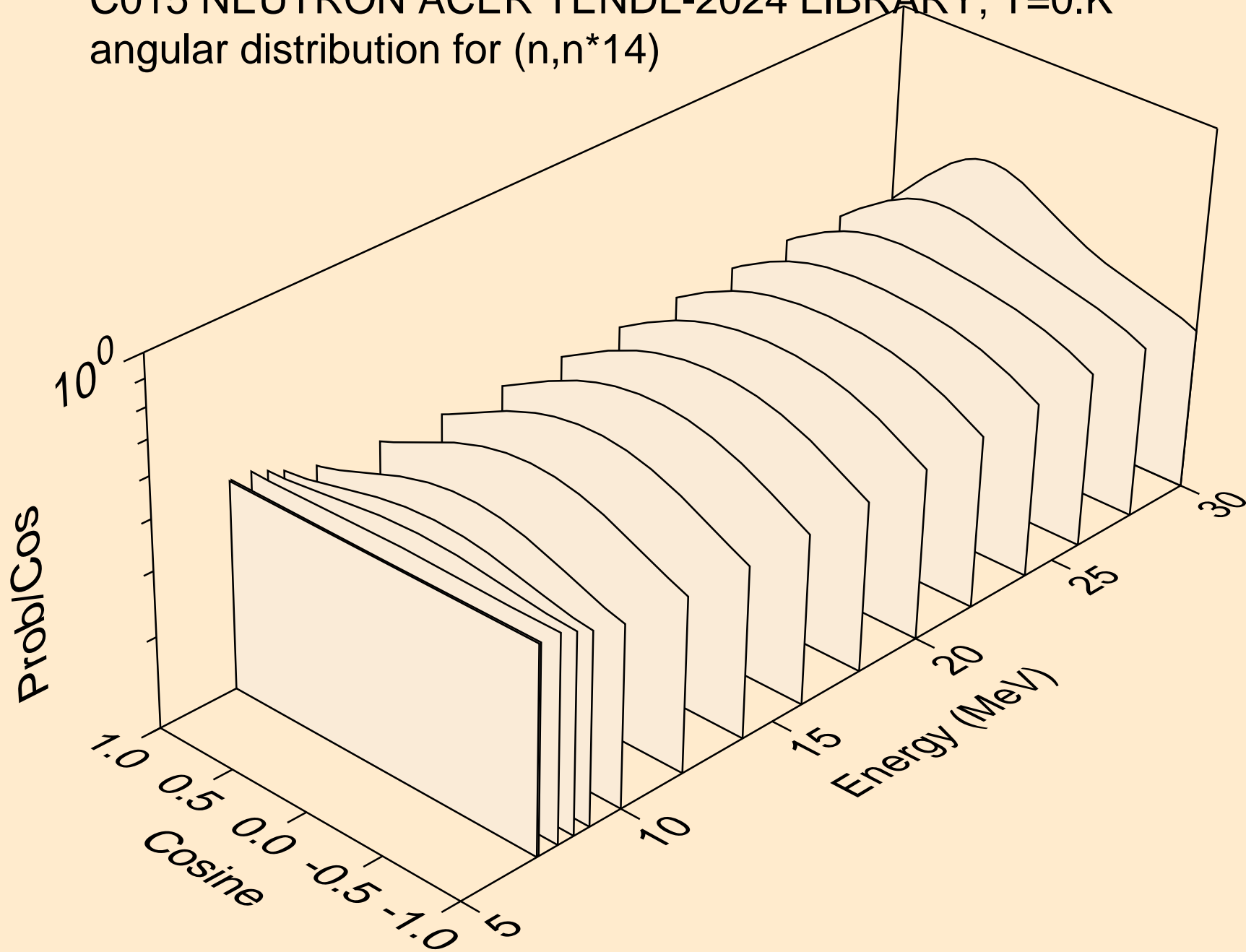

C015 NEUTRON ACER TENDL-2024 LIBRARY; T=0.K
angular distribution for (n,n*15)

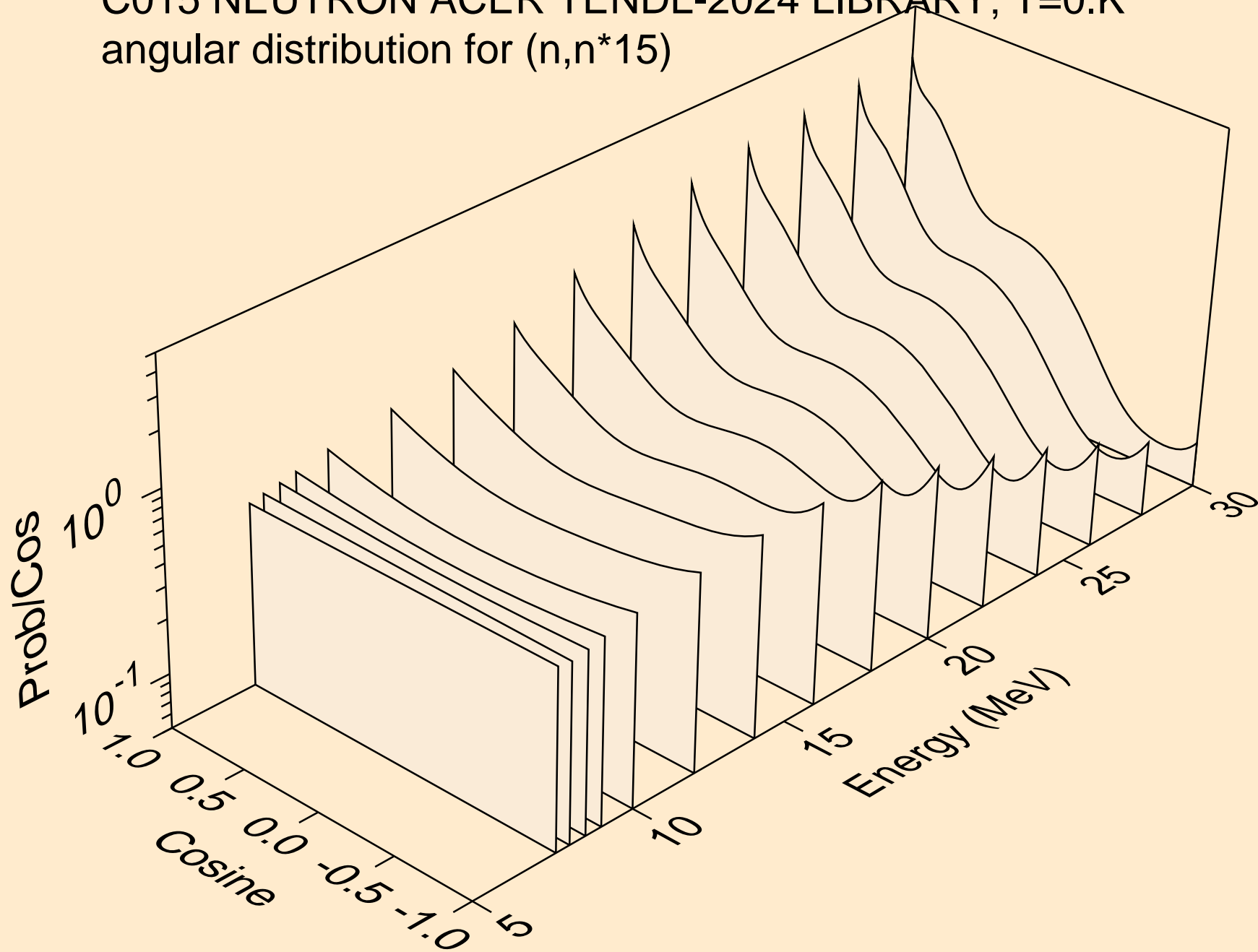

C015 NEUTRON ACER TENDL-2024 LIBRARY; T=0.K
angular distribution for (n,n*16)

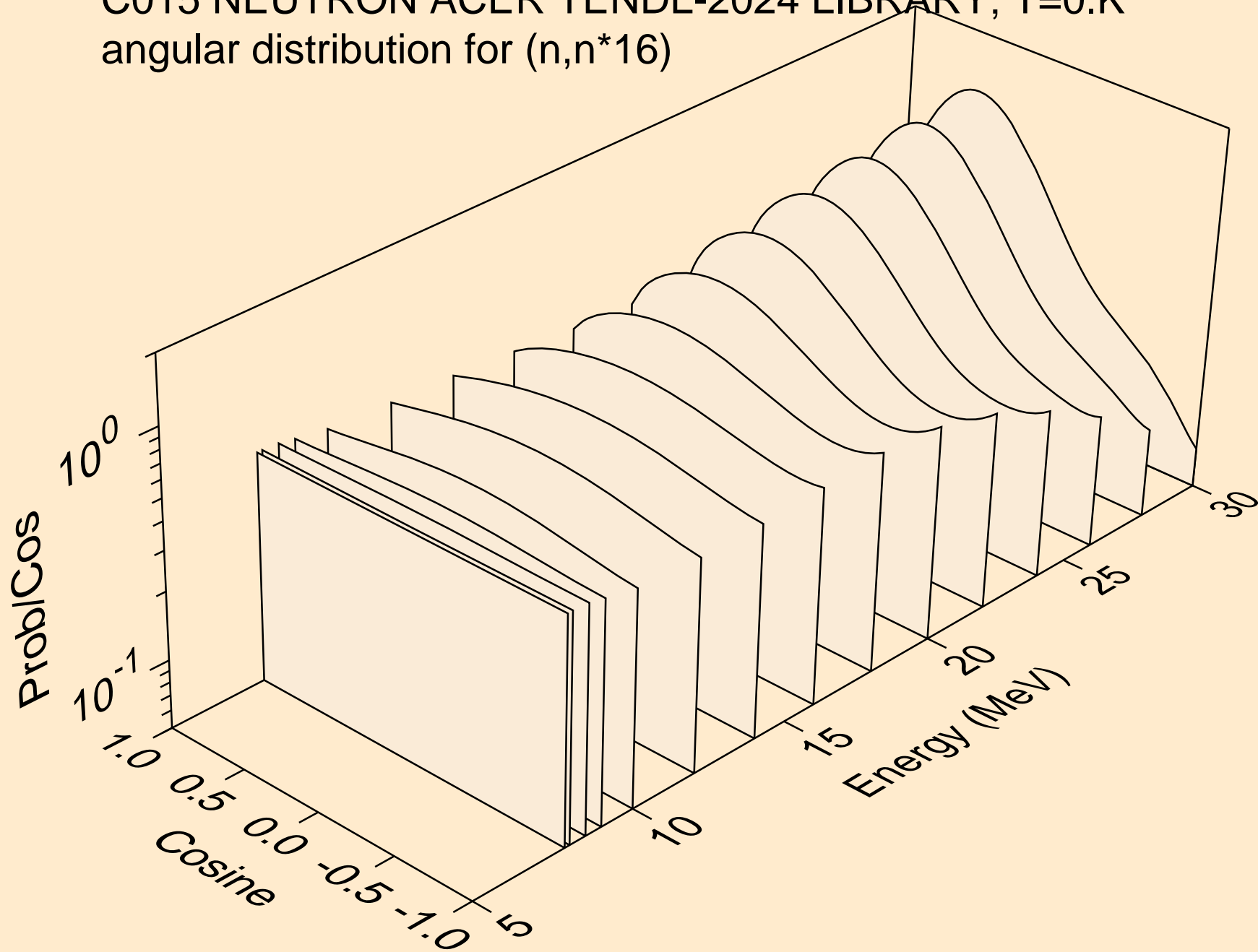

C015 NEUTRON ACER TENDL-2024 LIBRARY; T=0.K
angular distribution for (n,n*17)

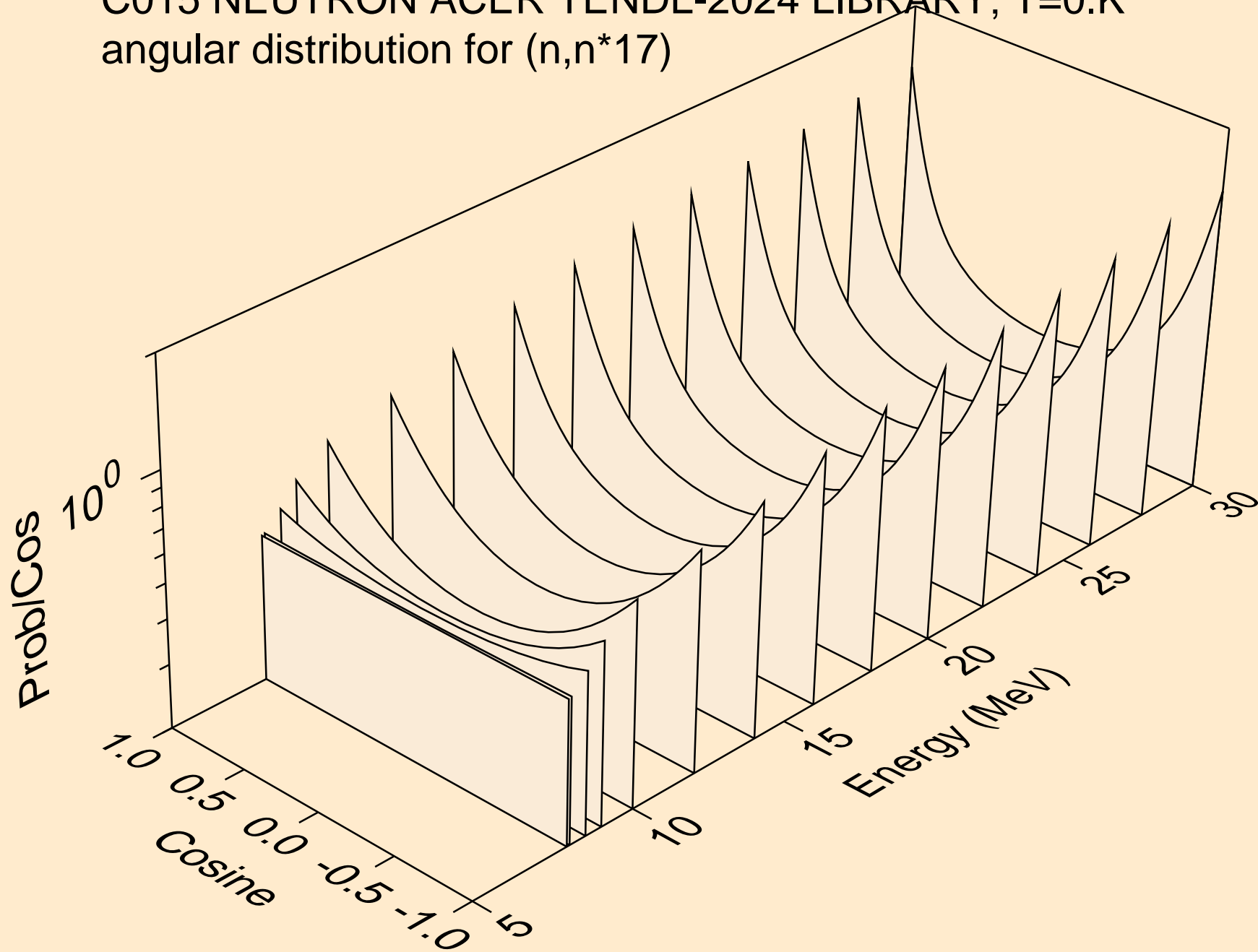

C015 NEUTRON ACER TENDL-2024 LIBRARY; T=0.K
angular distribution for (n,n*18)

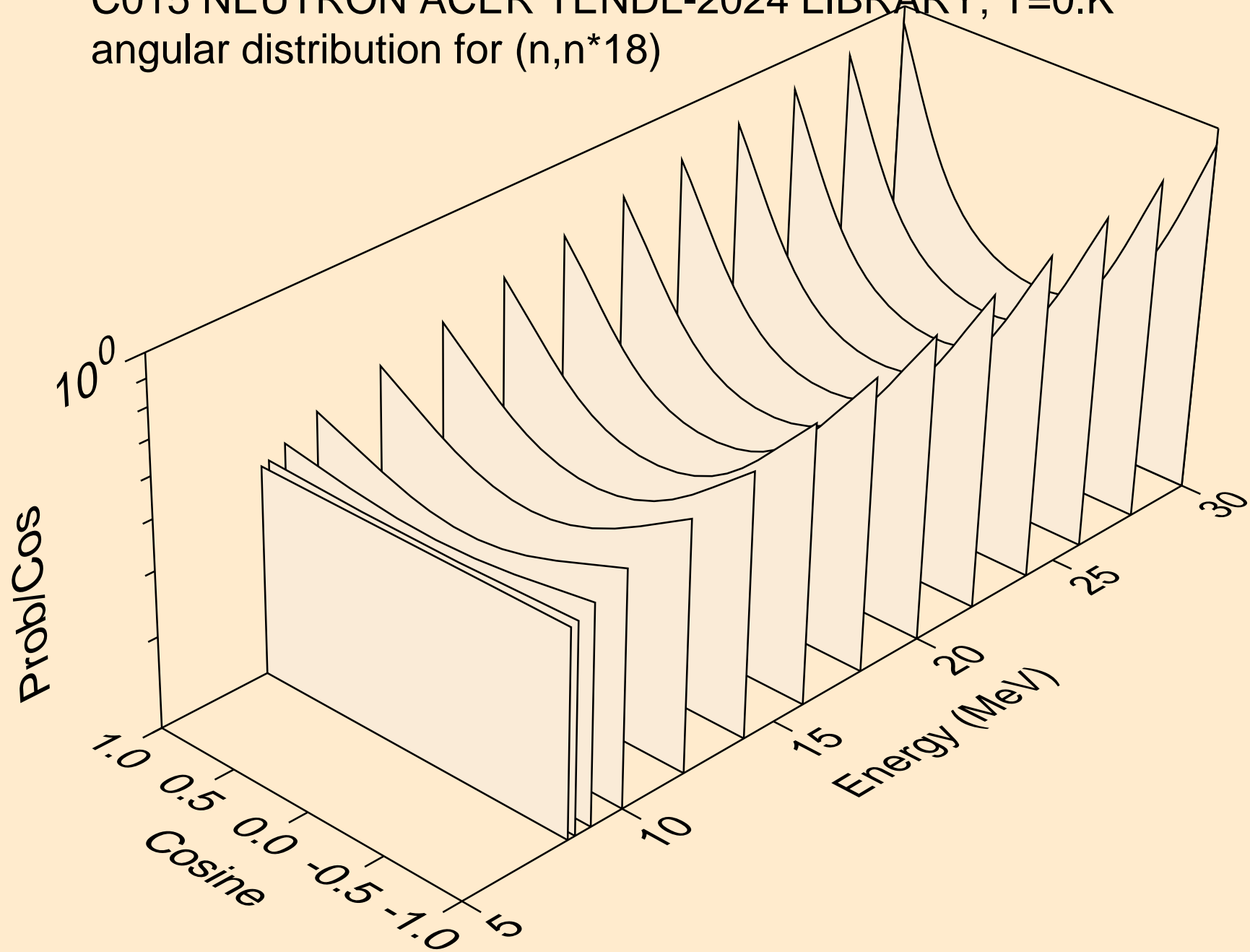

C015 NEUTRON ACER TENDL-2024 LIBRARY; T=0.K
angular distribution for (n,n*19)

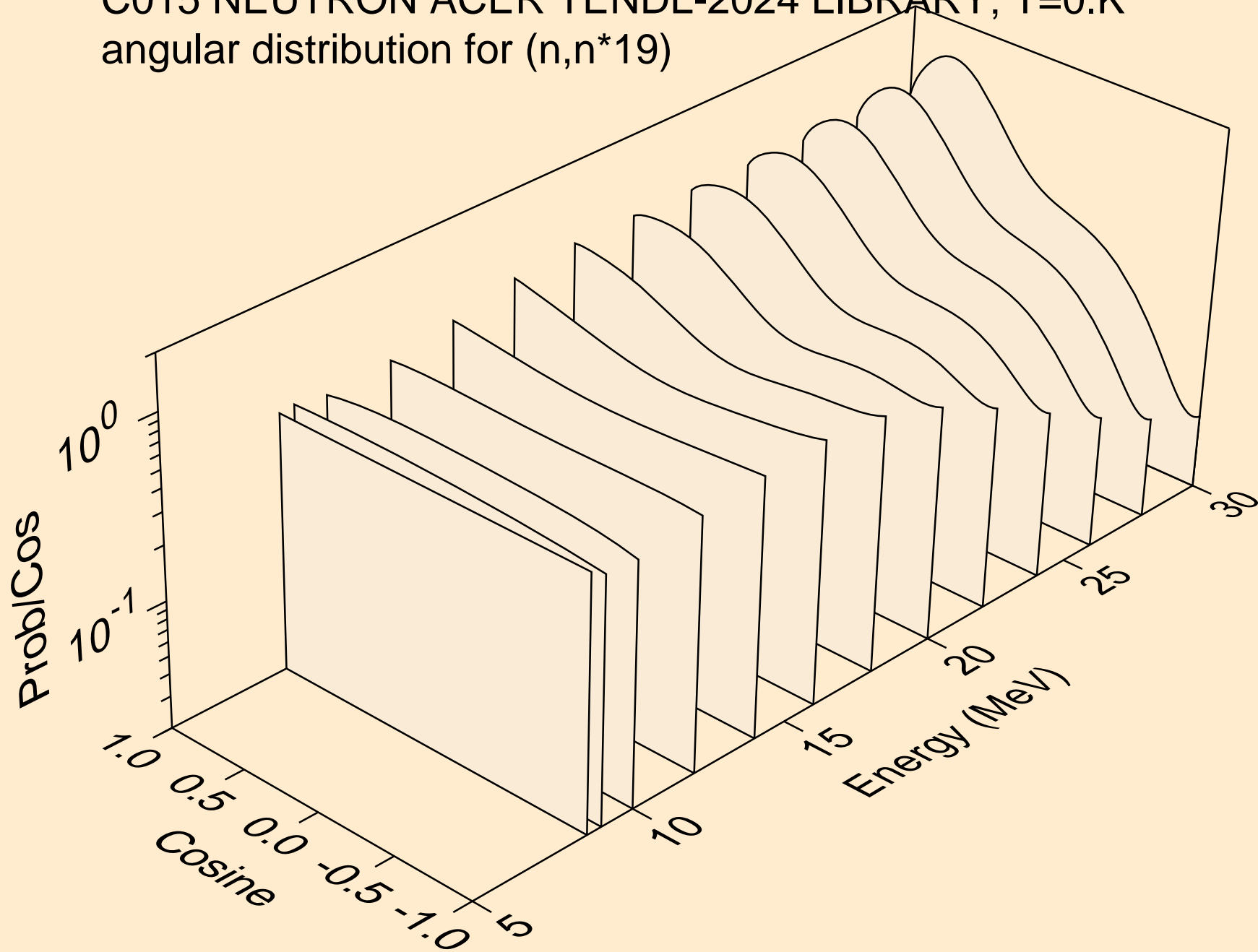

C015 NEUTRON ACER TENDL-2024 LIBRARY; T=0.K
angular distribution for (n,n*20)

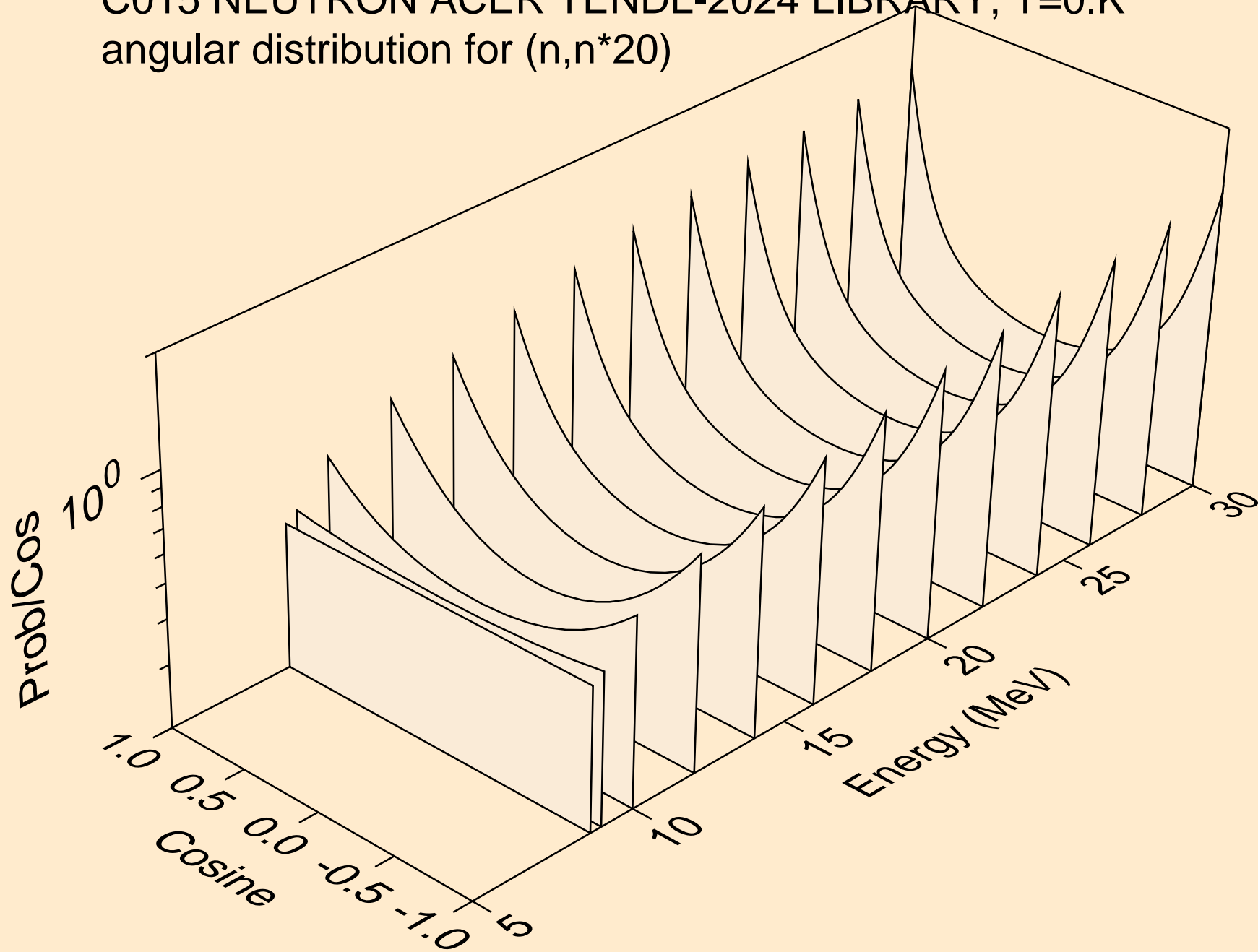

C015 NEUTRON ACER TENDL-2024 LIBRARY; T=0.K
angular distribution for (n,n*21)

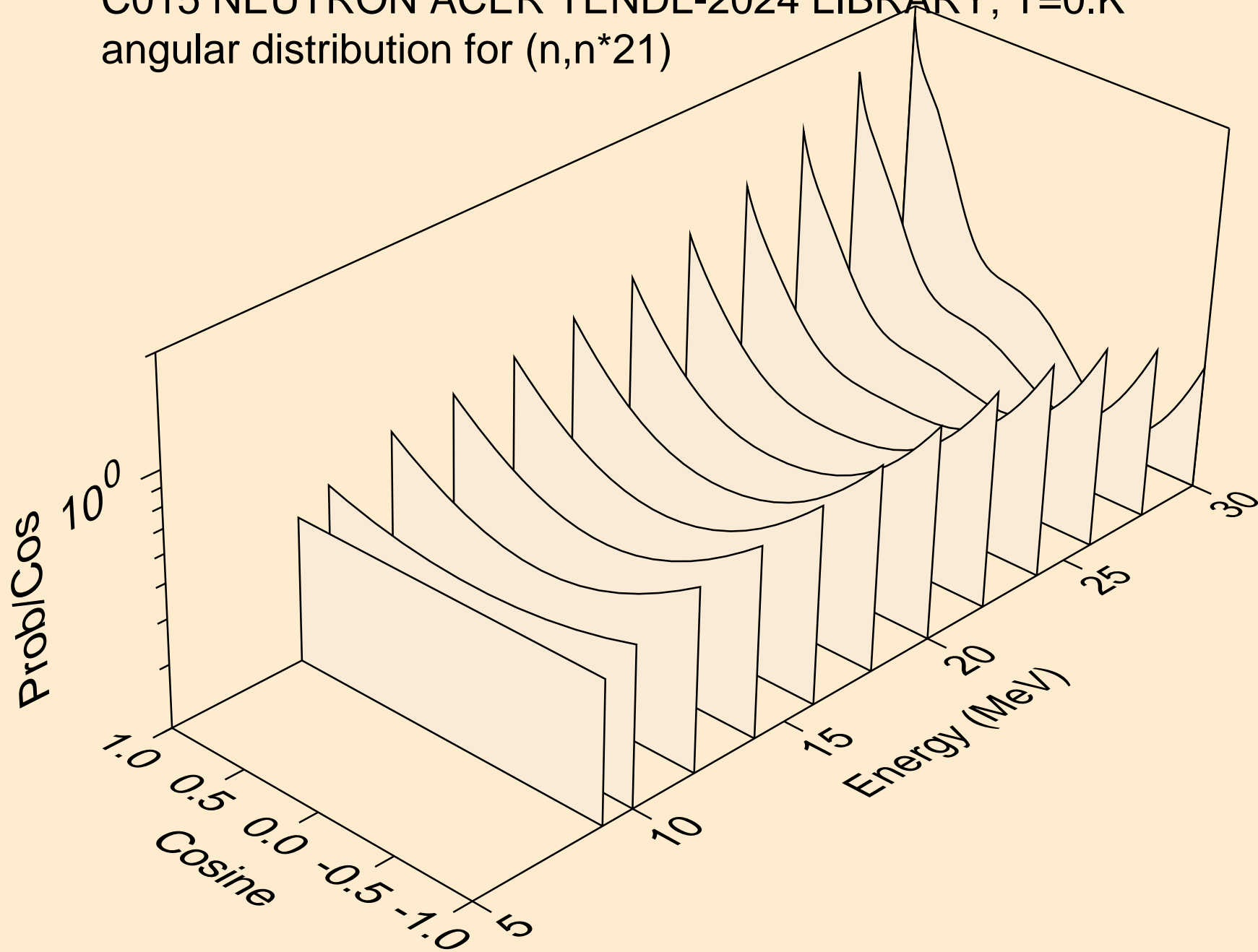

C015 NEUTRON ACER TENDL-2024 LIBRARY; T=0.K
angular distribution for (n,n*22)

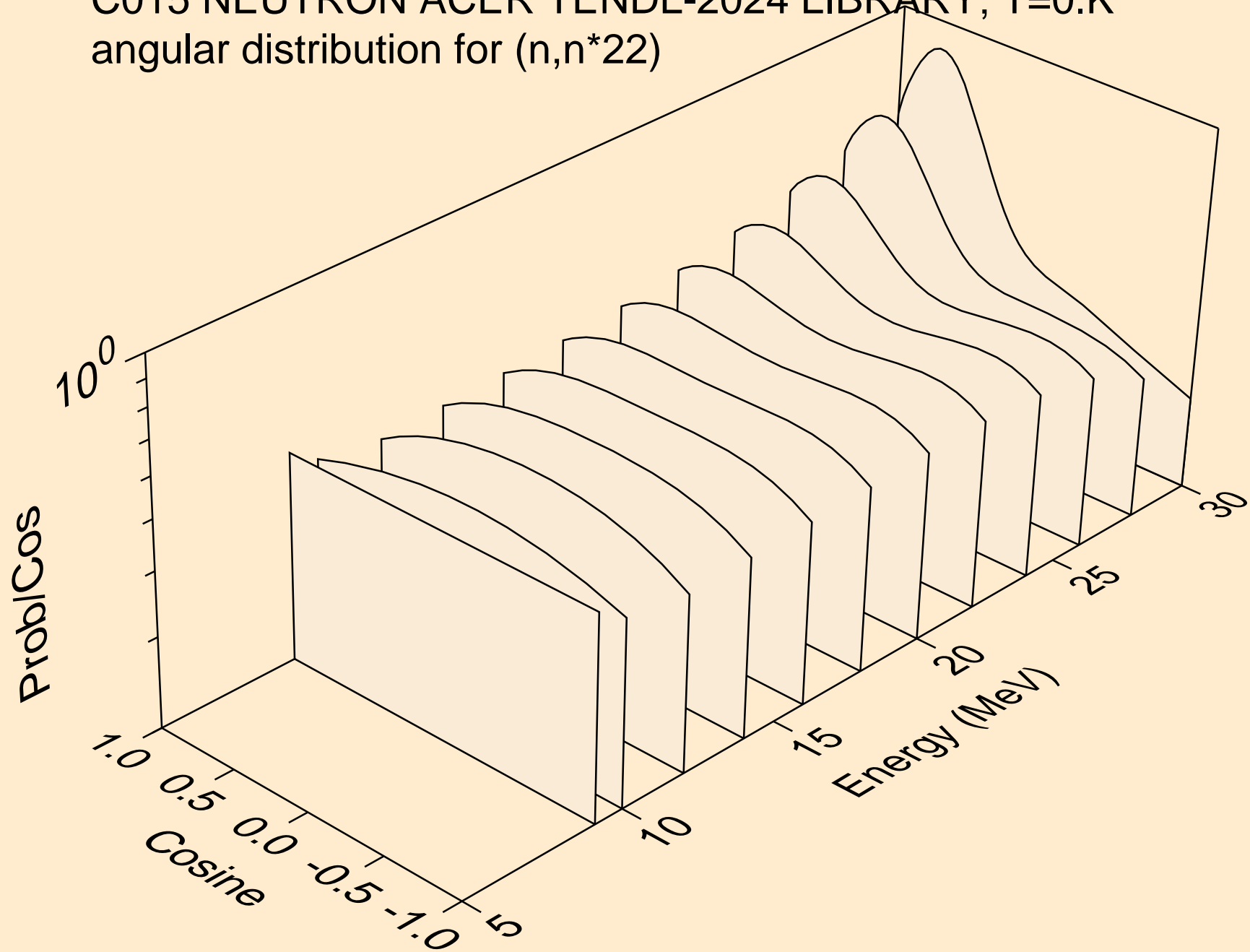

C015 NEUTRON ACER TENDL-2024 LIBRARY; T=0.K
angular distribution for (n,n*23)

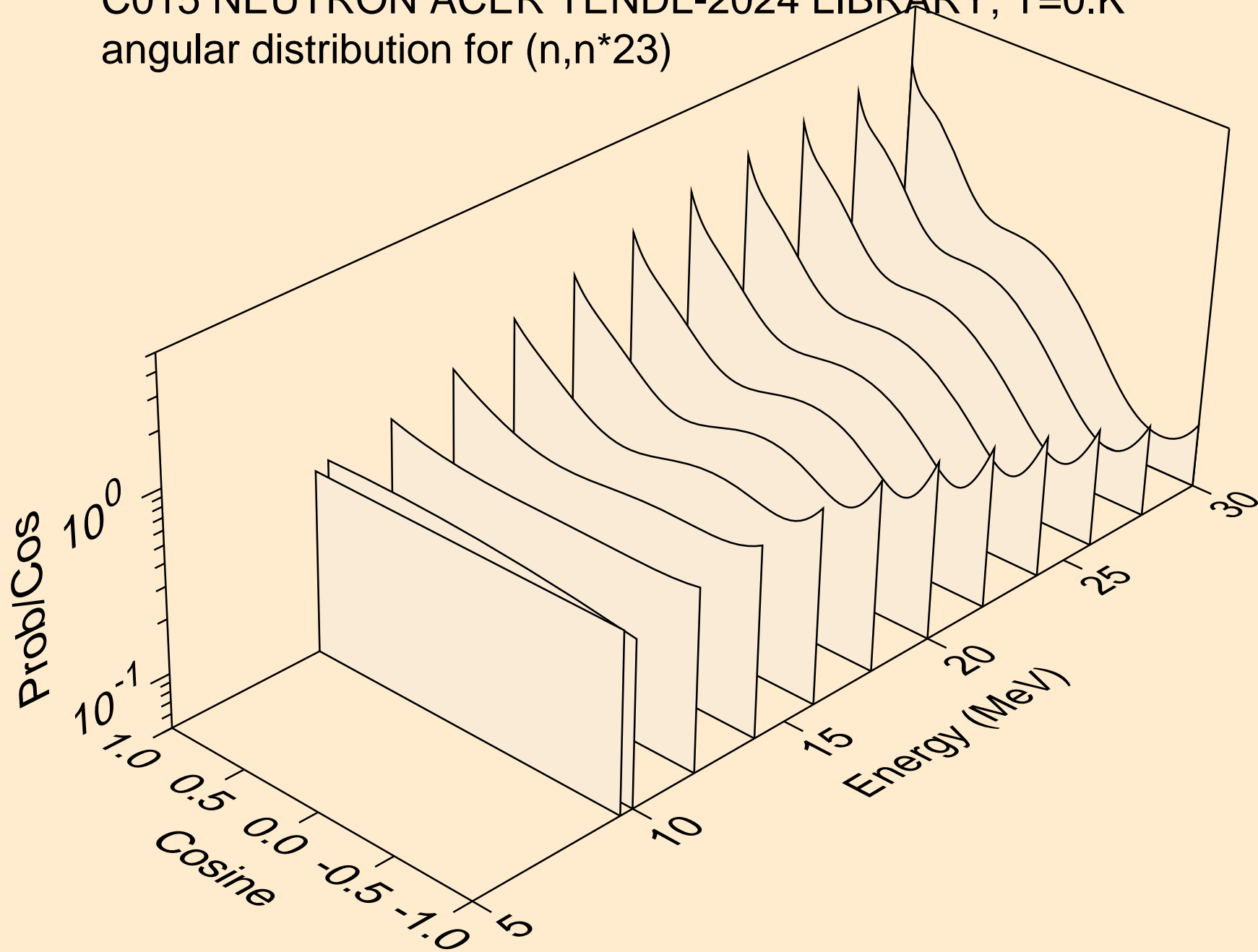

C015 NEUTRON ACER TENDL-2024 LIBRARY; T=0.K
Neutron emission for (n,x)

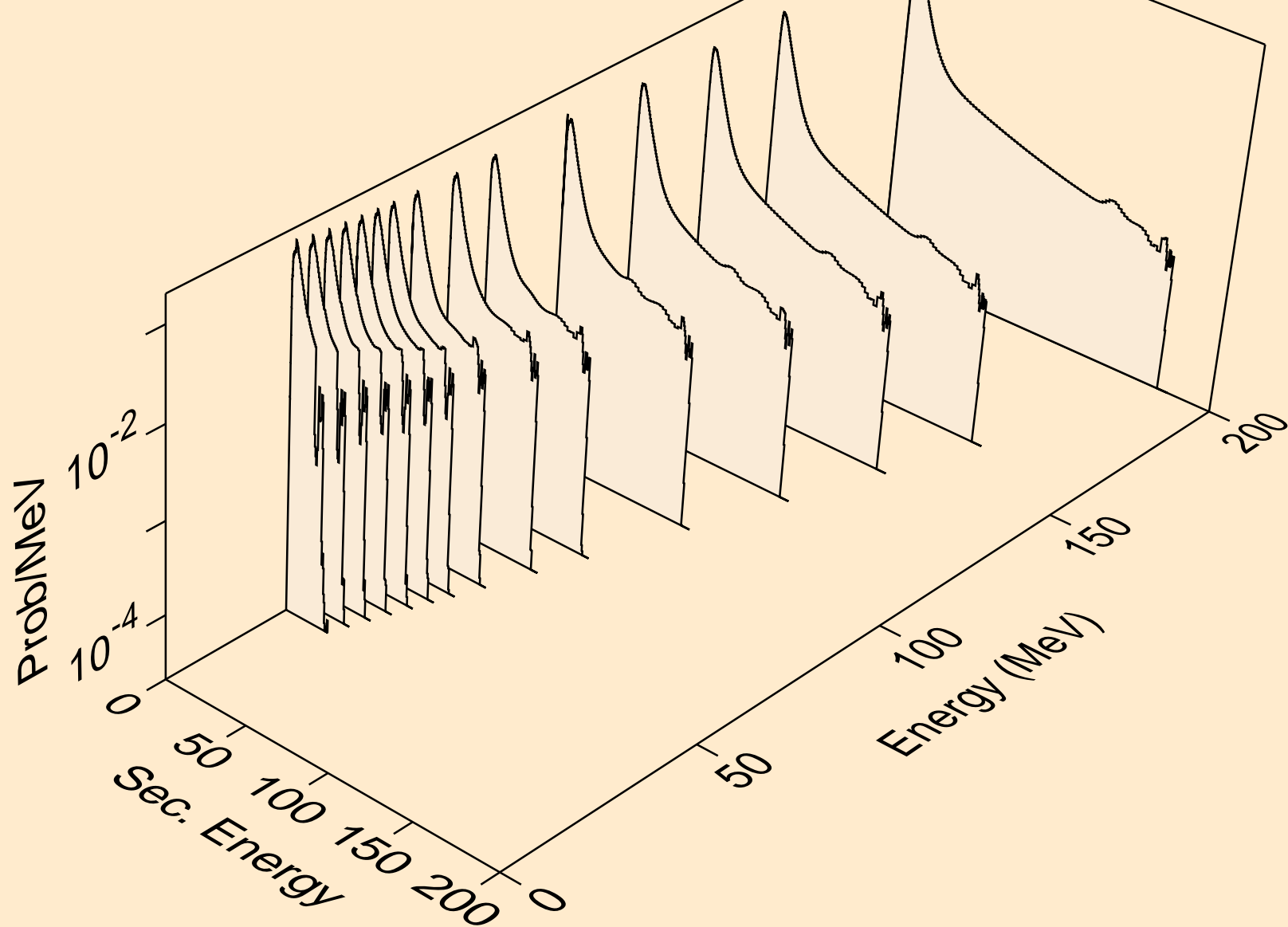

C015 NEUTRON ACER TENDL-2024 LIBRARY; T=0.K
Neutron emission for (n,2nd)

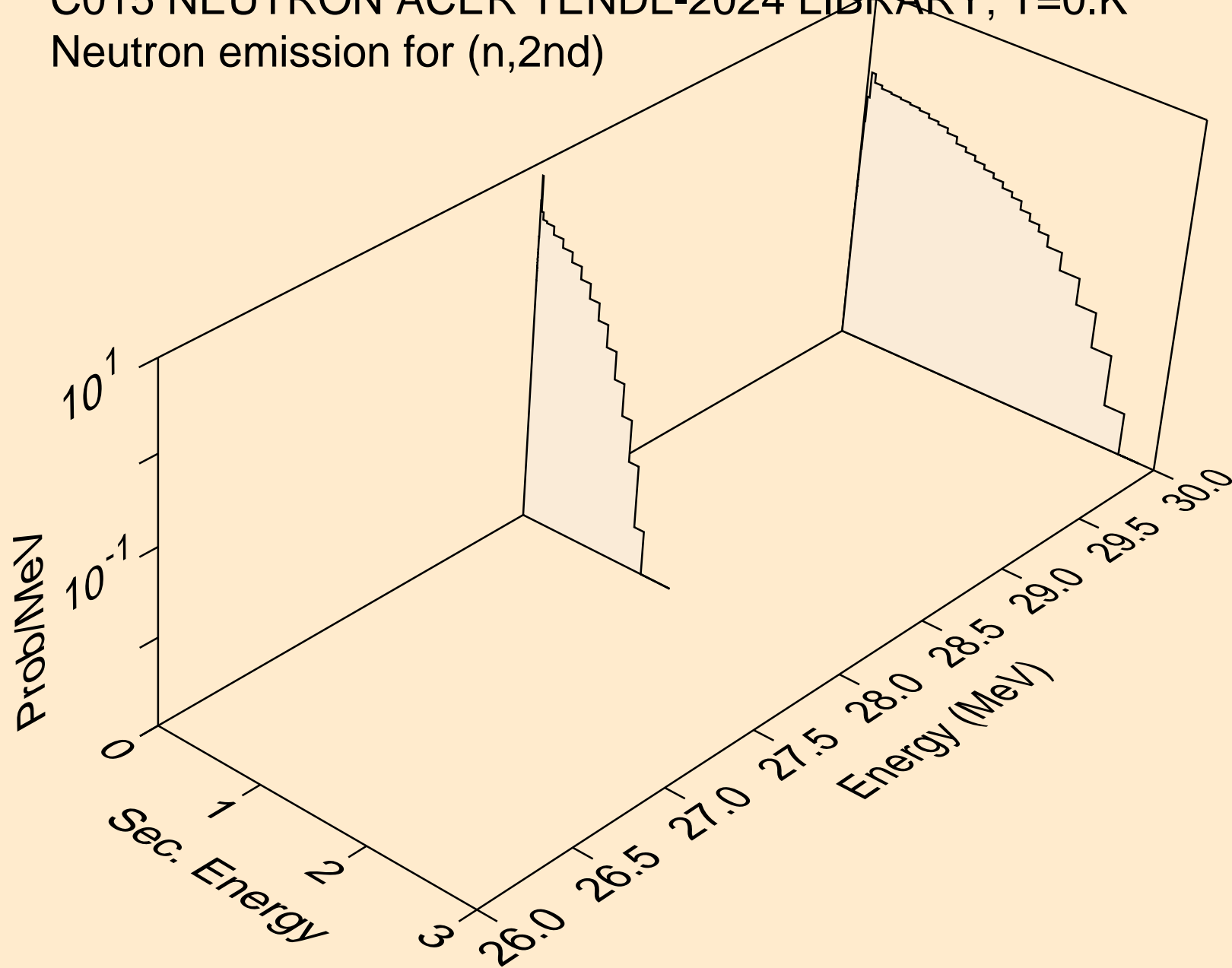

C015 NEUTRON ACER TENDL-2024 LIBRARY; T=0.K
Neutron emission for (n,2n)

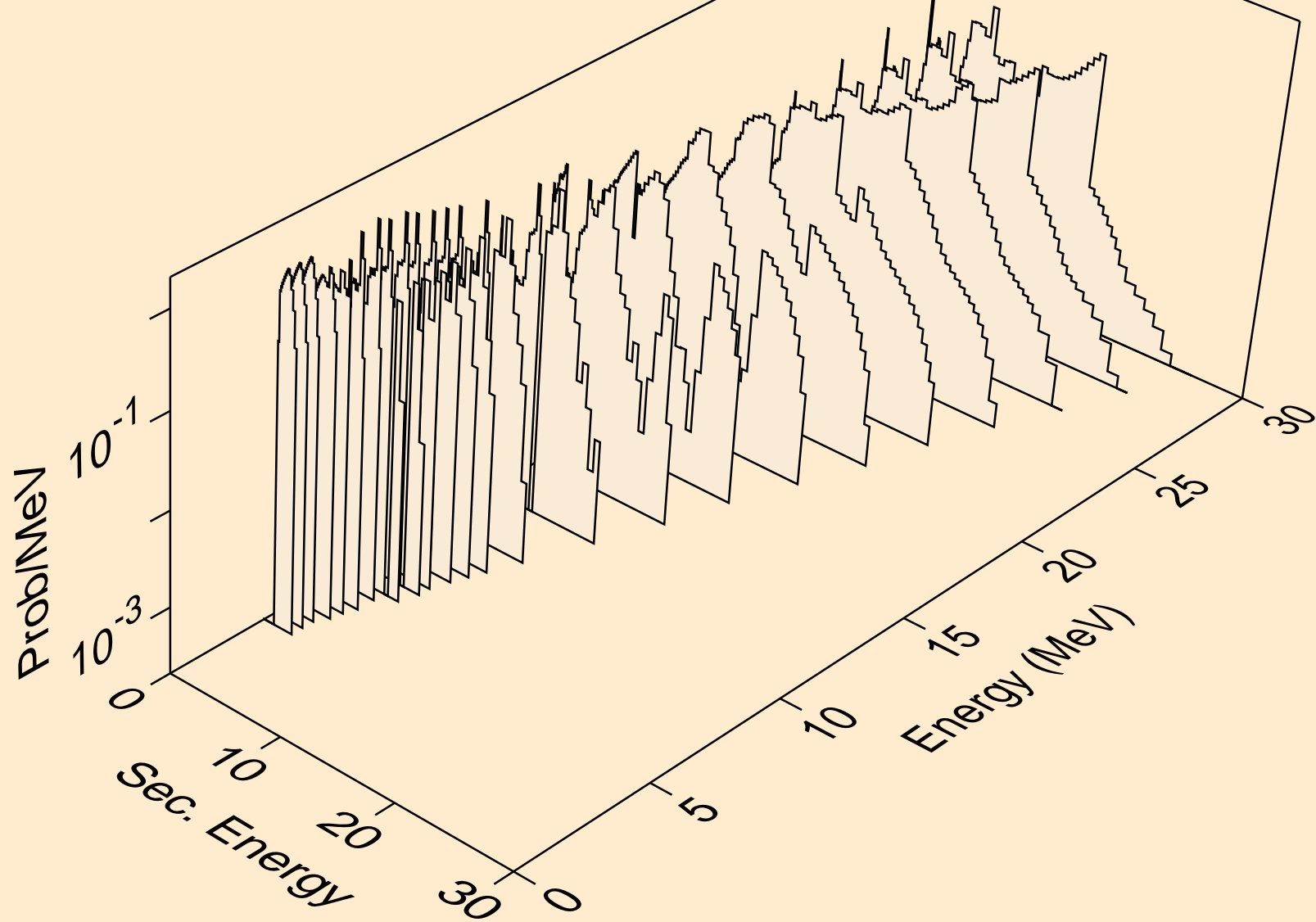

C015 NEUTRON ACER TENDL-2024 LIBRARY; T=0.K
Neutron emission for (n,3n)

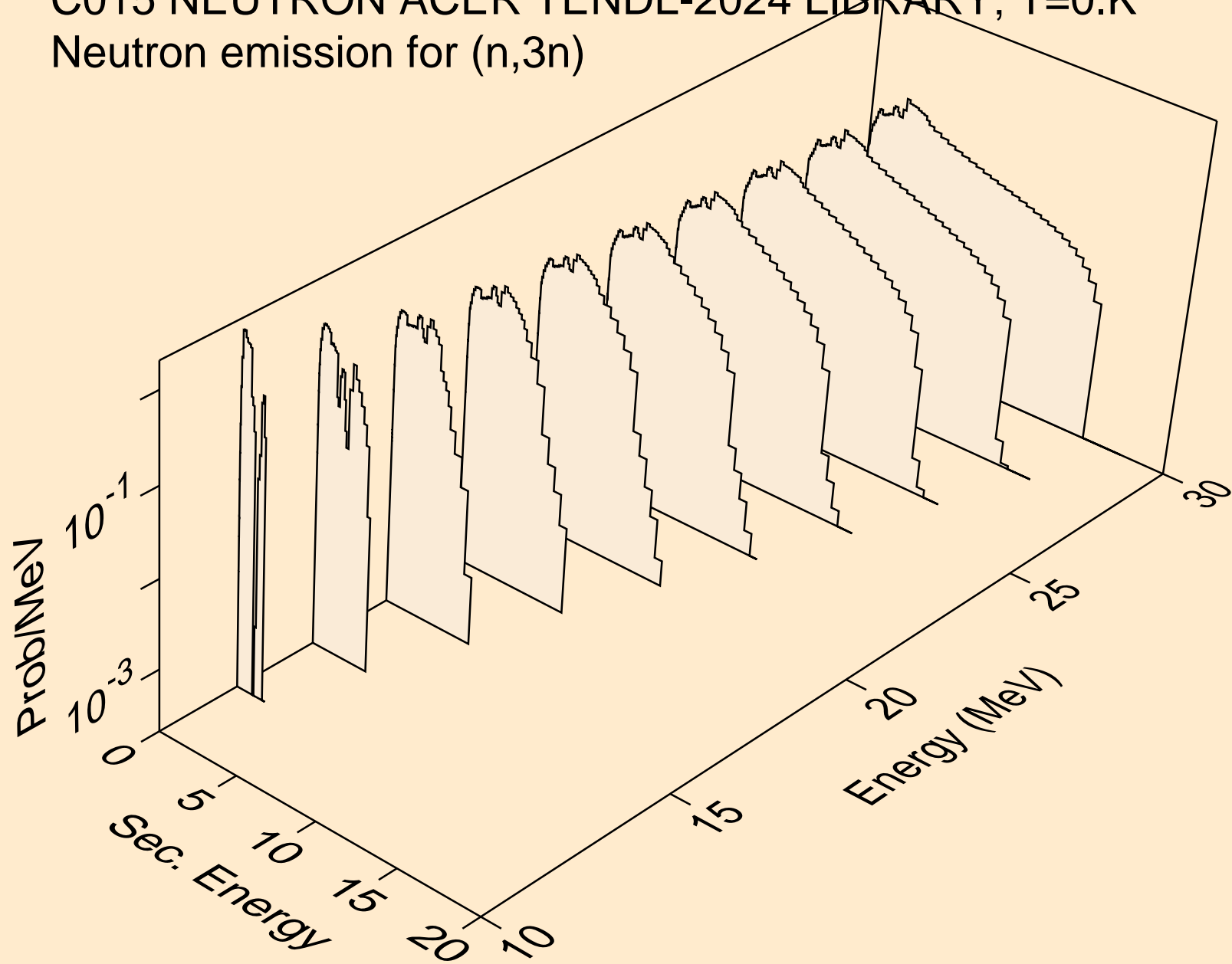

C015 NEUTRON ACER TENDL-2024 LIBRARY; T=0.K
Neutron emission for (n,n*)a

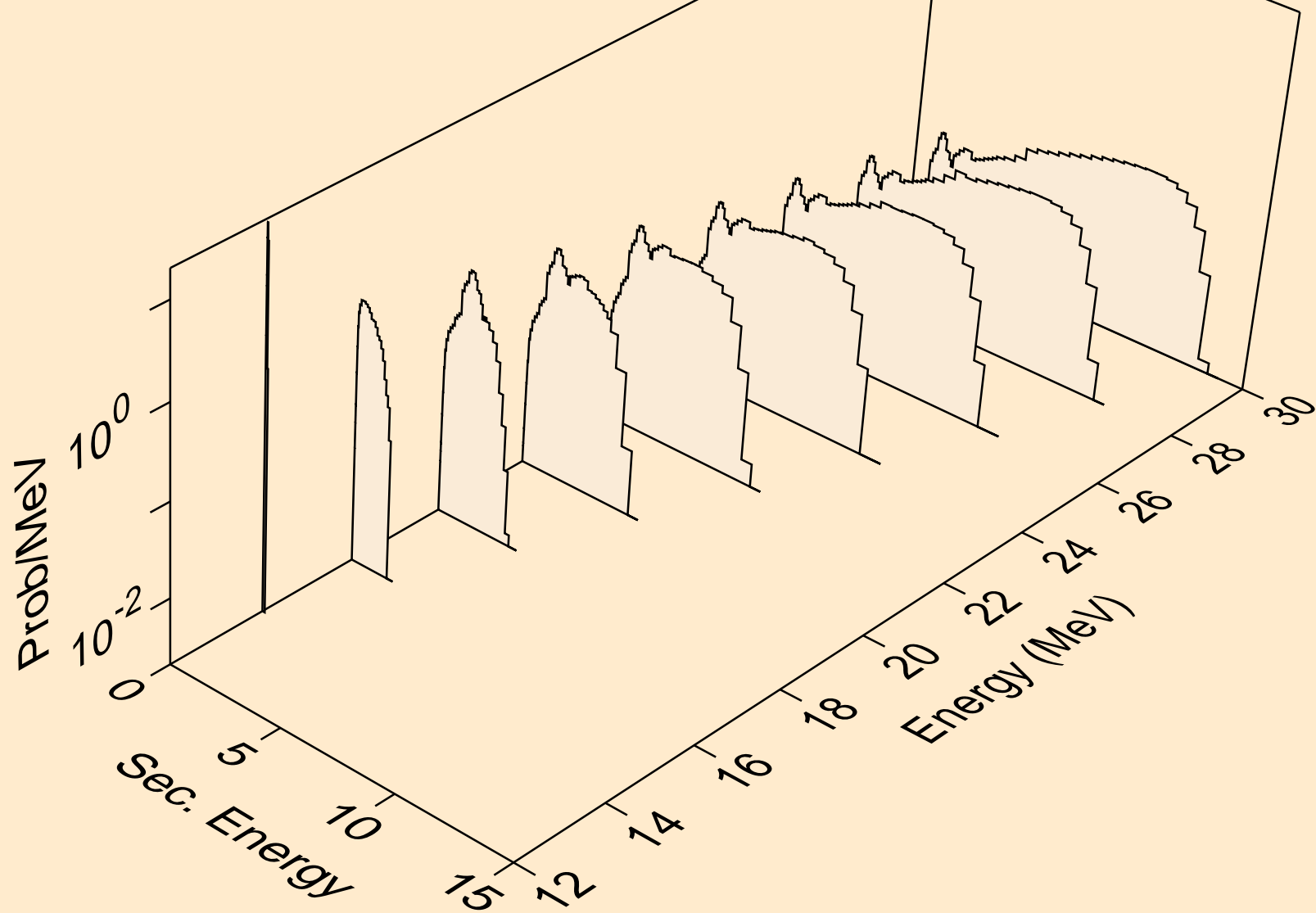

C015 NEUTRON ACER TENDL-2024 LIBRARY; T=0.K
Neutron emission for (n,2n)a

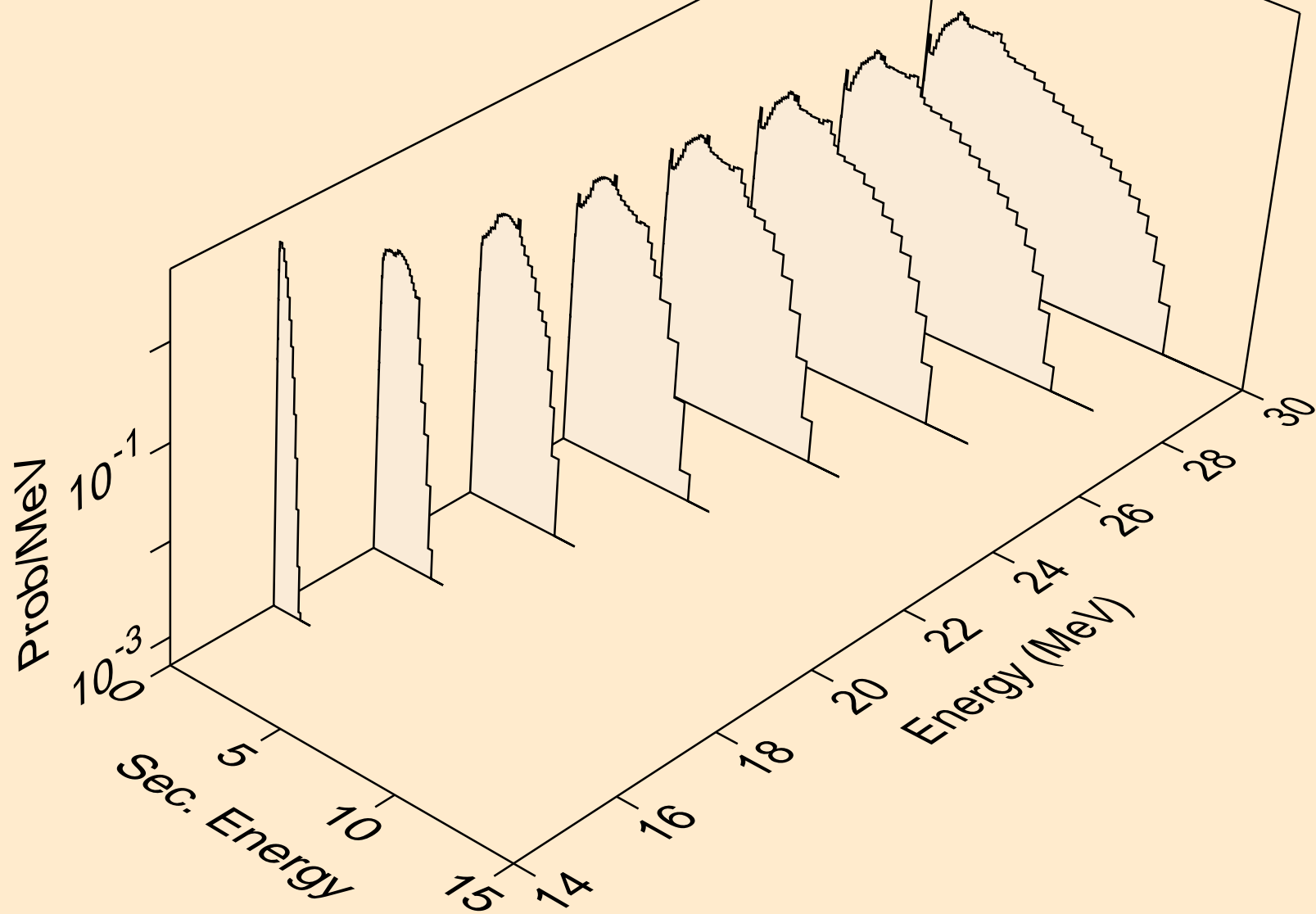

C015 NEUTRON ACER TENDL-2024 LIBRARY; T=0.K
Neutron emission for (n,3n)a

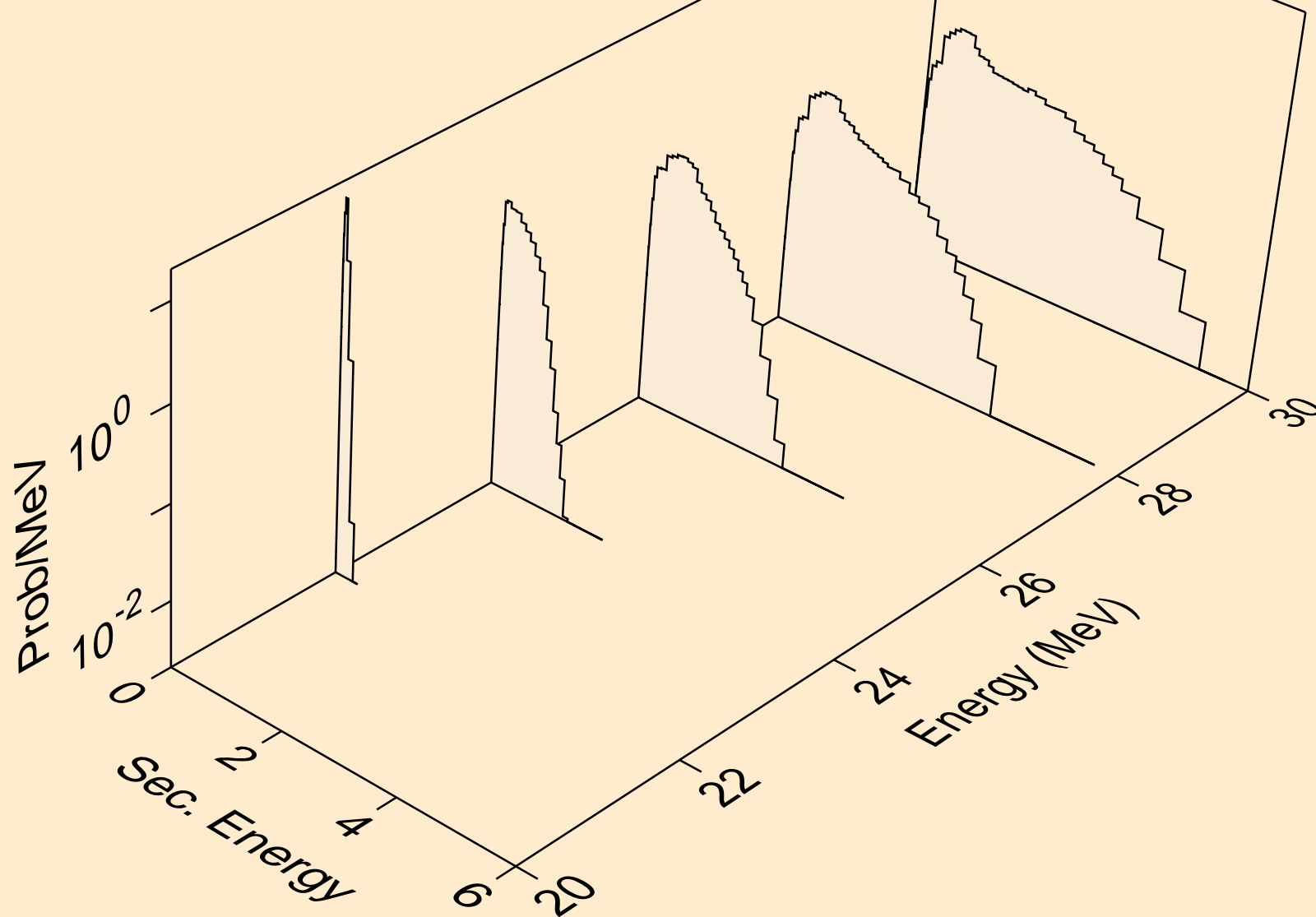

C015 NEUTRON ACER TENDL-2024 LIBRARY; T=0.K
Neutron emission for (n,n*)p

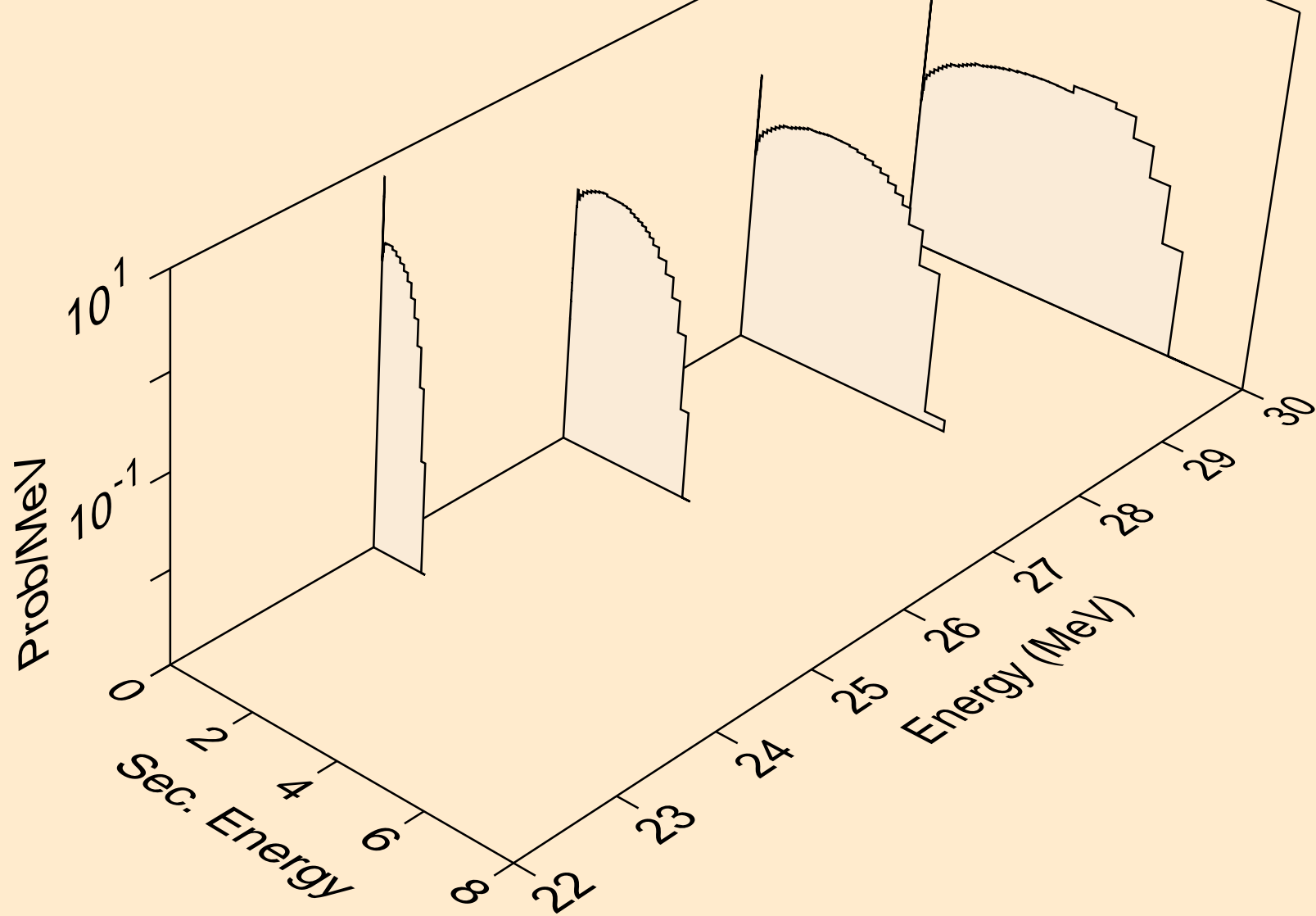

C015 NEUTRON ACER TENDL-2024 LIBRARY; T=0.K
Neutron emission for (n,n*)d

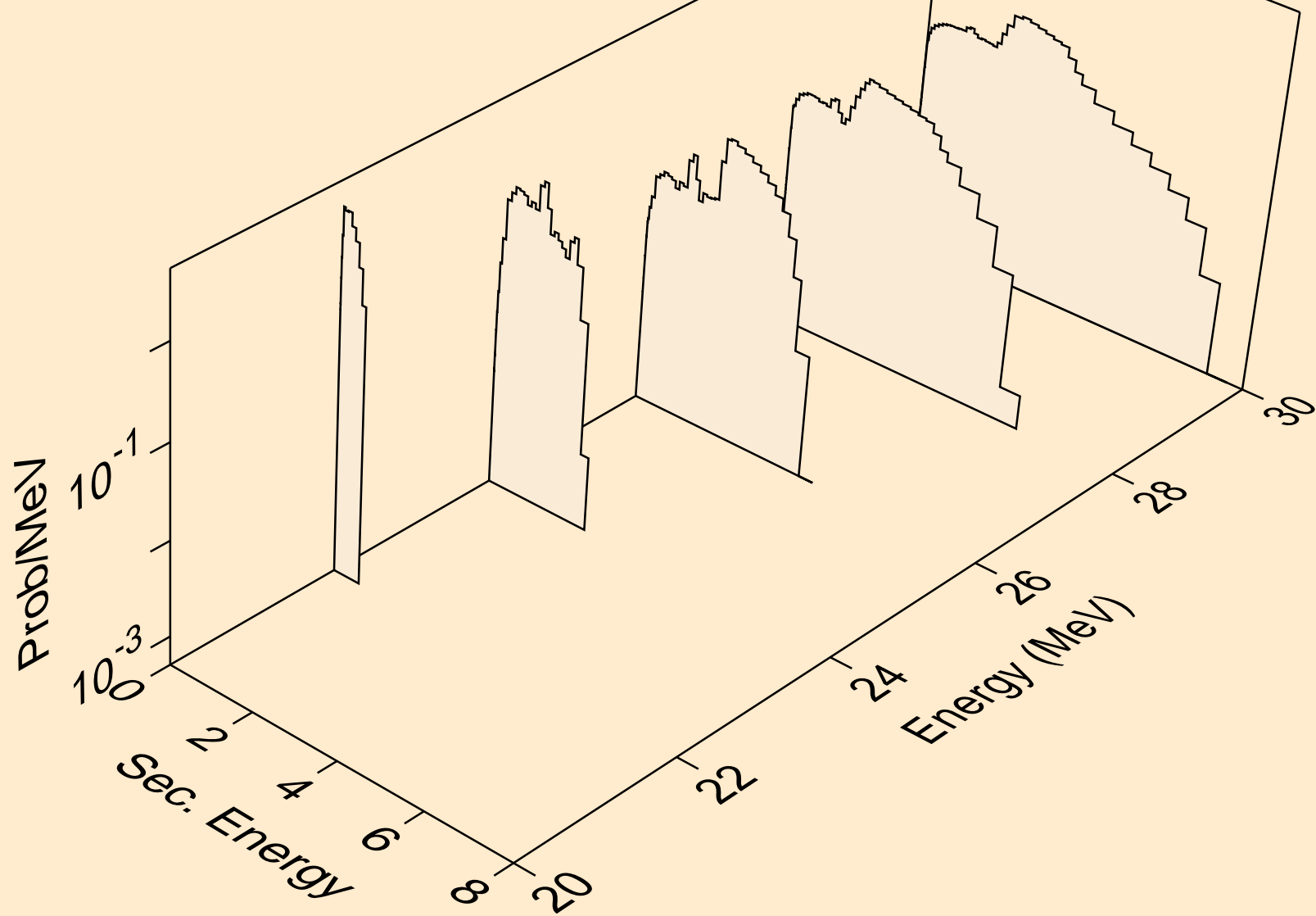

C015 NEUTRON ACER TENDL-2024 LIBRARY; T=0.K
Neutron emission for (n,n*)t

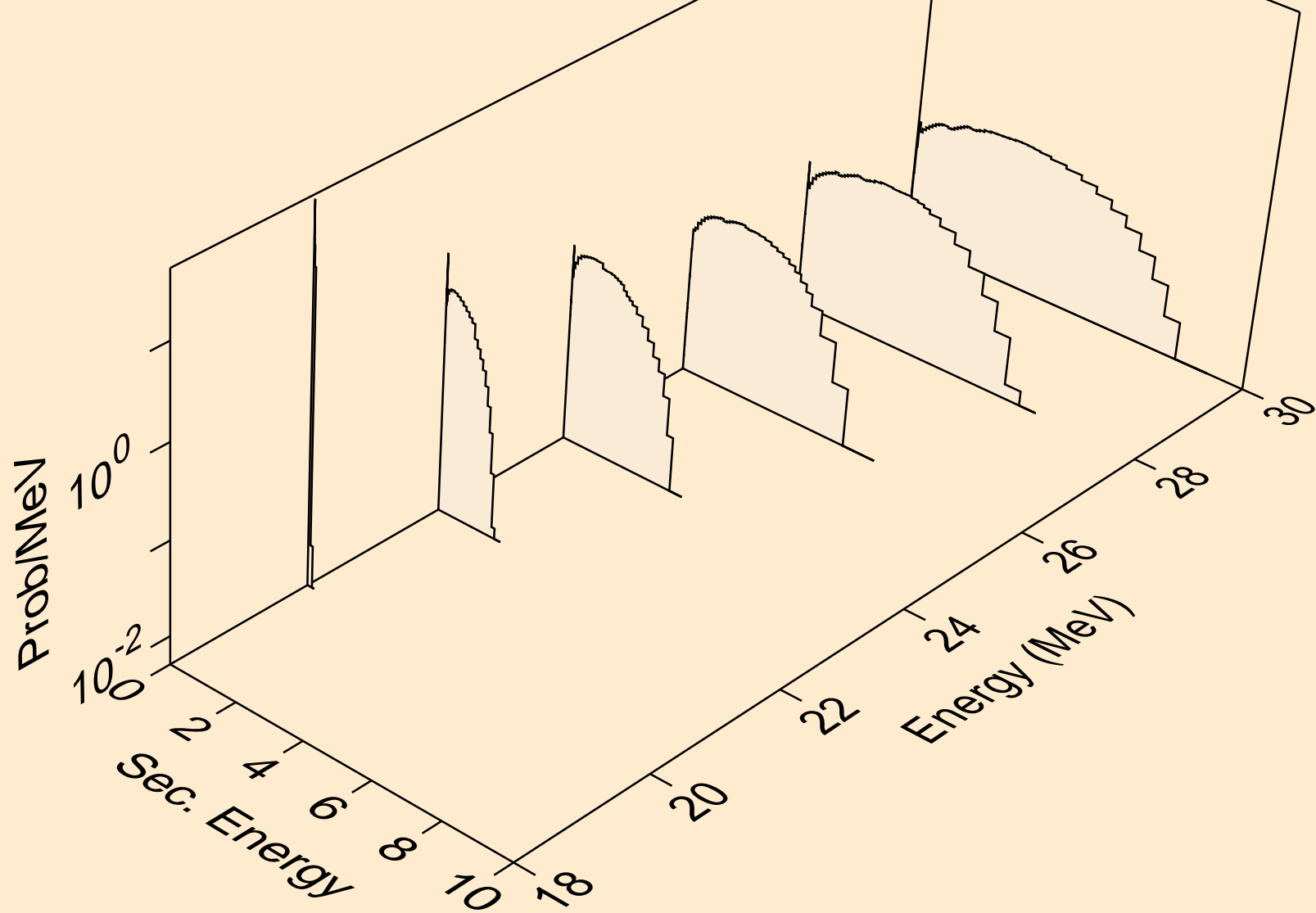

C015 NEUTRON ACER TENDL-2024 LIBRARY; T=0.K
Neutron emission for (n,4n)

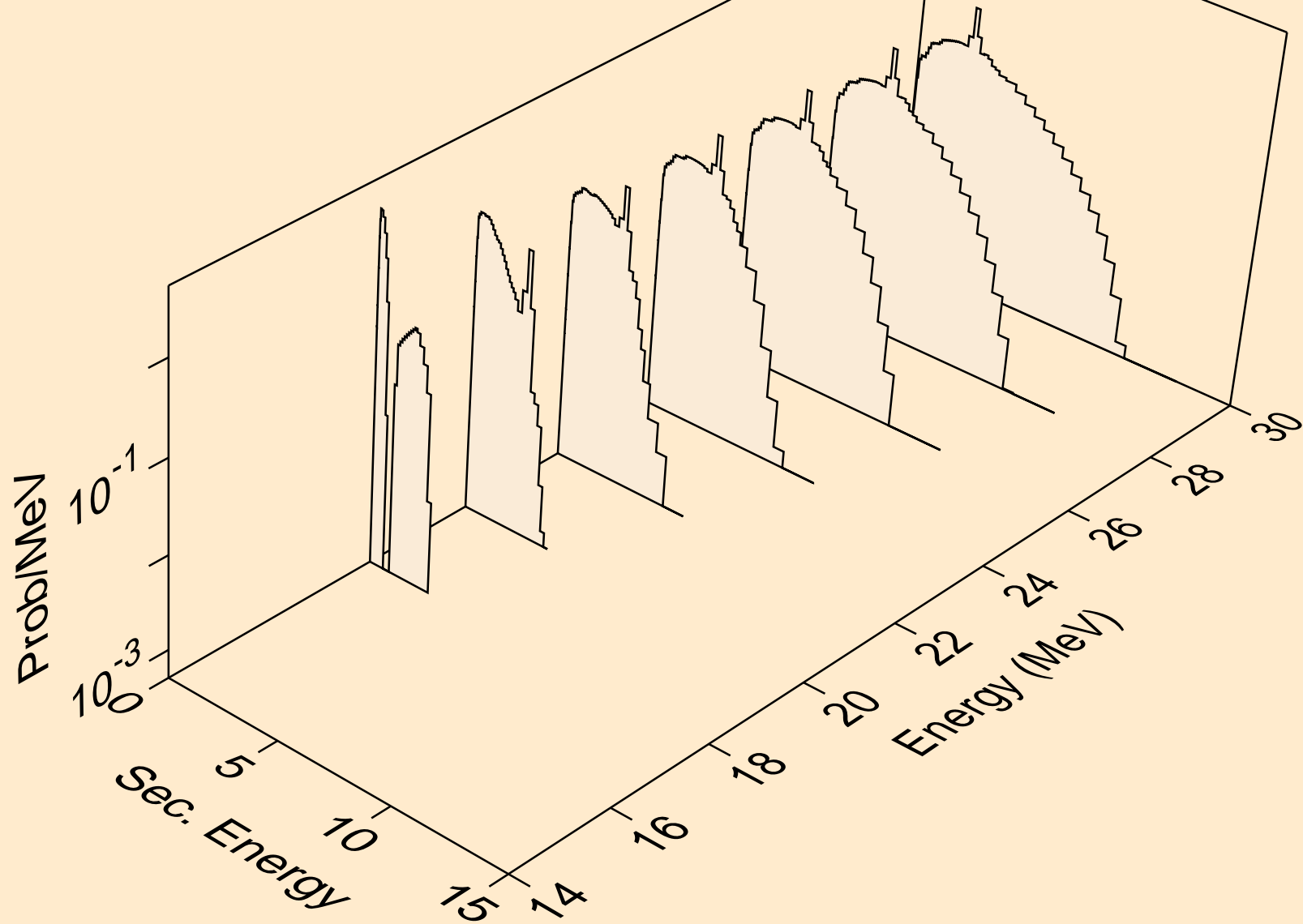

C015 NEUTRON ACER TENDL-2024 LIBRARY; T=0.K
Neutron emission for (n,2np)

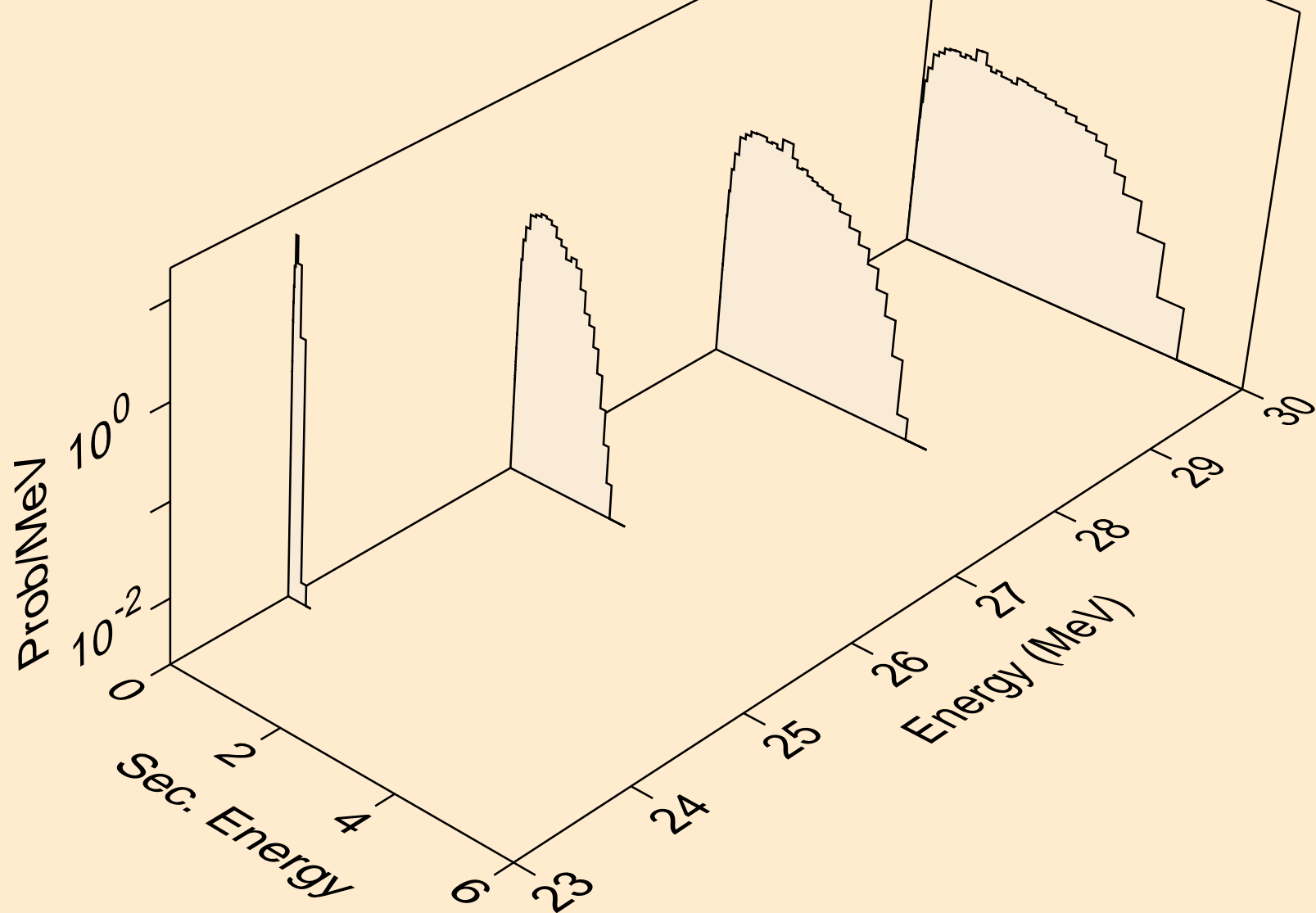

C015 NEUTRON ACER TENDL-2024 LIBRARY; T=0.K
Neutron emission for (n,3np)

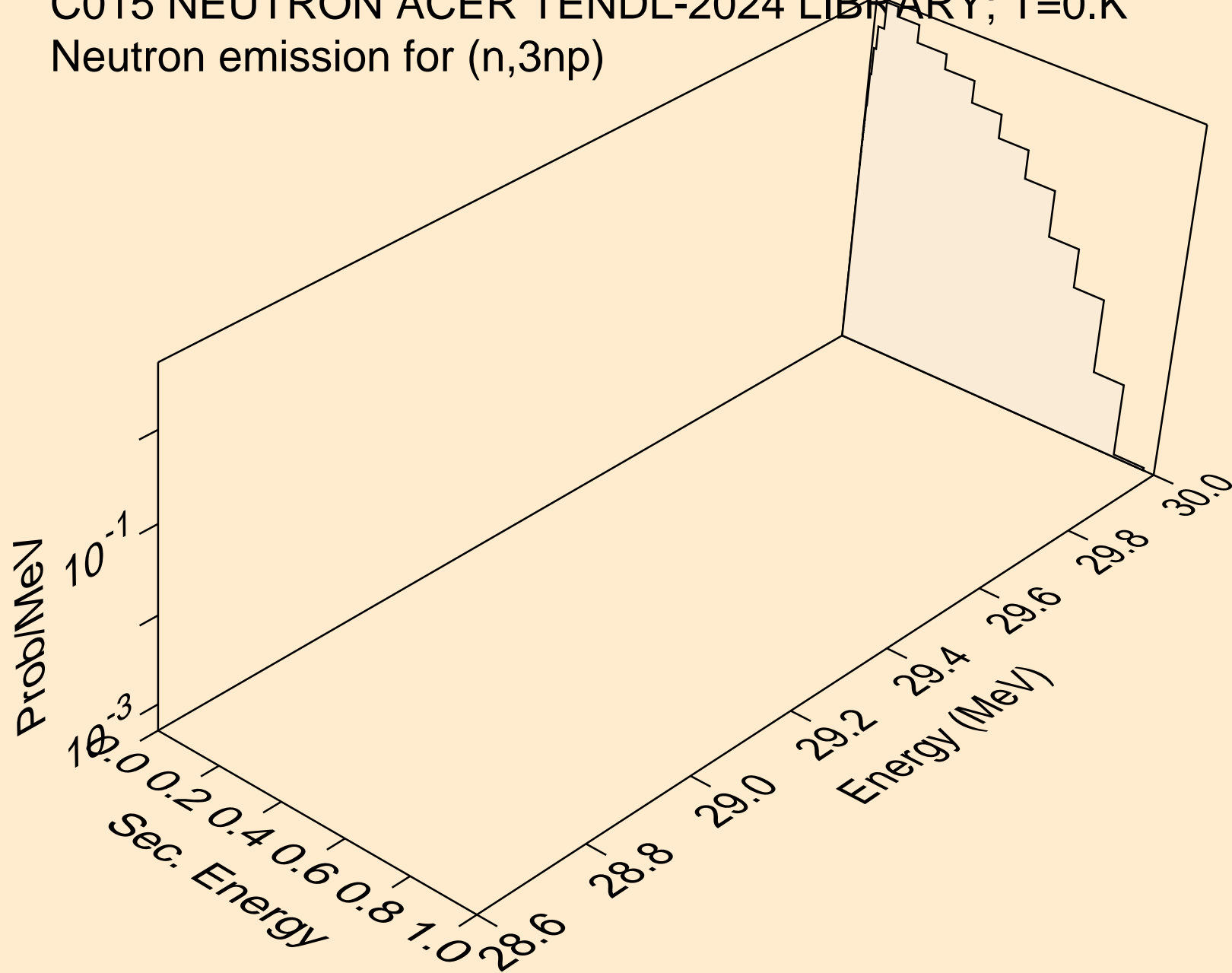

C015 NEUTRON ACER TENDL-2024 LIBRARY; T=0.K
Photon emission for (n,x)

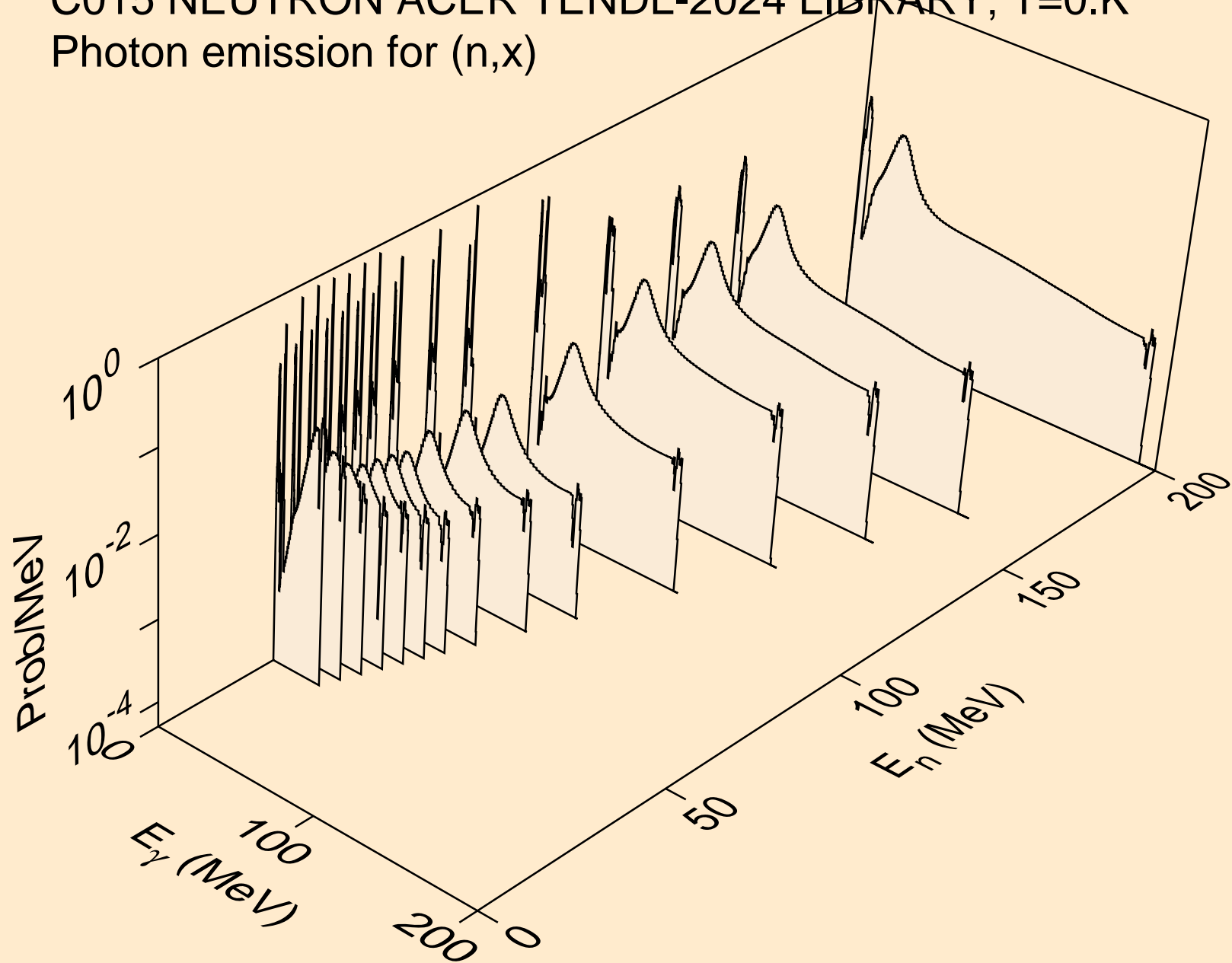

C015 NEUTRON ACER TENDL-2024 LIBRARY; T=0.K
Photon emission for (n,2nd)

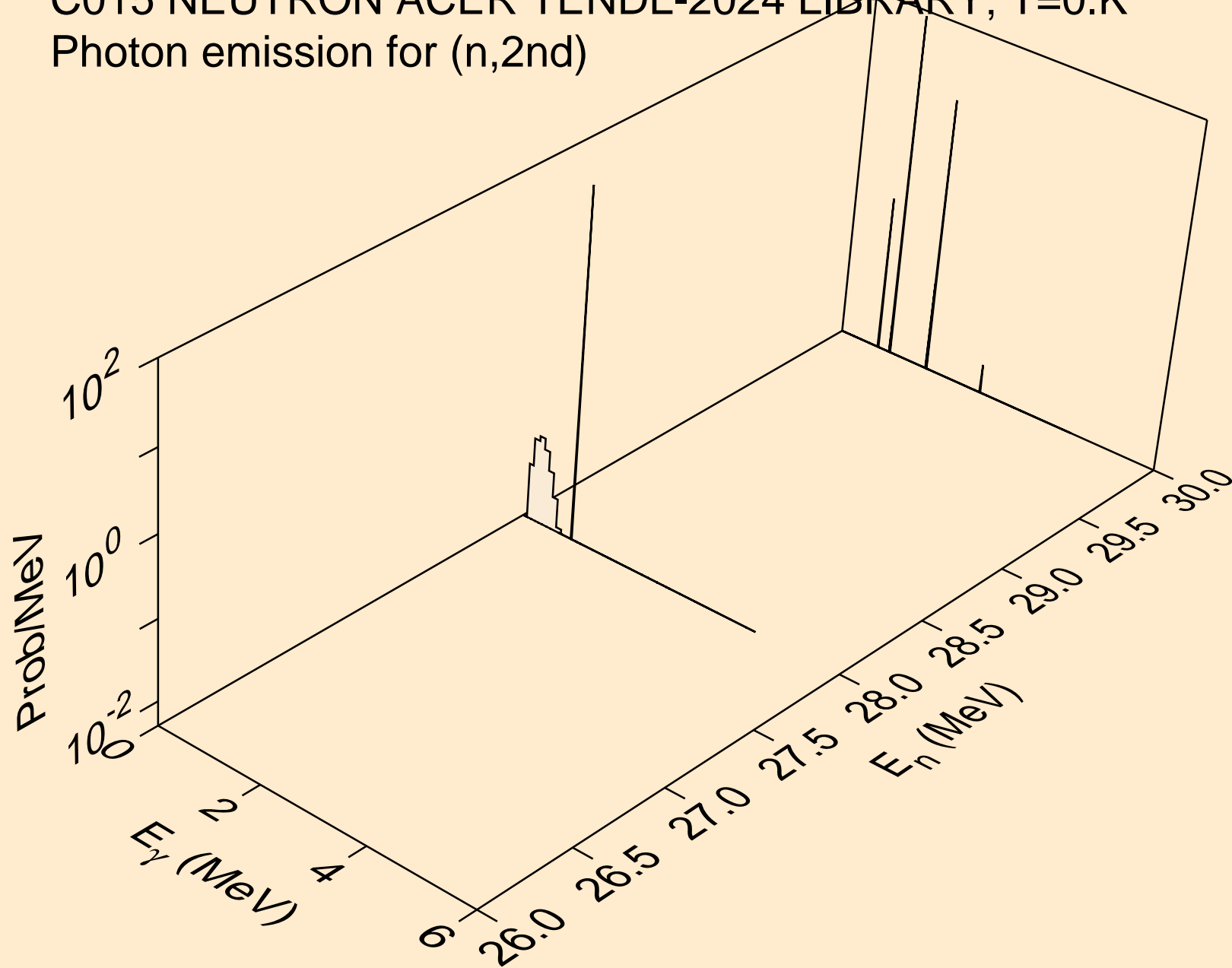

C015 NEUTRON ACER TENDL-2024 LIBRARY; T=0.K
Photon emission for (n,2n)

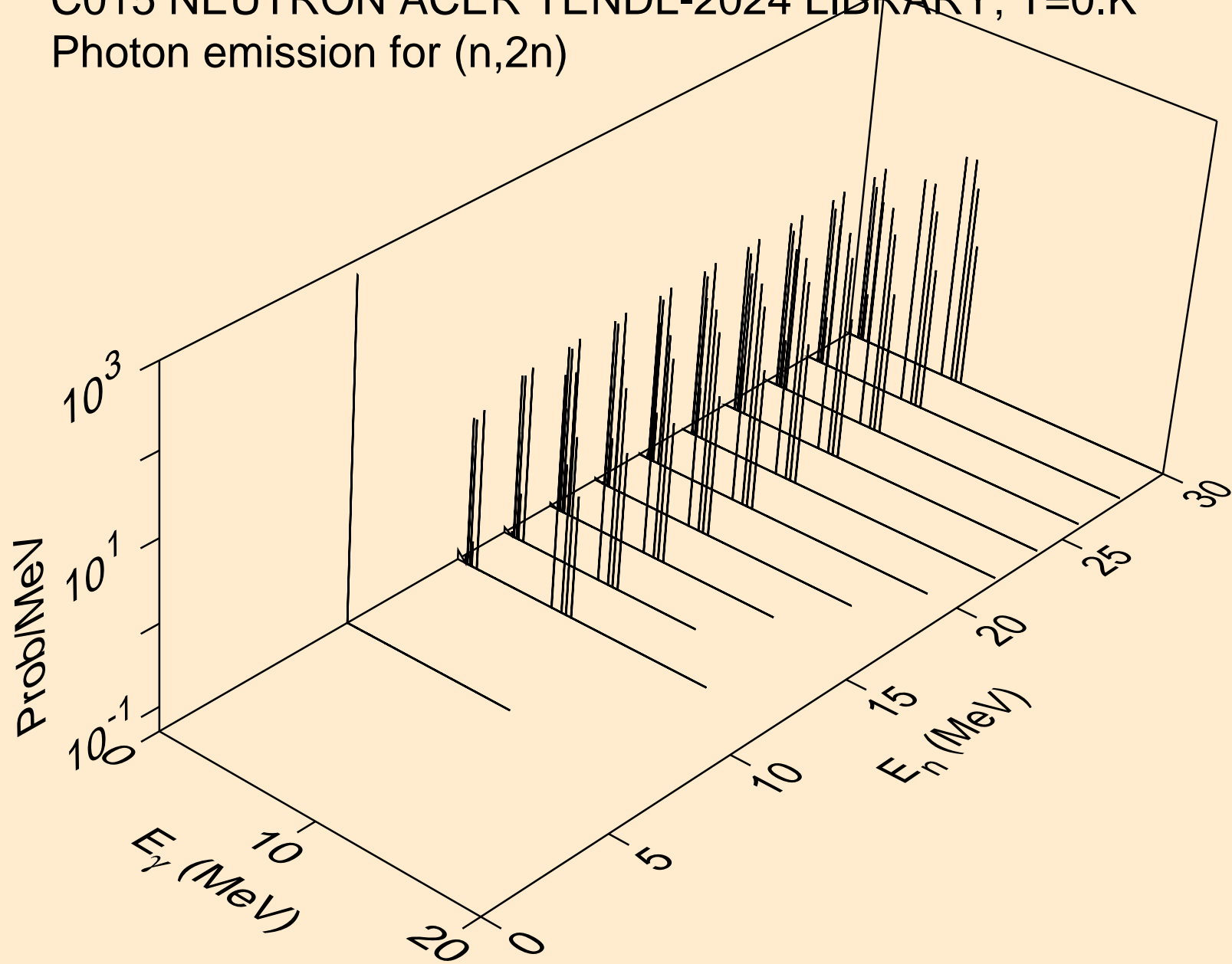

C015 NEUTRON ACER TENDL-2024 LIBRARY; T=0.K
Photon emission for (n,3n)

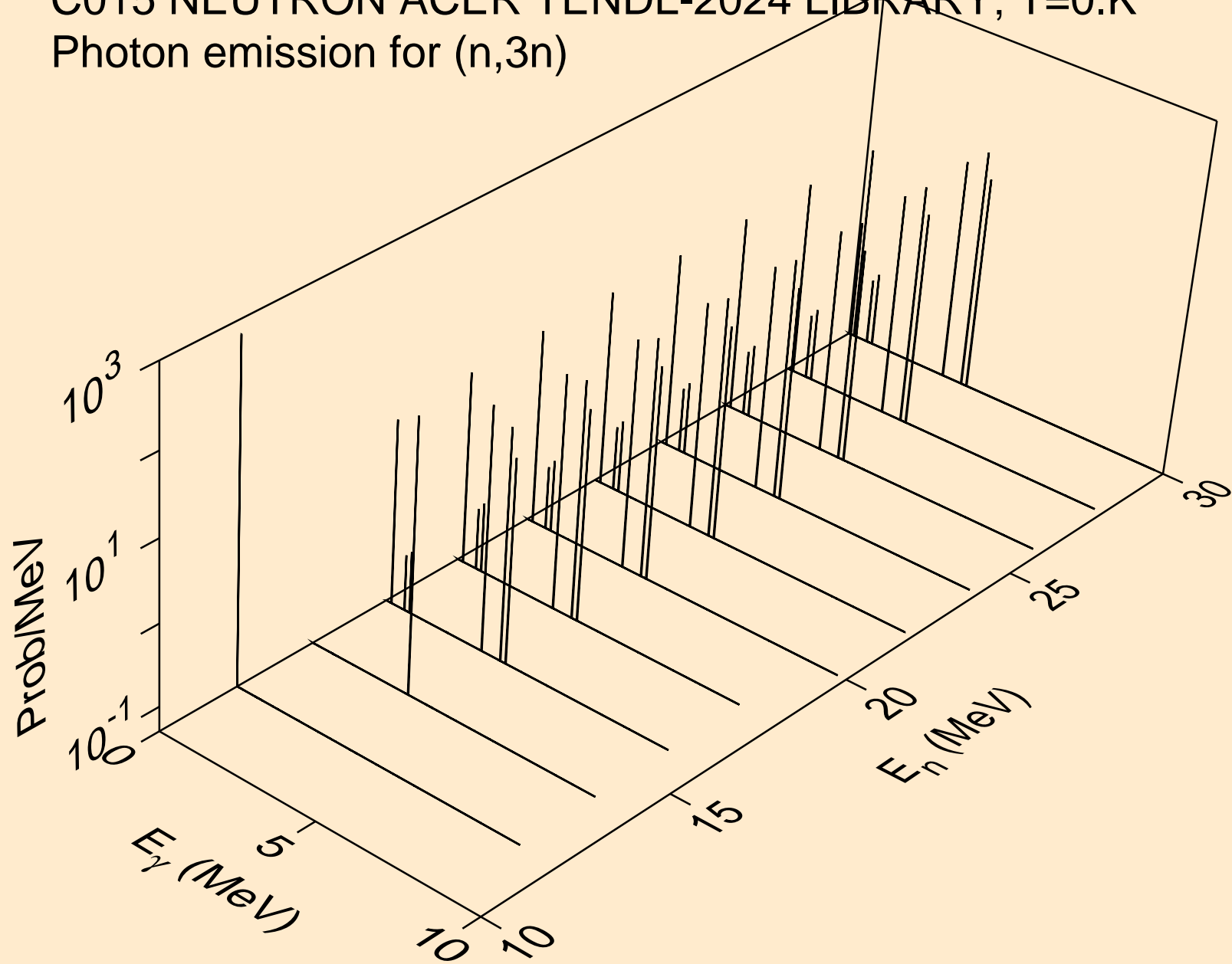

C015 NEUTRON ACER TENDL-2024 LIBRARY; T=0.K
Photon emission for (n,n*)a

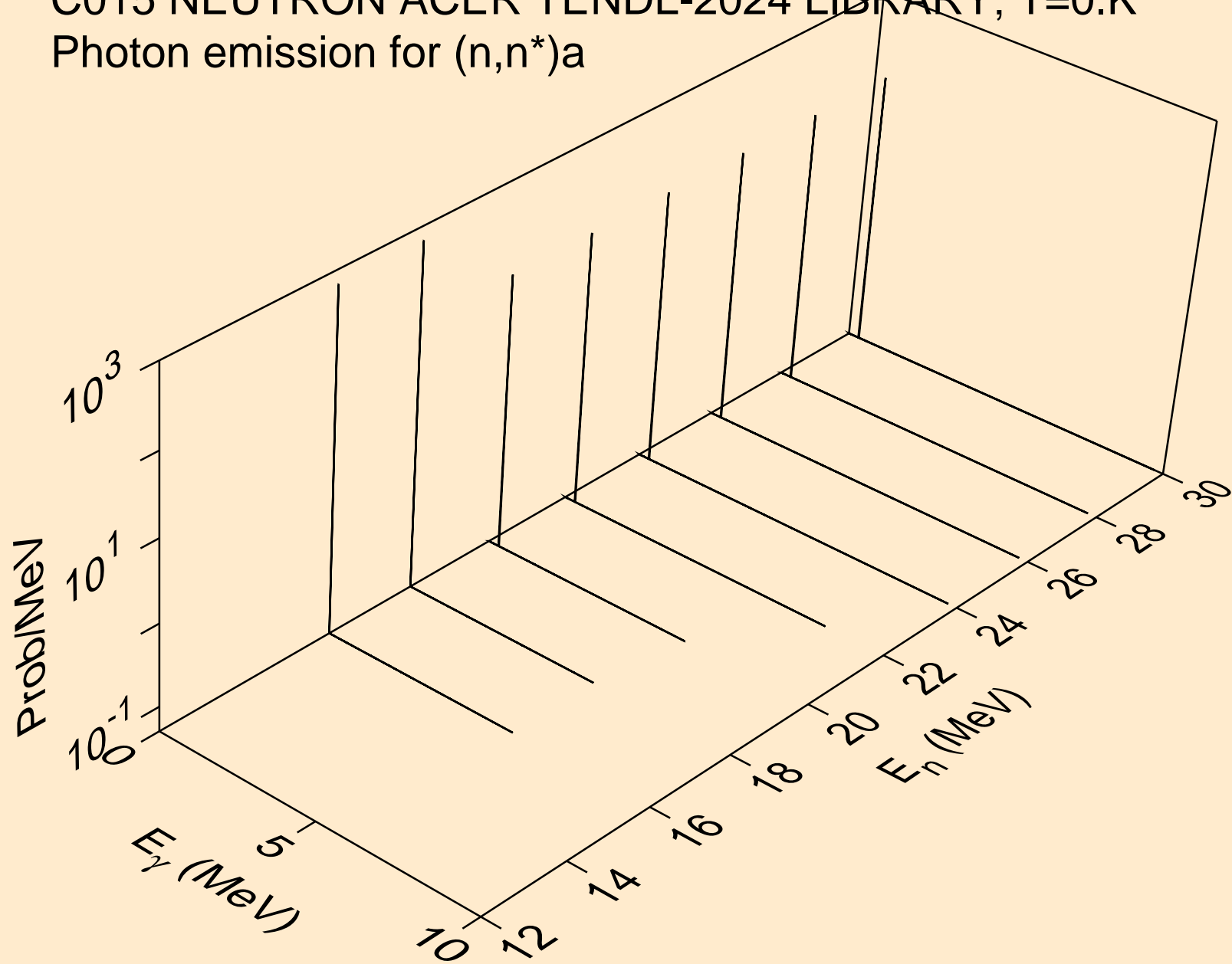

C015 NEUTRON ACER TENDL-2024 LIBRARY; T=0.K
Photon emission for (n,2n)a

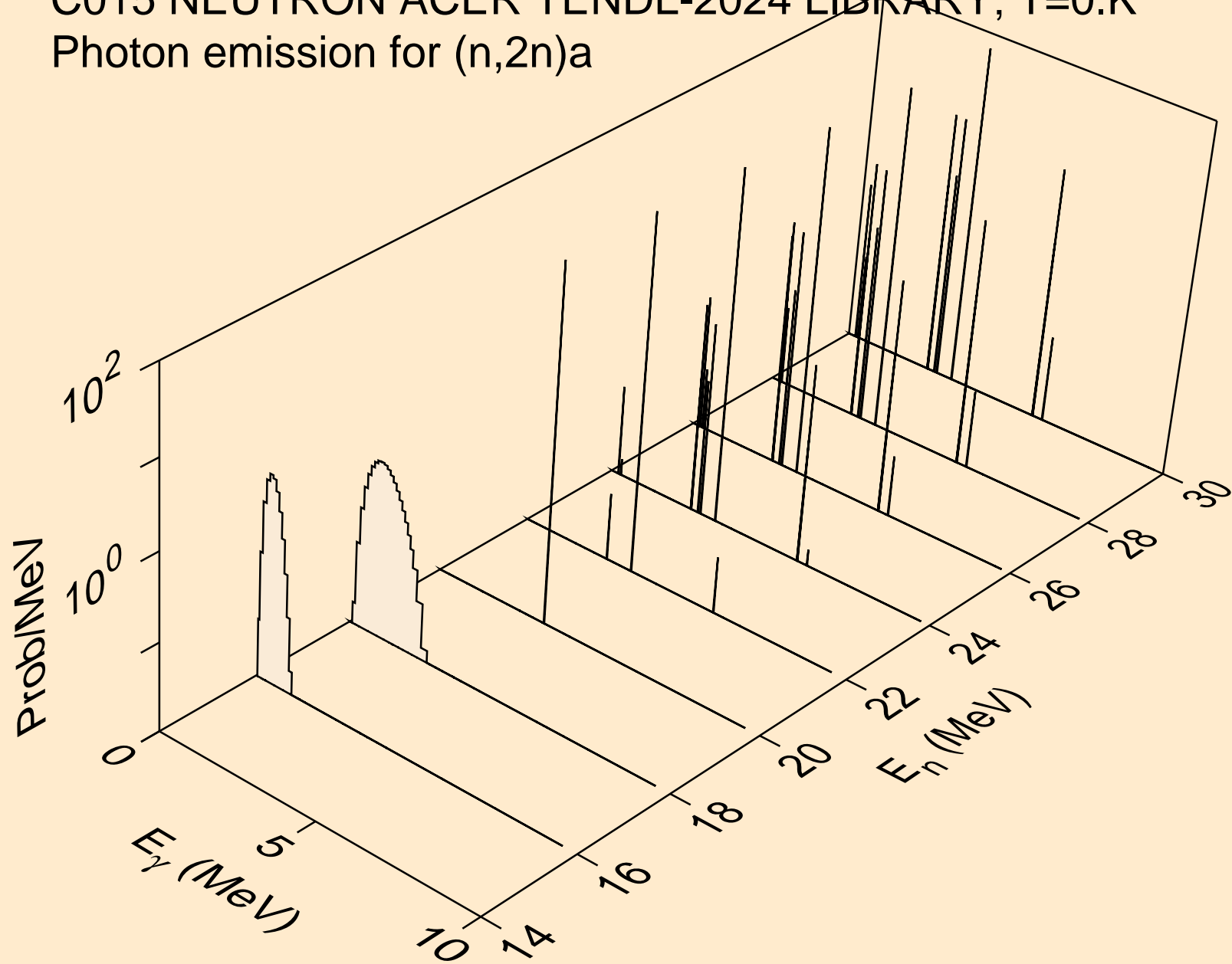

C015 NEUTRON ACER TENDL-2024 LIBRARY; T=0.K
Photon emission for (n,3n)a

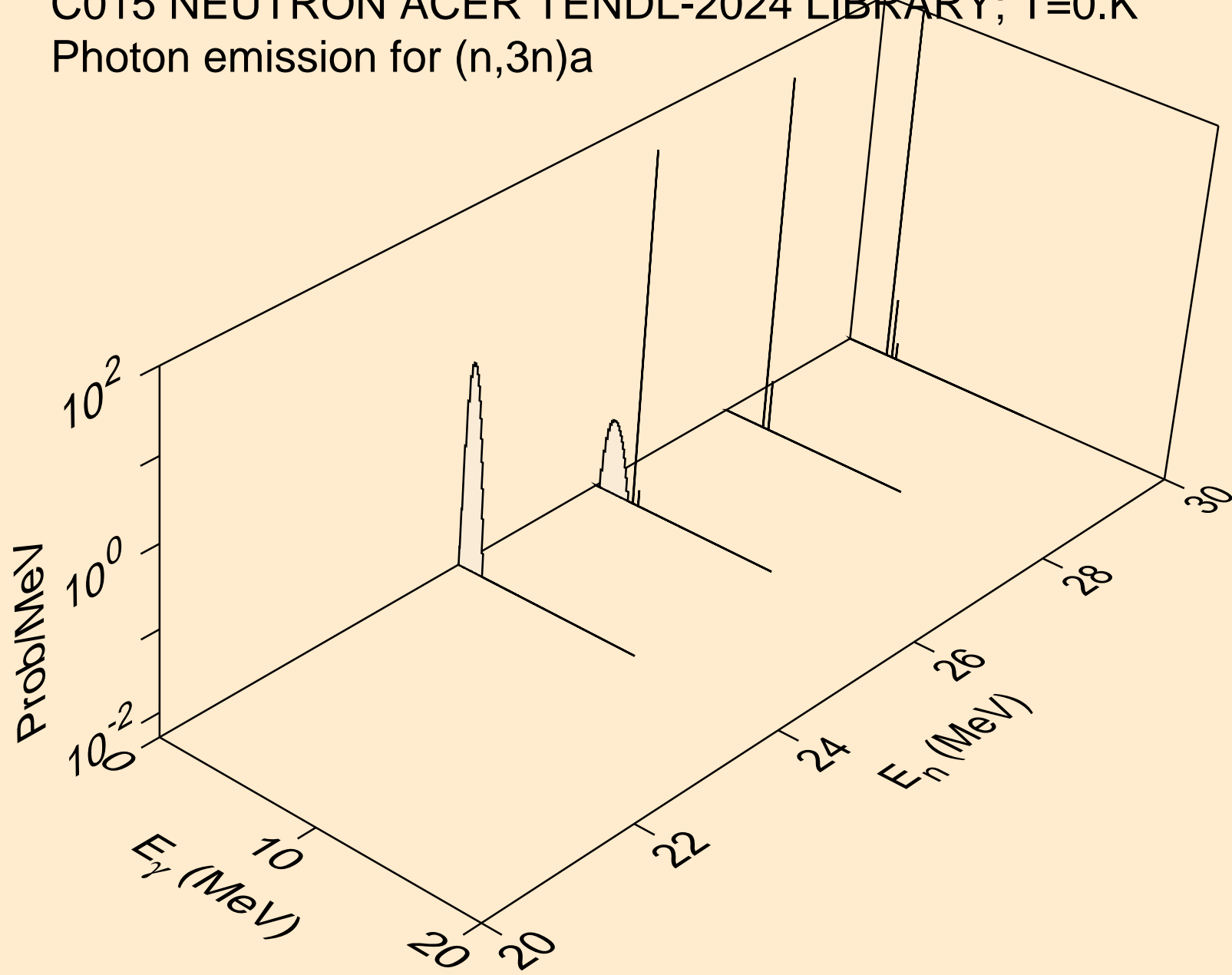

C015 NEUTRON ACER TENDL-2024 LIBRARY; T=0.K
Photon emission for (n,n*)p

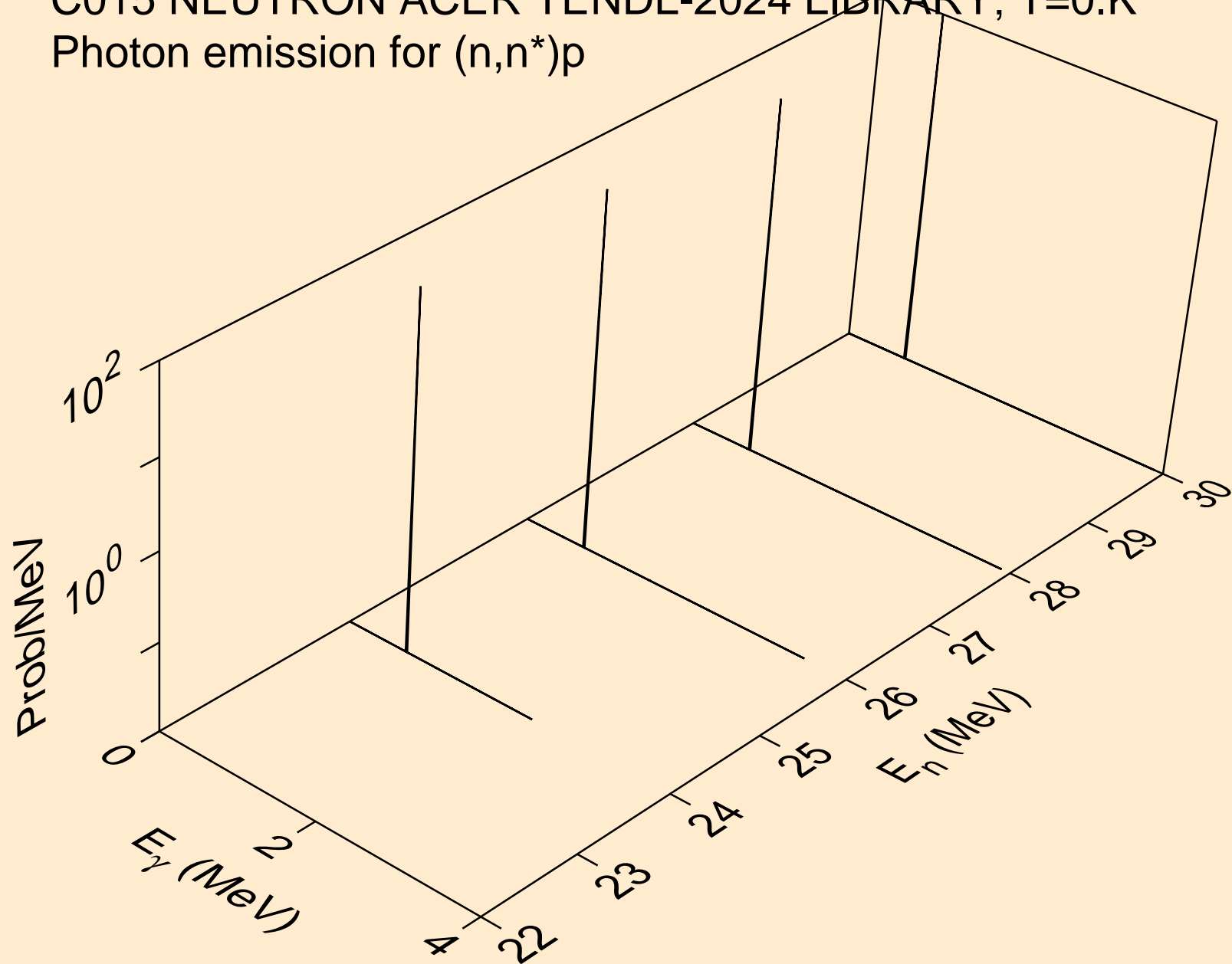

C015 NEUTRON ACER TENDL-2024 LIBRARY; T=0.K
Photon emission for (n,n*)d

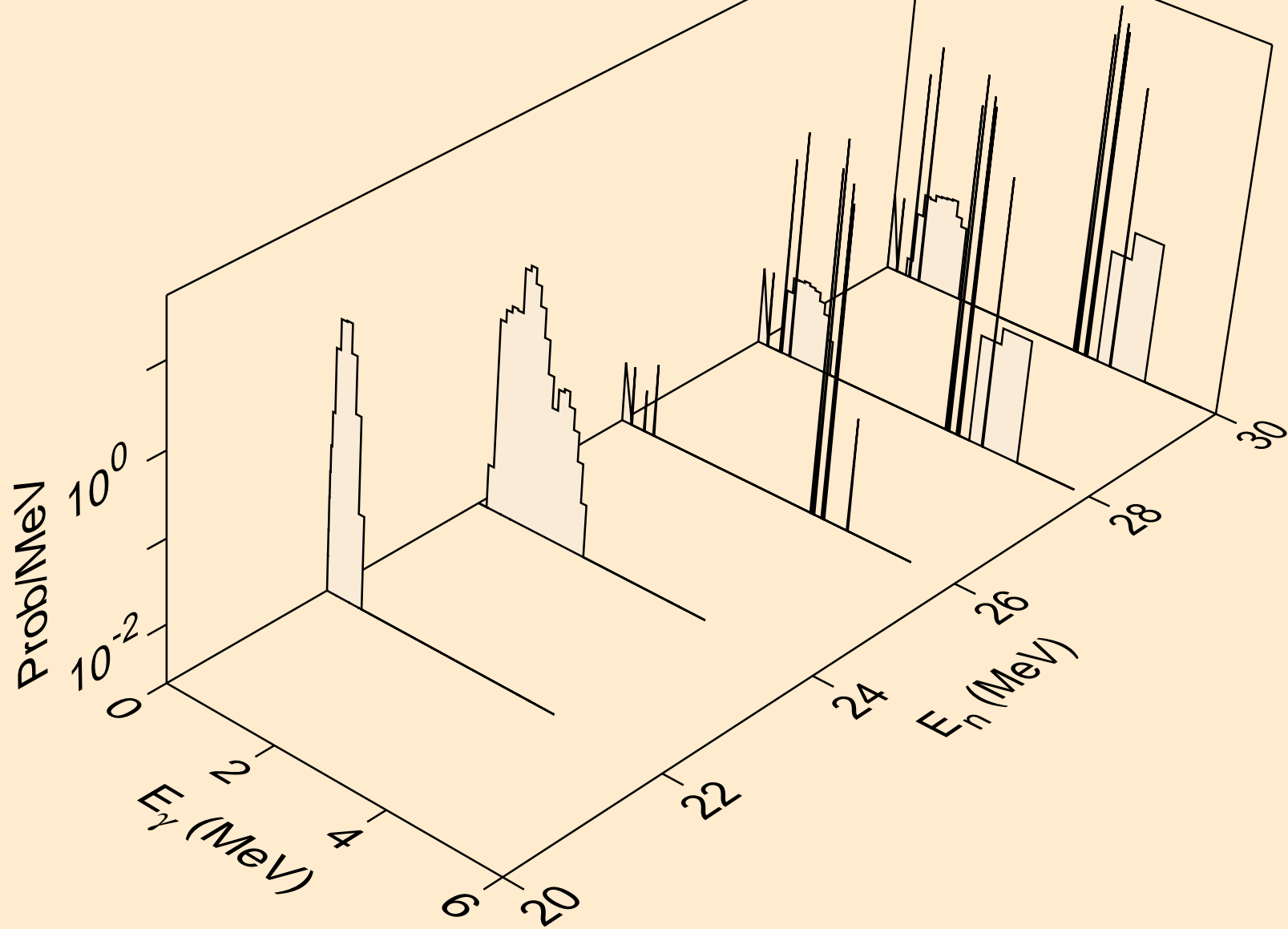

C015 NEUTRON ACER TENDL-2024 LIBRARY; T=0.K
Photon emission for (n,n*)t

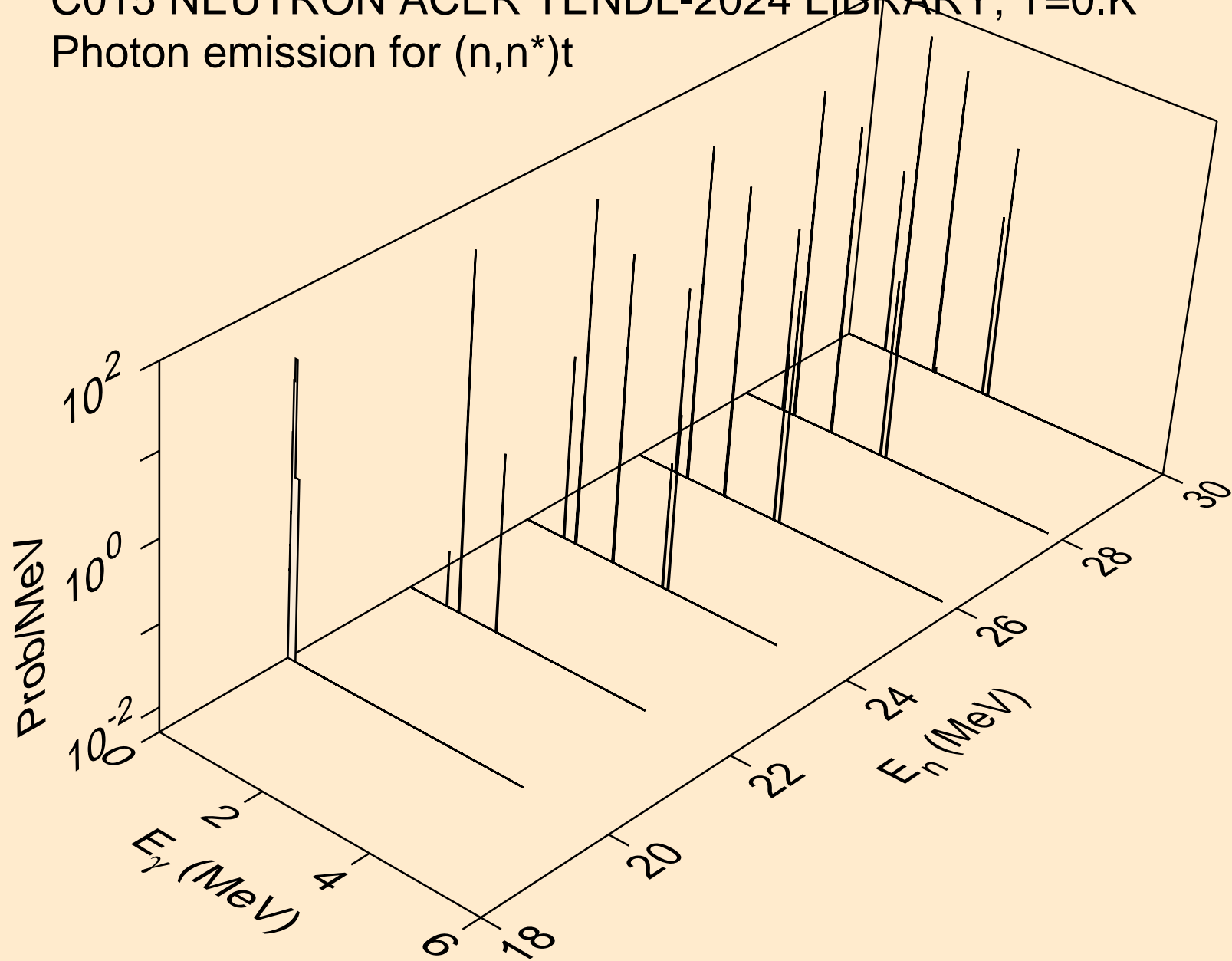

C015 NEUTRON ACER TENDL-2024 LIBRARY; T=0.K
Photon emission for (n,4n)

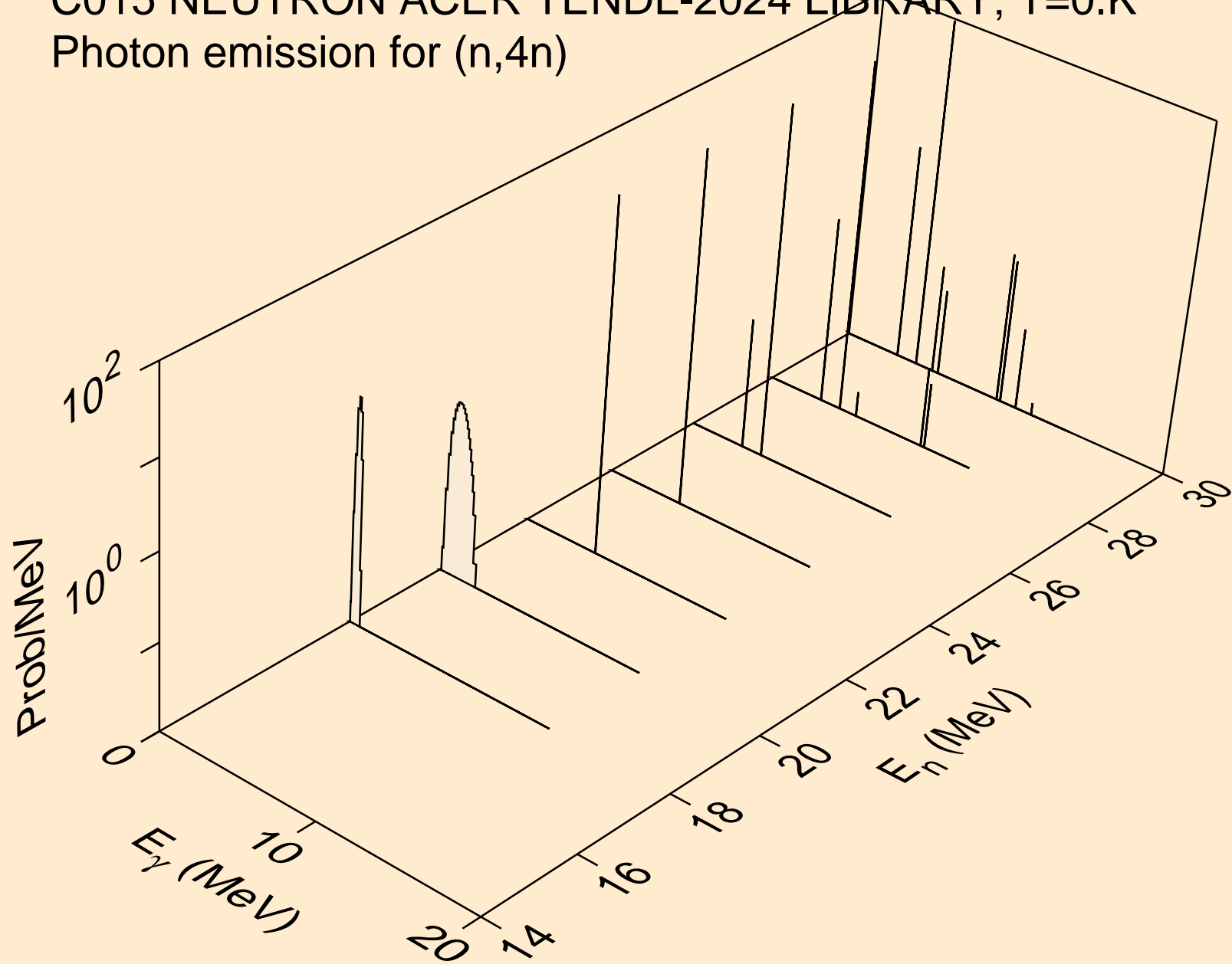

C015 NEUTRON ACER TENDL-2024 LIBRARY; T=0.K
Photon emission for (n,2np)

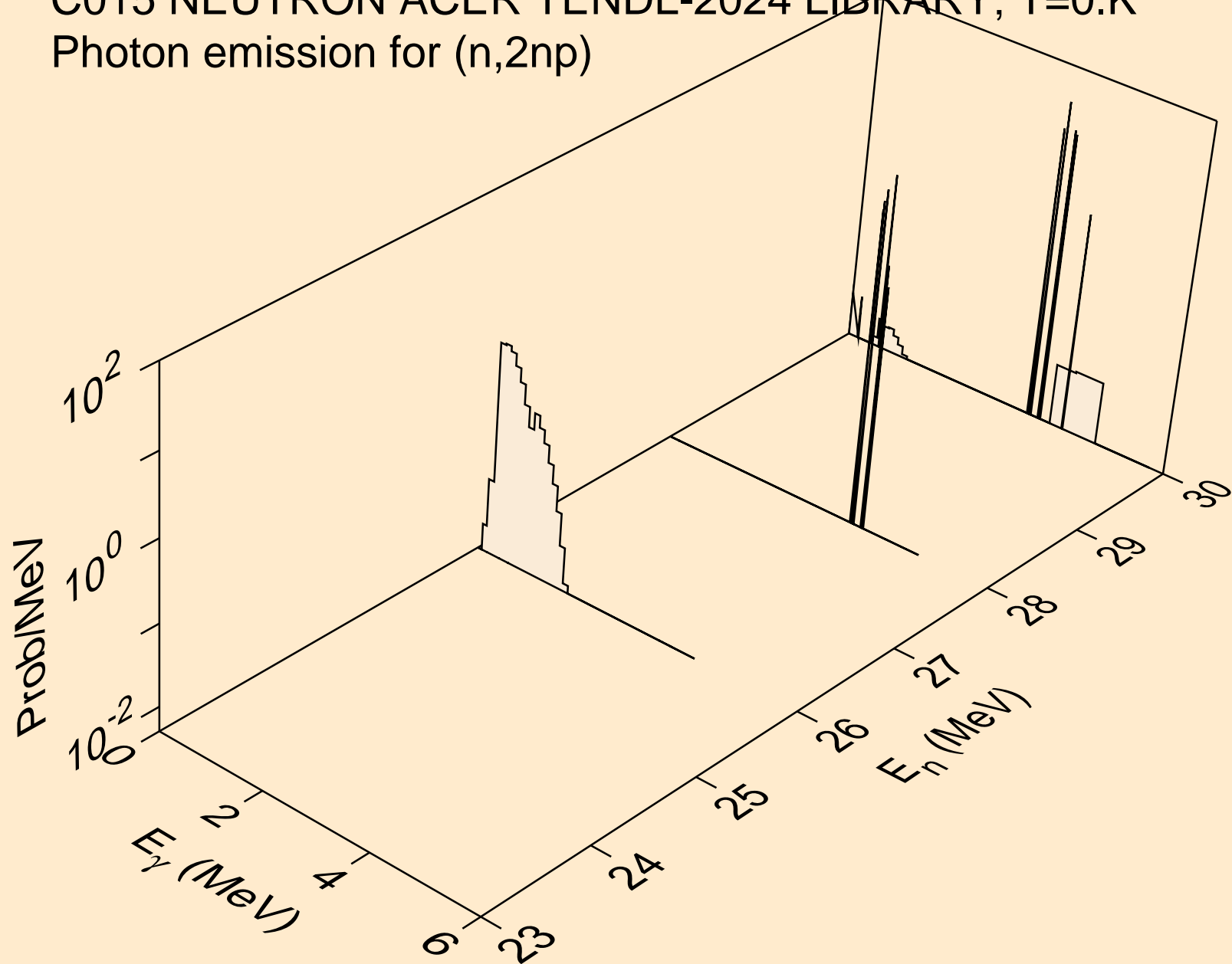

C015 NEUTRON ACER TENDL-2024 LIBRARY; T=0.K
Photon emission for (n,3np)

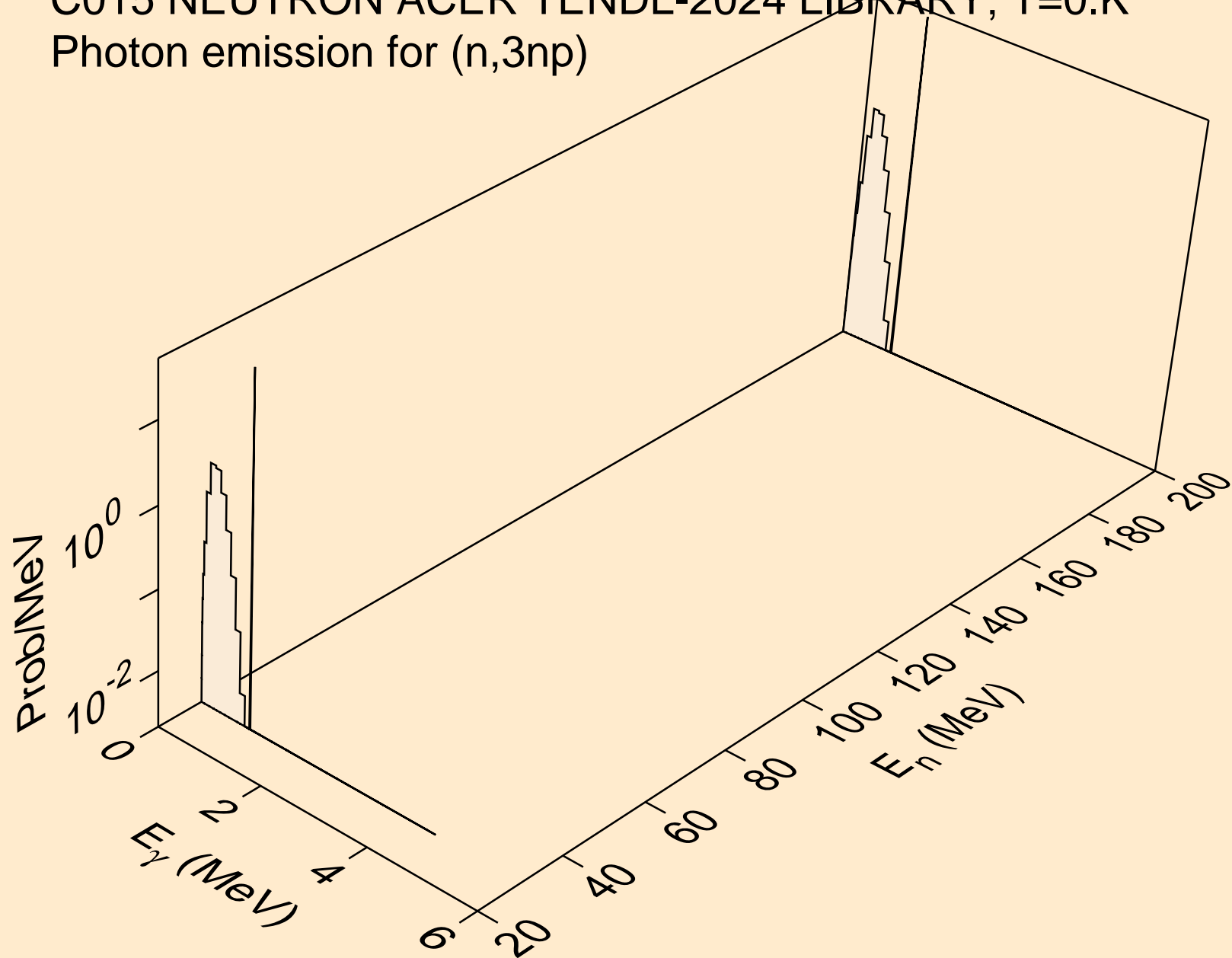

C015 NEUTRON ACER TENDL-2024 LIBRARY; T=0.K
Photon emission for (n,n*c)

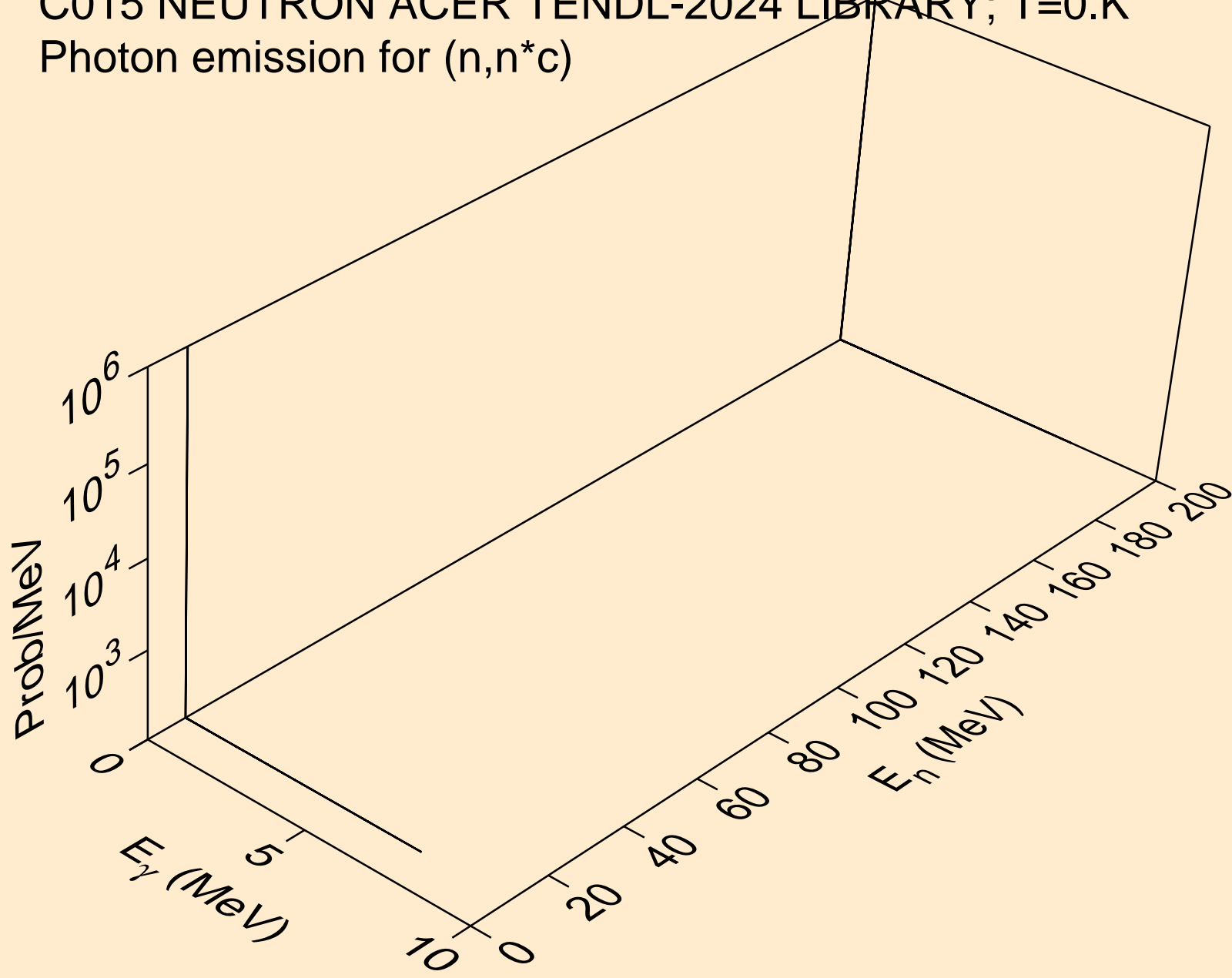

C015 NEUTRON ACER TENDL-2024 LIBRARY; T=0.K
Photon emission for (n,gma)

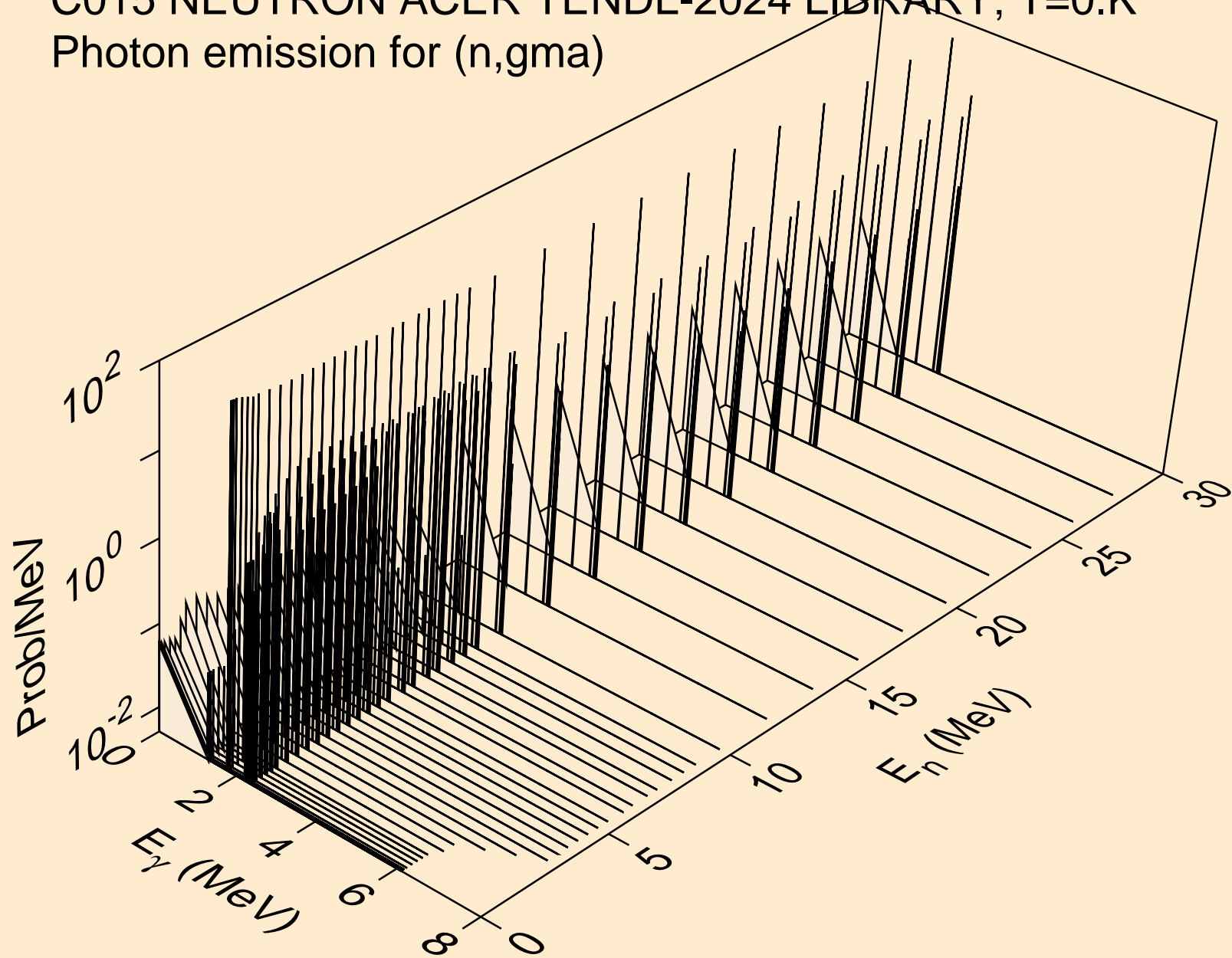

C015 NEUTRON ACER TENDL-2024 LIBRARY; T=0.K
Photon emission for (n,p)

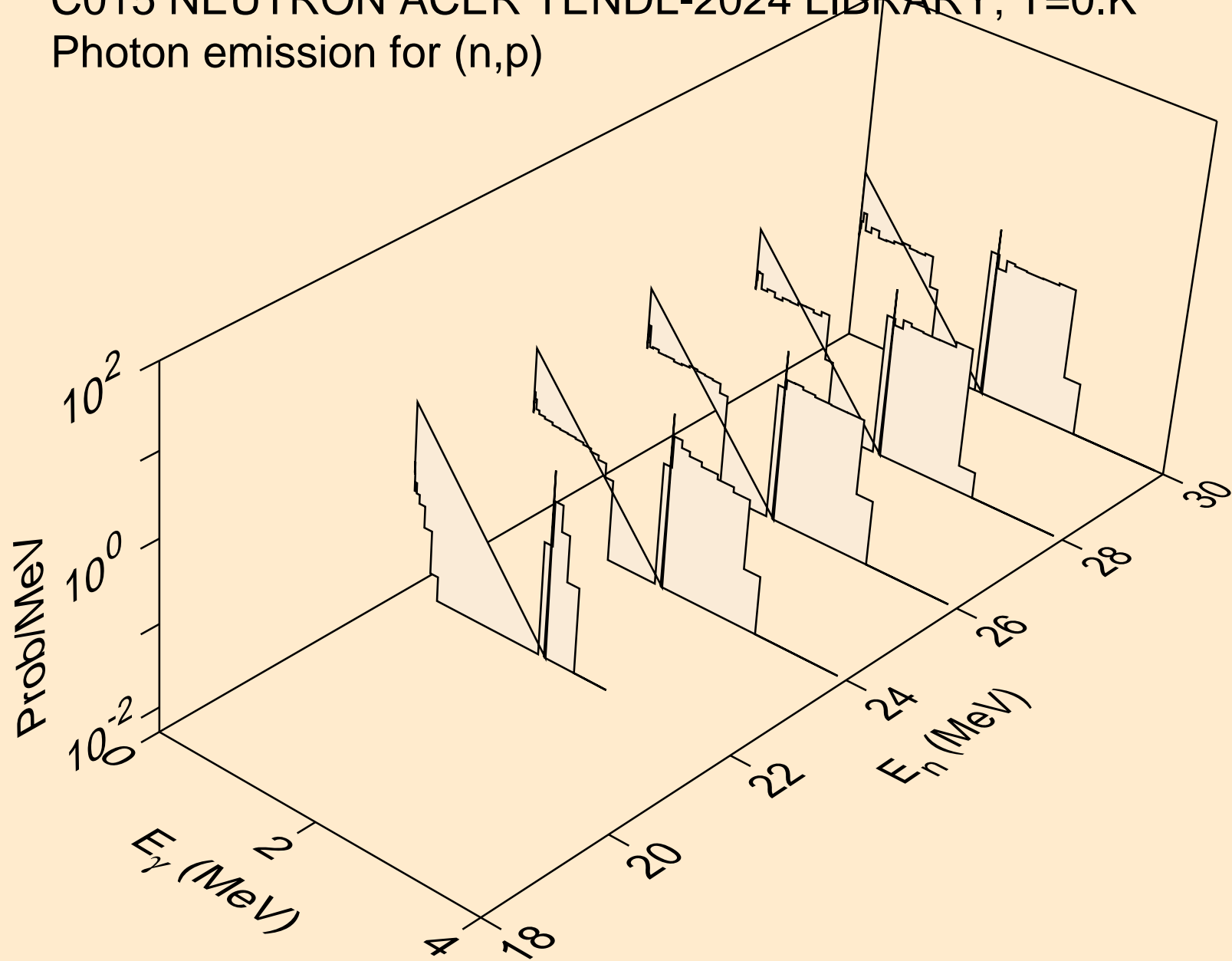

C015 NEUTRON ACER TENDL-2024 LIBRARY; T=0.K
Photon emission for (n,d)

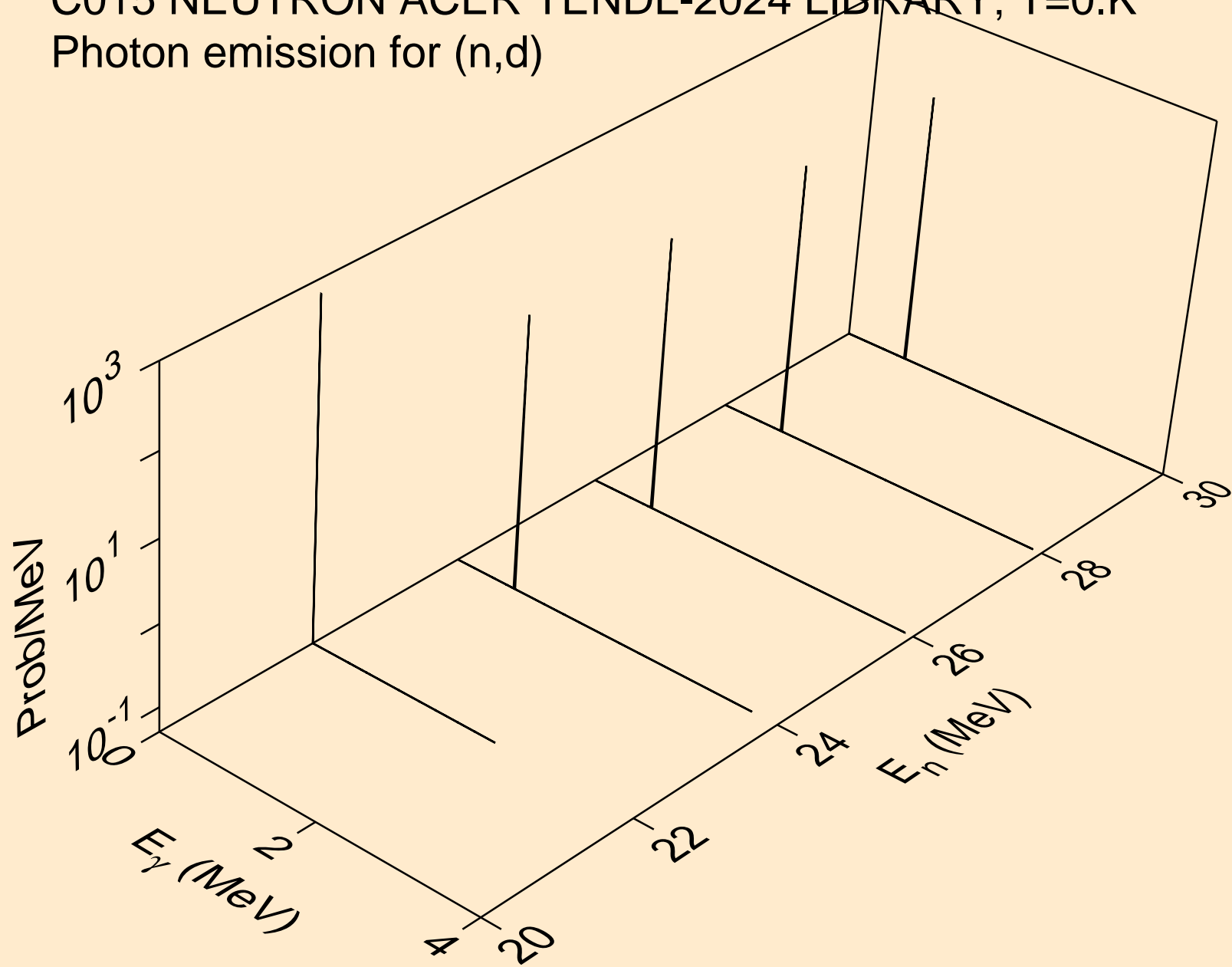

C015 NEUTRON ACER TENDL-2024 LIBRARY; T=0.K
Photon emission for (n,t)

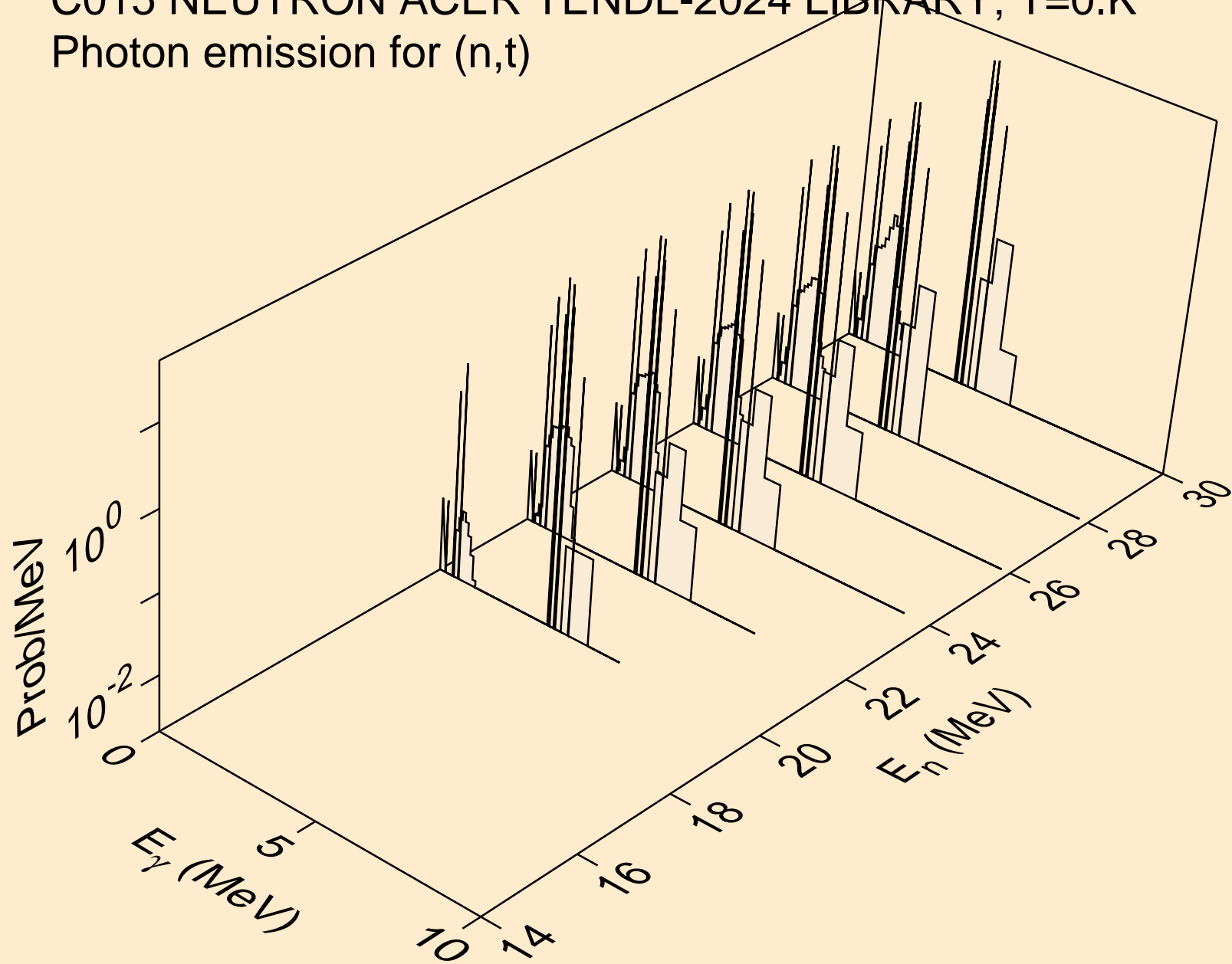

C015 NEUTRON ACER TENDL-2024 LIBRARY; T=0.K
Photon emission for (n,a)

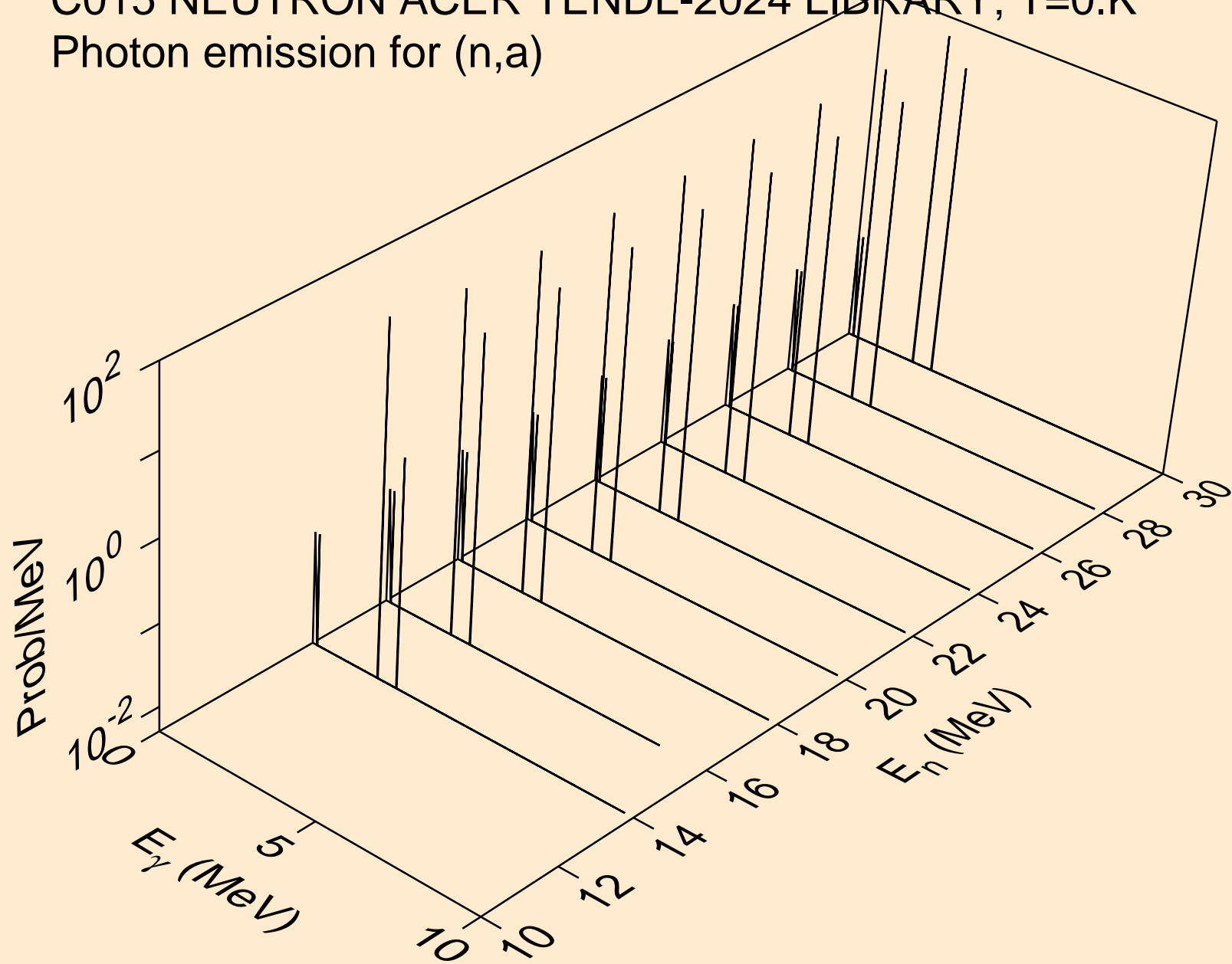

C015 NEUTRON ACER TENDL-2024 LIBRARY; T=0.K
thermal capture photon spectrum

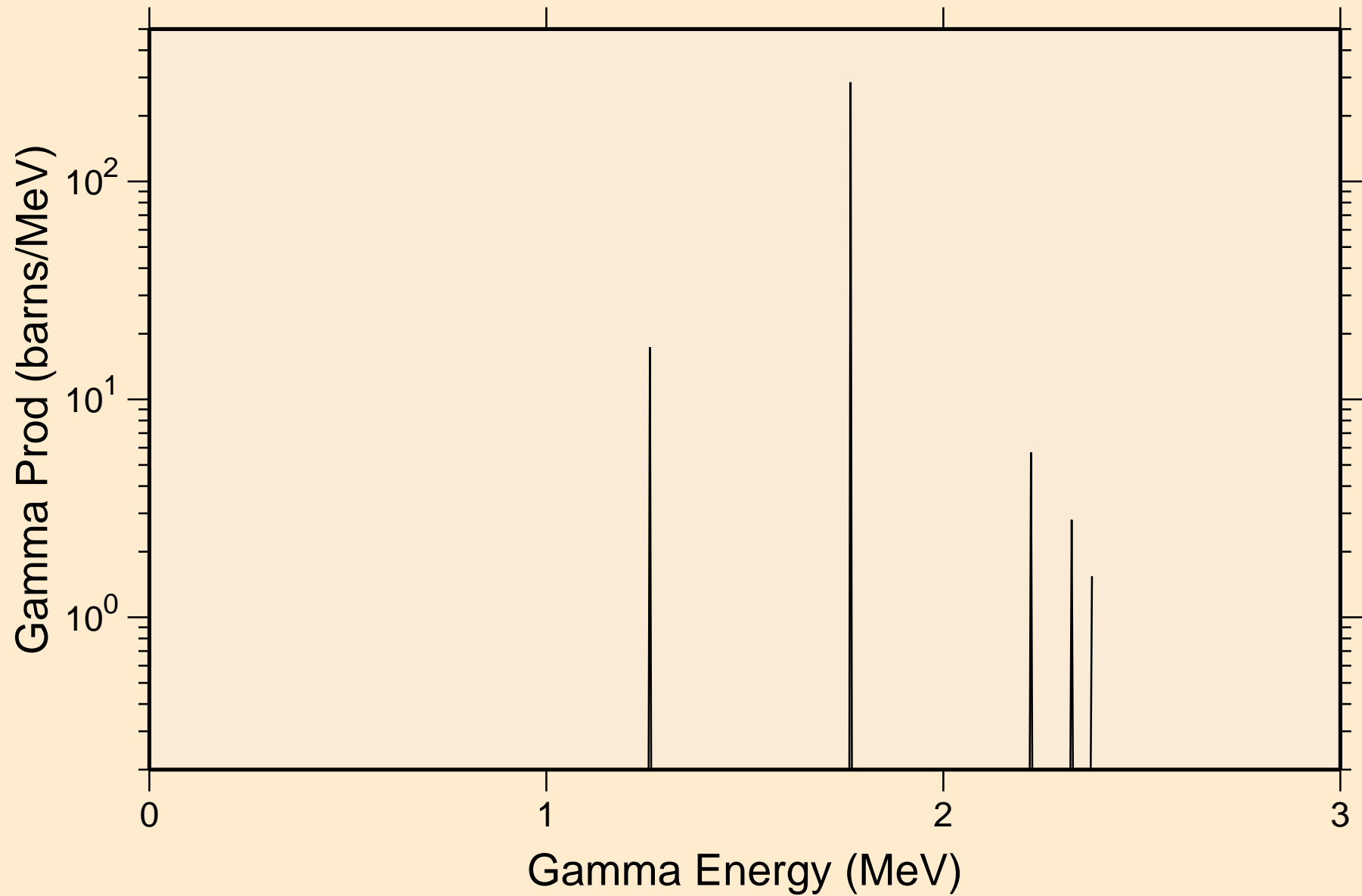

C015 NEUTRON ACER TENDL-2024 LIBRARY; T=0.K
14 MeV photon spectrum

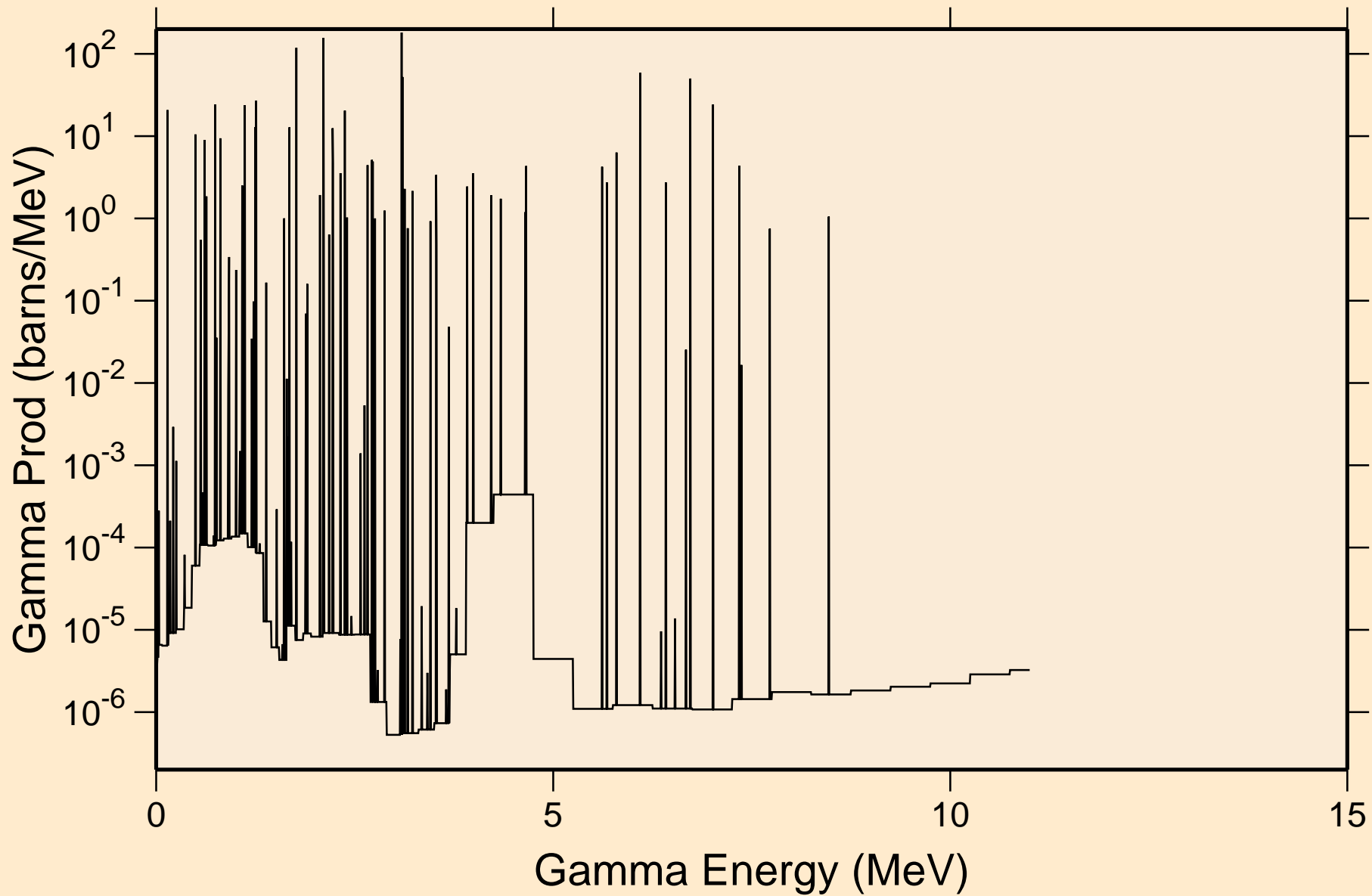

C015 NEUTRON ACER TENDL-2024 LIBRARY; T=0.K

Particle heating contributions

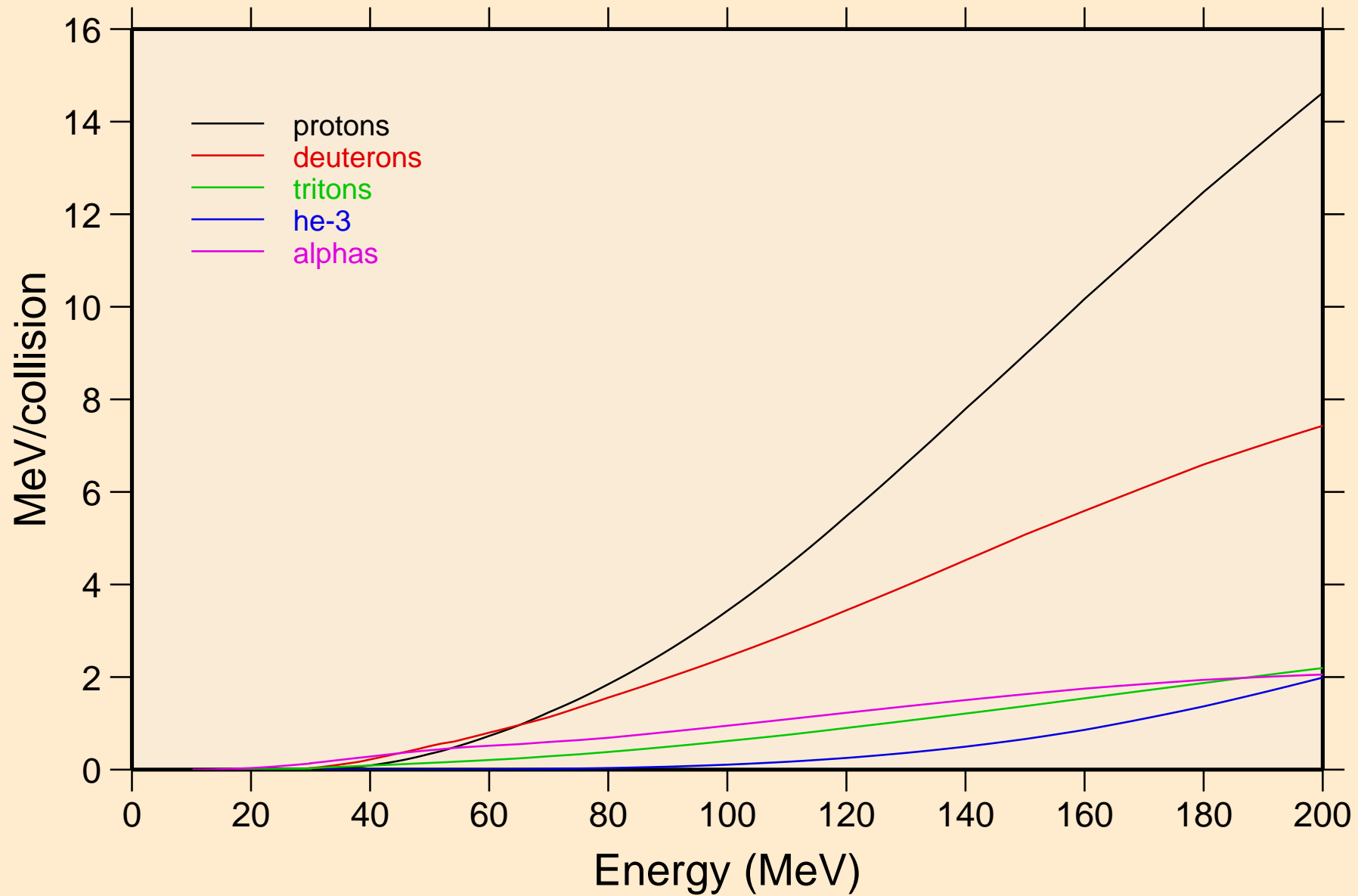

C015 NEUTRON ACER TENDL-2024 LIBRARY; T=0.K
Recoil Heating

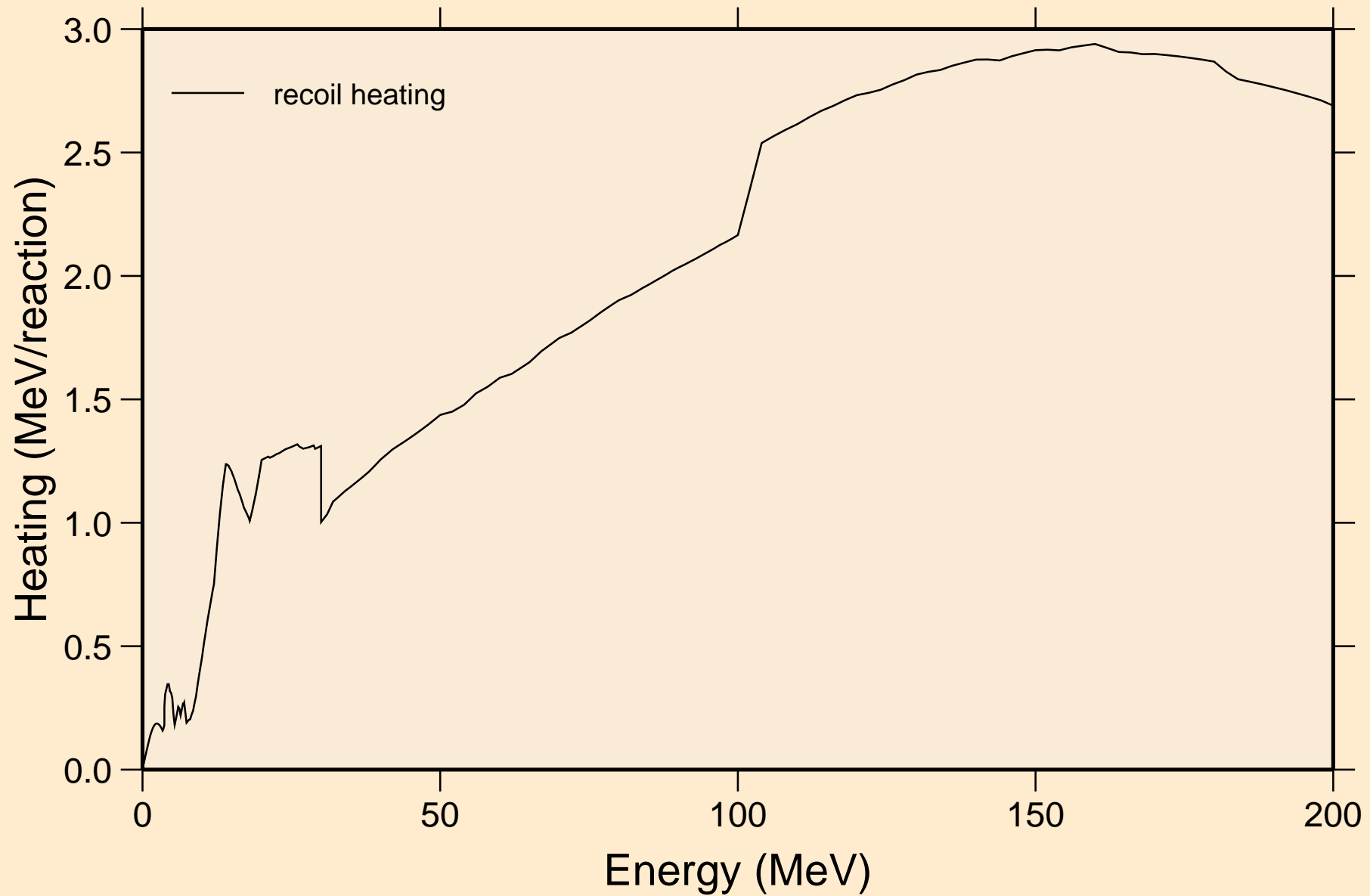

C015 NEUTRON ACER TENDL-2024 LIBRARY; T=0.K

Particle production cross sections

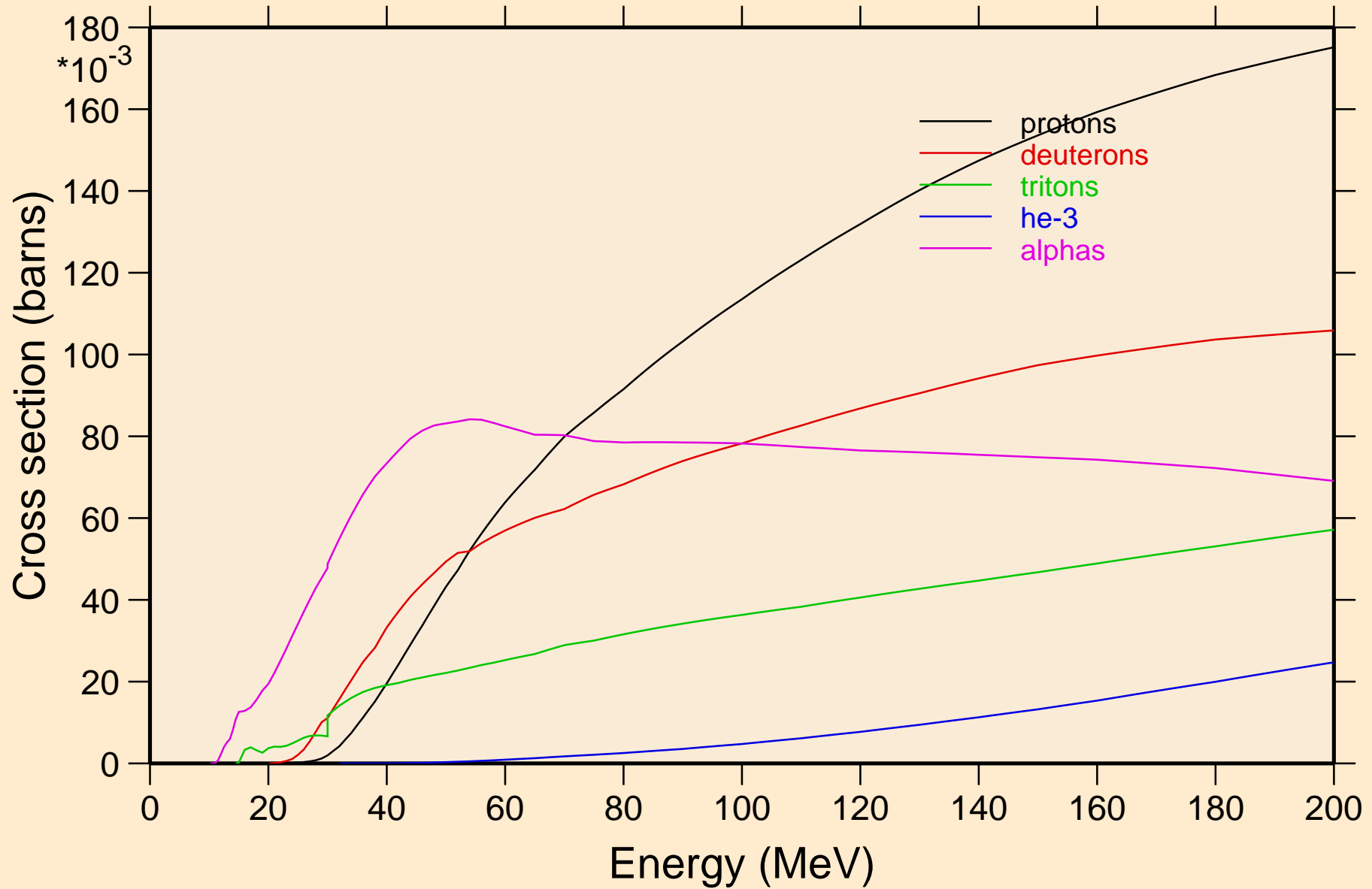

C015 NEUTRON ACER TENDL-2024 LIBRARY; T=0.K
protons from (n,x)

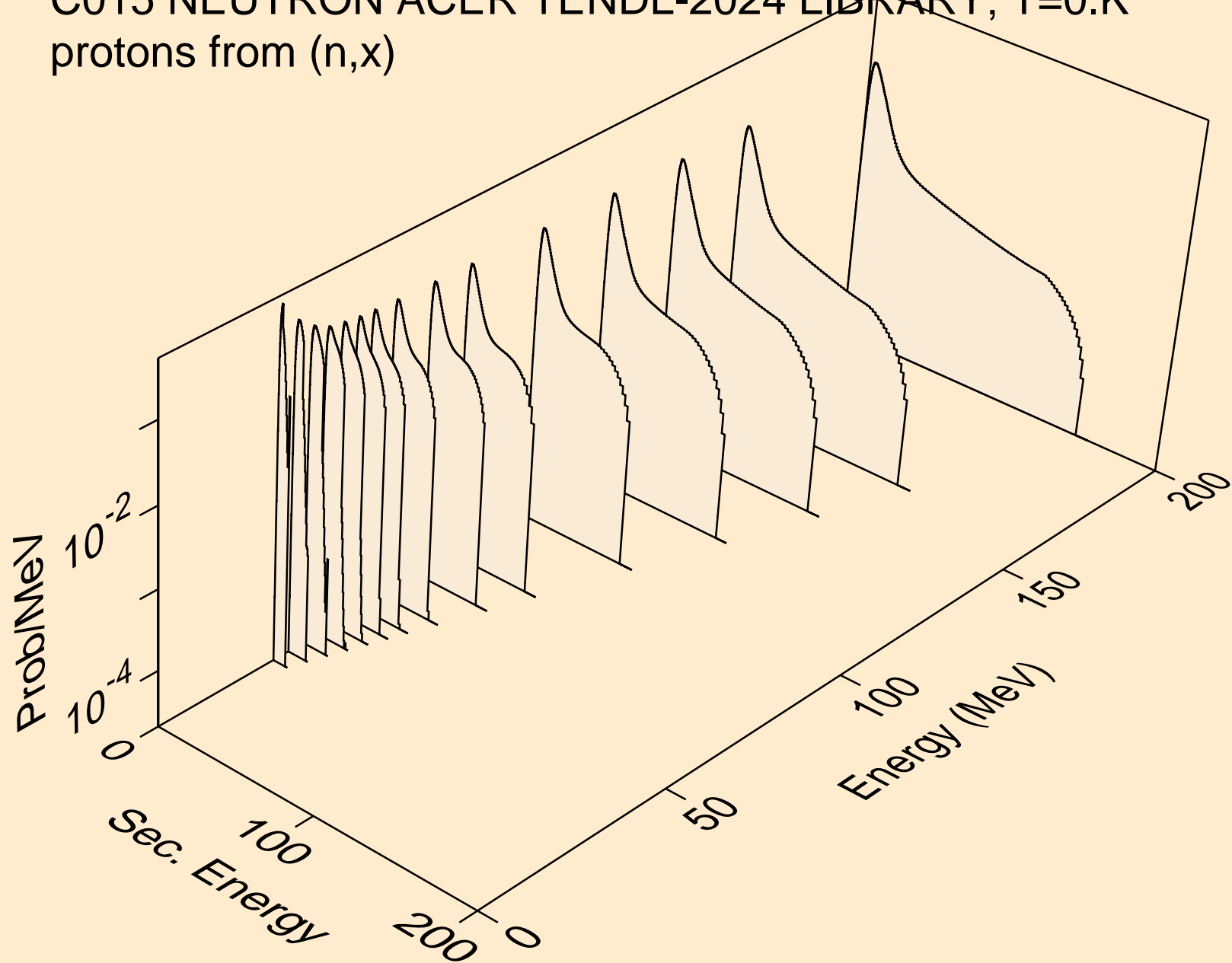

C015 NEUTRON ACER TENDL-2024 LIBRARY; T=0.K
protons from (n,n*)p

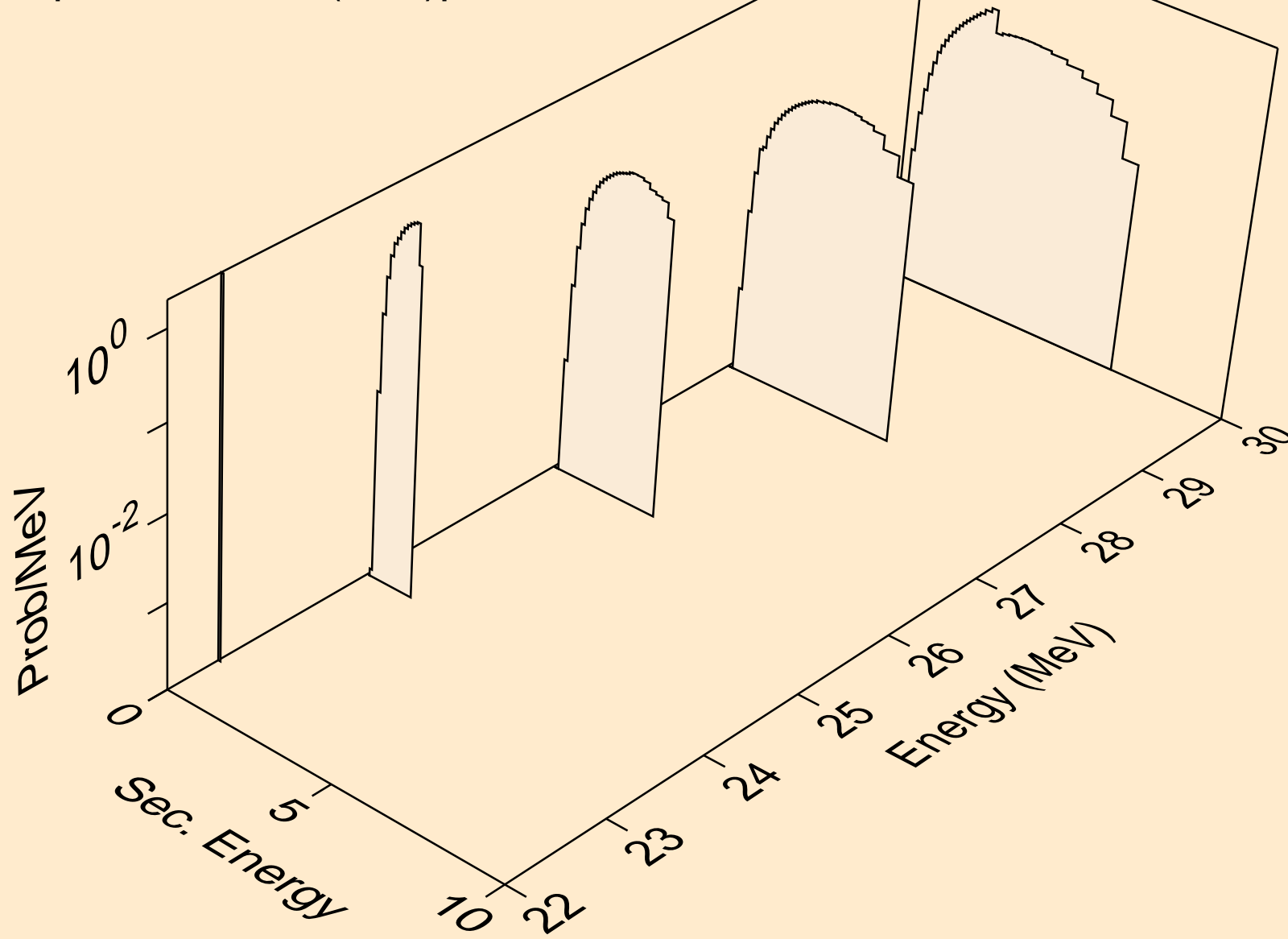

C015 NEUTRON ACER TENDL-2024 LIBRARY; T=0.K
protons from (n,2np)

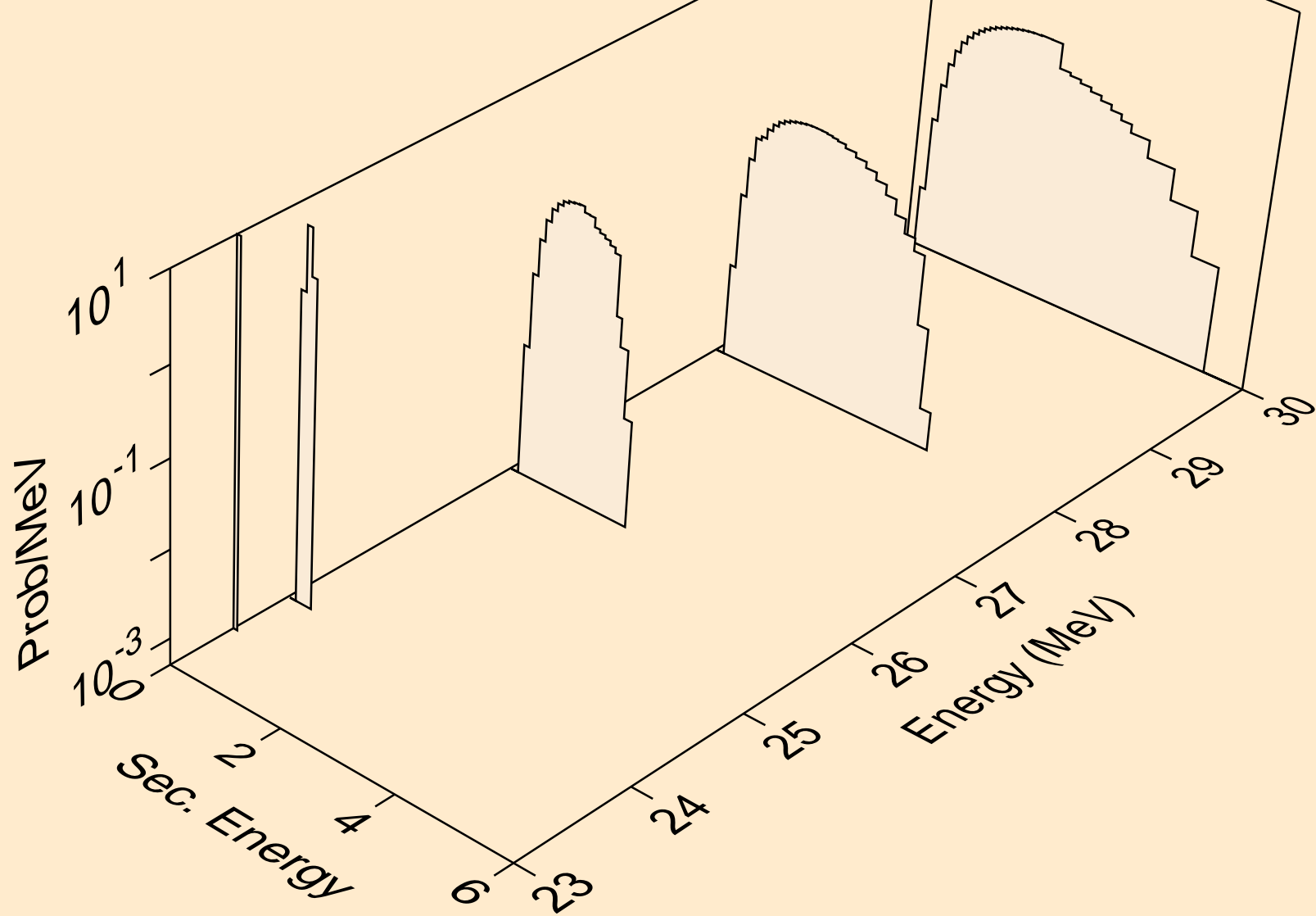

C015 NEUTRON ACER TENDL-2024 LIBRARY; T=0.K
protons from (n,3np)

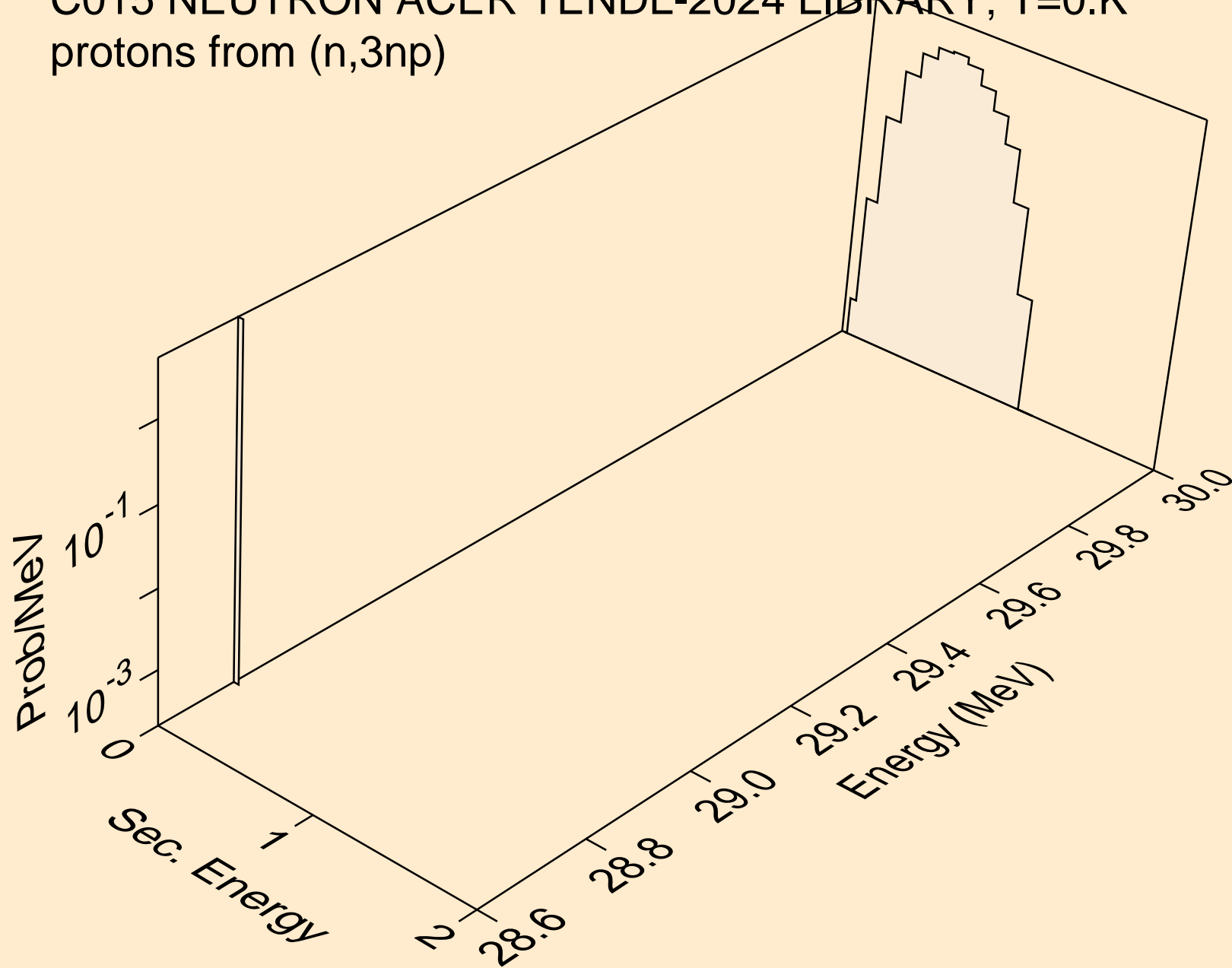

C015 NEUTRON ACER TENDL-2024 LIBRARY; T=0.K
protons from (n,p)

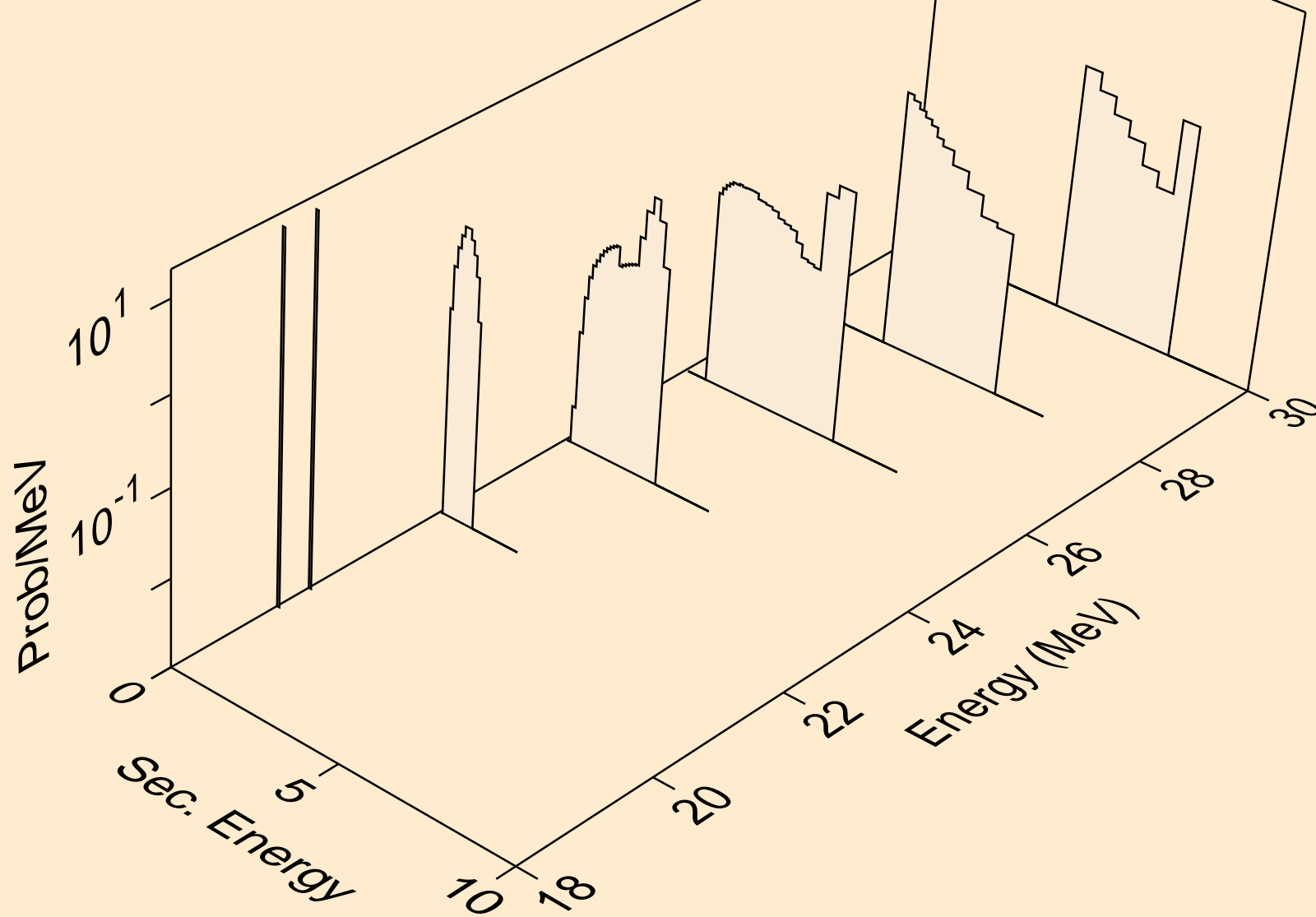

C015 NEUTRON ACER TENDL-2024 LIBRARY; T=0.K
deuterons from (n,x)

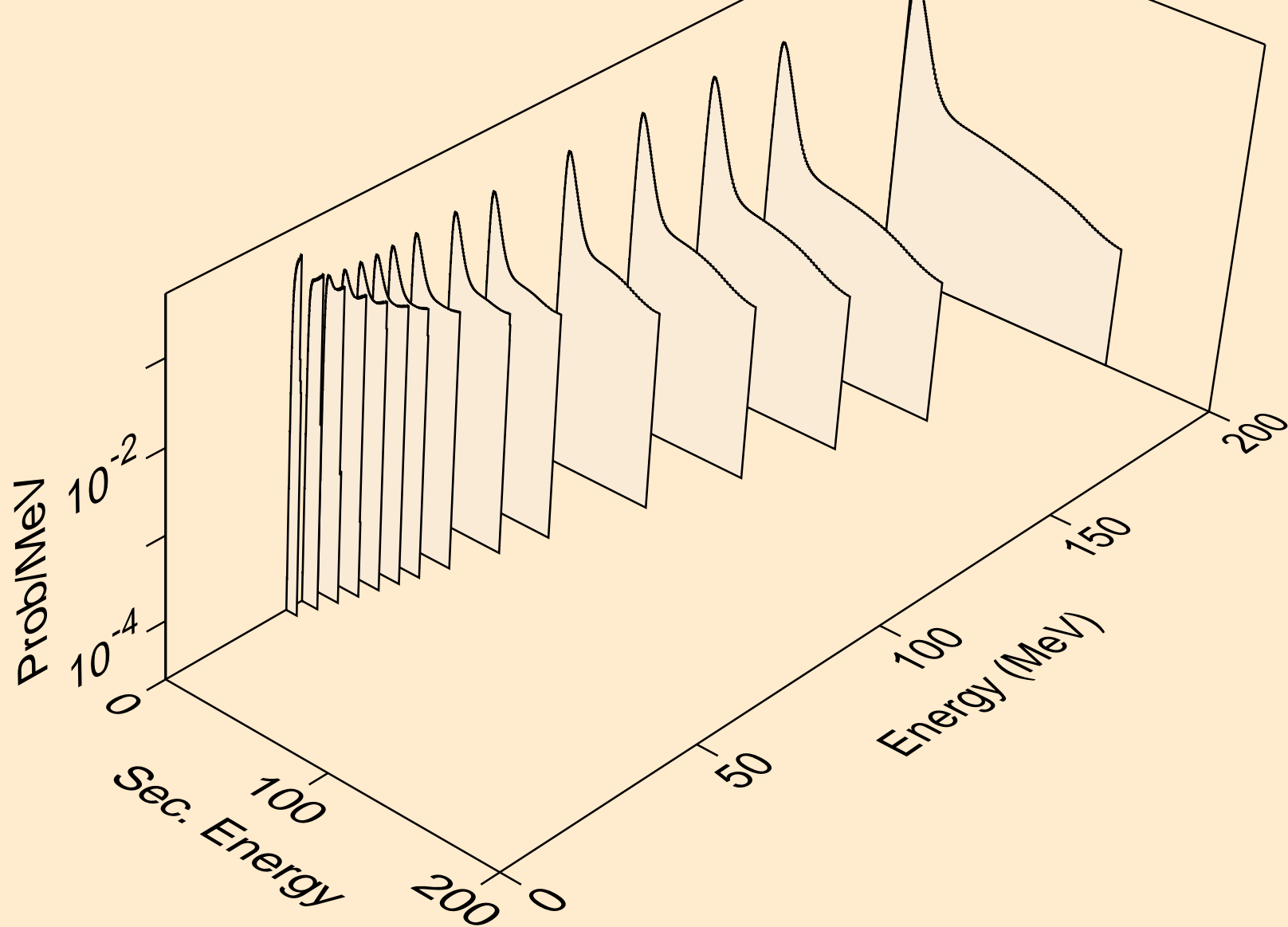

C015 NEUTRON ACER TENDL-2024 LIBRARY; T=0.K
deuterons from (n,2nd)

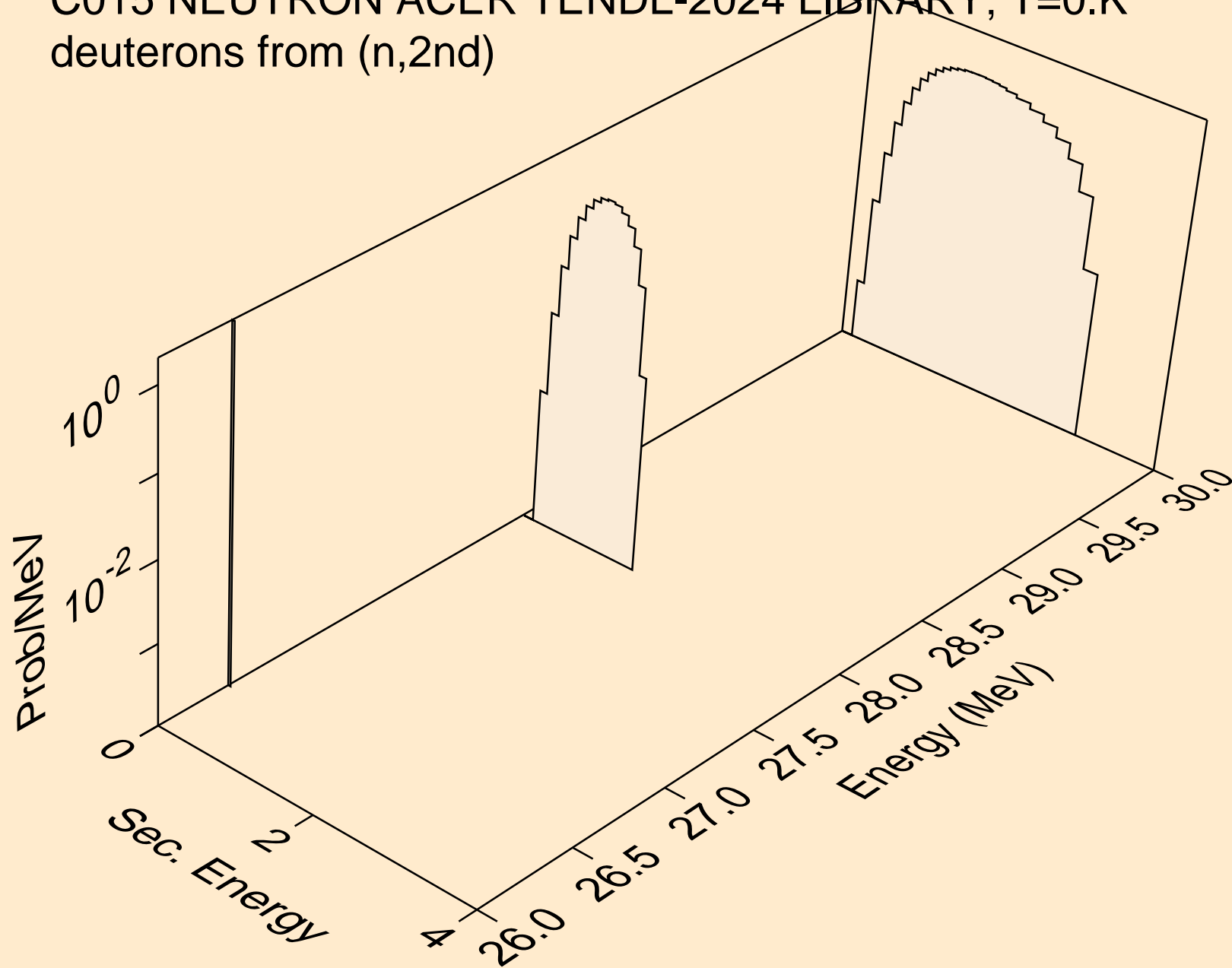

C015 NEUTRON ACER TENDL-2024 LIBRARY; T=0.K
deuterons from (n,n*)d

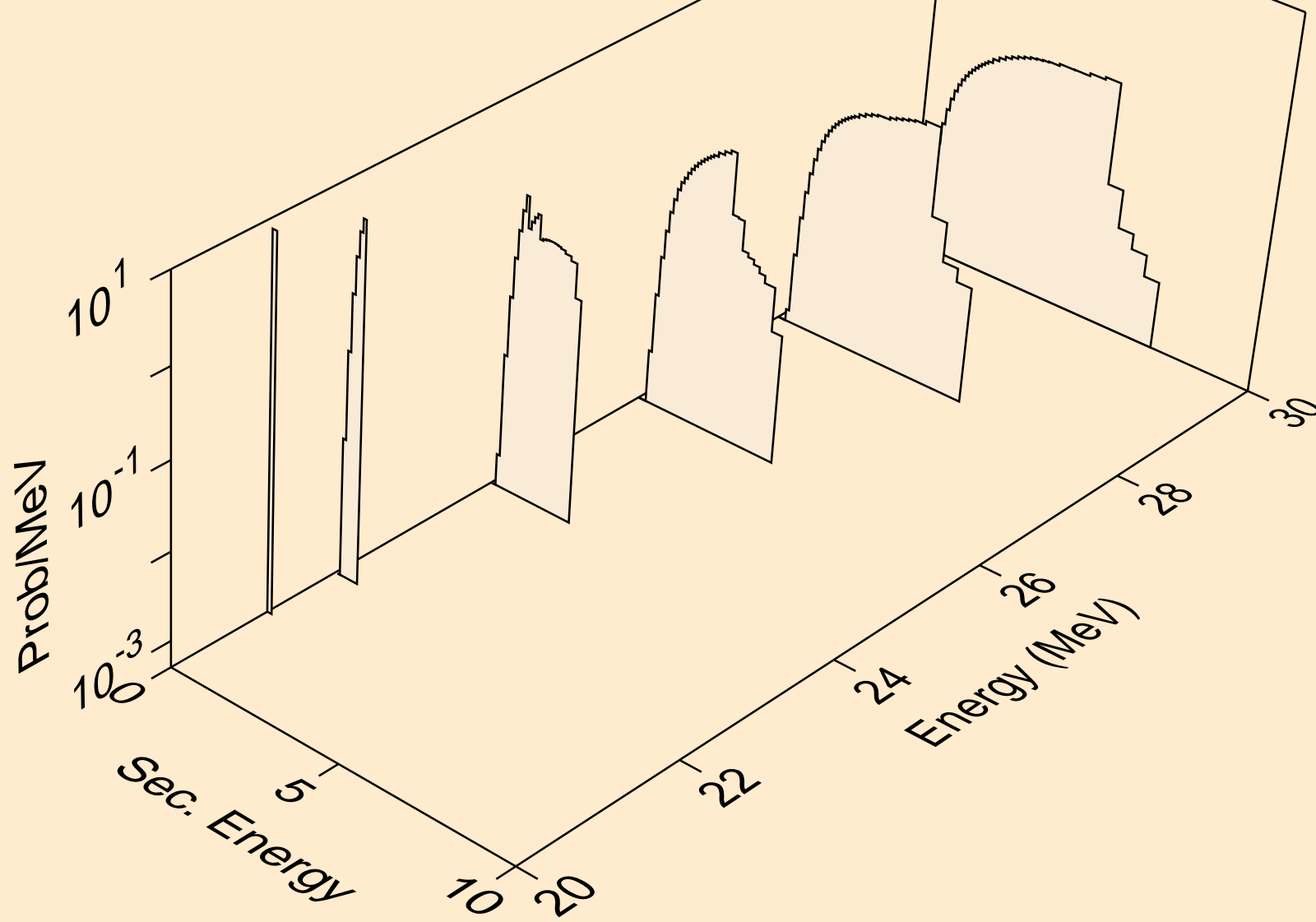

C015 NEUTRON ACER TENDL-2024 LIBRARY; T=0.K
deuterons from (n,d)

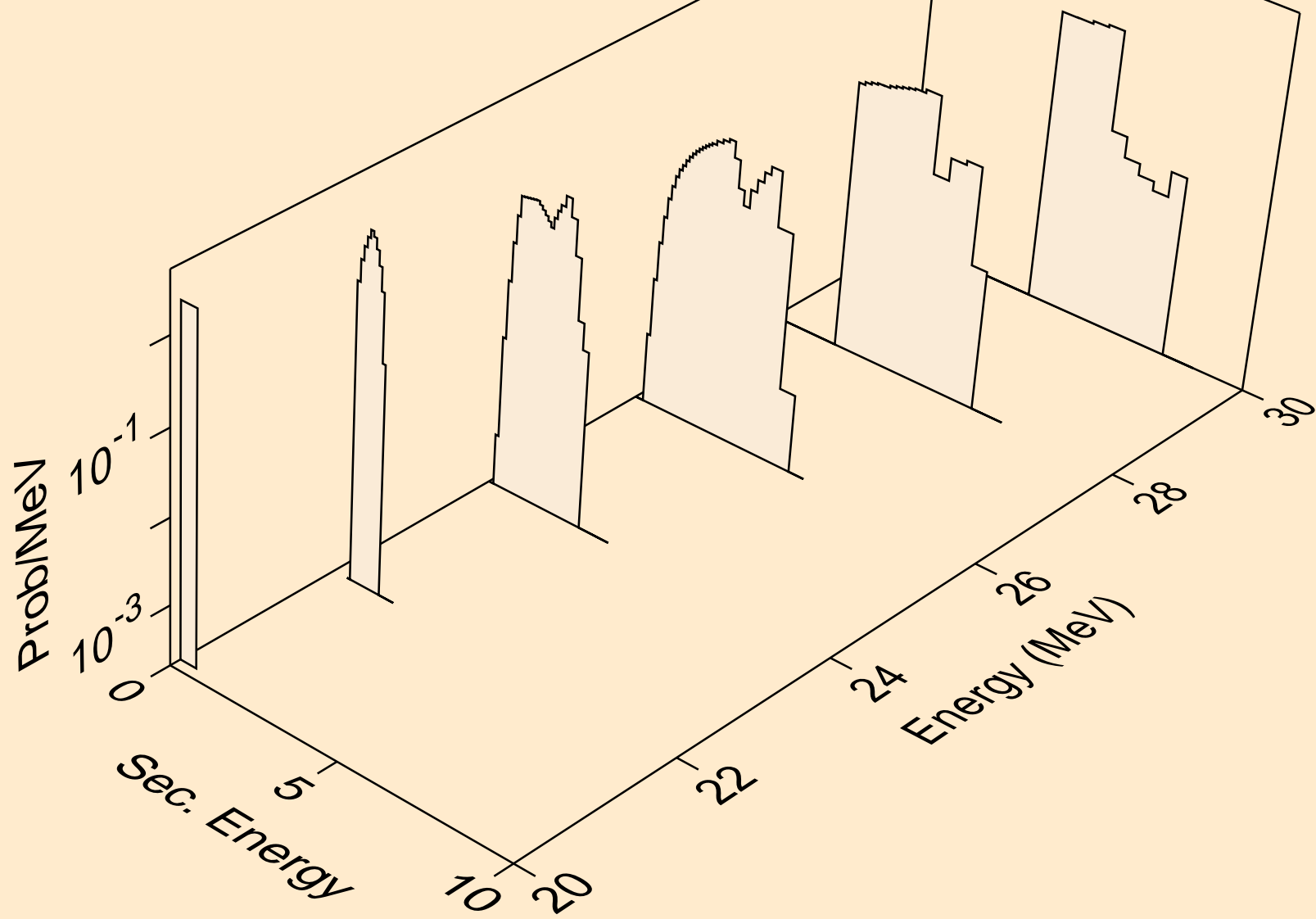

C015 NEUTRON ACER TENDL-2024 LIBRARY; T=0.K
tritons from (n,x)

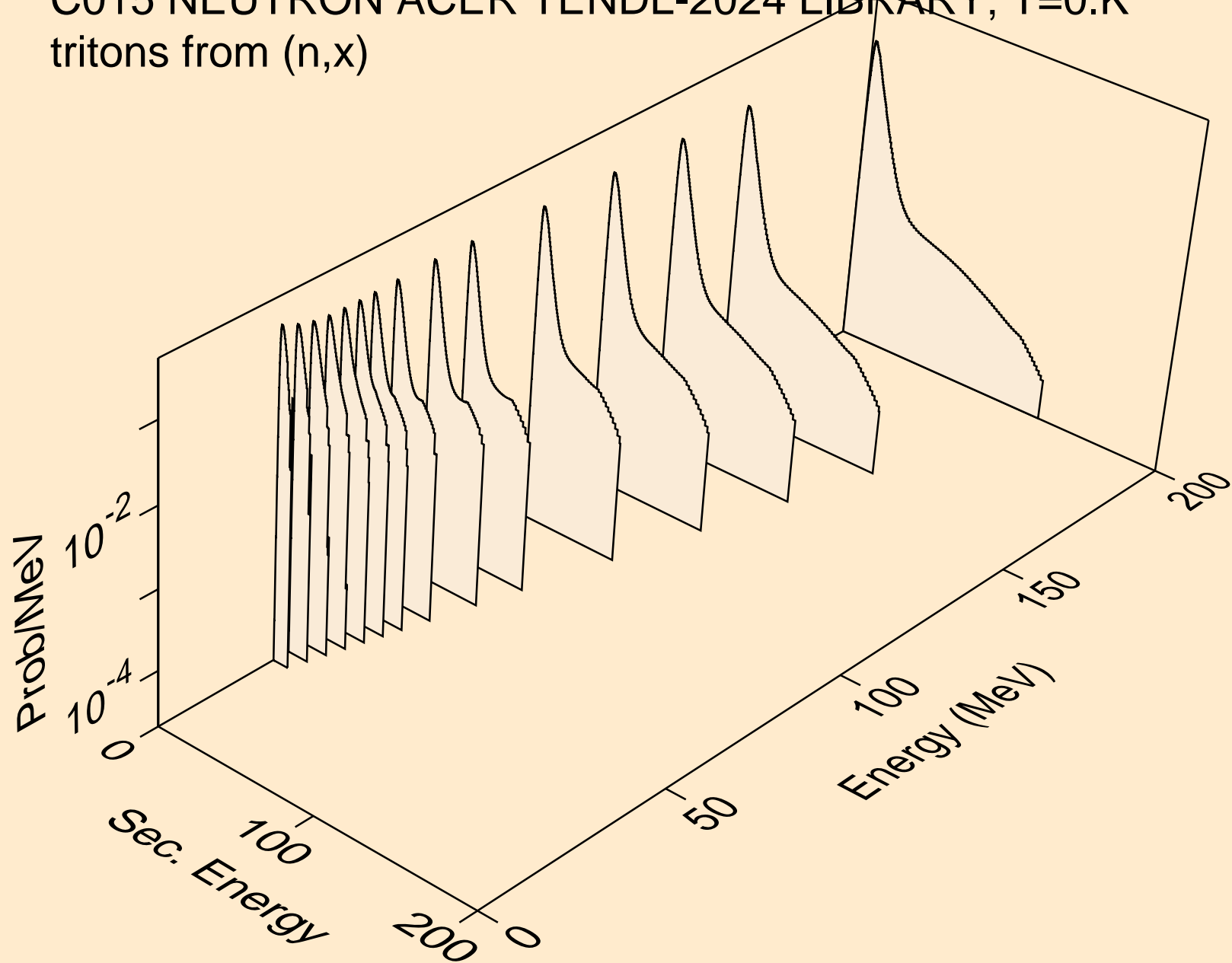

C015 NEUTRON ACER TENDL-2024 LIBRARY; T=0.K
tritons from (n,n*)t

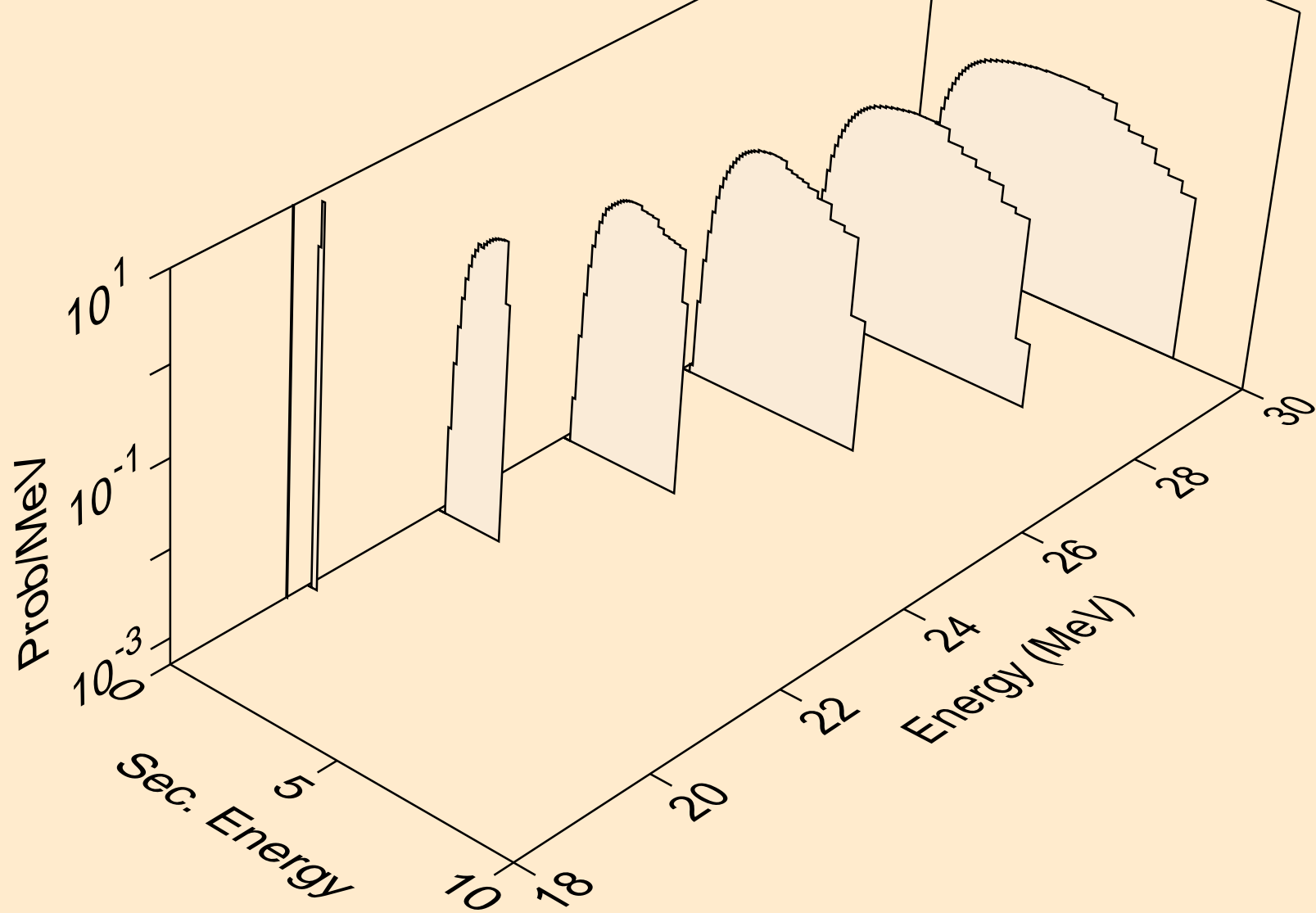

C015 NEUTRON ACER TENDL-2024 LIBRARY; T=0.K
tritons from (n,t)

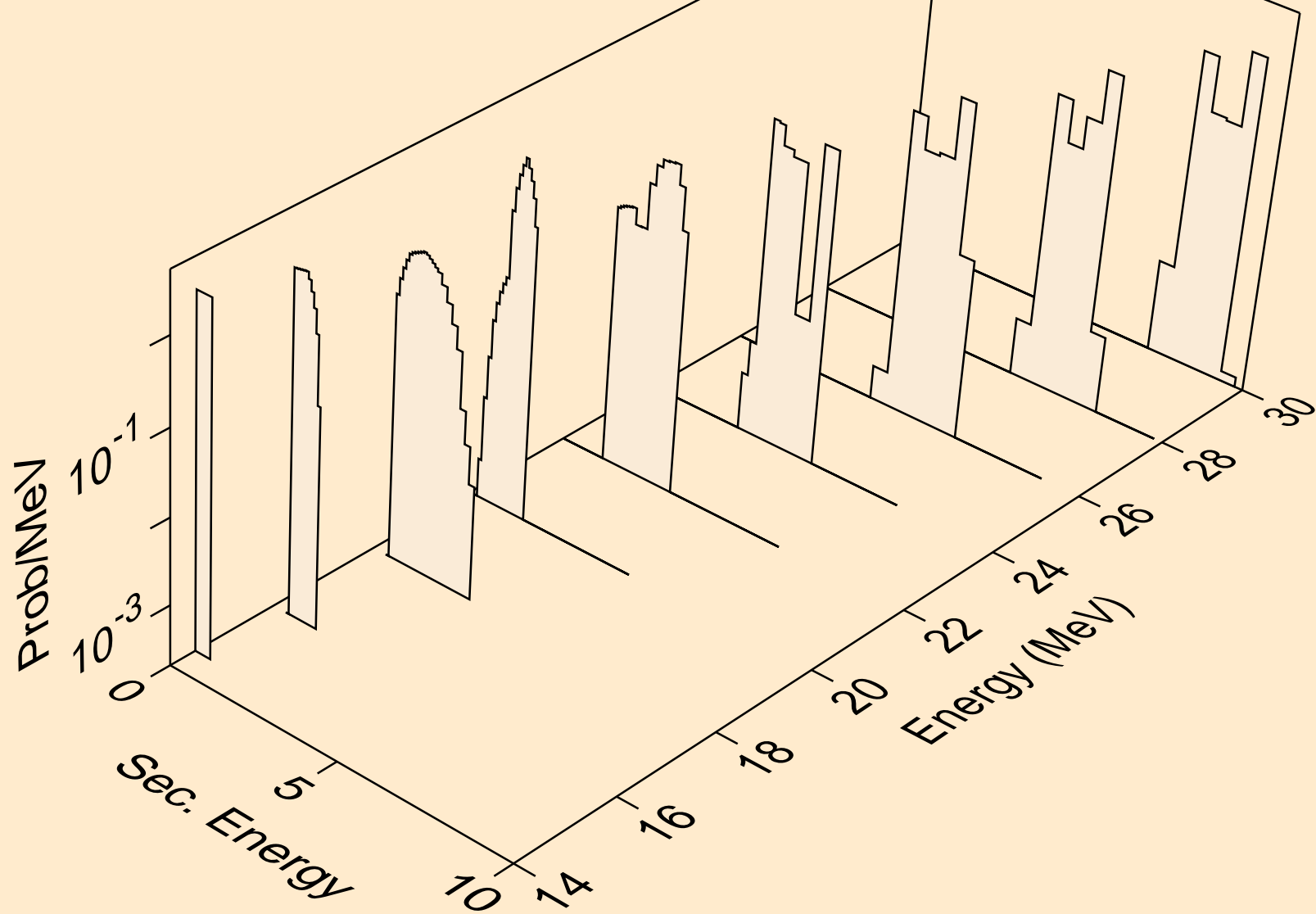

C015 NEUTRON ACER TENDL-2024 LIBRARY; T=0.K
he3s from (n,x)

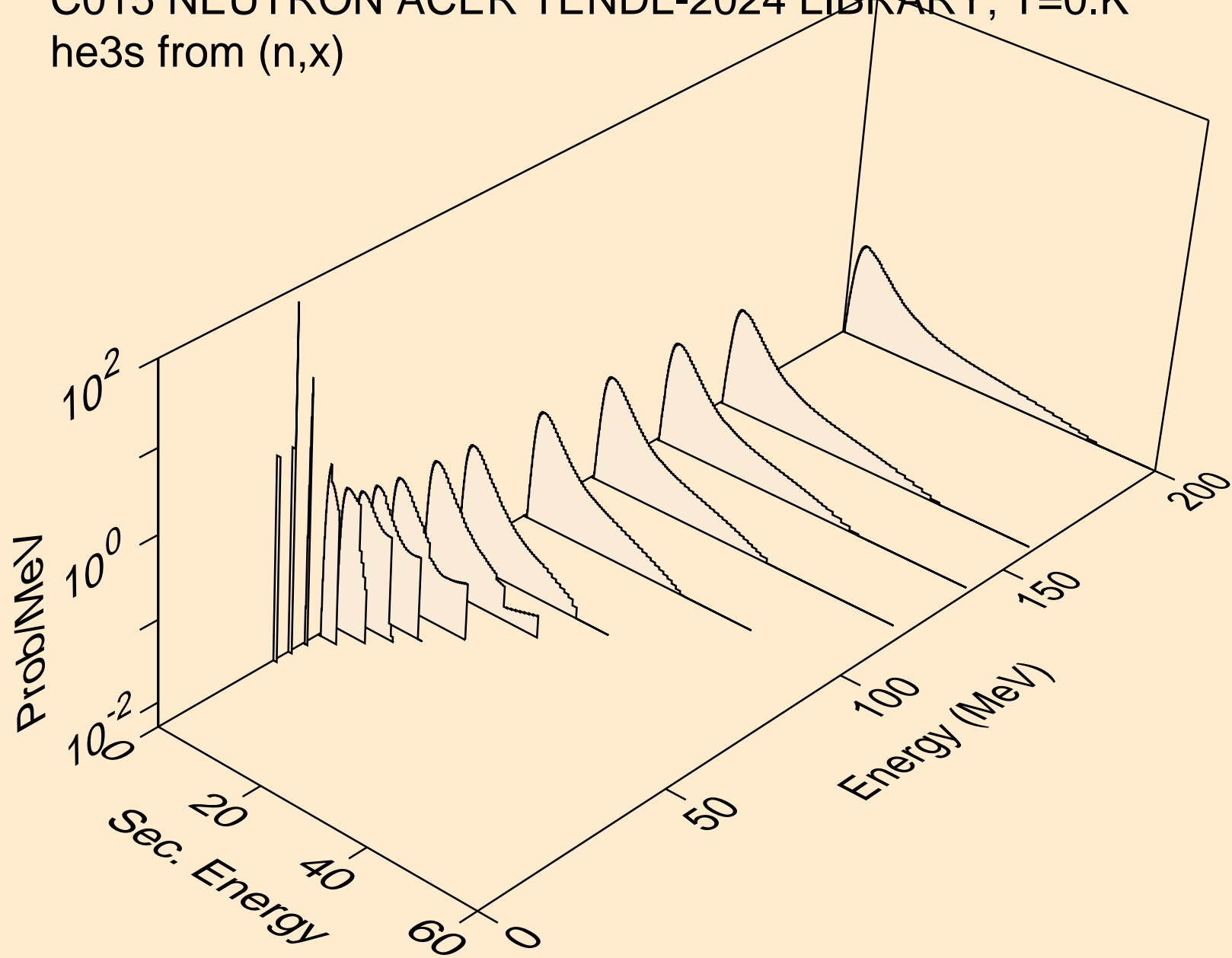

C015 NEUTRON ACER TENDL-2024 LIBRARY; T=0.K
alphas from (n,x)

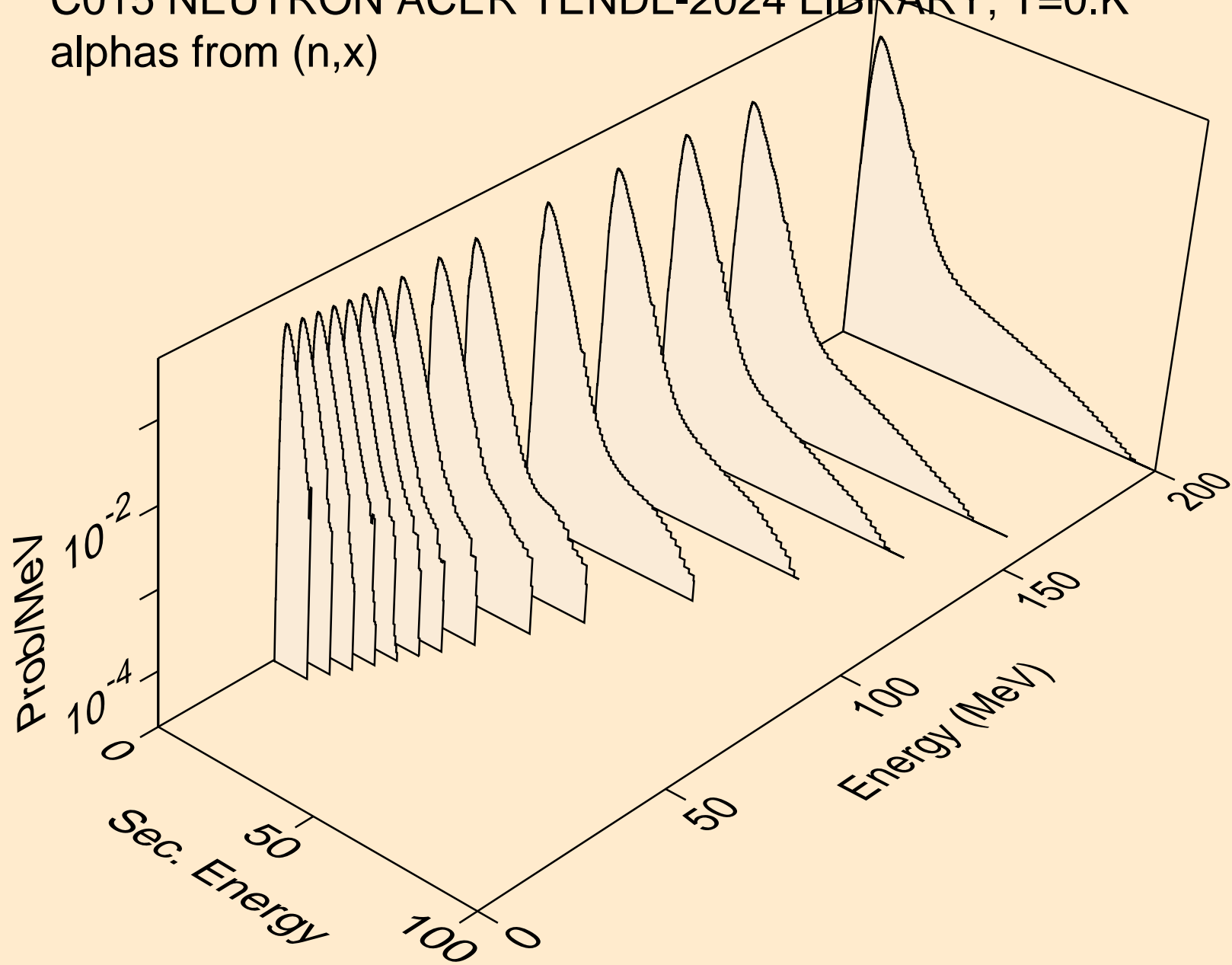

C015 NEUTRON ACER TENDL-2024 LIBRARY; T=0.K
alphas from (n,n*)a

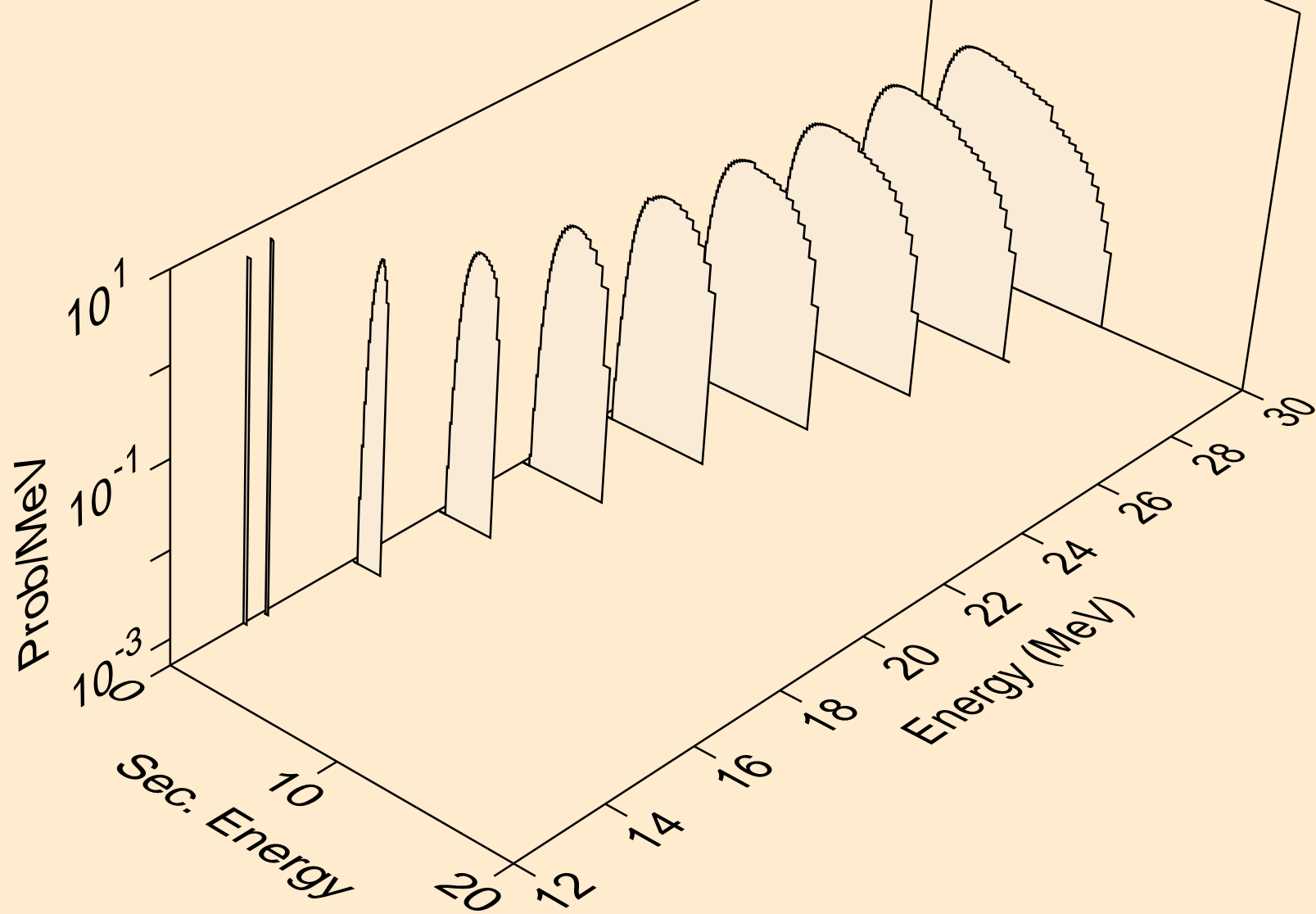

C015 NEUTRON ACER TENDL-2024 LIBRARY; T=0.K
alphas from (n,2n)a

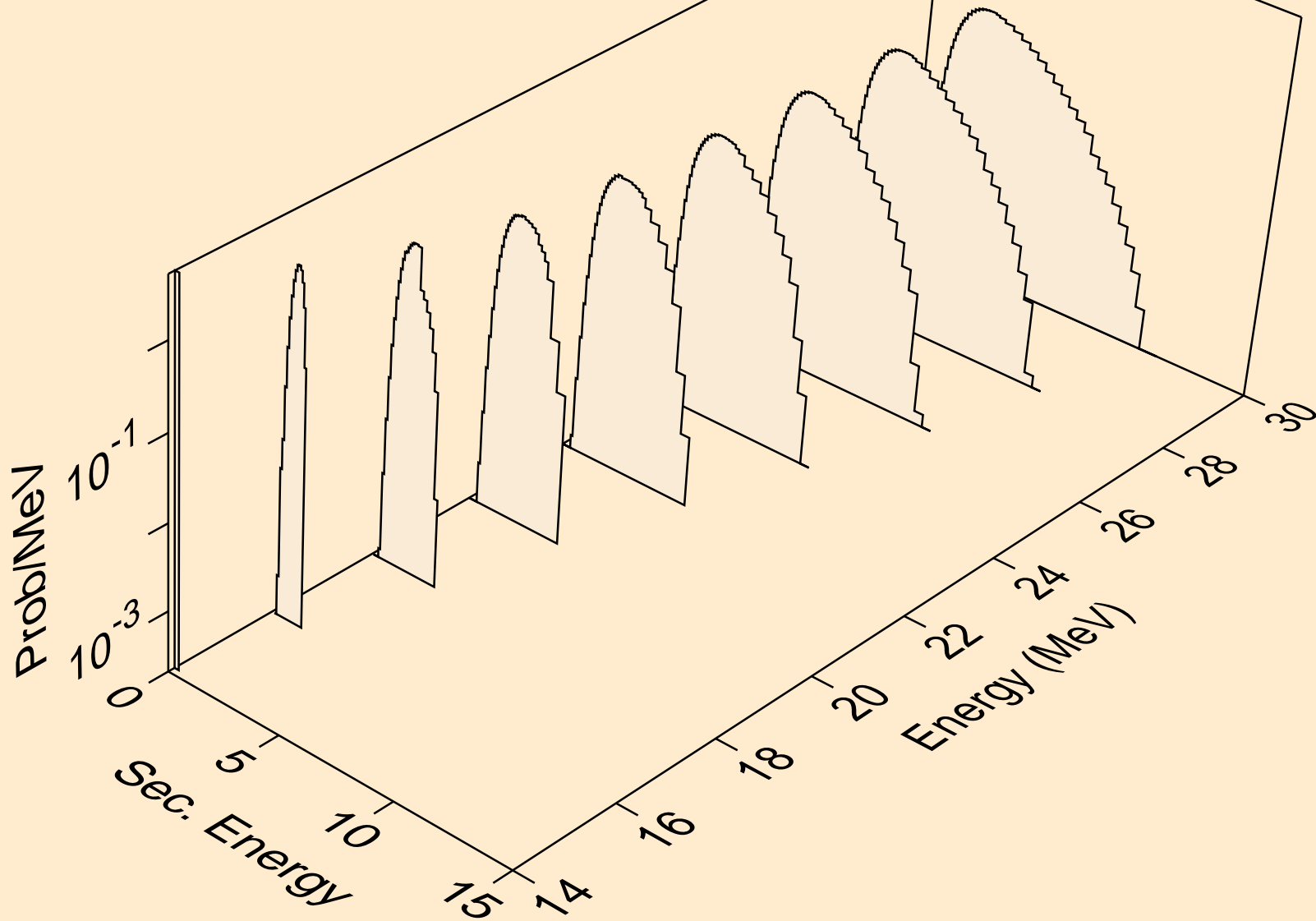

C015 NEUTRON ACER TENDL-2024 LIBRARY; T=0.K
alphas from (n,3n)a

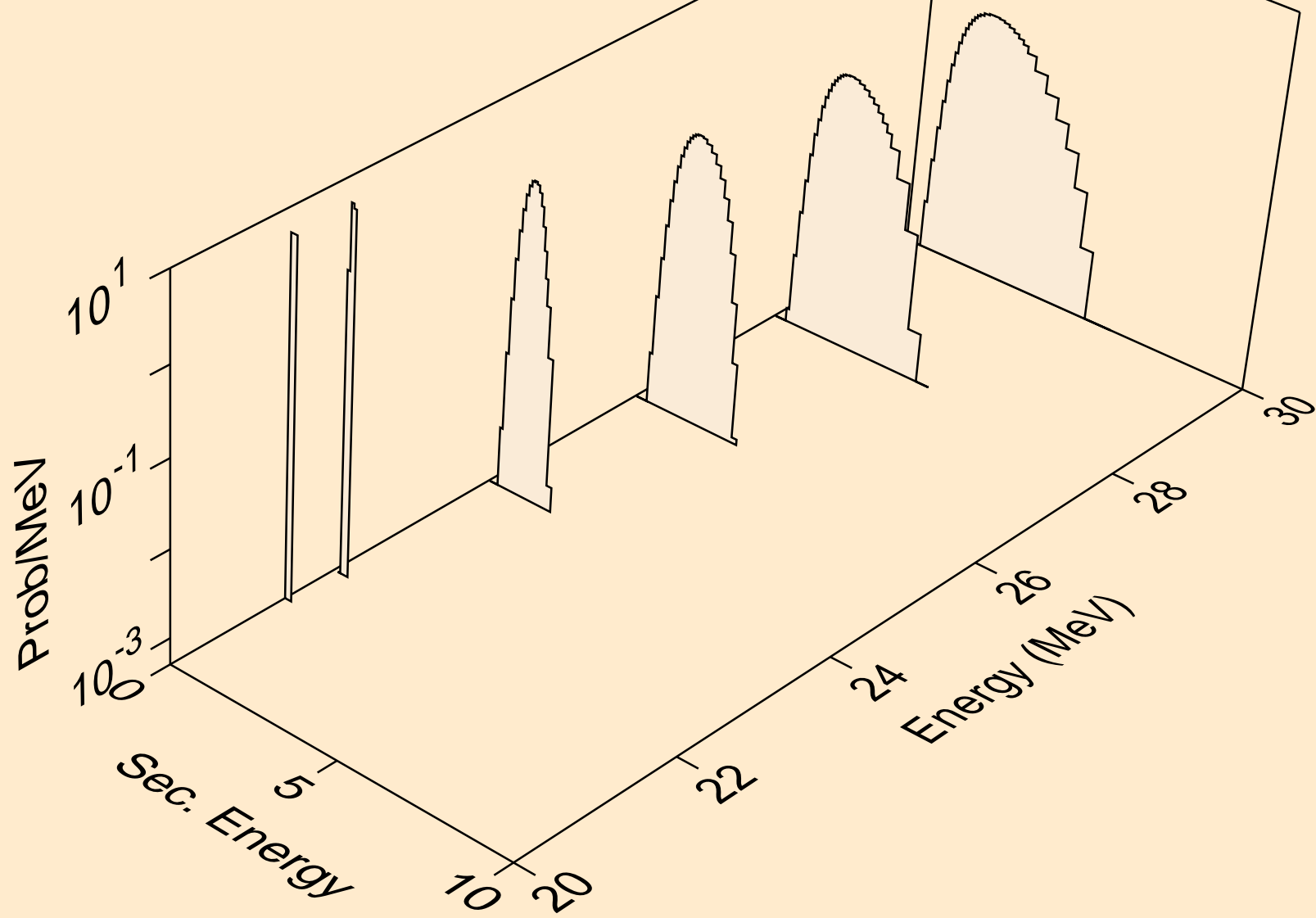

C015 NEUTRON ACER TENDL-2024 LIBRARY; T=0.K
alphas from (n,a)

