

CE149 NEUTRON ACER TENDL-2024 LIBRARY; T=0.K

Principal cross sections

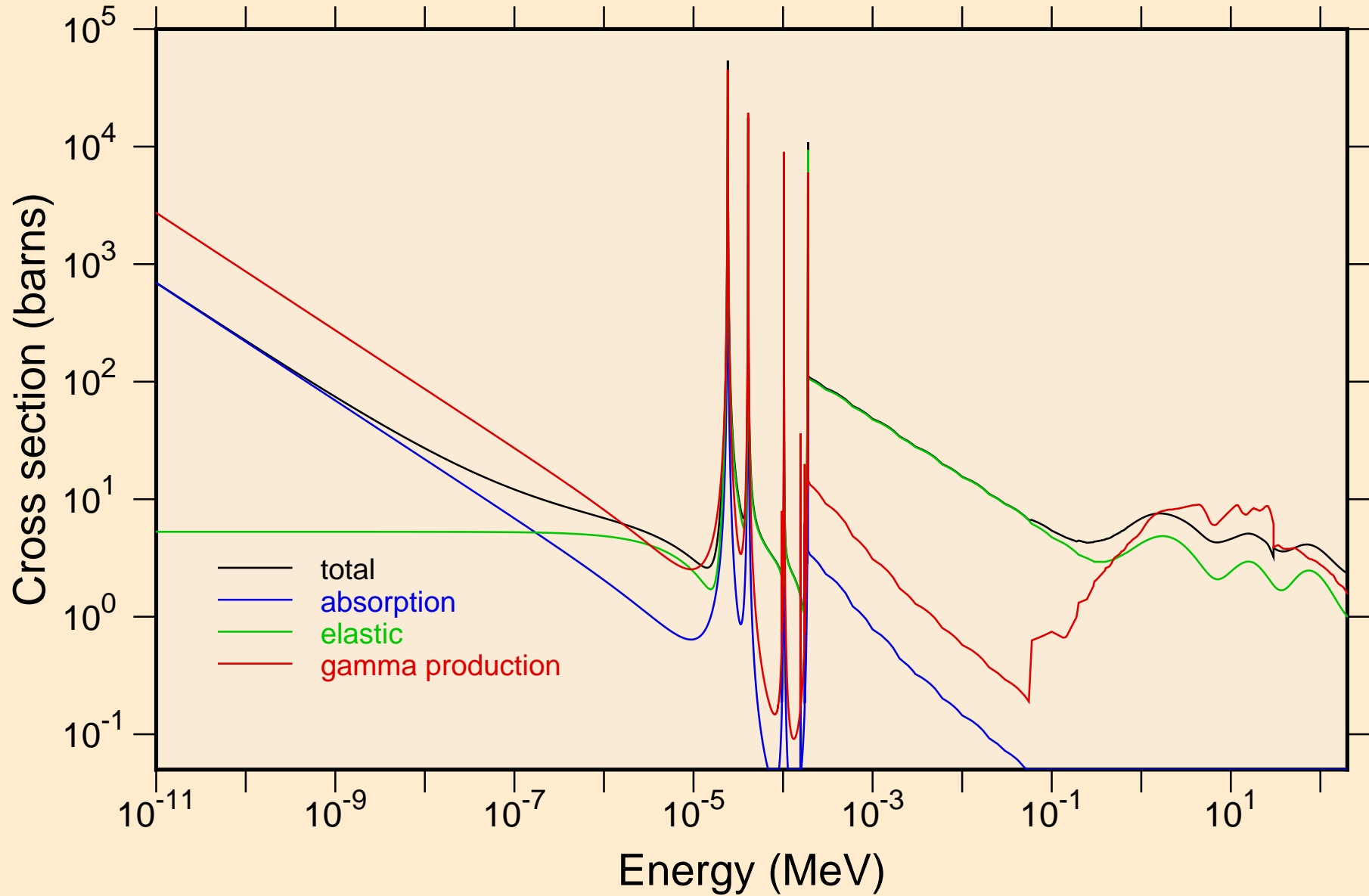

CE149 NEUTRON ACER TENDL-2024 LIBRARY; T=0.K
resonance total cross section

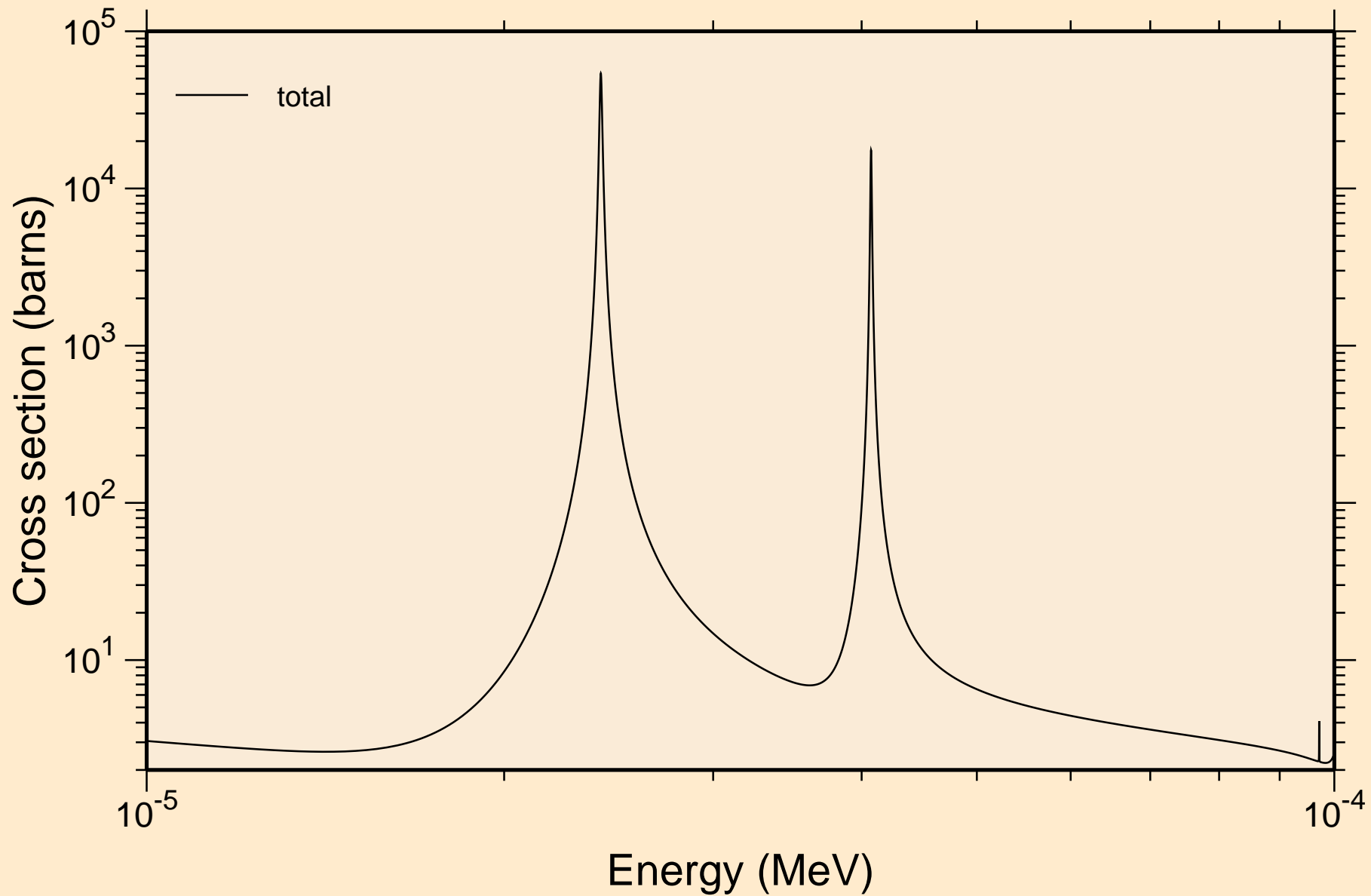

CE149 NEUTRON ACER TENDL-2024 LIBRARY; T=0.K
resonance total cross section

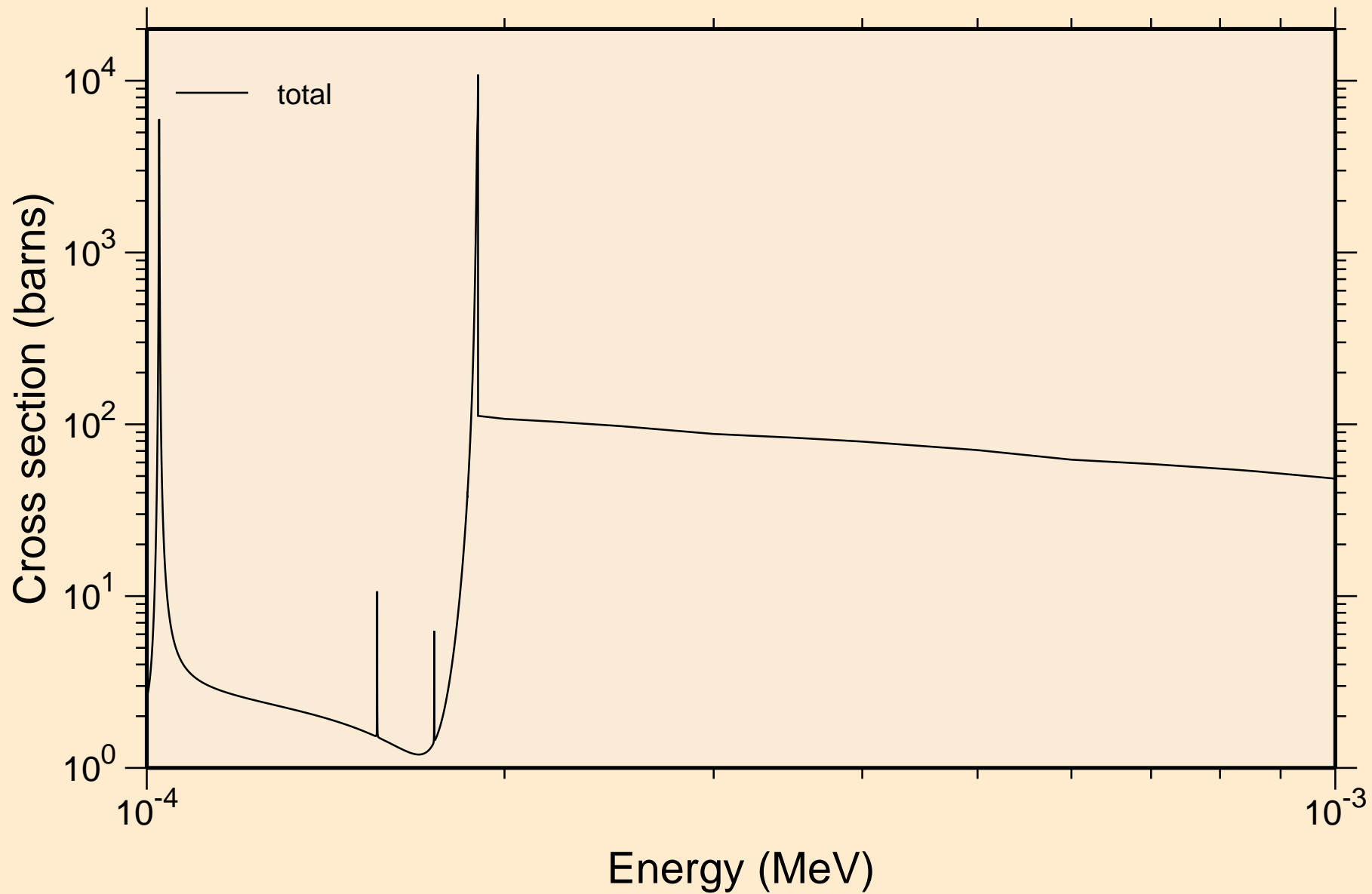

CE149 NEUTRON ACER TENDL-2024 LIBRARY; T=0.K
resonance total cross section

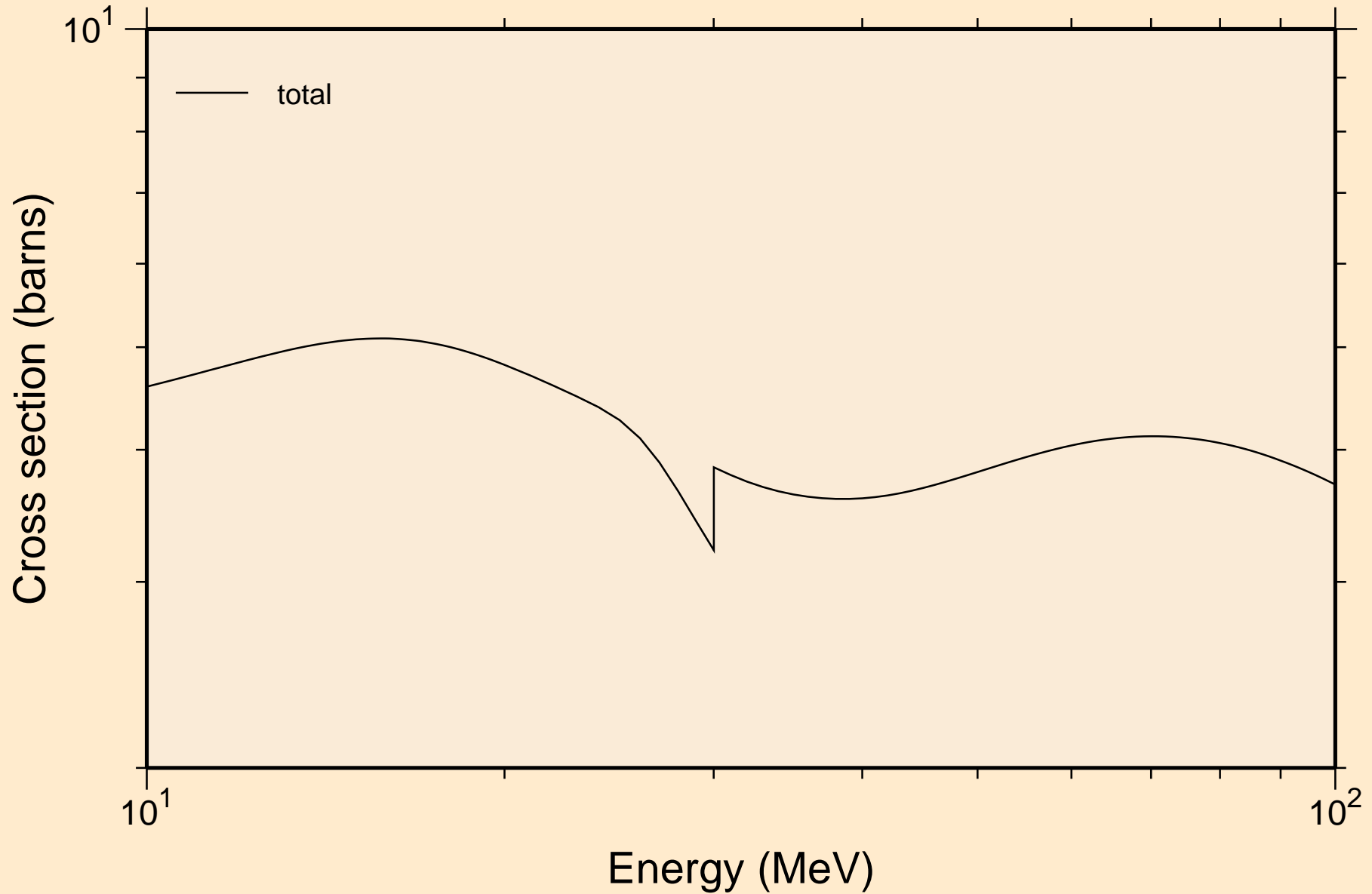

CE149 NEUTRON ACER TENDL-2024 LIBRARY; T=0.K
resonance absorption cross sections

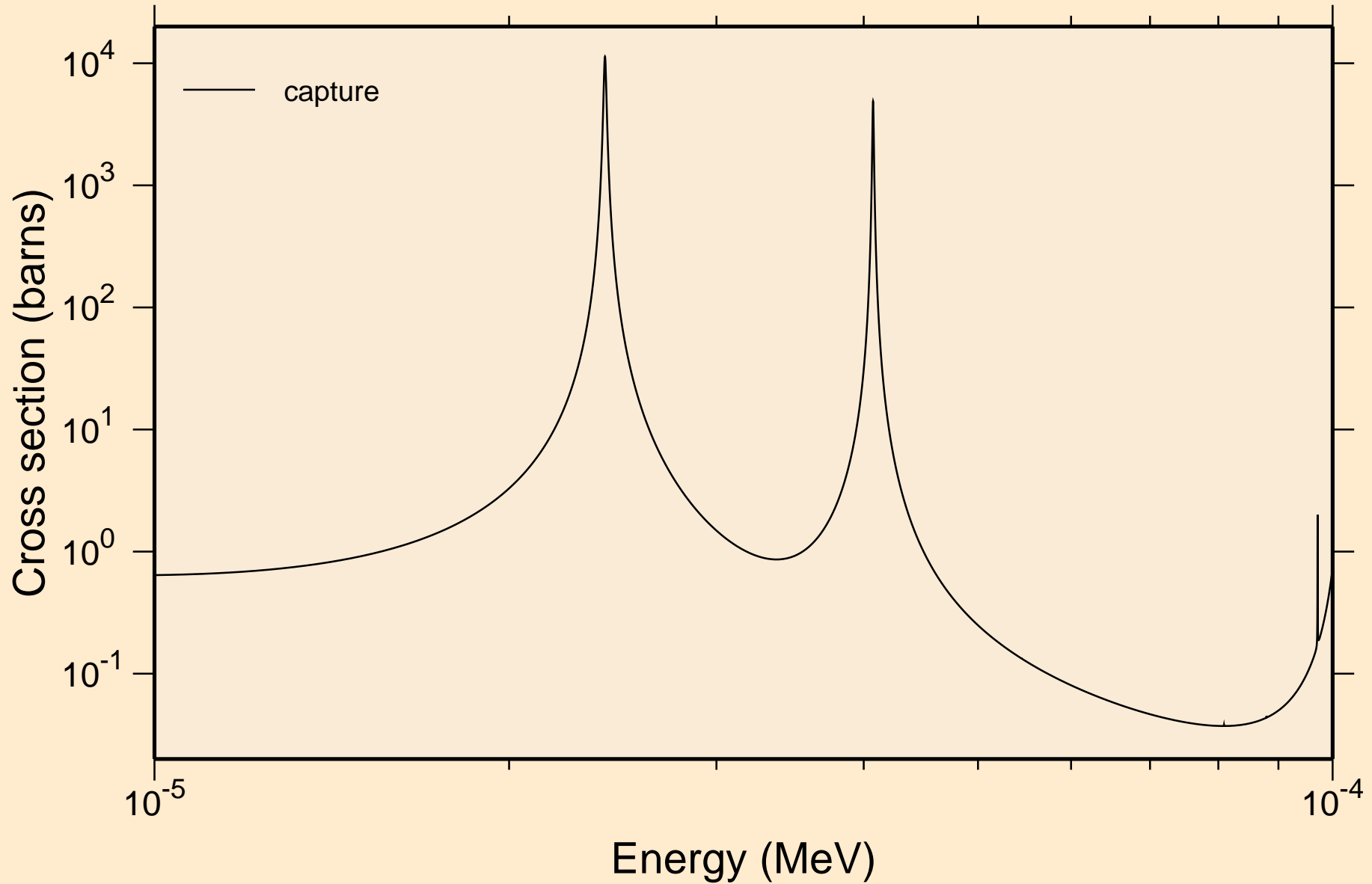

CE149 NEUTRON ACER TENDL-2024 LIBRARY; T=0.K
resonance absorption cross sections

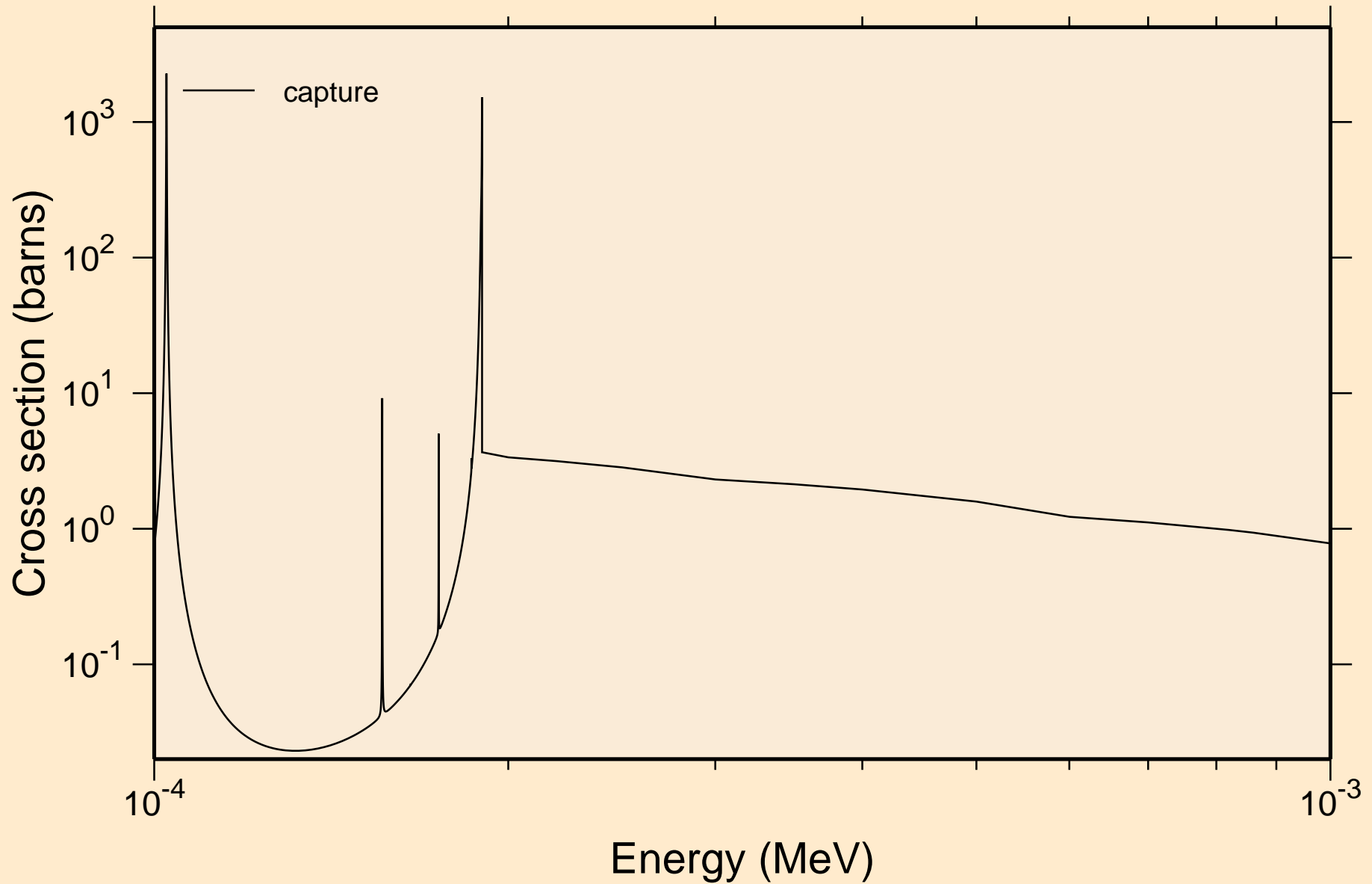

CE149 NEUTRON ACER TENDL-2024 LIBRARY; T=0.K
resonance absorption cross sections

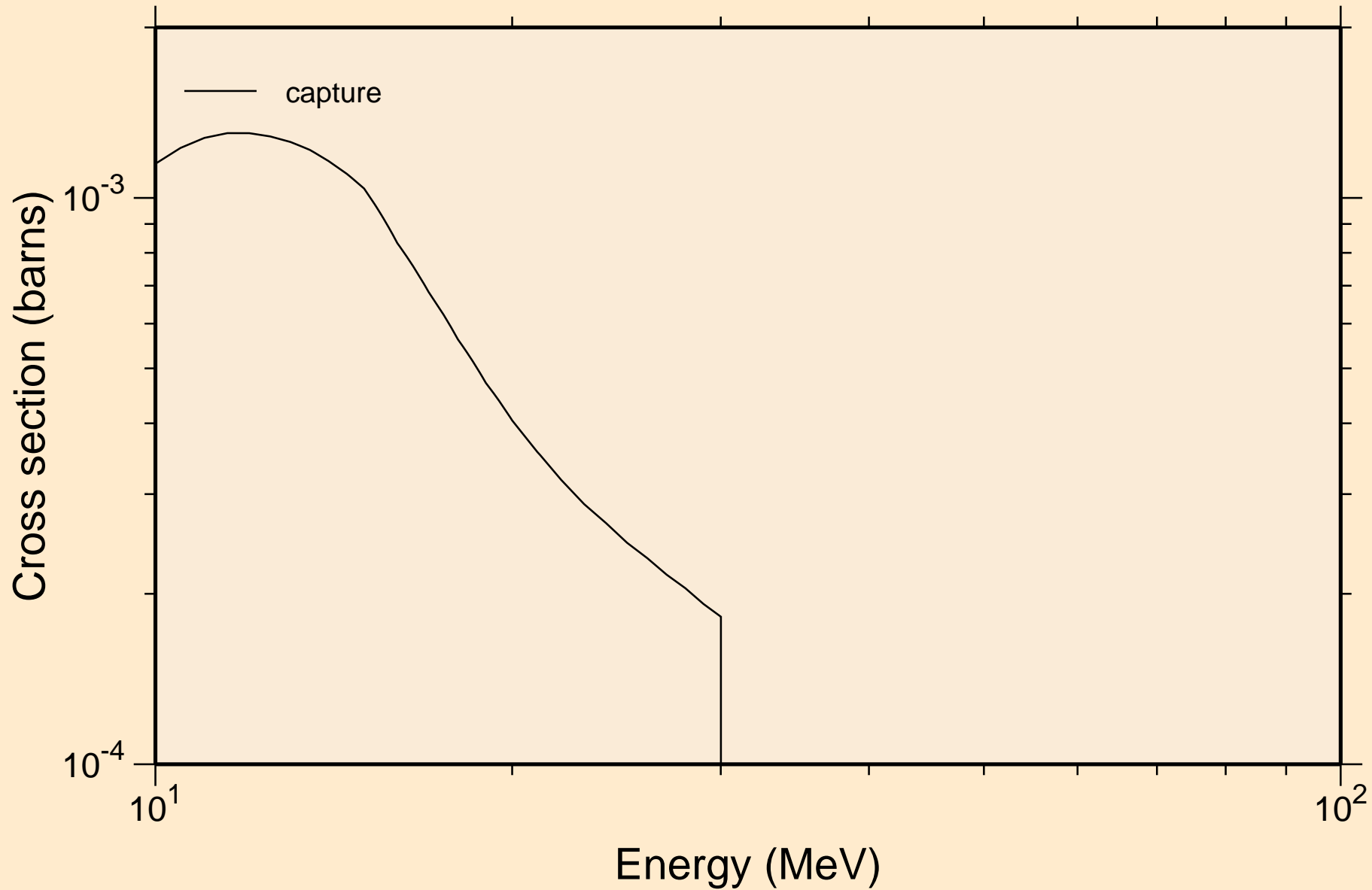

CE149 NEUTRON ACER TENDL-2024 LIBRARY; T=0.K
Heating

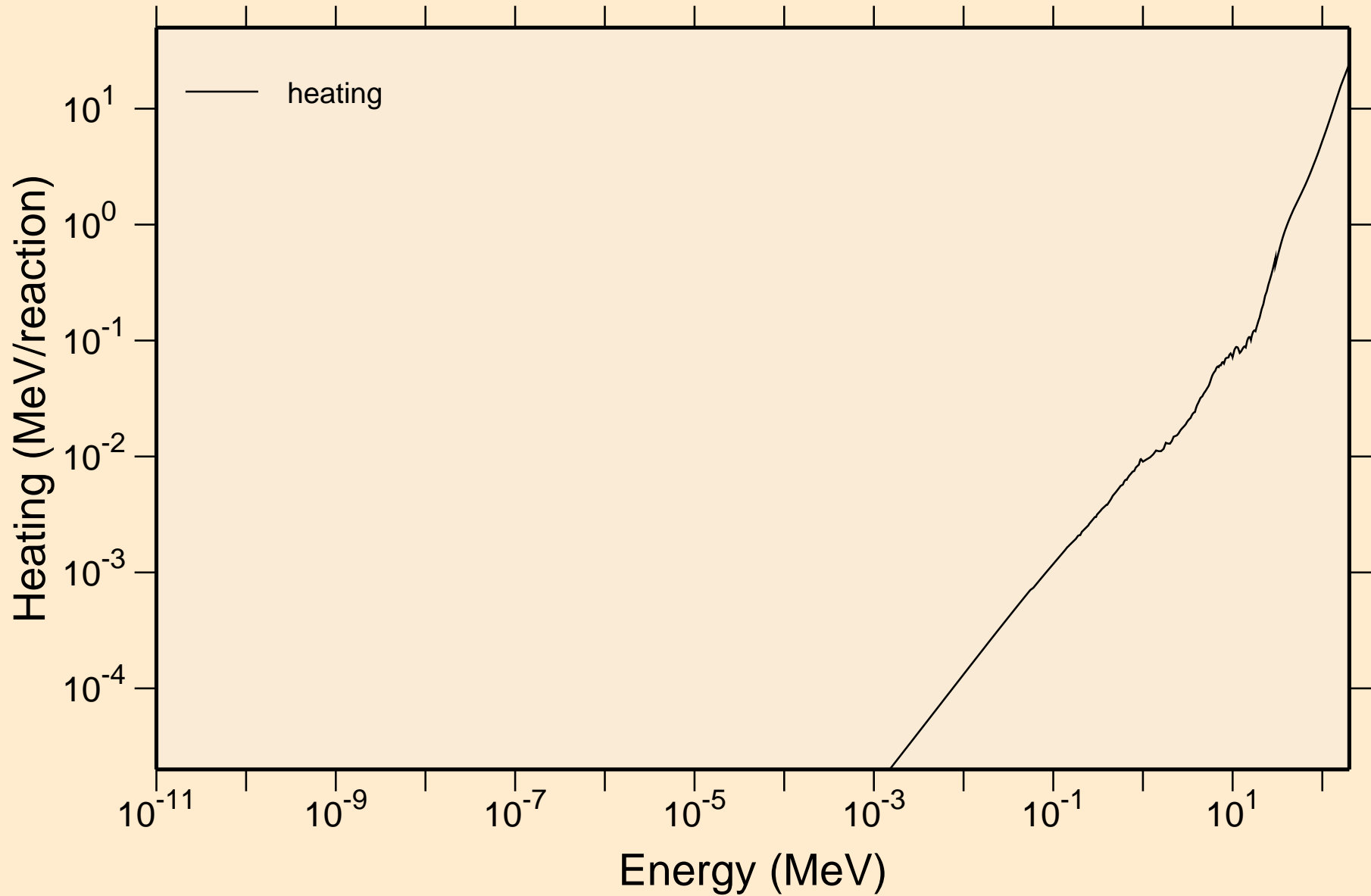

CE149 NEUTRON ACER TENDL-2024 LIBRARY; T=0.K

Damage

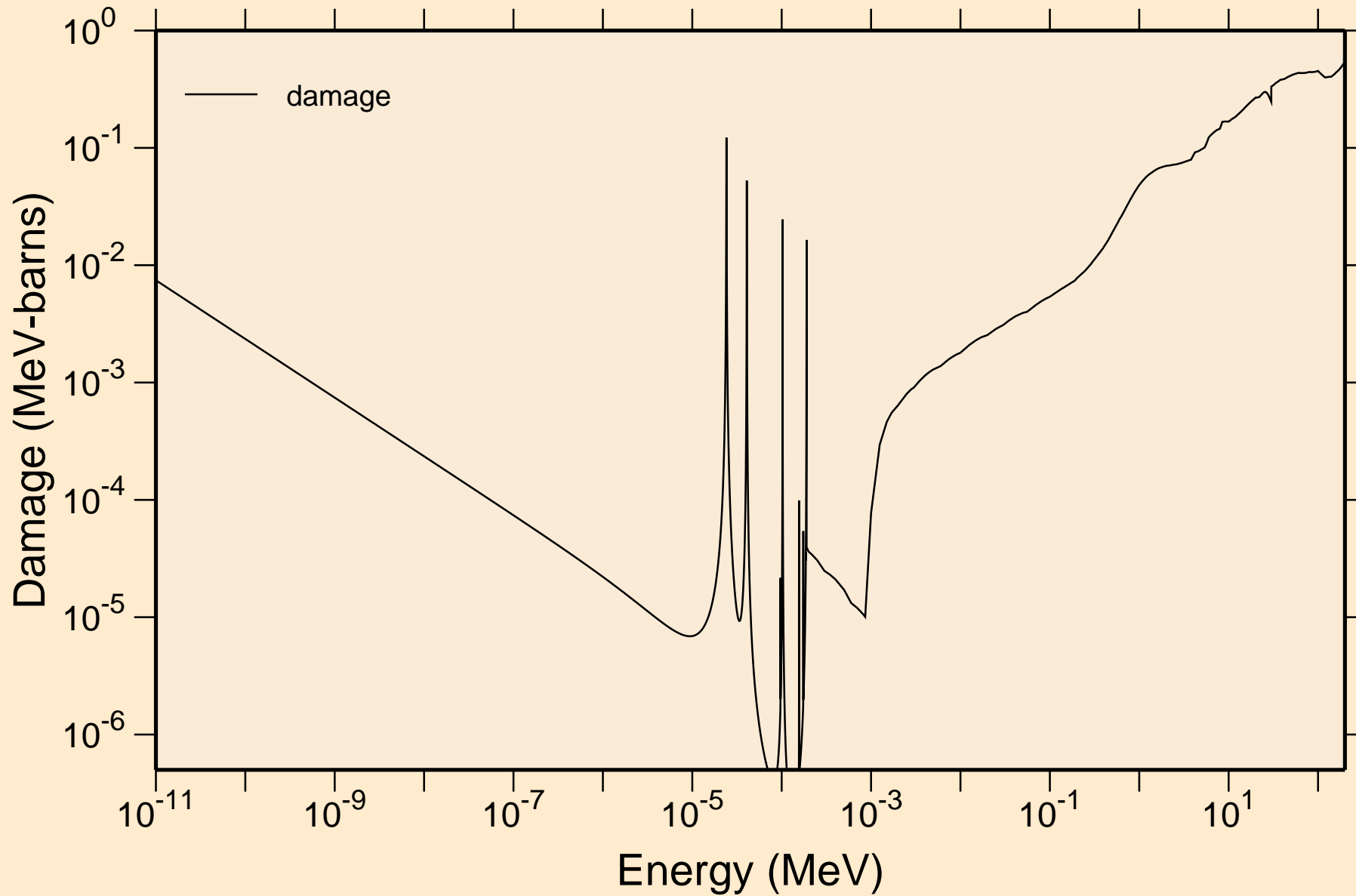

CE149 NEUTRON ACER TENDL-2024 LIBRARY; T=0.K
Non-threshold reactions

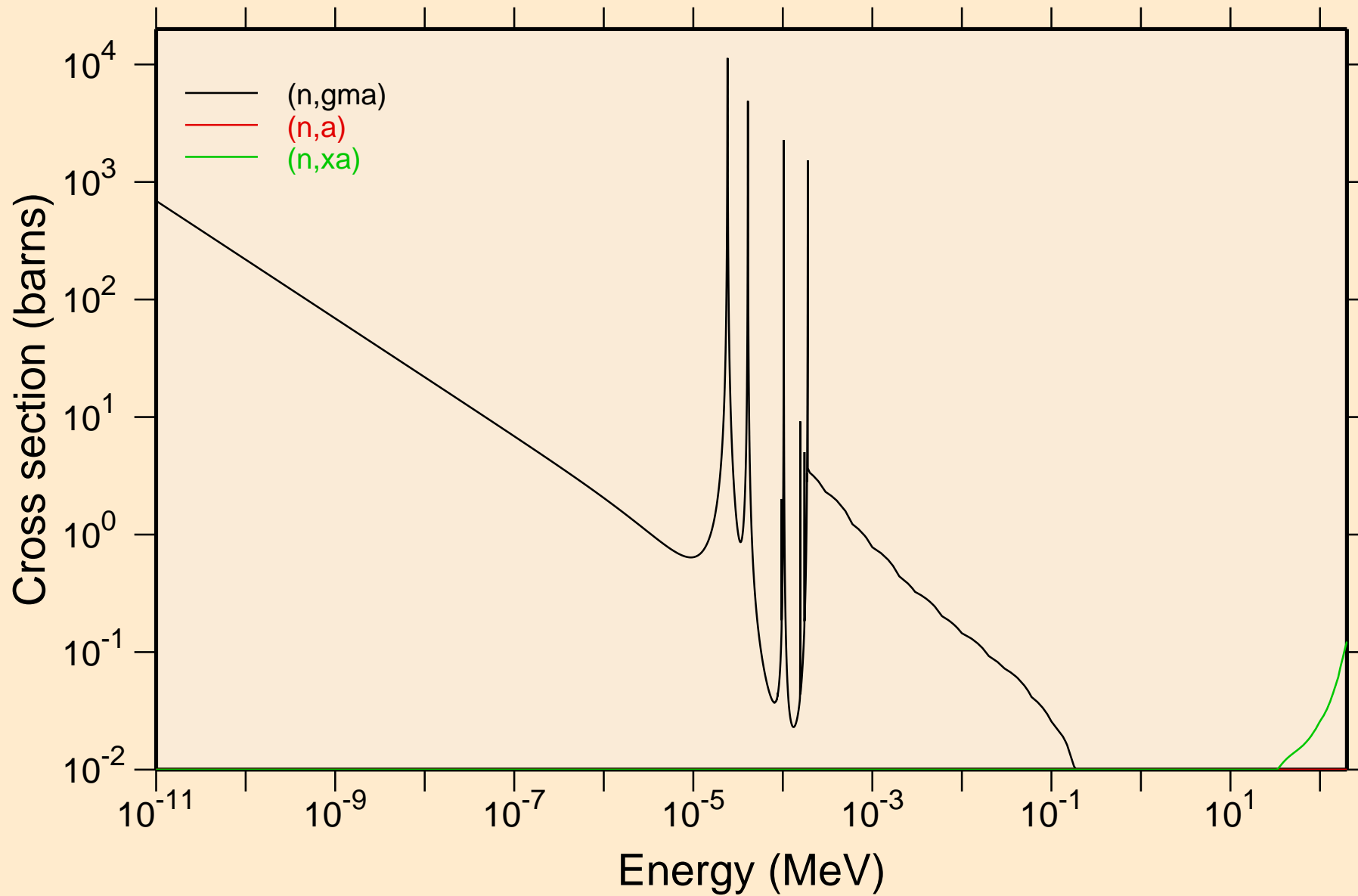

CE149 NEUTRON ACER TENDL-2024 LIBRARY; T=0.K

Principal cross sections

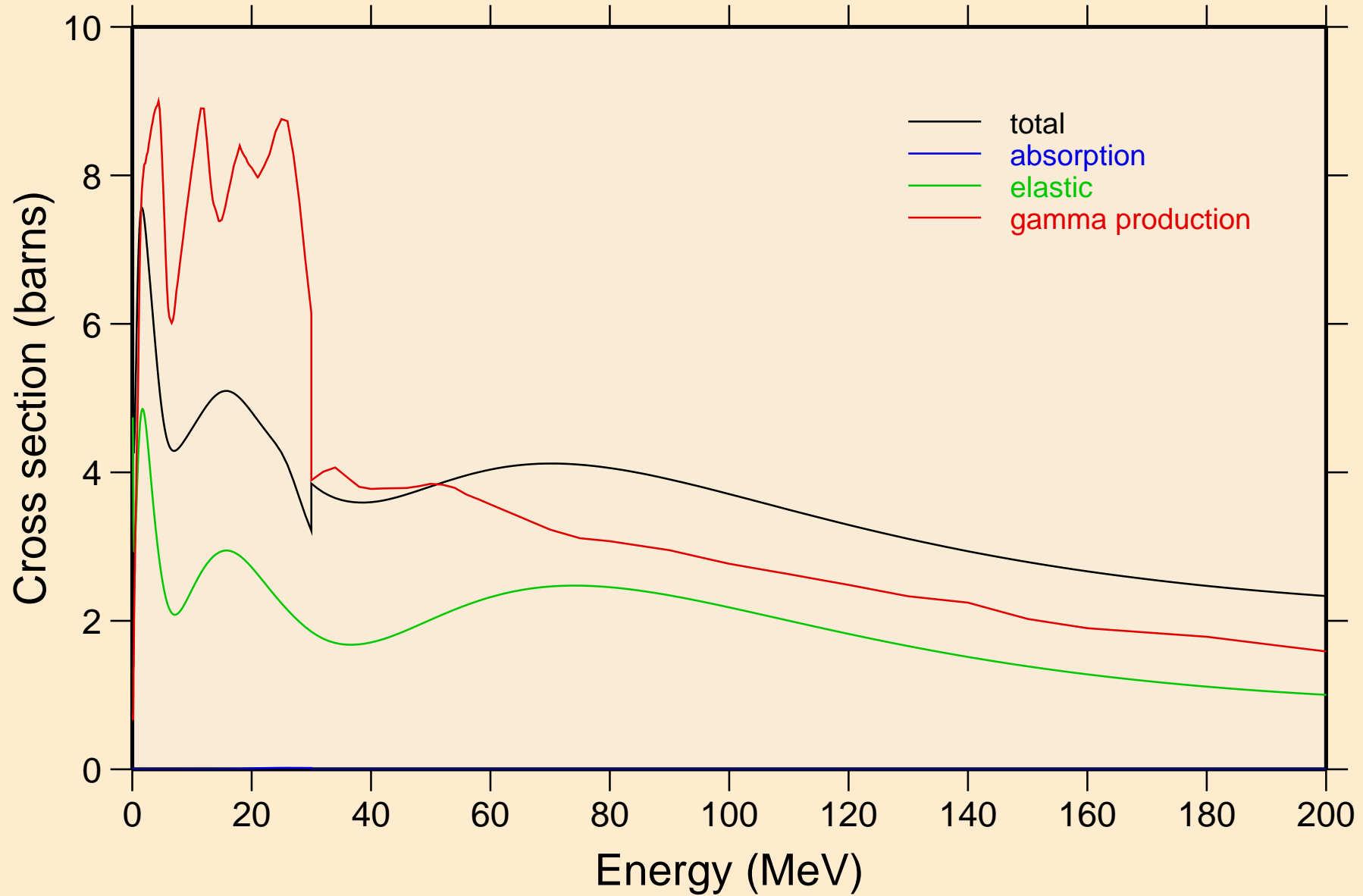

CE149 NEUTRON ACER TENDL-2024 LIBRARY; T=0.K

Heating

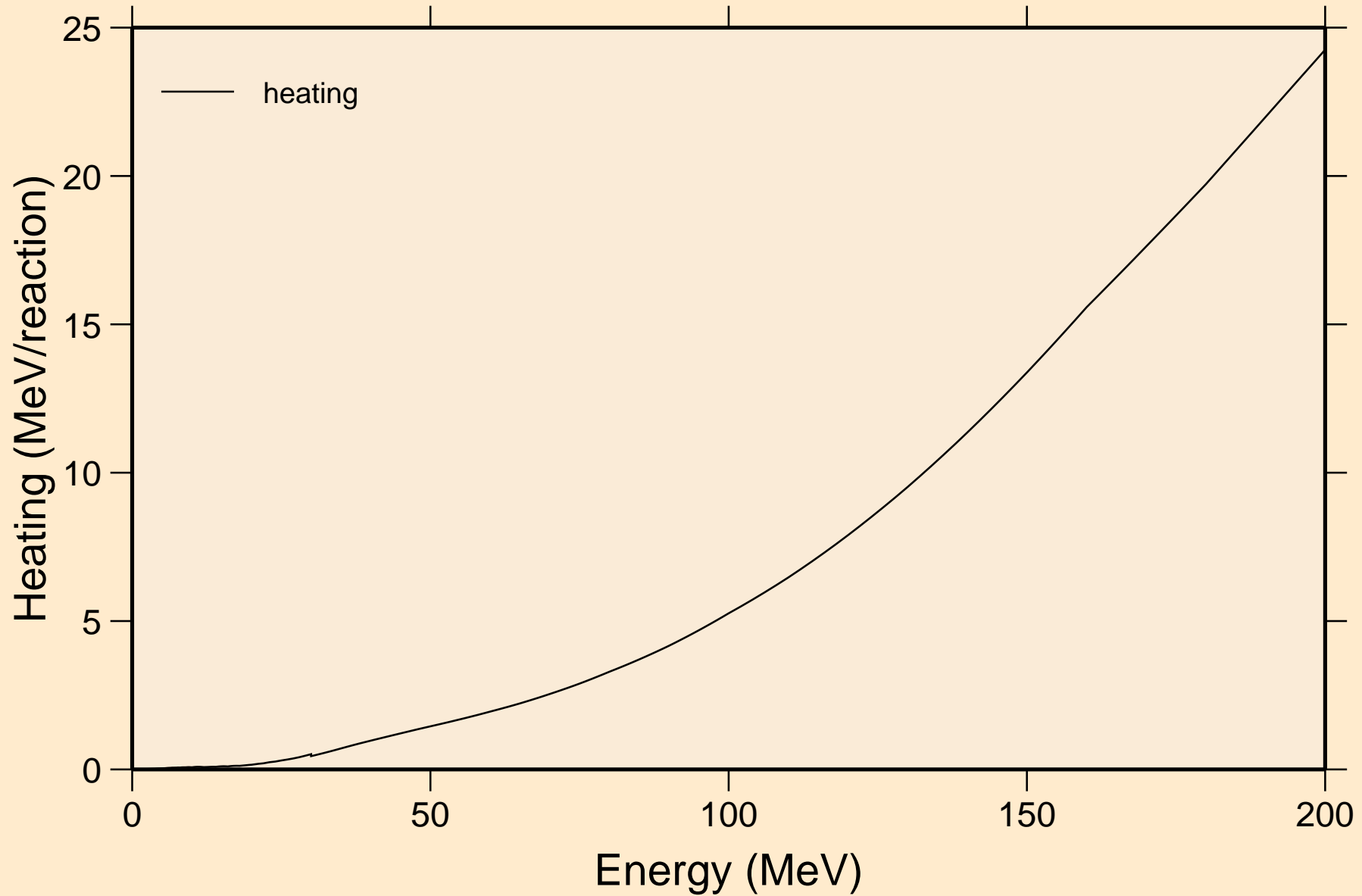

CE149 NEUTRON ACER TENDL-2024 LIBRARY; T=0.K

Damage

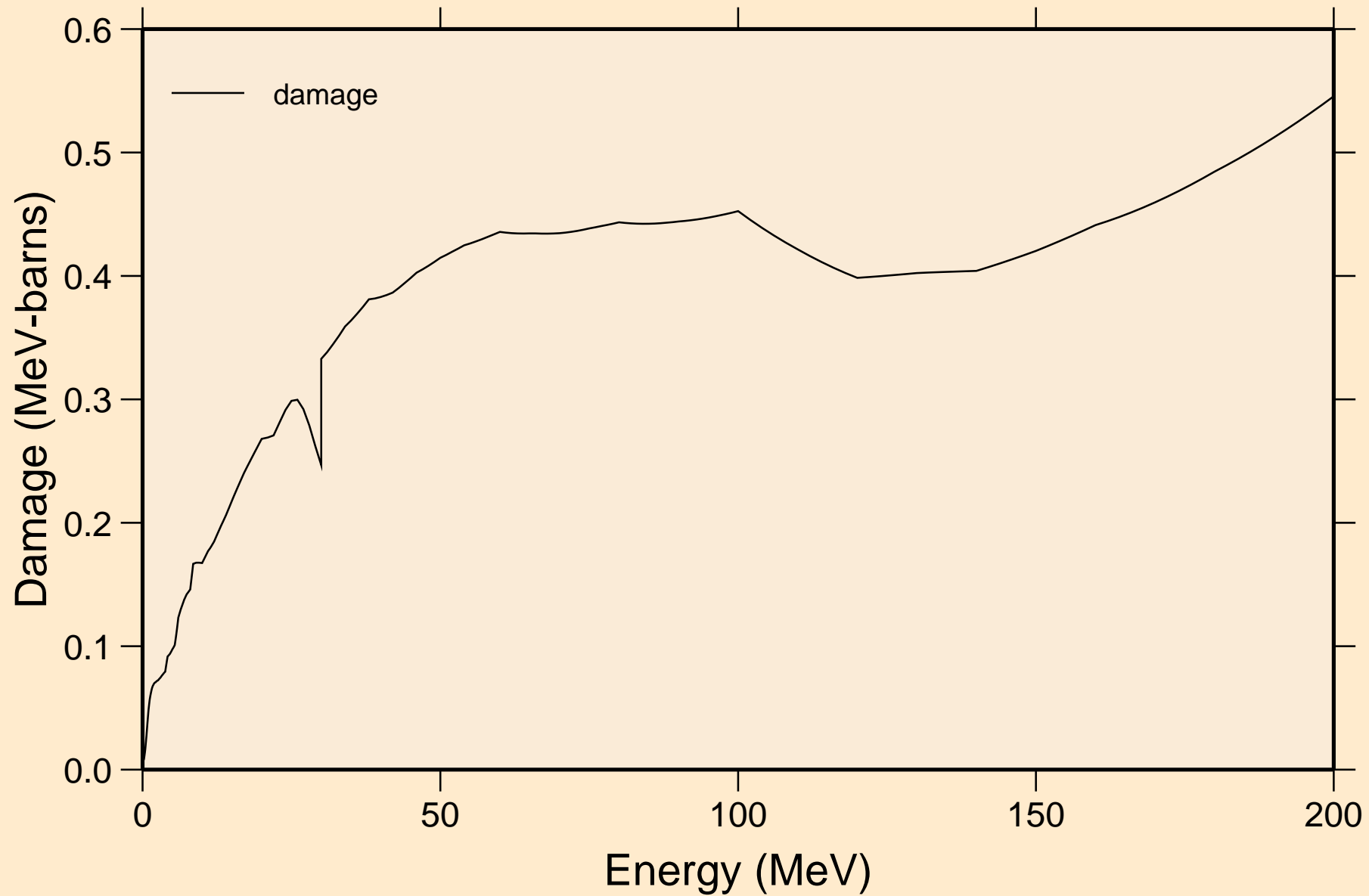

CE149 NEUTRON ACER TENDL-2024 LIBRARY; T=0.K
Non-threshold reactions

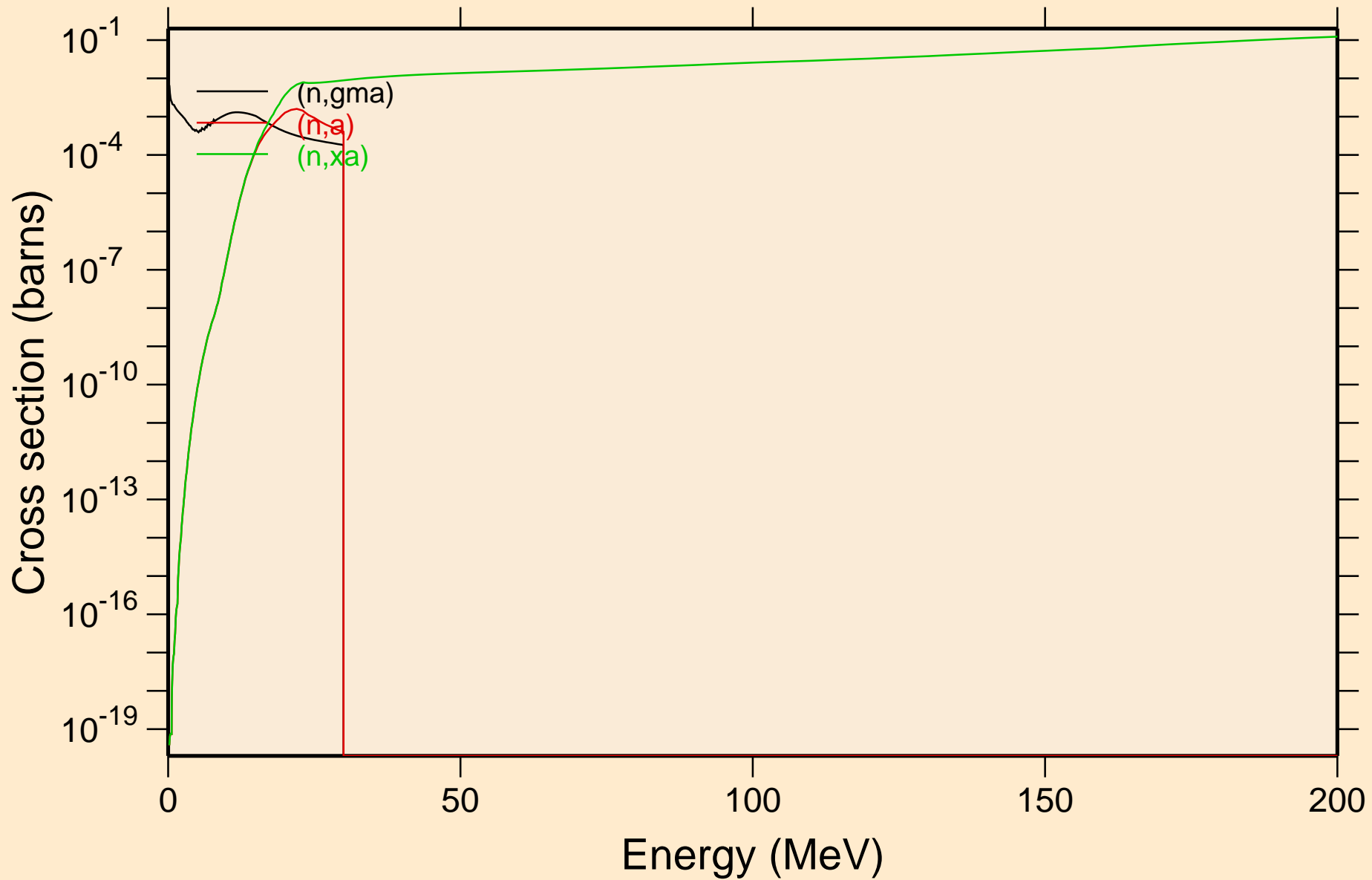

CE149 NEUTRON ACER TENDL-2024 LIBRARY; T=0.K
Inelastic levels

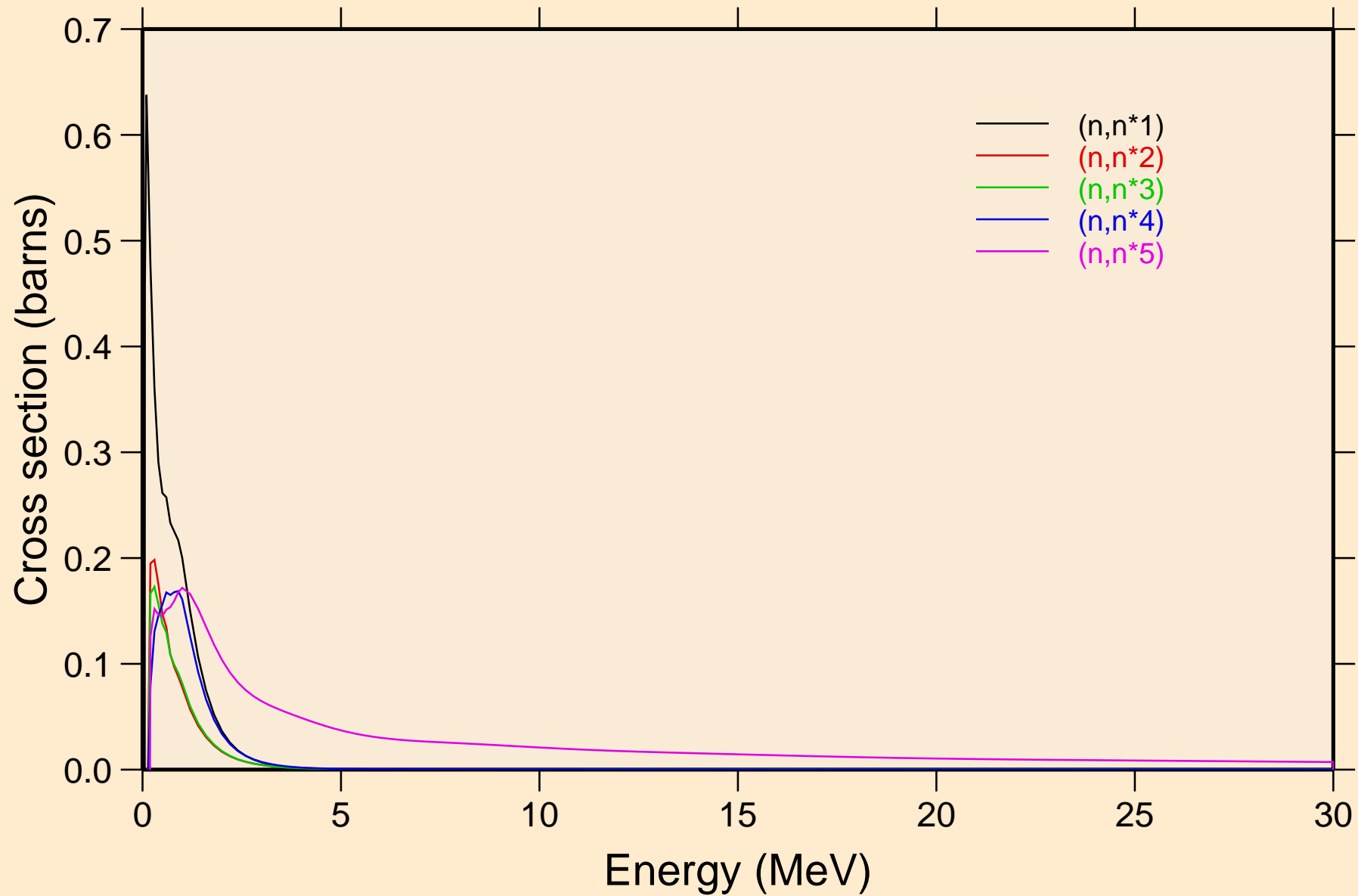

CE149 NEUTRON ACER TENDL-2024 LIBRARY; T=0.K
Inelastic levels

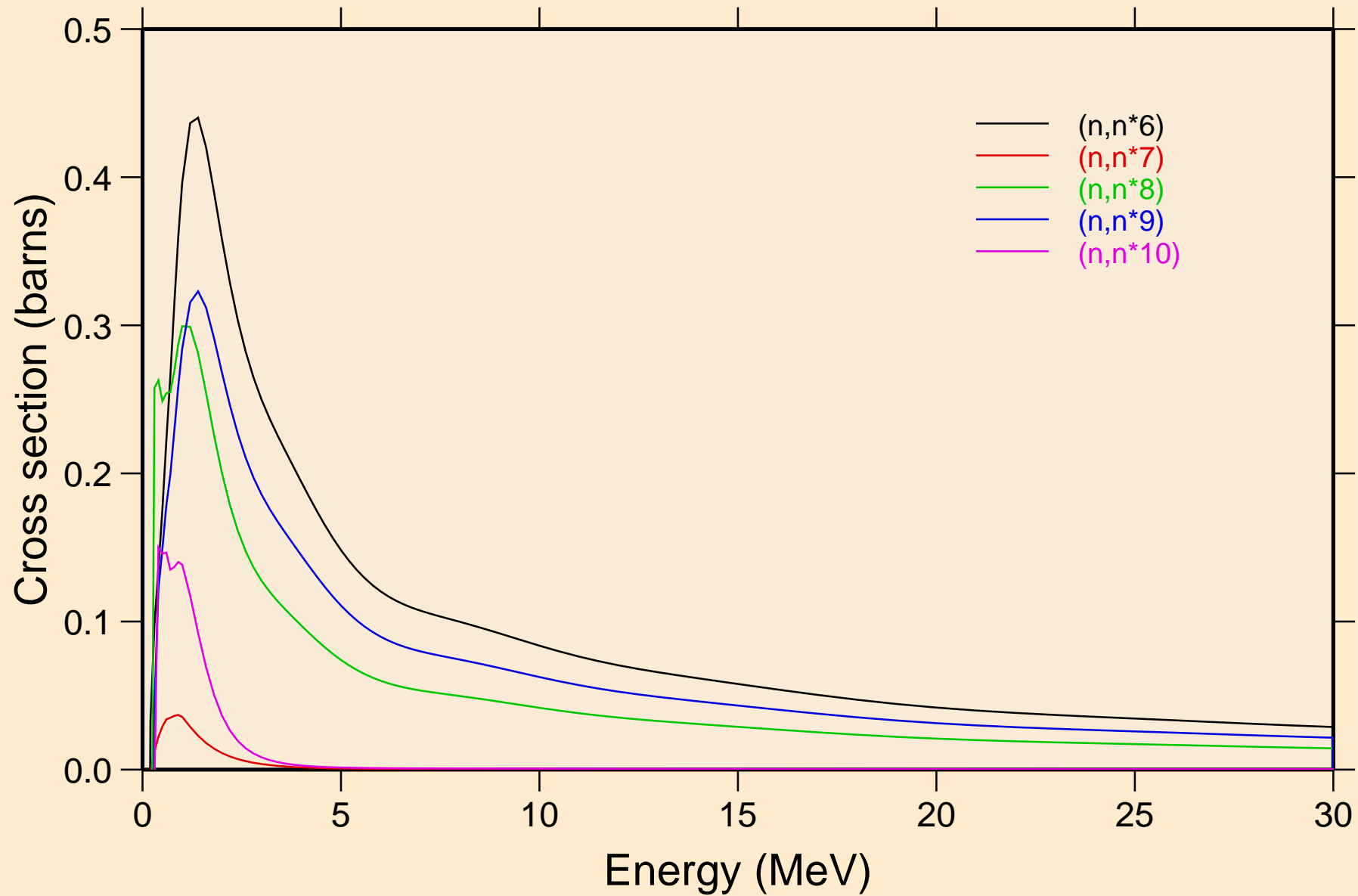

CE149 NEUTRON ACER TENDL-2024 LIBRARY; T=0.K
Inelastic levels

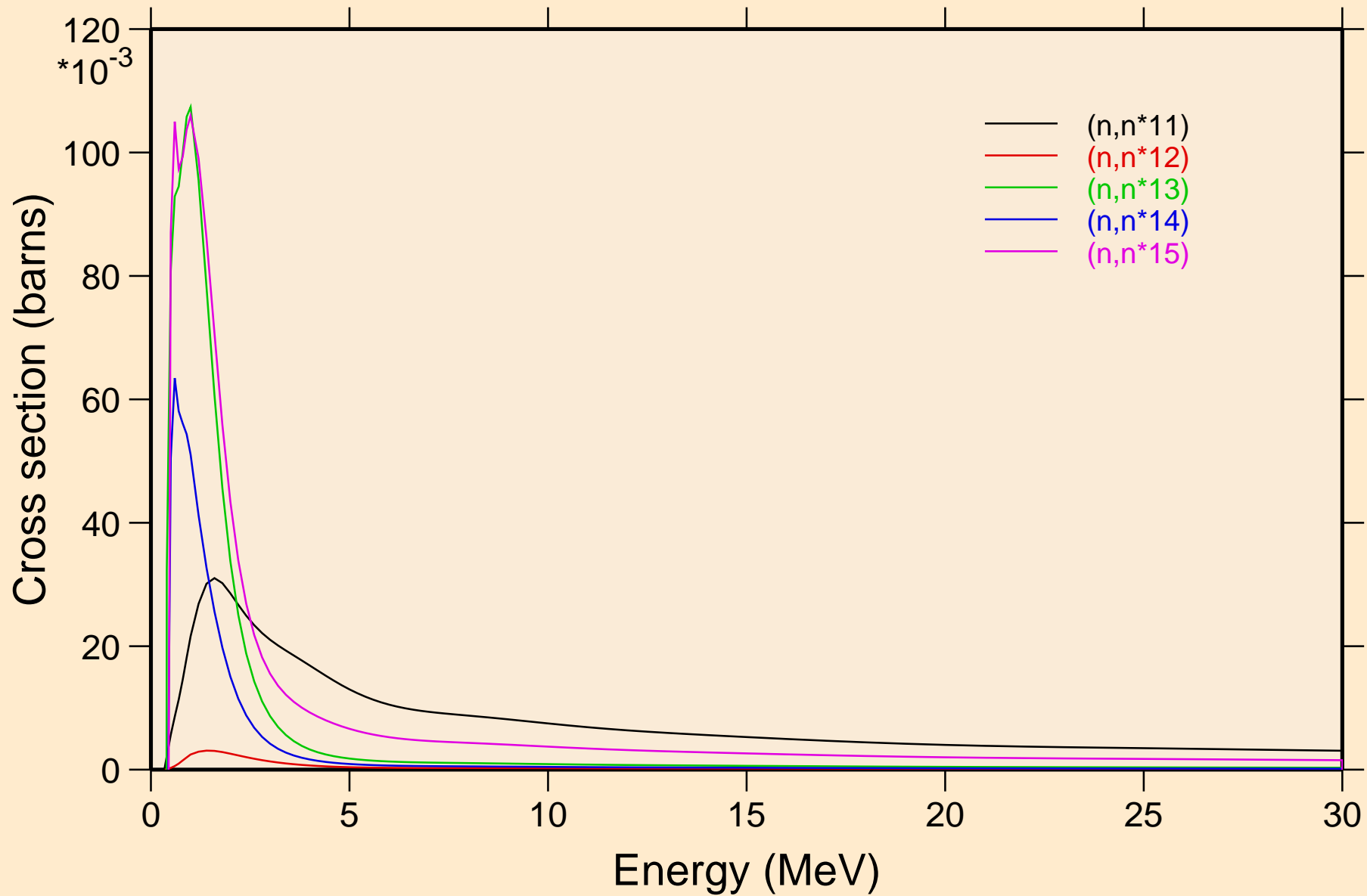

CE149 NEUTRON ACER TENDL-2024 LIBRARY; T=0.K
Inelastic levels

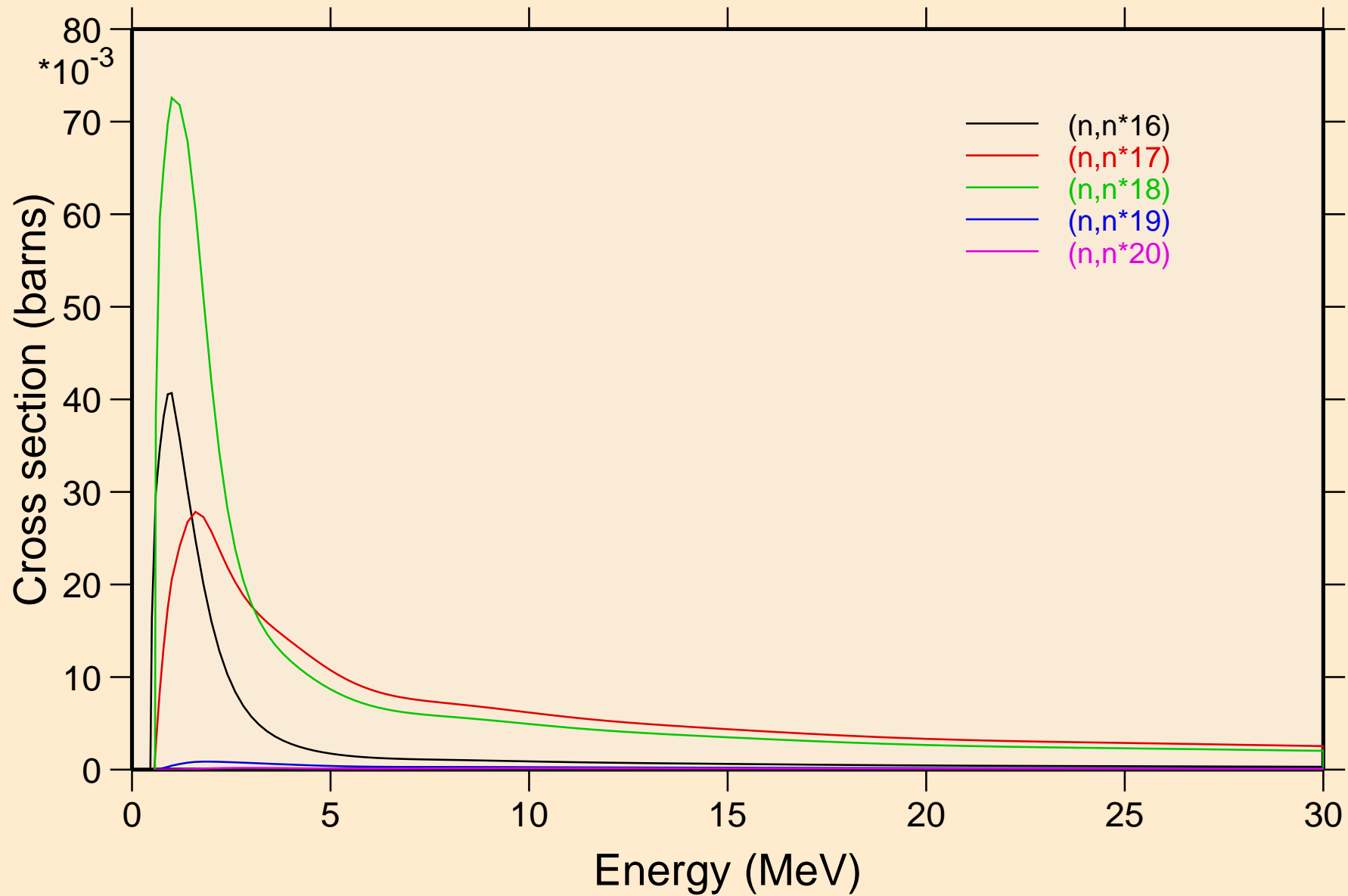

CE149 NEUTRON ACER TENDL-2024 LIBRARY; T=0.K
Inelastic levels

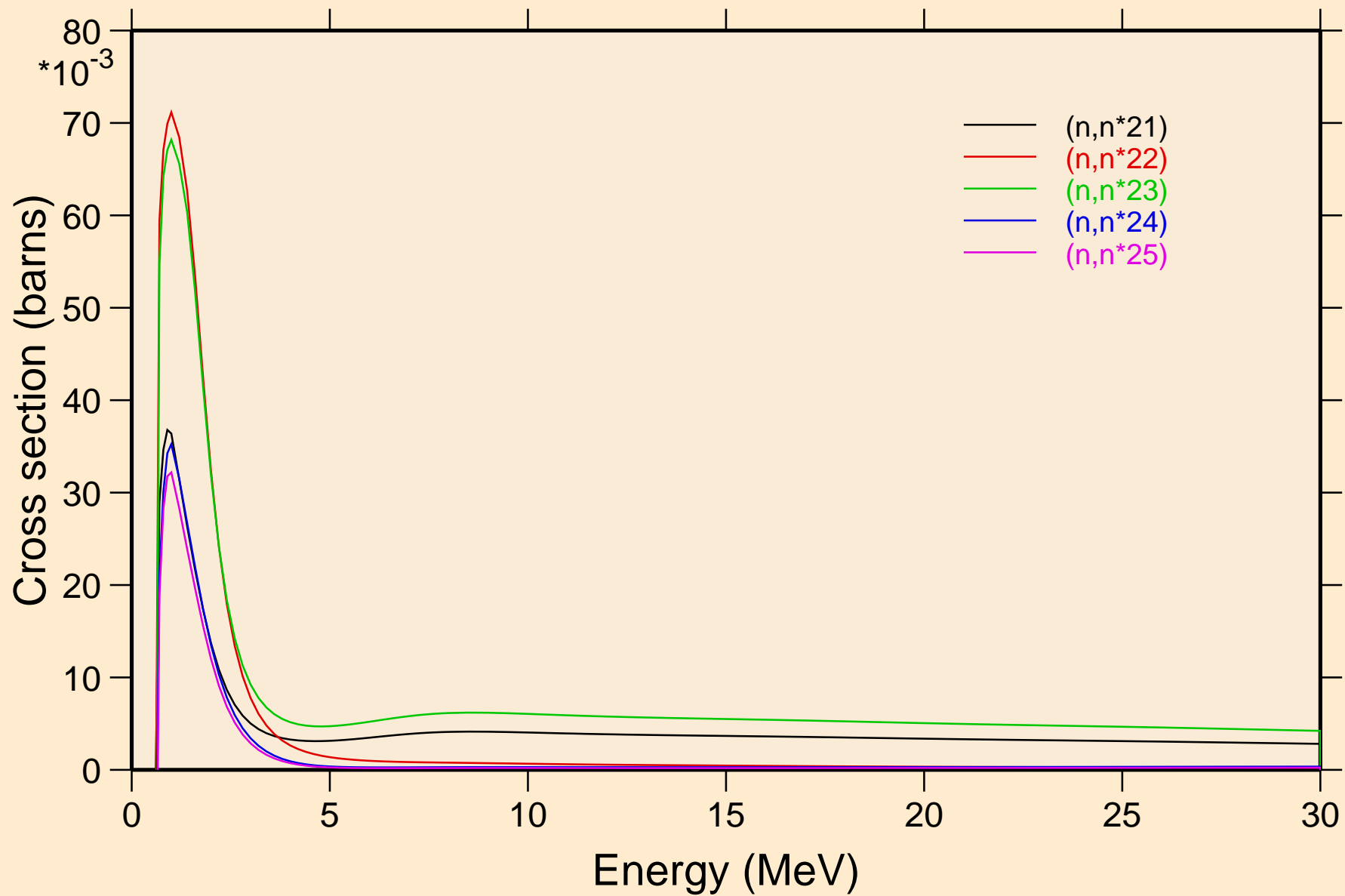

CE149 NEUTRON ACER TENDL-2024 LIBRARY; T=0.K
Inelastic levels

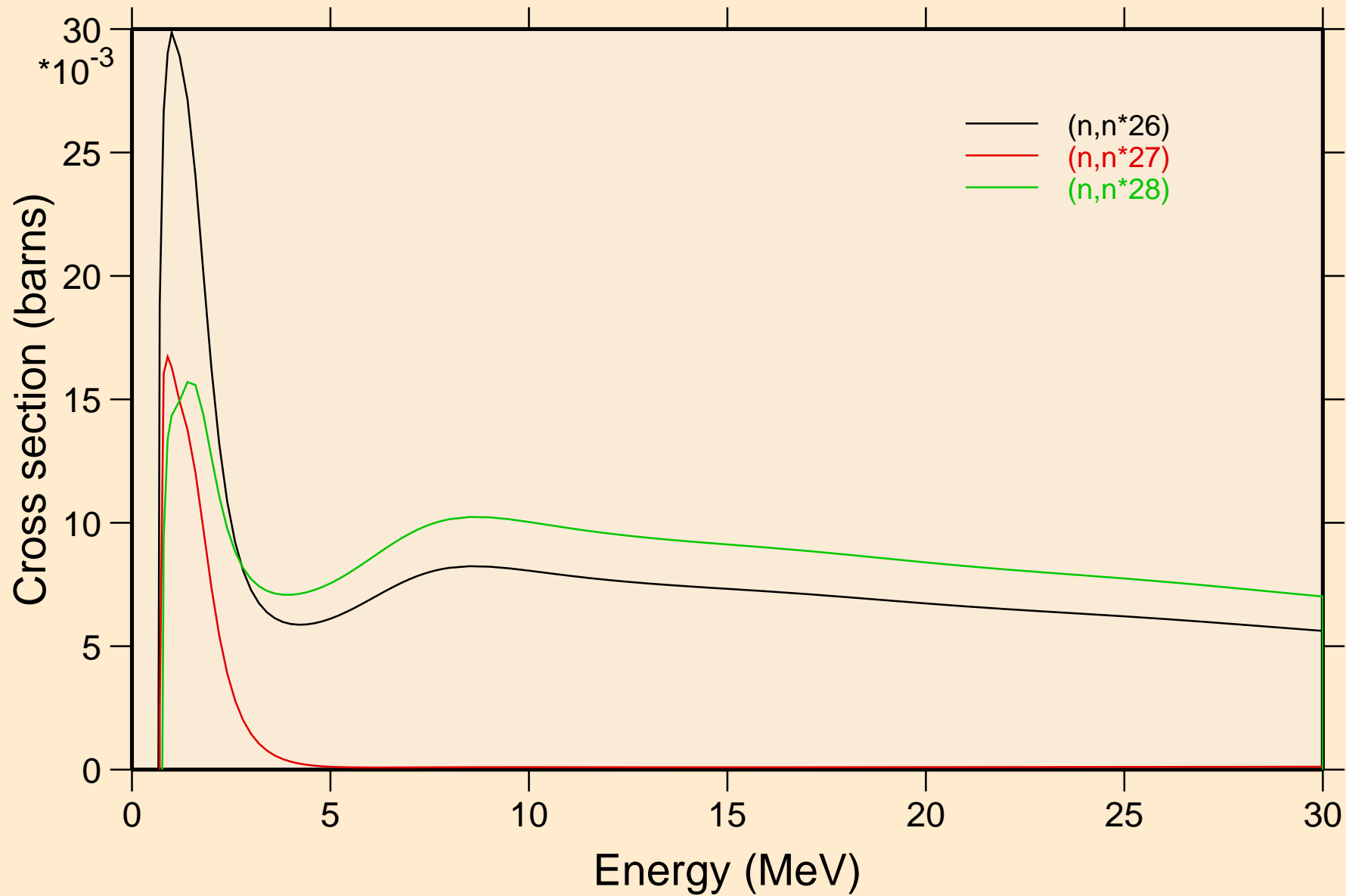

CE149 NEUTRON ACER TENDL-2024 LIBRARY; T=0.K
Threshold reactions

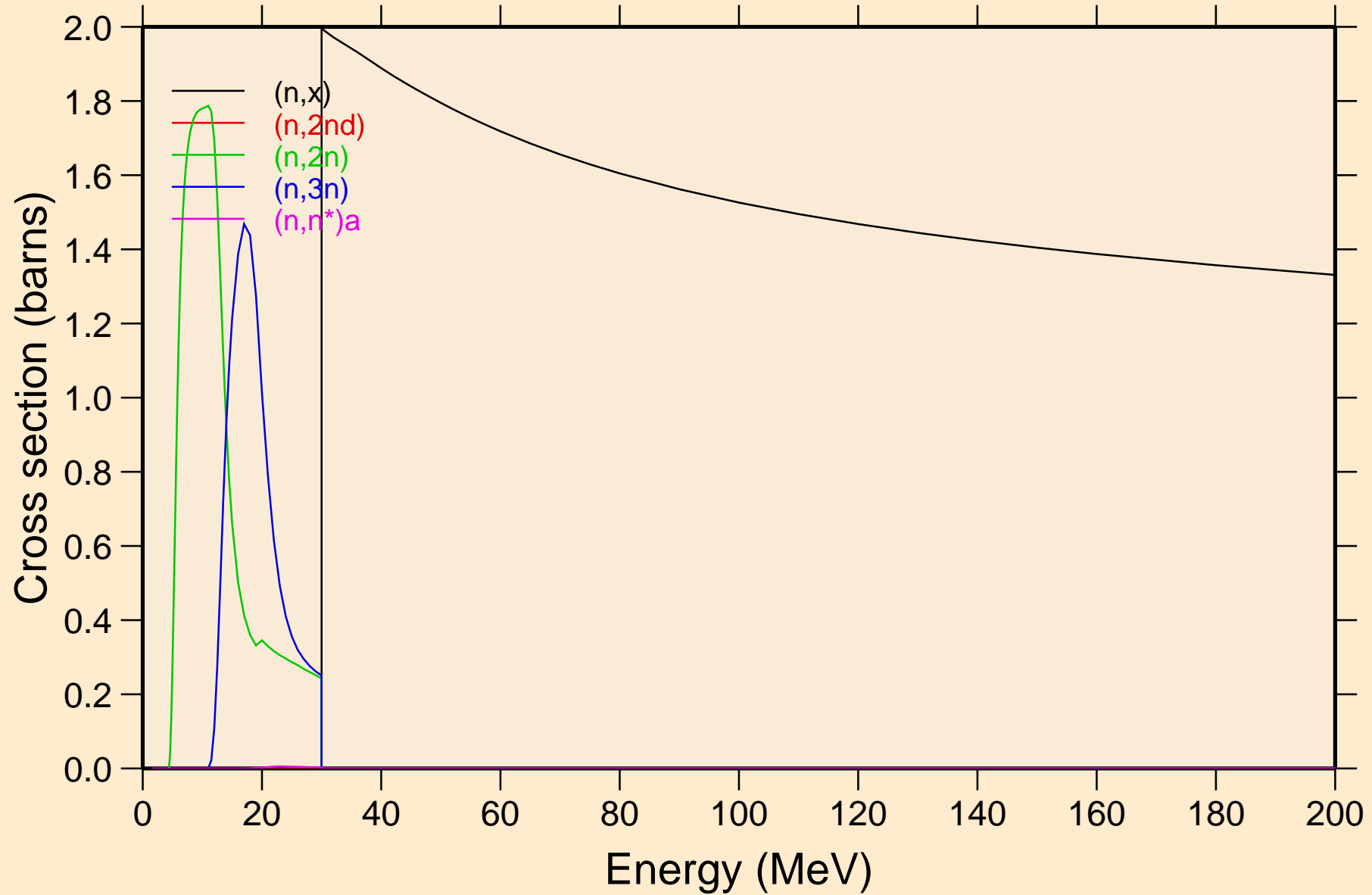

CE149 NEUTRON ACER TENDL-2024 LIBRARY; T=0.K

Threshold reactions

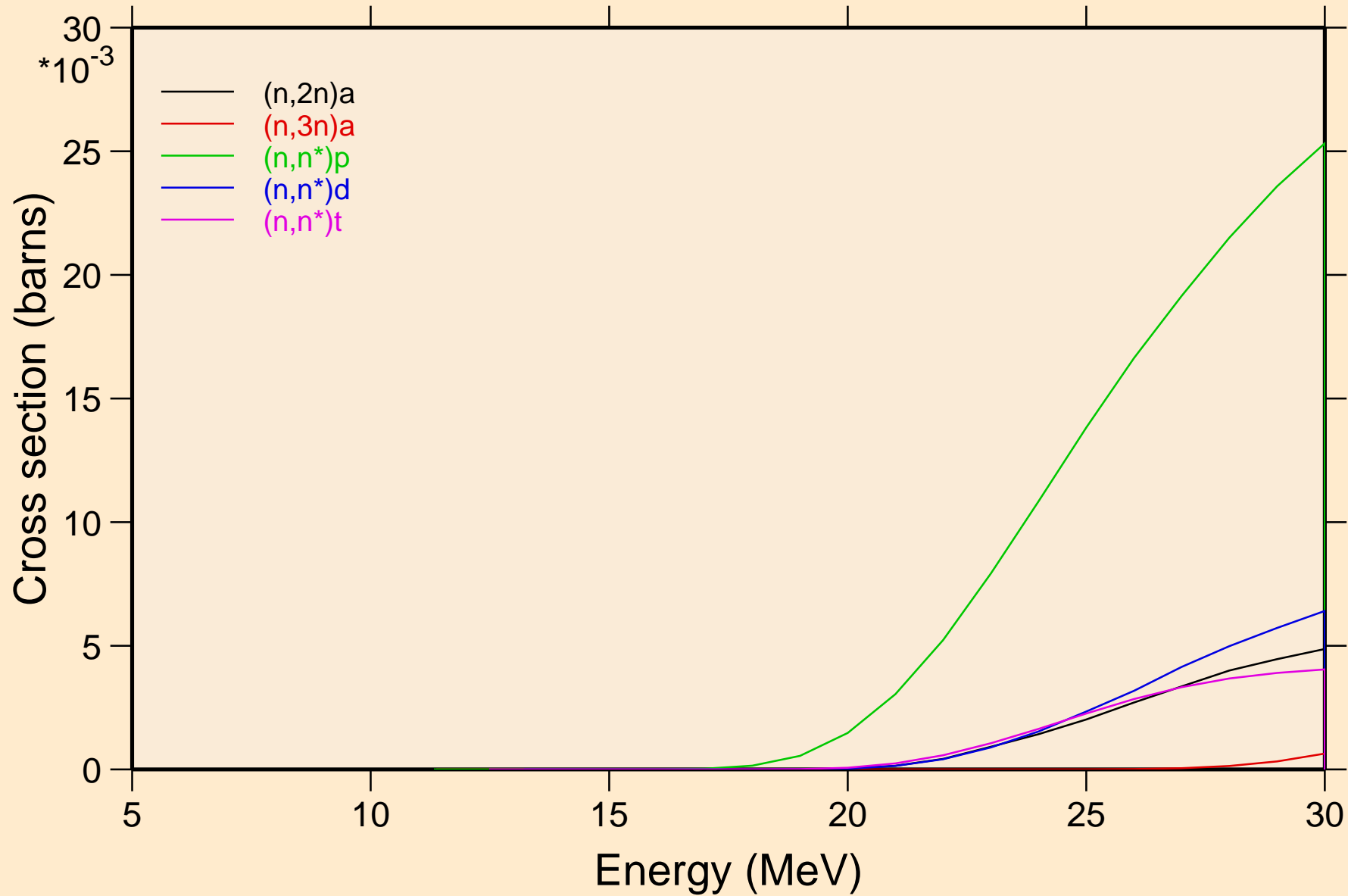

CE149 NEUTRON ACER TENDL-2024 LIBRARY; T=0.K
Threshold reactions

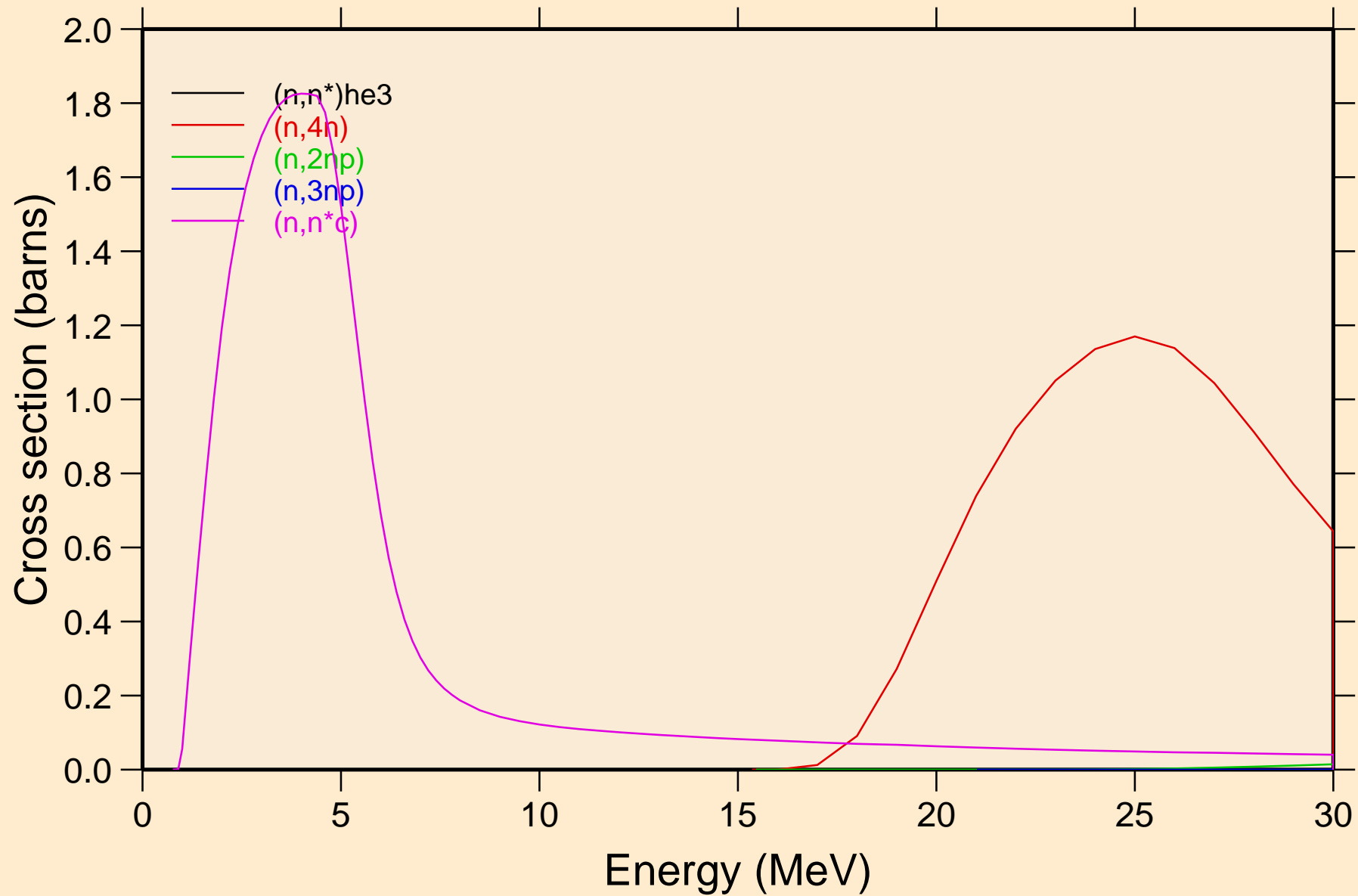

CE149 NEUTRON ACER TENDL-2024 LIBRARY; T=0.K
Threshold reactions

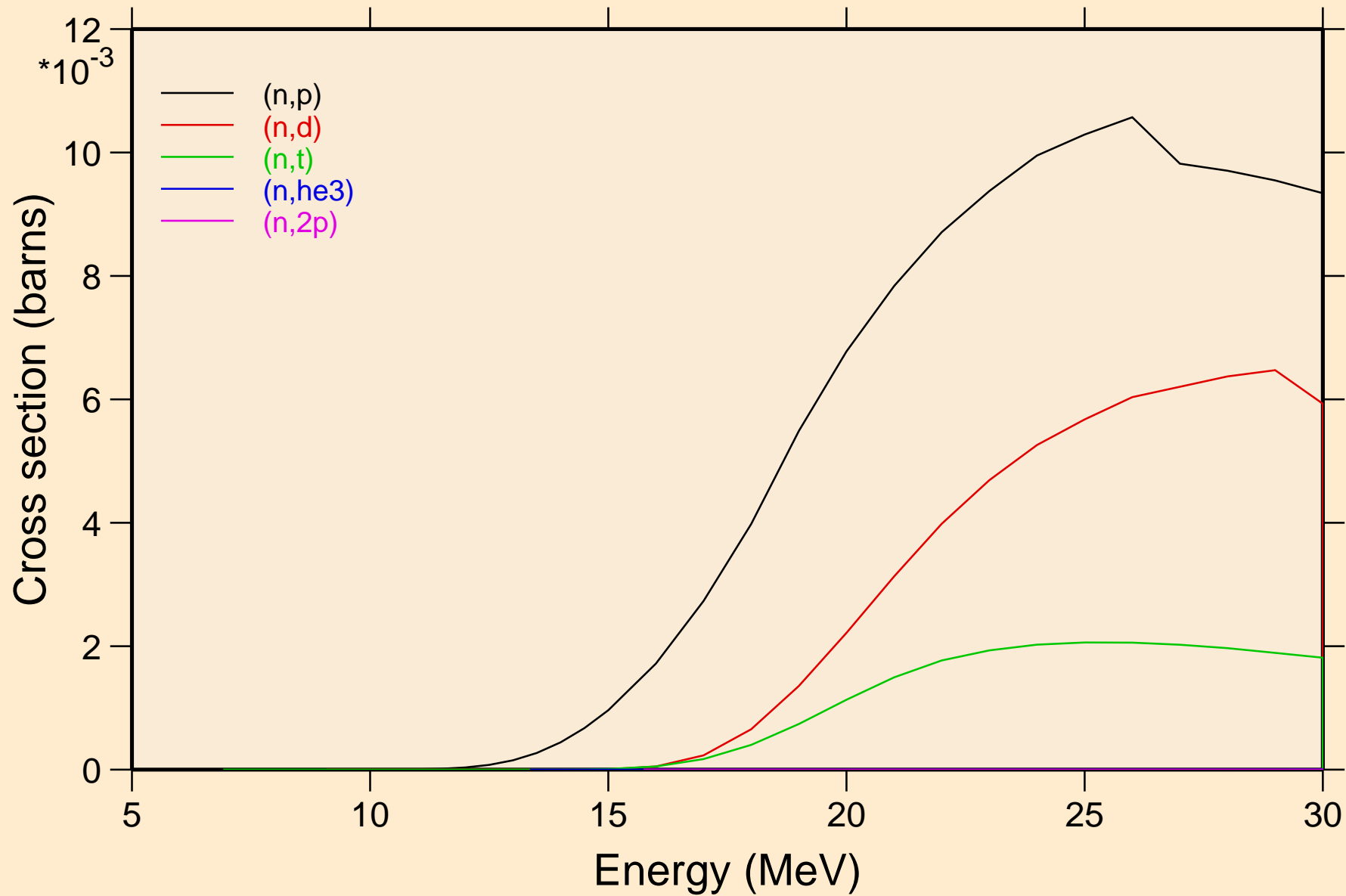

CE149 NEUTRON ACER TENDL-2024 LIBRARY; T=0.K
Threshold reactions

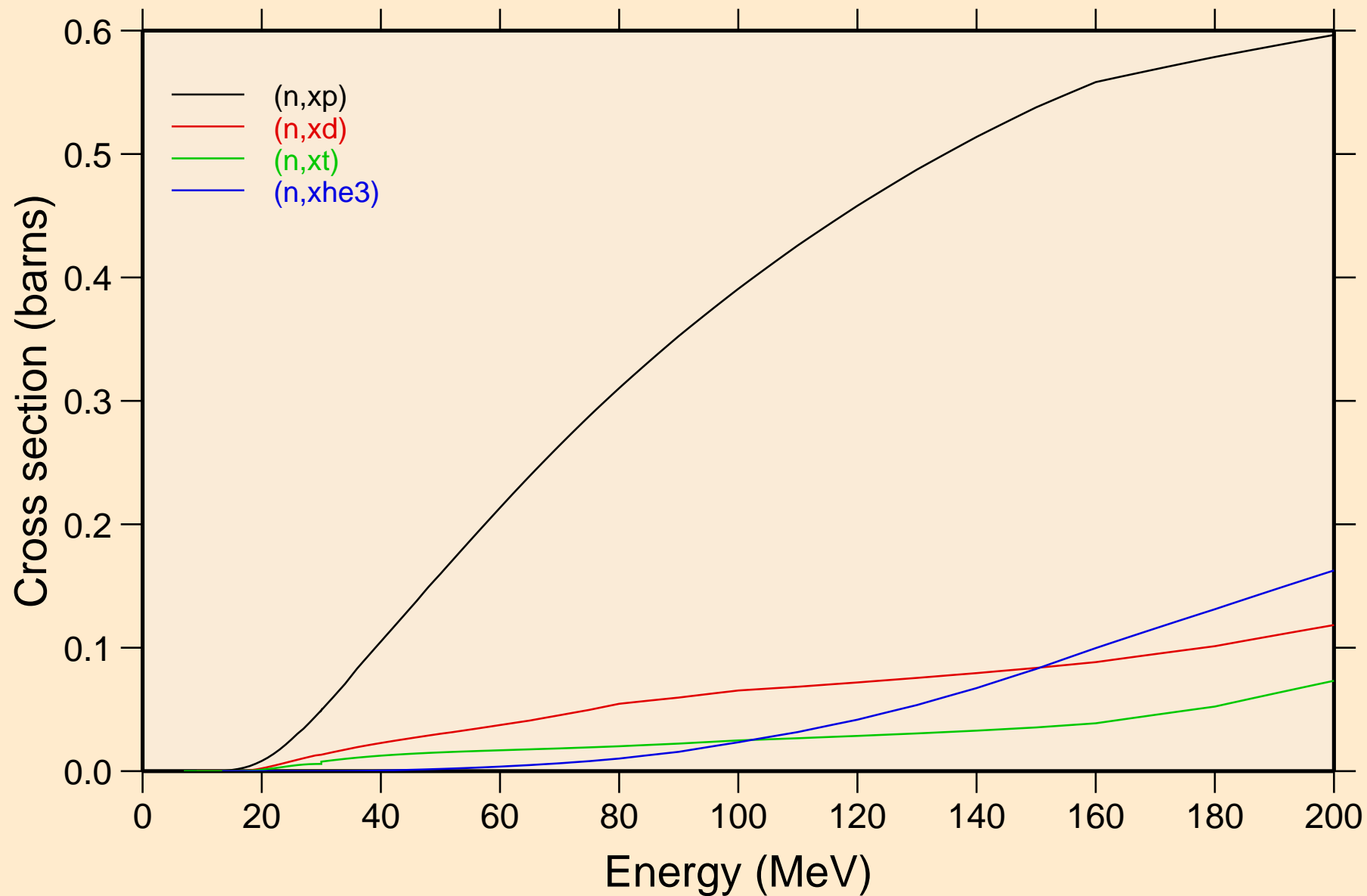

CE149 NEUTRON ACER TENDL-2024 LIBRARY; T=0.K
angular distribution for elastic

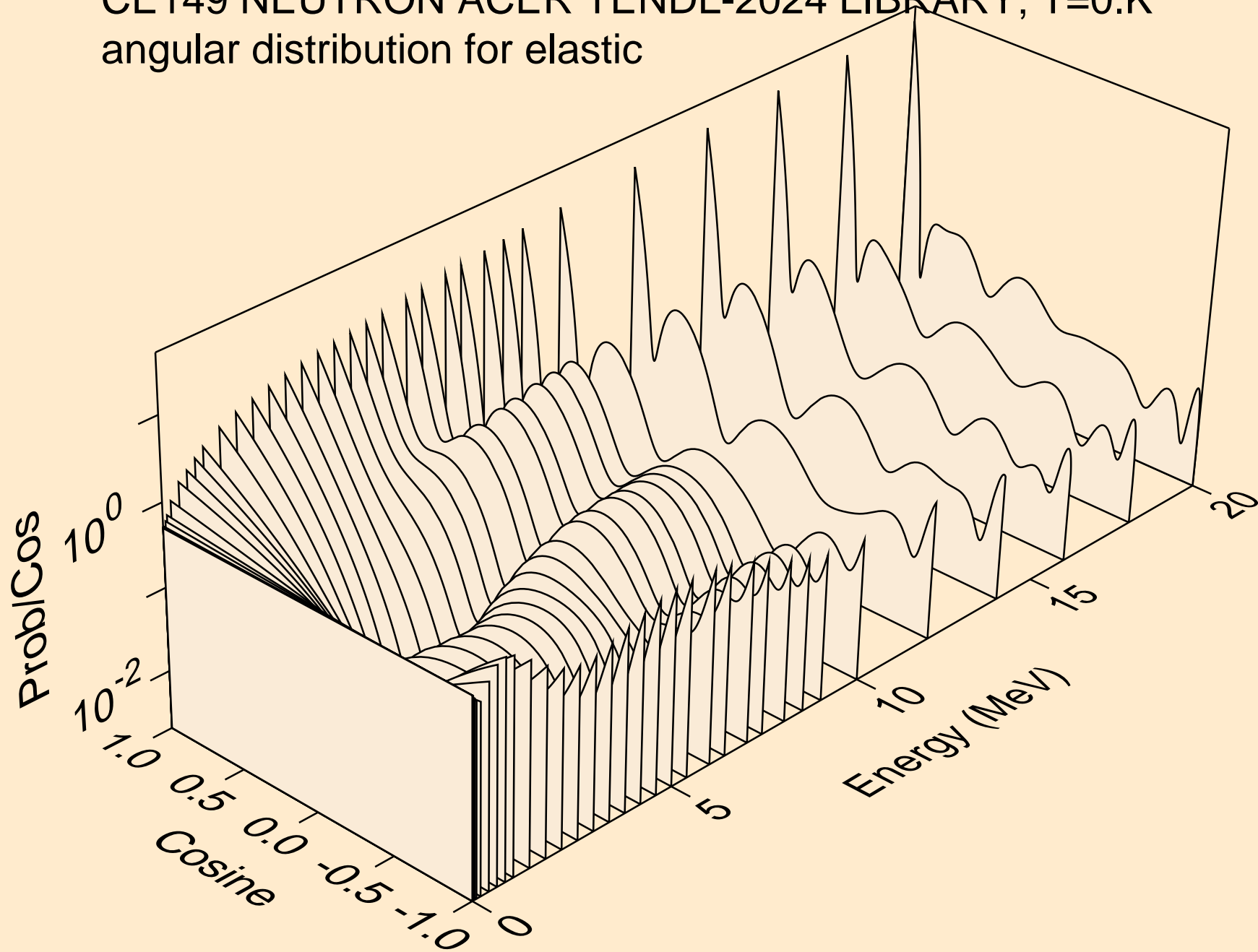

CE149 NEUTRON ACER TENDL-2024 LIBRARY; T=0.K
angular distribution for elastic

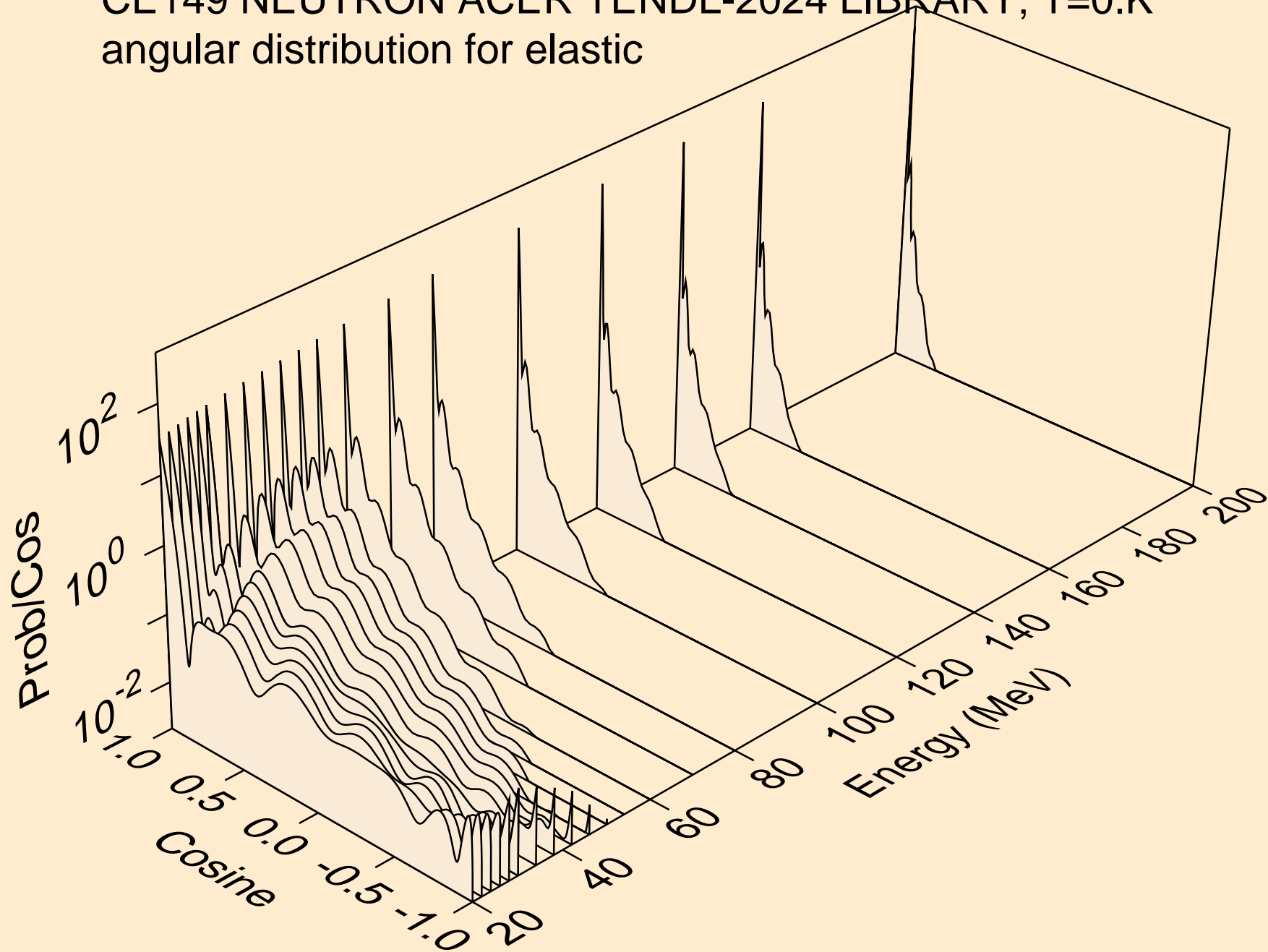

CE149 NEUTRON ACER TENDL-2024 LIBRARY; T=0.K
angular distribution for (n,n*1)

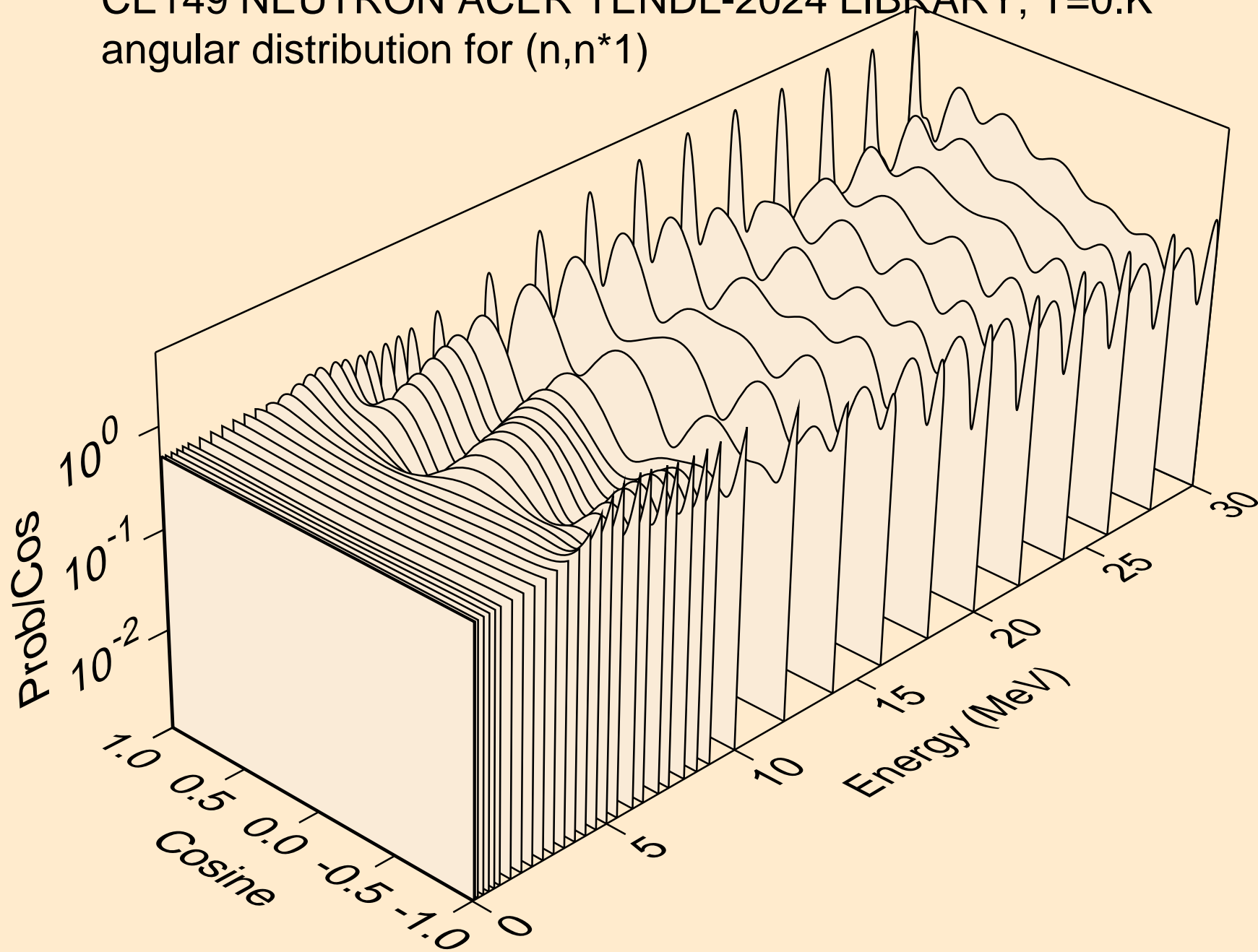

CE149 NEUTRON ACER TENDL-2024 LIBRARY; T=0.K
angular distribution for (n,n*2)

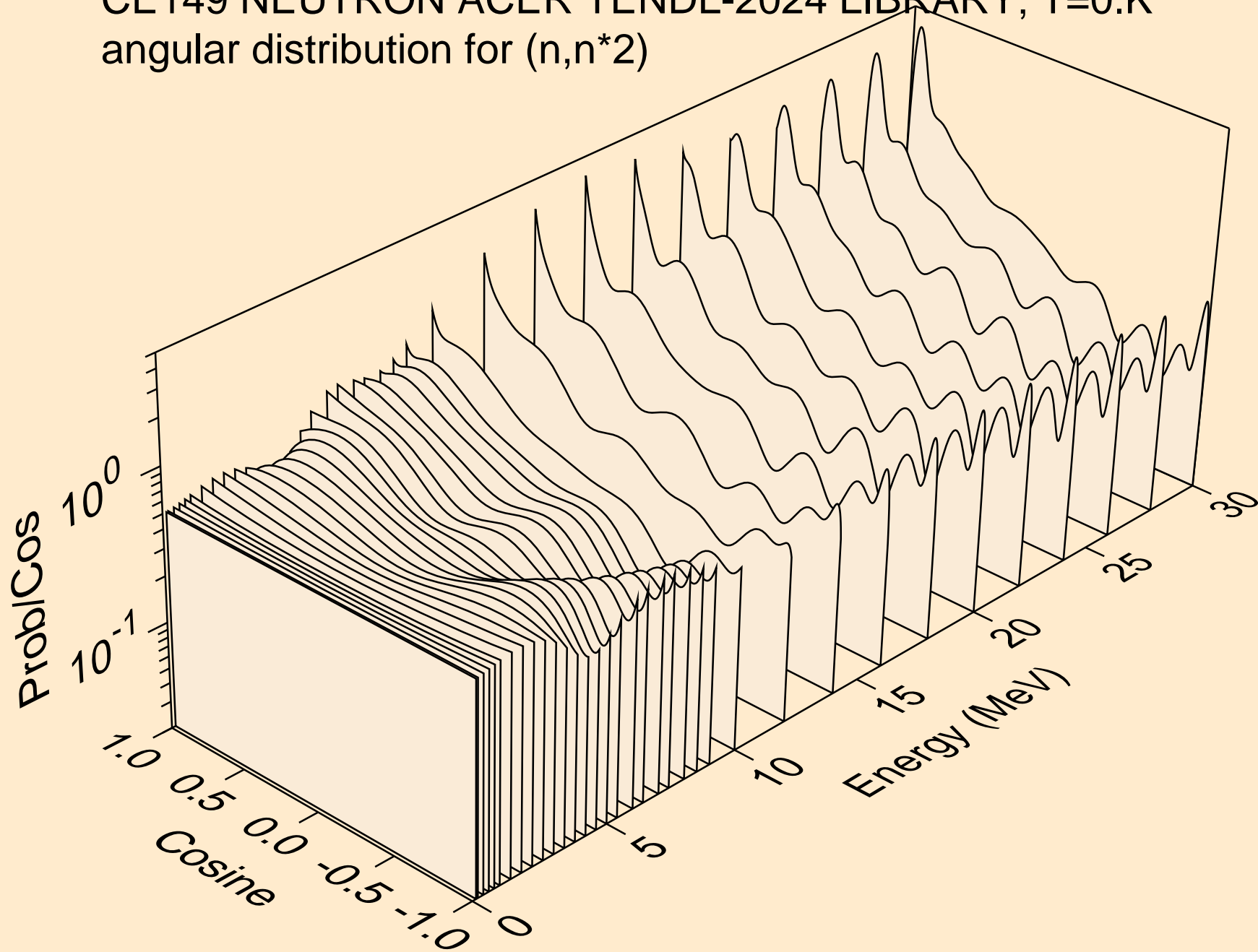

CE149 NEUTRON ACER TENDL-2024 LIBRARY; T=0.K
angular distribution for (n,n*3)

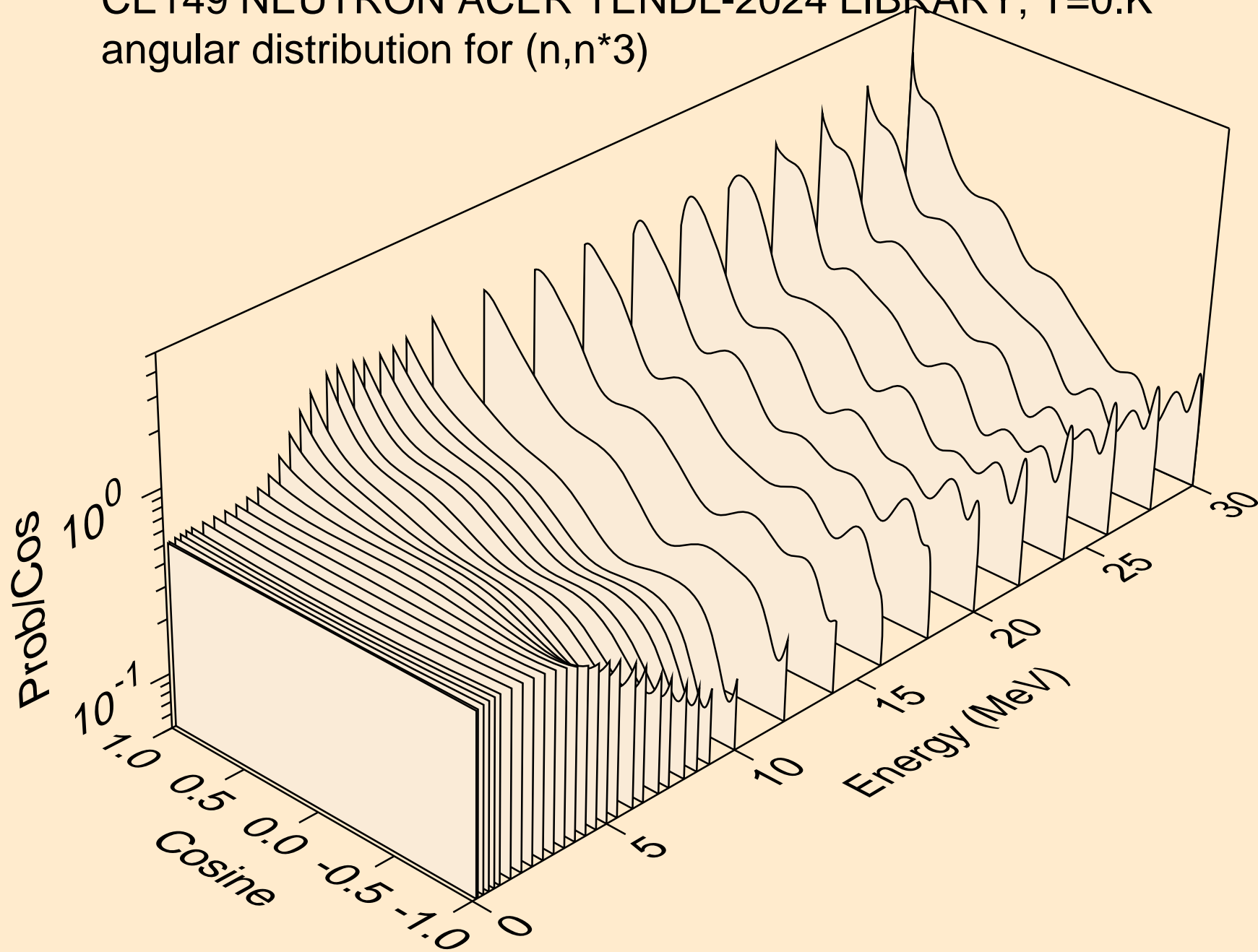

CE149 NEUTRON ACER TENDL-2024 LIBRARY; T=0.K
angular distribution for (n,n*4)

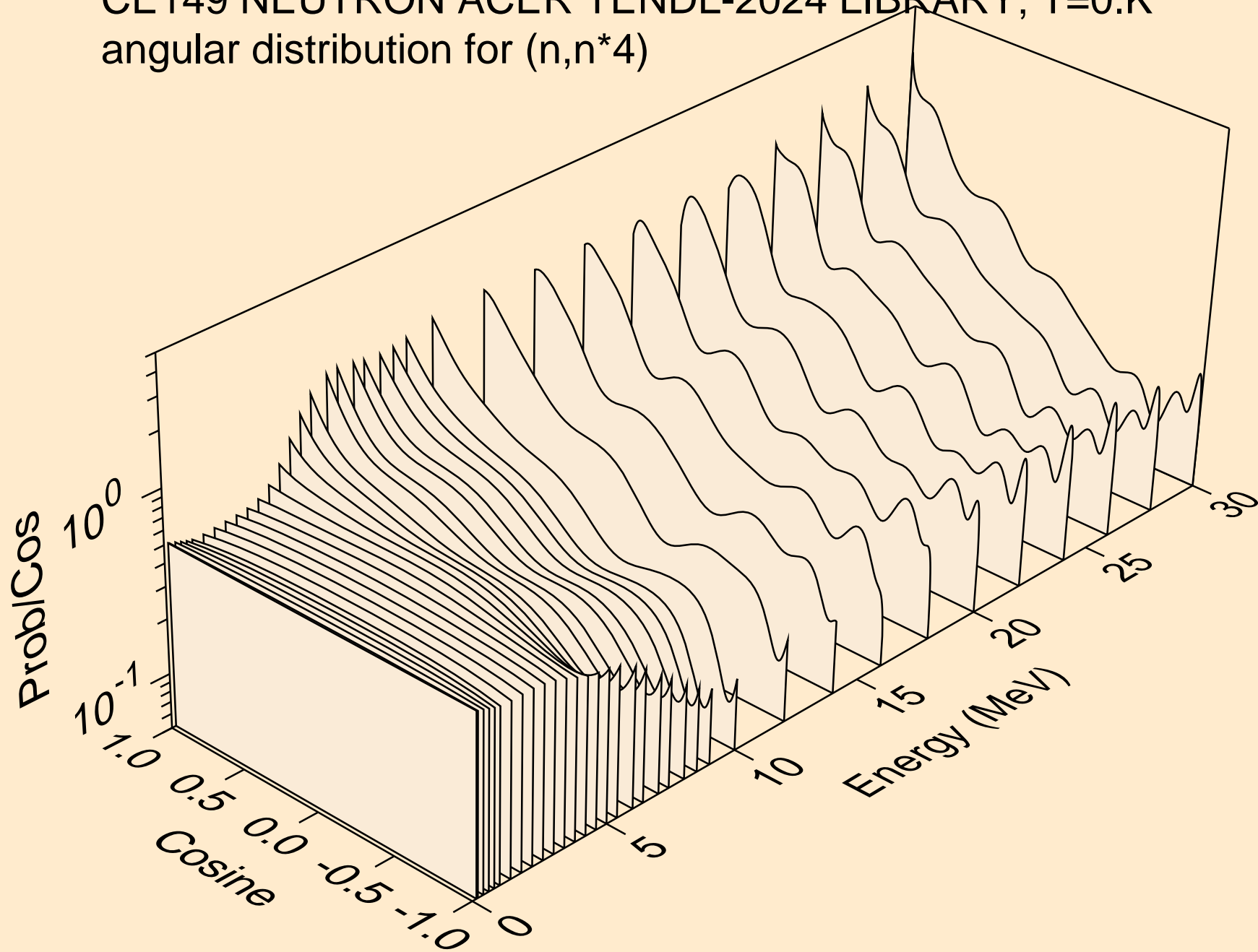

CE149 NEUTRON ACER TENDL-2024 LIBRARY; T=0.K
angular distribution for (n,n*5)

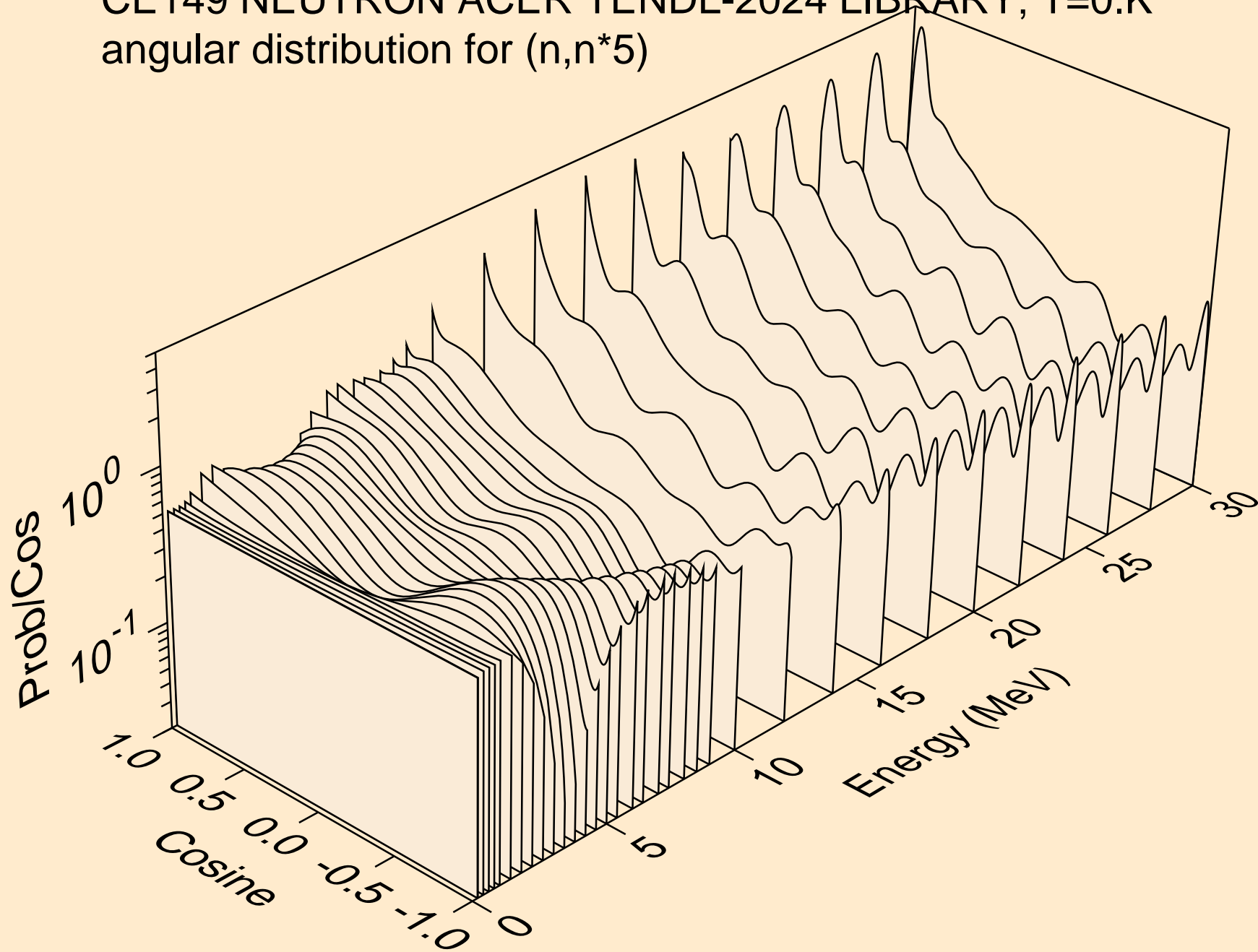

CE149 NEUTRON ACER TENDL-2024 LIBRARY; T=0.K
angular distribution for (n,n*6)

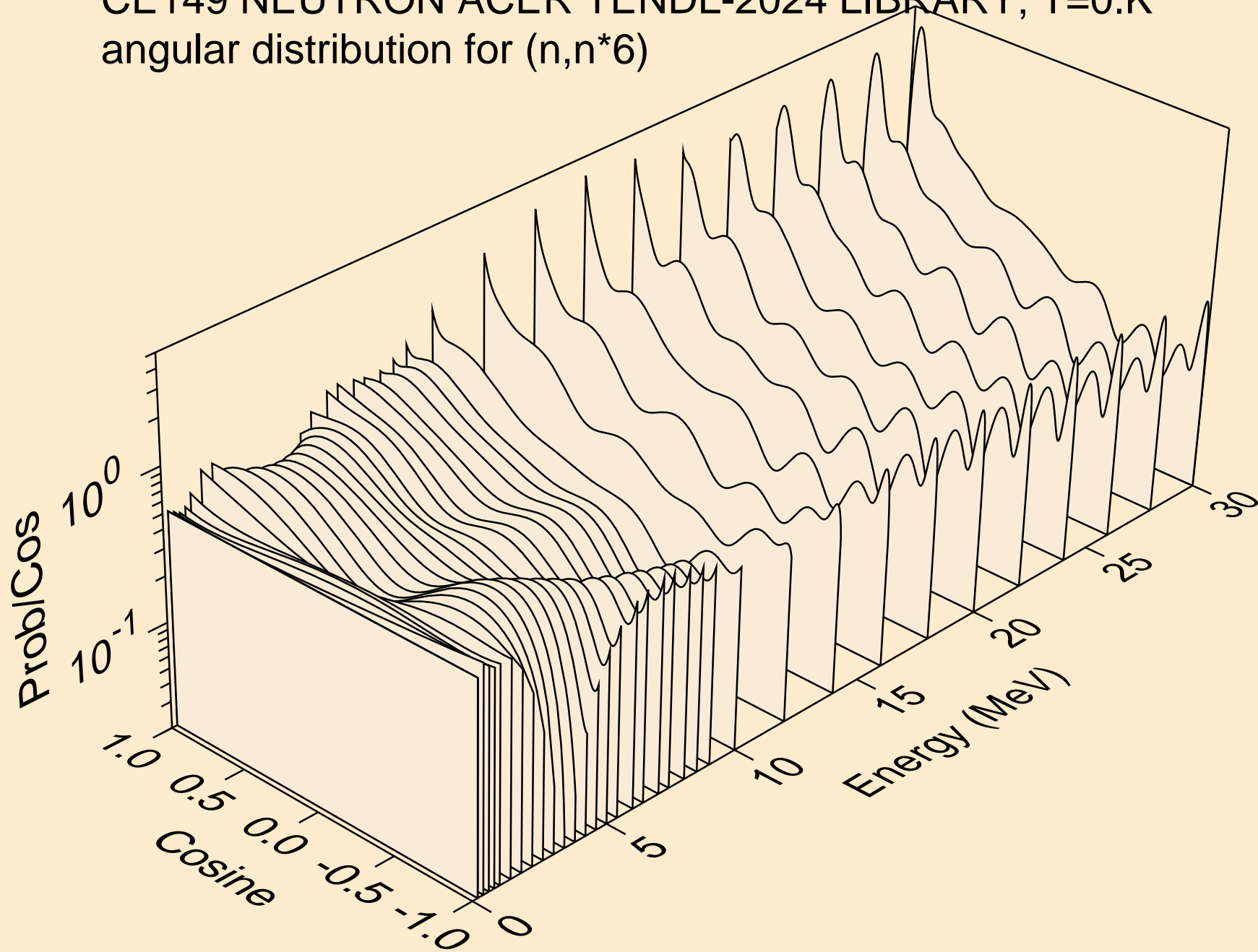

CE149 NEUTRON ACER TENDL-2024 LIBRARY; T=0.K
angular distribution for (n,n*7)

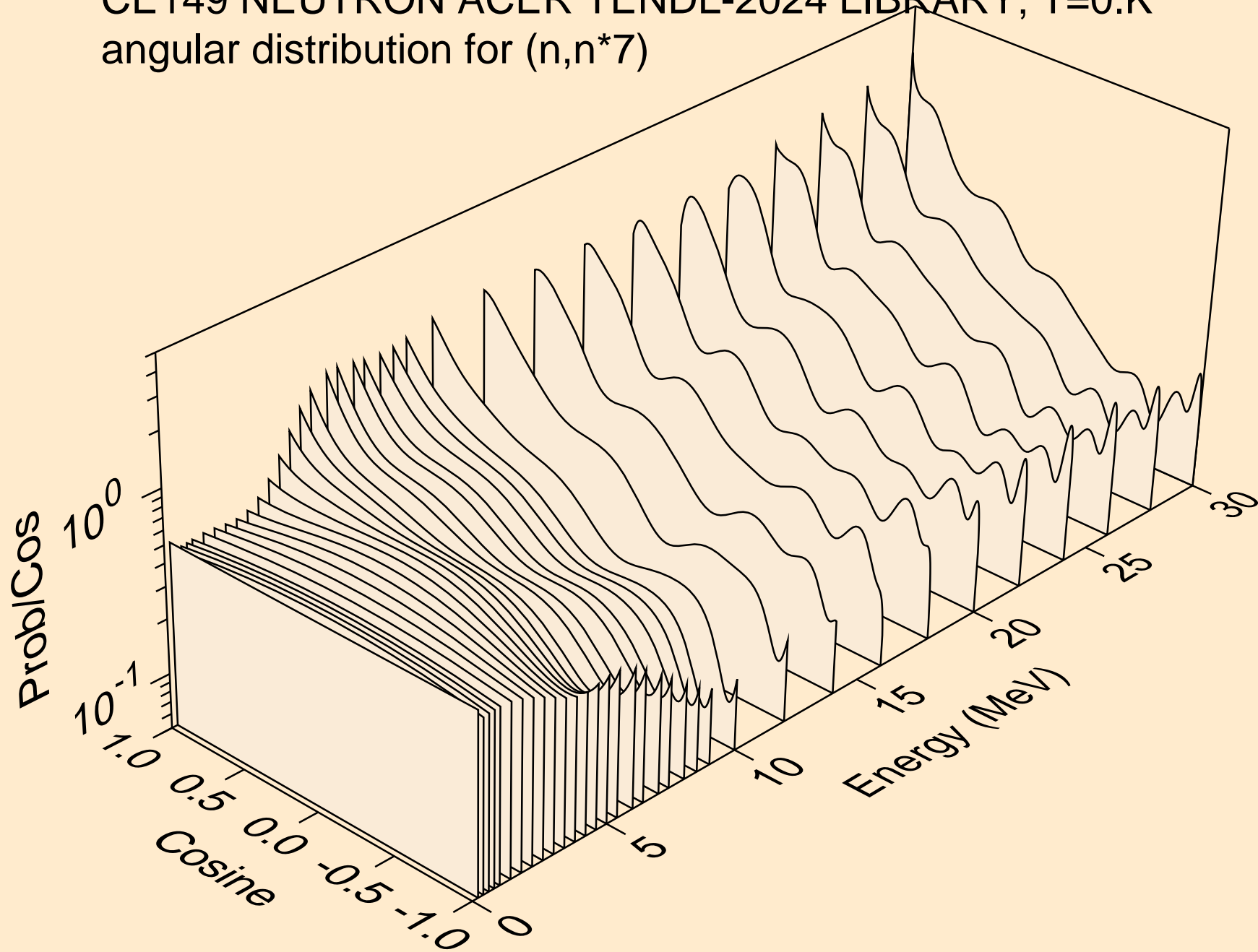

CE149 NEUTRON ACER TENDL-2024 LIBRARY; T=0.K
angular distribution for (n,n*8)

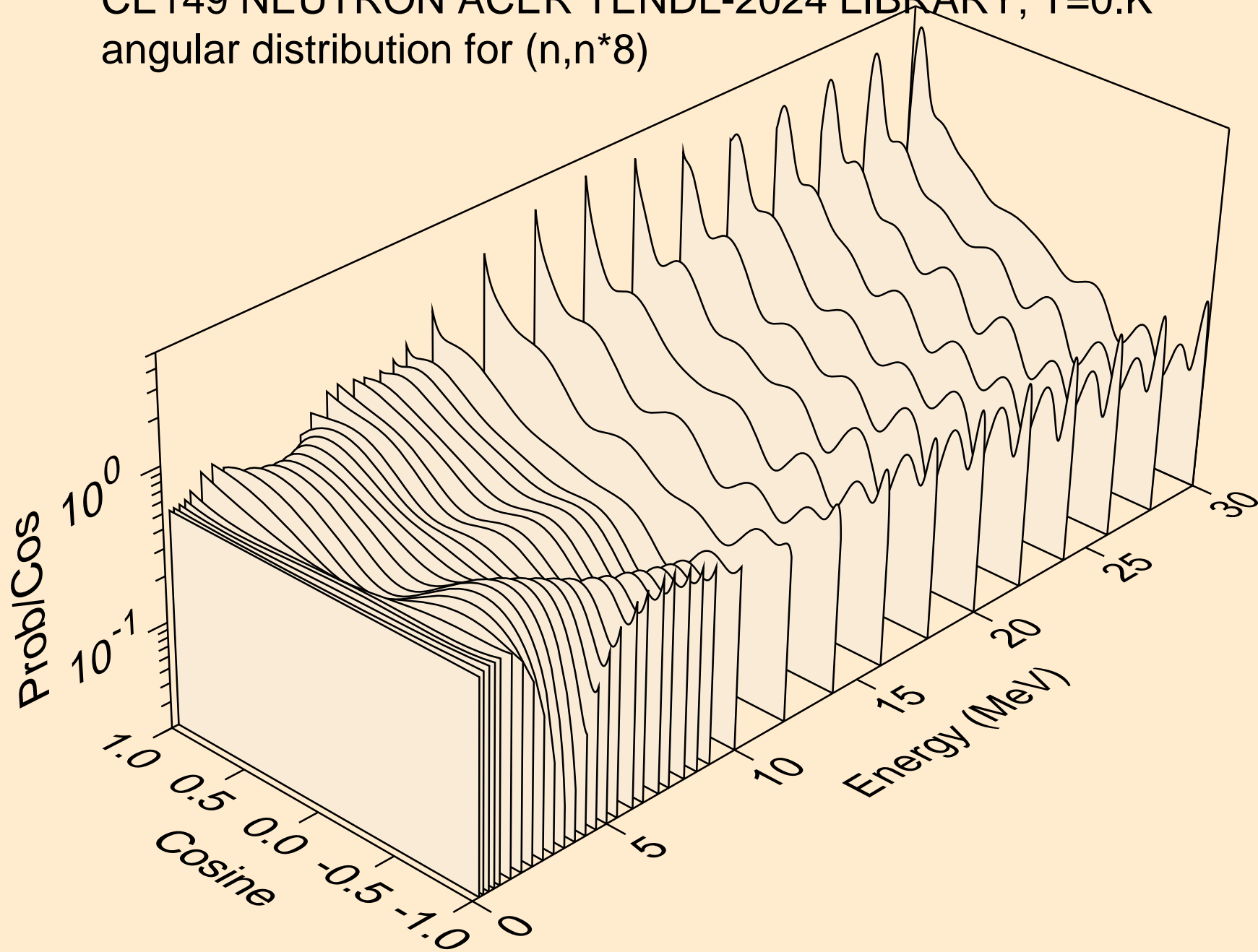

CE149 NEUTRON ACER TENDL-2024 LIBRARY; T=0.K
angular distribution for (n,n*9)

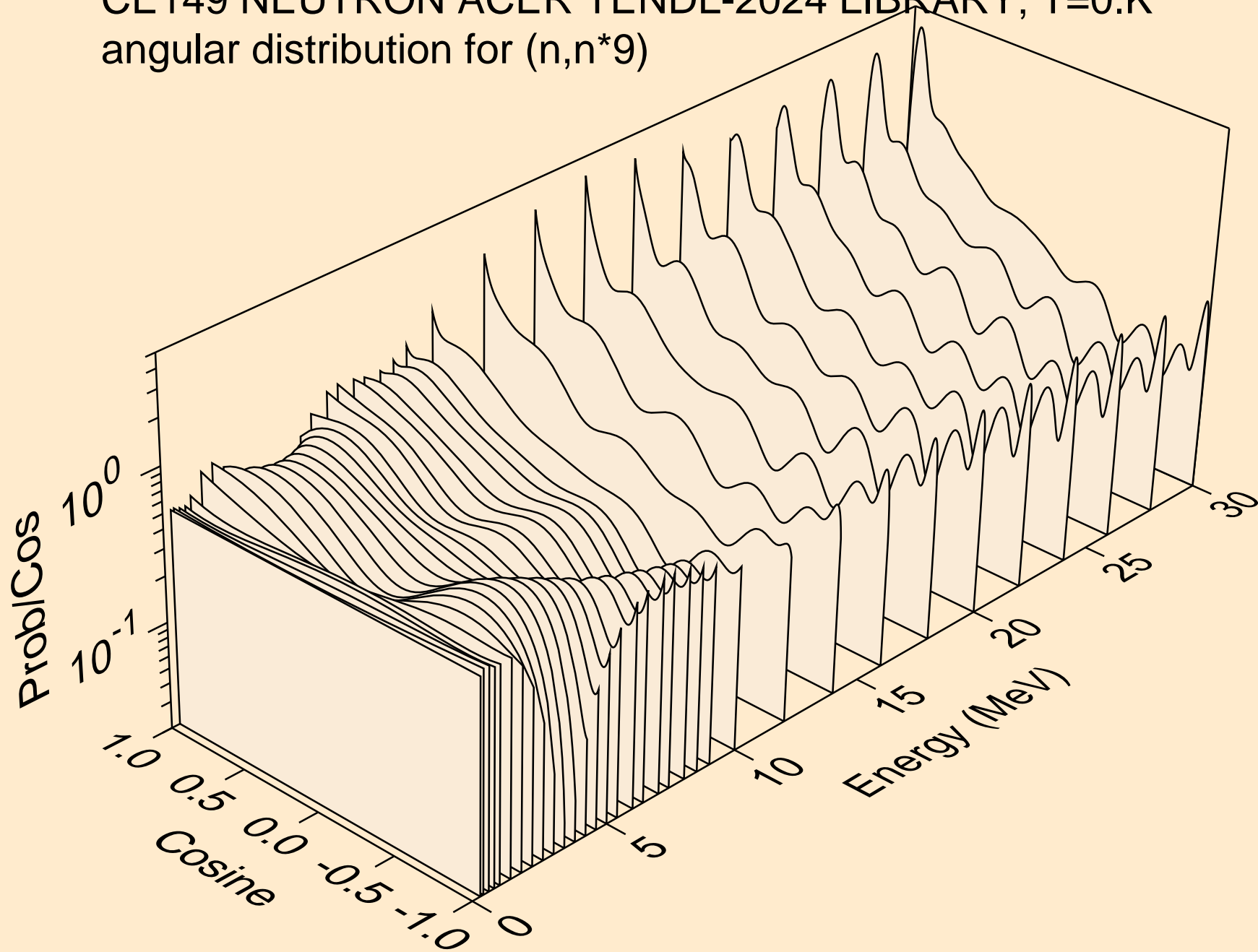

CE149 NEUTRON ACER TENDL-2024 LIBRARY; T=0.K
angular distribution for (n,n*10)

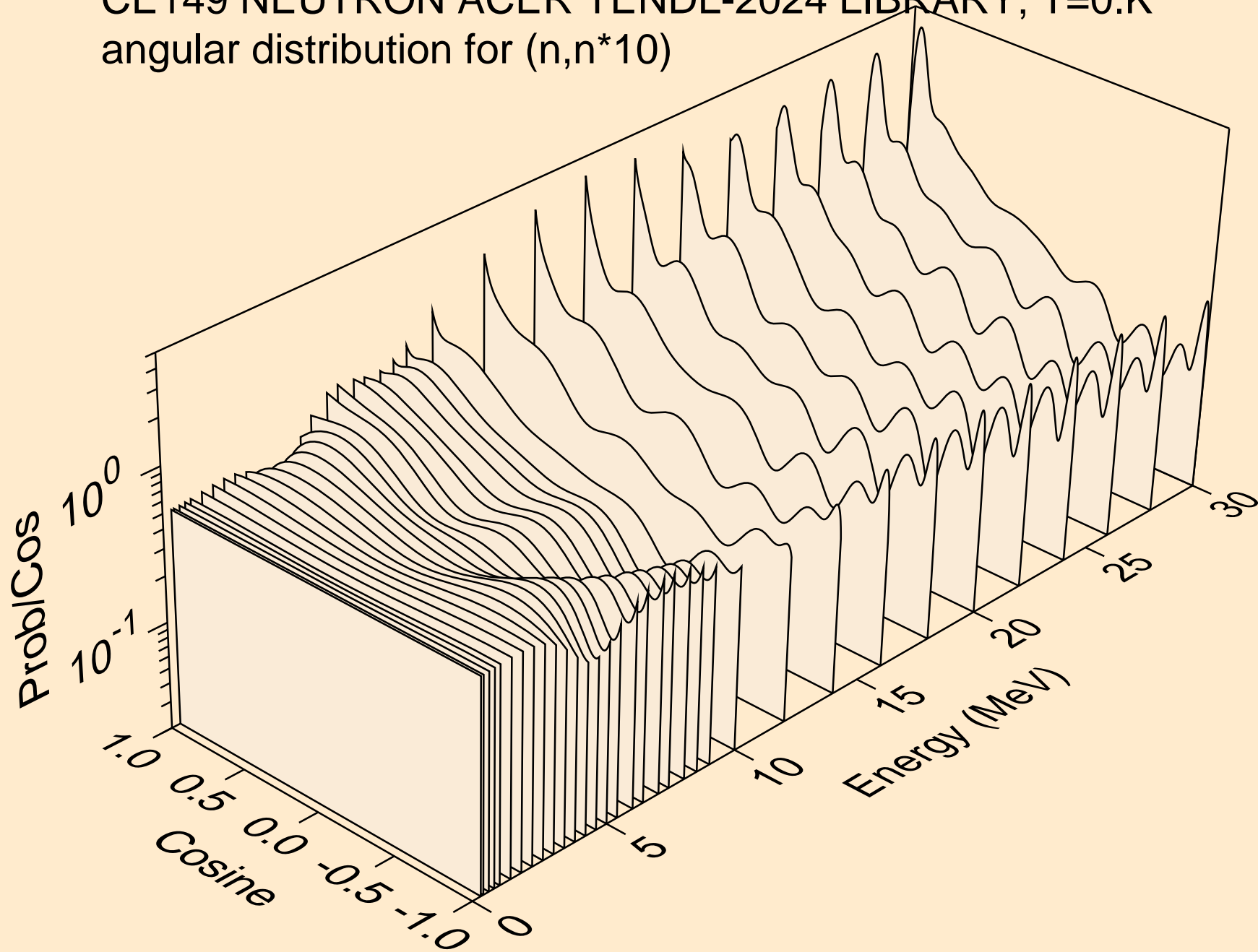

CE149 NEUTRON ACER TENDL-2024 LIBRARY; T=0.K
angular distribution for (n,n*11)

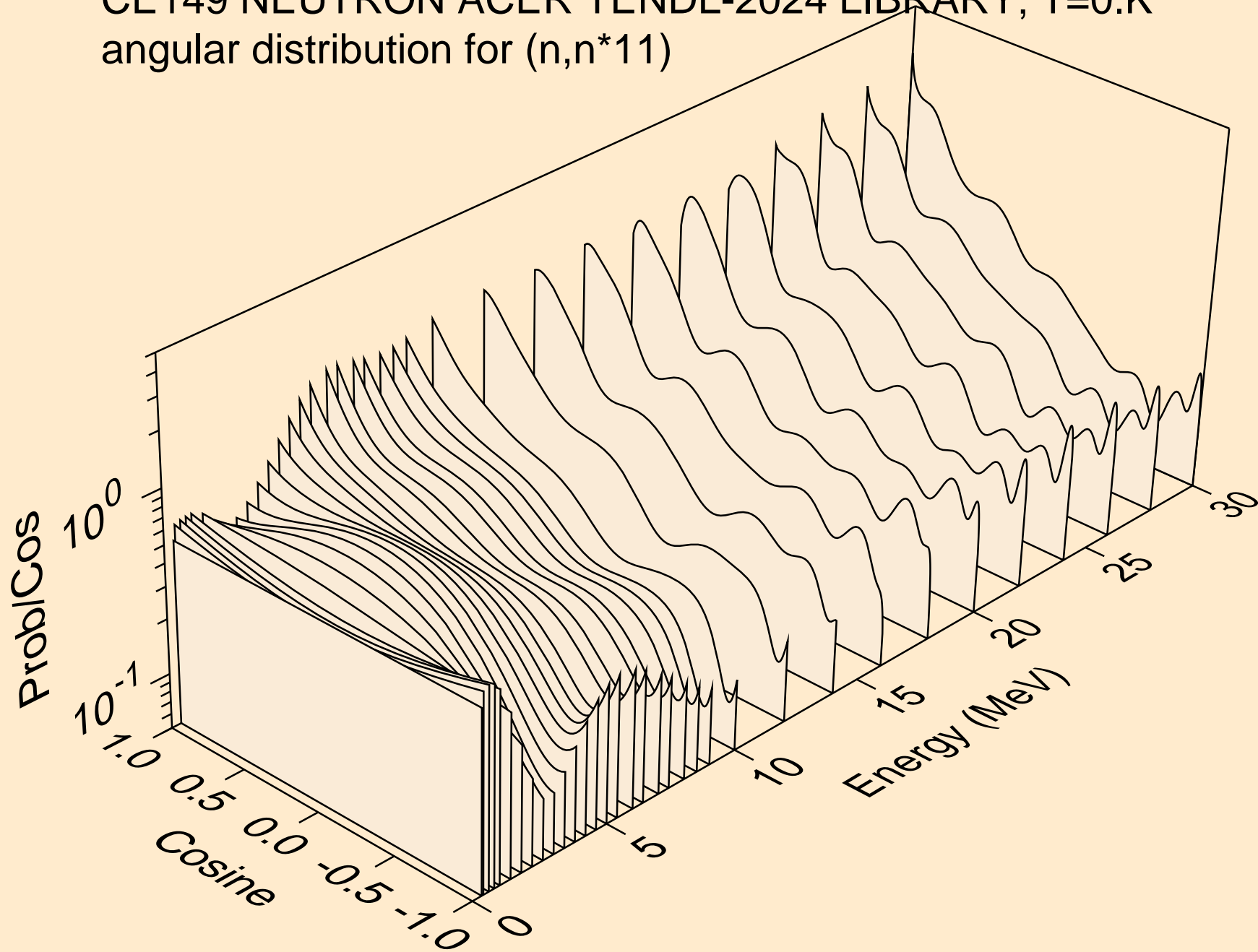

CE149 NEUTRON ACER TENDL-2024 LIBRARY; T=0.K
angular distribution for (n,n*12)

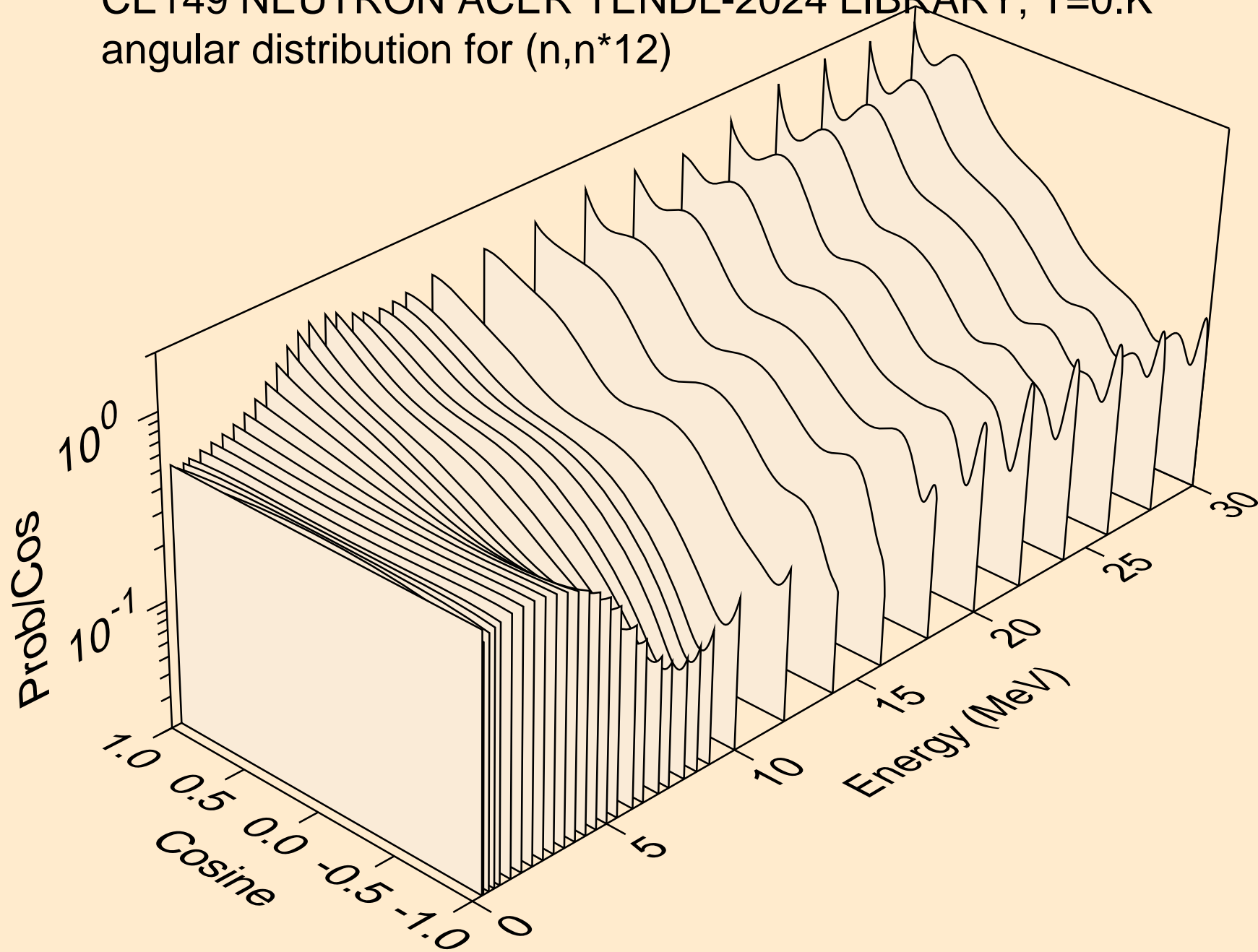

CE149 NEUTRON ACER TENDL-2024 LIBRARY; T=0.K
angular distribution for (n,n*13)

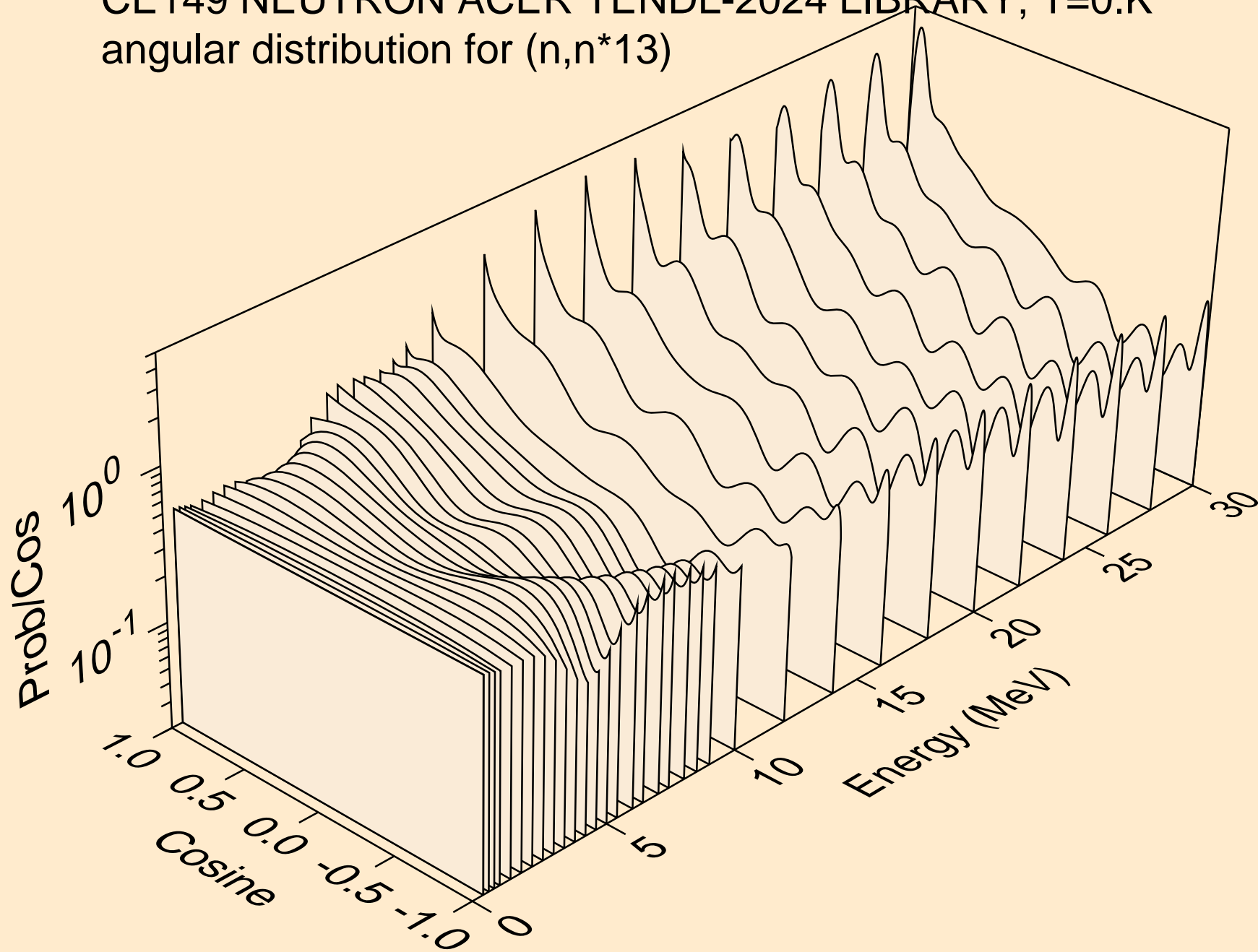

CE149 NEUTRON ACER TENDL-2024 LIBRARY; T=0.K
angular distribution for (n,n*14)

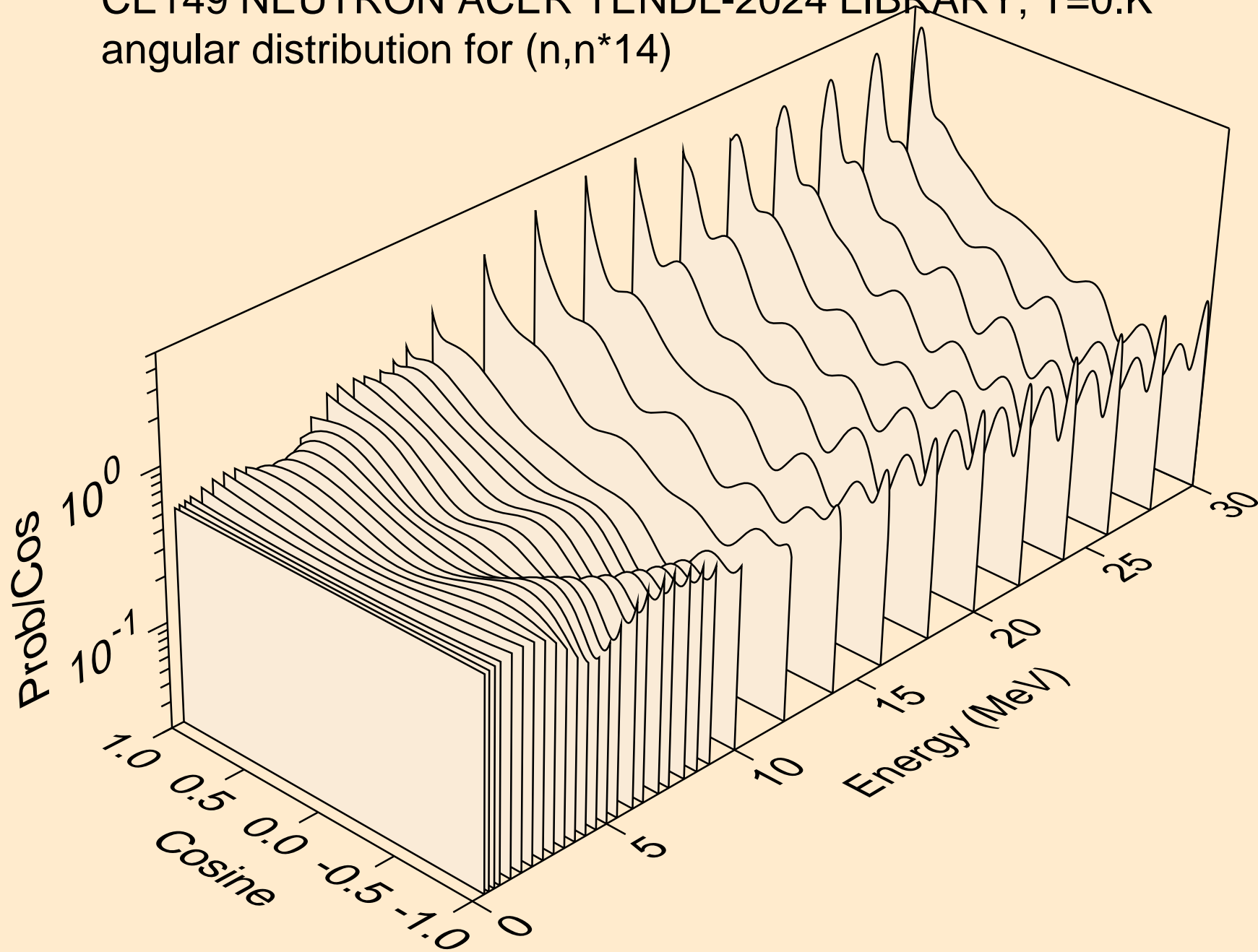

CE149 NEUTRON ACER TENDL-2024 LIBRARY; T=0.K
angular distribution for (n,n*15)

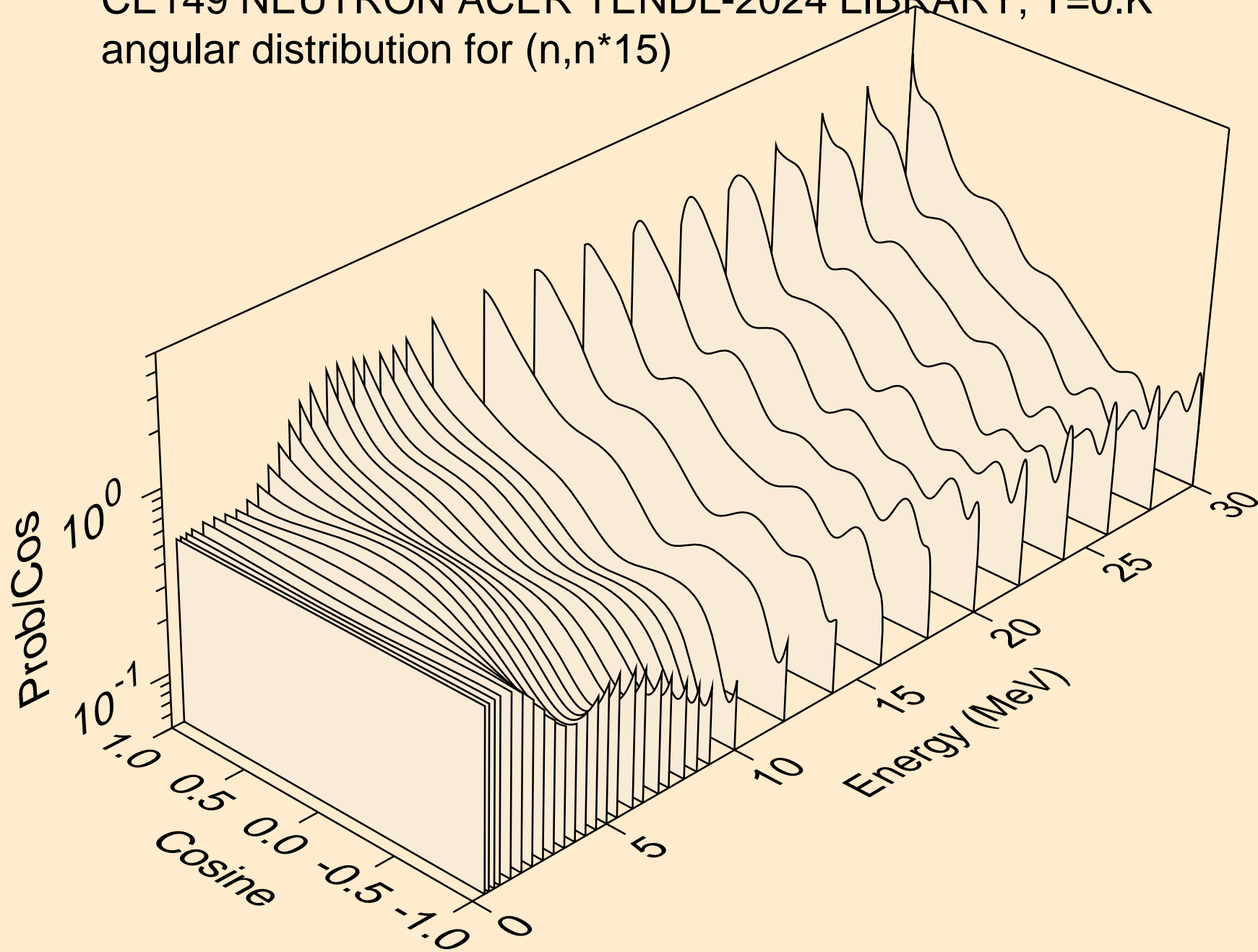

CE149 NEUTRON ACER TENDL-2024 LIBRARY; T=0.K
angular distribution for (n,n*16)

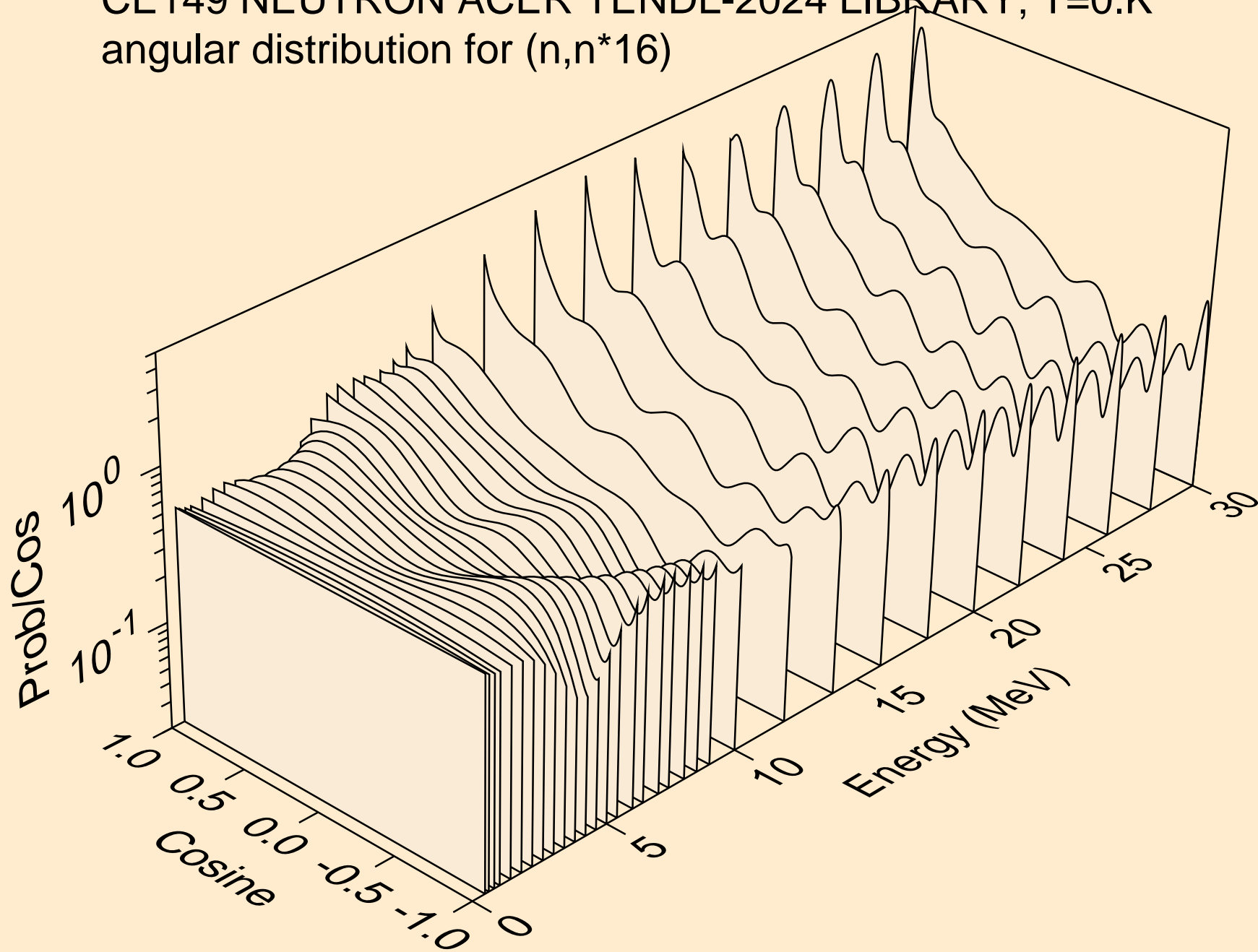

CE149 NEUTRON ACER TENDL-2024 LIBRARY; T=0.K
angular distribution for (n,n*17)

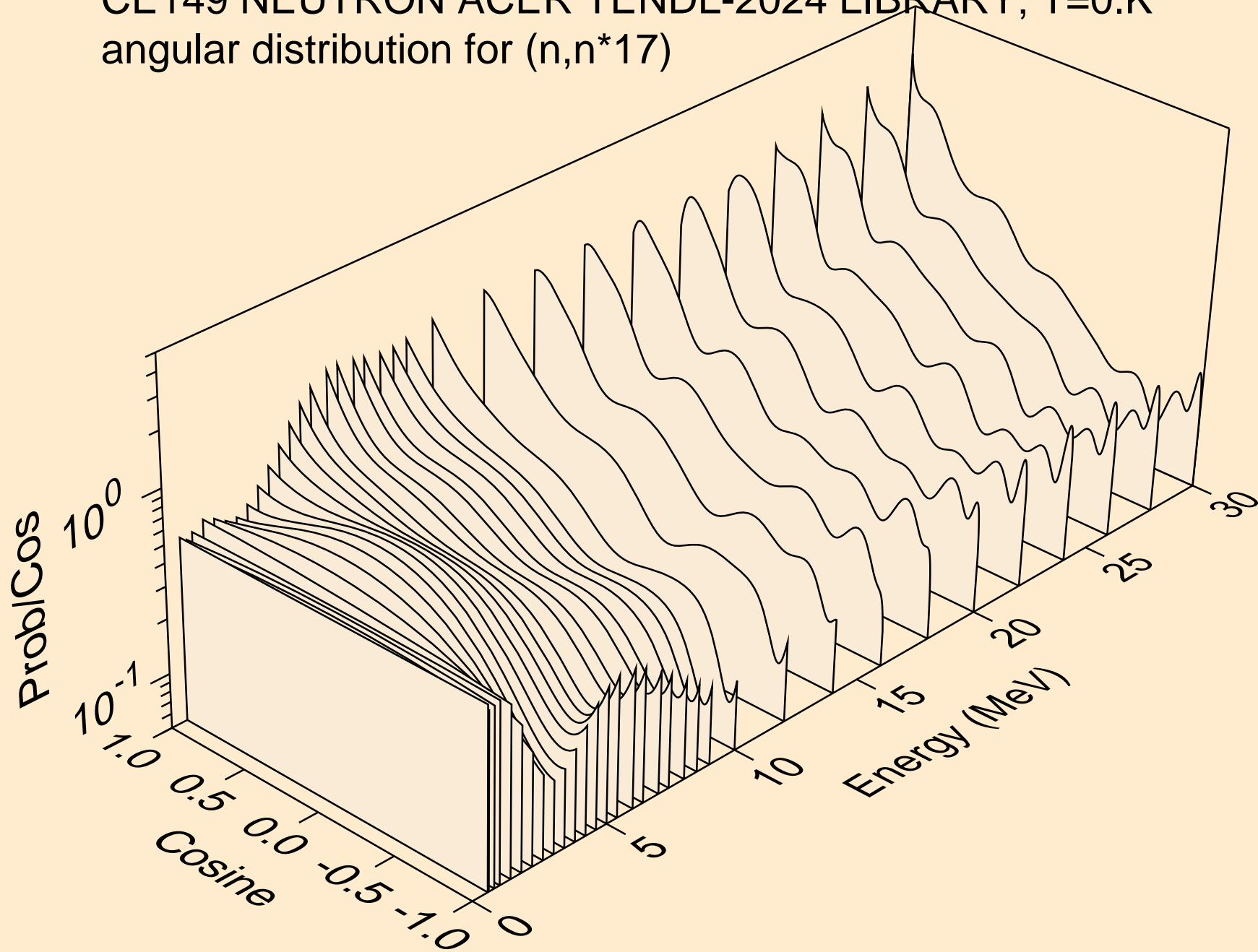

CE149 NEUTRON ACER TENDL-2024 LIBRARY; T=0.K
angular distribution for (n,n*18)

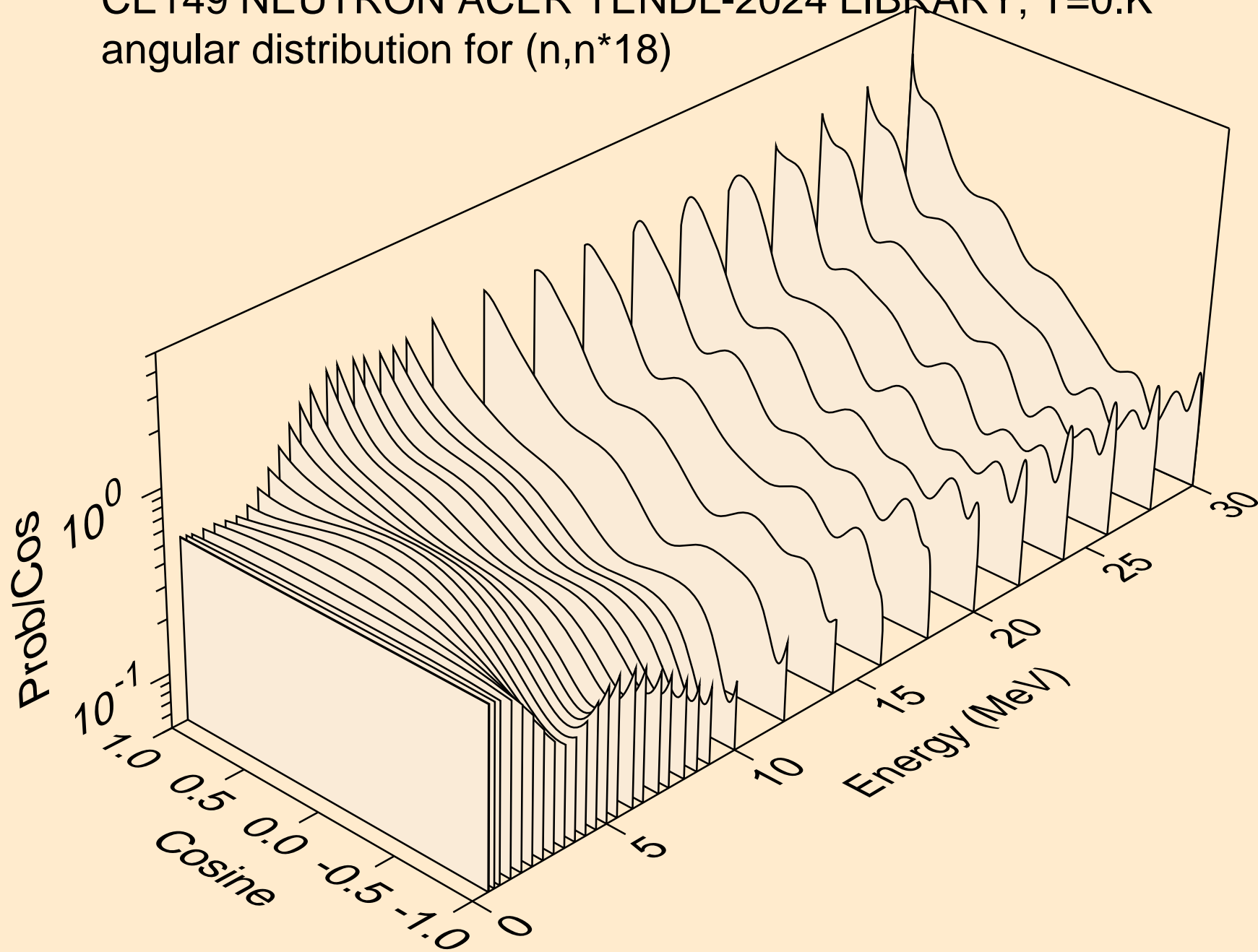

CE149 NEUTRON ACER TENDL-2024 LIBRARY; T=0.K
angular distribution for (n,n*19)

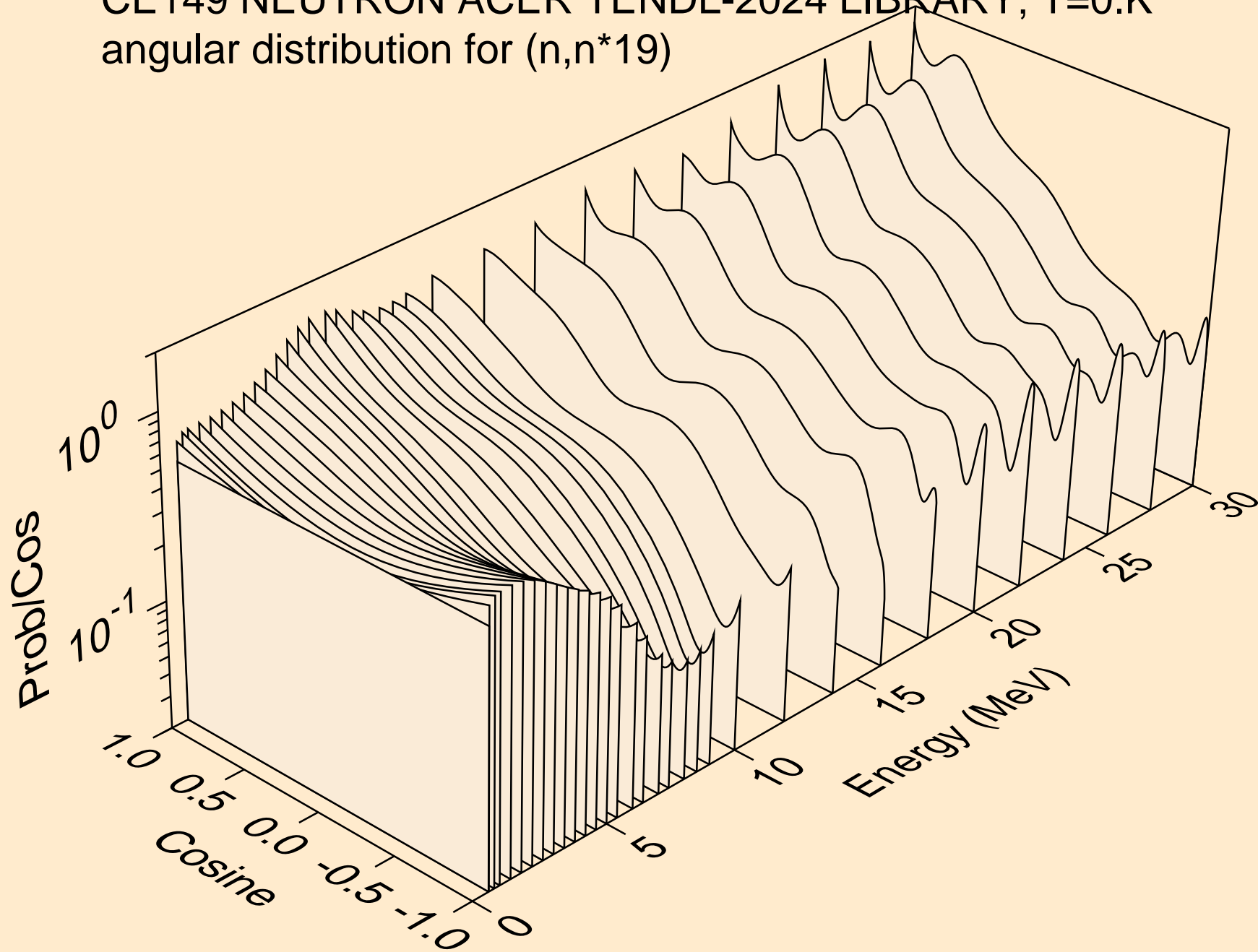

CE149 NEUTRON ACER TENDL-2024 LIBRARY; T=0.K
angular distribution for (n,n*20)

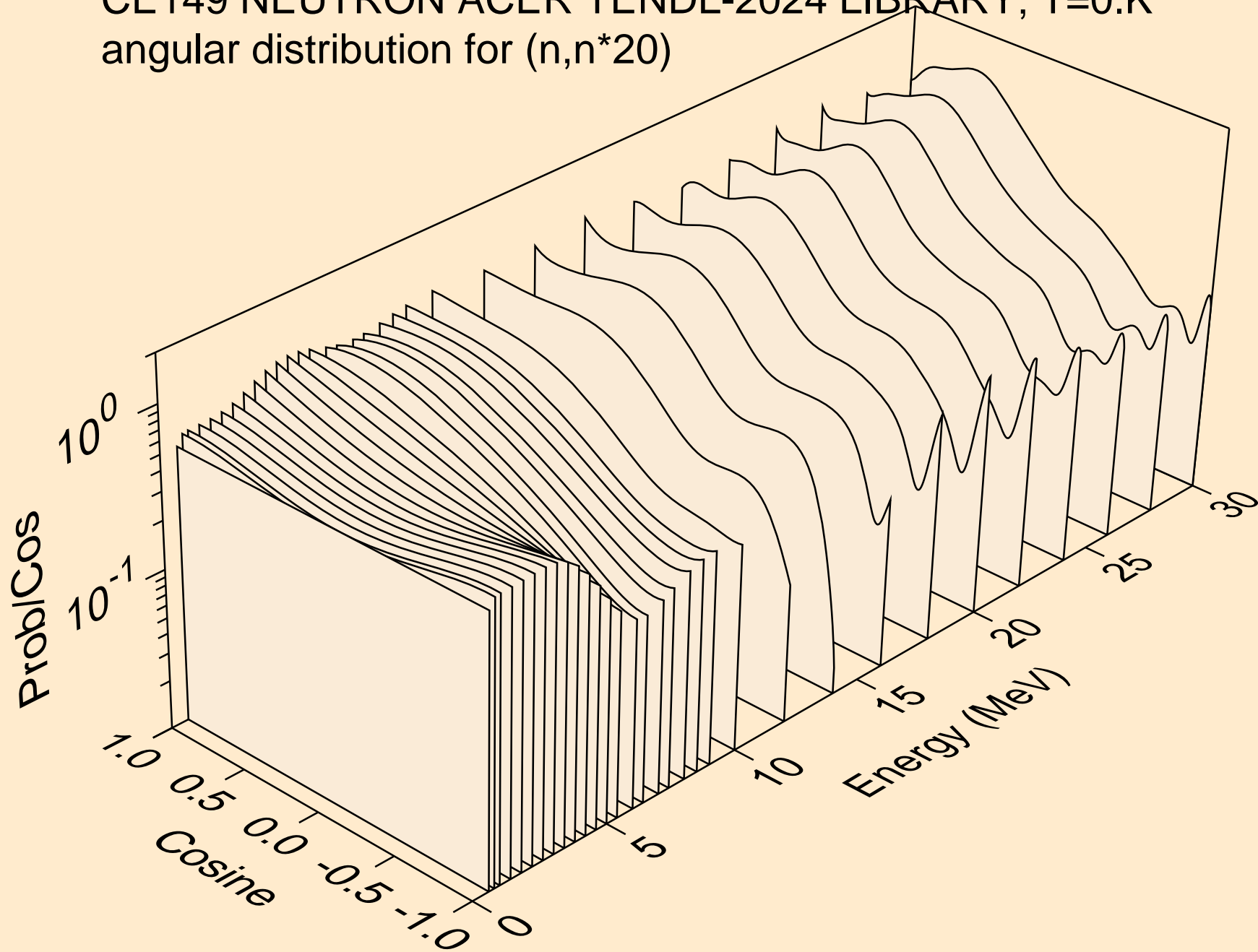

CE149 NEUTRON ACER TENDL-2024 LIBRARY; T=0.K
angular distribution for (n,n*21)

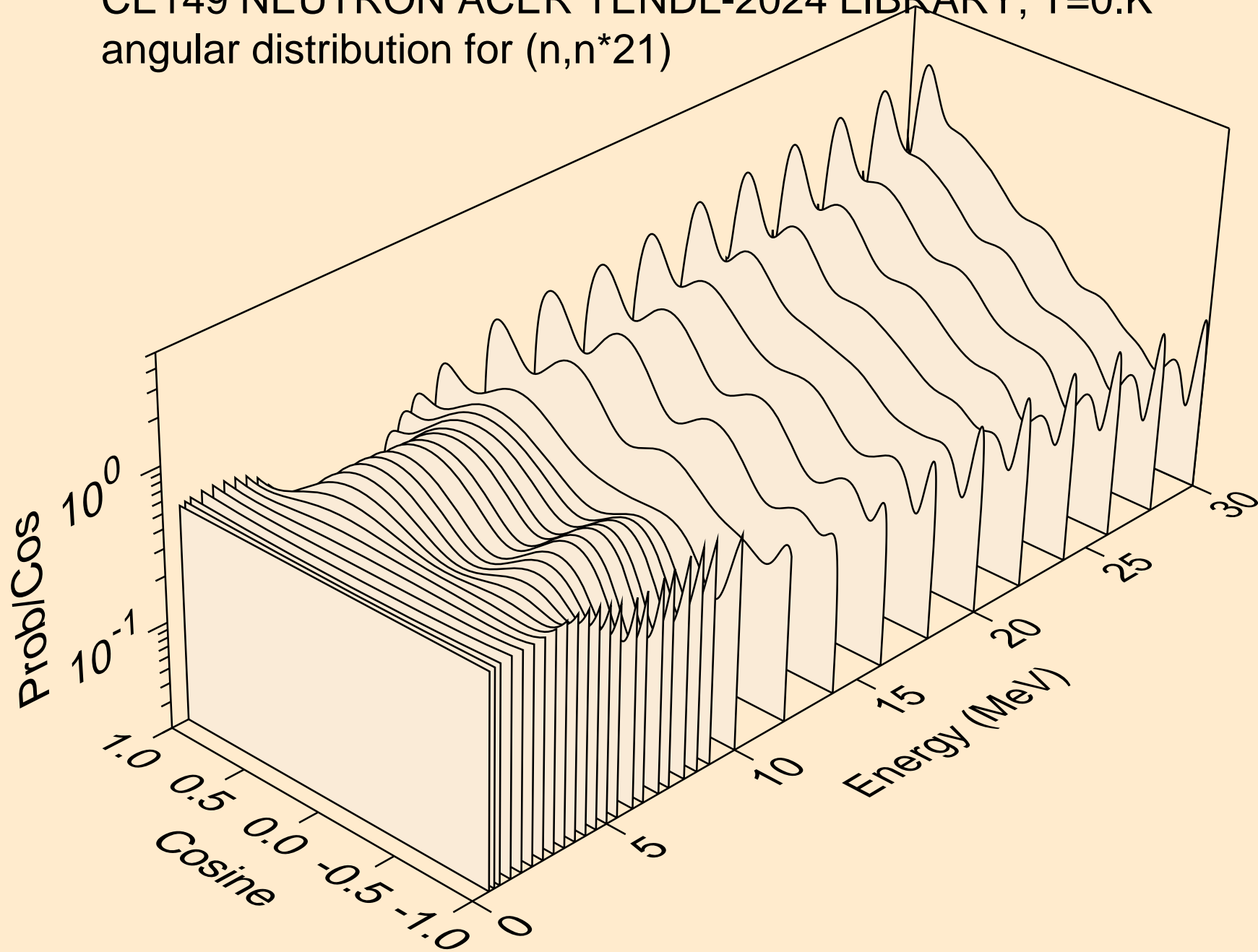

CE149 NEUTRON ACER TENDL-2024 LIBRARY; T=0.K
angular distribution for (n,n*22)

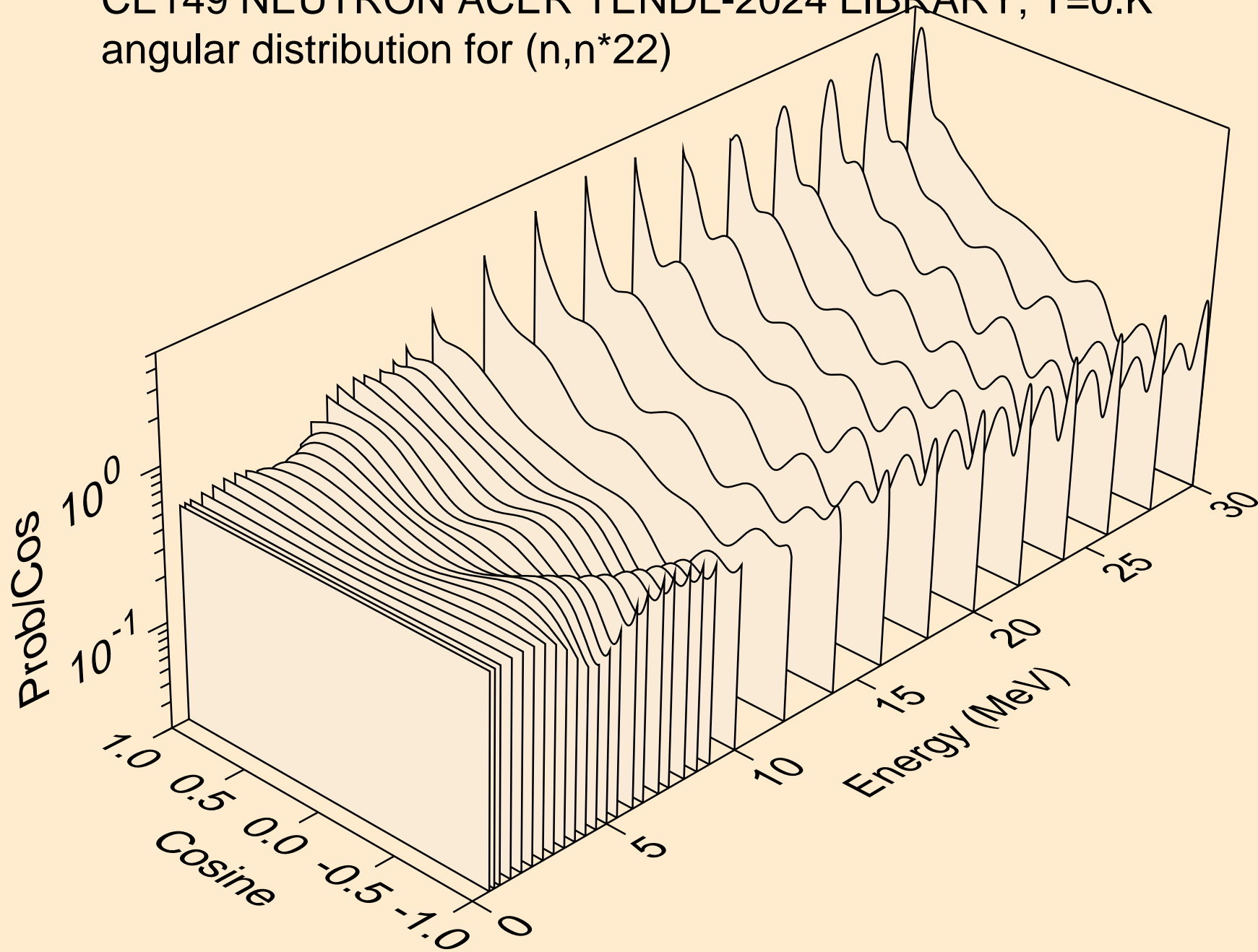

CE149 NEUTRON ACER TENDL-2024 LIBRARY; T=0.K
angular distribution for (n,n*23)

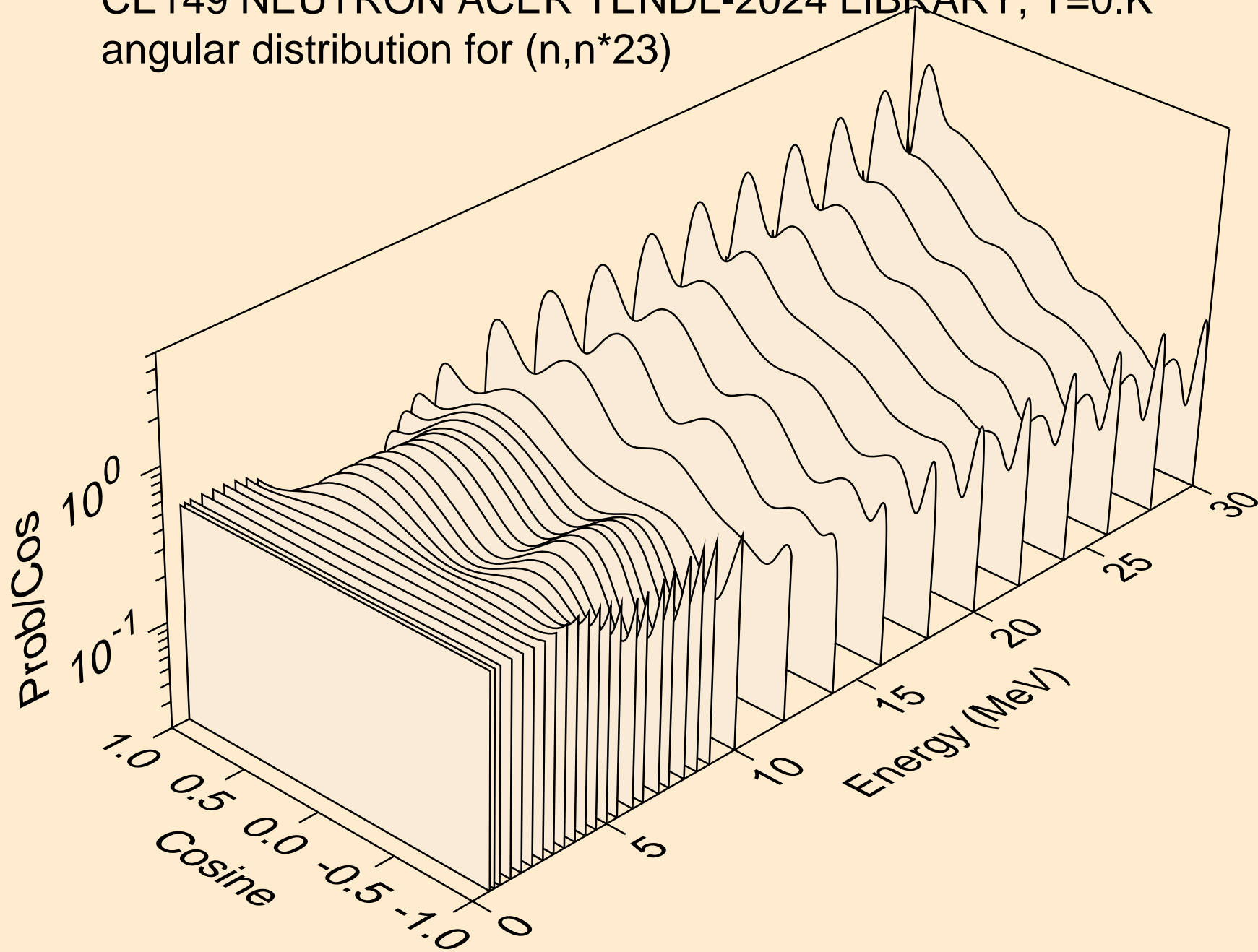

CE149 NEUTRON ACER TENDL-2024 LIBRARY; T=0.K
angular distribution for (n,n*24)

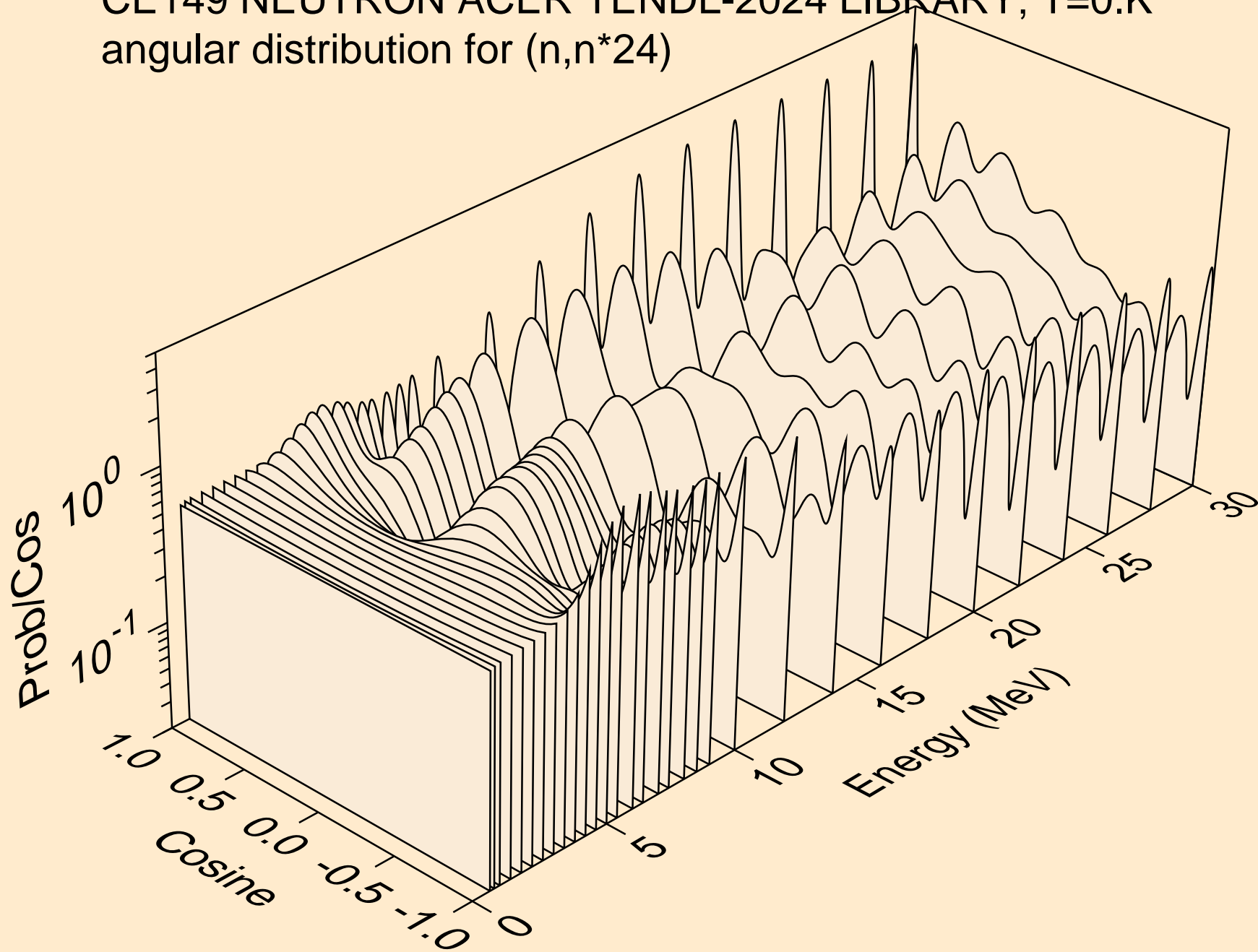

CE149 NEUTRON ACER TENDL-2024 LIBRARY; T=0.K
angular distribution for (n,n*25)

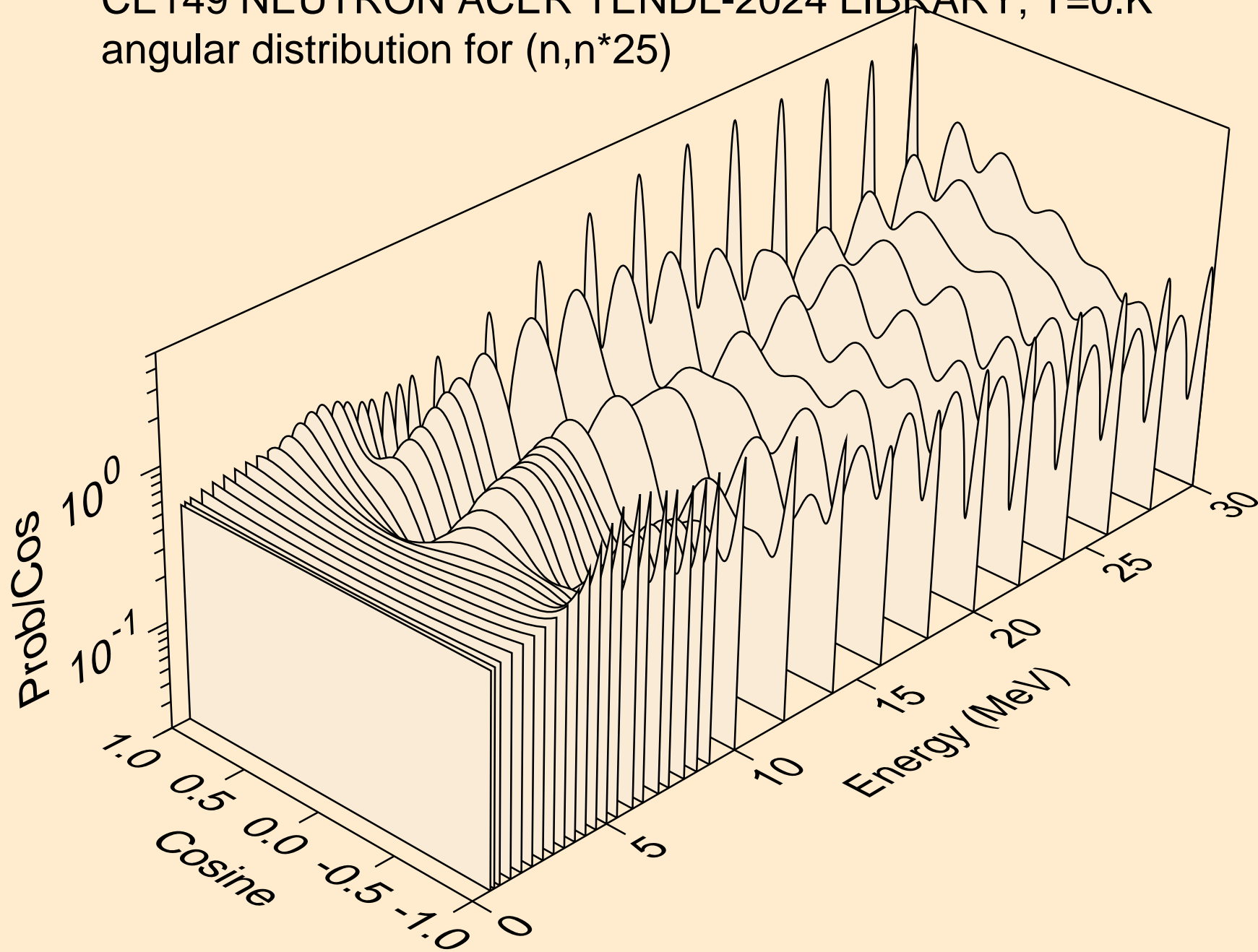

CE149 NEUTRON ACER TENDL-2024 LIBRARY; T=0.K
angular distribution for (n,n*26)

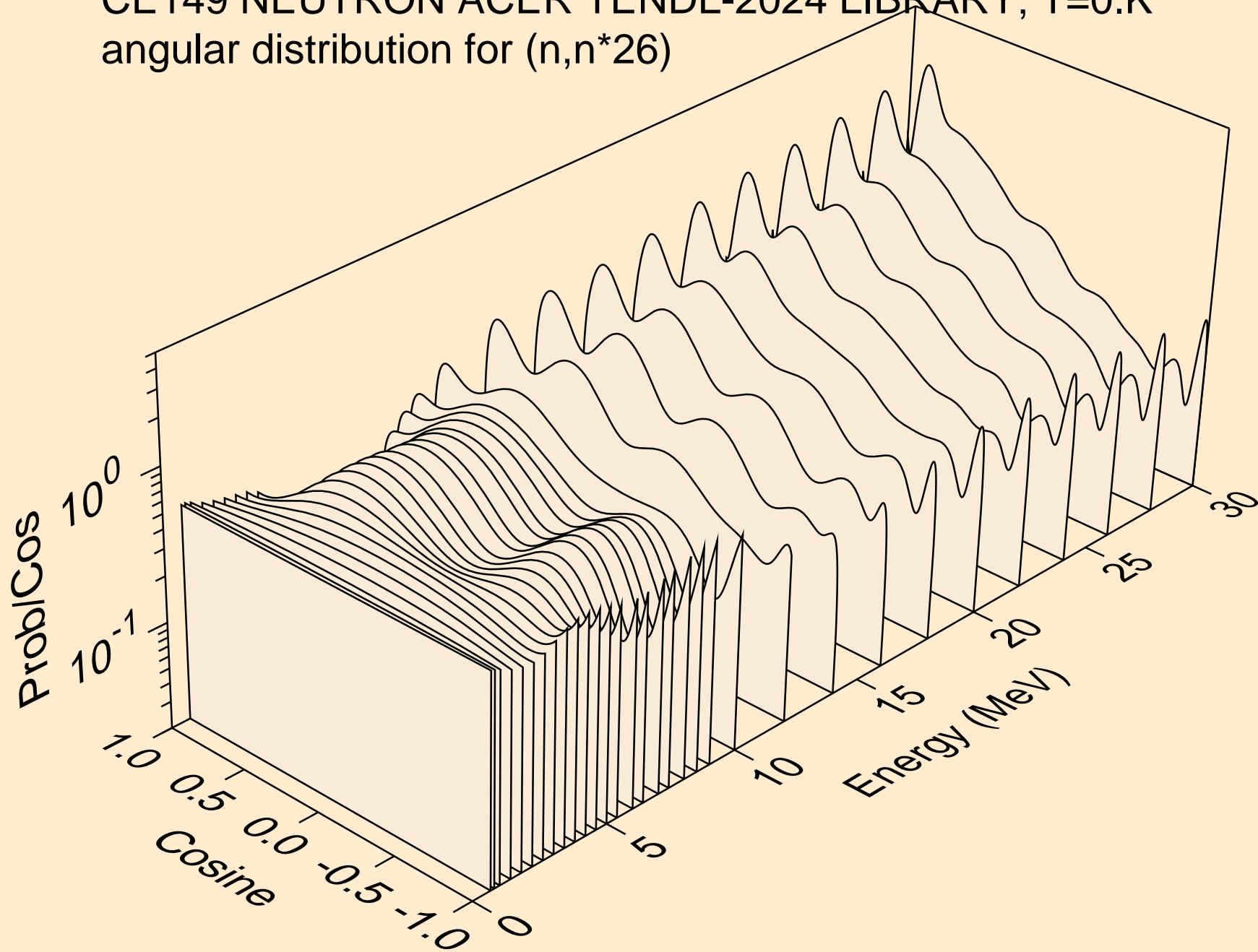

CE149 NEUTRON ACER TENDL-2024 LIBRARY; T=0.K
angular distribution for (n,n*27)

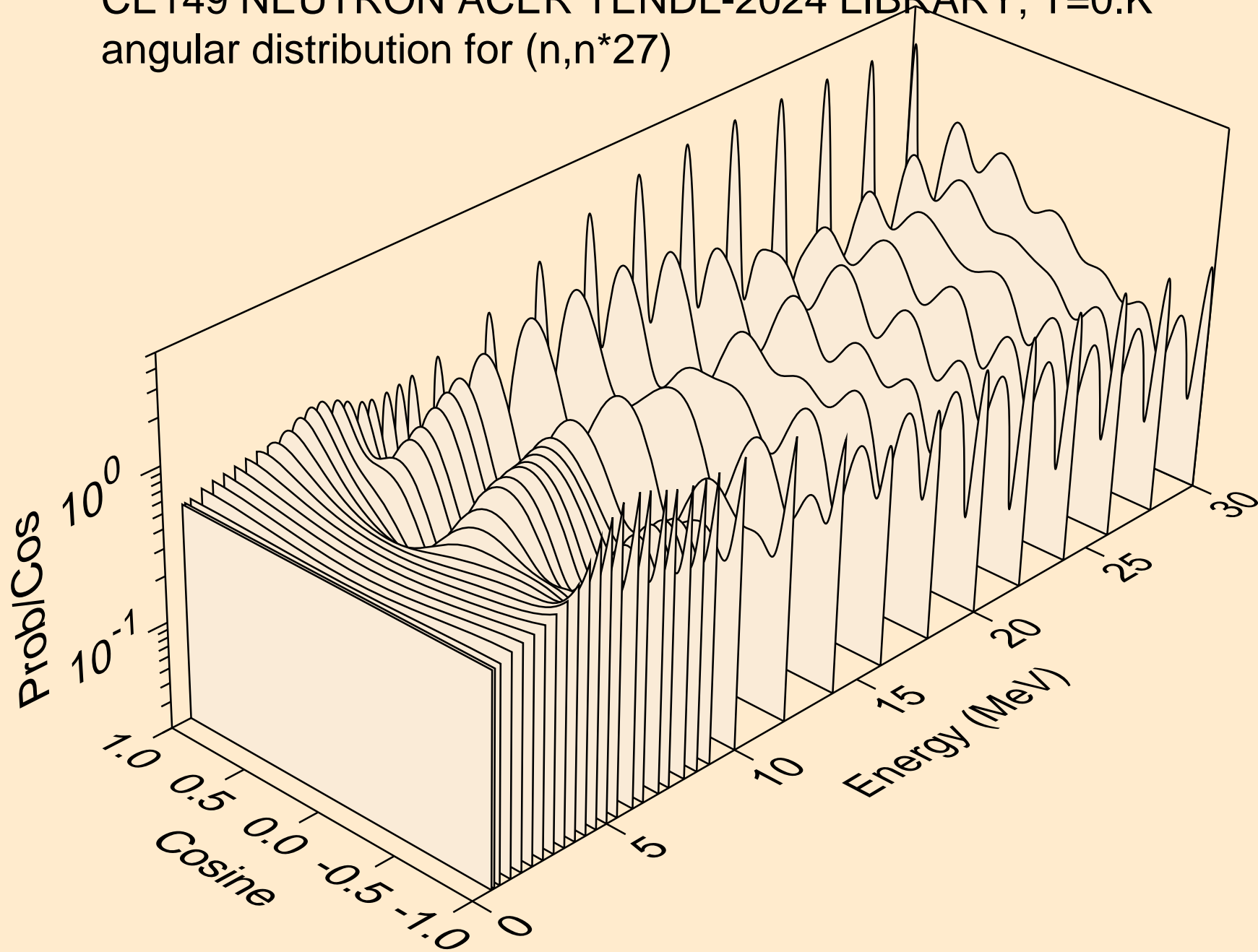

CE149 NEUTRON ACER TENDL-2024 LIBRARY; T=0.K
angular distribution for (n,n*28)

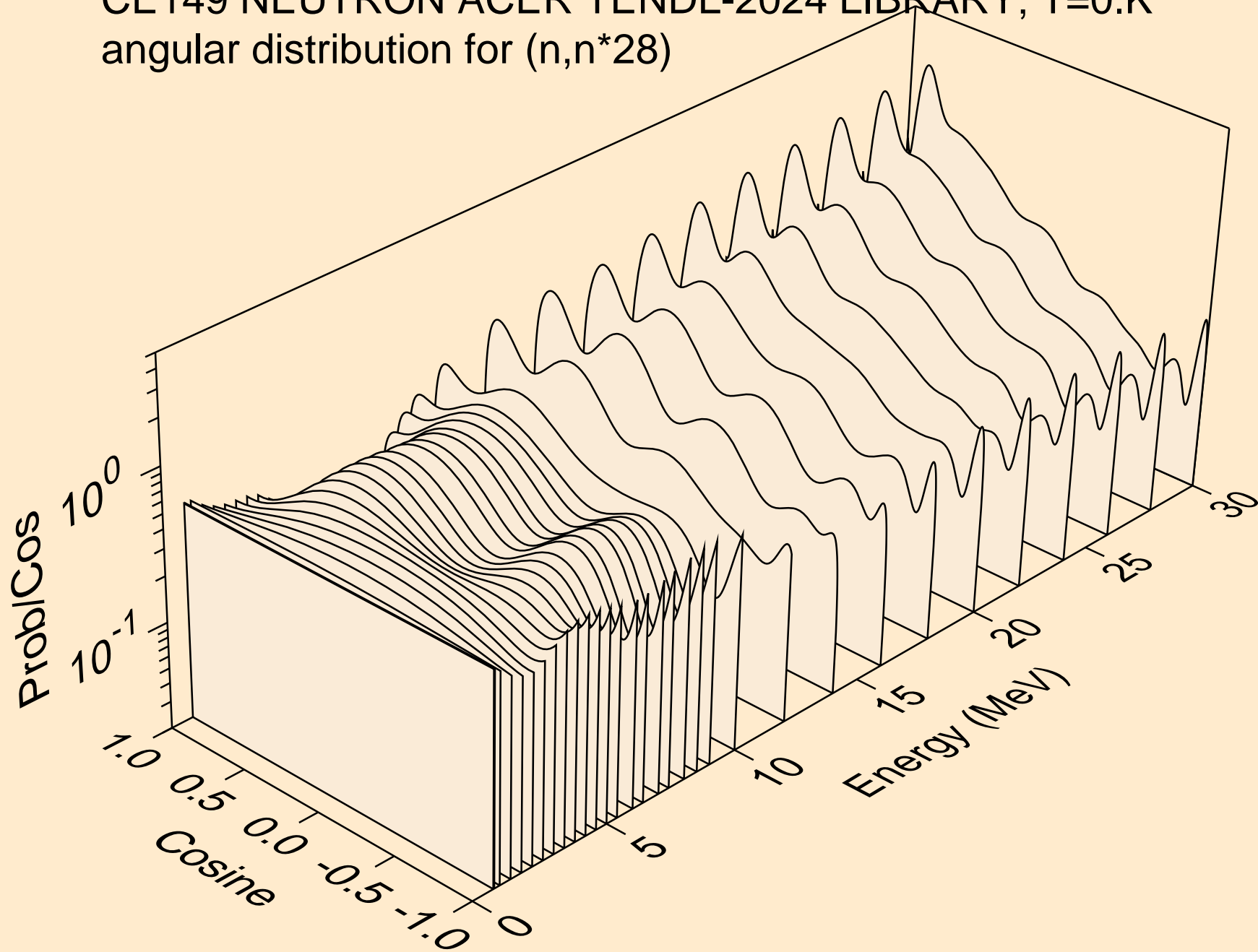

CE149 NEUTRON ACER TENDL-2024 LIBRARY; T=0.K
Neutron emission for (n,x)

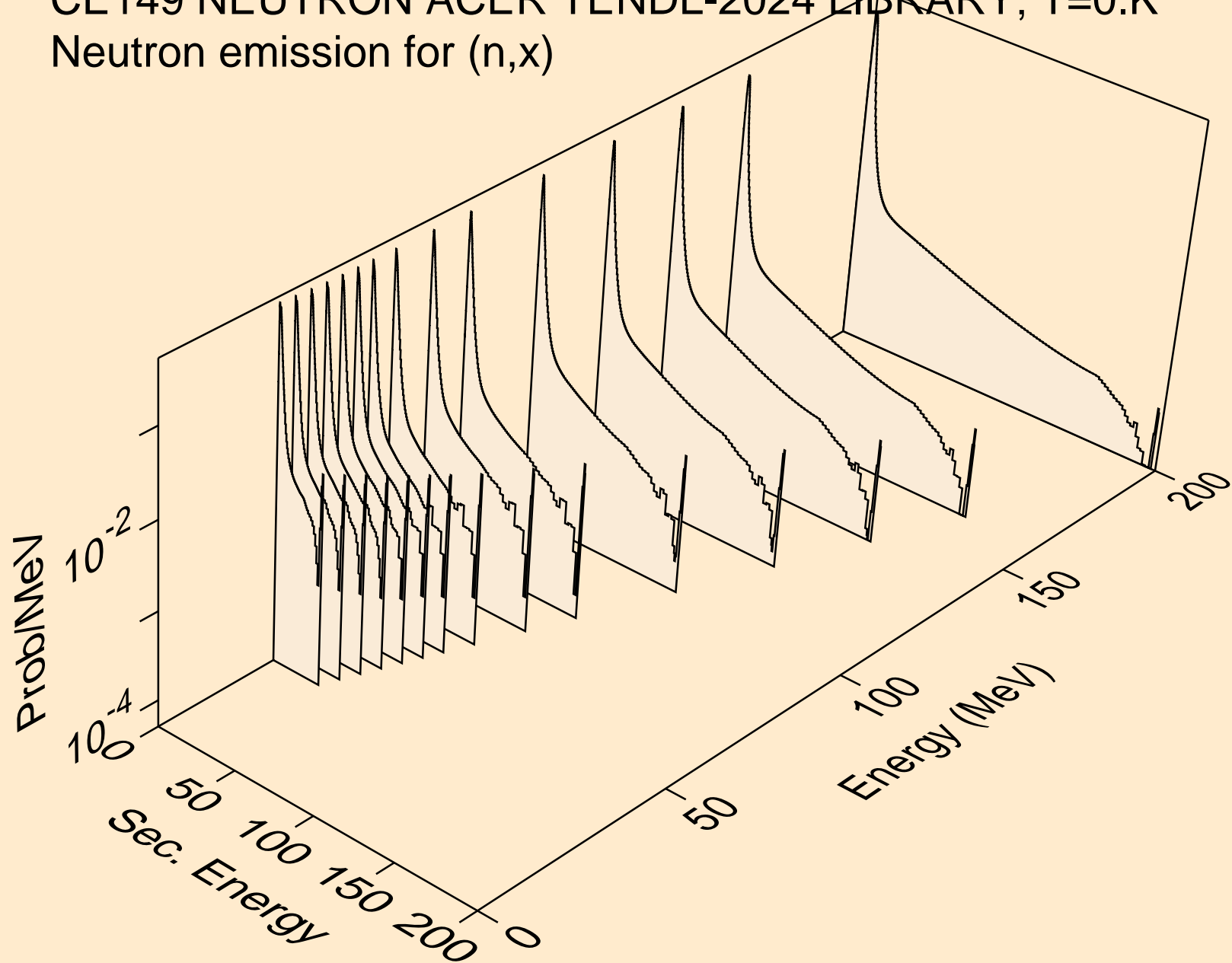

CE149 NEUTRON ACER TENDL-2024 LIBRARY; T=0.K
Neutron emission for (n,2nd)

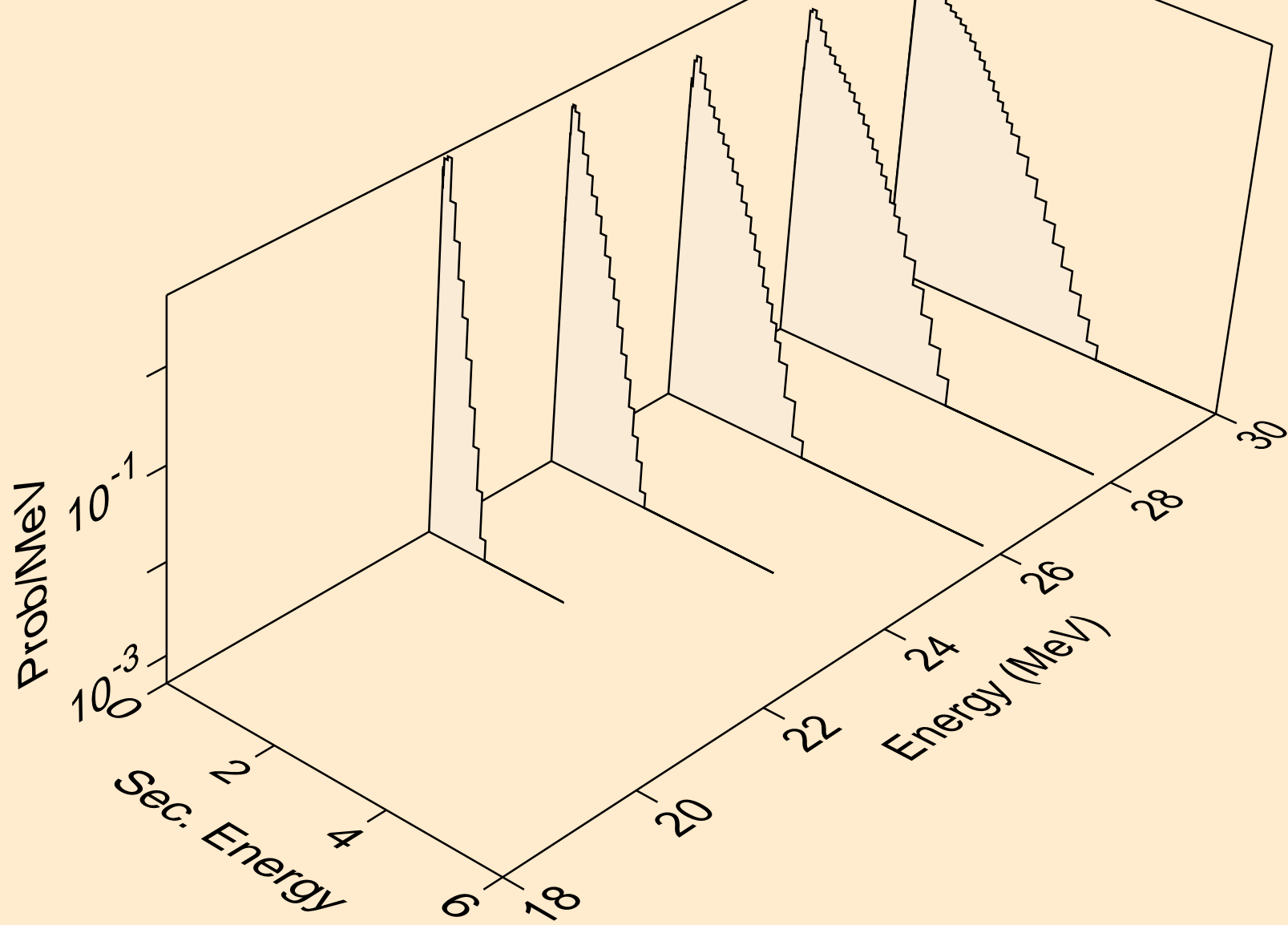

CE149 NEUTRON ACER TENDL-2024 LIBRARY; T=0.K
Neutron emission for (n,2n)

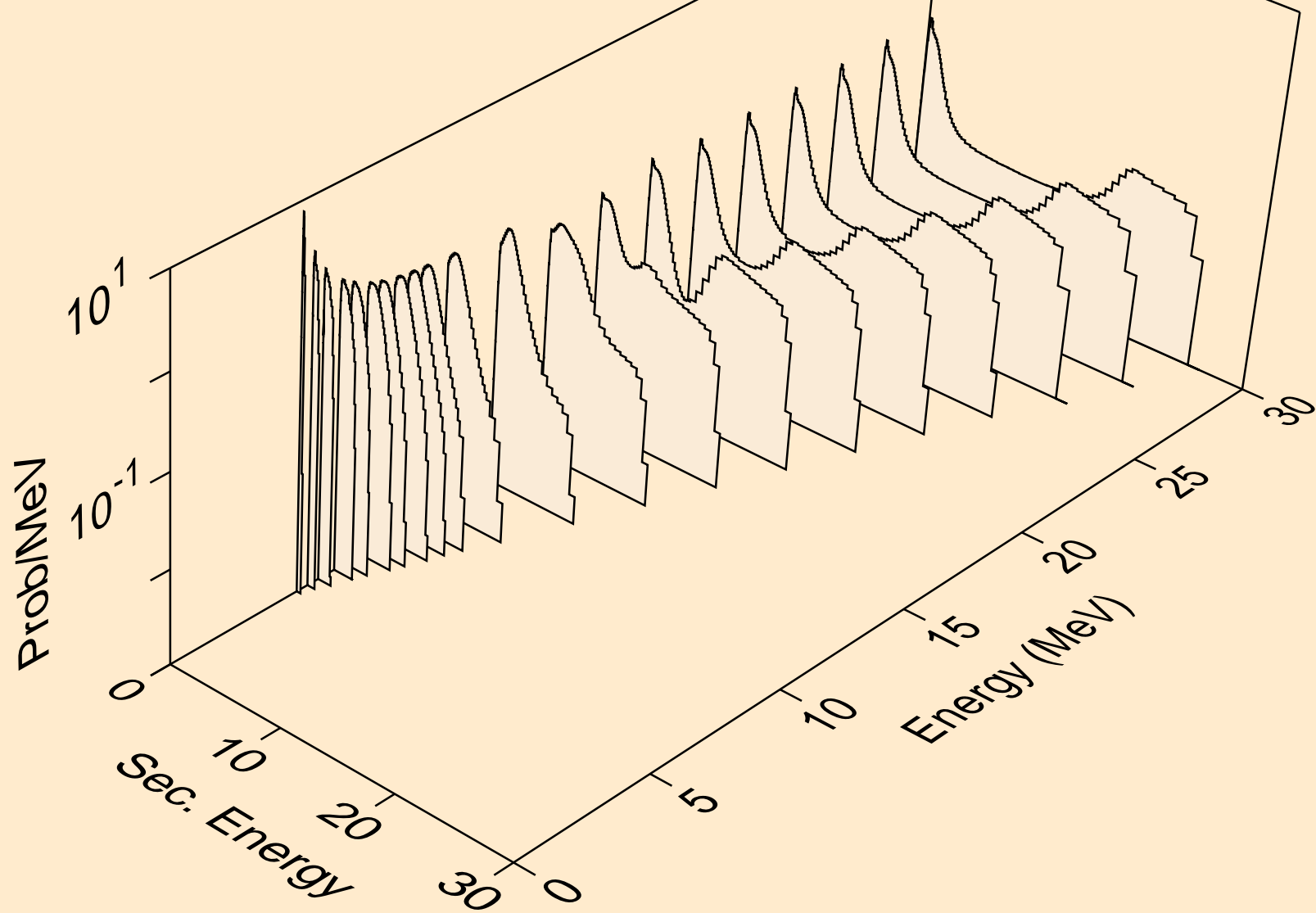

CE149 NEUTRON ACER TENDL-2024 LIBRARY; T=0.K
Neutron emission for (n,3n)

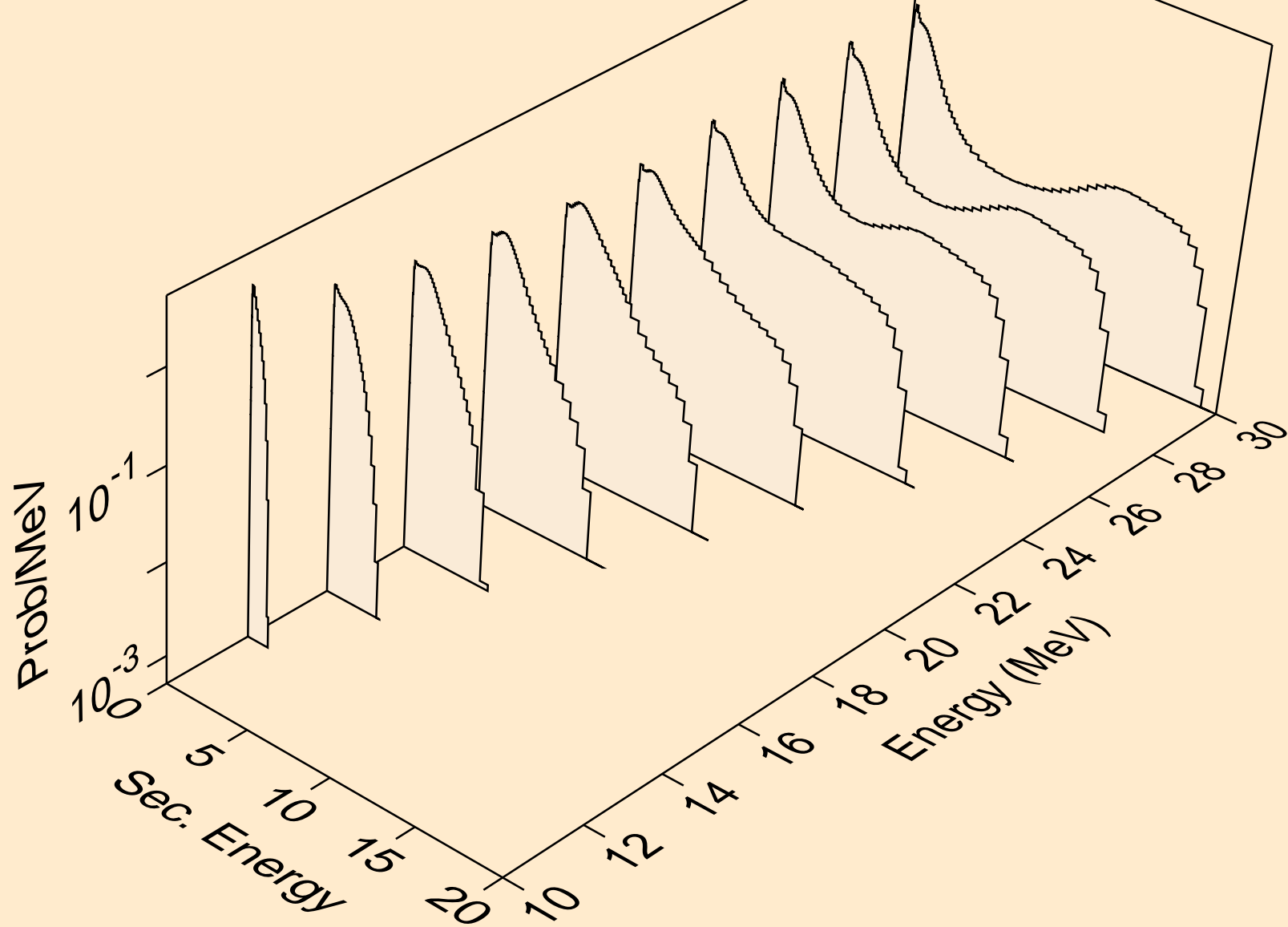

CE149 NEUTRON ACER TENDL-2024 LIBRARY; T=0.K
Neutron emission for (n,n*)a

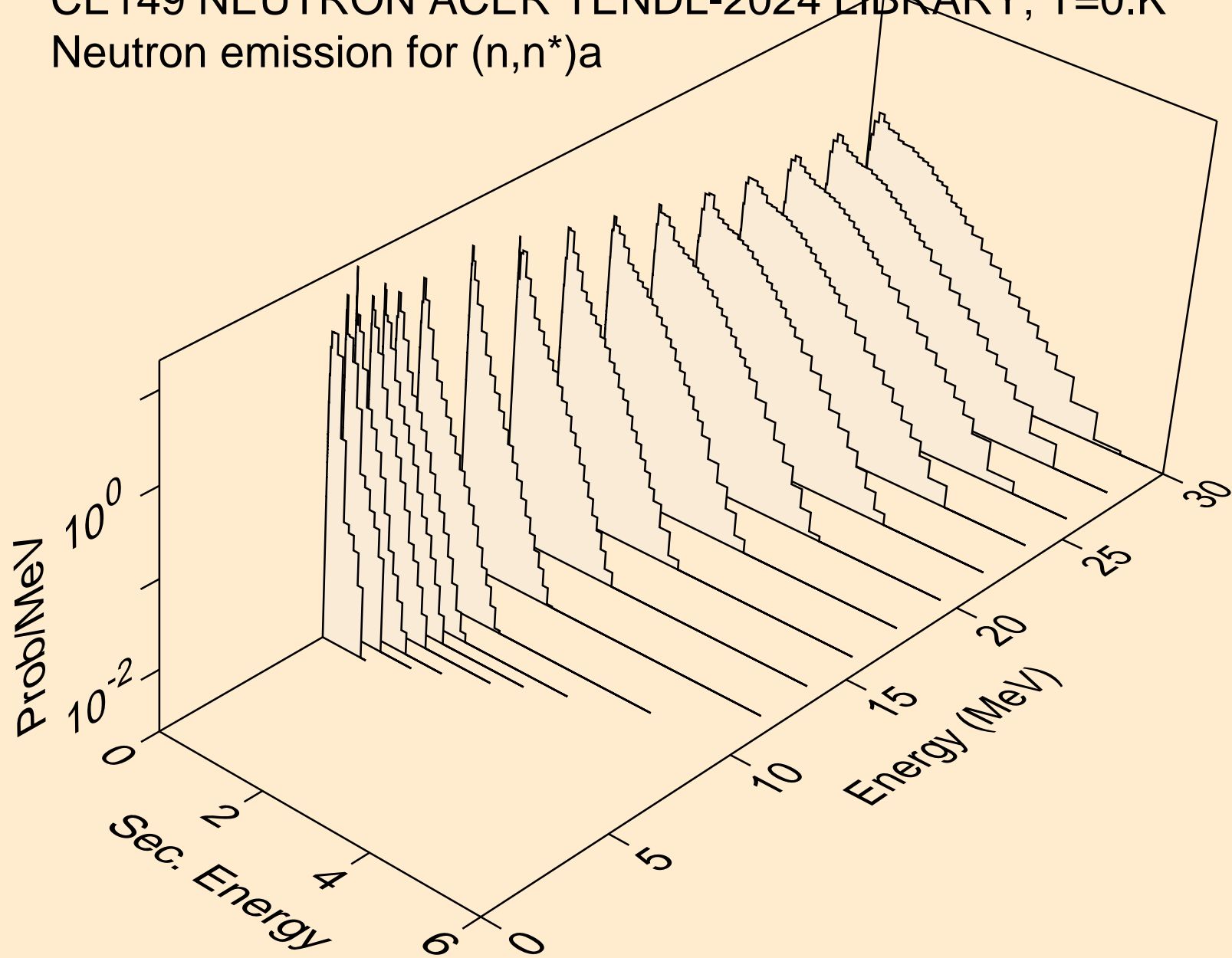

CE149 NEUTRON ACER TENDL-2024 LIBRARY; T=0.K
Neutron emission for (n,2n)a

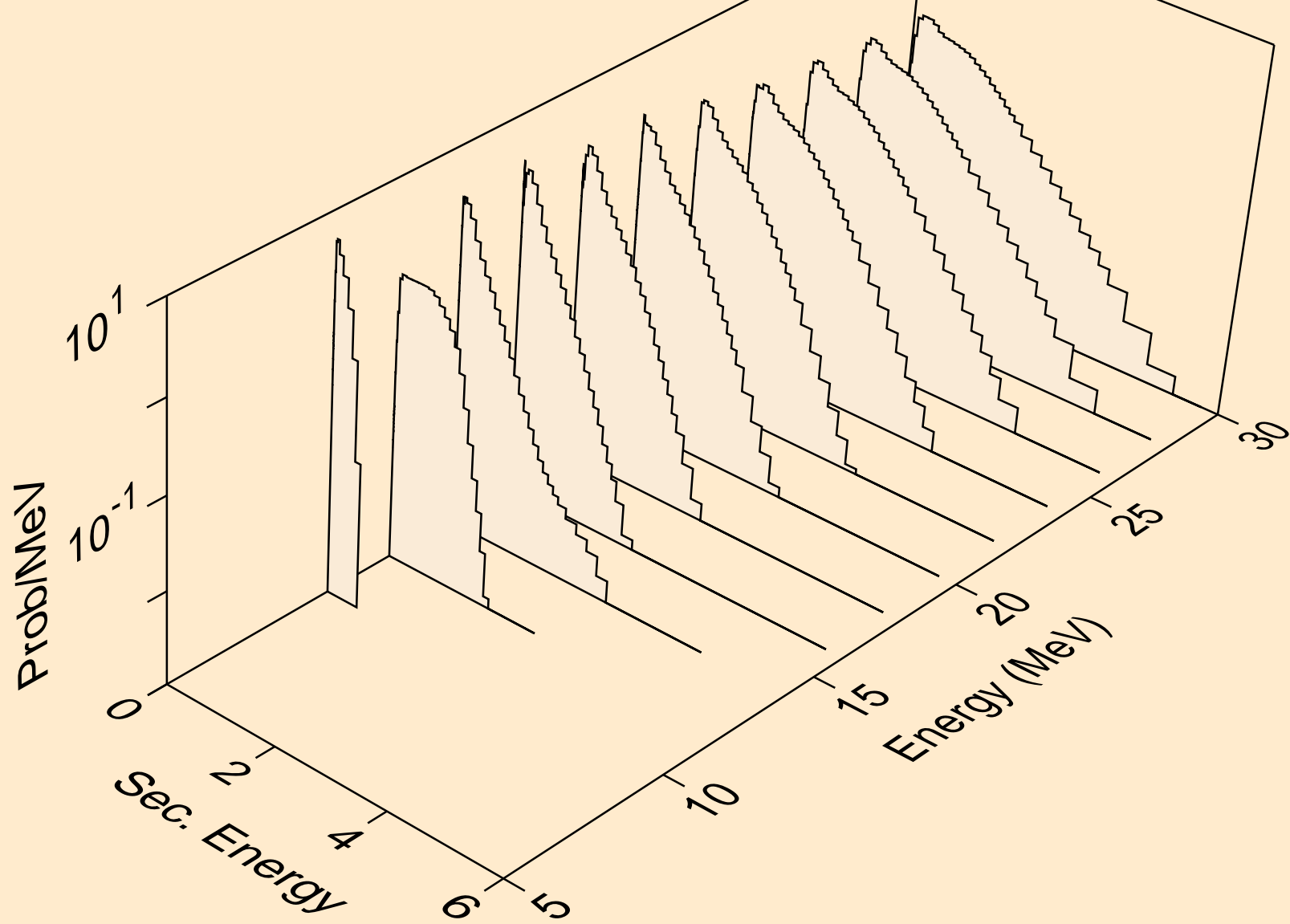

CE149 NEUTRON ACER TENDL-2024 LIBRARY; T=0.K
Neutron emission for (n,3n)a

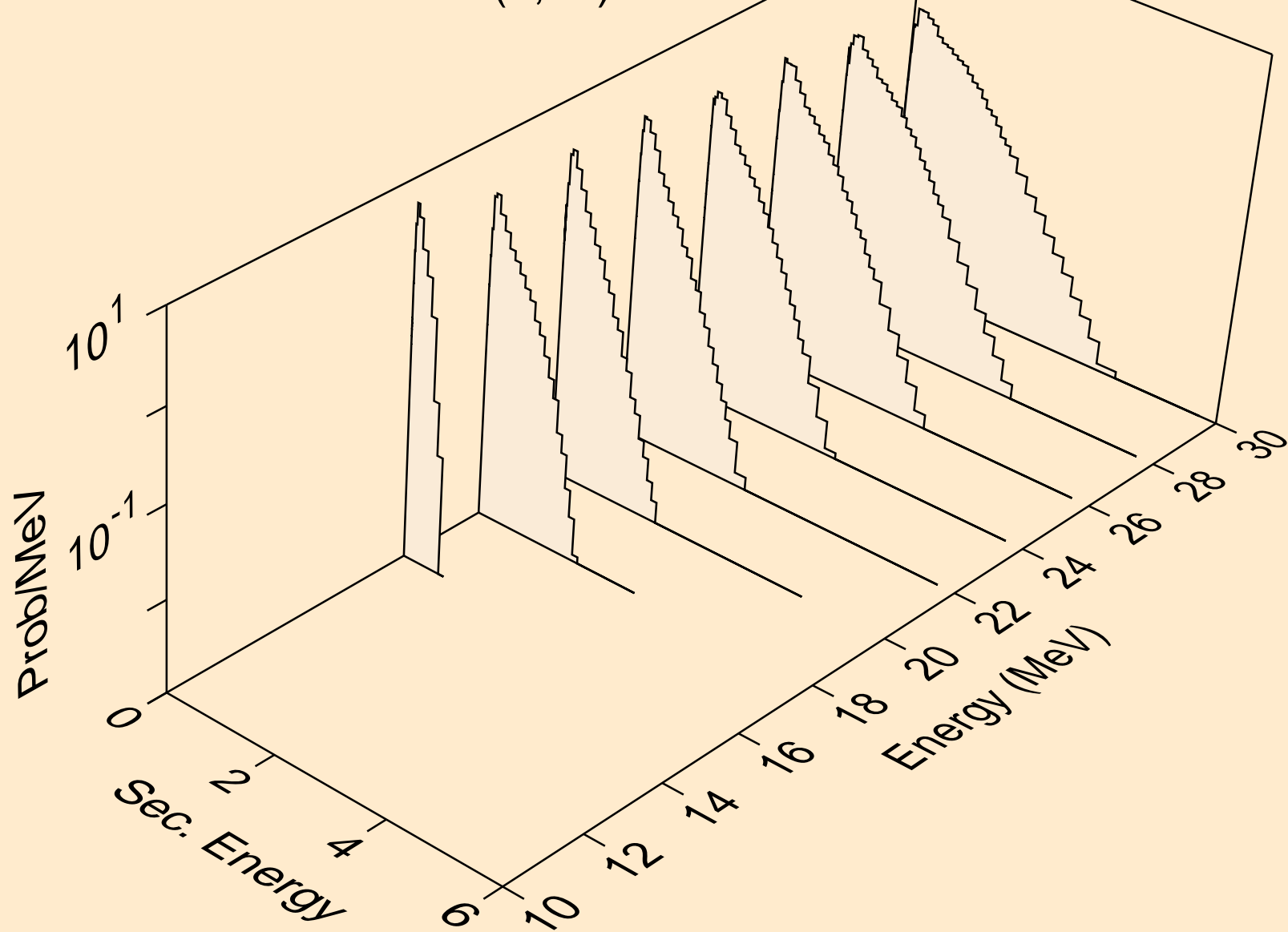

CE149 NEUTRON ACER TENDL-2024 LIBRARY; T=0.K
Neutron emission for (n,n*)p

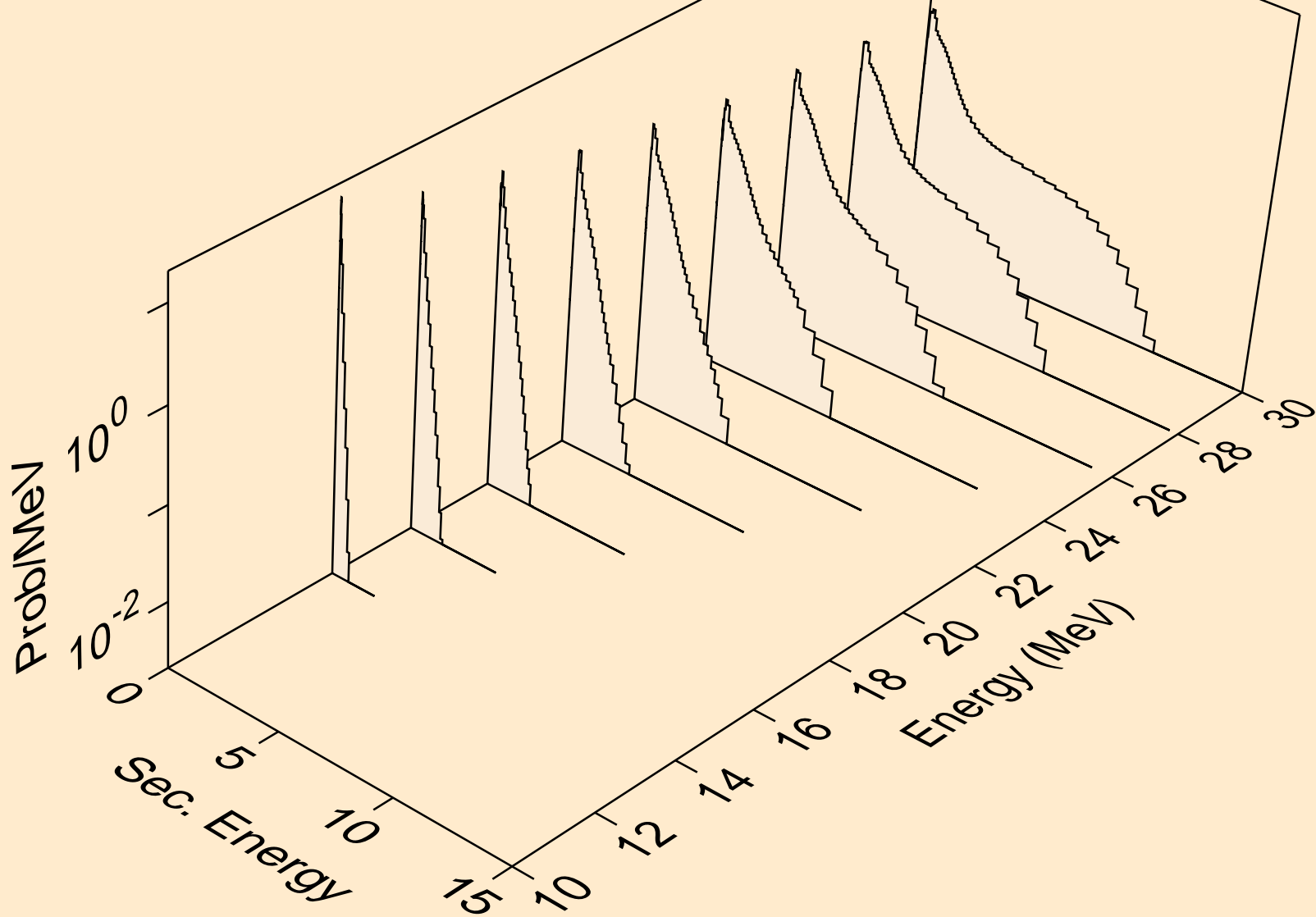

CE149 NEUTRON ACER TENDL-2024 LIBRARY; T=0.K
Neutron emission for (n,n*)d

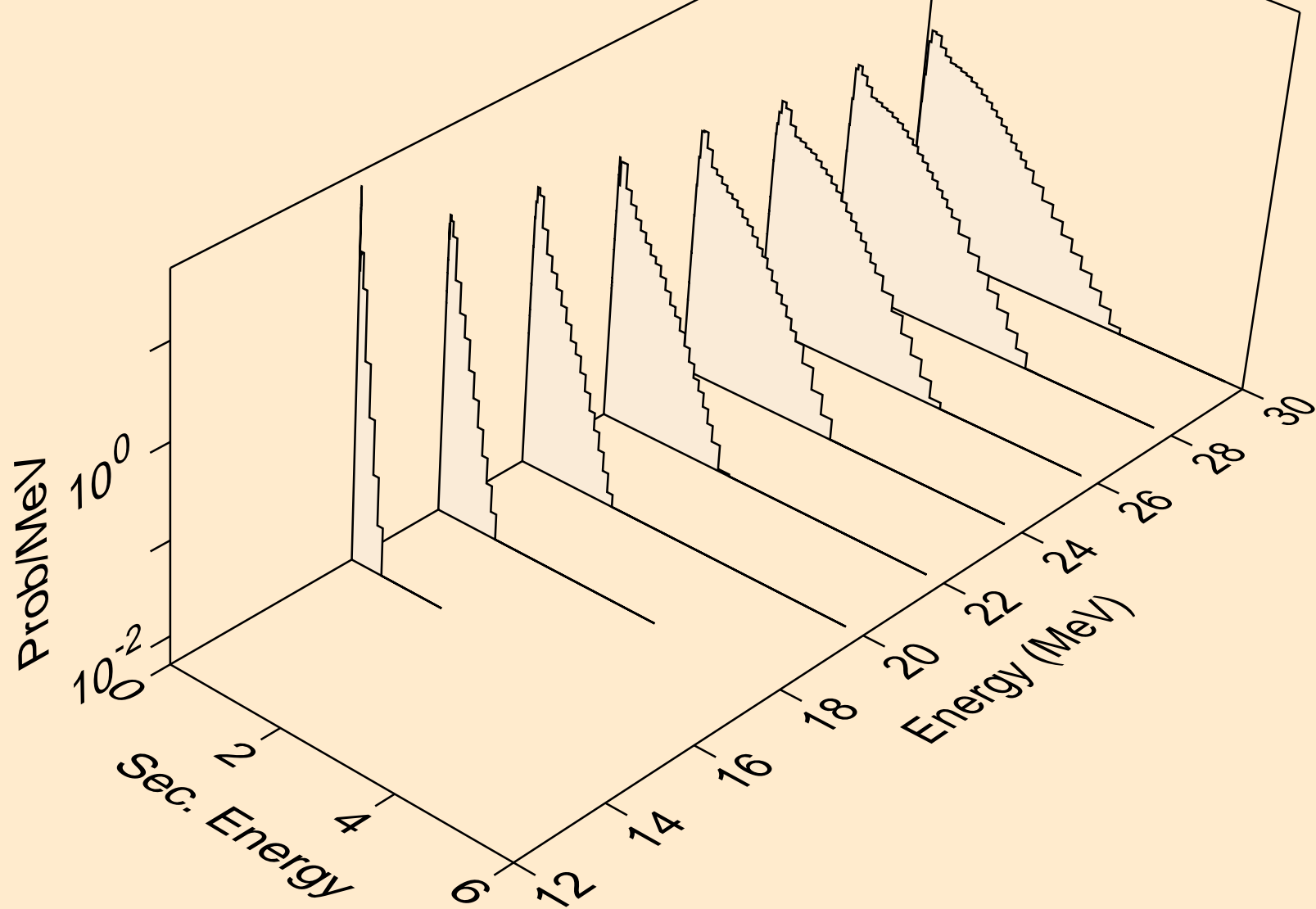

CE149 NEUTRON ACER TENDL-2024 LIBRARY; T=0.K
Neutron emission for (n,n*)t

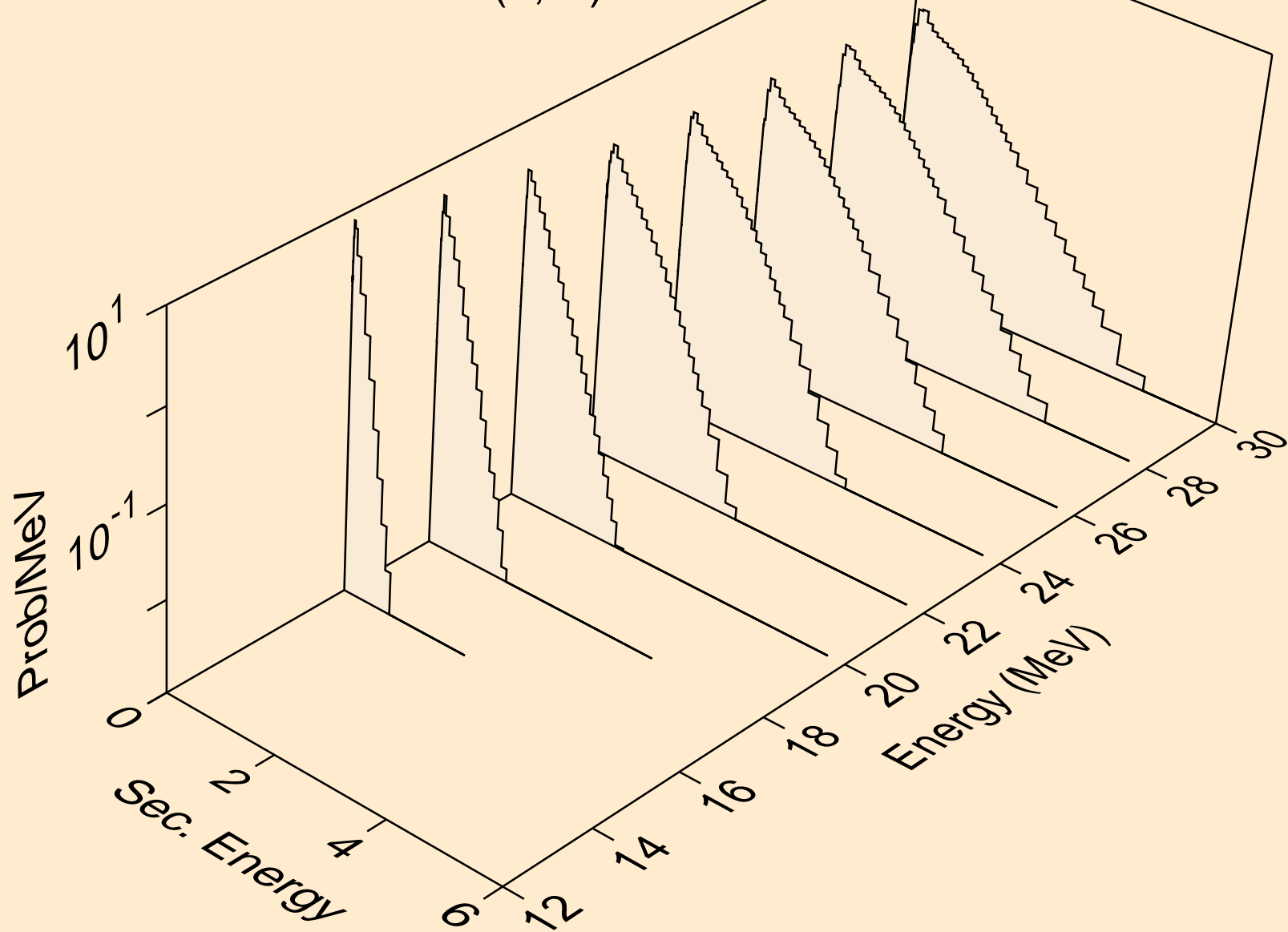

CE149 NEUTRON ACER TENDL-2024 LIBRARY; T=0.K
Neutron emission for (n,n*)he3

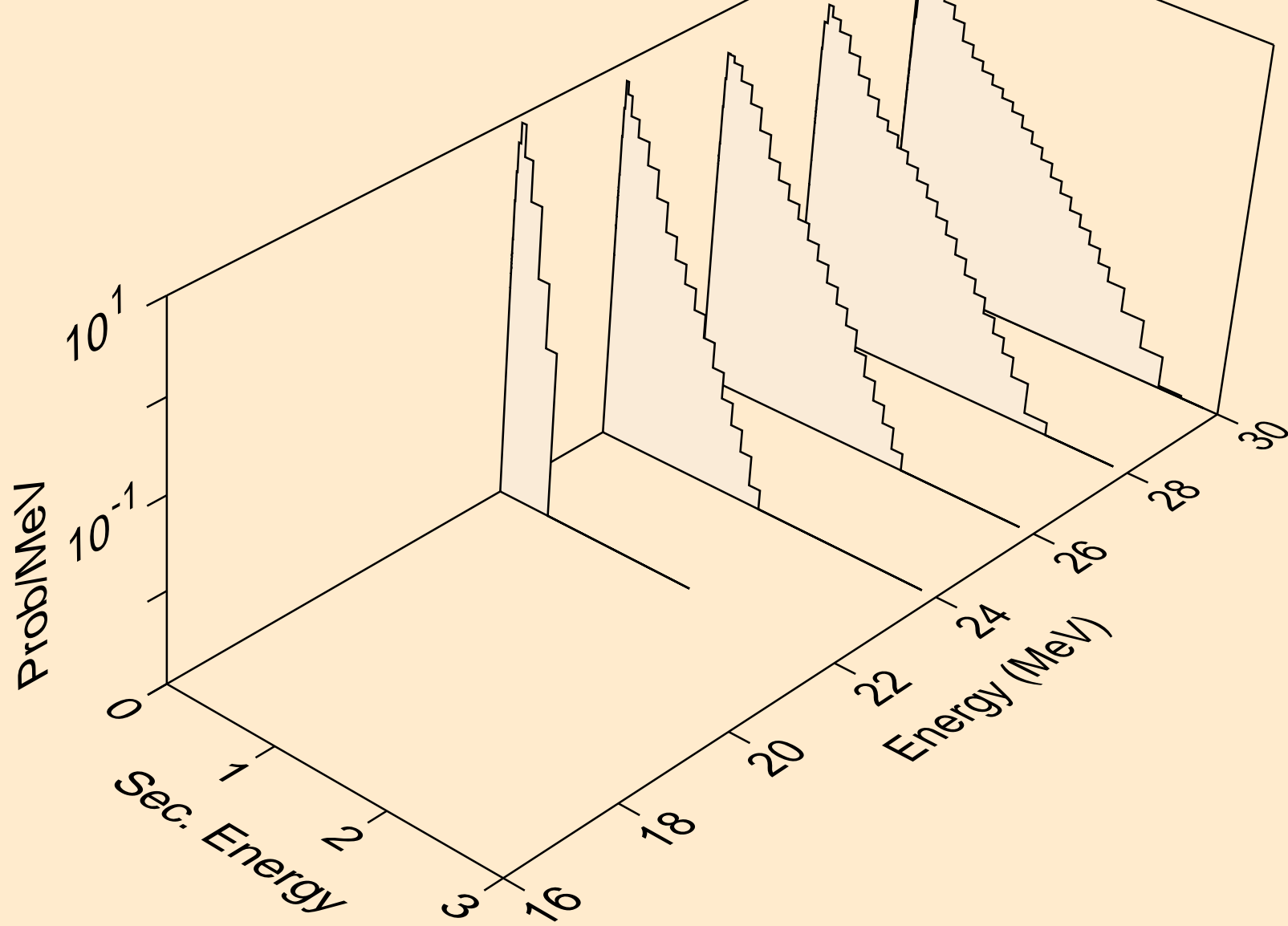

CE149 NEUTRON ACER TENDL-2024 LIBRARY; T=0.K
Neutron emission for (n,4n)

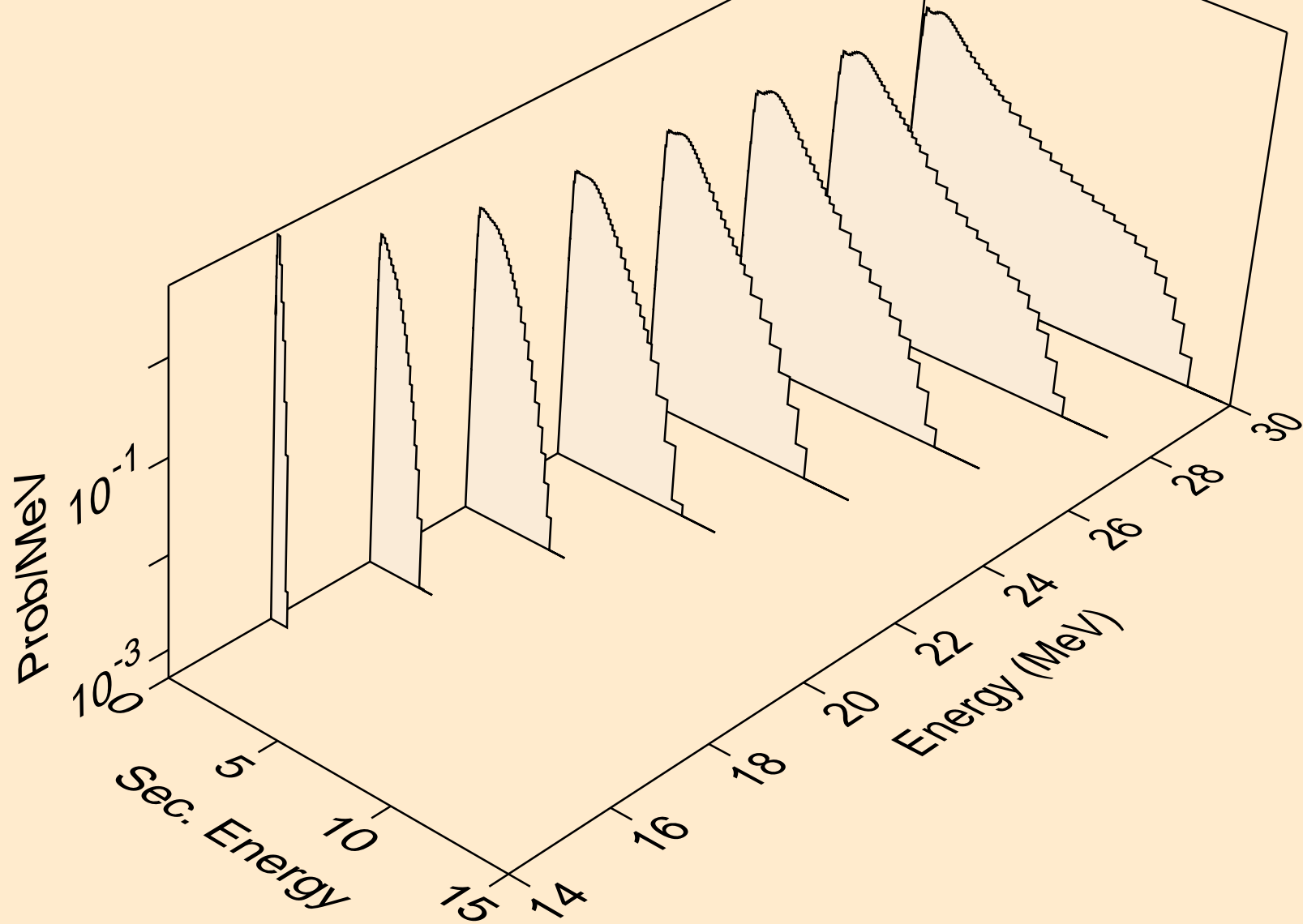

CE149 NEUTRON ACER TENDL-2024 LIBRARY; T=0.K
Neutron emission for (n,2np)

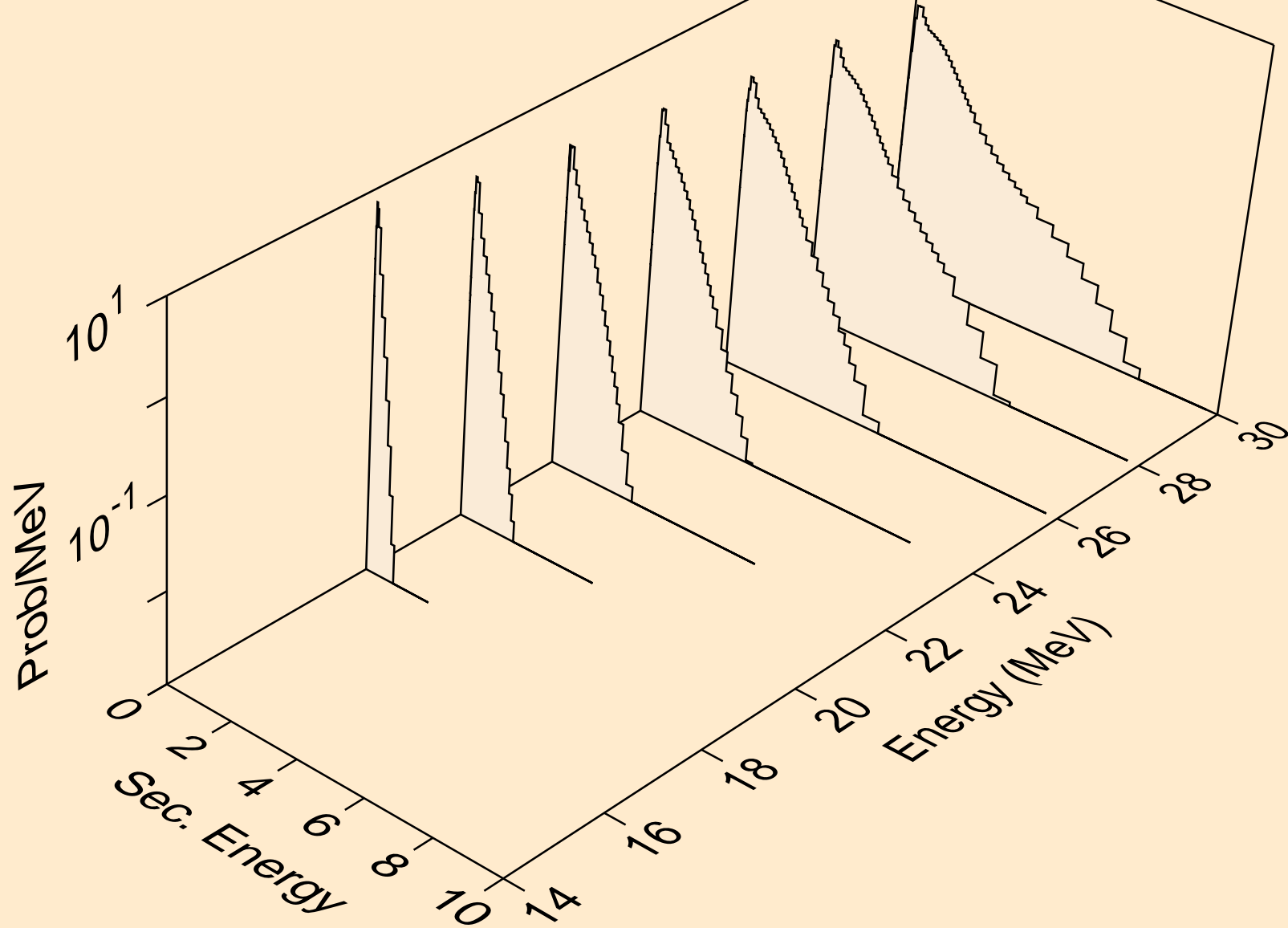

CE149 NEUTRON ACER TENDL-2024 LIBRARY; T=0.K
Neutron emission for (n,3np)

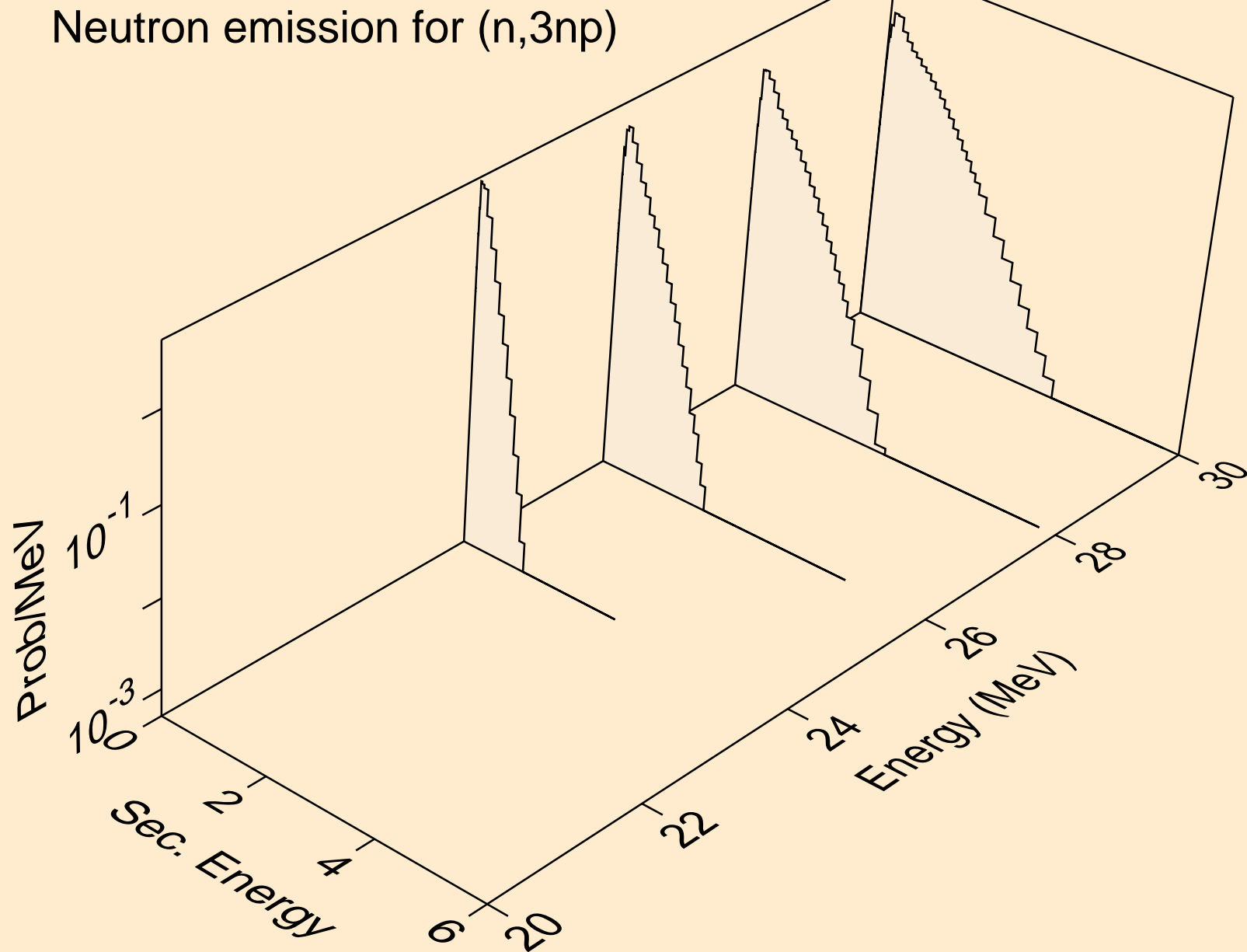

CE149 NEUTRON ACER TENDL-2024 LIBRARY; T=0.K
Neutron emission for (n,n*c)

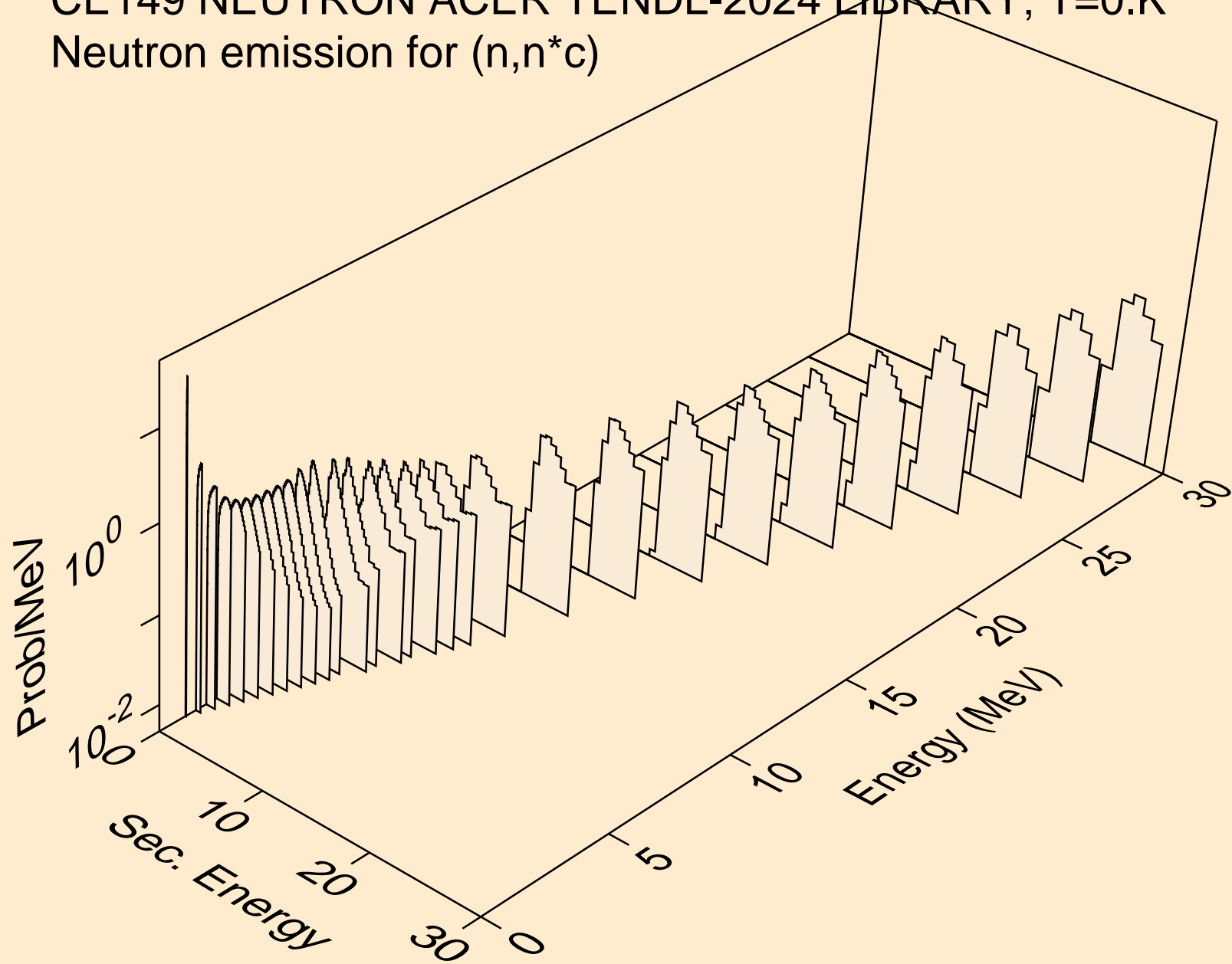

CE149 NEUTRON ACER TENDL-2024 LIBRARY; T=0.K
Photon emission for (n,x)

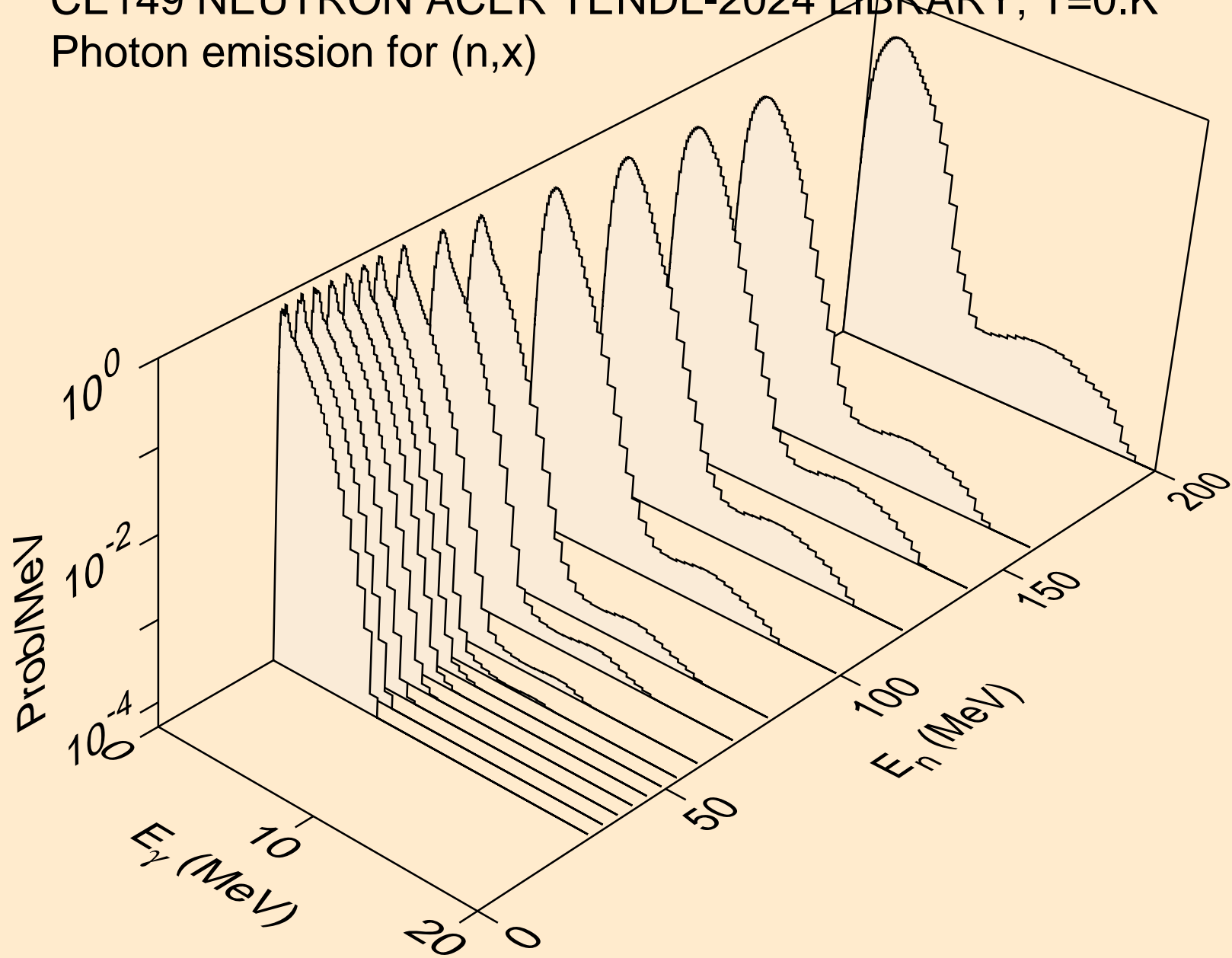

CE149 NEUTRON ACER TENDL-2024 LIBRARY; T=0.K
Photon emission for (n,2nd)

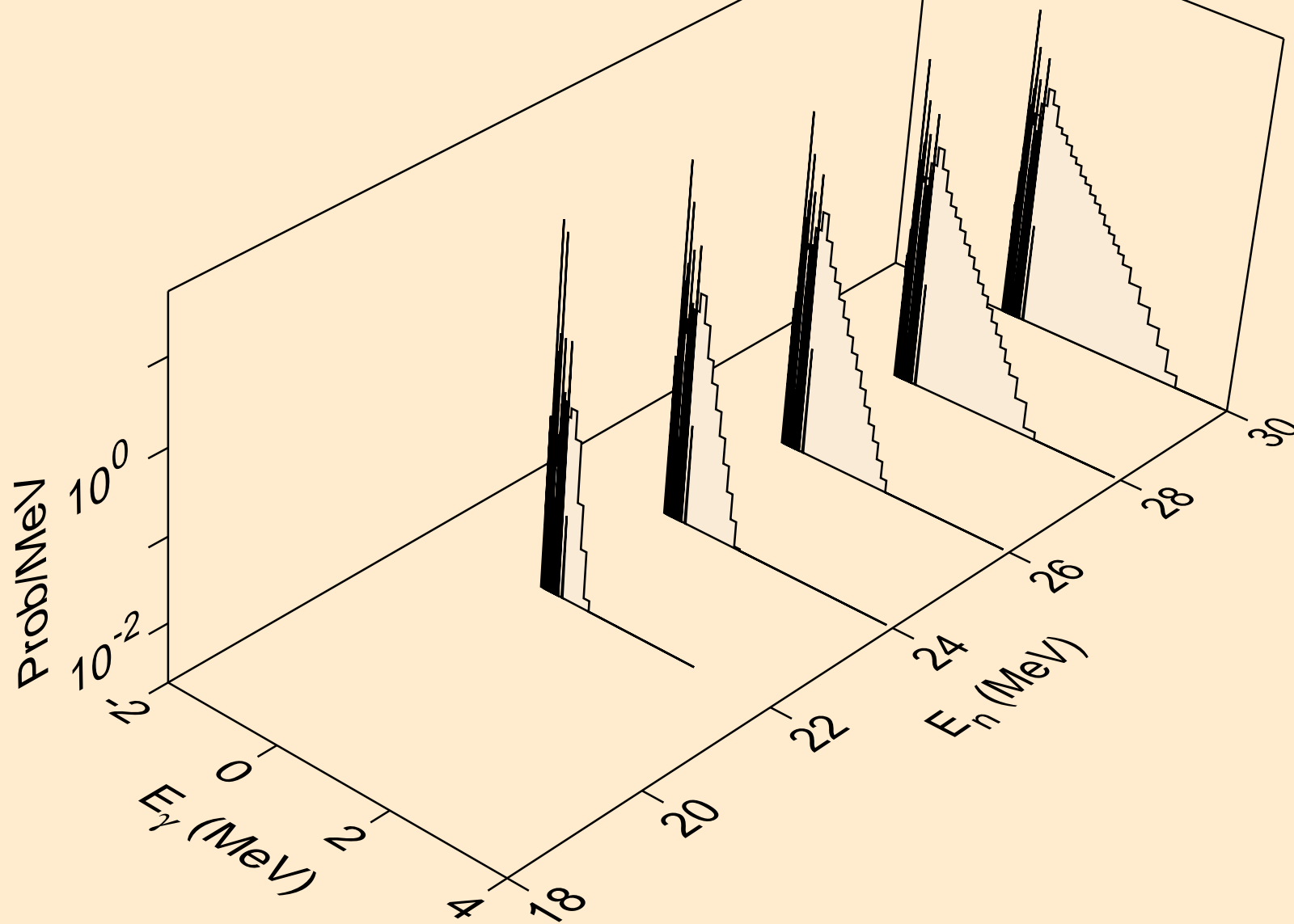

CE149 NEUTRON ACER TENDL-2024 LIBRARY; T=0.K
Photon emission for (n,2n)

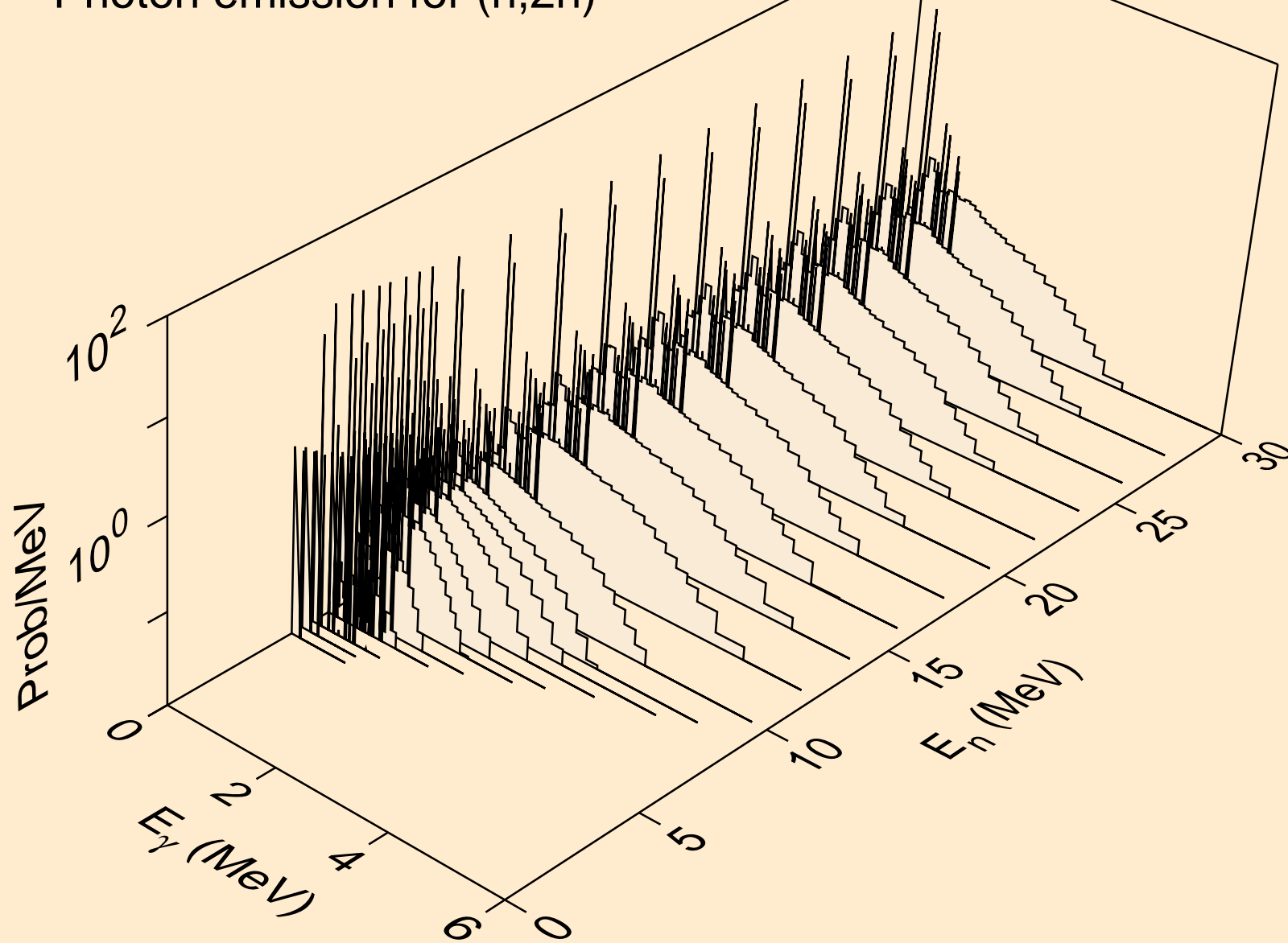

CE149 NEUTRON ACER TENDL-2024 LIBRARY; T=0.K
Photon emission for (n,3n)

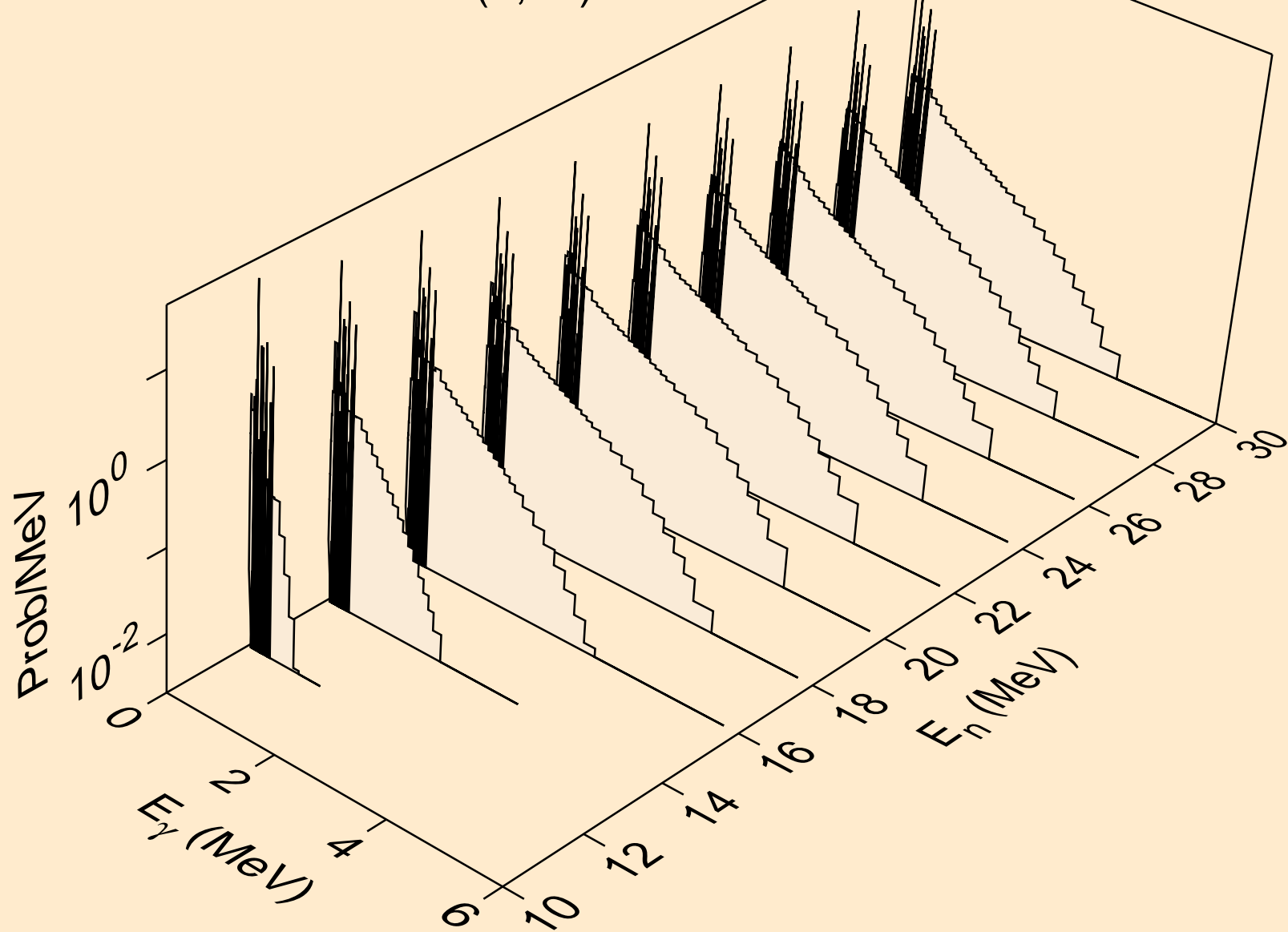

CE149 NEUTRON ACER TENDL-2024 LIBRARY; T=0.K
Photon emission for (n,n*)a

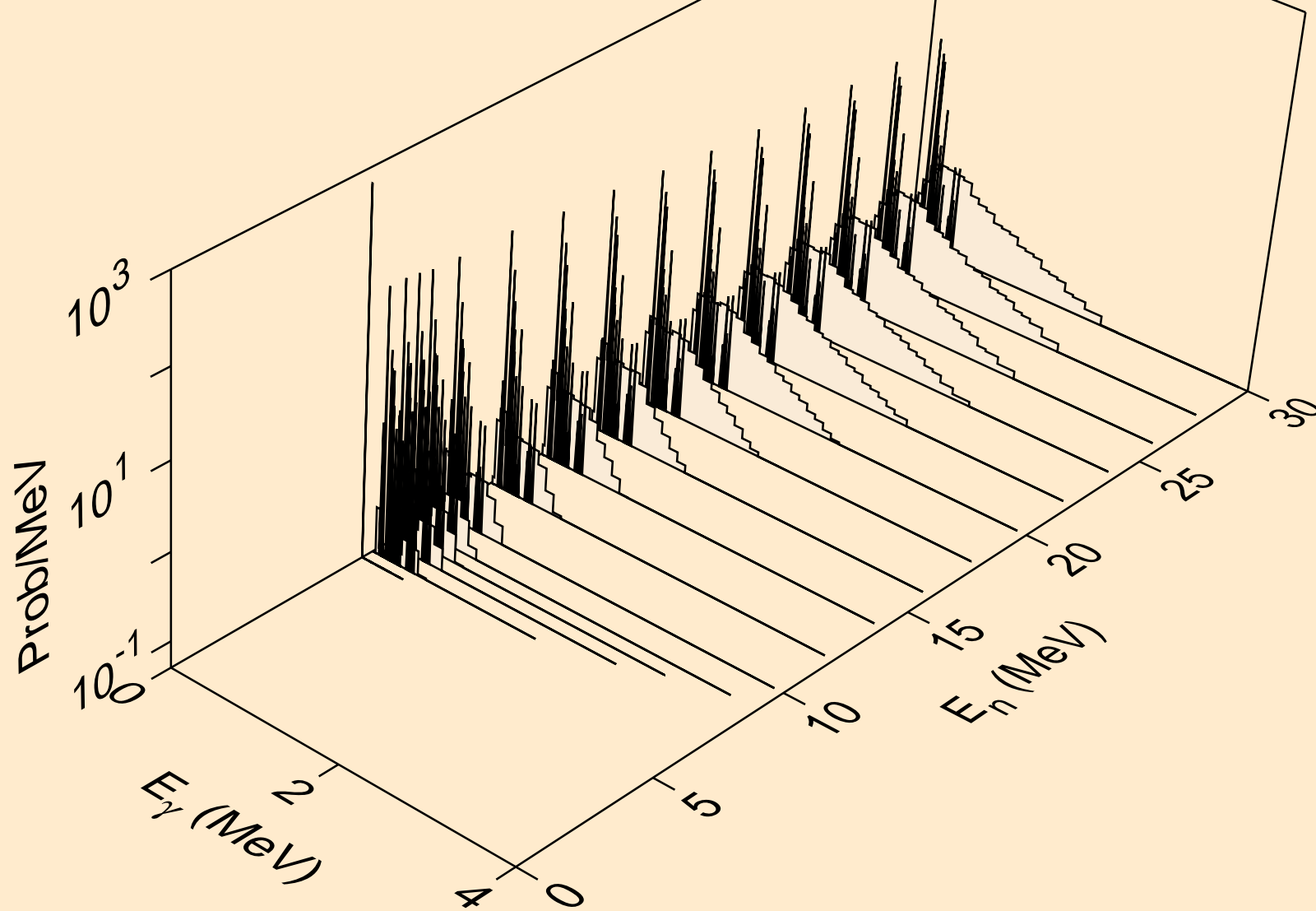

CE149 NEUTRON ACER TENDL-2024 LIBRARY; T=0.K
Photon emission for (n,2n)a

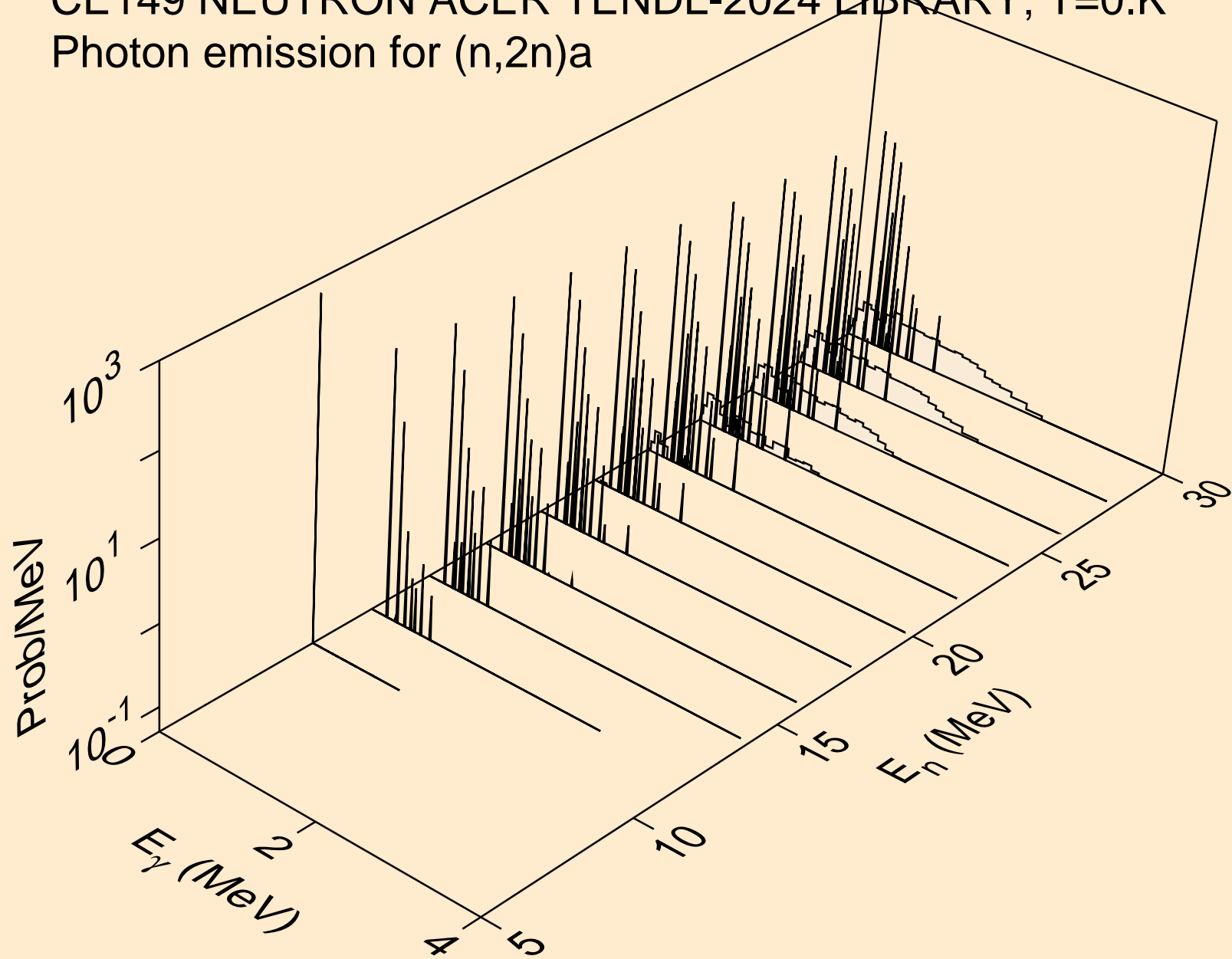

CE149 NEUTRON ACER TENDL-2024 LIBRARY; T=0.K
Photon emission for (n,3n)a

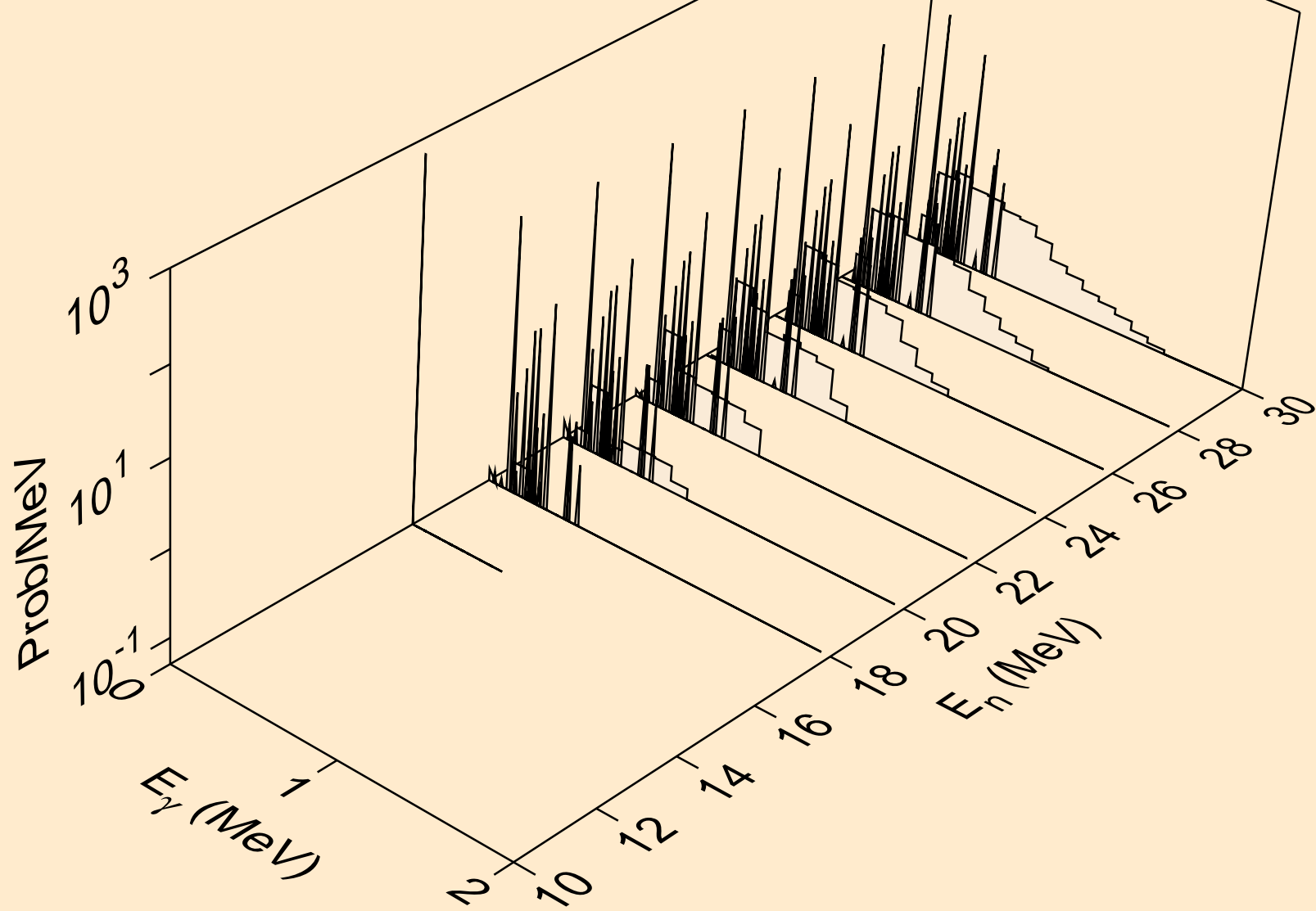

CE149 NEUTRON ACER TENDL-2024 LIBRARY; T=0.K
Photon emission for (n,n*)p

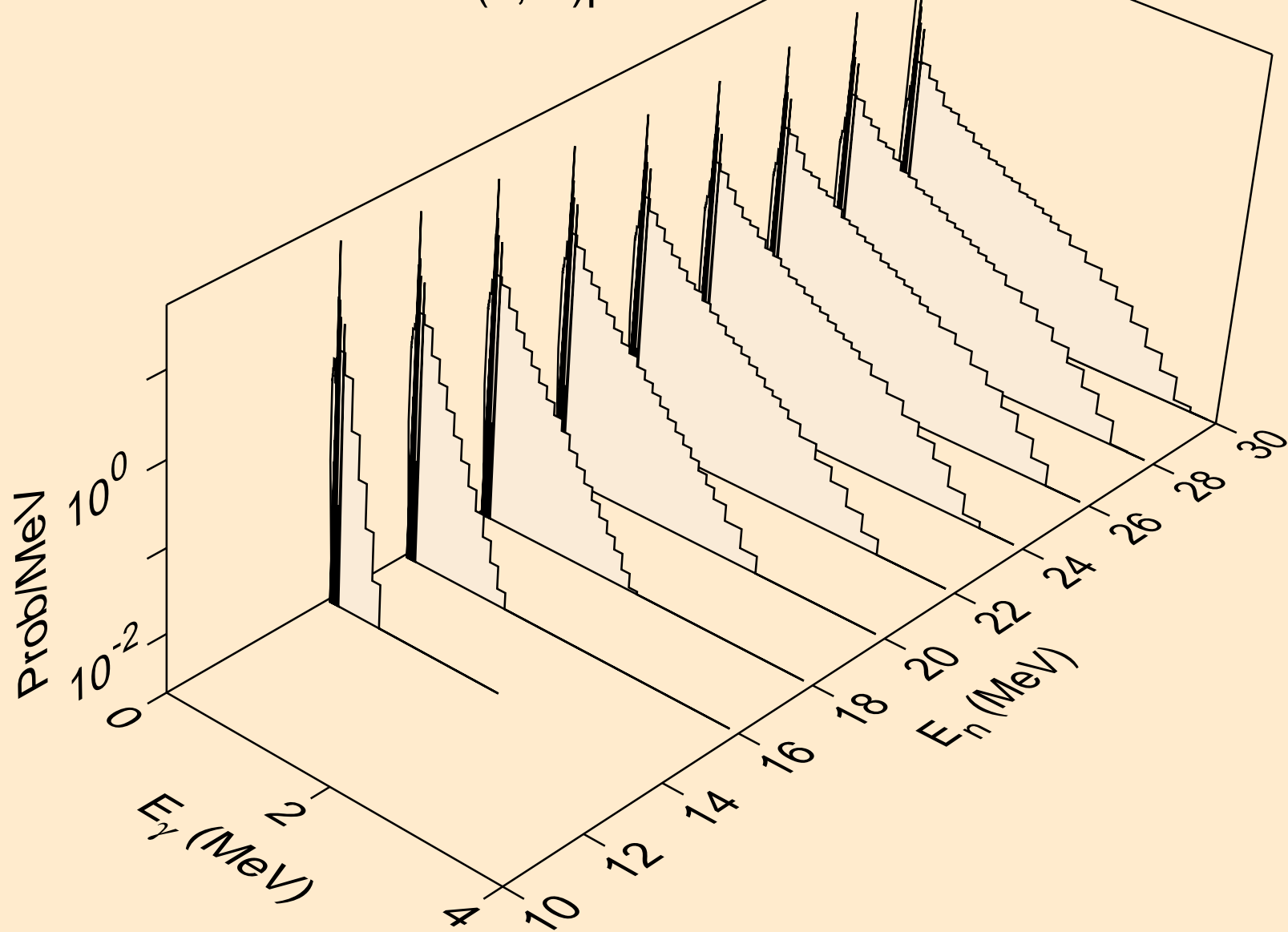

CE149 NEUTRON ACER TENDL-2024 LIBRARY; T=0.K
Photon emission for (n,n*)d

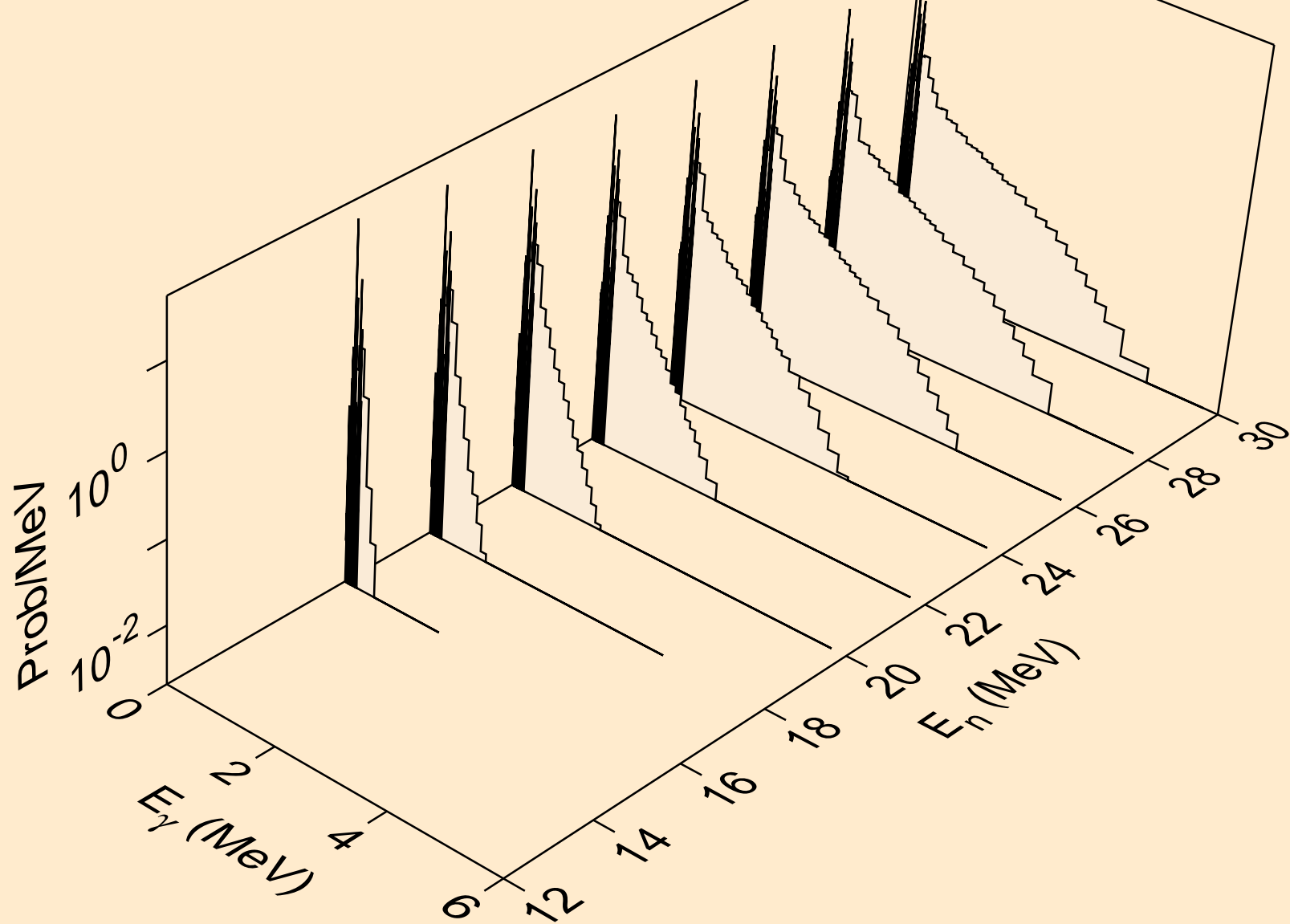

CE149 NEUTRON ACER TENDL-2024 LIBRARY; T=0.K
Photon emission for (n,n*)t

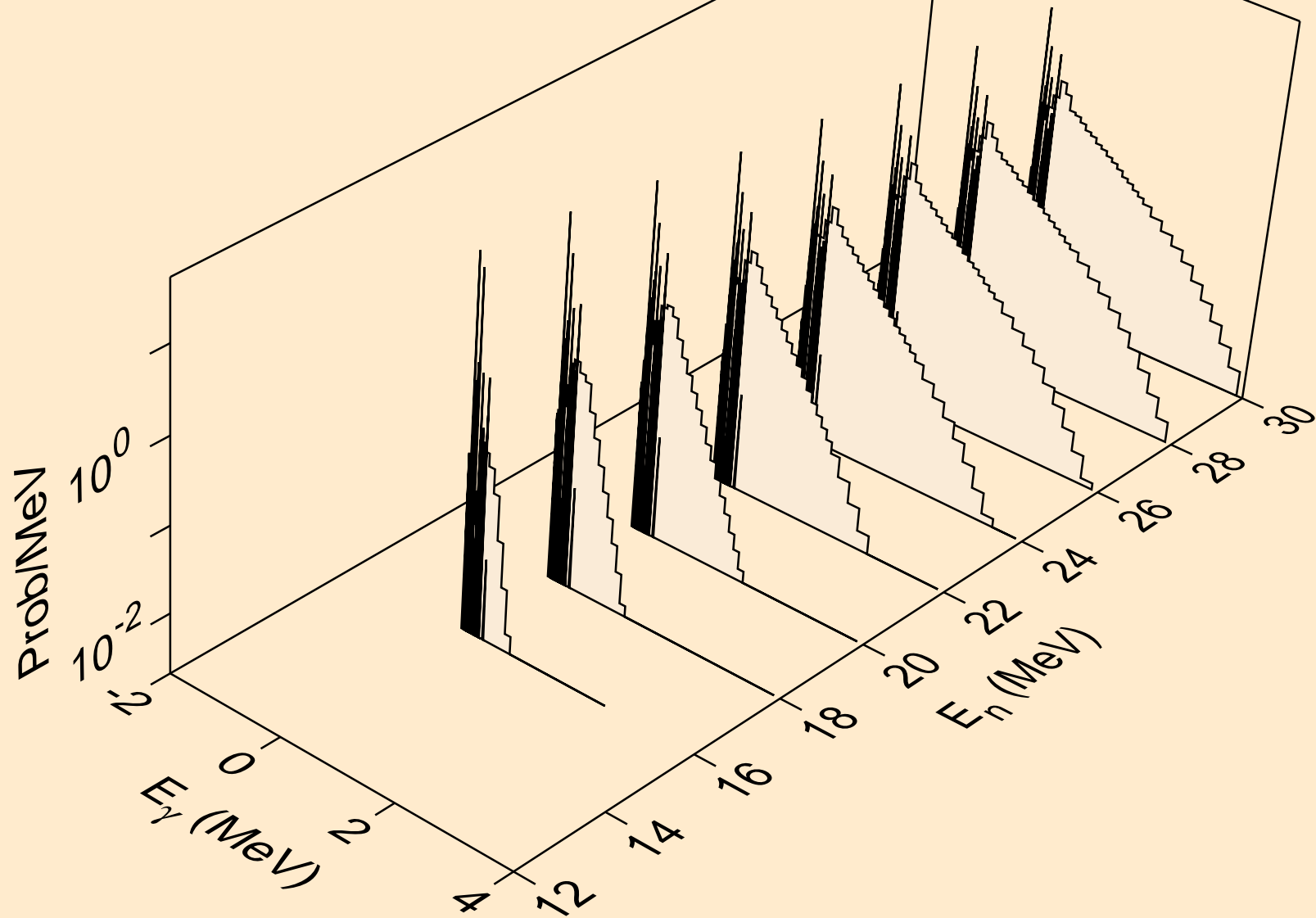

CE149 NEUTRON ACER TENDL-2024 LIBRARY; T=0.K
Photon emission for (n,n*)he3

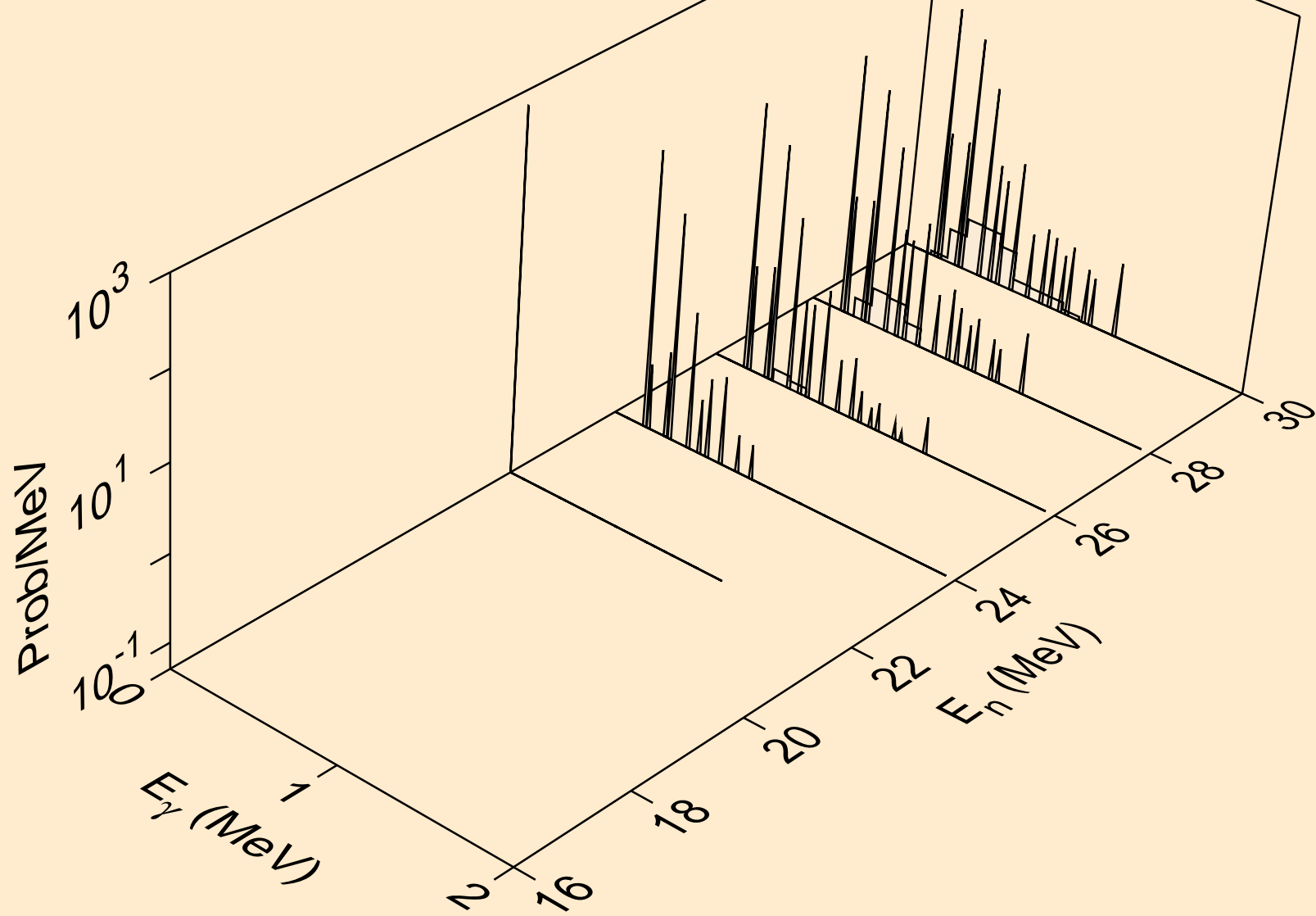

CE149 NEUTRON ACER TENDL-2024 LIBRARY; T=0.K
Photon emission for (n,4n)

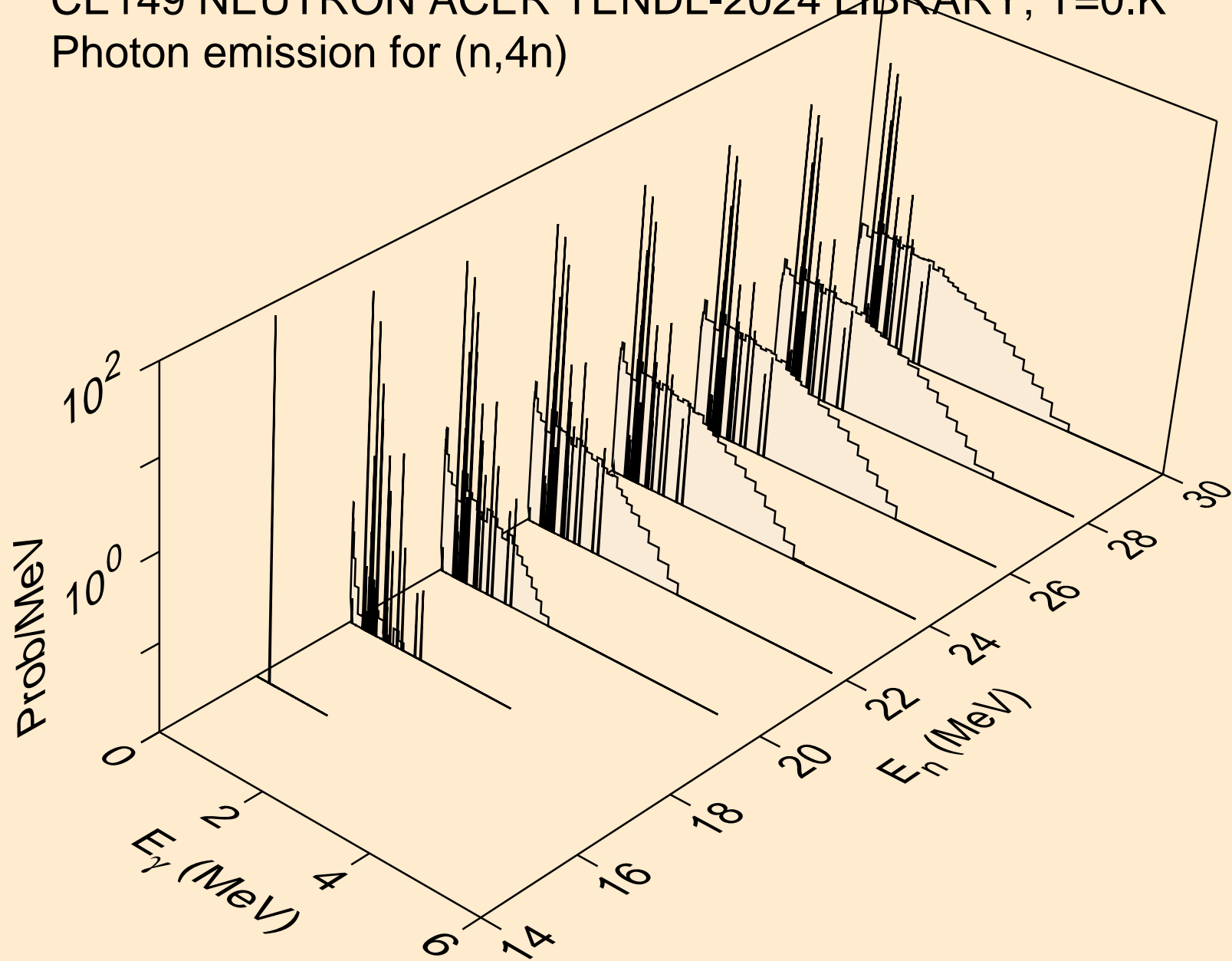

CE149 NEUTRON ACER TENDL-2024 LIBRARY; T=0.K
Photon emission for (n,2np)

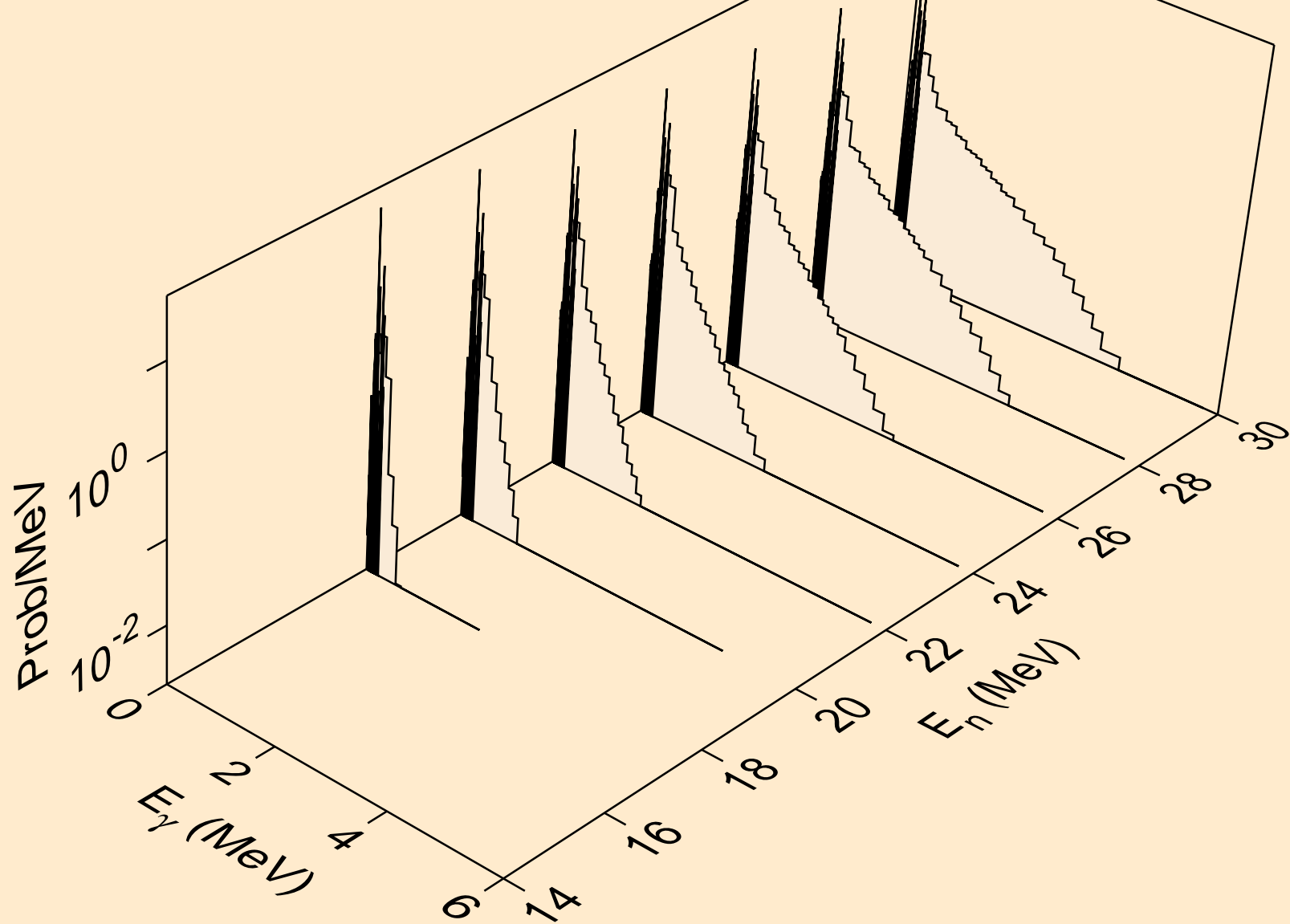

CE149 NEUTRON ACER TENDL-2024 LIBRARY; T=0.K
Photon emission for (n,3np)

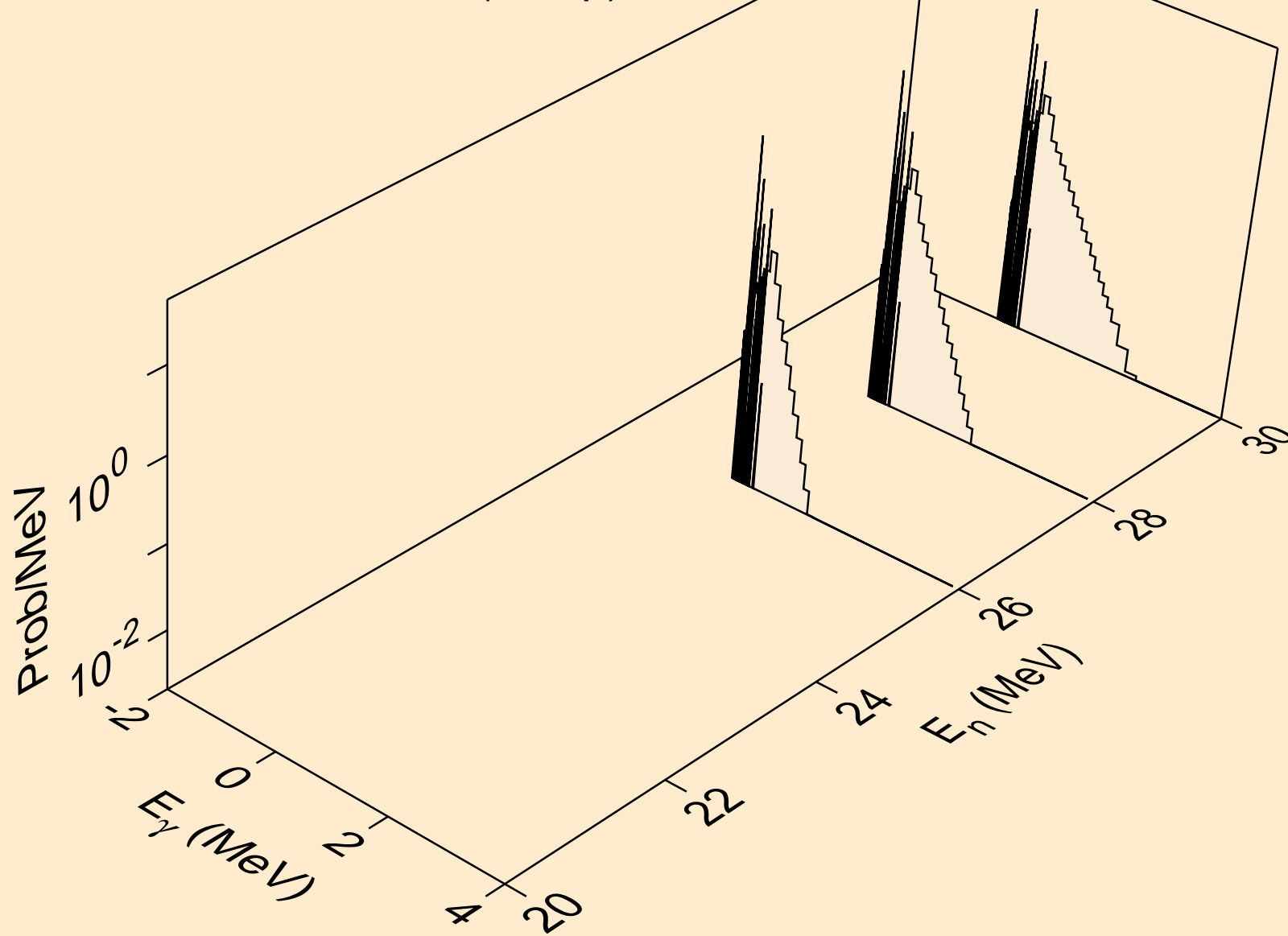

CE149 NEUTRON ACER TENDL-2024 LIBRARY; T=0.K
Photon emission for (n,n*c)

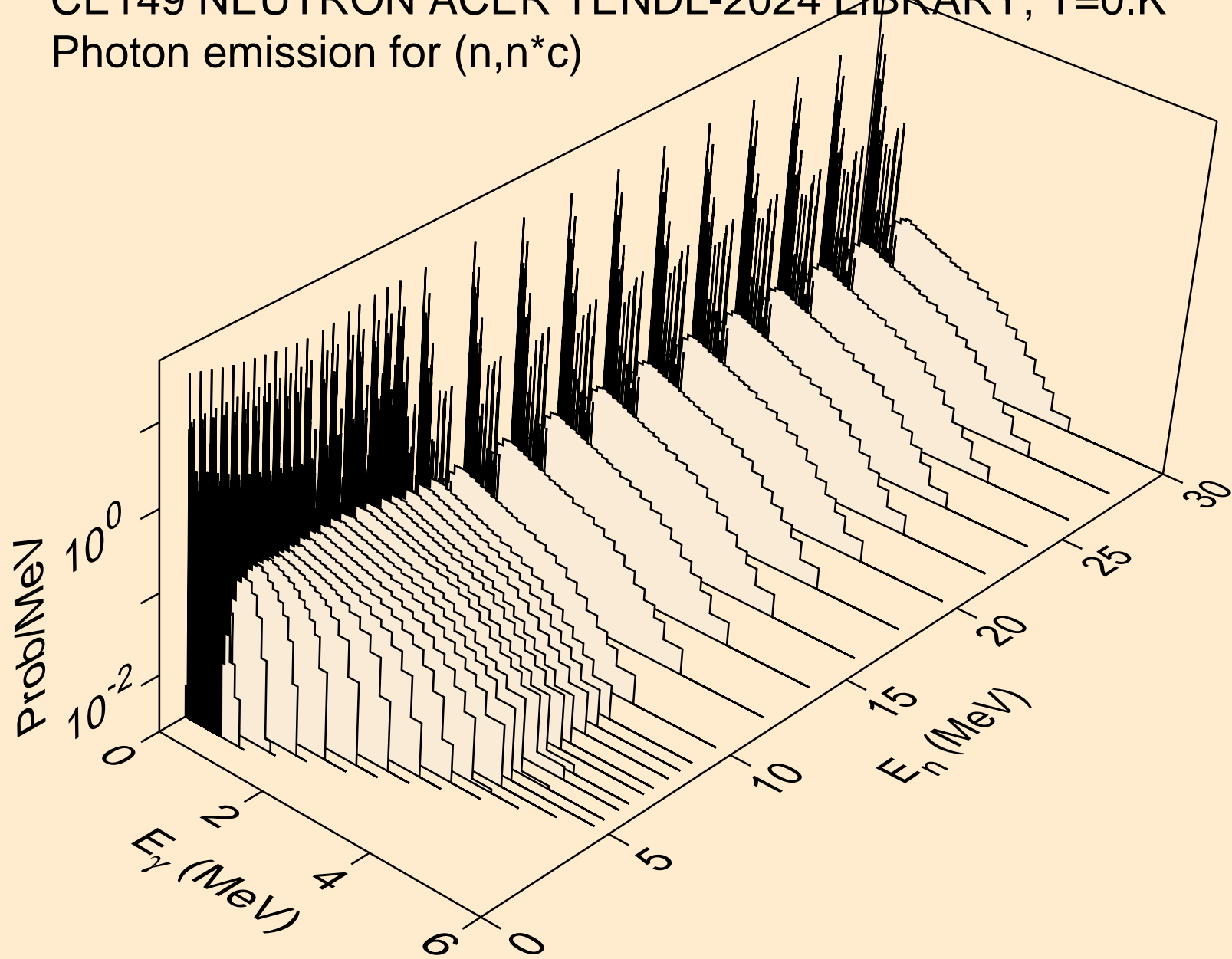

CE149 NEUTRON ACER TENDL-2024 LIBRARY; T=0.K
Photon emission for (n,gma)

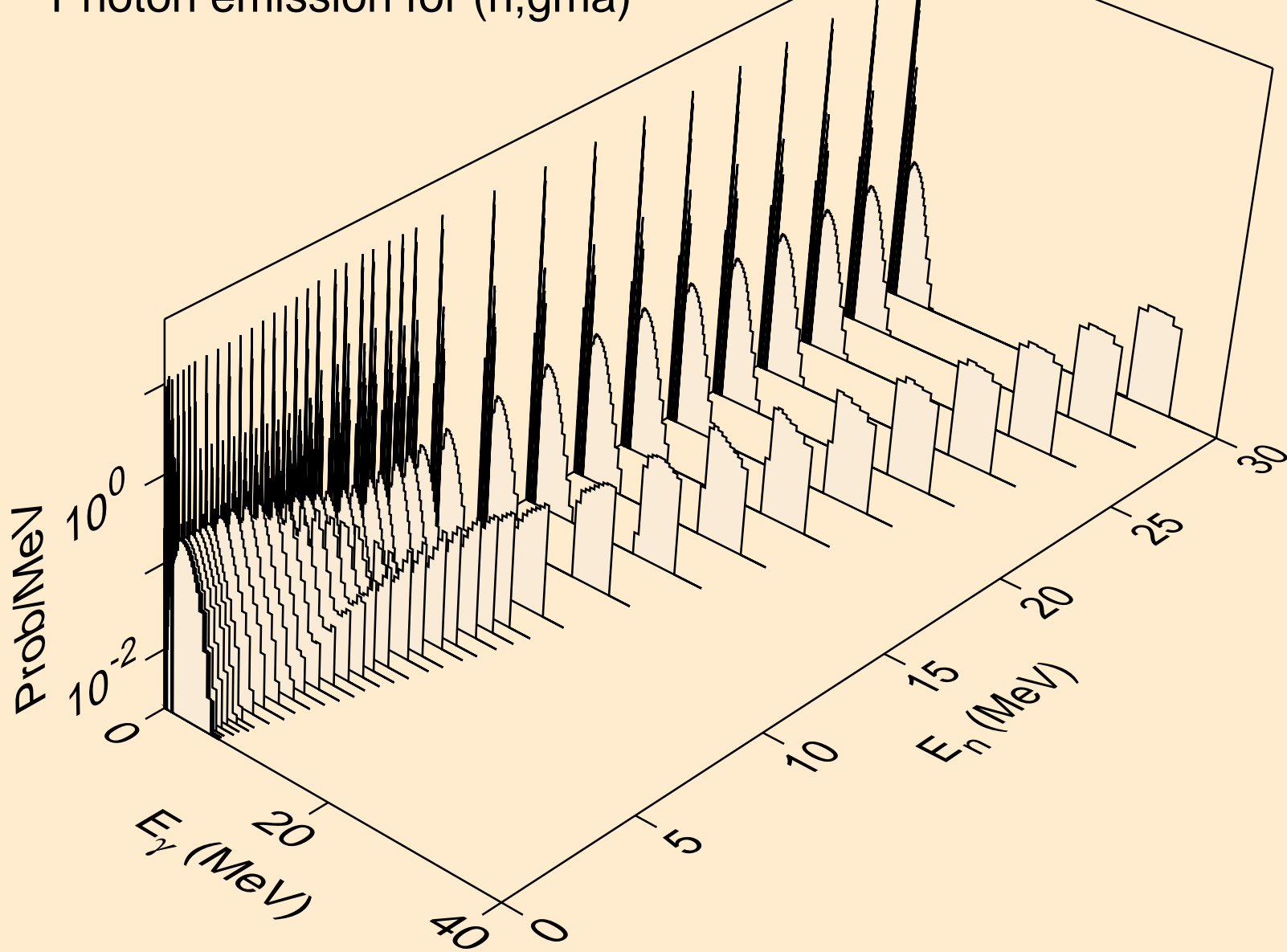

CE149 NEUTRON ACER TENDL-2024 LIBRARY; T=0.K
Photon emission for (n,p)

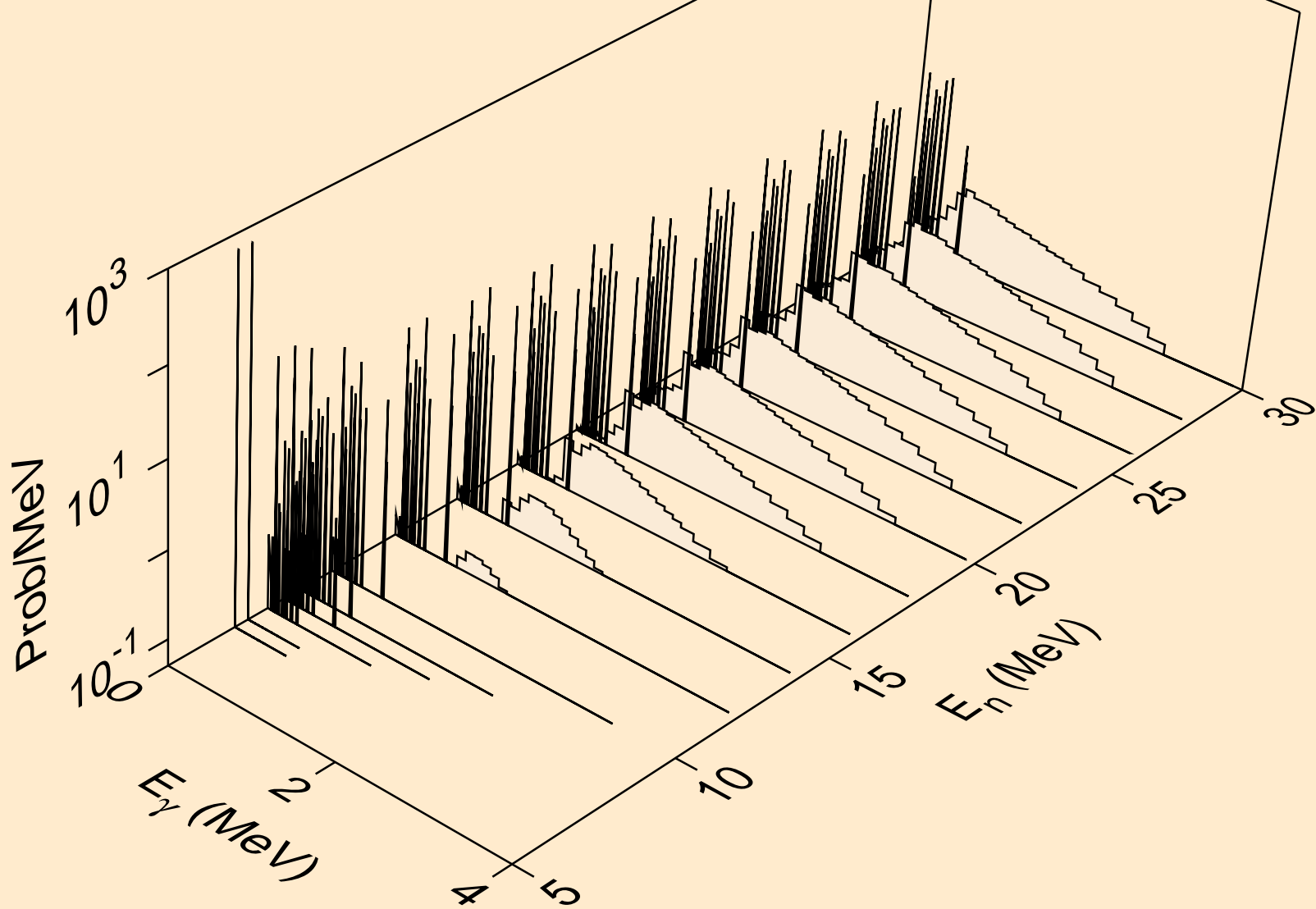

CE149 NEUTRON ACER TENDL-2024 LIBRARY; T=0.K
Photon emission for (n,d)

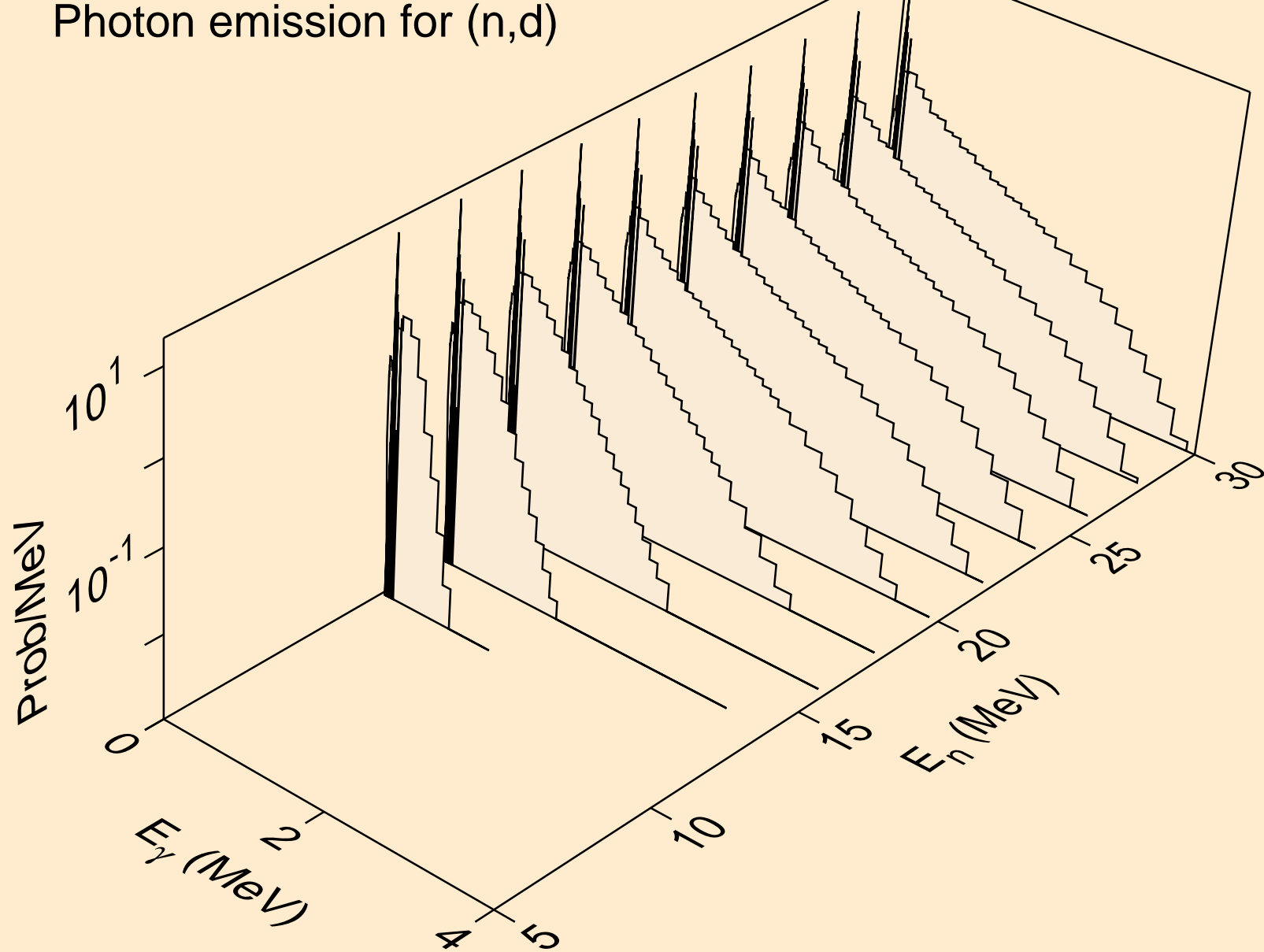

CE149 NEUTRON ACER TENDL-2024 LIBRARY; T=0.K
Photon emission for (n,t)

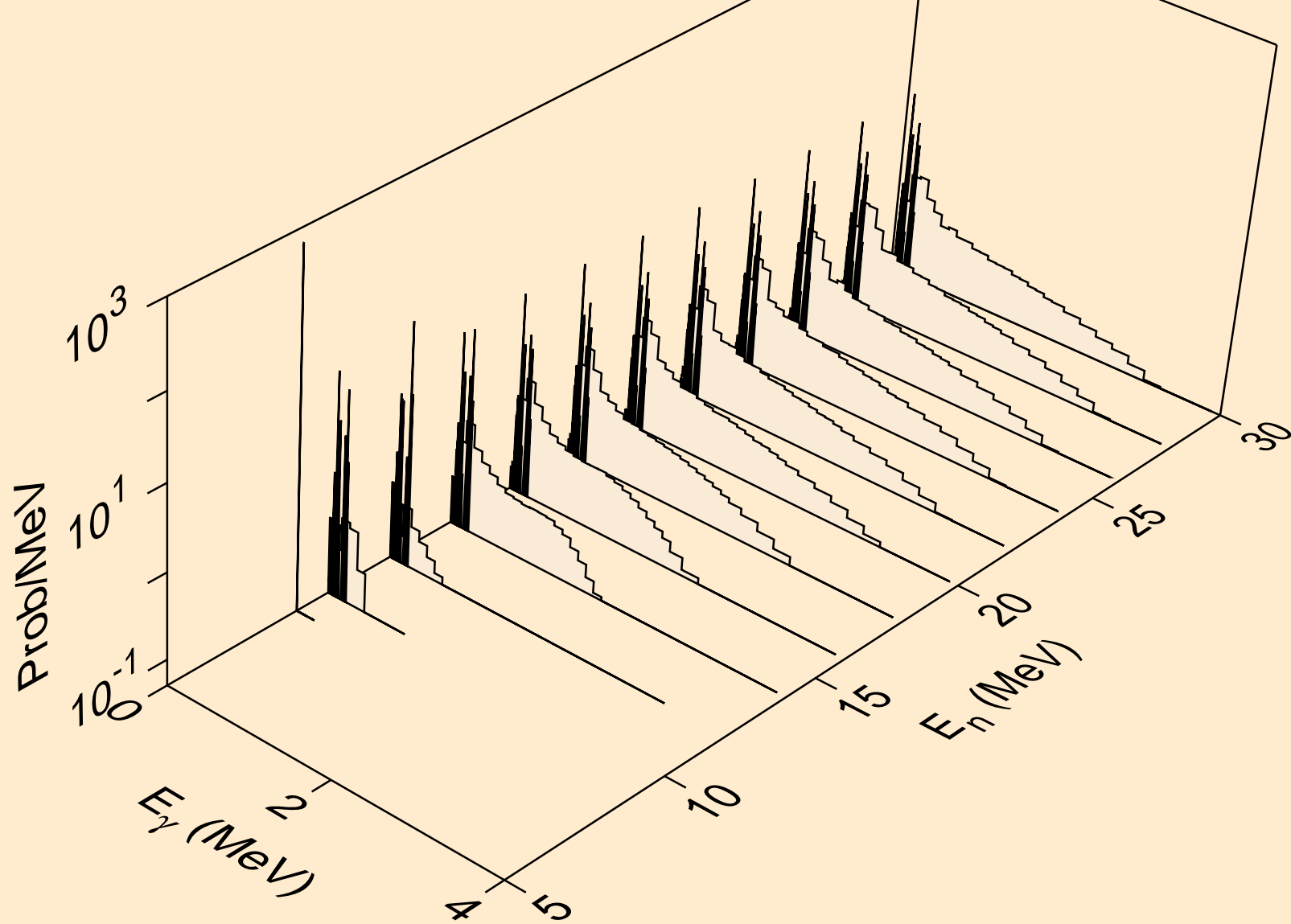

CE149 NEUTRON ACER TENDL-2024 LIBRARY; T=0.K
Photon emission for (n,he3)

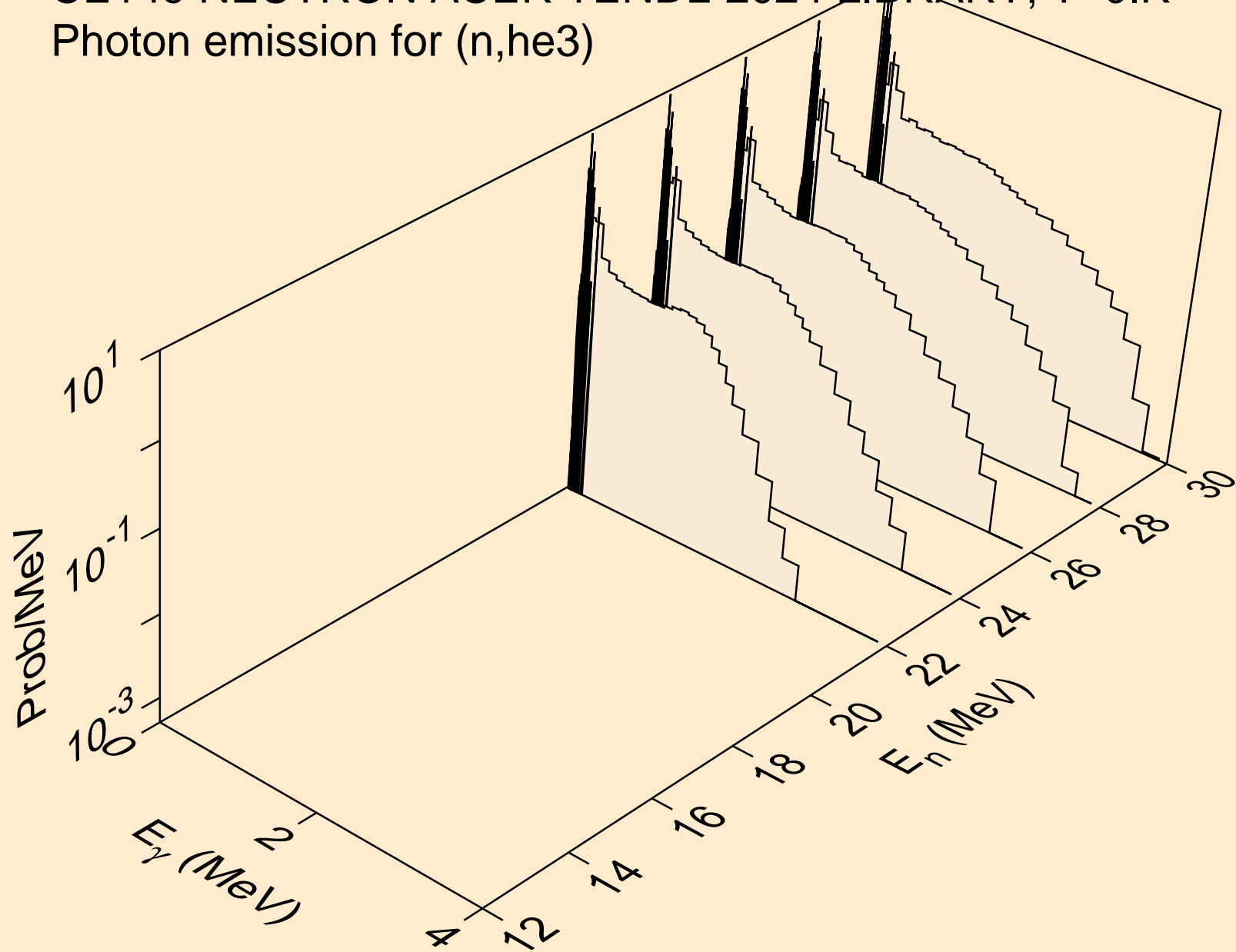

CE149 NEUTRON ACER TENDL-2024 LIBRARY; T=0.K
Photon emission for (n,a)

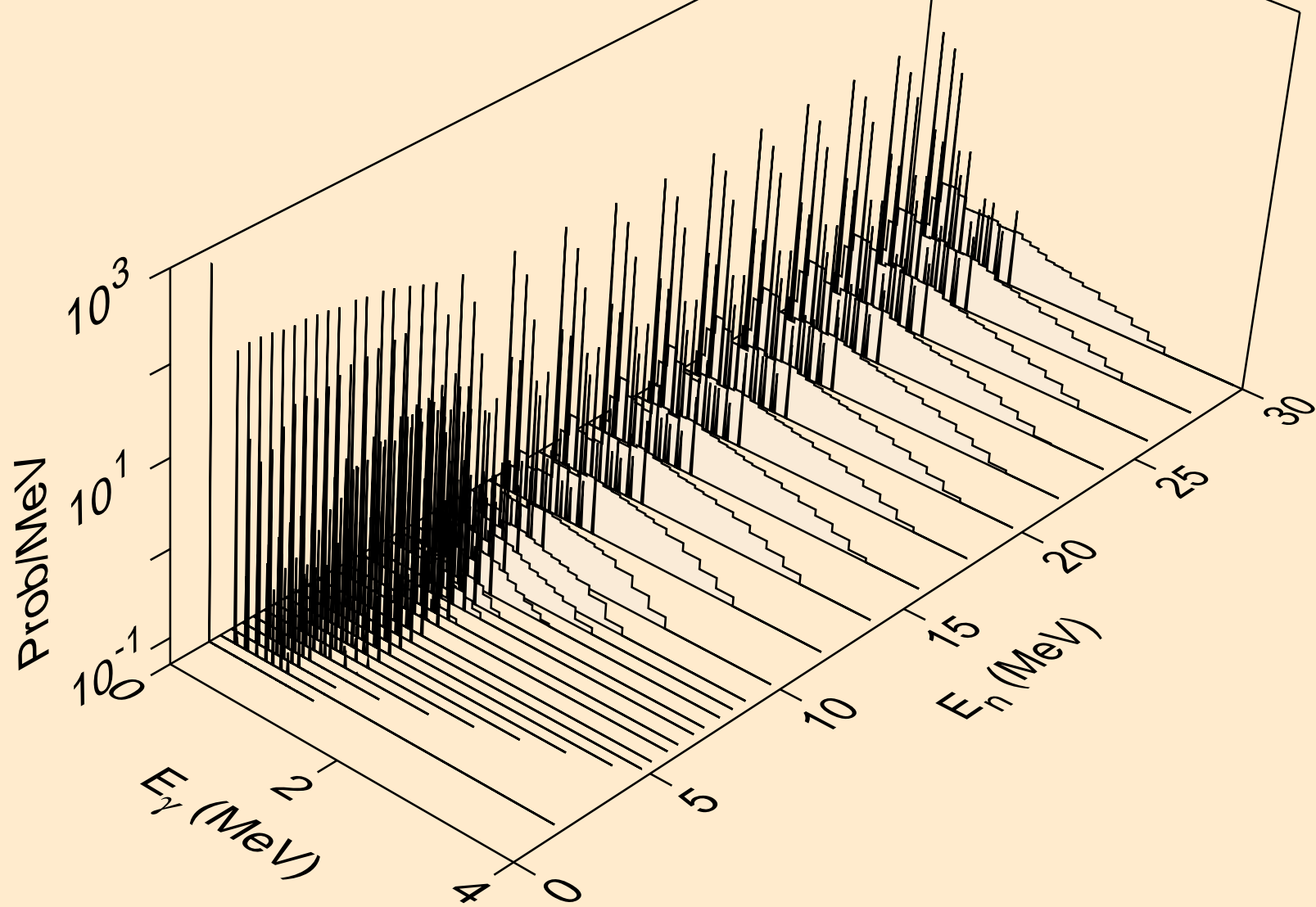

CE149 NEUTRON ACER TENDL-2024 LIBRARY; T=0.K
Photon emission for (n,2p)

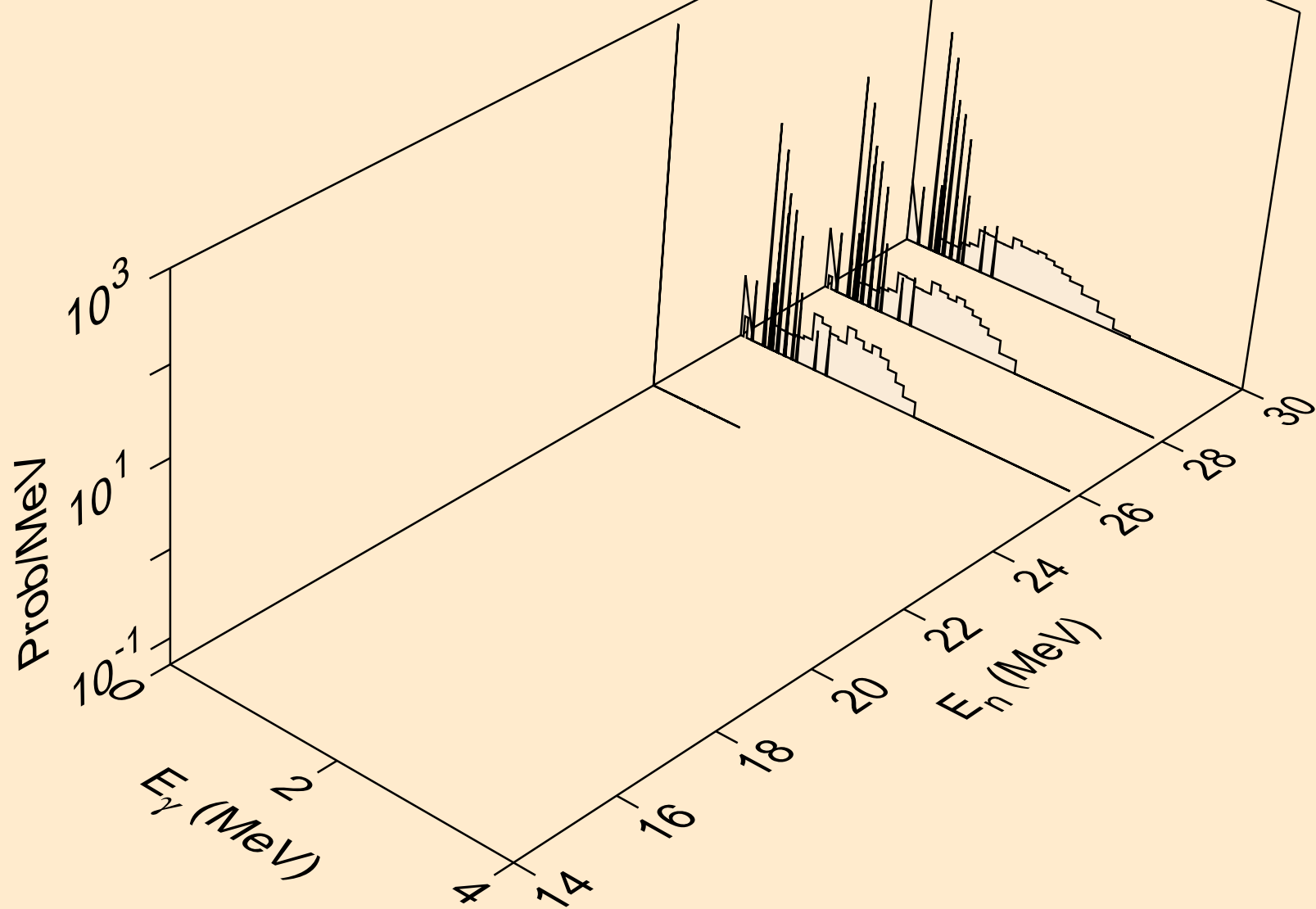

CE149 NEUTRON ACER TENDL-2024 LIBRARY; T=0.K
thermal capture photon spectrum

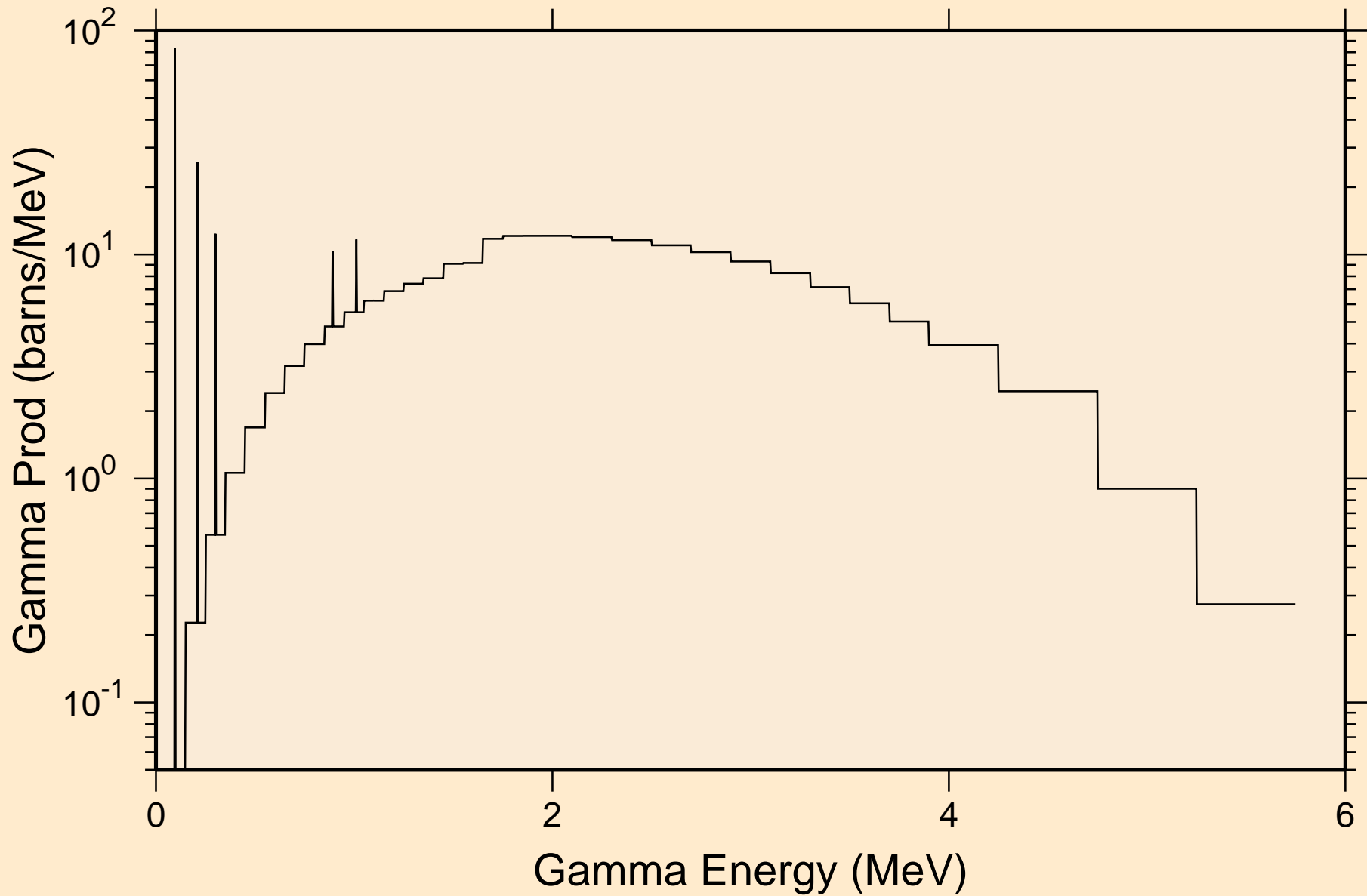

CE149 NEUTRON ACER TENDL-2024 LIBRARY; T=0.K
14 MeV photon spectrum

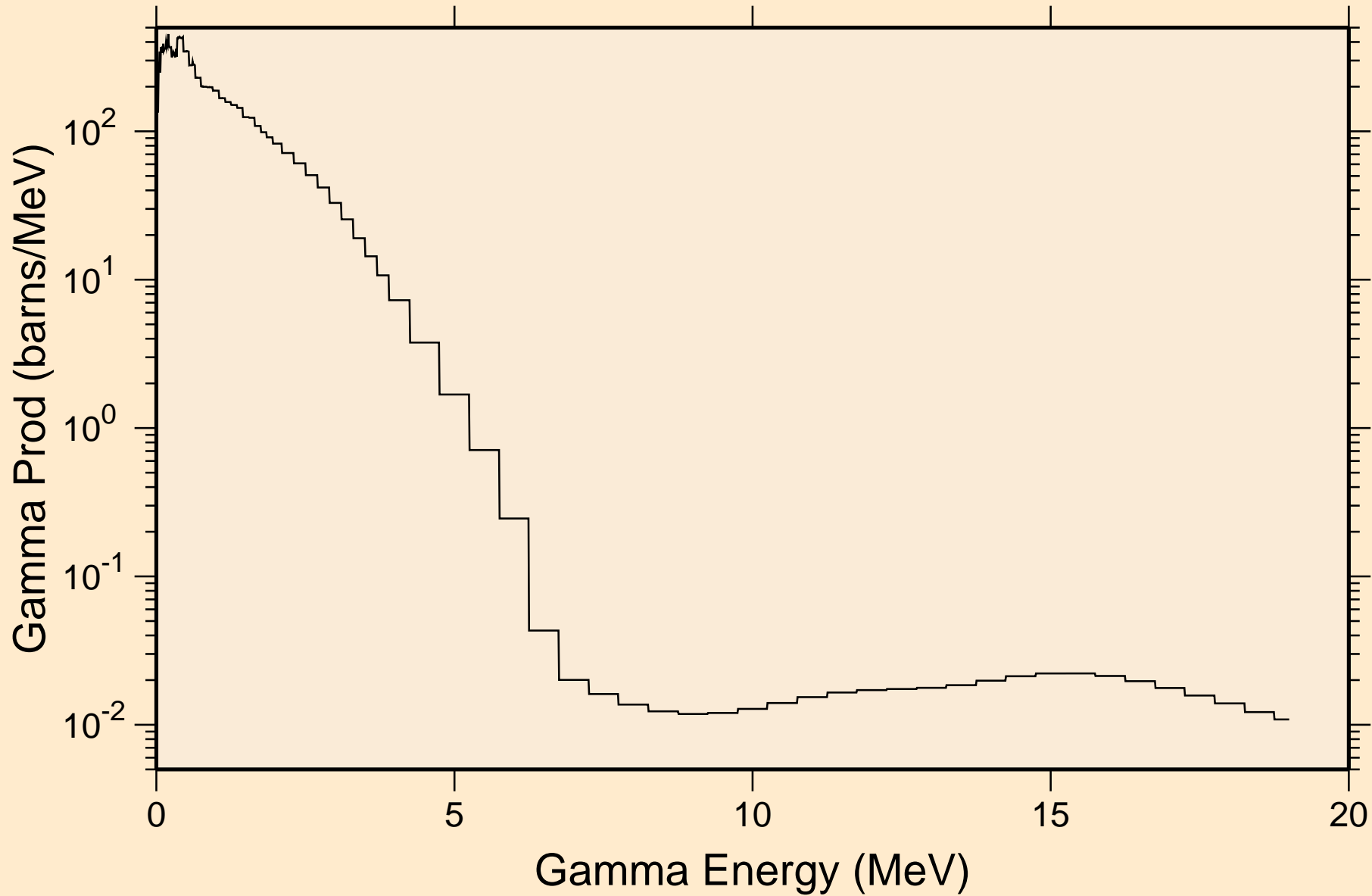

CE149 NEUTRON ACER TENDL-2024 LIBRARY; T=0.K

Particle heating contributions

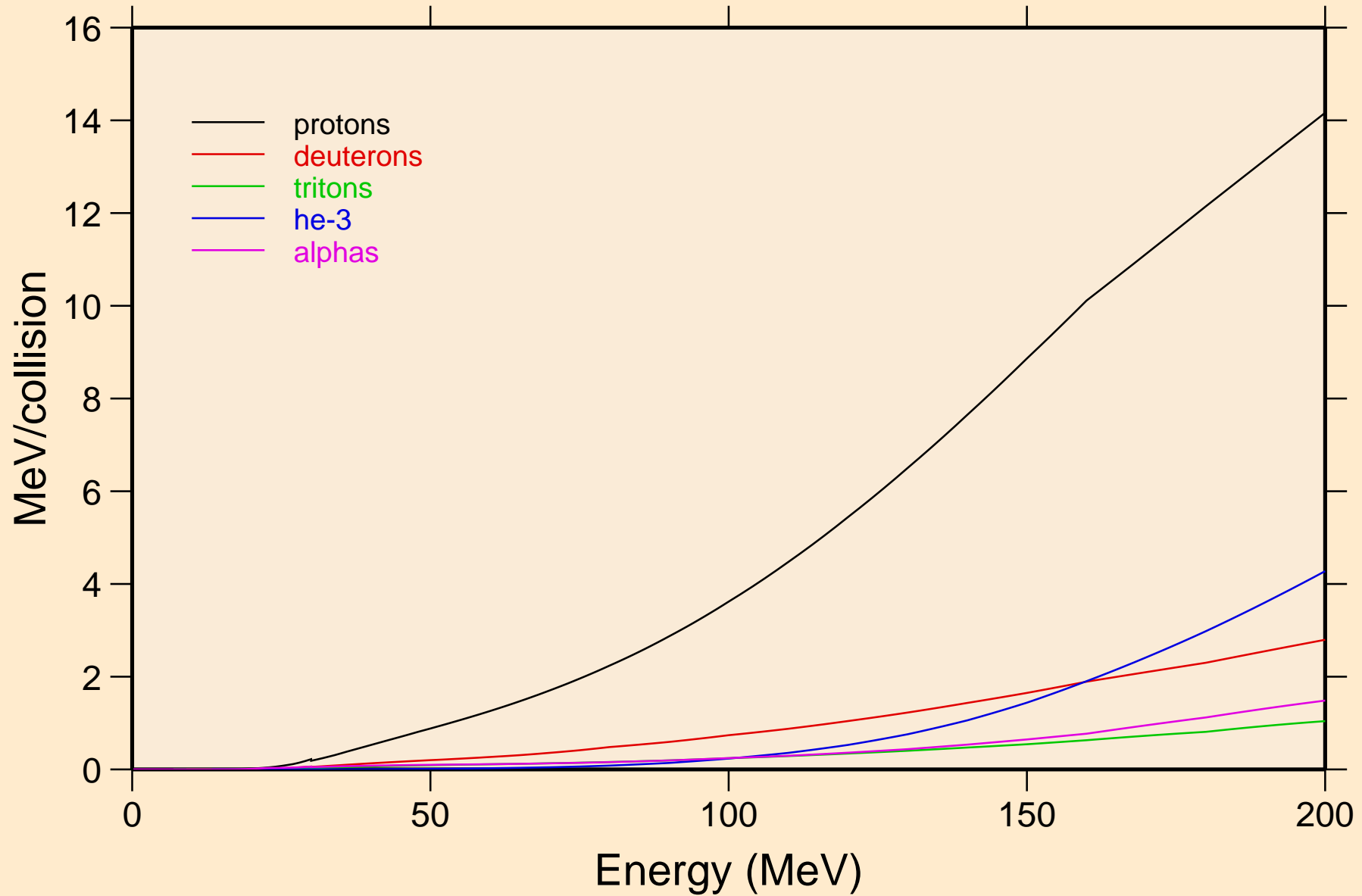

CE149 NEUTRON ACER TENDL-2024 LIBRARY; T=0.K
Recoil Heating

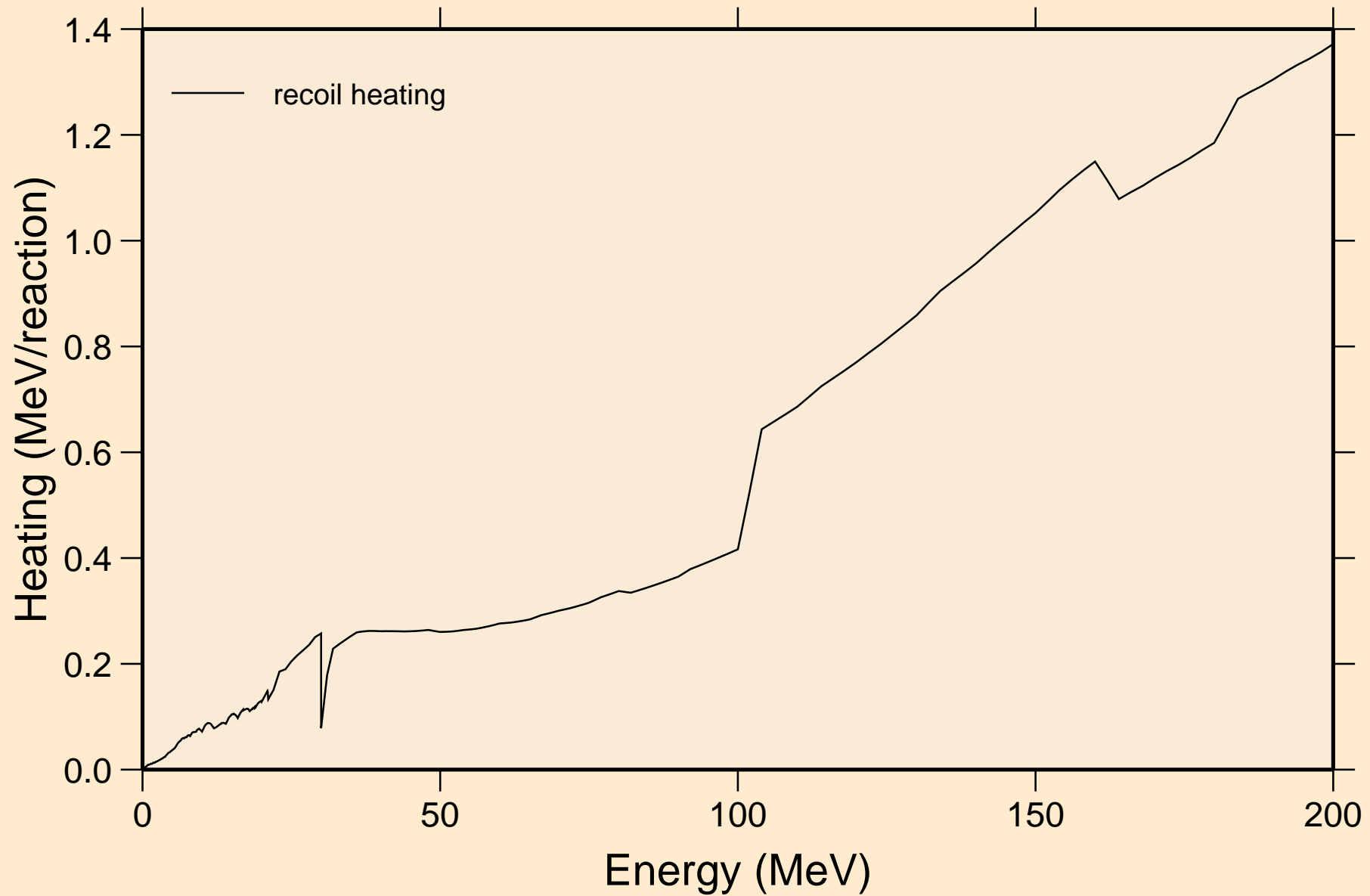

CE149 NEUTRON ACER TENDL-2024 LIBRARY; T=0.K
Particle production cross sections

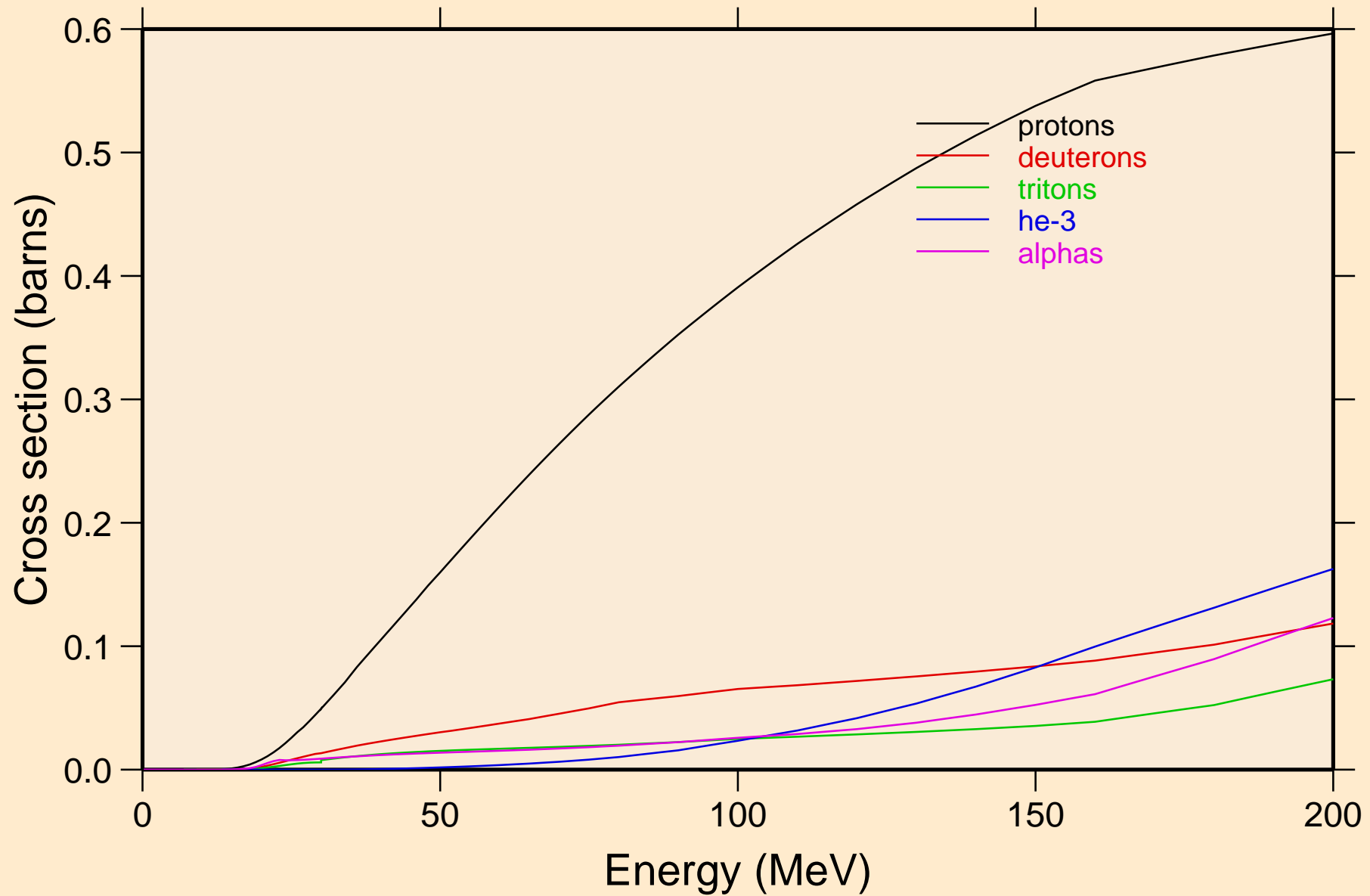

CE149 NEUTRON ACER TENDL-2024 LIBRARY; T=0.K
protons from (n,x)

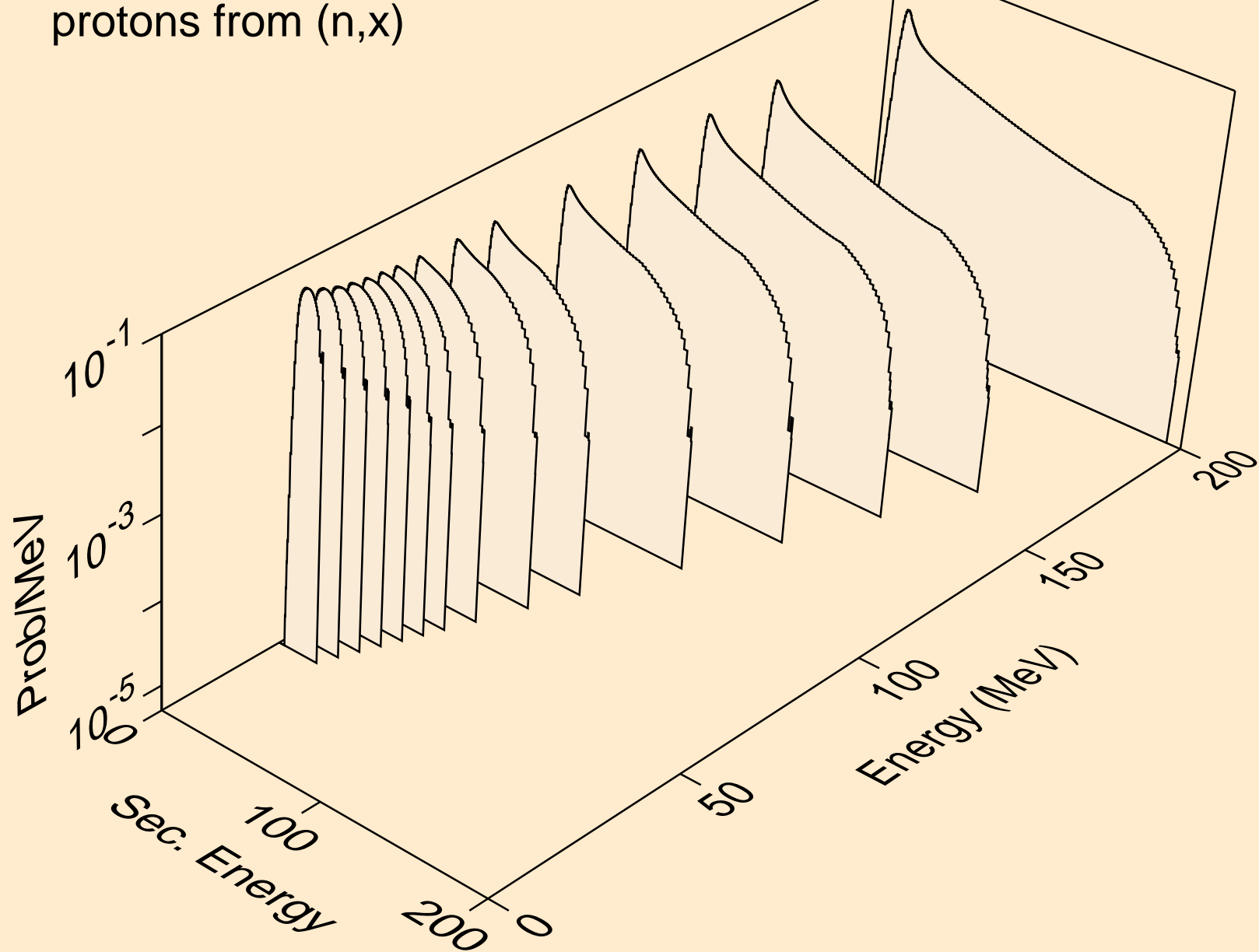

CE149 NEUTRON ACER TENDL-2024 LIBRARY; T=0.K
protons from (n,n*)p

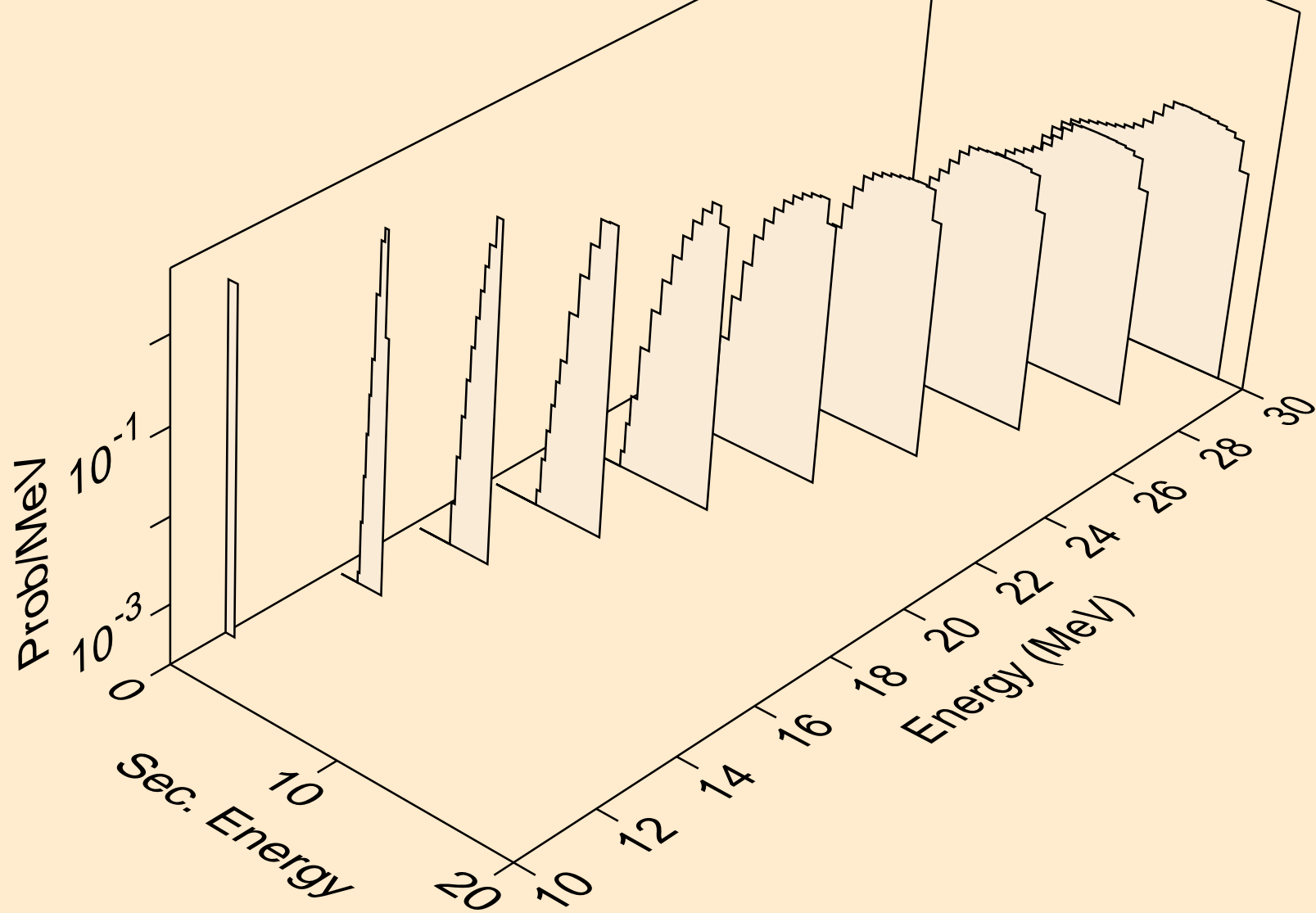

CE149 NEUTRON ACER TENDL-2024 LIBRARY; T=0.K
protons from (n,2np)

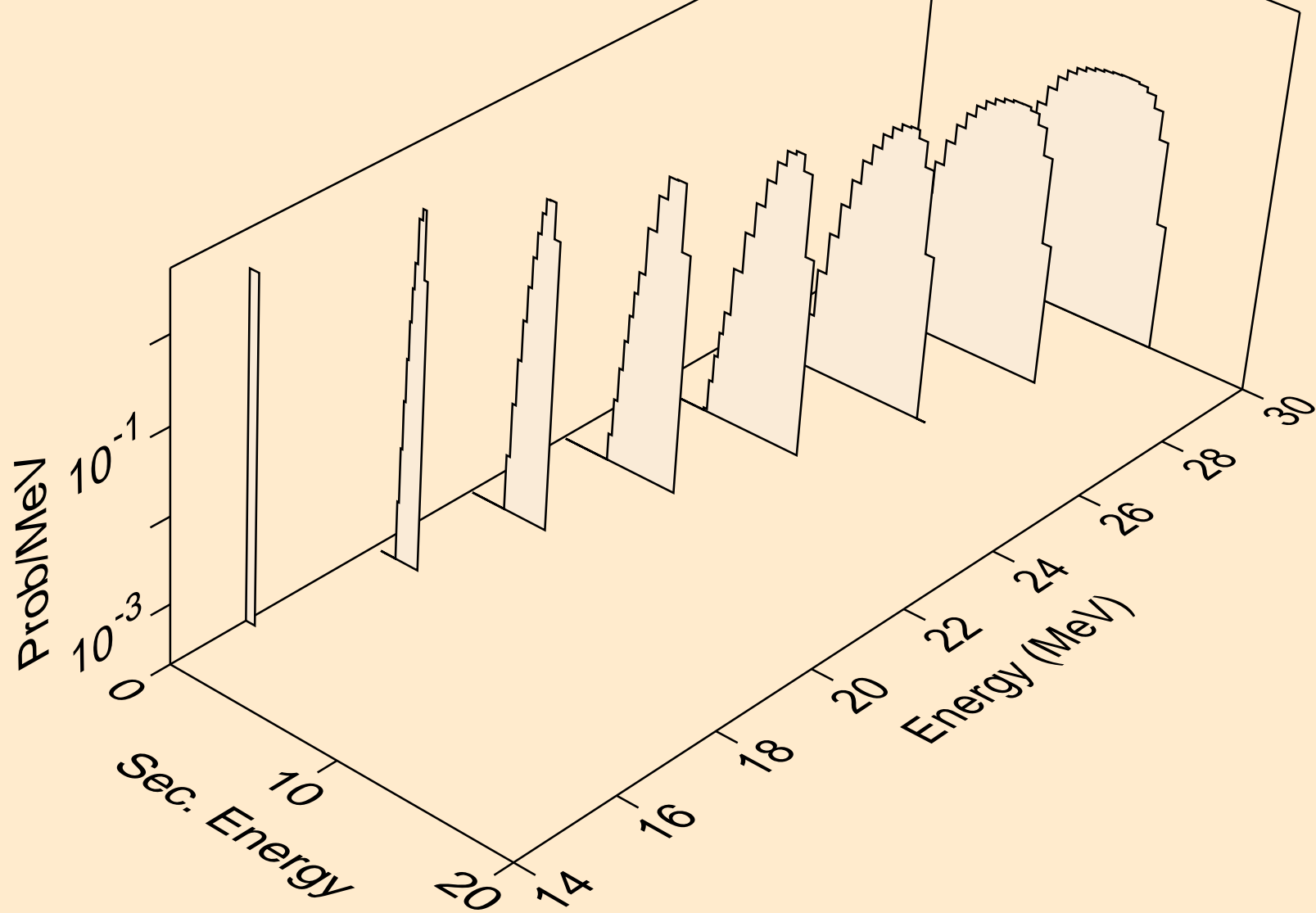

CE149 NEUTRON ACER TENDL-2024 LIBRARY; T=0.K
protons from (n,3np)

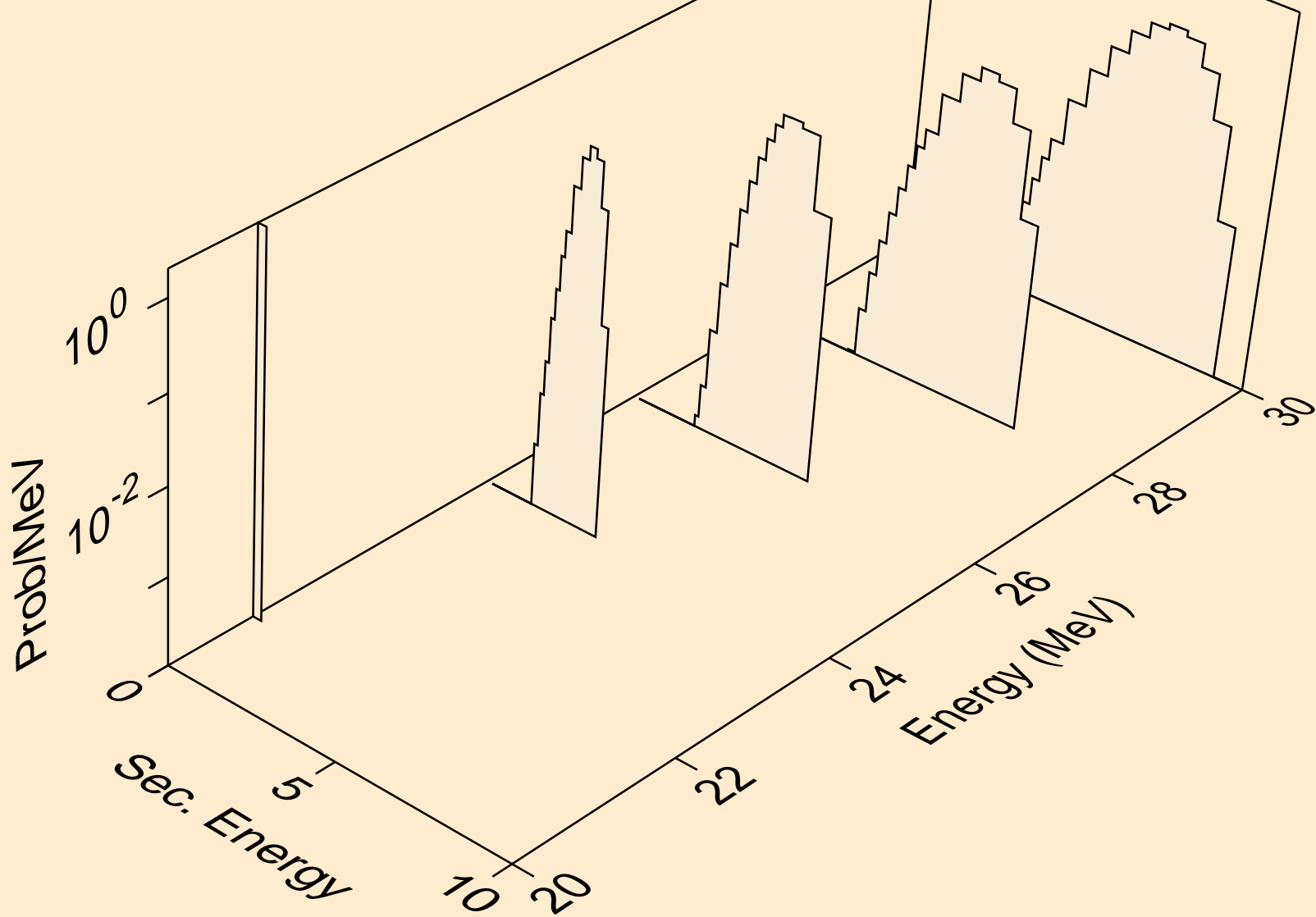

CE149 NEUTRON ACER TENDL-2024 LIBRARY; T=0.K
protons from (n,p)

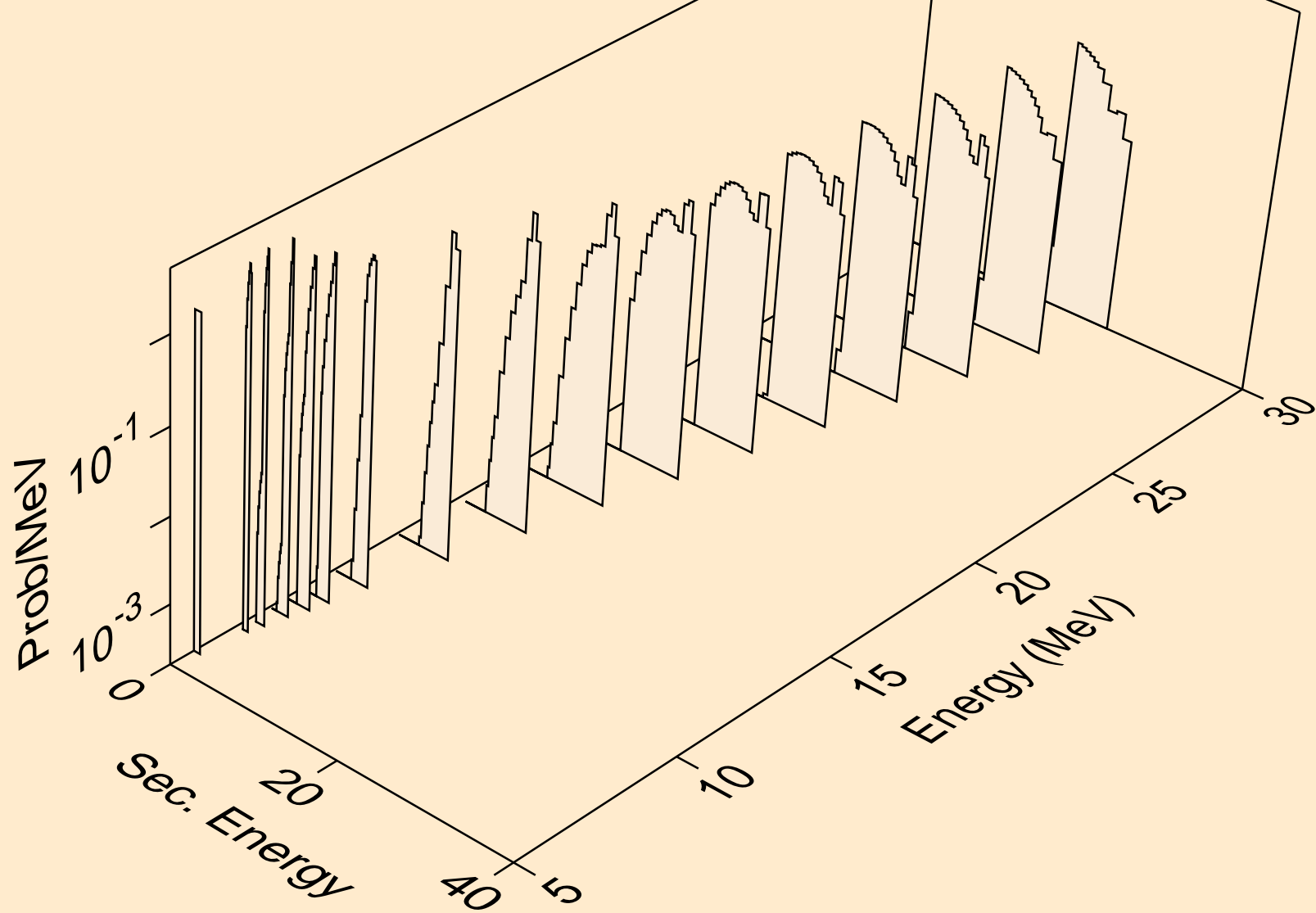

CE149 NEUTRON ACER TENDL-2024 LIBRARY; T=0.K
protons from (n,2p)

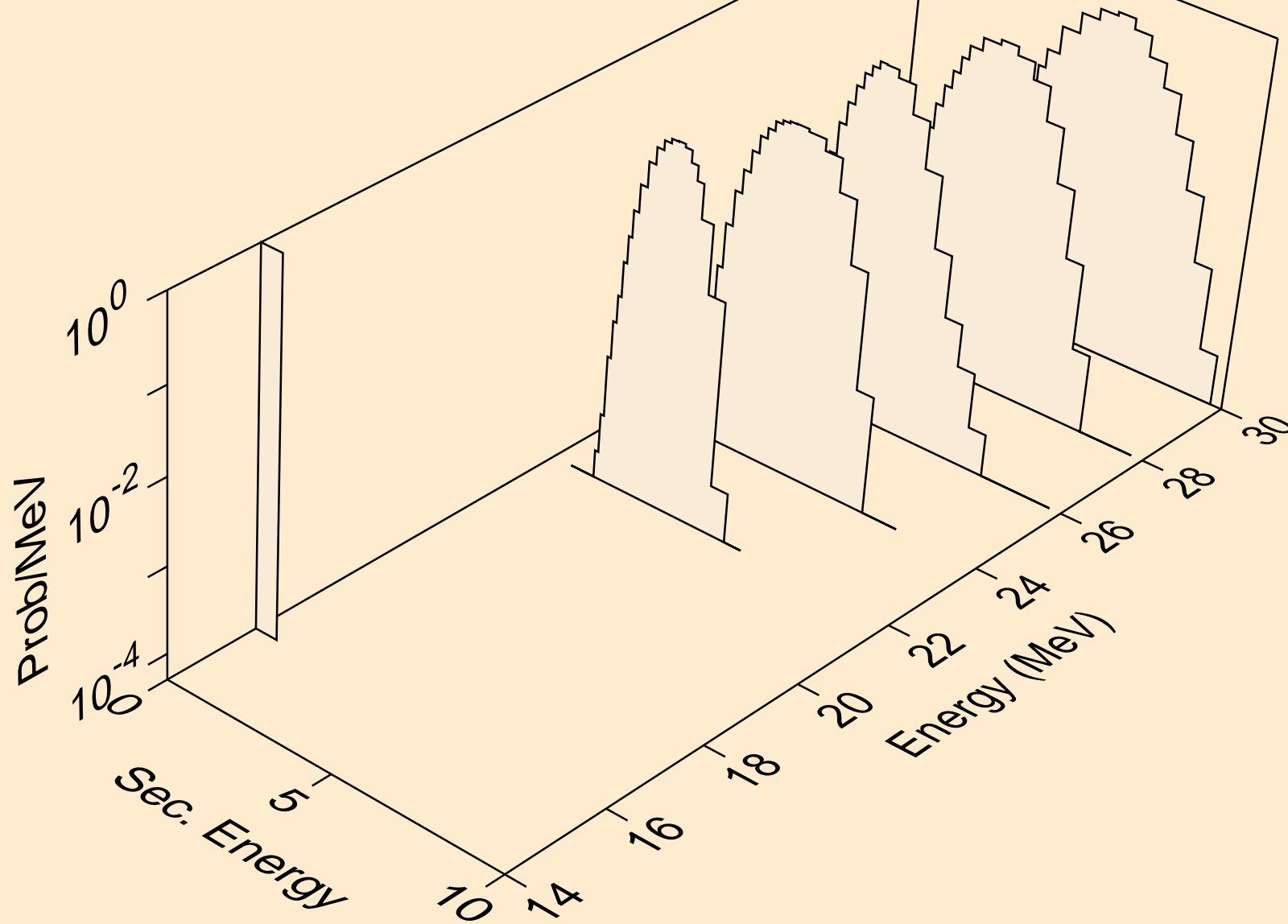

CE149 NEUTRON ACER TENDL-2024 LIBRARY; T=0.K
deuterons from (n,x)

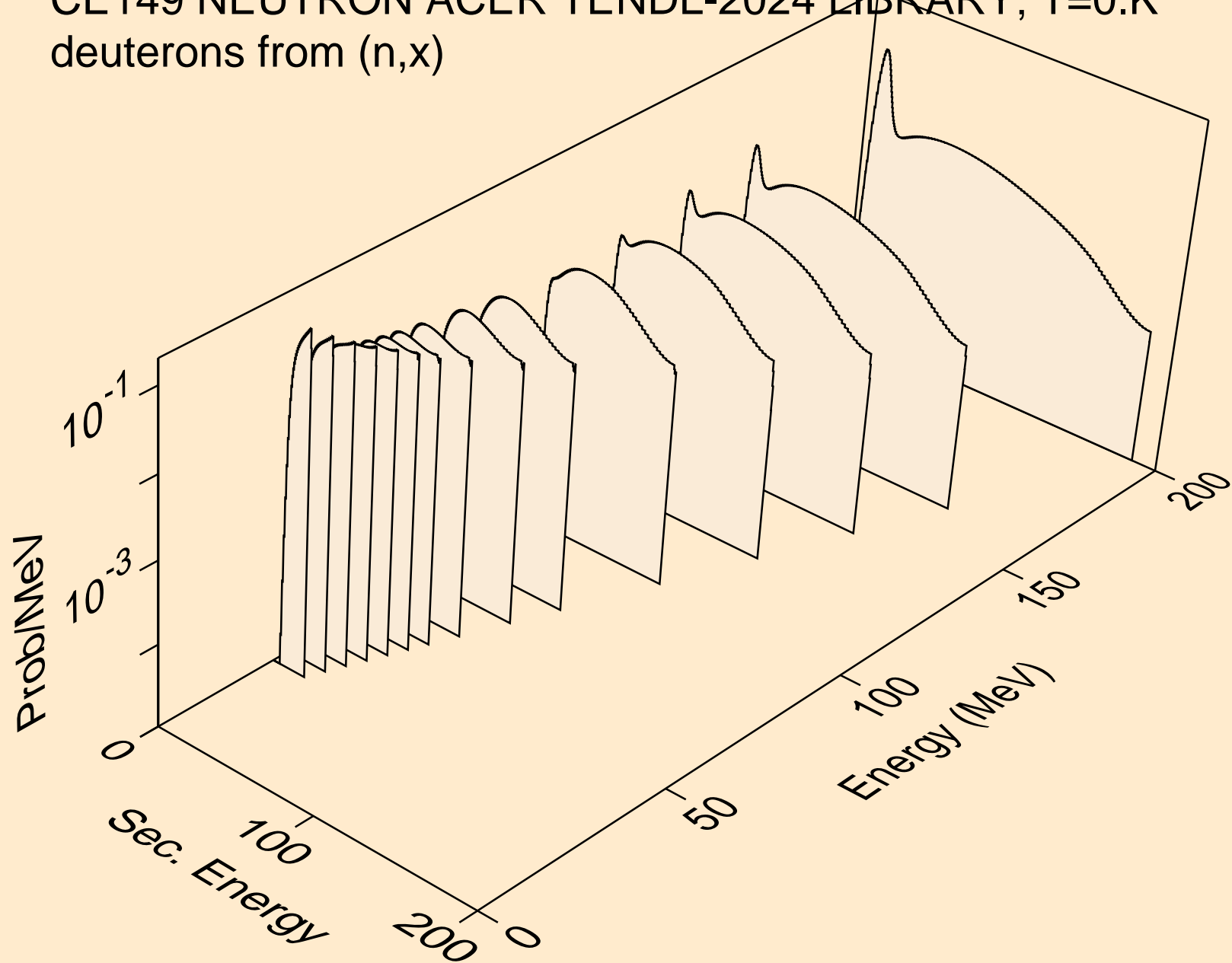

CE149 NEUTRON ACER TENDL-2024 LIBRARY; T=0.K
deuterons from (n,2nd)

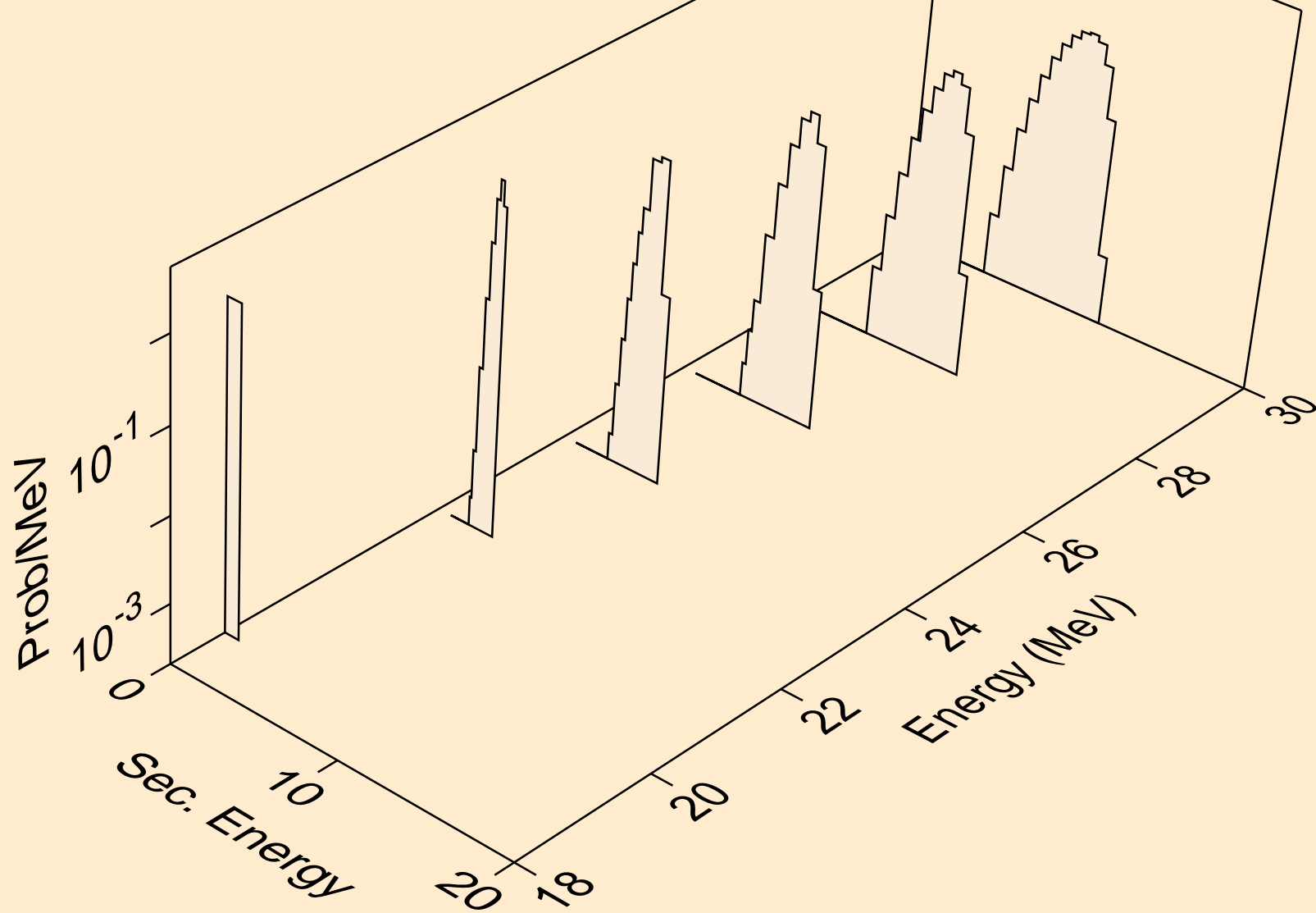

CE149 NEUTRON ACER TENDL-2024 LIBRARY; T=0.K
deuterons from (n,n*)d

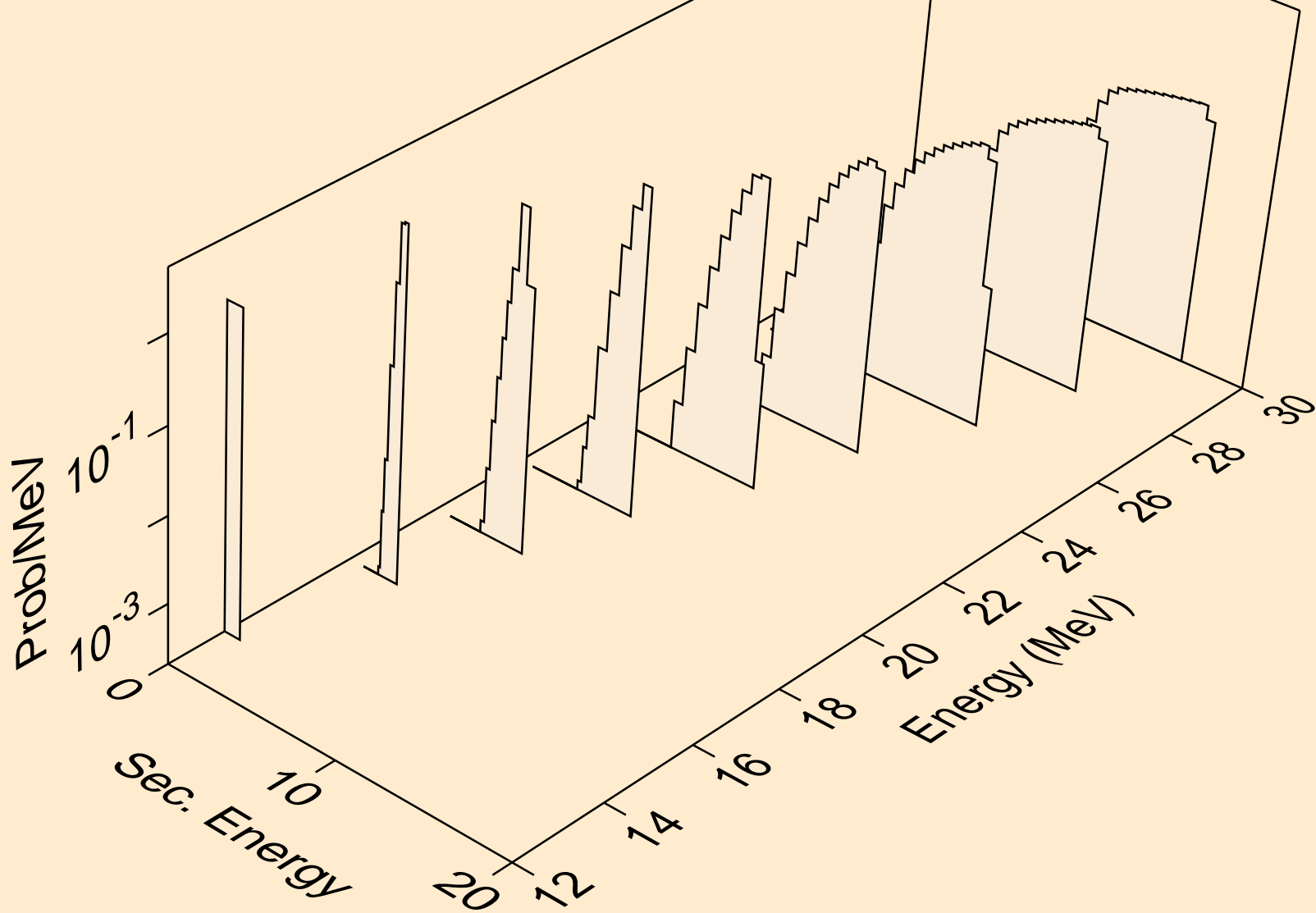

CE149 NEUTRON ACER TENDL-2024 LIBRARY; T=0.K
deuterons from (n,d)

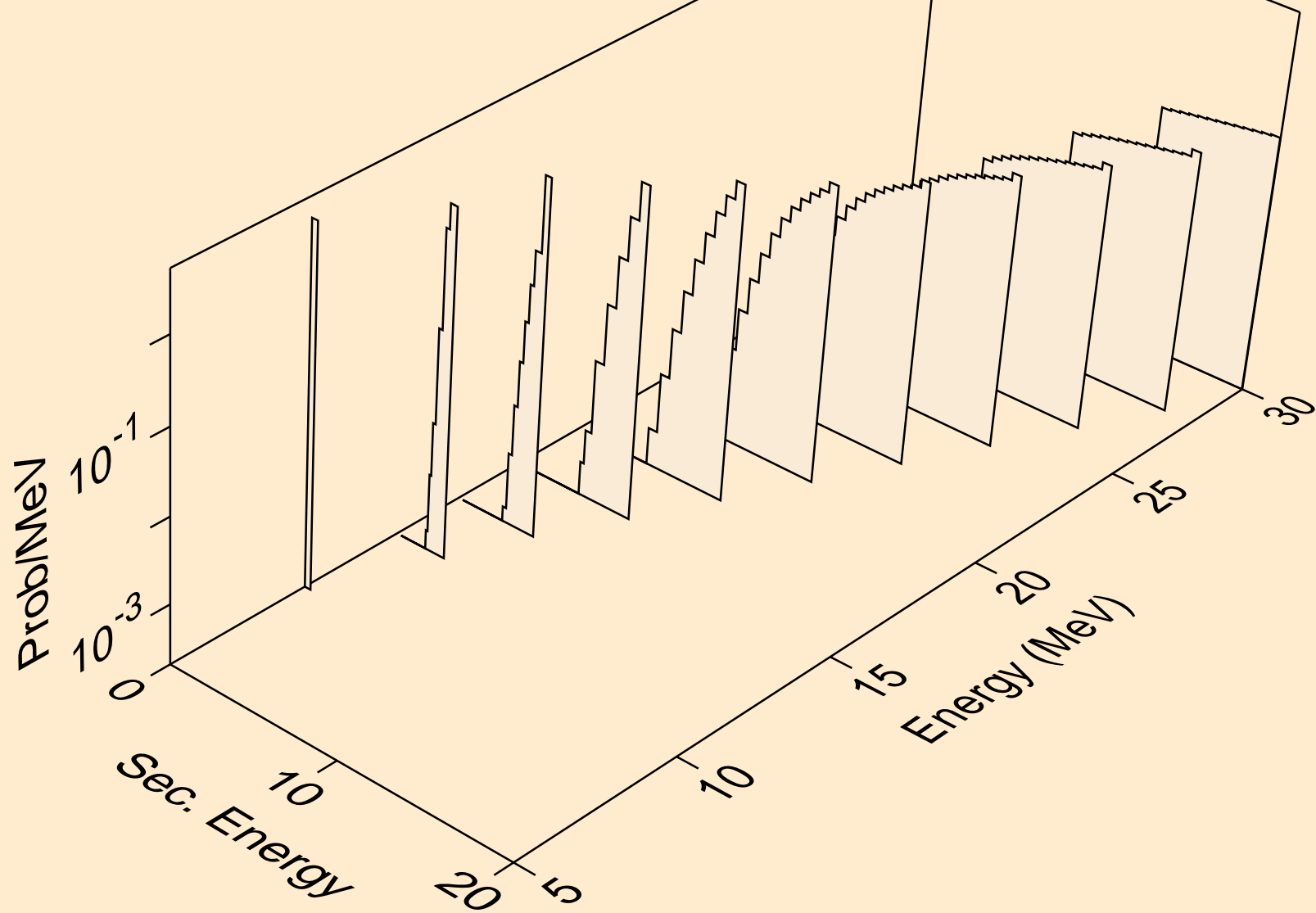

CE149 NEUTRON ACER TENDL-2024 LIBRARY; T=0.K
tritons from (n,x)

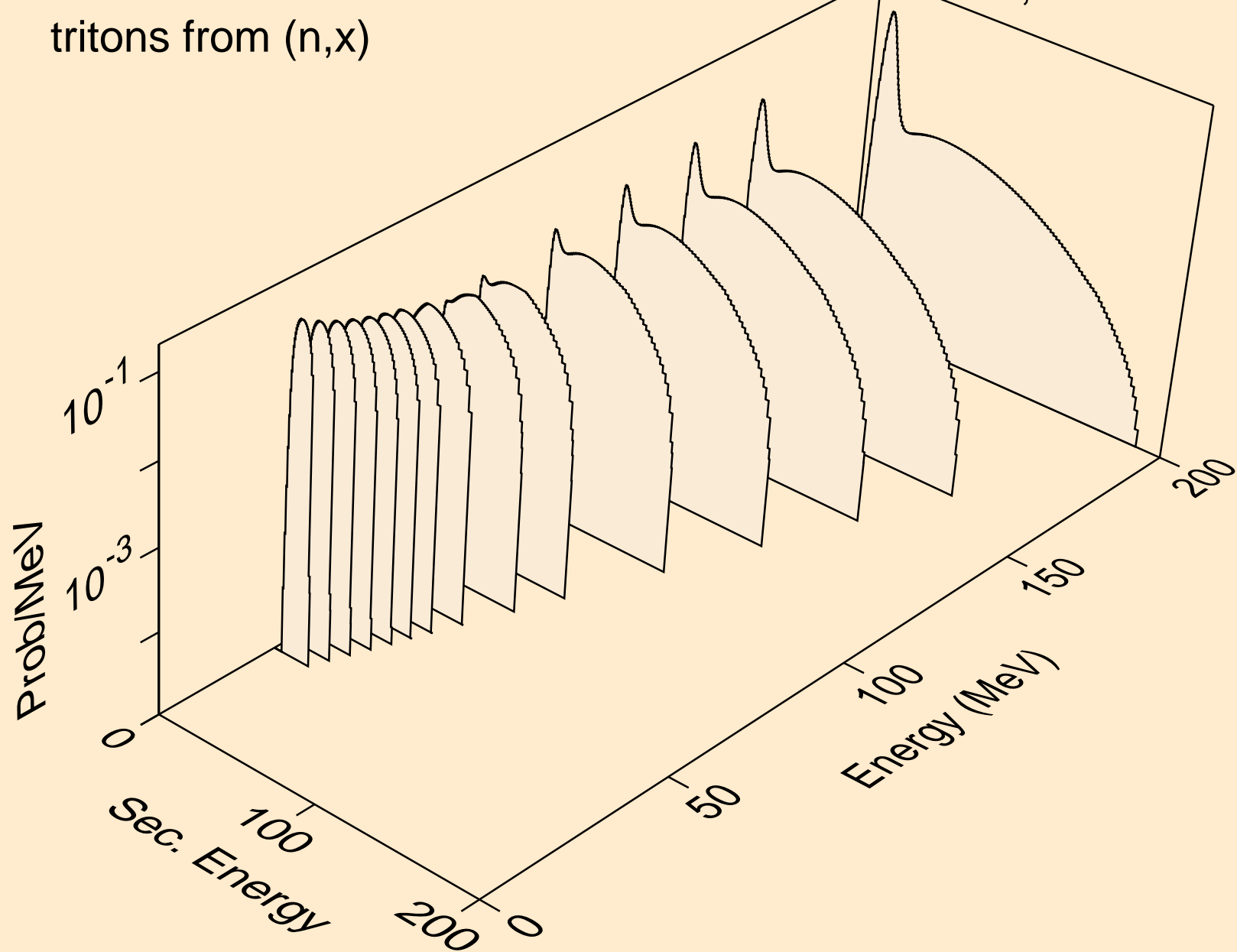

CE149 NEUTRON ACER TENDL-2024 LIBRARY; T=0.K
tritons from (n,n*)t

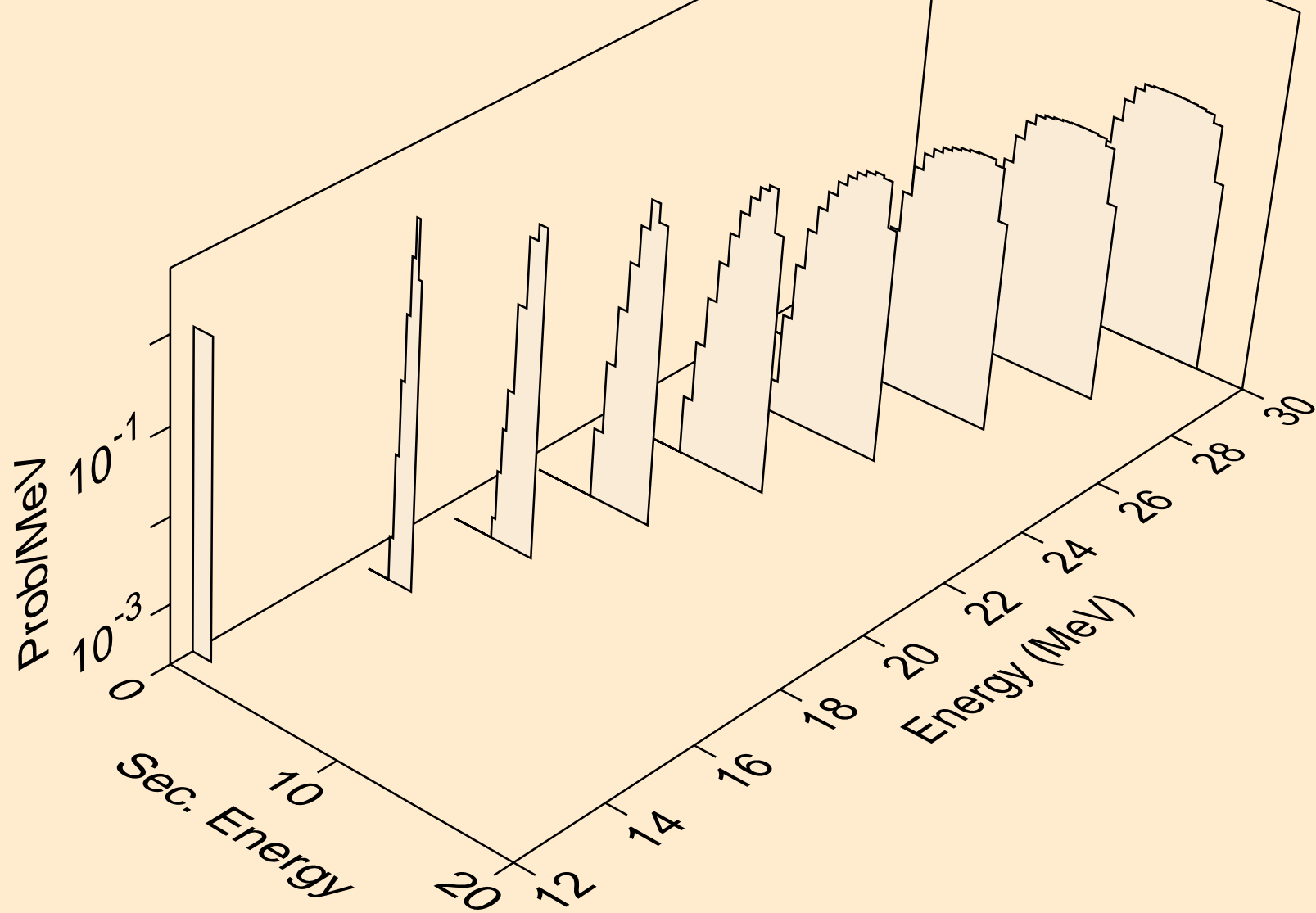

CE149 NEUTRON ACER TENDL-2024 LIBRARY; T=0.K
tritons from (n,t)

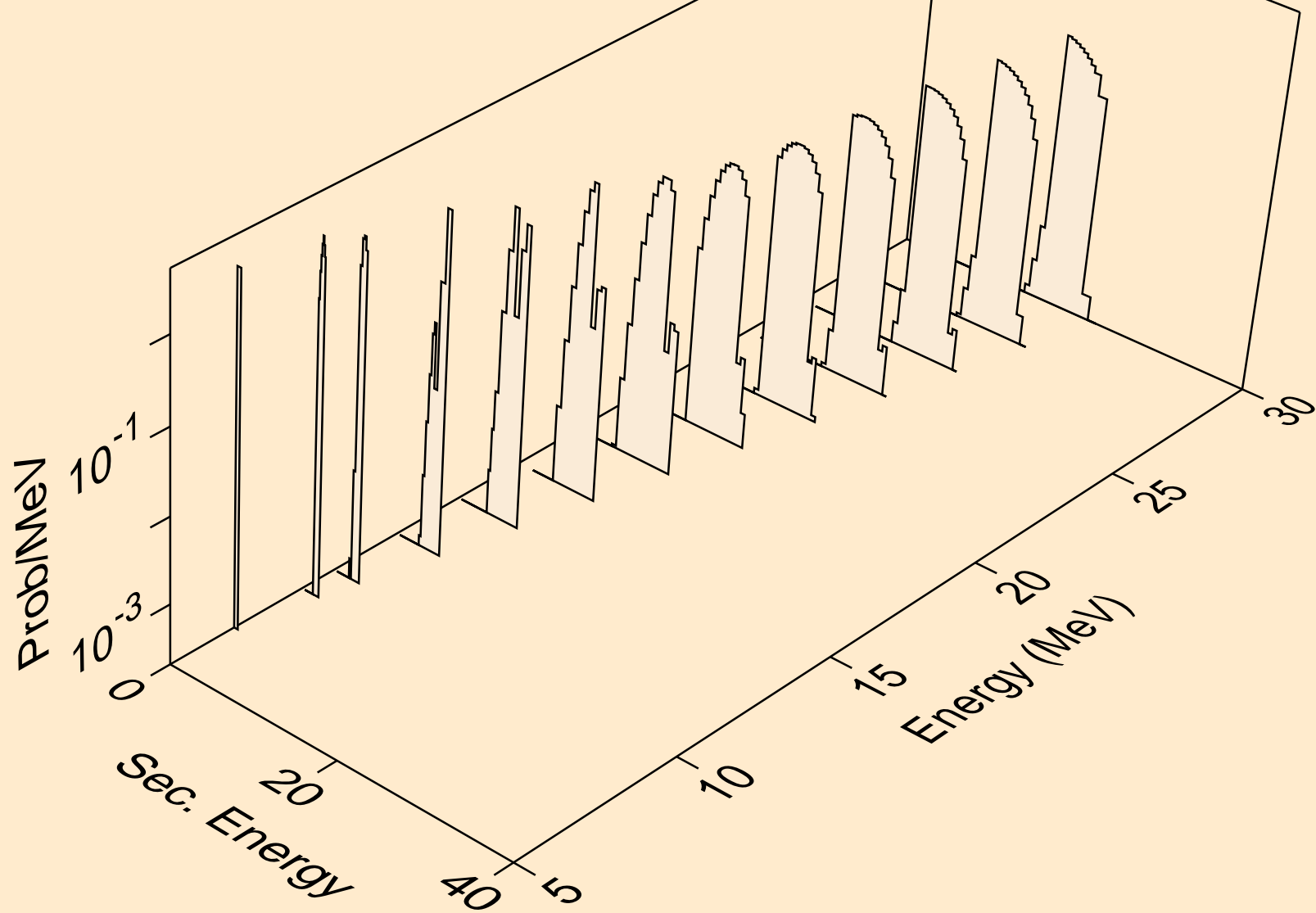

CE149 NEUTRON ACER TENDL-2024 LIBRARY; T=0.K
he3s from (n,x)

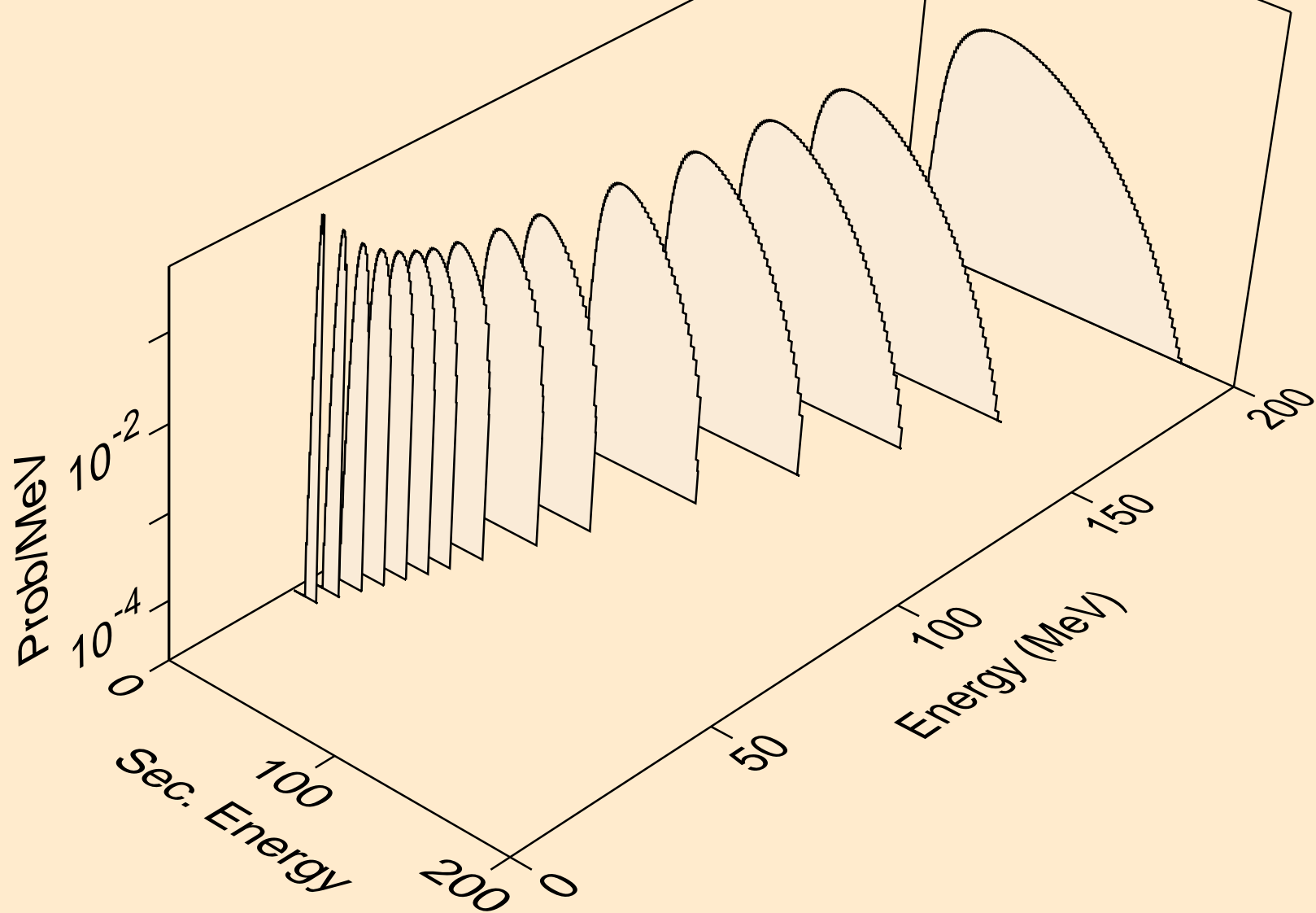

CE149 NEUTRON ACER TENDL-2024 LIBRARY; T=0.K
he3s from (n,n*)he3

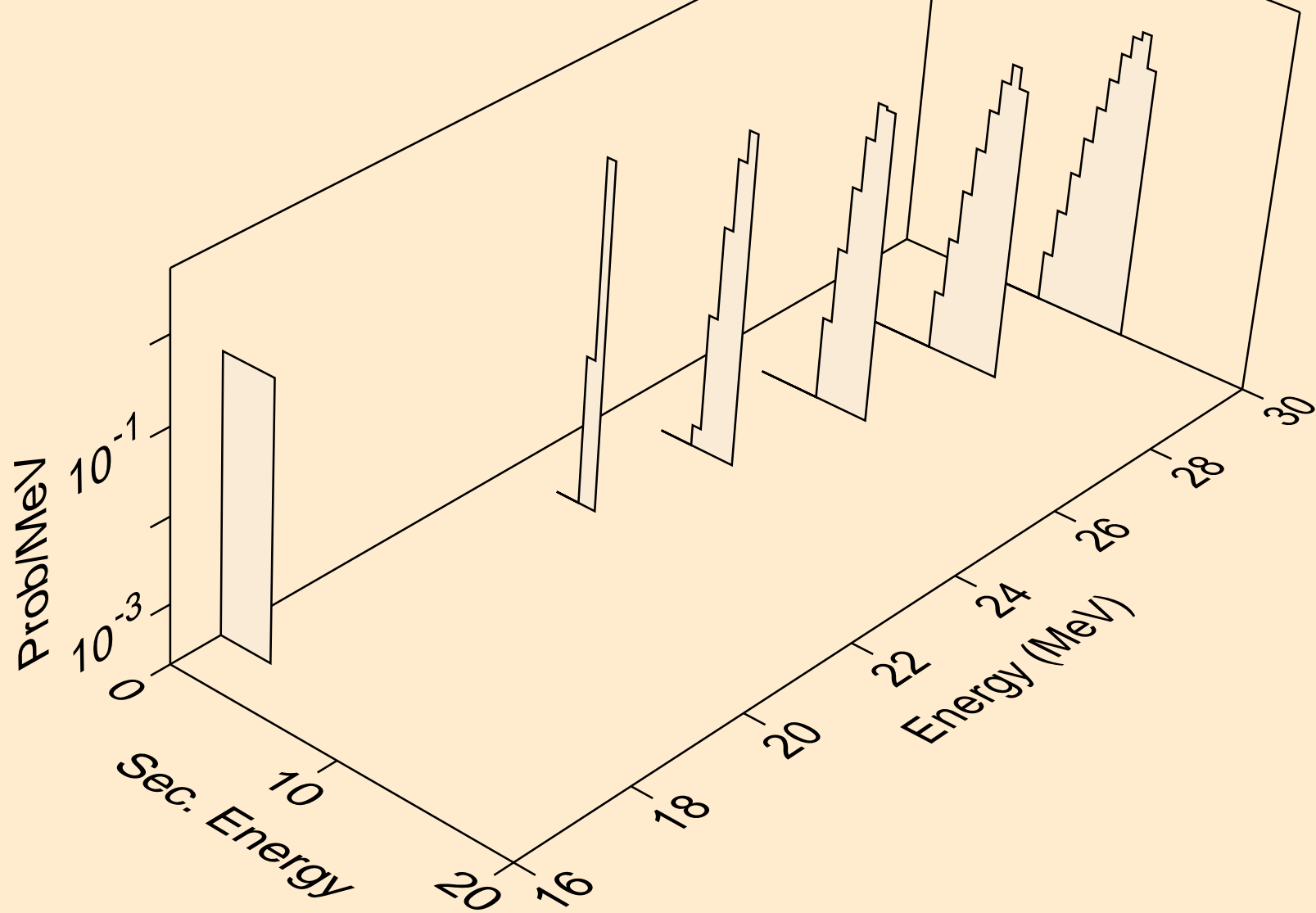

CE149 NEUTRON ACER TENDL-2024 LIBRARY; T=0.K
he3s from (n,he3)

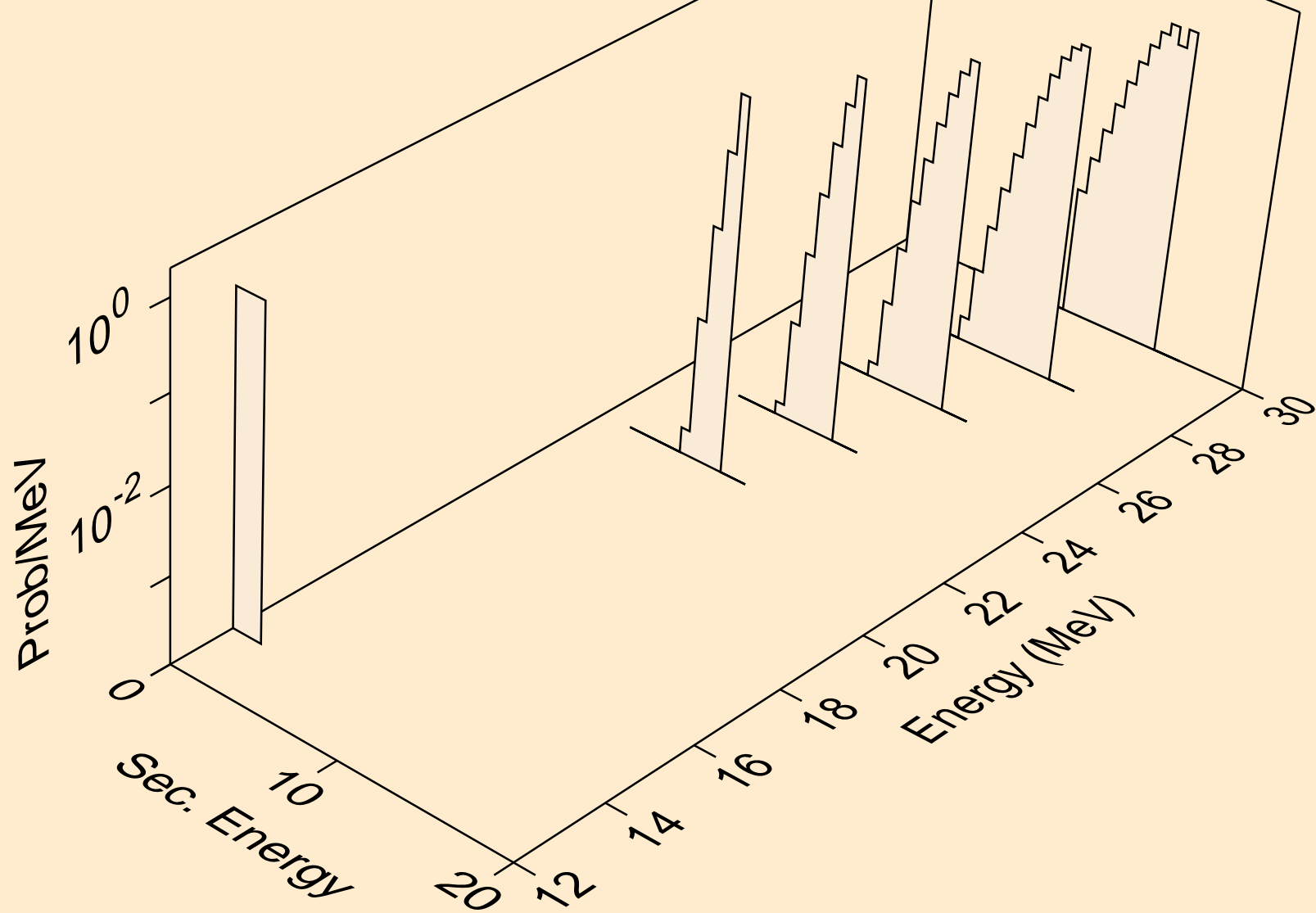

CE149 NEUTRON ACER TENDL-2024 LIBRARY; T=0.K
alphas from (n,x)

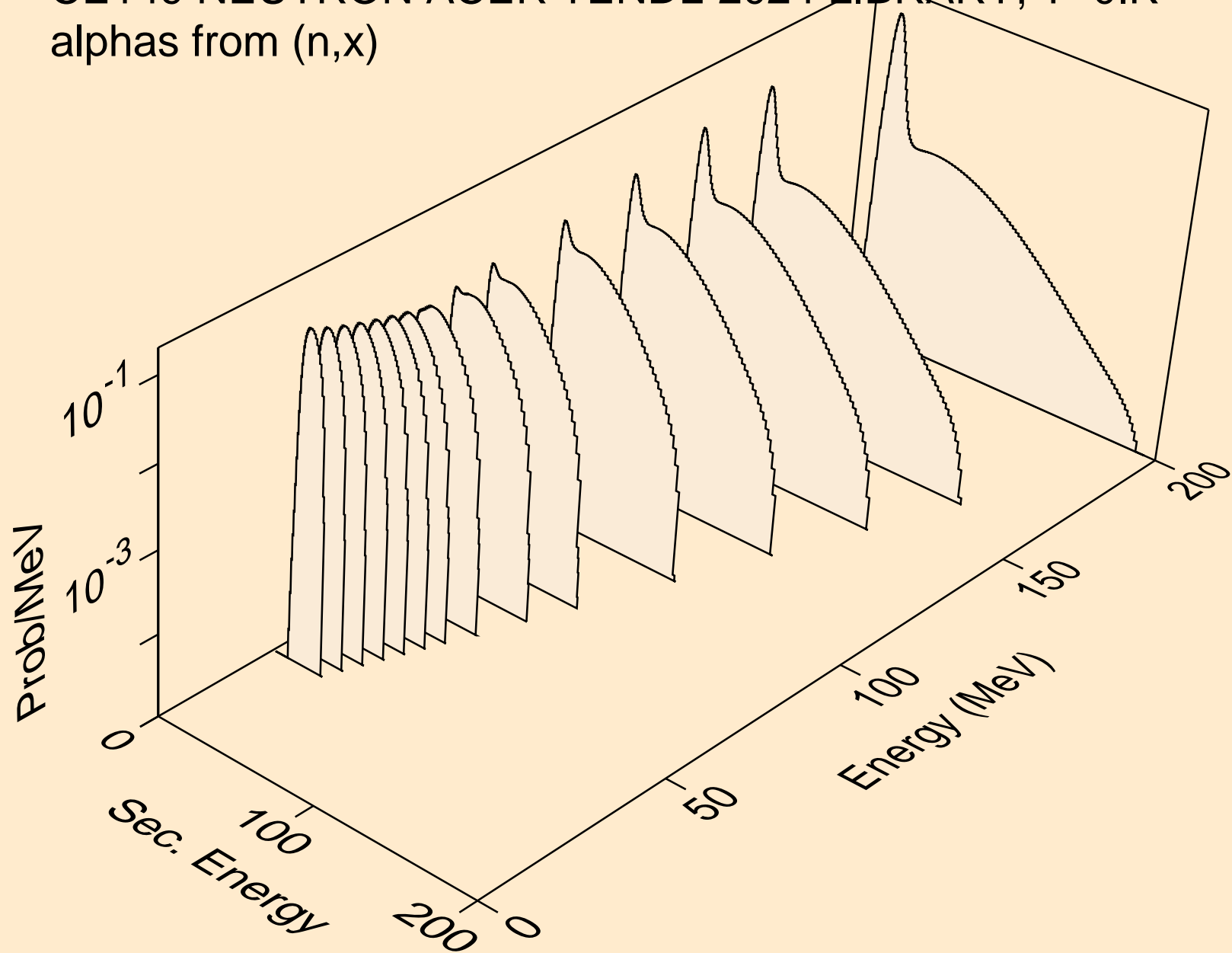

CE149 NEUTRON ACER TENDL-2024 LIBRARY; T=0.K
alphas from (n,n*)a

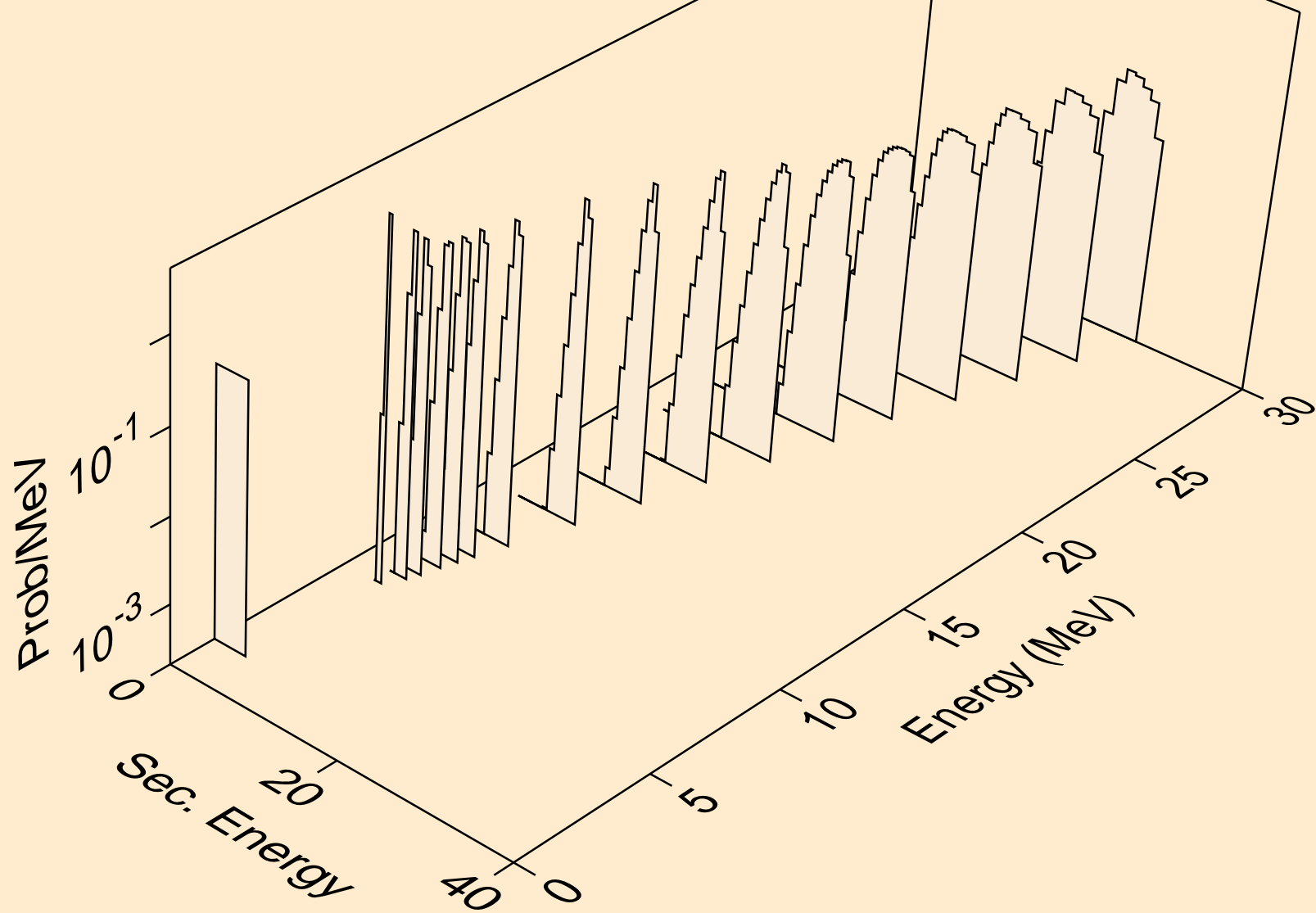

CE149 NEUTRON ACER TENDL-2024 LIBRARY; T=0.K
alphas from (n,2n)a

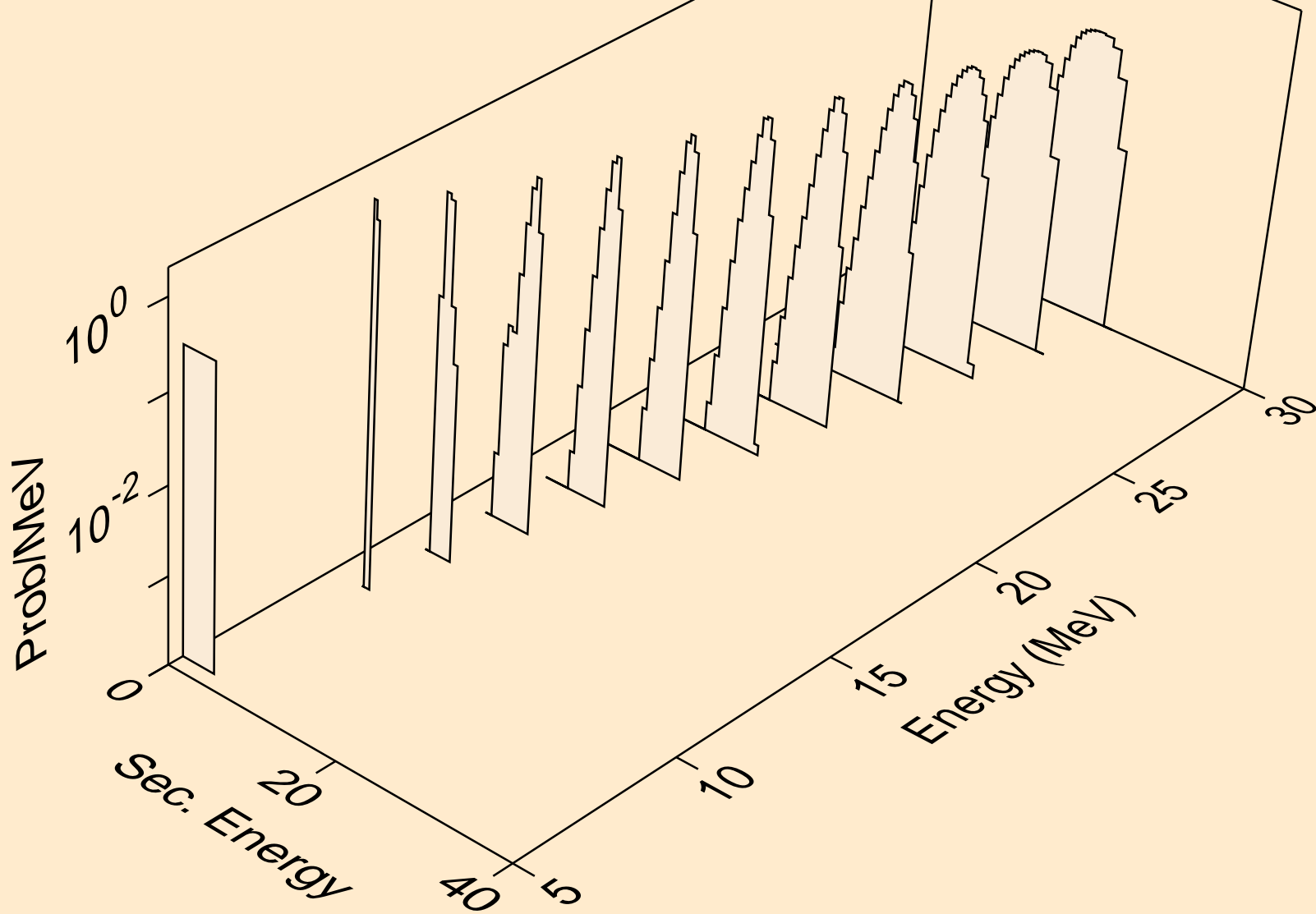

CE149 NEUTRON ACER TENDL-2024 LIBRARY; T=0.K
alphas from (n,3n)a

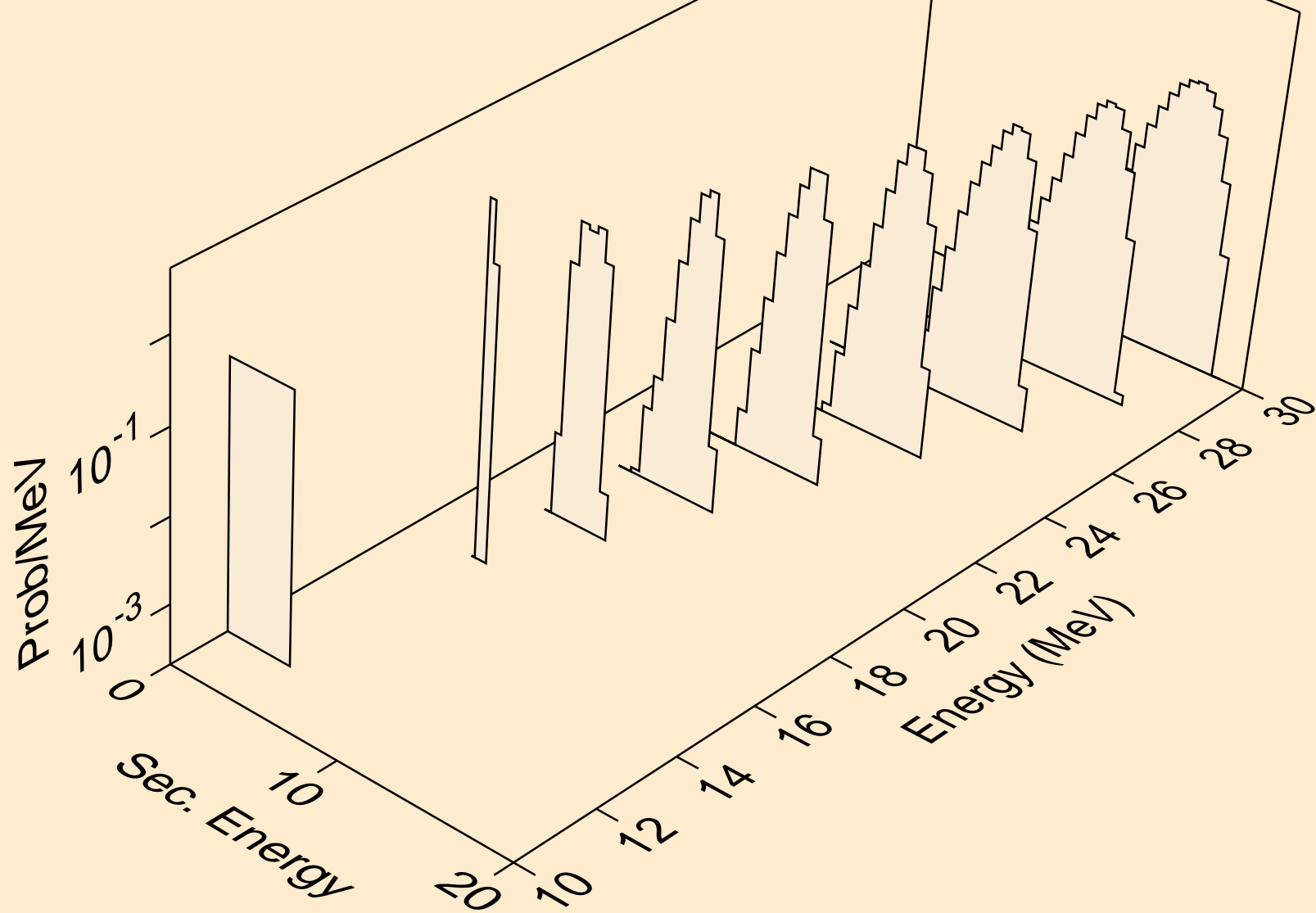

CE149 NEUTRON ACER TENDL-2024 LIBRARY; T=0.K
alphas from (n,a)

