

CM251 NEUTRON ACER TENDL-2024 LIBRARY; T=0.K

Principal cross sections

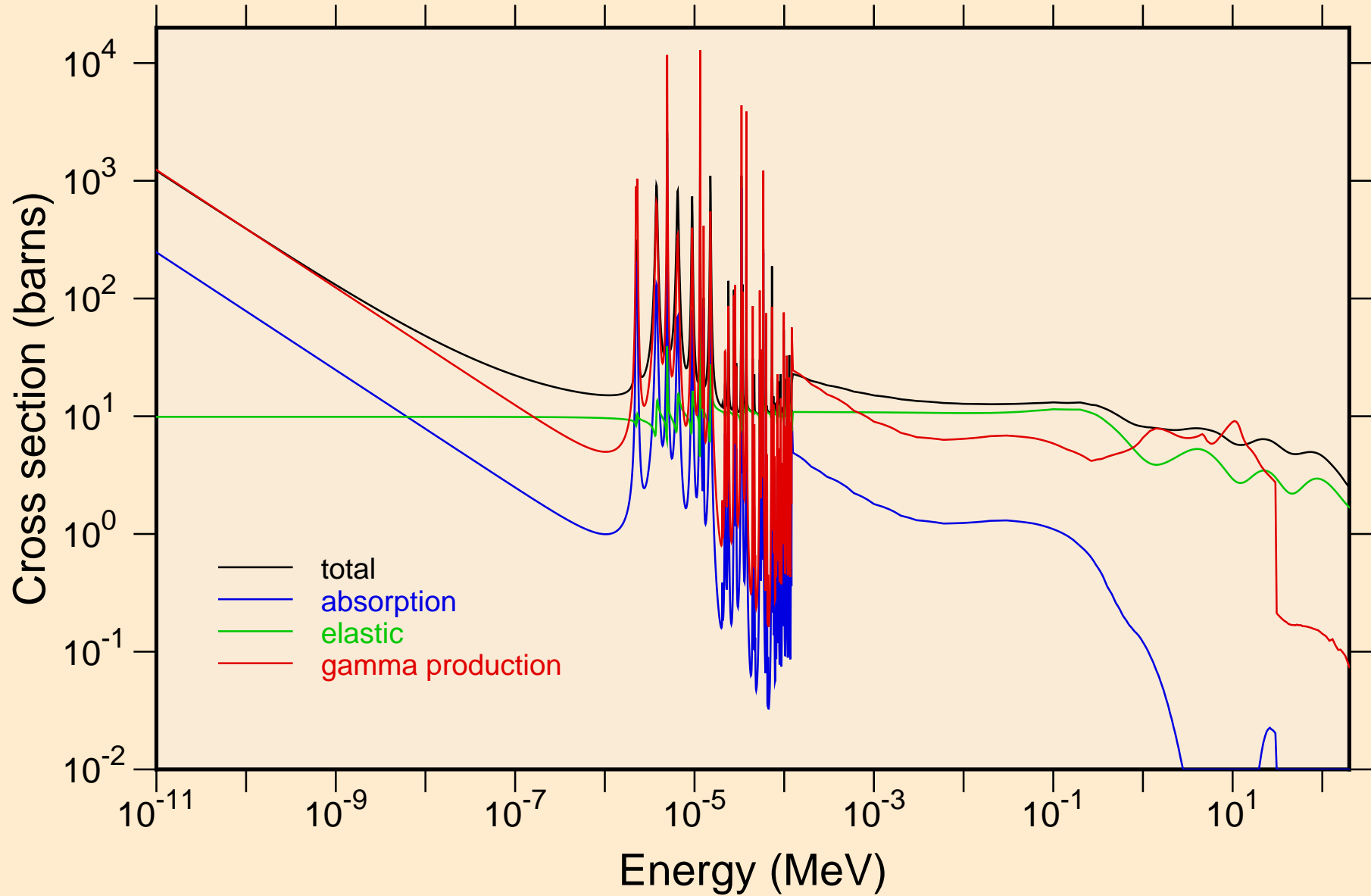

CM251 NEUTRON ACER TENDL-2024 LIBRARY; T=0.K
resonance total cross section

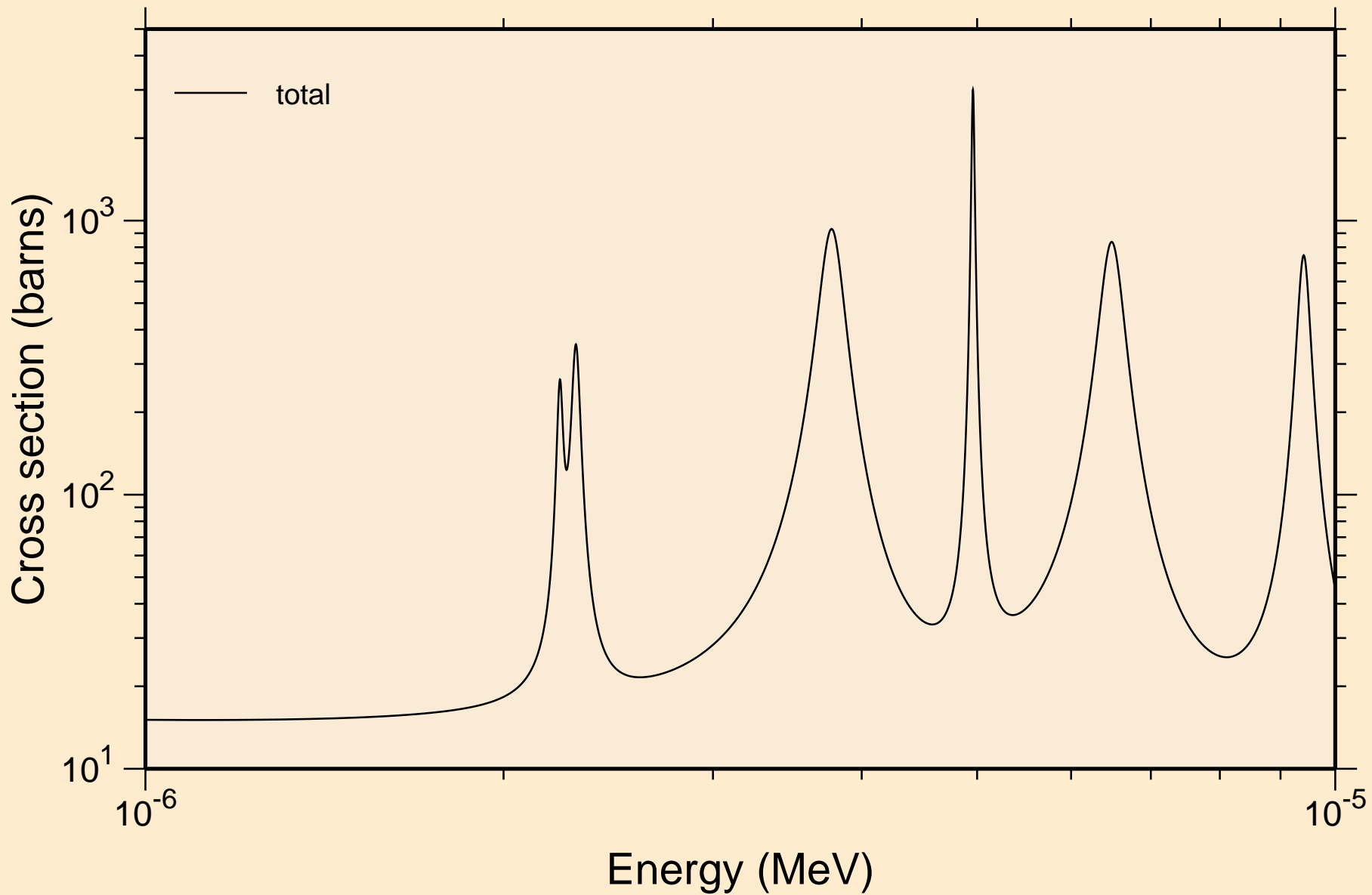

CM251 NEUTRON ACER TENDL-2024 LIBRARY; T=0.K
resonance total cross section

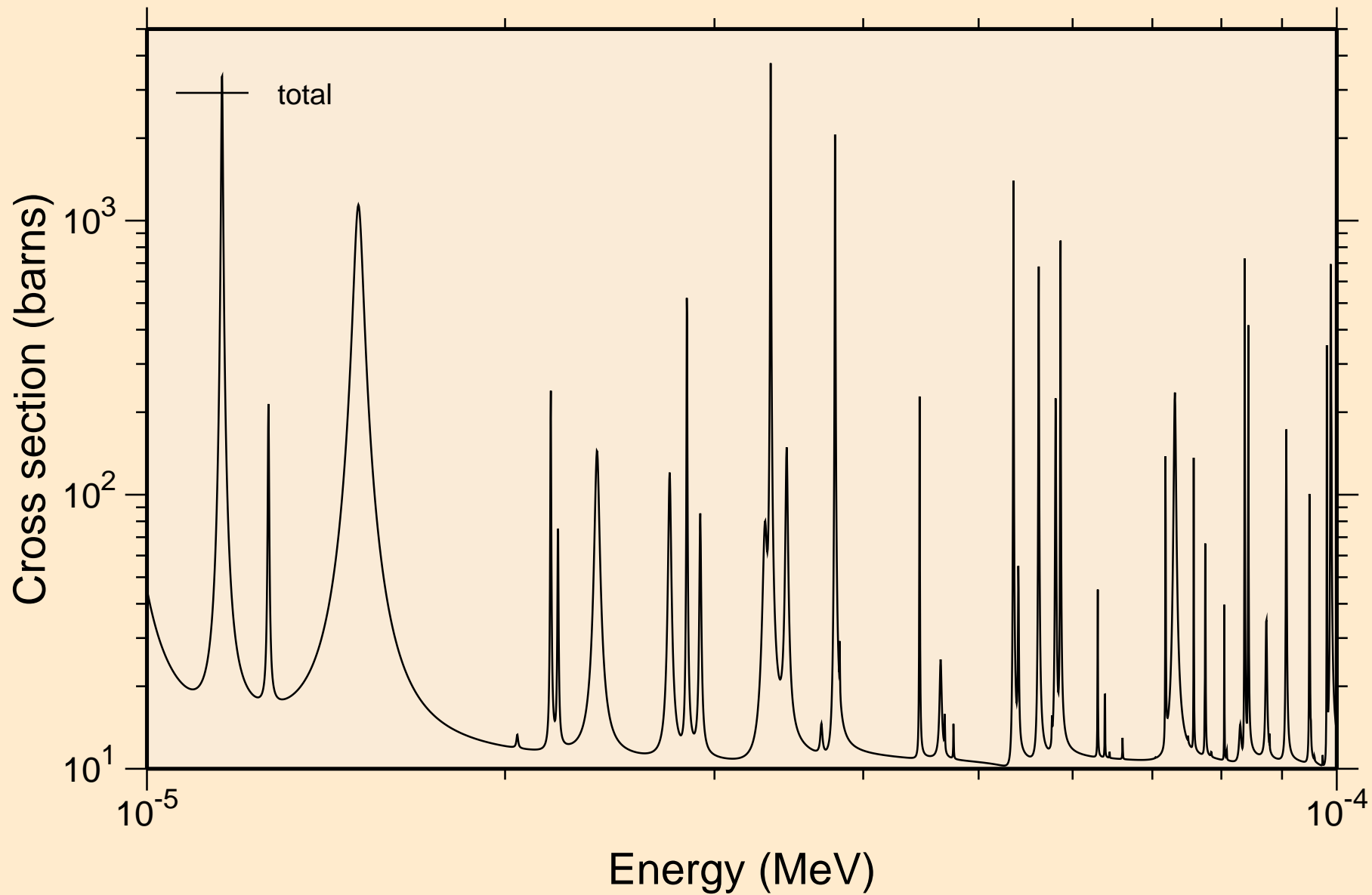

CM251 NEUTRON ACER TENDL-2024 LIBRARY; T=0.K
resonance total cross section

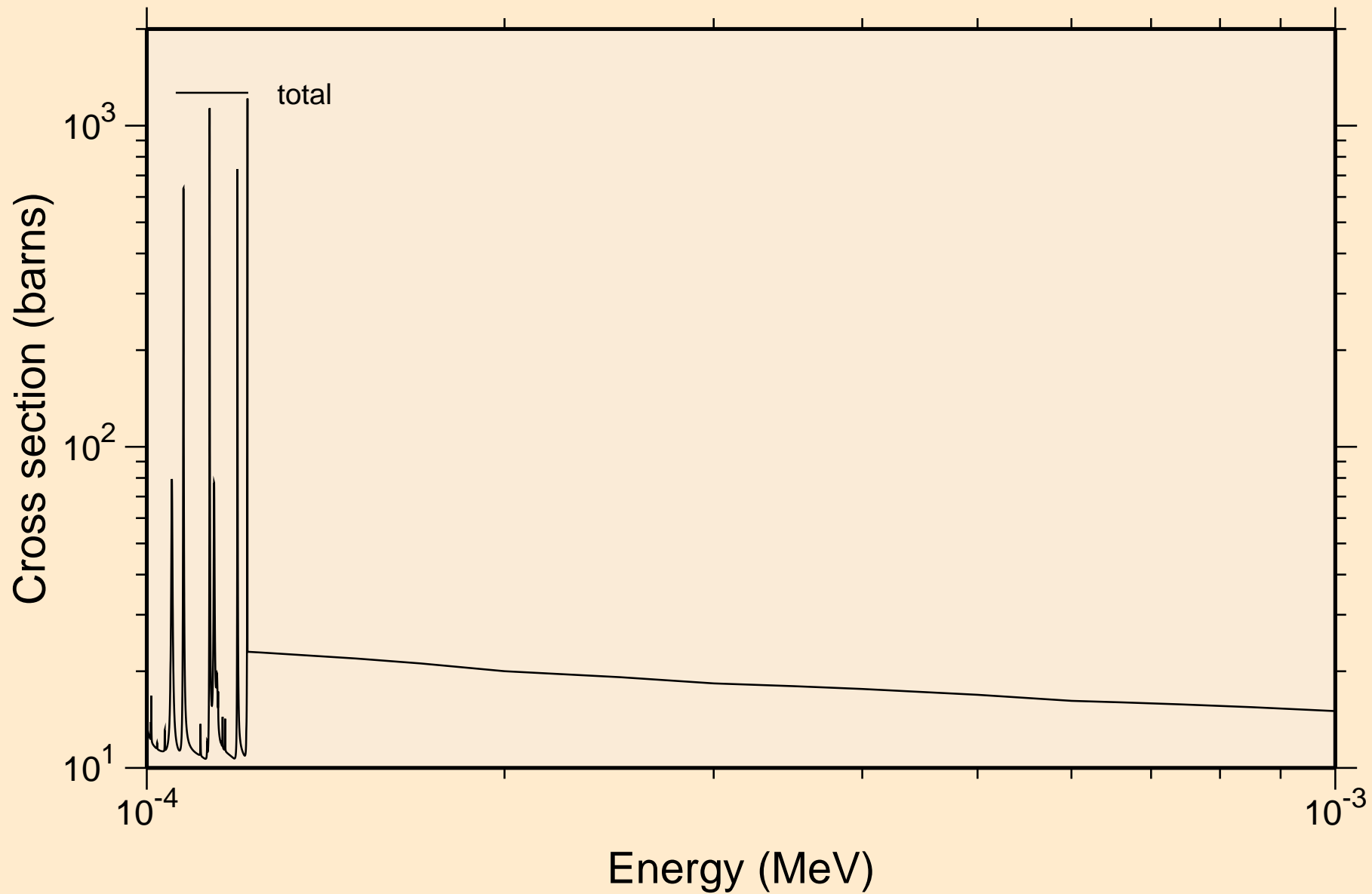

CM251 NEUTRON ACER TENDL-2024 LIBRARY; T=0.K
resonance total cross section

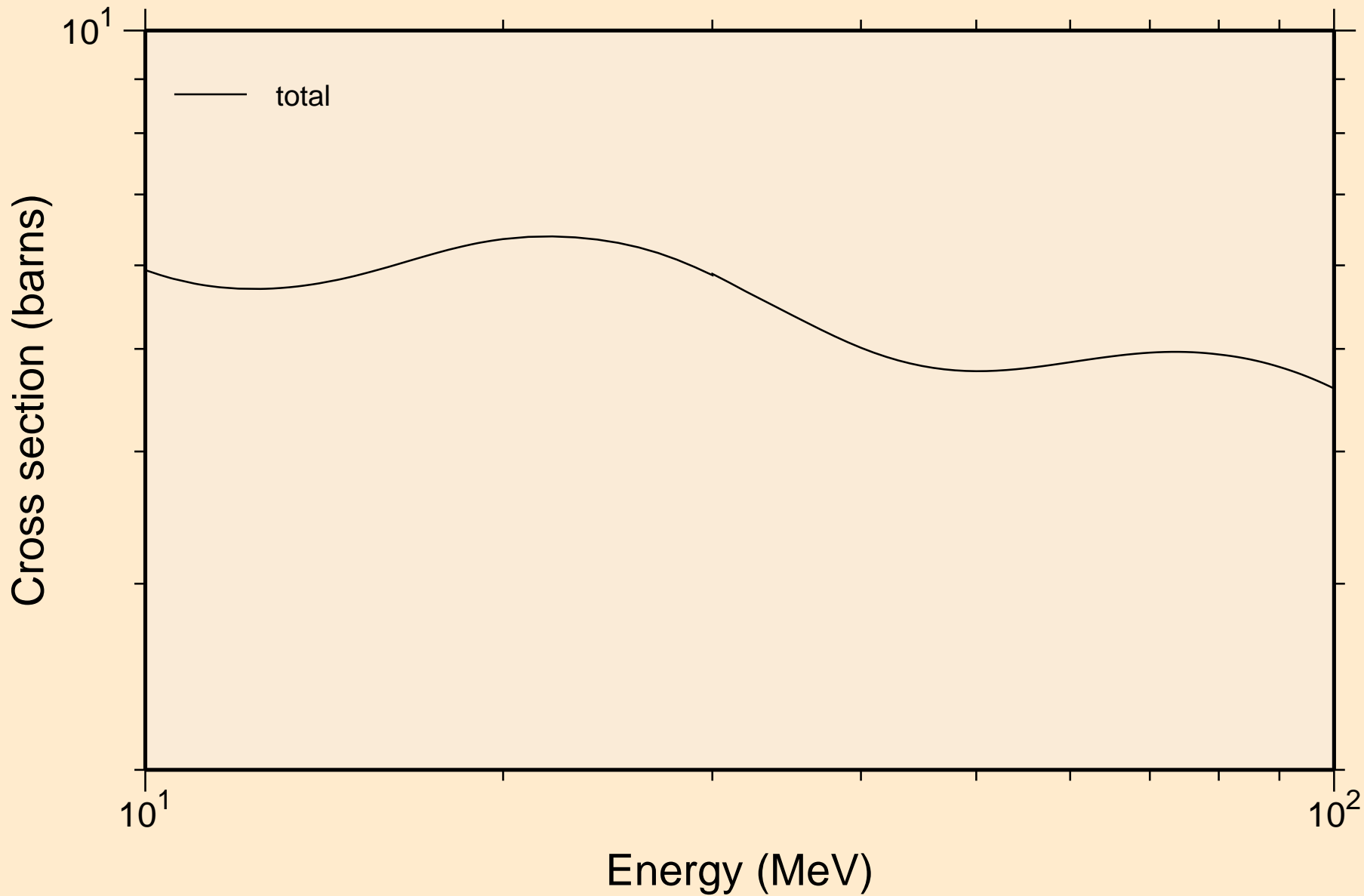

CM251 NEUTRON ACER TENDL-2024 LIBRARY; T=0.K
resonance absorption cross sections

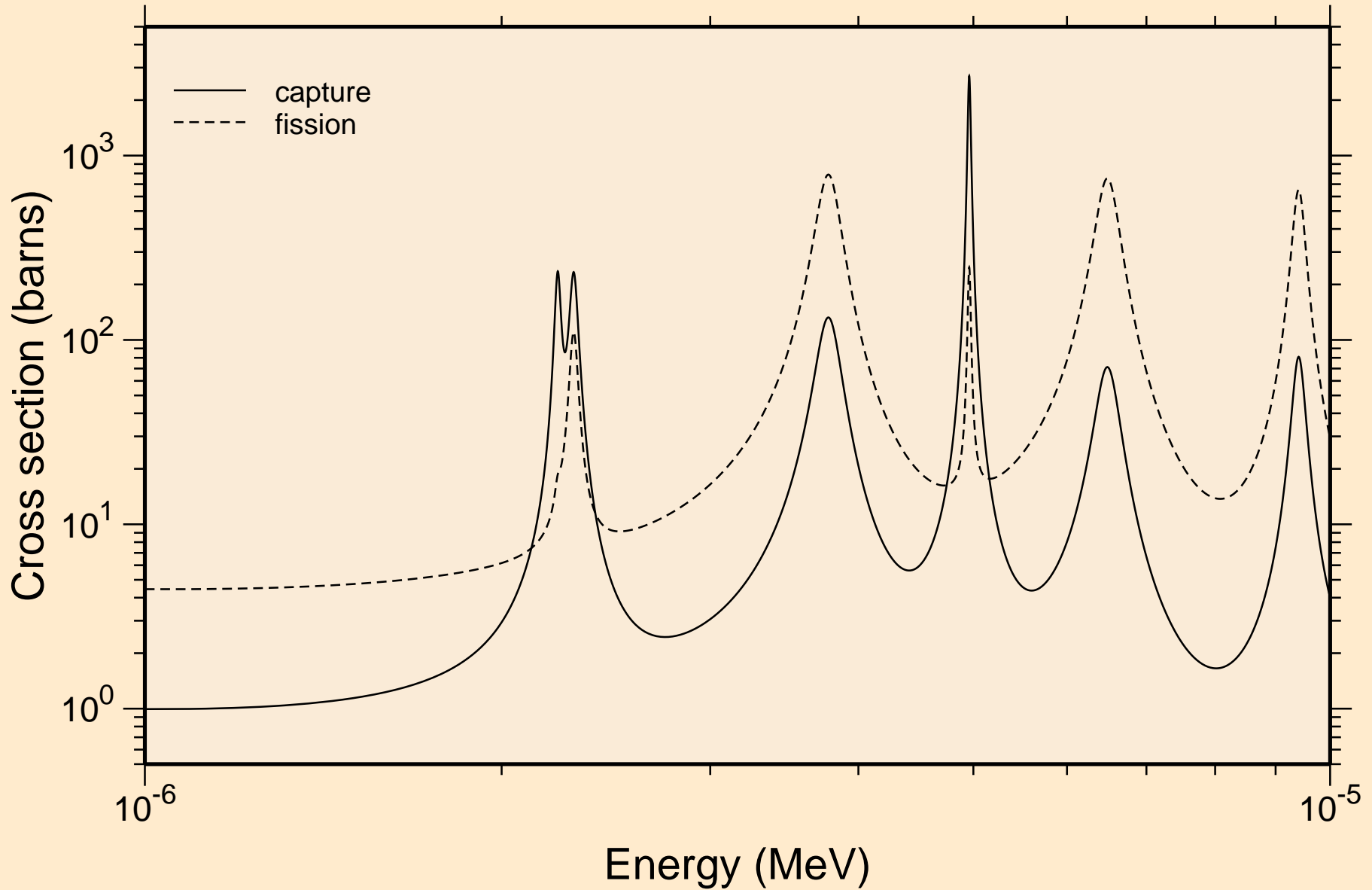

CM251 NEUTRON ACER TENDL-2024 LIBRARY; T=0.K
resonance absorption cross sections

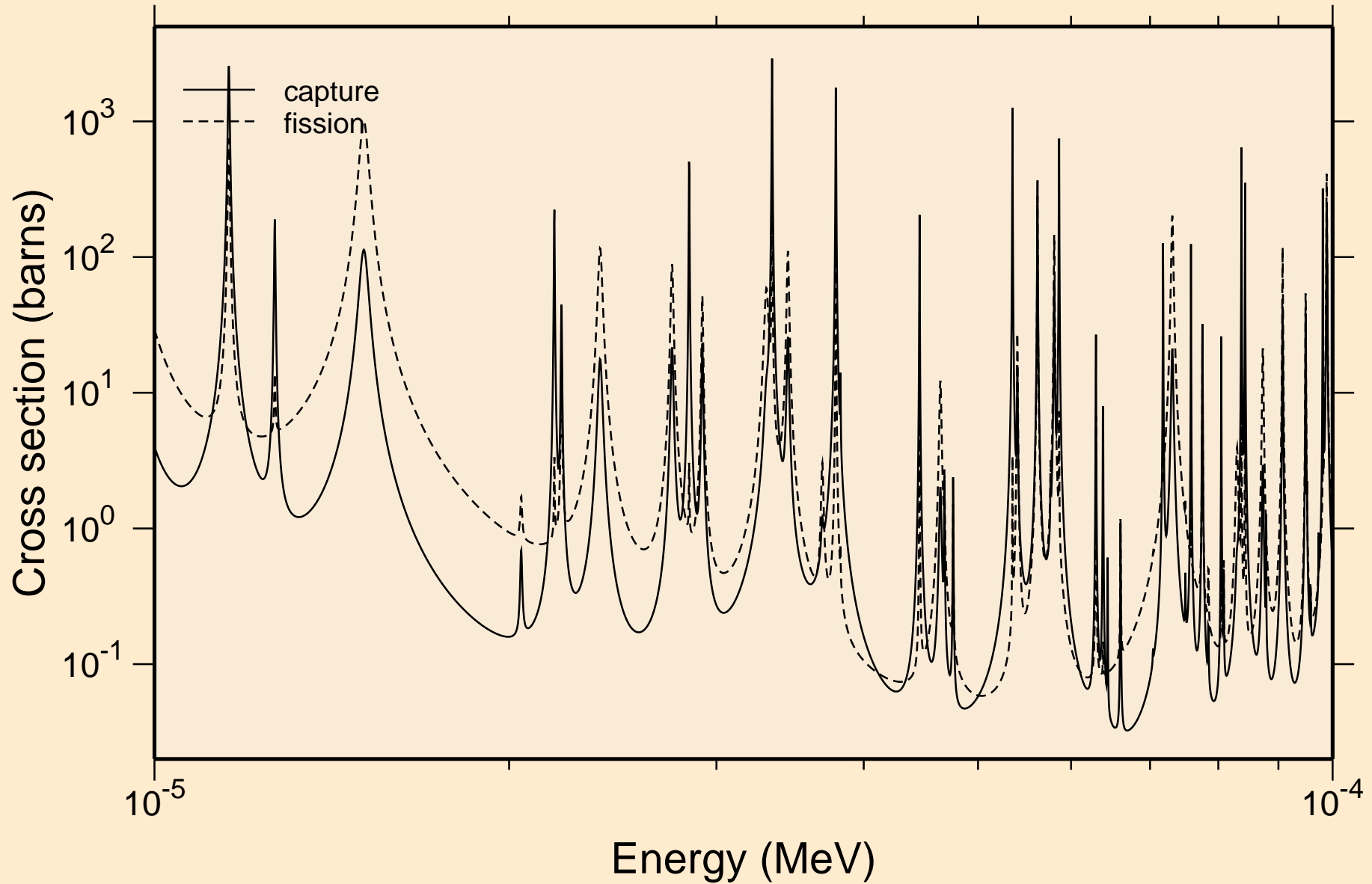

CM251 NEUTRON ACER TENDL-2024 LIBRARY; T=0.K
resonance absorption cross sections

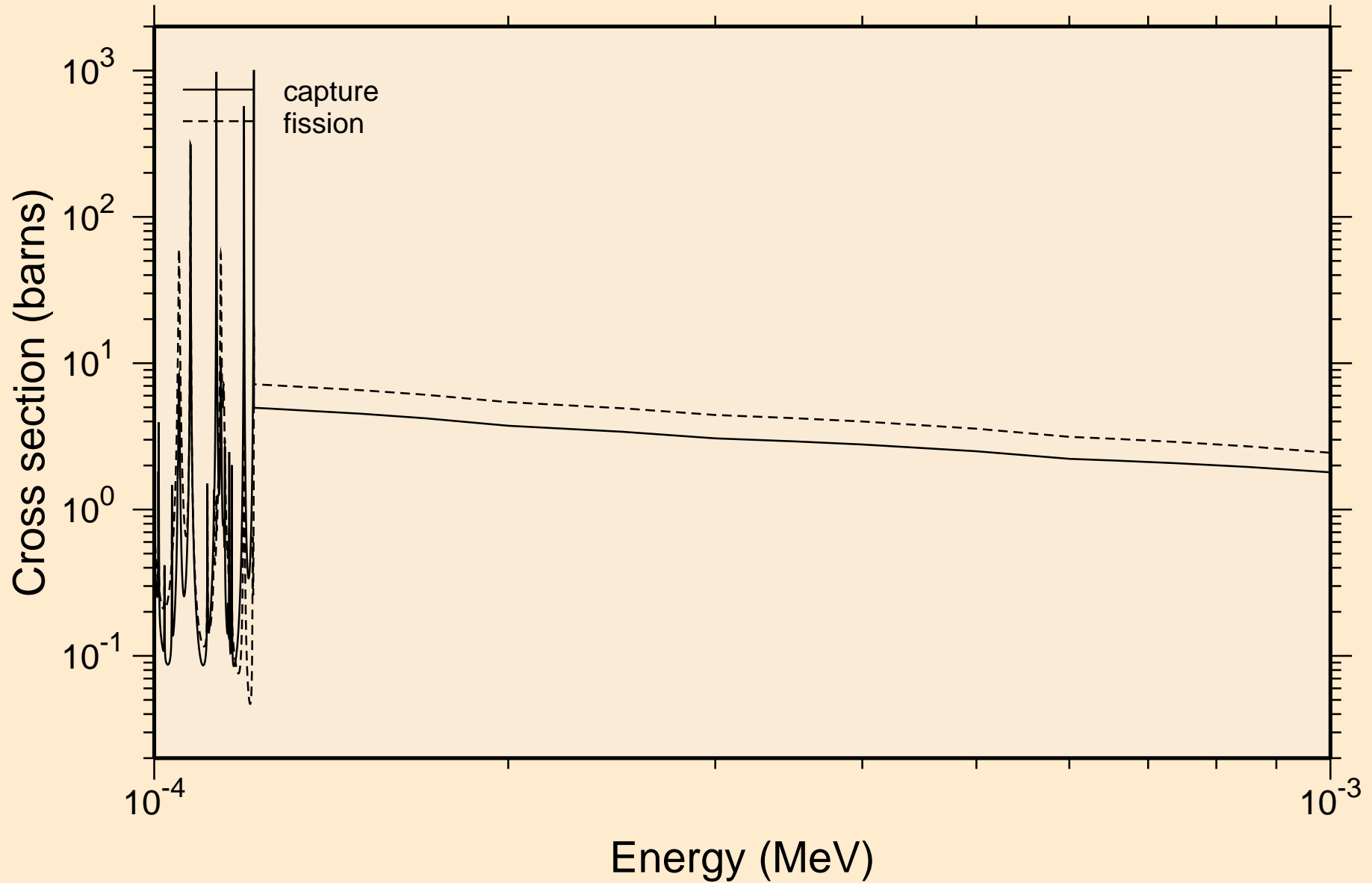

CM251 NEUTRON ACER TENDL-2024 LIBRARY; T=0.K
resonance absorption cross sections

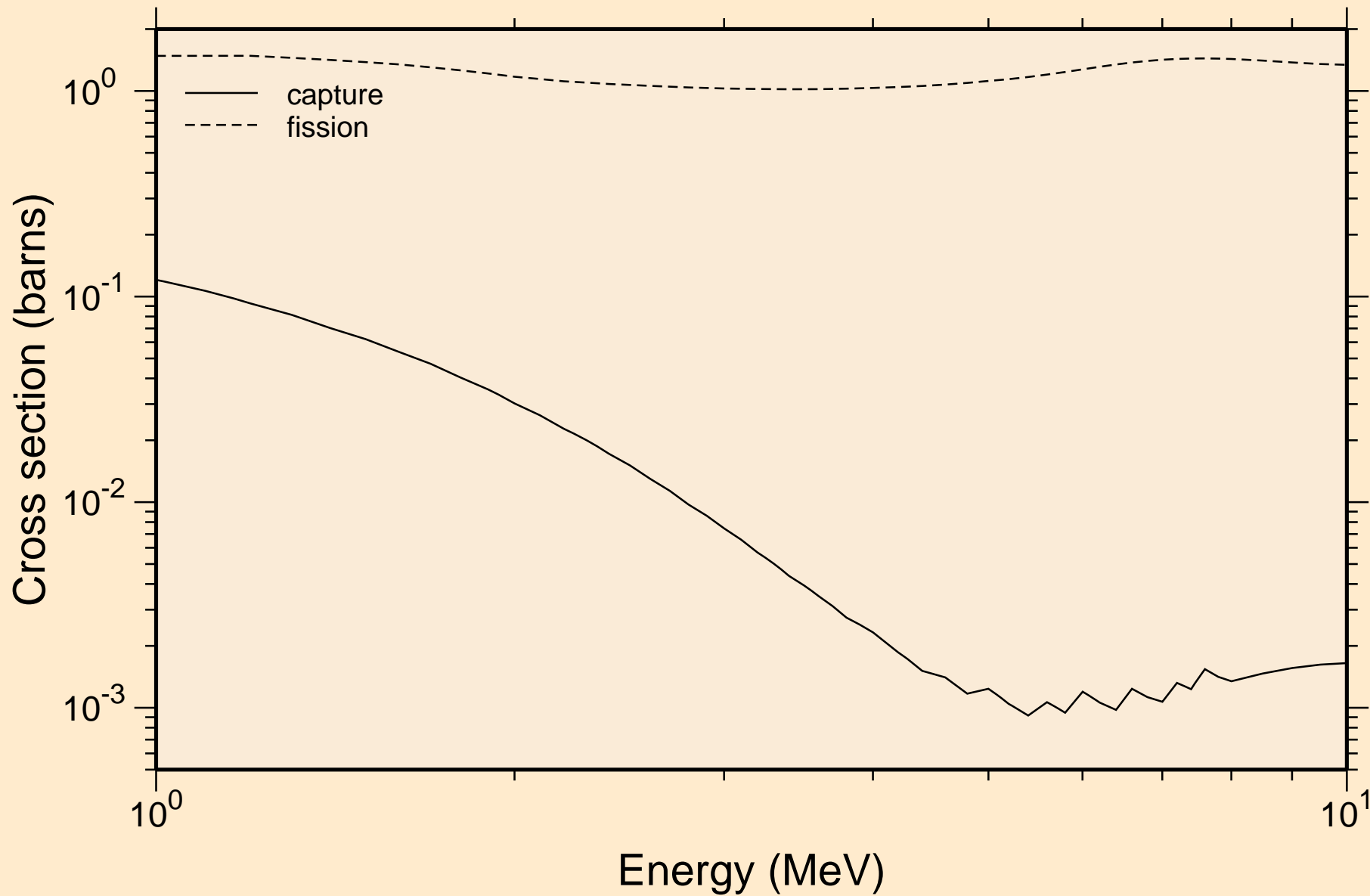

CM251 NEUTRON ACER TENDL-2024 LIBRARY; T=0.K

Heating

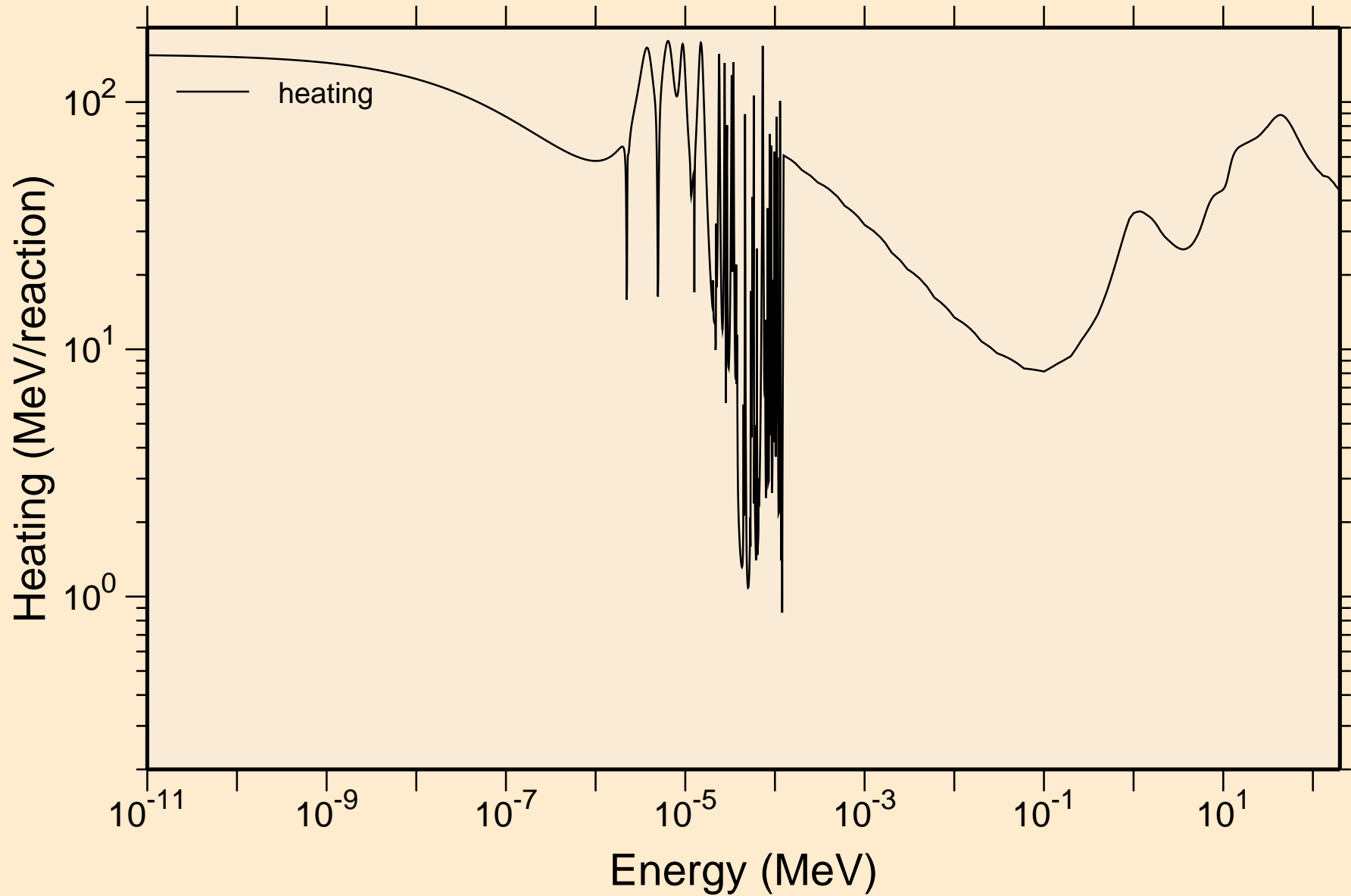

CM251 NEUTRON ACER TENDL-2024 LIBRARY; T=0.K

Damage

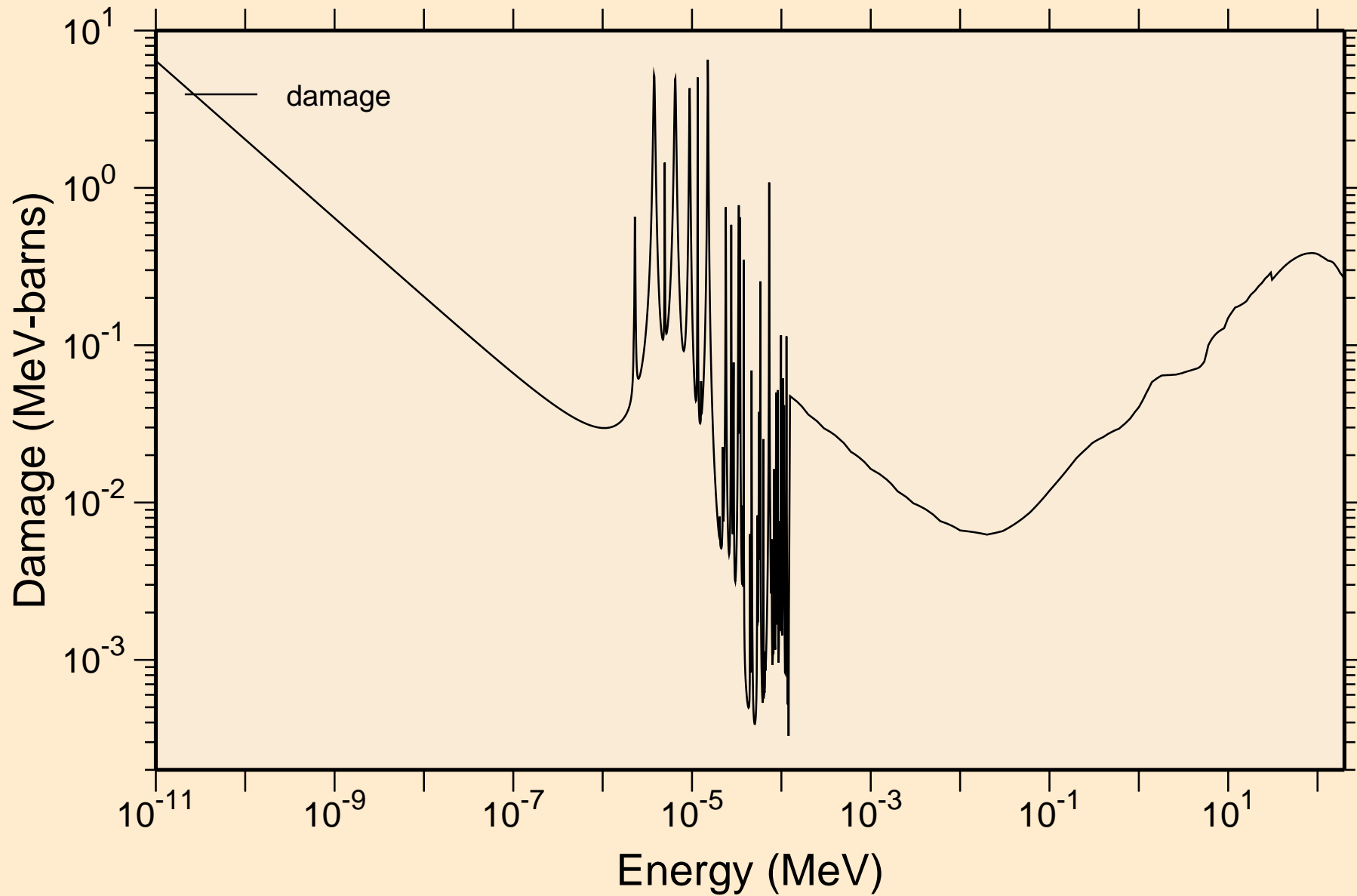

CM251 NEUTRON ACER TENDL-2024 LIBRARY; T=0.K

Non-threshold reactions

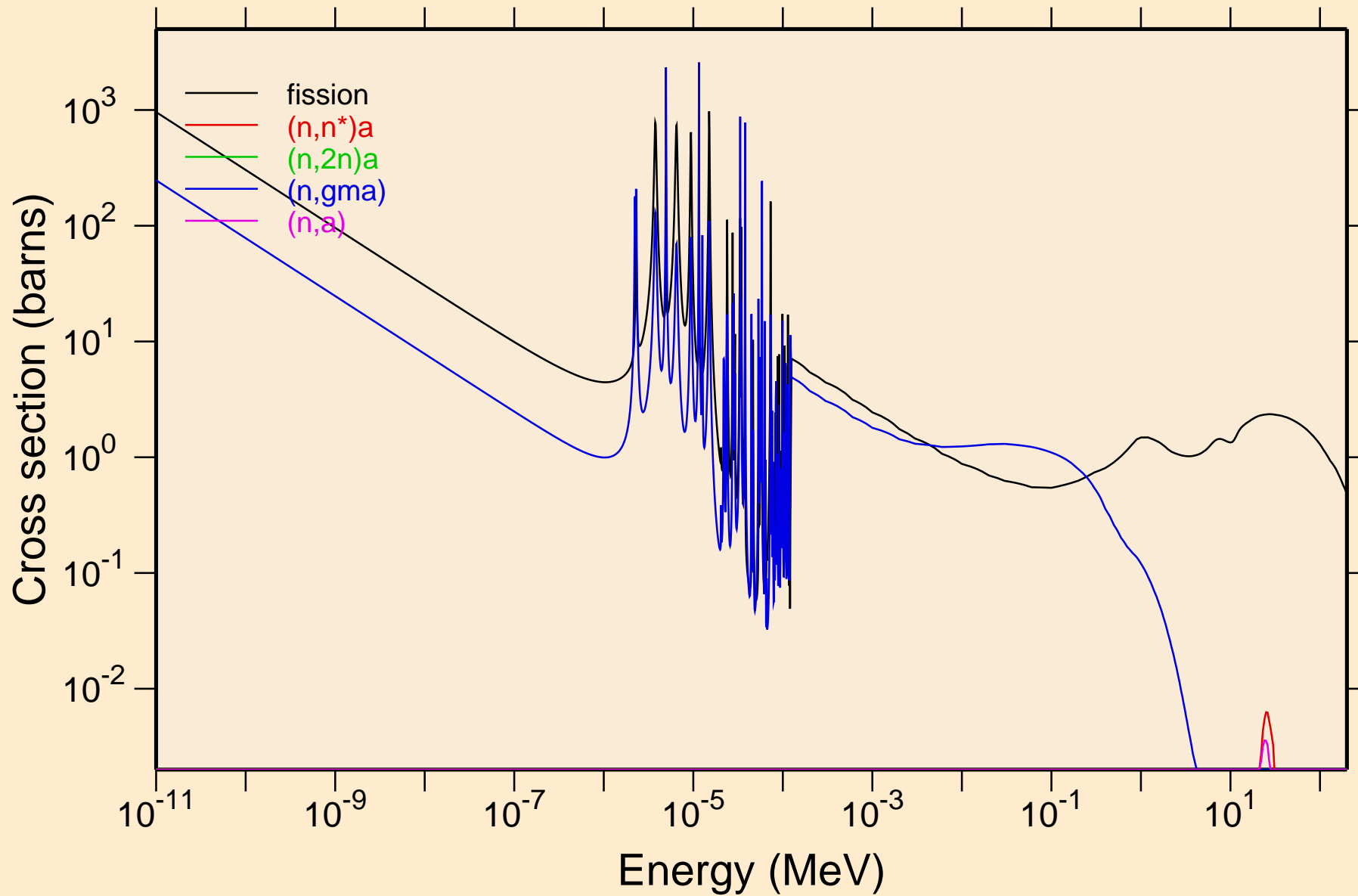

CM251 NEUTRON ACER TENDL-2024 LIBRARY; T=0.K
Non-threshold reactions

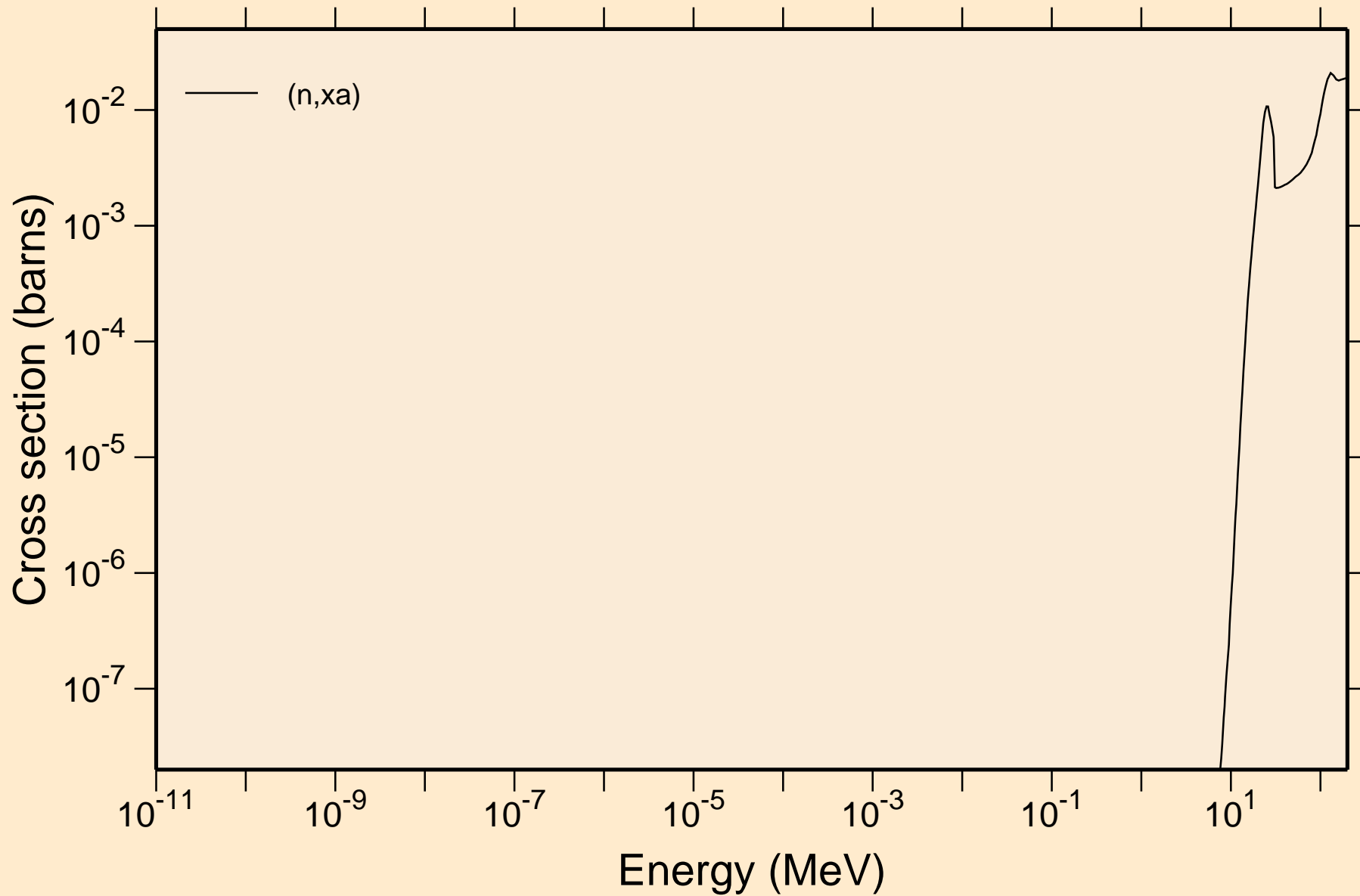

CM251 NEUTRON ACER TENDL-2024 LIBRARY; T=0.K

Principal cross sections

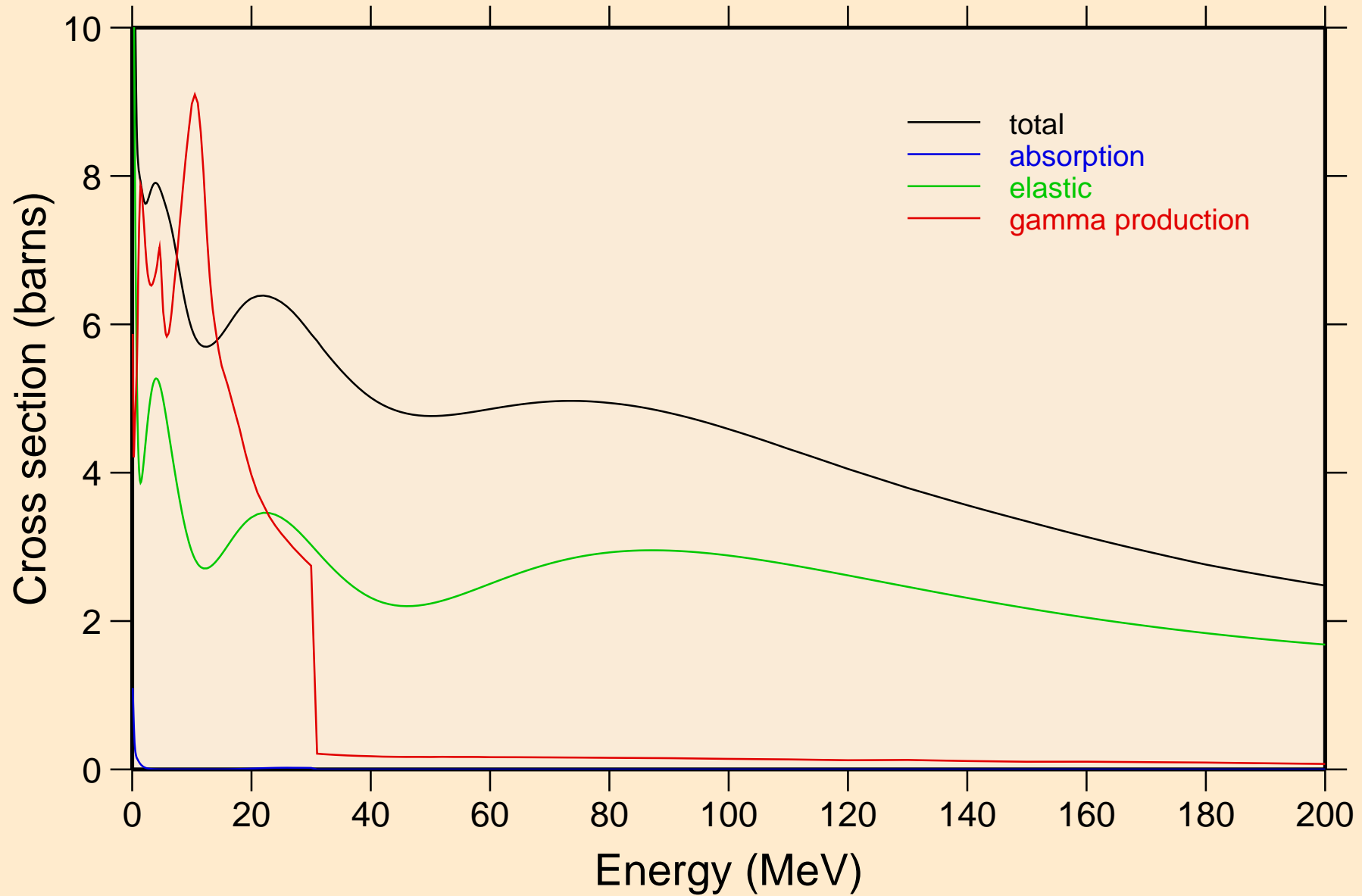

CM251 NEUTRON ACER TENDL-2024 LIBRARY; T=0.K

Heating

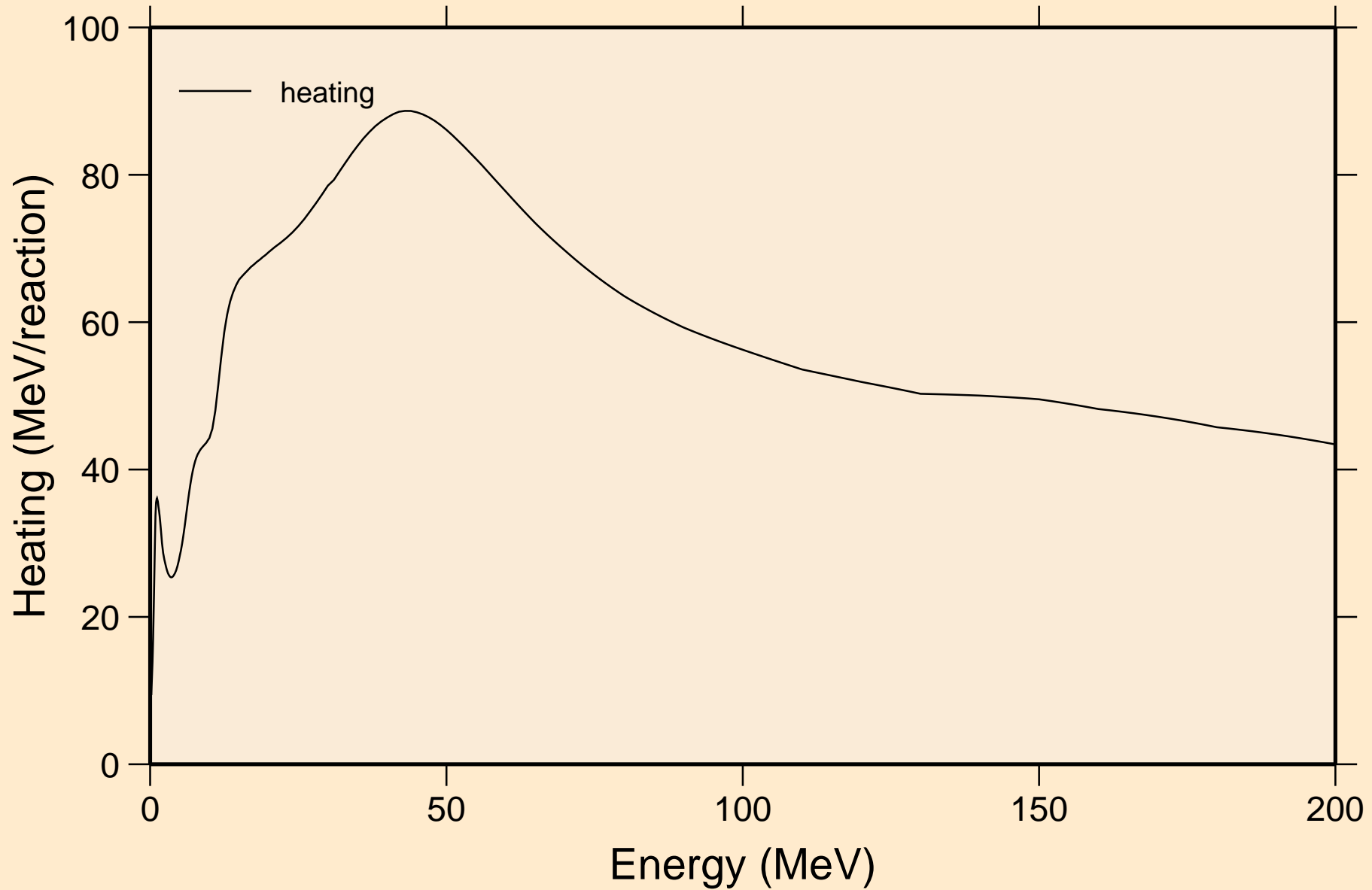

CM251 NEUTRON ACER TENDL-2024 LIBRARY; T=0.K

Damage

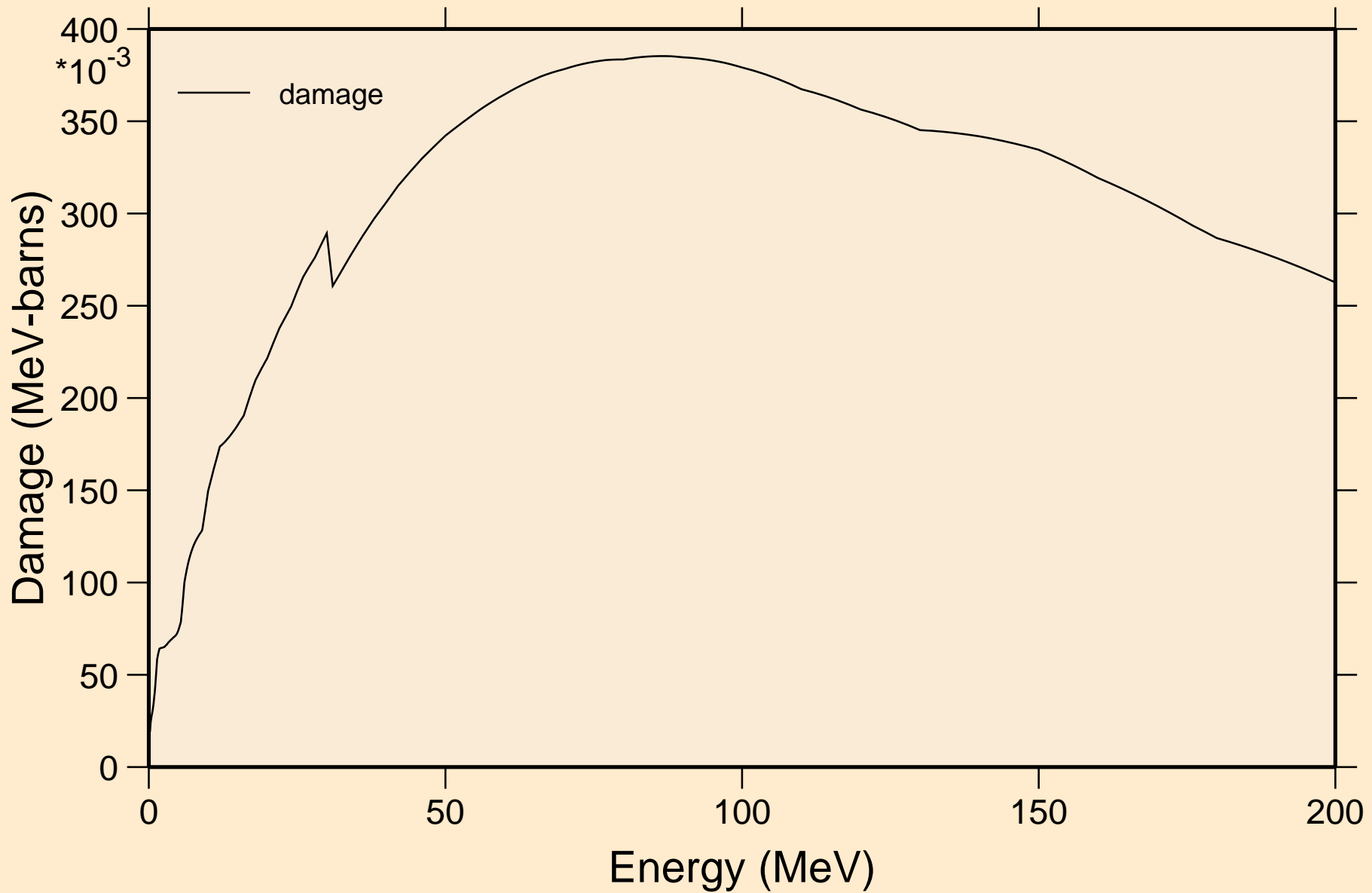

CM251 NEUTRON ACER TENDL-2024 LIBRARY; T=0.K

Non-threshold reactions

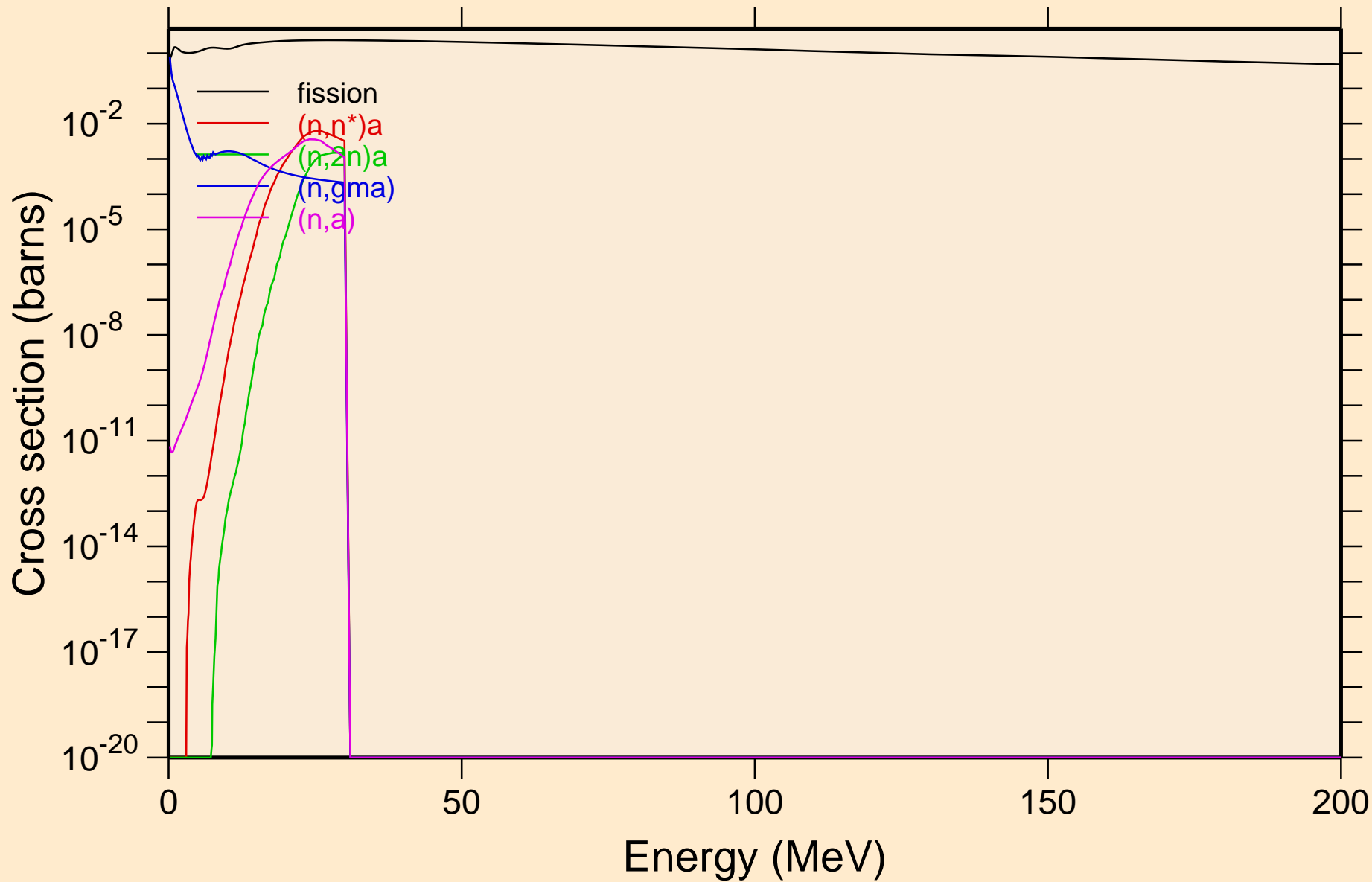

CM251 NEUTRON ACER TENDL-2024 LIBRARY; T=0.K
Non-threshold reactions

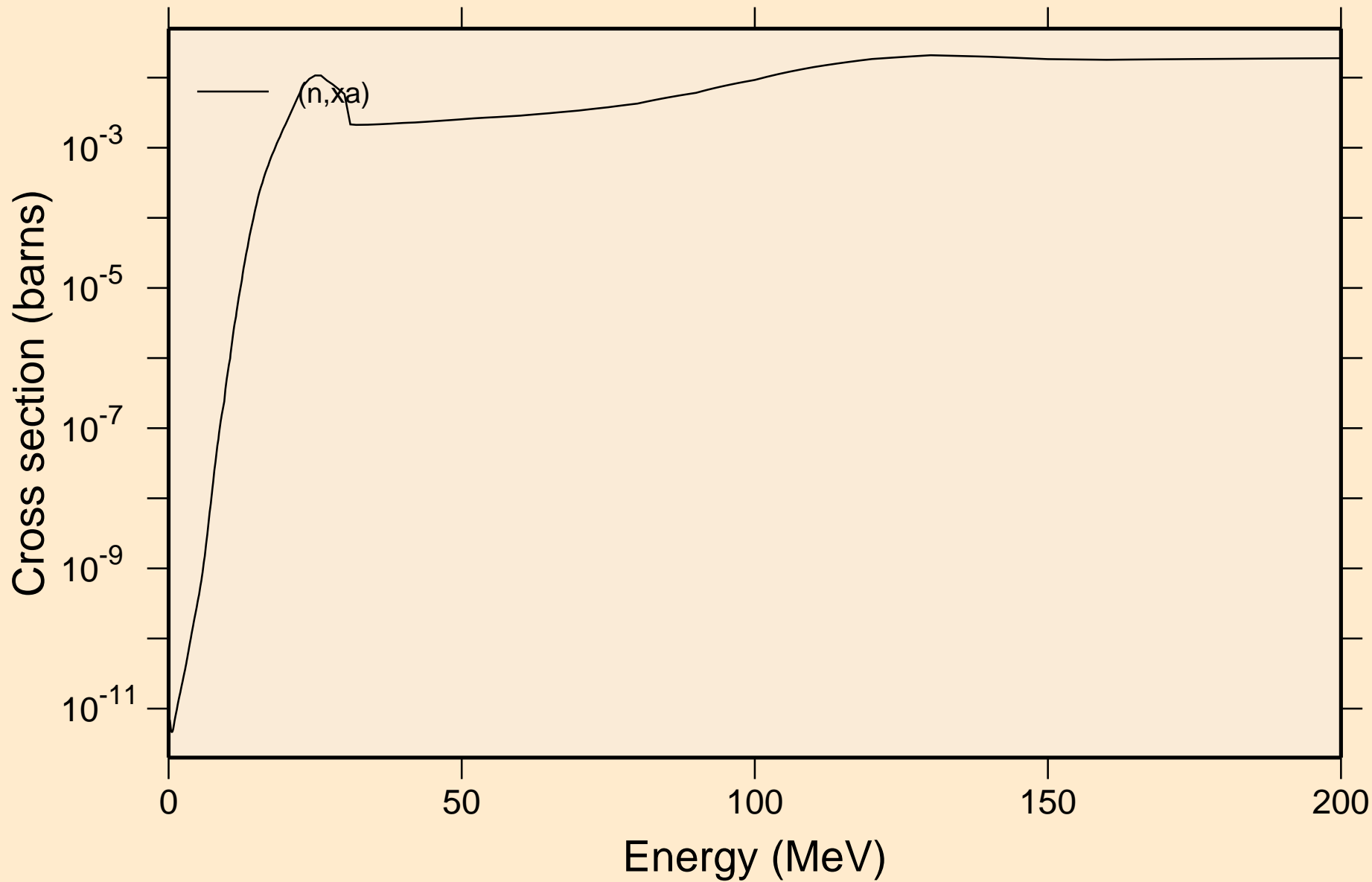

CM251 NEUTRON ACER TENDL-2024 LIBRARY; T=0.K
Inelastic levels

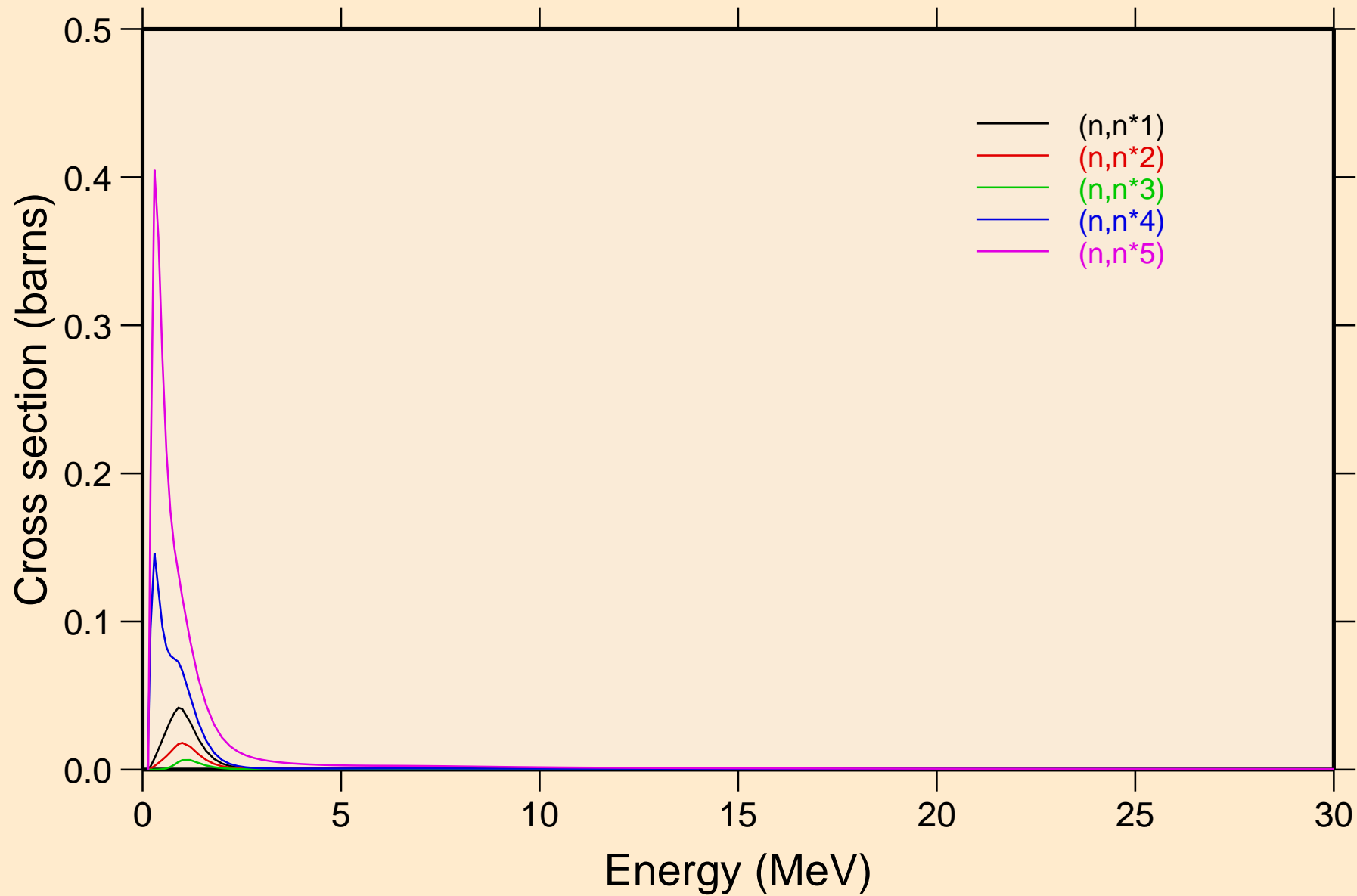

CM251 NEUTRON ACER TENDL-2024 LIBRARY; T=0.K
Inelastic levels

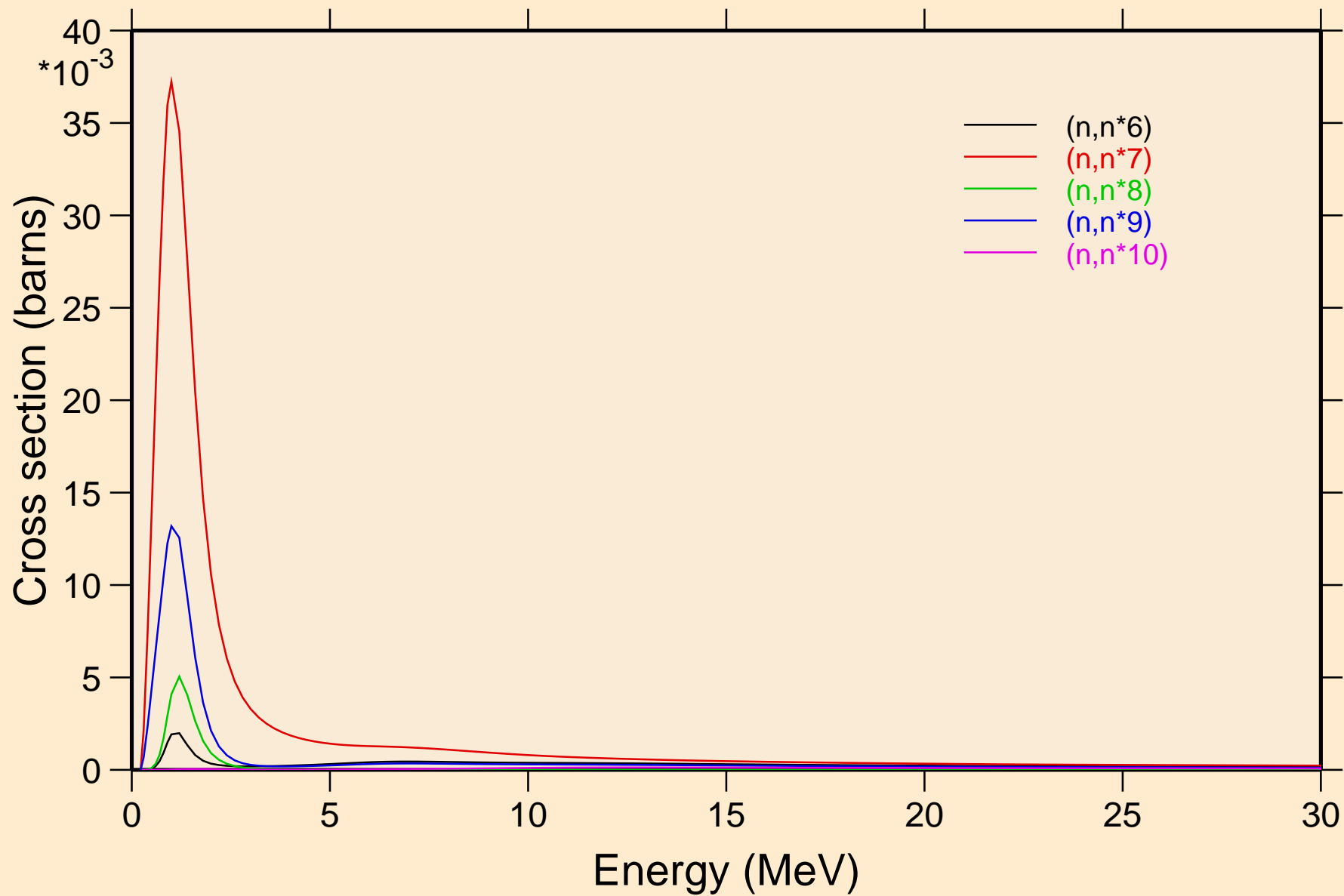

CM251 NEUTRON ACER TENDL-2024 LIBRARY; T=0.K

Inelastic levels

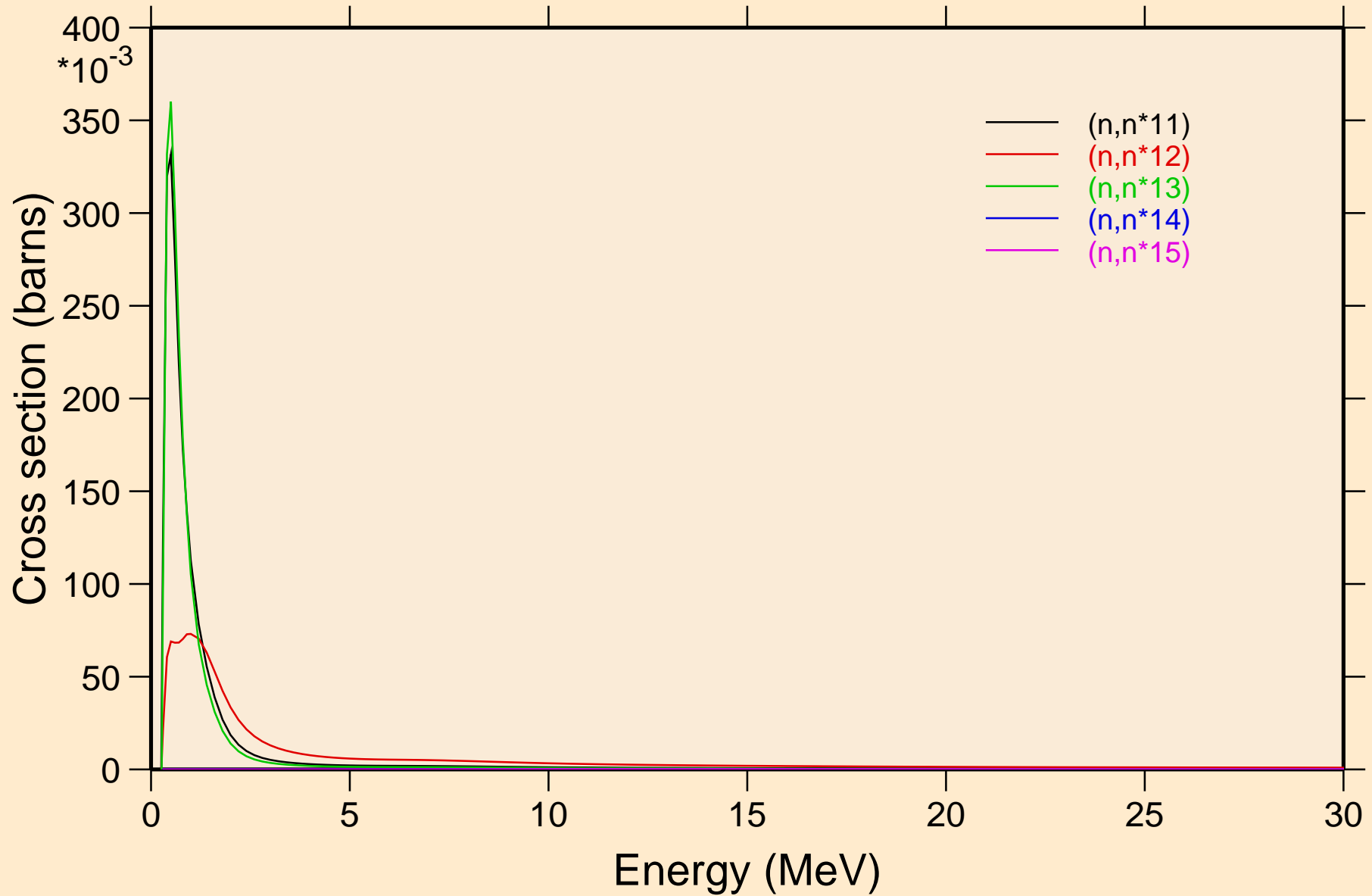

CM251 NEUTRON ACER TENDL-2024 LIBRARY; T=0.K

Inelastic levels

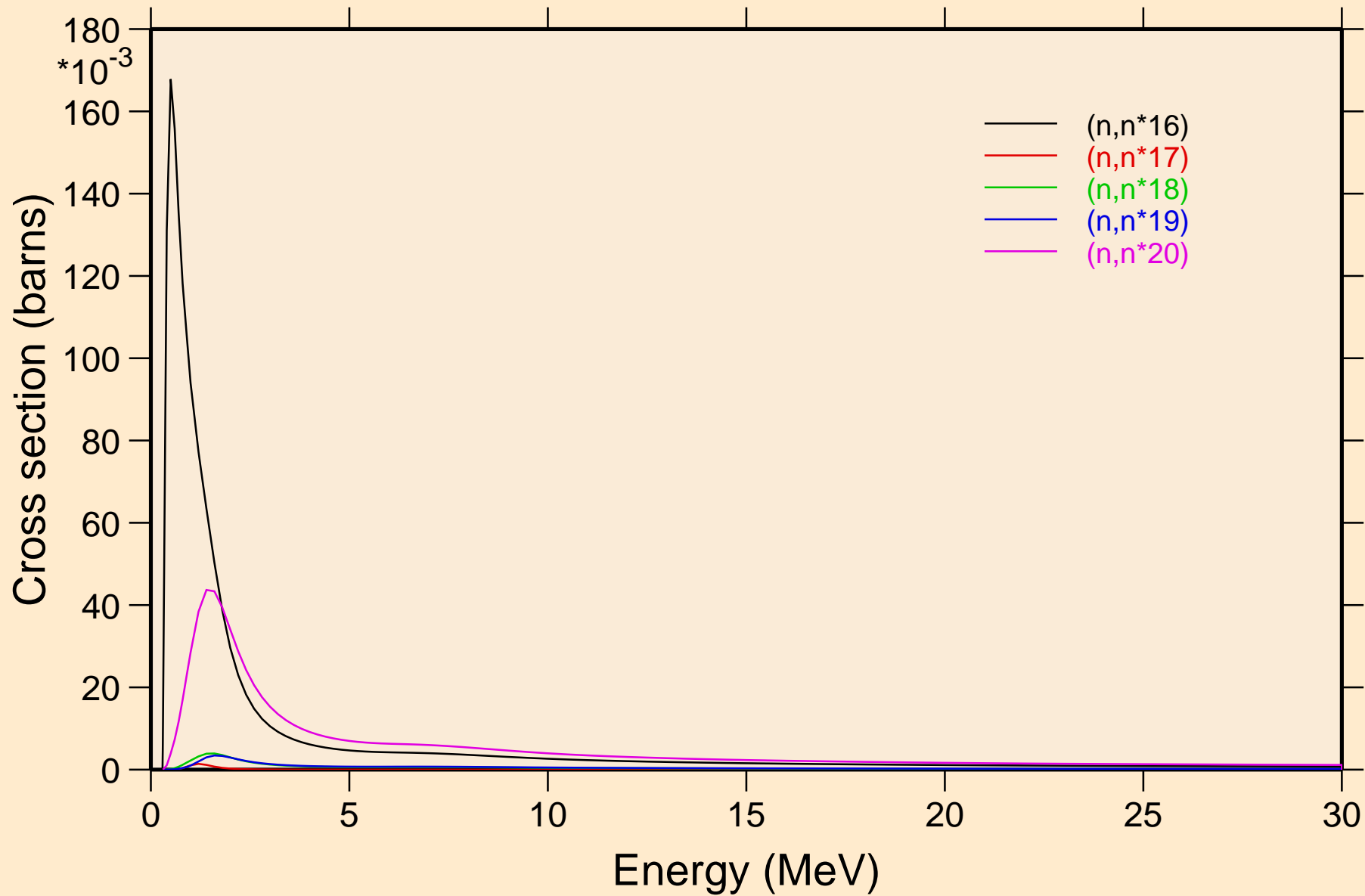

CM251 NEUTRON ACER TENDL-2024 LIBRARY; T=0.K
Inelastic levels

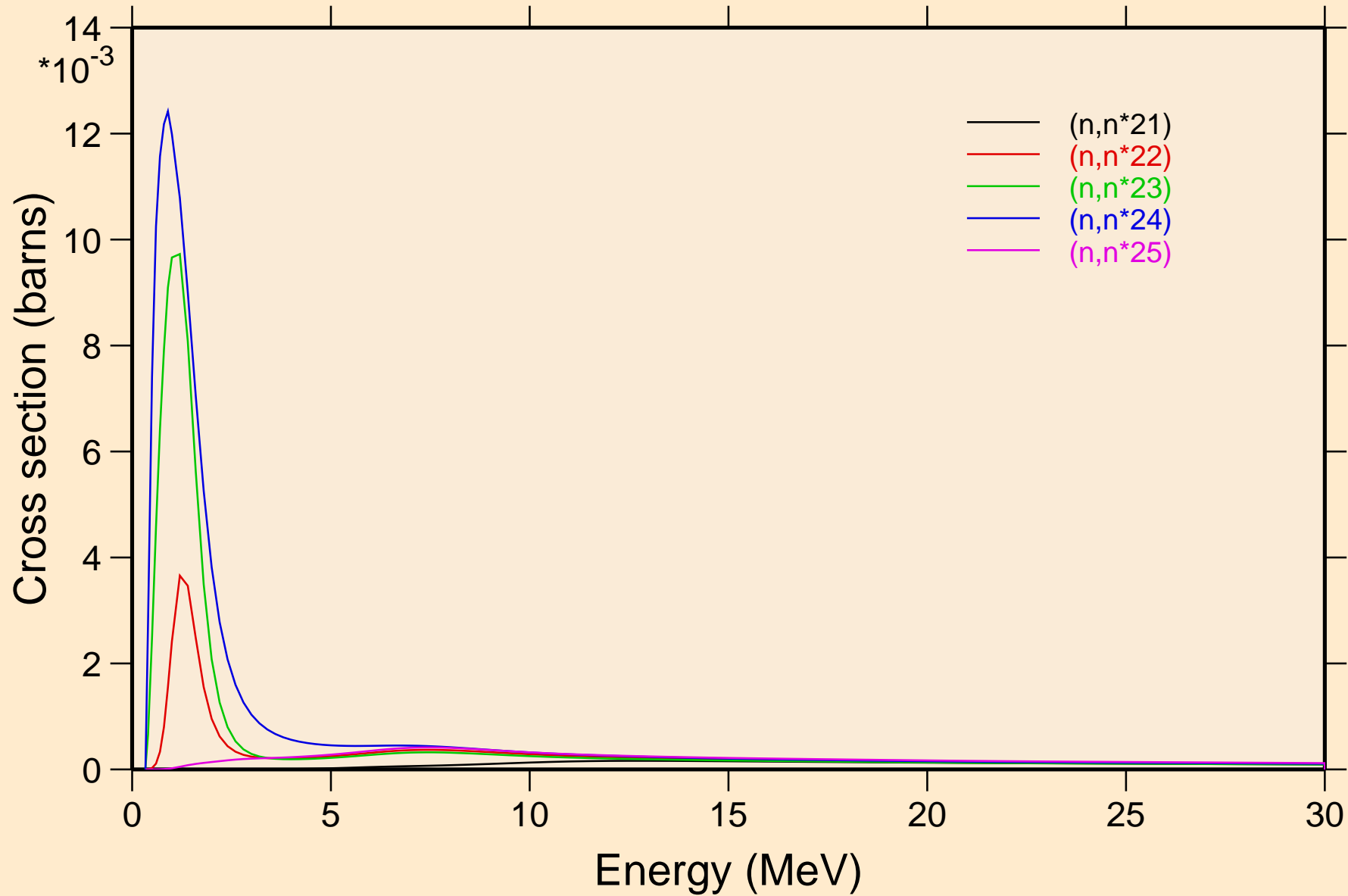

CM251 NEUTRON ACER TENDL-2024 LIBRARY; T=0.K
Inelastic levels

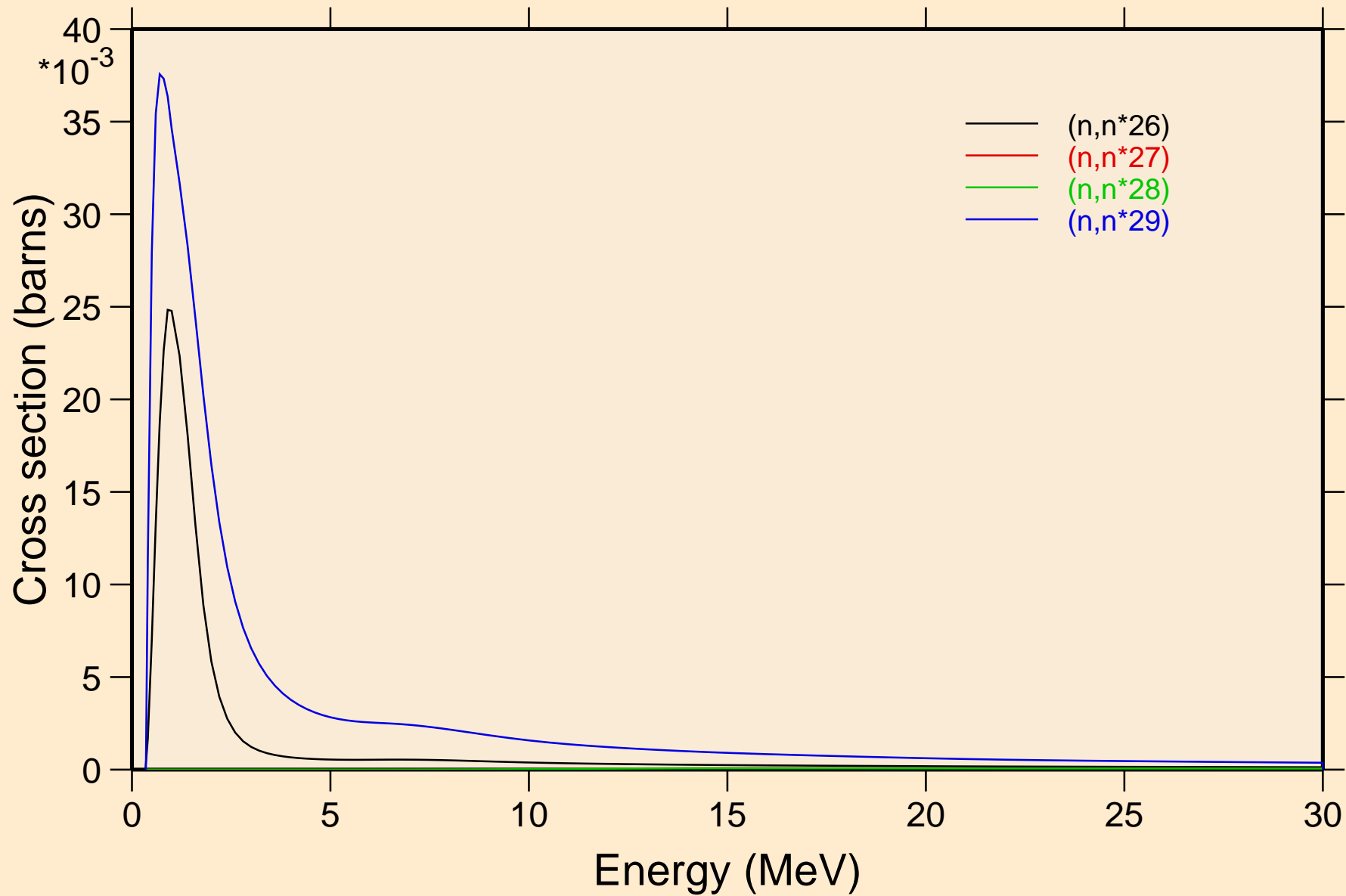

CM251 NEUTRON ACER TENDL-2024 LIBRARY; T=0.K

Threshold reactions

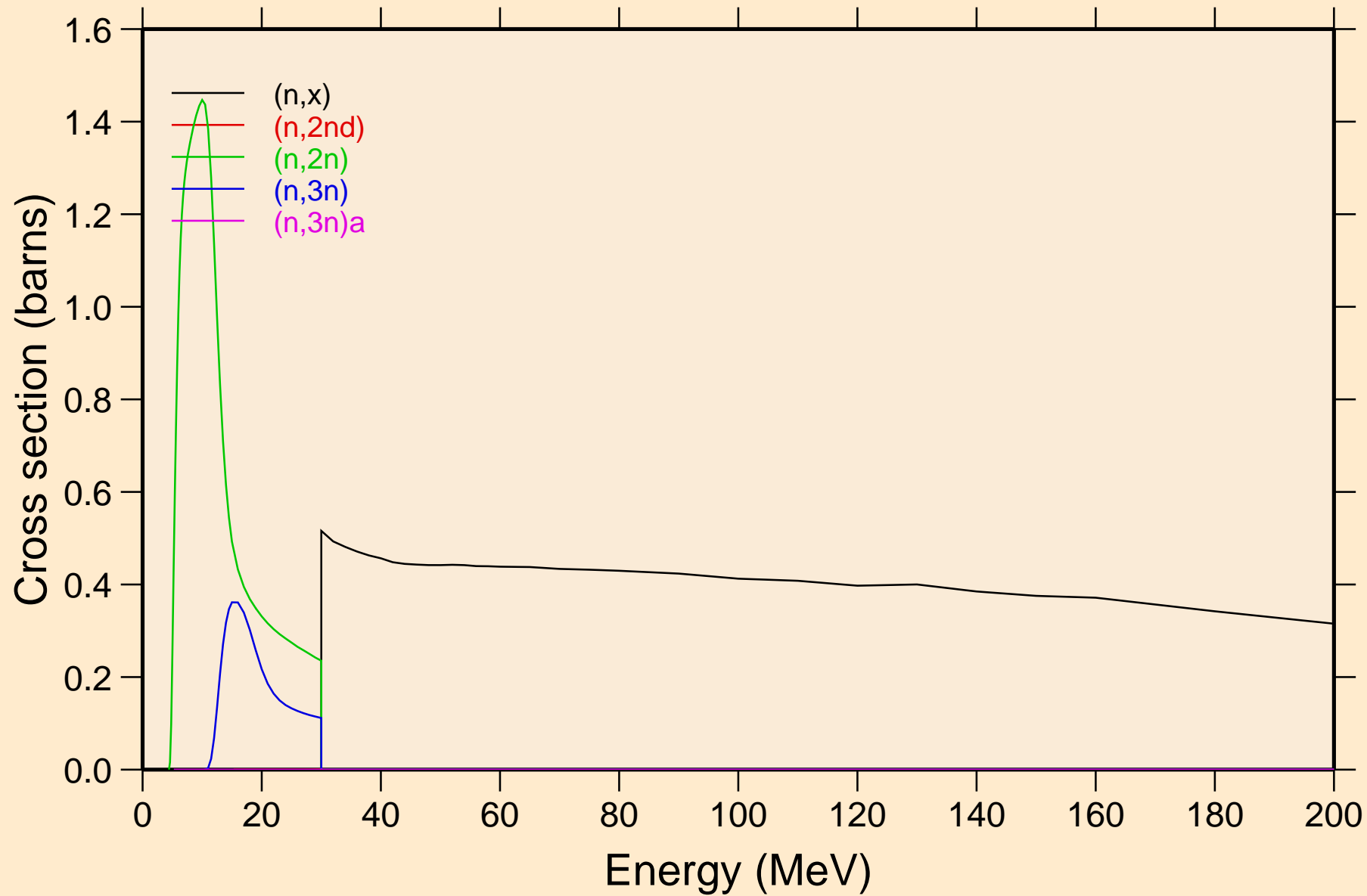

CM251 NEUTRON ACER TENDL-2024 LIBRARY; T=0.K

Threshold reactions

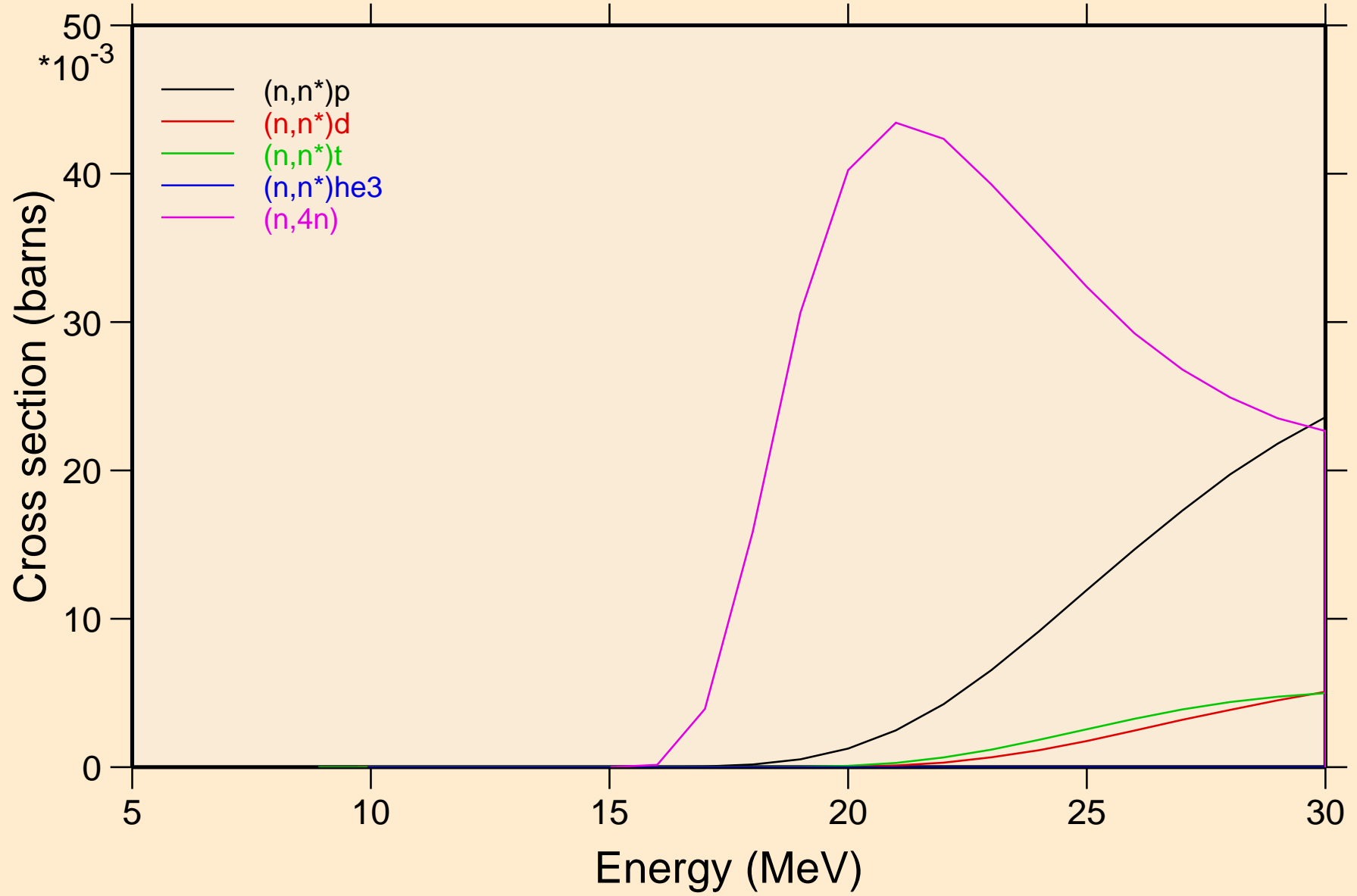

CM251 NEUTRON ACER TENDL-2024 LIBRARY; T=0.K

Threshold reactions

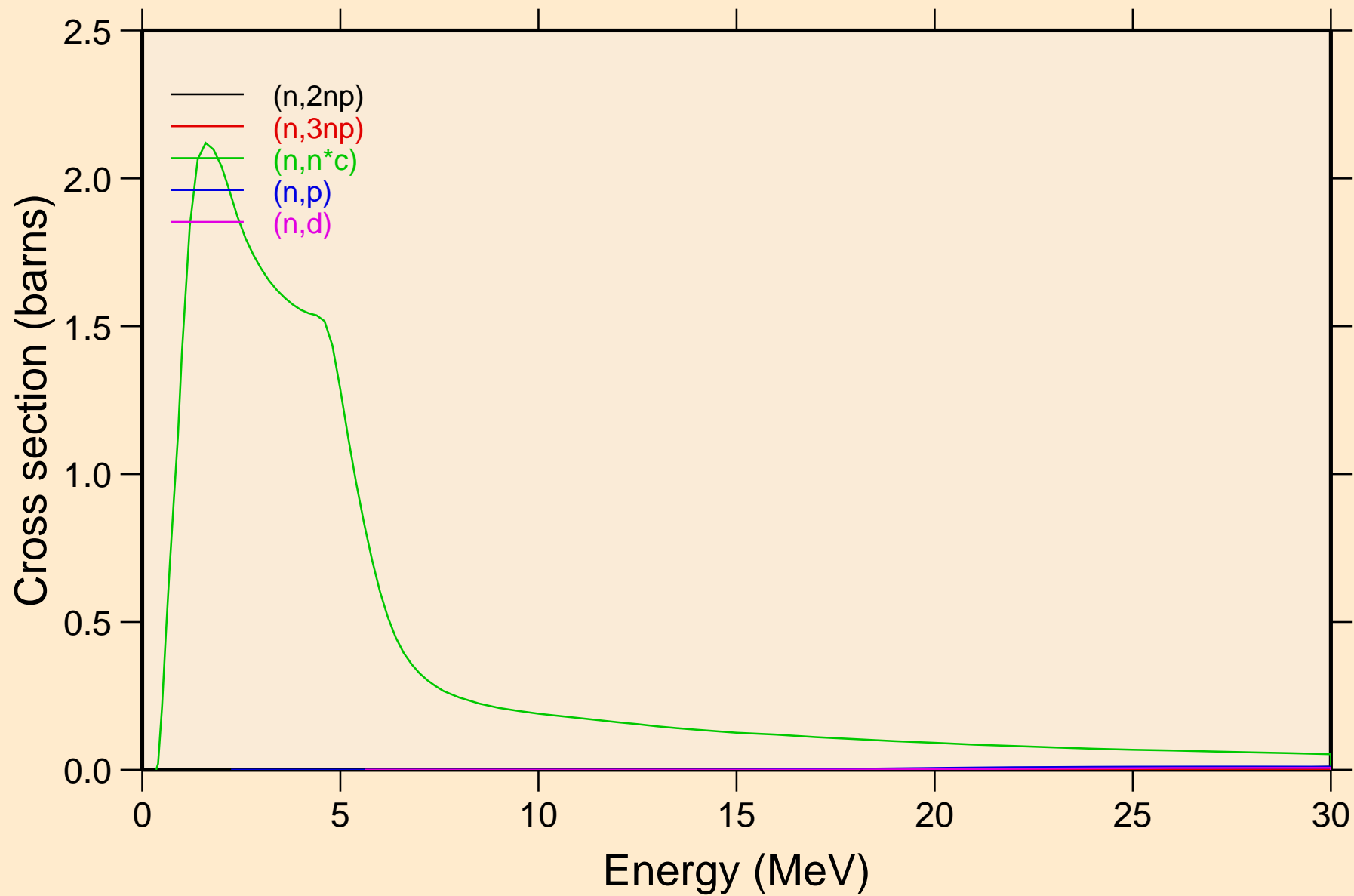

CM251 NEUTRON ACER TENDL-2024 LIBRARY; T=0.K
Threshold reactions

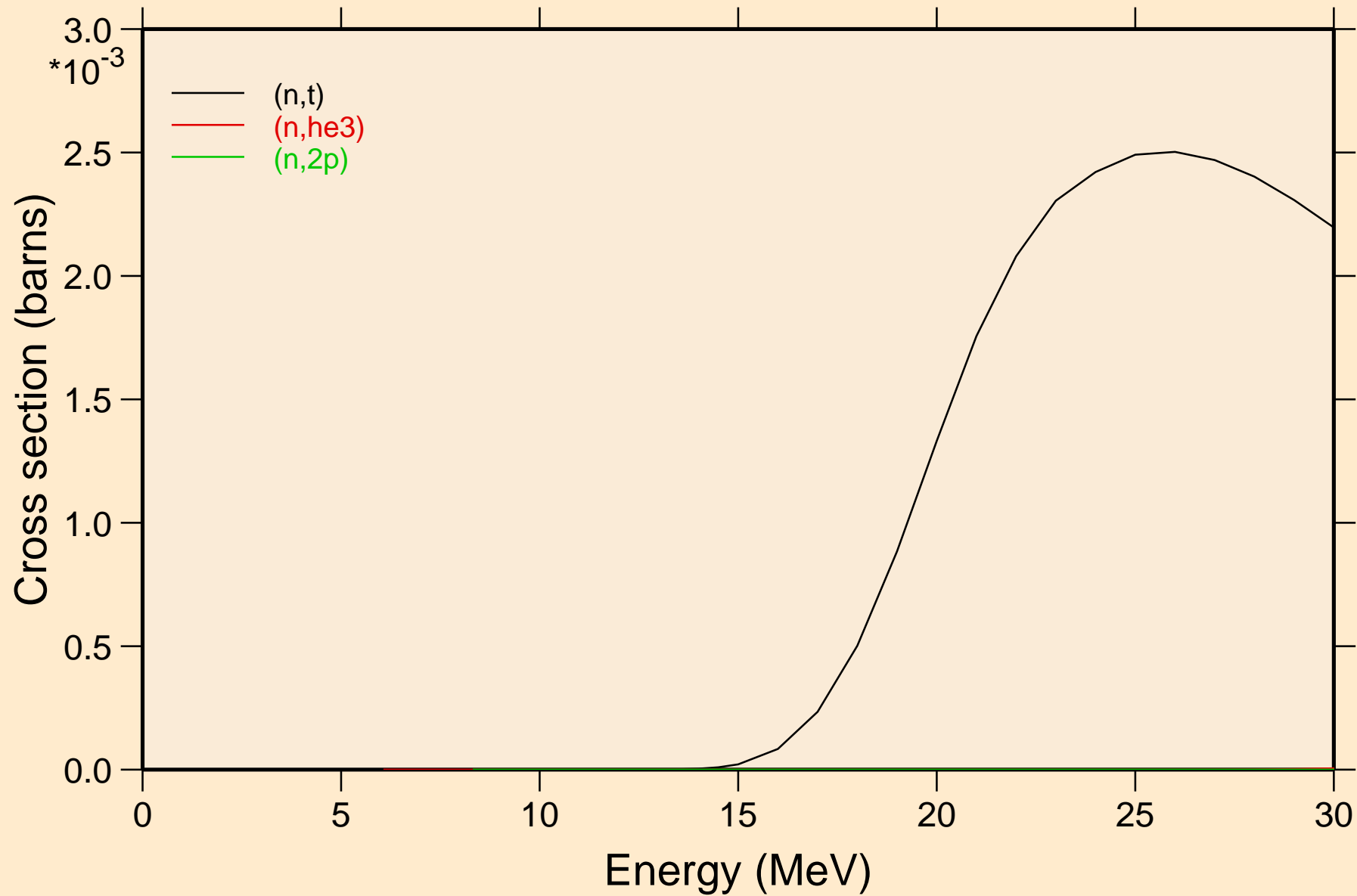

CM251 NEUTRON ACER TENDL-2024 LIBRARY; T=0.K

Threshold reactions

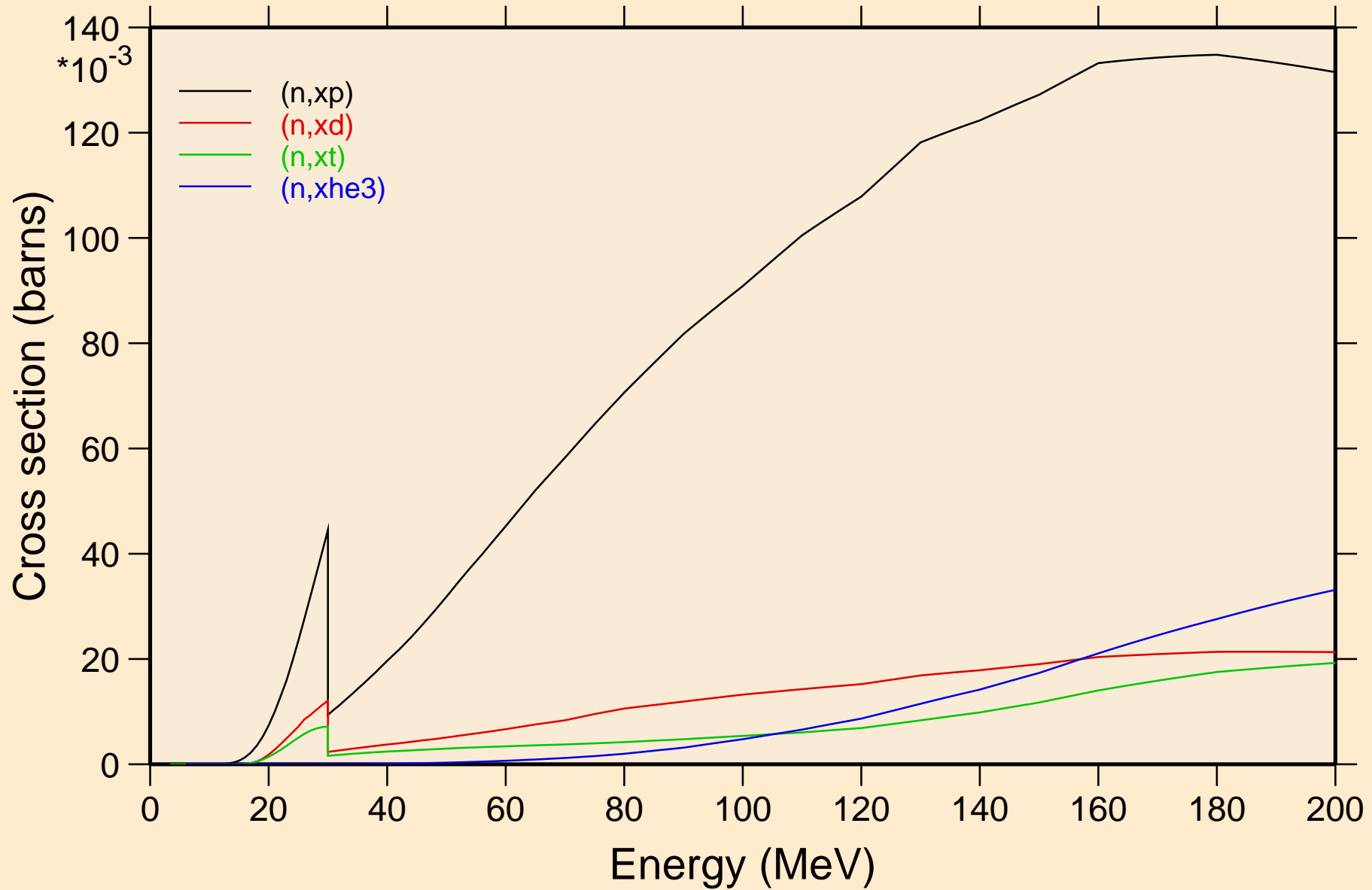

CM251 NEUTRON ACER TENDL-2024 LIBRARY; T=0.K
angular distribution for elastic

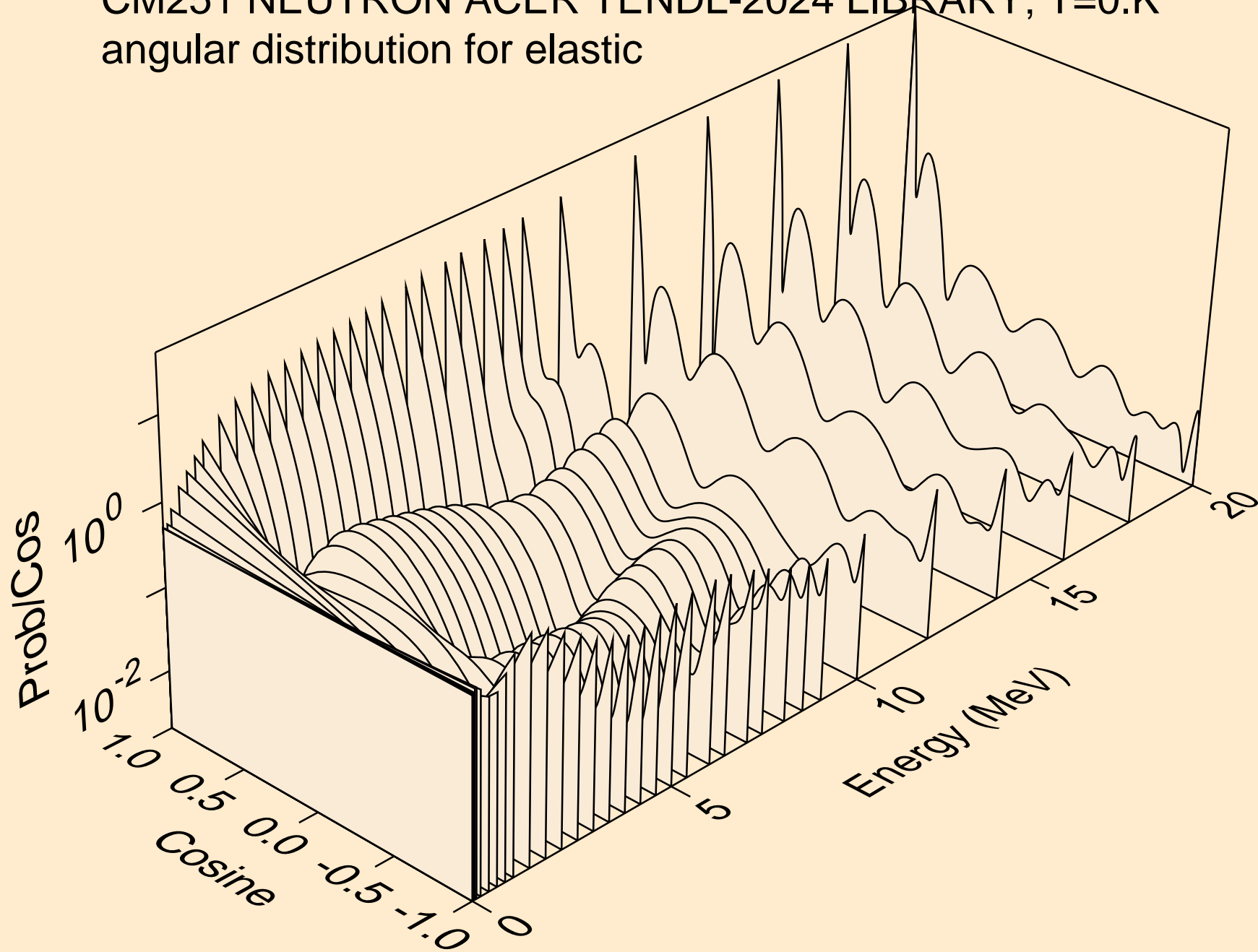

CM251 NEUTRON ACER TENDL-2024 LIBRARY; T=0.K
angular distribution for elastic

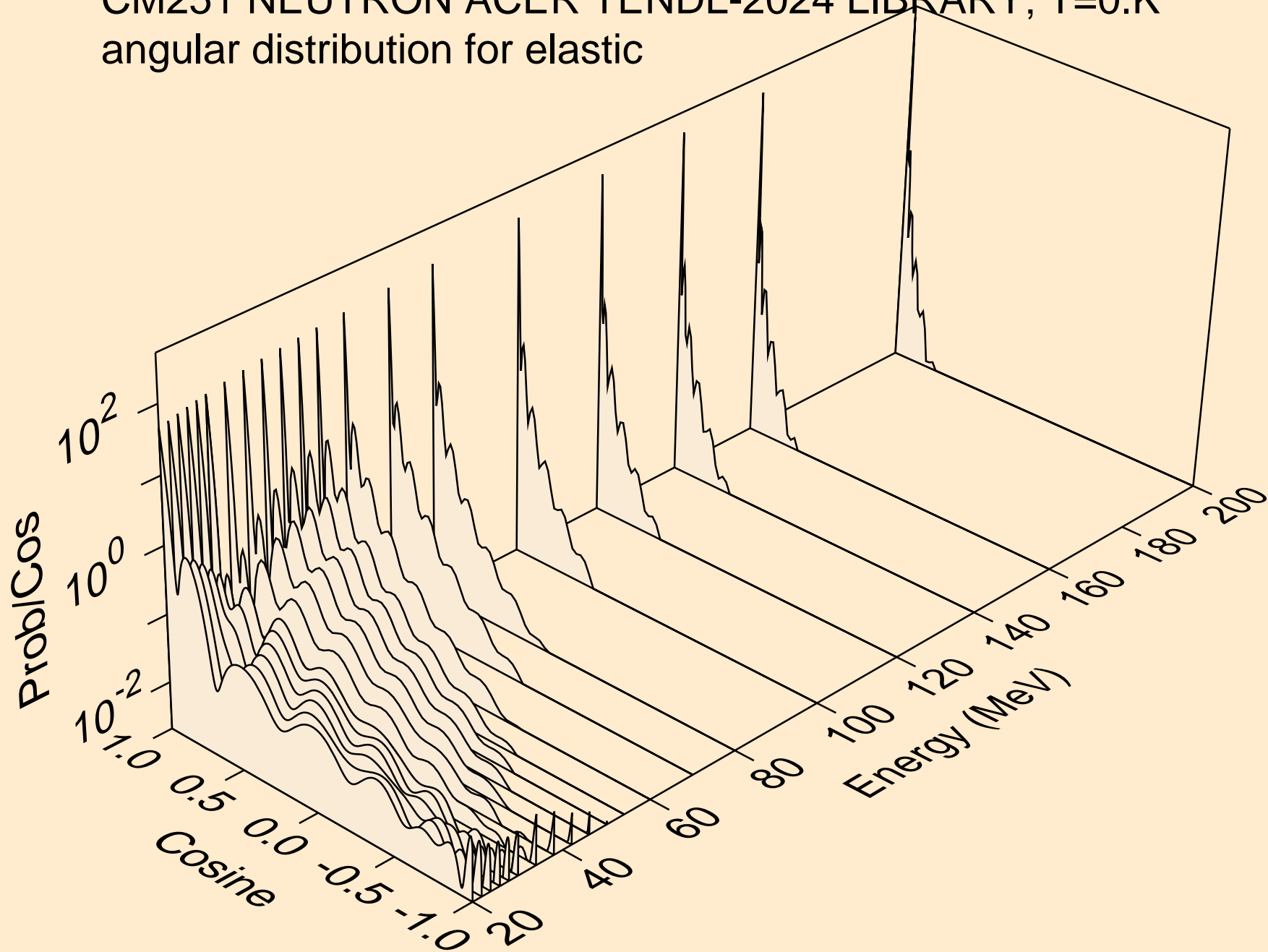

CM251 NEUTRON ACER TENDL-2024 LIBRARY; T=0.K
angular distribution for (n,n*1)

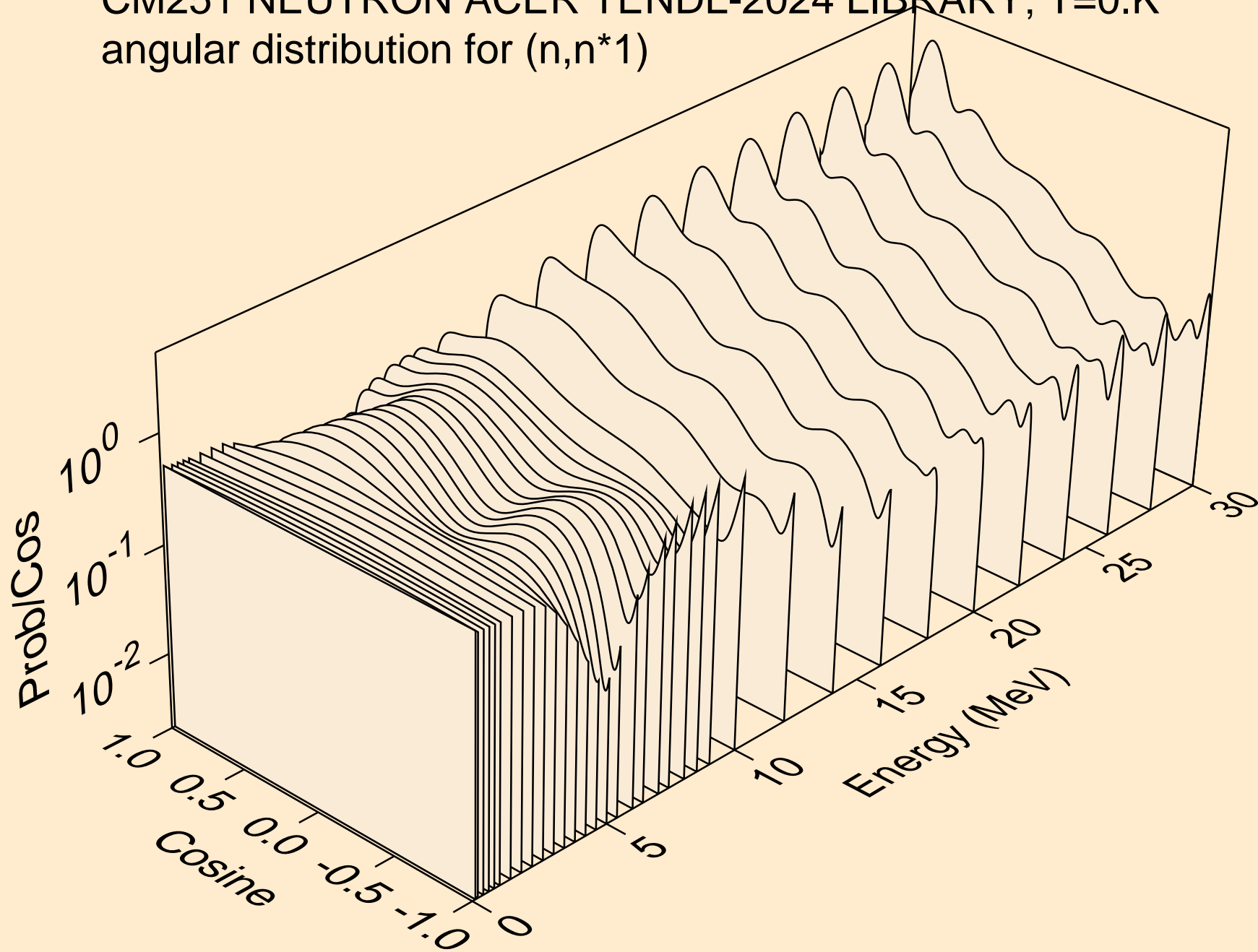

CM251 NEUTRON ACER TENDL-2024 LIBRARY; T=0.K
angular distribution for (n,n*2)

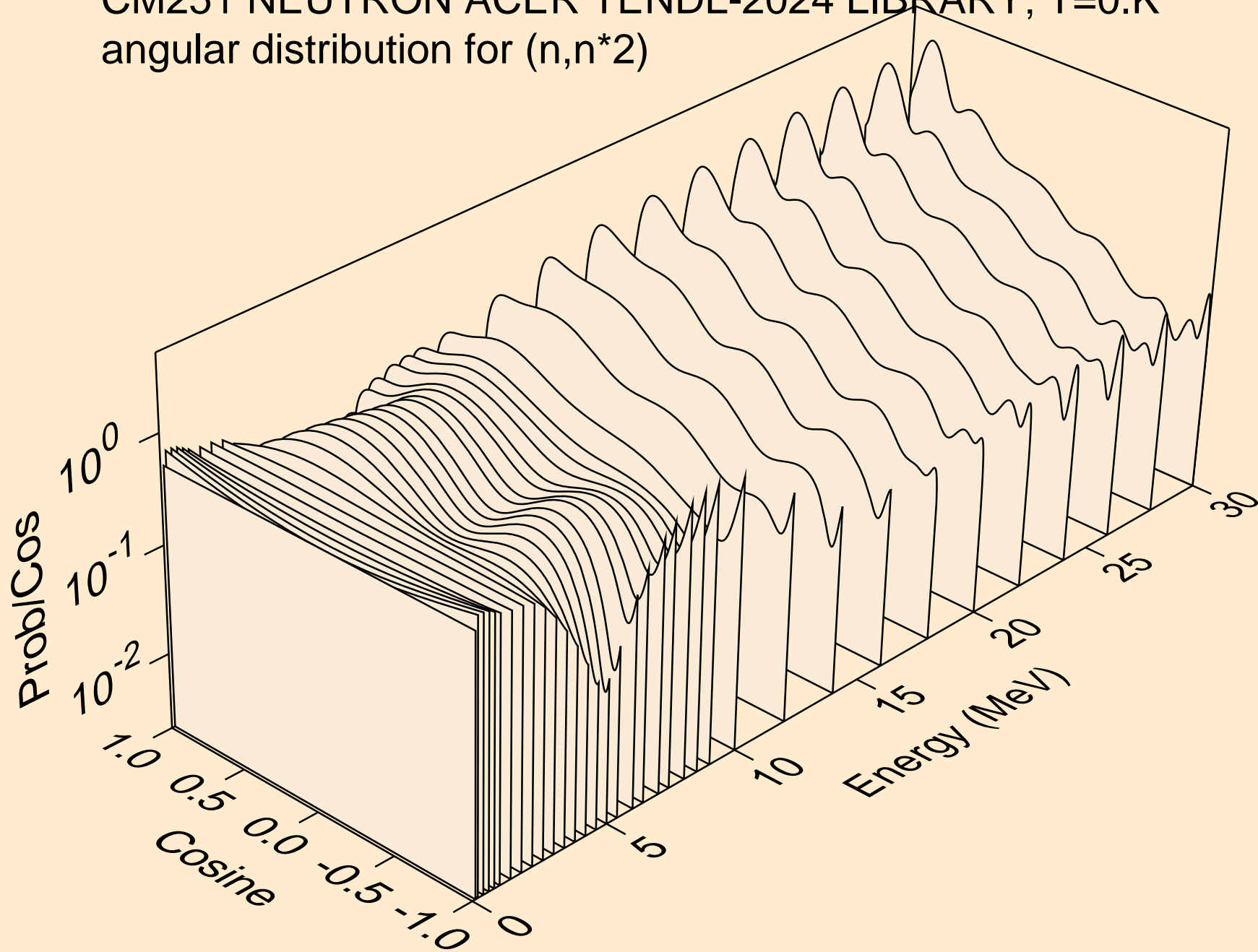

CM251 NEUTRON ACER TENDL-2024 LIBRARY; T=0.K
angular distribution for (n,n*3)

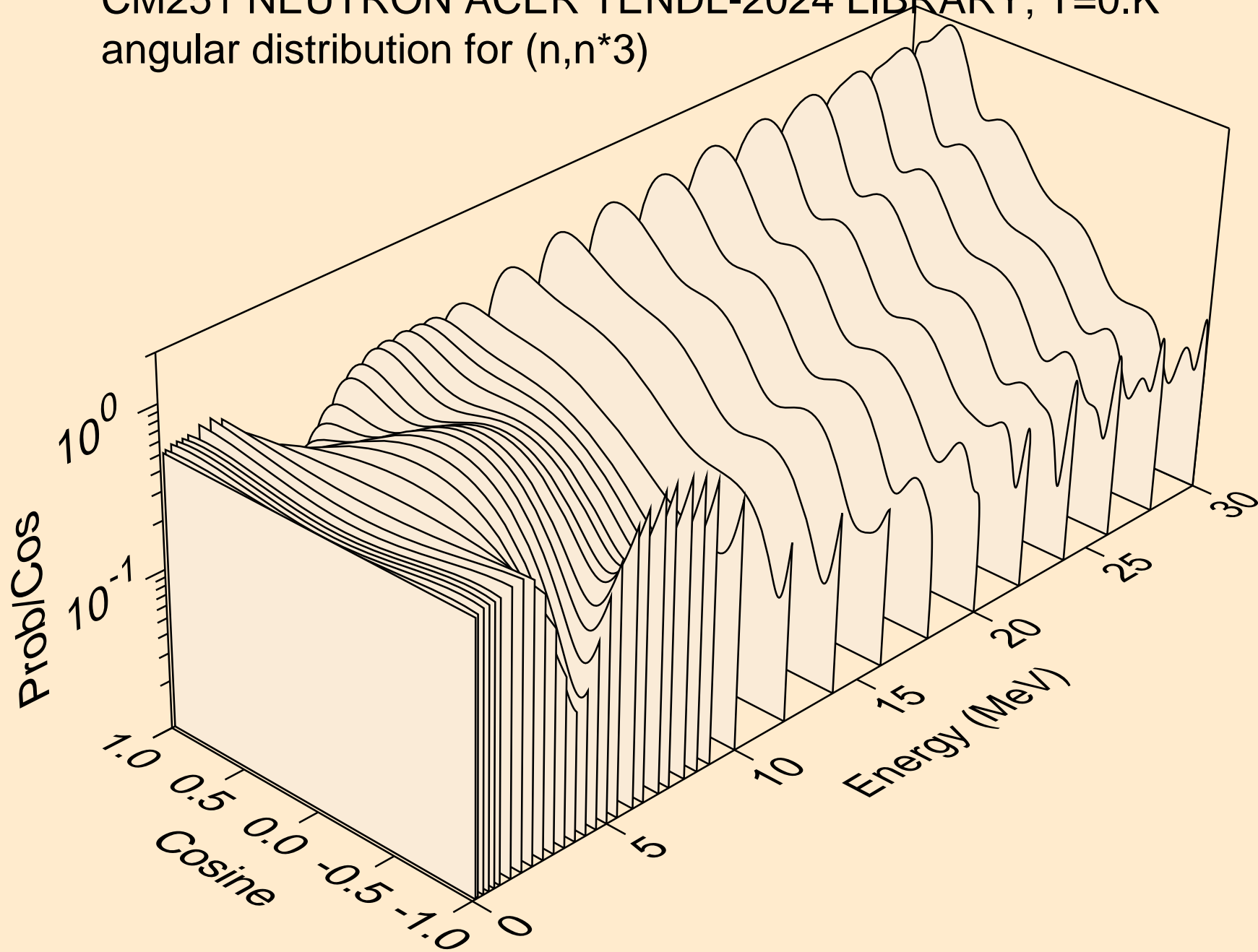

CM251 NEUTRON ACER TENDL-2024 LIBRARY; T=0.K
angular distribution for (n,n*4)

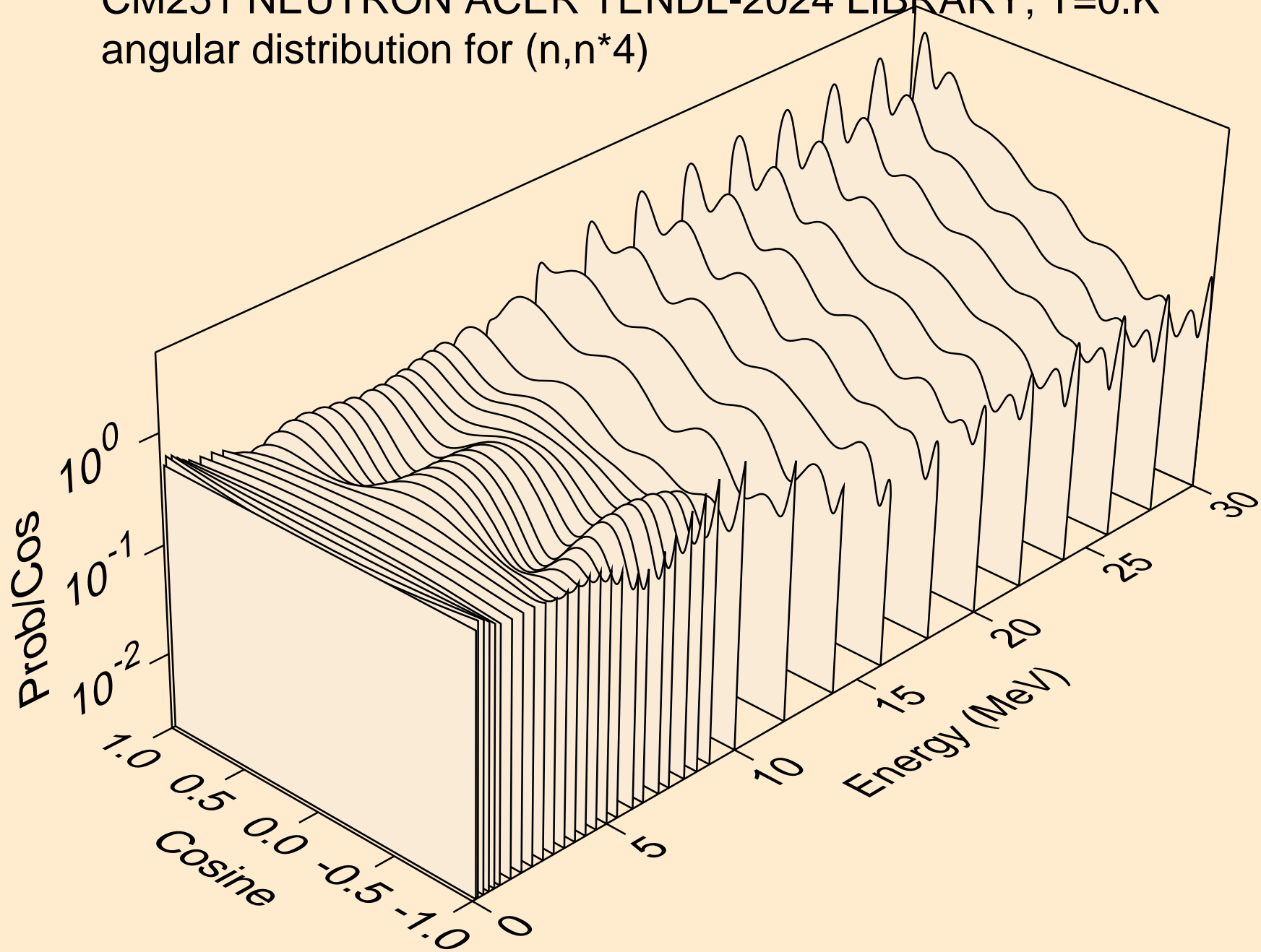

CM251 NEUTRON ACER TENDL-2024 LIBRARY; T=0.K
angular distribution for (n,n*5)

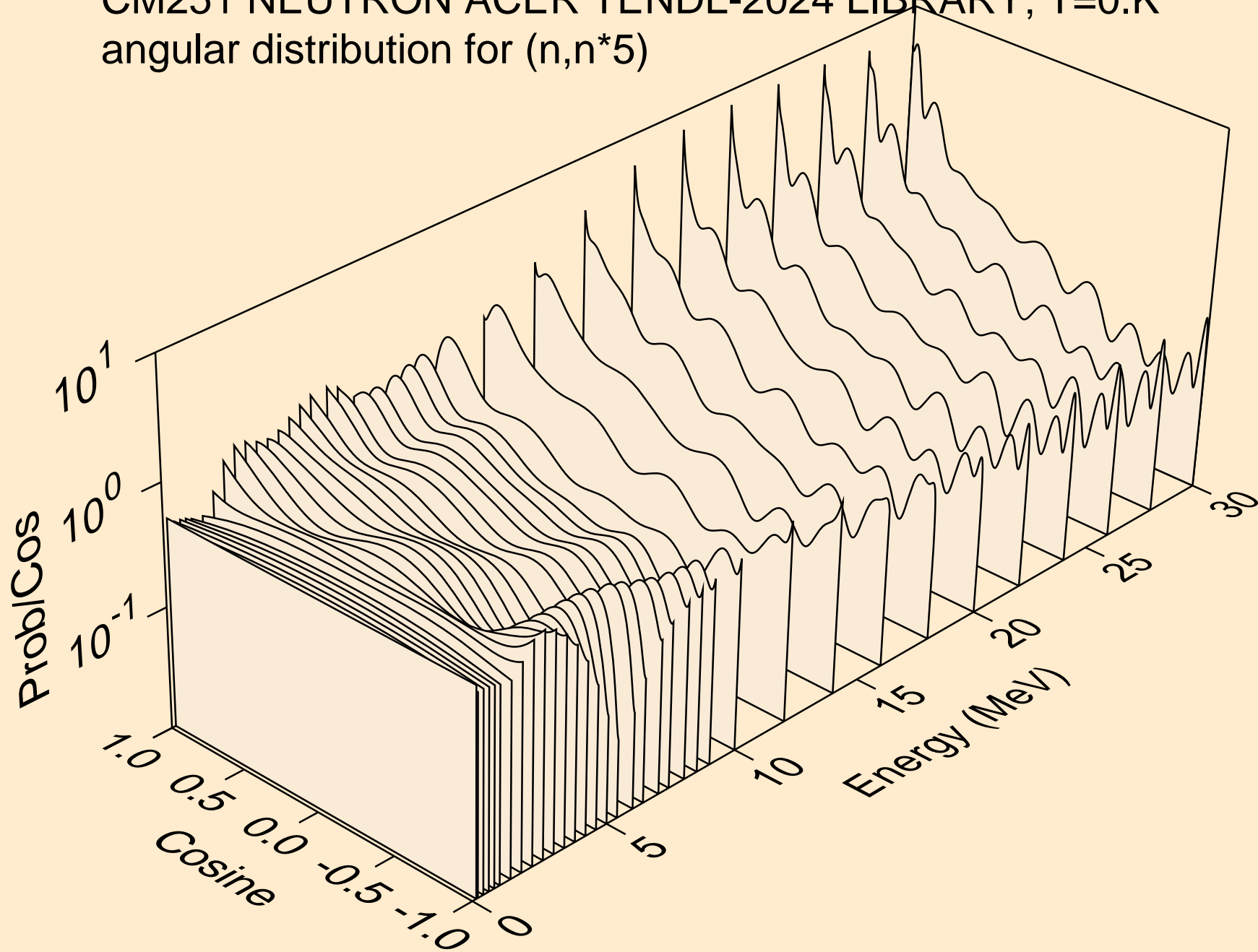

CM251 NEUTRON ACER TENDL-2024 LIBRARY; T=0.K
angular distribution for (n,n*6)

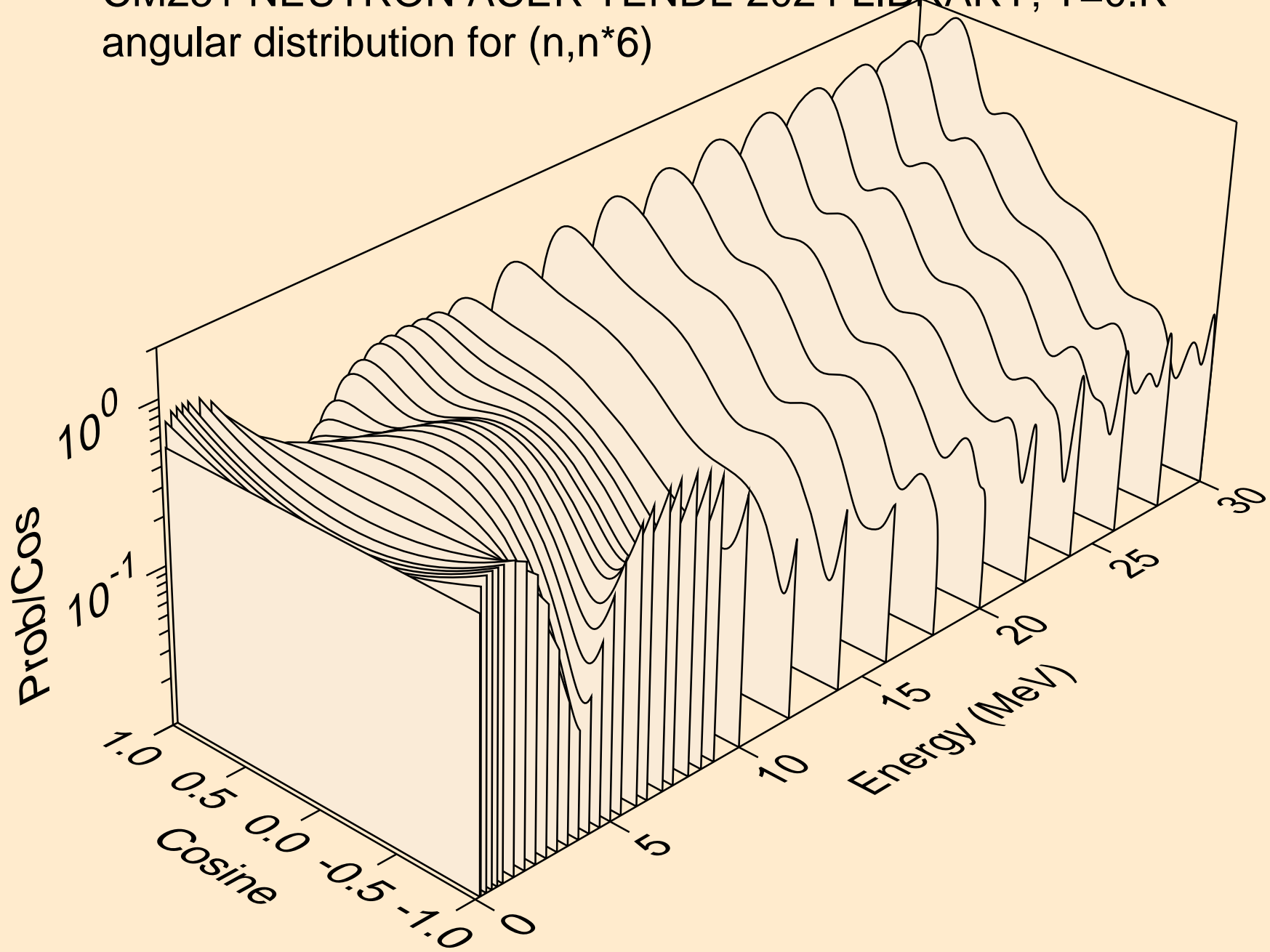

CM251 NEUTRON ACER TENDL-2024 LIBRARY; T=0.K
angular distribution for (n,n*7)

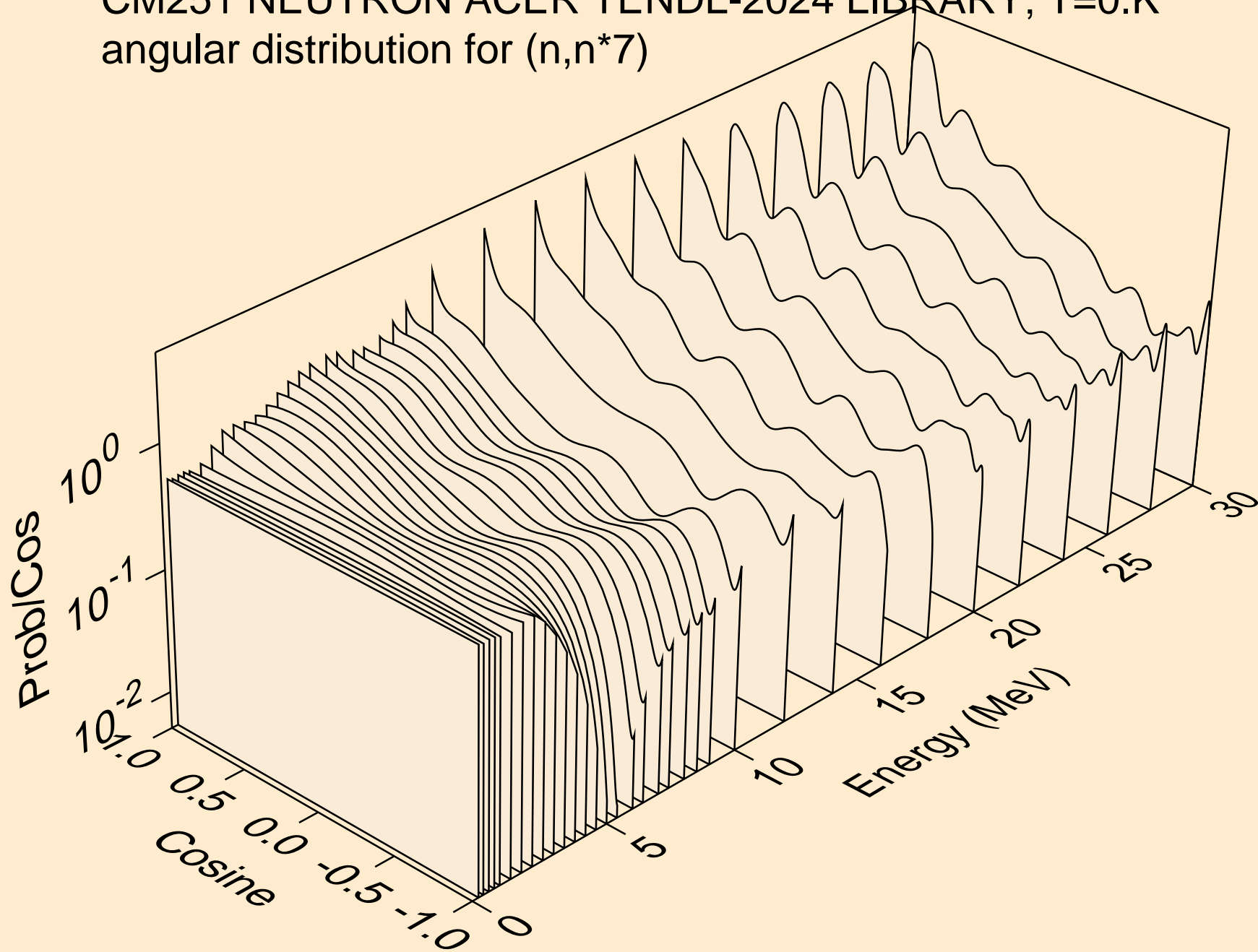

CM251 NEUTRON ACER TENDL-2024 LIBRARY; T=0.K
angular distribution for (n,n*8)

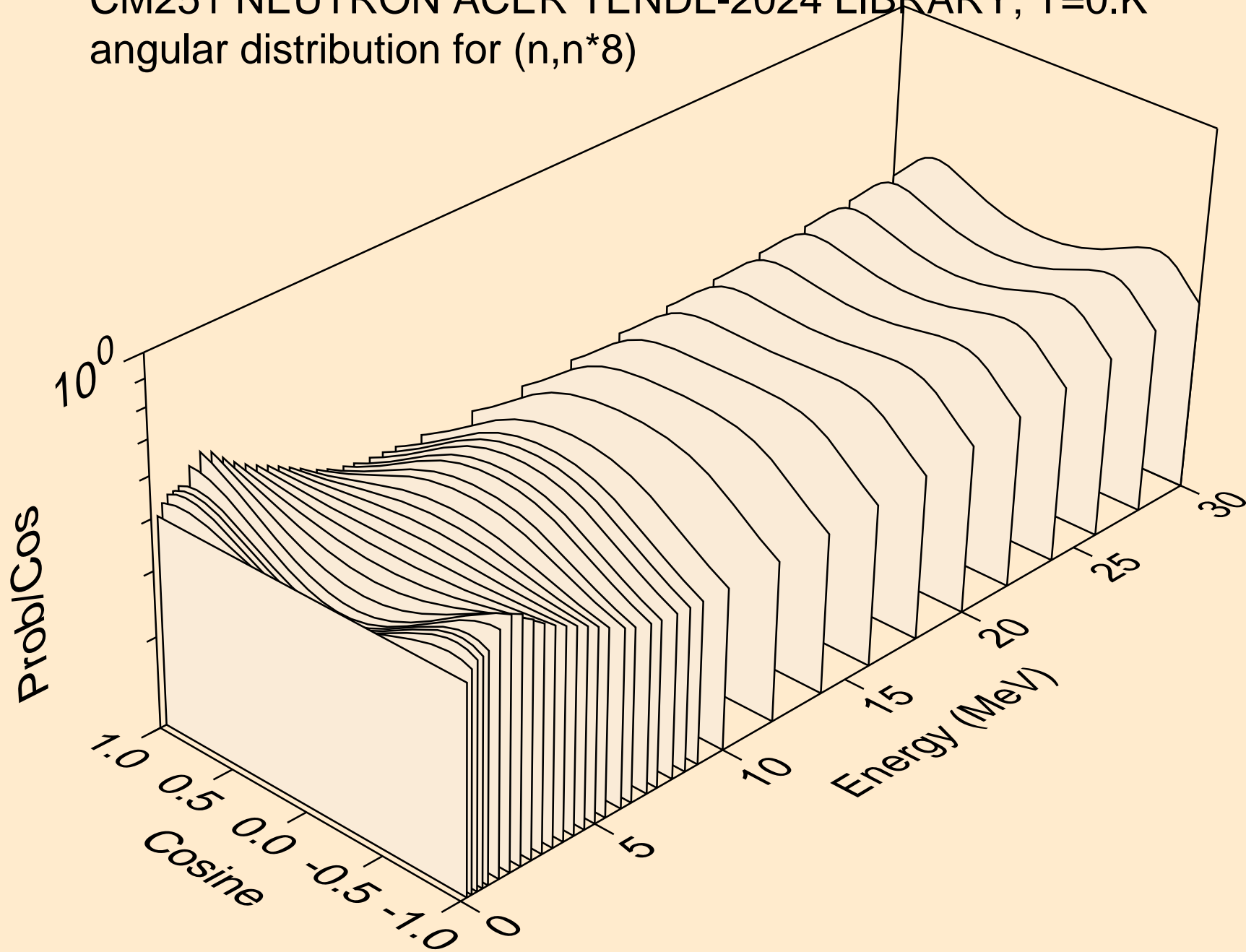

CM251 NEUTRON ACER TENDL-2024 LIBRARY; T=0.K
angular distribution for (n,n*9)

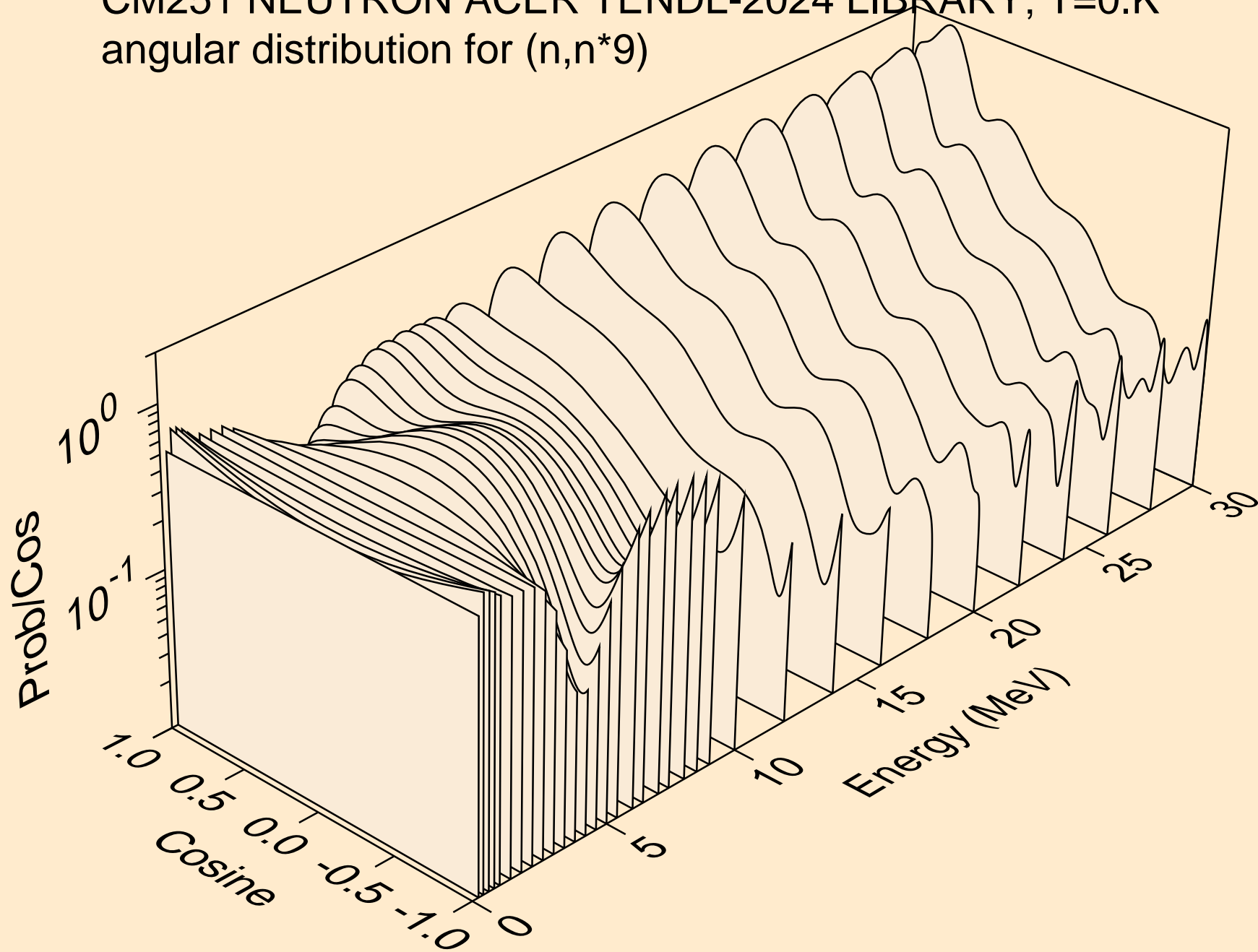

CM251 NEUTRON ACER TENDL-2024 LIBRARY; T=0.K
angular distribution for (n,n*10)

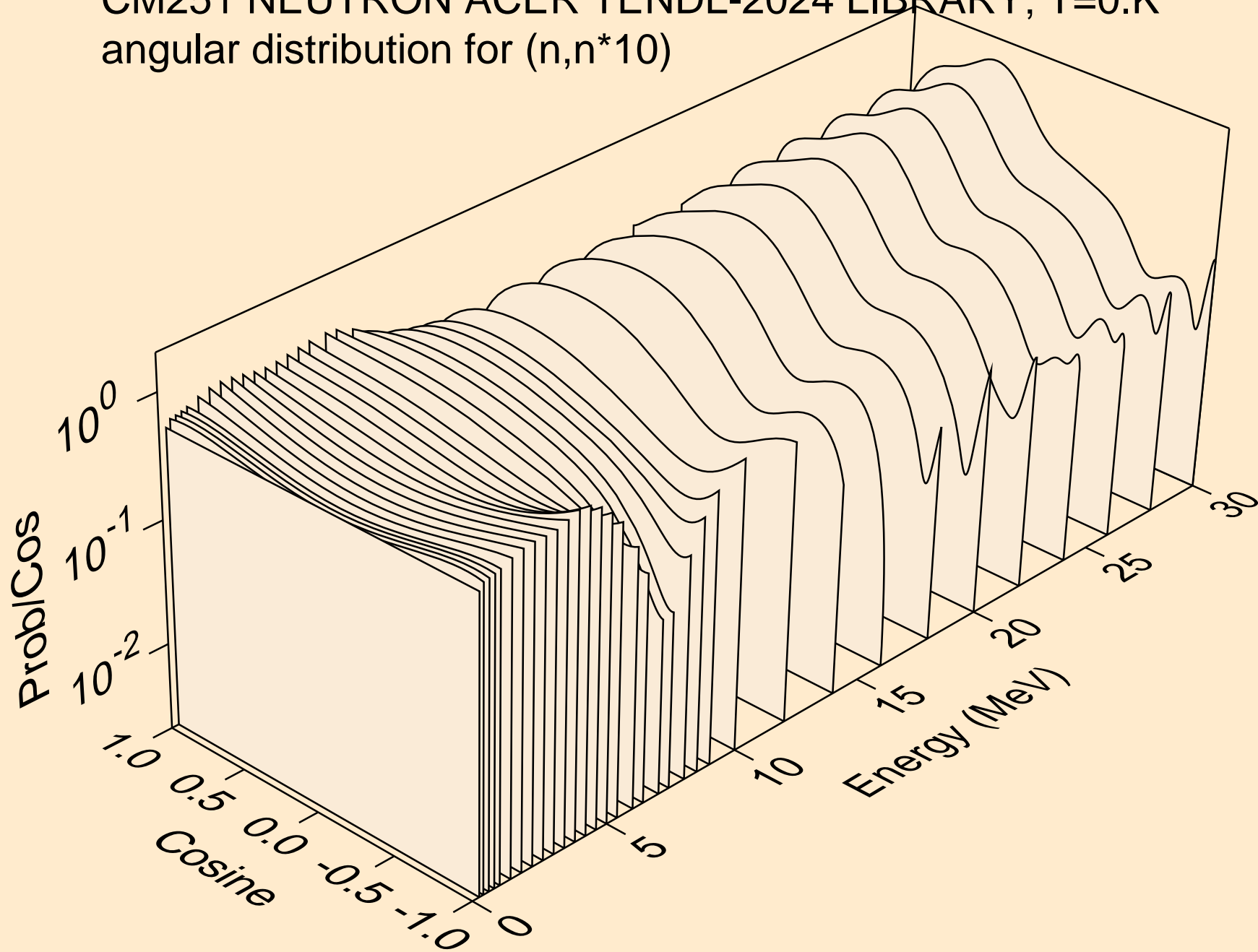

CM251 NEUTRON ACER TENDL-2024 LIBRARY; T=0.K
angular distribution for (n,n*11)

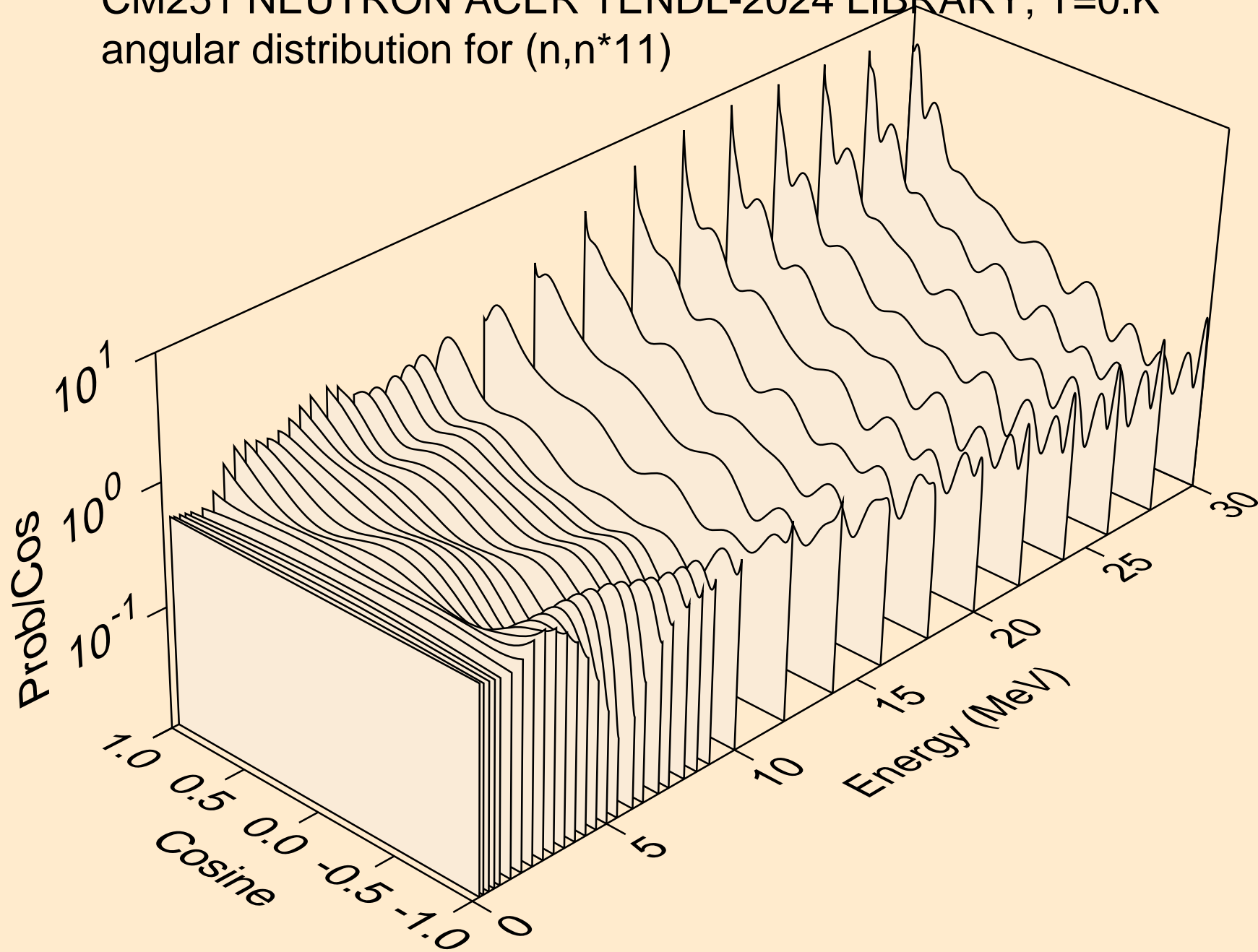

CM251 NEUTRON ACER TENDL-2024 LIBRARY; T=0.K
angular distribution for (n,n*12)

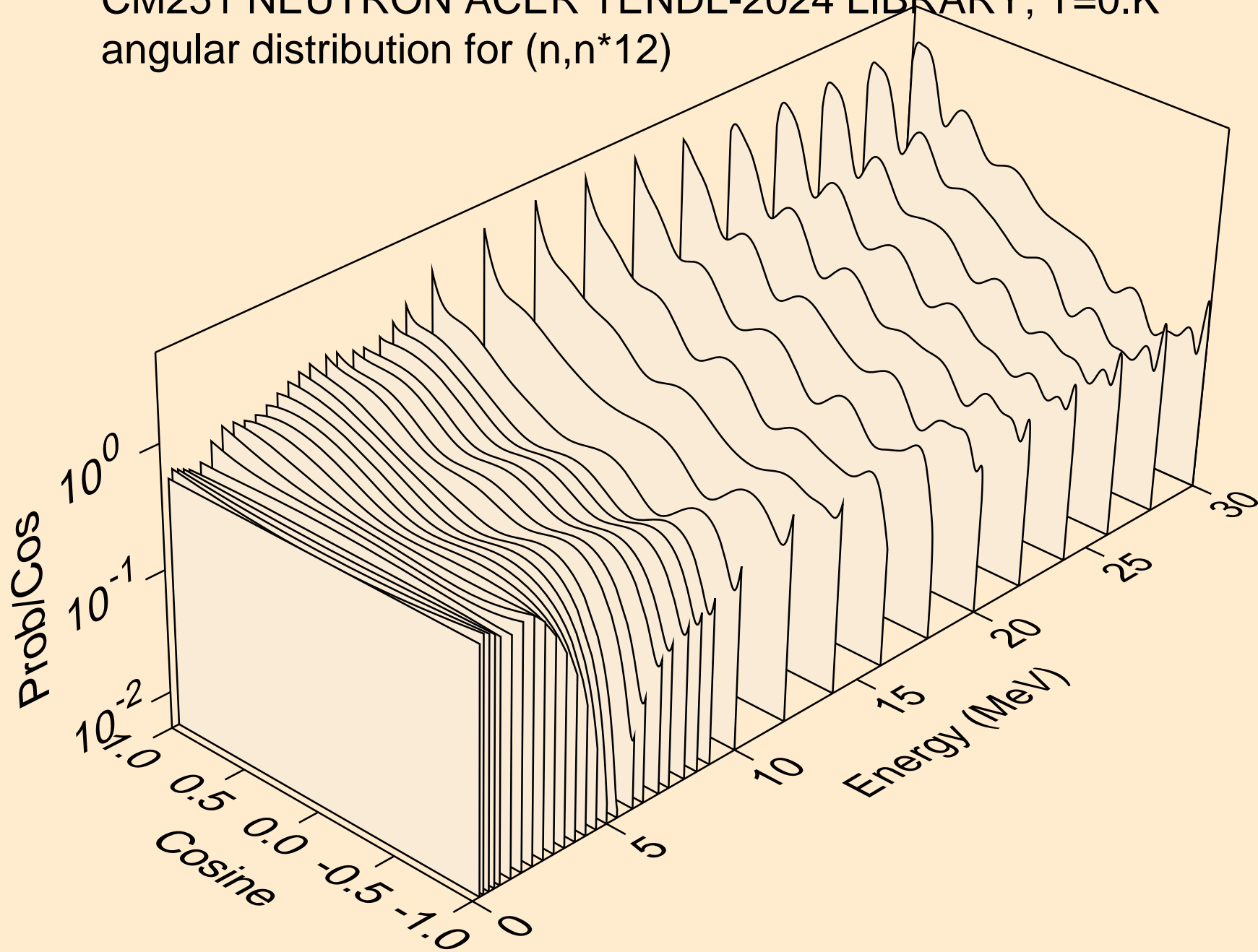

CM251 NEUTRON ACER TENDL-2024 LIBRARY; T=0.K
angular distribution for (n,n*13)

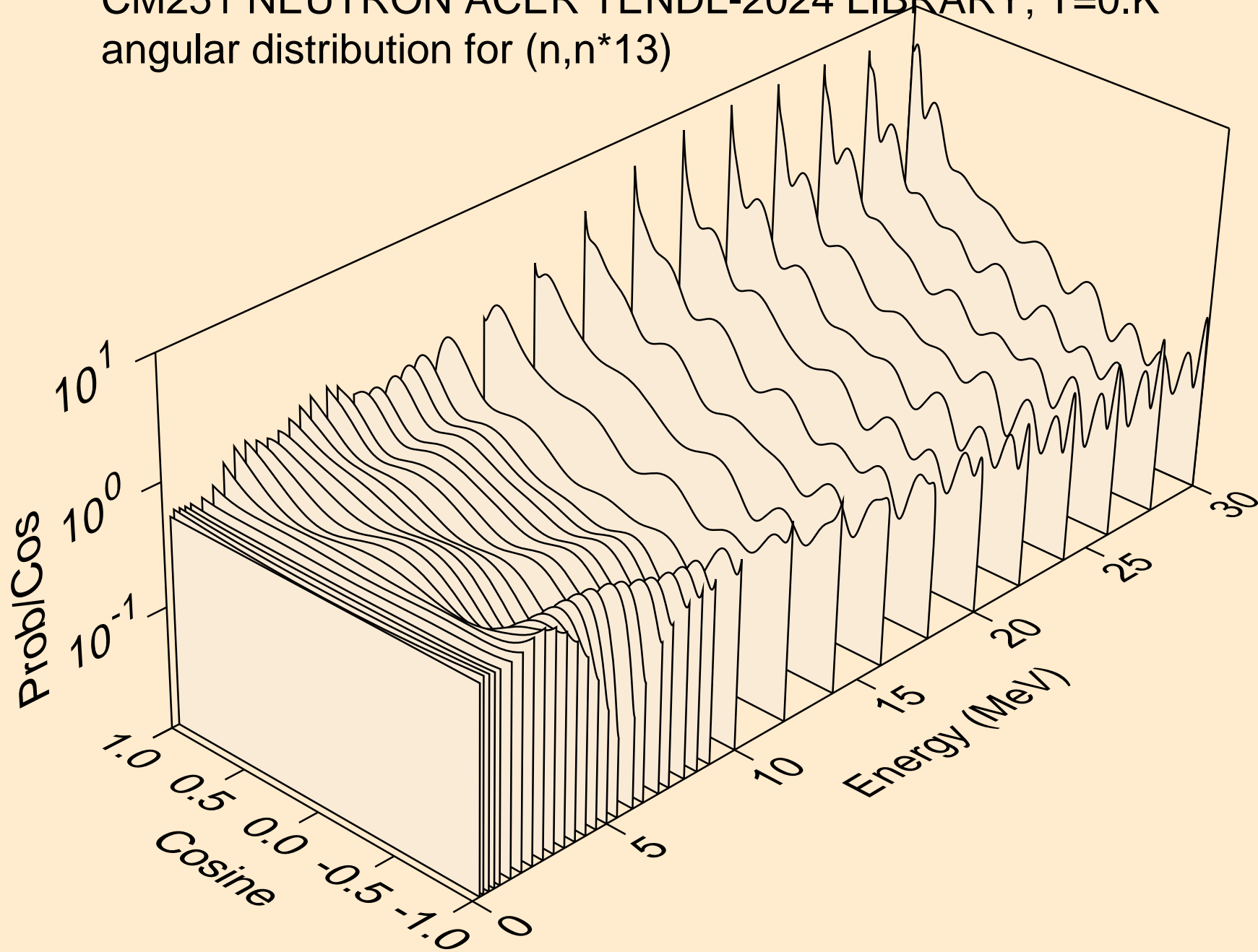

CM251 NEUTRON ACER TENDL-2024 LIBRARY; T=0.K
angular distribution for (n,n*14)

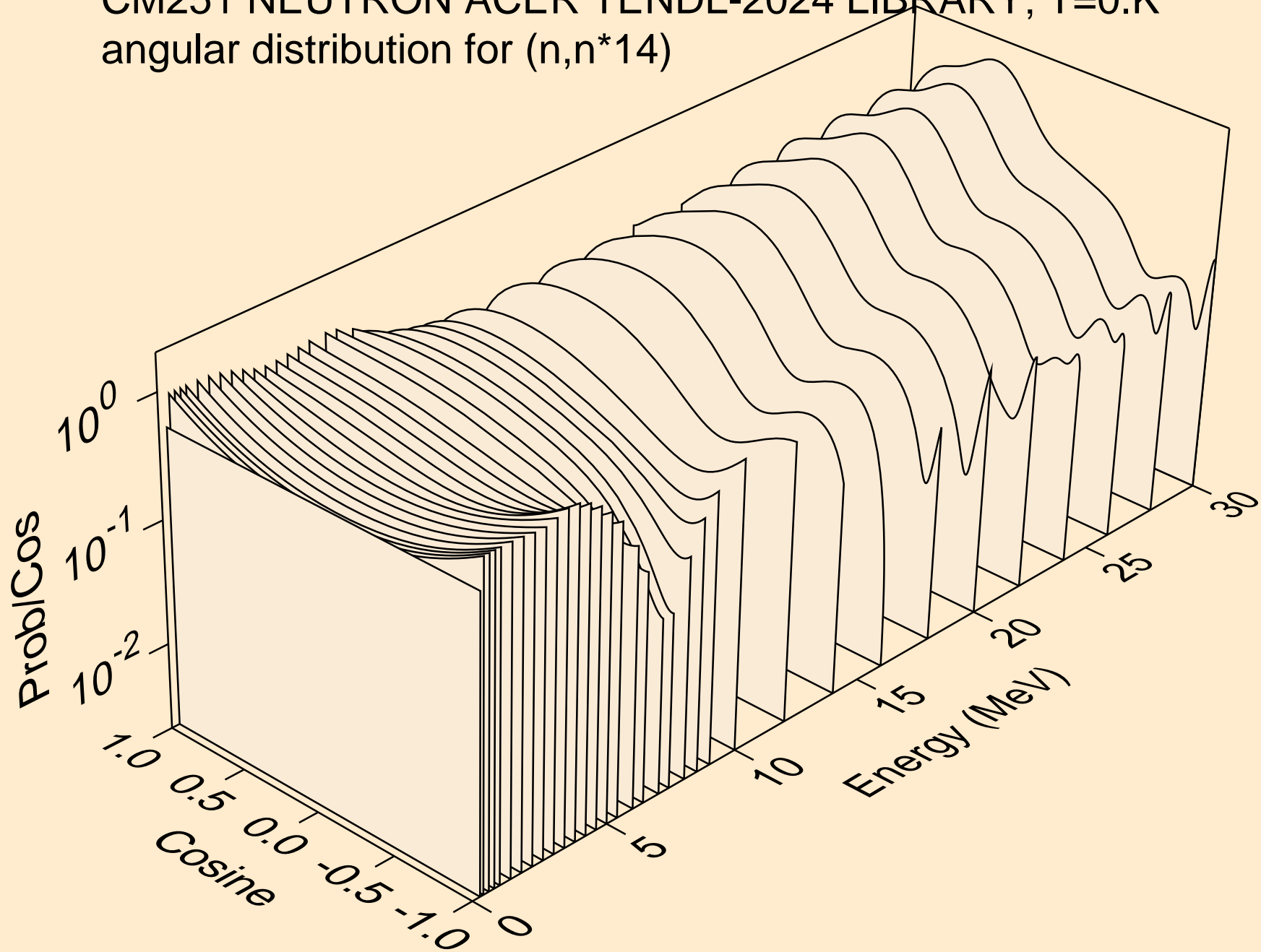

CM251 NEUTRON ACER TENDL-2024 LIBRARY; T=0.K
angular distribution for (n,n*15)

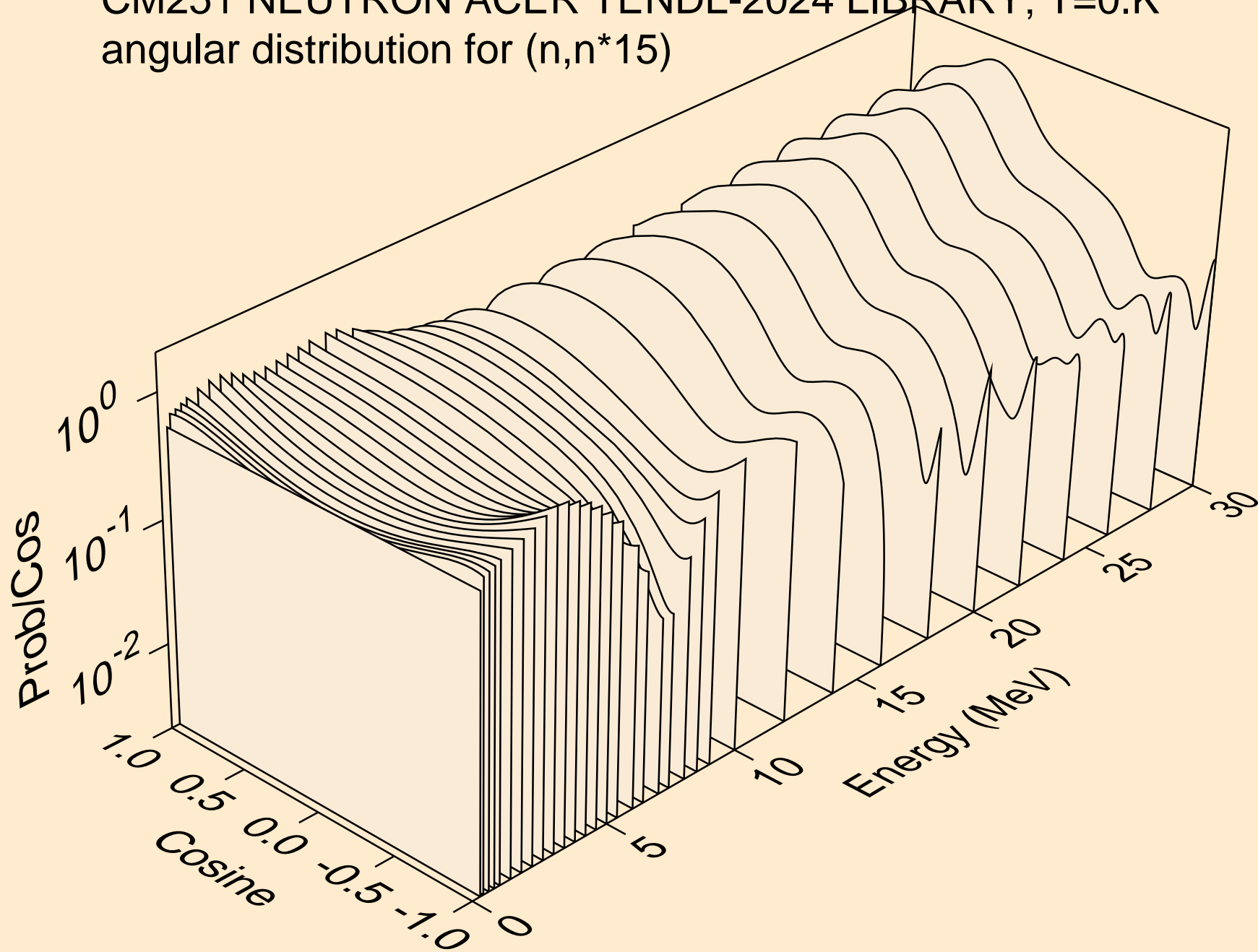

CM251 NEUTRON ACER TENDL-2024 LIBRARY; T=0.K
angular distribution for (n,n*16)

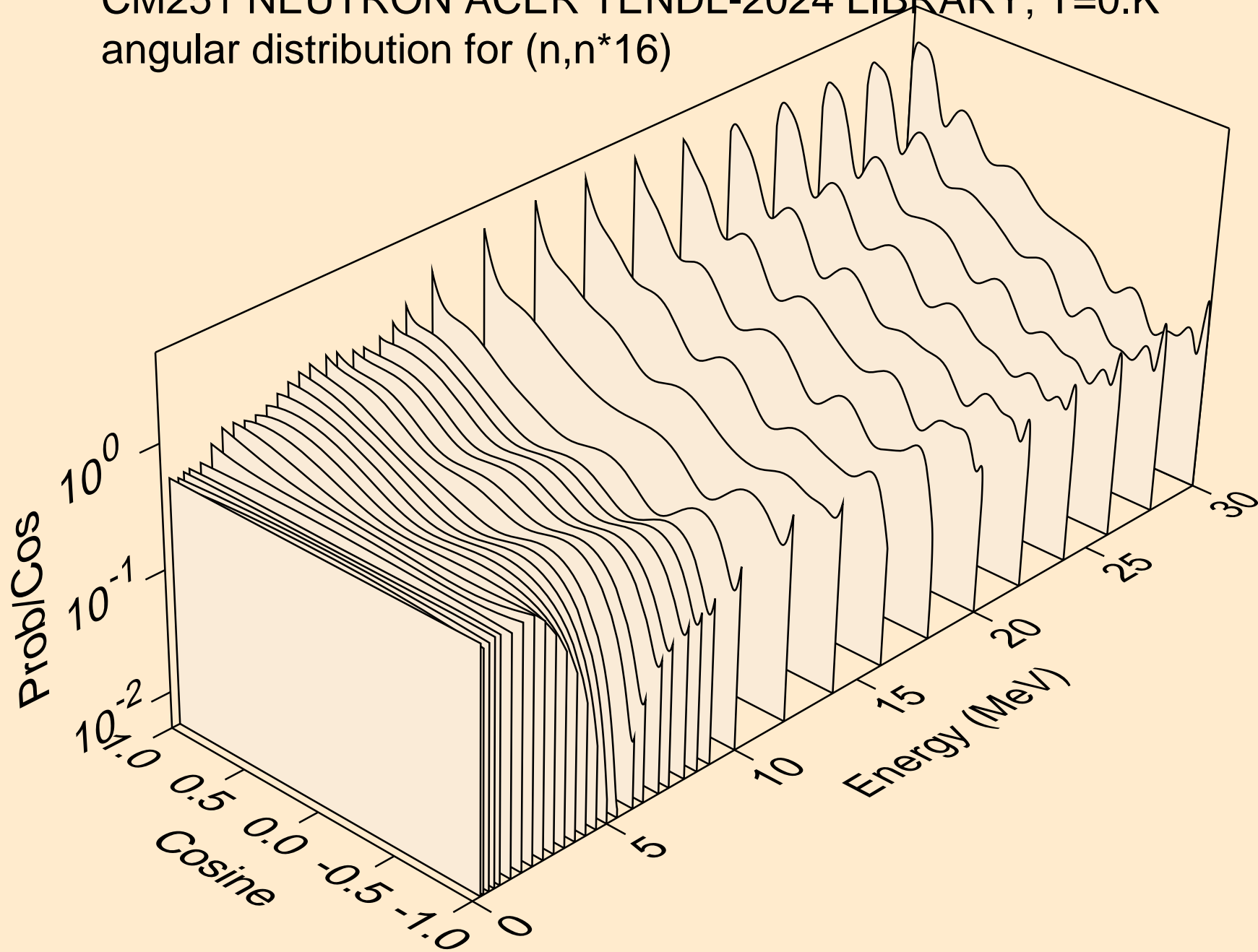

CM251 NEUTRON ACER TENDL-2024 LIBRARY; T=0.K
angular distribution for (n,n*17)

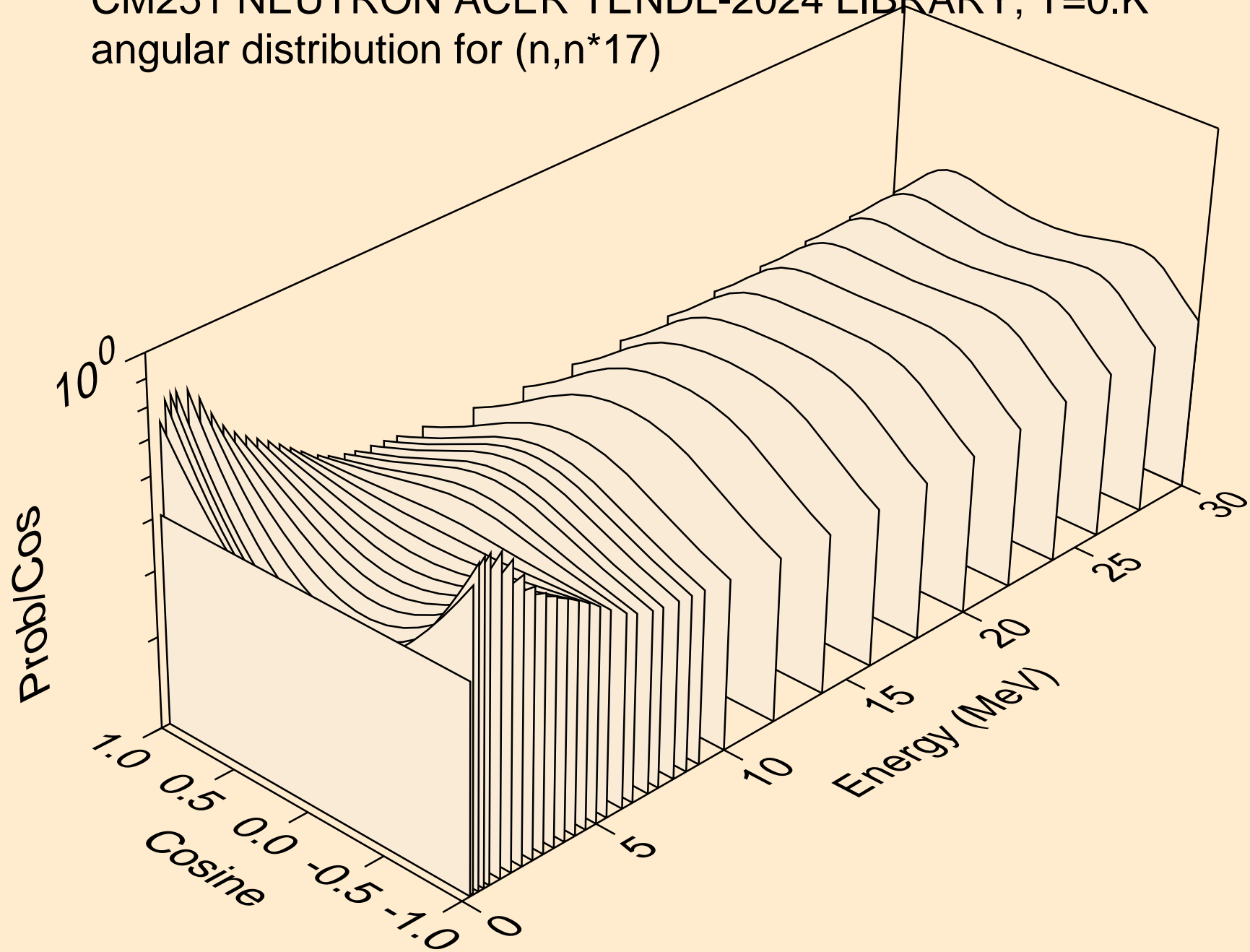

CM251 NEUTRON ACER TENDL-2024 LIBRARY; T=0.K
angular distribution for (n,n*18)

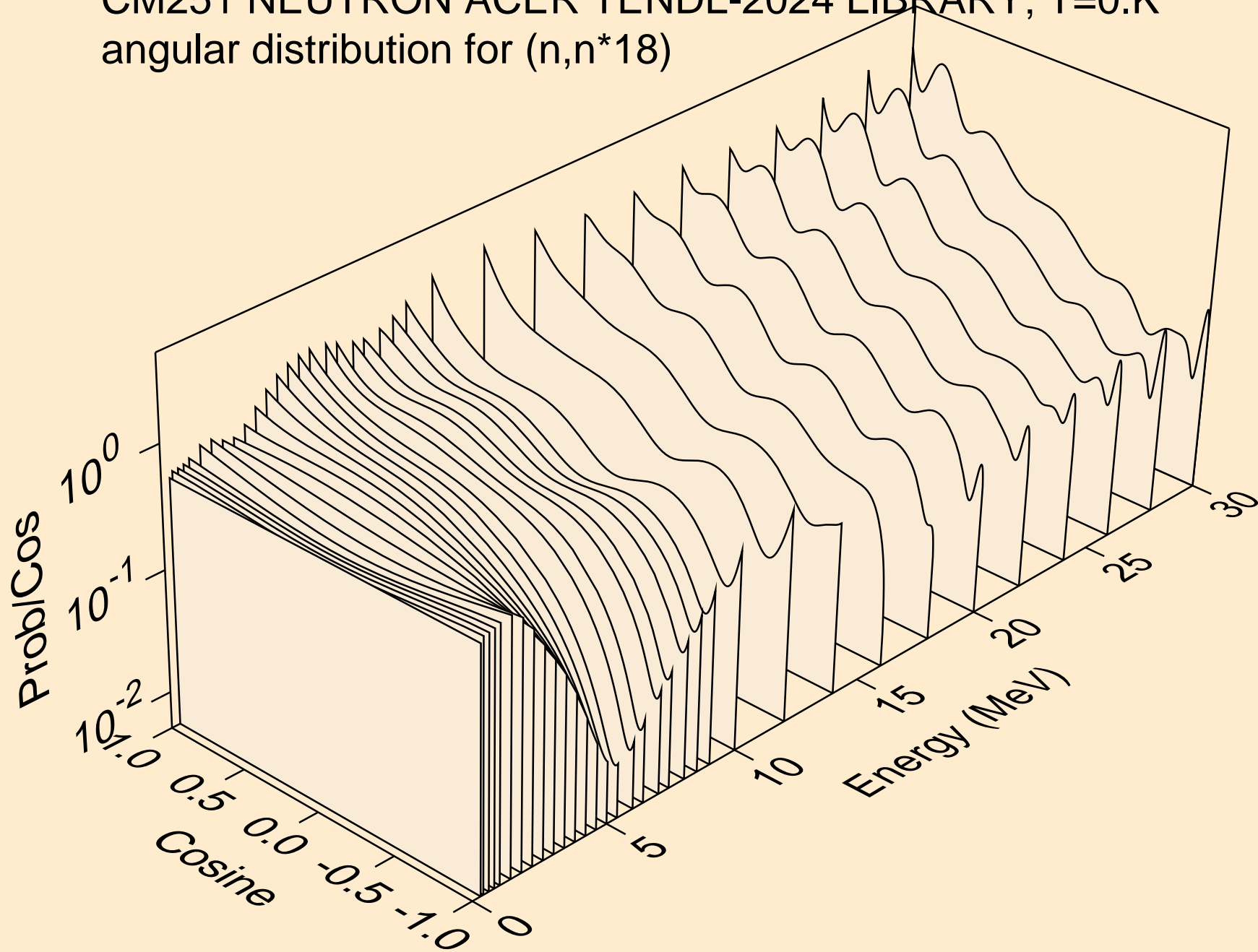

CM251 NEUTRON ACER TENDL-2024 LIBRARY; T=0.K
angular distribution for (n,n*19)

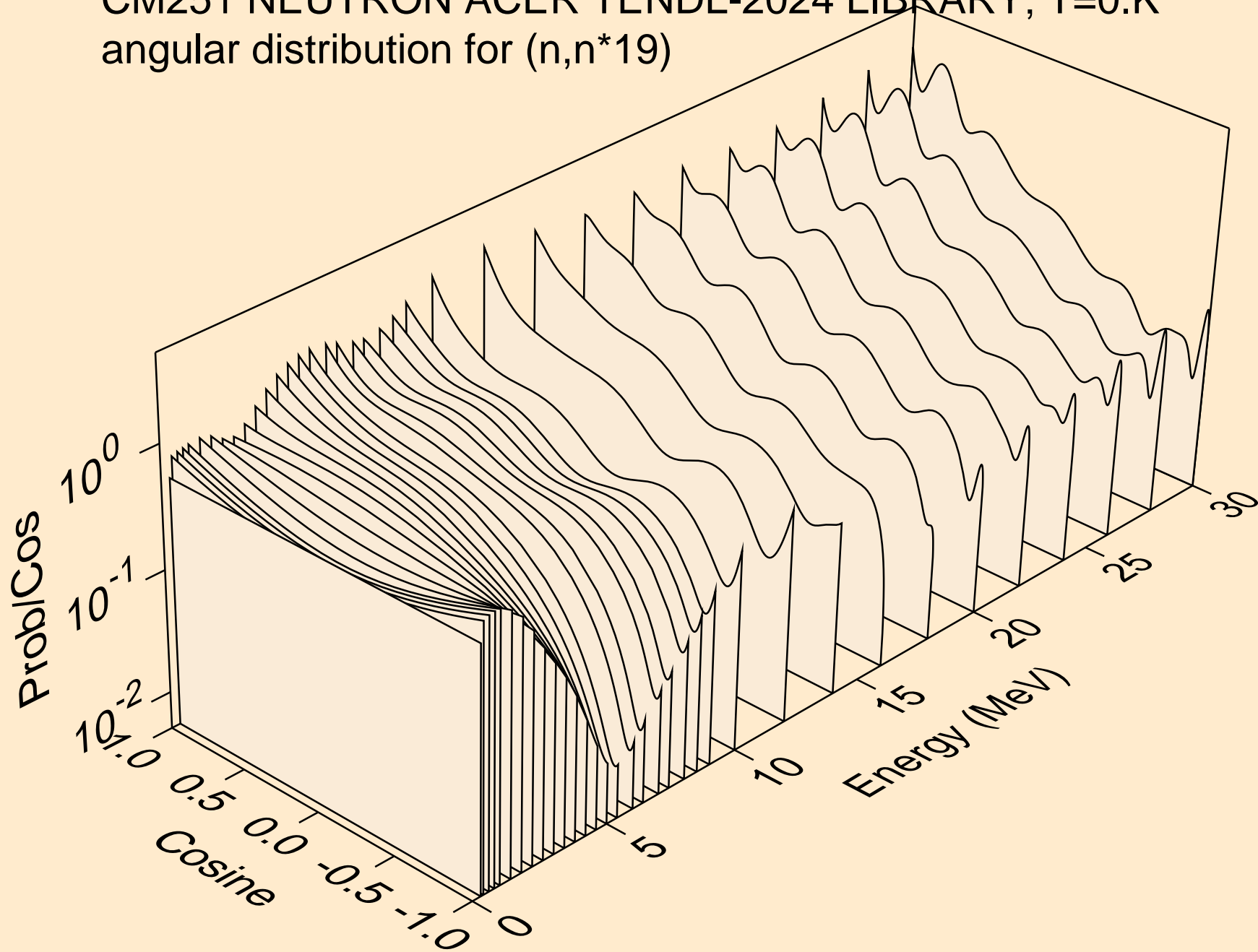

CM251 NEUTRON ACER TENDL-2024 LIBRARY; T=0.K
angular distribution for (n,n*20)

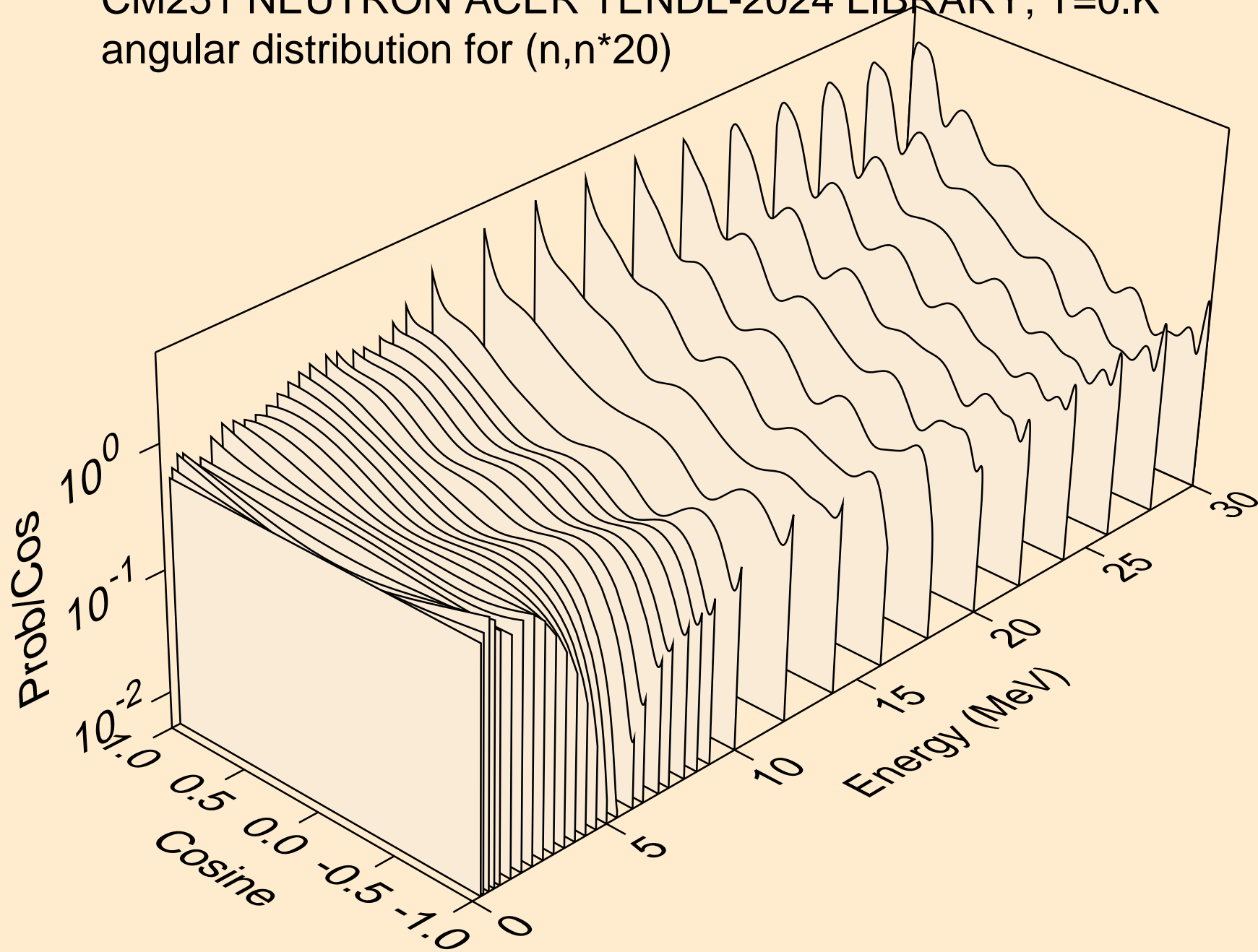

CM251 NEUTRON ACER TENDL-2024 LIBRARY; T=0.K
angular distribution for (n,n*21)

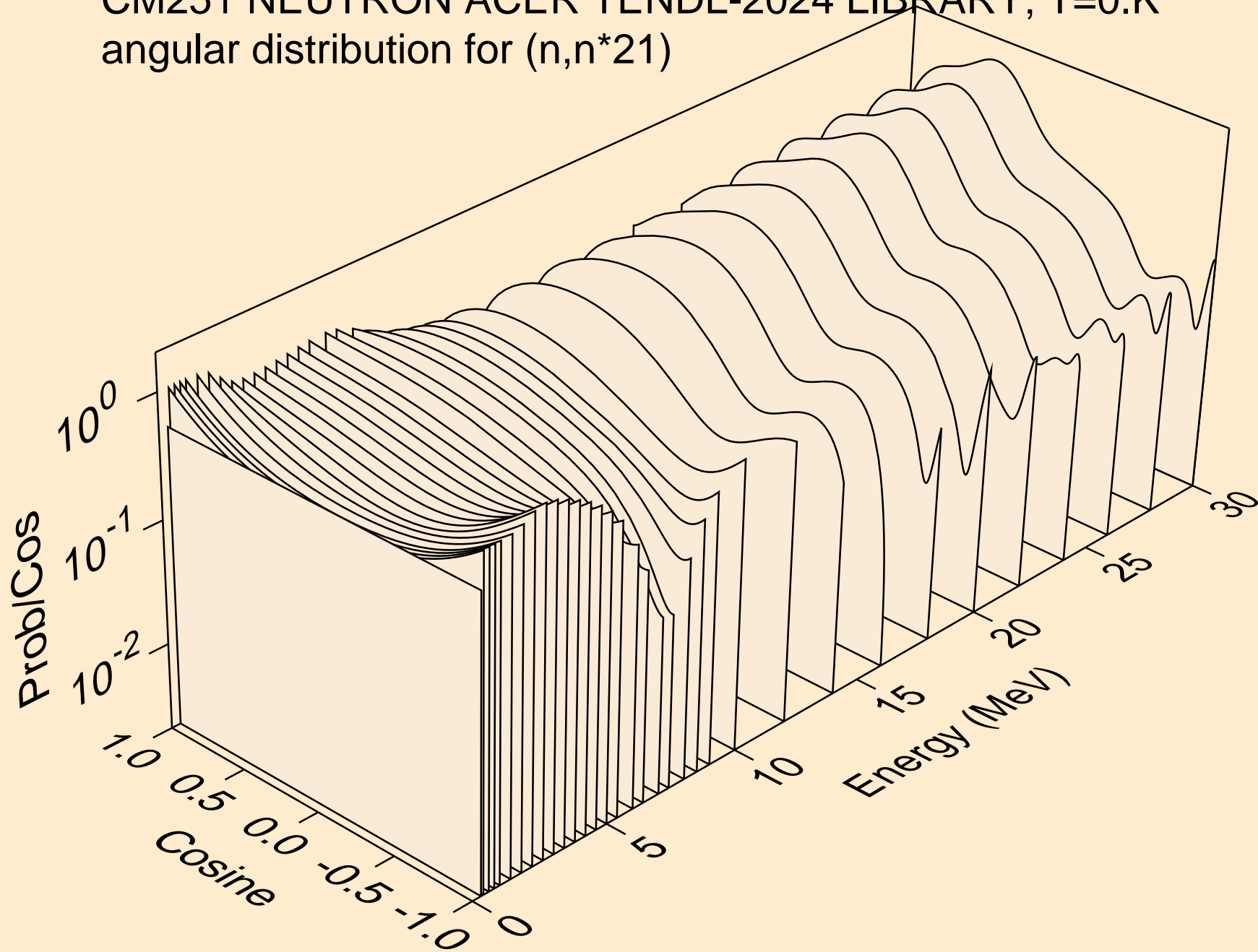

CM251 NEUTRON ACER TENDL-2024 LIBRARY; T=0.K
angular distribution for (n,n*22)

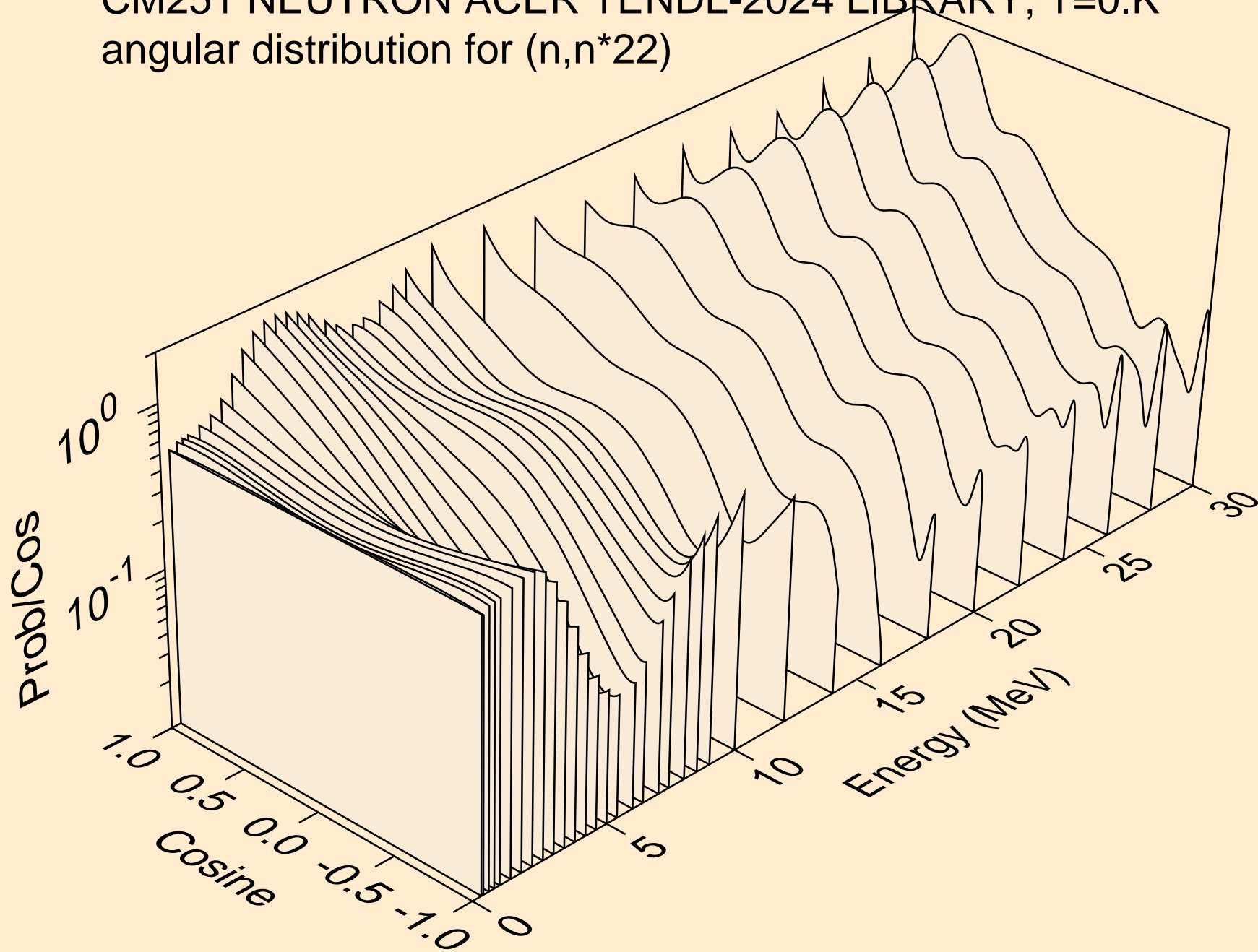

CM251 NEUTRON ACER TENDL-2024 LIBRARY; T=0.K
angular distribution for (n,n*23)

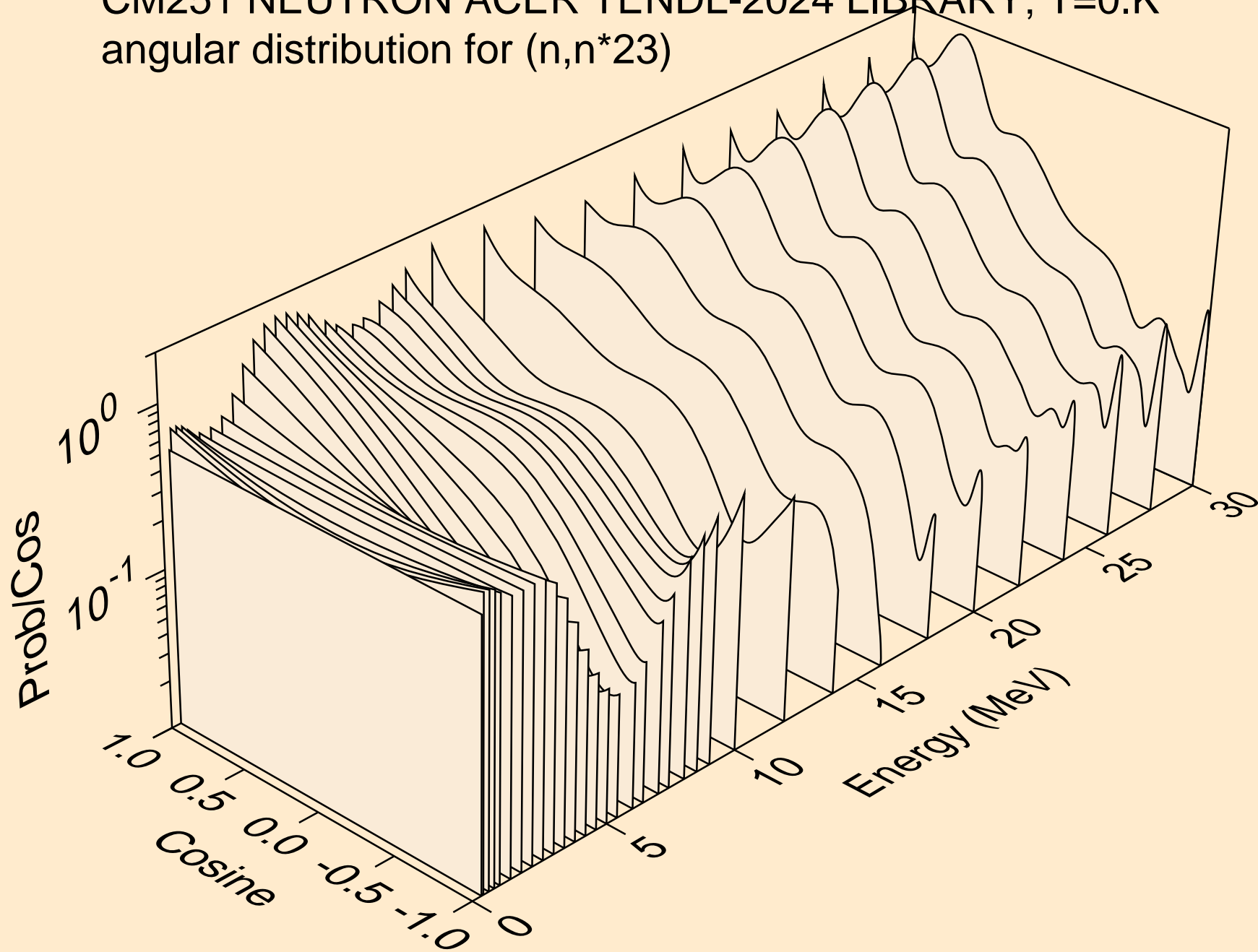

CM251 NEUTRON ACER TENDL-2024 LIBRARY; T=0.K
angular distribution for (n,n*24)

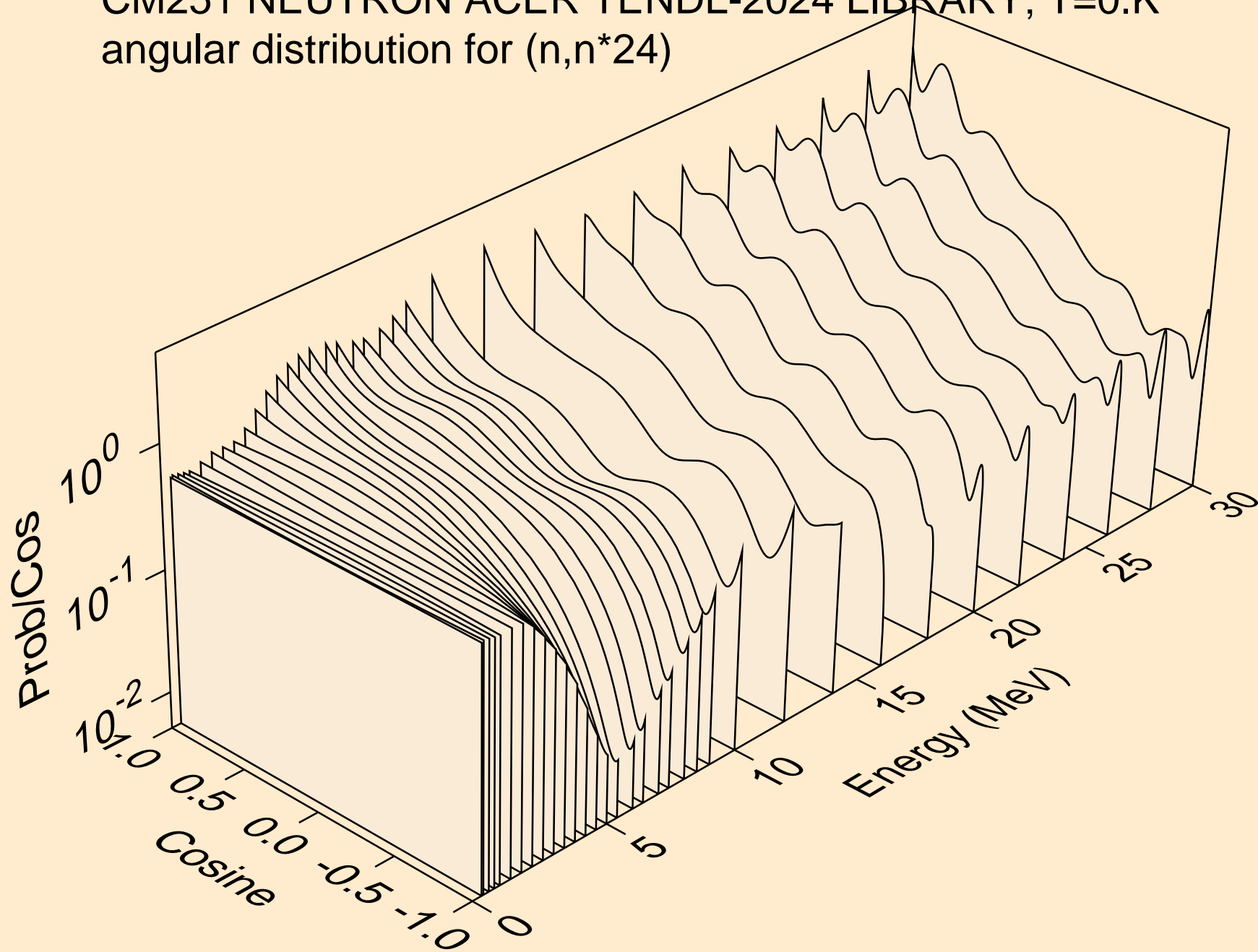

CM251 NEUTRON ACER TENDL-2024 LIBRARY; T=0.K
angular distribution for (n,n*25)

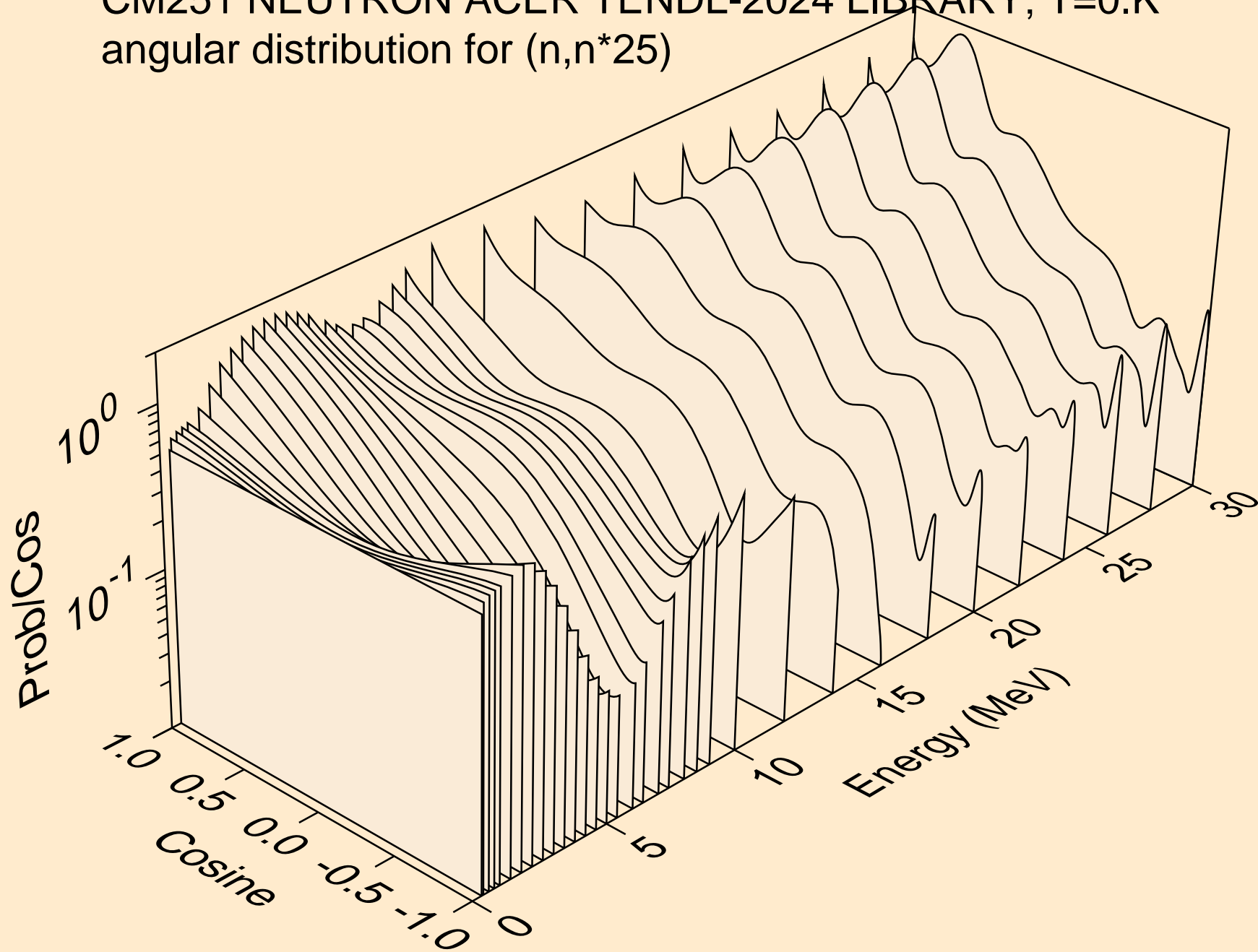

CM251 NEUTRON ACER TENDL-2024 LIBRARY; T=0.K
angular distribution for (n,n*26)

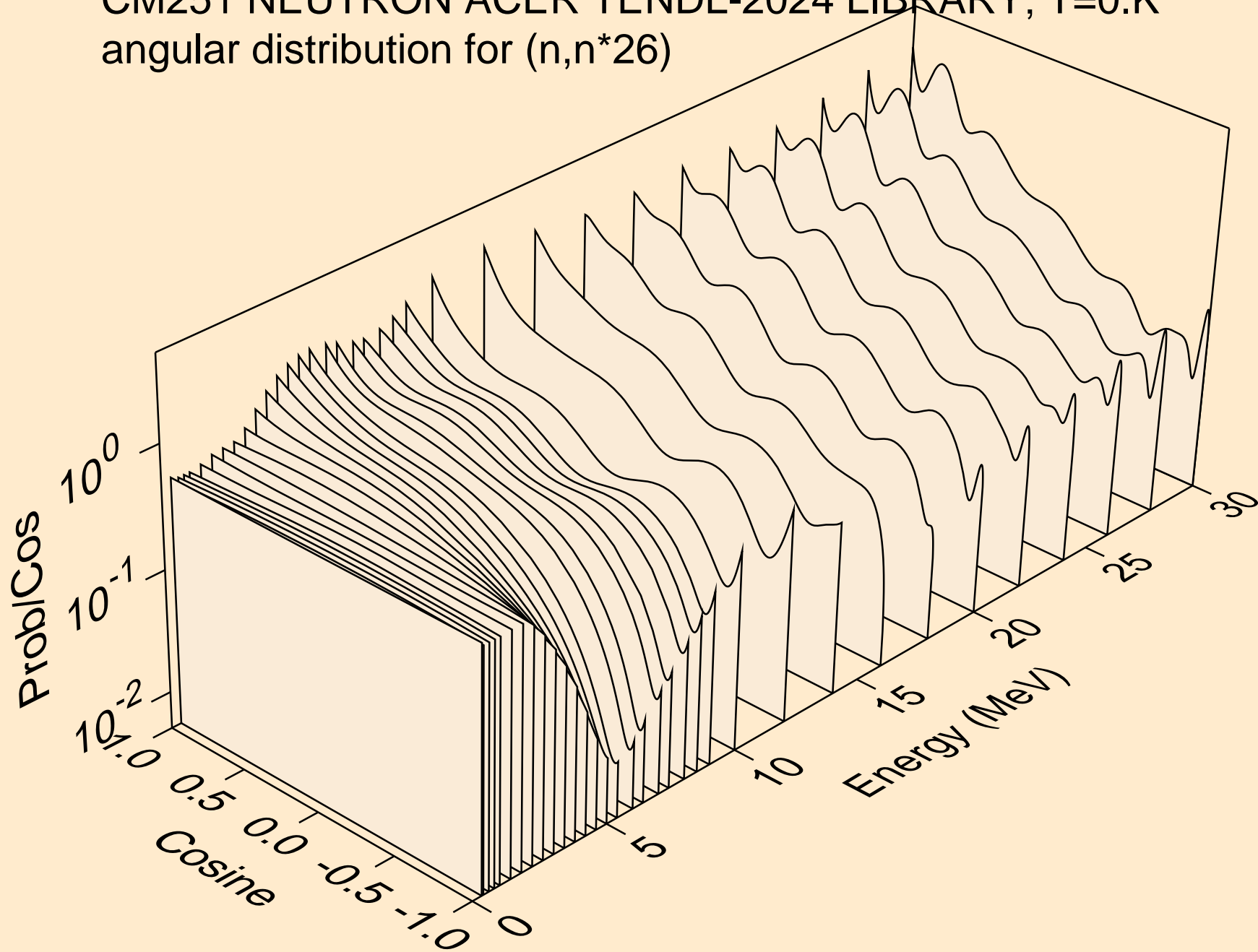

CM251 NEUTRON ACER TENDL-2024 LIBRARY; T=0.K
angular distribution for (n,n*27)

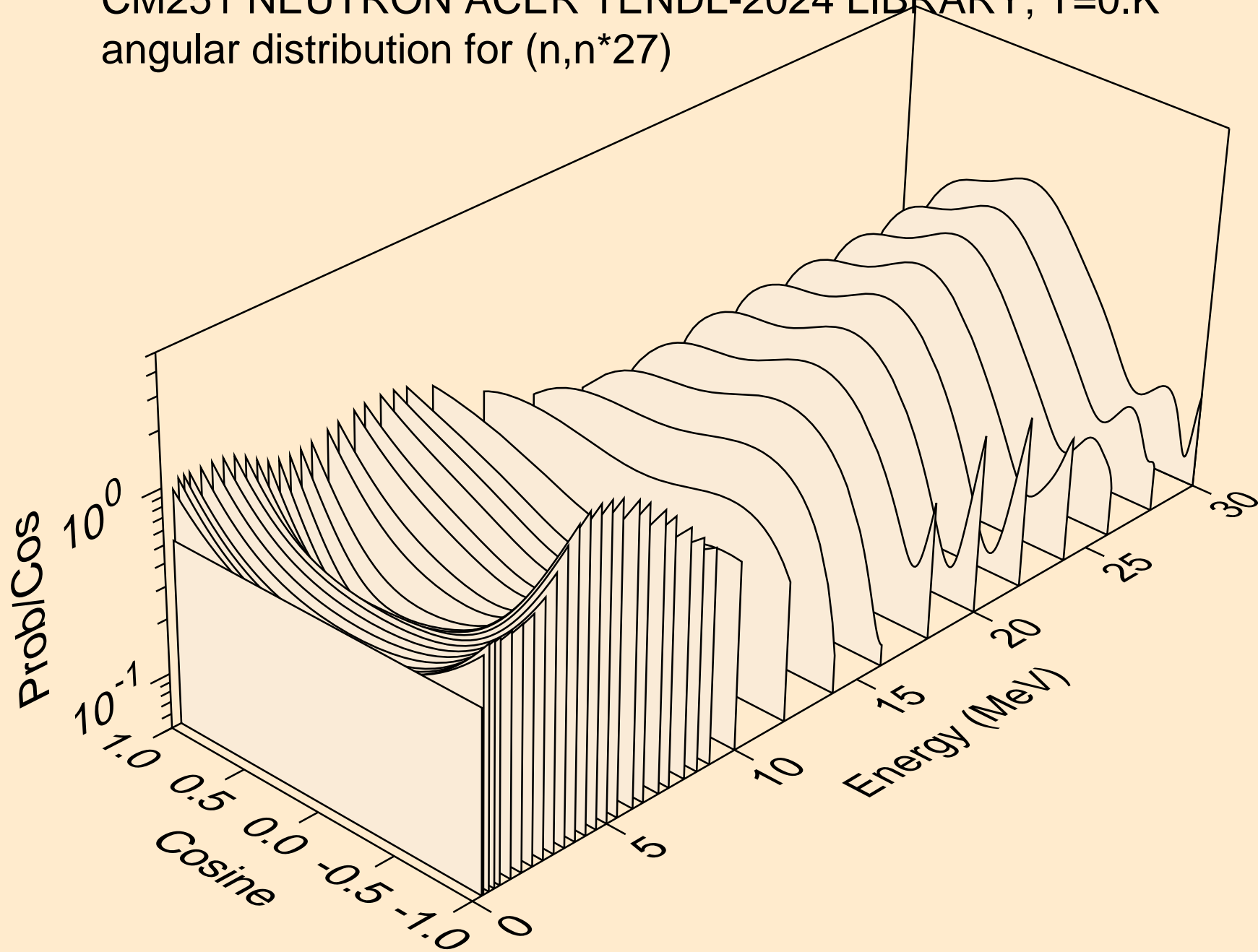

CM251 NEUTRON ACER TENDL-2024 LIBRARY; T=0.K
angular distribution for (n,n*28)

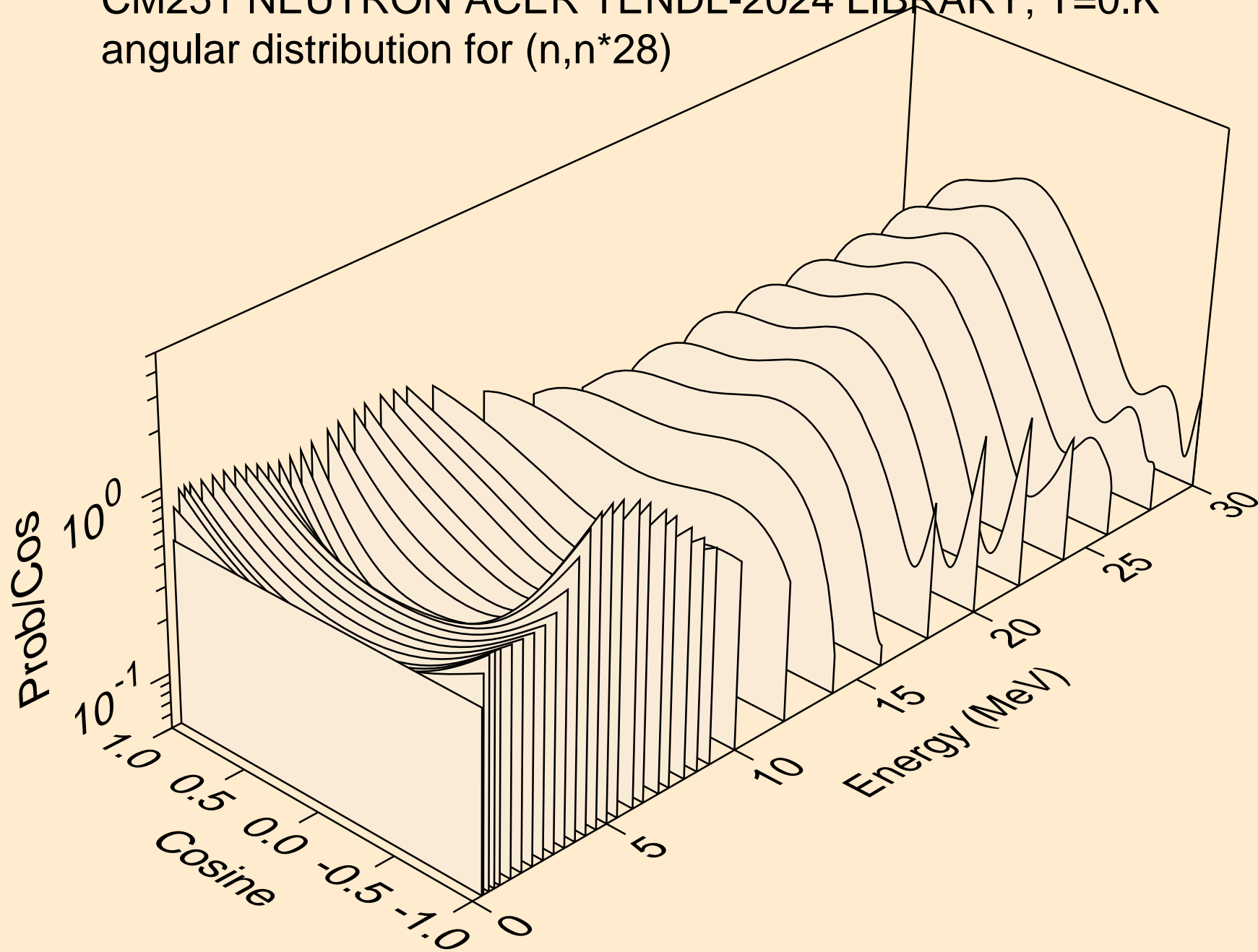

CM251 NEUTRON ACER TENDL-2024 LIBRARY; T=0.K
angular distribution for (n,n*29)

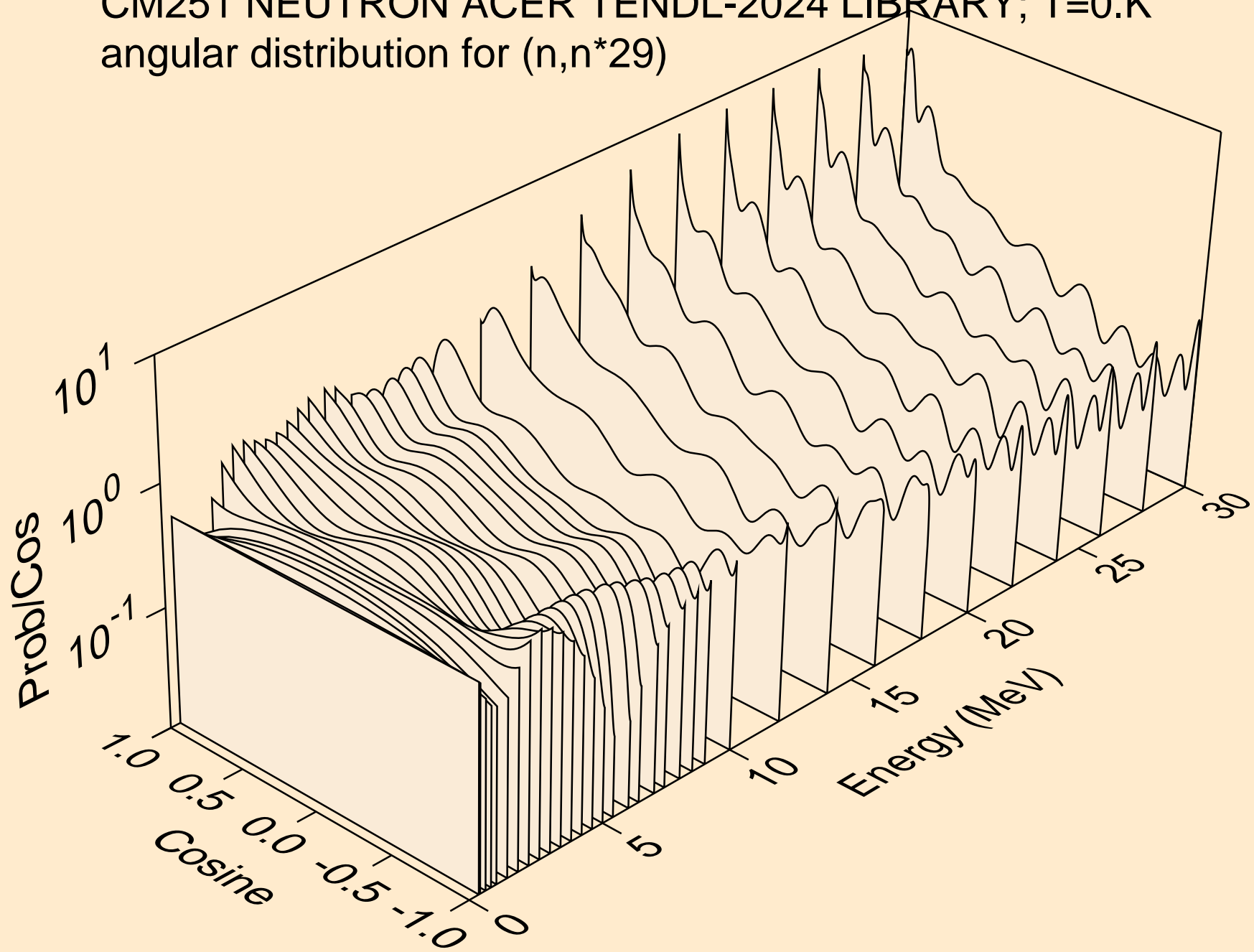

CM251 NEUTRON ACER TENDL-2024 LIBRARY; T=0.K

Total fission nubar

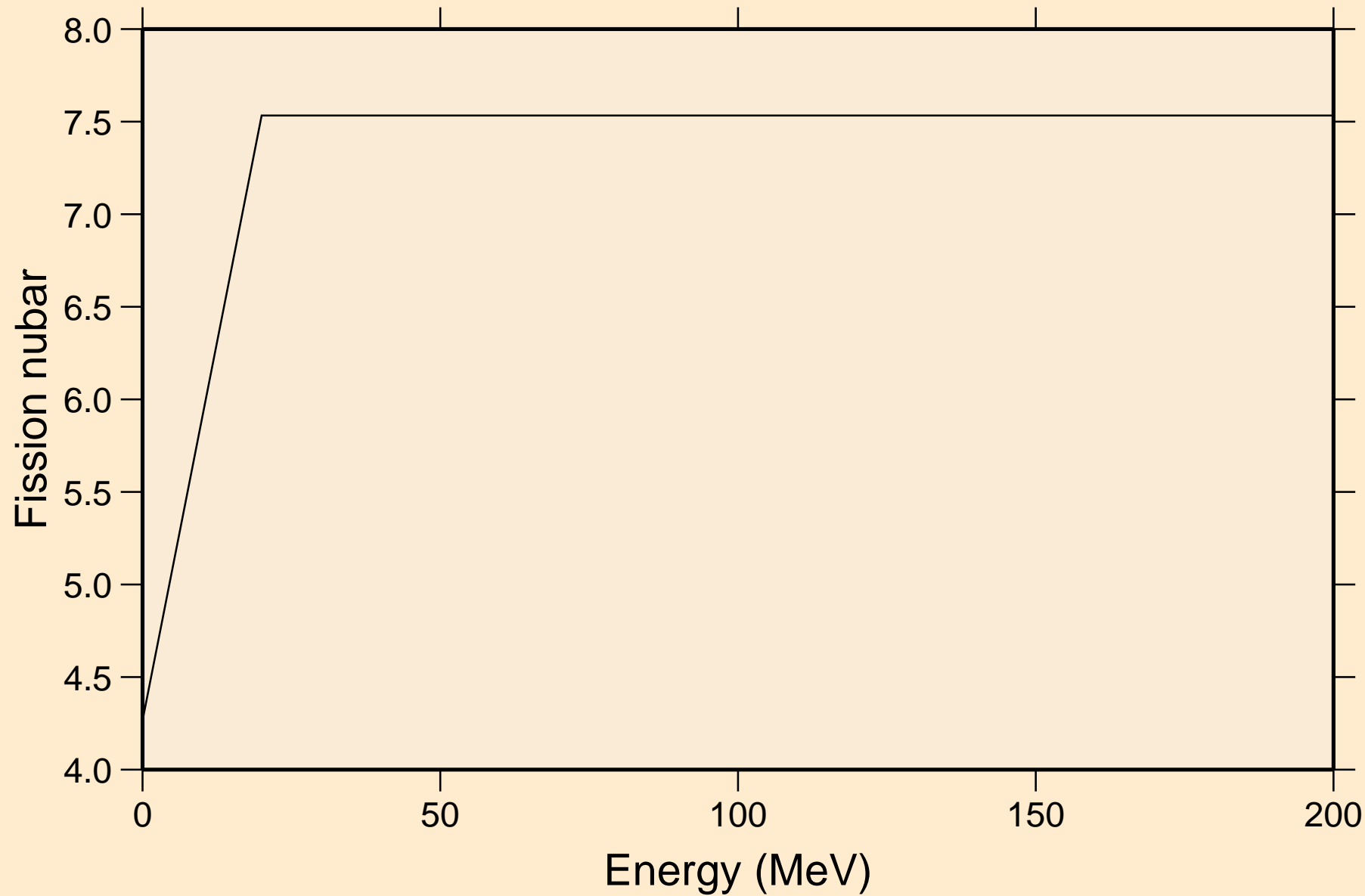

CM251 NEUTRON ACER TENDL-2024 LIBRARY; T=0.K
Neutron emission for (n,x)

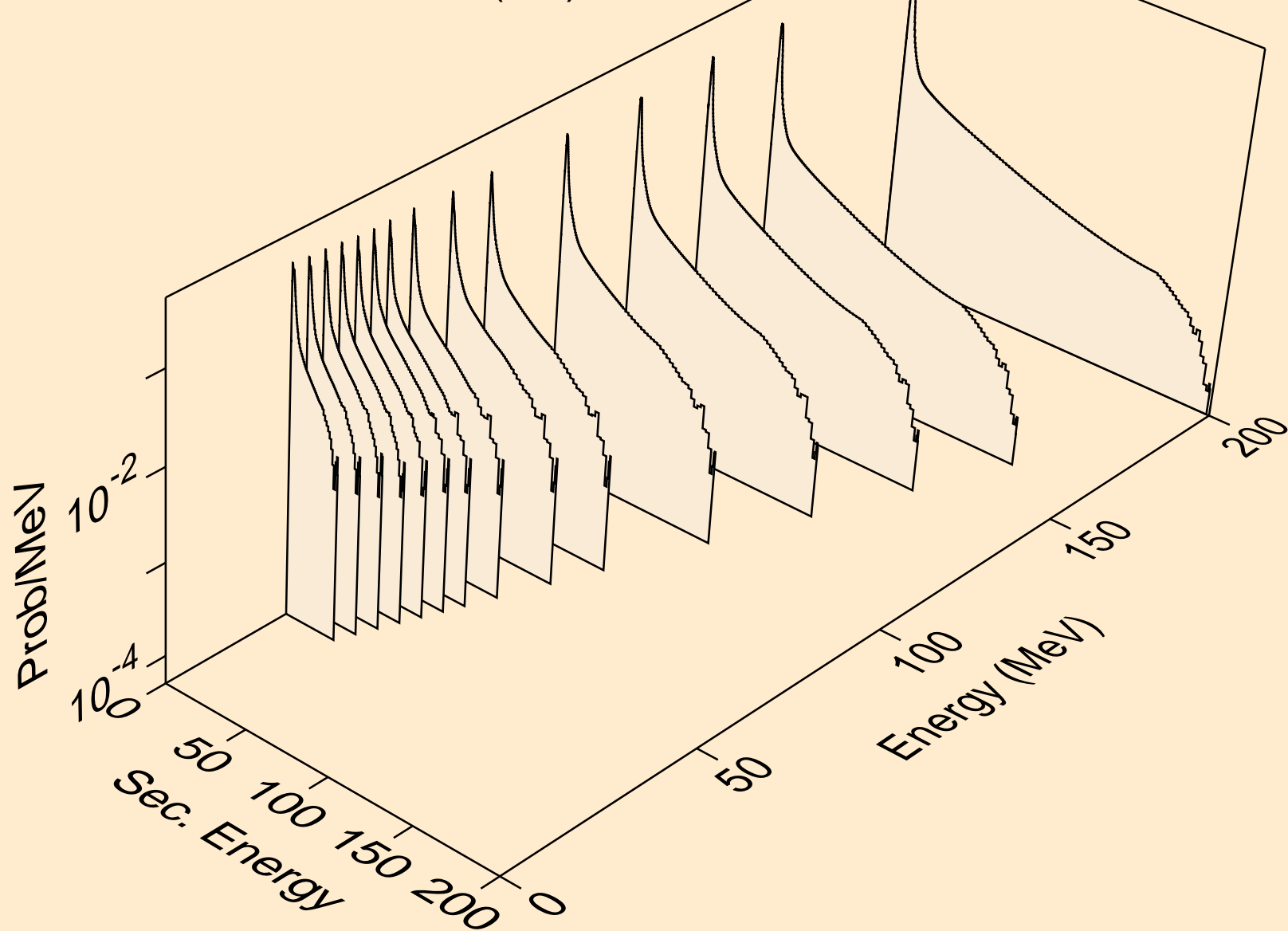

CM251 NEUTRON ACER TENDL-2024 LIBRARY; T=0.K
Neutron emission for (n,2nd)

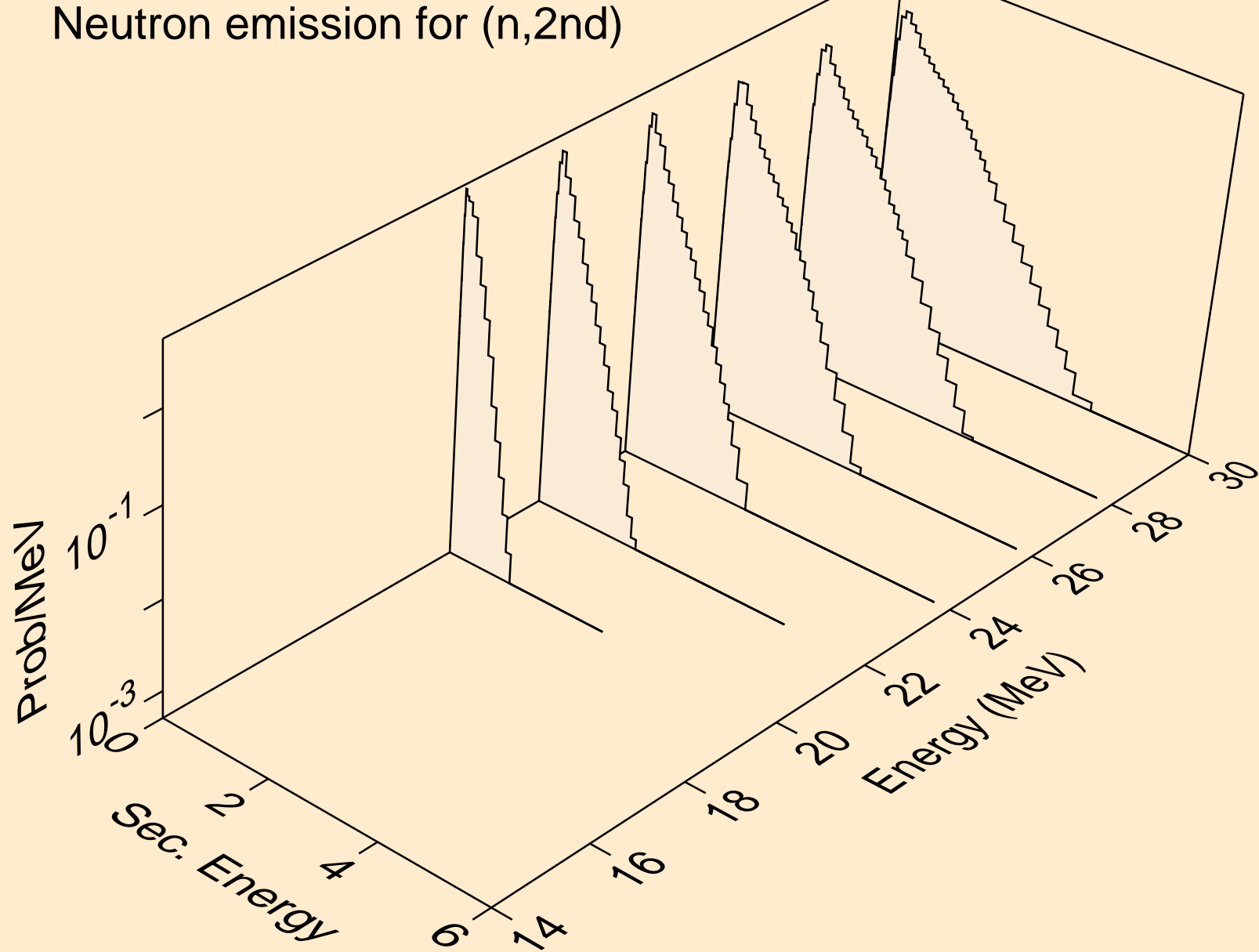

CM251 NEUTRON ACER TENDL-2024 LIBRARY; T=0.K
Neutron emission for (n,2n)

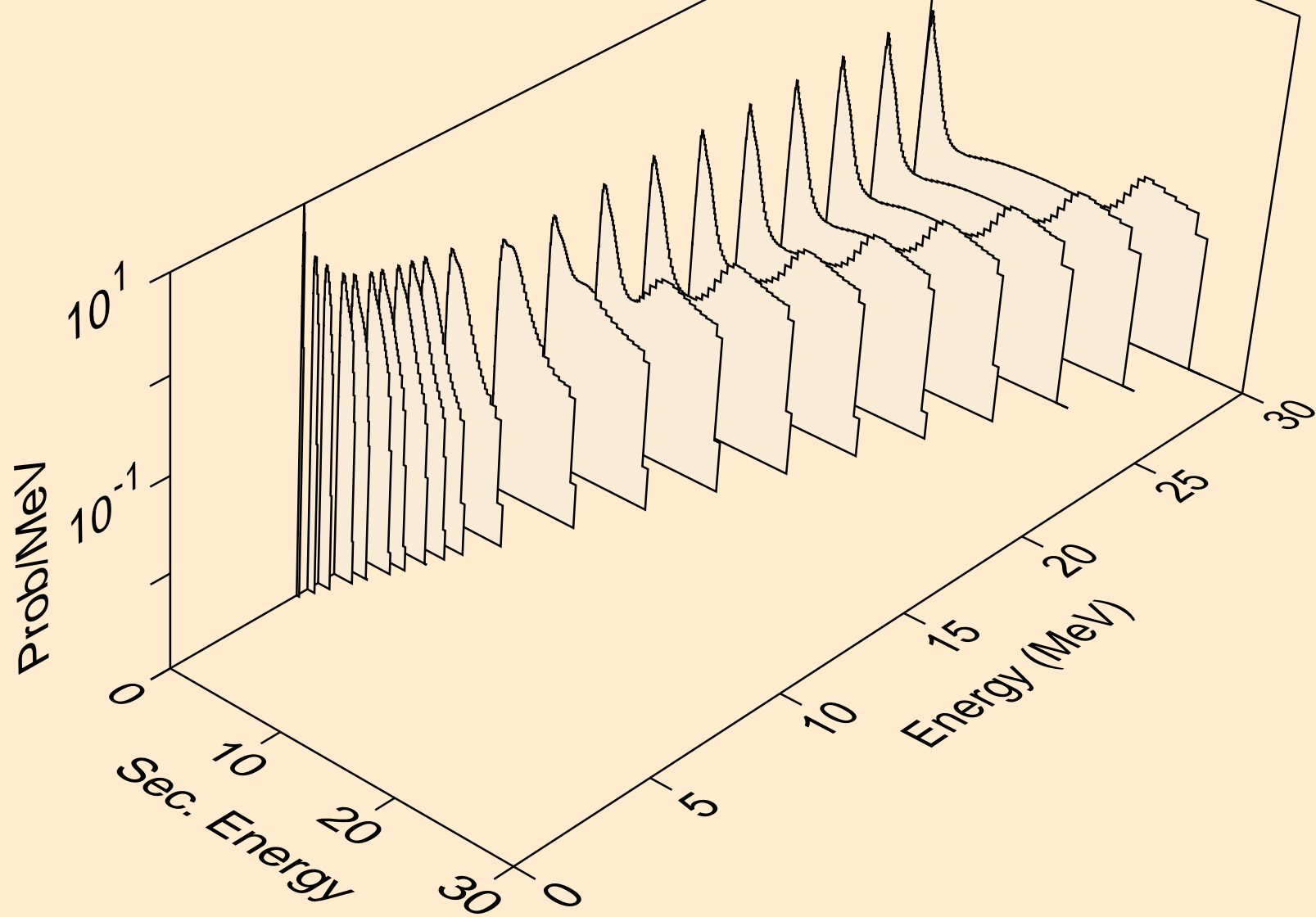

CM251 NEUTRON ACER TENDL-2024 LIBRARY; T=0.K
Neutron emission for (n,3n)

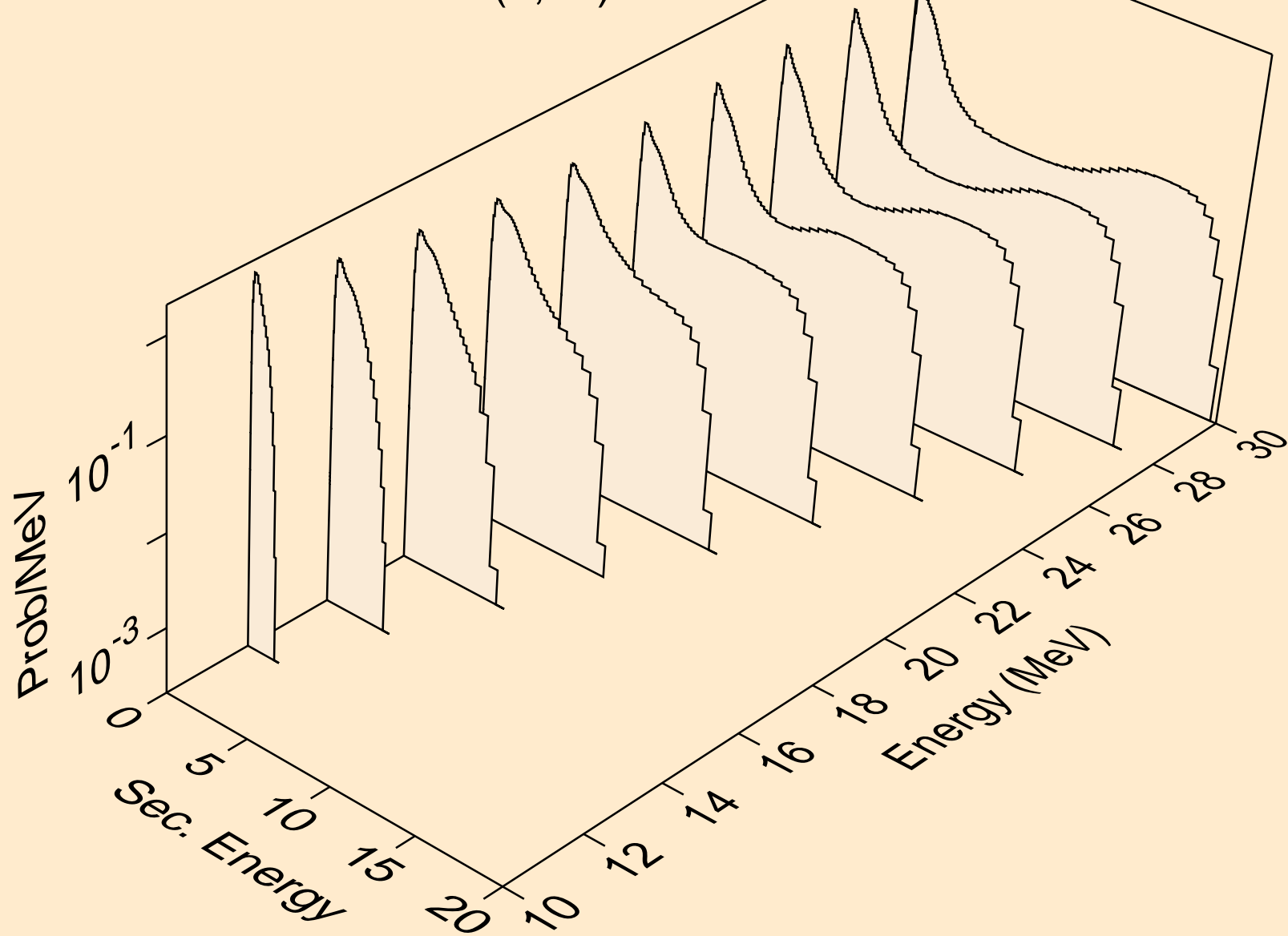

CM251 NEUTRON ACER TENDL-2024 LIBRARY; T=0.K
Neutron emission for fission

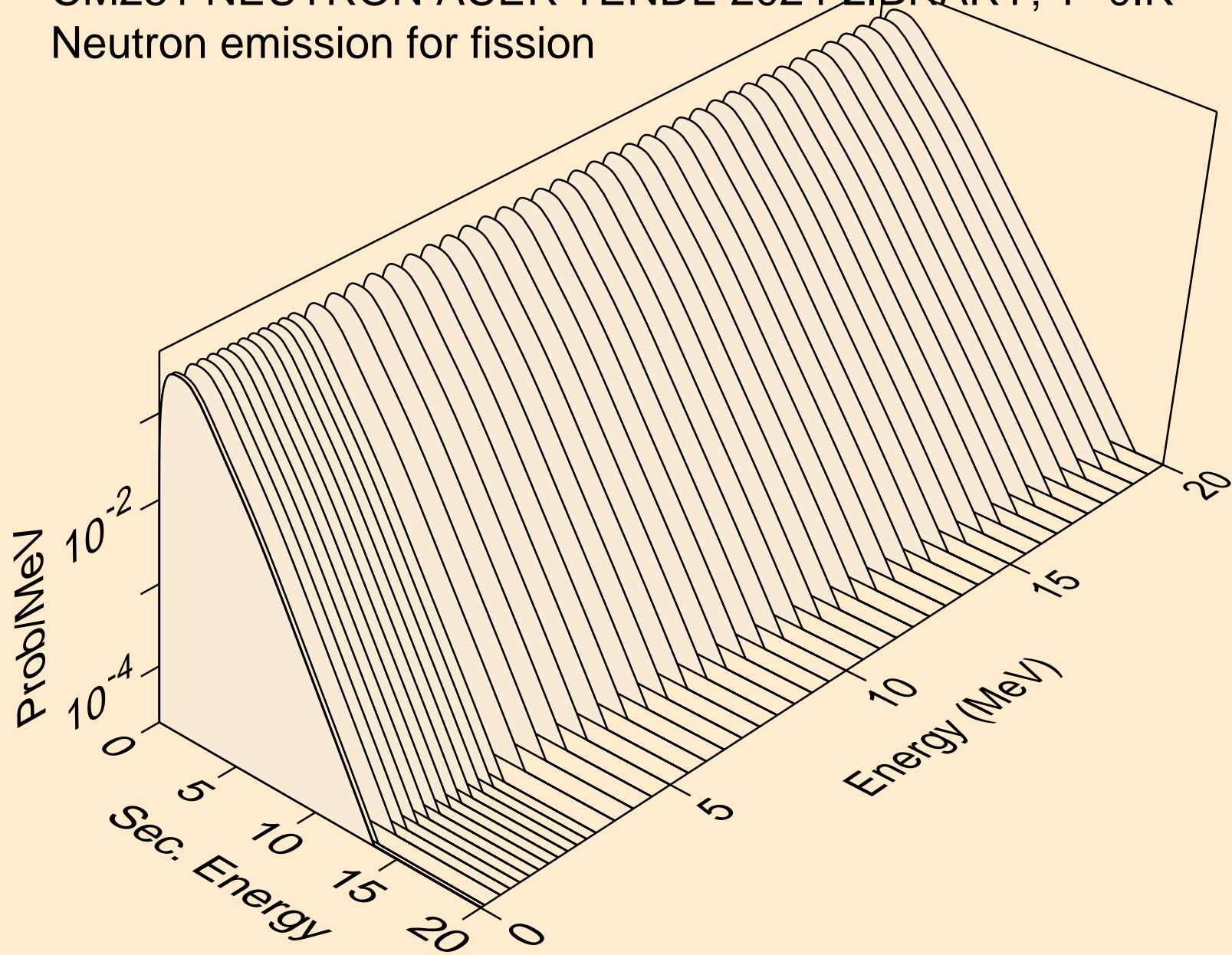

CM251 NEUTRON ACER TENDL-2024 LIBRARY; T=0.K
Neutron emission for (n,n*)a

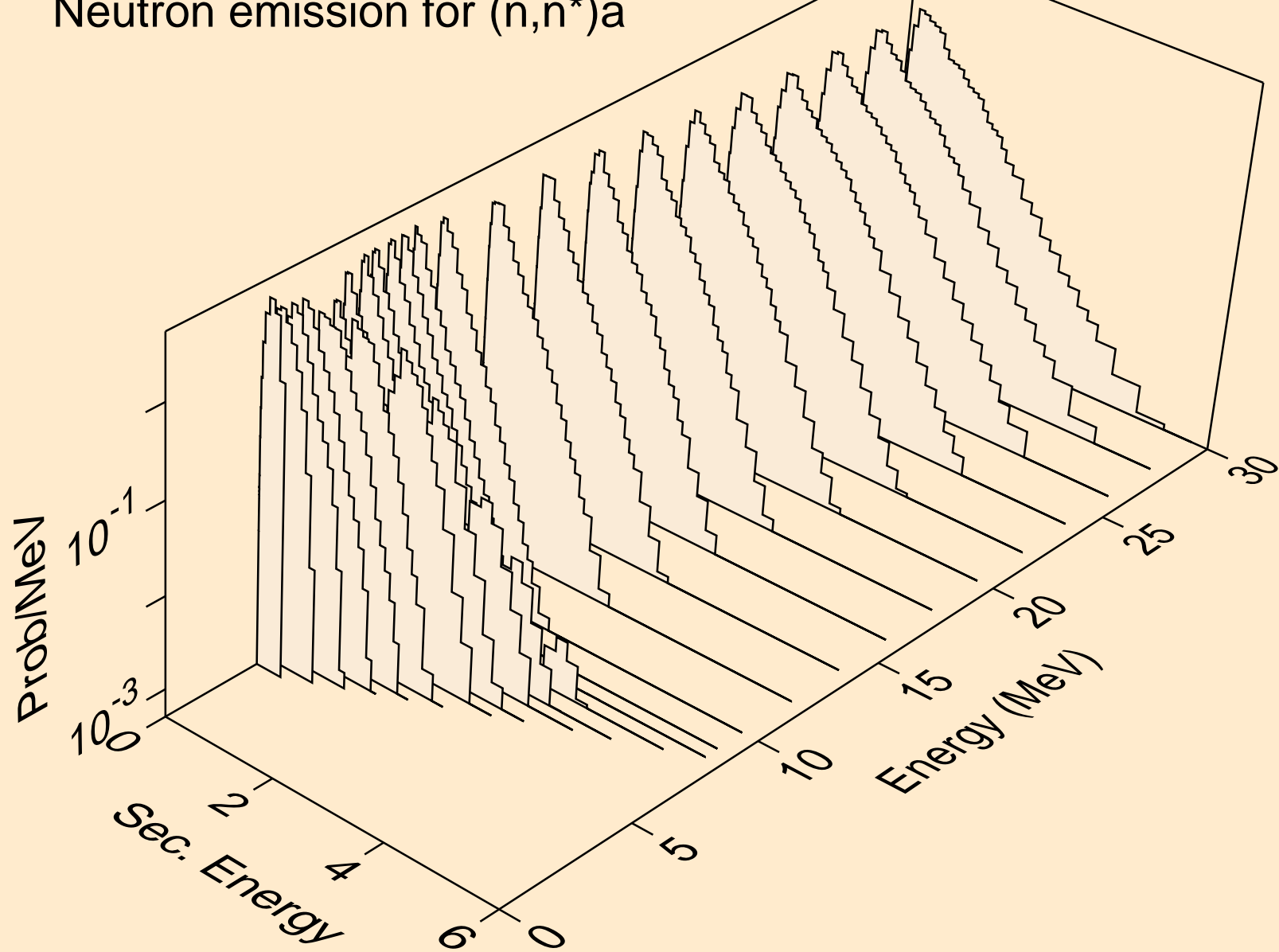

CM251 NEUTRON ACER TENDL-2024 LIBRARY; T=0.K
Neutron emission for (n,2n)a

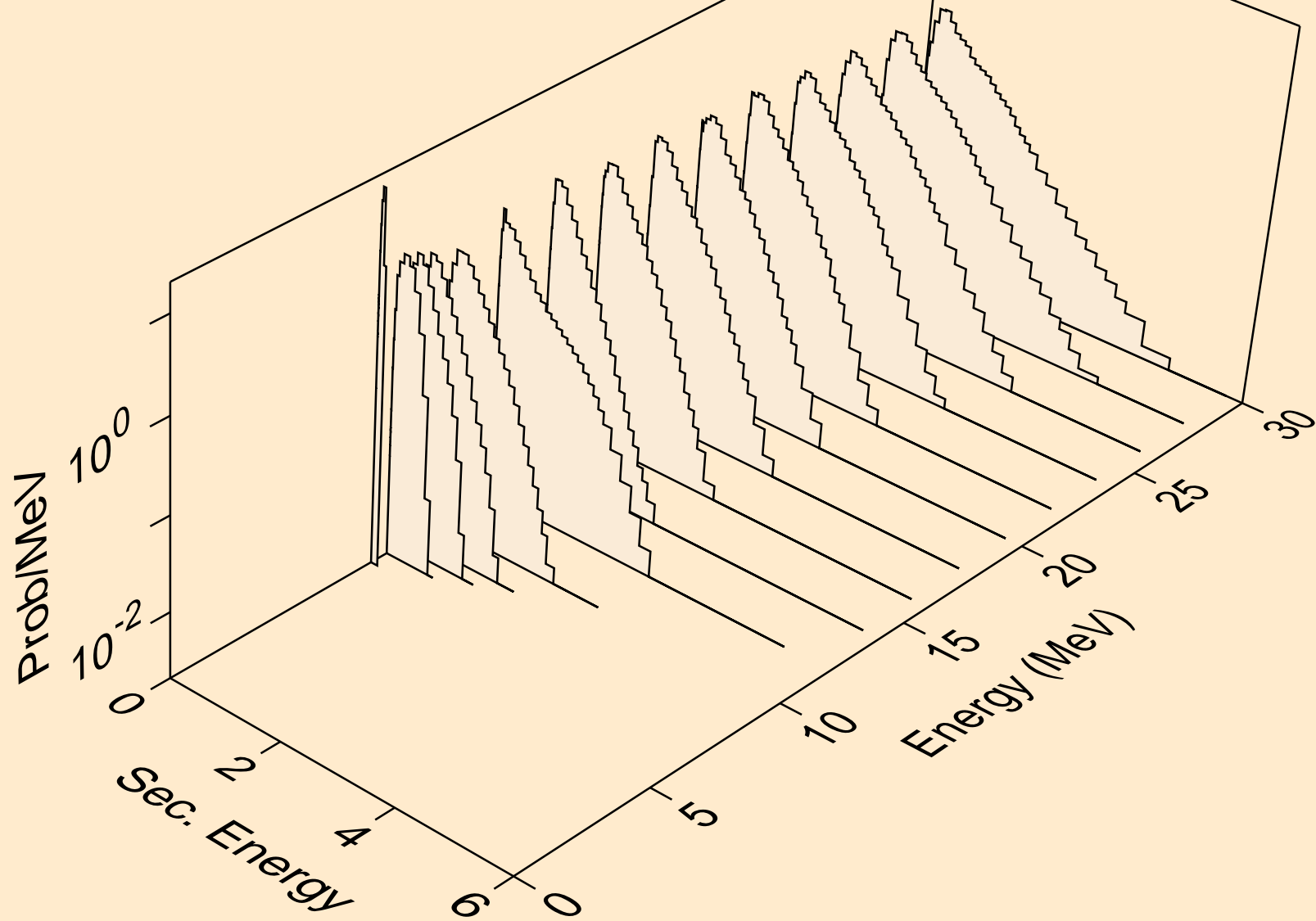

CM251 NEUTRON ACER TENDL-2024 LIBRARY; T=0.K
Neutron emission for (n,3n)a

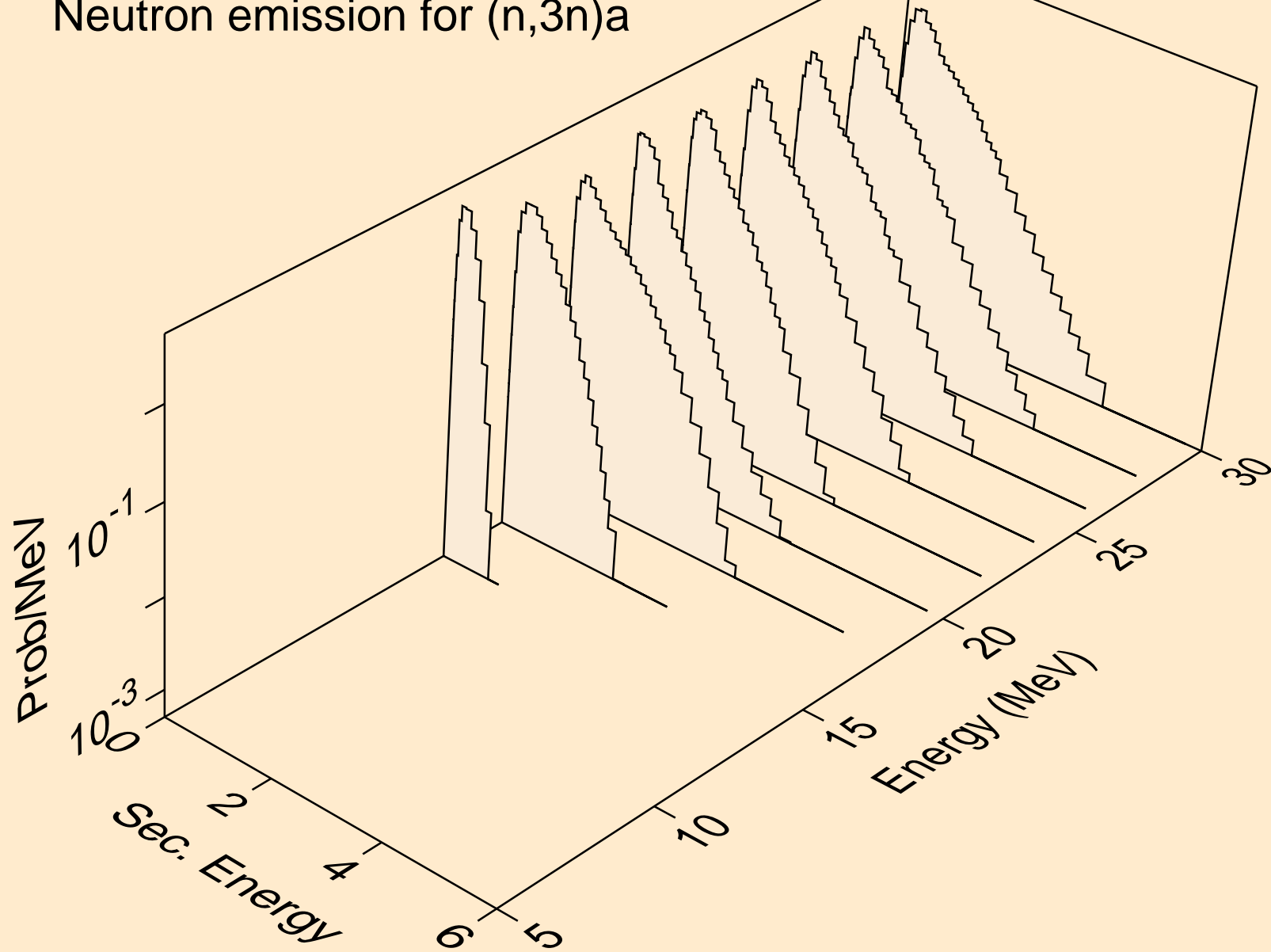

CM251 NEUTRON ACER TENDL-2024 LIBRARY; T=0.K
Neutron emission for (n,n*)p

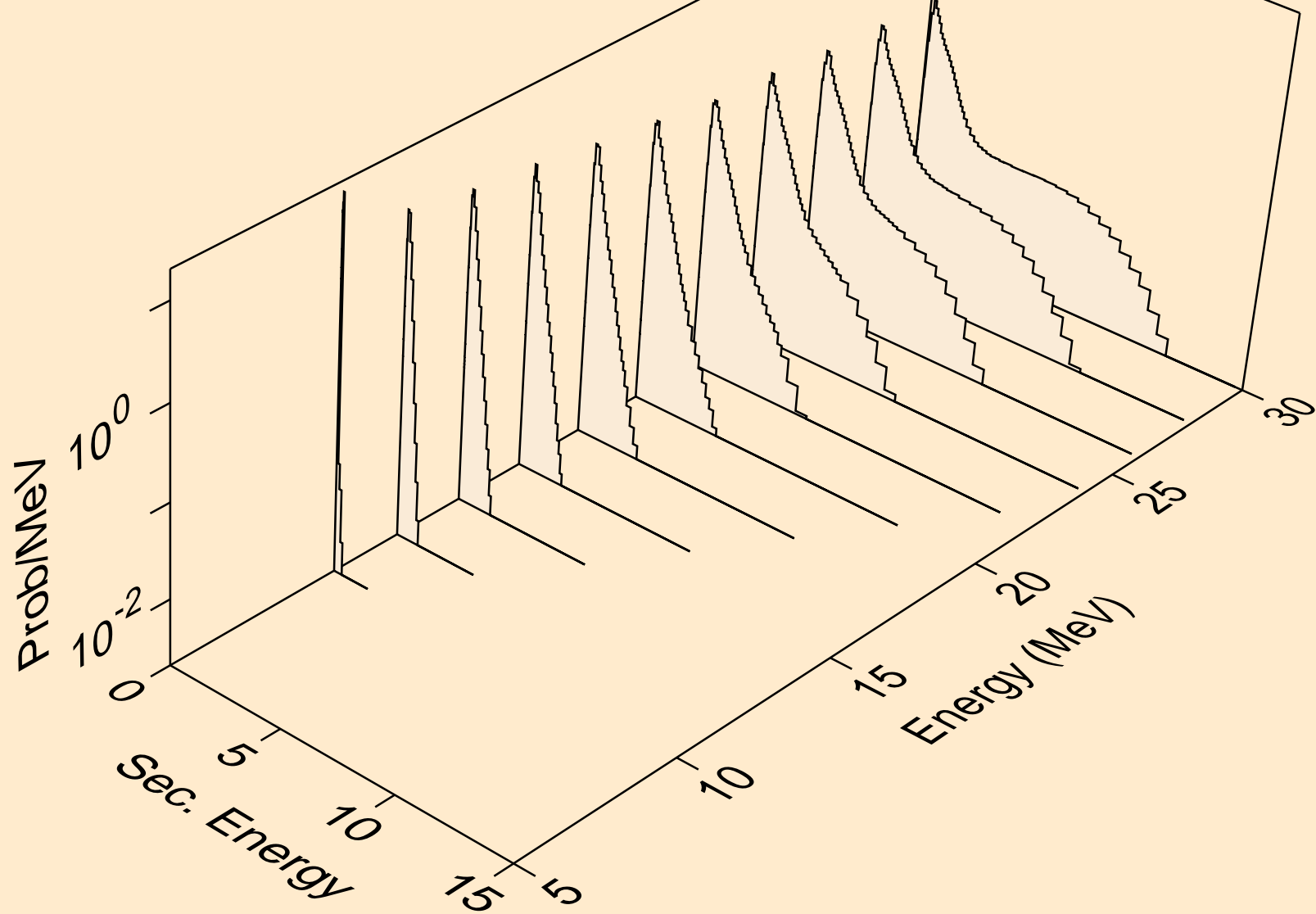

CM251 NEUTRON ACER TENDL-2024 LIBRARY; T=0.K
Neutron emission for (n,n*)d

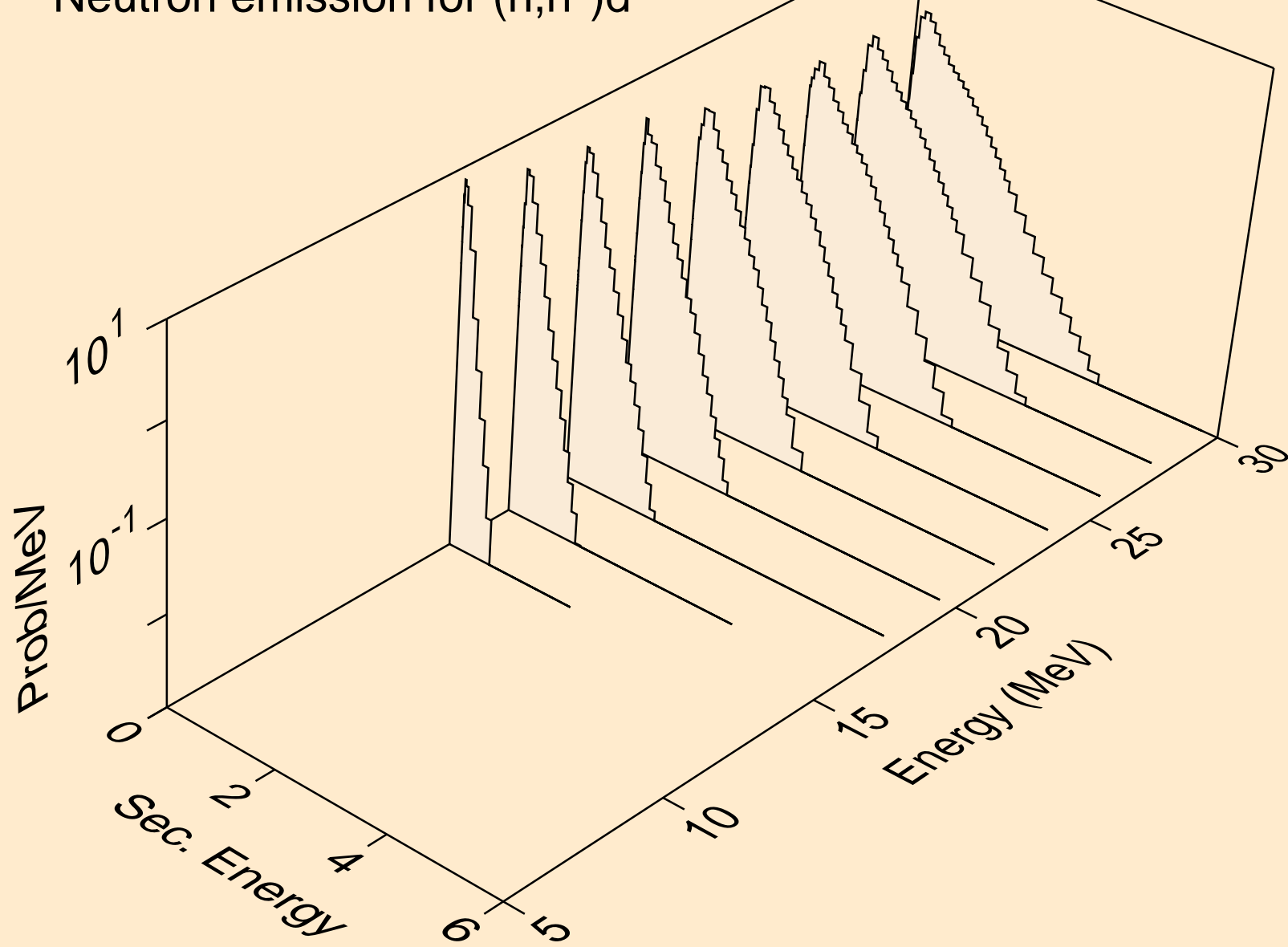

CM251 NEUTRON ACER TENDL-2024 LIBRARY; T=0.K
Neutron emission for (n,n*)t

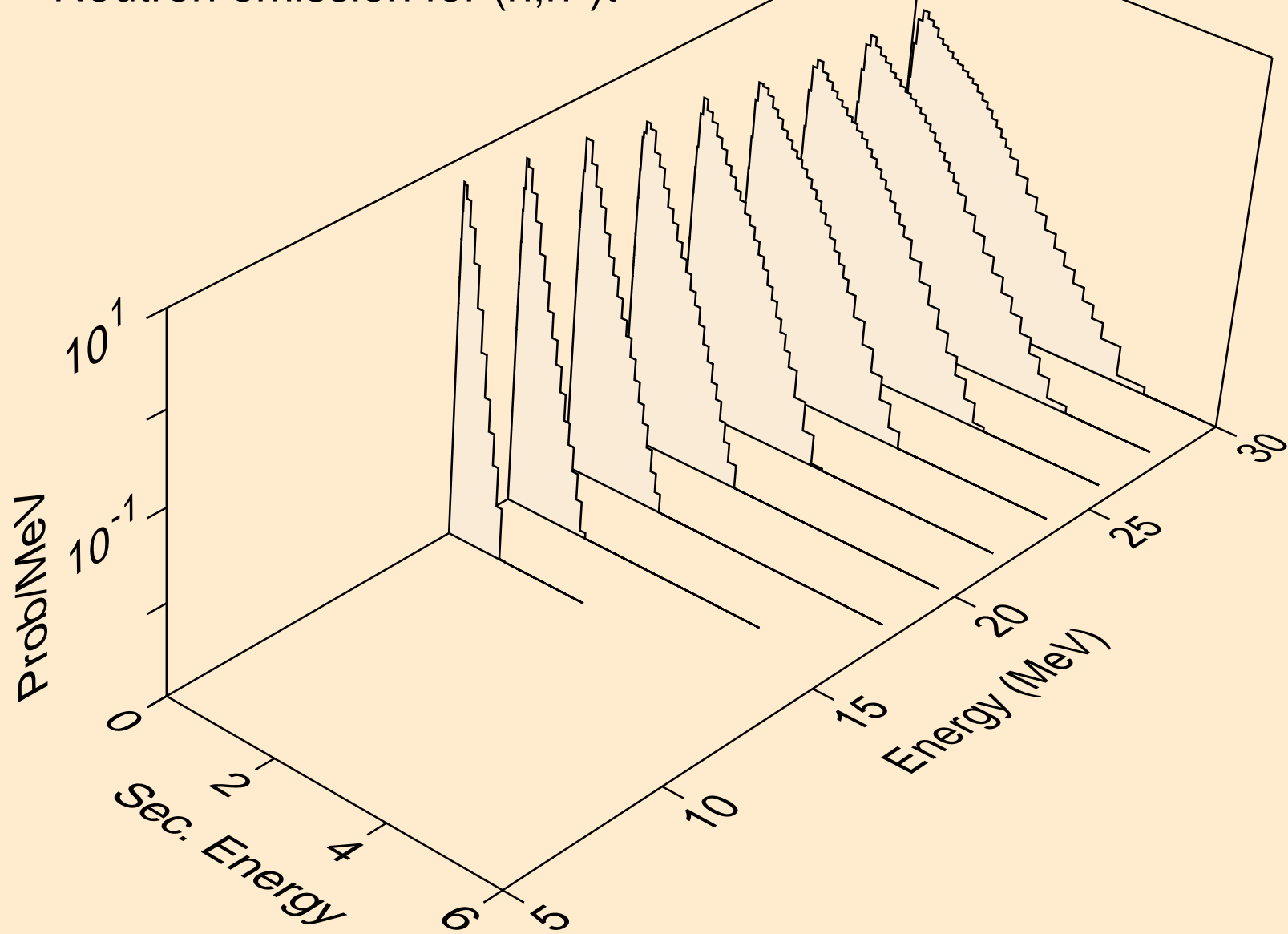

CM251 NEUTRON ACER TENDL-2024 LIBRARY; T=0.K
Neutron emission for (n,n*)he3

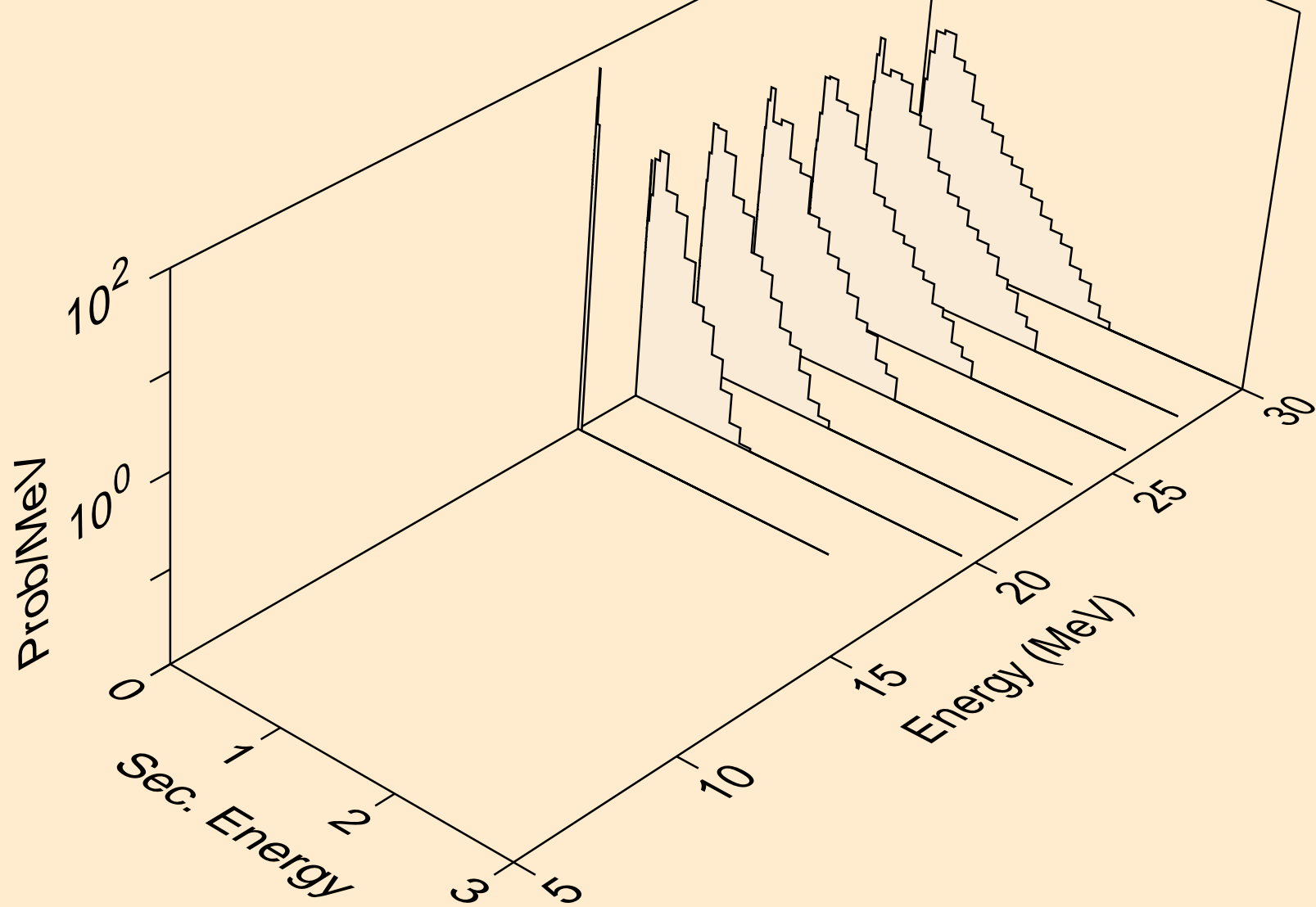

CM251 NEUTRON ACER TENDL-2024 LIBRARY; T=0.K
Neutron emission for (n,4n)

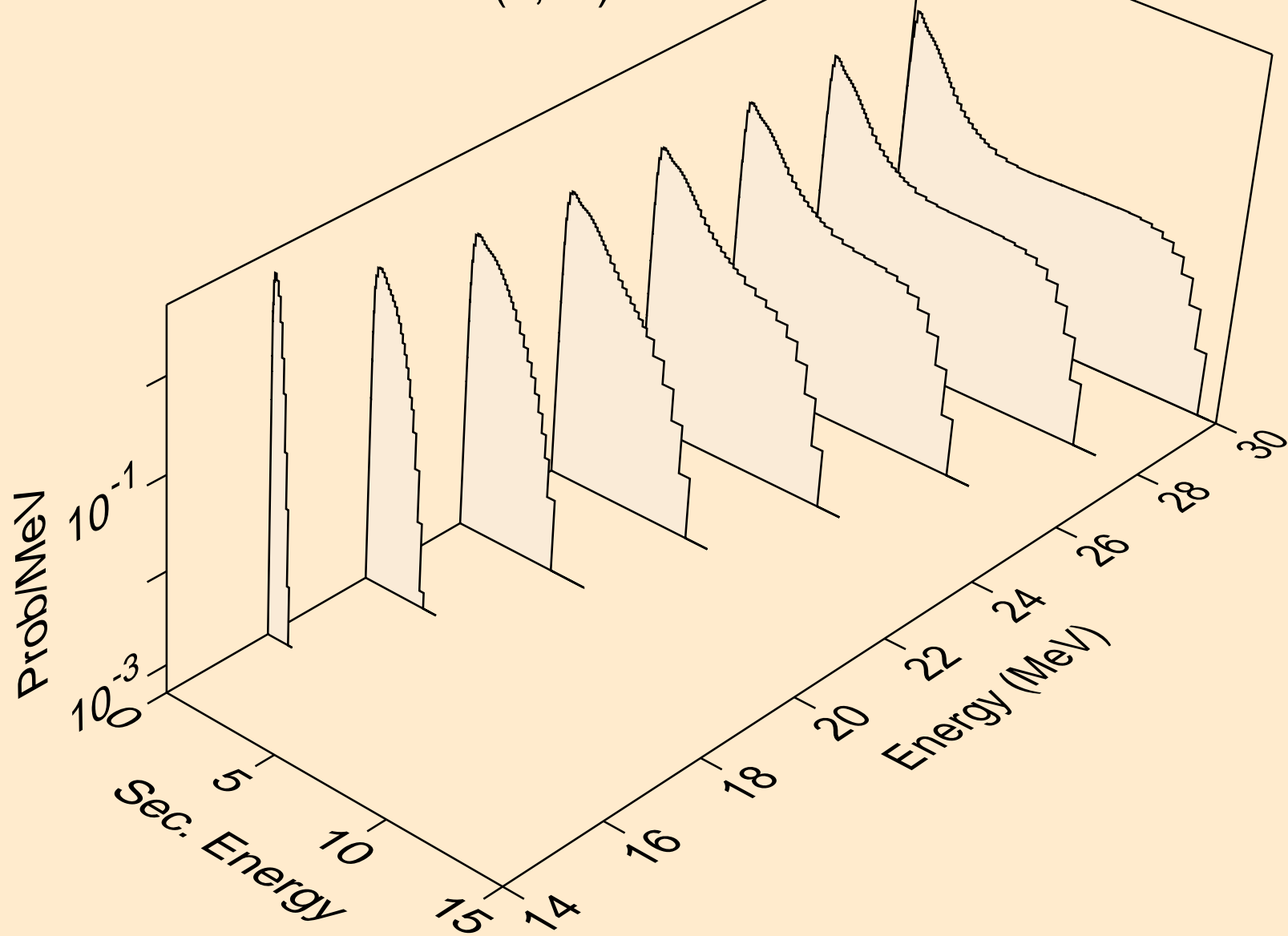

CM251 NEUTRON ACER TENDL-2024 LIBRARY; T=0.K
Neutron emission for (n,2np)

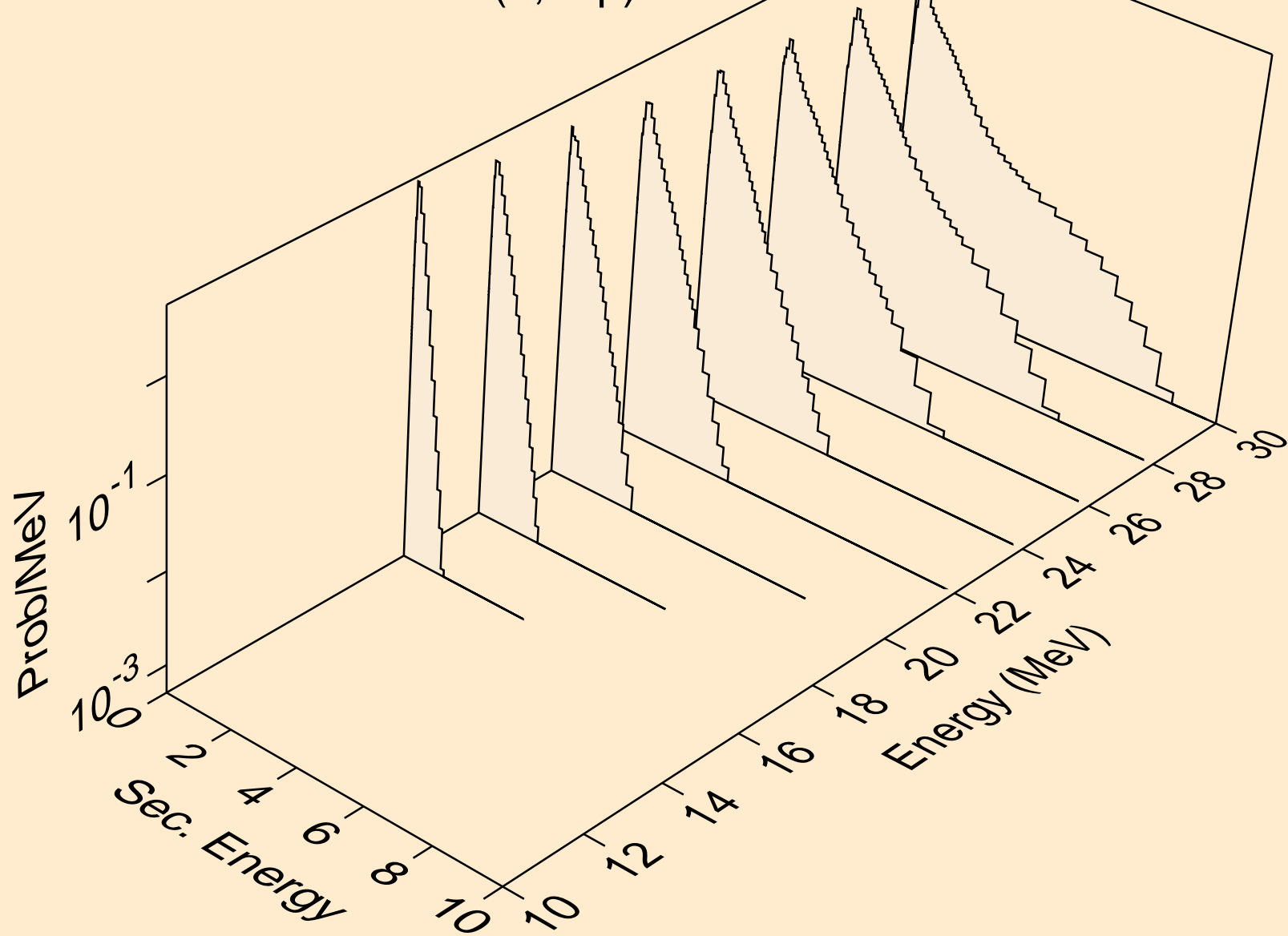

CM251 NEUTRON ACER TENDL-2024 LIBRARY; T=0.K
Neutron emission for (n,3np)

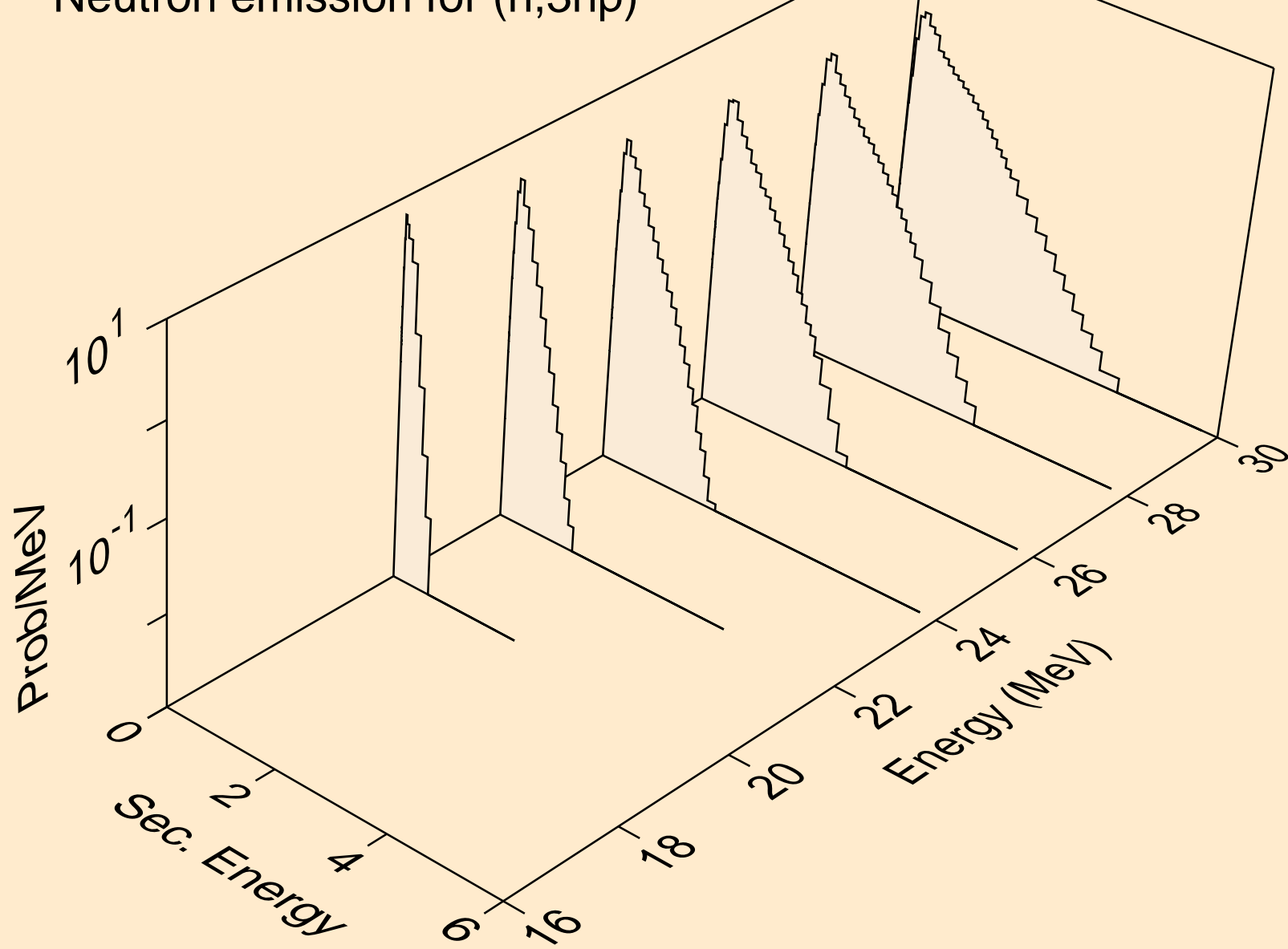

CM251 NEUTRON ACER TENDL-2024 LIBRARY; T=0.K
Neutron emission for (n,n*c)

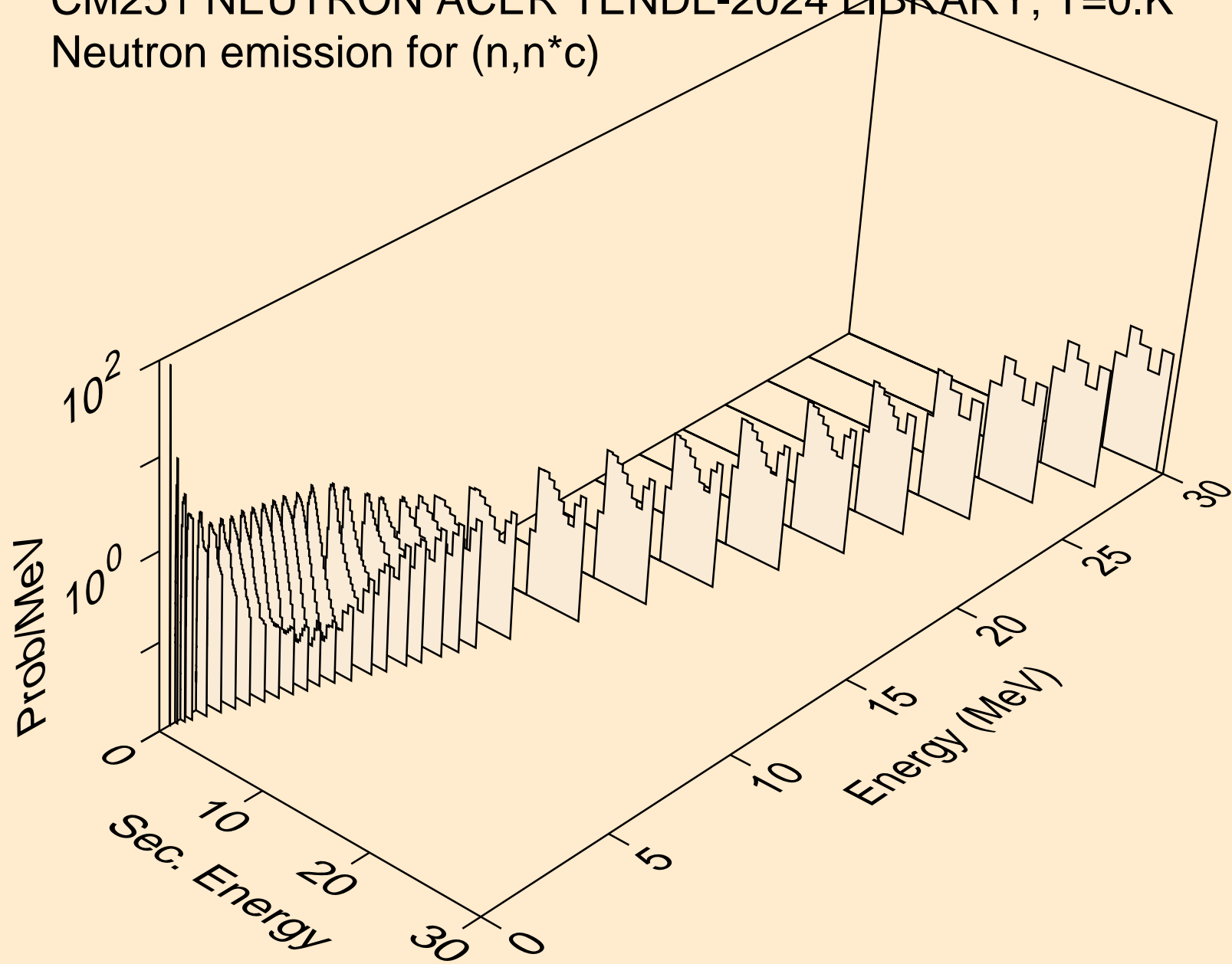

CM251 NEUTRON ACER TENDL-2024 LIBRARY; T=0.K

Delayed nubar

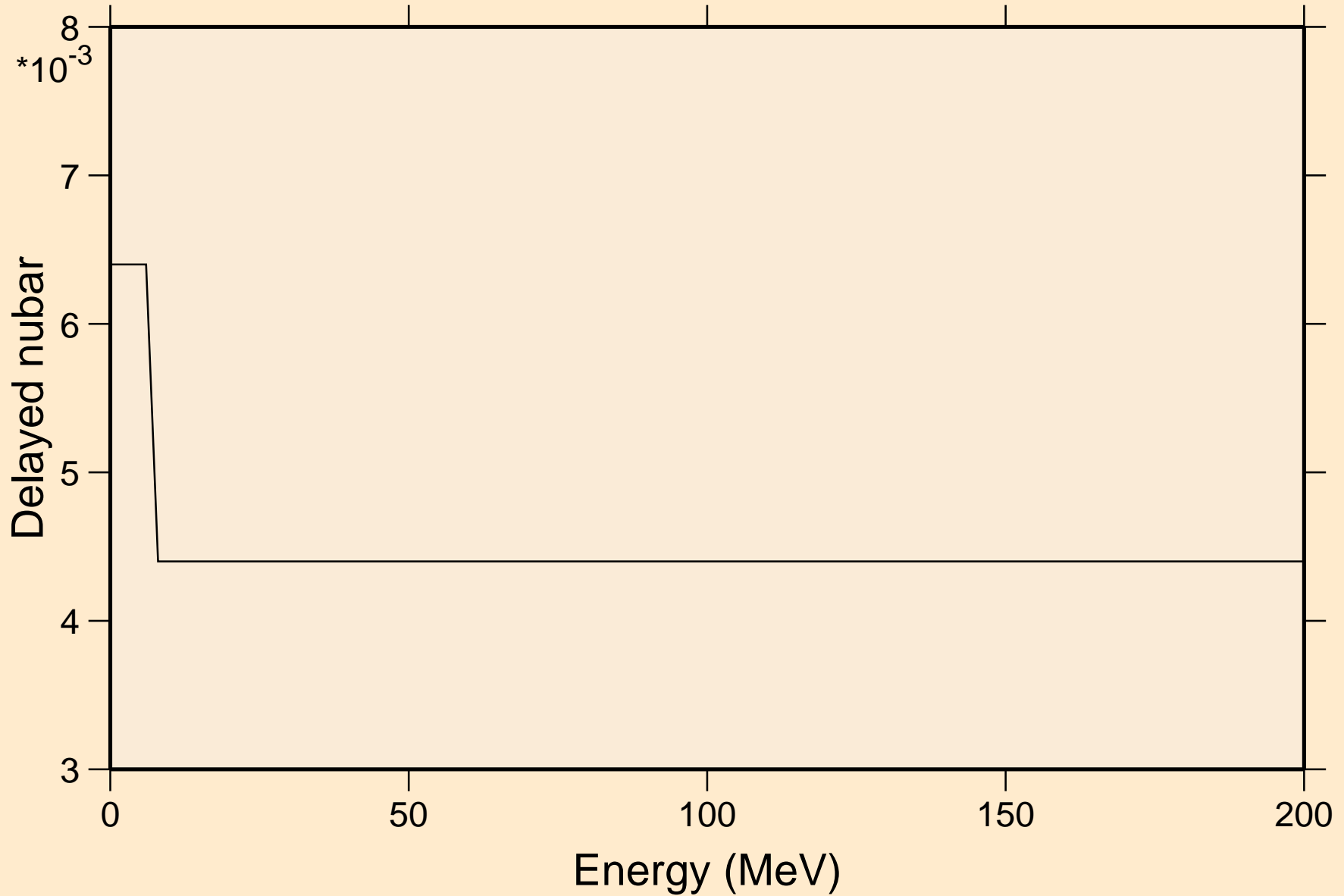

CM251 NEUTRON ACER TENDL-2024 LIBRARY; T=0.K

Delayed neutron spectra

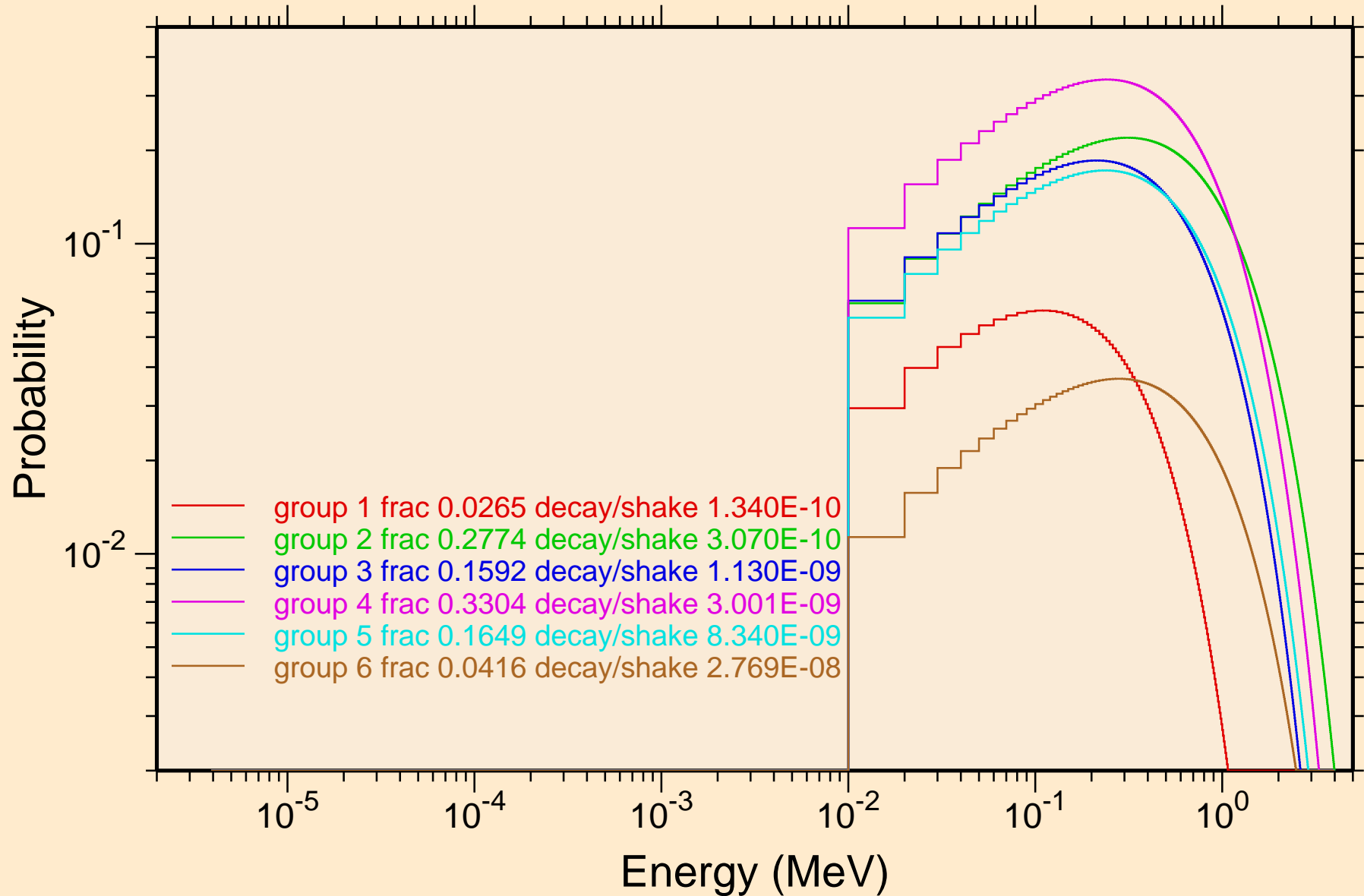

CM251 NEUTRON ACER TENDL-2024 LIBRARY; T=0.K
Photon emission for (n,x)

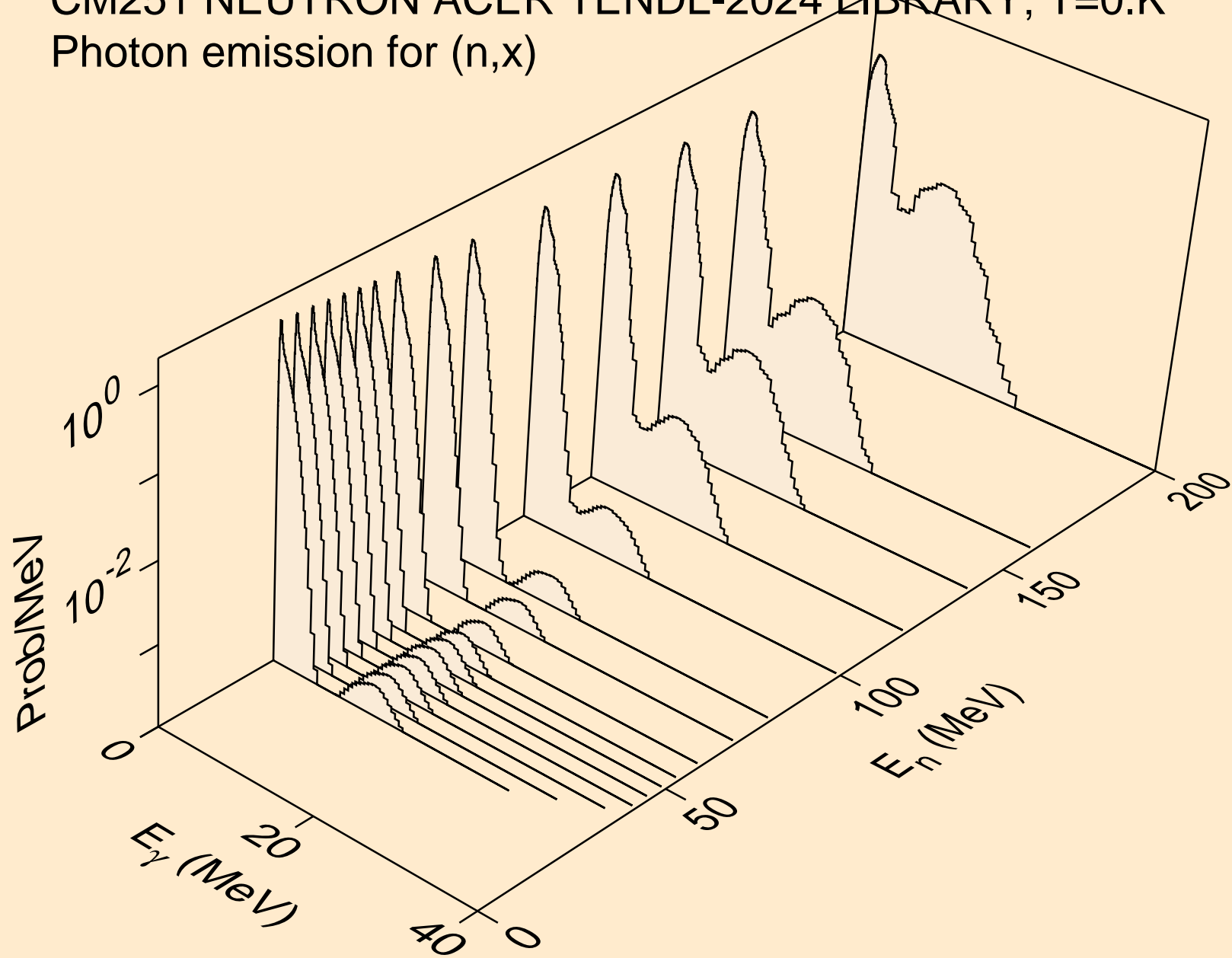

CM251 NEUTRON ACER TENDL-2024 LIBRARY; T=0.K
Photon emission for (n,2nd)

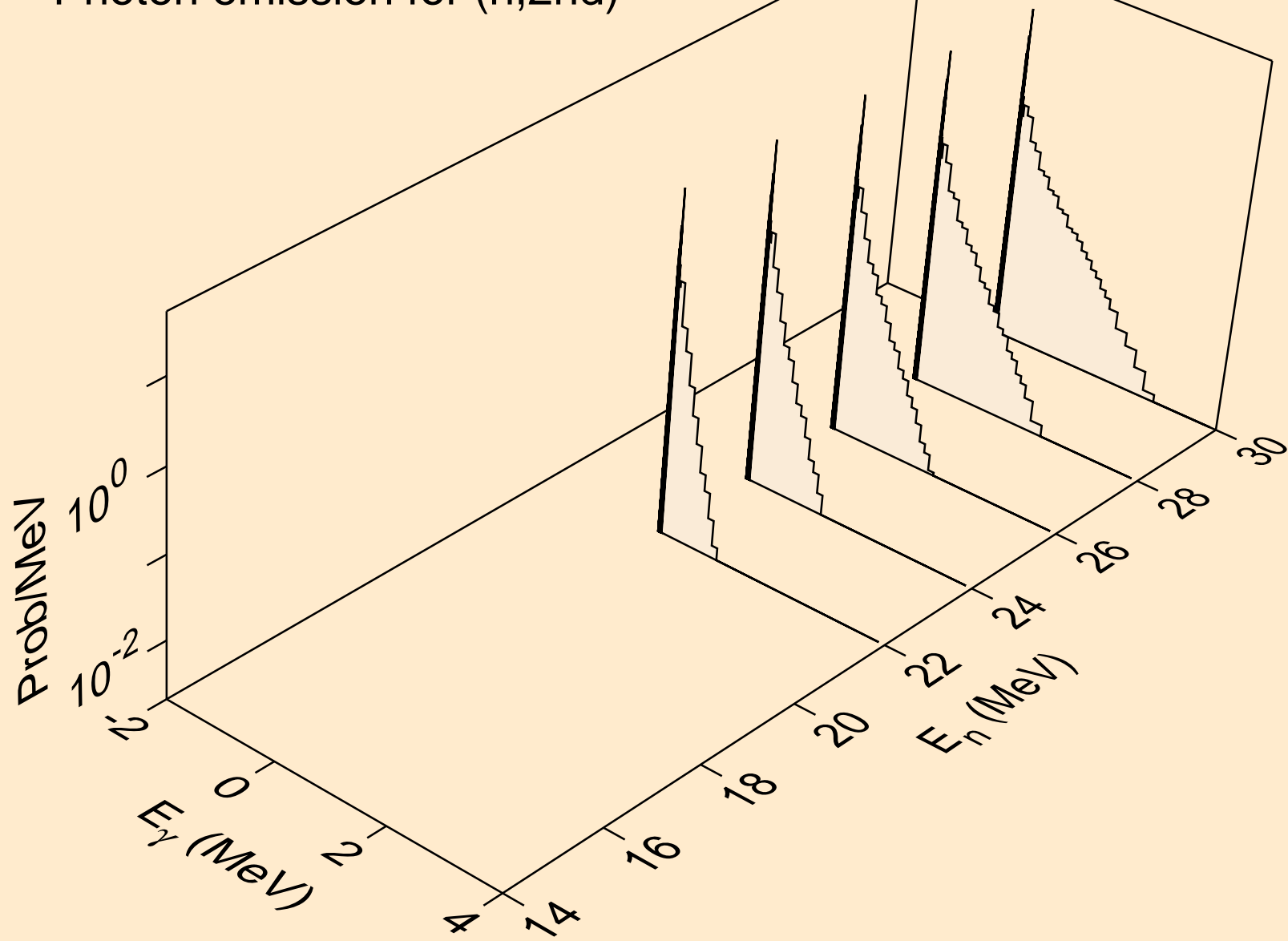

CM251 NEUTRON ACER TENDL-2024 LIBRARY; T=0.K
Photon emission for (n,2n)

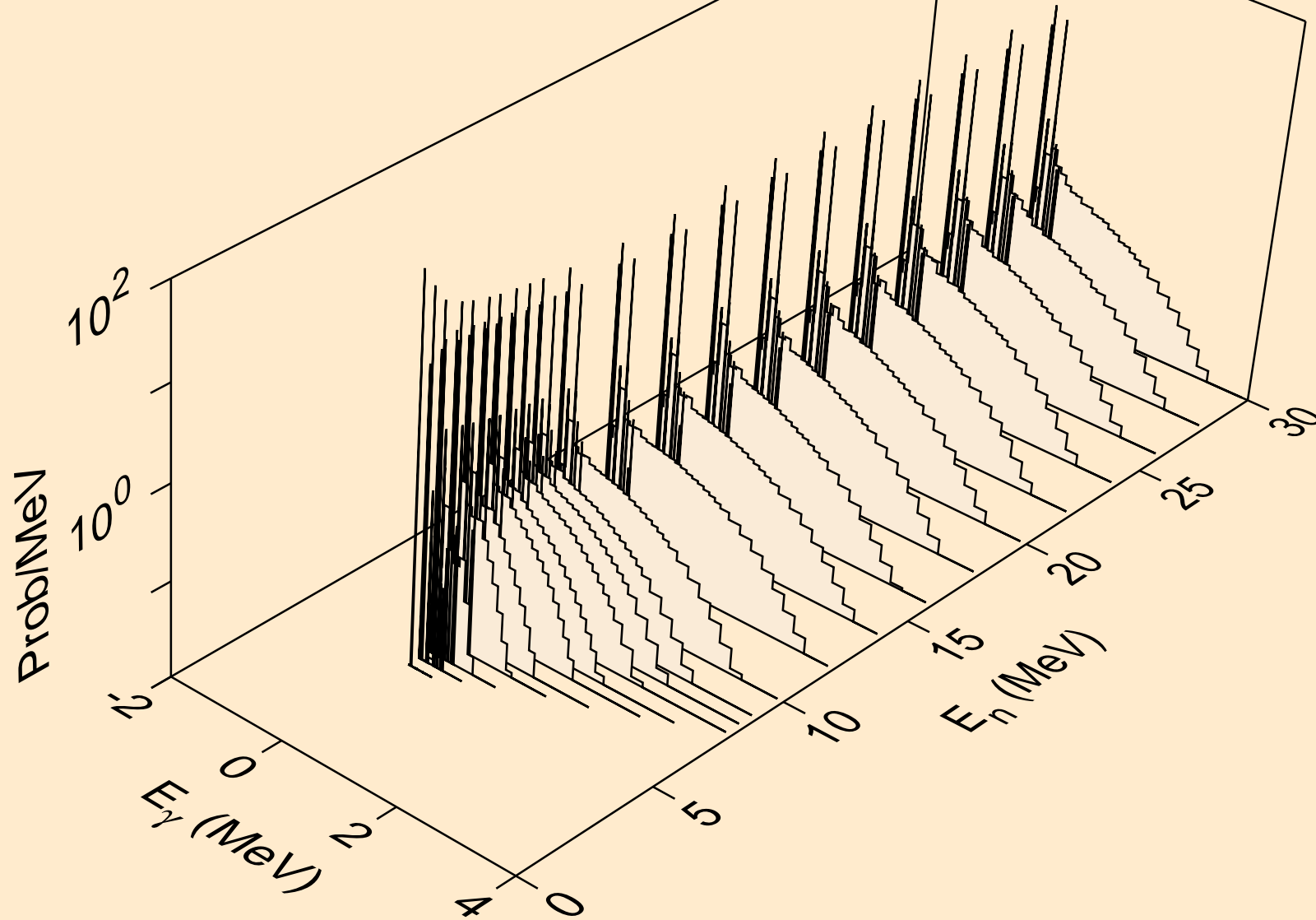

CM251 NEUTRON ACER TENDL-2024 LIBRARY; T=0.K
Photon emission for (n,3n)

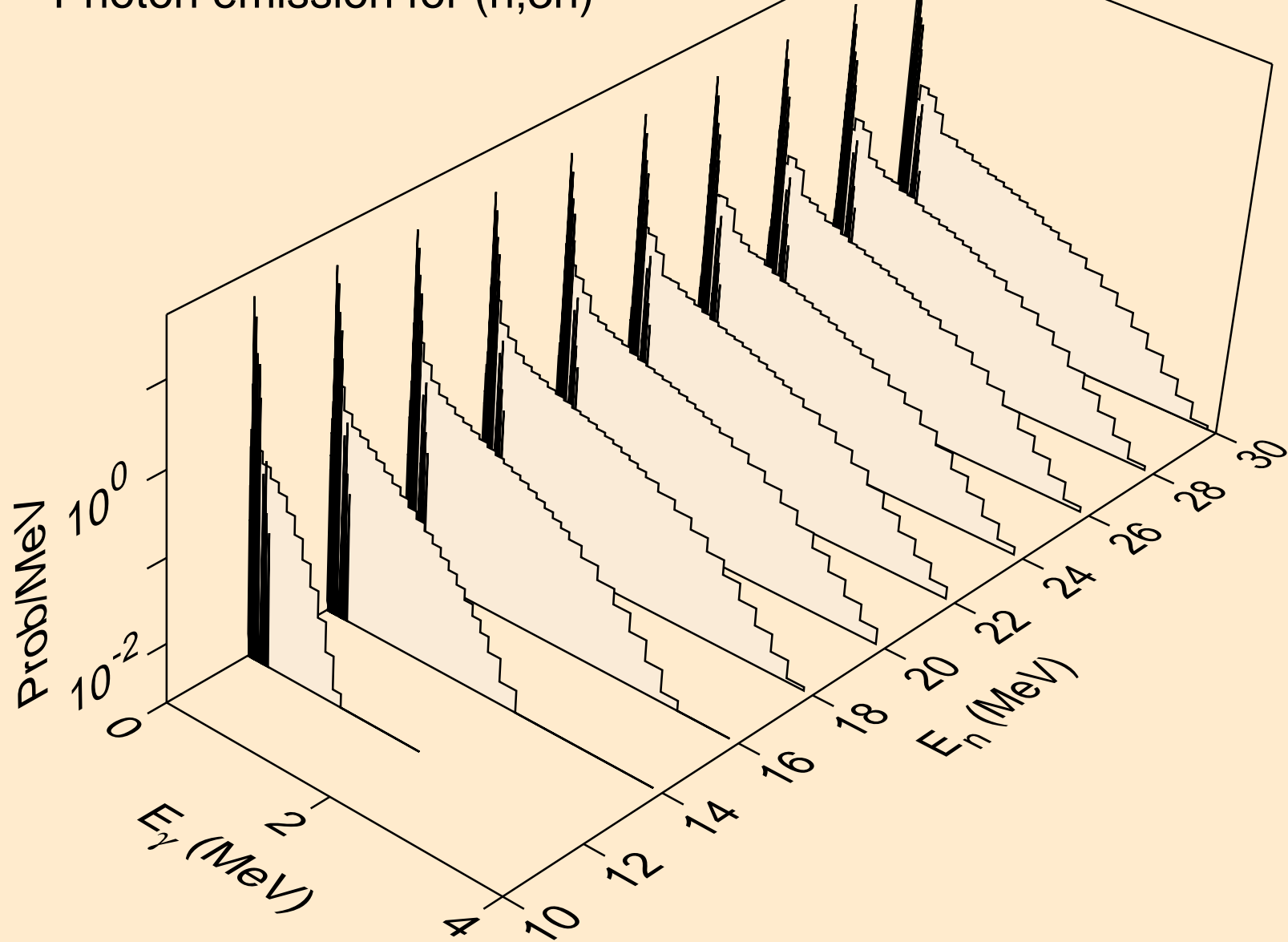

CM251 NEUTRON ACER TENDL-2024 LIBRARY; T=0.K
Photon emission for (n,n*)a

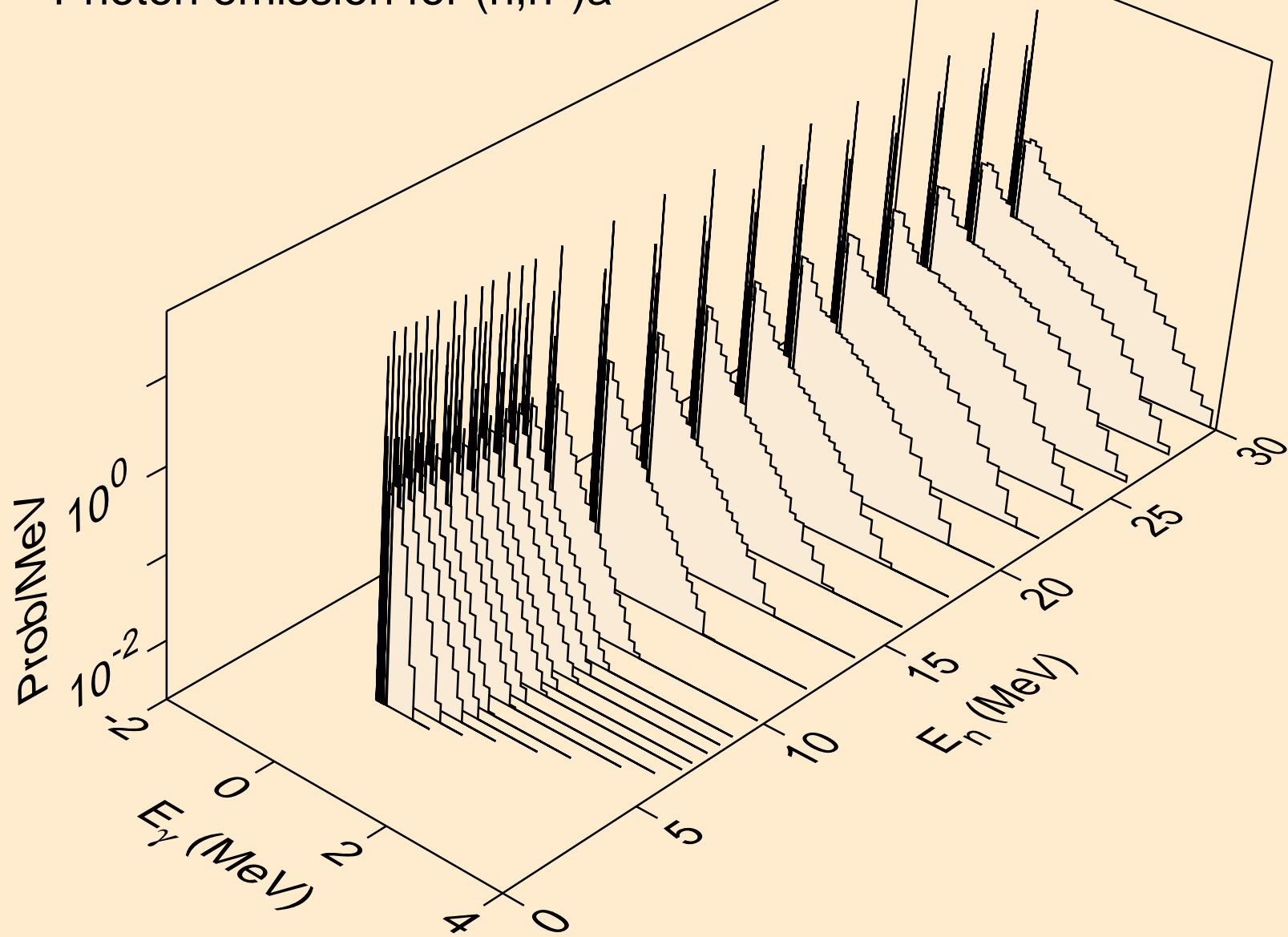

CM251 NEUTRON ACER TENDL-2024 LIBRARY; T=0.K
Photon emission for (n,2n)a

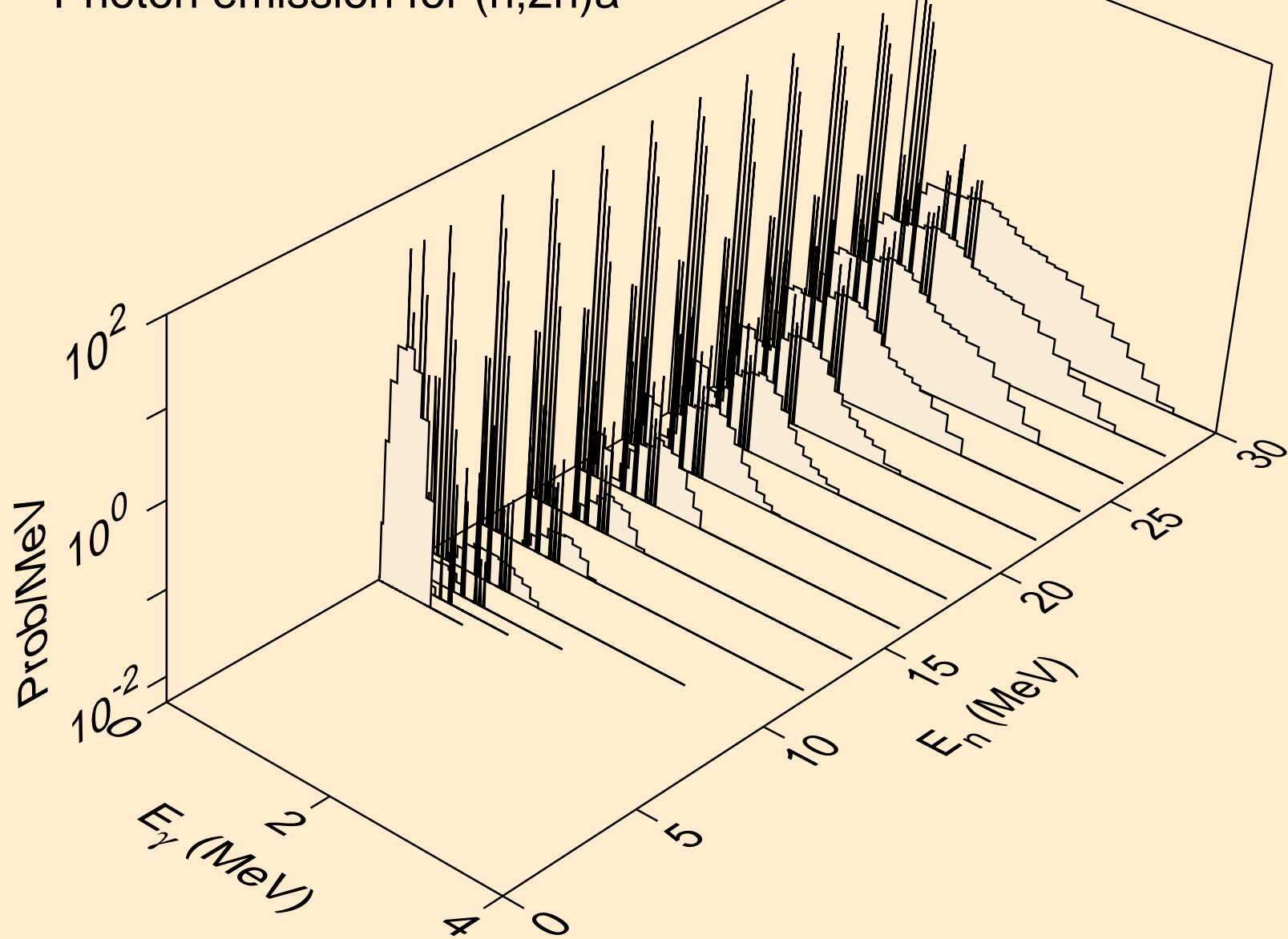

CM251 NEUTRON ACER TENDL-2024 LIBRARY; T=0.K
Photon emission for (n,3n)a

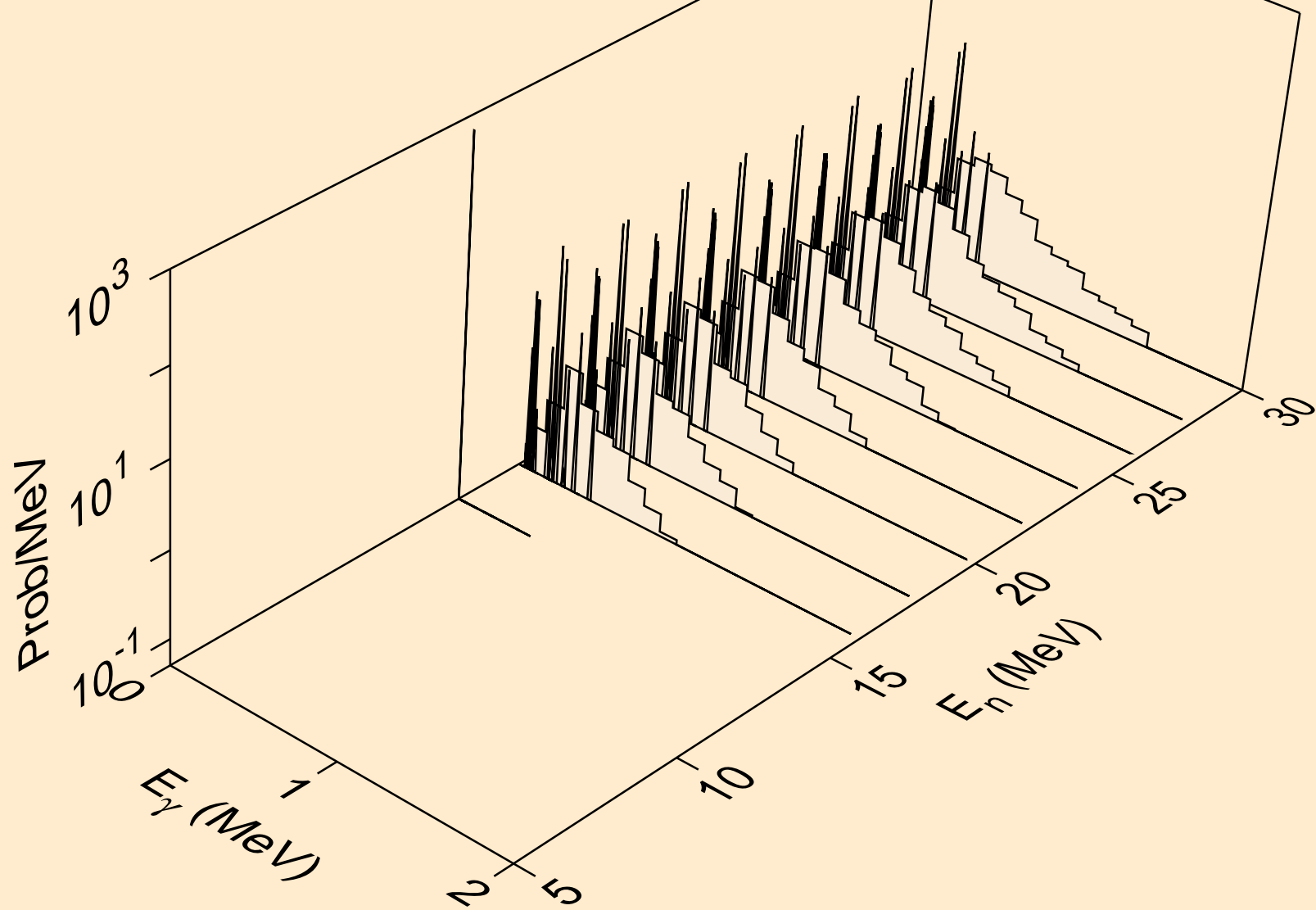

CM251 NEUTRON ACER TENDL-2024 LIBRARY; T=0.K
Photon emission for (n,n*)p

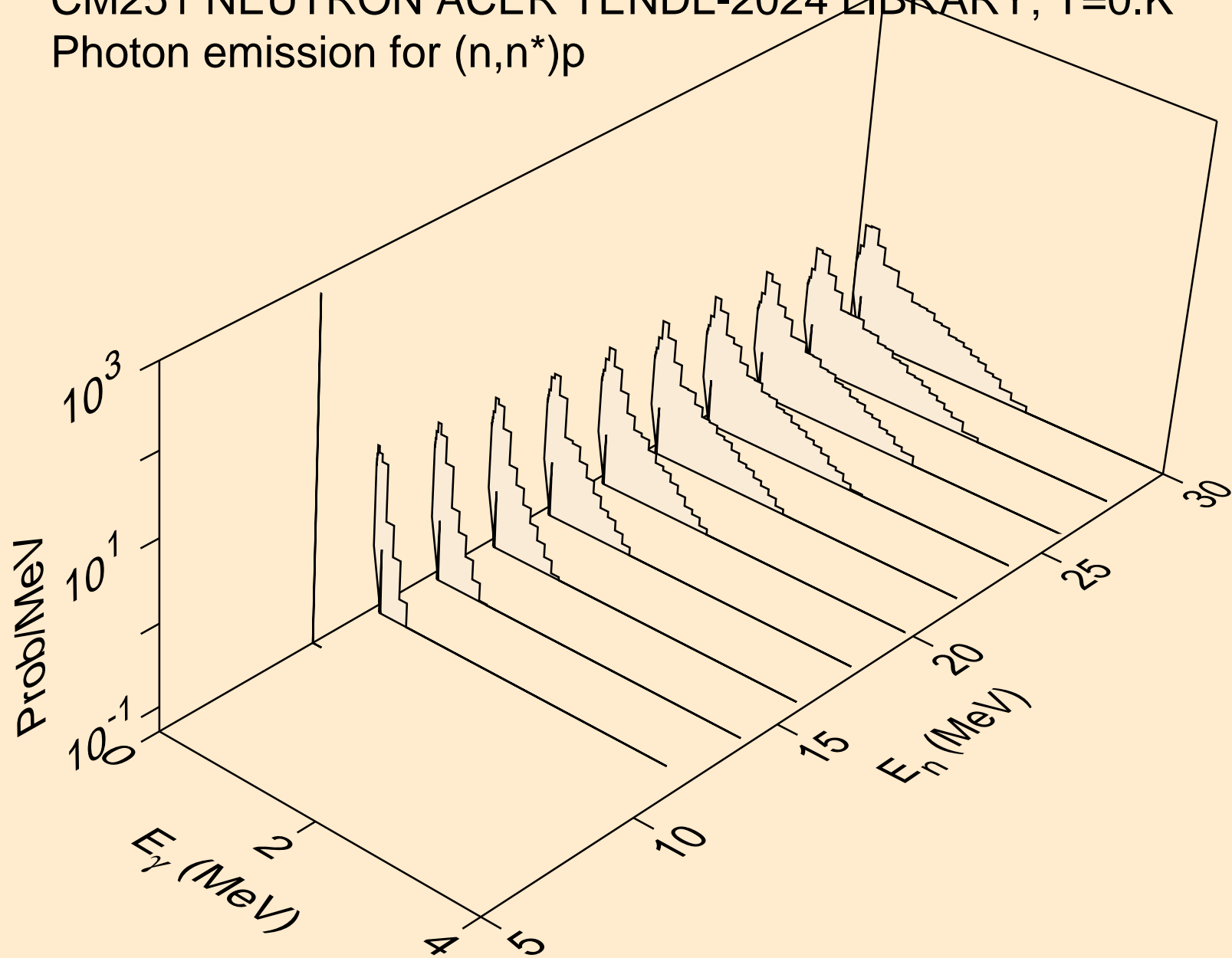

CM251 NEUTRON ACER TENDL-2024 LIBRARY; T=0.K
Photon emission for (n,n*)d

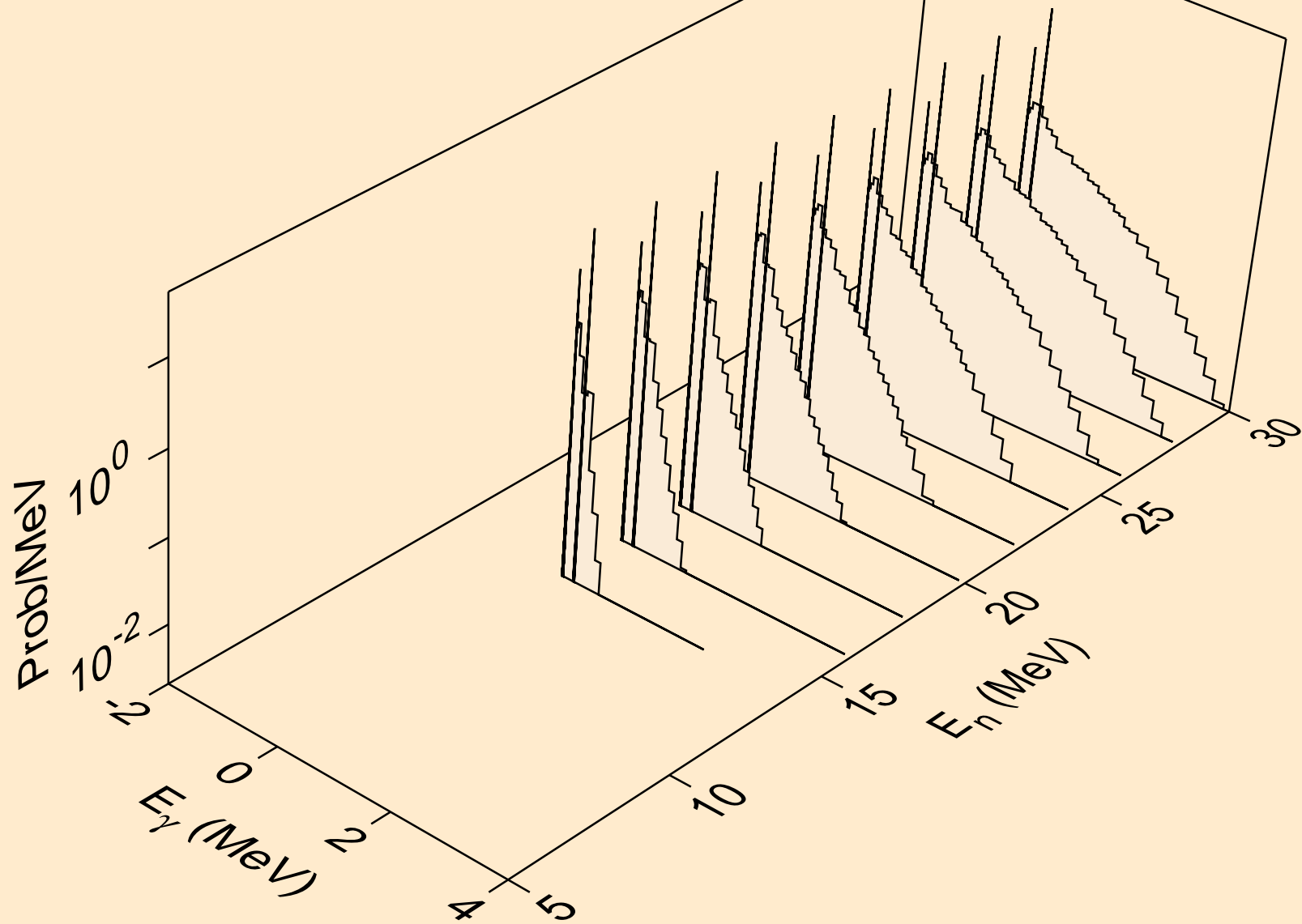

CM251 NEUTRON ACER TENDL-2024 LIBRARY; T=0.K
Photon emission for (n,n*)t

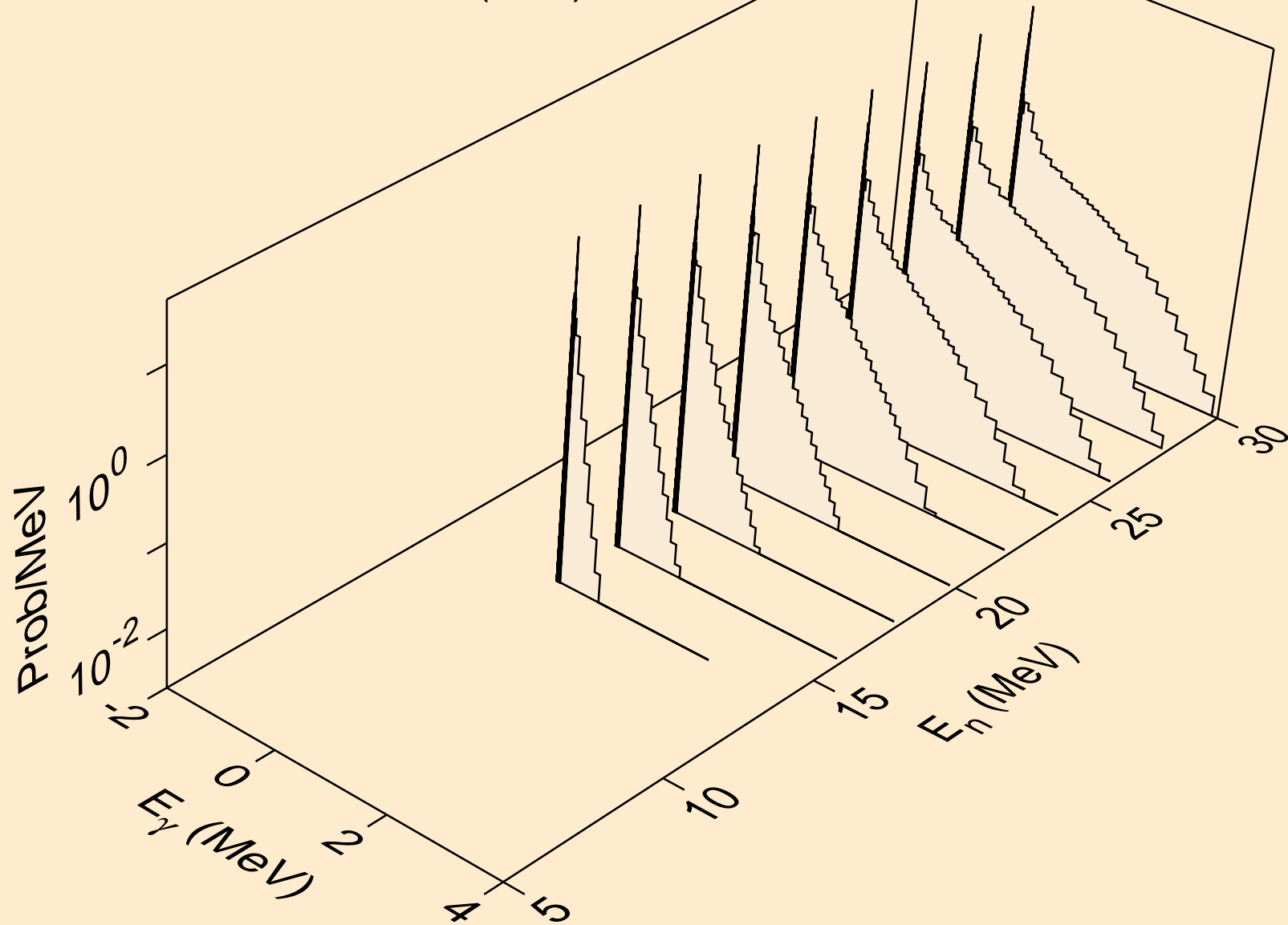

CM251 NEUTRON ACER TENDL-2024 LIBRARY; T=0.K
Photon emission for (n,n*)he3

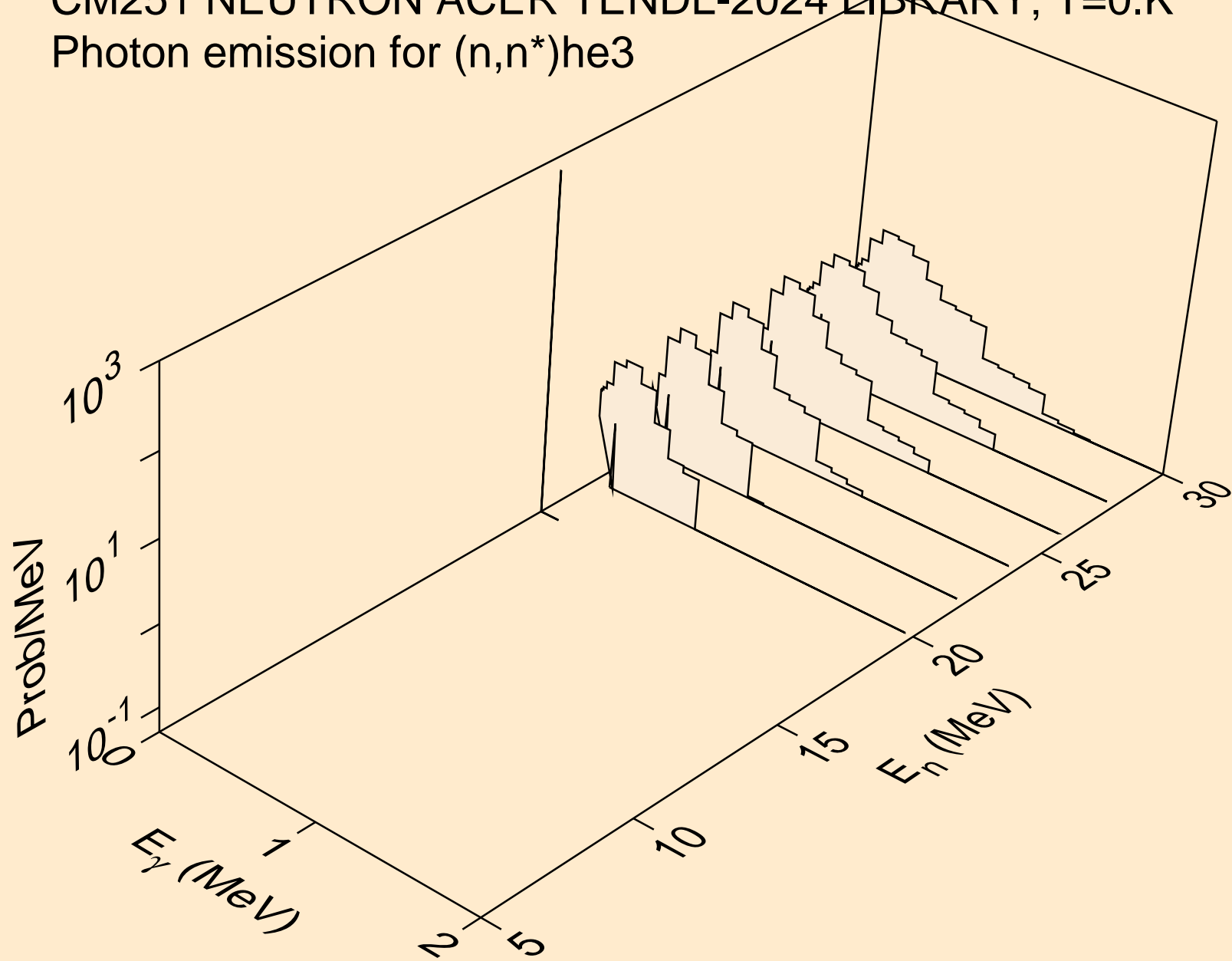

CM251 NEUTRON ACER TENDL-2024 LIBRARY; T=0.K
Photon emission for (n,4n)

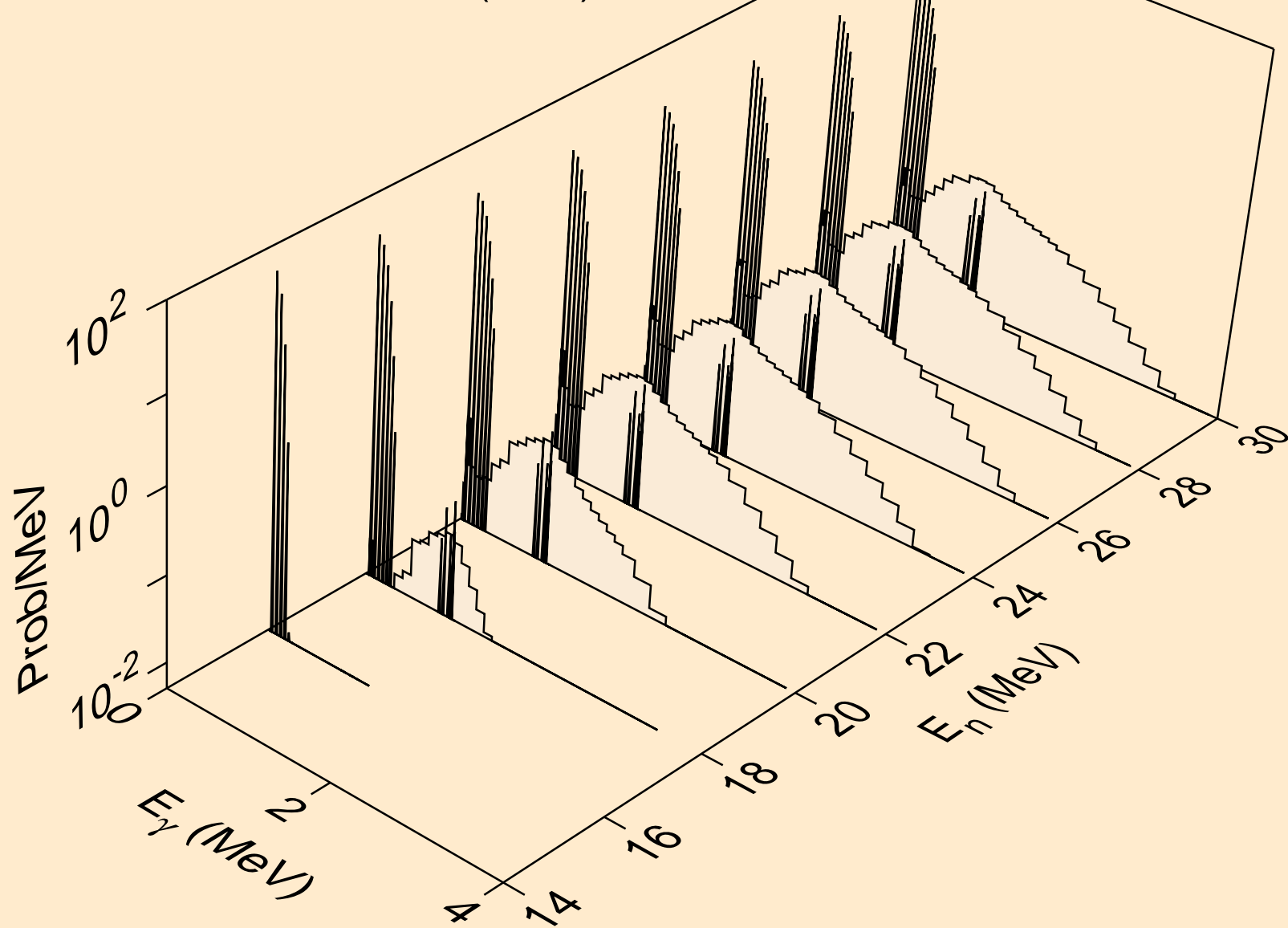

CM251 NEUTRON ACER TENDL-2024 LIBRARY; T=0.K
Photon emission for (n,2np)

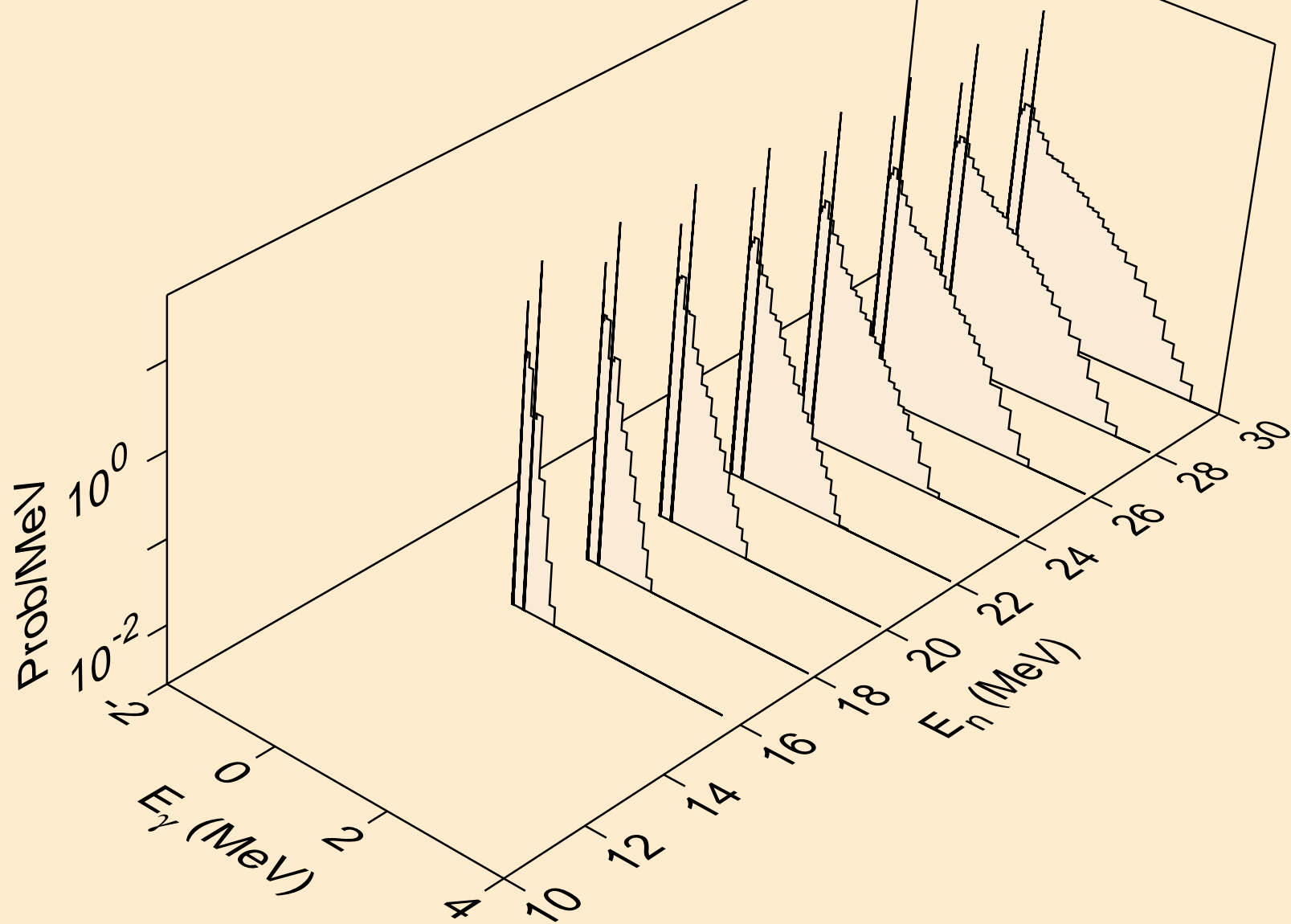

CM251 NEUTRON ACER TENDL-2024 LIBRARY; T=0.K
Photon emission for (n,3np)

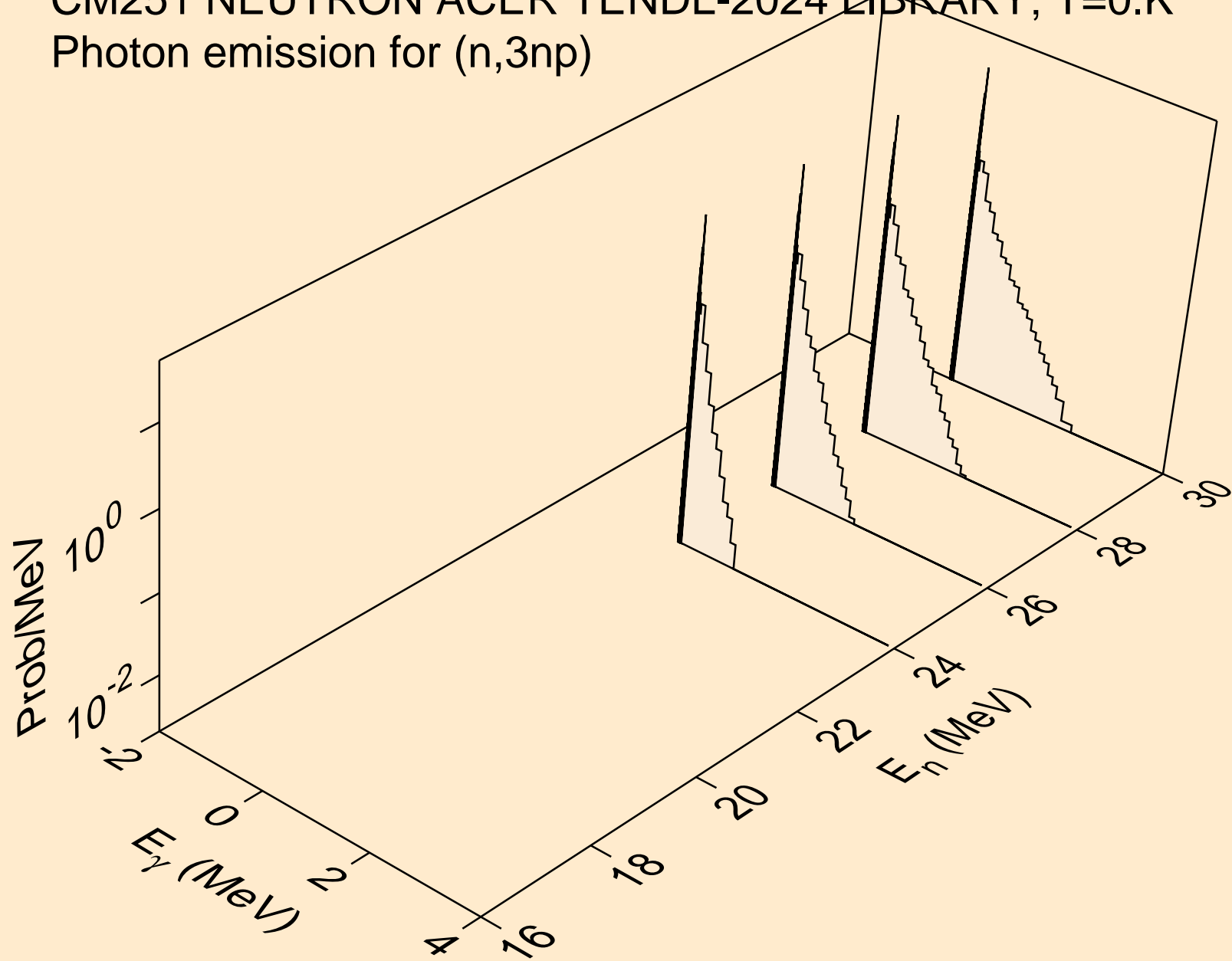

CM251 NEUTRON ACER TENDL-2024 LIBRARY; T=0.K
Photon emission for (n,n*c)

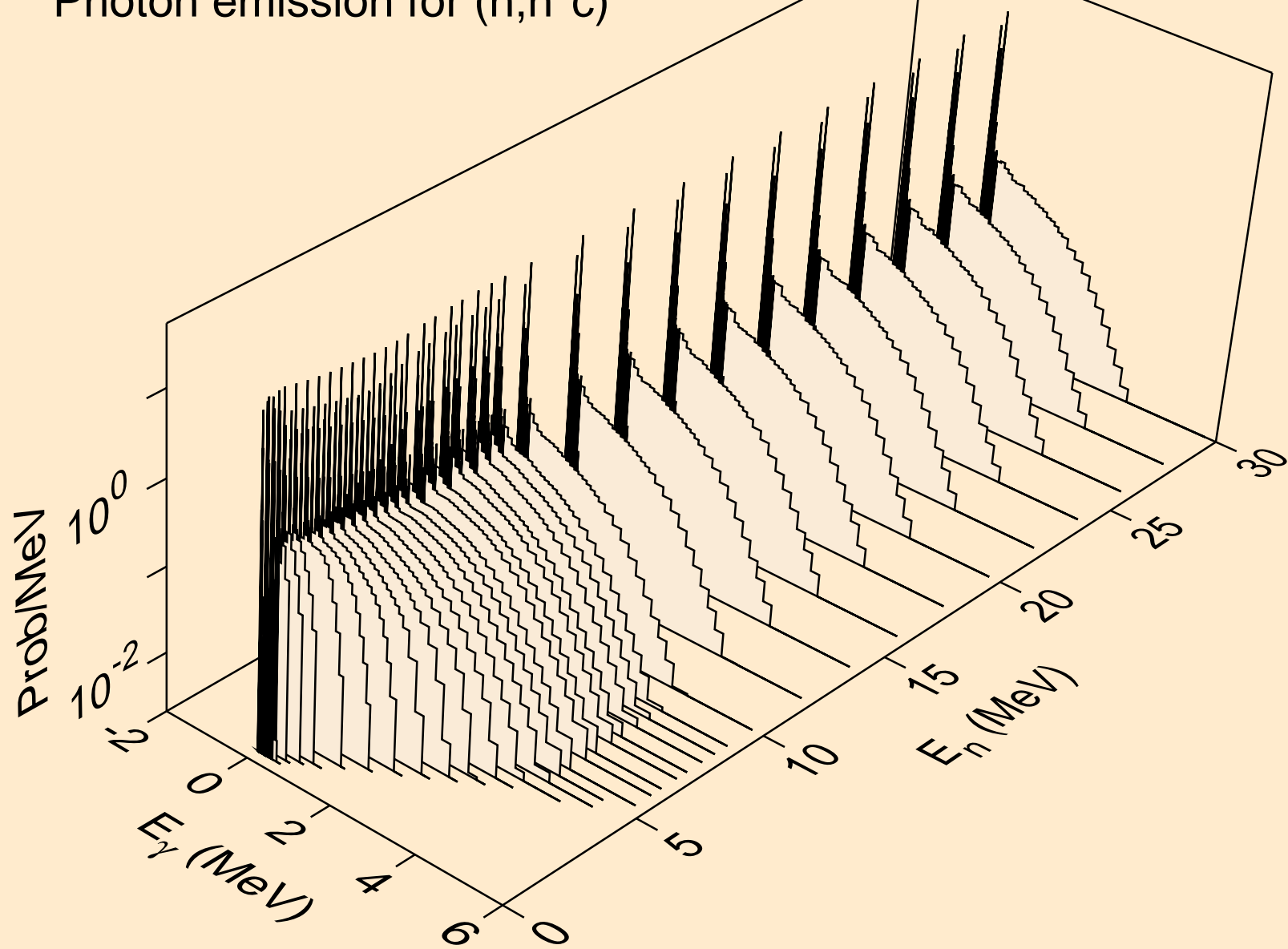

CM251 NEUTRON ACER TENDL-2024 LIBRARY; T=0.K
Photon emission for (n,gma)

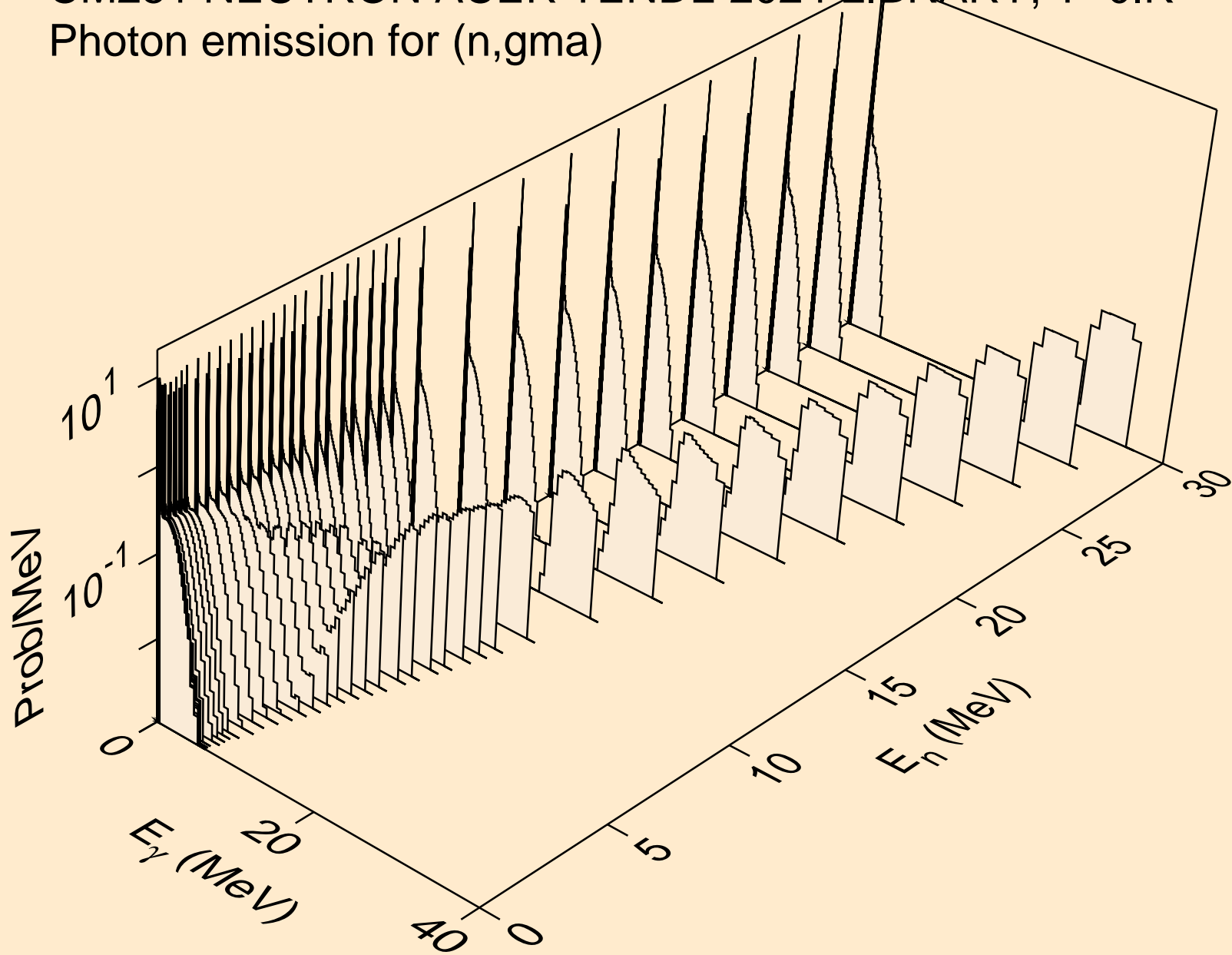

CM251 NEUTRON ACER TENDL-2024 LIBRARY; T=0.K
Photon emission for (n,p)

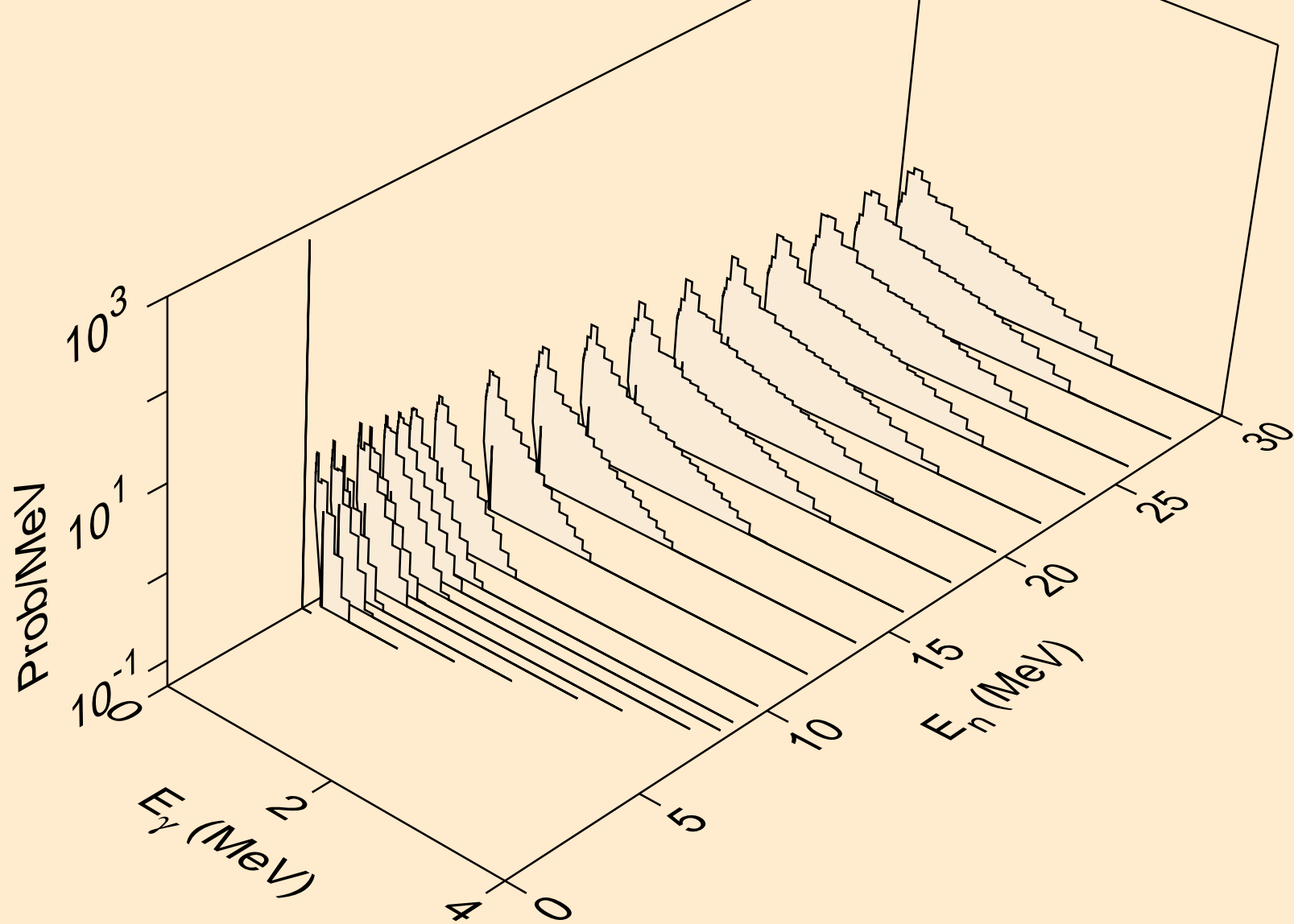

CM251 NEUTRON ACER TENDL-2024 LIBRARY; T=0.K
Photon emission for (n,d)

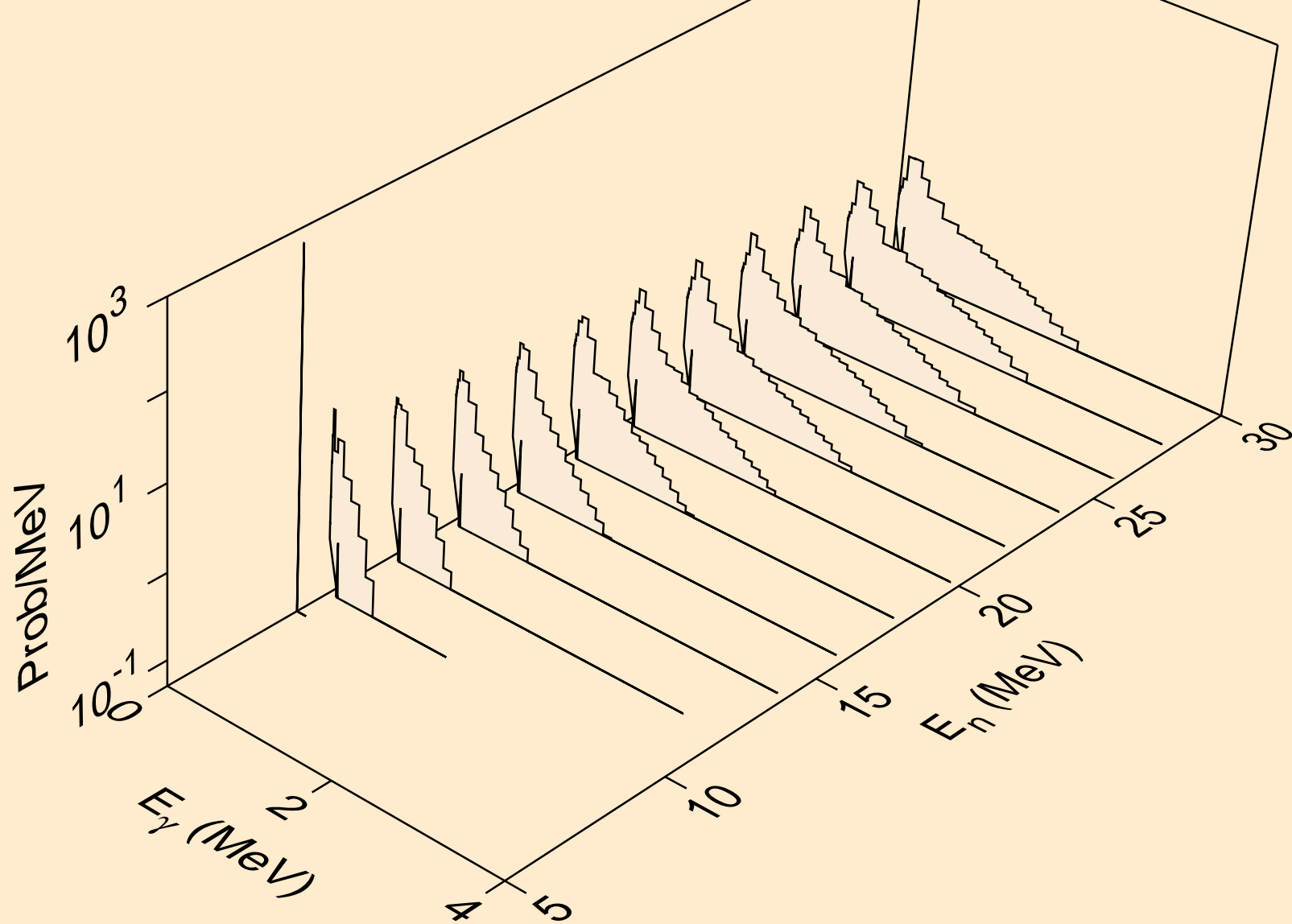

CM251 NEUTRON ACER TENDL-2024 LIBRARY; T=0.K
Photon emission for (n,t)

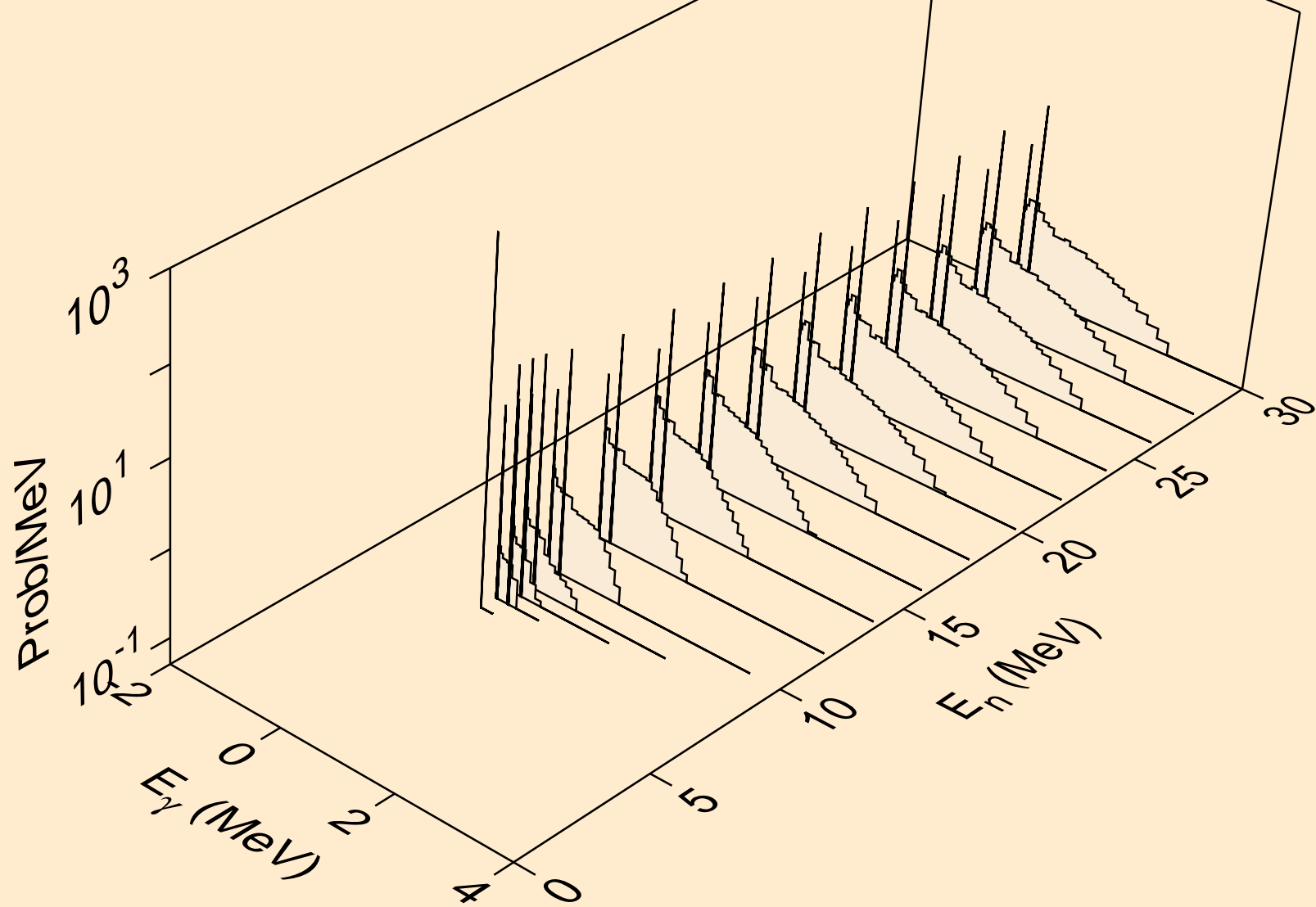

CM251 NEUTRON ACER TENDL-2024 LIBRARY; T=0.K
Photon emission for (n,he3)

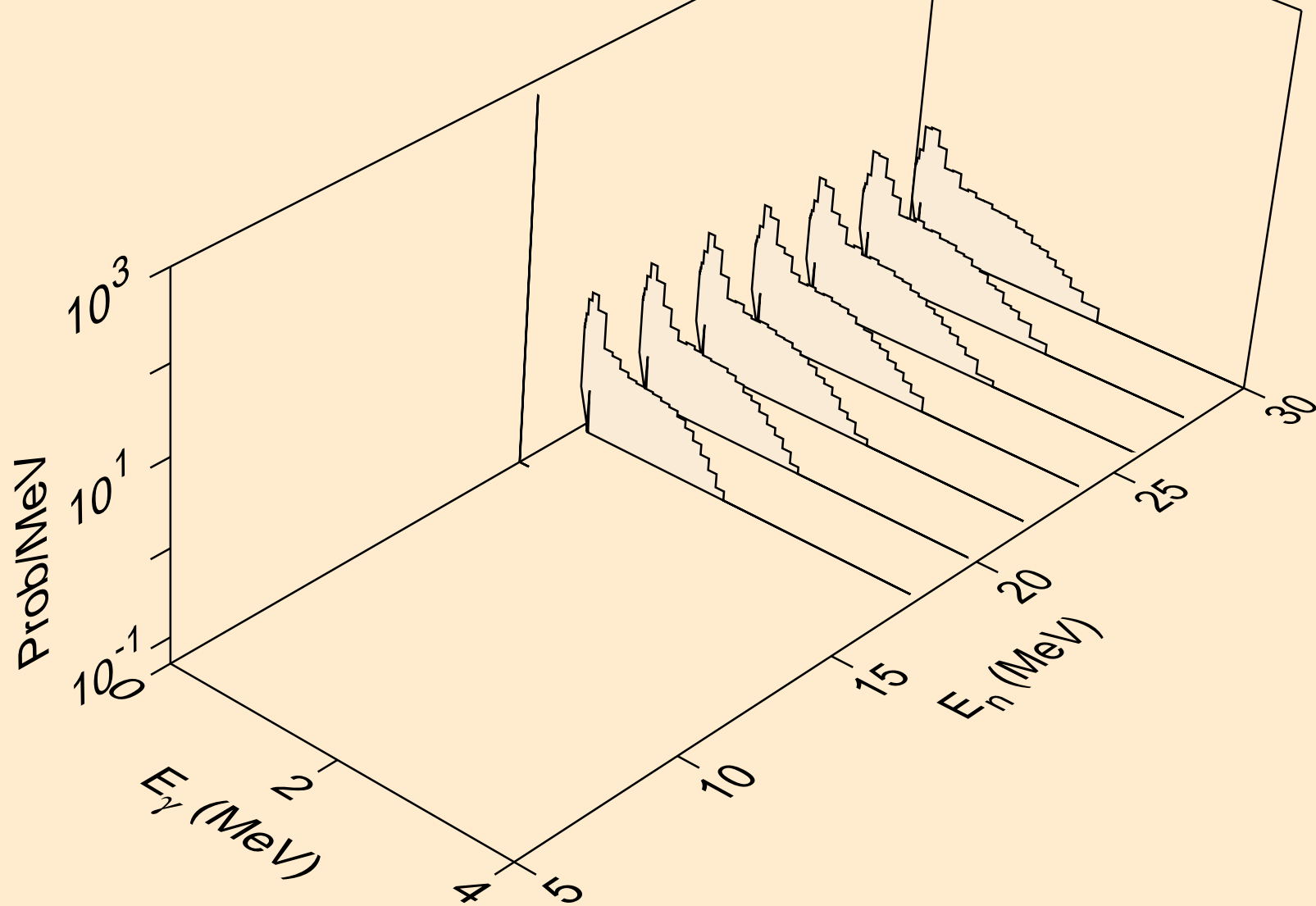

CM251 NEUTRON ACER TENDL-2024 LIBRARY; T=0.K
Photon emission for (n,a)

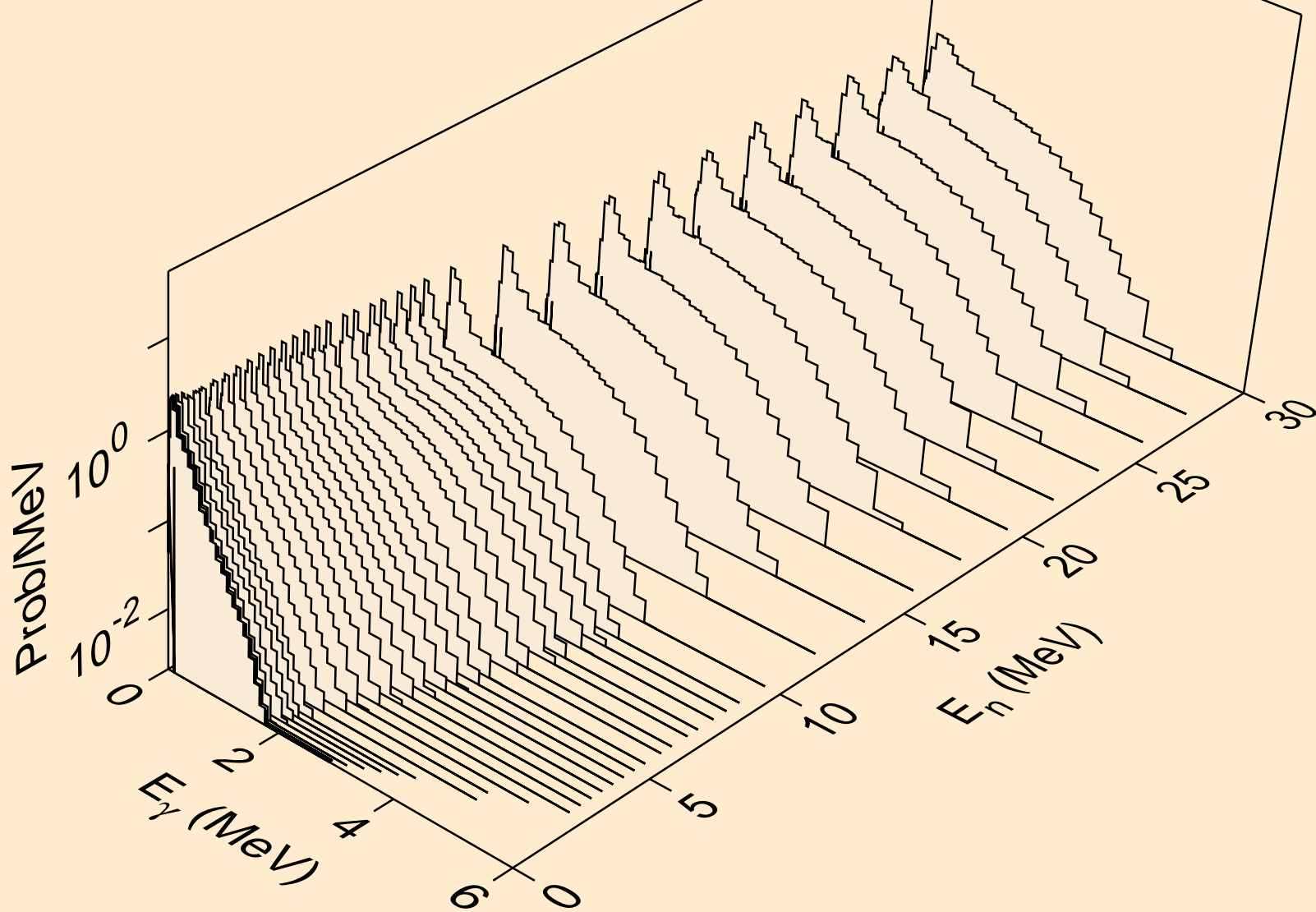

CM251 NEUTRON ACER TENDL-2024 LIBRARY; T=0.K
Photon emission for (n,2p)

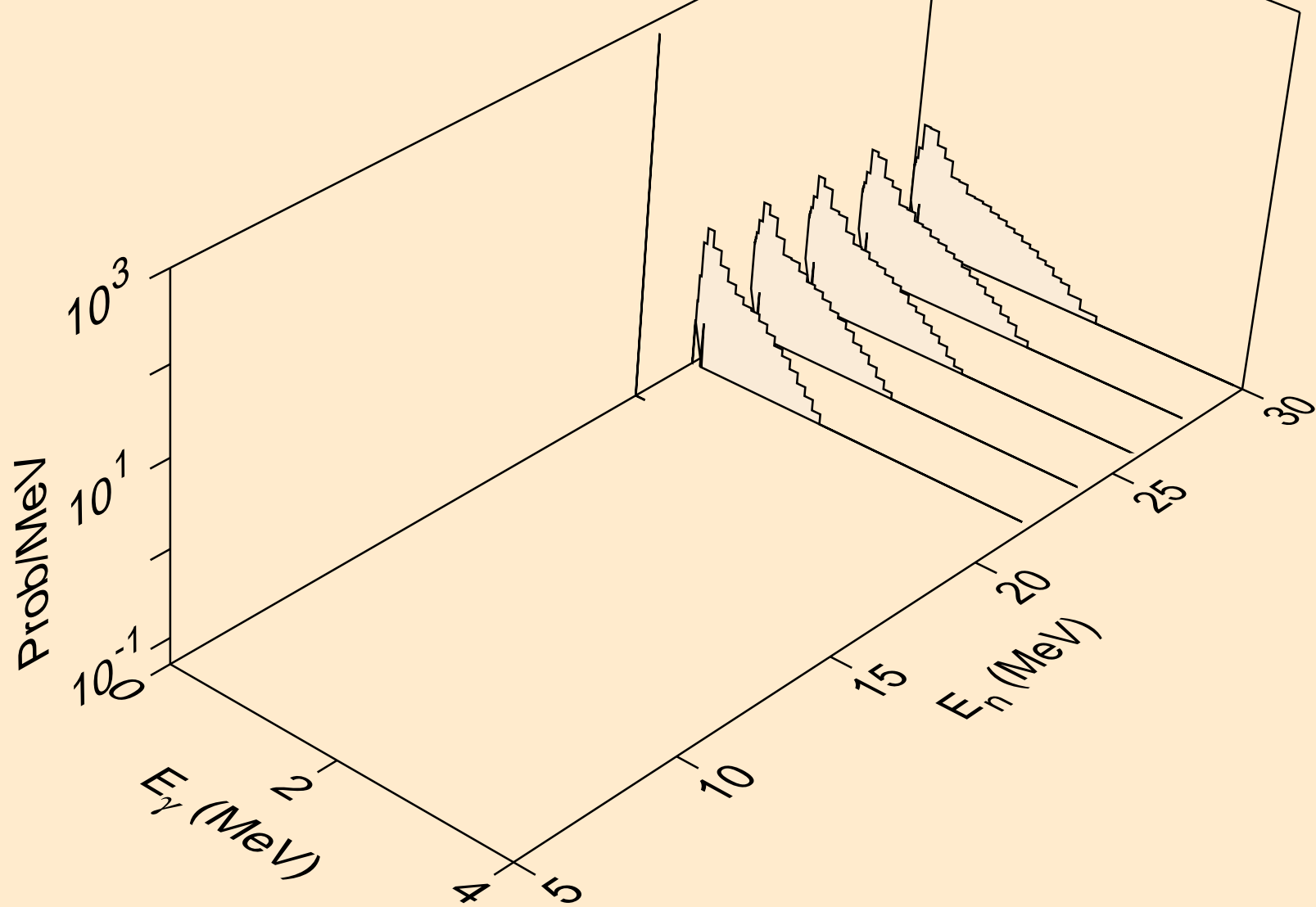

CM251 NEUTRON ACER TENDL-2024 LIBRARY; T=0.K
thermal capture photon spectrum

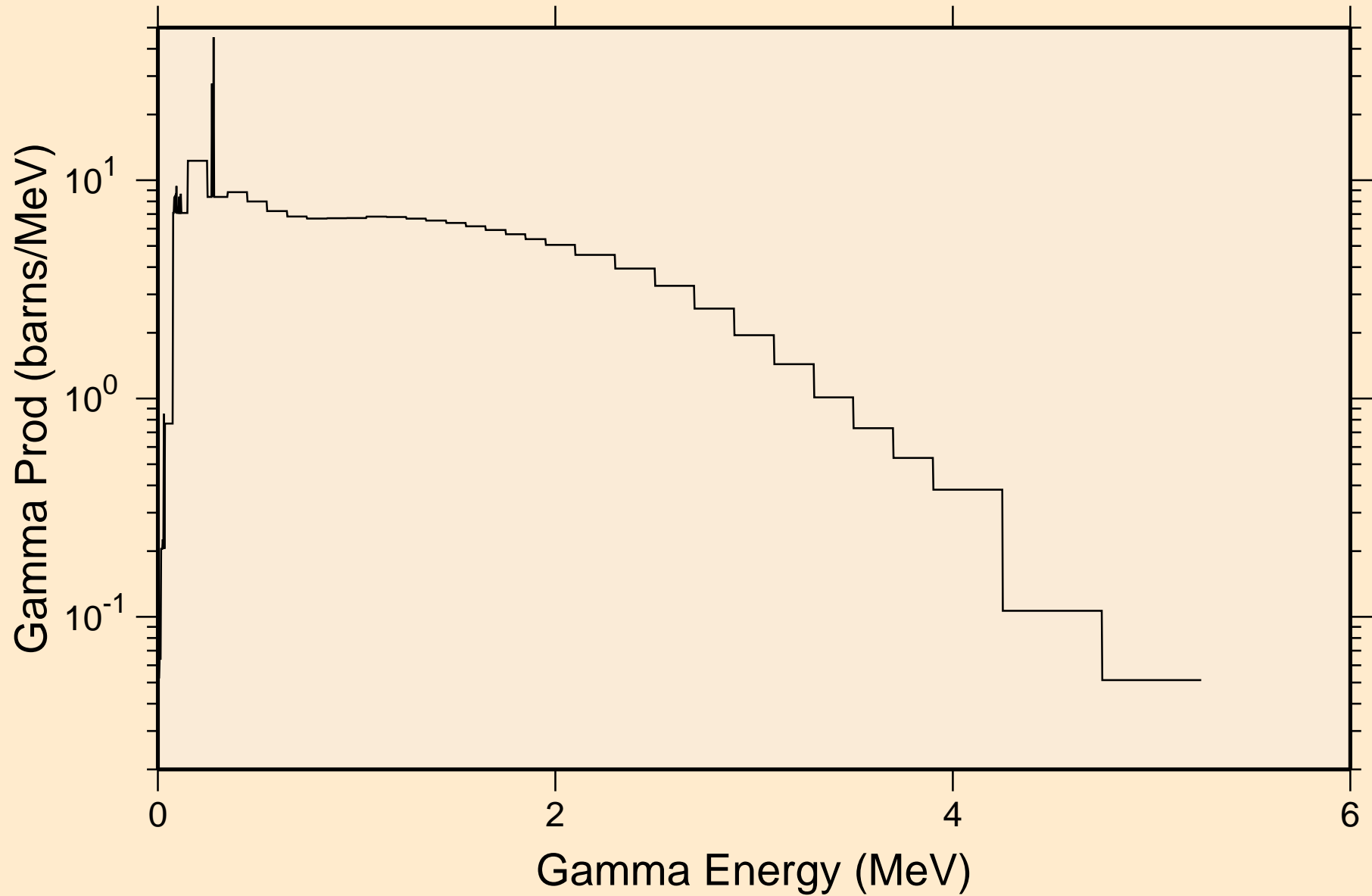

CM251 NEUTRON ACER TENDL-2024 LIBRARY; T=0.K
14 MeV photon spectrum

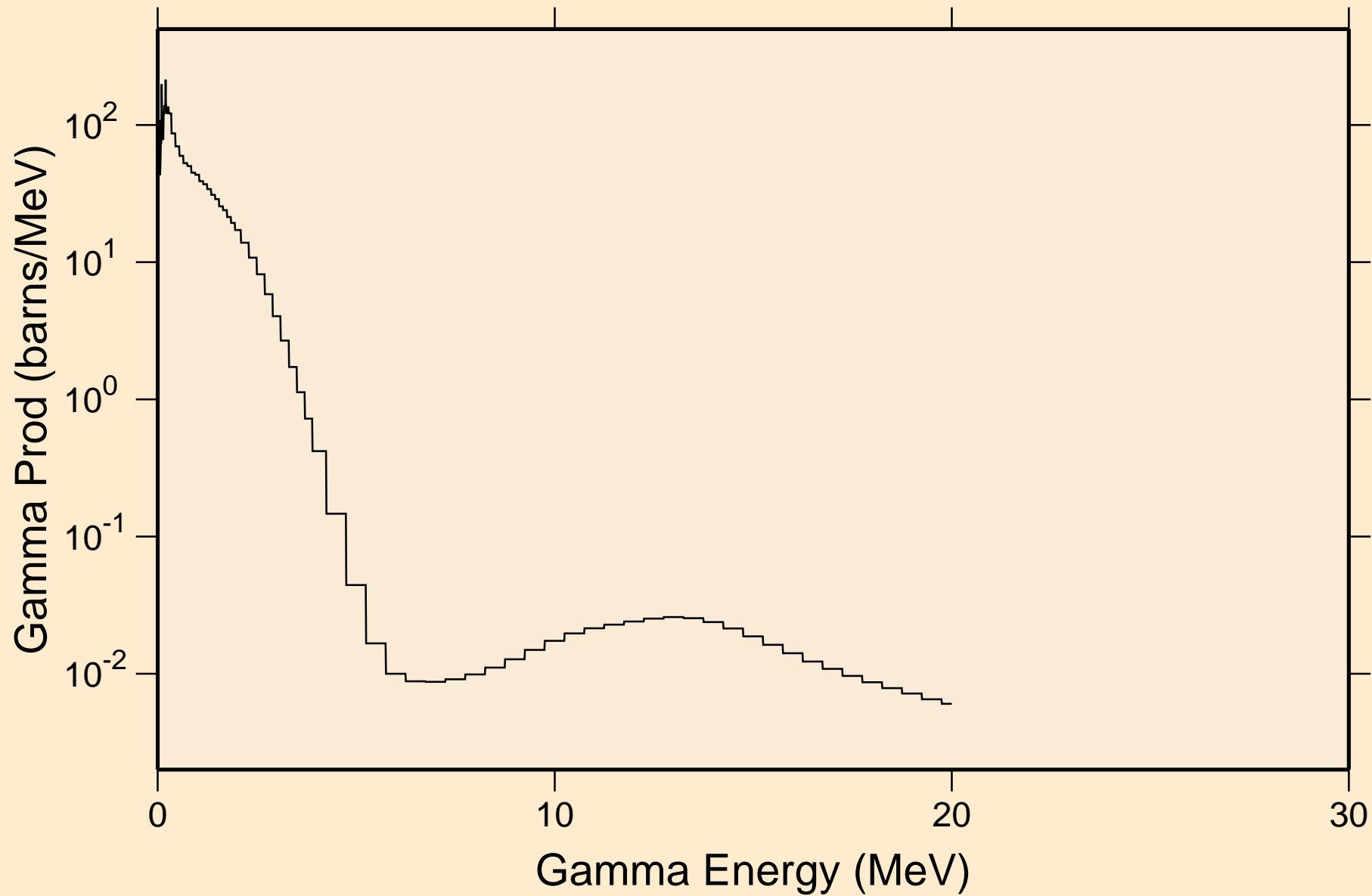

CM251 NEUTRON ACER TENDL-2024 LIBRARY; T=0.K

Particle heating contributions

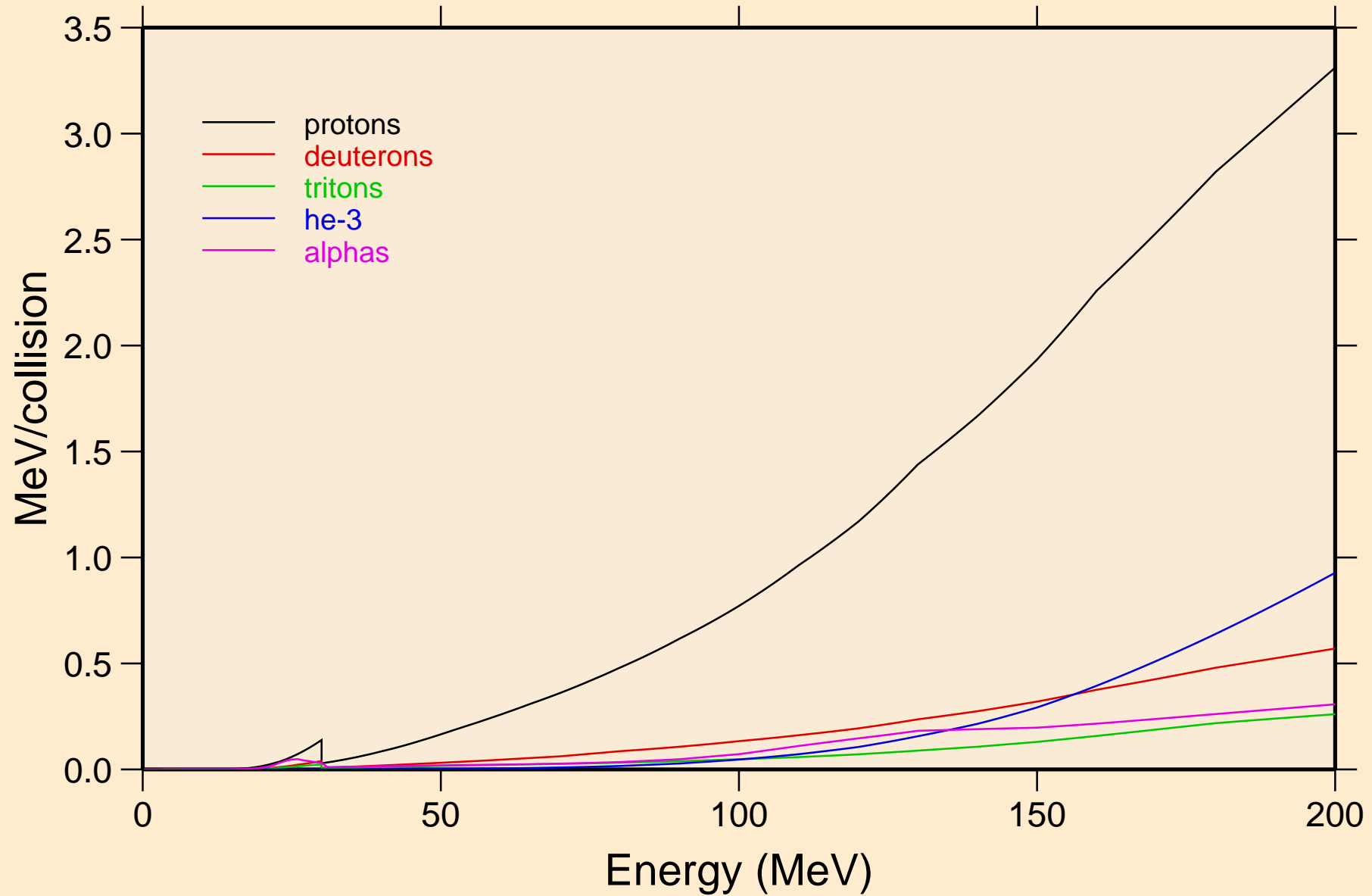

CM251 NEUTRON ACER TENDL-2024 LIBRARY; T=0.K
Recoil Heating

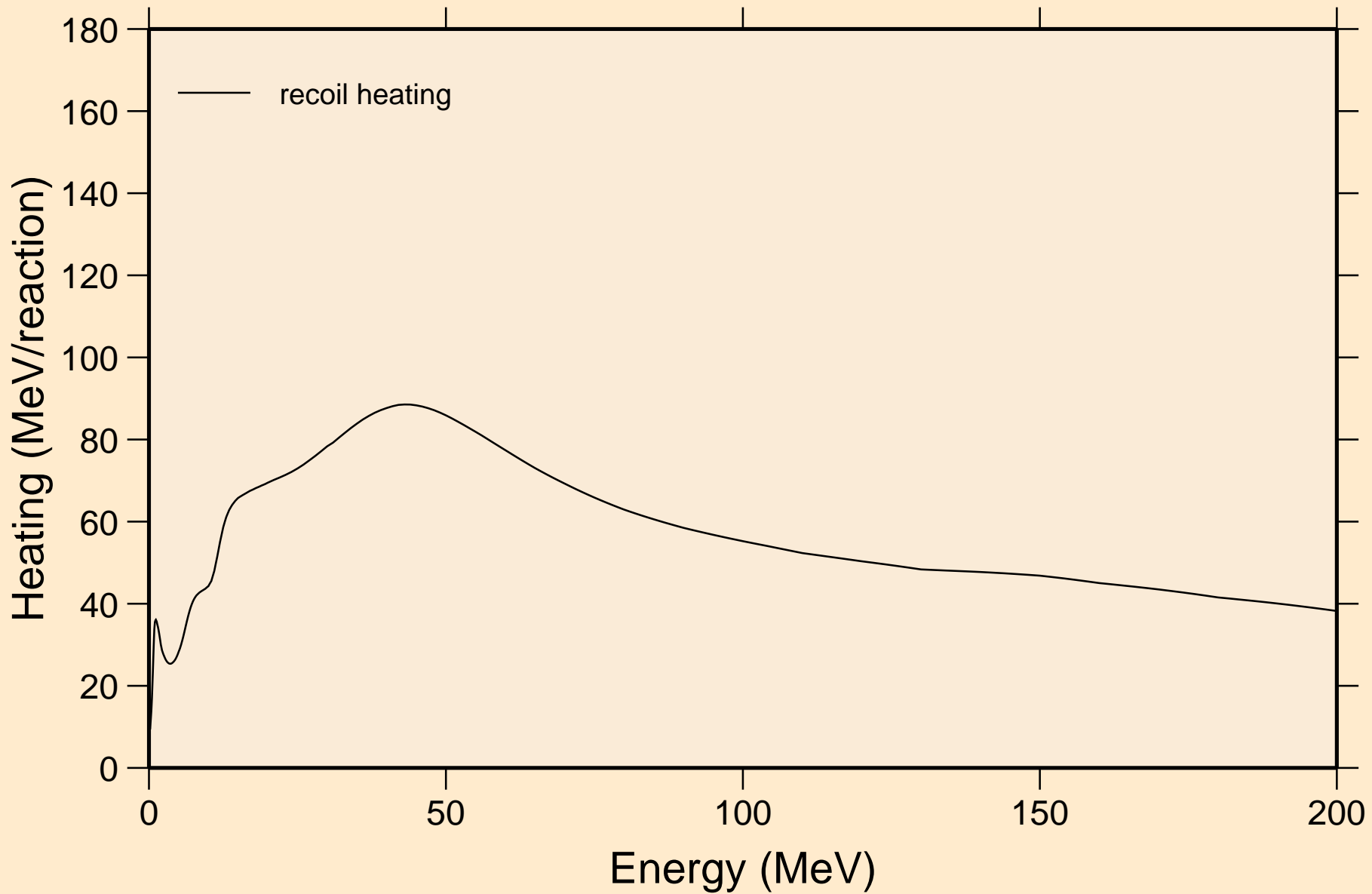

CM251 NEUTRON ACER TENDL-2024 LIBRARY; T=0.K

Particle production cross sections

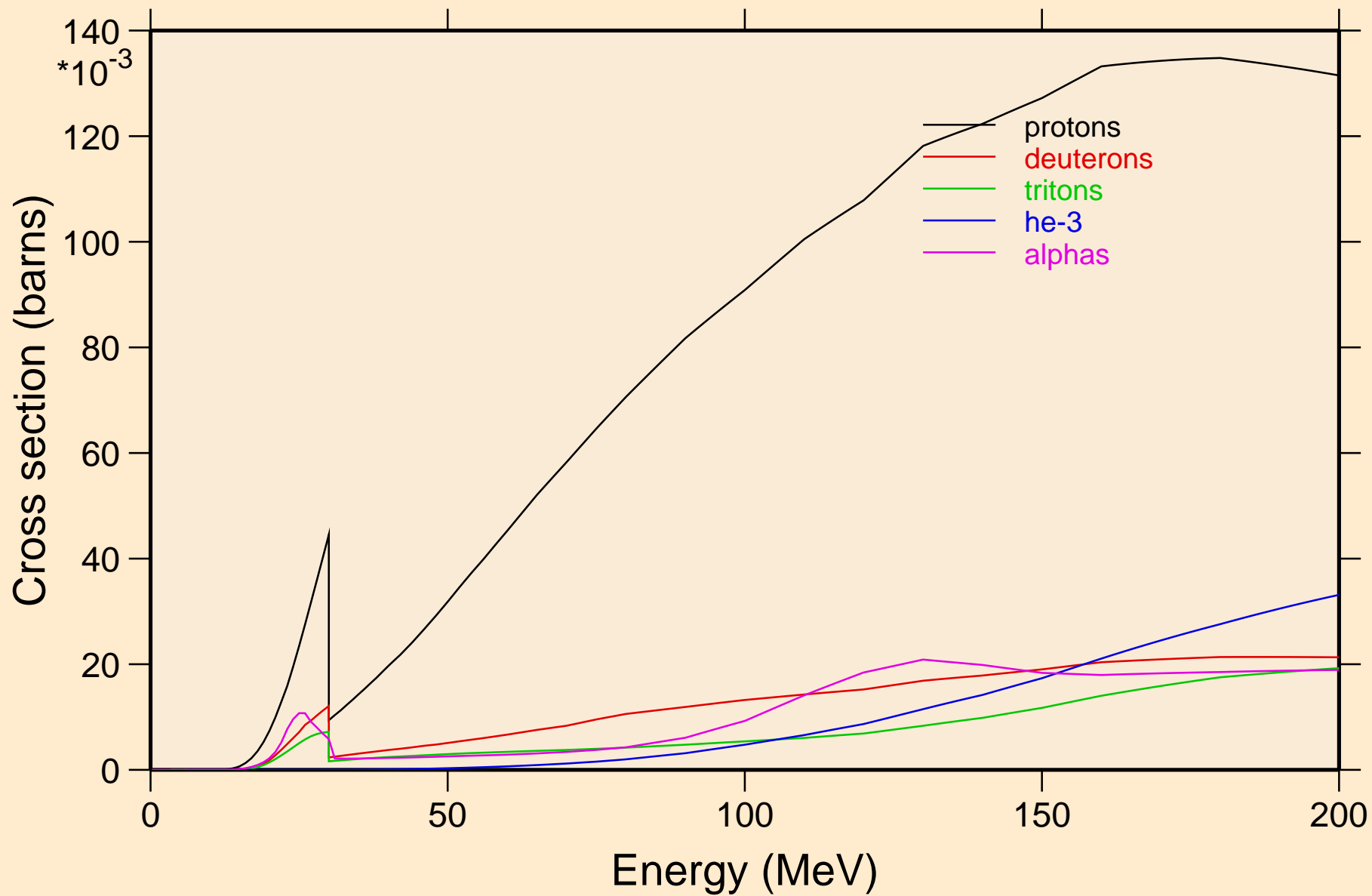

CM251 NEUTRON ACER TENDL-2024 LIBRARY; T=0.K
protons from (n,x)

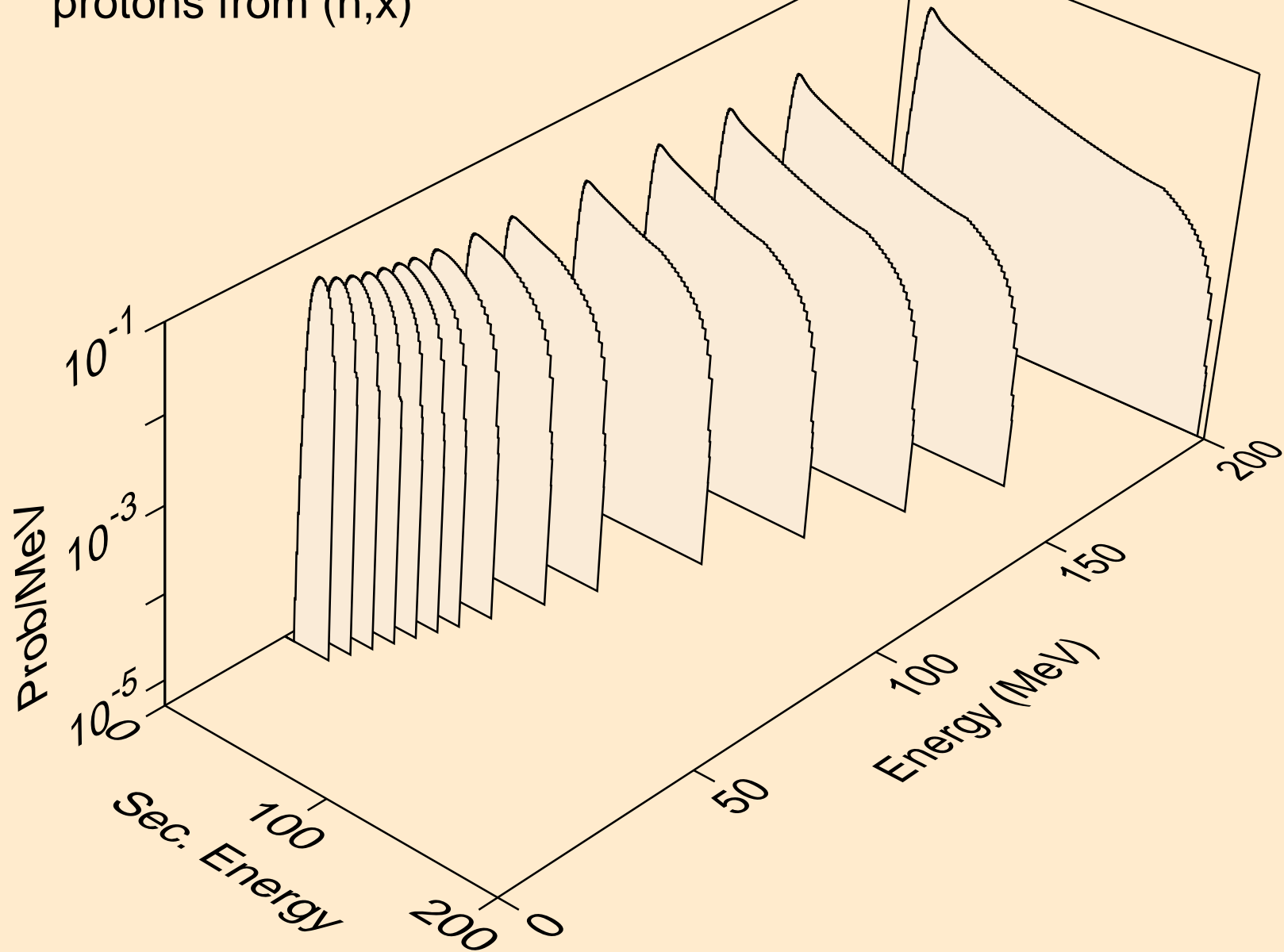

CM251 NEUTRON ACER TENDL-2024 LIBRARY; T=0.K
protons from (n,n*)p

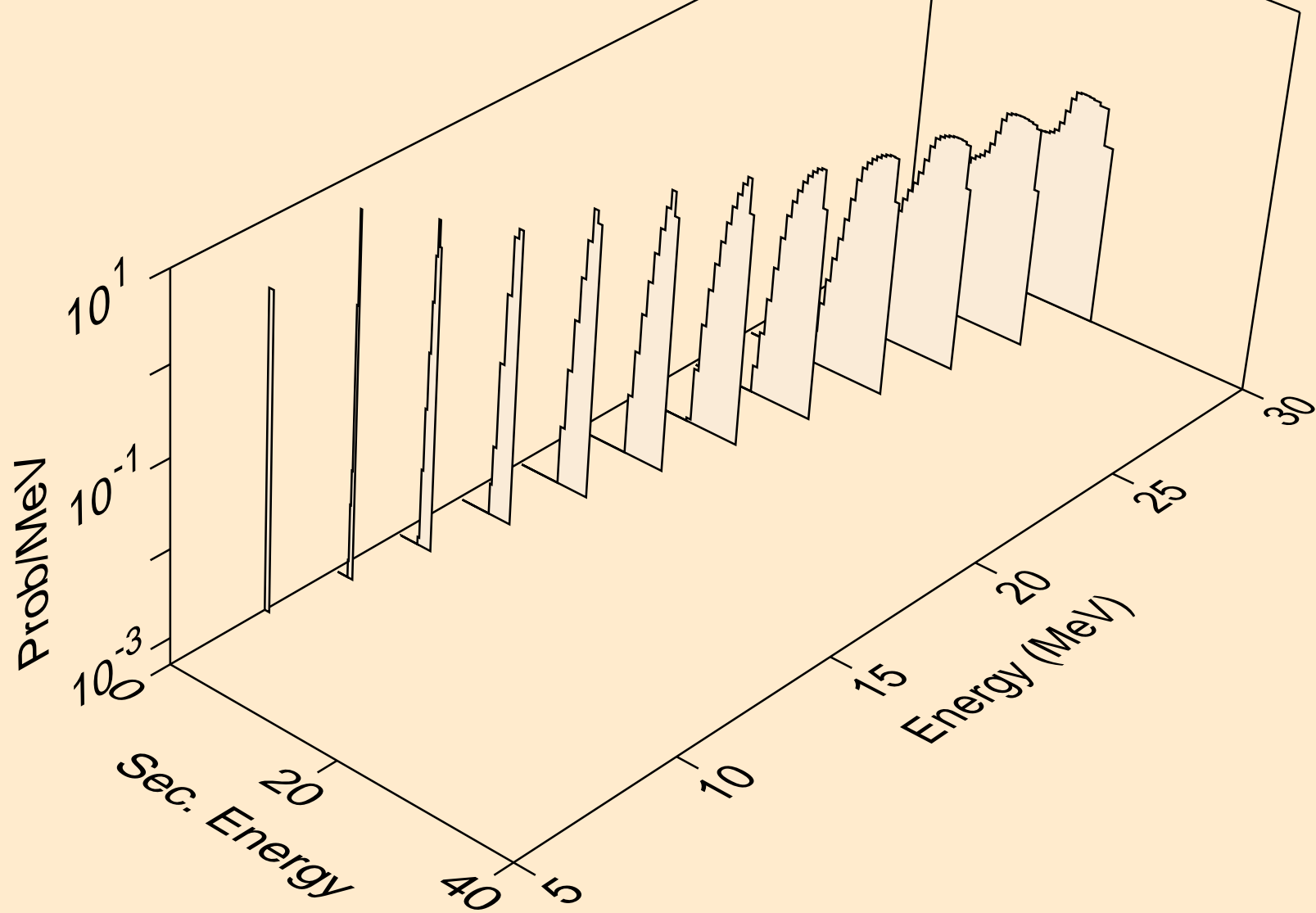

CM251 NEUTRON ACER TENDL-2024 LIBRARY; T=0.K
protons from (n,2np)

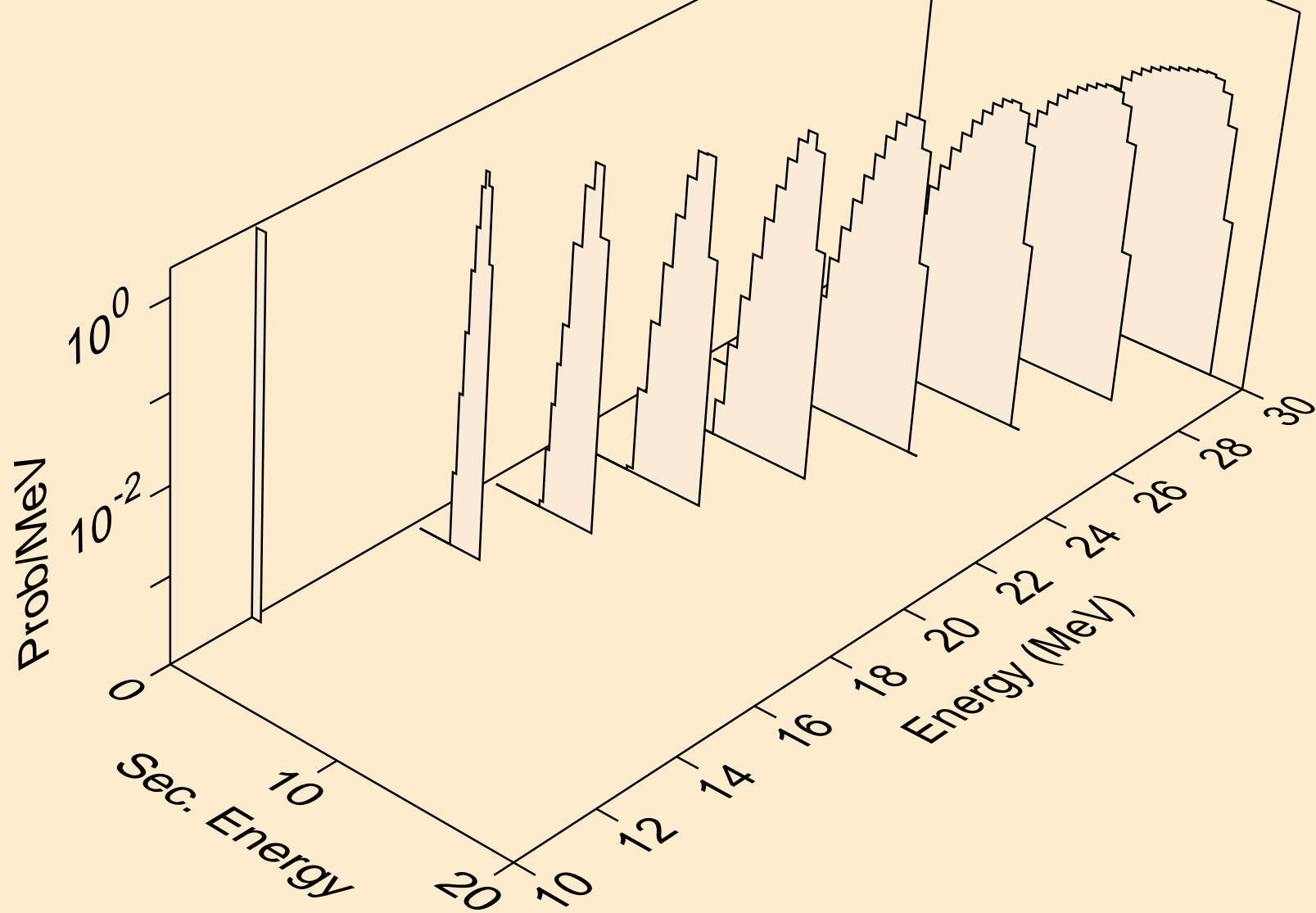

CM251 NEUTRON ACER TENDL-2024 LIBRARY; T=0.K
protons from (n,3np)

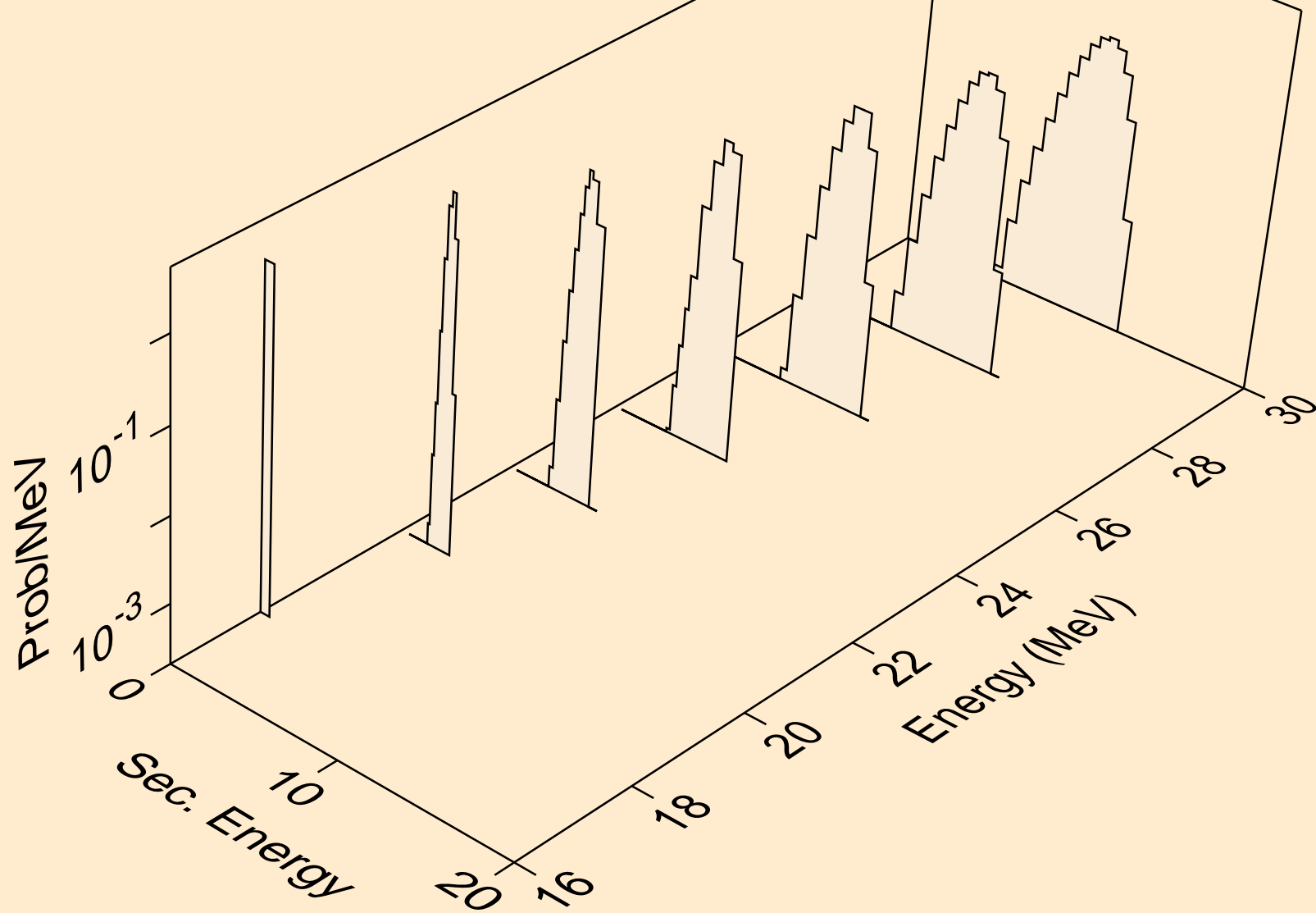

CM251 NEUTRON ACER TENDL-2024 LIBRARY; T=0.K
protons from (n,p)

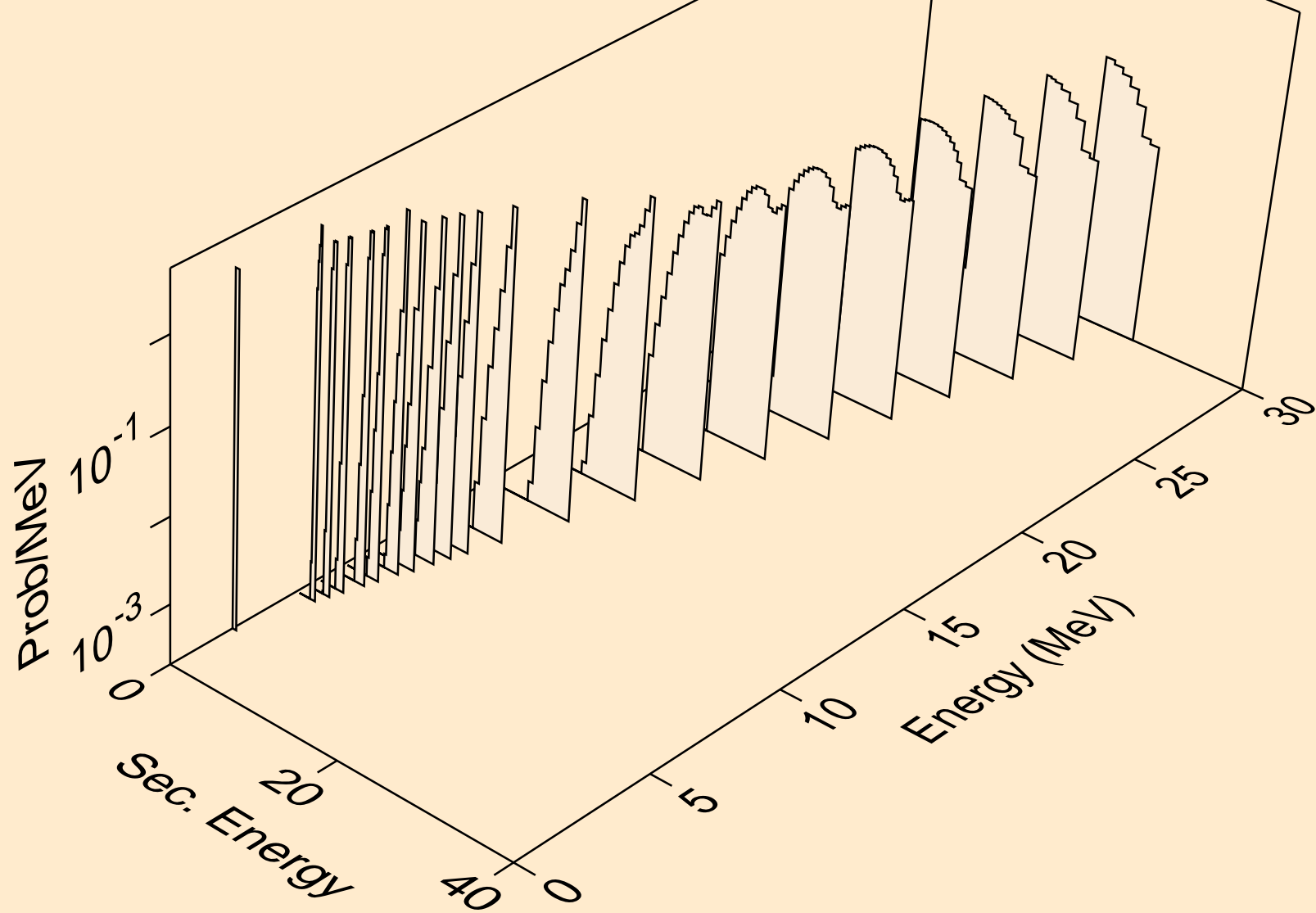

CM251 NEUTRON ACER TENDL-2024 LIBRARY; T=0.K
protons from (n,2p)

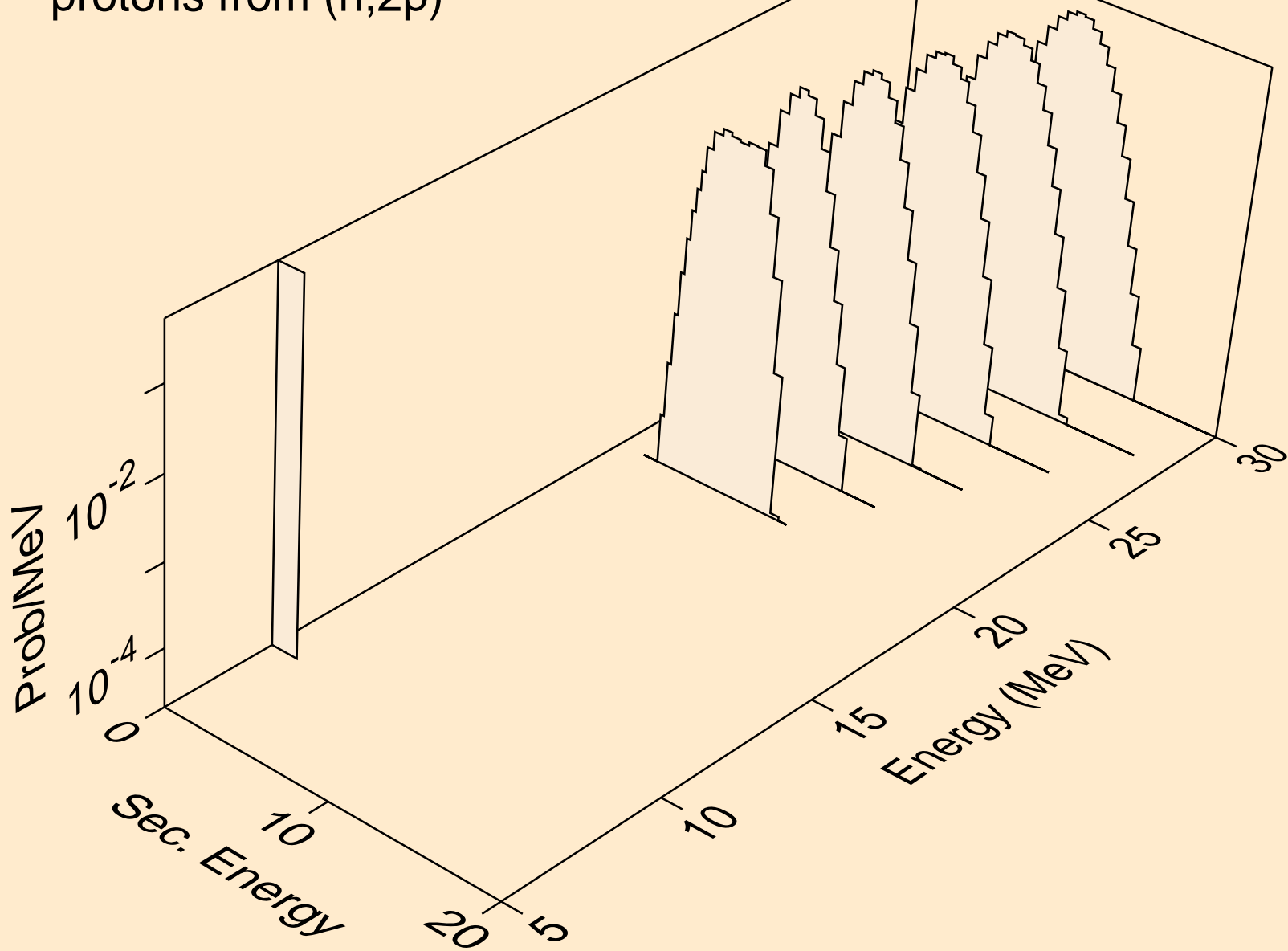

CM251 NEUTRON ACER TENDL-2024 LIBRARY; T=0.K
deuterons from (n,x)

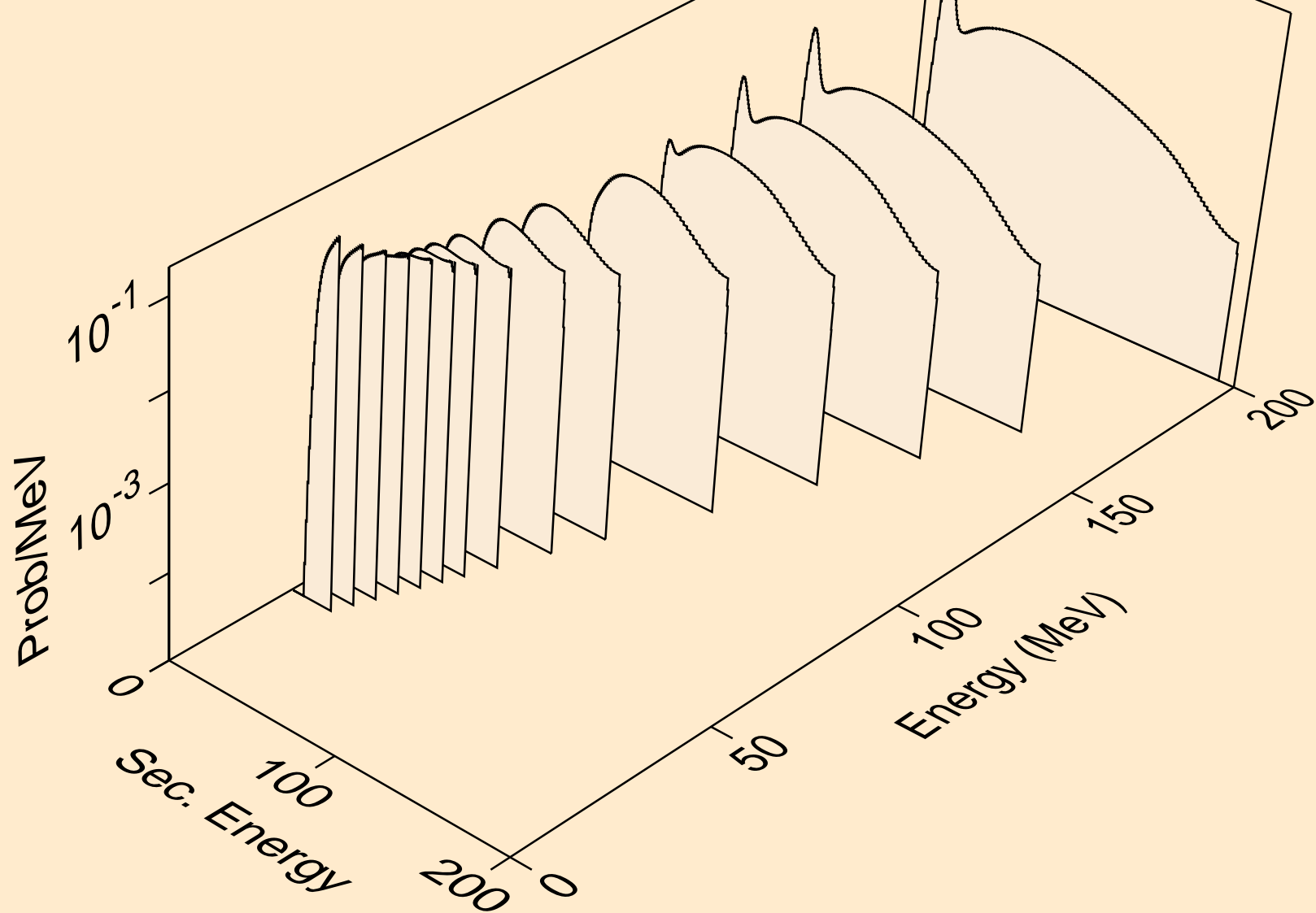

CM251 NEUTRON ACER TENDL-2024 LIBRARY; T=0.K
deuterons from (n,2nd)

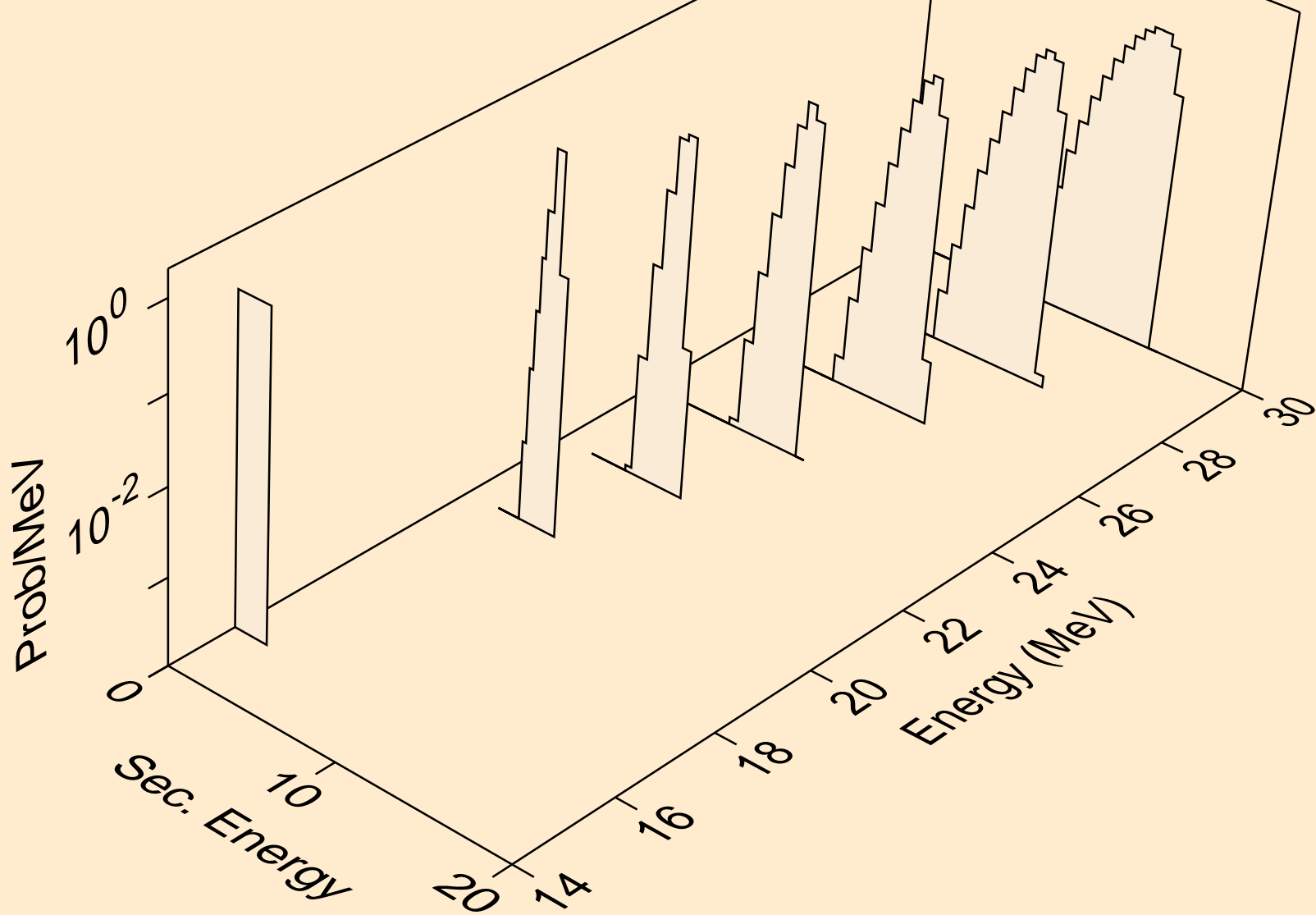

CM251 NEUTRON ACER TENDL-2024 LIBRARY; T=0.K
deuterons from (n,n*)d

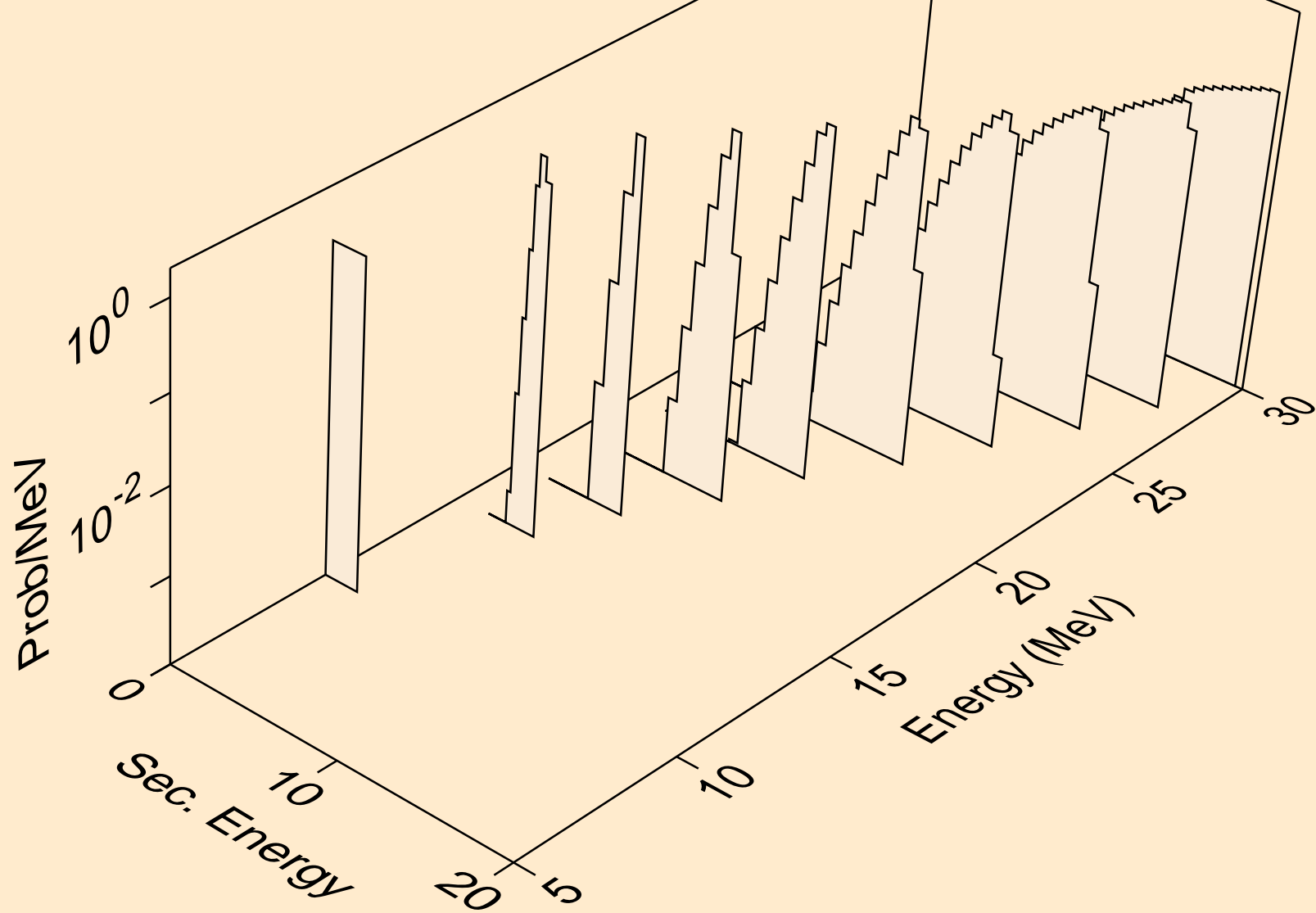

CM251 NEUTRON ACER TENDL-2024 LIBRARY; T=0.K
deuterons from (n,d)

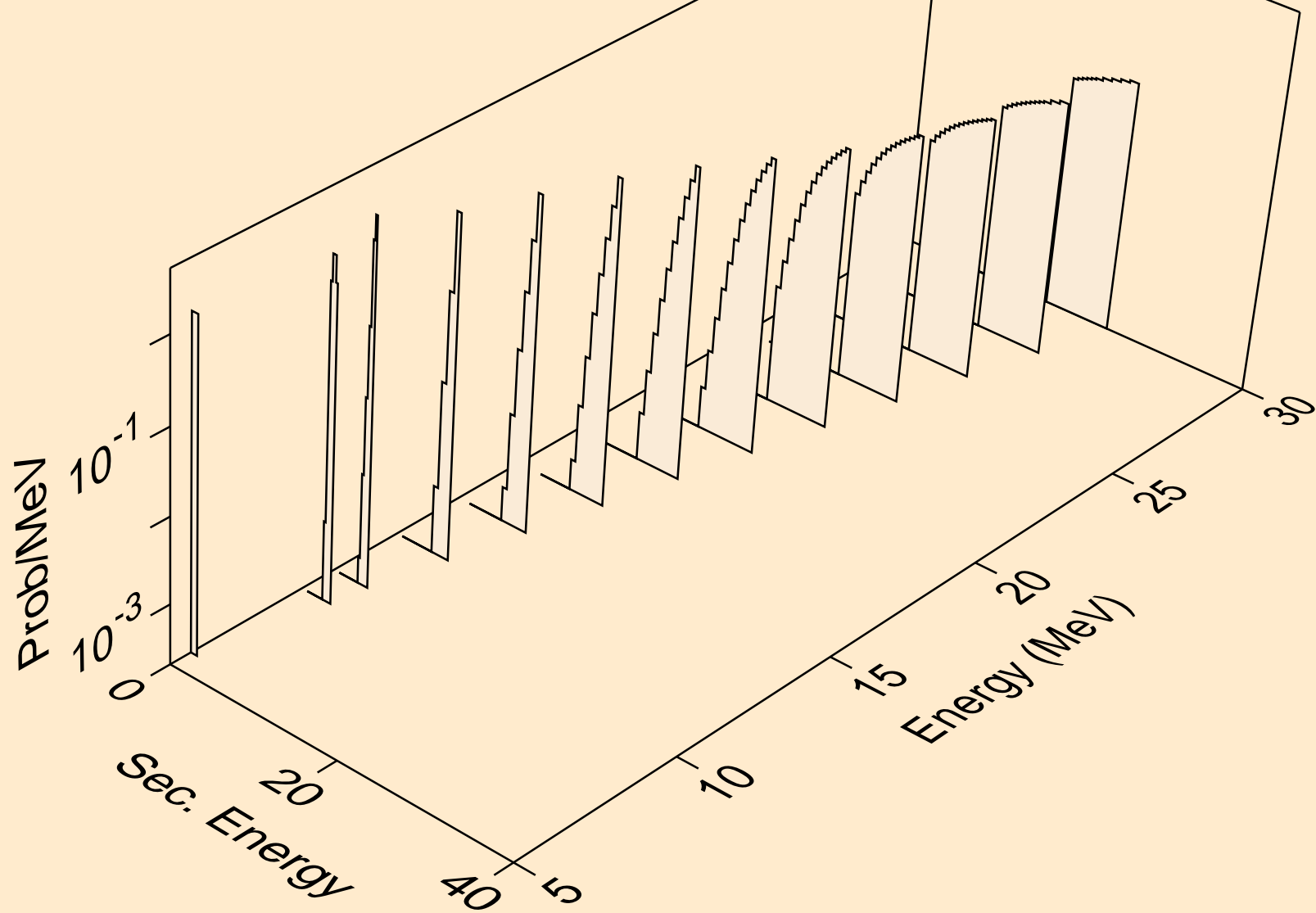

CM251 NEUTRON ACER TENDL-2024 LIBRARY; T=0.K
tritons from (n,x)

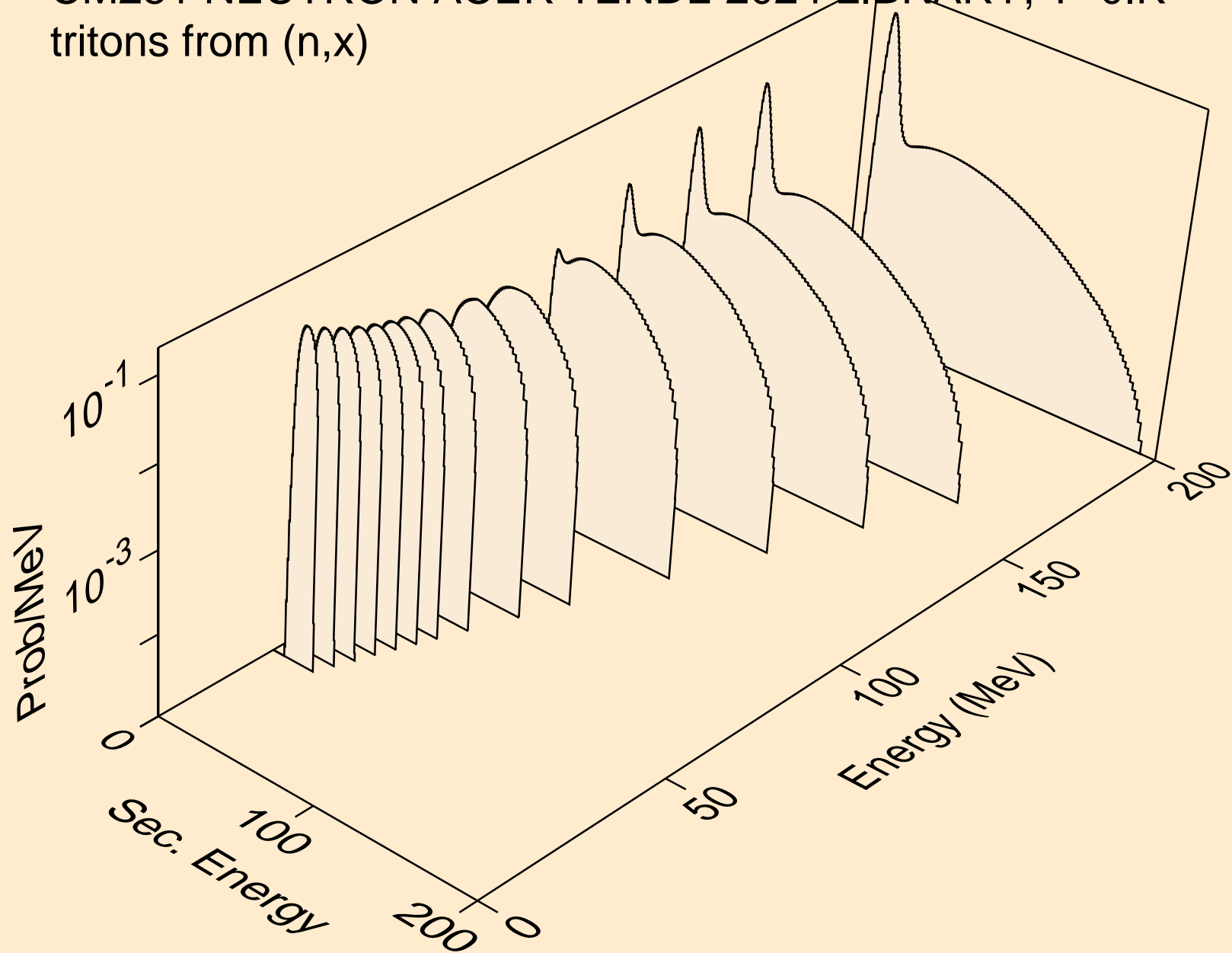

CM251 NEUTRON ACER TENDL-2024 LIBRARY; T=0.K
tritons from (n,n*)t

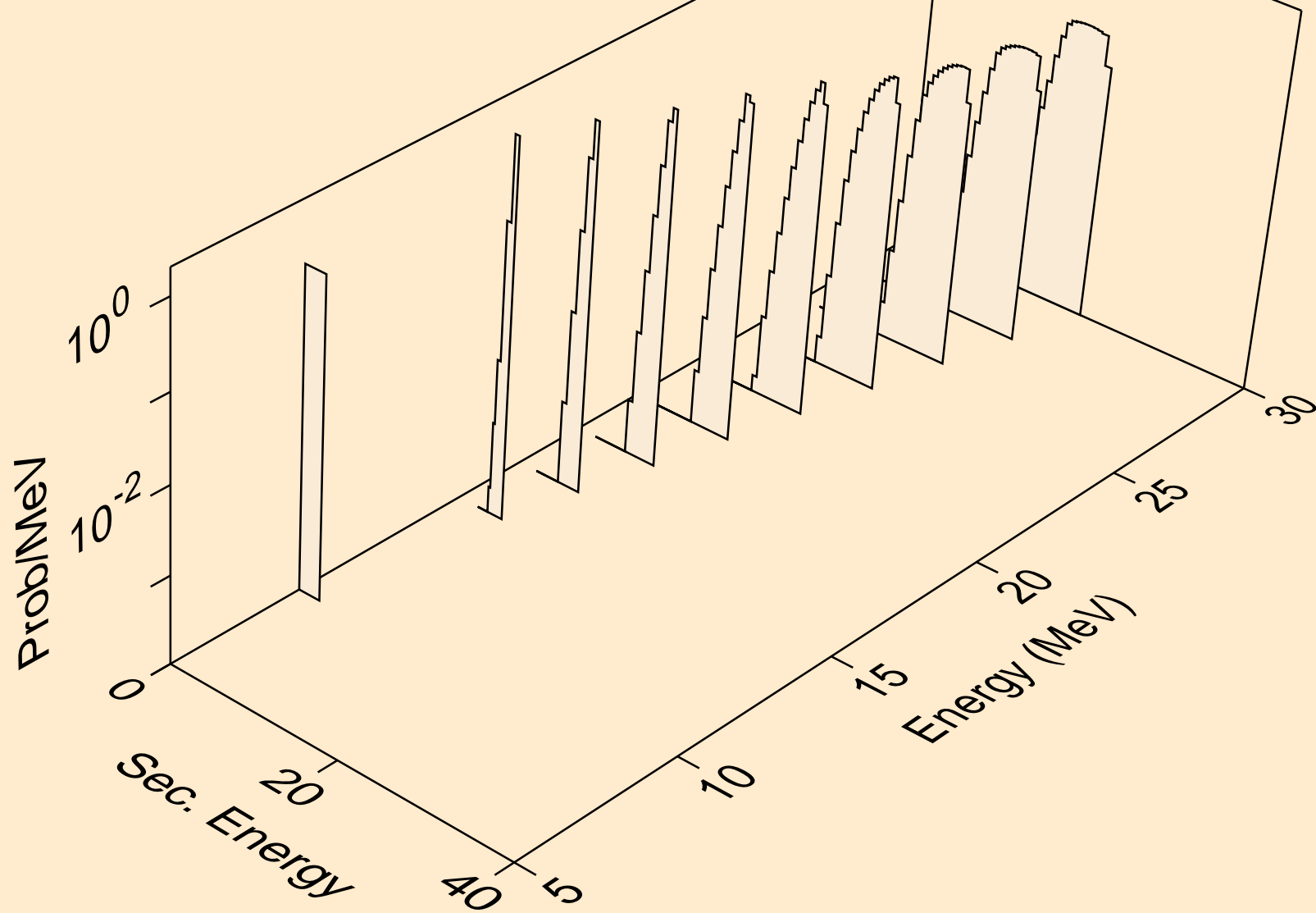

CM251 NEUTRON ACER TENDL-2024 LIBRARY; T=0.K
tritons from (n,t)

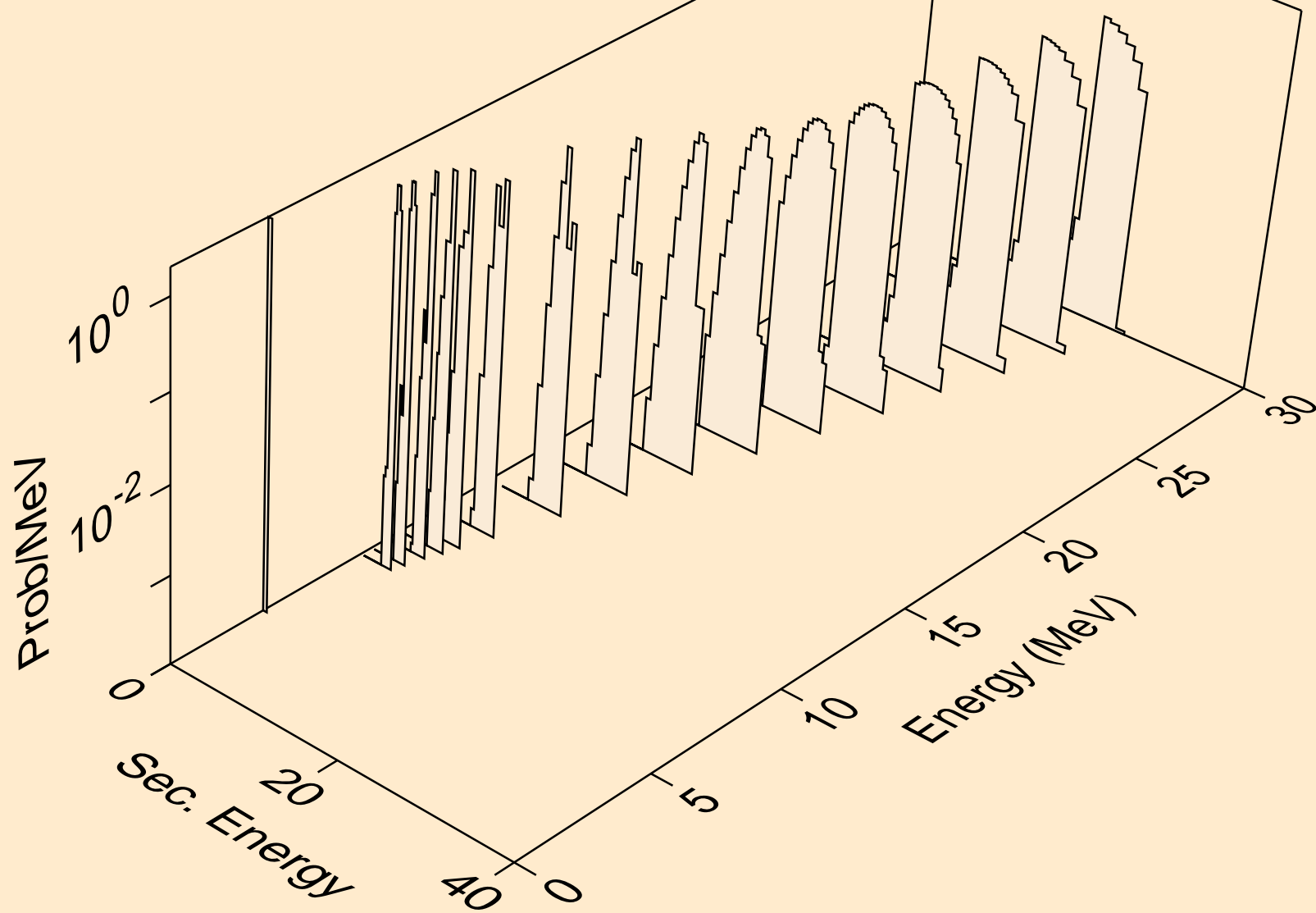

CM251 NEUTRON ACER TENDL-2024 LIBRARY; T=0.K
he3s from (n,x)

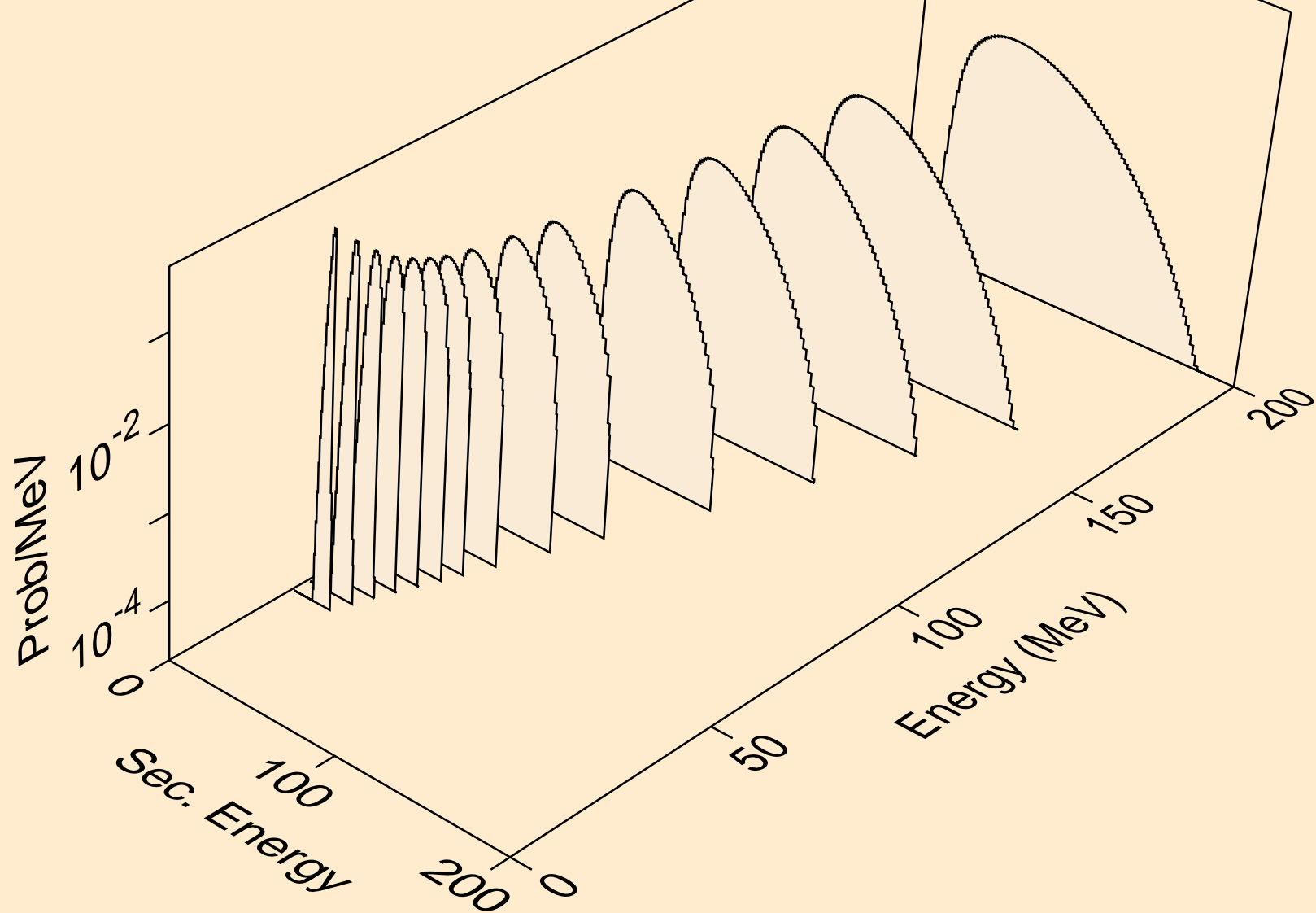

CM251 NEUTRON ACER TENDL-2024 LIBRARY; T=0.K
he3s from (n,n*)he3

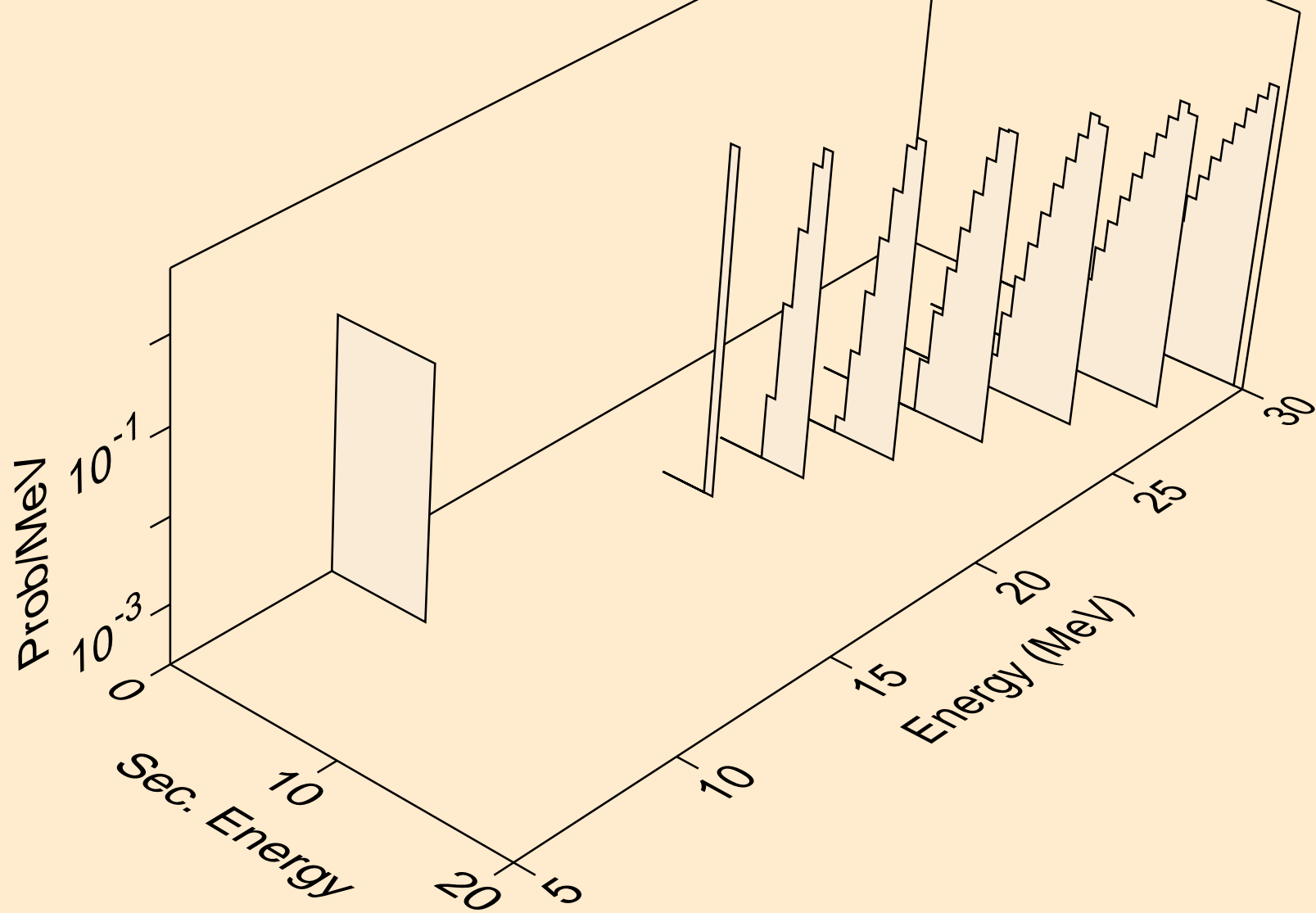

CM251 NEUTRON ACER TENDL-2024 LIBRARY; T=0.K
he3s from (n,he3)

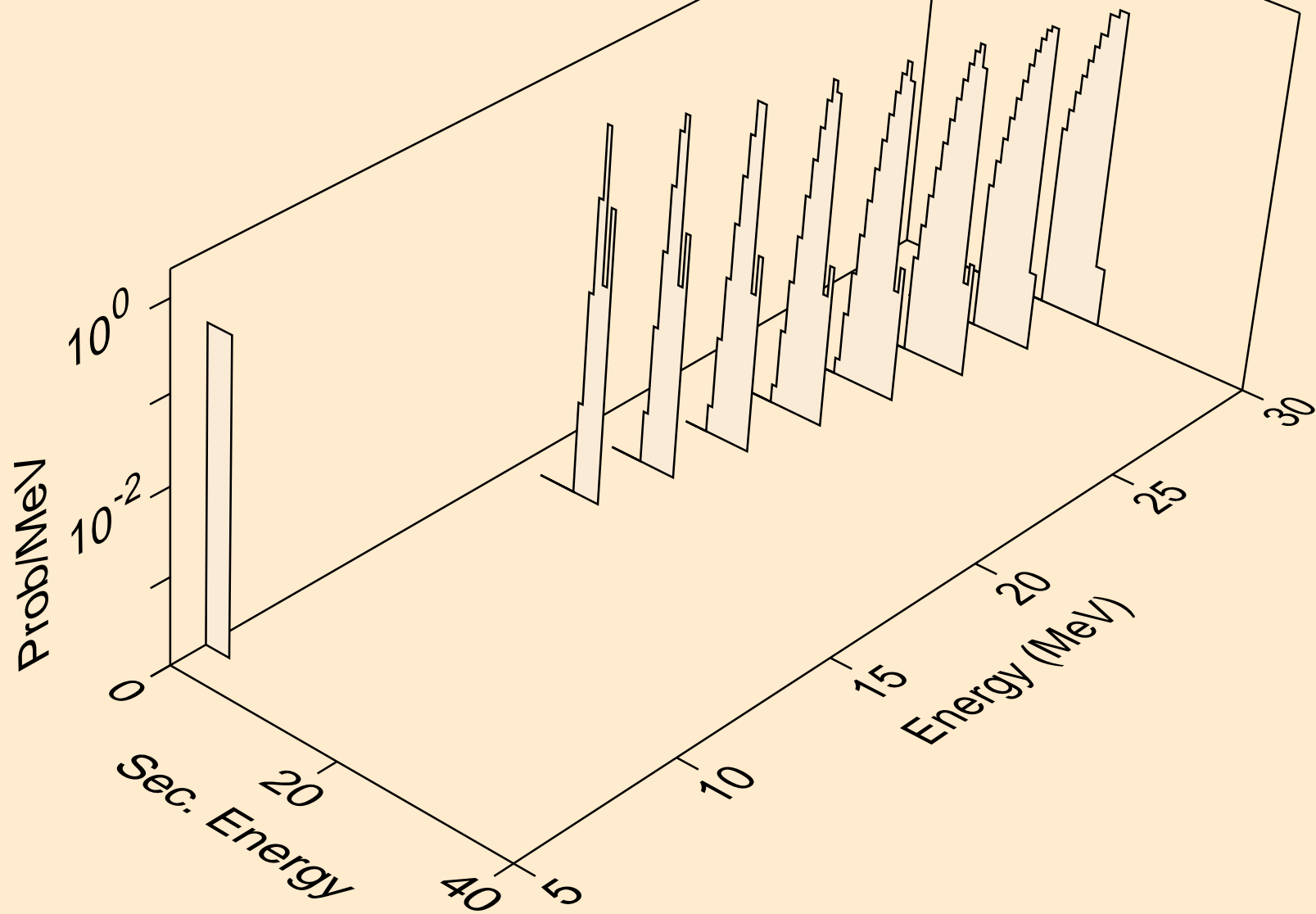

CM251 NEUTRON ACER TENDL-2024 LIBRARY; T=0.K
alphas from (n,x)

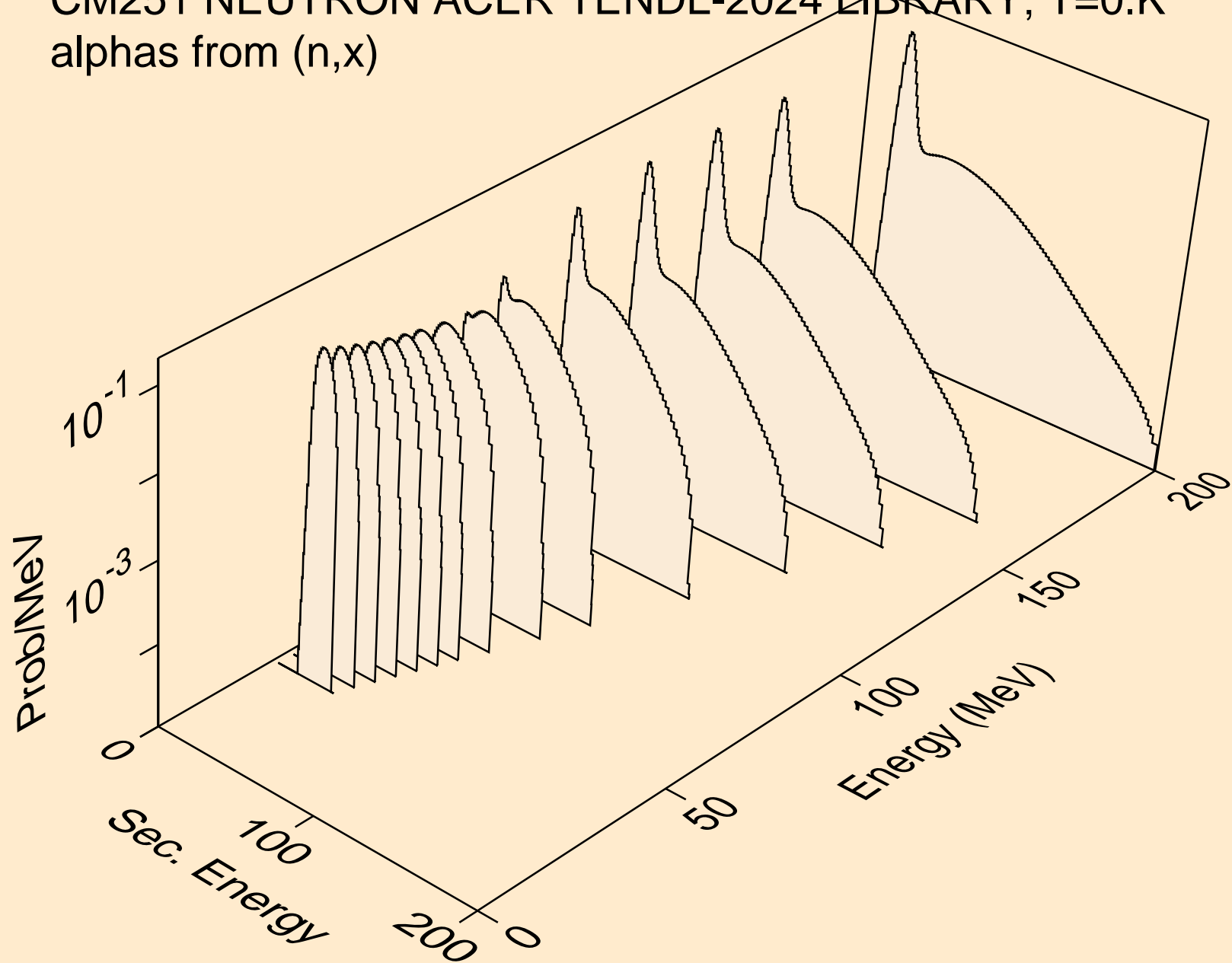

CM251 NEUTRON ACER TENDL-2024 LIBRARY; T=0.K
alphas from (n,n*)a

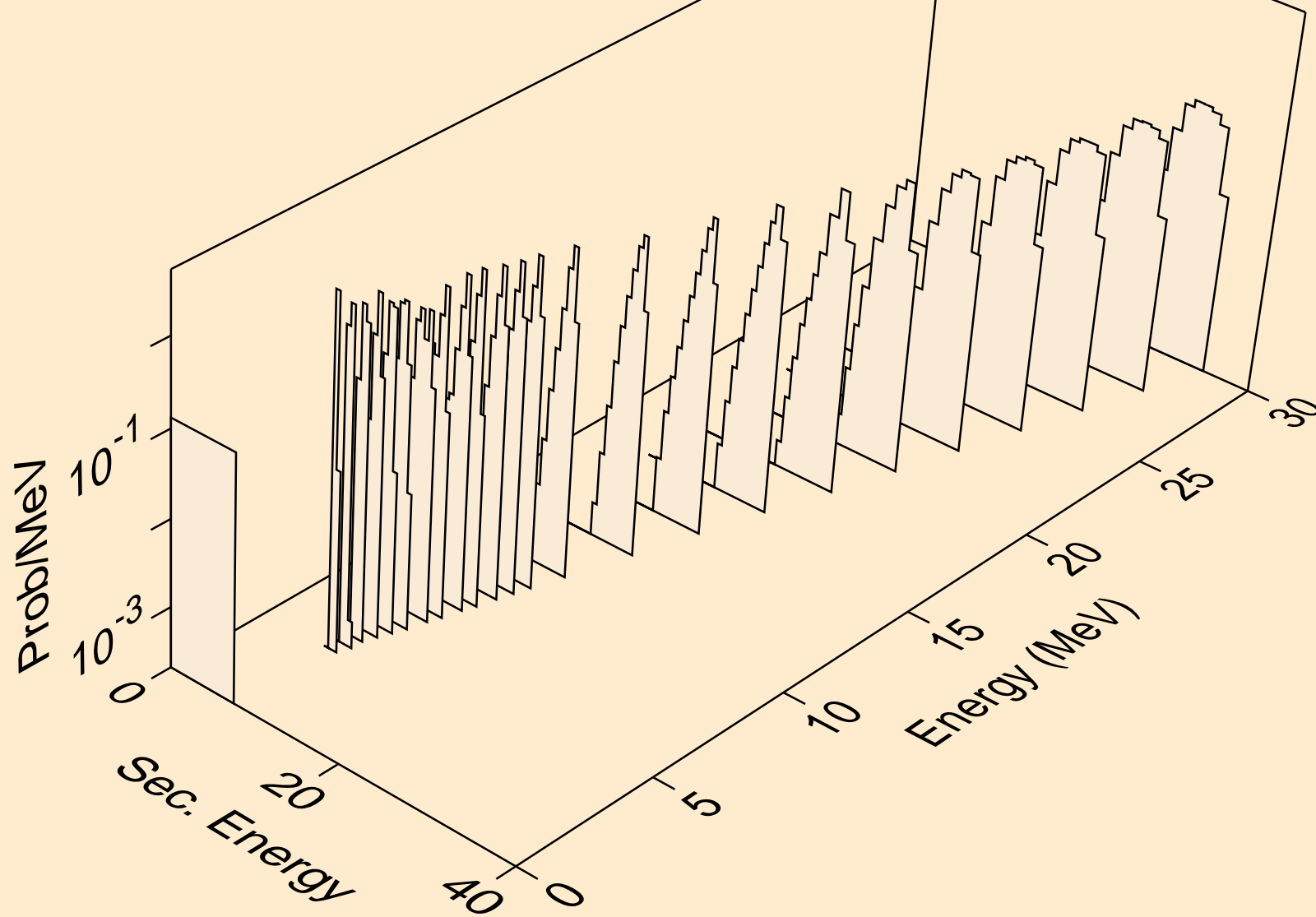

CM251 NEUTRON ACER TENDL-2024 LIBRARY; T=0.K
alphas from (n,2n)a

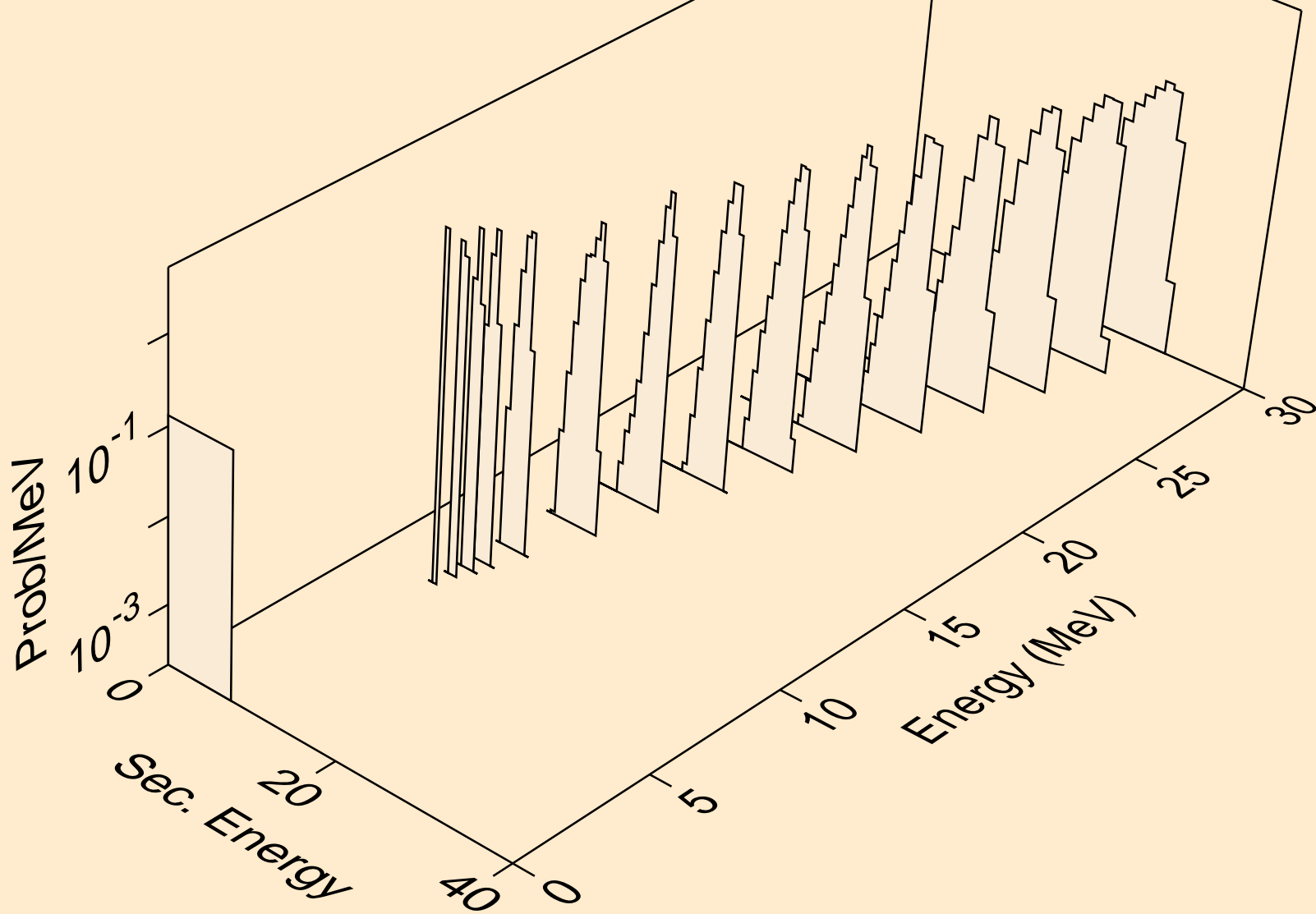

CM251 NEUTRON ACER TENDL-2024 LIBRARY; T=0.K
alphas from (n,3n)a

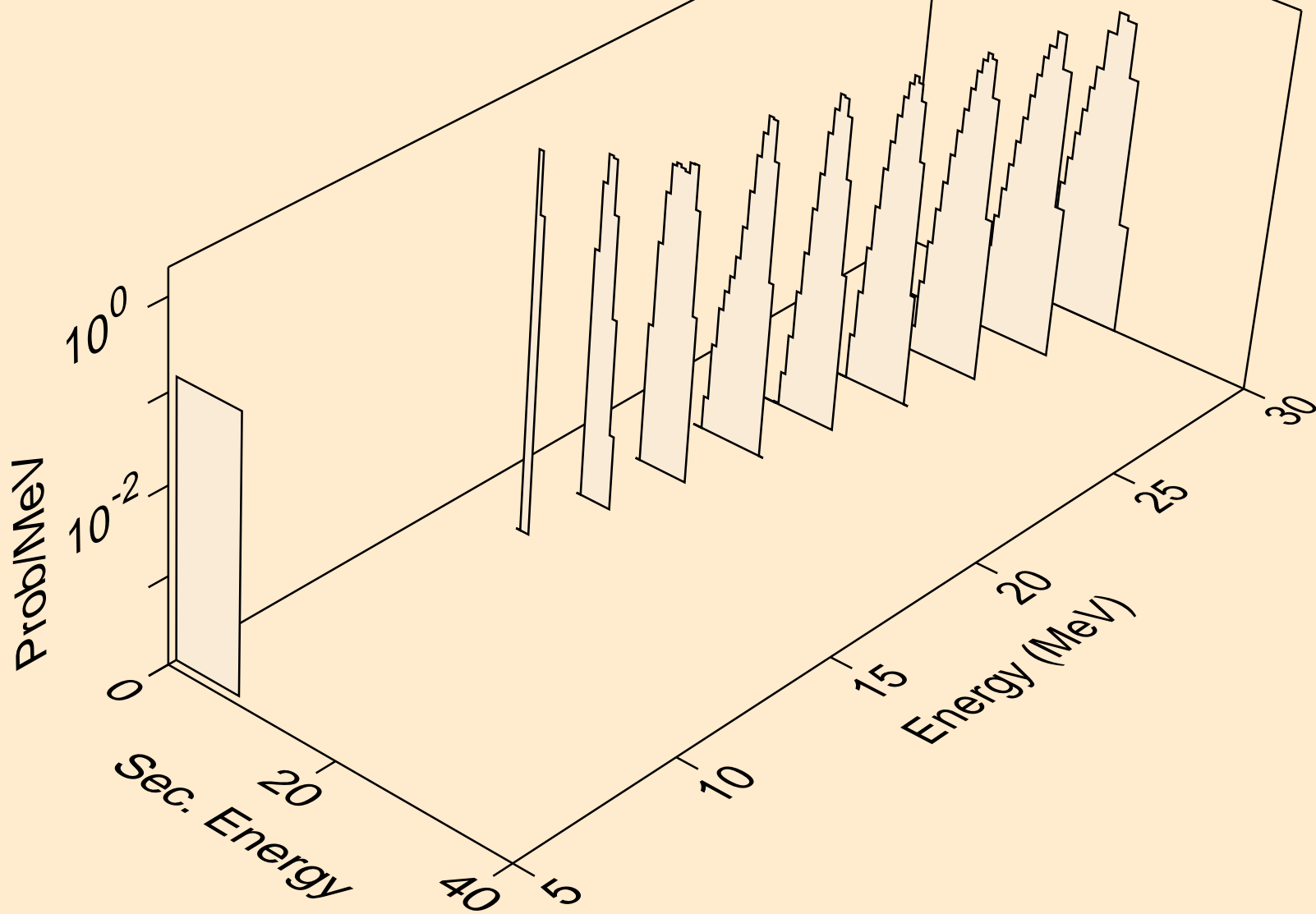

CM251 NEUTRON ACER TENDL-2024 LIBRARY; T=0.K
alphas from (n,a)

