

CO055 NEUTRON ACER TENDL-2024 LIBRARY; T=0.K

Principal cross sections

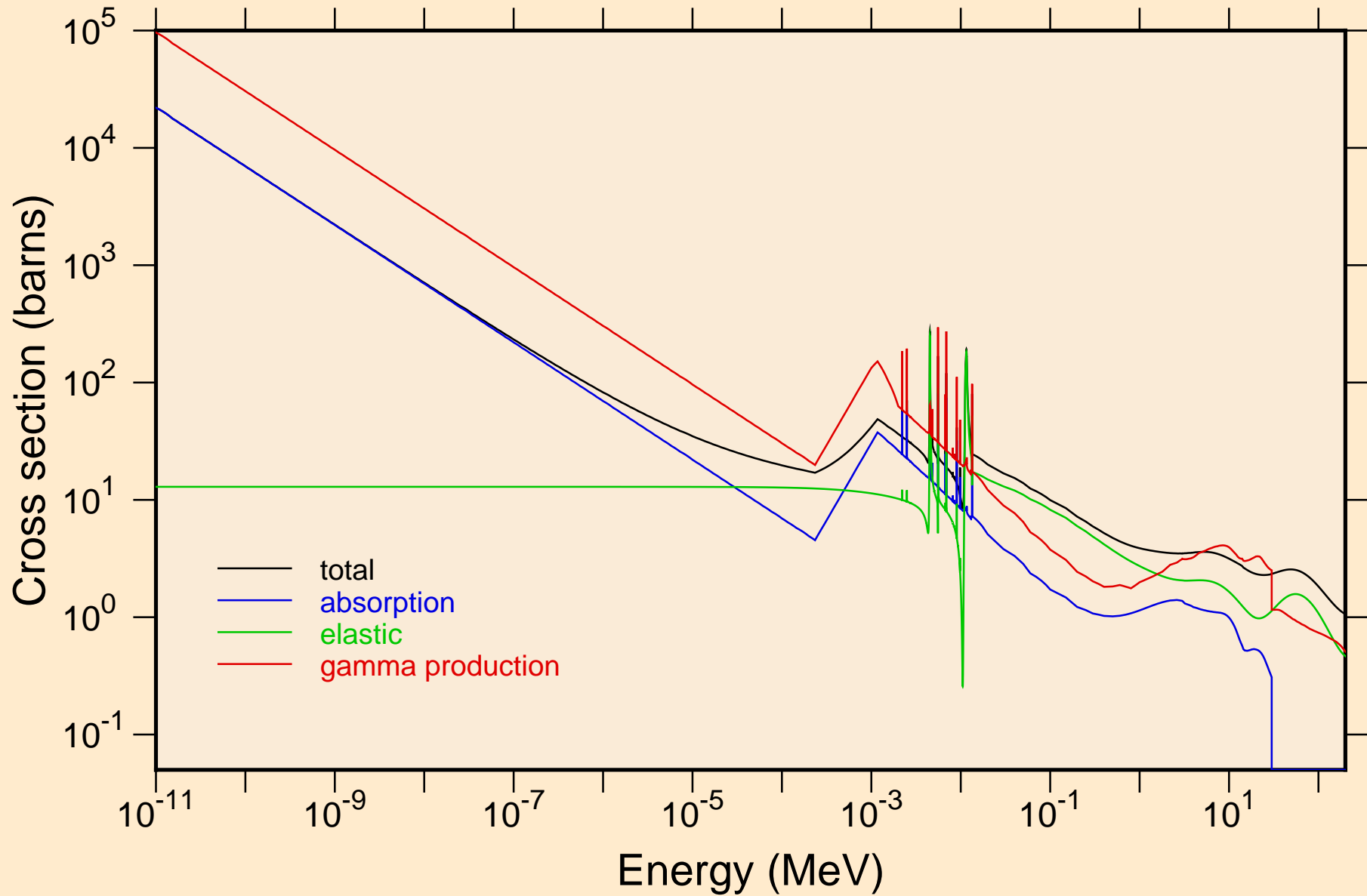

CO055 NEUTRON ACER TENDL-2024 LIBRARY; T=0.K
resonance total cross section

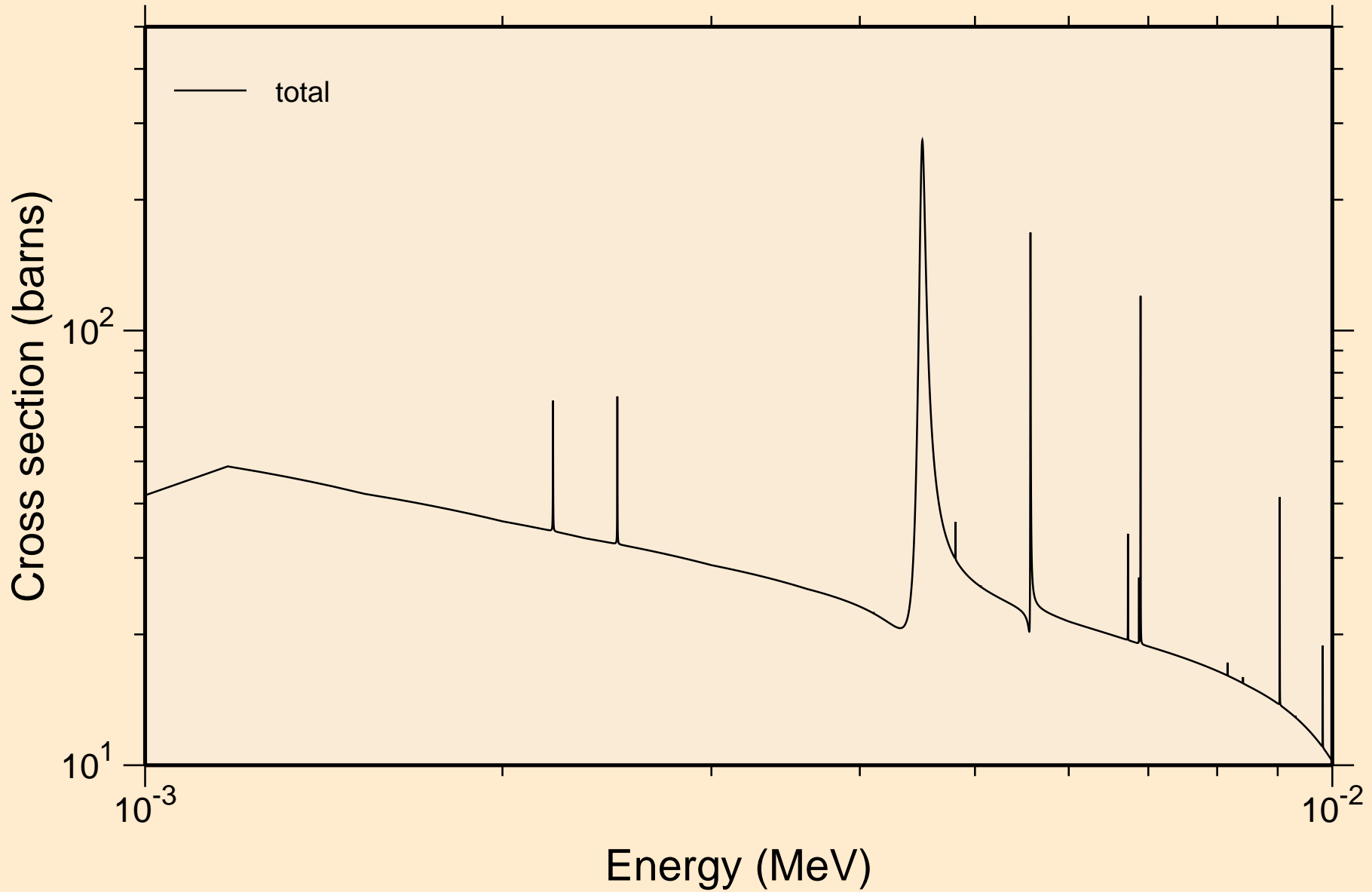

CO055 NEUTRON ACER TENDL-2024 LIBRARY; T=0.K
resonance total cross section

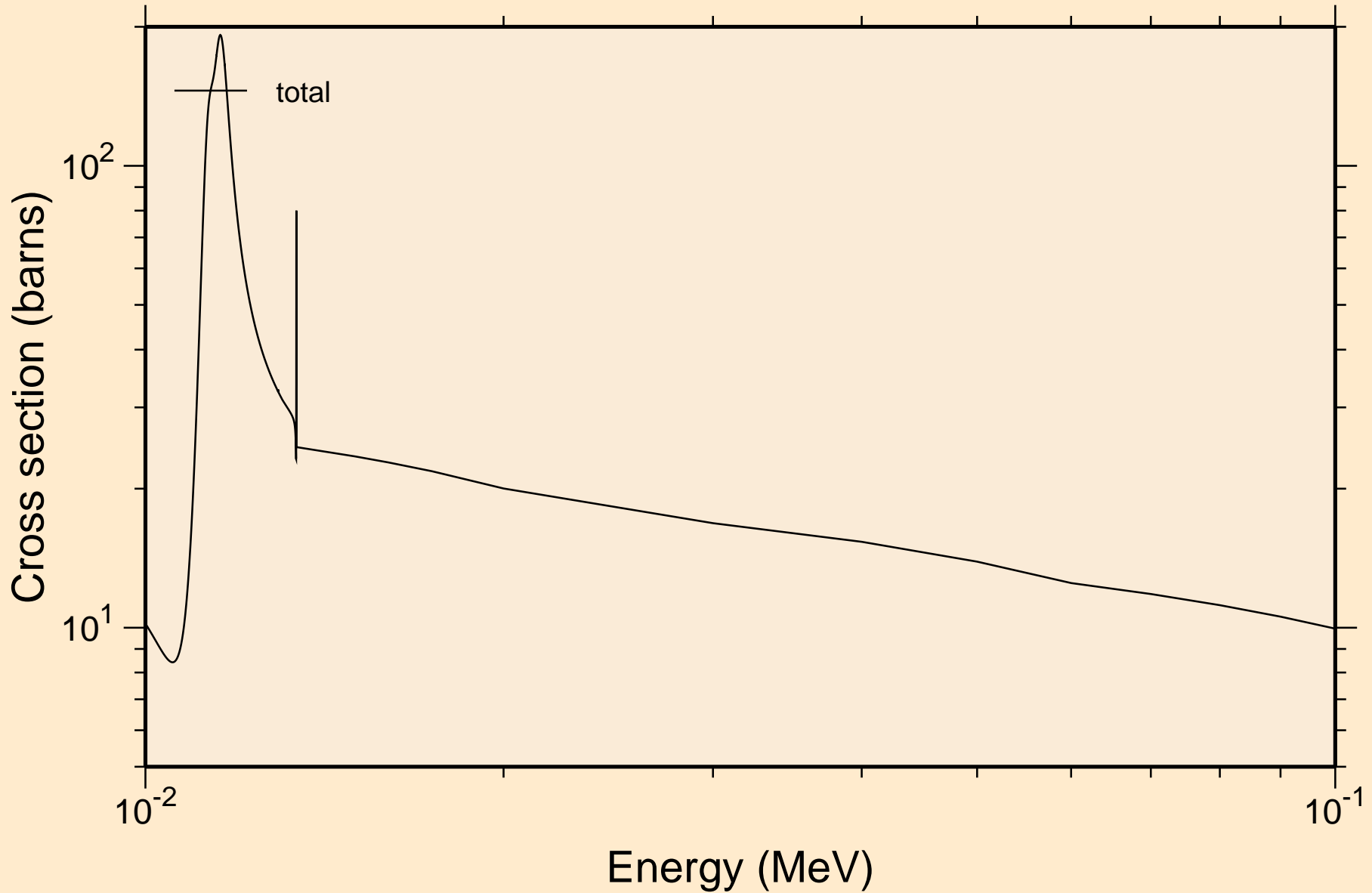

C0055 NEUTRON ACER TENDL-2024 LIBRARY; T=0.K
resonance total cross section

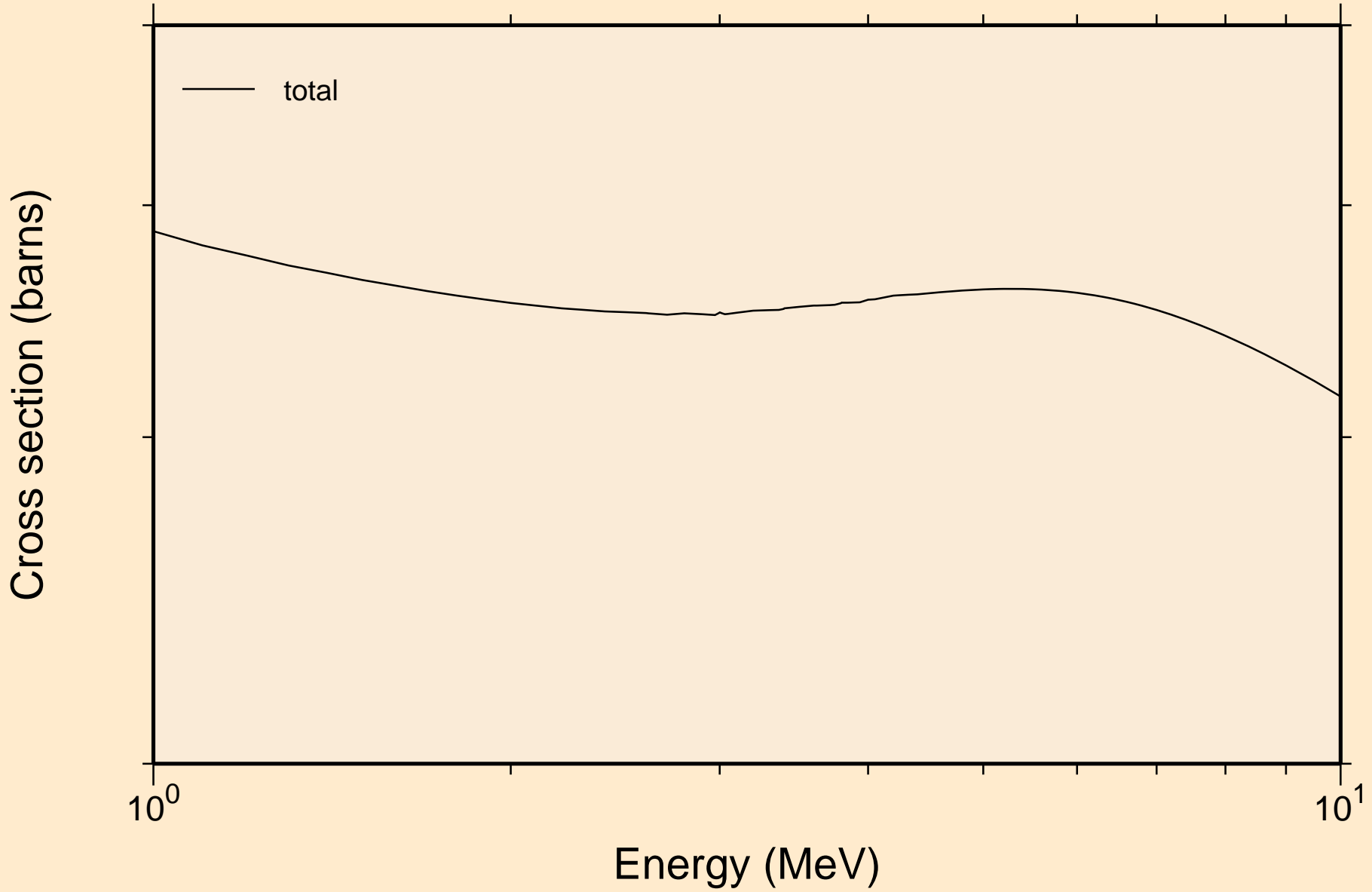

CO055 NEUTRON ACER TENDL-2024 LIBRARY; T=0.K
resonance absorption cross sections

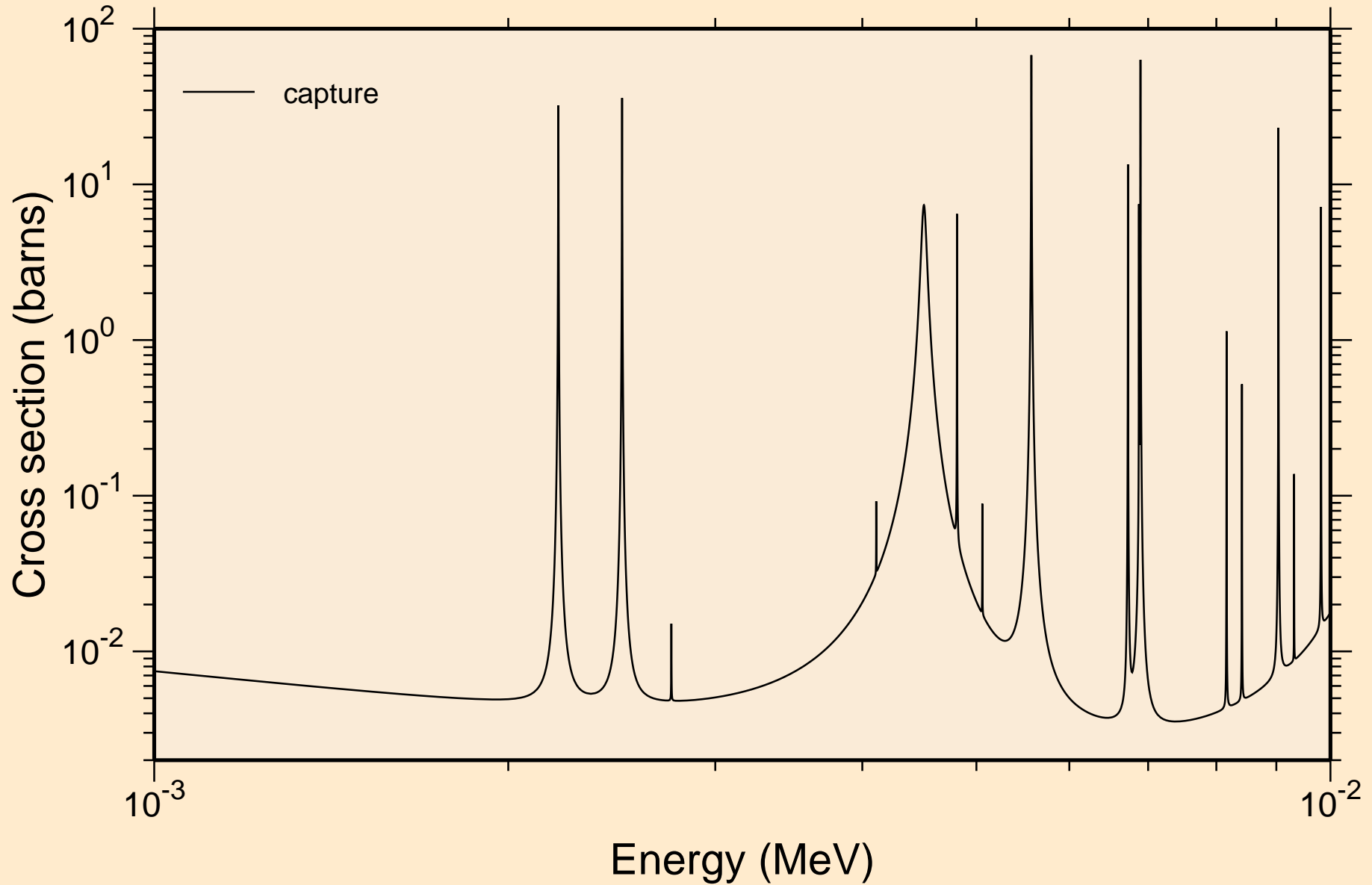

CO055 NEUTRON ACER TENDL-2024 LIBRARY; T=0.K
resonance absorption cross sections

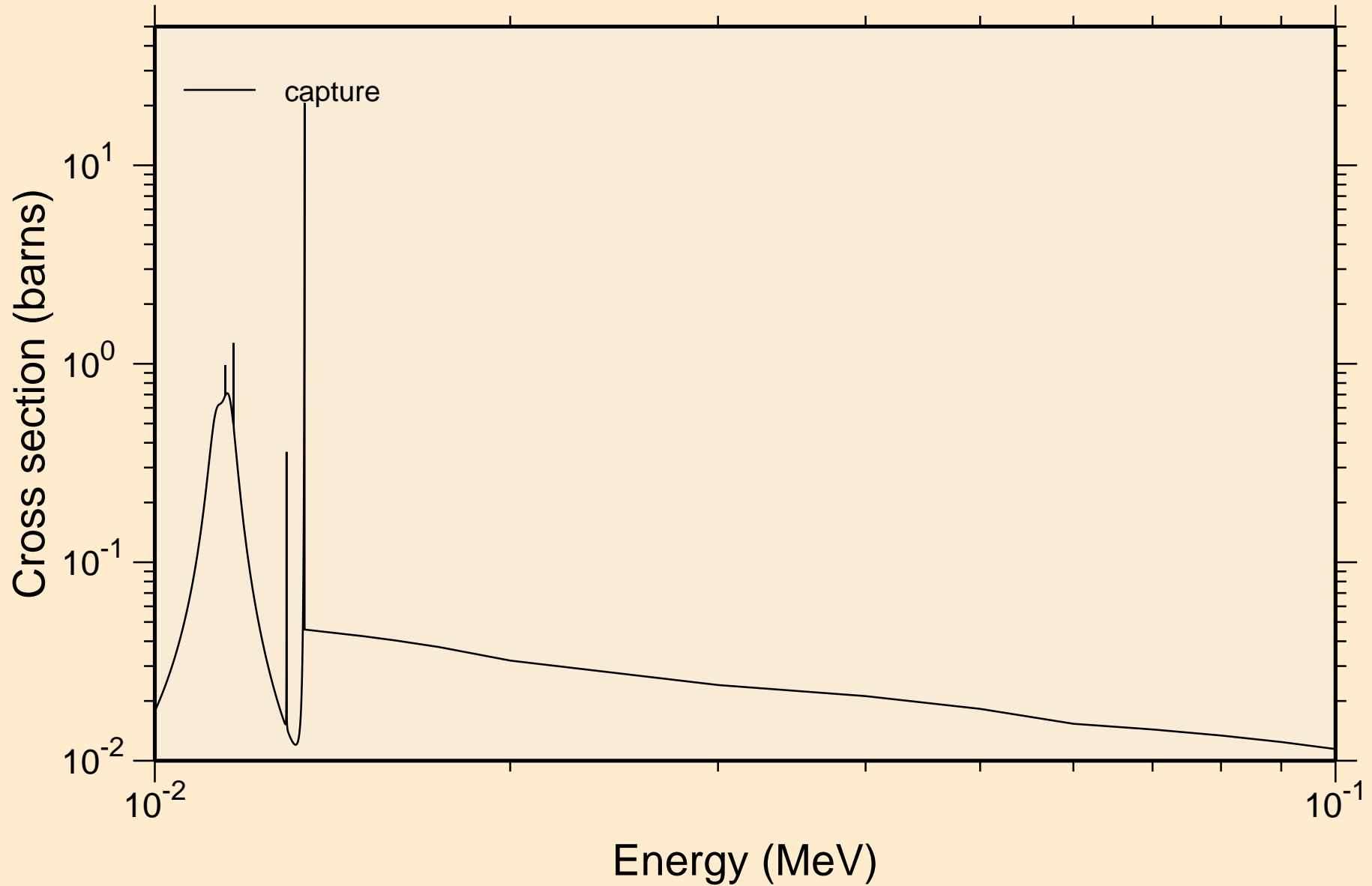

CO055 NEUTRON ACER TENDL-2024 LIBRARY; T=0.K
resonance absorption cross sections

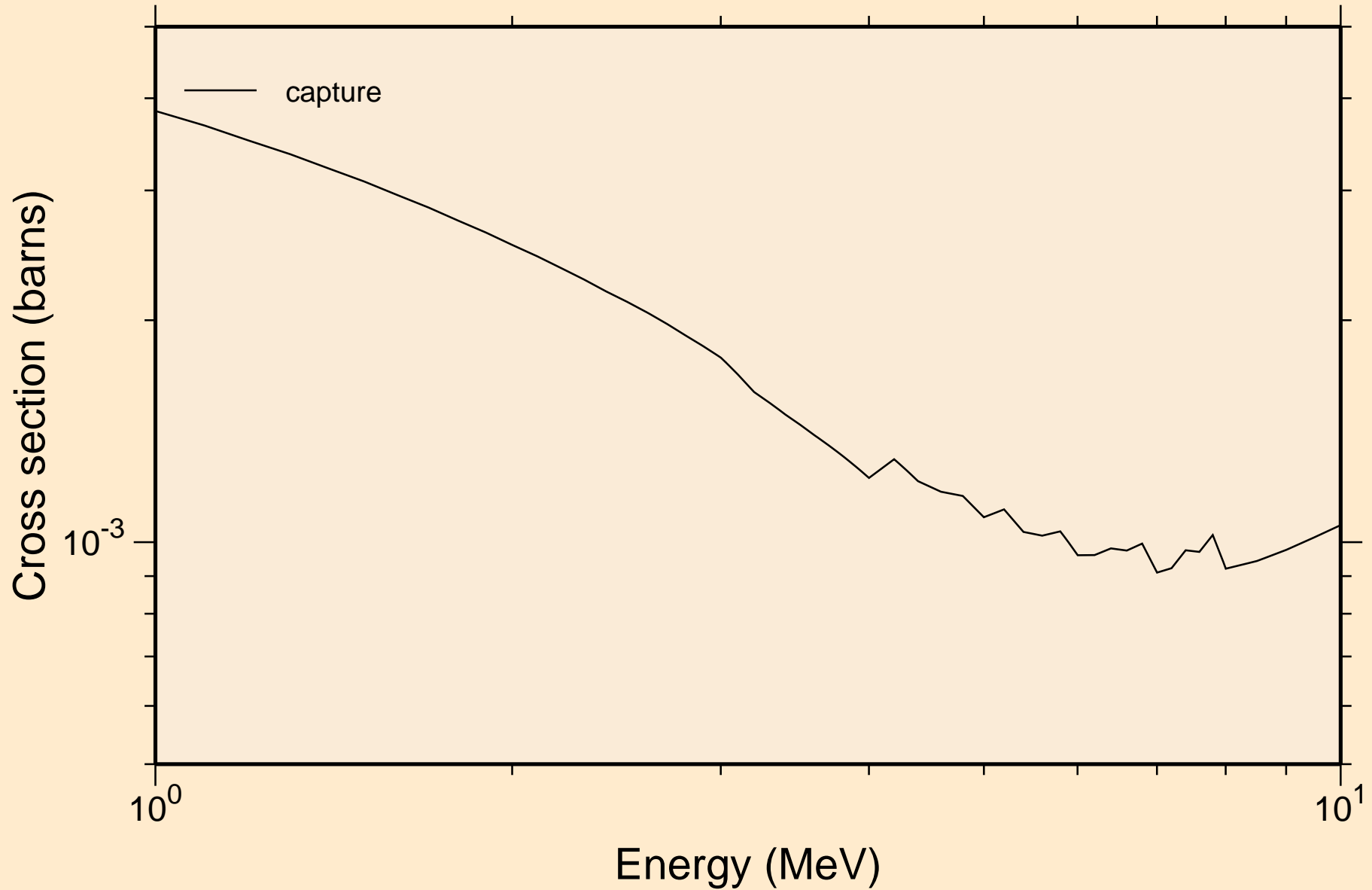

CO055 NEUTRON ACER TENDL-2024 LIBRARY; T=0.K

Heating

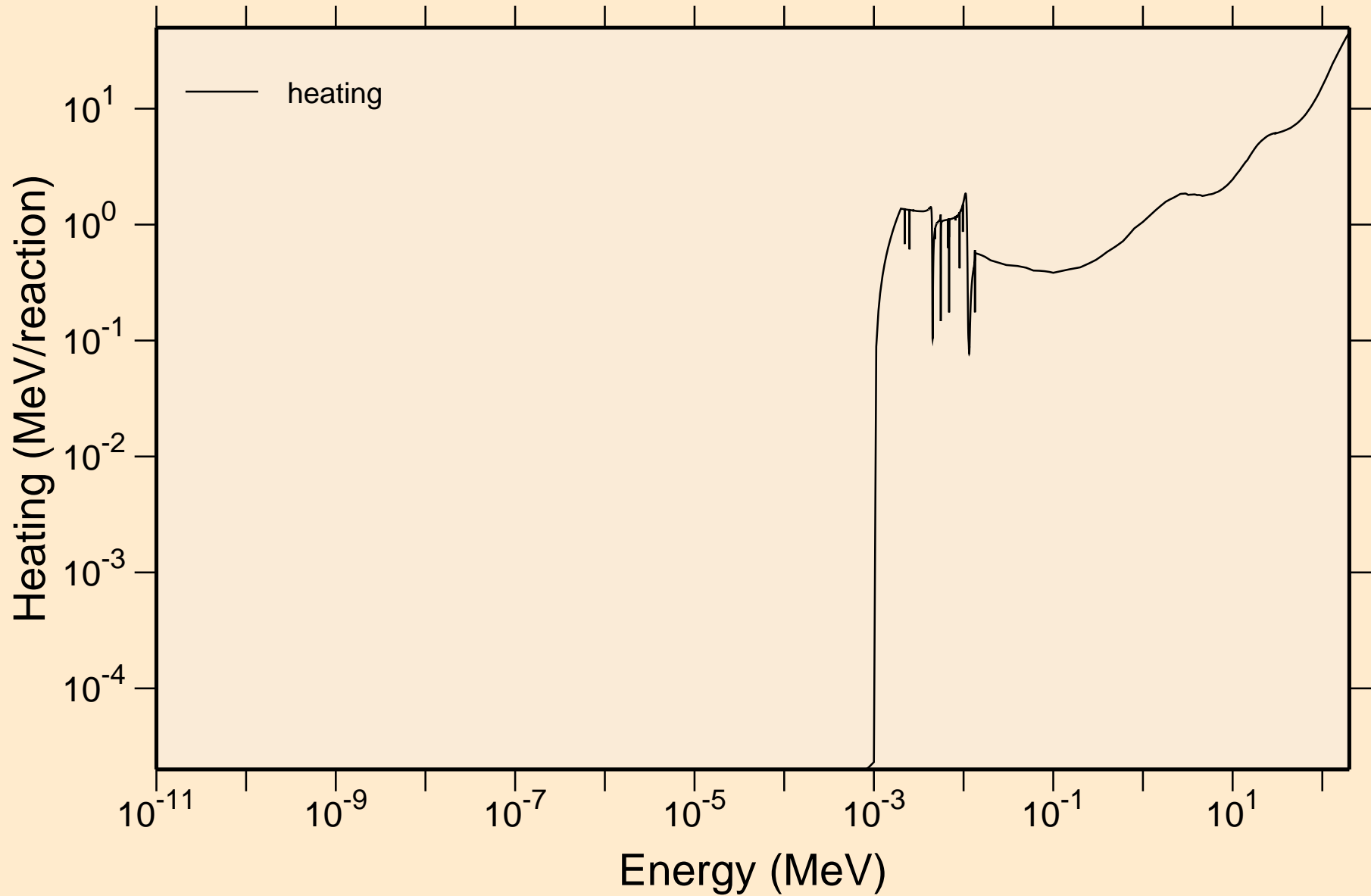

CO055 NEUTRON ACER TENDL-2024 LIBRARY; T=0.K
Damage

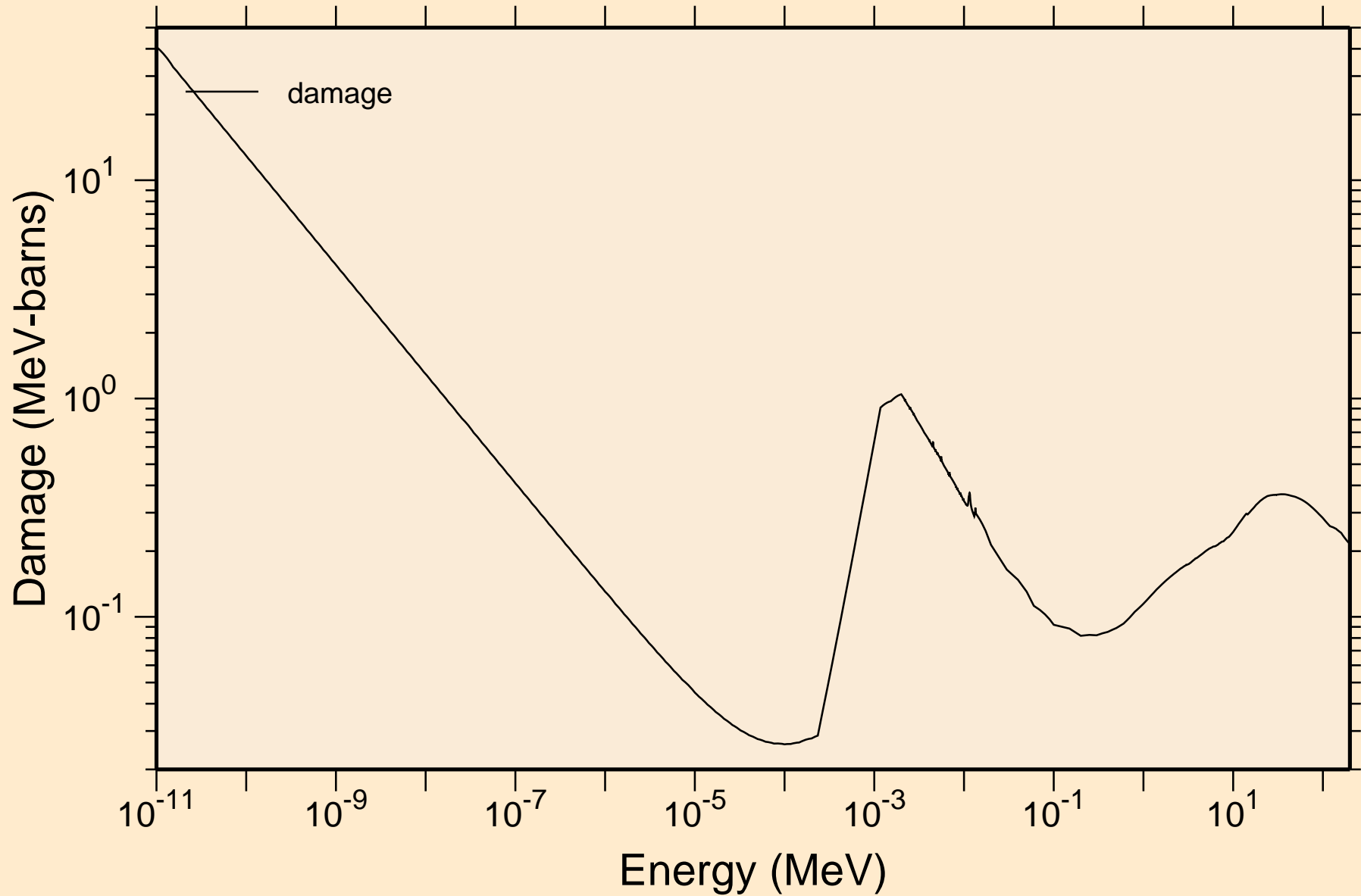

CO055 NEUTRON ACER TENDL-2024 LIBRARY; T=0.K

Non-threshold reactions

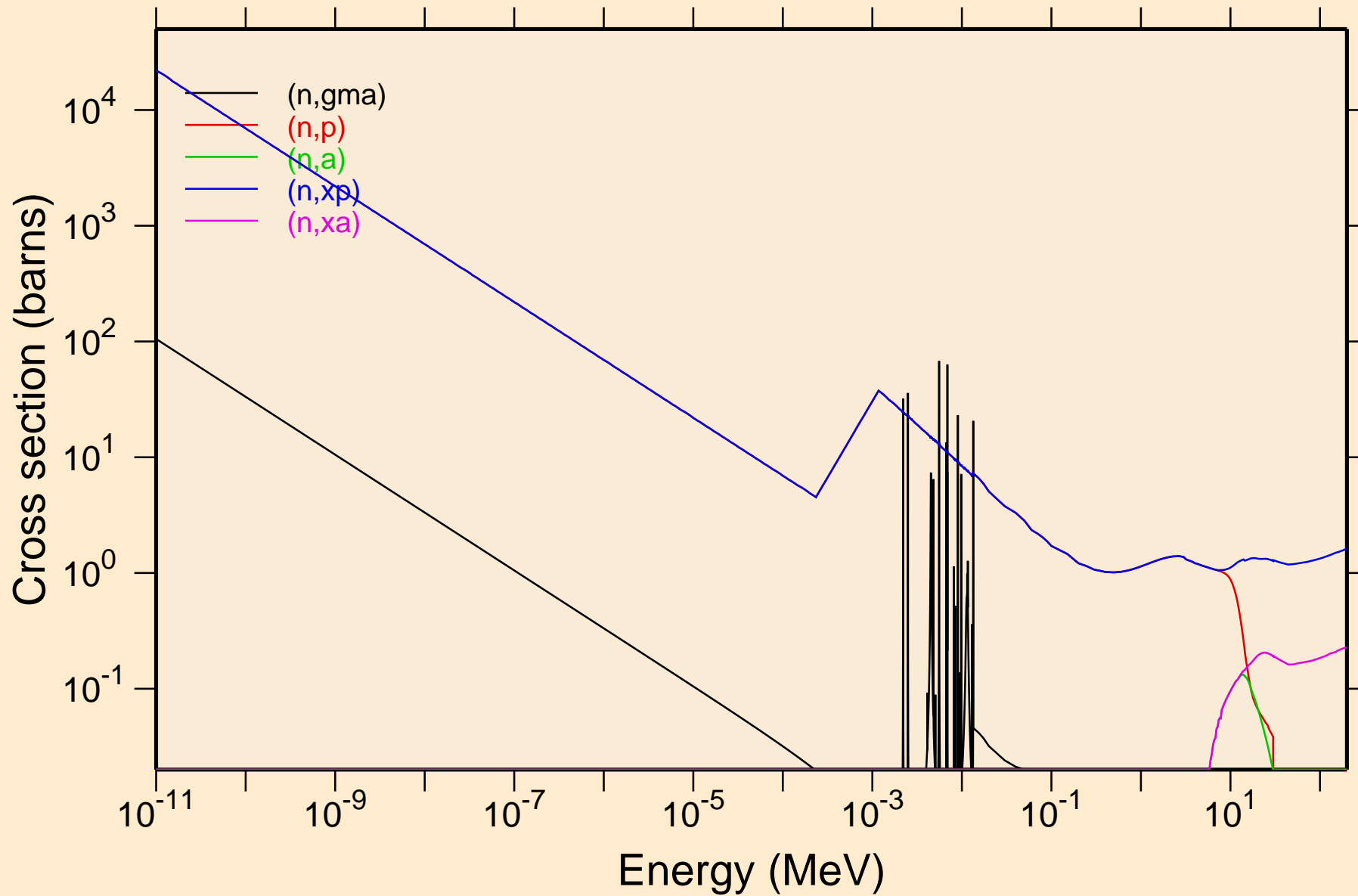

CO055 NEUTRON ACER TENDL-2024 LIBRARY; T=0.K

Principal cross sections

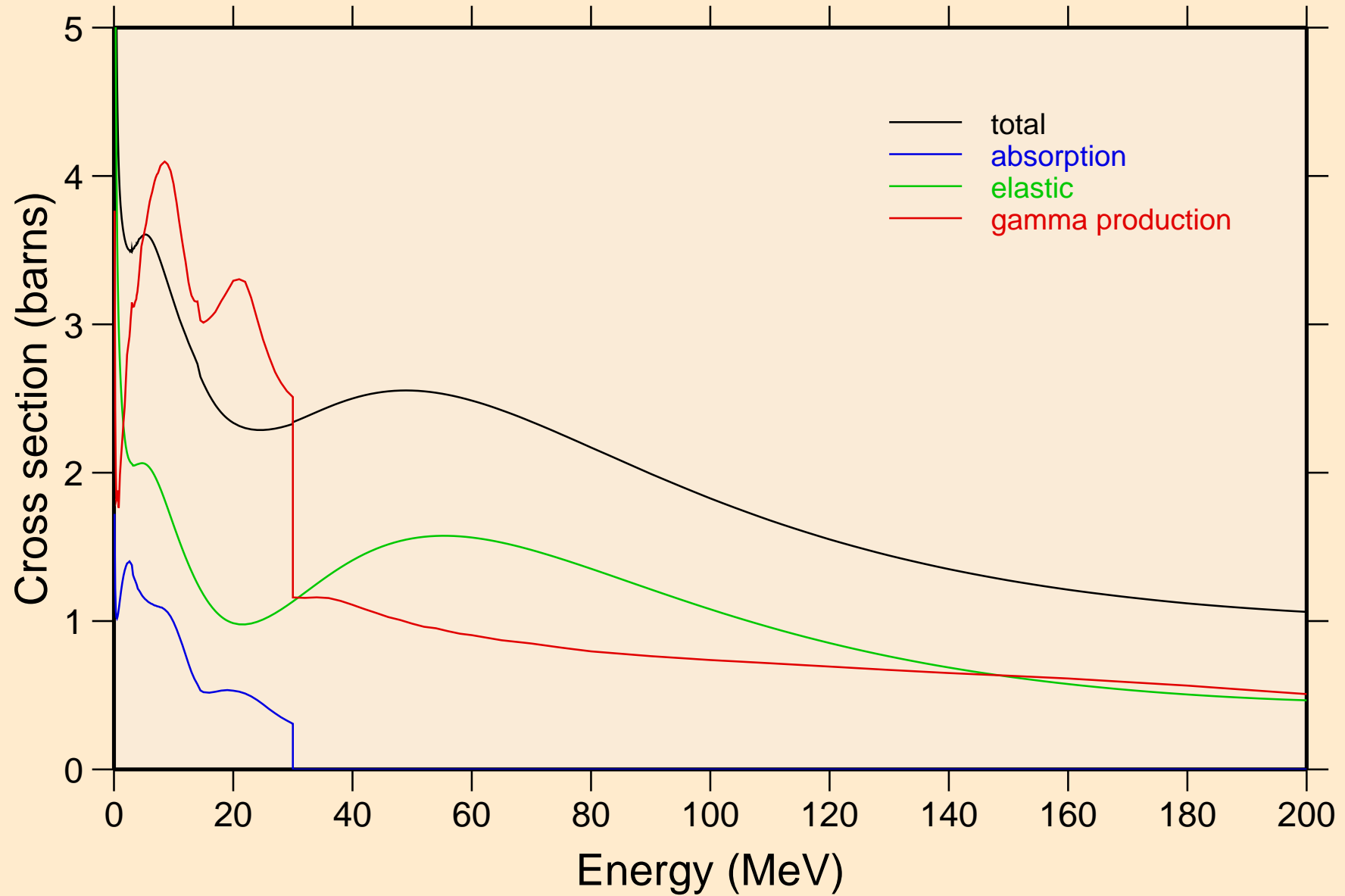

CO055 NEUTRON ACER TENDL-2024 LIBRARY; T=0.K

Heating

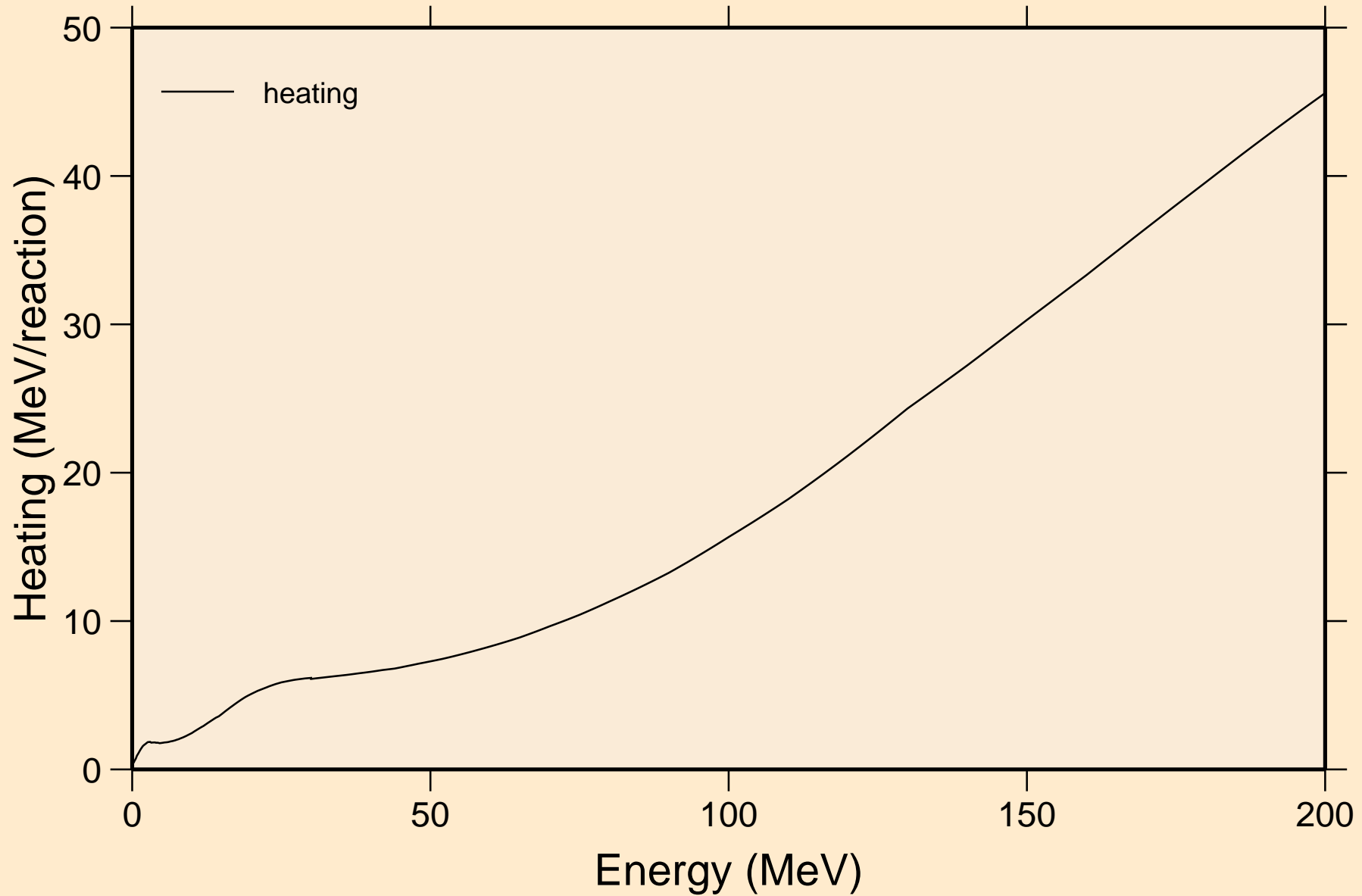

CO055 NEUTRON ACER TENDL-2024 LIBRARY; T=0.K

Damage

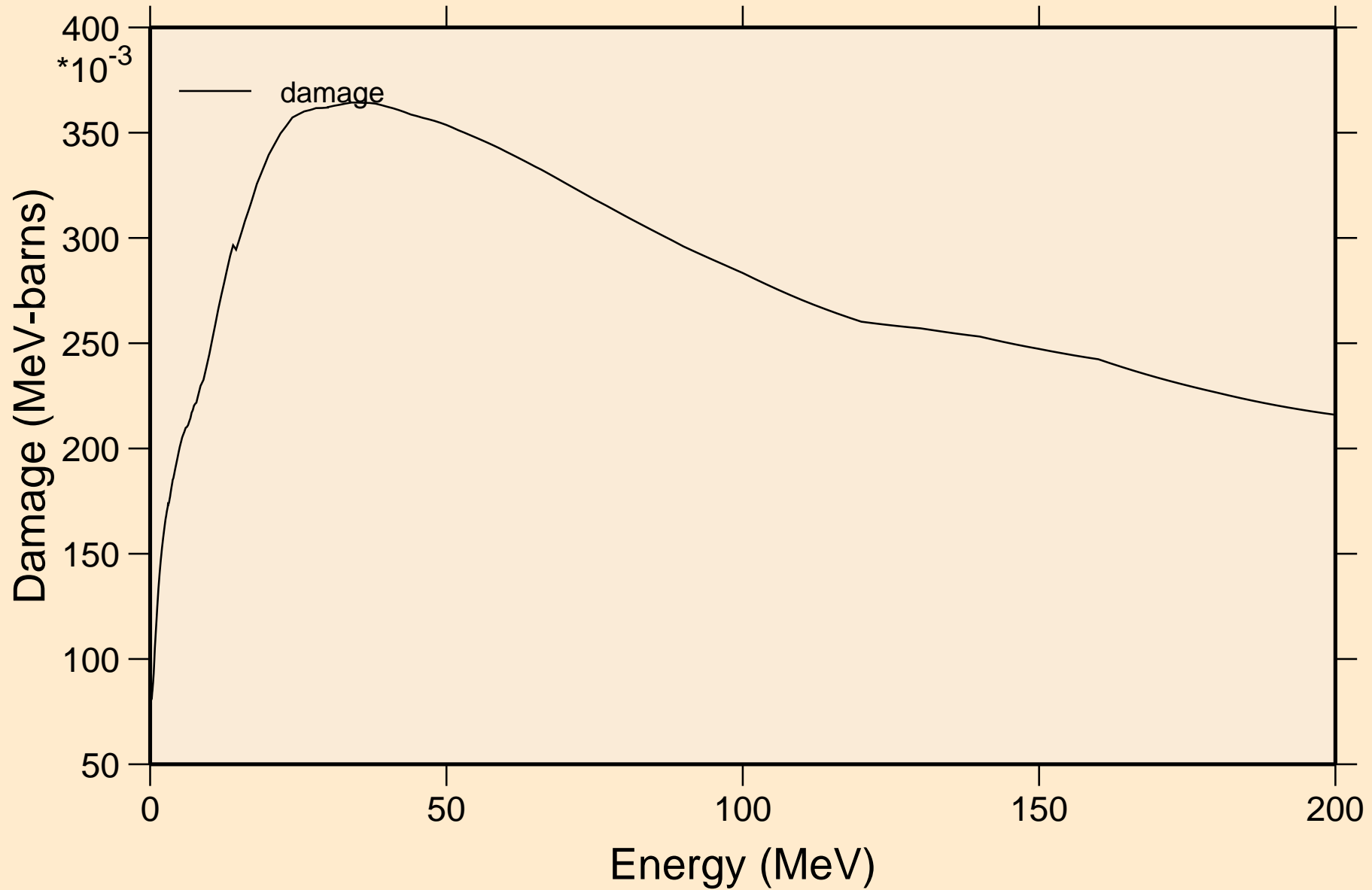

CO055 NEUTRON ACER TENDL-2024 LIBRARY; T=0.K

Non-threshold reactions

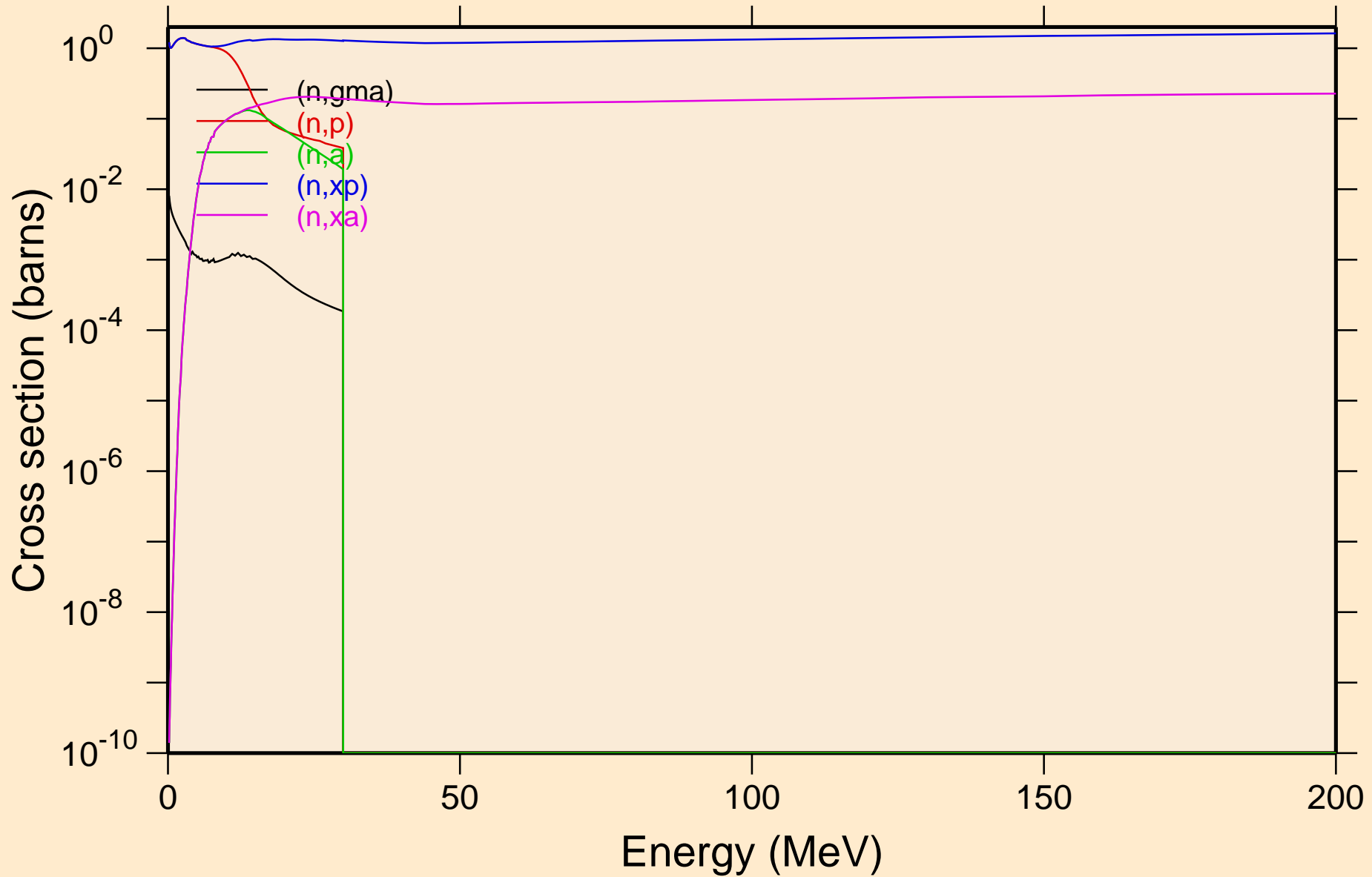

CO055 NEUTRON ACER TENDL-2024 LIBRARY; T=0.K
Inelastic levels

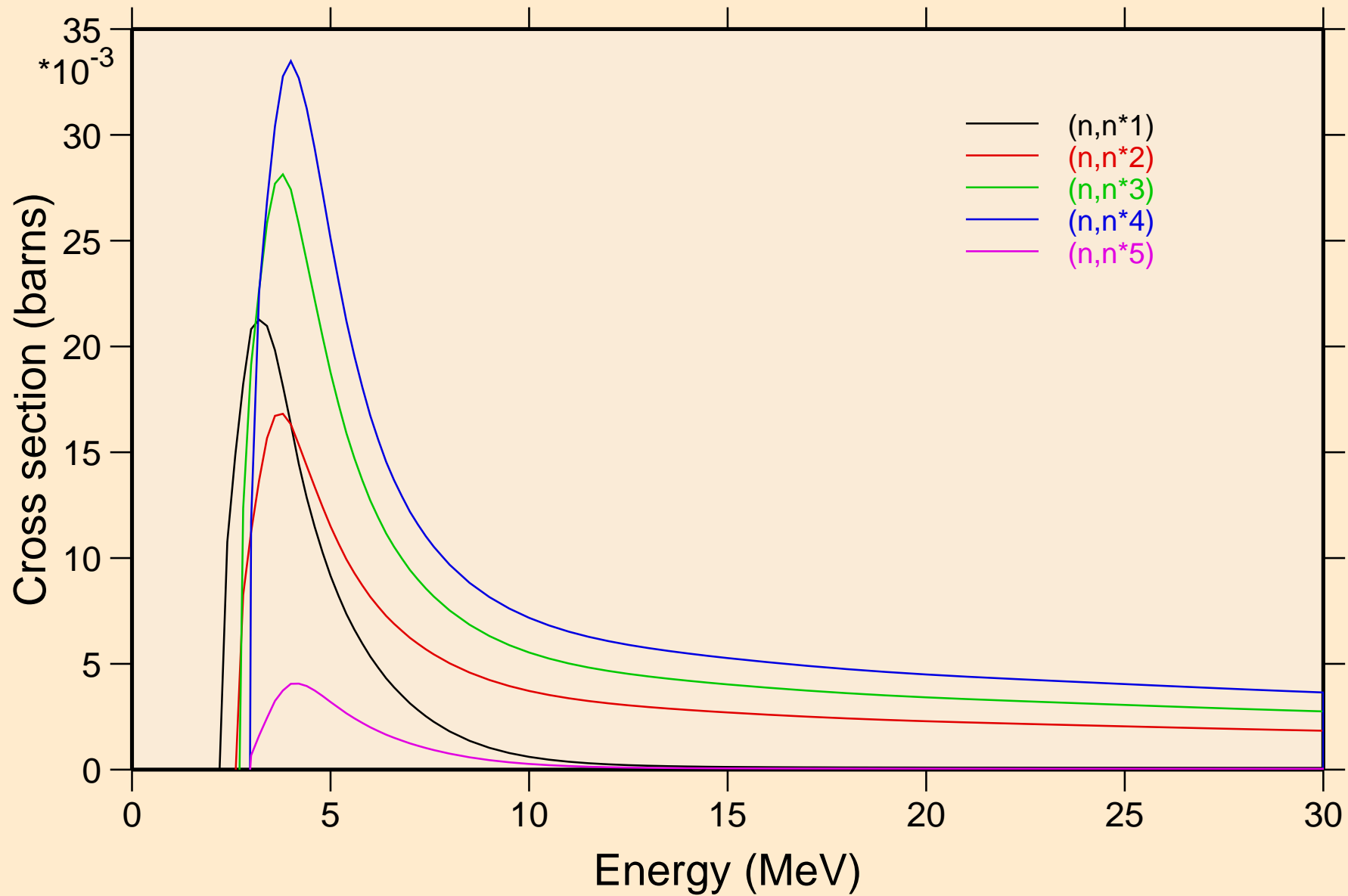

CO055 NEUTRON ACER TENDL-2024 LIBRARY; T=0.K
Inelastic levels

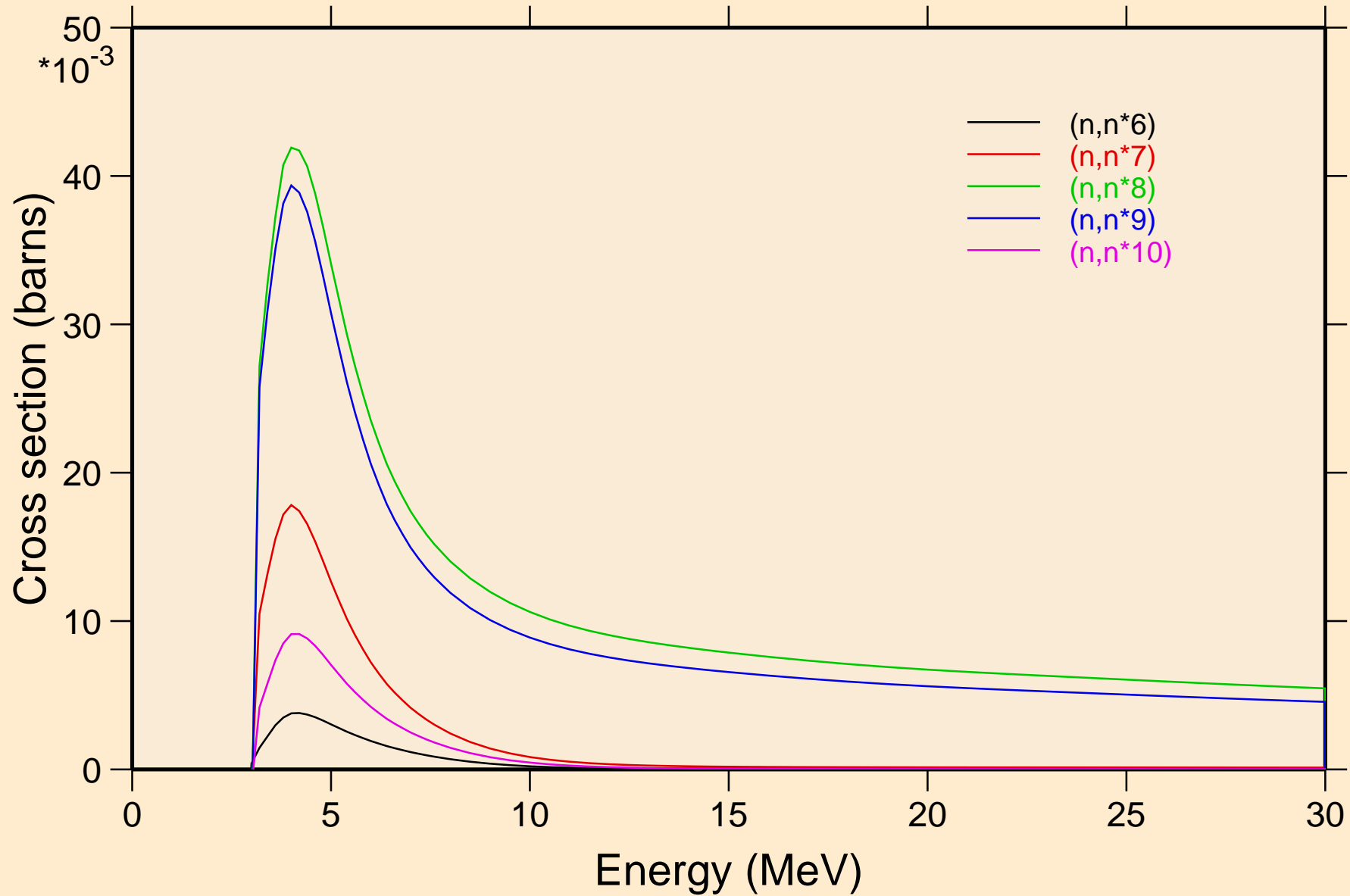

CO055 NEUTRON ACER TENDL-2024 LIBRARY; T=0.K
Inelastic levels

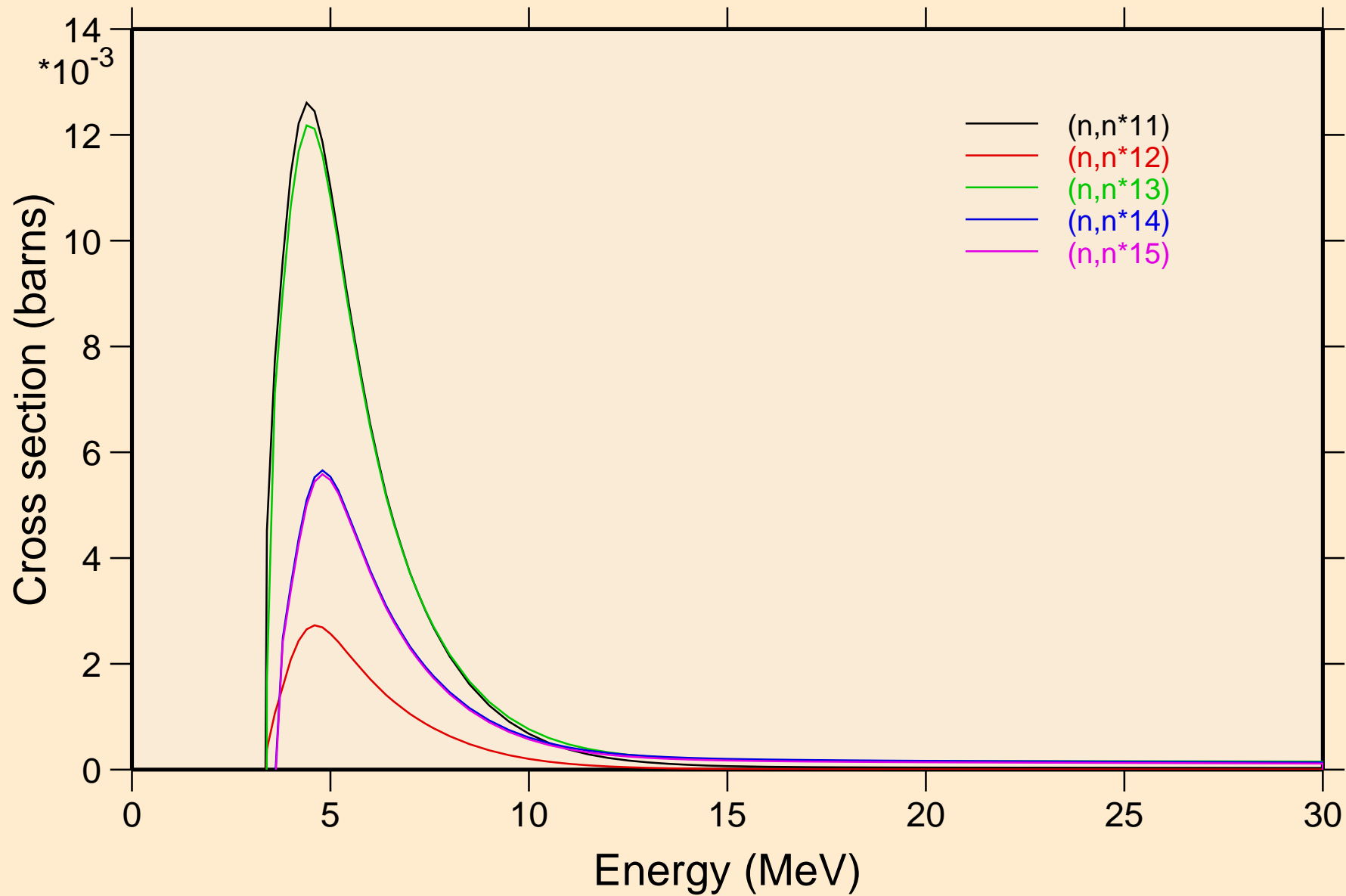

CO055 NEUTRON ACER TENDL-2024 LIBRARY; T=0.K
Inelastic levels

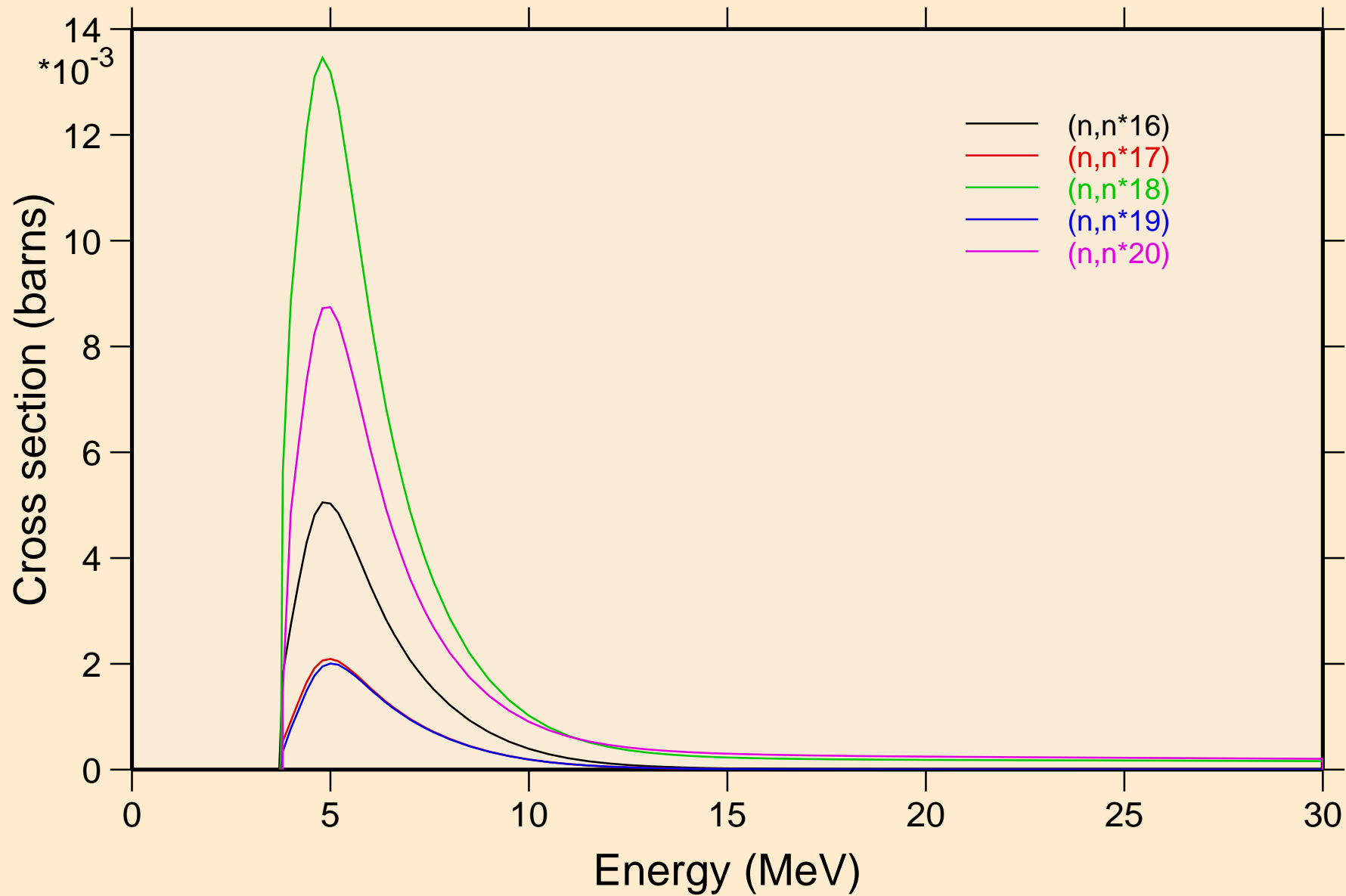

CO055 NEUTRON ACER TENDL-2024 LIBRARY; T=0.K
Inelastic levels

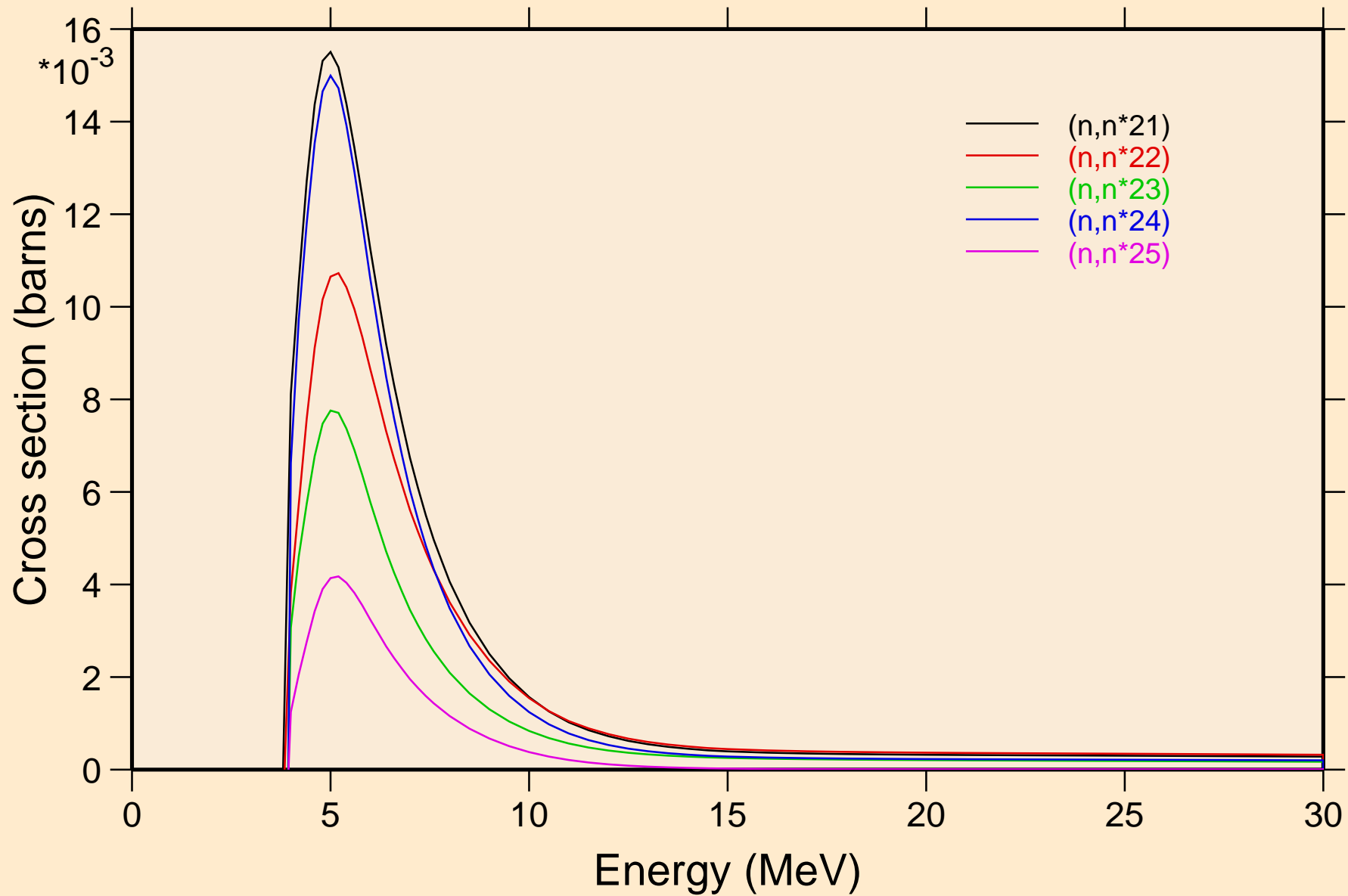

CO055 NEUTRON ACER TENDL-2024 LIBRARY; T=0.K
Inelastic levels

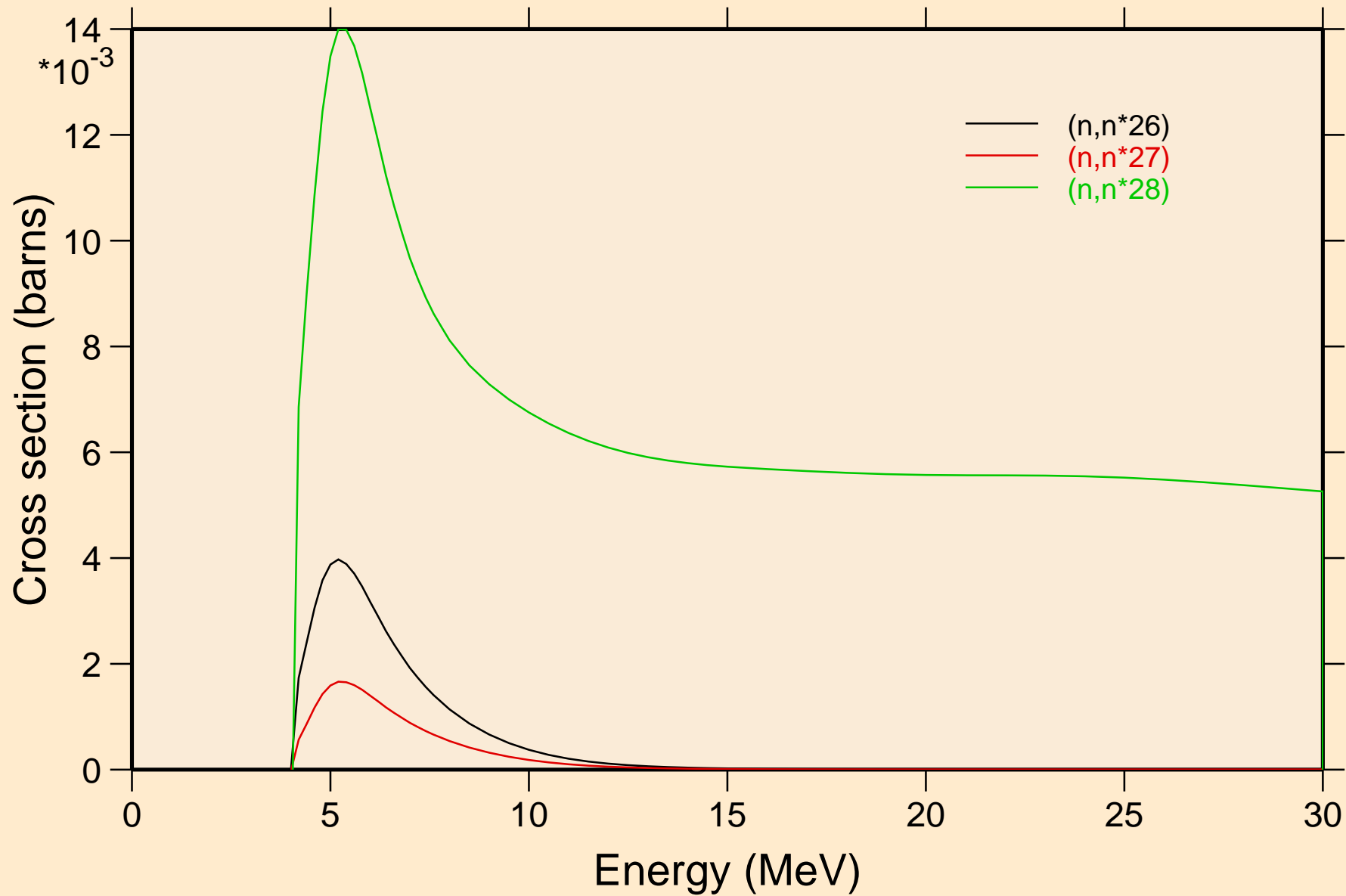

CO055 NEUTRON ACER TENDL-2024 LIBRARY; T=0.K
Threshold reactions

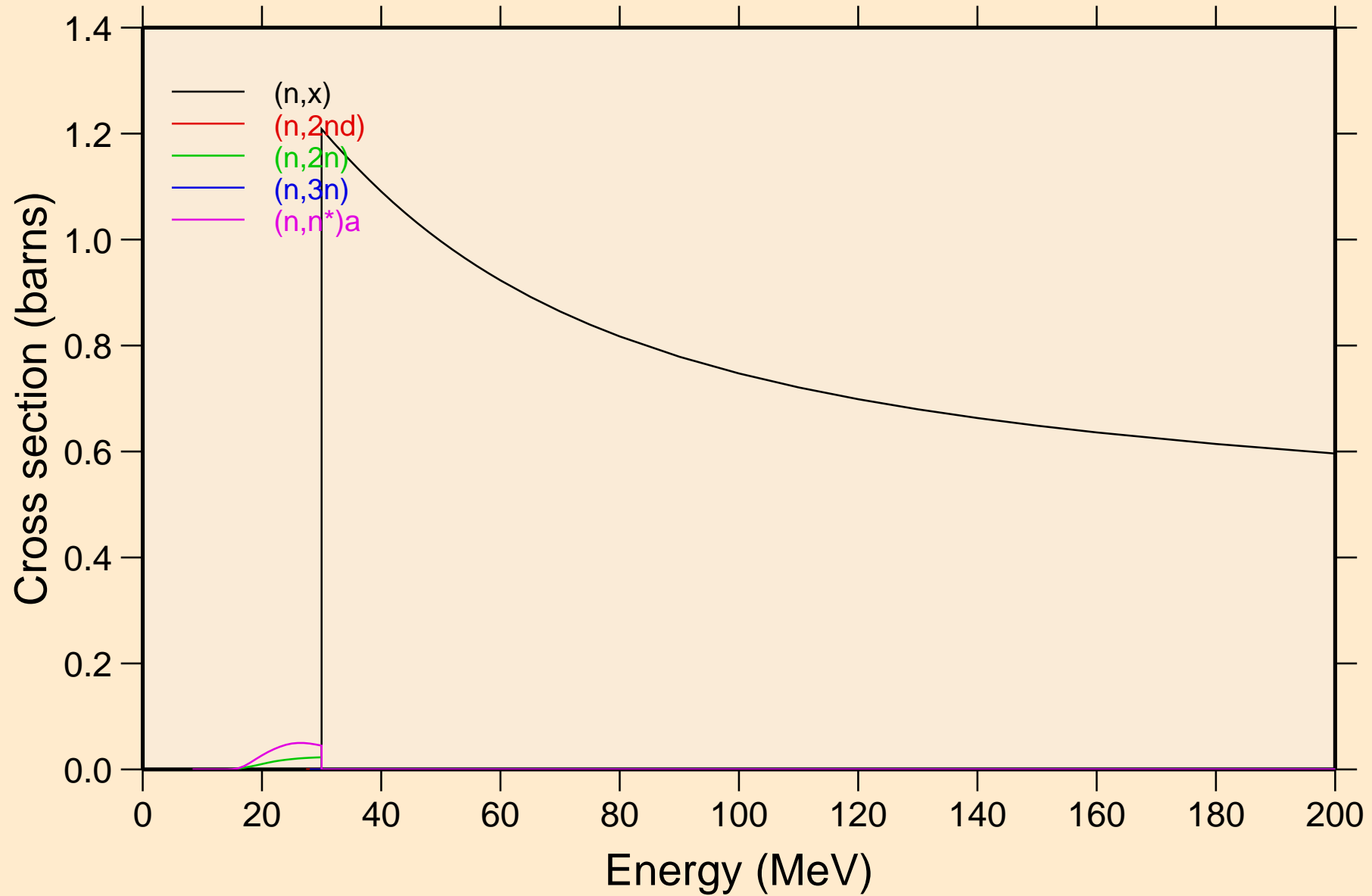

CO055 NEUTRON ACER TENDL-2024 LIBRARY; T=0.K
Threshold reactions

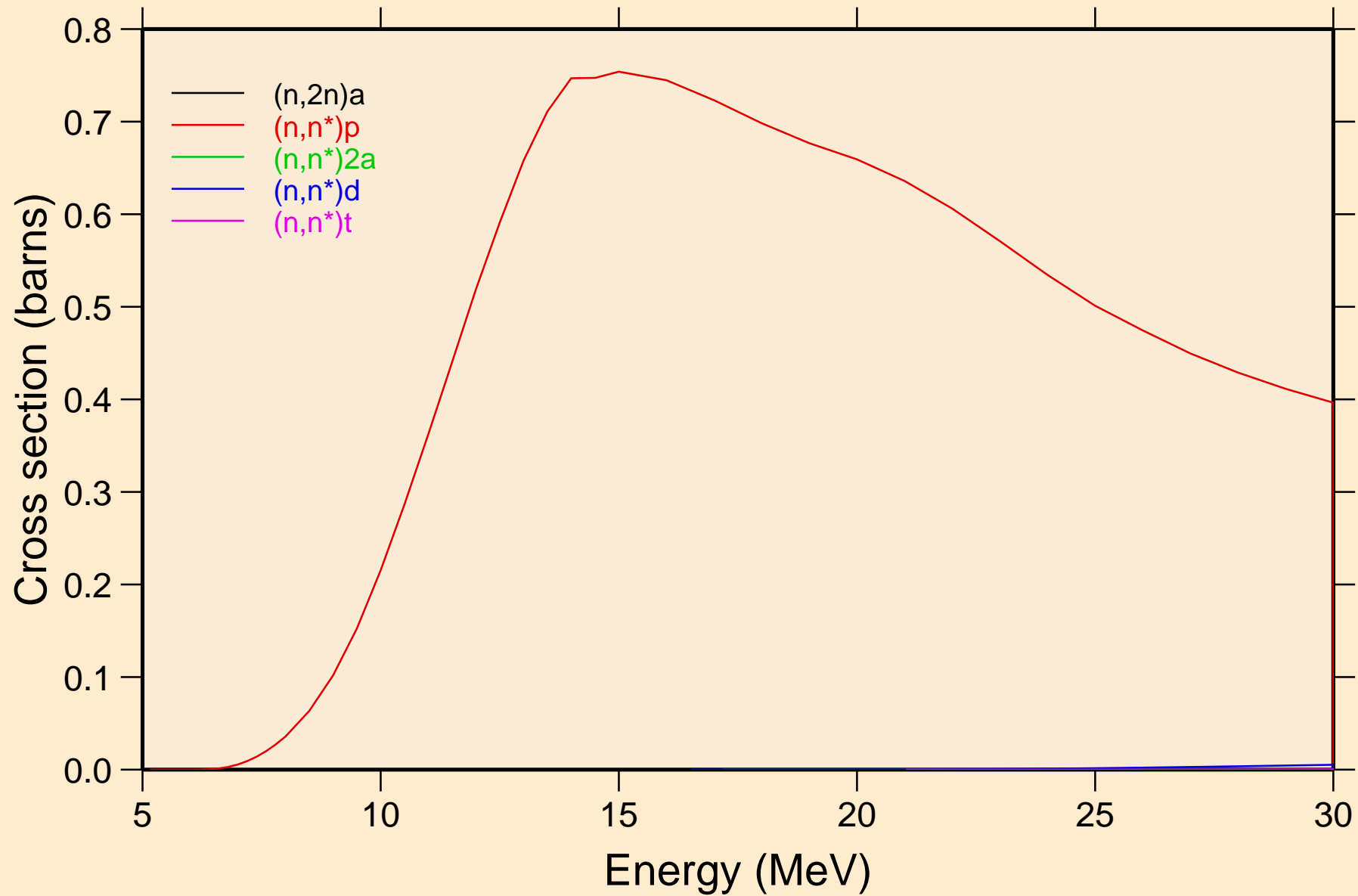

CO055 NEUTRON ACER TENDL-2024 LIBRARY; T=0.K
Threshold reactions

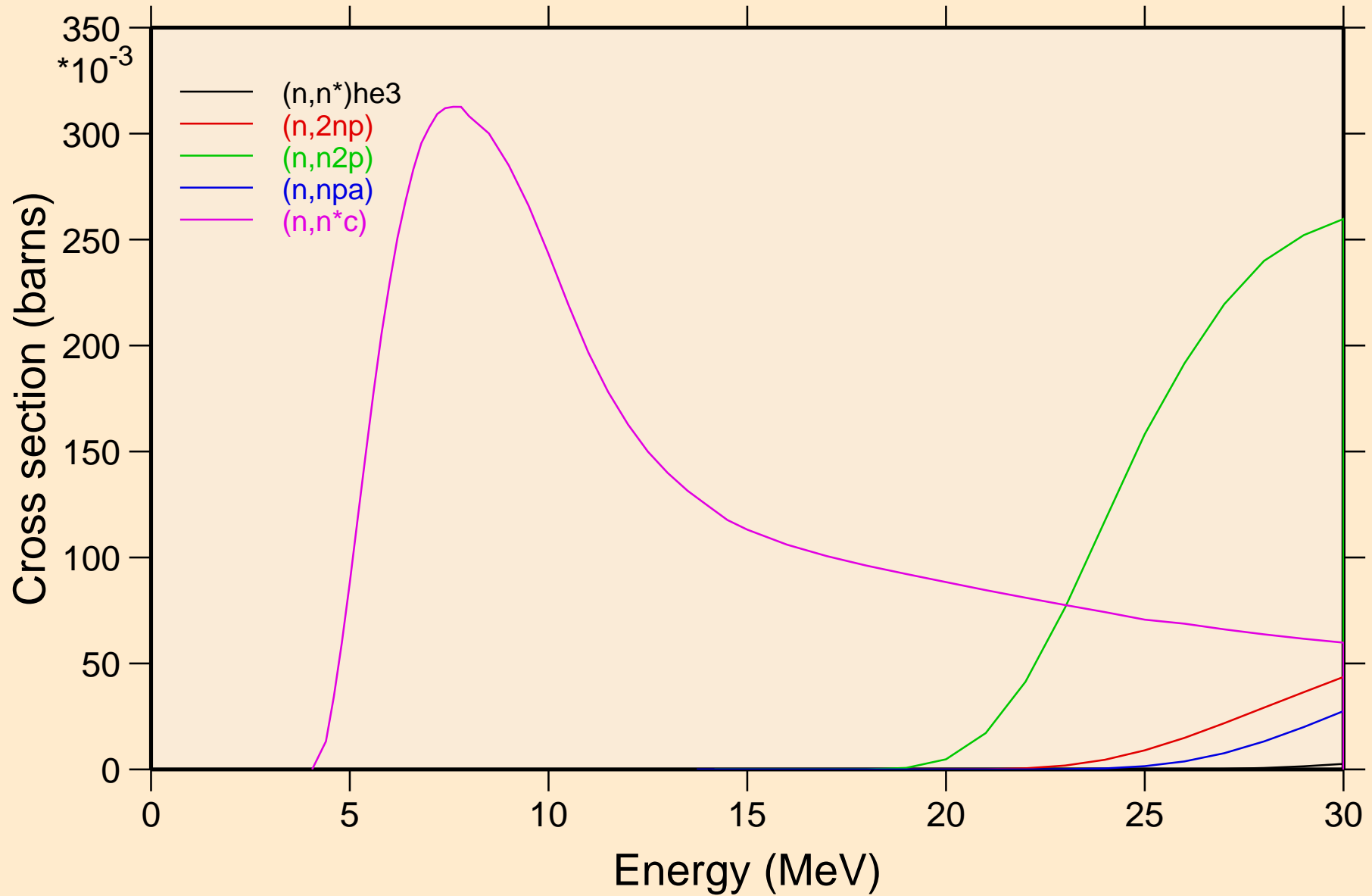

CO055 NEUTRON ACER TENDL-2024 LIBRARY; T=0.K
Threshold reactions

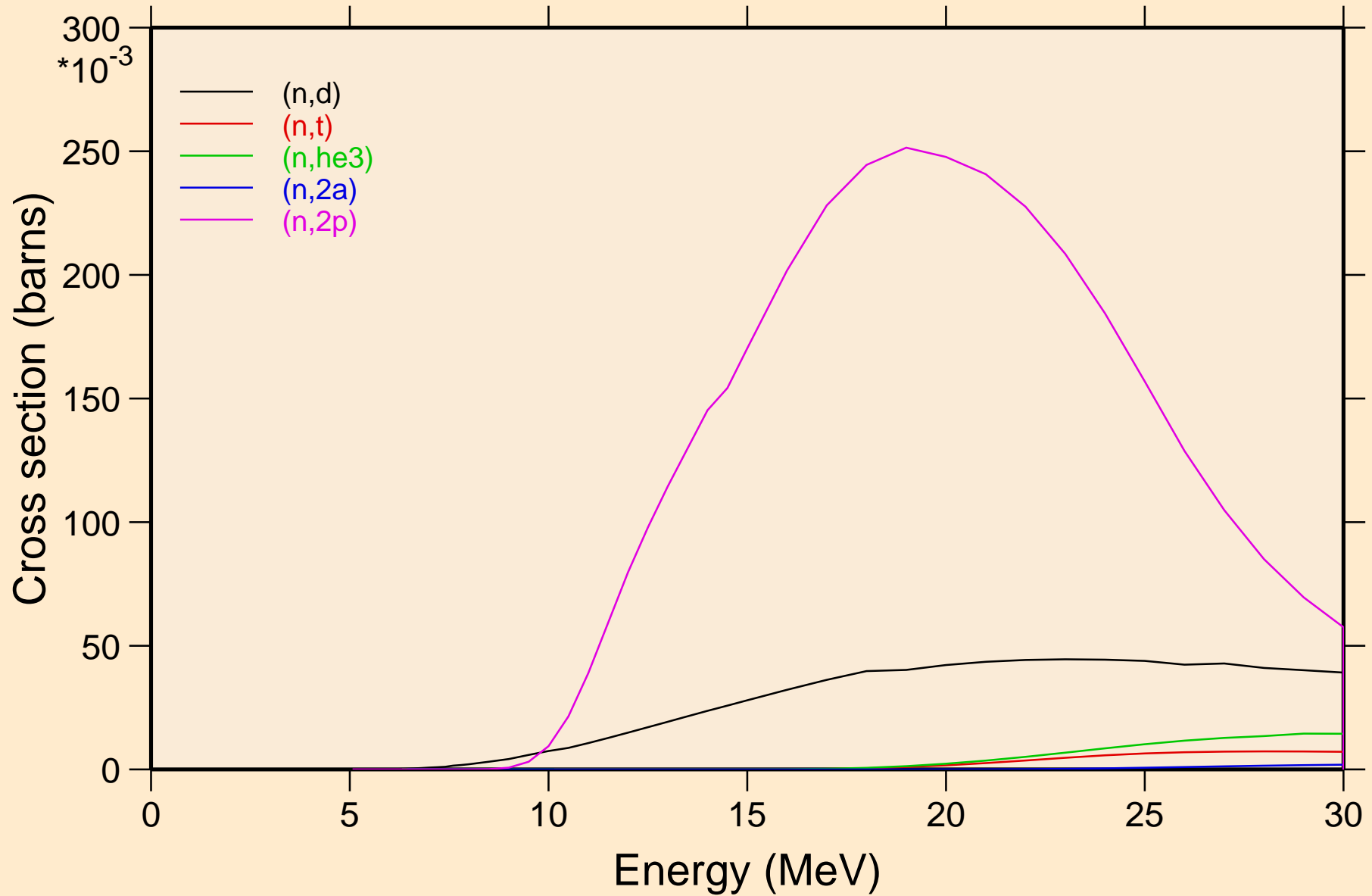

CO055 NEUTRON ACER TENDL-2024 LIBRARY; T=0.K
Threshold reactions

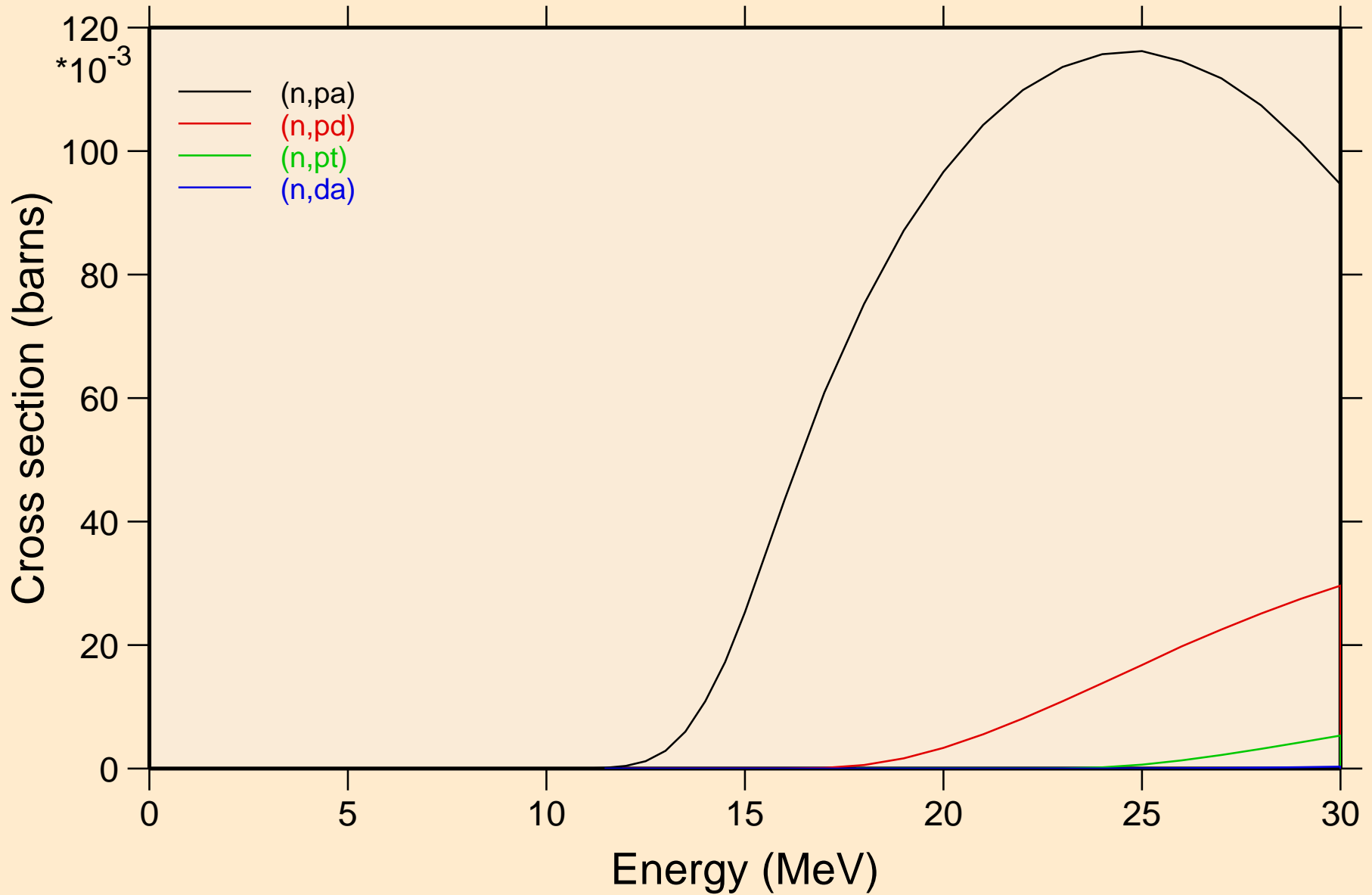

CO055 NEUTRON ACER TENDL-2024 LIBRARY; T=0.K
Threshold reactions

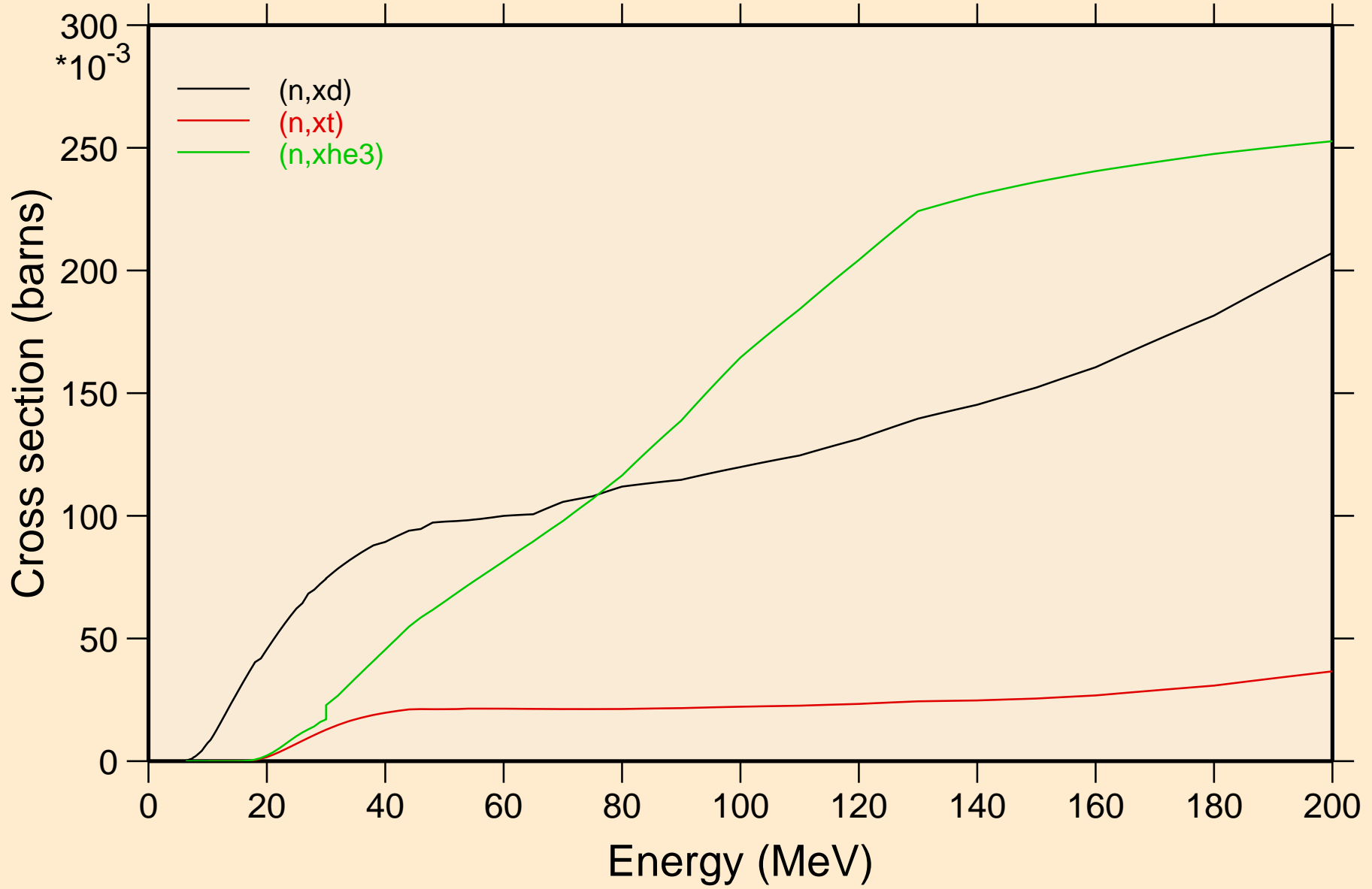

CO055 NEUTRON ACER TENDL-2024 LIBRARY; T=0.K
angular distribution for elastic

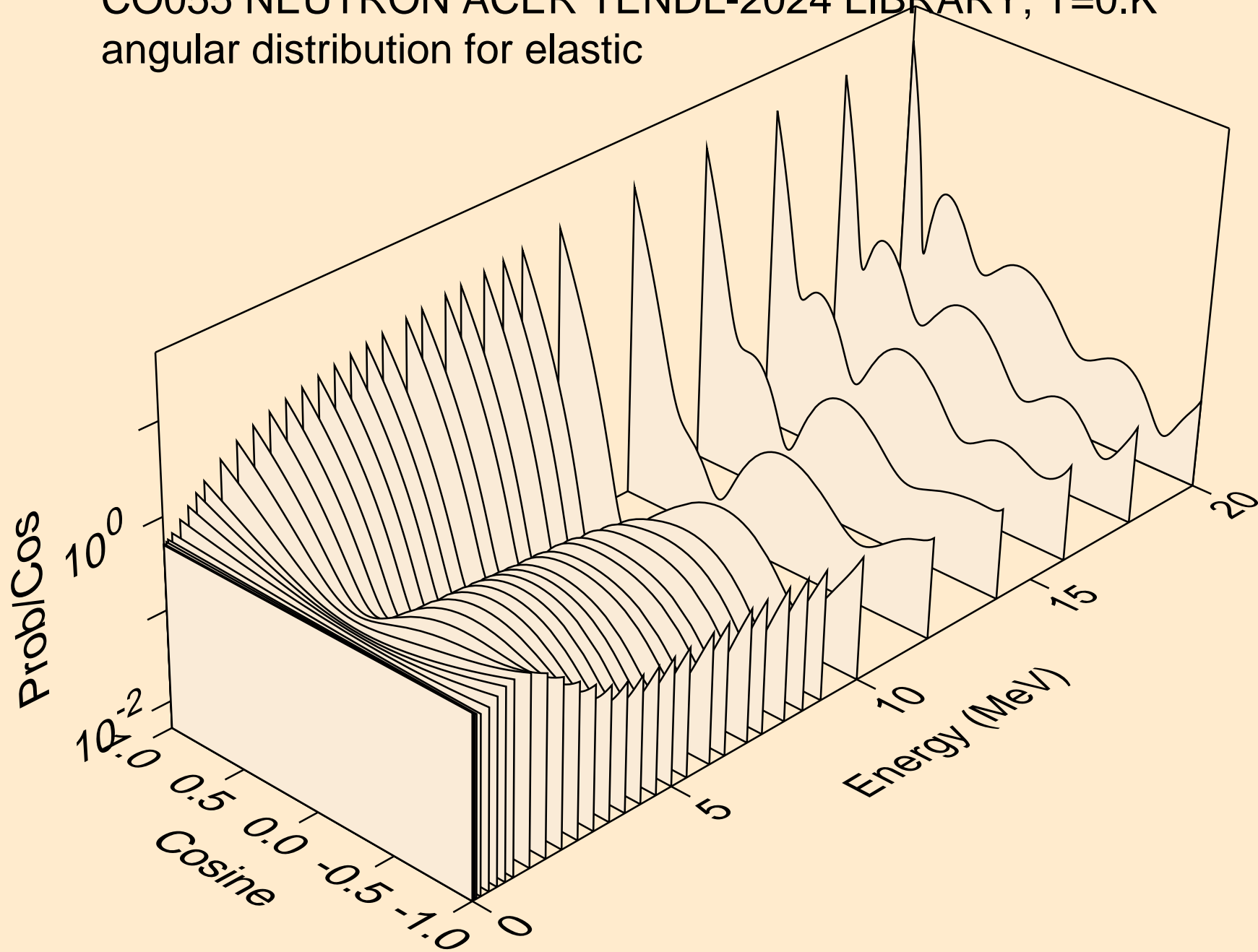

CO055 NEUTRON ACER TENDL-2024 LIBRARY; T=0.K
angular distribution for elastic

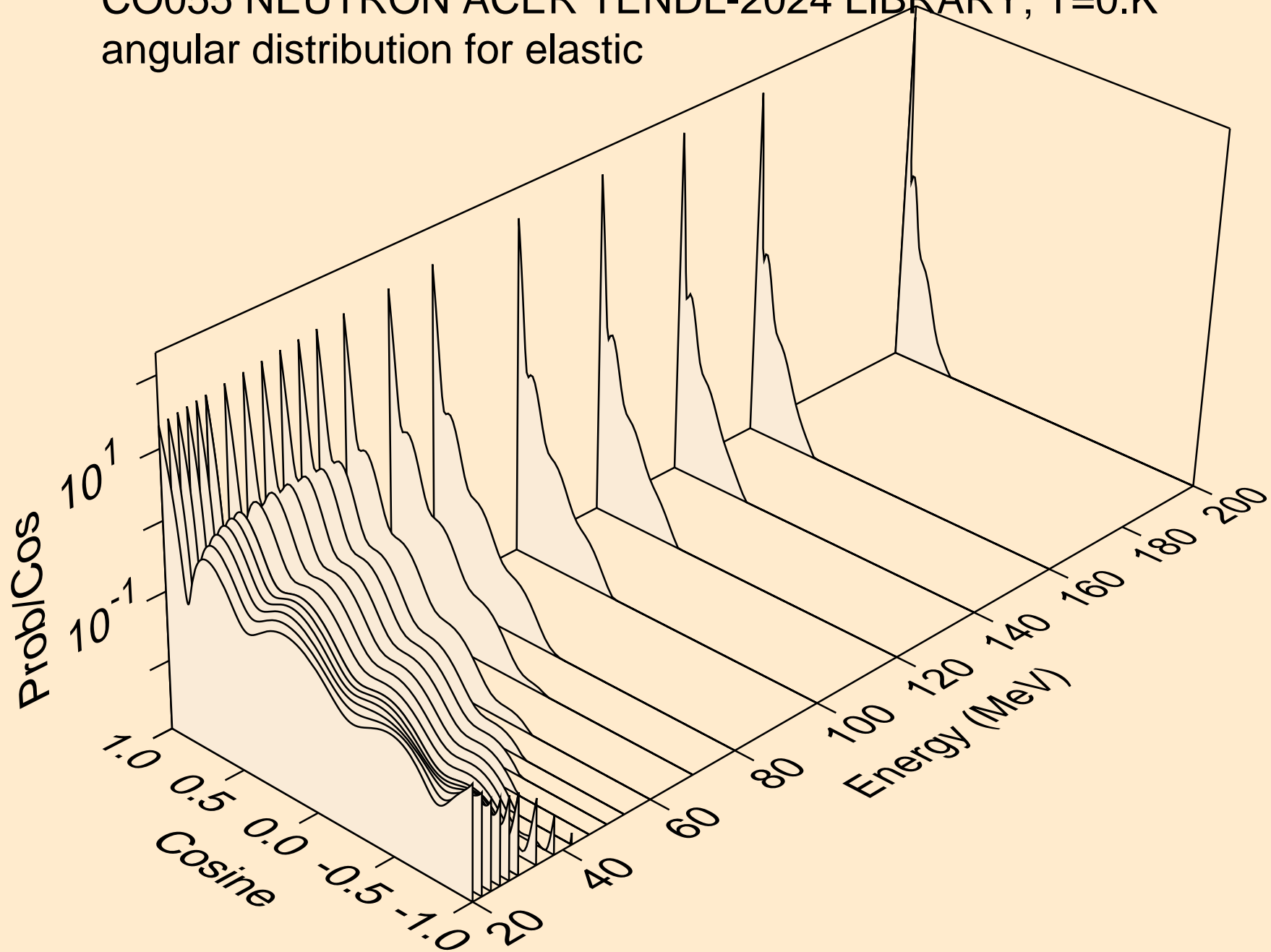

CO055 NEUTRON ACER TENDL-2024 LIBRARY; T=0.K
angular distribution for (n,n*1)

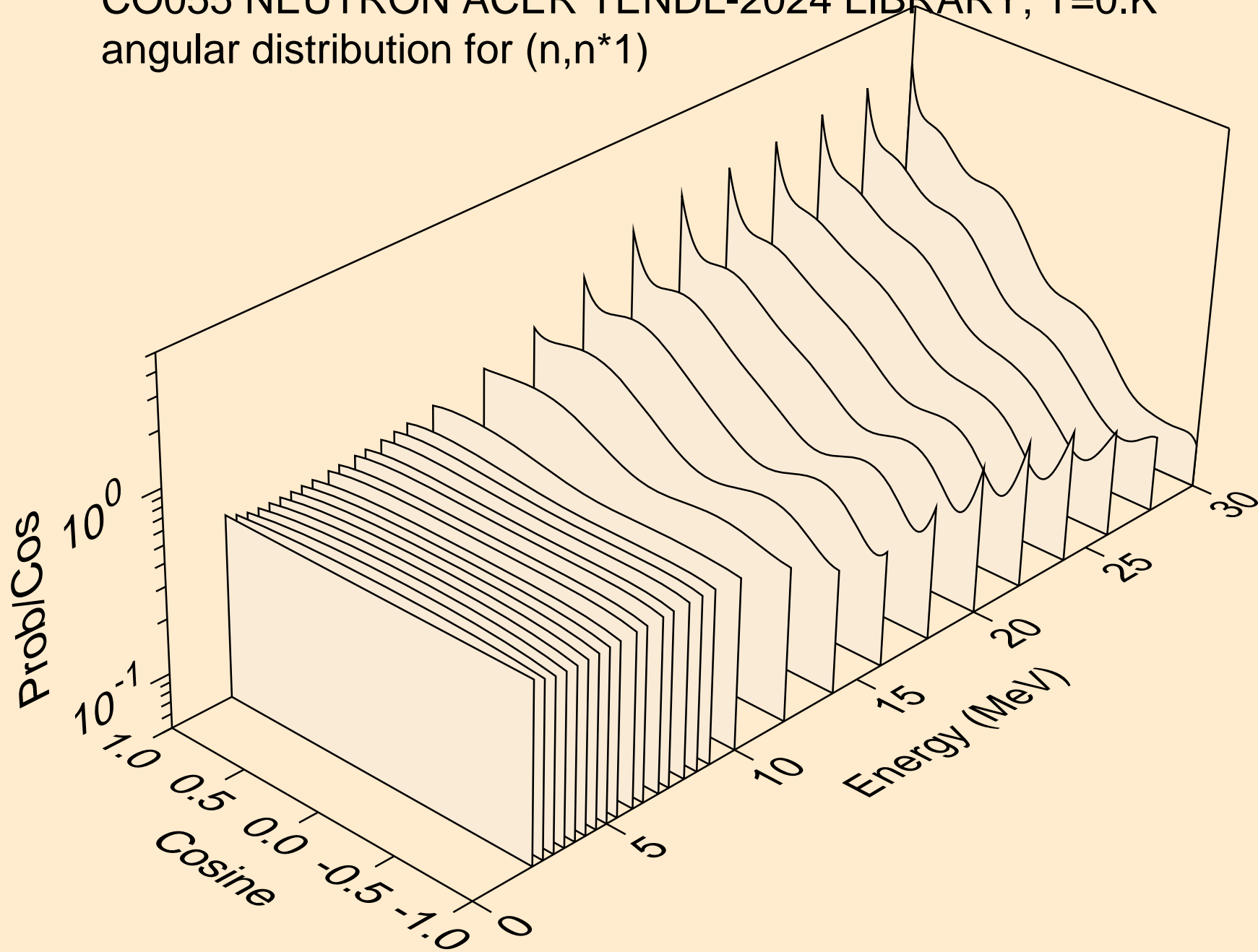

CO055 NEUTRON ACER TENDL-2024 LIBRARY; T=0.K
angular distribution for (n,n*2)

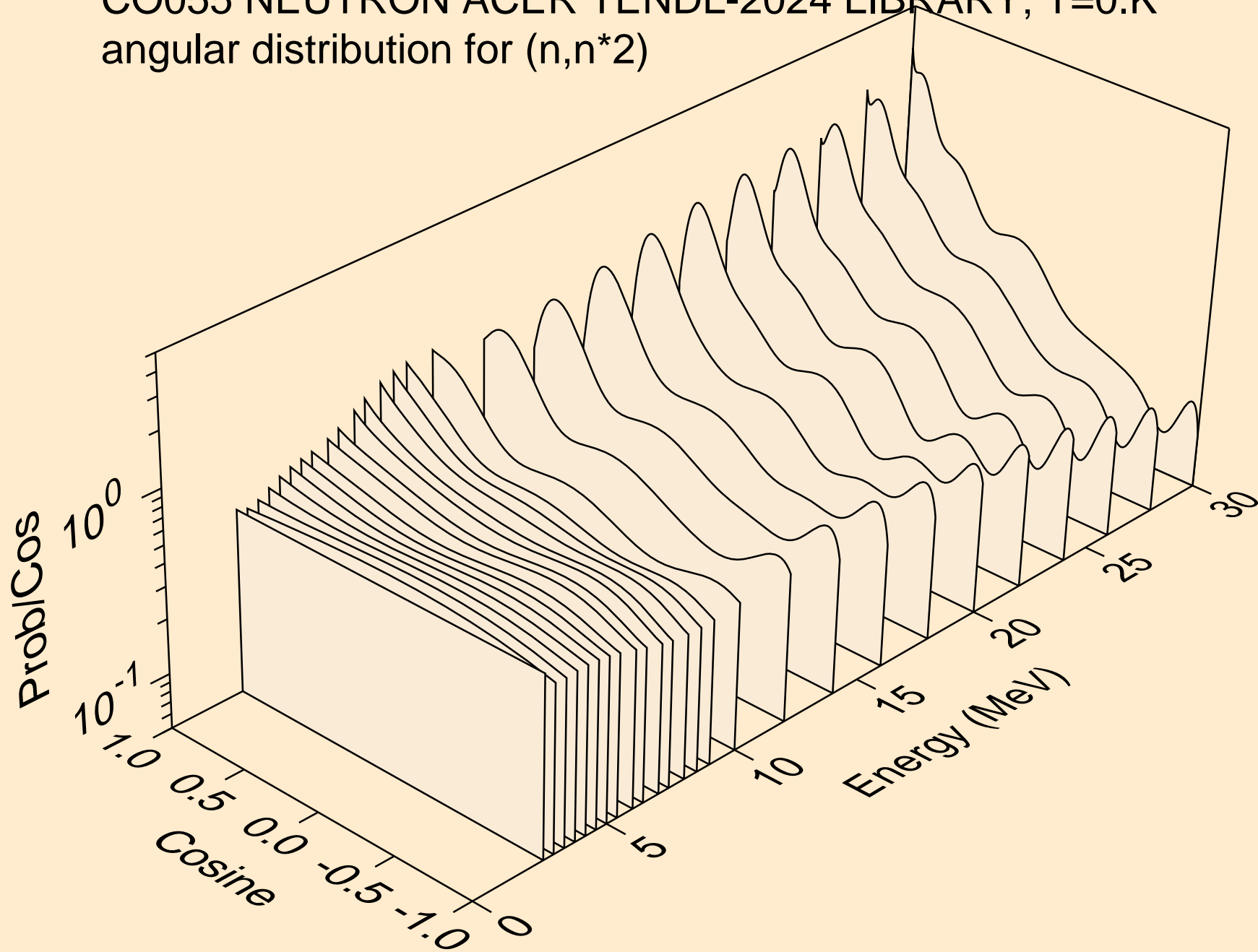

CO055 NEUTRON ACER TENDL-2024 LIBRARY; T=0.K
angular distribution for (n,n*3)

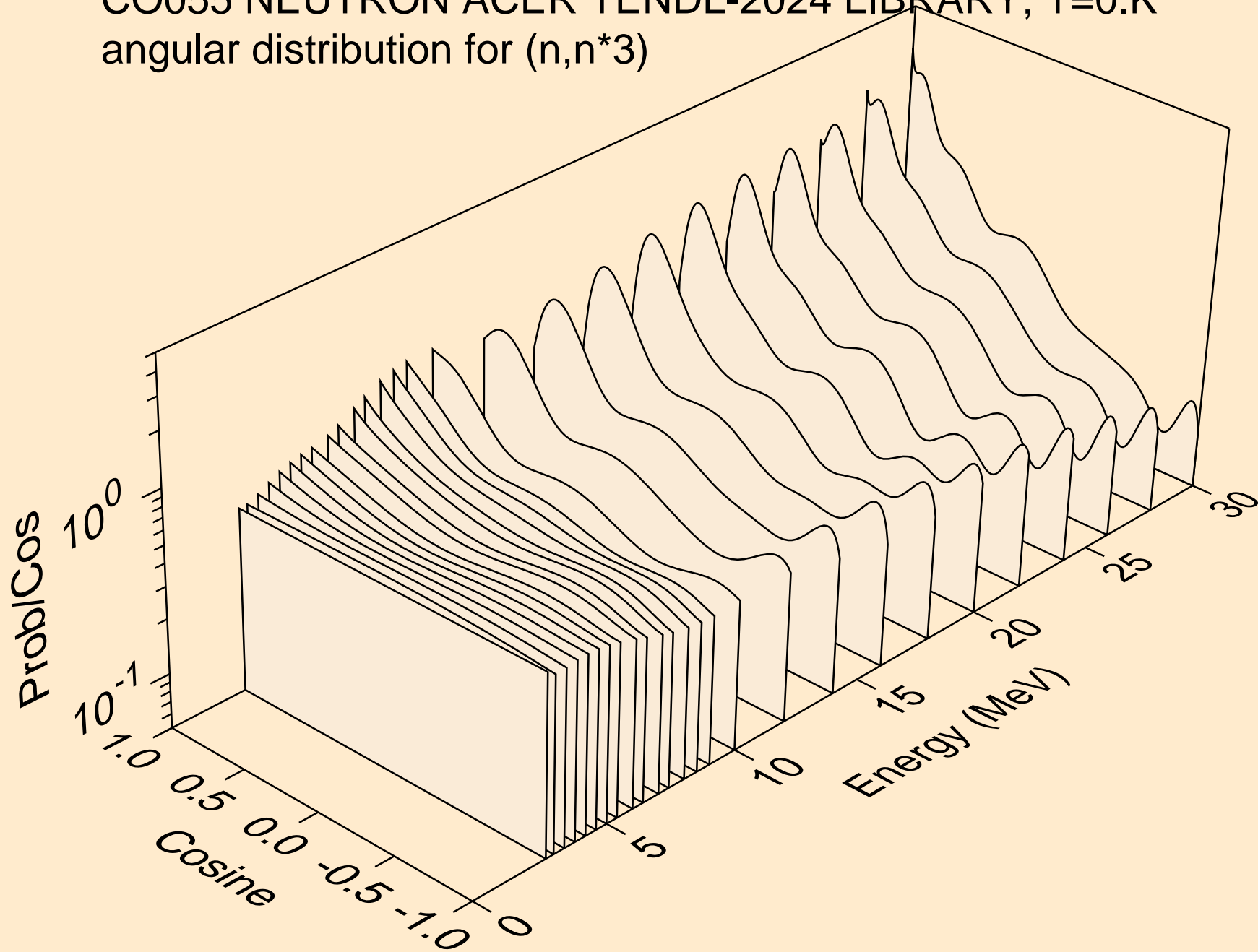

CO055 NEUTRON ACER TENDL-2024 LIBRARY; T=0.K
angular distribution for (n,n*4)

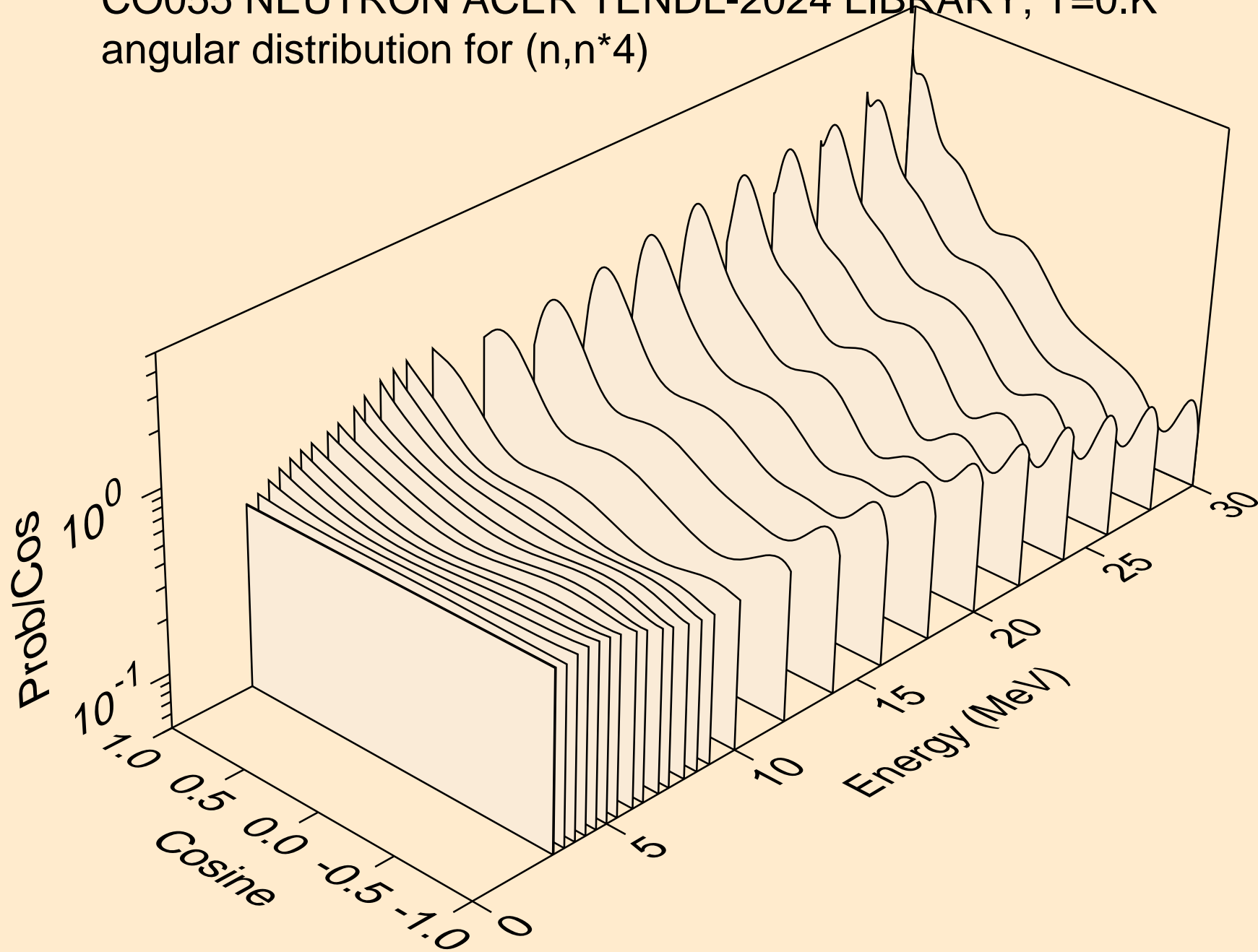

CO055 NEUTRON ACER TENDL-2024 LIBRARY; T=0.K
angular distribution for (n,n*5)

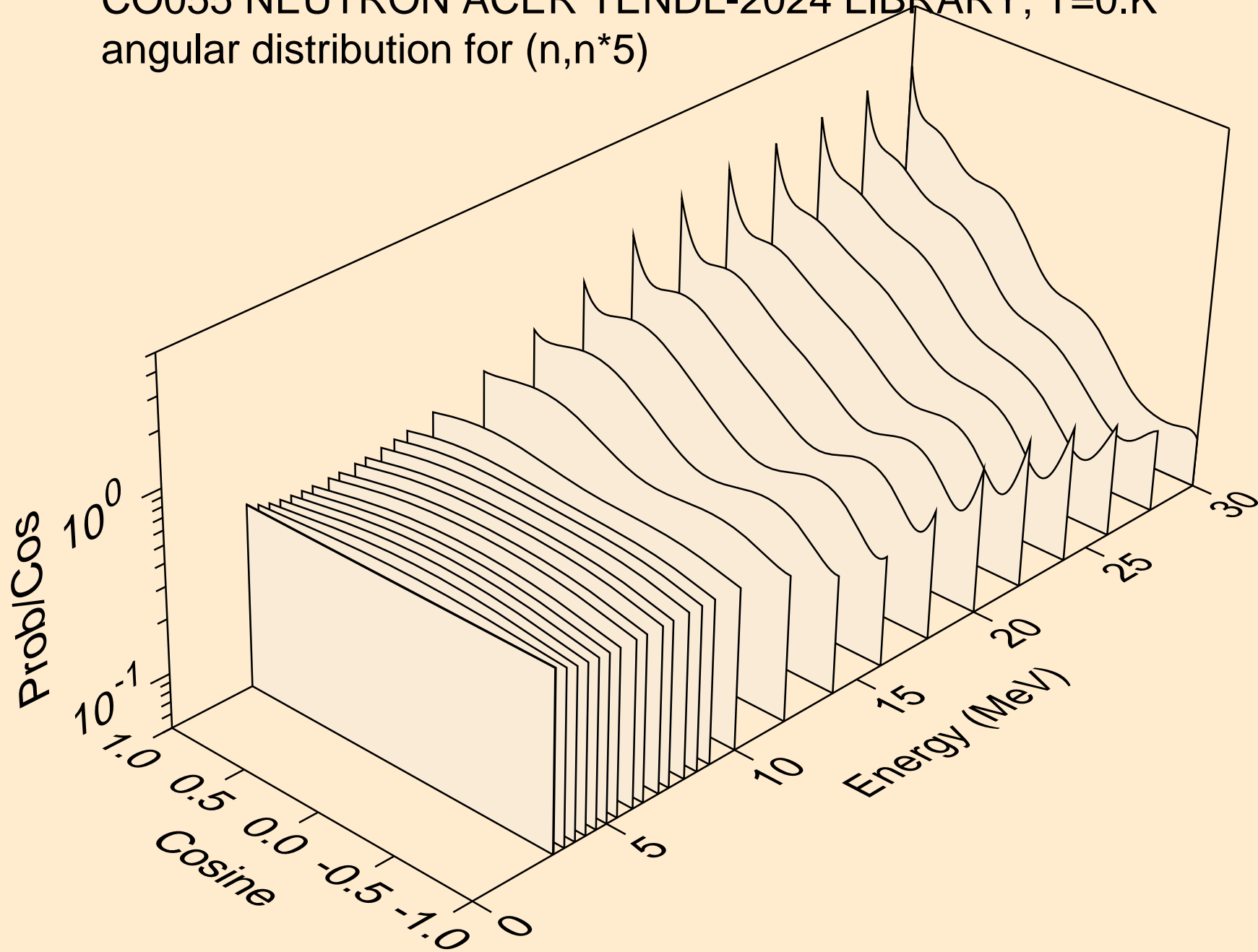

CO055 NEUTRON ACER TENDL-2024 LIBRARY; T=0.K
angular distribution for (n,n*6)

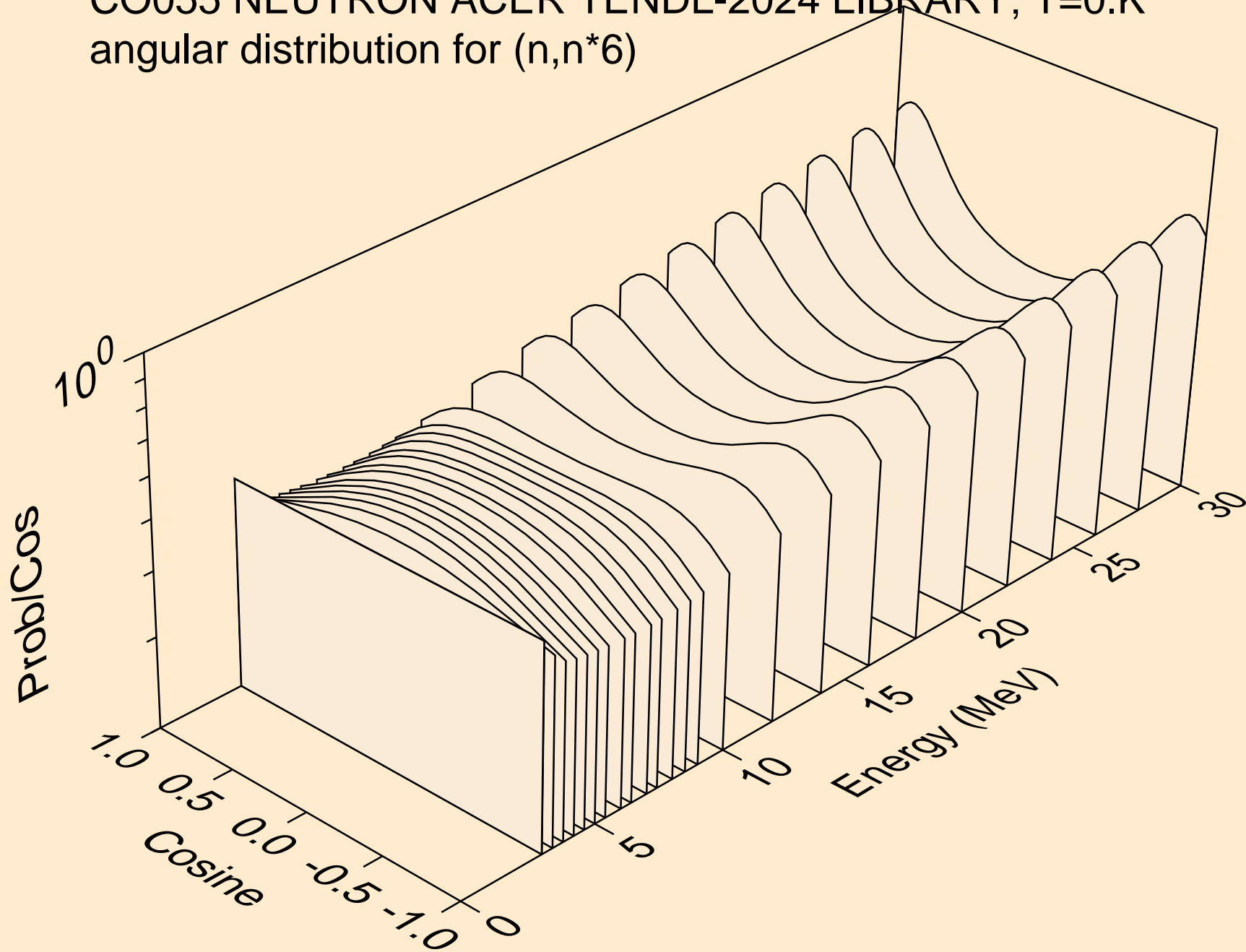

CO055 NEUTRON ACER TENDL-2024 LIBRARY; T=0.K
angular distribution for (n,n*7)

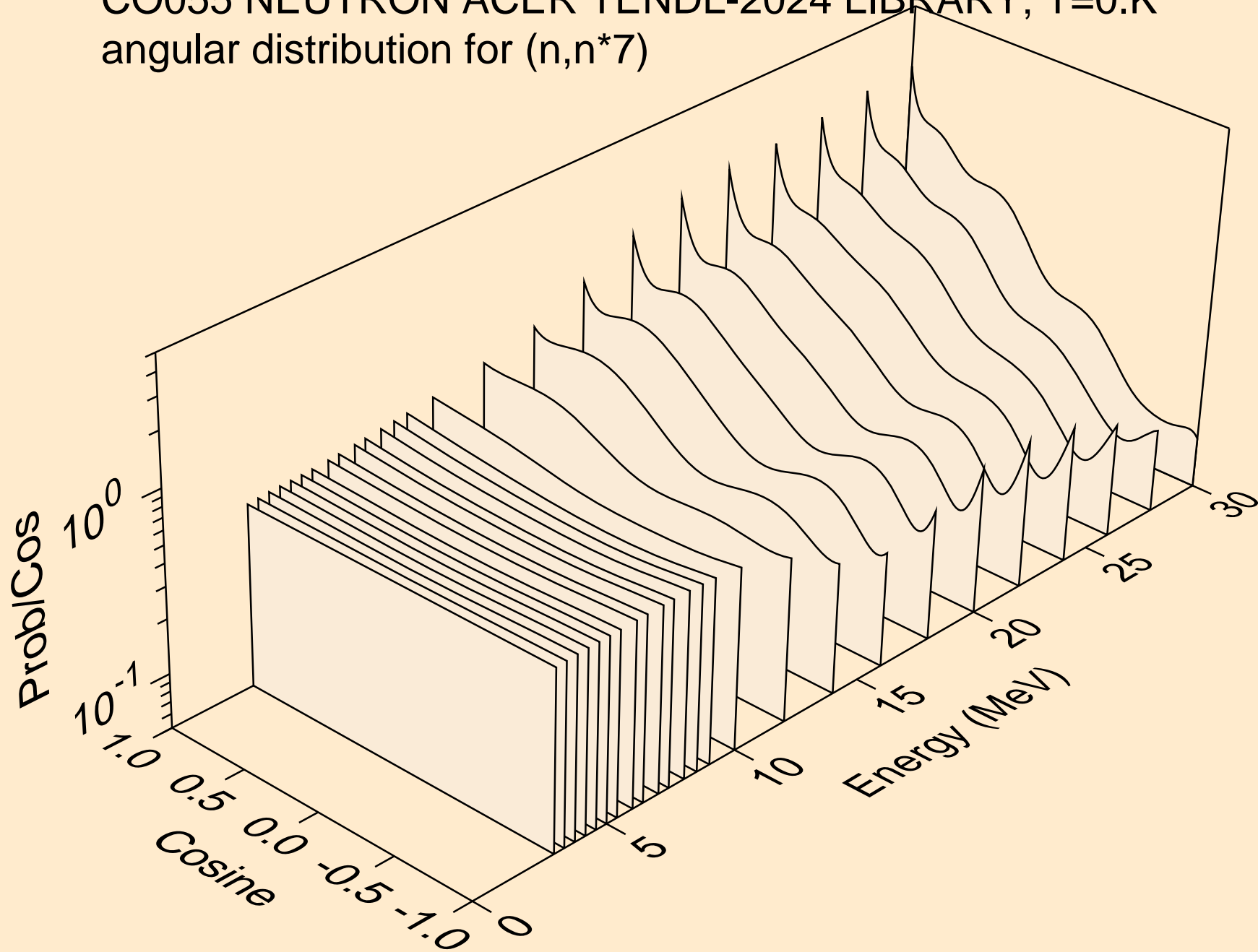

CO055 NEUTRON ACER TENDL-2024 LIBRARY; T=0.K
angular distribution for (n,n*8)

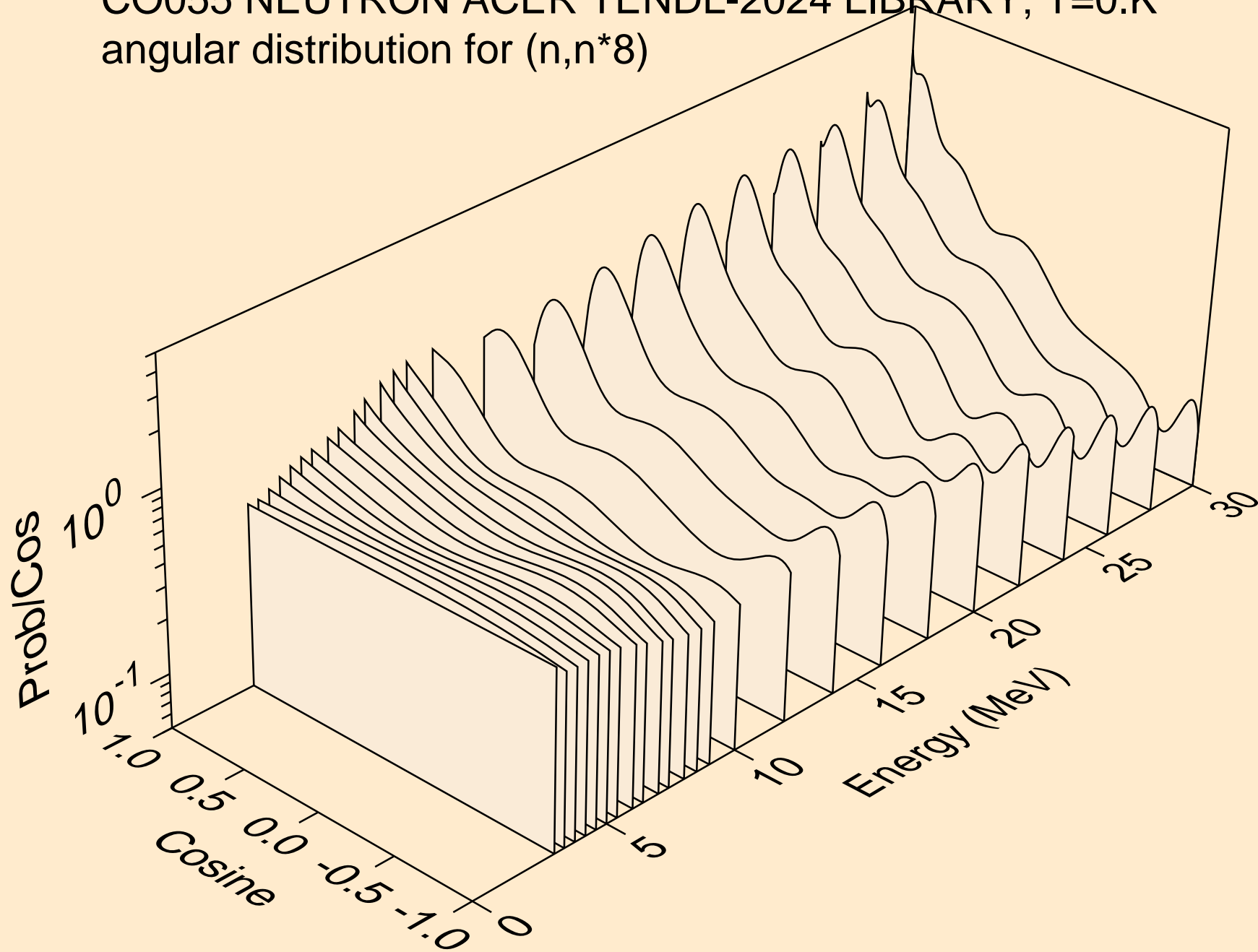

CO055 NEUTRON ACER TENDL-2024 LIBRARY; T=0.K
angular distribution for (n,n*9)

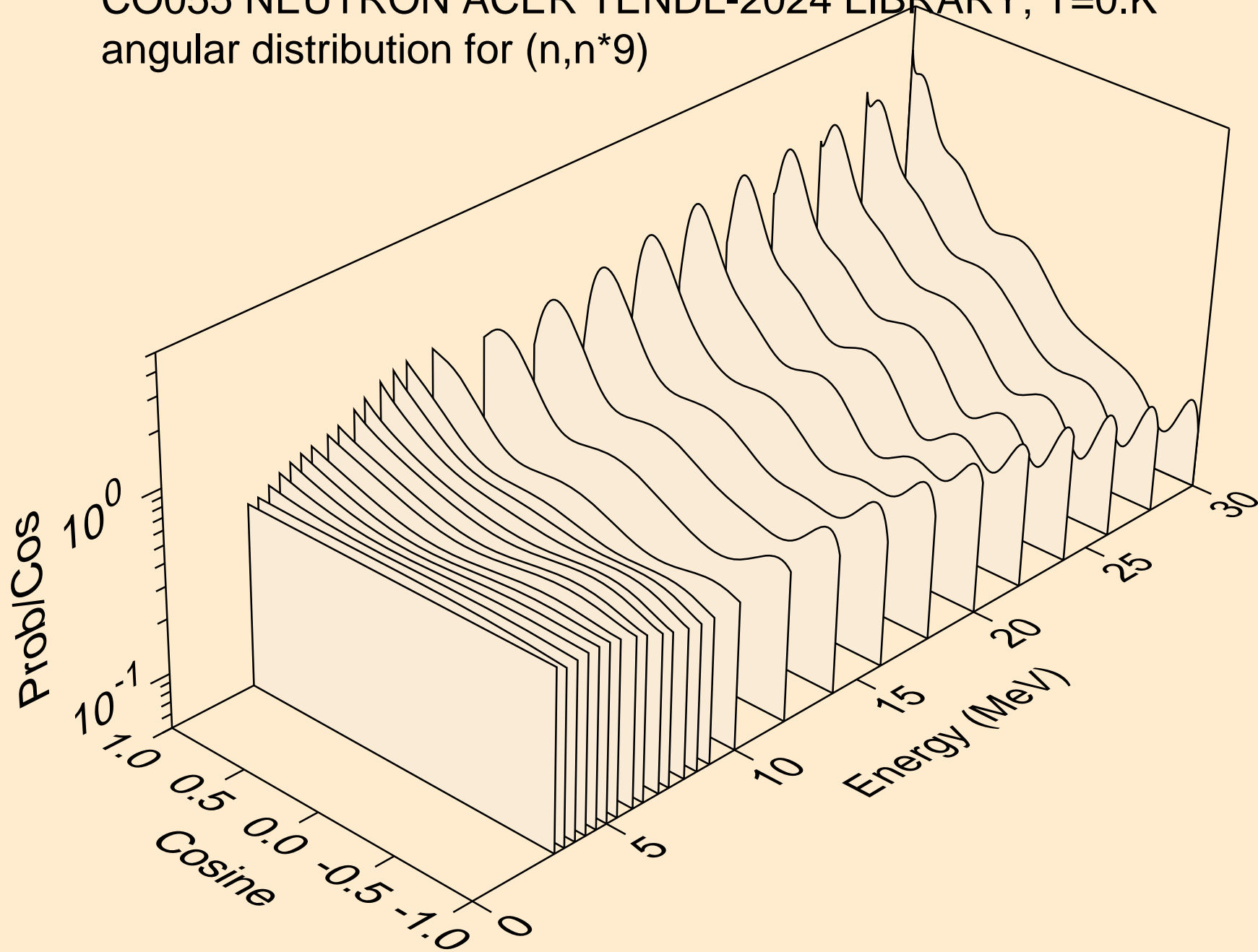

CO055 NEUTRON ACER TENDL-2024 LIBRARY; T=0.K
angular distribution for (n,n*10)

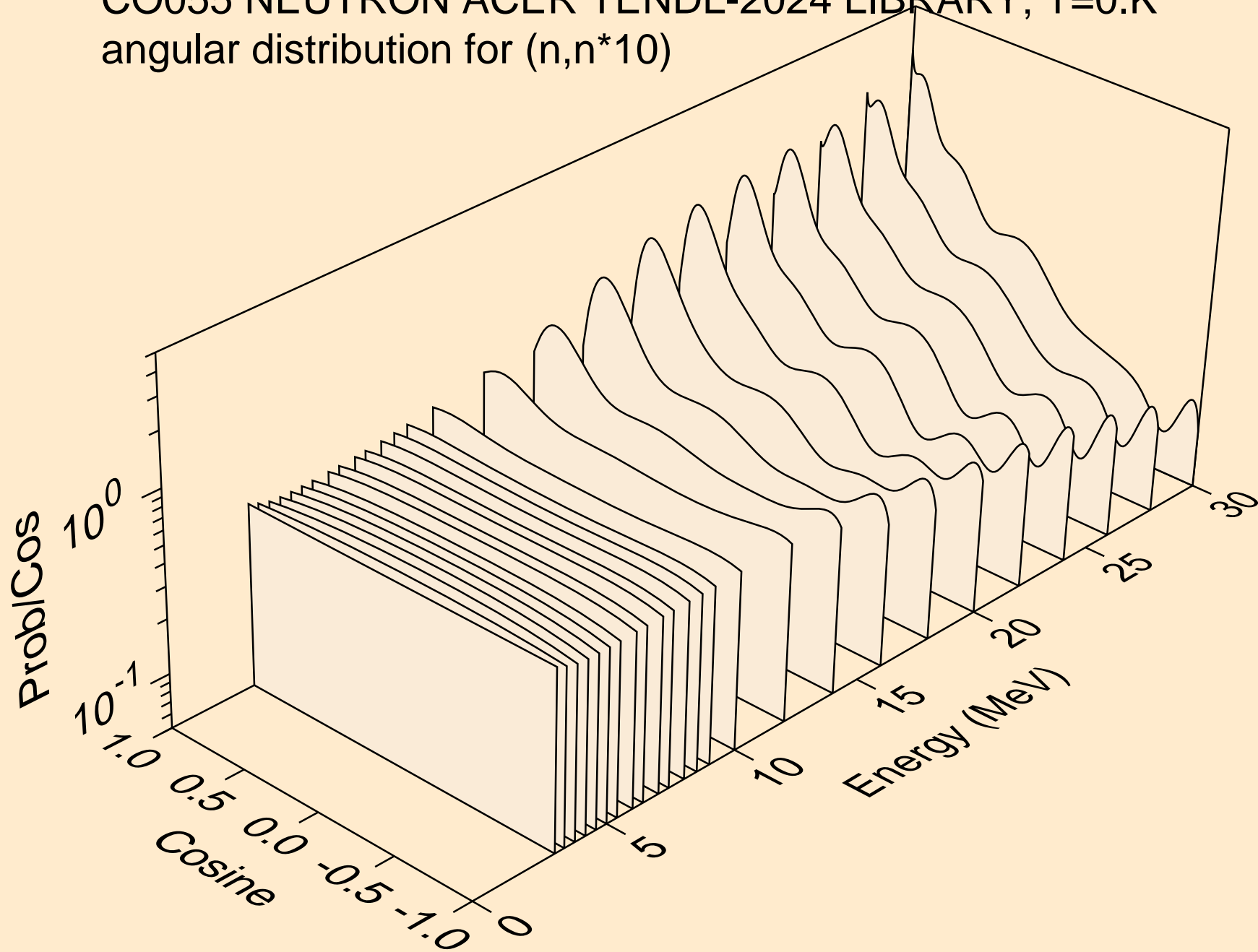

CO055 NEUTRON ACER TENDL-2024 LIBRARY; T=0.K
angular distribution for (n,n*11)

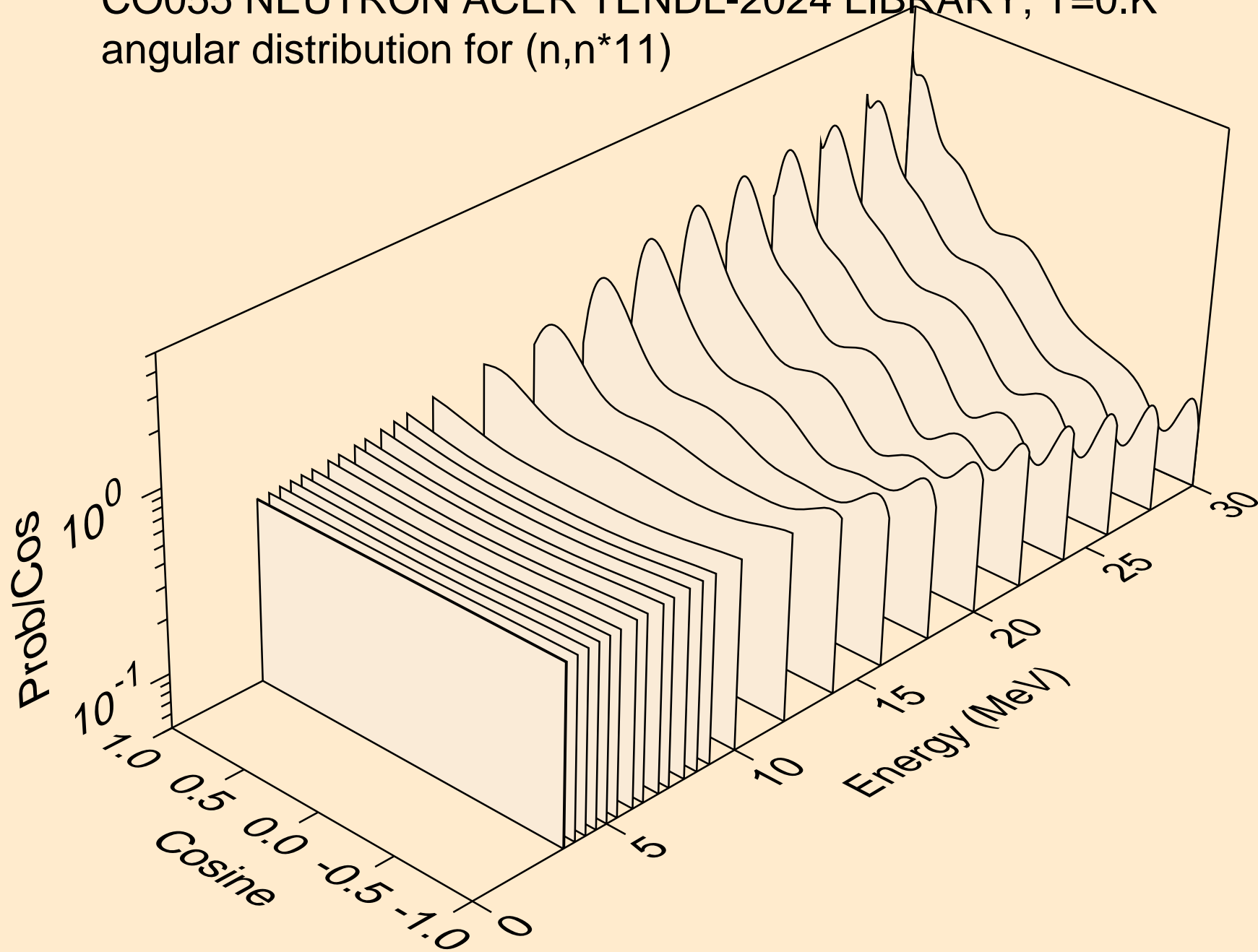

CO055 NEUTRON ACER TENDL-2024 LIBRARY; T=0.K
angular distribution for (n,n*12)

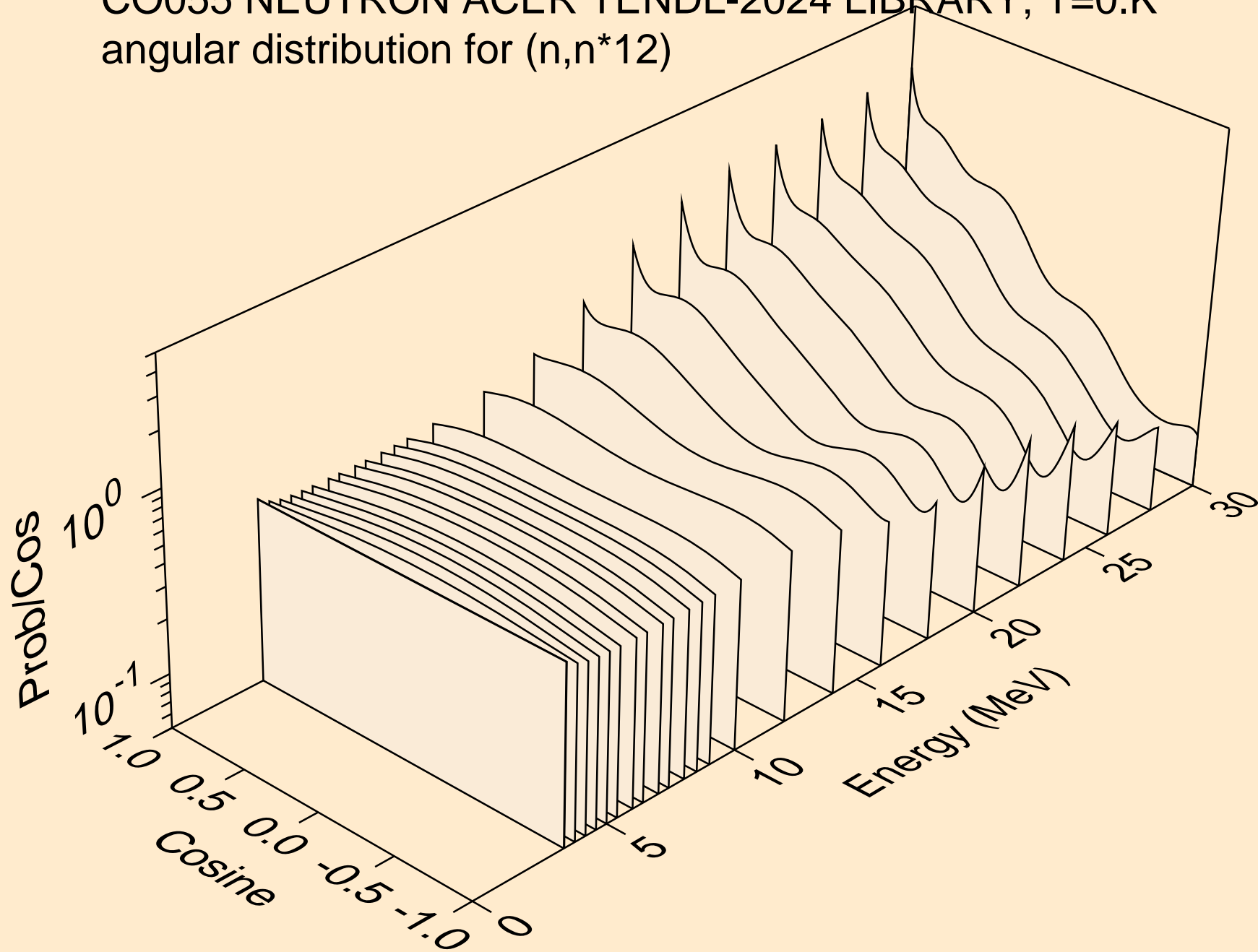

CO055 NEUTRON ACER TENDL-2024 LIBRARY; T=0.K
angular distribution for (n,n*13)

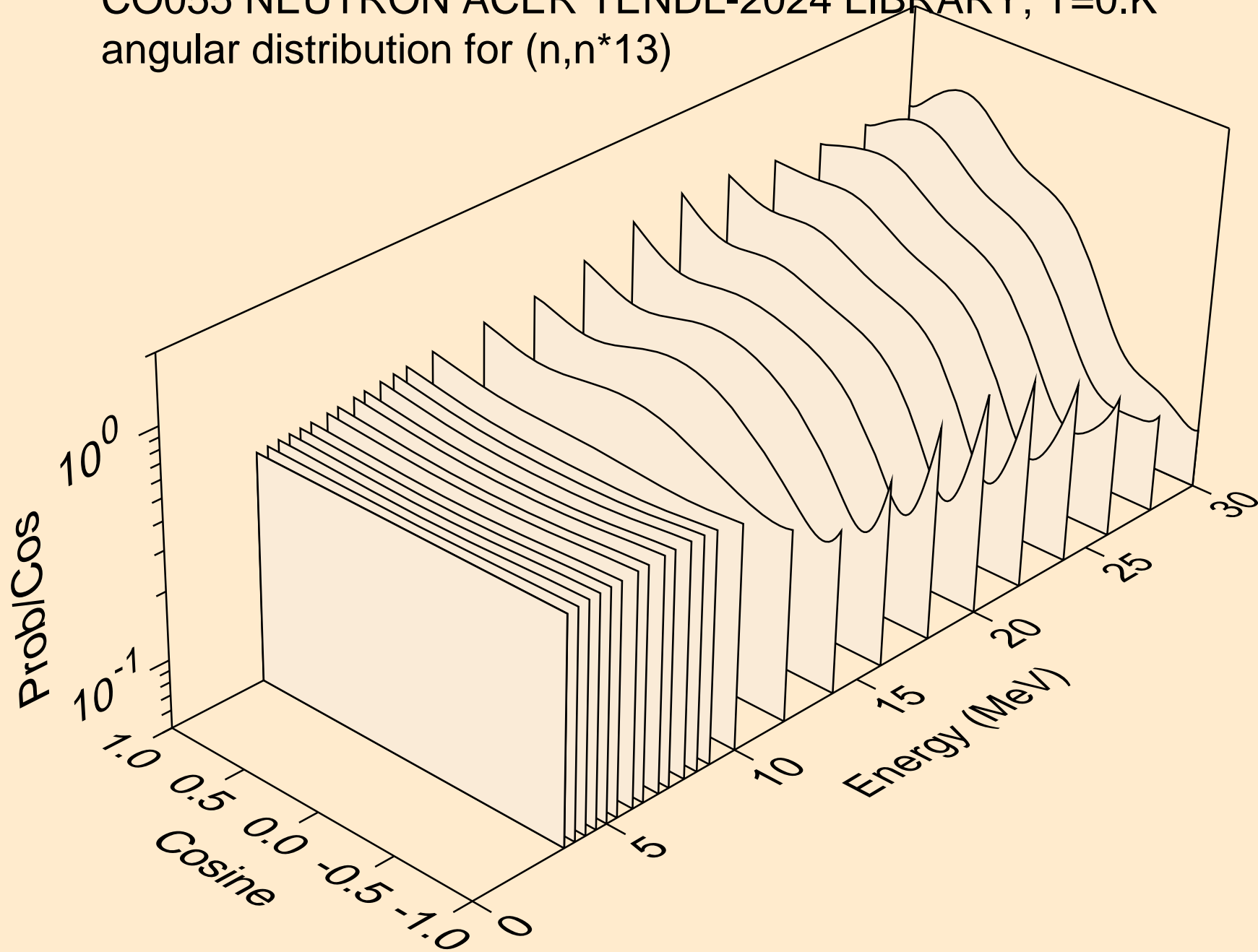

CO055 NEUTRON ACER TENDL-2024 LIBRARY; T=0.K
angular distribution for (n,n*14)

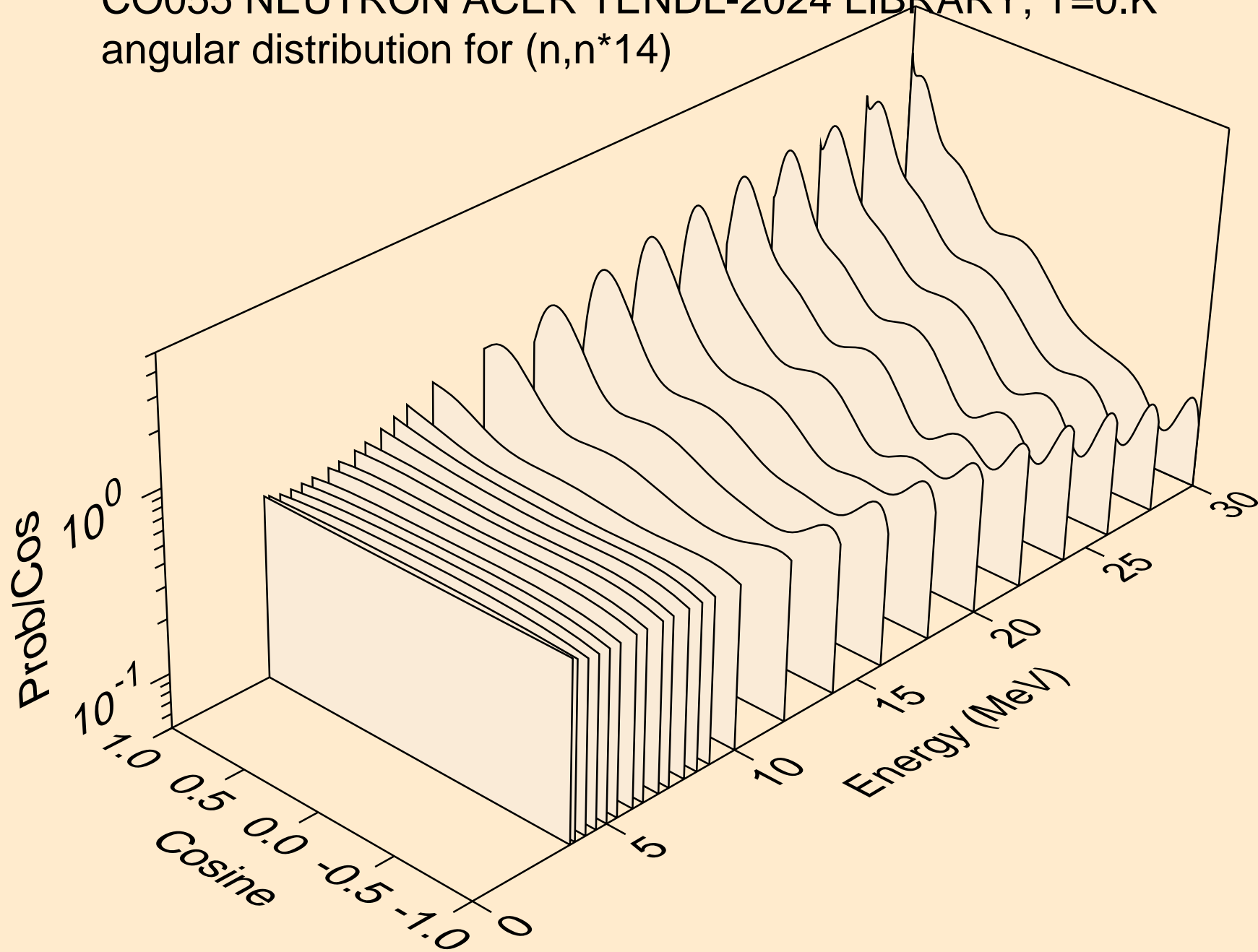

CO055 NEUTRON ACER TENDL-2024 LIBRARY; T=0.K
angular distribution for (n,n*15)

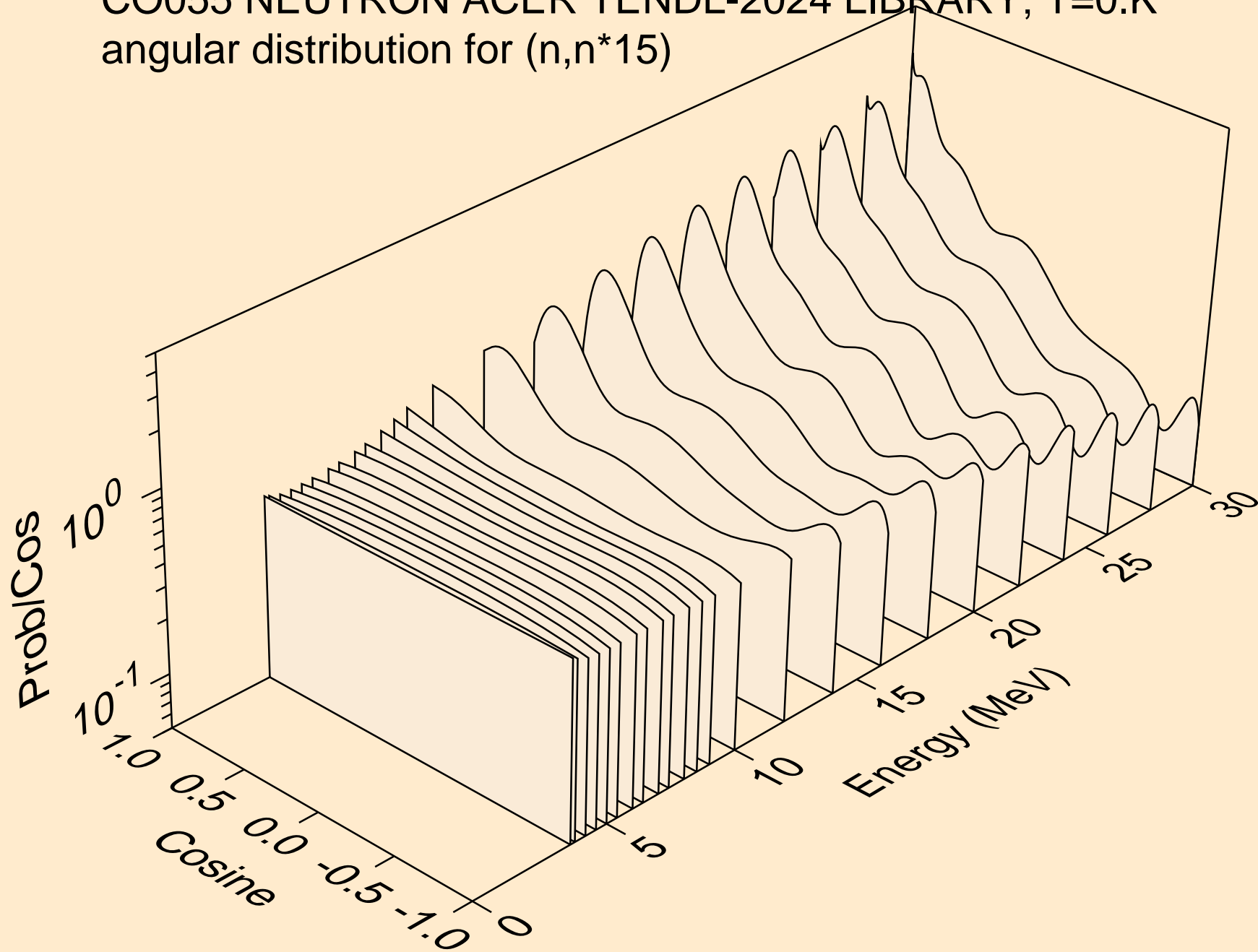

CO055 NEUTRON ACER TENDL-2024 LIBRARY; T=0.K
angular distribution for (n,n*16)

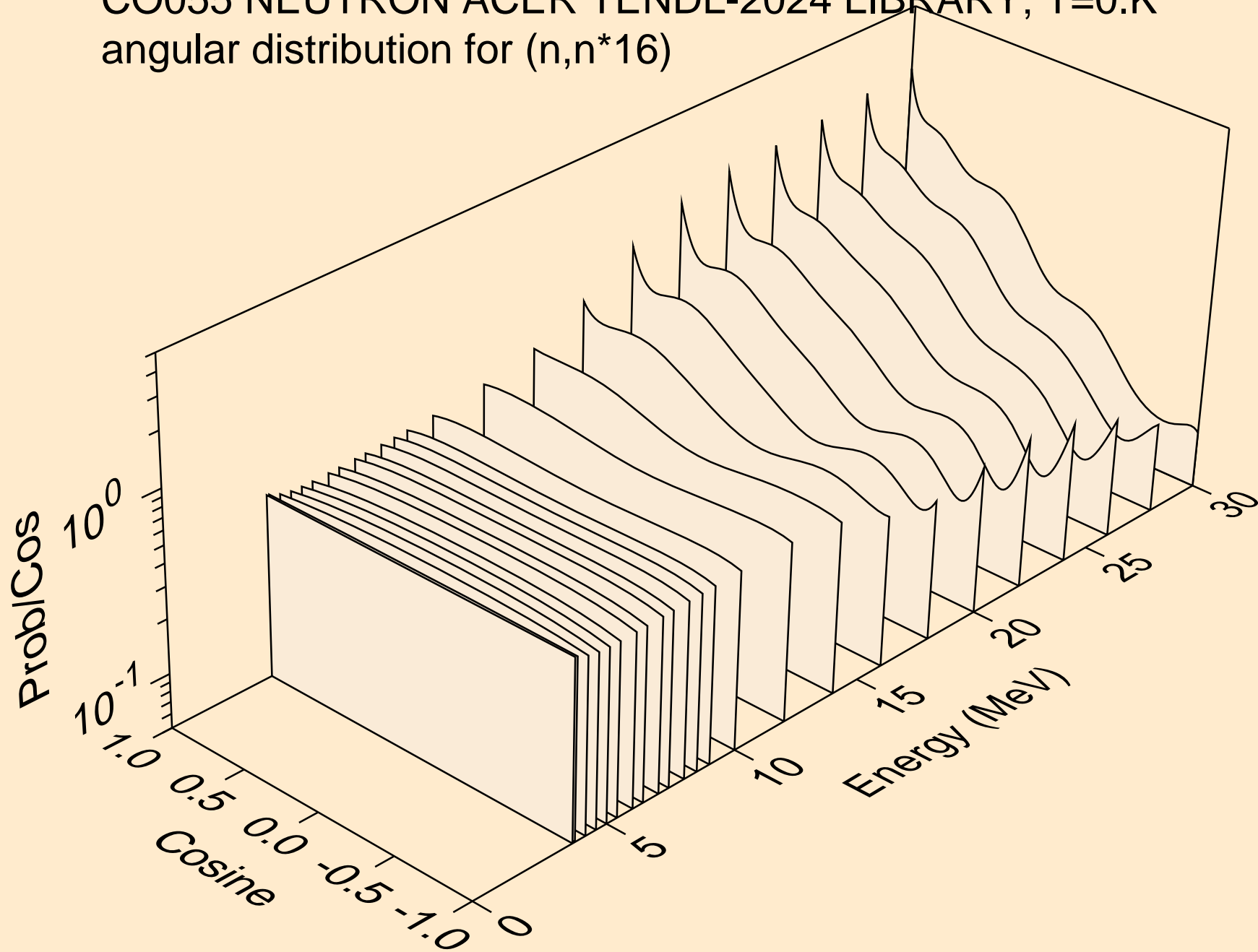

CO055 NEUTRON ACER TENDL-2024 LIBRARY; T=0.K
angular distribution for (n,n*17)

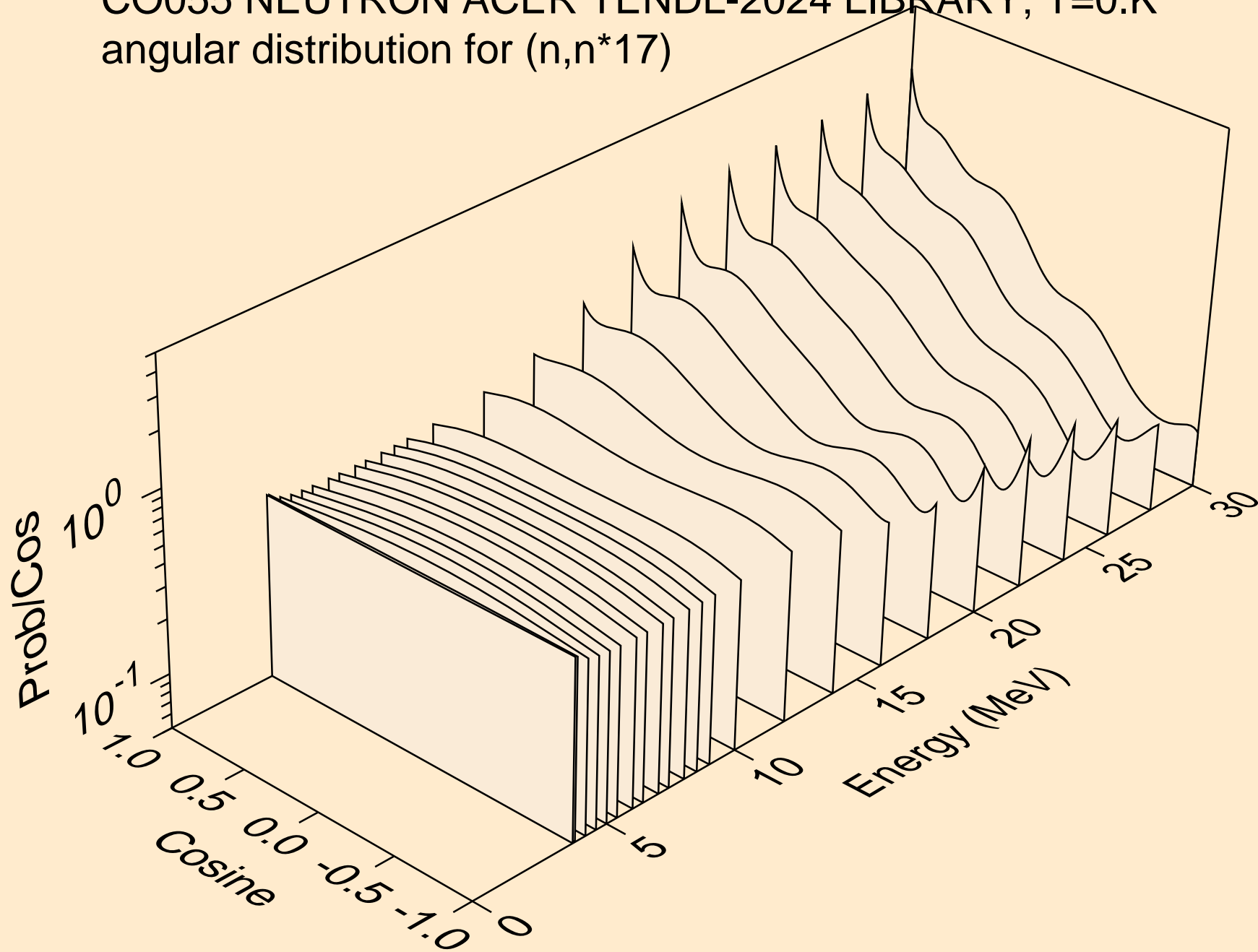

CO055 NEUTRON ACER TENDL-2024 LIBRARY; T=0.K
angular distribution for (n,n*18)

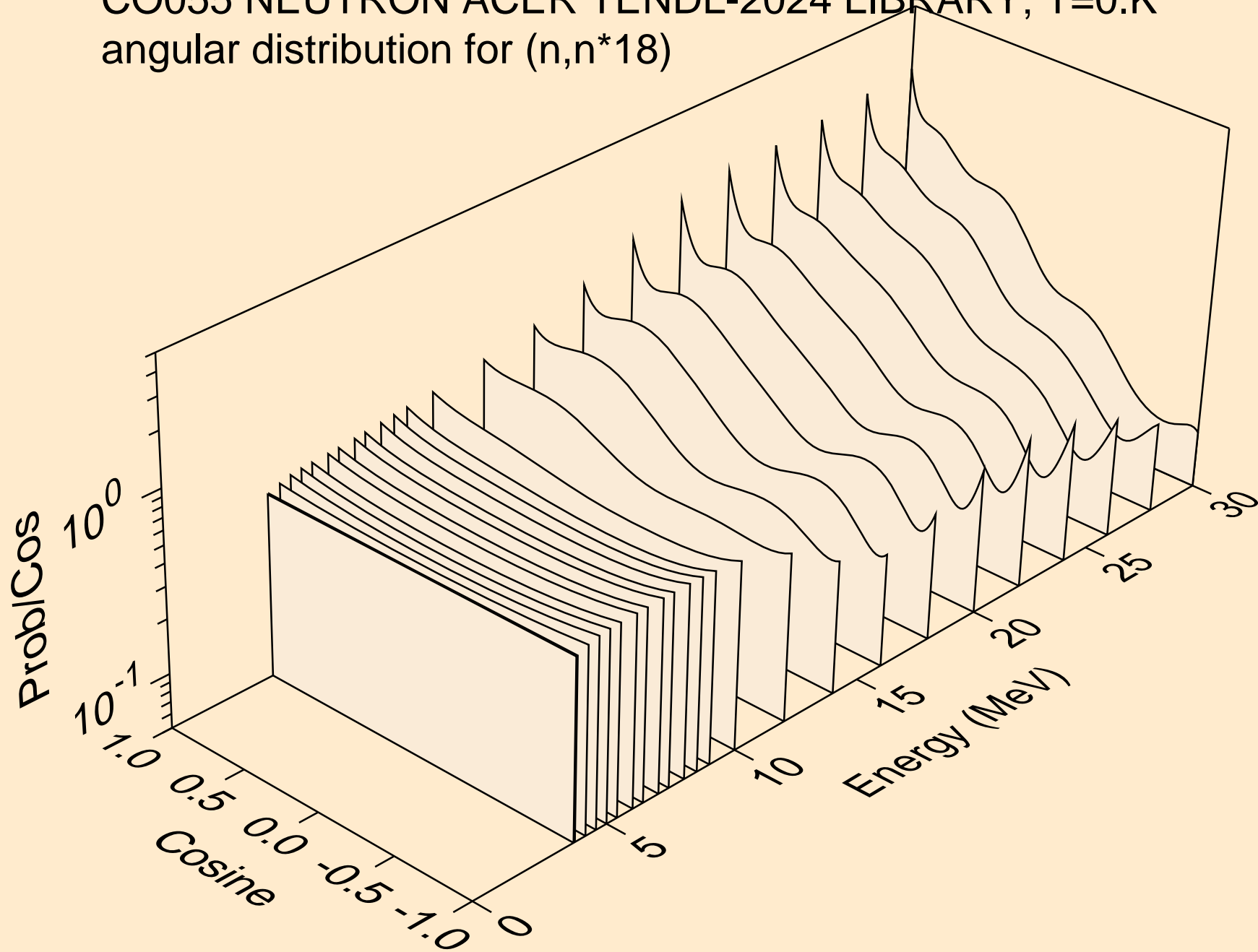

CO055 NEUTRON ACER TENDL-2024 LIBRARY; T=0.K
angular distribution for (n,n*19)

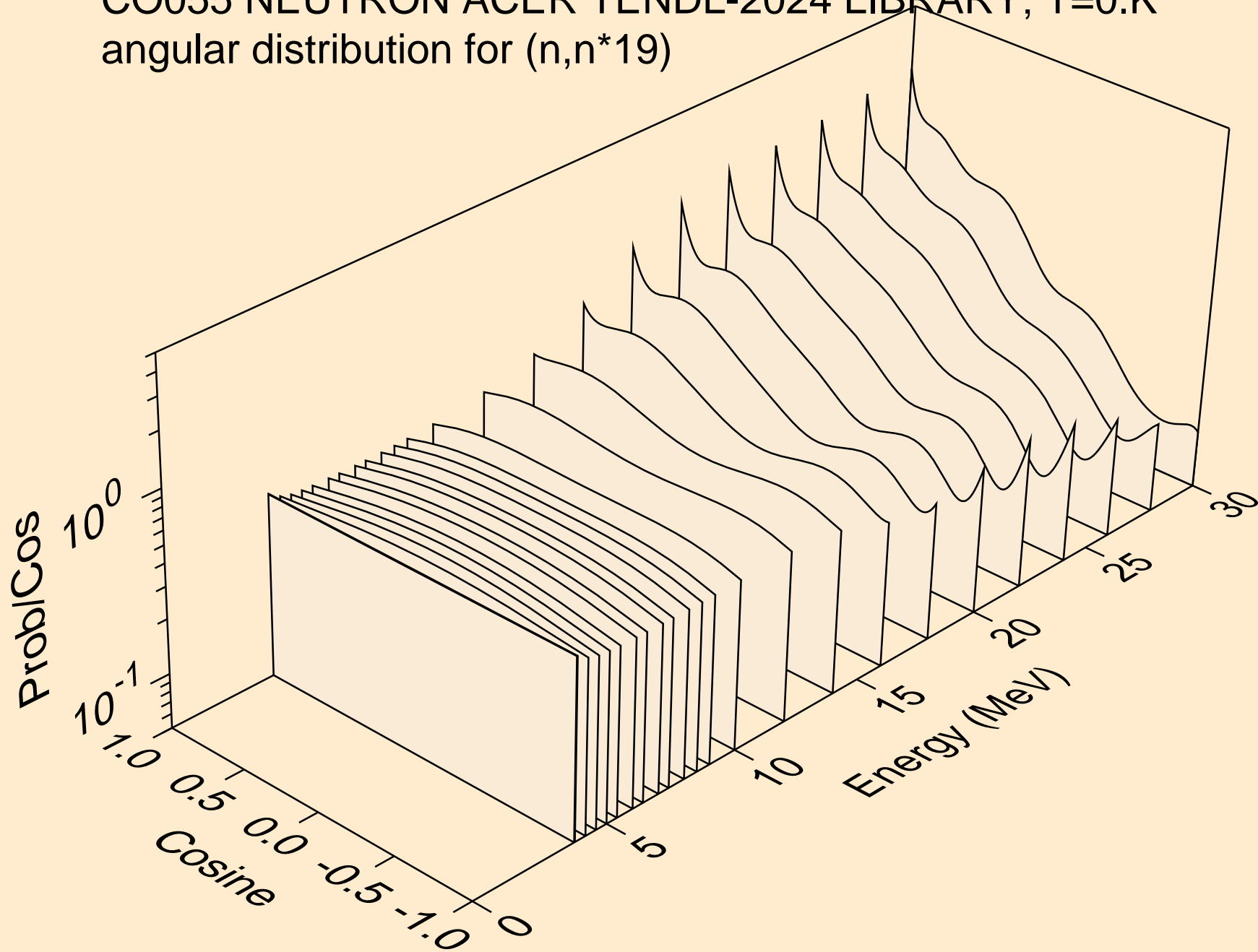

CO055 NEUTRON ACER TENDL-2024 LIBRARY; T=0.K
angular distribution for (n,n*20)

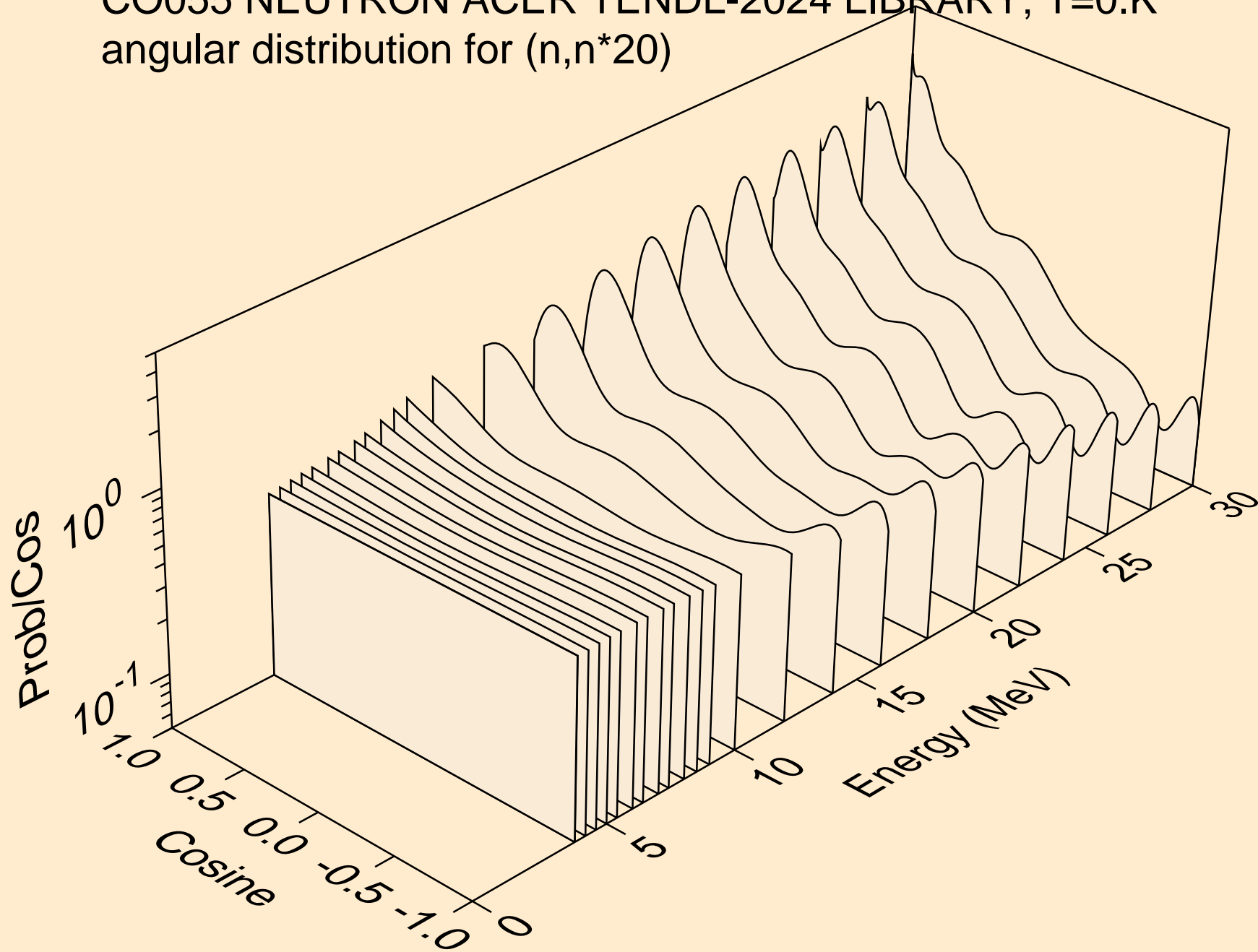

CO055 NEUTRON ACER TENDL-2024 LIBRARY; T=0.K
angular distribution for (n,n*21)

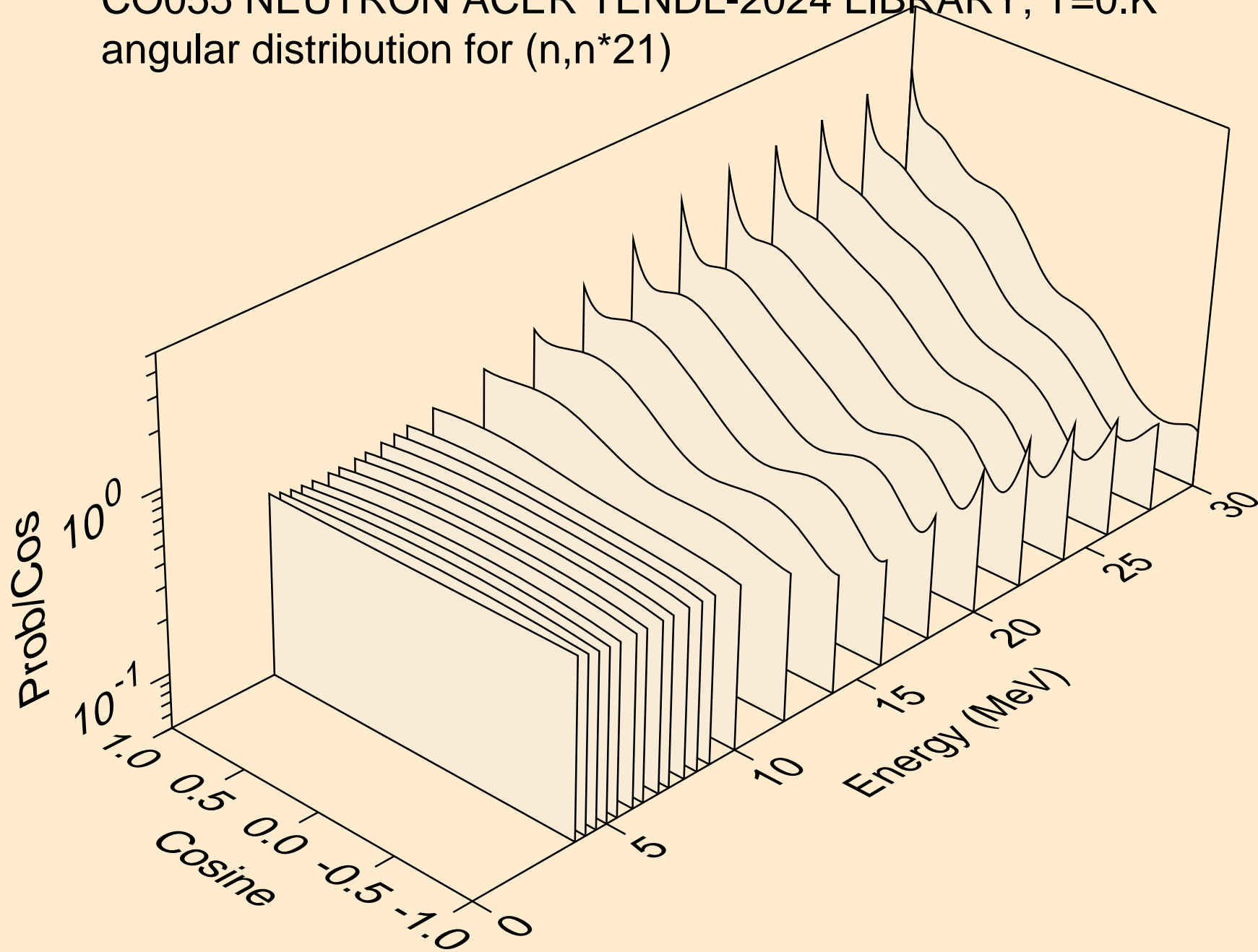

CO055 NEUTRON ACER TENDL-2024 LIBRARY; T=0.K
angular distribution for (n,n*22)

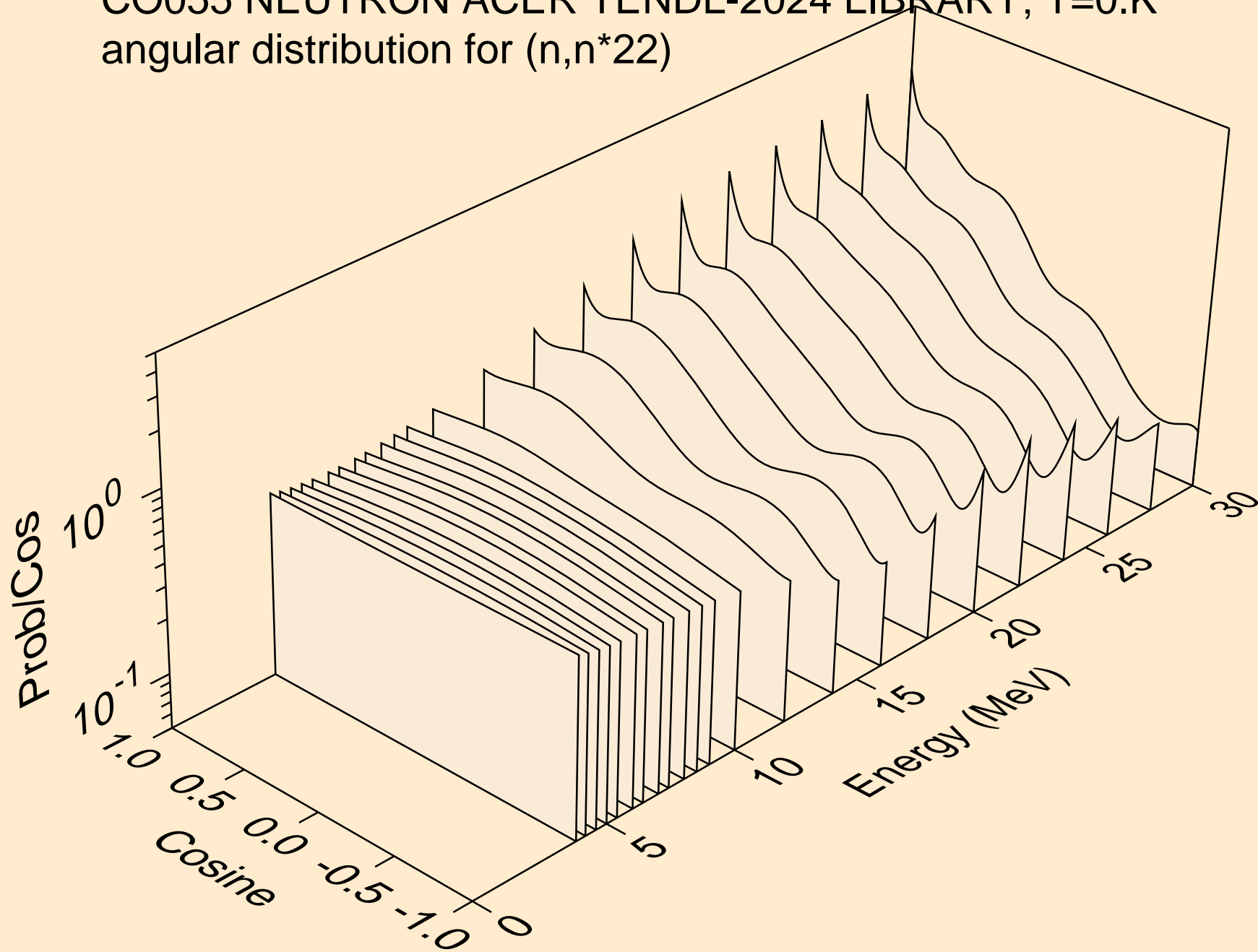

CO055 NEUTRON ACER TENDL-2024 LIBRARY; T=0.K
angular distribution for (n,n*23)

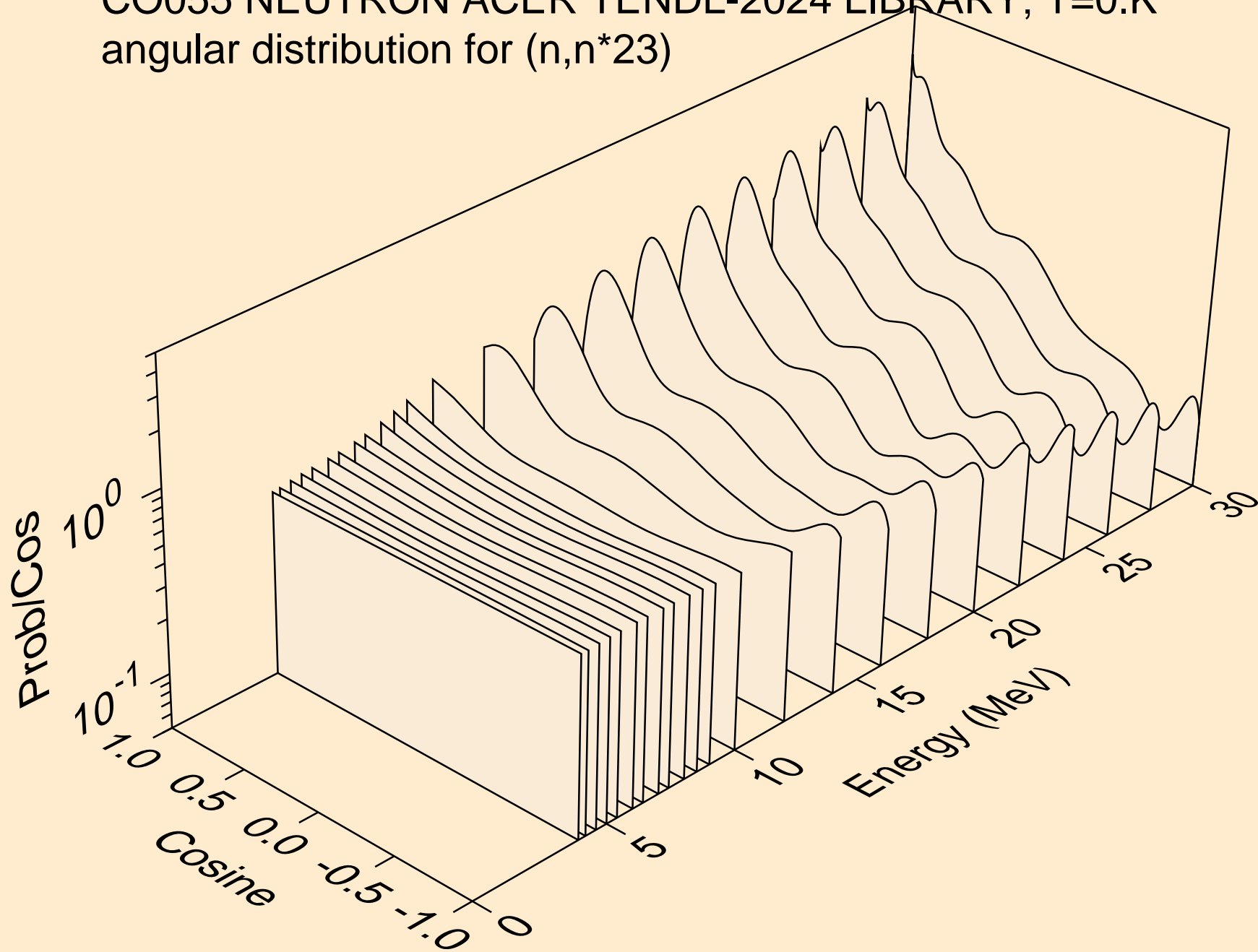

CO055 NEUTRON ACER TENDL-2024 LIBRARY; T=0.K
angular distribution for (n,n*24)

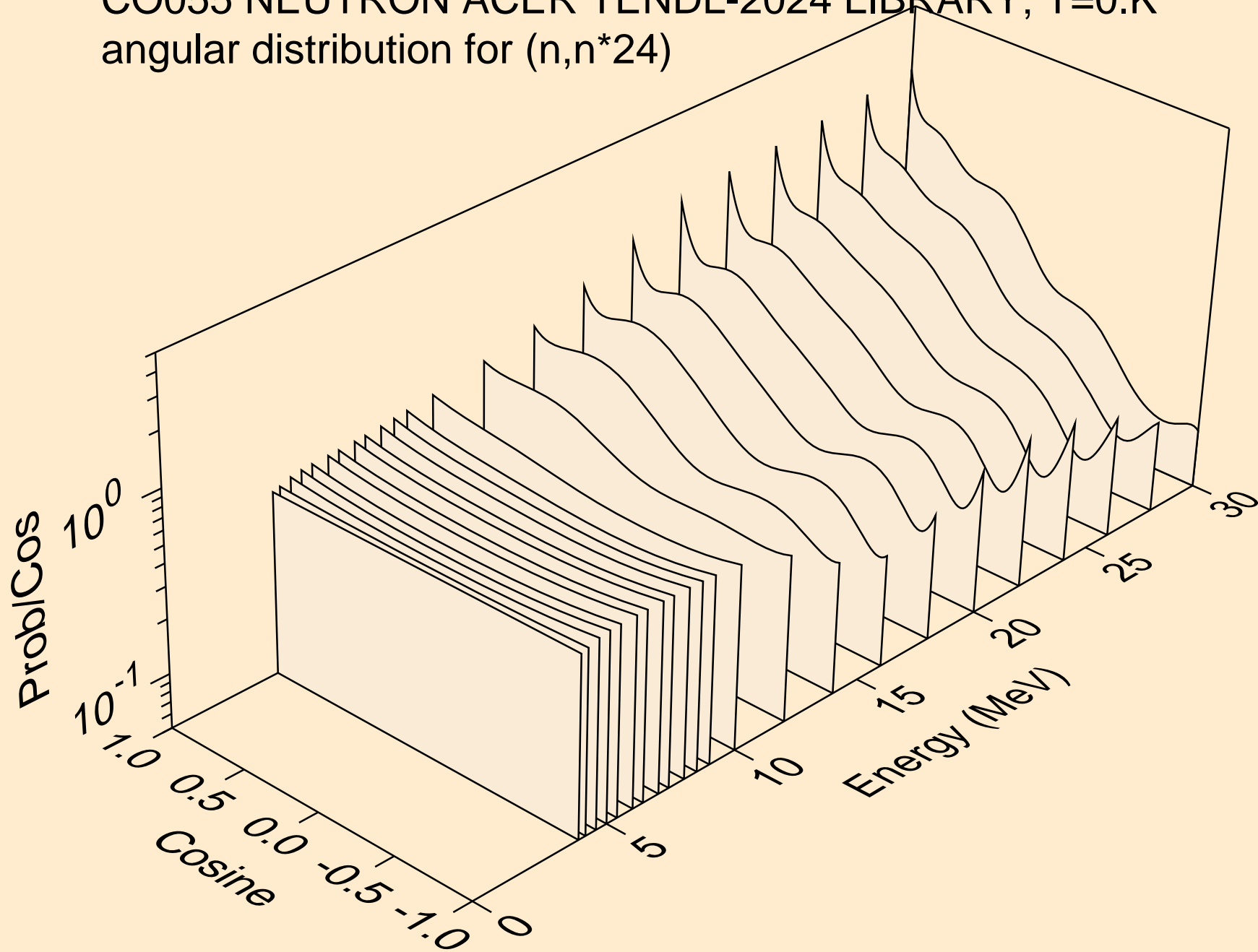

CO055 NEUTRON ACER TENDL-2024 LIBRARY; T=0.K
angular distribution for (n,n*25)

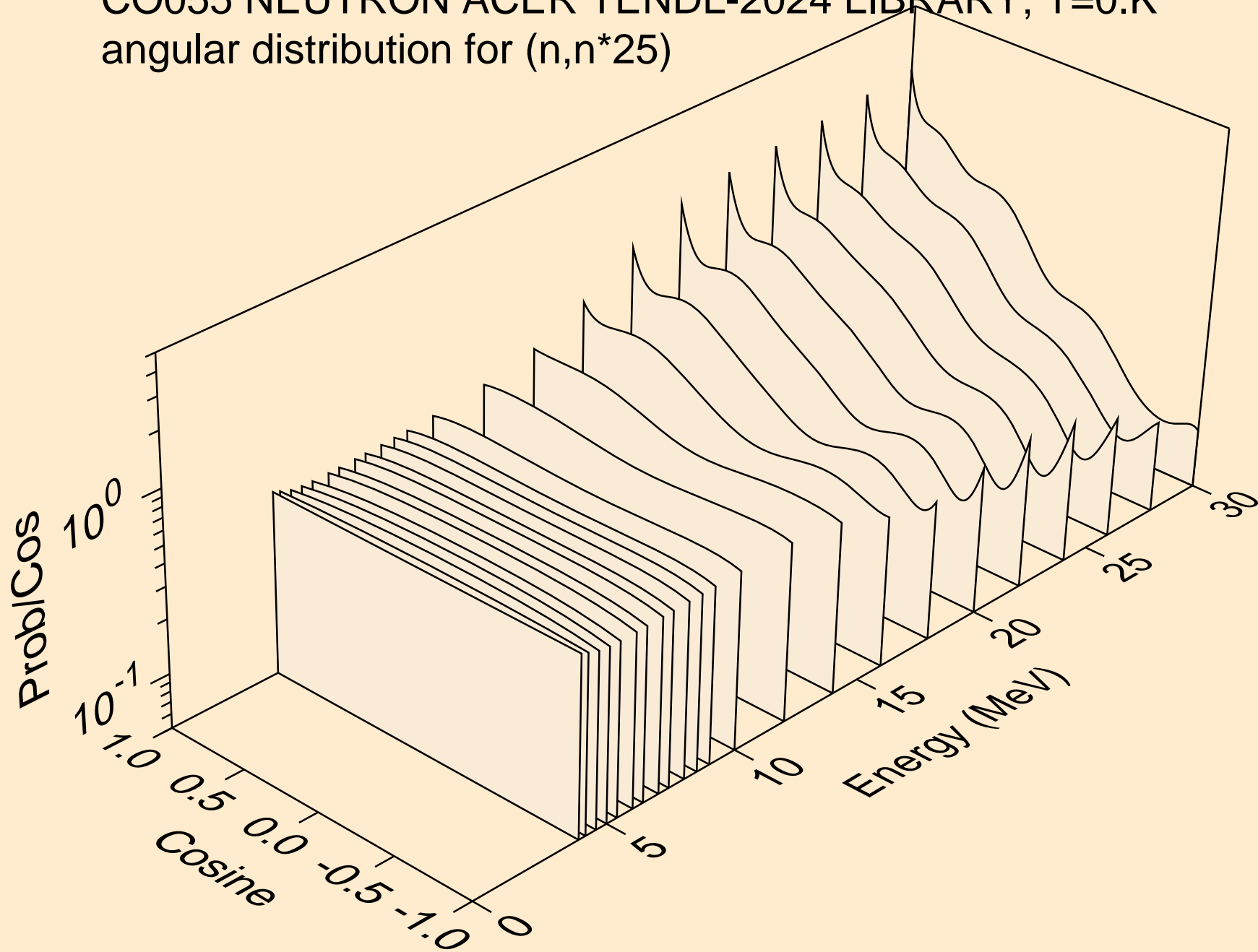

CO055 NEUTRON ACER TENDL-2024 LIBRARY; T=0.K
angular distribution for (n,n*26)

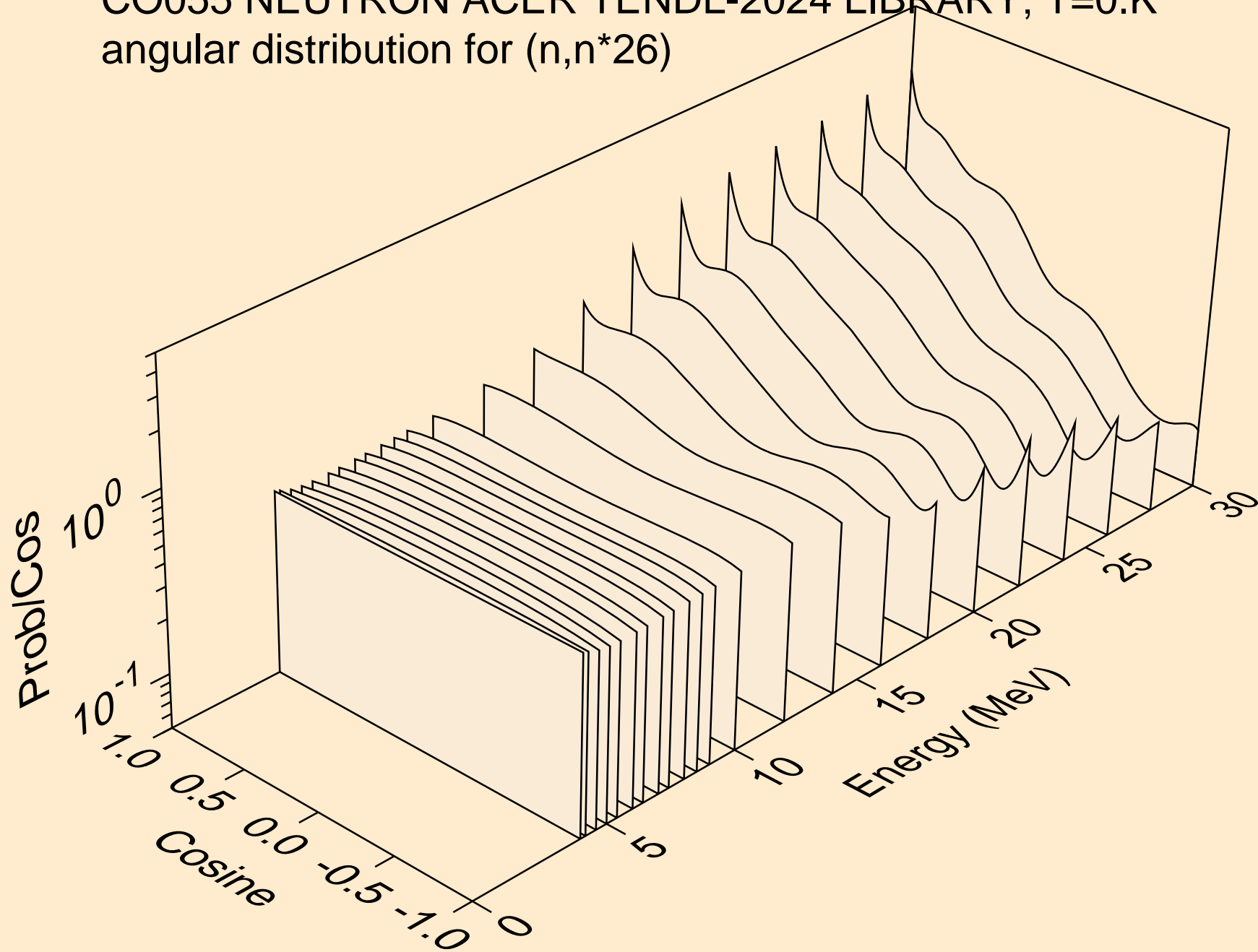

CO055 NEUTRON ACER TENDL-2024 LIBRARY; T=0.K
angular distribution for (n,n*27)

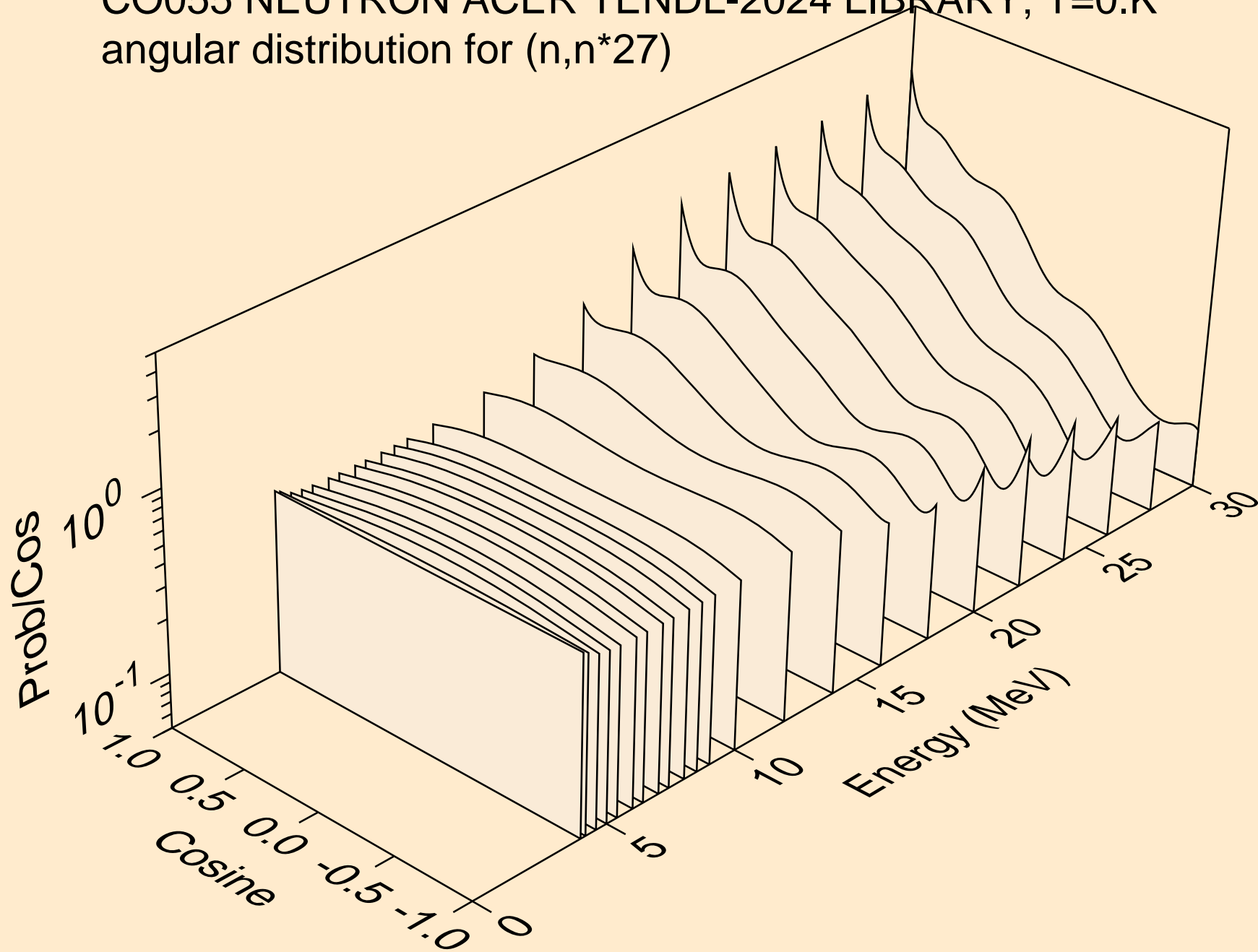

CO055 NEUTRON ACER TENDL-2024 LIBRARY; T=0.K
angular distribution for (n,n*28)

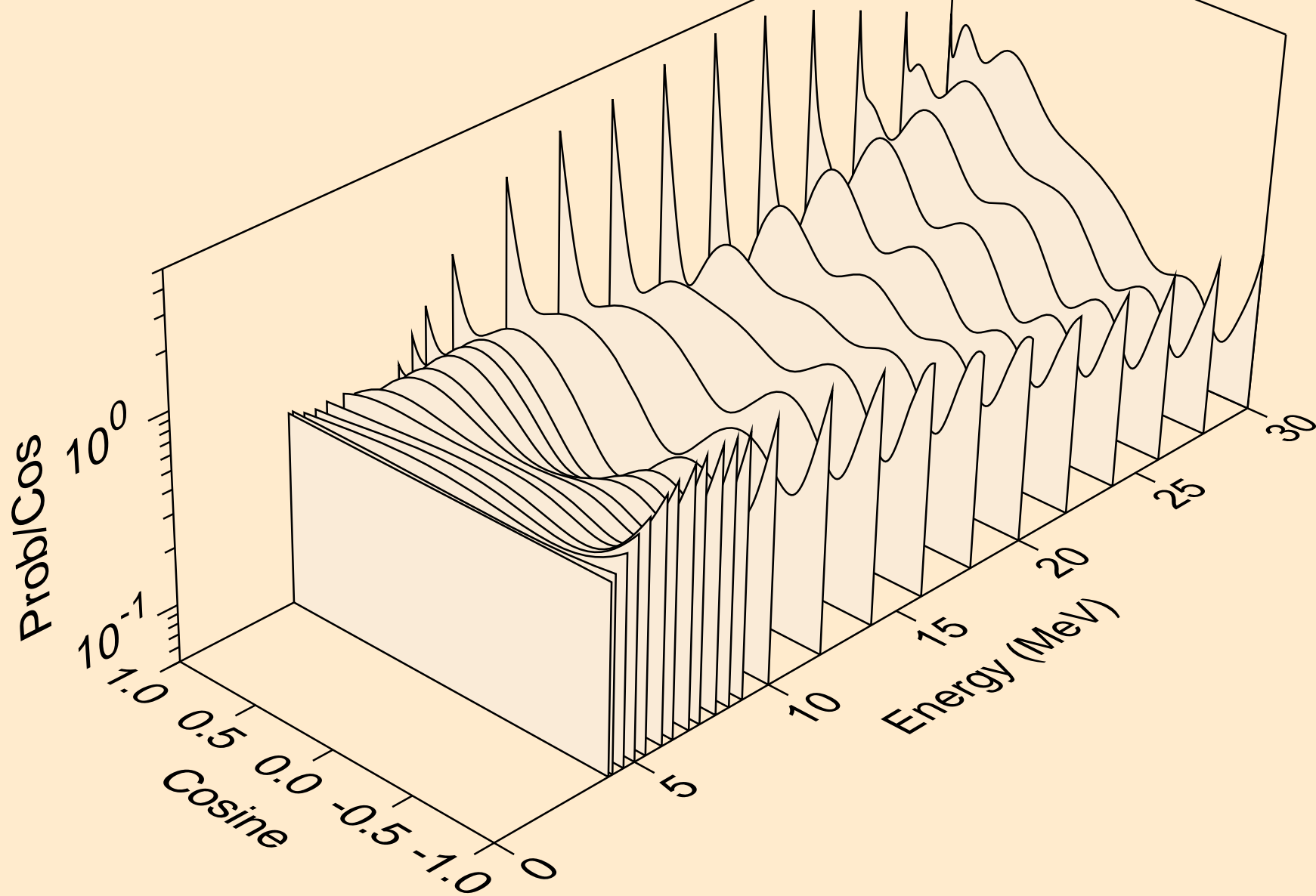

CO055 NEUTRON ACER TENDL-2024 LIBRARY; T=0.K
Neutron emission for (n,x)

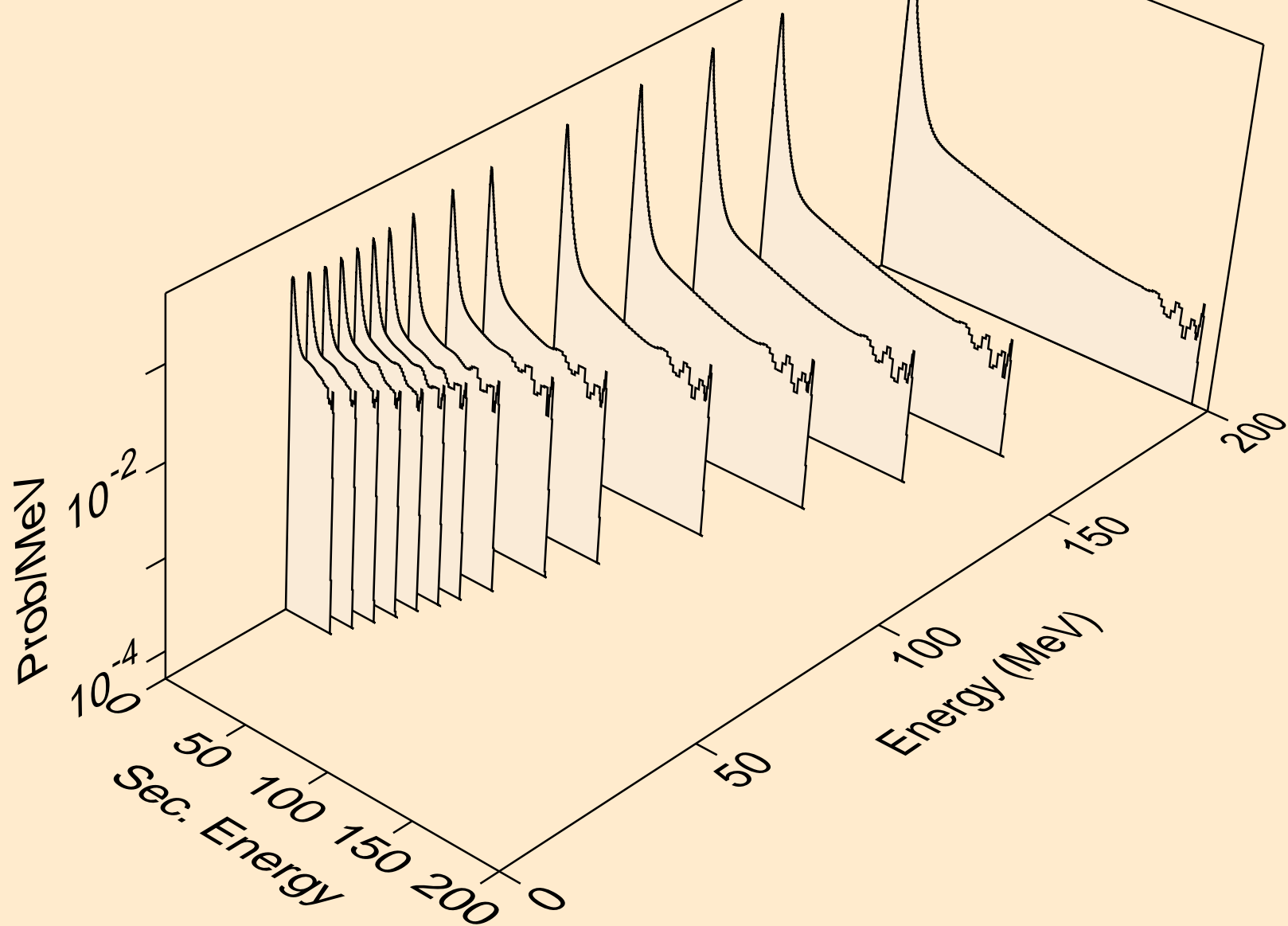

CO055 NEUTRON ACER TENDL-2024 LIBRARY; T=0.K
Neutron emission for (n,2nd)

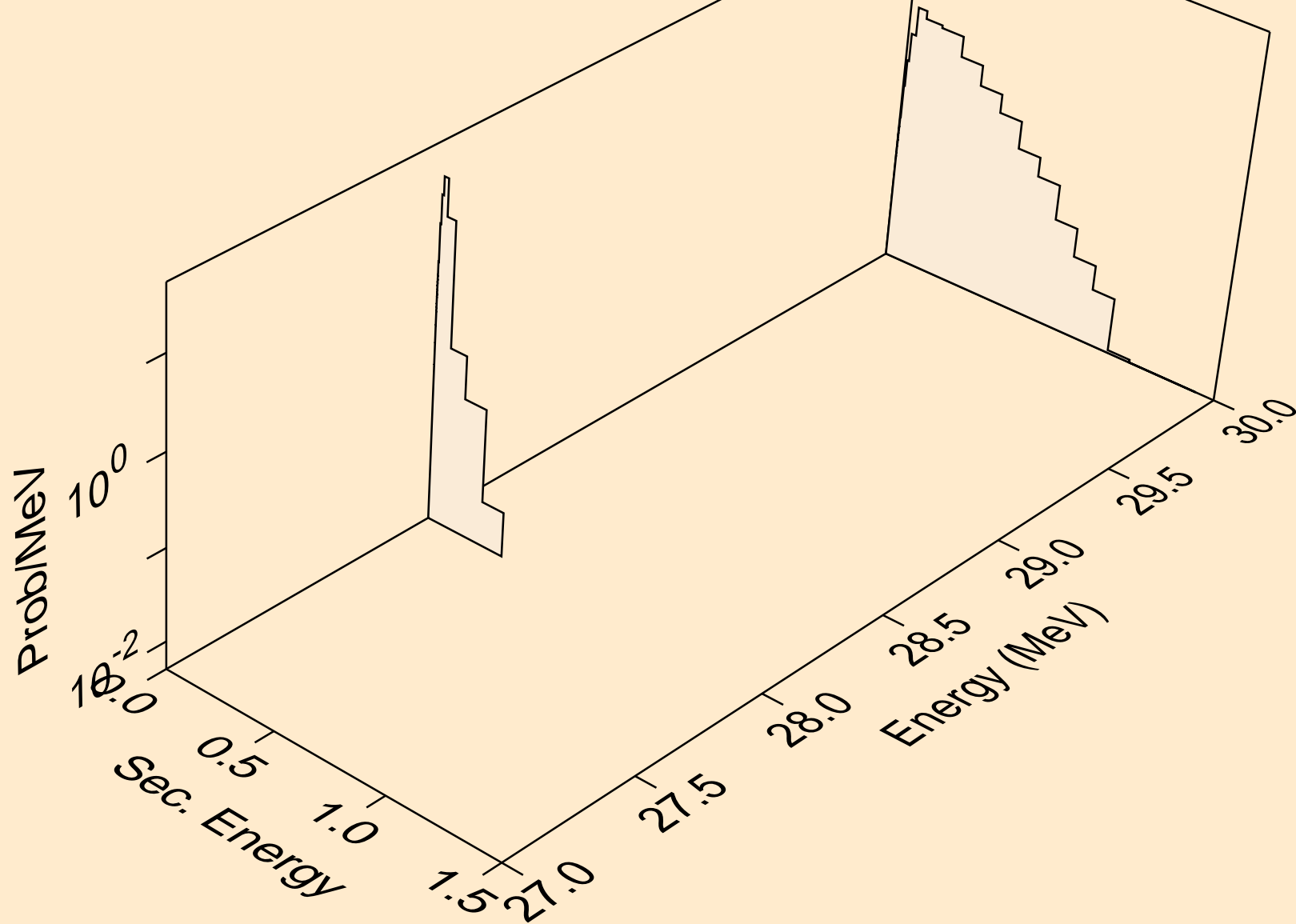

CO055 NEUTRON ACER TENDL-2024 LIBRARY; T=0.K
Neutron emission for (n,2n)

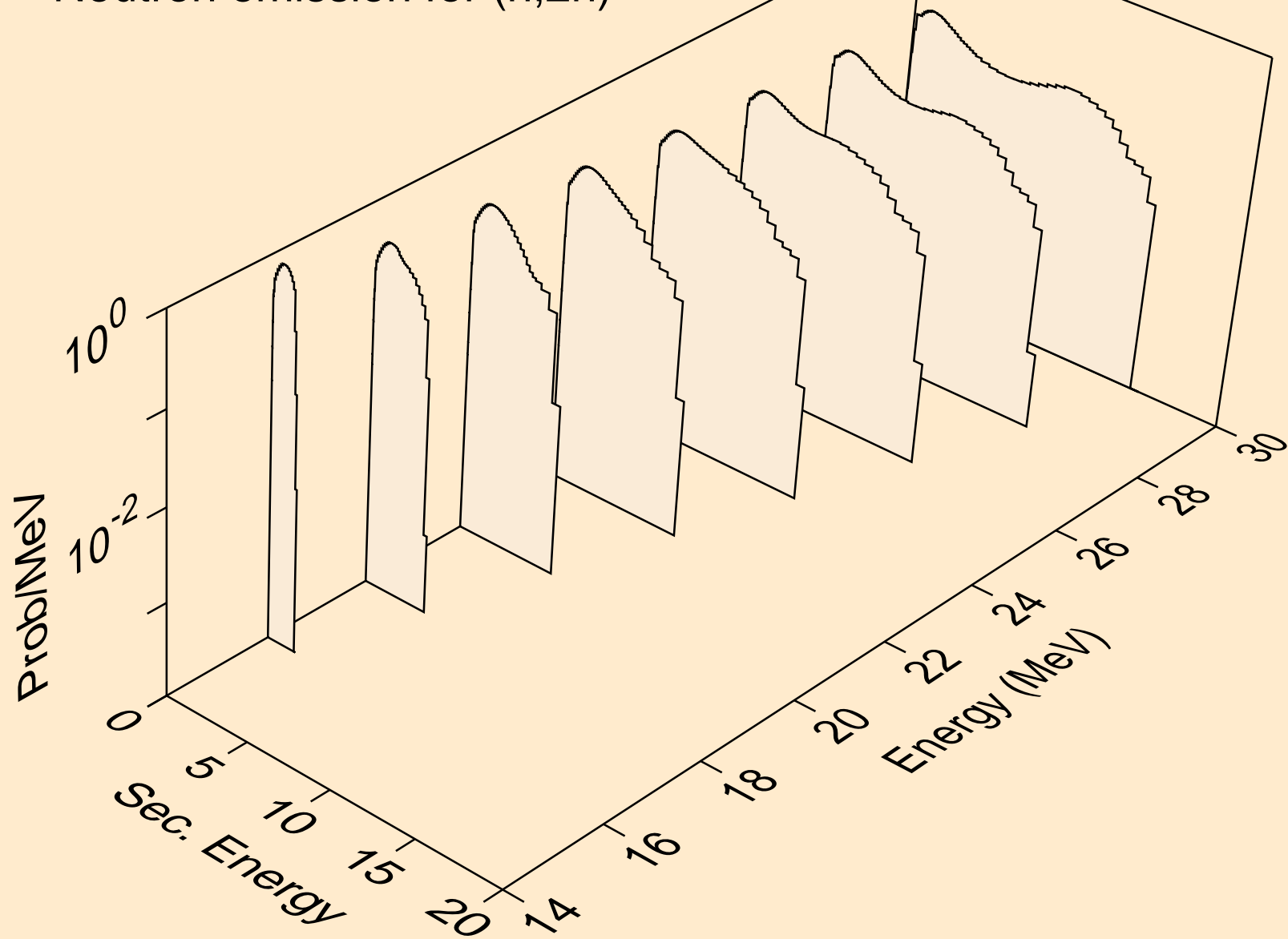

CO055 NEUTRON ACER TENDL-2024 LIBRARY; T=0.K
Neutron emission for (n,3n)

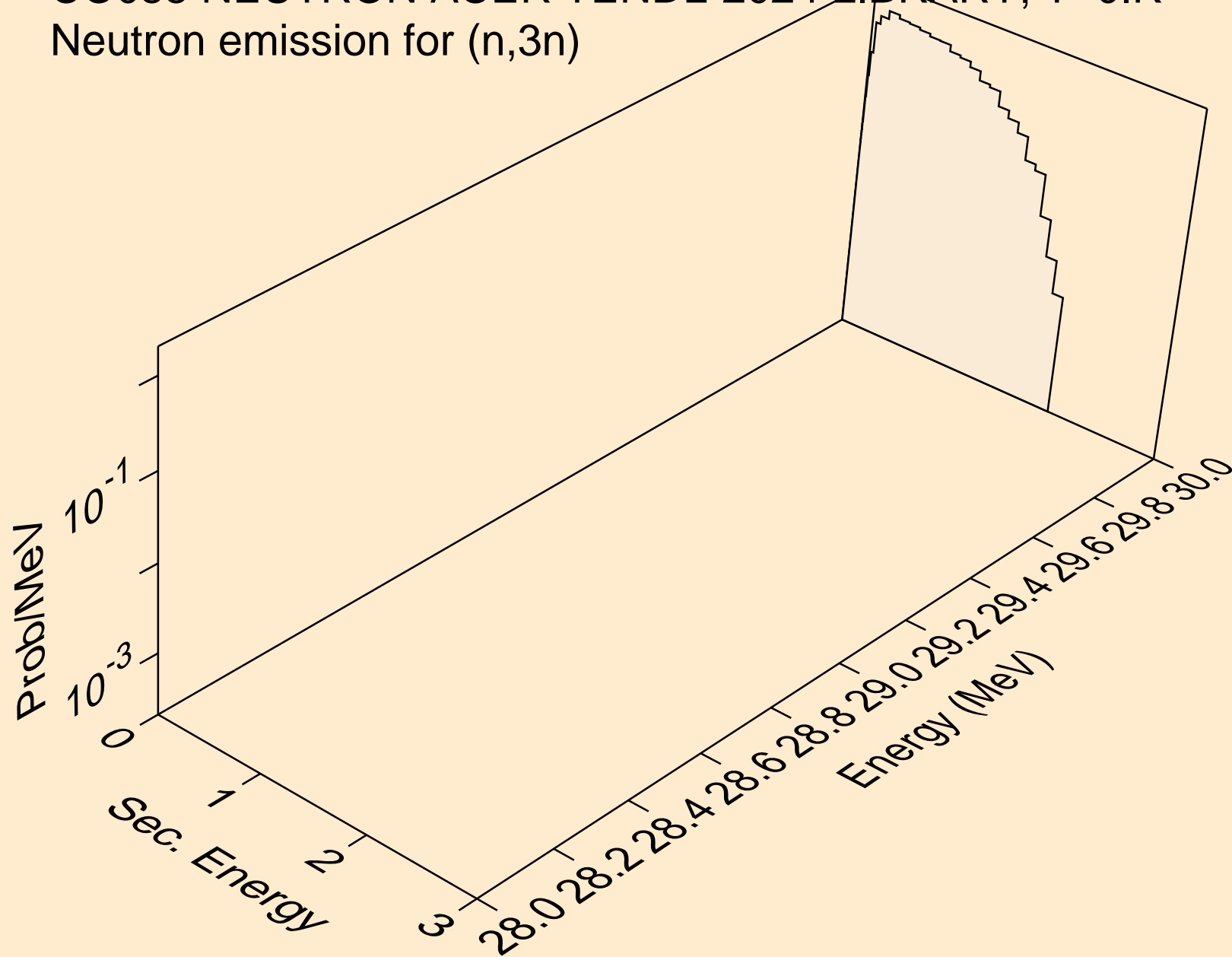

CO055 NEUTRON ACER TENDL-2024 LIBRARY; T=0.K
Neutron emission for (n,n*)a

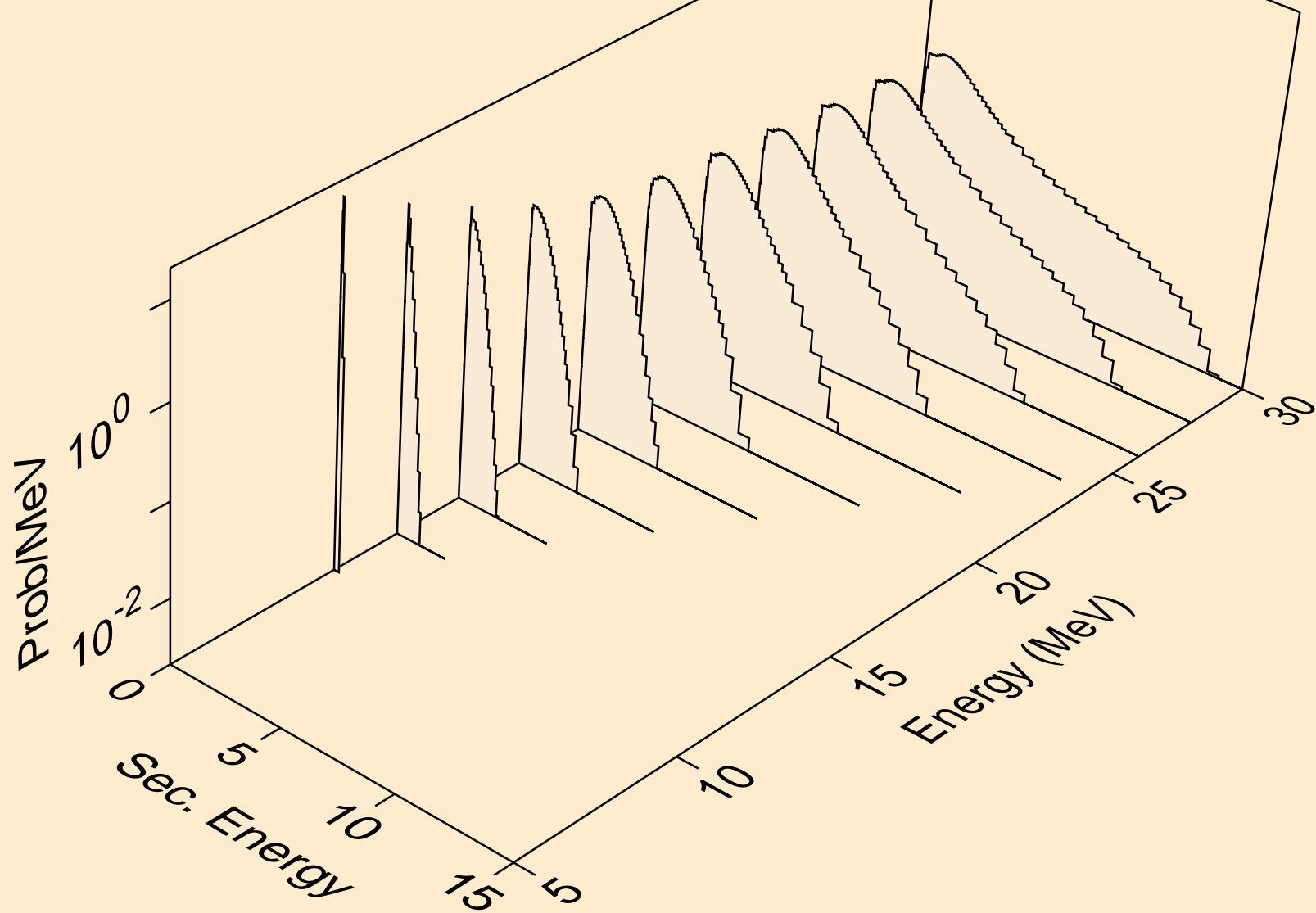

CO055 NEUTRON ACER TENDL-2024 LIBRARY; T=0.K
Neutron emission for (n,2n)a

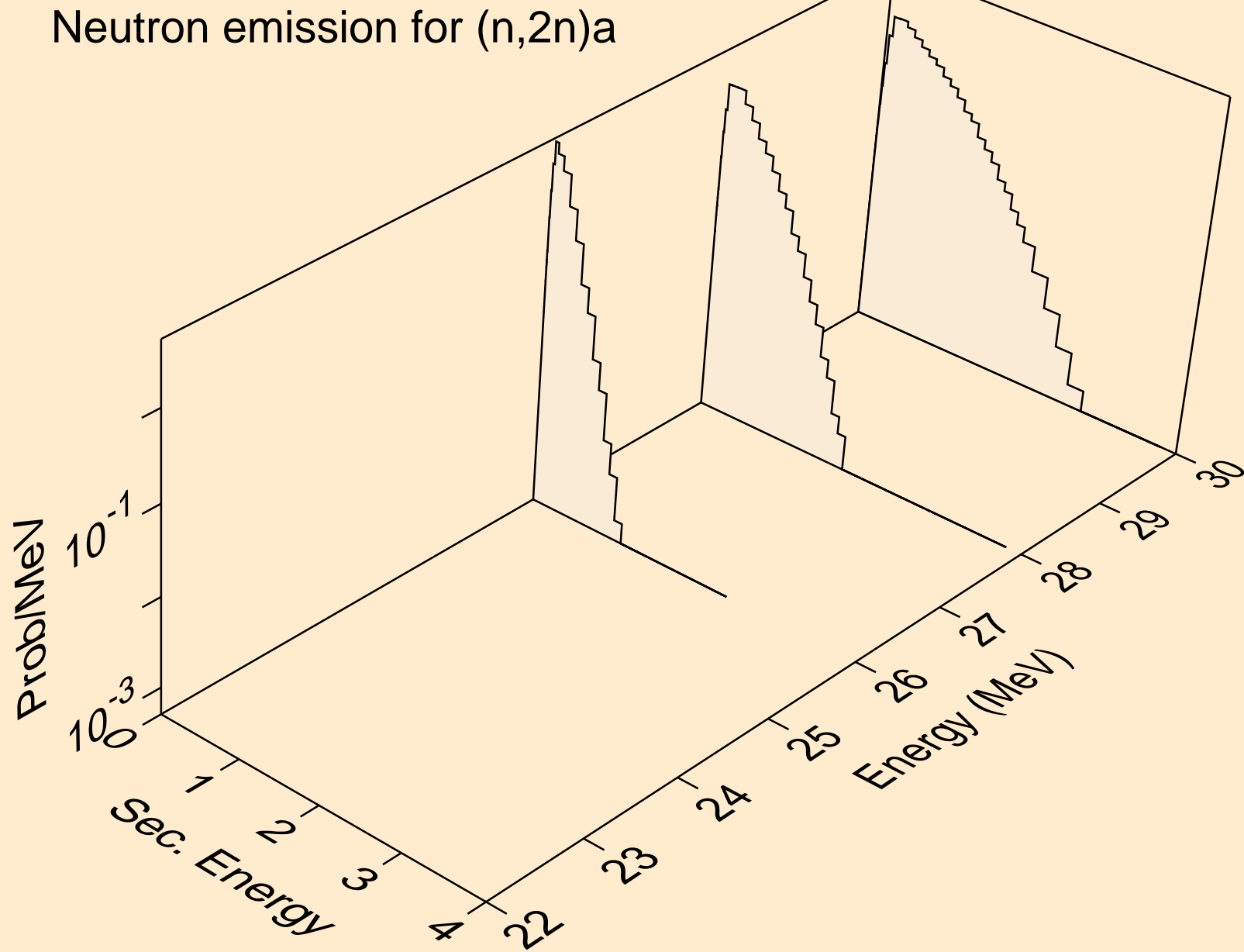

CO055 NEUTRON ACER TENDL-2024 LIBRARY; T=0.K
Neutron emission for (n,n*)p

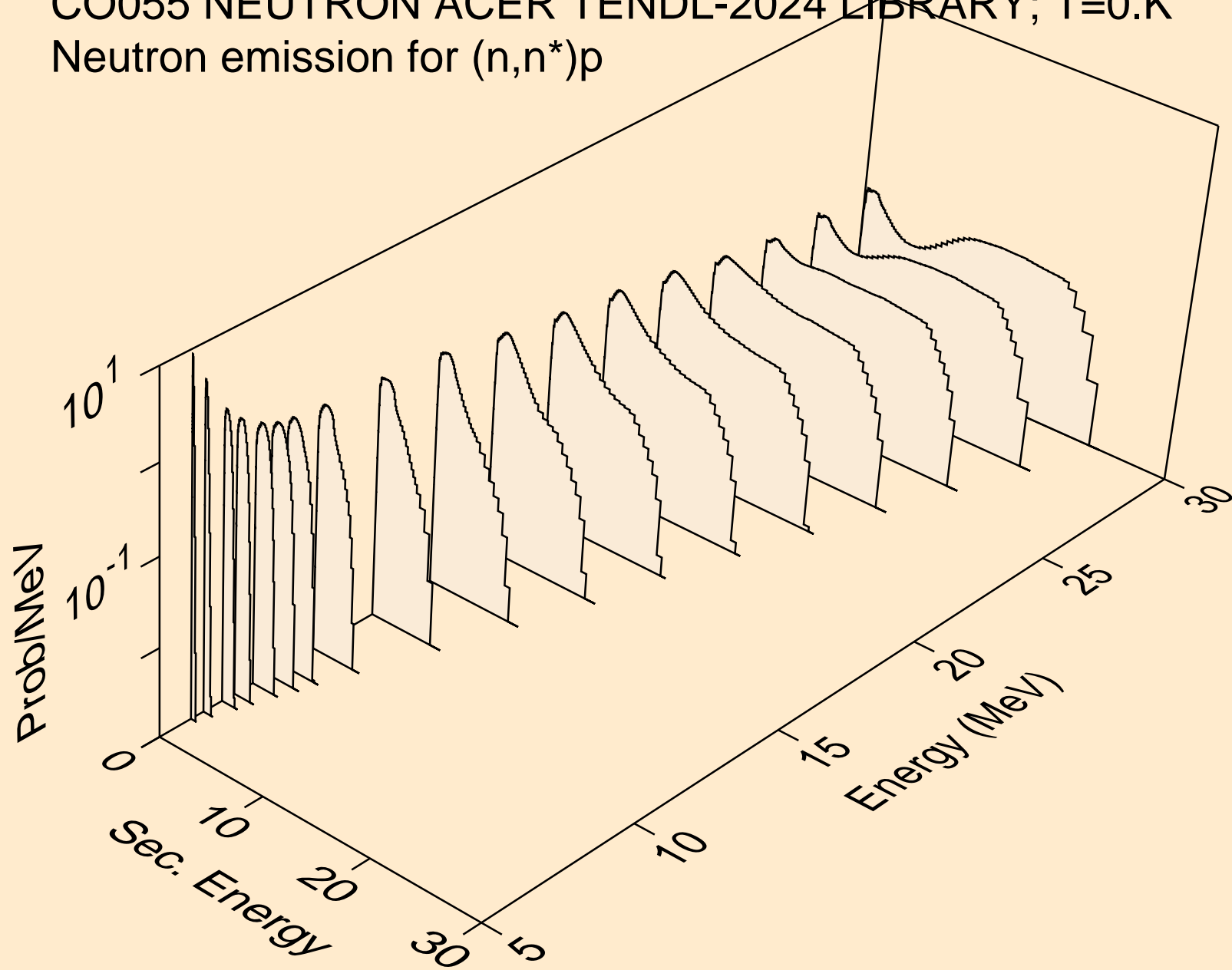

CO055 NEUTRON ACER TENDL-2024 LIBRARY; T=0.K
Neutron emission for (n,n*)2a

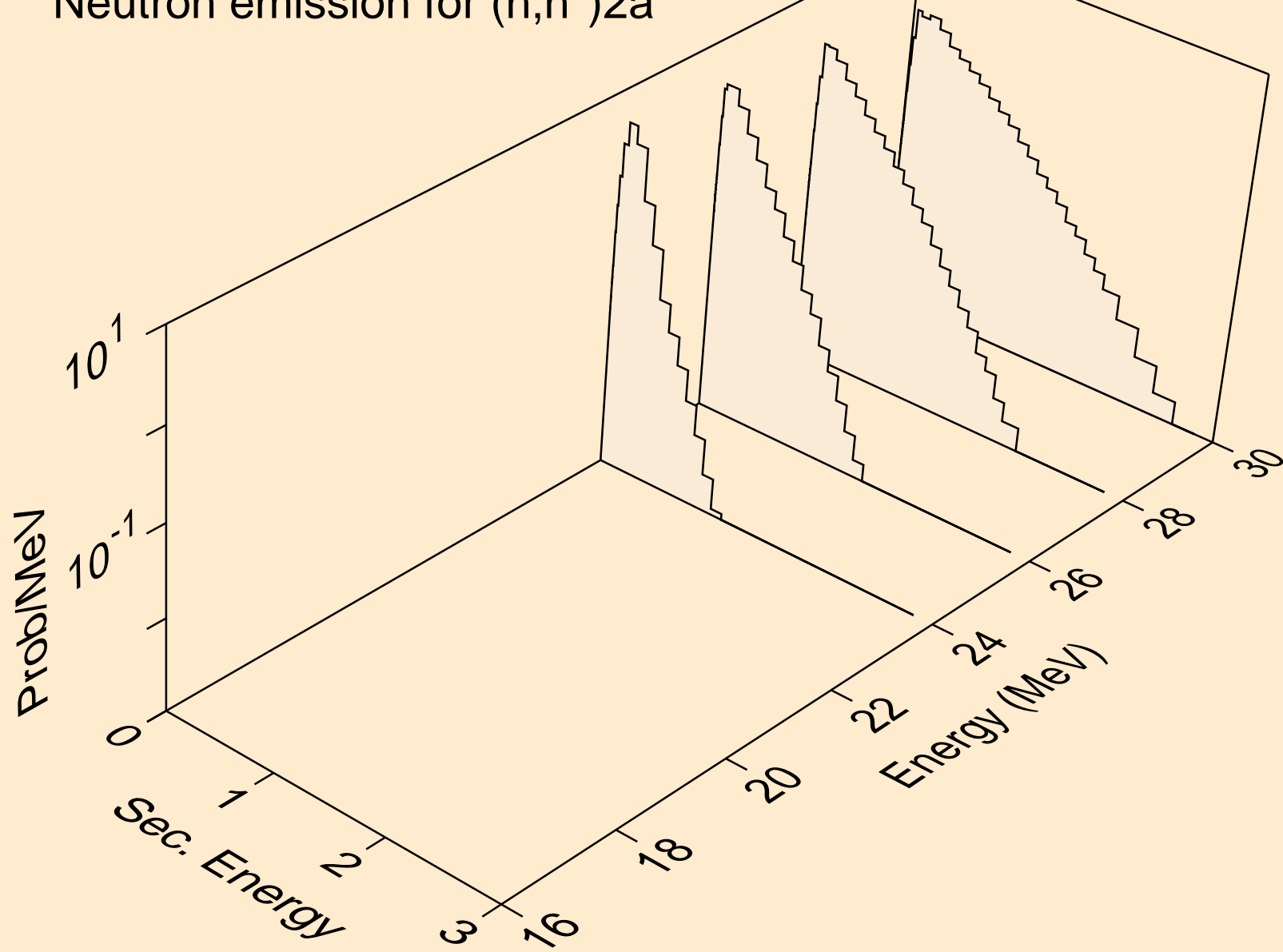

CO055 NEUTRON ACER TENDL-2024 LIBRARY; T=0.K
Neutron emission for (n,n*)d

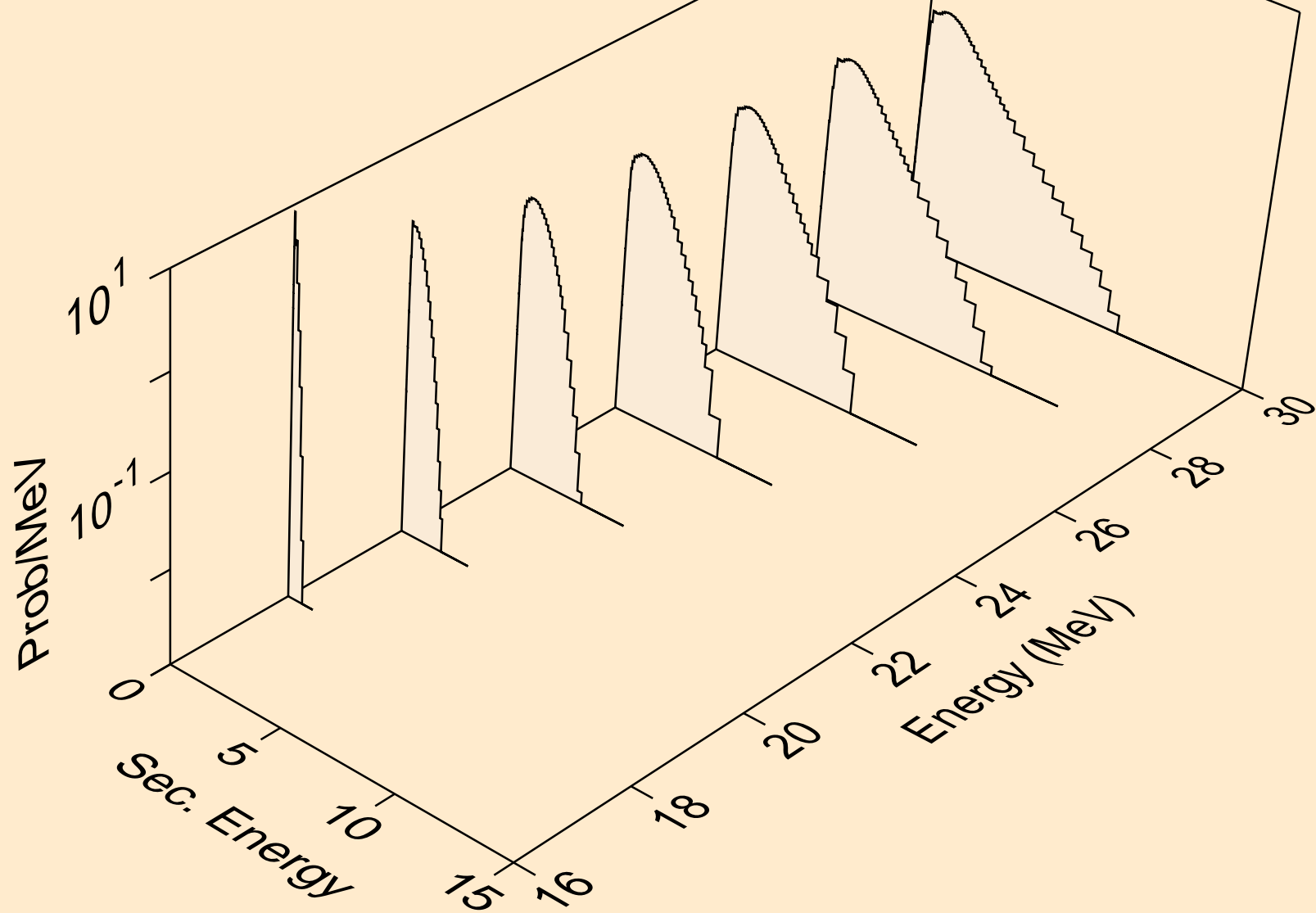

CO055 NEUTRON ACER TENDL-2024 LIBRARY; T=0.K
Neutron emission for (n,n*)t

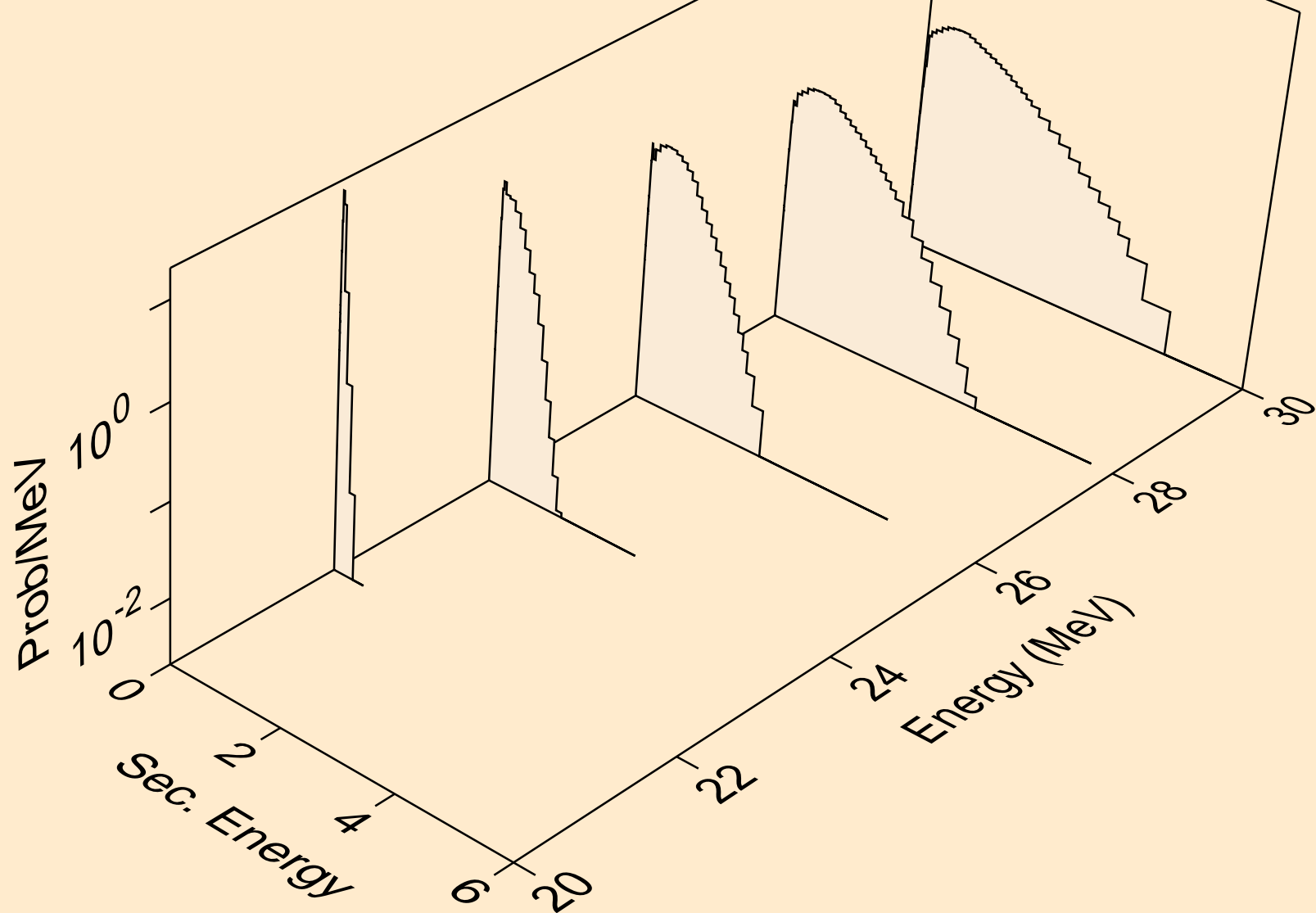

CO055 NEUTRON ACER TENDL-2024 LIBRARY; T=0.K
Neutron emission for (n,n*)he3

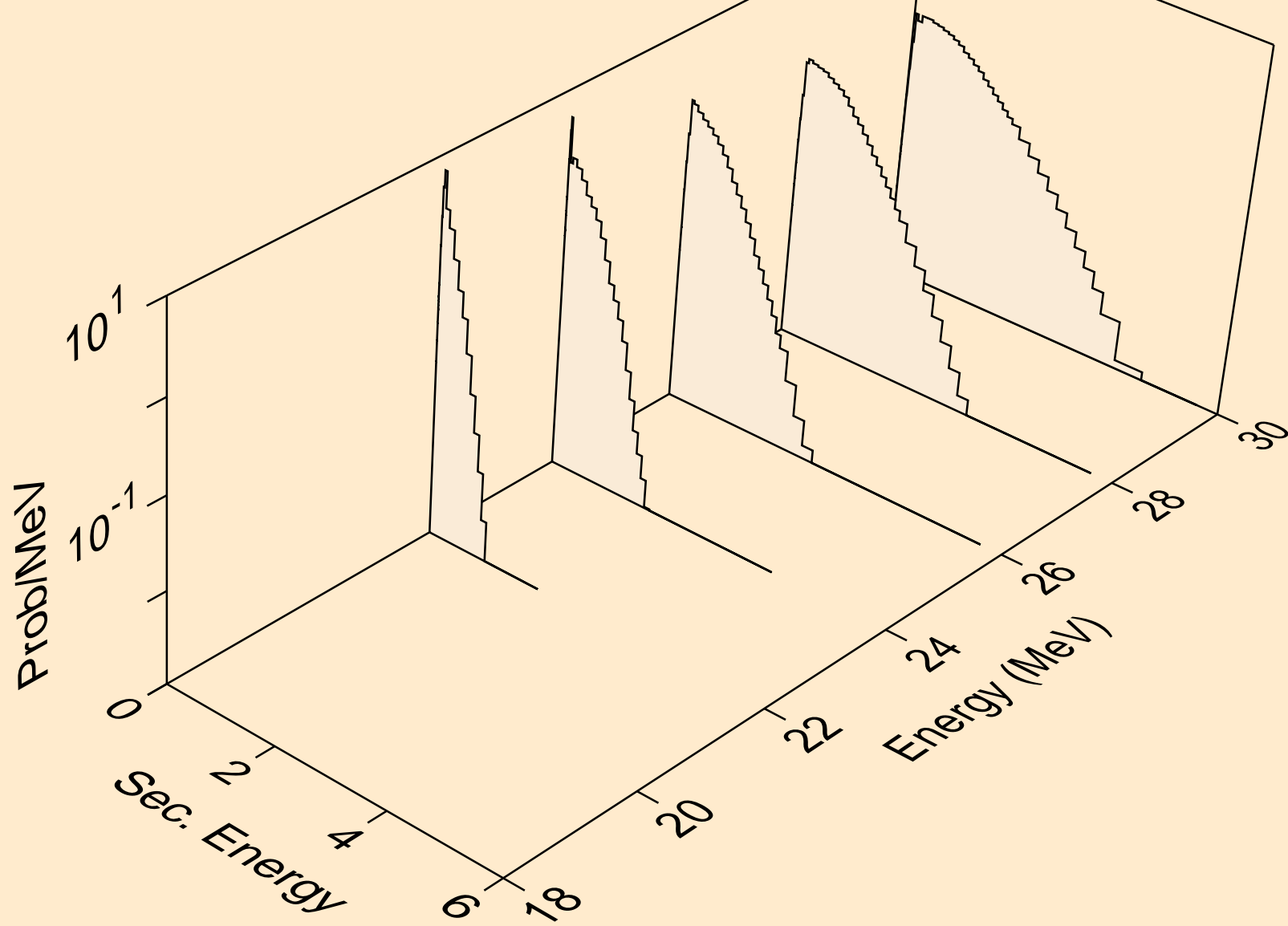

CO055 NEUTRON ACER TENDL-2024 LIBRARY; T=0.K
Neutron emission for (n,2np)

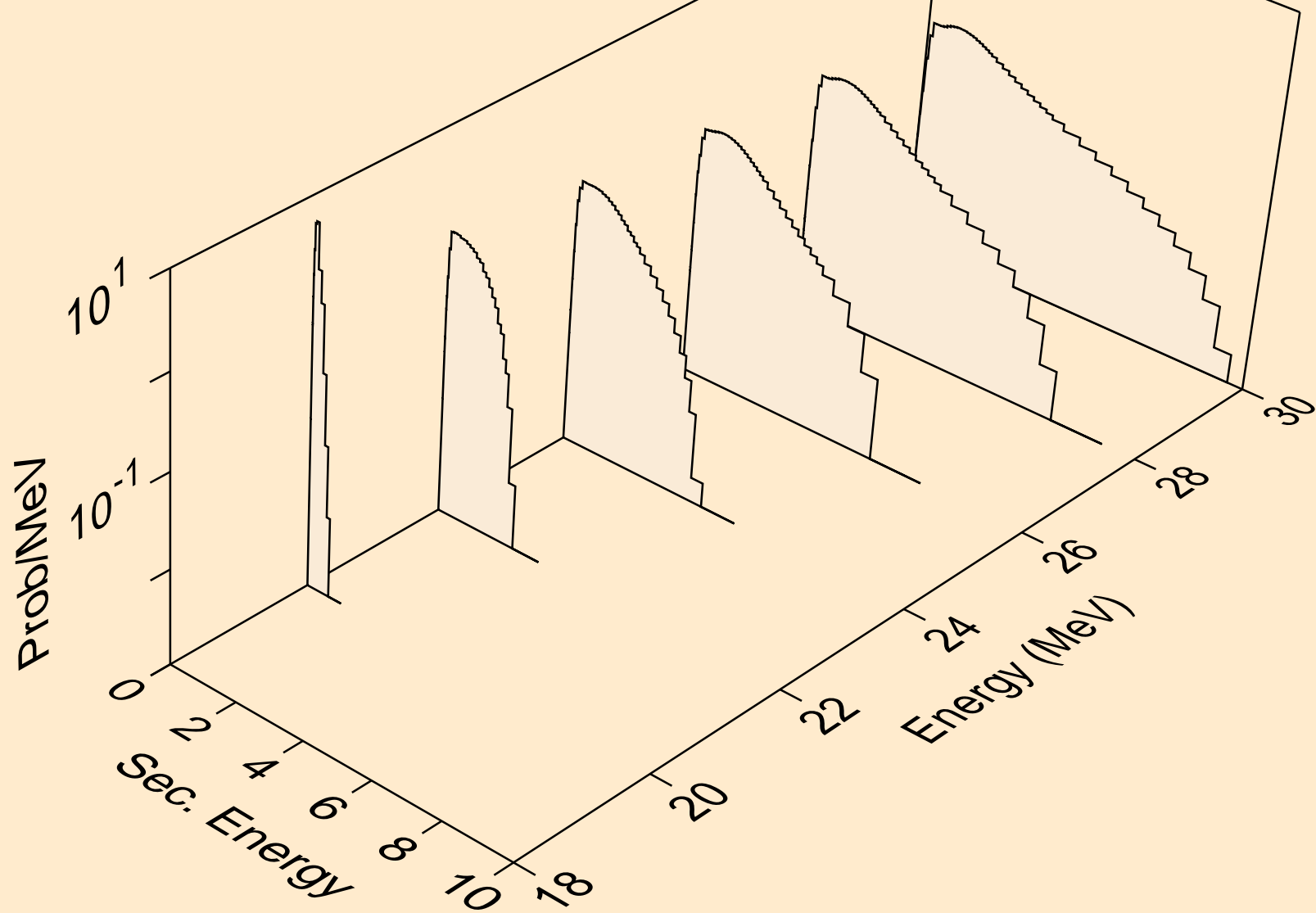

CO055 NEUTRON ACER TENDL-2024 LIBRARY; T=0.K
Neutron emission for (n,n2p)

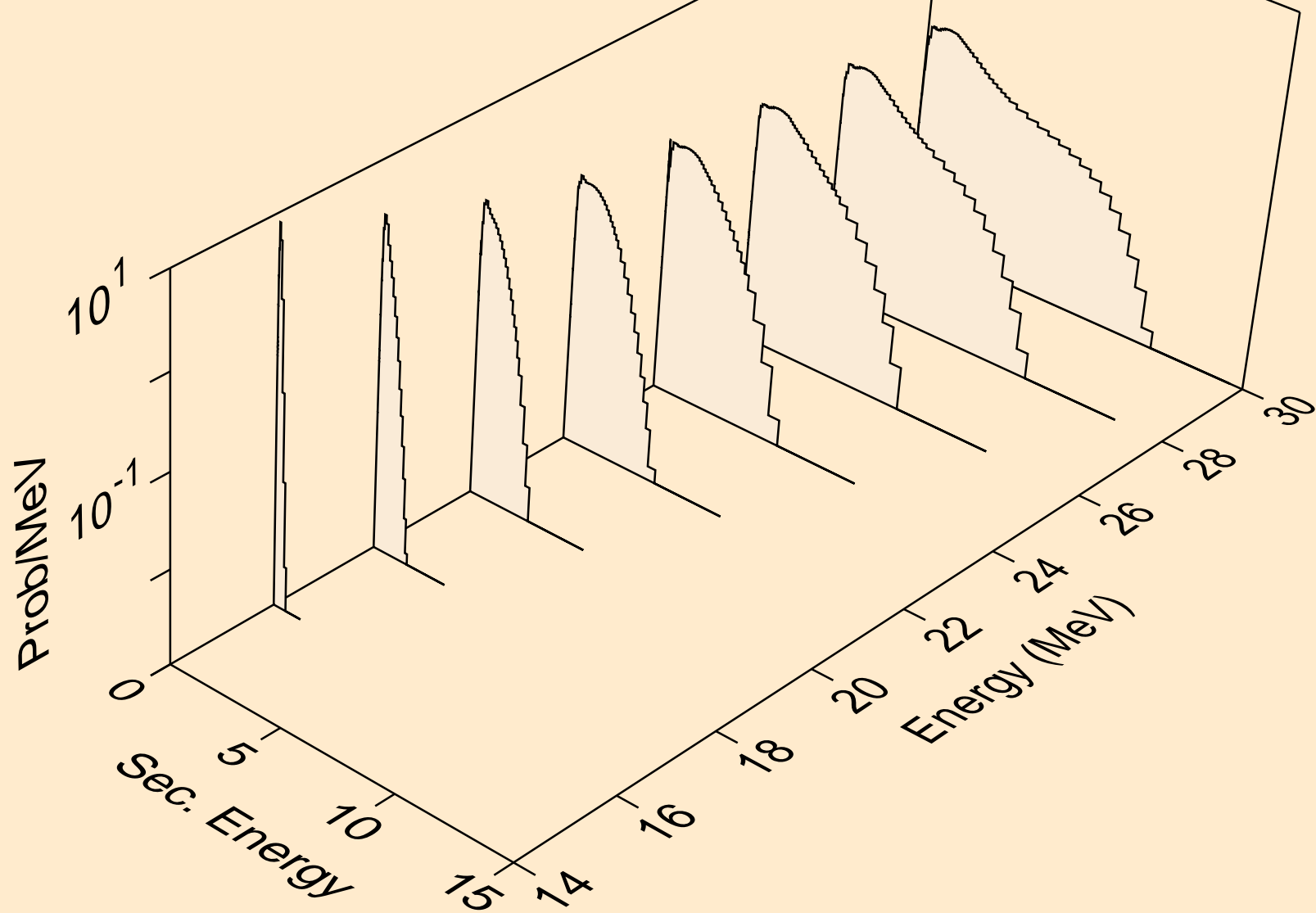

CO055 NEUTRON ACER TENDL-2024 LIBRARY; T=0.K
Neutron emission for (n,npa)

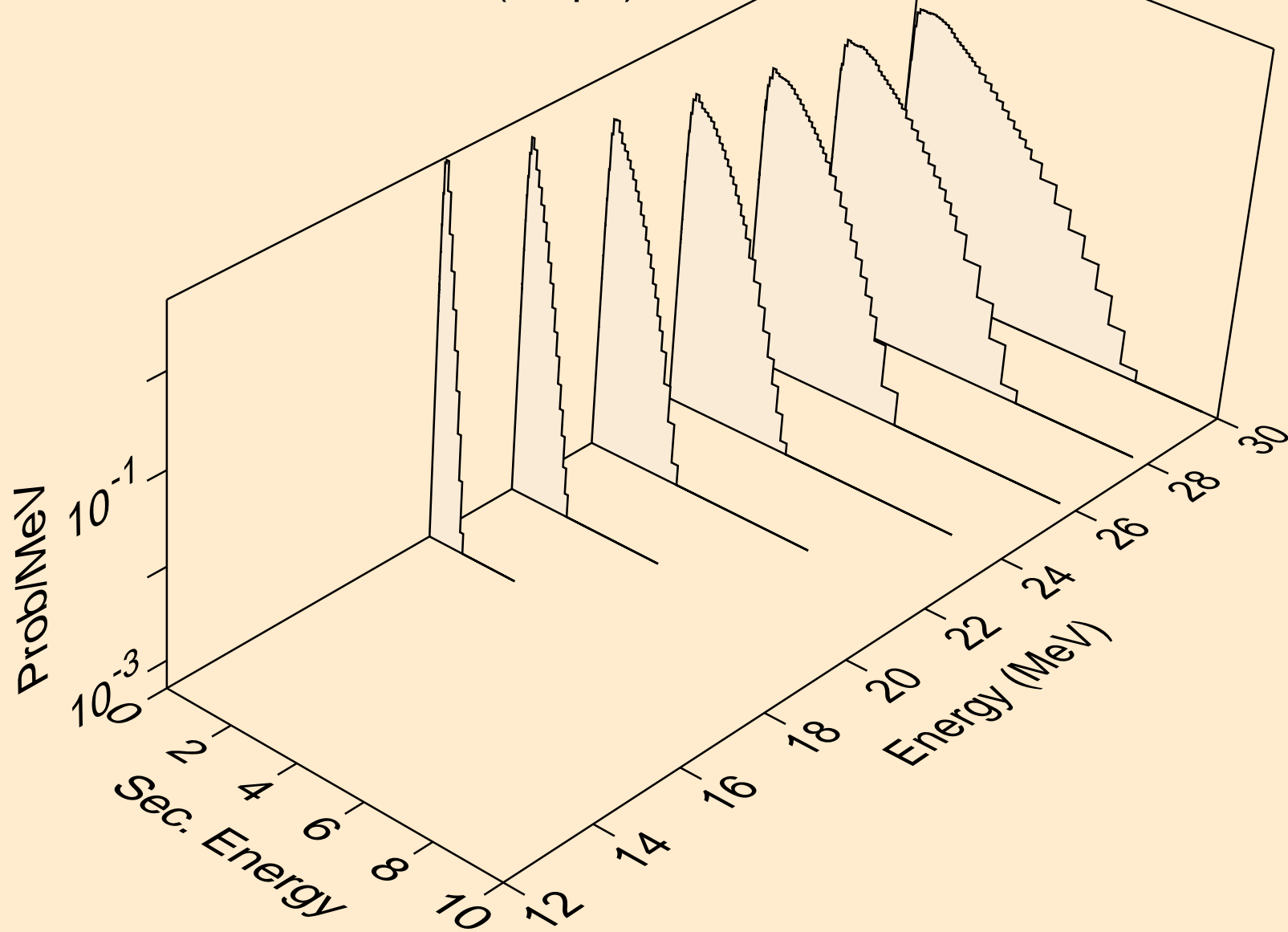

CO055 NEUTRON ACER TENDL-2024 LIBRARY; T=0.K
Neutron emission for (n,n*c)

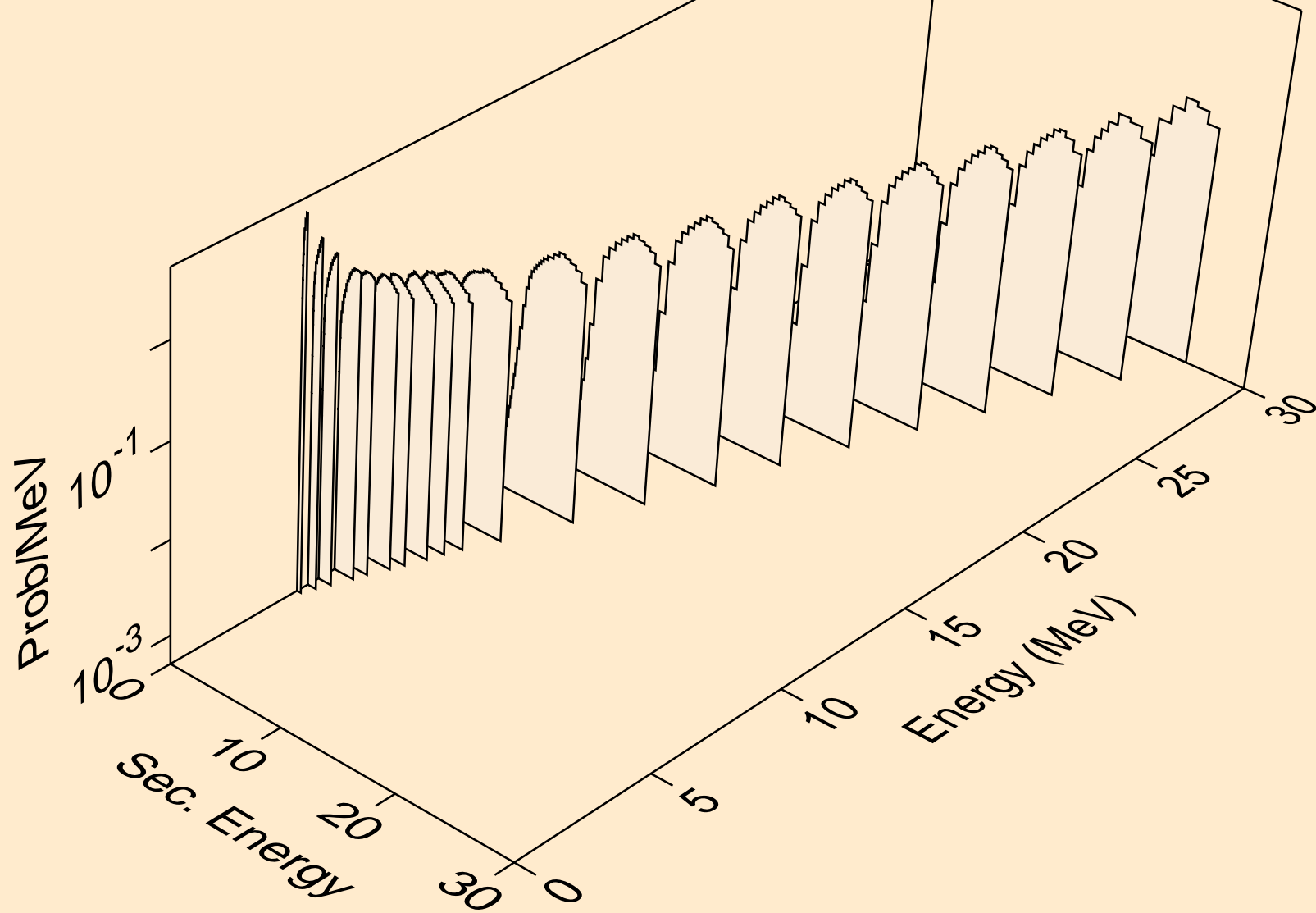

CO055 NEUTRON ACER TENDL-2024 LIBRARY; T=0.K
Photon emission for (n,x)

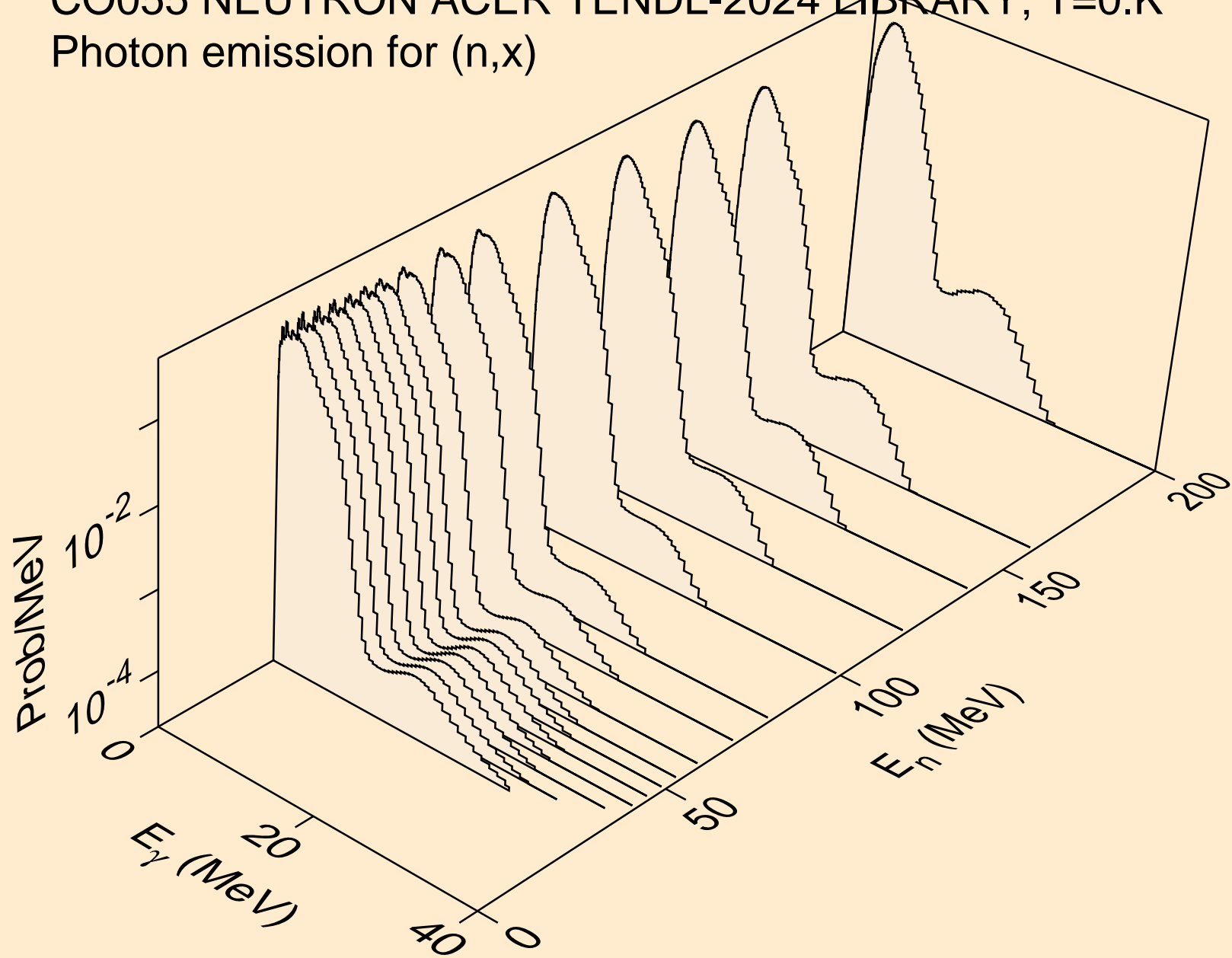

CO055 NEUTRON ACER TENDL-2024 LIBRARY; T=0.K
Photon emission for (n,2nd)

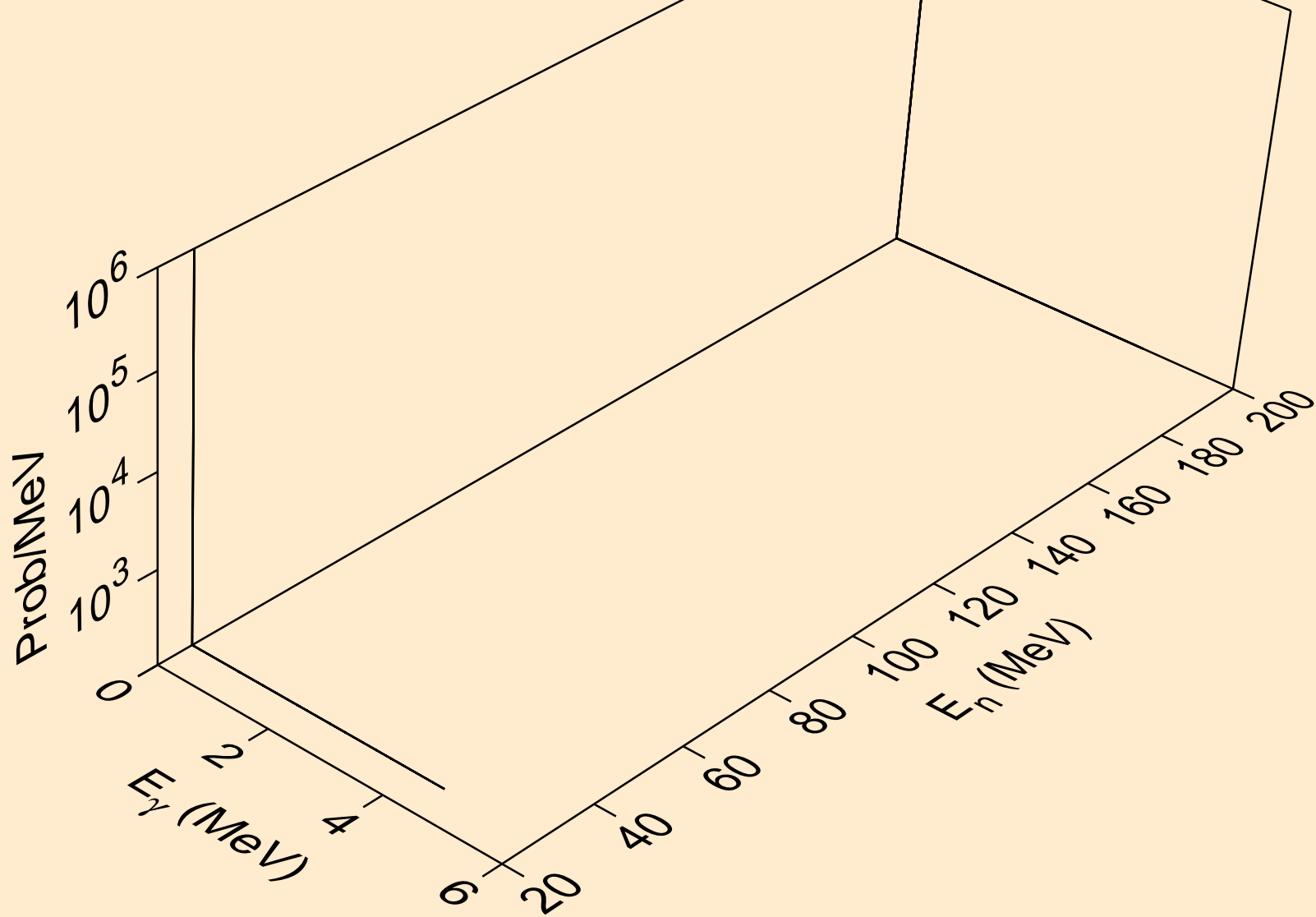

CO055 NEUTRON ACER TENDL-2024 LIBRARY; T=0.K
Photon emission for (n,2n)

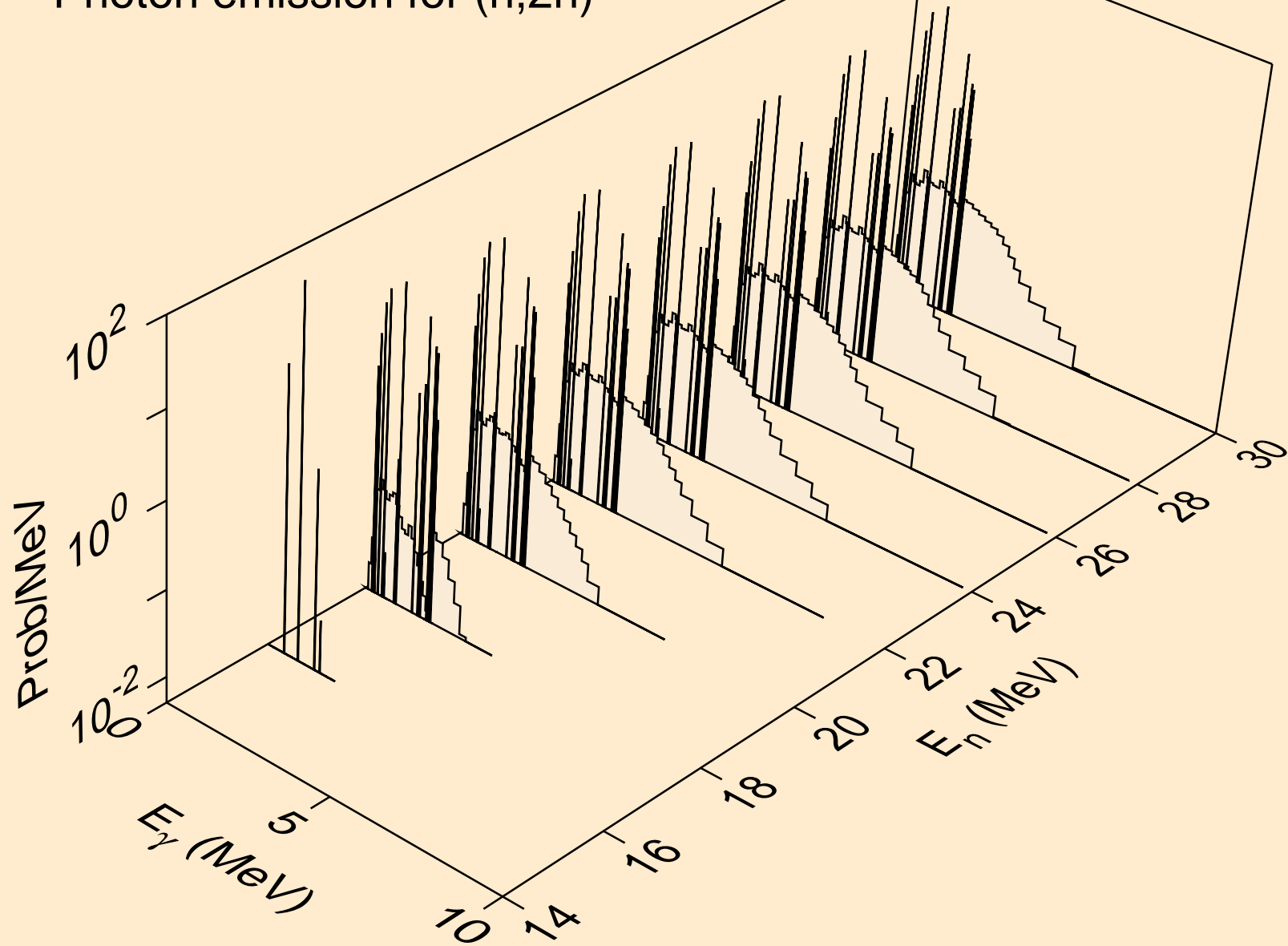

CO055 NEUTRON ACER TENDL-2024 LIBRARY; T=0.K
Photon emission for (n,3n)

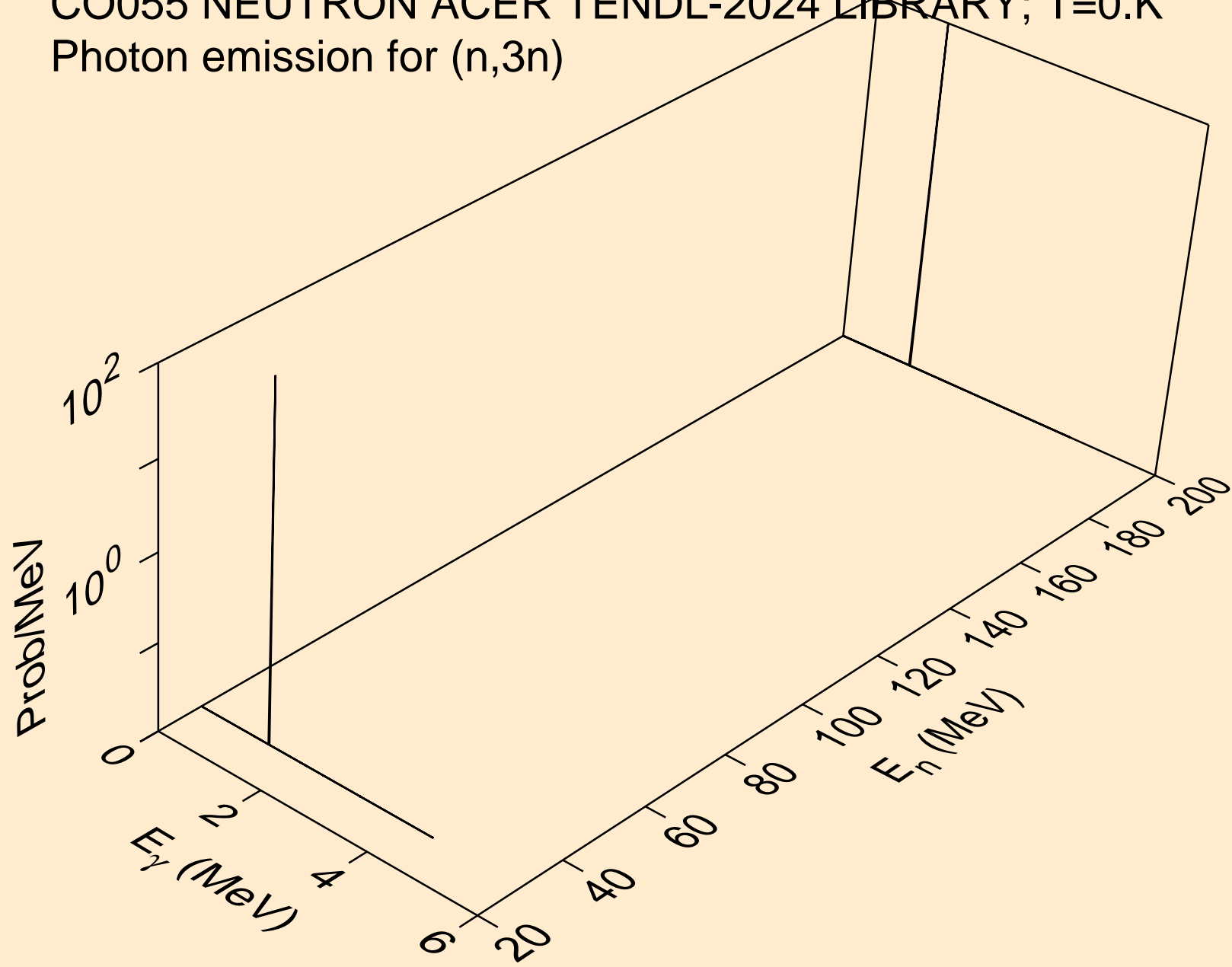

CO055 NEUTRON ACER TENDL-2024 LIBRARY; T=0.K
Photon emission for (n,n*)a

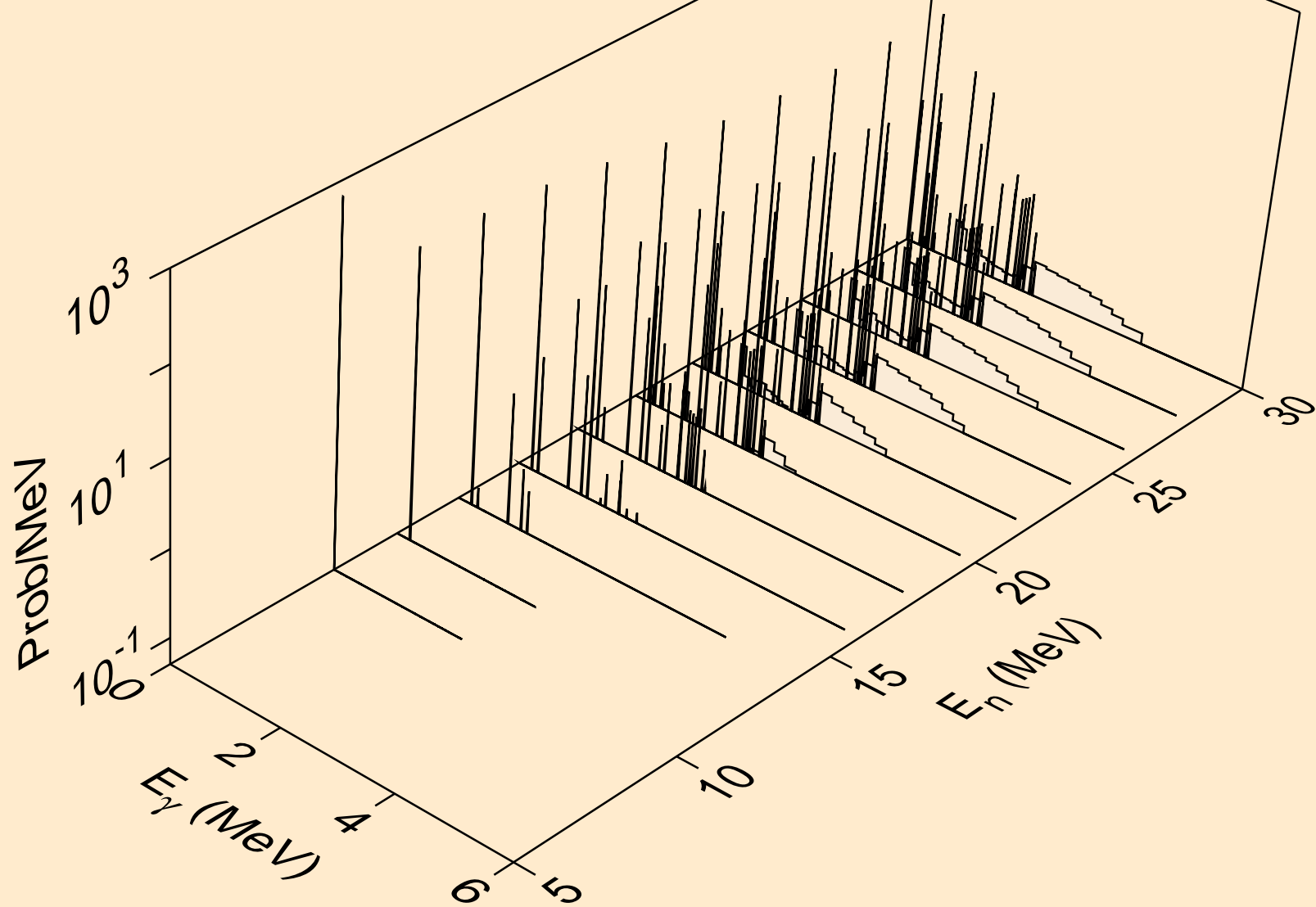

CO055 NEUTRON ACER TENDL-2024 LIBRARY; T=0.K
Photon emission for (n,2n)a

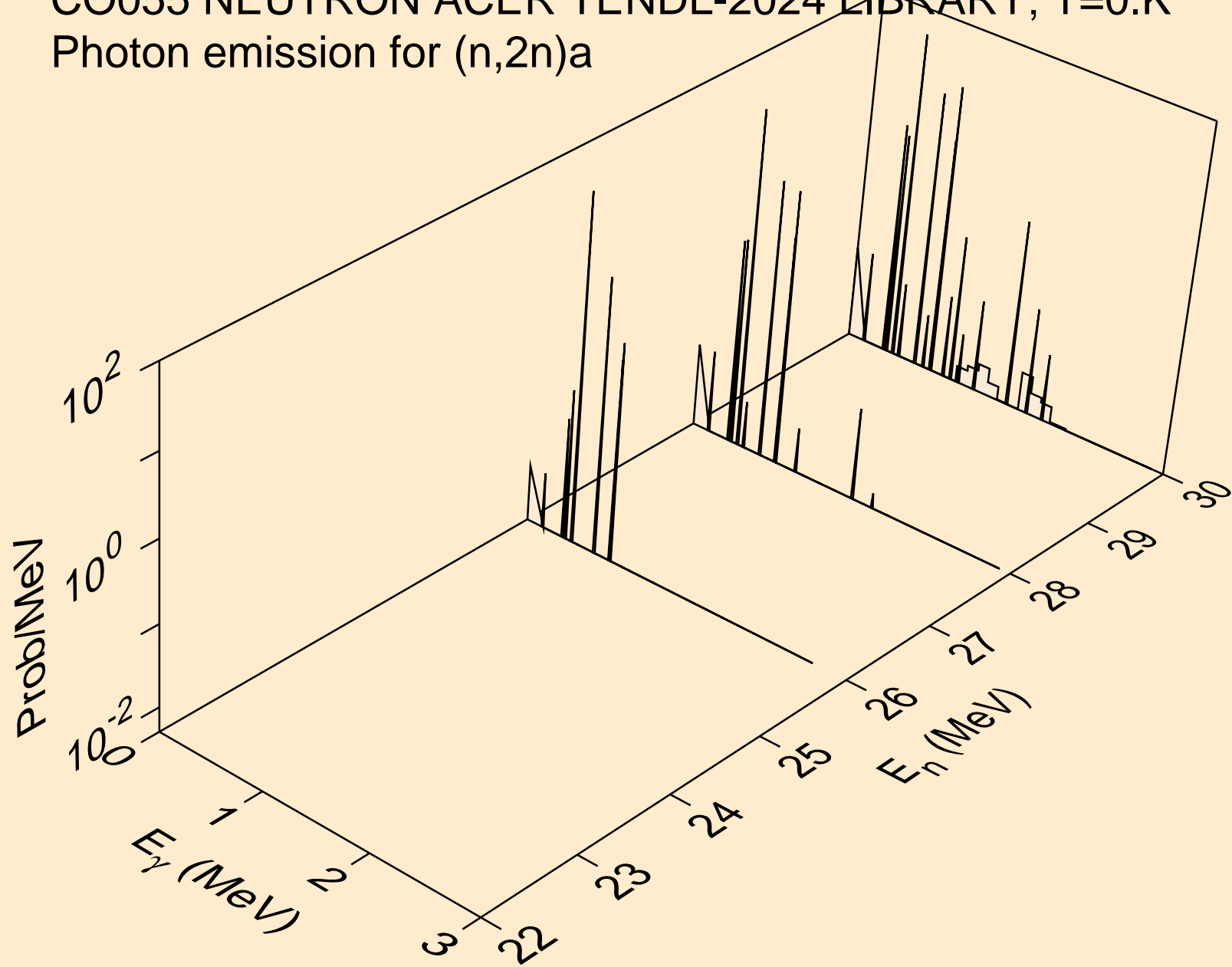

CO055 NEUTRON ACER TENDL-2024 LIBRARY; T=0.K
Photon emission for (n,n*)p

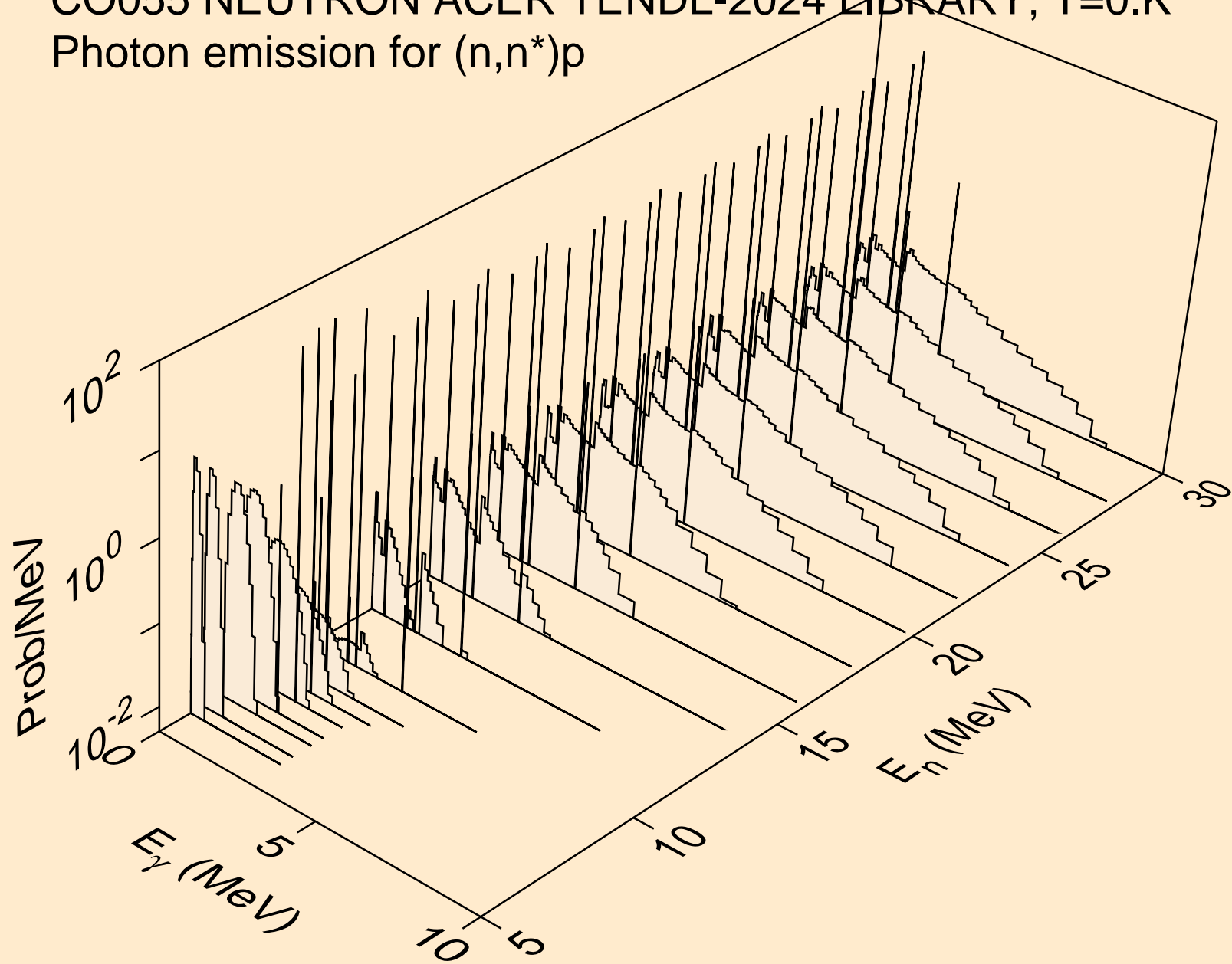

CO055 NEUTRON ACER TENDL-2024 LIBRARY; T=0.K
Photon emission for (n,n*)2a

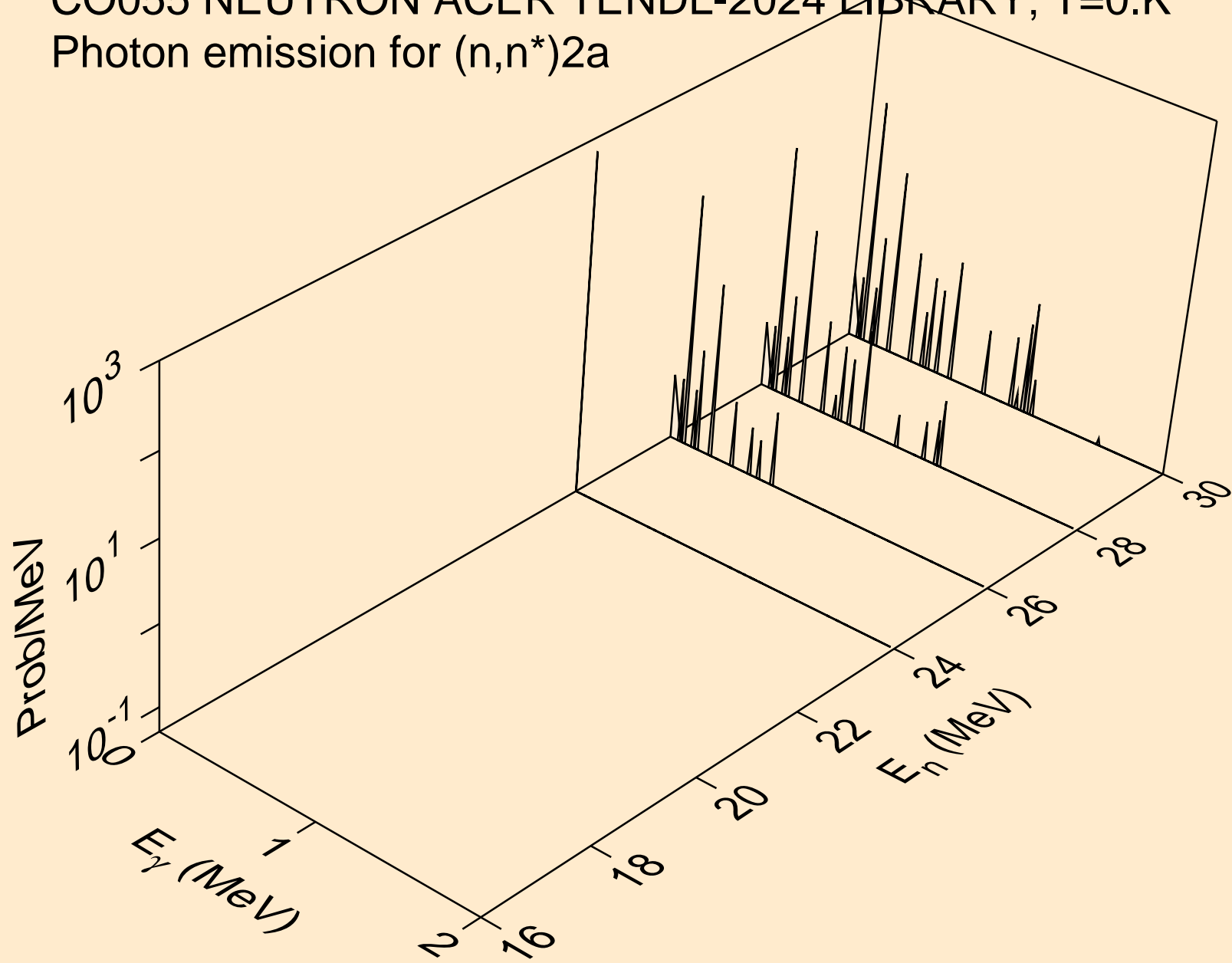

CO055 NEUTRON ACER TENDL-2024 LIBRARY; T=0.K
Photon emission for (n,n*)d

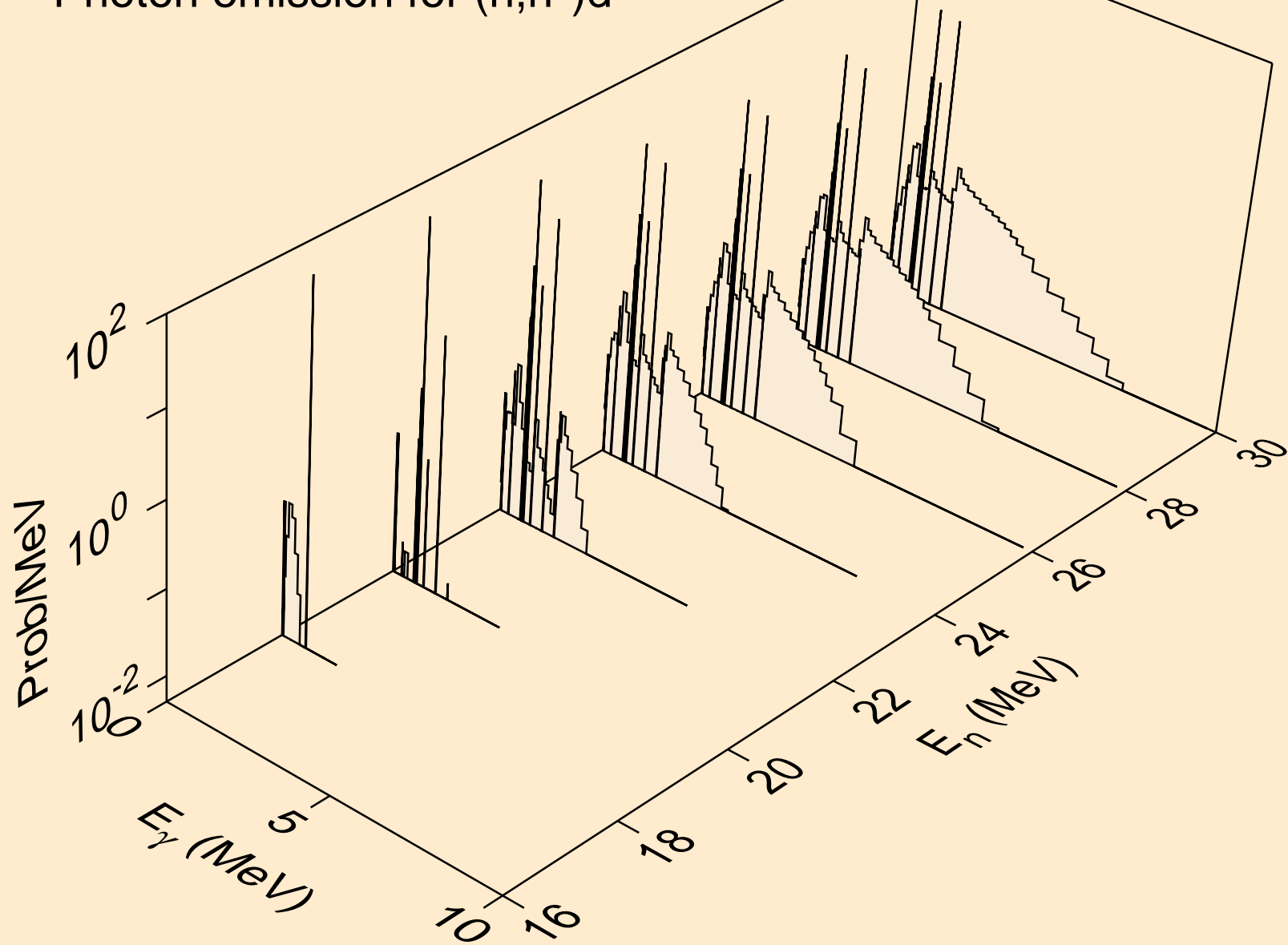

CO055 NEUTRON ACER TENDL-2024 LIBRARY; T=0.K
Photon emission for (n,n*)t

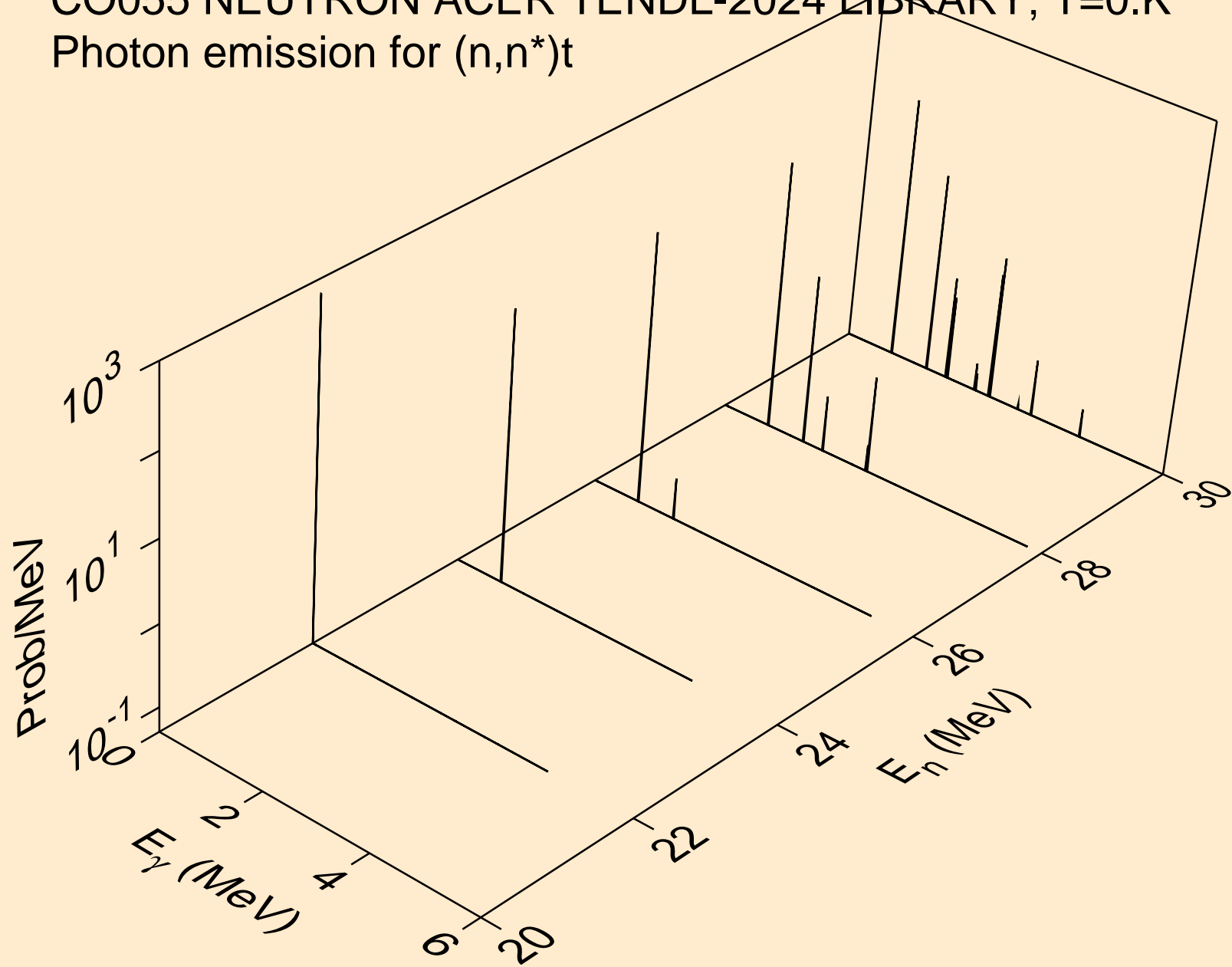

CO055 NEUTRON ACER TENDL-2024 LIBRARY; T=0.K
Photon emission for (n,n*)he3

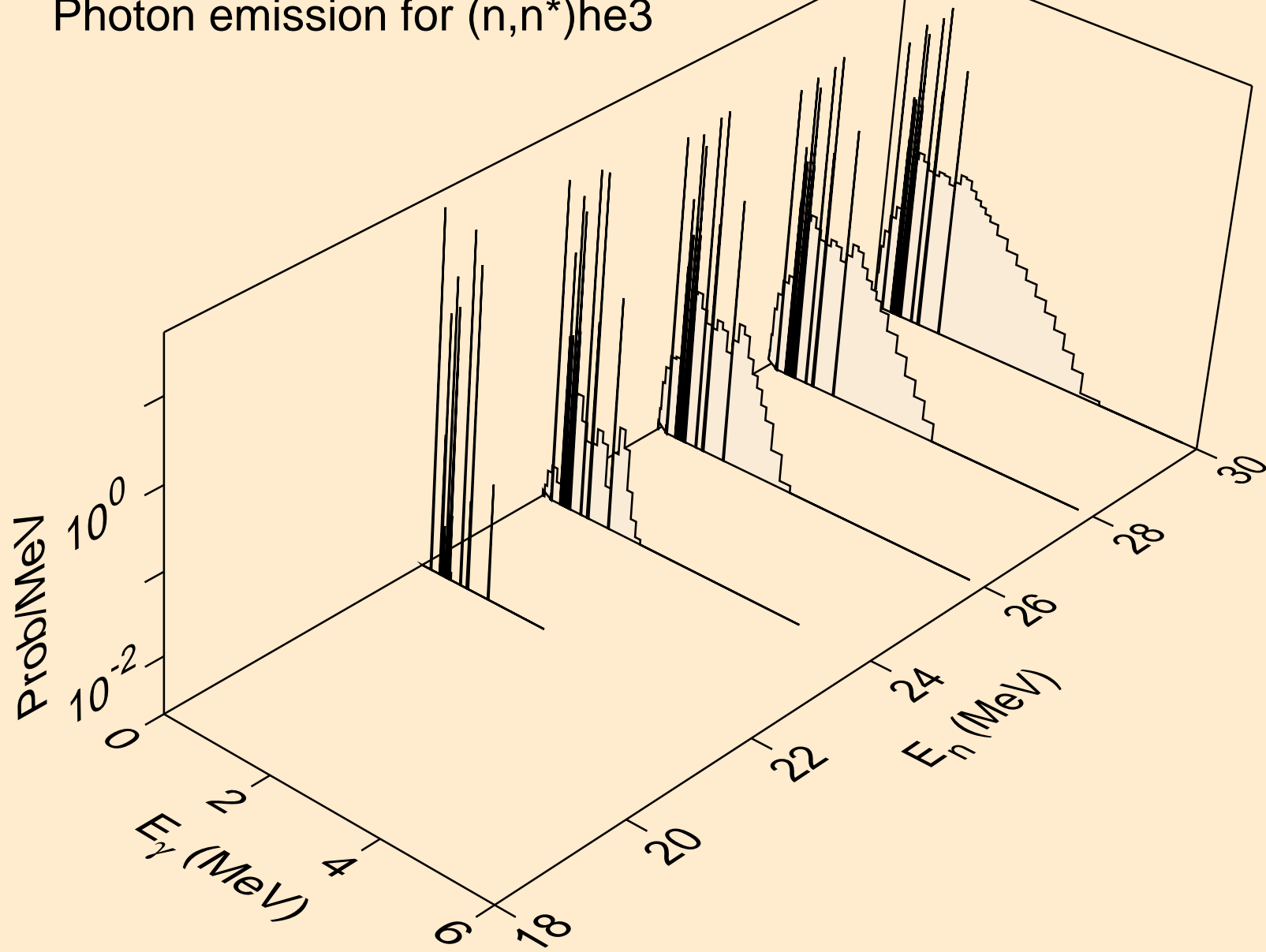

CO055 NEUTRON ACER TENDL-2024 LIBRARY; T=0.K
Photon emission for (n,2np)

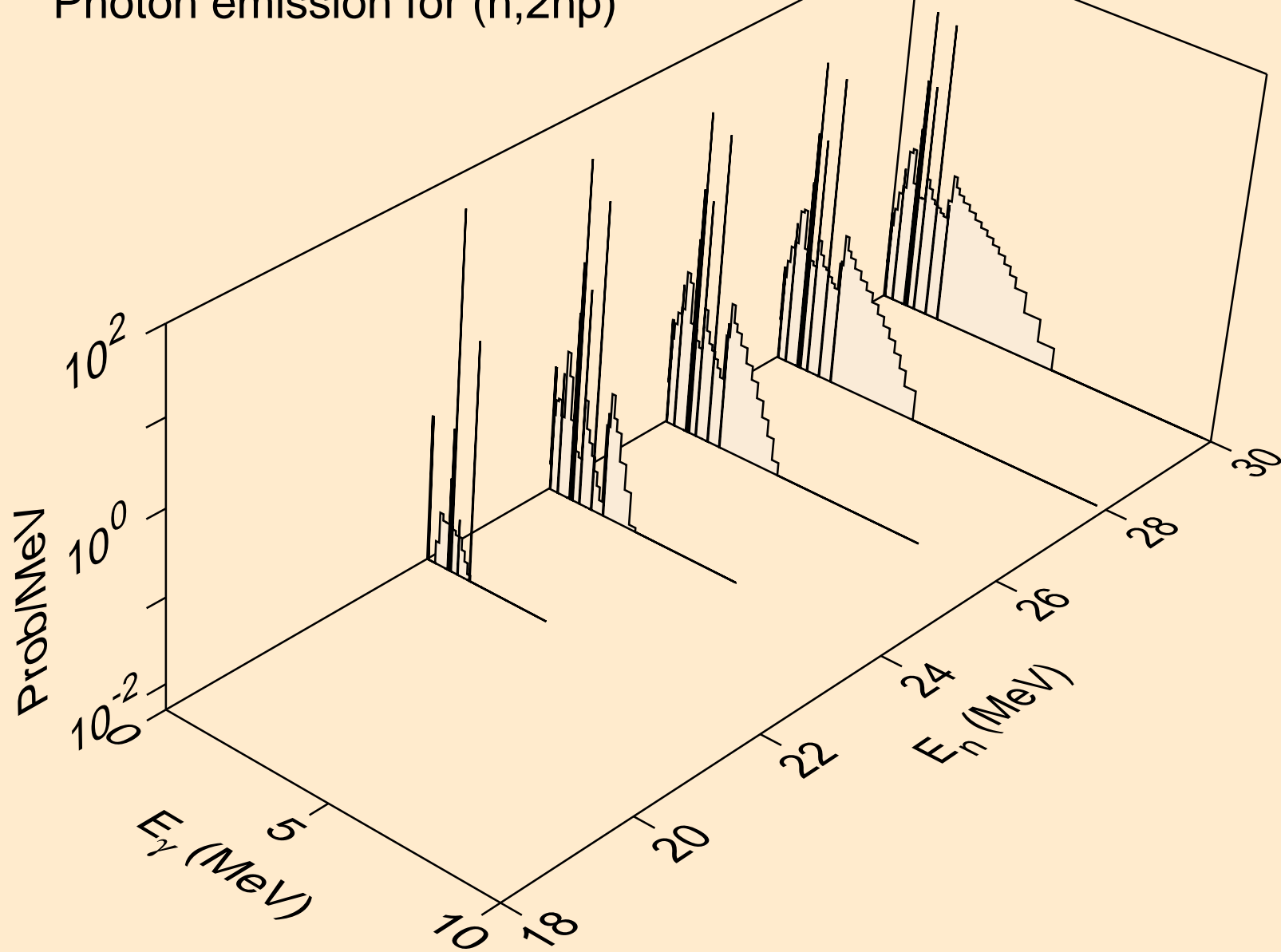

CO055 NEUTRON ACER TENDL-2024 LIBRARY; T=0.K
Photon emission for (n,n2p)

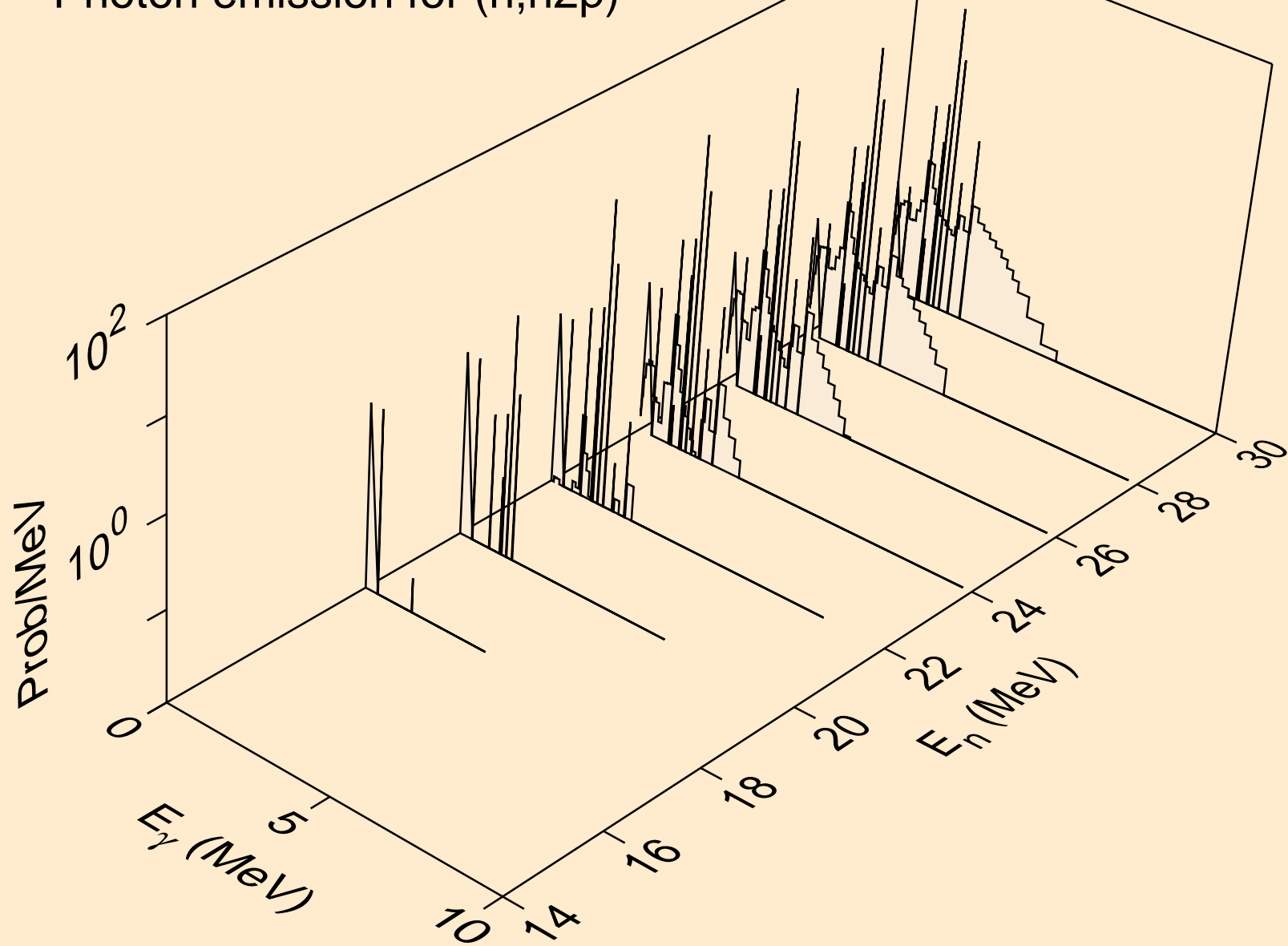

CO055 NEUTRON ACER TENDL-2024 LIBRARY; T=0.K
Photon emission for (n,npa)

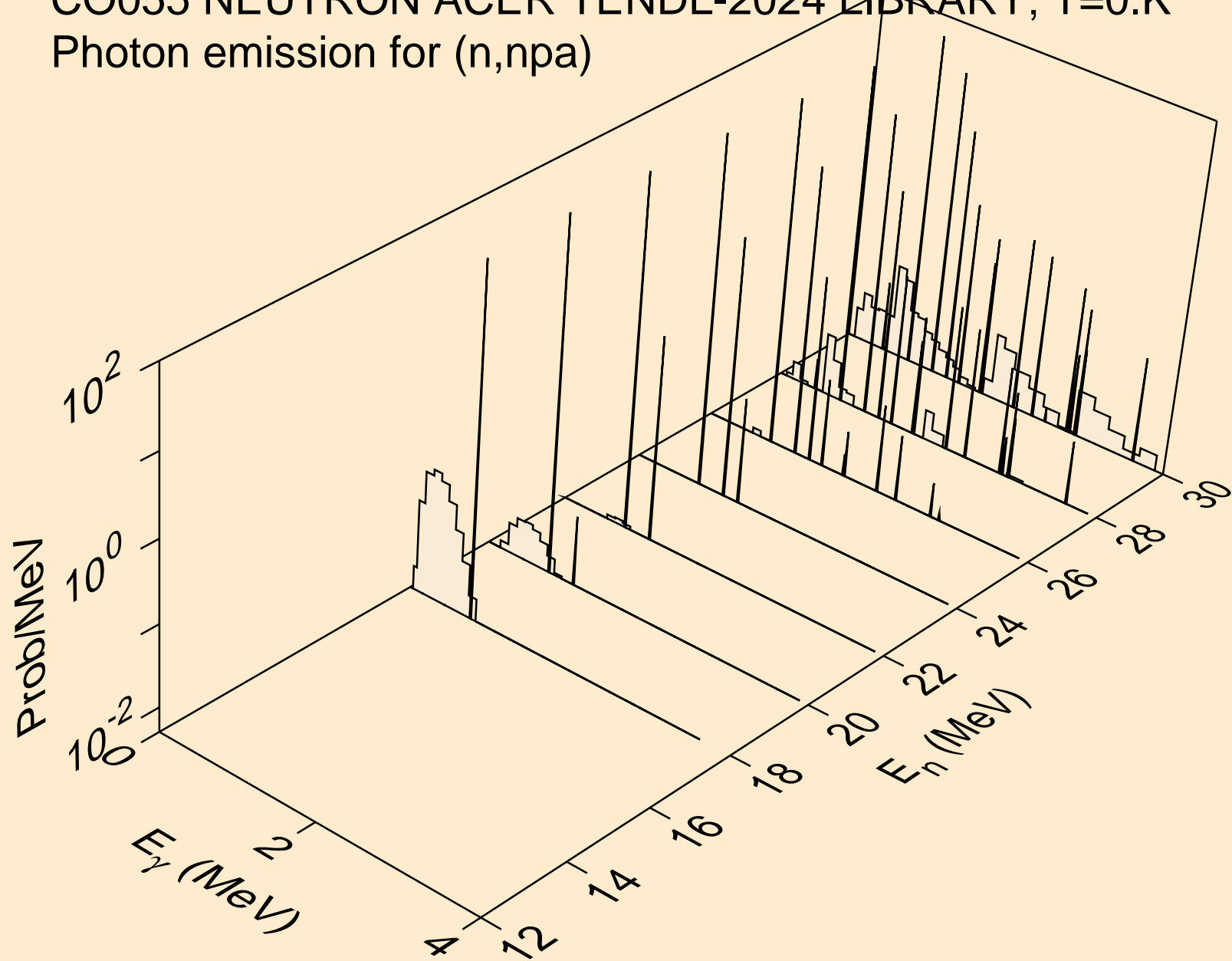

CO055 NEUTRON ACER TENDL-2024 LIBRARY; T=0.K
Photon emission for (n,n*c)

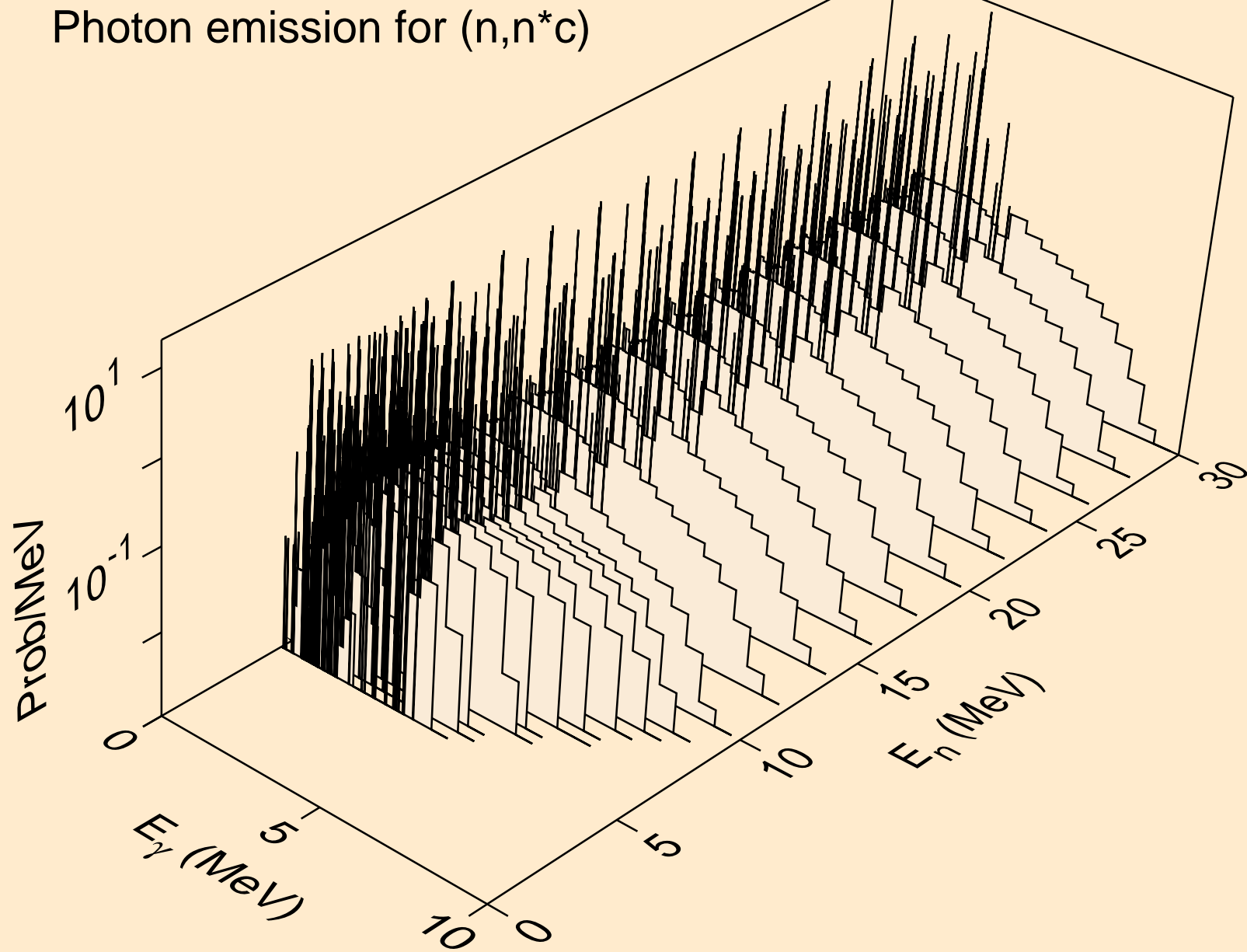

CO055 NEUTRON ACER TENDL-2024 LIBRARY; T=0.K
Photon emission for (n,gma)

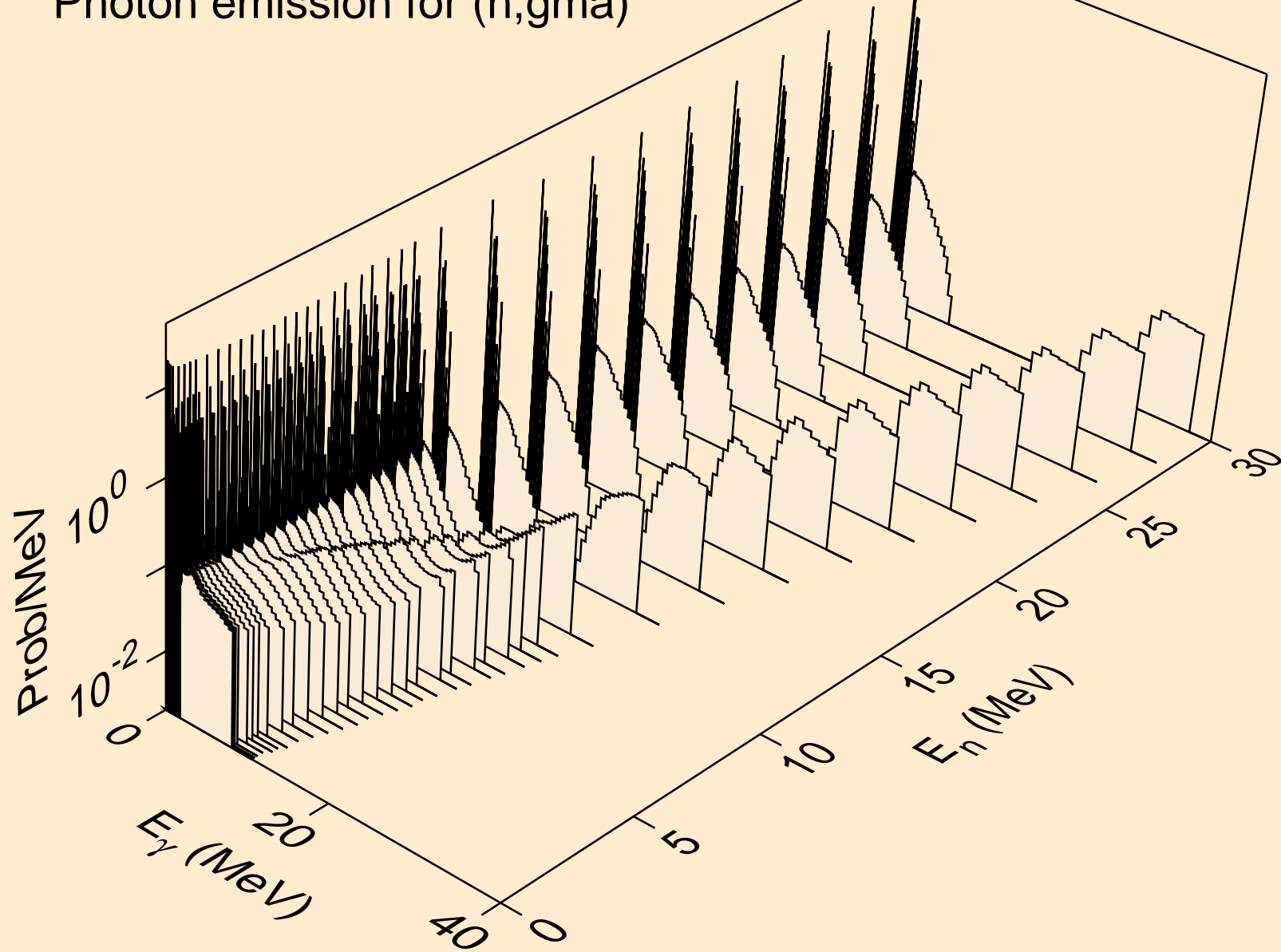

CO055 NEUTRON ACER TENDL-2024 LIBRARY; T=0.K
Photon emission for (n,p)

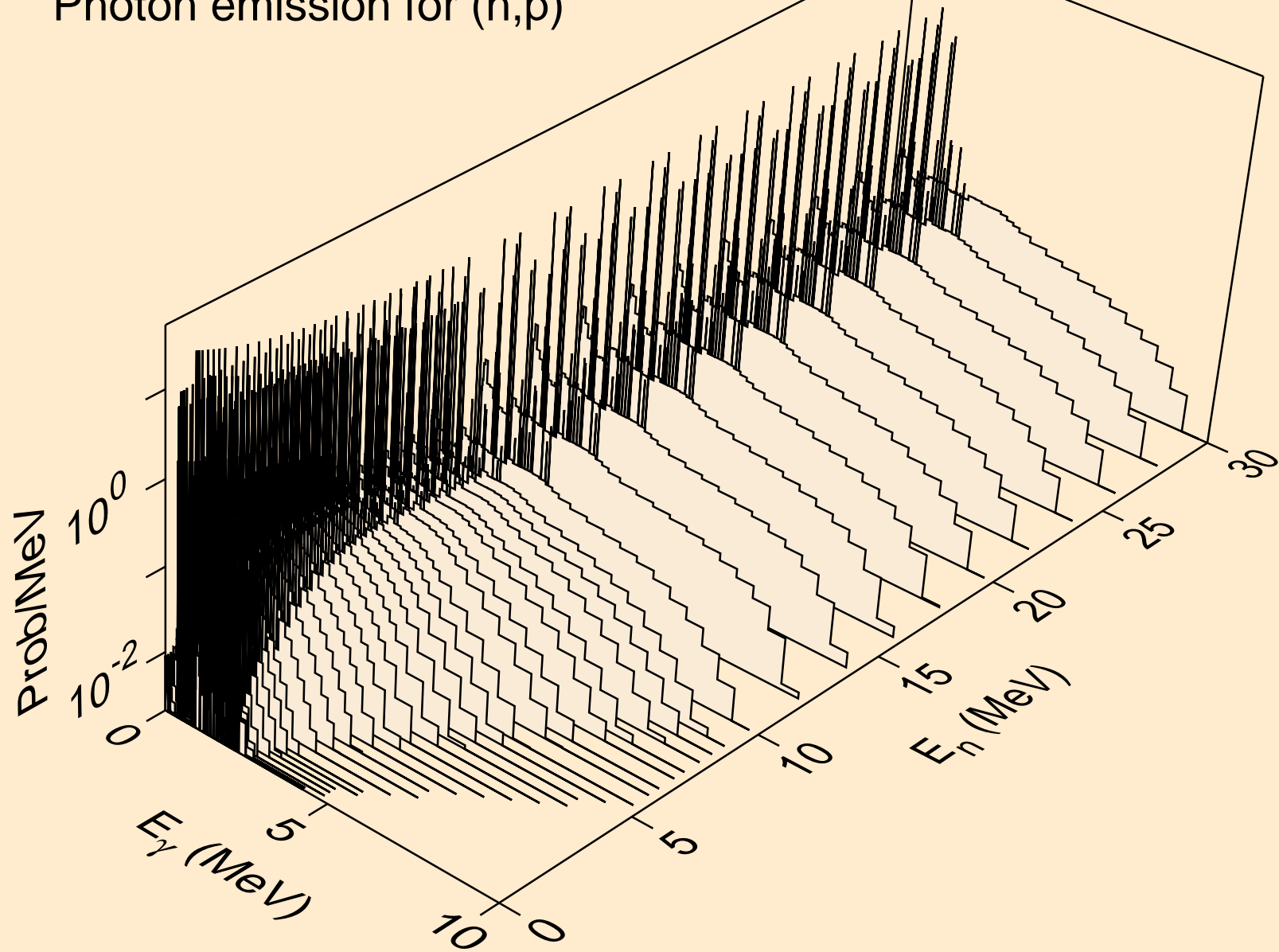

CO055 NEUTRON ACER TENDL-2024 LIBRARY; T=0.K
Photon emission for (n,d)

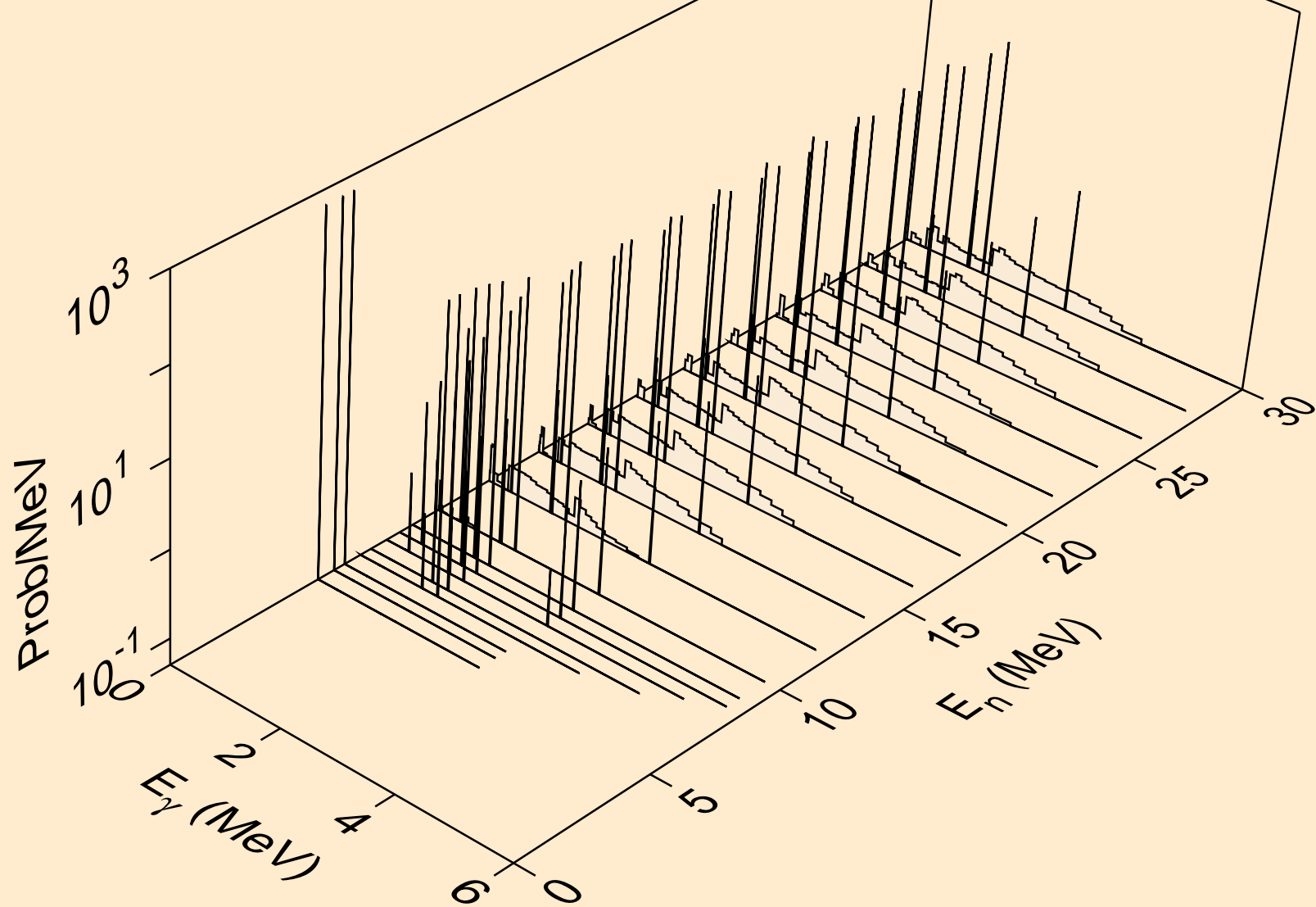

CO055 NEUTRON ACER TENDL-2024 LIBRARY; T=0.K
Photon emission for (n,t)

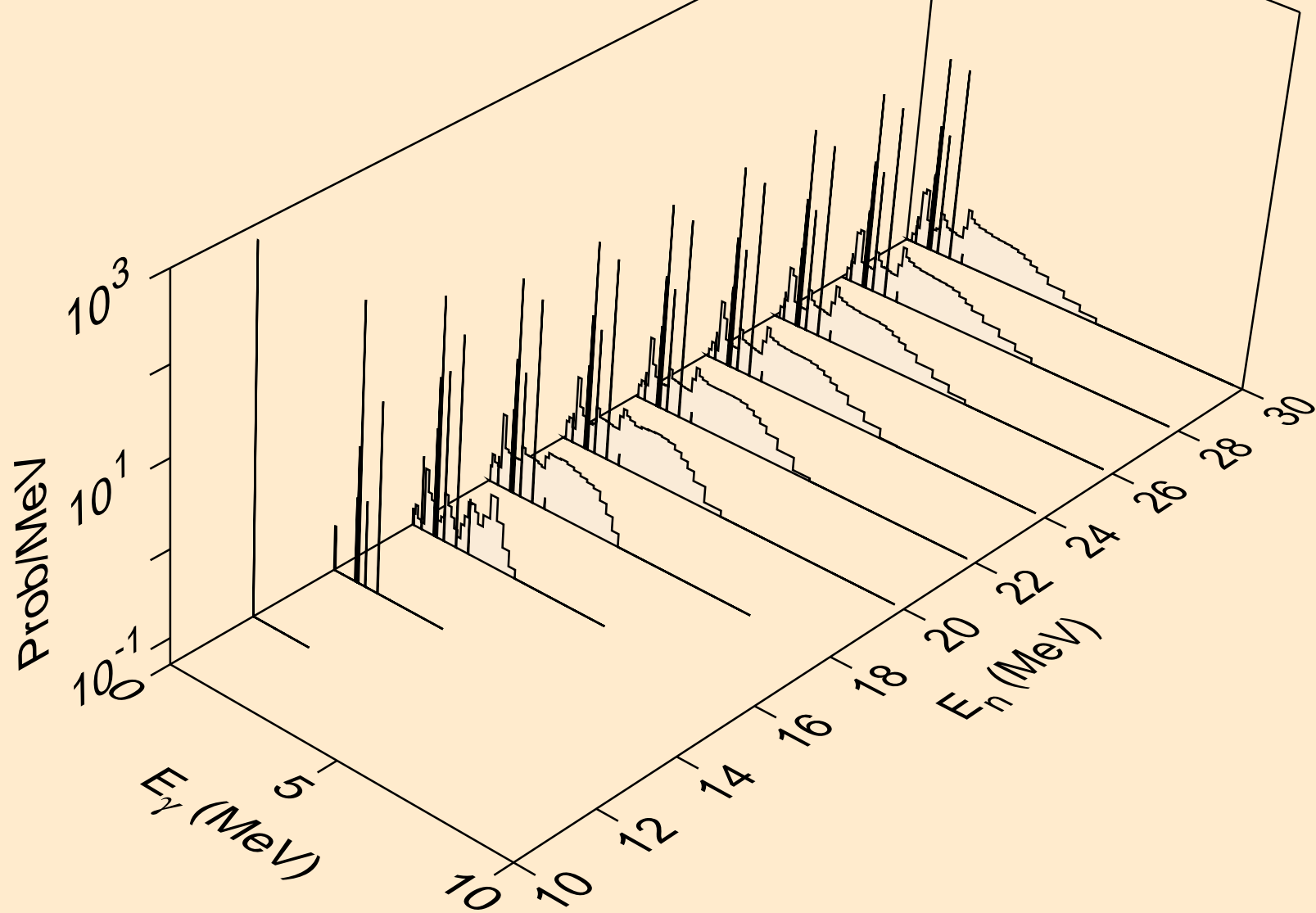

CO055 NEUTRON ACER TENDL-2024 LIBRARY; T=0.K
Photon emission for (n,he3)

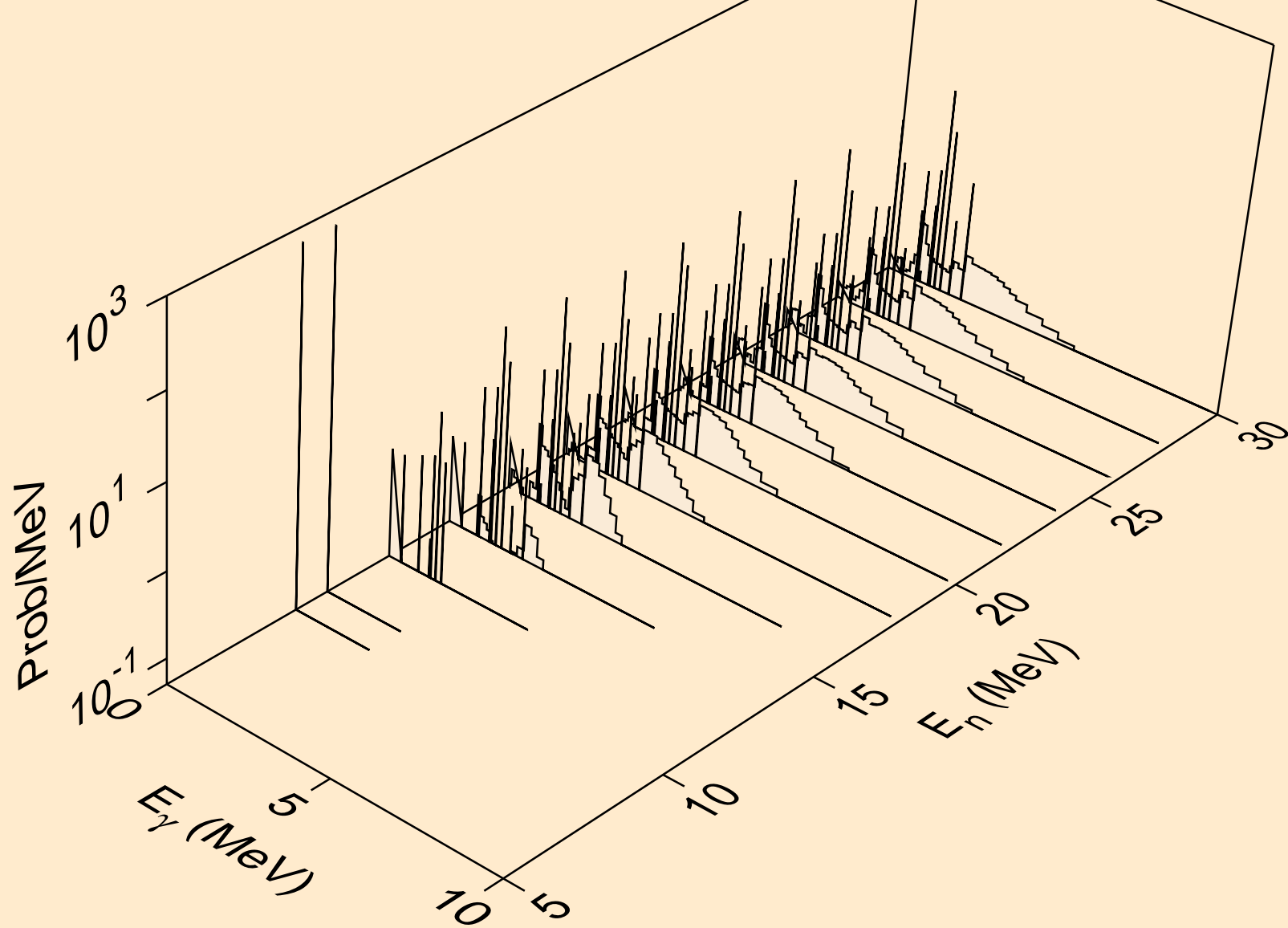

CO055 NEUTRON ACER TENDL-2024 LIBRARY; T=0.K
Photon emission for (n,a)

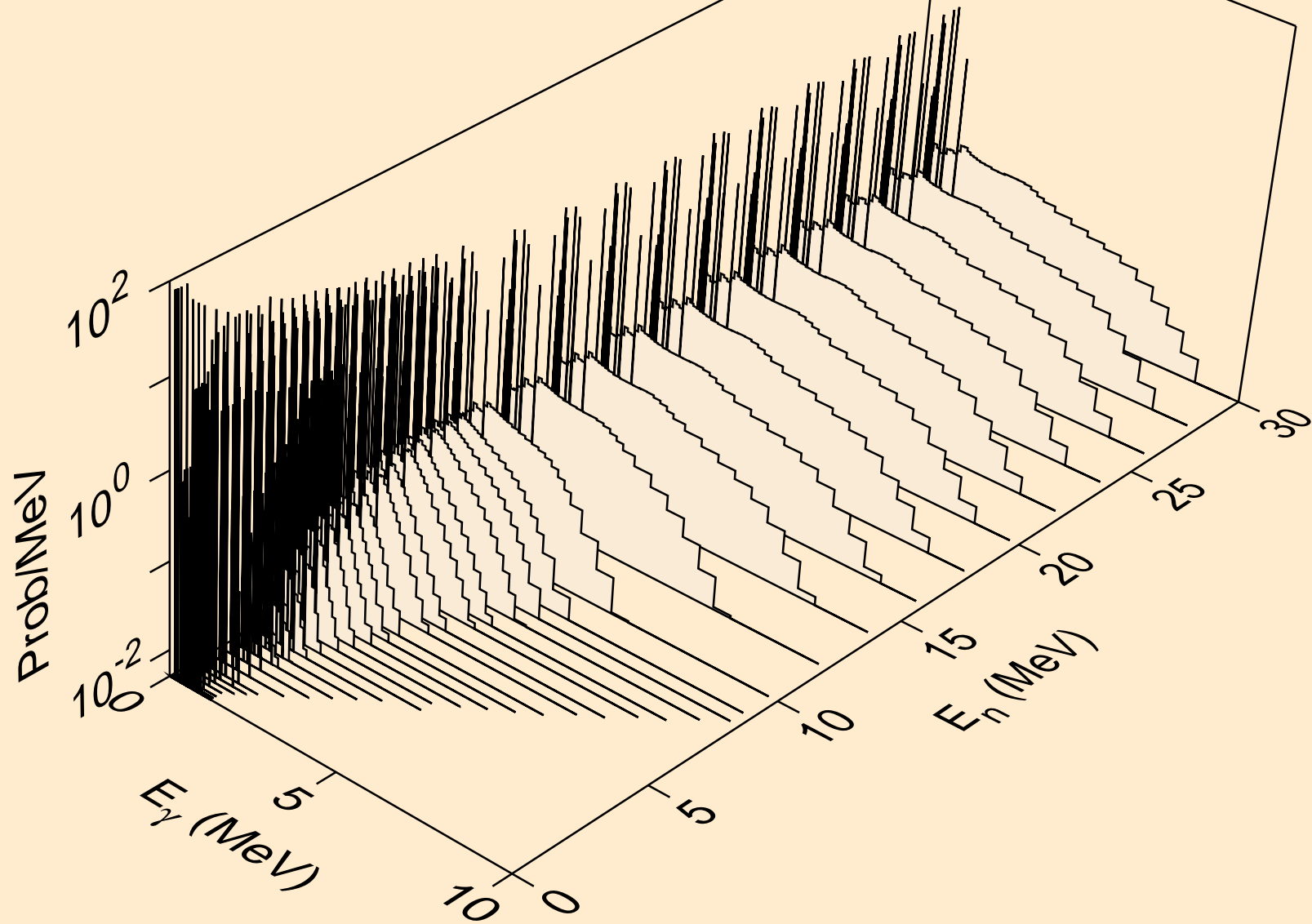

CO055 NEUTRON ACER TENDL-2024 LIBRARY; T=0.K
Photon emission for (n,2a)

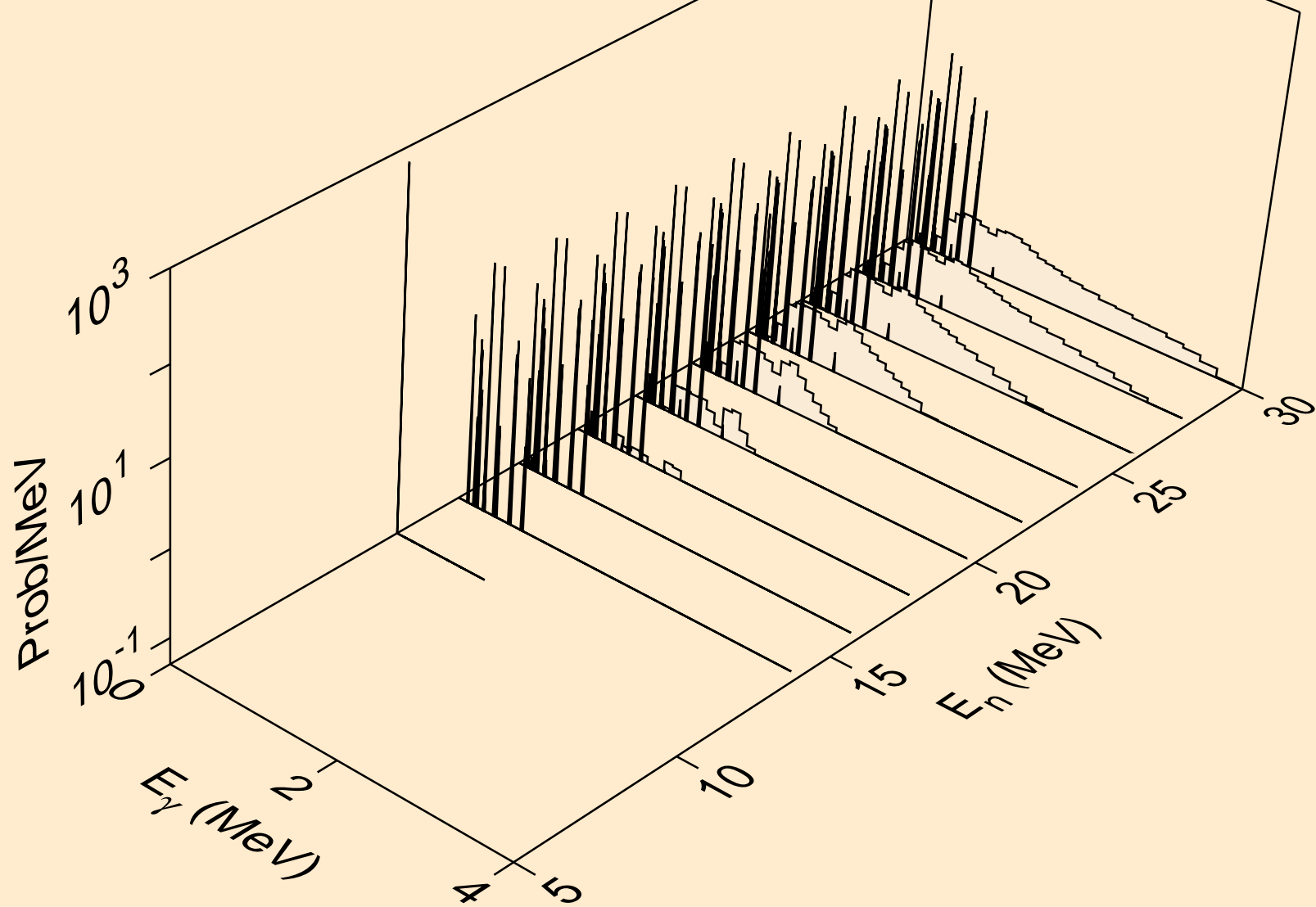

CO055 NEUTRON ACER TENDL-2024 LIBRARY; T=0.K
Photon emission for (n,2p)

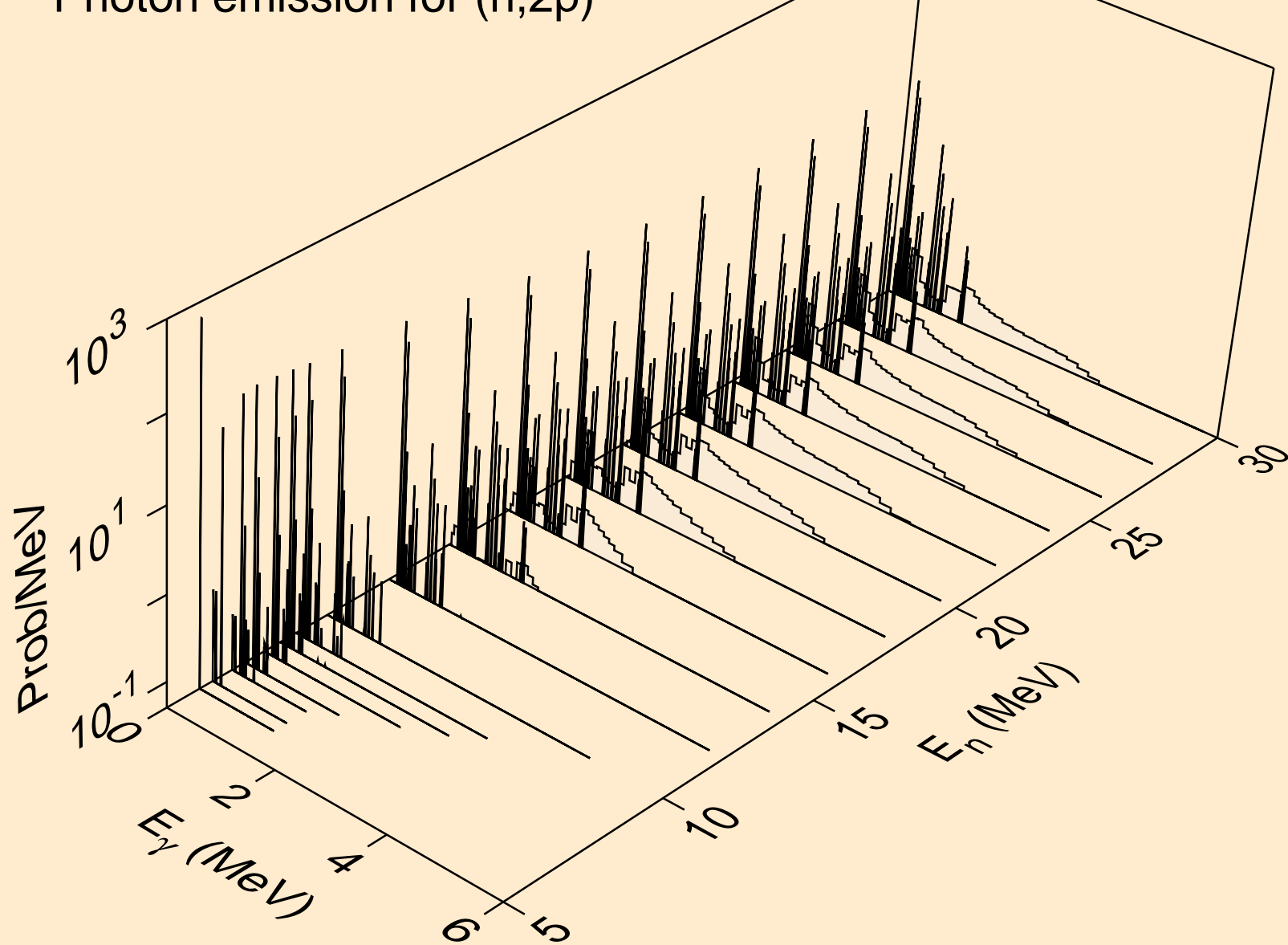

CO055 NEUTRON ACER TENDL-2024 LIBRARY; T=0.K
Photon emission for (n,p α)

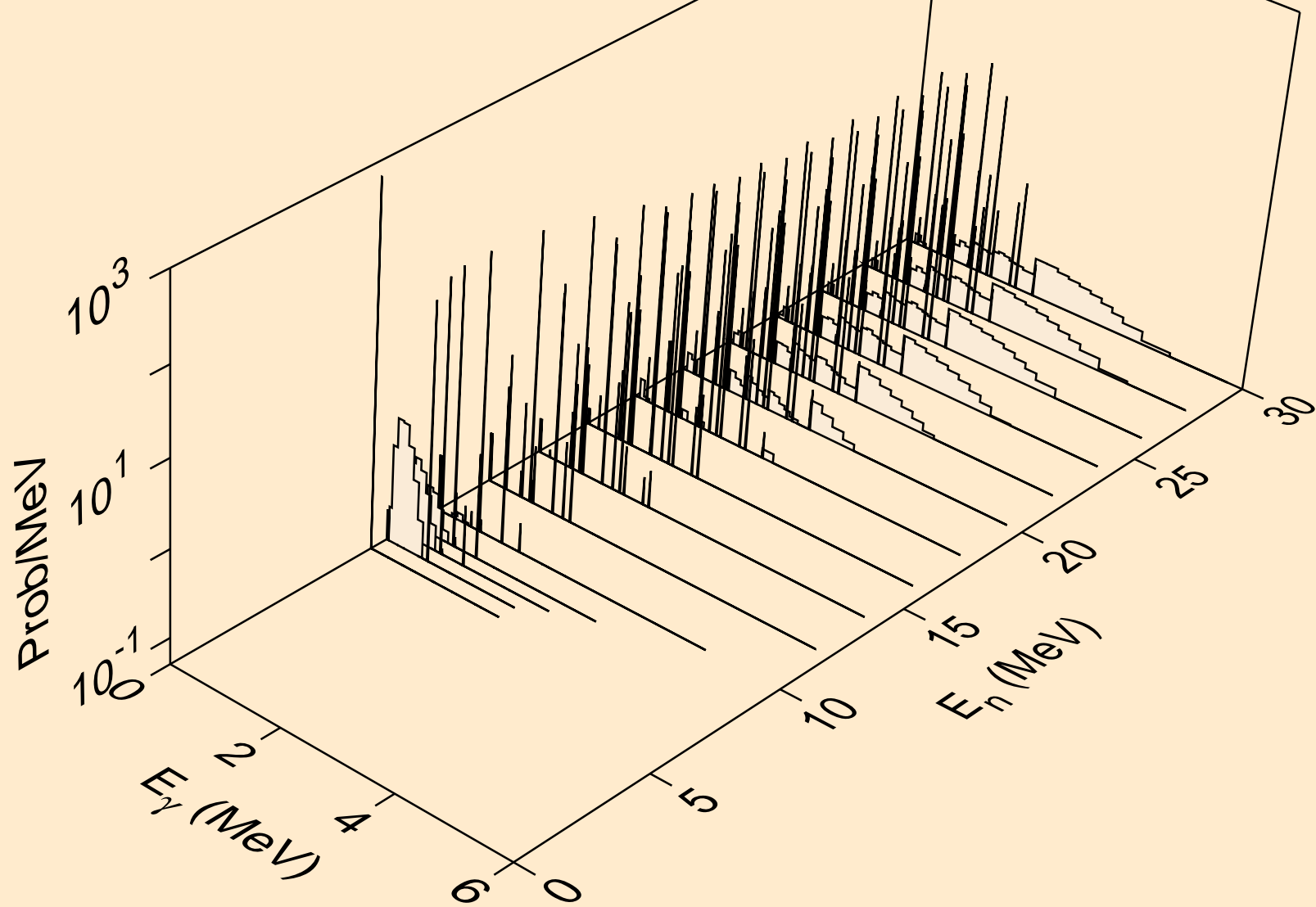

CO055 NEUTRON ACER TENDL-2024 LIBRARY; T=0.K
Photon emission for (n,pd)

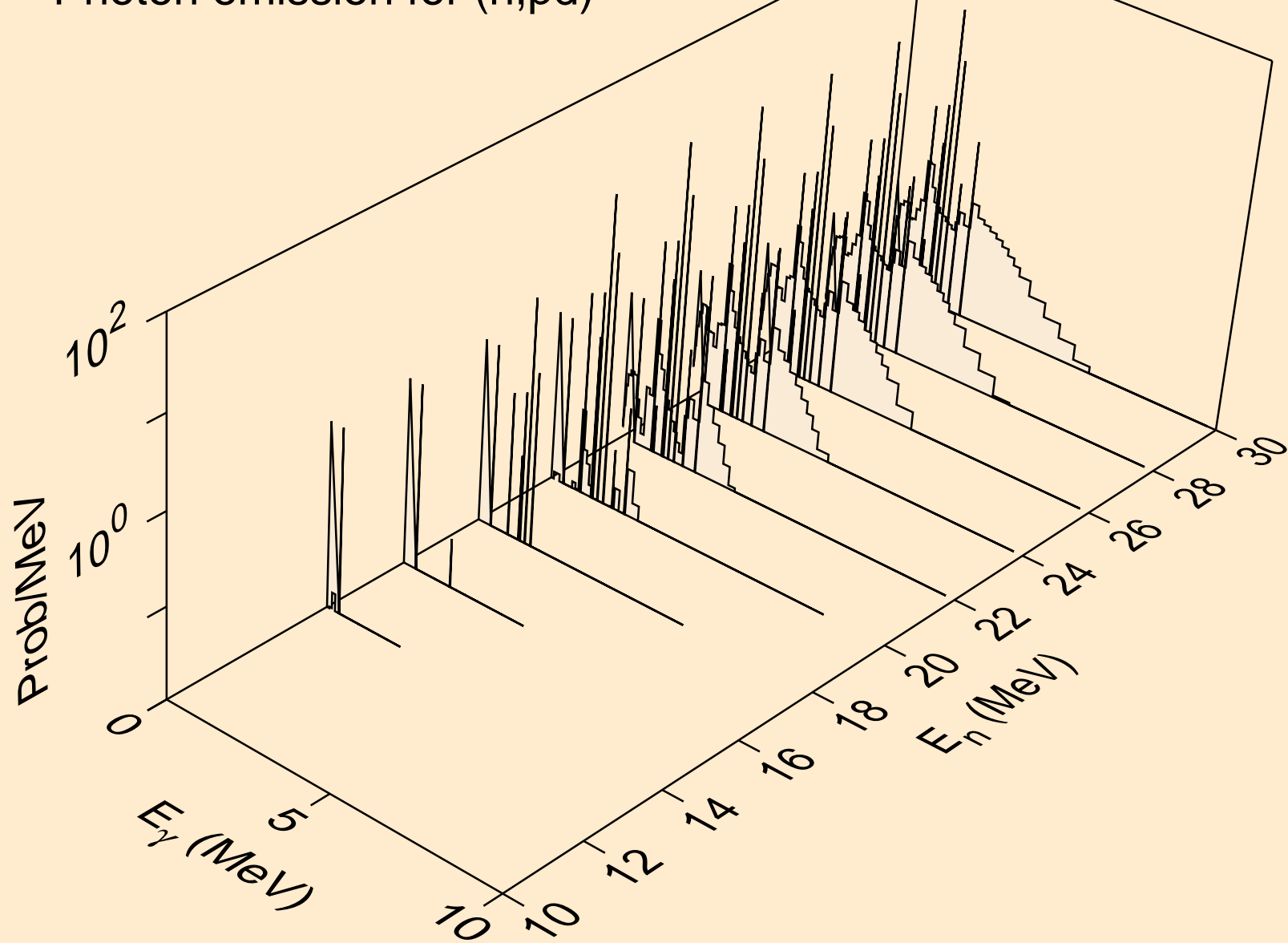

CO055 NEUTRON ACER TENDL-2024 LIBRARY; T=0.K
Photon emission for (n,pt)

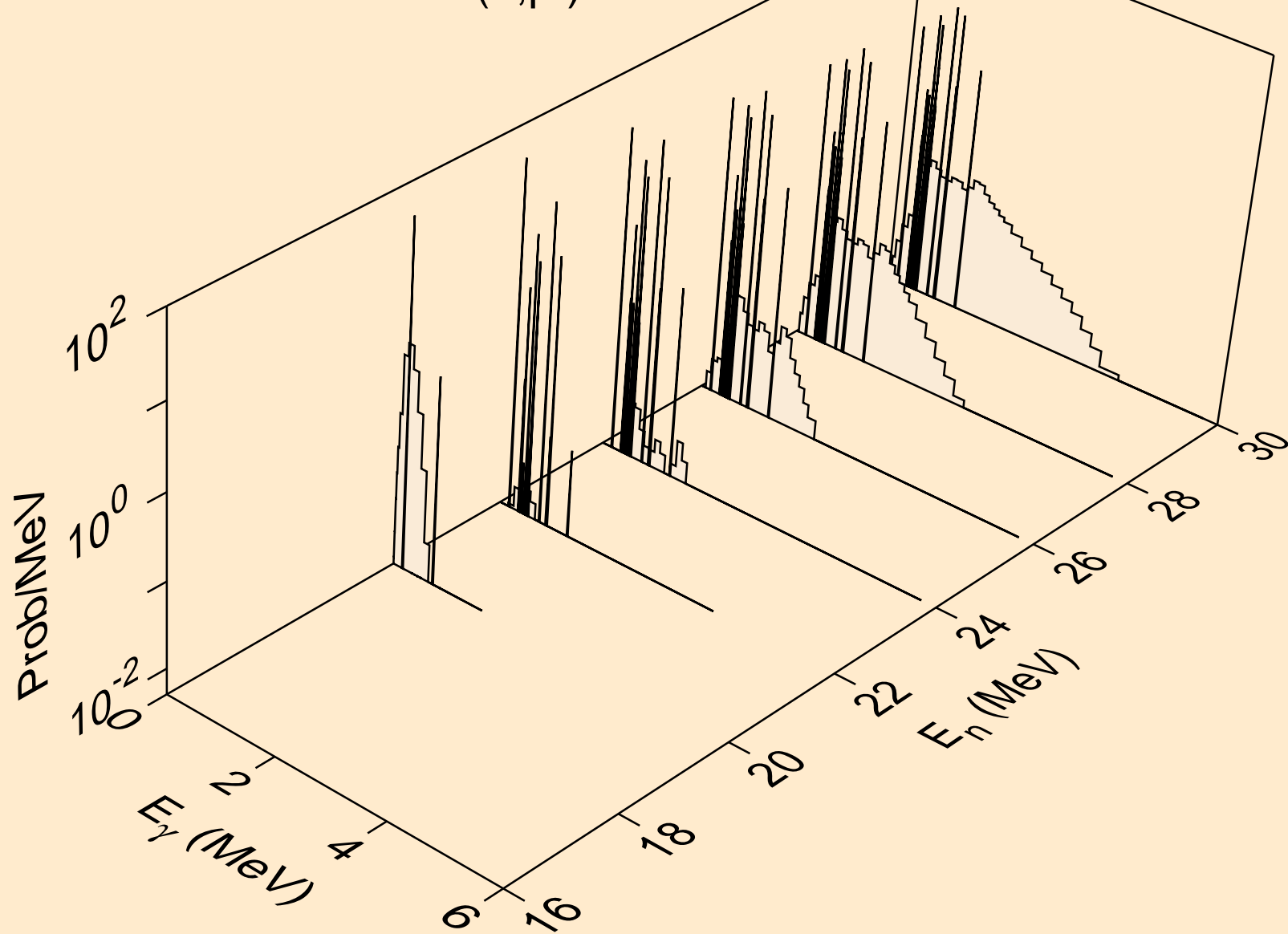

CO055 NEUTRON ACER TENDL-2024 LIBRARY; T=0.K
Photon emission for (n,da)

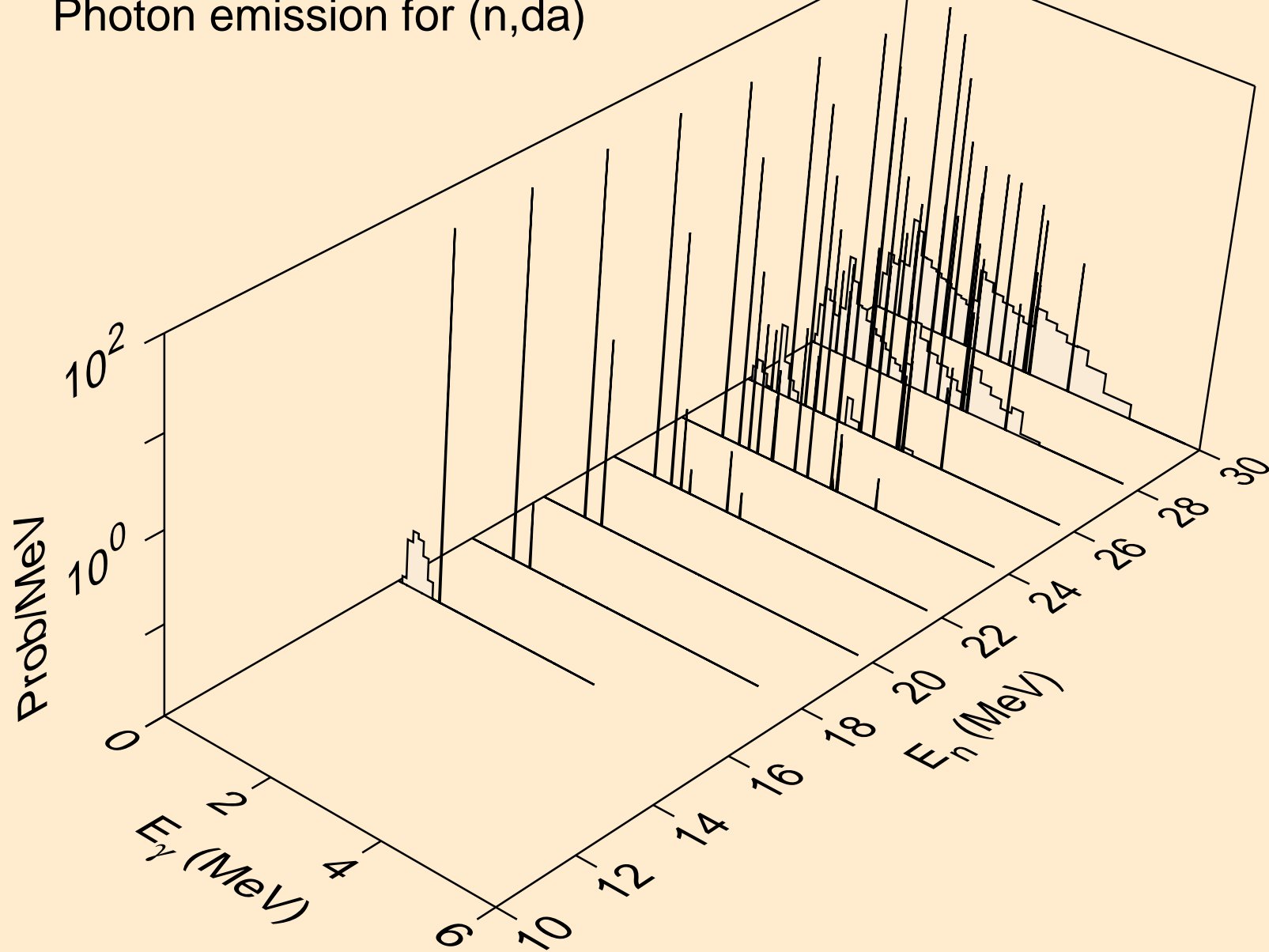

CO055 NEUTRON ACER TENDL-2024 LIBRARY; T=0.K
thermal capture photon spectrum

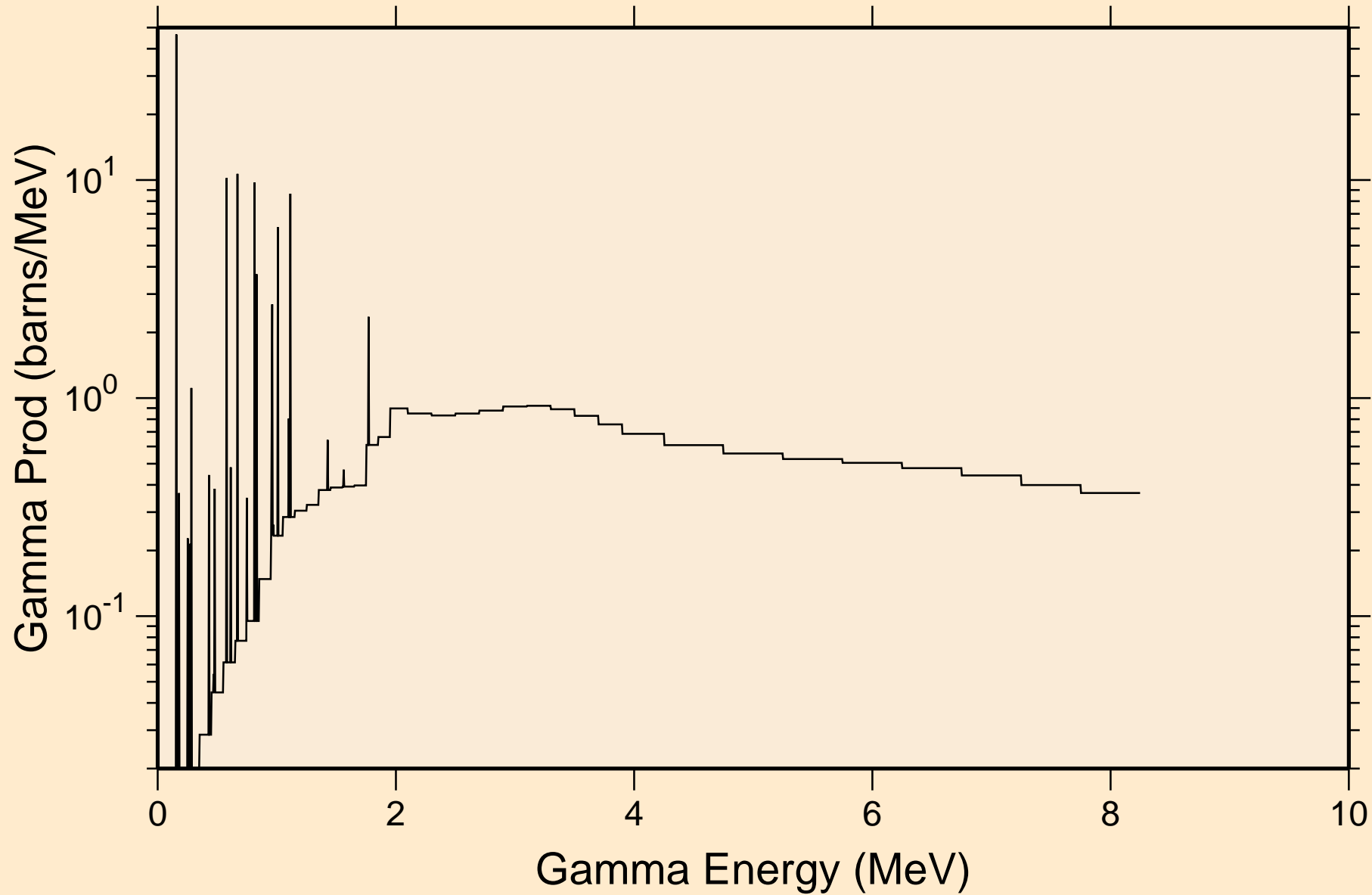

CO055 NEUTRON ACER TENDL-2024 LIBRARY; T=0.K
14 MeV photon spectrum

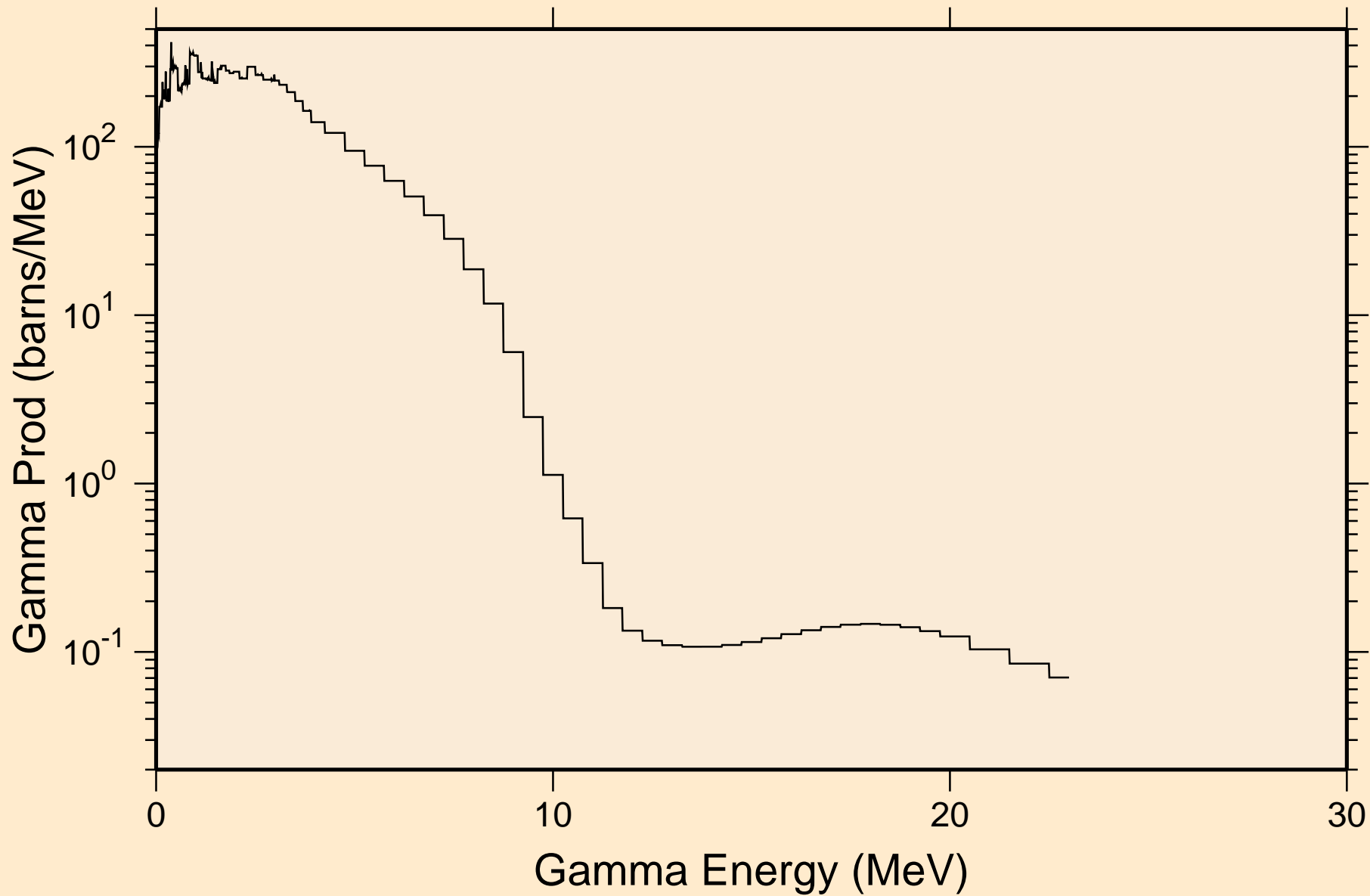

CO055 NEUTRON ACER TENDL-2024 LIBRARY; T=0.K

Particle heating contributions

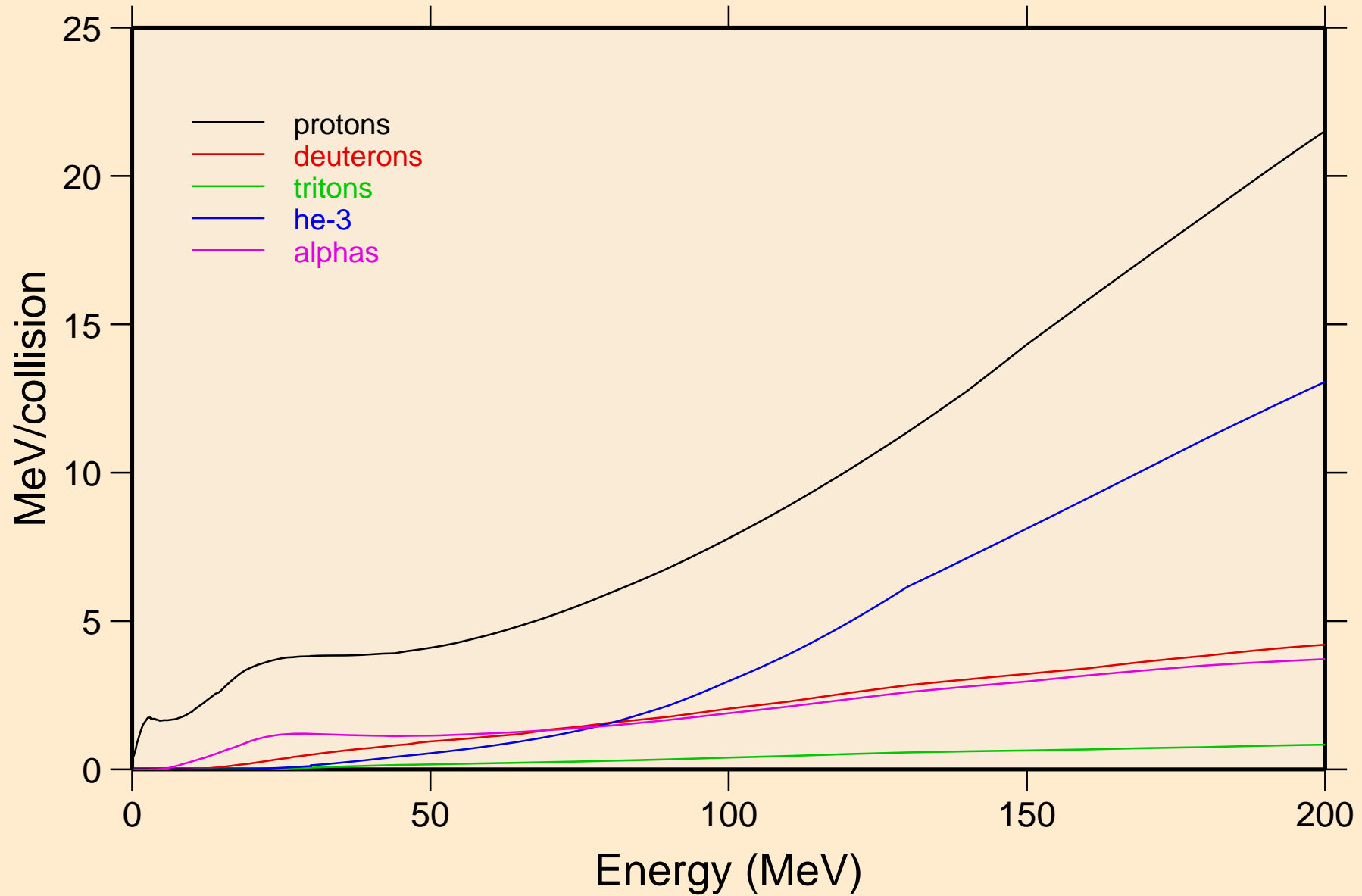

CO055 NEUTRON ACER TENDL-2024 LIBRARY; T=0.K
Recoil Heating

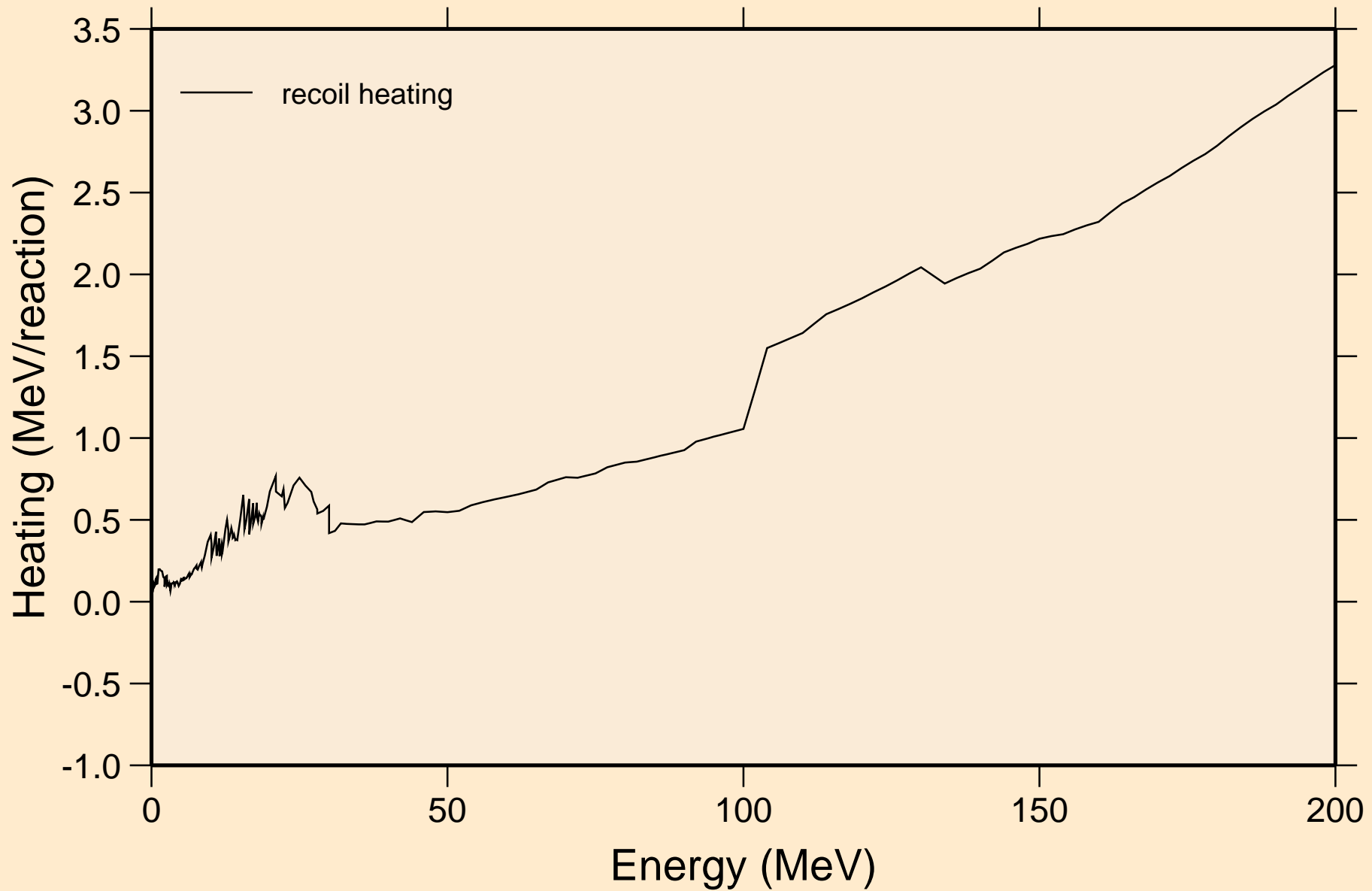

CO055 NEUTRON ACER TENDL-2024 LIBRARY; T=0.K
Particle production cross sections

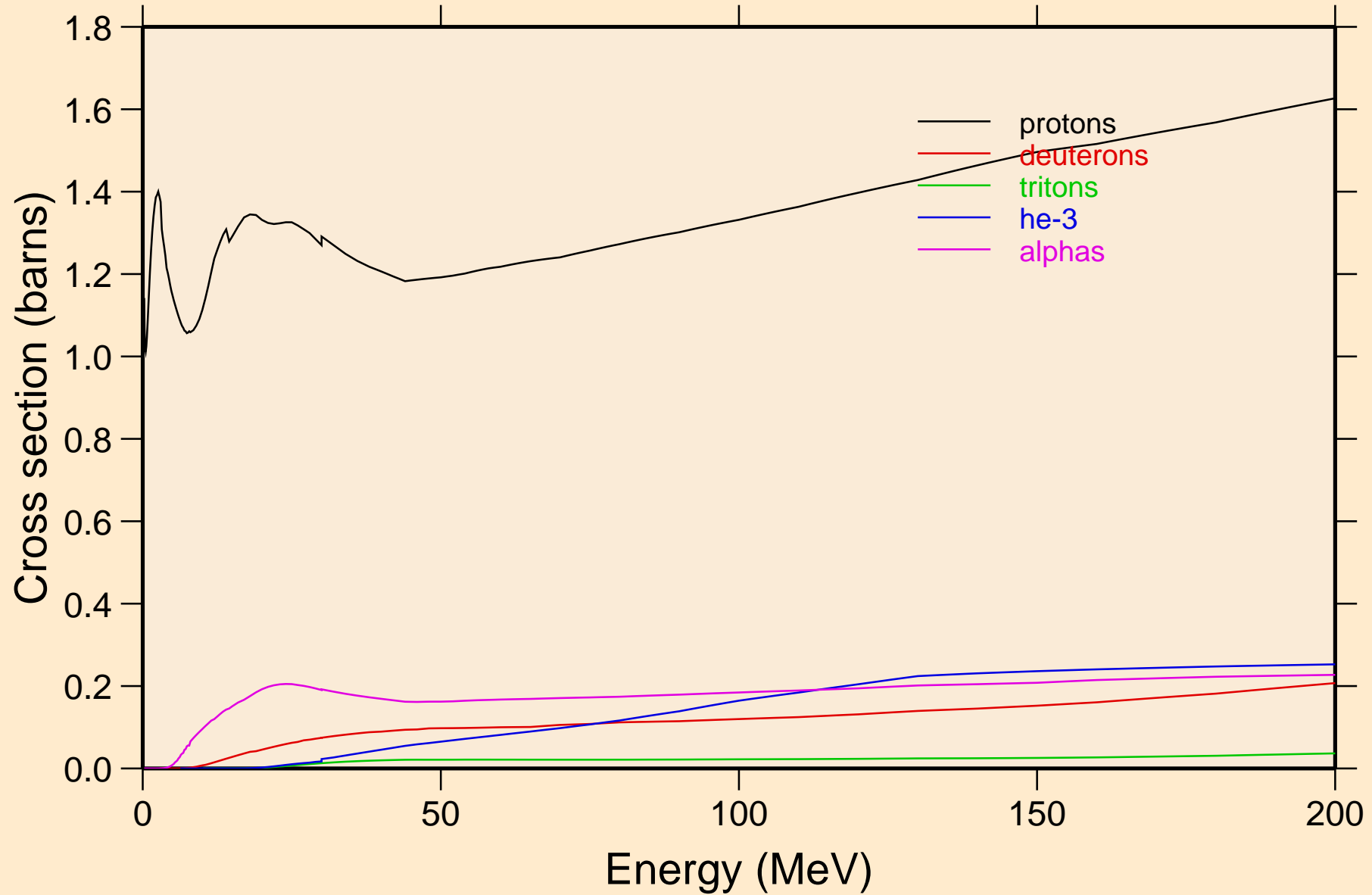

CO055 NEUTRON ACER TENDL-2024 LIBRARY; T=0.K
protons from (n,x)

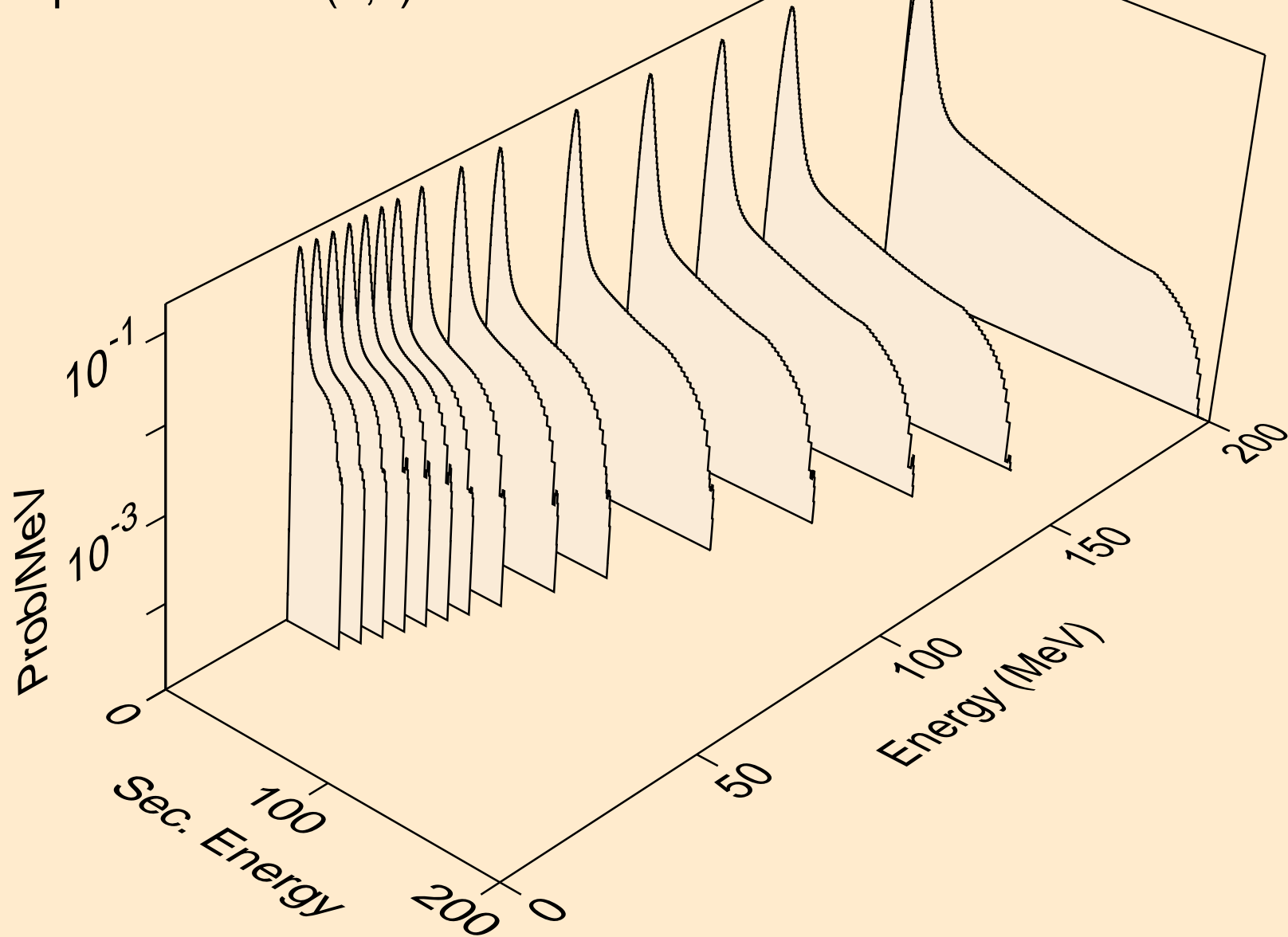

CO055 NEUTRON ACER TENDL-2024 LIBRARY; T=0.K
protons from (n,n*)p

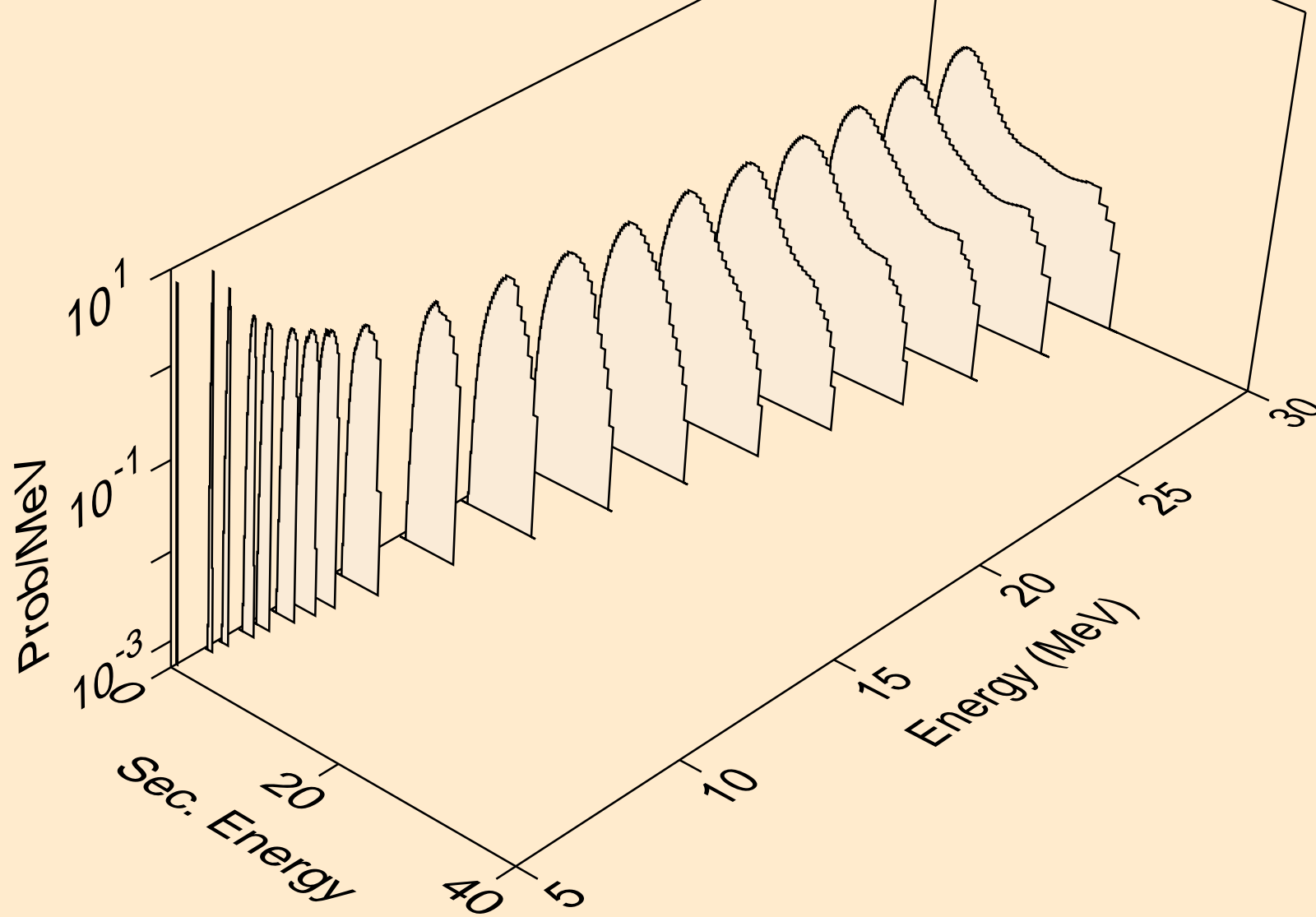

CO055 NEUTRON ACER TENDL-2024 LIBRARY; T=0.K
protons from (n,2np)

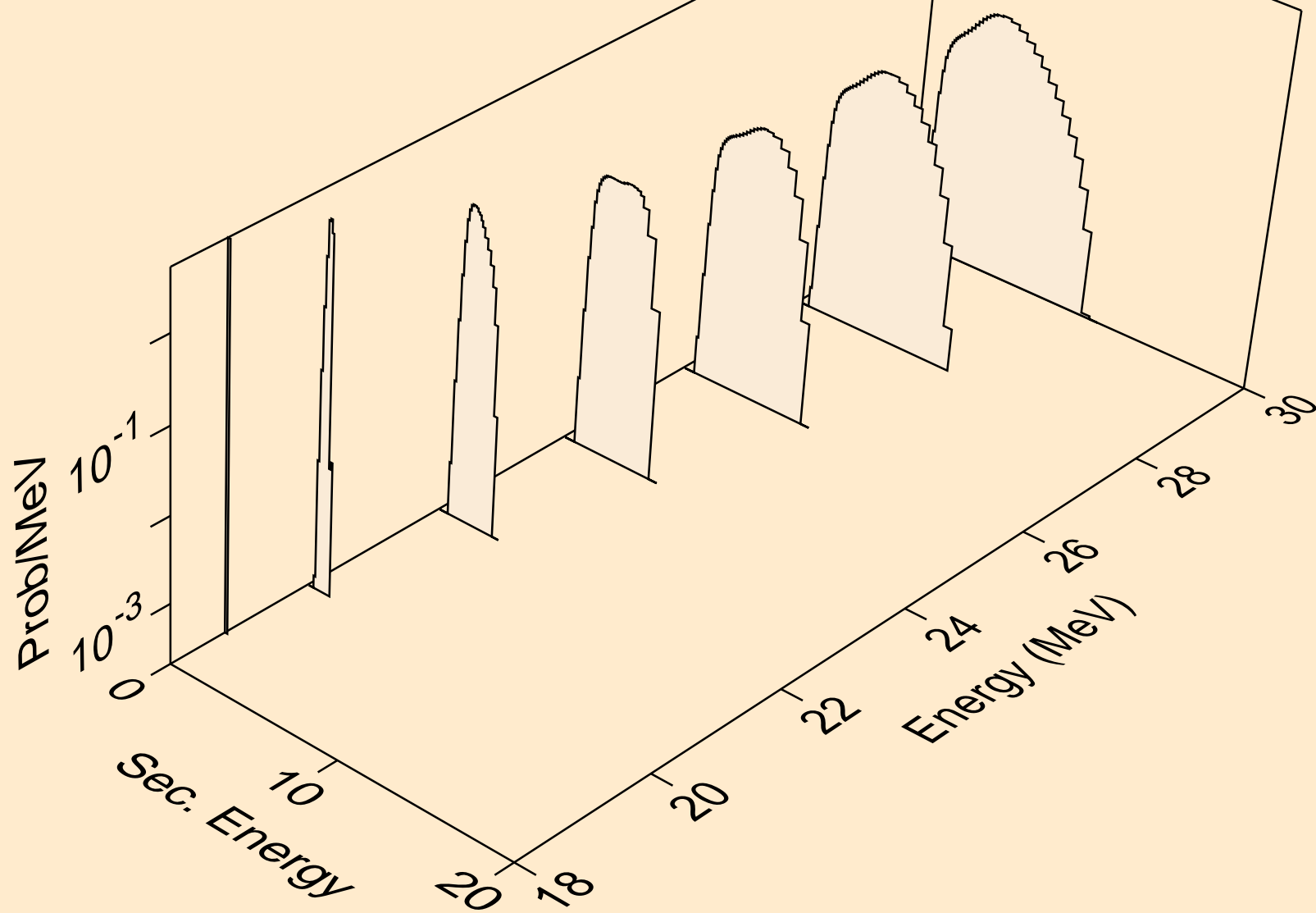

CO055 NEUTRON ACER TENDL-2024 LIBRARY; T=0.K
protons from (n,n2p)

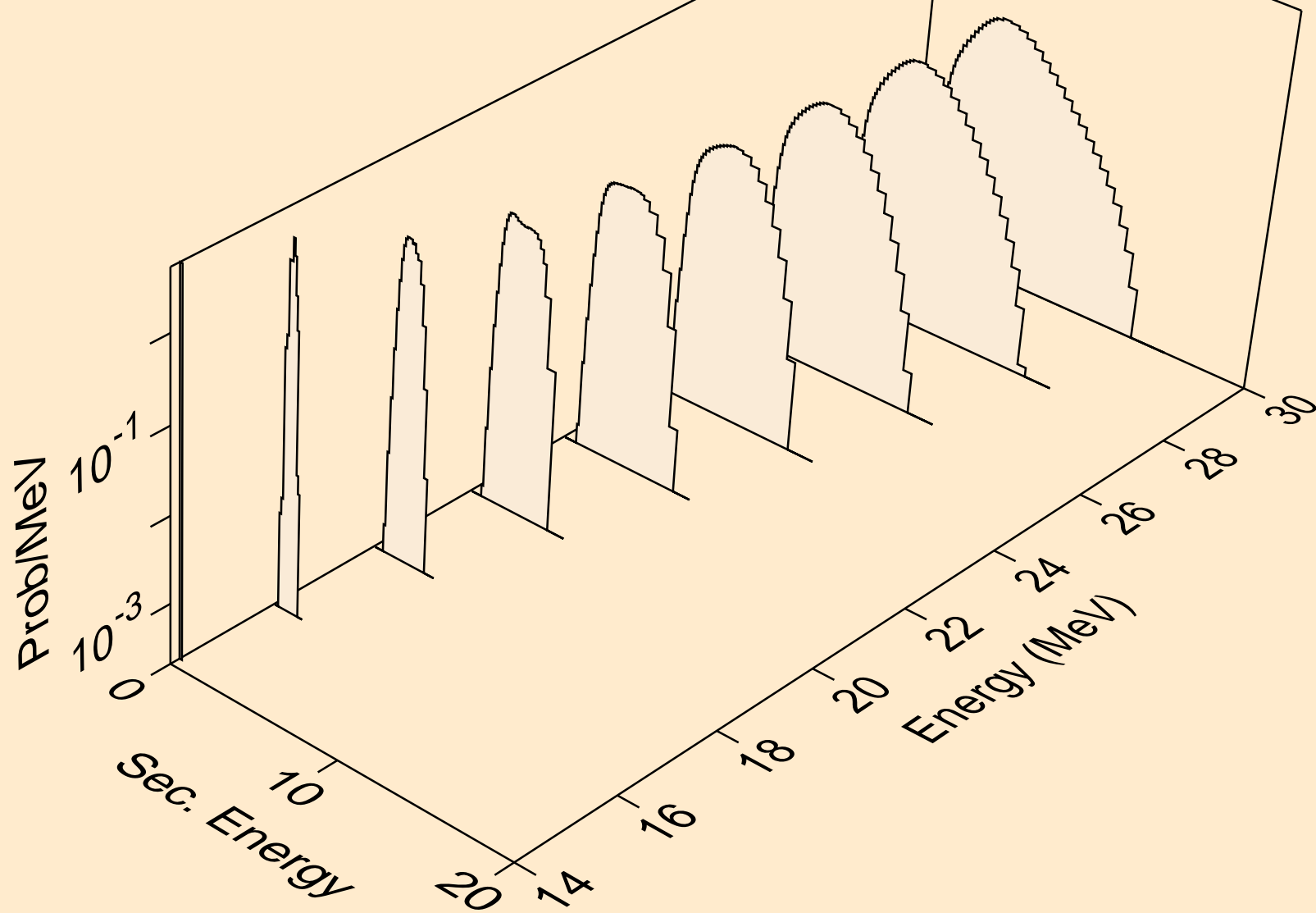

CO055 NEUTRON ACER TENDL-2024 LIBRARY; T=0.K
protons from (n,npa)

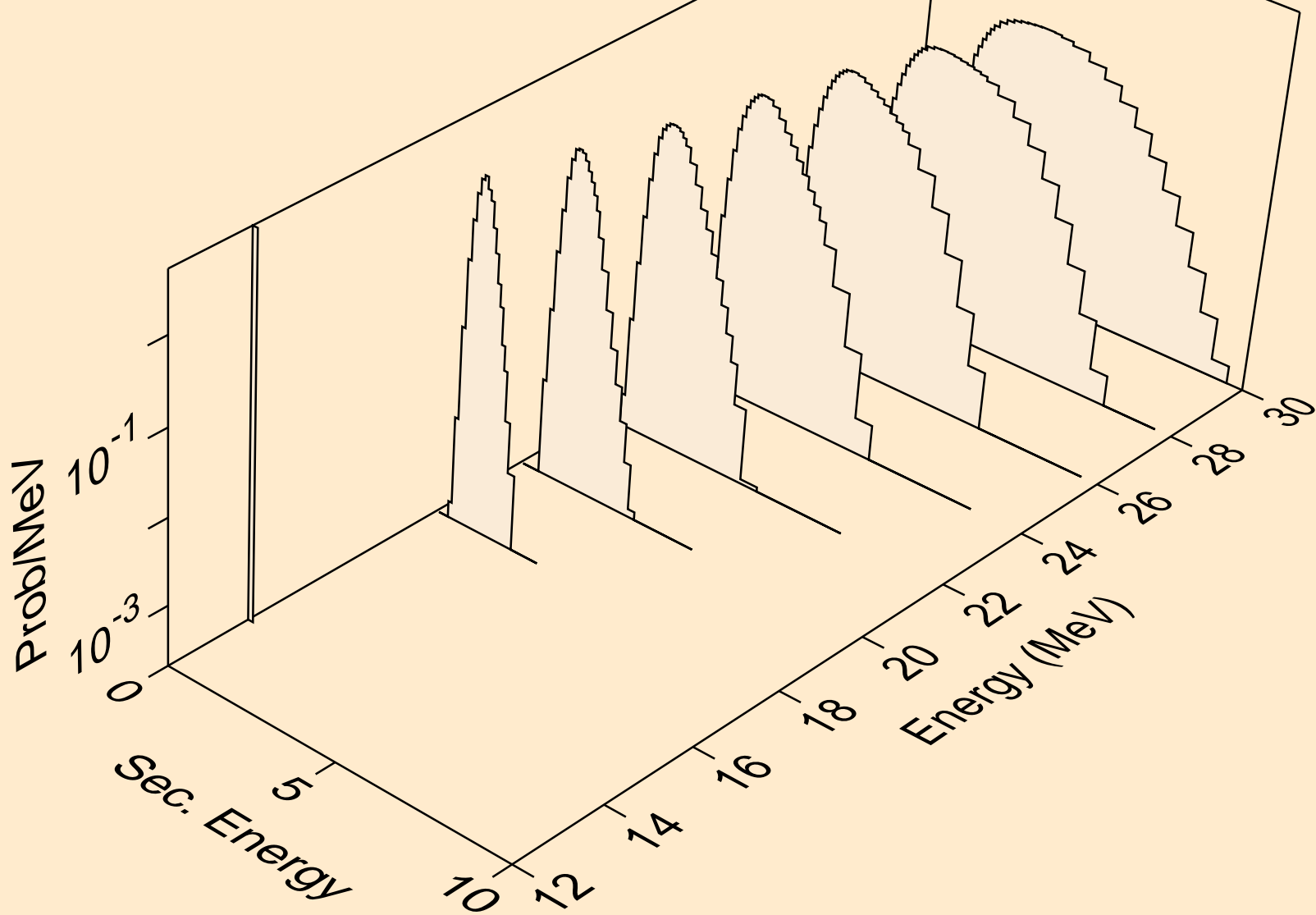

CO055 NEUTRON ACER TENDL-2024 LIBRARY; T=0.K
protons from (n,p)

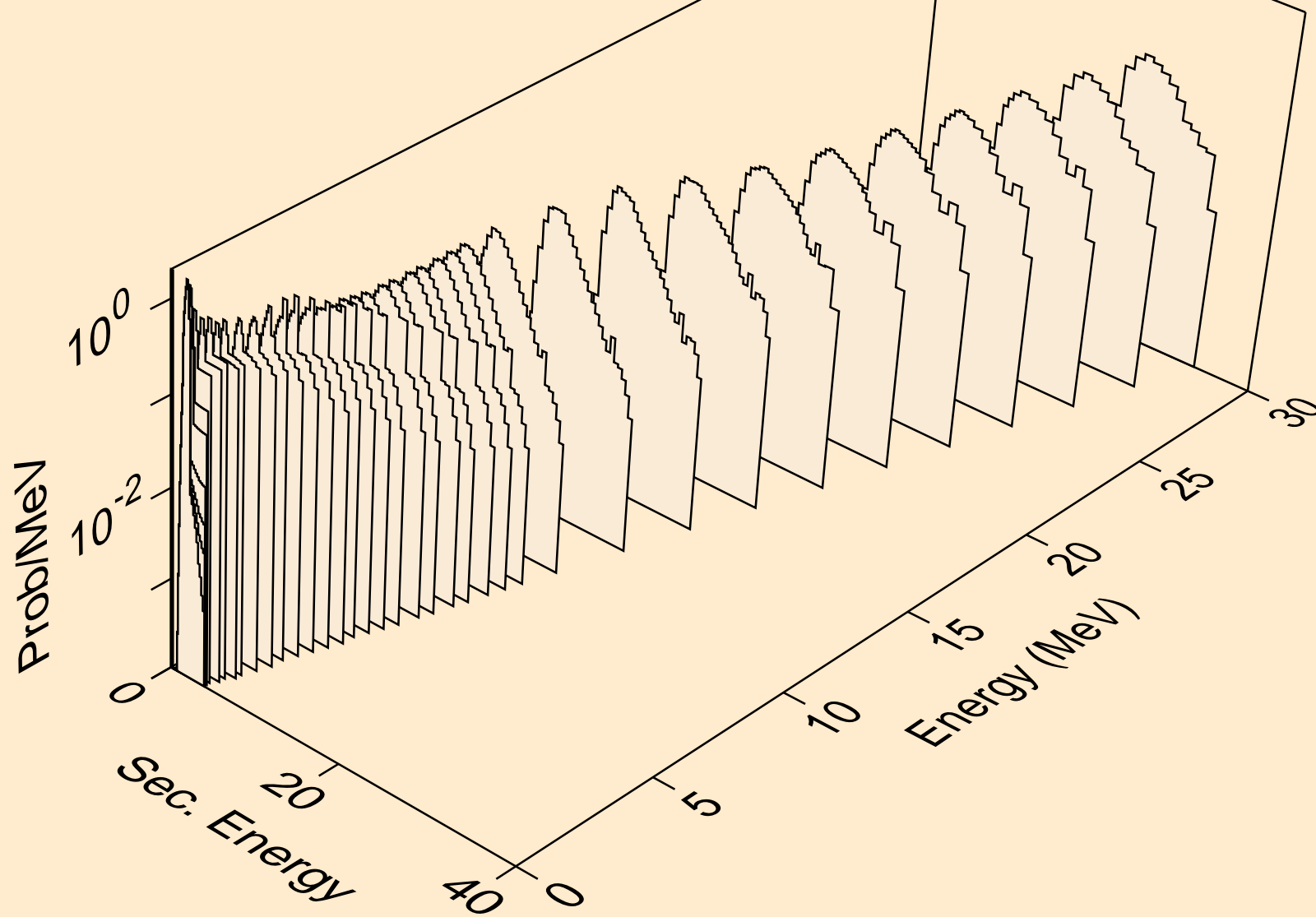

CO055 NEUTRON ACER TENDL-2024 LIBRARY; T=0.K
protons from (n,2p)

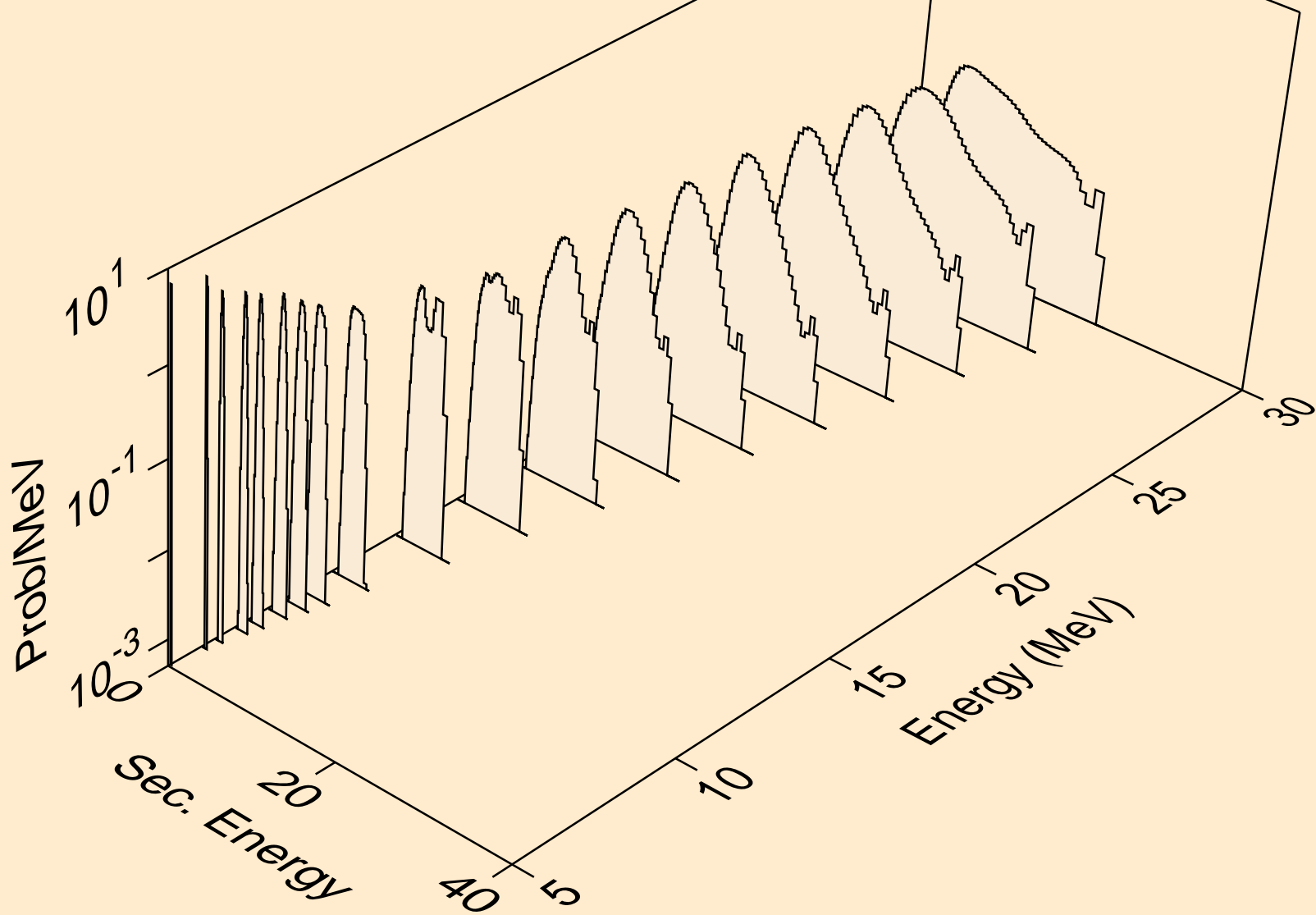

CO055 NEUTRON ACER TENDL-2024 LIBRARY; T=0.K
protons from (n,p)

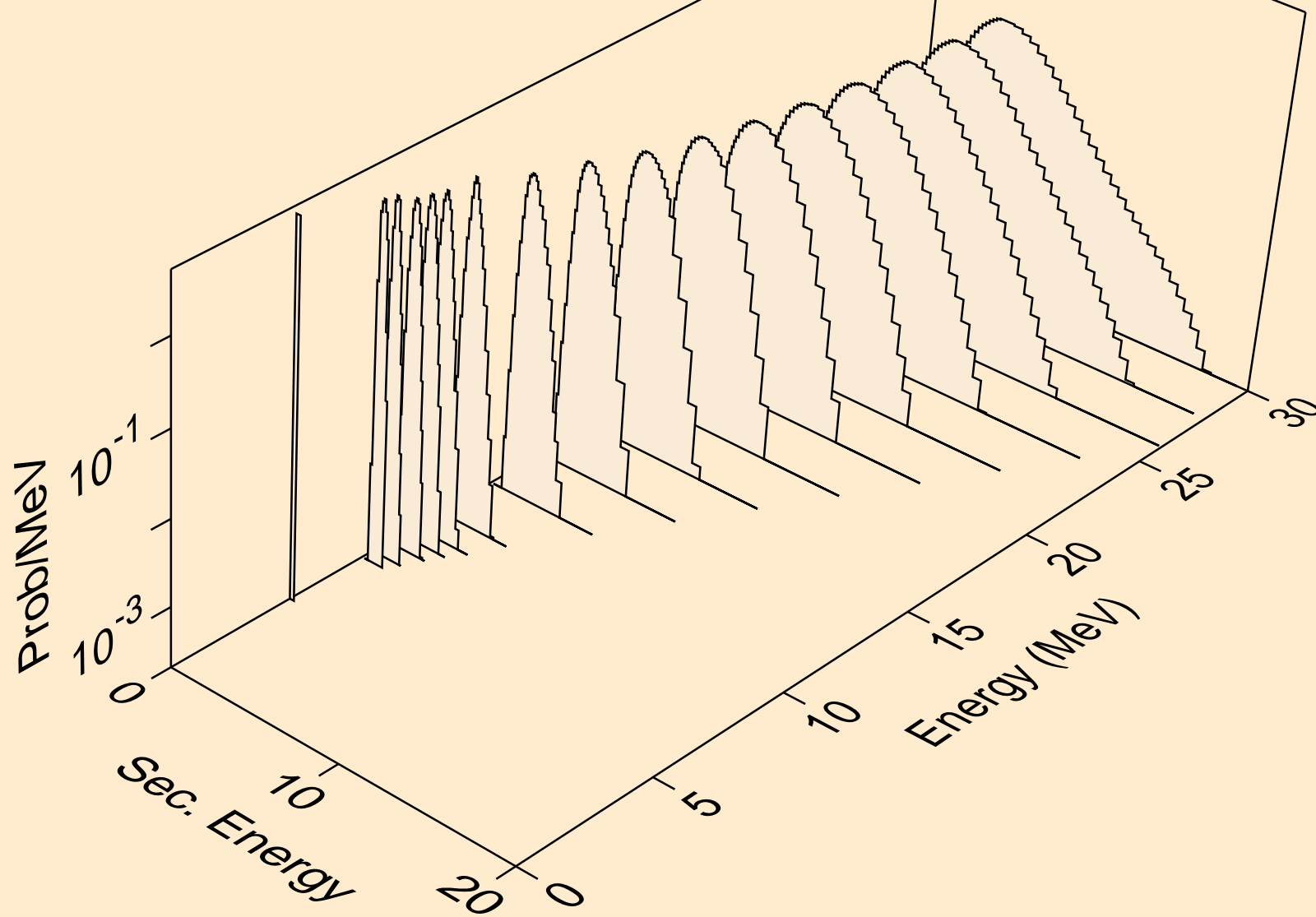

CO055 NEUTRON ACER TENDL-2024 LIBRARY; T=0.K
protons from (n,pd)

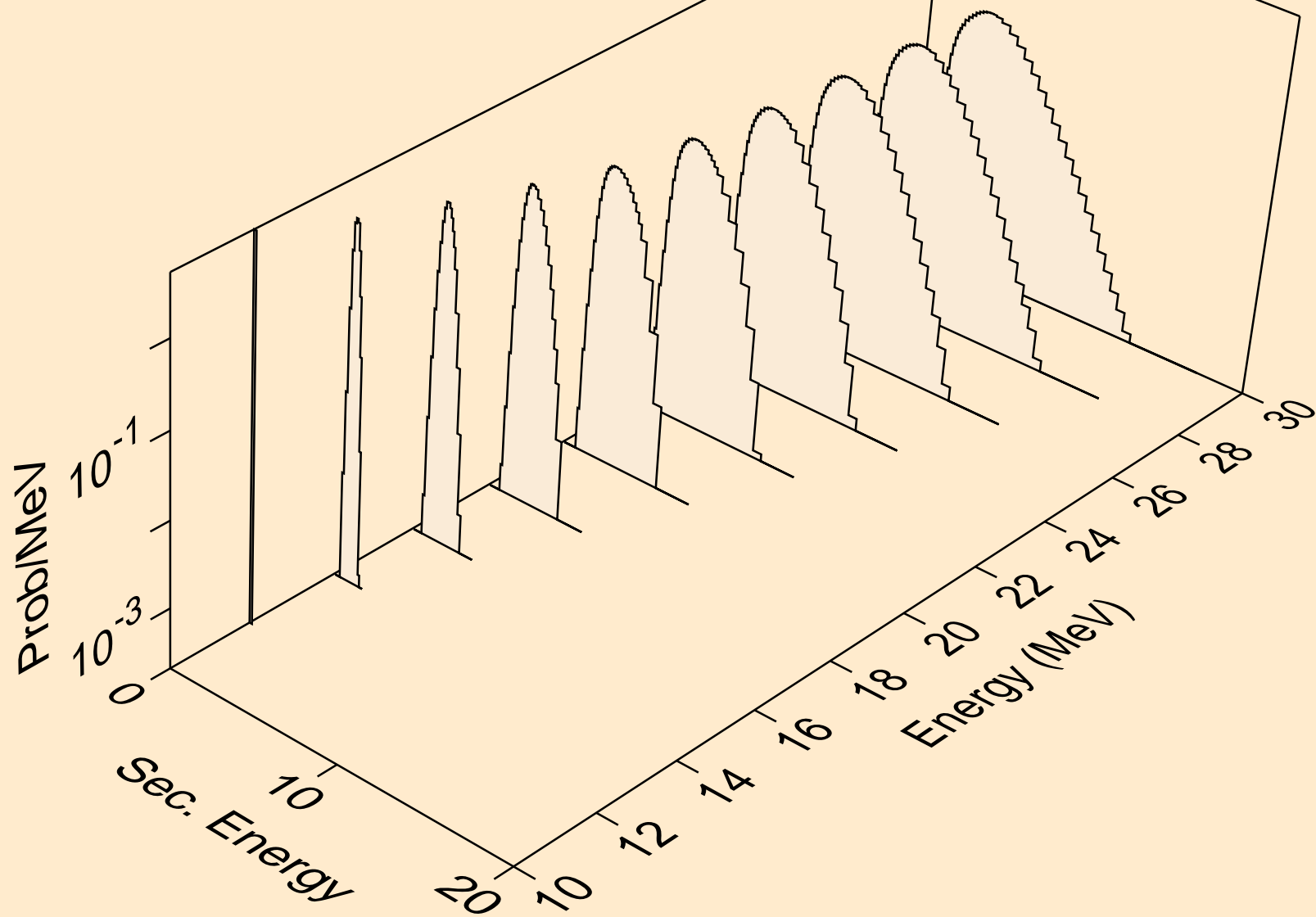

CO055 NEUTRON ACER TENDL-2024 LIBRARY; T=0.K
protons from (n,pt)

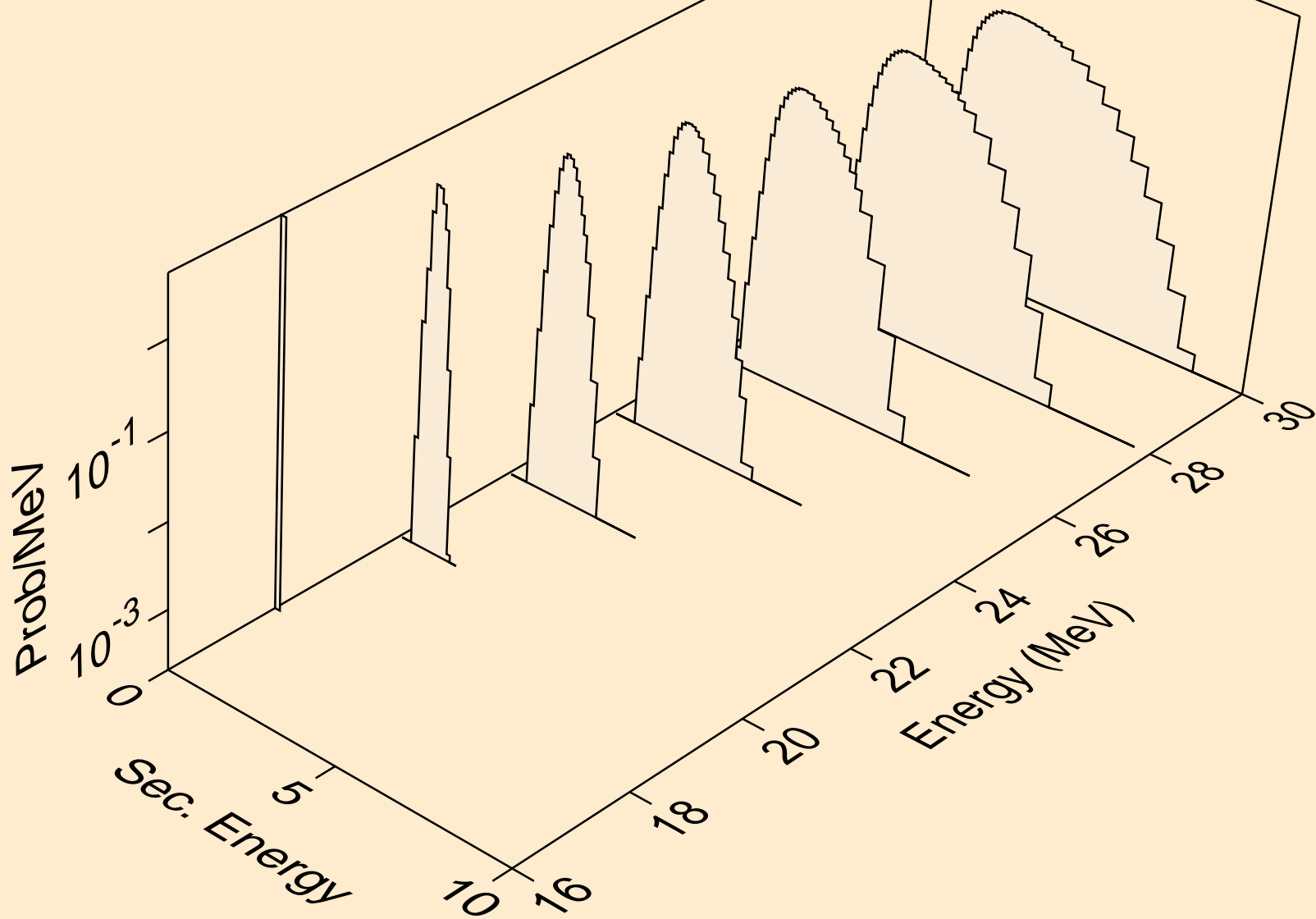

CO055 NEUTRON ACER TENDL-2024 LIBRARY; T=0.K
deuterons from (n,x)

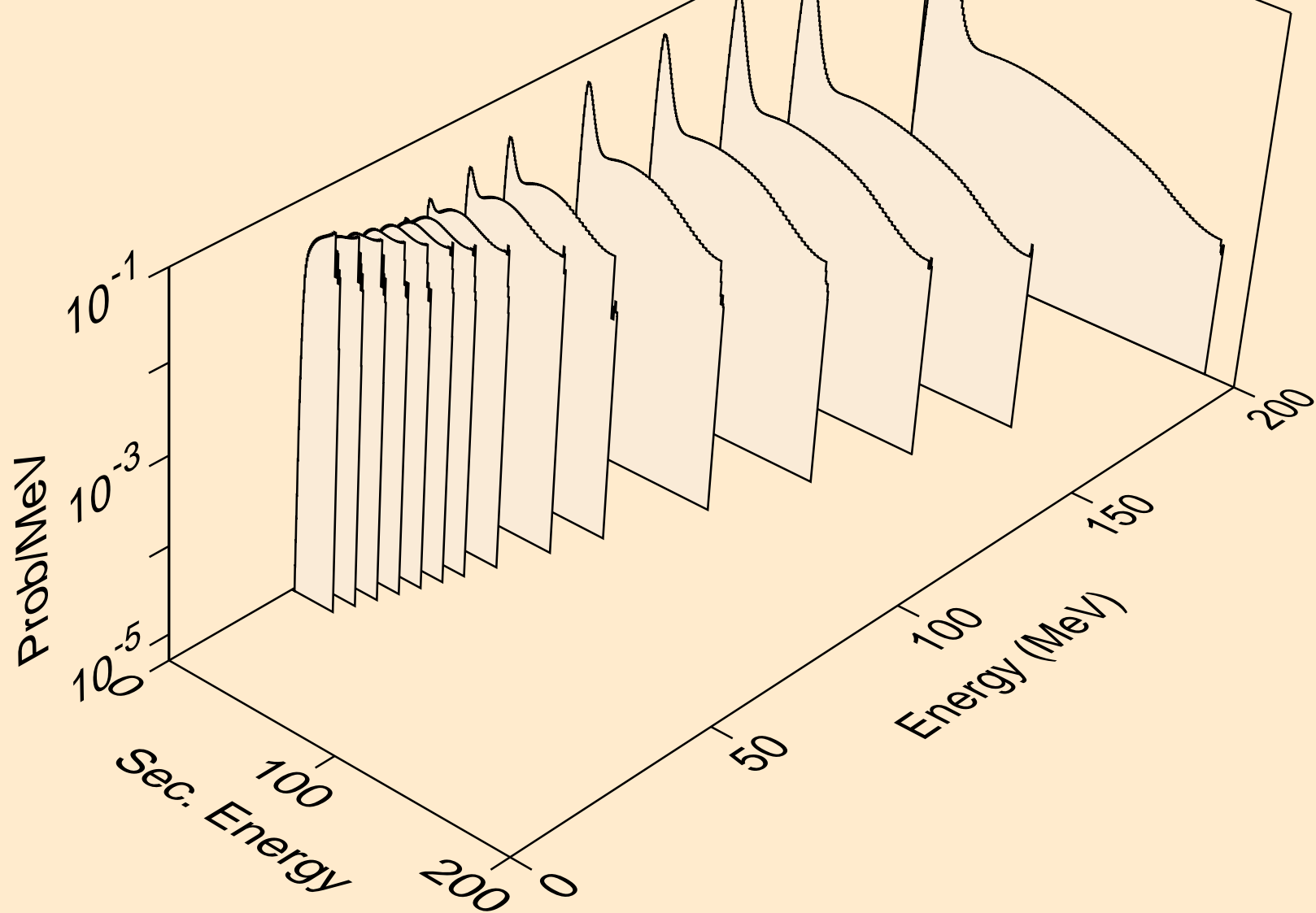

CO055 NEUTRON ACER TENDL-2024 LIBRARY; T=0.K
deuterons from (n,2nd)

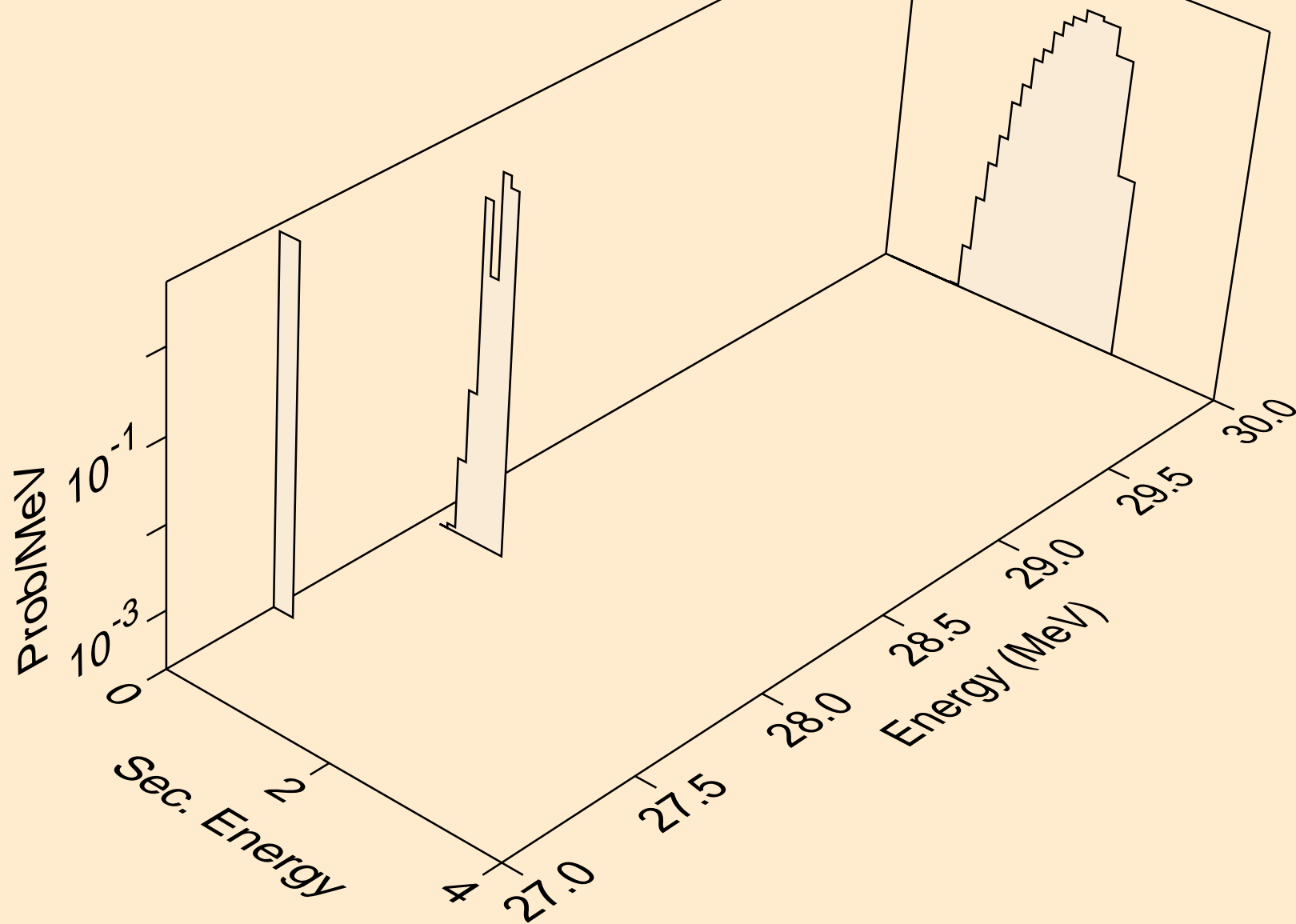

CO055 NEUTRON ACER TENDL-2024 LIBRARY; T=0.K
deuterons from (n,n*)d

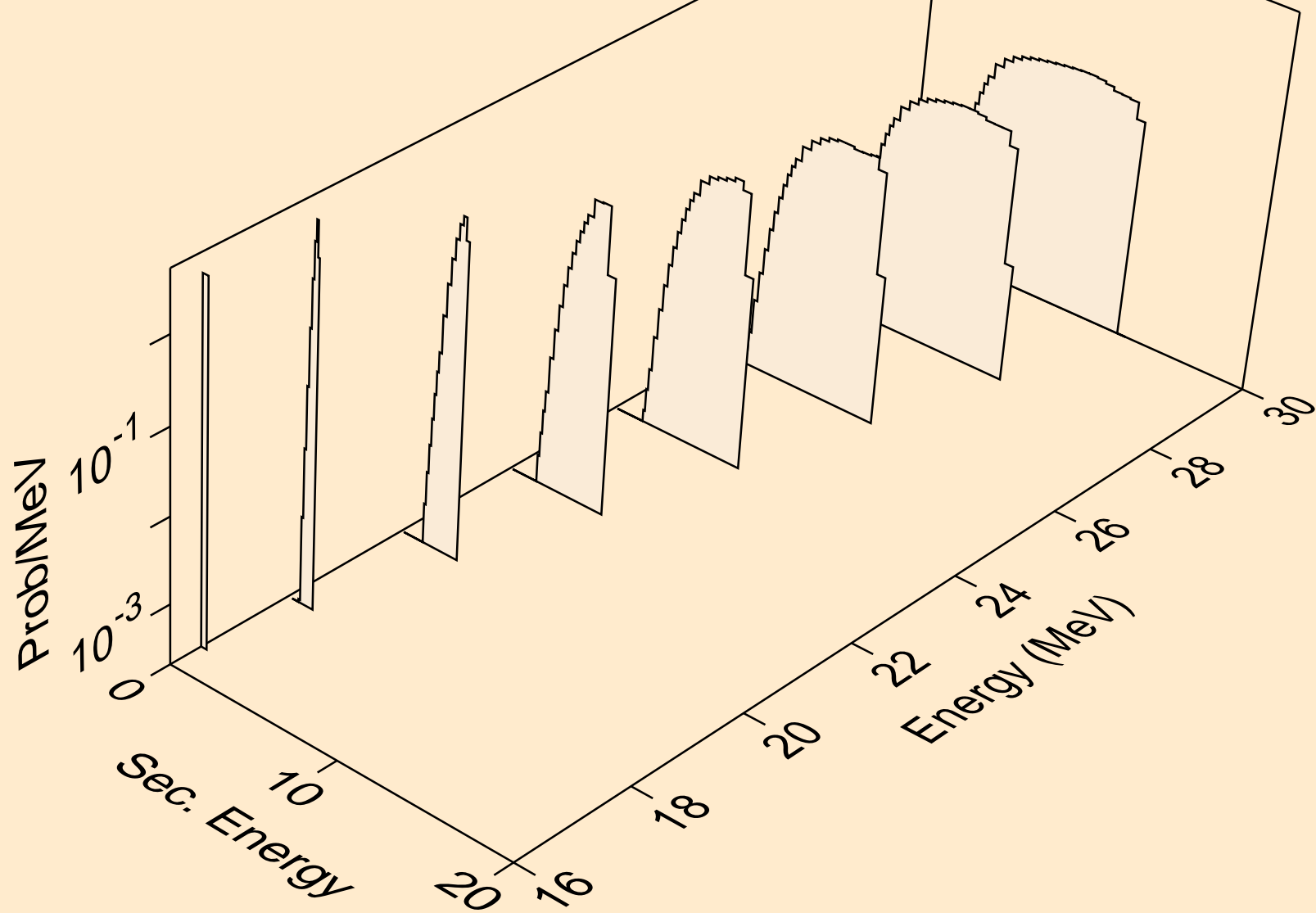

CO055 NEUTRON ACER TENDL-2024 LIBRARY; T=0.K
deuterons from (n,d)

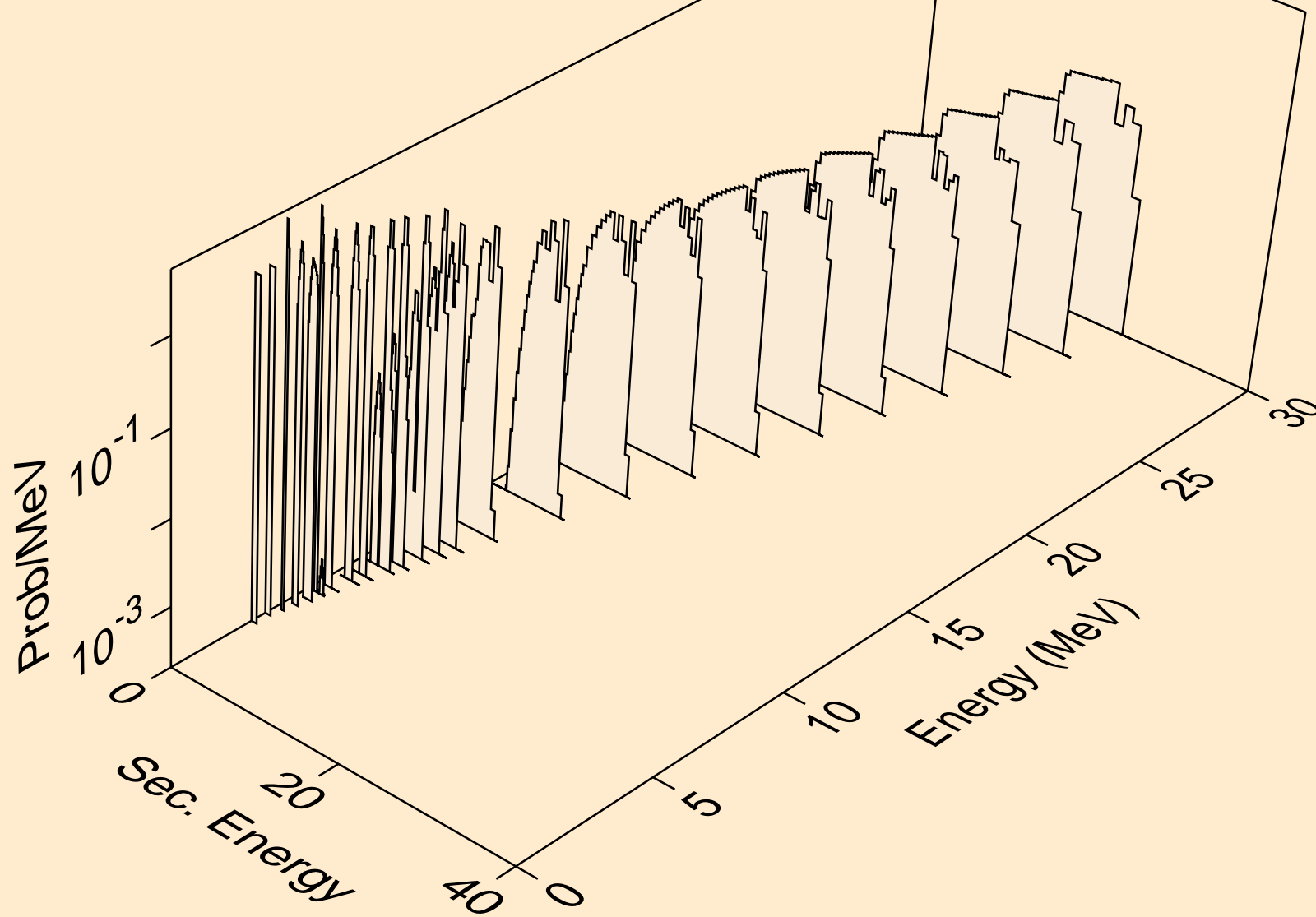

CO055 NEUTRON ACER TENDL-2024 LIBRARY; T=0.K
deuterons from (n,pd)

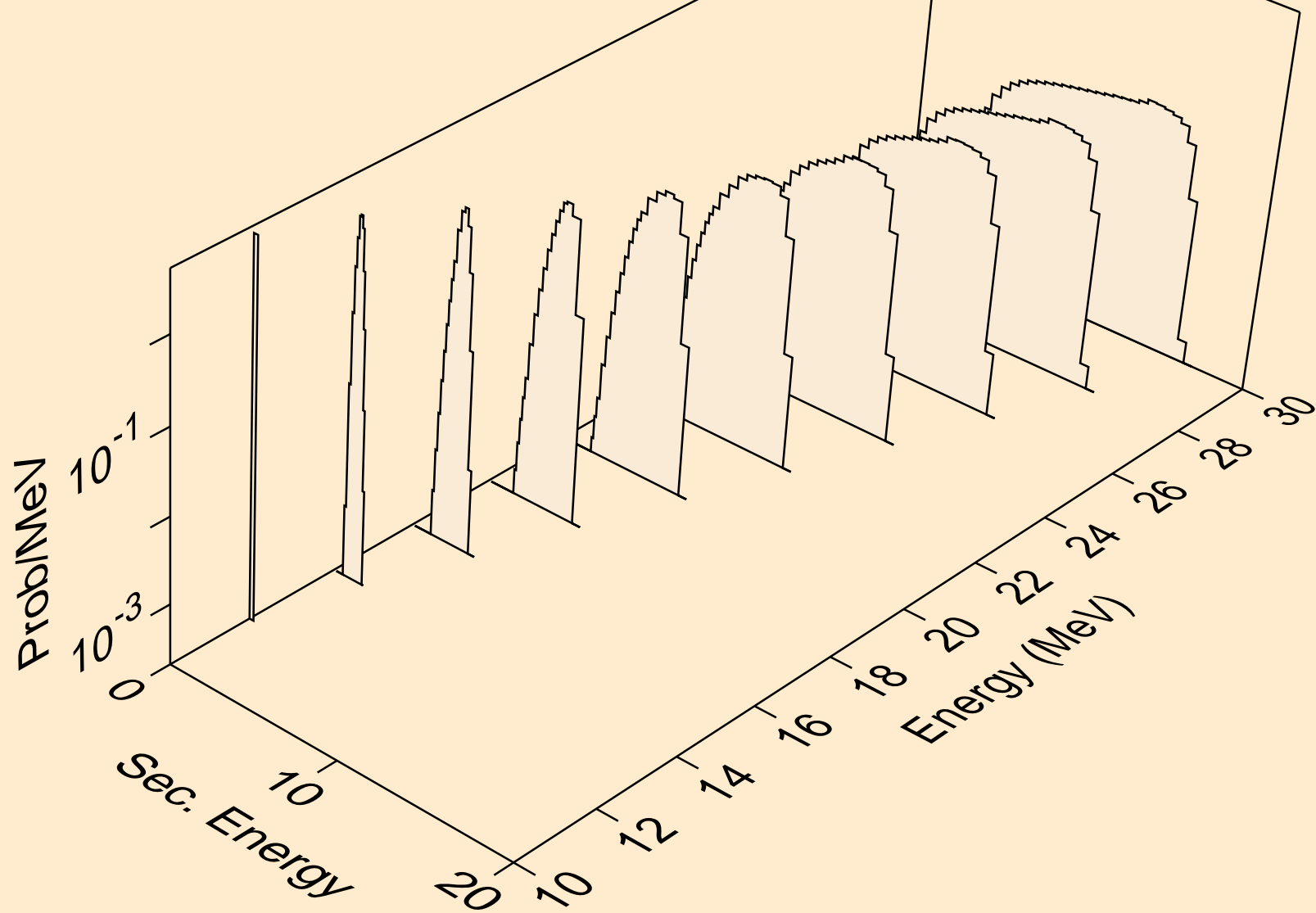

CO055 NEUTRON ACER TENDL-2024 LIBRARY; T=0.K
deuterons from (n,da)

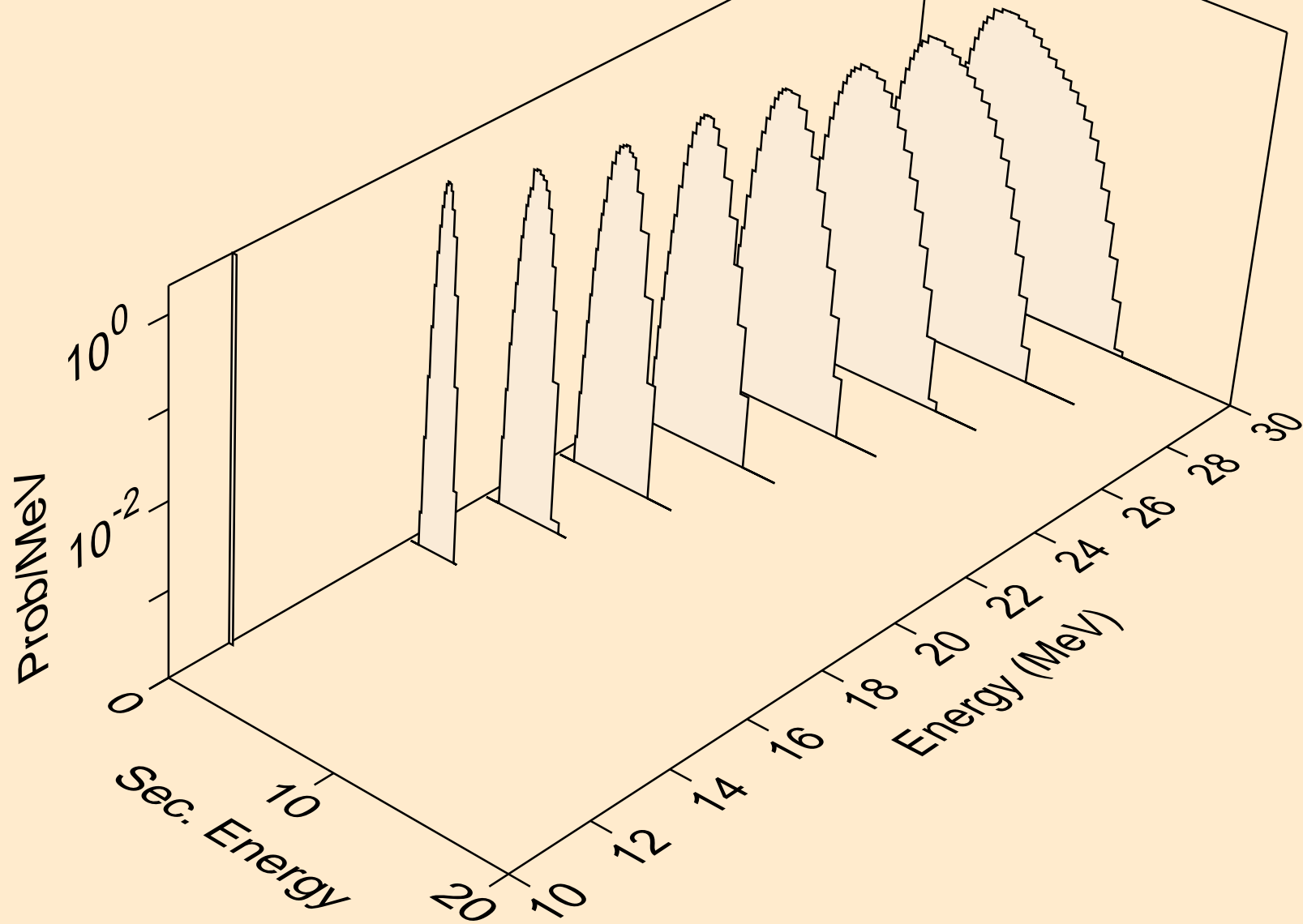

CO055 NEUTRON ACER TENDL-2024 LIBRARY; T=0.K
tritons from (n,x)

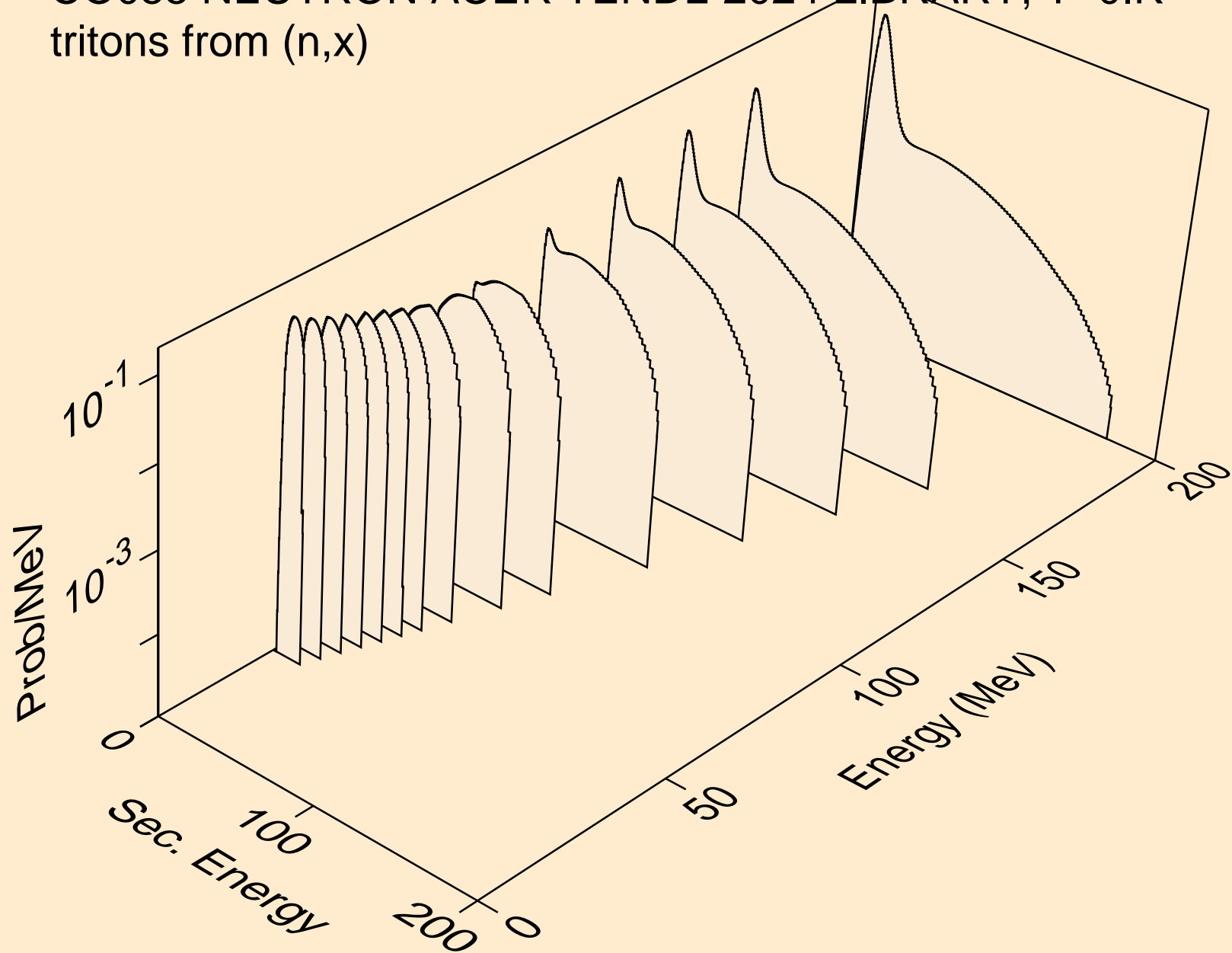

CO055 NEUTRON ACER TENDL-2024 LIBRARY; T=0.K
tritons from (n,n*)t

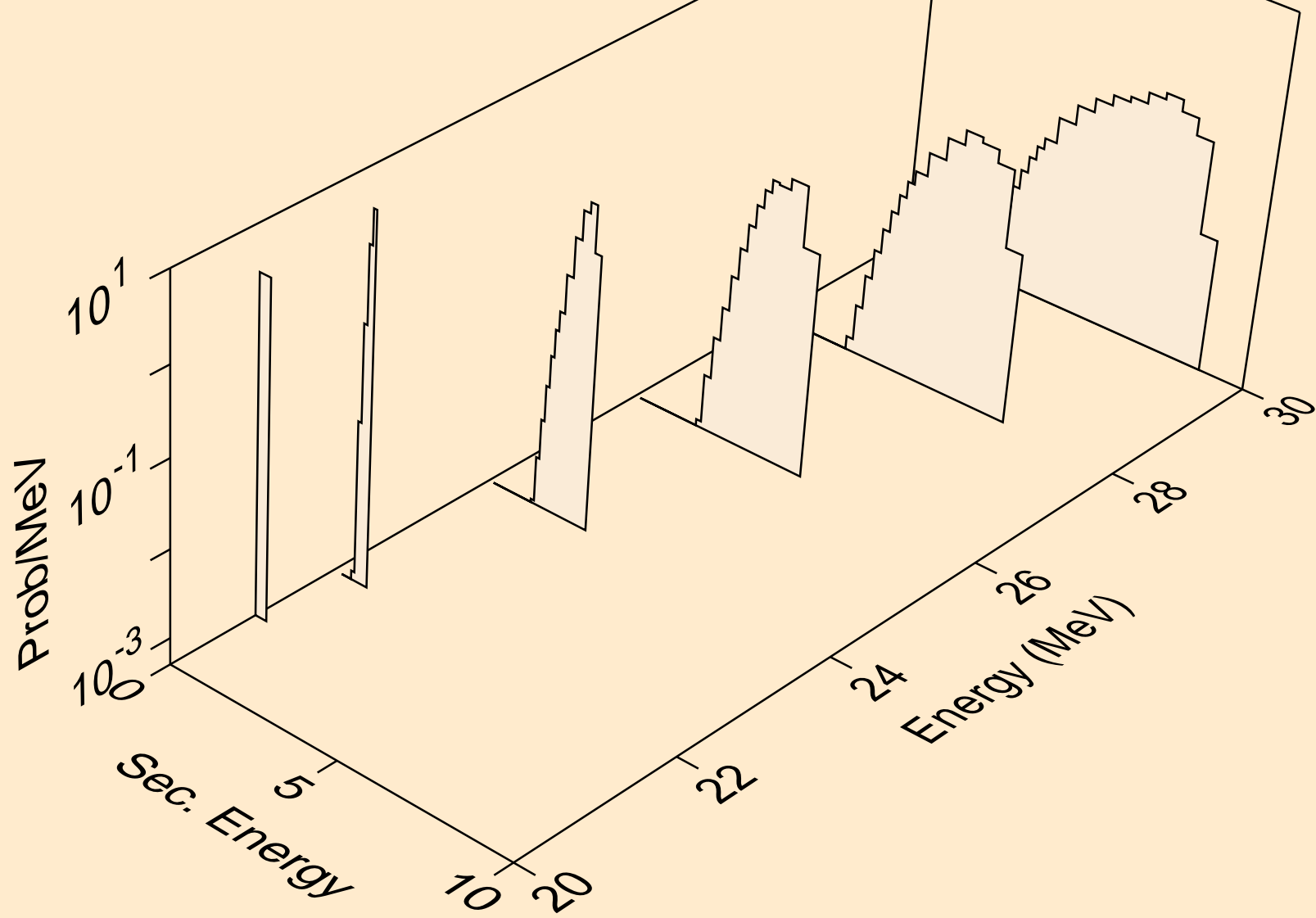

CO055 NEUTRON ACER TENDL-2024 LIBRARY; T=0.K
tritons from (n,t)

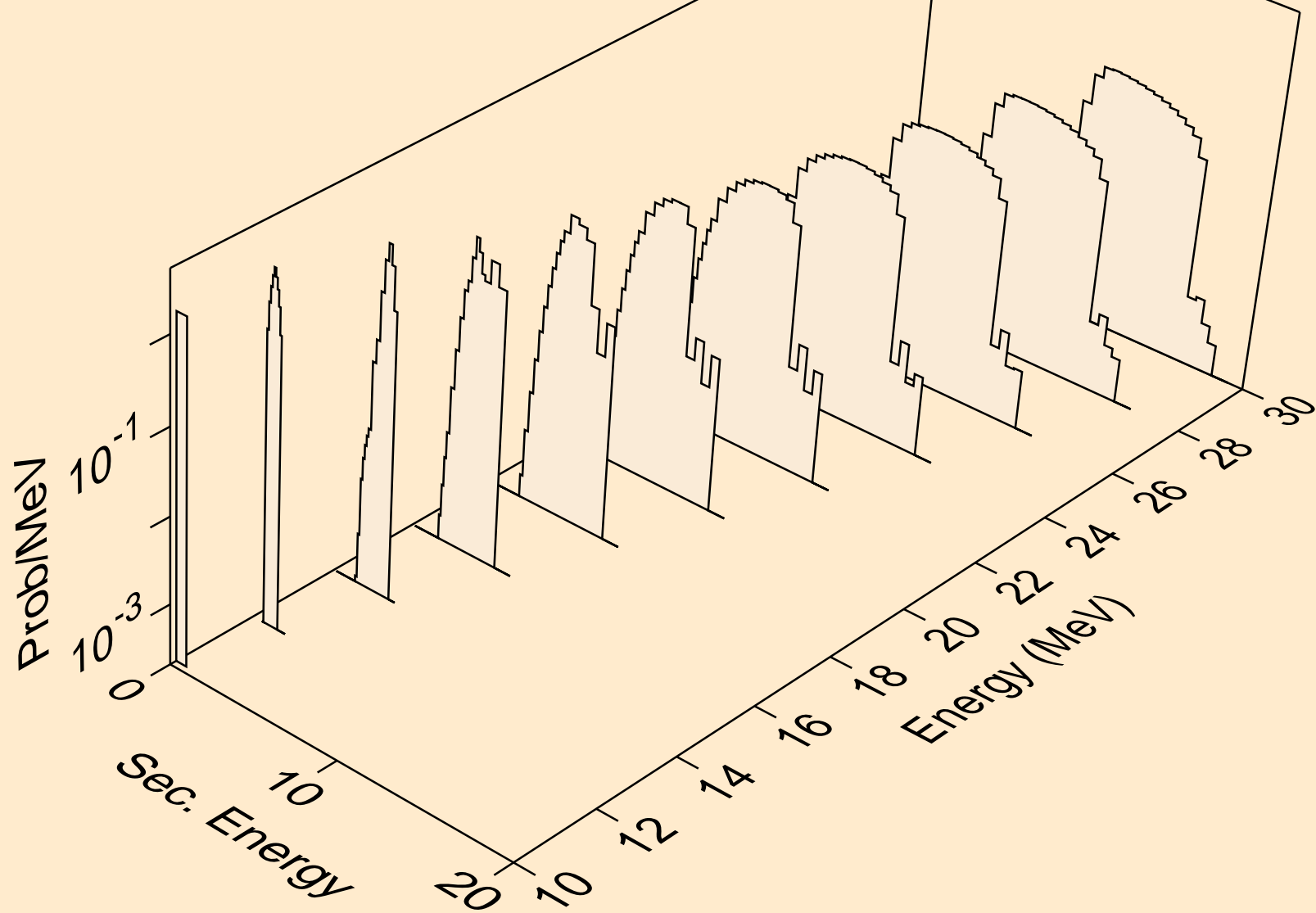

CO055 NEUTRON ACER TENDL-2024 LIBRARY; T=0.K
tritons from (n,pt)

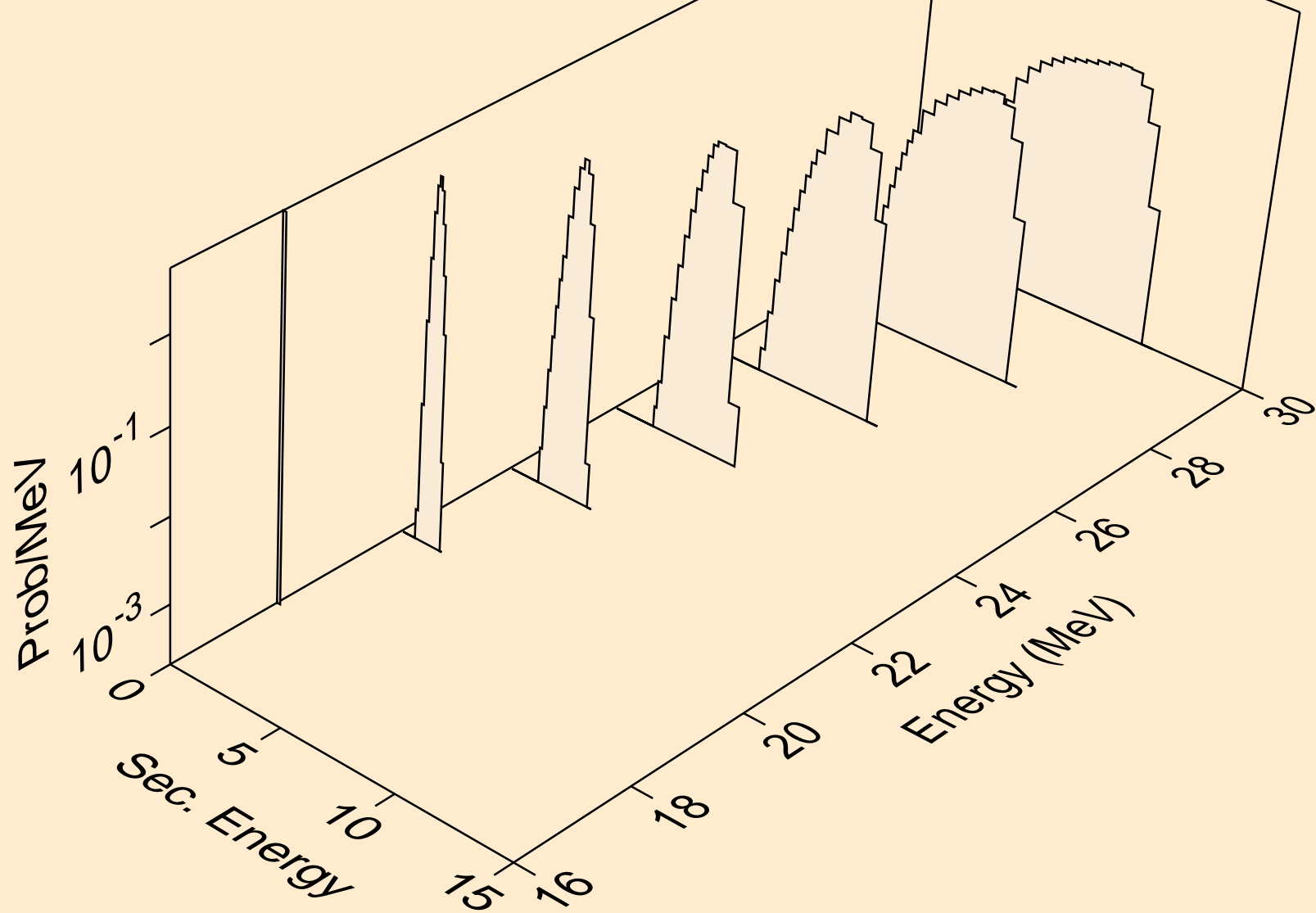

CO055 NEUTRON ACER TENDL-2024 LIBRARY; T=0.K
he3s from (n,x)

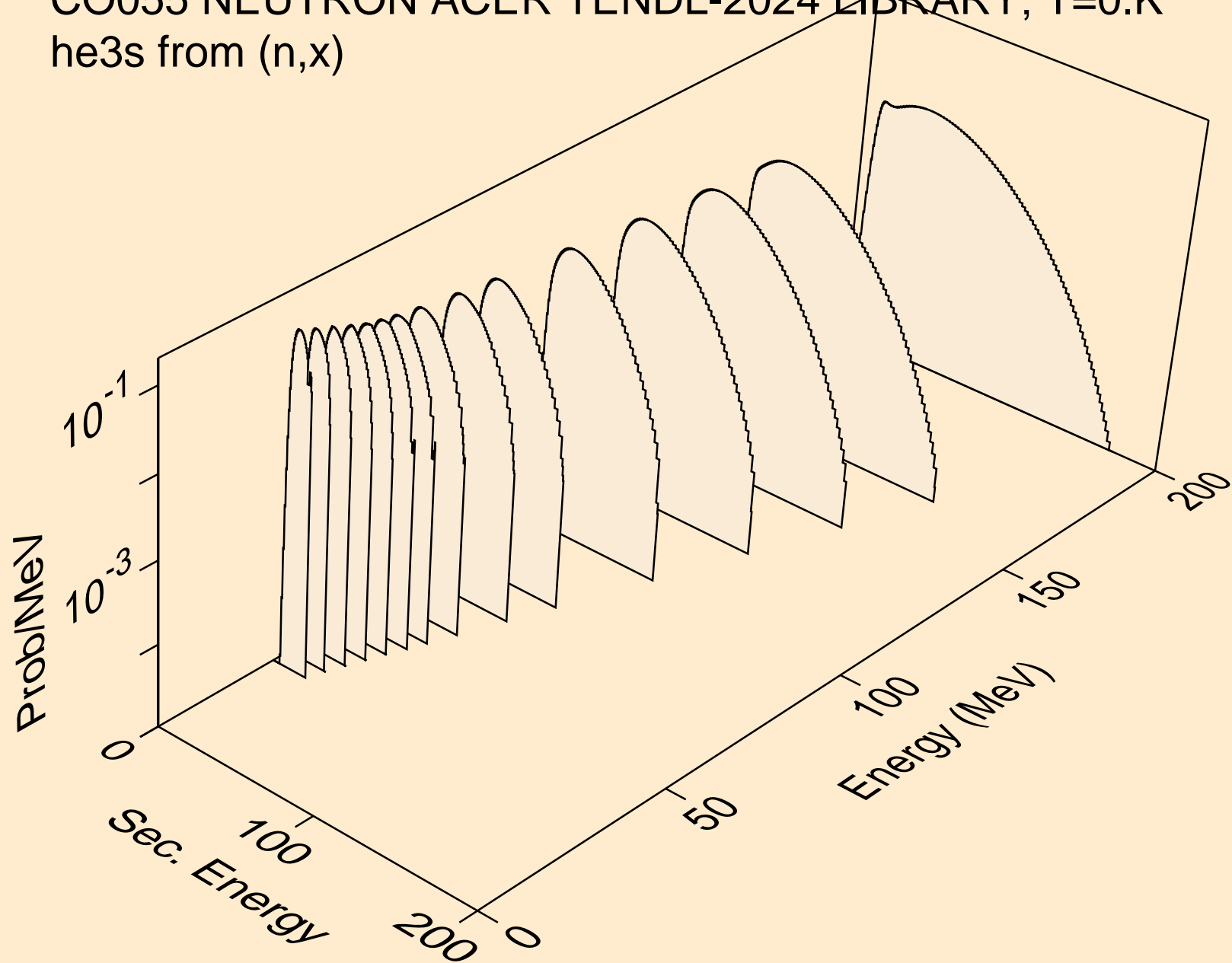

CO055 NEUTRON ACER TENDL-2024 LIBRARY; T=0.K
he3s from (n,n*)he3

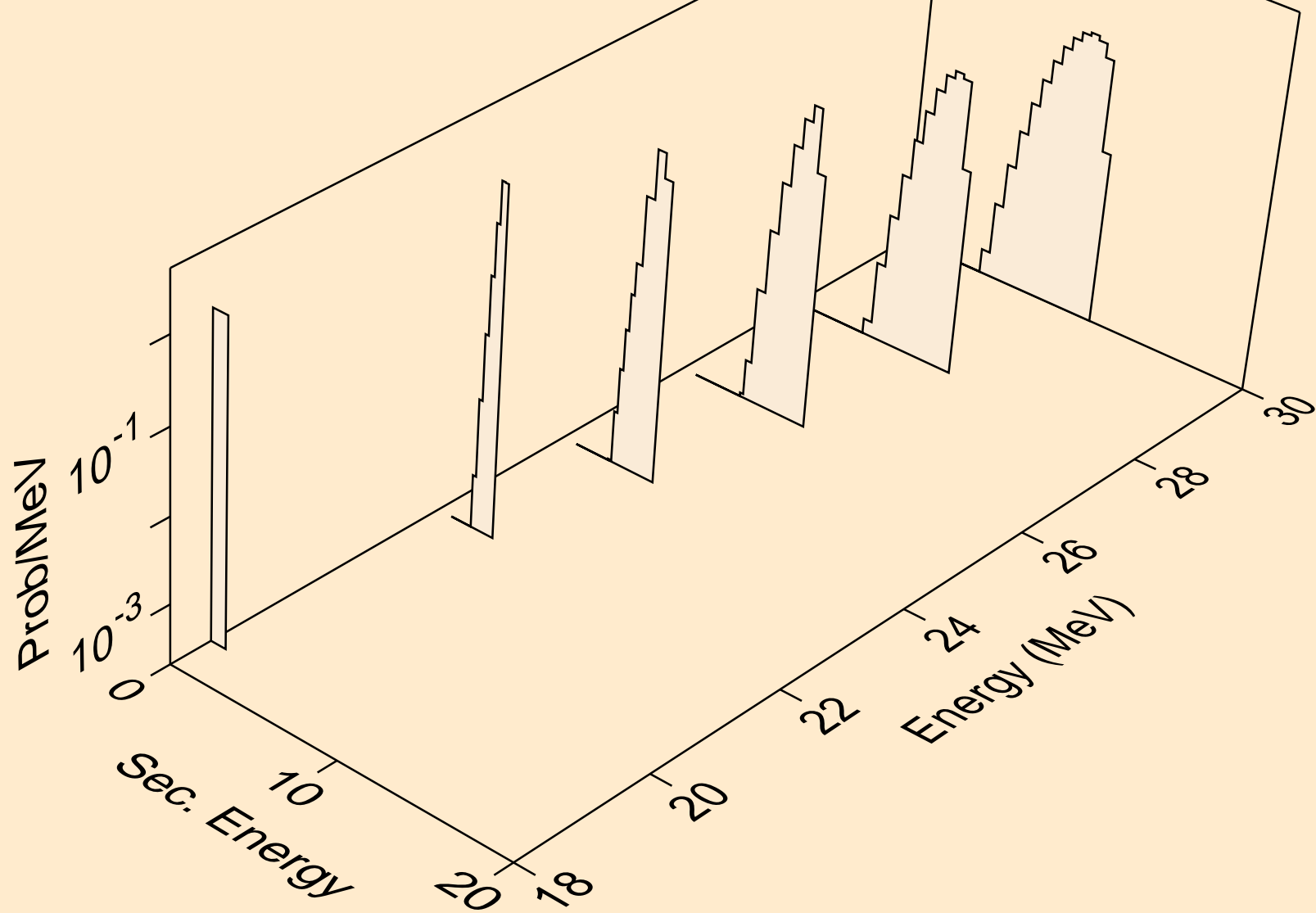

CO055 NEUTRON ACER TENDL-2024 LIBRARY; T=0.K
he3s from (n,he3)

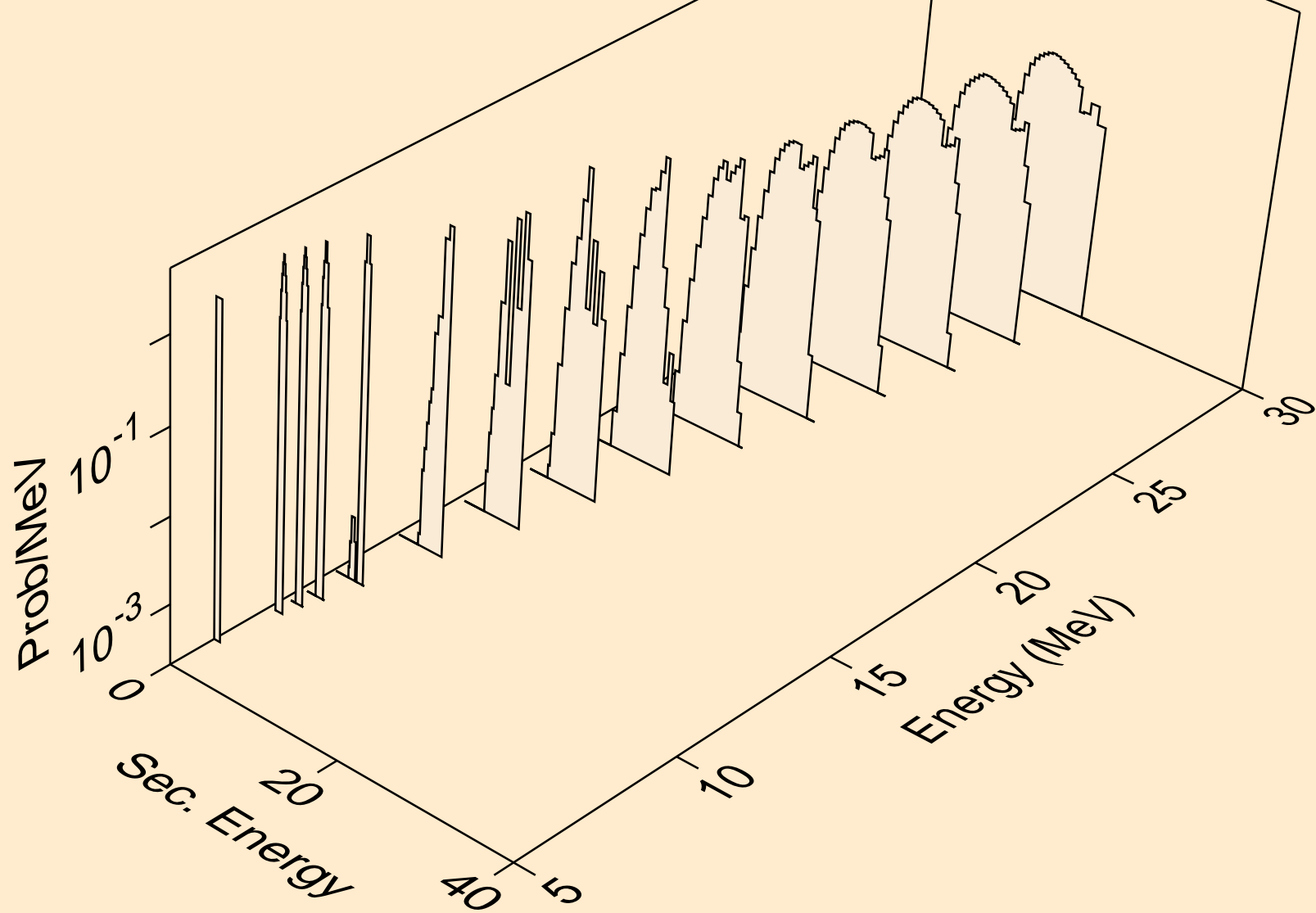

CO055 NEUTRON ACER TENDL-2024 LIBRARY; T=0.K
alphas from (n,x)

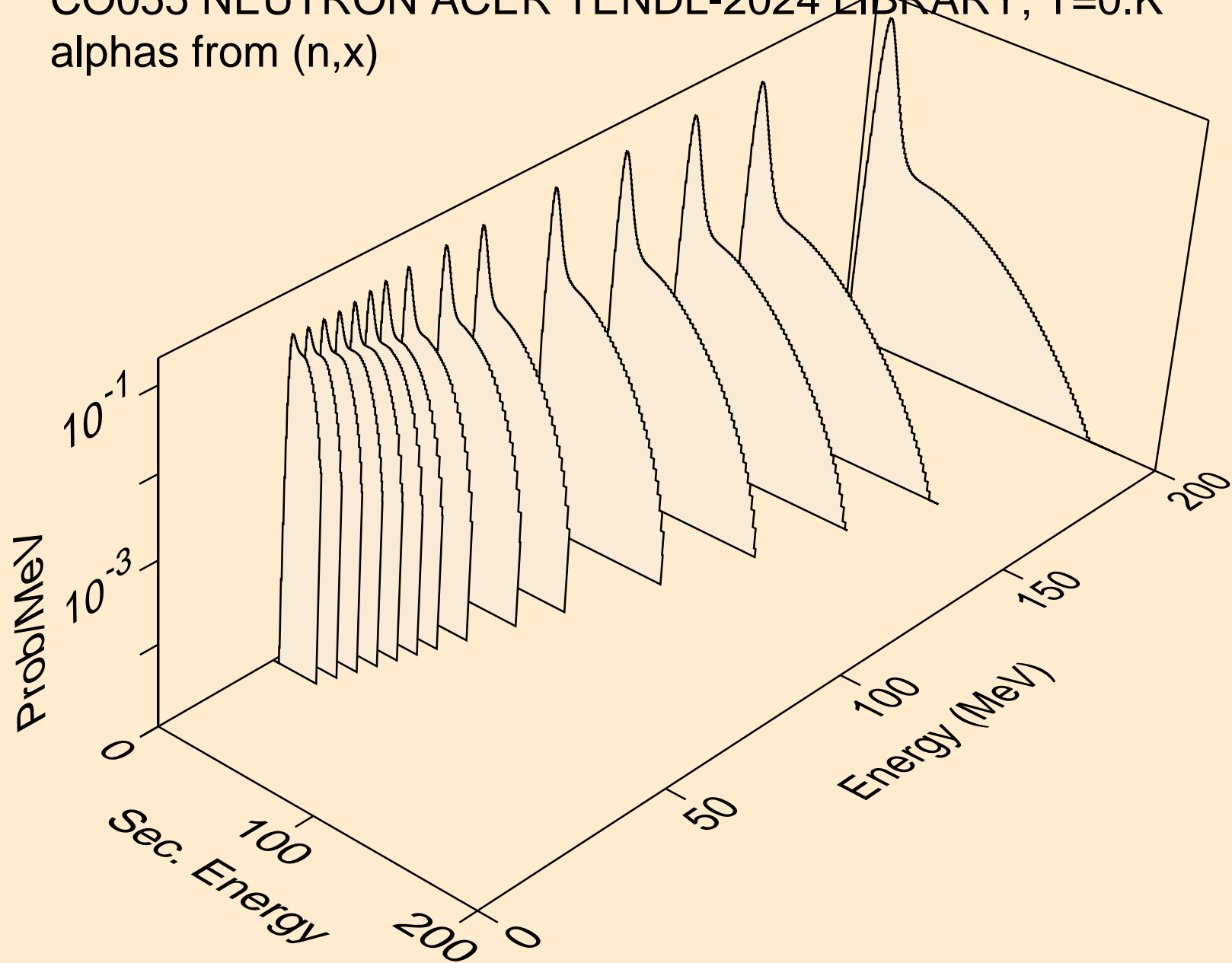

CO055 NEUTRON ACER TENDL-2024 LIBRARY; T=0.K
alphas from (n,n*)a

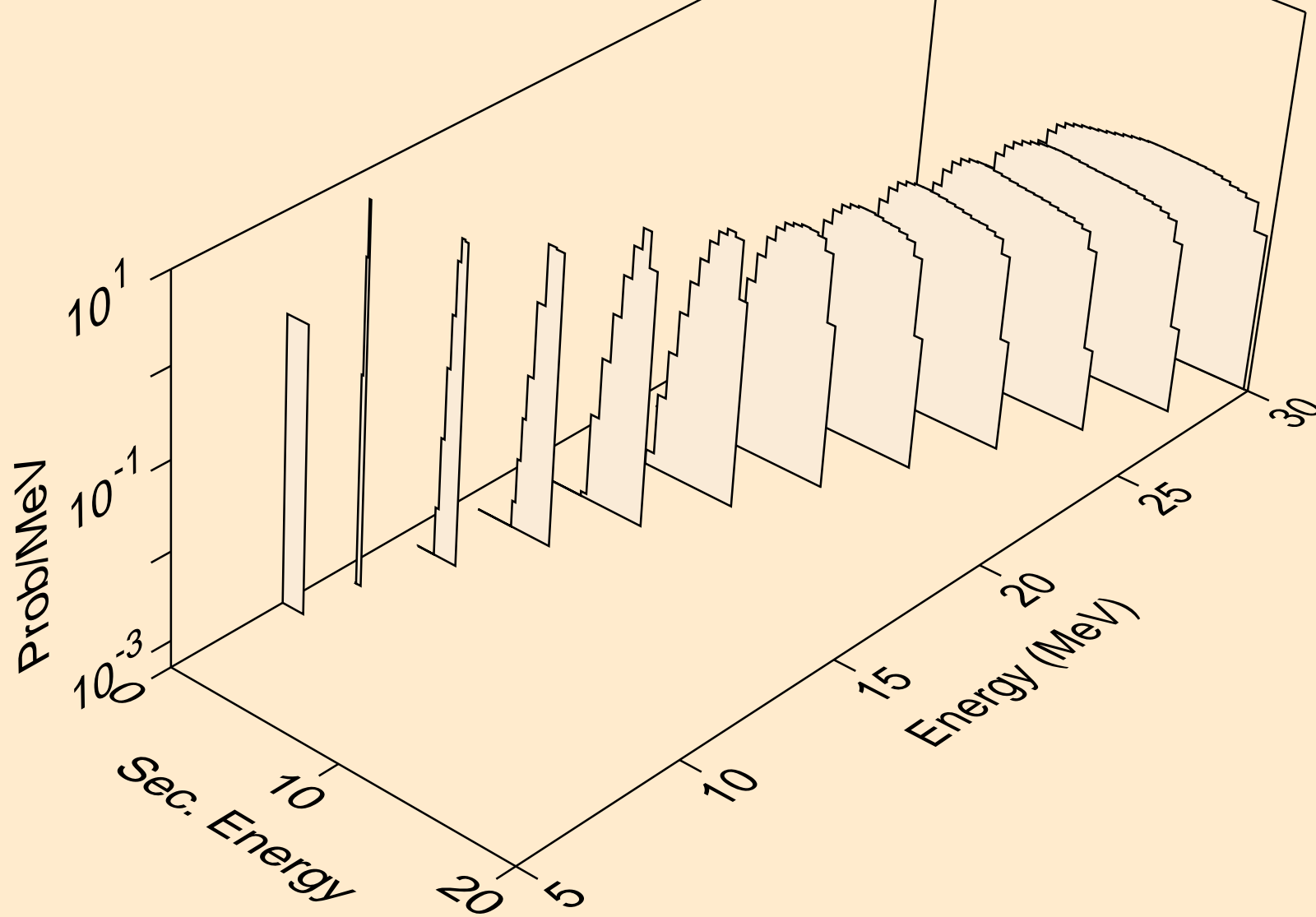

CO055 NEUTRON ACER TENDL-2024 LIBRARY; T=0.K
alphas from (n,2n)a

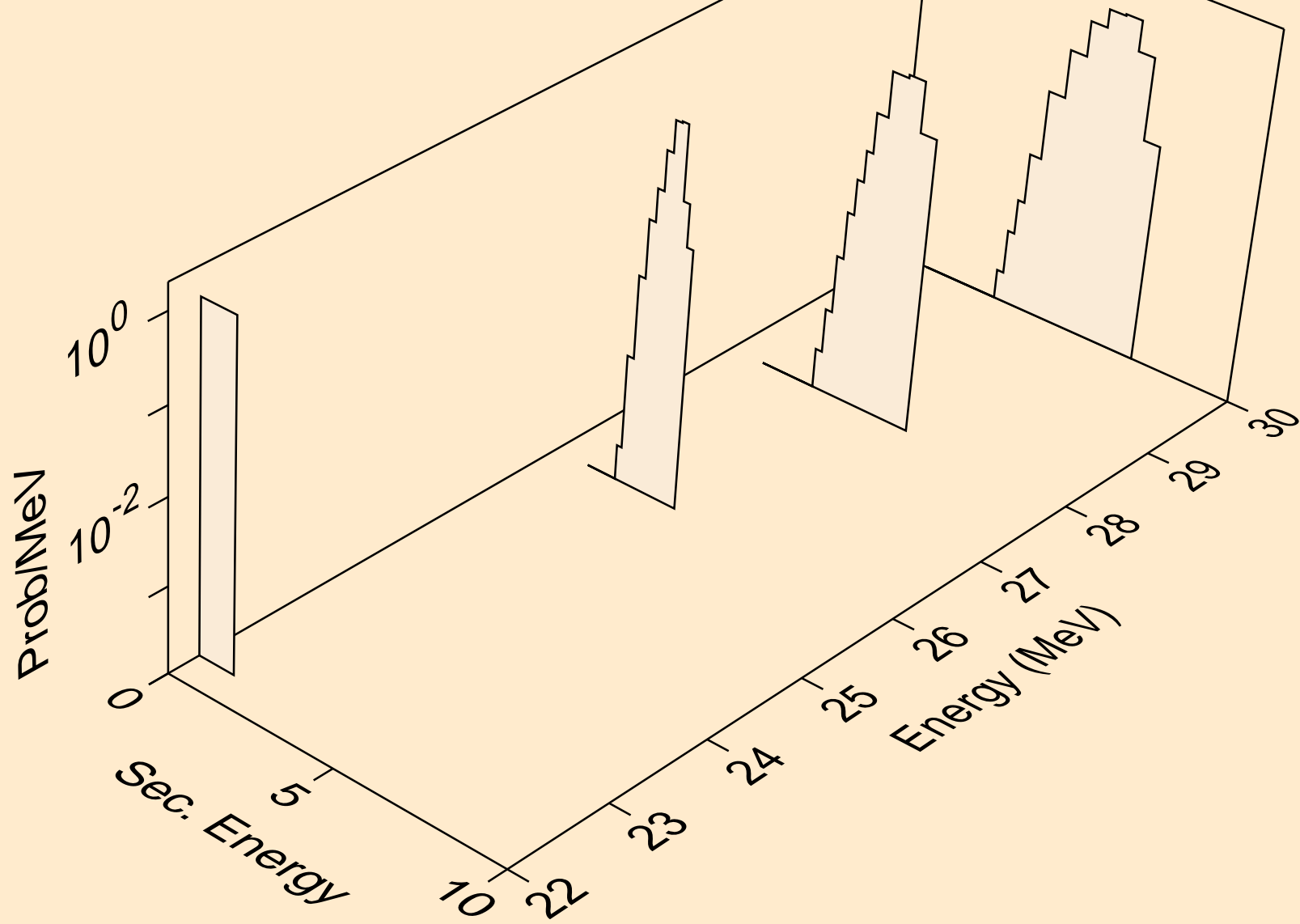

CO055 NEUTRON ACER TENDL-2024 LIBRARY; T=0.K
alphas from (n,n*)2a

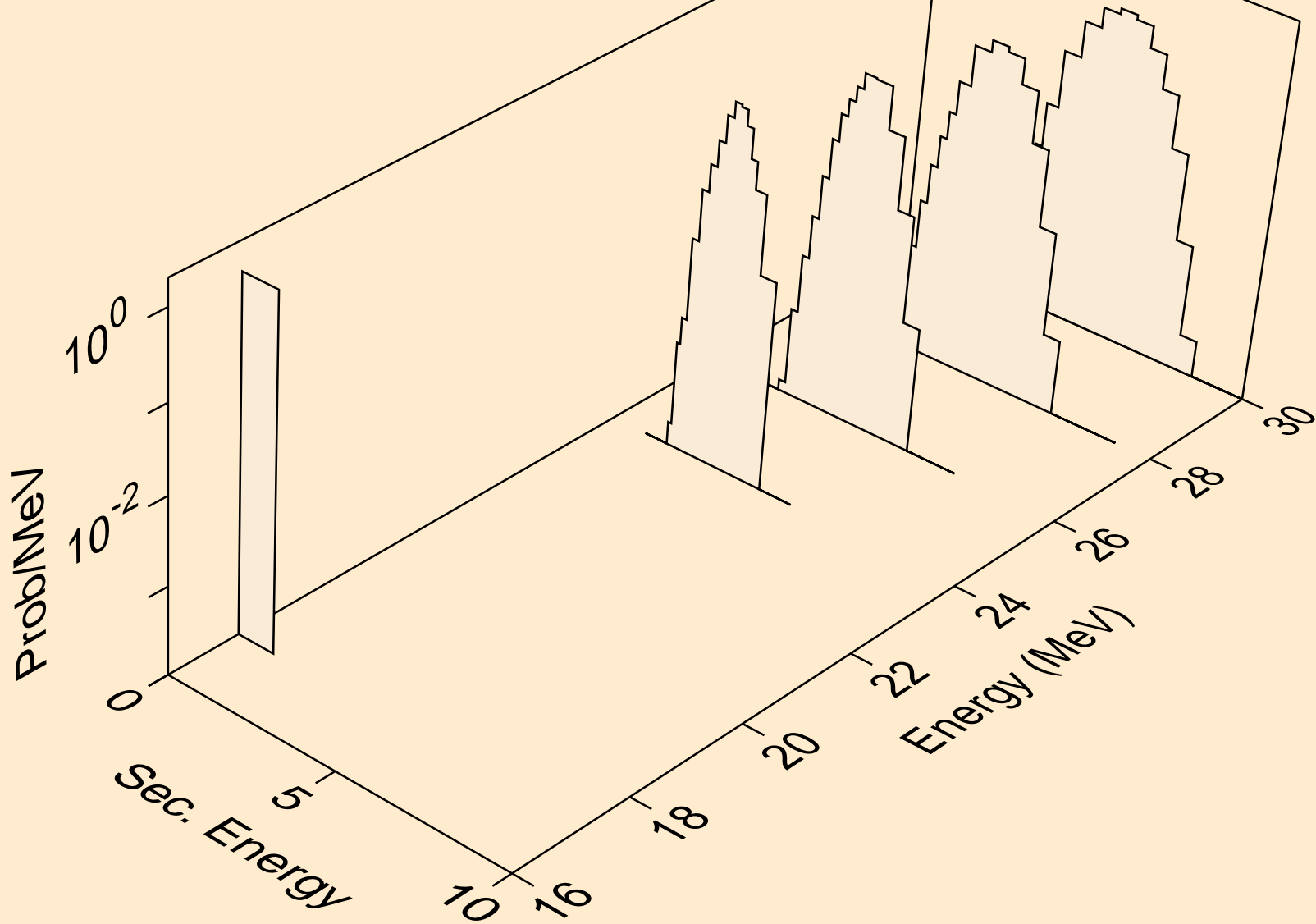

CO055 NEUTRON ACER TENDL-2024 LIBRARY; T=0.K
alphas from (n,npa)

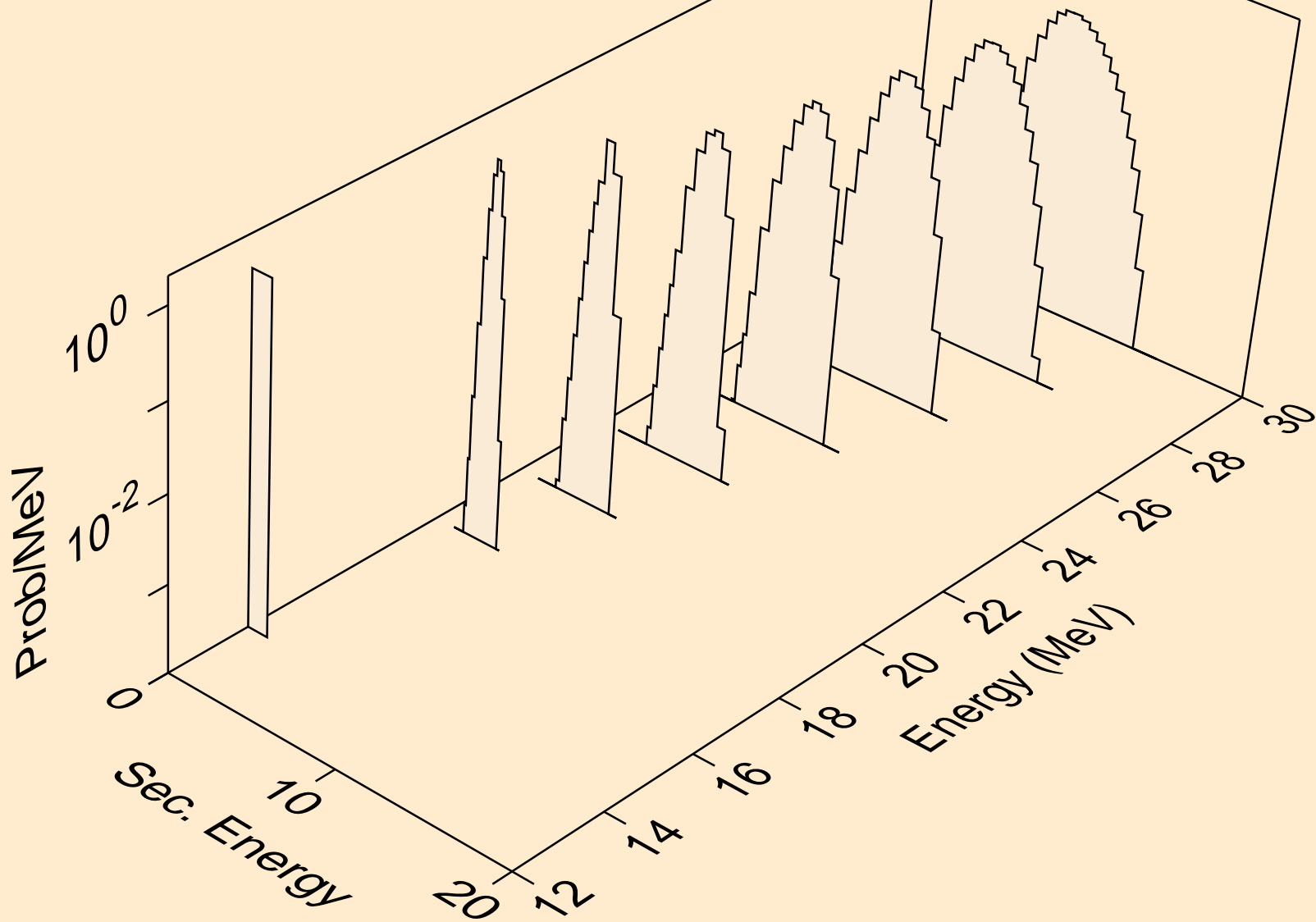

CO055 NEUTRON ACER TENDL-2024 LIBRARY; T=0.K
alphas from (n,a)

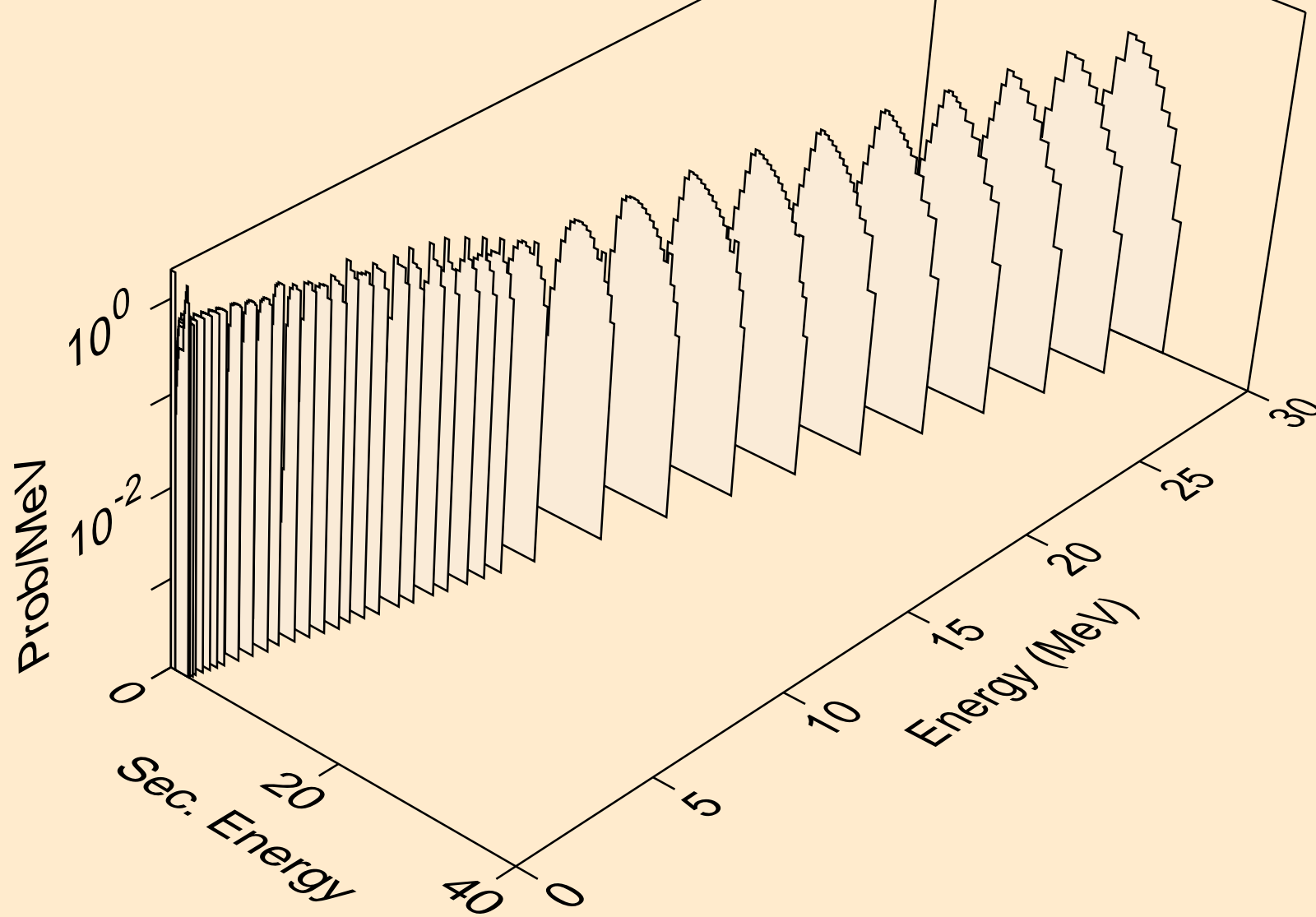

CO055 NEUTRON ACER TENDL-2024 LIBRARY; T=0.K
alphas from (n,2a)

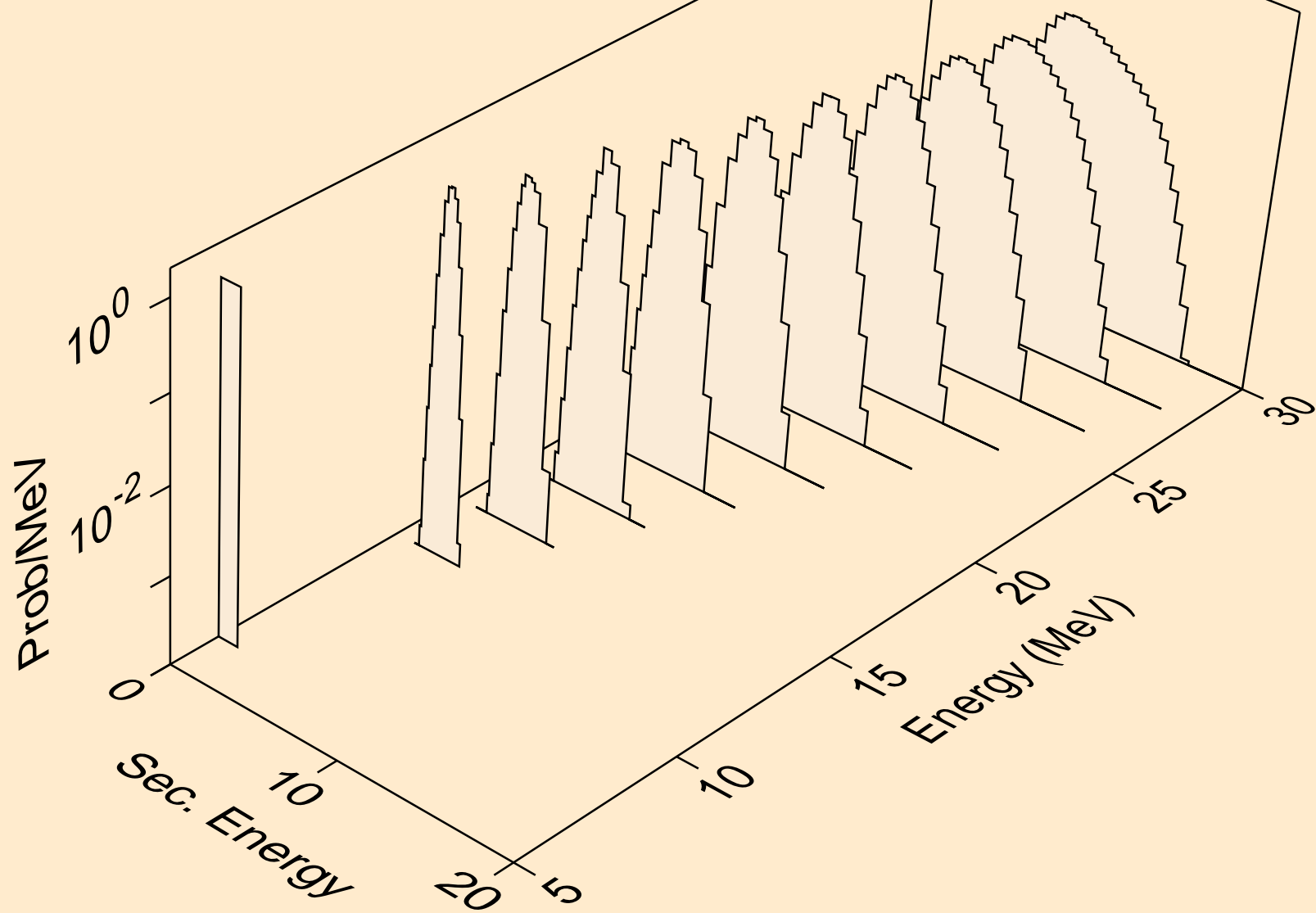

CO055 NEUTRON ACER TENDL-2024 LIBRARY; T=0.K
alphas from (n,pa)

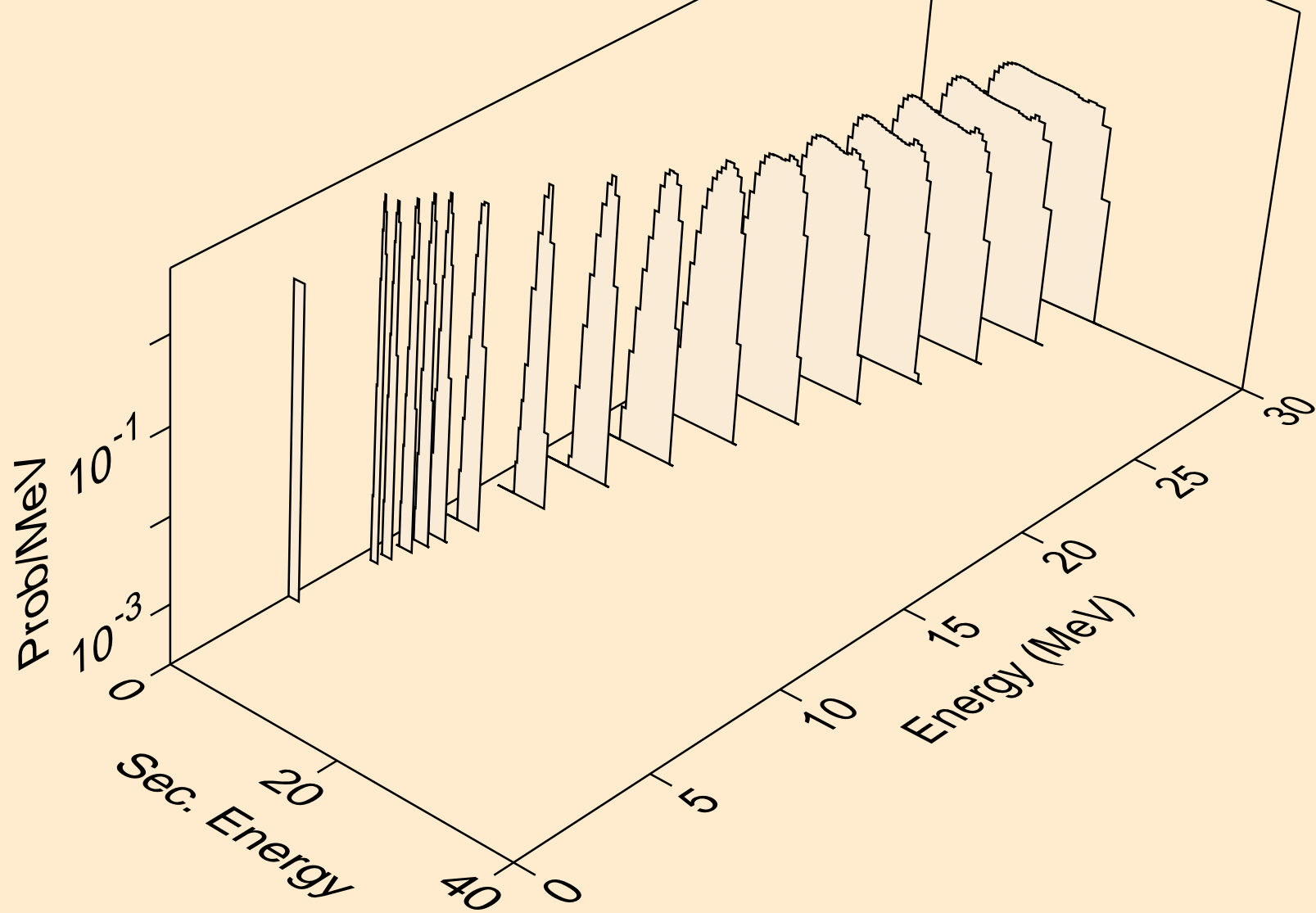

CO055 NEUTRON ACER TENDL-2024 LIBRARY; T=0.K
alphas from (n,da)

