

CR056 NEUTRON ACER TENDL-2024 LIBRARY; T=0.K

Principal cross sections

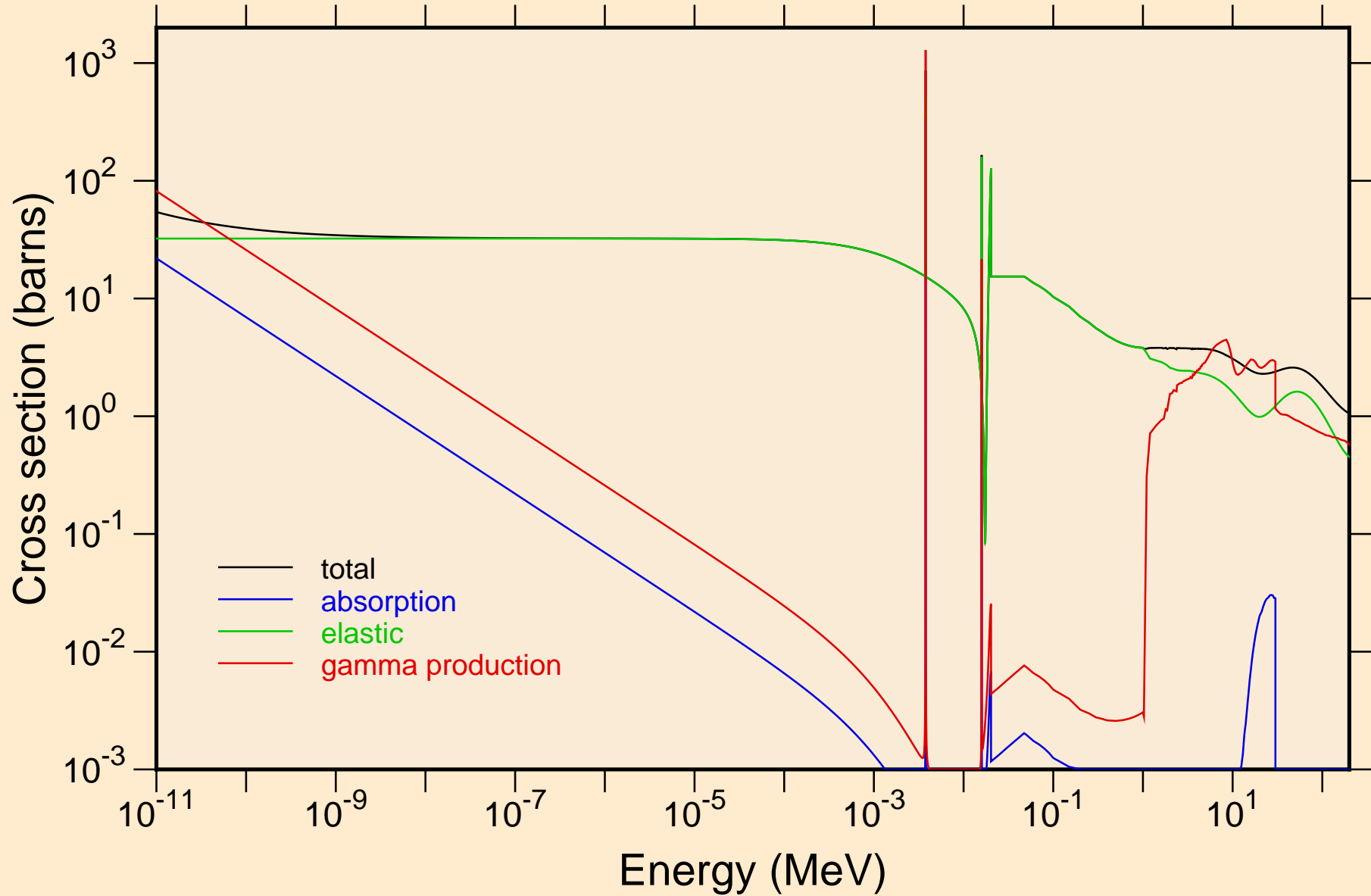

CR056 NEUTRON ACER TENDL-2024 LIBRARY; T=0.K
Heating

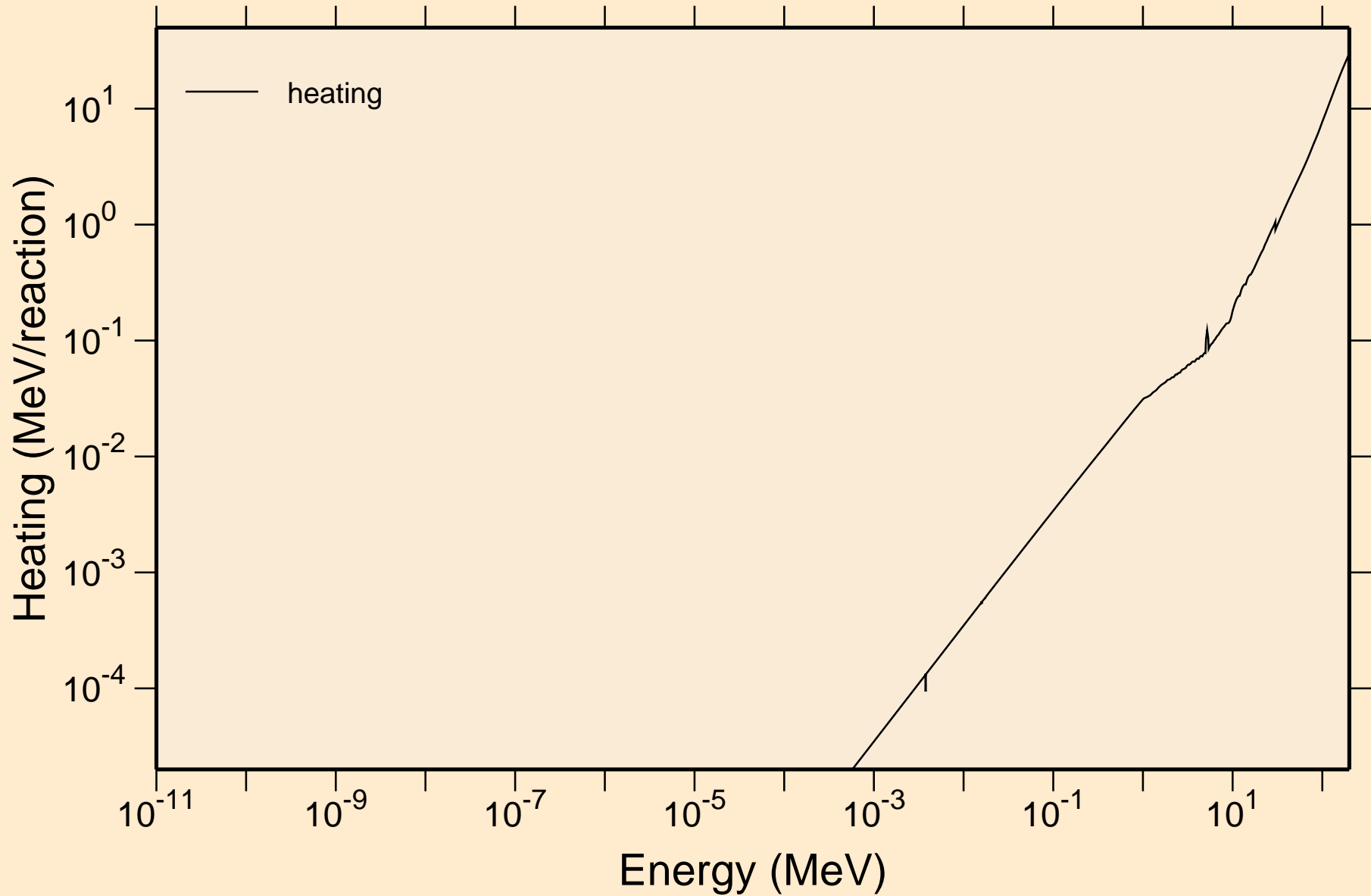

CR056 NEUTRON ACER TENDL-2024 LIBRARY; T=0.K

Damage

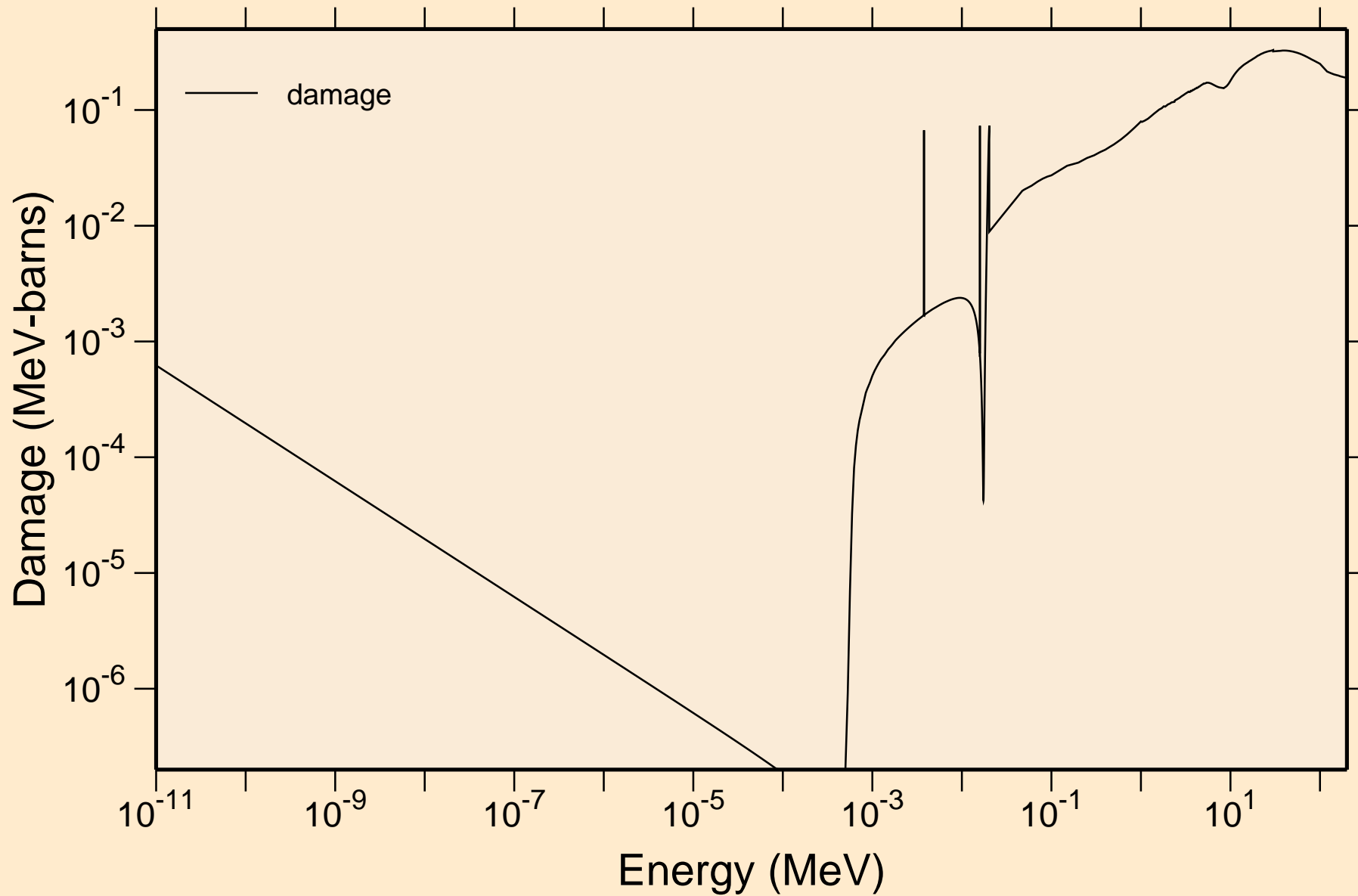

CR056 NEUTRON ACER TENDL-2024 LIBRARY; T=0.K
Non-threshold reactions

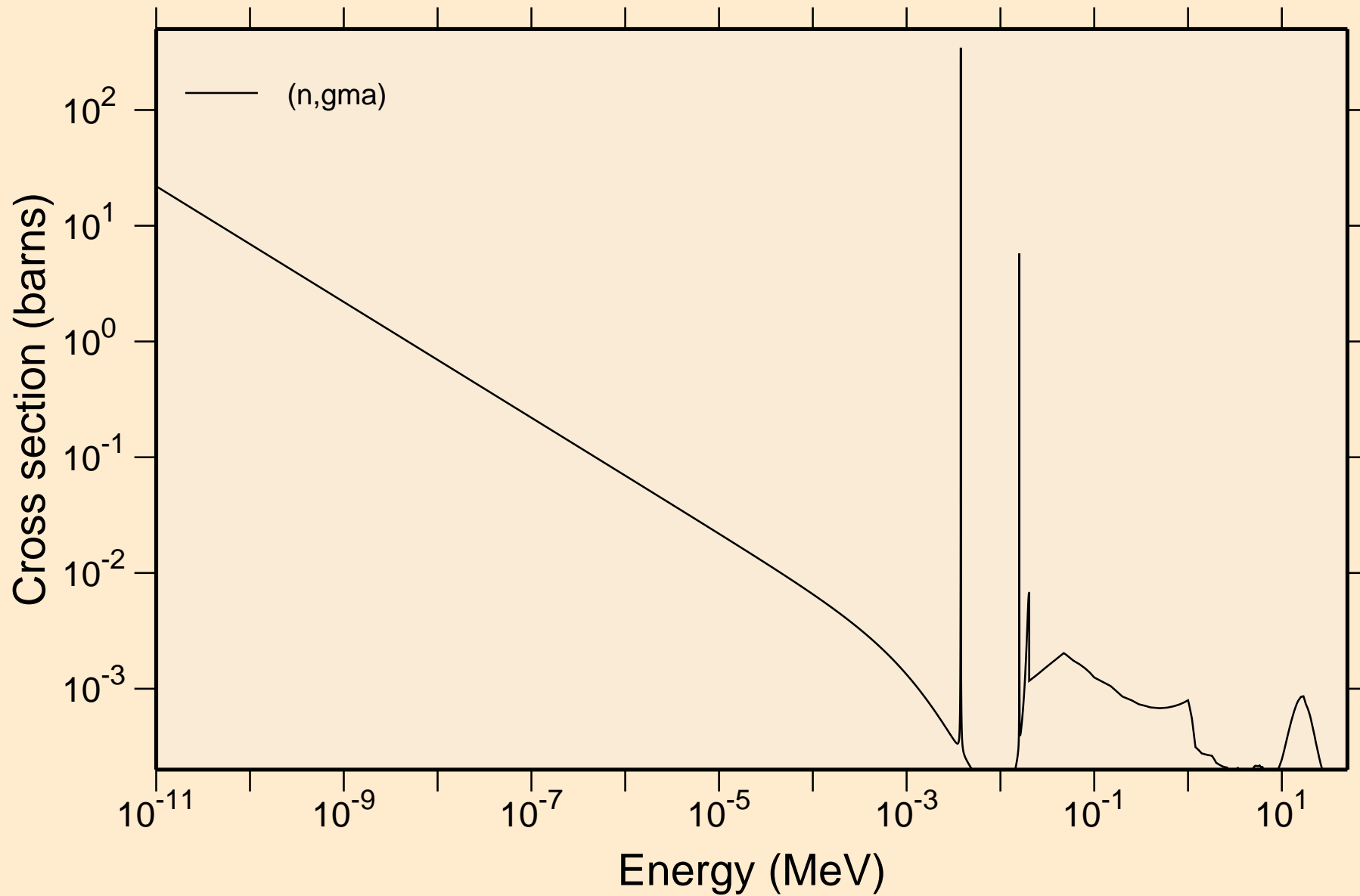

CR056 NEUTRON ACER TENDL-2024 LIBRARY; T=0.K

Principal cross sections

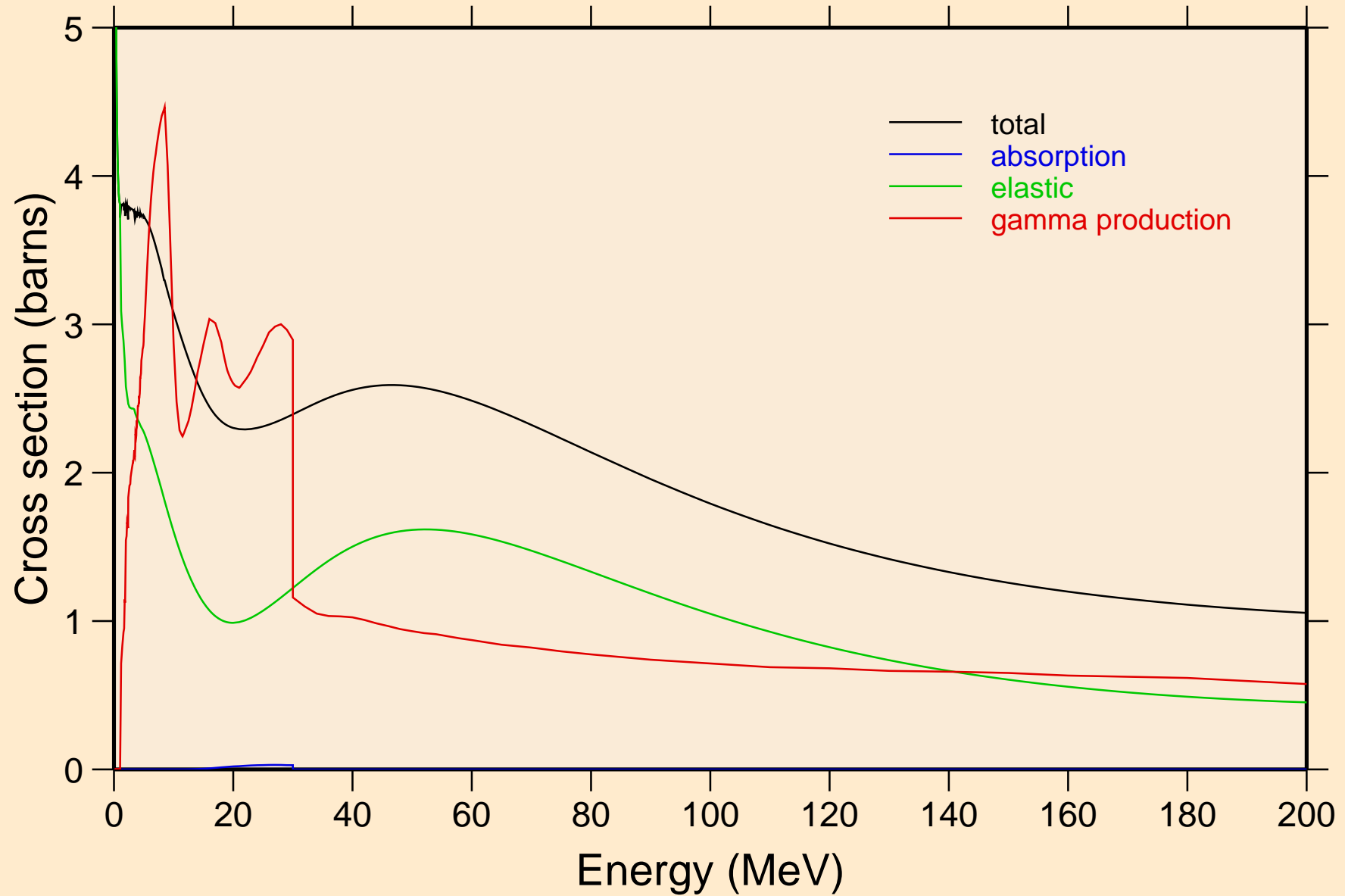

CR056 NEUTRON ACER TENDL-2024 LIBRARY; T=0.K

Heating

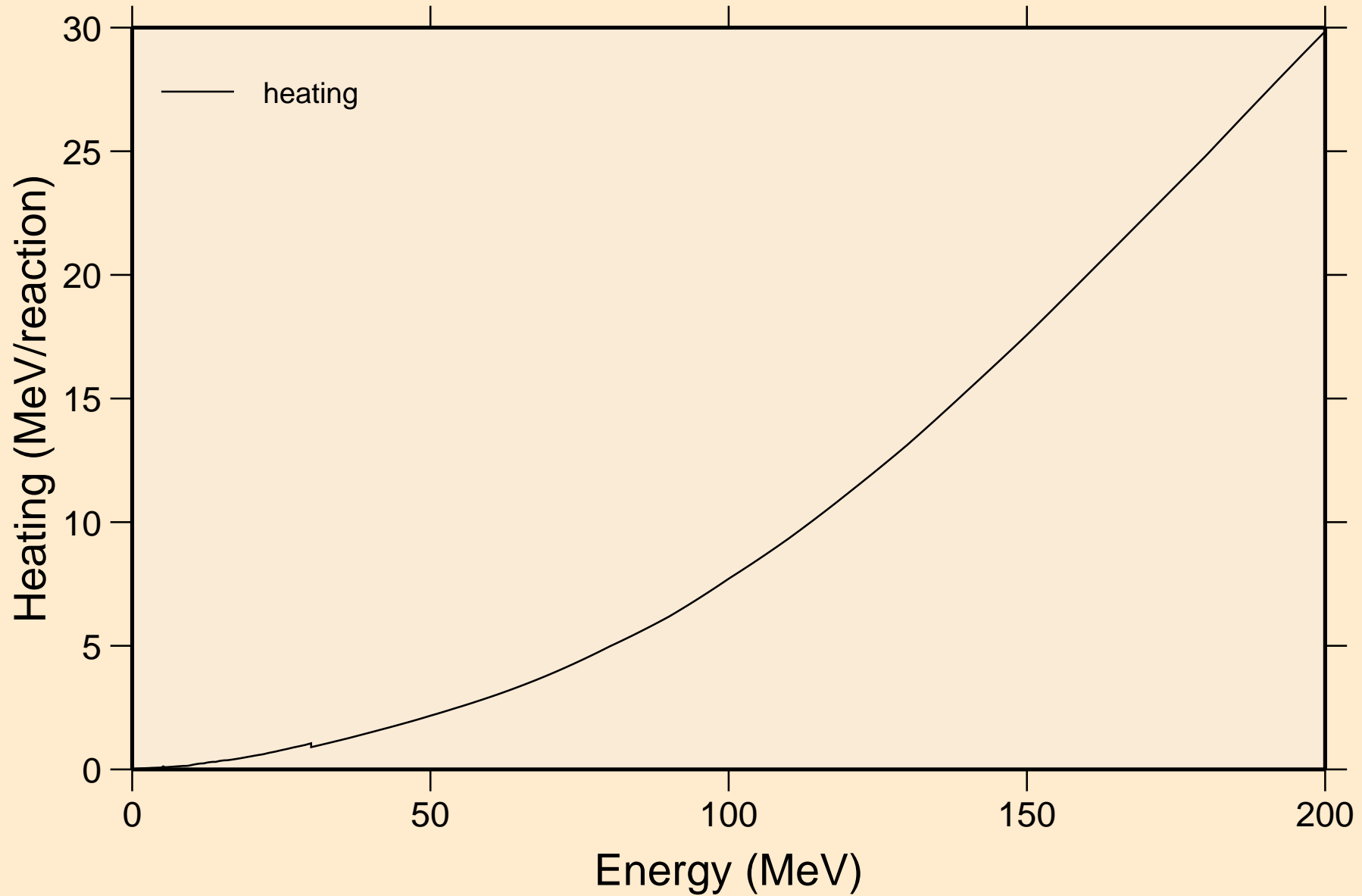

CR056 NEUTRON ACER TENDL-2024 LIBRARY; T=0.K

Damage

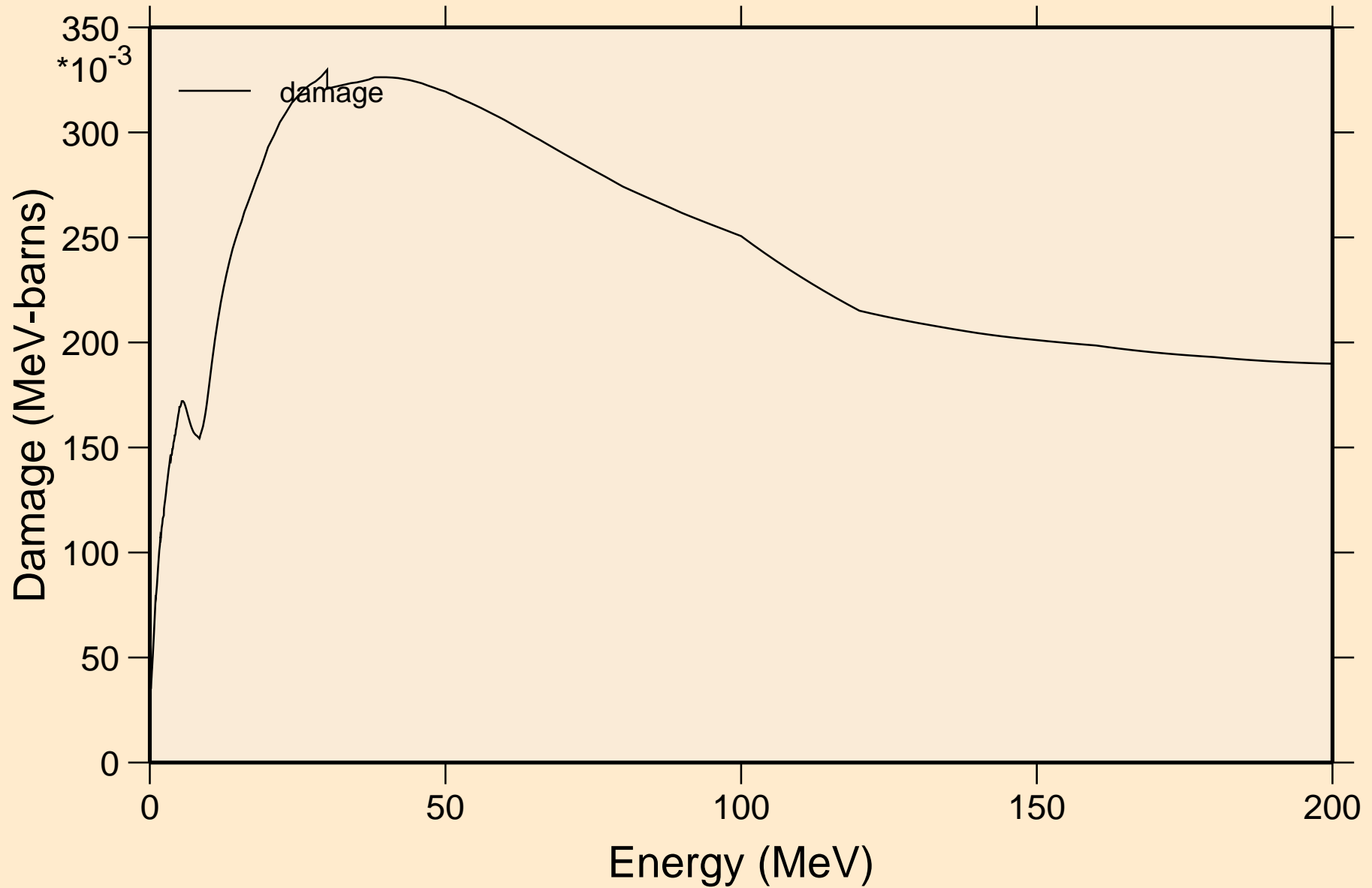

CR056 NEUTRON ACER TENDL-2024 LIBRARY; T=0.K
Non-threshold reactions

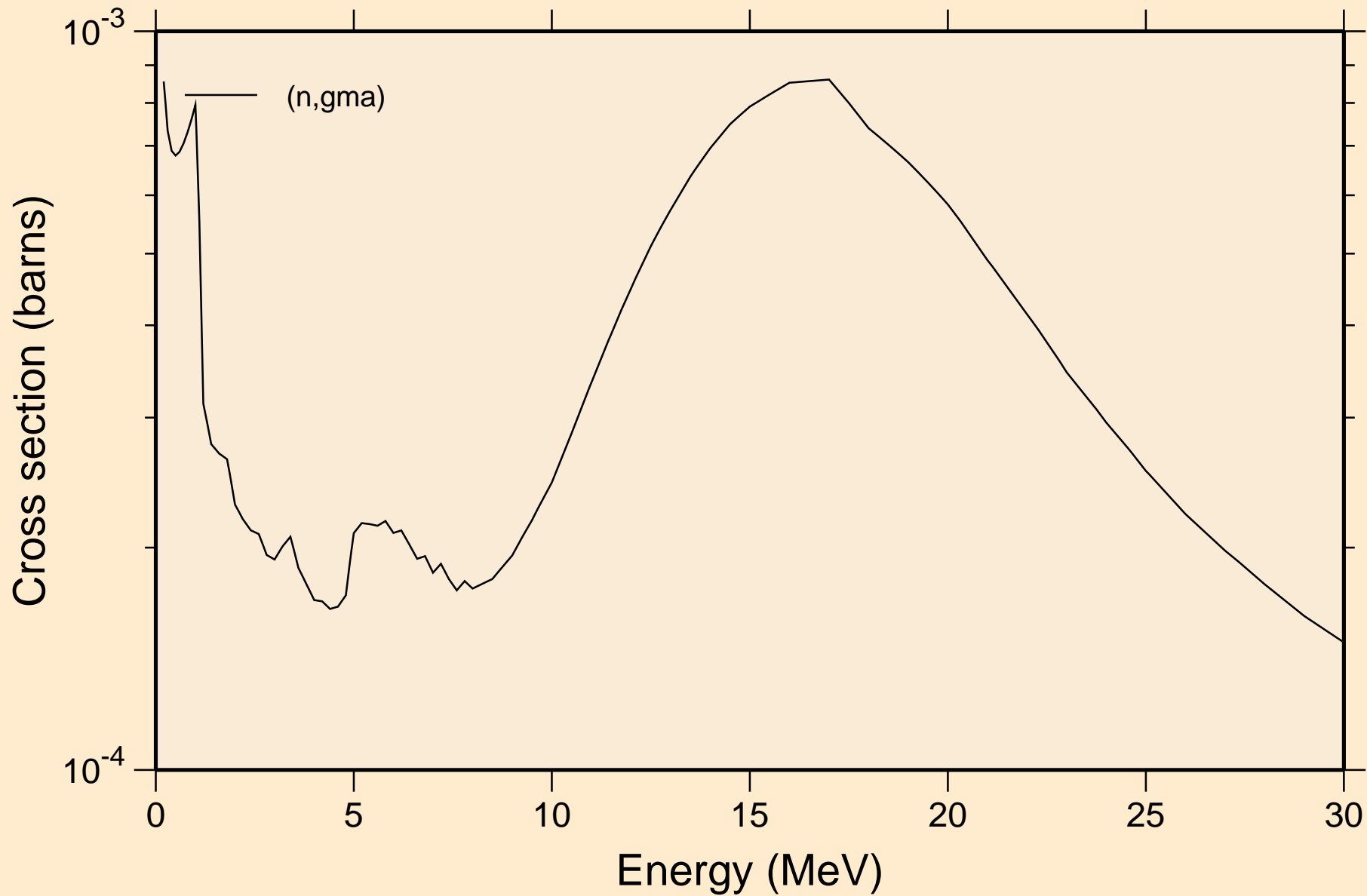

CR056 NEUTRON ACER TENDL-2024 LIBRARY; T=0.K
Inelastic levels

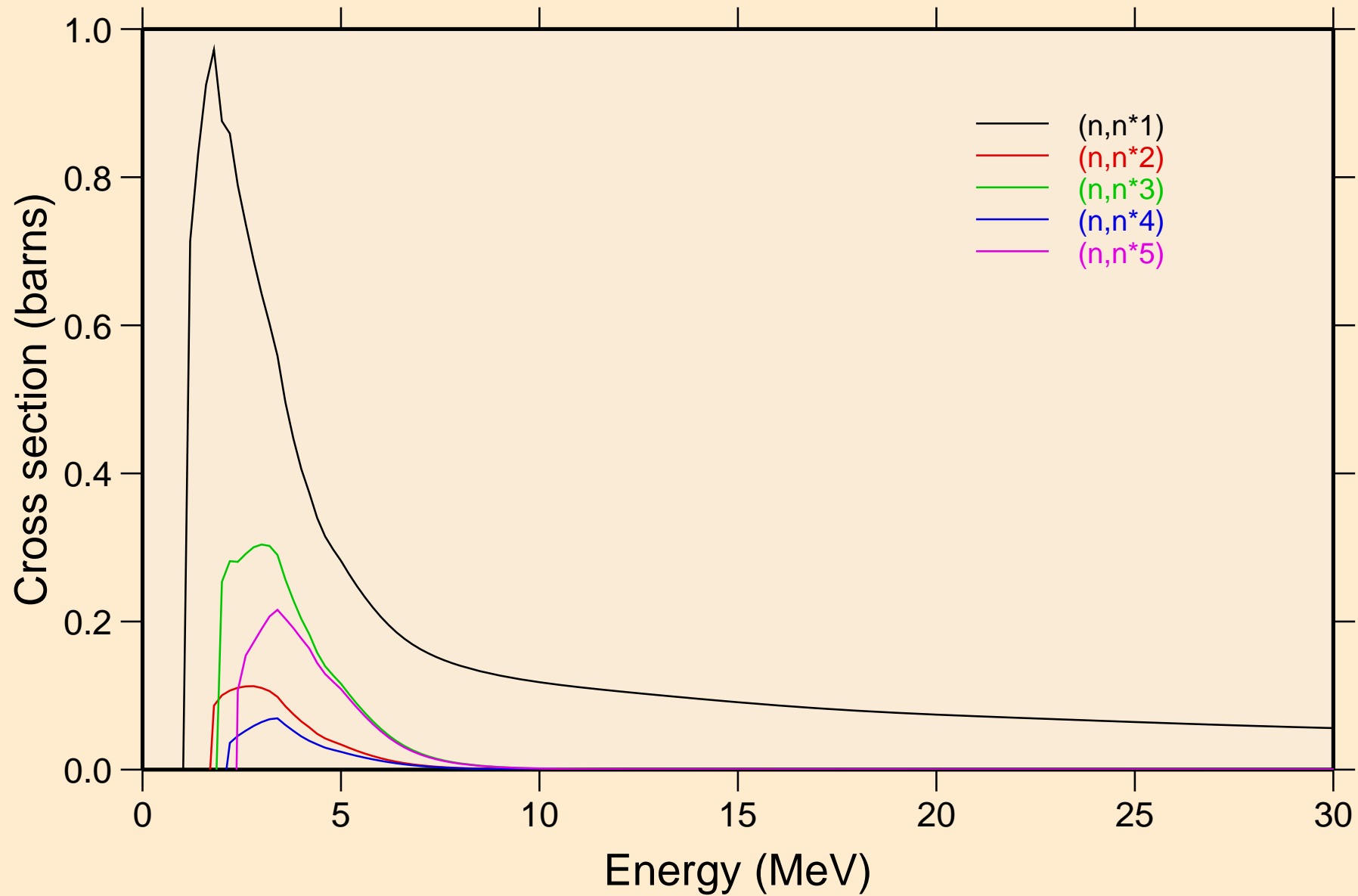

CR056 NEUTRON ACER TENDL-2024 LIBRARY; T=0.K
Inelastic levels

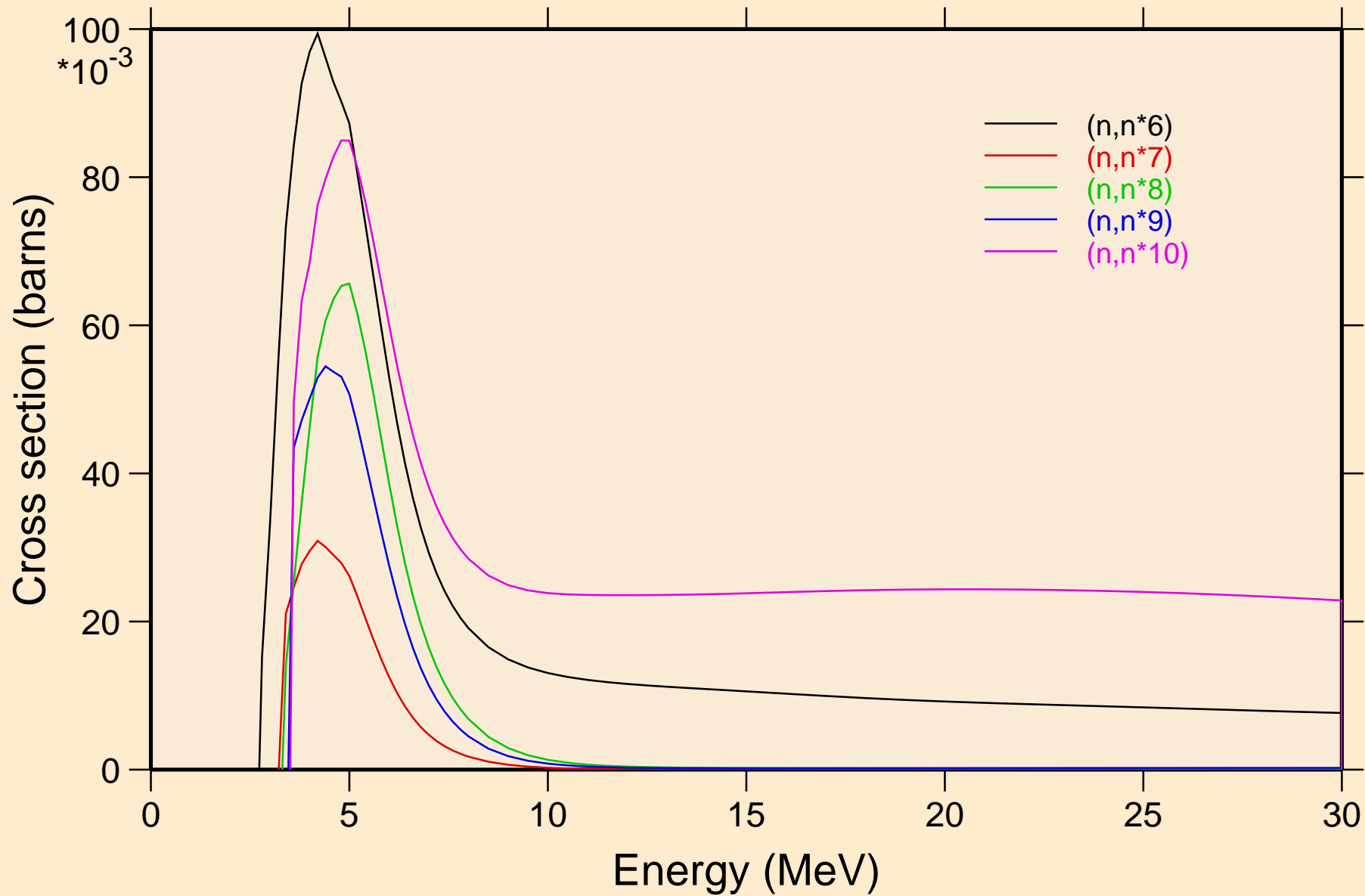

CR056 NEUTRON ACER TENDL-2024 LIBRARY; T=0.K
Inelastic levels

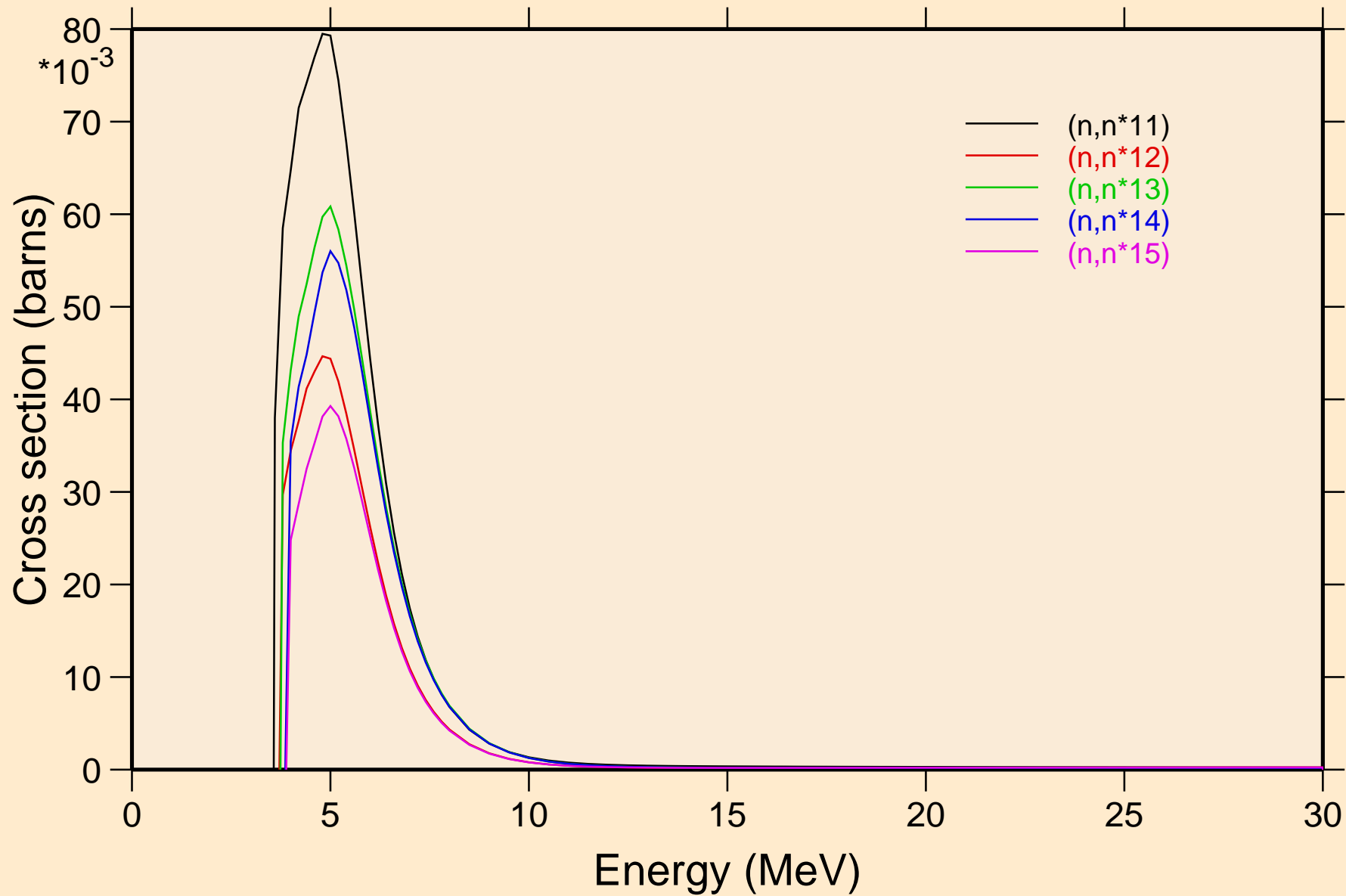

CR056 NEUTRON ACER TENDL-2024 LIBRARY; T=0.K
Inelastic levels

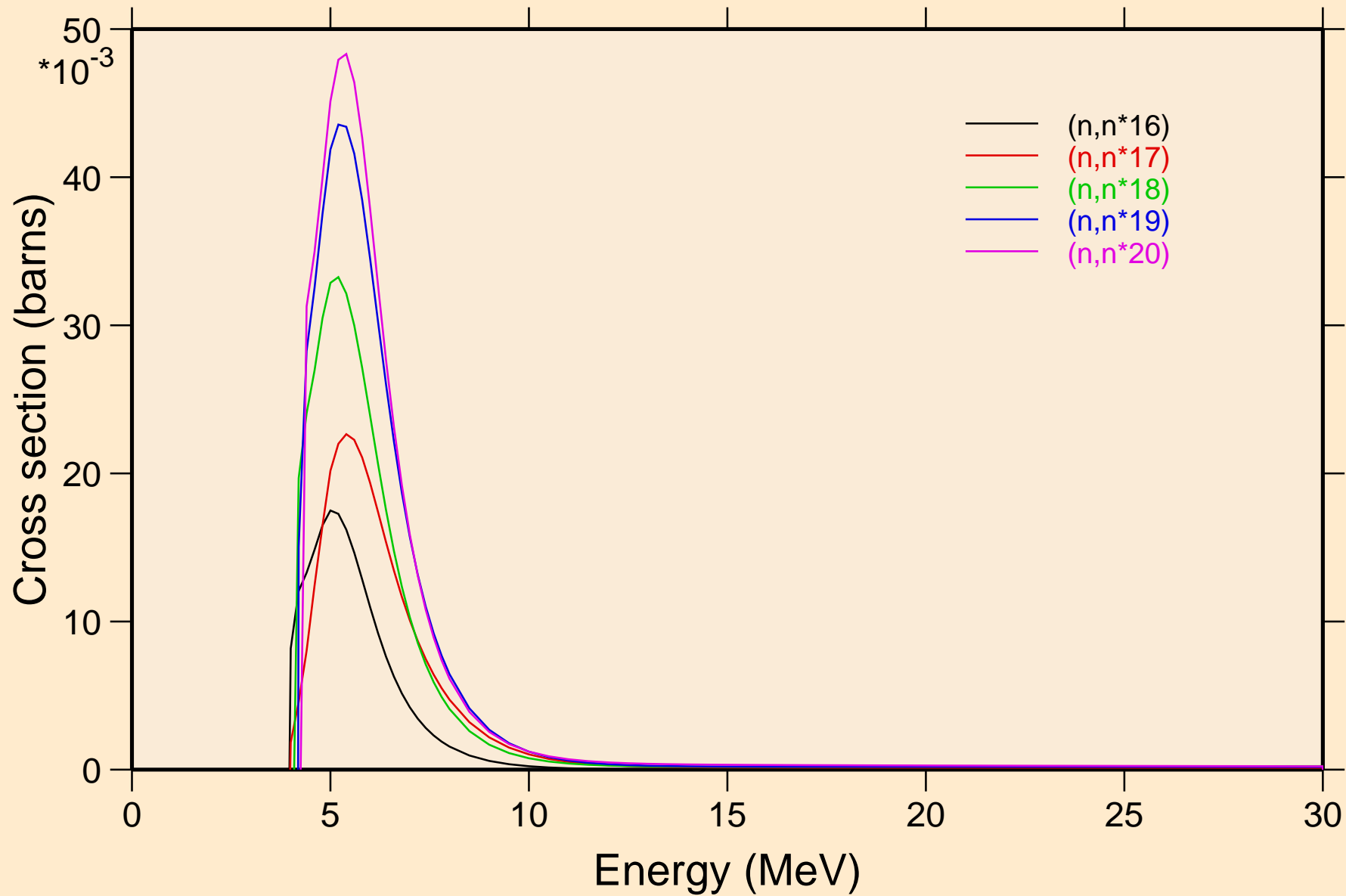

CR056 NEUTRON ACER TENDL-2024 LIBRARY; T=0.K
Inelastic levels

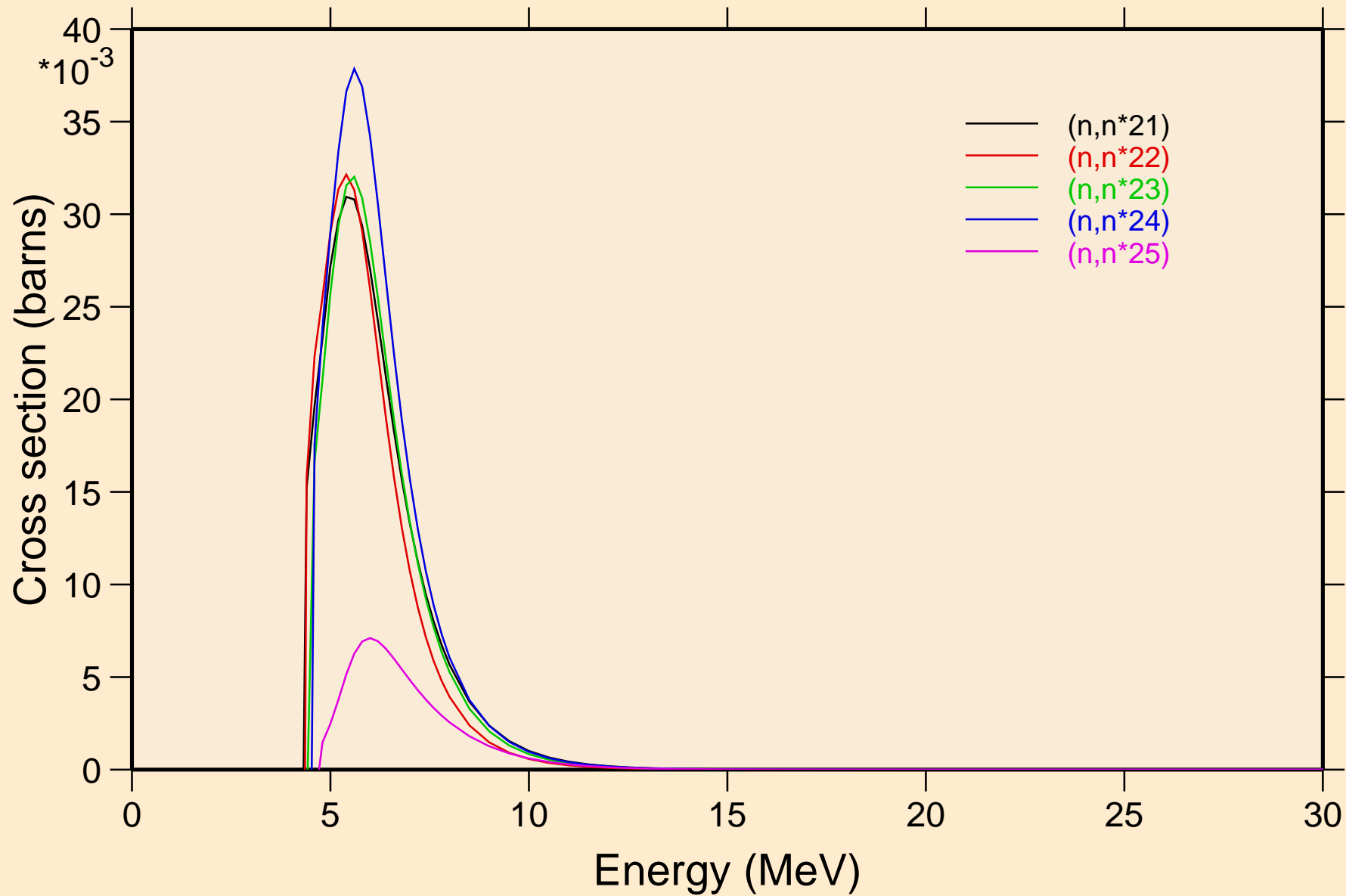

CR056 NEUTRON ACER TENDL-2024 LIBRARY; T=0.K
Inelastic levels

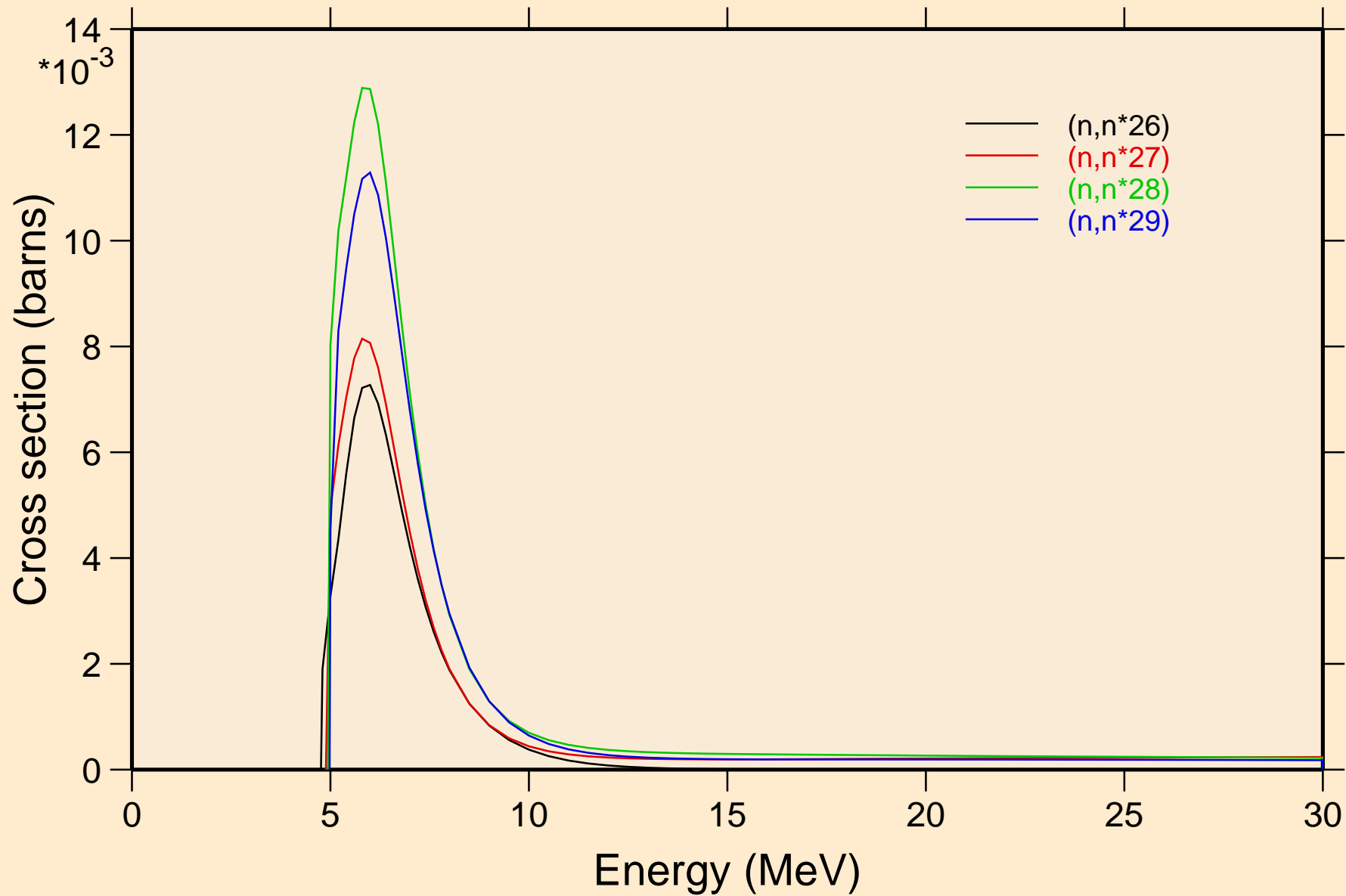

CR056 NEUTRON ACER TENDL-2024 LIBRARY; T=0.K

Threshold reactions

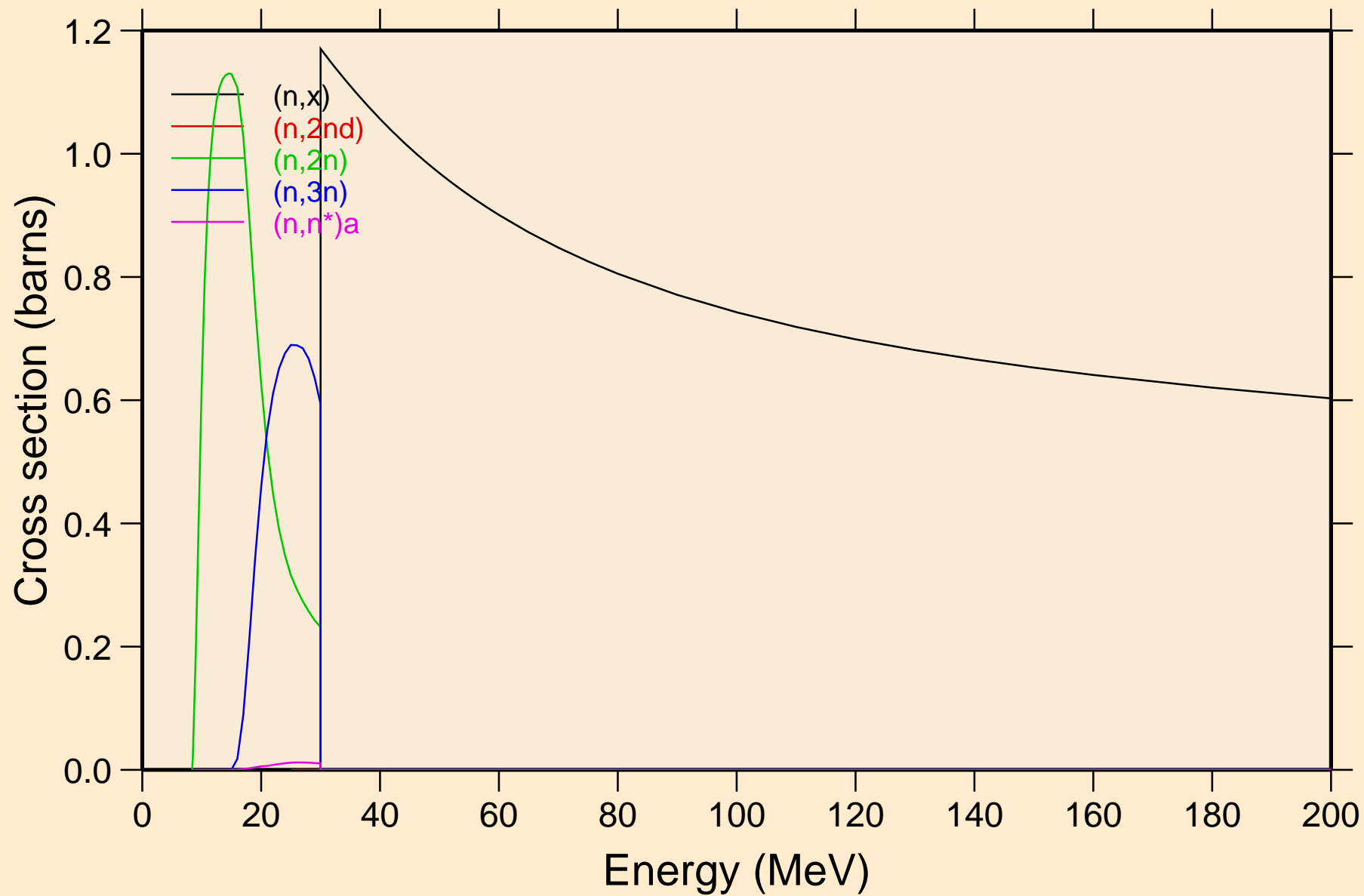

CR056 NEUTRON ACER TENDL-2024 LIBRARY; T=0.K

Threshold reactions

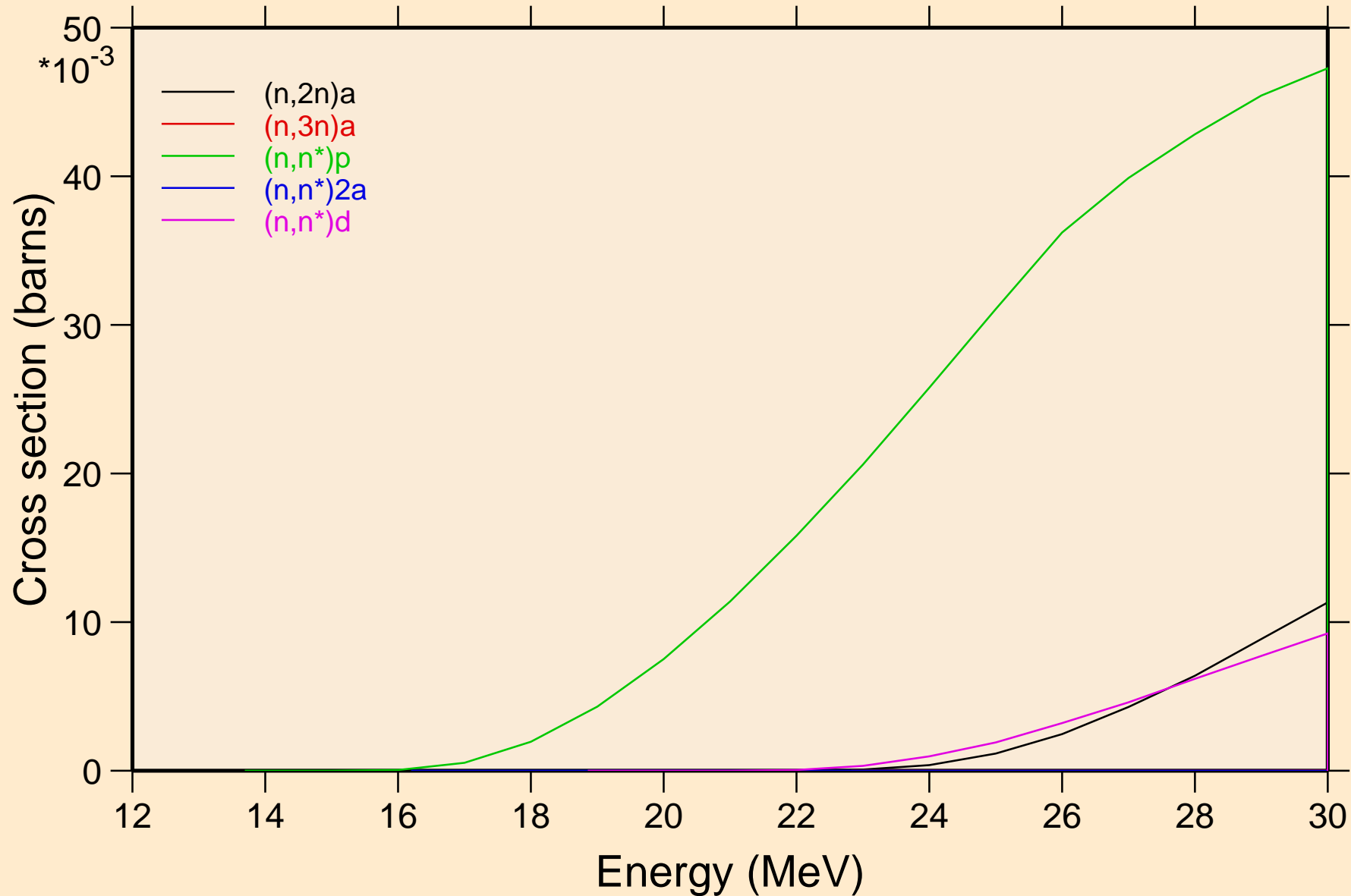

CR056 NEUTRON ACER TENDL-2024 LIBRARY; T=0.K

Threshold reactions

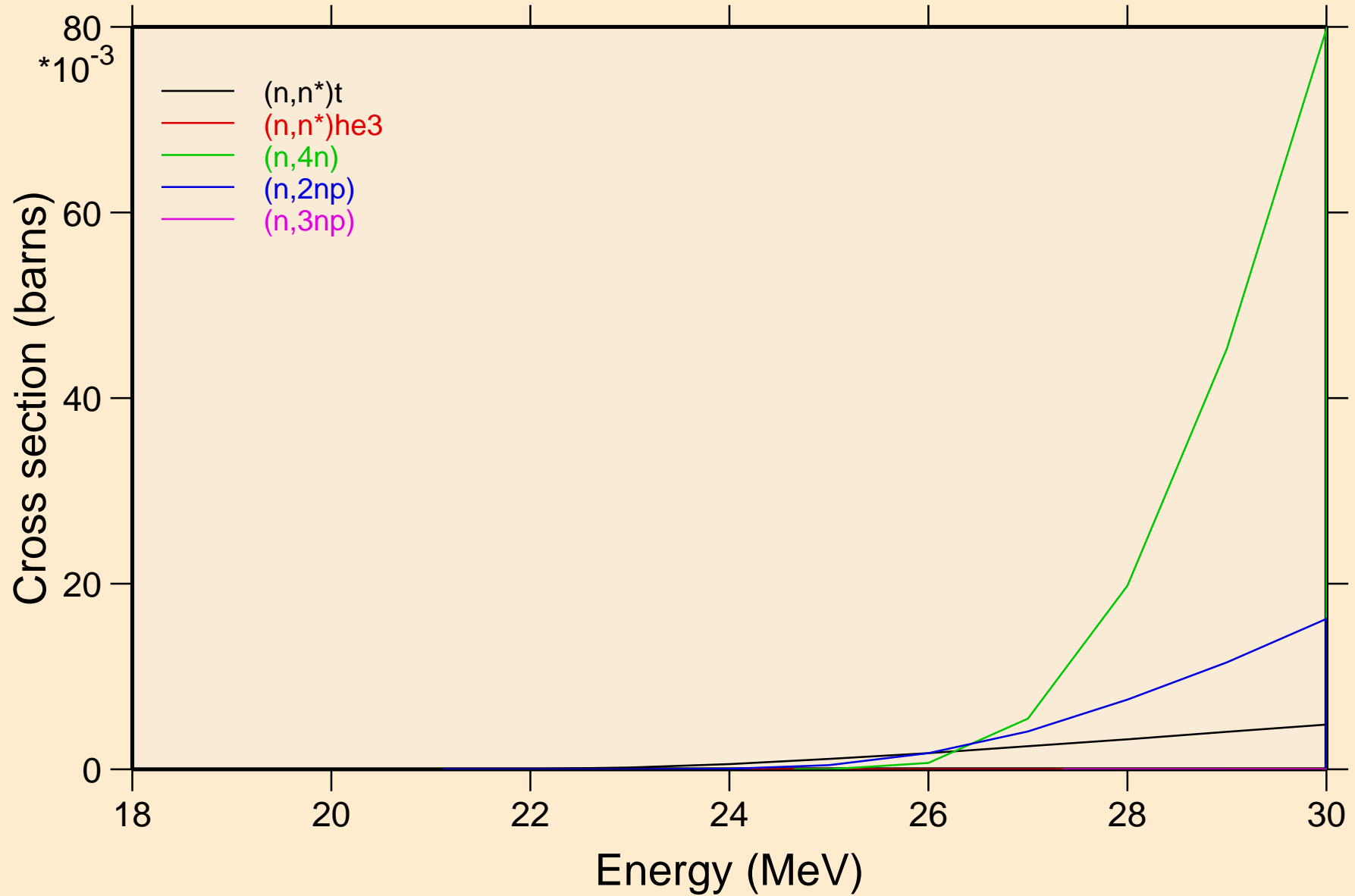

CR056 NEUTRON ACER TENDL-2024 LIBRARY; T=0.K

Threshold reactions

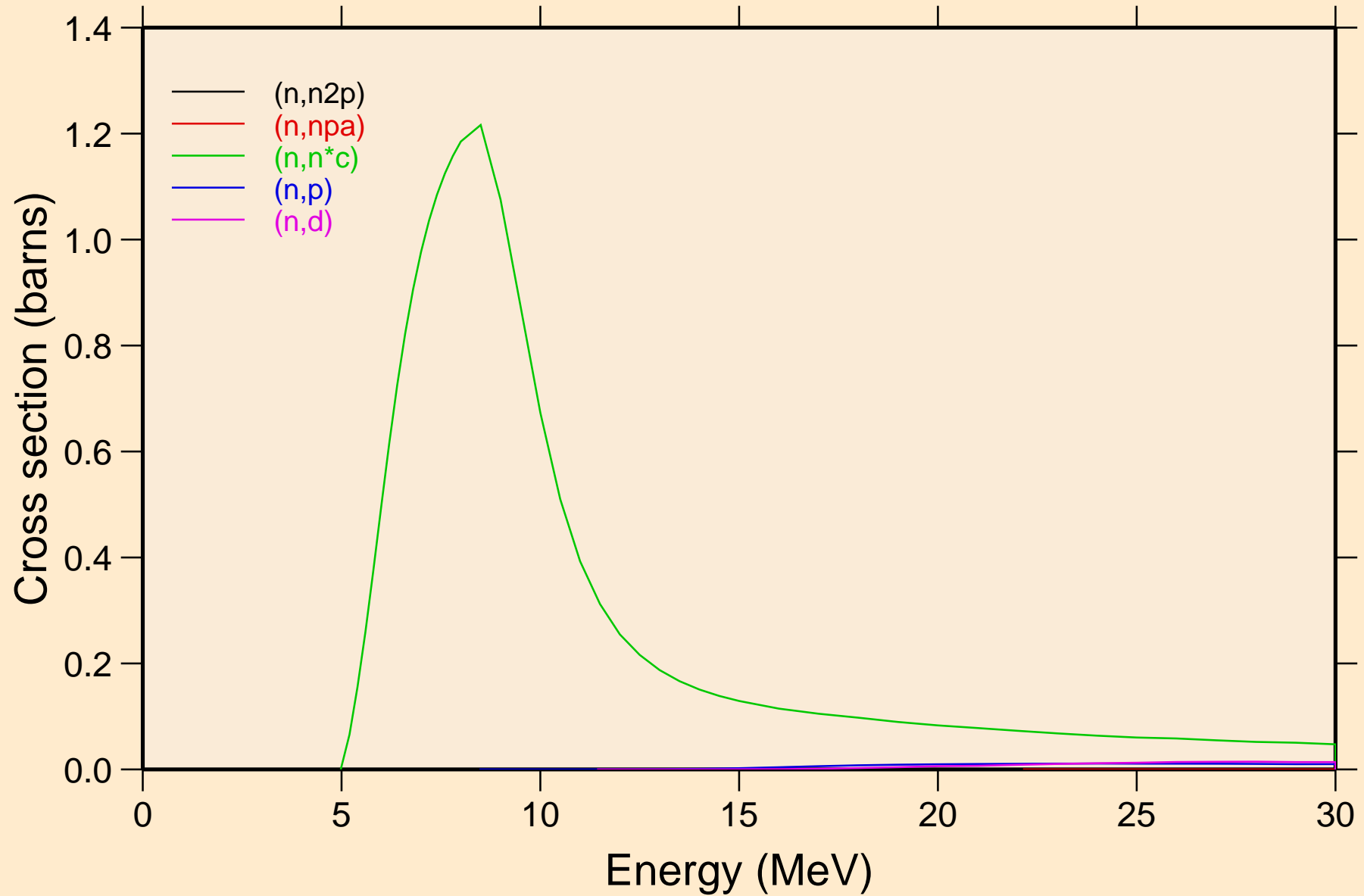

CR056 NEUTRON ACER TENDL-2024 LIBRARY; T=0.K

Threshold reactions

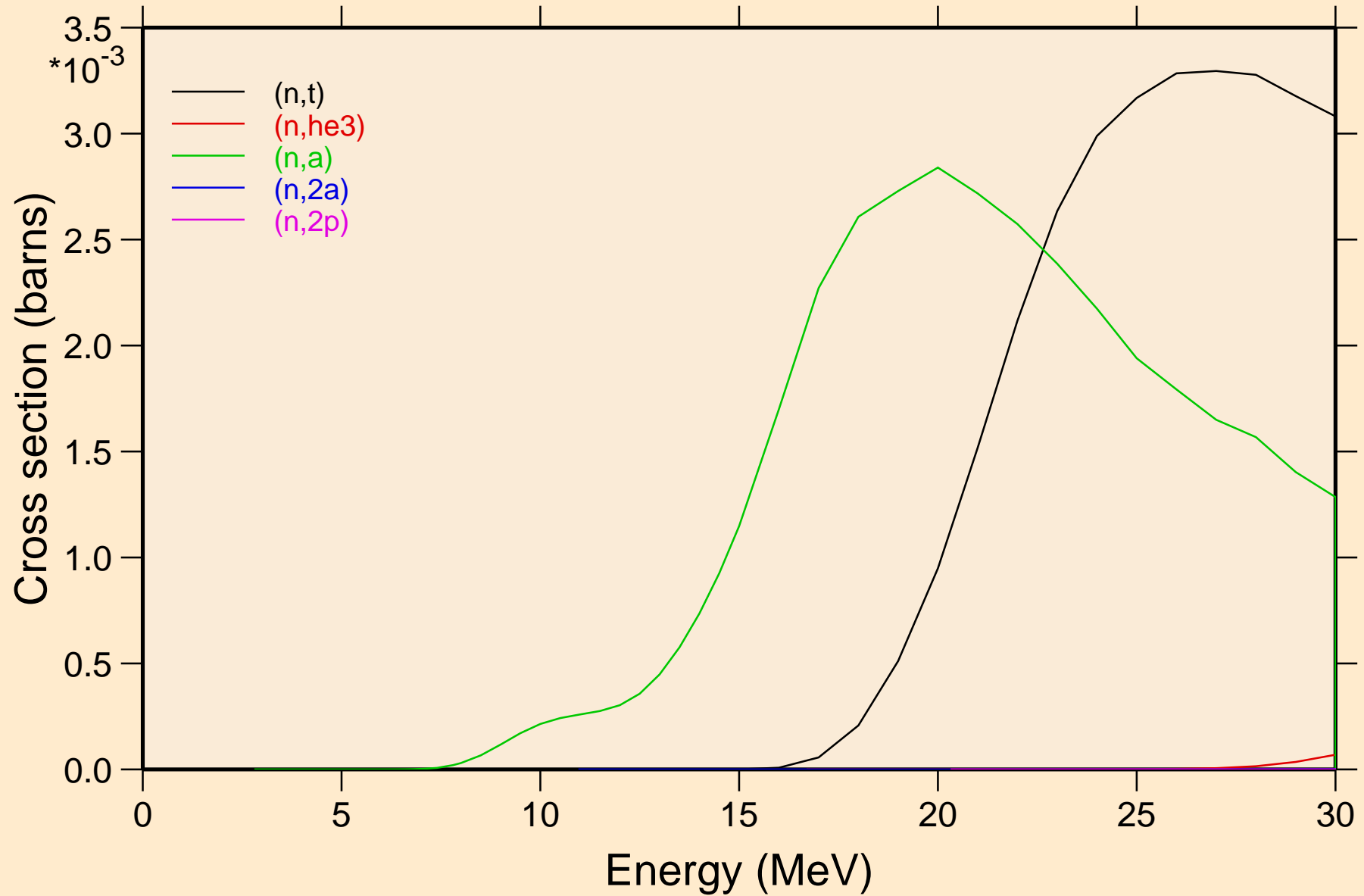

CR056 NEUTRON ACER TENDL-2024 LIBRARY; T=0.K

Threshold reactions

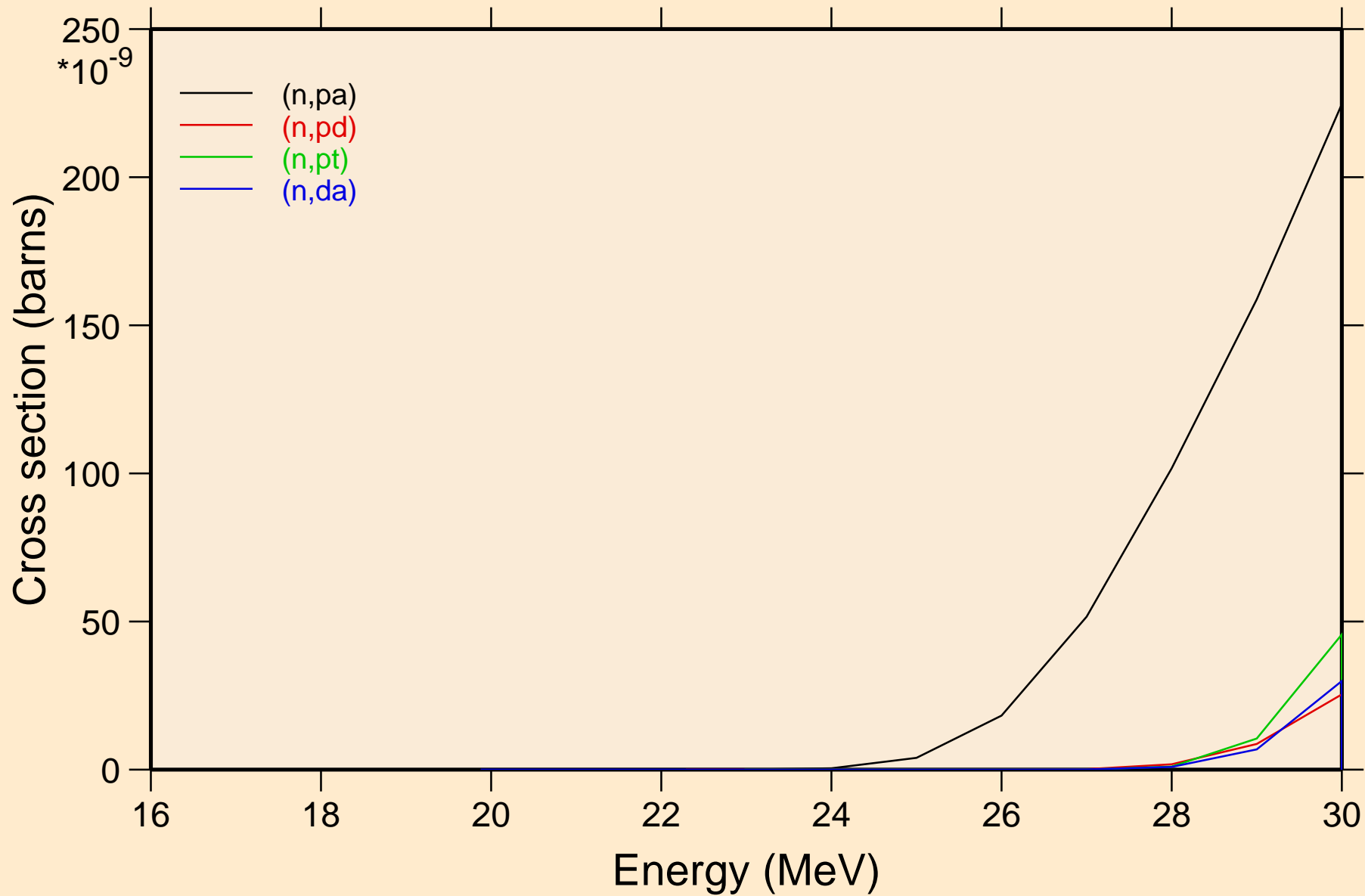

CR056 NEUTRON ACER TENDL-2024 LIBRARY; T=0.K

Threshold reactions

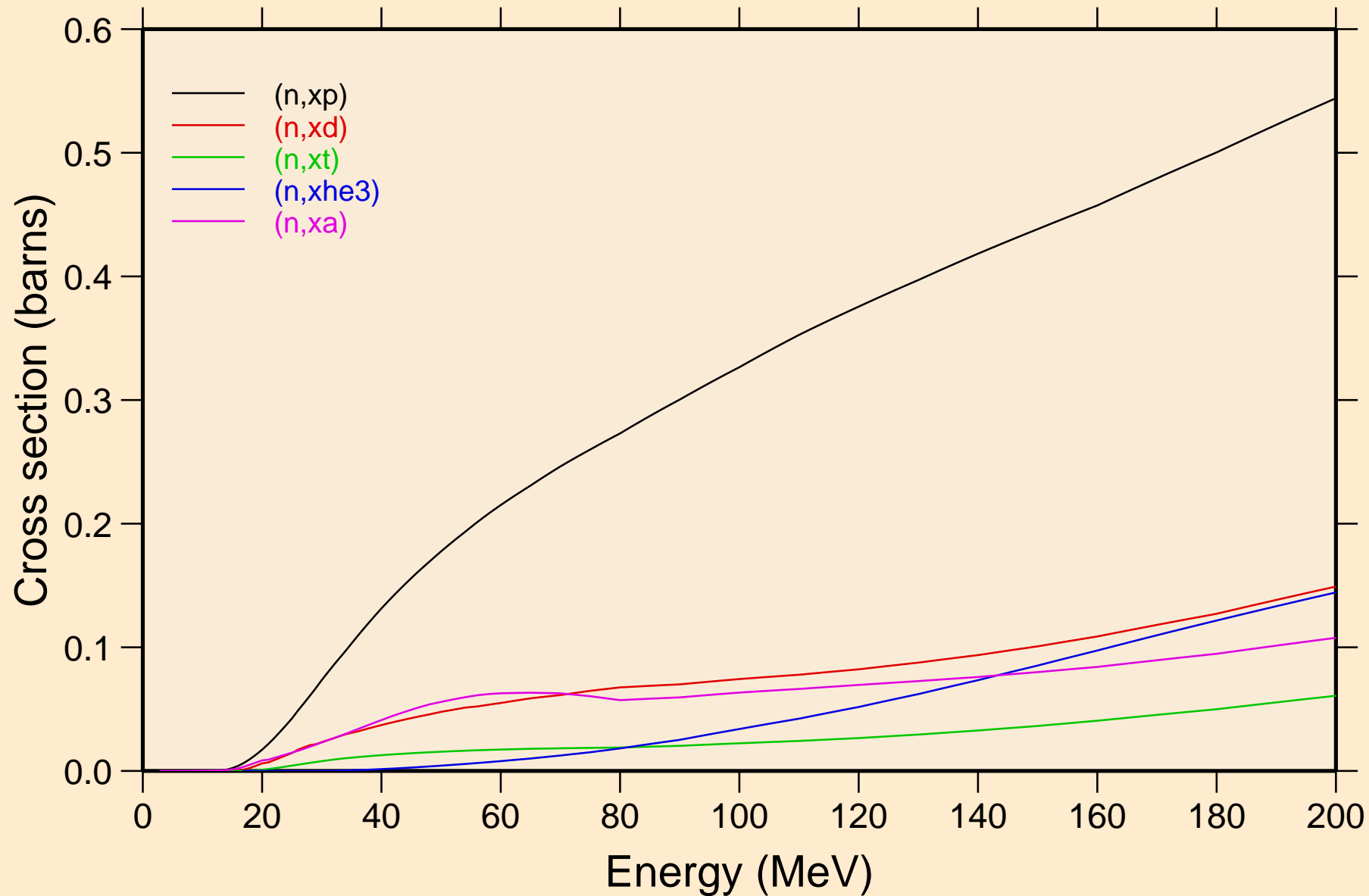

CR056 NEUTRON ACER TENDL-2024 LIBRARY; T=0.K
angular distribution for elastic

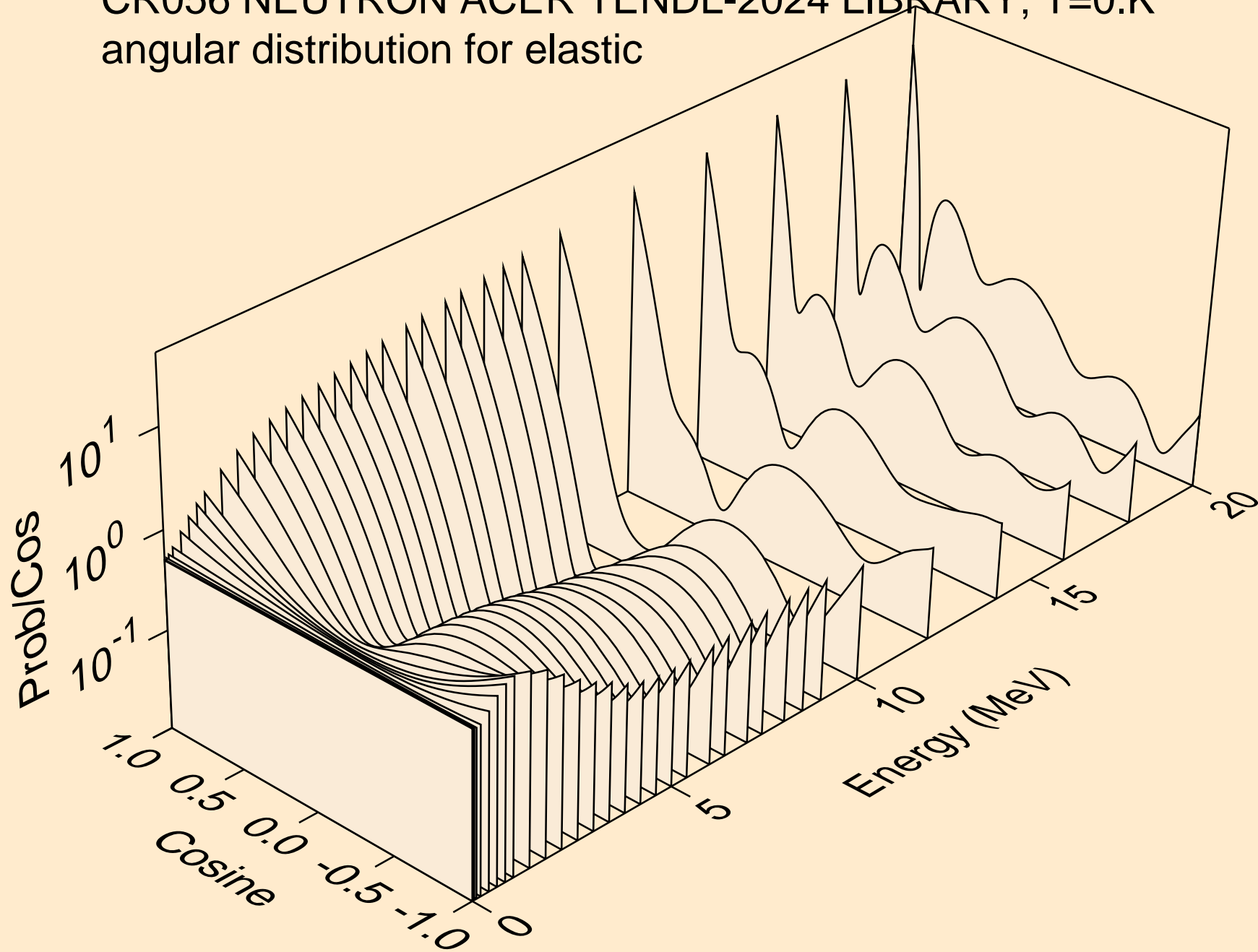

CR056 NEUTRON ACER TENDL-2024 LIBRARY; T=0.K
angular distribution for elastic

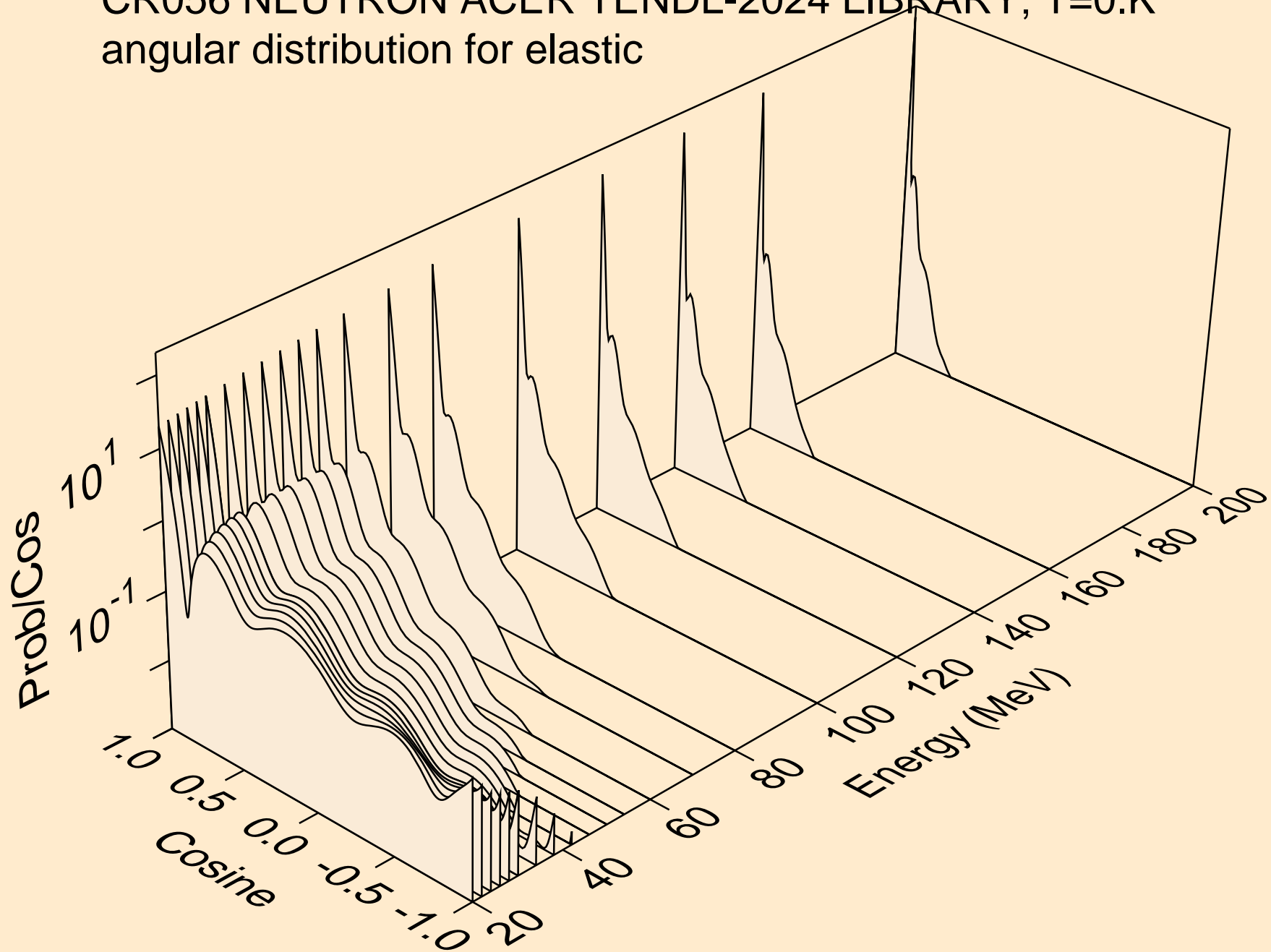

CR056 NEUTRON ACER TENDL-2024 LIBRARY; T=0.K
angular distribution for (n,n*1)

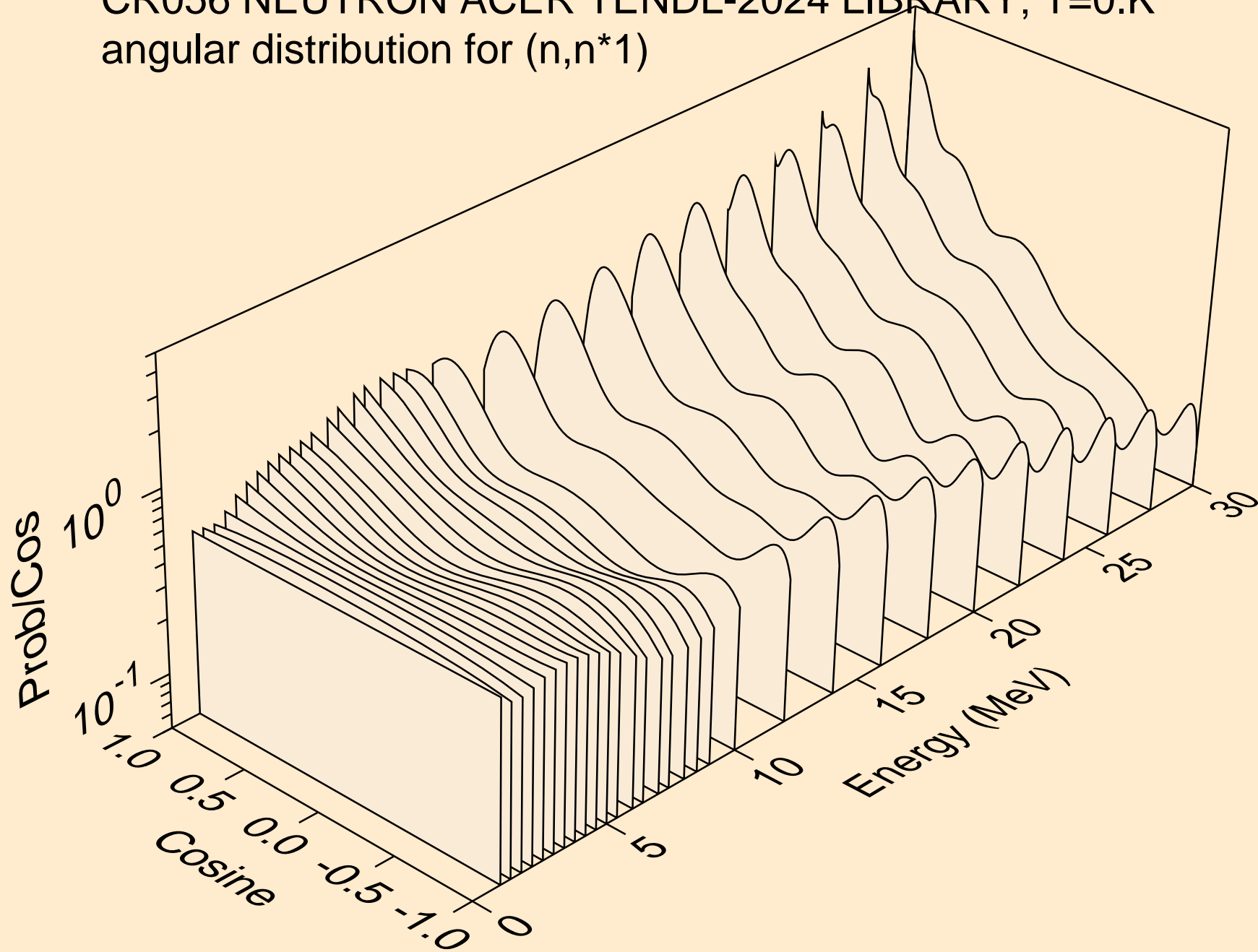

CR056 NEUTRON ACER TENDL-2024 LIBRARY; T=0.K
angular distribution for (n,n*2)

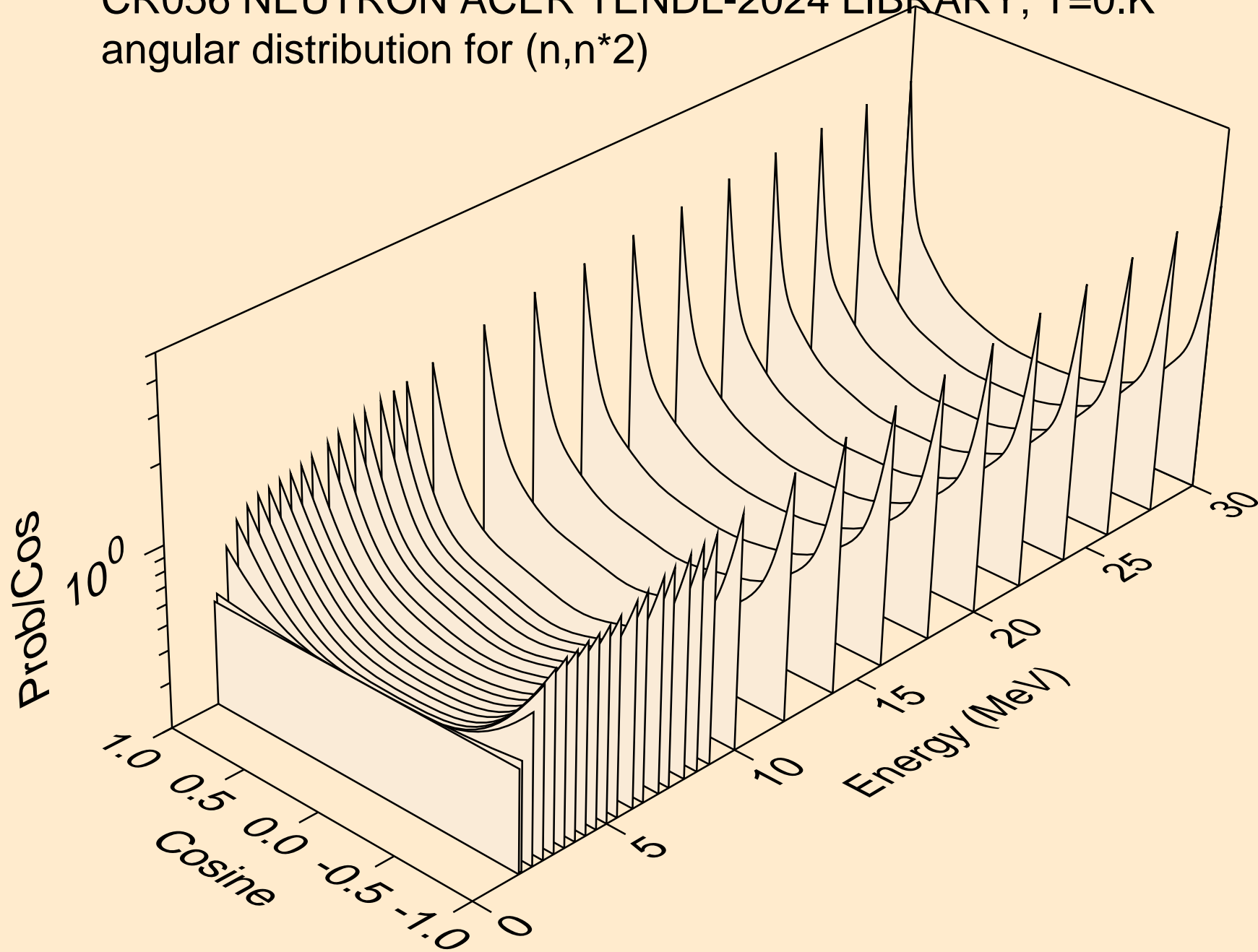

CR056 NEUTRON ACER TENDL-2024 LIBRARY; T=0.K
angular distribution for (n,n*3)

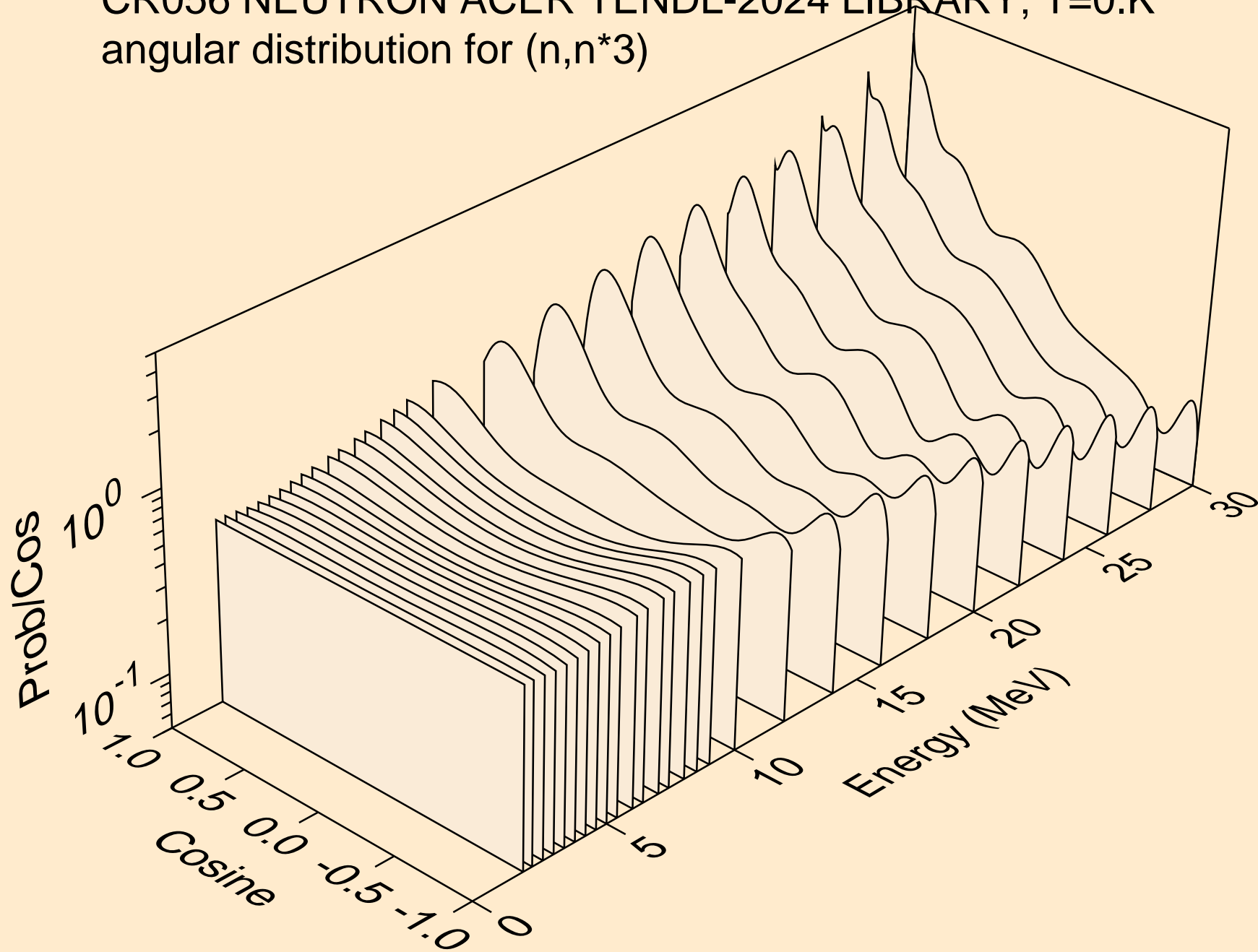

CR056 NEUTRON ACER TENDL-2024 LIBRARY; T=0.K
angular distribution for (n,n*4)

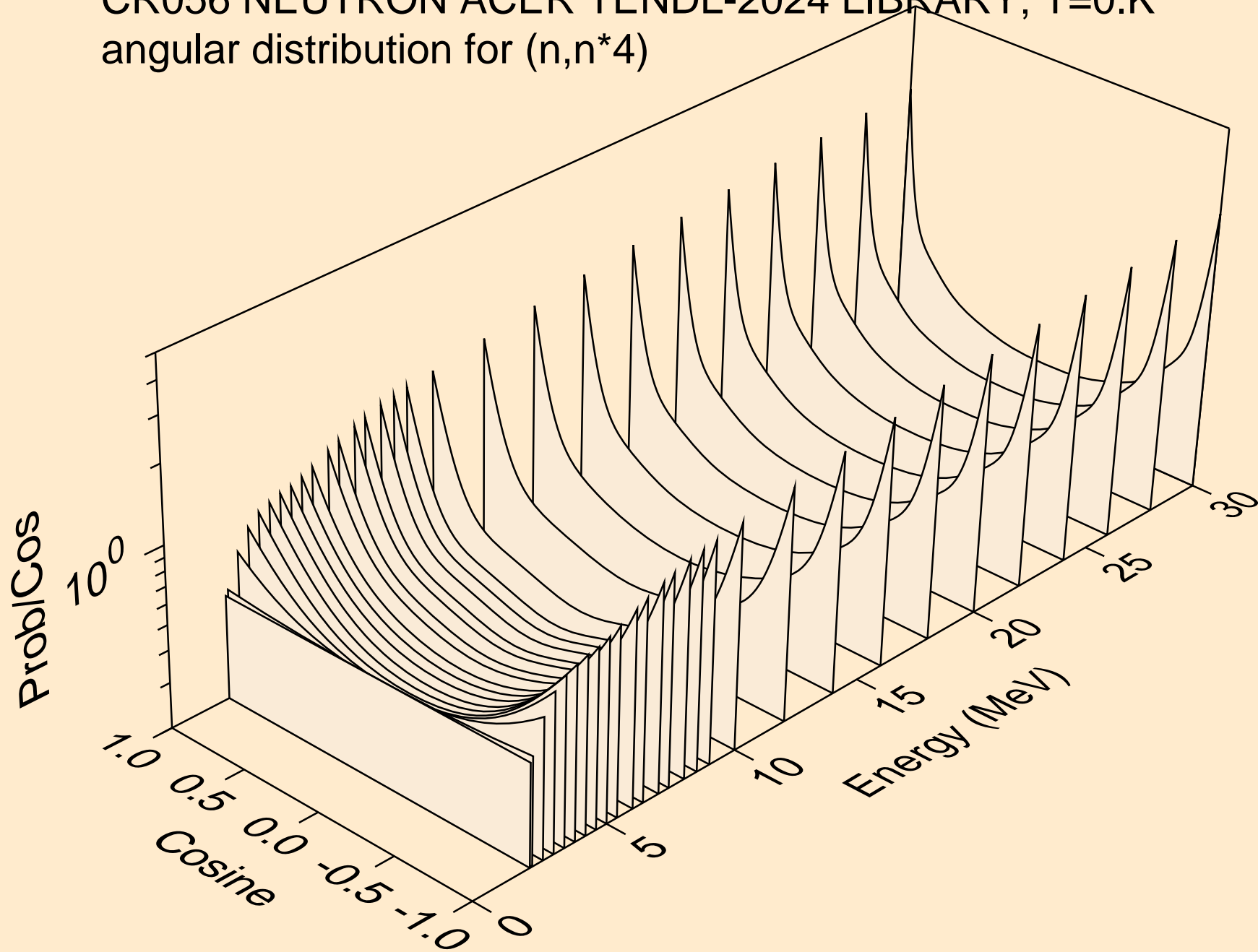

CR056 NEUTRON ACER TENDL-2024 LIBRARY; T=0.K
angular distribution for (n,n*5)

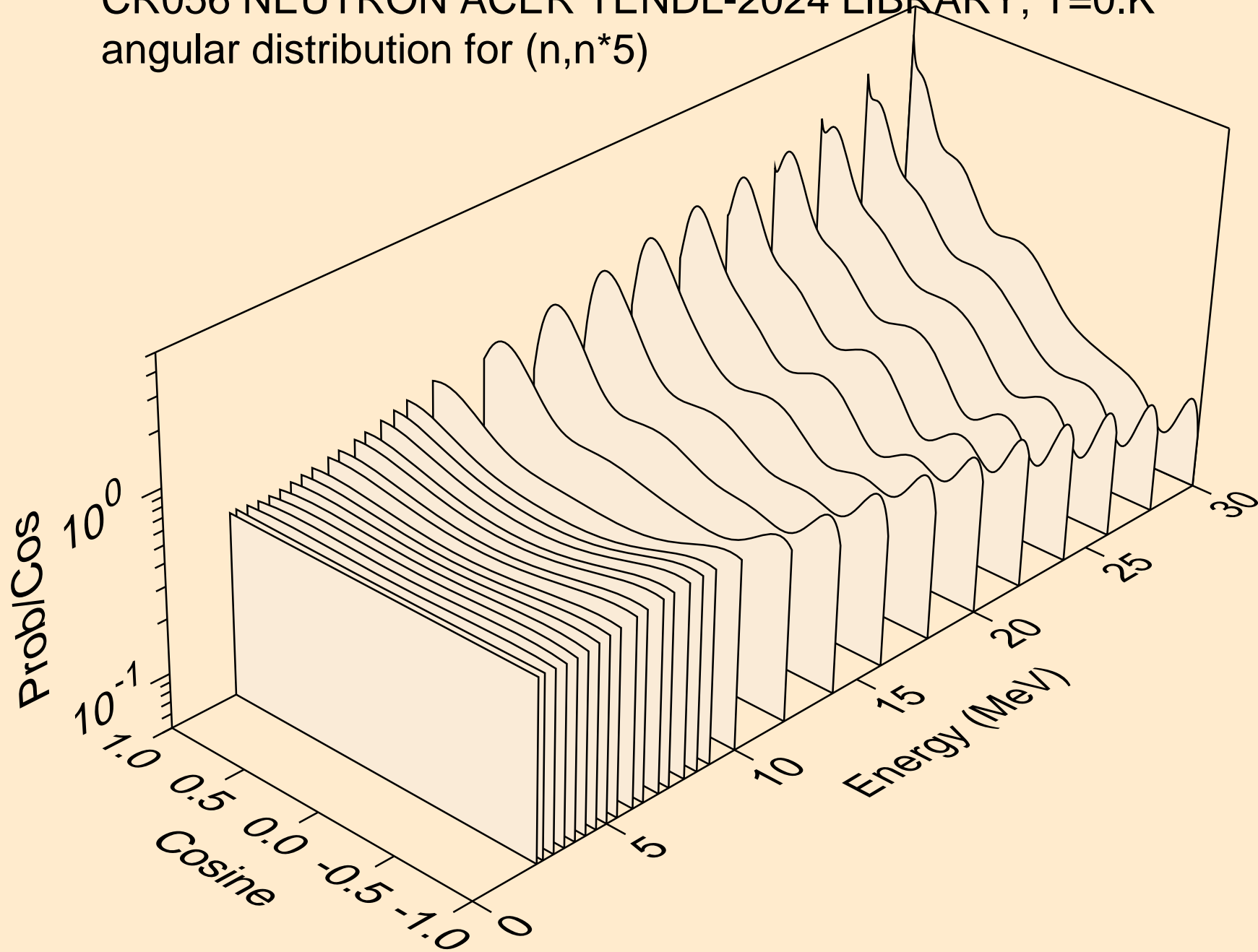

CR056 NEUTRON ACER TENDL-2024 LIBRARY; T=0.K
angular distribution for (n,n*6)

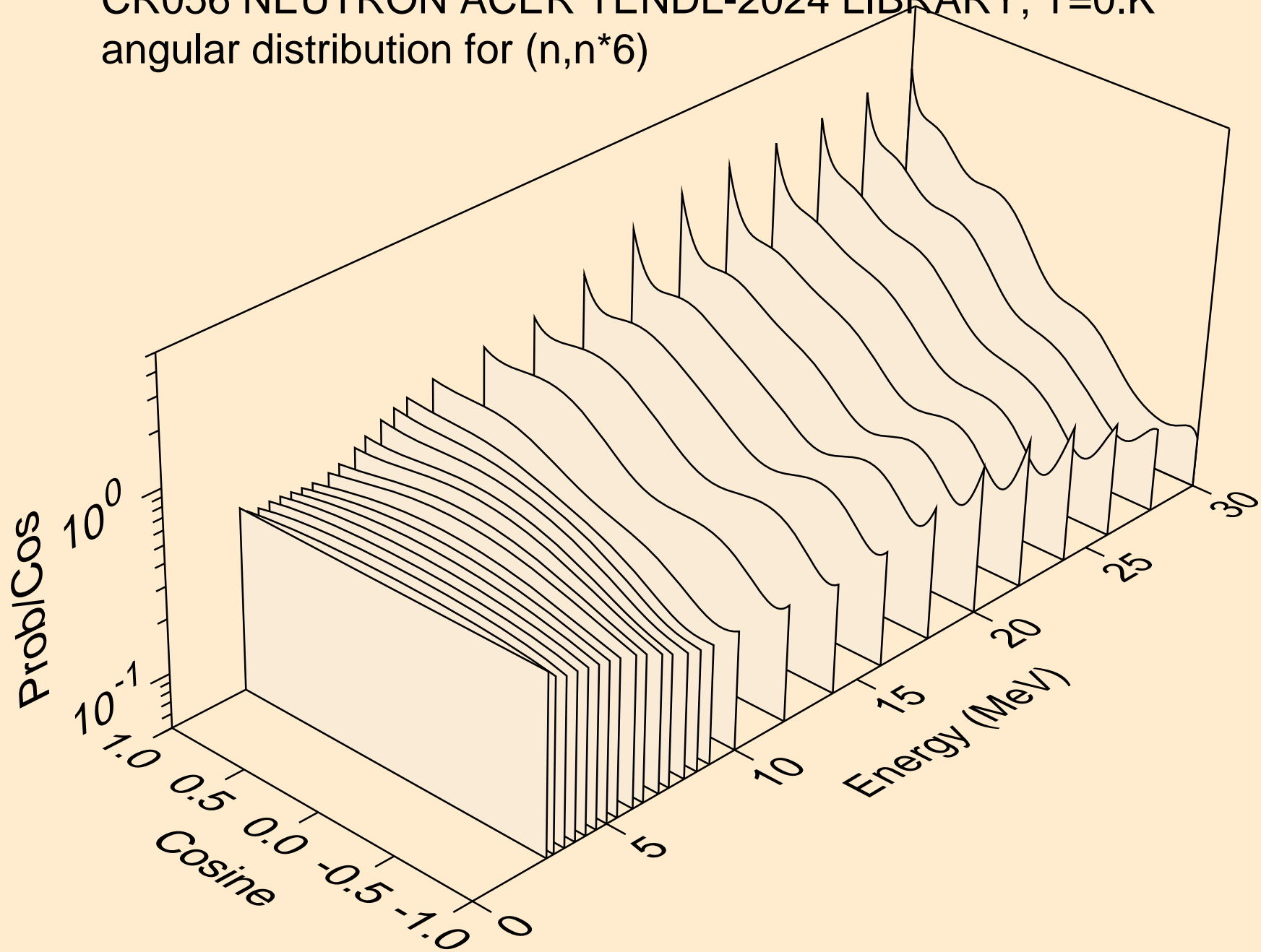

CR056 NEUTRON ACER TENDL-2024 LIBRARY; T=0.K
angular distribution for (n,n*7)

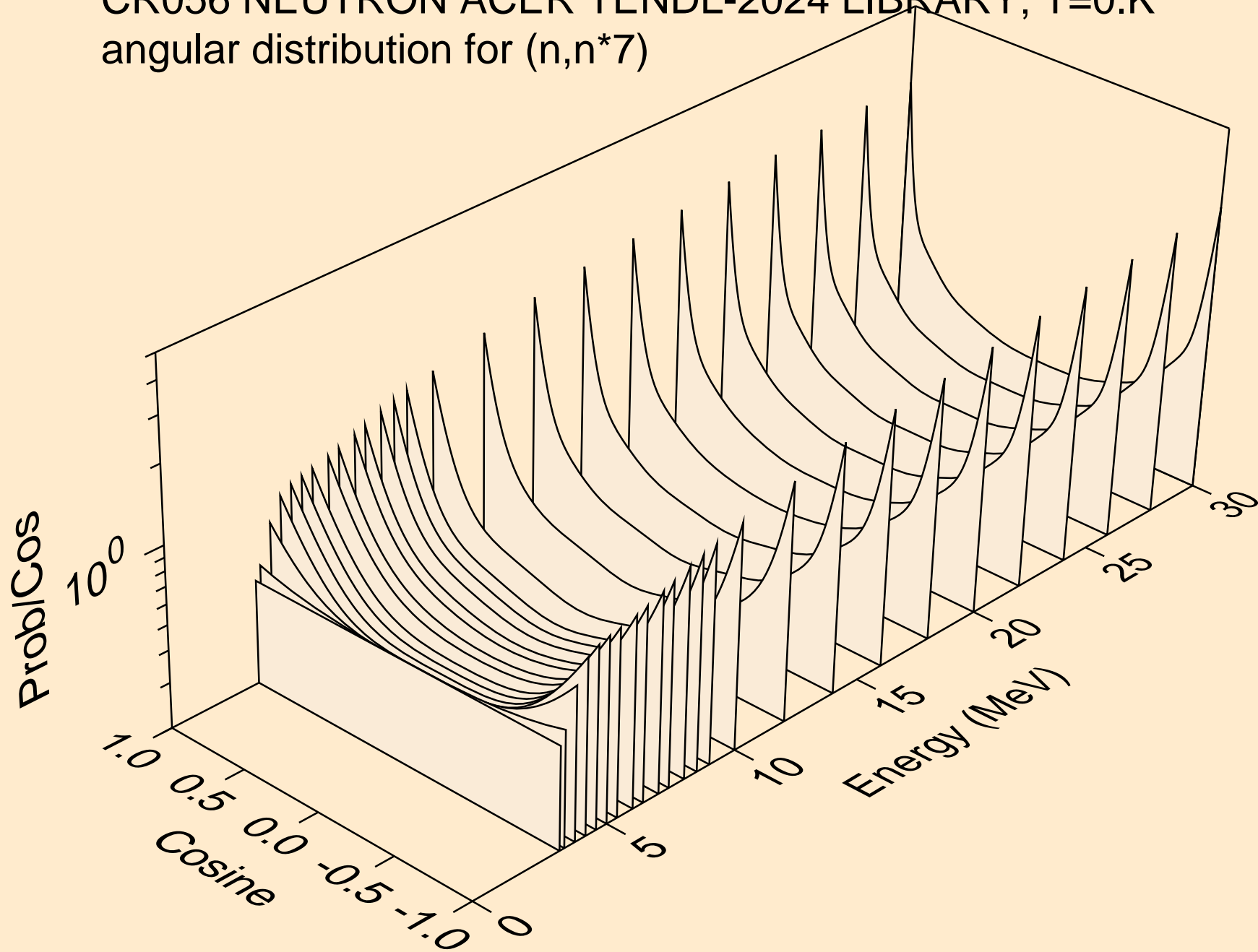

CR056 NEUTRON ACER TENDL-2024 LIBRARY; T=0.K
angular distribution for (n,n*8)

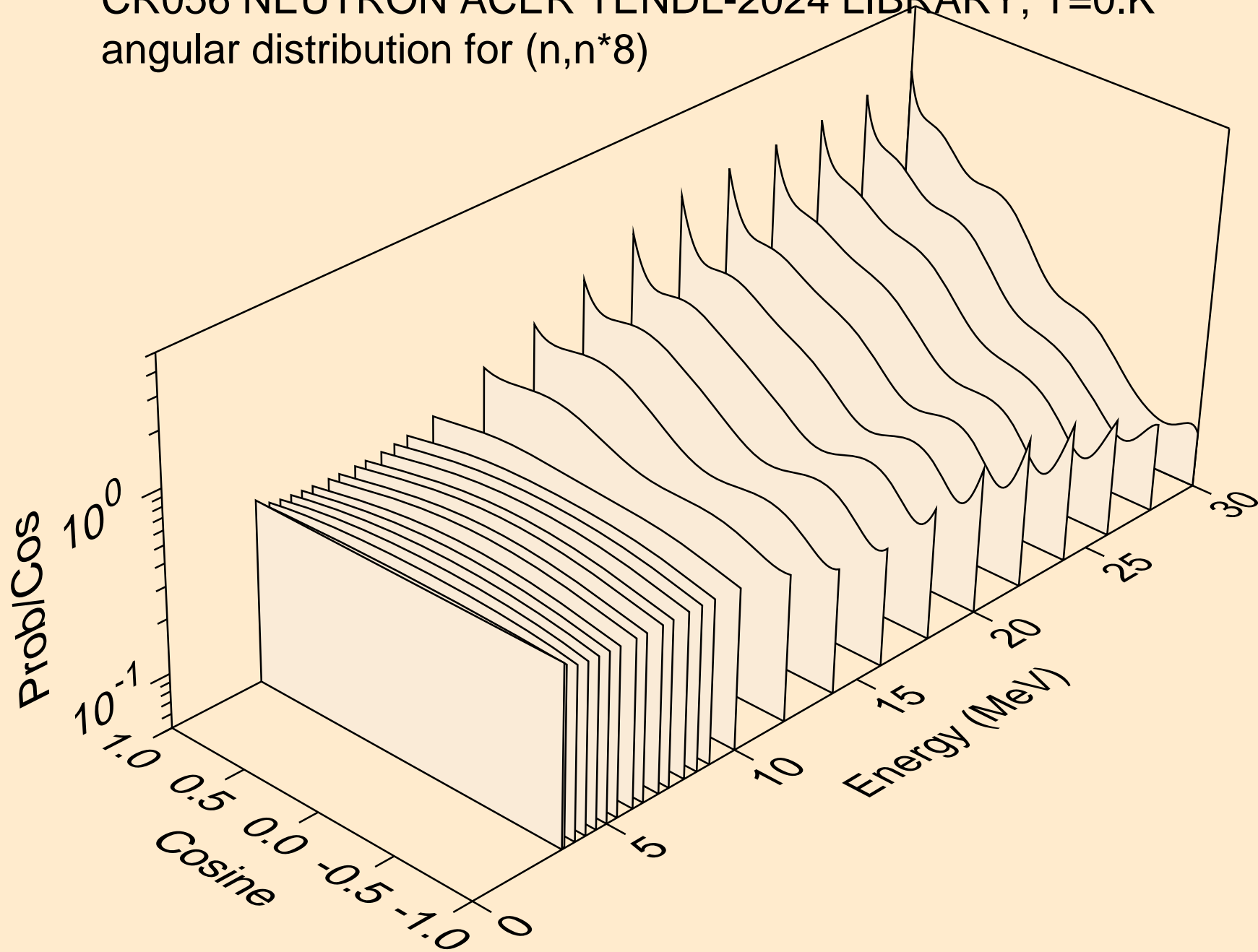

CR056 NEUTRON ACER TENDL-2024 LIBRARY; T=0.K
angular distribution for (n,n*9)

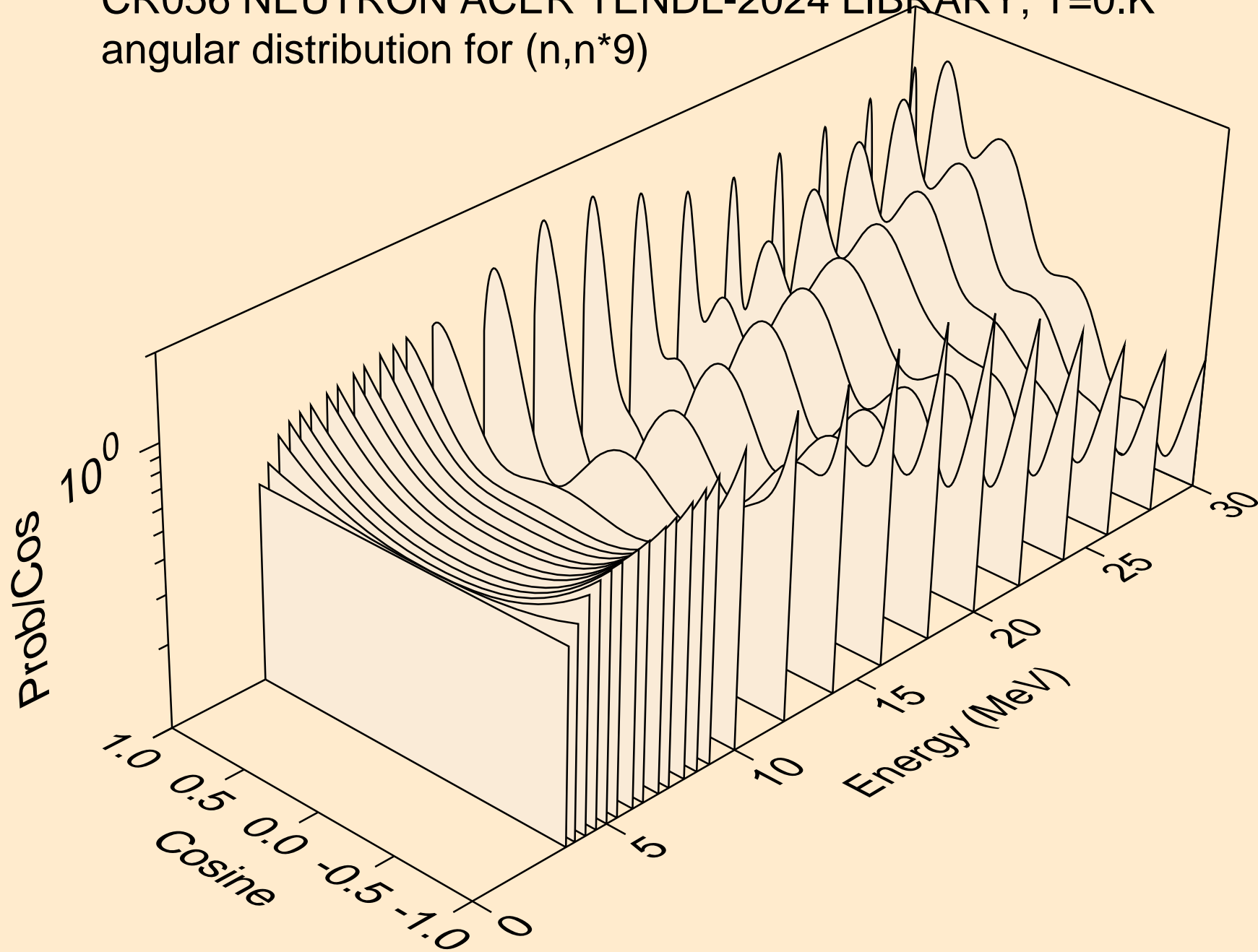

CR056 NEUTRON ACER TENDL-2024 LIBRARY; T=0.K
angular distribution for (n,n*10)

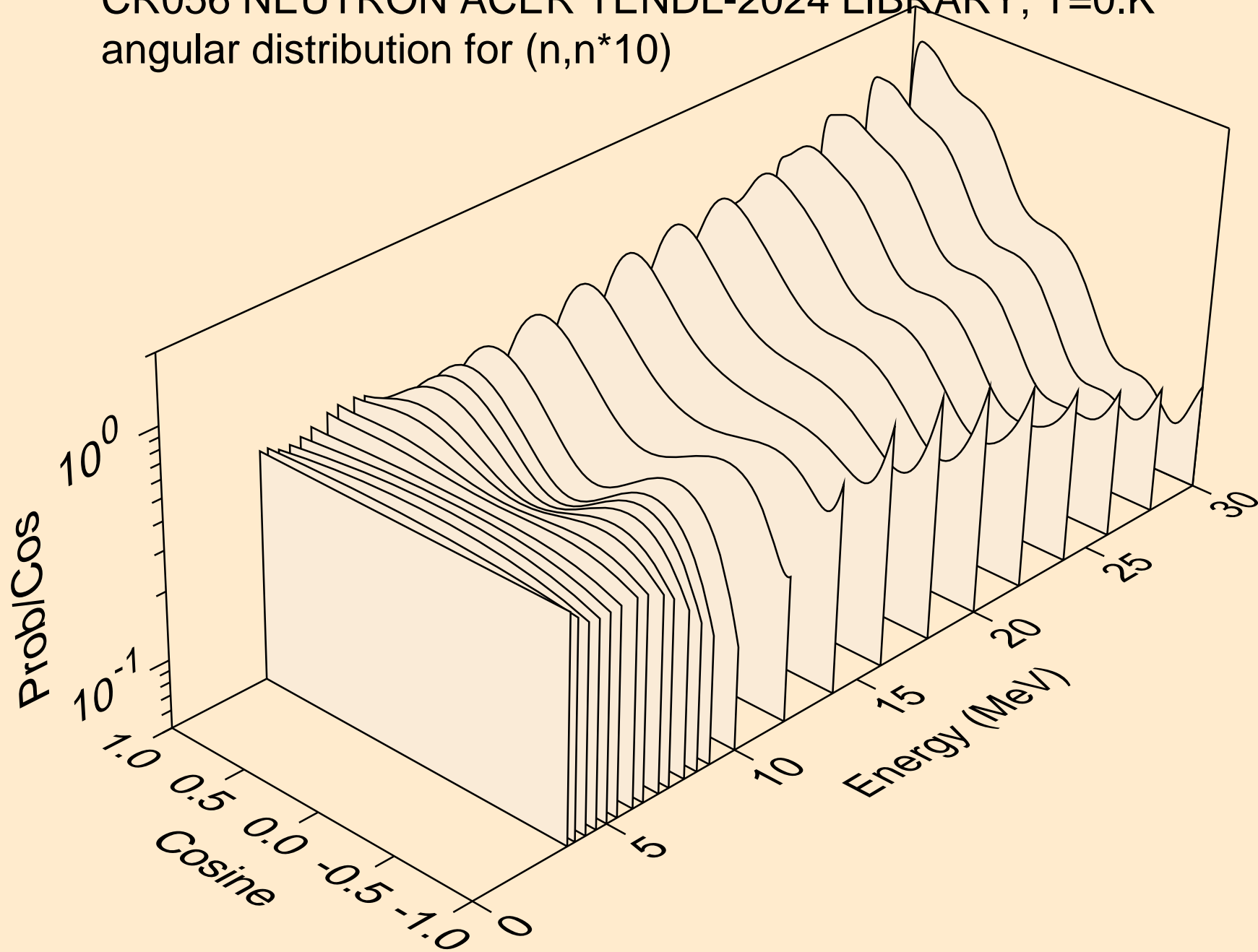

CR056 NEUTRON ACER TENDL-2024 LIBRARY; T=0.K
angular distribution for (n,n*11)

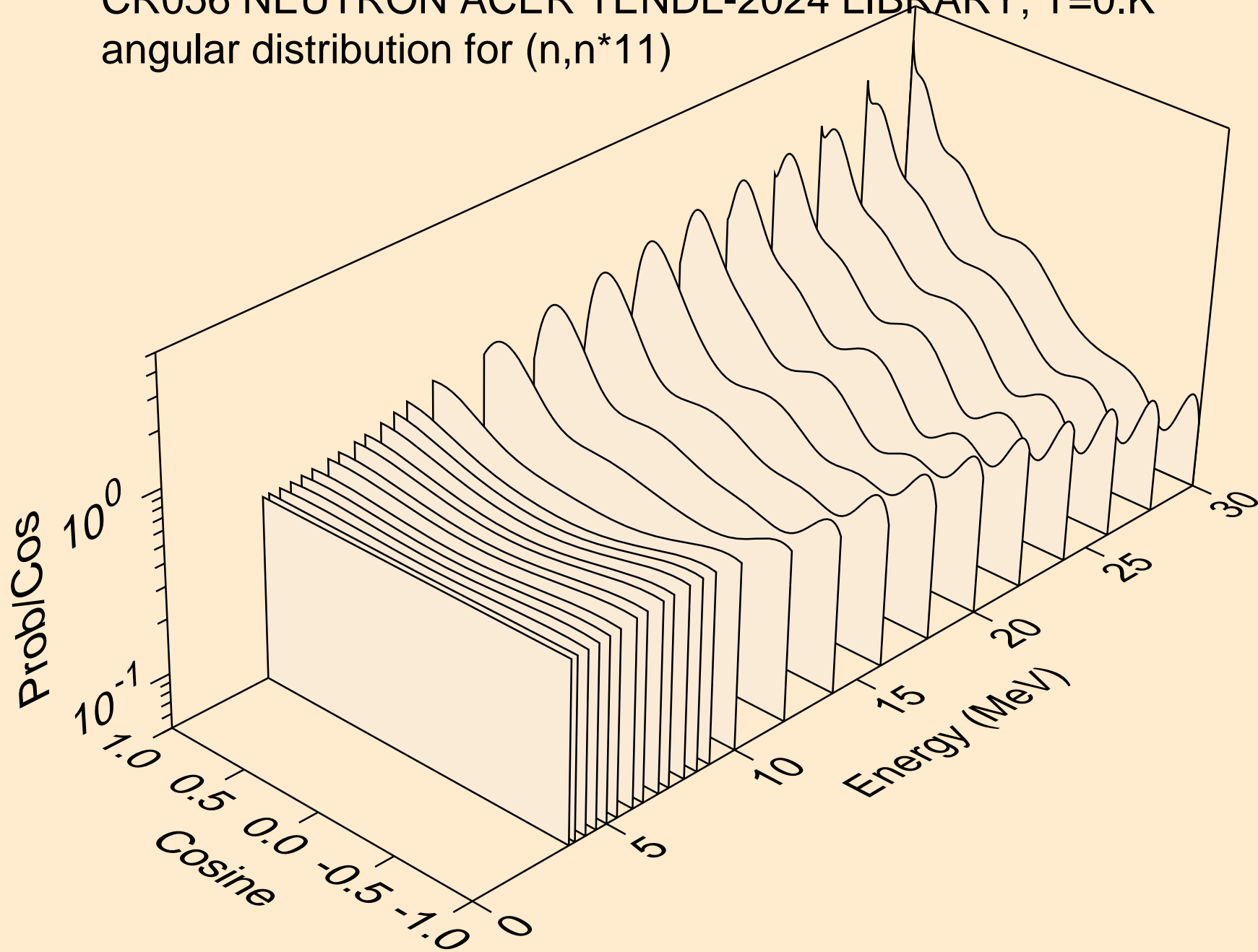

CR056 NEUTRON ACER TENDL-2024 LIBRARY; T=0.K
angular distribution for (n,n*12)

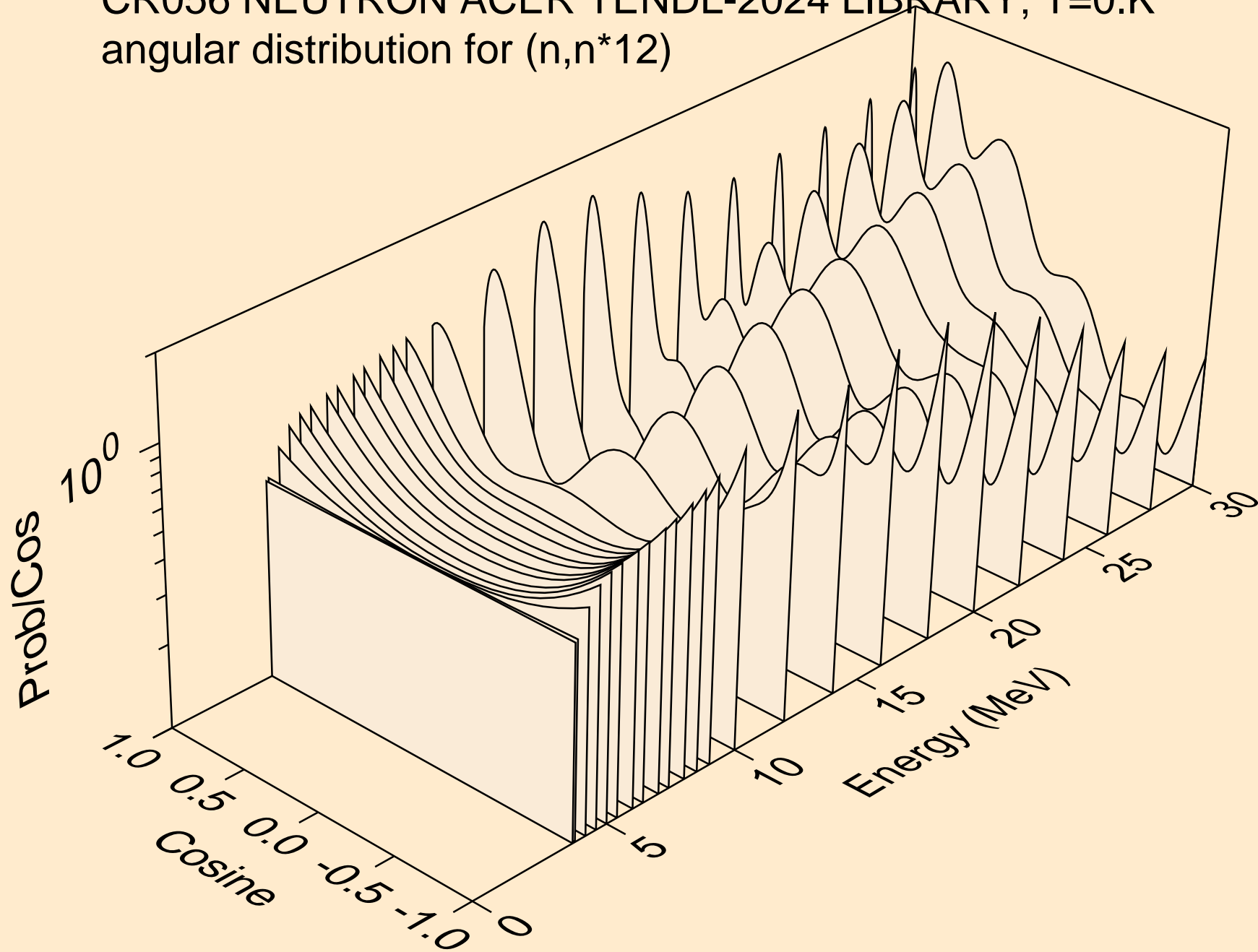

CR056 NEUTRON ACER TENDL-2024 LIBRARY; T=0.K
angular distribution for (n,n*13)

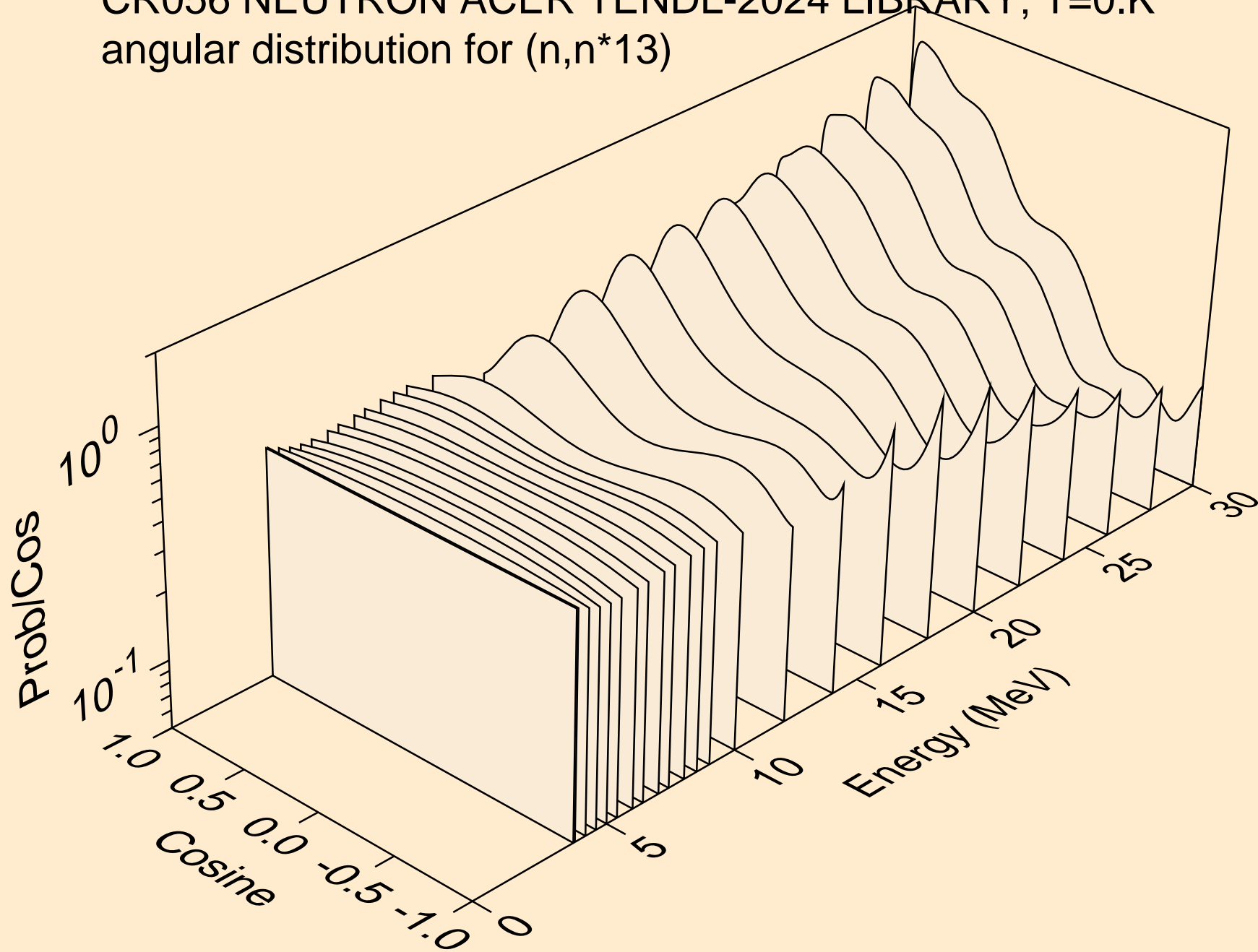

CR056 NEUTRON ACER TENDL-2024 LIBRARY; T=0.K
angular distribution for (n,n*14)

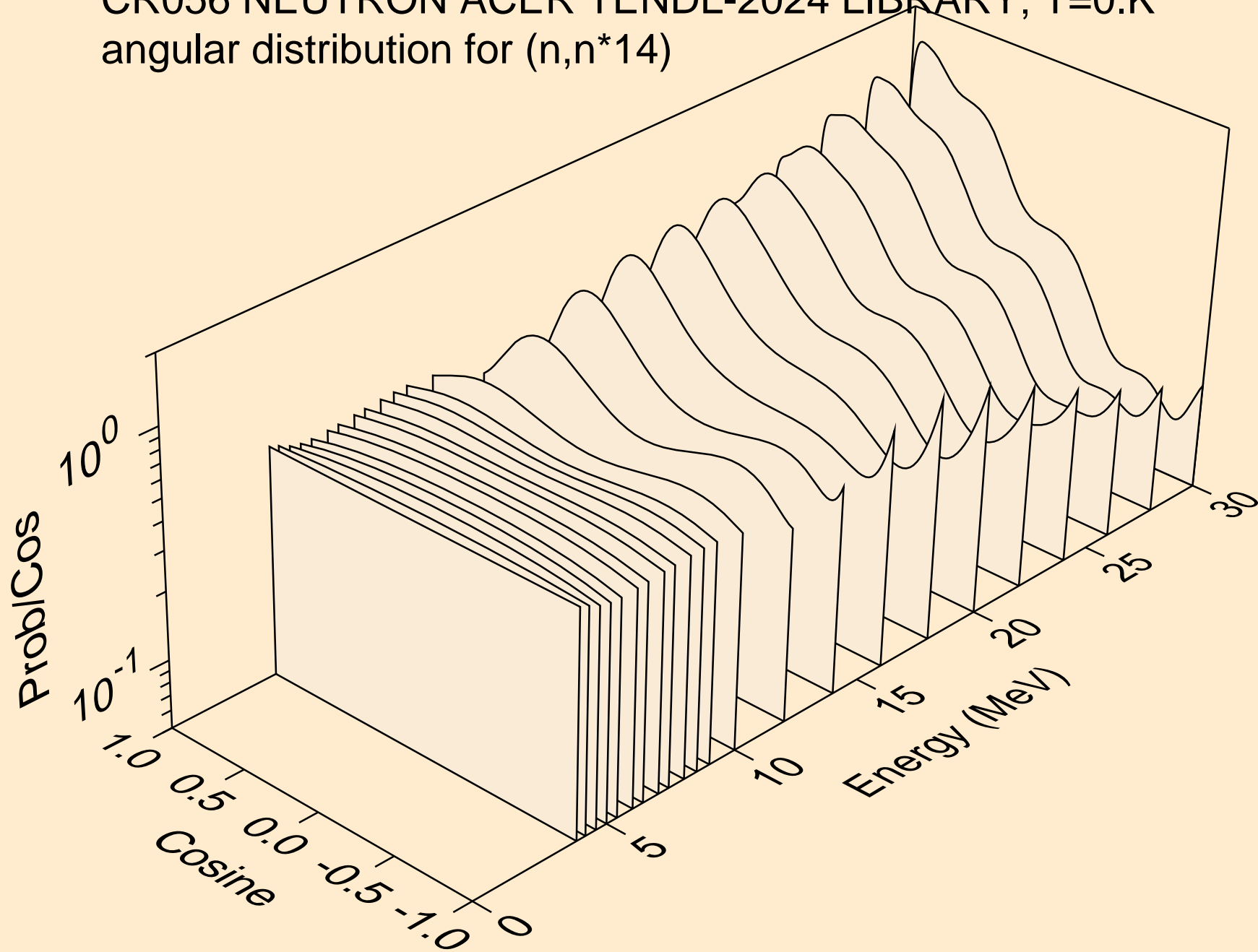

CR056 NEUTRON ACER TENDL-2024 LIBRARY; T=0.K
angular distribution for (n,n*15)

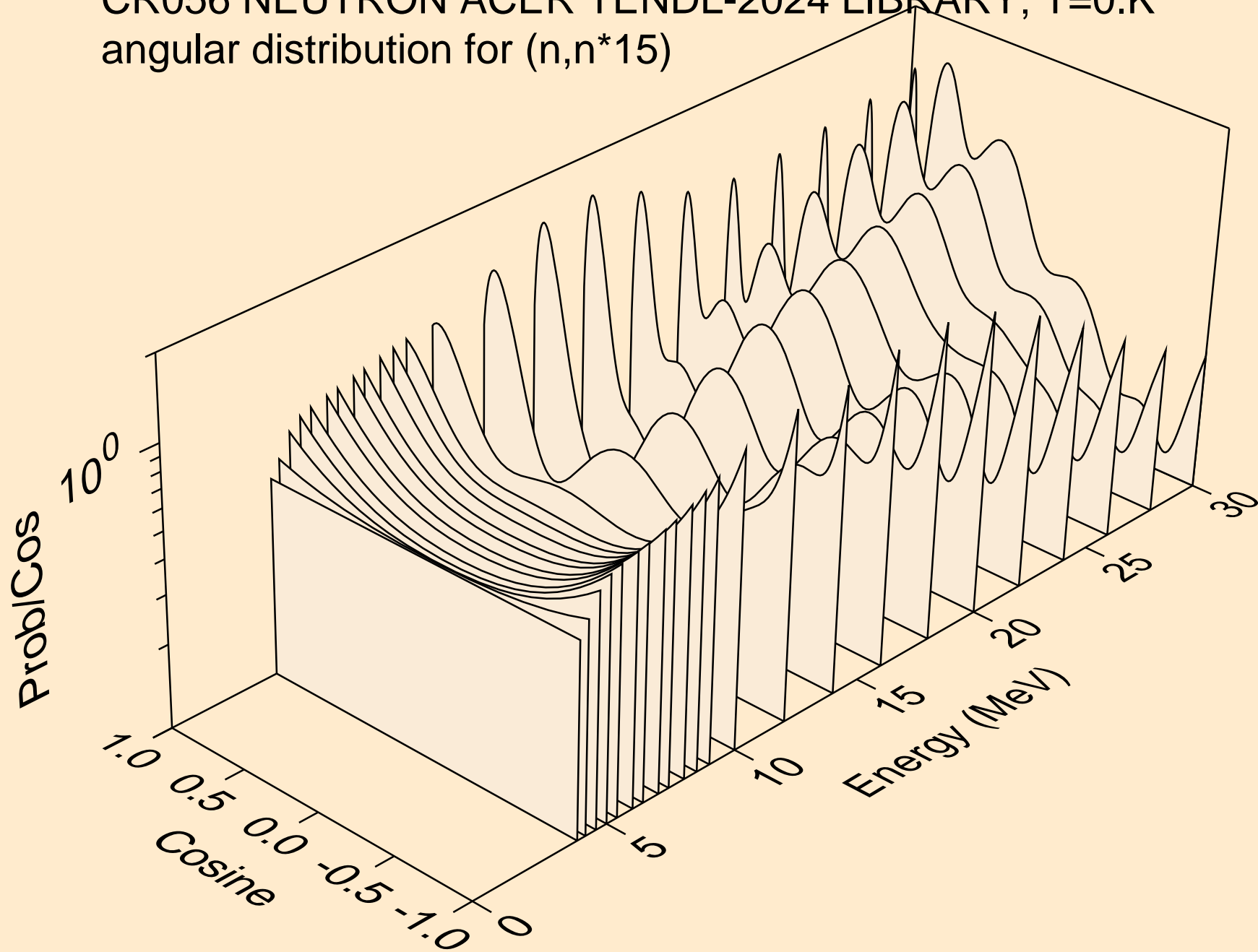

CR056 NEUTRON ACER TENDL-2024 LIBRARY; T=0.K
angular distribution for (n,n*16)

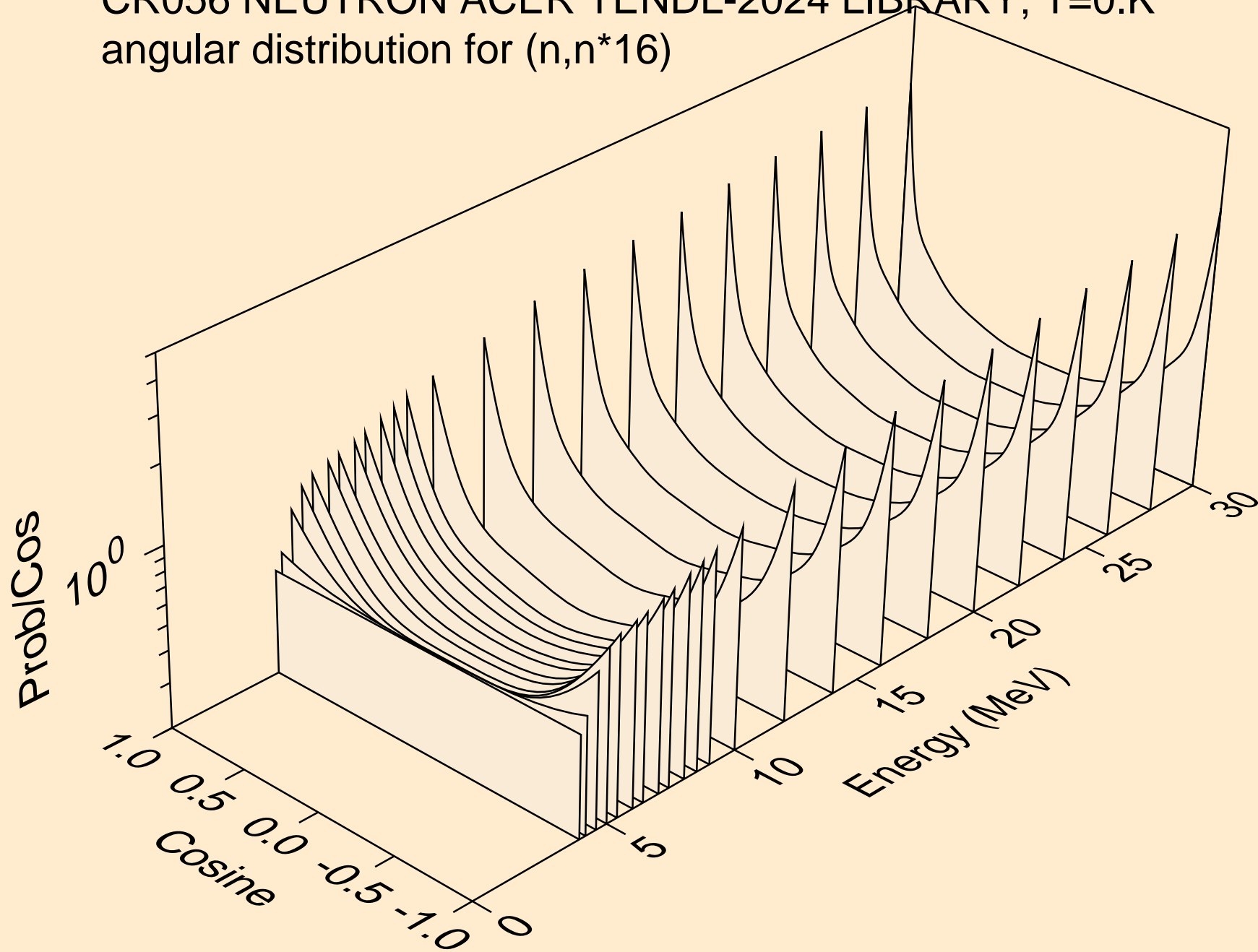

CR056 NEUTRON ACER TENDL-2024 LIBRARY; T=0.K
angular distribution for (n,n*17)

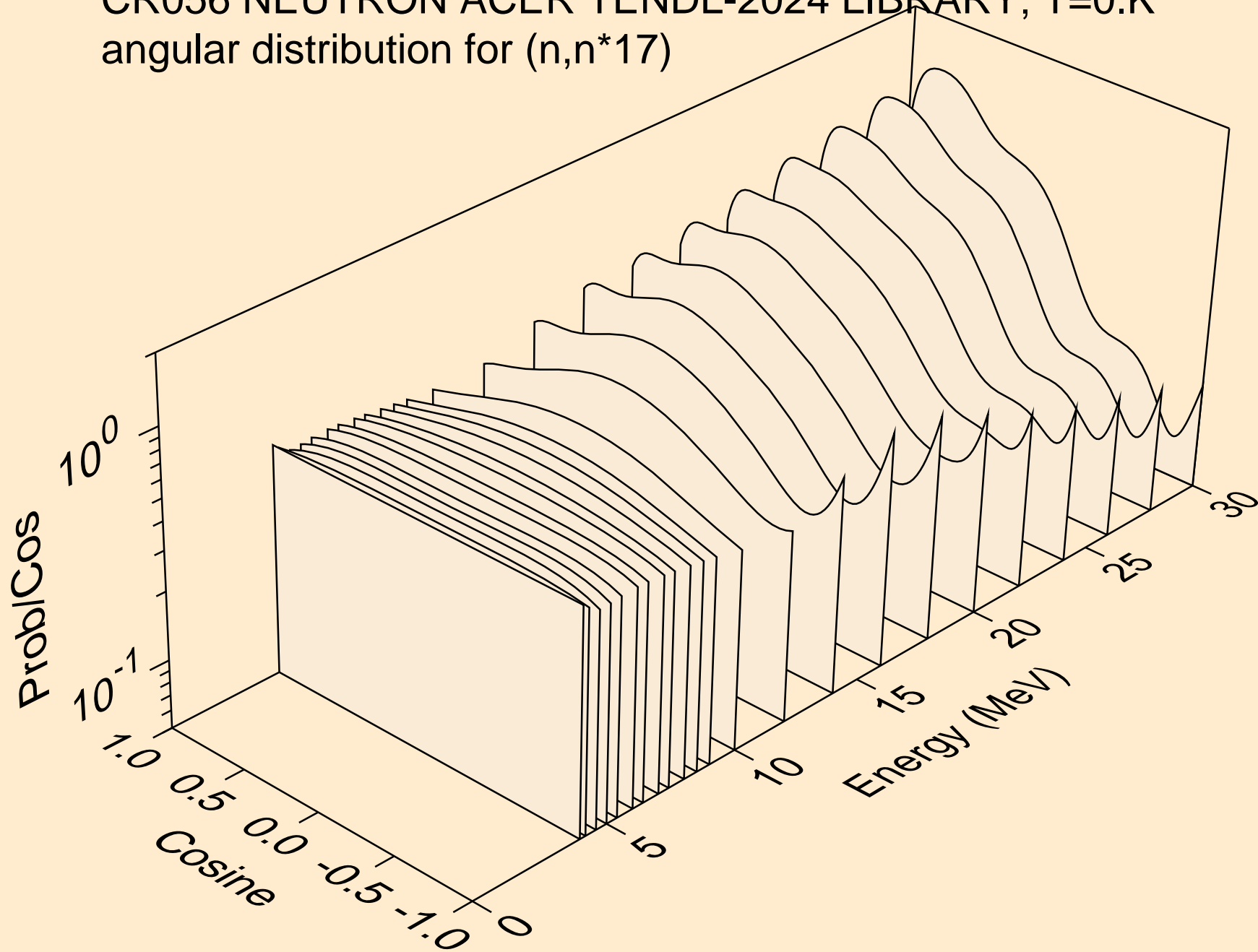

CR056 NEUTRON ACER TENDL-2024 LIBRARY; T=0.K
angular distribution for (n,n*18)

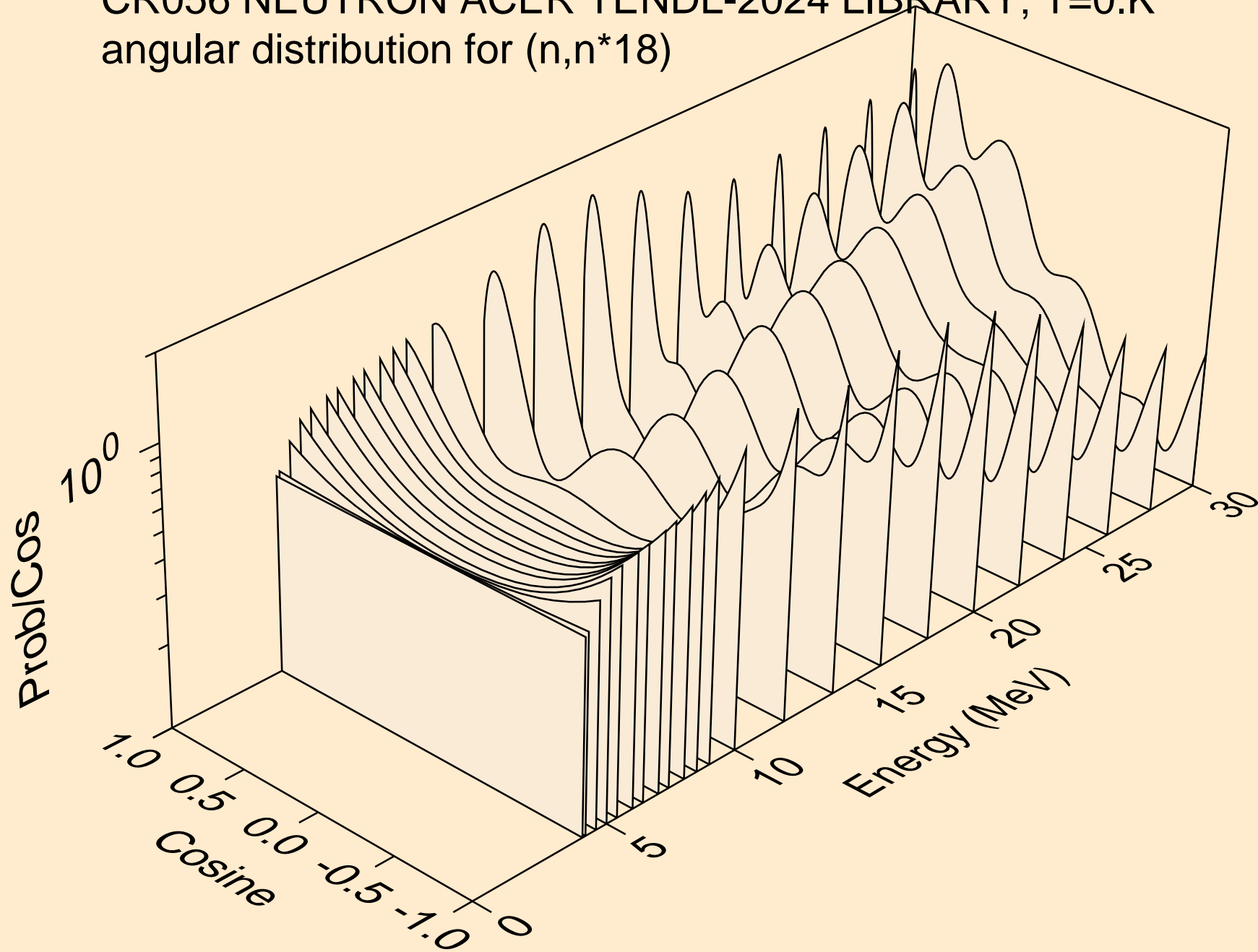

CR056 NEUTRON ACER TENDL-2024 LIBRARY; T=0.K
angular distribution for (n,n*19)

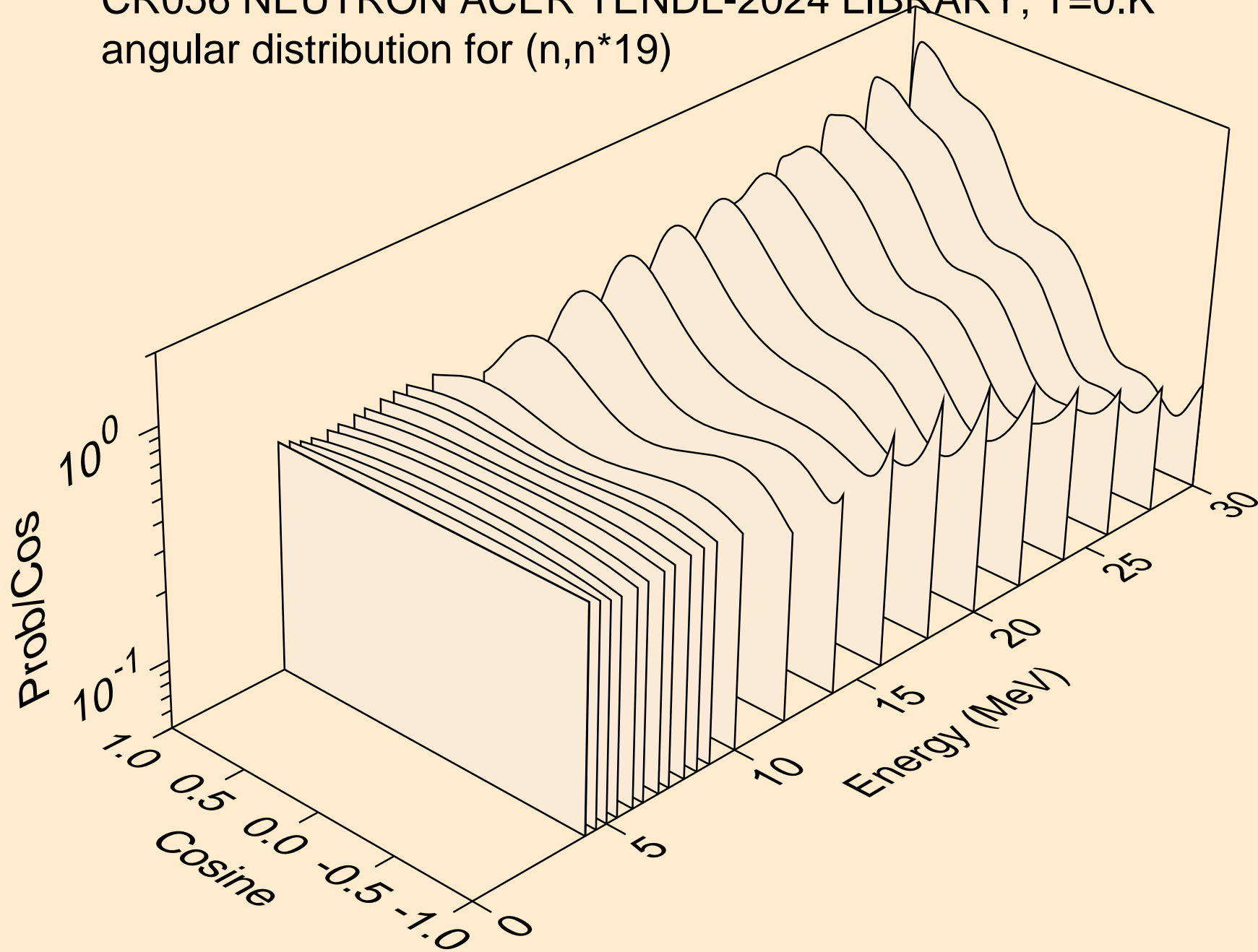

CR056 NEUTRON ACER TENDL-2024 LIBRARY; T=0.K
angular distribution for (n,n*20)

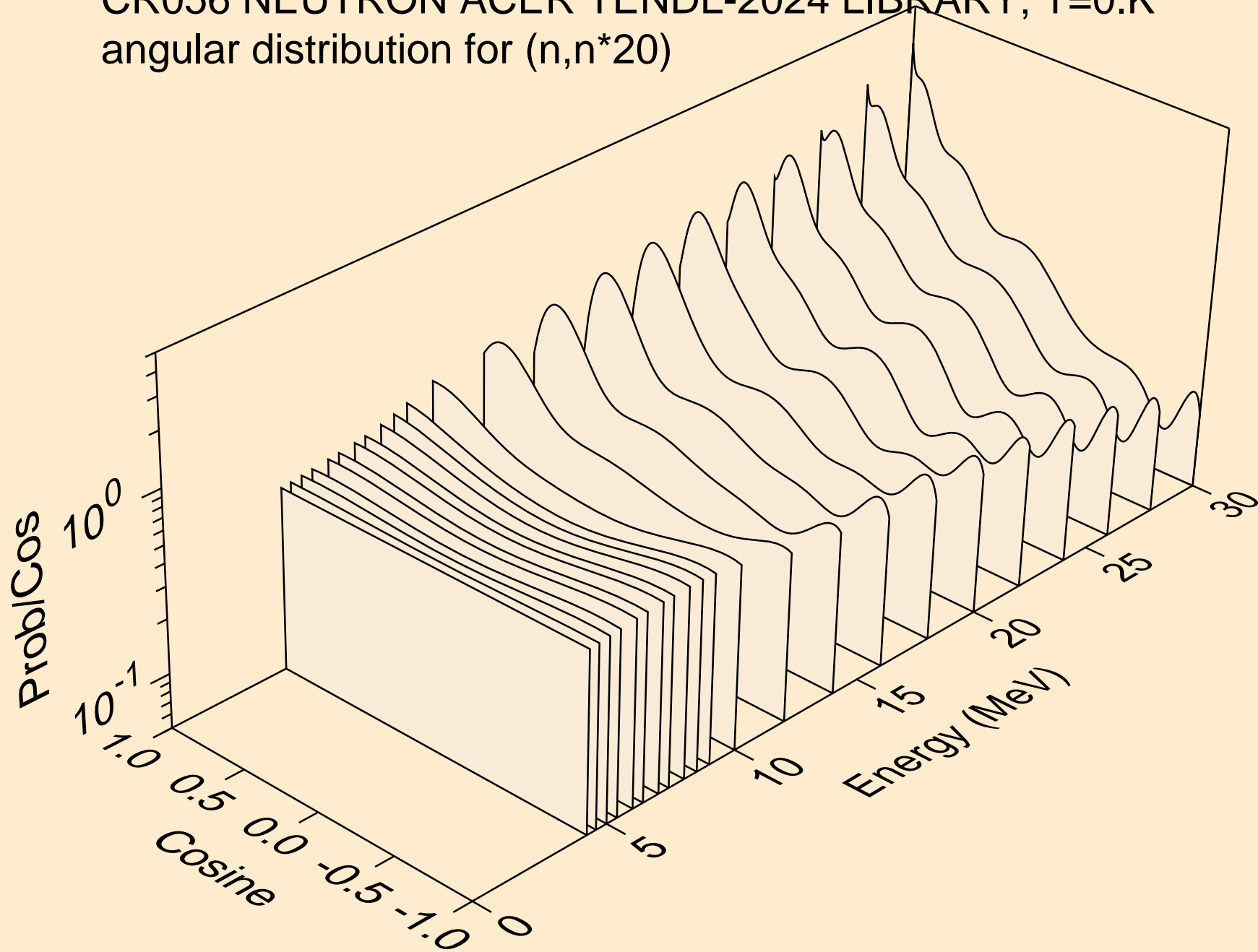

CR056 NEUTRON ACER TENDL-2024 LIBRARY; T=0.K
angular distribution for (n,n*21)

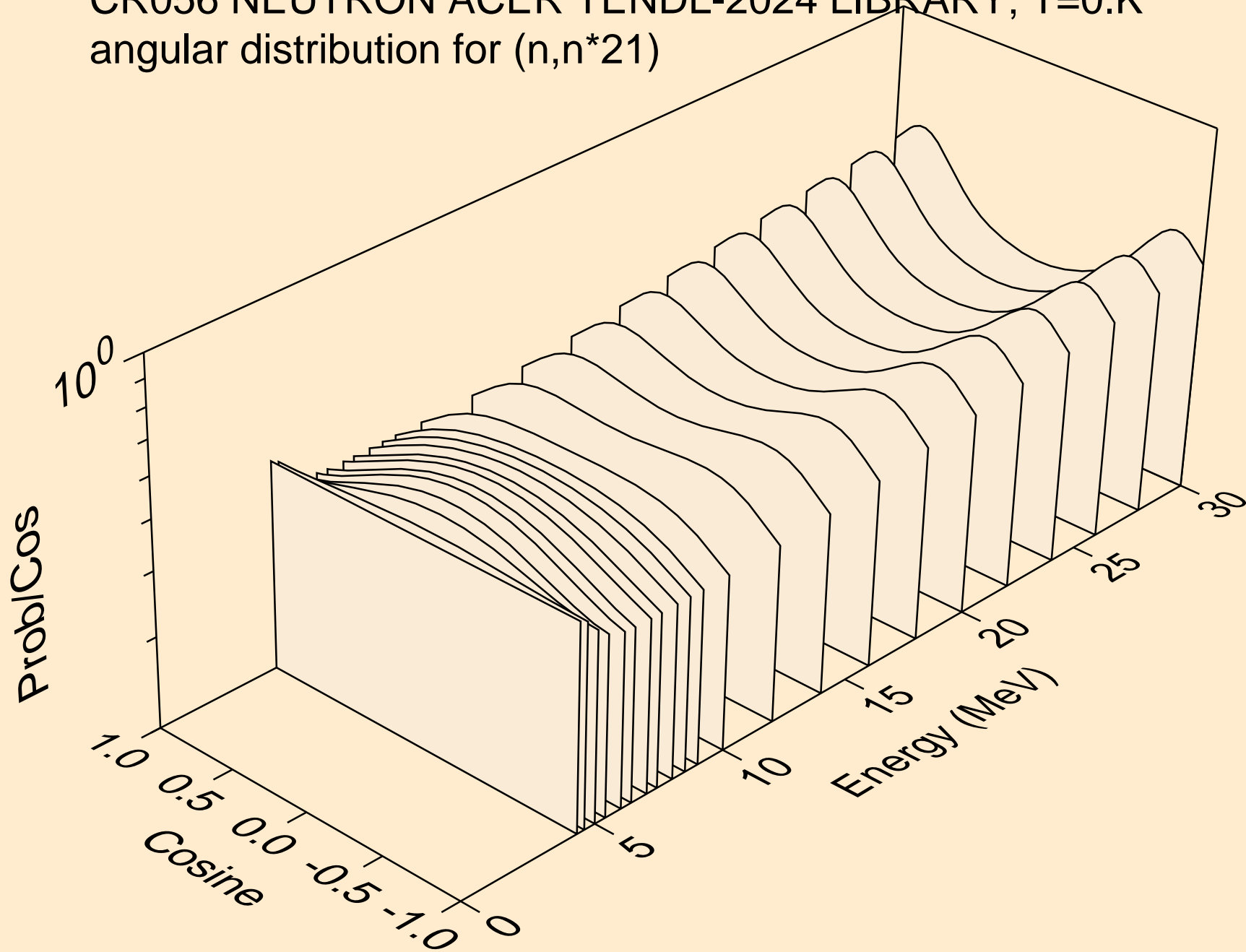

CR056 NEUTRON ACER TENDL-2024 LIBRARY; T=0.K
angular distribution for (n,n*22)

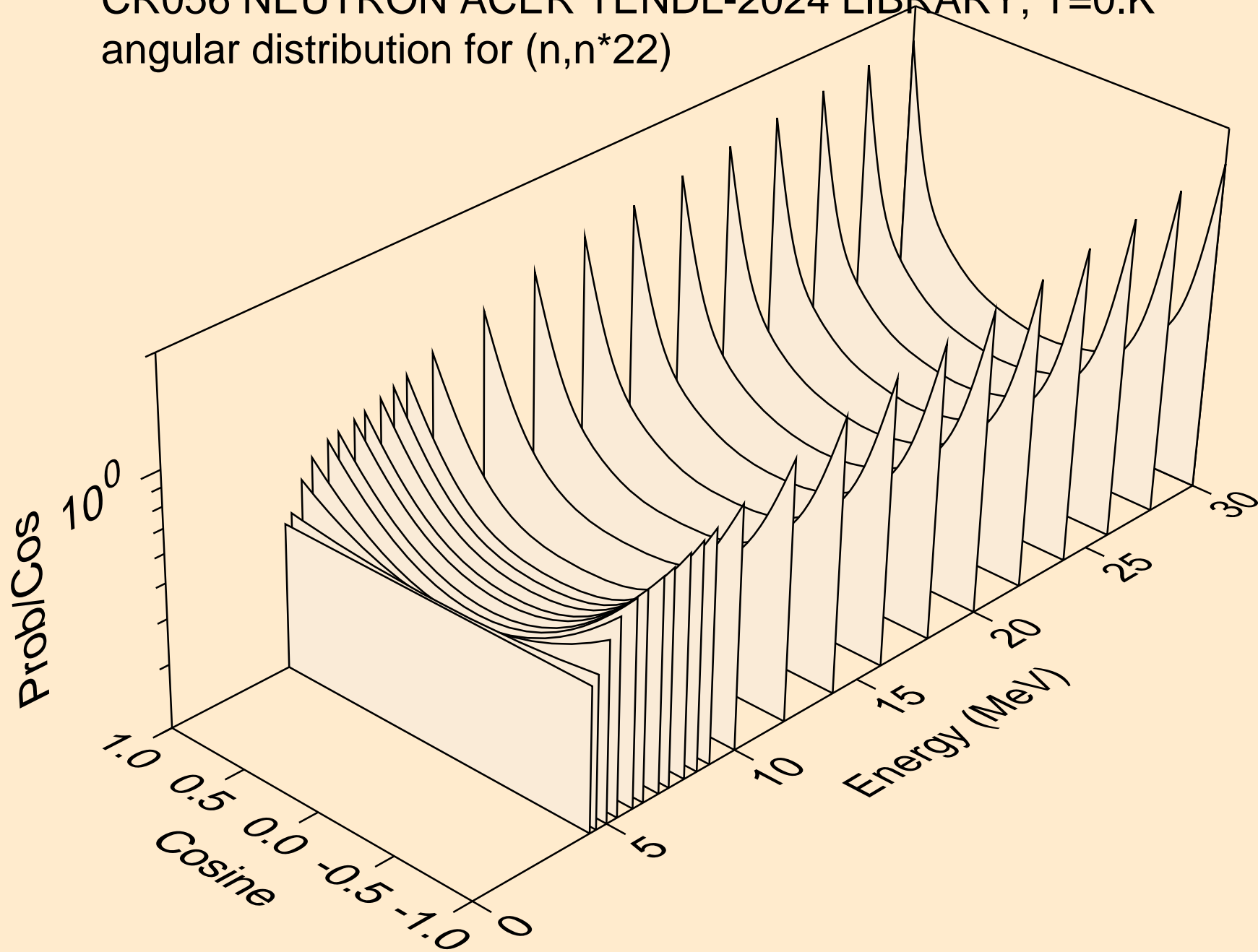

CR056 NEUTRON ACER TENDL-2024 LIBRARY; T=0.K
angular distribution for (n,n*23)

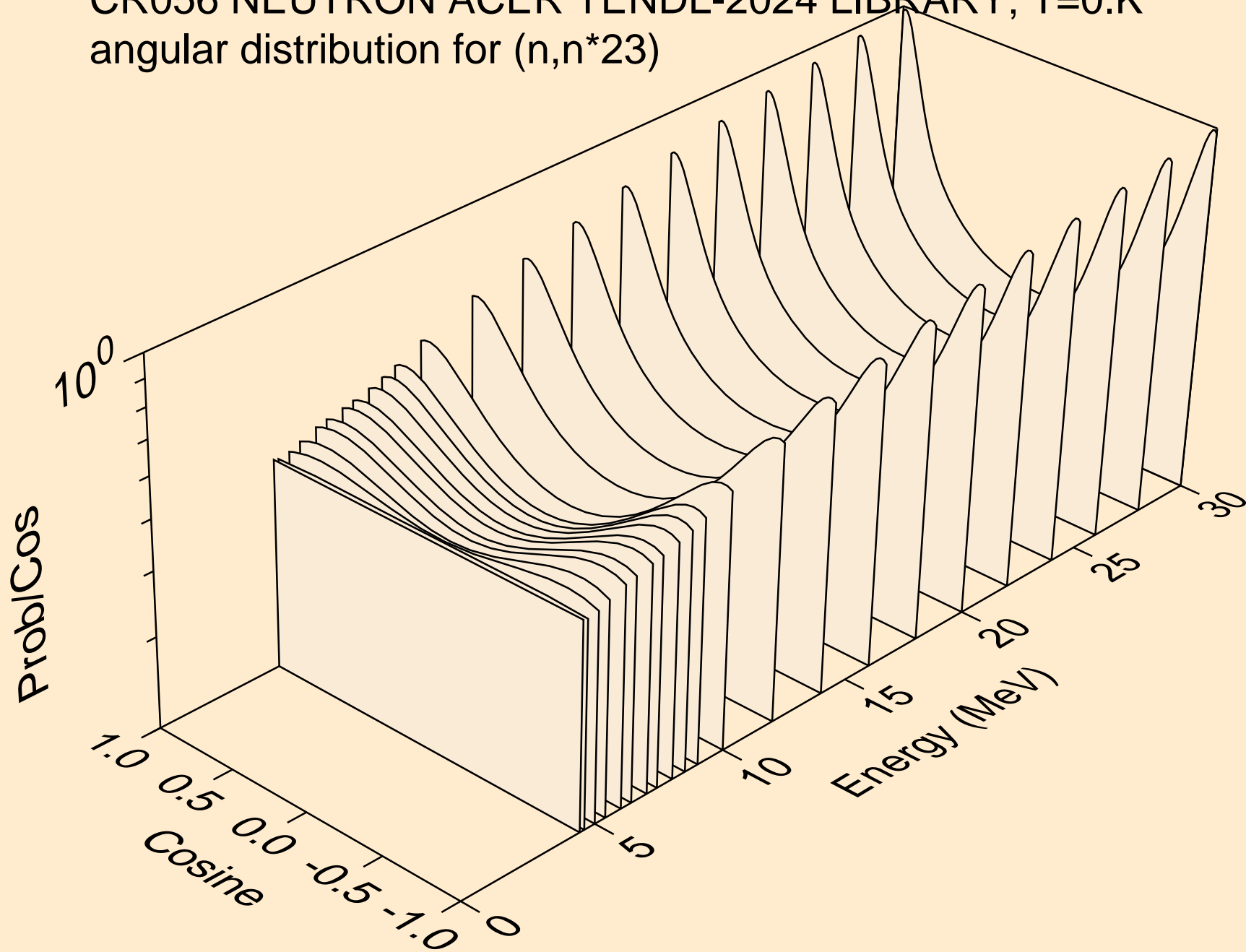

CR056 NEUTRON ACER TENDL-2024 LIBRARY; T=0.K
angular distribution for (n,n*24)

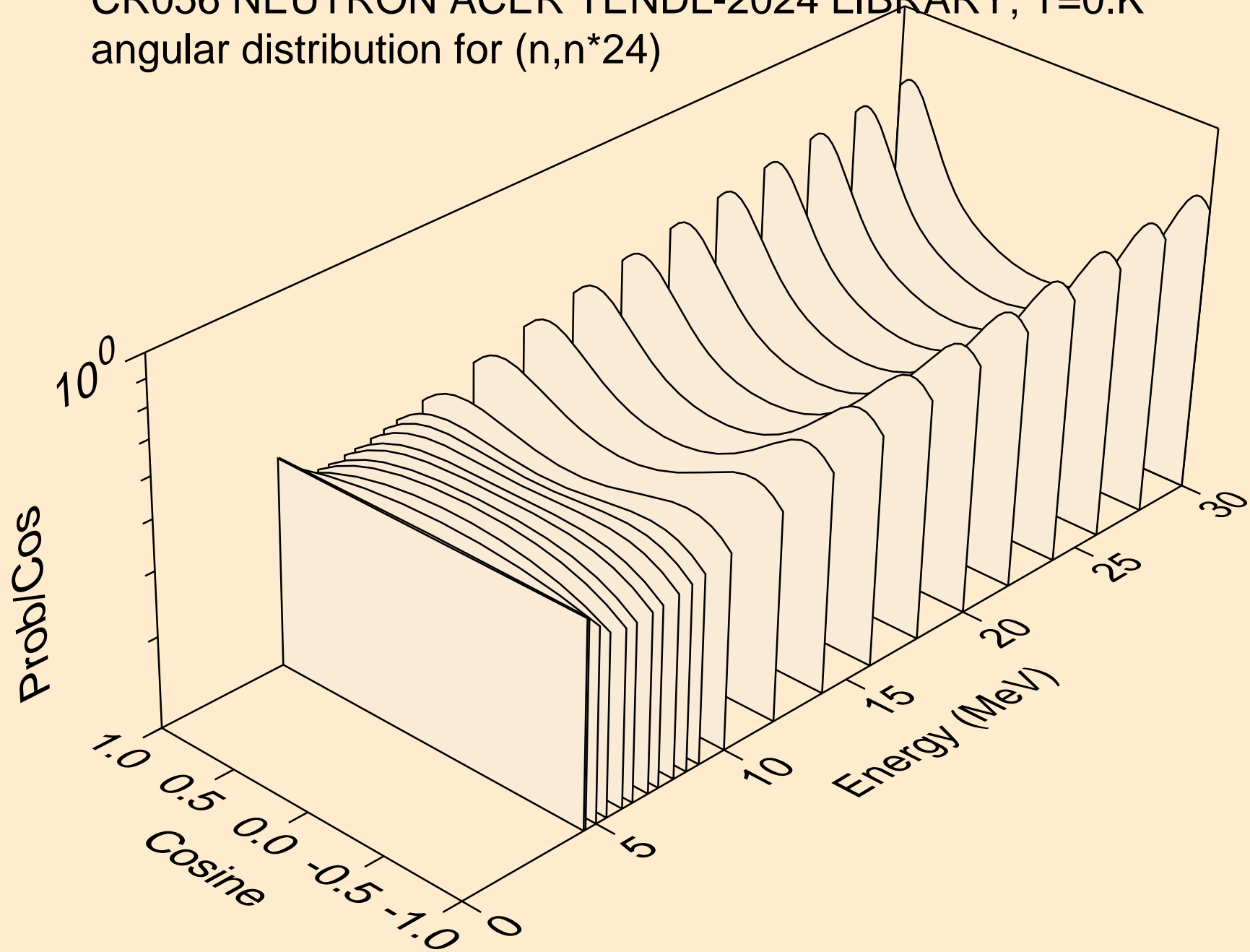

CR056 NEUTRON ACER TENDL-2024 LIBRARY; T=0.K
angular distribution for (n,n*25)

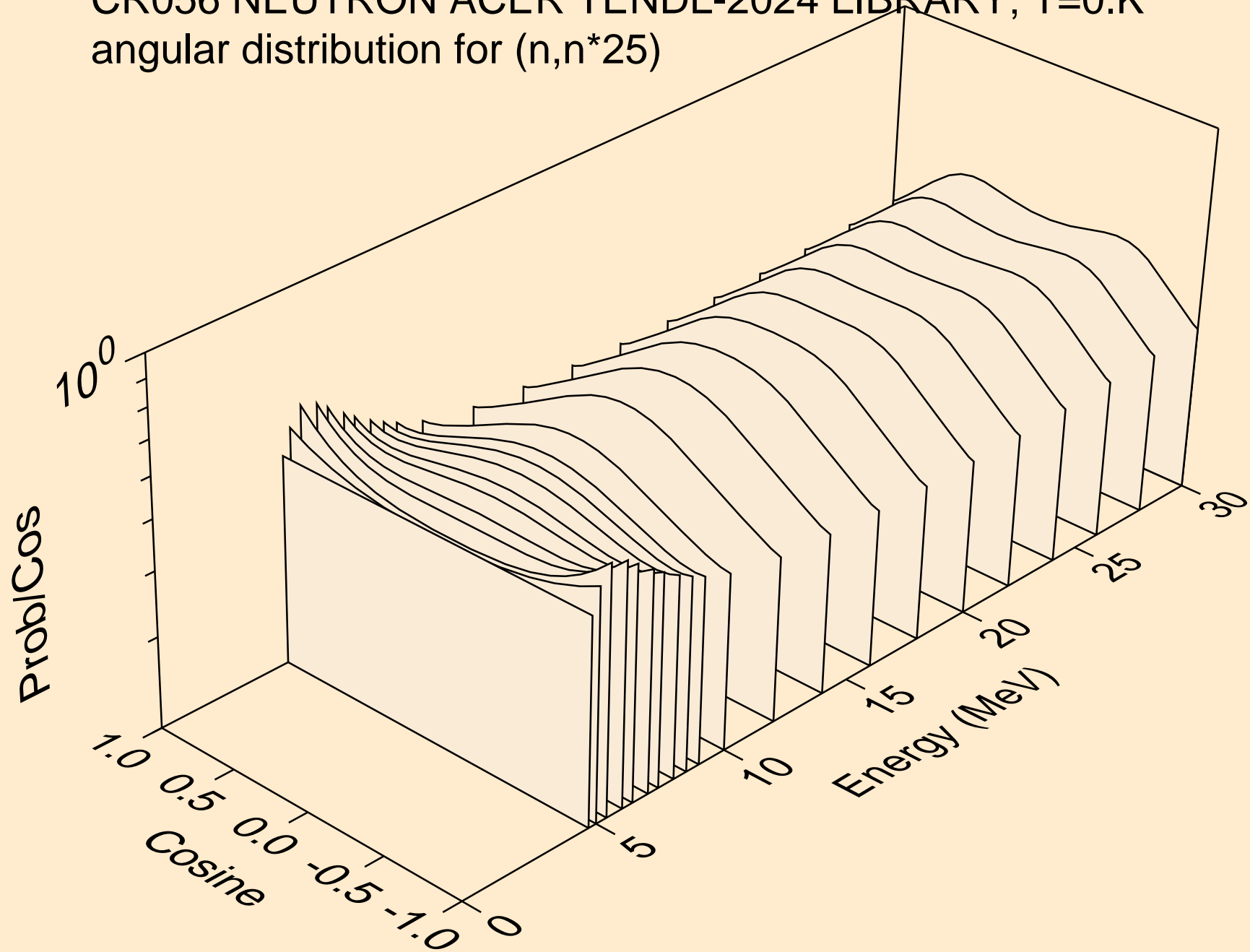

CR056 NEUTRON ACER TENDL-2024 LIBRARY; T=0.K
angular distribution for (n,n*26)

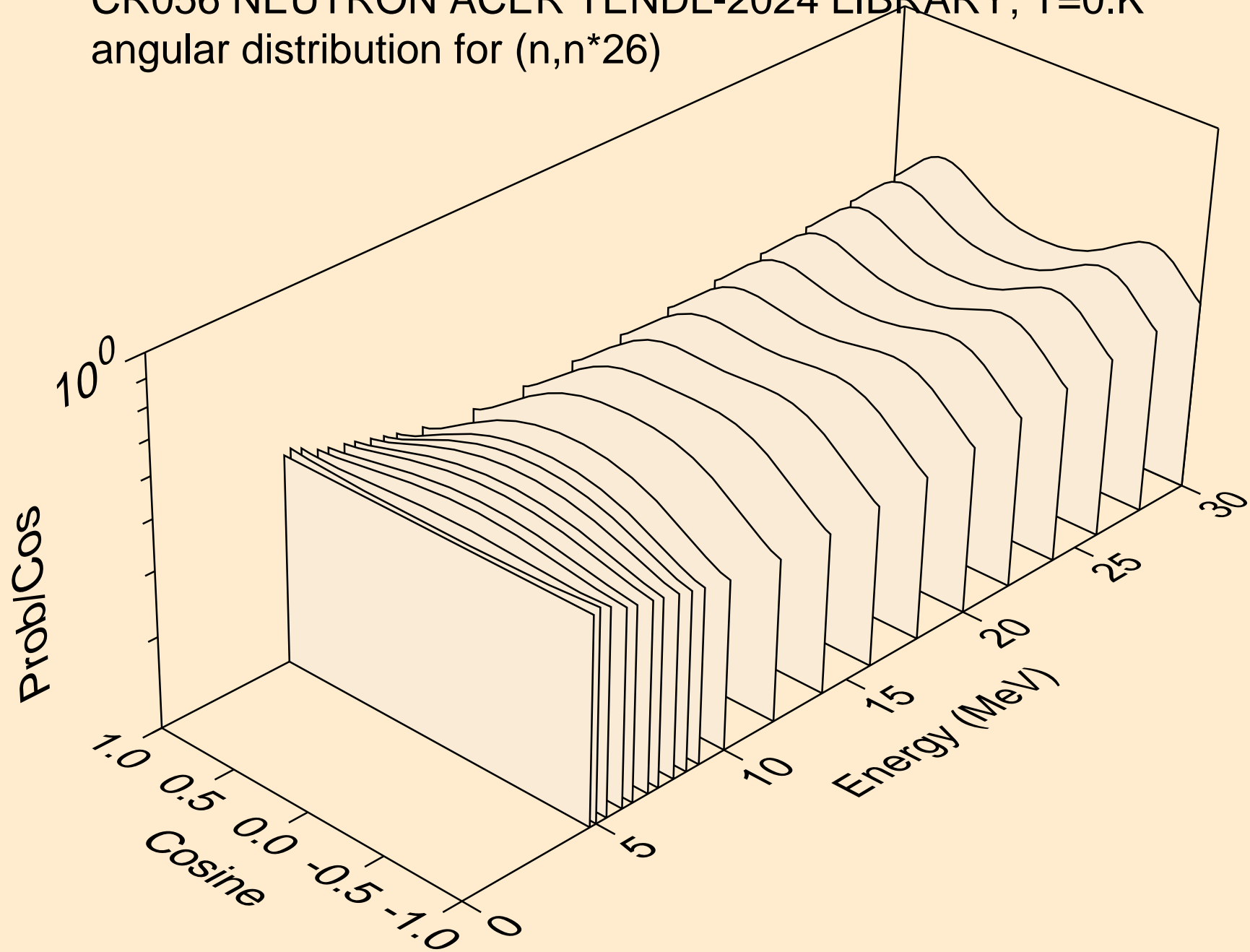

CR056 NEUTRON ACER TENDL-2024 LIBRARY; T=0.K
angular distribution for (n,n*27)

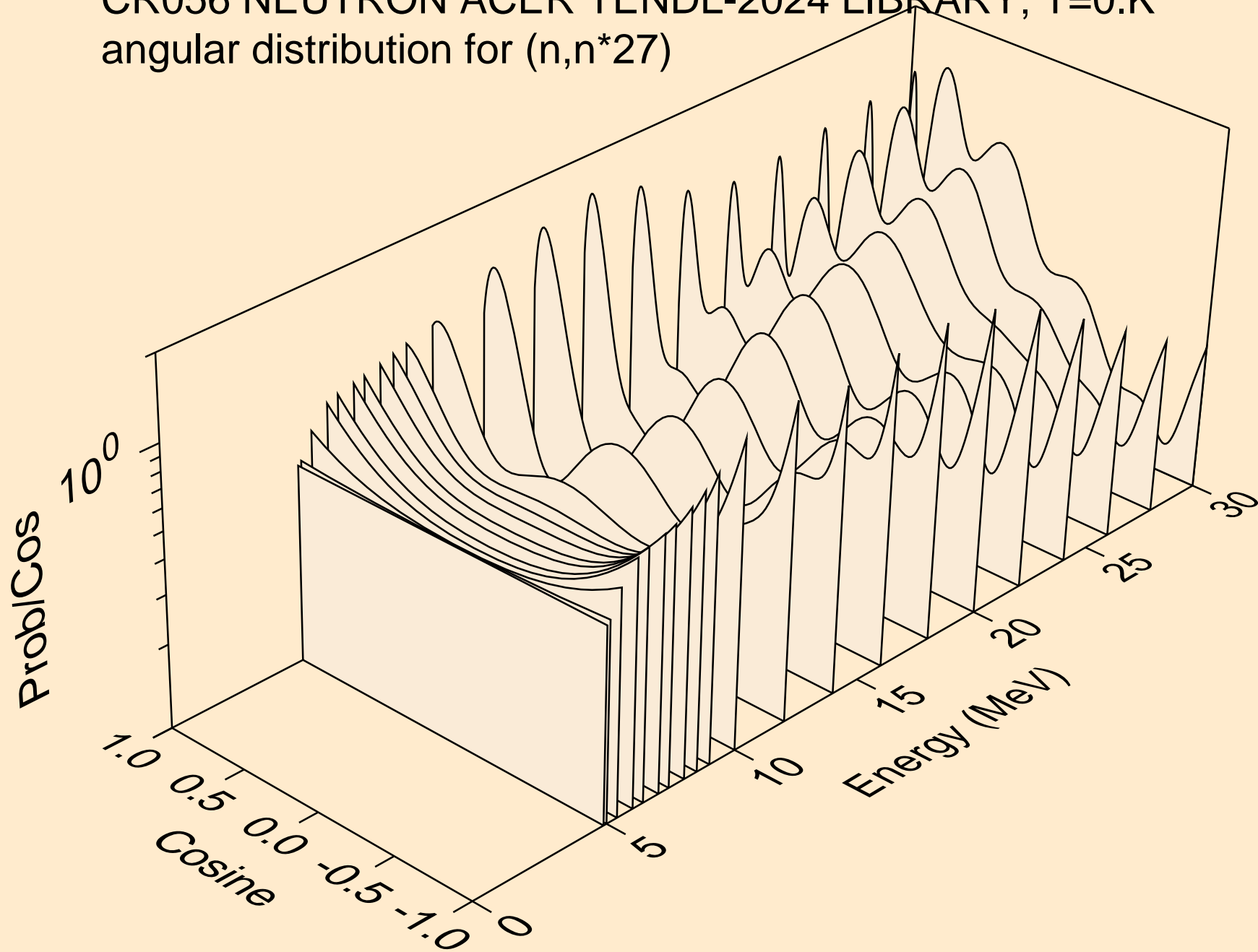

CR056 NEUTRON ACER TENDL-2024 LIBRARY; T=0.K
angular distribution for (n,n*28)

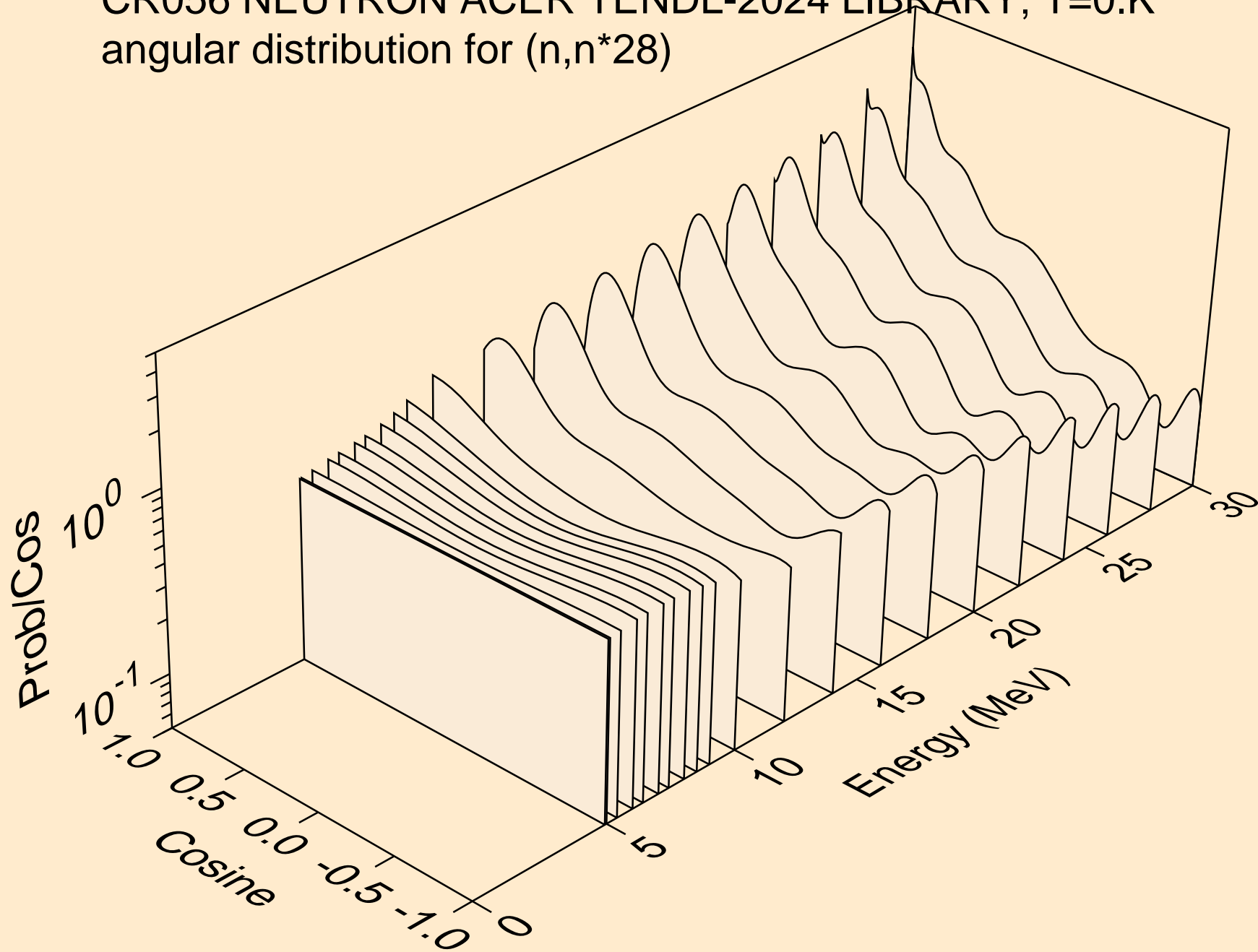

CR056 NEUTRON ACER TENDL-2024 LIBRARY; T=0.K
angular distribution for (n,n*29)

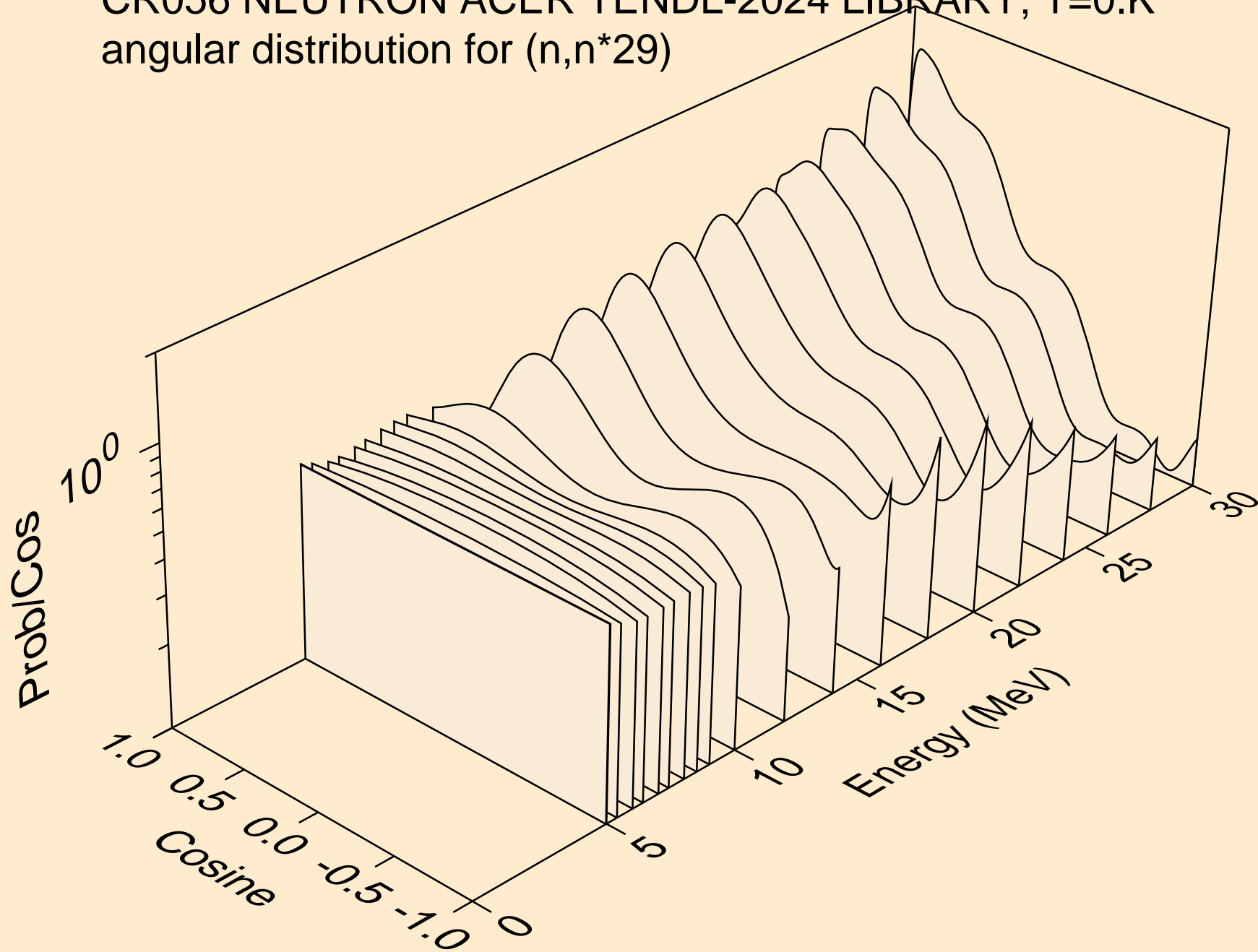

CR056 NEUTRON ACER TENDL-2024 LIBRARY; T=0.K
Neutron emission for (n,x)

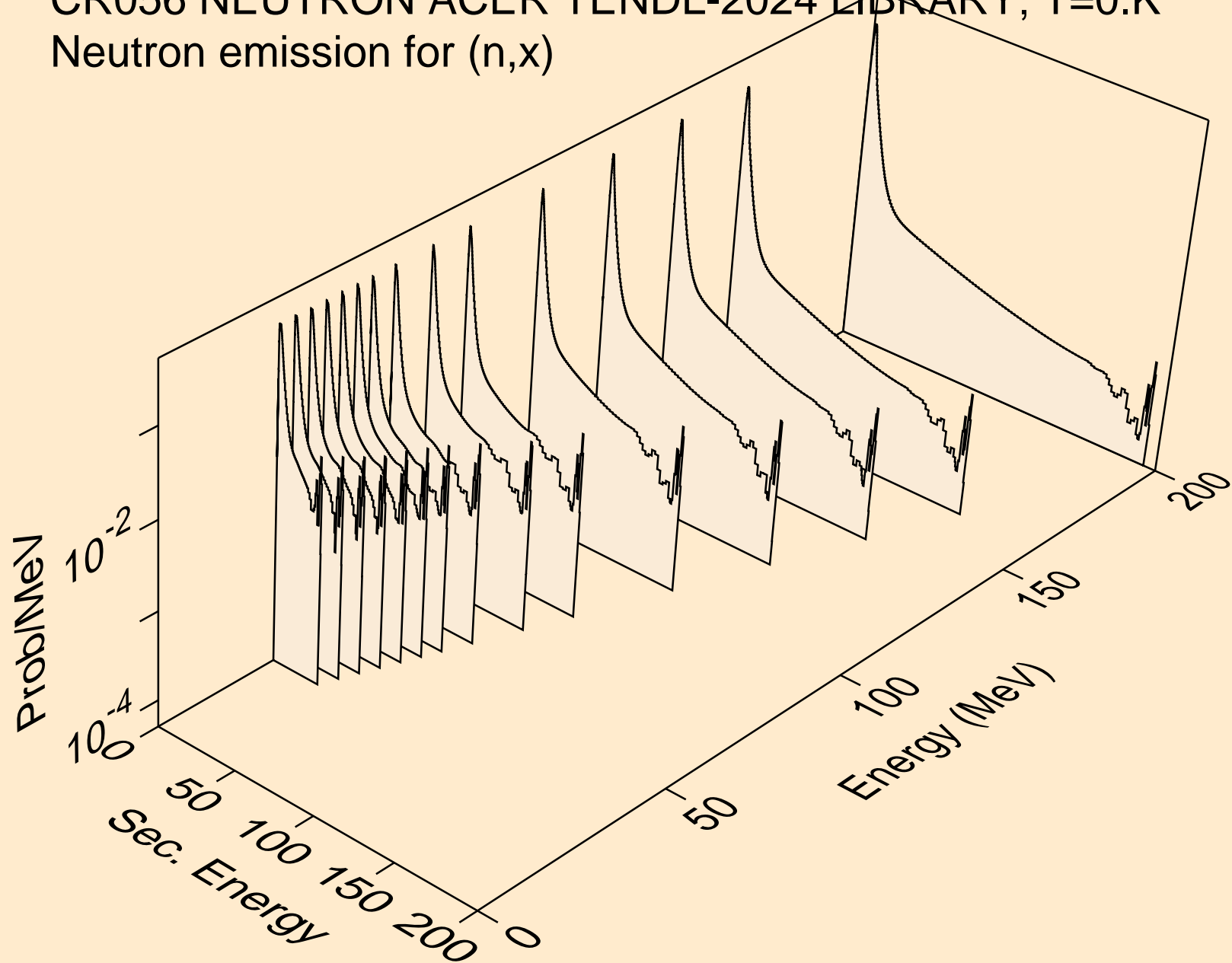

CR056 NEUTRON ACER TENDL-2024 LIBRARY; T=0.K
Neutron emission for (n,2nd)

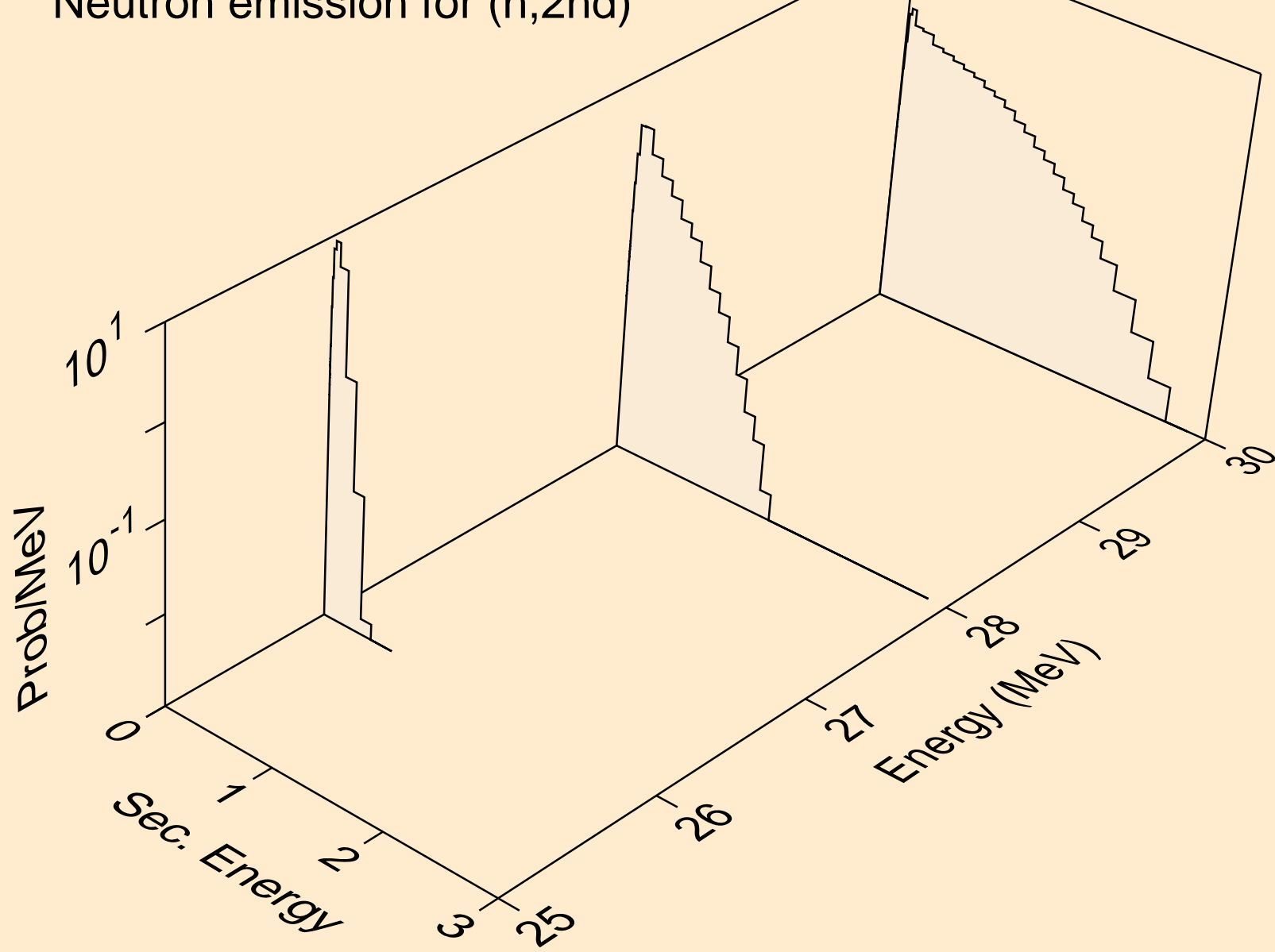

CR056 NEUTRON ACER TENDL-2024 LIBRARY; T=0.K
Neutron emission for (n,2n)

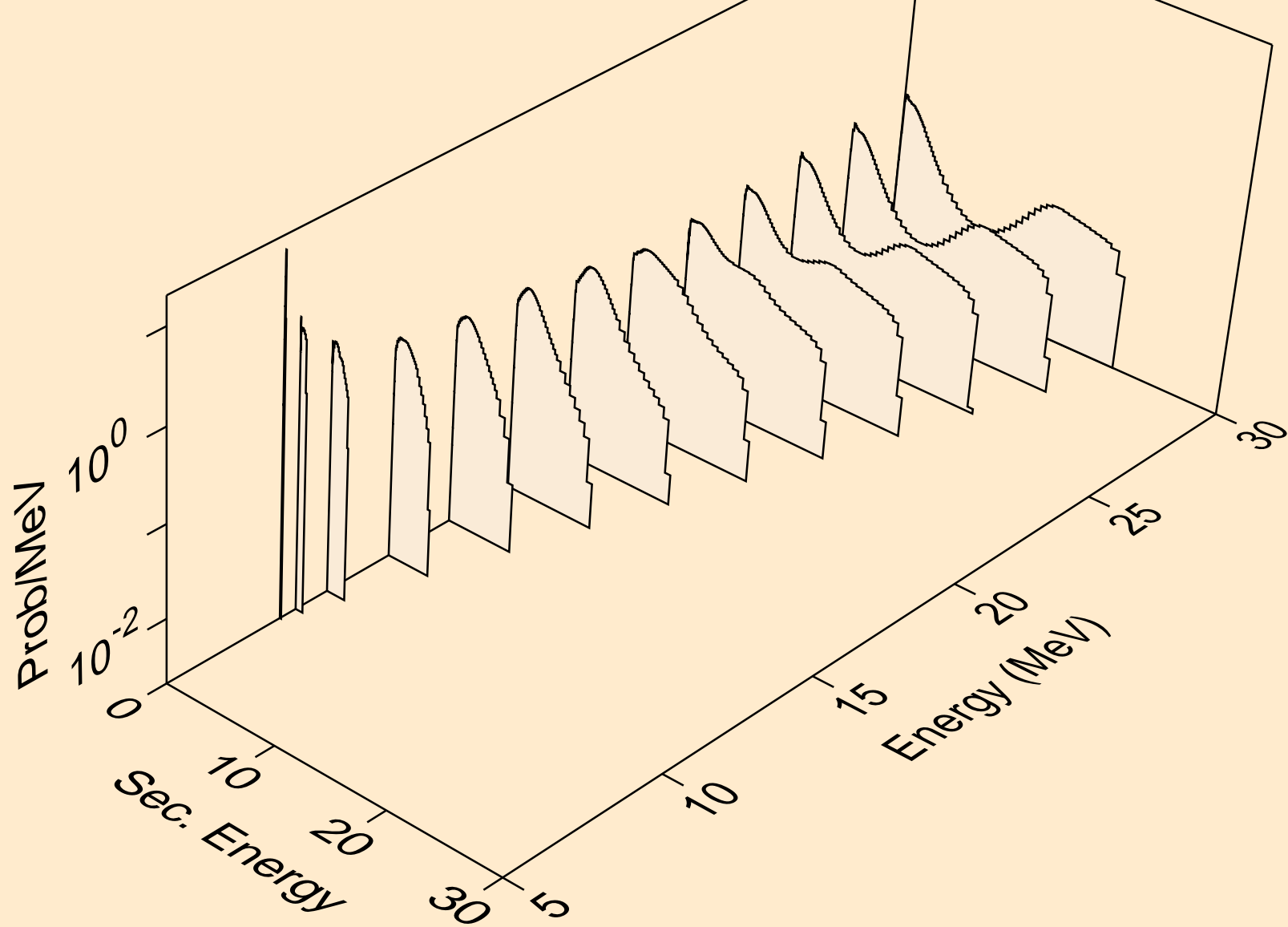

CR056 NEUTRON ACER TENDL-2024 LIBRARY; T=0.K
Neutron emission for (n,3n)

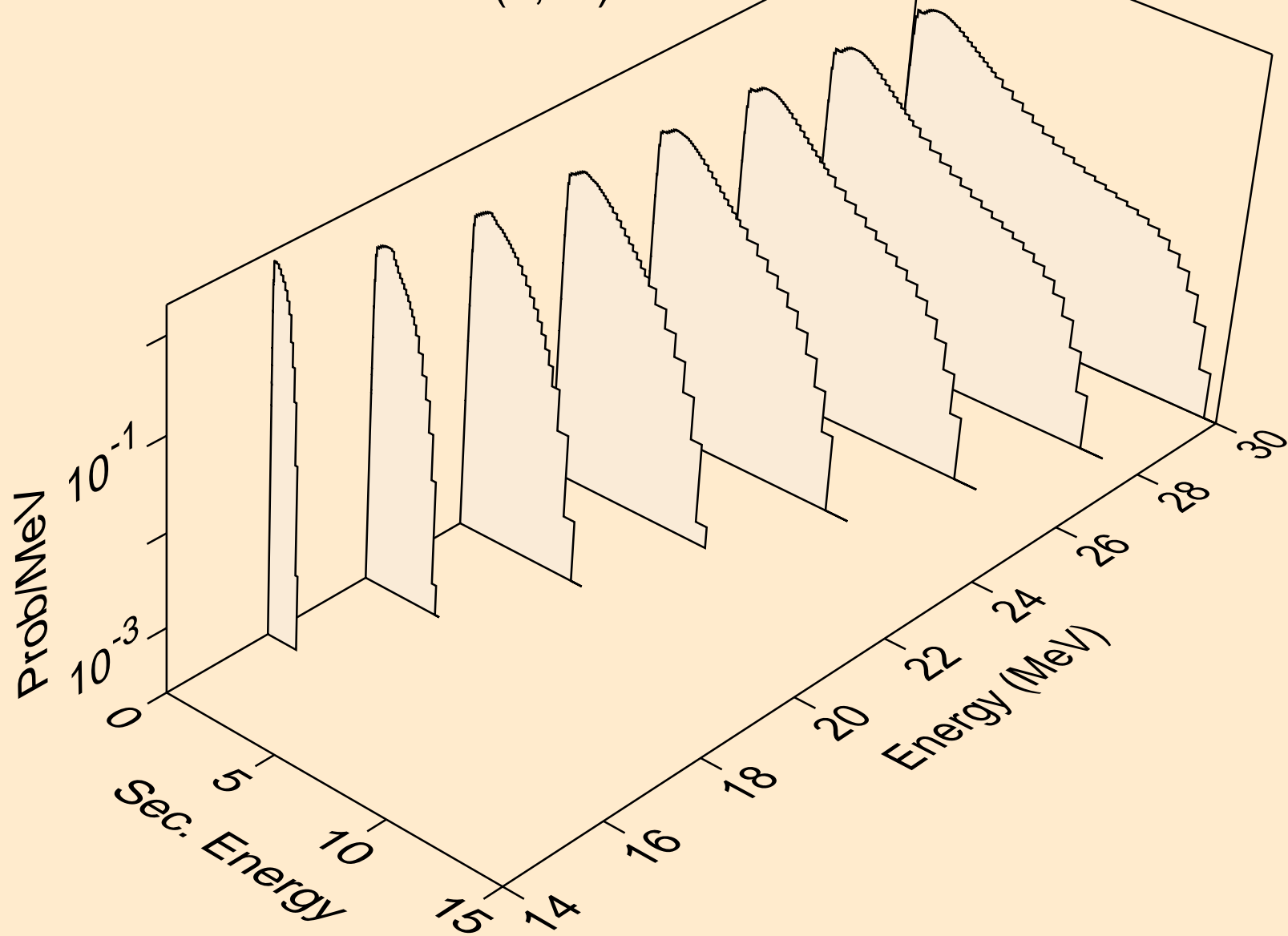

CR056 NEUTRON ACER TENDL-2024 LIBRARY; T=0.K
Neutron emission for (n,n*)a

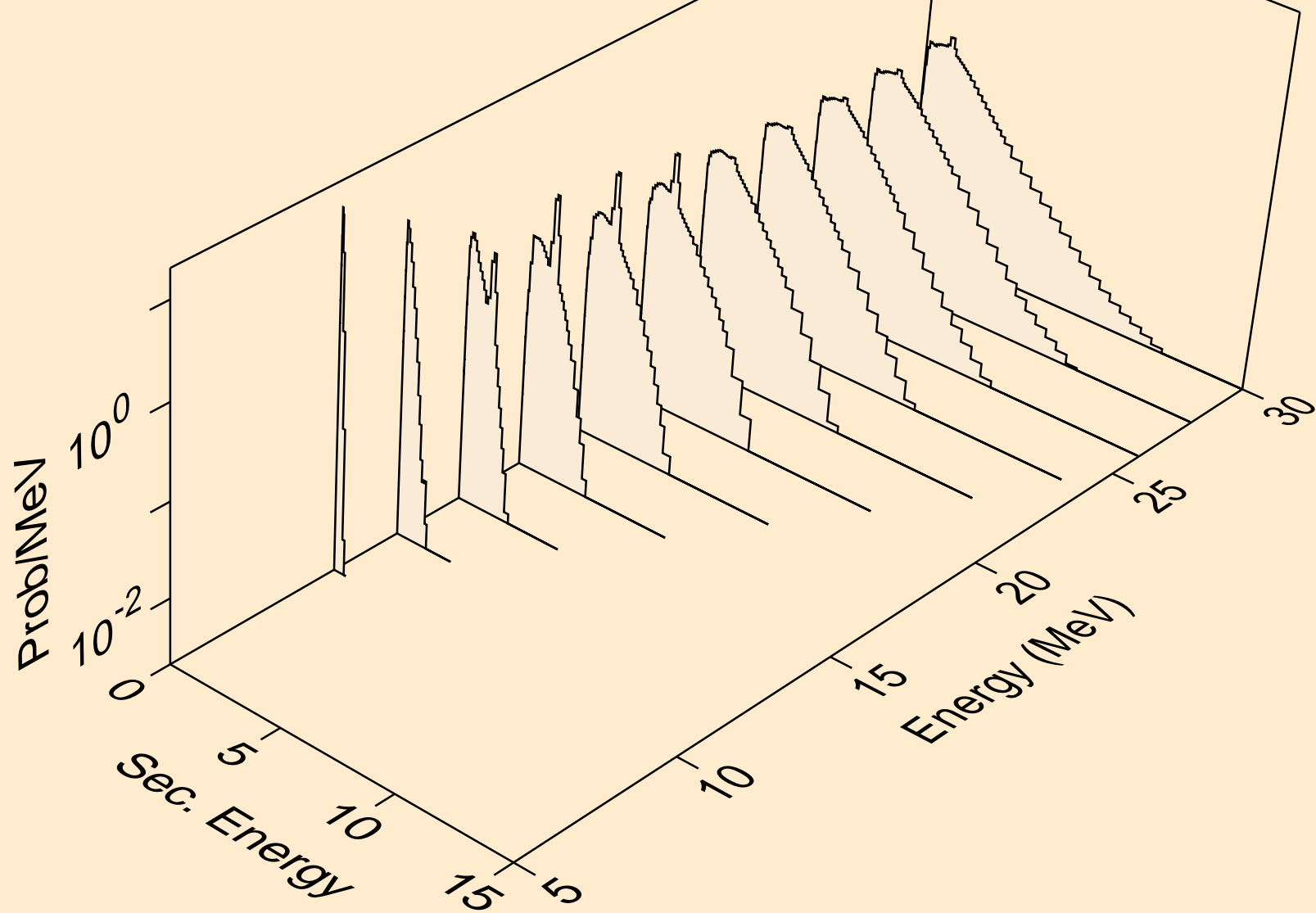

CR056 NEUTRON ACER TENDL-2024 LIBRARY; T=0.K
Neutron emission for (n,2n)a

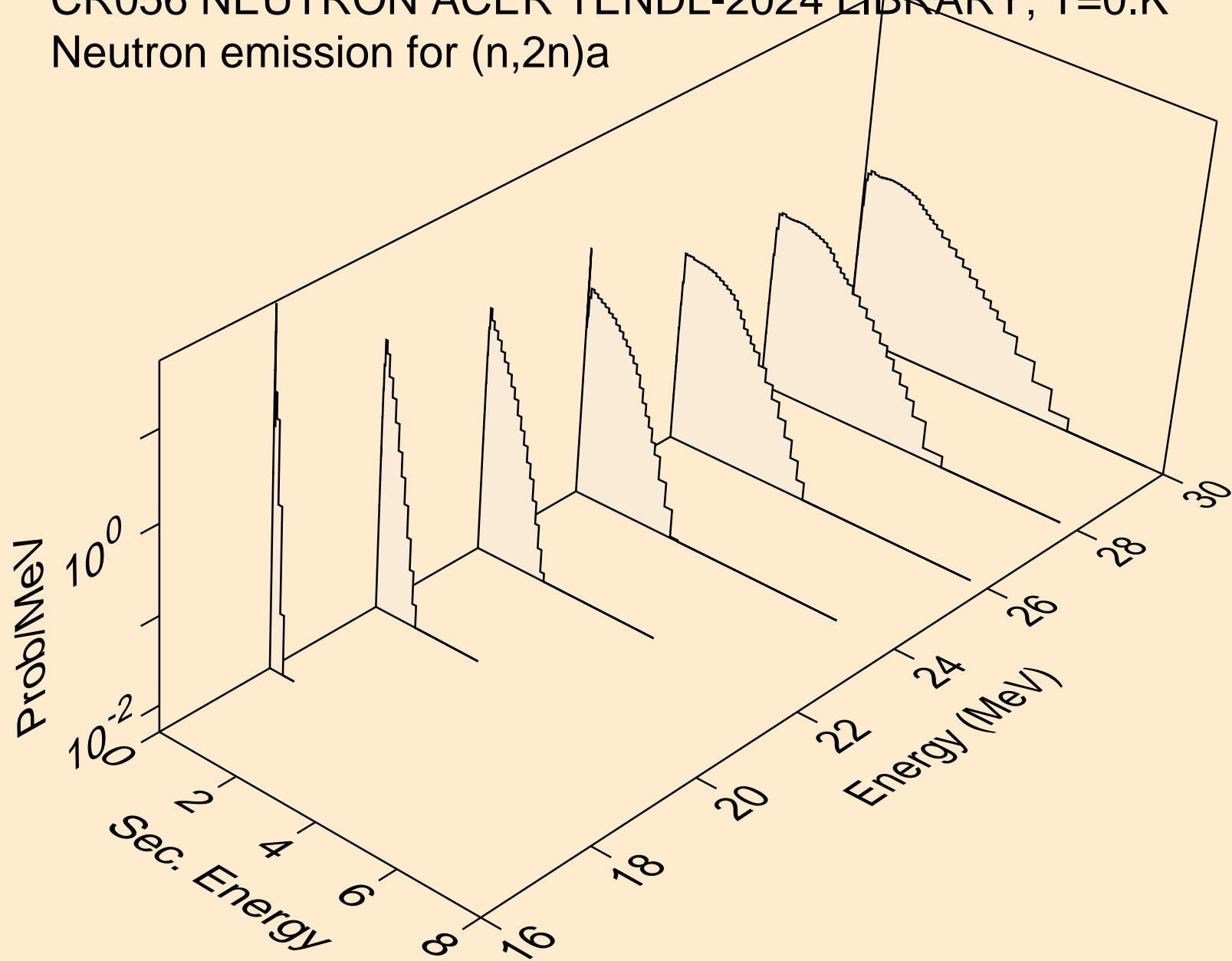

CR056 NEUTRON ACER TENDL-2024 LIBRARY; T=0.K
Neutron emission for (n,3n)a

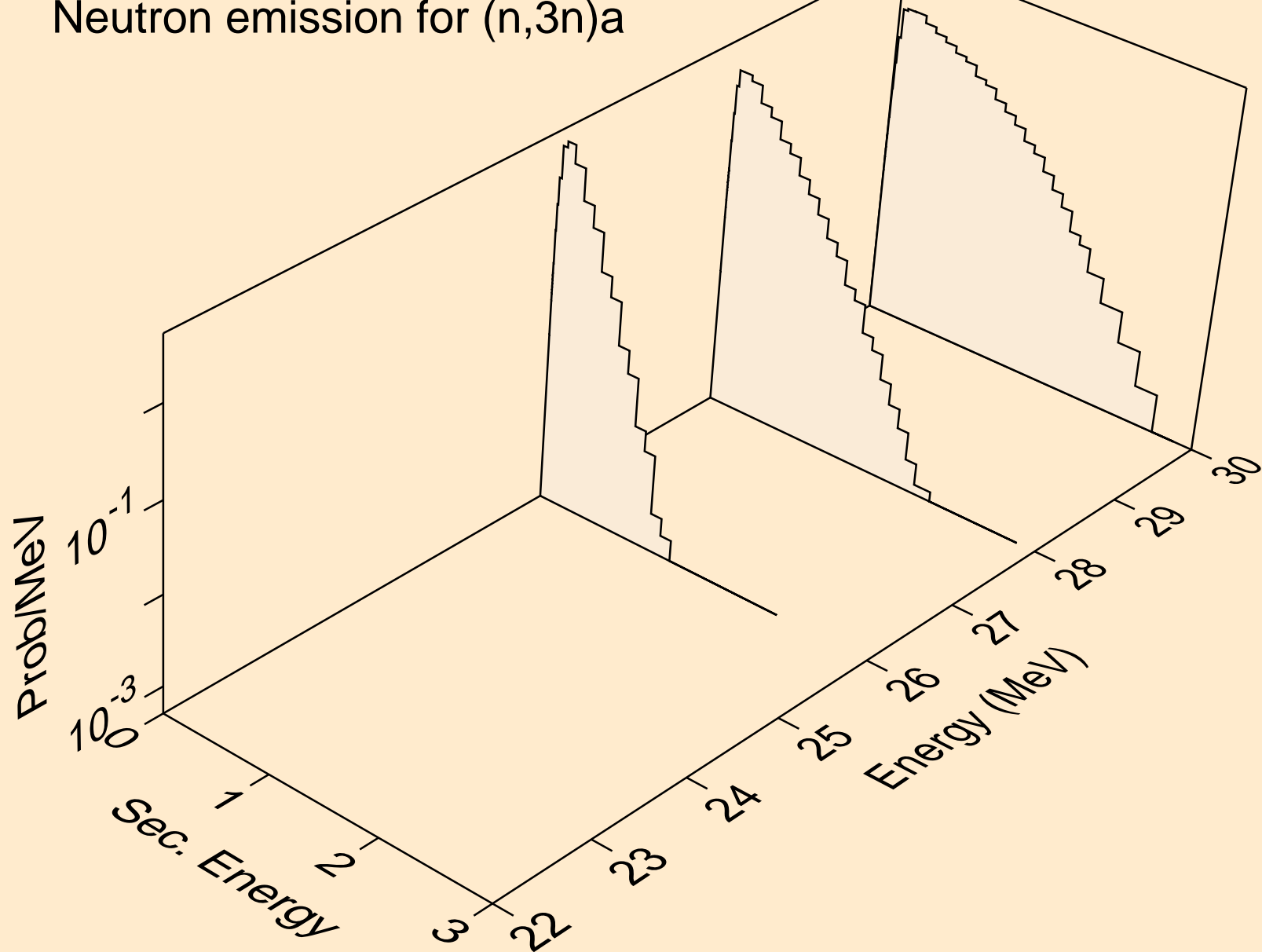

CR056 NEUTRON ACER TENDL-2024 LIBRARY; T=0.K
Neutron emission for (n,n*)p

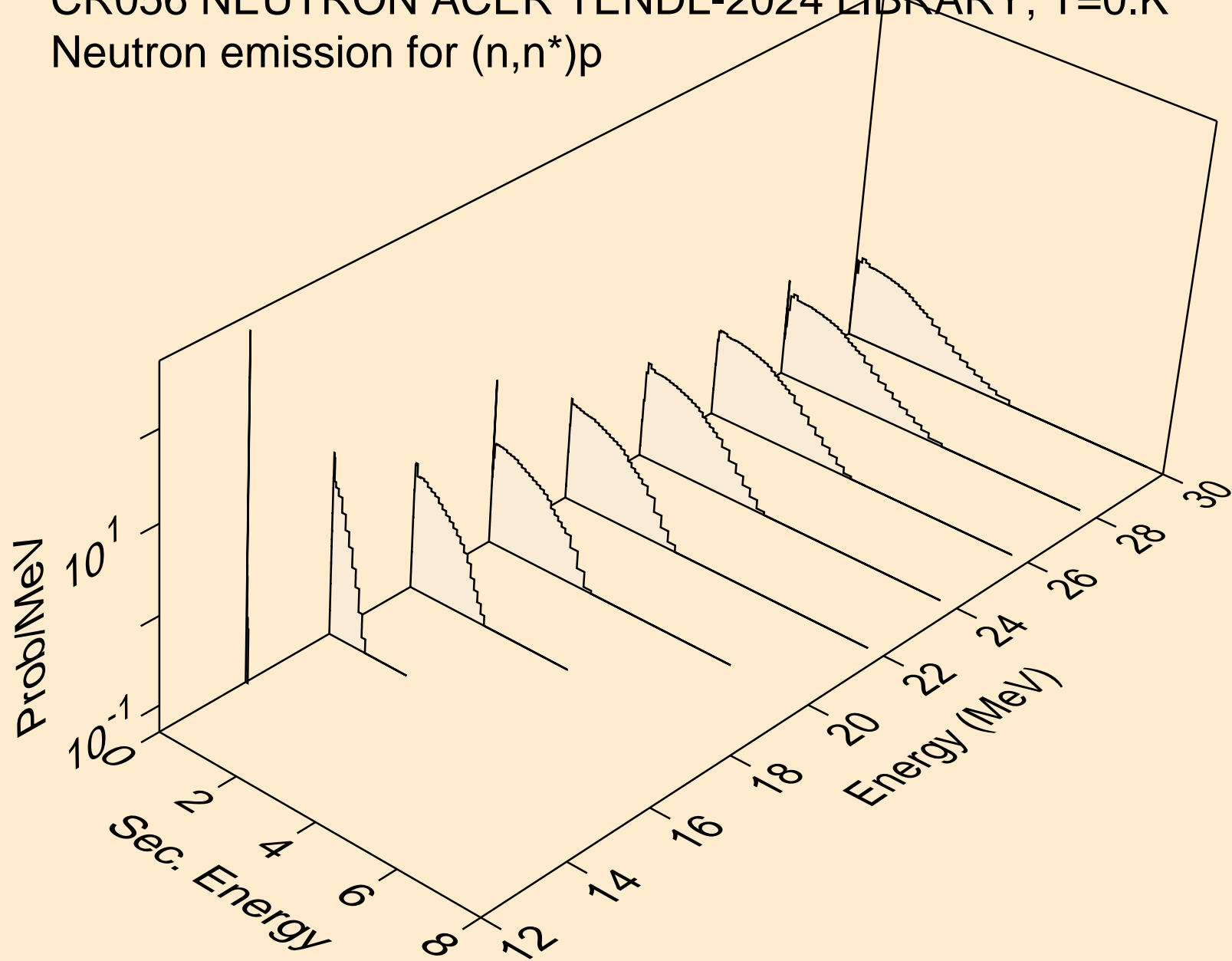

CR056 NEUTRON ACER TENDL-2024 LIBRARY; T=0.K
Neutron emission for (n,n*)2a

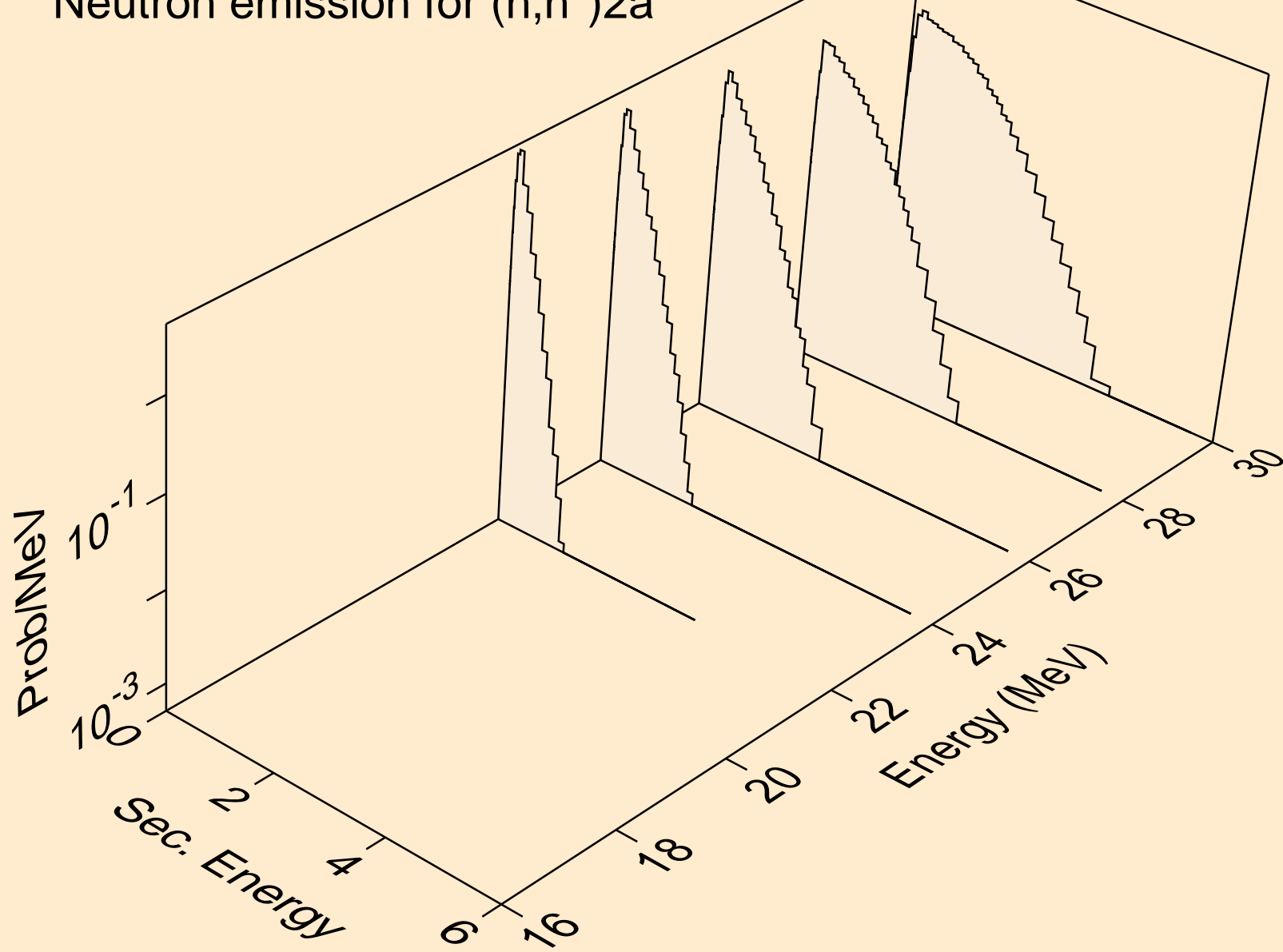

CR056 NEUTRON ACER TENDL-2024 LIBRARY; T=0.K
Neutron emission for (n,n*)d

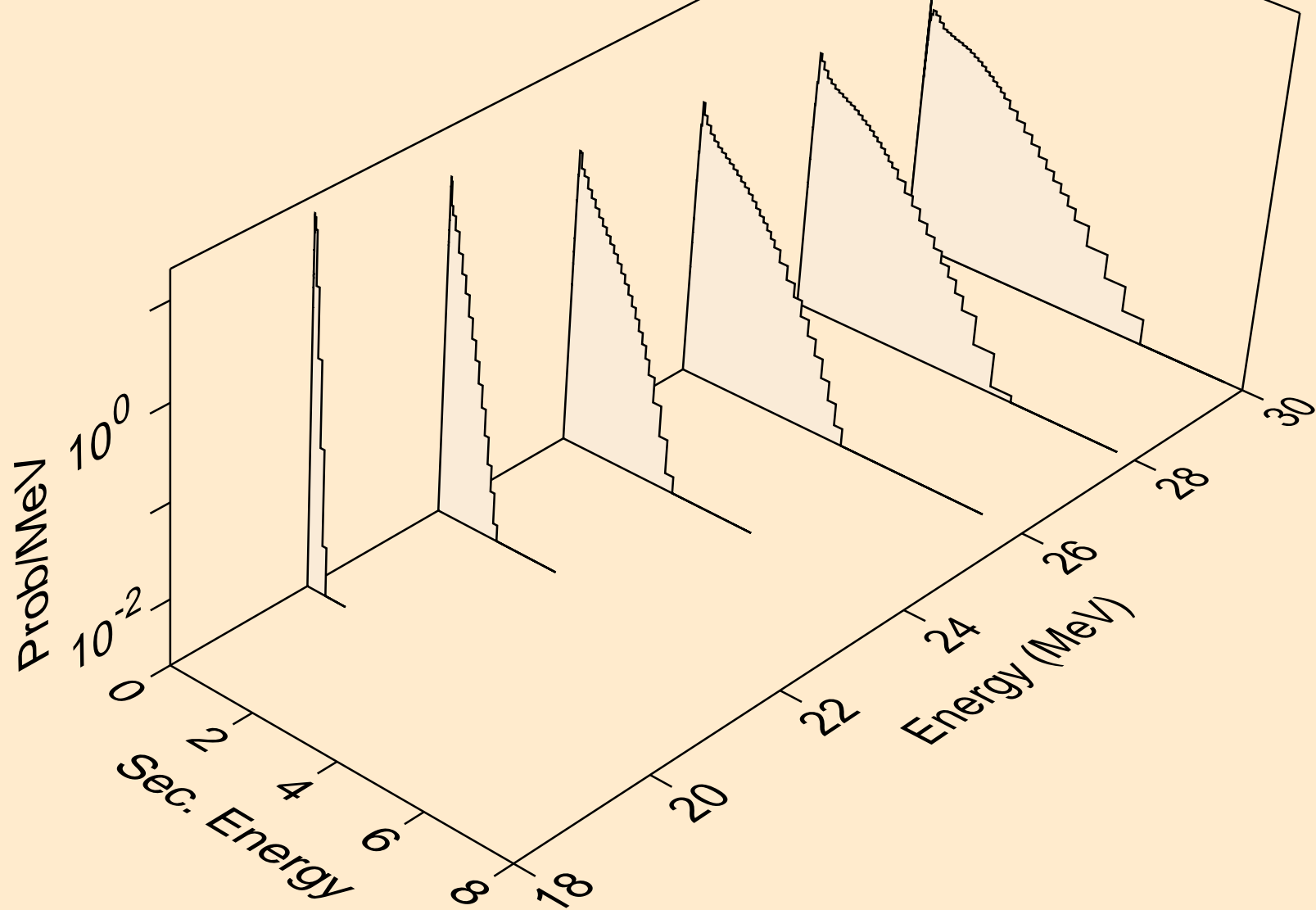

CR056 NEUTRON ACER TENDL-2024 LIBRARY; T=0.K
Neutron emission for (n,n*)t

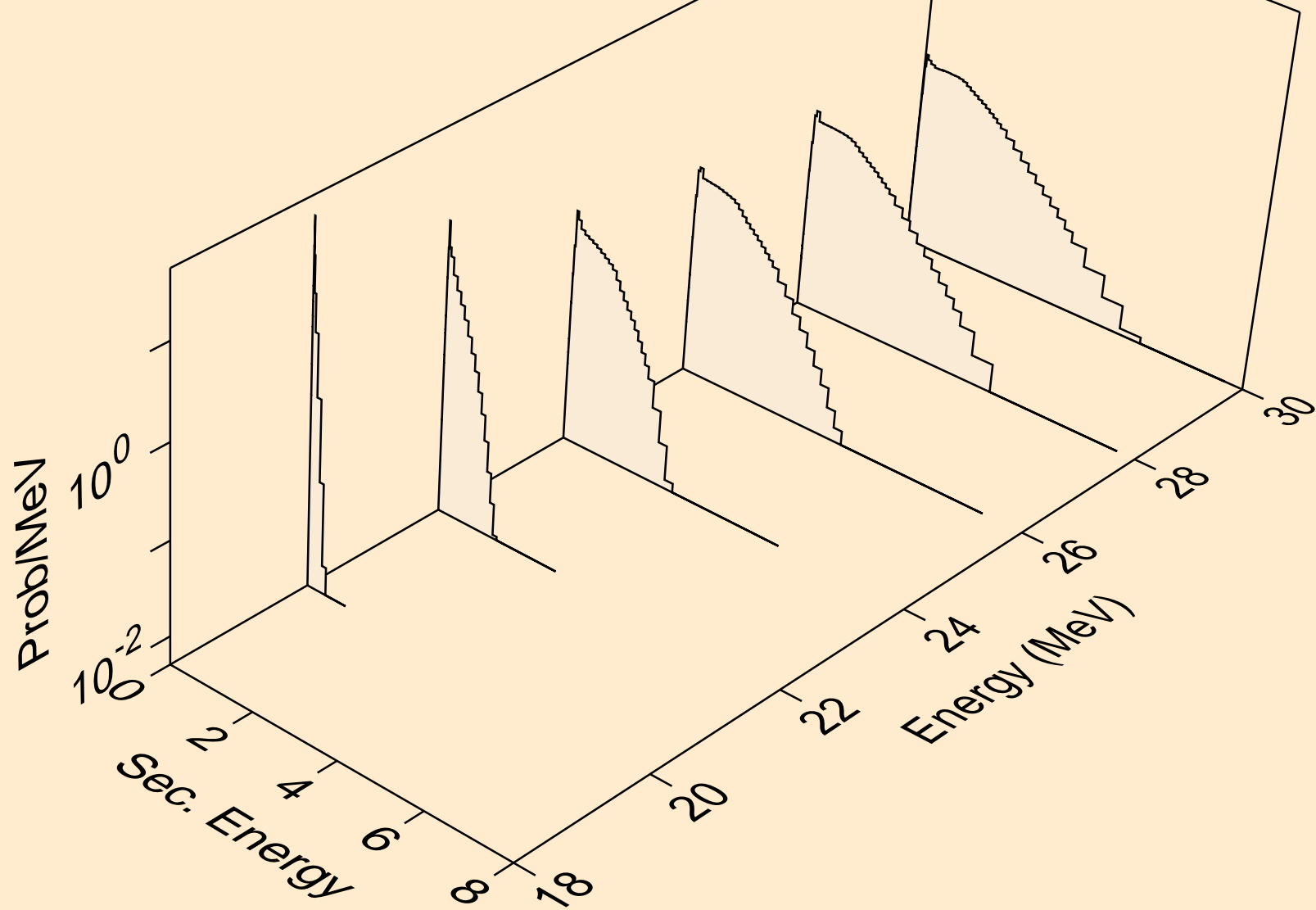

CR056 NEUTRON ACER TENDL-2024 LIBRARY; T=0.K
Neutron emission for (n,n*)he3

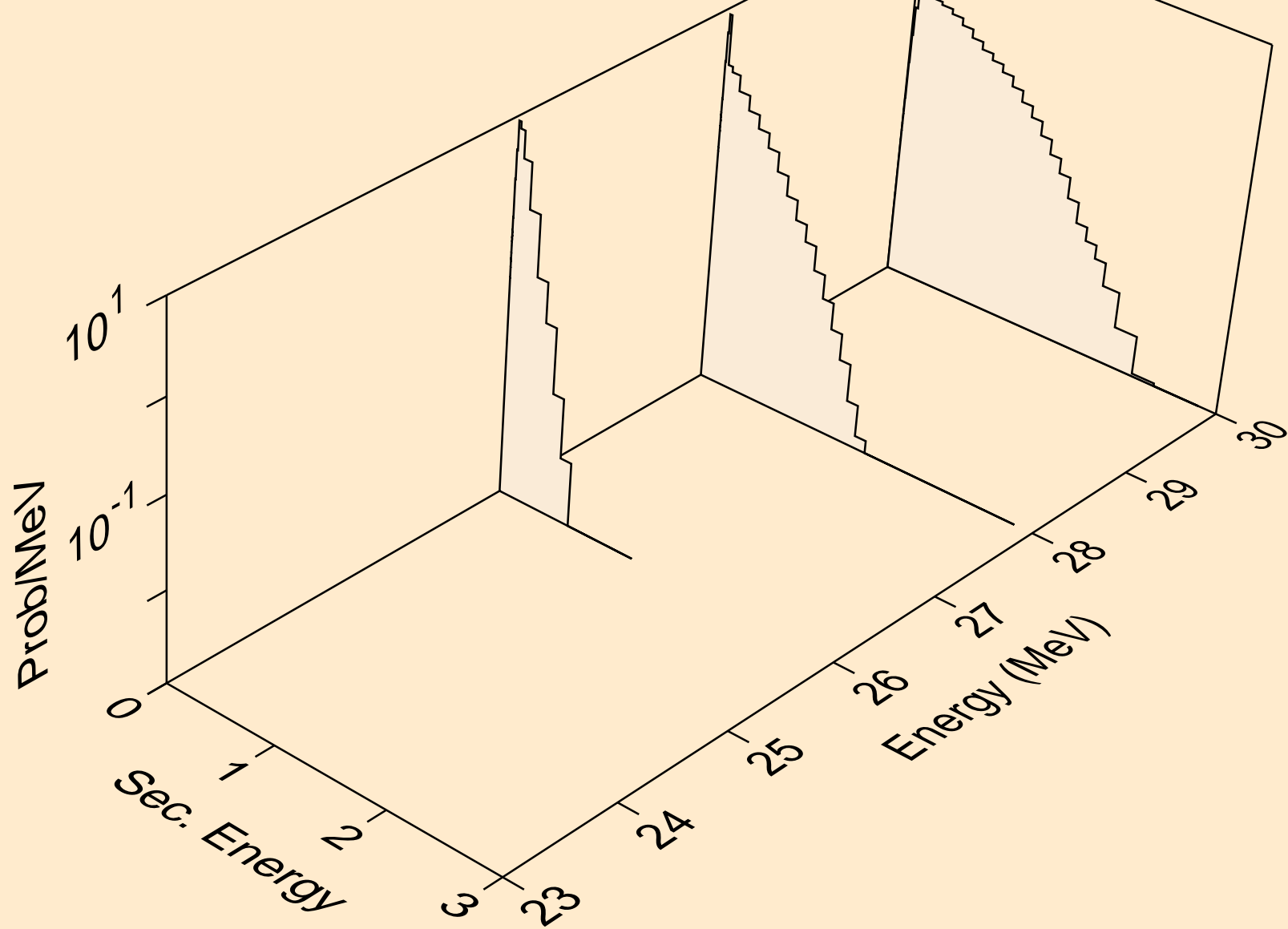

CR056 NEUTRON ACER TENDL-2024 LIBRARY; T=0.K
Neutron emission for (n,4n)

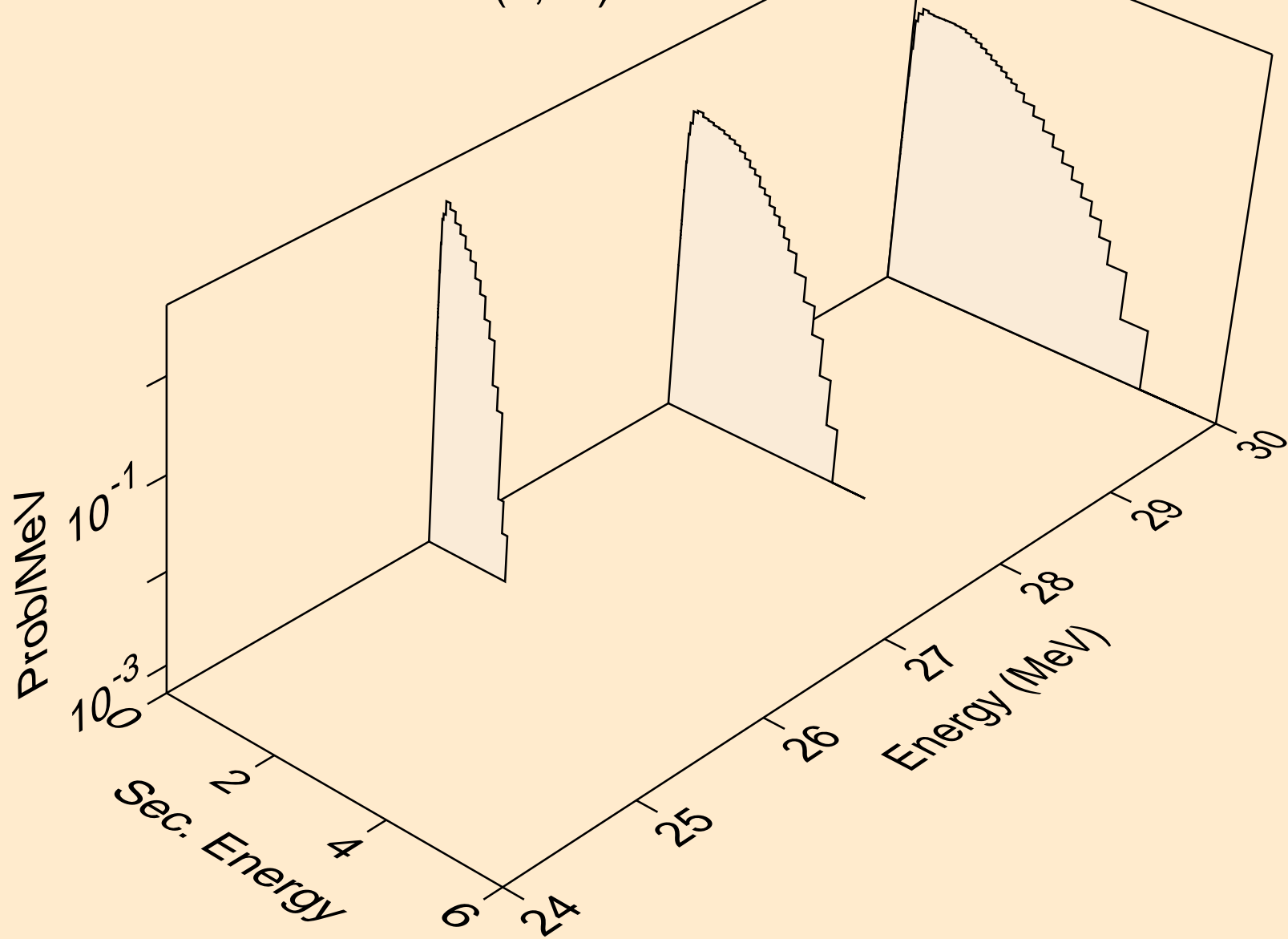

CR056 NEUTRON ACER TENDL-2024 LIBRARY; T=0.K
Neutron emission for (n,2np)

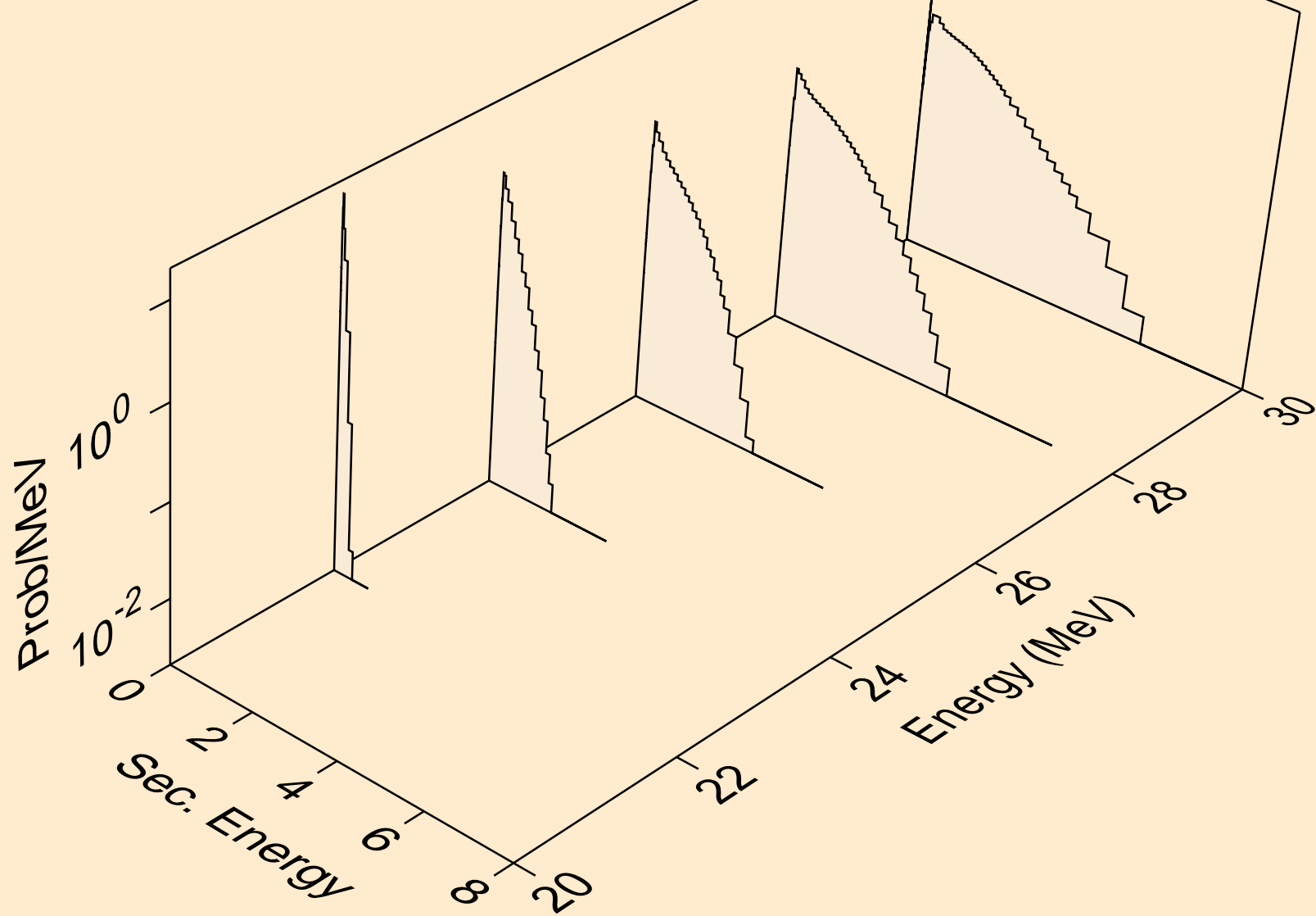

CR056 NEUTRON ACER TENDL-2024 LIBRARY; T=0.K
Neutron emission for (n,3np)

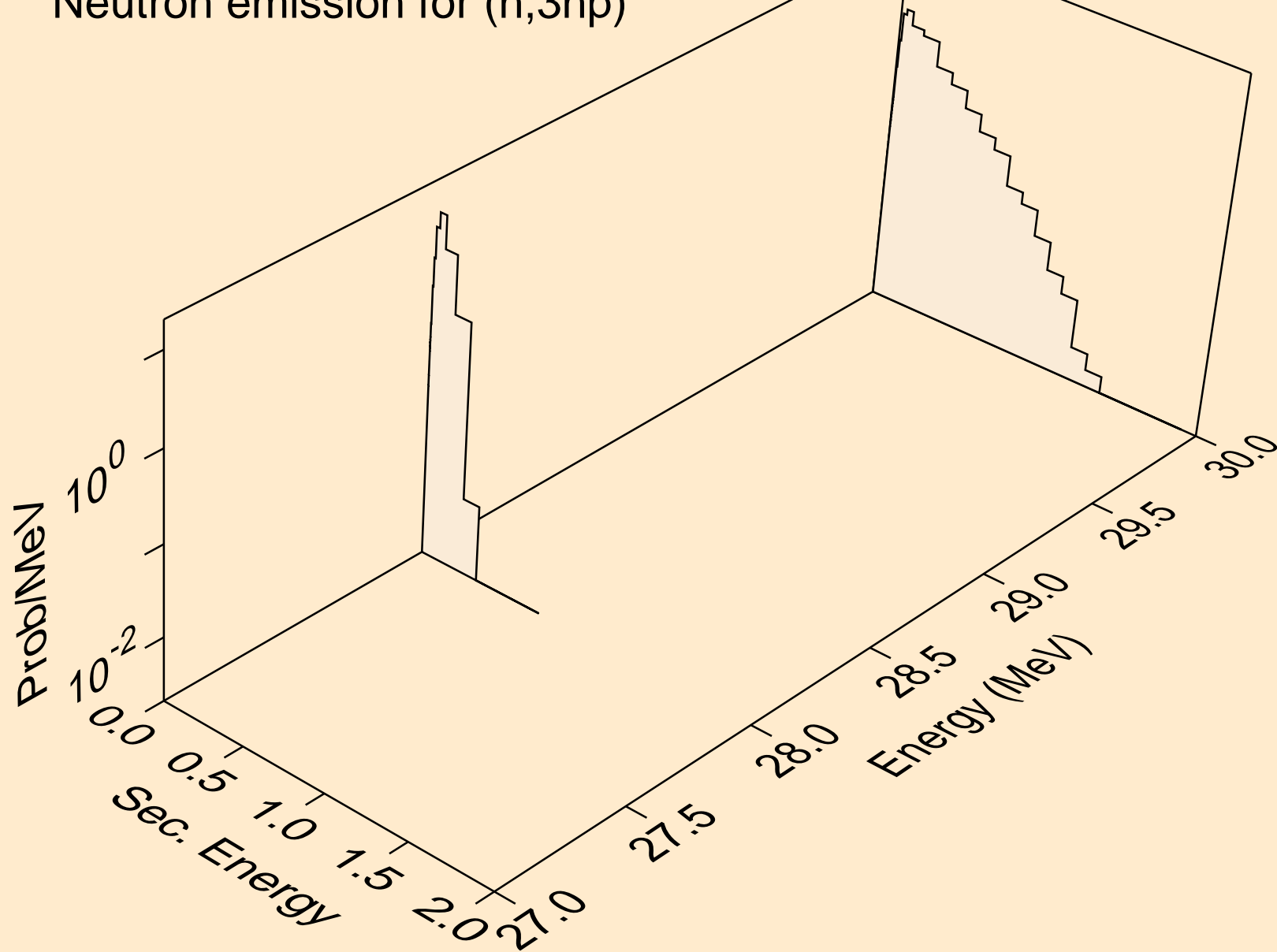

CR056 NEUTRON ACER TENDL-2024 LIBRARY; T=0.K
Neutron emission for (n,n2p)

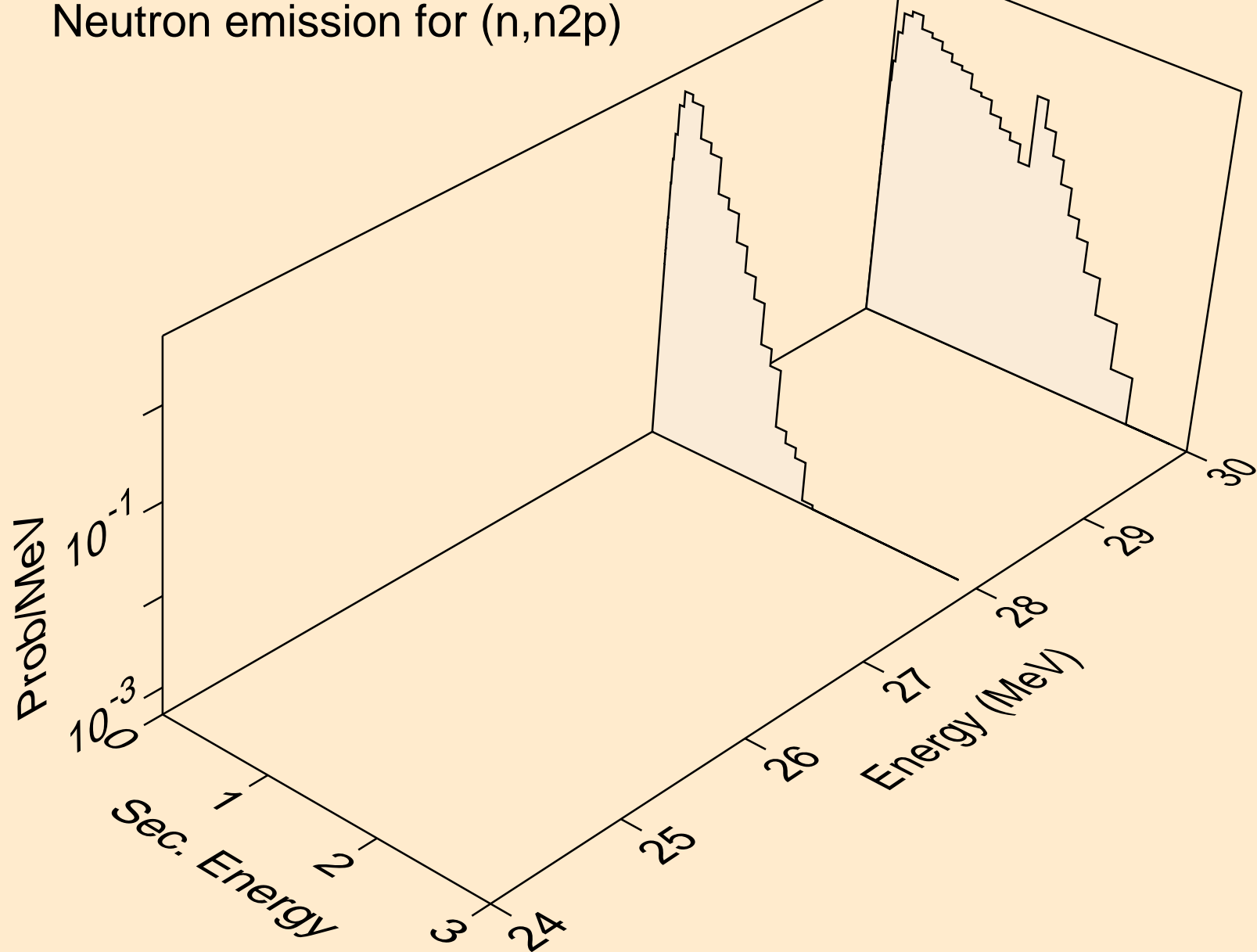

CR056 NEUTRON ACER TENDL-2024 LIBRARY; T=0.K
Neutron emission for (n,npa)

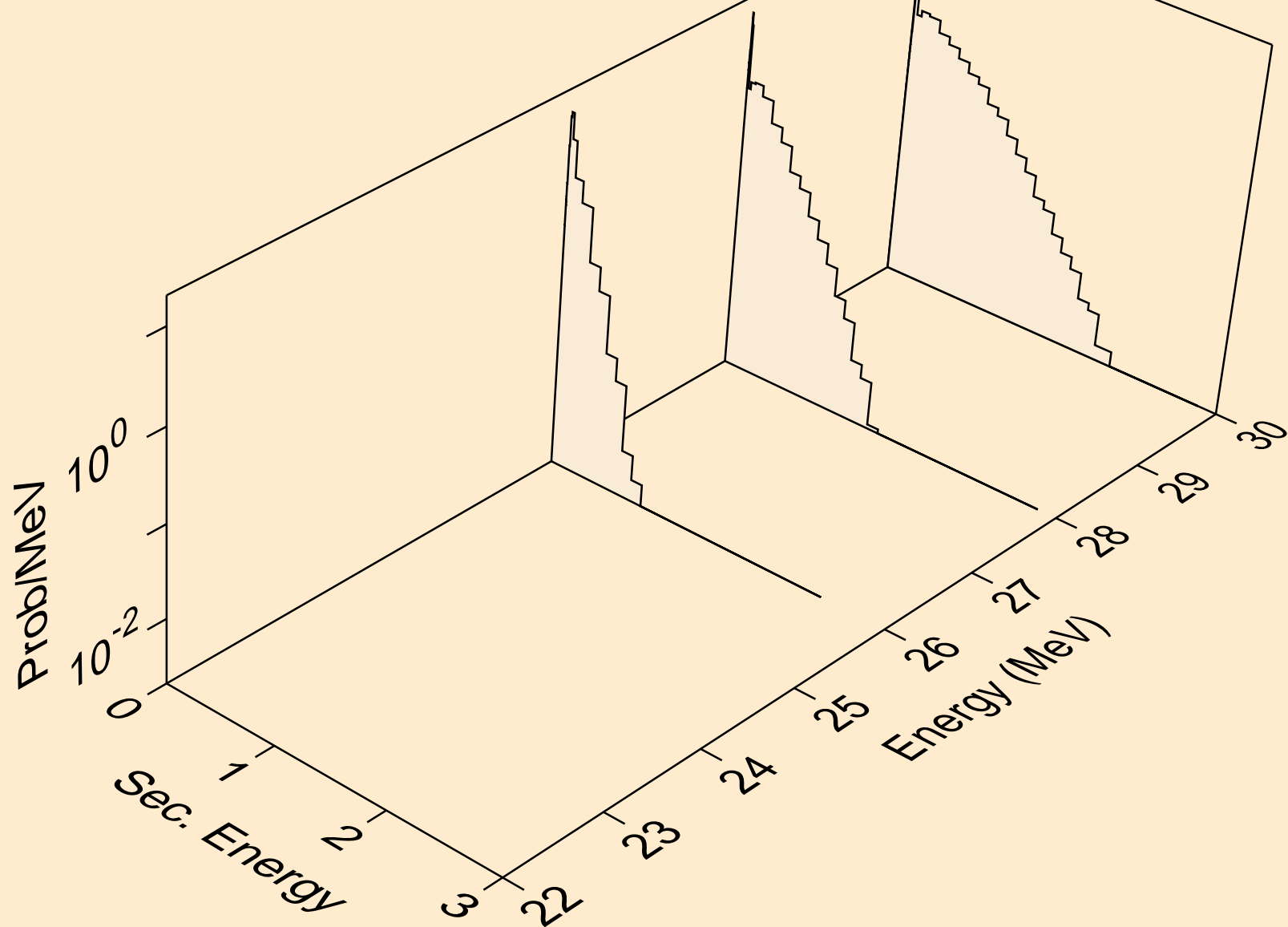

CR056 NEUTRON ACER TENDL-2024 LIBRARY; T=0.K
Neutron emission for (n,n*c)

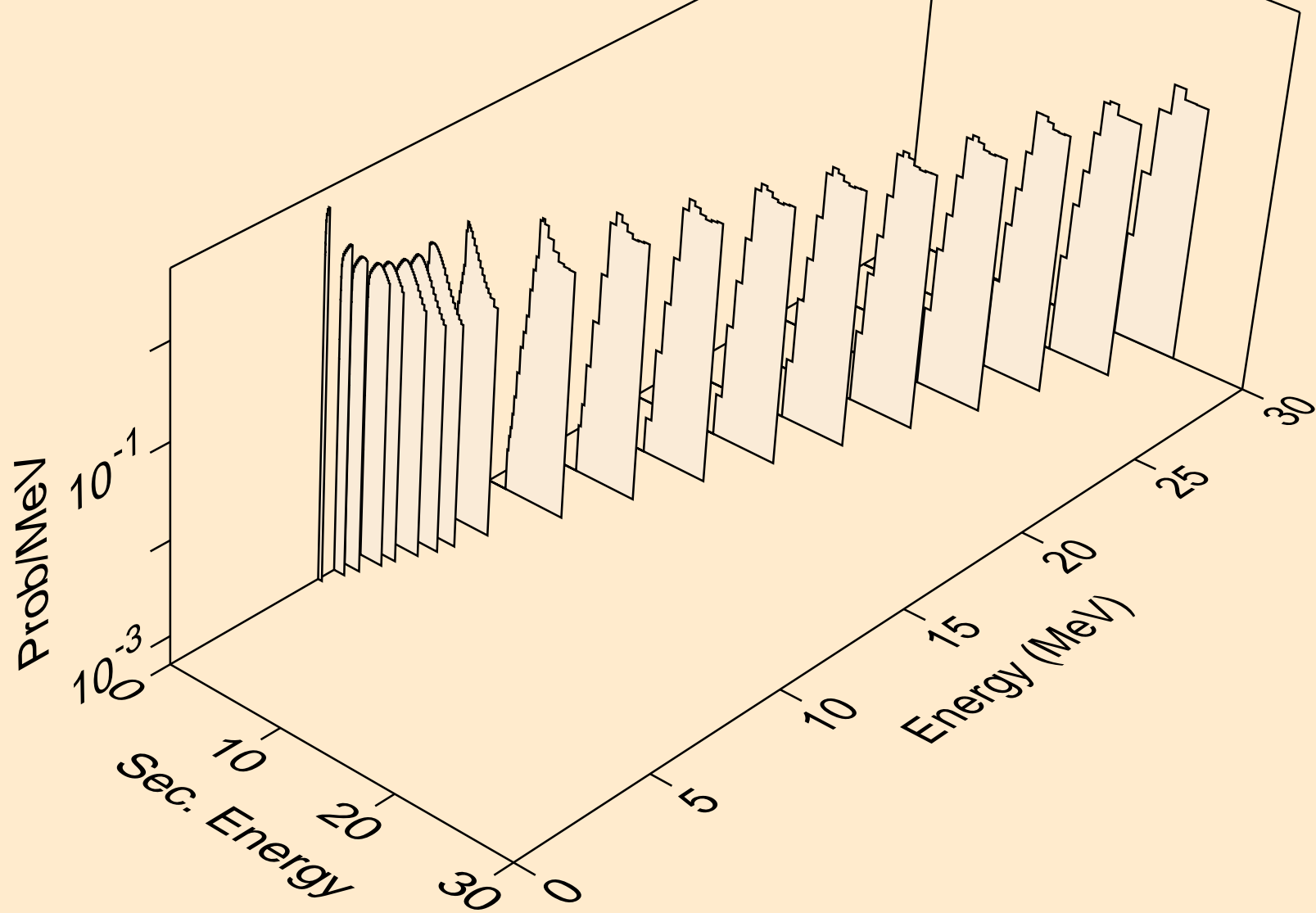

CR056 NEUTRON ACER TENDL-2024 LIBRARY; T=0.K
Photon emission for (n,x)

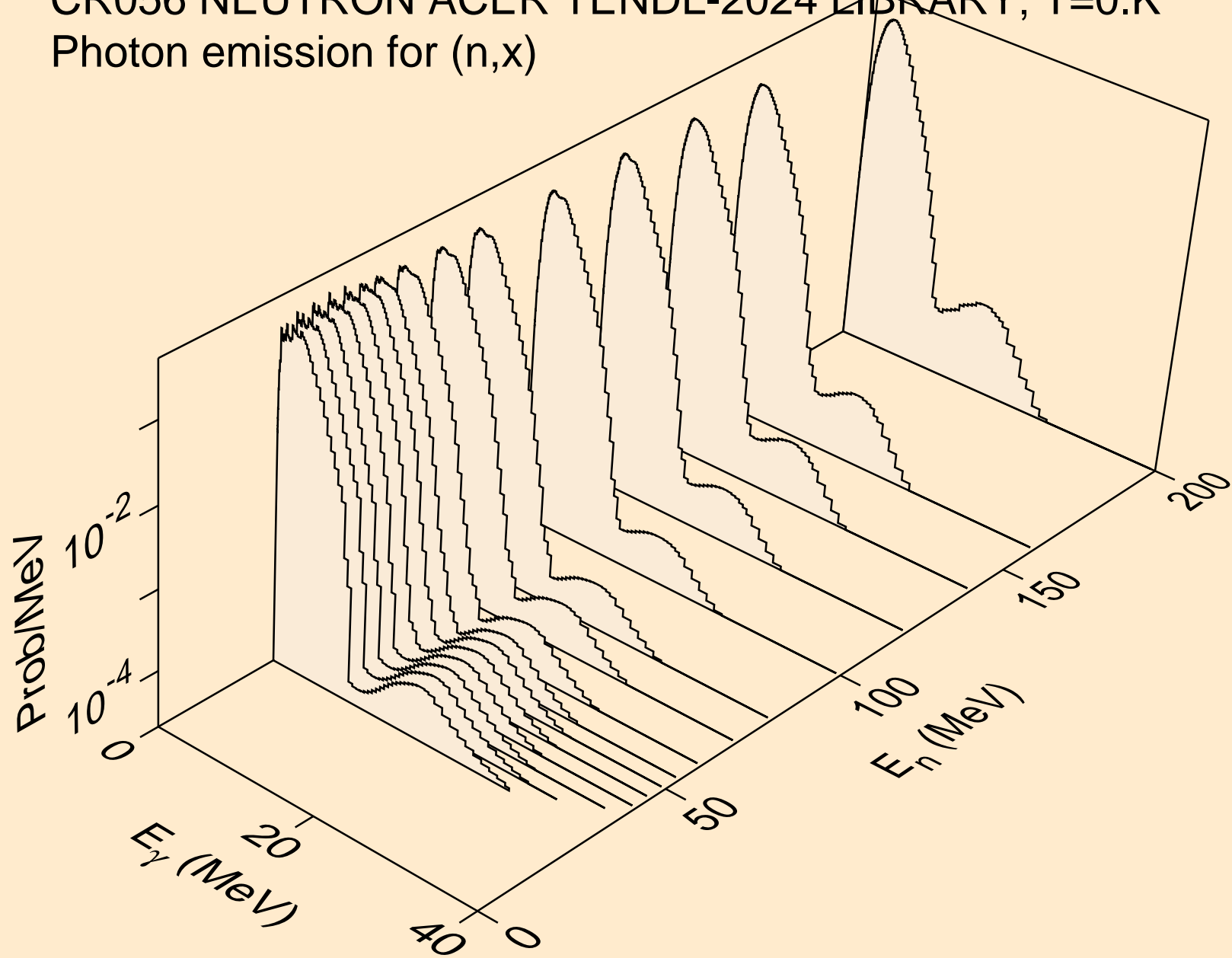

CR056 NEUTRON ACER TENDL-2024 LIBRARY; T=0.K
Photon emission for (n,2nd)

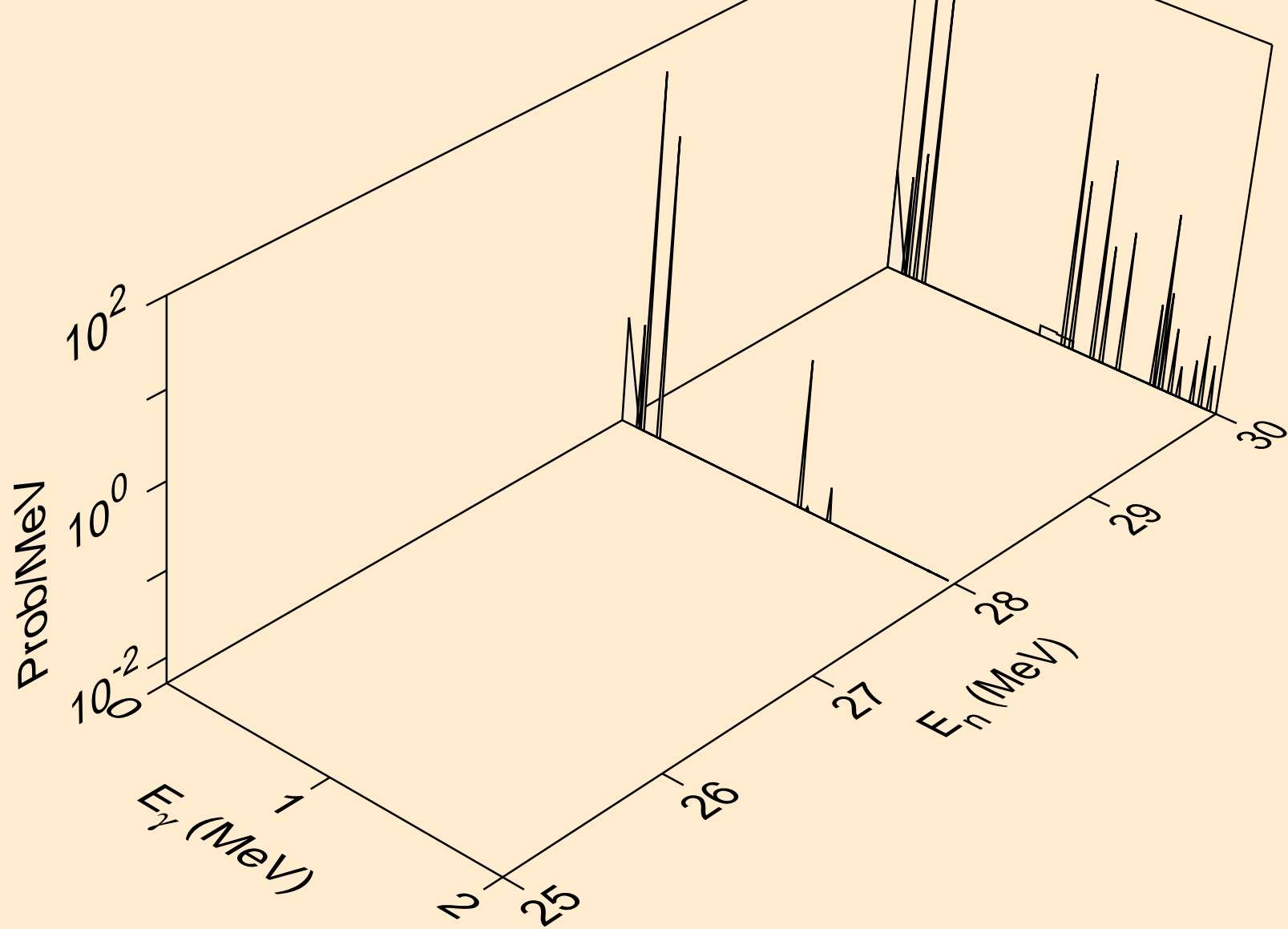

CR056 NEUTRON ACER TENDL-2024 LIBRARY; T=0.K
Photon emission for (n,2n)

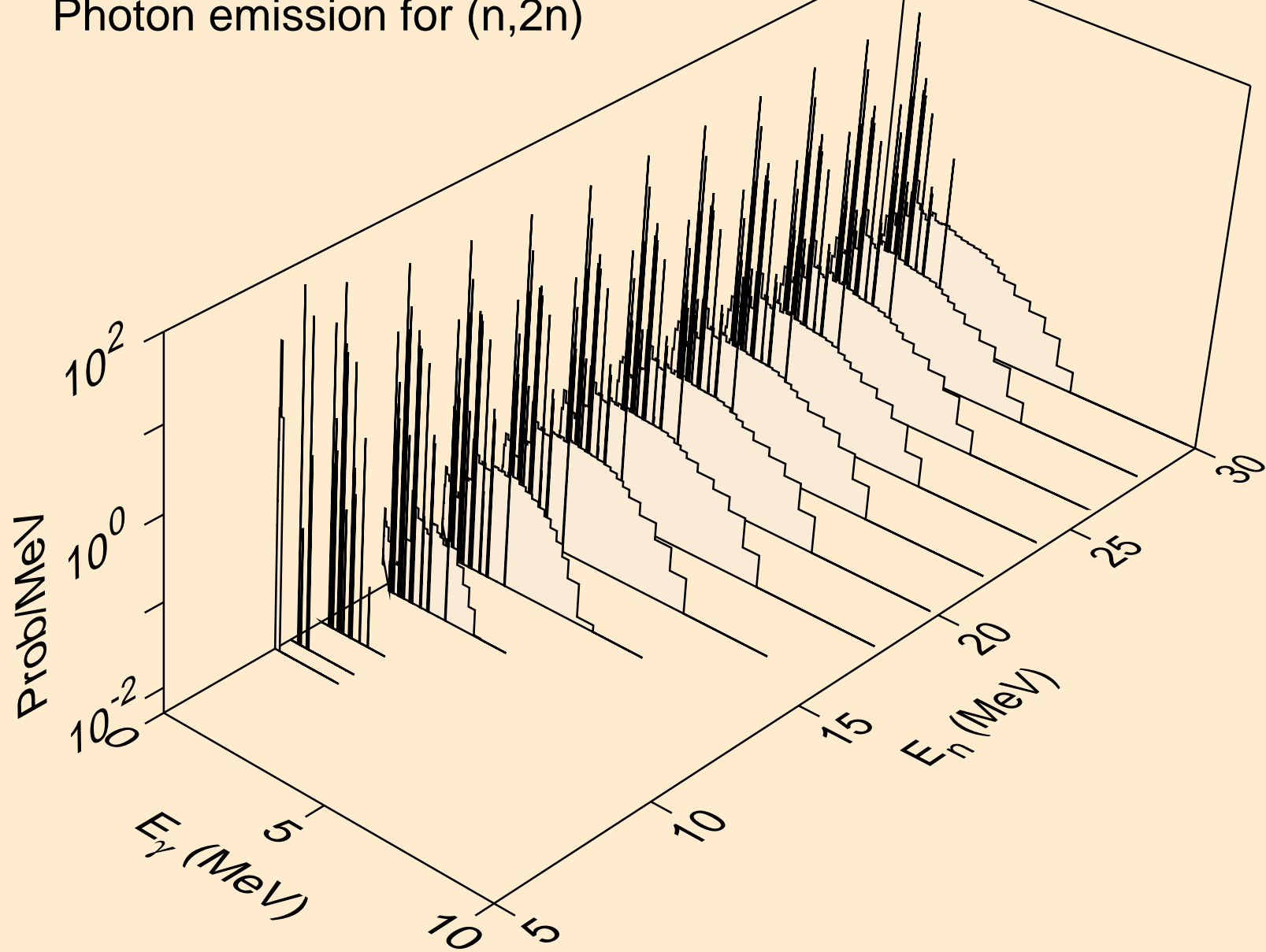

CR056 NEUTRON ACER TENDL-2024 LIBRARY; T=0.K
Photon emission for (n,3n)

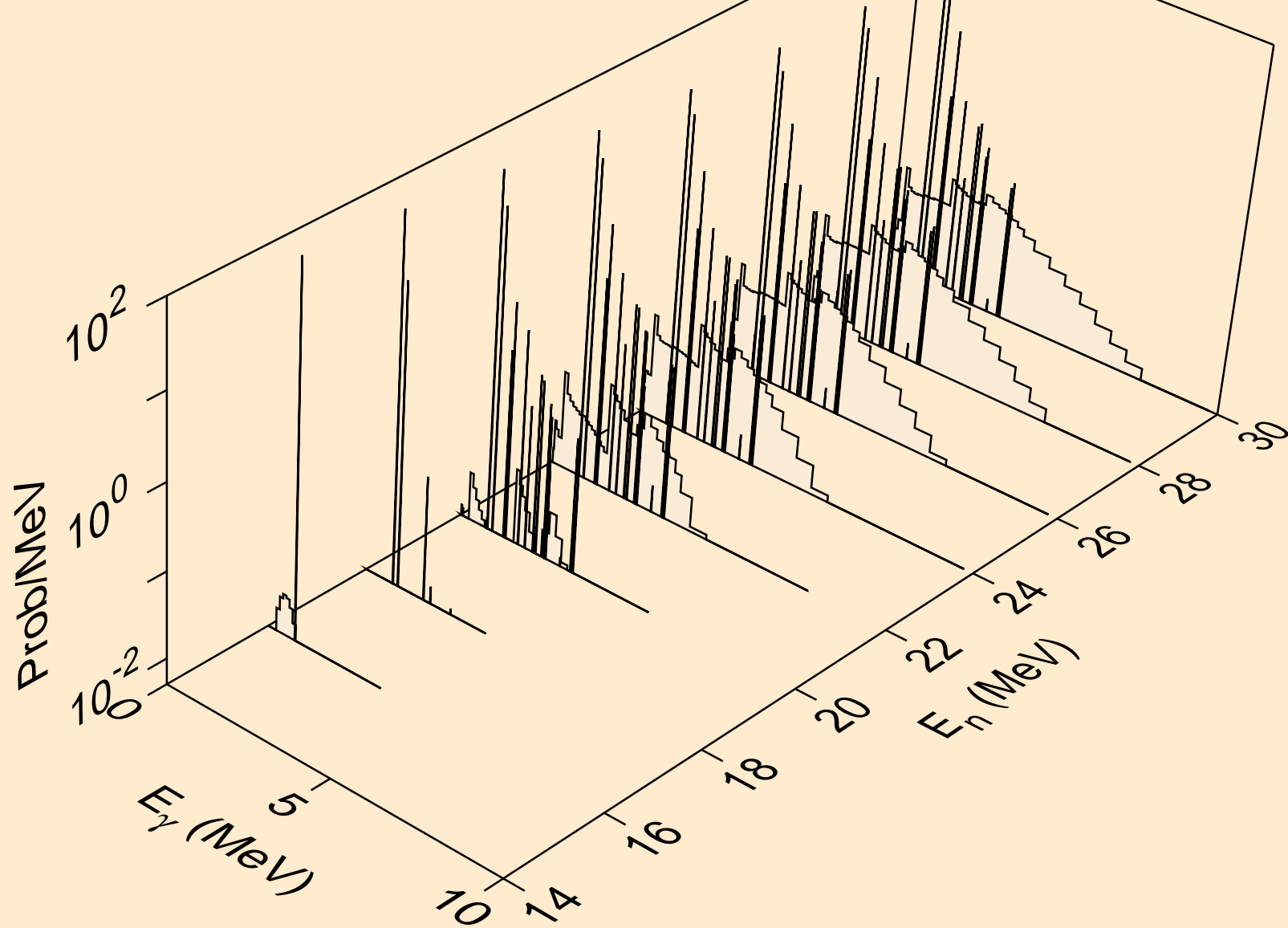

CR056 NEUTRON ACER TENDL-2024 LIBRARY; T=0.K
Photon emission for (n,n*)a

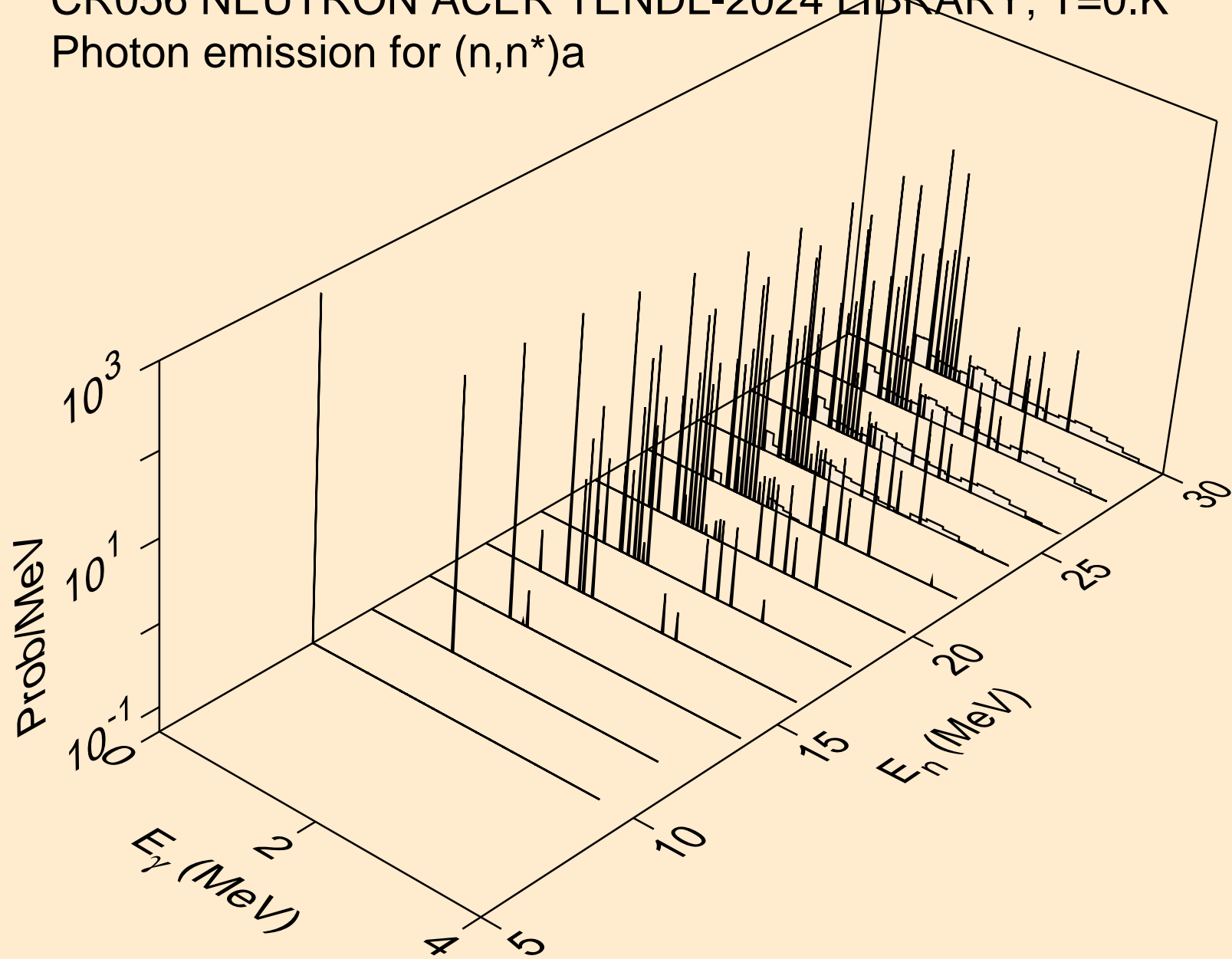

CR056 NEUTRON ACER TENDL-2024 LIBRARY; T=0.K
Photon emission for (n,2n)a

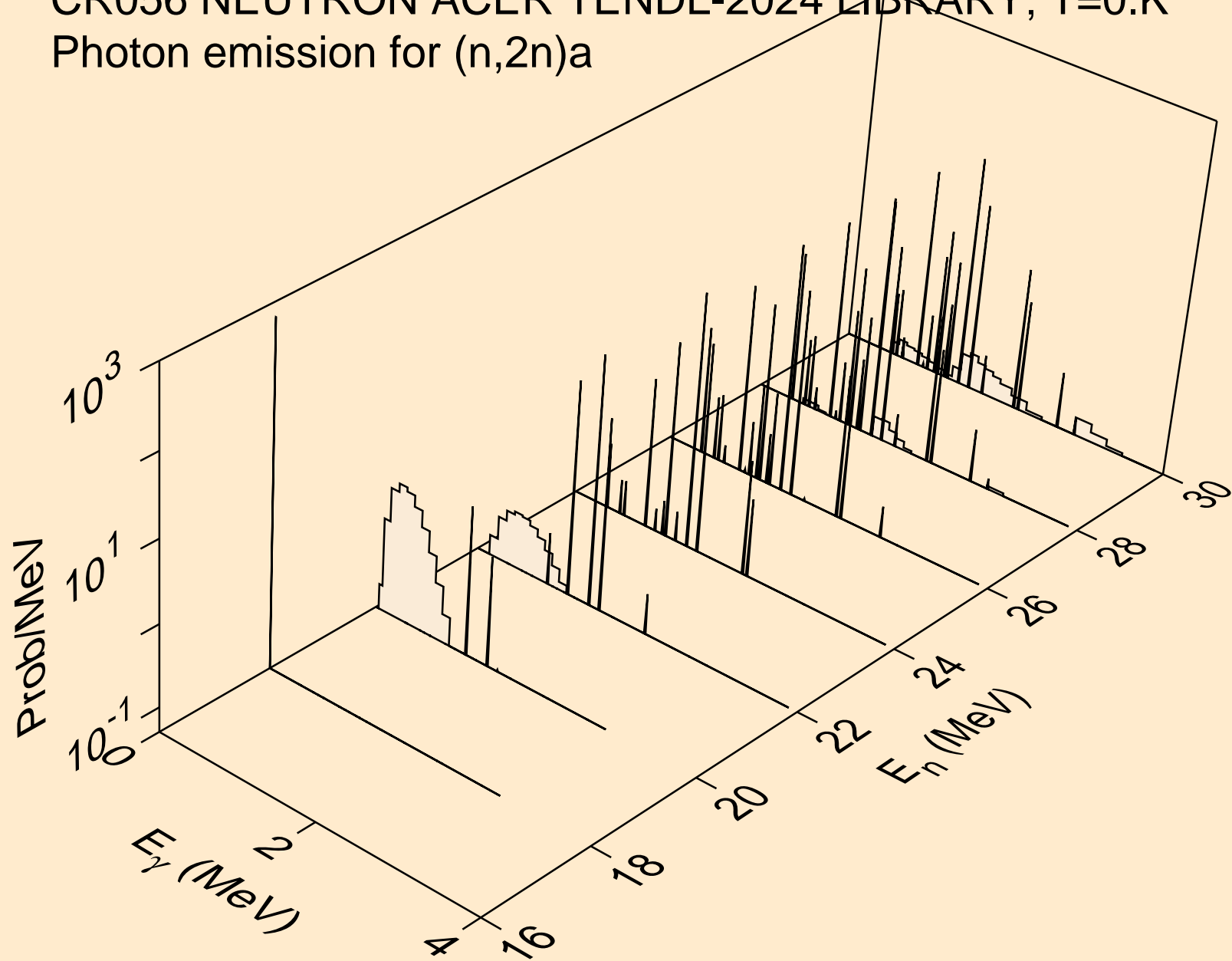

CR056 NEUTRON ACER TENDL-2024 LIBRARY; T=0.K
Photon emission for (n,3n)a

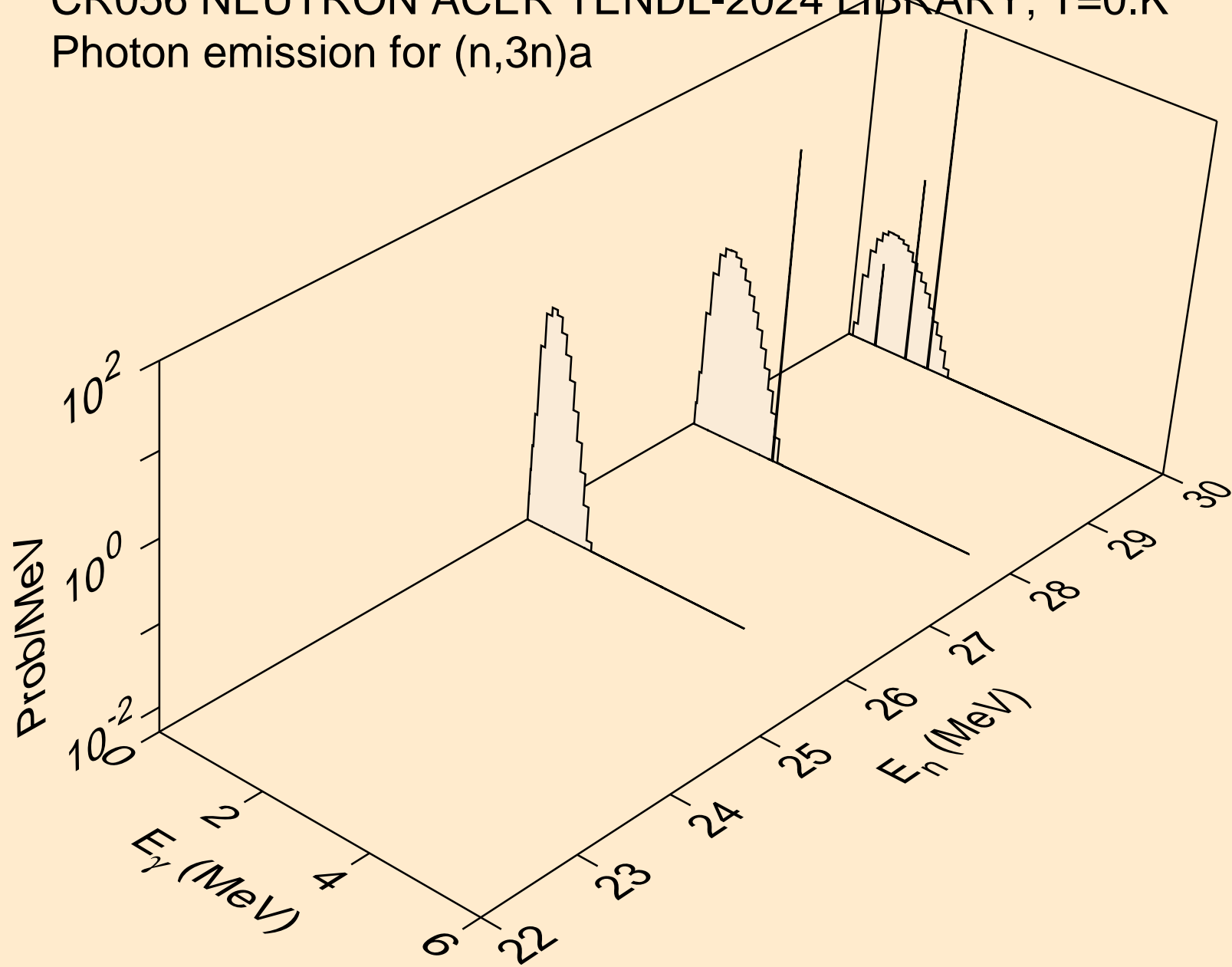

CR056 NEUTRON ACER TENDL-2024 LIBRARY; T=0.K
Photon emission for (n,n*)p

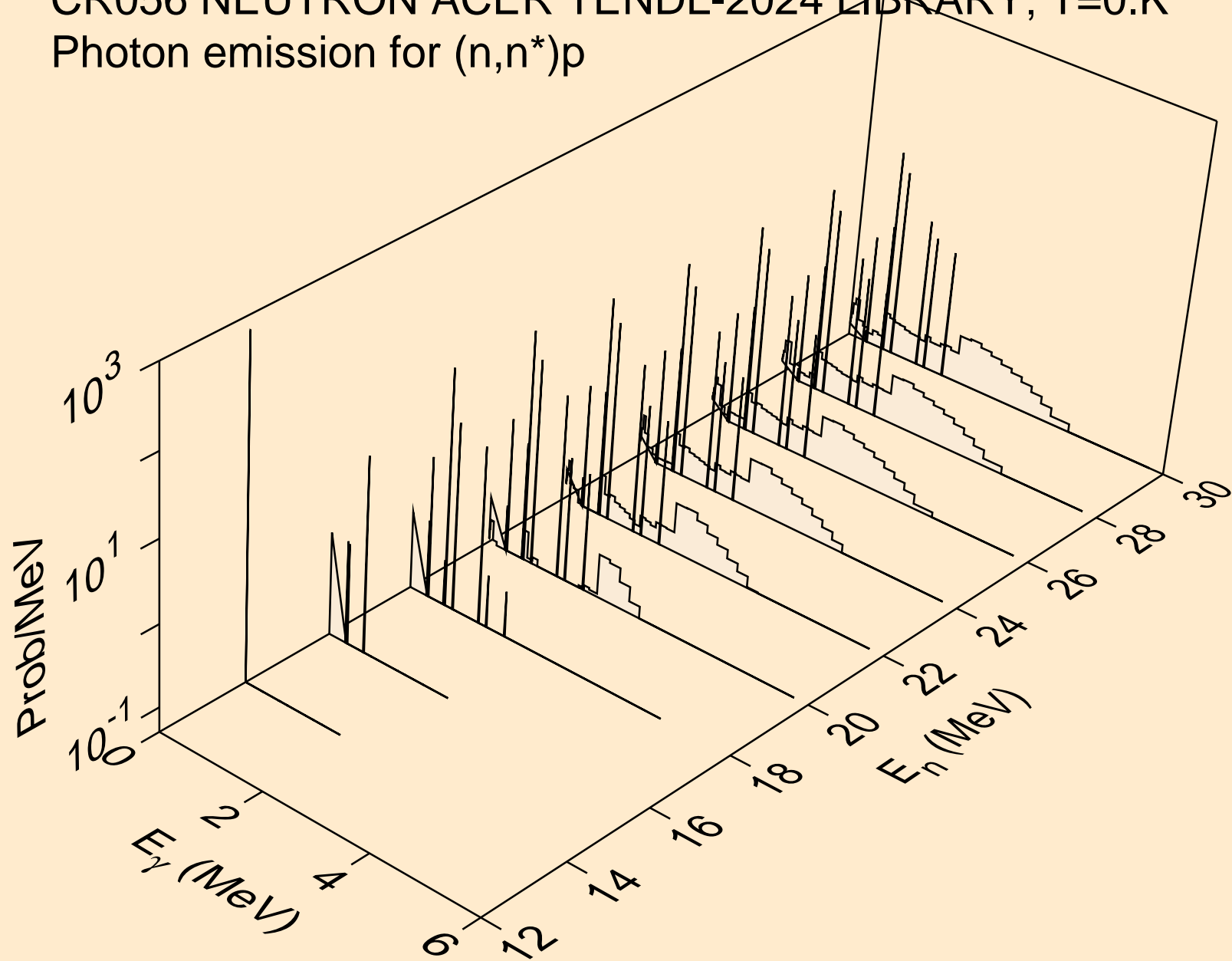

CR056 NEUTRON ACER TENDL-2024 LIBRARY; T=0.K
Photon emission for (n,n*)2a

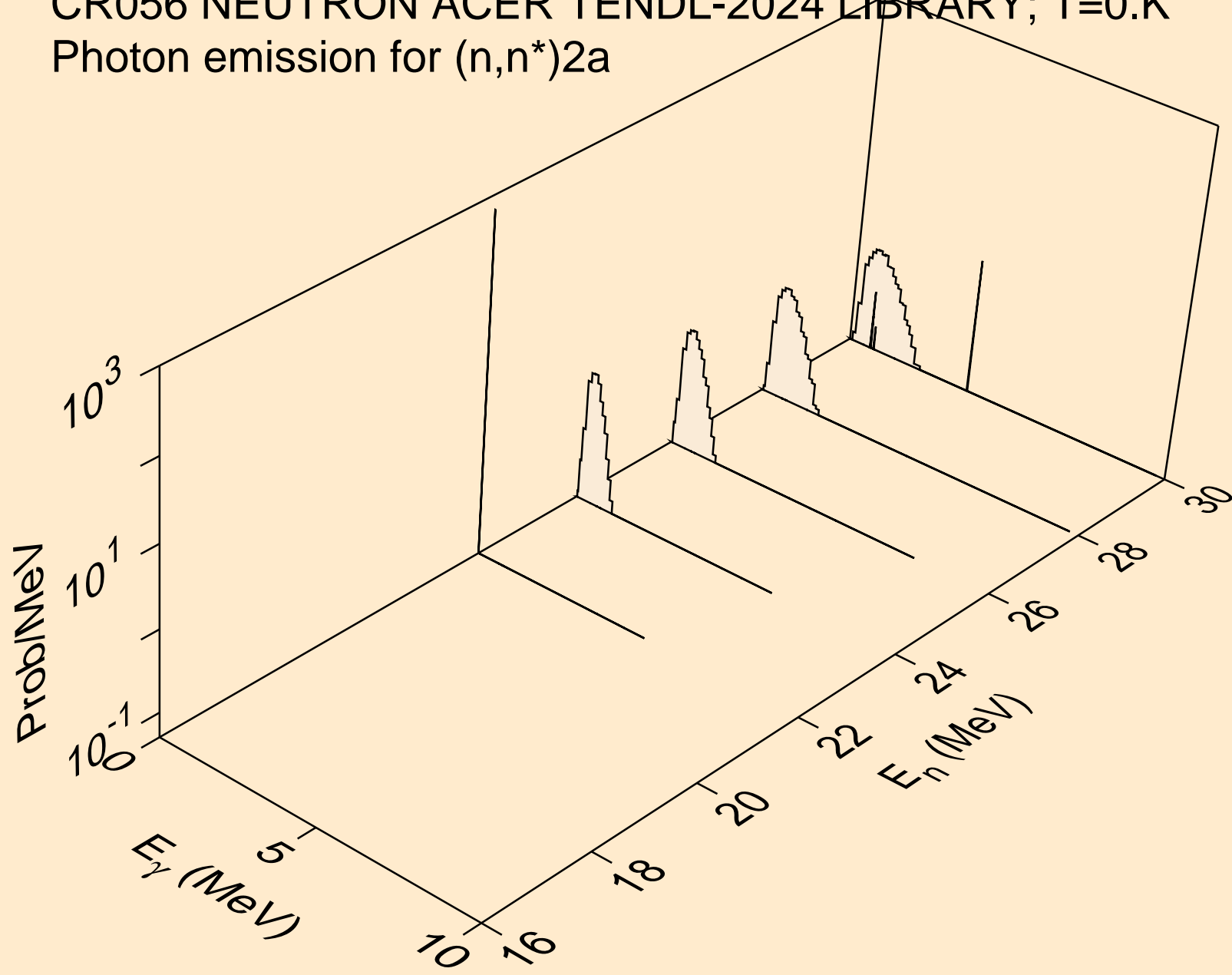

CR056 NEUTRON ACER TENDL-2024 LIBRARY; T=0.K
Photon emission for (n,n*)d

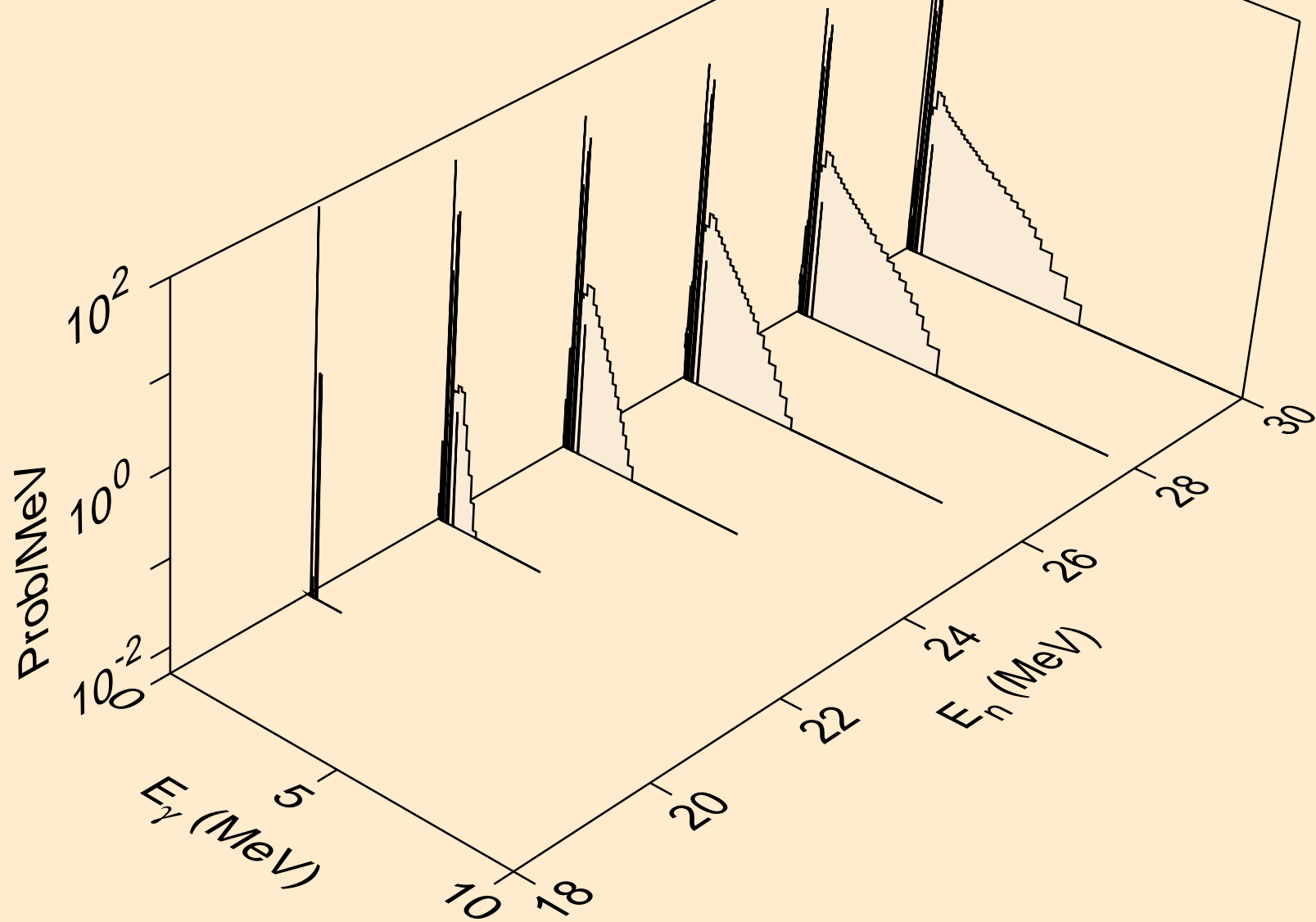

CR056 NEUTRON ACER TENDL-2024 LIBRARY; T=0.K
Photon emission for (n,n*)t

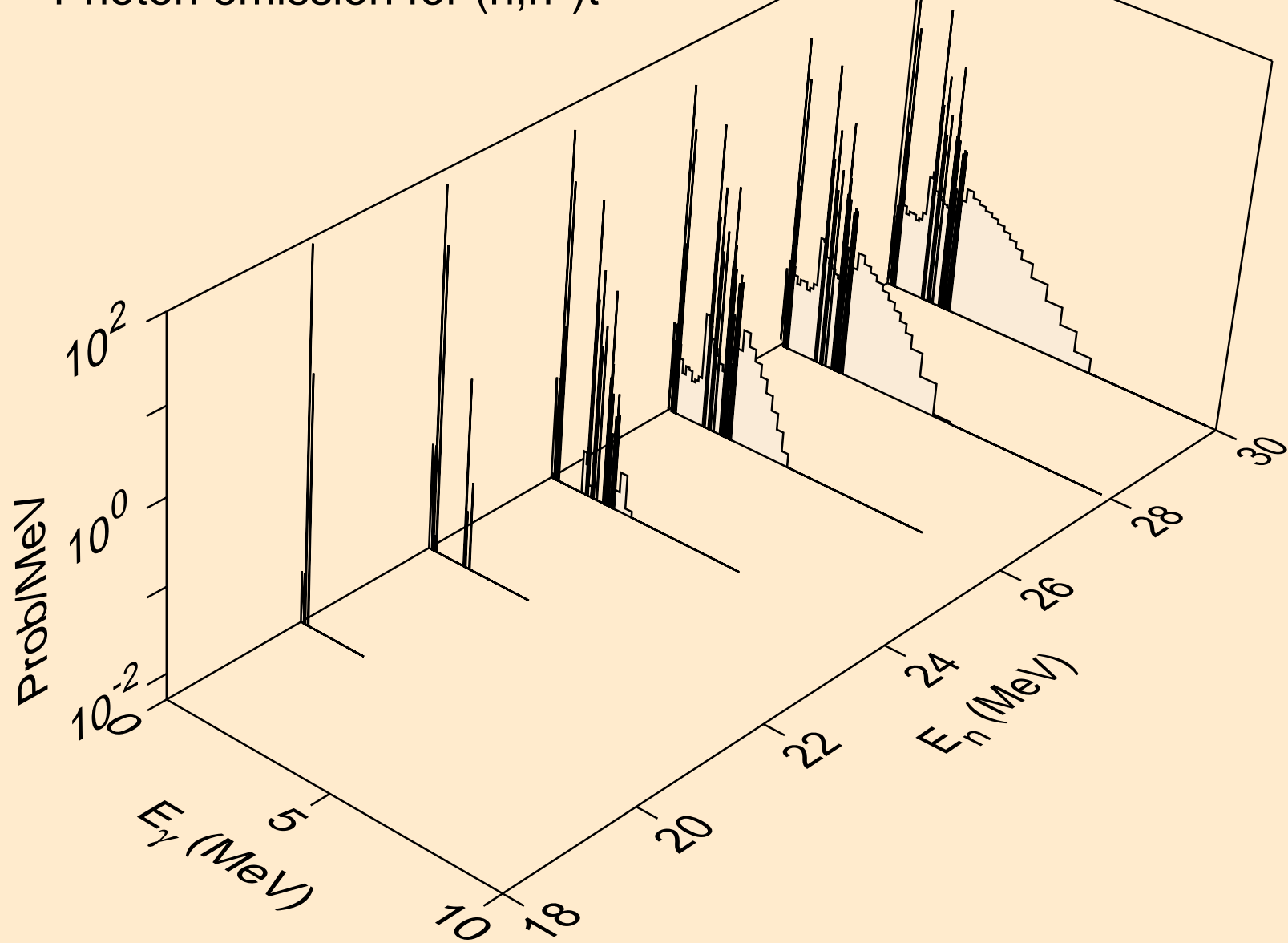

CR056 NEUTRON ACER TENDL-2024 LIBRARY; T=0.K
Photon emission for (n,n*)he3

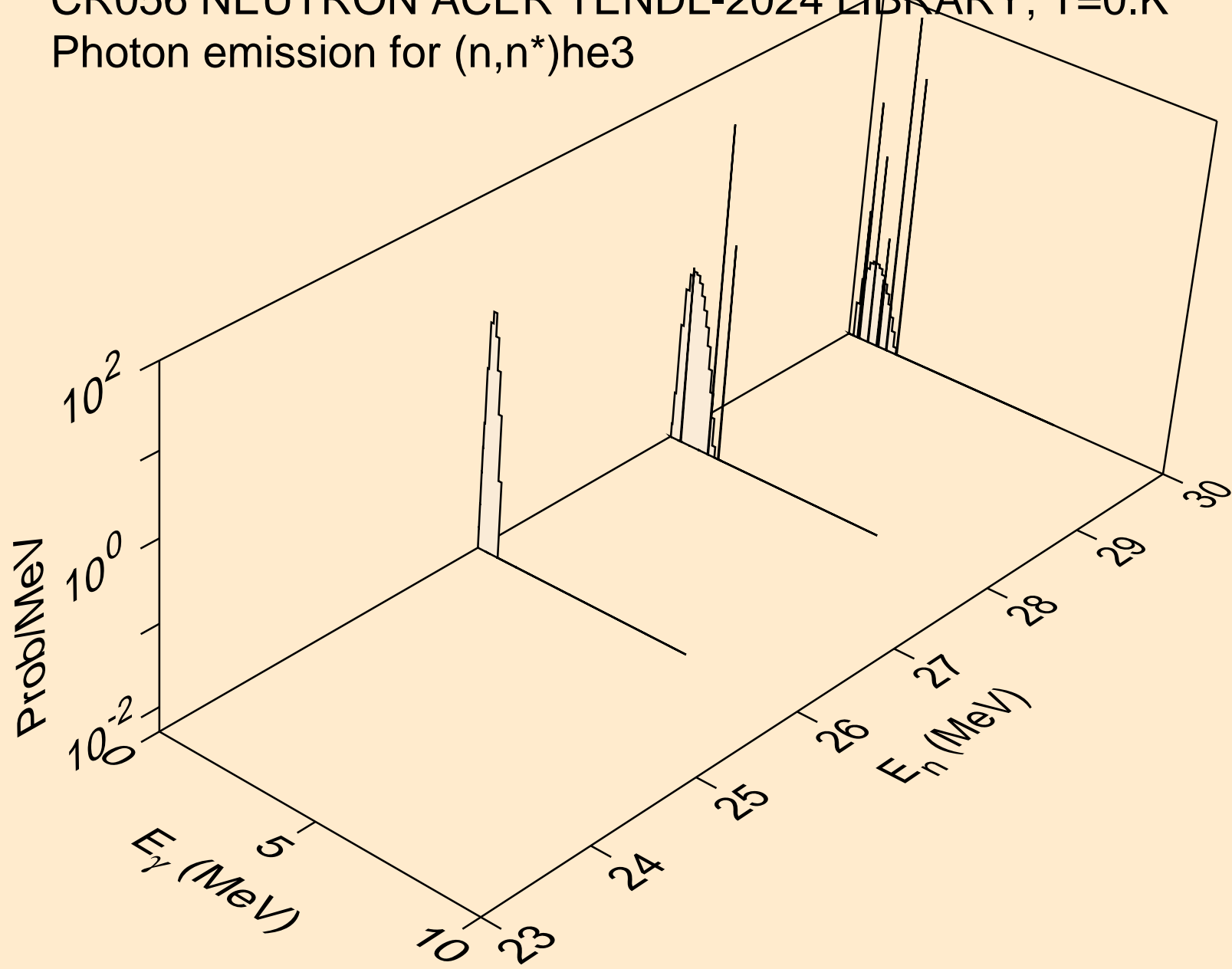

CR056 NEUTRON ACER TENDL-2024 LIBRARY; T=0.K
Photon emission for (n,4n)

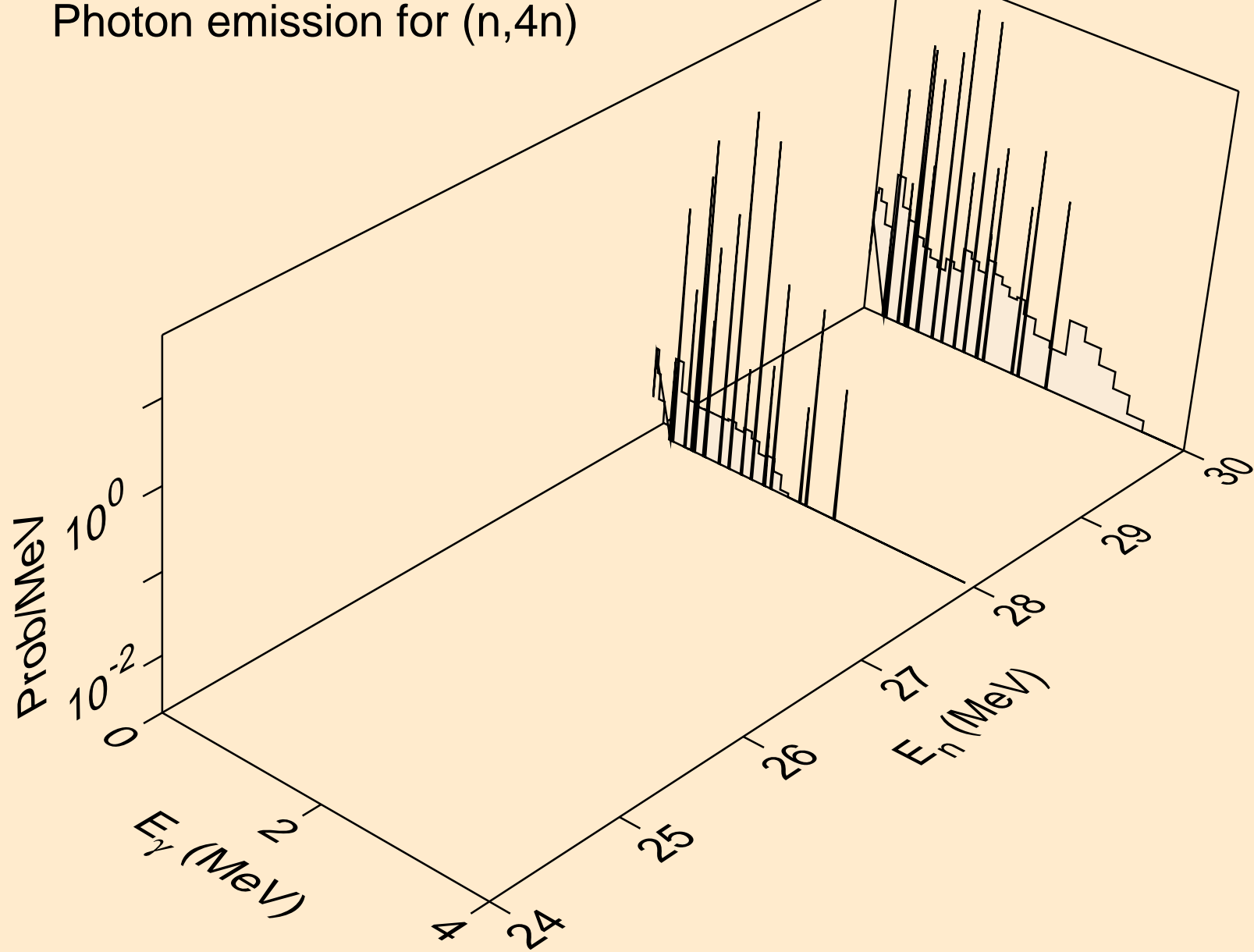

CR056 NEUTRON ACER TENDL-2024 LIBRARY; T=0.K
Photon emission for (n,2np)

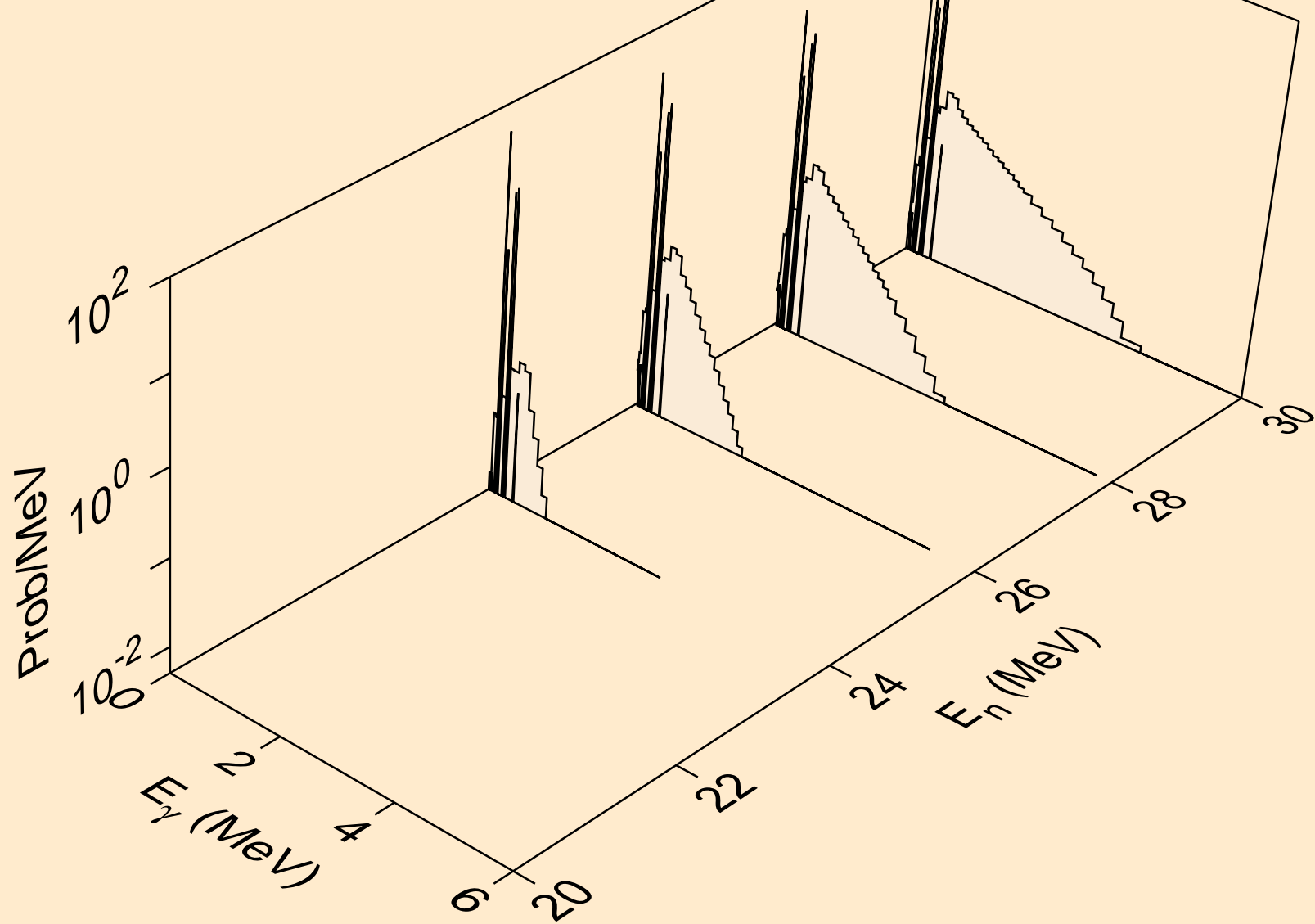

CR056 NEUTRON ACER TENDL-2024 LIBRARY; T=0.K
Photon emission for (n,3np)

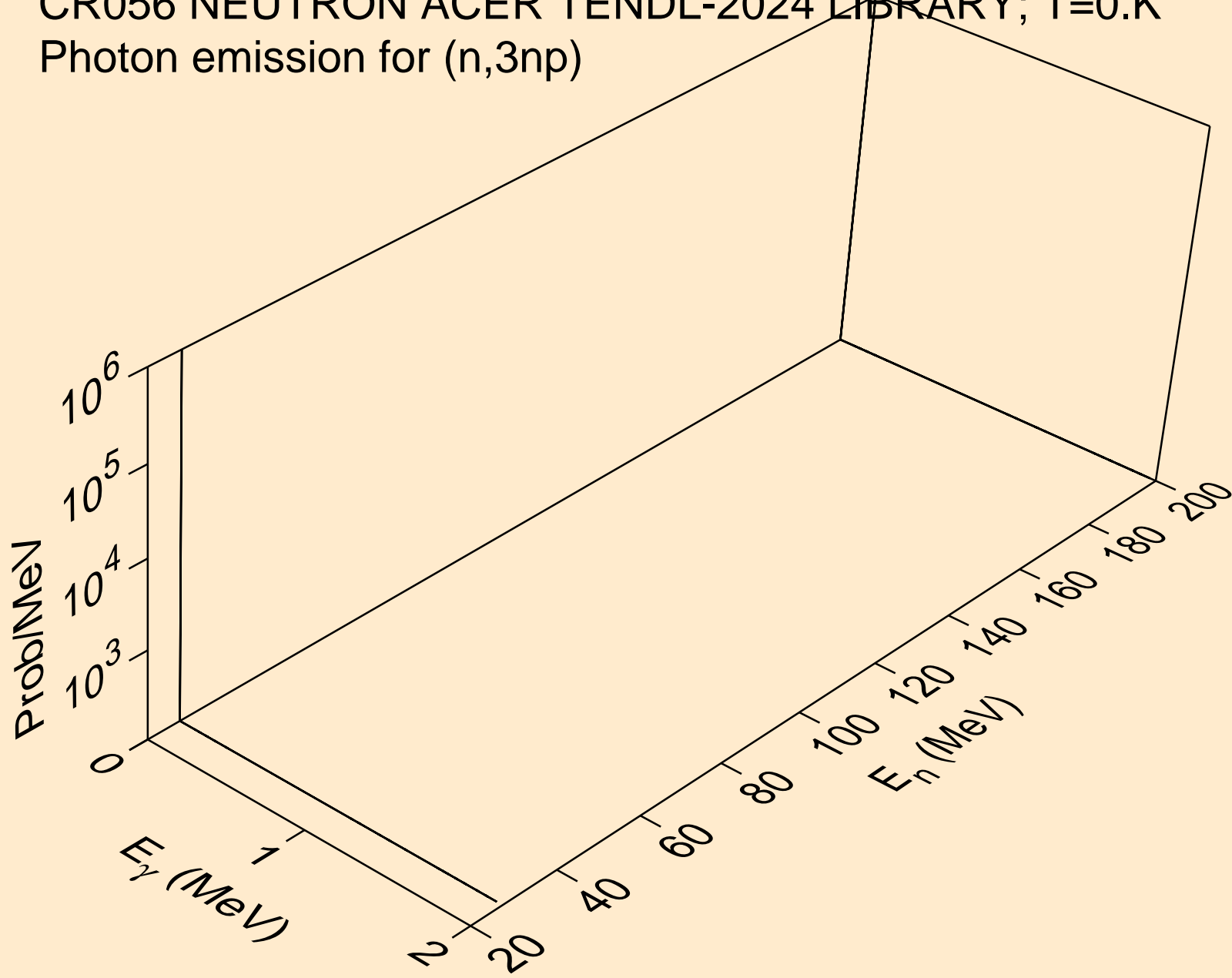

CR056 NEUTRON ACER TENDL-2024 LIBRARY; T=0.K
Photon emission for (n,n2p)

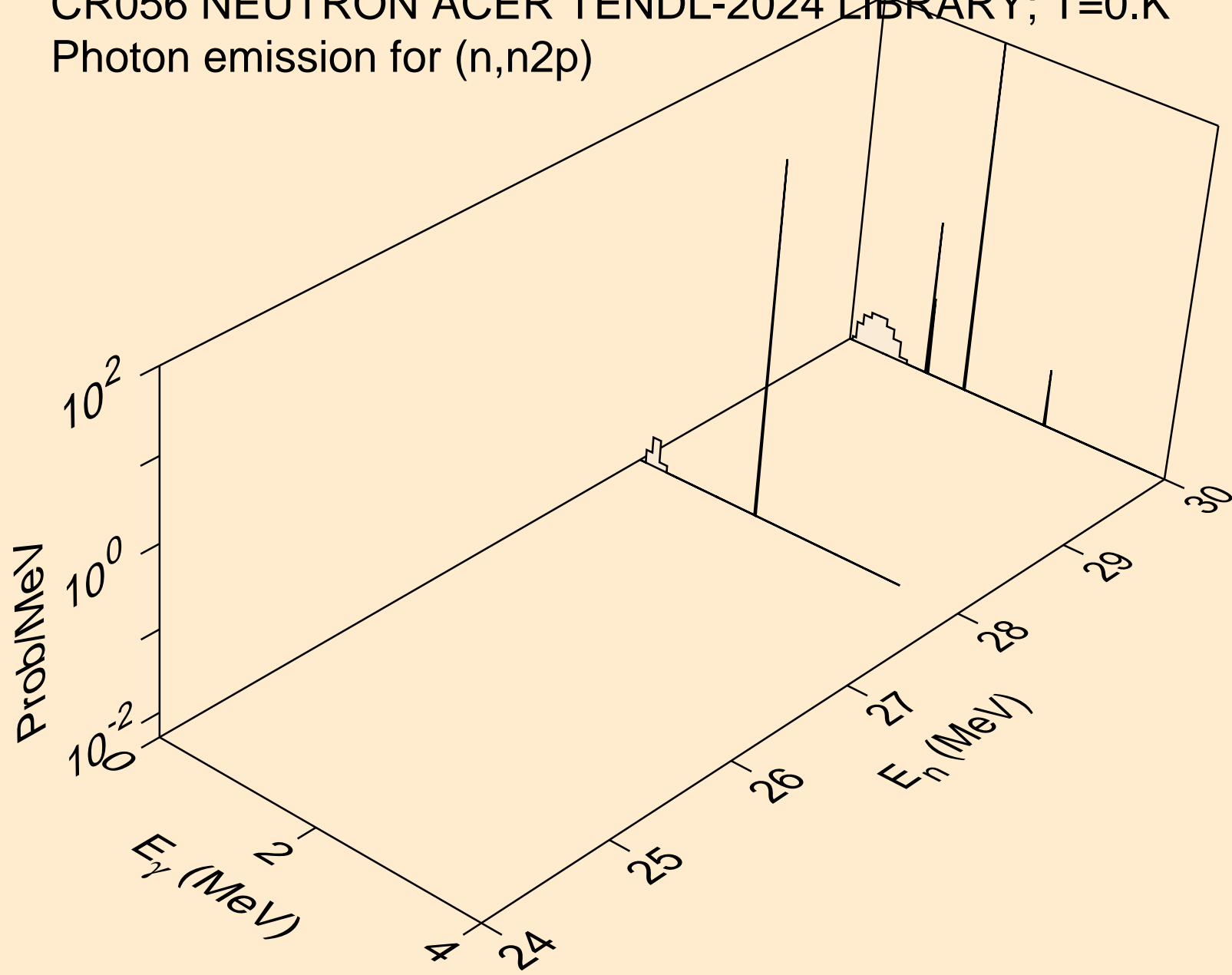

CR056 NEUTRON ACER TENDL-2024 LIBRARY; T=0.K
Photon emission for (n,npa)

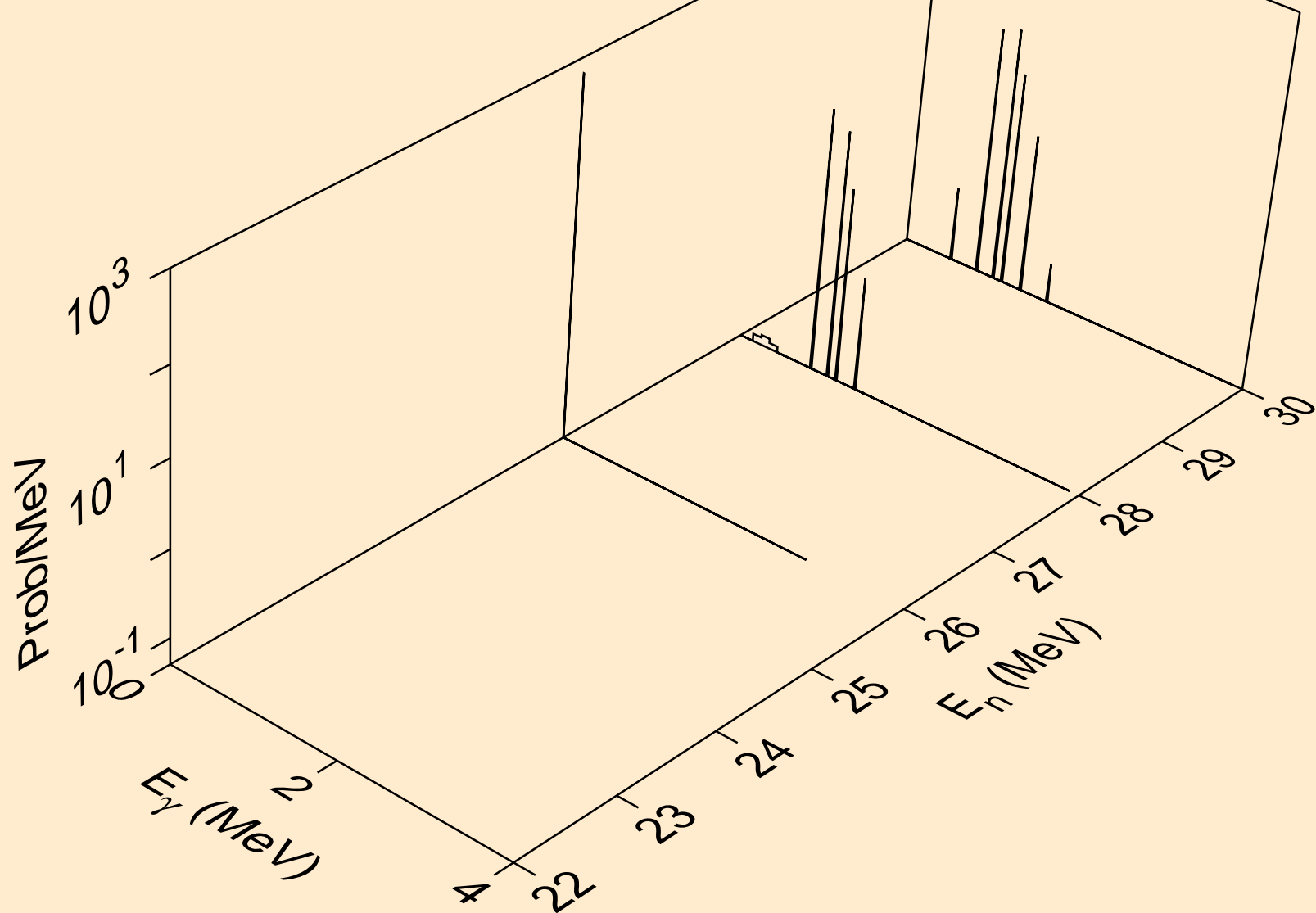

CR056 NEUTRON ACER TENDL-2024 LIBRARY; T=0.K
Photon emission for (n,n*c)

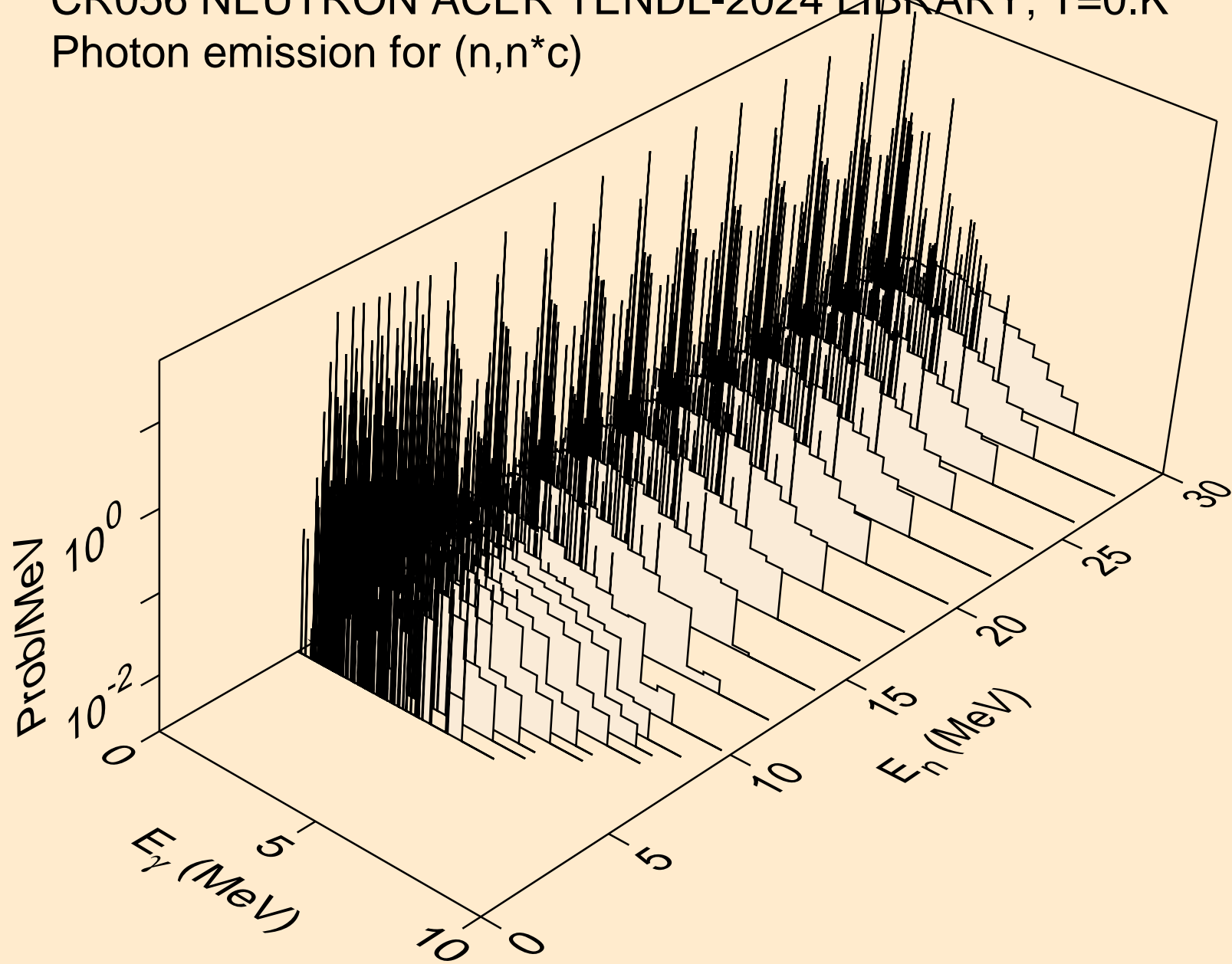

CR056 NEUTRON ACER TENDL-2024 LIBRARY; T=0.K
Photon emission for (n,gma)

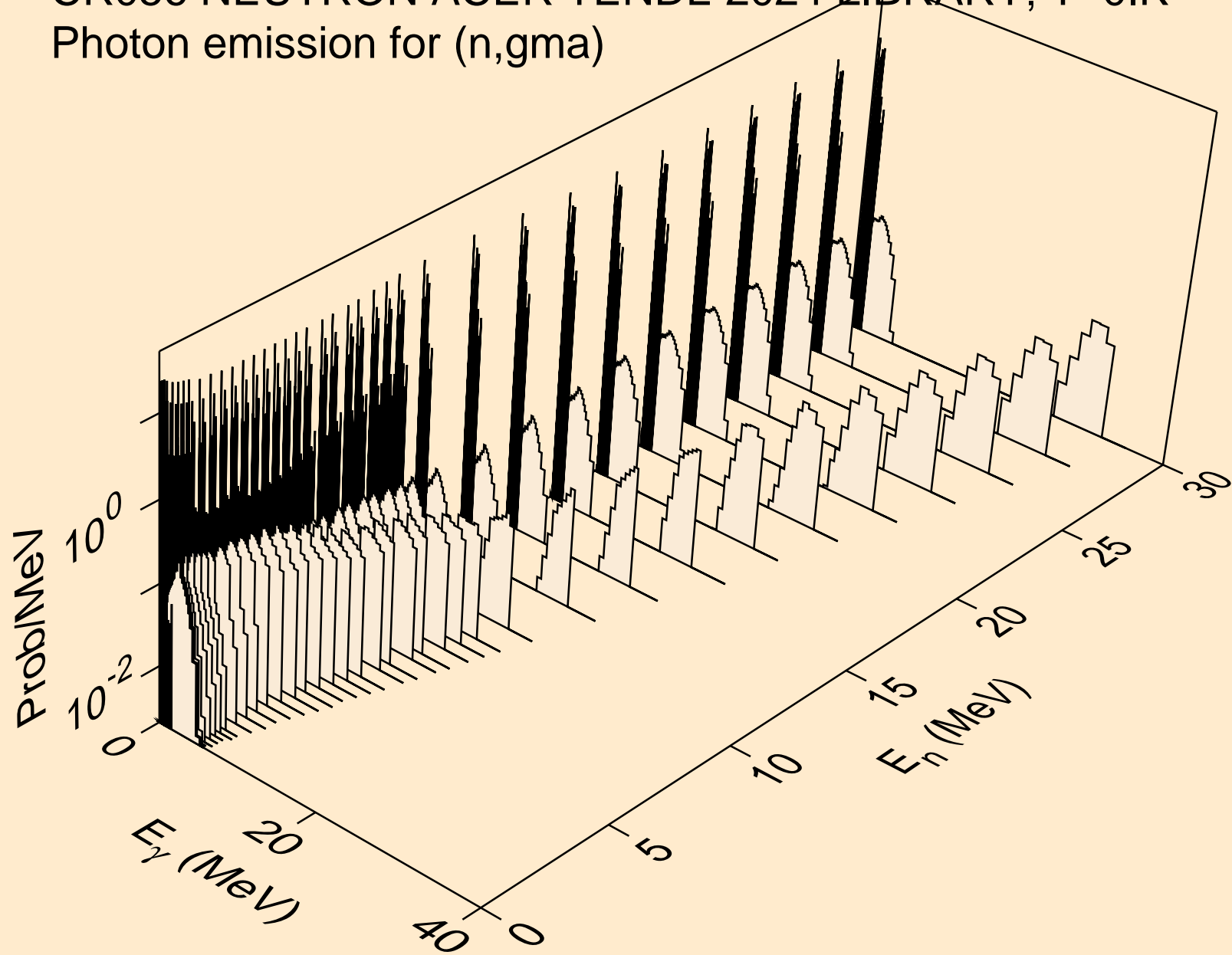

CR056 NEUTRON ACER TENDL-2024 LIBRARY; T=0.K
Photon emission for (n,p)

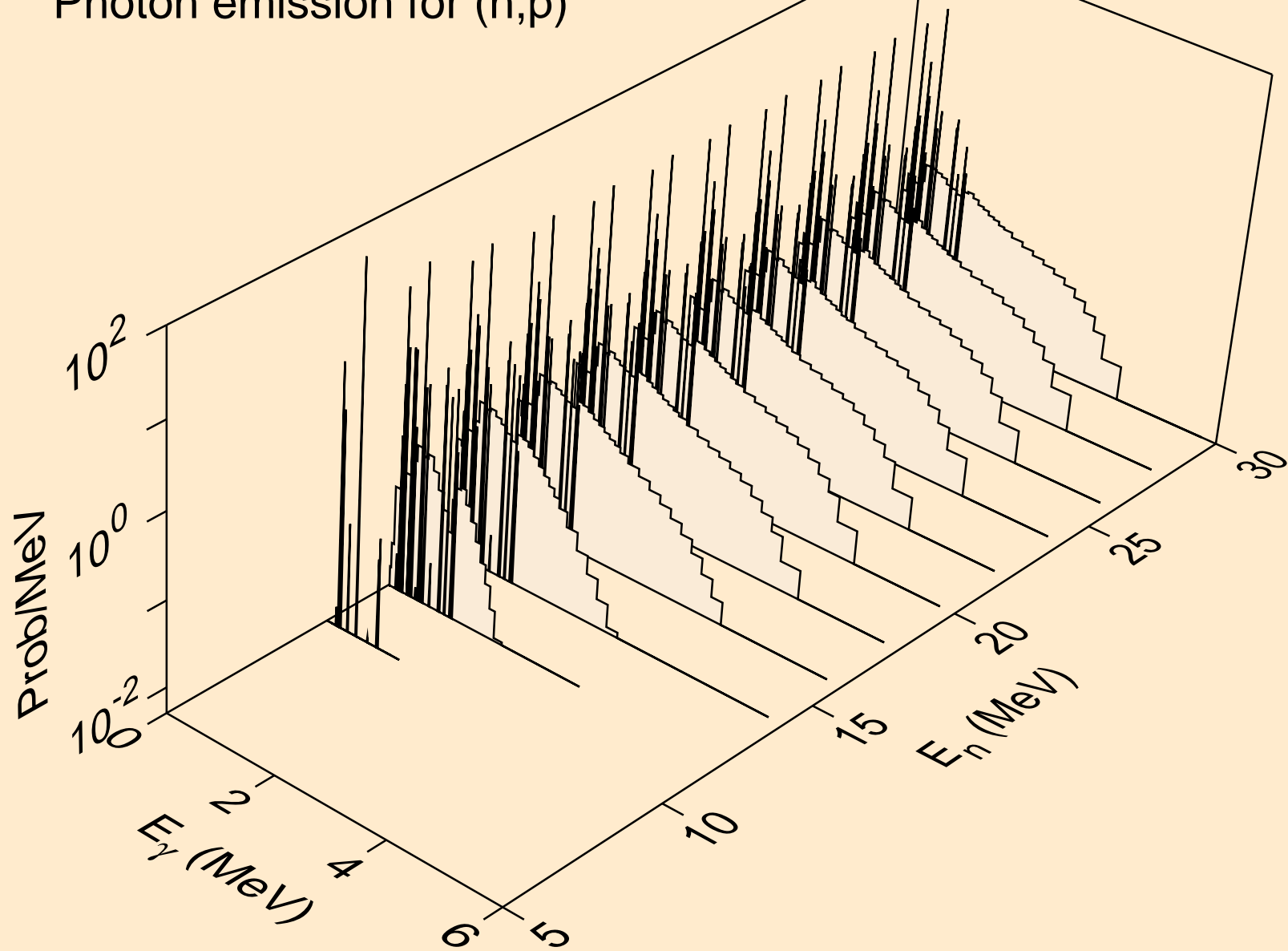

CR056 NEUTRON ACER TENDL-2024 LIBRARY; T=0.K
Photon emission for (n,d)

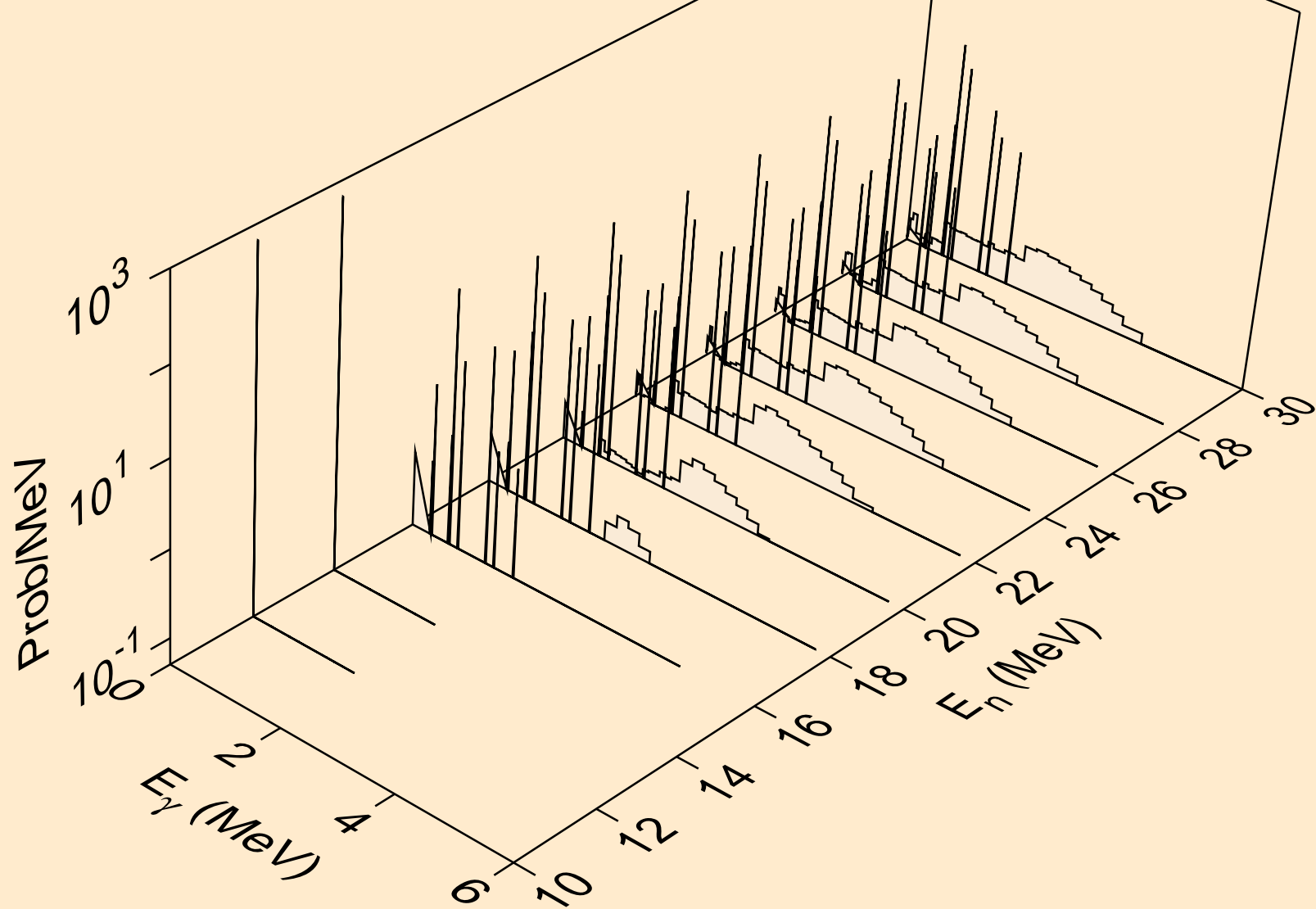

CR056 NEUTRON ACER TENDL-2024 LIBRARY; T=0.K
Photon emission for (n,t)

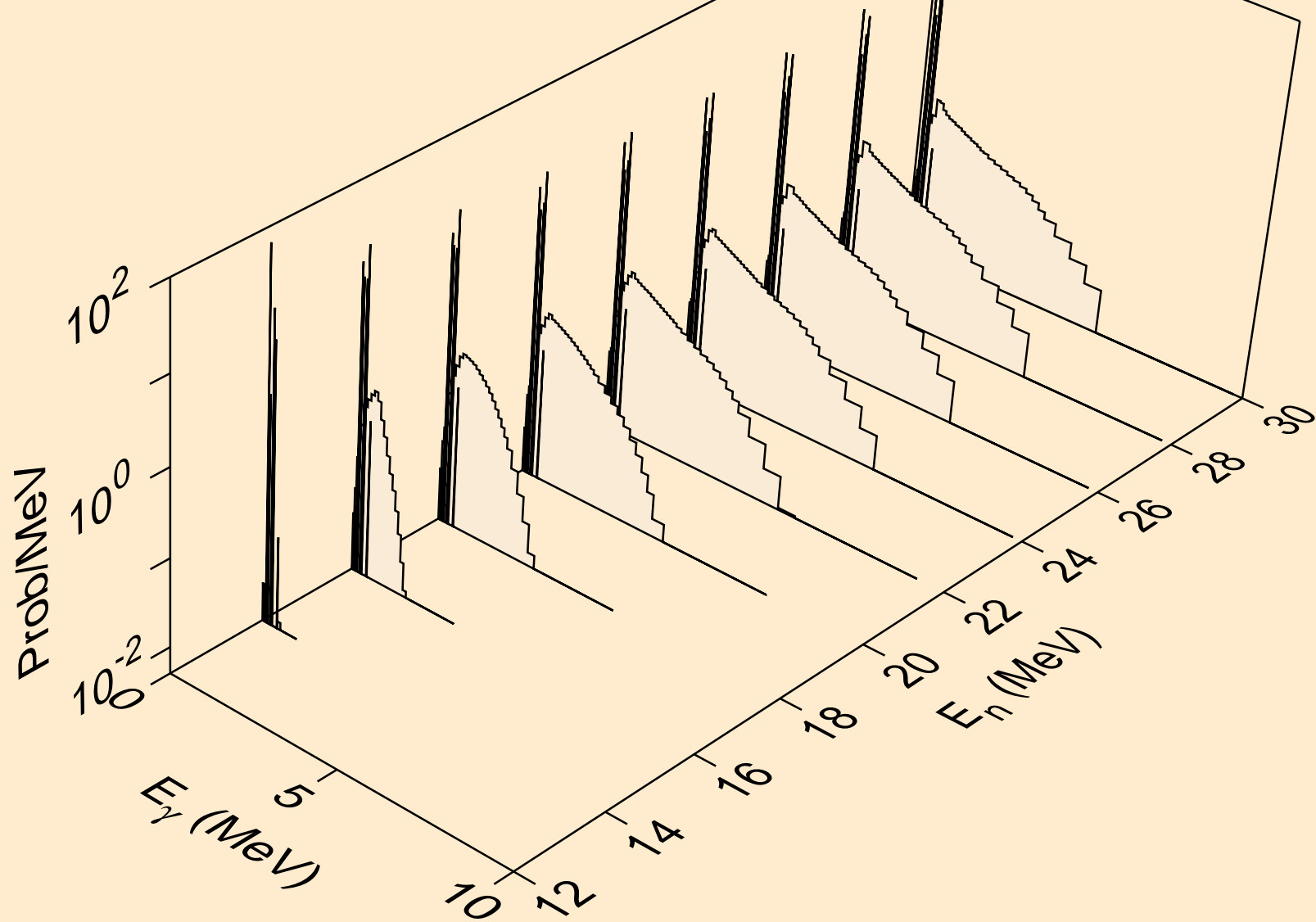

CR056 NEUTRON ACER TENDL-2024 LIBRARY; T=0.K
Photon emission for (n,he3)

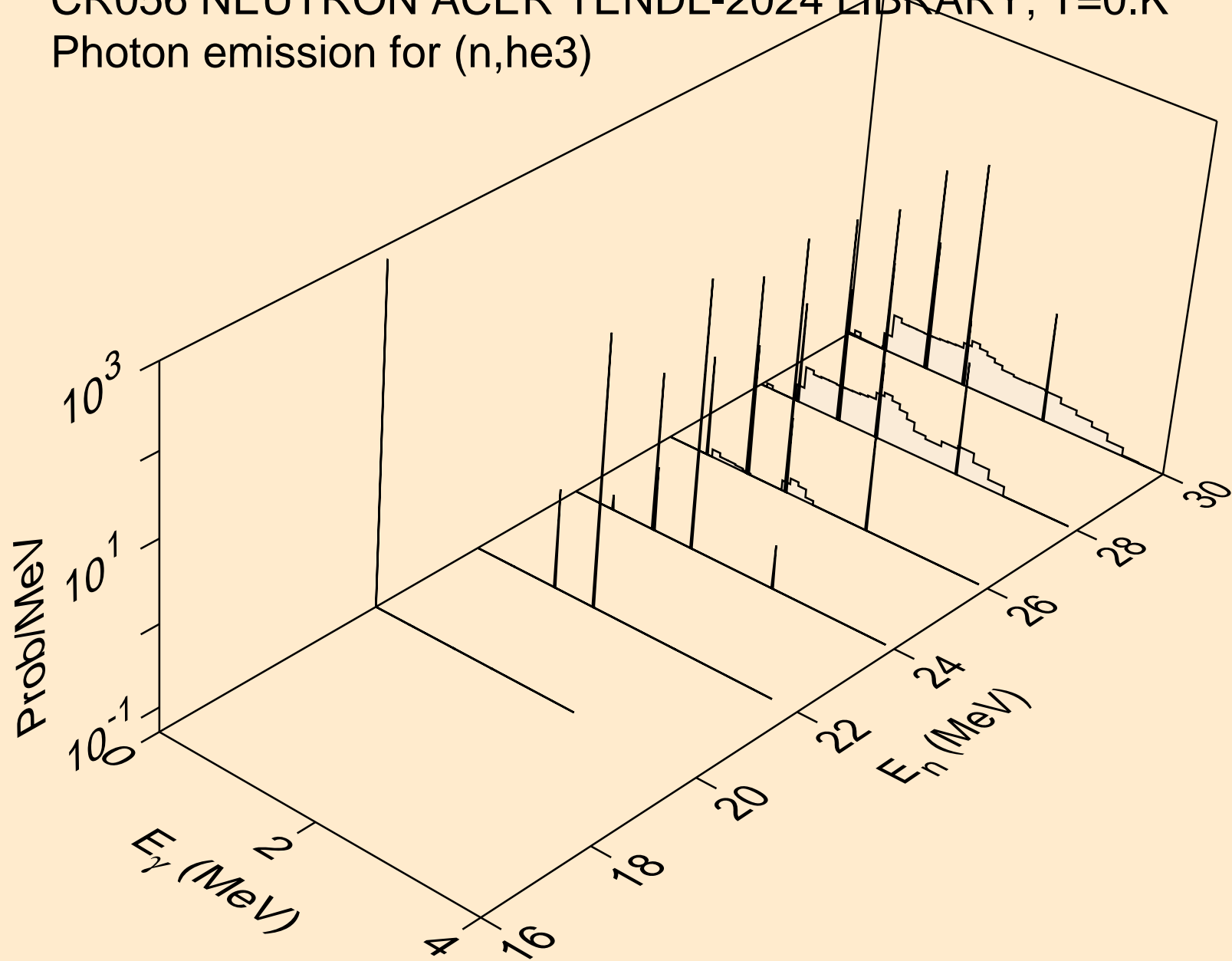

CR056 NEUTRON ACER TENDL-2024 LIBRARY; T=0.K
Photon emission for (n,a)

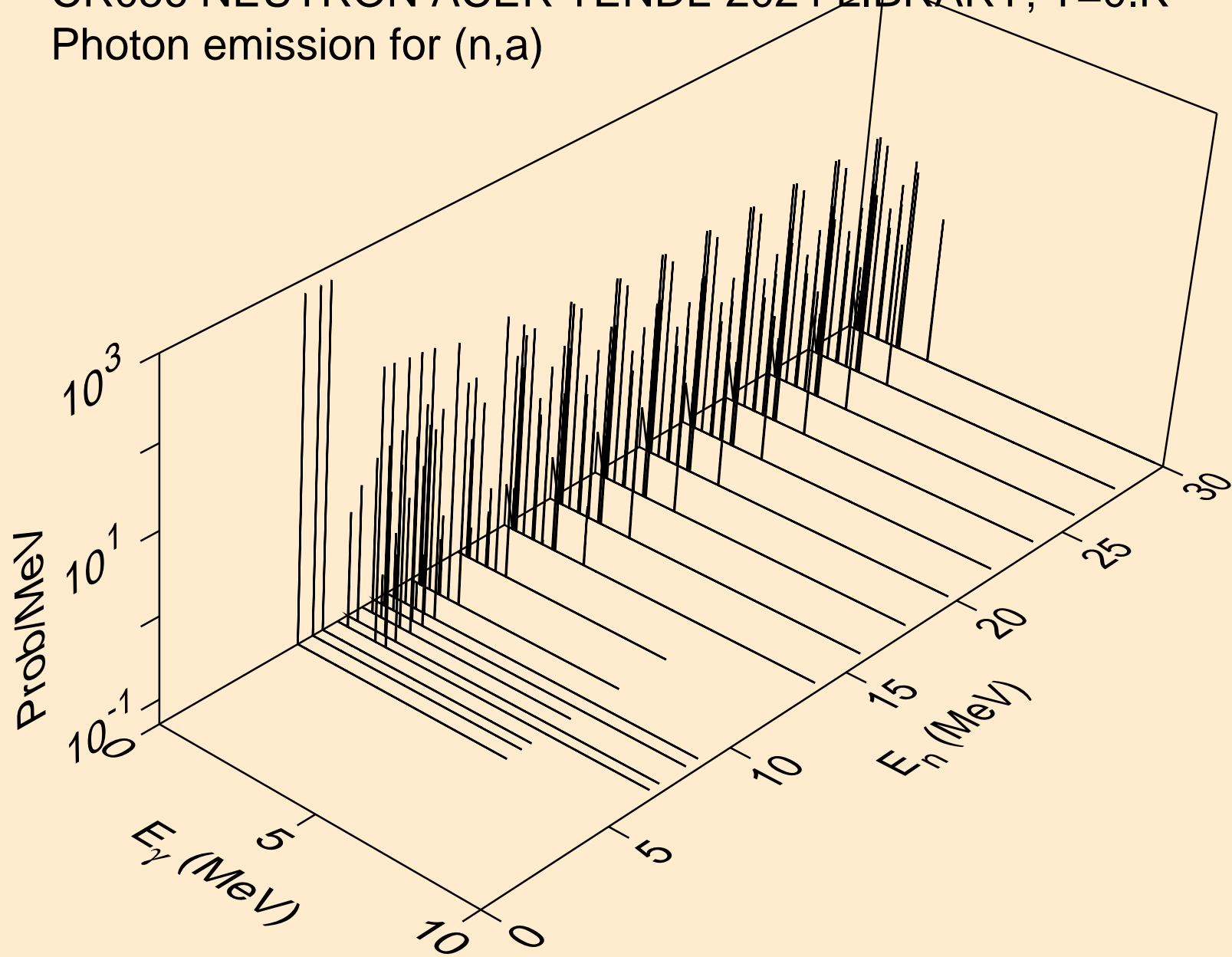

CR056 NEUTRON ACER TENDL-2024 LIBRARY; T=0.K
Photon emission for (n,2a)

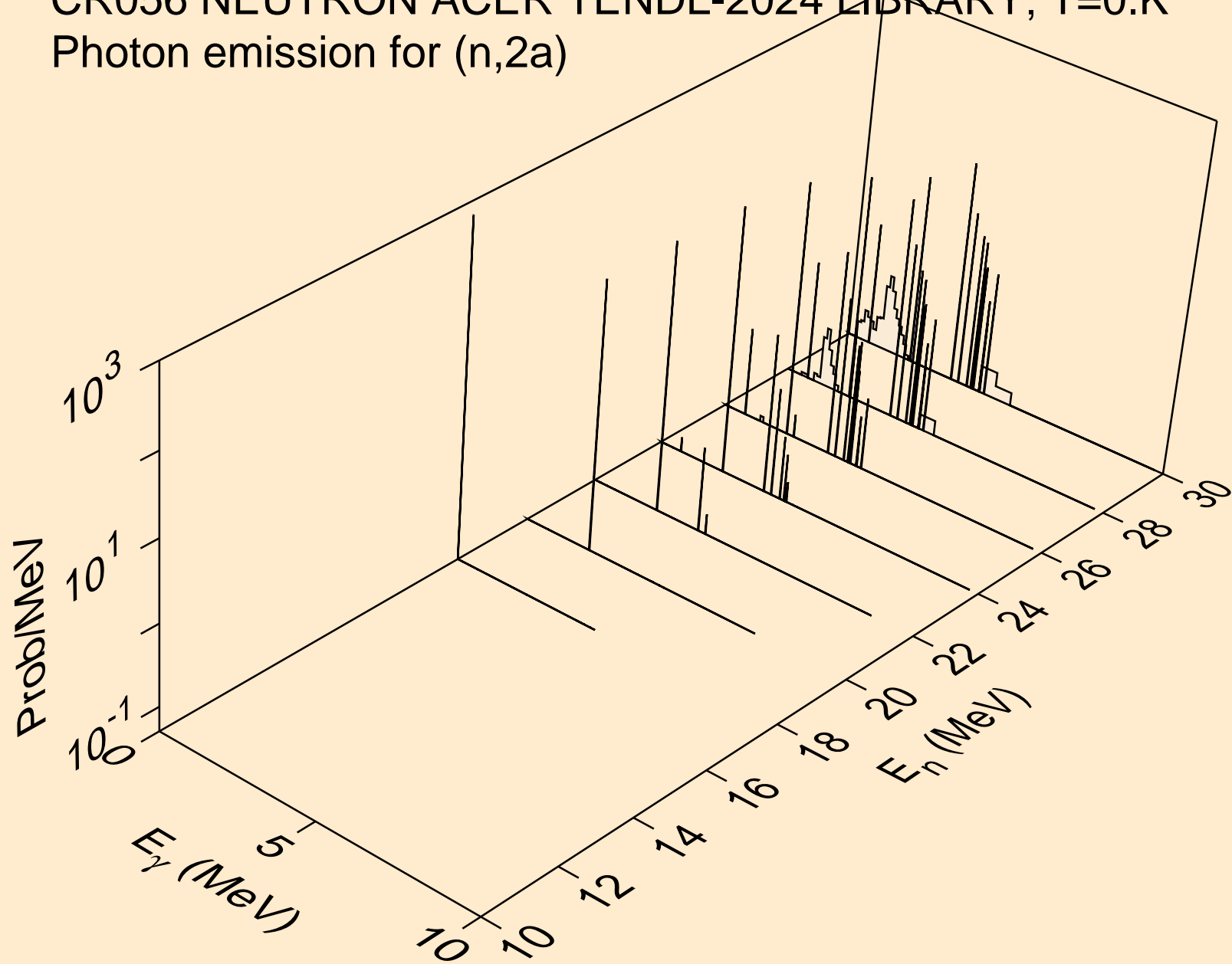

CR056 NEUTRON ACER TENDL-2024 LIBRARY; T=0.K
Photon emission for (n,2p)

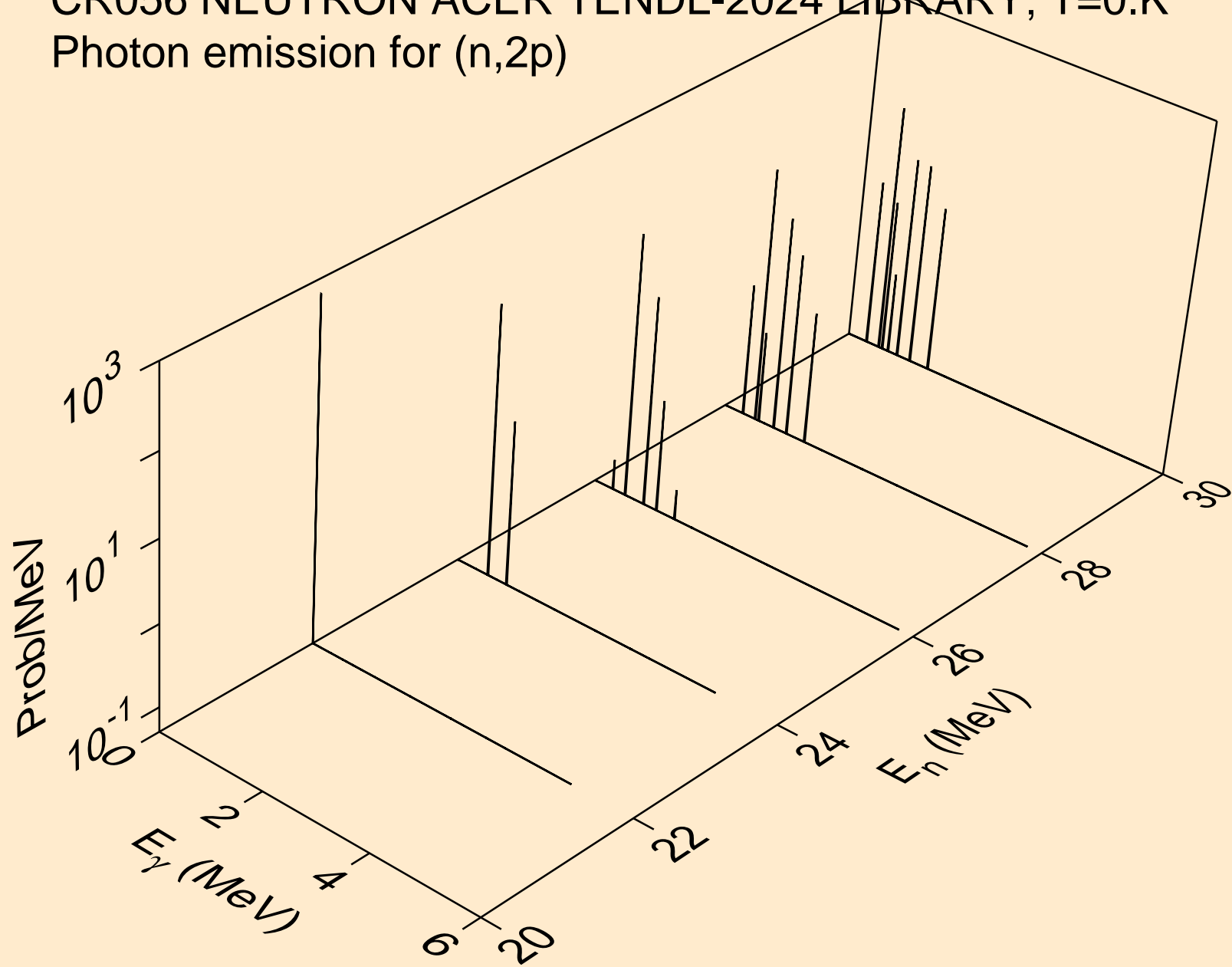

CR056 NEUTRON ACER TENDL-2024 LIBRARY; T=0.K
Photon emission for (n,p)

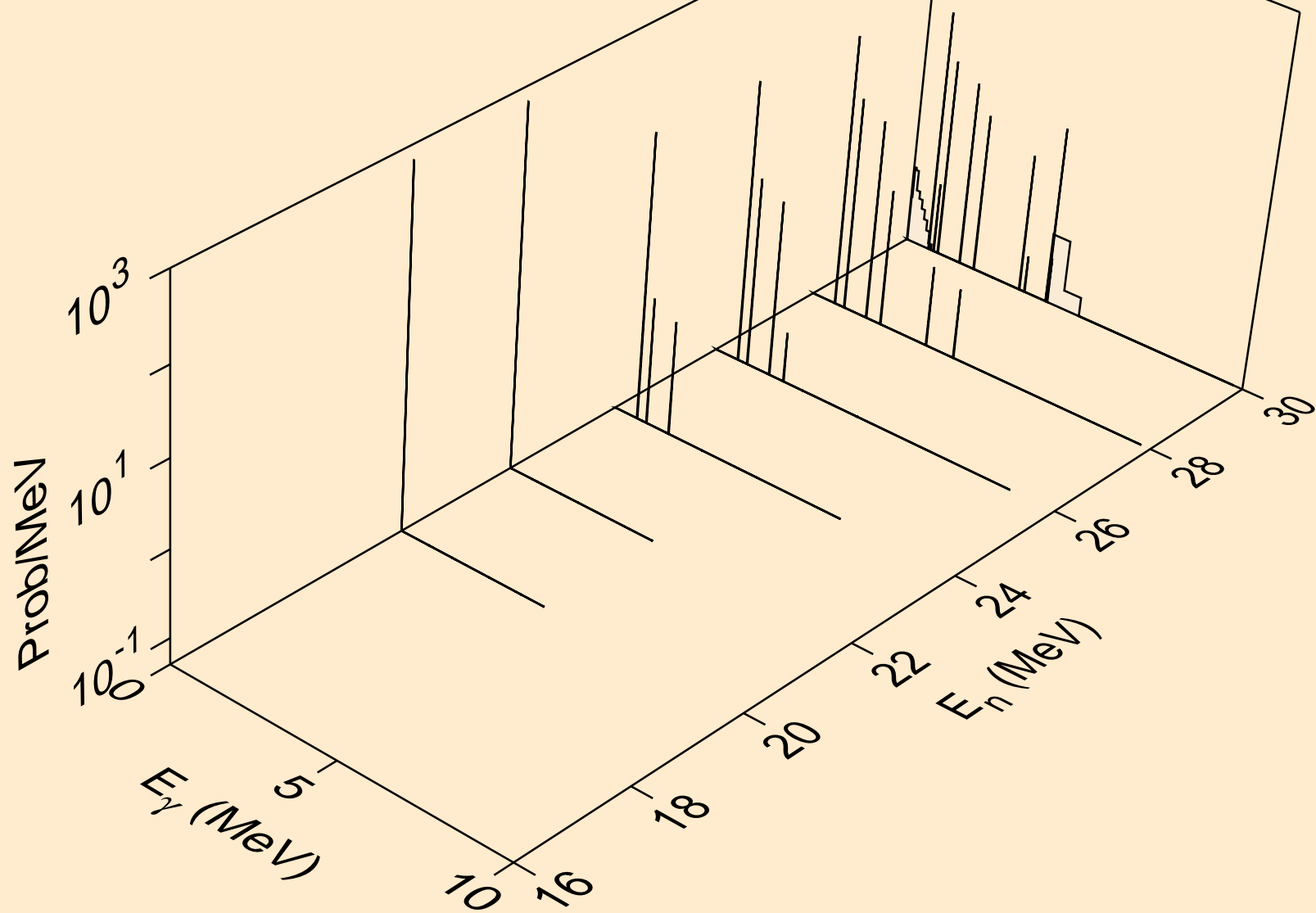

CR056 NEUTRON ACER TENDL-2024 LIBRARY; T=0.K
Photon emission for (n,pd)

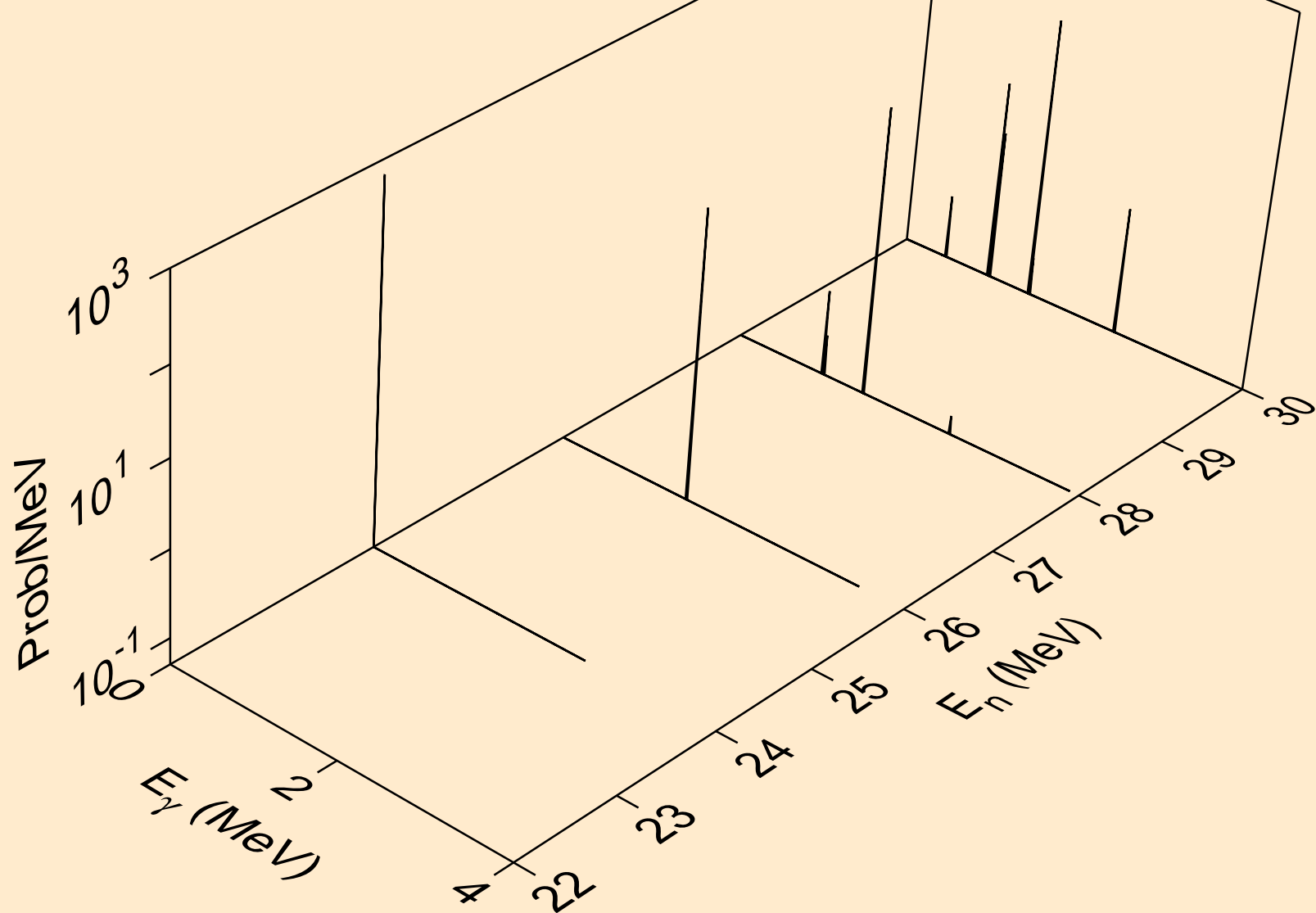

CR056 NEUTRON ACER TENDL-2024 LIBRARY; T=0.K
Photon emission for (n,pt)

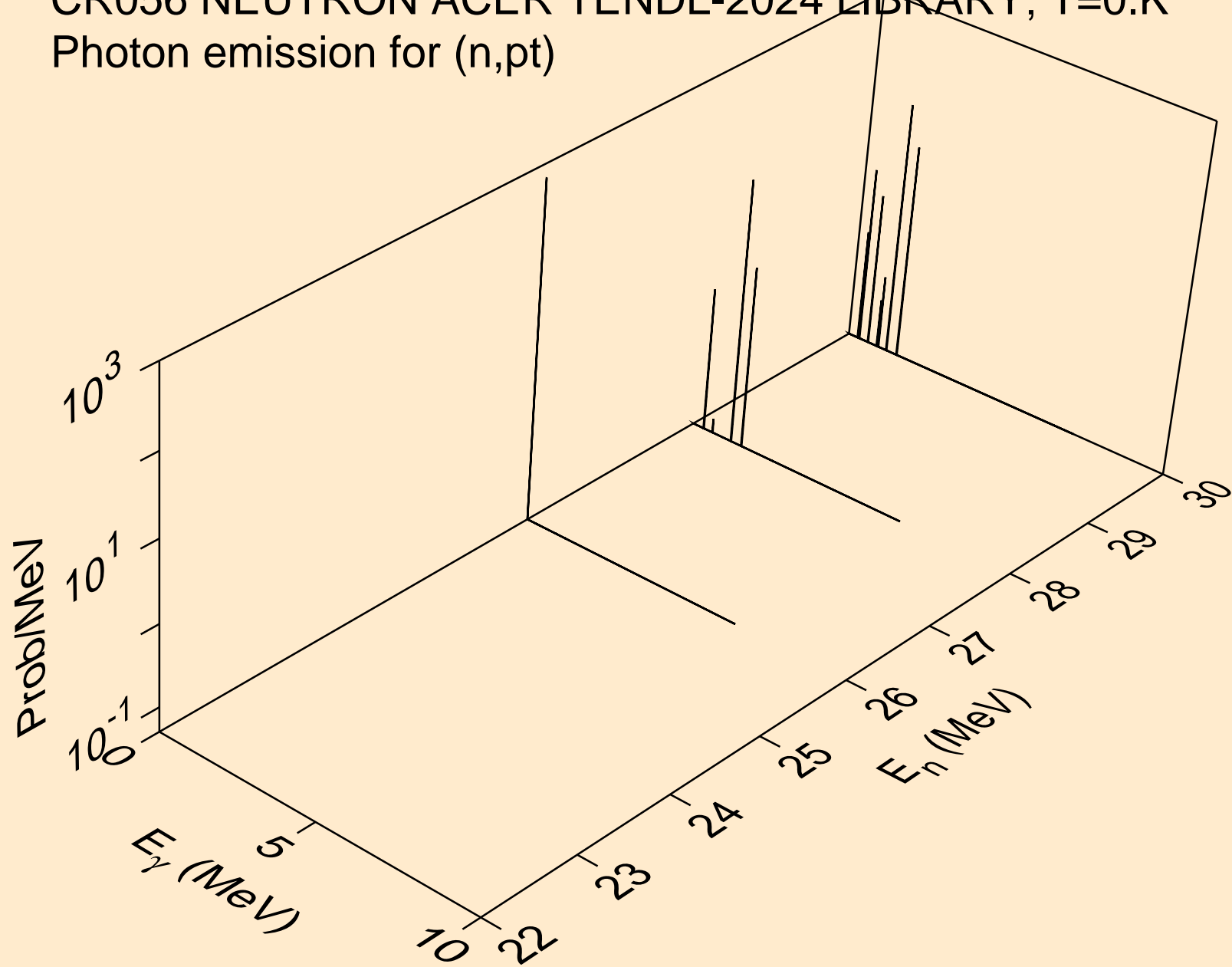

CR056 NEUTRON ACER TENDL-2024 LIBRARY; T=0.K
Photon emission for (n,da)

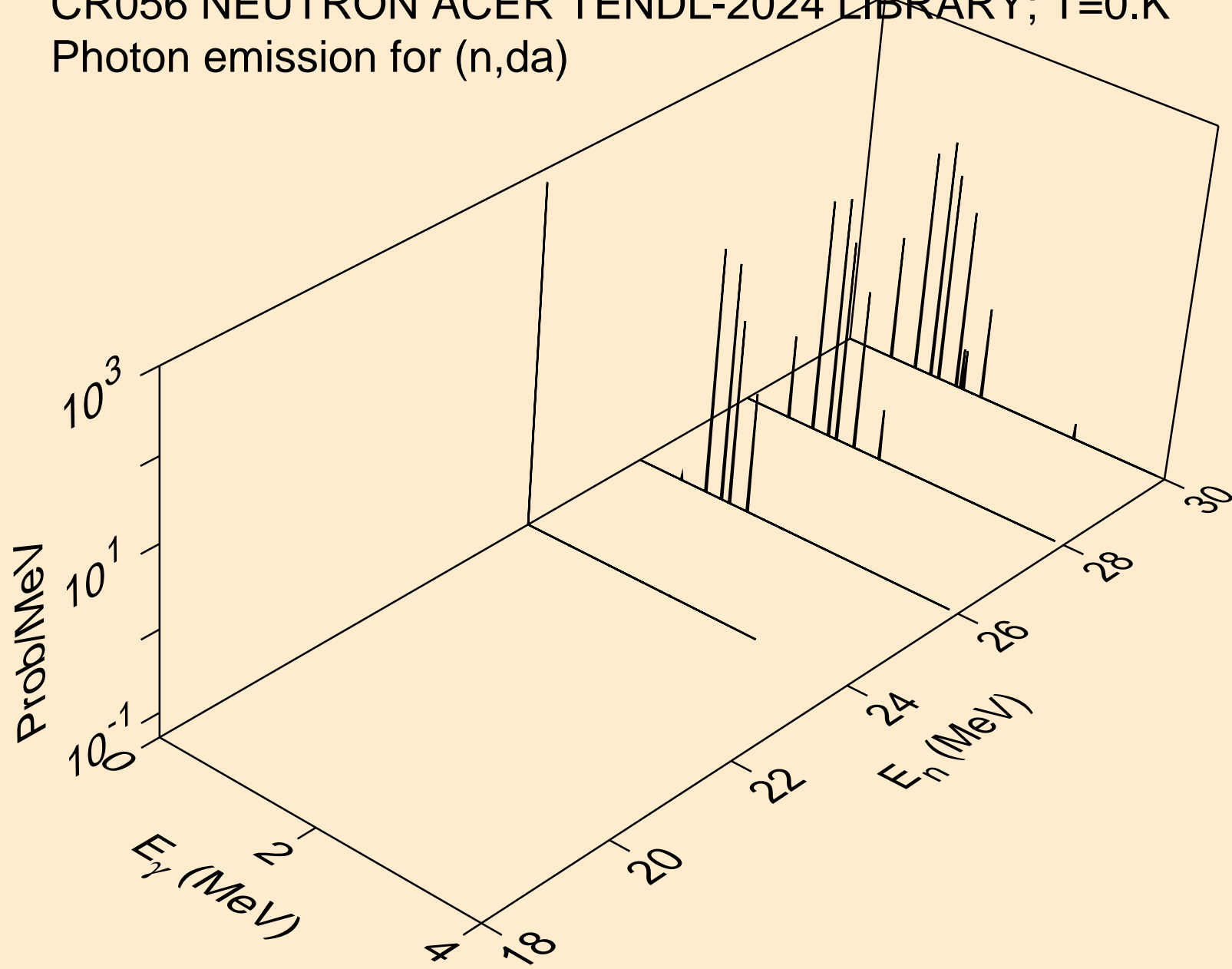

CR056 NEUTRON ACER TENDL-2024 LIBRARY; T=0.K
thermal capture photon spectrum

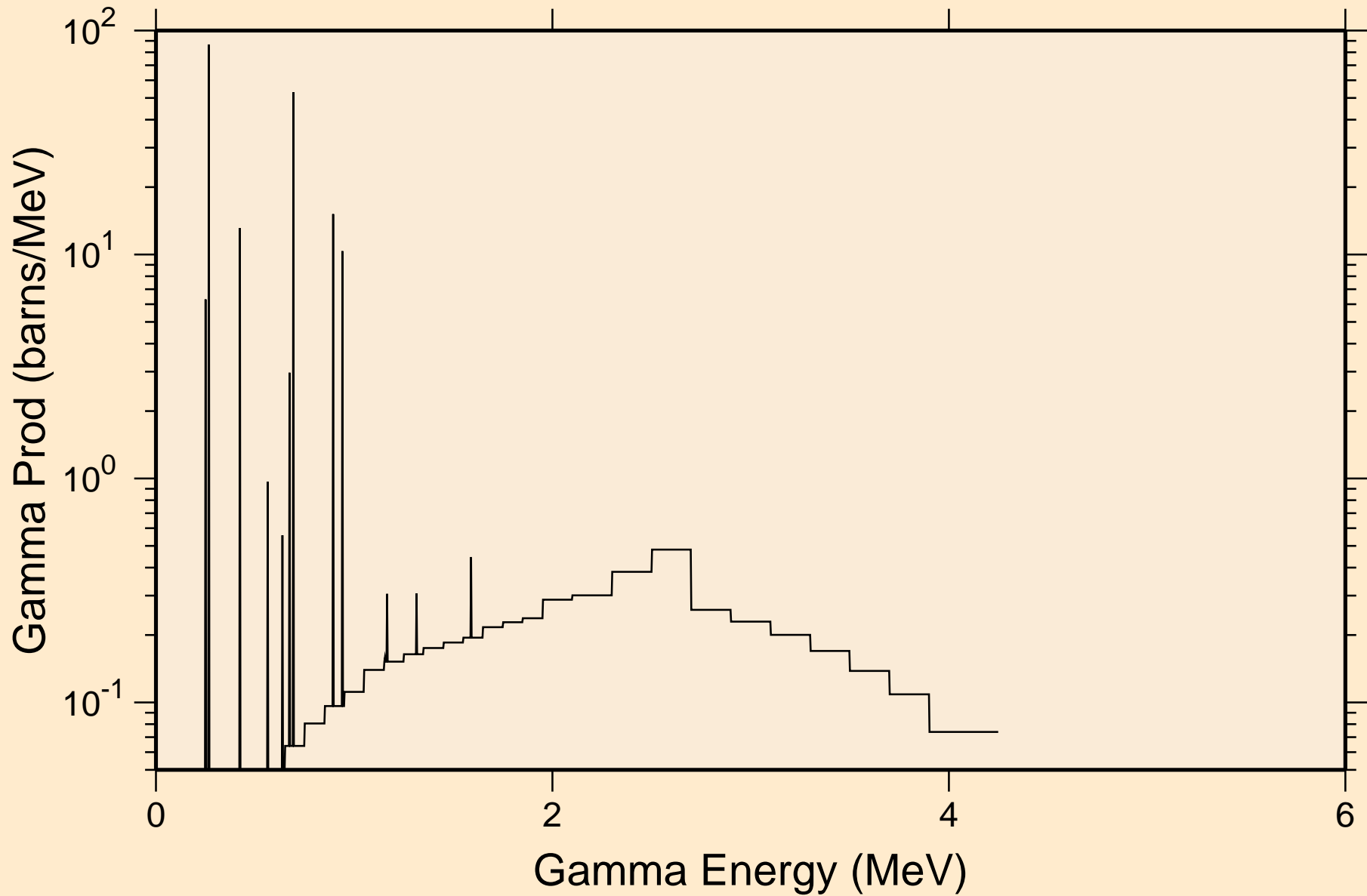

CR056 NEUTRON ACER TENDL-2024 LIBRARY; T=0.K
14 MeV photon spectrum

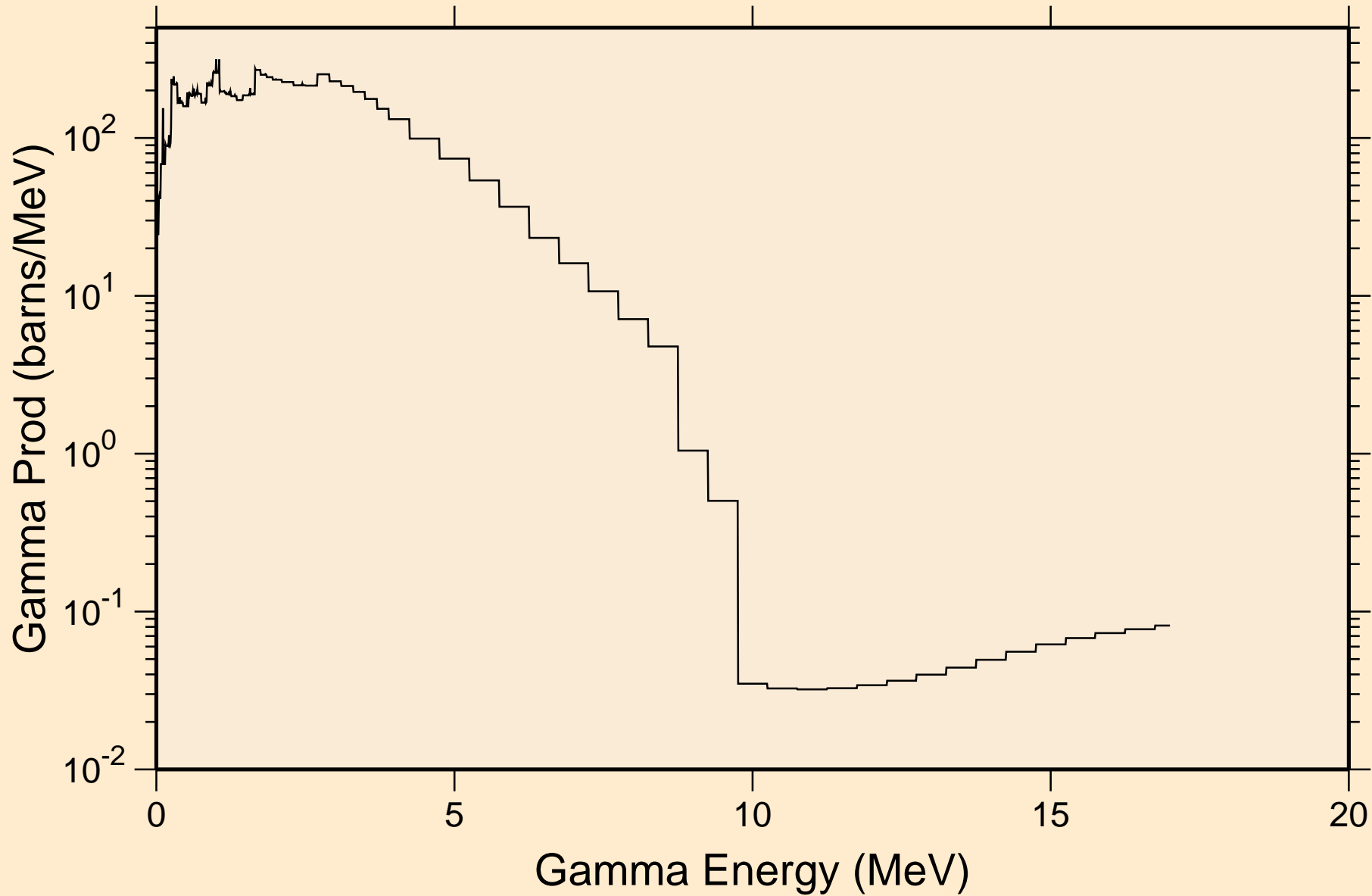

CR056 NEUTRON ACER TENDL-2024 LIBRARY; T=0.K

Particle heating contributions

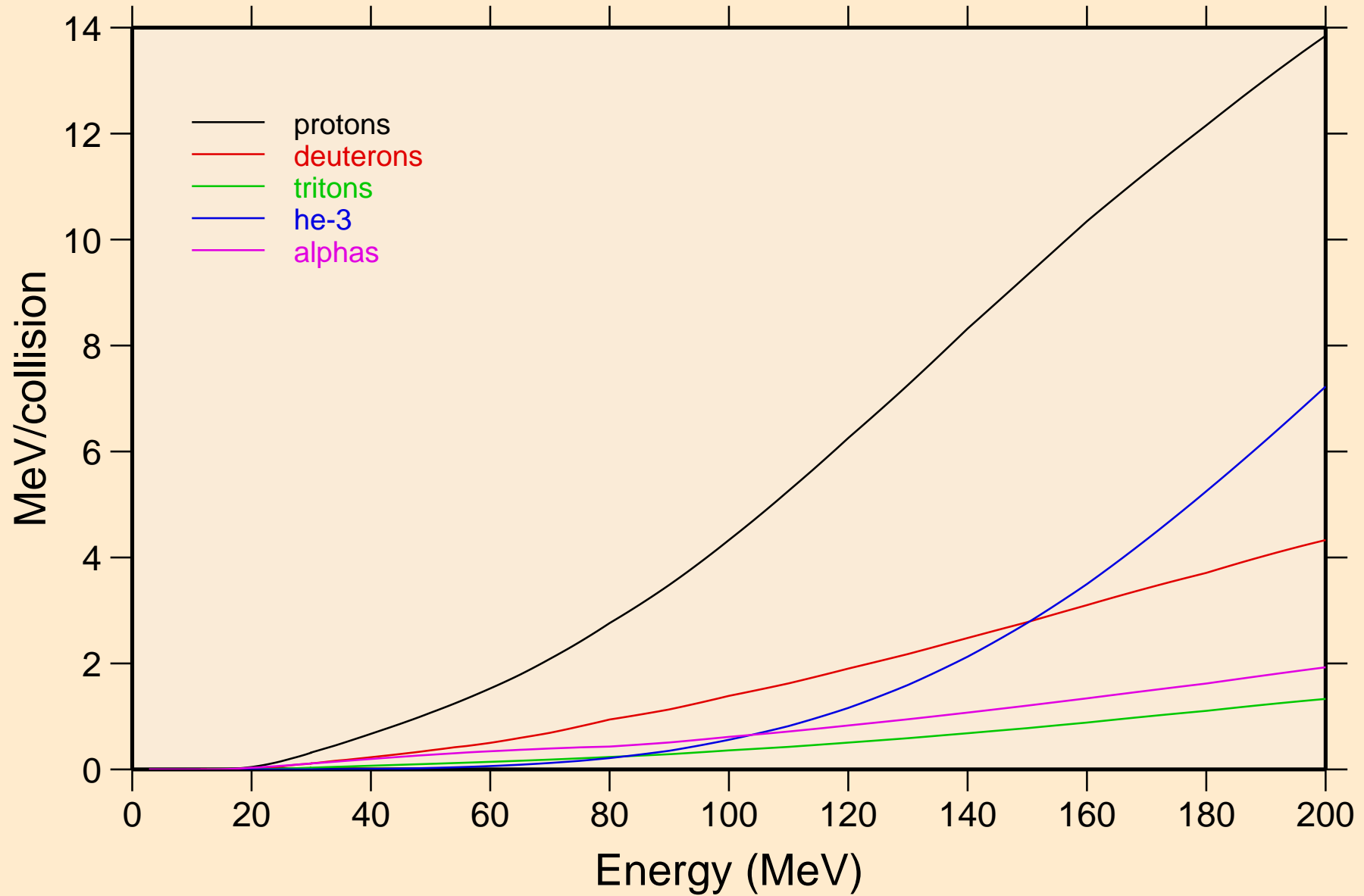

CR056 NEUTRON ACER TENDL-2024 LIBRARY; T=0.K
Recoil Heating

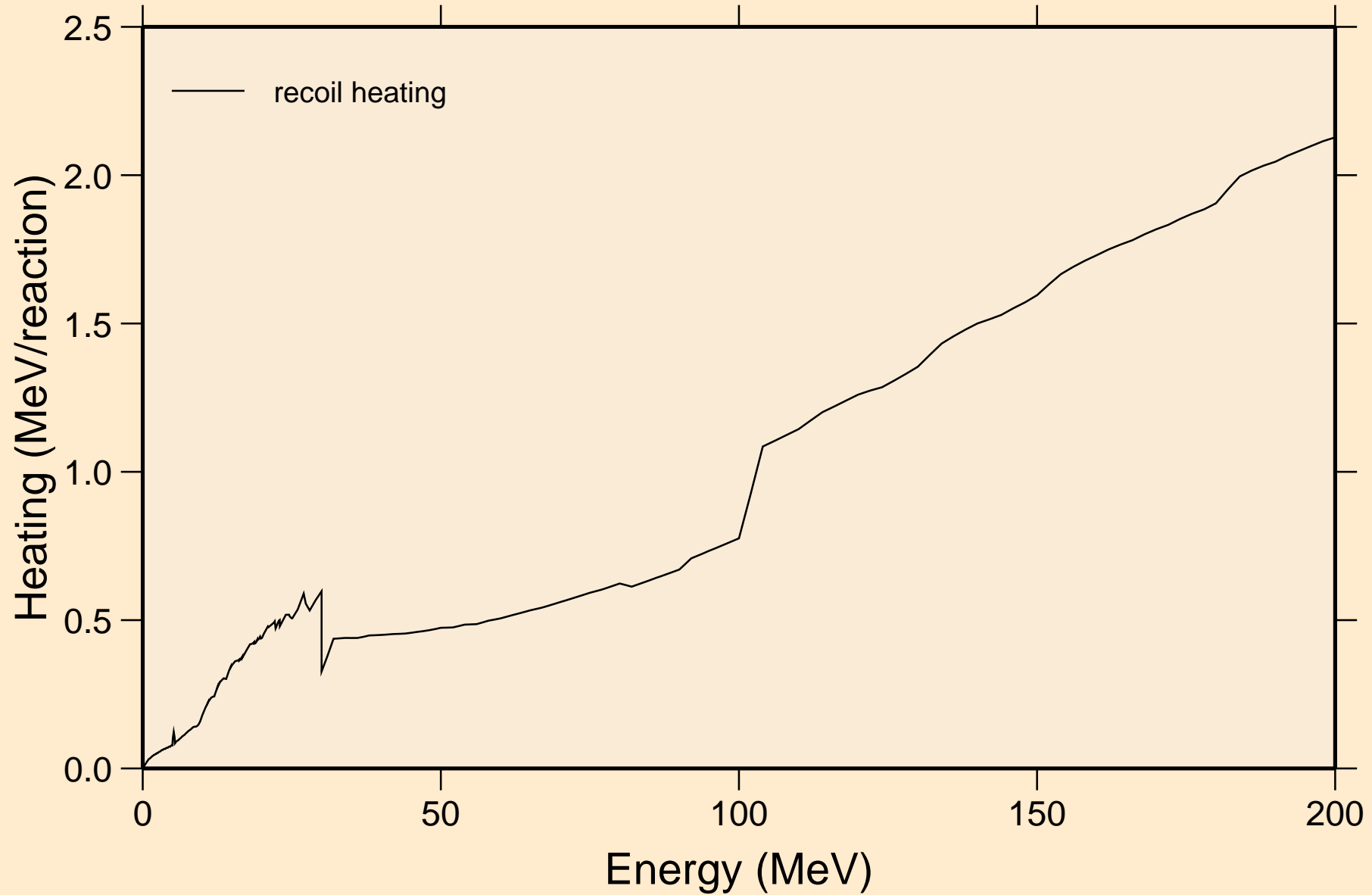

CR056 NEUTRON ACER TENDL-2024 LIBRARY; T=0.K

Particle production cross sections

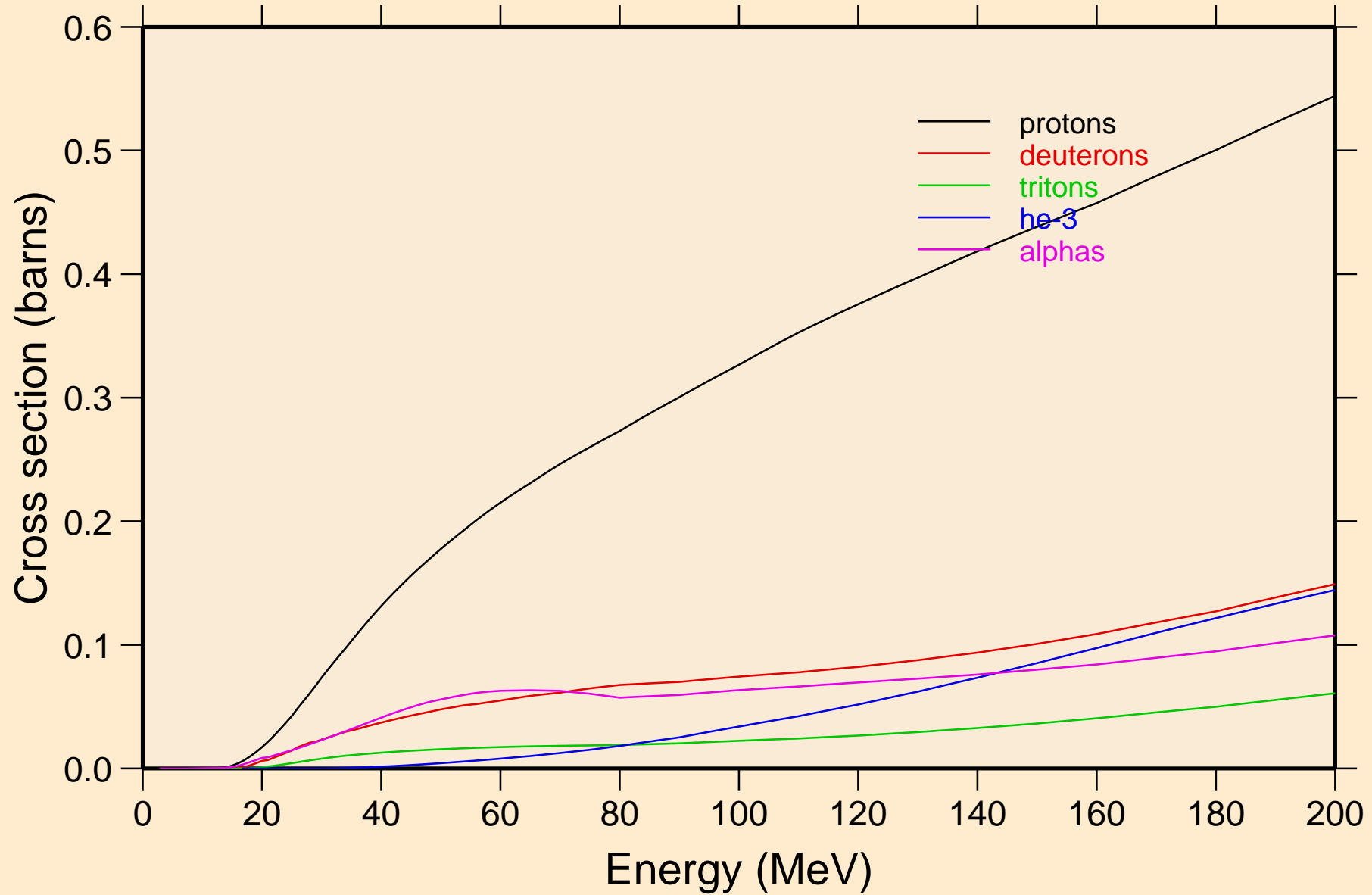

CR056 NEUTRON ACER TENDL-2024 LIBRARY; T=0.K
protons from (n,x)

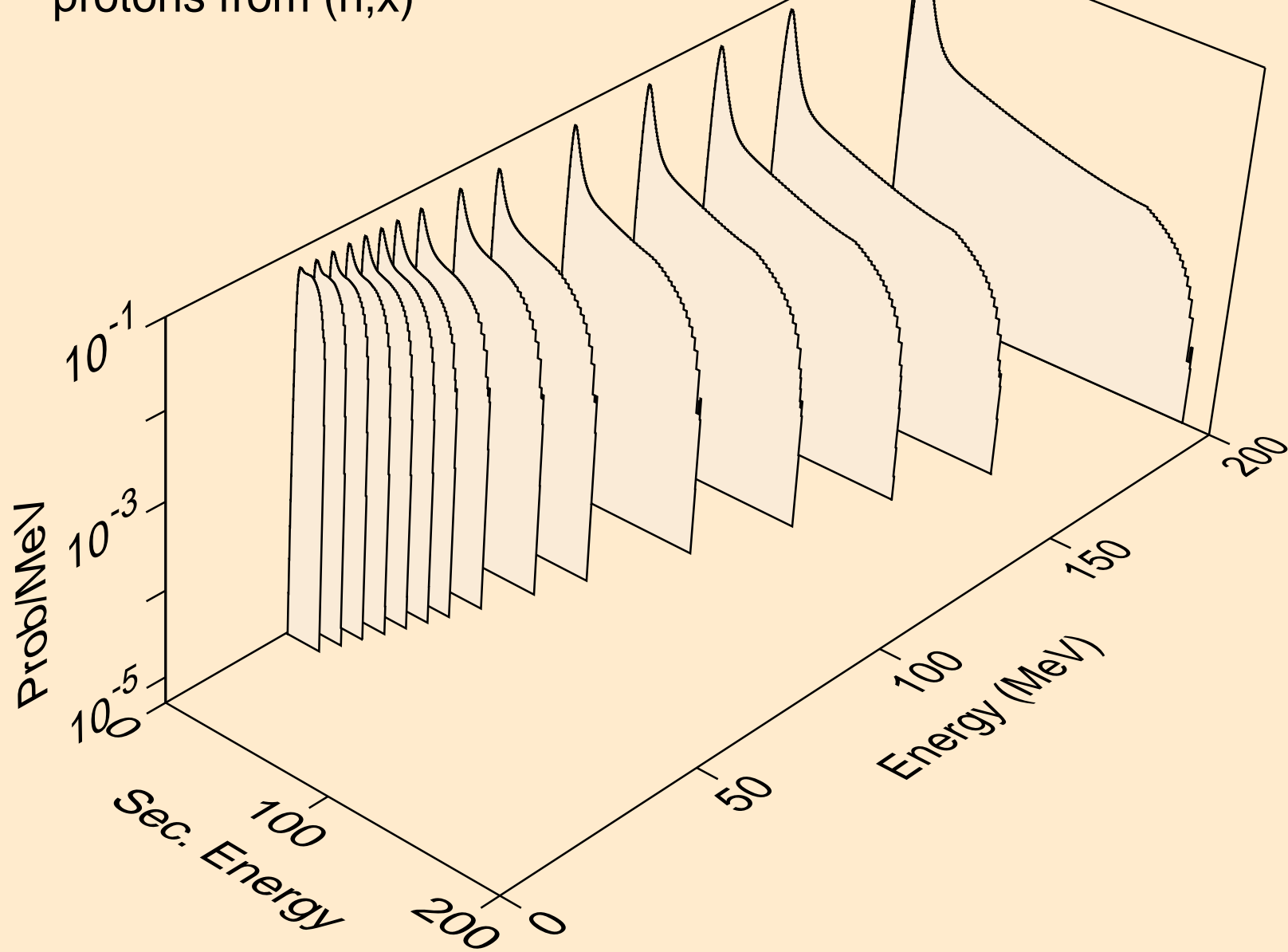

CR056 NEUTRON ACER TENDL-2024 LIBRARY; T=0.K
protons from (n,n*)p

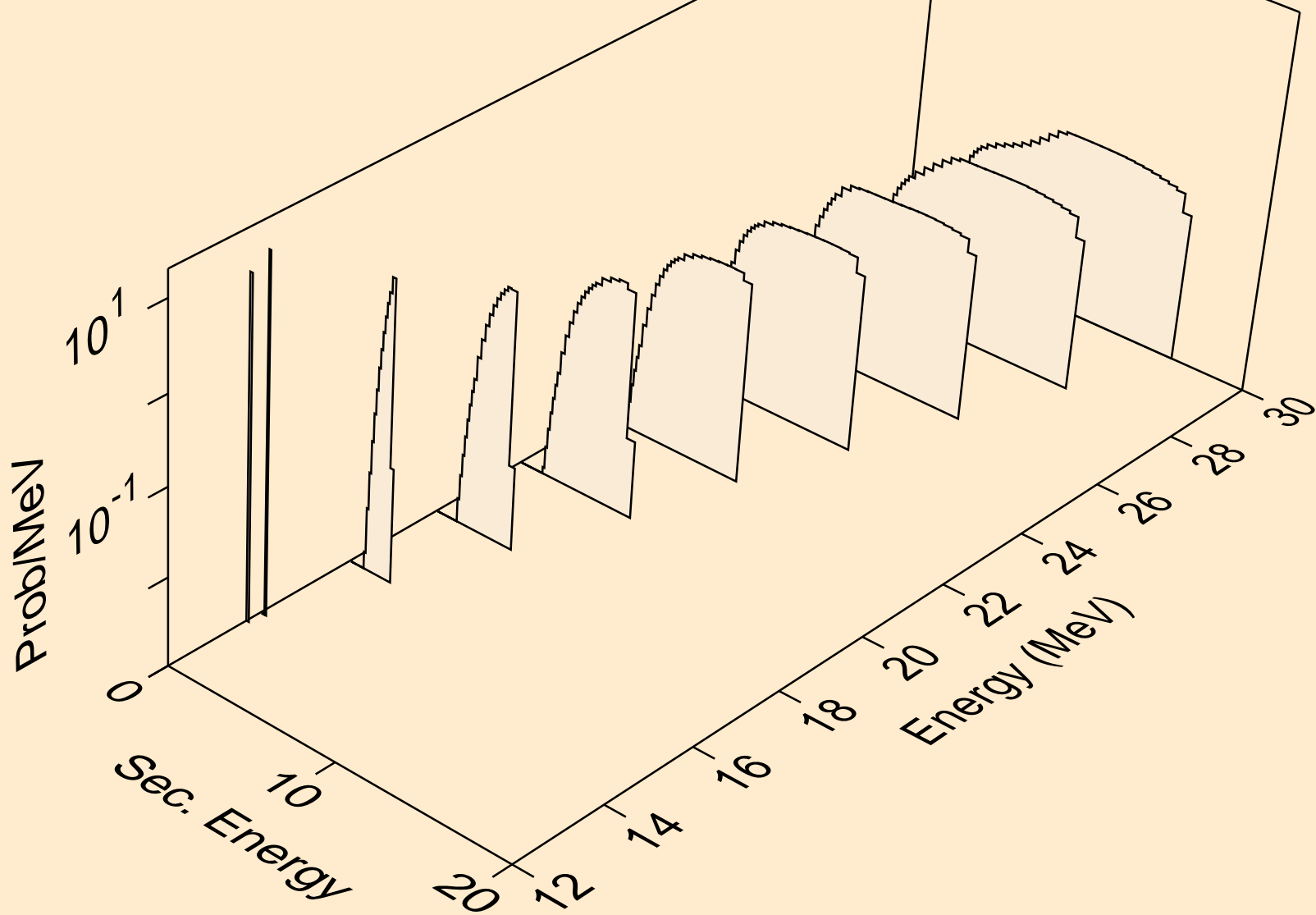

CR056 NEUTRON ACER TENDL-2024 LIBRARY; T=0.K
protons from (n,2np)

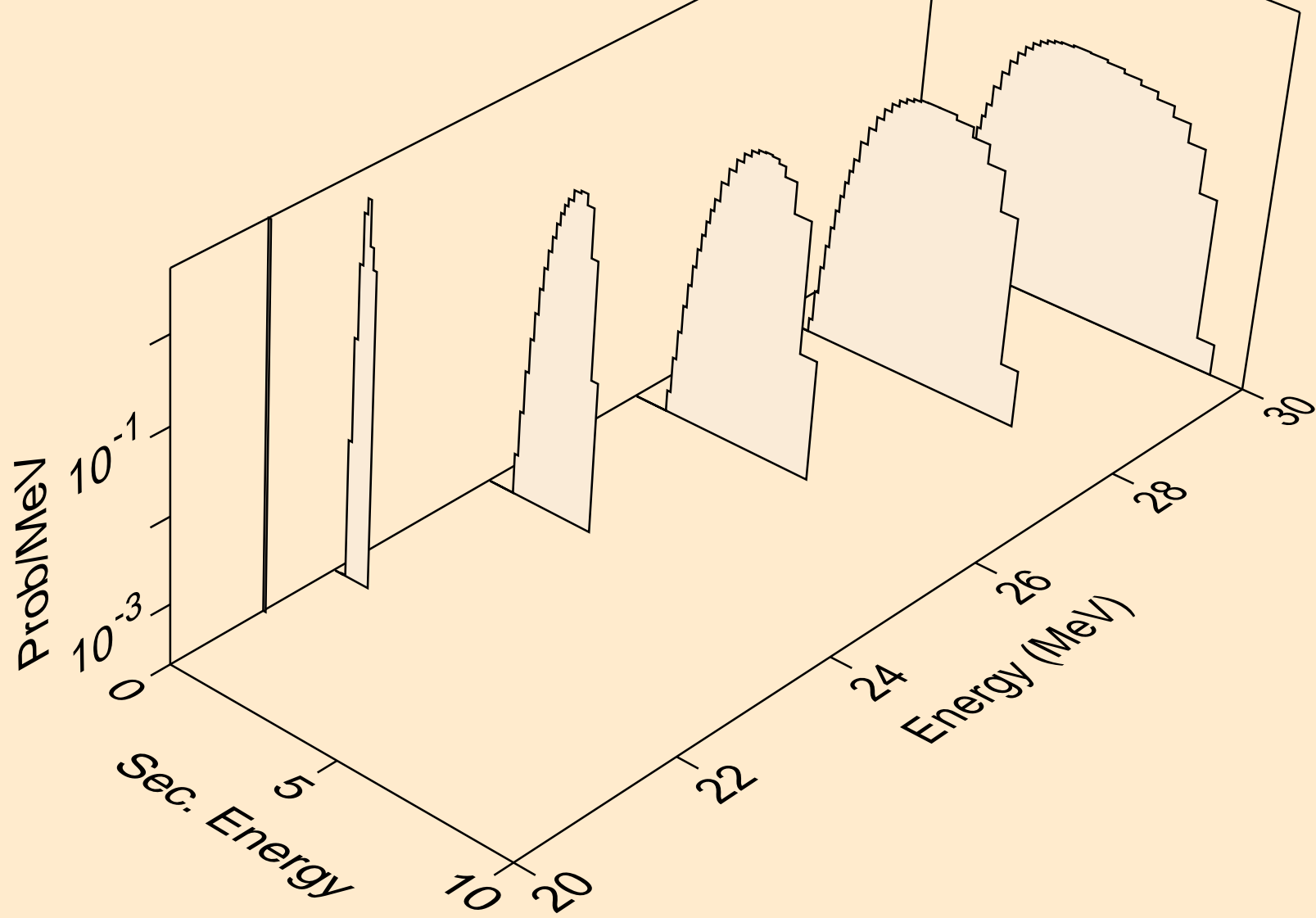

CR056 NEUTRON ACER TENDL-2024 LIBRARY; T=0.K
protons from (n,3np)

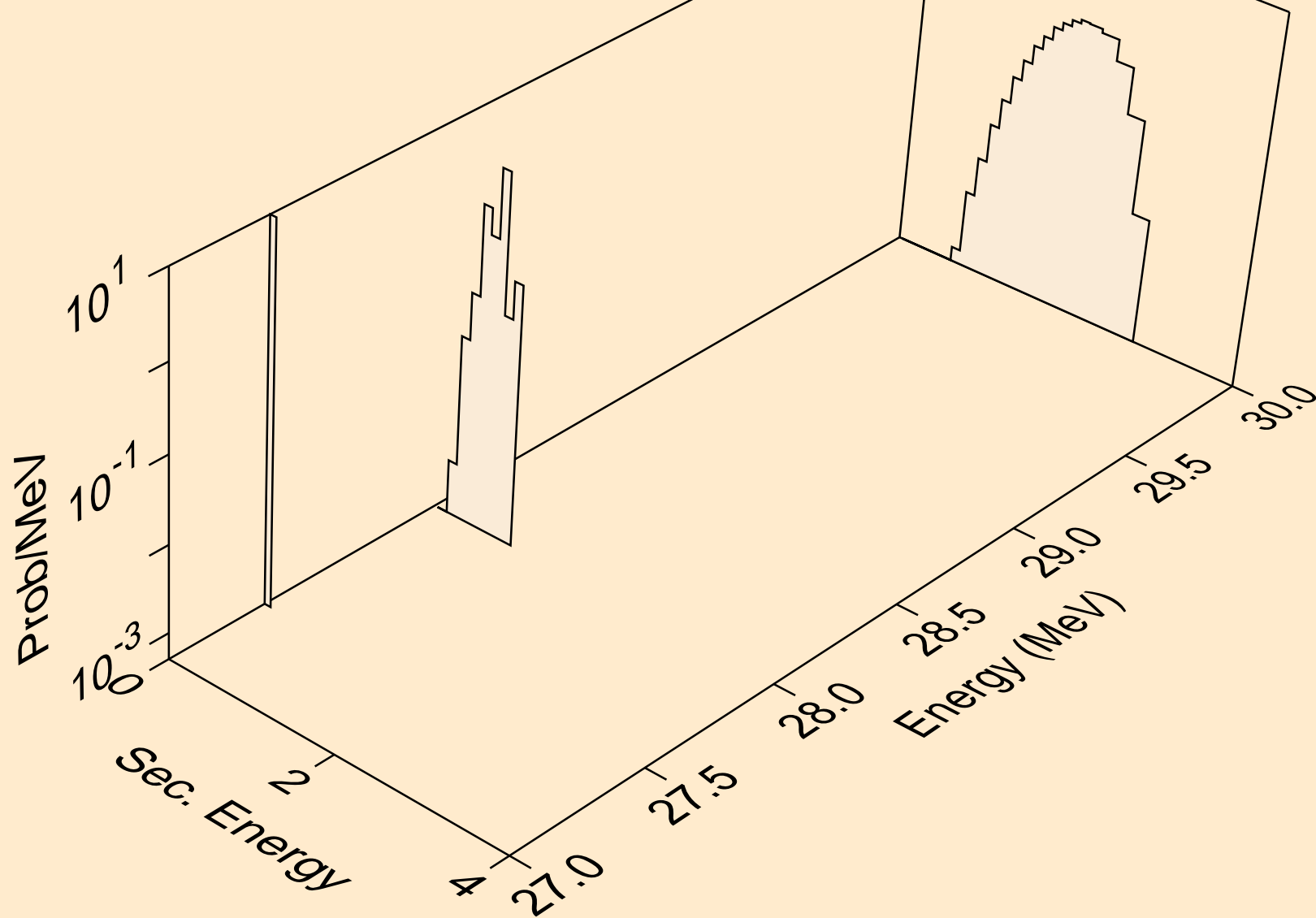

CR056 NEUTRON ACER TENDL-2024 LIBRARY; T=0.K
protons from (n,n2p)

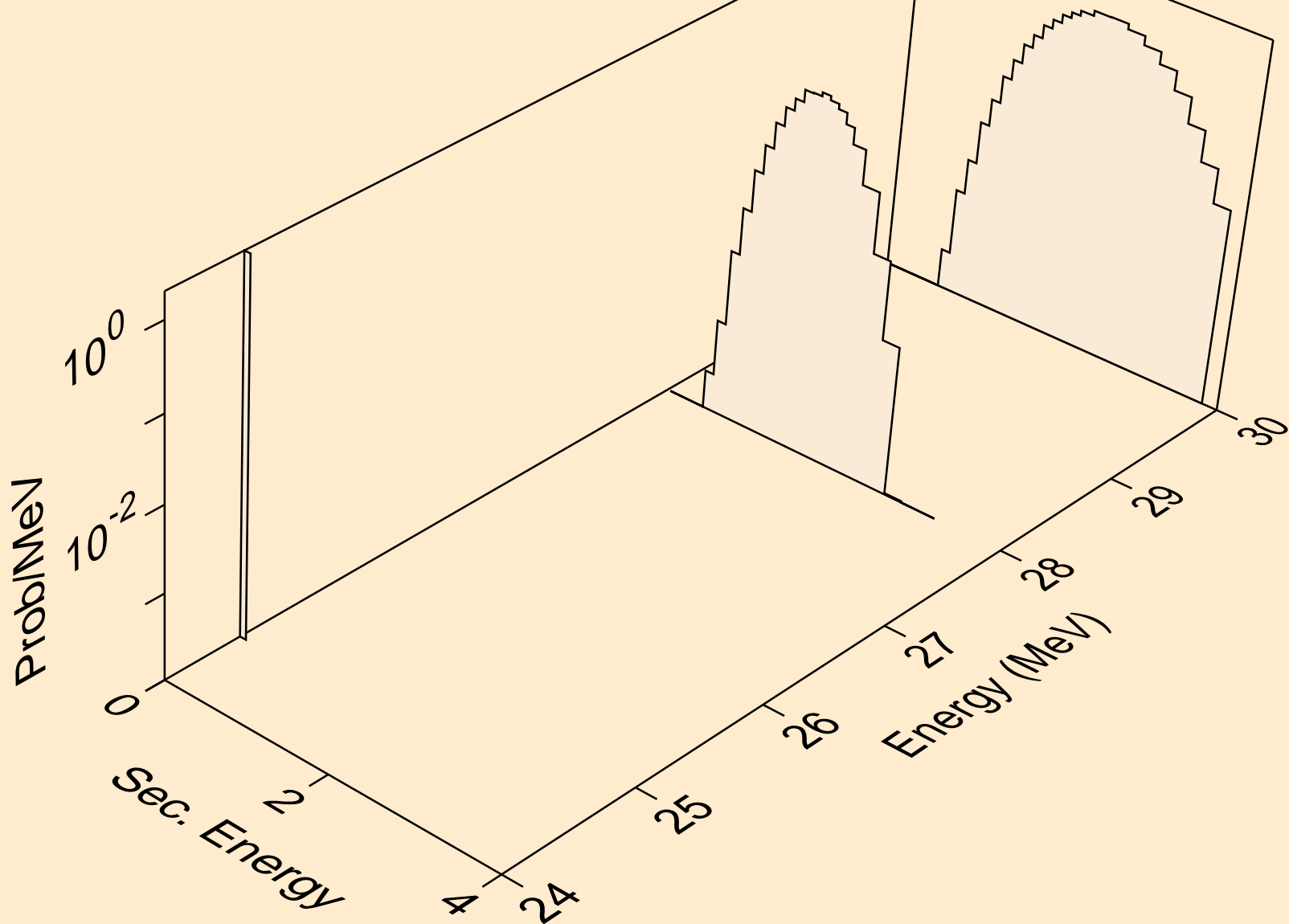

CR056 NEUTRON ACER TENDL-2024 LIBRARY; T=0.K
protons from (n,npa)

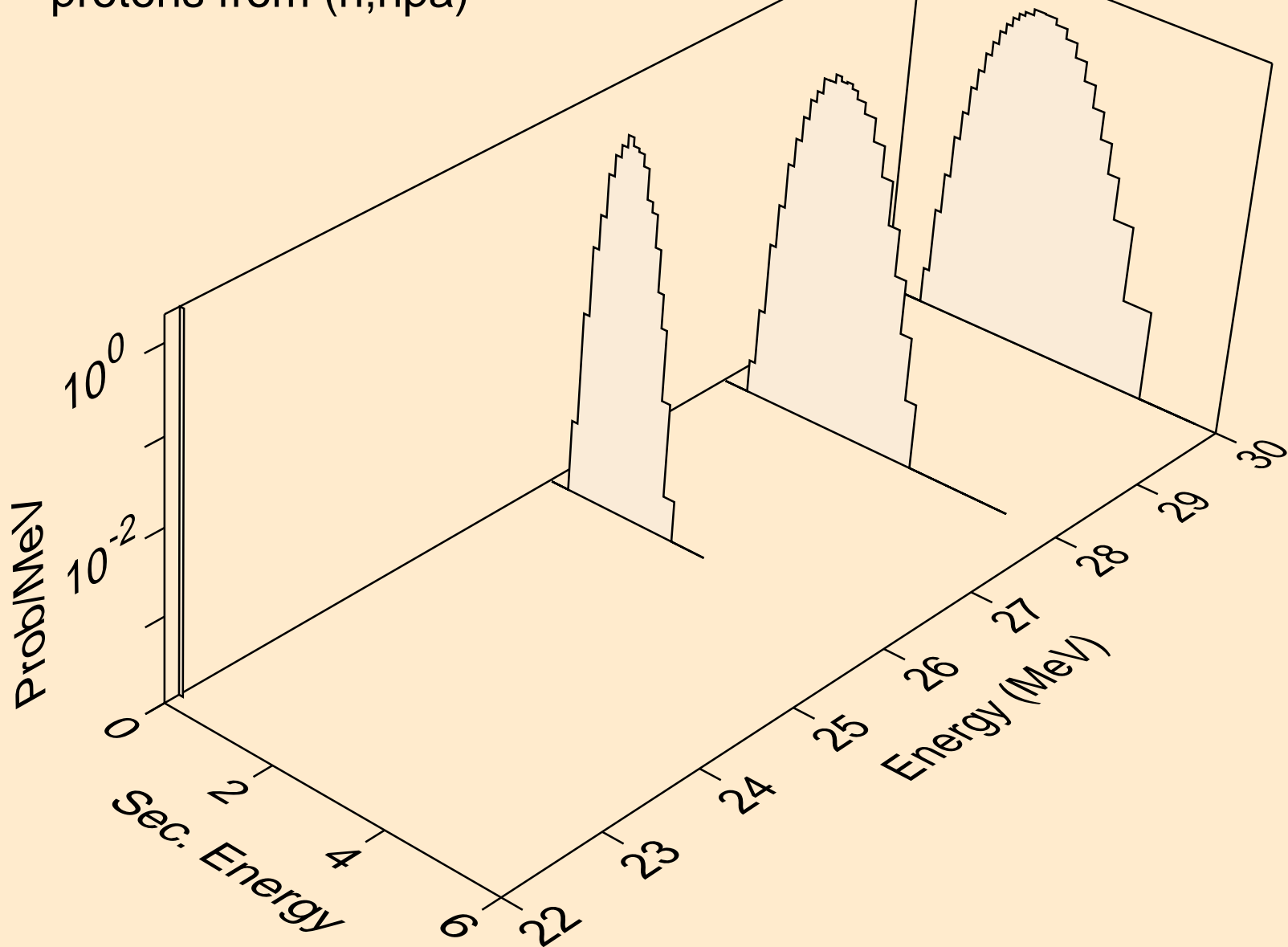

CR056 NEUTRON ACER TENDL-2024 LIBRARY; T=0.K
protons from (n,p)

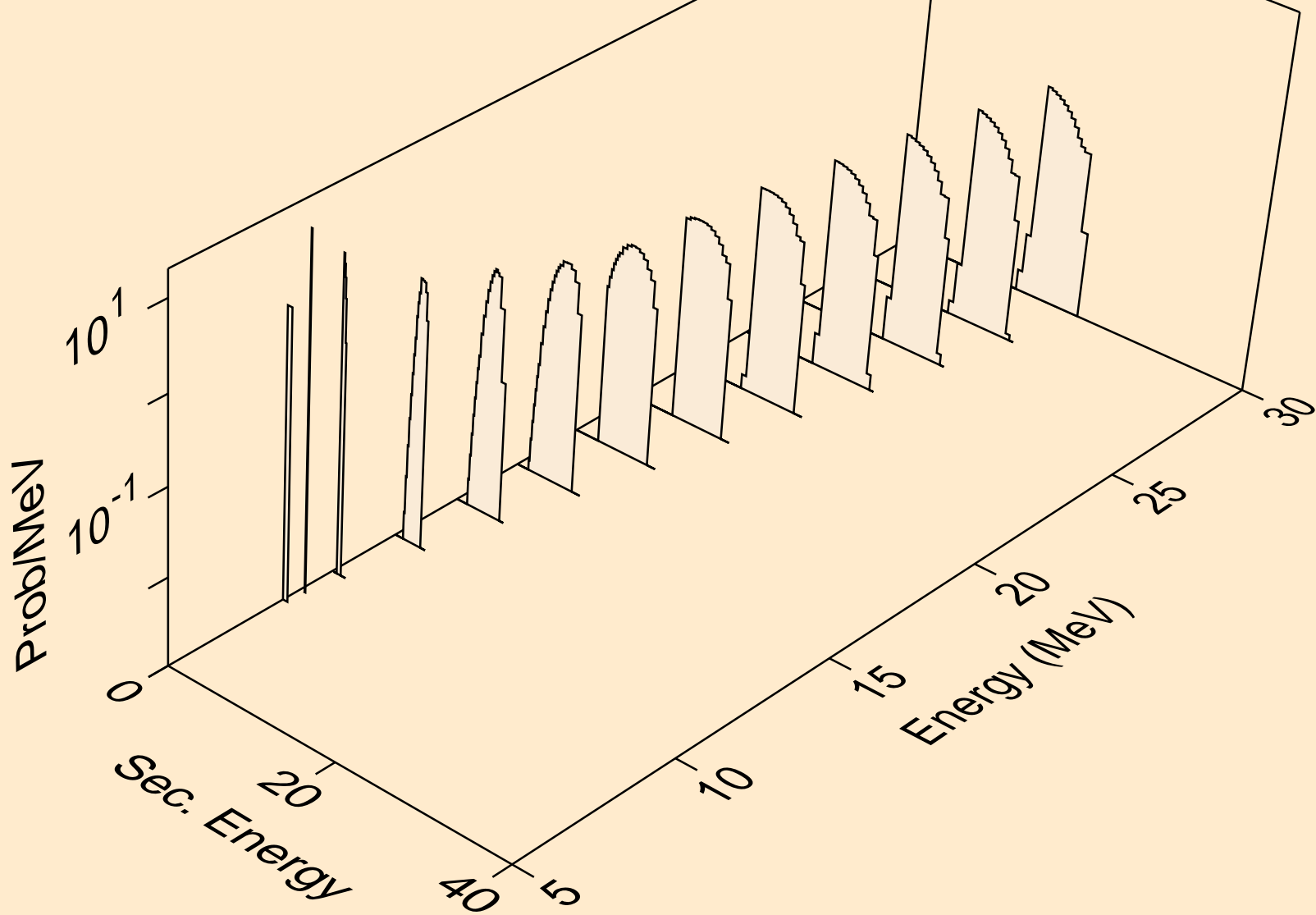

CR056 NEUTRON ACER TENDL-2024 LIBRARY; T=0.K
protons from (n,2p)

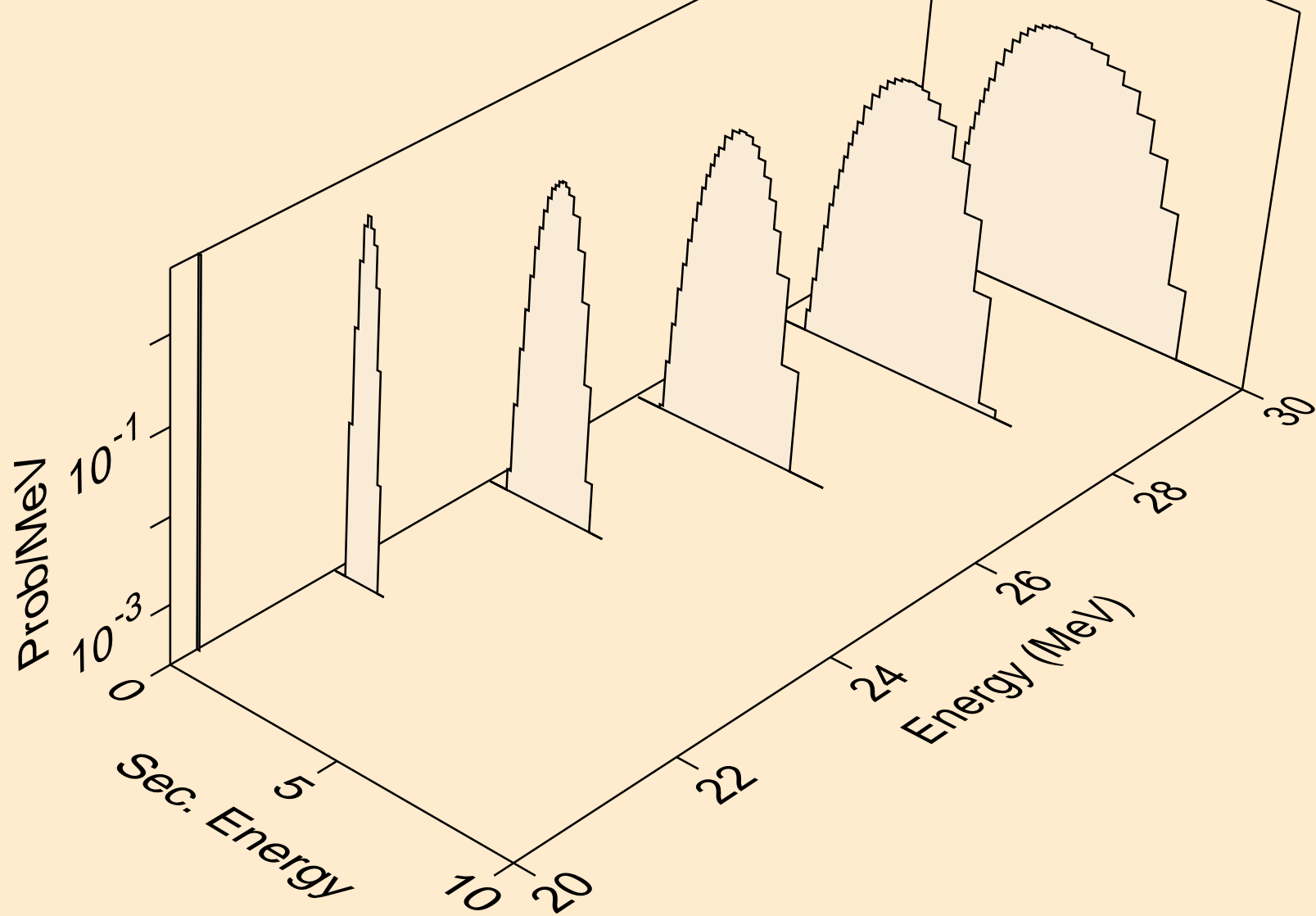

CR056 NEUTRON ACER TENDL-2024 LIBRARY; T=0.K
protons from (n,p)

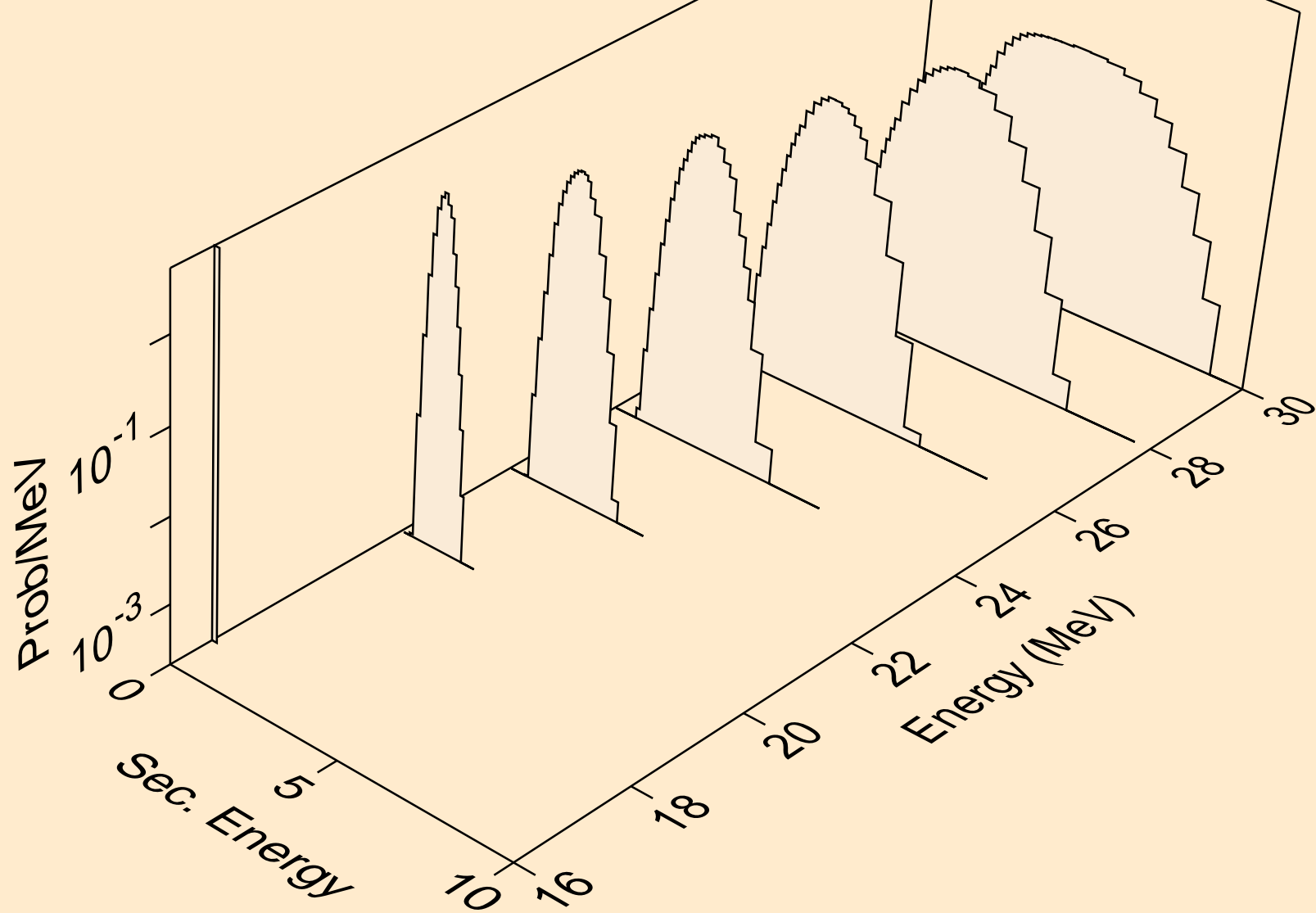

CR056 NEUTRON ACER TENDL-2024 LIBRARY; T=0.K
protons from (n,pd)

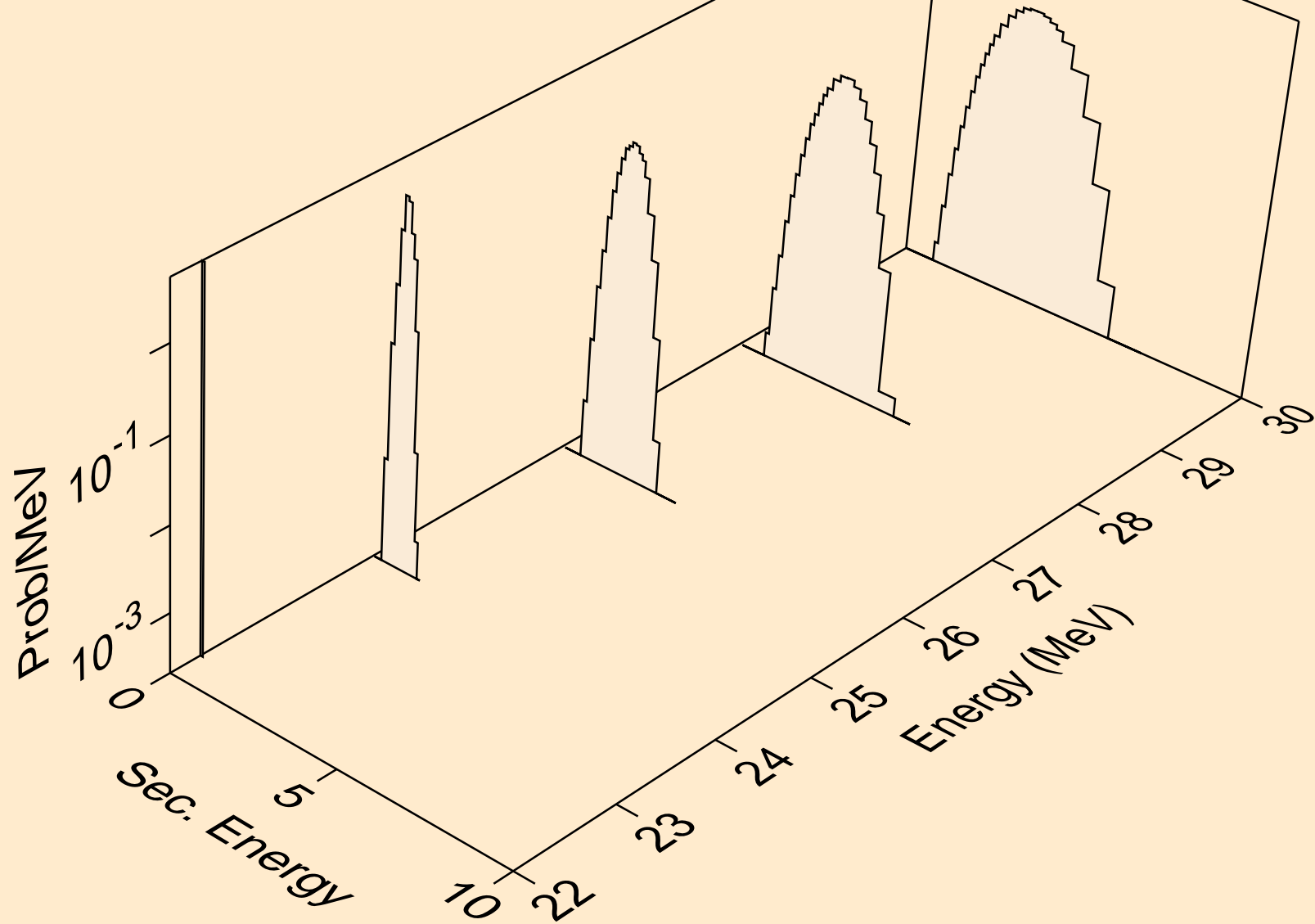

CR056 NEUTRON ACER TENDL-2024 LIBRARY; T=0.K
protons from (n,pt)

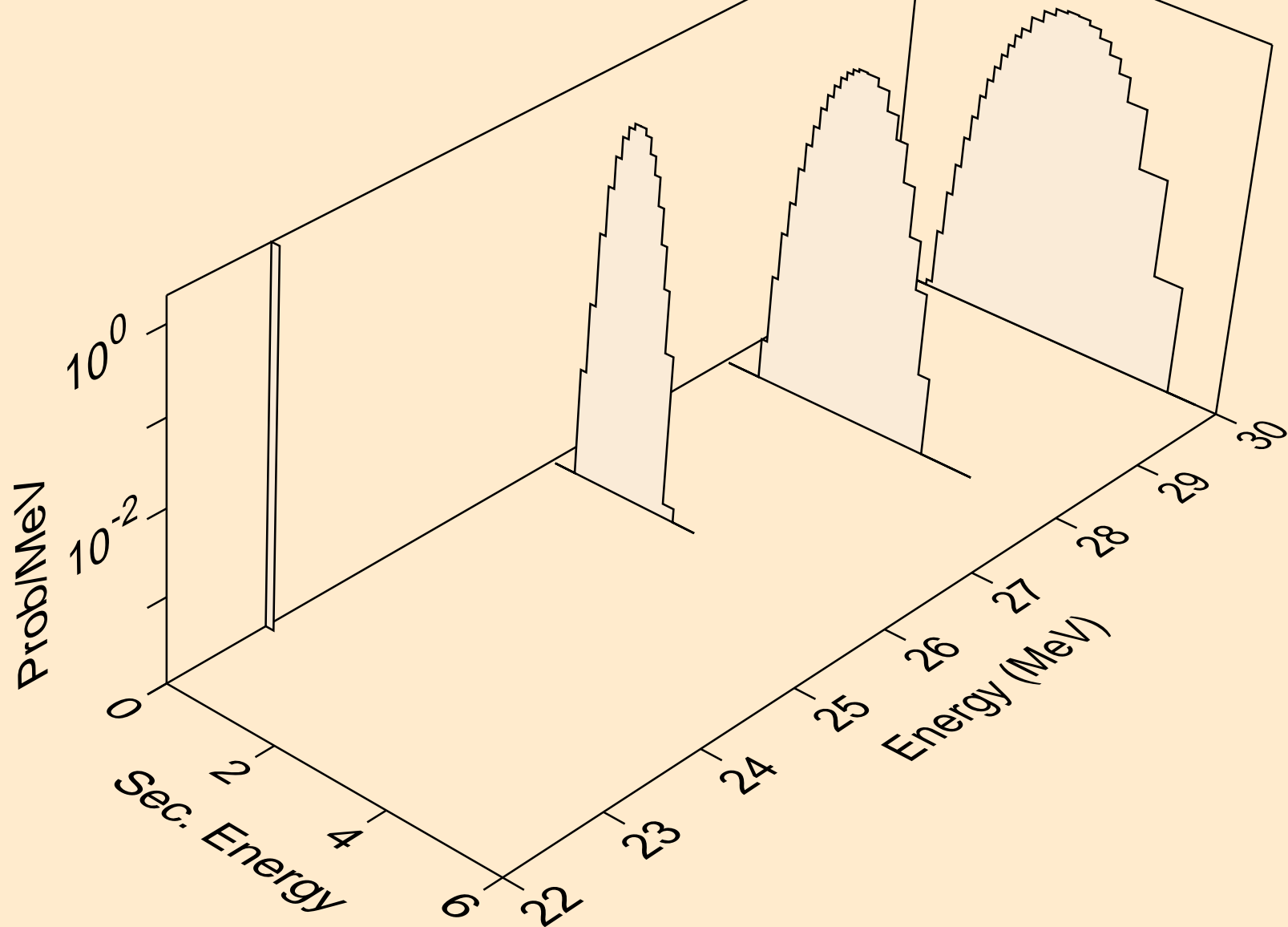

CR056 NEUTRON ACER TENDL-2024 LIBRARY; T=0.K
deuterons from (n,x)

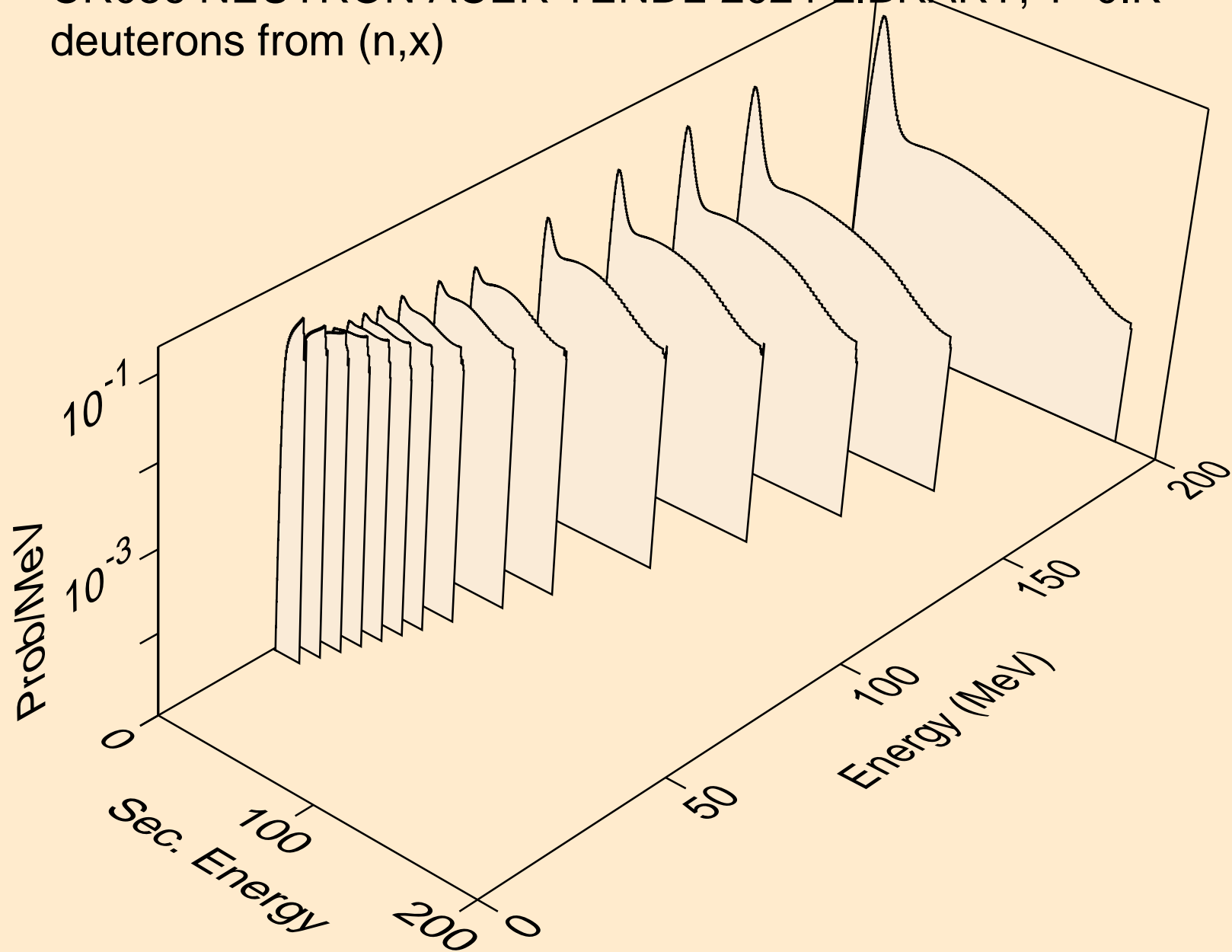

CR056 NEUTRON ACER TENDL-2024 LIBRARY; T=0.K
deuterons from (n,2nd)

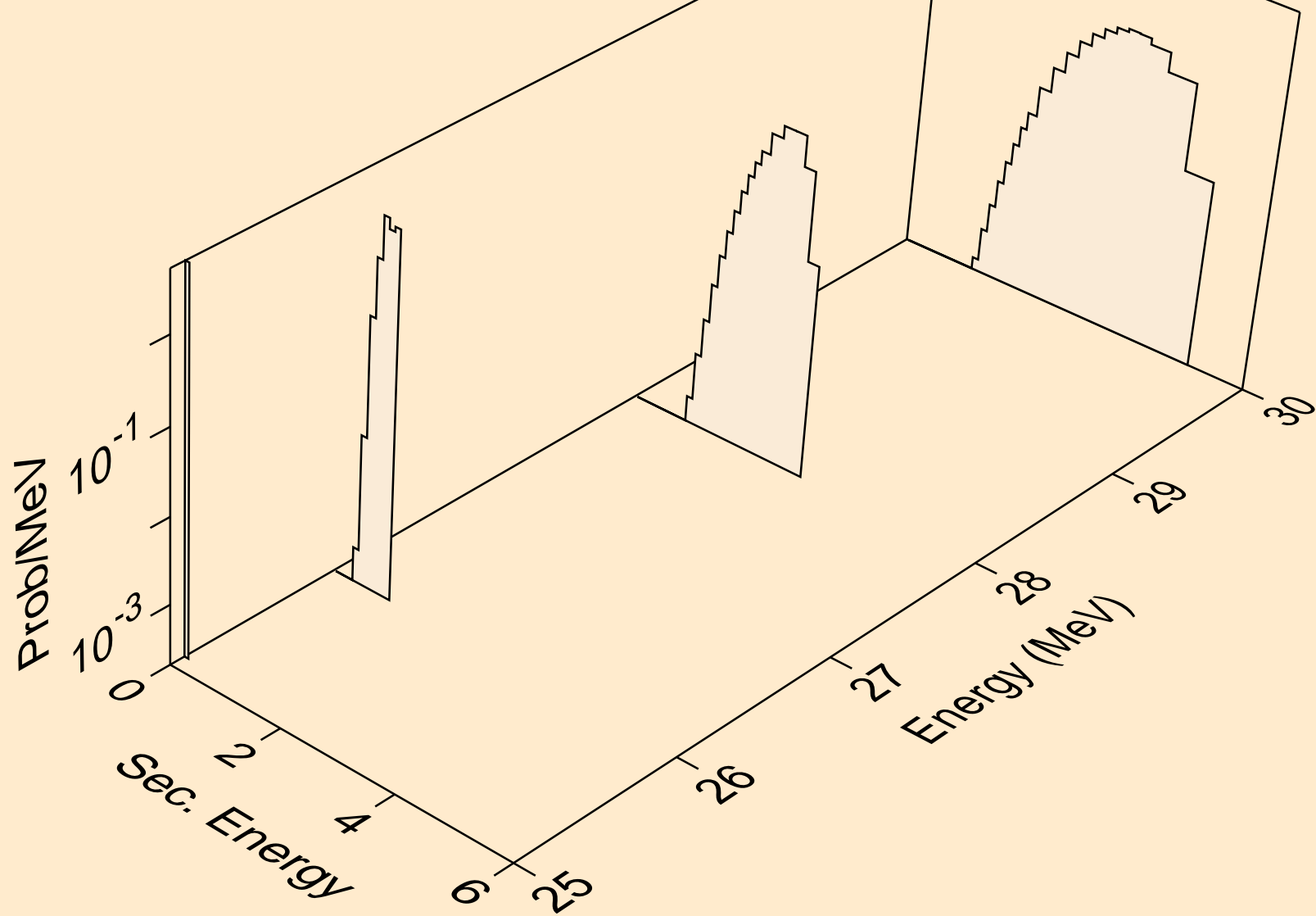

CR056 NEUTRON ACER TENDL-2024 LIBRARY; T=0.K
deuterons from (n,n*)d

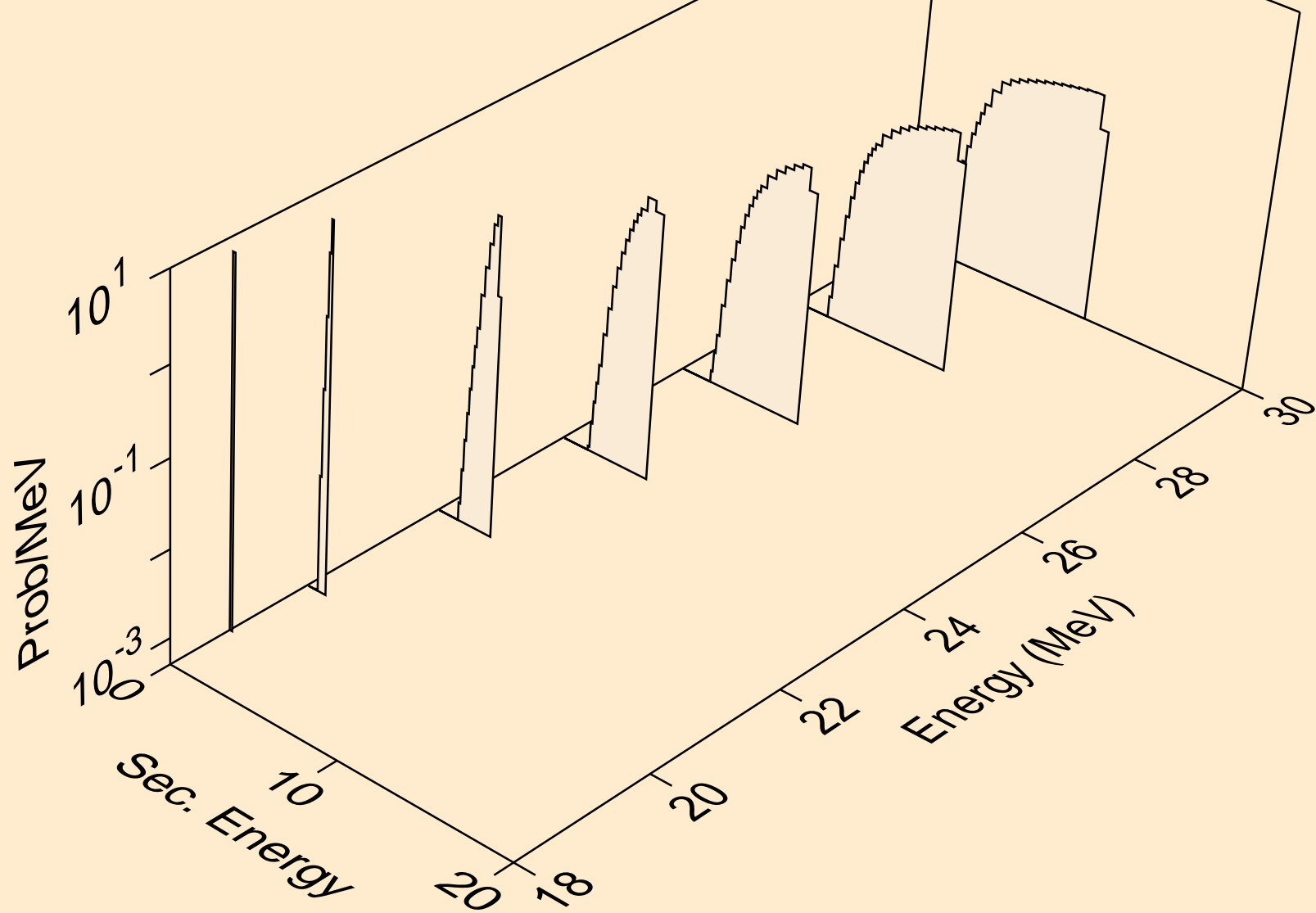

CR056 NEUTRON ACER TENDL-2024 LIBRARY; T=0.K
deuterons from (n,d)

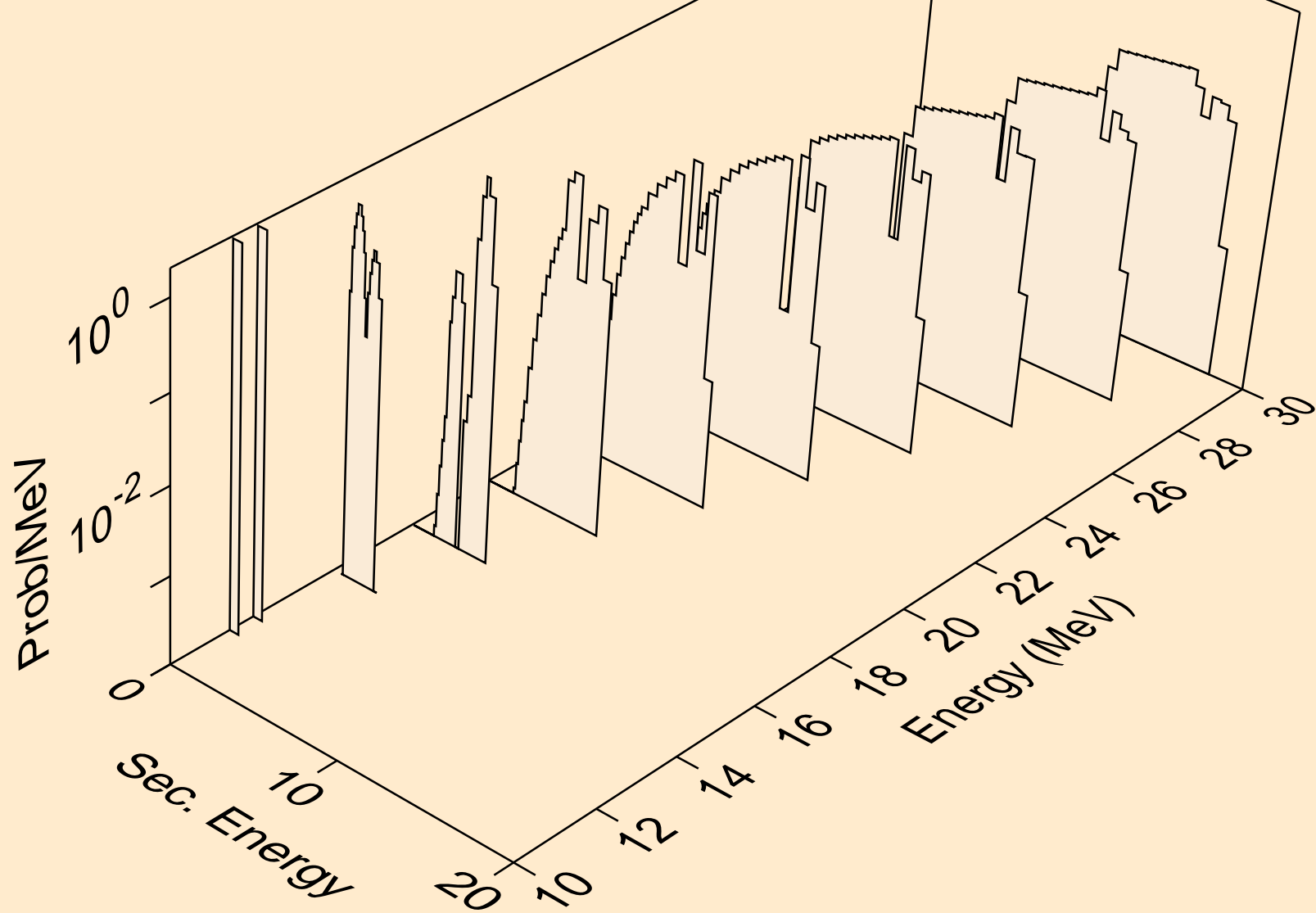

CR056 NEUTRON ACER TENDL-2024 LIBRARY; T=0.K
deuterons from (n,pd)

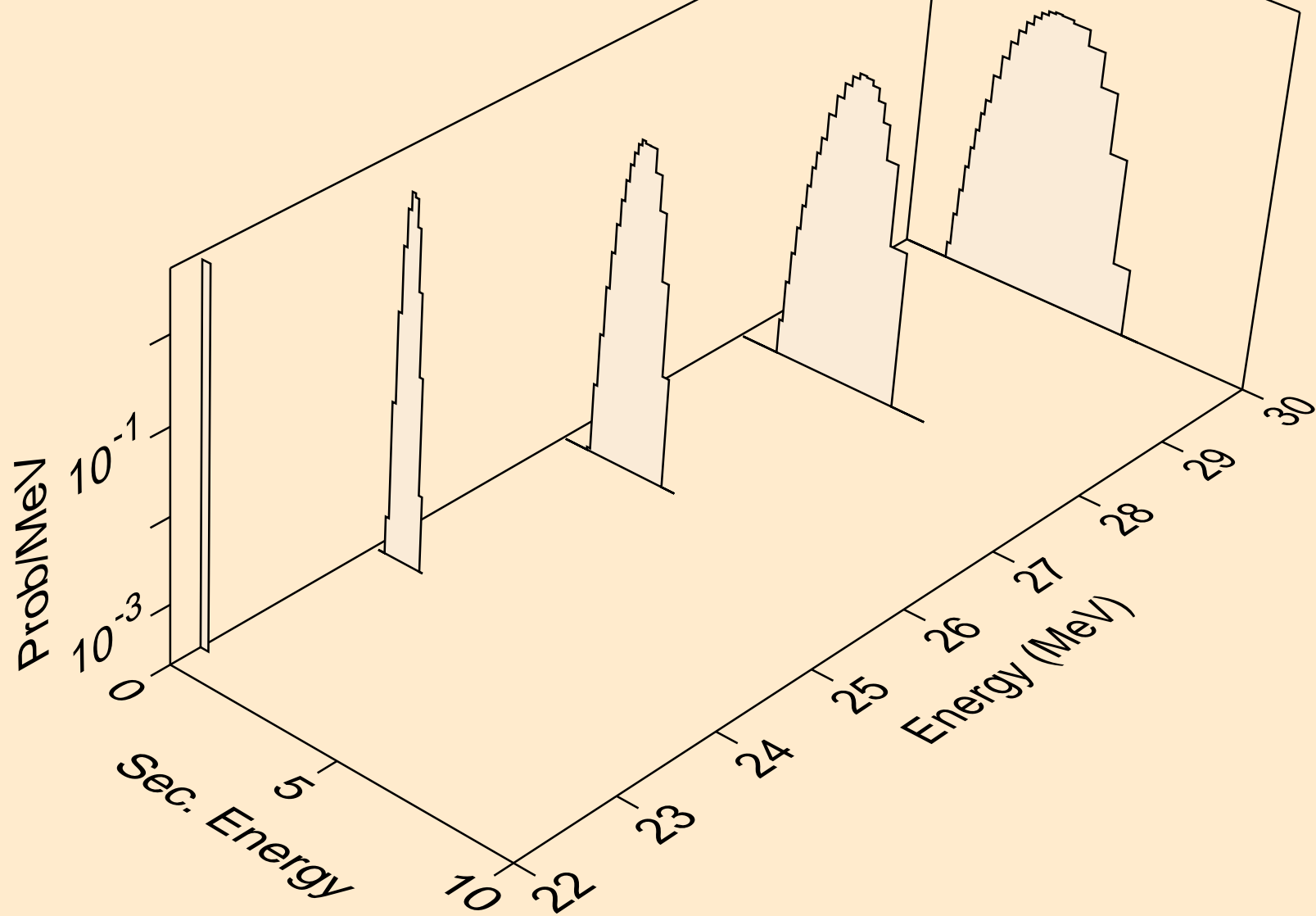

CR056 NEUTRON ACER TENDL-2024 LIBRARY; T=0.K
deuterons from (n,da)

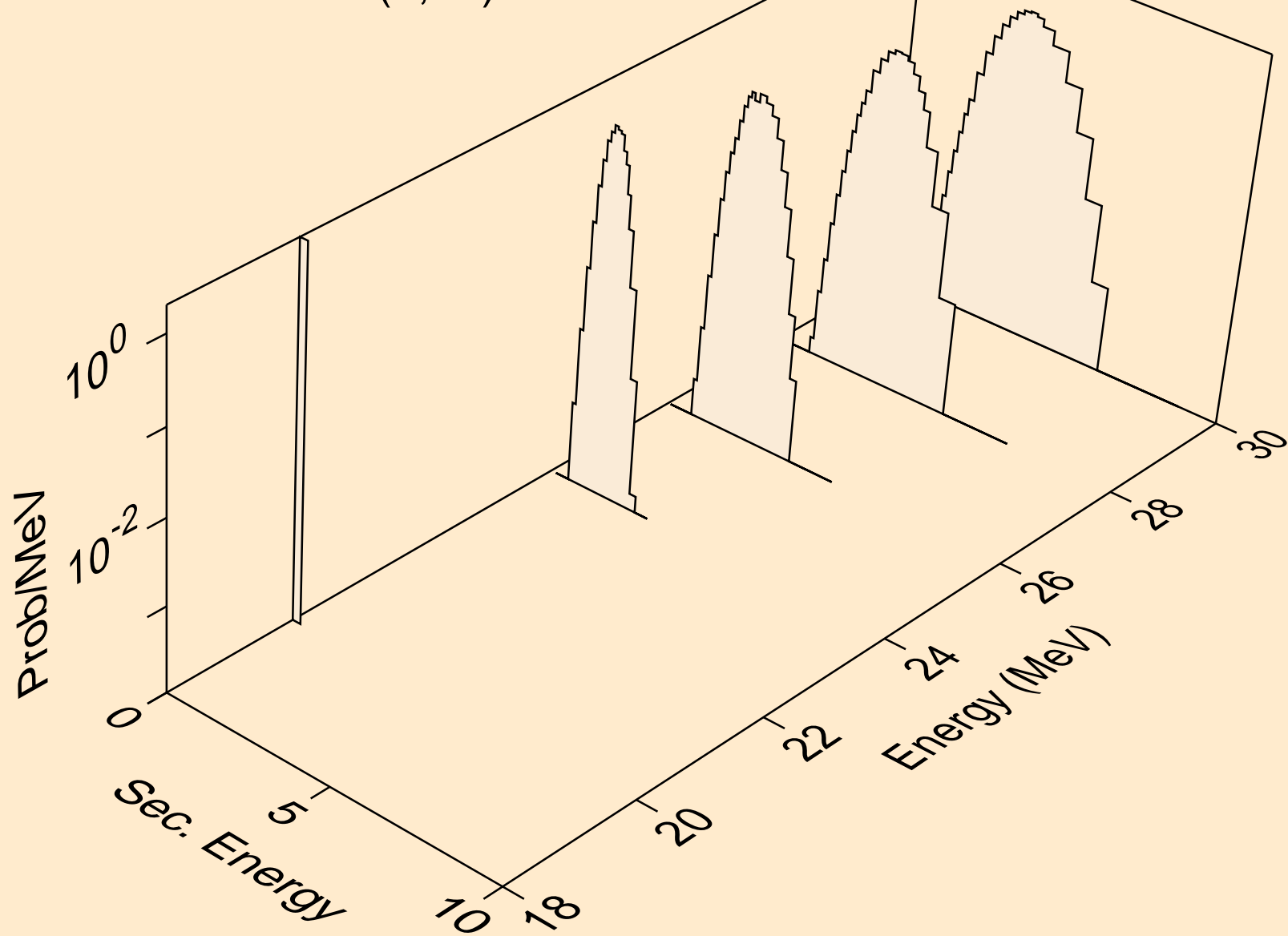

CR056 NEUTRON ACER TENDL-2024 LIBRARY; T=0.K
tritons from (n,x)

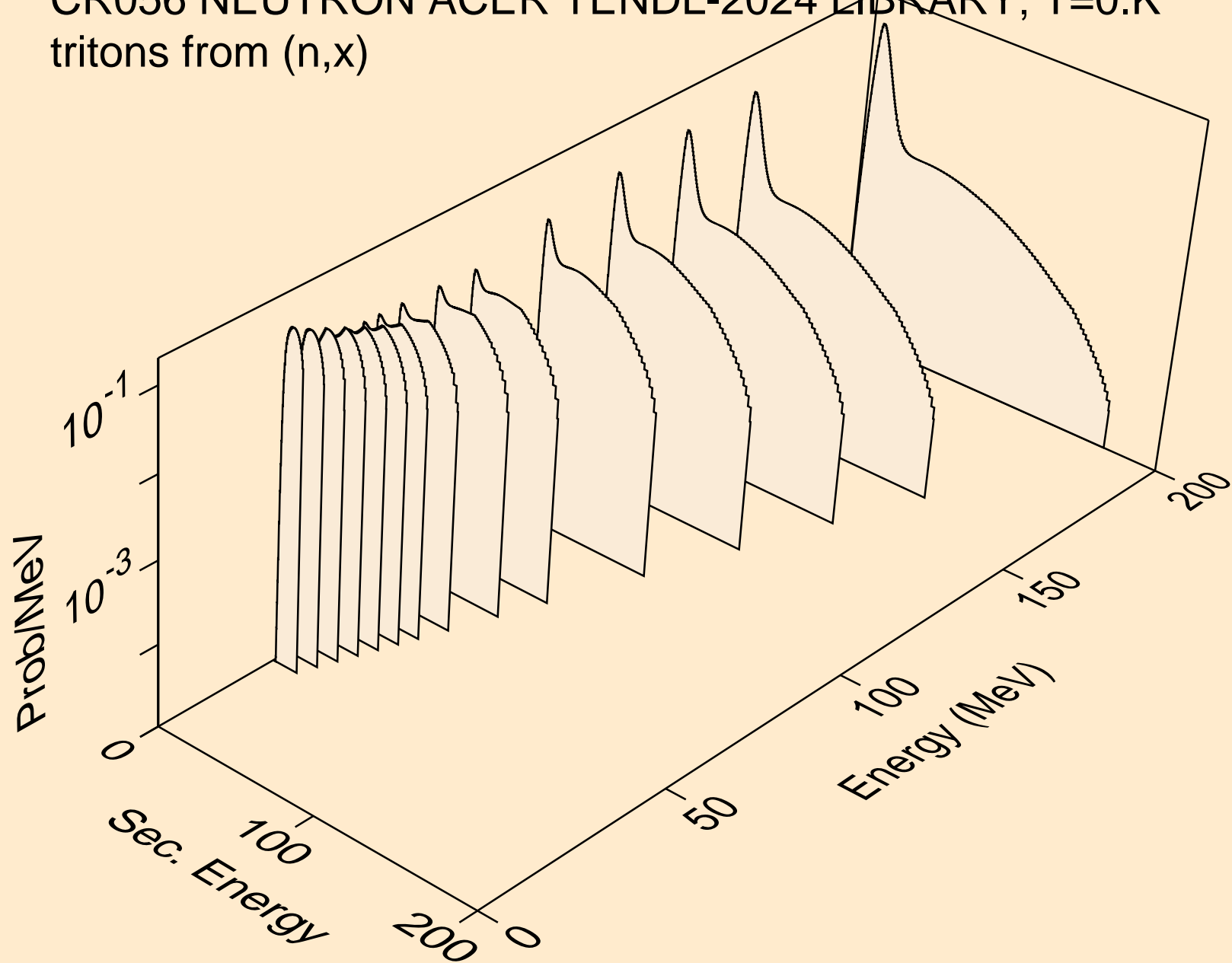

CR056 NEUTRON ACER TENDL-2024 LIBRARY; T=0.K
tritons from (n,n*)t

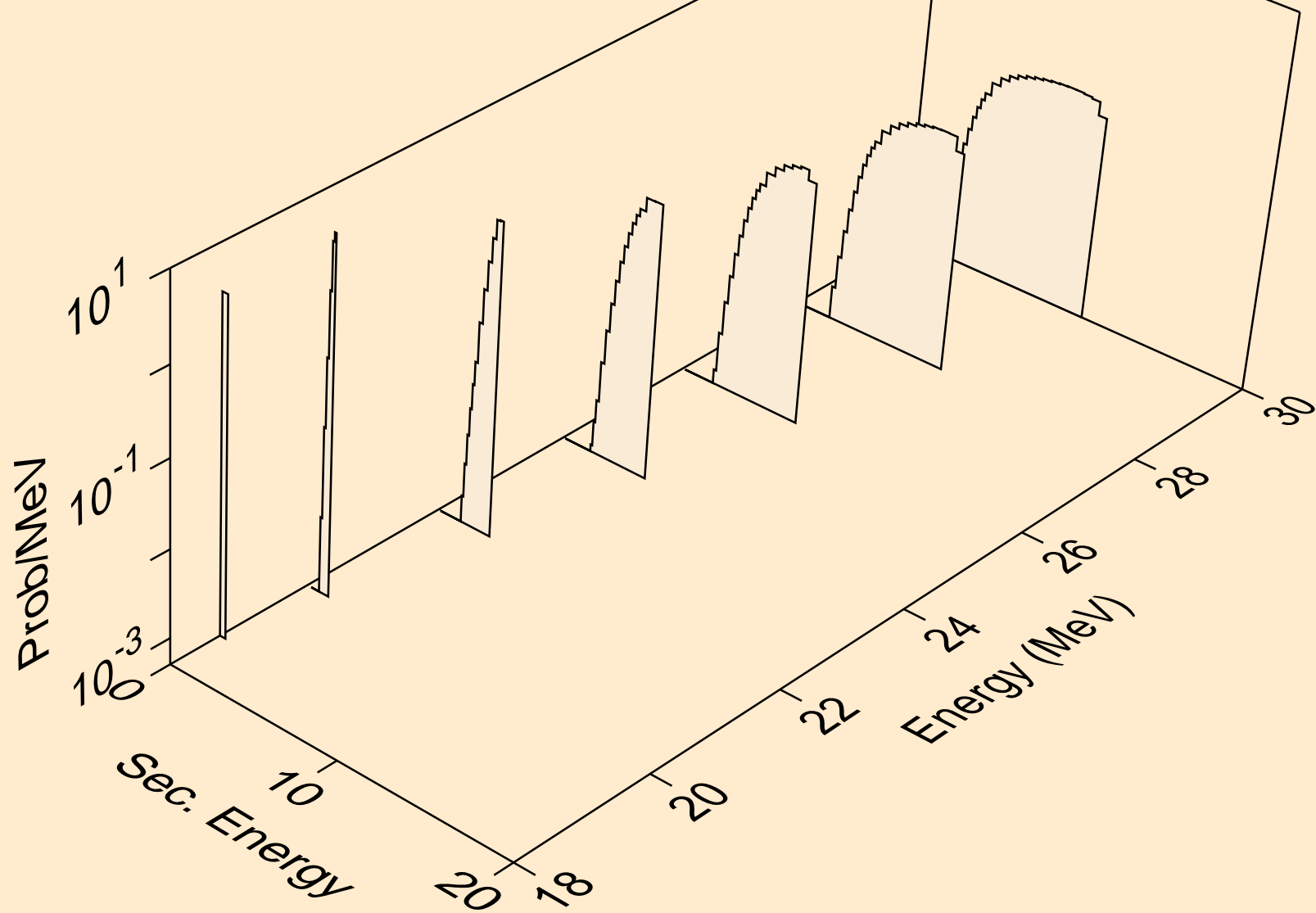

CR056 NEUTRON ACER TENDL-2024 LIBRARY; T=0.K
tritons from (n,t)

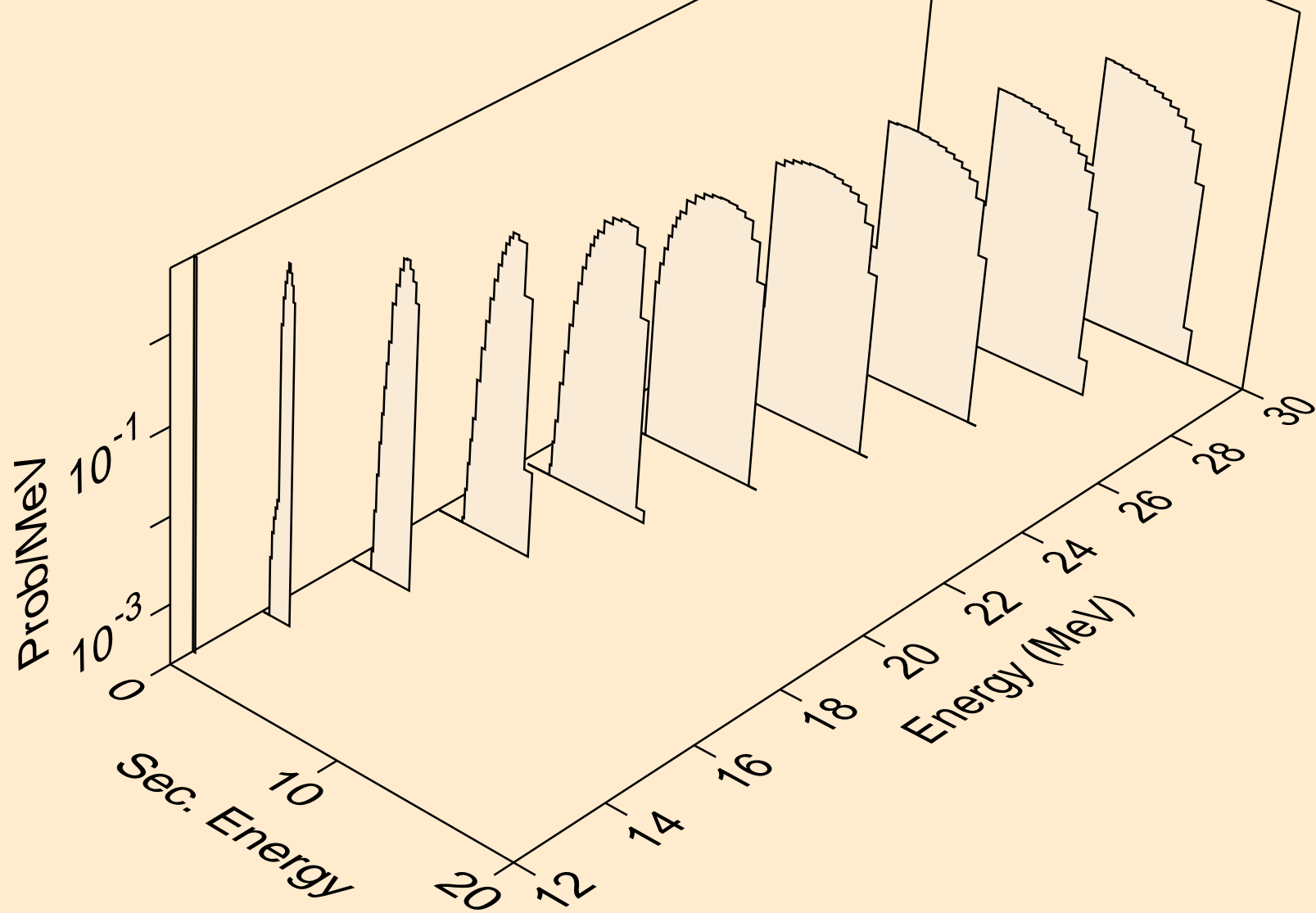

CR056 NEUTRON ACER TENDL-2024 LIBRARY; T=0.K
tritons from (n,pt)

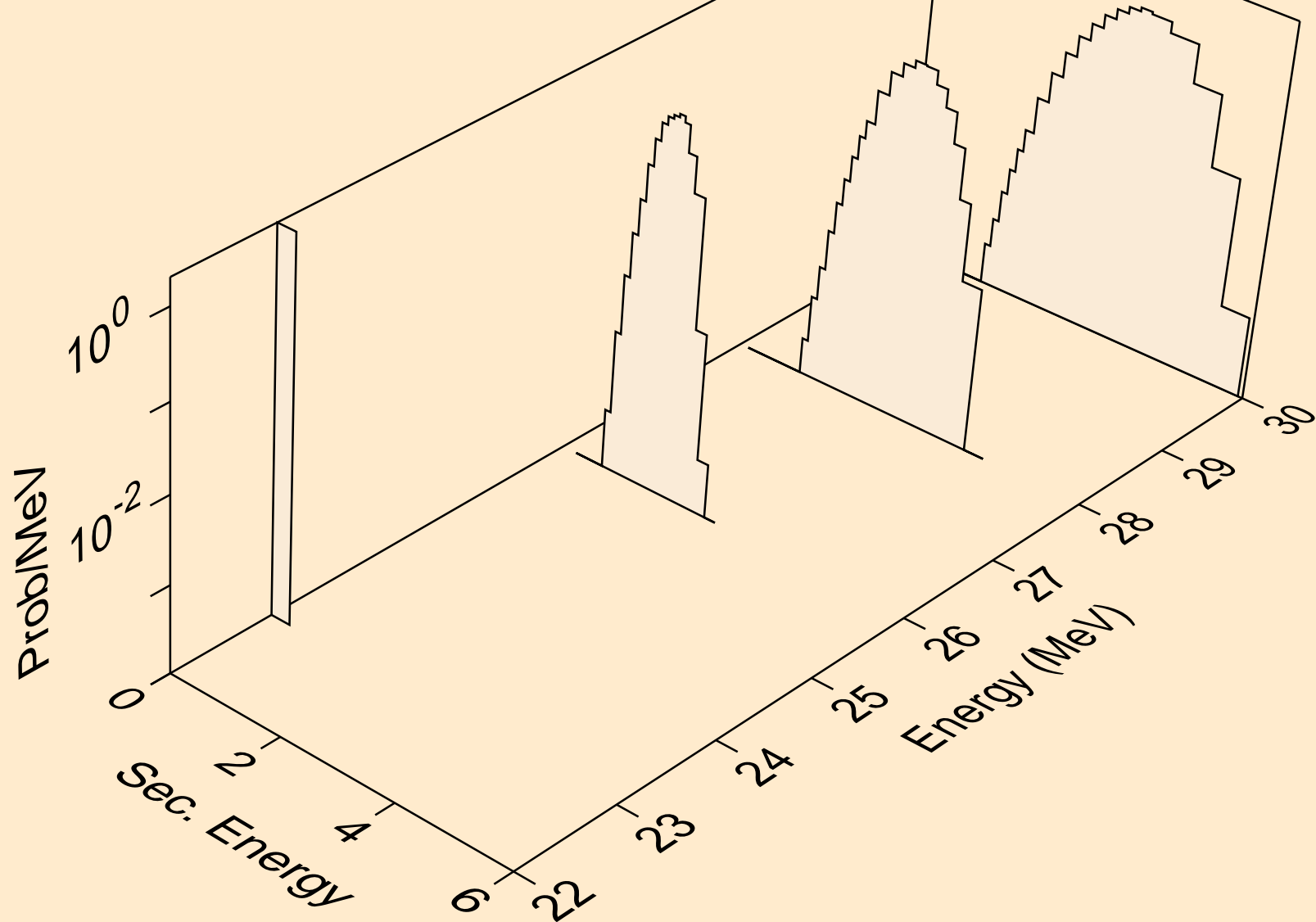

CR056 NEUTRON ACER TENDL-2024 LIBRARY; T=0.K
he3s from (n,x)

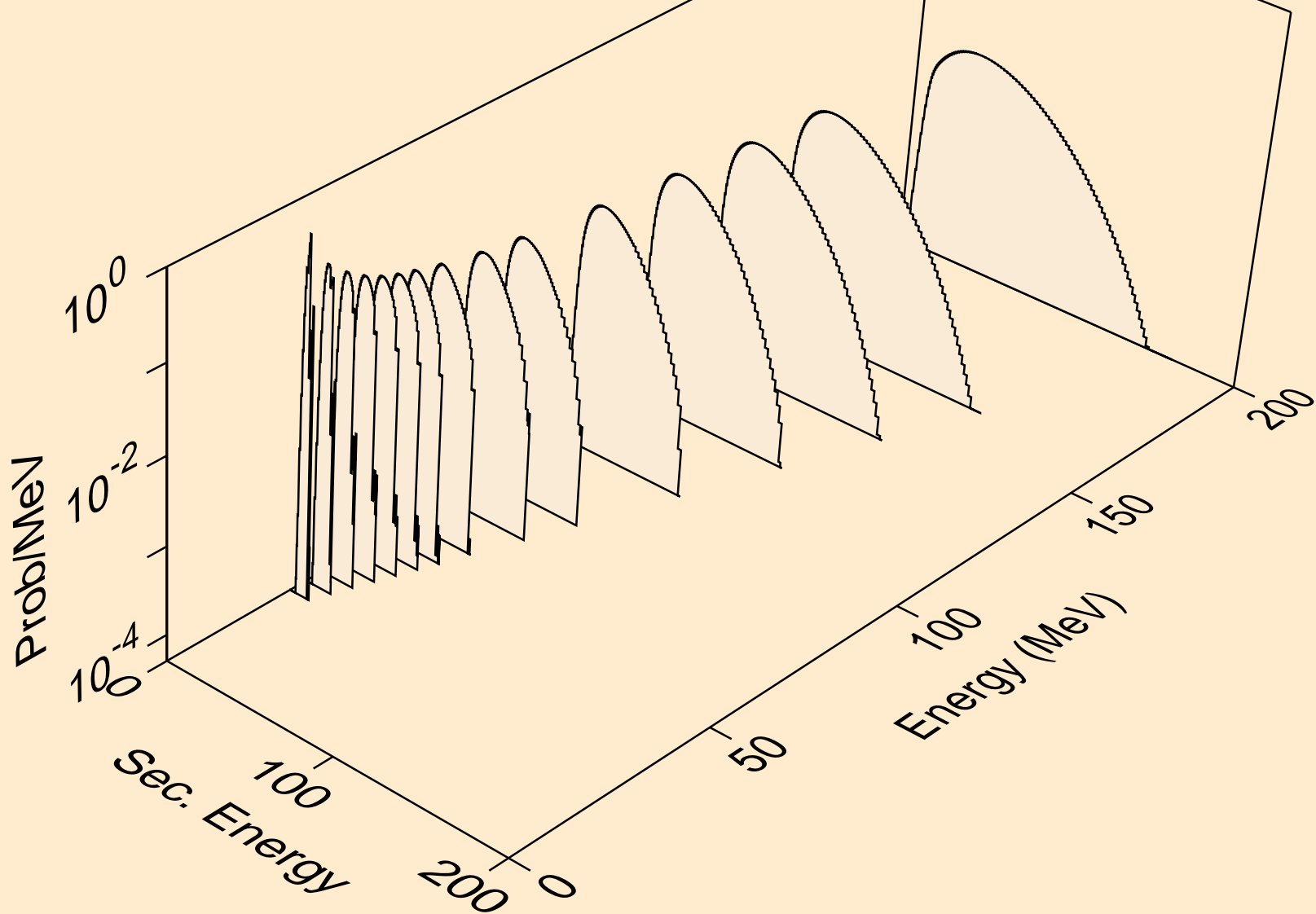

CR056 NEUTRON ACER TENDL-2024 LIBRARY; T=0.K
he3s from (n,n*)he3

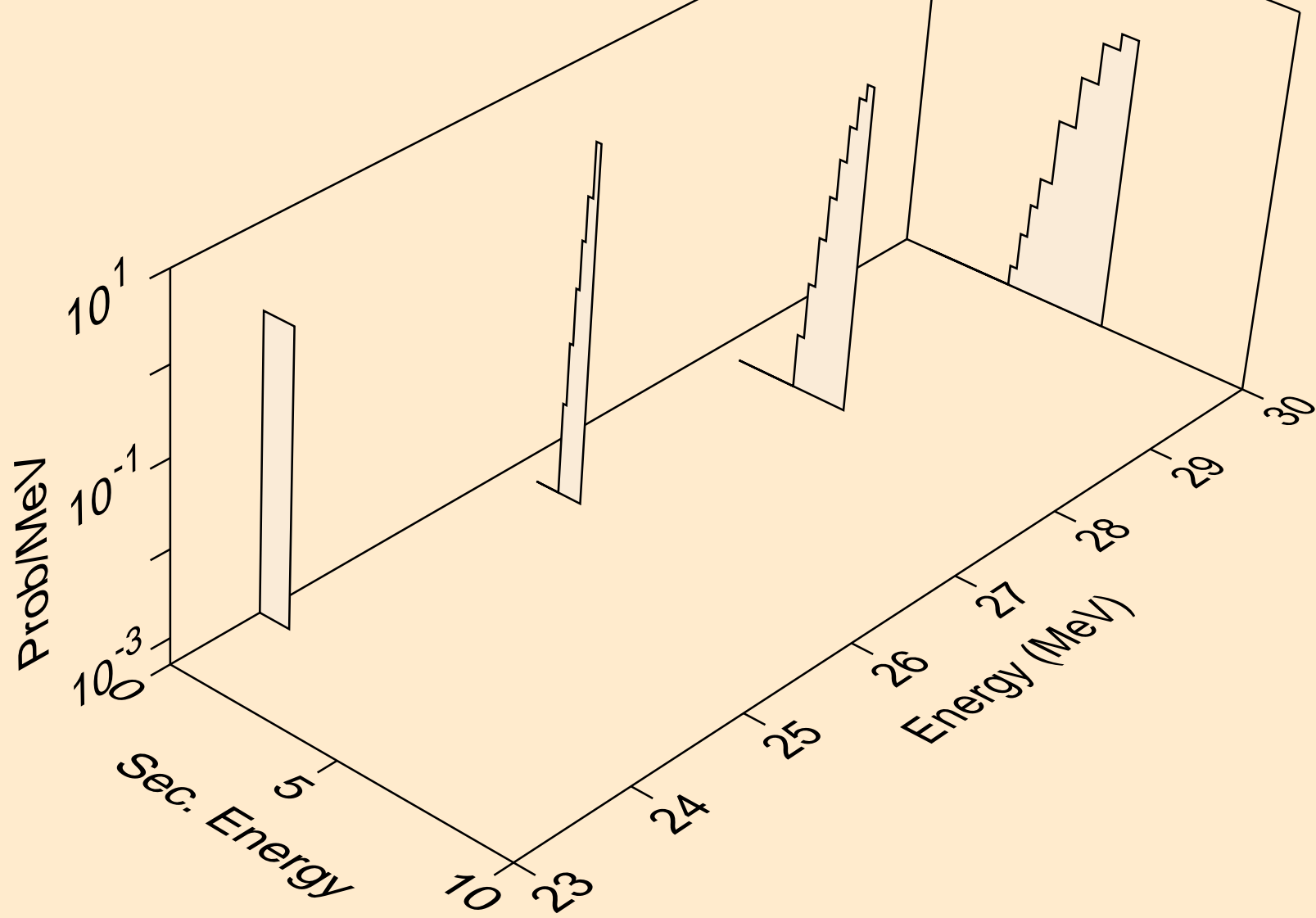

CR056 NEUTRON ACER TENDL-2024 LIBRARY; T=0.K
he3s from (n,he3)

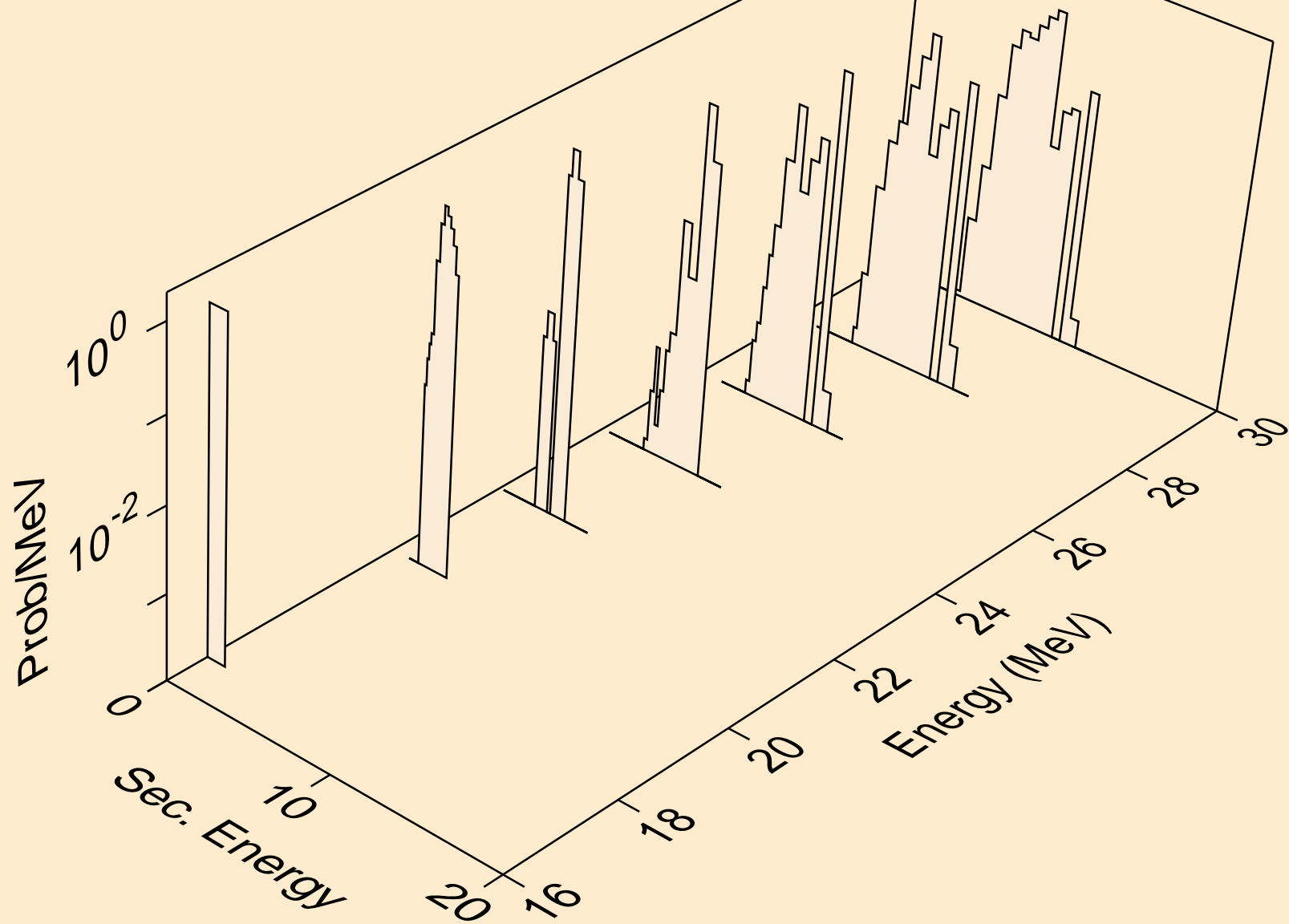

CR056 NEUTRON ACER TENDL-2024 LIBRARY; T=0.K
alphas from (n,x)

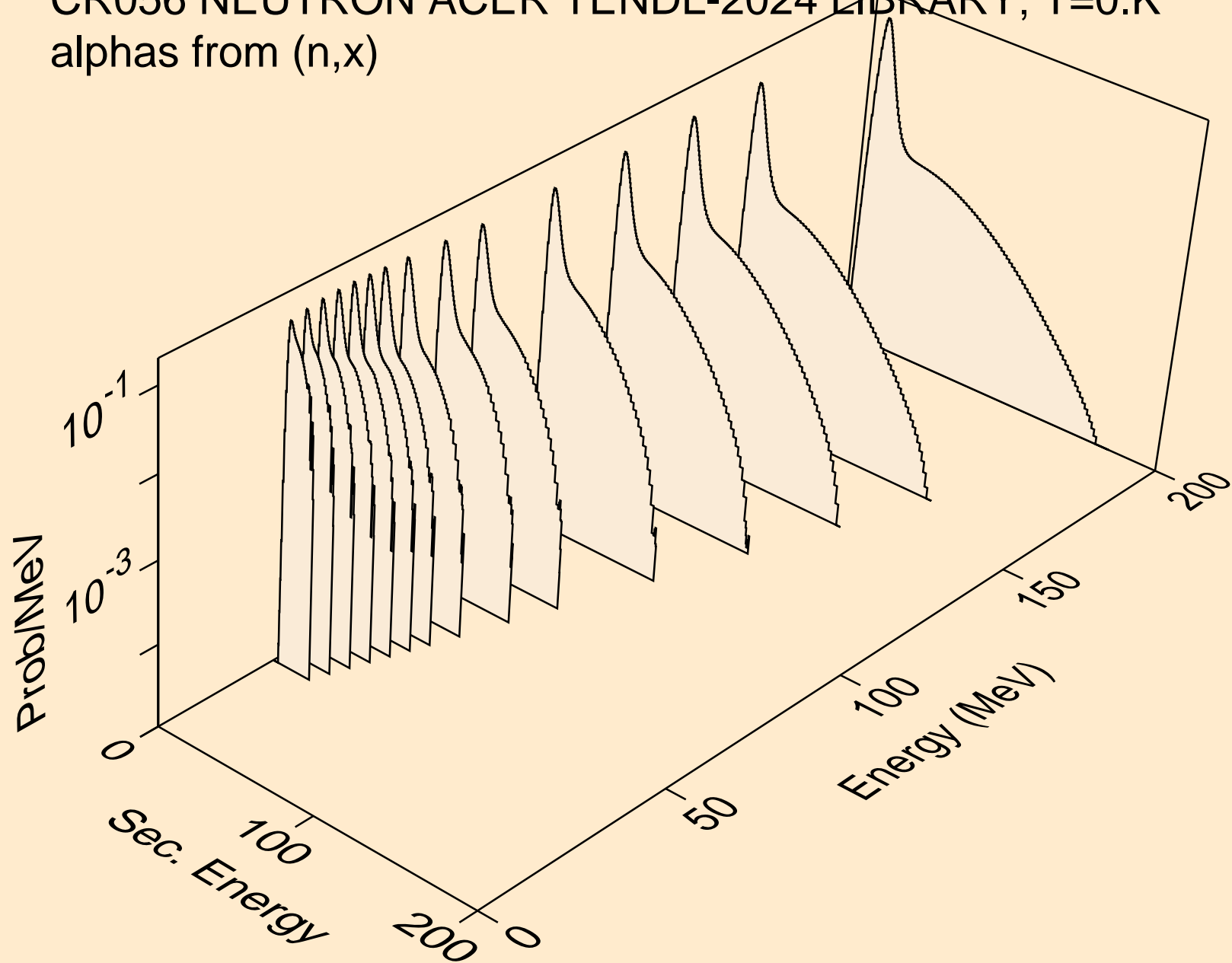

CR056 NEUTRON ACER TENDL-2024 LIBRARY; T=0.K
alphas from (n,n*)a

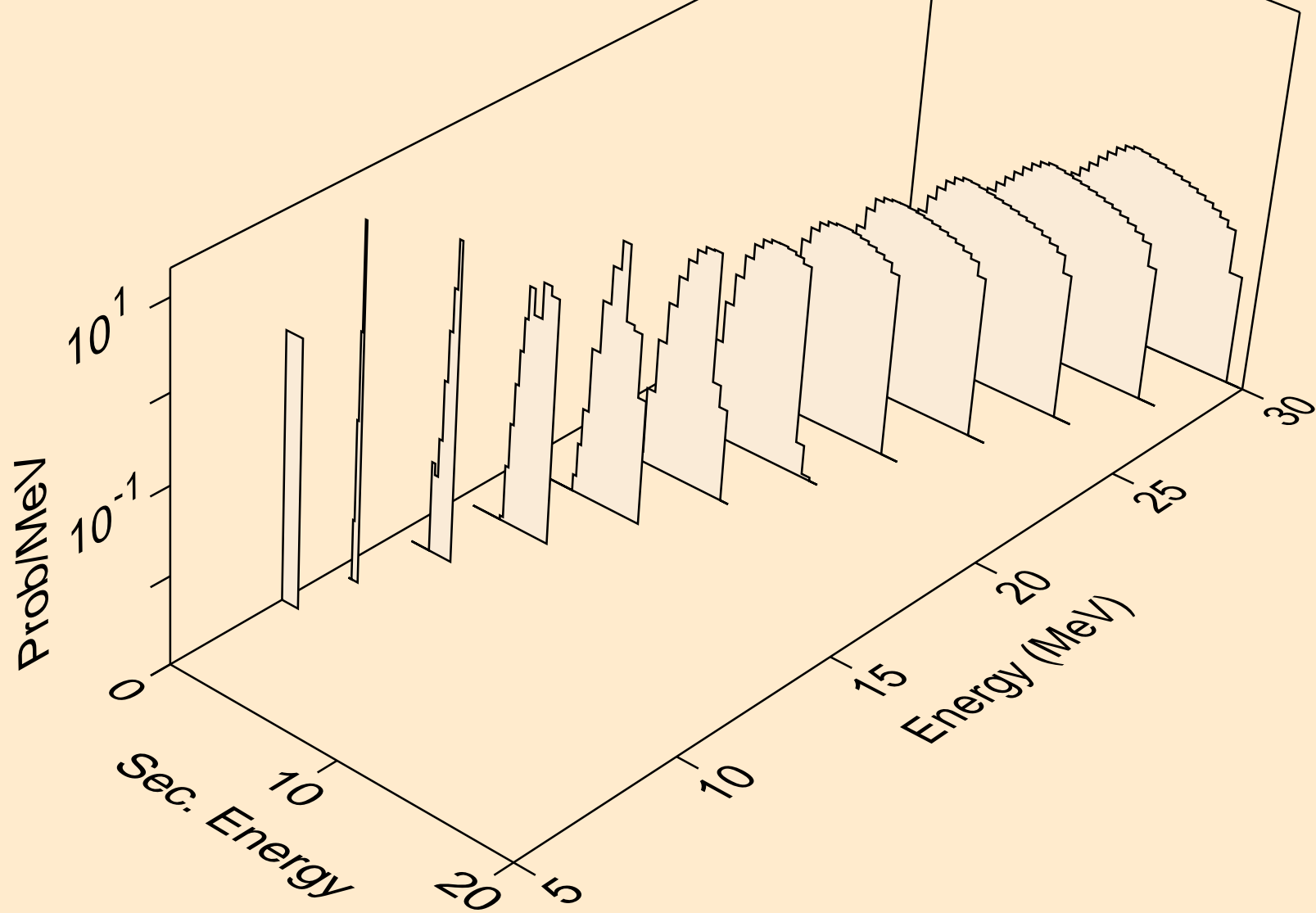

CR056 NEUTRON ACER TENDL-2024 LIBRARY; T=0.K
alphas from (n,2n)a

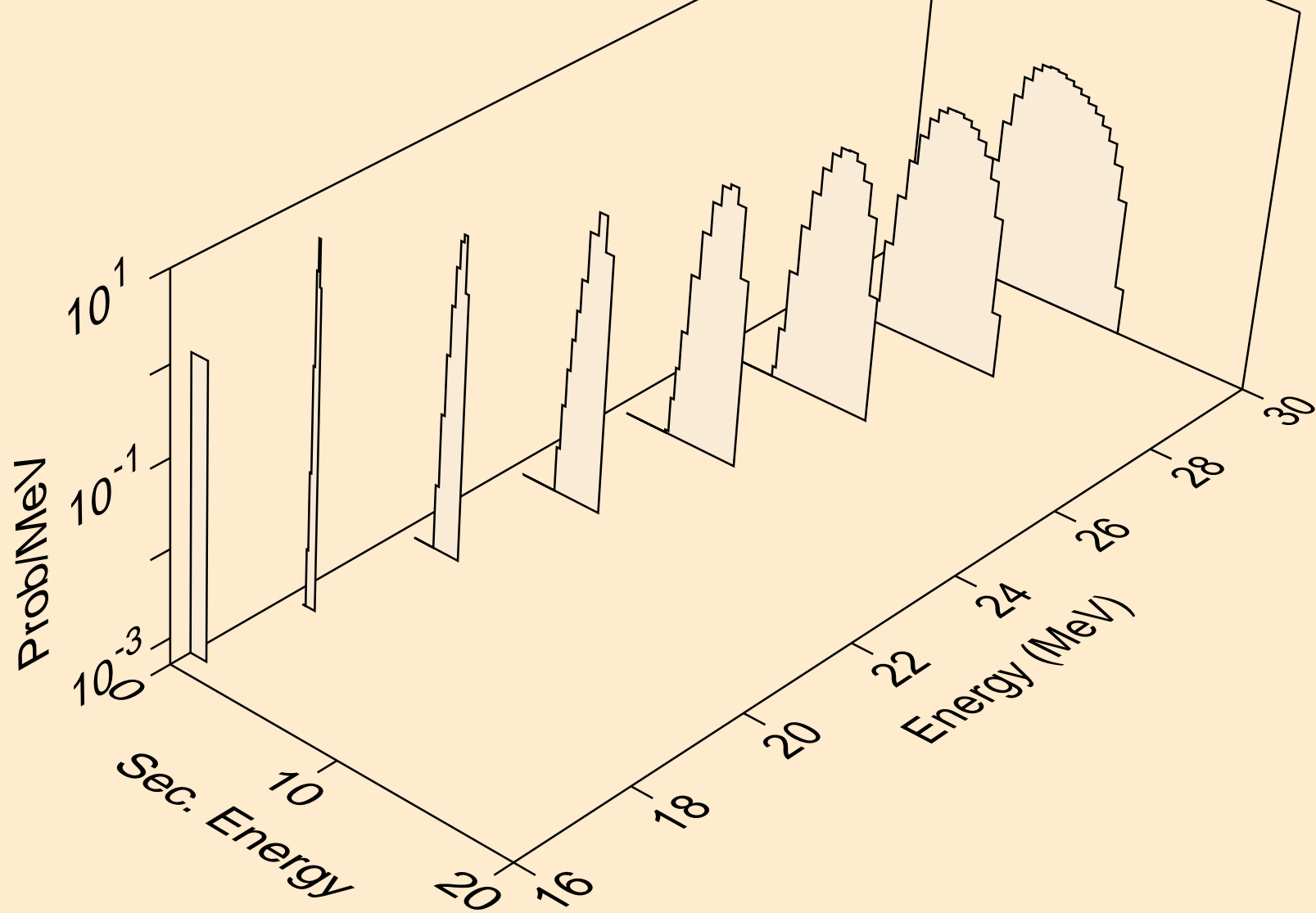

CR056 NEUTRON ACER TENDL-2024 LIBRARY; T=0.K
alphas from (n,3n)a

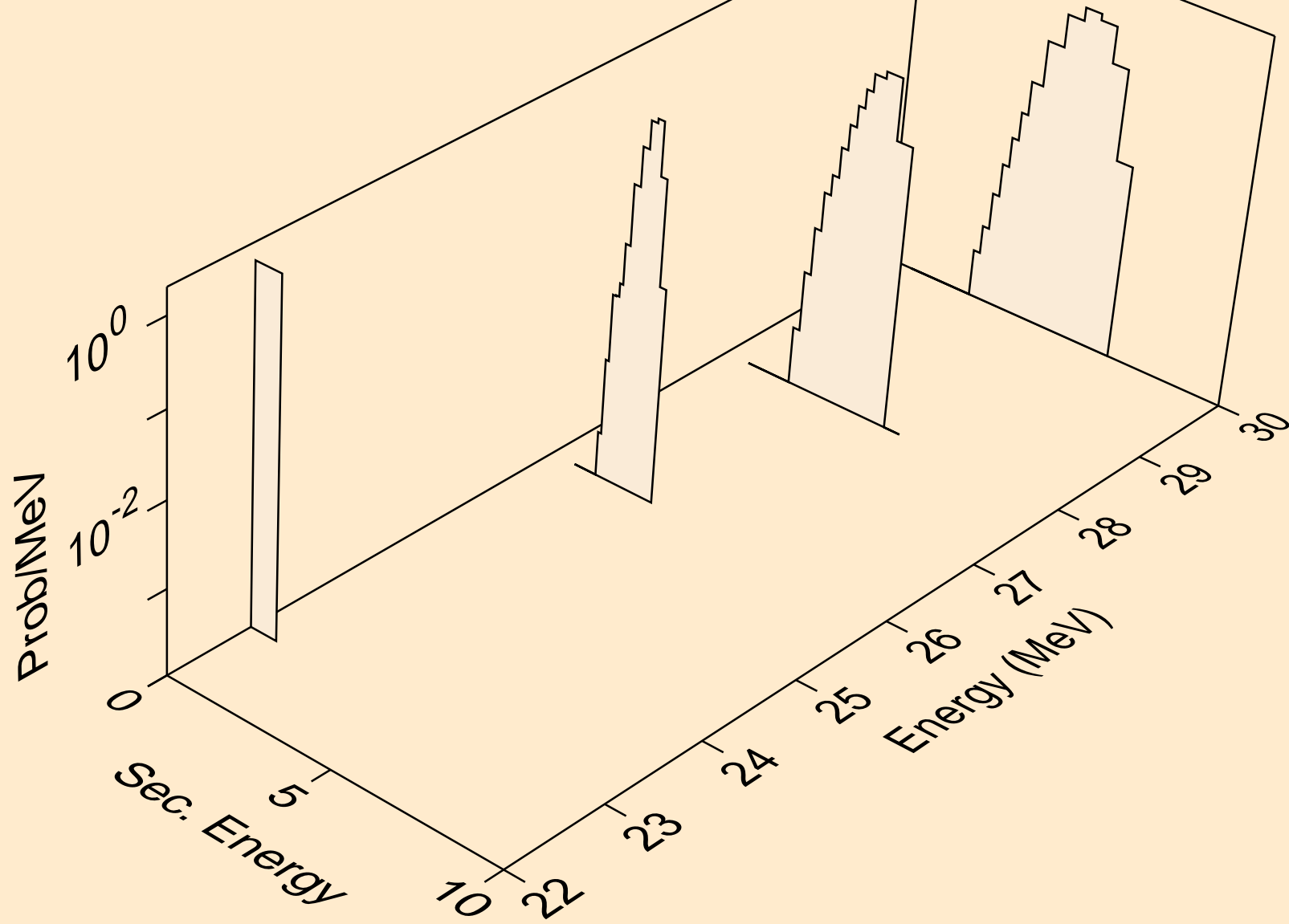

CR056 NEUTRON ACER TENDL-2024 LIBRARY; T=0.K
alphas from (n,n*)2a

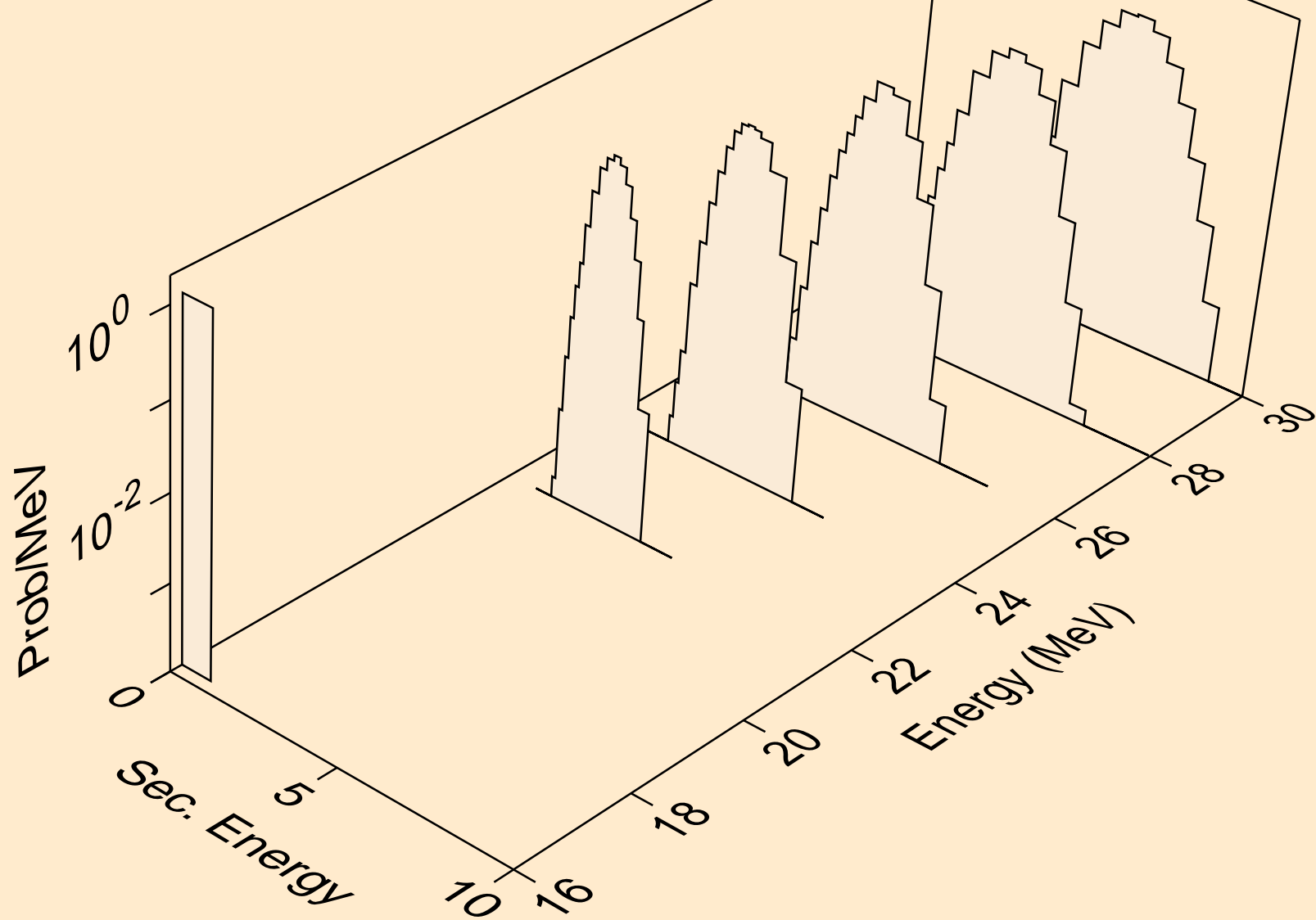

CR056 NEUTRON ACER TENDL-2024 LIBRARY; T=0.K
alphas from (n,npa)

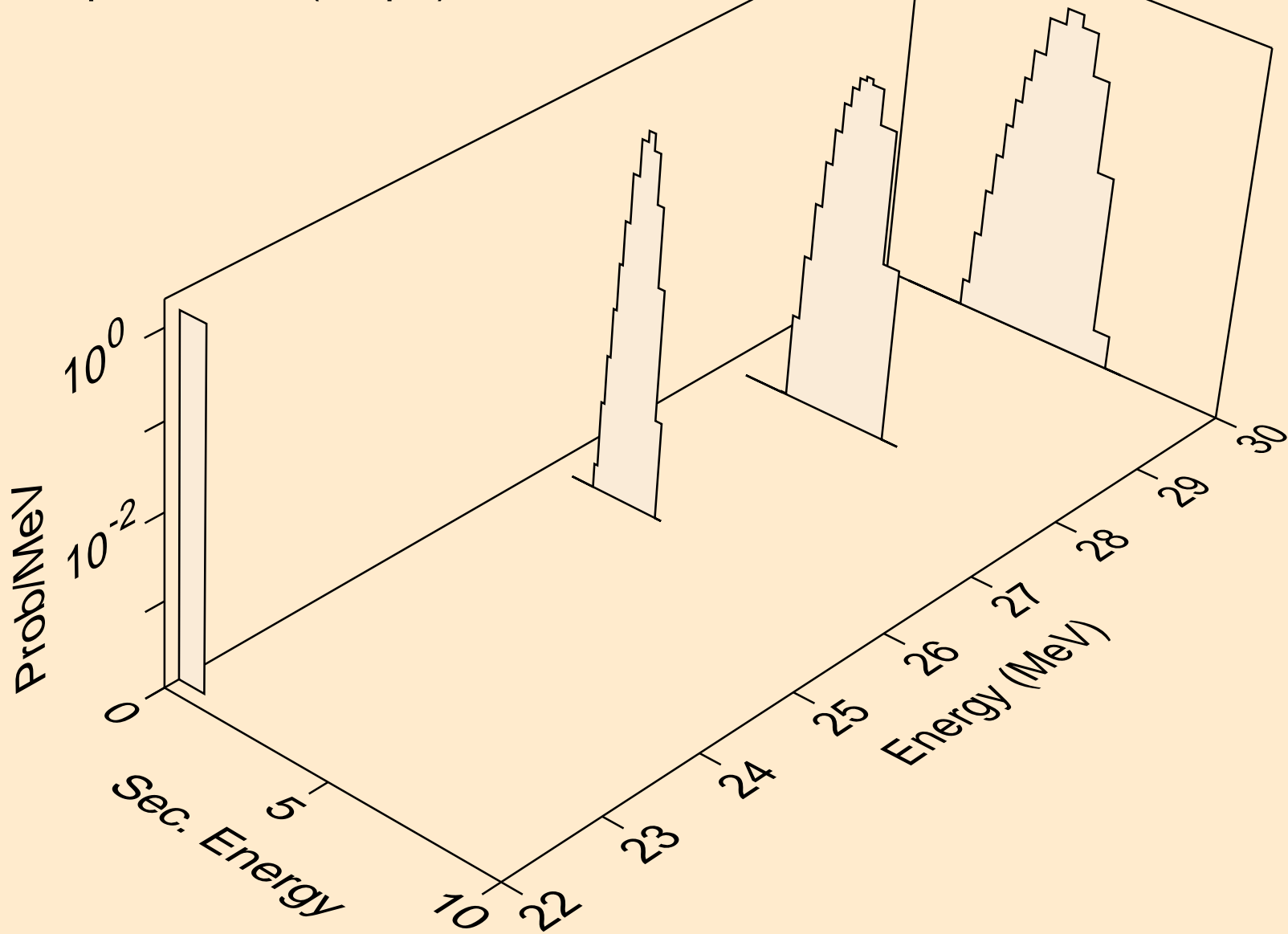

CR056 NEUTRON ACER TENDL-2024 LIBRARY; T=0.K
alphas from (n,a)

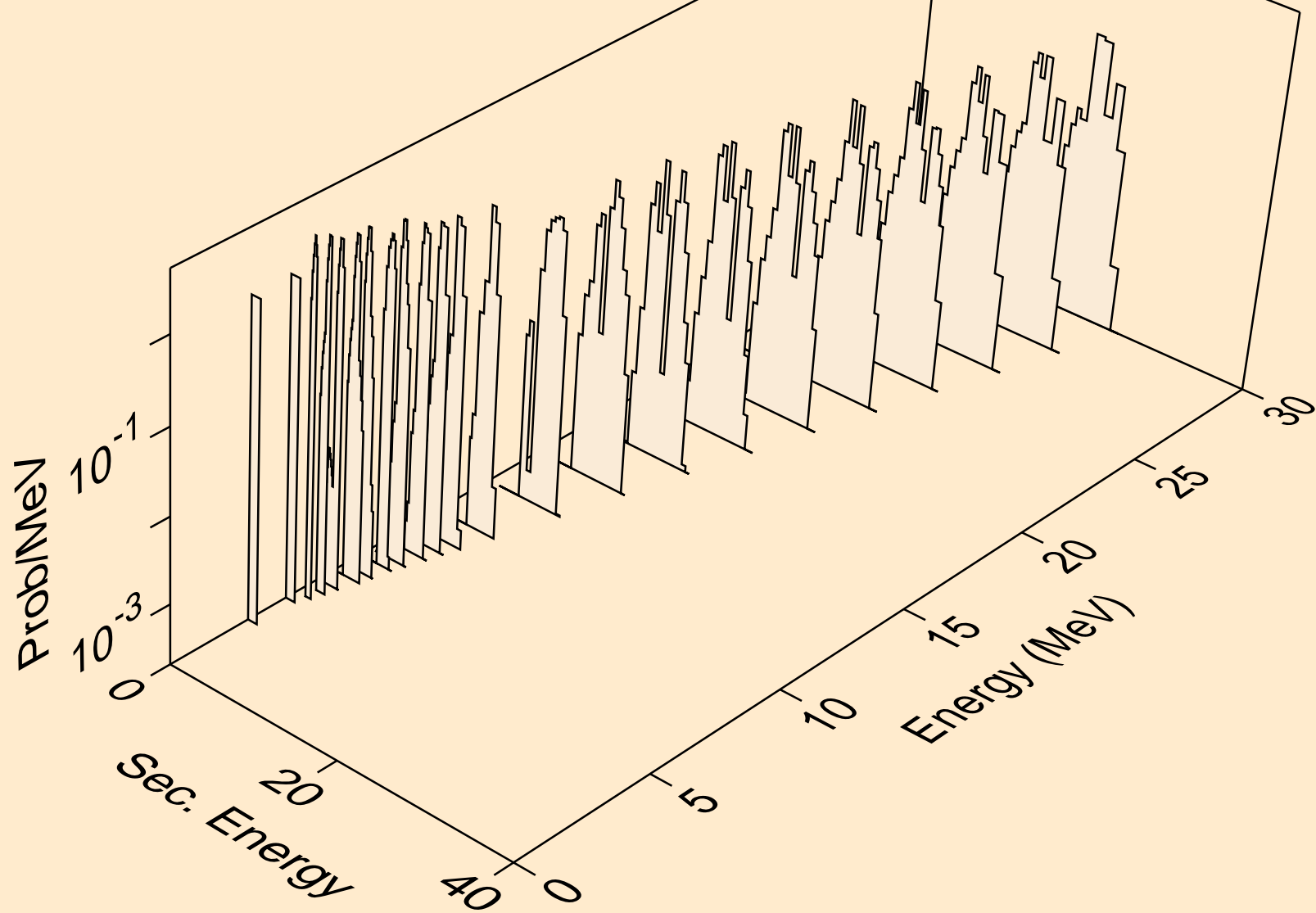

CR056 NEUTRON ACER TENDL-2024 LIBRARY; T=0.K
alphas from (n,2a)

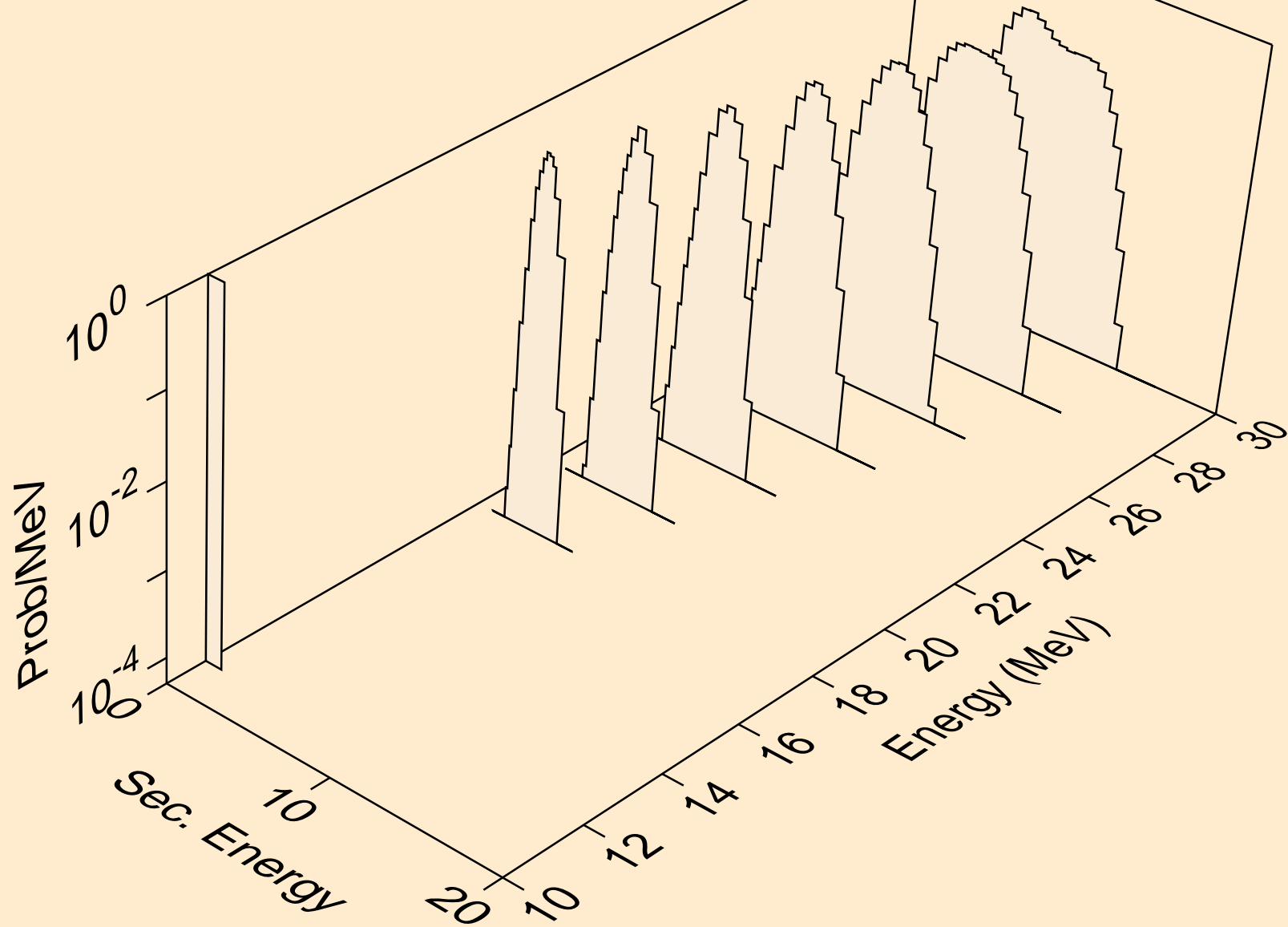

CR056 NEUTRON ACER TENDL-2024 LIBRARY; T=0.K
alphas from (n,pa)

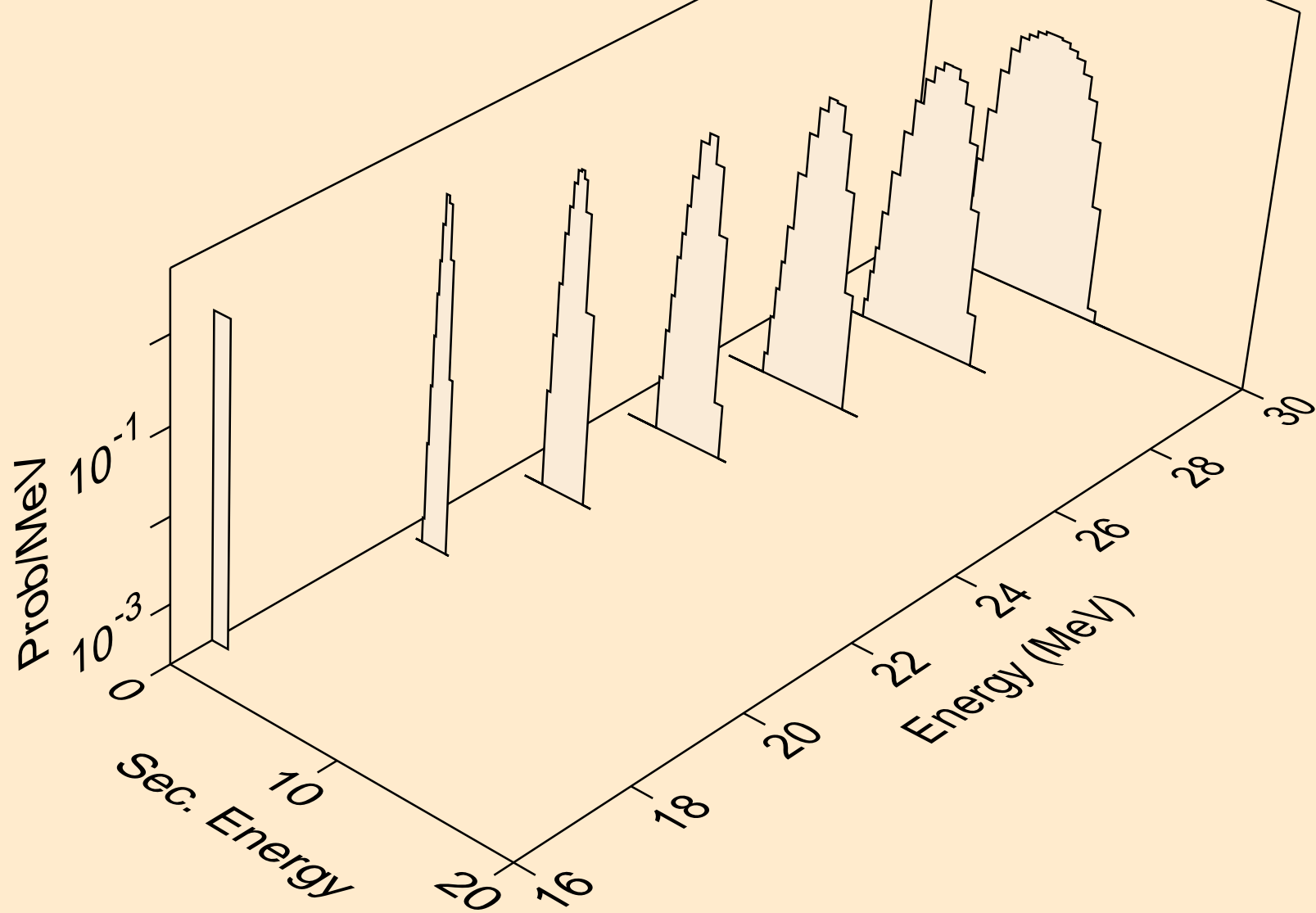

CR056 NEUTRON ACER TENDL-2024 LIBRARY; T=0.K
alphas from (n,da)

