

CS136 NEUTRON ACER TENDL-2024 LIBRARY; T=0.K

Principal cross sections

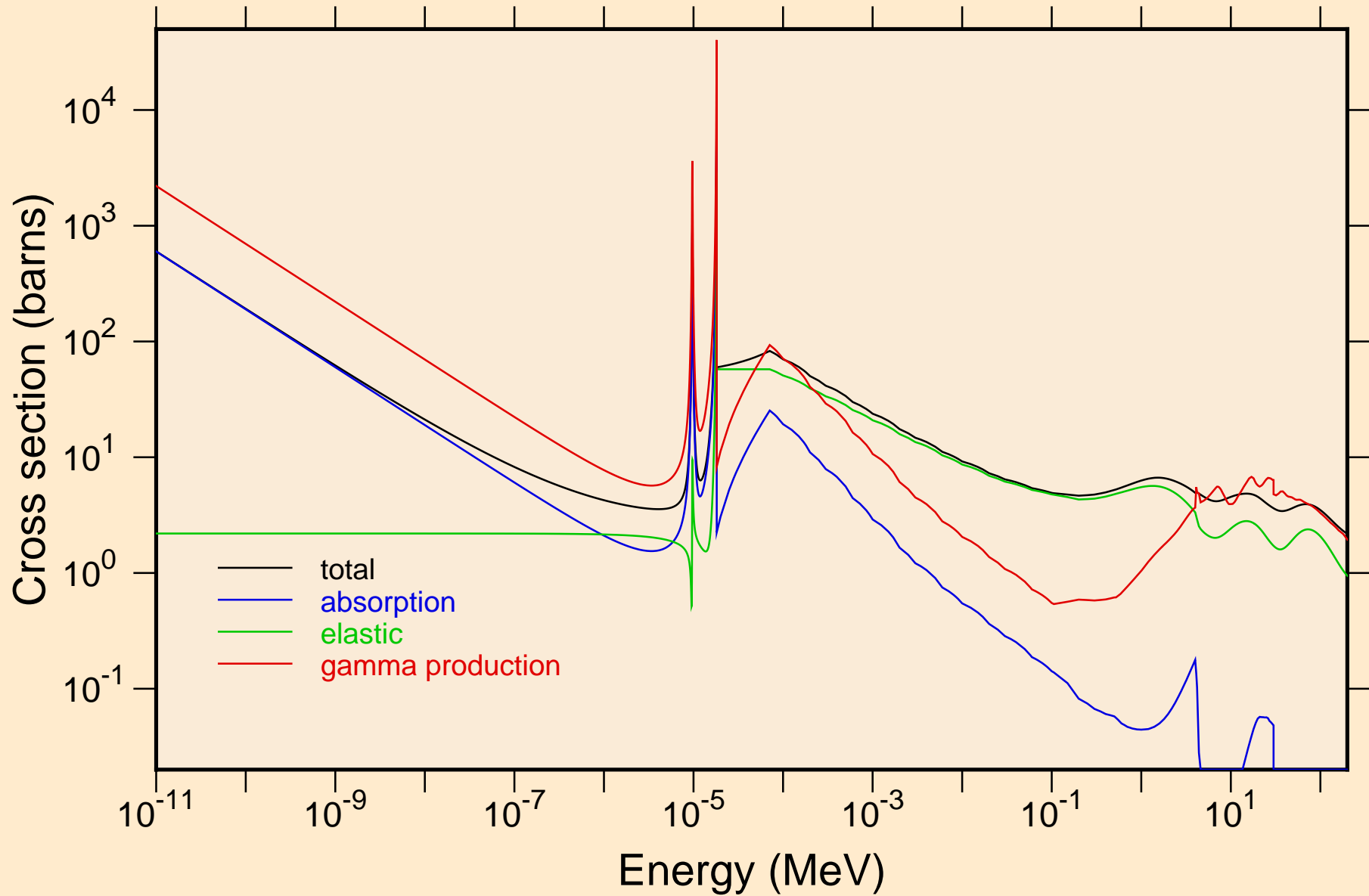

CS136 NEUTRON ACER TENDL-2024 LIBRARY; T=0.K

Heating

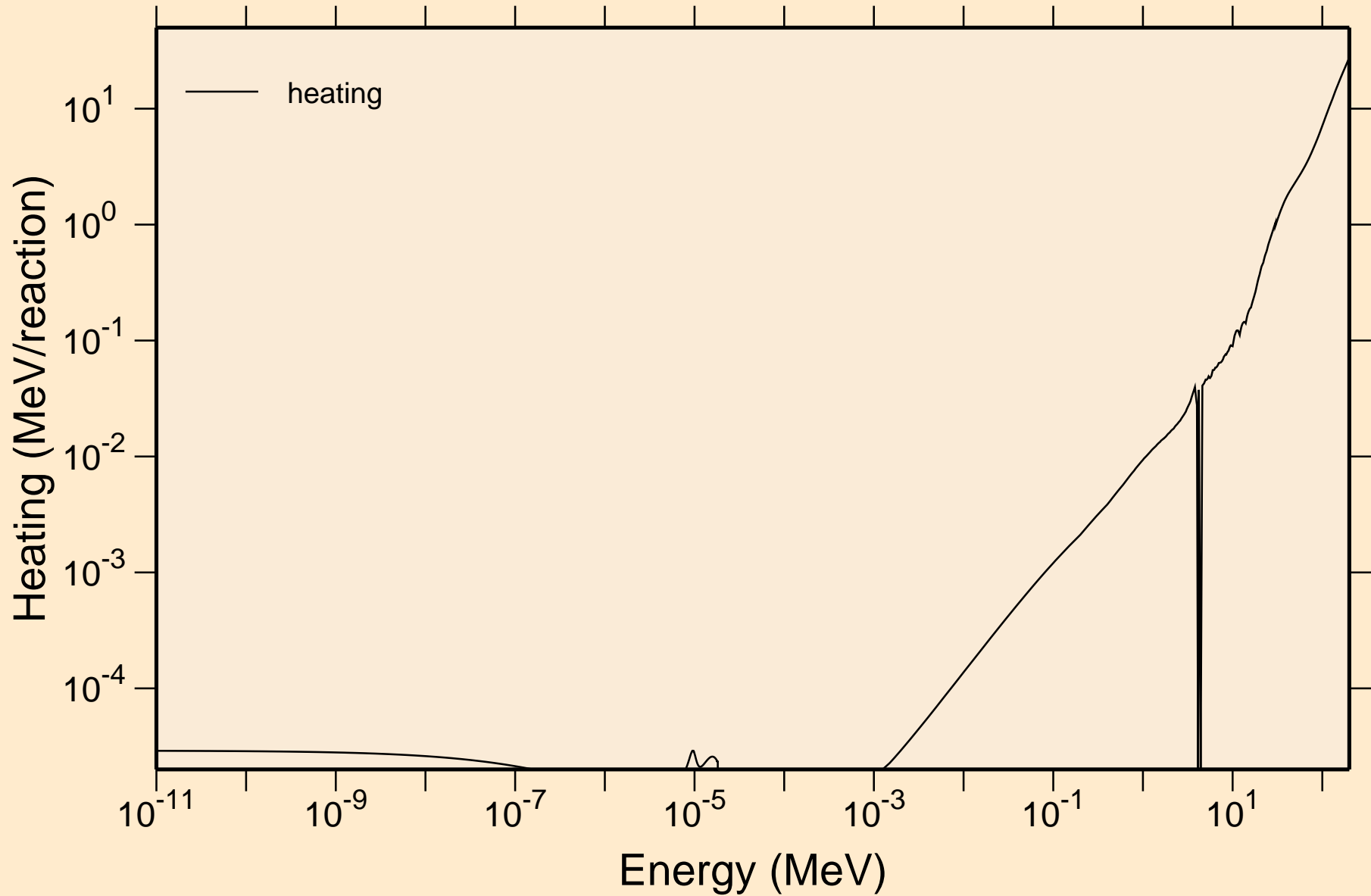

CS136 NEUTRON ACER TENDL-2024 LIBRARY; T=0.K

Damage

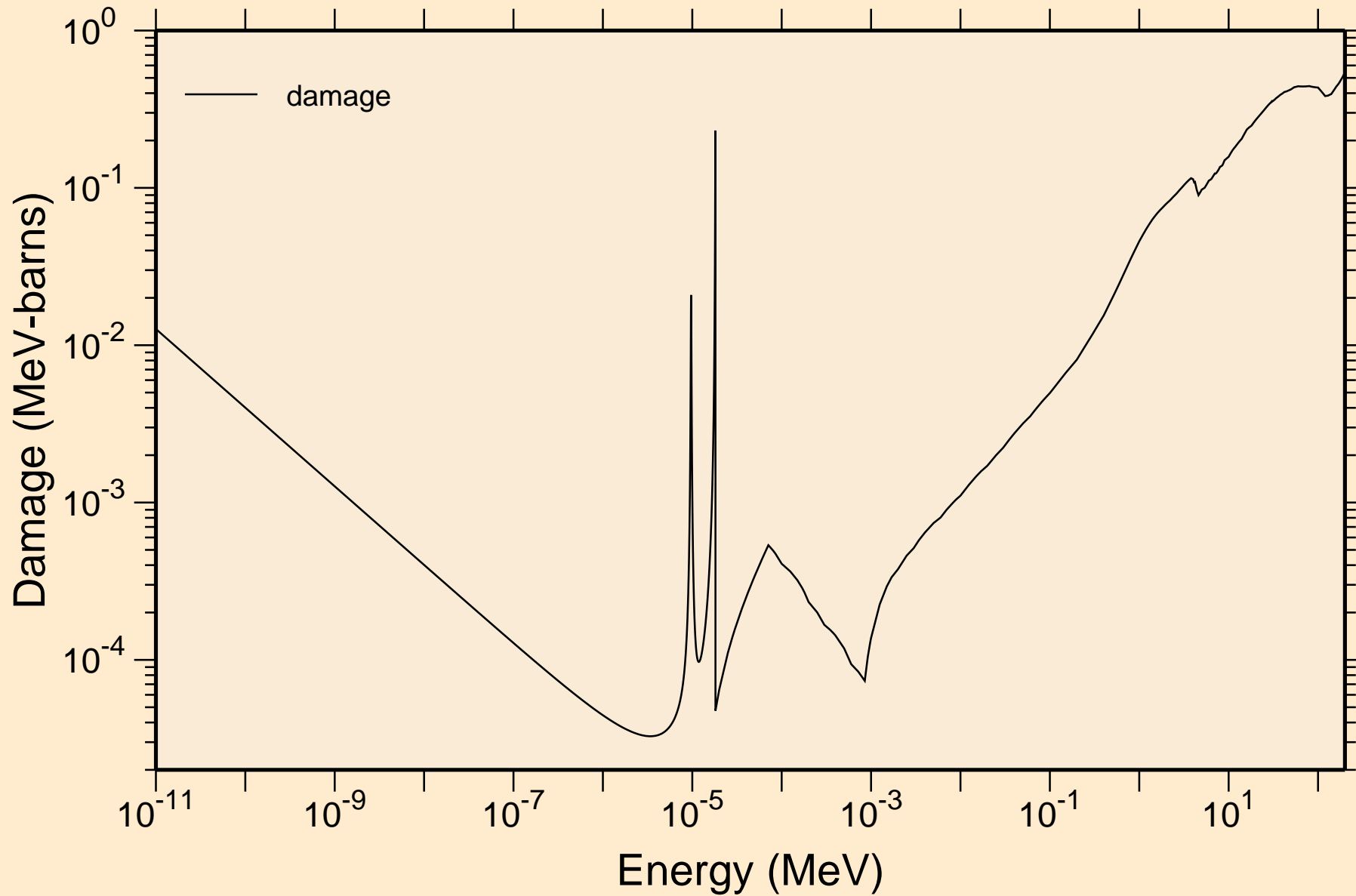

CS136 NEUTRON ACER TENDL-2024 LIBRARY; T=0.K

Non-threshold reactions

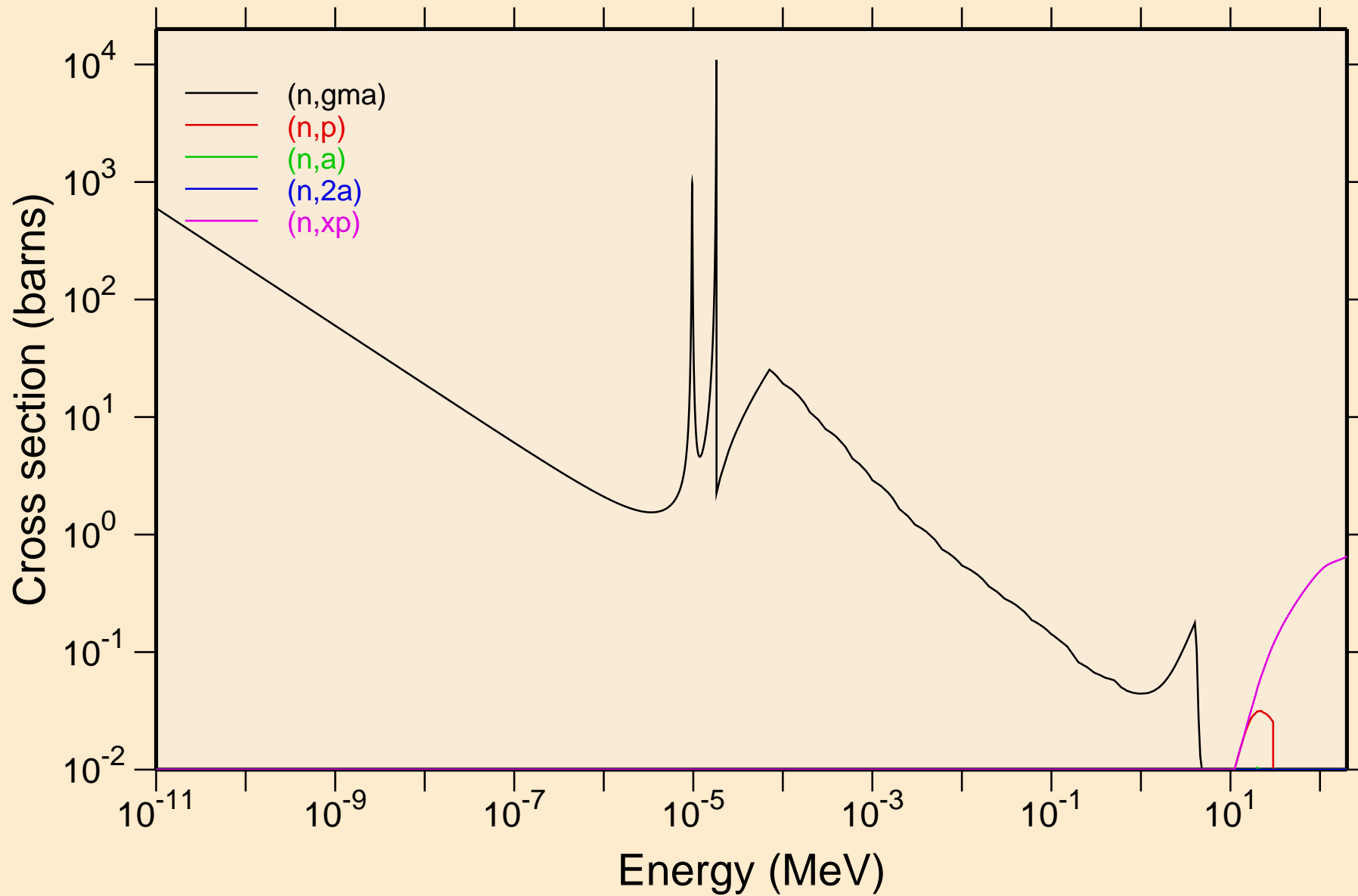

CS136 NEUTRON ACER TENDL-2024 LIBRARY; T=0.K
Non-threshold reactions

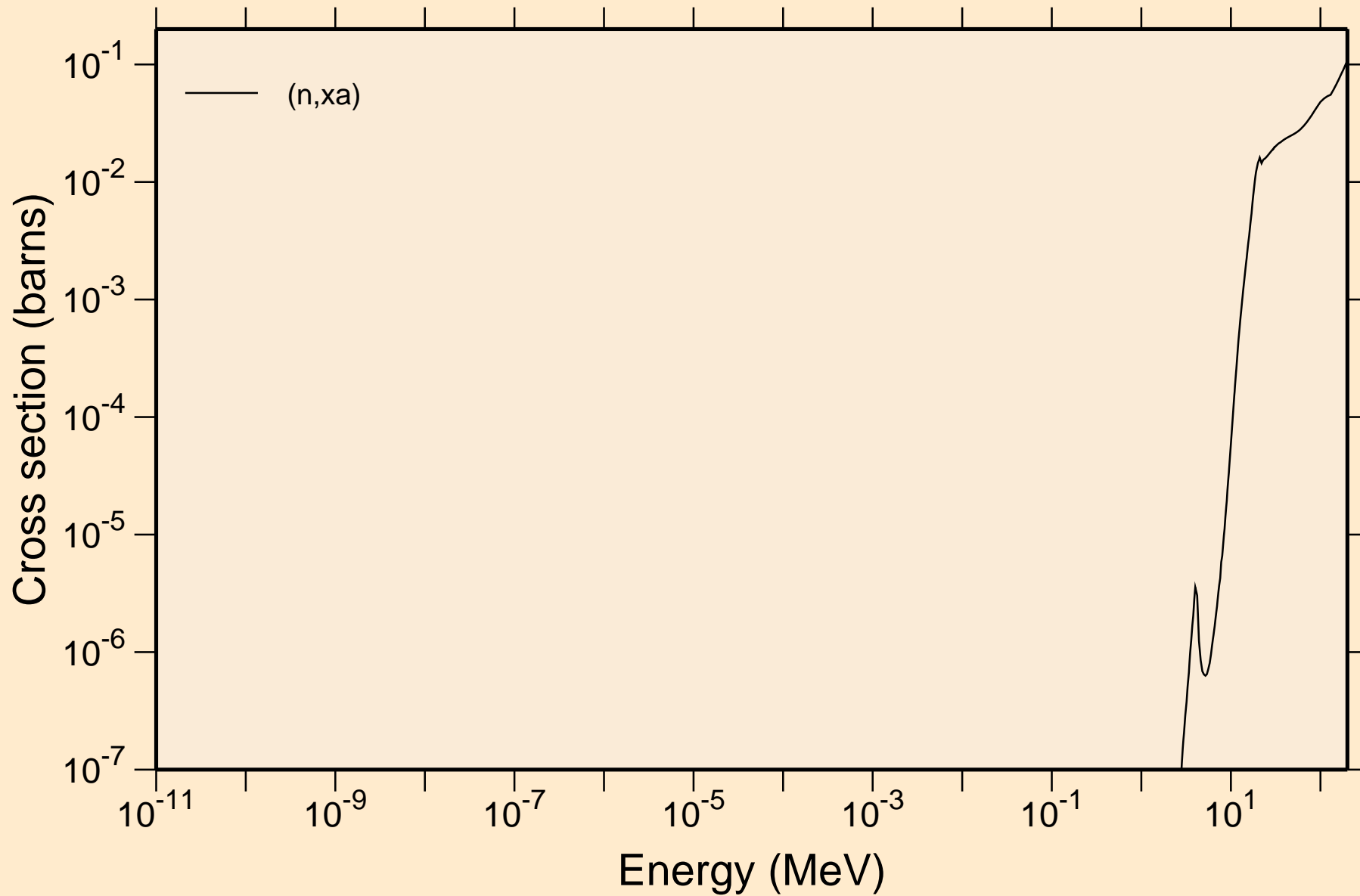

CS136 NEUTRON ACER TENDL-2024 LIBRARY; T=0.K

Principal cross sections

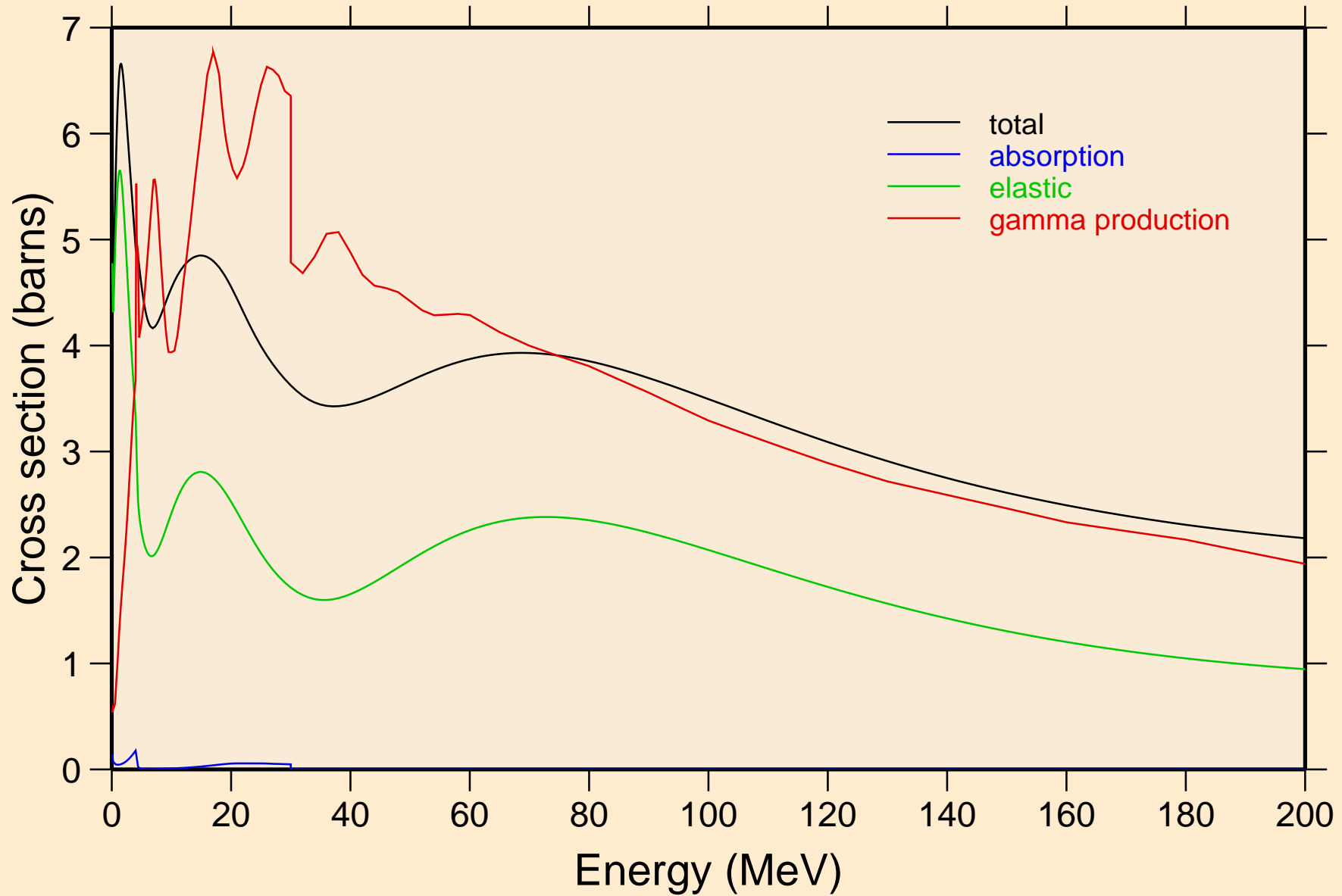

CS136 NEUTRON ACER TENDL-2024 LIBRARY; T=0.K

Heating

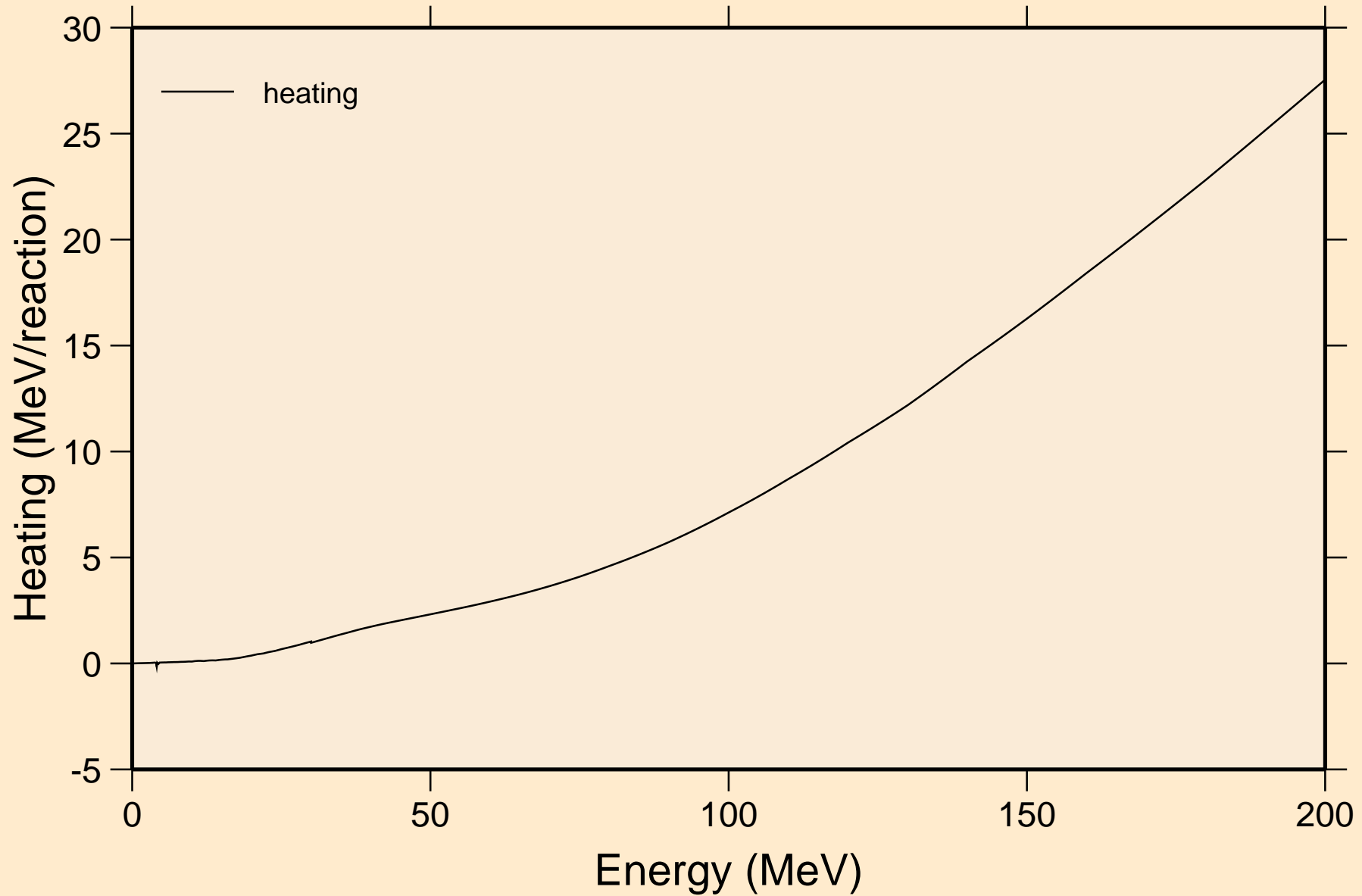

CS136 NEUTRON ACER TENDL-2024 LIBRARY; T=0.K

Damage

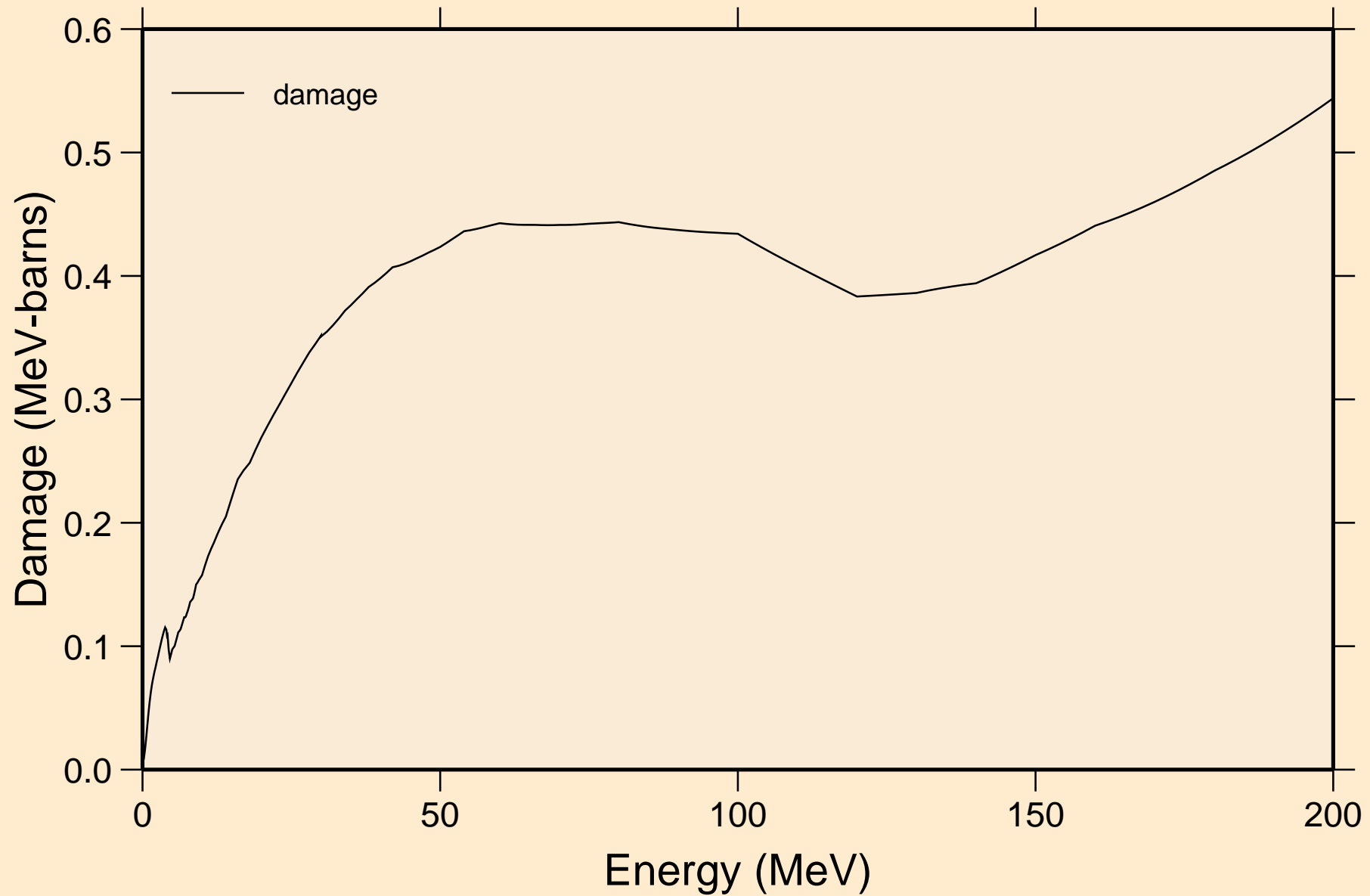

CS136 NEUTRON ACER TENDL-2024 LIBRARY; T=0.K

Non-threshold reactions

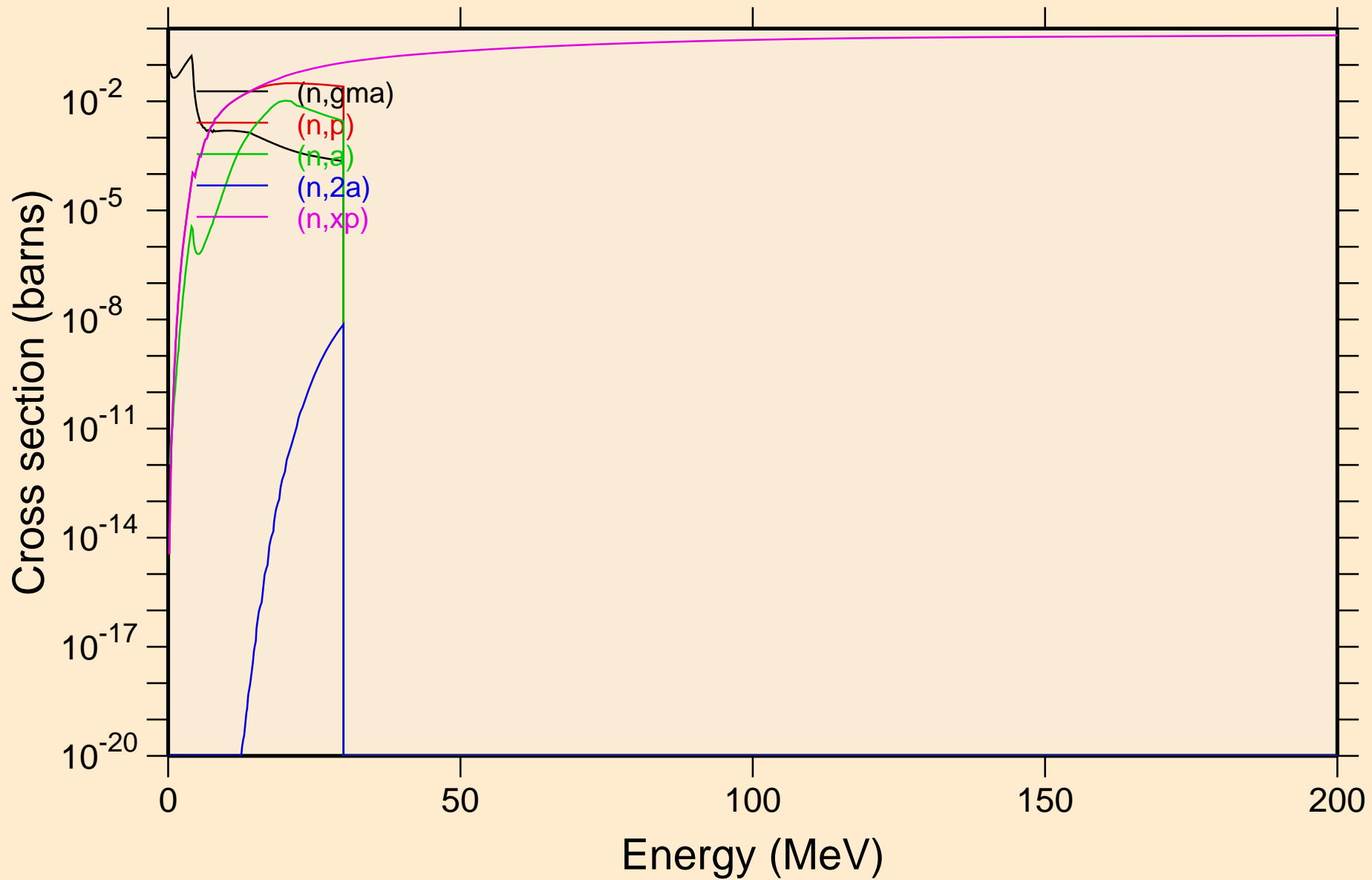

CS136 NEUTRON ACER TENDL-2024 LIBRARY; T=0.K
Non-threshold reactions

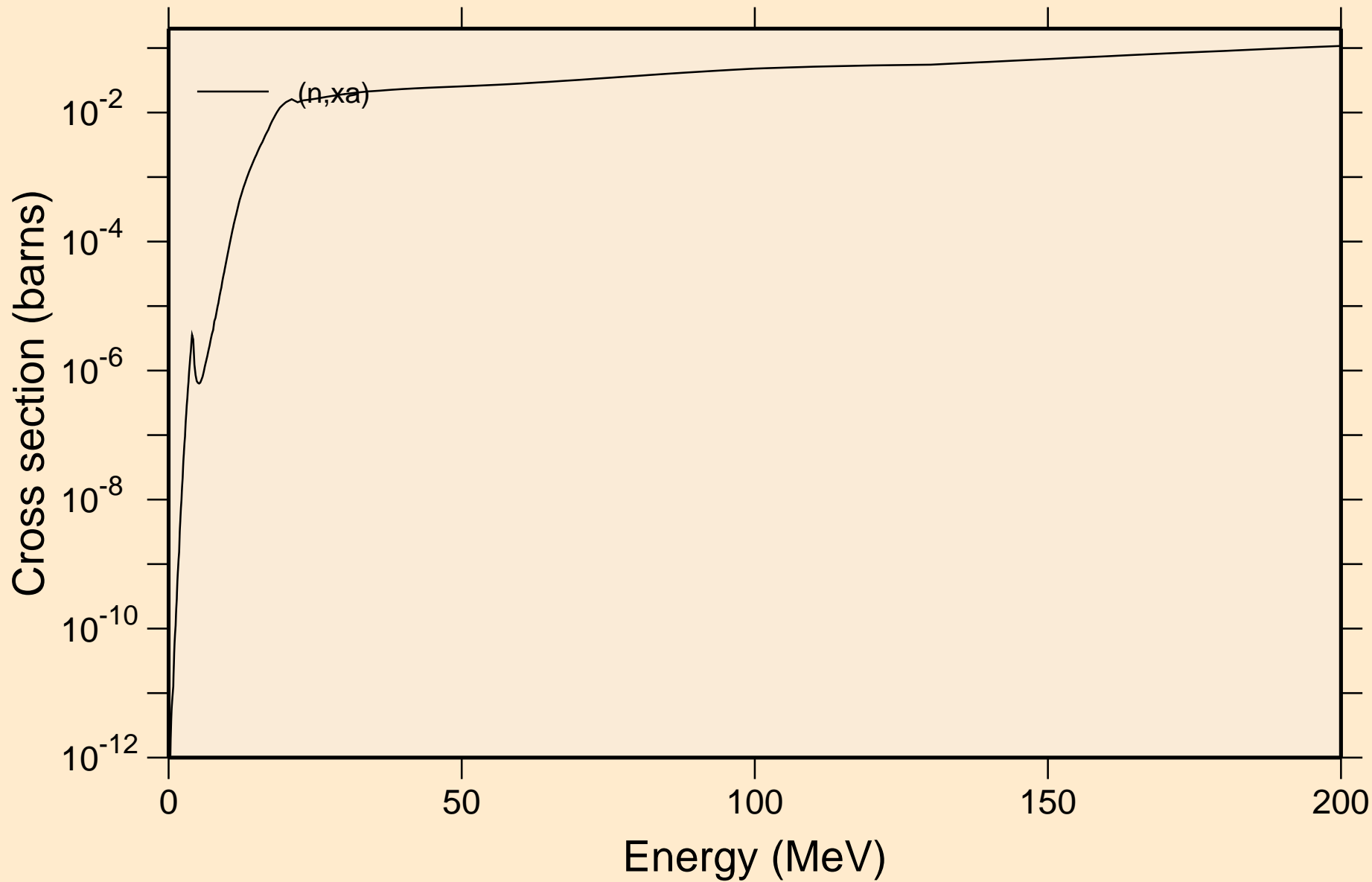

CS136 NEUTRON ACER TENDL-2024 LIBRARY; T=0.K
Inelastic levels

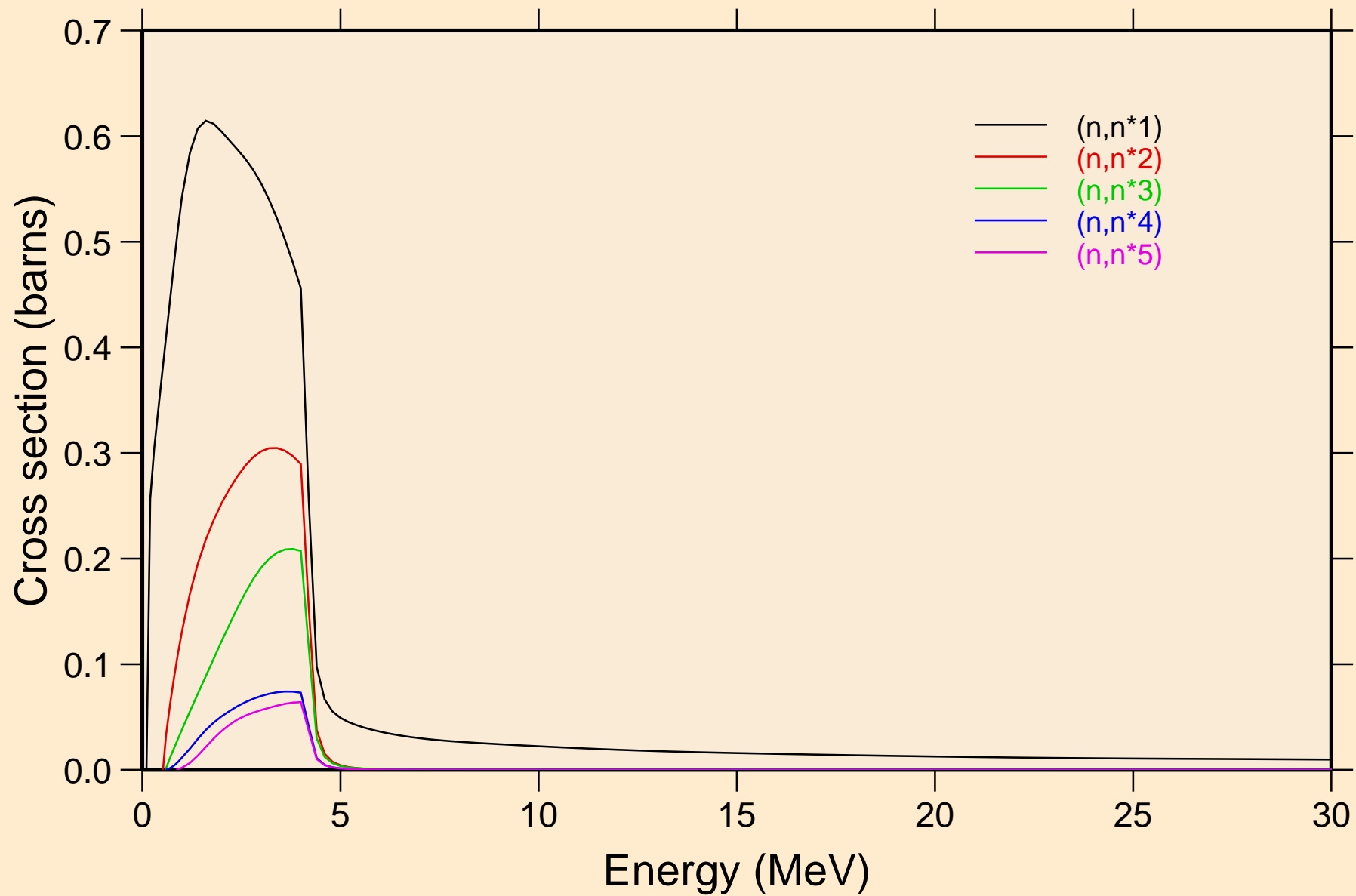

CS136 NEUTRON ACER TENDL-2024 LIBRARY; T=0.K

Inelastic levels

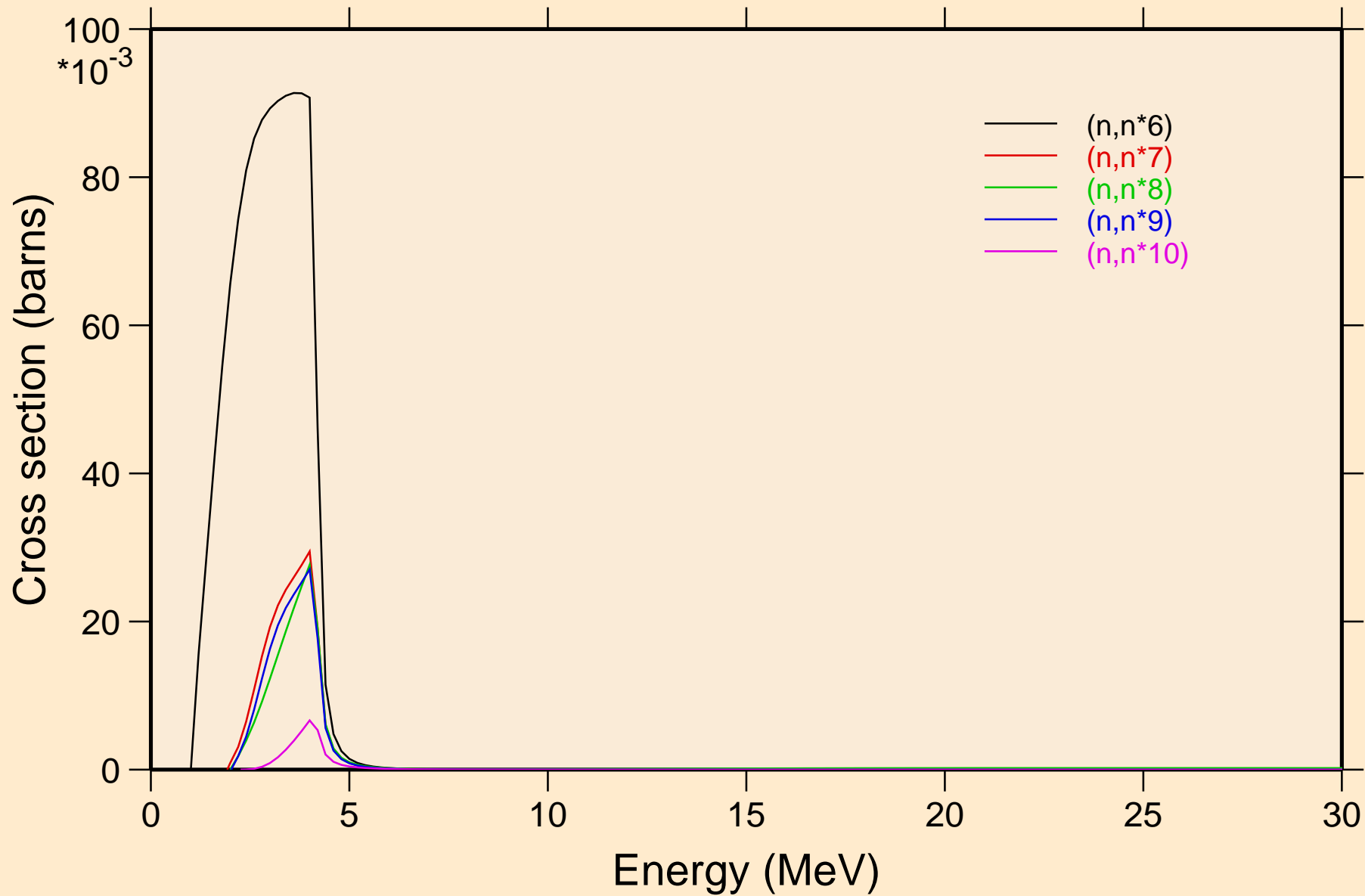

CS136 NEUTRON ACER TENDL-2024 LIBRARY; T=0.K
Inelastic levels

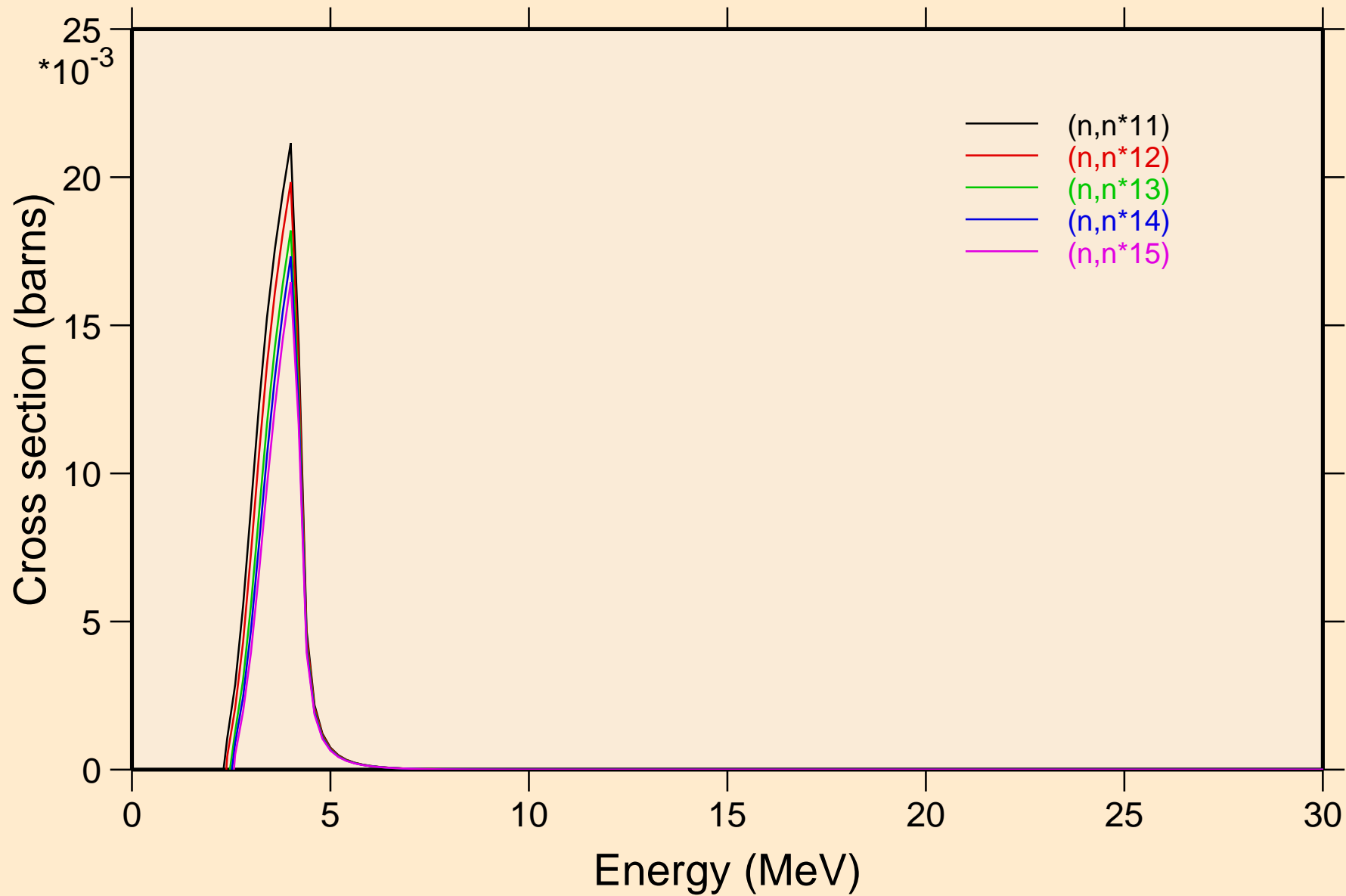

CS136 NEUTRON ACER TENDL-2024 LIBRARY; T=0.K
Inelastic levels

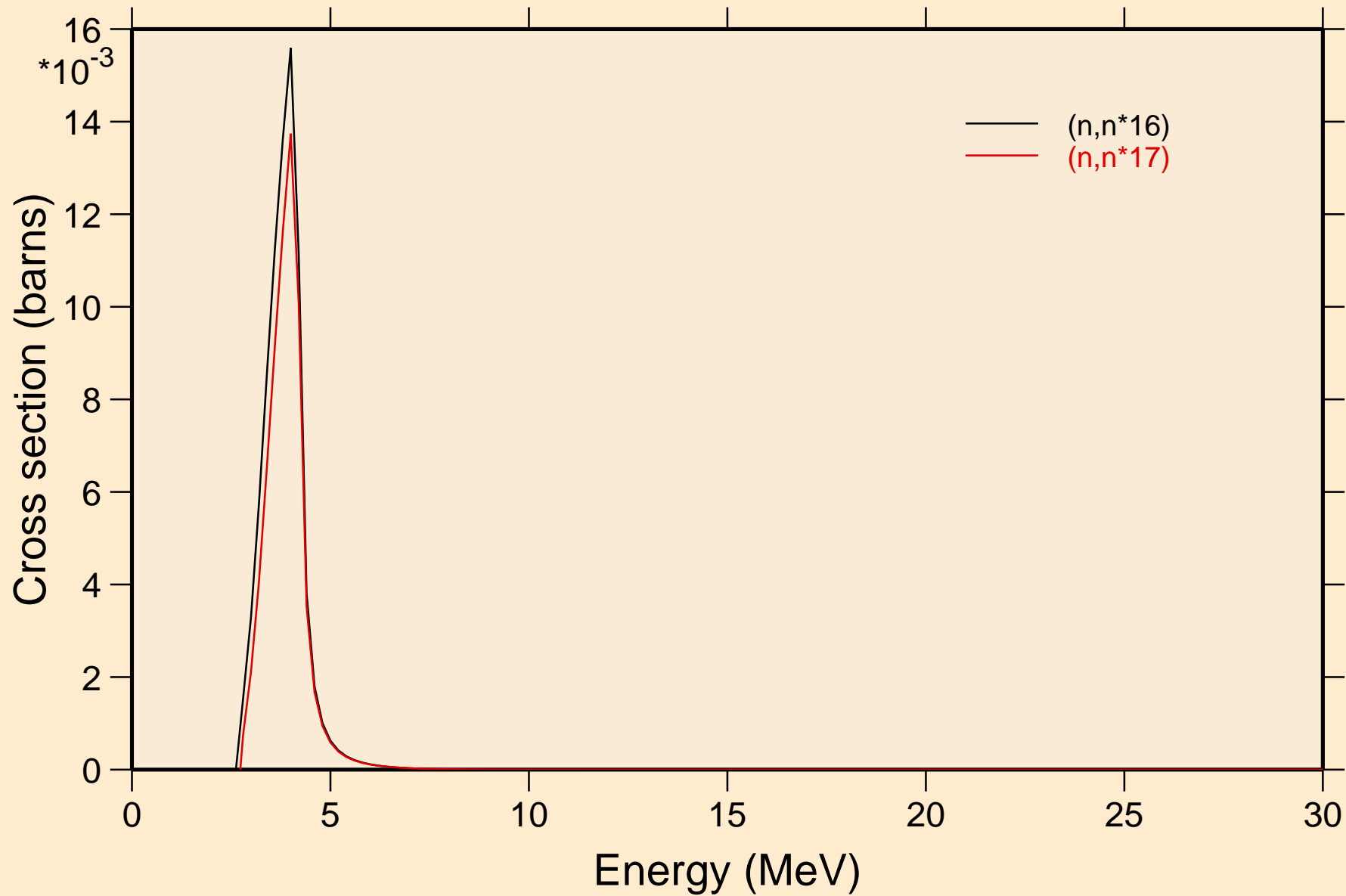

CS136 NEUTRON ACER TENDL-2024 LIBRARY; T=0.K

Threshold reactions

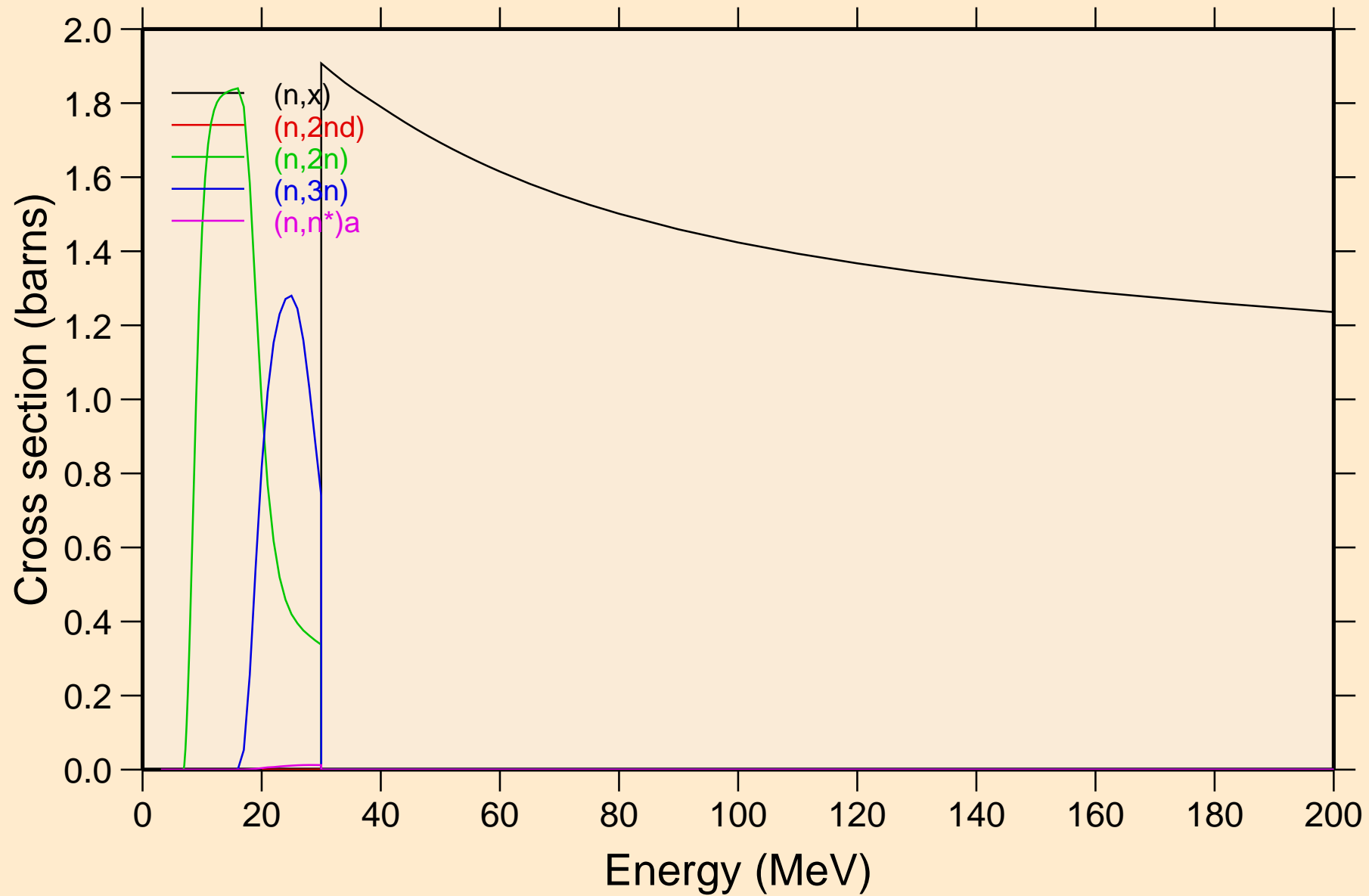

CS136 NEUTRON ACER TENDL-2024 LIBRARY; T=0.K

Threshold reactions

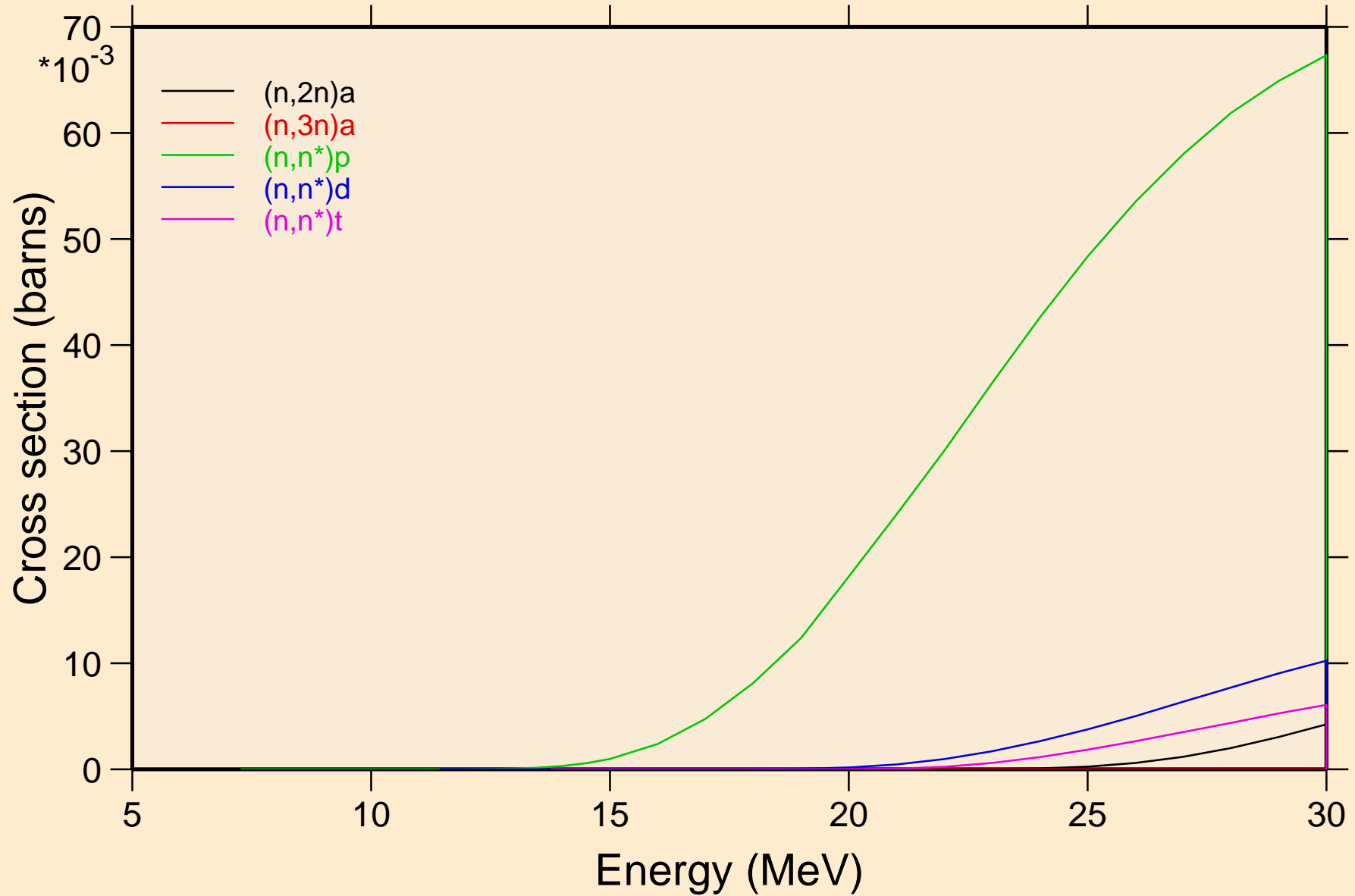

CS136 NEUTRON ACER TENDL-2024 LIBRARY; T=0.K

Threshold reactions

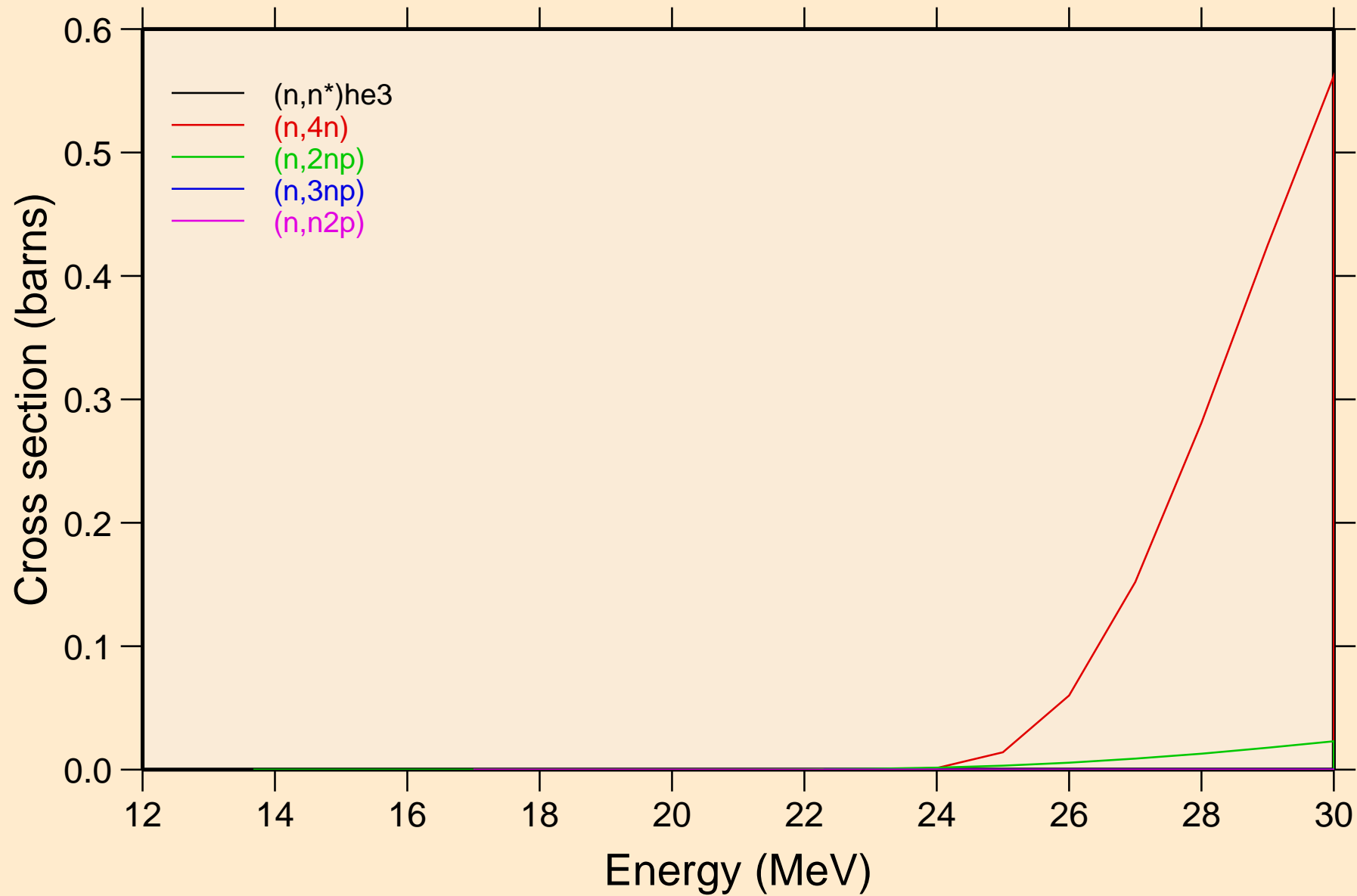

CS136 NEUTRON ACER TENDL-2024 LIBRARY; T=0.K

Threshold reactions

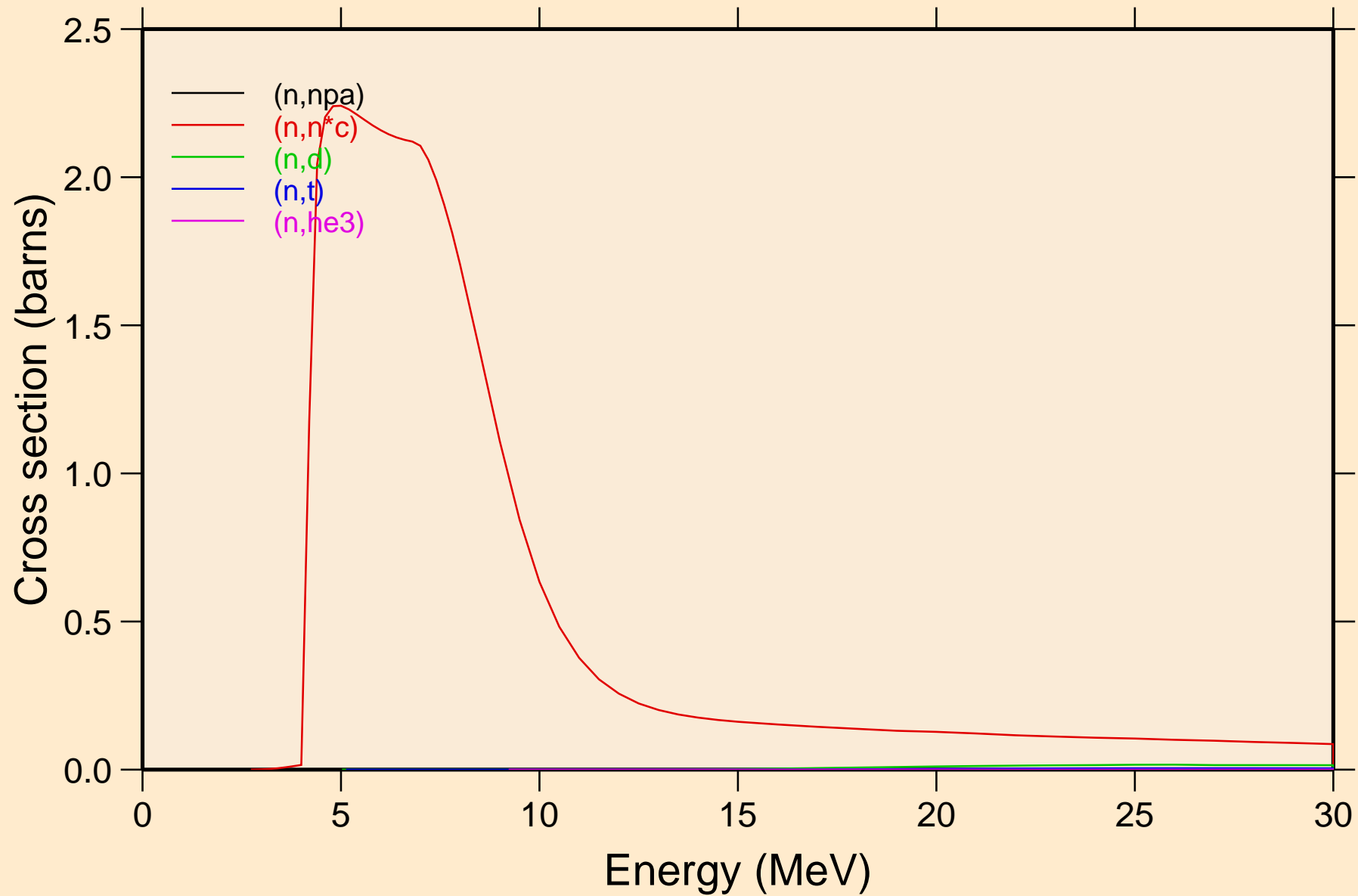

CS136 NEUTRON ACER TENDL-2024 LIBRARY; T=0.K

Threshold reactions

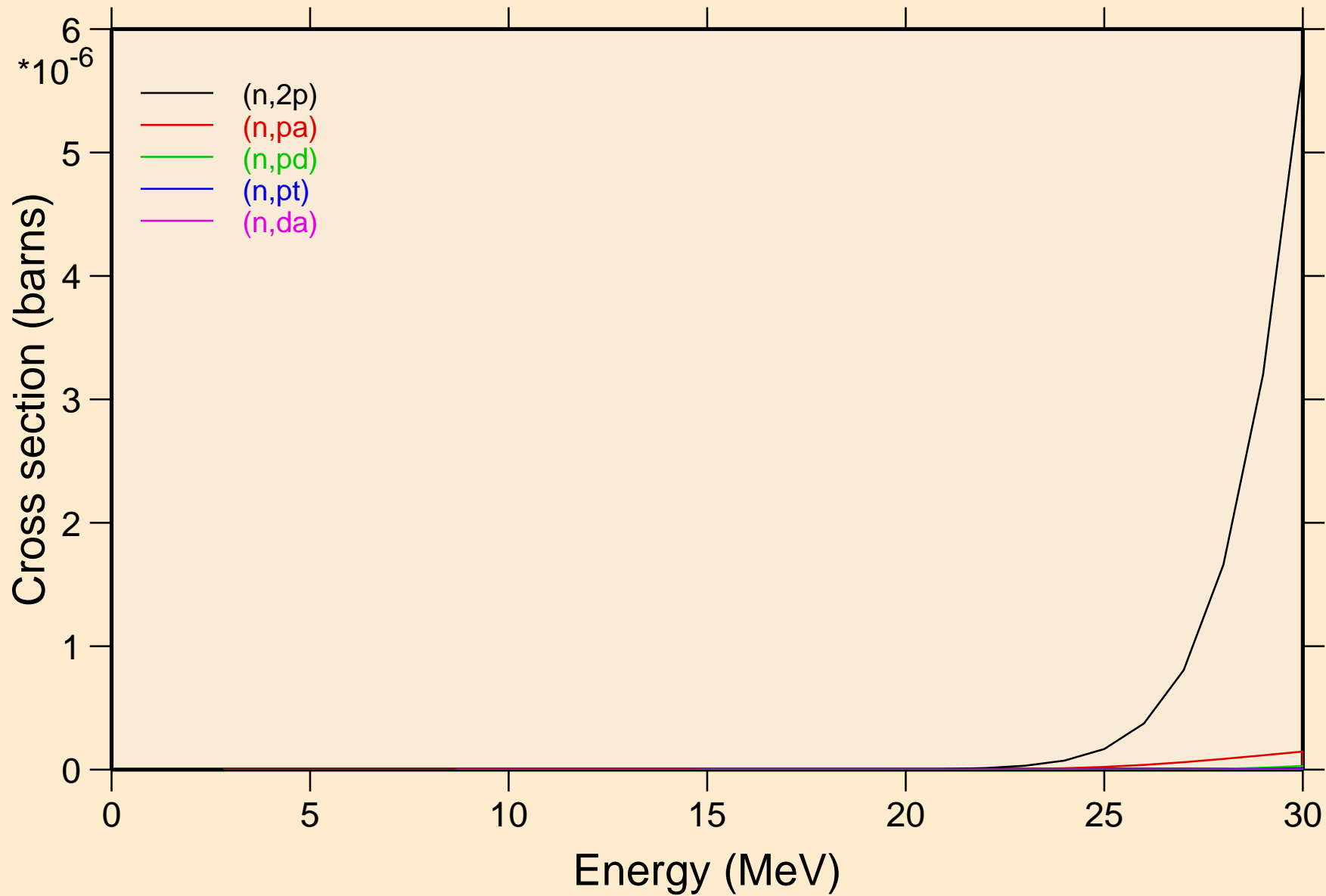

CS136 NEUTRON ACER TENDL-2024 LIBRARY; T=0.K

Threshold reactions

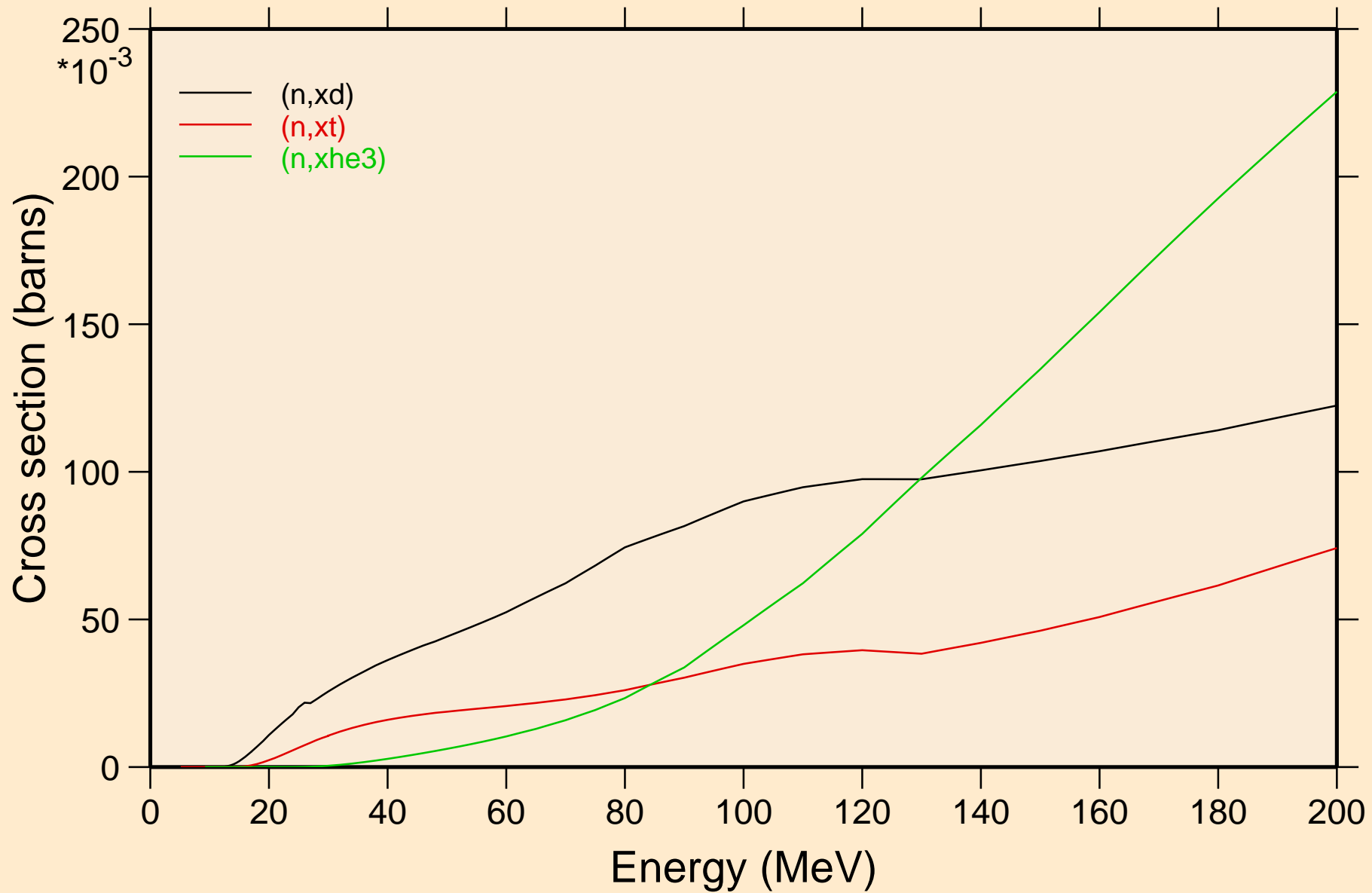

CS136 NEUTRON ACER TENDL-2024 LIBRARY; T=0.K
angular distribution for elastic

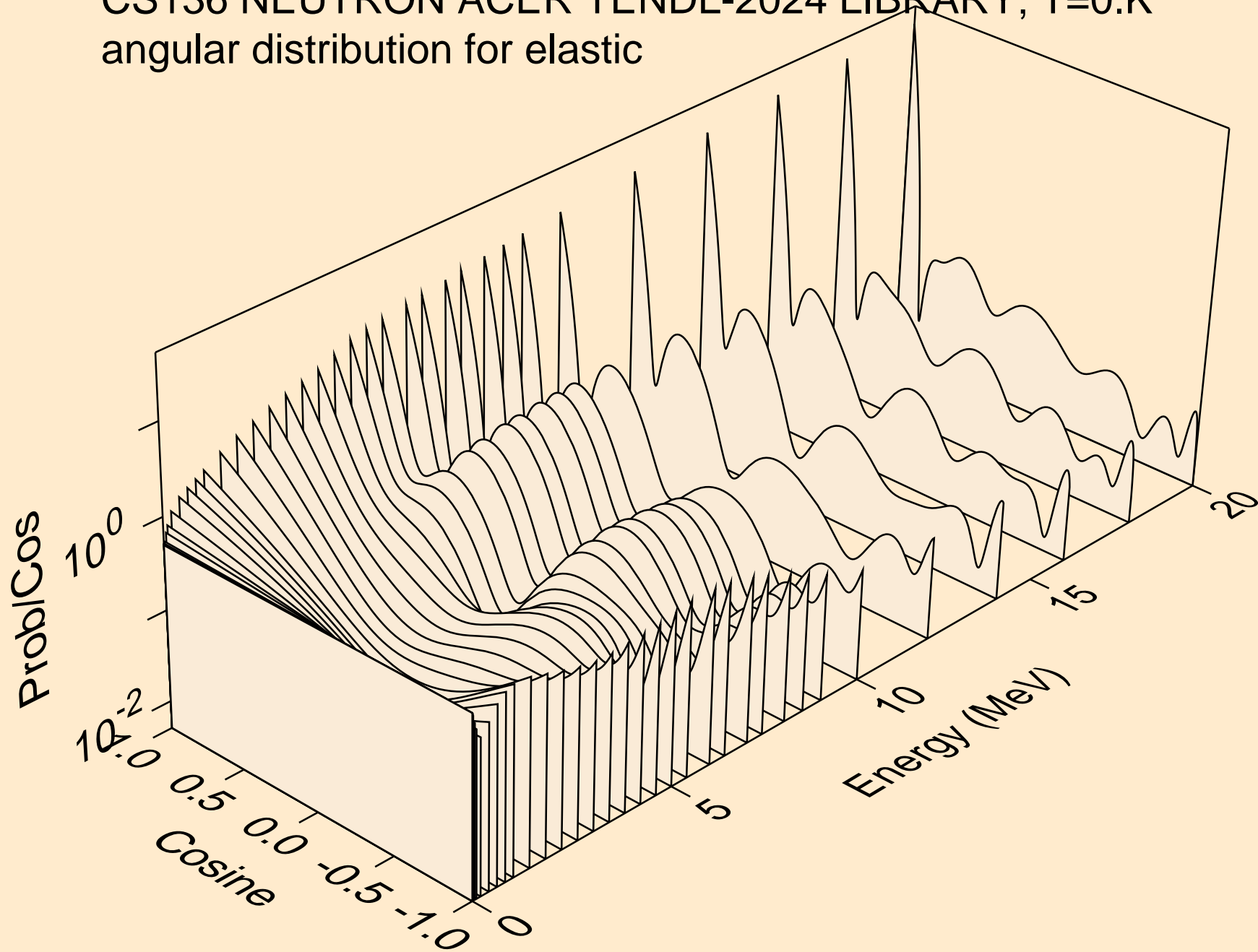

CS136 NEUTRON ACER TENDL-2024 LIBRARY; T=0.K
angular distribution for elastic

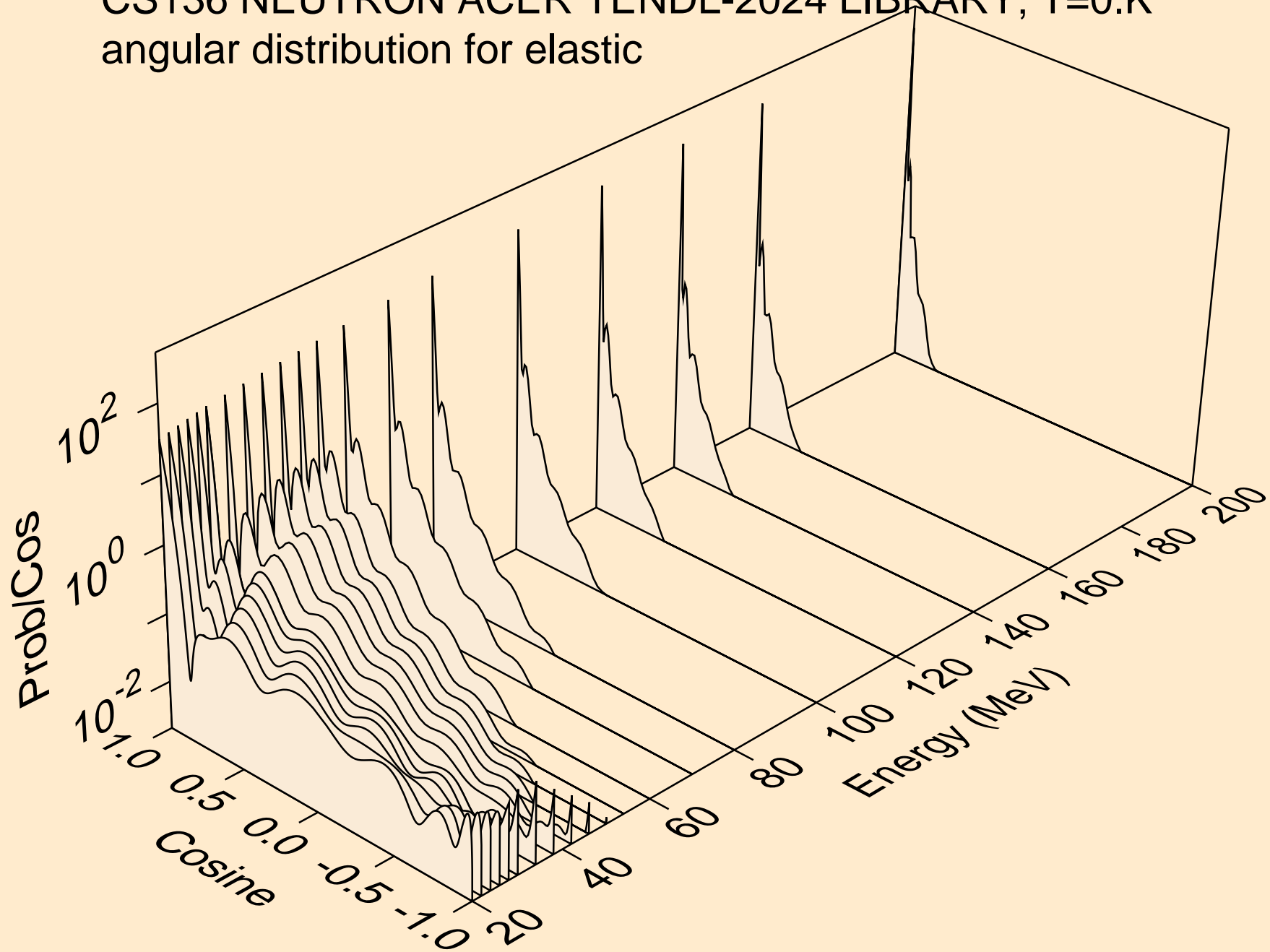

CS136 NEUTRON ACER TENDL-2024 LIBRARY; T=0.K
angular distribution for (n,n*1)

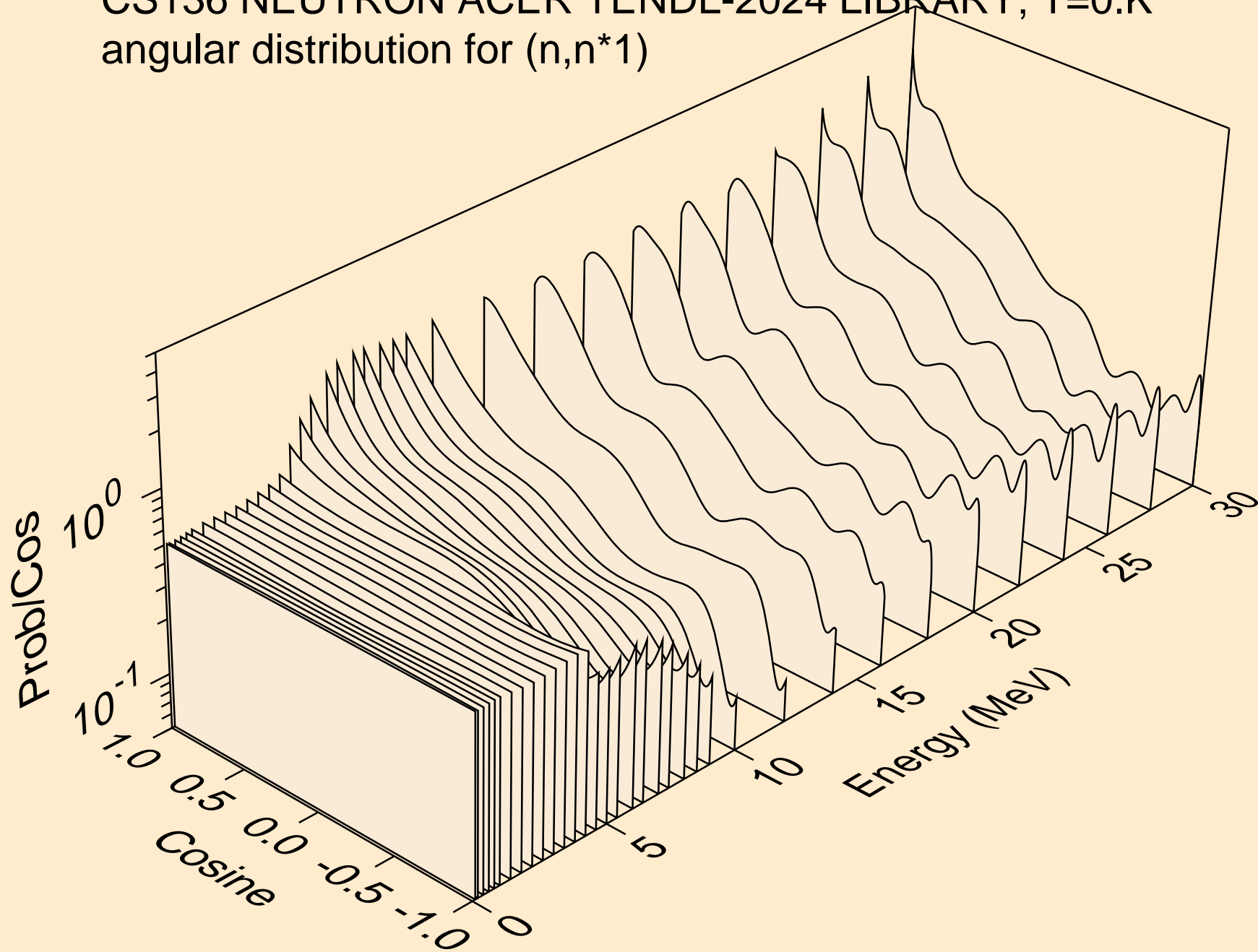

CS136 NEUTRON ACER TENDL-2024 LIBRARY; T=0.K
angular distribution for (n,n*2)

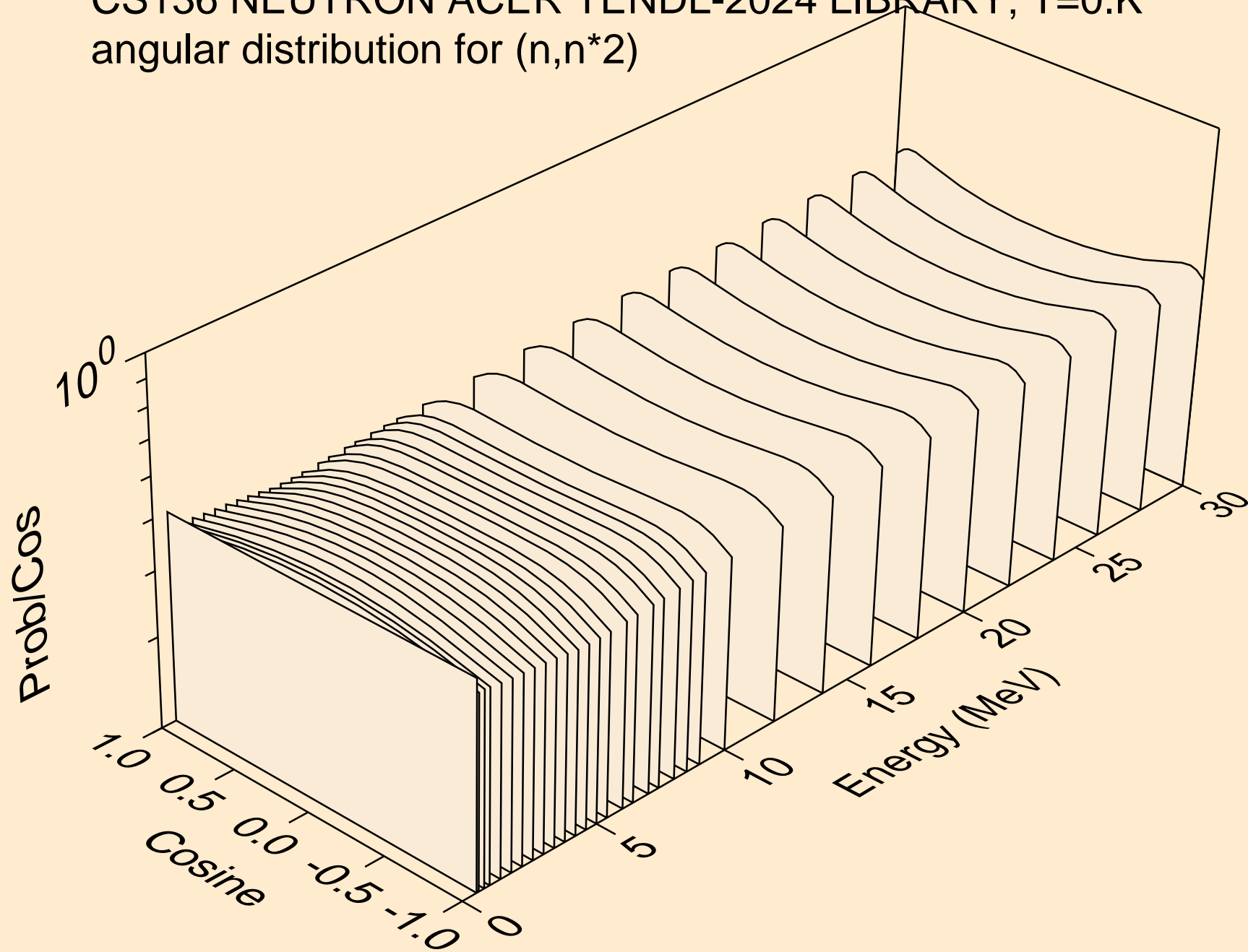

CS136 NEUTRON ACER TENDL-2024 LIBRARY; T=0.K
angular distribution for (n,n*3)

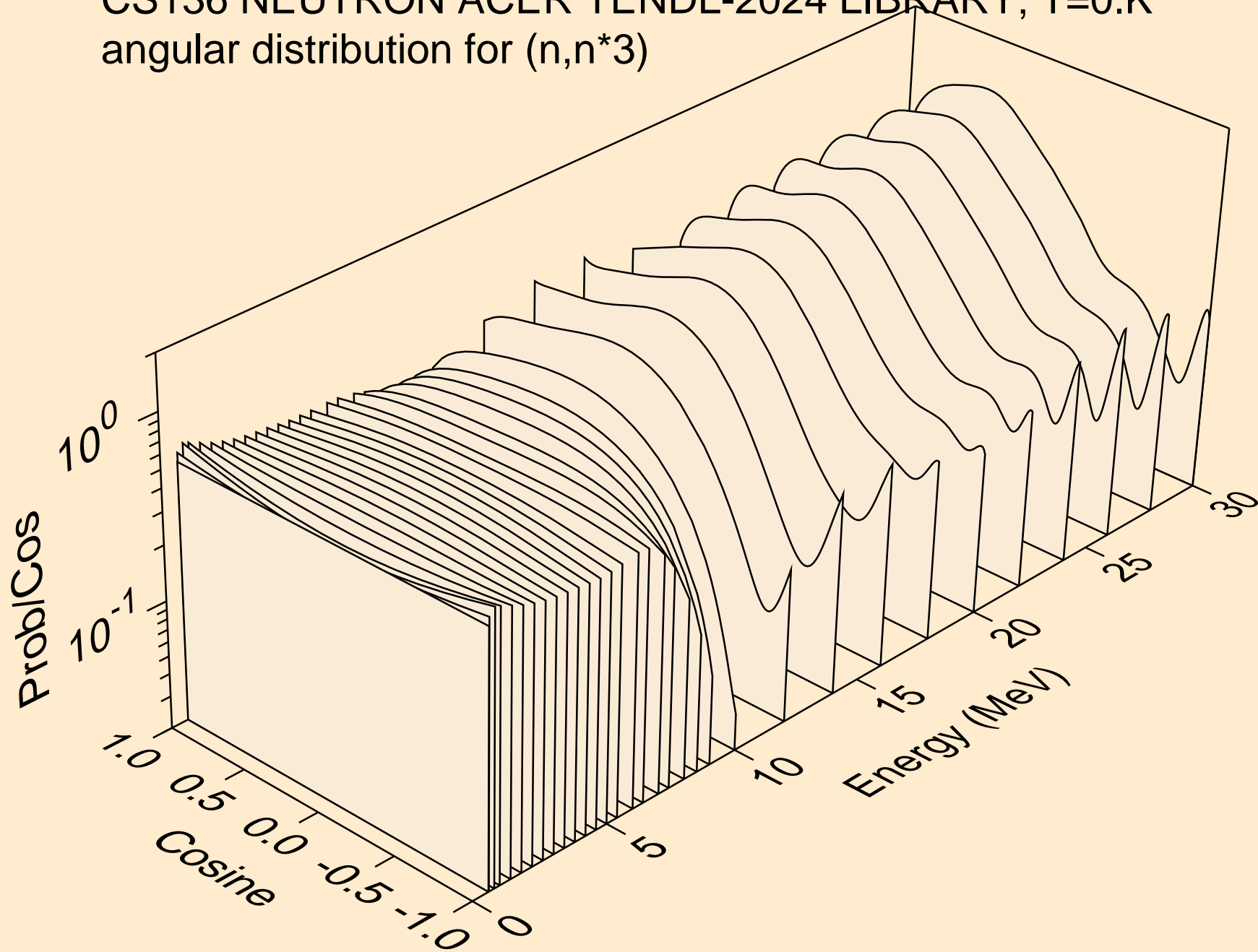

CS136 NEUTRON ACER TENDL-2024 LIBRARY; T=0.K
angular distribution for (n,n*4)

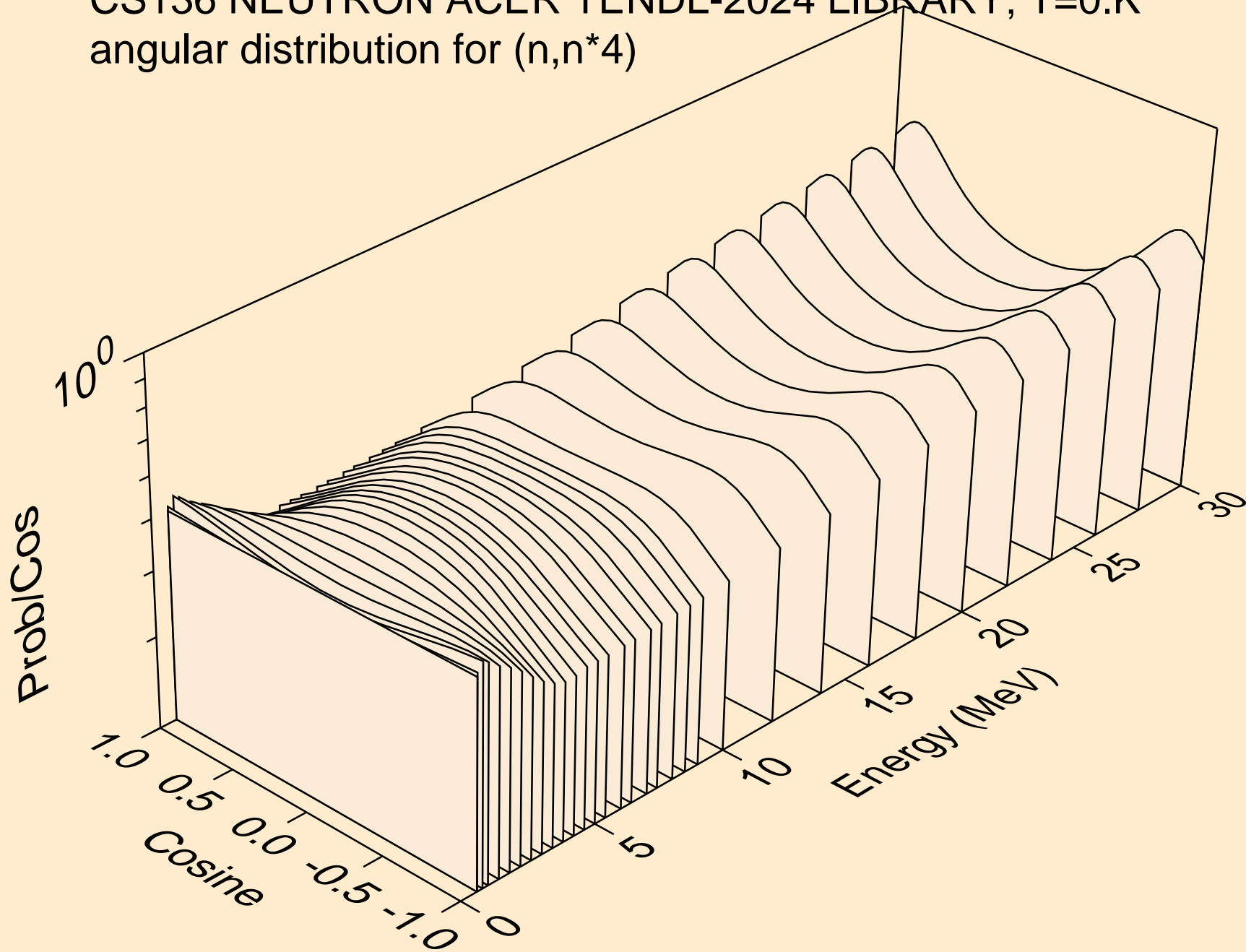

CS136 NEUTRON ACER TENDL-2024 LIBRARY; T=0.K
angular distribution for (n,n*5)

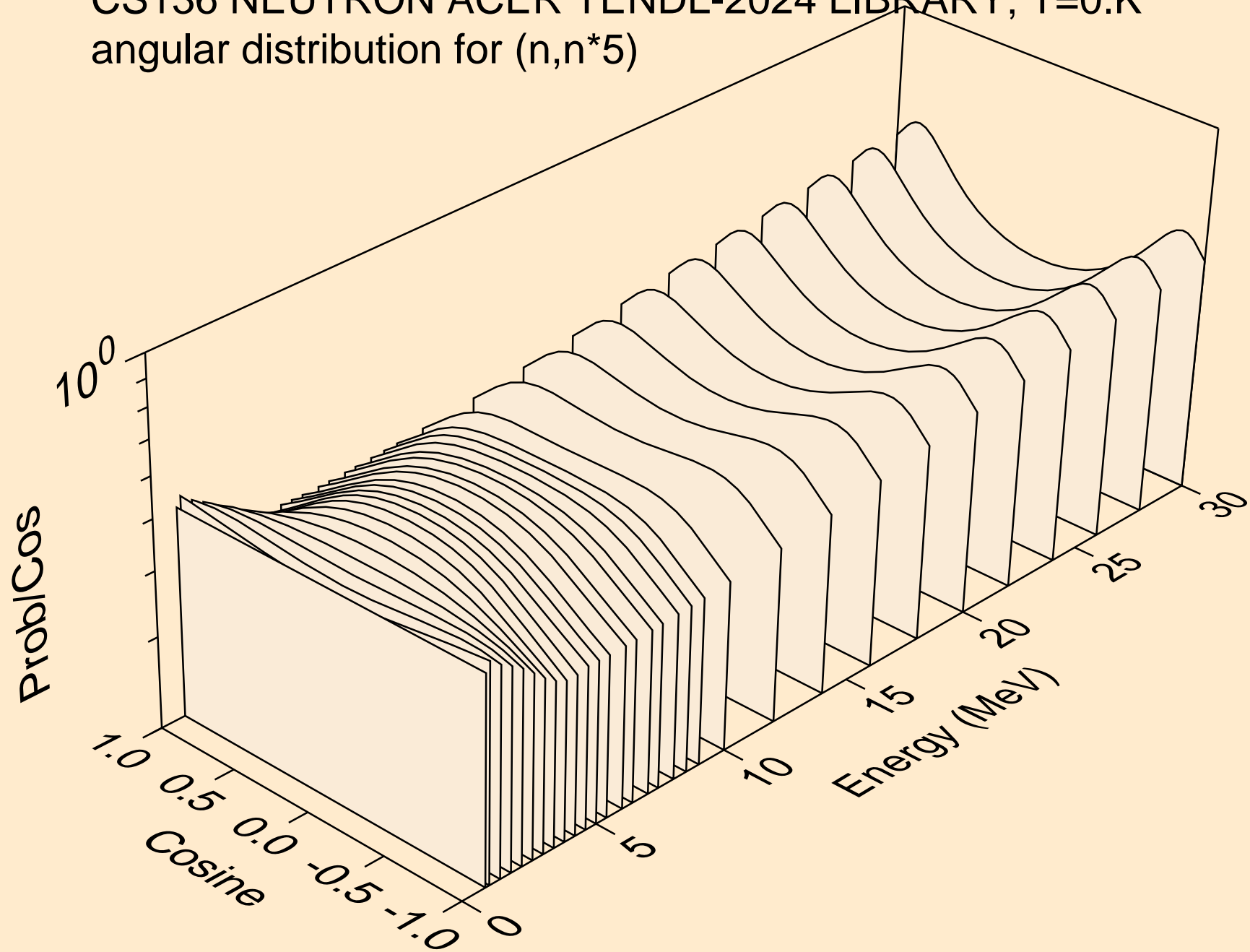

CS136 NEUTRON ACER TENDL-2024 LIBRARY; T=0.K
angular distribution for (n,n*6)

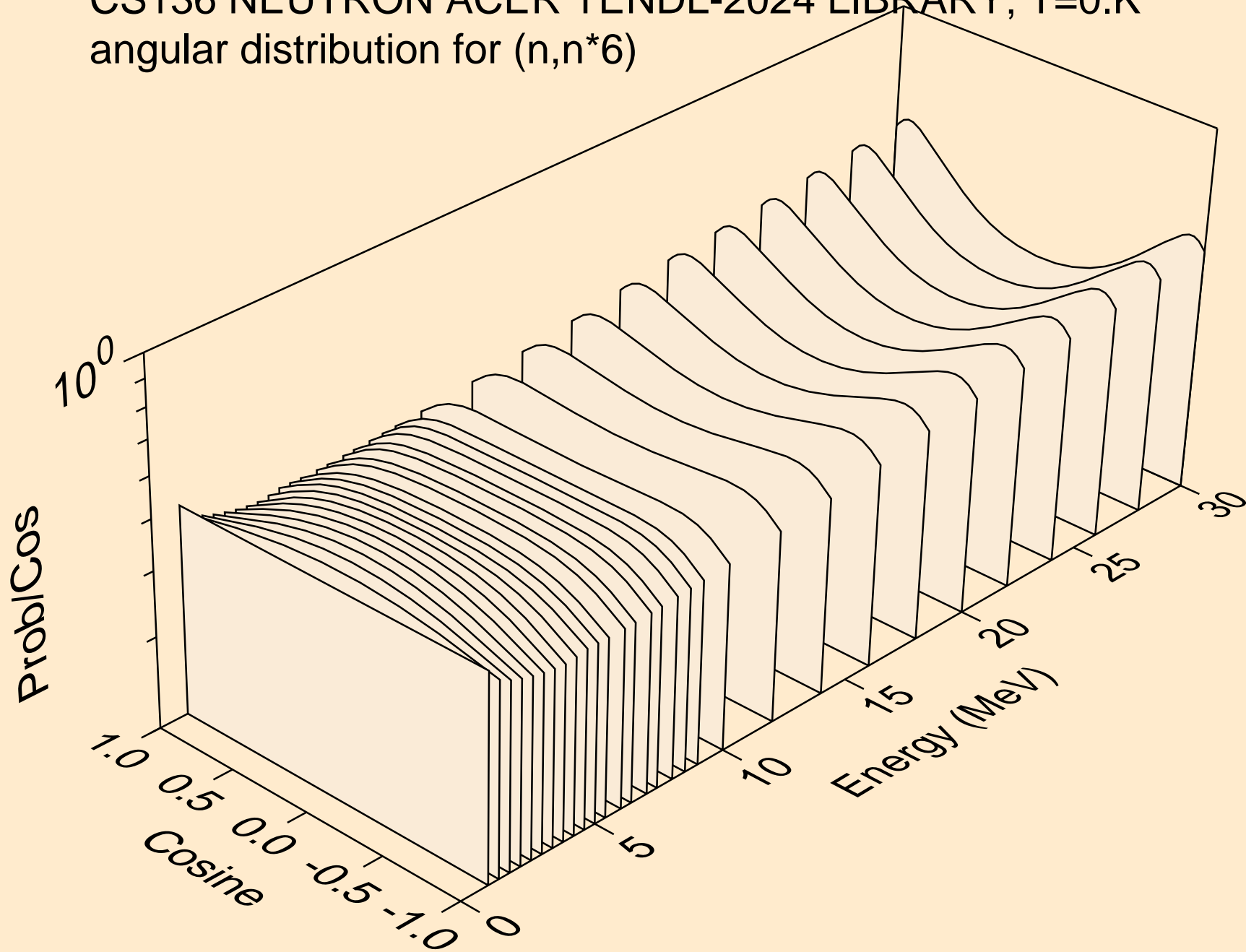

CS136 NEUTRON ACER TENDL-2024 LIBRARY; T=0.K
angular distribution for (n,n*7)

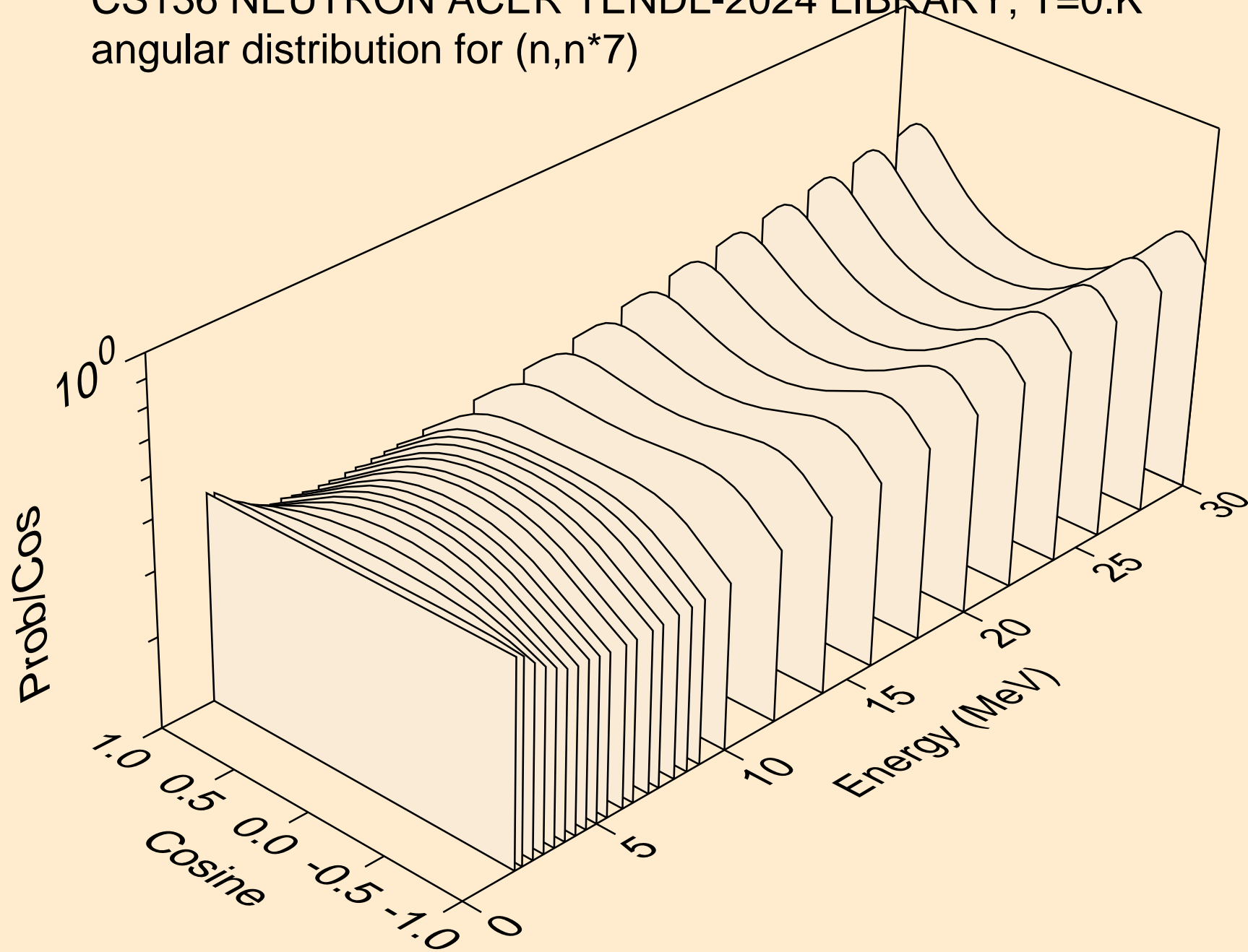

CS136 NEUTRON ACER TENDL-2024 LIBRARY; T=0.K
angular distribution for (n,n*8)

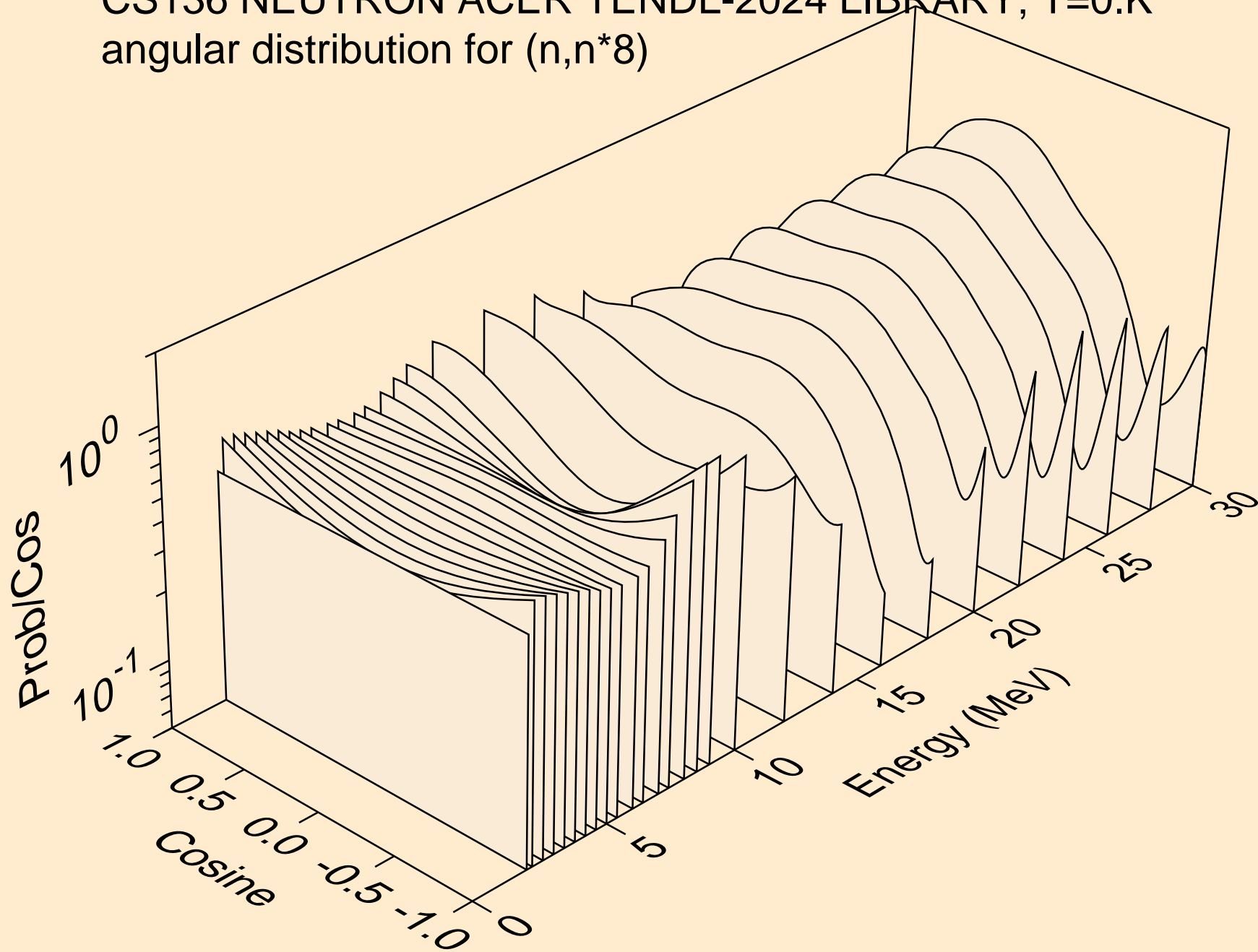

CS136 NEUTRON ACER TENDL-2024 LIBRARY; T=0.K
angular distribution for (n,n*9)

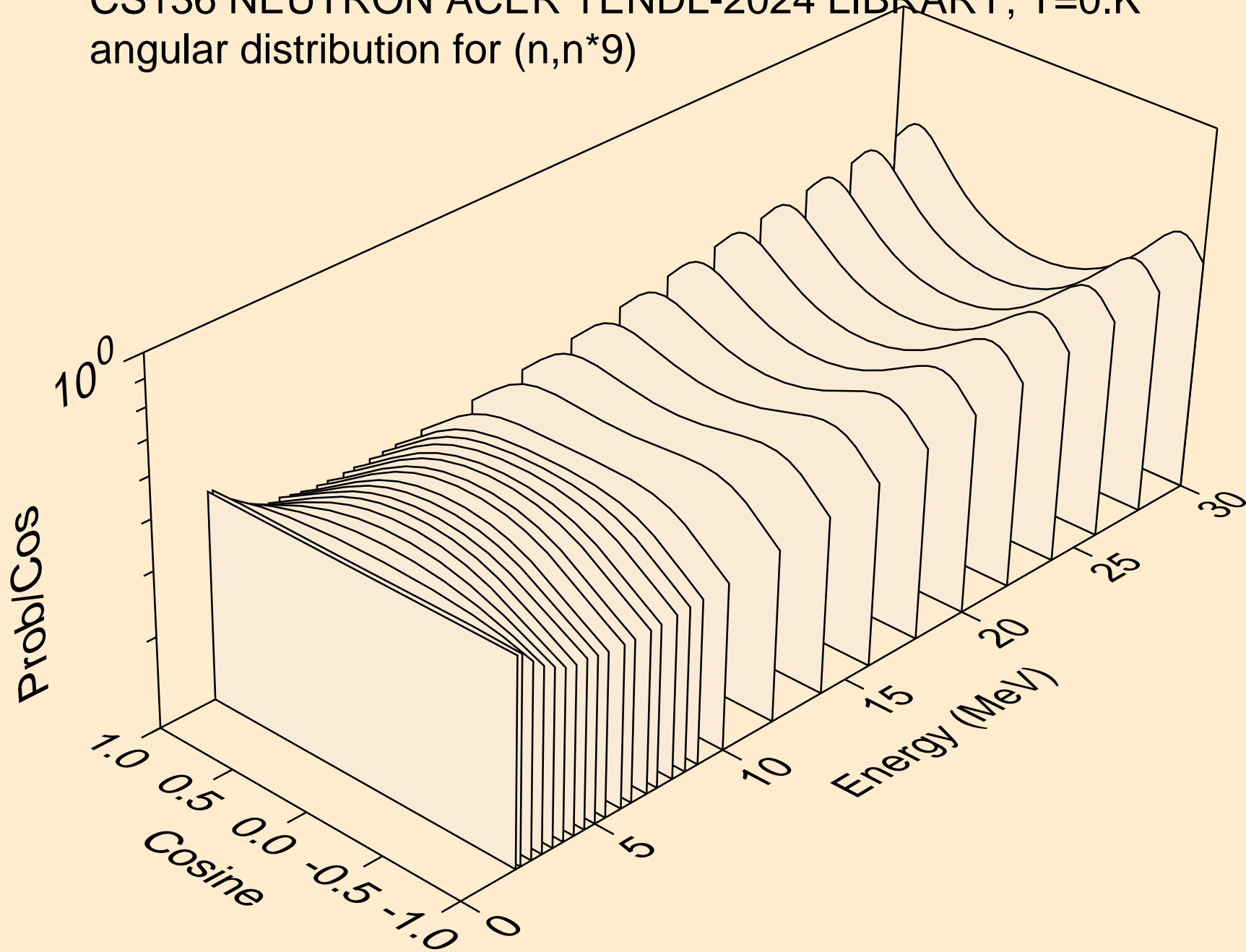

CS136 NEUTRON ACER TENDL-2024 LIBRARY; T=0.K
angular distribution for (n,n*10)

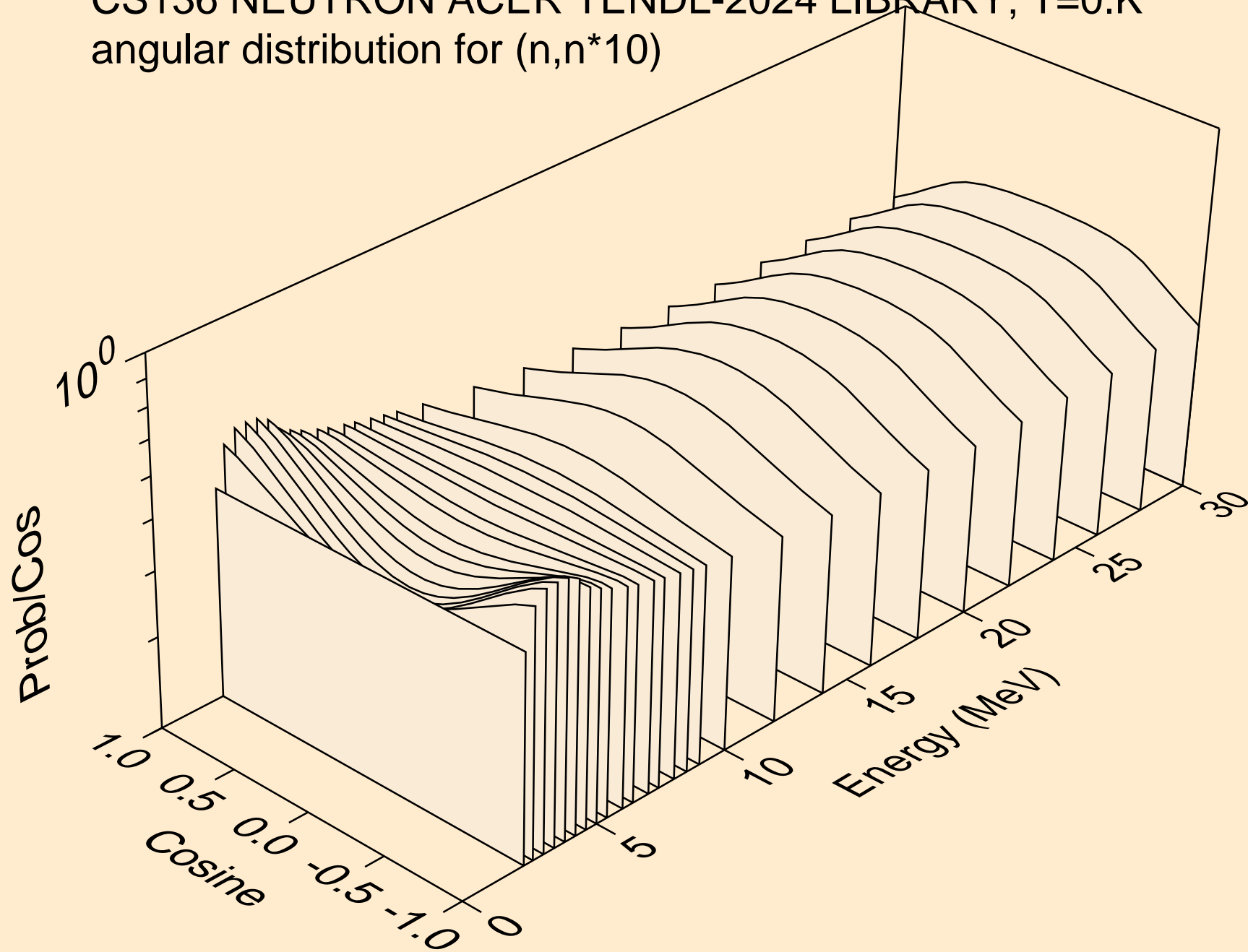

CS136 NEUTRON ACER TENDL-2024 LIBRARY; T=0.K
angular distribution for (n,n*11)

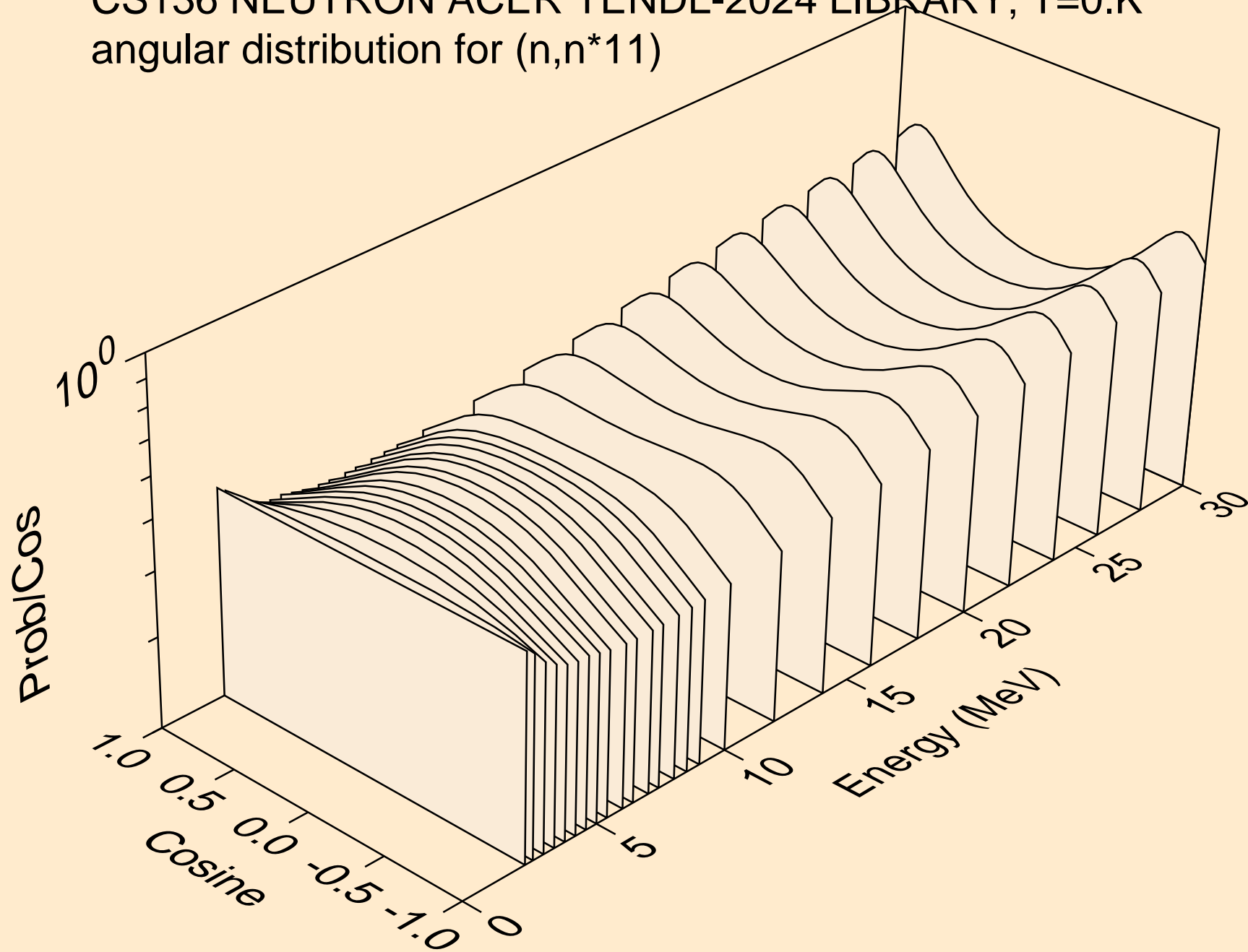

CS136 NEUTRON ACER TENDL-2024 LIBRARY; T=0.K
angular distribution for (n,n*12)

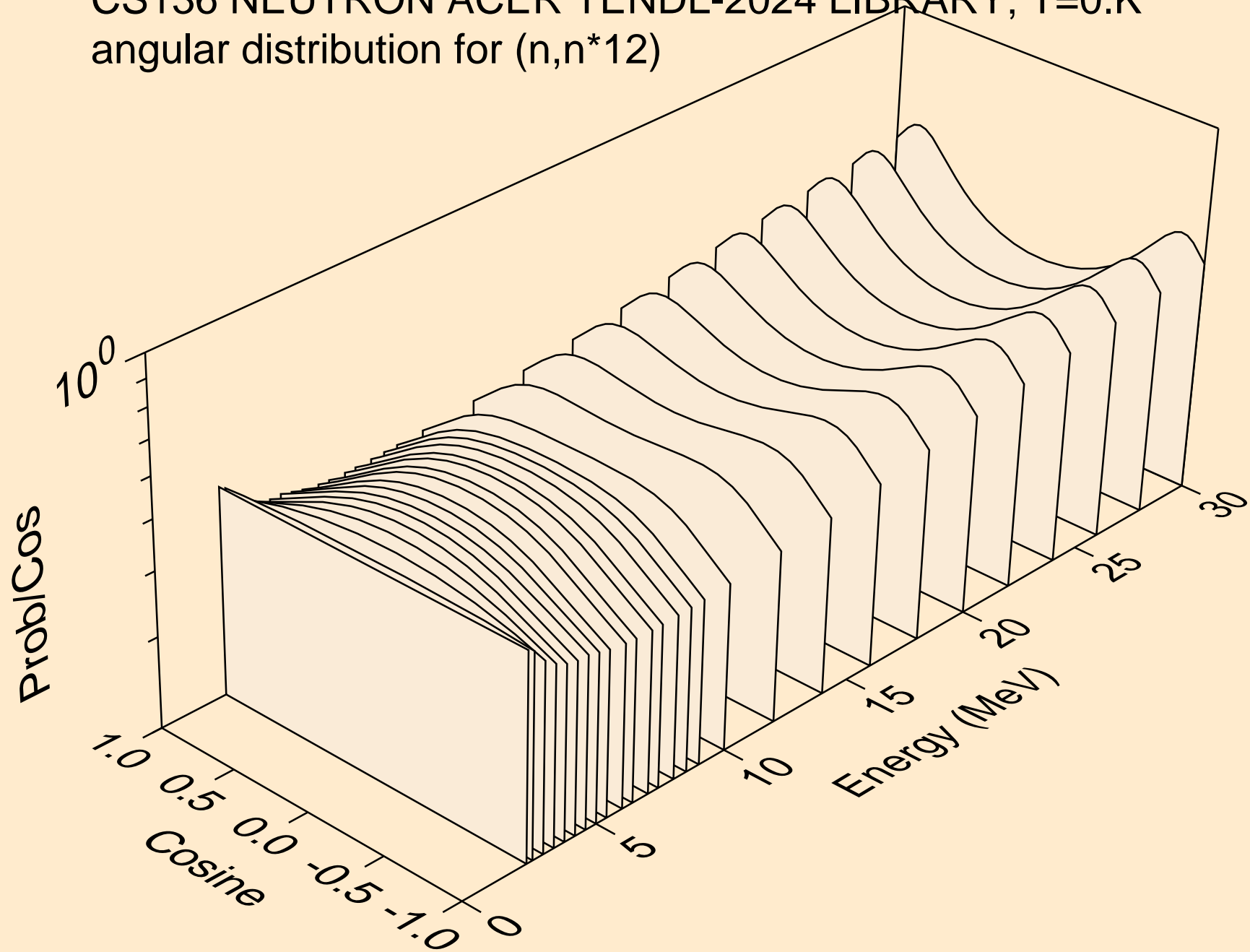

CS136 NEUTRON ACER TENDL-2024 LIBRARY; T=0.K
angular distribution for (n,n*13)

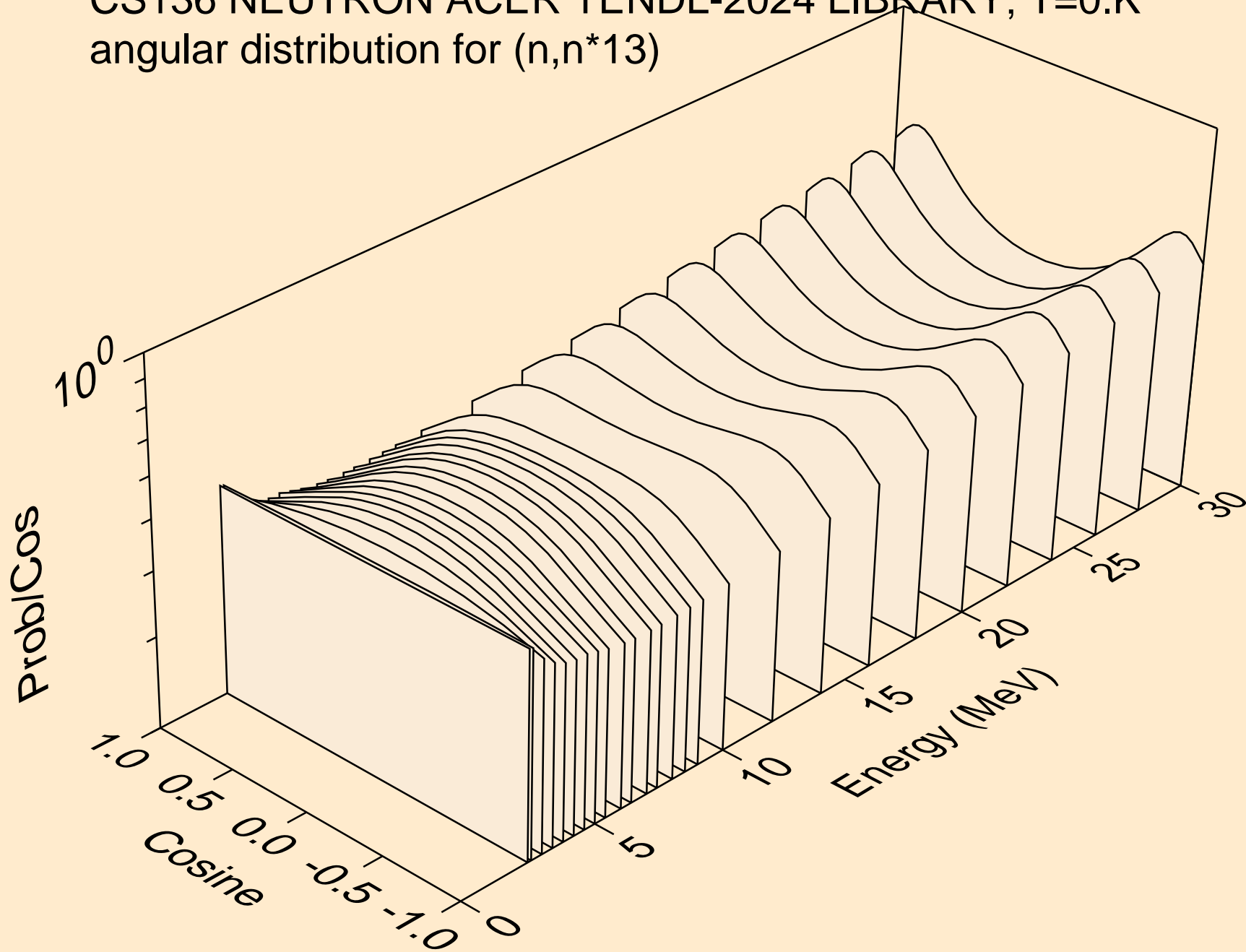

CS136 NEUTRON ACER TENDL-2024 LIBRARY; T=0.K
angular distribution for (n,n*14)

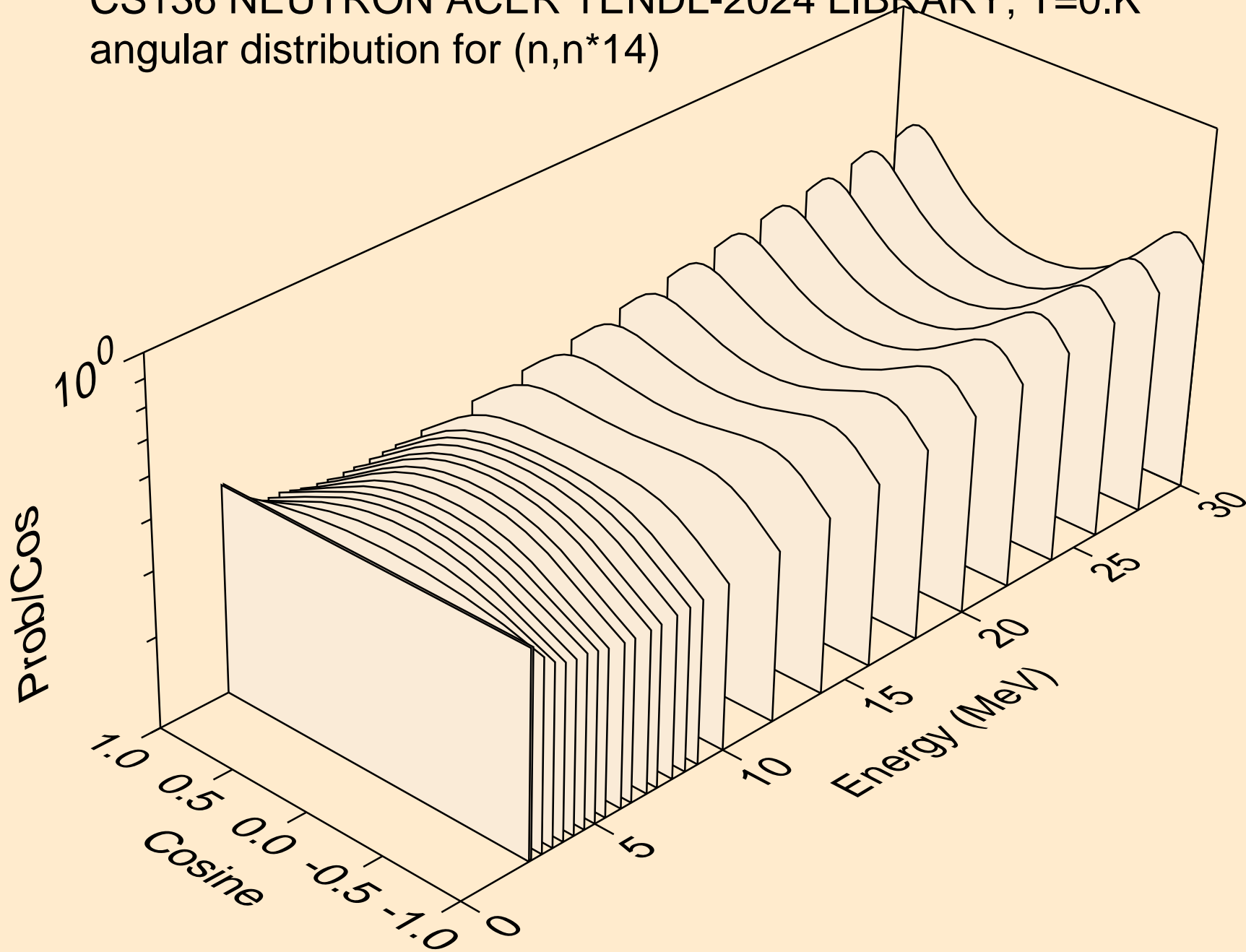

CS136 NEUTRON ACER TENDL-2024 LIBRARY; T=0.K
angular distribution for (n,n*15)

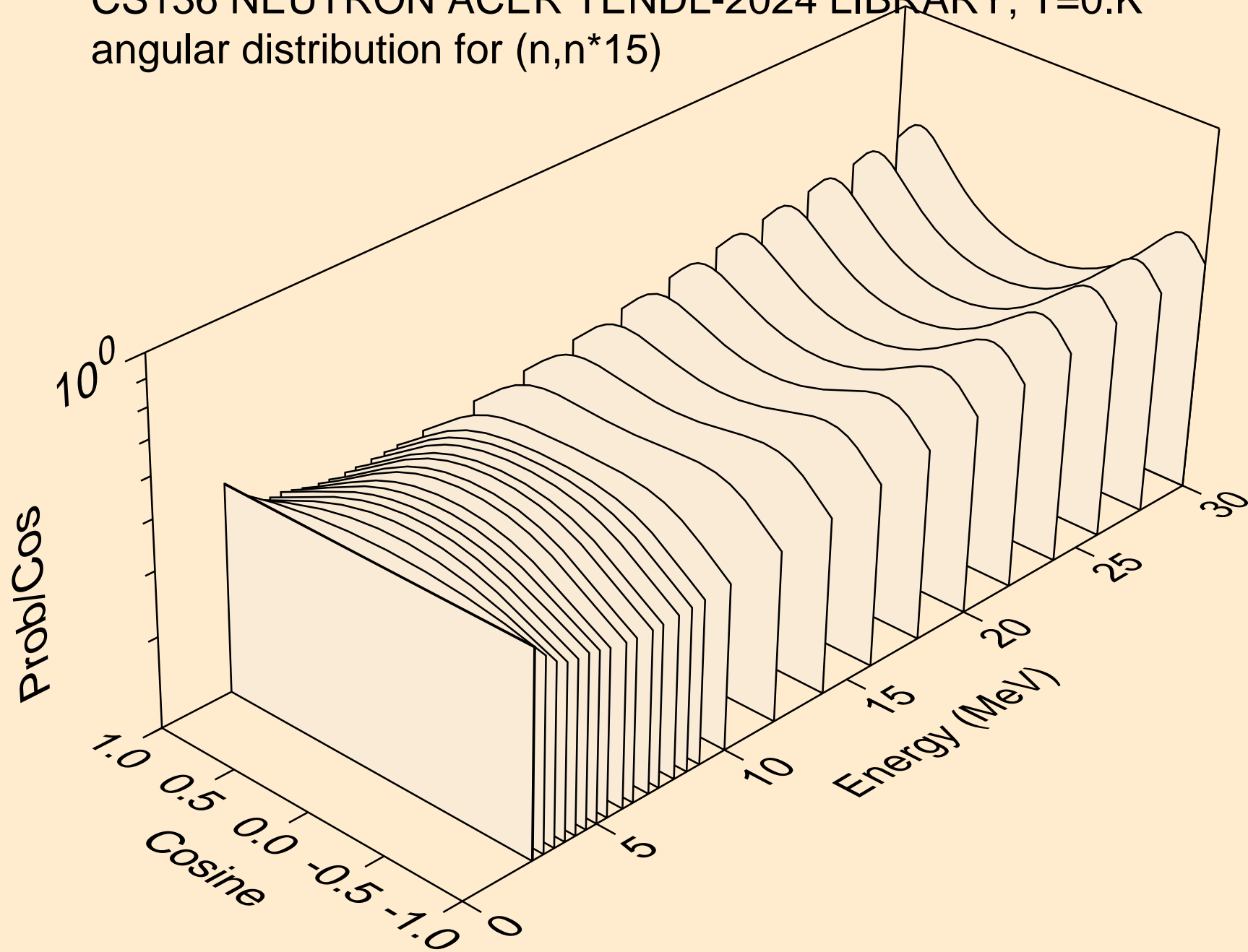

CS136 NEUTRON ACER TENDL-2024 LIBRARY; T=0.K
angular distribution for (n,n*16)

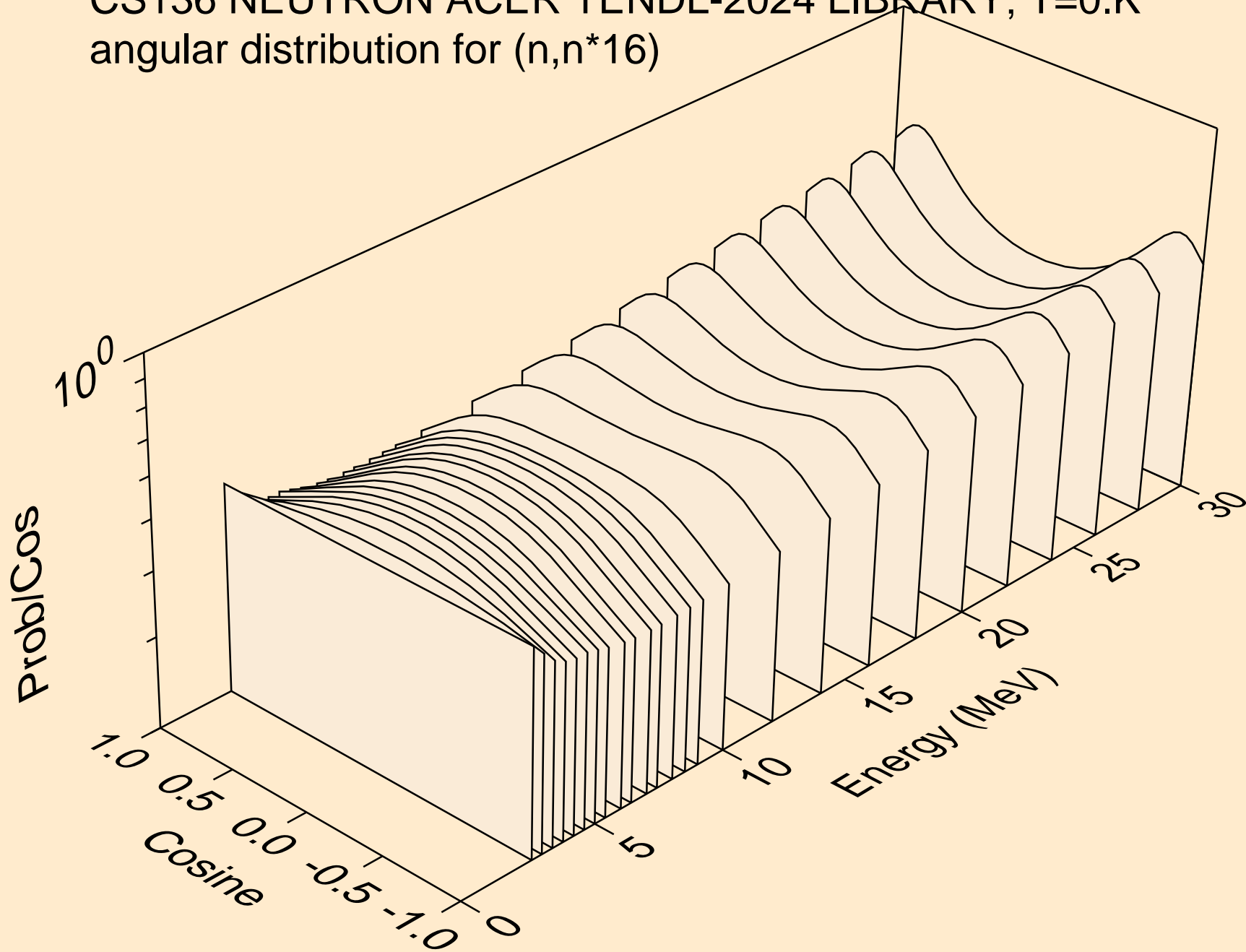

CS136 NEUTRON ACER TENDL-2024 LIBRARY; T=0.K
angular distribution for (n,n*17)

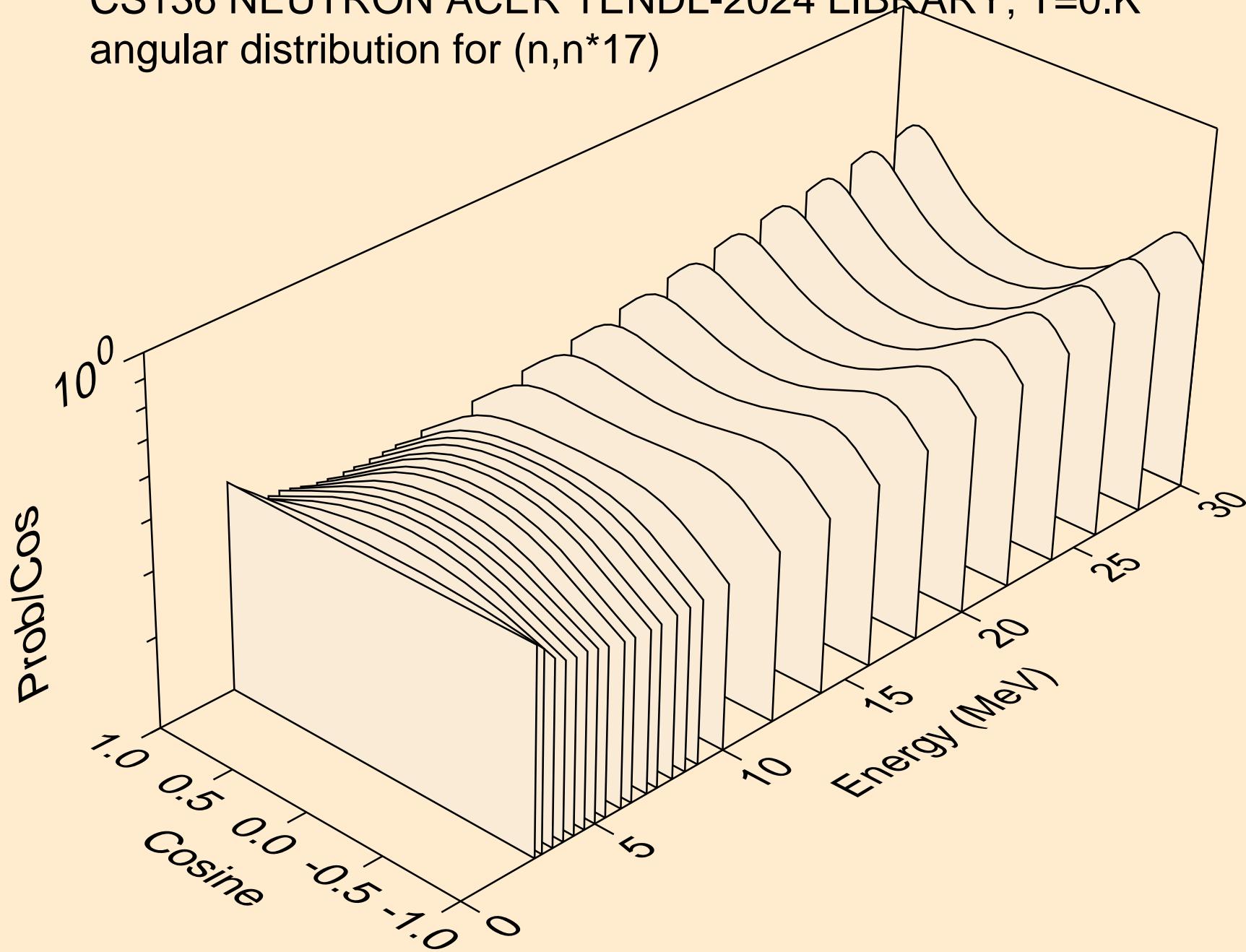

CS136 NEUTRON ACER TENDL-2024 LIBRARY; T=0.K
Neutron emission for (n,x)

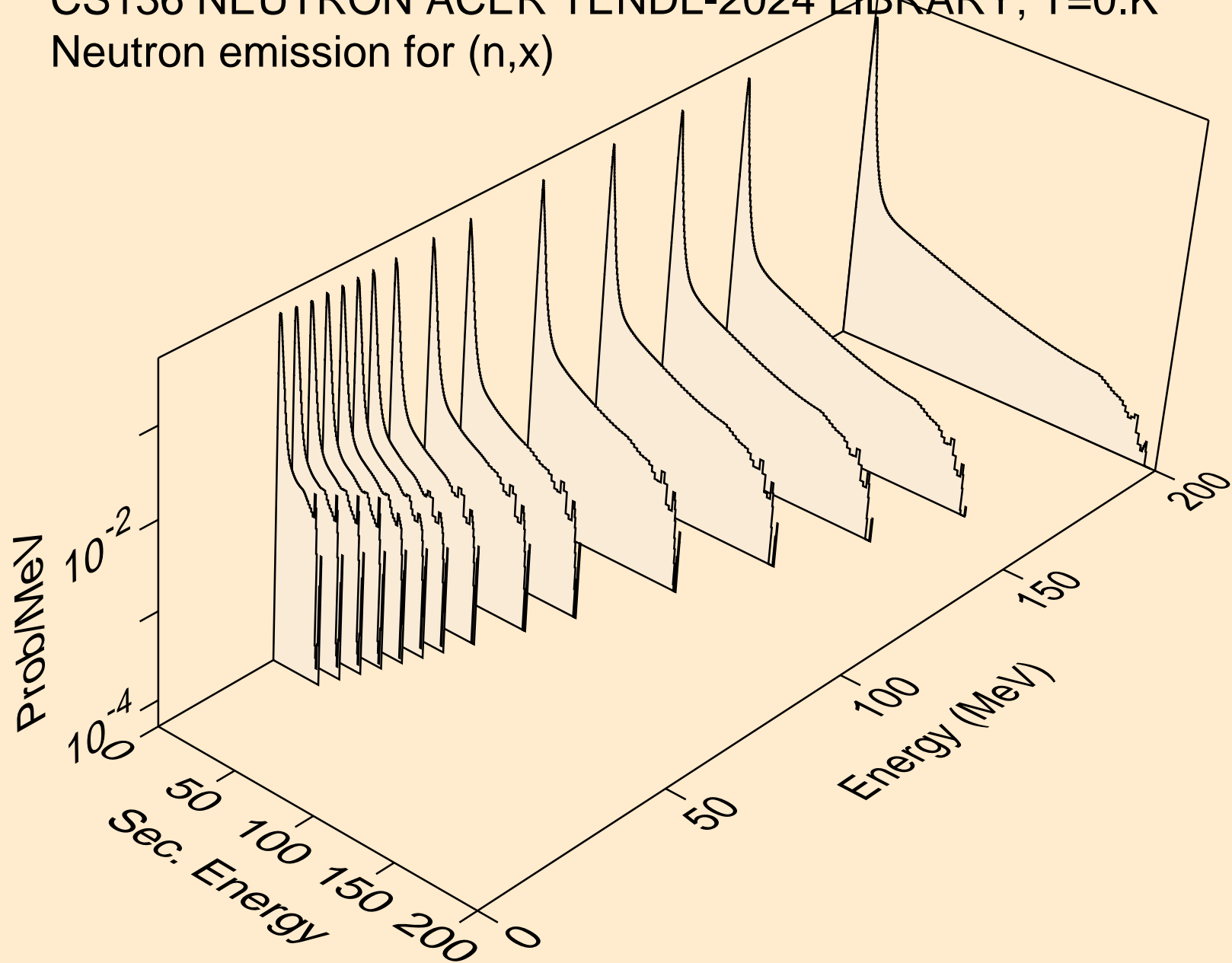

CS136 NEUTRON ACER TENDL-2024 LIBRARY; T=0.K
Neutron emission for (n,2nd)

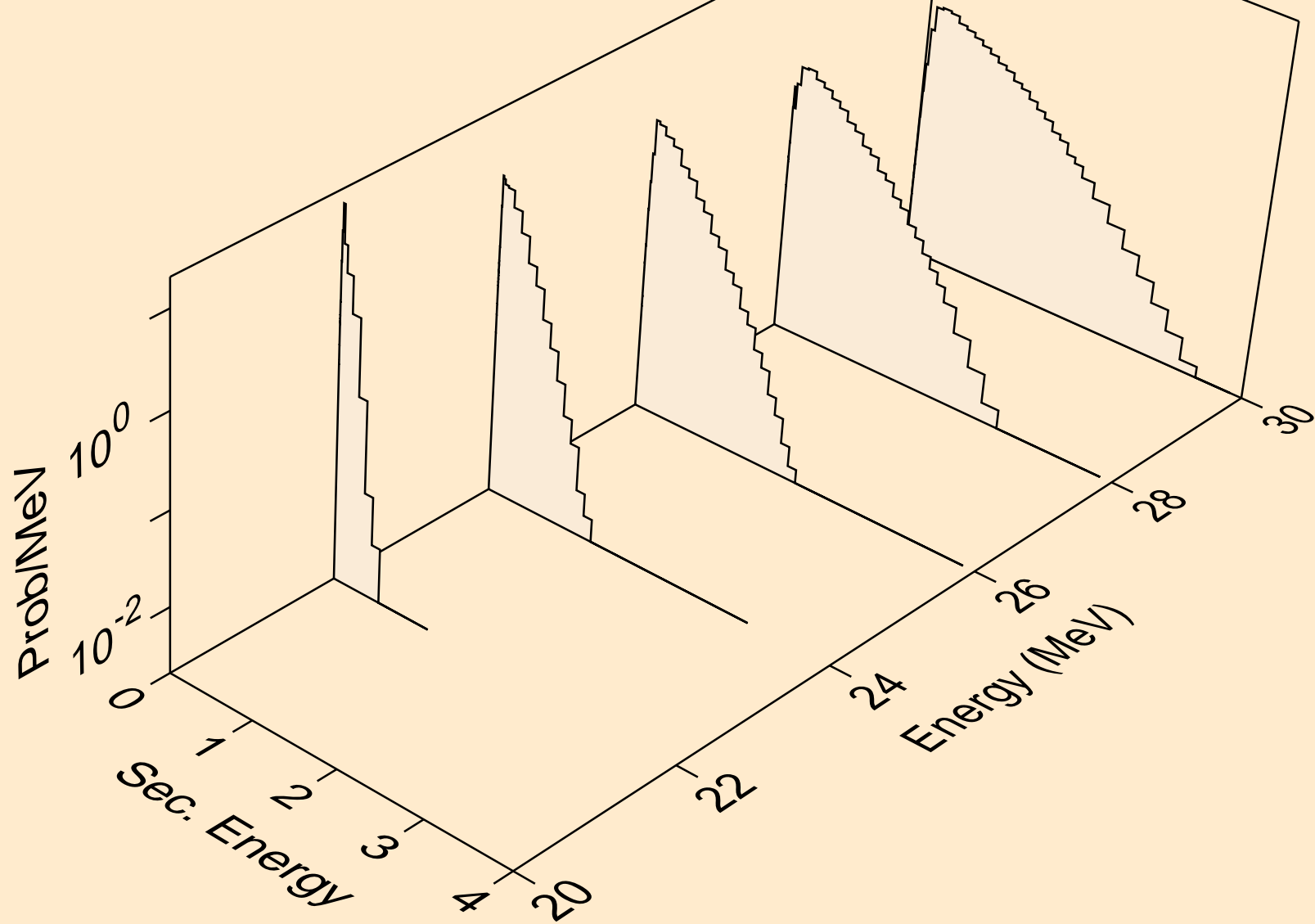

CS136 NEUTRON ACER TENDL-2024 LIBRARY; T=0.K
Neutron emission for (n,2n)

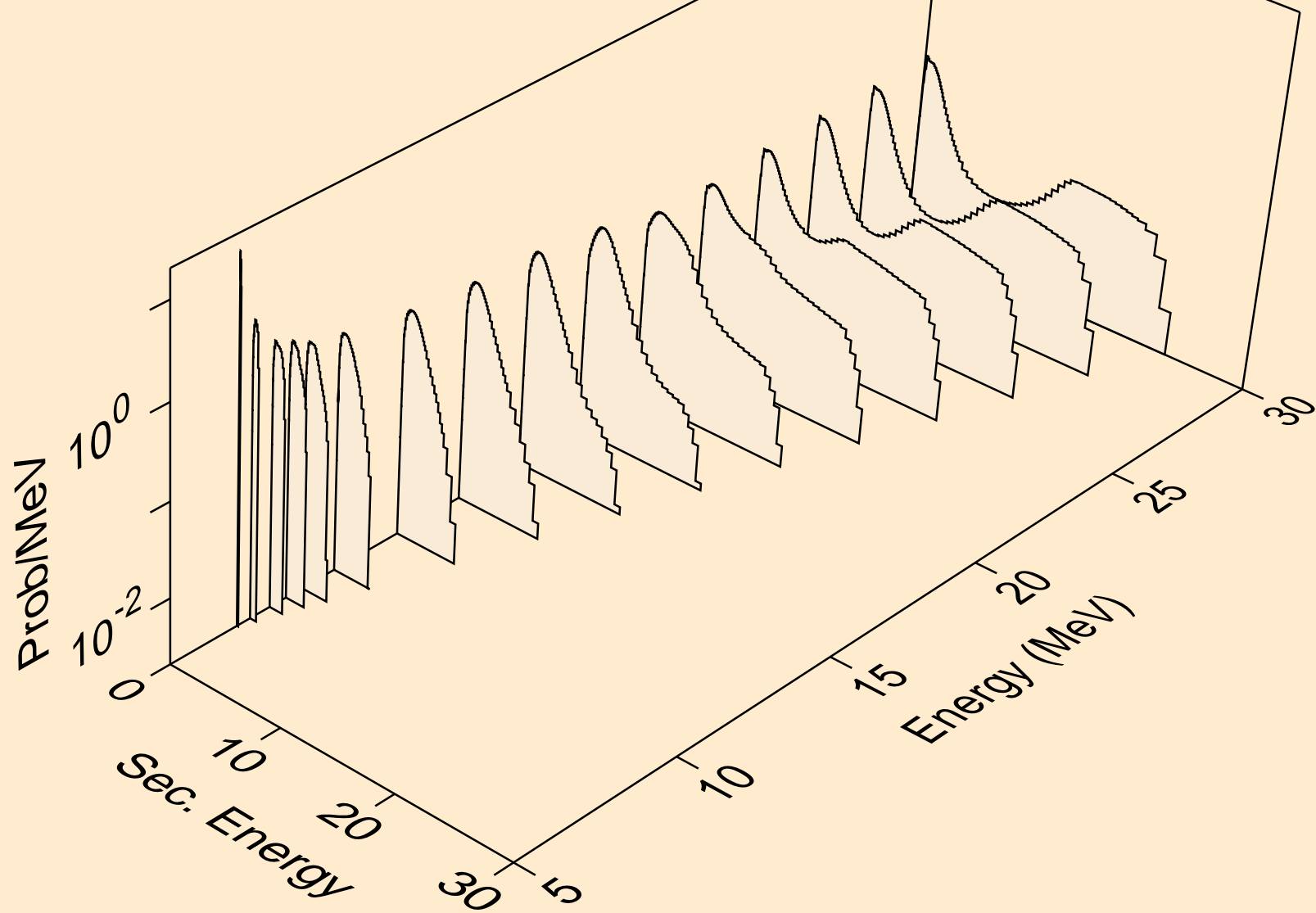

CS136 NEUTRON ACER TENDL-2024 LIBRARY; T=0.K
Neutron emission for (n,3n)

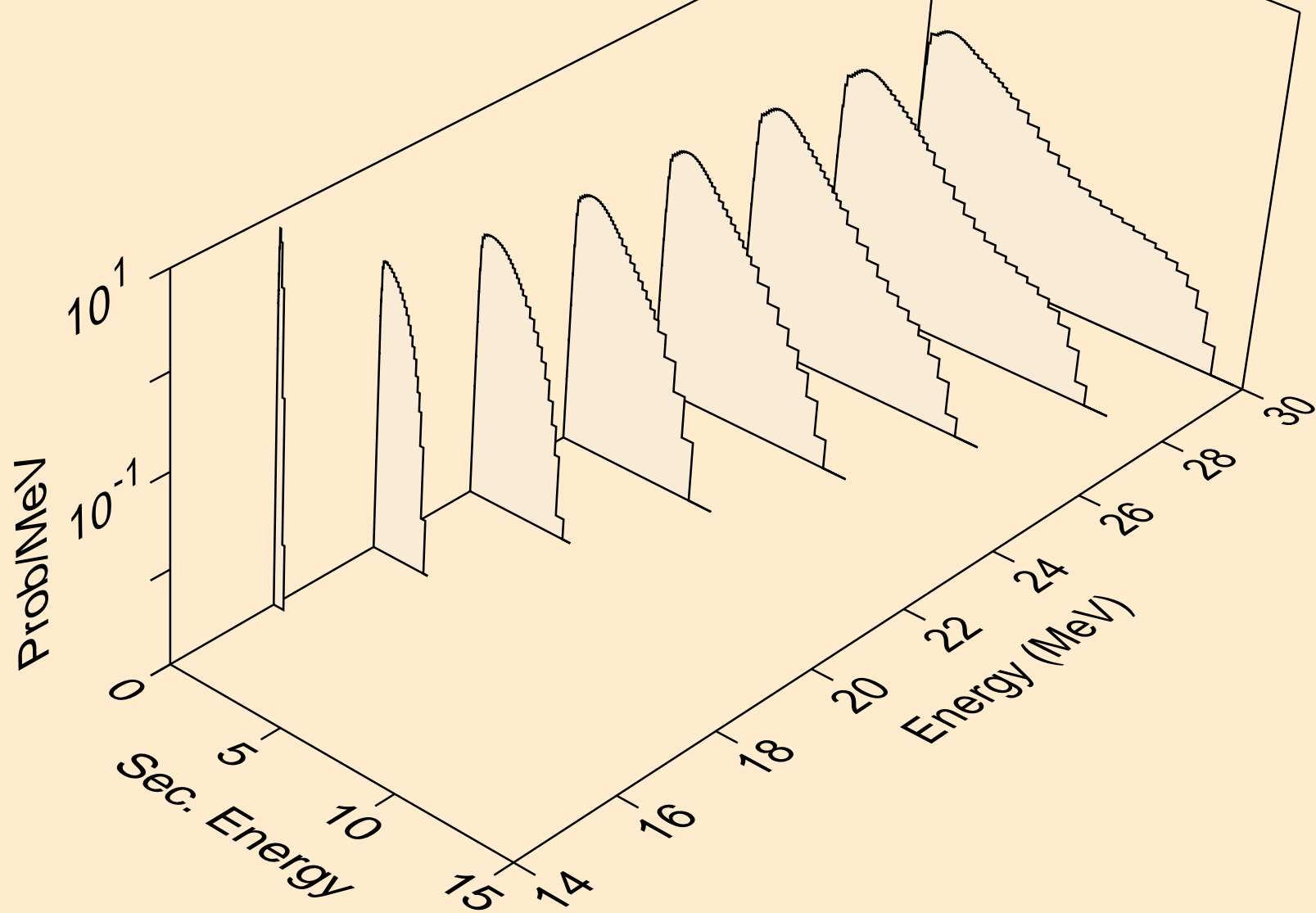

CS136 NEUTRON ACER TENDL-2024 LIBRARY; T=0.K
Neutron emission for (n,n*)a

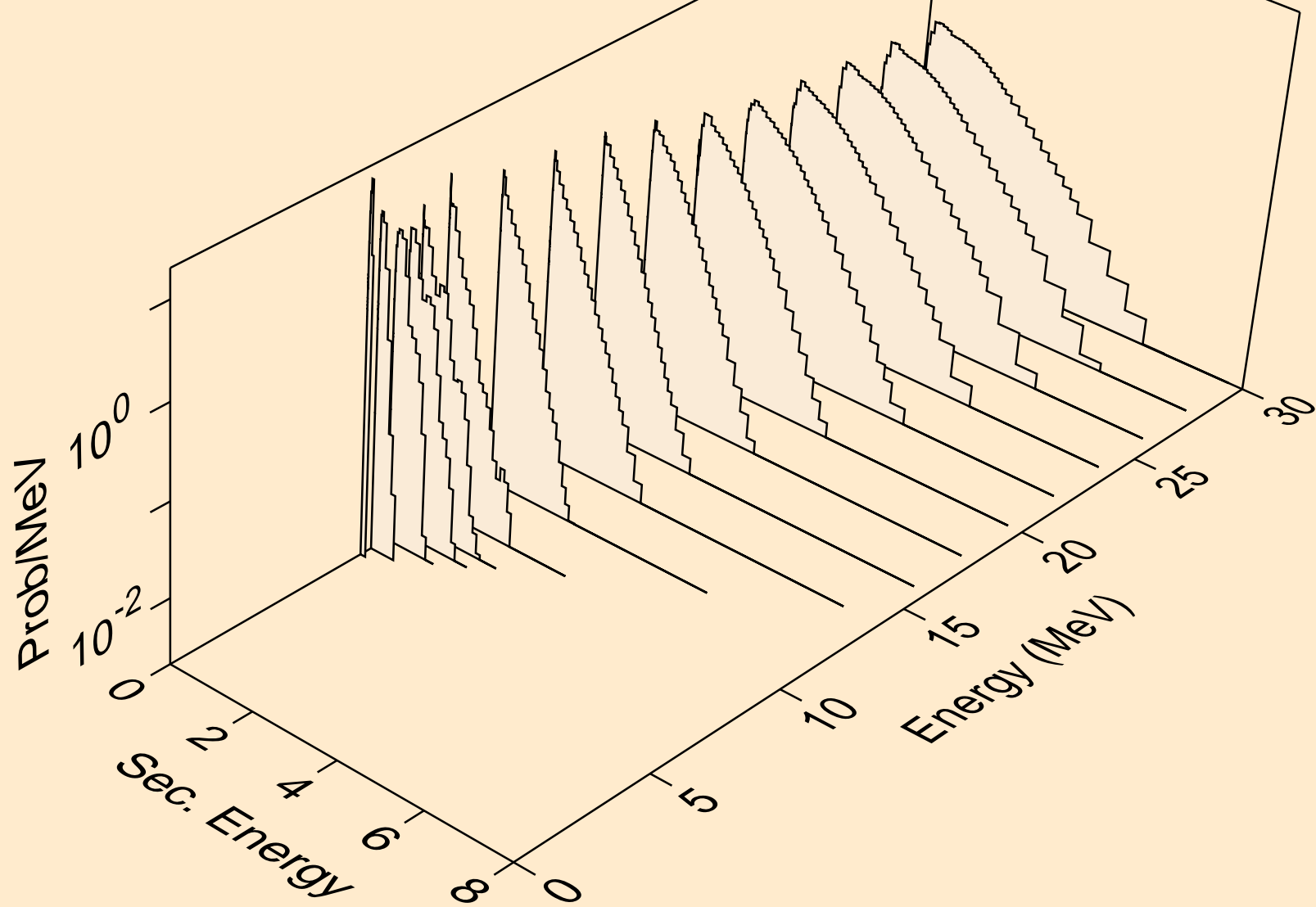

CS136 NEUTRON ACER TENDL-2024 LIBRARY; T=0.K
Neutron emission for (n,2n)a

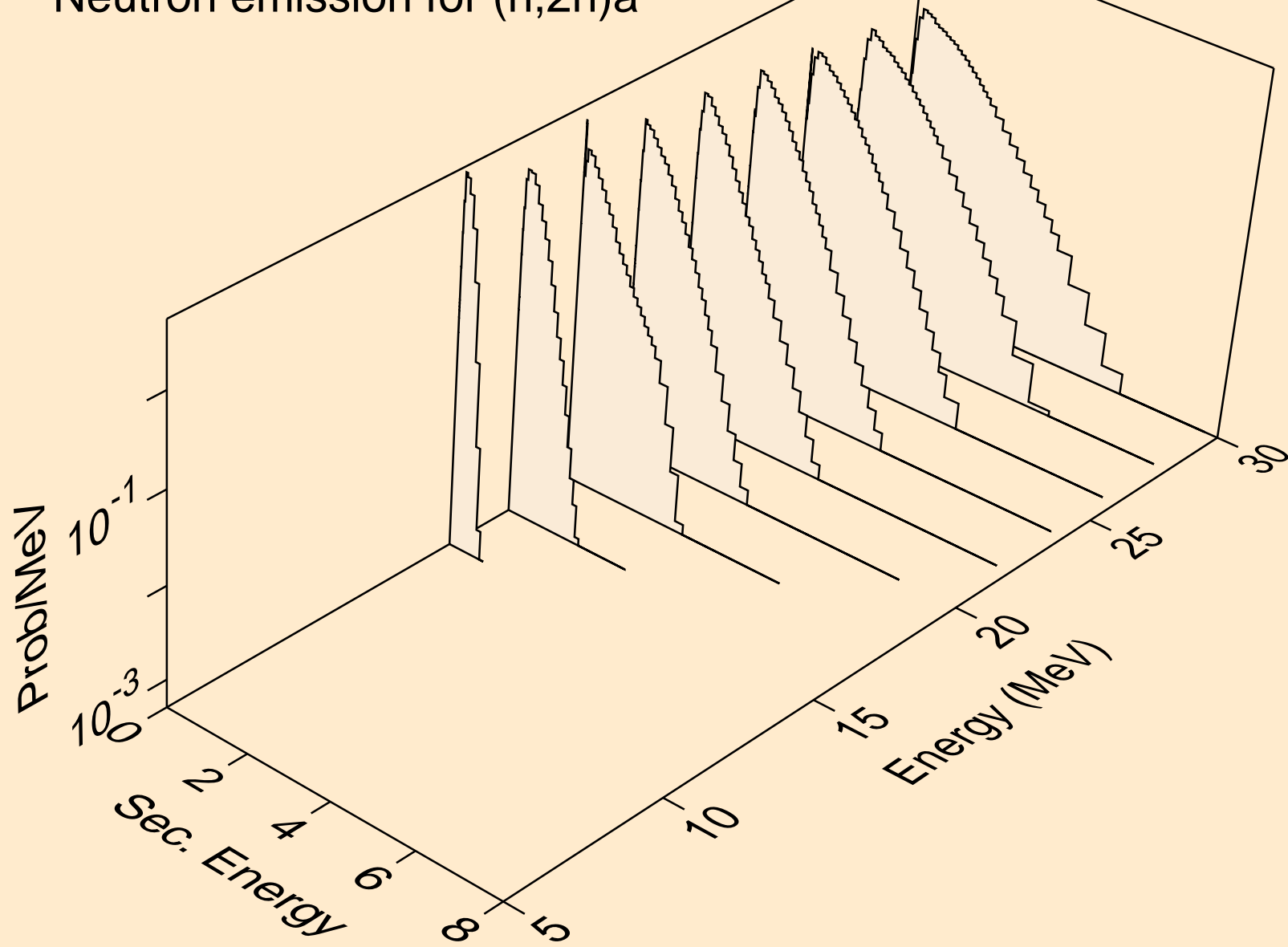

CS136 NEUTRON ACER TENDL-2024 LIBRARY; T=0.K
Neutron emission for (n,3n)a

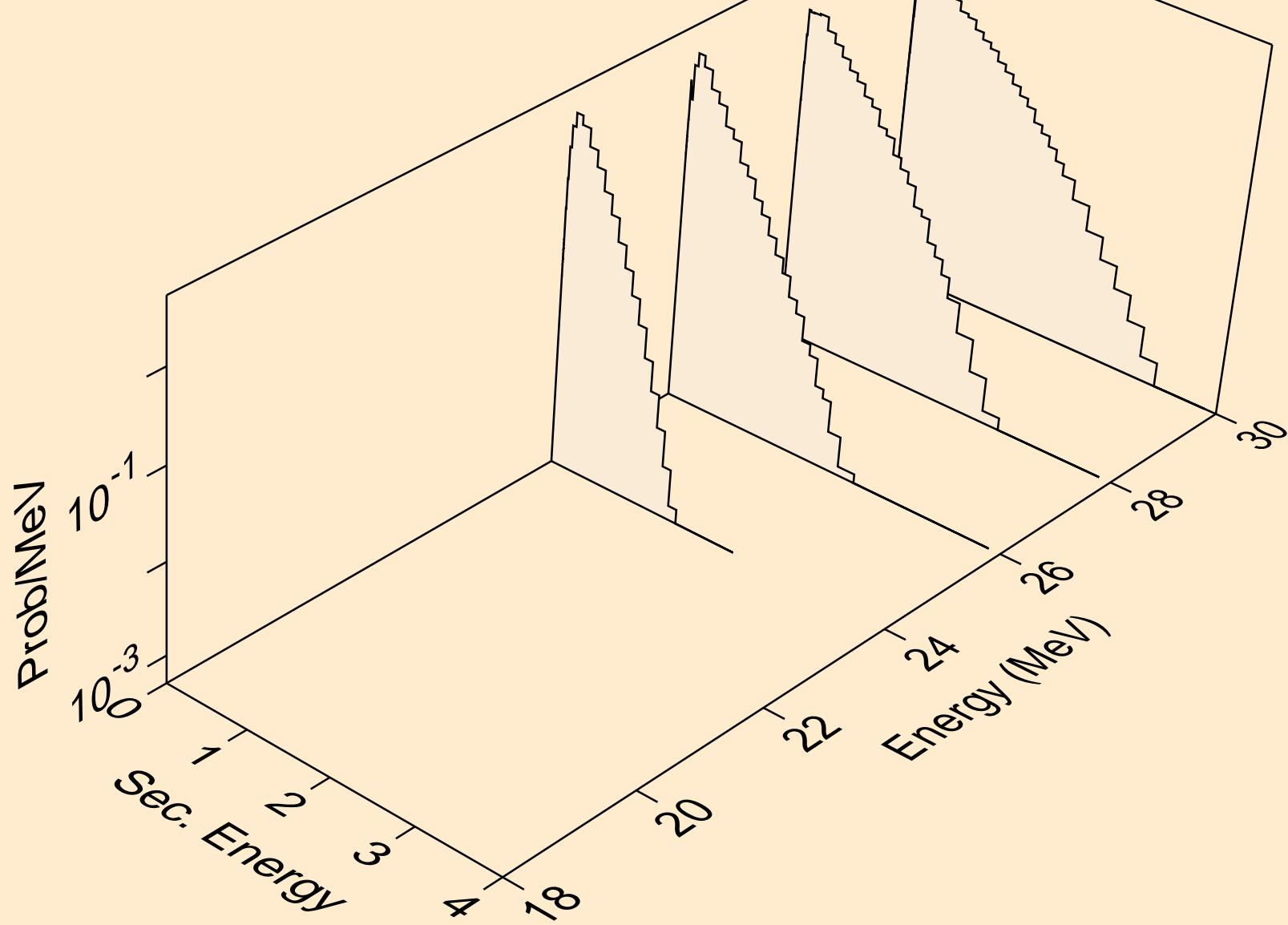

CS136 NEUTRON ACER TENDL-2024 LIBRARY; T=0.K
Neutron emission for (n,n*)p

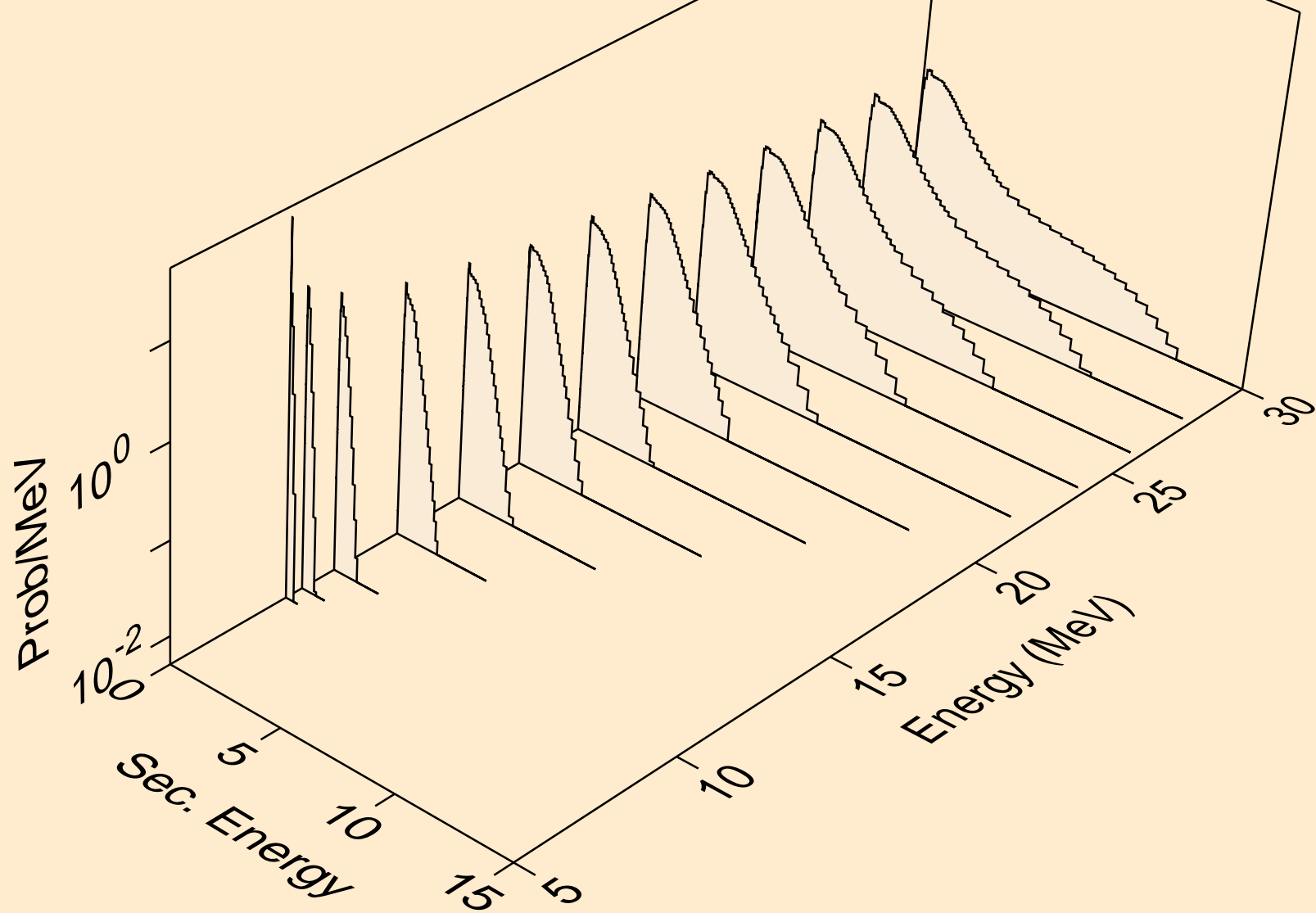

CS136 NEUTRON ACER TENDL-2024 LIBRARY; T=0.K
Neutron emission for (n,n*)d

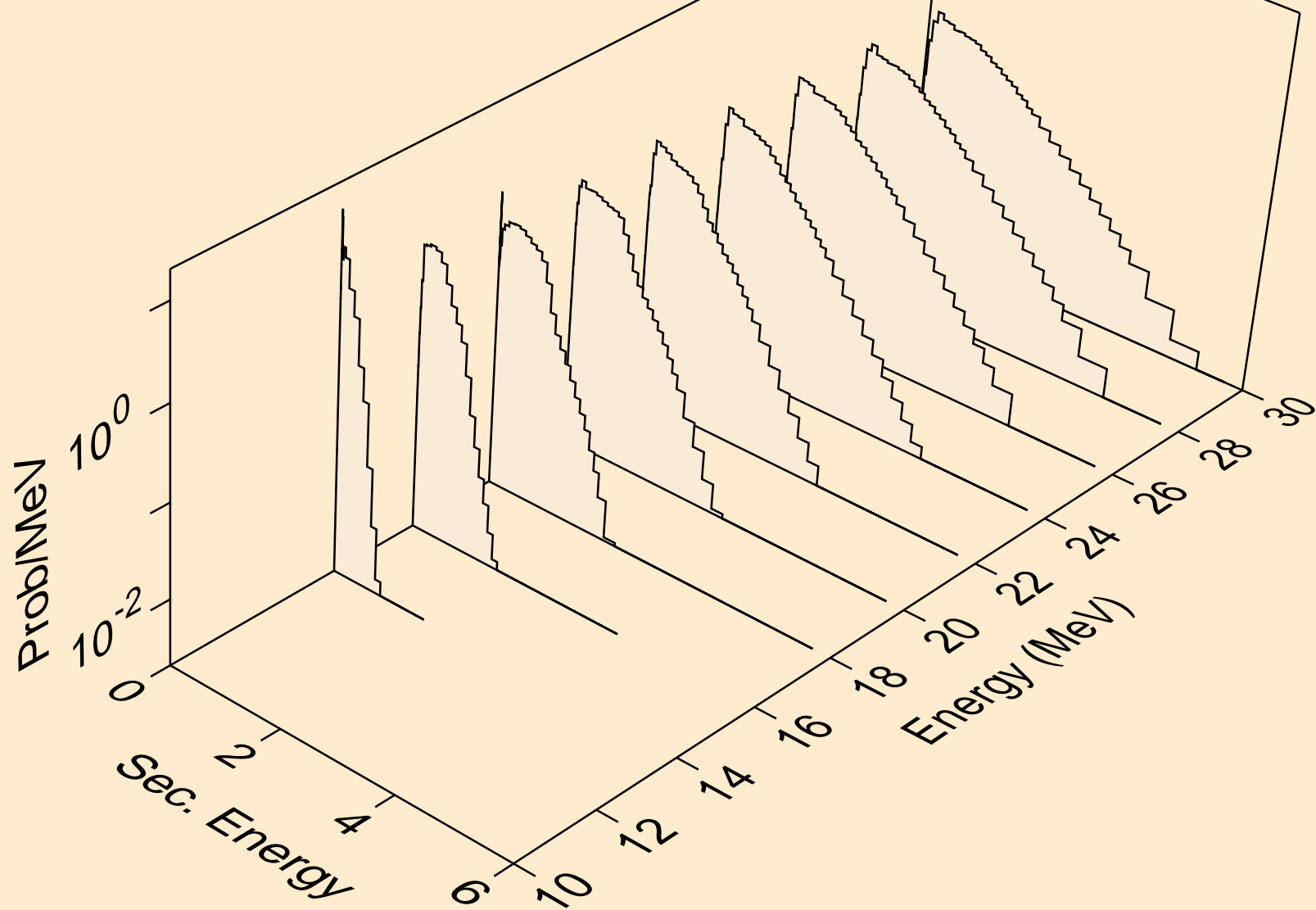

CS136 NEUTRON ACER TENDL-2024 LIBRARY; T=0.K
Neutron emission for (n,n*)t

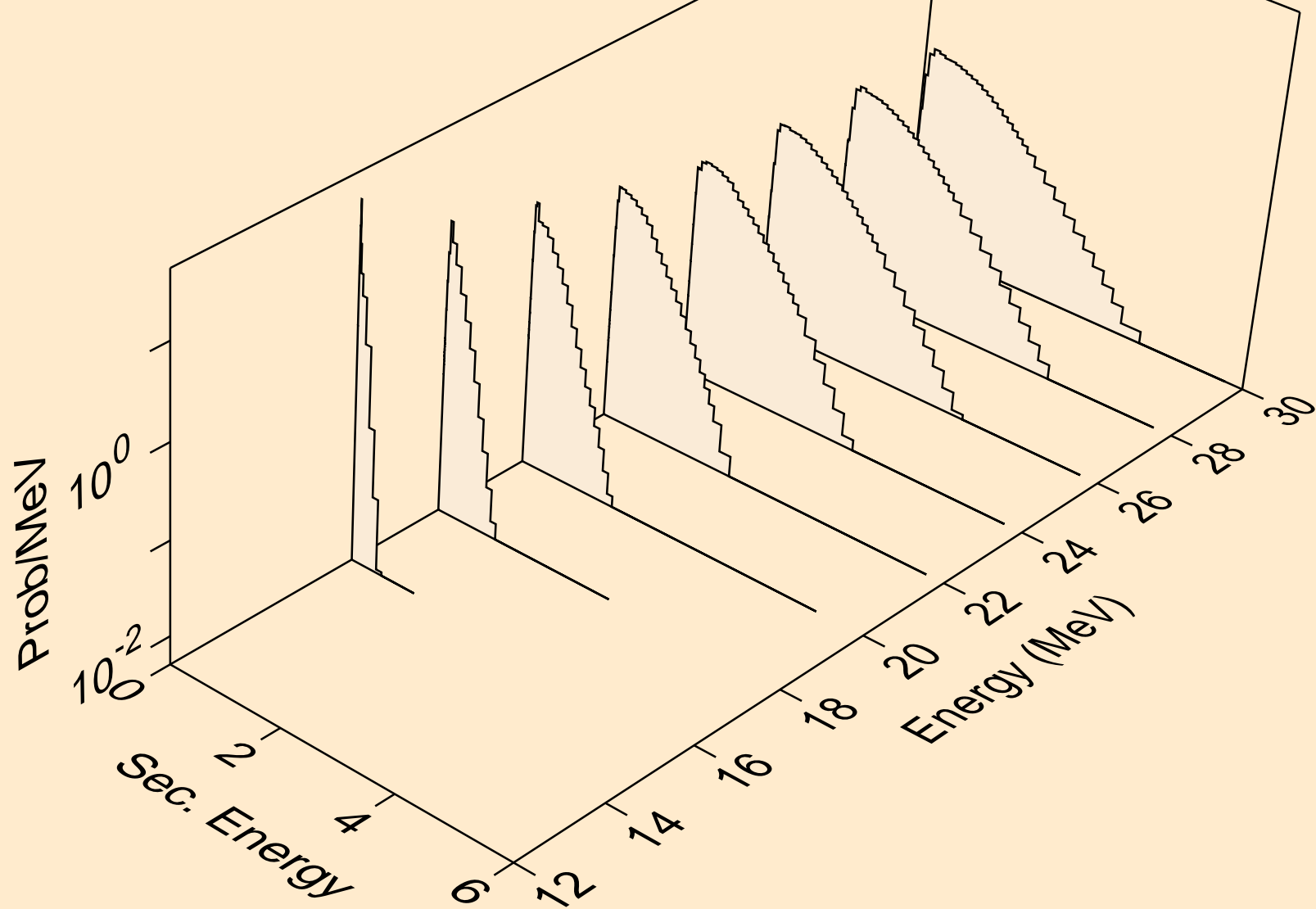

CS136 NEUTRON ACER TENDL-2024 LIBRARY; T=0.K
Neutron emission for (n,n*)he3

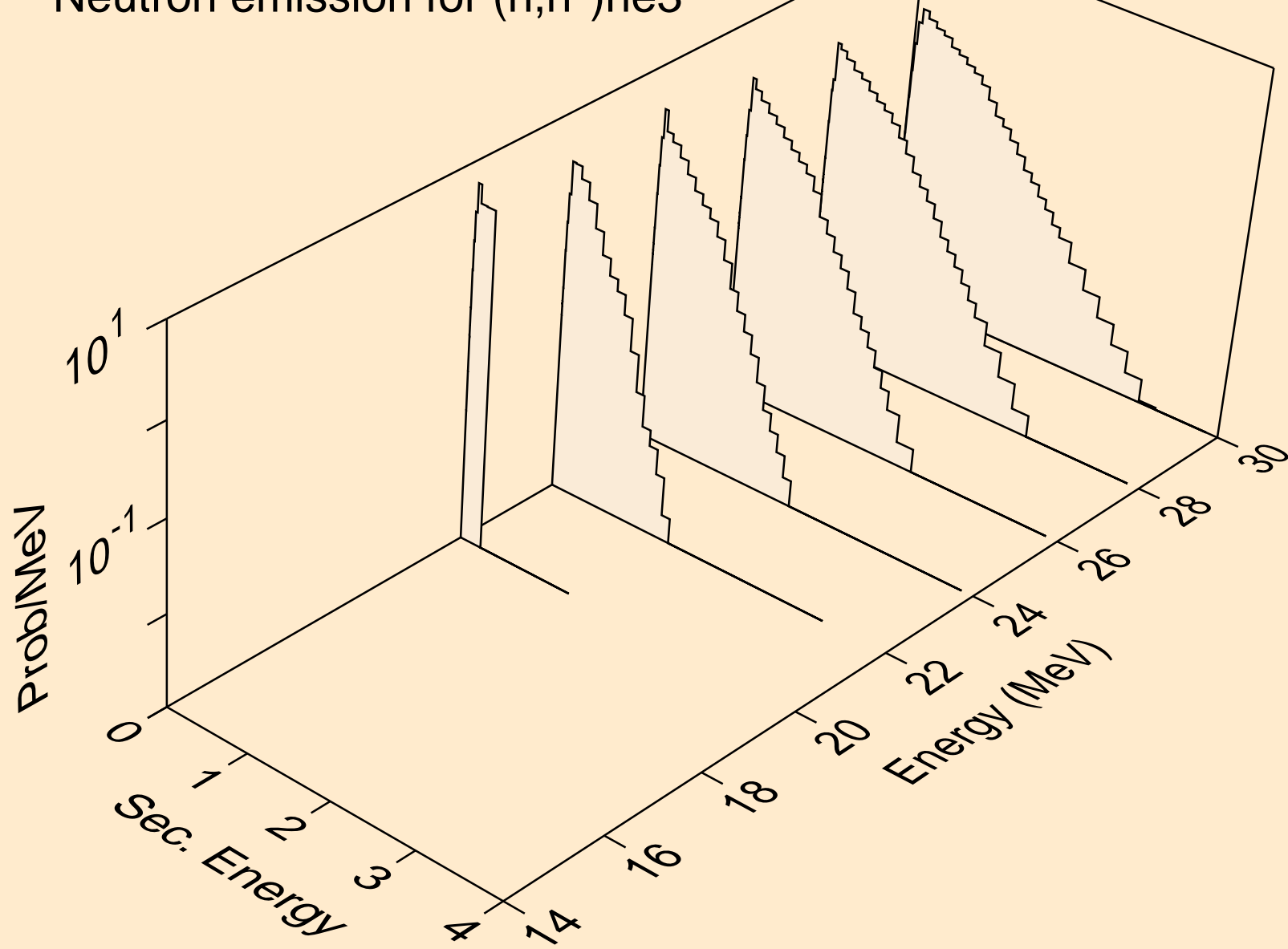

CS136 NEUTRON ACER TENDL-2024 LIBRARY; T=0.K
Neutron emission for (n,4n)

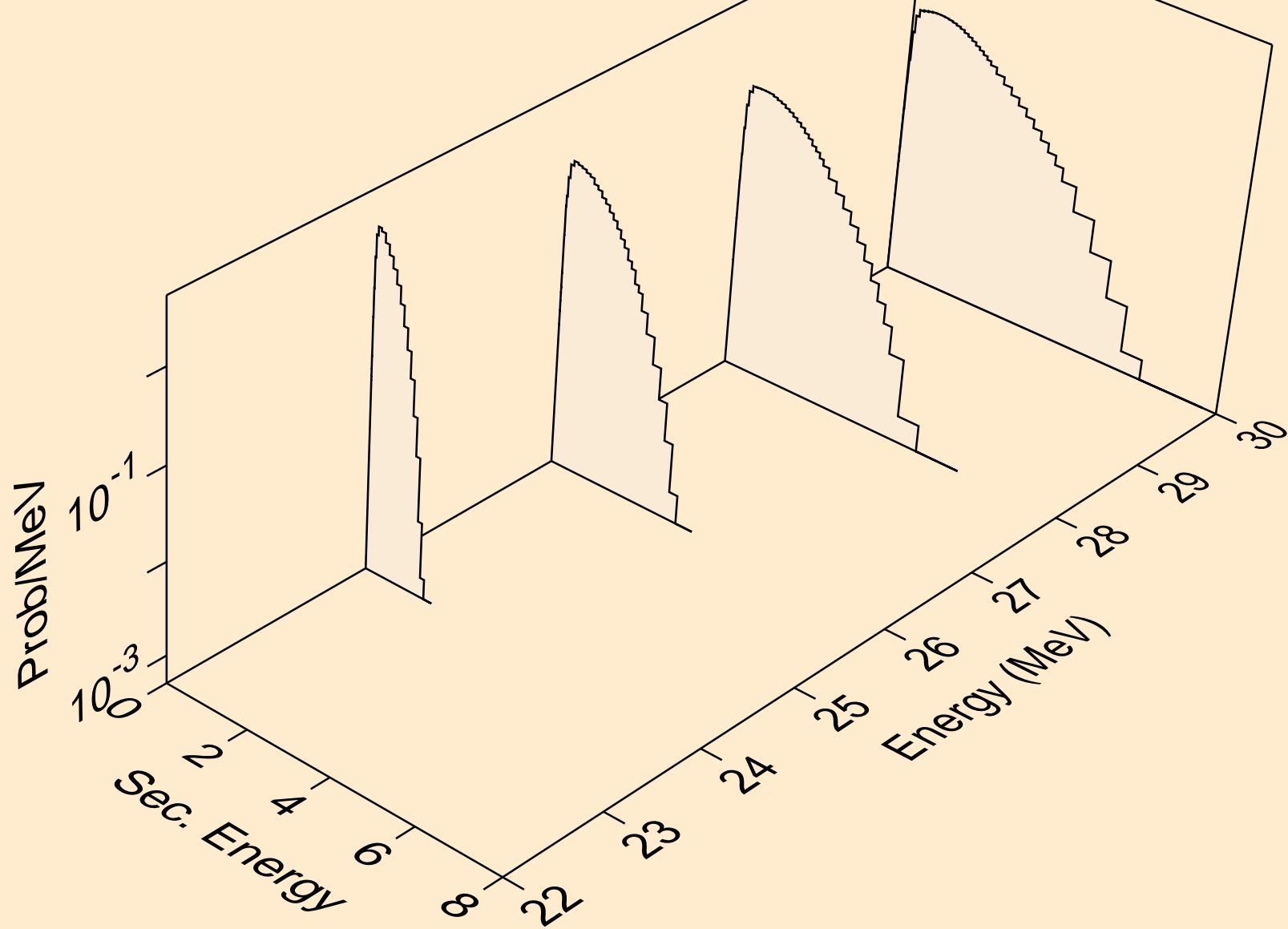

CS136 NEUTRON ACER TENDL-2024 LIBRARY; T=0.K
Neutron emission for (n,2np)

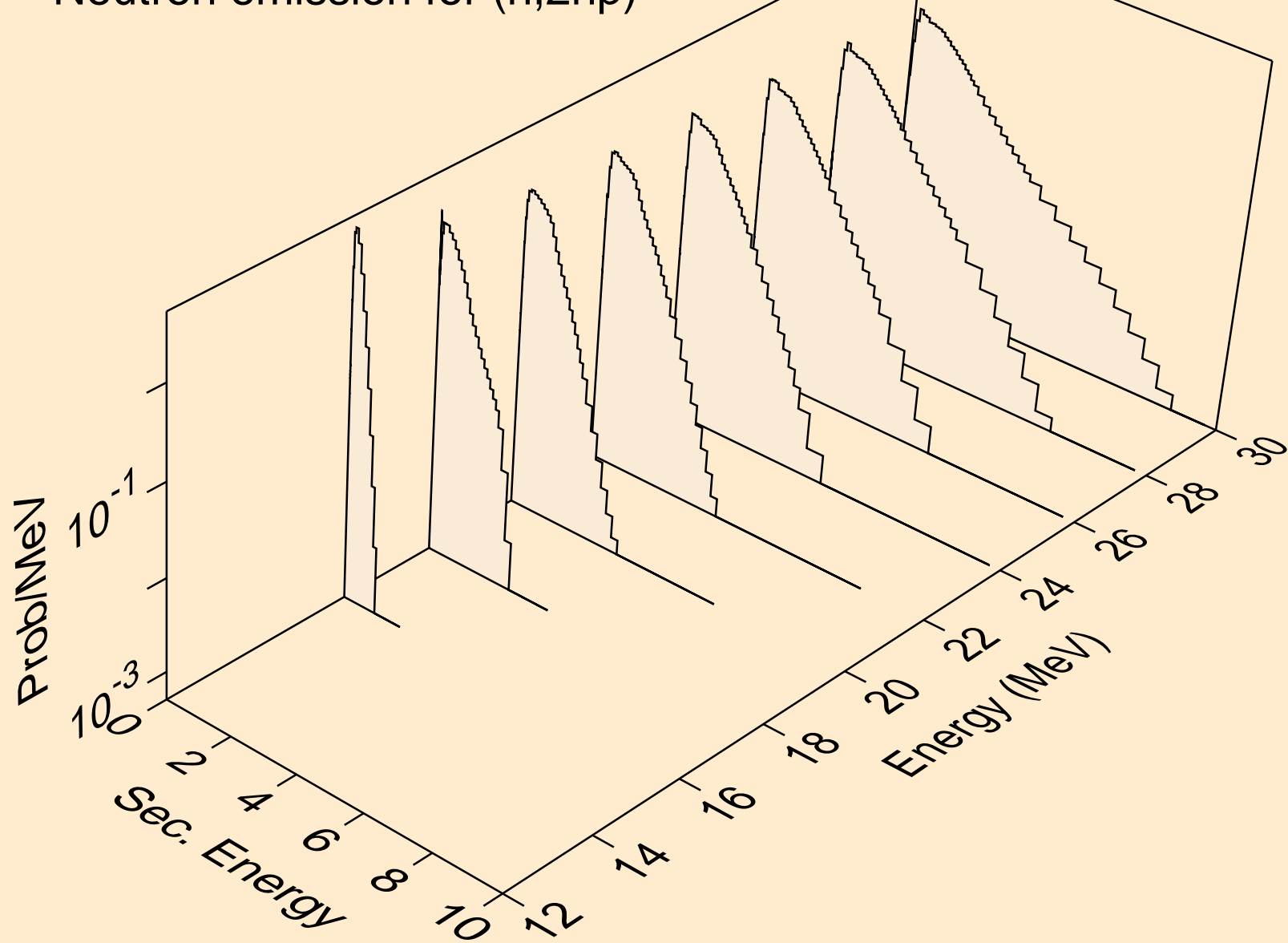

CS136 NEUTRON ACER TENDL-2024 LIBRARY; T=0.K
Neutron emission for (n,3np)

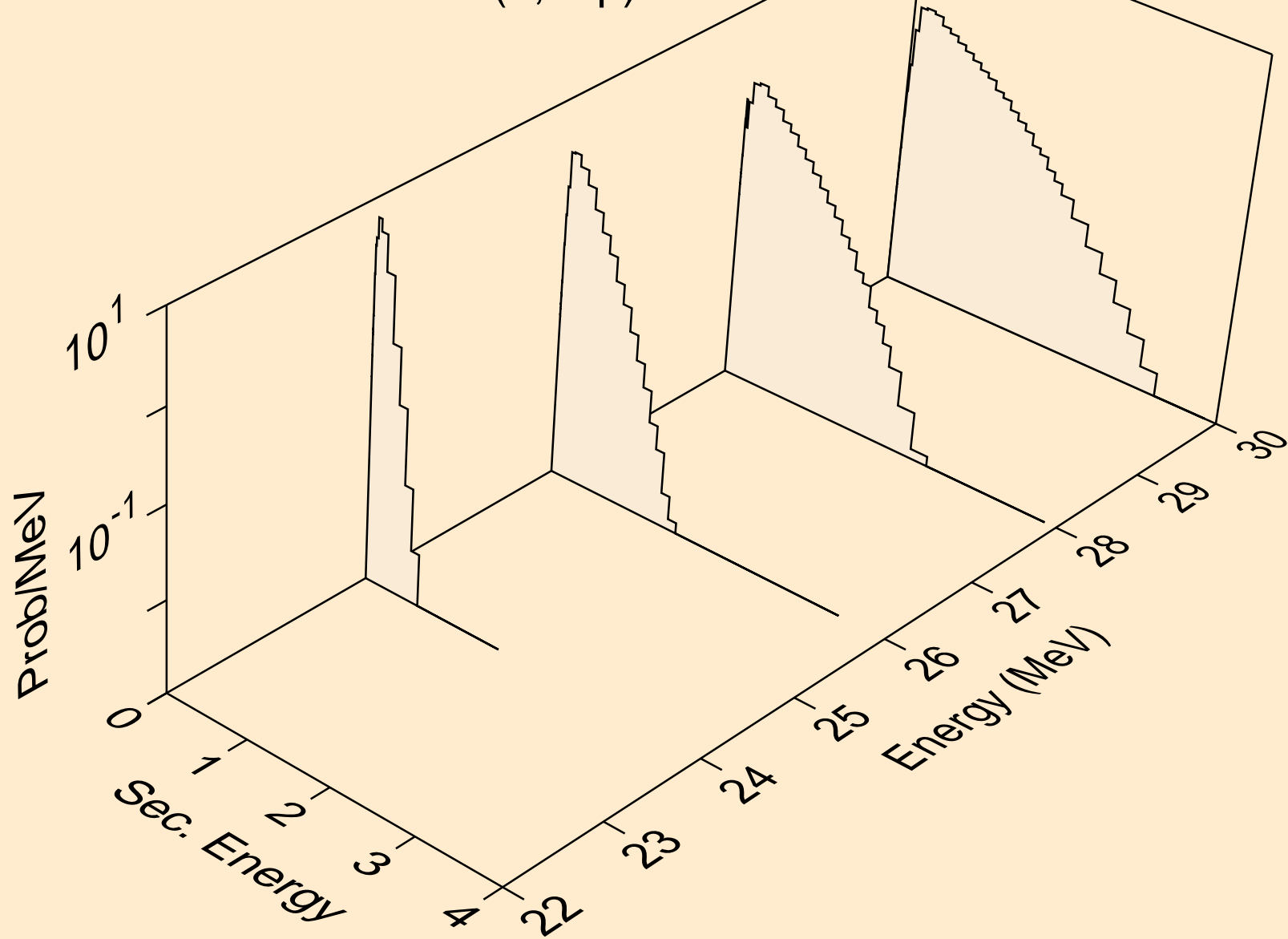

CS136 NEUTRON ACER TENDL-2024 LIBRARY; T=0.K
Neutron emission for (n,n2p)

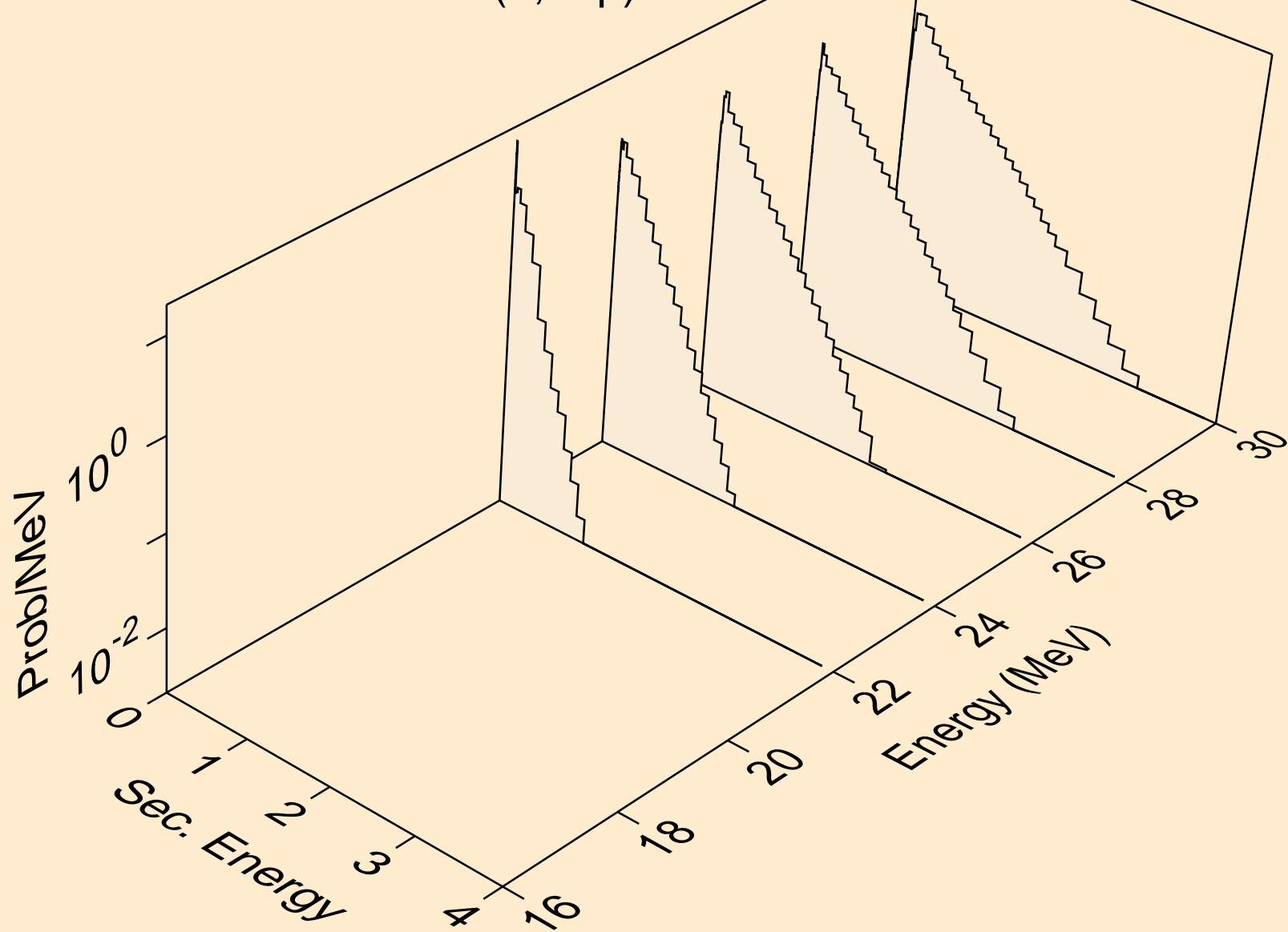

CS136 NEUTRON ACER TENDL-2024 LIBRARY; T=0.K
Neutron emission for (n,npa)

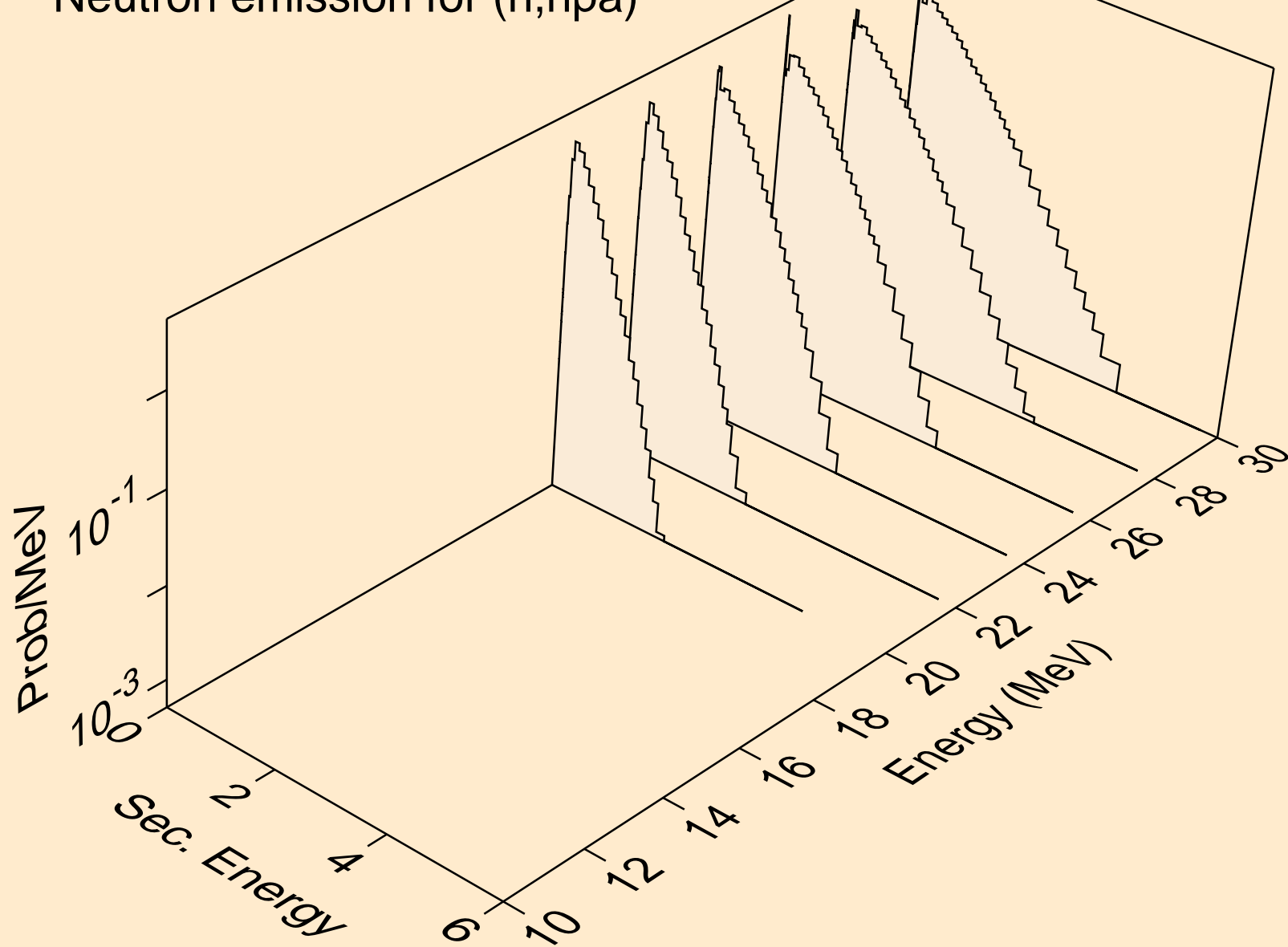

CS136 NEUTRON ACER TENDL-2024 LIBRARY; T=0.K
Neutron emission for (n,n*c)

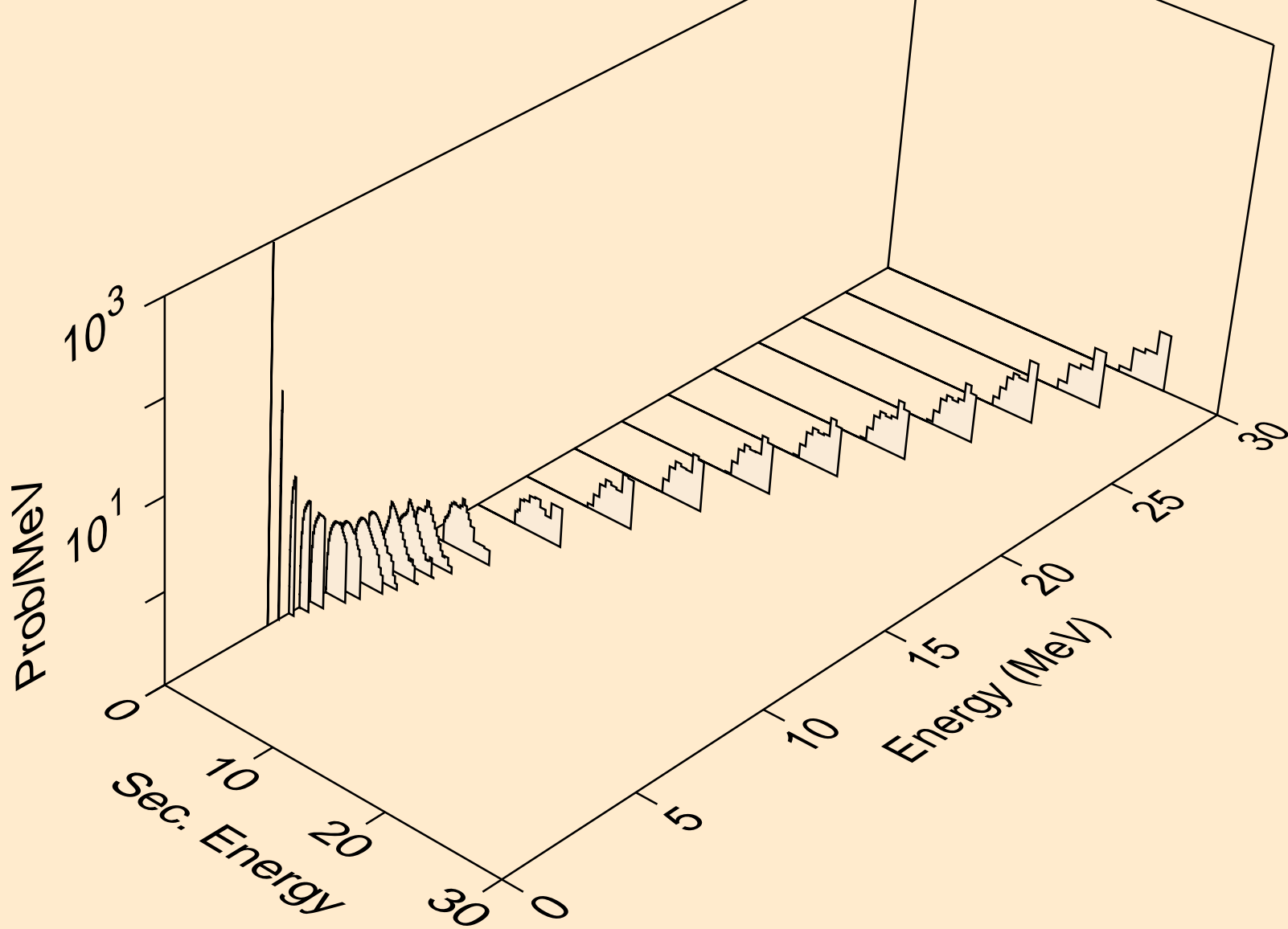

CS136 NEUTRON ACER TENDL-2024 LIBRARY; T=0.K
Photon emission for (n,x)

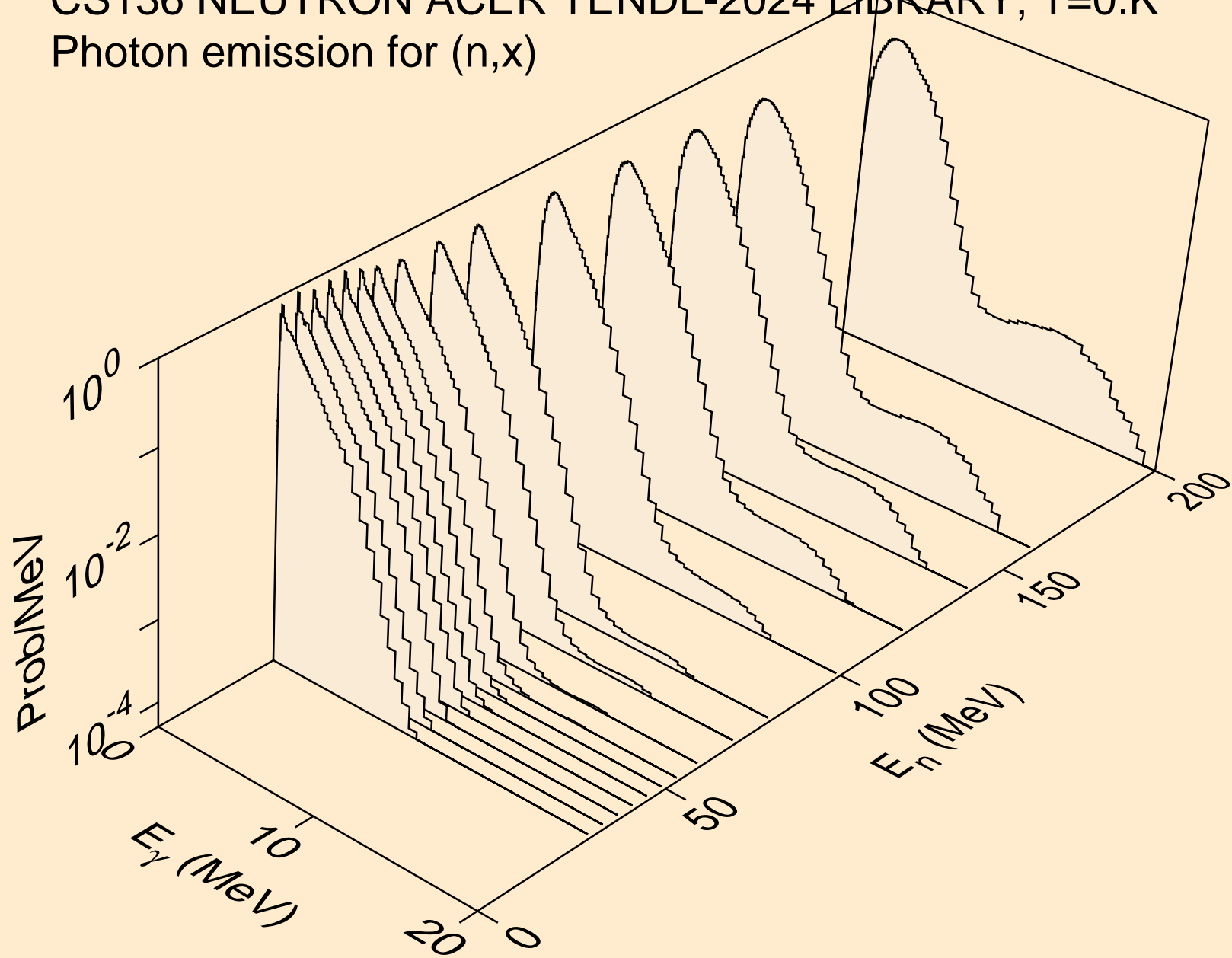

CS136 NEUTRON ACER TENDL-2024 LIBRARY; T=0.K
Photon emission for (n,2nd)

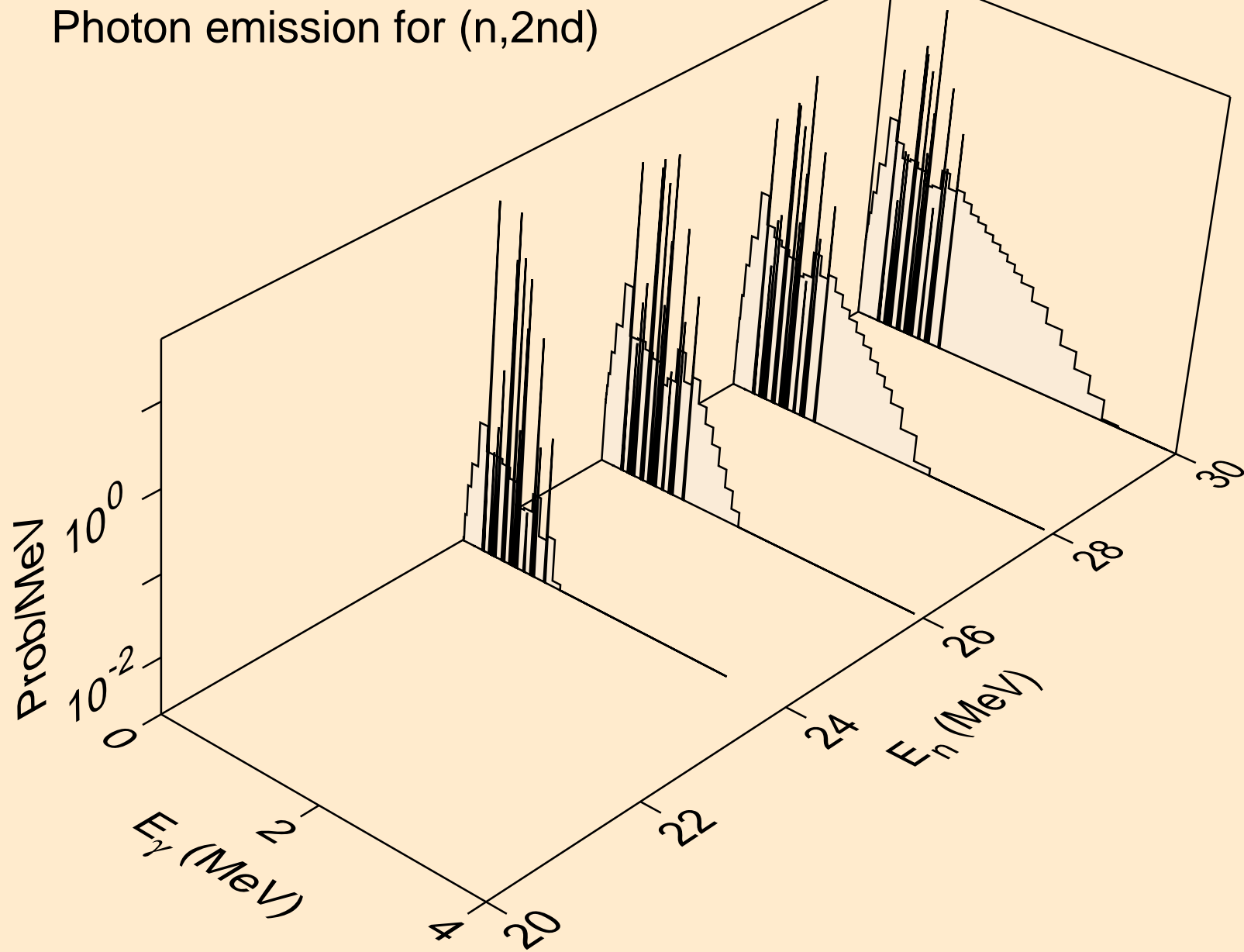

CS136 NEUTRON ACER TENDL-2024 LIBRARY; T=0.K
Photon emission for (n,2n)

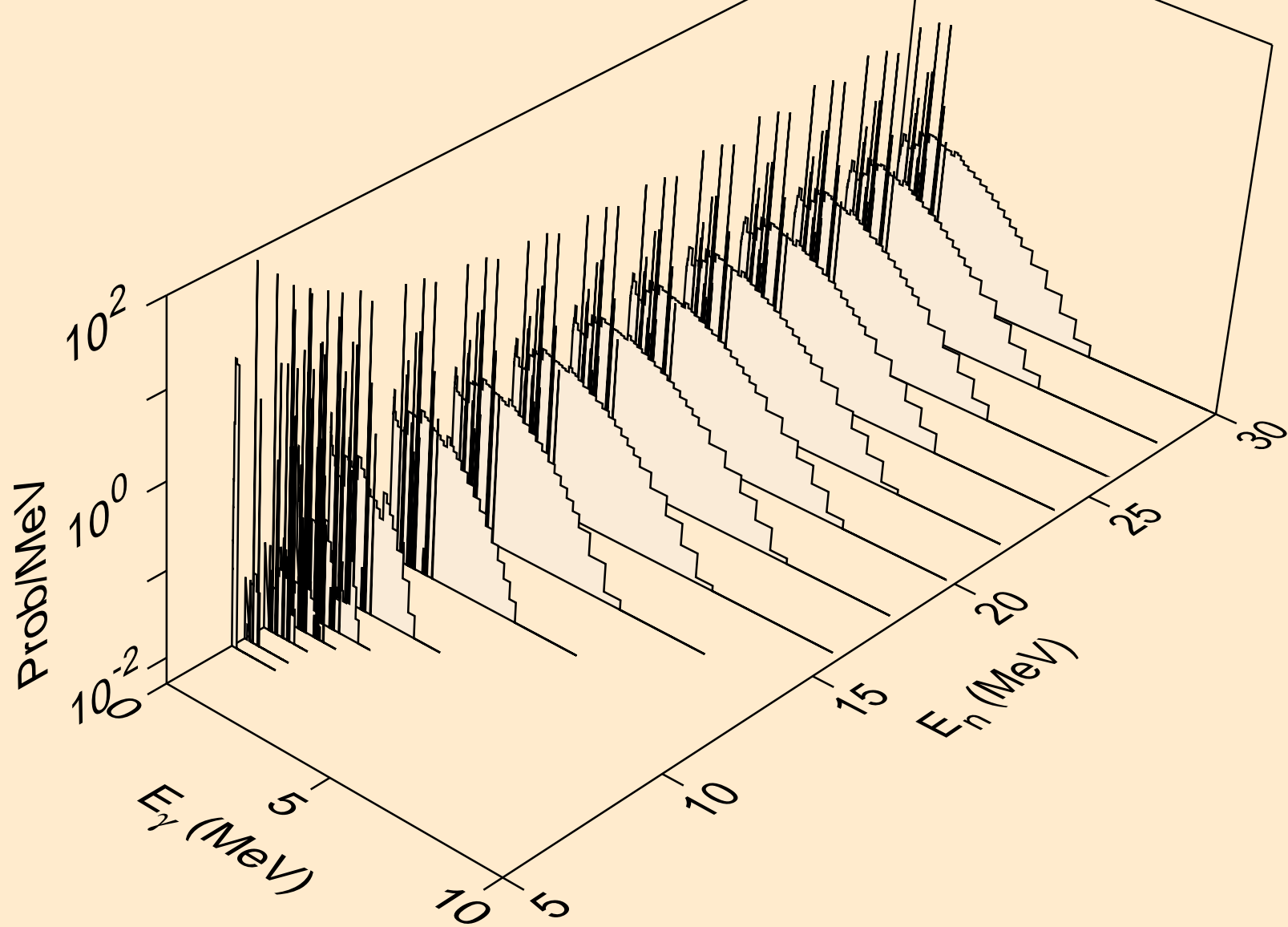

CS136 NEUTRON ACER TENDL-2024 LIBRARY; T=0.K
Photon emission for (n,3n)

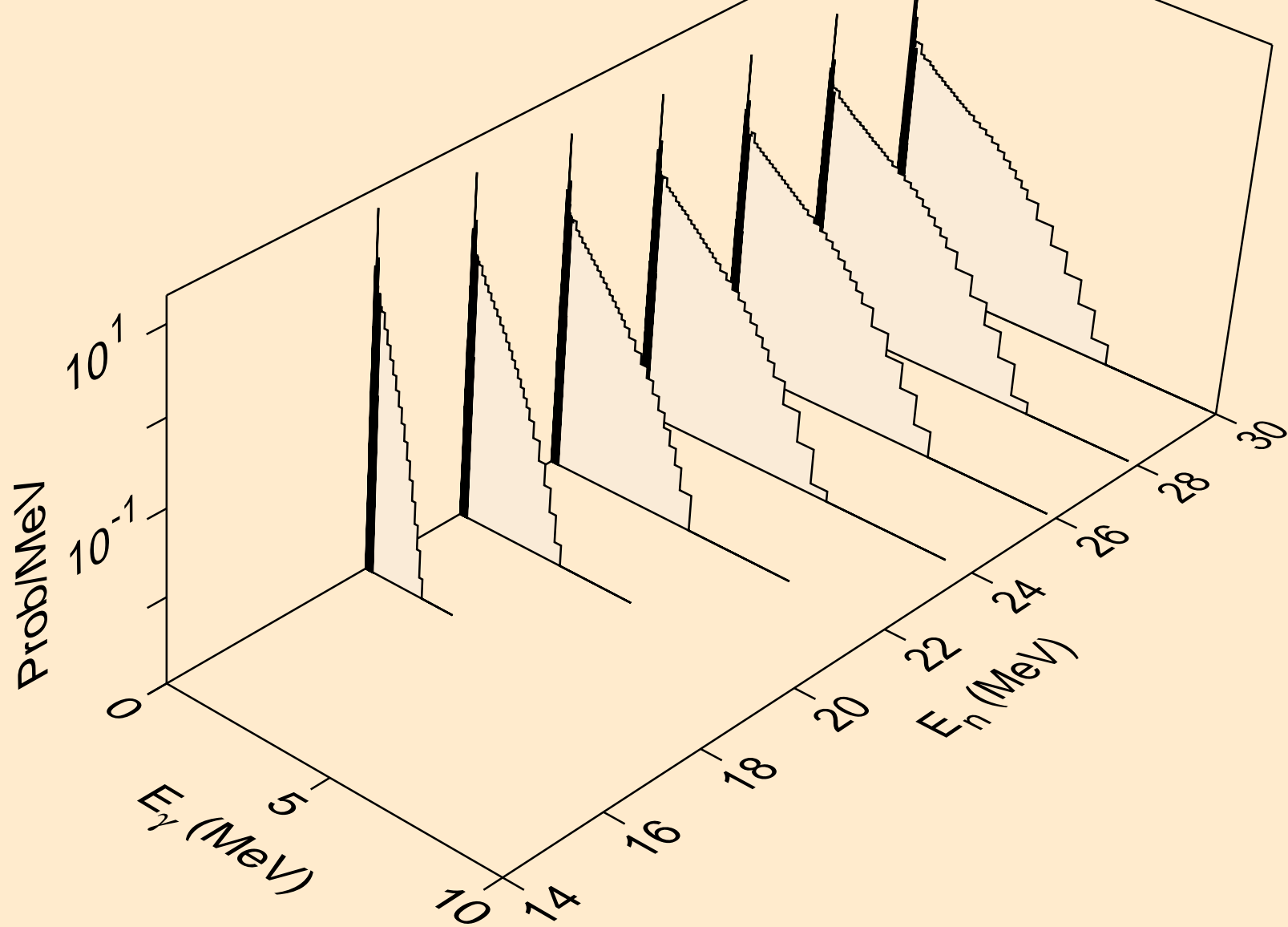

CS136 NEUTRON ACER TENDL-2024 LIBRARY; T=0.K
Photon emission for (n,n*)a

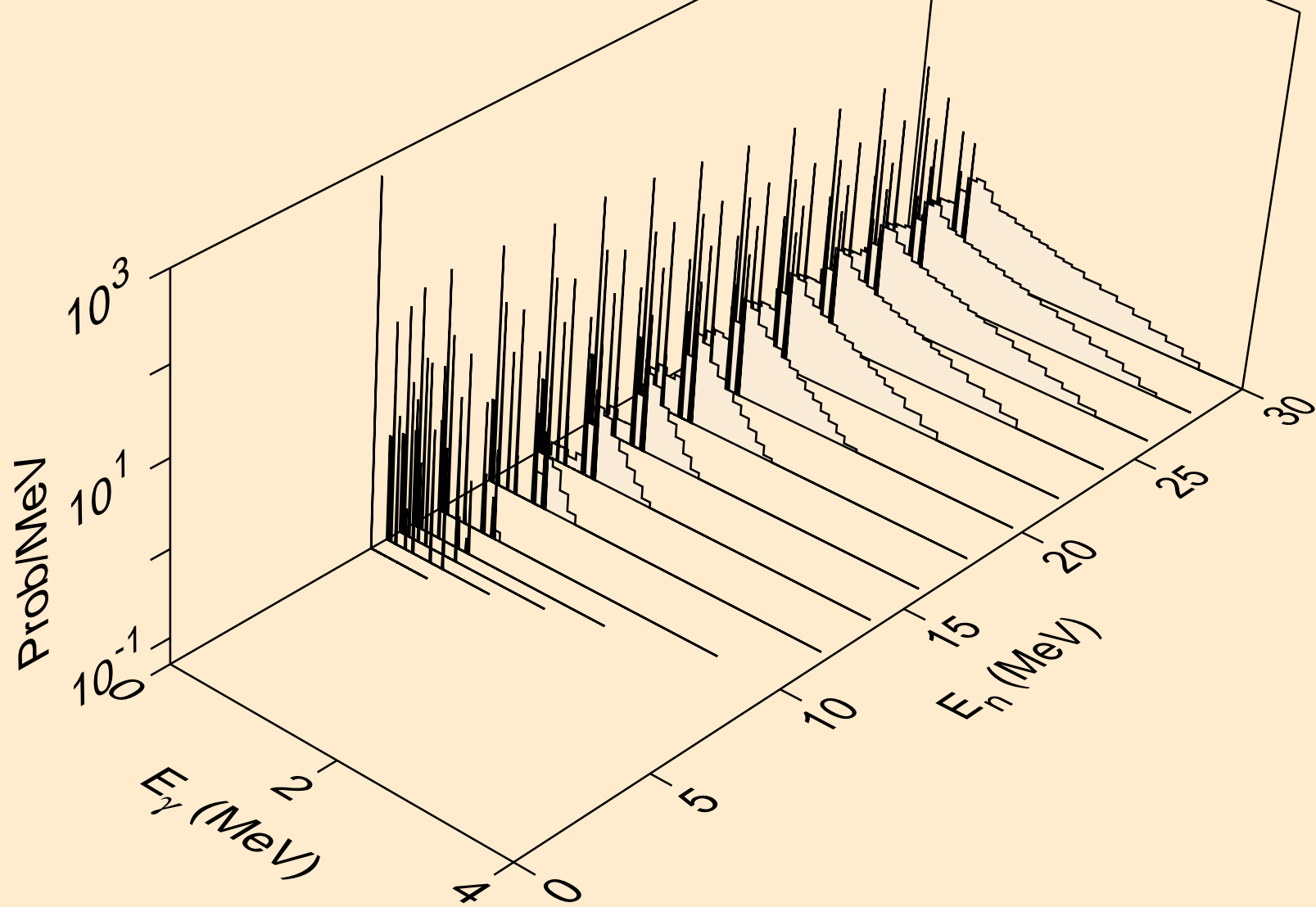

CS136 NEUTRON ACER TENDL-2024 LIBRARY; T=0.K
Photon emission for (n,2n)a

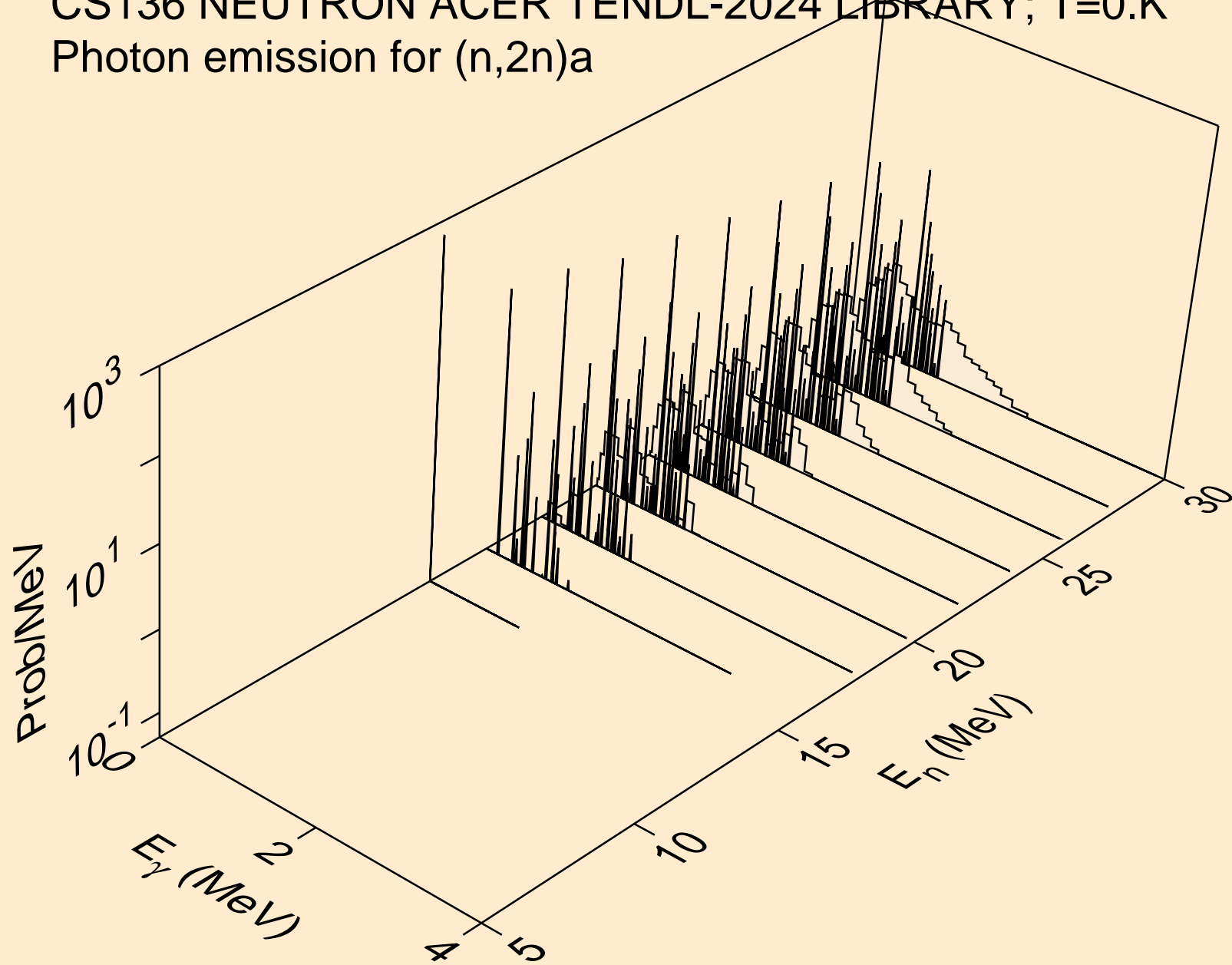

CS136 NEUTRON ACER TENDL-2024 LIBRARY; T=0.K
Photon emission for (n,3n)a

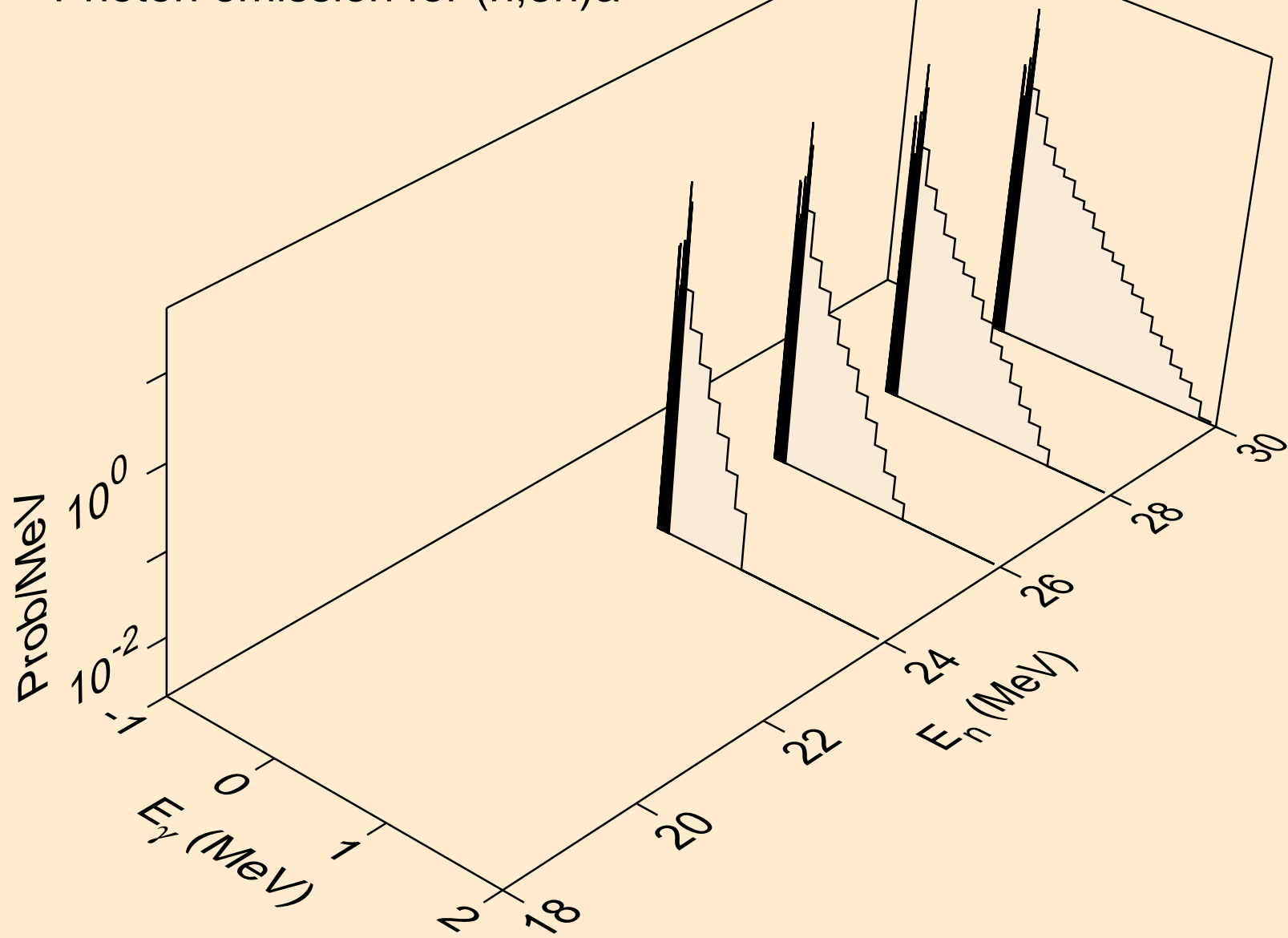

CS136 NEUTRON ACER TENDL-2024 LIBRARY; T=0.K
Photon emission for (n,n*)p

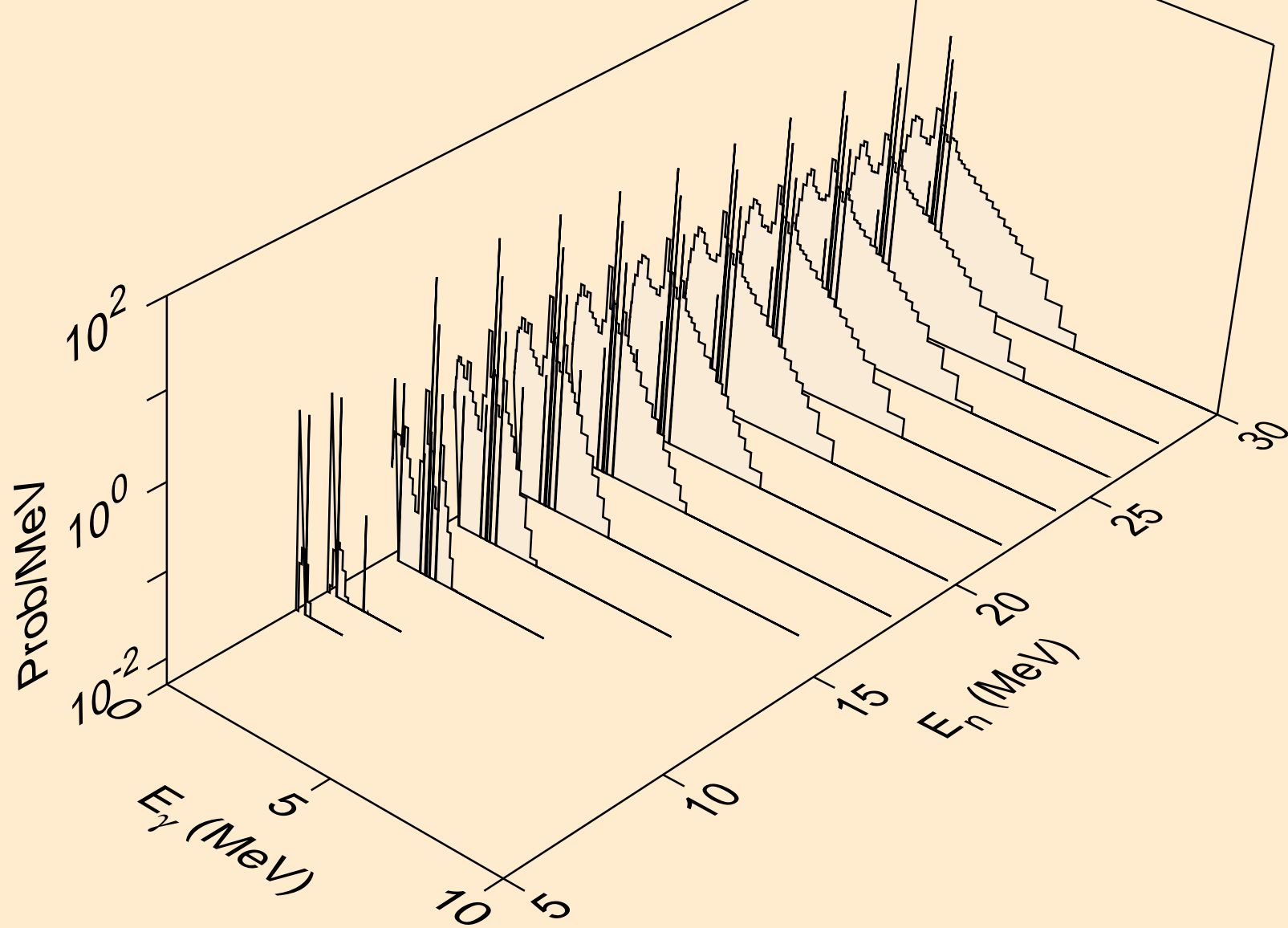

CS136 NEUTRON ACER TENDL-2024 LIBRARY; T=0.K
Photon emission for (n,n*)d

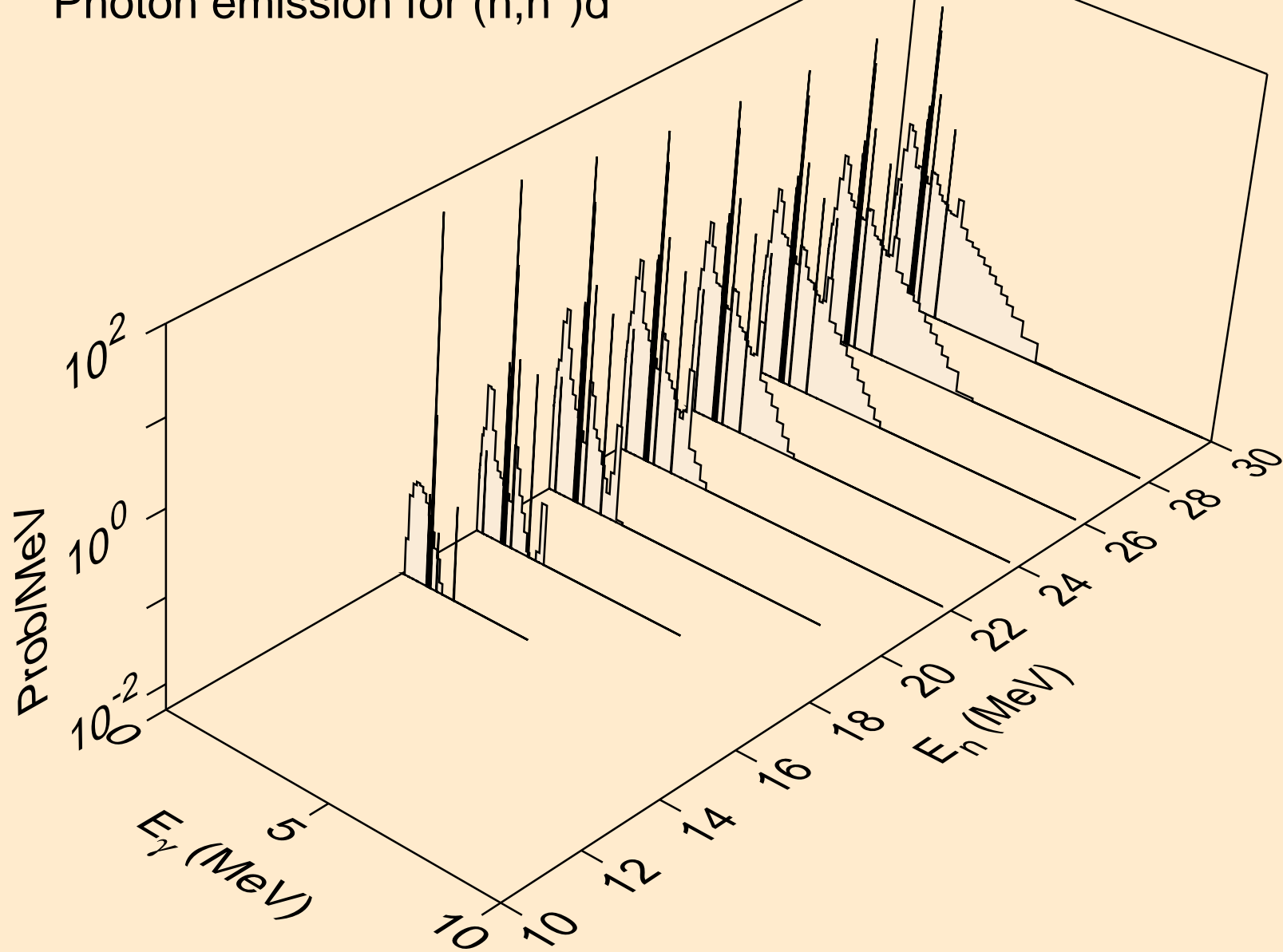

CS136 NEUTRON ACER TENDL-2024 LIBRARY; T=0.K
Photon emission for (n,n*)t

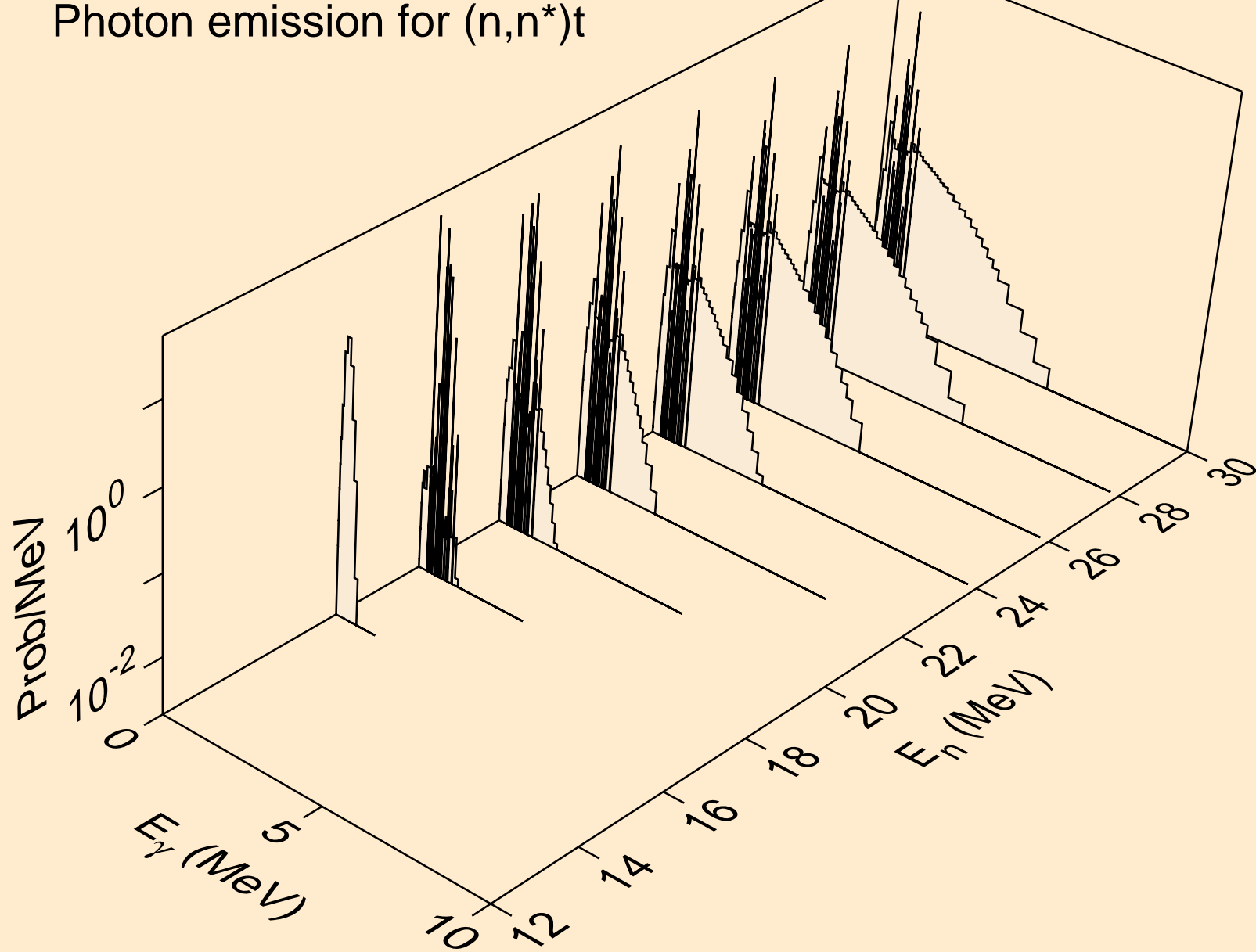

CS136 NEUTRON ACER TENDL-2024 LIBRARY; T=0.K
Photon emission for (n,n*)he3

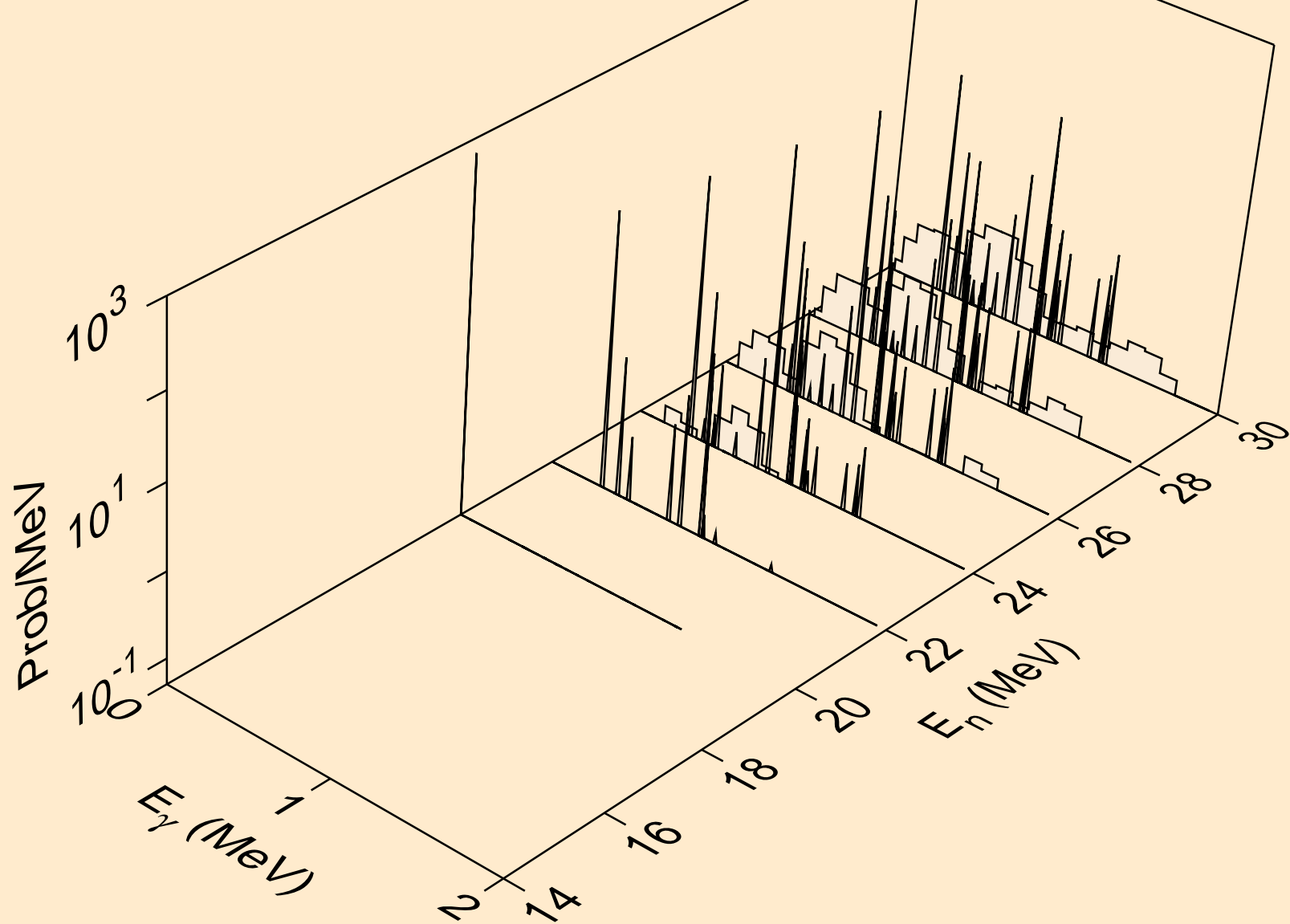

CS136 NEUTRON ACER TENDL-2024 LIBRARY; T=0.K
Photon emission for (n,4n)

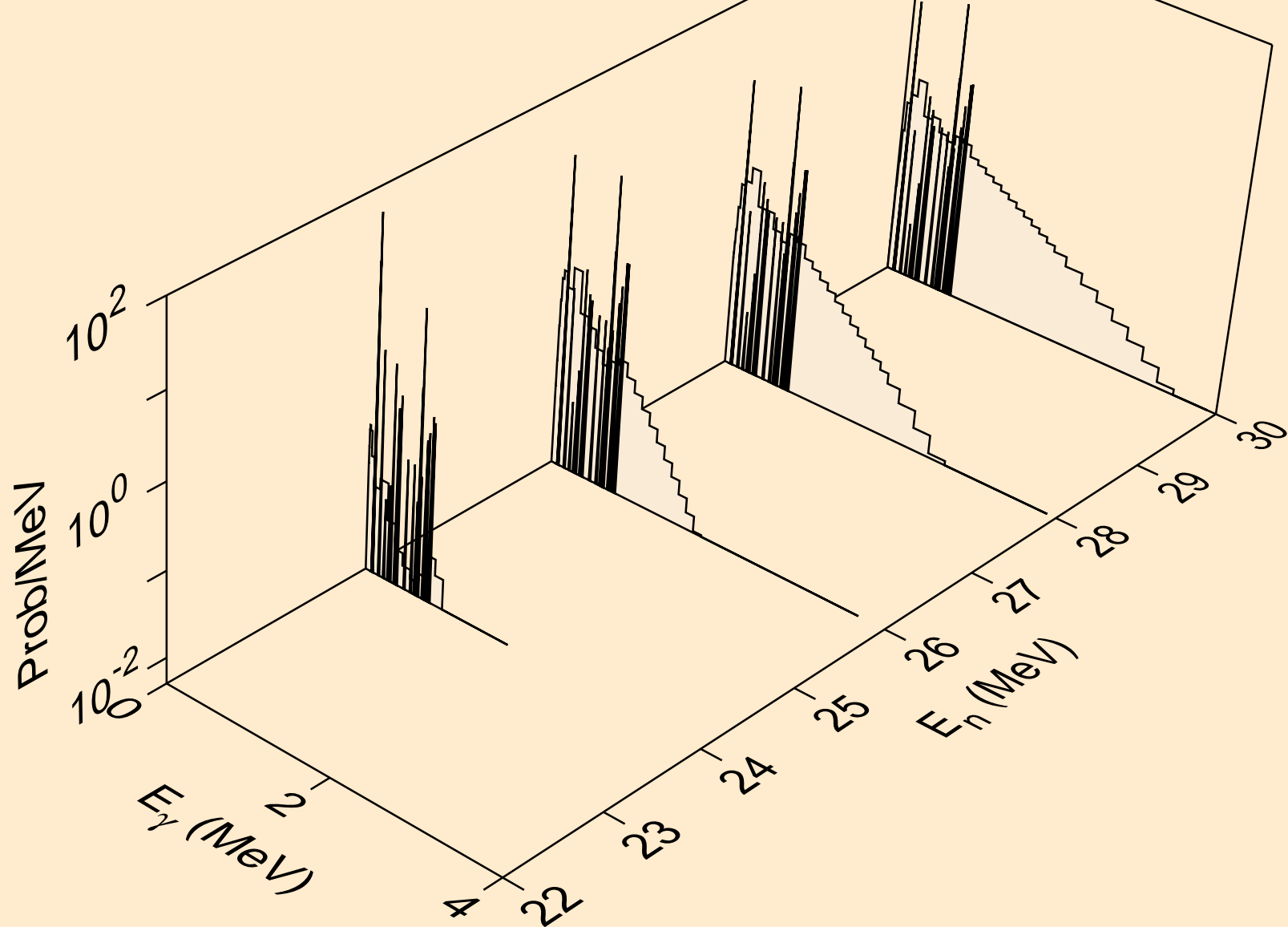

CS136 NEUTRON ACER TENDL-2024 LIBRARY; T=0.K
Photon emission for (n,2np)

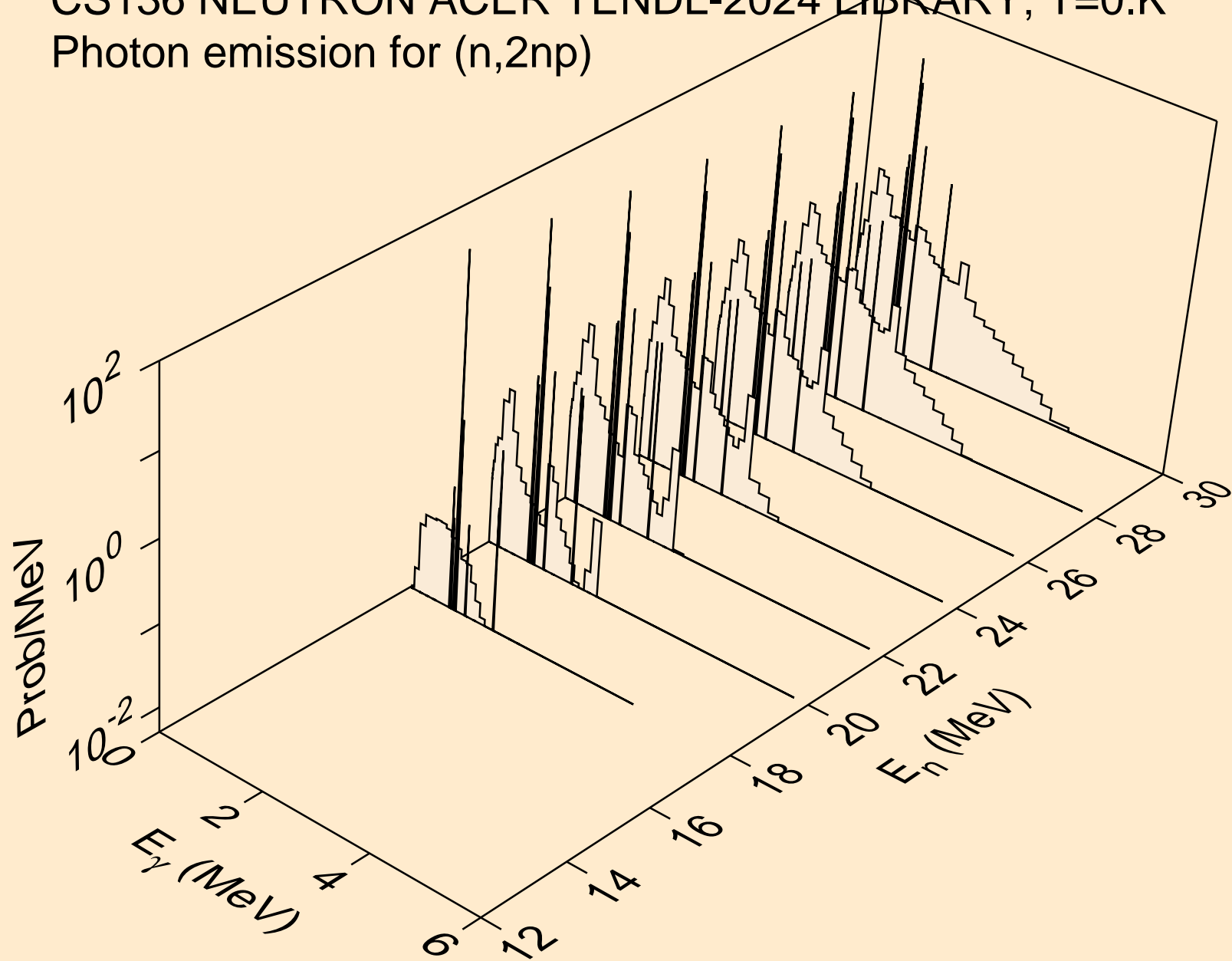

CS136 NEUTRON ACER TENDL-2024 LIBRARY; T=0.K
Photon emission for (n,3np)

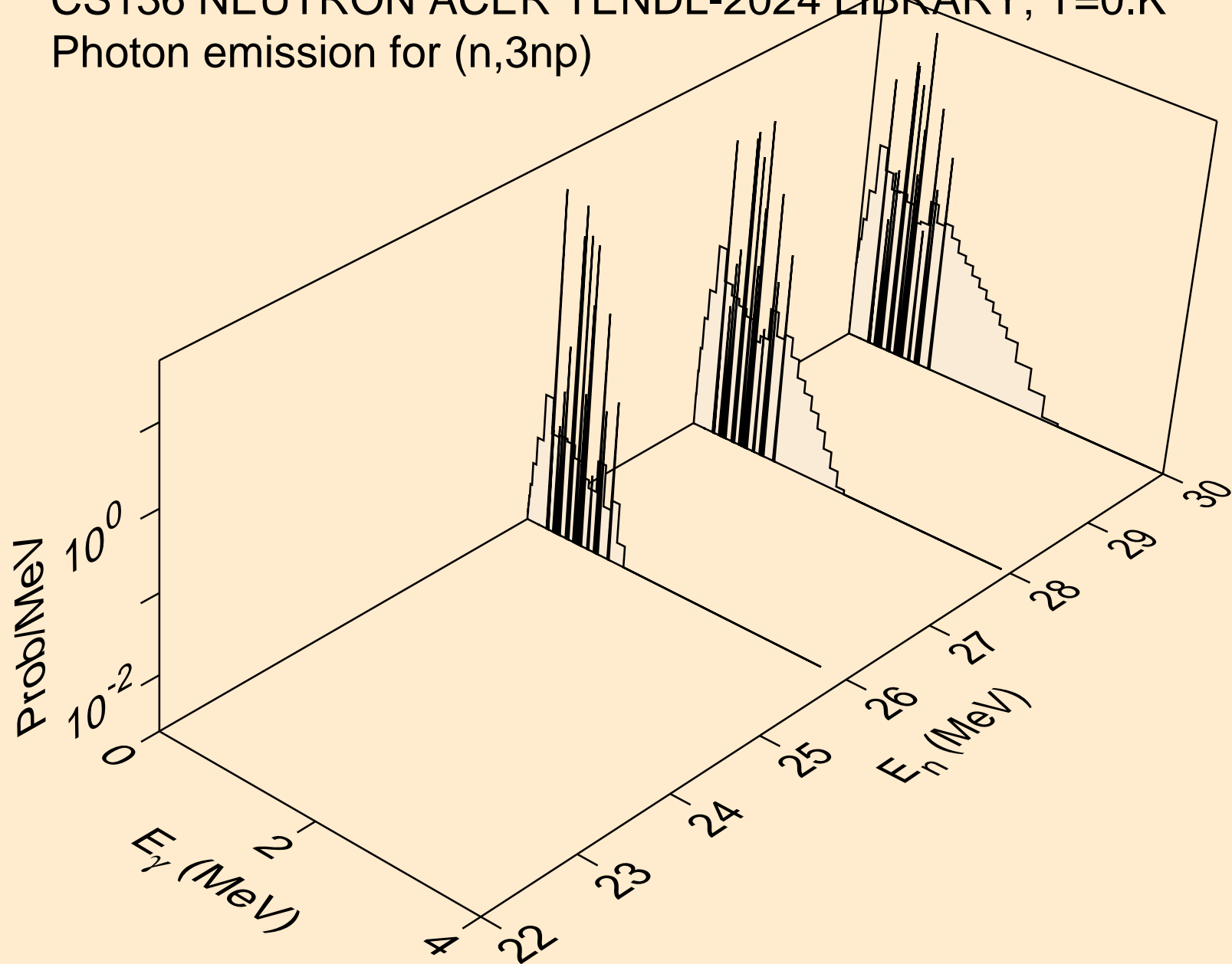

CS136 NEUTRON ACER TENDL-2024 LIBRARY; T=0.K
Photon emission for (n,n2p)

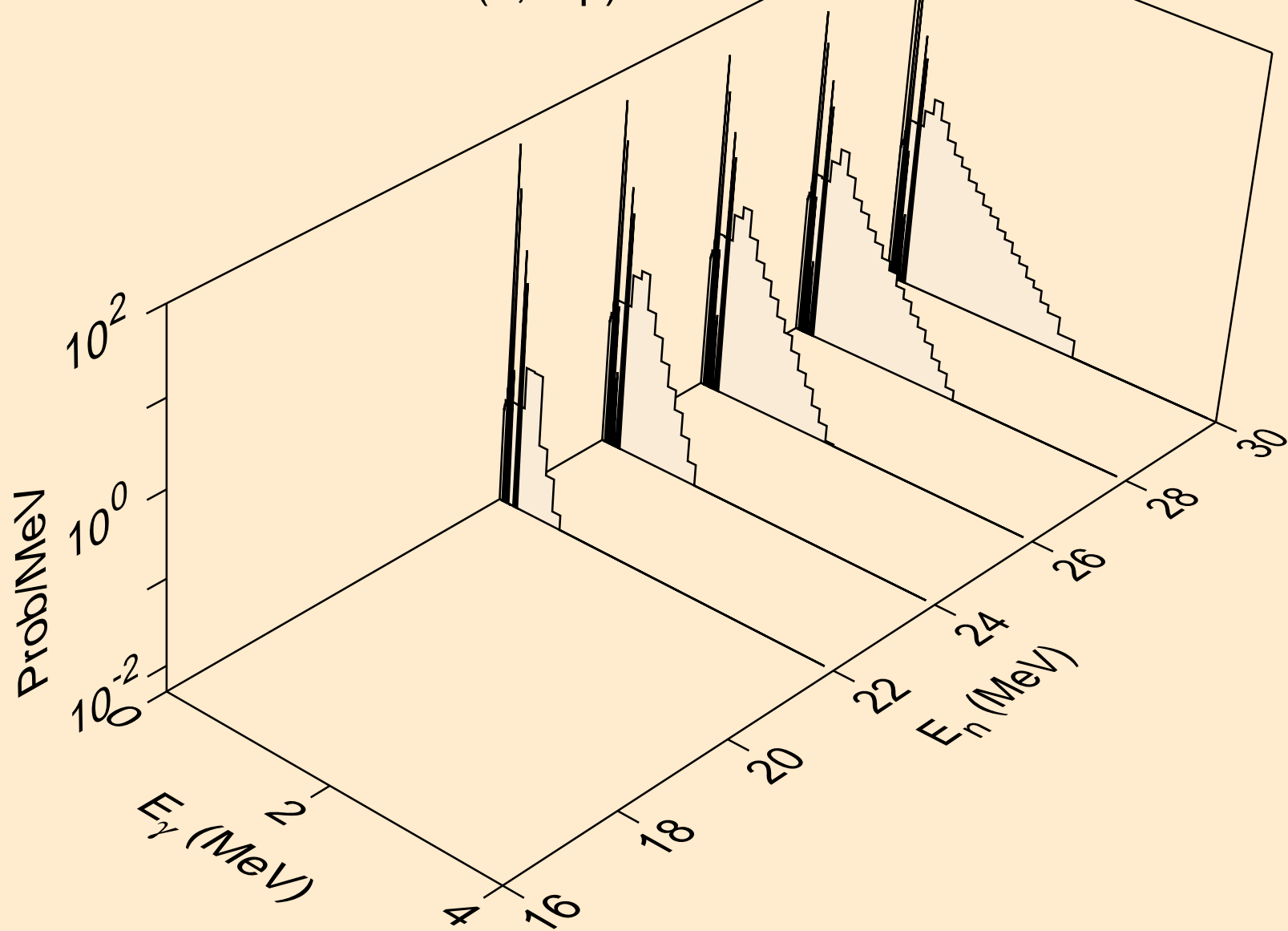

CS136 NEUTRON ACER TENDL-2024 LIBRARY; T=0.K
Photon emission for (n,npa)

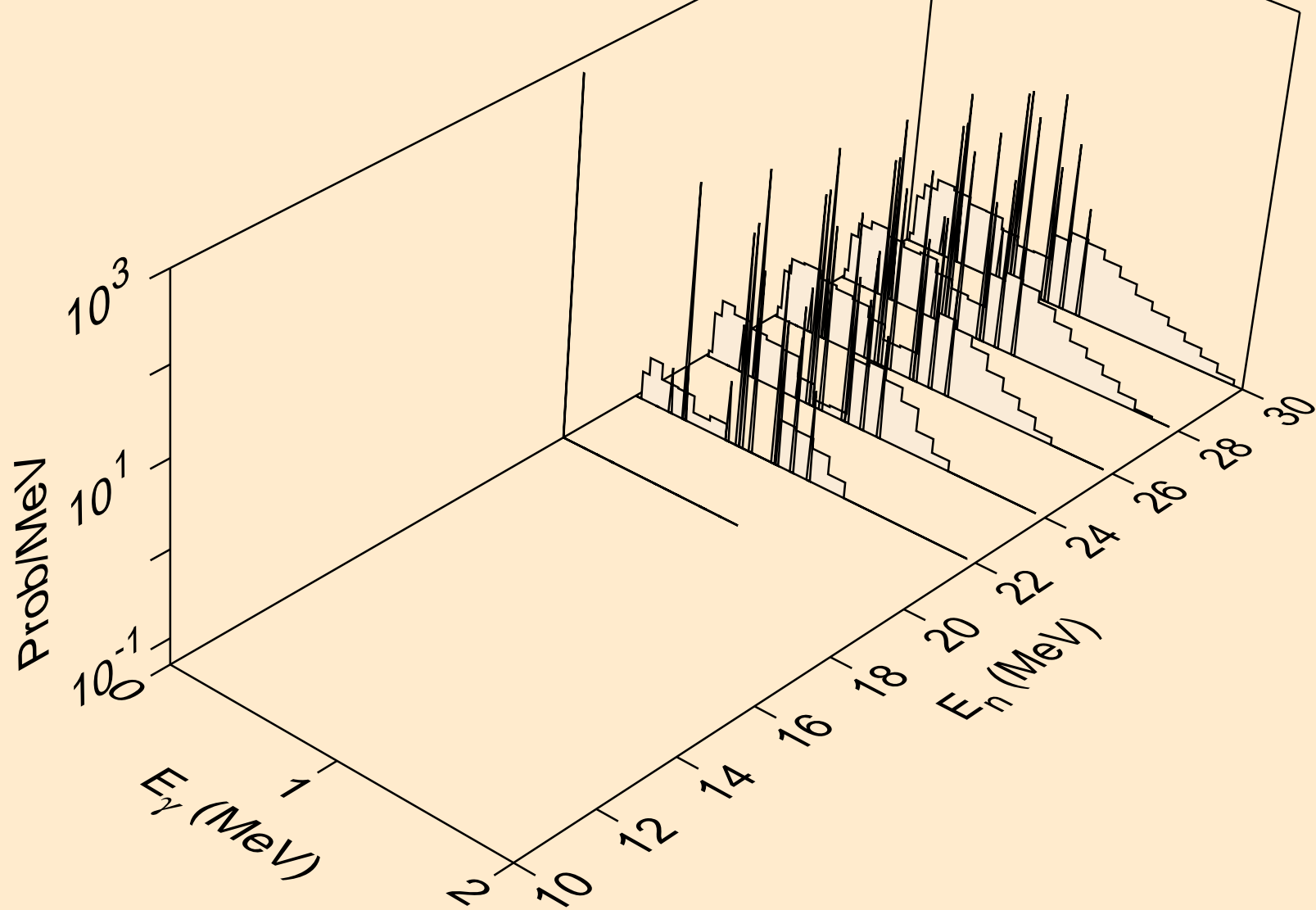

CS136 NEUTRON ACER TENDL-2024 LIBRARY; T=0.K
Photon emission for (n,n*c)

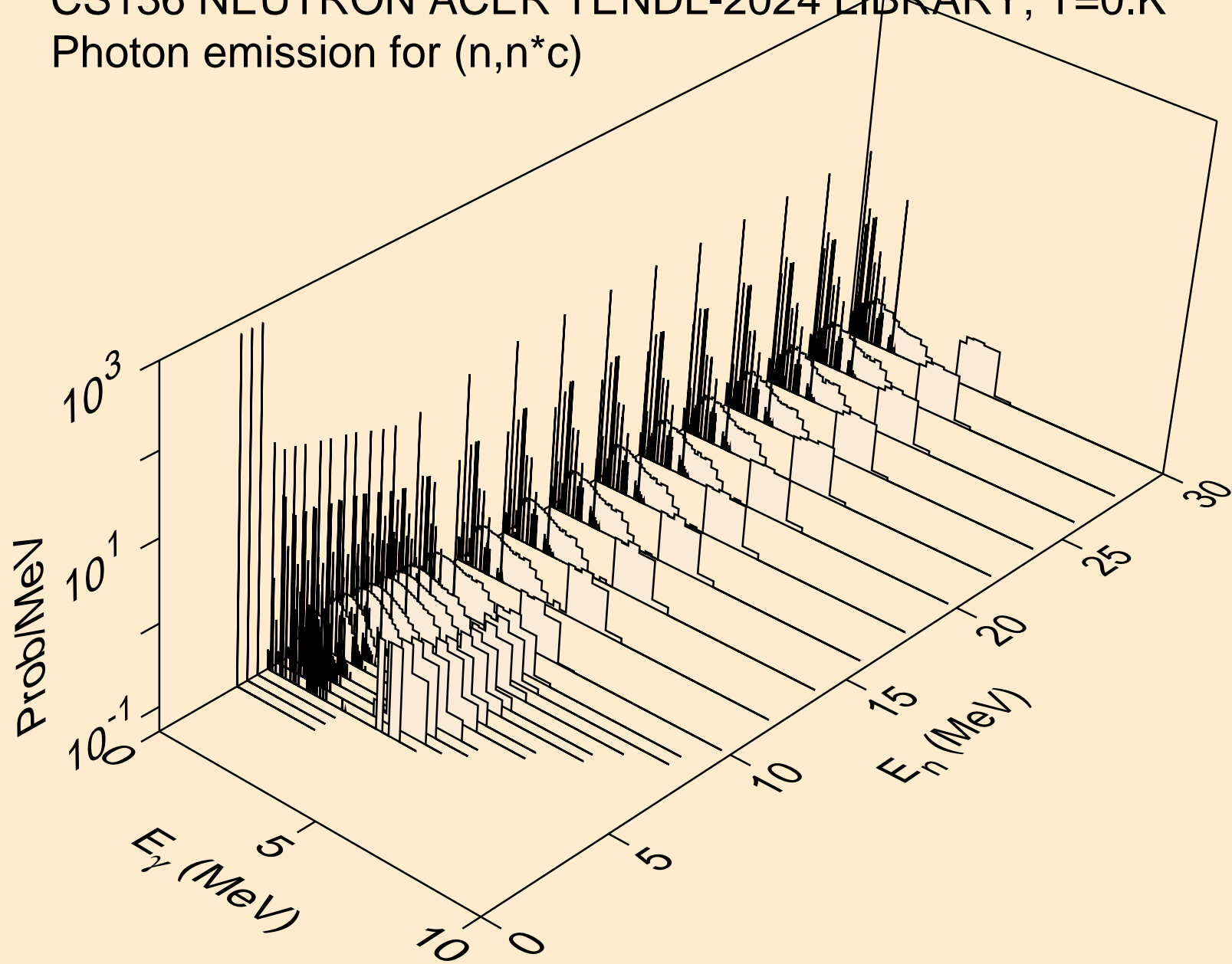

CS136 NEUTRON ACER TENDL-2024 LIBRARY; T=0.K
Photon emission for (n,gma)

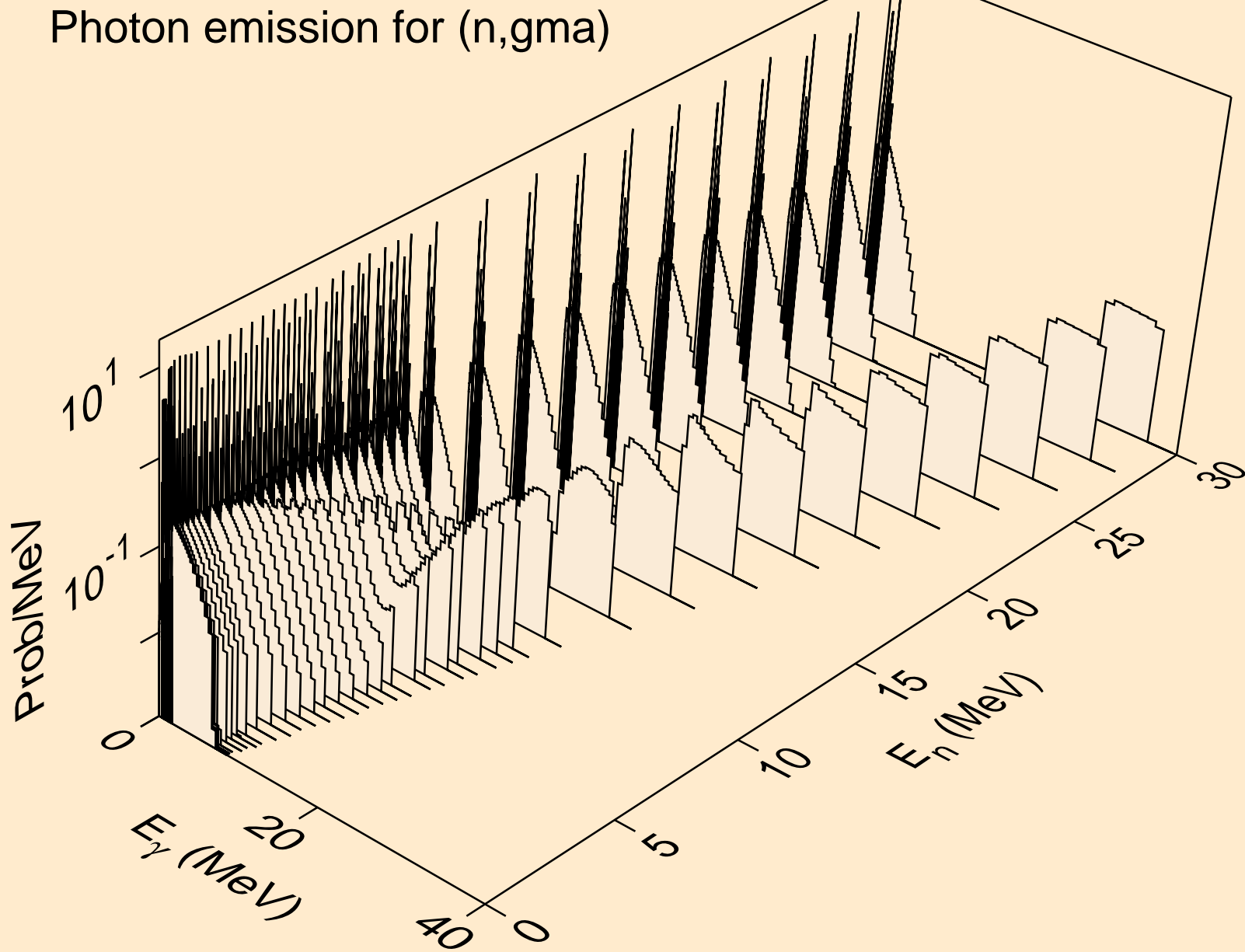

CS136 NEUTRON ACER TENDL-2024 LIBRARY; T=0.K
Photon emission for (n,p)

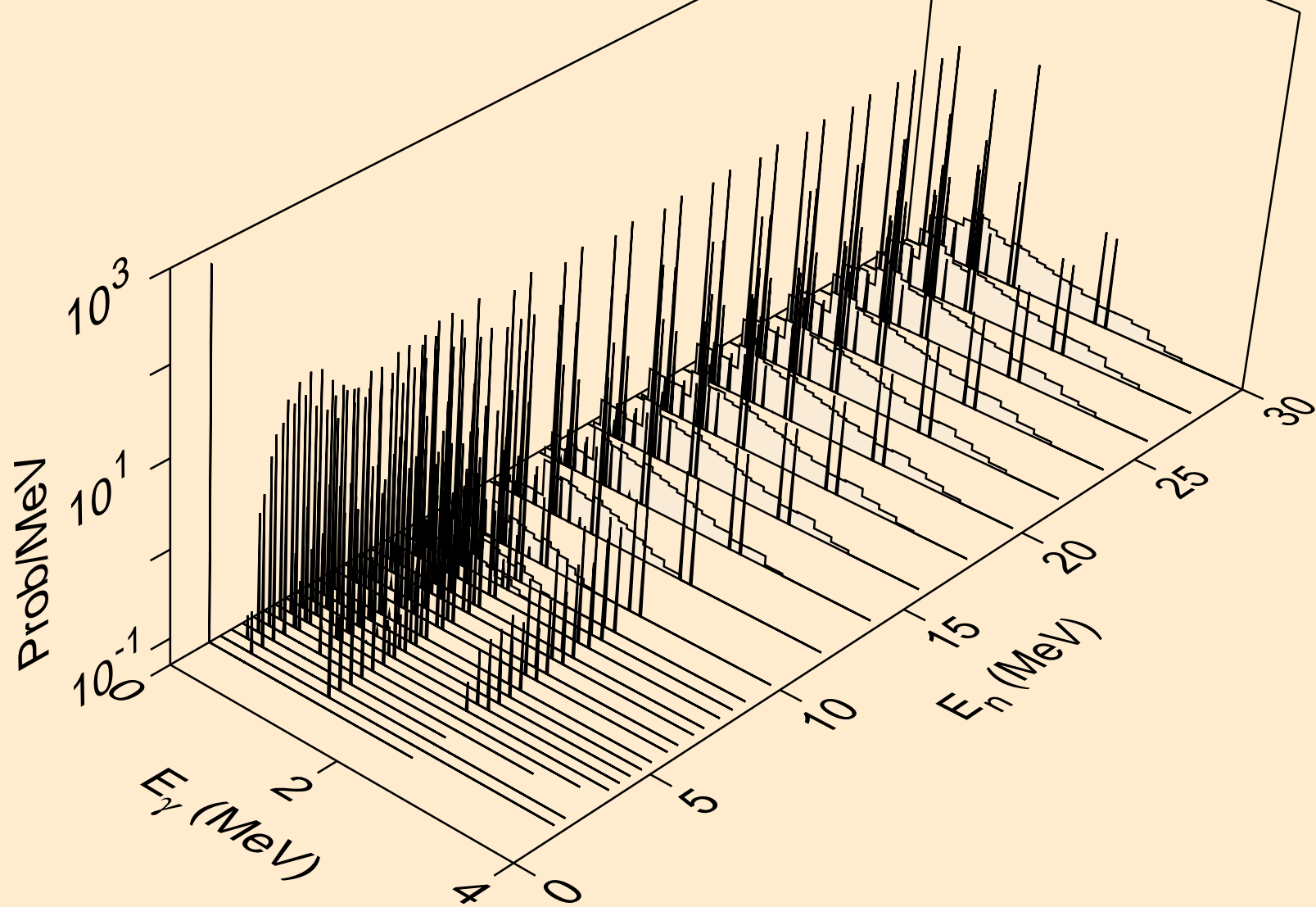

CS136 NEUTRON ACER TENDL-2024 LIBRARY; T=0.K
Photon emission for (n,d)

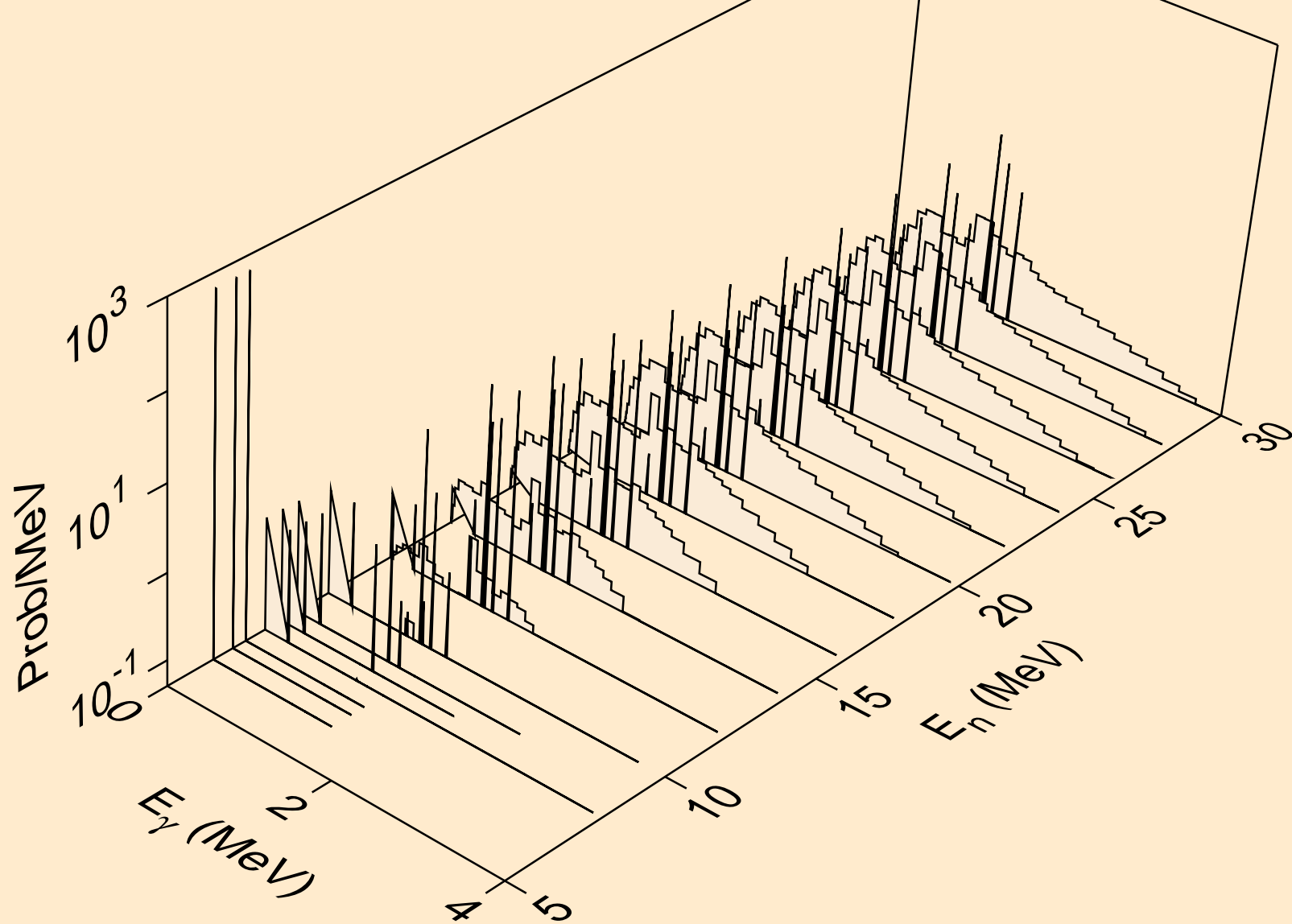

CS136 NEUTRON ACER TENDL-2024 LIBRARY; T=0.K
Photon emission for (n,t)

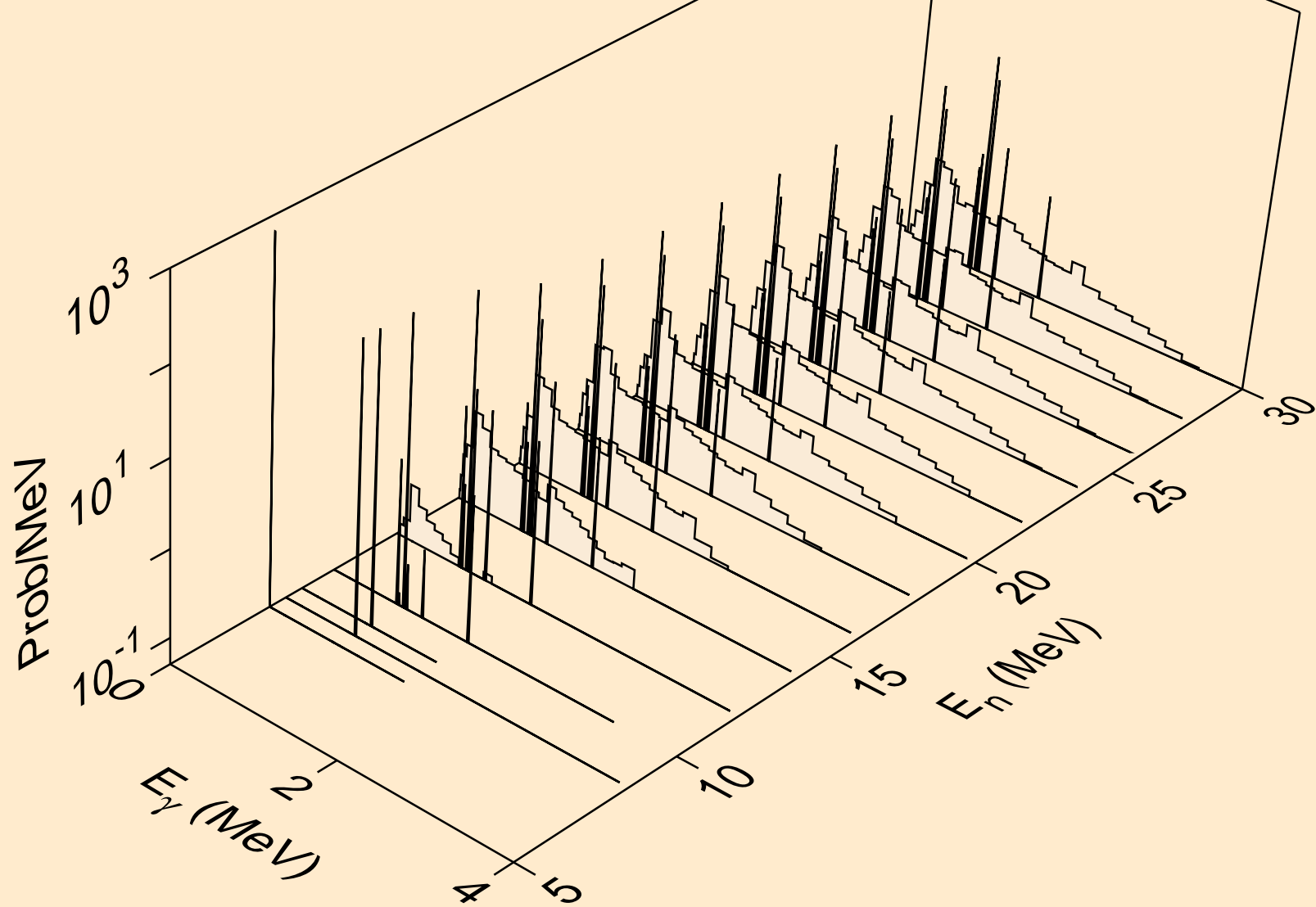

CS136 NEUTRON ACER TENDL-2024 LIBRARY; T=0.K
Photon emission for (n,he3)

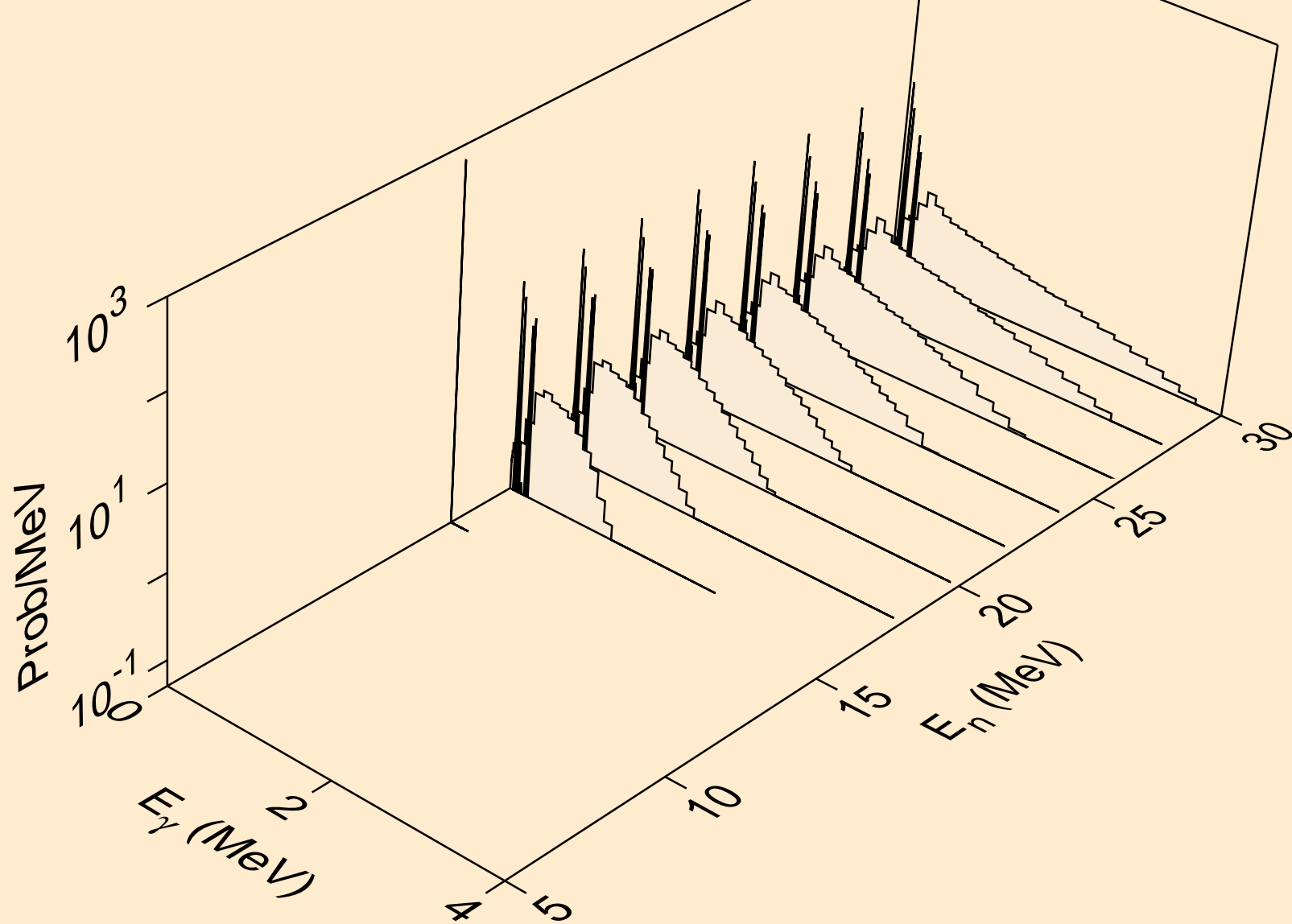

CS136 NEUTRON ACER TENDL-2024 LIBRARY; T=0.K
Photon emission for (n,a)

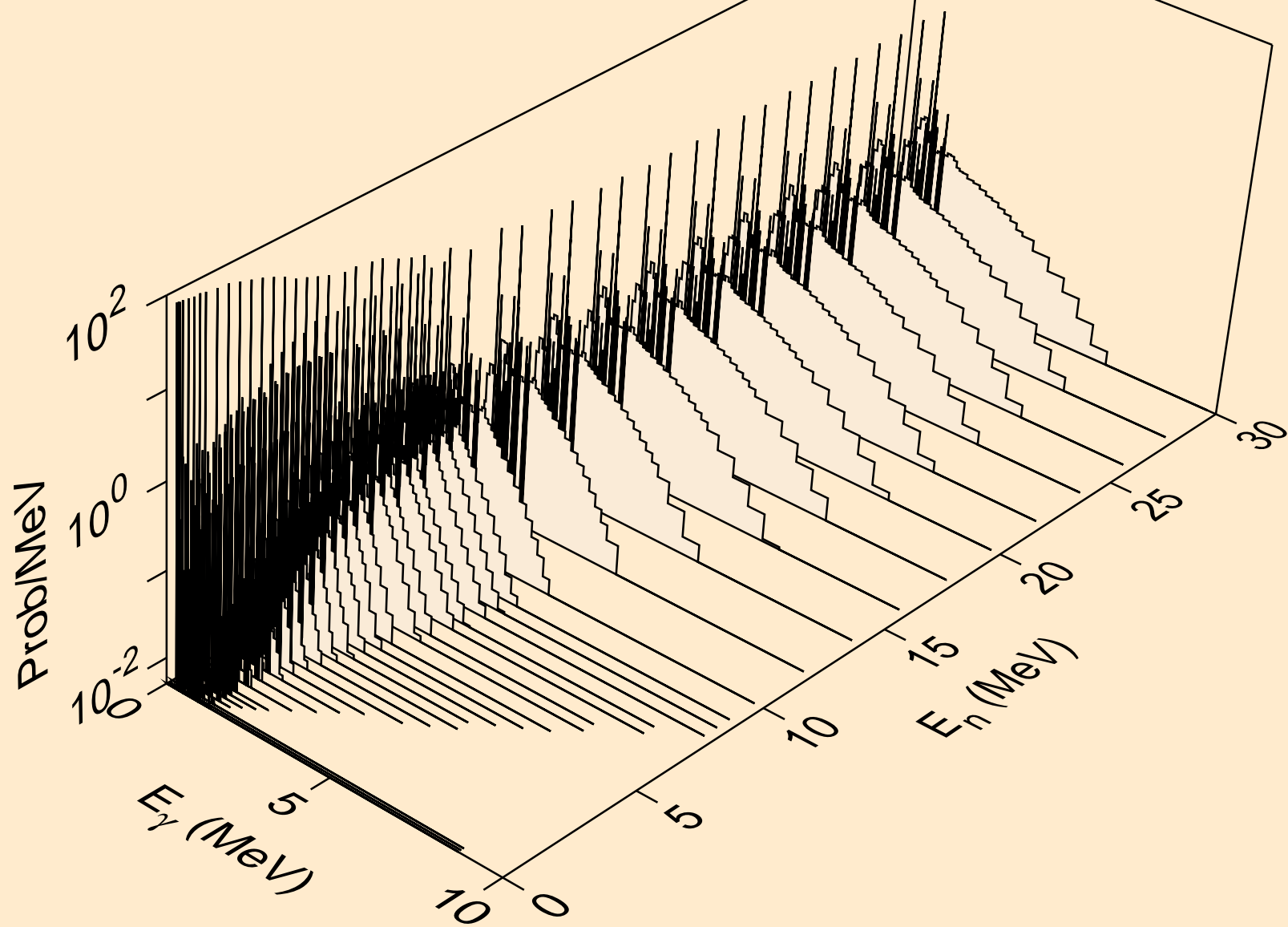

CS136 NEUTRON ACER TENDL-2024 LIBRARY; T=0.K
Photon emission for (n,2a)

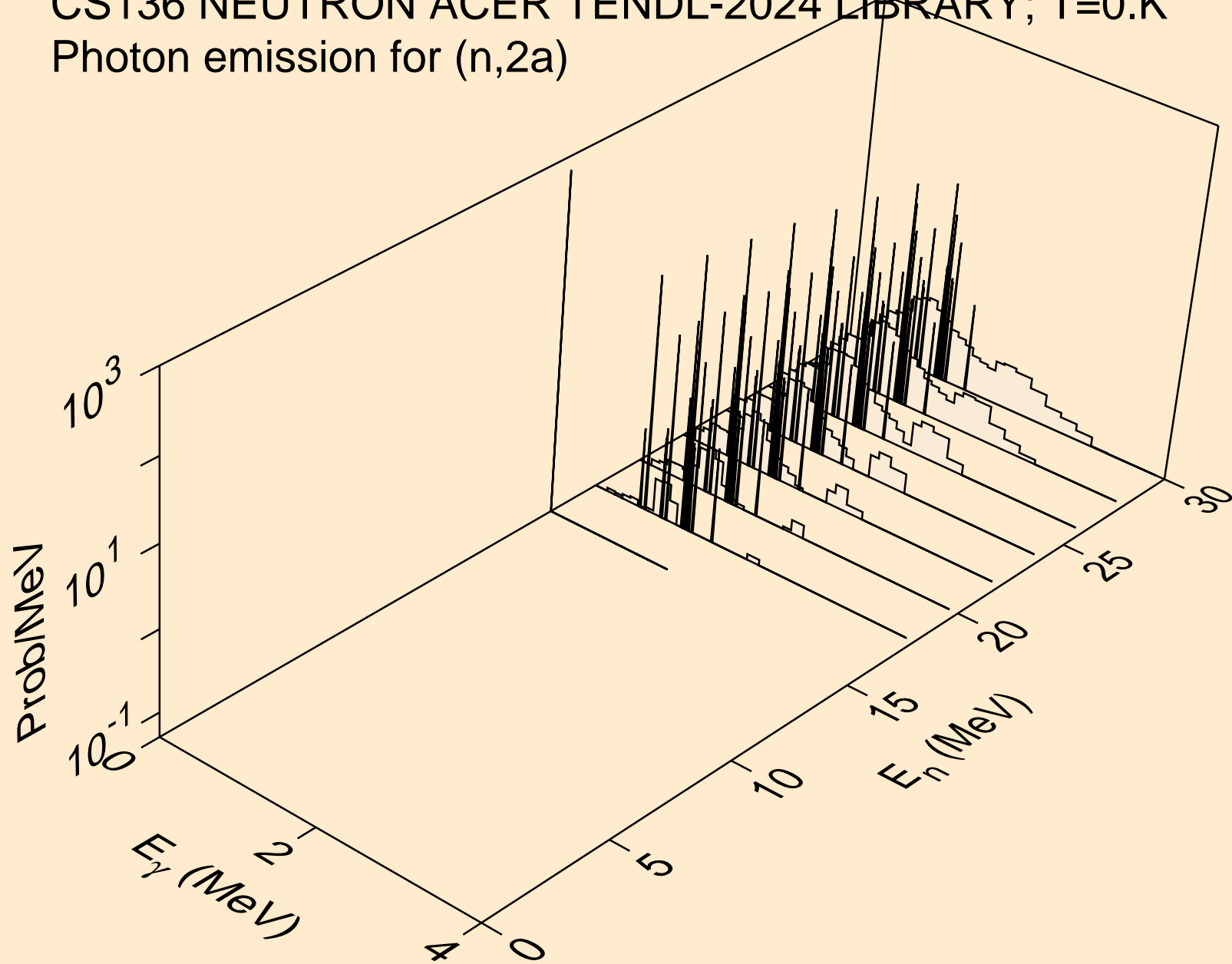

CS136 NEUTRON ACER TENDL-2024 LIBRARY; T=0.K
Photon emission for (n,2p)

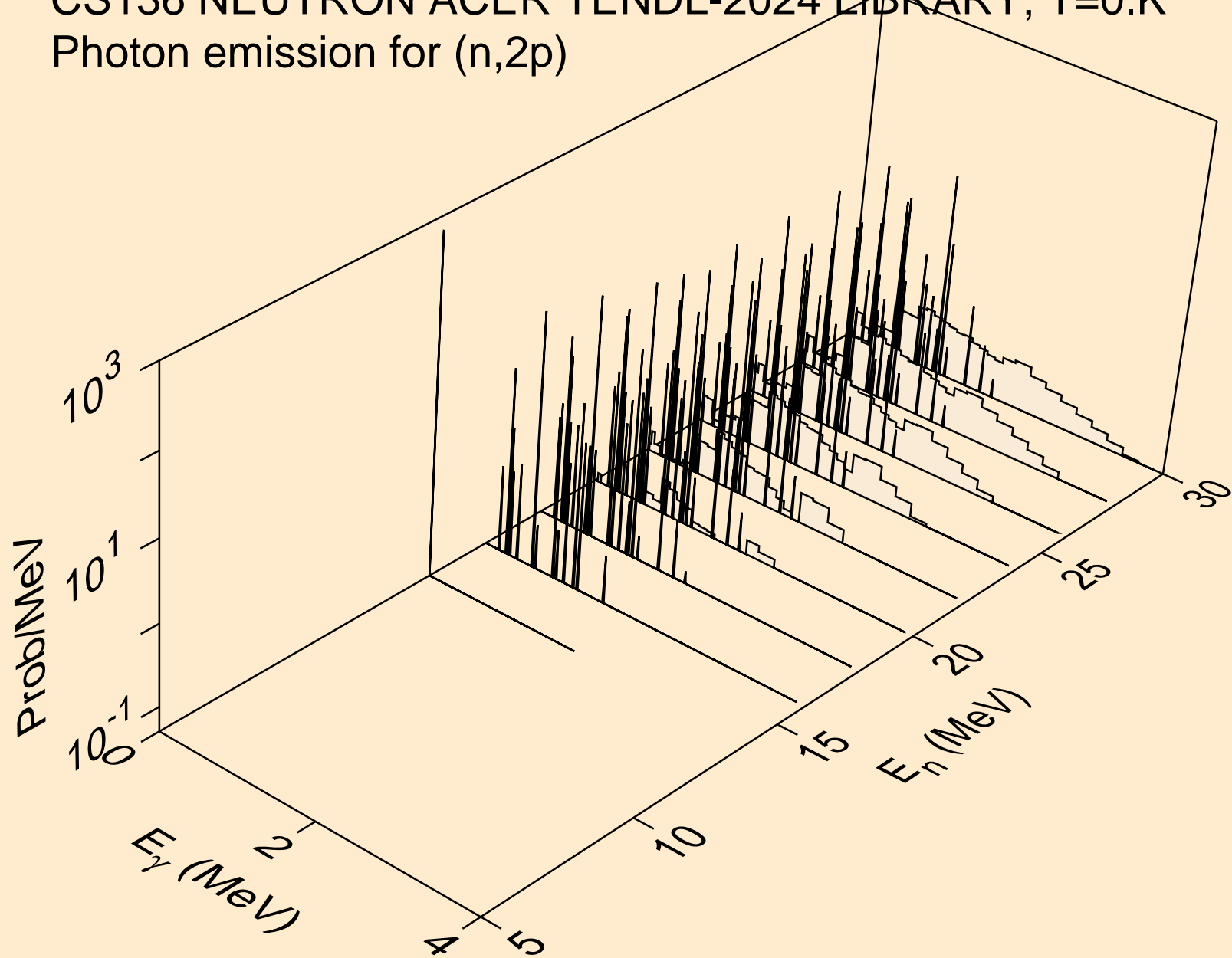

CS136 NEUTRON ACER TENDL-2024 LIBRARY; T=0.K
Photon emission for (n,p α)

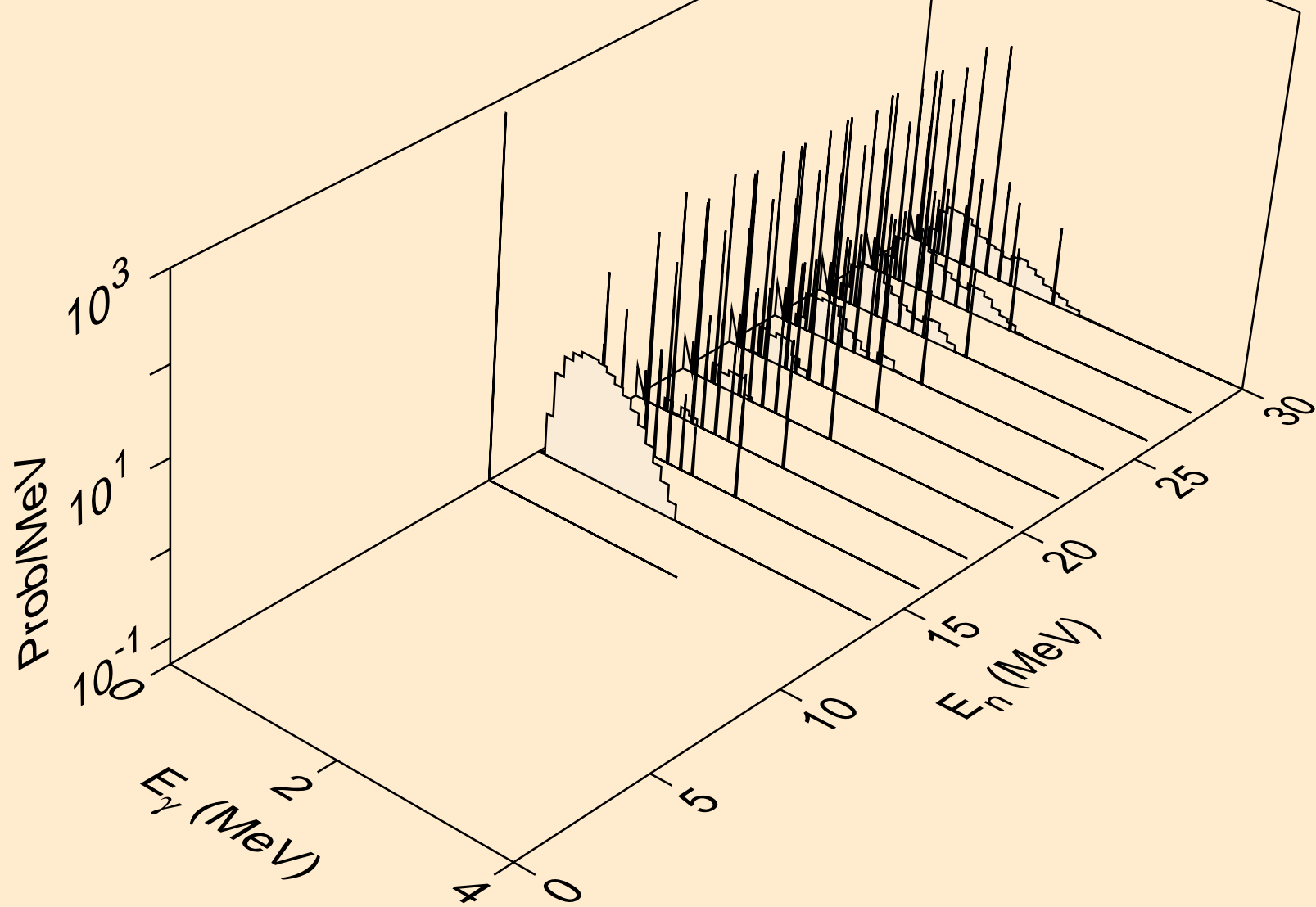

CS136 NEUTRON ACER TENDL-2024 LIBRARY; T=0.K
Photon emission for (n,pd)

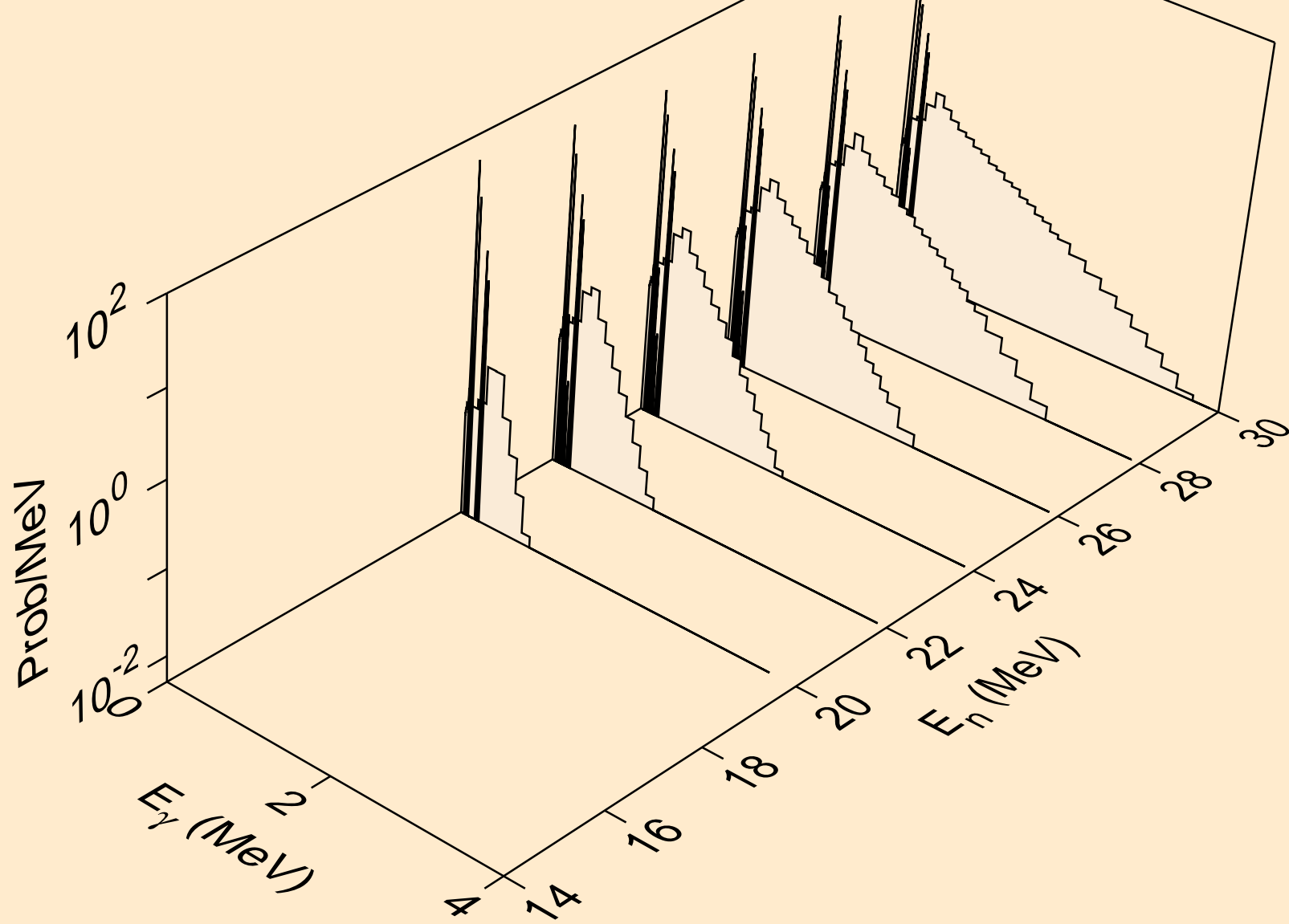

CS136 NEUTRON ACER TENDL-2024 LIBRARY; T=0.K
Photon emission for (n,pt)

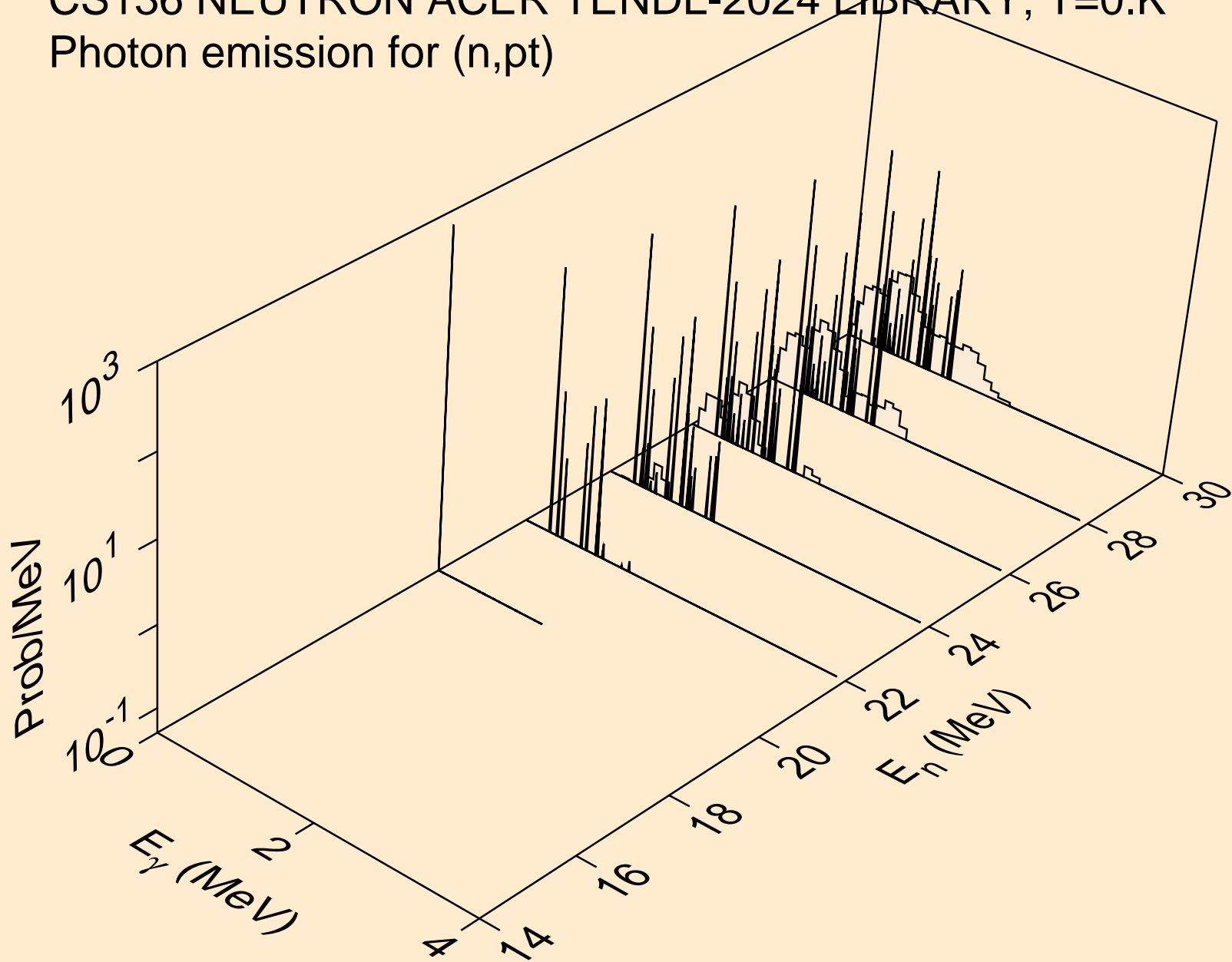

CS136 NEUTRON ACER TENDL-2024 LIBRARY; T=0.K
Photon emission for (n,da)

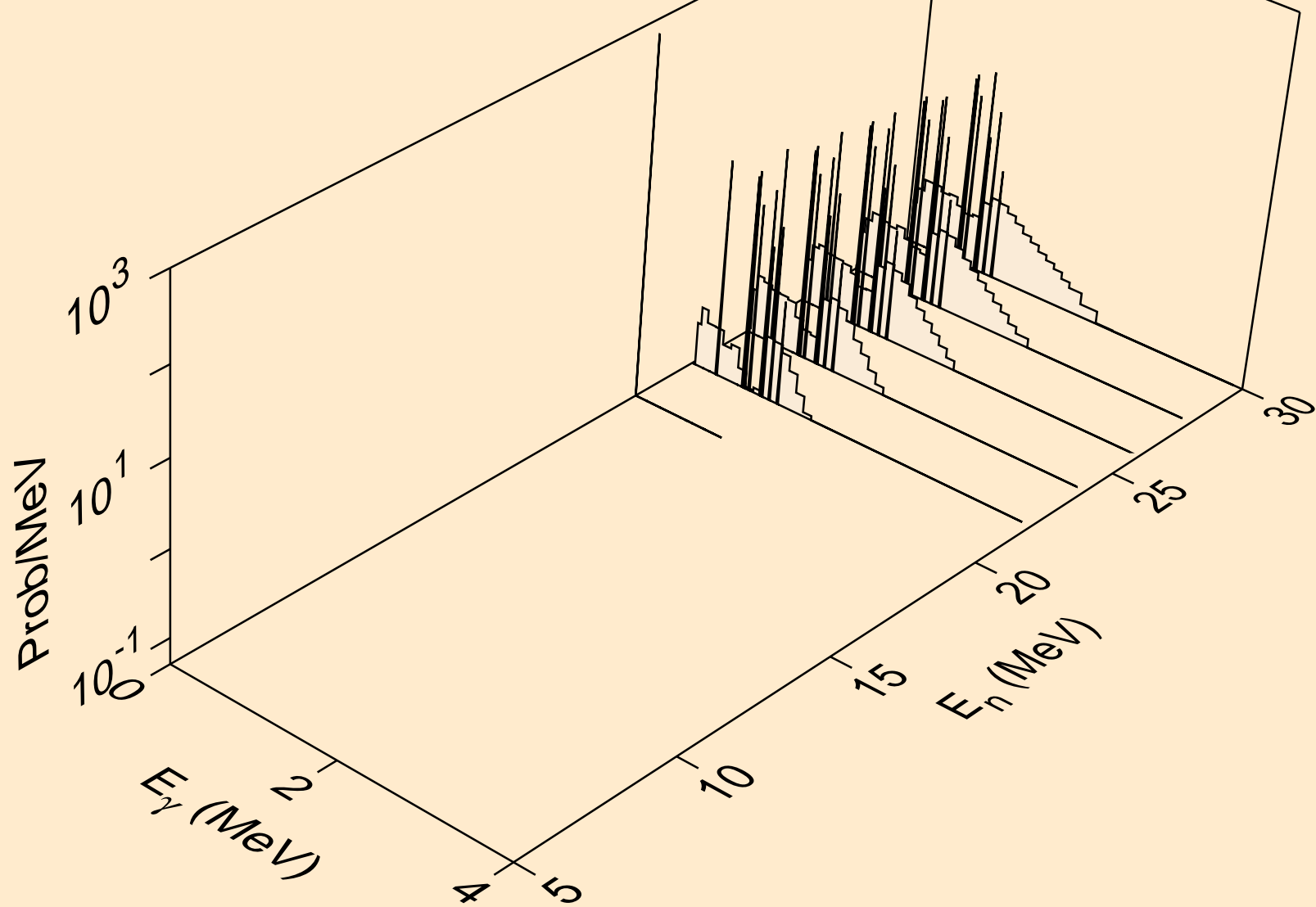

CS136 NEUTRON ACER TENDL-2024 LIBRARY; T=0.K
thermal capture photon spectrum

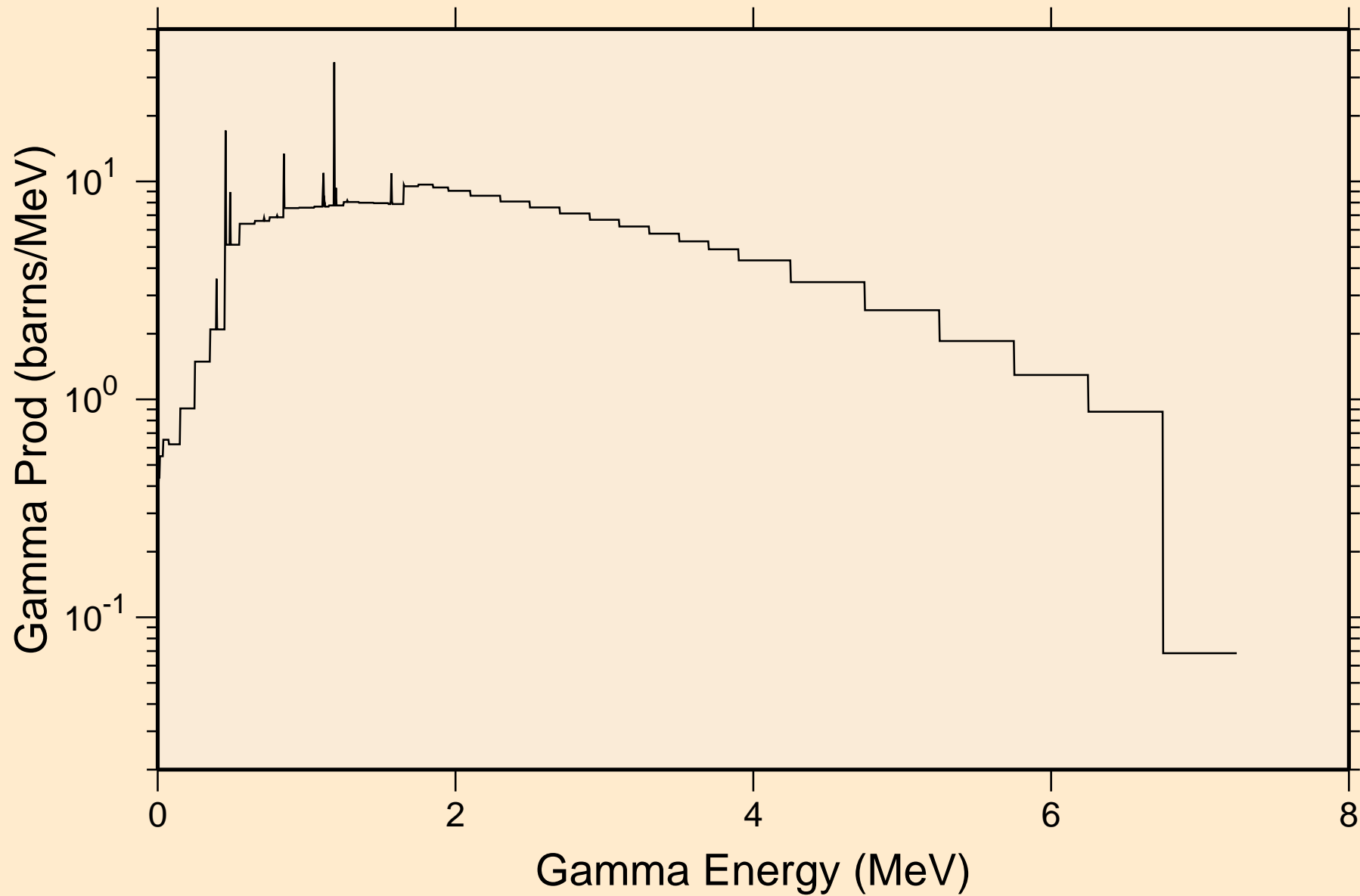

CS136 NEUTRON ACER TENDL-2024 LIBRARY; T=0.K
14 MeV photon spectrum

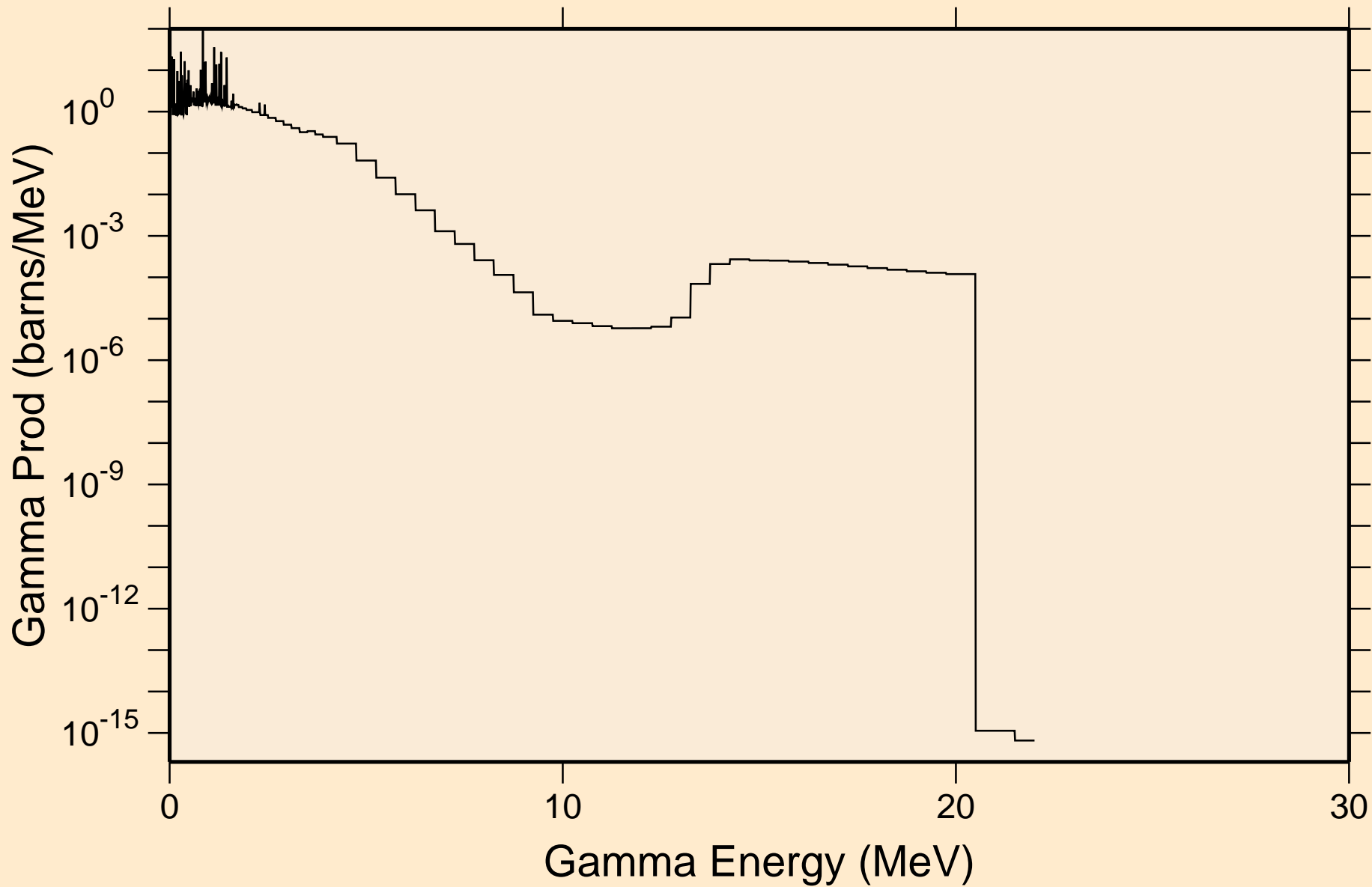

CS136 NEUTRON ACER TENDL-2024 LIBRARY; T=0.K

Particle heating contributions

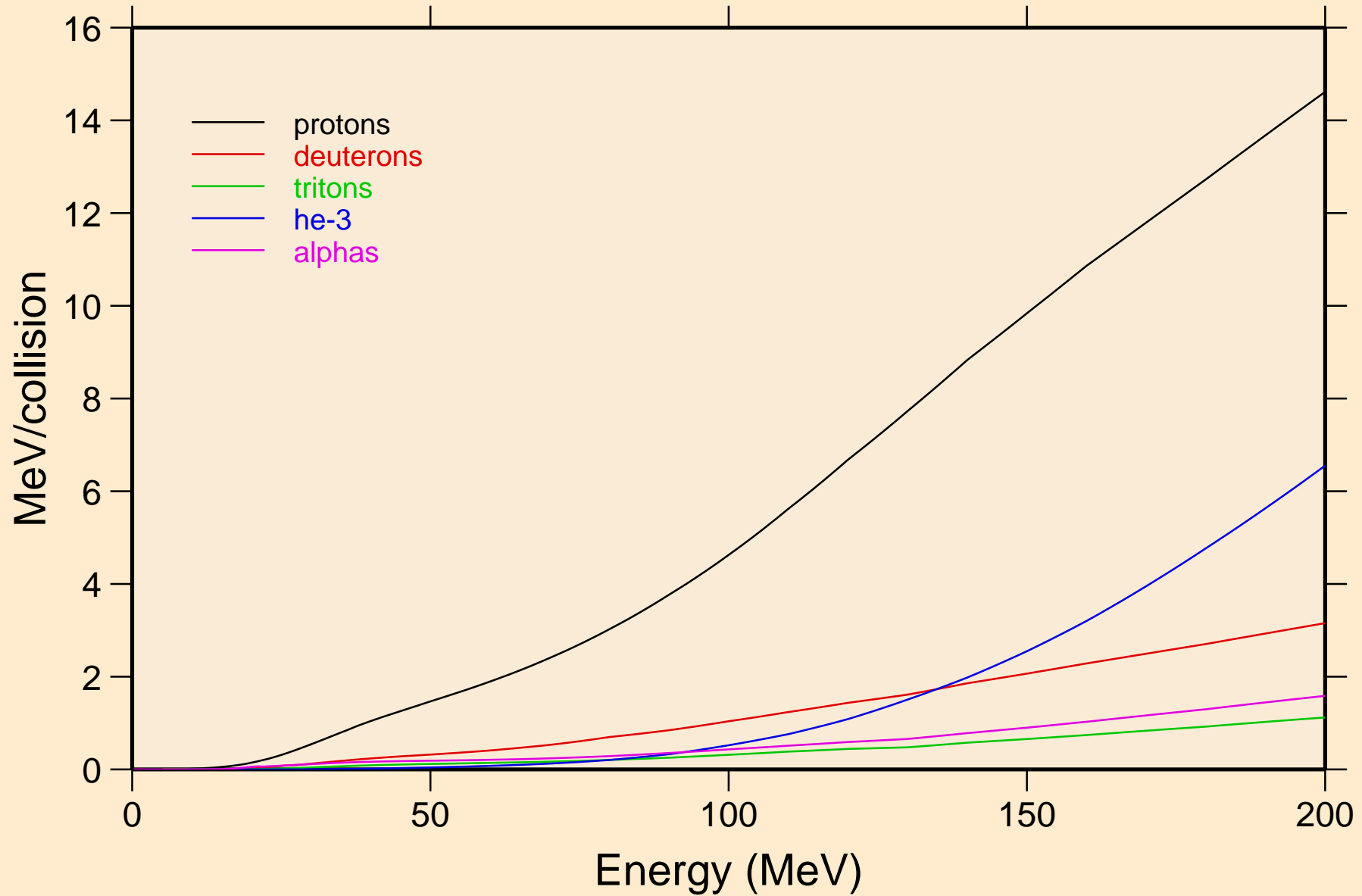

CS136 NEUTRON ACER TENDL-2024 LIBRARY; T=0.K
Recoil Heating

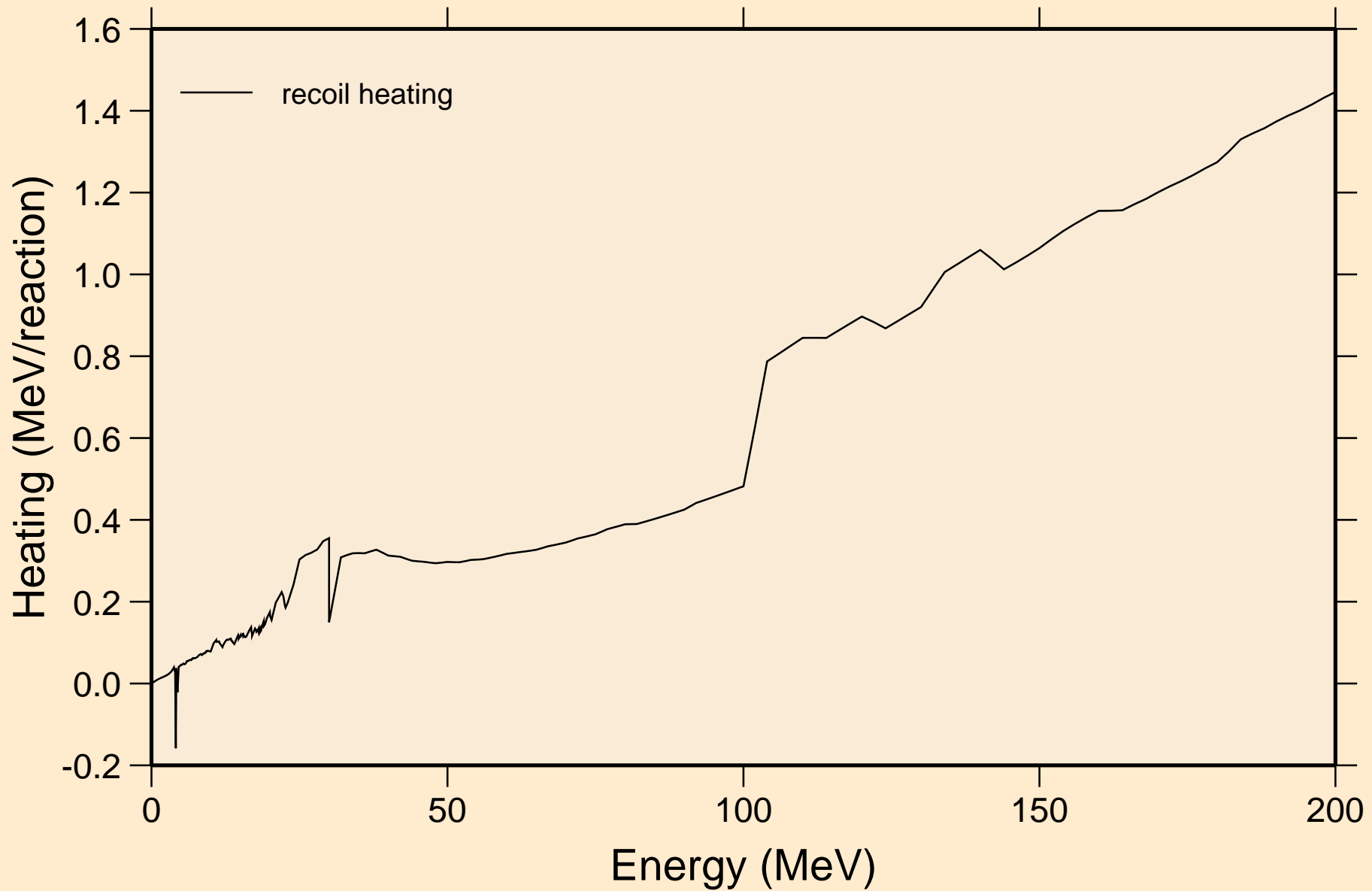

CS136 NEUTRON ACER TENDL-2024 LIBRARY; T=0.K

Particle production cross sections

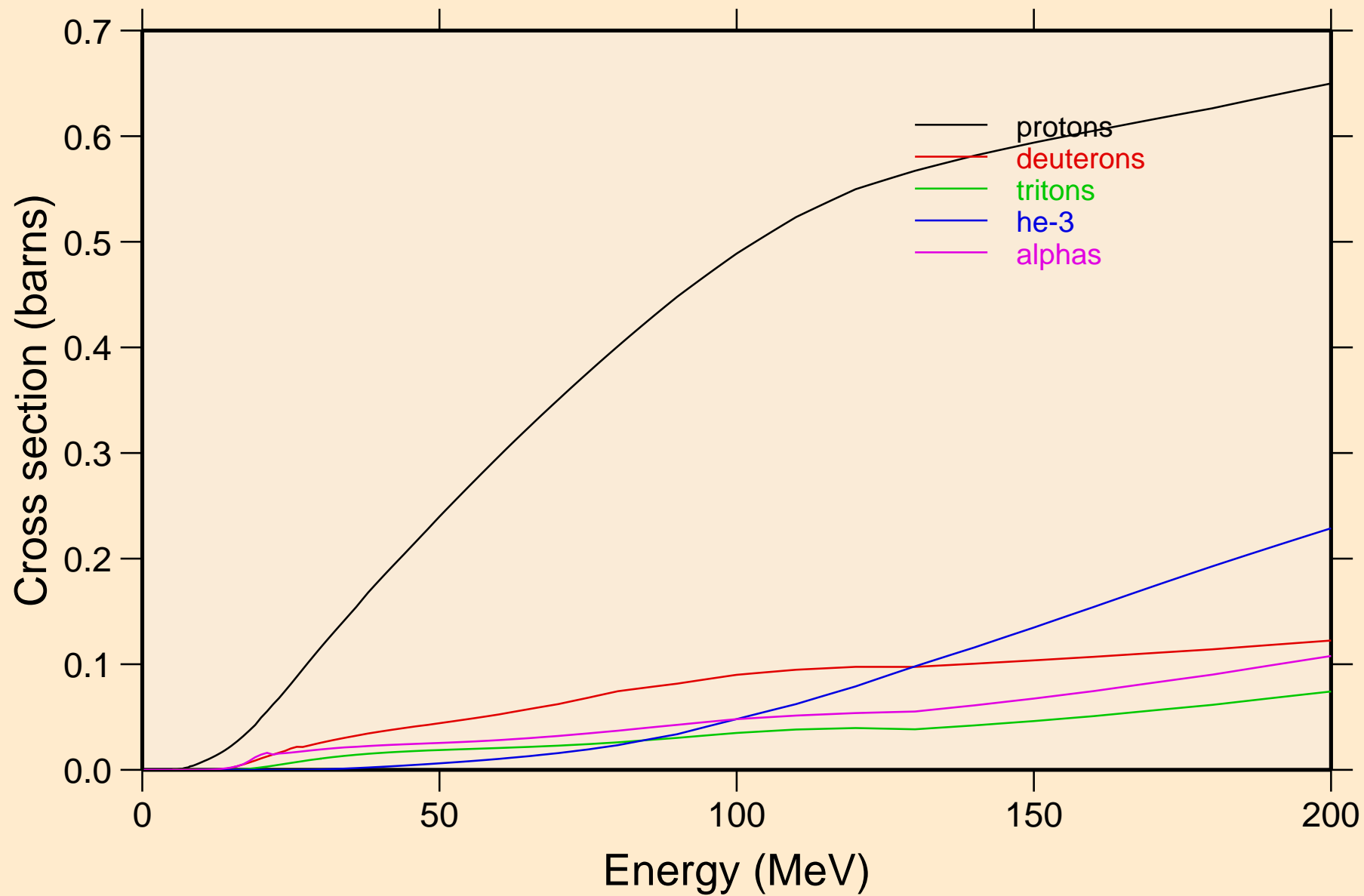

CS136 NEUTRON ACER TENDL-2024 LIBRARY; T=0.K
protons from (n,x)

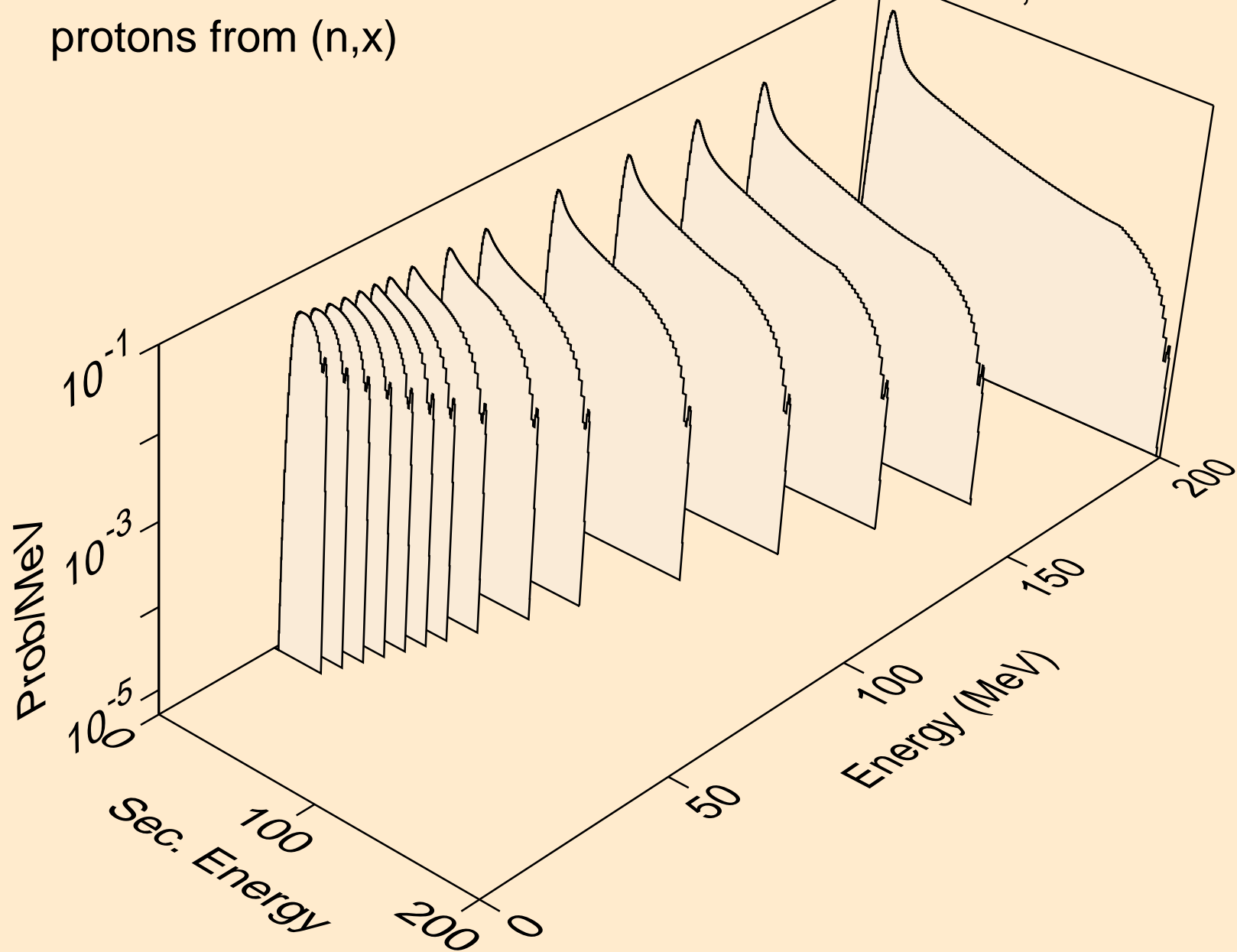

CS136 NEUTRON ACER TENDL-2024 LIBRARY; T=0.K
protons from (n,n*)p

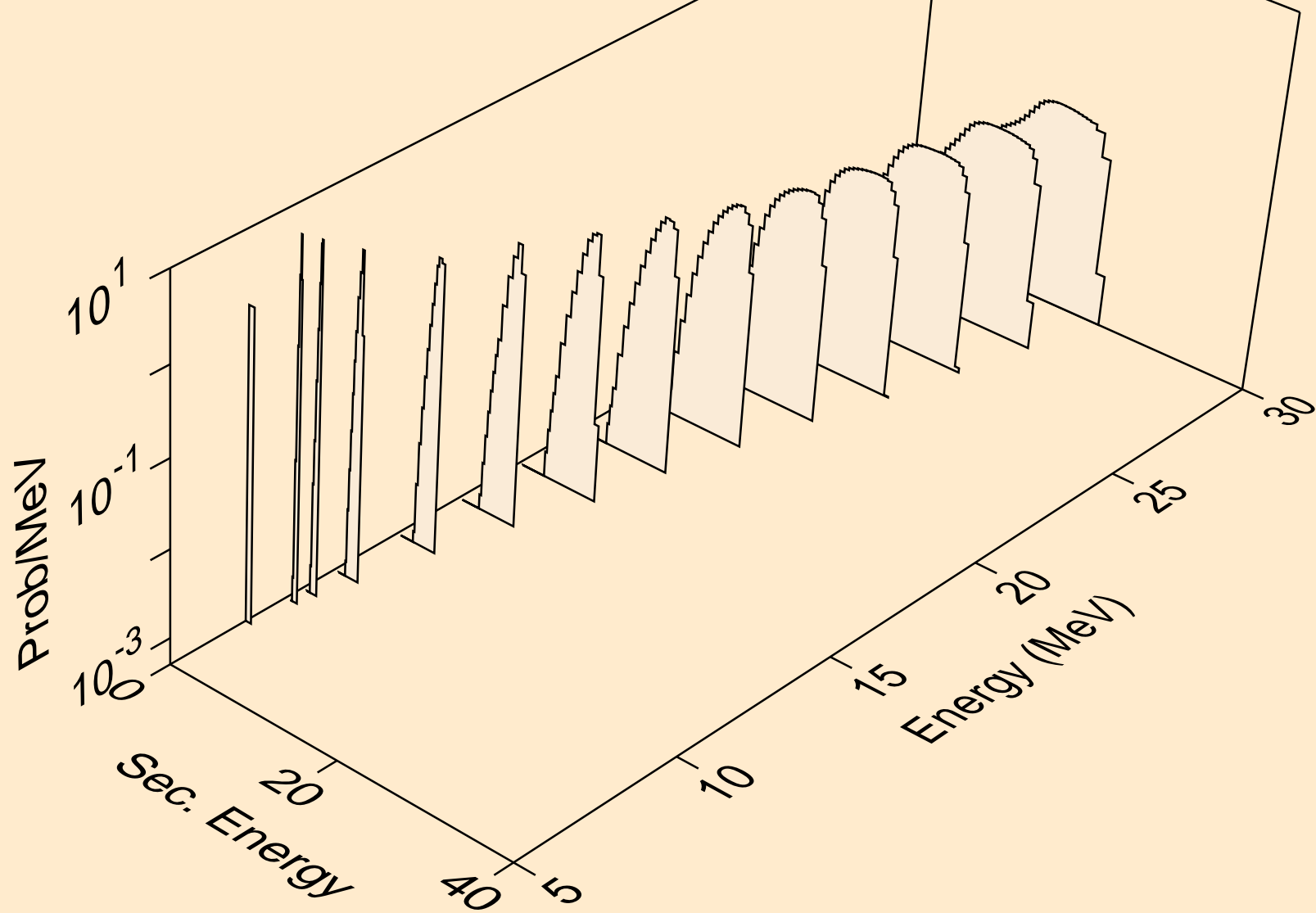

CS136 NEUTRON ACER TENDL-2024 LIBRARY; T=0.K
protons from (n,2np)

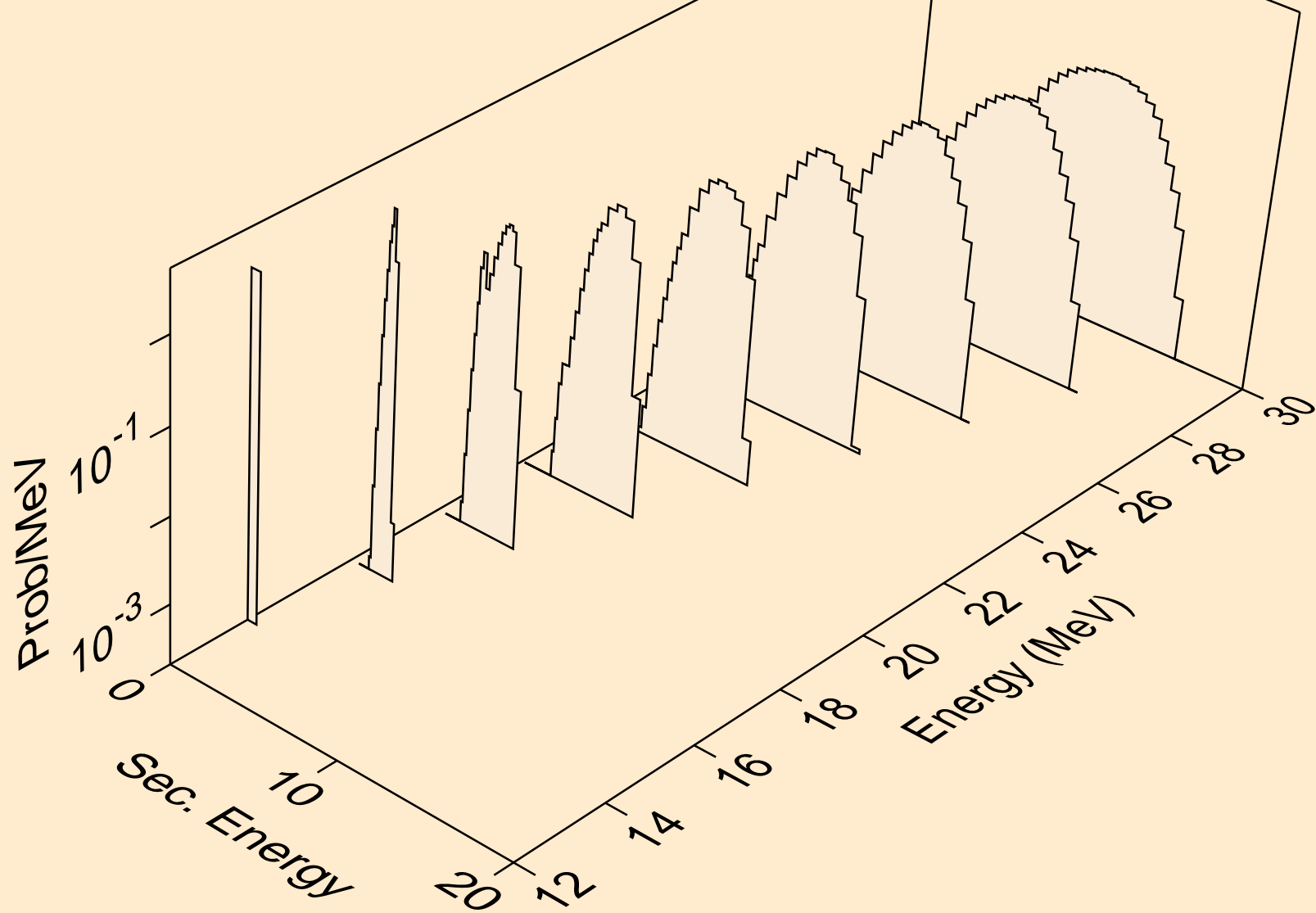

CS136 NEUTRON ACER TENDL-2024 LIBRARY; T=0.K
protons from (n,3np)

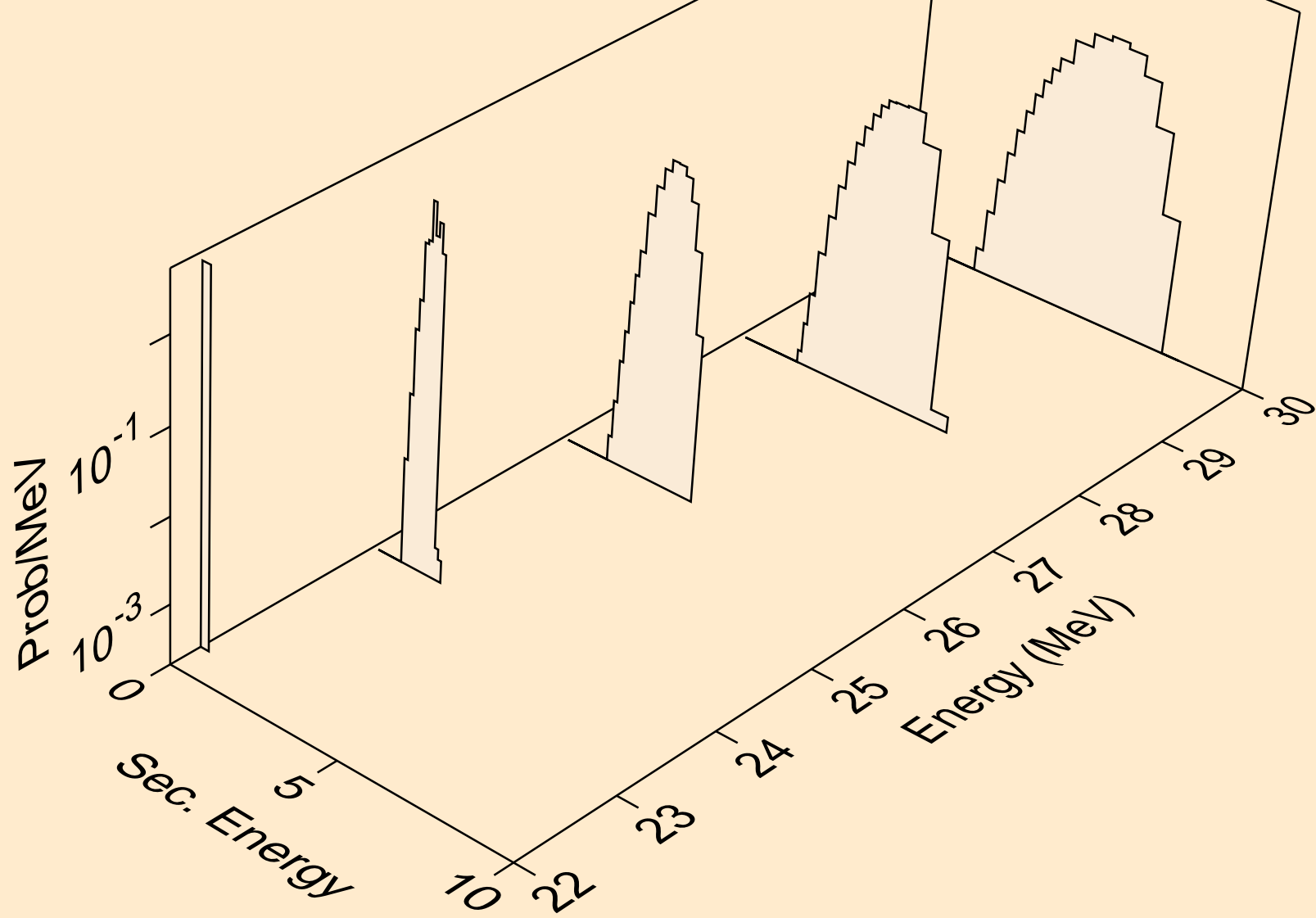

CS136 NEUTRON ACER TENDL-2024 LIBRARY; T=0.K
protons from (n,n2p)

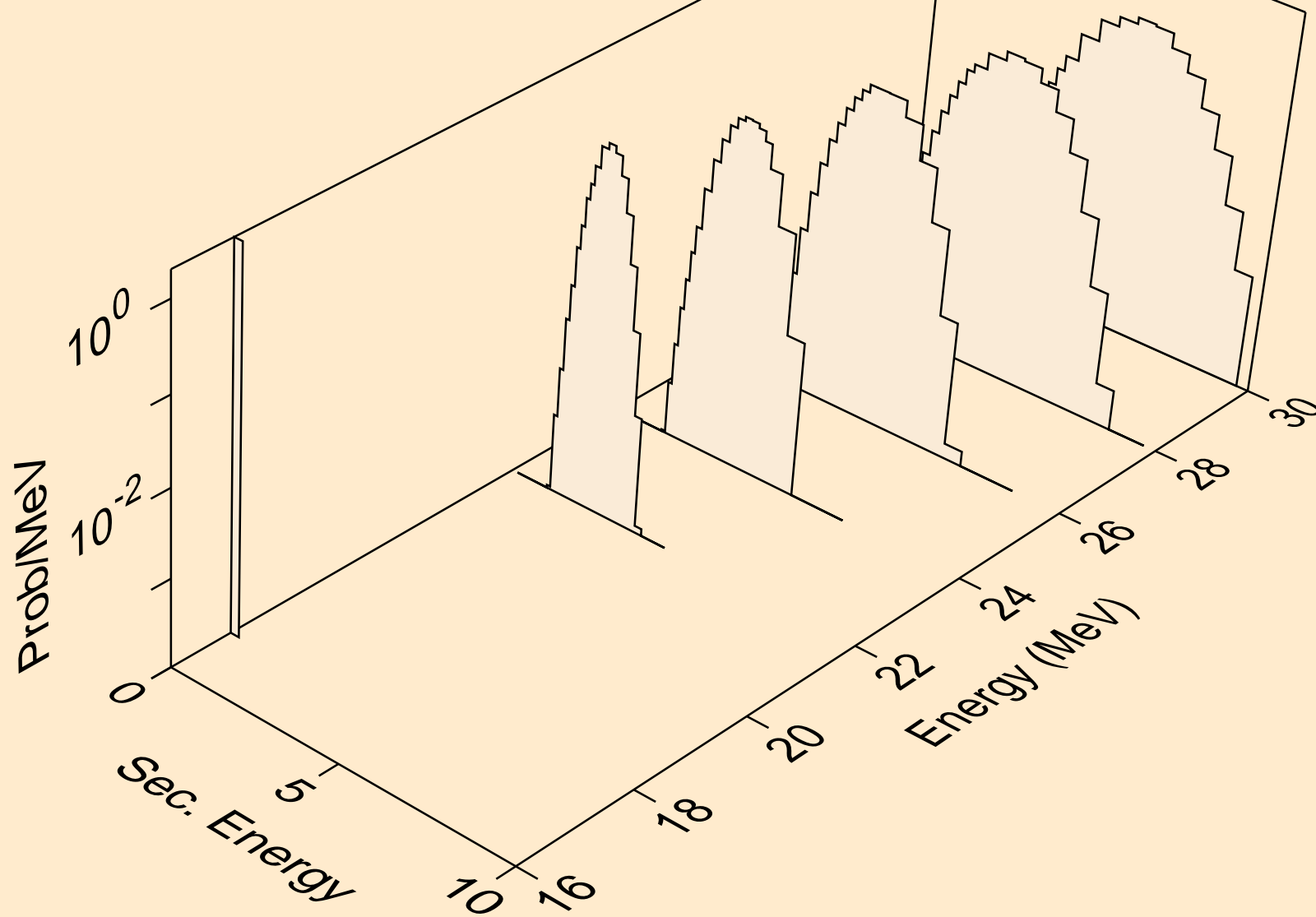

CS136 NEUTRON ACER TENDL-2024 LIBRARY; T=0.K
protons from (n,npa)

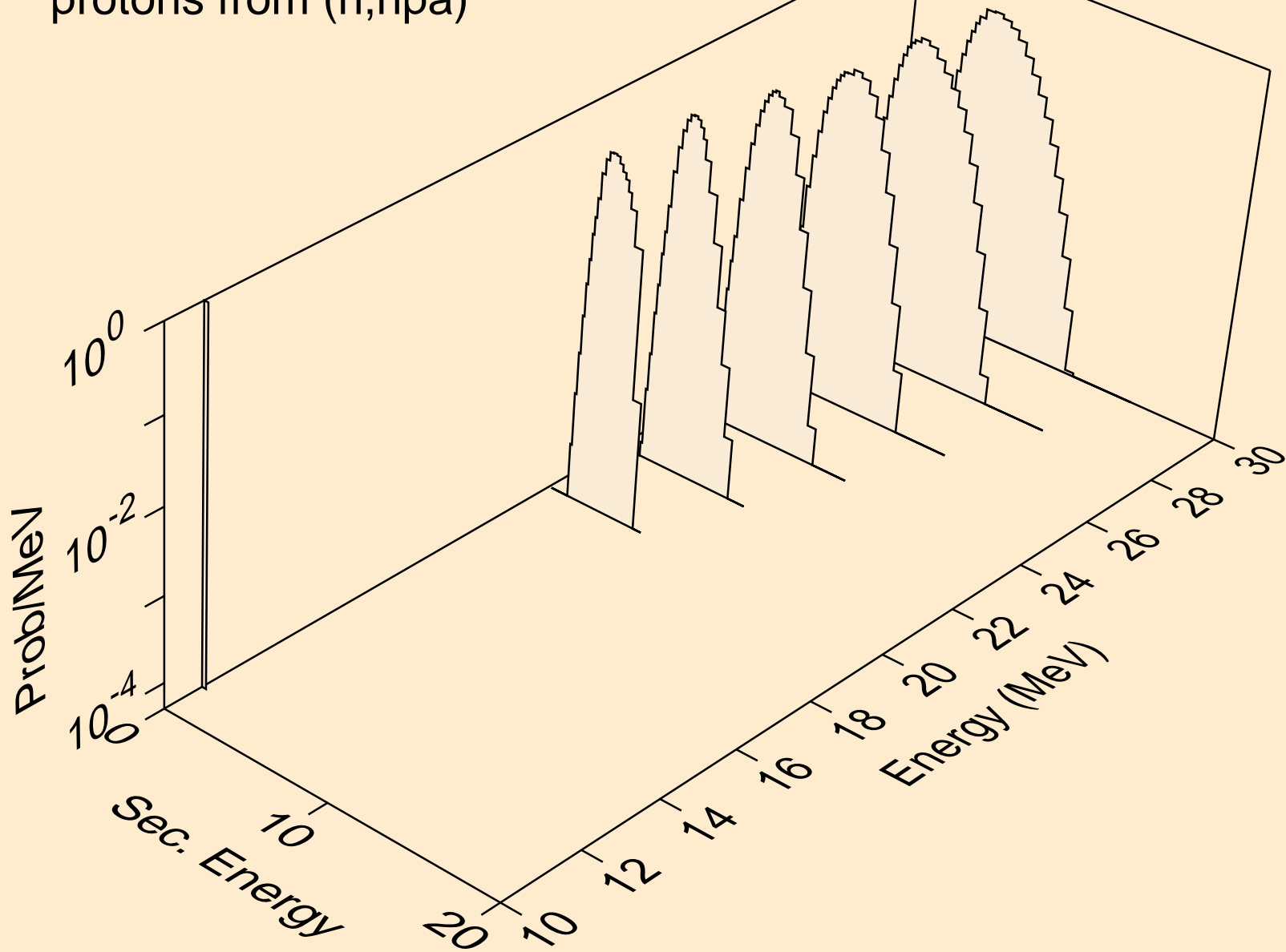

CS136 NEUTRON ACER TENDL-2024 LIBRARY; T=0.K
protons from (n,p)

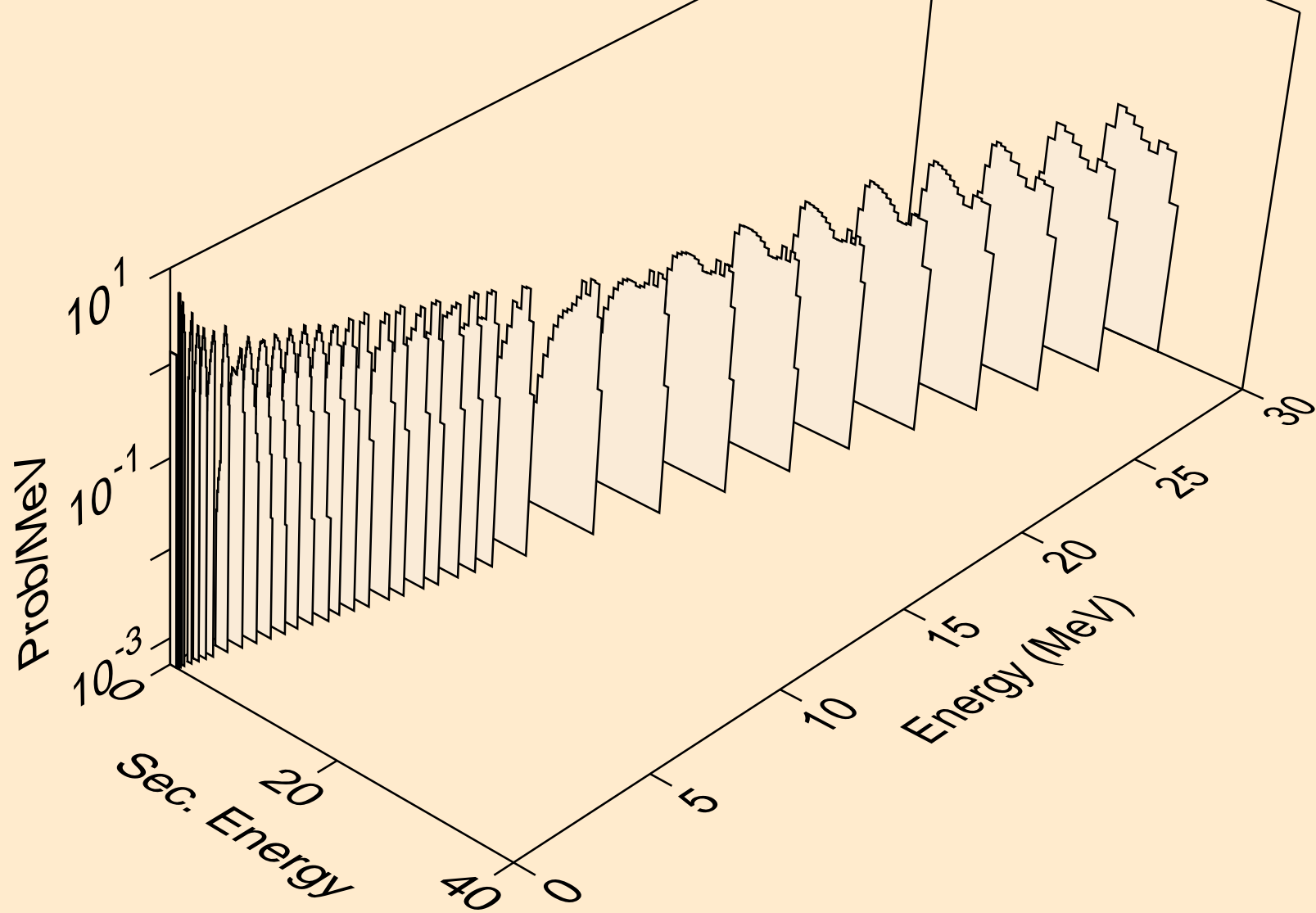

CS136 NEUTRON ACER TENDL-2024 LIBRARY; T=0.K
protons from (n,2p)

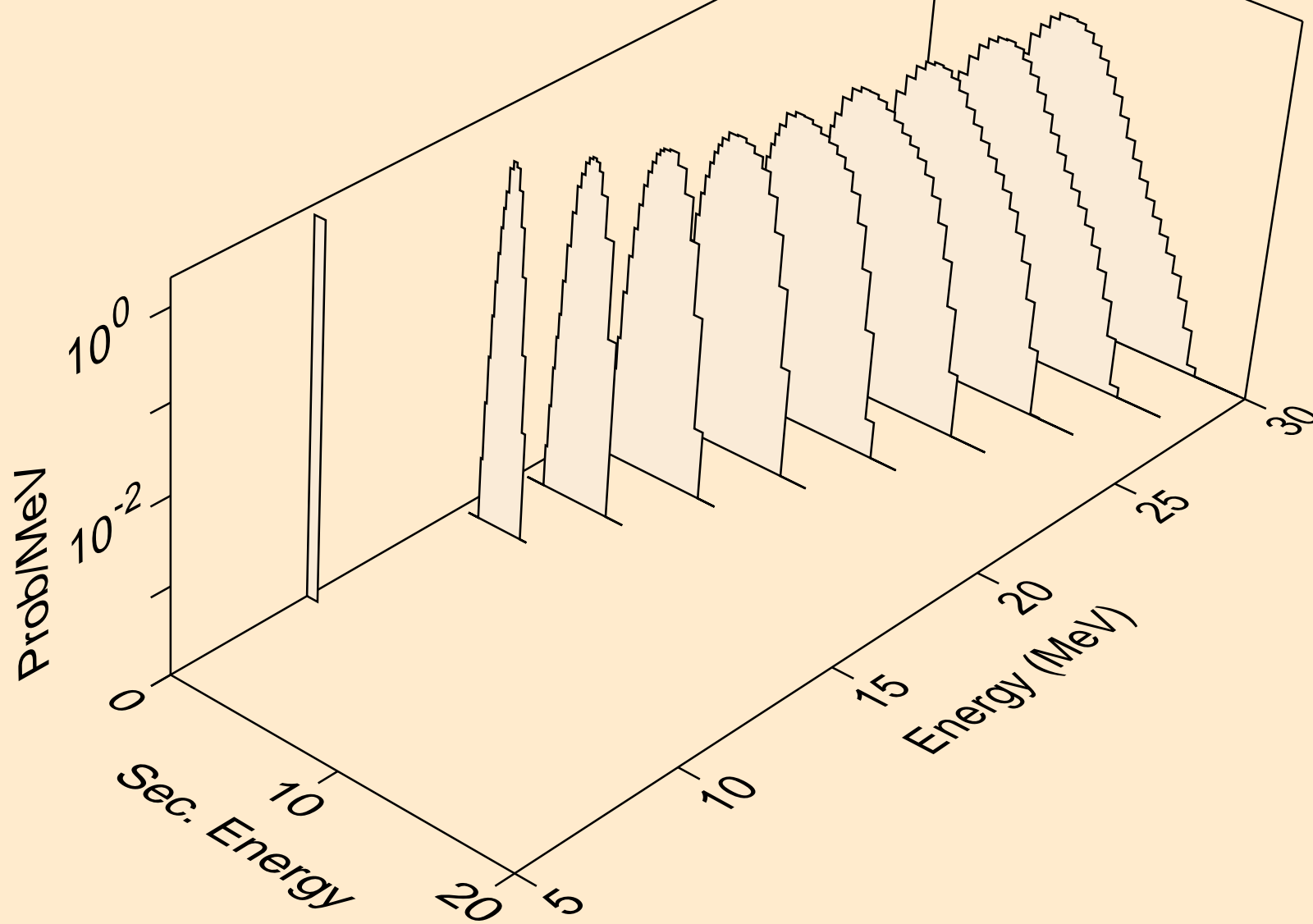

CS136 NEUTRON ACER TENDL-2024 LIBRARY; T=0.K
protons from (n,pa)

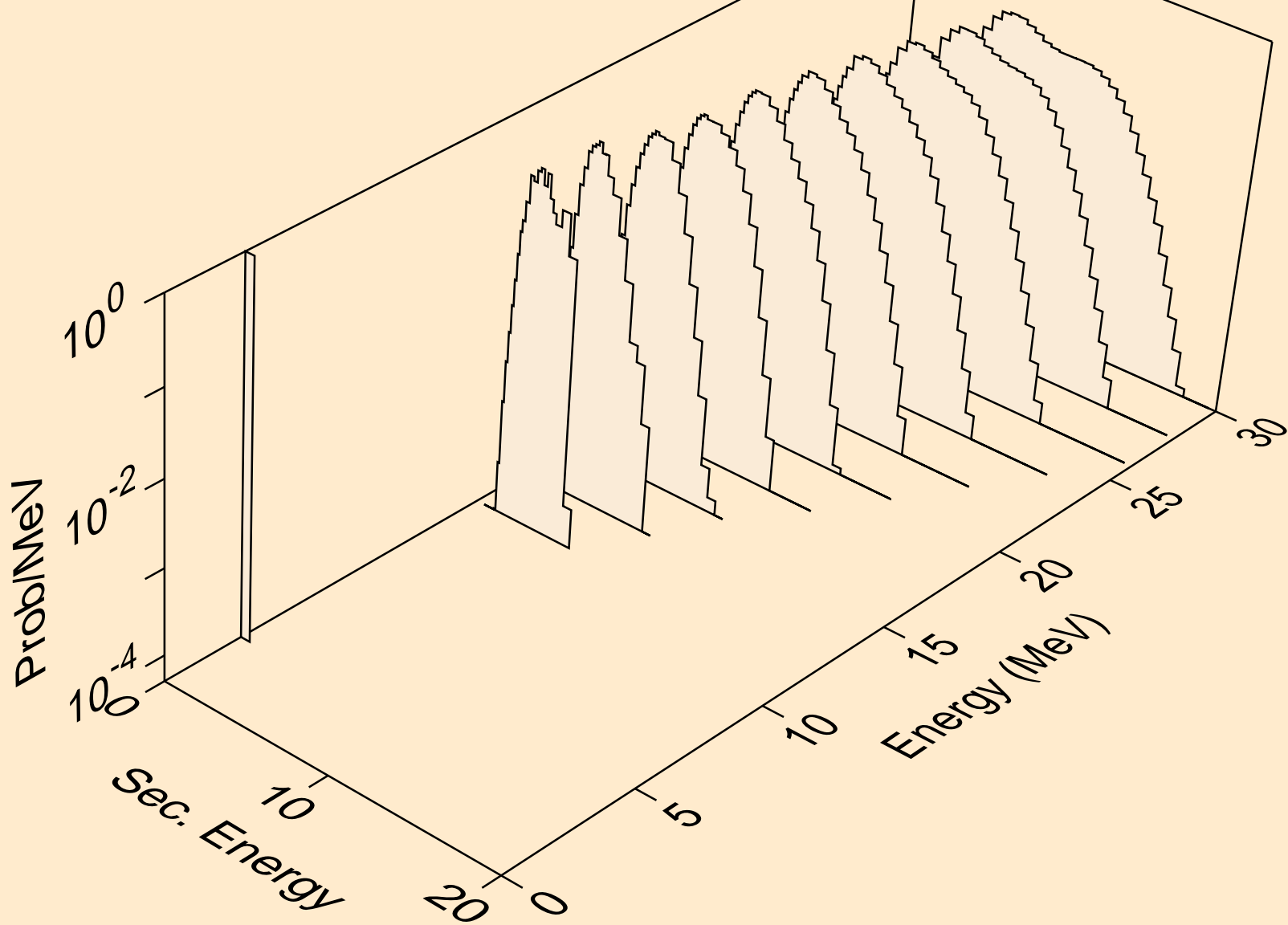

CS136 NEUTRON ACER TENDL-2024 LIBRARY; T=0.K
protons from (n,pd)

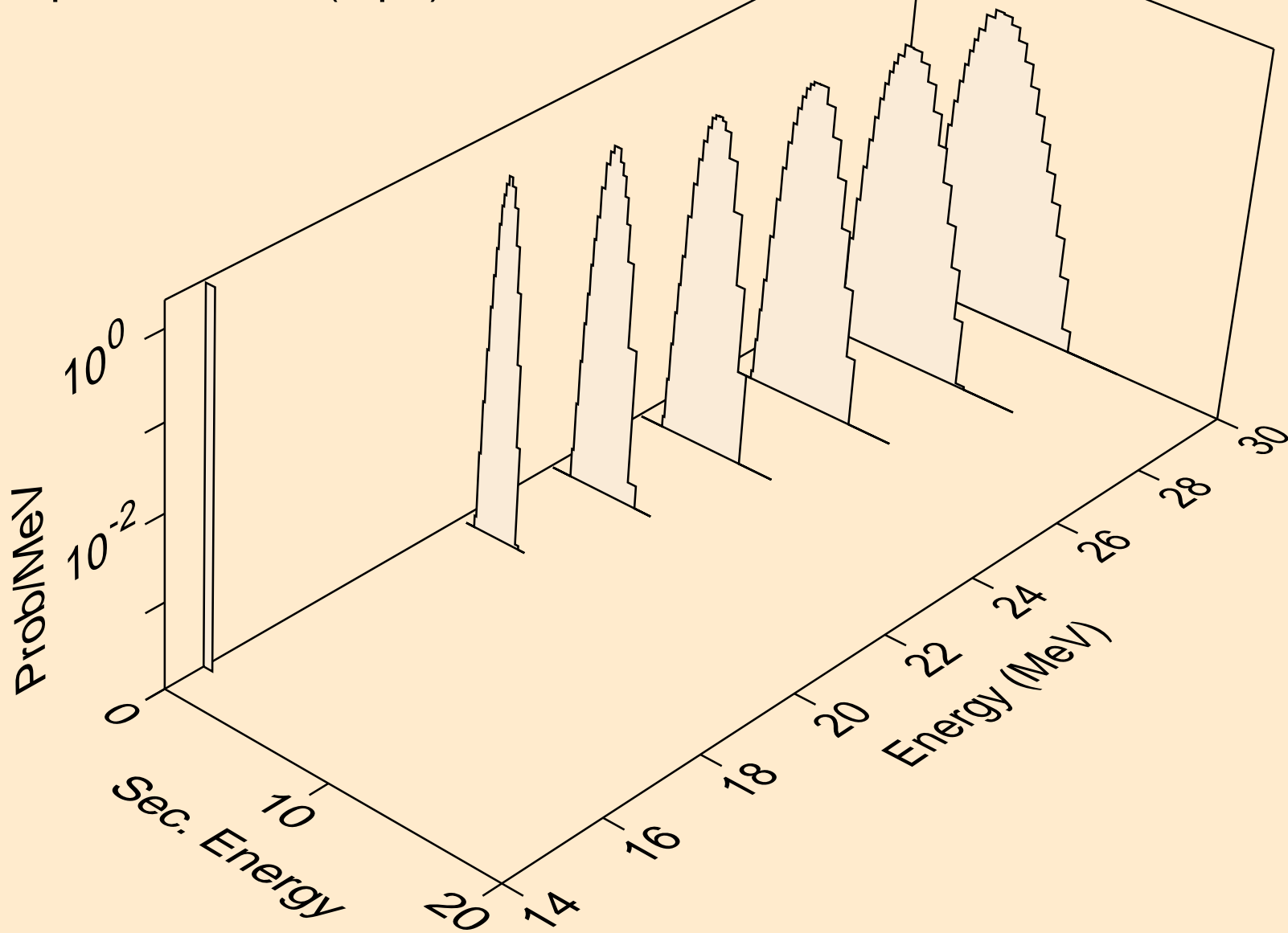

CS136 NEUTRON ACER TENDL-2024 LIBRARY; T=0.K
protons from (n,pt)

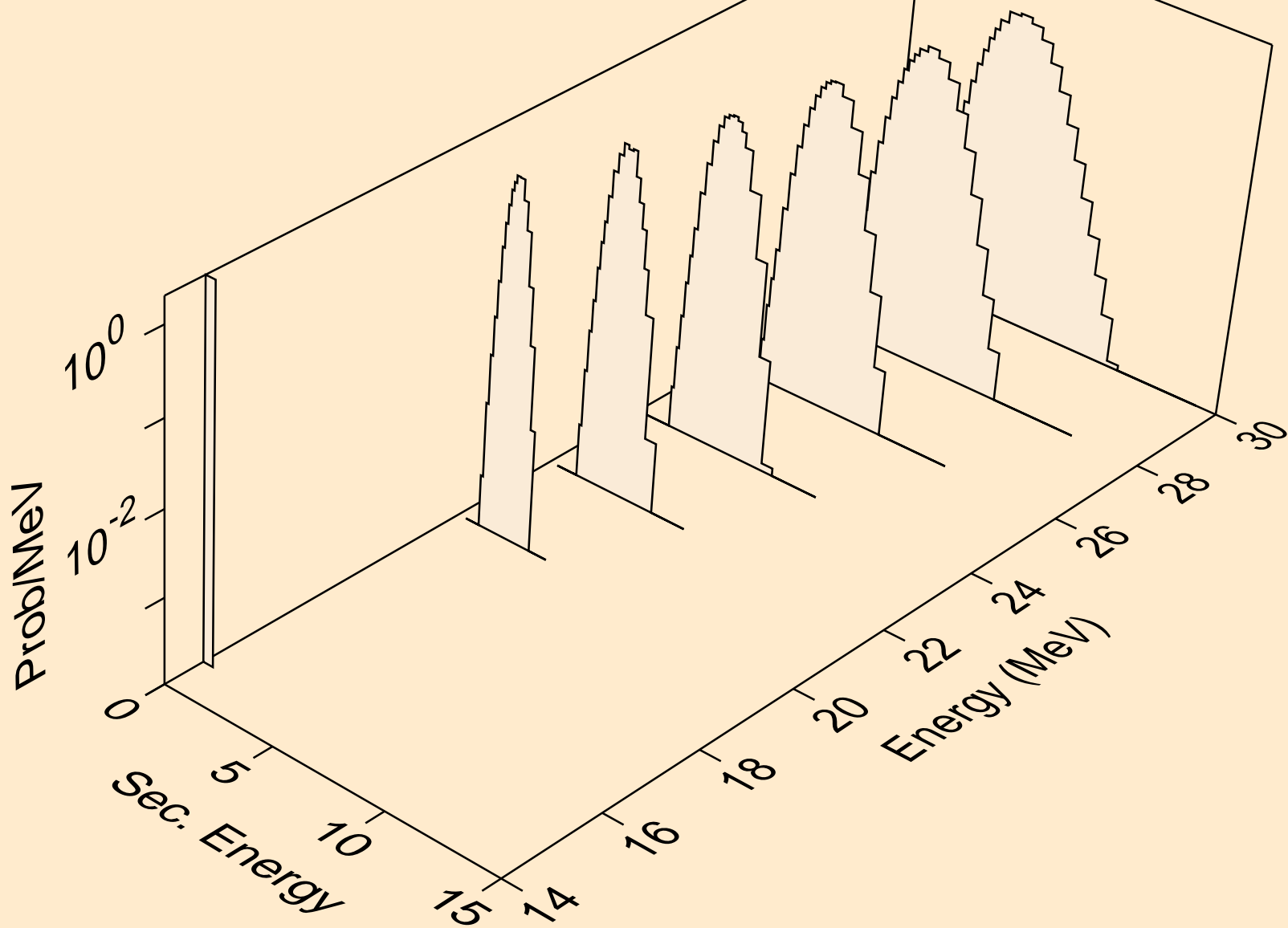

CS136 NEUTRON ACER TENDL-2024 LIBRARY; T=0.K
deuterons from (n,x)

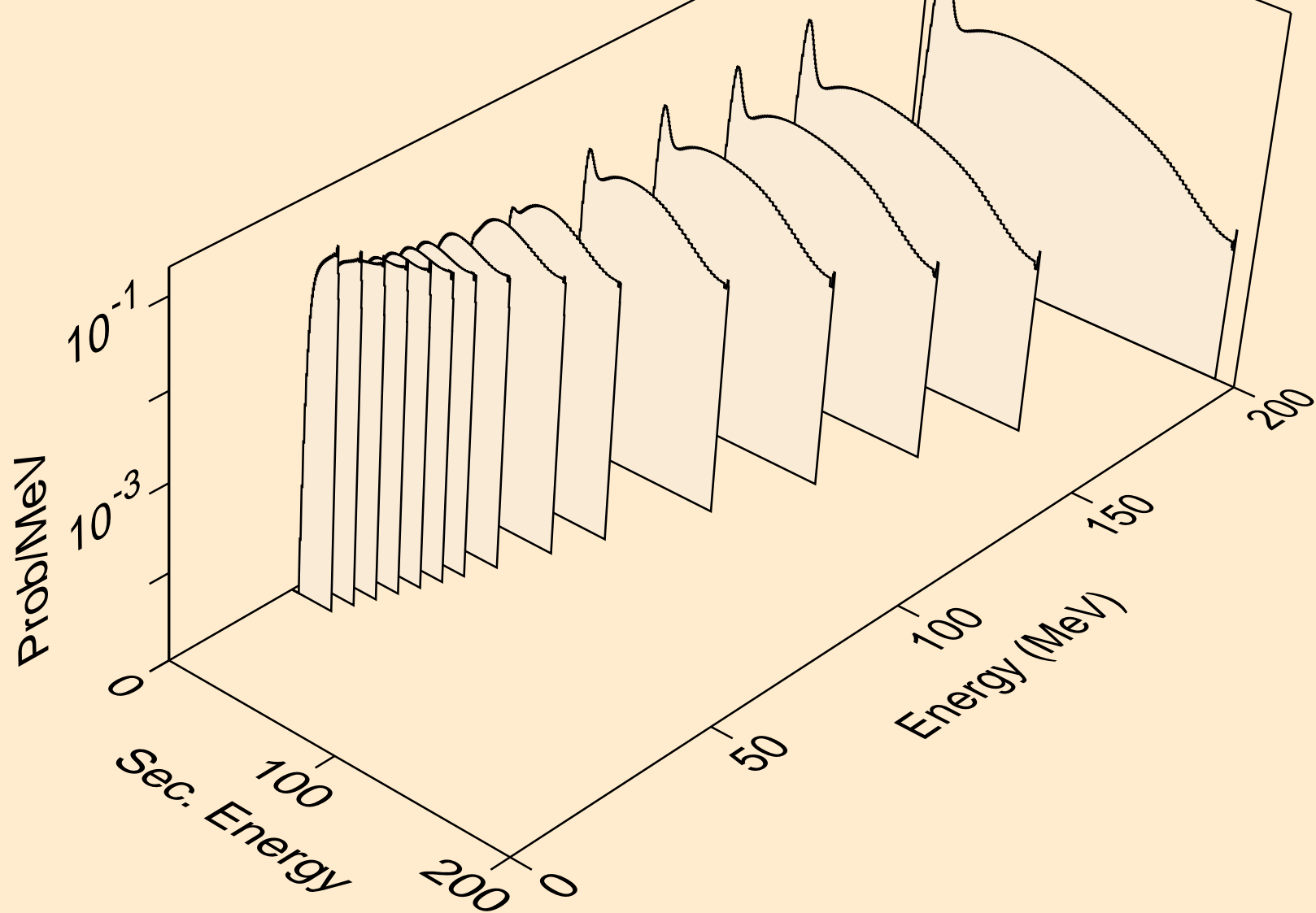

CS136 NEUTRON ACER TENDL-2024 LIBRARY; T=0.K
deuterons from (n,2nd)

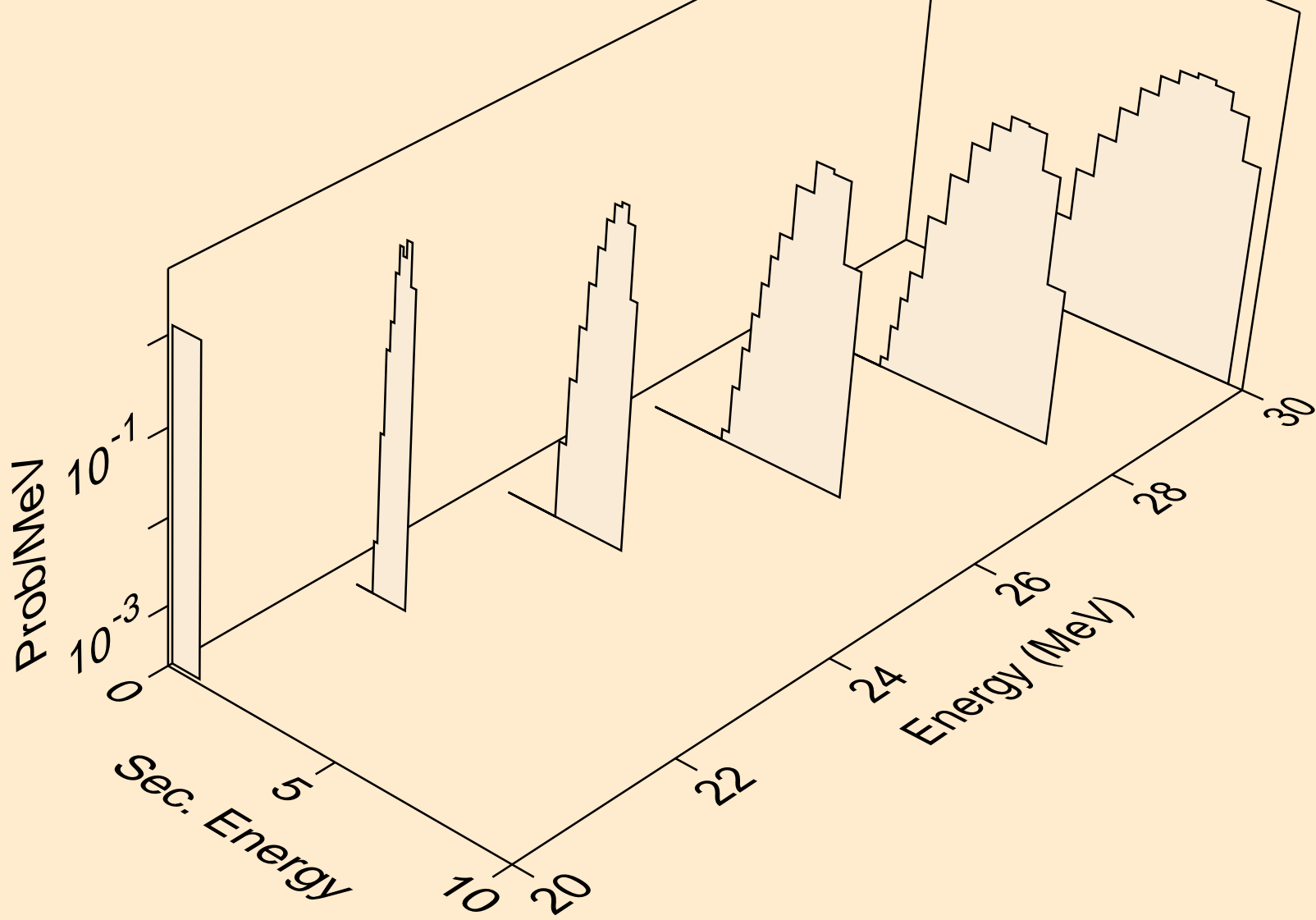

CS136 NEUTRON ACER TENDL-2024 LIBRARY; T=0.K
deuterons from (n,n*)d

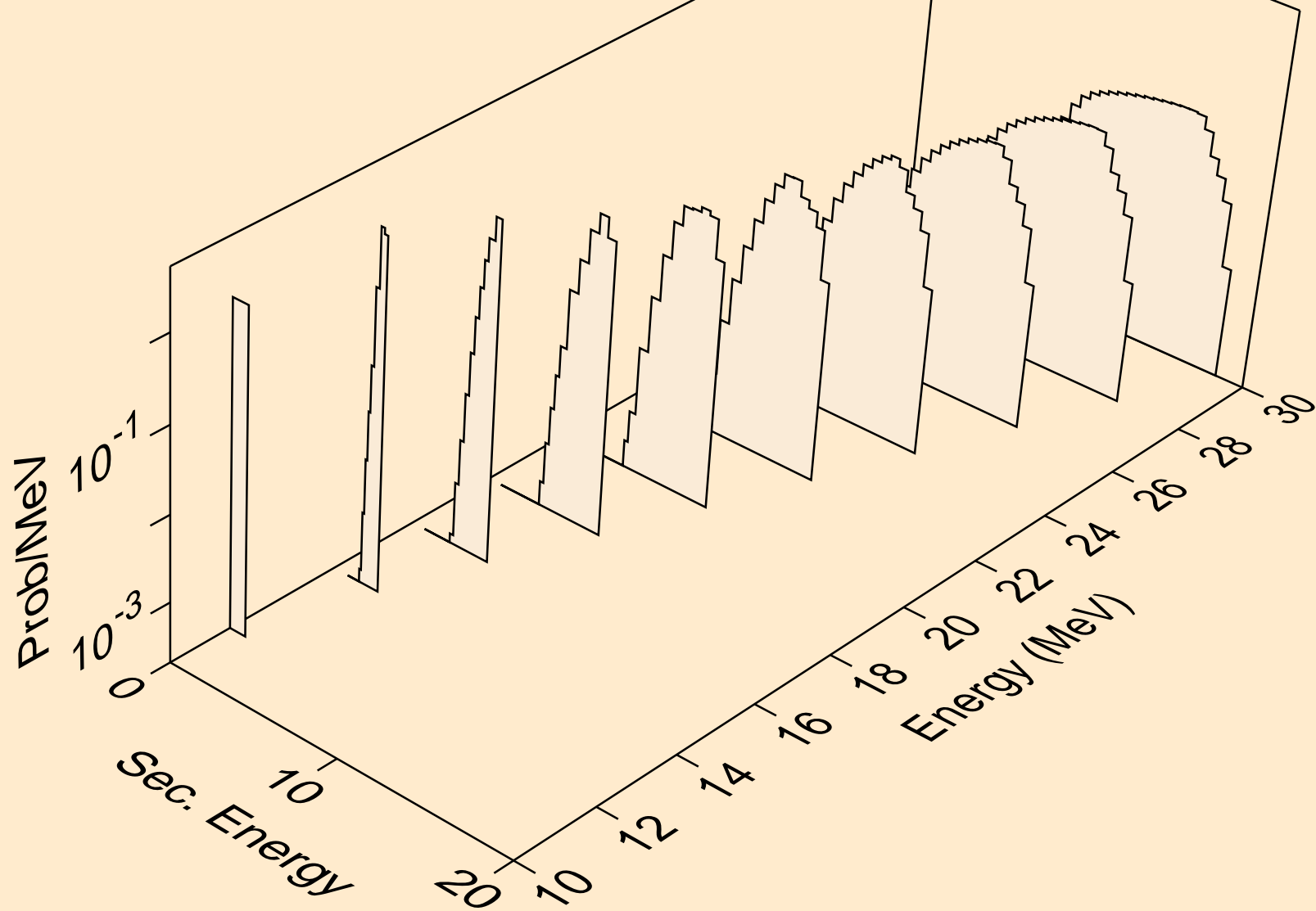

CS136 NEUTRON ACER TENDL-2024 LIBRARY; T=0.K
deuterons from (n,d)

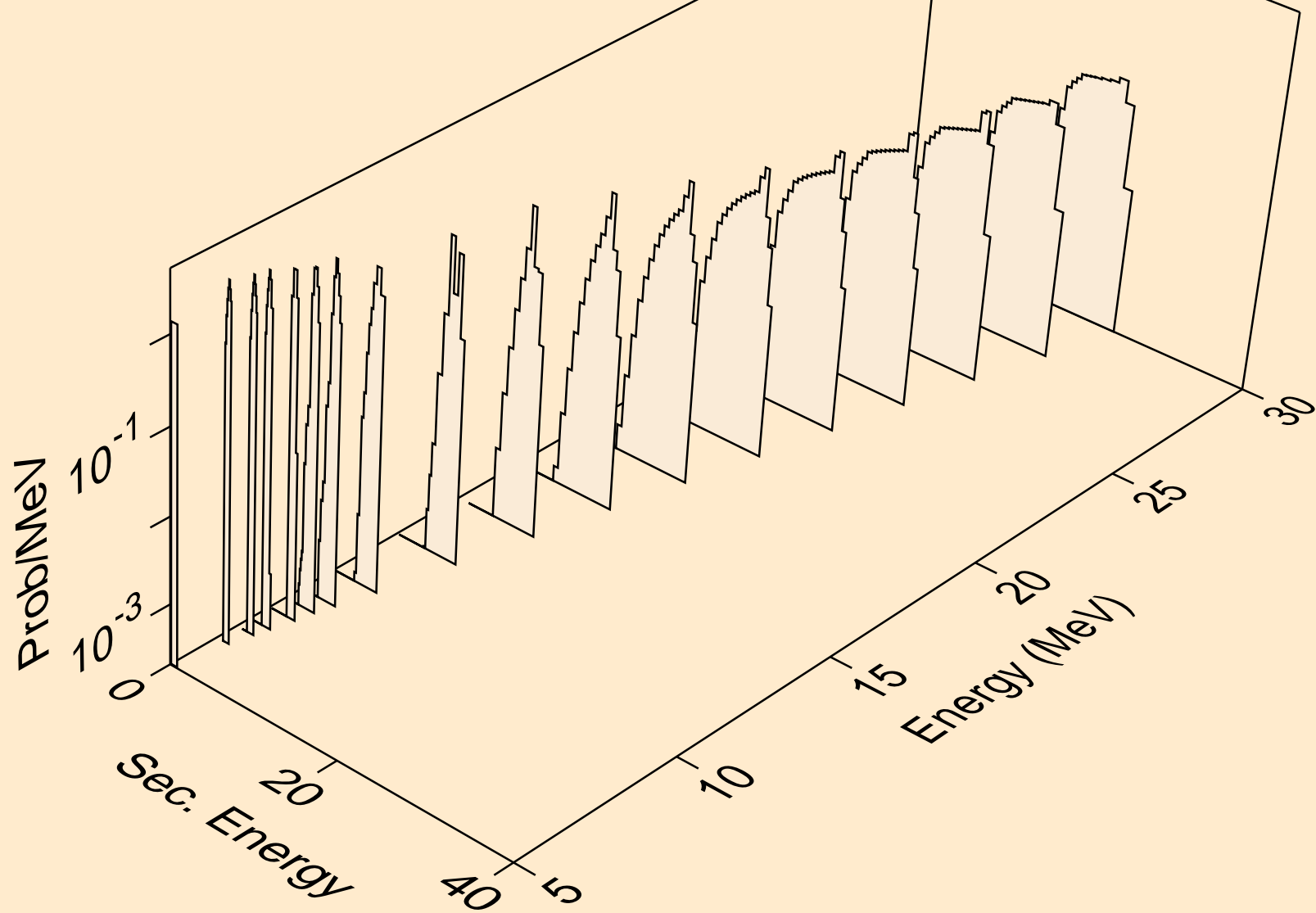

CS136 NEUTRON ACER TENDL-2024 LIBRARY; T=0.K
deuterons from (n,pd)

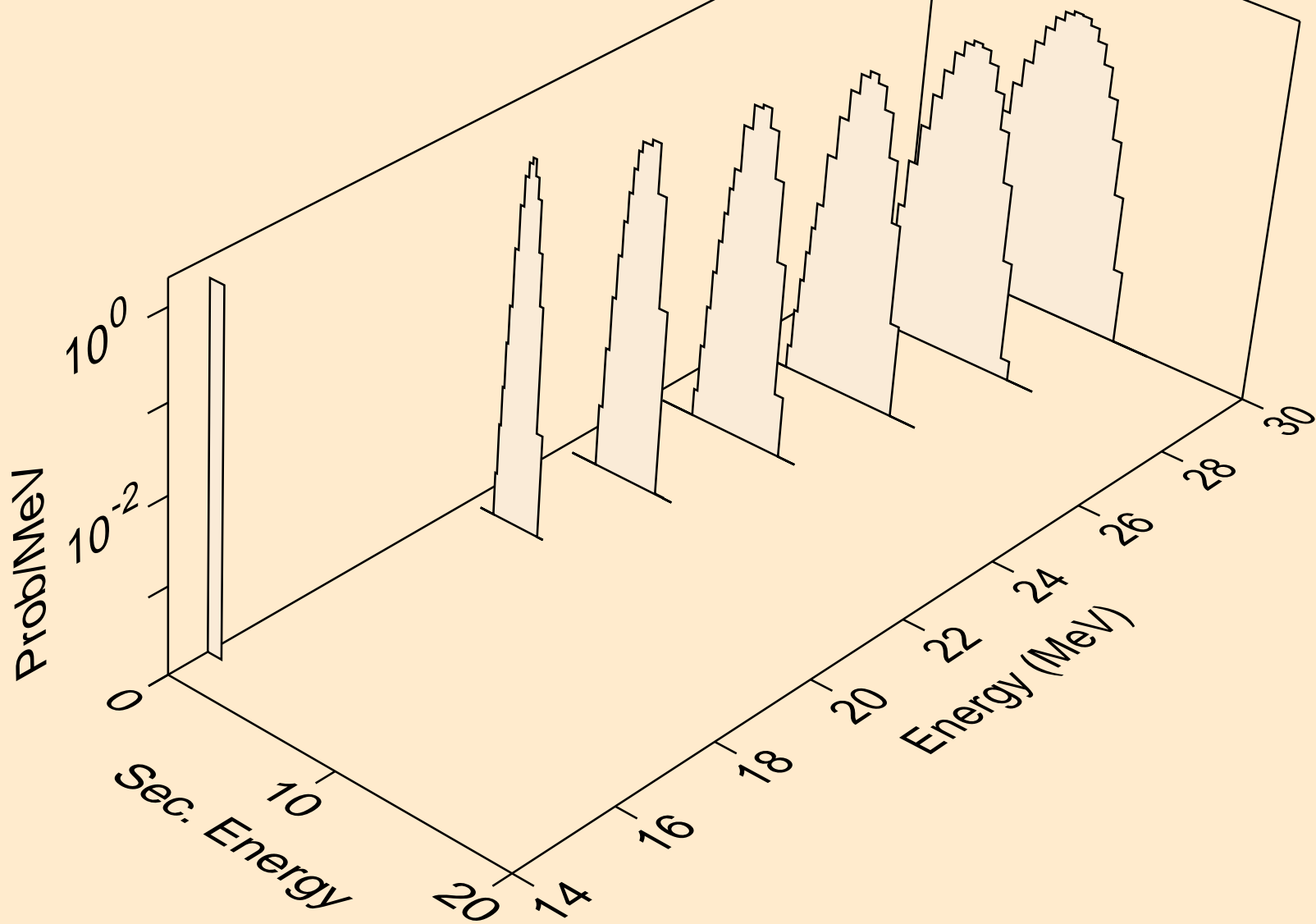

CS136 NEUTRON ACER TENDL-2024 LIBRARY; T=0.K
deuterons from (n,da)

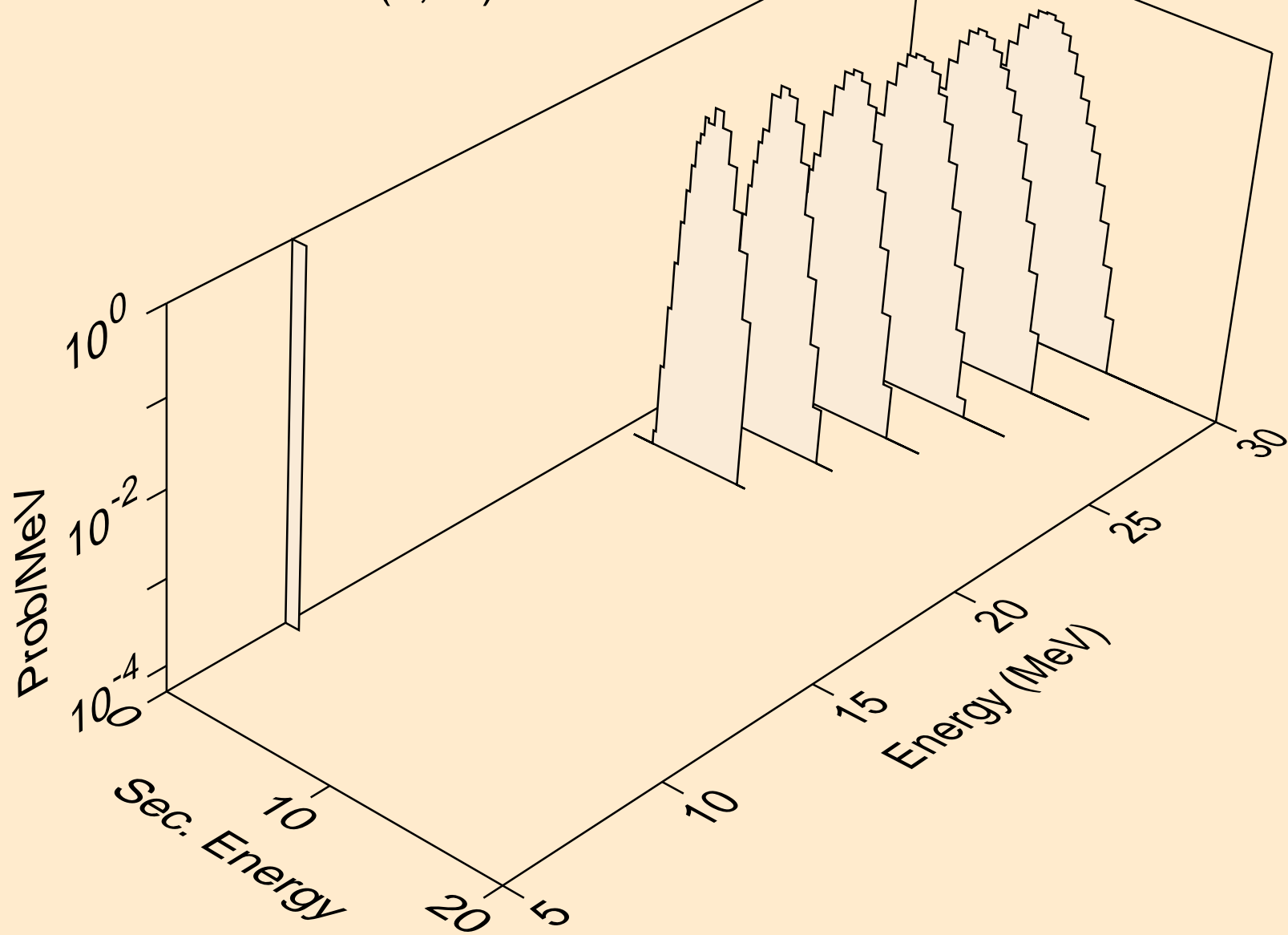

CS136 NEUTRON ACER TENDL-2024 LIBRARY; T=0.K
tritons from (n,x)

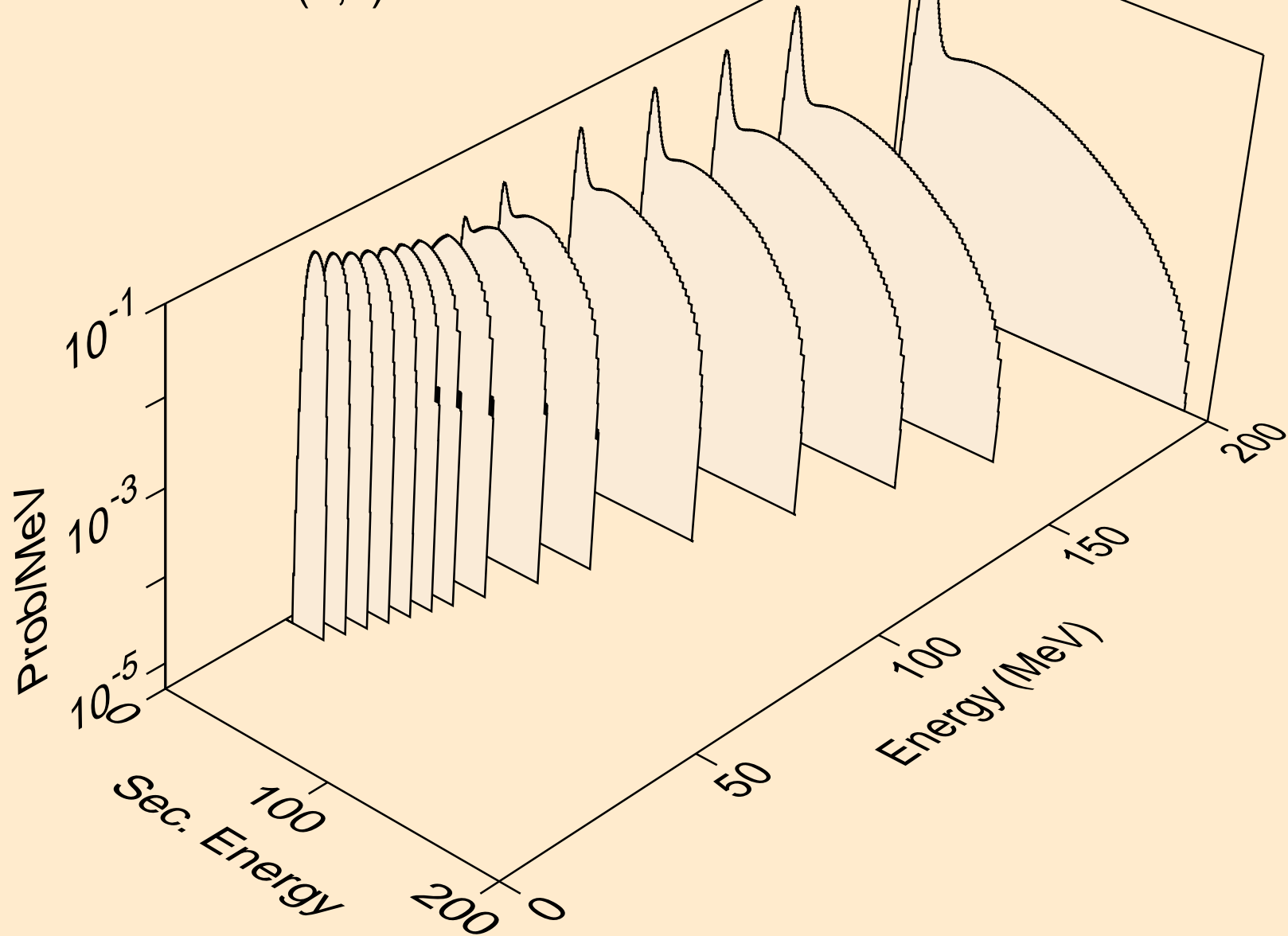

CS136 NEUTRON ACER TENDL-2024 LIBRARY; T=0.K
tritons from (n,n*)t

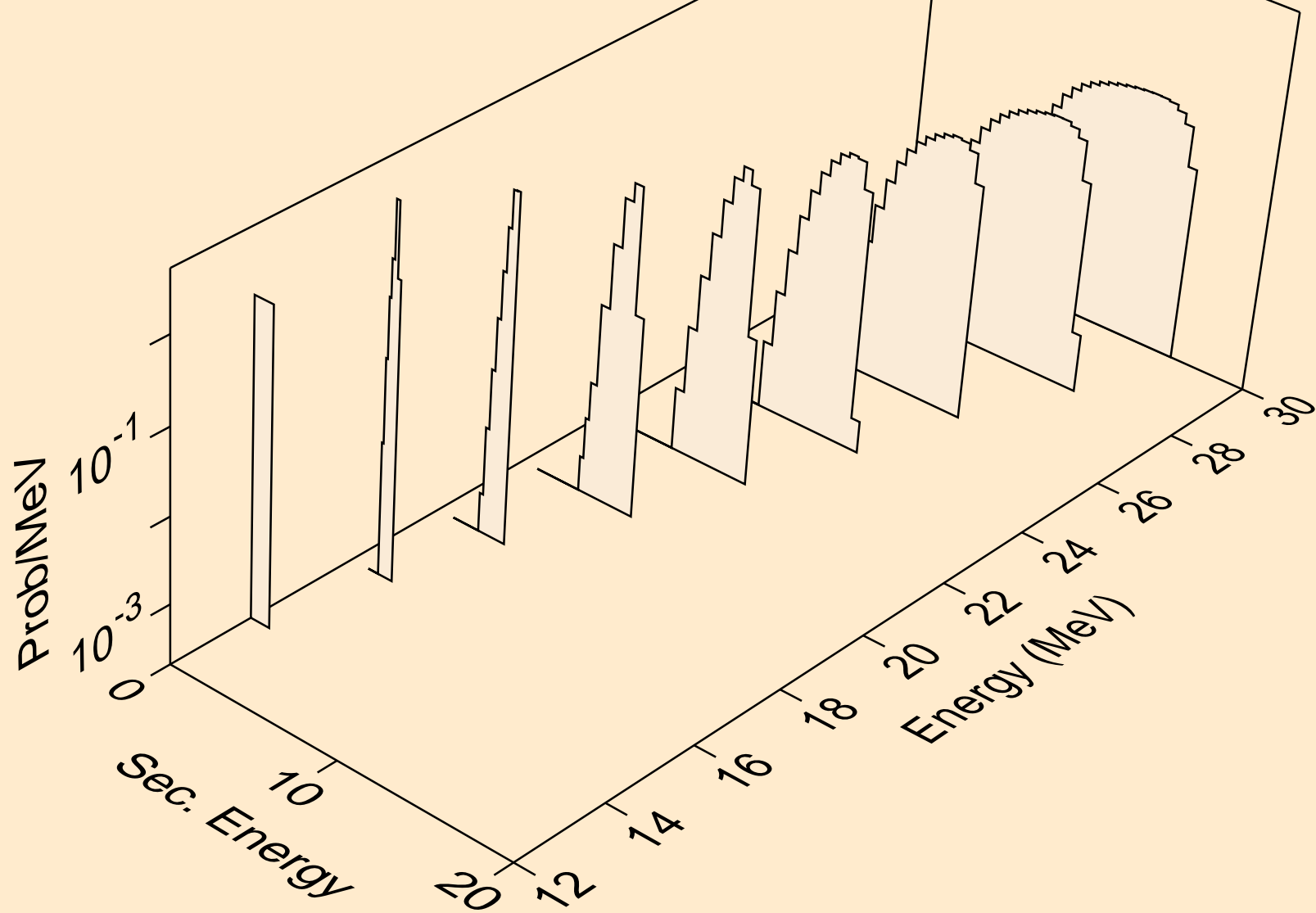

CS136 NEUTRON ACER TENDL-2024 LIBRARY; T=0.K
tritons from (n,t)

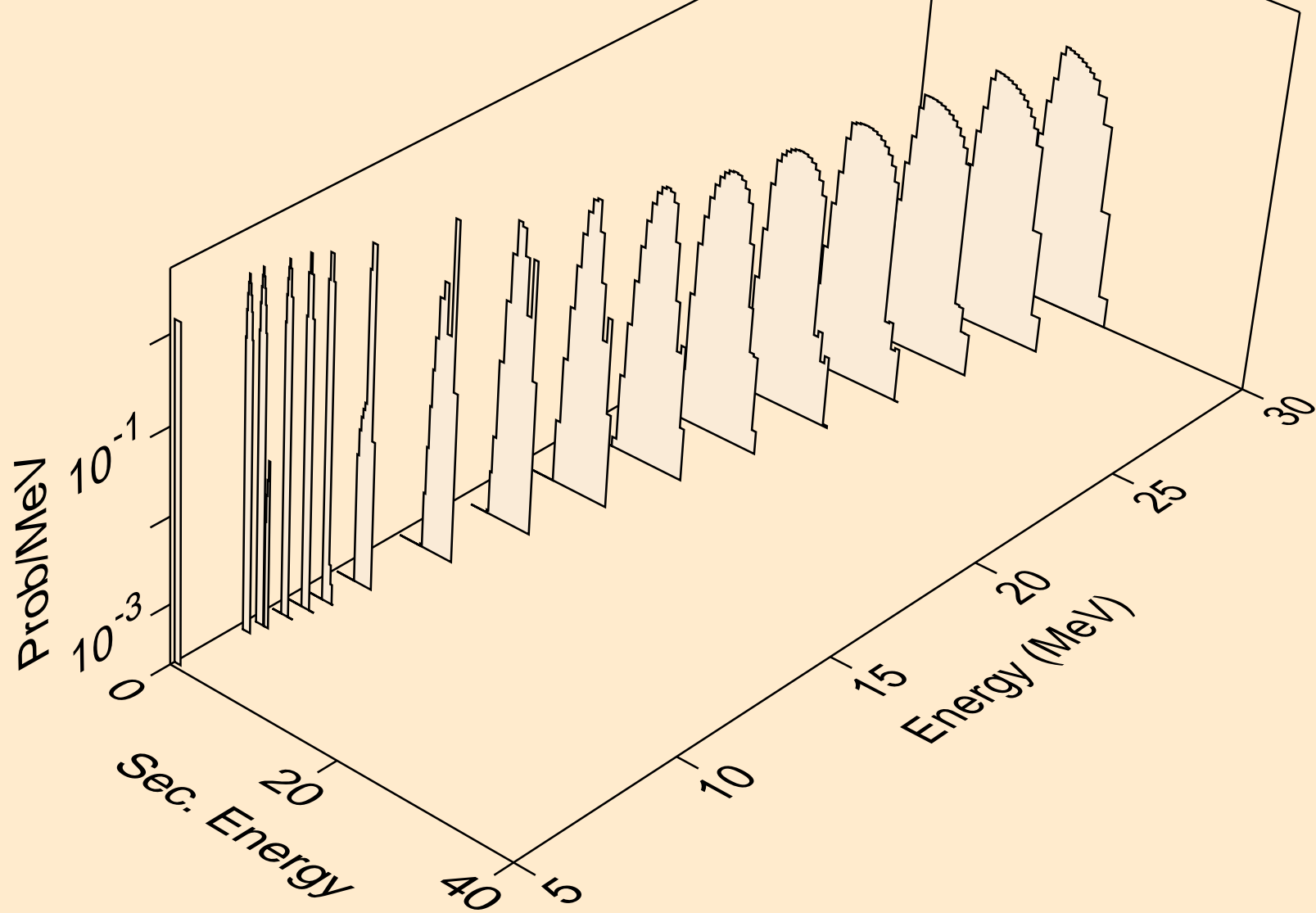

CS136 NEUTRON ACER TENDL-2024 LIBRARY; T=0.K
tritons from (n,pt)

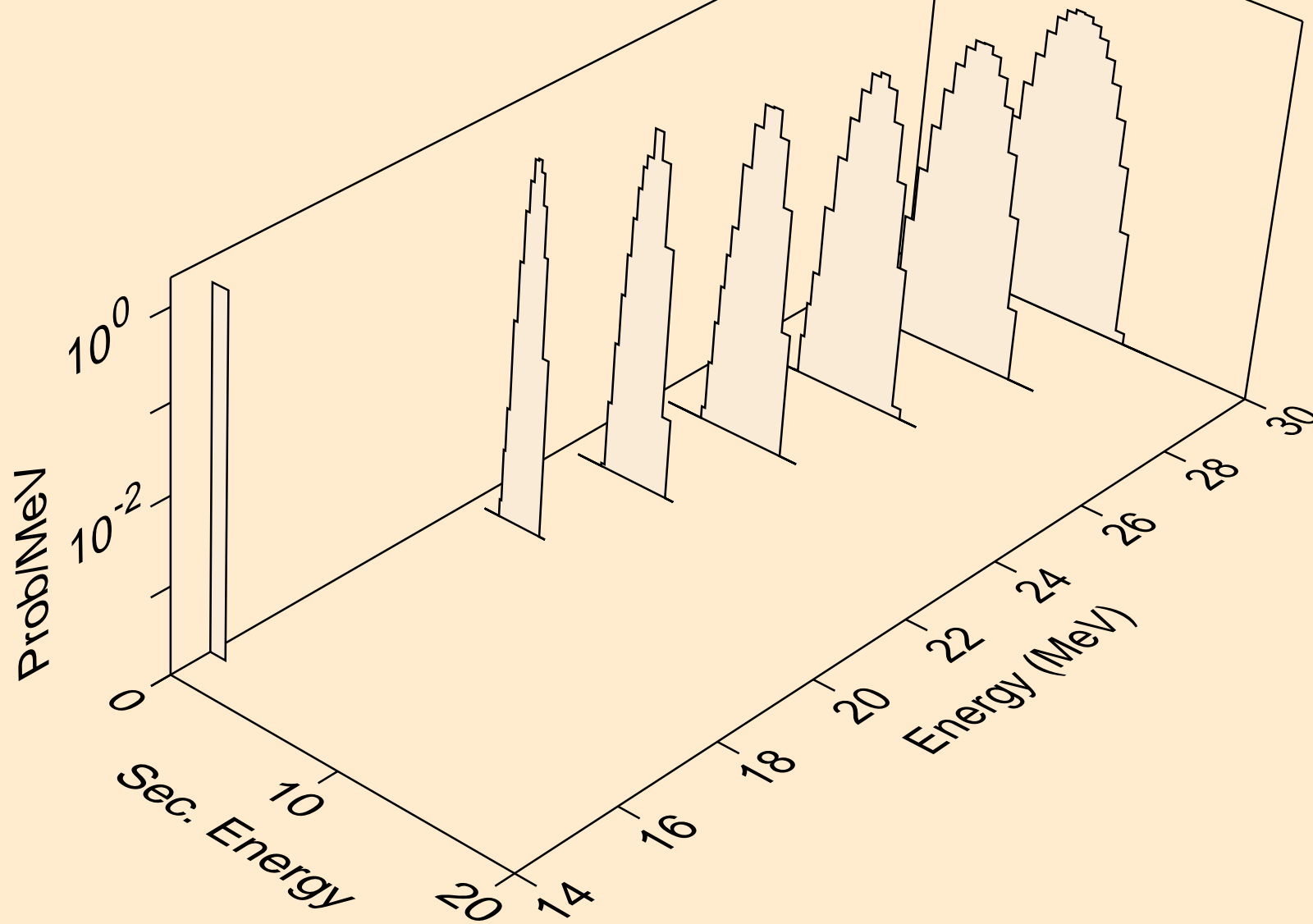

CS136 NEUTRON ACER TENDL-2024 LIBRARY; T=0.K
he3s from (n,x)

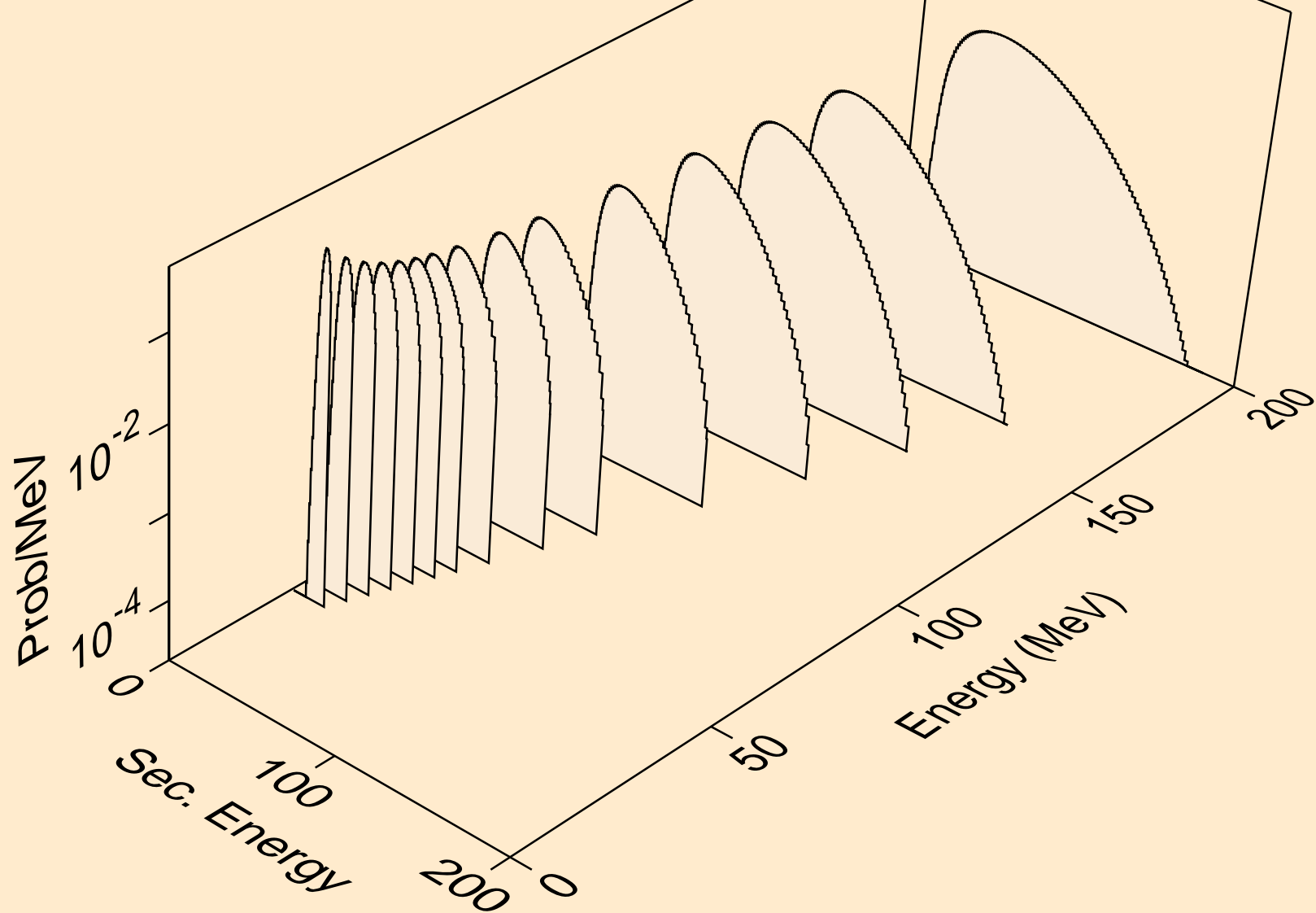

CS136 NEUTRON ACER TENDL-2024 LIBRARY; T=0.K
he3s from (n,n*)he3

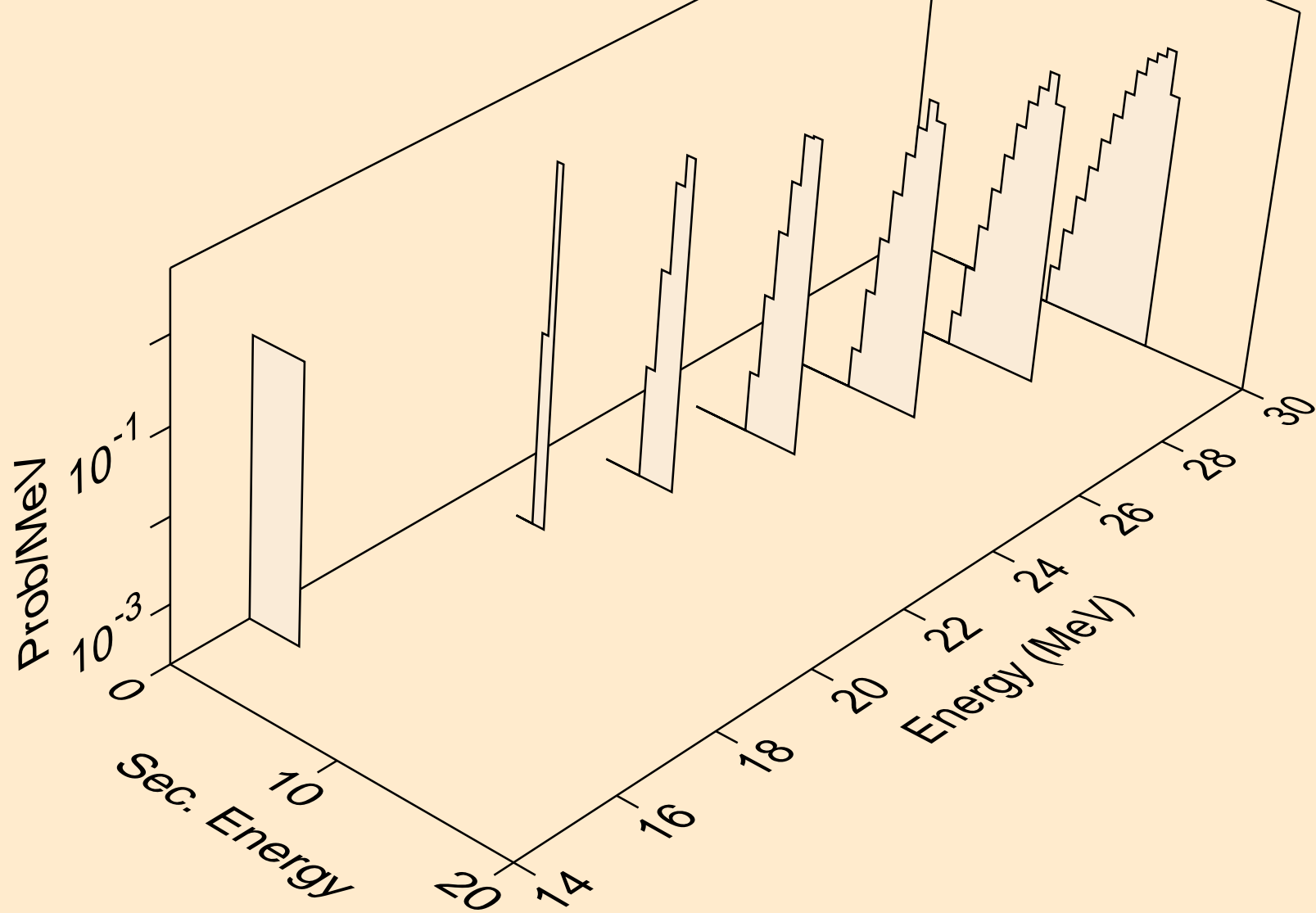

CS136 NEUTRON ACER TENDL-2024 LIBRARY; T=0.K
he3s from (n,he3)

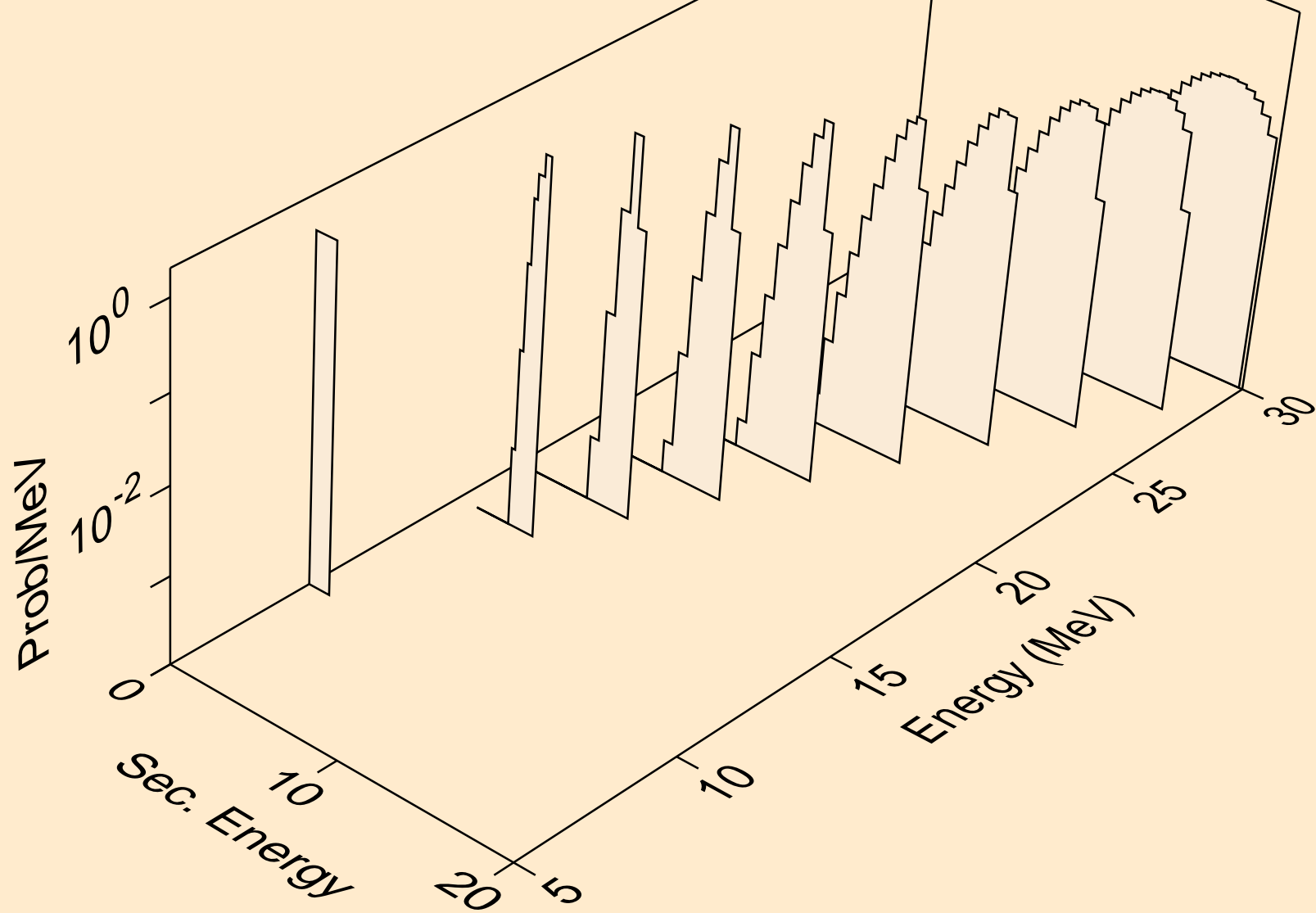

CS136 NEUTRON ACER TENDL-2024 LIBRARY; T=0.K
alphas from (n,x)

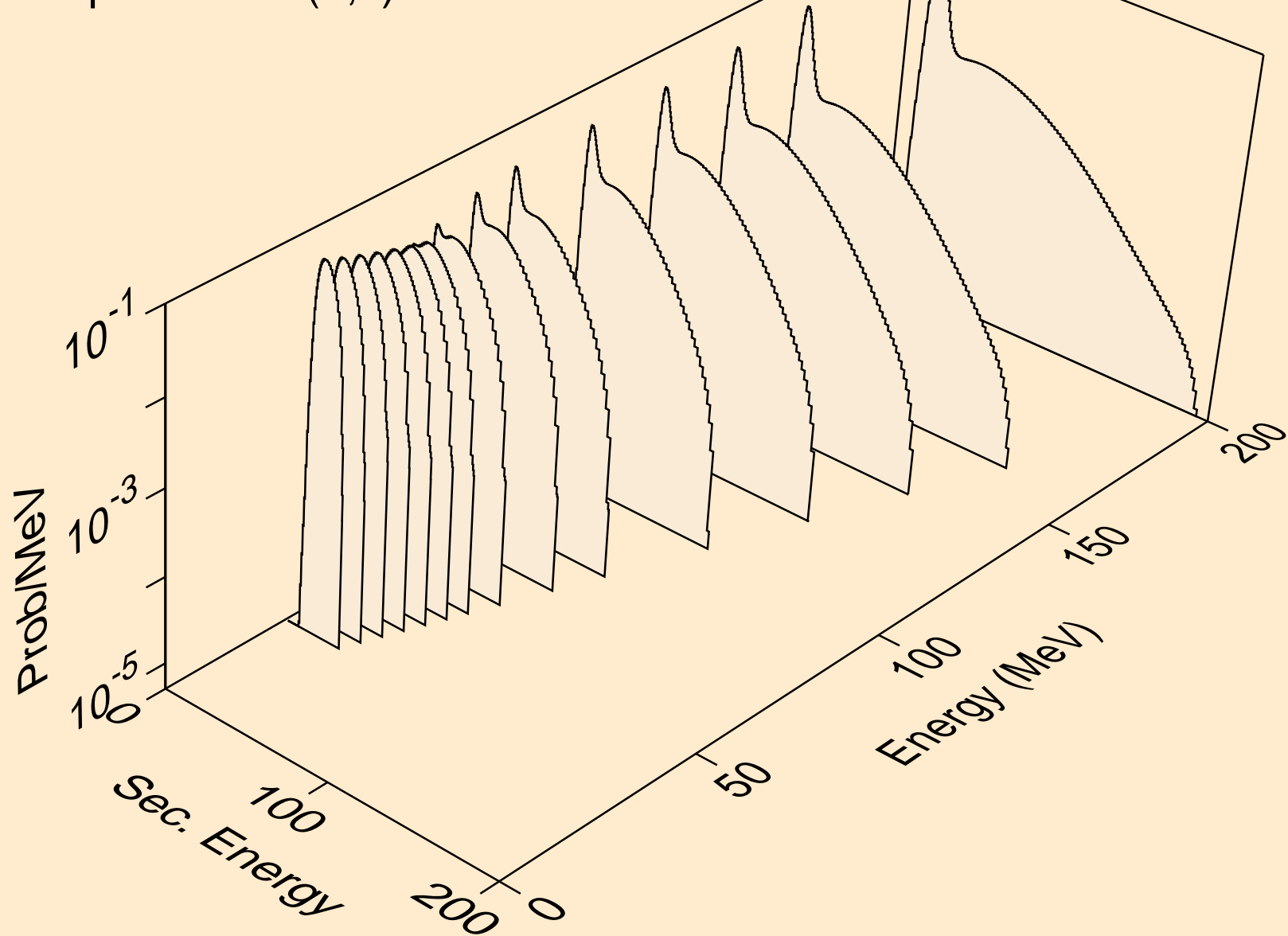

CS136 NEUTRON ACER TENDL-2024 LIBRARY; T=0.K
alphas from (n,n*)a

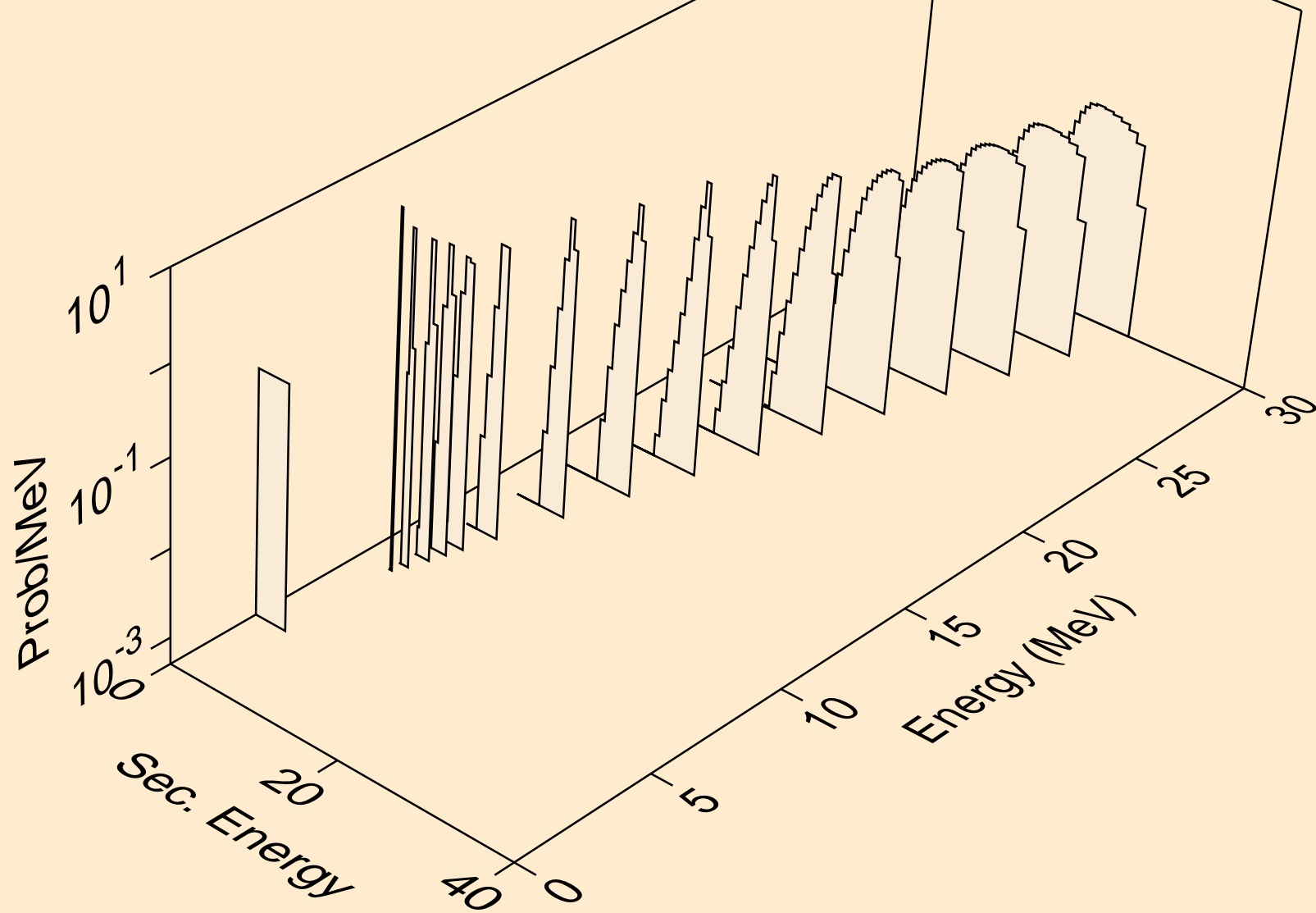

CS136 NEUTRON ACER TENDL-2024 LIBRARY; T=0.K
alphas from (n,2n)a

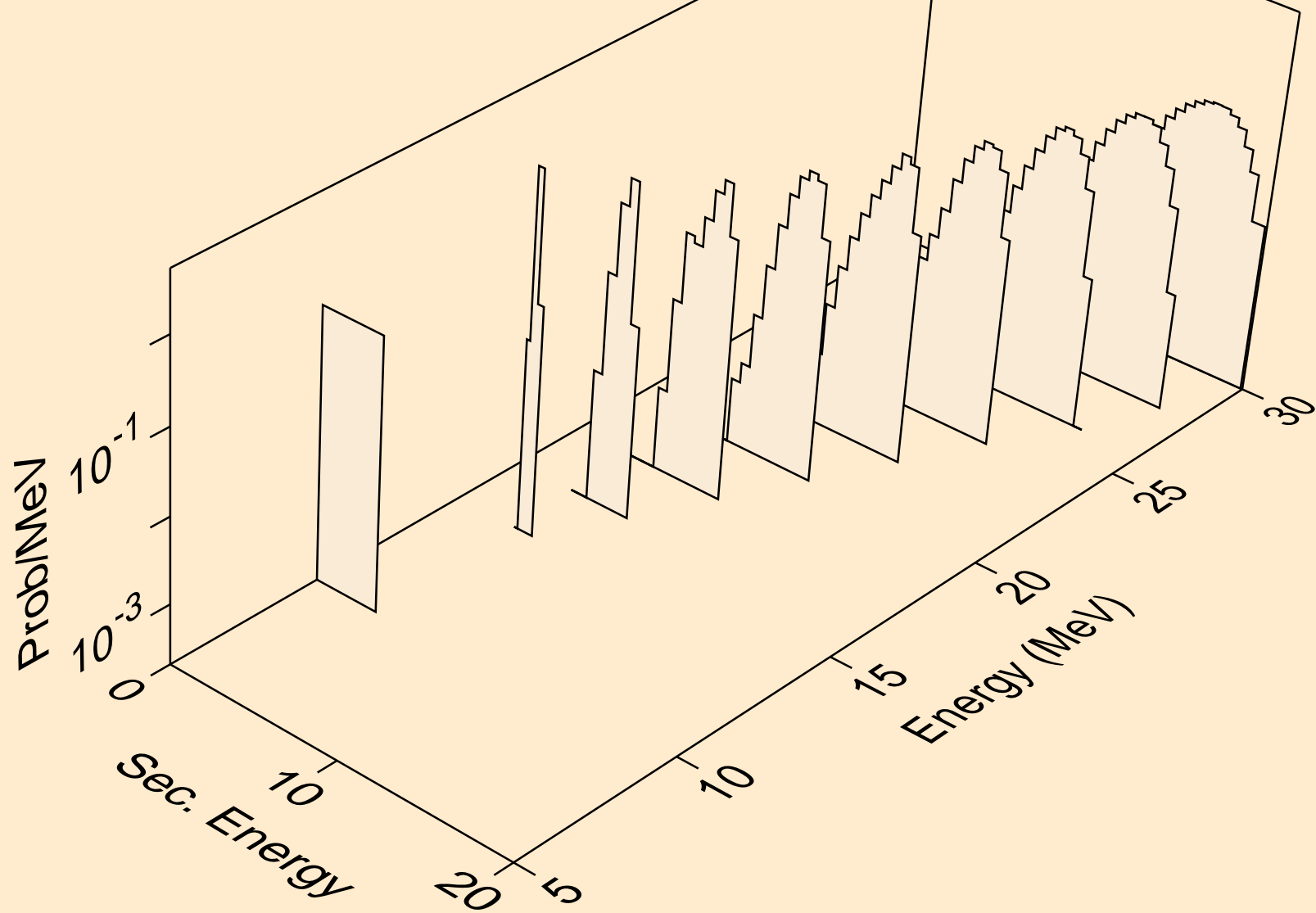

CS136 NEUTRON ACER TENDL-2024 LIBRARY; T=0.K
alphas from (n,3n)a

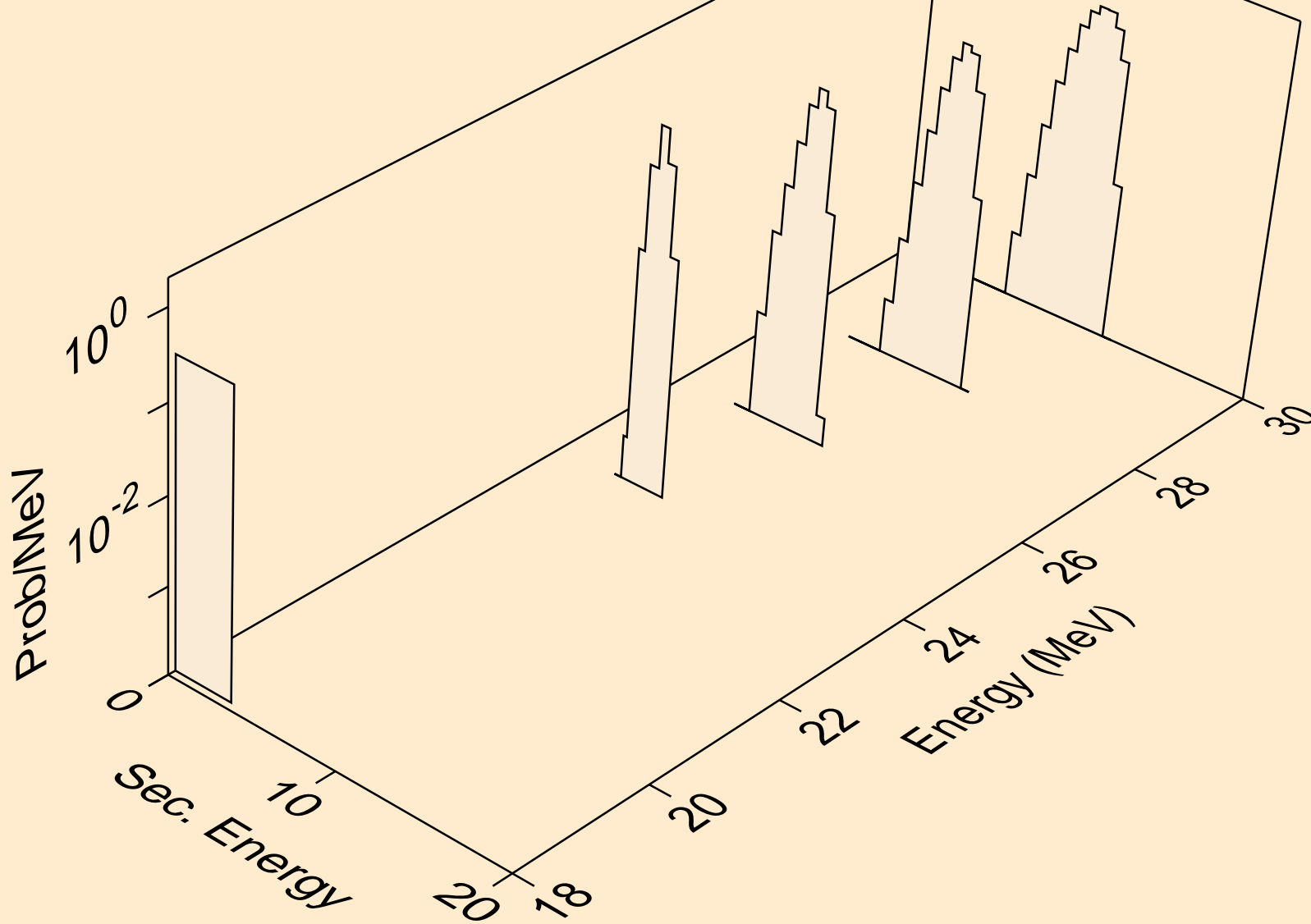

CS136 NEUTRON ACER TENDL-2024 LIBRARY; T=0.K
alphas from (n,npa)

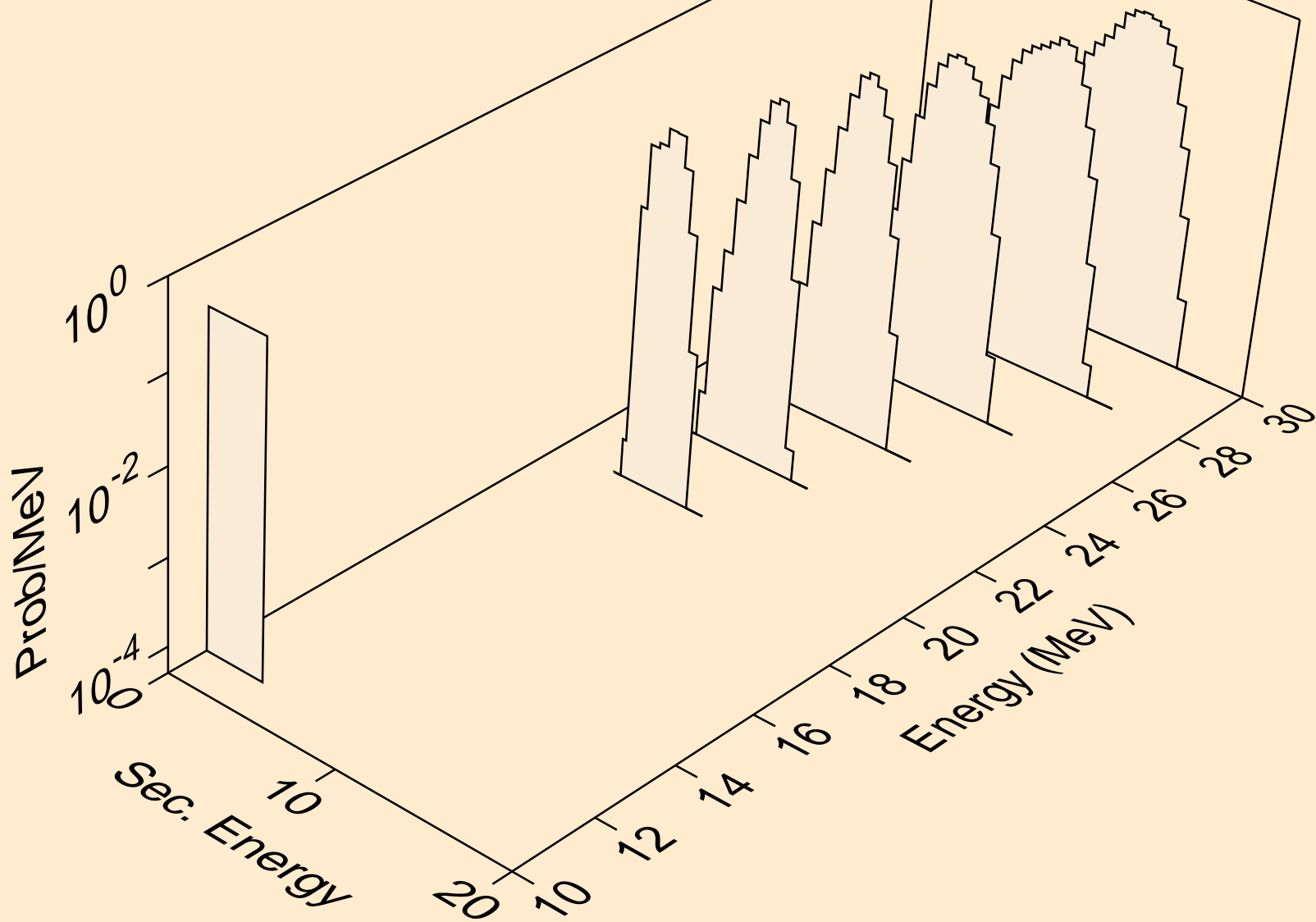

CS136 NEUTRON ACER TENDL-2024 LIBRARY; T=0.K
alphas from (n,a)

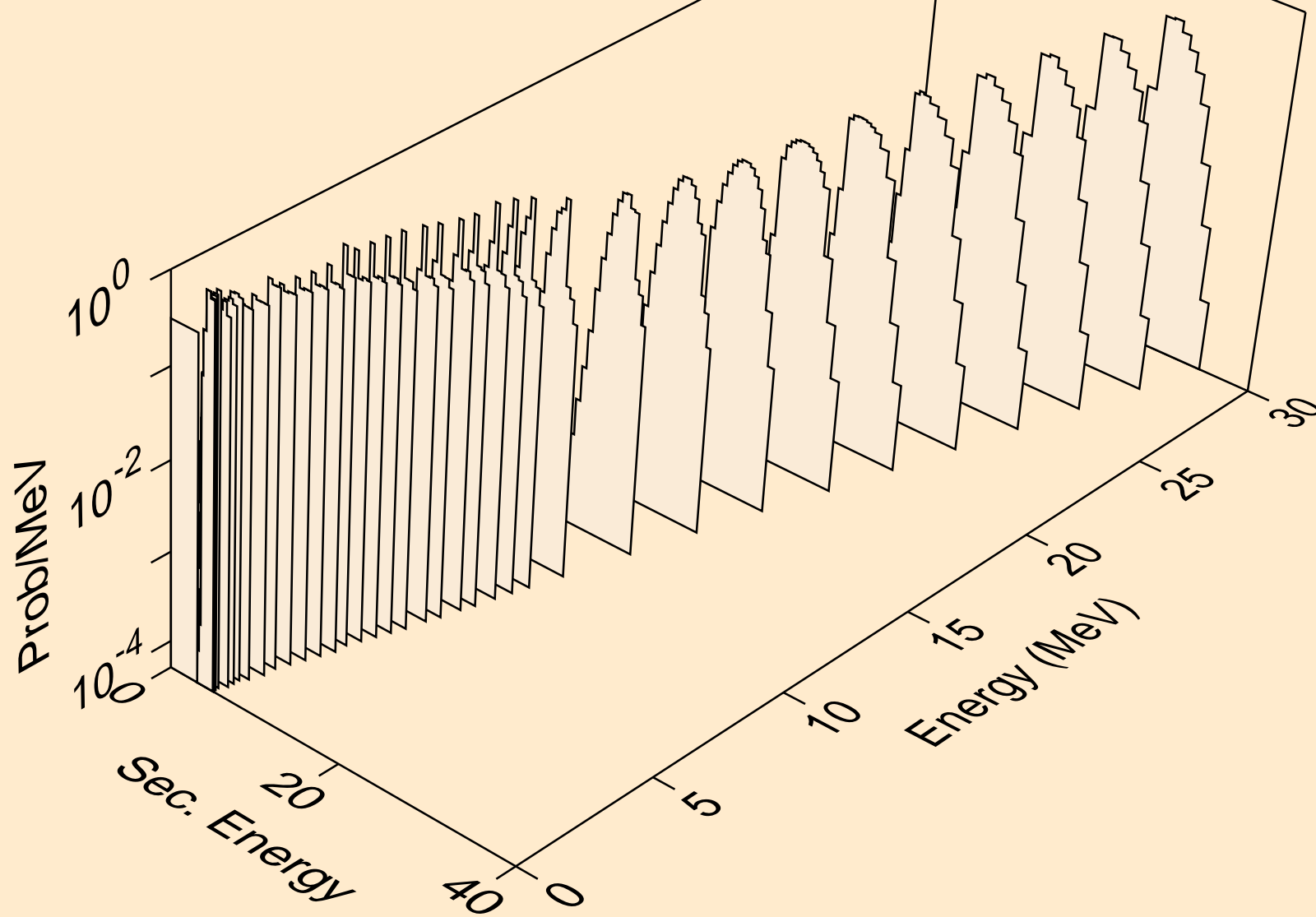

CS136 NEUTRON ACER TENDL-2024 LIBRARY; T=0.K
alphas from (n,2a)

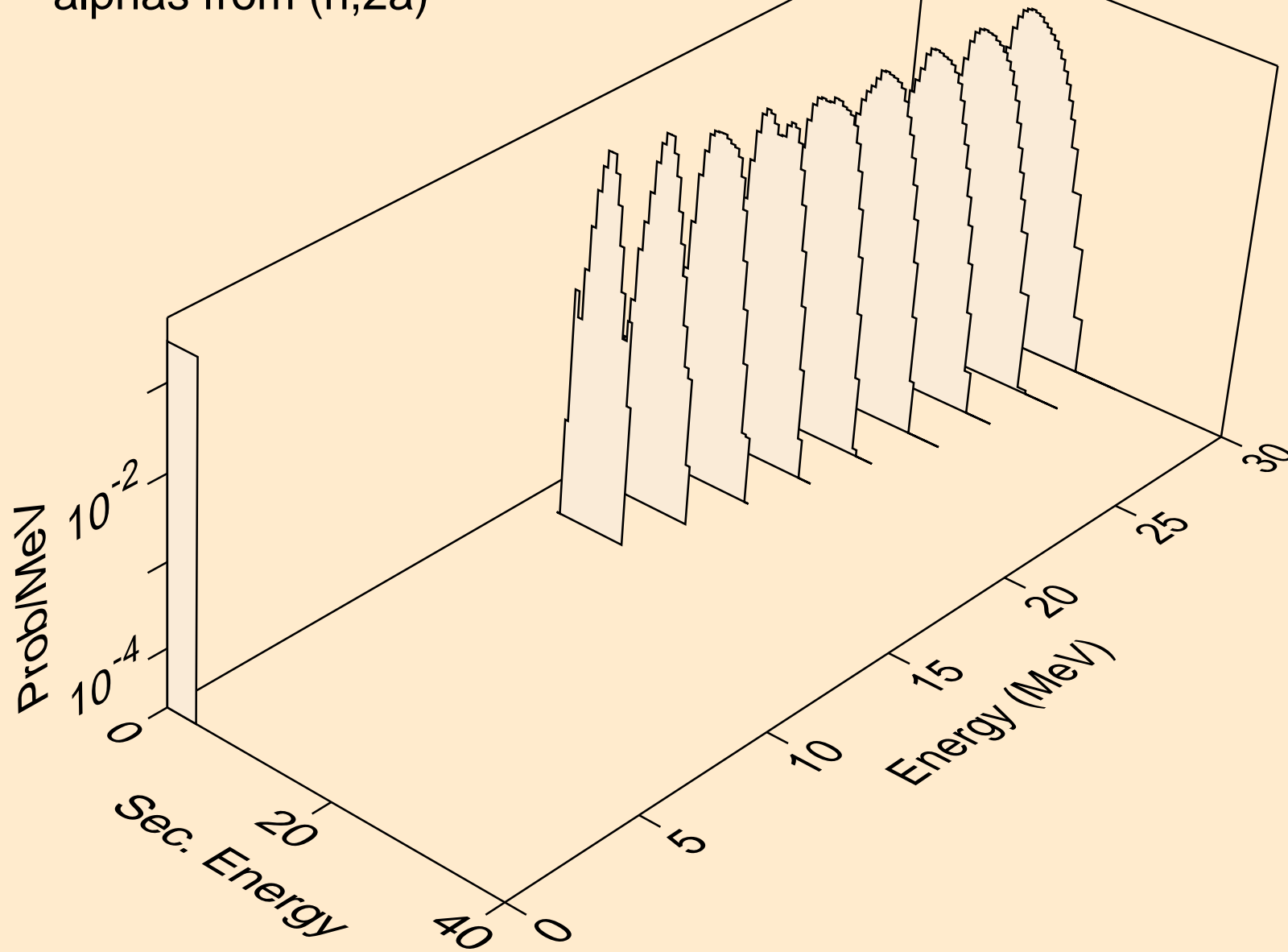

CS136 NEUTRON ACER TENDL-2024 LIBRARY; T=0.K
alphas from (n,pa)

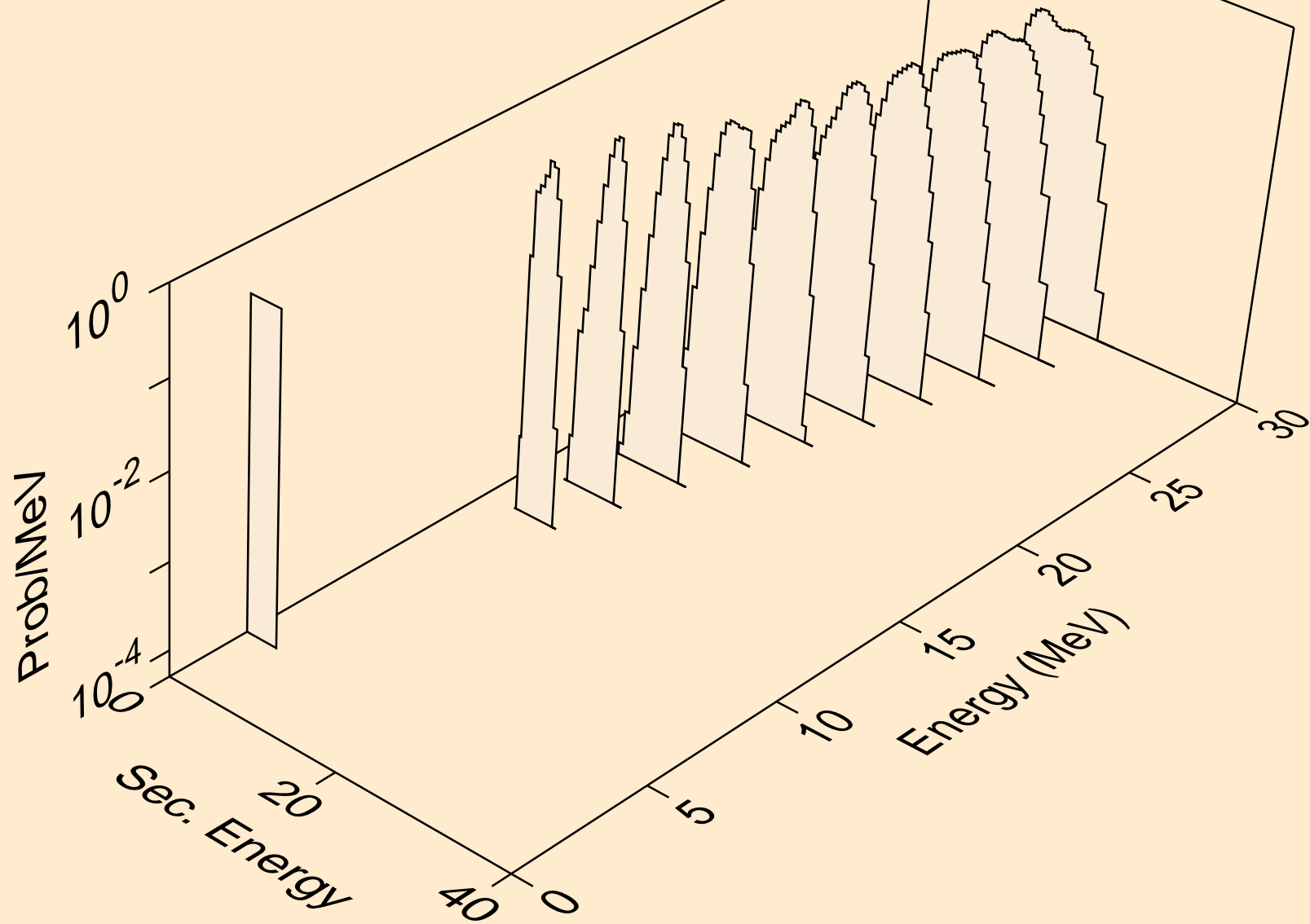

CS136 NEUTRON ACER TENDL-2024 LIBRARY; T=0.K
alphas from (n,da)

