

EU142M NEUTRON ACER TENDL-2024 LIBRARY; T=0.K

Principal cross sections

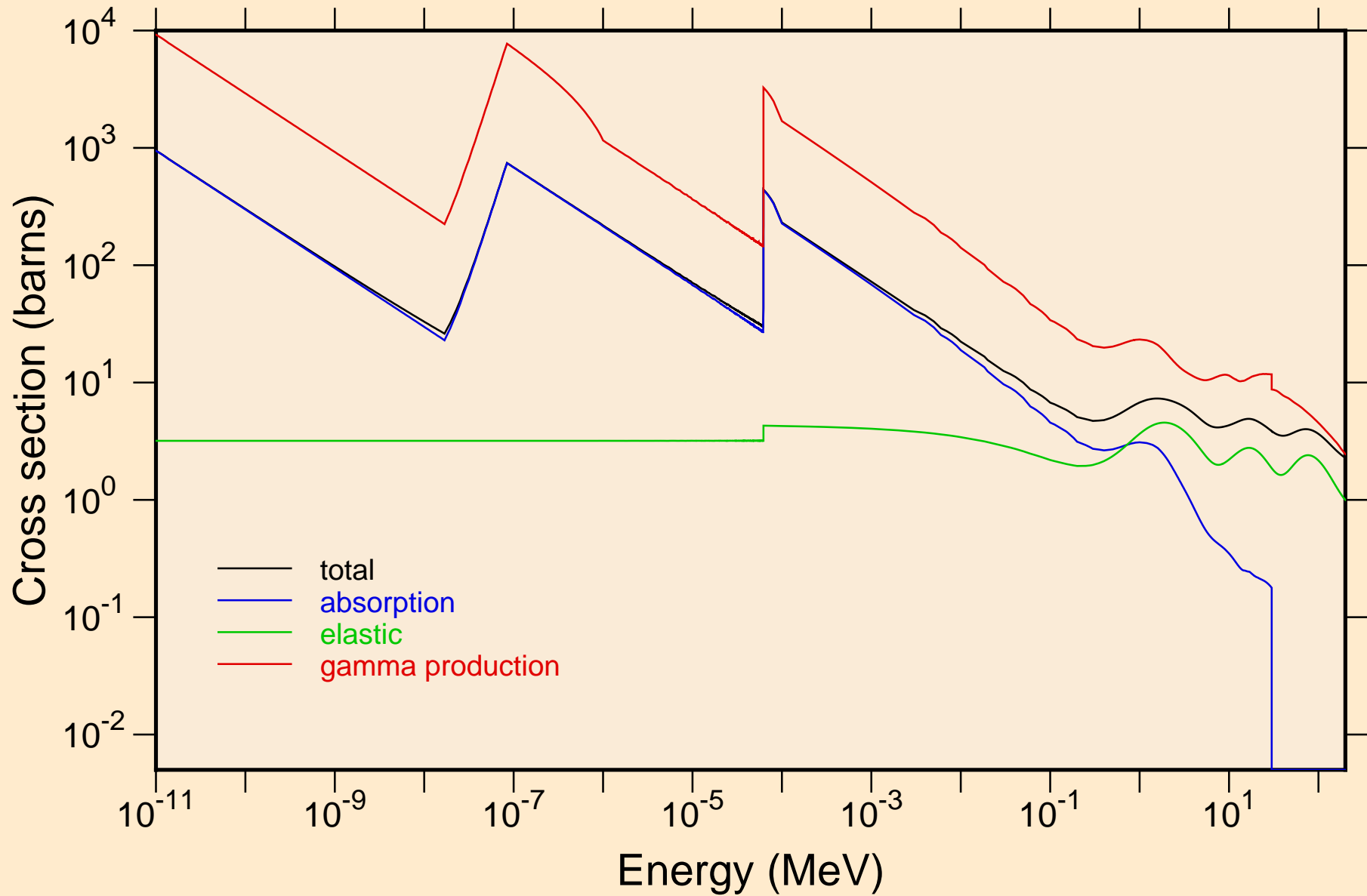

EU142M NEUTRON ACER TENDL-2024 LIBRARY; T=0.K
resonance total cross section

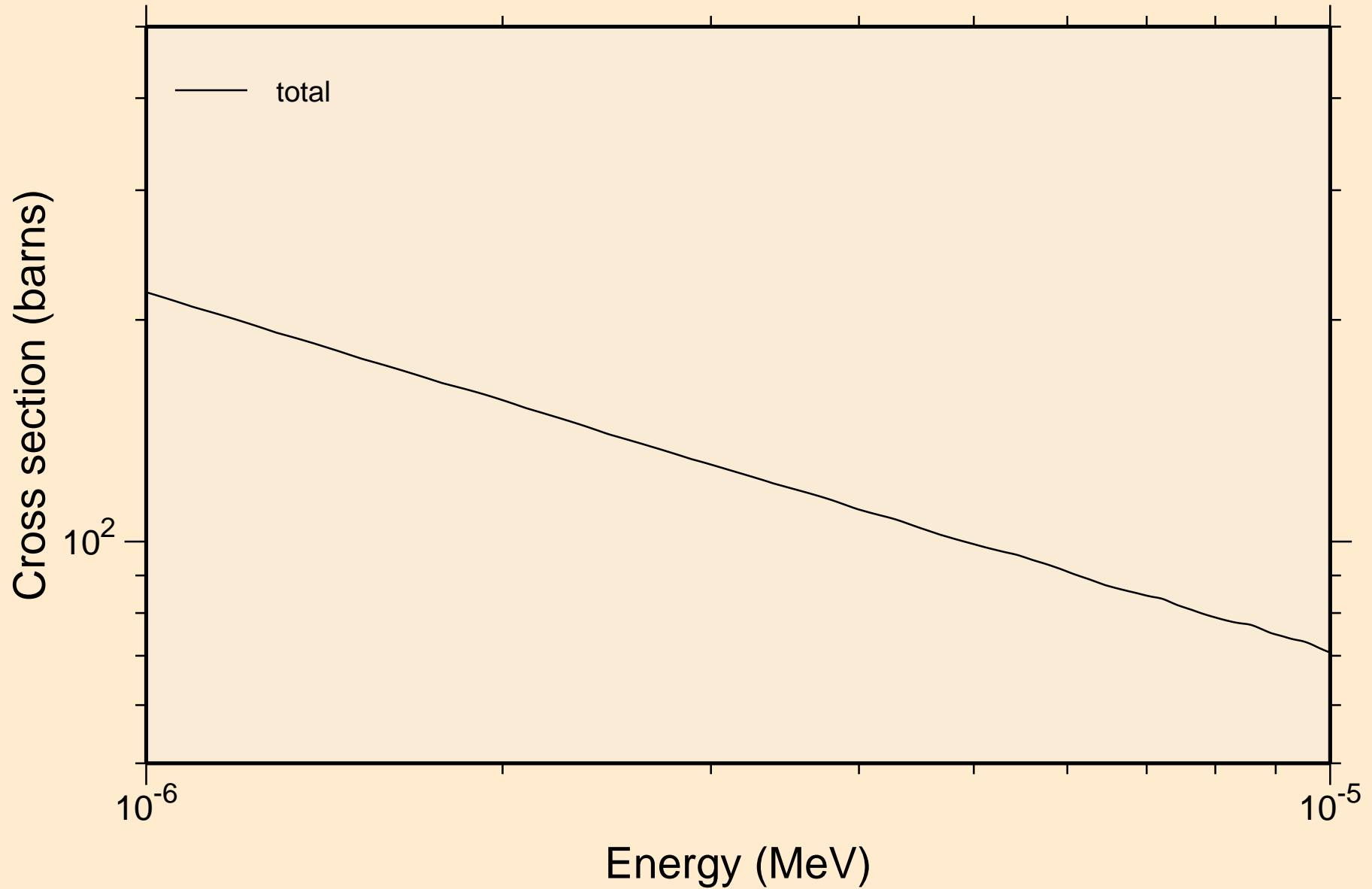

EU142M NEUTRON ACER TENDL-2024 LIBRARY; T=0.K
resonance total cross section

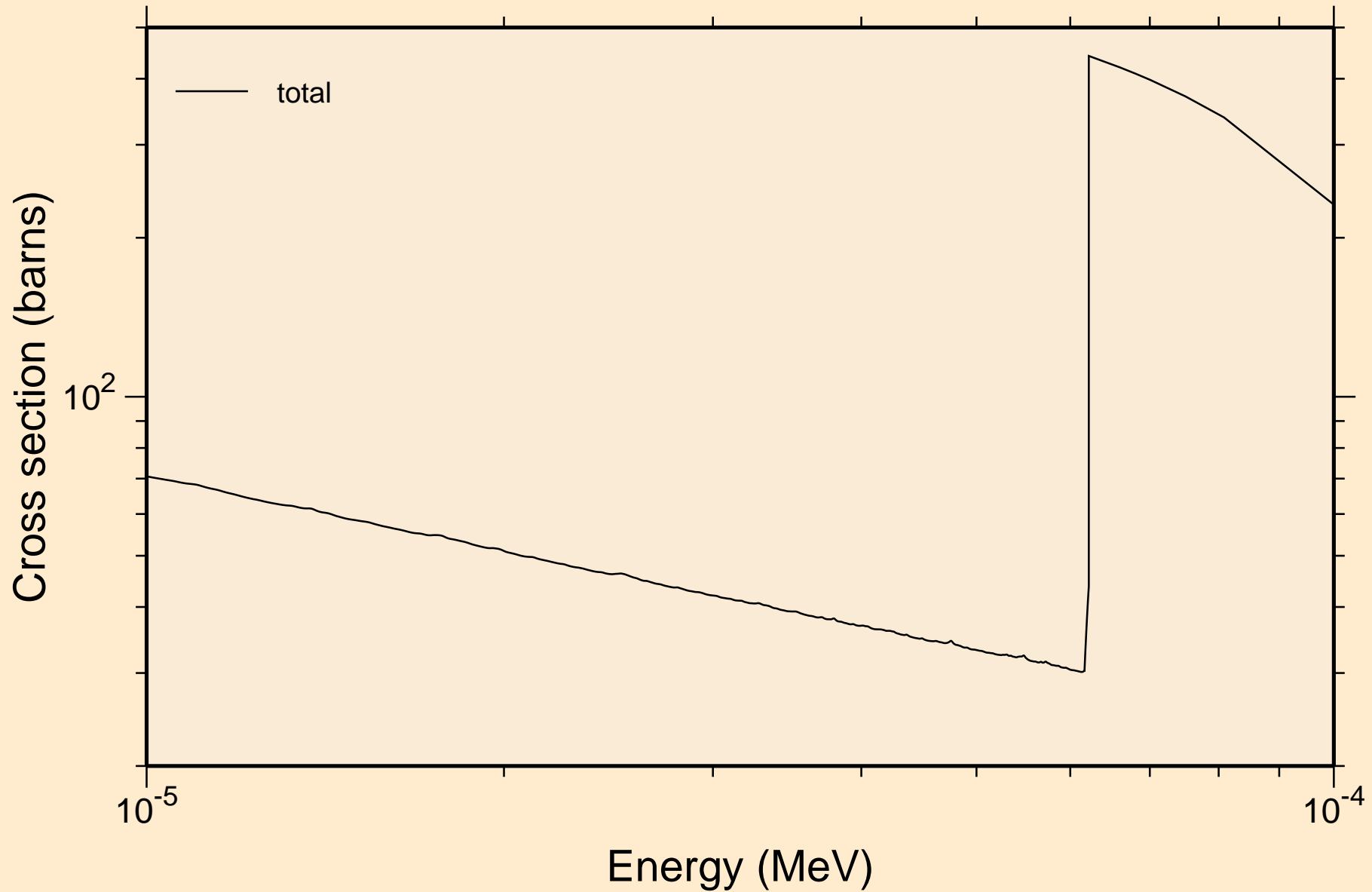

EÜ142M NEUTRON ACER TENDL-2024 LIBRARY; T=0.K
resonance total cross section

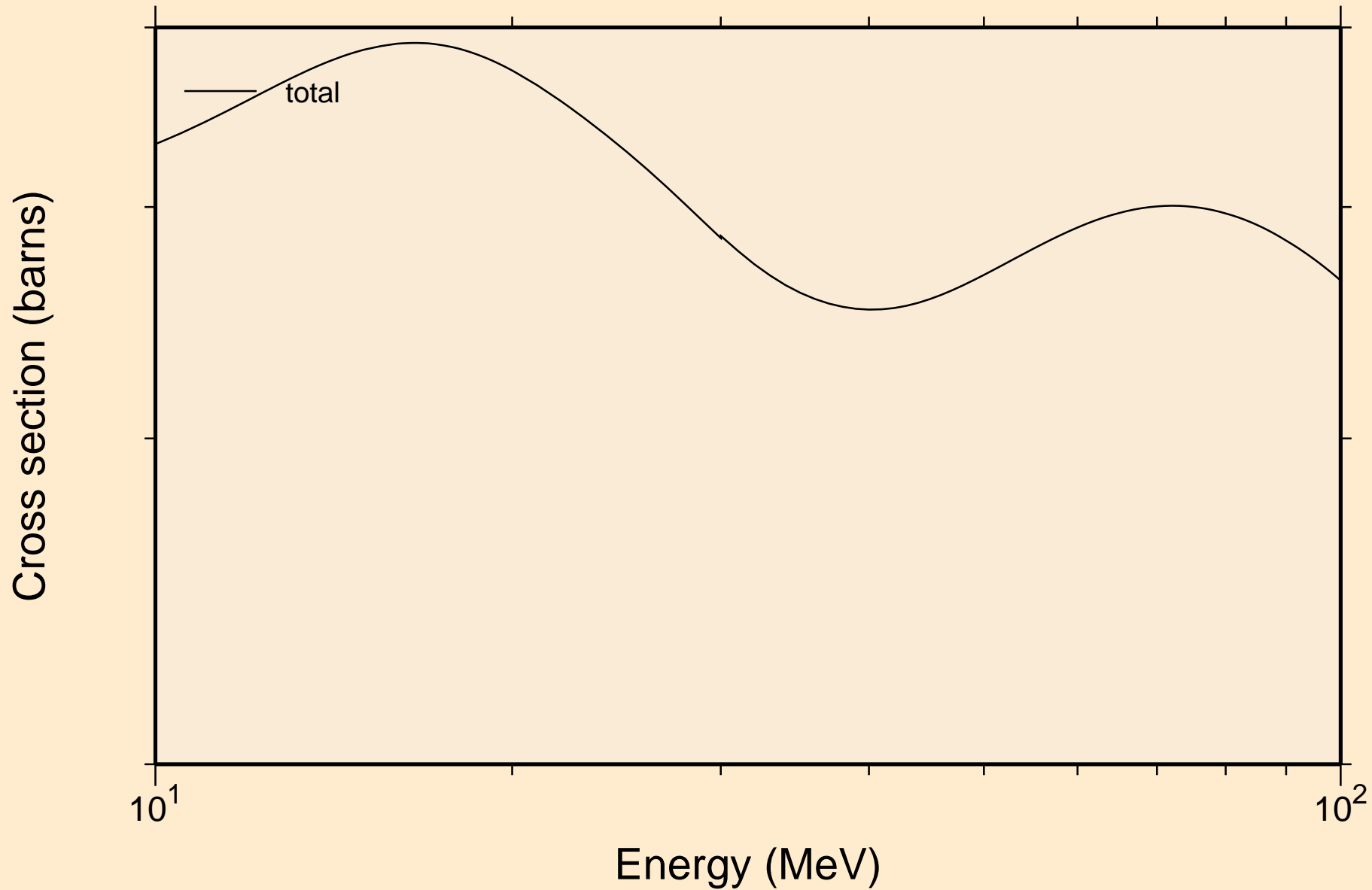

EU142M NEUTRON ACER TENDL-2024 LIBRARY; T=0.K
resonance absorption cross sections

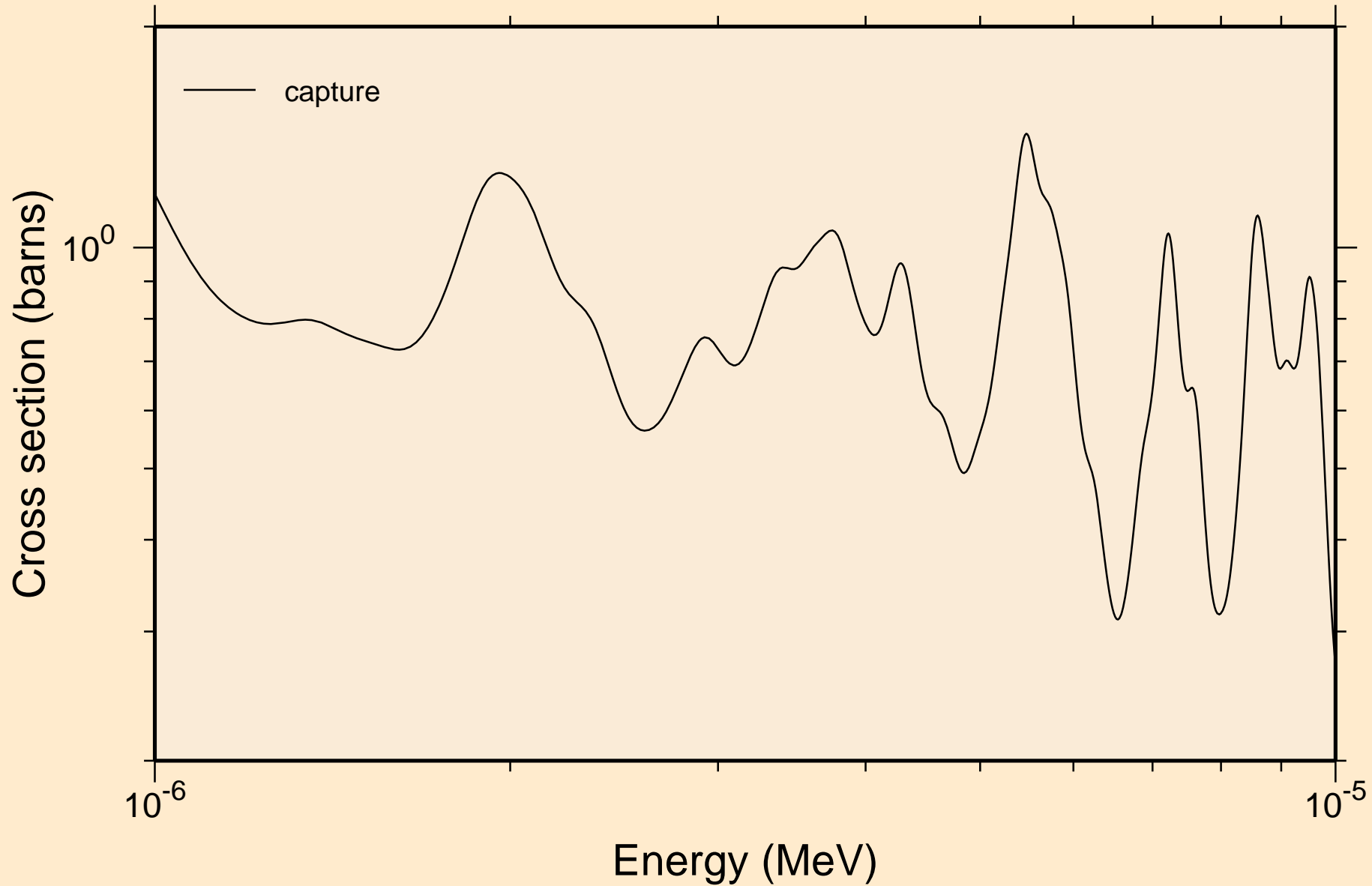

EU142M NEUTRON ACER TENDL-2024 LIBRARY; T=0.K
resonance absorption cross sections

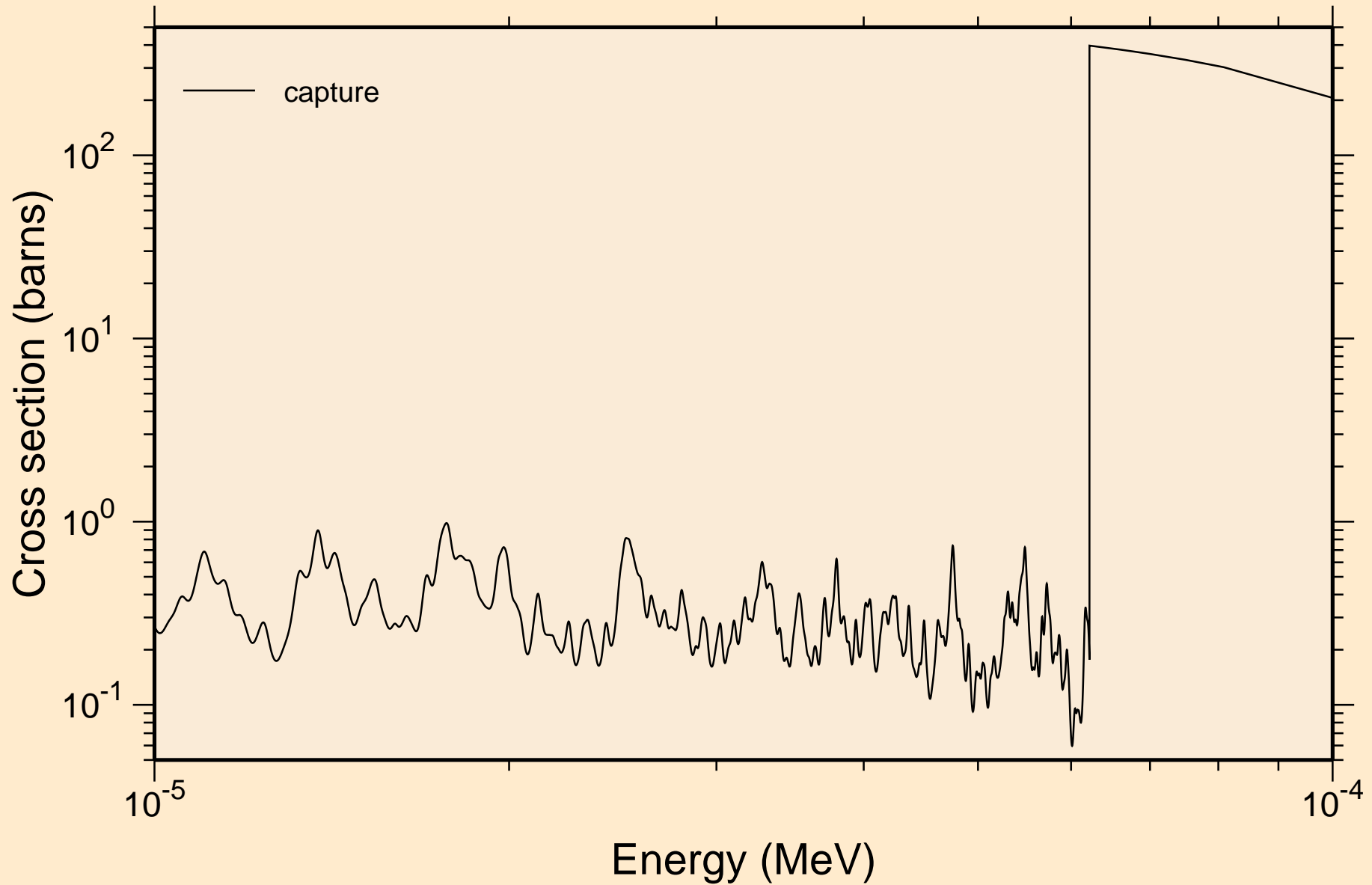

EU142M NEUTRON ACER TENDL-2024 LIBRARY; T=0.K
resonance absorption cross sections

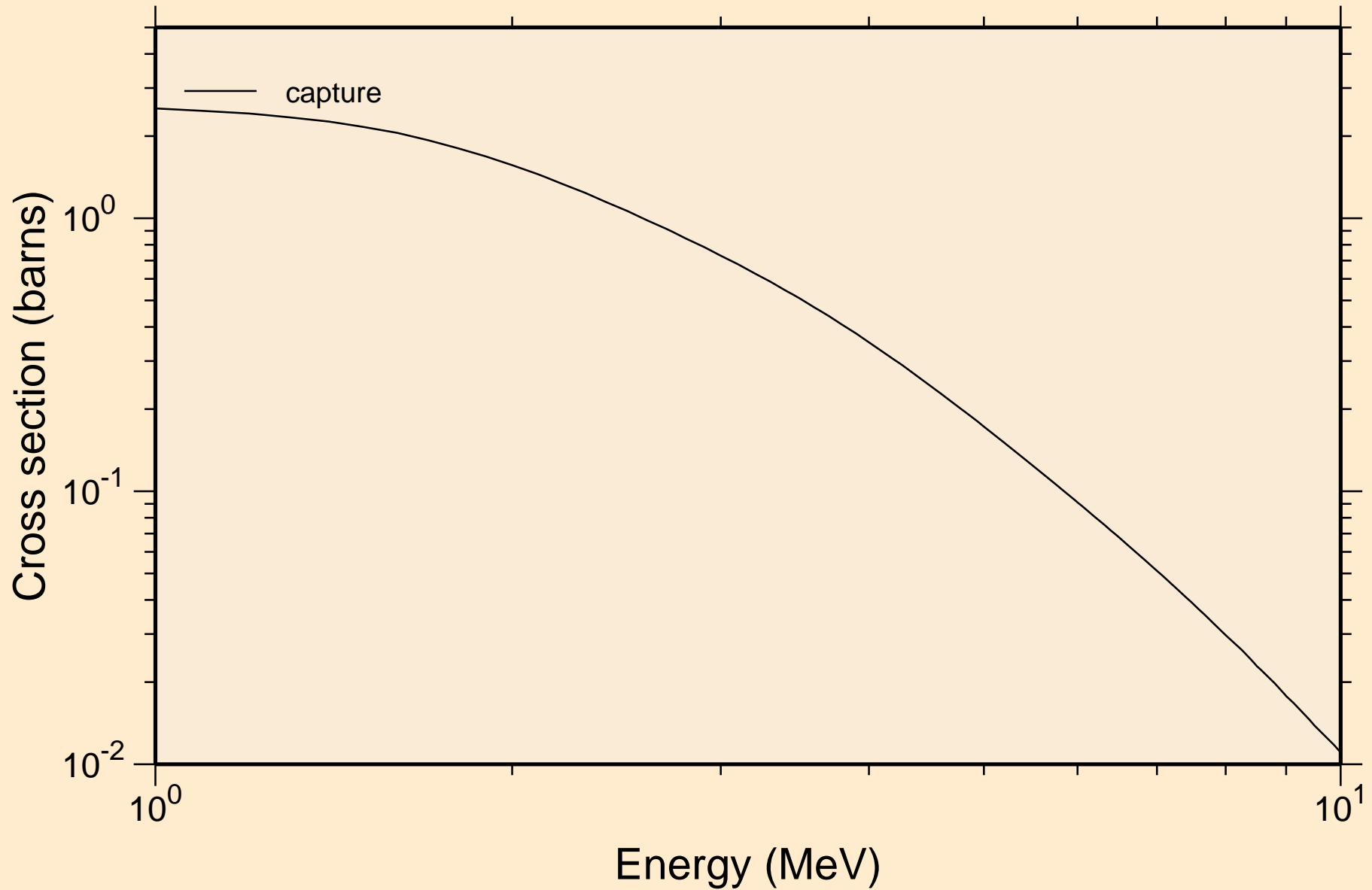

EU142M NEUTRON ACER TENDL-2024 LIBRARY; T=0.K

Heating

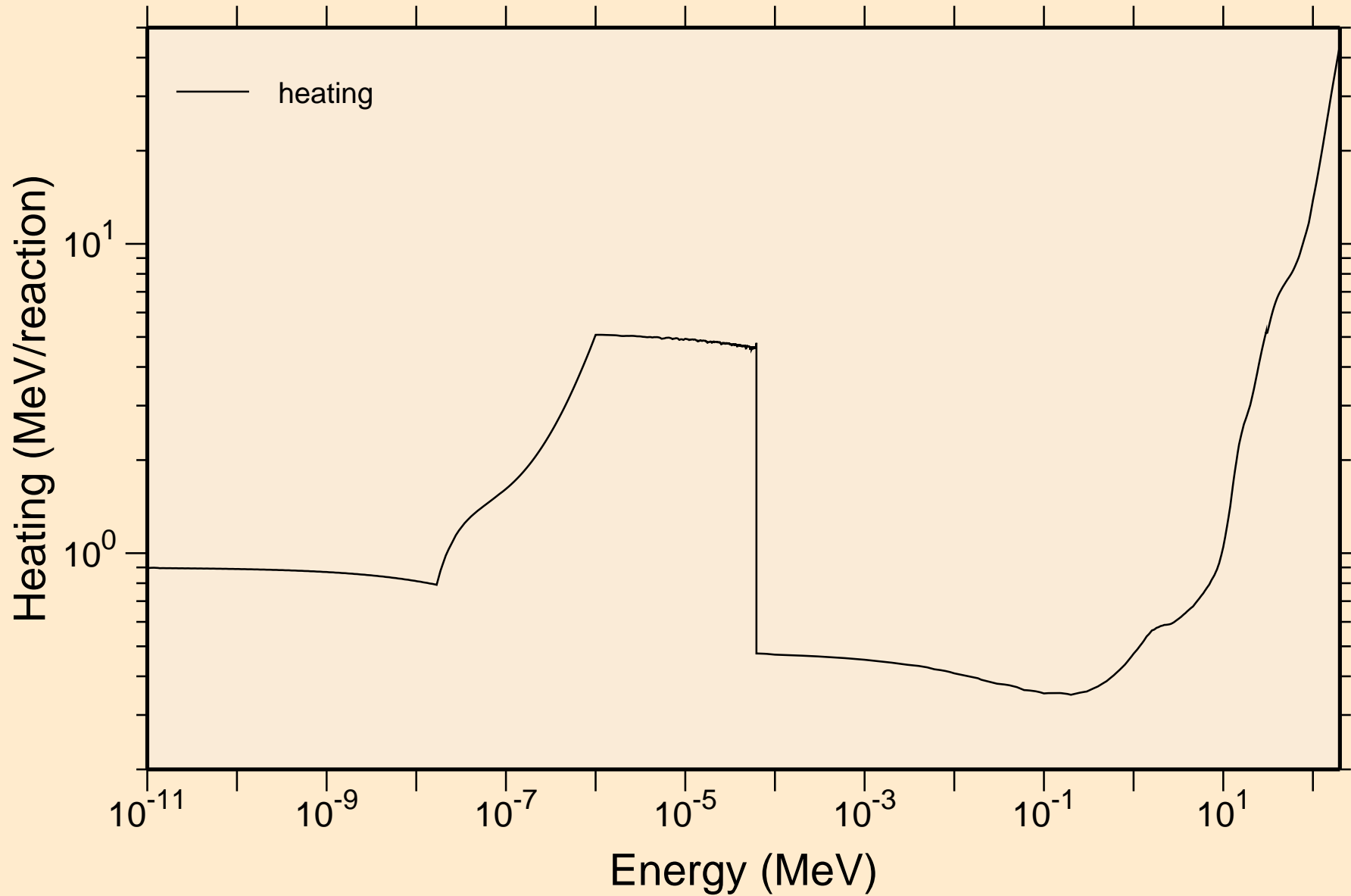

EU142M NEUTRON ACER TENDL-2024 LIBRARY; T=0.K

Damage

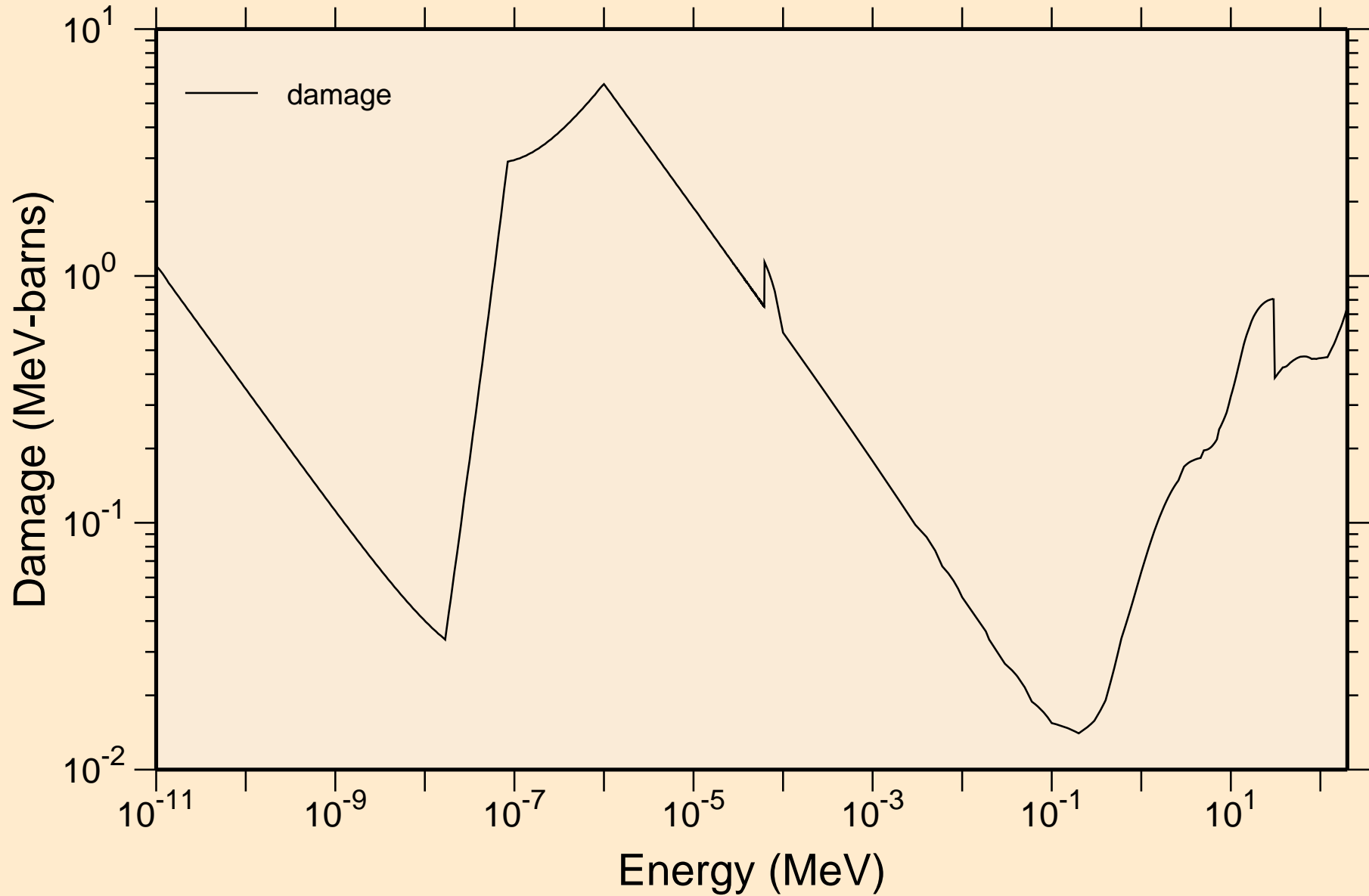

EU142M NEUTRON ACER TENDL-2024 LIBRARY; T=0.K

Non-threshold reactions

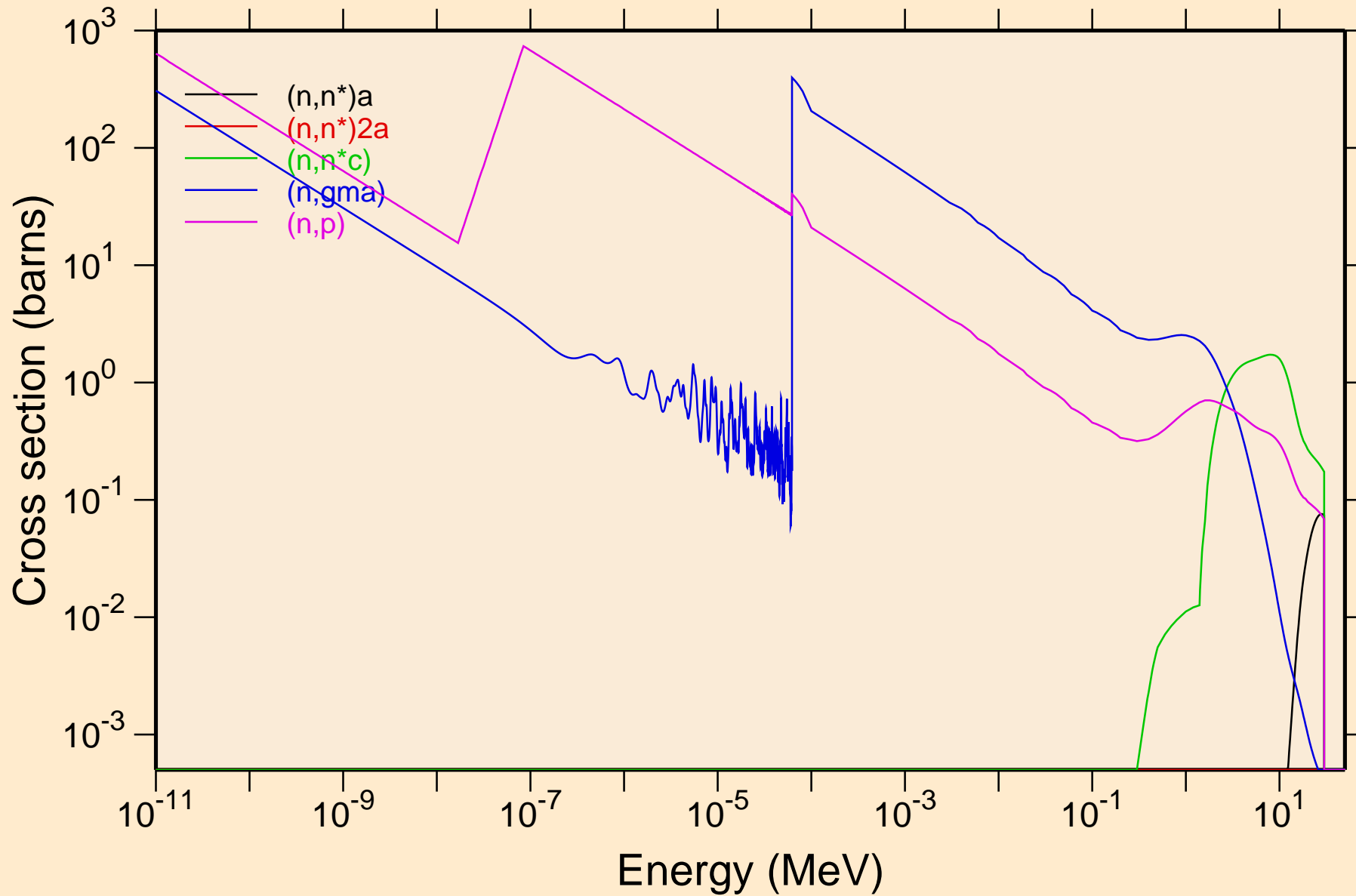

EU142M NEUTRON ACER TENDL-2024 LIBRARY; T=0.K
Non-threshold reactions

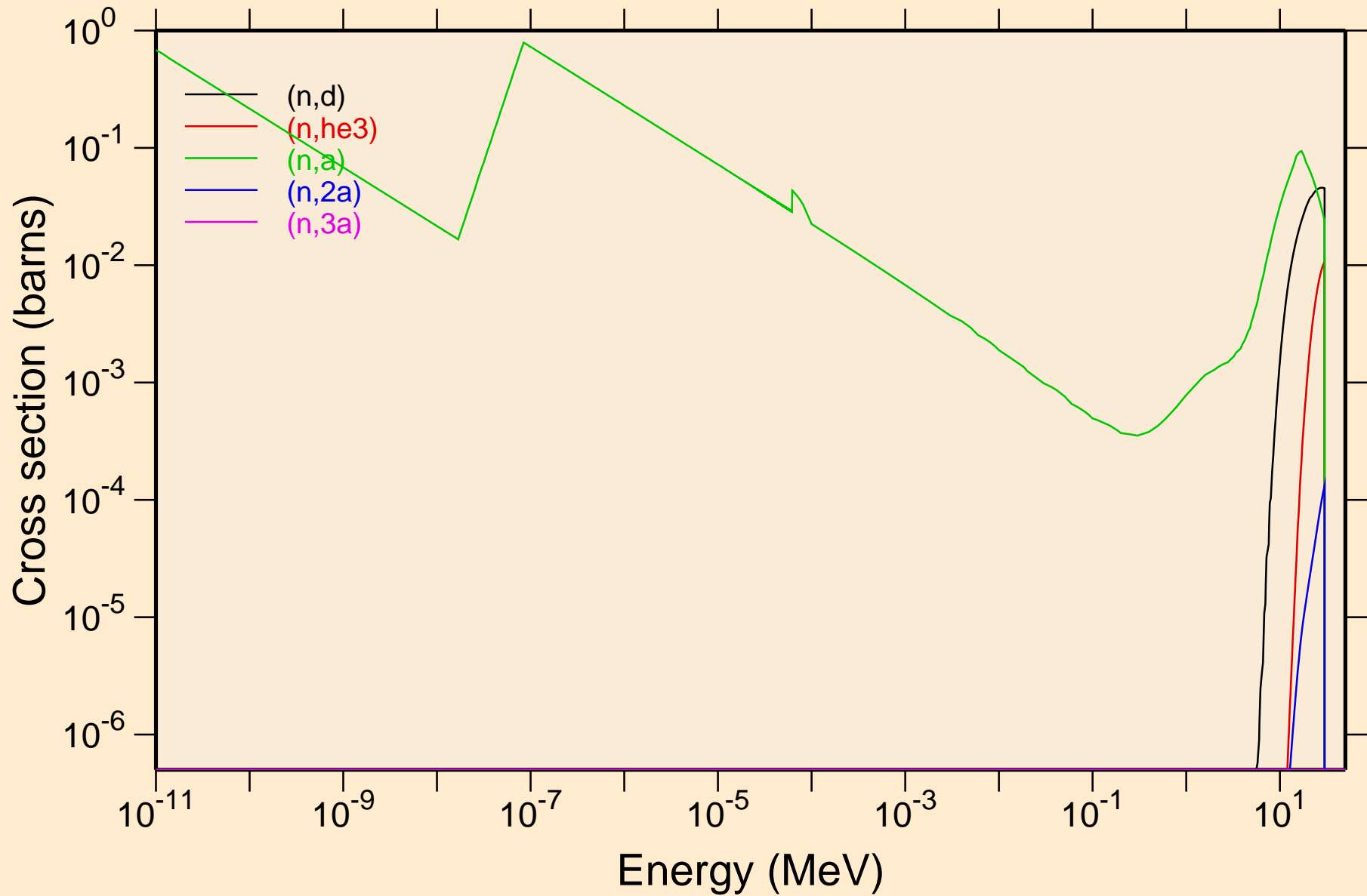

EU142M NEUTRON ACER TENDL-2024 LIBRARY; T=0.K

Non-threshold reactions

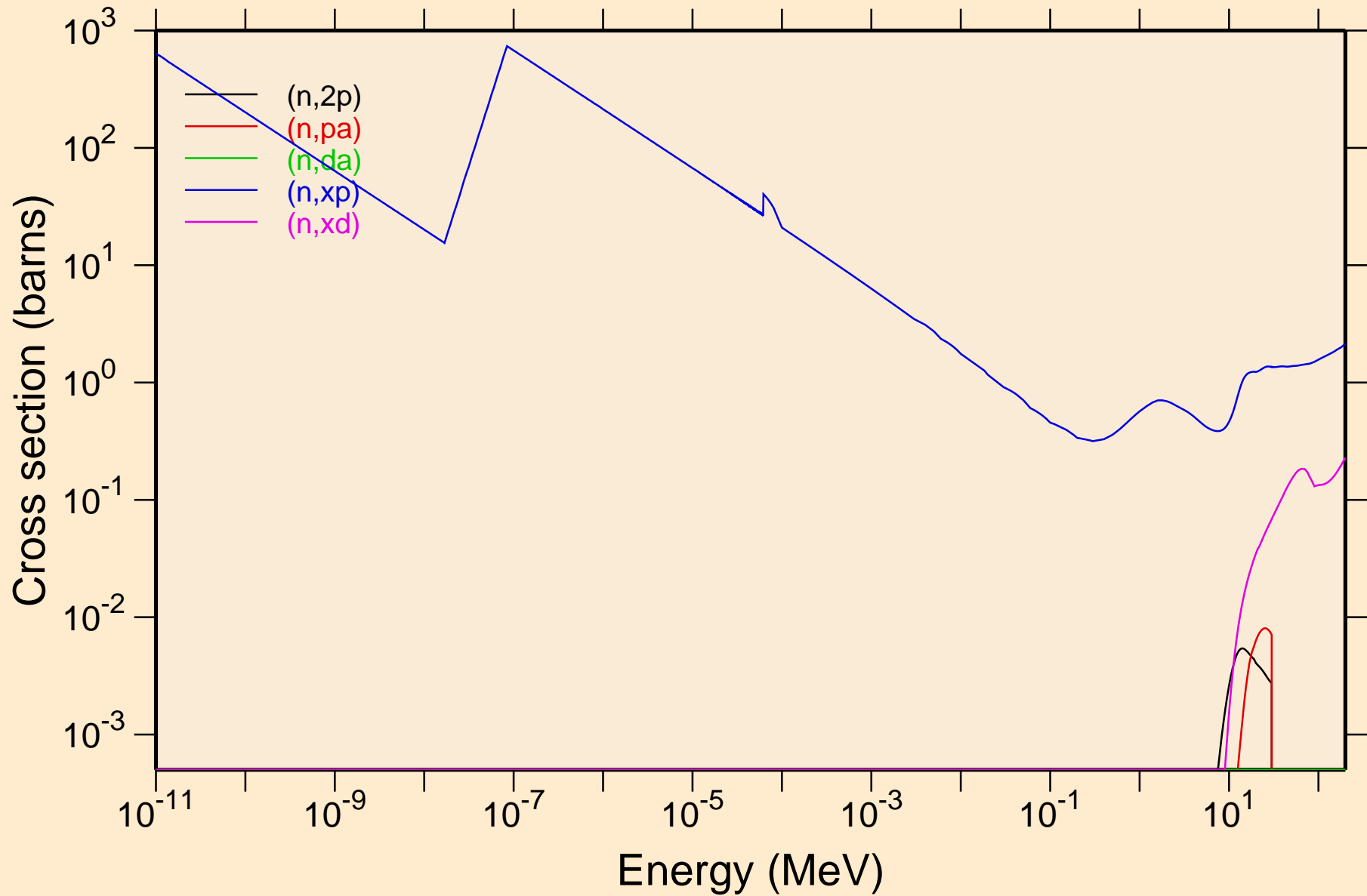

EU142M NEUTRON ACER TENDL-2024 LIBRARY; T=0.K
Non-threshold reactions

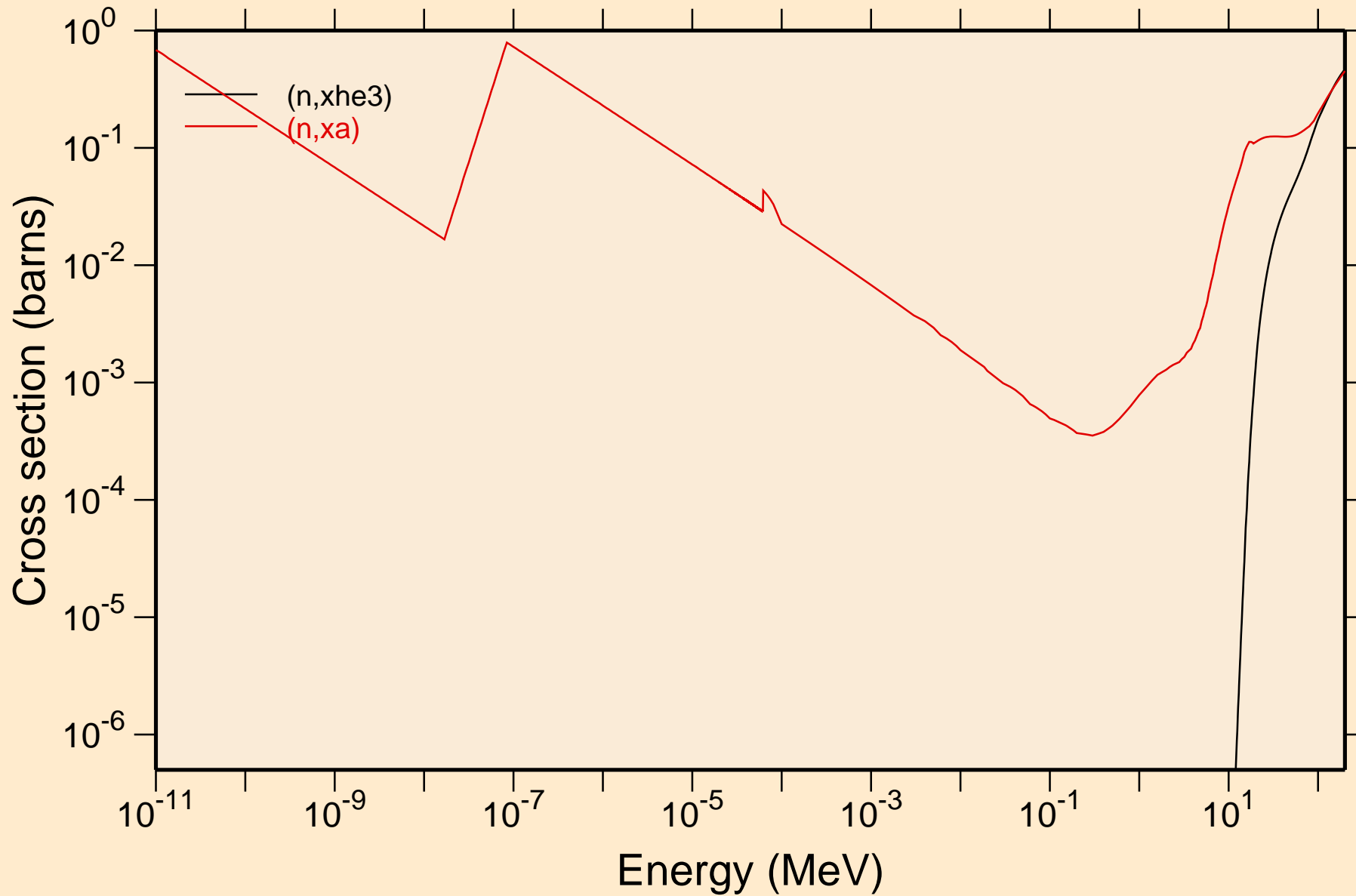

EU142M NEUTRON ACER TENDL-2024 LIBRARY; T=0.K

Principal cross sections

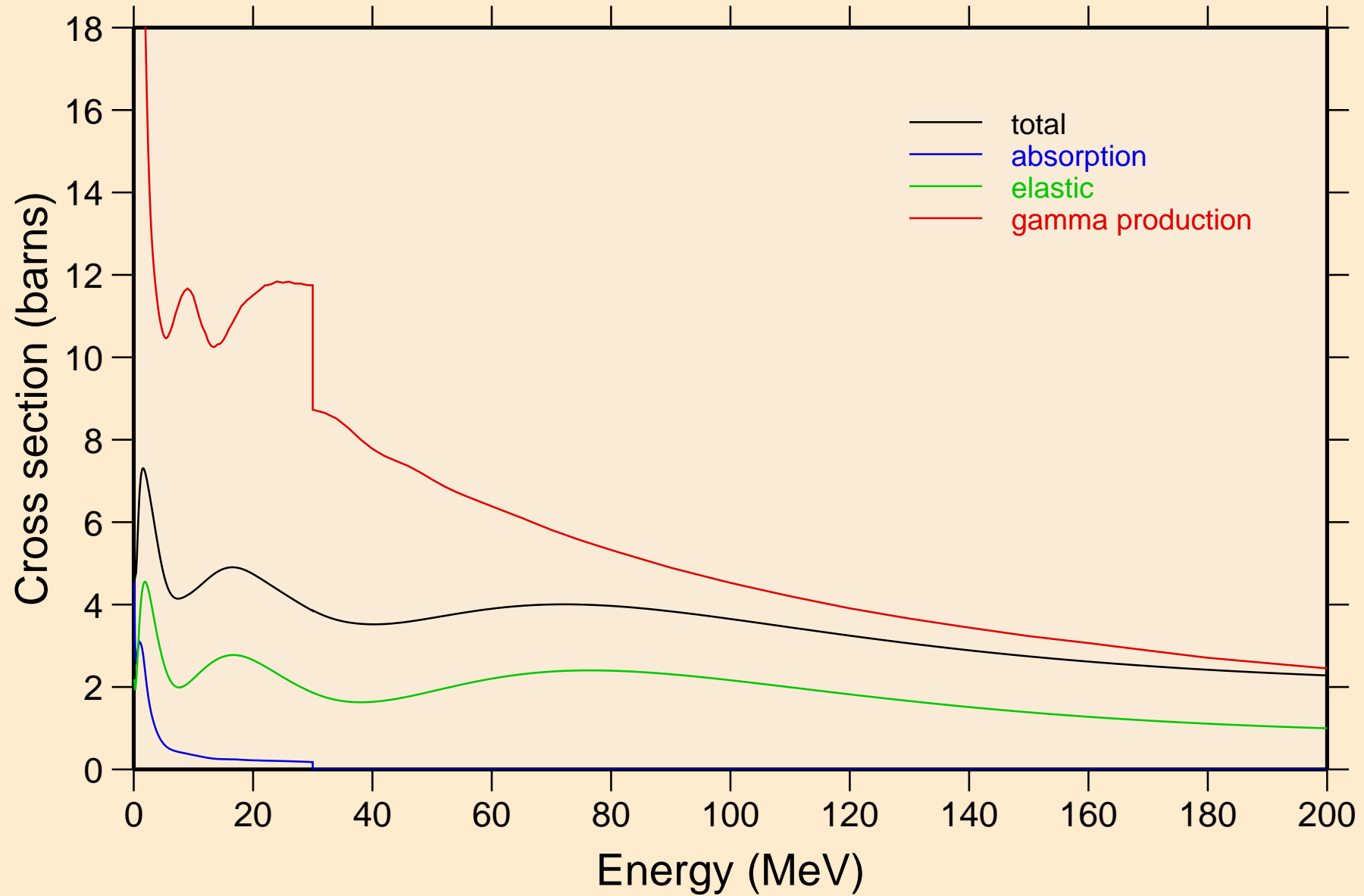

EU142M NEUTRON ACER TENDL-2024 LIBRARY; T=0.K

Heating

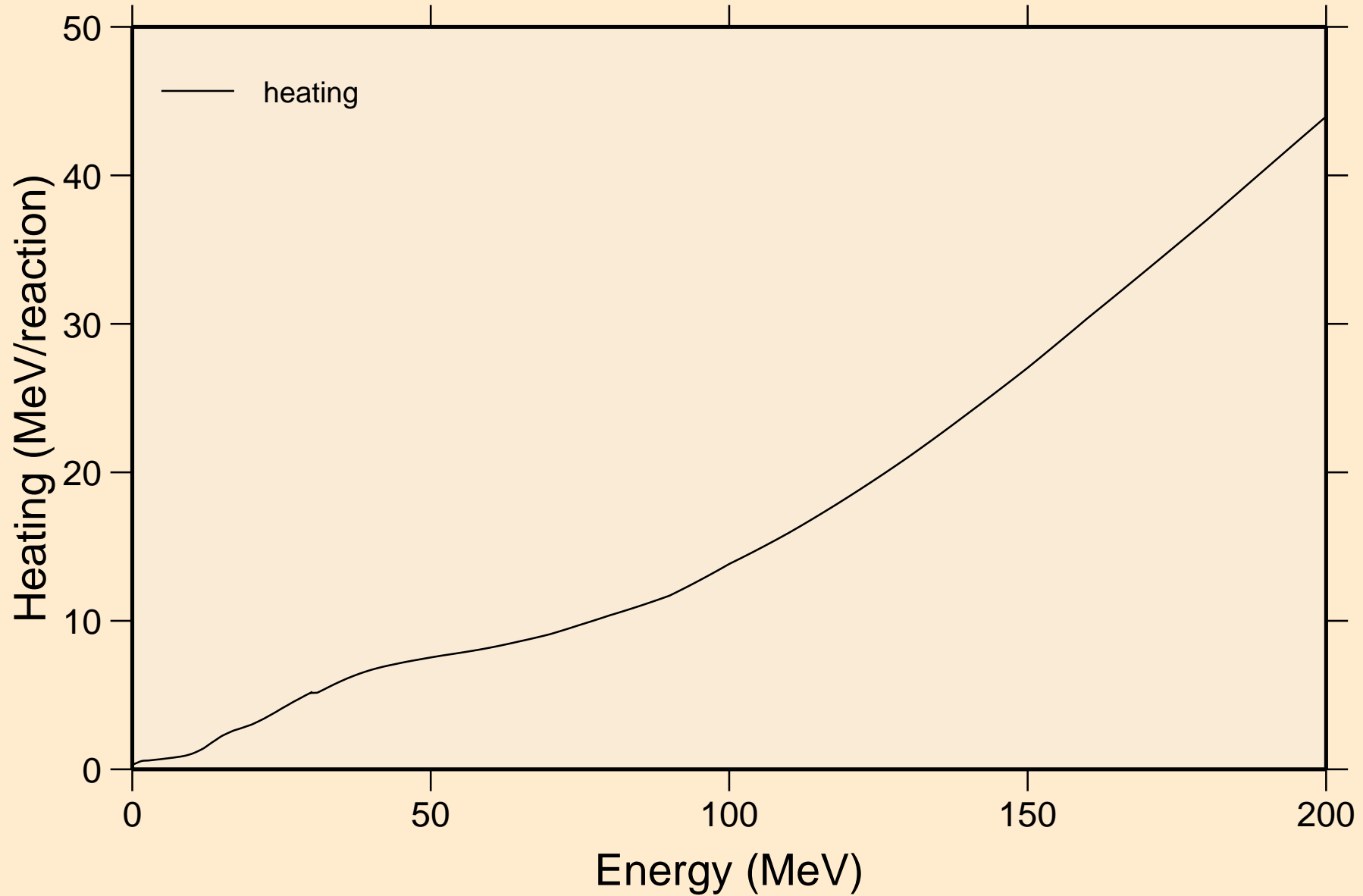

EU142M NEUTRON ACER TENDL-2024 LIBRARY; T=0.K
Damage

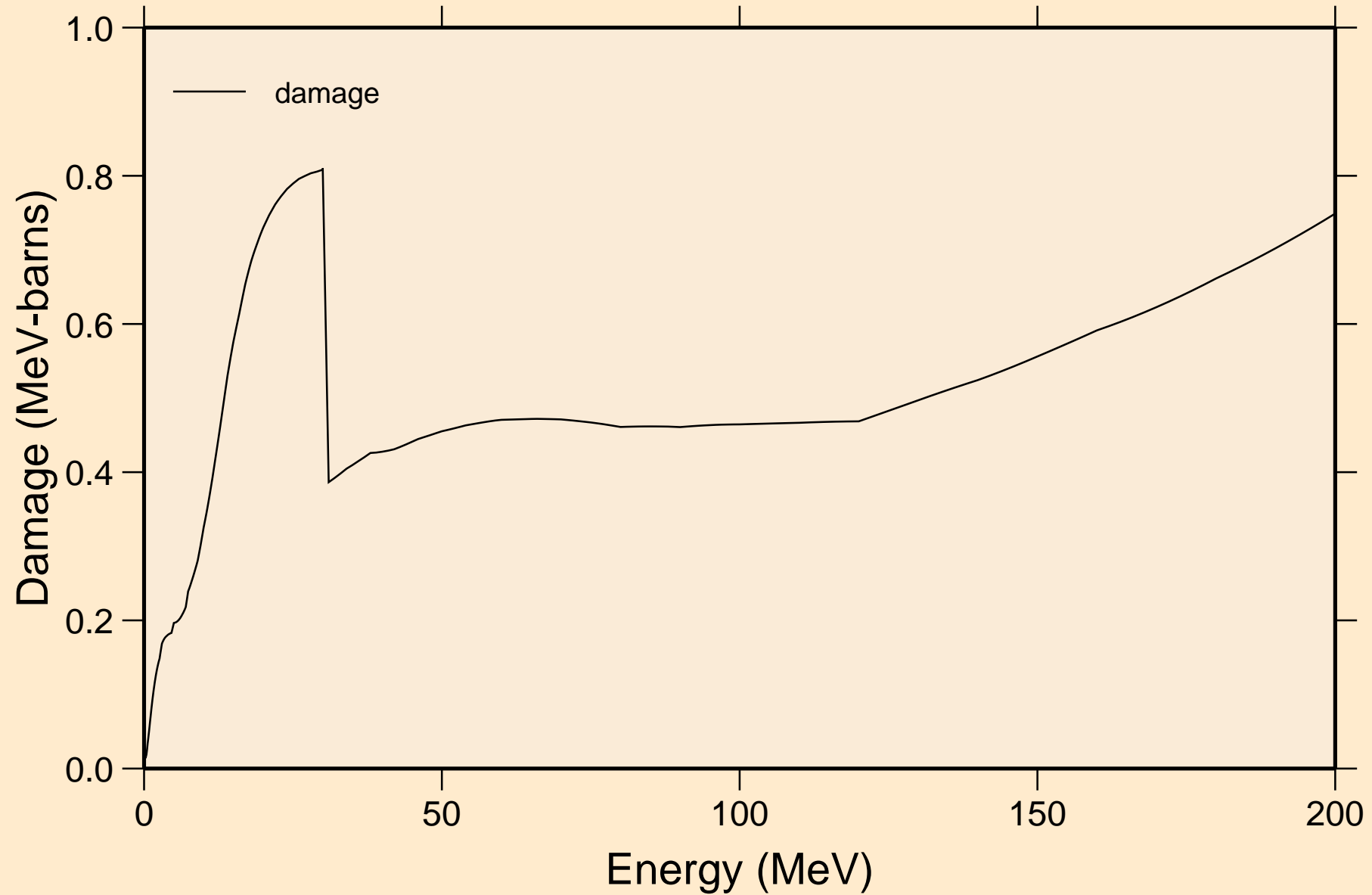

EU142M NEUTRON ACER TENDL-2024 LIBRARY; T=0.K

Non-threshold reactions

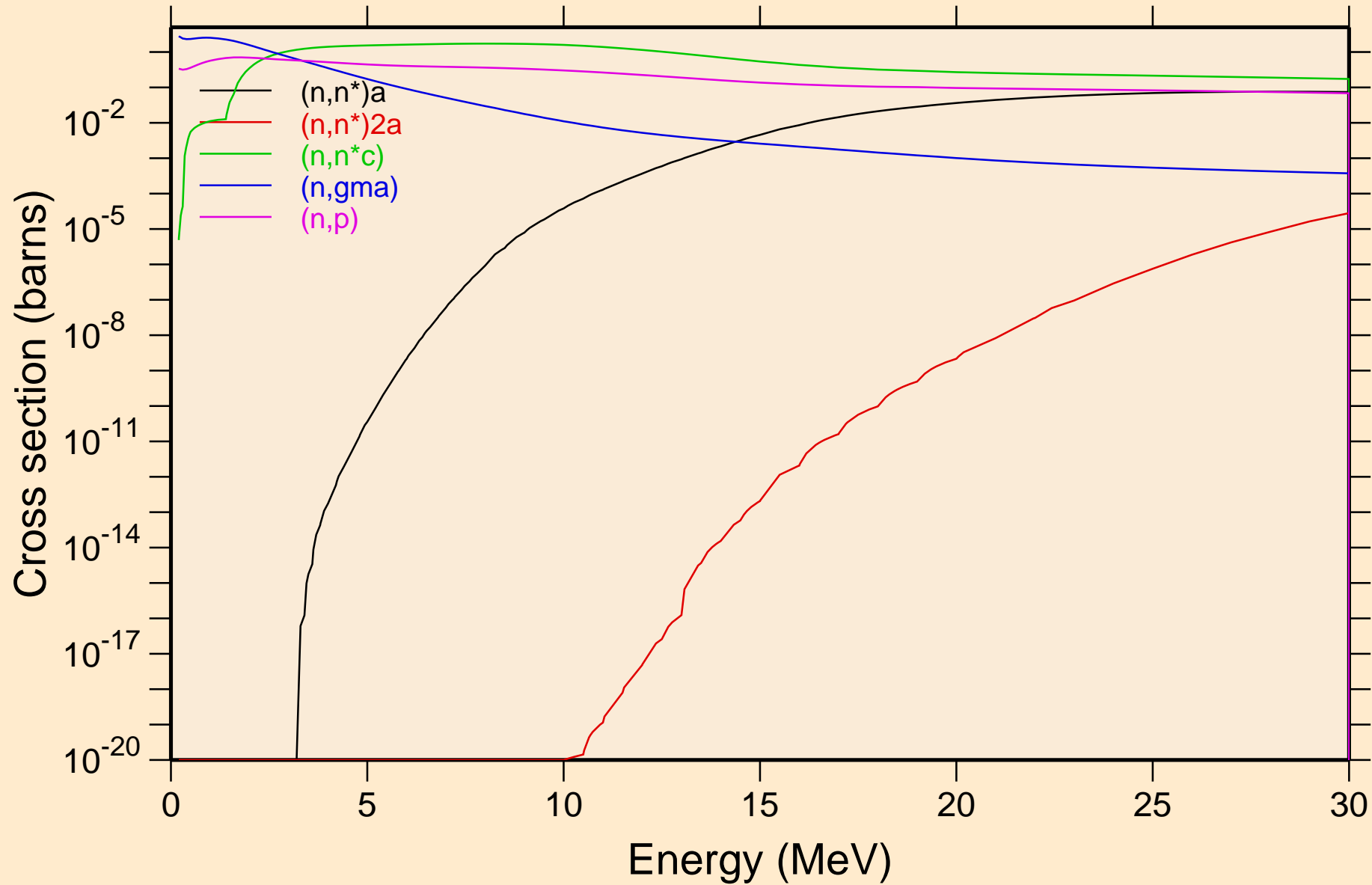

EU142M NEUTRON ACER TENDL-2024 LIBRARY; T=0.K

Non-threshold reactions

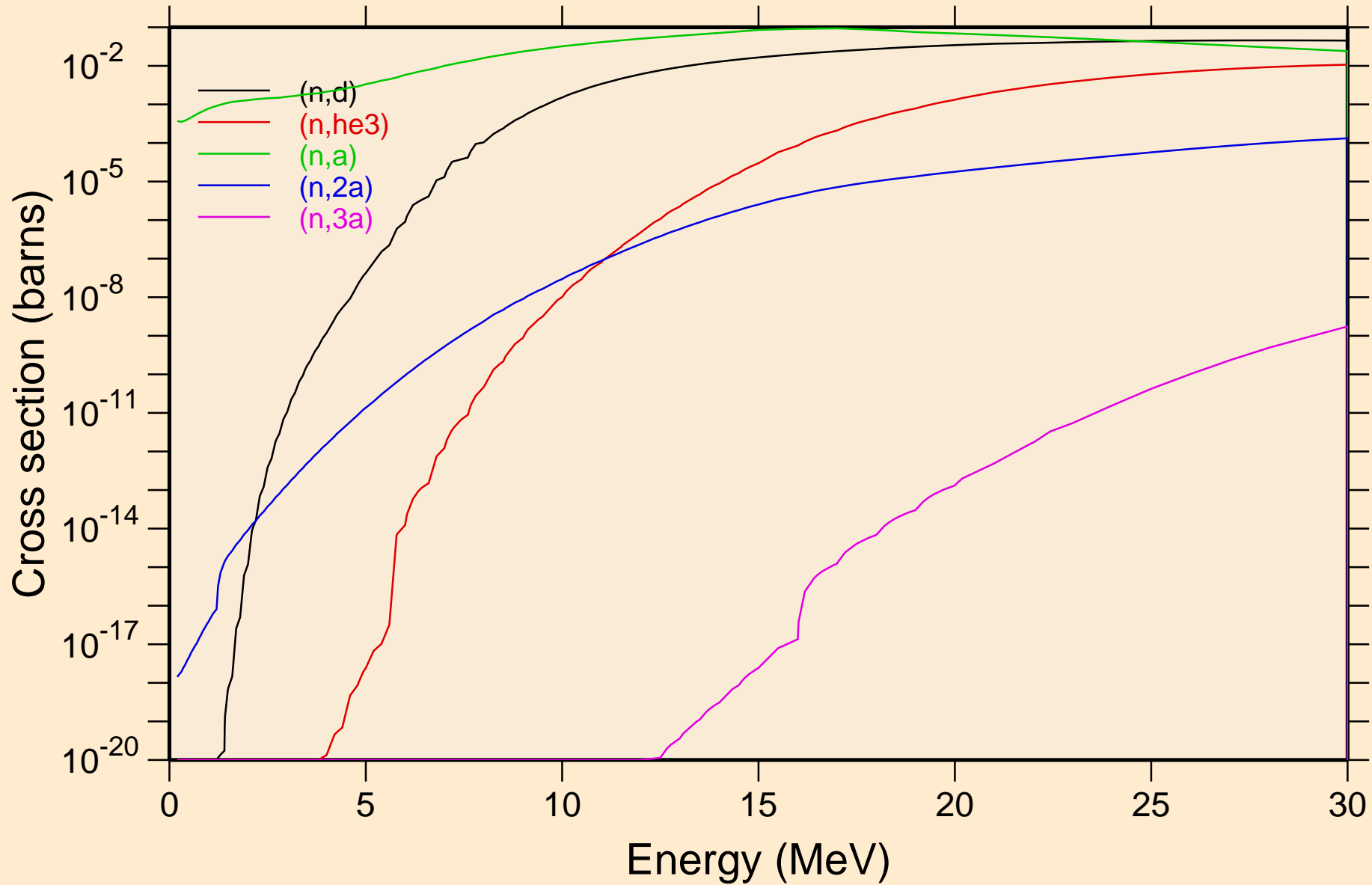

EU142M NEUTRON ACER TENDL-2024 LIBRARY; T=0.K

Non-threshold reactions

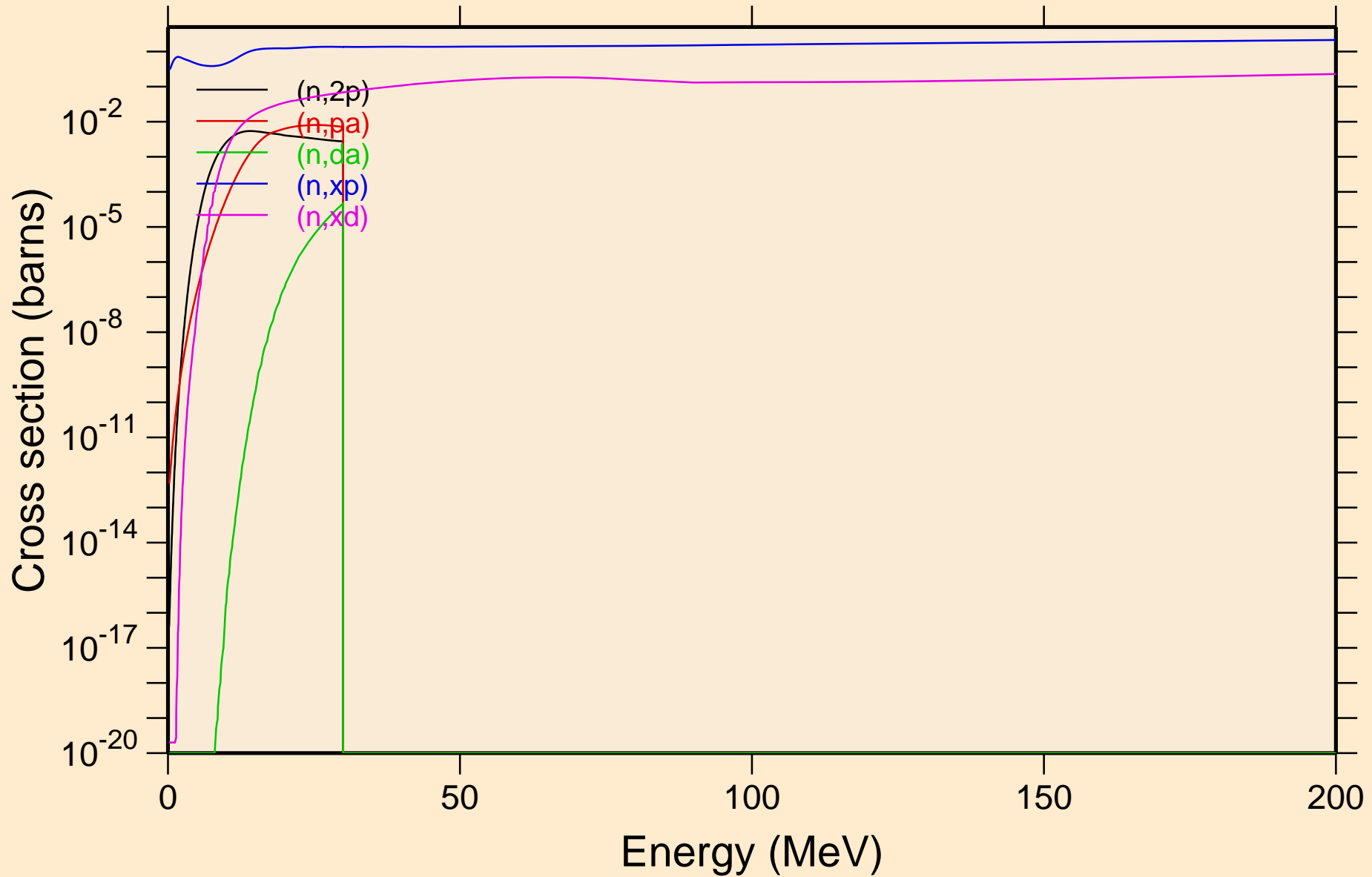

EU142M NEUTRON ACER TENDL-2024 LIBRARY; T=0.K
Non-threshold reactions

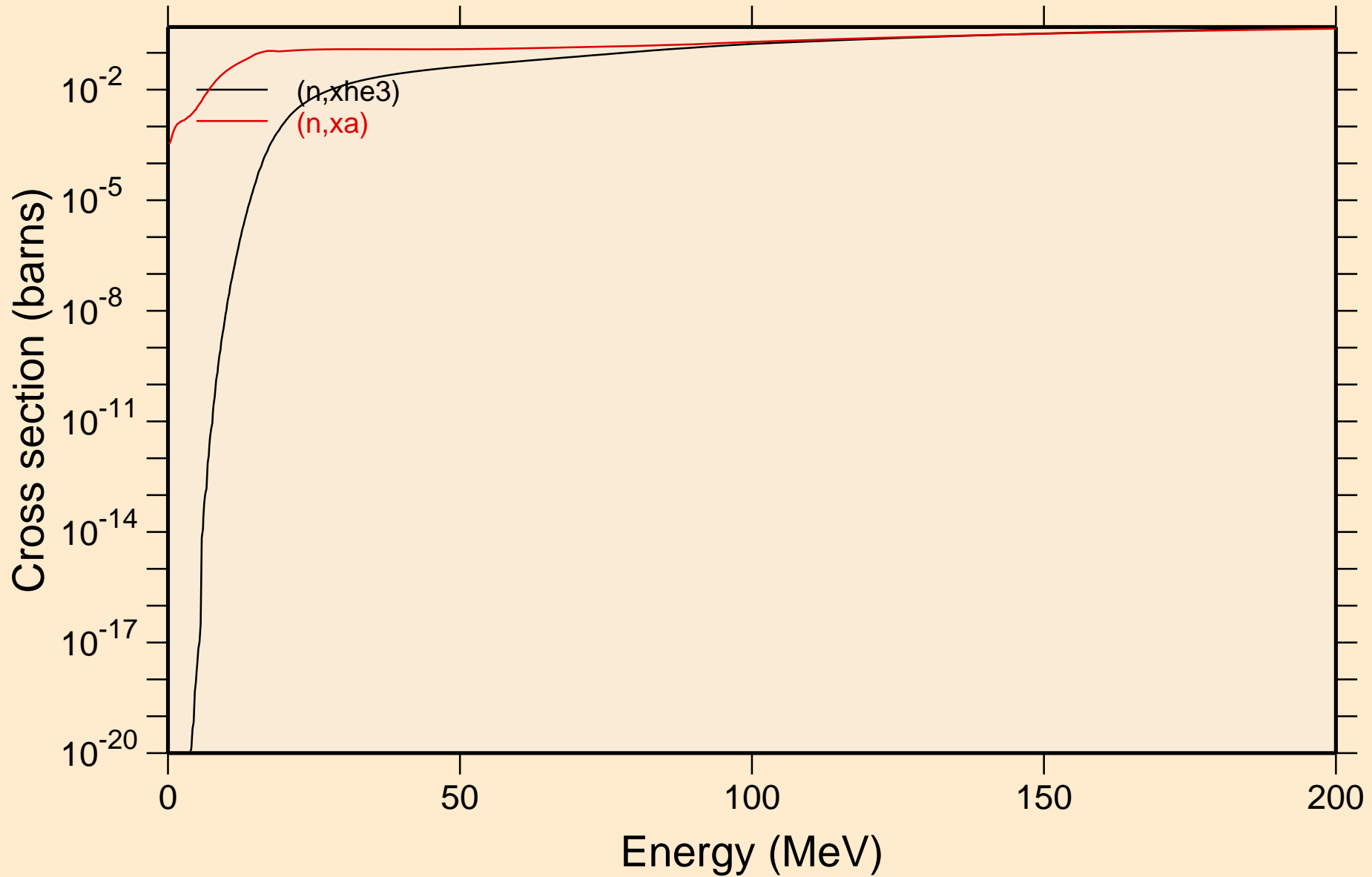

EU142M NEUTRON ACER TENDL-2024 LIBRARY; T=0.K
Inelastic levels

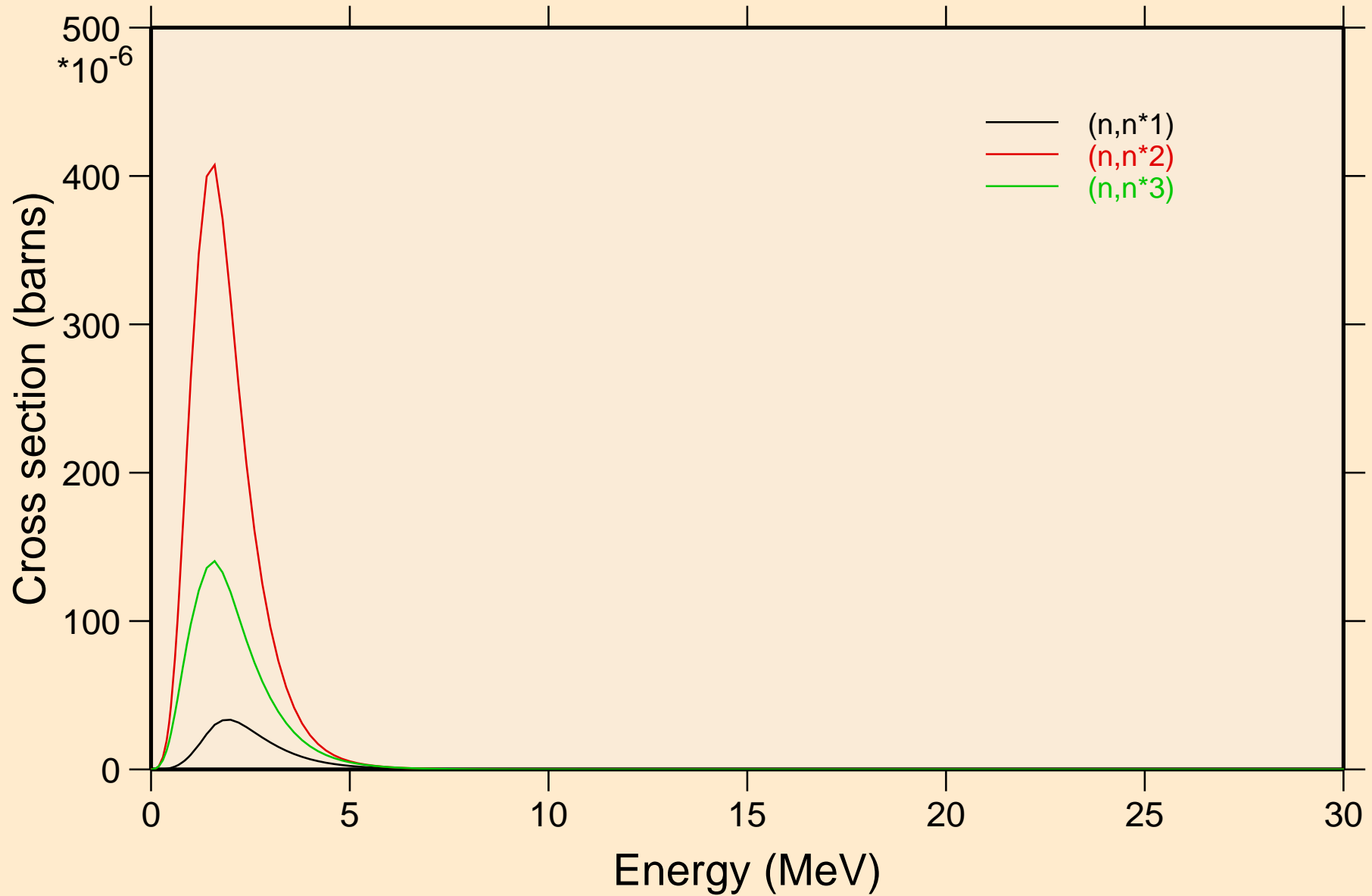

EU142M NEUTRON ACER TENDL-2024 LIBRARY; T=0.K

Threshold reactions

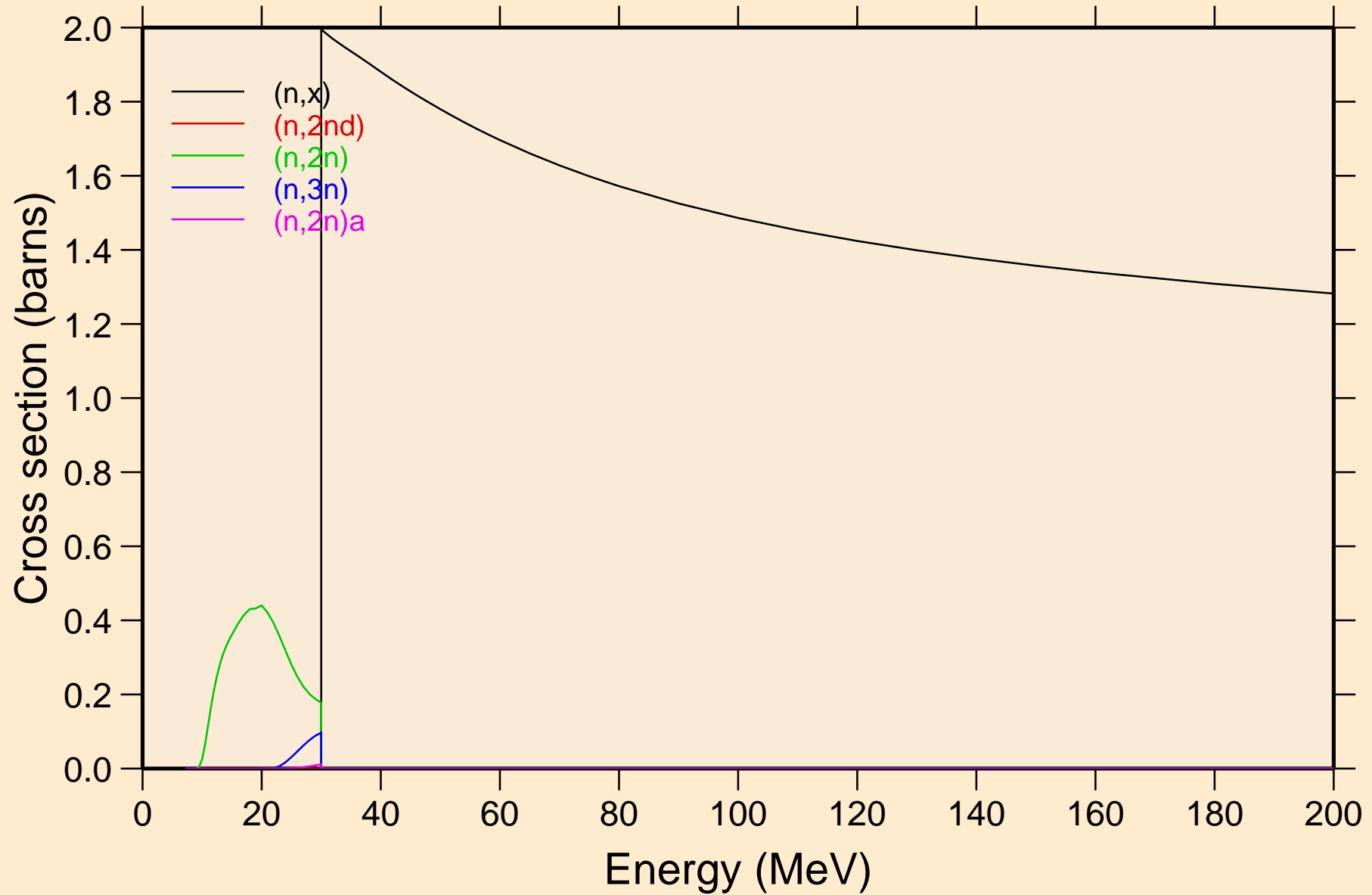

EU142M NEUTRON ACER TENDL-2024 LIBRARY; T=0.K

Threshold reactions

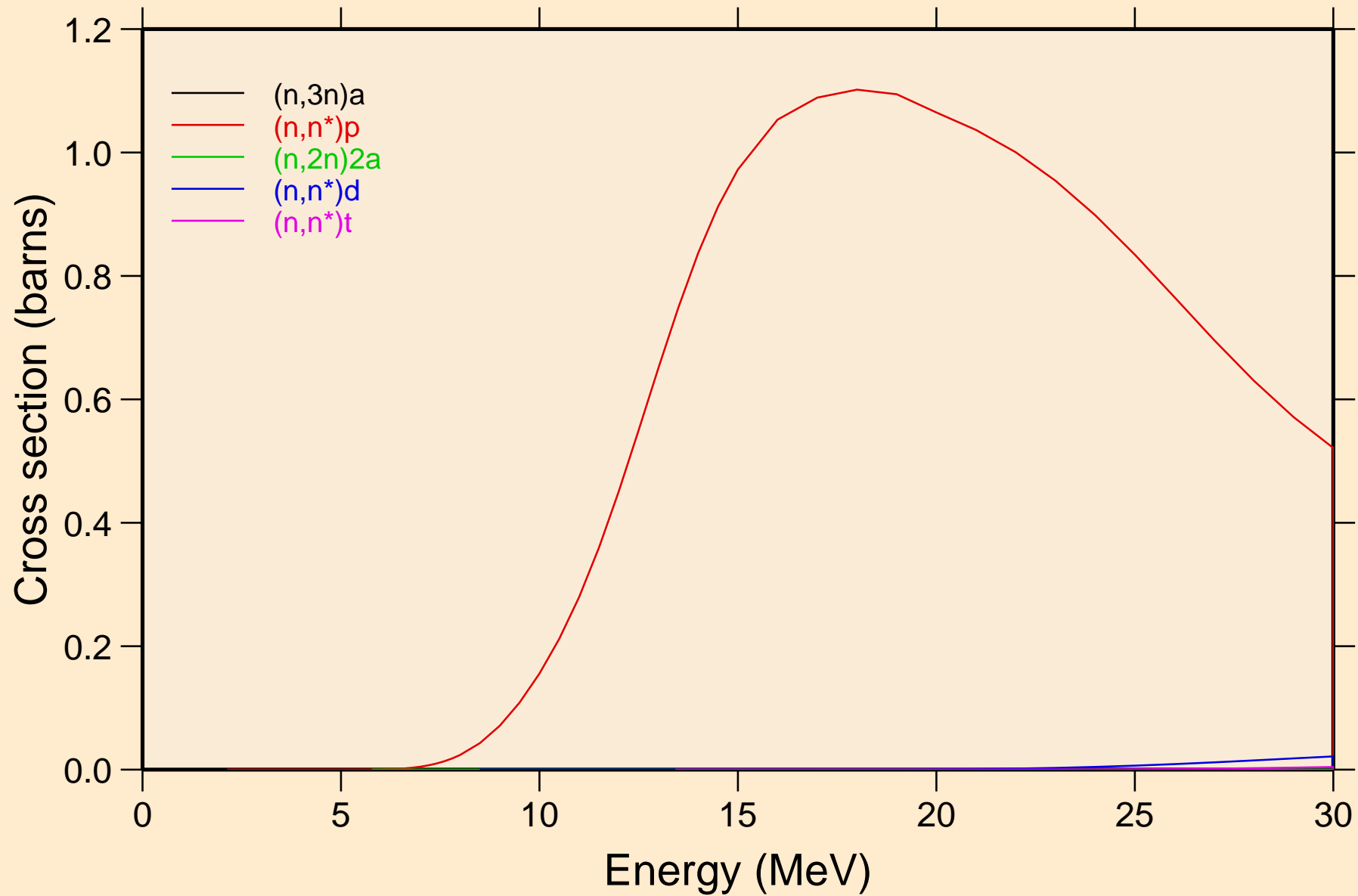

EU142M NEUTRON ACER TENDL-2024 LIBRARY; T=0.K
Threshold reactions

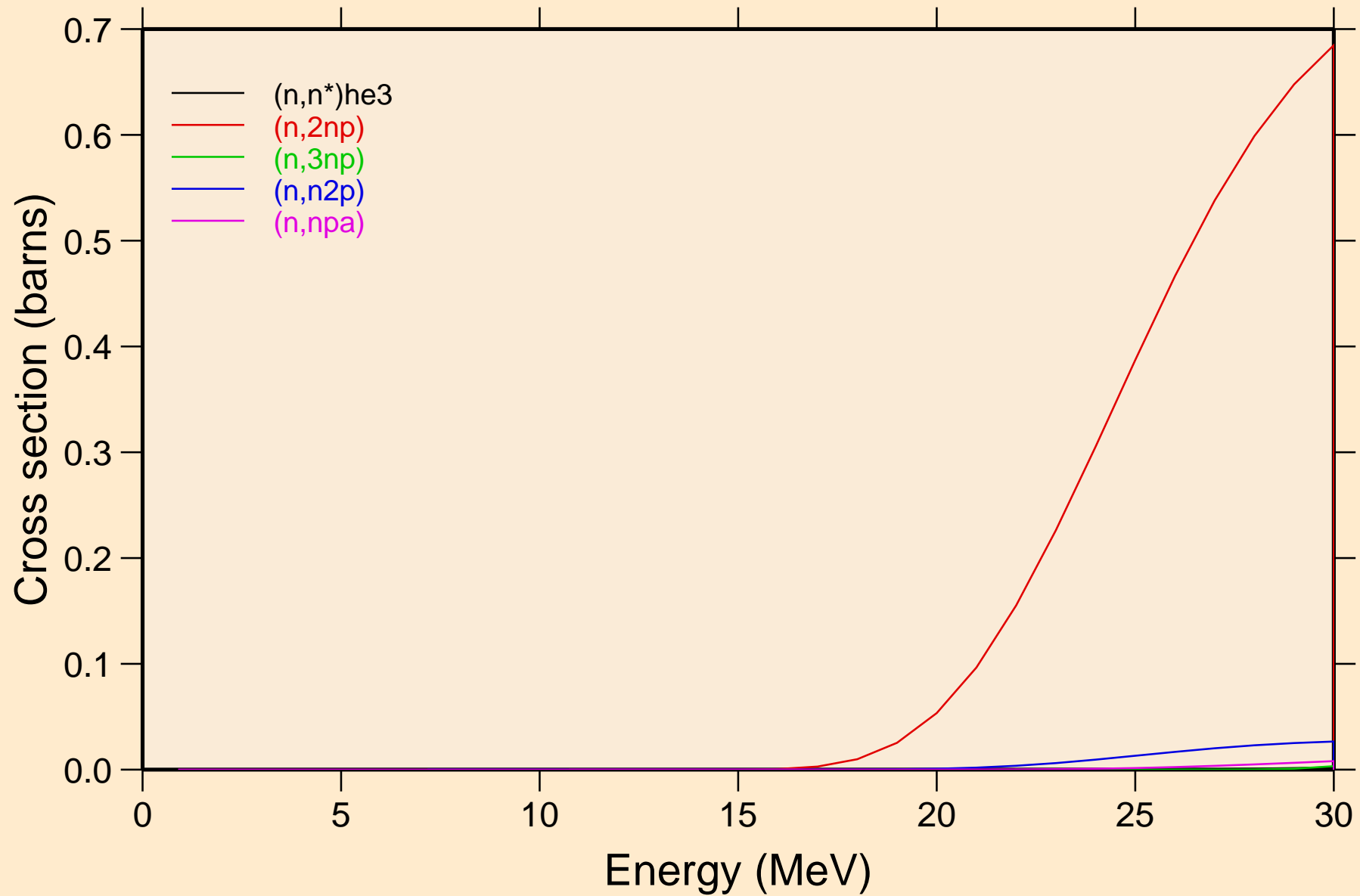

EU142M NEUTRON ACER TENDL-2024 LIBRARY; T=0.K
Threshold reactions

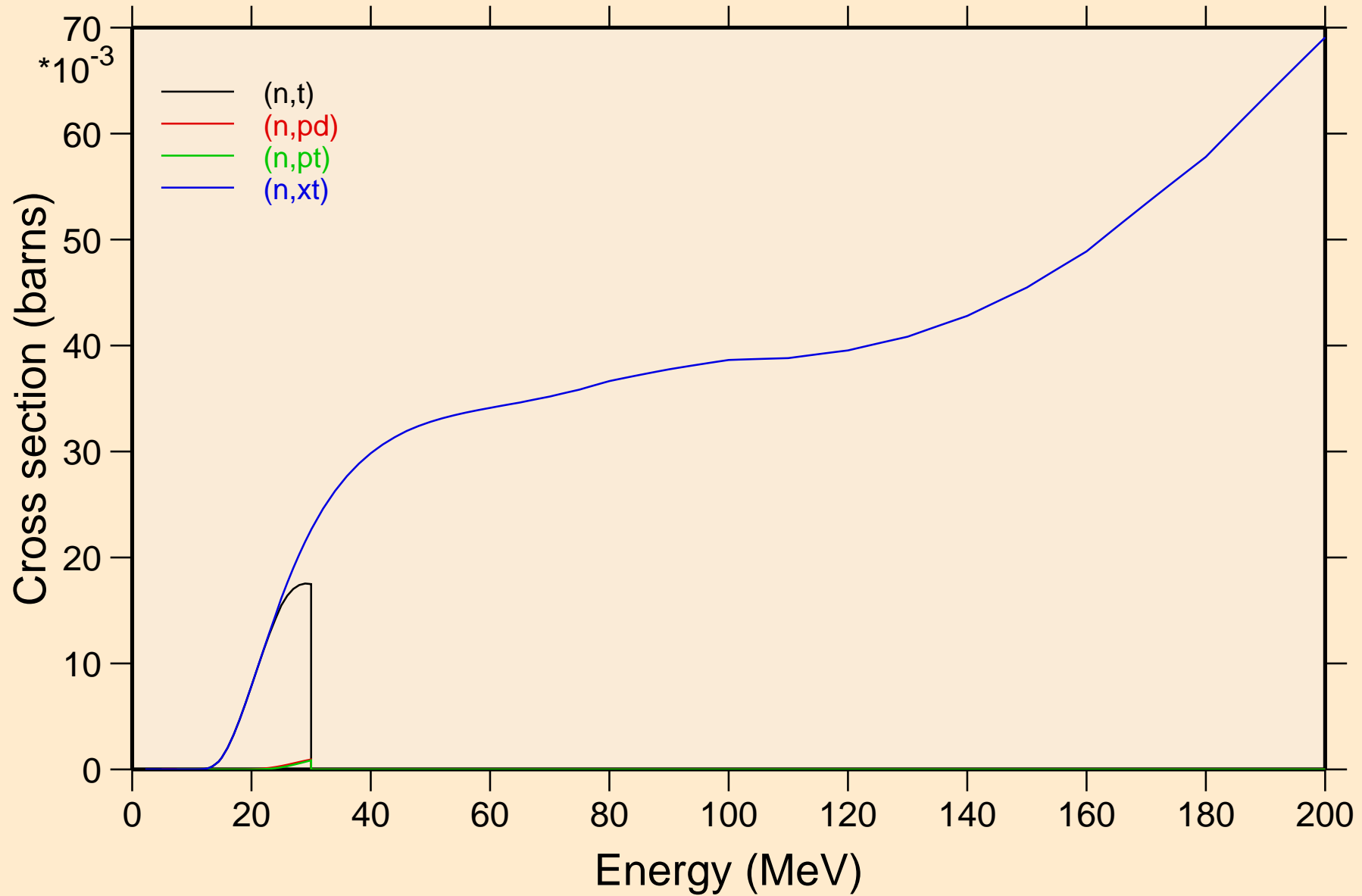

EU142M NEUTRON ACER TENDL-2024 LIBRARY; T=0.K
angular distribution for elastic

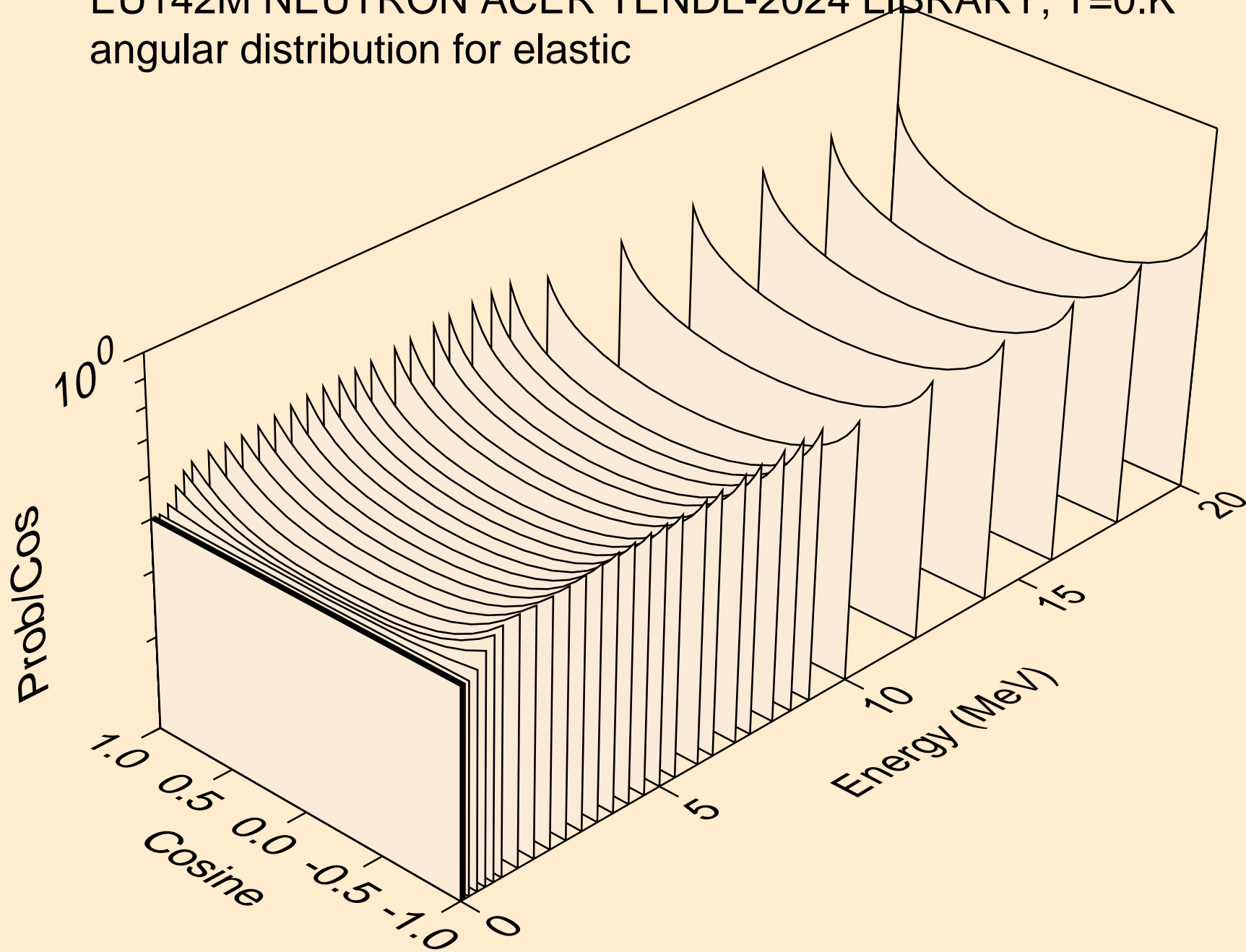

EU142M NEUTRON ACER TENDL-2024 LIBRARY; T=0.K
angular distribution for elastic

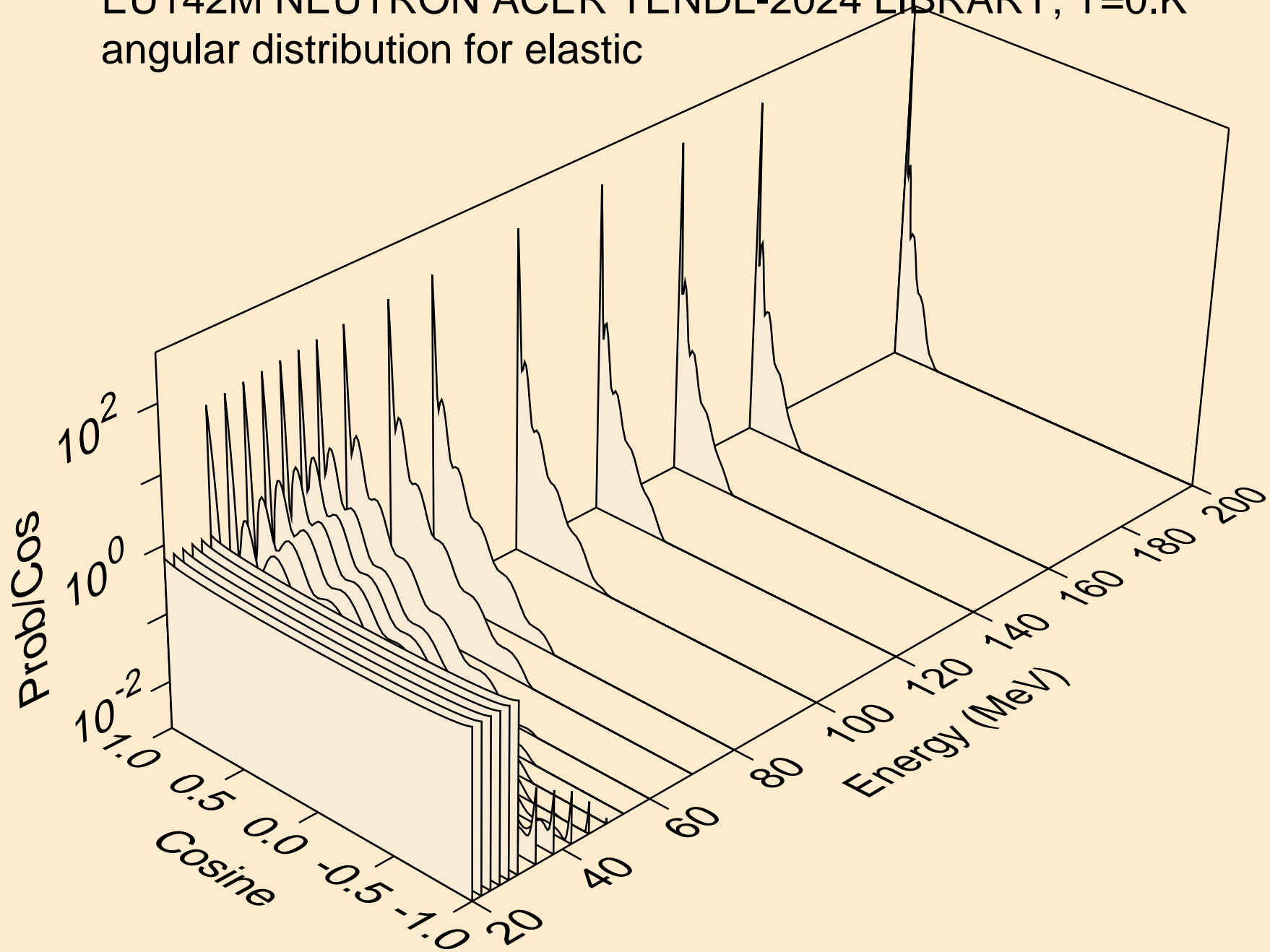

EU142M NEUTRON ACER TENDL-2024 LIBRARY; T=0.K
angular distribution for (n,n*1)

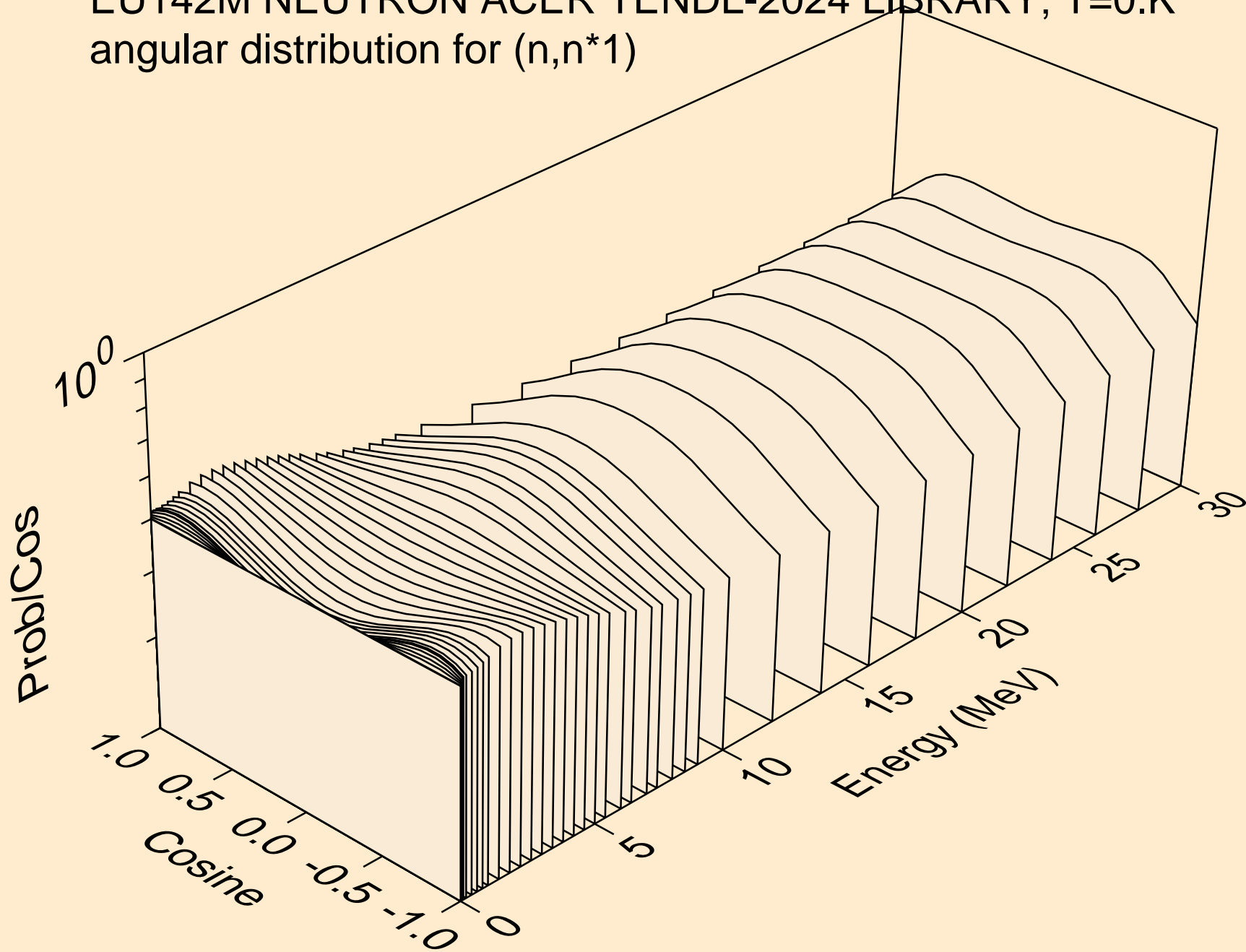

EU142M NEUTRON ACER TENDL-2024 LIBRARY; T=0.K
angular distribution for (n,n*2)

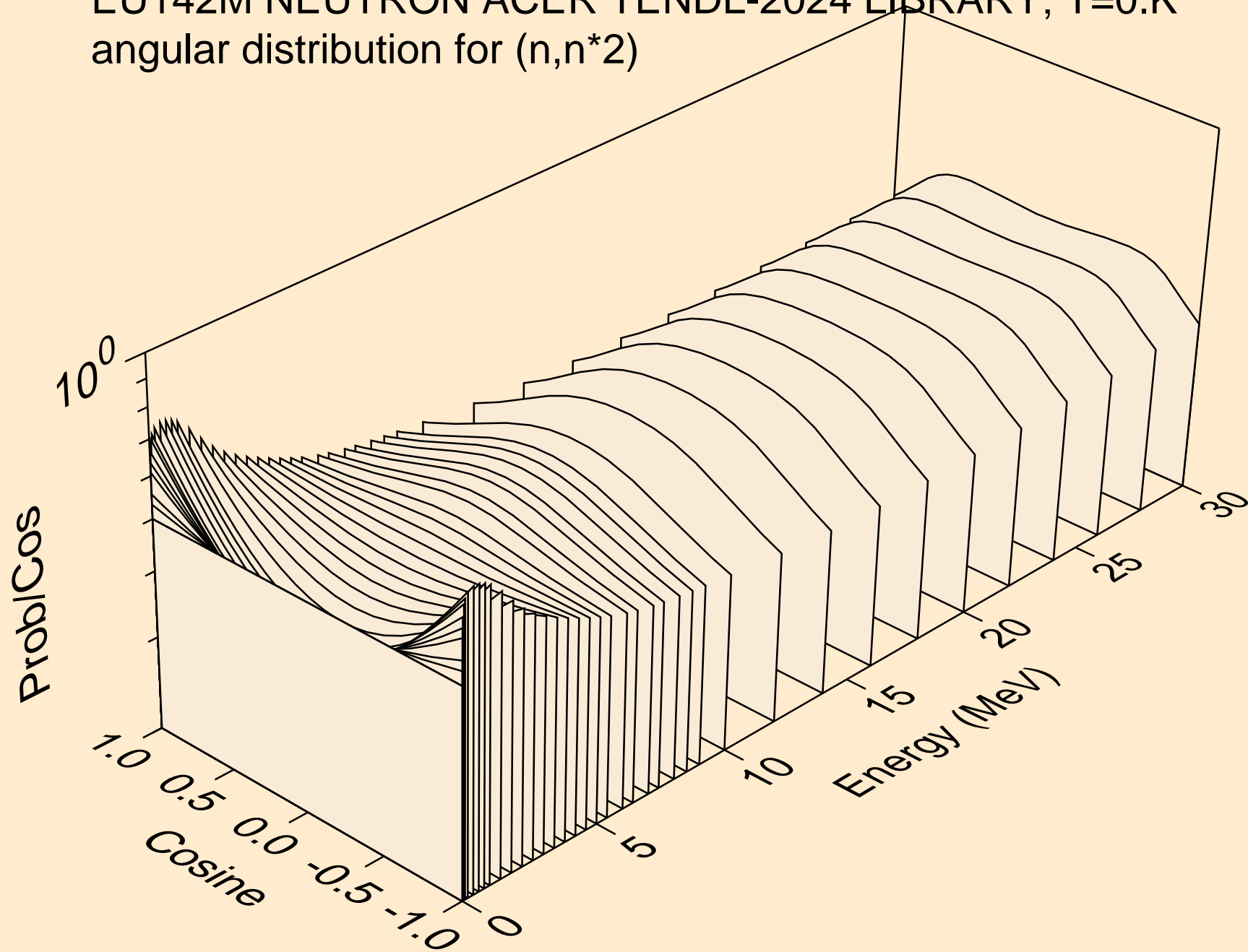

EU142M NEUTRON ACER TENDL-2024 LIBRARY; T=0.K
angular distribution for (n,n*3)

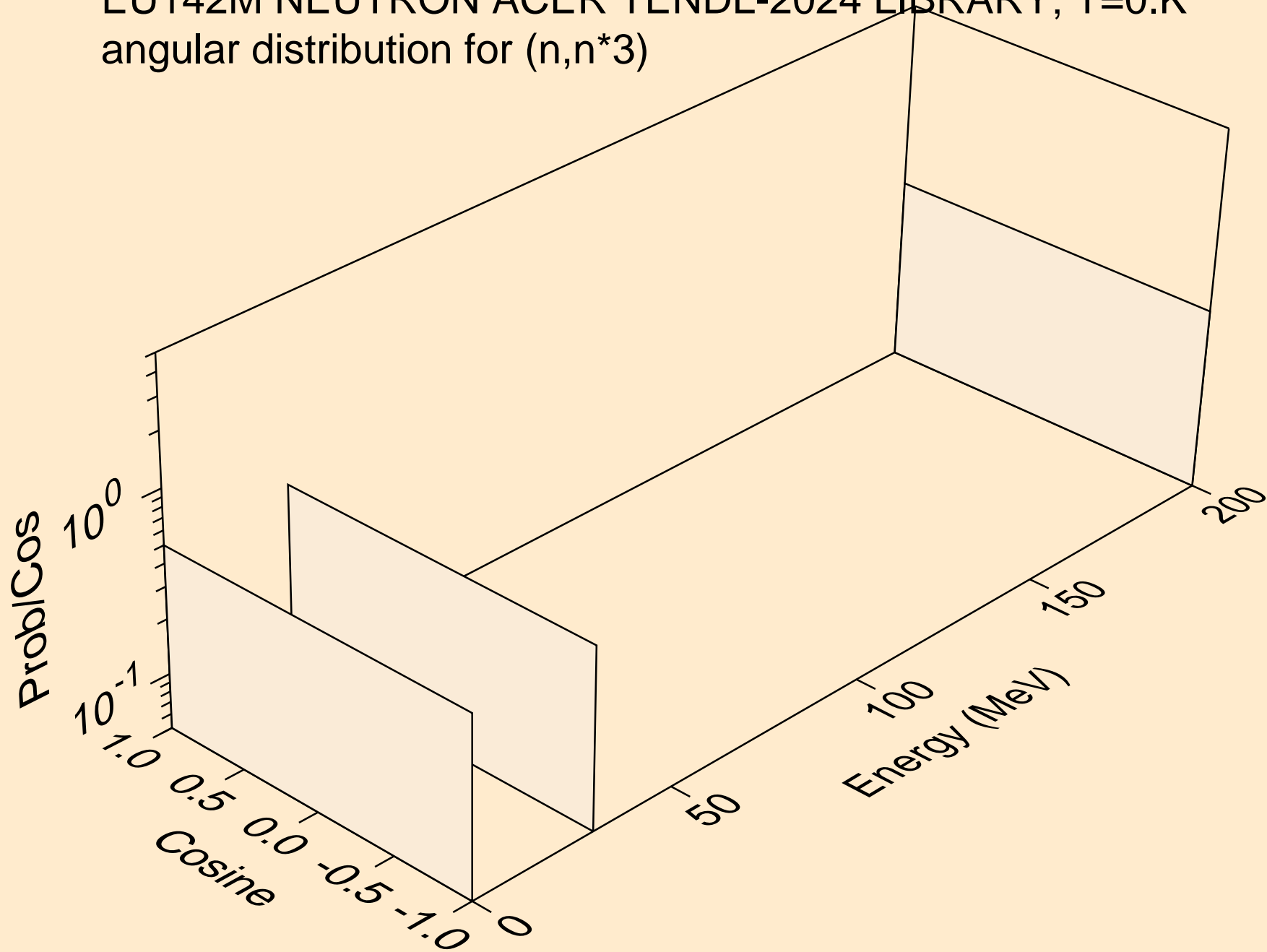

EU142M NEUTRON ACER TENDL-2024 LIBRARY; T=0.K
Neutron emission for (n,x)

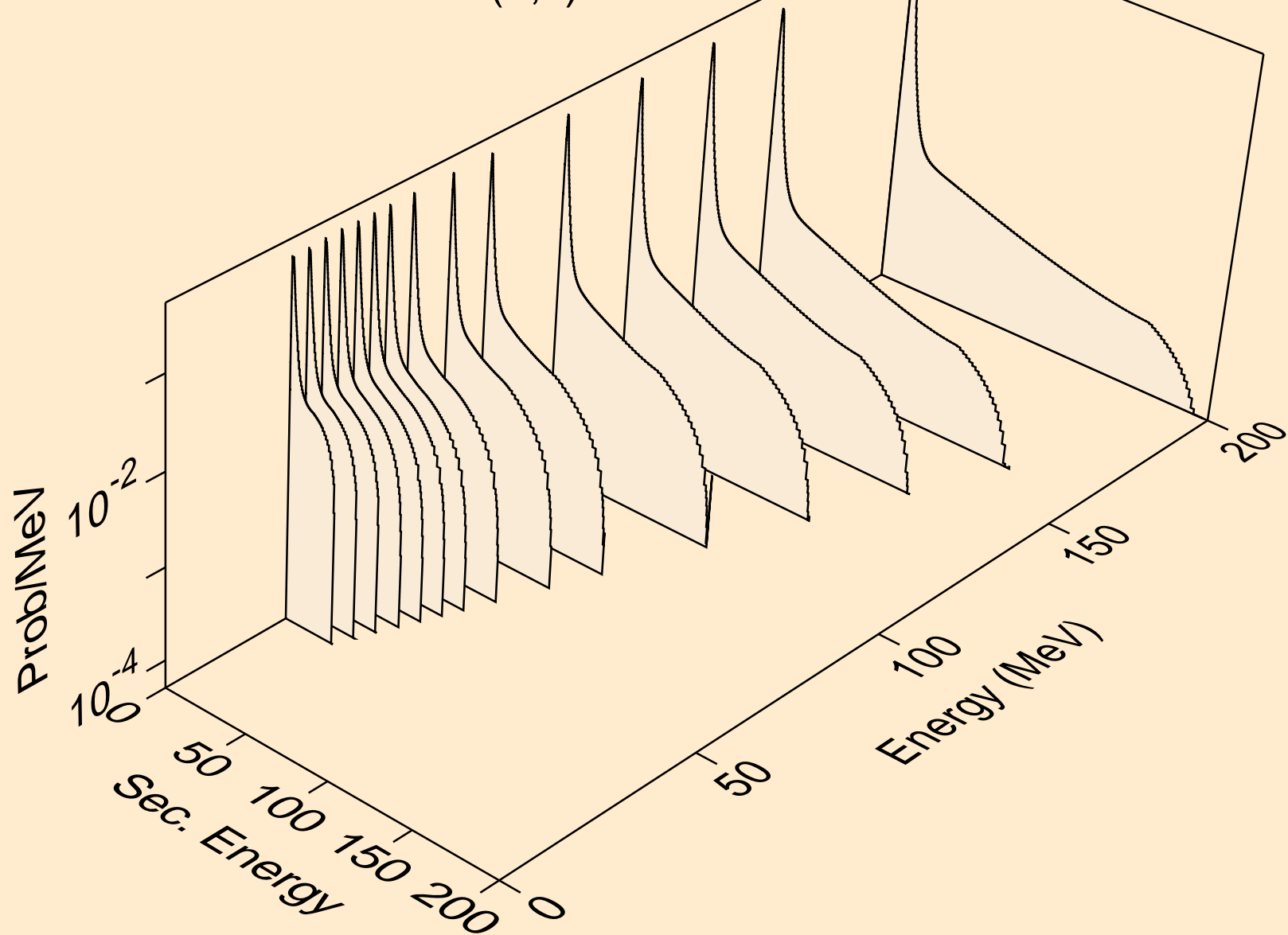

EU142M NEUTRON ACER TENDL-2024 LIBRARY; T=0.K
Neutron emission for (n,2nd)

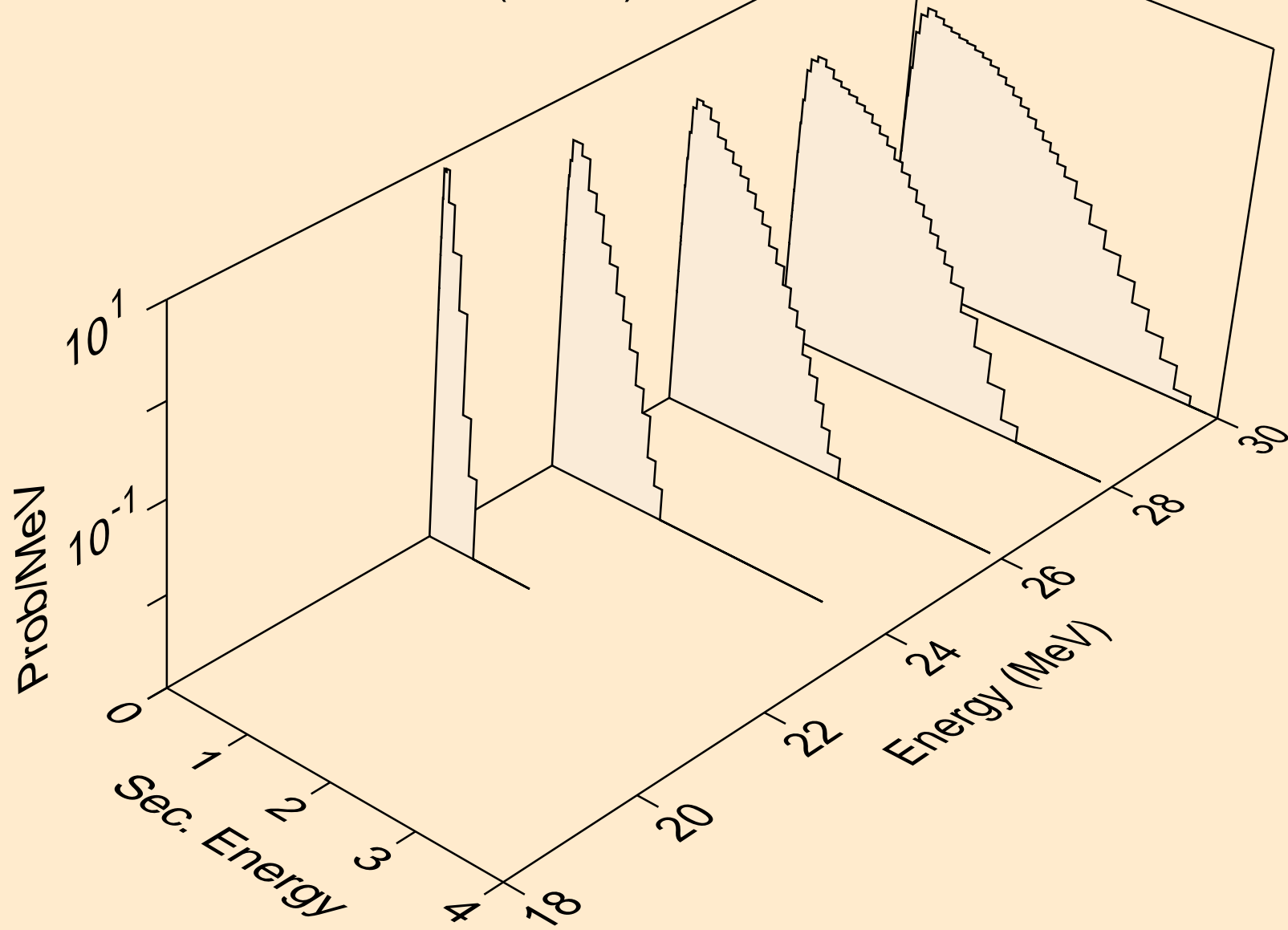

EU142M NEUTRON ACER TENDL-2024 LIBRARY; T=0.K
Neutron emission for (n,2n)

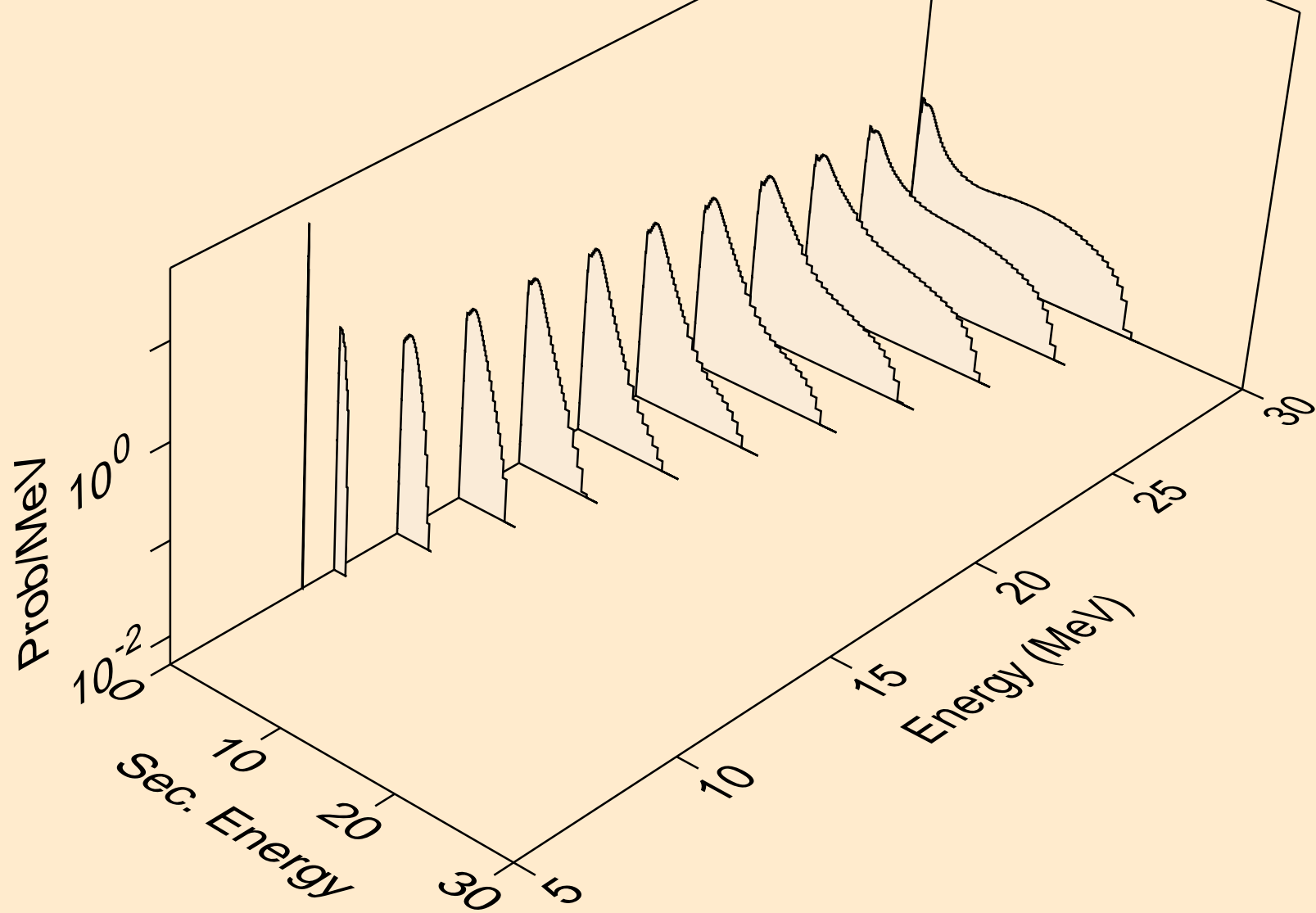

EU142M NEUTRON ACER TENDL-2024 LIBRARY; T=0.K
Neutron emission for (n,3n)

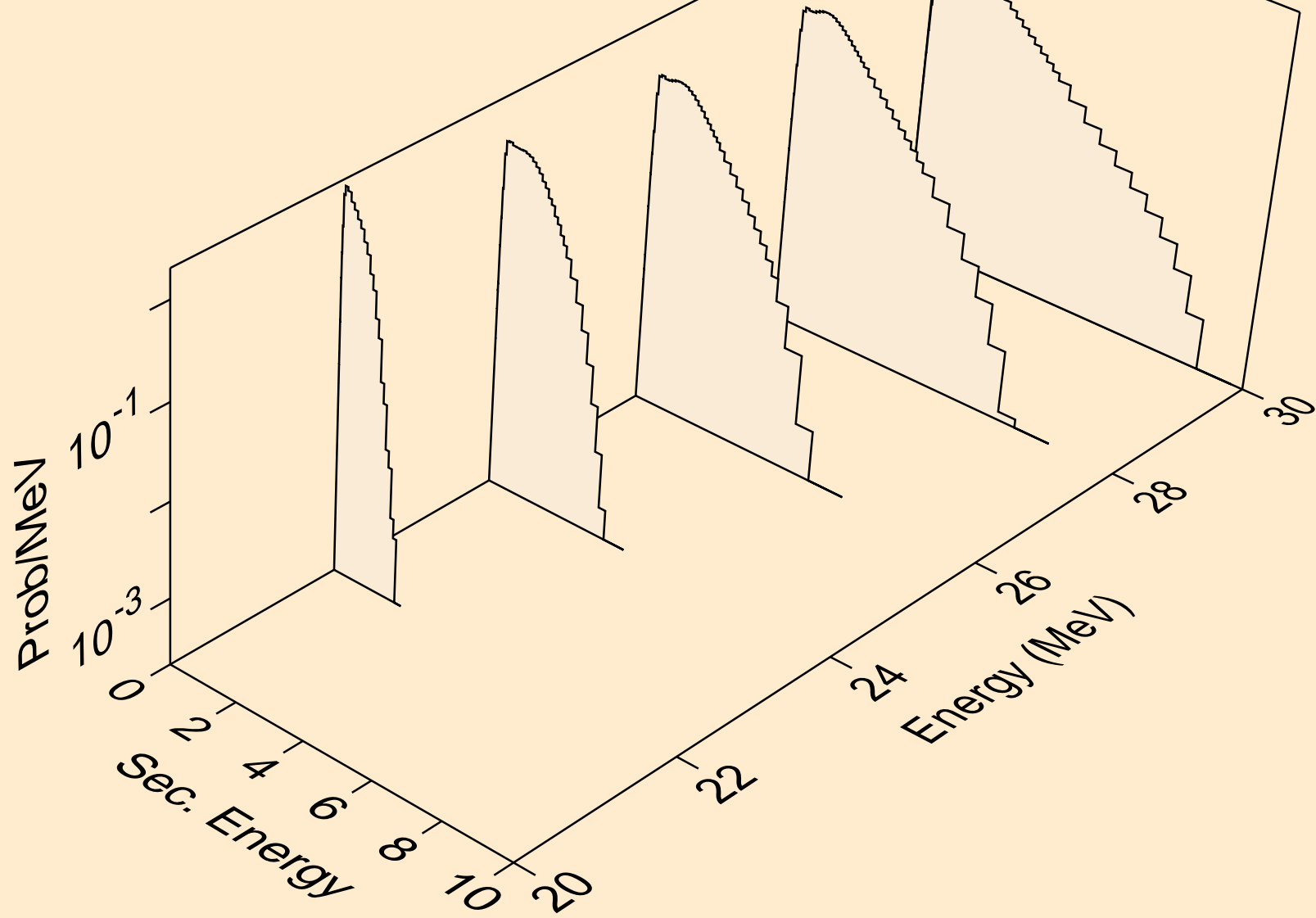

EU142M NEUTRON ACER TENDL-2024 LIBRARY; T=0.K
Neutron emission for (n,n*)a

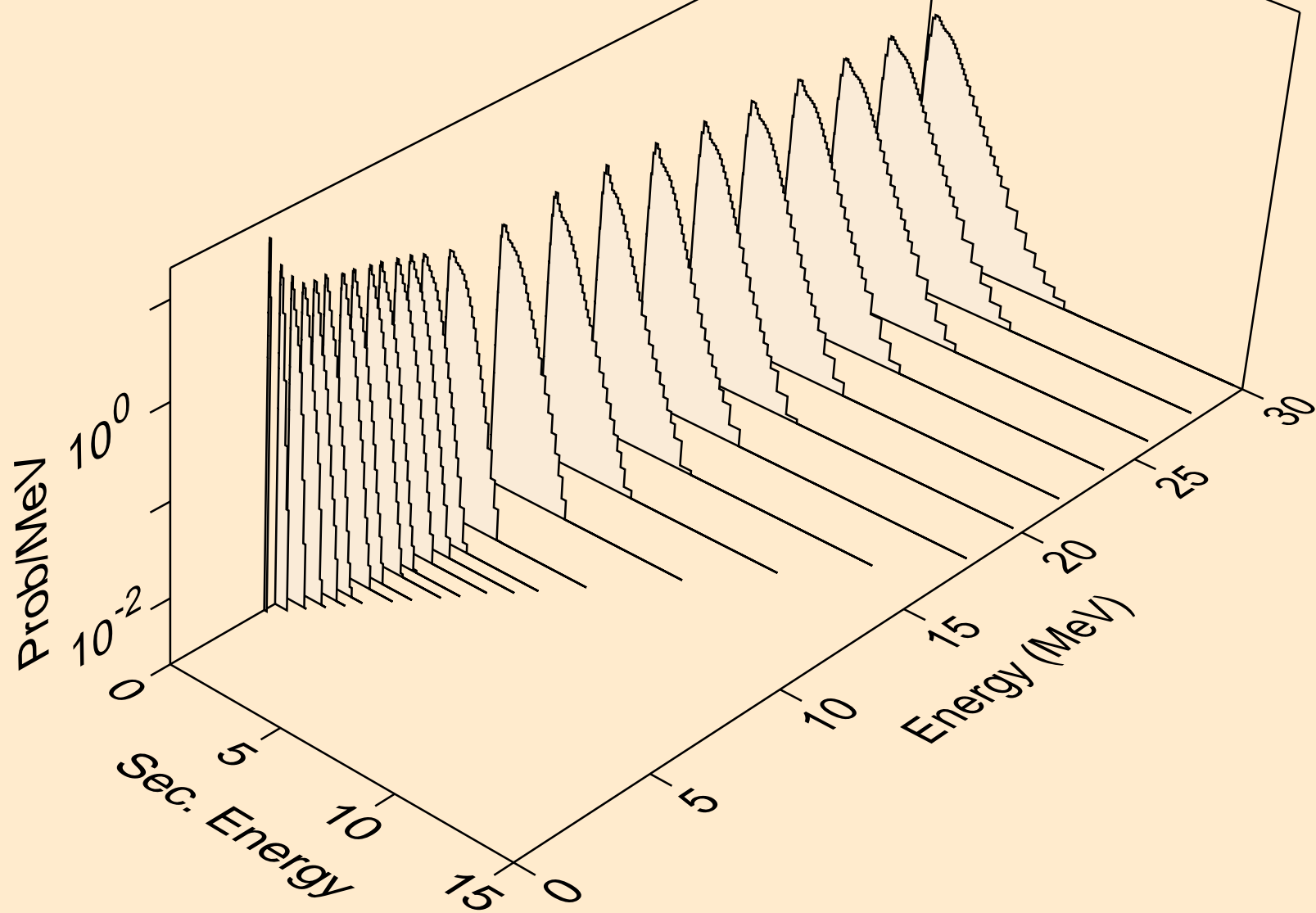

EU142M NEUTRON ACER TENDL-2024 LIBRARY; T=0.K
Neutron emission for (n,2n)a

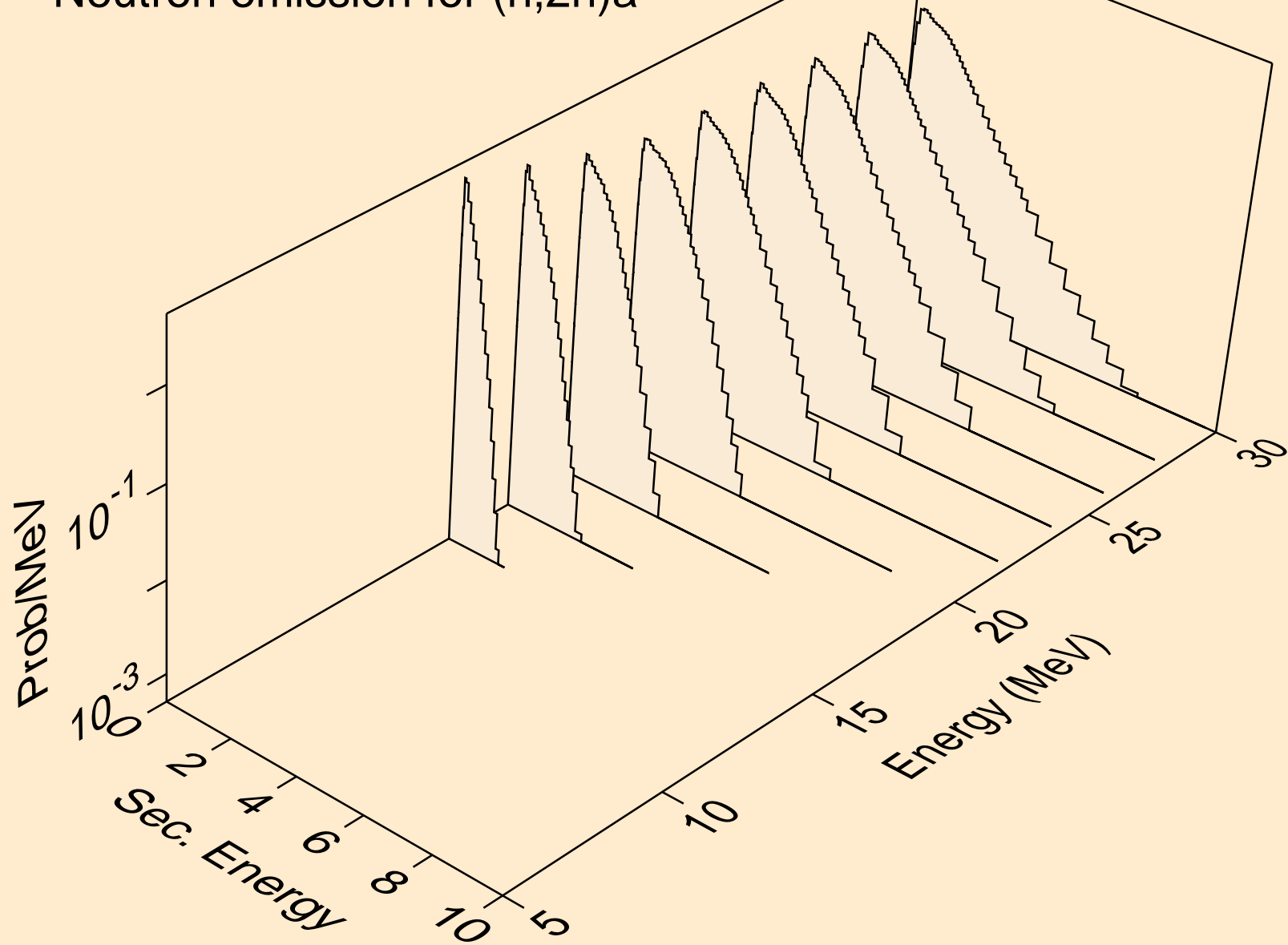

EU142M NEUTRON ACER TENDL-2024 LIBRARY; T=0.K
Neutron emission for (n,3n)a

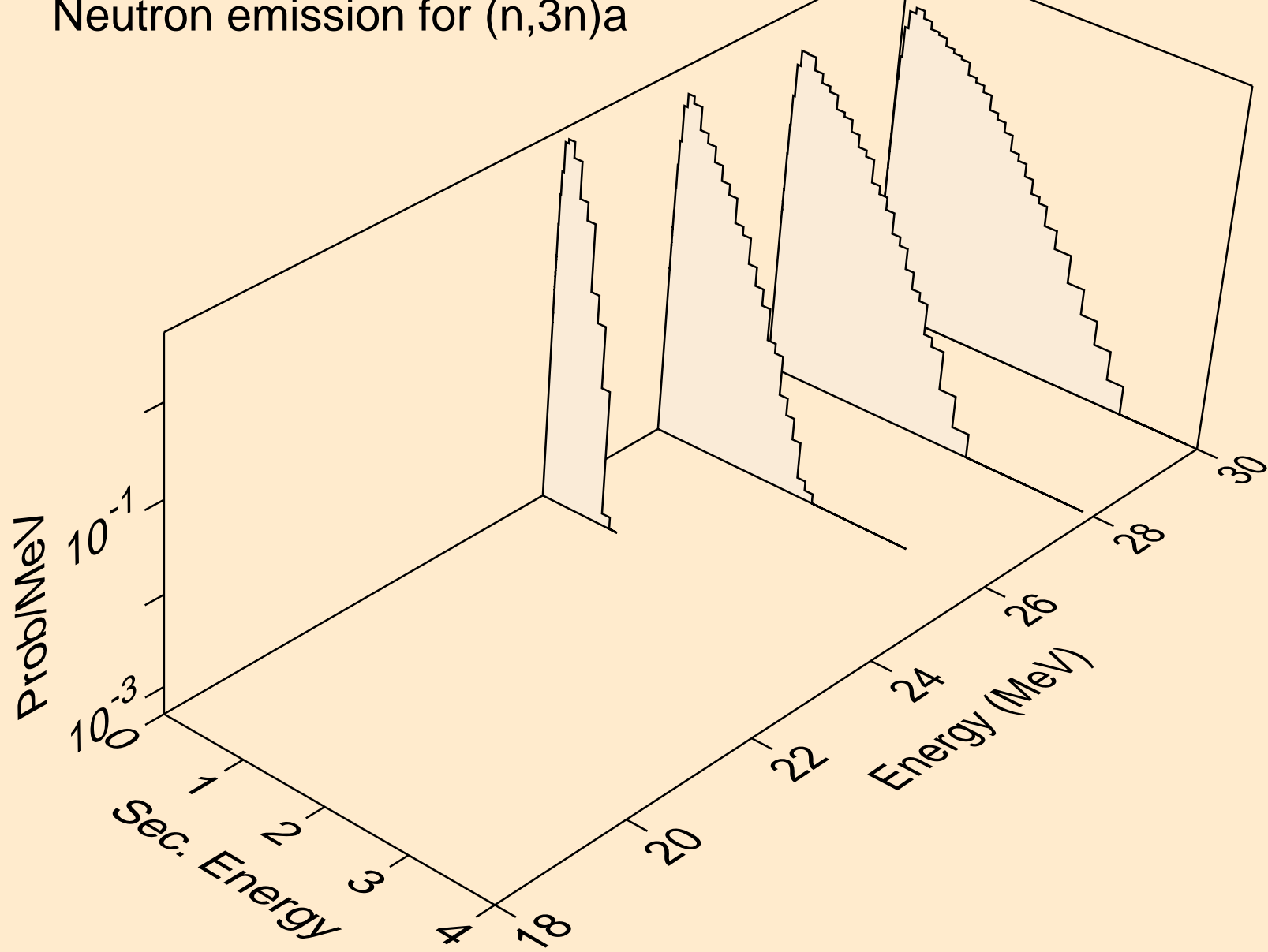

EU142M NEUTRON ACER TENDL-2024 LIBRARY; T=0.K
Neutron emission for (n,n*)p

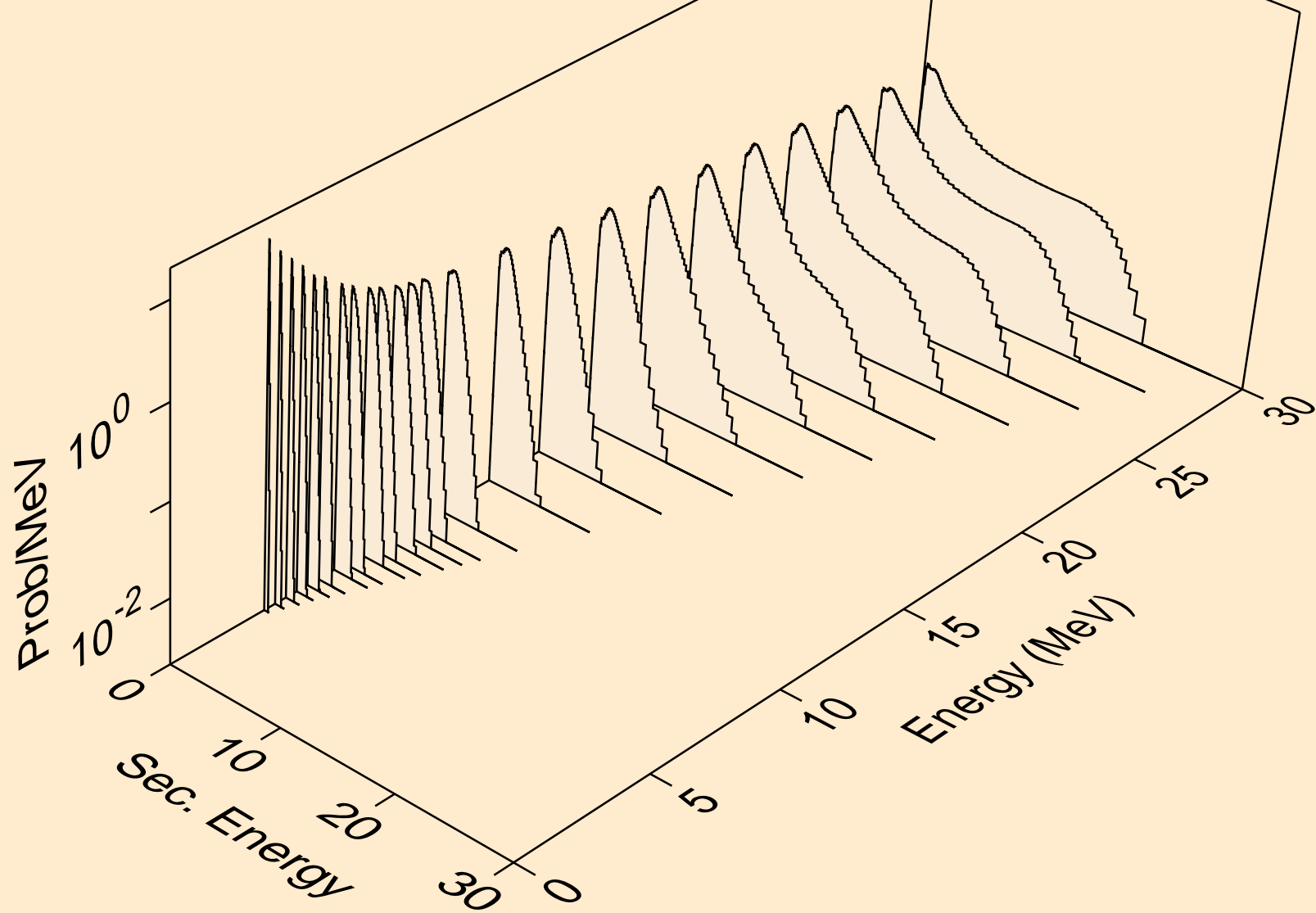

EU142M NEUTRON ACER TENDL-2024 LIBRARY; T=0.K
Neutron emission for (n,n*)2a

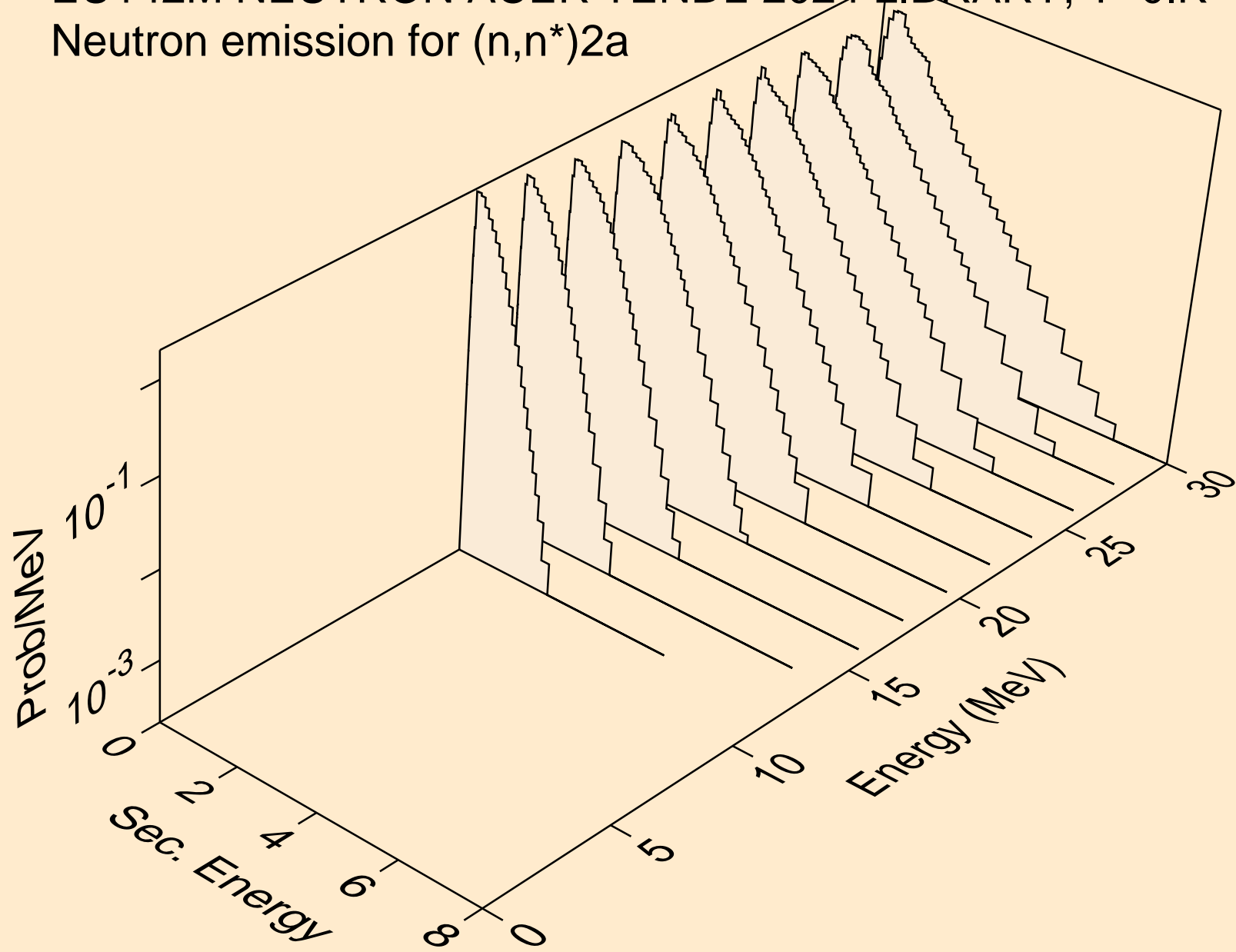

EU142M NEUTRON ACER TENDL-2024 LIBRARY; T=0.K
Neutron emission for (n,2n)2a

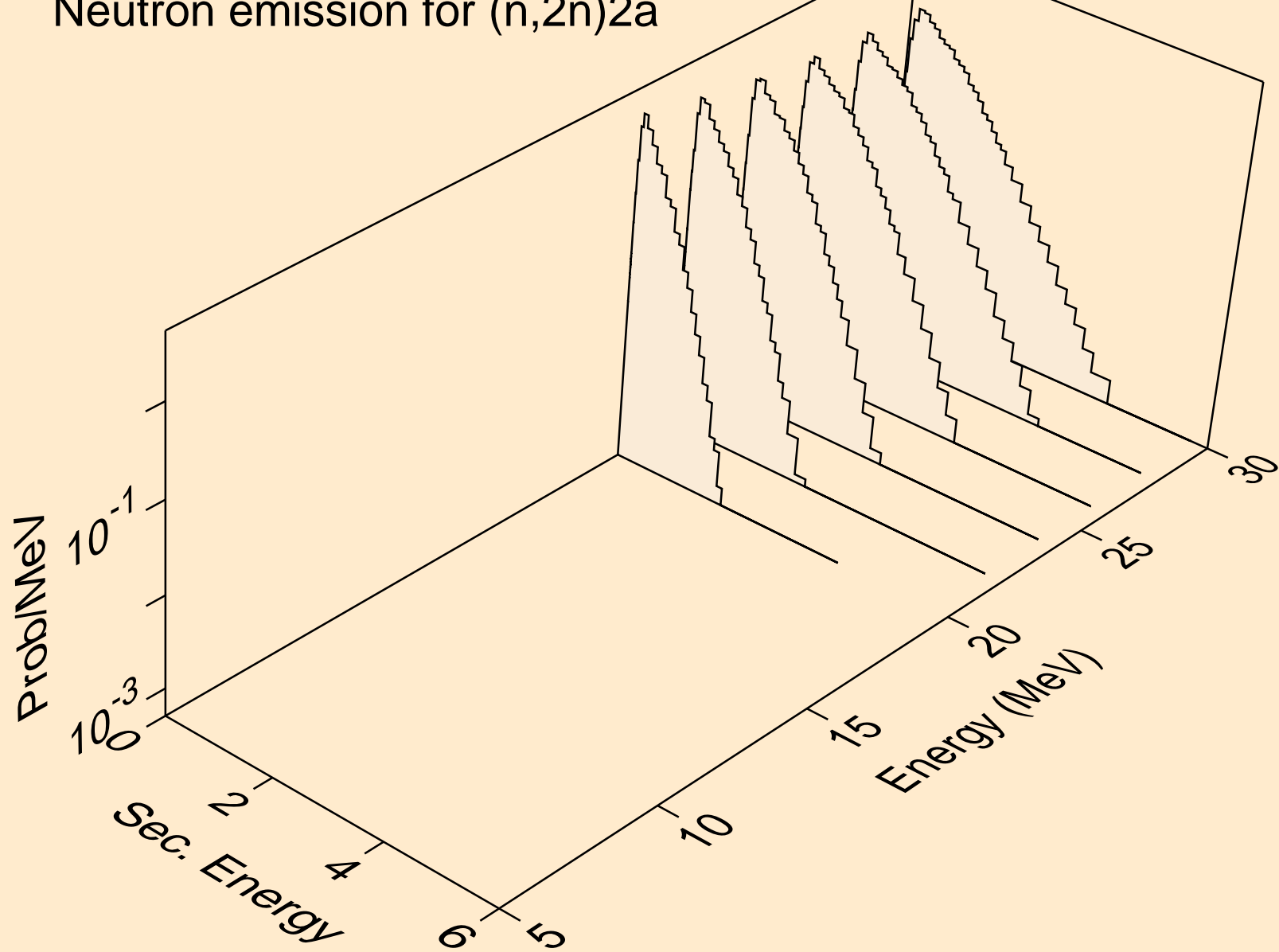

EU142M NEUTRON ACER TENDL-2024 LIBRARY; T=0.K
Neutron emission for (n,n*)d

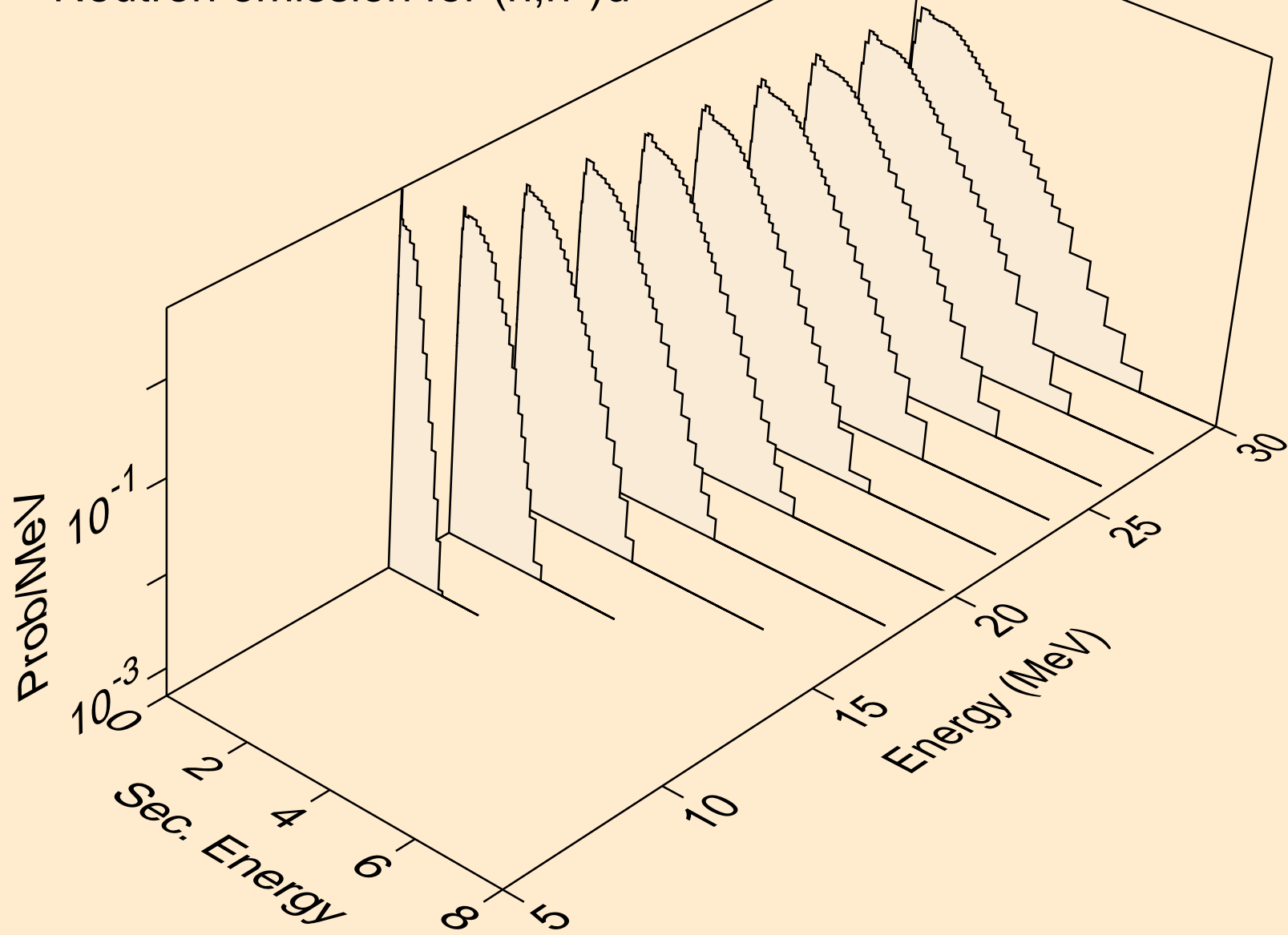

EU142M NEUTRON ACER TENDL-2024 LIBRARY; T=0.K
Neutron emission for (n,n*)t

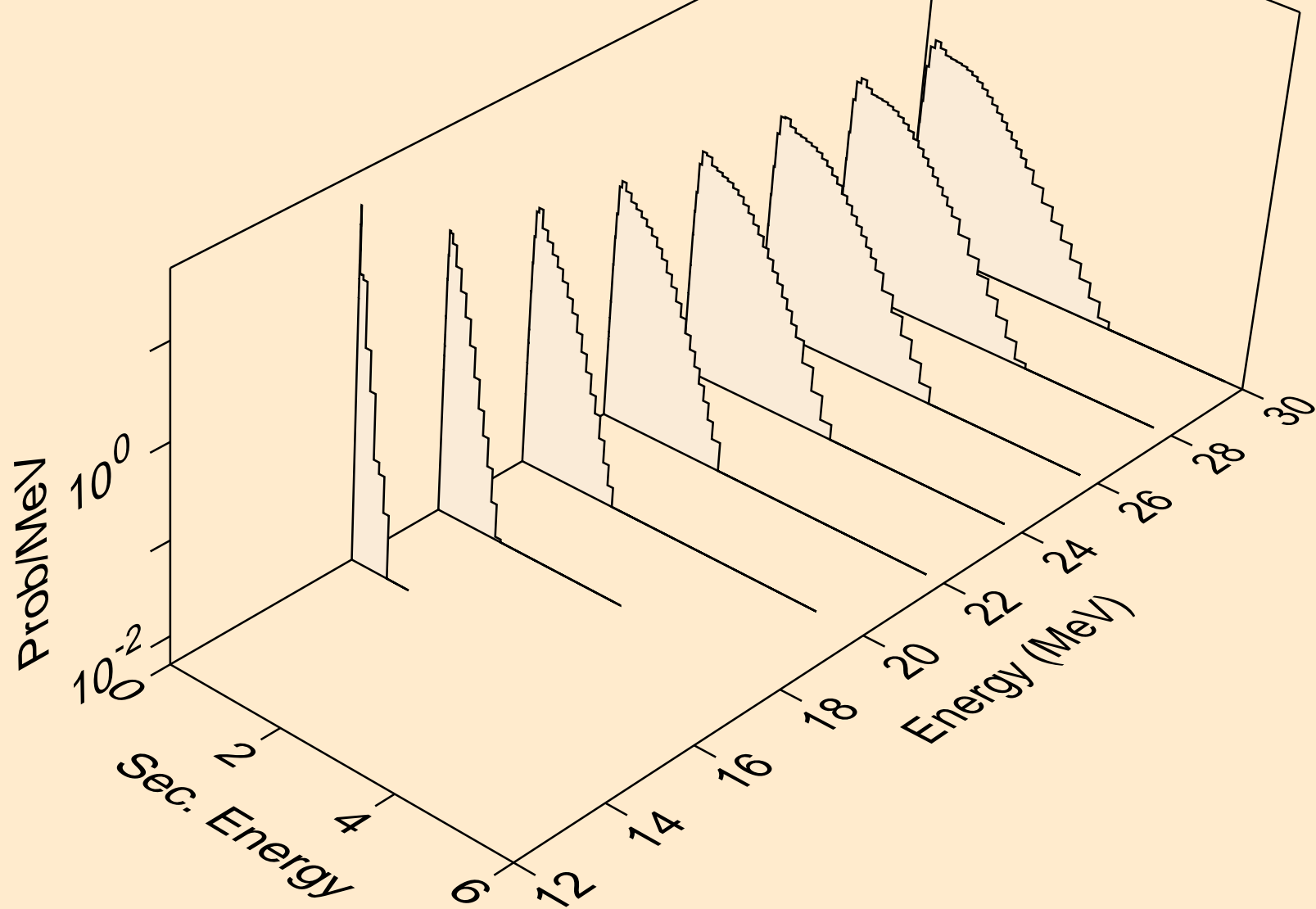

EU142M NEUTRON ACER TENDL-2024 LIBRARY; T=0.K
Neutron emission for (n,n*)he3

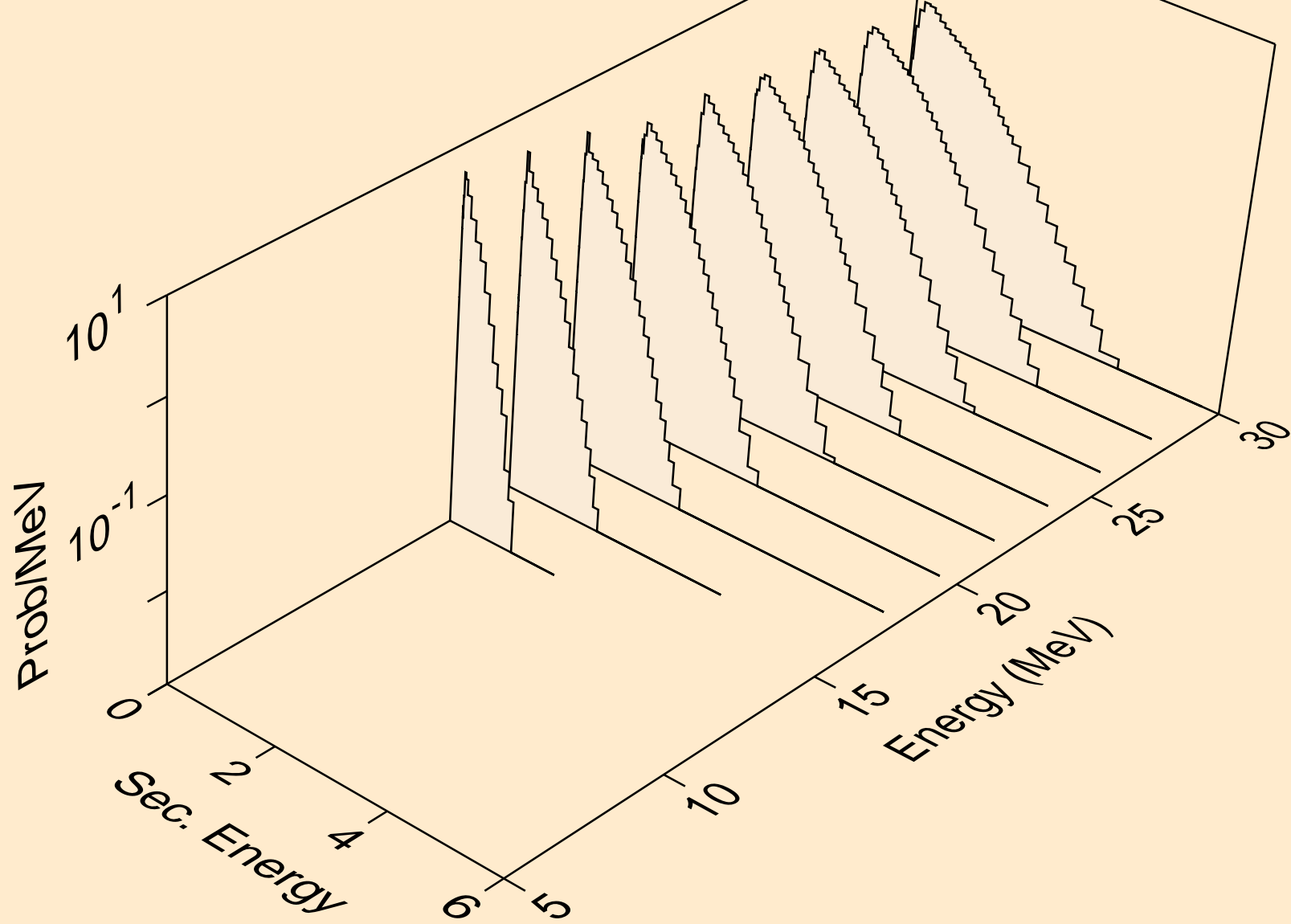

EU142M NEUTRON ACER TENDL-2024 LIBRARY; T=0.K
Neutron emission for (n,2np)

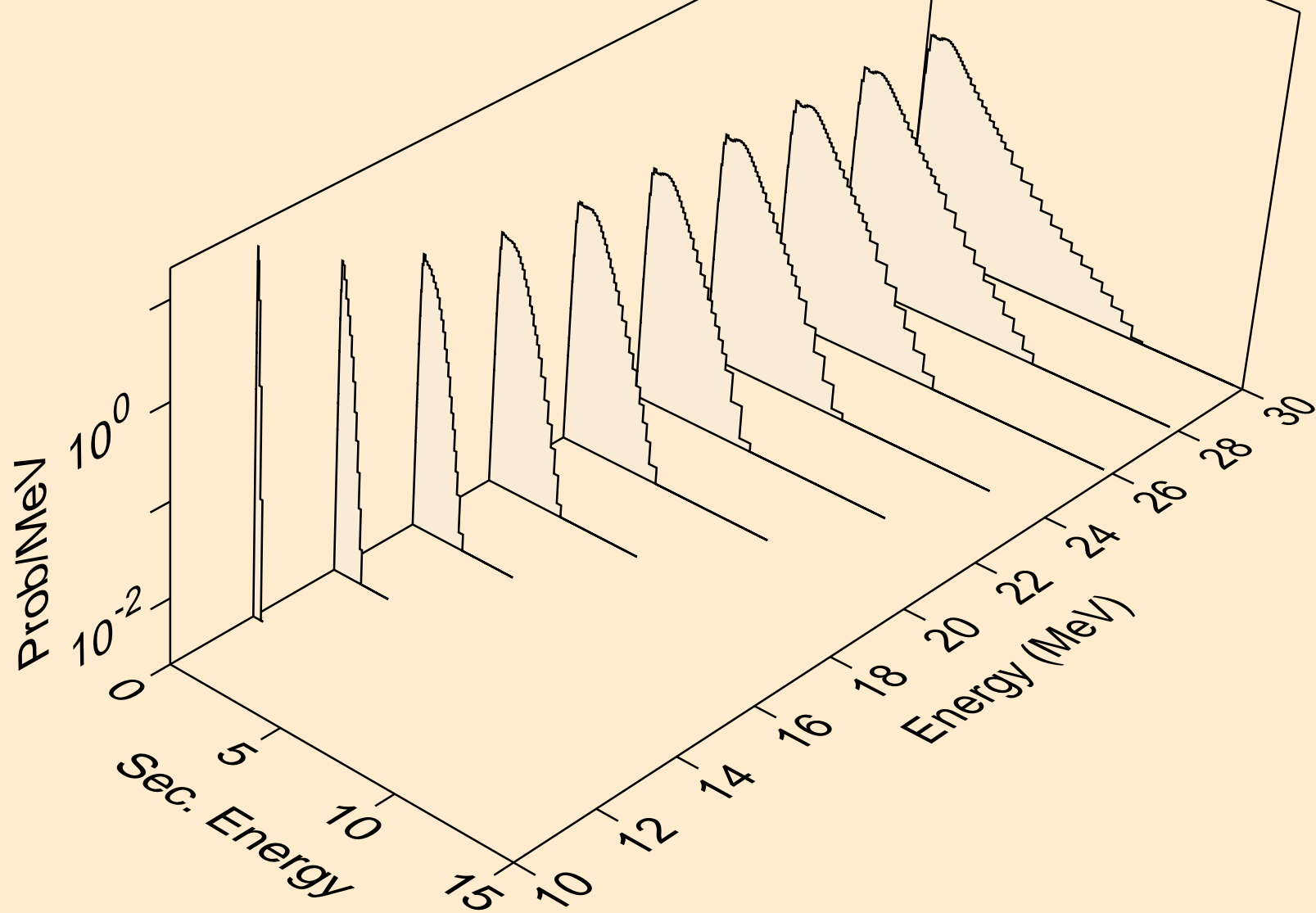

EU142M NEUTRON ACER TENDL-2024 LIBRARY; T=0.K
Neutron emission for (n,3np)

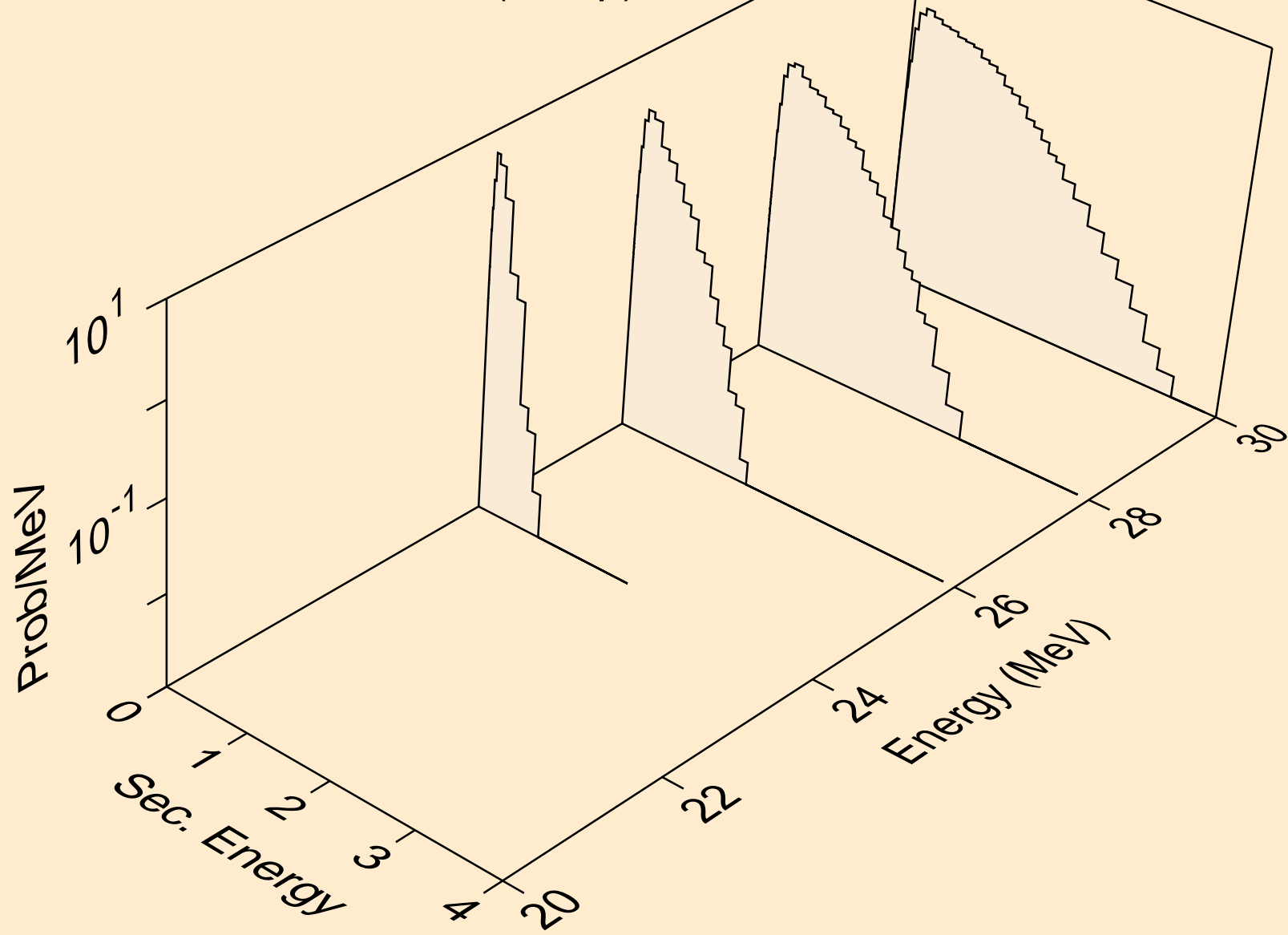

EU142M NEUTRON ACER TENDL-2024 LIBRARY; T=0.K
Neutron emission for (n,n2p)

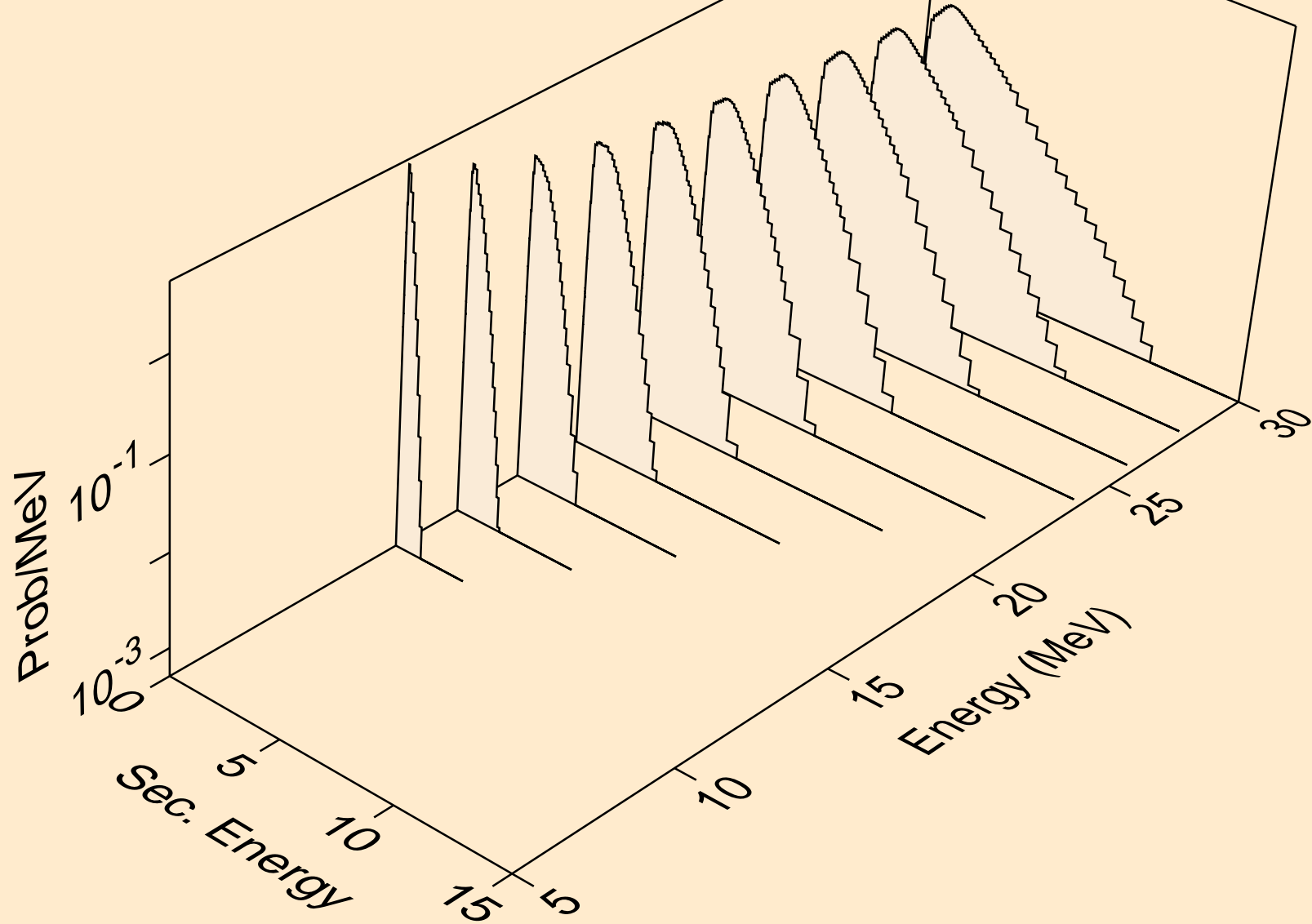

EU142M NEUTRON ACER TENDL-2024 LIBRARY; T=0.K
Neutron emission for (n,npa)

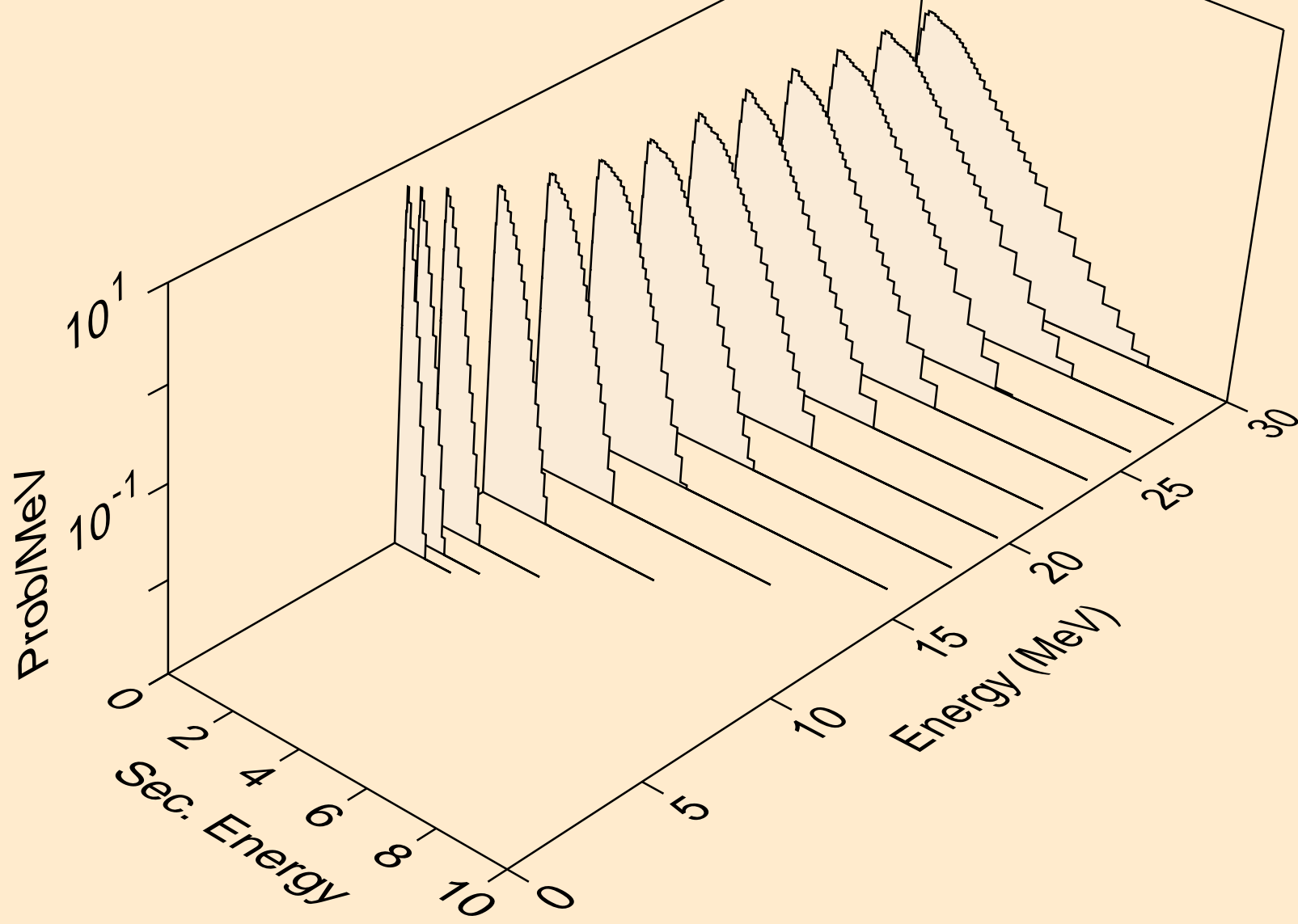

EU142M NEUTRON ACER TENDL-2024 LIBRARY; T=0.K
Neutron emission for (n,n*c)

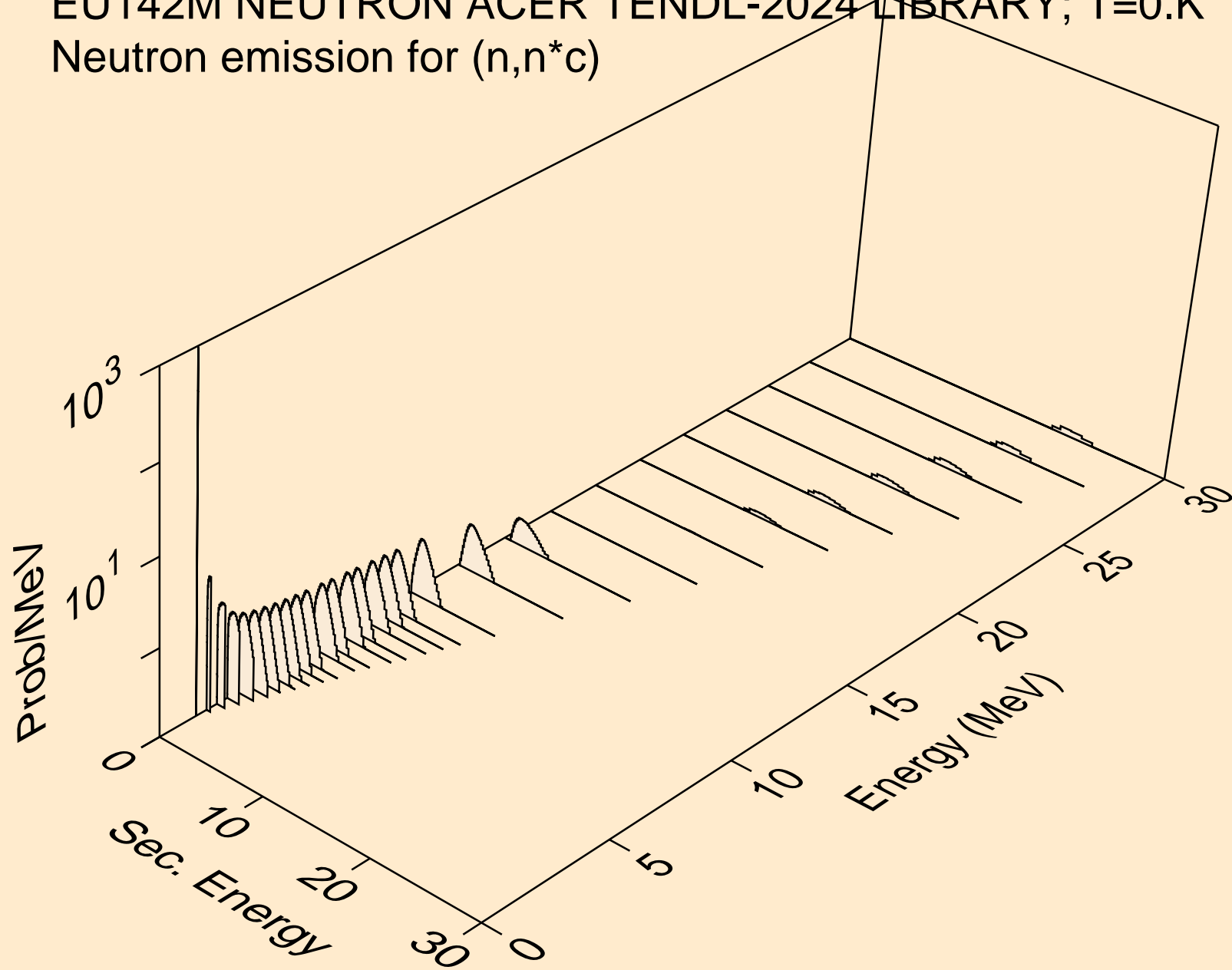

EU142M NEUTRON ACER TENDL-2024 LIBRARY; T=0.K
Photon emission for (n,x)

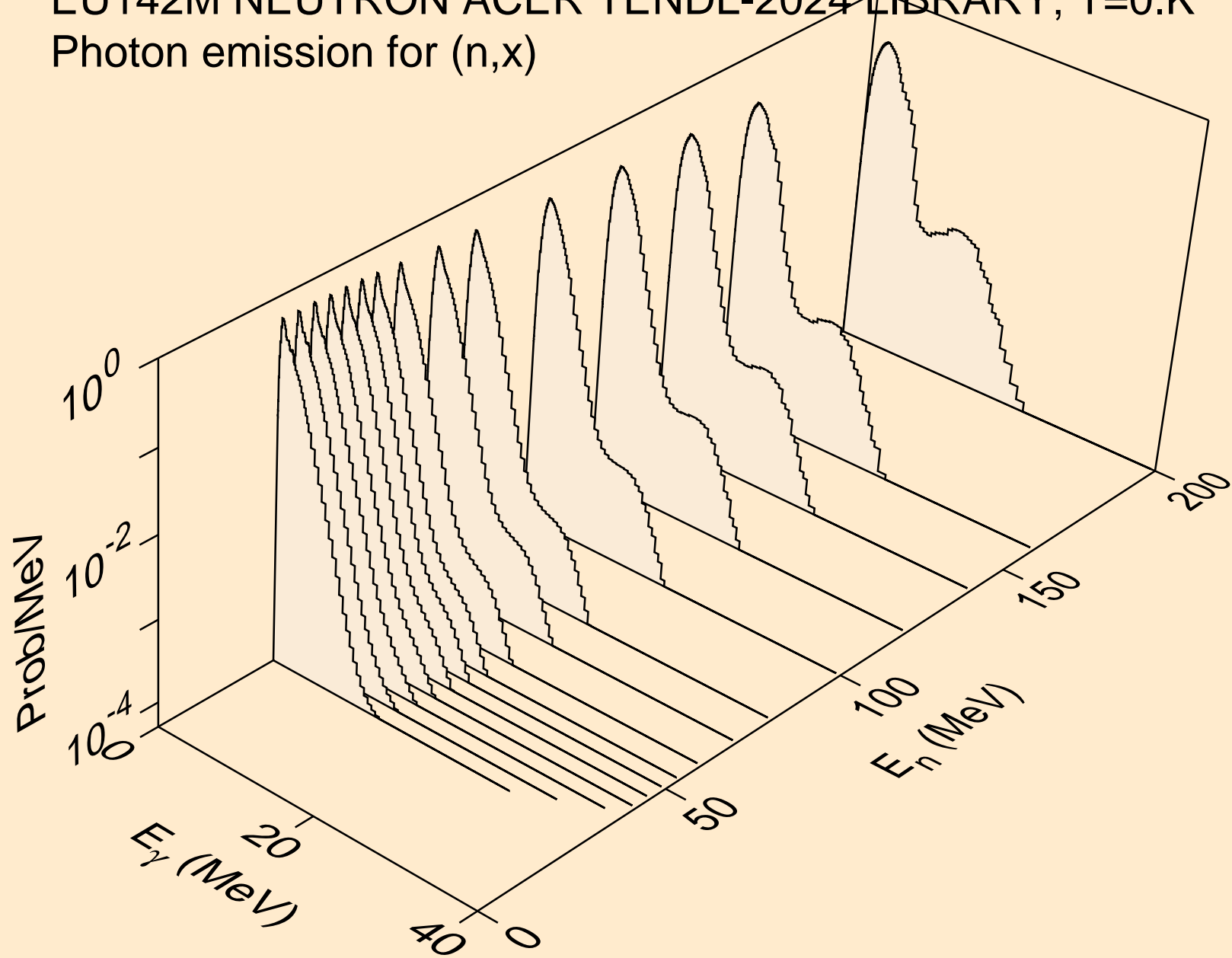

EU142M NEUTRON ACER TENDL-2024 LIBRARY; T=0.K
Photon emission for (n,2nd)

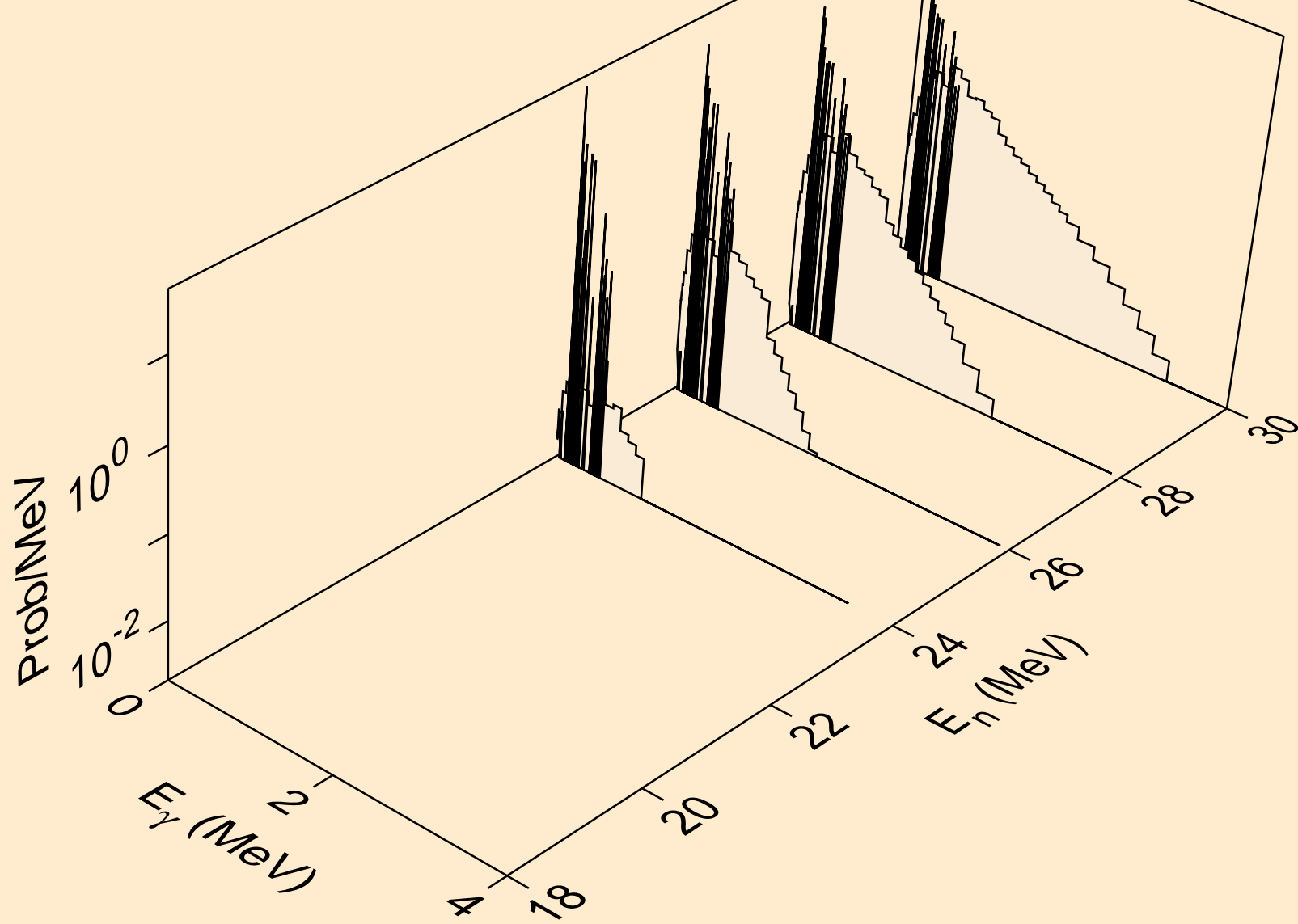

EU142M NEUTRON ACER TENDL-2024 LIBRARY; T=0.K
Photon emission for (n,2n)

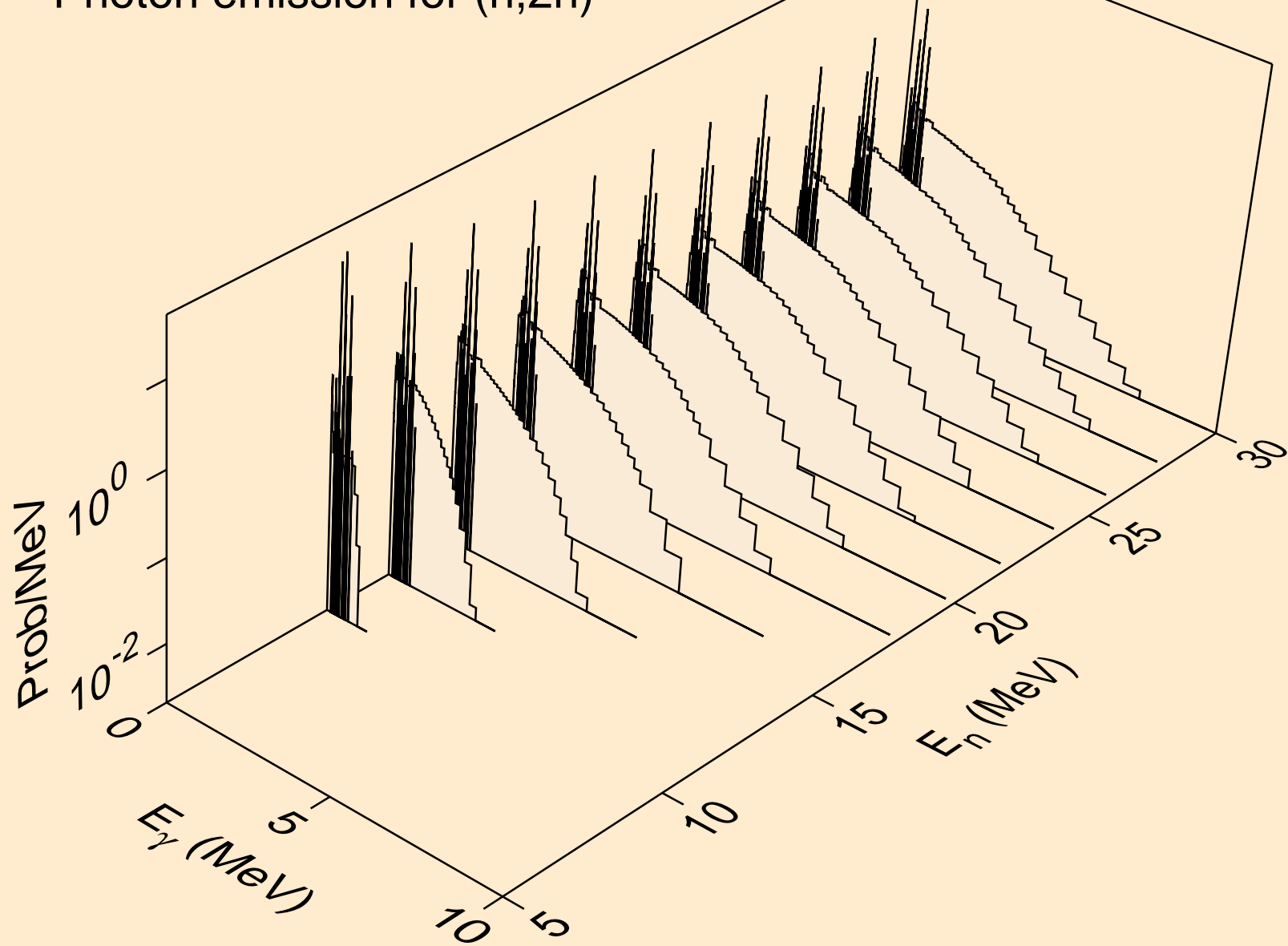

EU142M NEUTRON ACER TENDL-2024 LIBRARY; T=0.K
Photon emission for (n,3n)

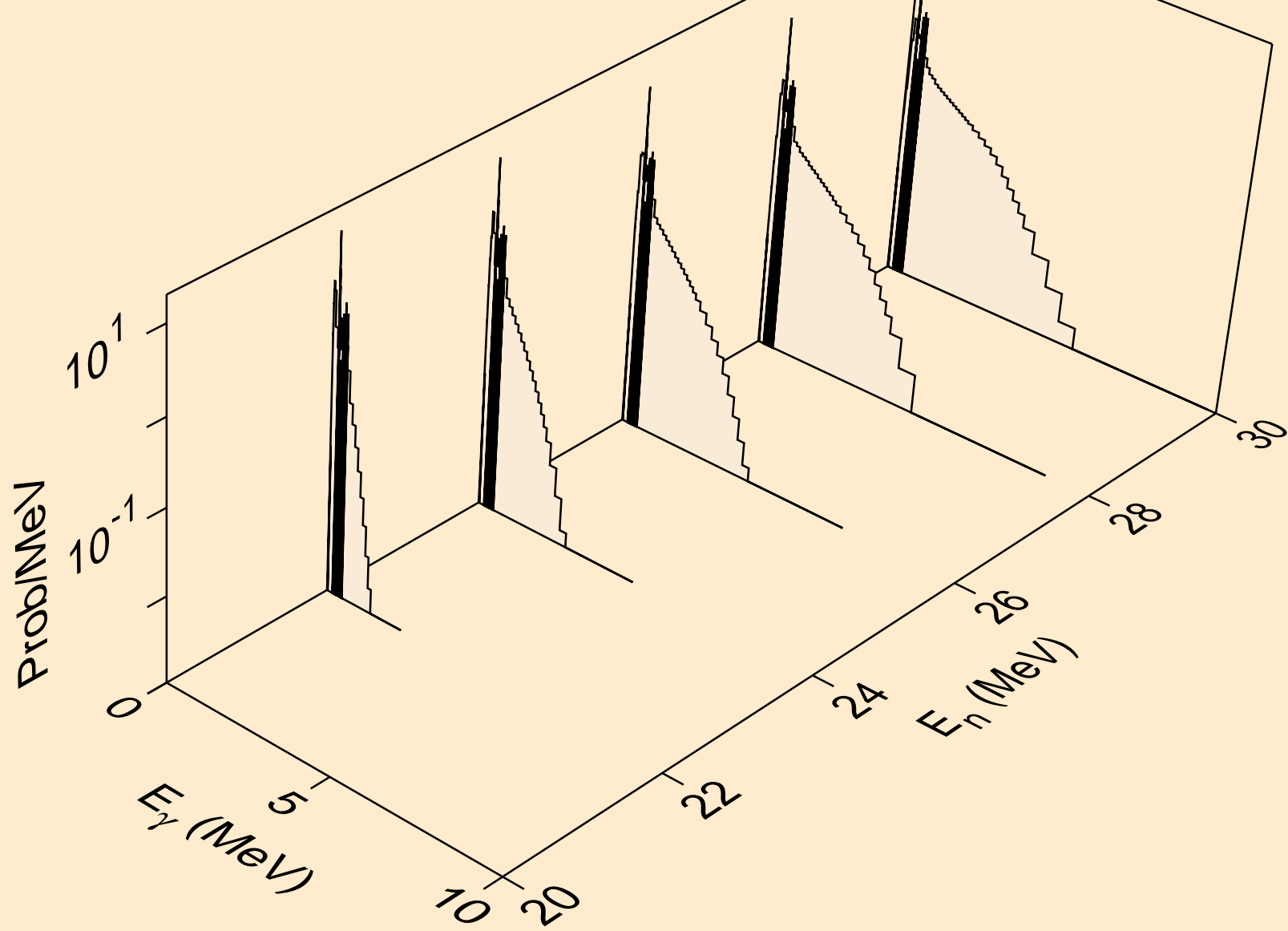

EU142M NEUTRON ACER TENDL-2024 LIBRARY; T=0.K
Photon emission for (n,n*)a

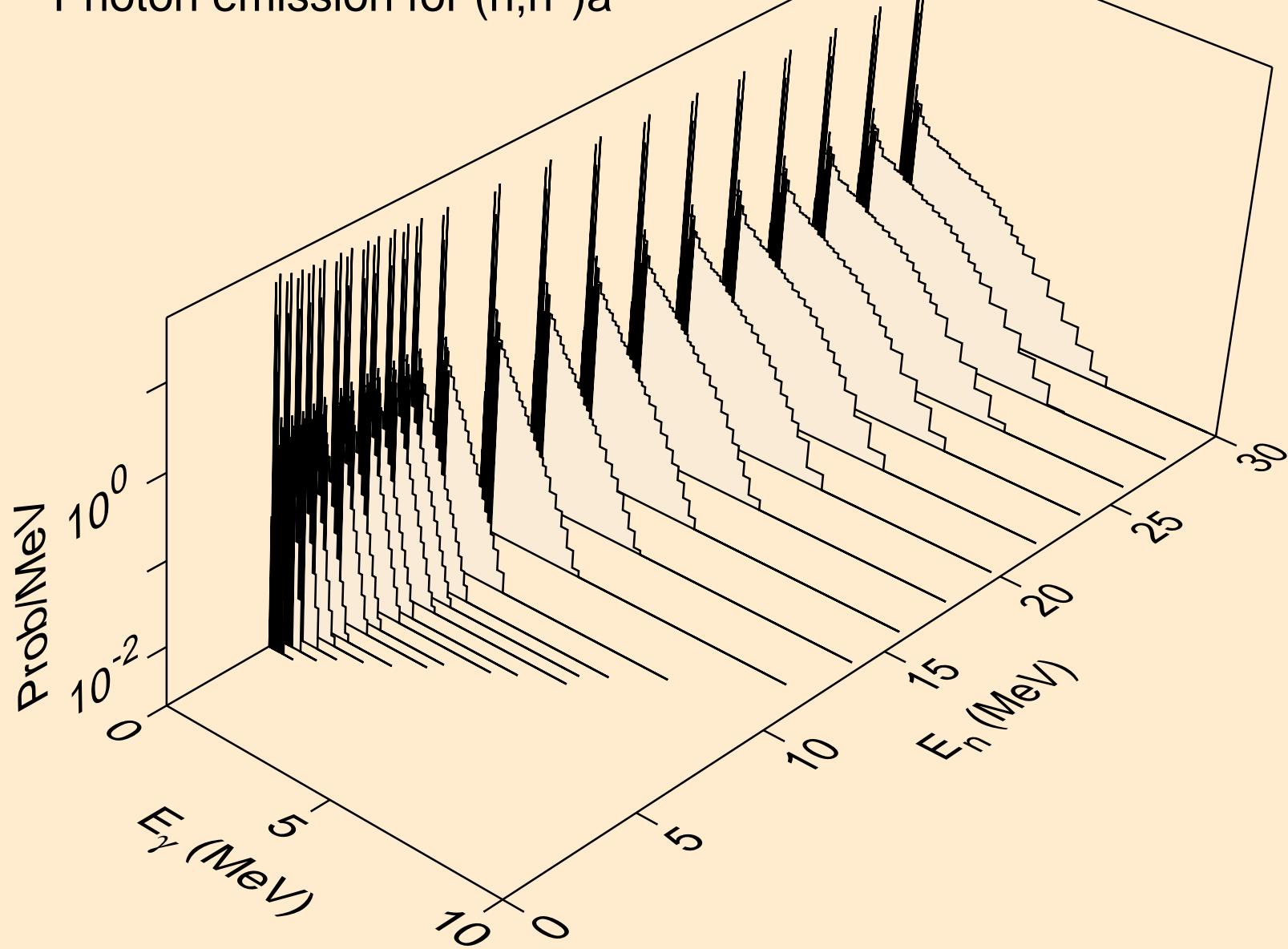

EU142M NEUTRON ACER TENDL-2024 LIBRARY; T=0.K
Photon emission for (n,2n)a

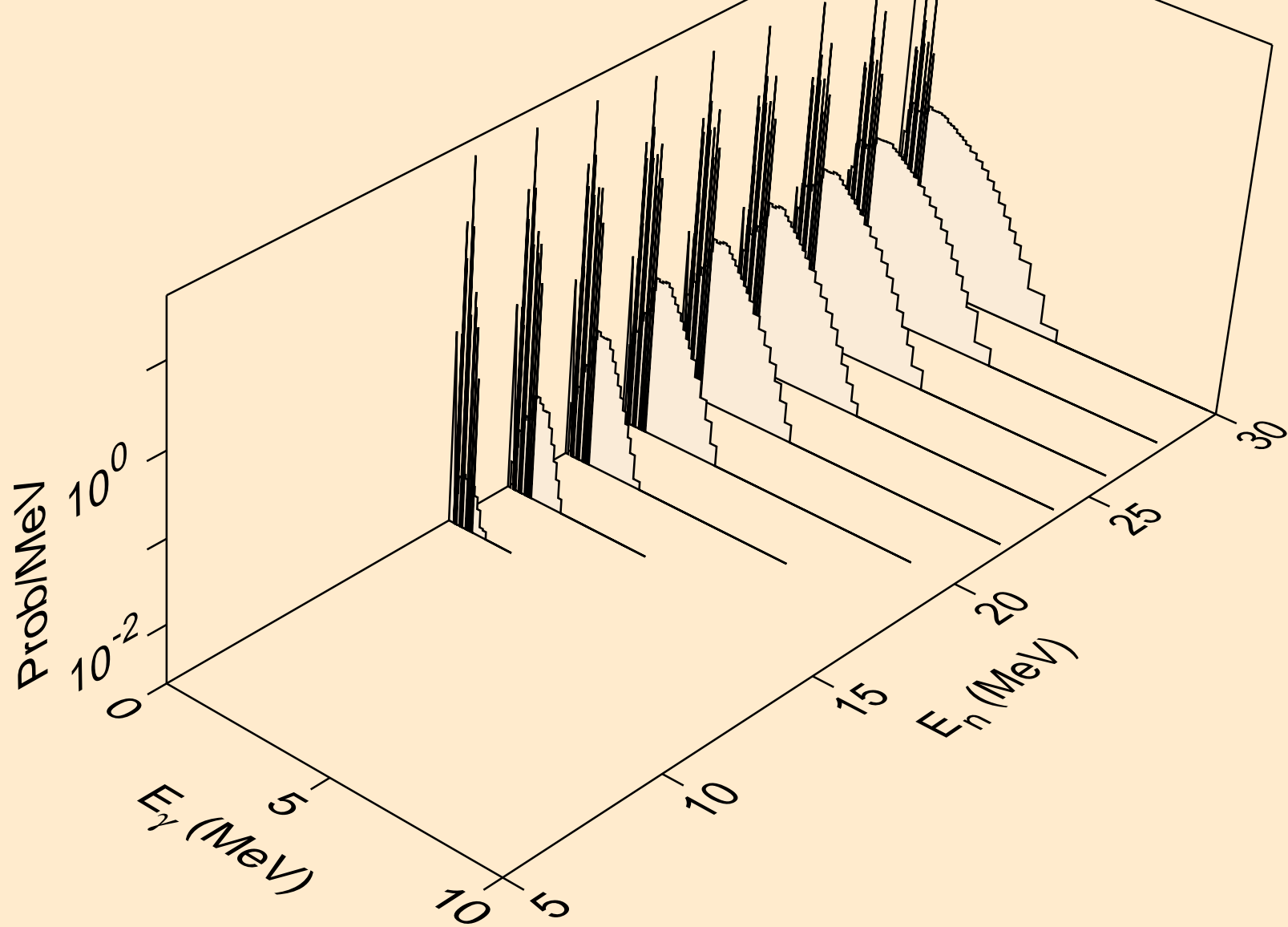

EU142M NEUTRON ACER TENDL-2024 LIBRARY; T=0.K
Photon emission for (n,3n)a

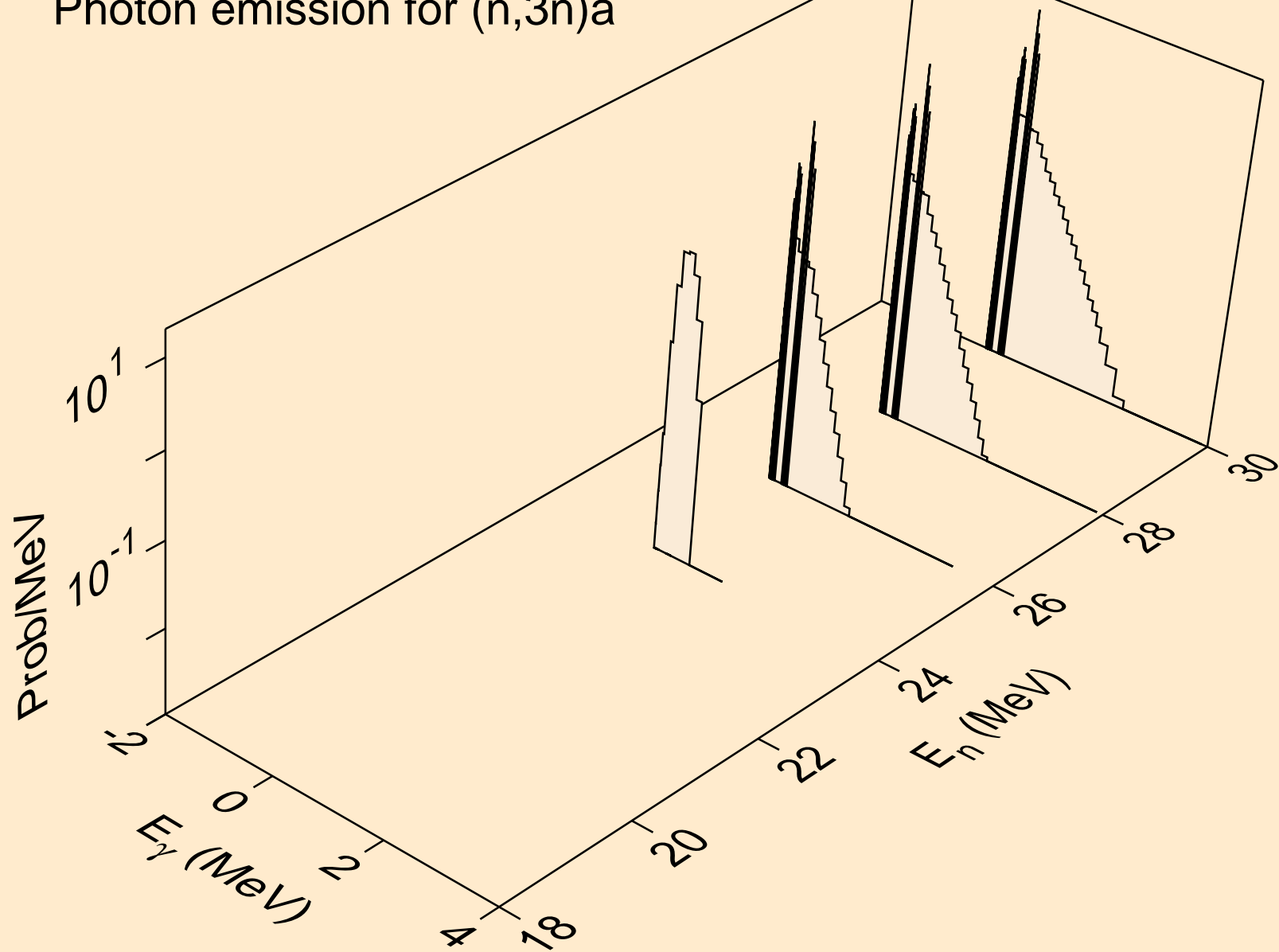

EU142M NEUTRON ACER TENDL-2024 LIBRARY; T=0.K
Photon emission for (n,n*)p

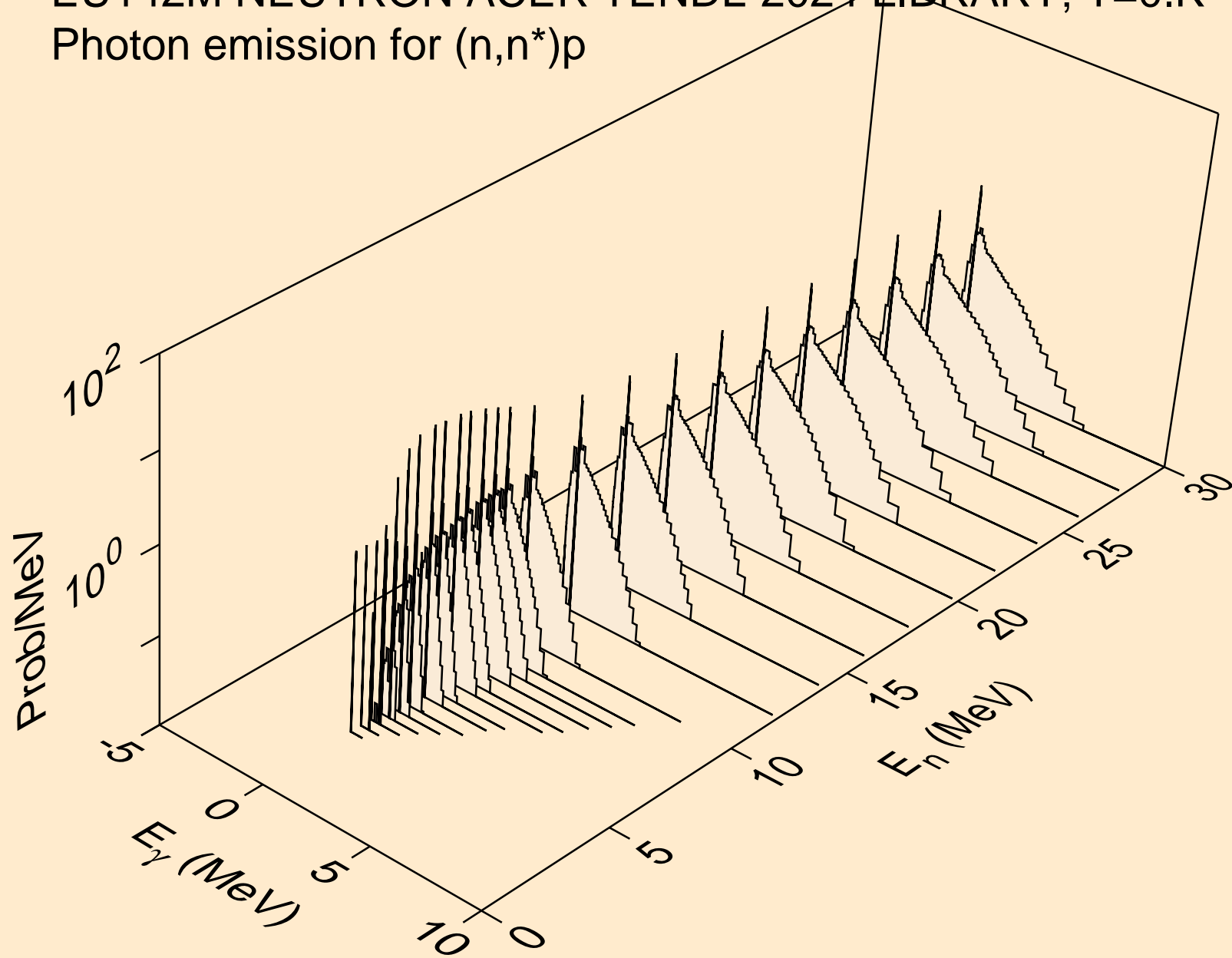

EU142M NEUTRON ACER TENDL-2024 LIBRARY; T=0.K
Photon emission for (n,n*)2a

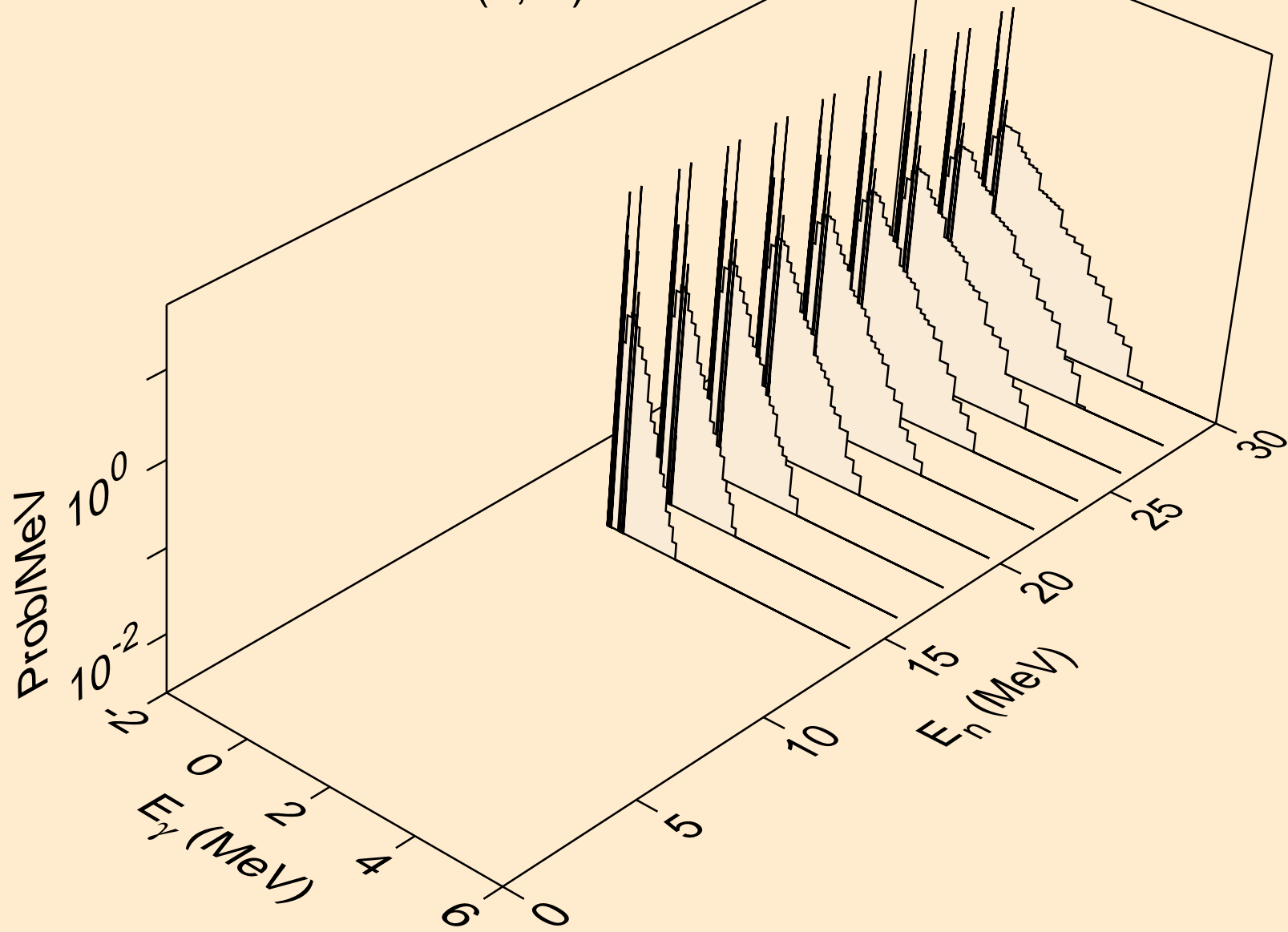

EU142M NEUTRON ACER TENDL-2024 LIBRARY; T=0.K
Photon emission for (n,2n)2a

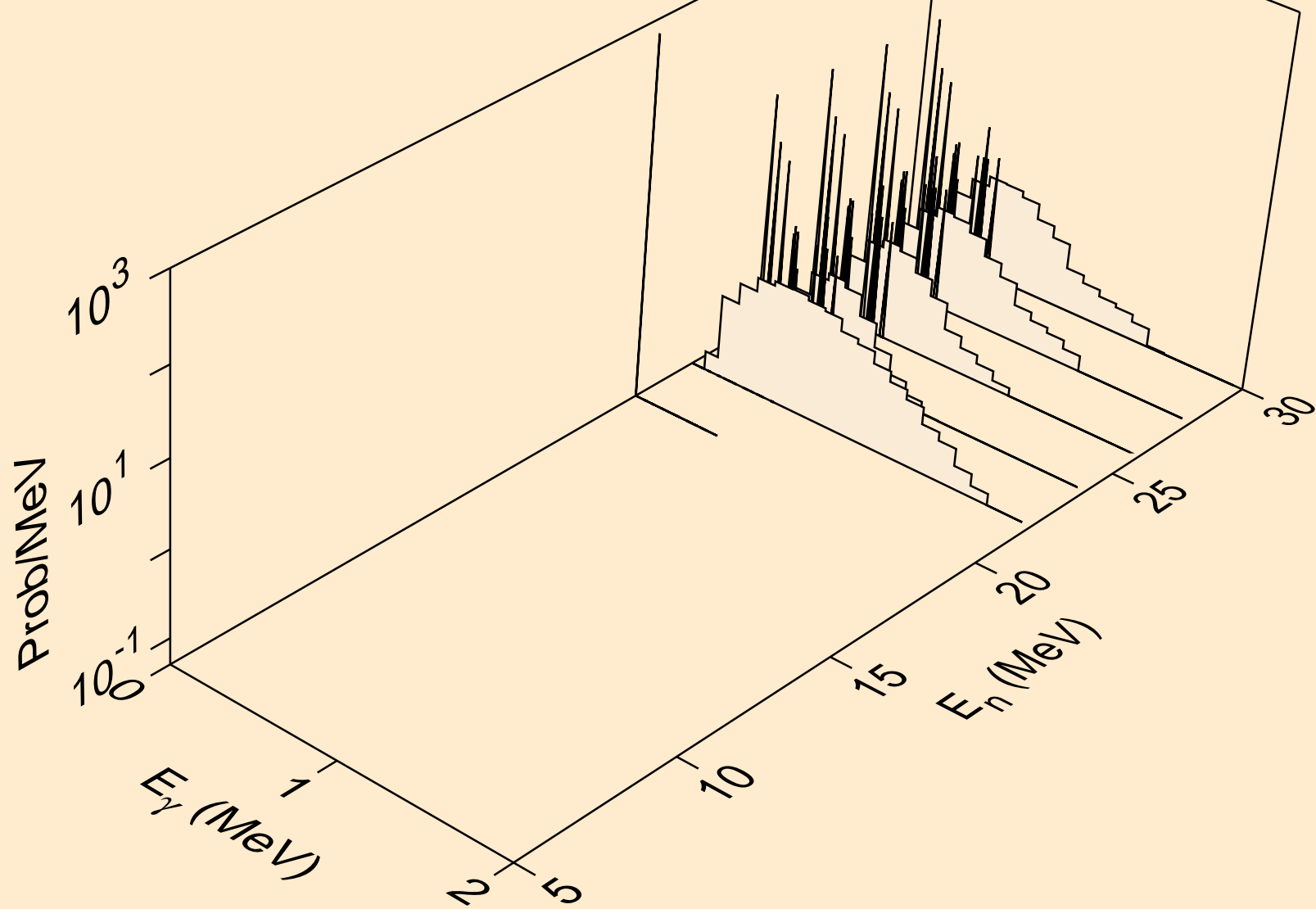

EU142M NEUTRON ACER TENDL-2024 LIBRARY; T=0.K
Photon emission for (n,n*)d

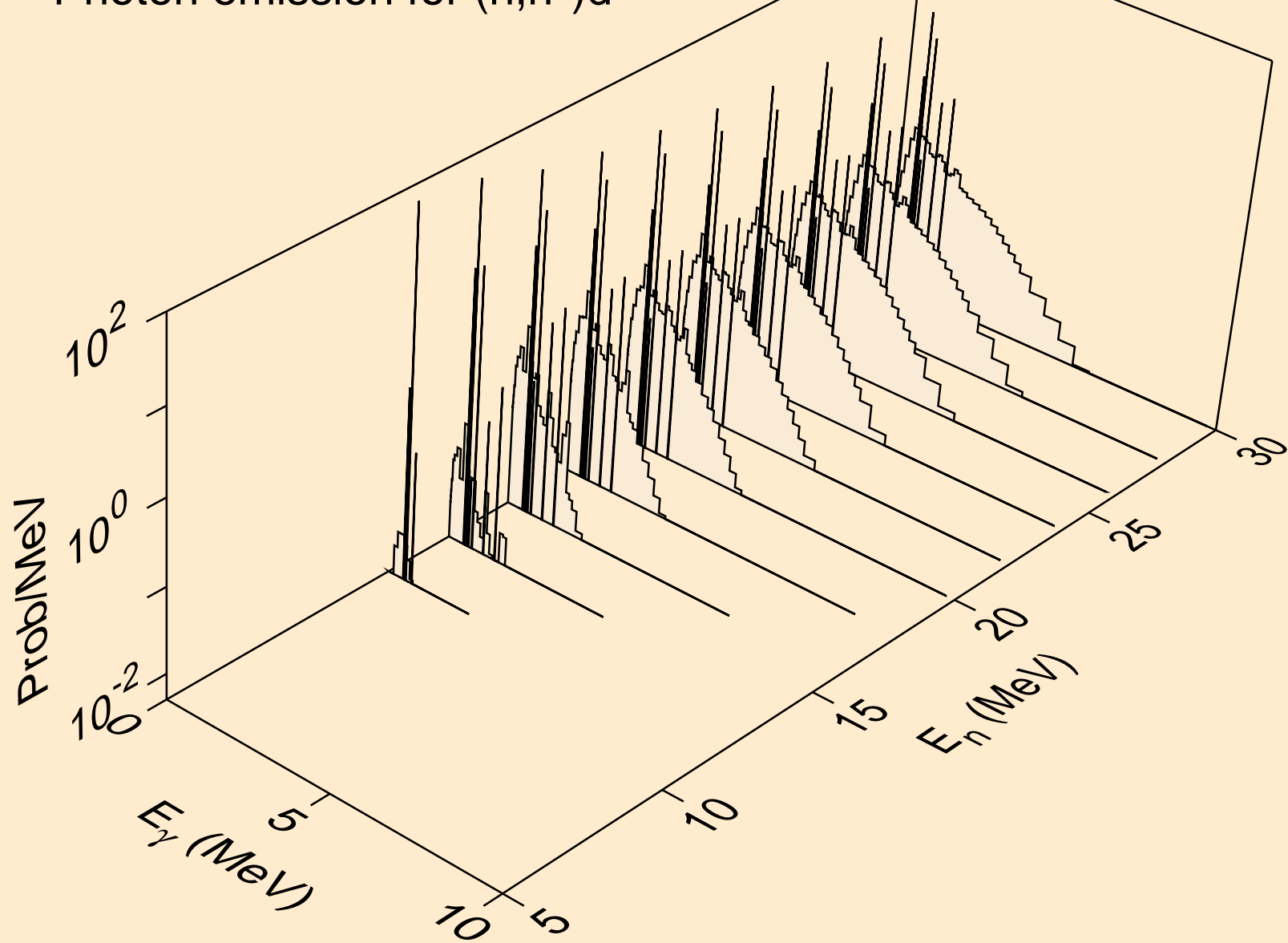

EU142M NEUTRON ACER TENDL-2024 LIBRARY; T=0.K
Photon emission for (n,n*)t

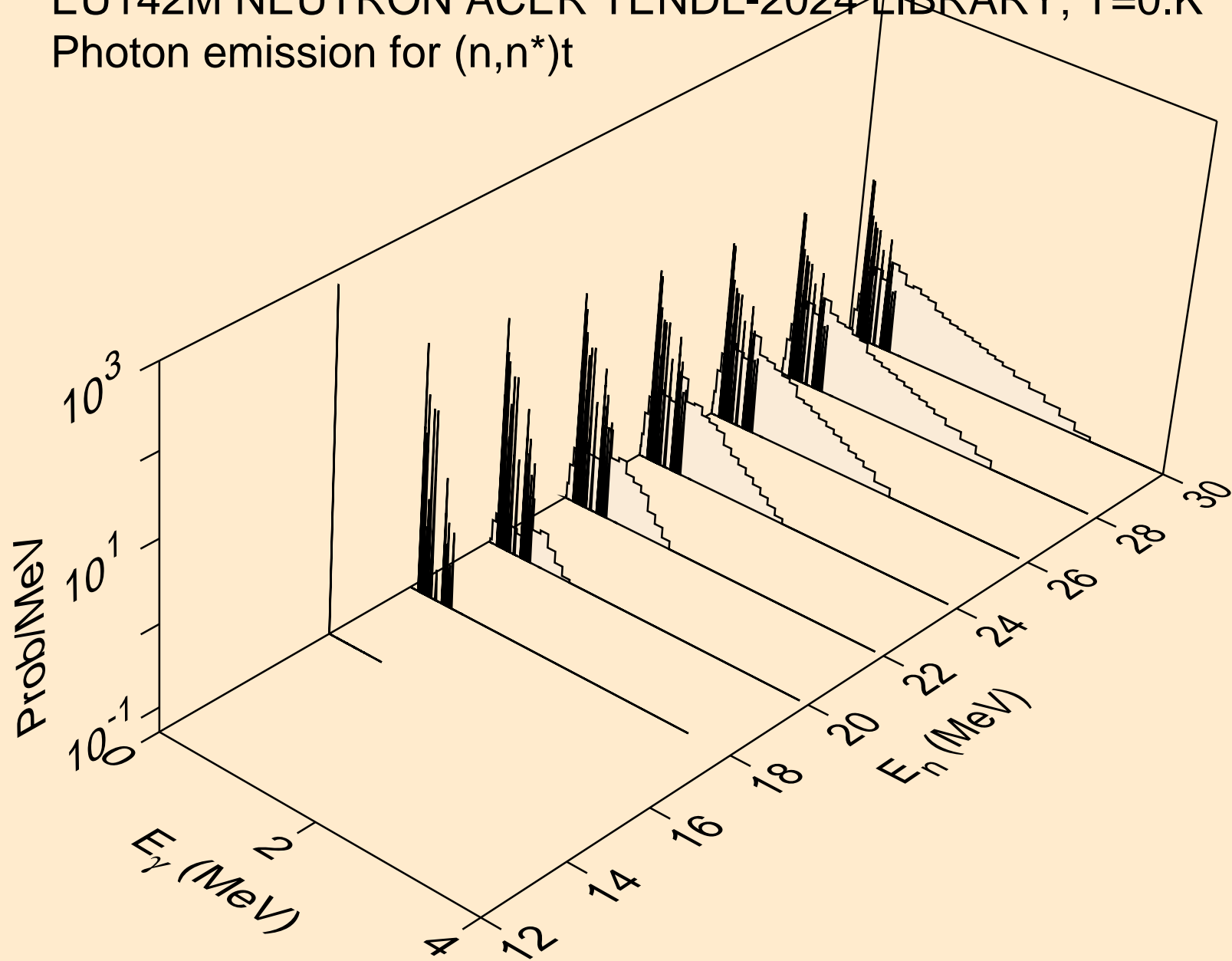

EU142M NEUTRON ACER TENDL-2024 LIBRARY; T=0.K
Photon emission for (n,n*)he3

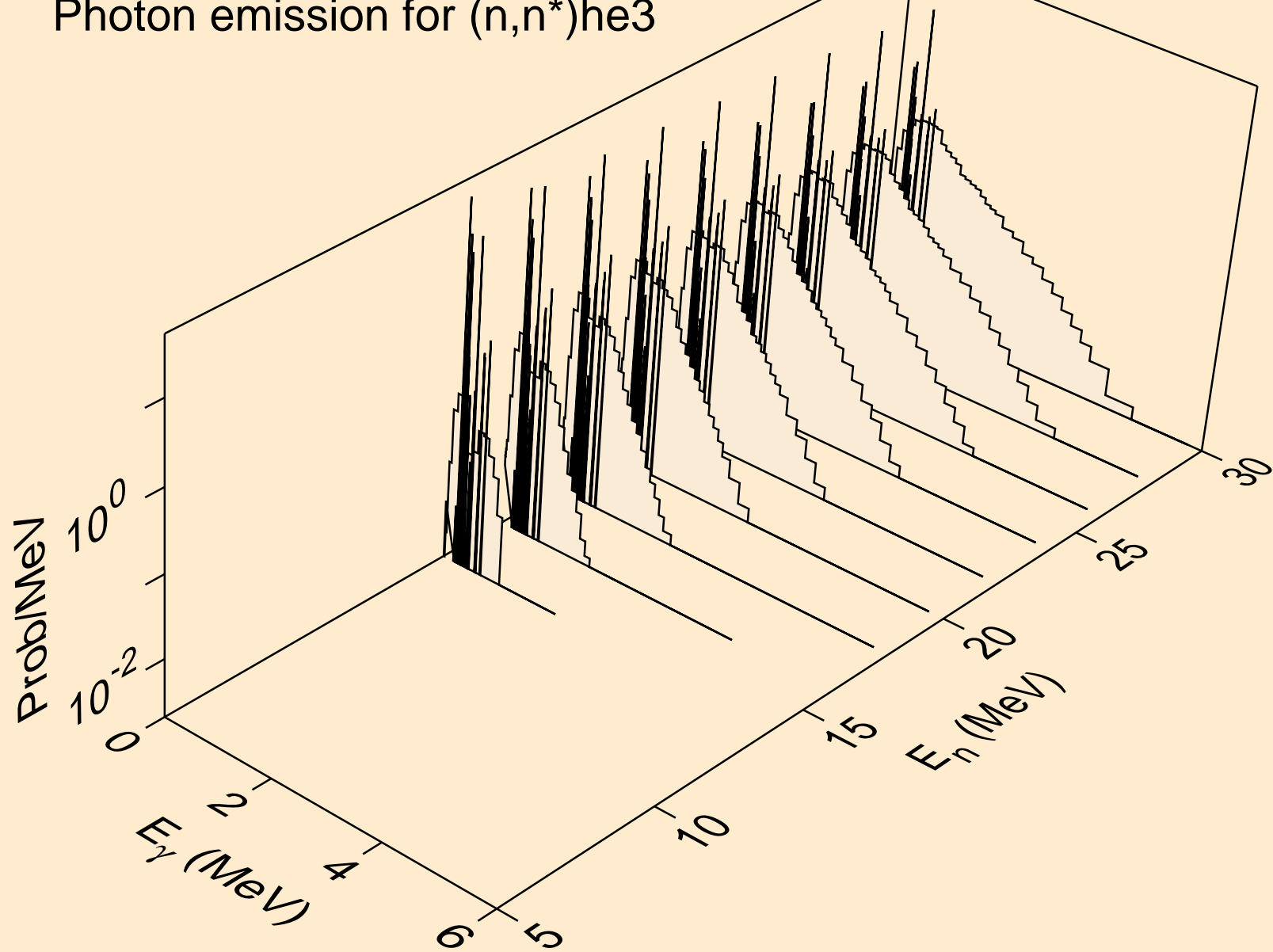

EU142M NEUTRON ACER TENDL-2024 LIBRARY; T=0.K
Photon emission for (n,2np)

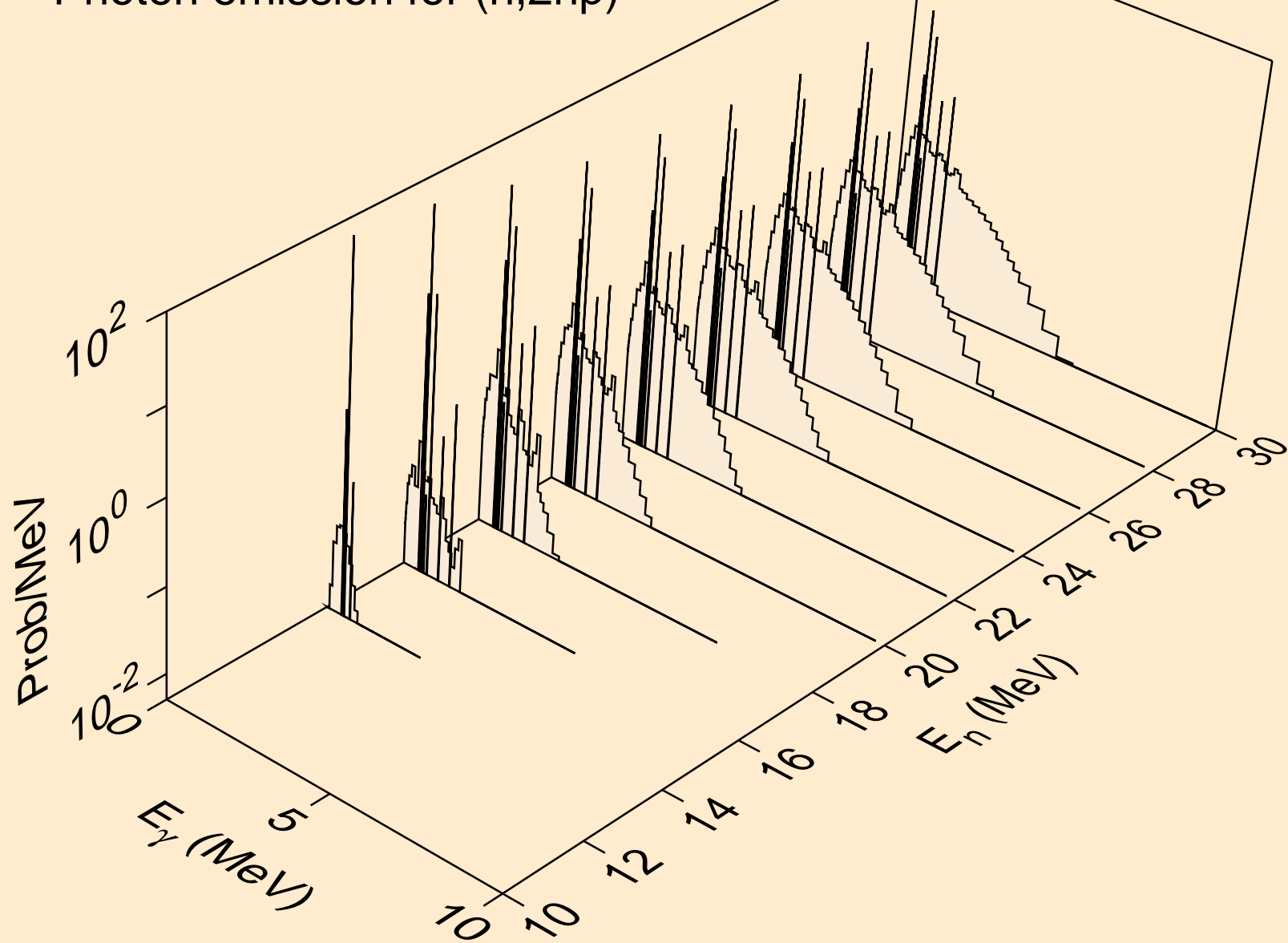

EU142M NEUTRON ACER TENDL-2024 LIBRARY; T=0.K
Photon emission for (n,3np)

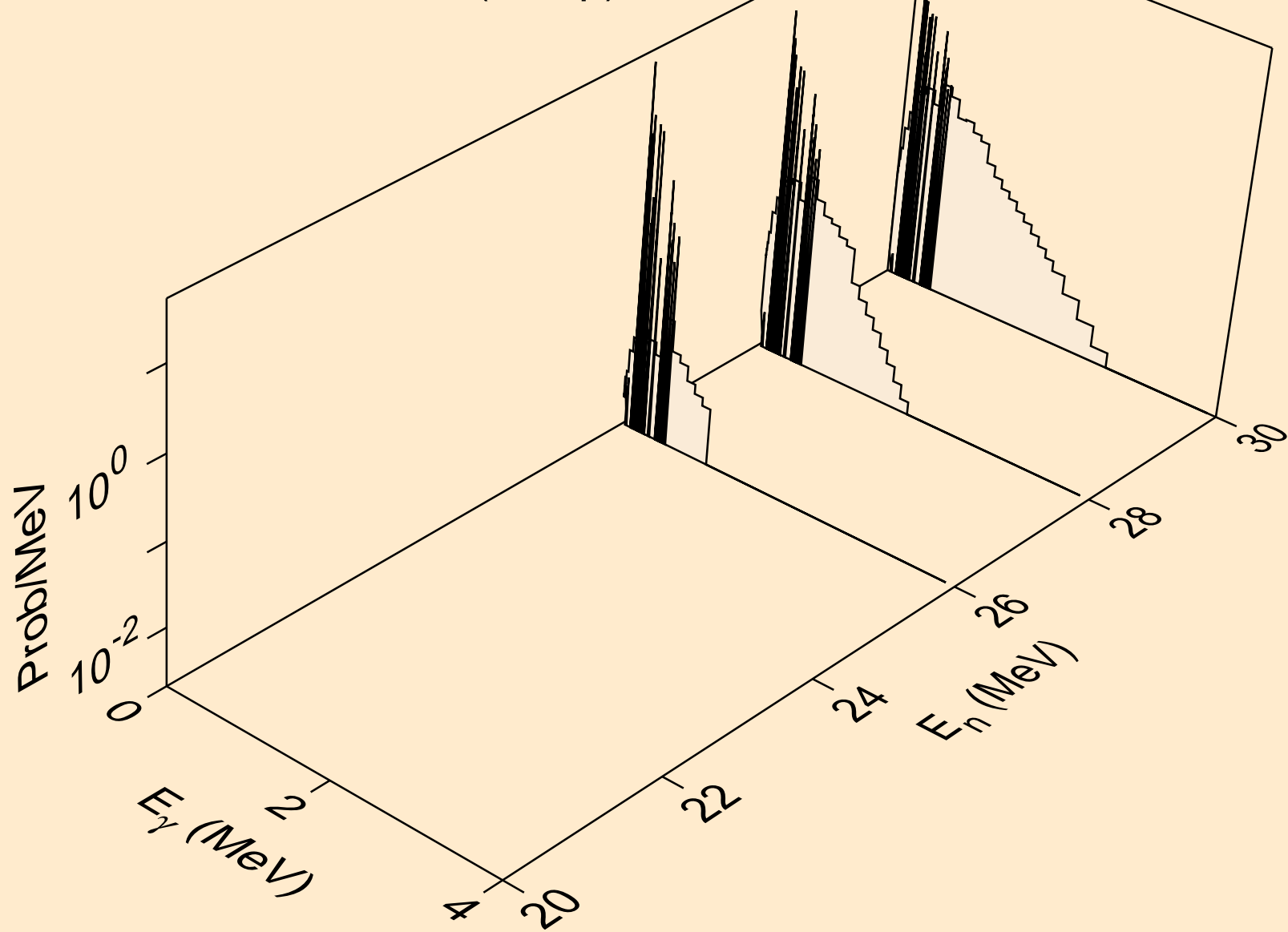

EU142M NEUTRON ACER TENDL-2024 LIBRARY; T=0.K
Photon emission for (n,n2p)

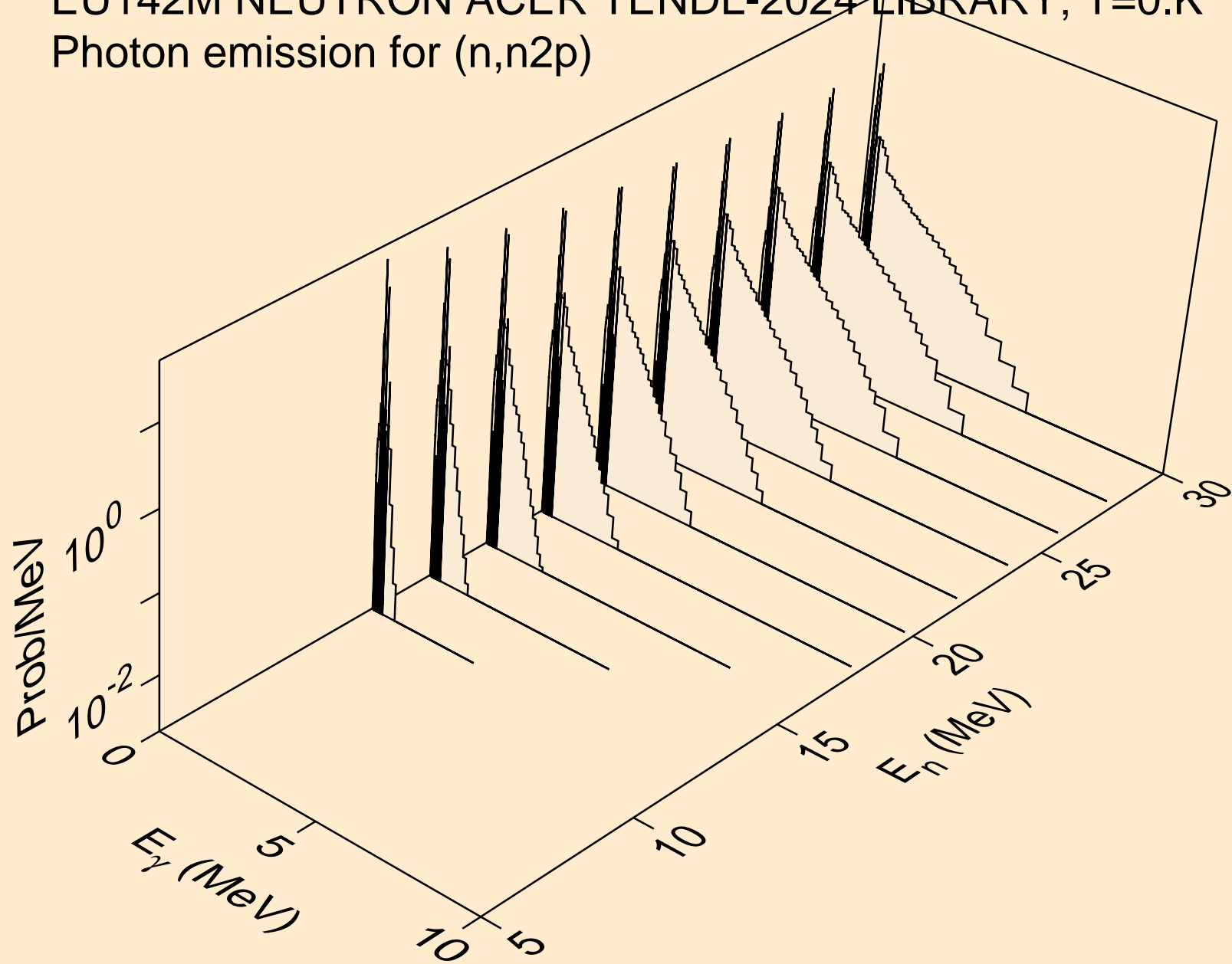

EU142M NEUTRON ACER TENDL-2024 LIBRARY; T=0.K
Photon emission for (n,npa)

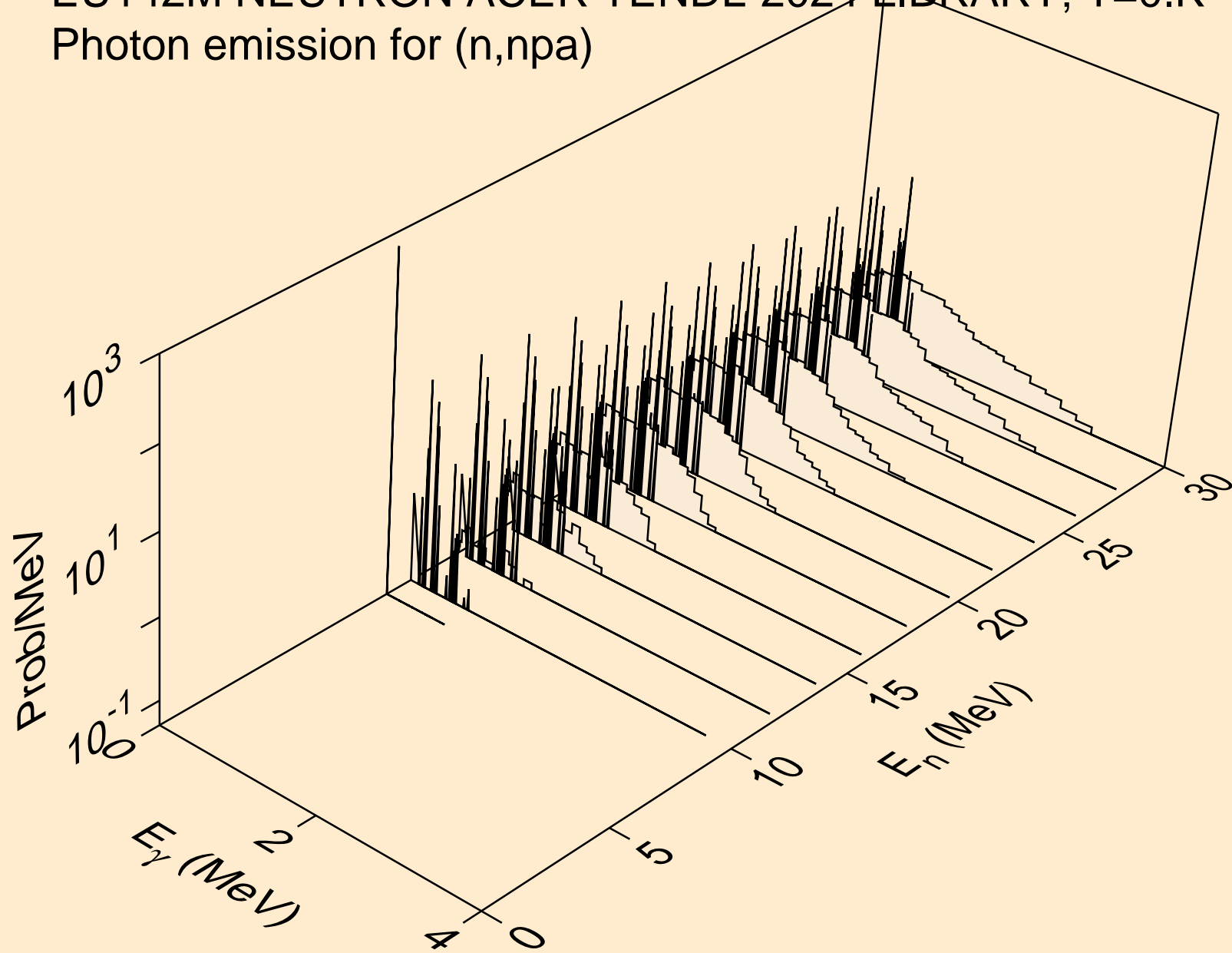

EU142M NEUTRON ACER TENDL-2024 LIBRARY; T=0.K
Photon emission for (n,n*1)

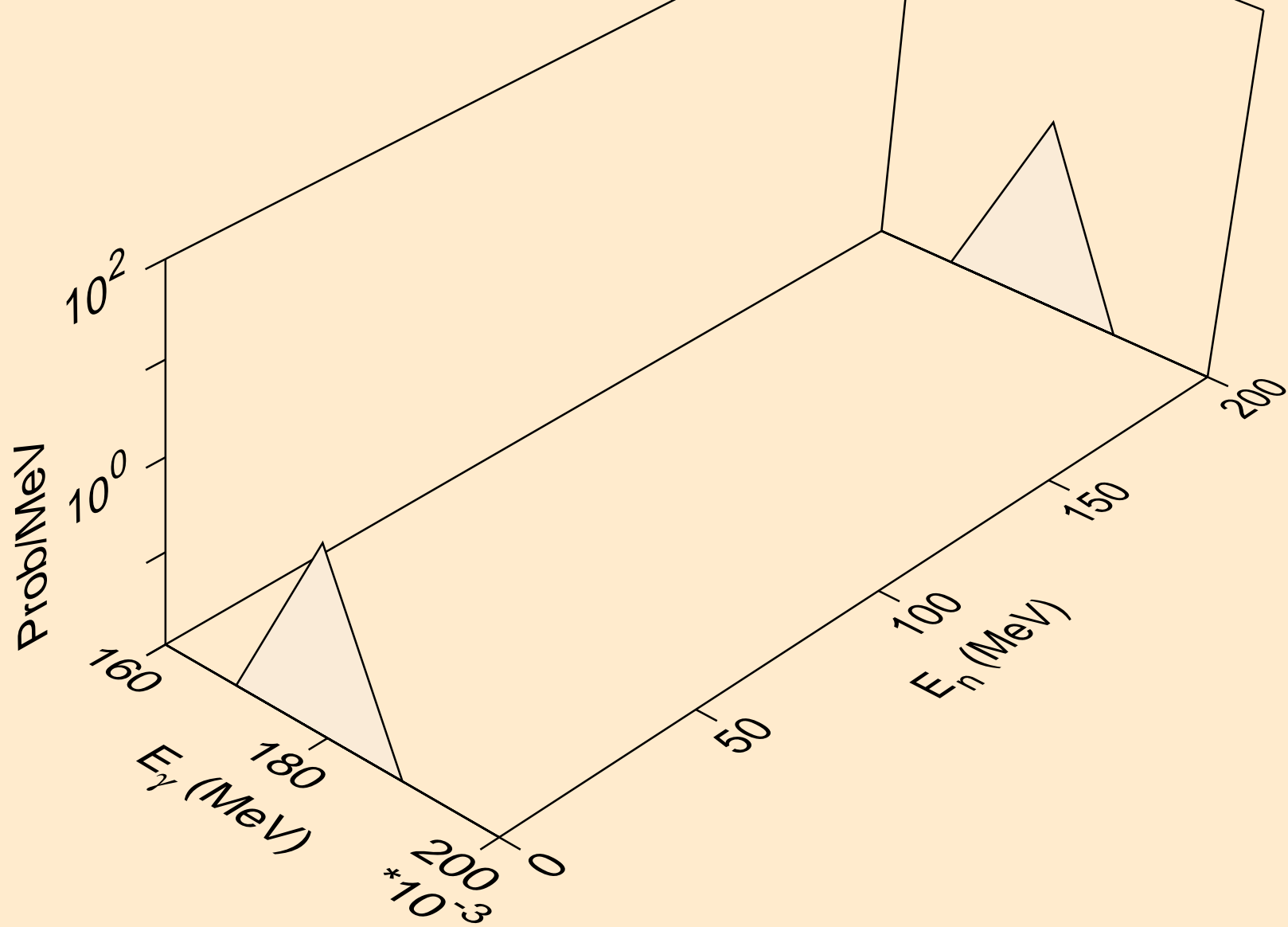

EU142M NEUTRON ACER TENDL-2024 LIBRARY; T=0.K
Photon emission for (n,n*2)

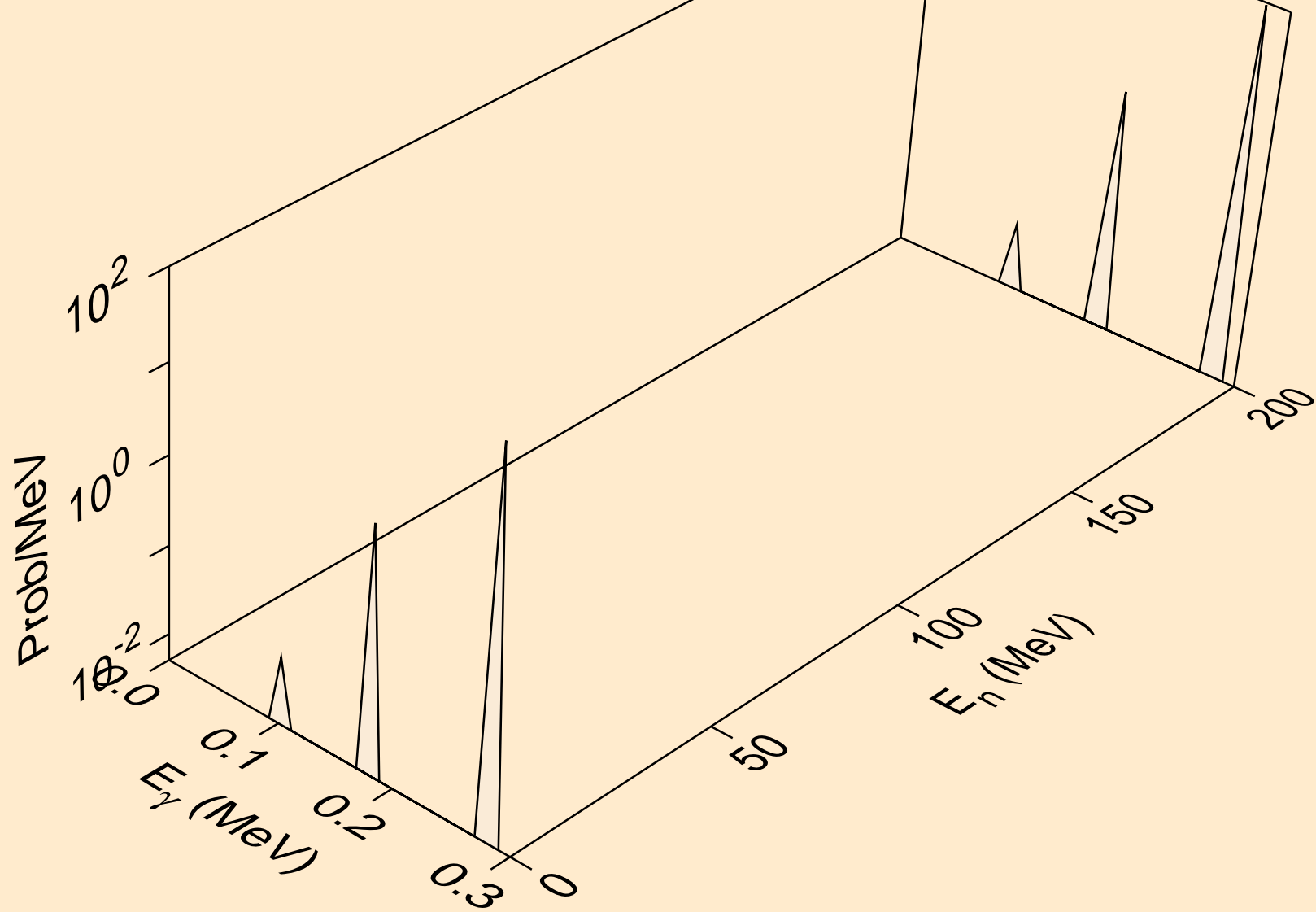

EU142M NEUTRON ACER TENDL-2024 LIBRARY; T=0.K
Photon emission for (n,n*3)

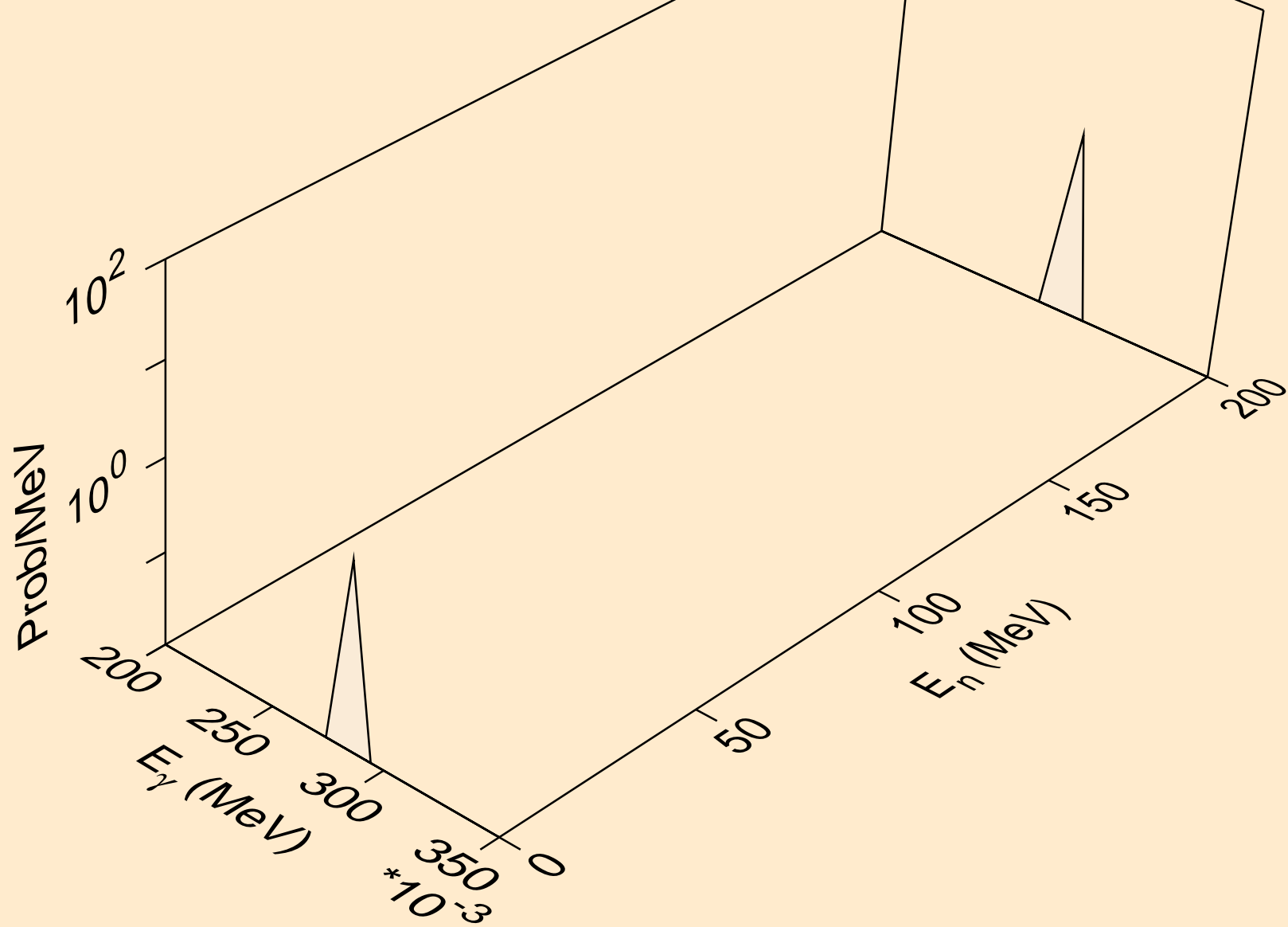

EU142M NEUTRON ACER TENDL-2024 LIBRARY; T=0.K
Photon emission for (n,n*c)

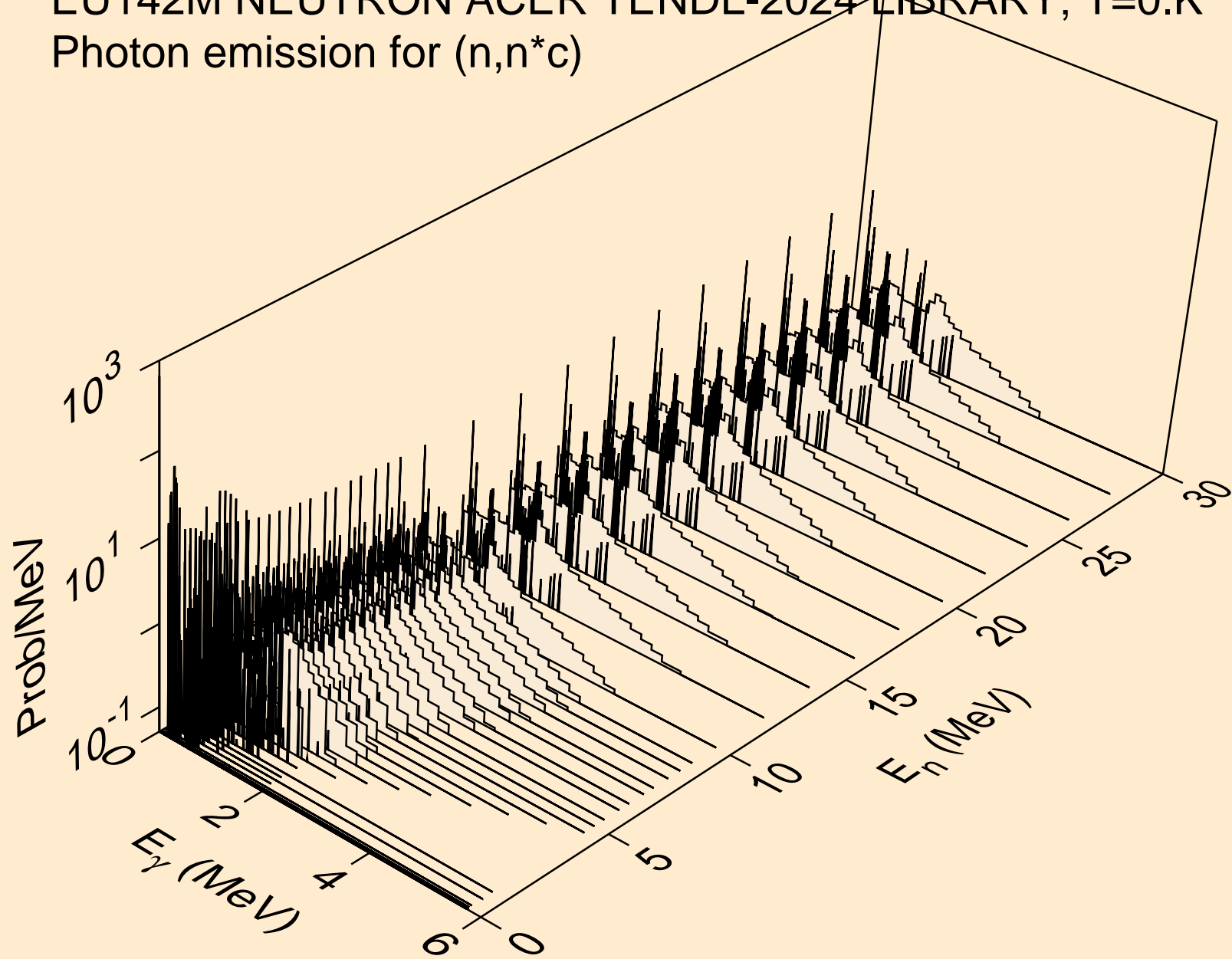

EU142M NEUTRON ACER TENDL-2024 LIBRARY; T=0.K
Photon emission for (n,gma)

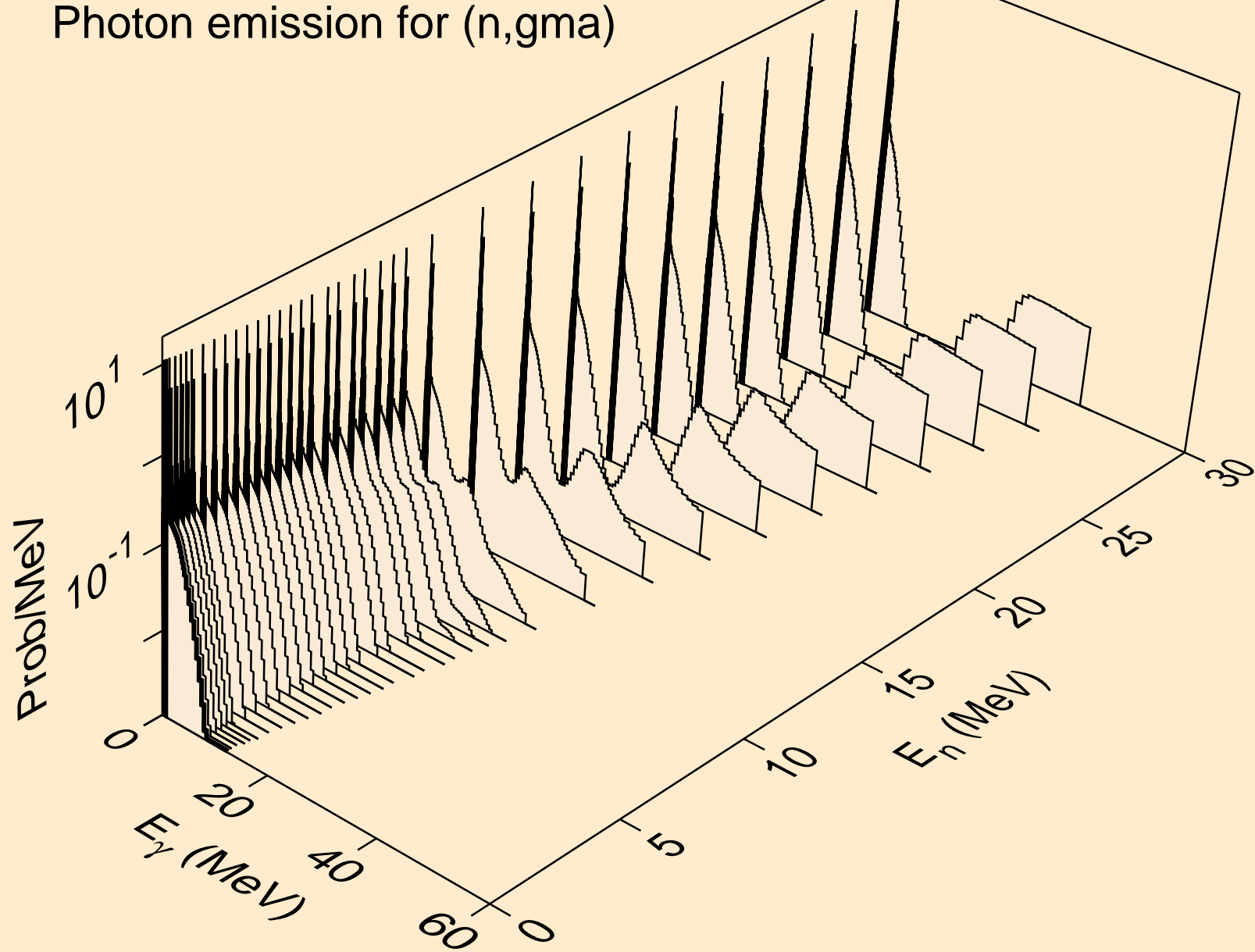

EU142M NEUTRON ACER TENDL-2024 LIBRARY; T=0.K
Photon emission for (n,p)

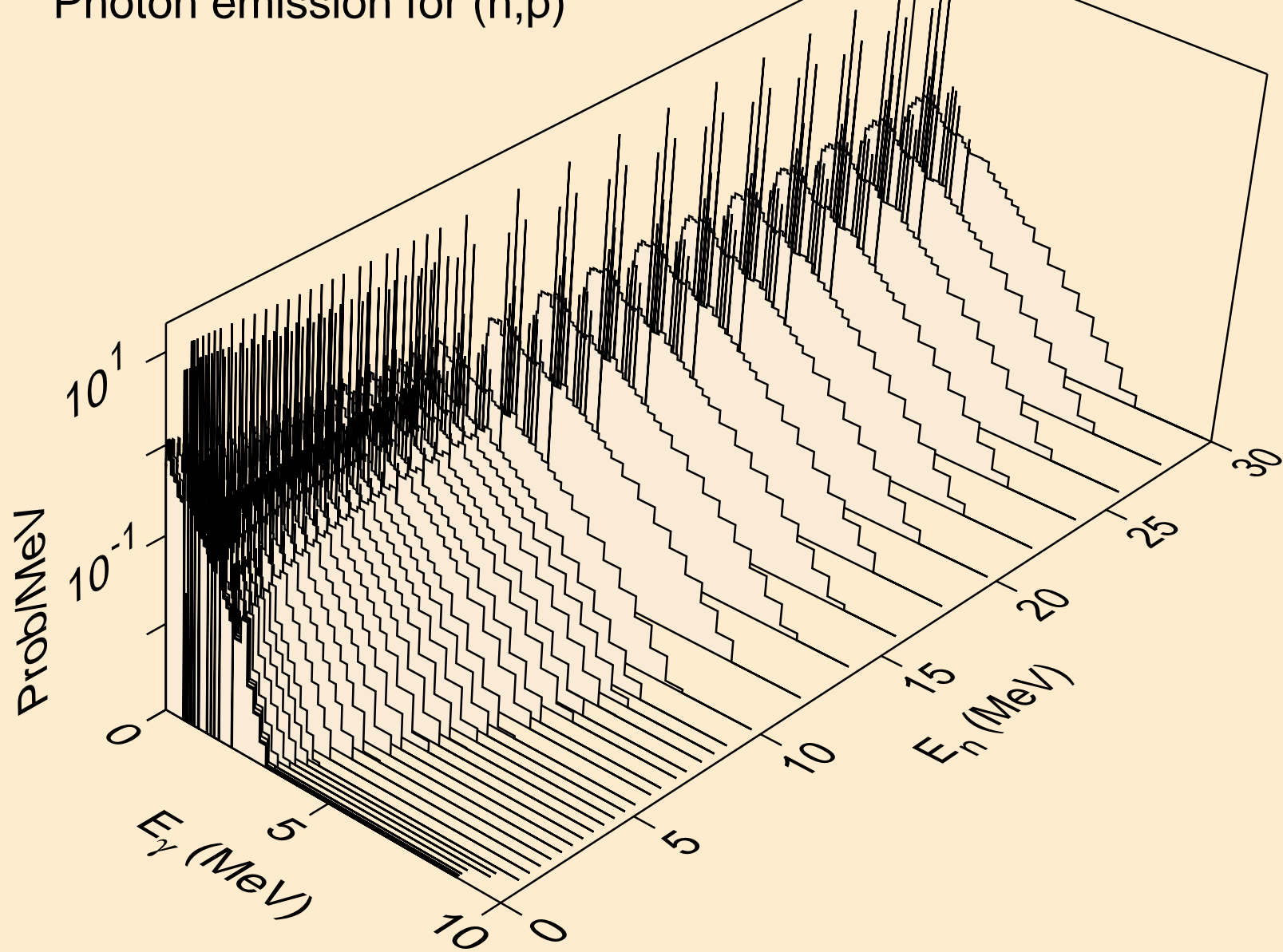

EU142M NEUTRON ACER TENDL-2024 LIBRARY; T=0.K
Photon emission for (n,d)

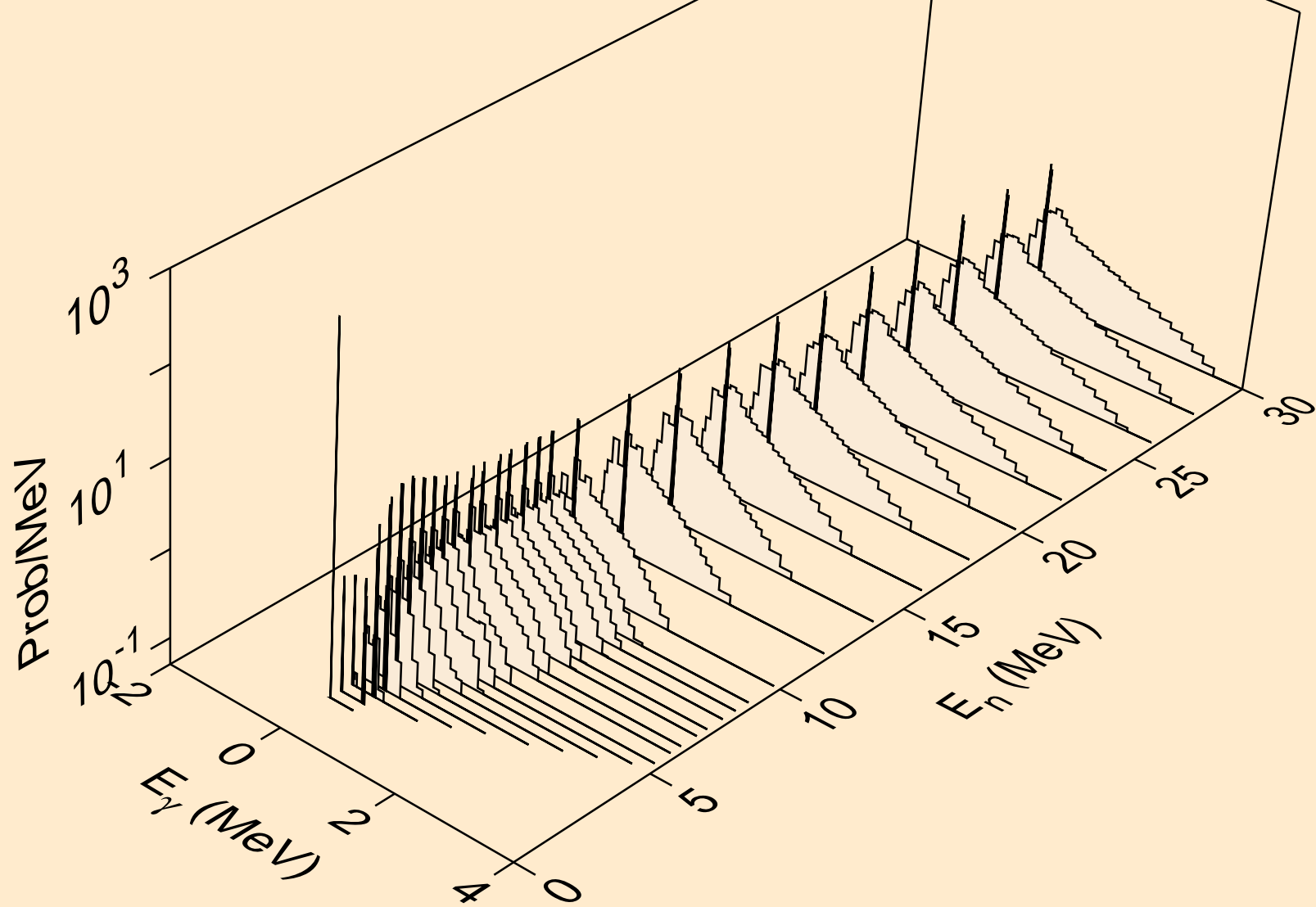

EU142M NEUTRON ACER TENDL-2024 LIBRARY; T=0.K
Photon emission for (n,t)

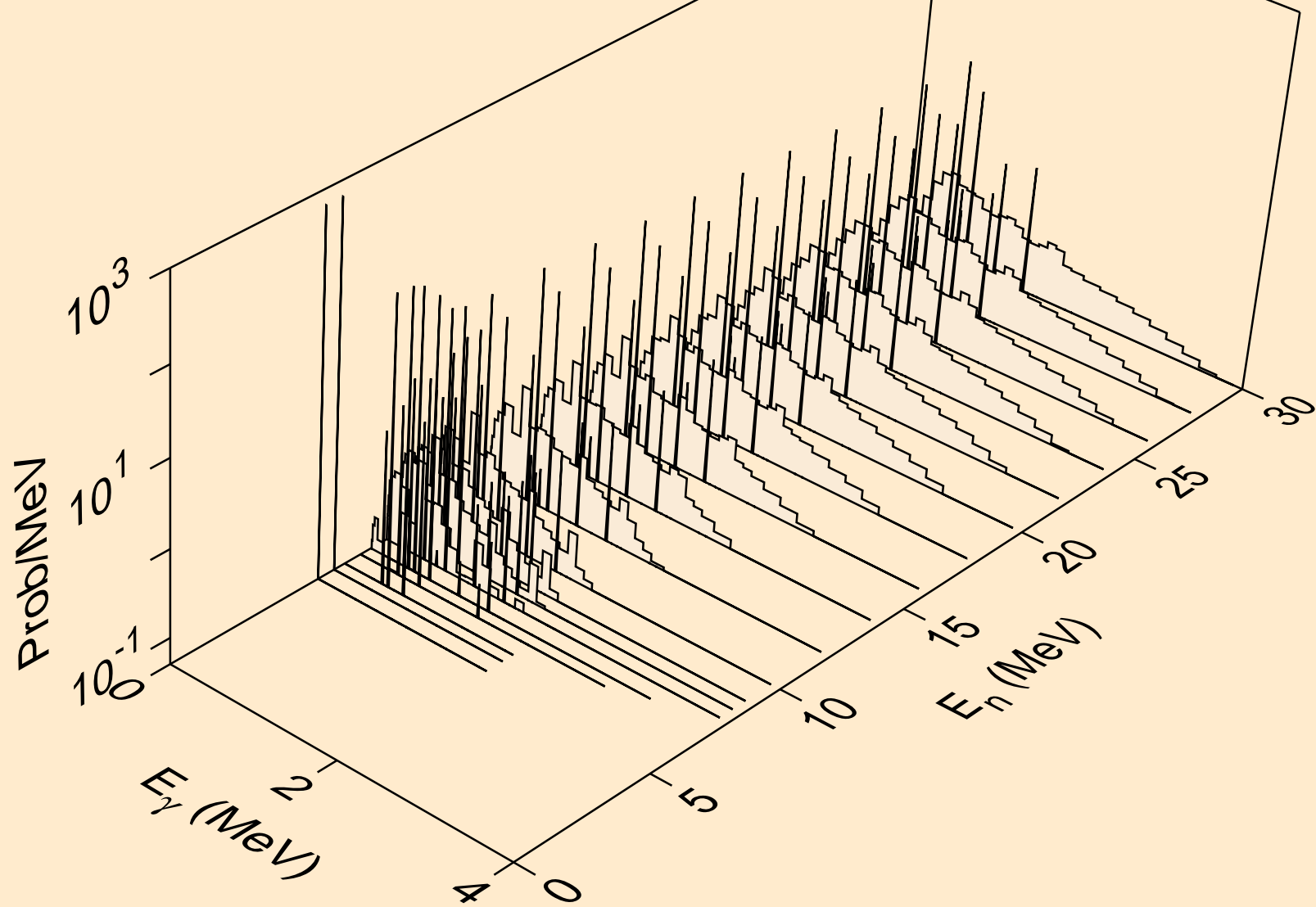

EU142M NEUTRON ACER TENDL-2024 LIBRARY; T=0.K
Photon emission for (n,he3)

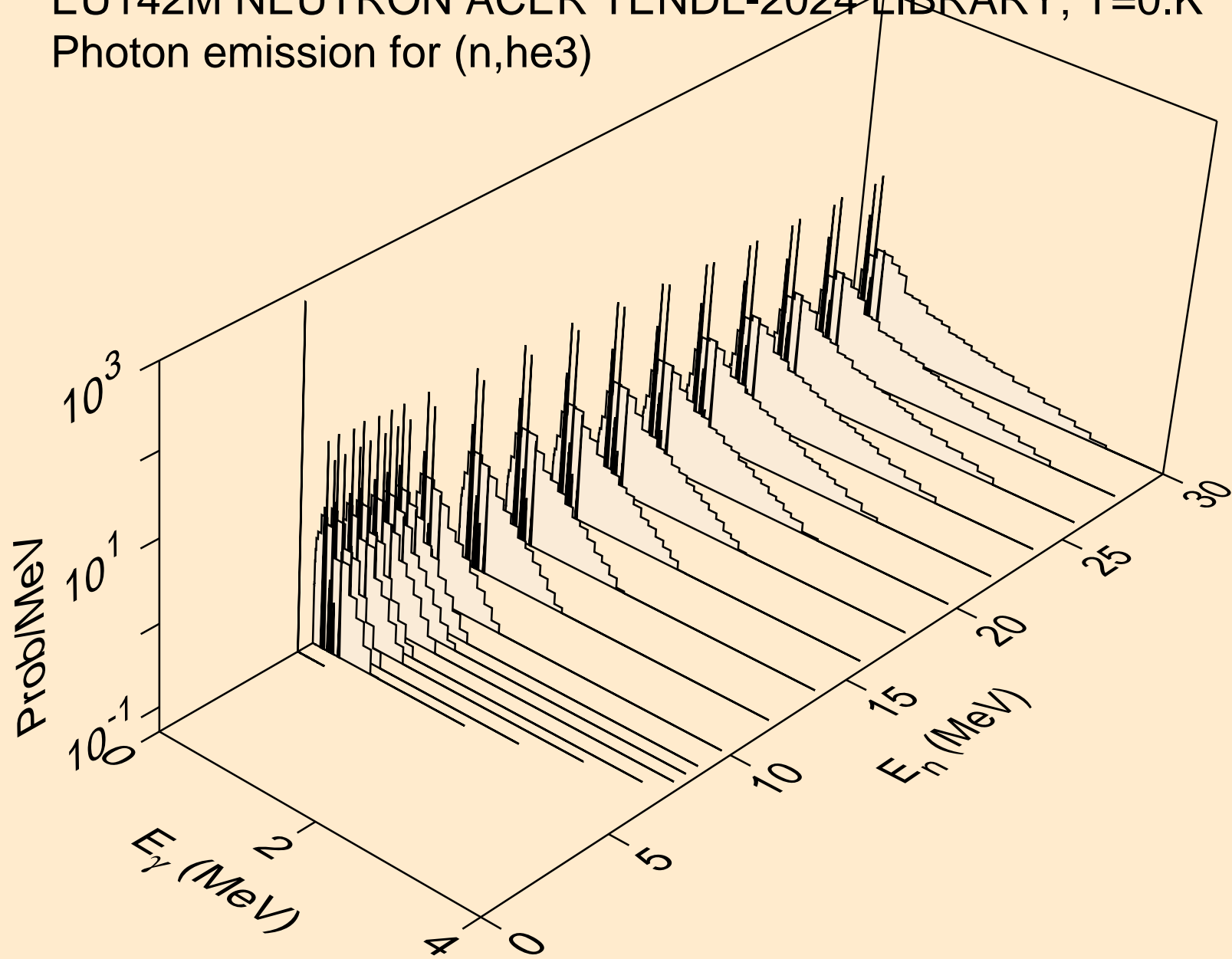

EU142M NEUTRON ACER TENDL-2024 LIBRARY; T=0.K
Photon emission for (n,a)

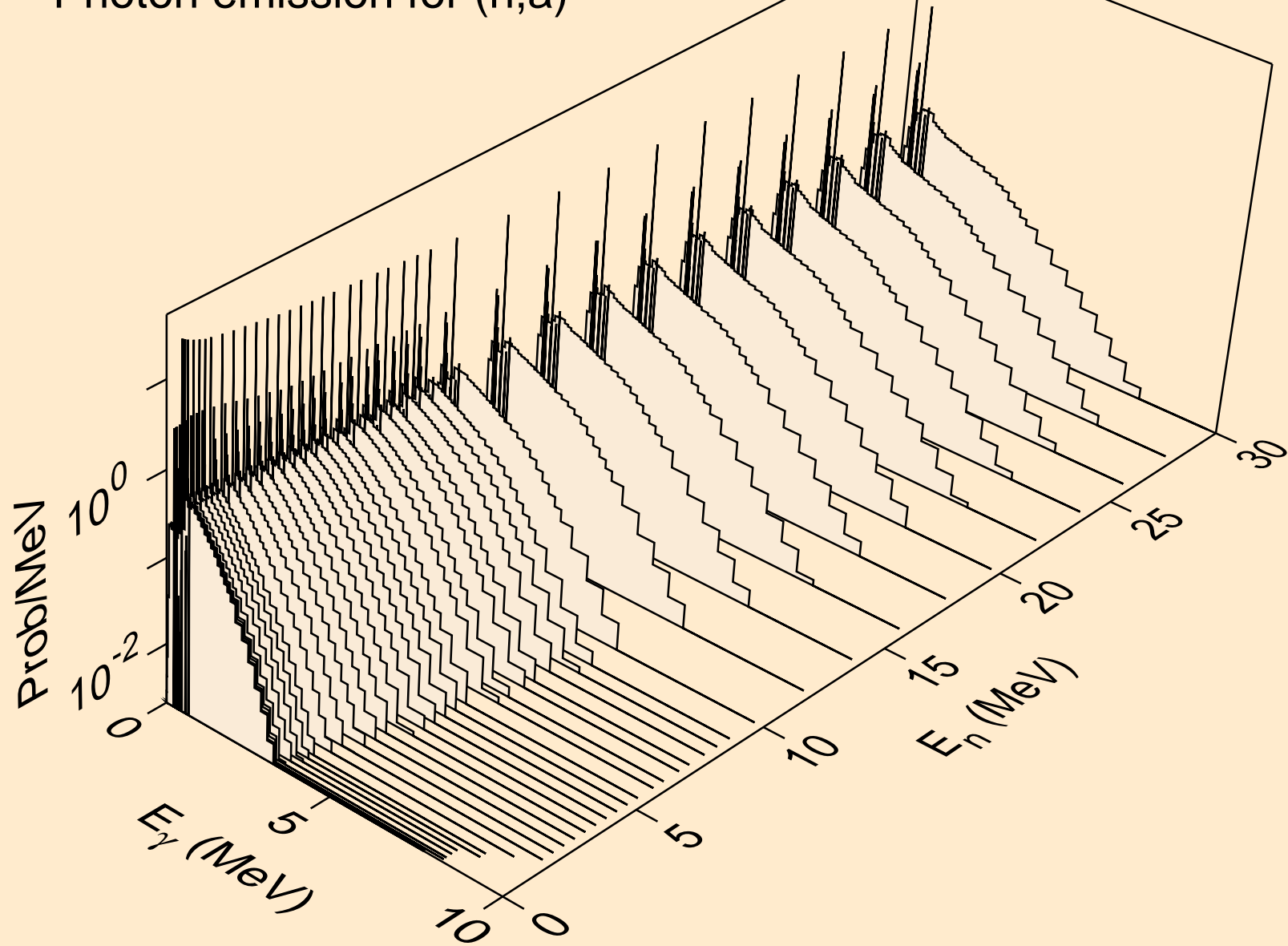

EU142M NEUTRON ACER TENDL-2024 LIBRARY; T=0.K
Photon emission for (n,2a)

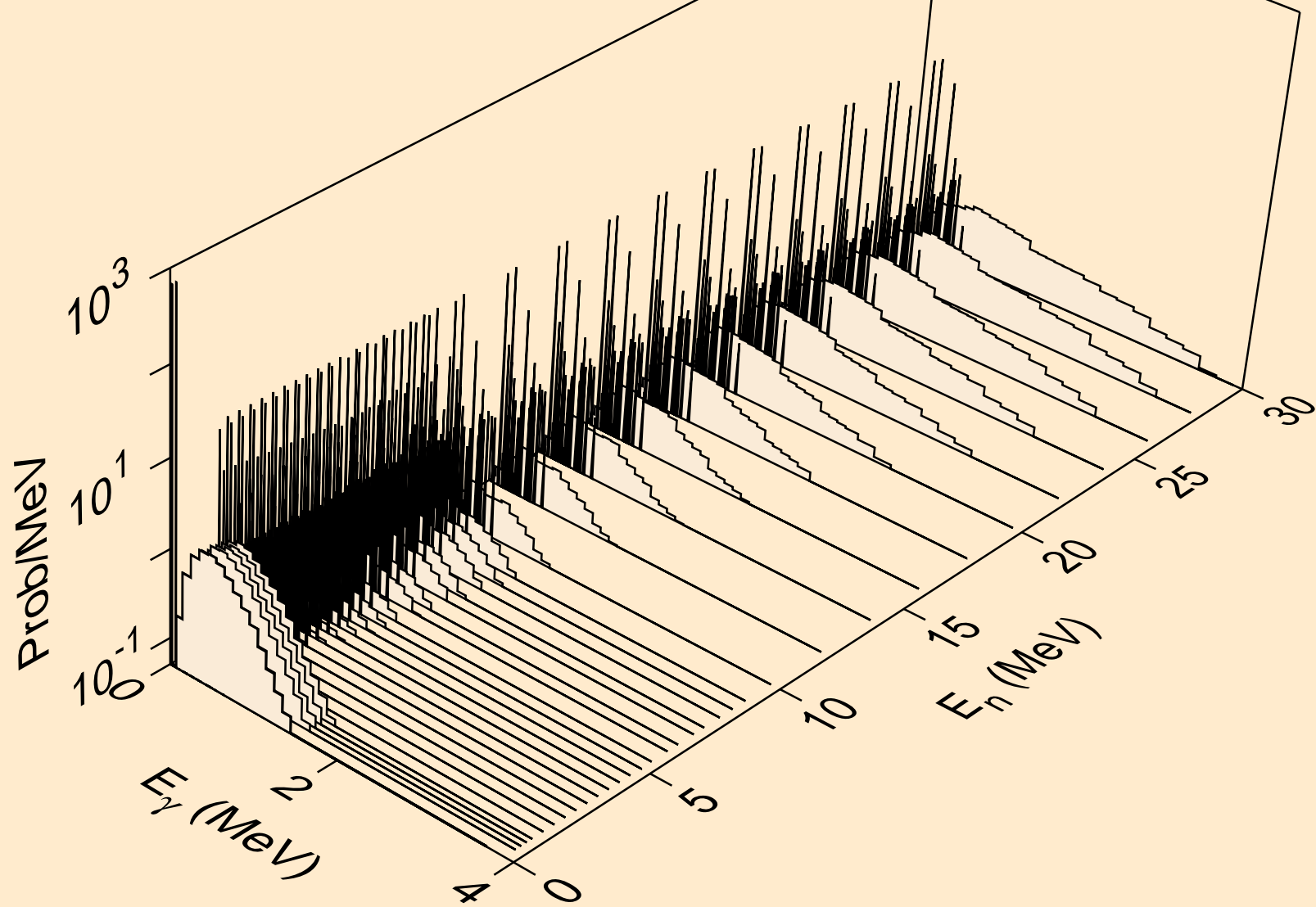

EU142M NEUTRON ACER TENDL-2024 LIBRARY; T=0.K
Photon emission for (n,3a)

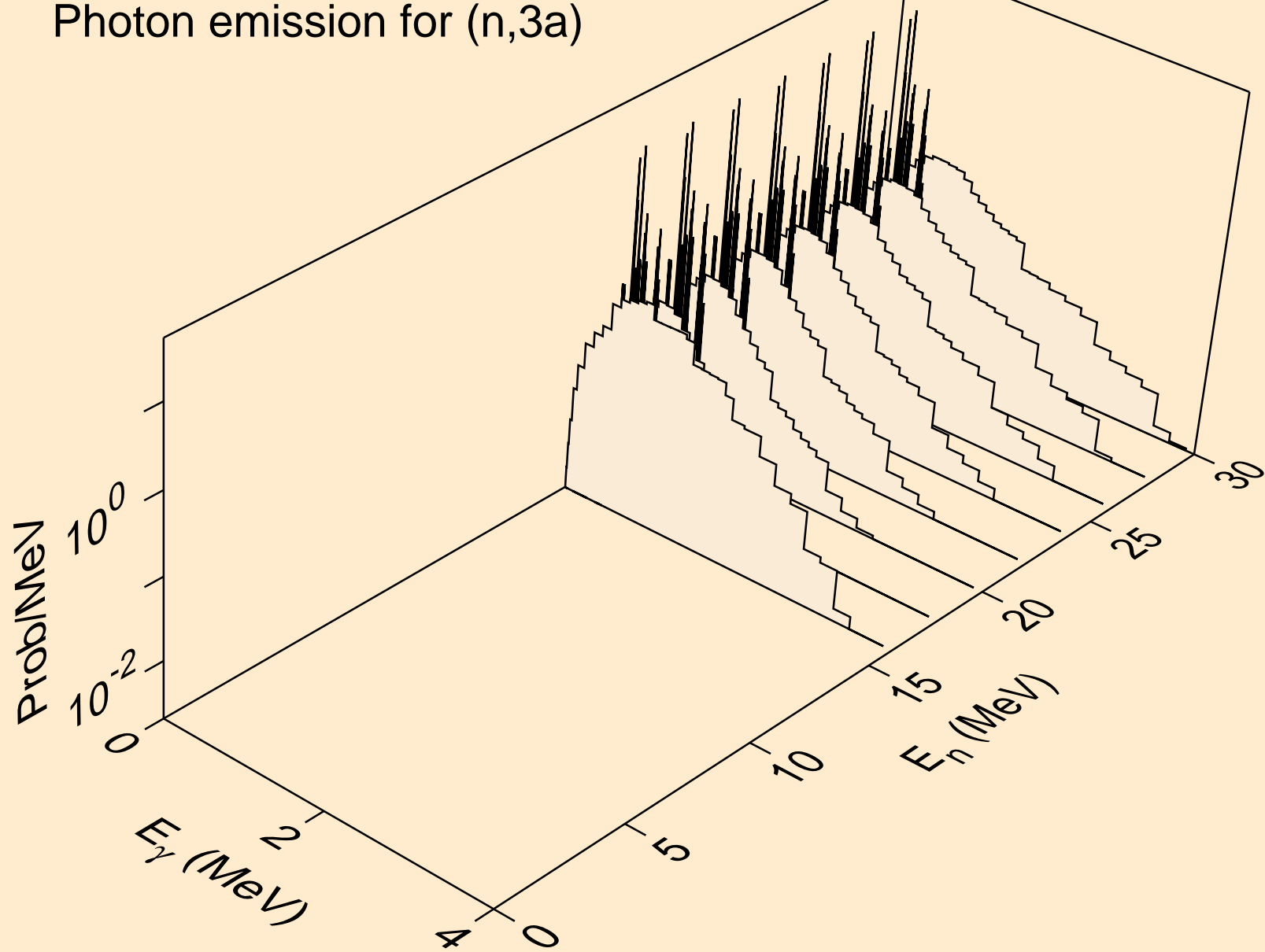

EU142M NEUTRON ACER TENDL-2024 LIBRARY; T=0.K
Photon emission for (n,2p)

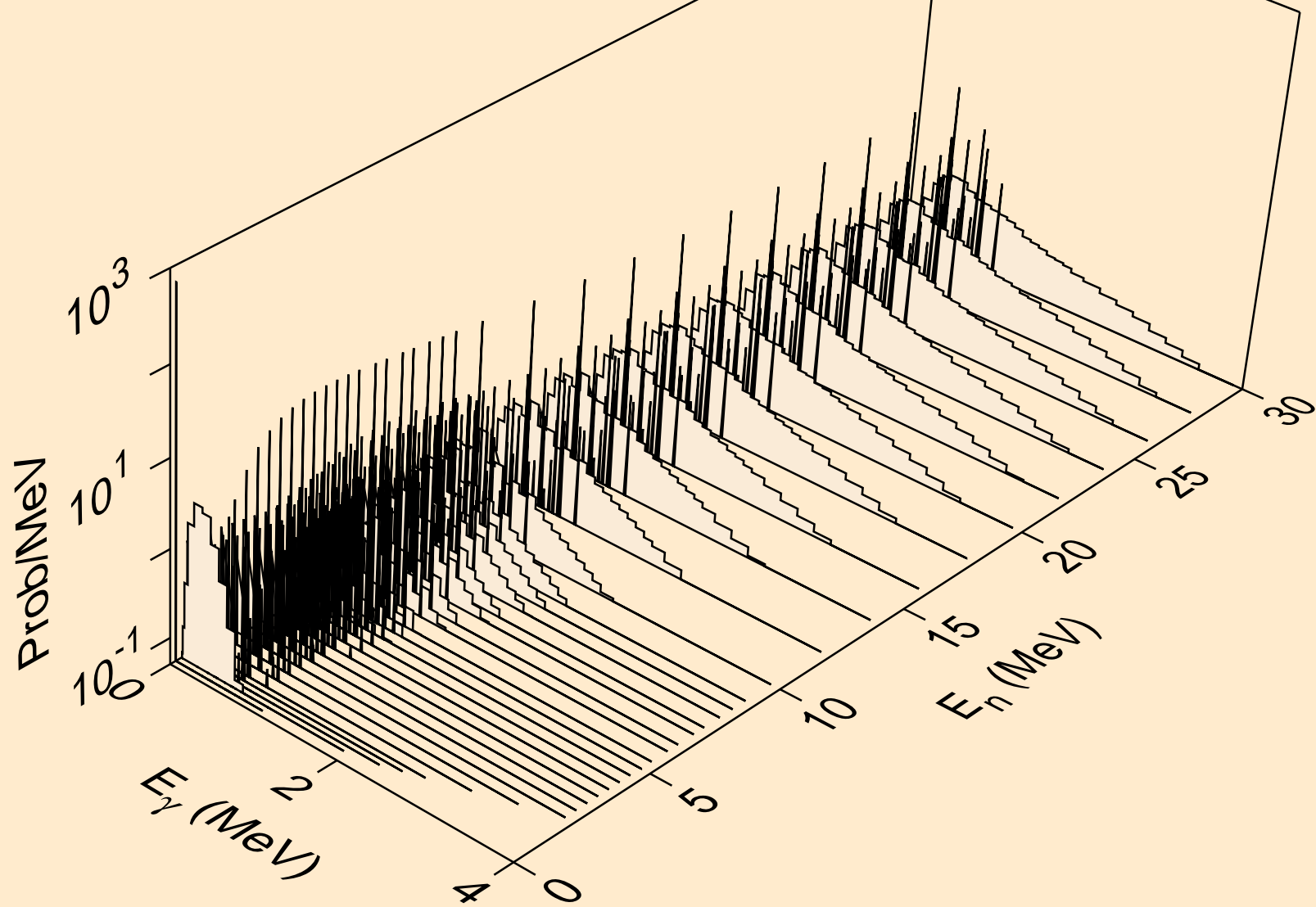

EU142M NEUTRON ACER TENDL-2024 LIBRARY; T=0.K
Photon emission for (n,p α)

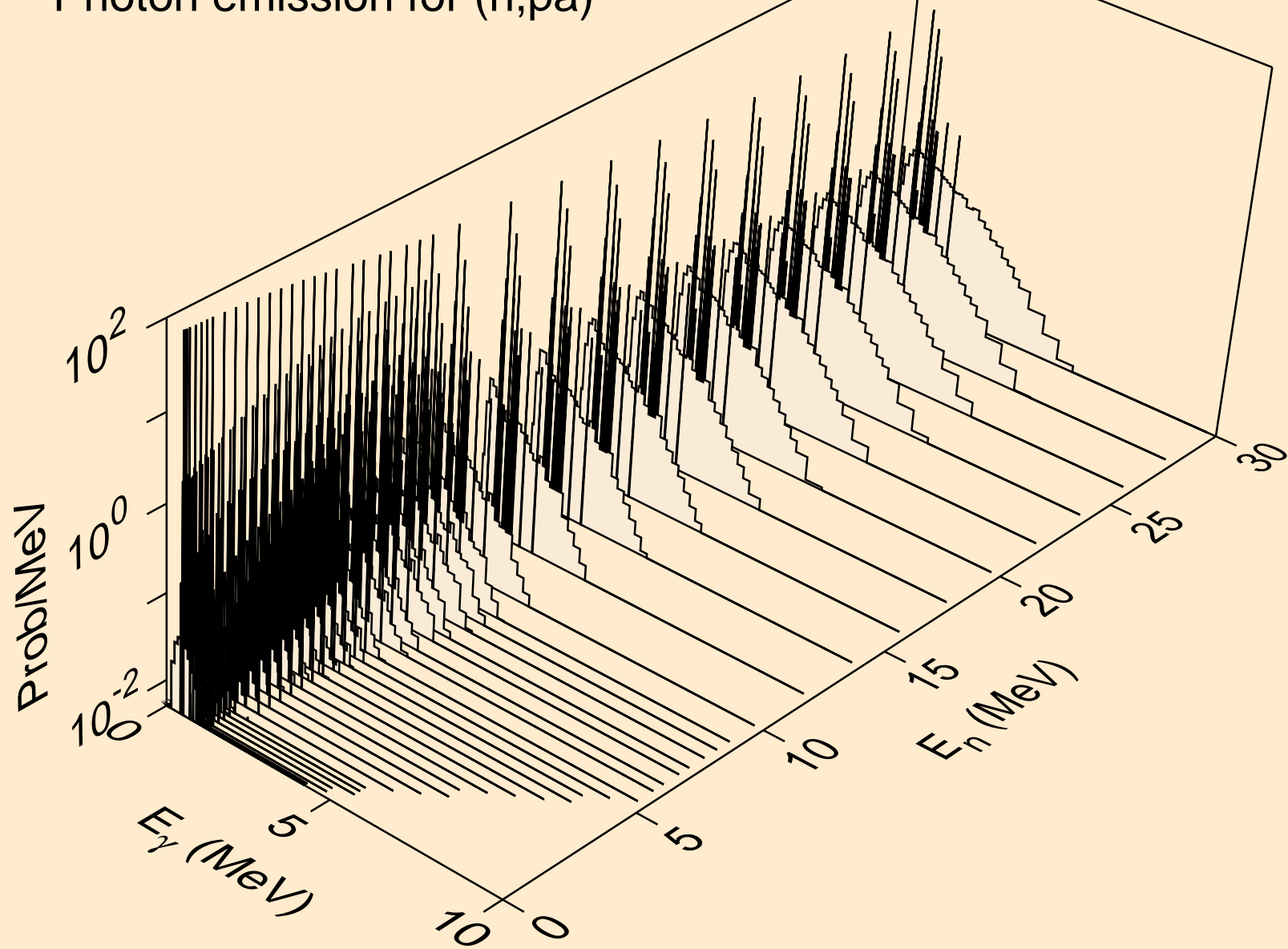

EU142M NEUTRON ACER TENDL-2024 LIBRARY; T=0.K
Photon emission for (n,pd)

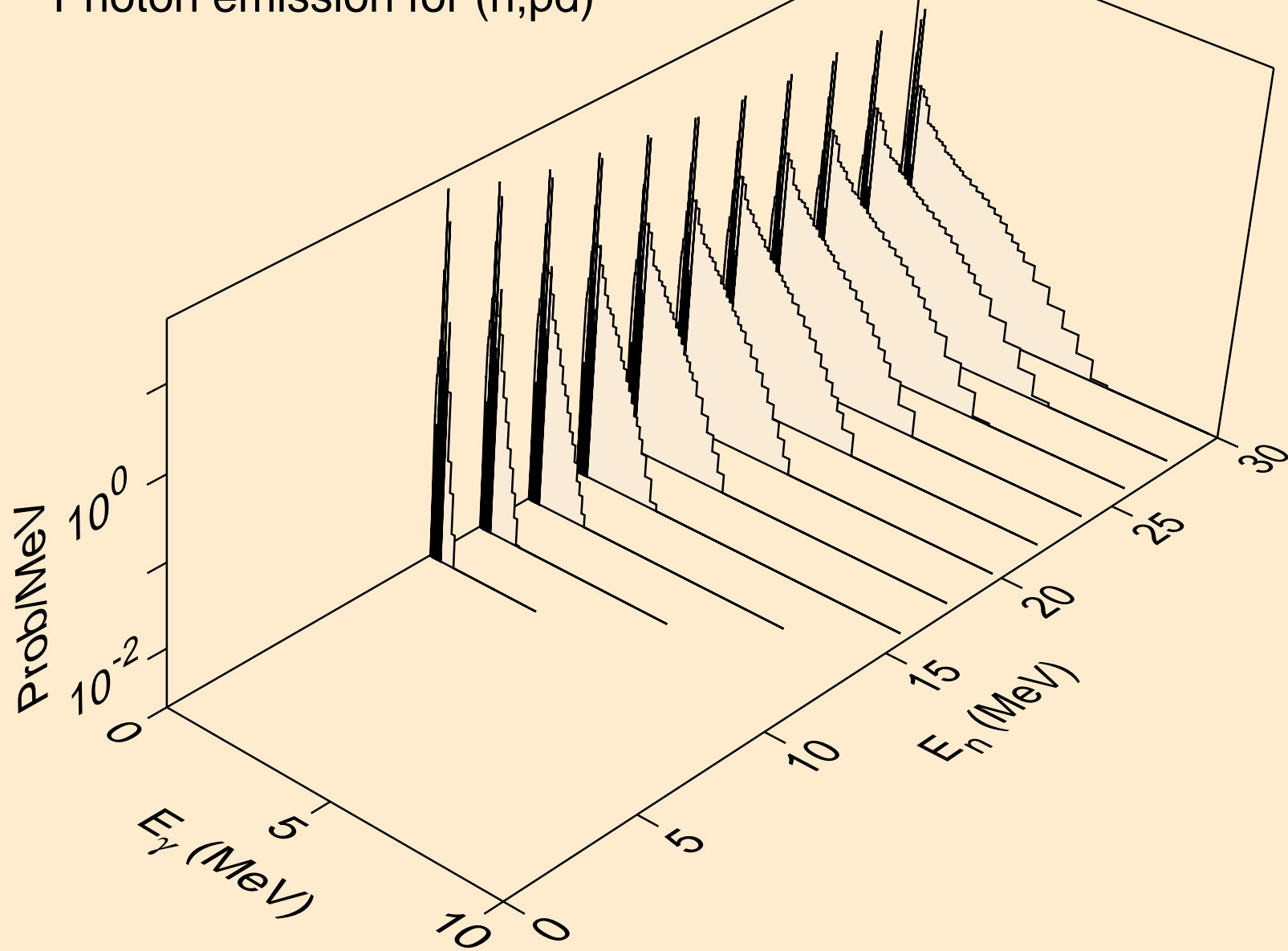

EU142M NEUTRON ACER TENDL-2024 LIBRARY; T=0.K
Photon emission for (n,pt)

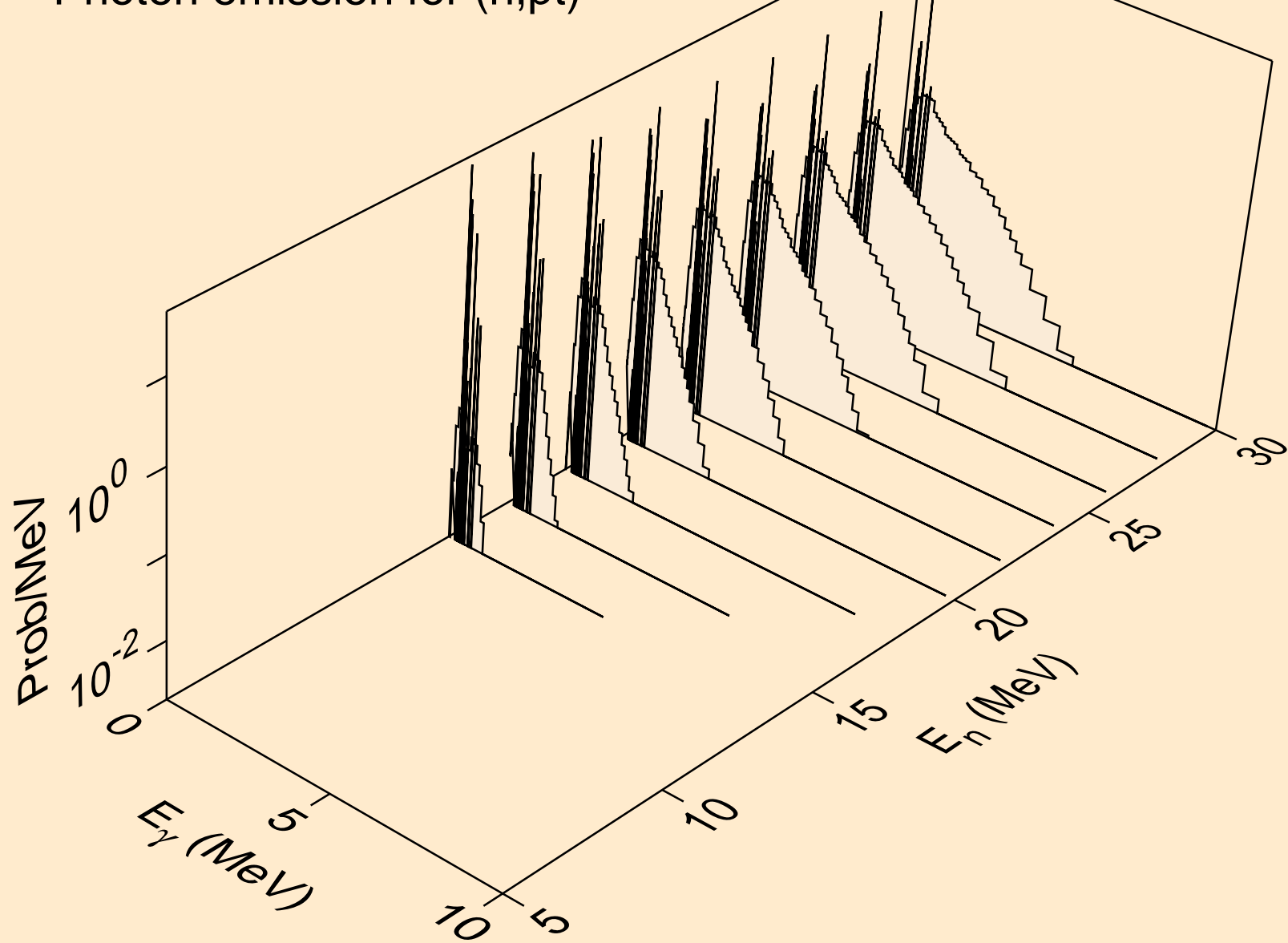

EU142M NEUTRON ACER TENDL-2024 LIBRARY; T=0.K
Photon emission for (n,da)

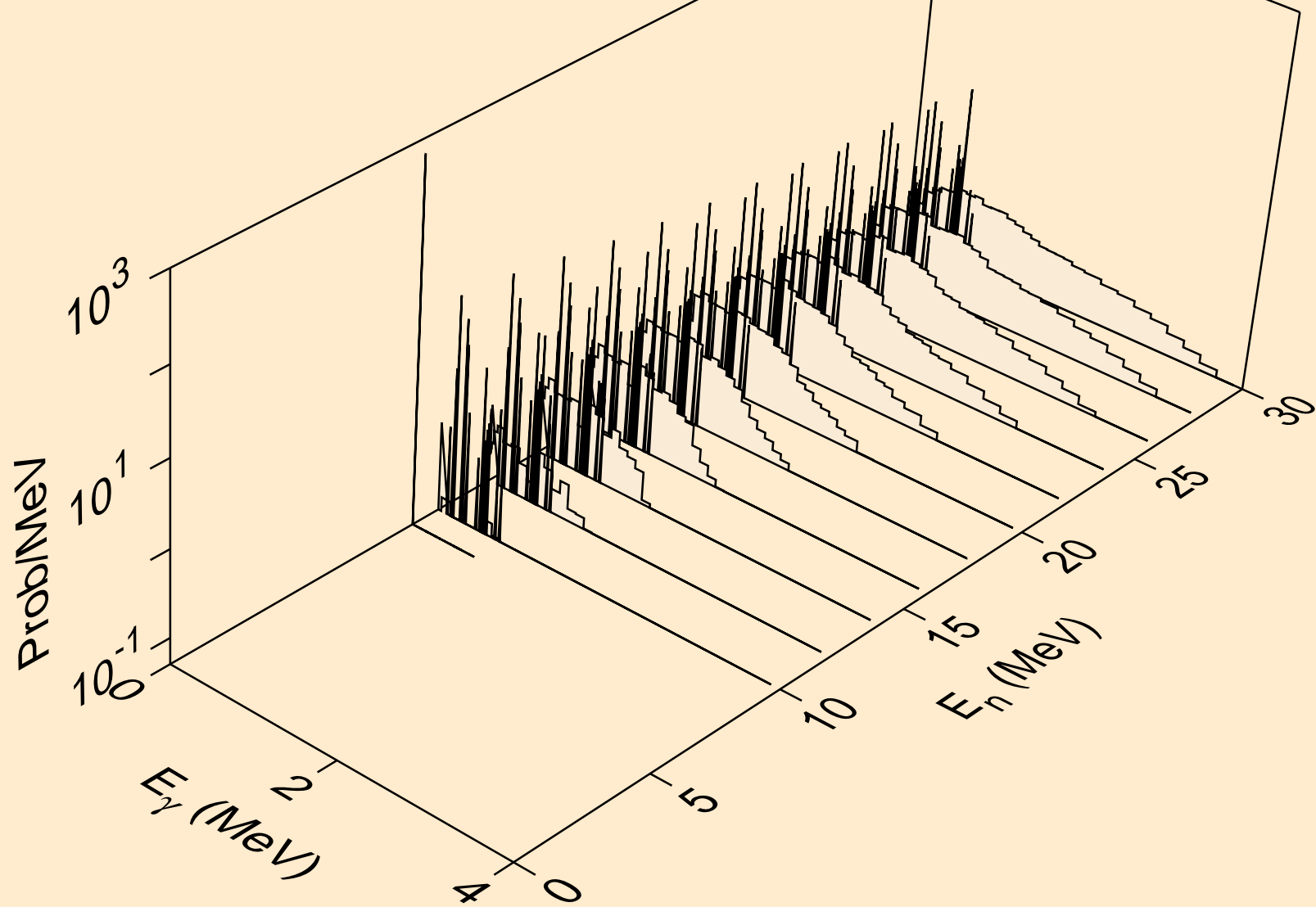

EU142M NEUTRON ACER TENDL-2024 LIBRARY; T=0.K
thermal capture photon spectrum

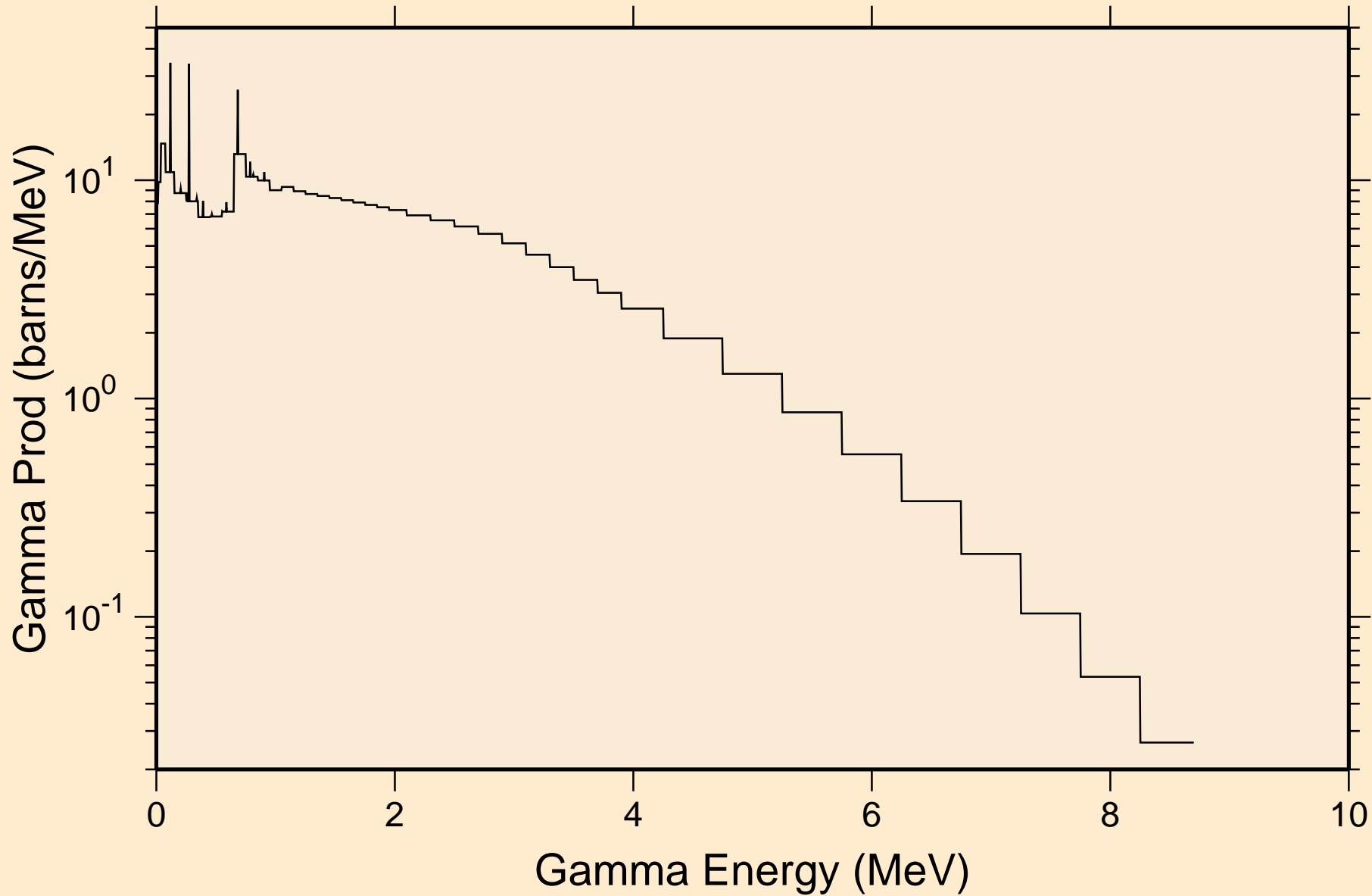

EU142M NEUTRON ACER TENDL-2024 LIBRARY; T=0.K
14 MeV photon spectrum

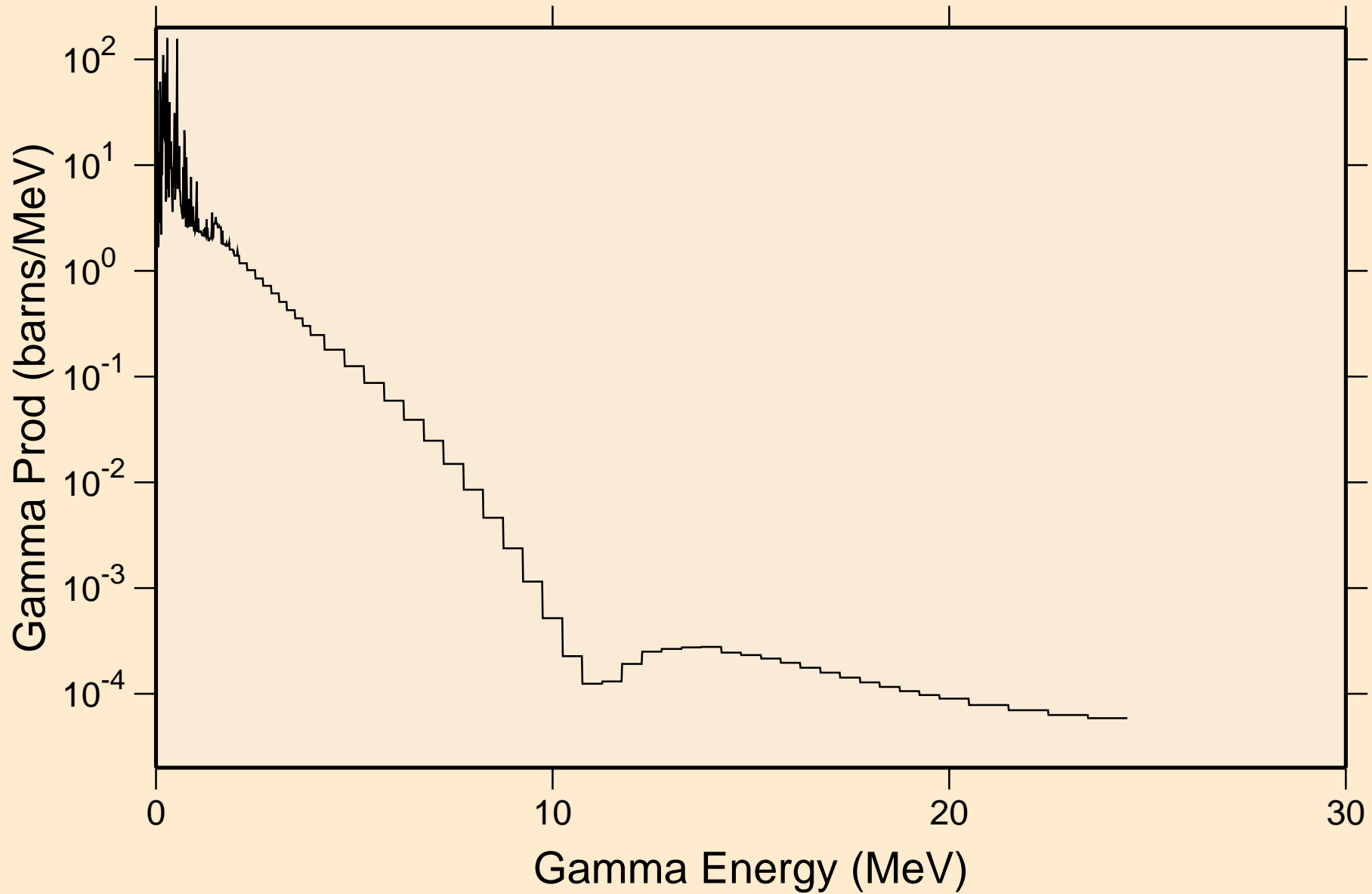

EU142M NEUTRON ACER TENDL-2024 LIBRARY; T=0.K

Particle heating contributions

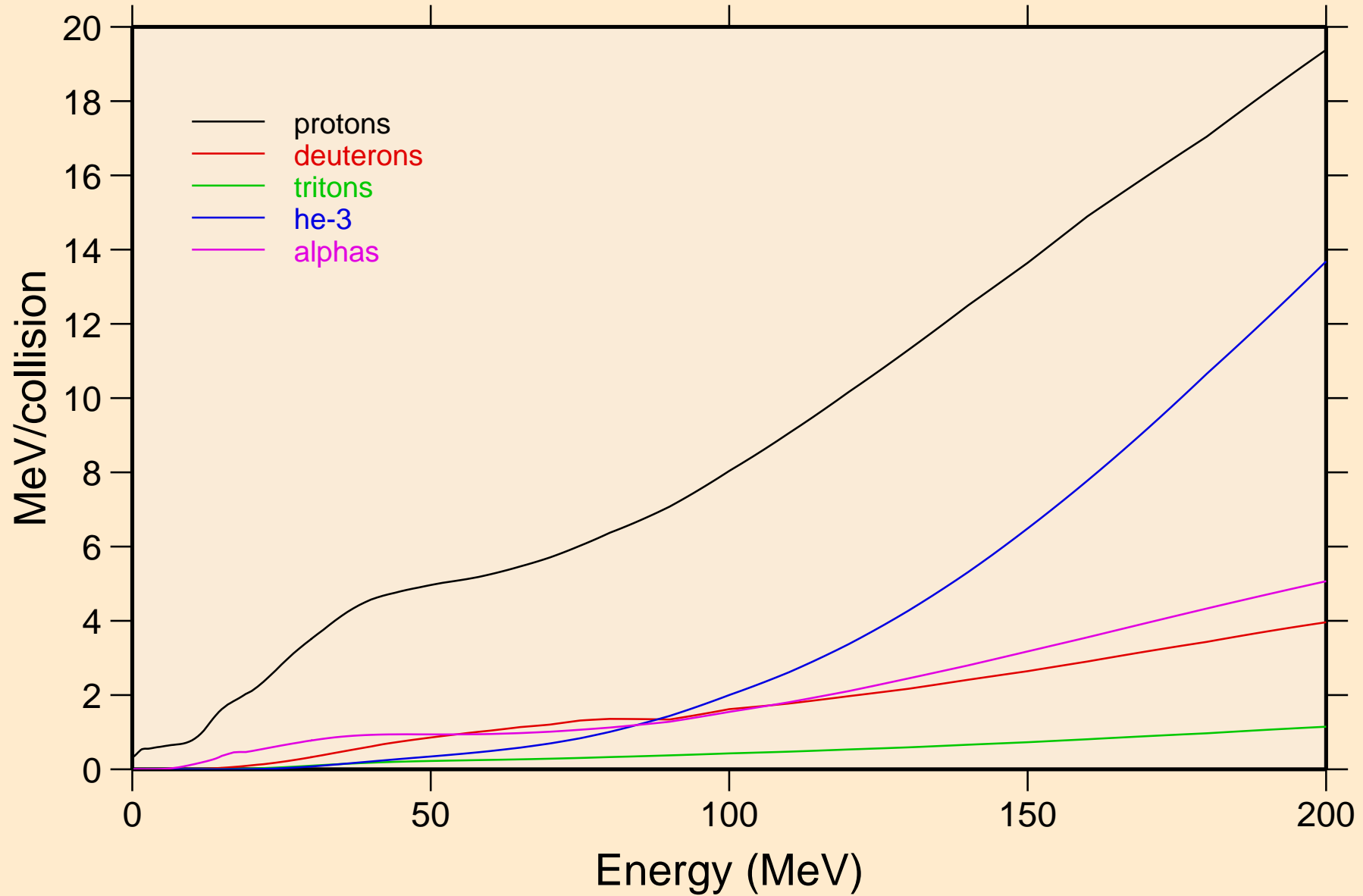

EU142M NEUTRON ACER TENDL-2024 LIBRARY; T=0.K
Recoil Heating

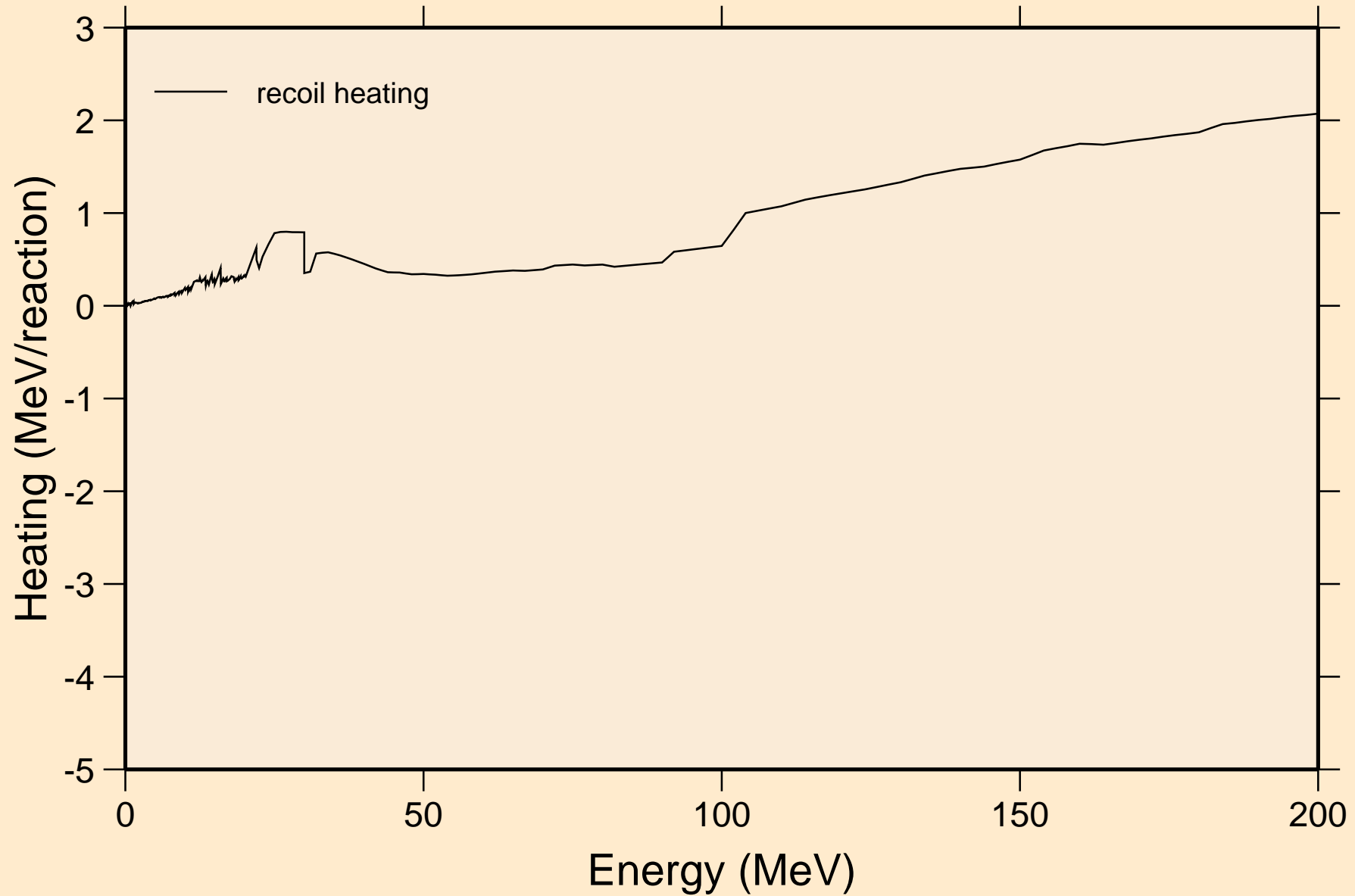

EU142M NEUTRON ACER TENDL-2024 LIBRARY; T=0.K

Particle production cross sections

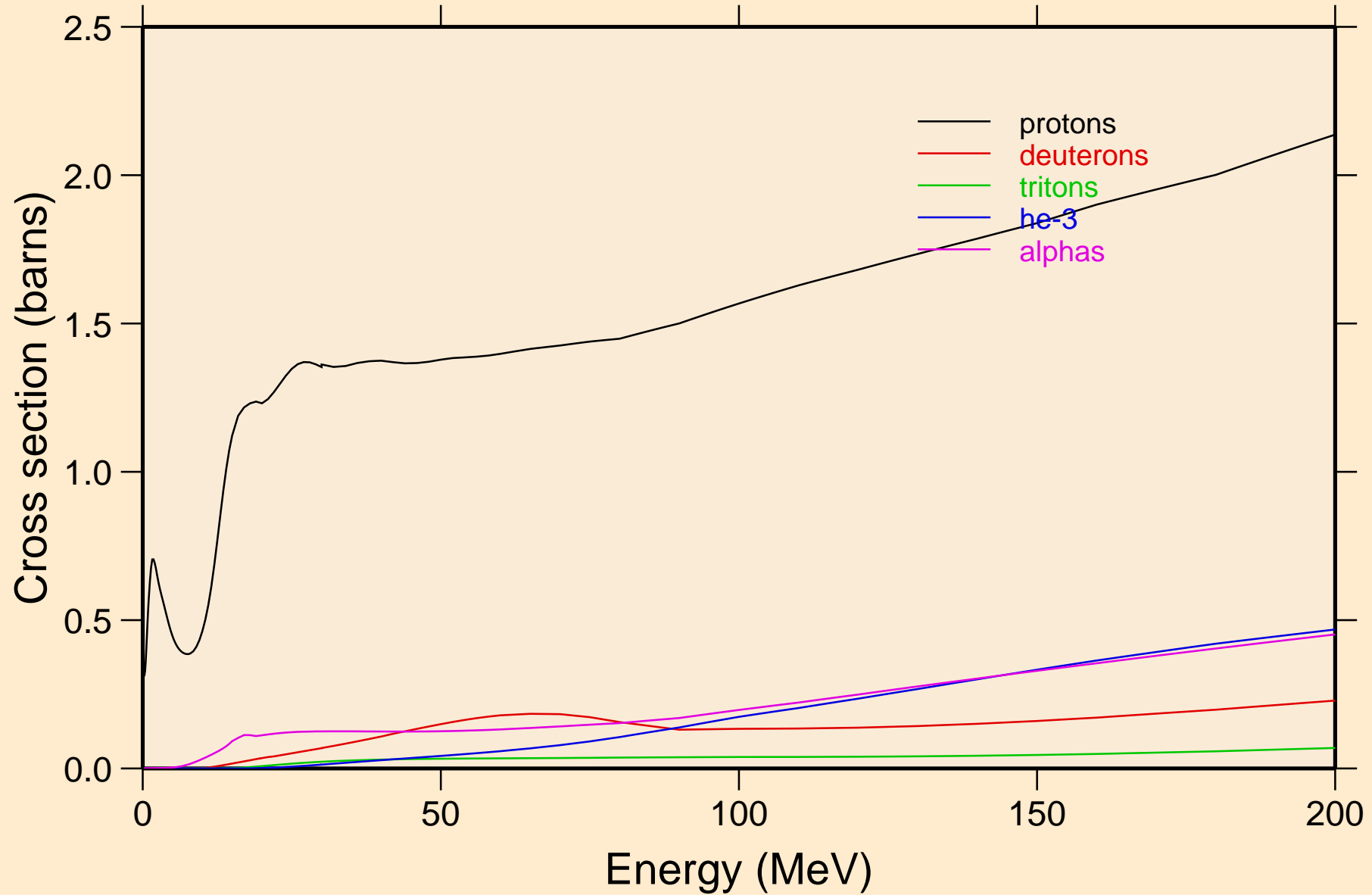

EU142M NEUTRON ACER TENDL-2024 LIBRARY; T=0.K
protons from (n,x)

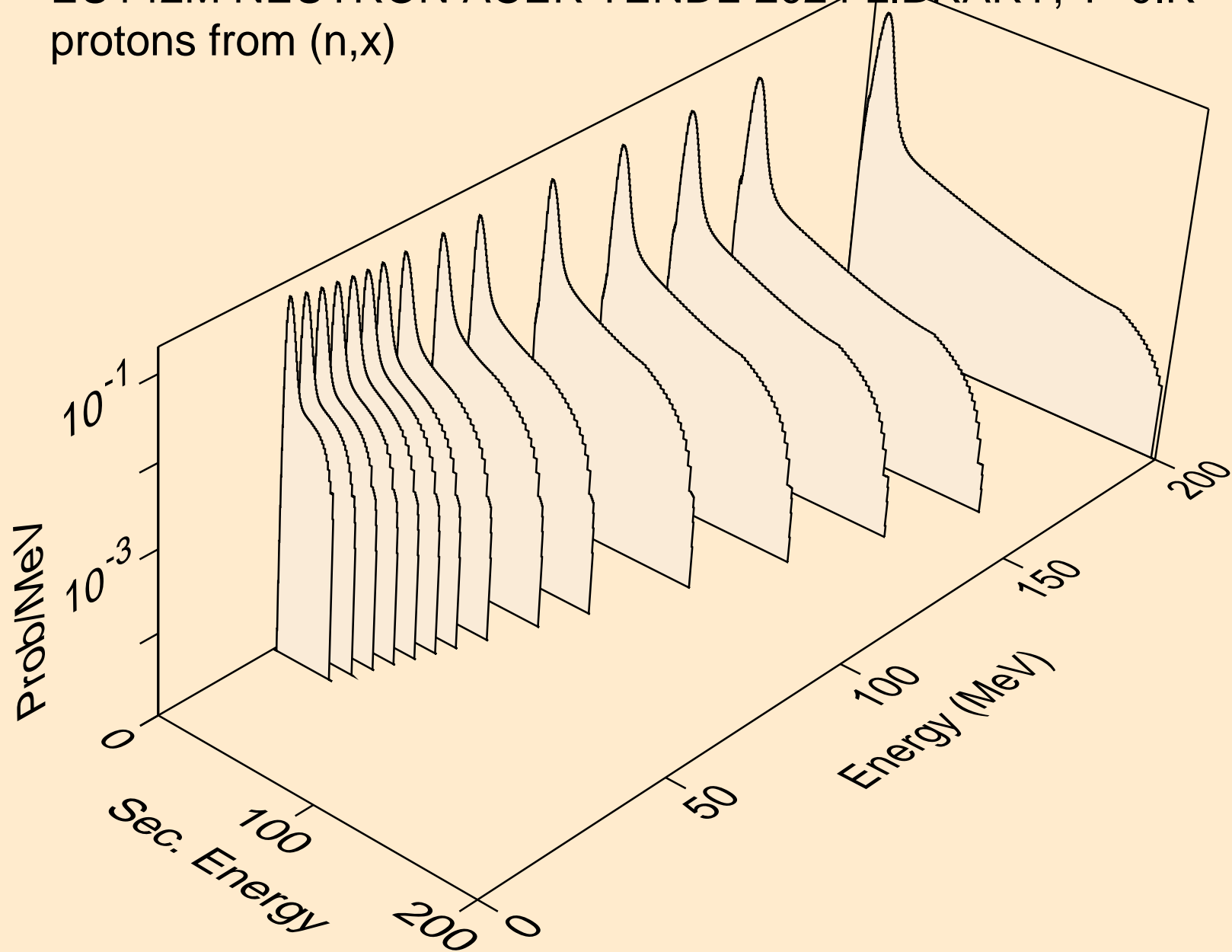

EU142M NEUTRON ACER TENDL-2024 LIBRARY; T=0.K
protons from (n,n*)p

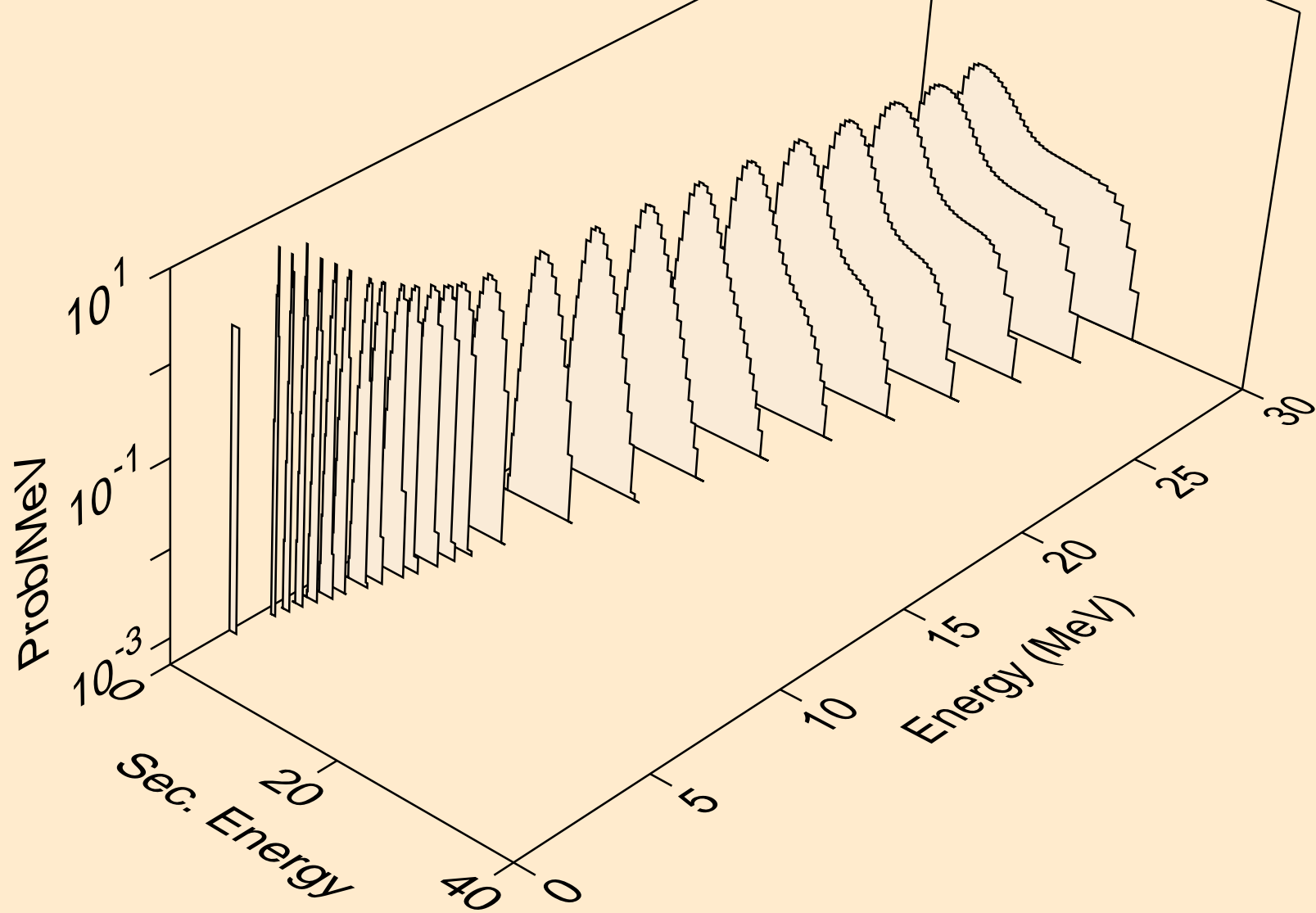

EU142M NEUTRON ACER TENDL-2024 LIBRARY; T=0.K
protons from (n,2np)

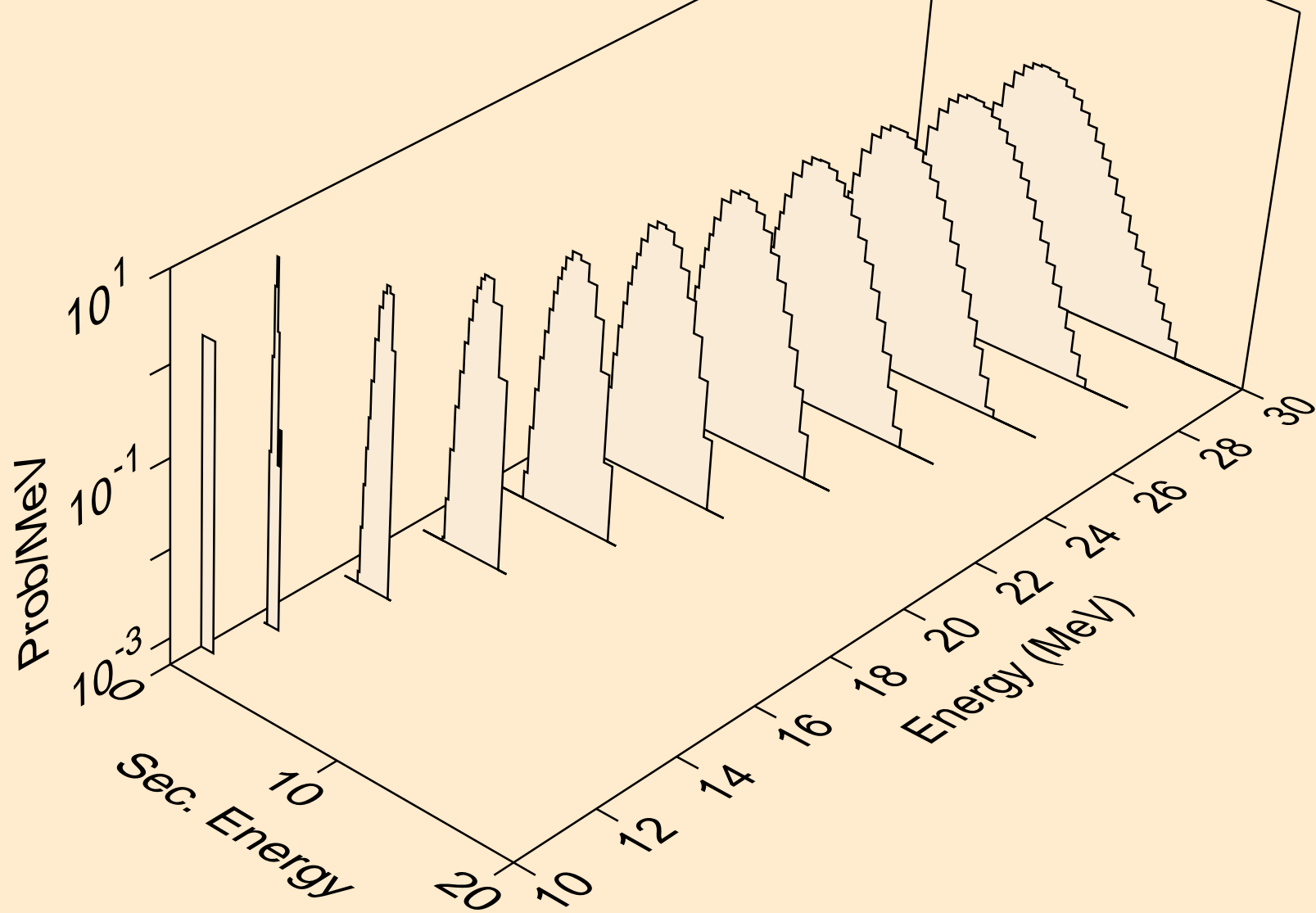

EU142M NEUTRON ACER TENDL-2024 LIBRARY; T=0.K
protons from (n,3np)

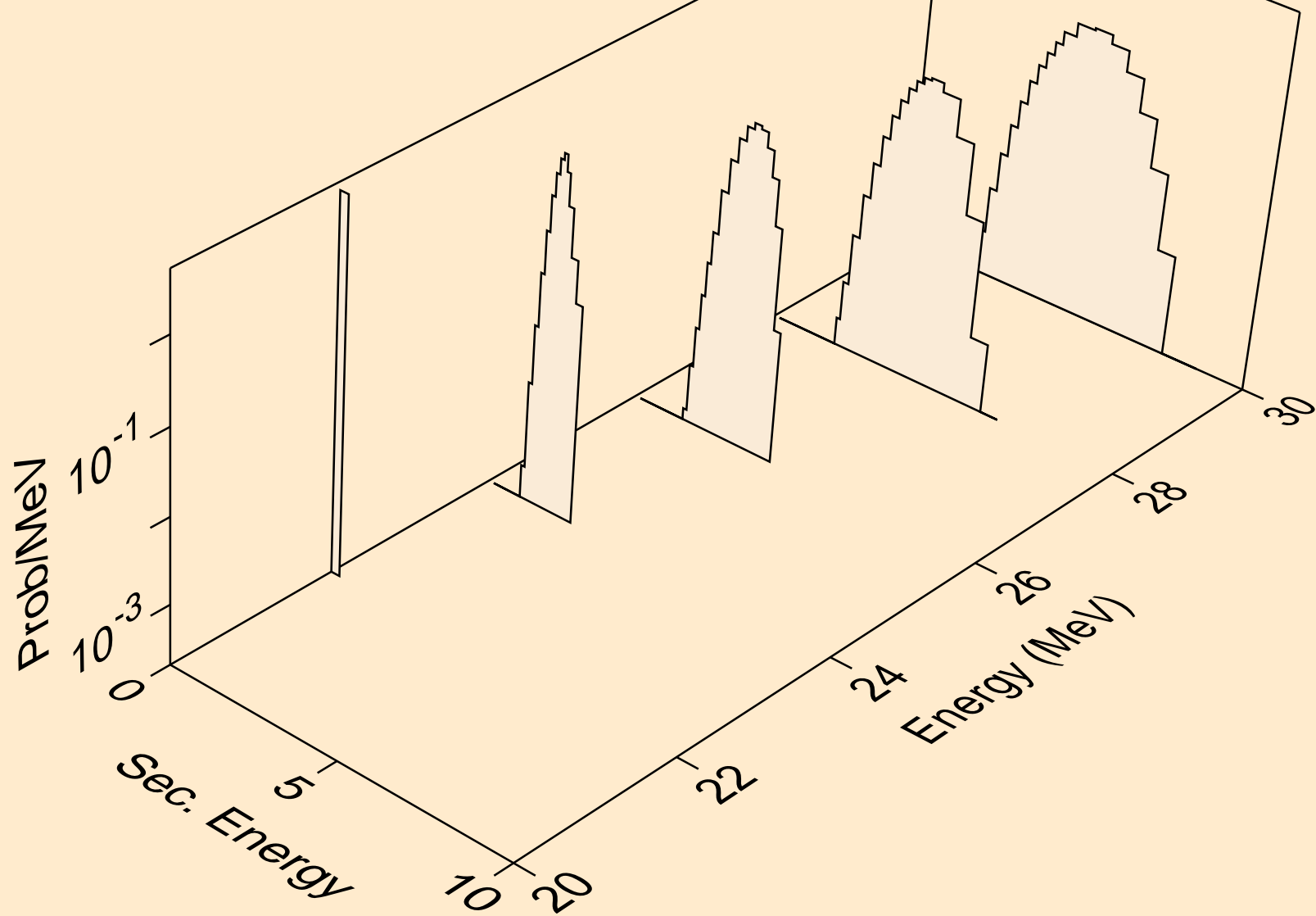

EU142M NEUTRON ACER TENDL-2024 LIBRARY; T=0.K
protons from (n,n2p)

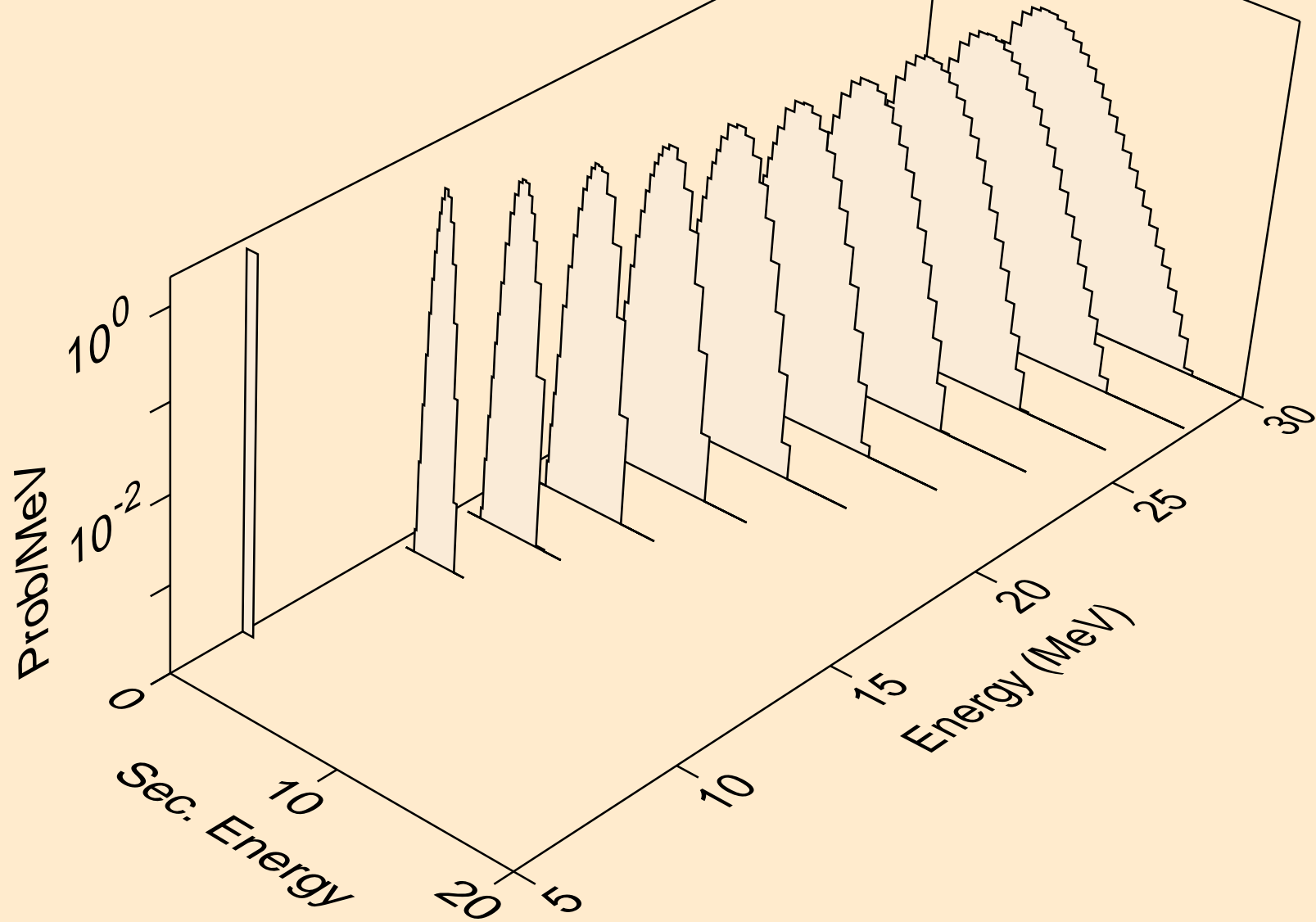

EU142M NEUTRON ACER TENDL-2024 LIBRARY; T=0.K
protons from (n,npa)

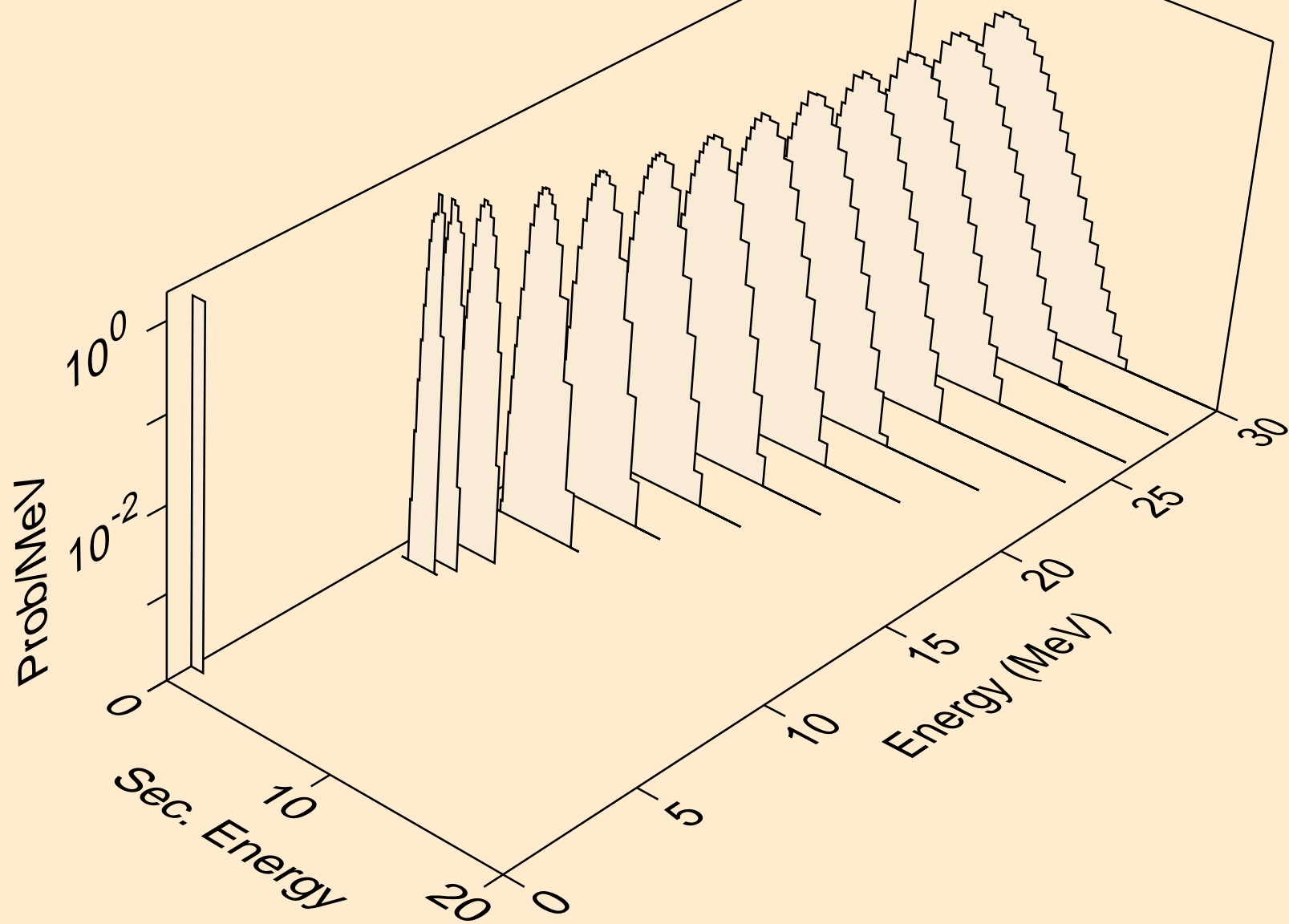

EU142M NEUTRON ACER TENDL-2024 LIBRARY; T=0.K
protons from (n,p)

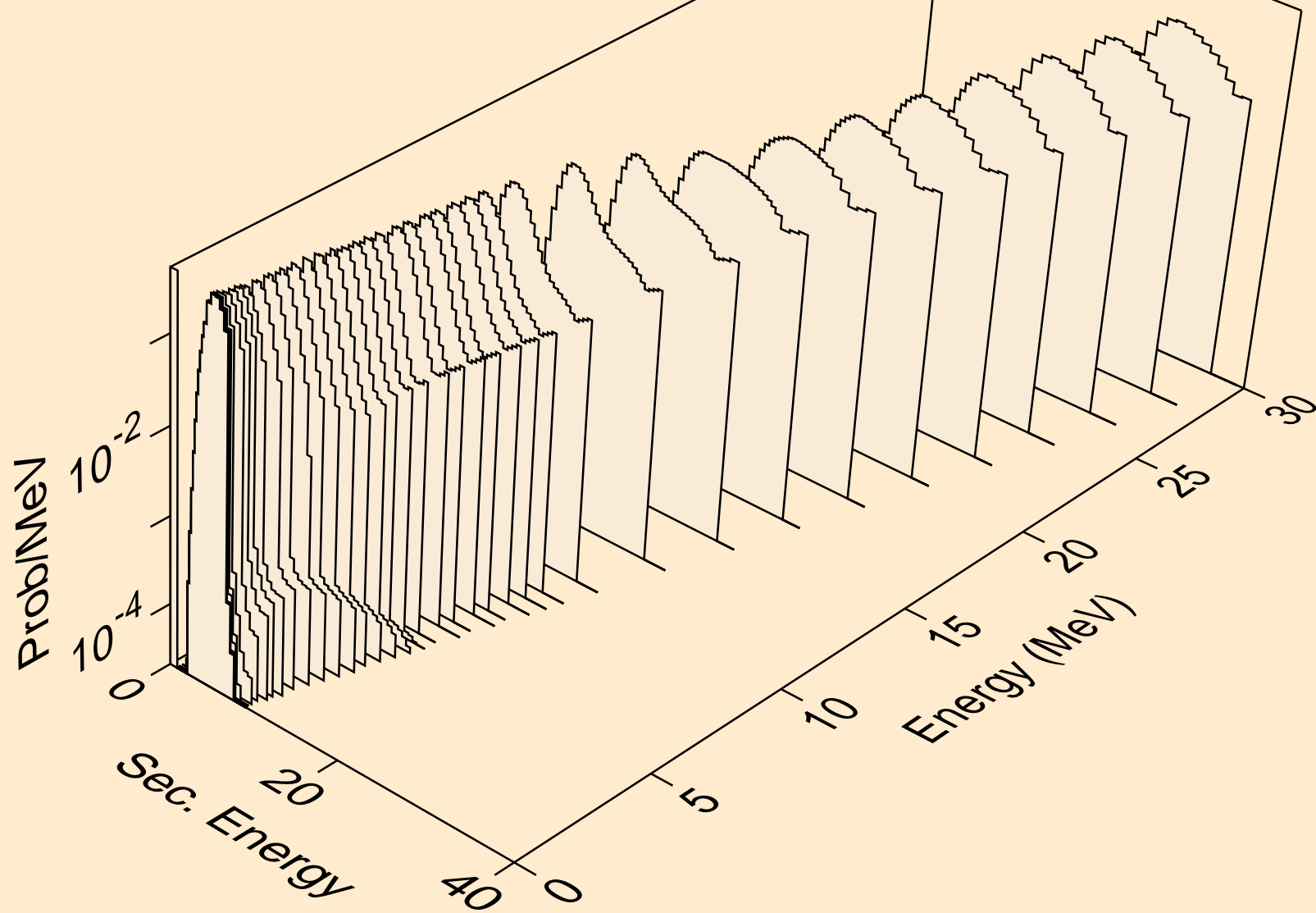

EU142M NEUTRON ACER TENDL-2024 LIBRARY; T=0.K
protons from (n,2p)

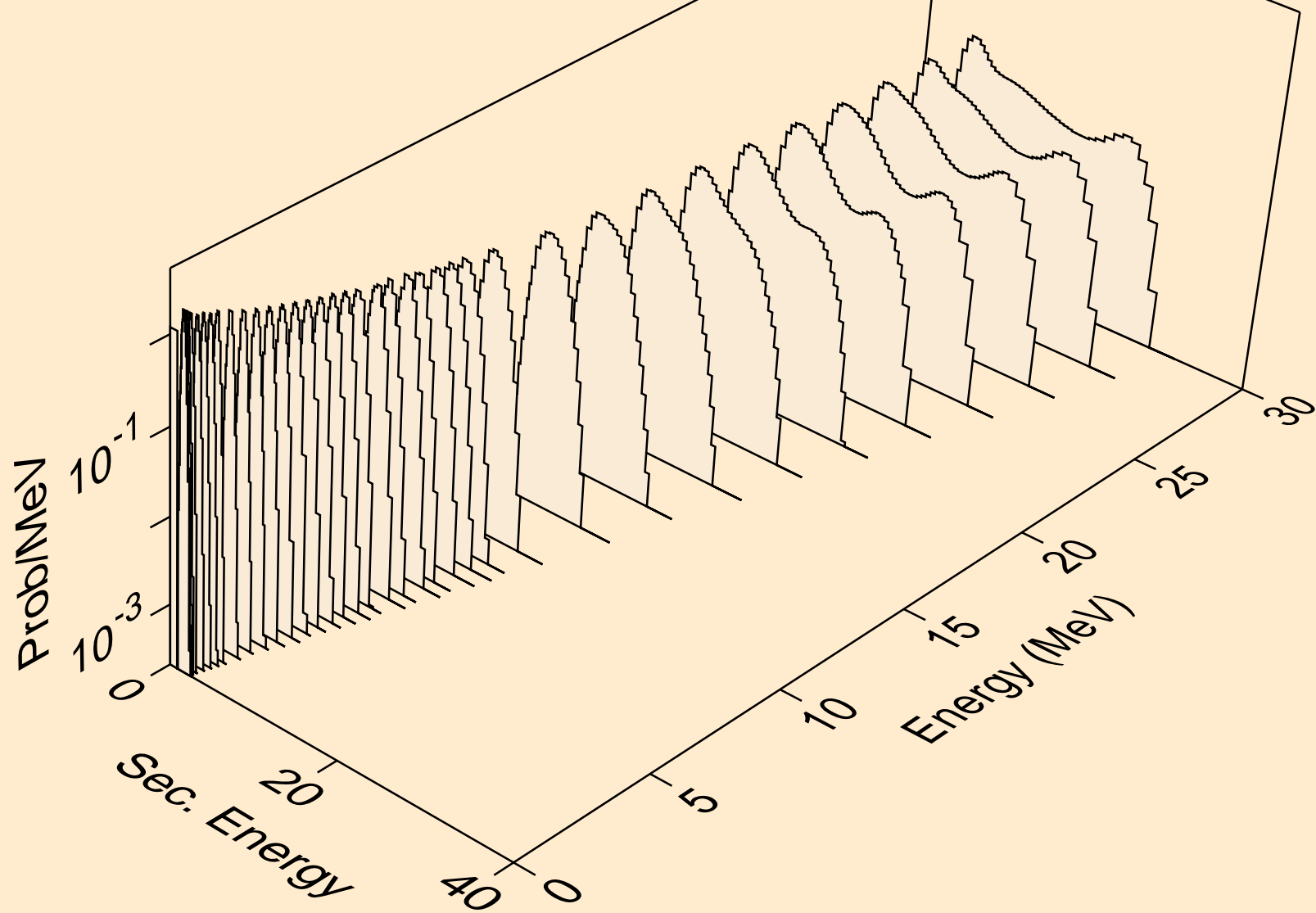

EU142M NEUTRON ACER TENDL-2024 LIBRARY; T=0.K
protons from (n,p)

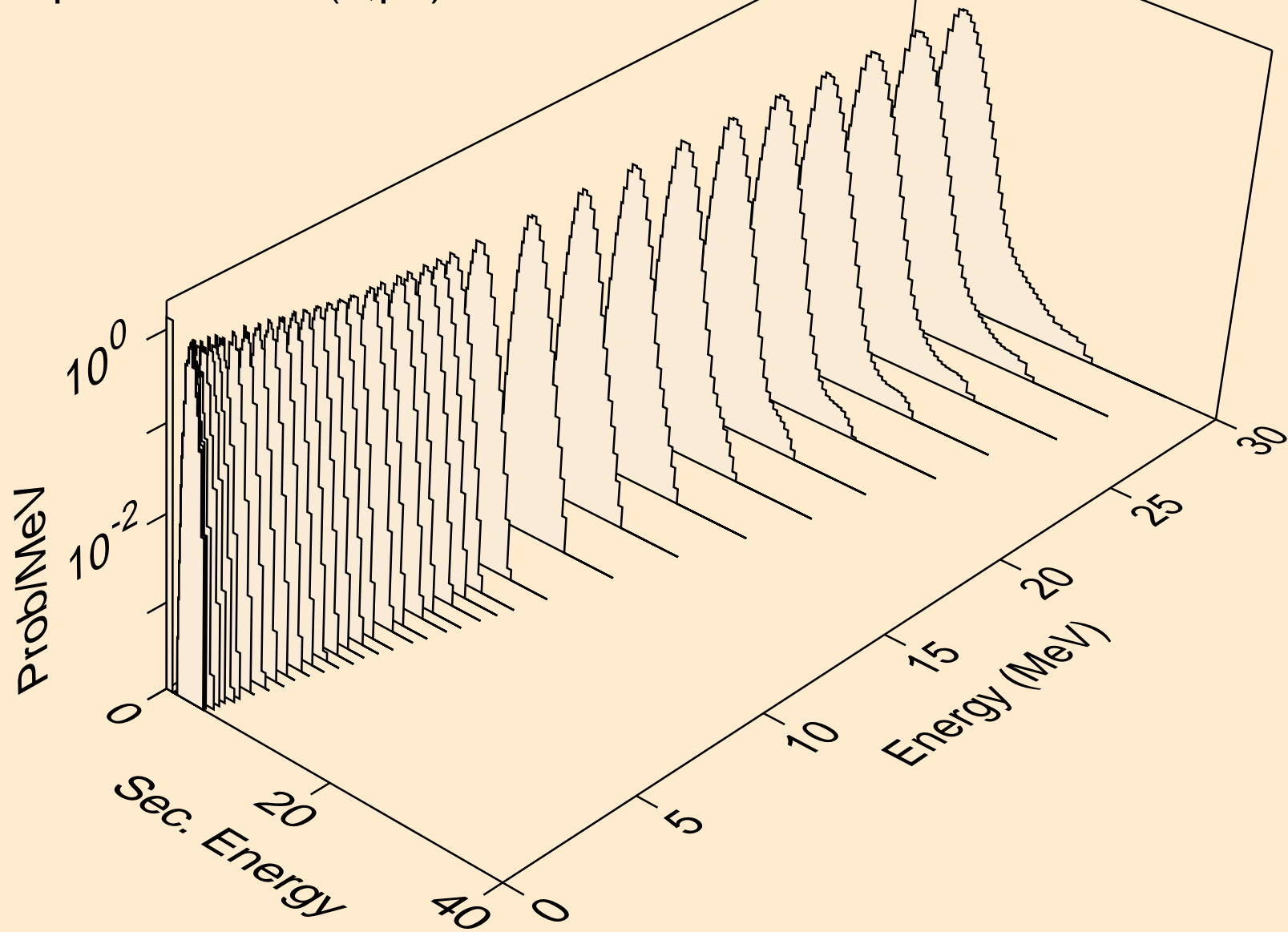

EU142M NEUTRON ACER TENDL-2024 LIBRARY; T=0.K
protons from (n,pd)

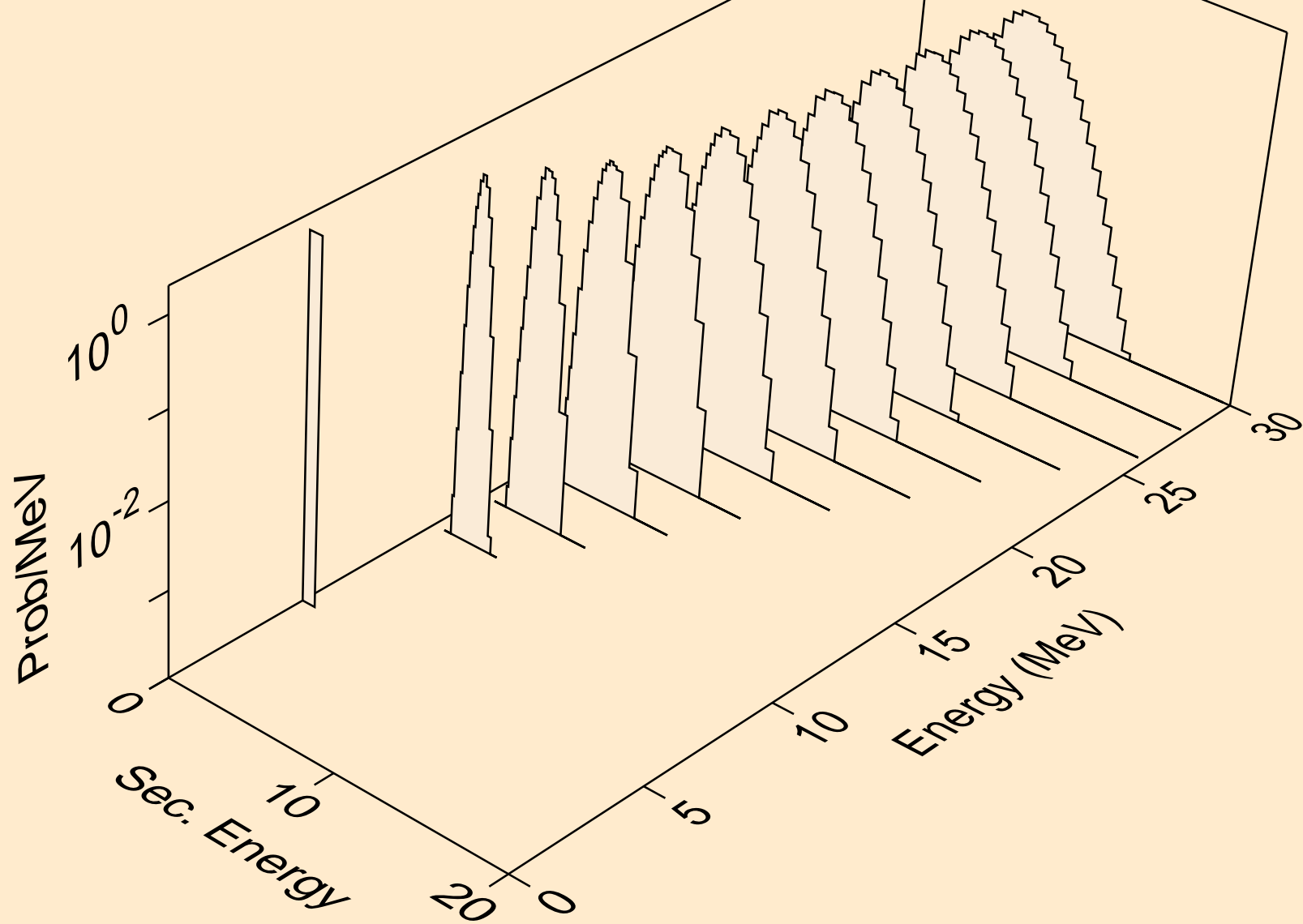

EU142M NEUTRON ACER TENDL-2024 LIBRARY; T=0.K
protons from (n,pt)

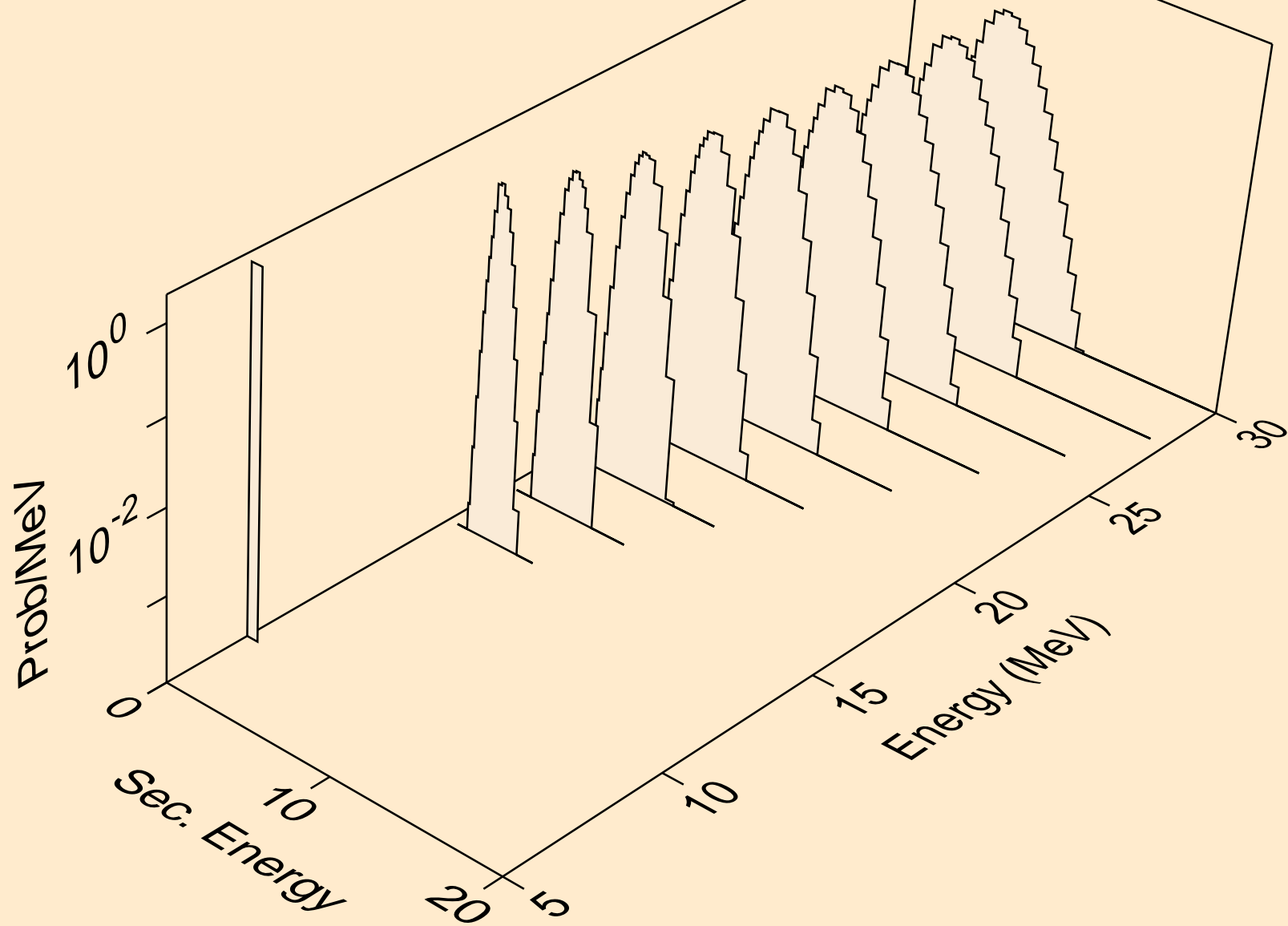

EU142M NEUTRON ACER TENDL-2024 LIBRARY; T=0.K
deuterons from (n,x)

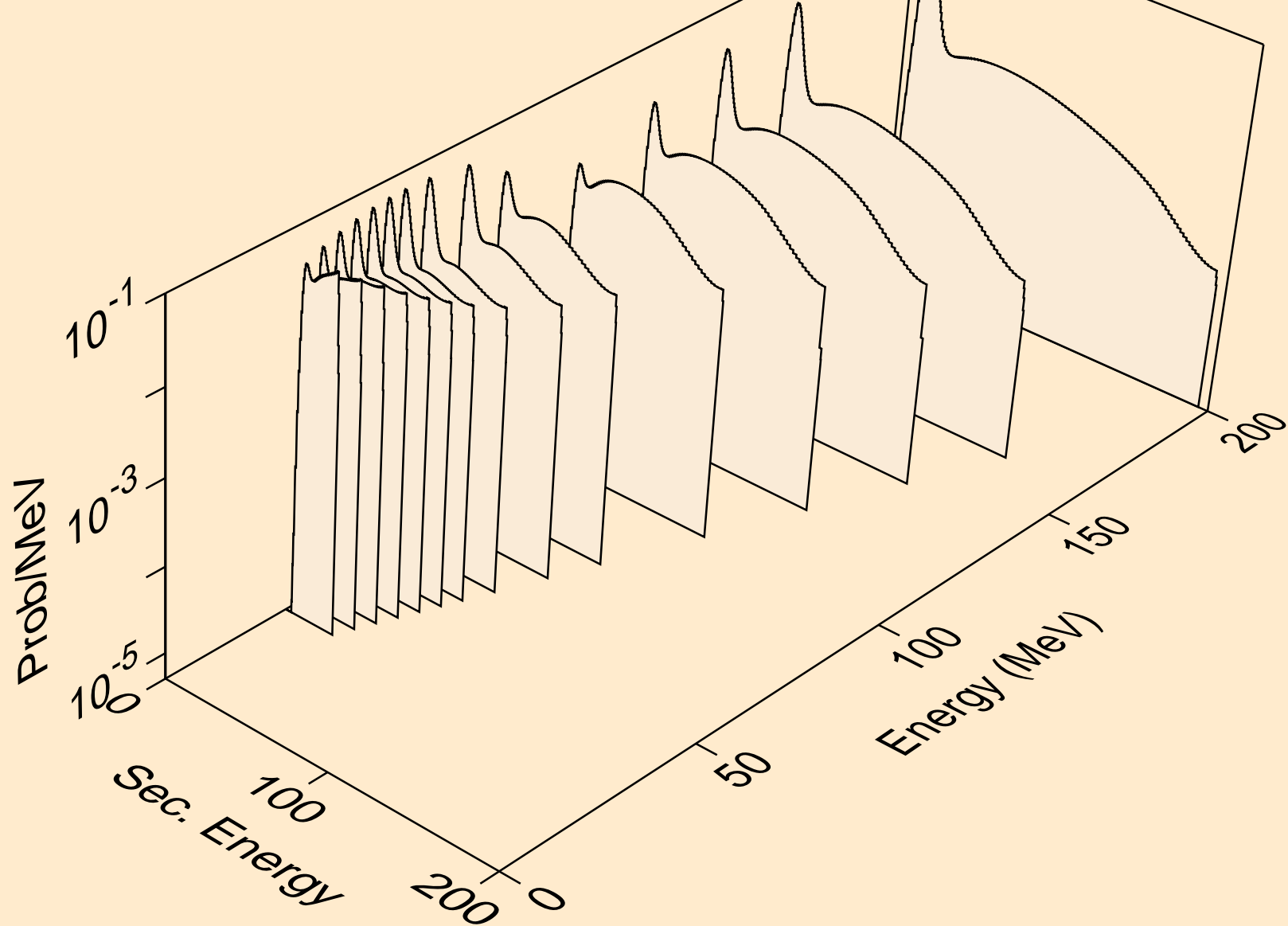

EU142M NEUTRON ACER TENDL-2024 LIBRARY; T=0.K
deuterons from (n,2nd)

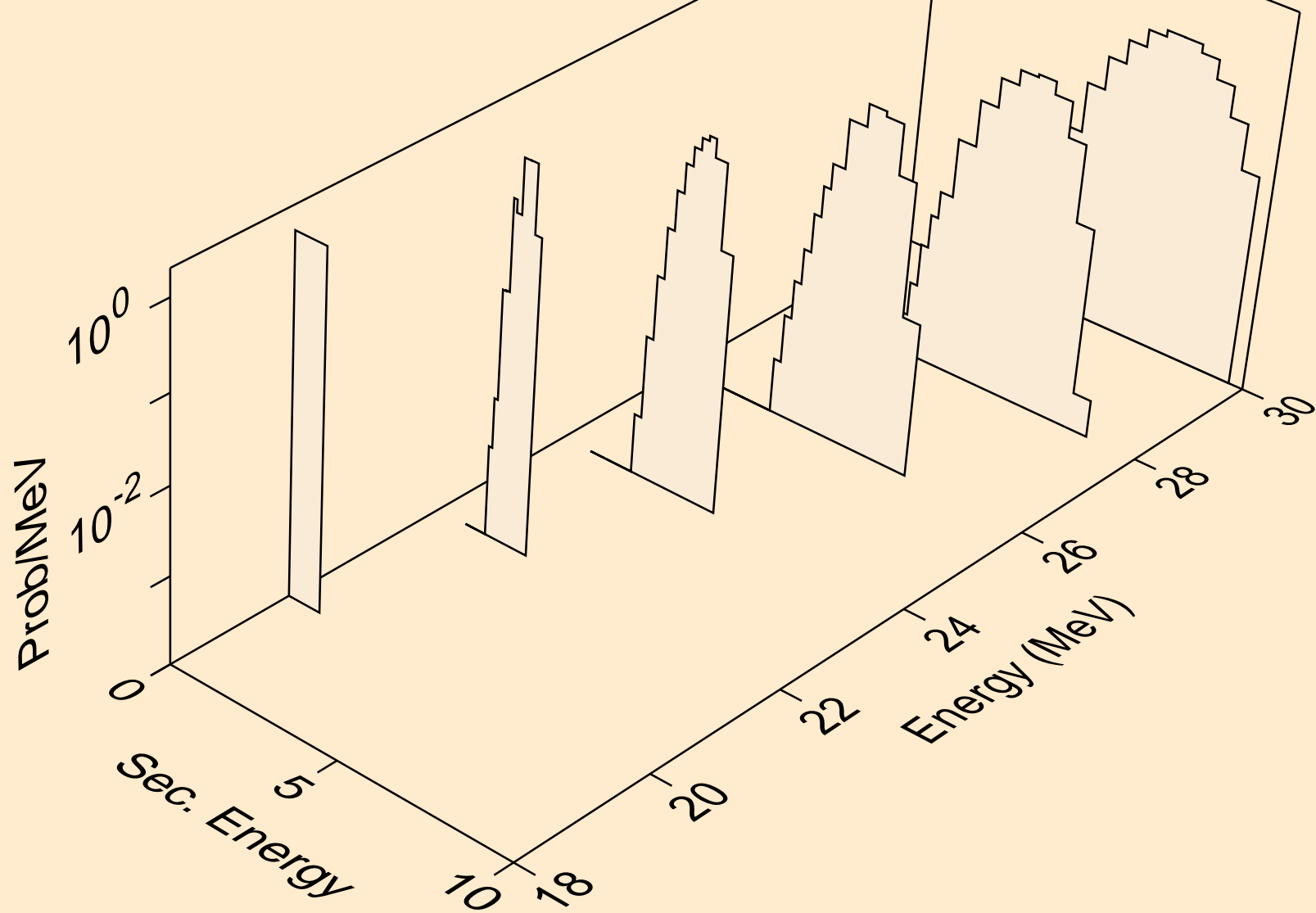

EU142M NEUTRON ACER TENDL-2024 LIBRARY; T=0.K
deuterons from (n,n*)d

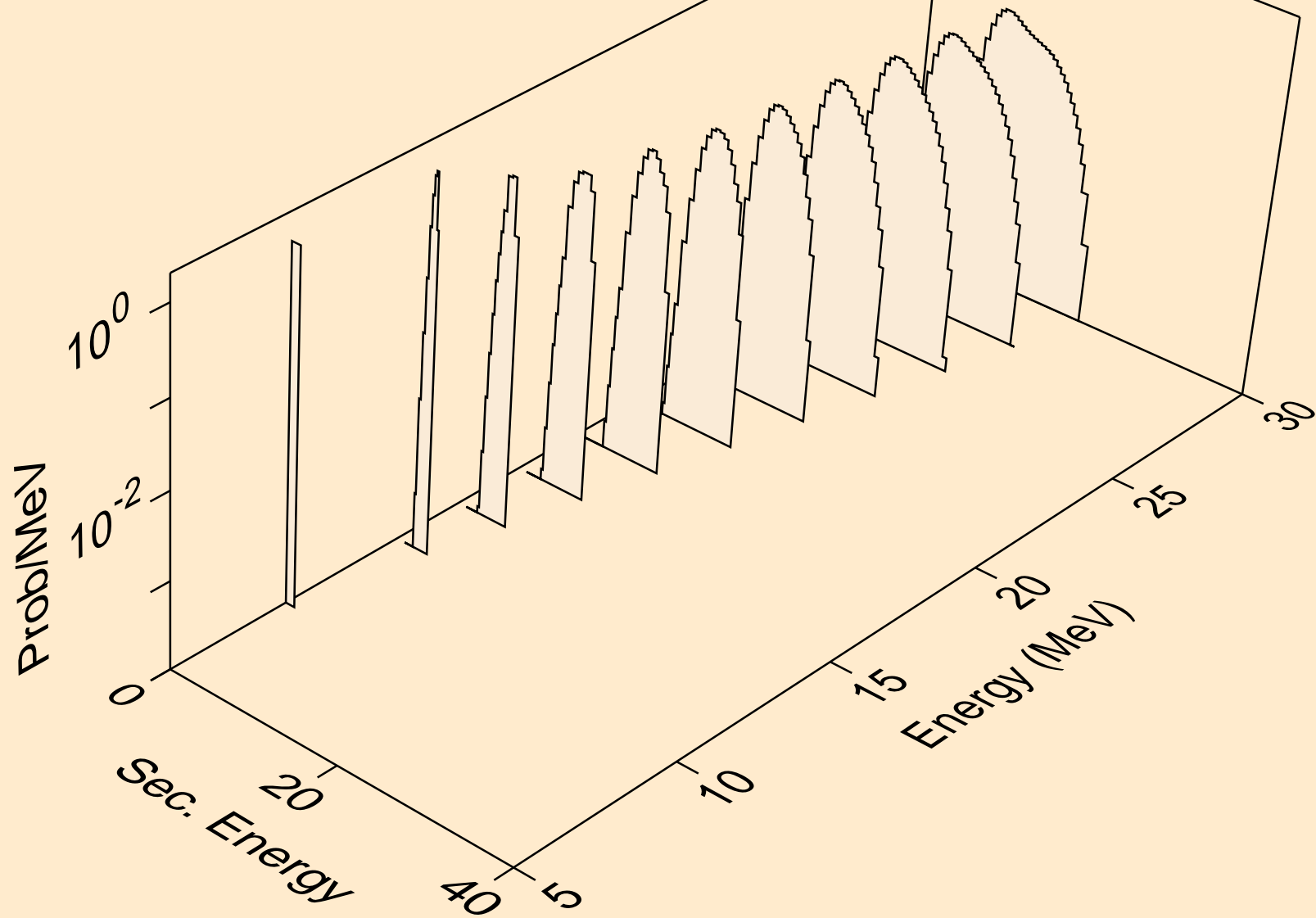

EU142M NEUTRON ACER TENDL-2024 LIBRARY; T=0.K
deuterons from (n,d)

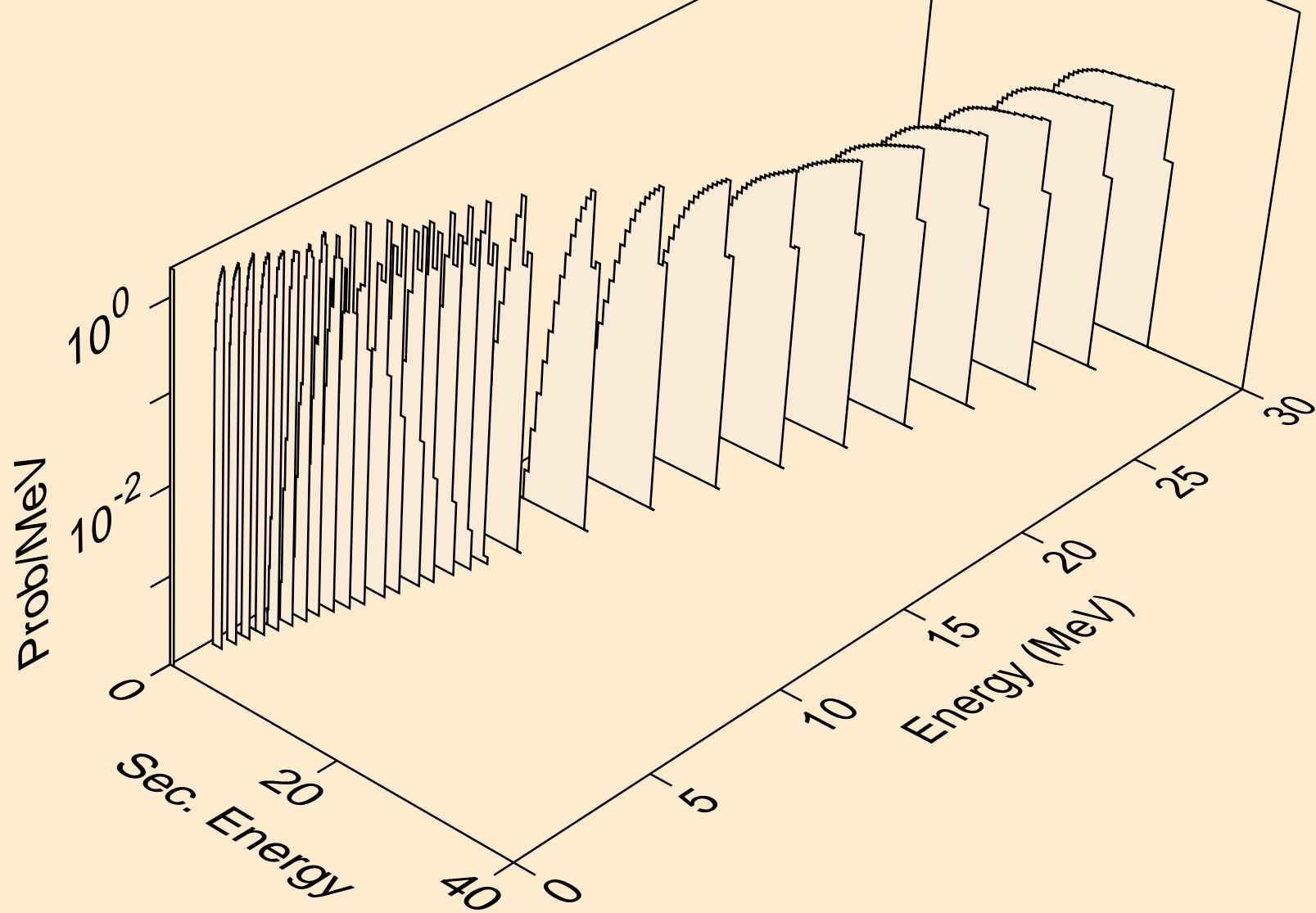

EU142M NEUTRON ACER TENDL-2024 LIBRARY; T=0.K
deuterons from (n,pd)

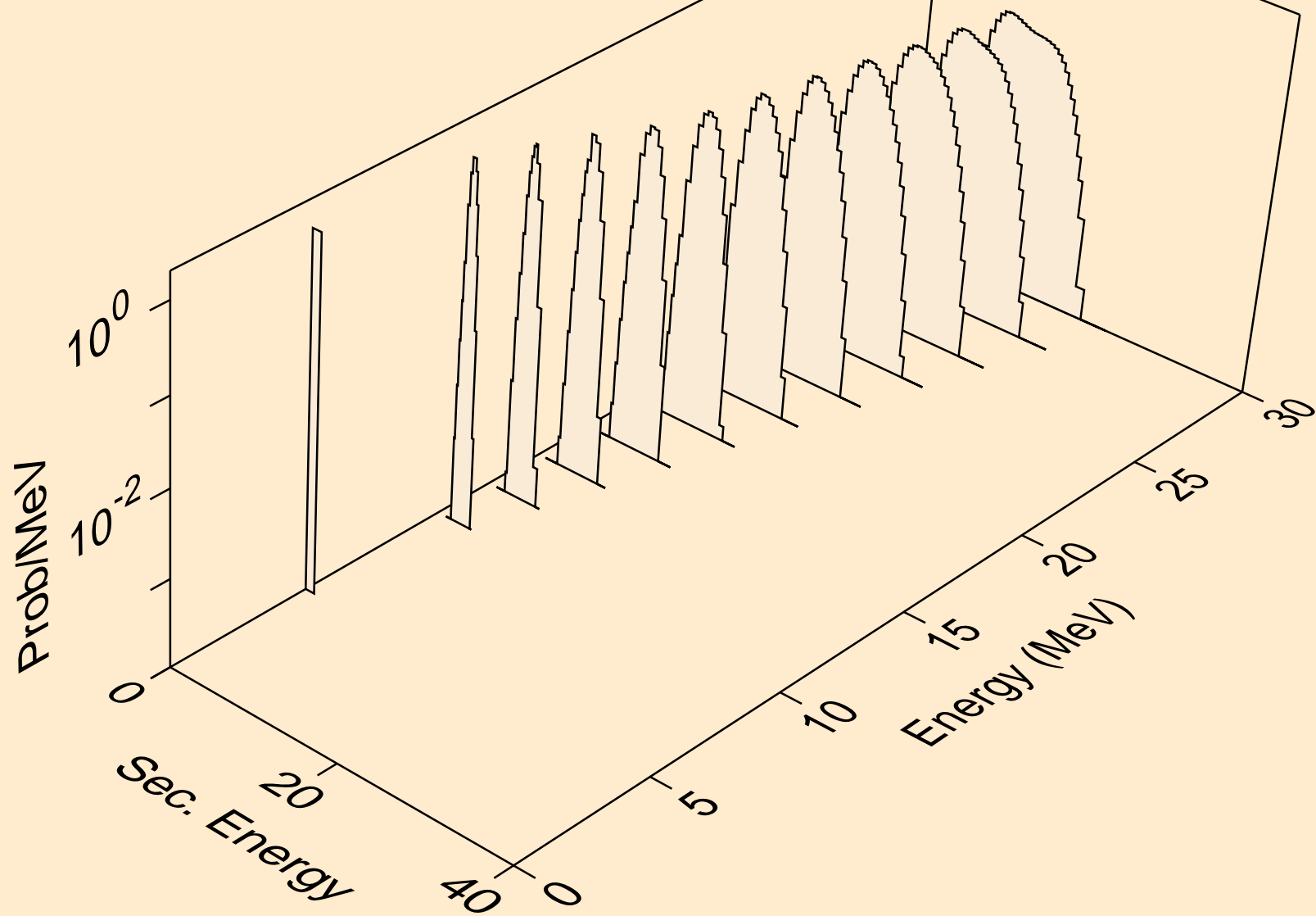

EU142M NEUTRON ACER TENDL-2024 LIBRARY; T=0.K
deuterons from (n,da)

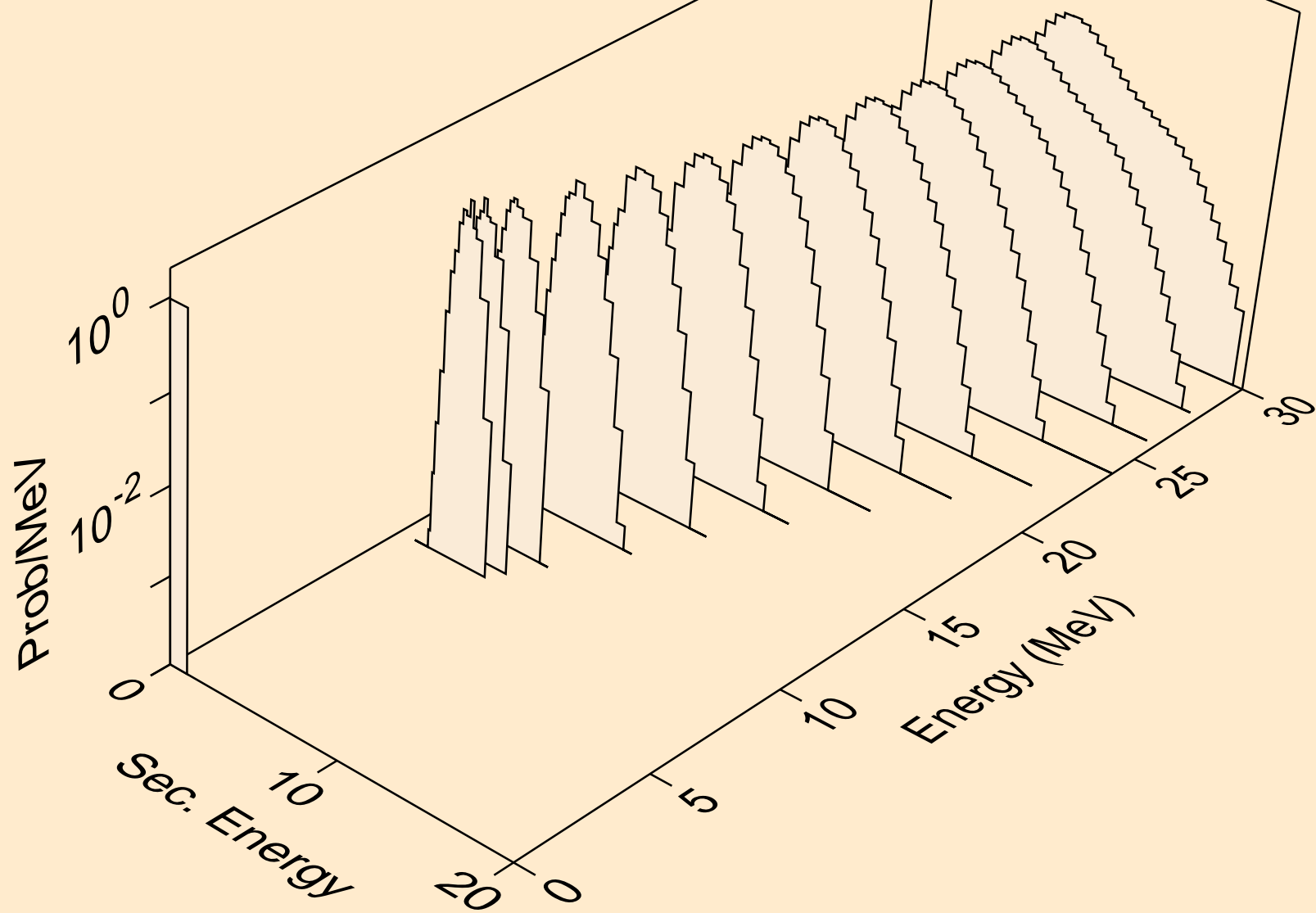

EU142M NEUTRON ACER TENDL-2024 LIBRARY; T=0.K
tritons from (n,x)

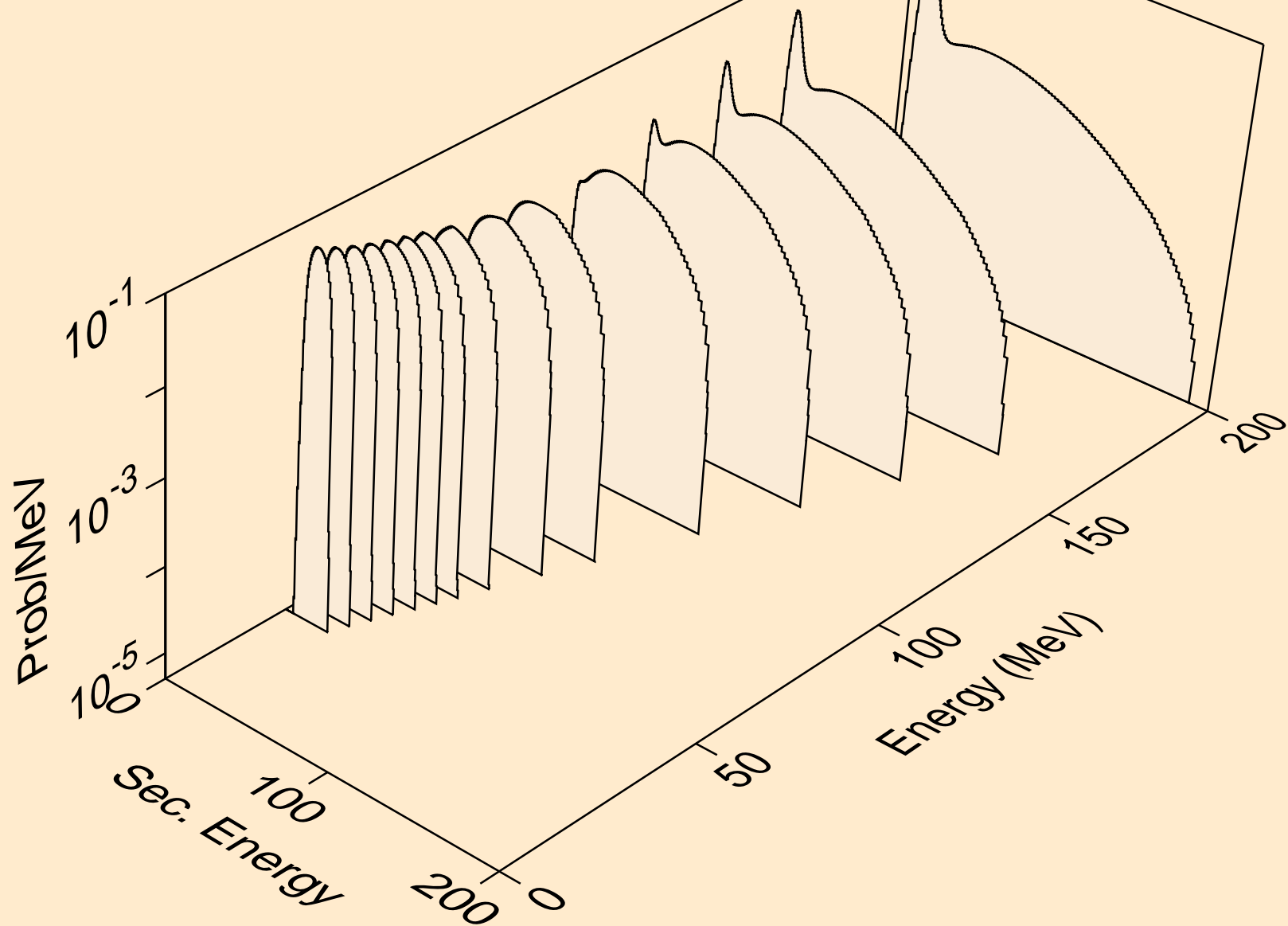

EU142M NEUTRON ACER TENDL-2024 LIBRARY; T=0.K
tritons from (n,n*)t

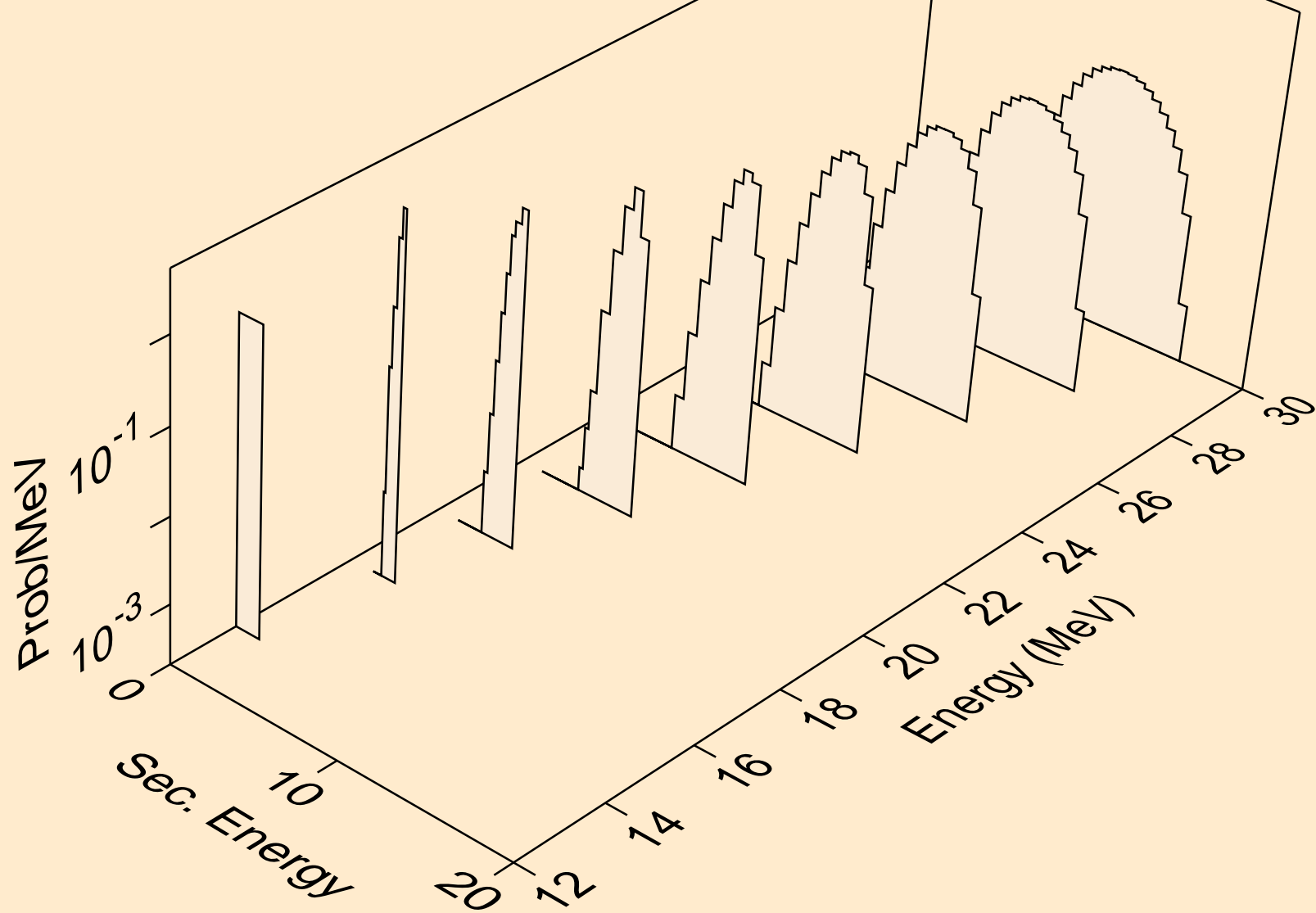

EU142M NEUTRON ACER TENDL-2024 LIBRARY; T=0.K
tritons from (n,t)

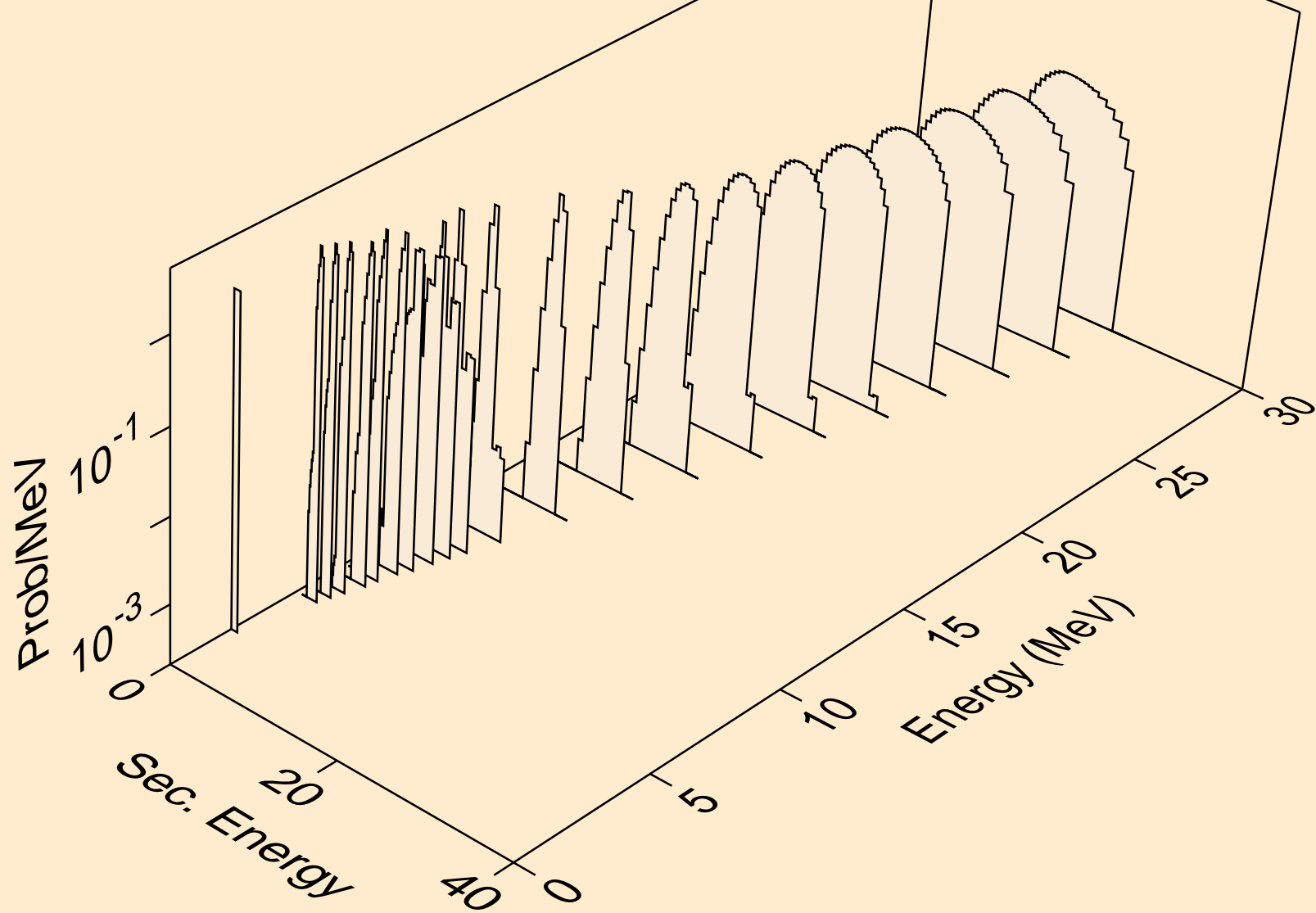

EU142M NEUTRON ACER TENDL-2024 LIBRARY; T=0.K
tritons from (n,pt)

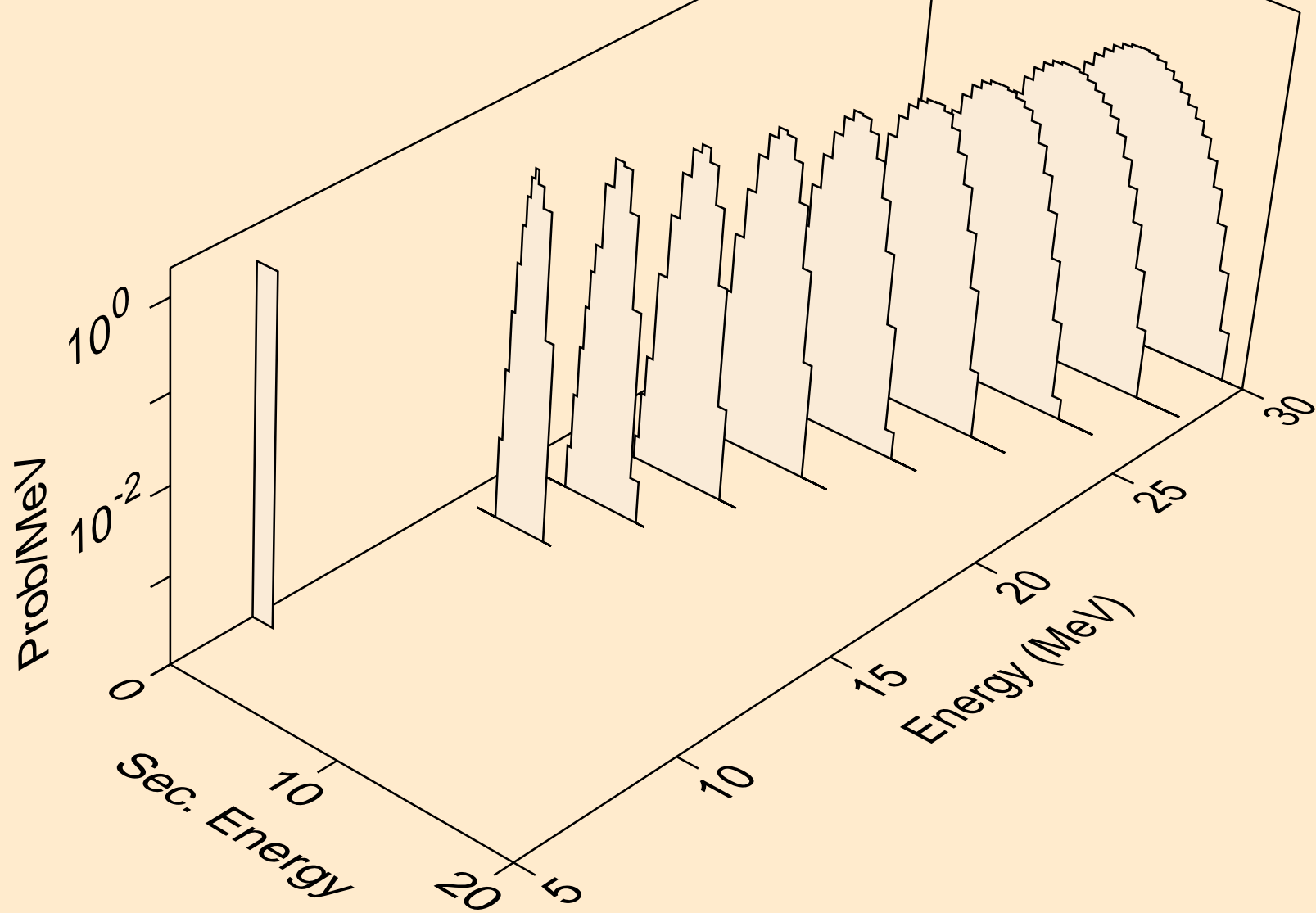

EU142M NEUTRON ACER TENDL-2024 LIBRARY; T=0.K
he3s from (n,x)

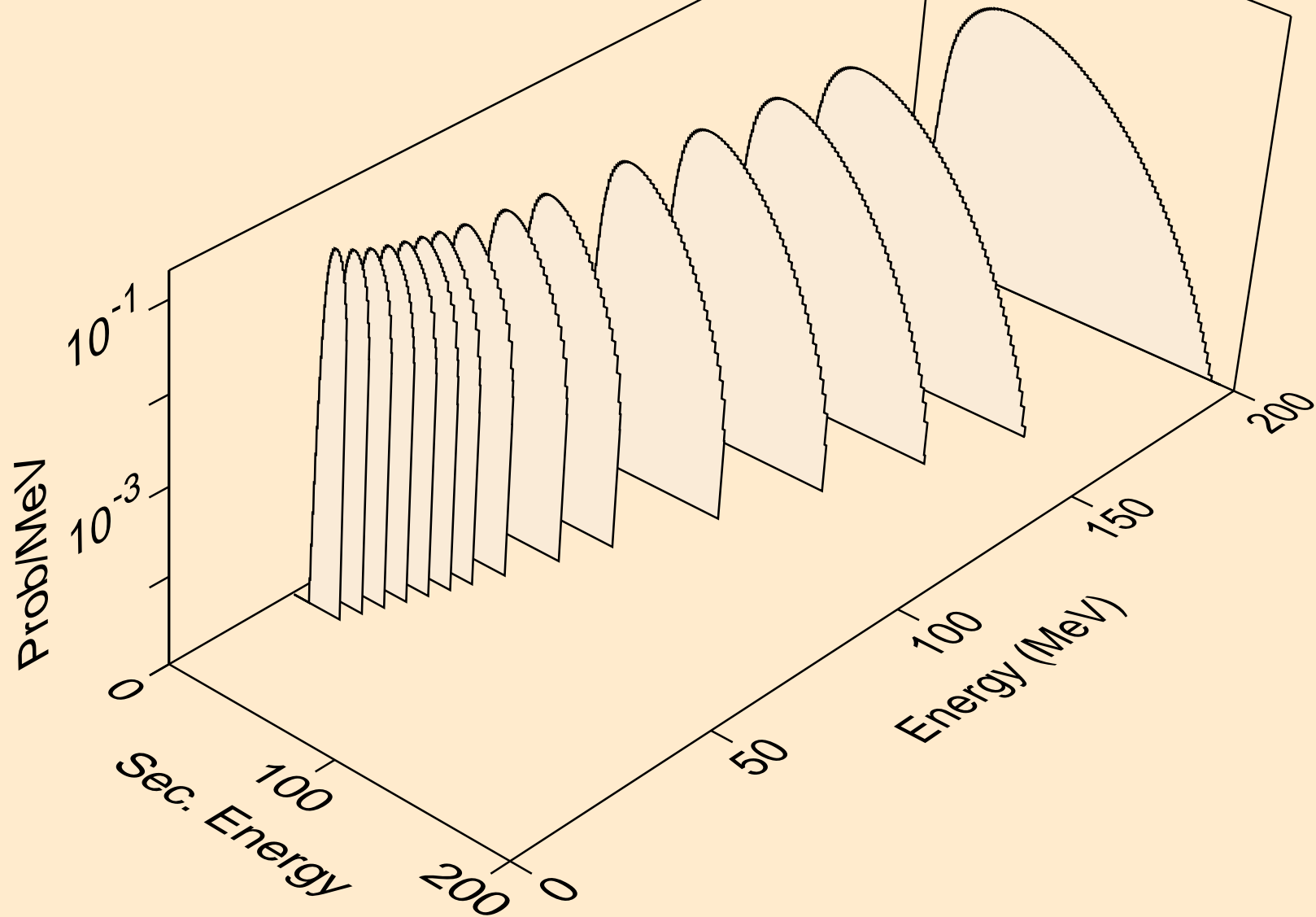

EU142M NEUTRON ACER TENDL-2024 LIBRARY; T=0.K
he3s from (n,n*)he3

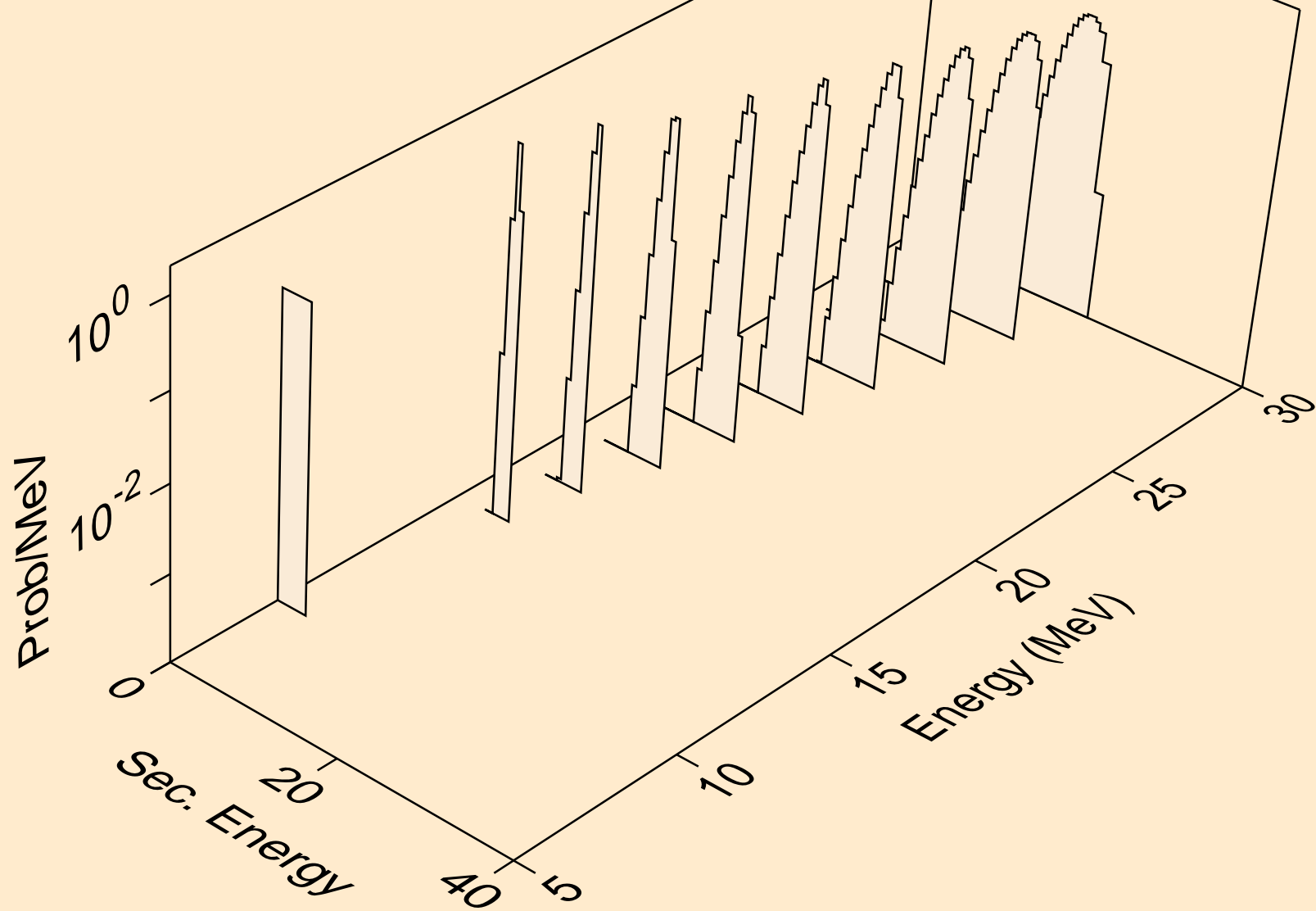

EU142M NEUTRON ACER TENDL-2024 LIBRARY; T=0.K
he3s from (n,he3)

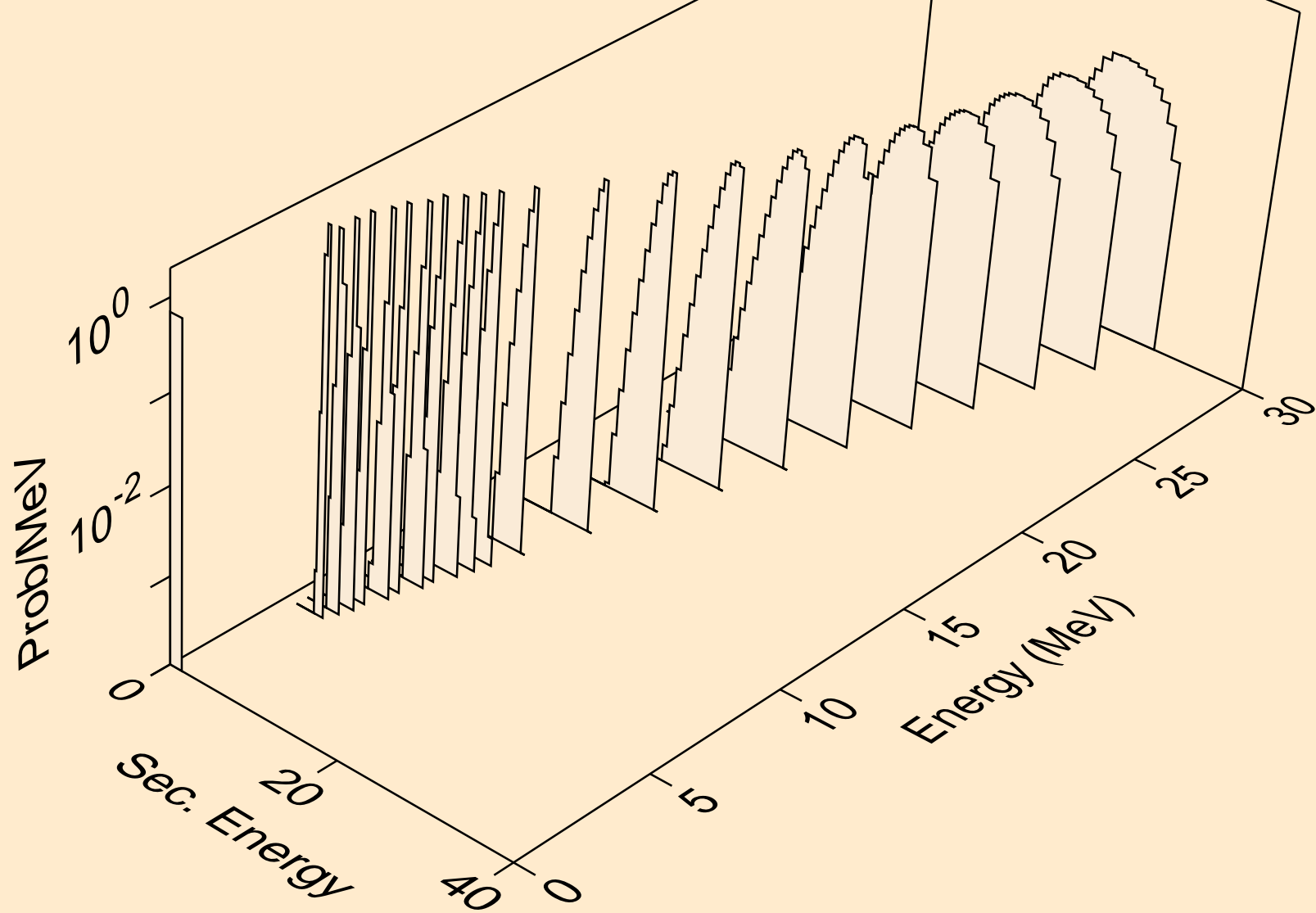

EU142M NEUTRON ACER TENDL-2024 LIBRARY; T=0.K
alphas from (n,x)

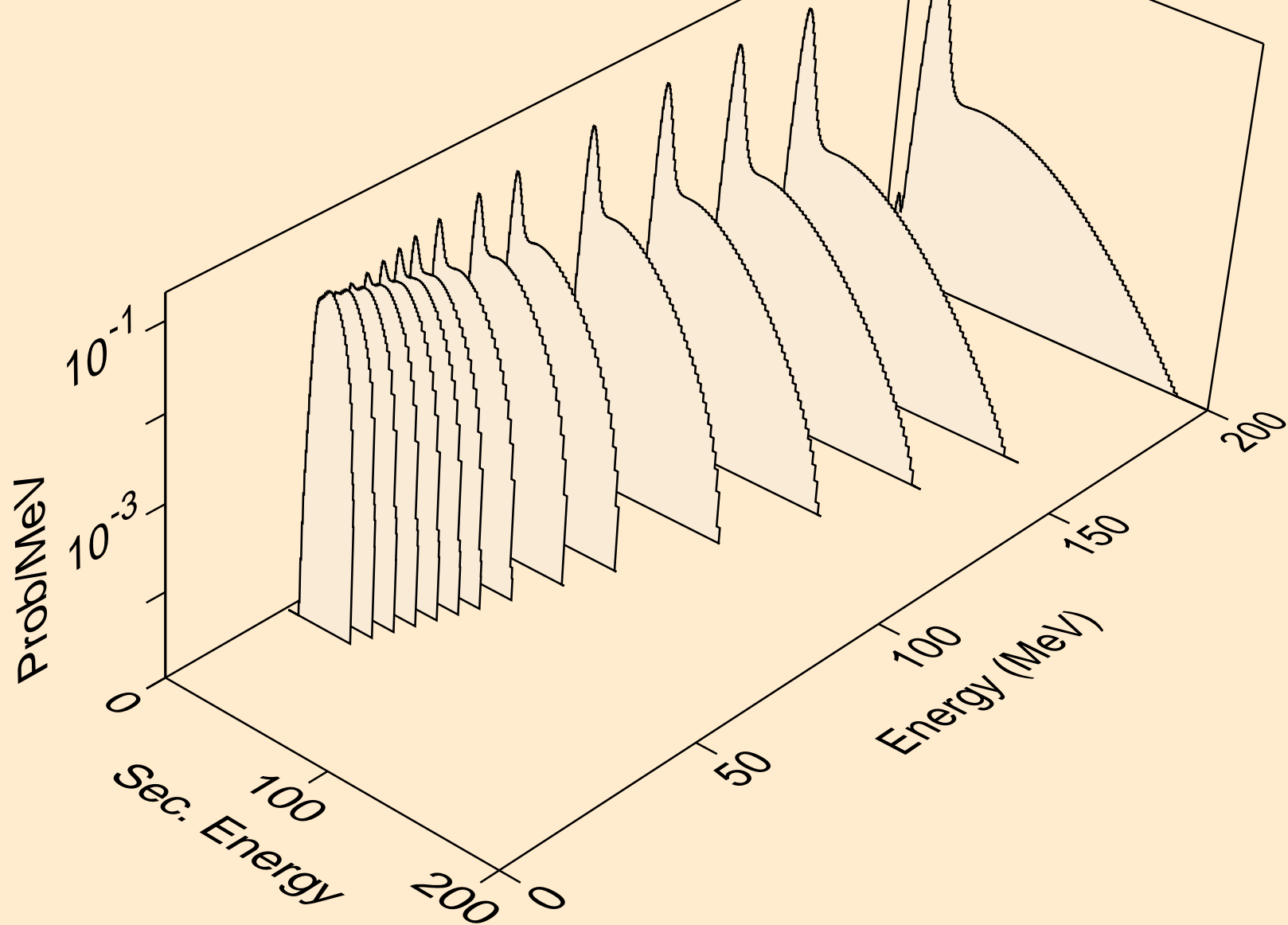

EU142M NEUTRON ACER TENDL-2024 LIBRARY; T=0.K
alphas from (n,n*)a

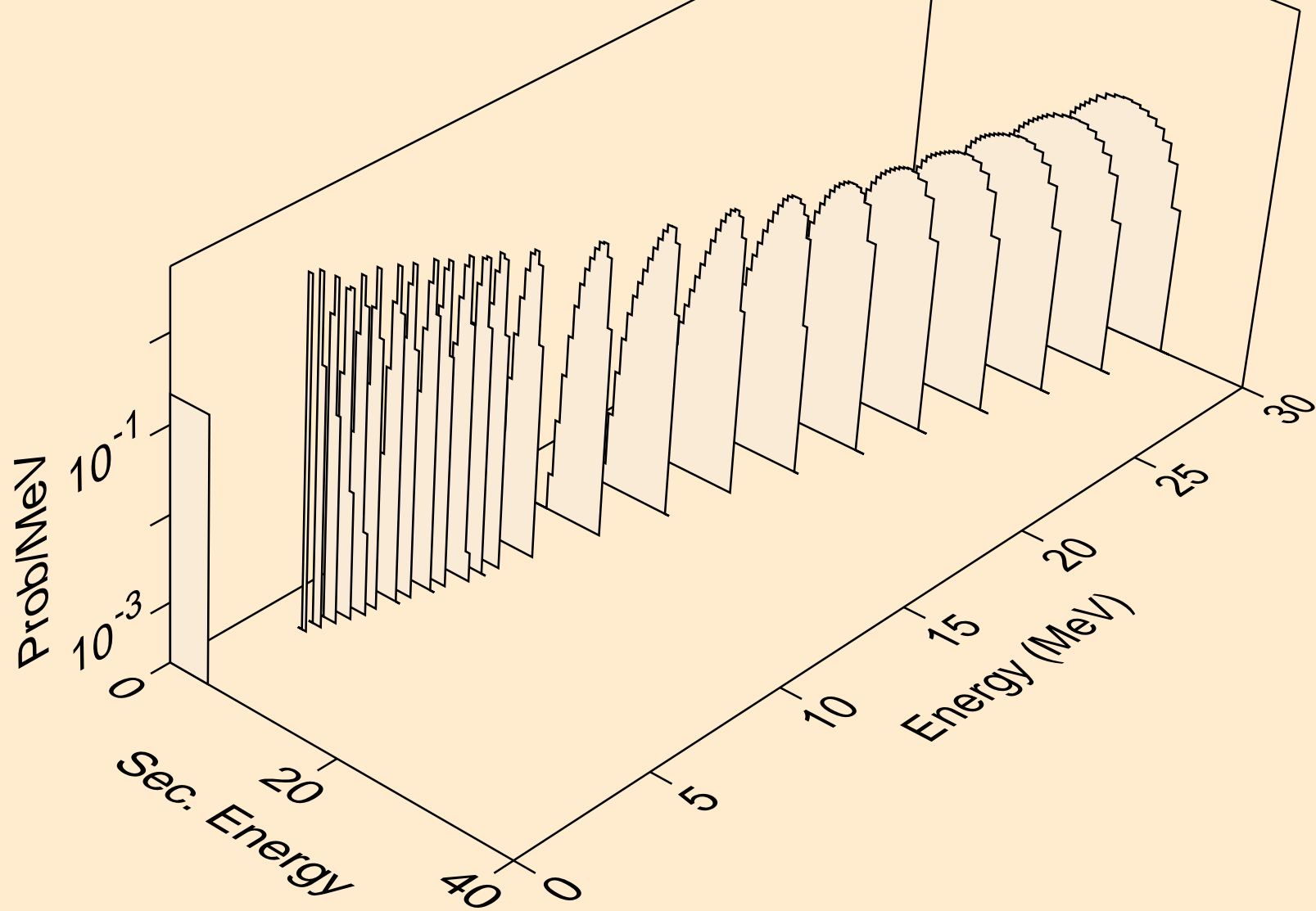

EU142M NEUTRON ACER TENDL-2024 LIBRARY; T=0.K
alphas from (n,2n)a

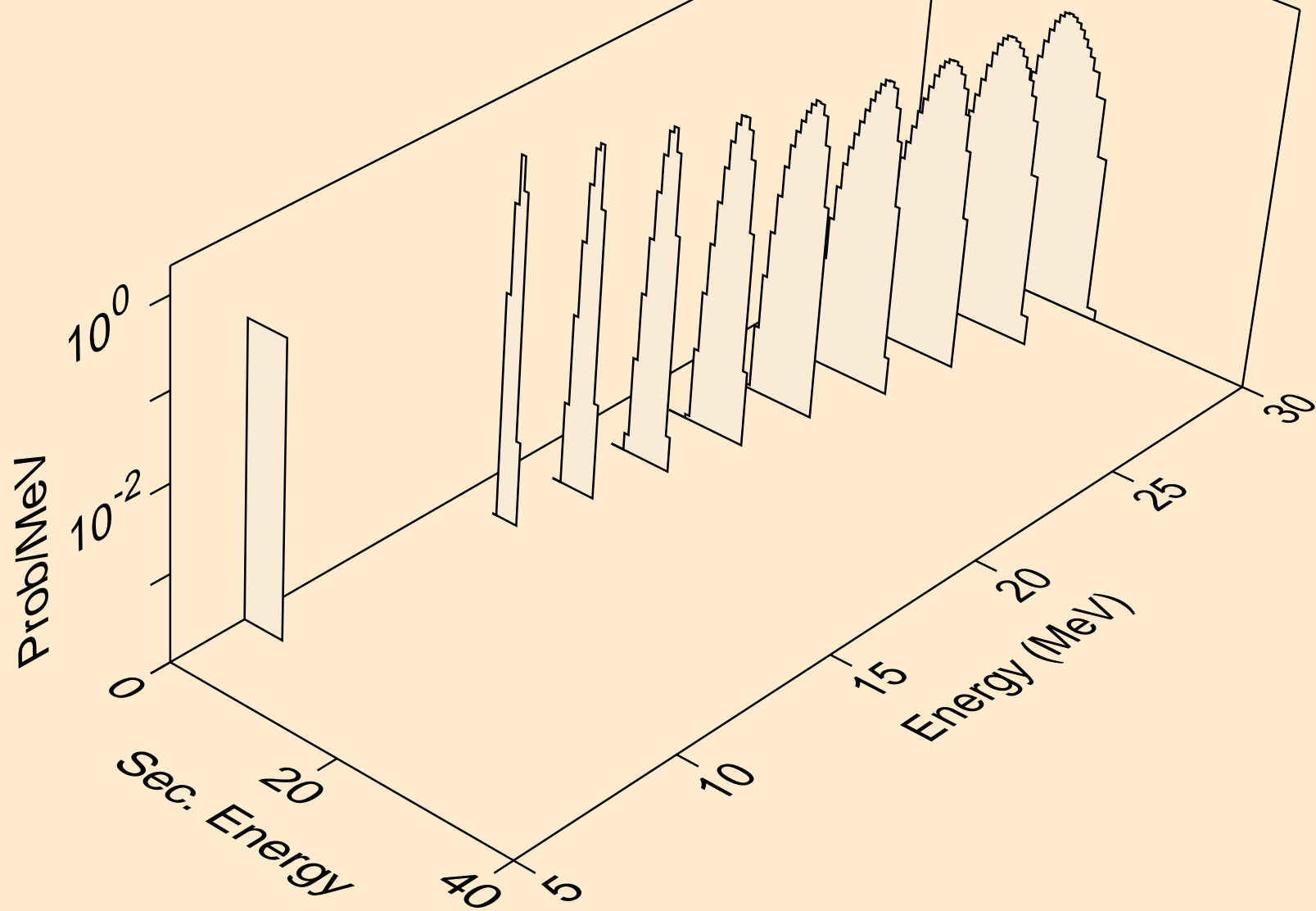

EU142M NEUTRON ACER TENDL-2024 LIBRARY; T=0.K
alphas from (n,3n)a

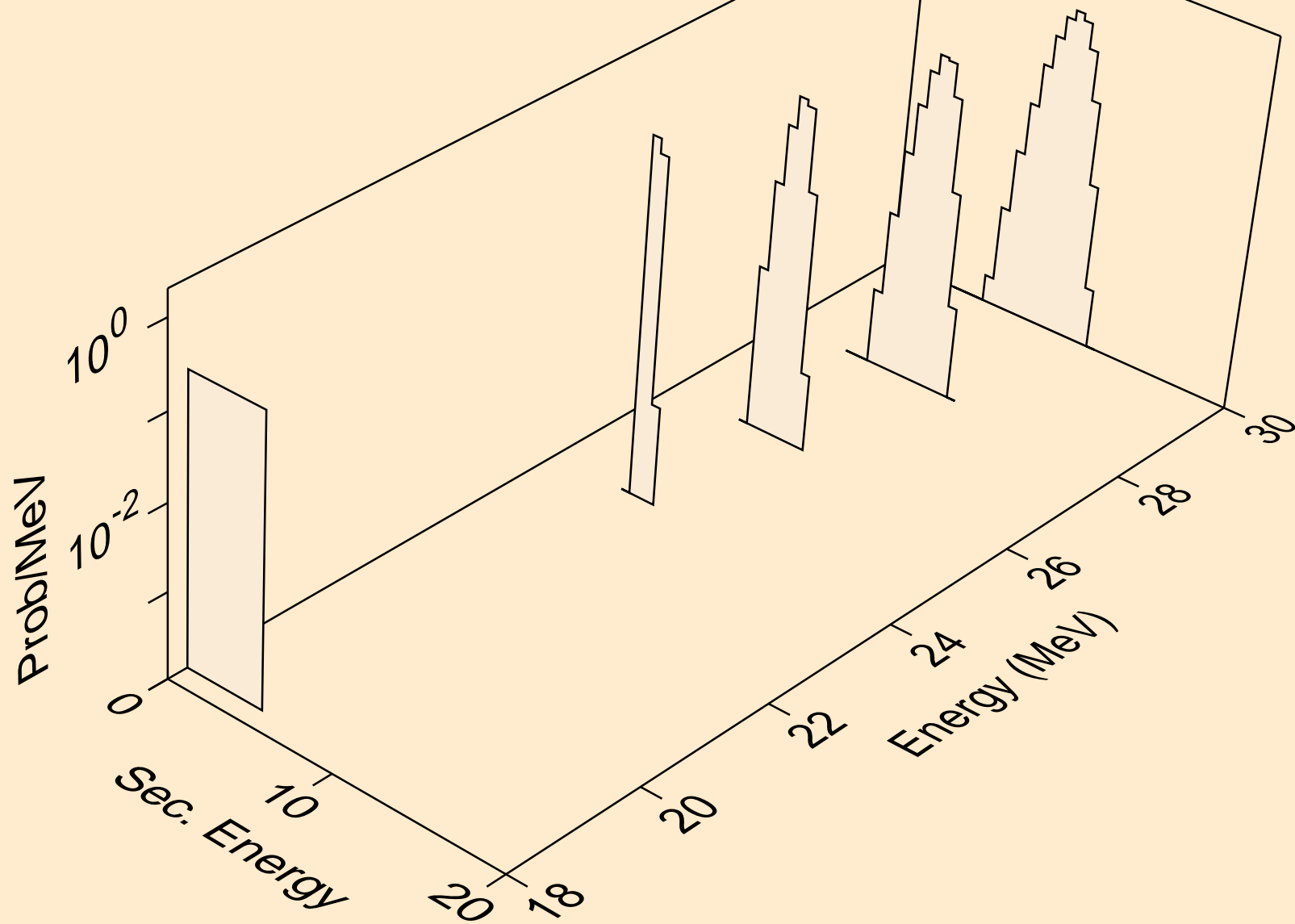

EU142M NEUTRON ACER TENDL-2024 LIBRARY; T=0.K
alphas from (n,n*)2a

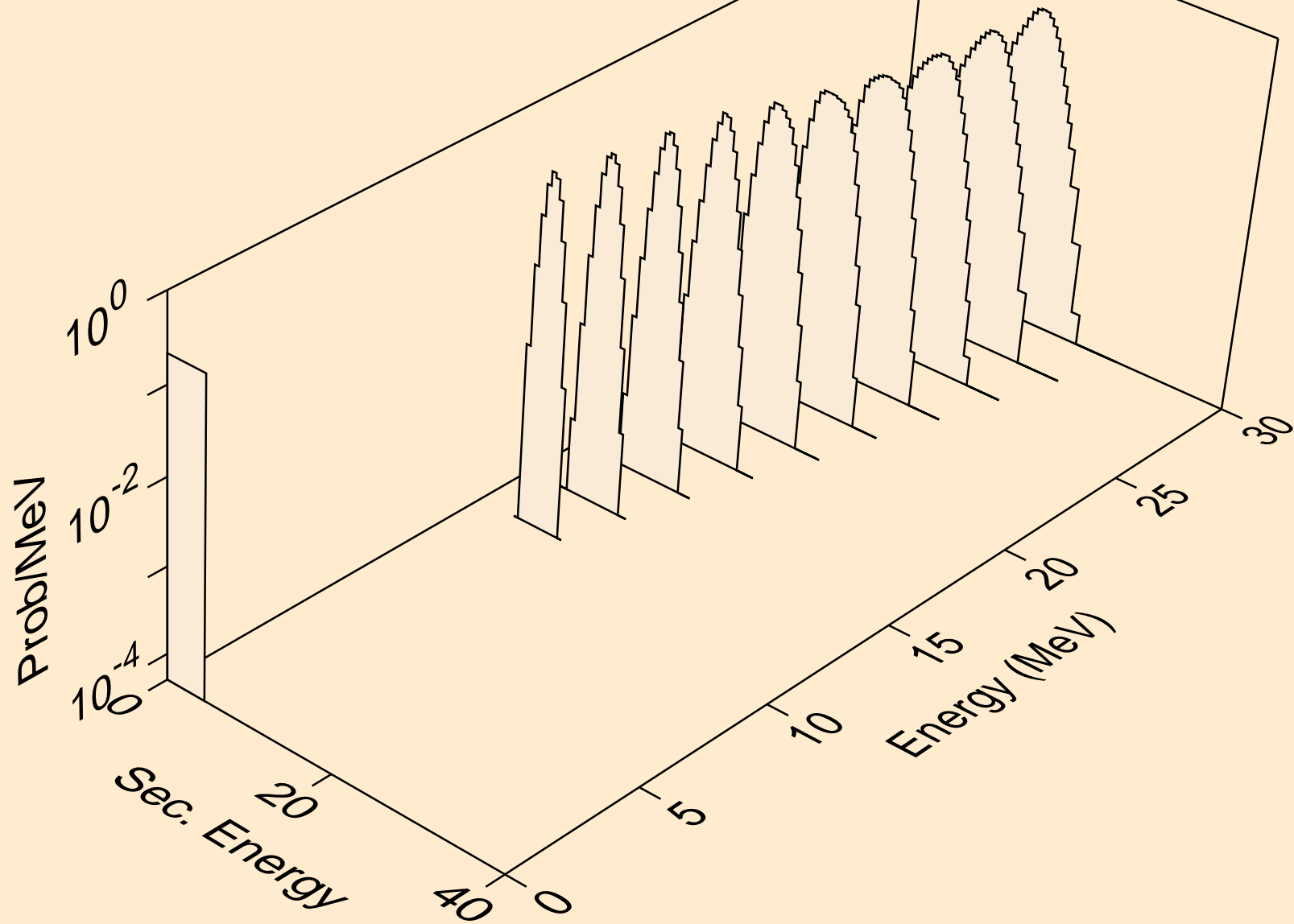

EU142M NEUTRON ACER TENDL-2024 LIBRARY; T=0.K
alphas from (n,2n)2a

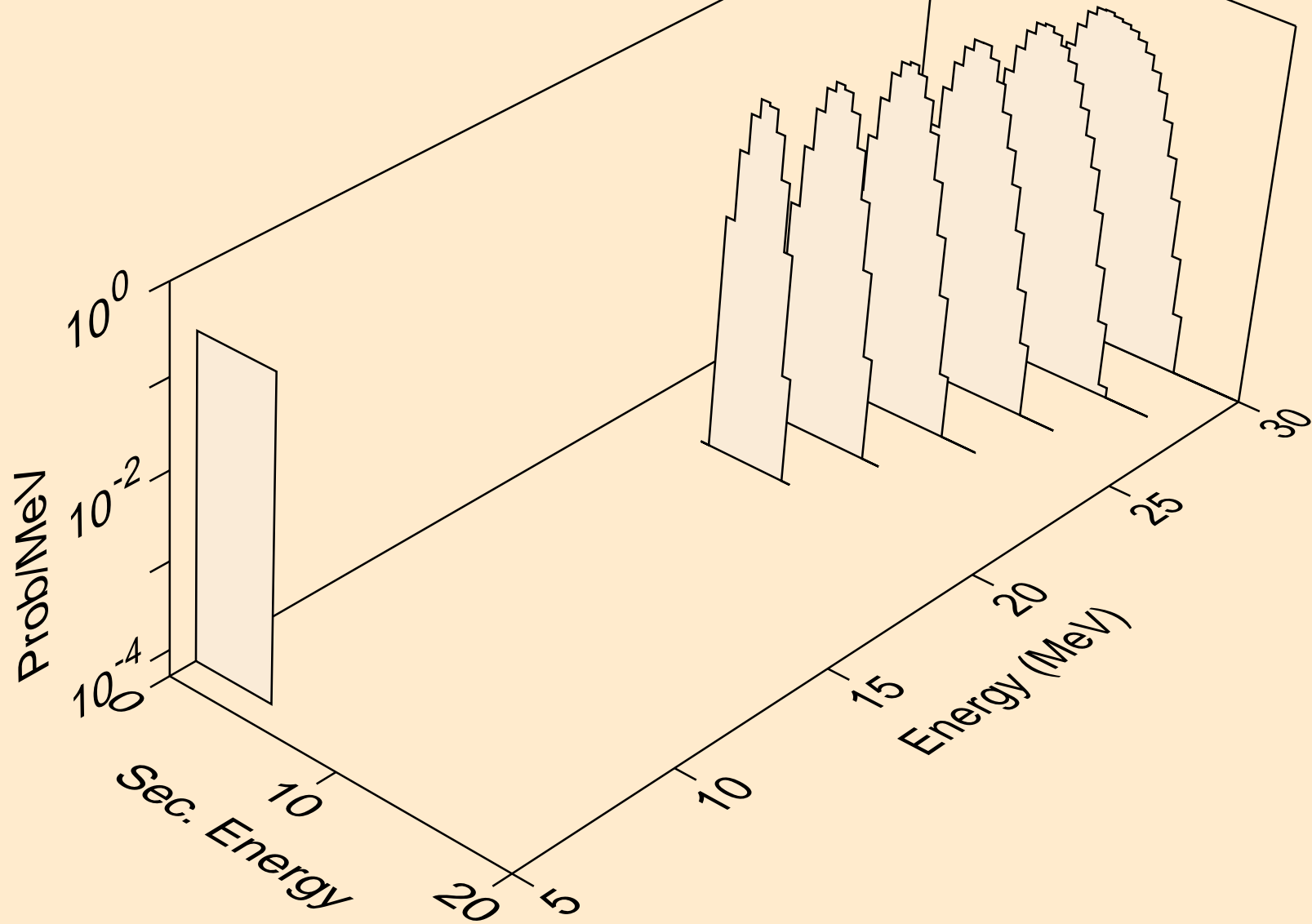

EU142M NEUTRON ACER TENDL-2024 LIBRARY; T=0.K
alphas from (n,npa)

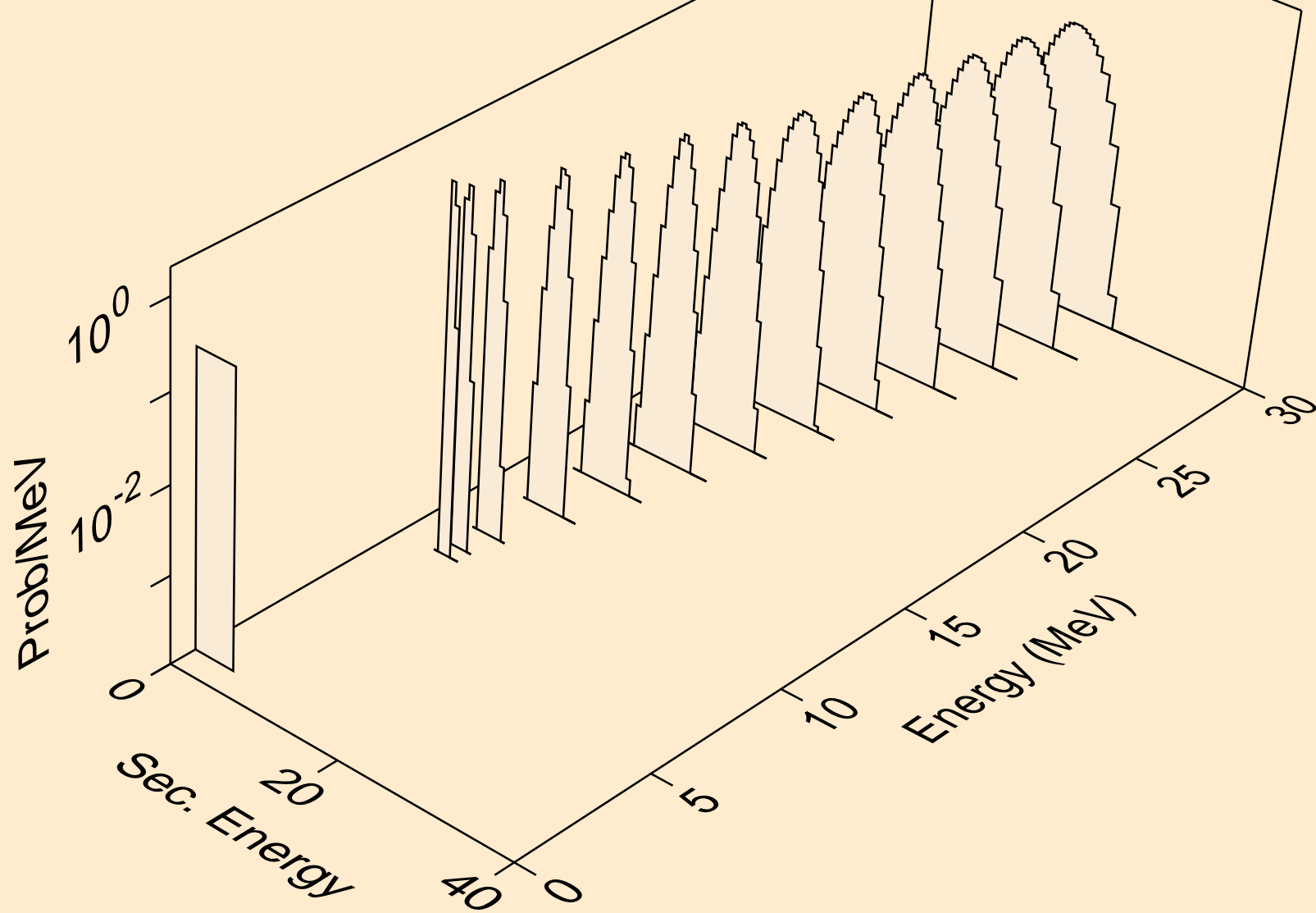

EU142M NEUTRON ACER TENDL-2024 LIBRARY; T=0.K
alphas from (n,a)

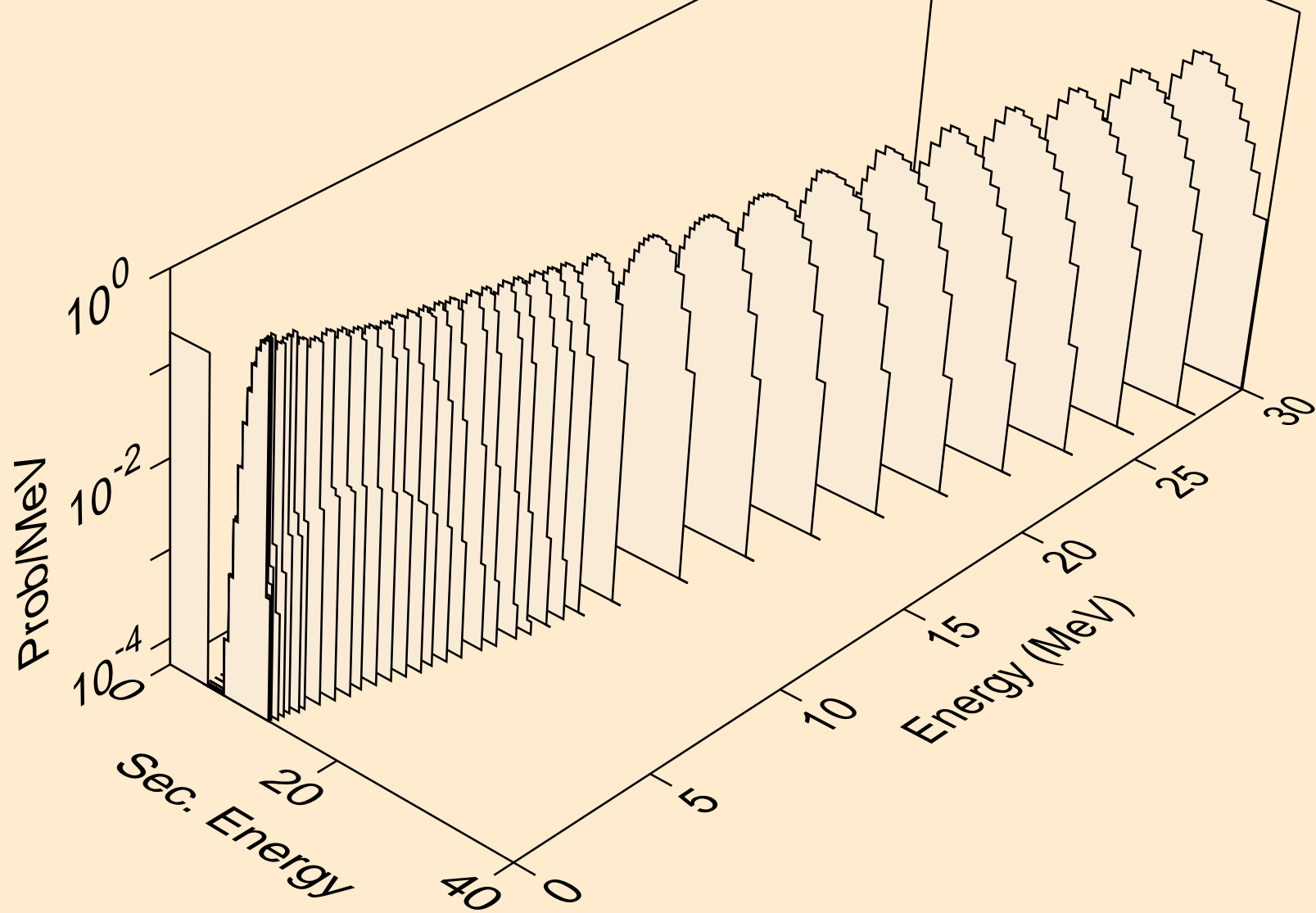

EU142M NEUTRON ACER TENDL-2024 LIBRARY; T=0.K
alphas from (n,2a)

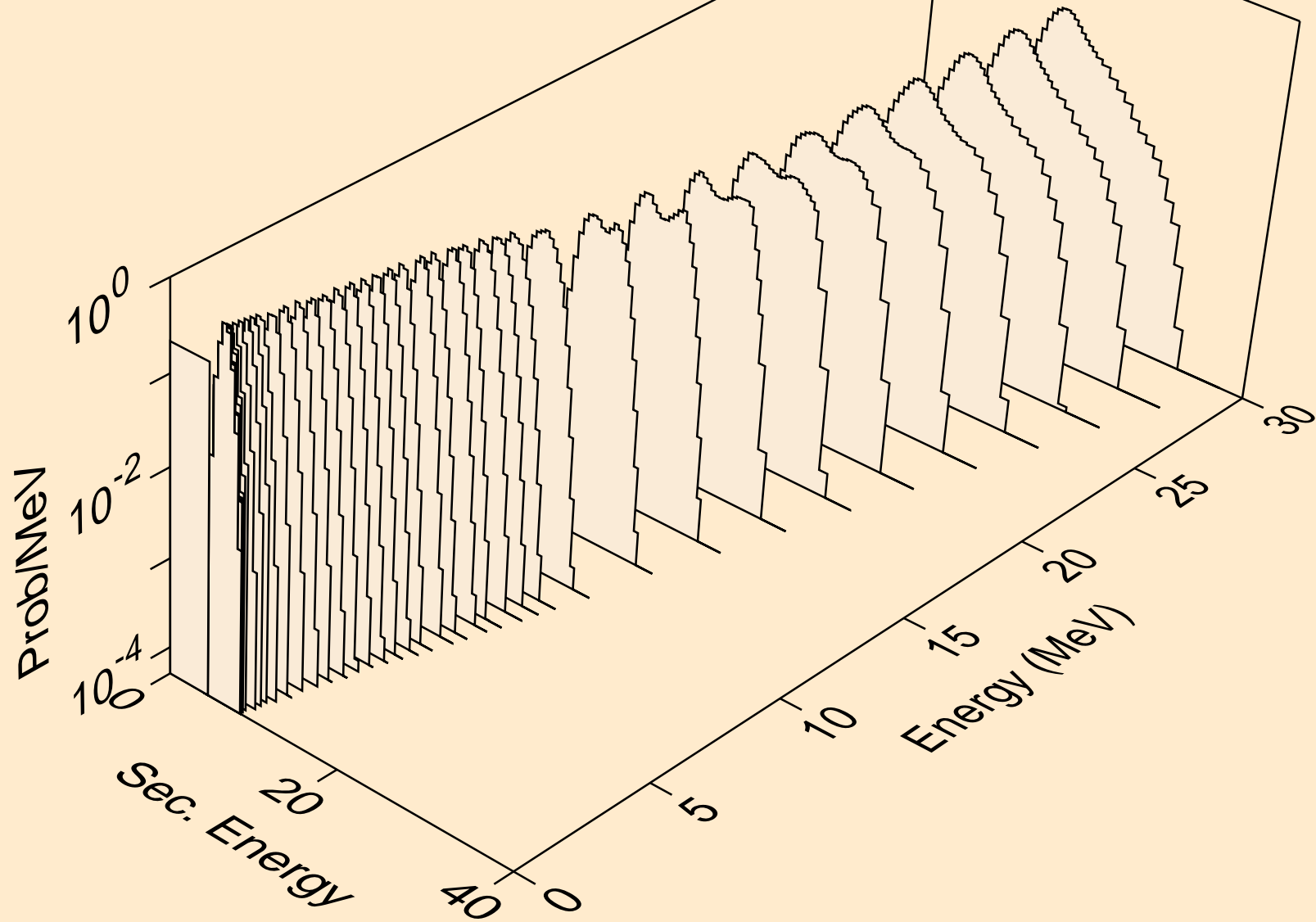

EU142M NEUTRON ACER TENDL-2024 LIBRARY; T=0.K
alphas from (n,3a)

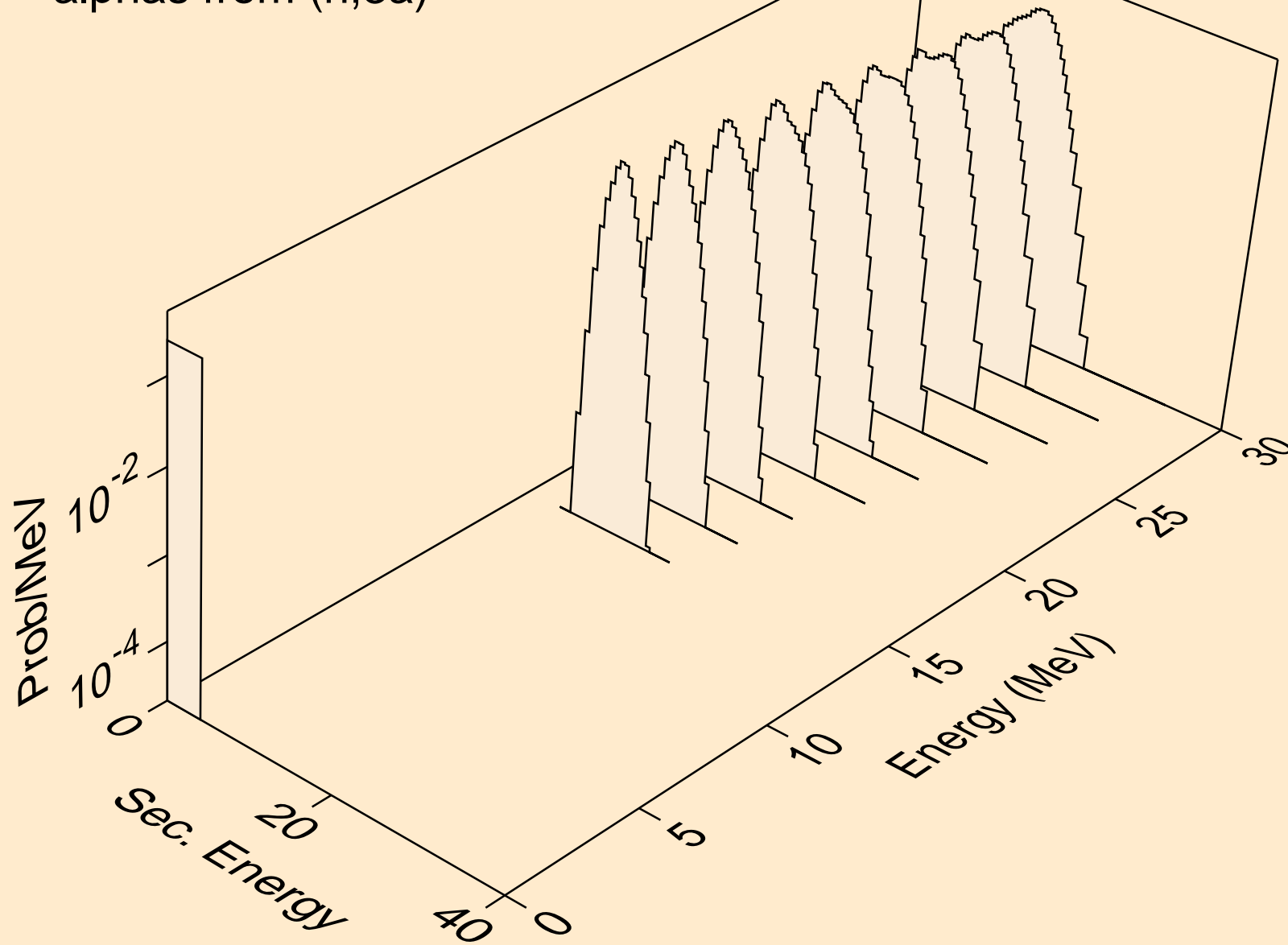

EU142M NEUTRON ACER TENDL-2024 LIBRARY; T=0.K
alphas from (n,pa)

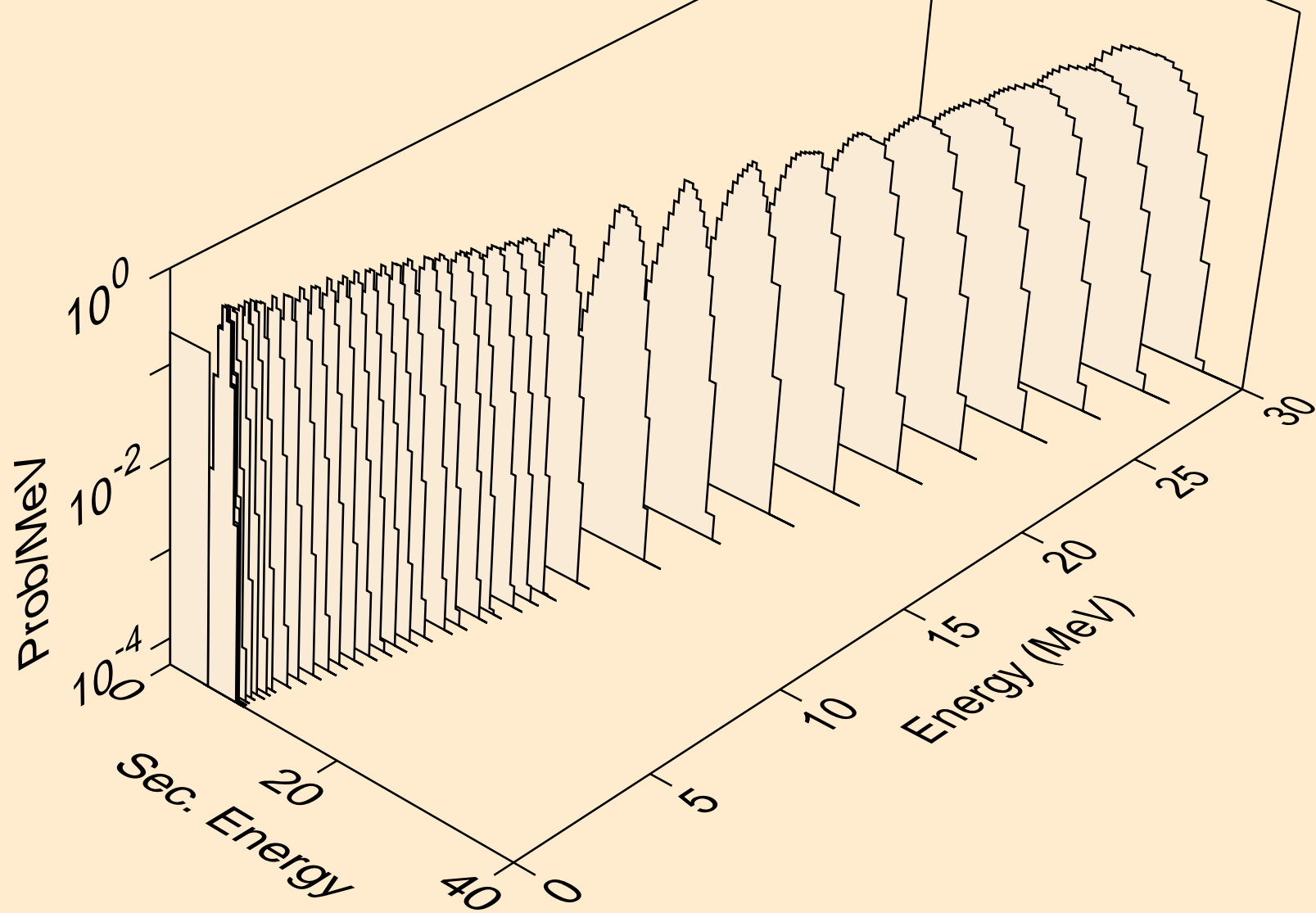

EU142M NEUTRON ACER TENDL-2024 LIBRARY; T=0.K
alphas from (n,da)

