

# FM246 NEUTRON ACER TENDL-2024 LIBRARY; T=0.K

## Principal cross sections

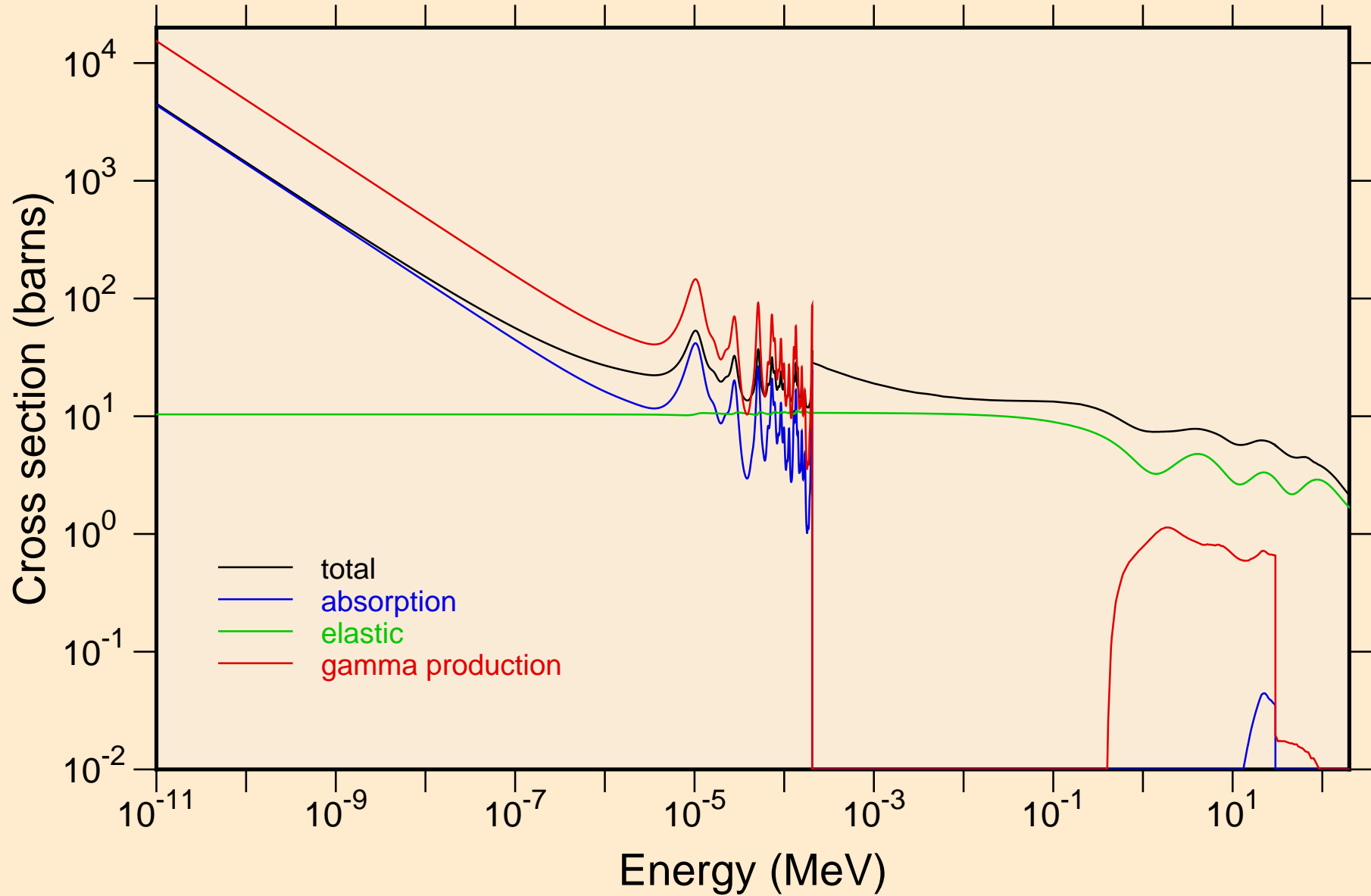

FM246 NEUTRON ACER TENDL-2024 LIBRARY; T=0.K  
resonance total cross section

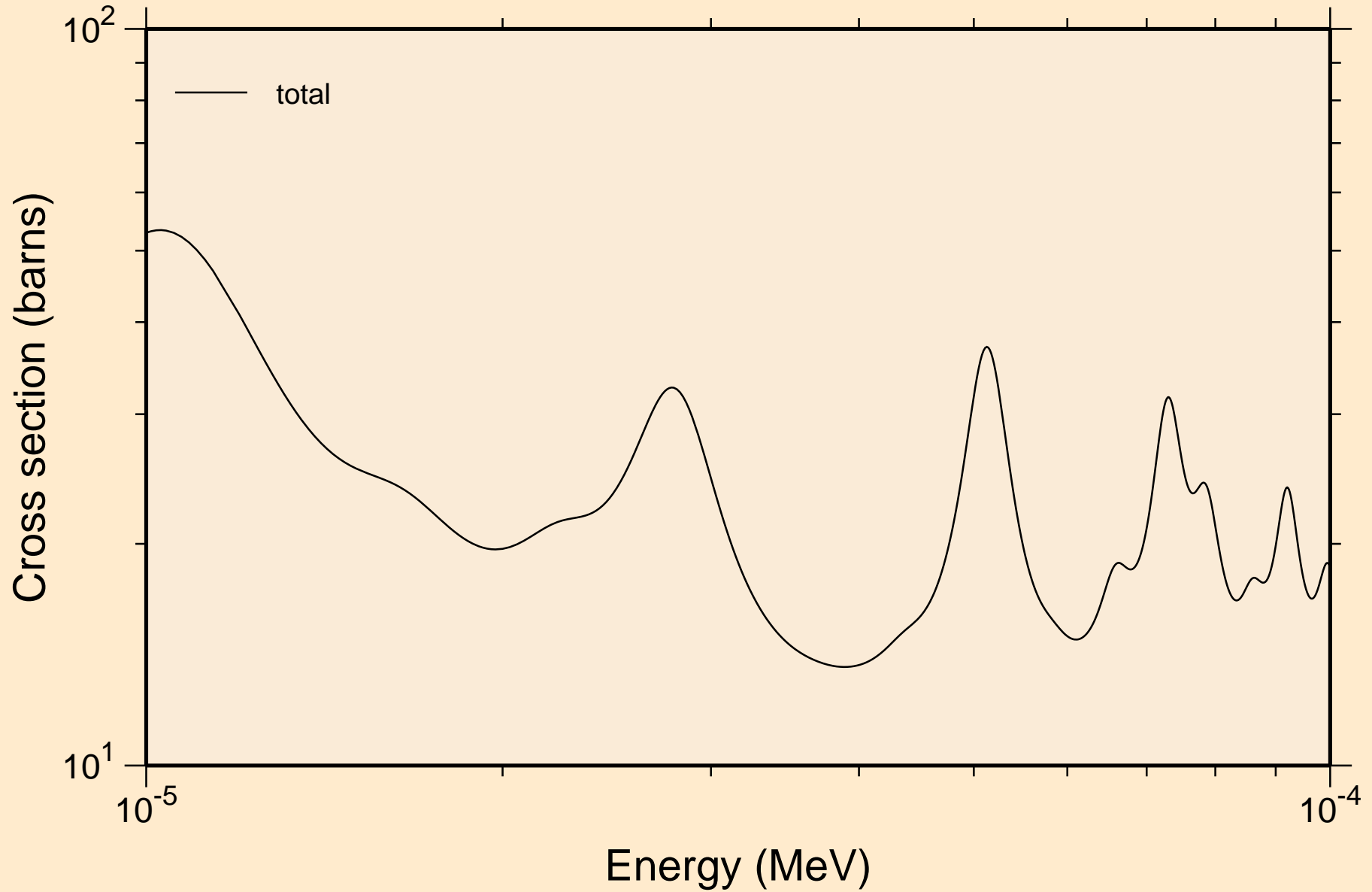

FM246 NEUTRON ACER TENDL-2024 LIBRARY; T=0.K  
resonance total cross section

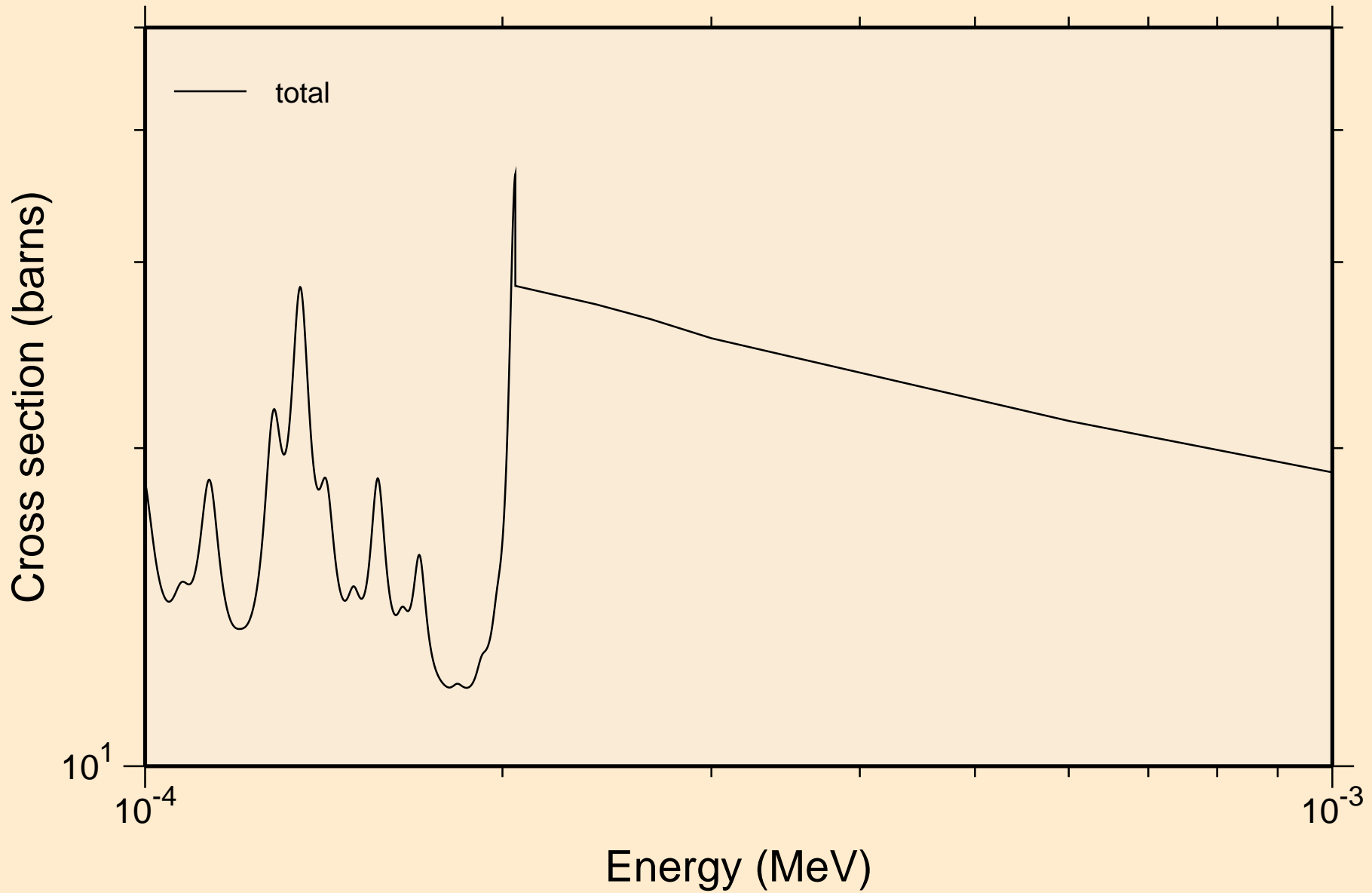

FM246 NEUTRON ACER TENDL-2024 LIBRARY; T=0.K  
resonance total cross section

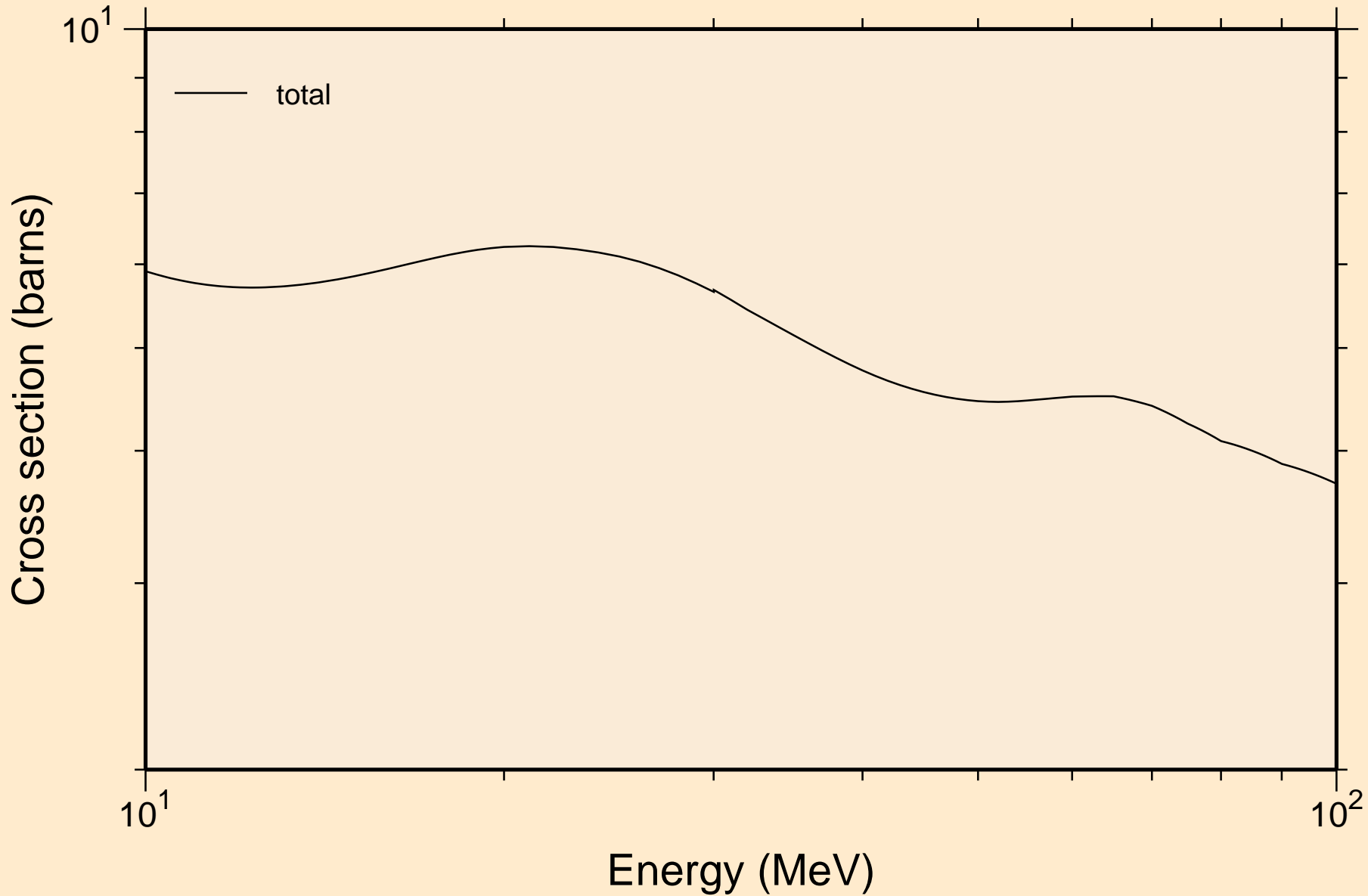

FM246 NEUTRON ACER TENDL-2024 LIBRARY; T=0.K  
resonance absorption cross sections

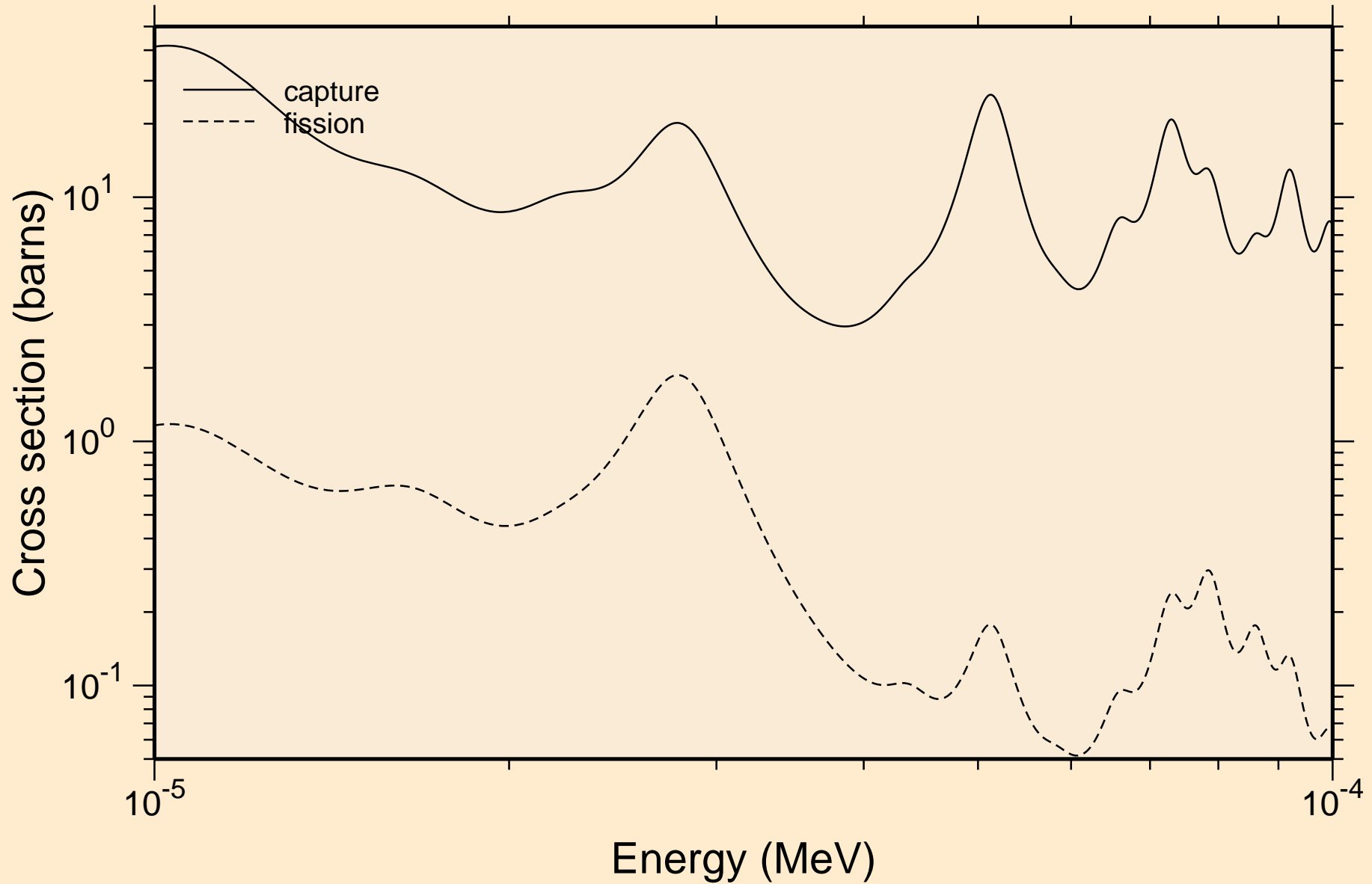

FM246 NEUTRON ACER TENDL-2024 LIBRARY; T=0.K  
resonance absorption cross sections

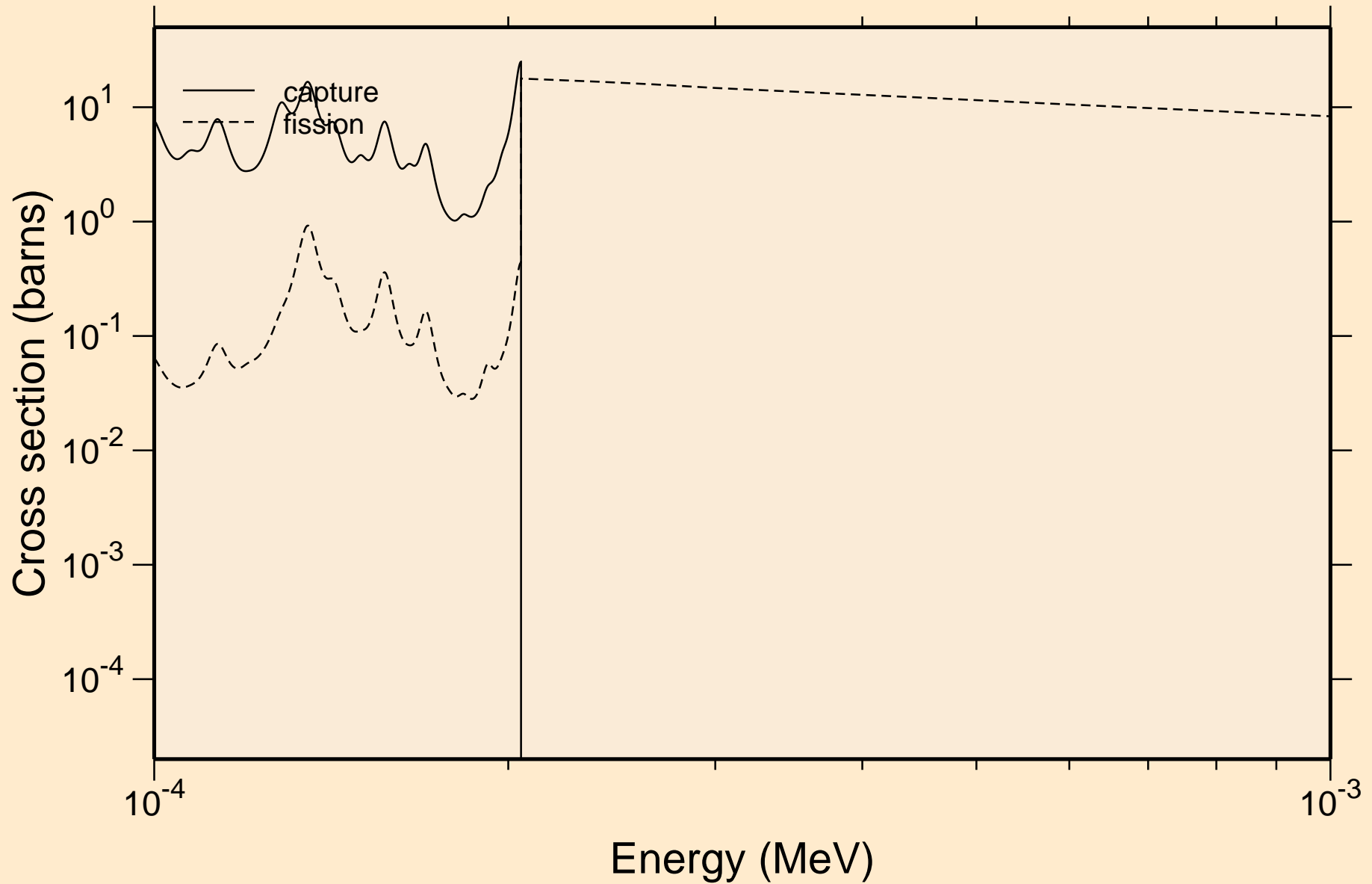

FM246 NEUTRON ACER TENDL-2024 LIBRARY; T=0.K  
resonance absorption cross sections

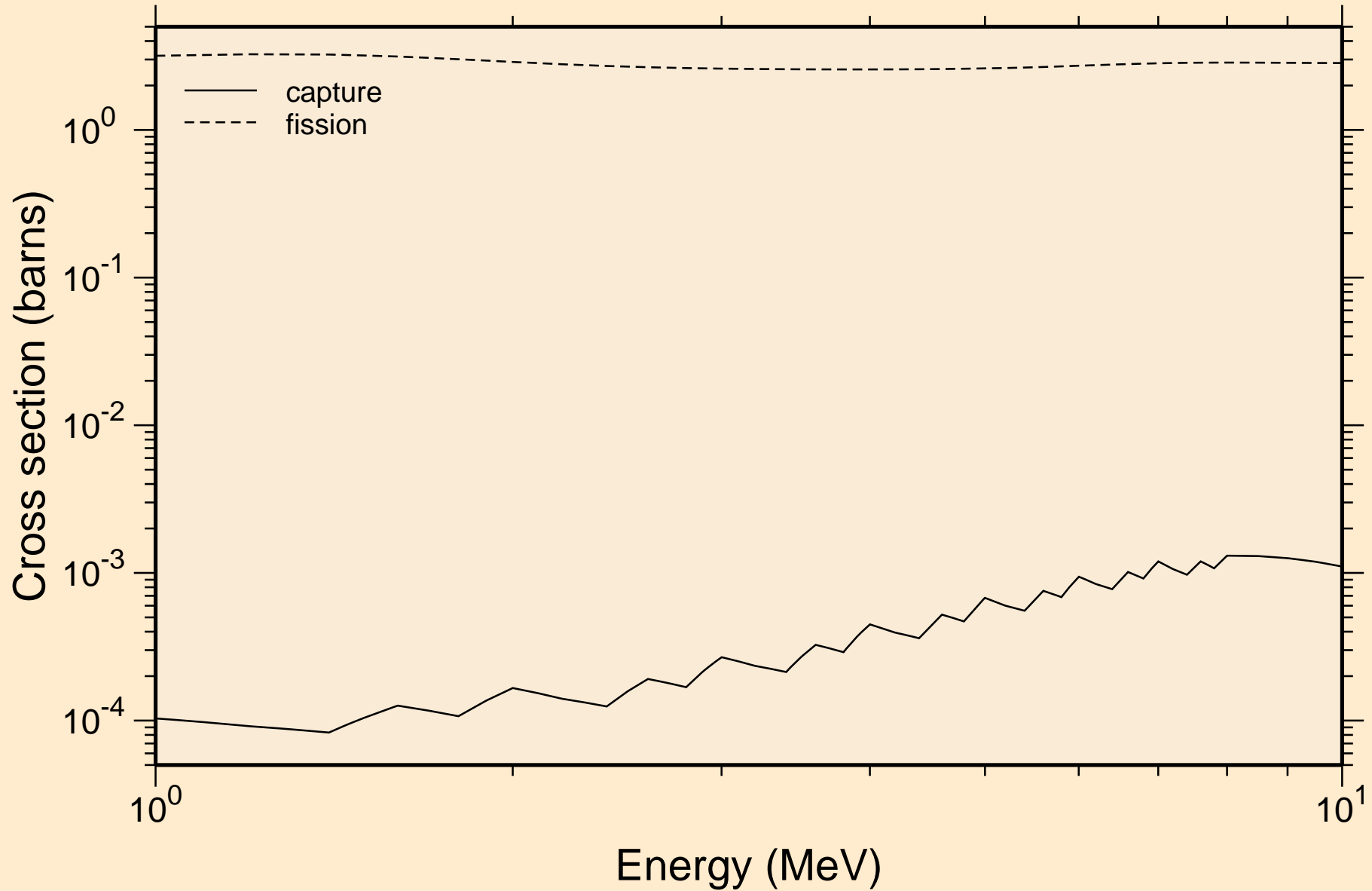

# FM246 NEUTRON ACER TENDL-2024 LIBRARY; T=0.K

## Heating

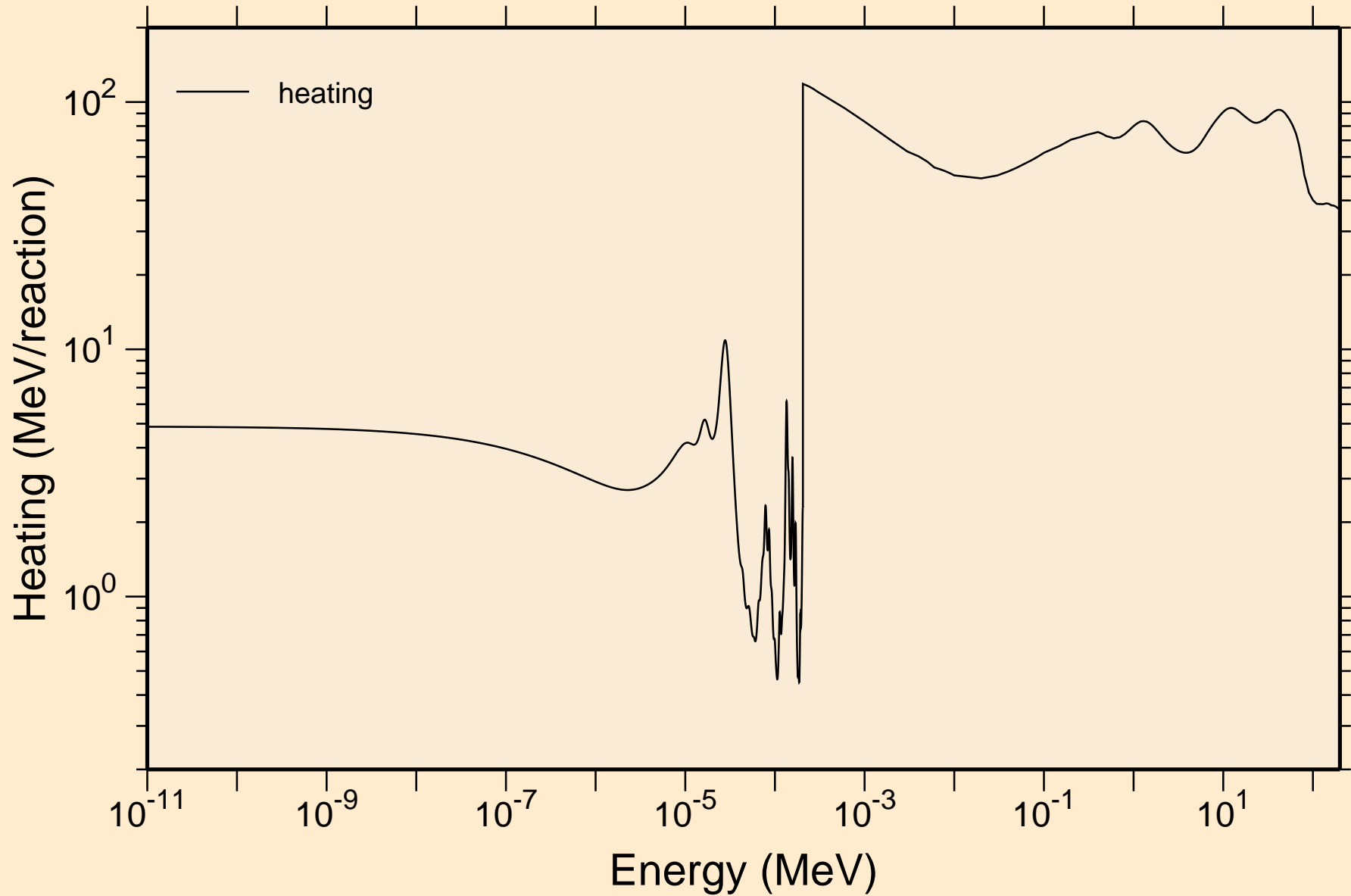



# FM246 NEUTRON ACER TENDL-2024 LIBRARY; T=0.K

## Damage

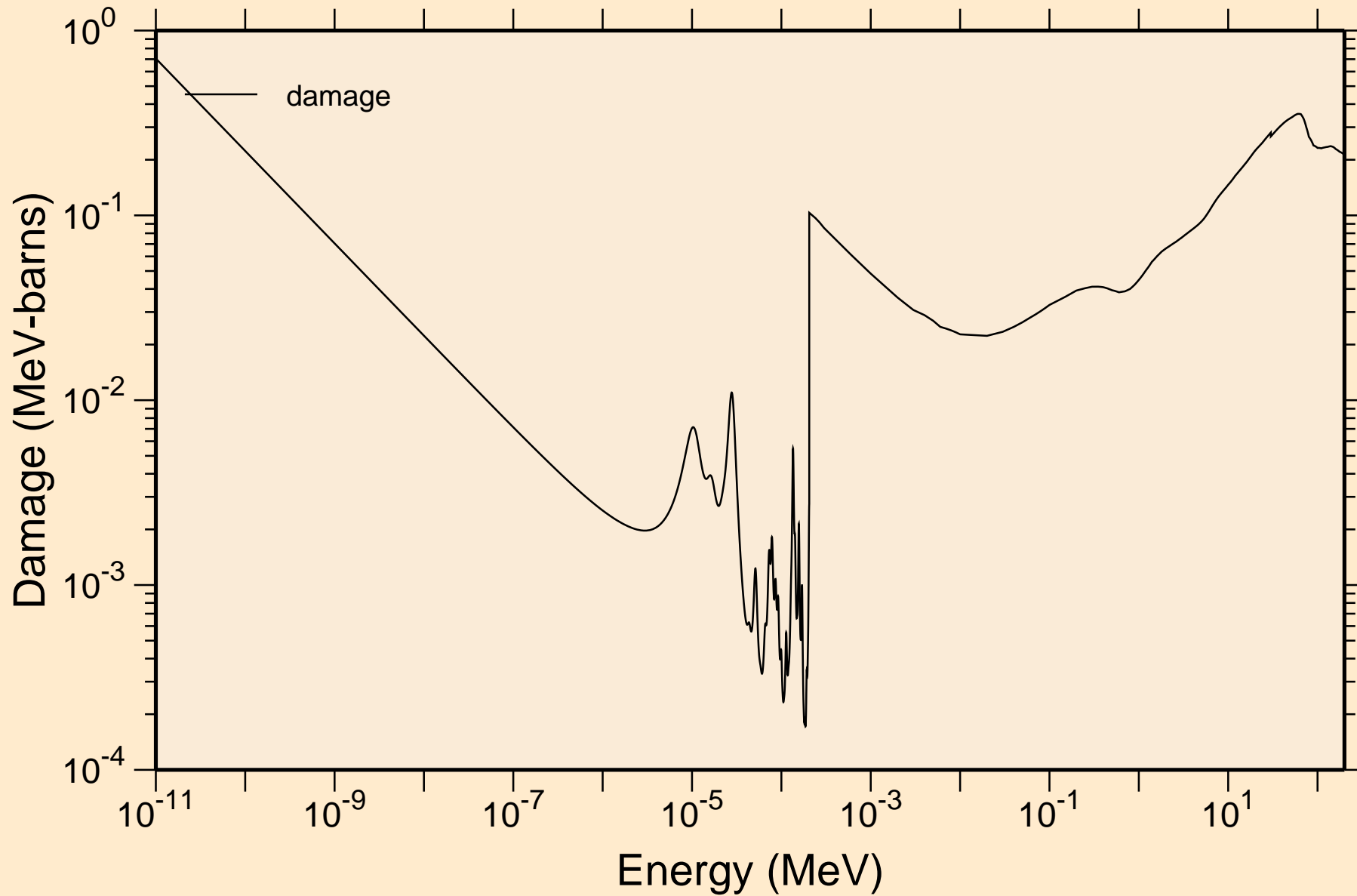

# FM246 NEUTRON ACER TENDL-2024 LIBRARY; T=0.K

## Non-threshold reactions

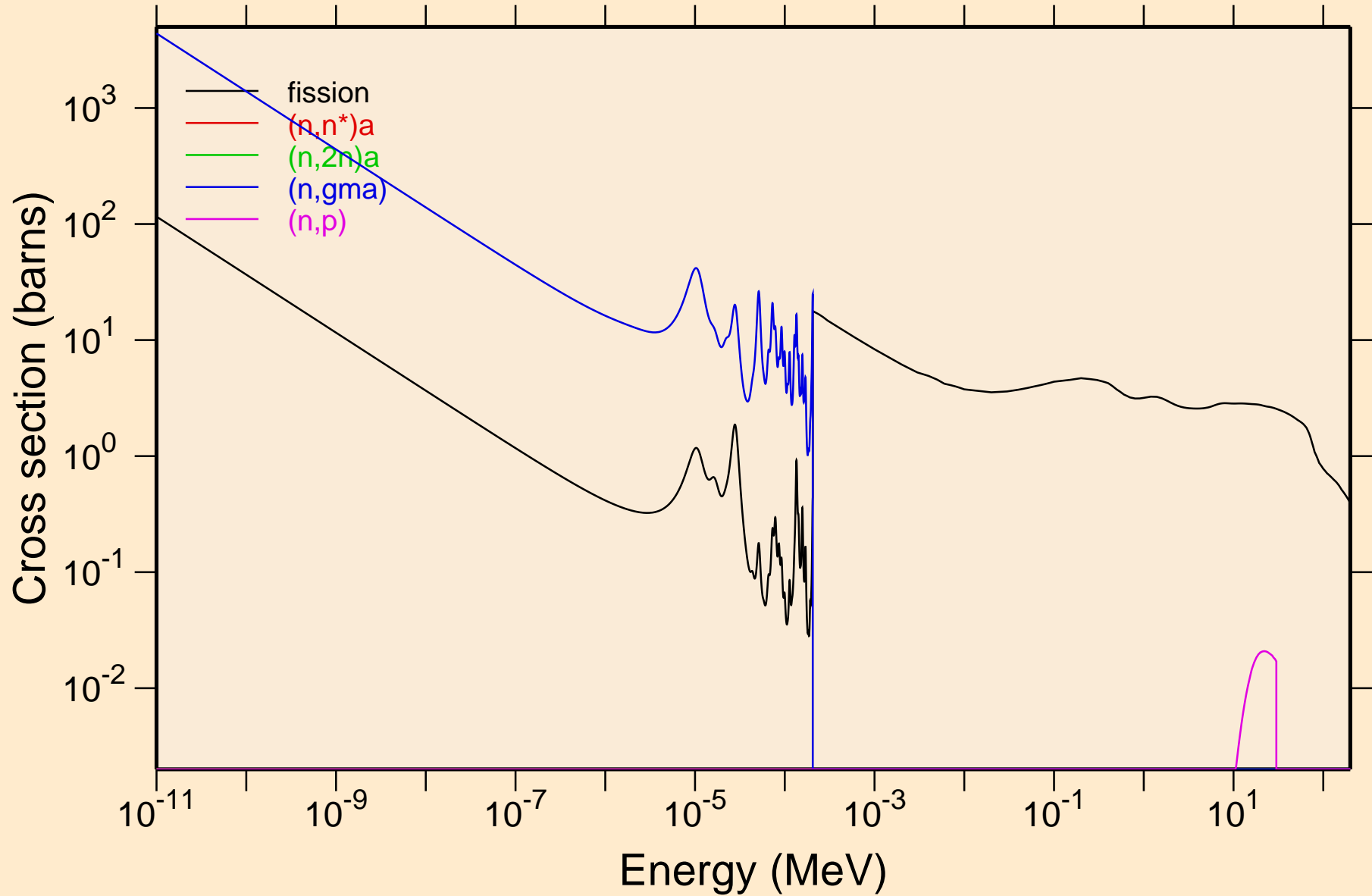

FM246 NEUTRON ACER TENDL-2024 LIBRARY; T=0.K  
Non-threshold reactions

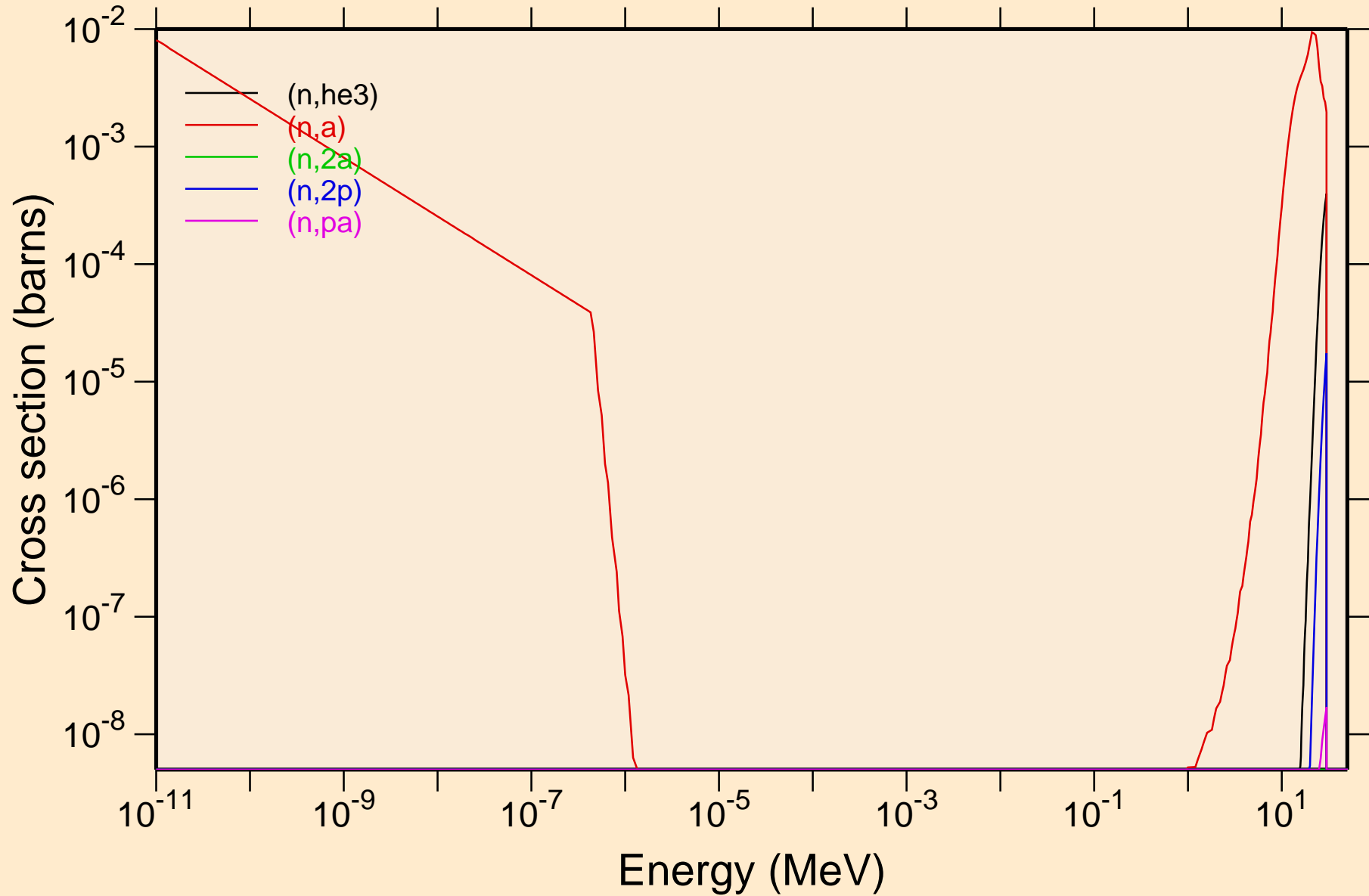

FM246 NEUTRON ACER TENDL-2024 LIBRARY; T=0.K  
Non-threshold reactions

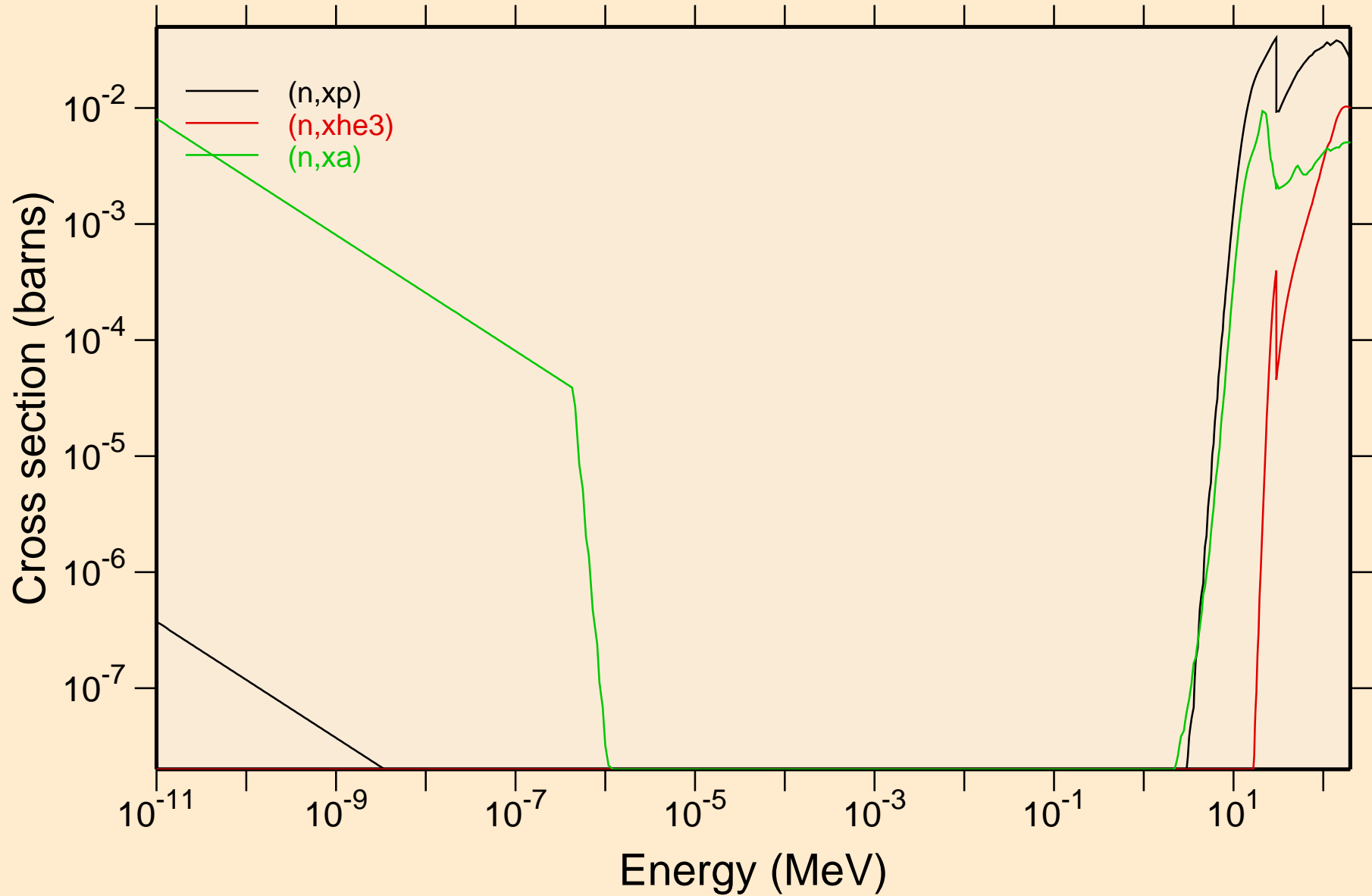

# FM246 NEUTRON ACER TENDL-2024 LIBRARY; T=0.K

## Principal cross sections

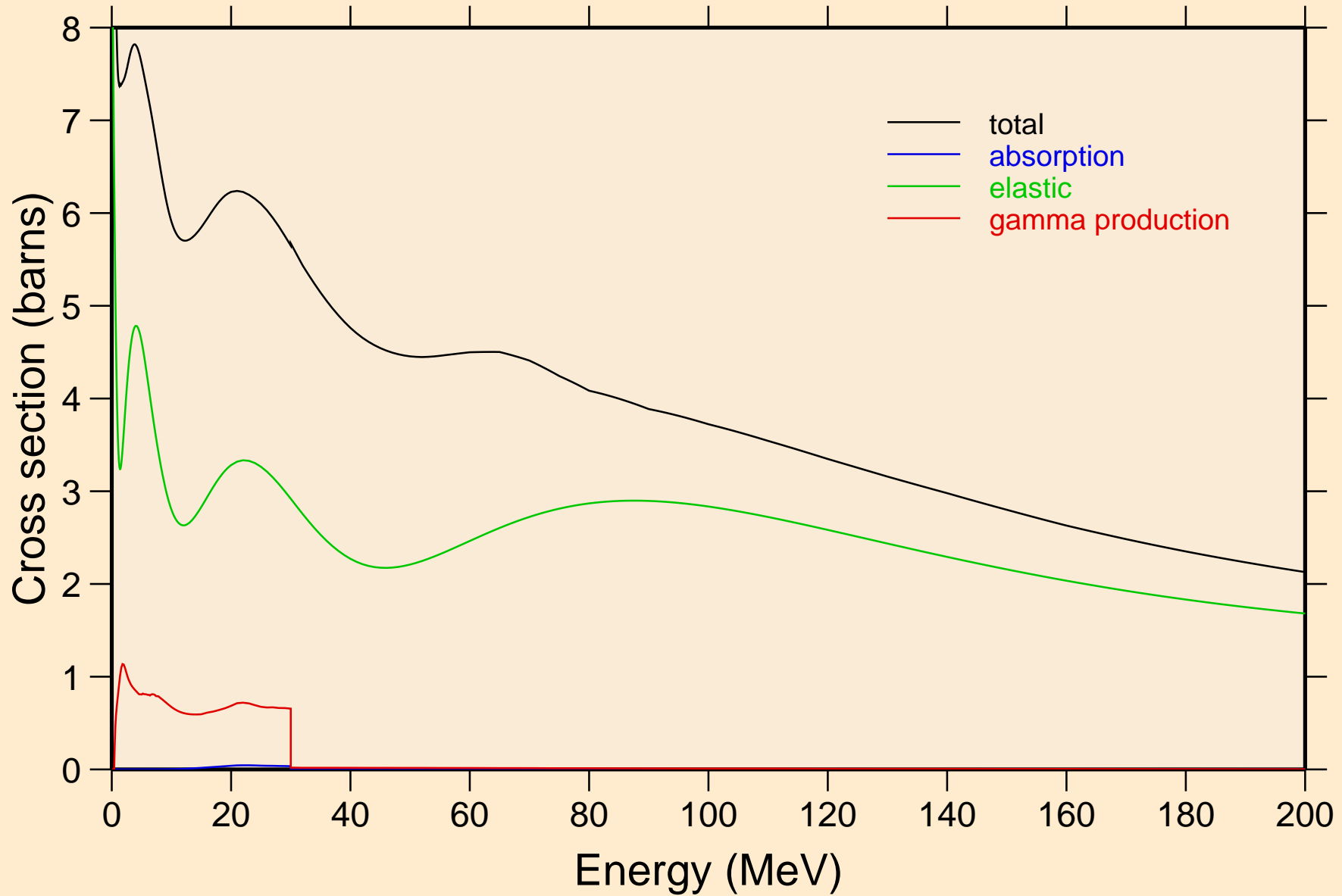

FM246 NEUTRON ACER TENDL-2024 LIBRARY; T=0.K  
Heating

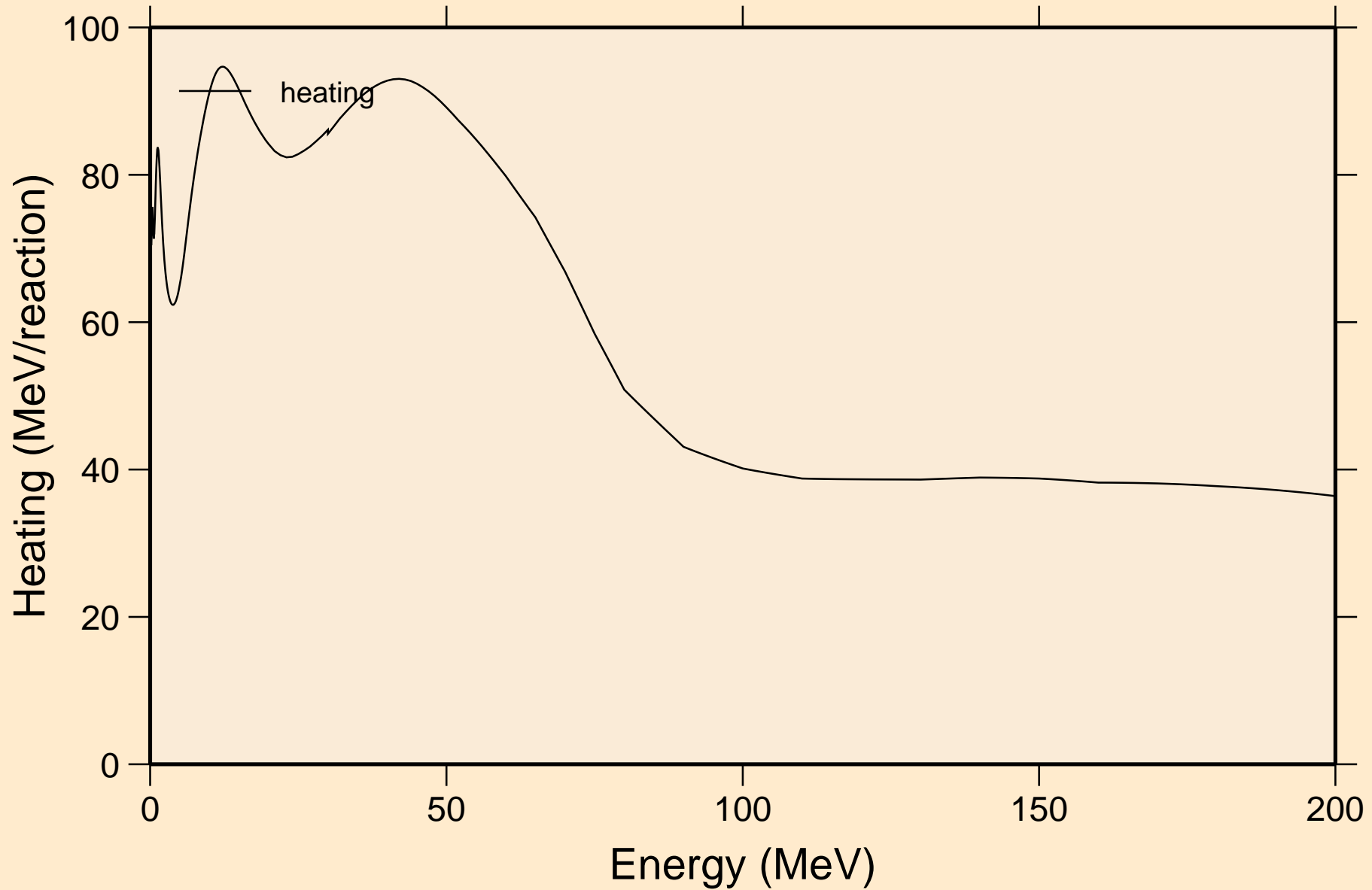

# FM246 NEUTRON ACER TENDL-2024 LIBRARY; T=0.K

## Damage

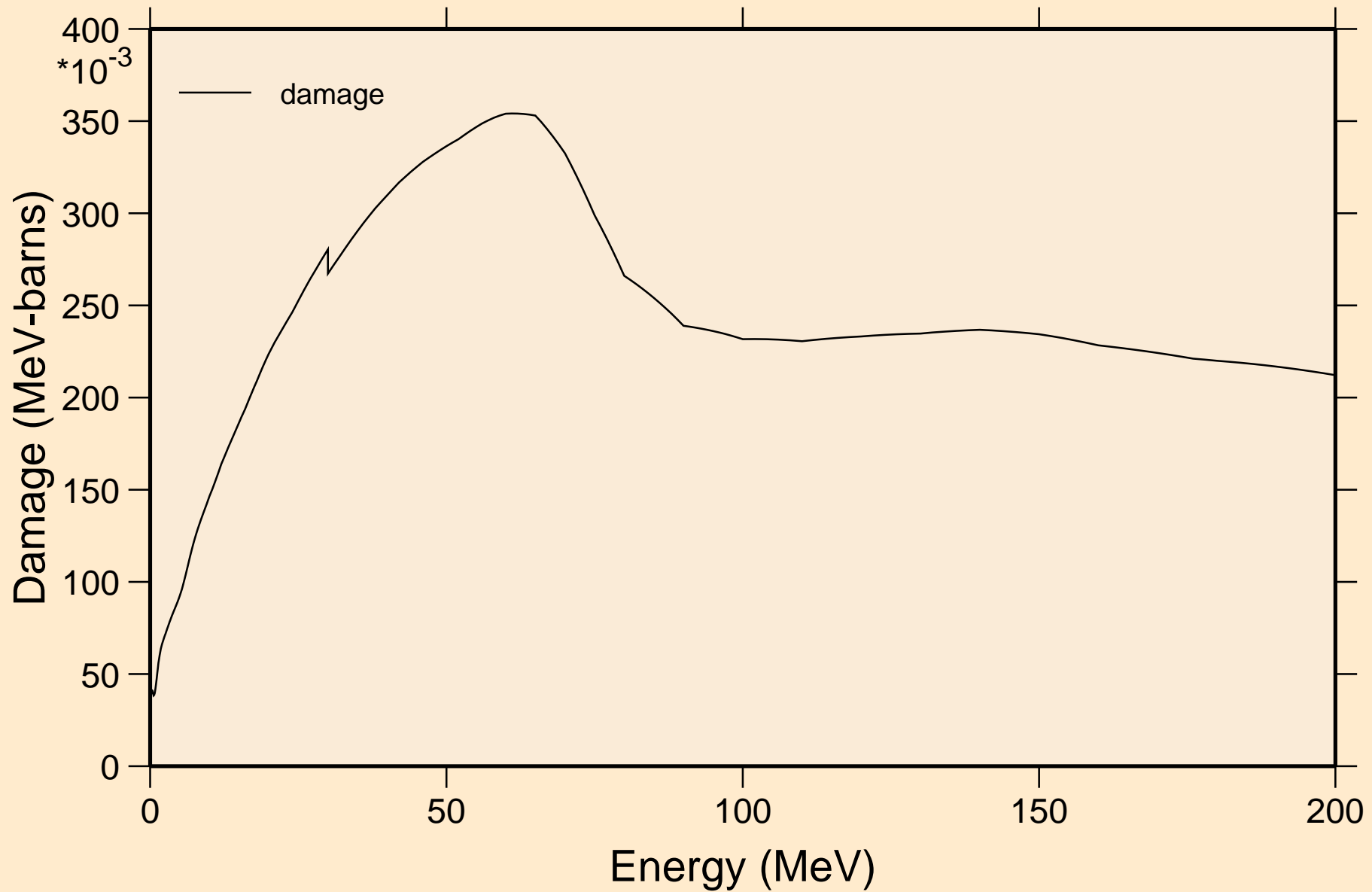

# FM246 NEUTRON ACER TENDL-2024 LIBRARY; T=0.K

## Non-threshold reactions

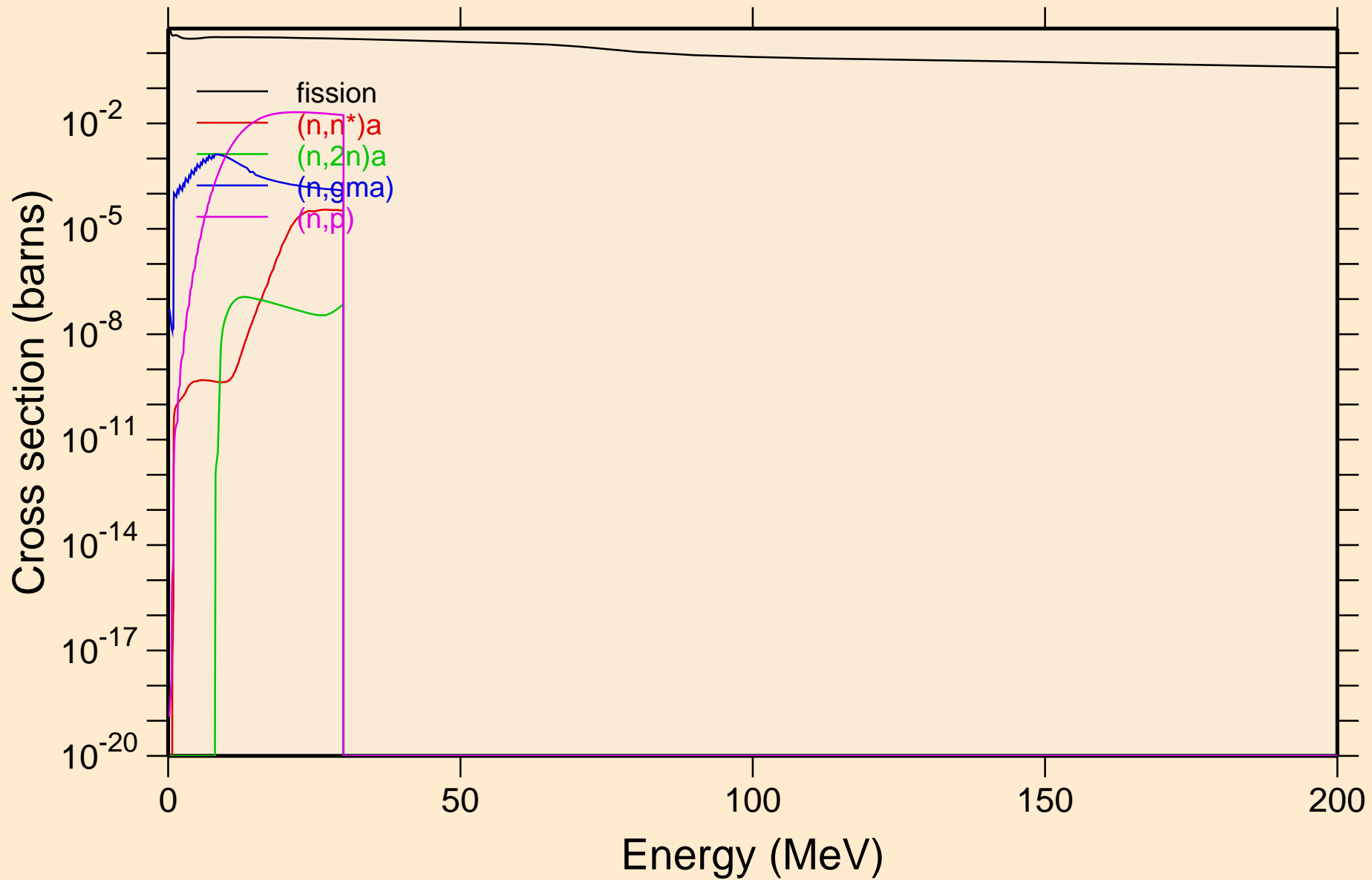



# FM246 NEUTRON ACER TENDL-2024 LIBRARY; T=0.K

## Non-threshold reactions

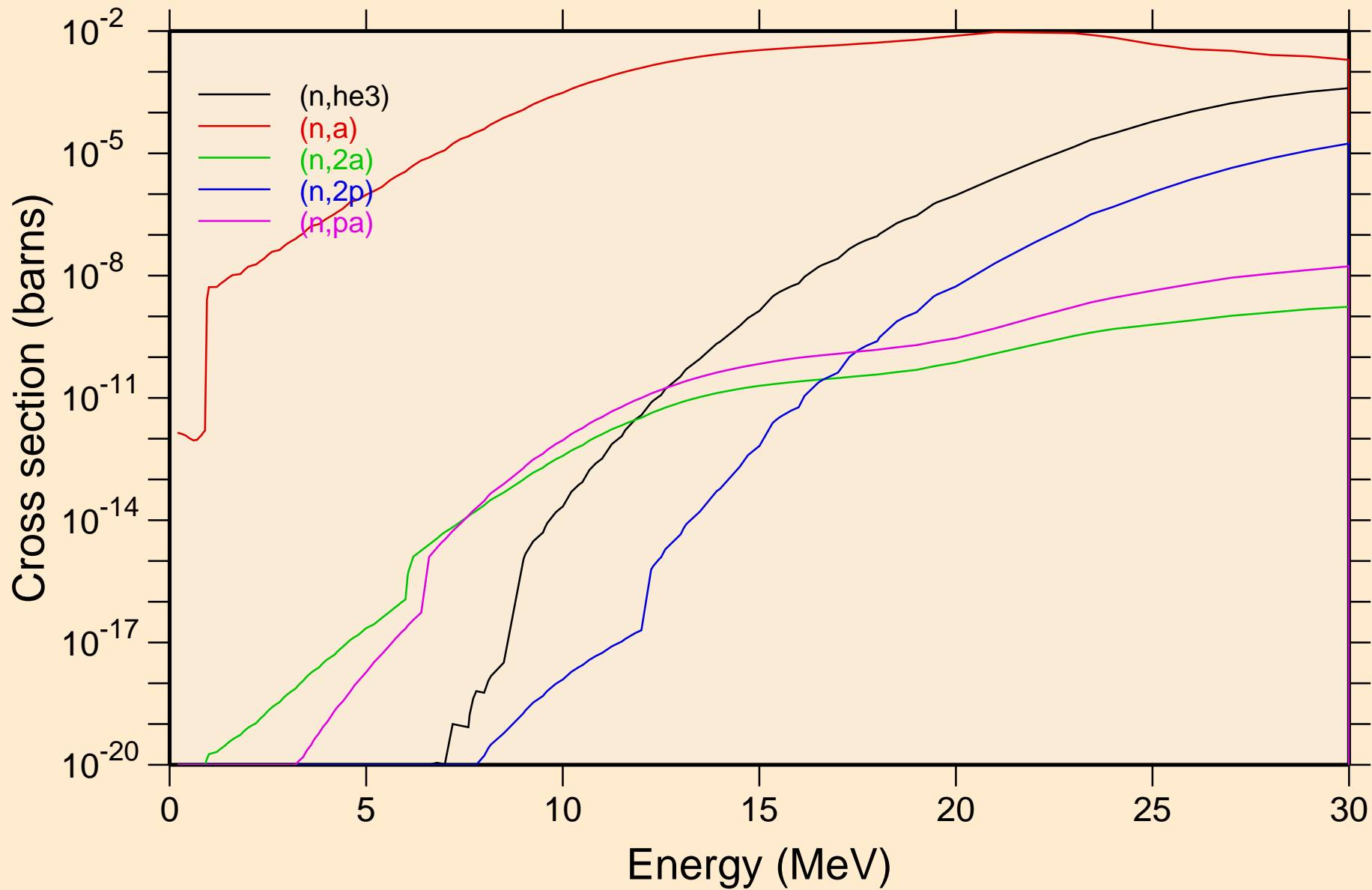

FM246 NEUTRON ACER TENDL-2024 LIBRARY; T=0.K  
Non-threshold reactions

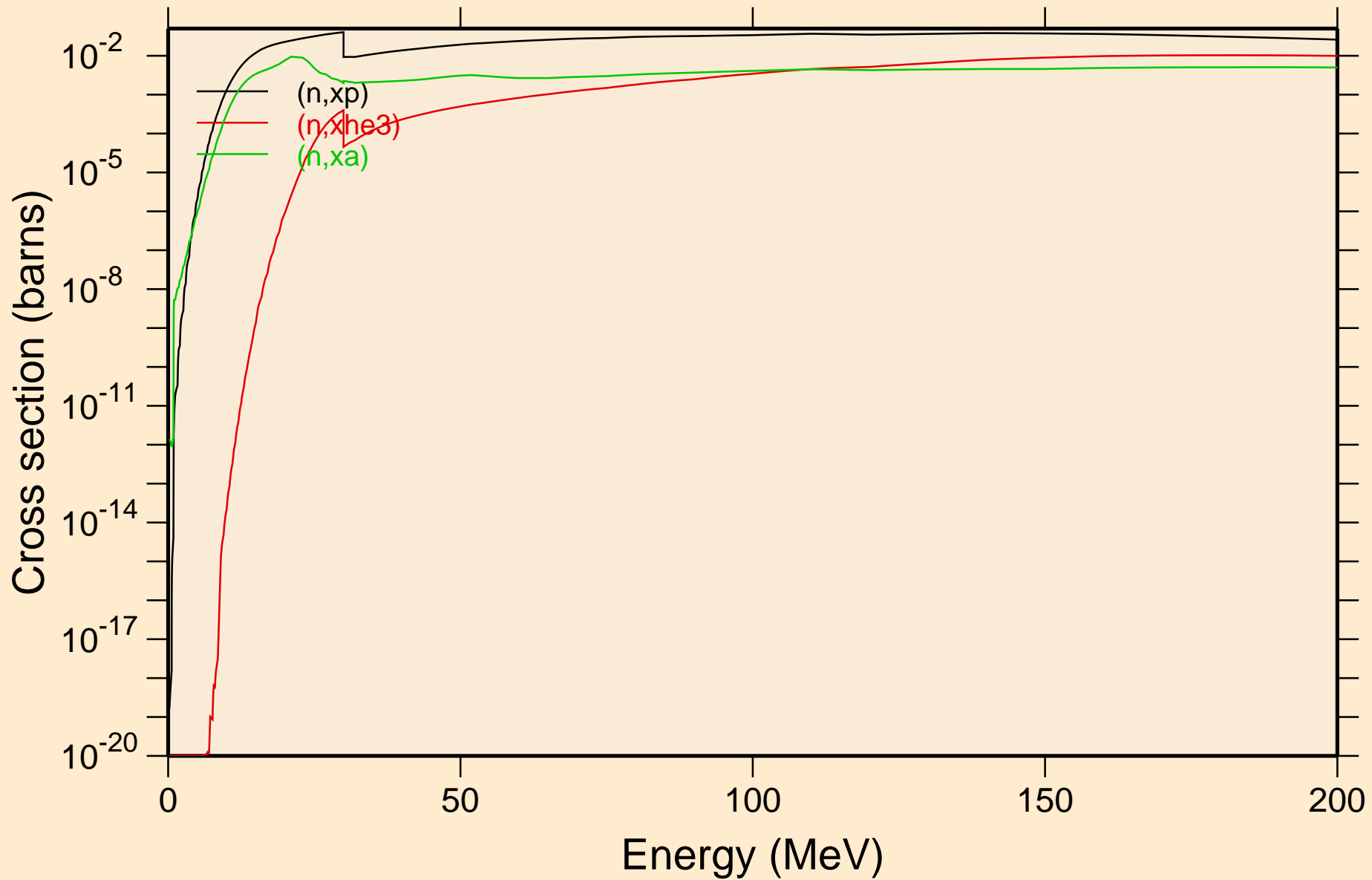

FM246 NEUTRON ACER TENDL-2024 LIBRARY; T=0.K  
Inelastic levels

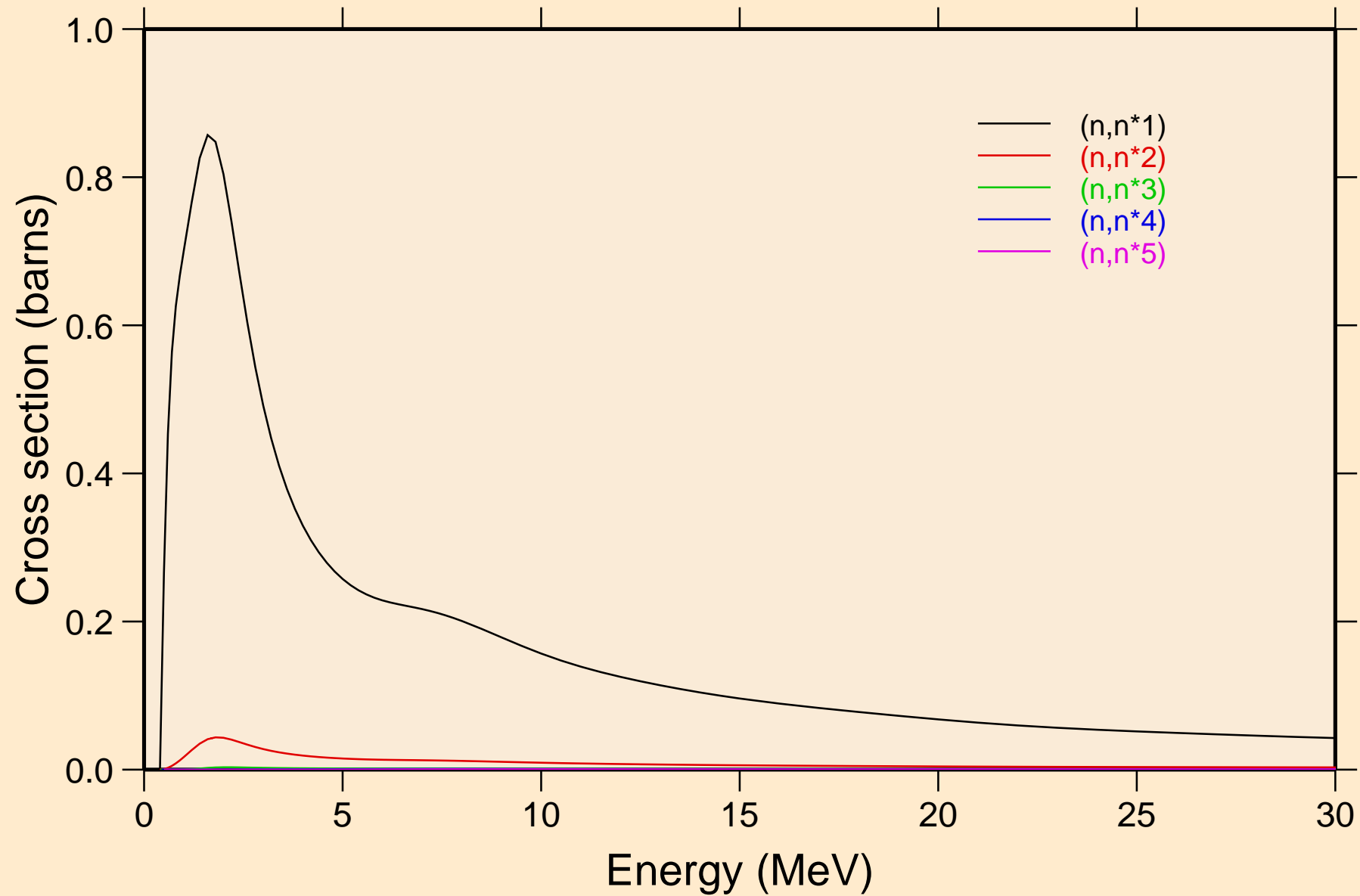

FM246 NEUTRON ACER TENDL-2024 LIBRARY; T=0.K  
Inelastic levels

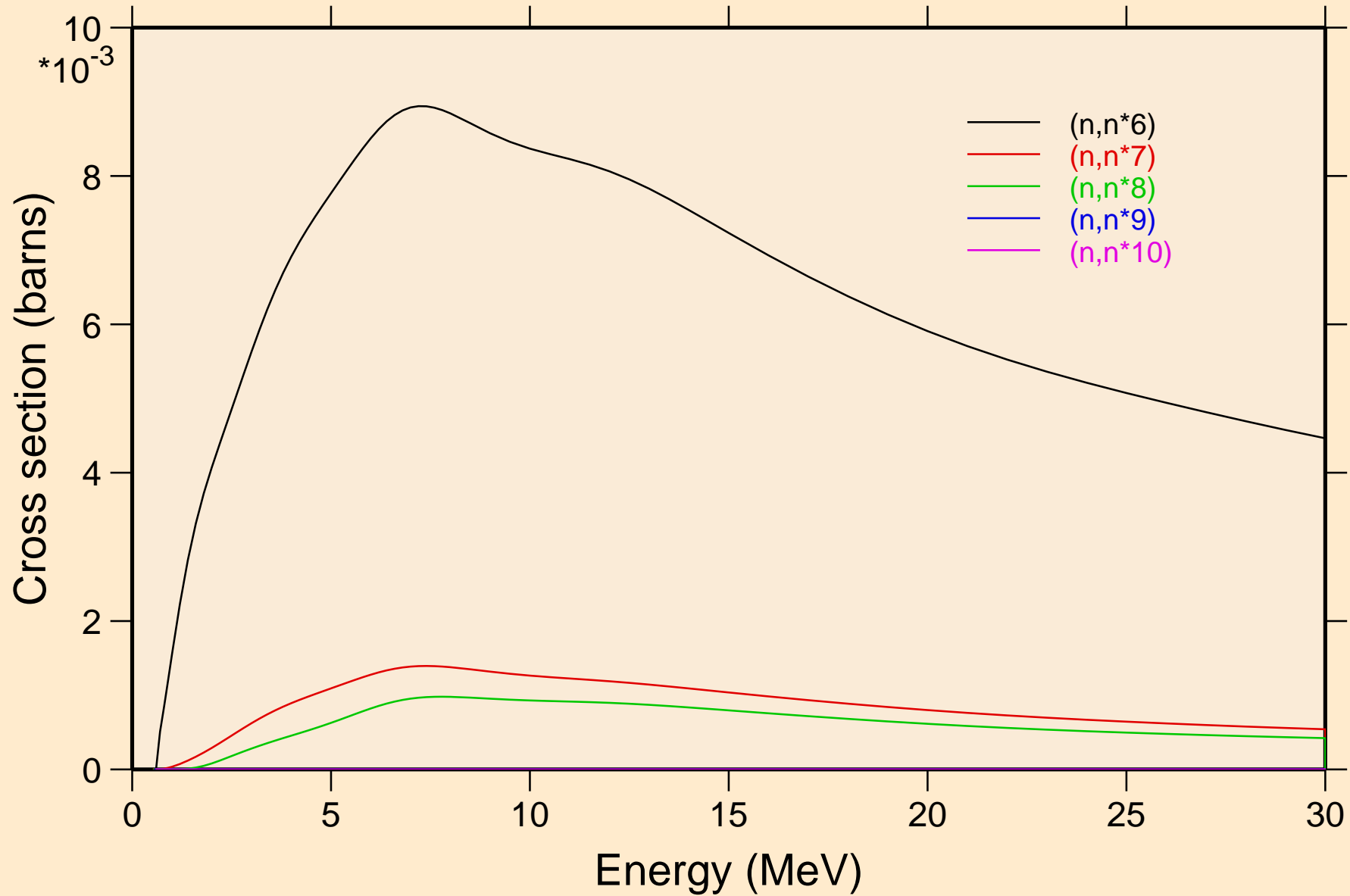

FM246 NEUTRON ACER TENDL-2024 LIBRARY; T=0.K  
Inelastic levels

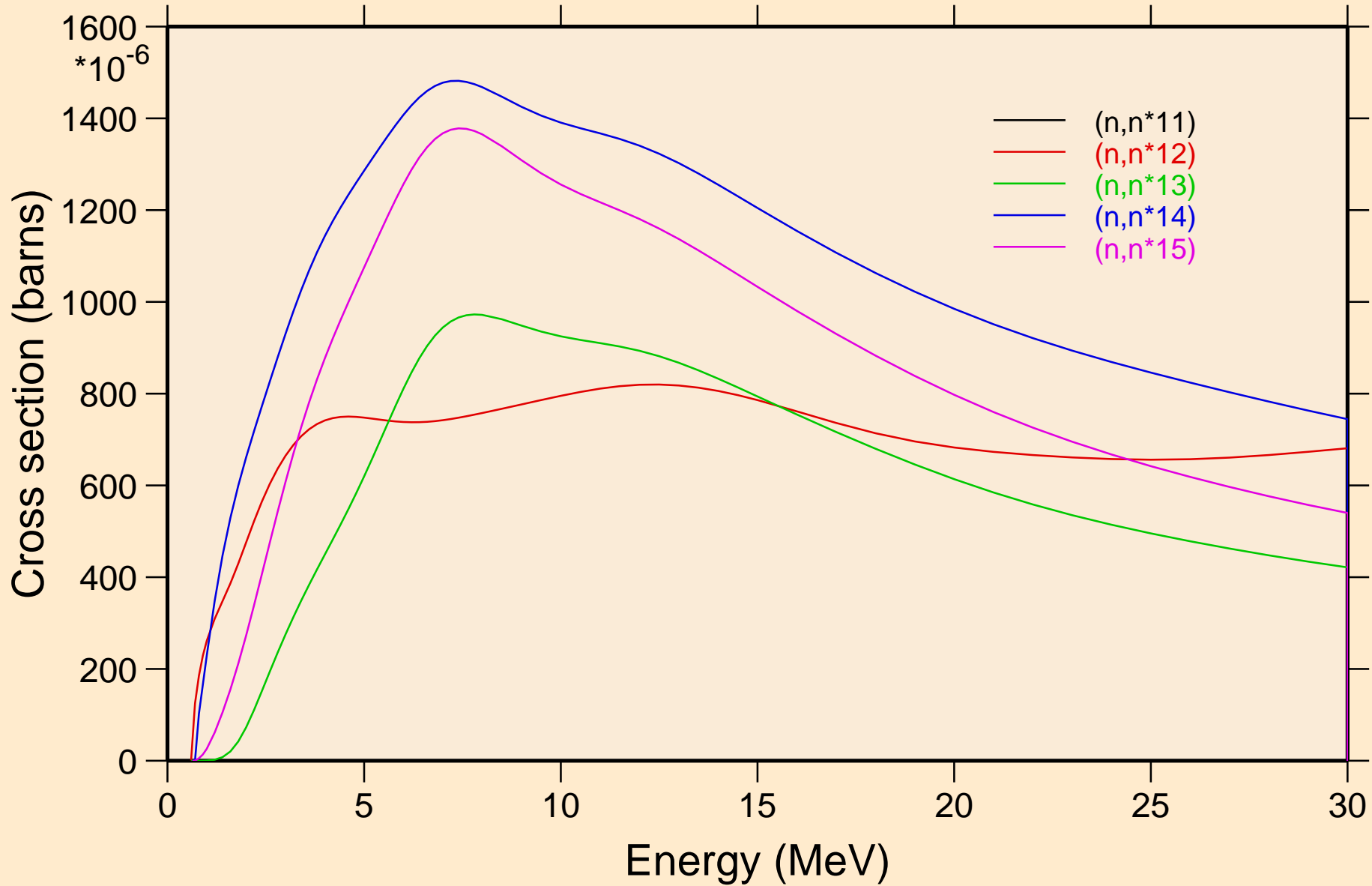

FM246 NEUTRON ACER TENDL-2024 LIBRARY; T=0.K  
Inelastic levels

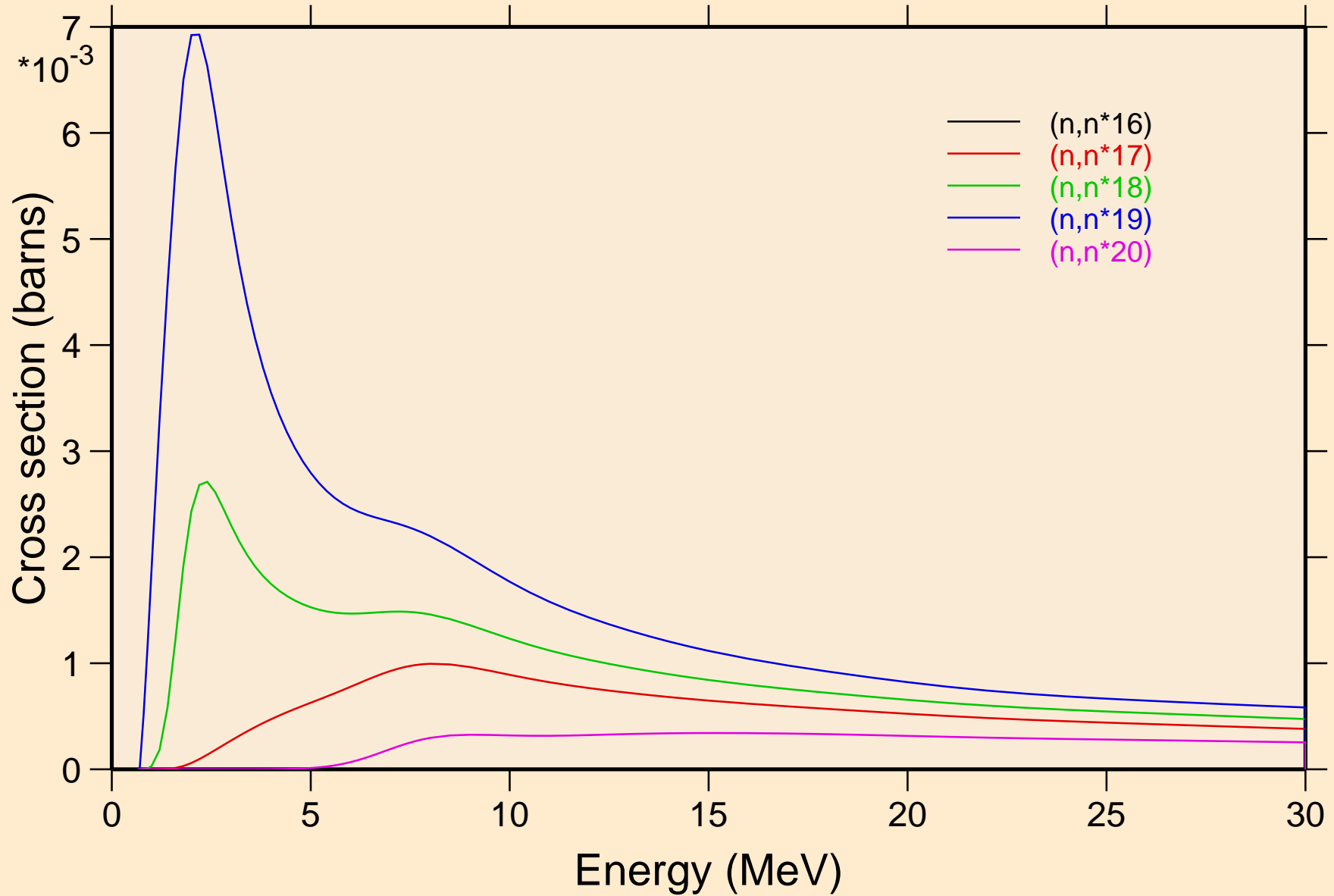

FM246 NEUTRON ACER TENDL-2024 LIBRARY; T=0.K  
Inelastic levels

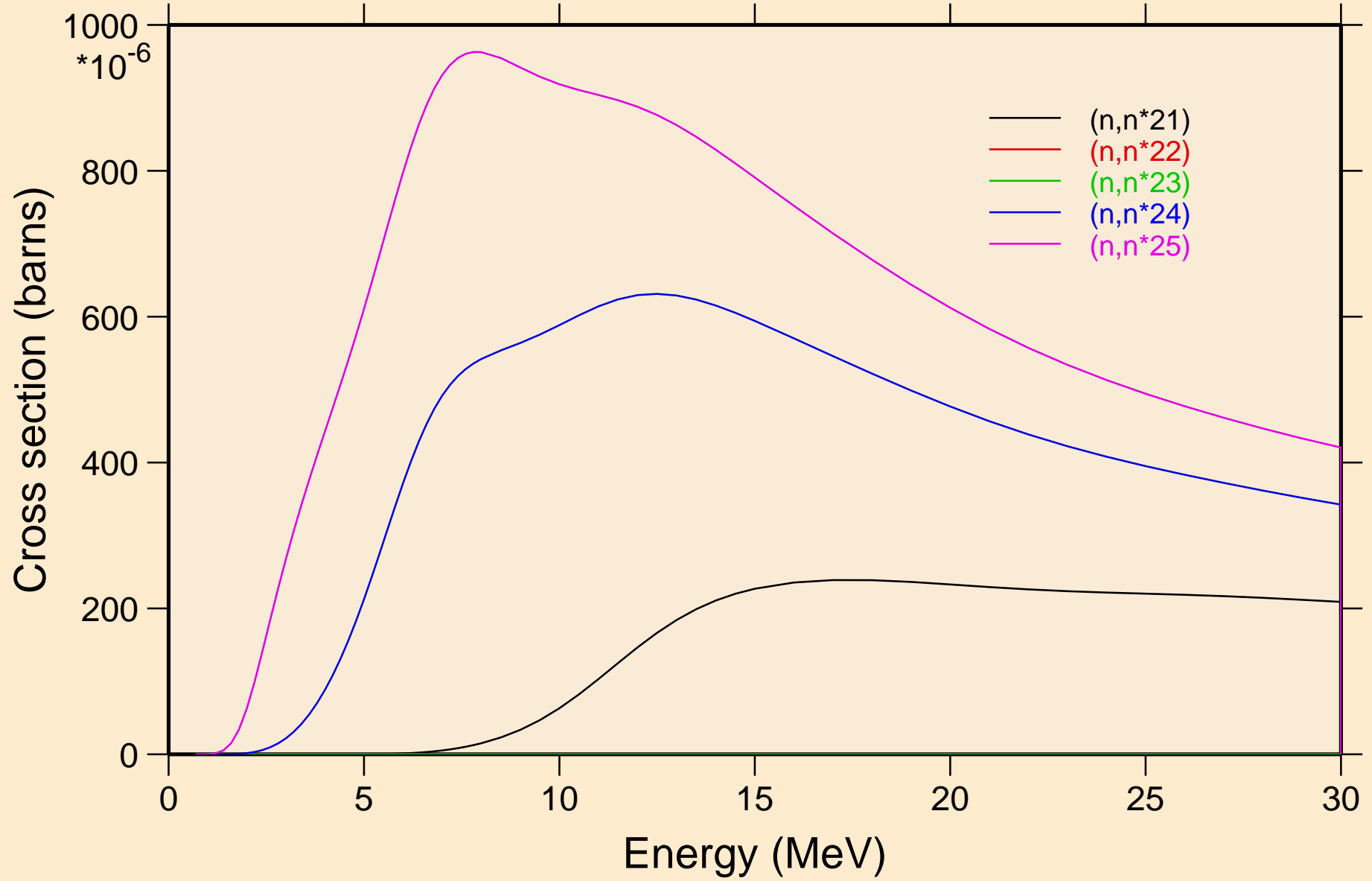

FM246 NEUTRON ACER TENDL-2024 LIBRARY; T=0.K  
Inelastic levels

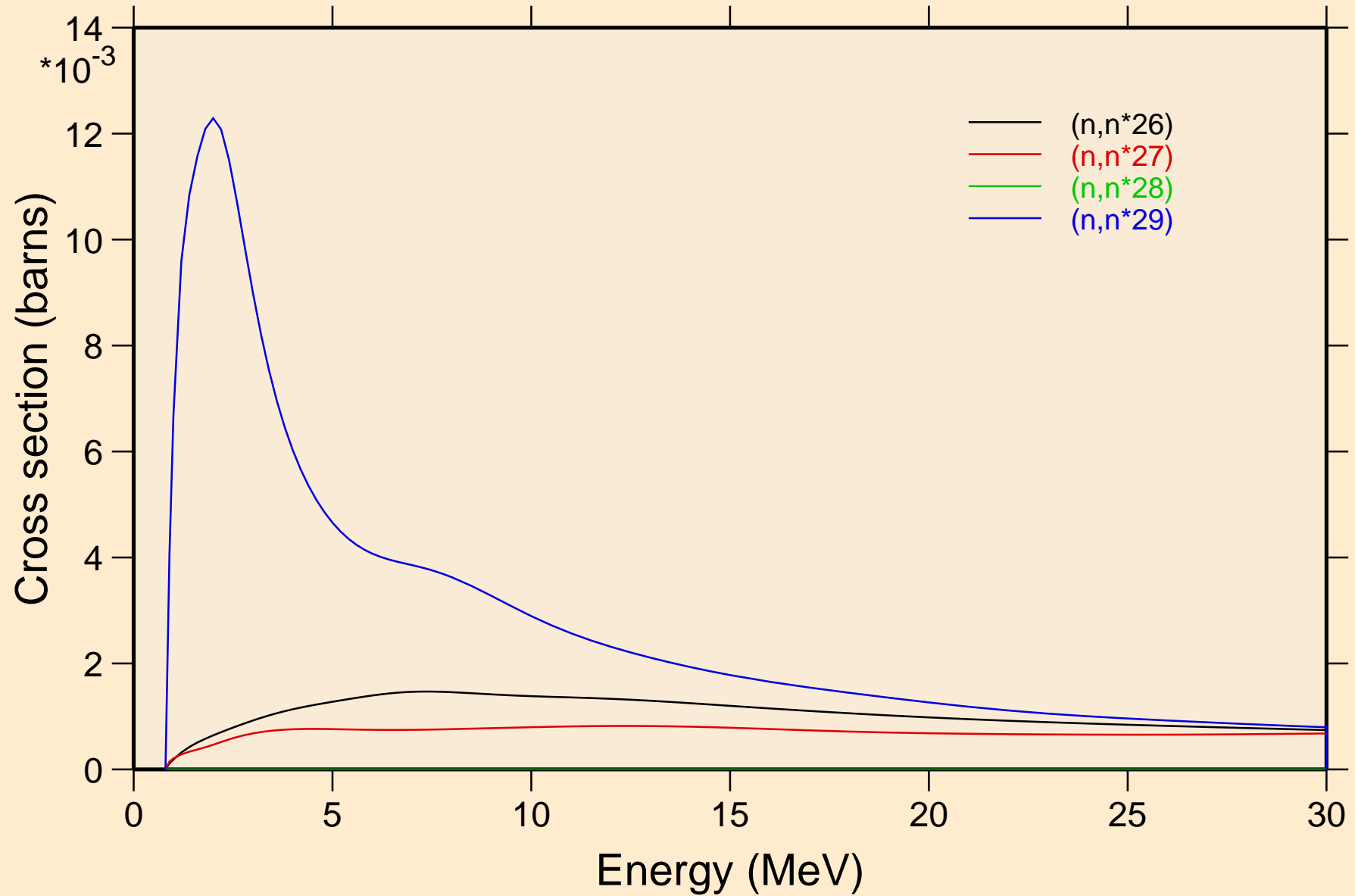



# FM246 NEUTRON ACER TENDL-2024 LIBRARY; T=0.K

## Threshold reactions

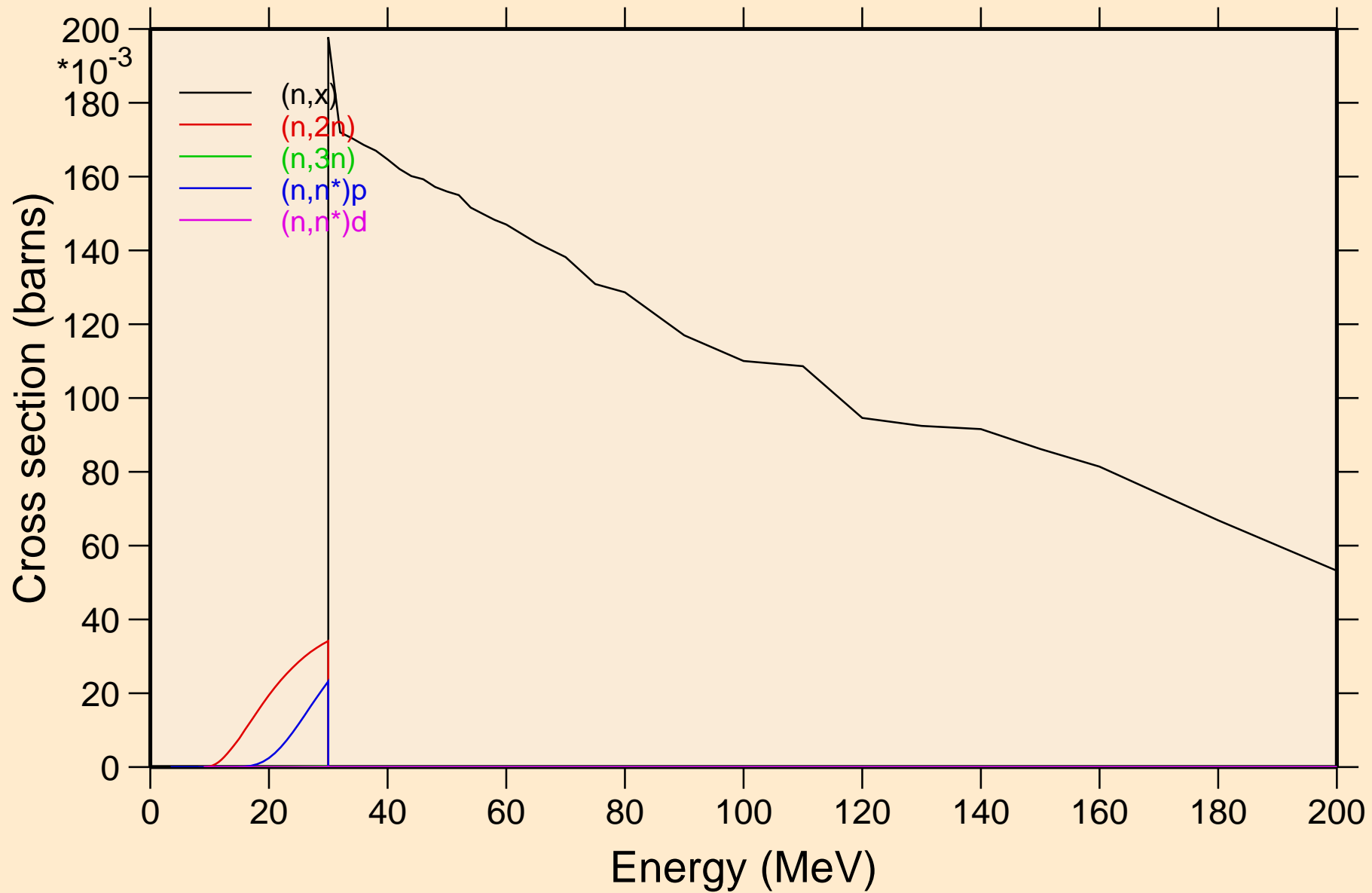

# FM246 NEUTRON ACER TENDL-2024 LIBRARY; T=0.K

## Threshold reactions

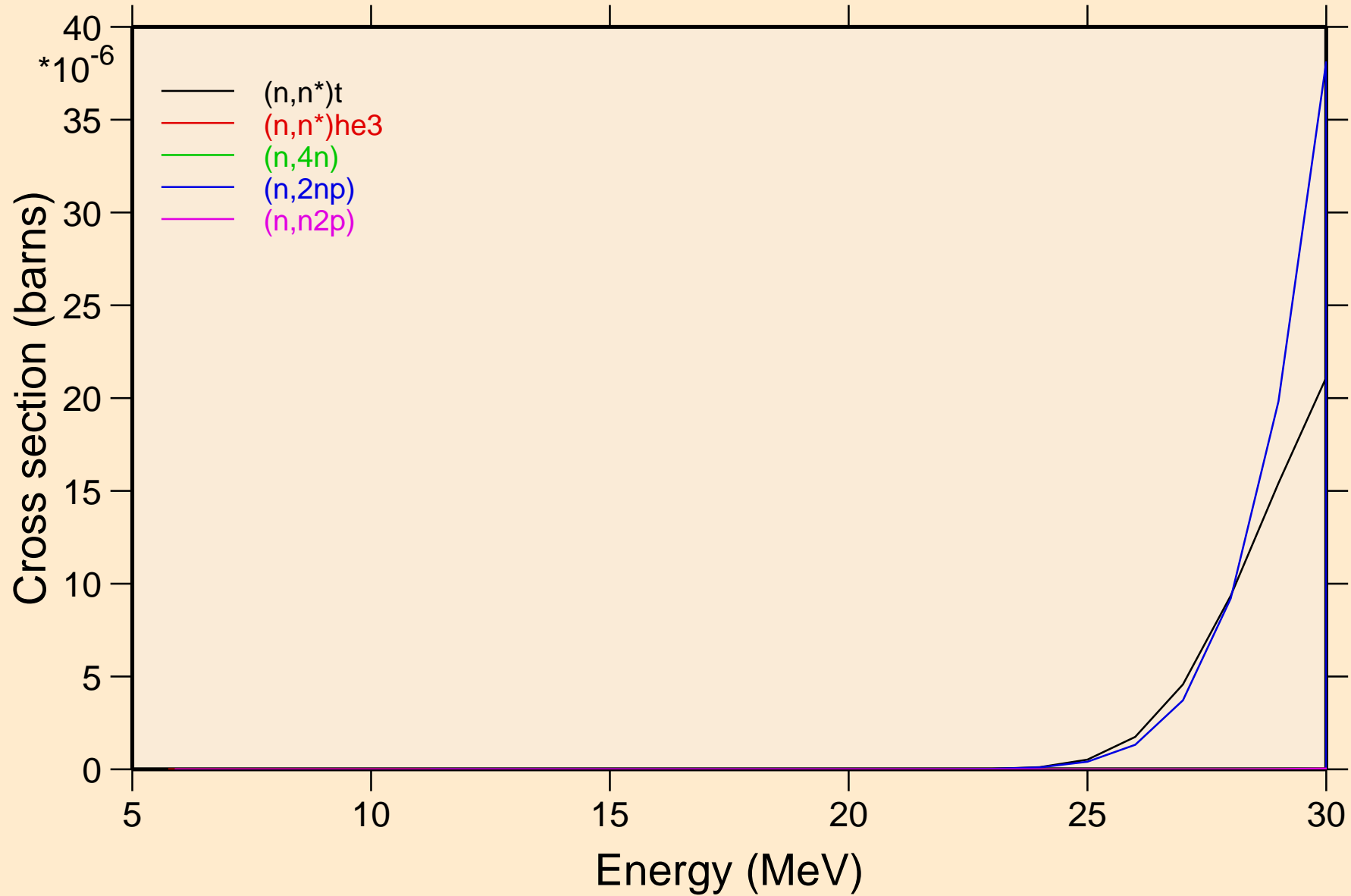

# FM246 NEUTRON ACER TENDL-2024 LIBRARY; T=0.K

## Threshold reactions

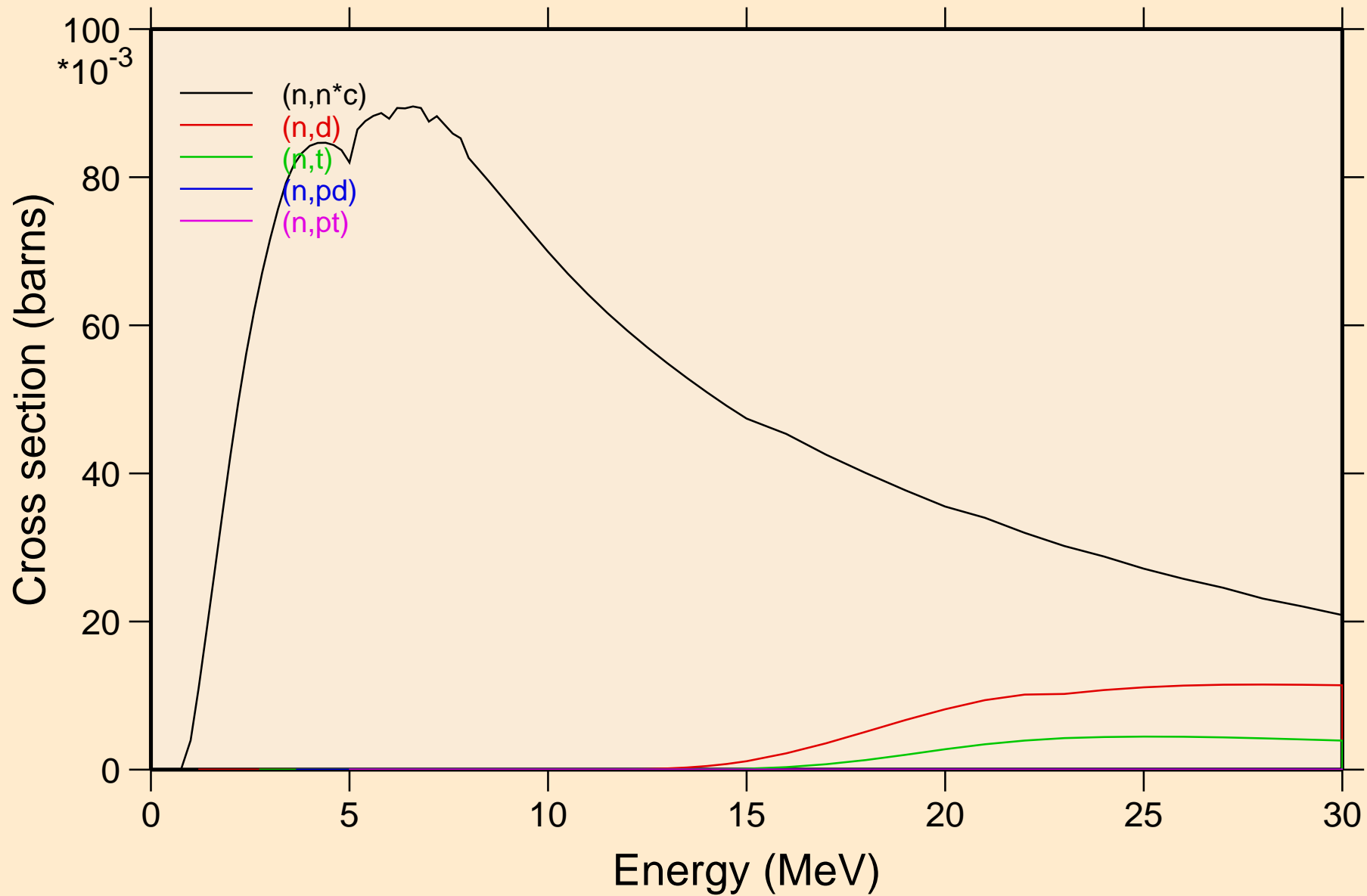

# FM246 NEUTRON ACER TENDL-2024 LIBRARY; T=0.K

## Threshold reactions

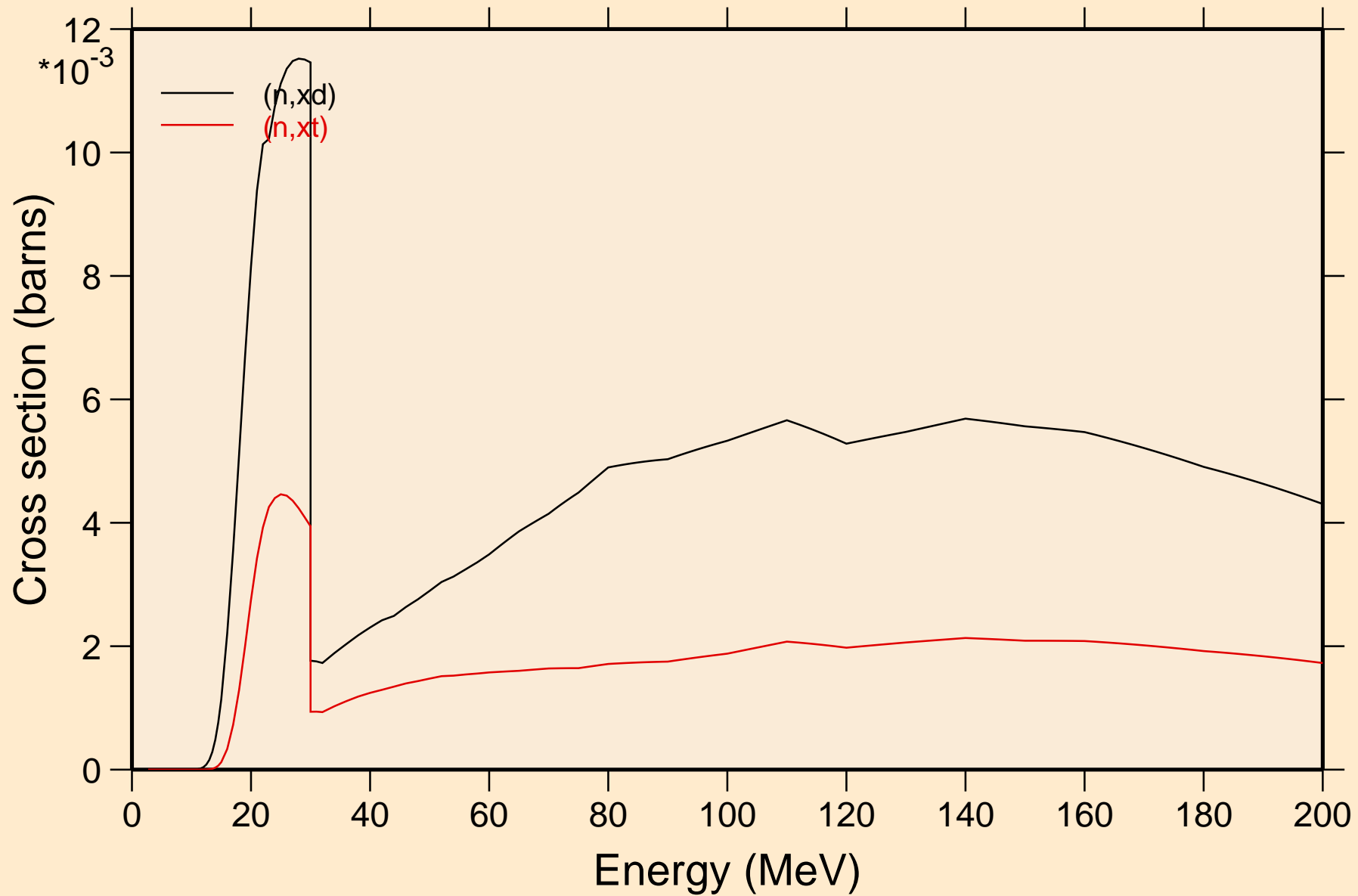

FM246 NEUTRON ACER TENDL-2024 LIBRARY; T=0.K  
angular distribution for elastic

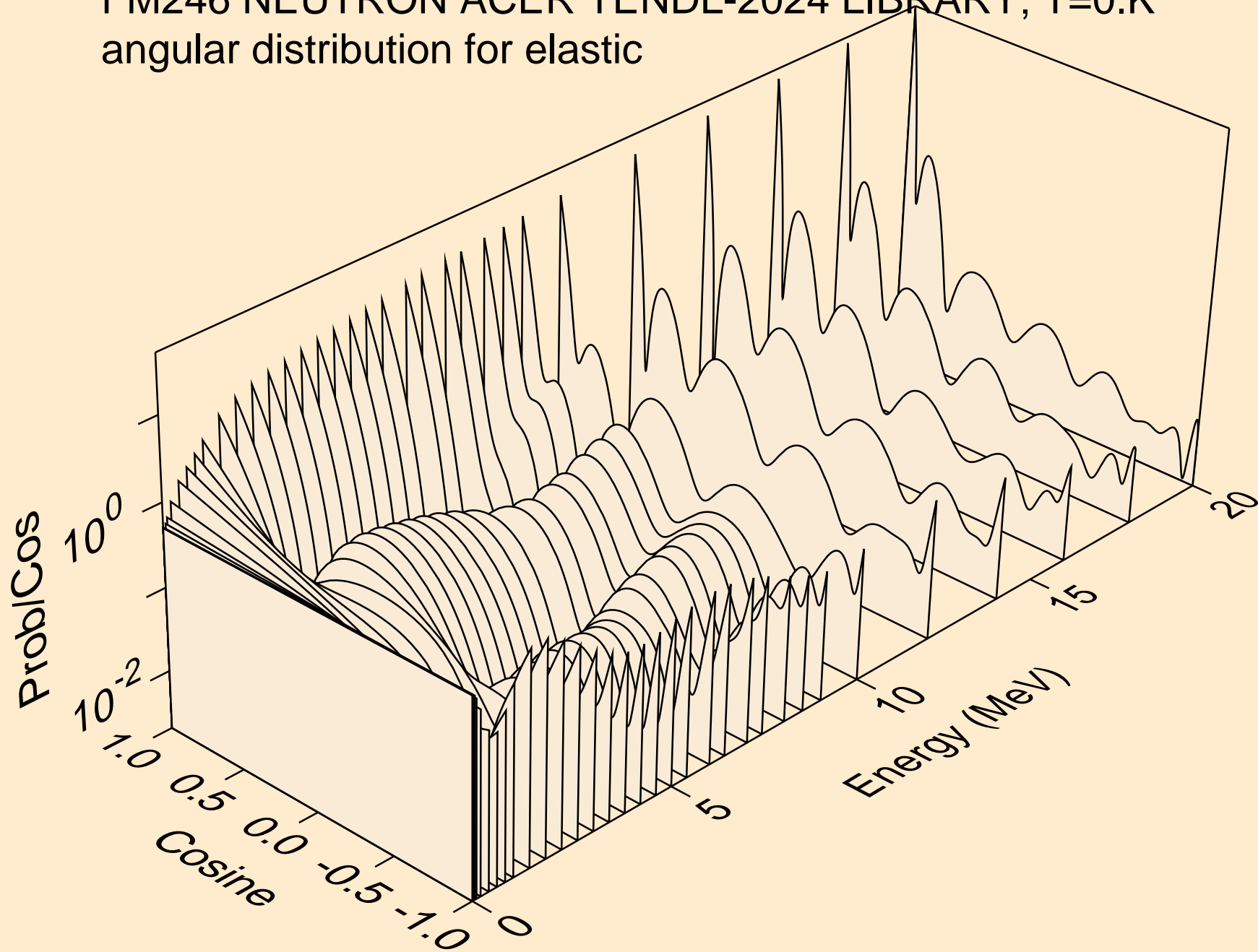

FM246 NEUTRON ACER TENDL-2024 LIBRARY; T=0.K  
angular distribution for elastic

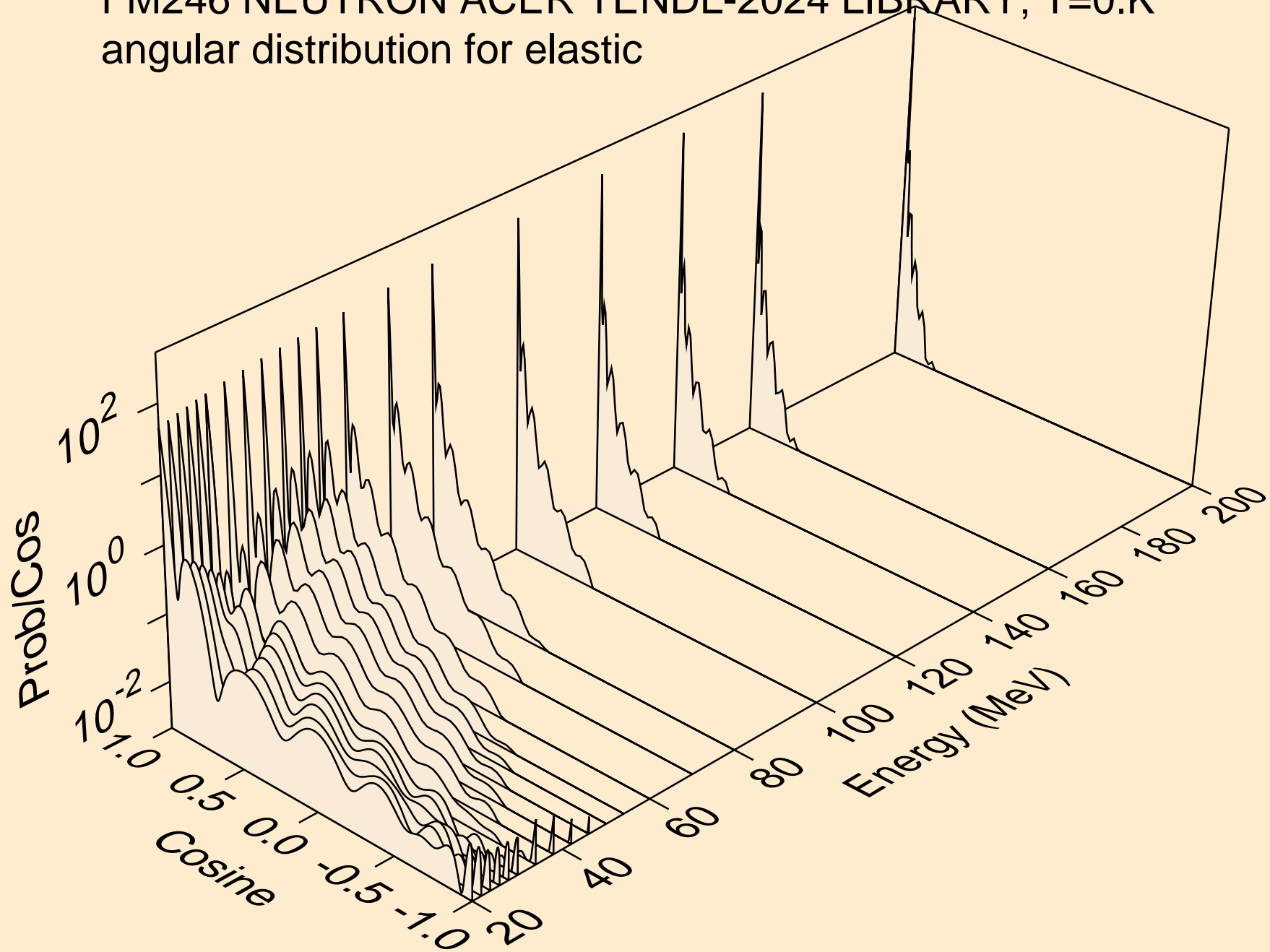

FM246 NEUTRON ACER TENDL-2024 LIBRARY; T=0.K  
angular distribution for (n,n\*1)

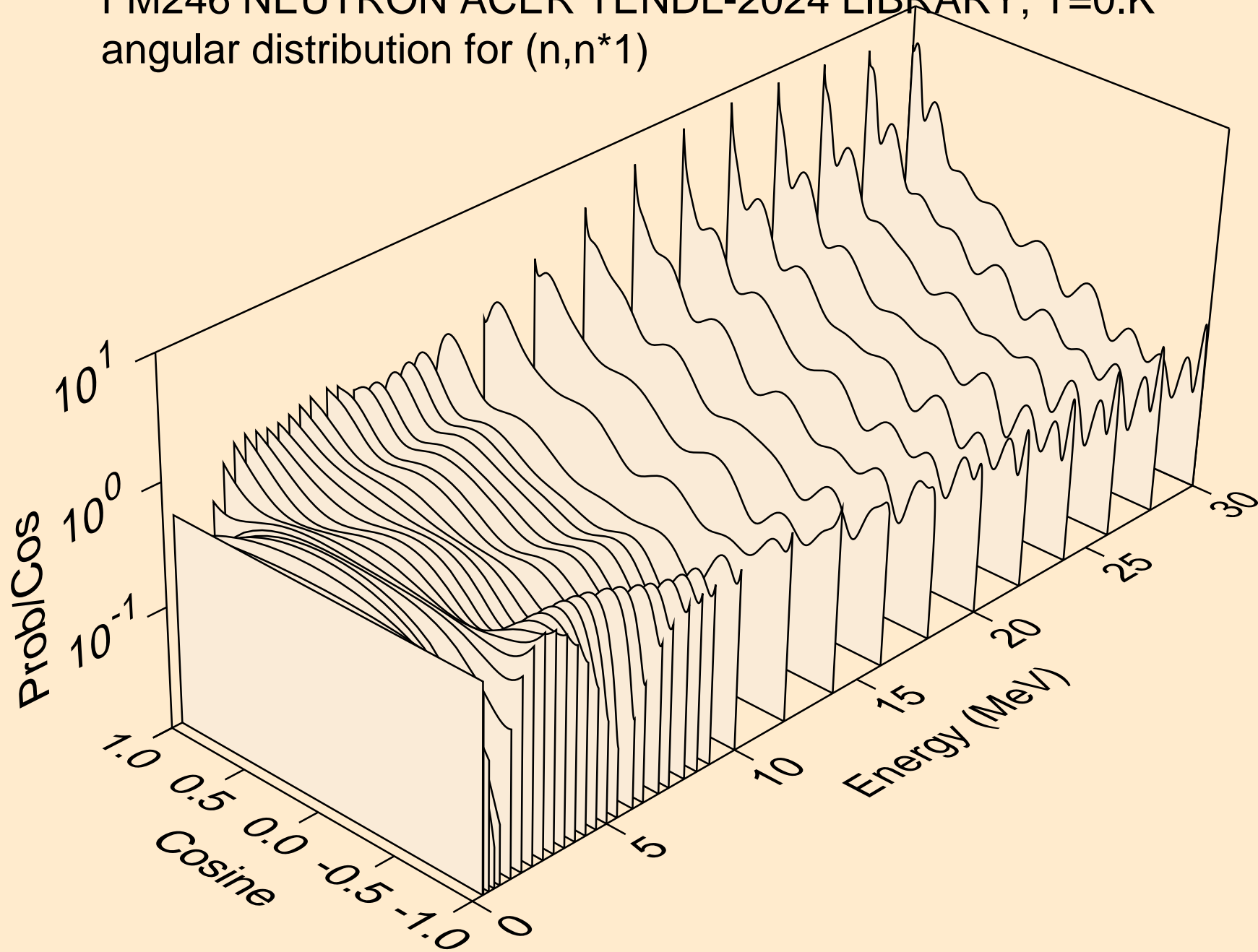

FM246 NEUTRON ACER TENDL-2024 LIBRARY; T=0.K  
angular distribution for (n,n\*2)

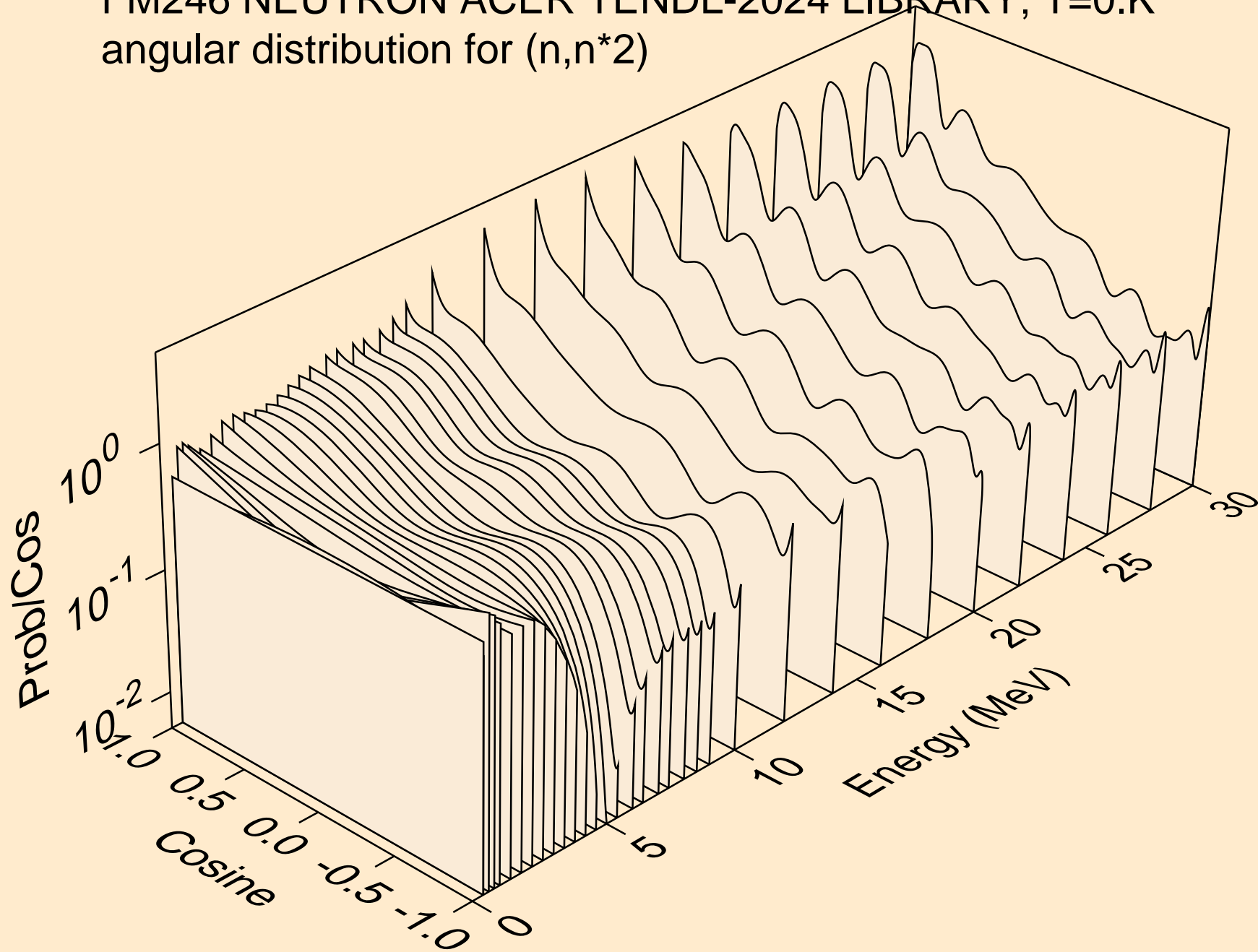



FM246 NEUTRON ACER TENDL-2024 LIBRARY; T=0.K  
angular distribution for (n,n\*3)

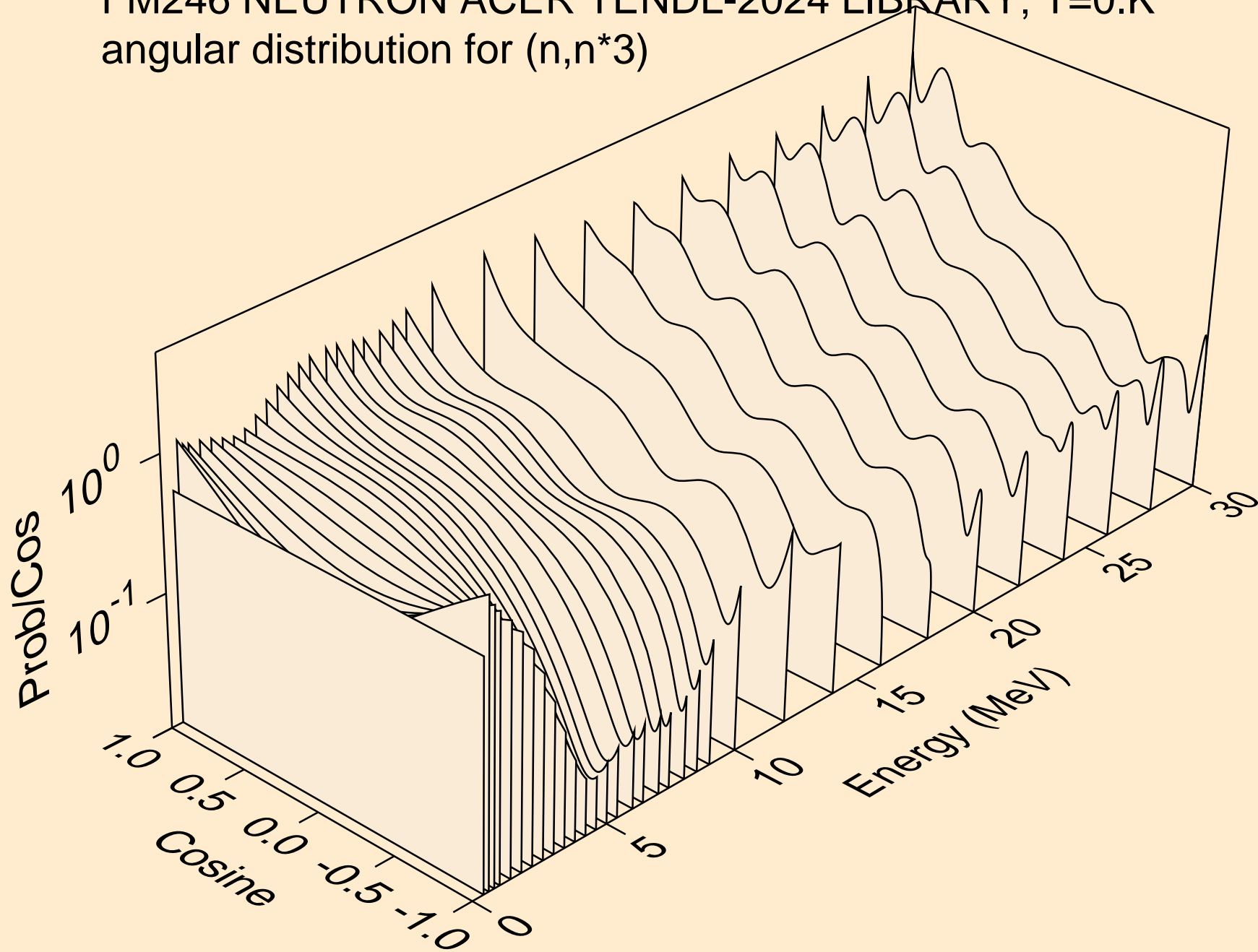

FM246 NEUTRON ACER TENDL-2024 LIBRARY; T=0.K  
angular distribution for (n,n\*4)

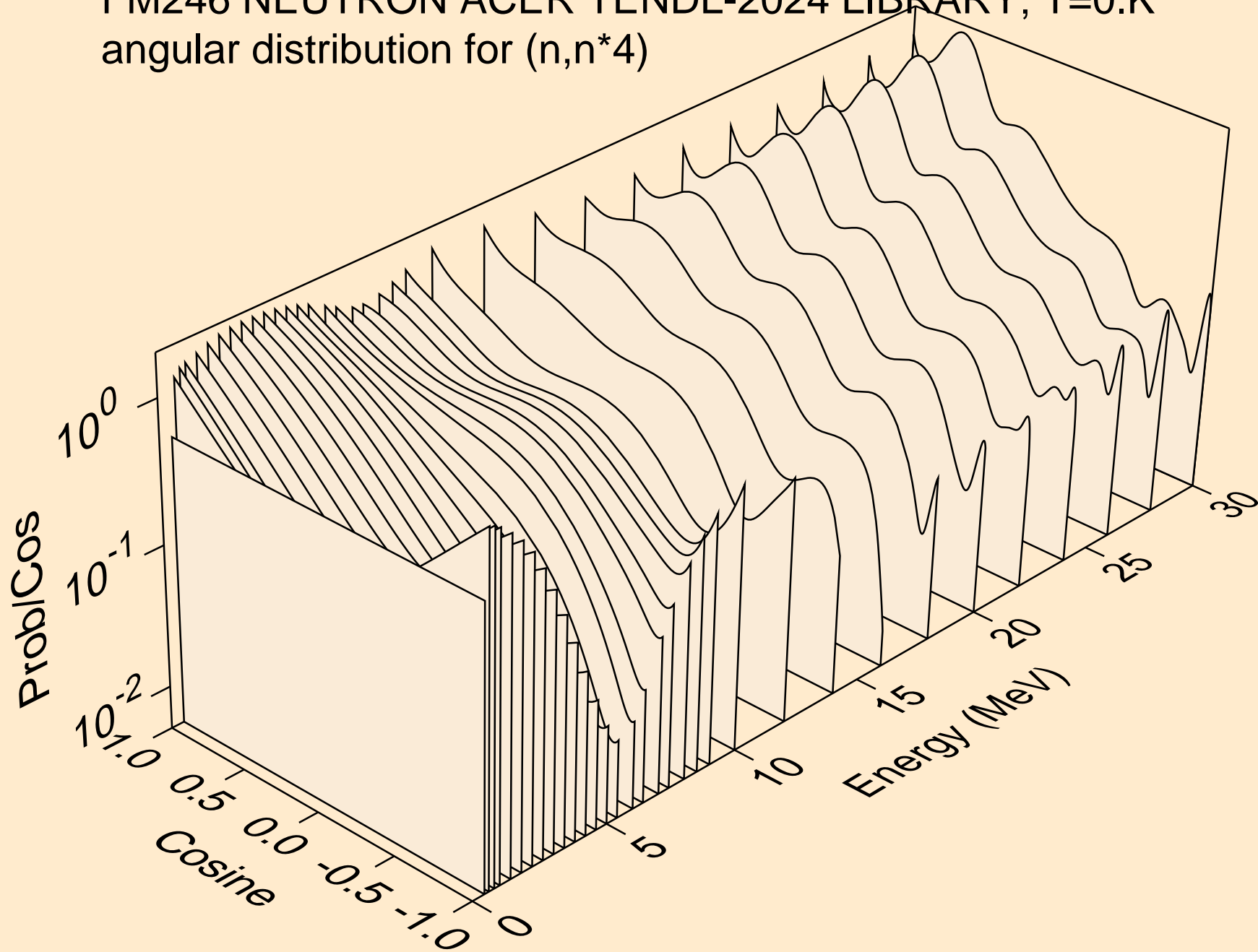

FM246 NEUTRON ACER TENDL-2024 LIBRARY; T=0.K  
angular distribution for (n,n\*5)

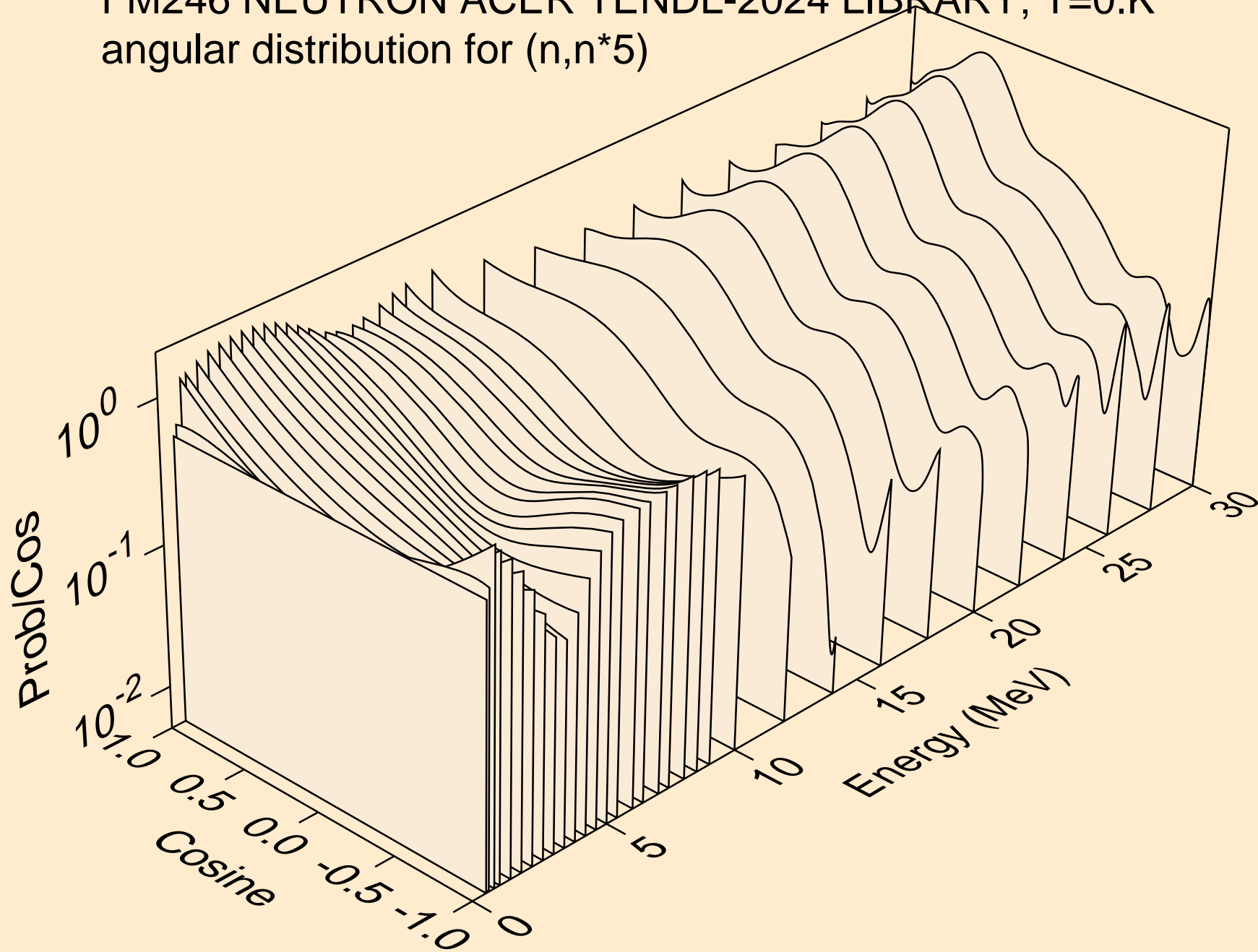

FM246 NEUTRON ACER TENDL-2024 LIBRARY; T=0.K  
angular distribution for (n,n\*6)

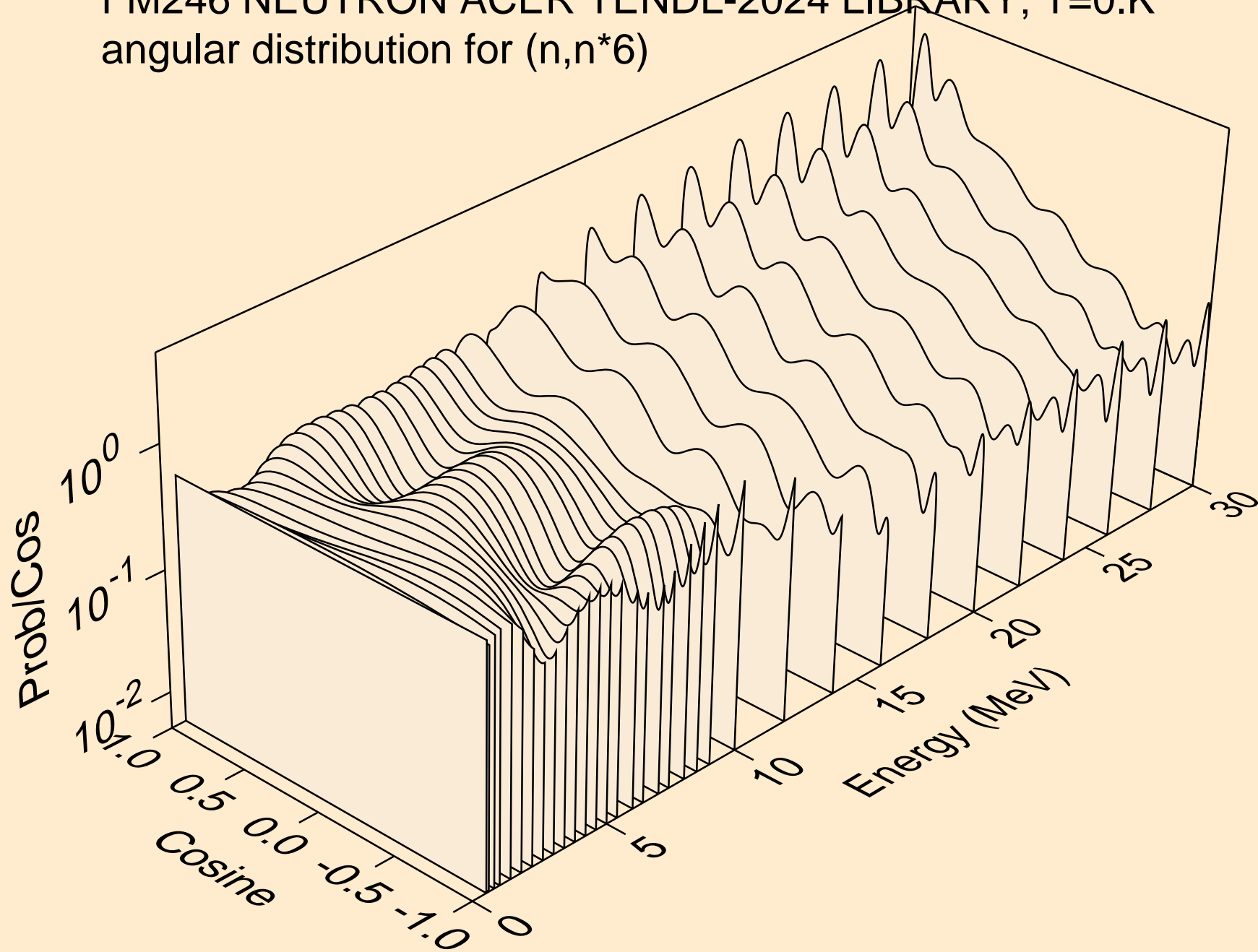

FM246 NEUTRON ACER TENDL-2024 LIBRARY; T=0.K  
angular distribution for (n,n\*7)

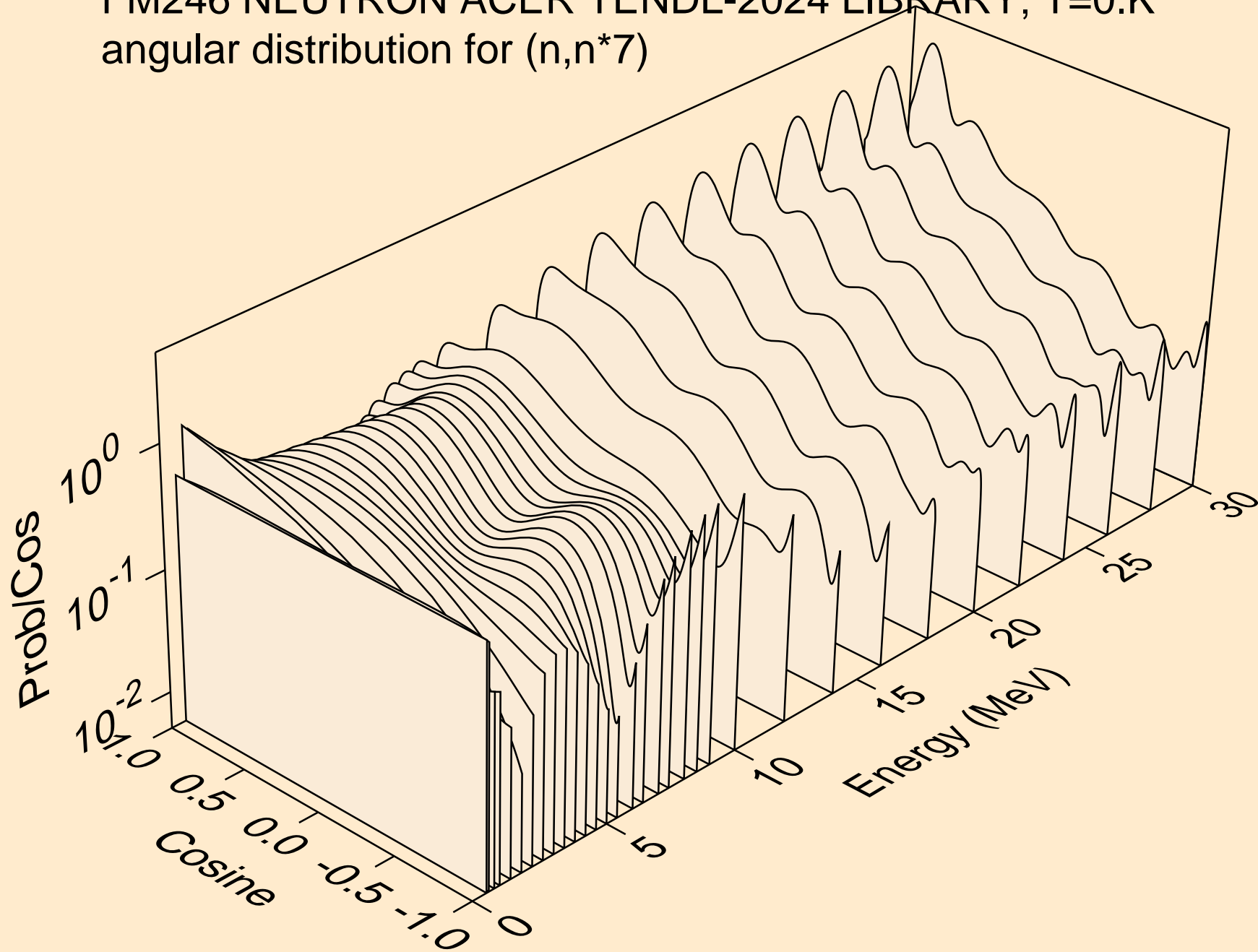

FM246 NEUTRON ACER TENDL-2024 LIBRARY; T=0.K  
angular distribution for (n,n\*8)

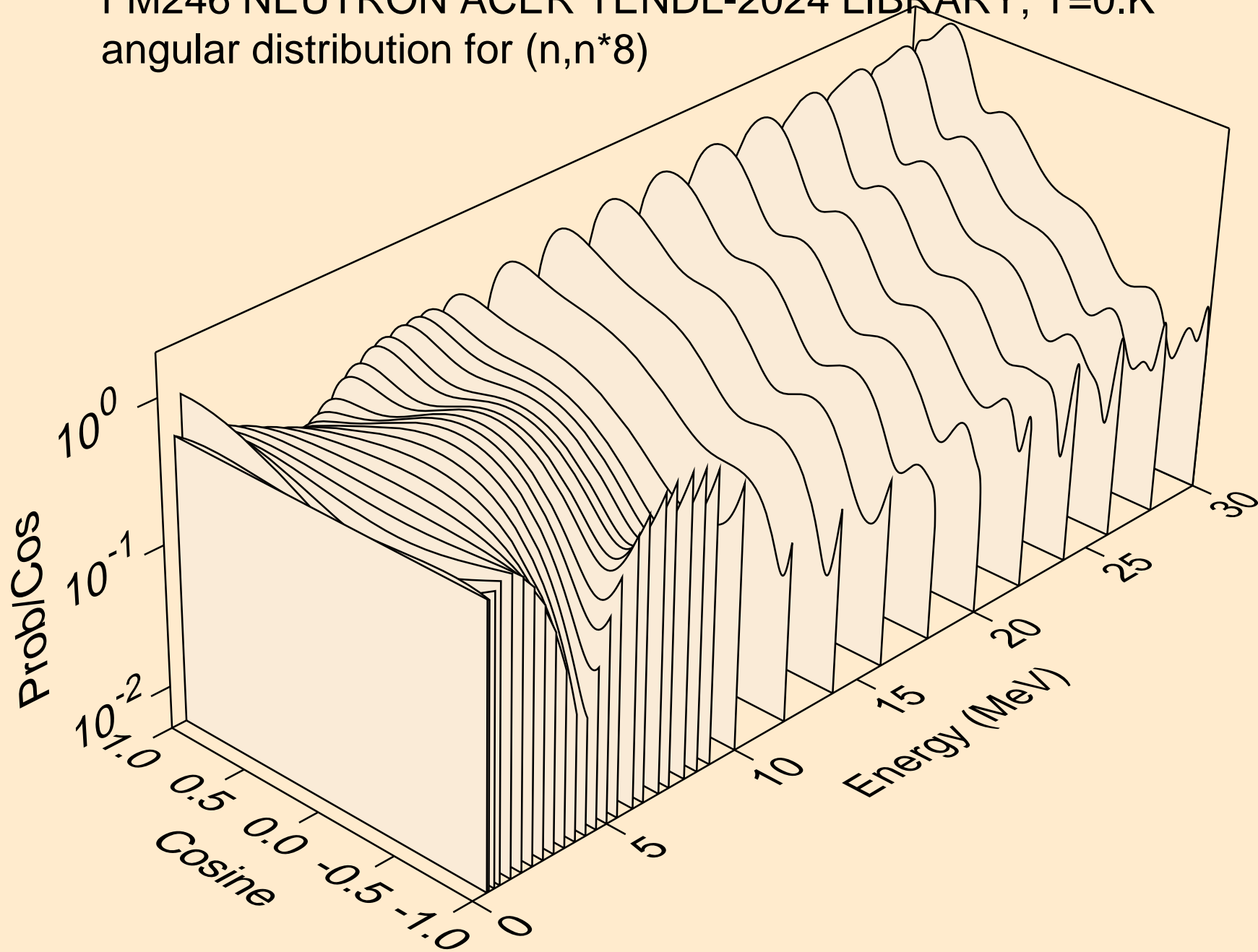

FM246 NEUTRON ACER TENDL-2024 LIBRARY; T=0.K  
angular distribution for (n,n\*9)

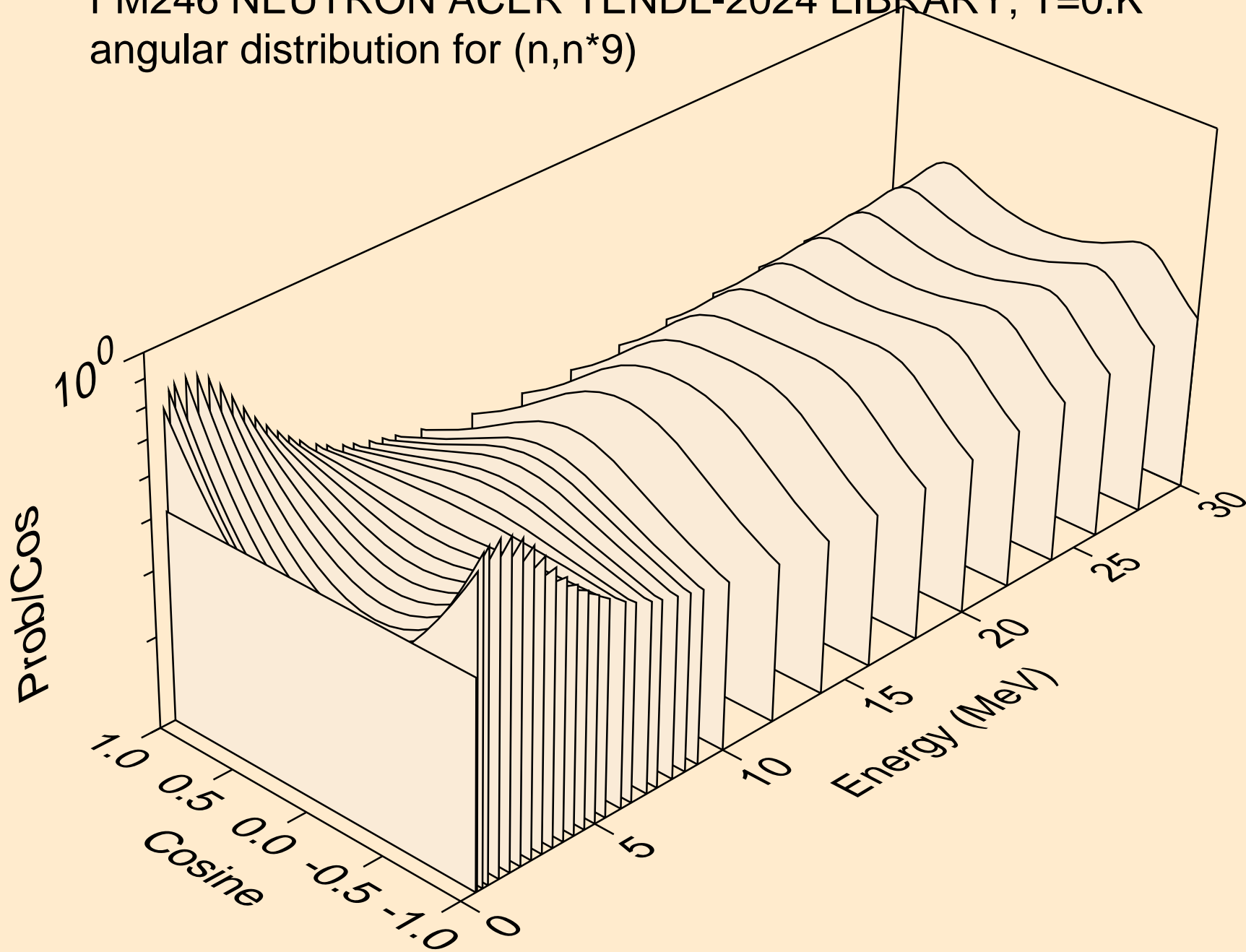

FM246 NEUTRON ACER TENDL-2024 LIBRARY; T=0.K  
angular distribution for (n,n\*10)

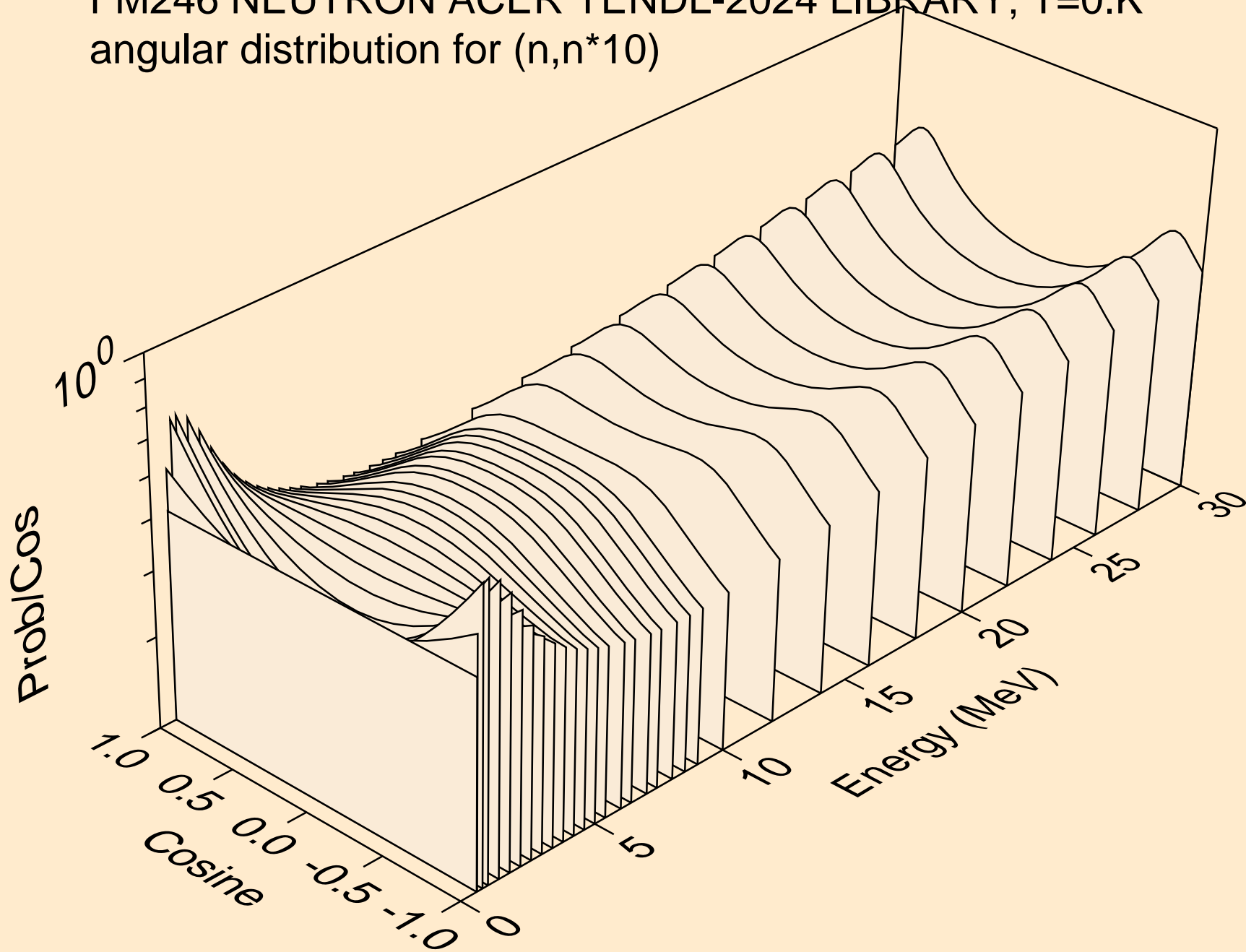



FM246 NEUTRON ACER TENDL-2024 LIBRARY; T=0.K  
angular distribution for (n,n\*11)

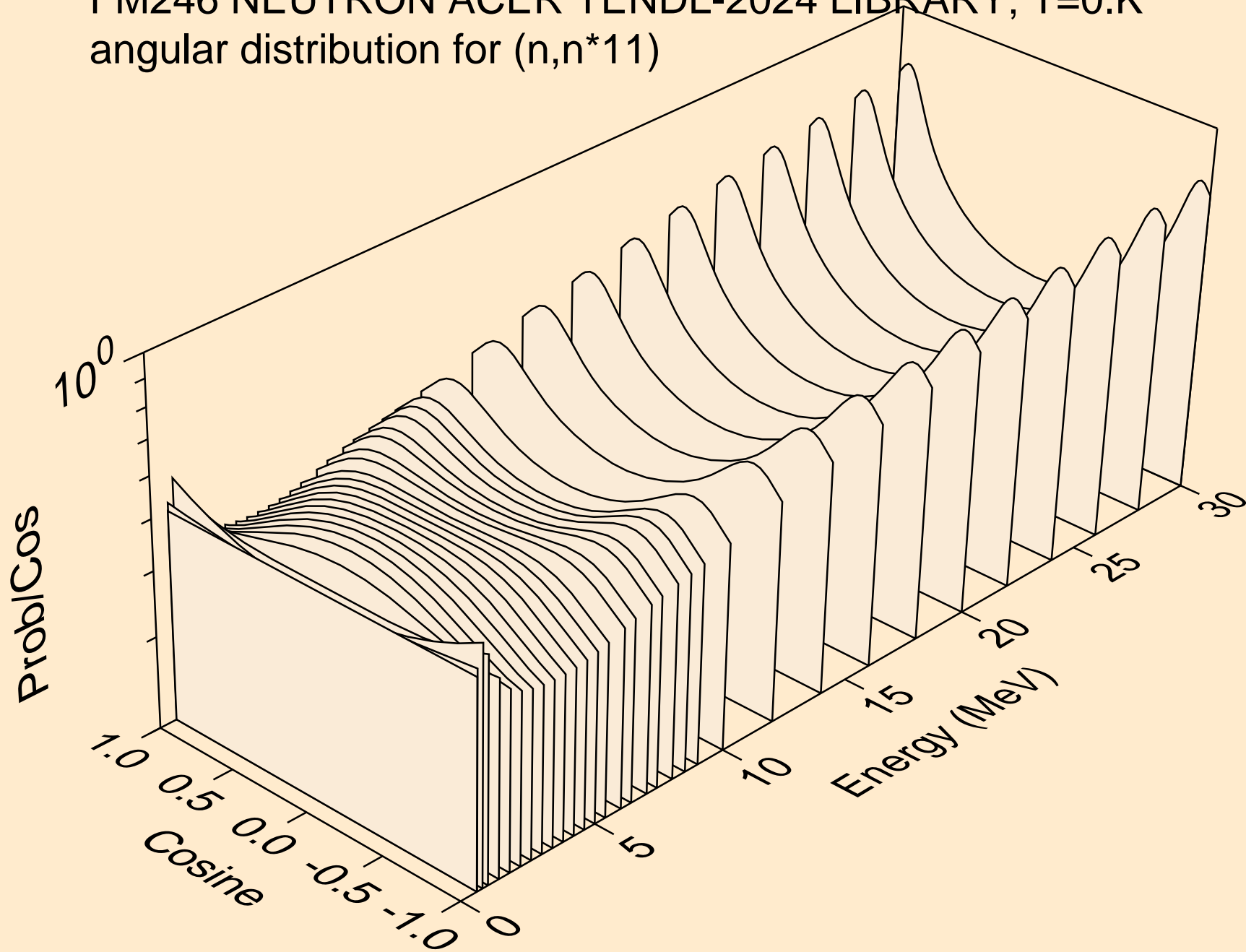

FM246 NEUTRON ACER TENDL-2024 LIBRARY; T=0.K  
angular distribution for (n,n\*12)

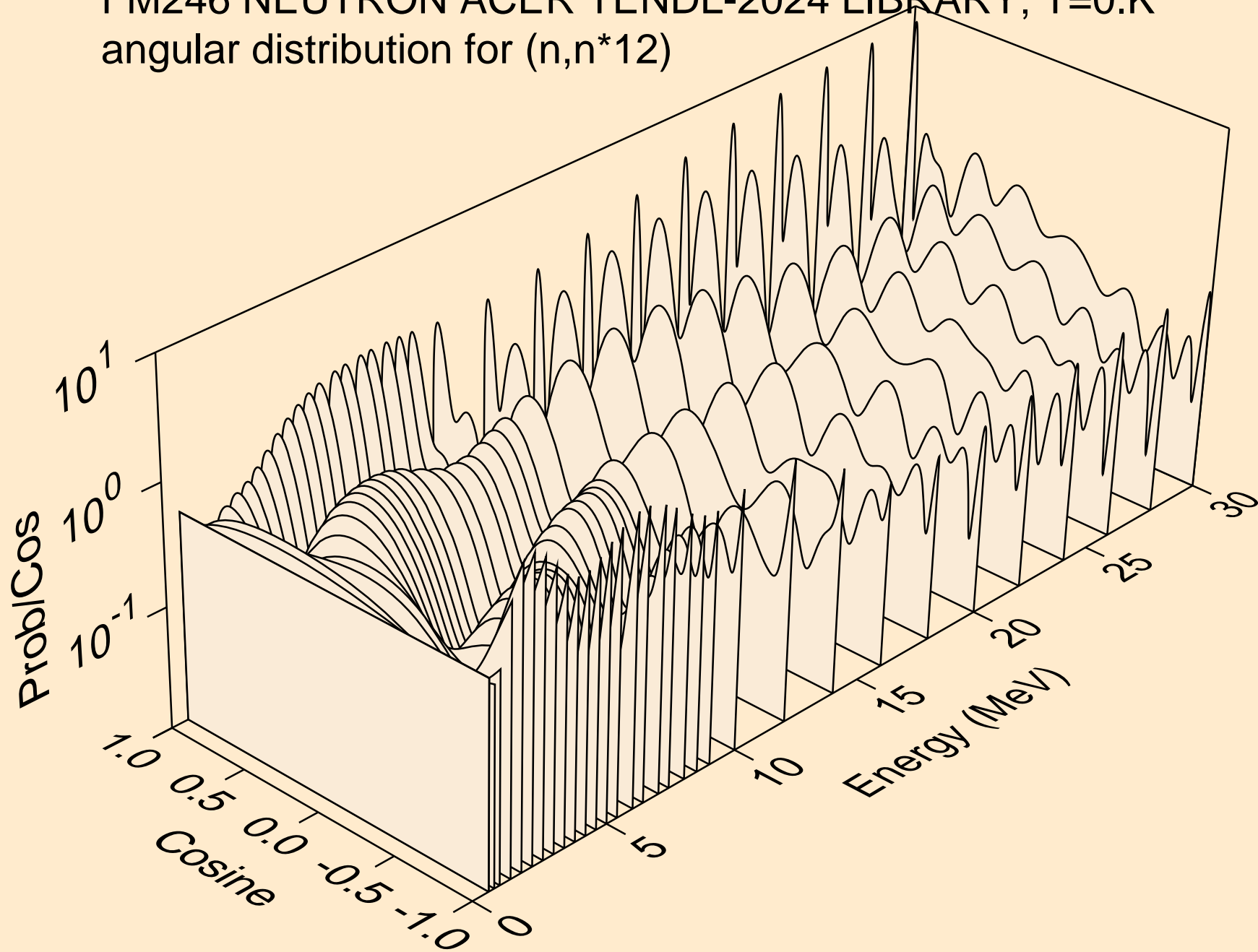

FM246 NEUTRON ACER TENDL-2024 LIBRARY; T=0.K  
angular distribution for (n,n\*13)

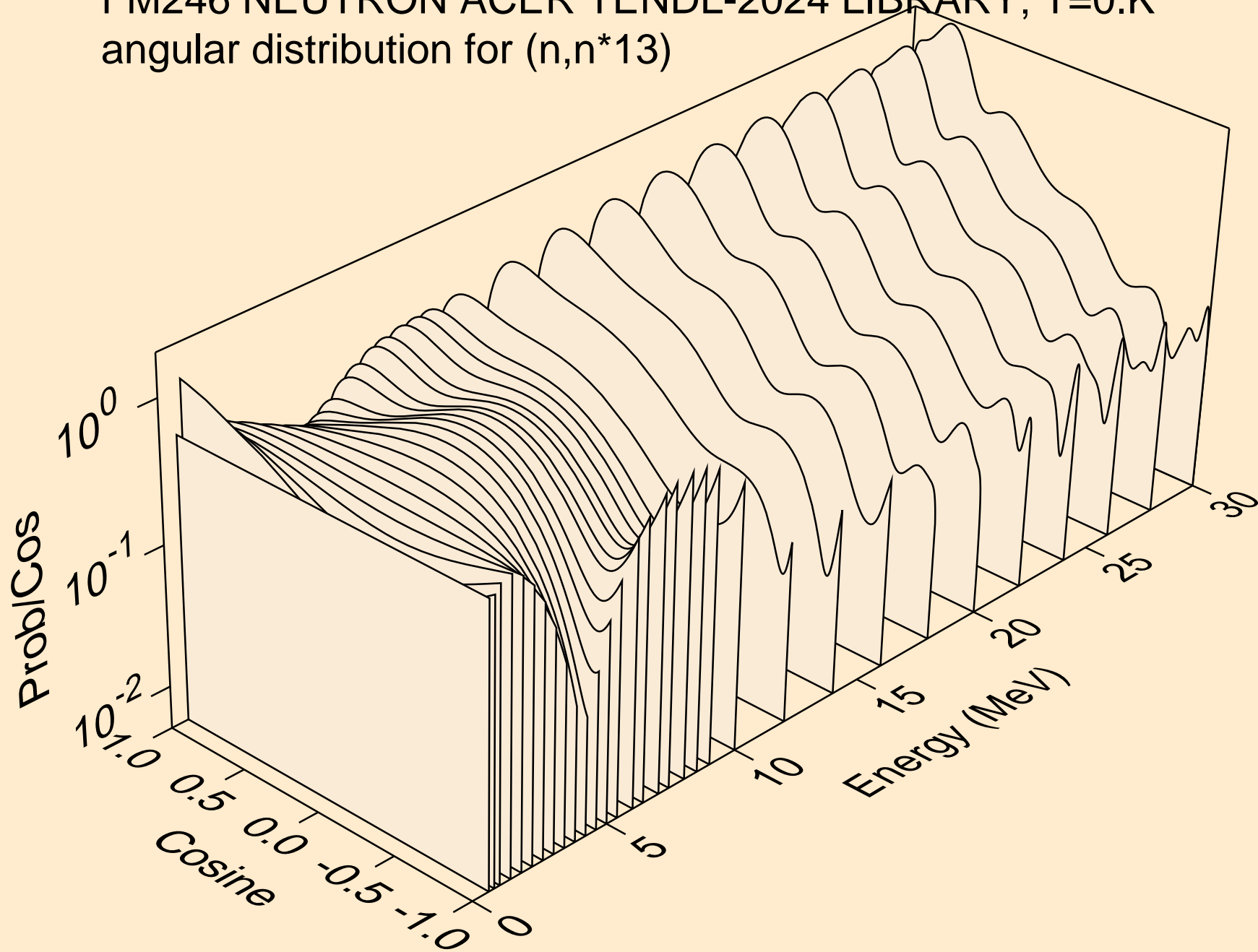

FM246 NEUTRON ACER TENDL-2024 LIBRARY; T=0.K  
angular distribution for (n,n\*14)

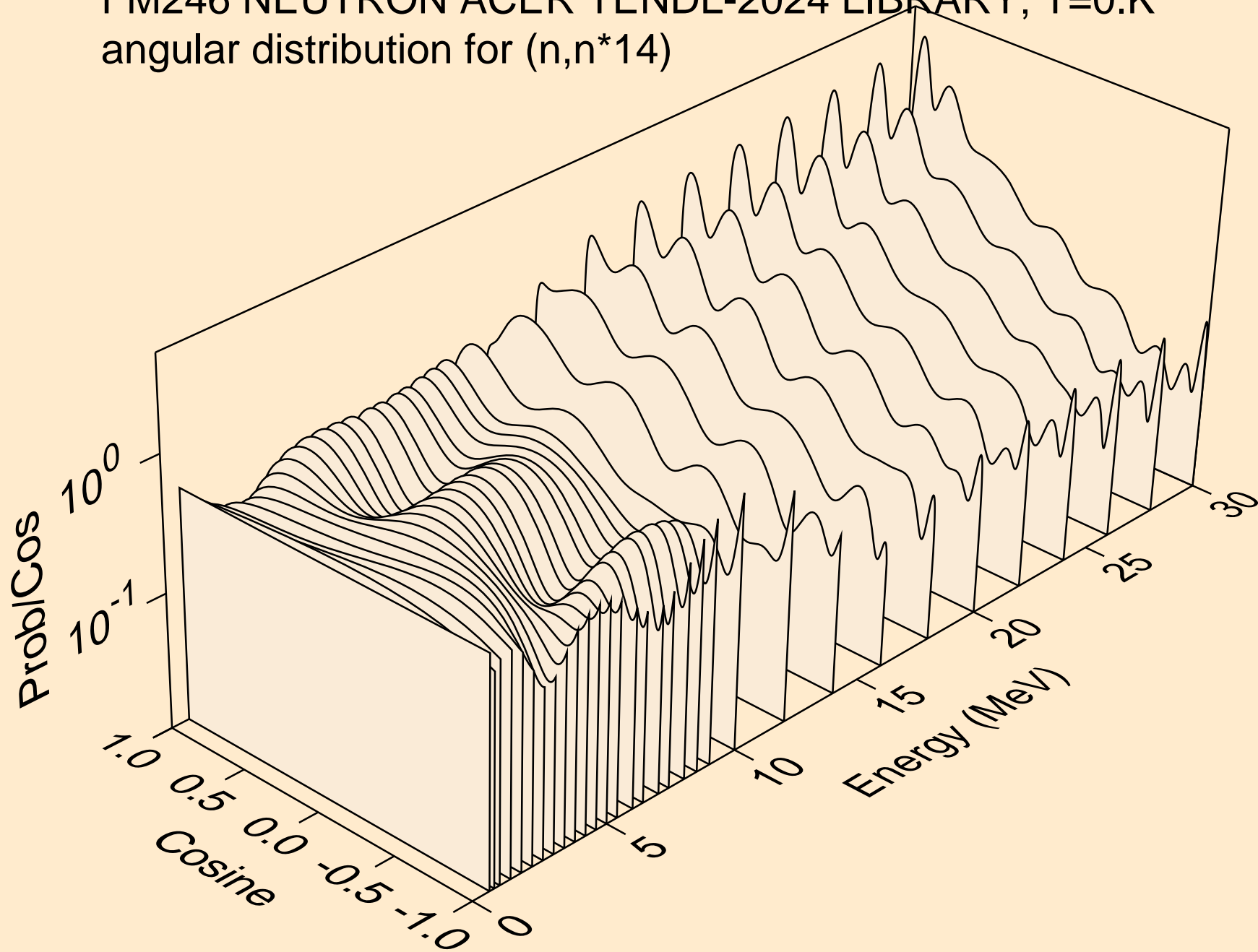

FM246 NEUTRON ACER TENDL-2024 LIBRARY; T=0.K  
angular distribution for (n,n\*15)

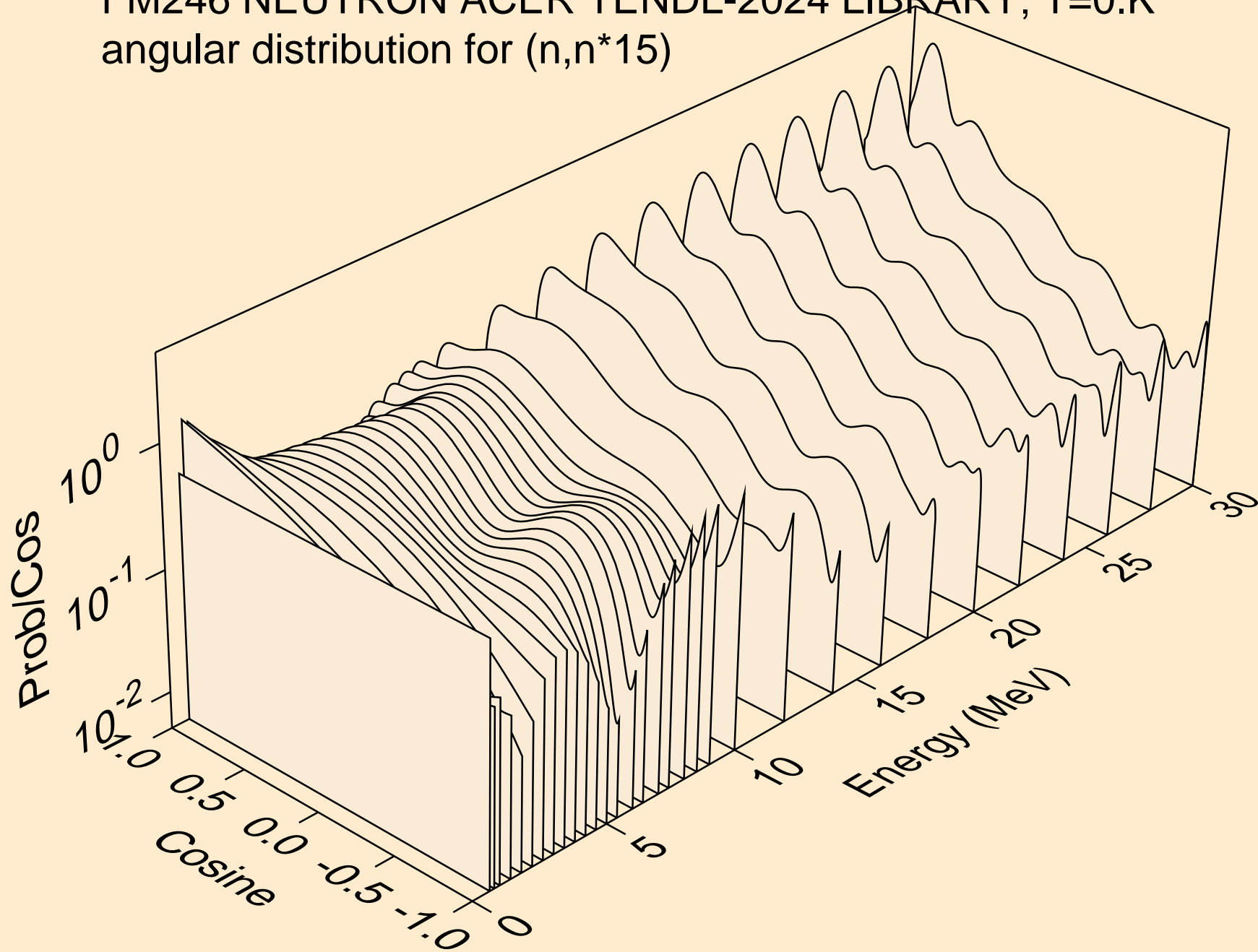

FM246 NEUTRON ACER TENDL-2024 LIBRARY; T=0.K  
angular distribution for (n,n\*16)

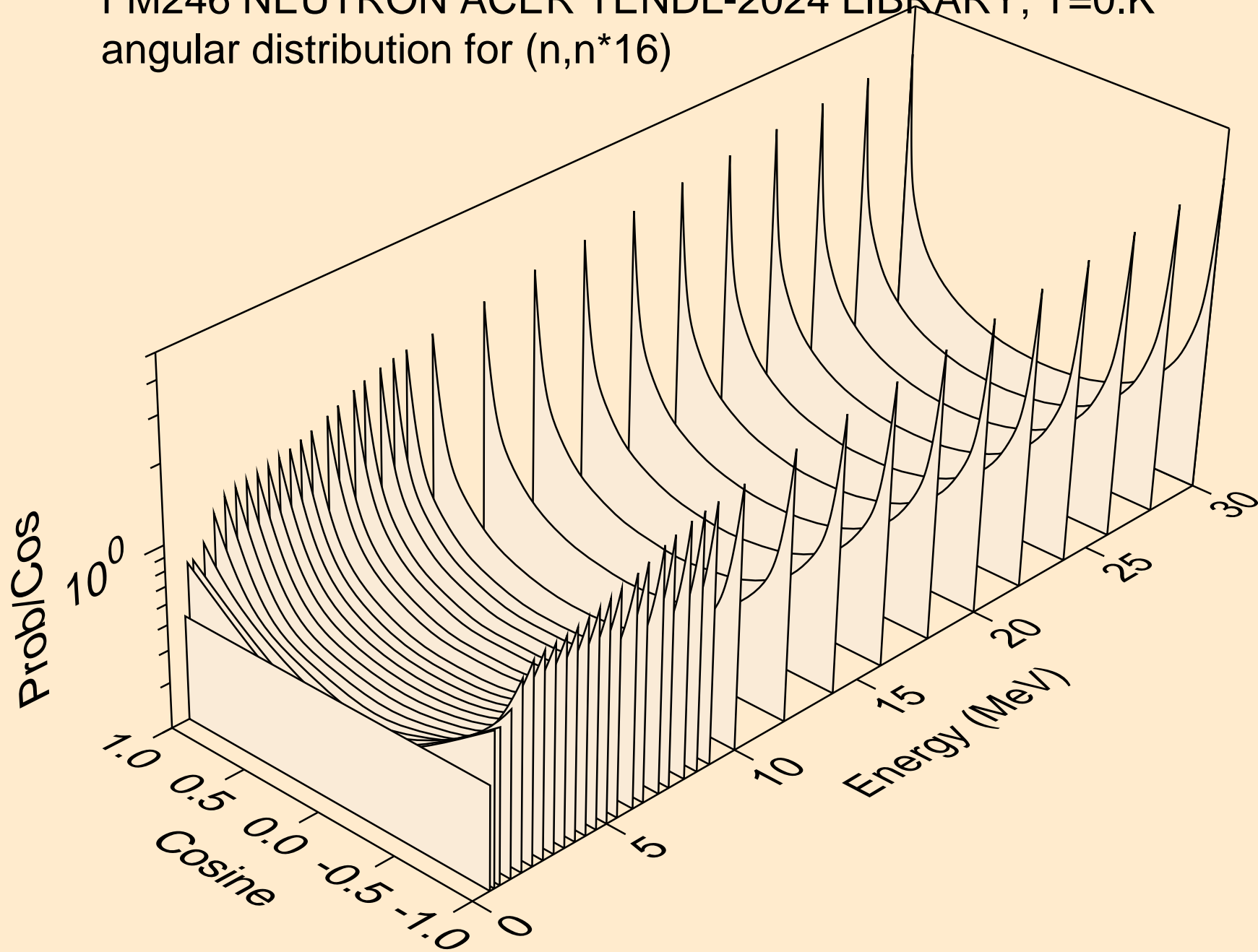

FM246 NEUTRON ACER TENDL-2024 LIBRARY; T=0.K  
angular distribution for (n,n\*17)

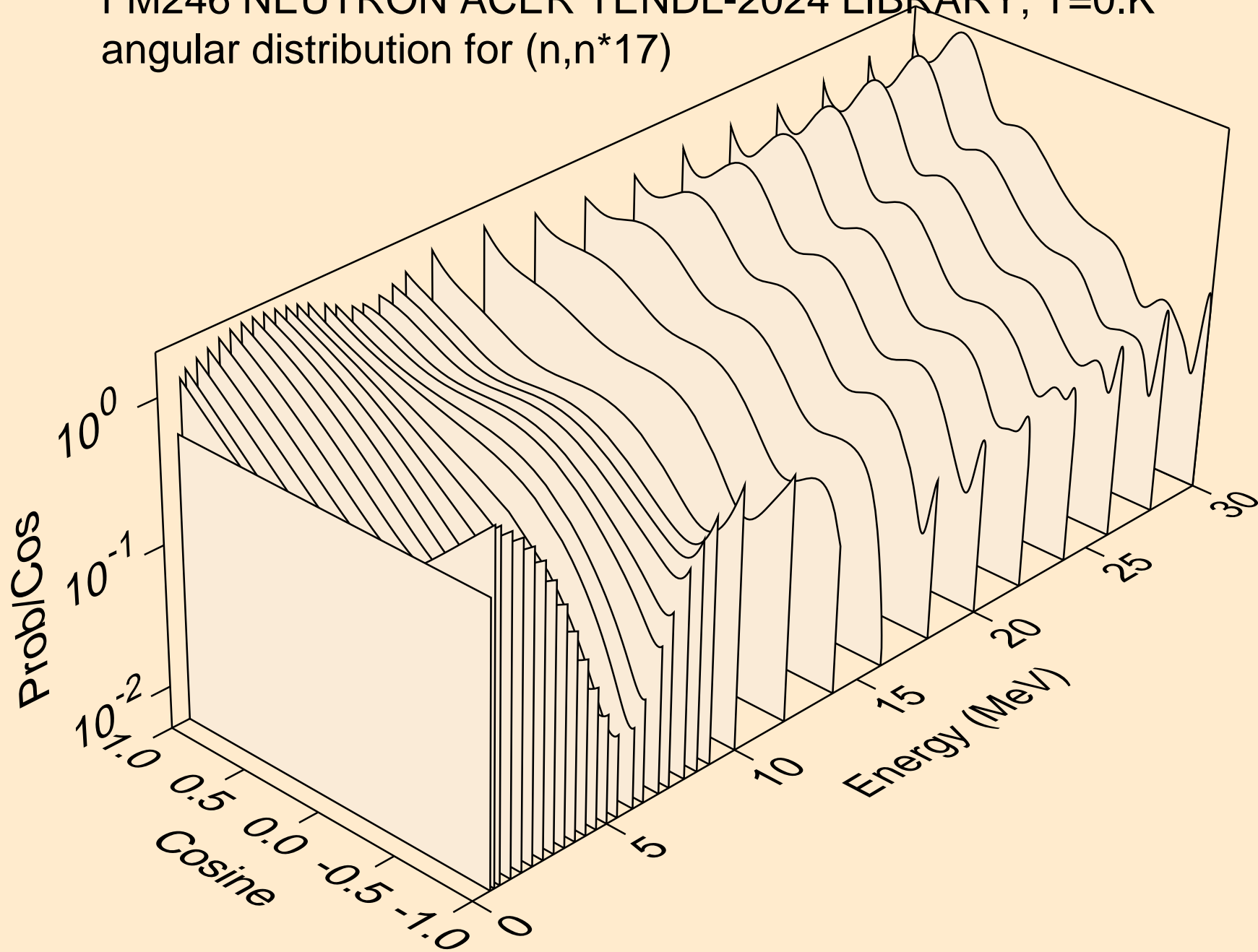

FM246 NEUTRON ACER TENDL-2024 LIBRARY; T=0.K  
angular distribution for (n,n\*18)

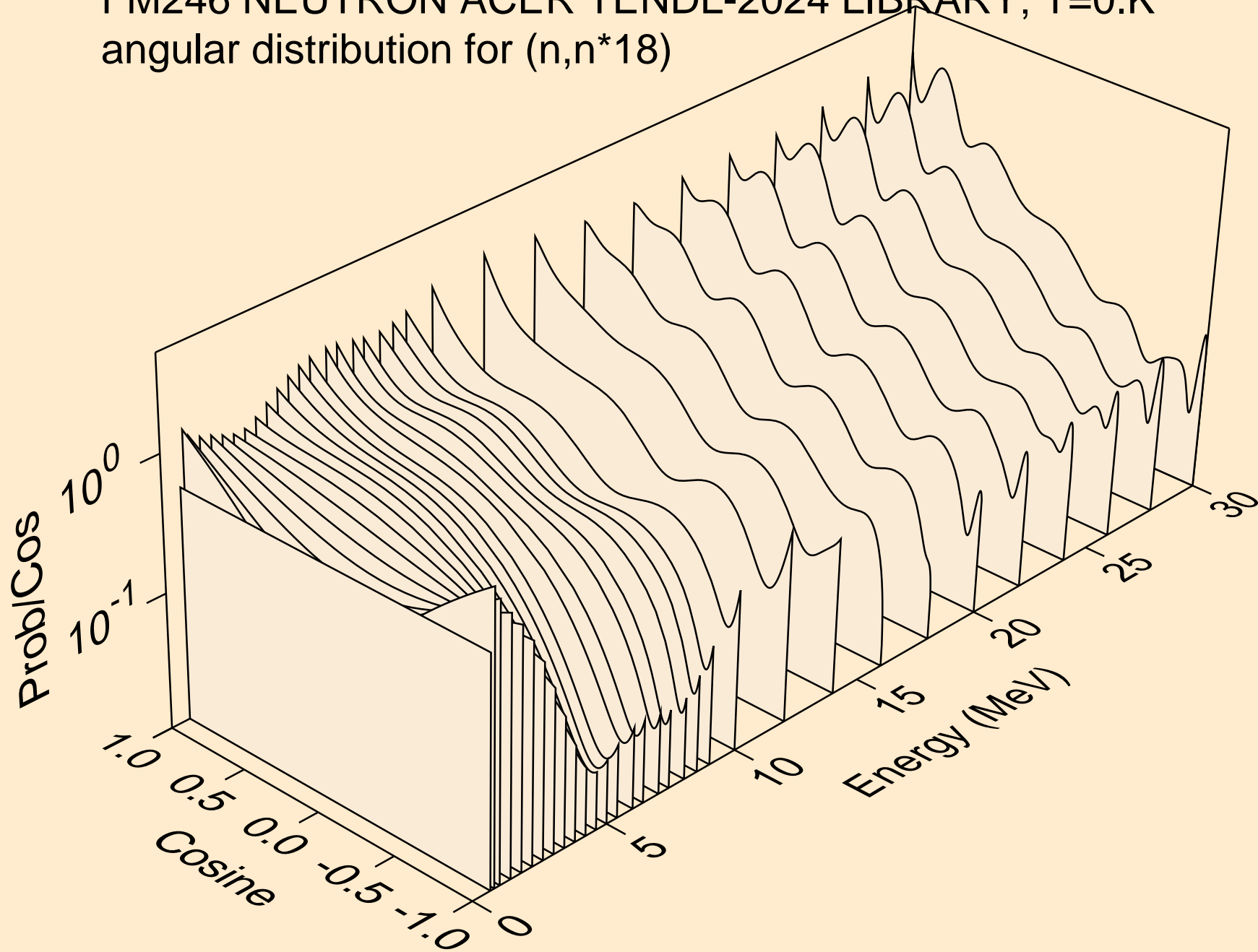



FM246 NEUTRON ACER TENDL-2024 LIBRARY; T=0.K  
angular distribution for (n,n\*19)

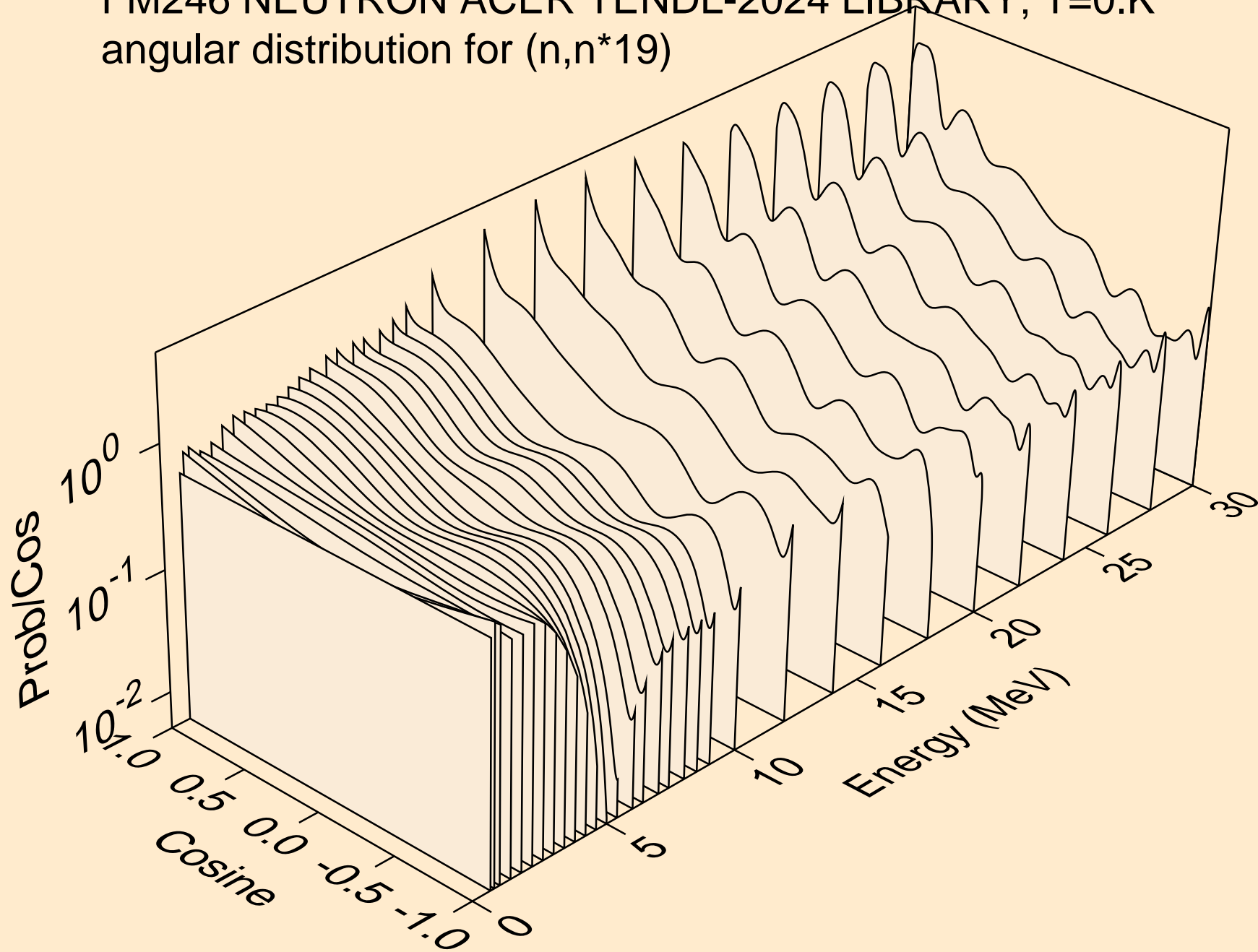

FM246 NEUTRON ACER TENDL-2024 LIBRARY; T=0.K  
angular distribution for (n,n\*20)

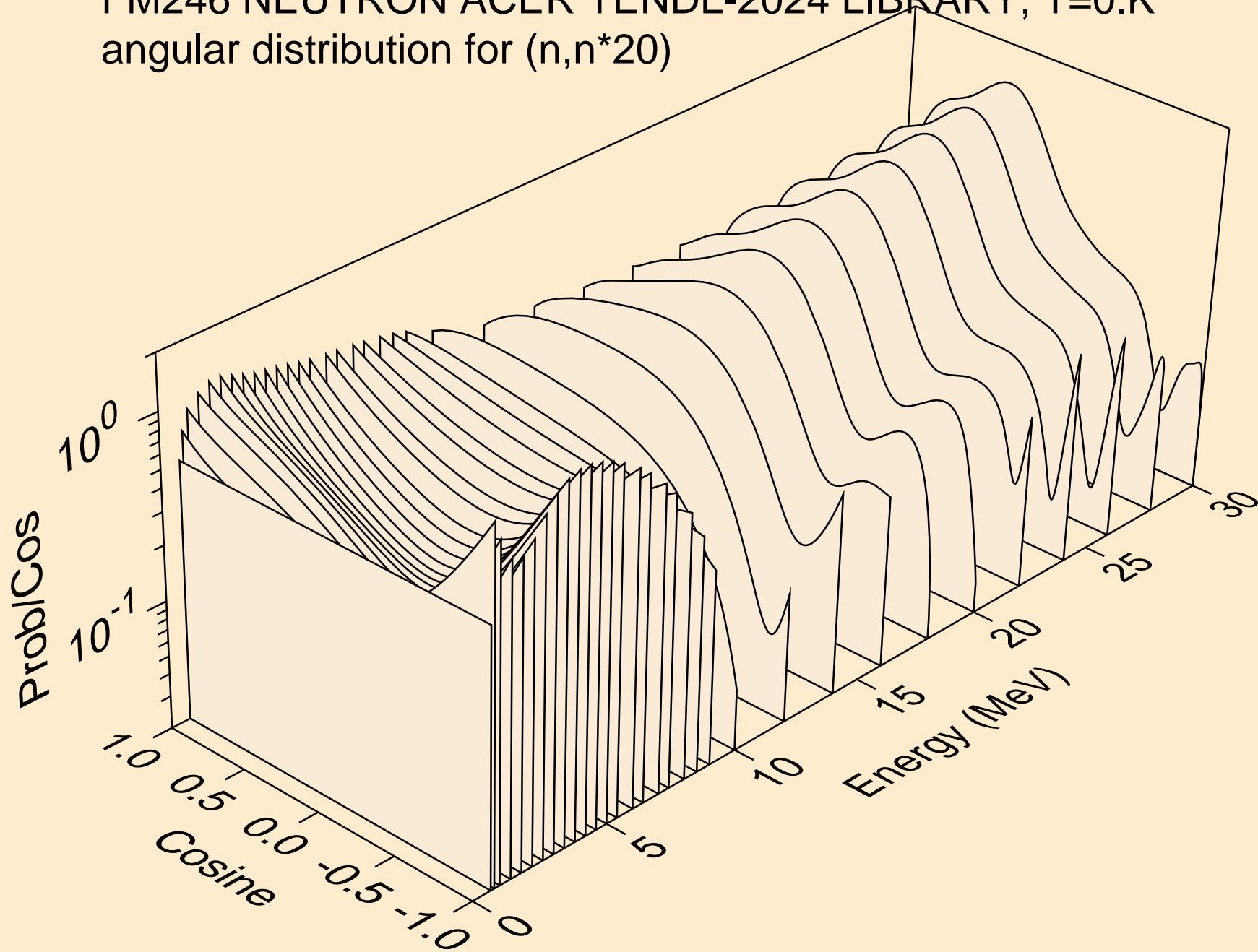

FM246 NEUTRON ACER TENDL-2024 LIBRARY; T=0.K  
angular distribution for (n,n\*21)

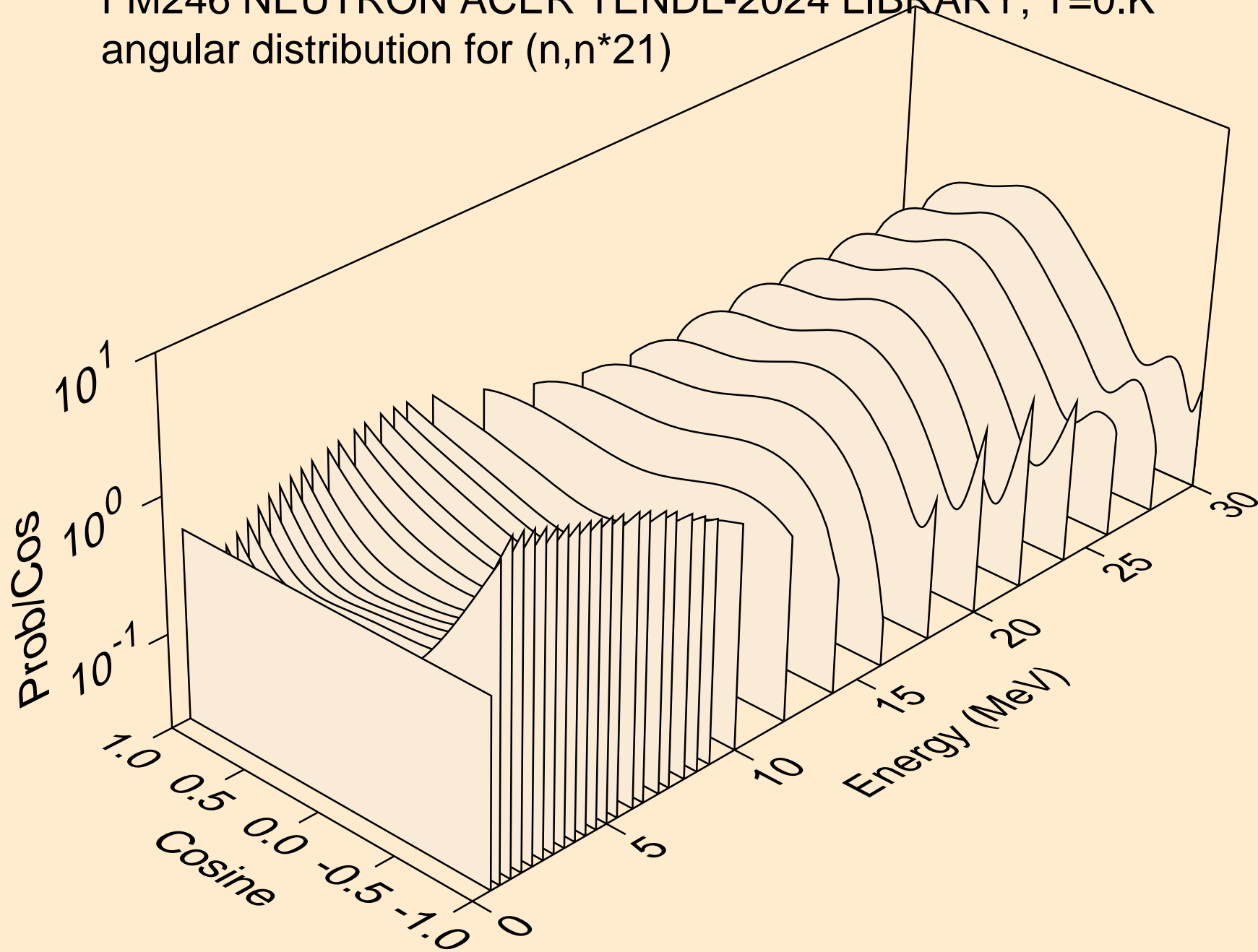

FM246 NEUTRON ACER TENDL-2024 LIBRARY; T=0.K  
angular distribution for (n,n\*22)

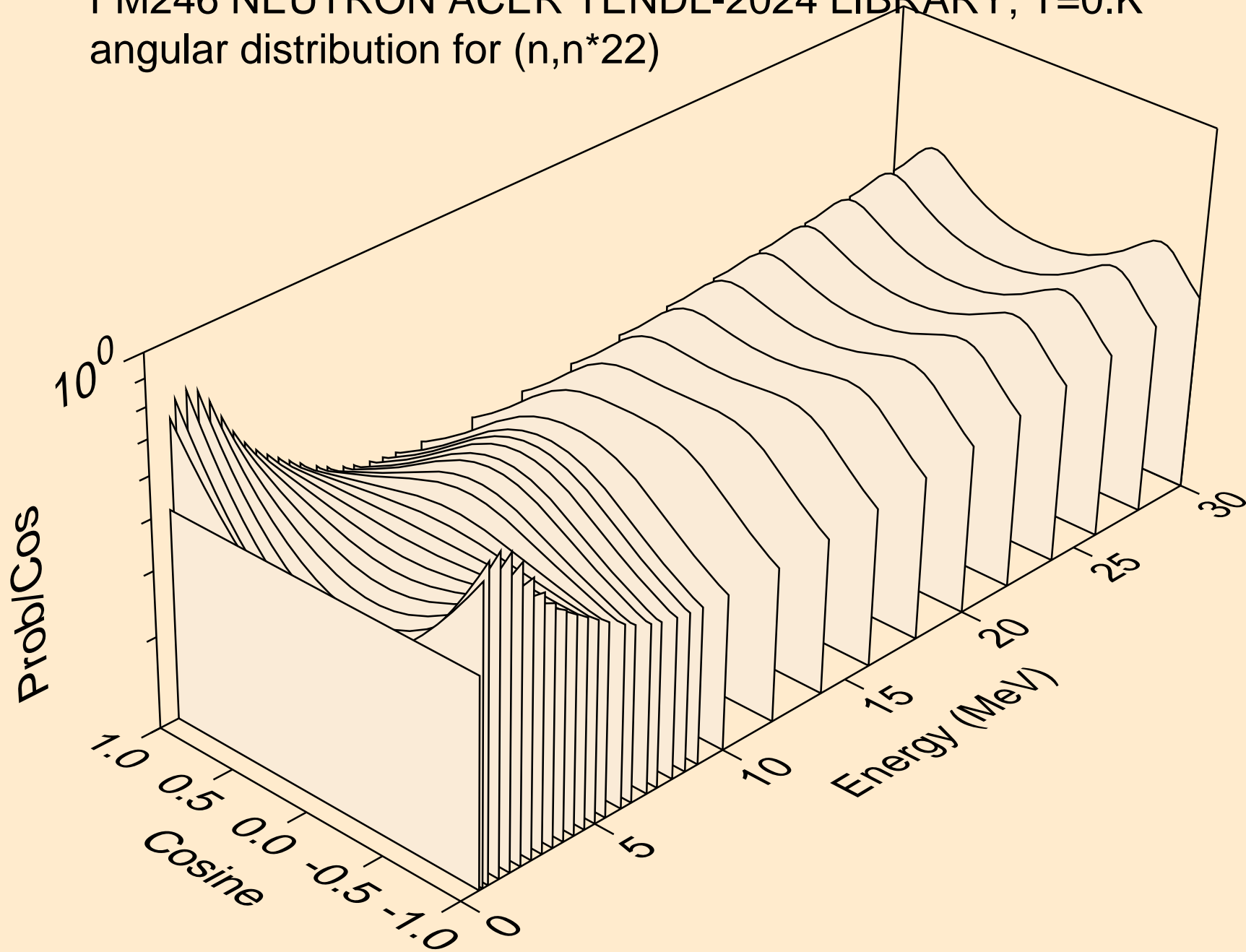

FM246 NEUTRON ACER TENDL-2024 LIBRARY; T=0.K  
angular distribution for (n,n\*23)

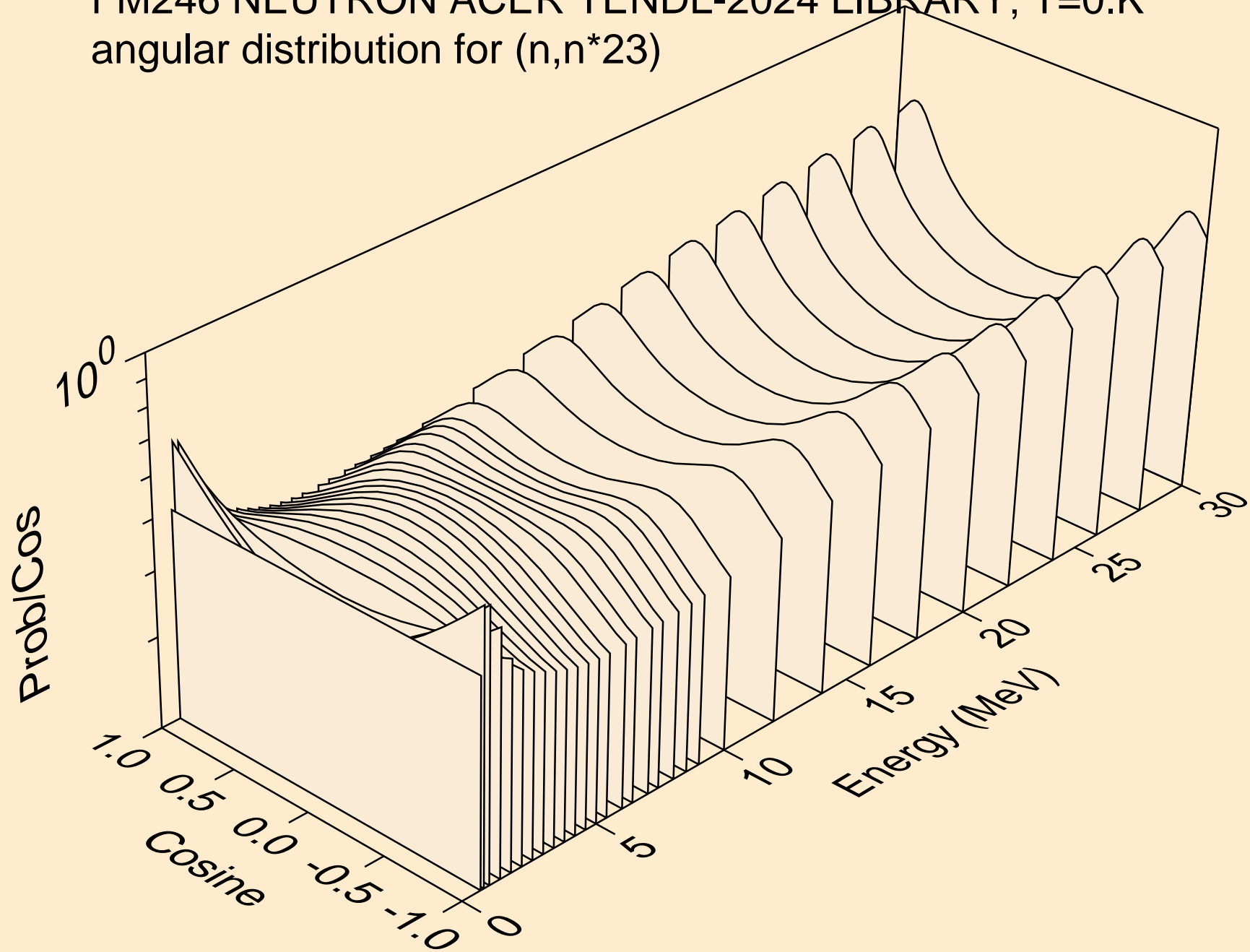

FM246 NEUTRON ACER TENDL-2024 LIBRARY; T=0.K  
angular distribution for (n,n\*24)

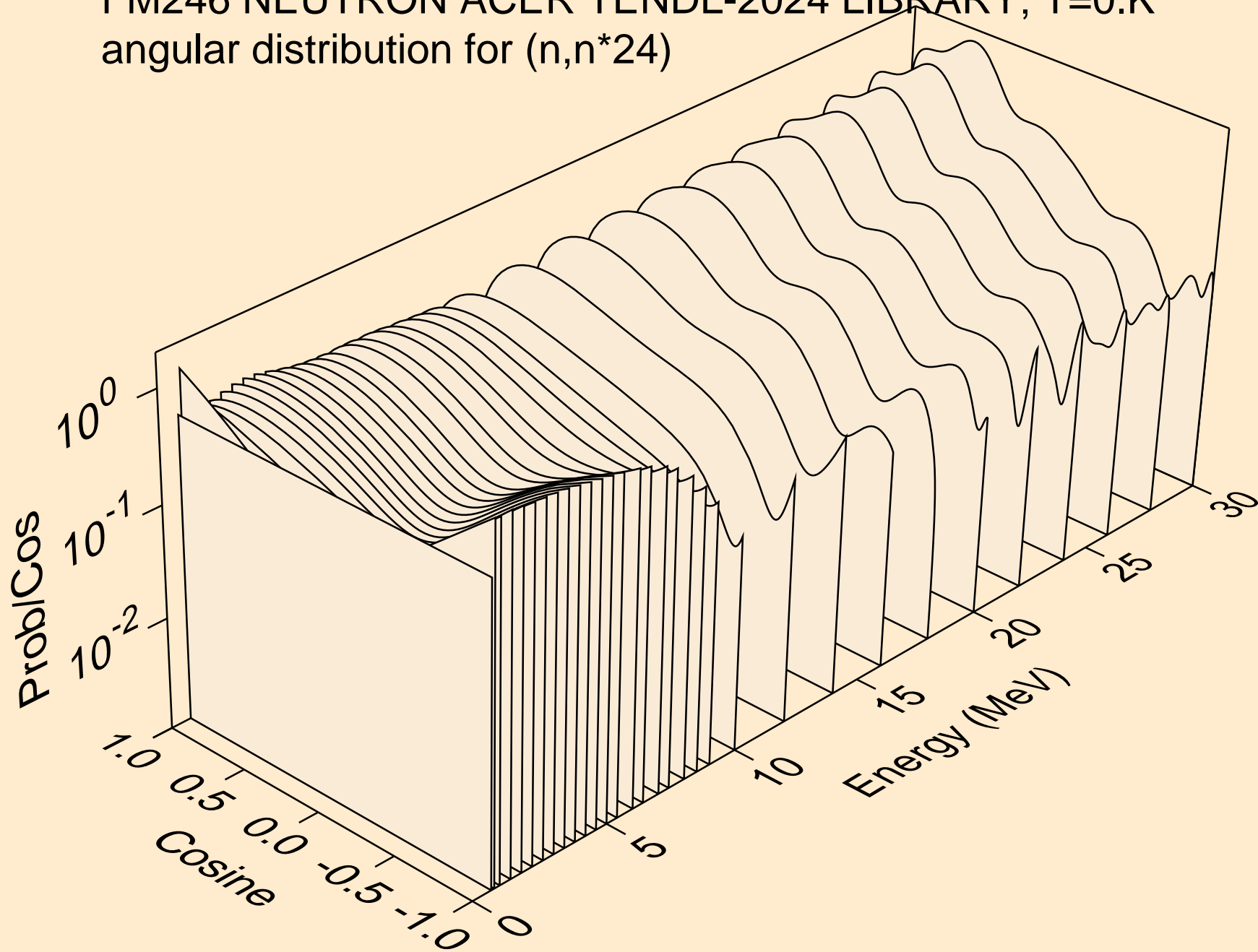

FM246 NEUTRON ACER TENDL-2024 LIBRARY; T=0.K  
angular distribution for (n,n\*25)

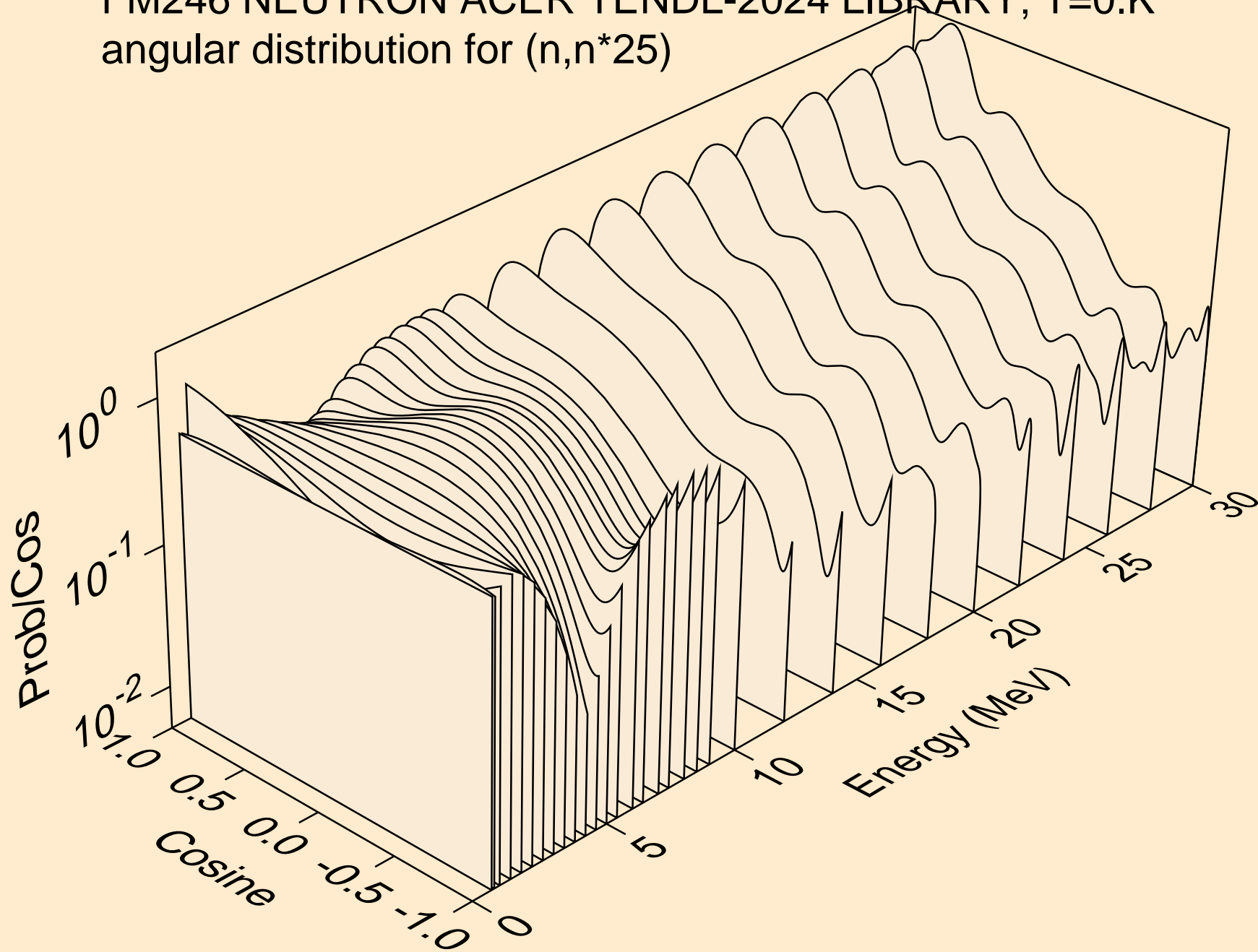

FM246 NEUTRON ACER TENDL-2024 LIBRARY; T=0.K  
angular distribution for (n,n\*26)

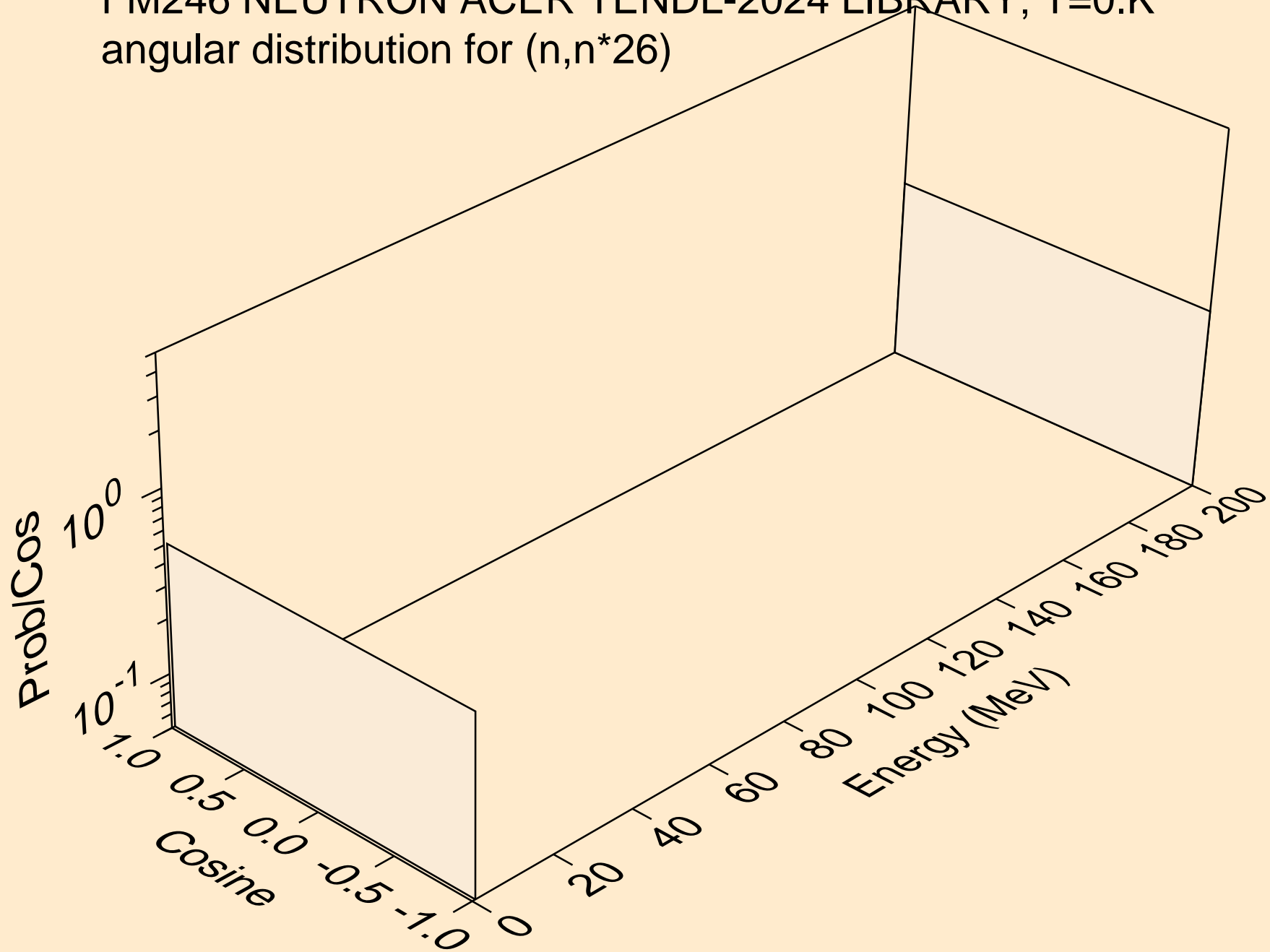



FM246 NEUTRON ACER TENDL-2024 LIBRARY; T=0.K  
angular distribution for (n,n\*27)

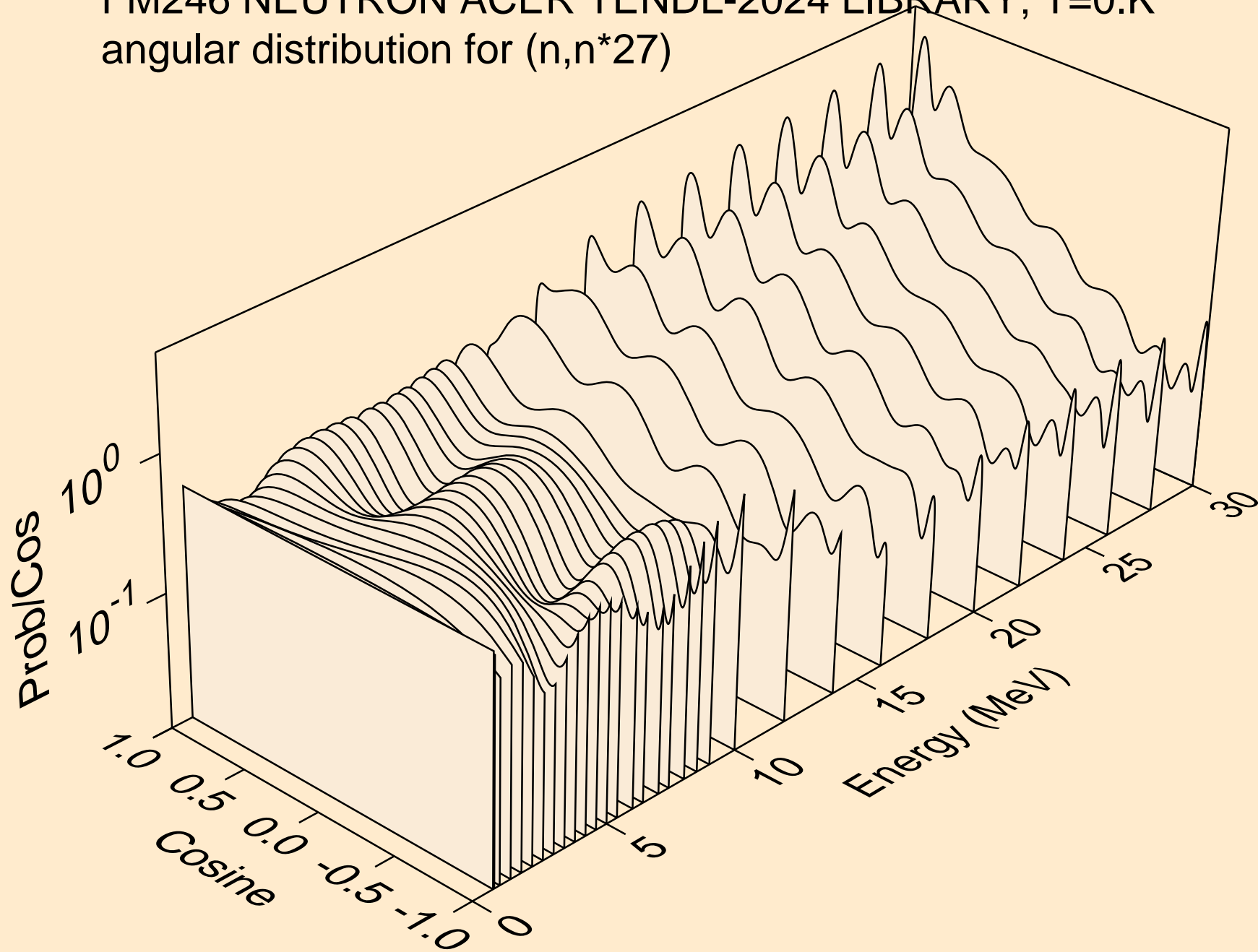

FM246 NEUTRON ACER TENDL-2024 LIBRARY; T=0.K  
angular distribution for (n,n\*28)

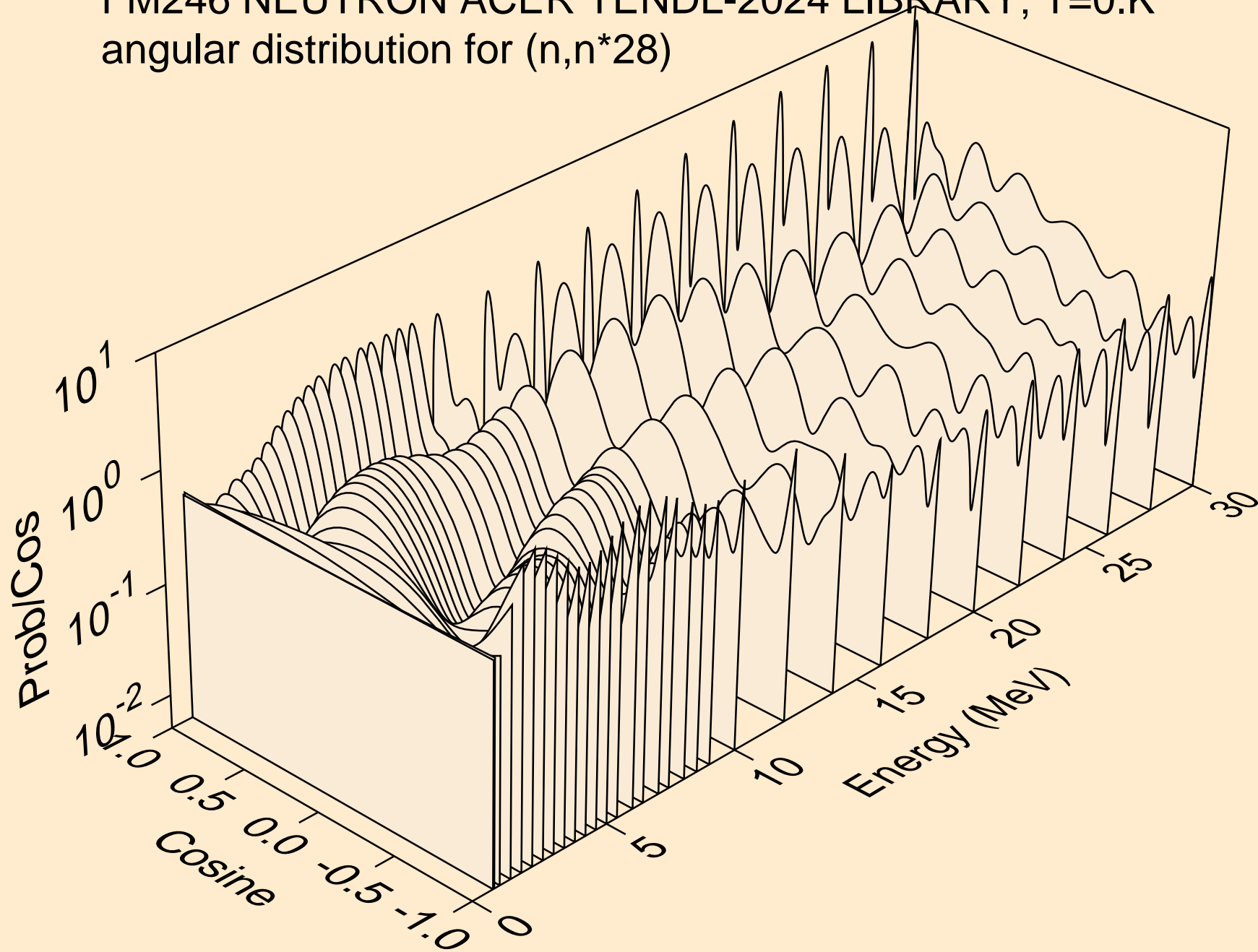

FM246 NEUTRON ACER TENDL-2024 LIBRARY; T=0.K  
angular distribution for (n,n\*29)

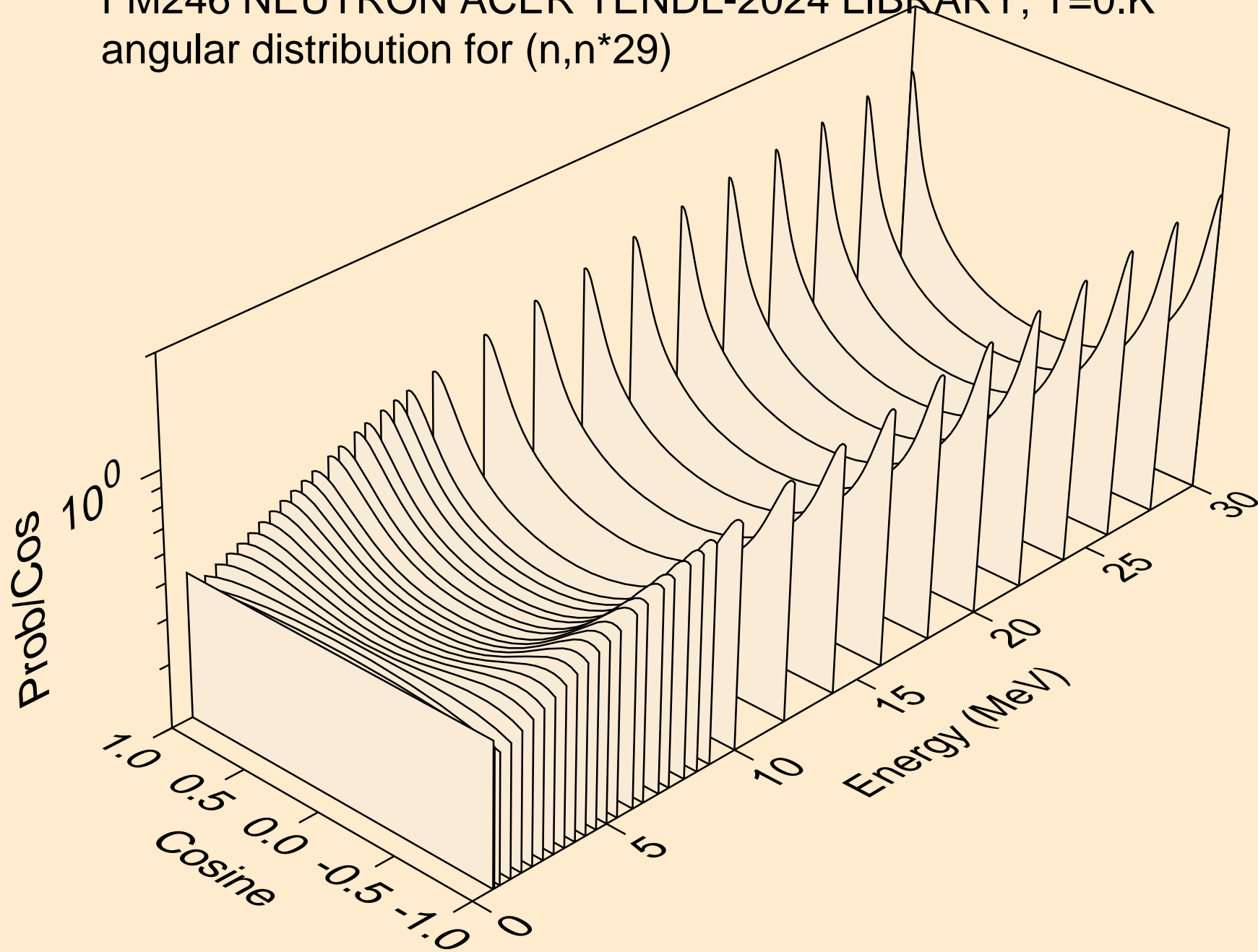

FM246 NEUTRON ACER TENDL-2024 LIBRARY; T=0.K  
Total fission nubar

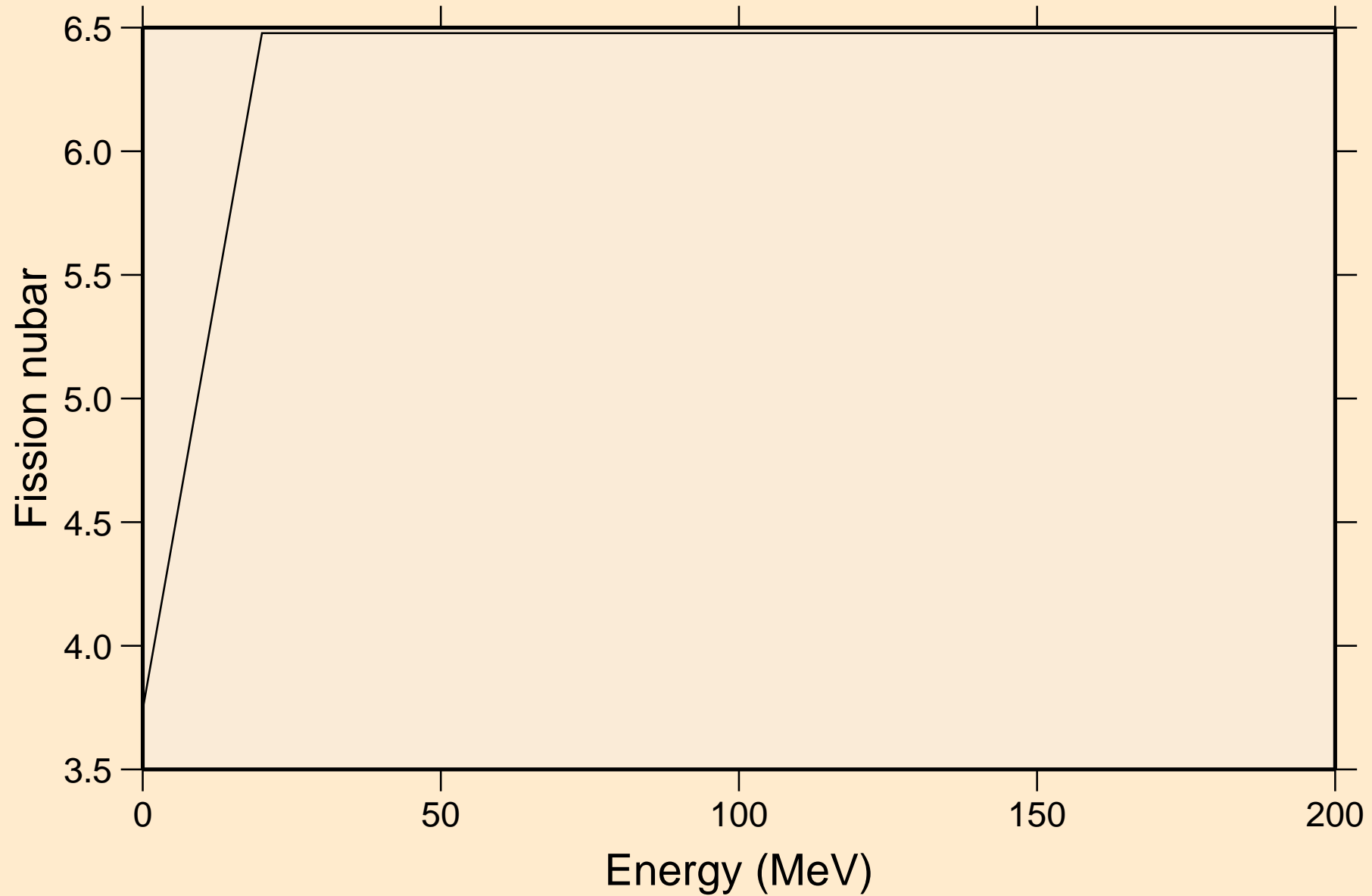

FM246 NEUTRON ACER TENDL-2024 LIBRARY; T=0.K  
Neutron emission for (n,x)

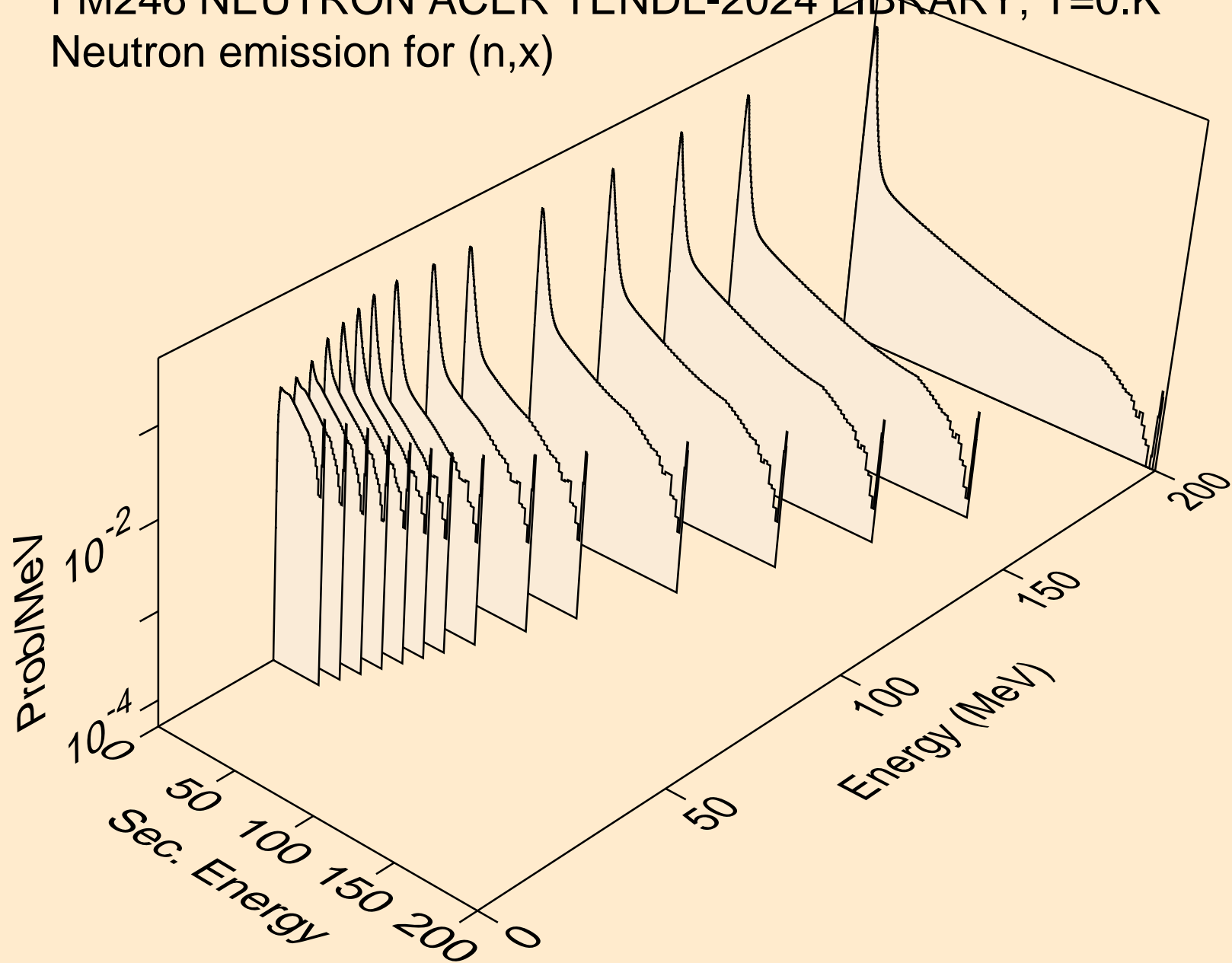

FM246 NEUTRON ACER TENDL-2024 LIBRARY; T=0.K  
Neutron emission for (n,2n)

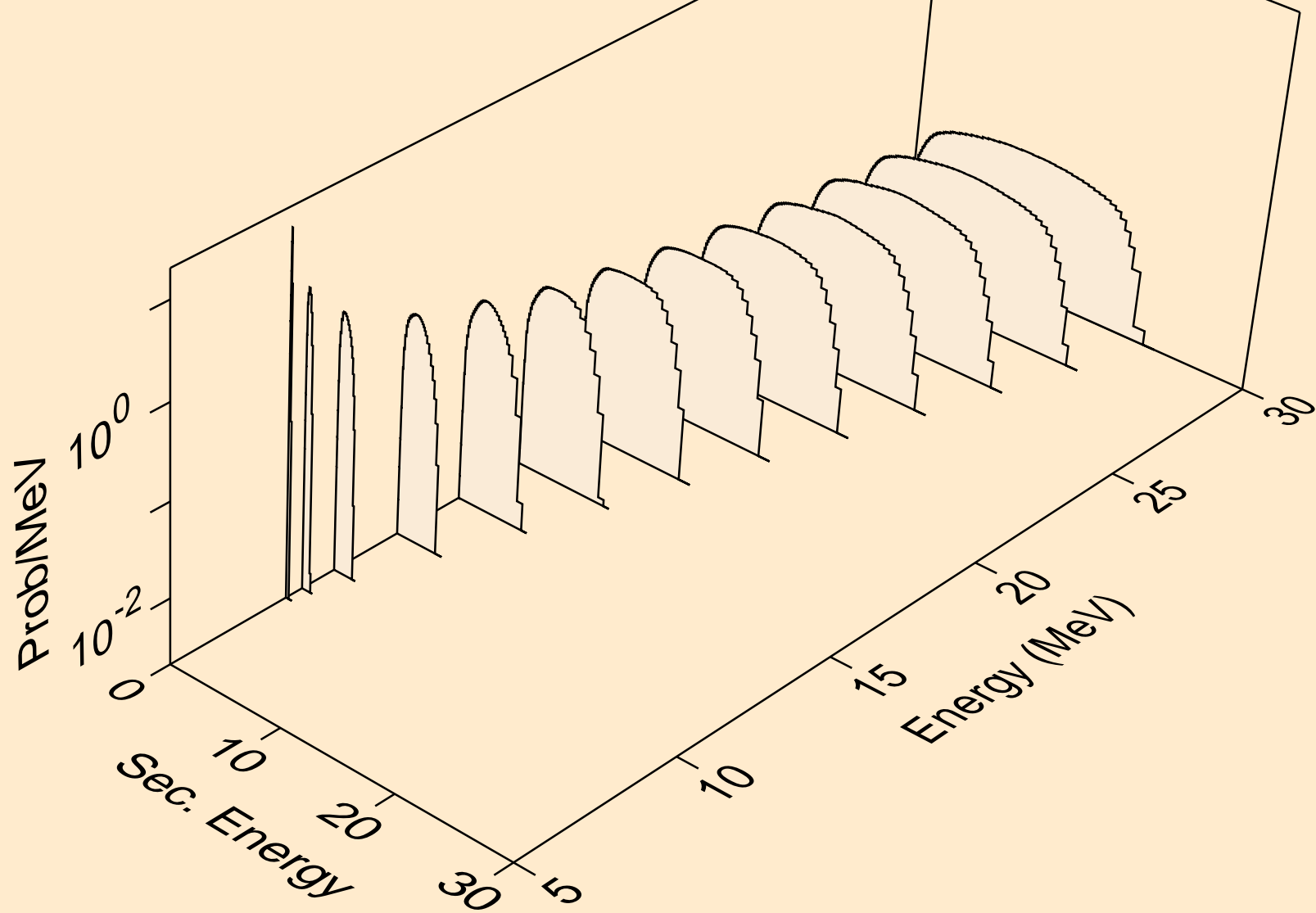

FM246 NEUTRON ACER TENDL-2024 LIBRARY; T=0.K  
Neutron emission for (n,3n)

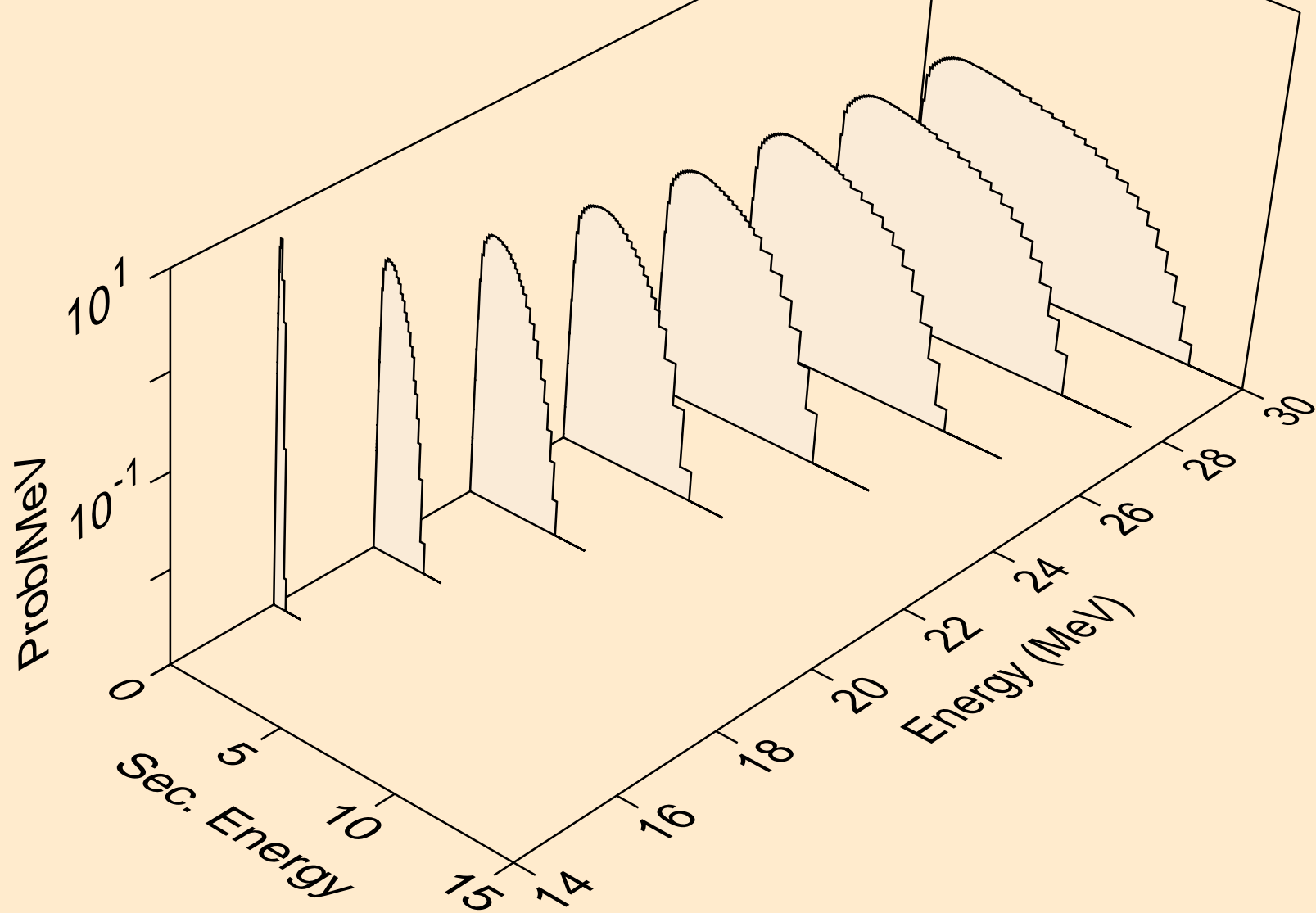

FM246 NEUTRON ACER TENDL-2024 LIBRARY; T=0.K  
Neutron emission for fission

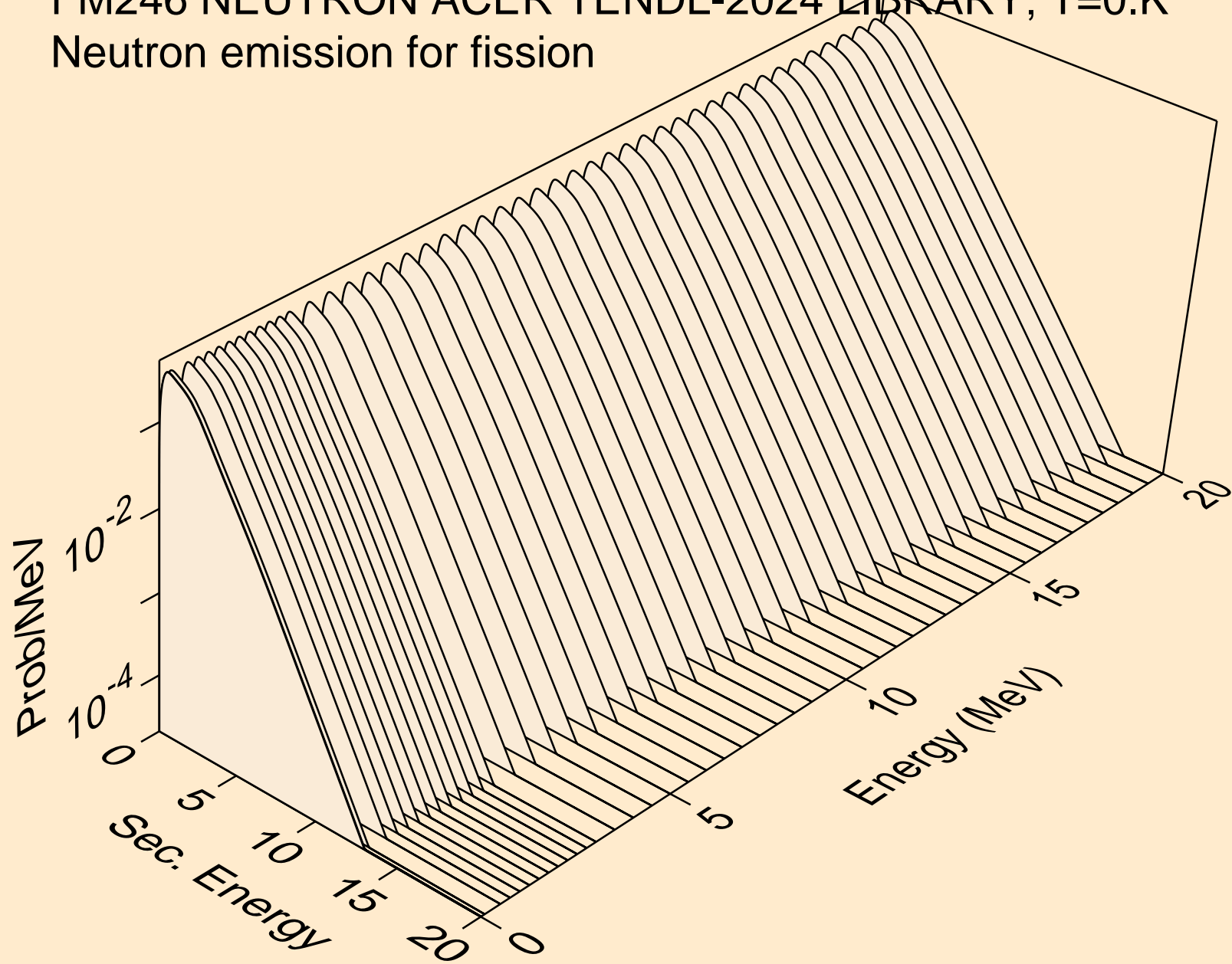



FM246 NEUTRON ACER TENDL-2024 LIBRARY; T=0.K  
Neutron emission for (n,n\*)a

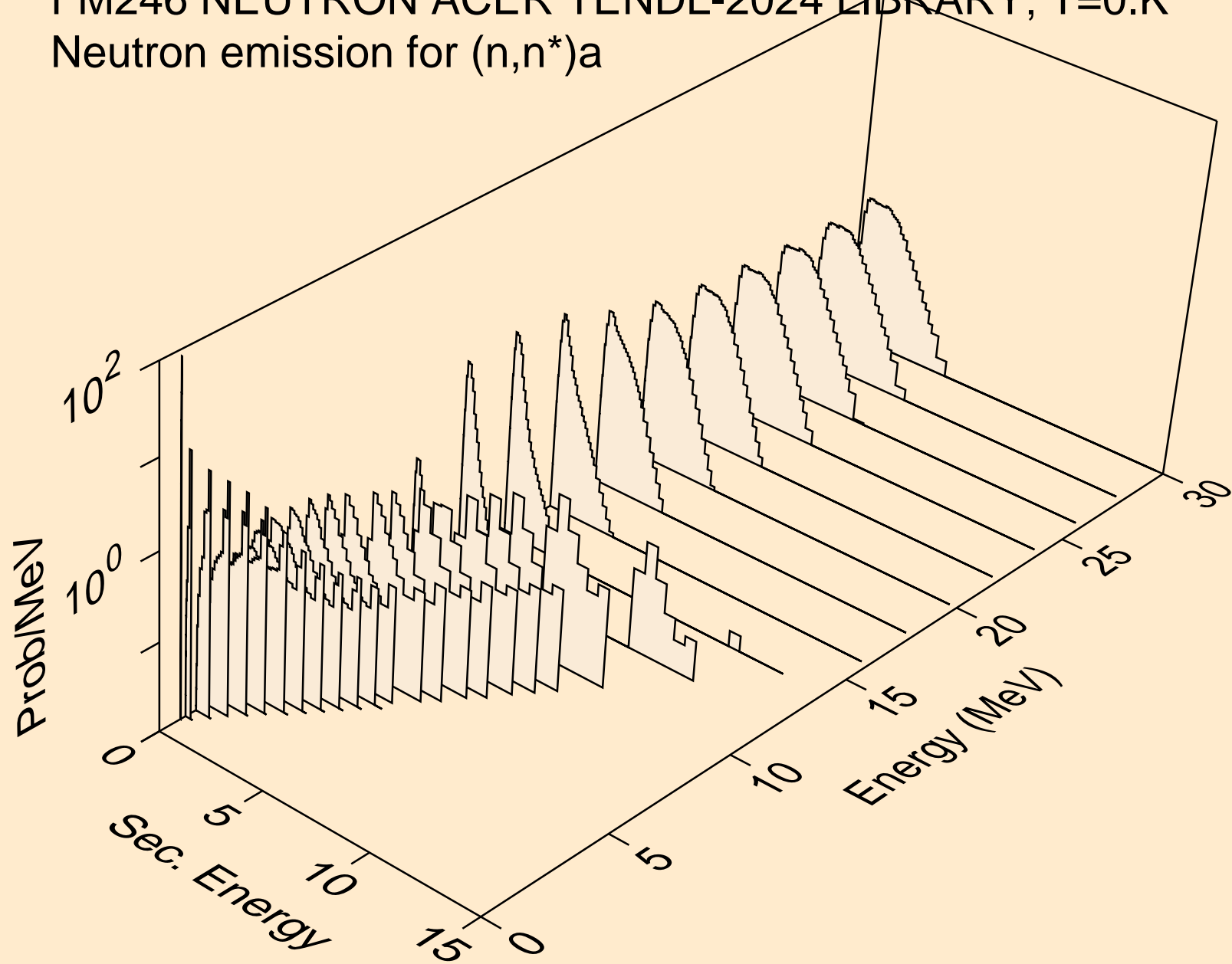

FM246 NEUTRON ACER TENDL-2024 LIBRARY; T=0.K  
Neutron emission for (n,2n)a

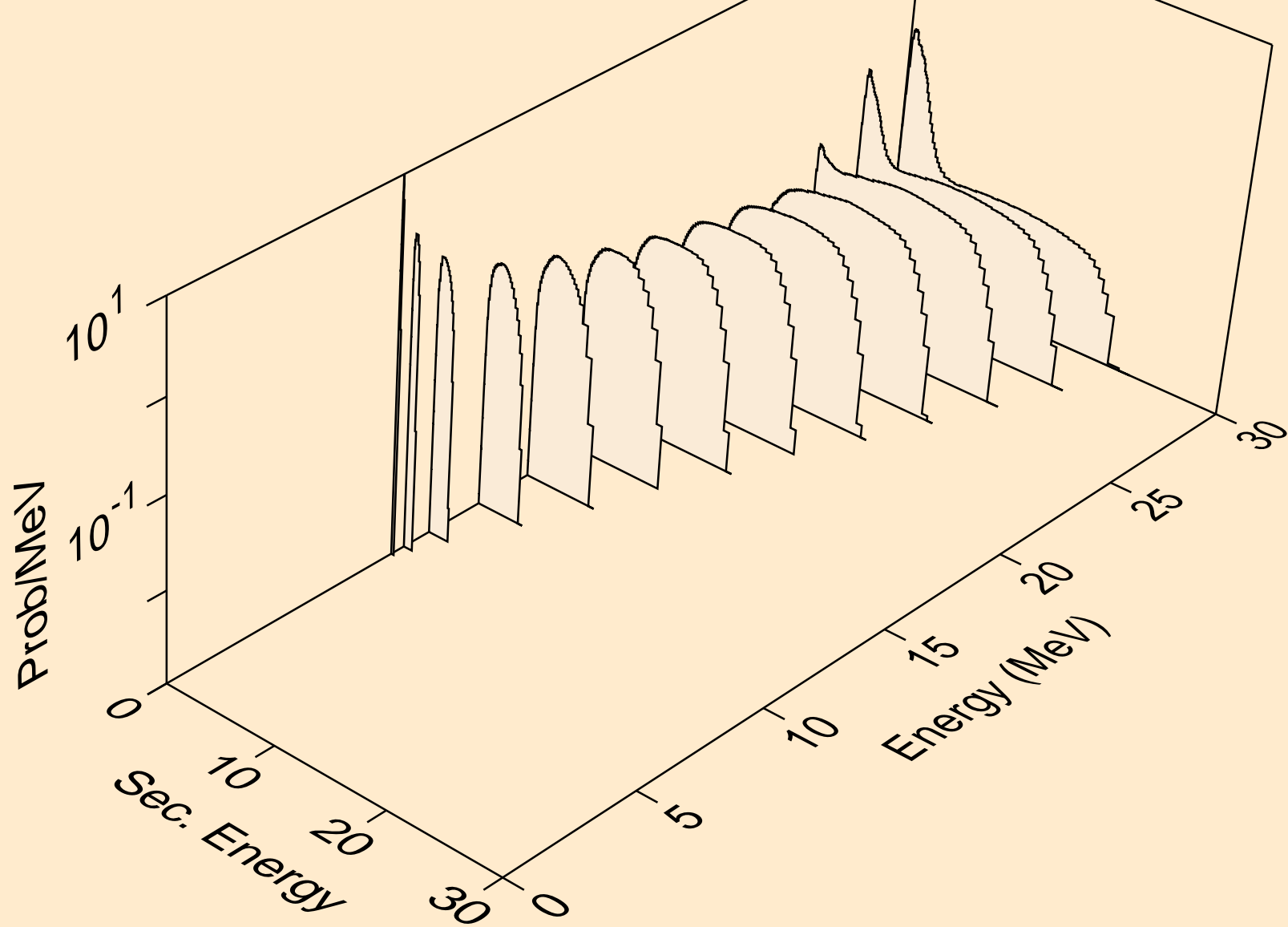

FM246 NEUTRON ACER TENDL-2024 LIBRARY; T=0.K  
Neutron emission for (n,n\*)p

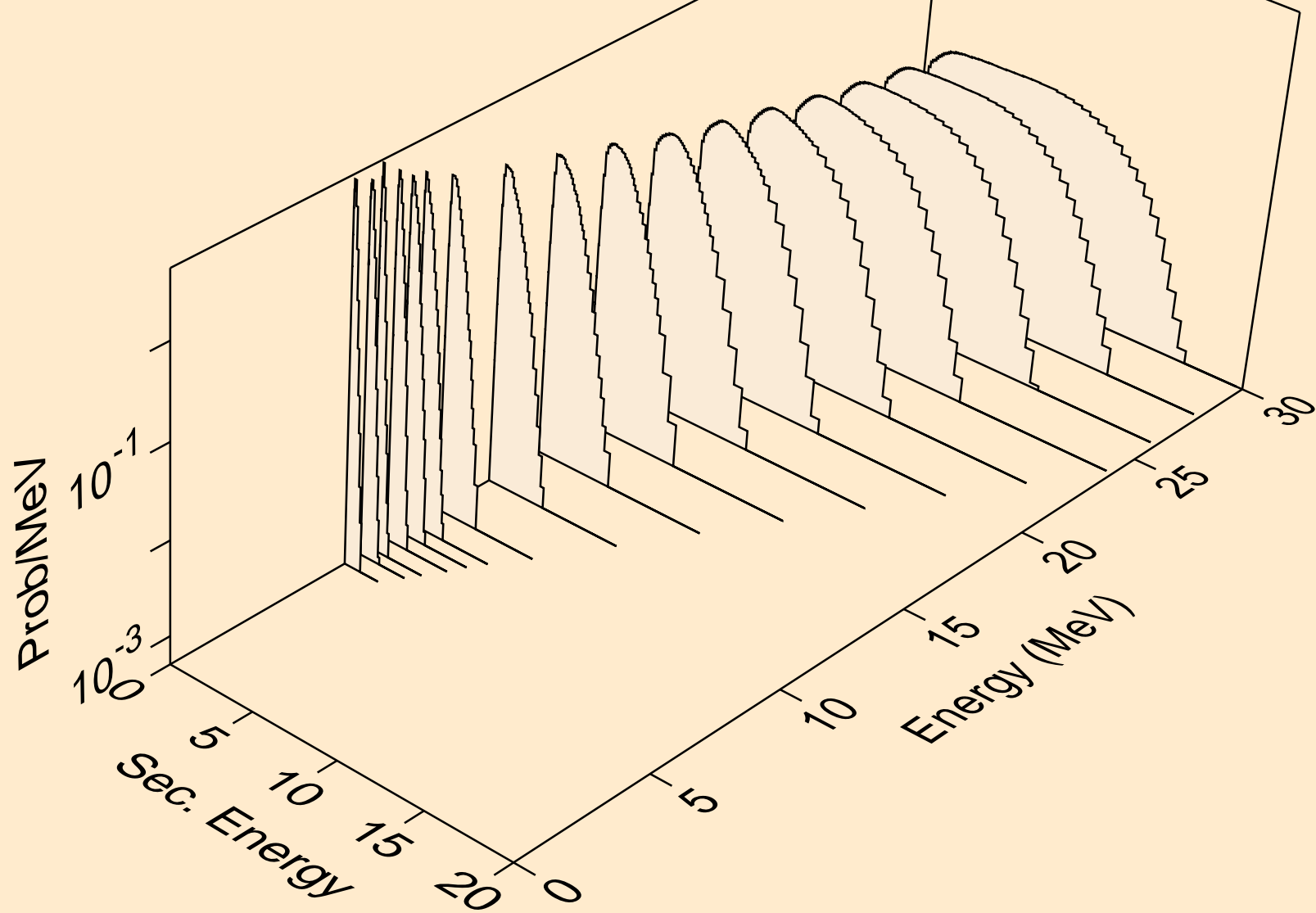

FM246 NEUTRON ACER TENDL-2024 LIBRARY; T=0.K  
Neutron emission for (n,n\*)d

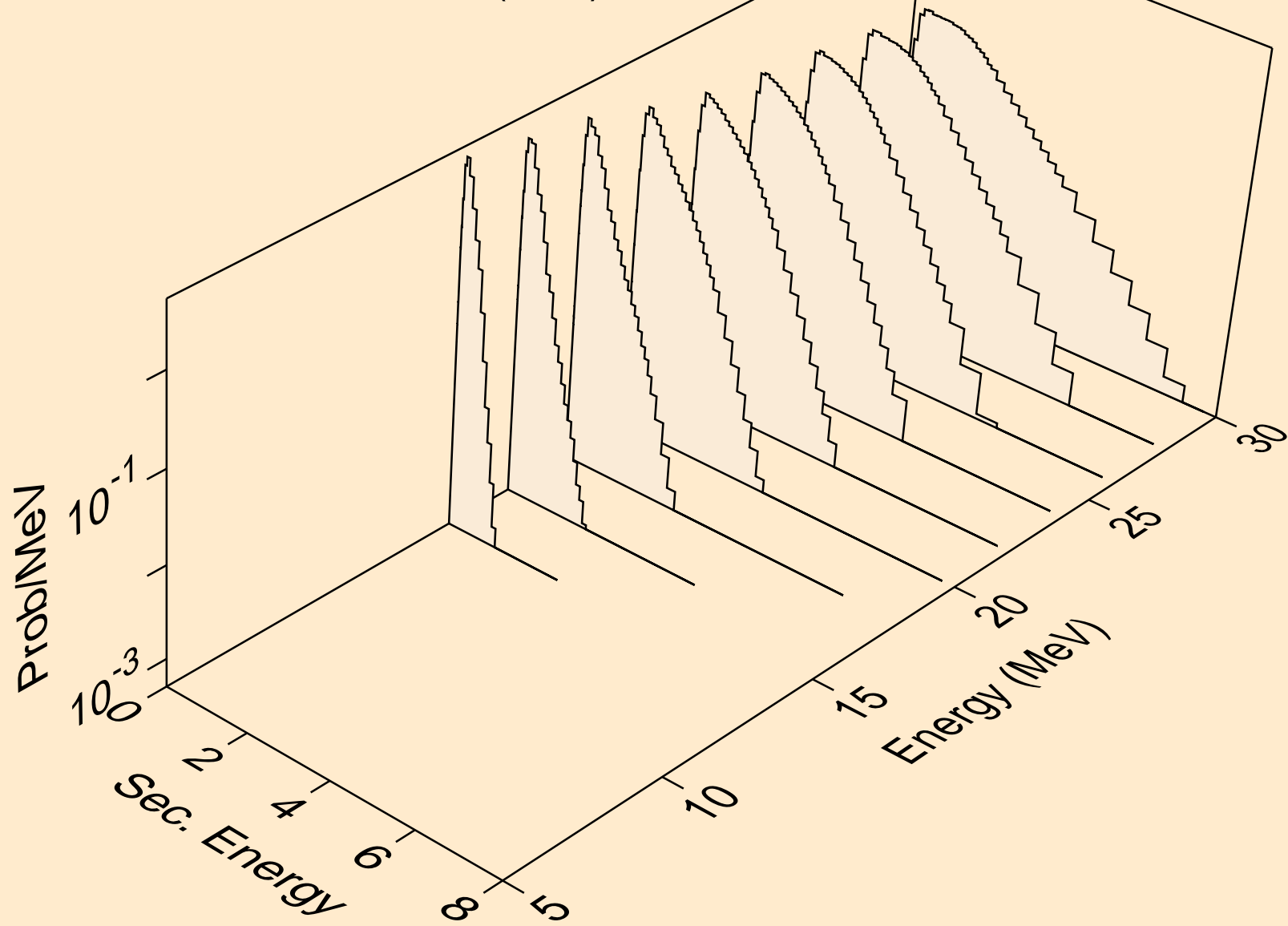

FM246 NEUTRON ACER TENDL-2024 LIBRARY; T=0.K  
Neutron emission for (n,n\*)t

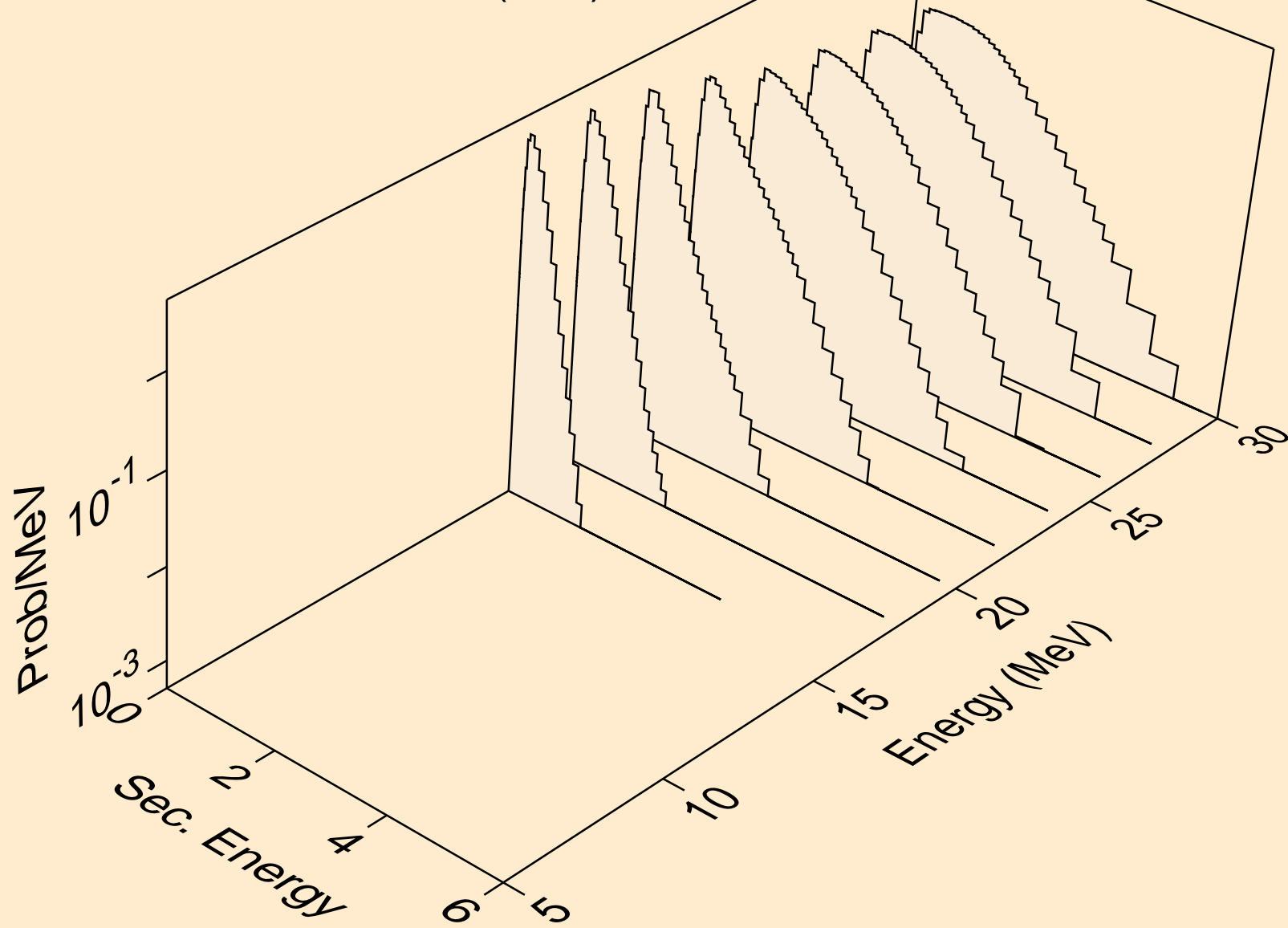

FM246 NEUTRON ACER TENDL-2024 LIBRARY; T=0.K  
Neutron emission for (n,n\*)he3

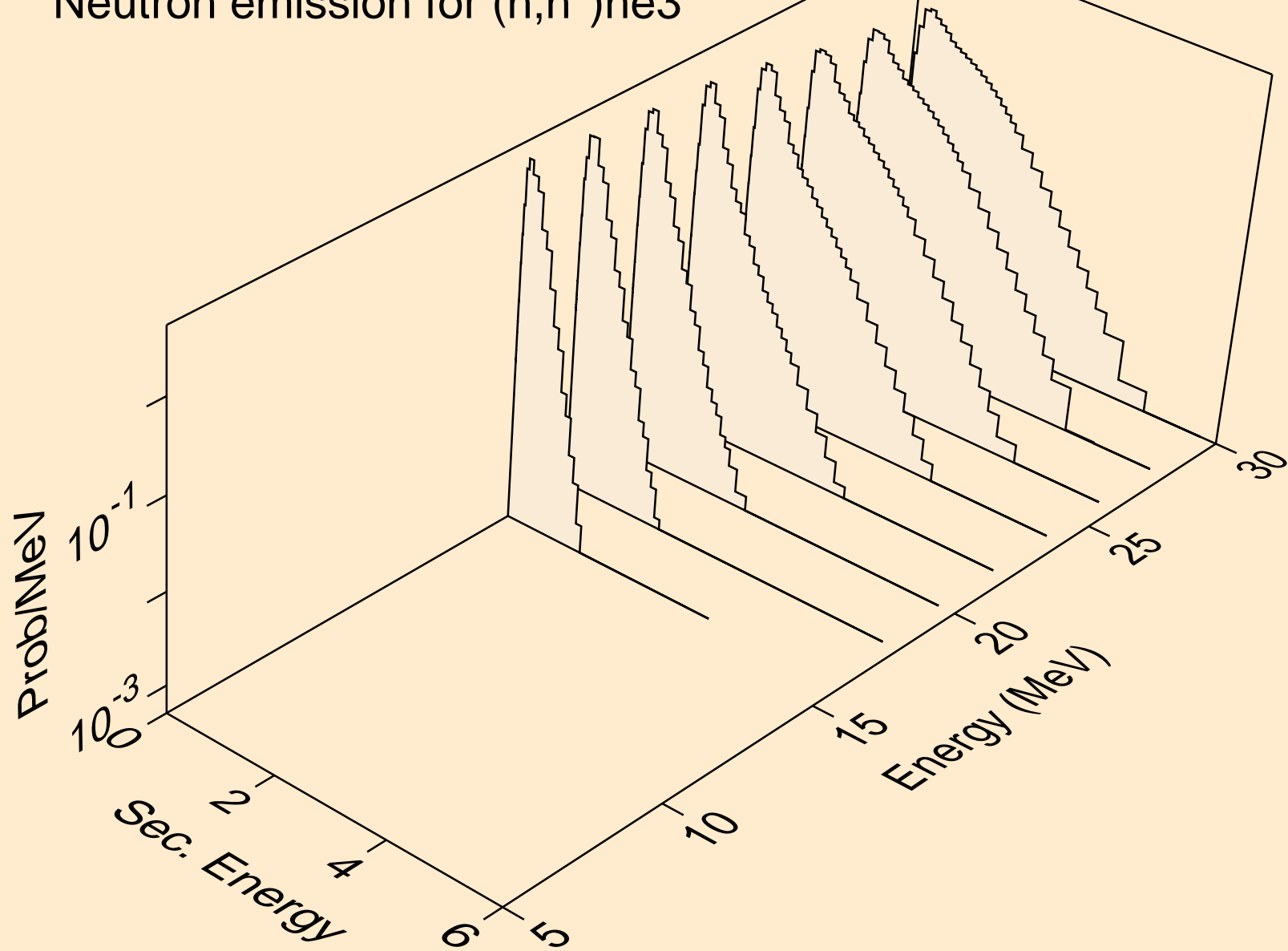

FM246 NEUTRON ACER TENDL-2024 LIBRARY; T=0.K  
Neutron emission for (n,4n)

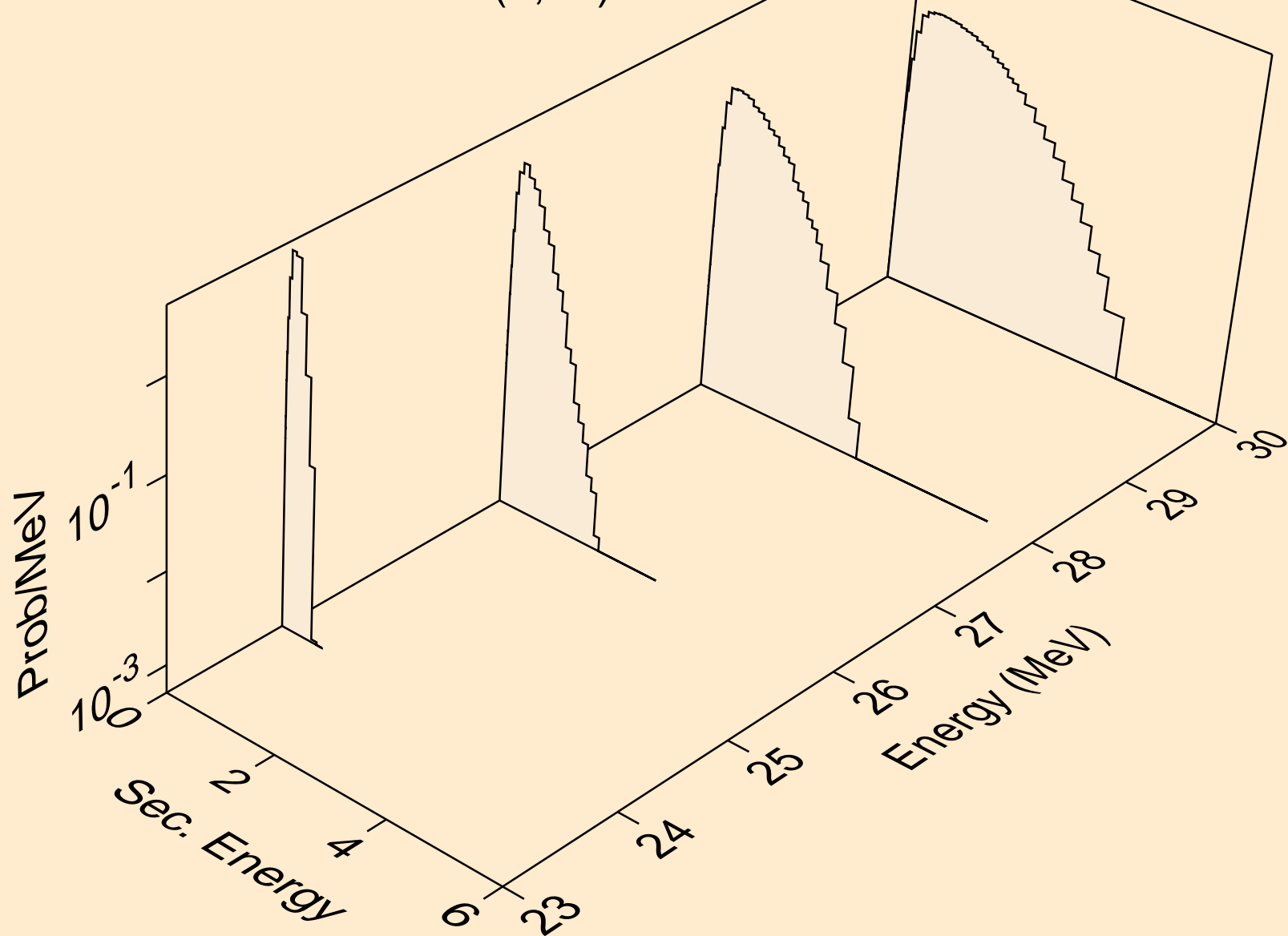

FM246 NEUTRON ACER TENDL-2024 LIBRARY; T=0.K  
Neutron emission for (n,2np)

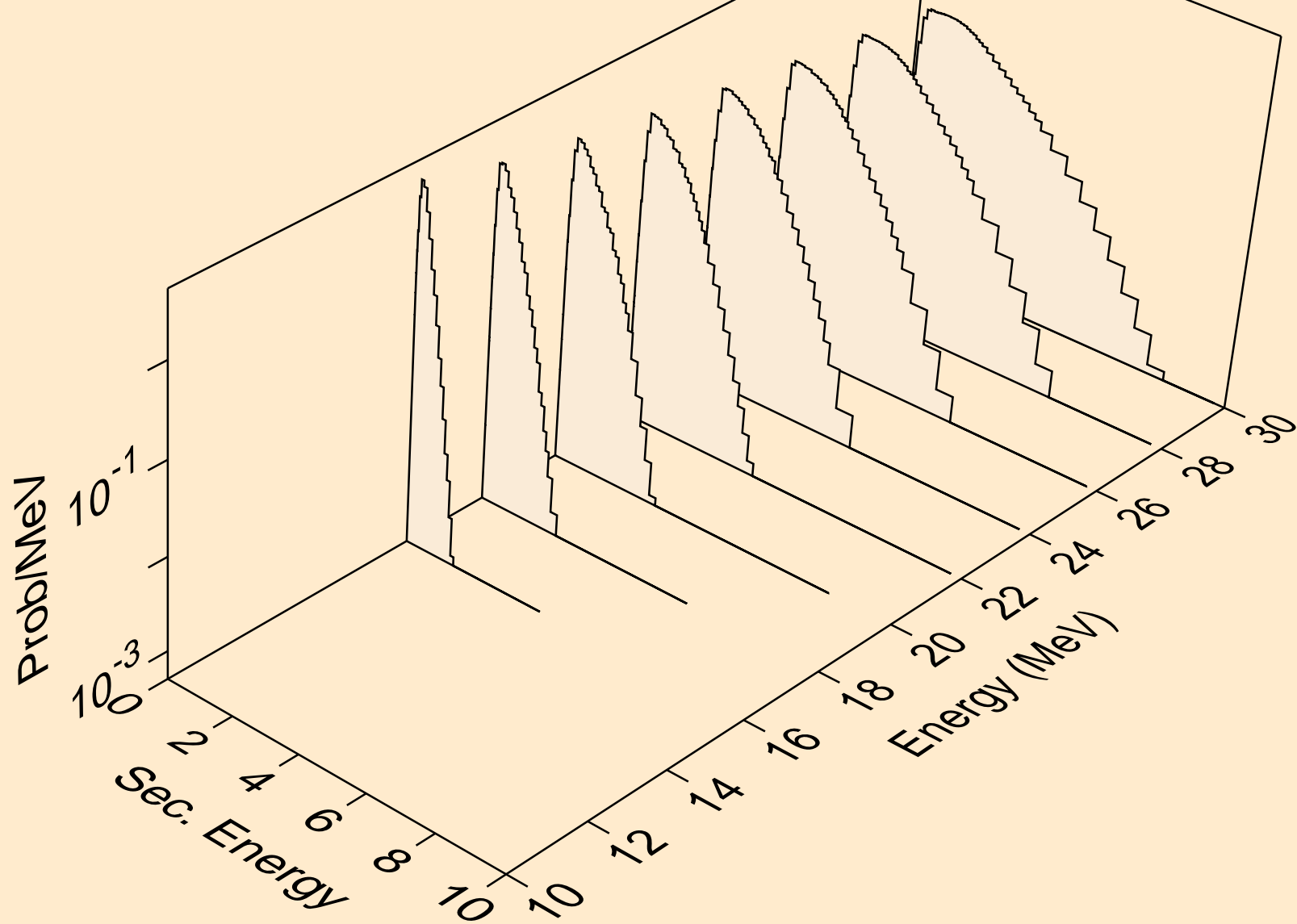



FM246 NEUTRON ACER TENDL-2024 LIBRARY; T=0.K  
Neutron emission for (n,n2p)

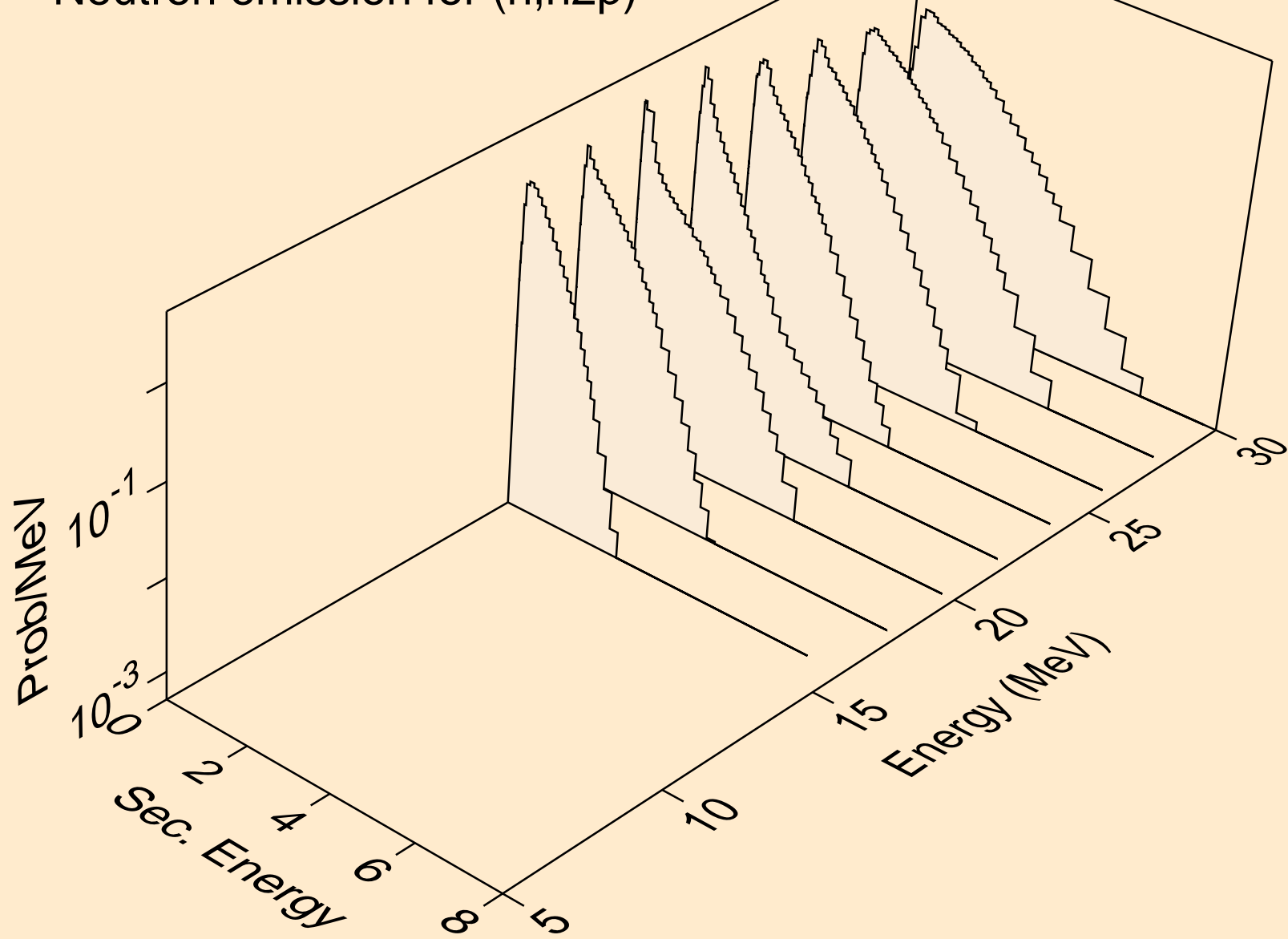

FM246 NEUTRON ACER TENDL-2024 LIBRARY; T=0.K  
Neutron emission for (n,n\*c)

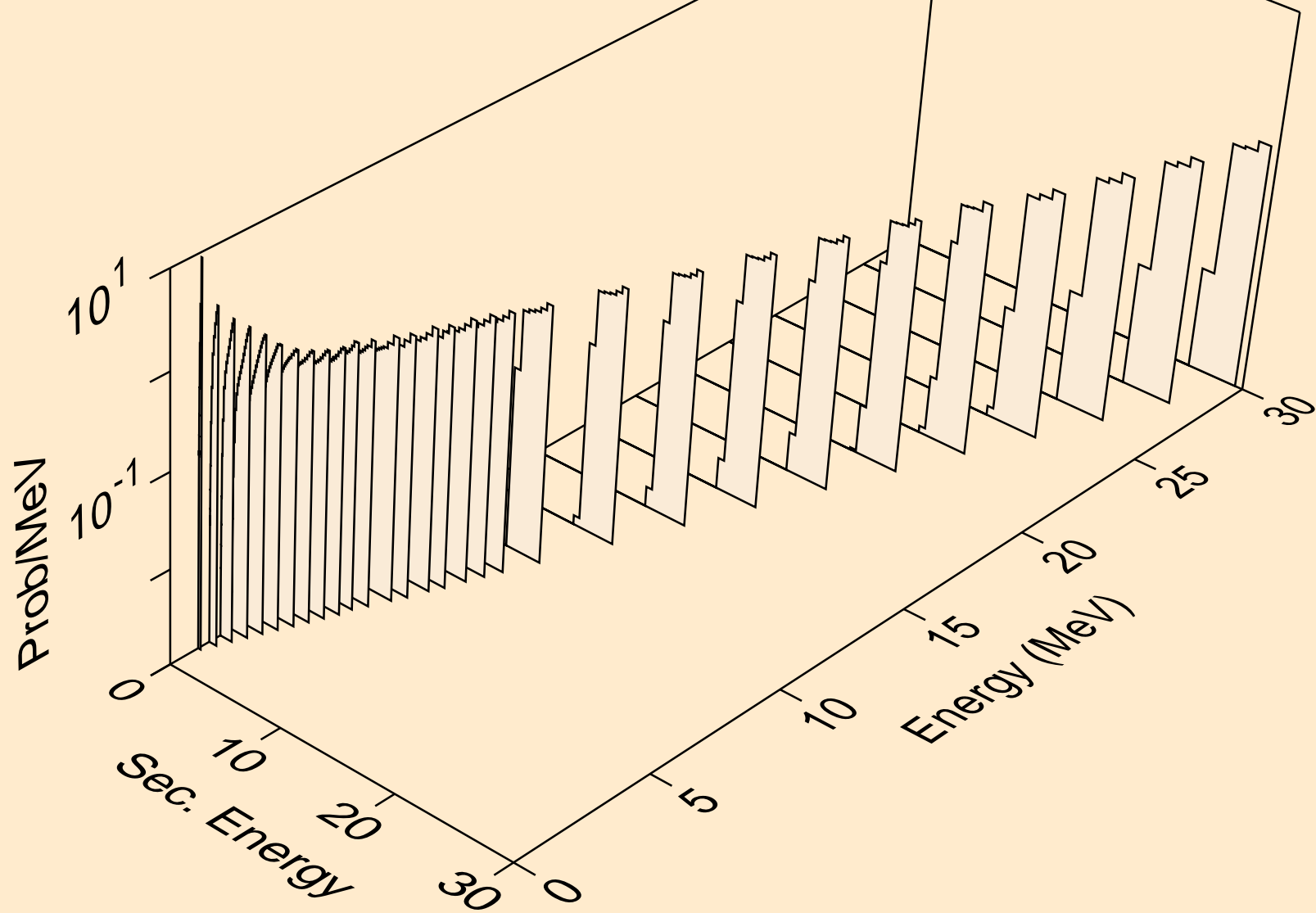

# FM246 NEUTRON ACER TENDL-2024 LIBRARY; T=0.K

## Delayed nubar

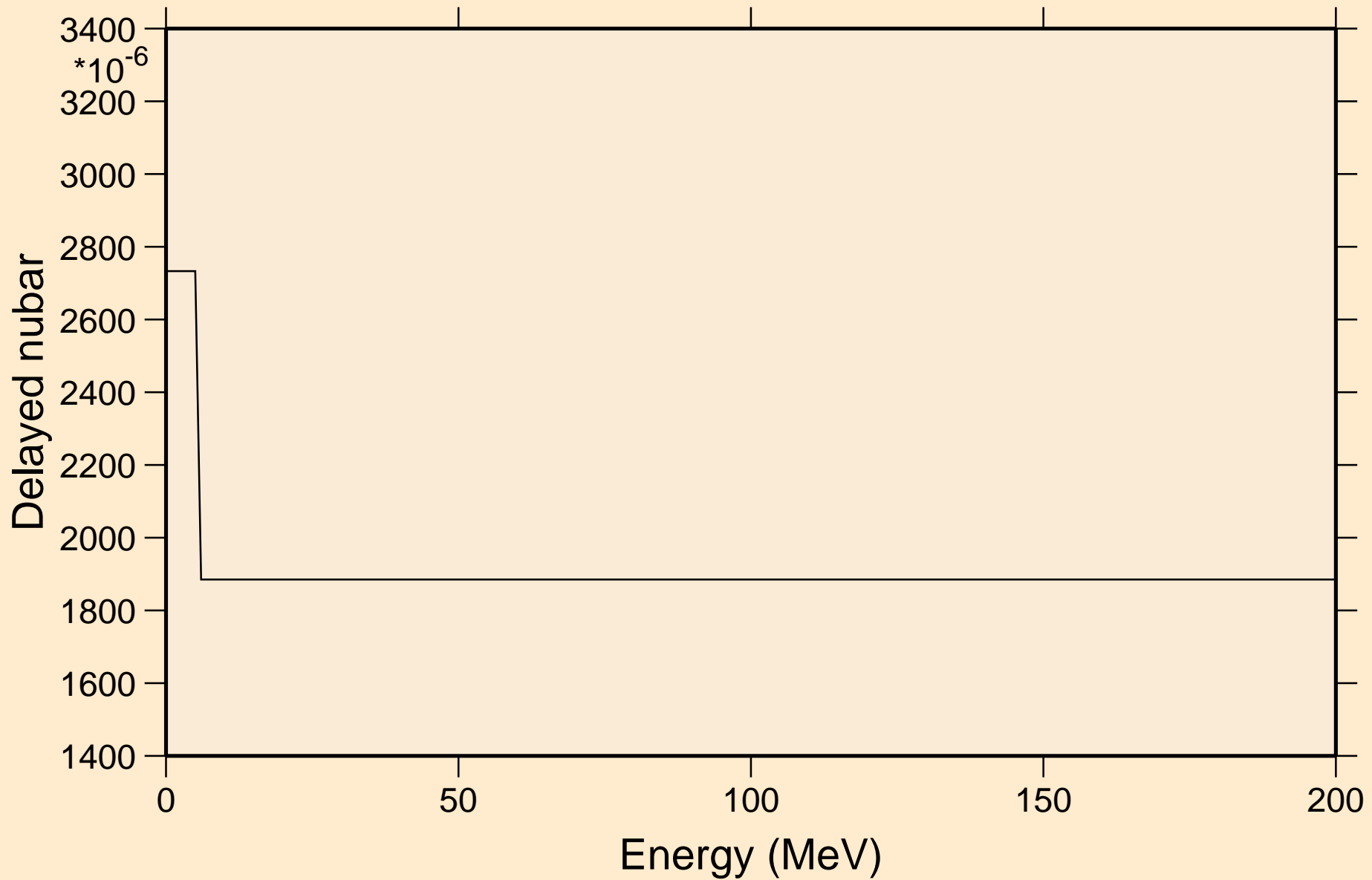

# FM246 NEUTRON ACER TENDL-2024 LIBRARY; T=0.K

## Delayed neutron spectra

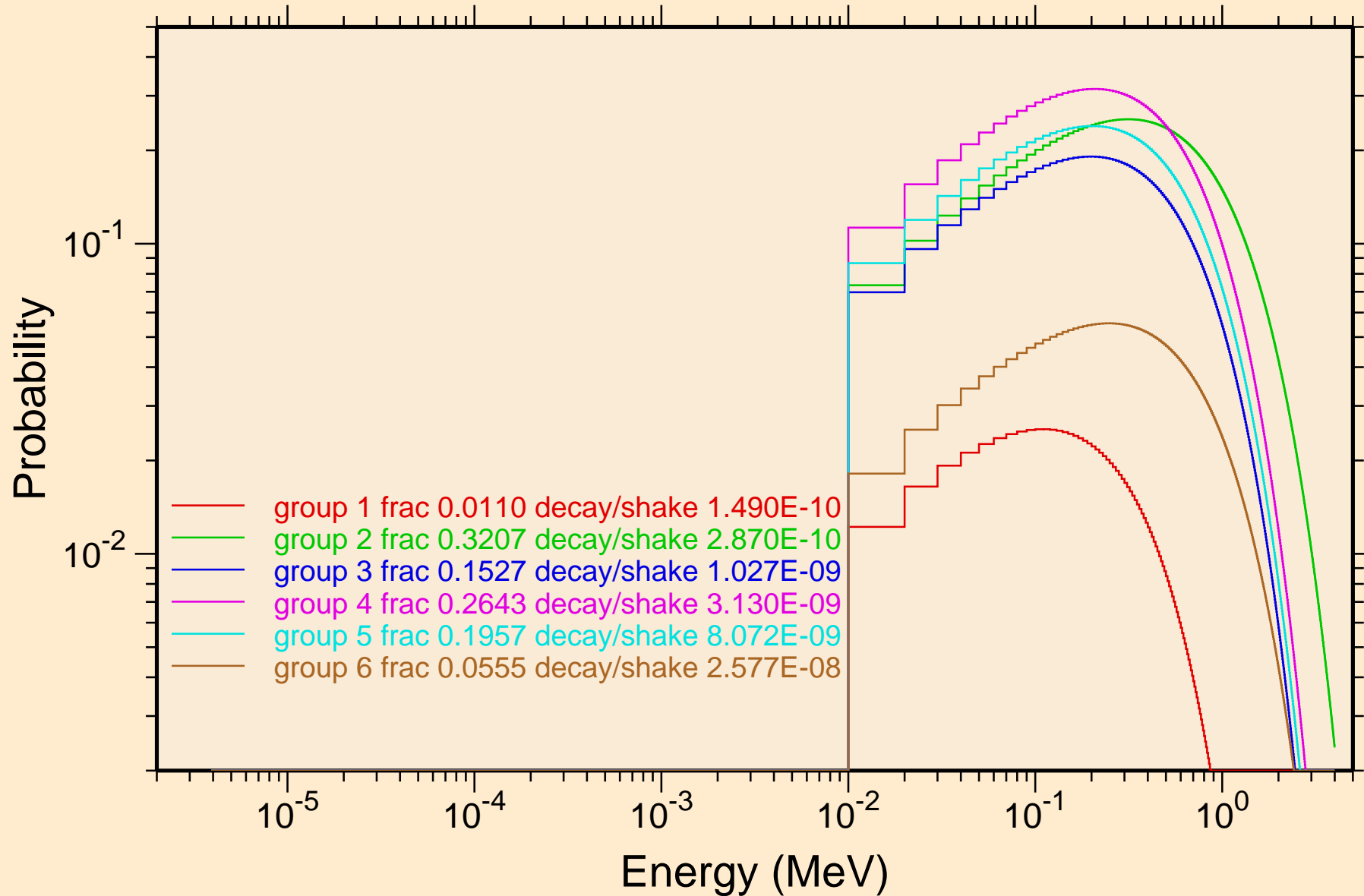

FM246 NEUTRON ACER TENDL-2024 LIBRARY; T=0.K  
Photon emission for (n,x)

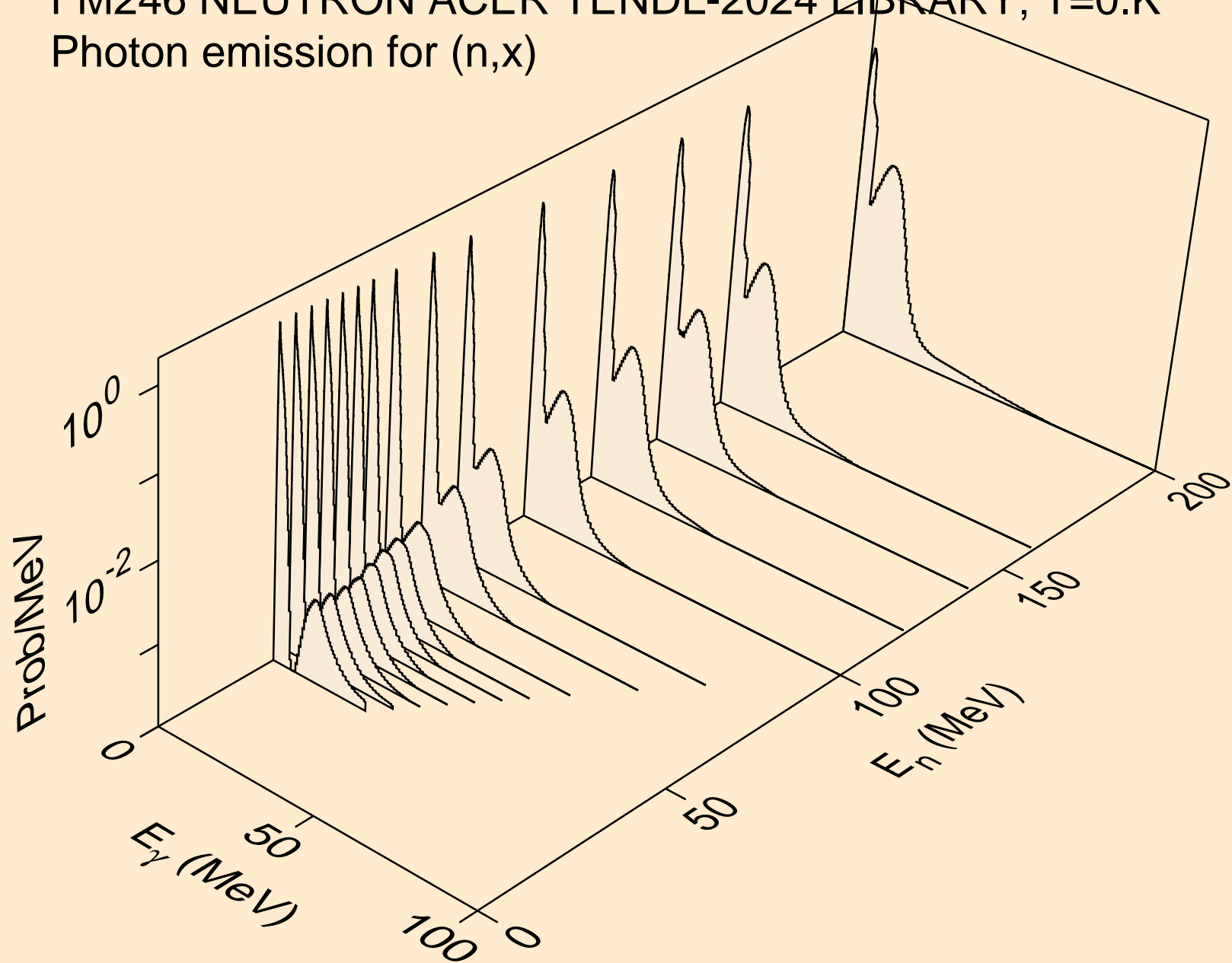

FM246 NEUTRON ACER TENDL-2024 LIBRARY; T=0.K  
Photon emission for (n,2n)

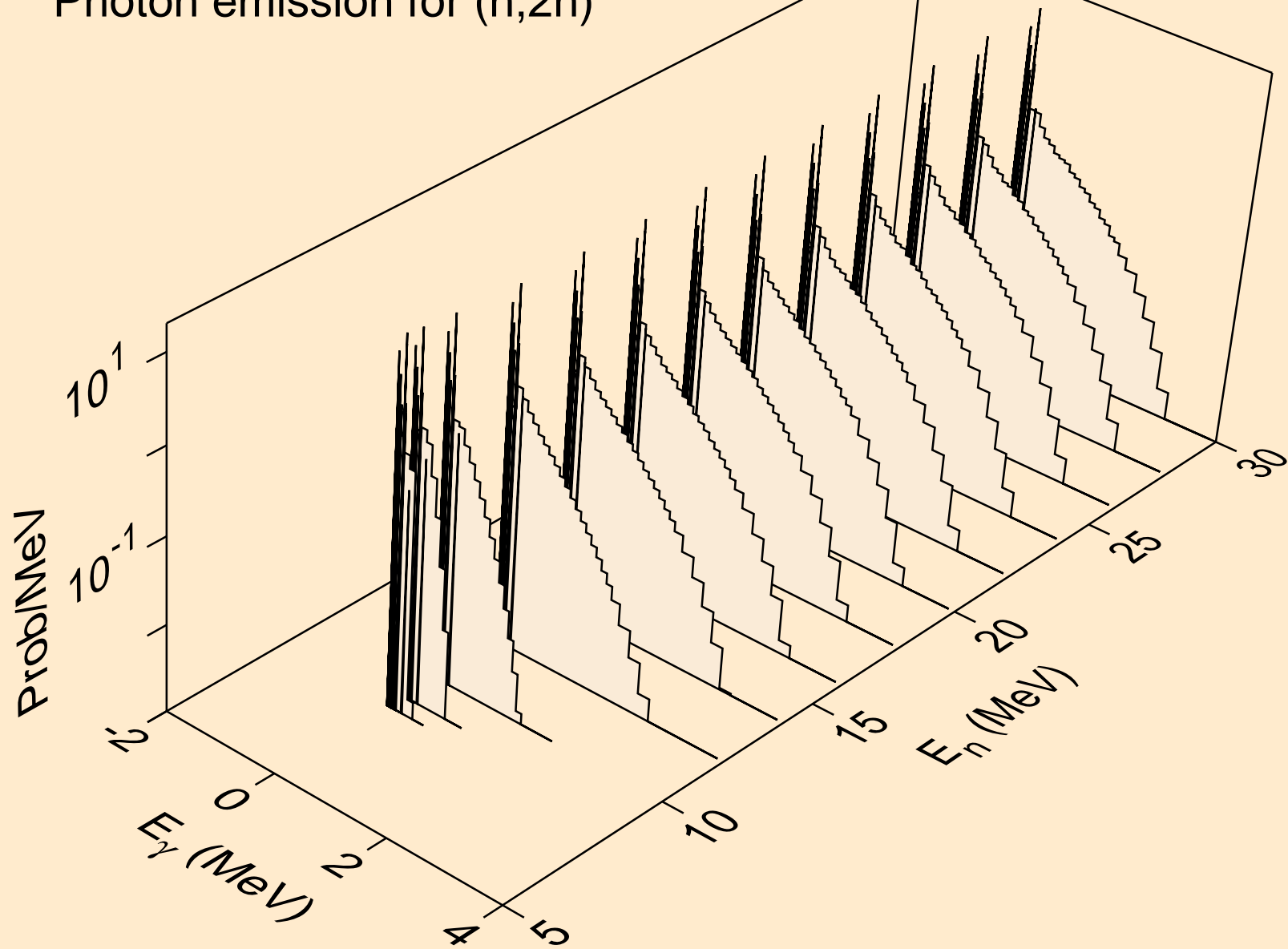

FM246 NEUTRON ACER TENDL-2024 LIBRARY; T=0.K  
Photon emission for (n,3n)

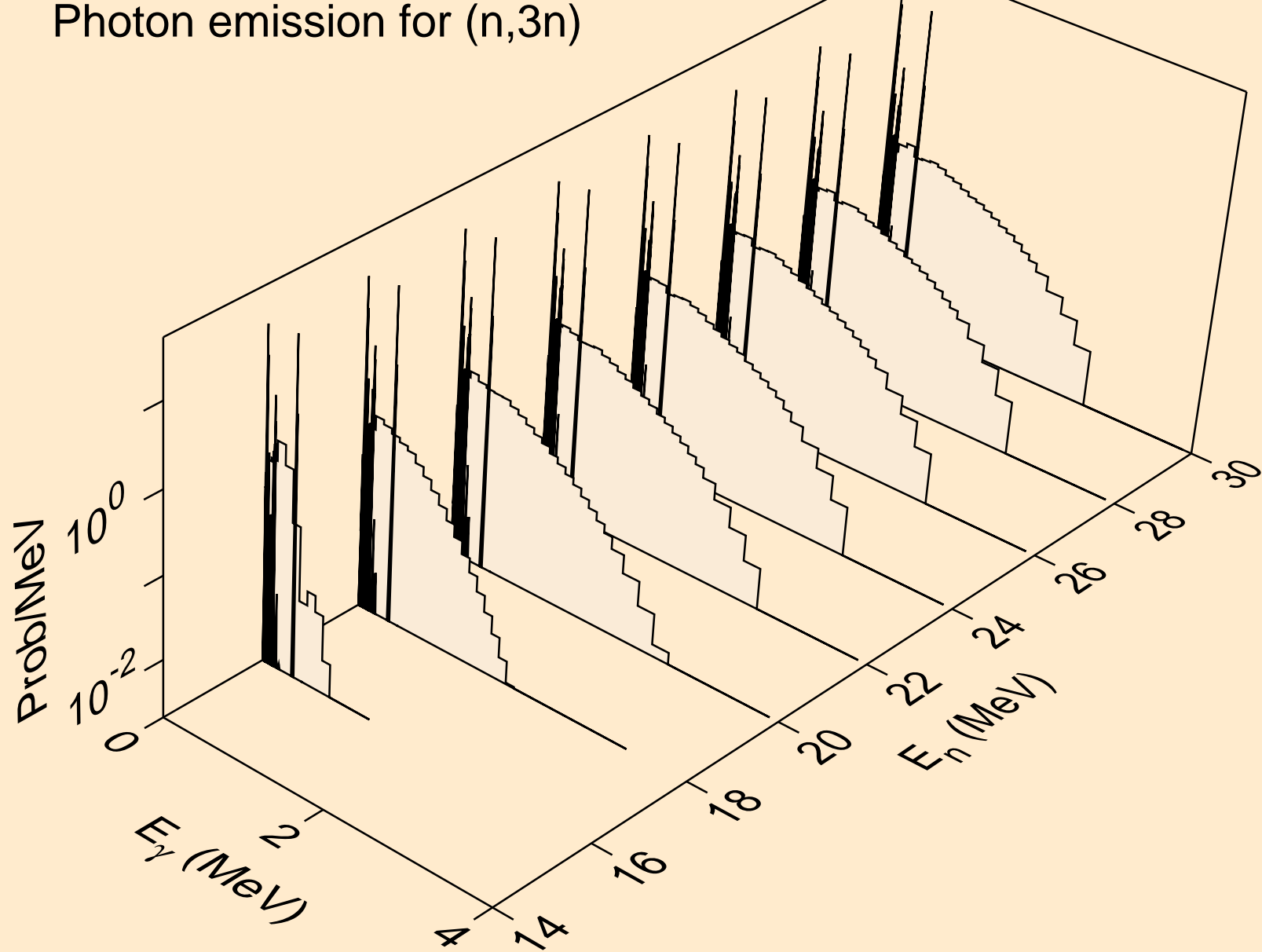

FM246 NEUTRON ACER TENDL-2024 LIBRARY; T=0.K  
Photon emission for (n,n\*)a

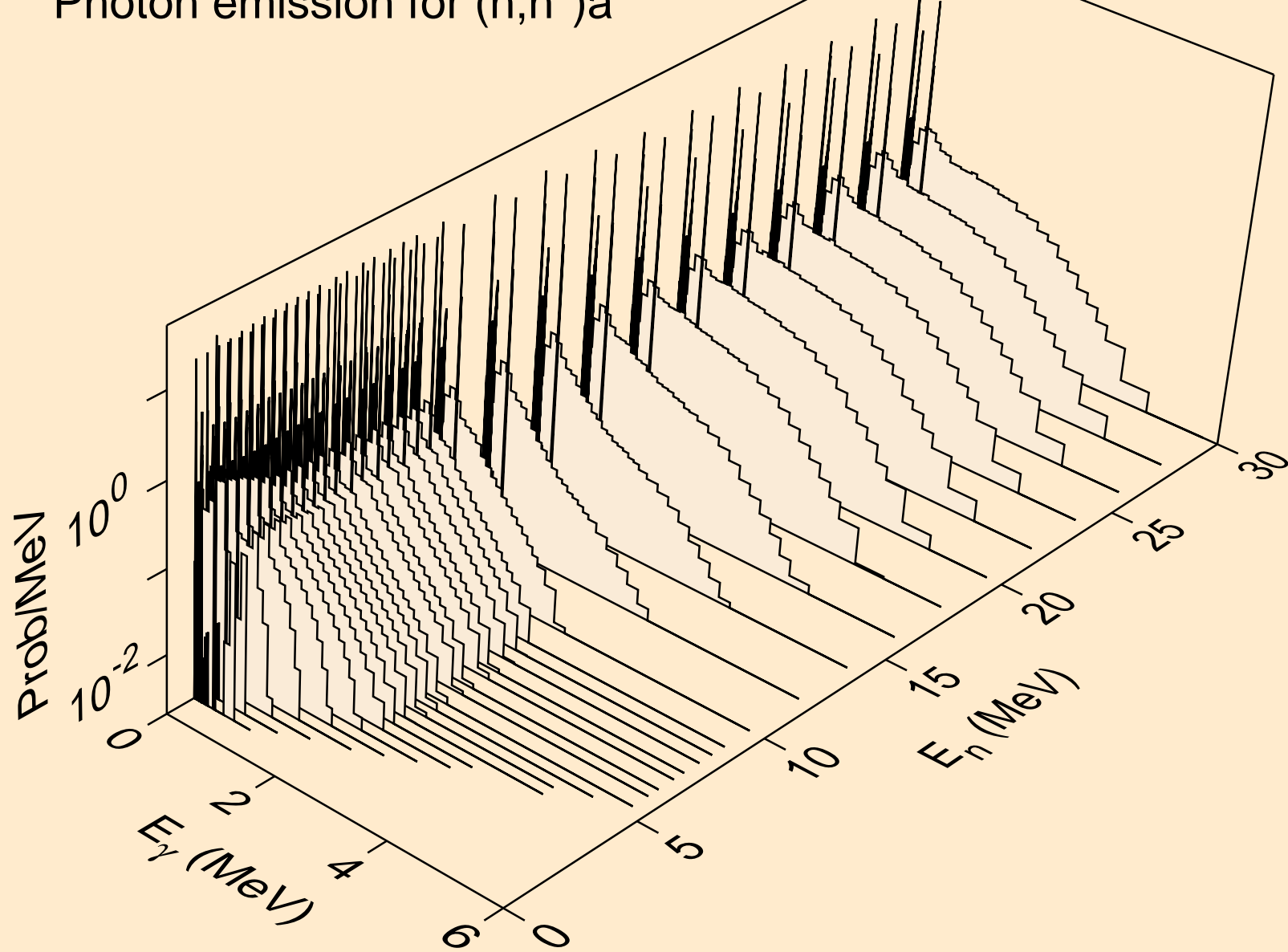



FM246 NEUTRON ACER TENDL-2024 LIBRARY; T=0.K  
Photon emission for (n,2n)a

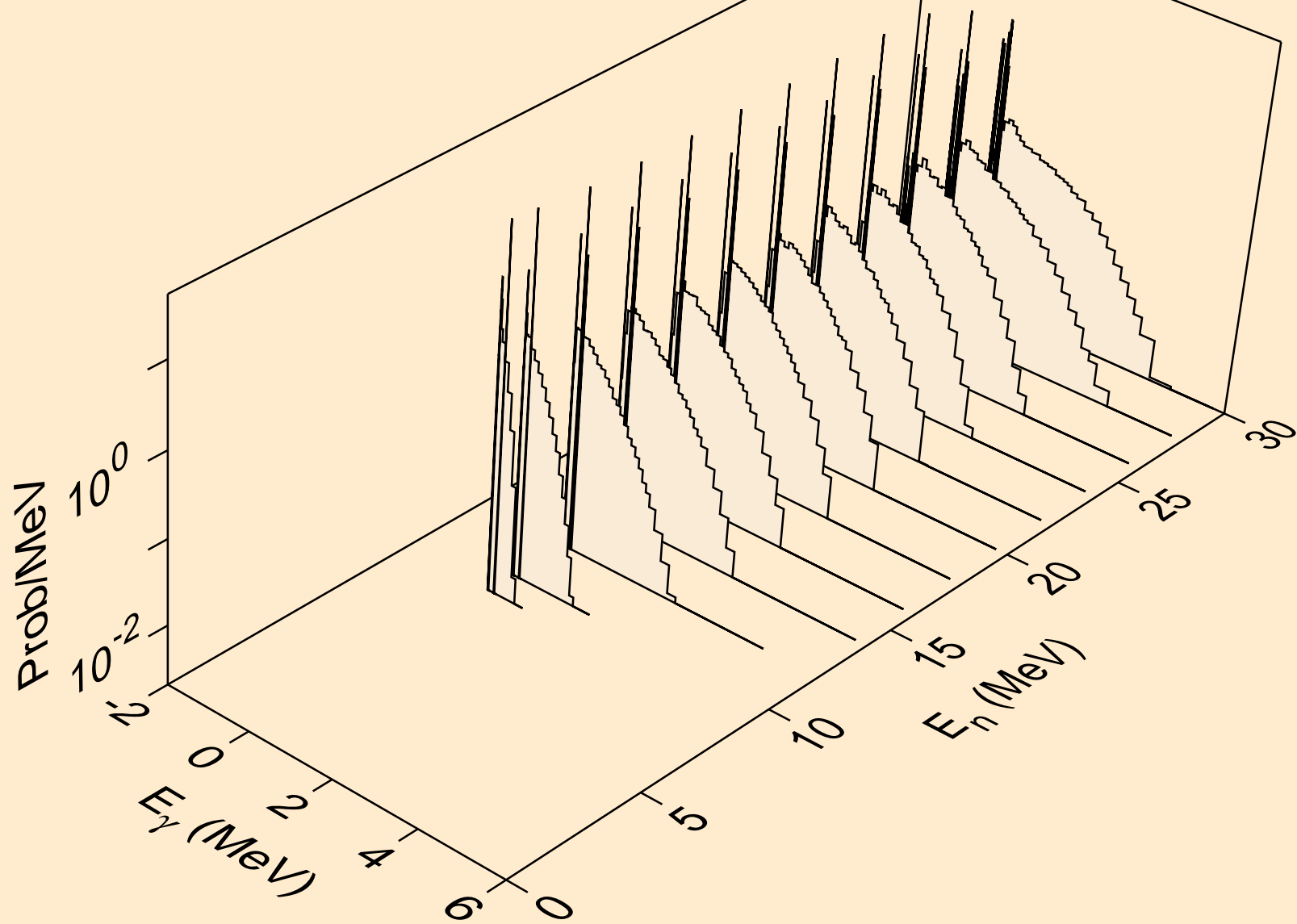

FM246 NEUTRON ACER TENDL-2024 LIBRARY; T=0.K  
Photon emission for (n,n\*)p

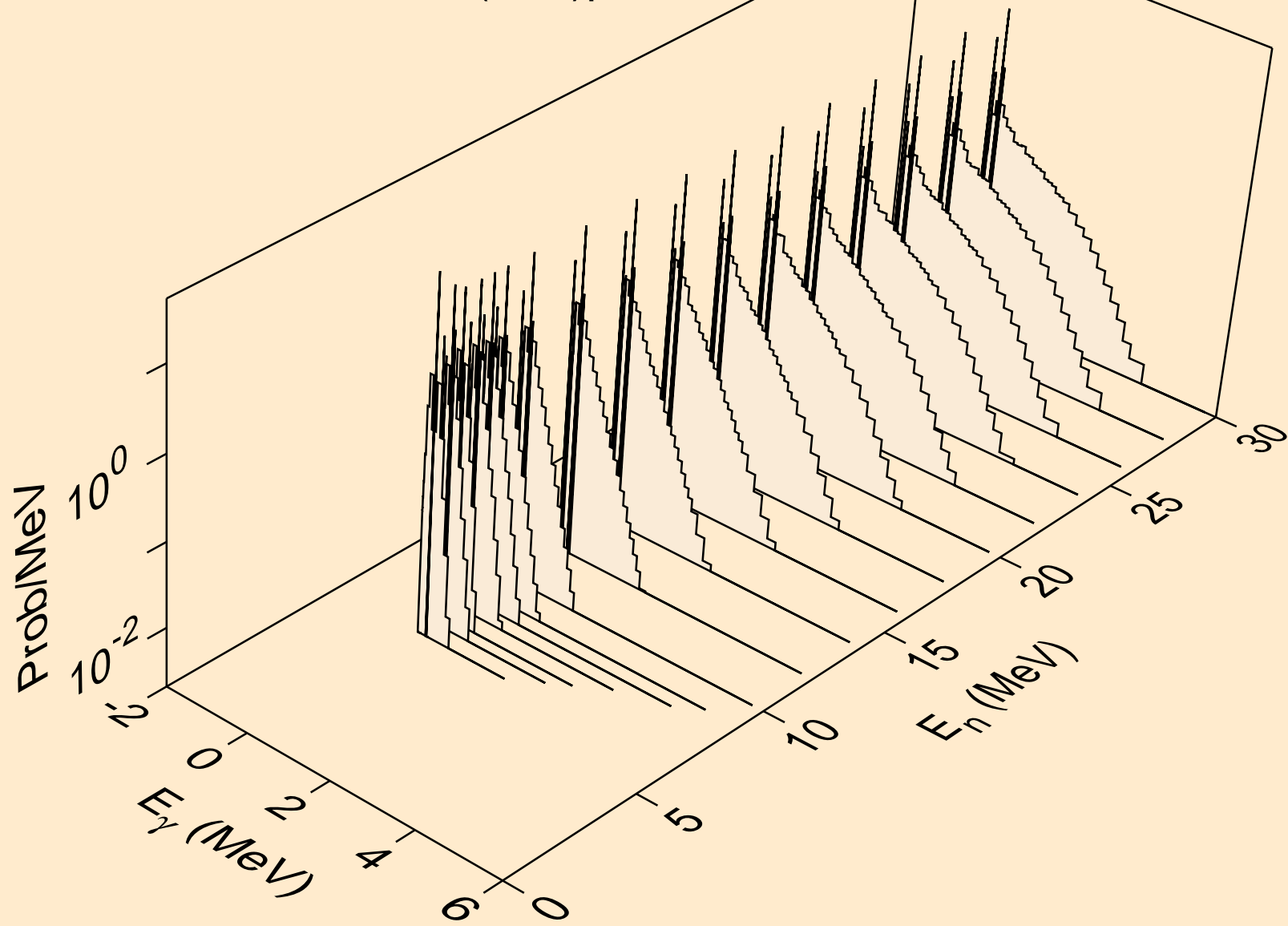

FM246 NEUTRON ACER TENDL-2024 LIBRARY; T=0.K  
Photon emission for (n,n\*)d

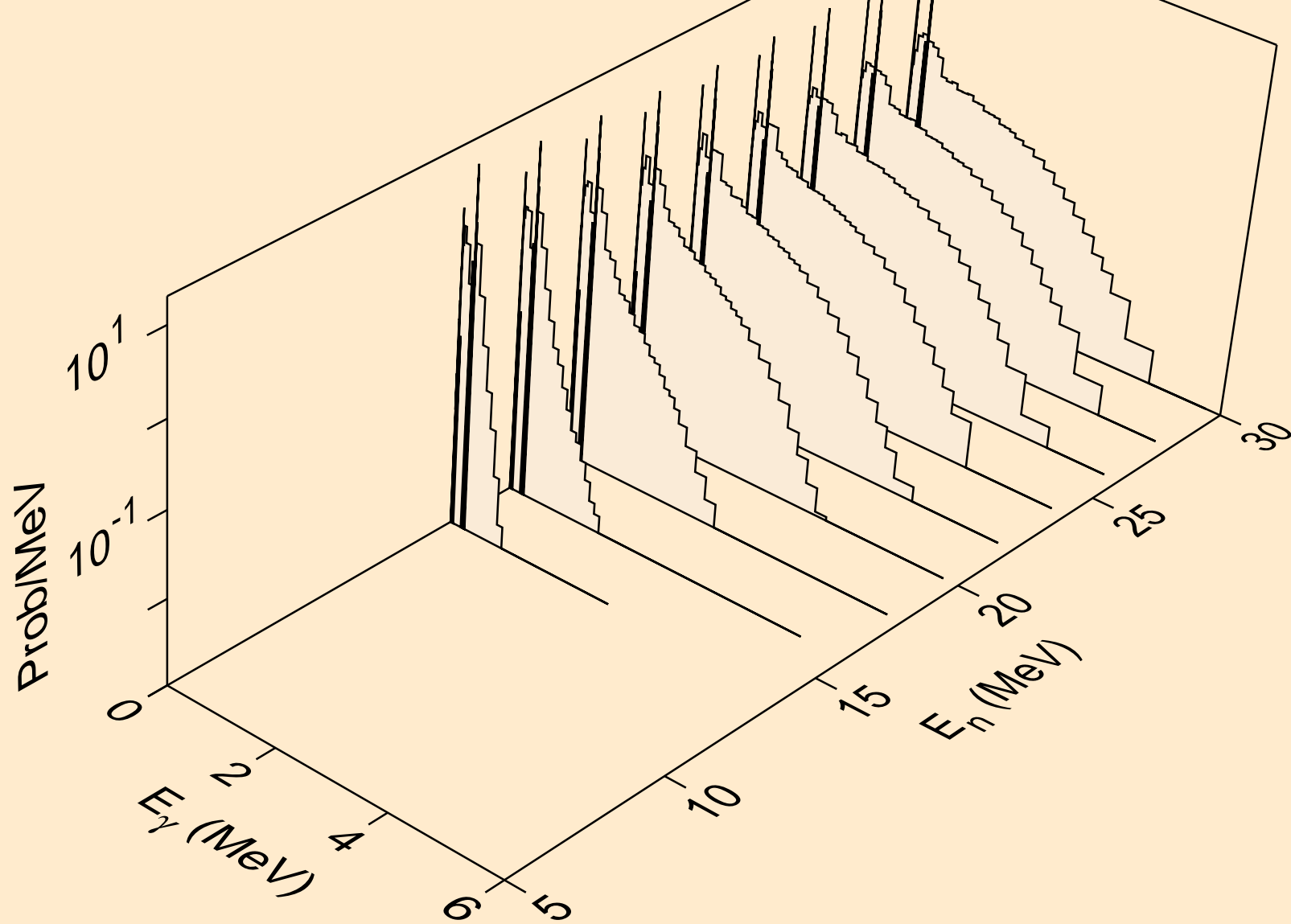

FM246 NEUTRON ACER TENDL-2024 LIBRARY; T=0.K  
Photon emission for (n,n\*)t

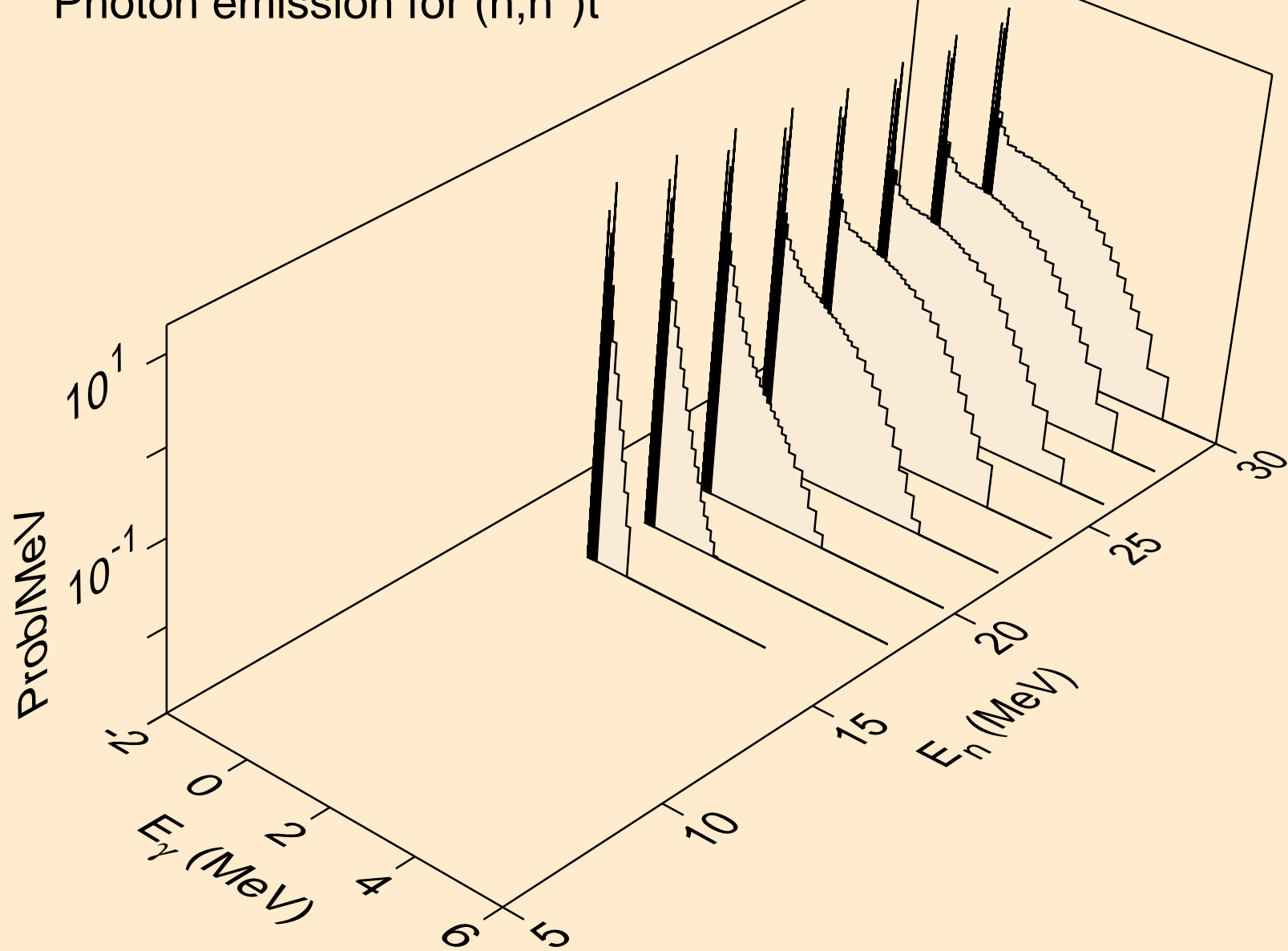

FM246 NEUTRON ACER TENDL-2024 LIBRARY; T=0.K  
Photon emission for (n,n\*)he3

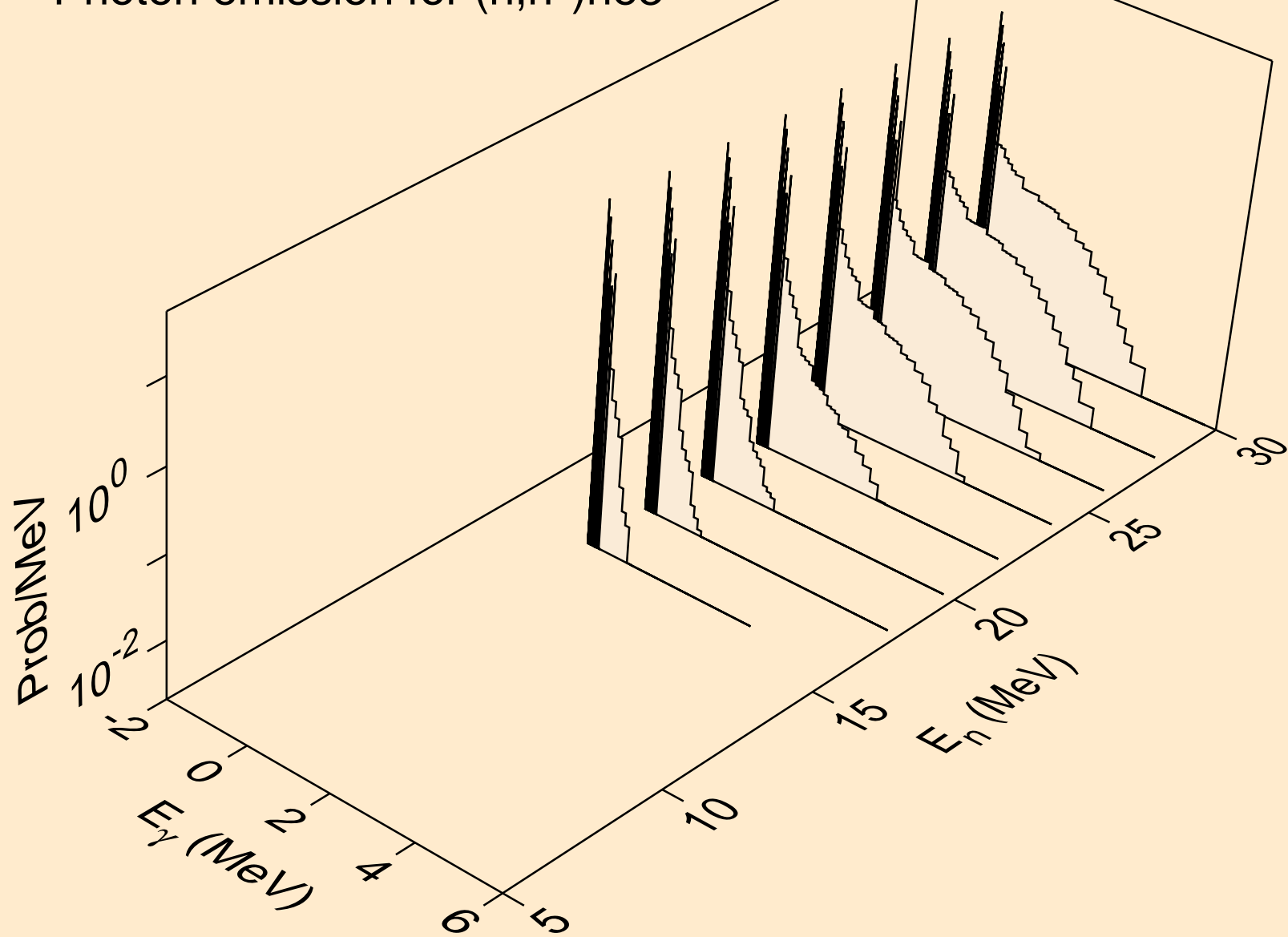

FM246 NEUTRON ACER TENDL-2024 LIBRARY; T=0.K  
Photon emission for (n,4n)

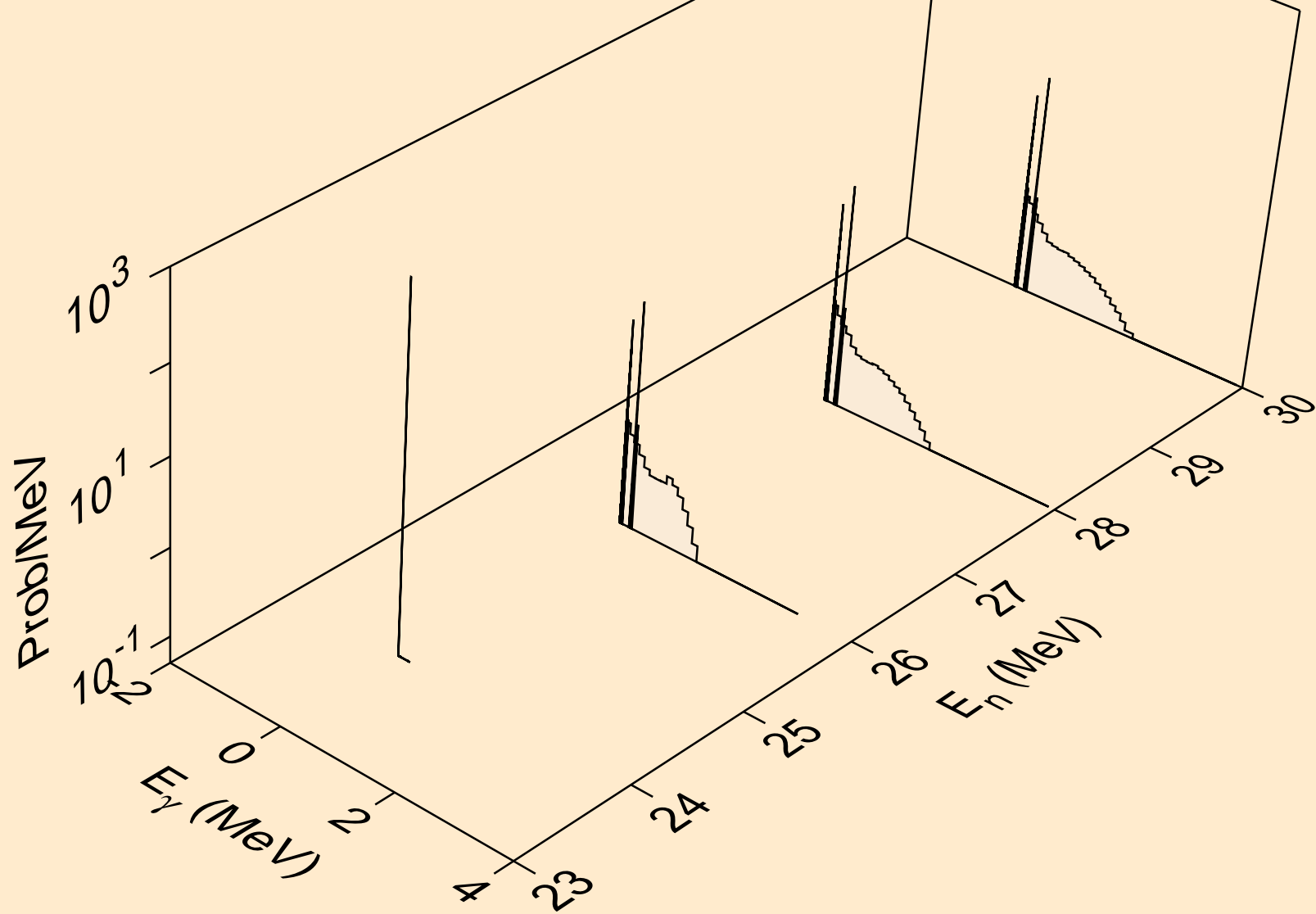

FM246 NEUTRON ACER TENDL-2024 LIBRARY; T=0.K  
Photon emission for (n,2np)

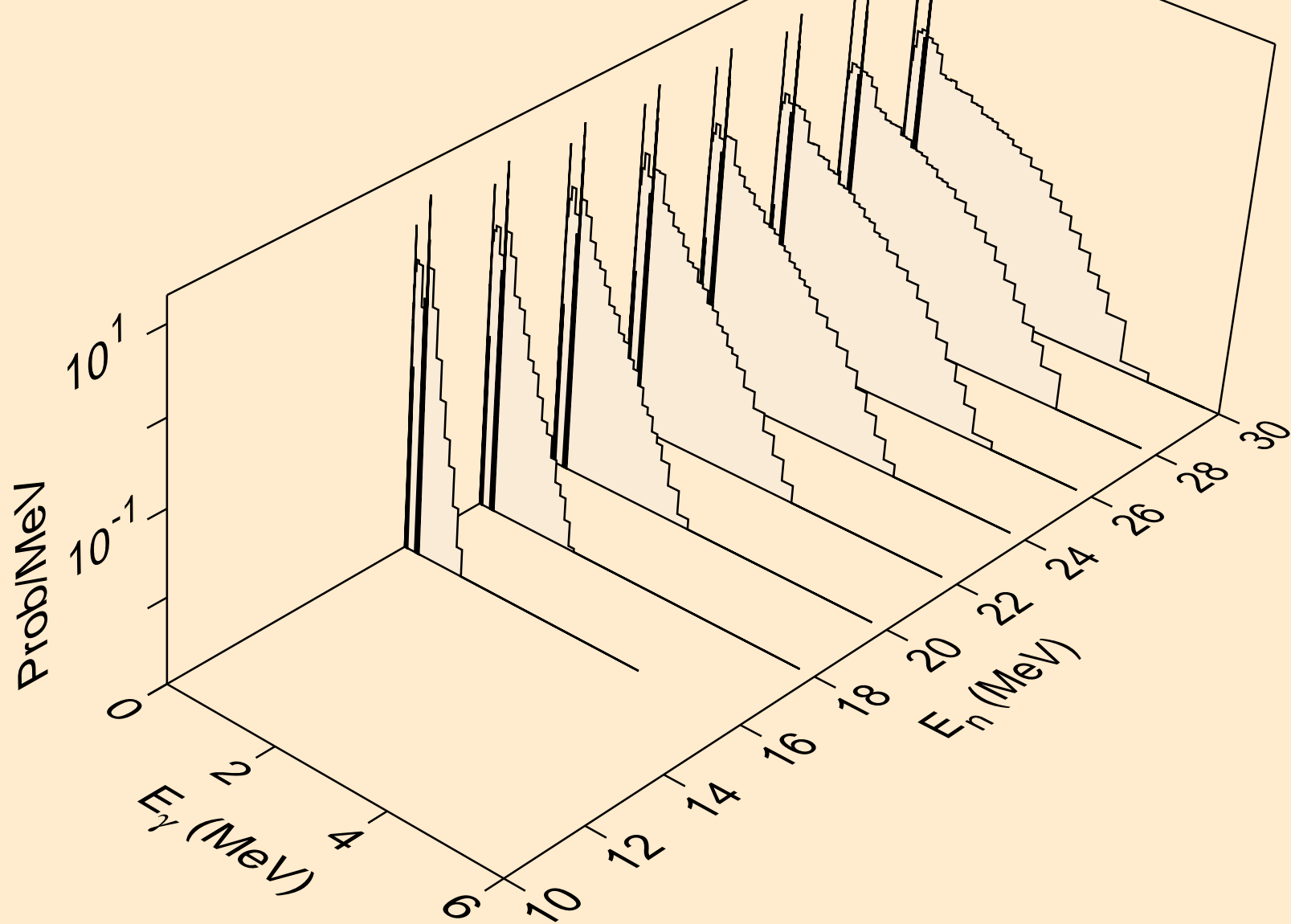

FM246 NEUTRON ACER TENDL-2024 LIBRARY; T=0.K  
Photon emission for (n,n2p)

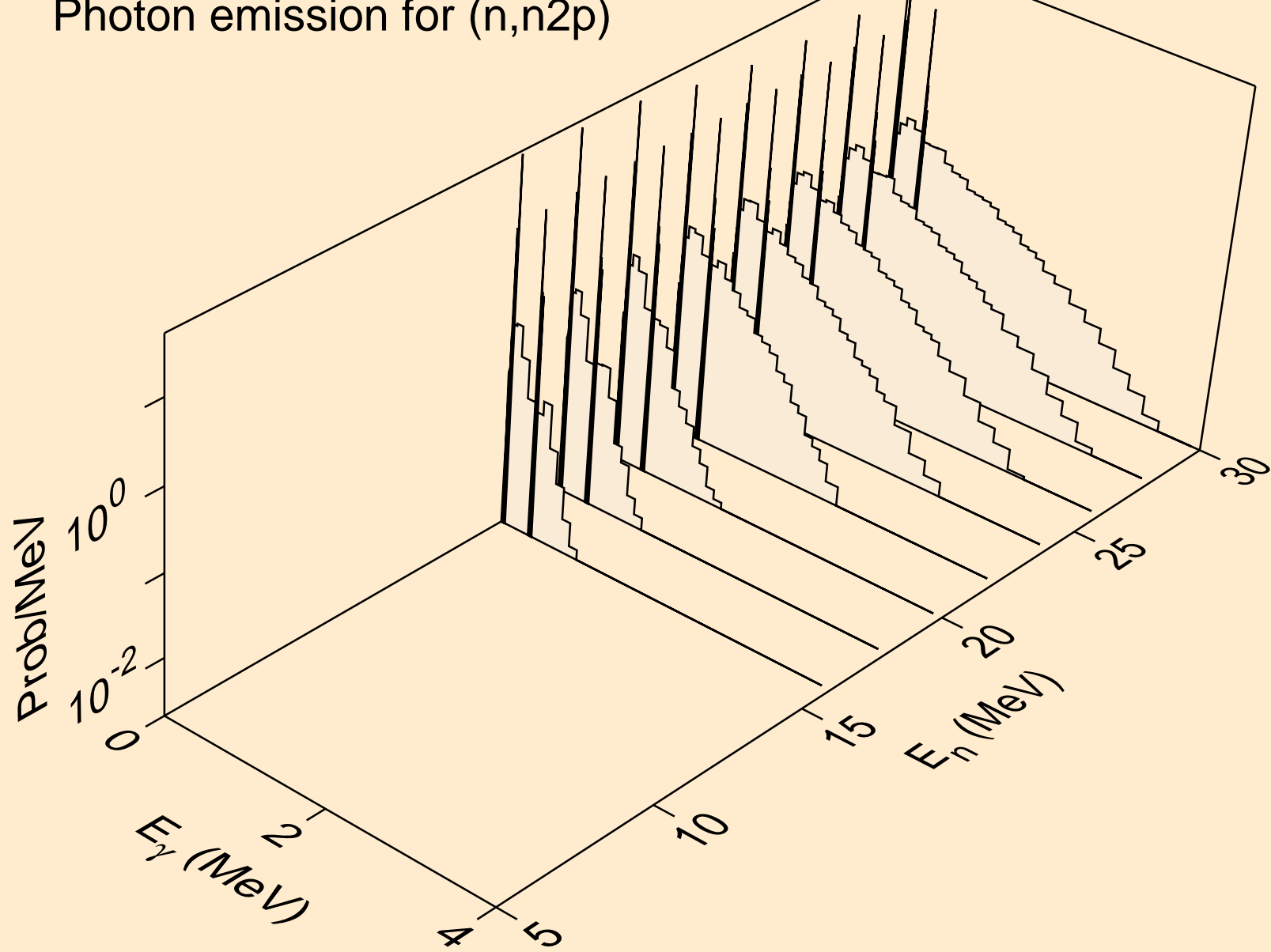



FM246 NEUTRON ACER TENDL-2024 LIBRARY; T=0.K  
Photon emission for (n,n\*c)

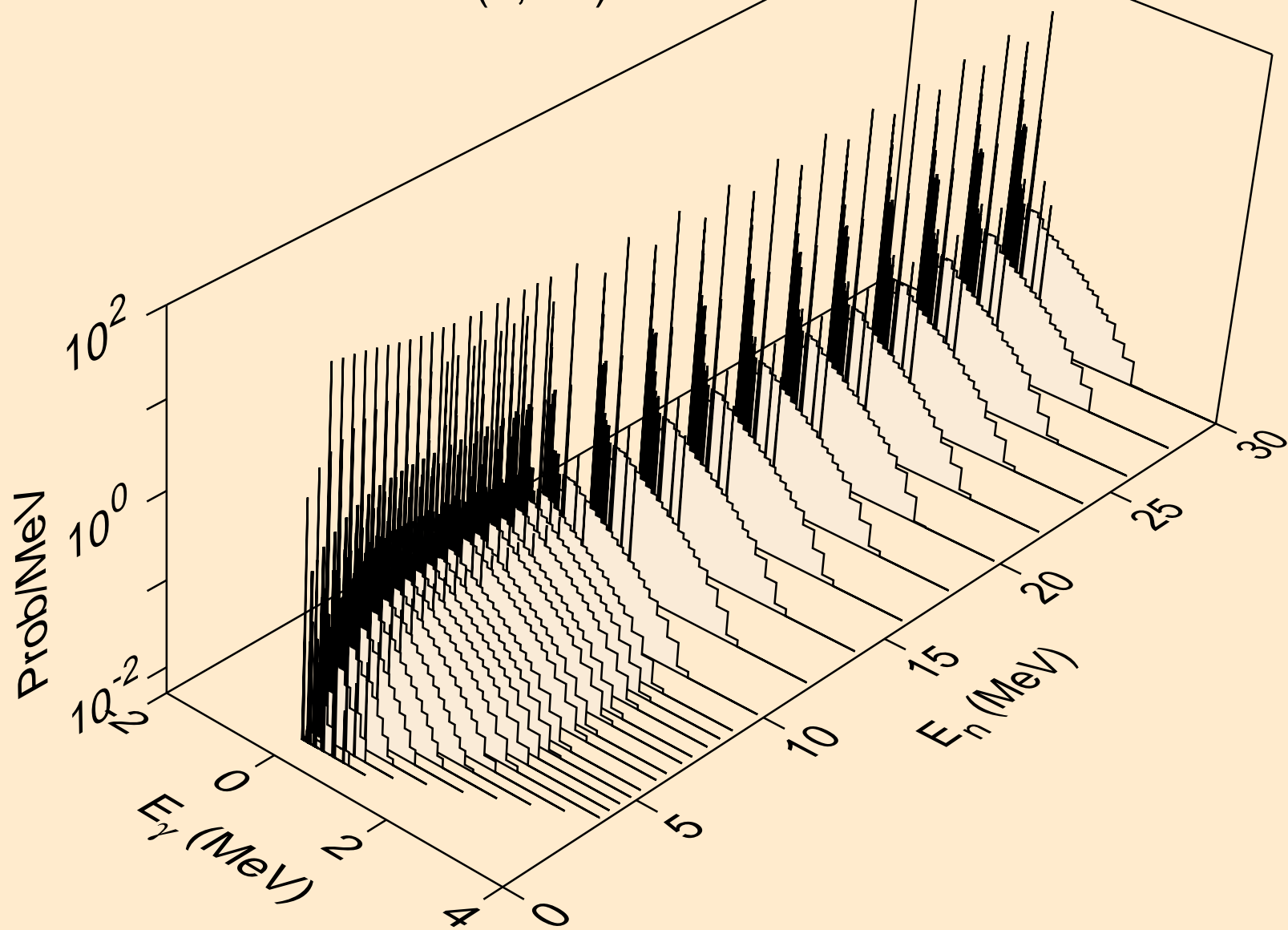

FM246 NEUTRON ACER TENDL-2024 LIBRARY; T=0.K  
Photon emission for (n,gma)

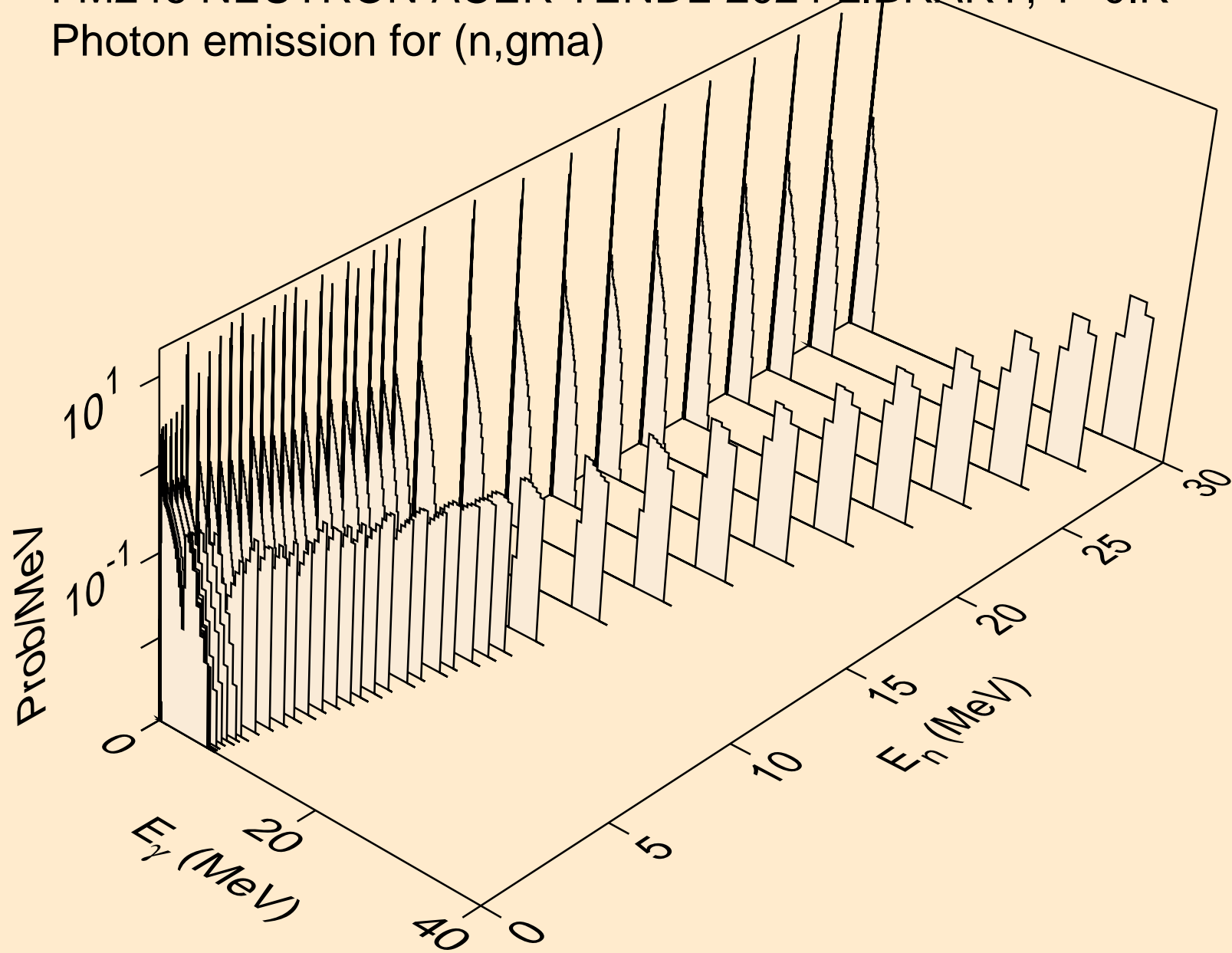

FM246 NEUTRON ACER TENDL-2024 LIBRARY; T=0.K  
Photon emission for (n,p)

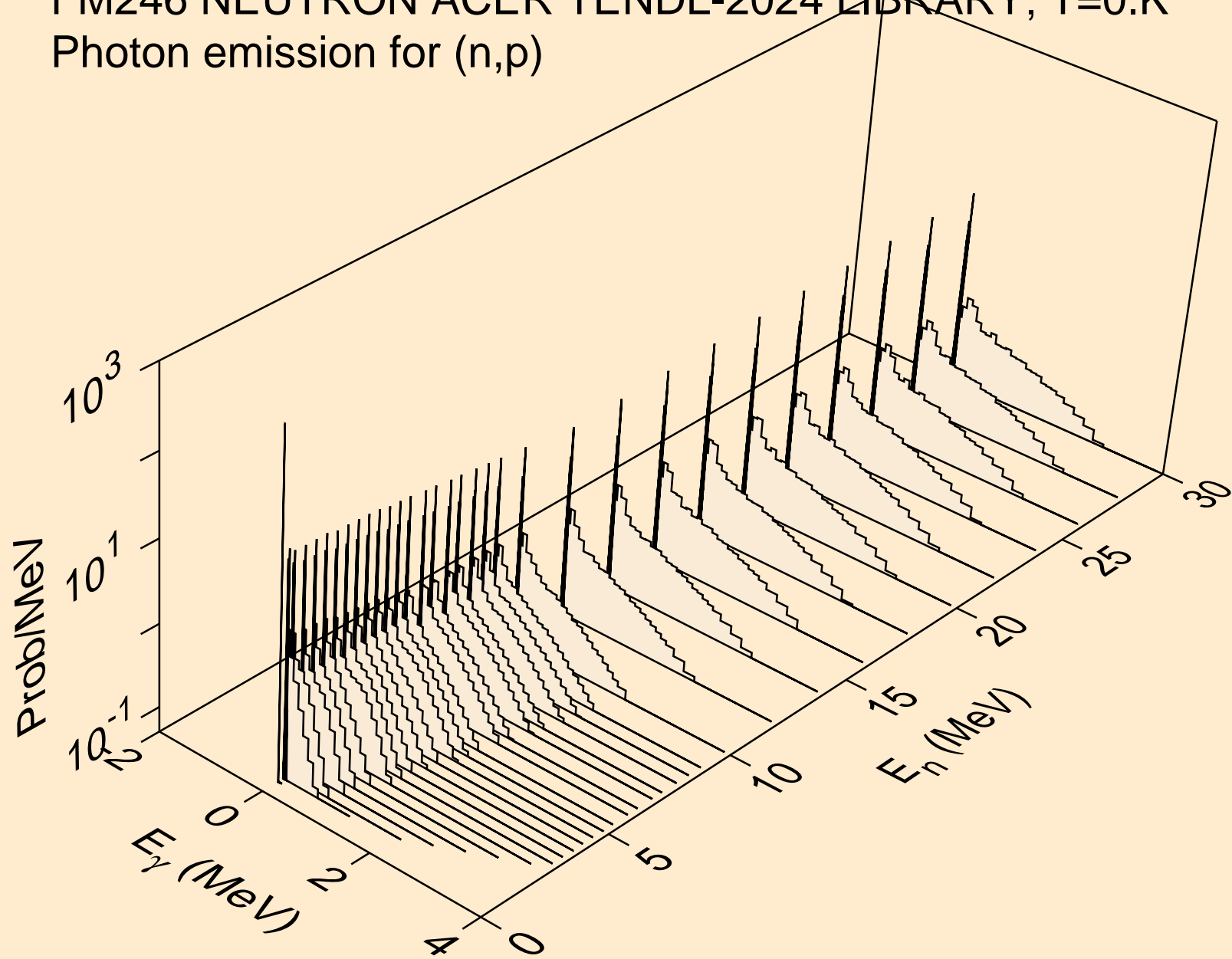

FM246 NEUTRON ACER TENDL-2024 LIBRARY; T=0.K  
Photon emission for (n,d)

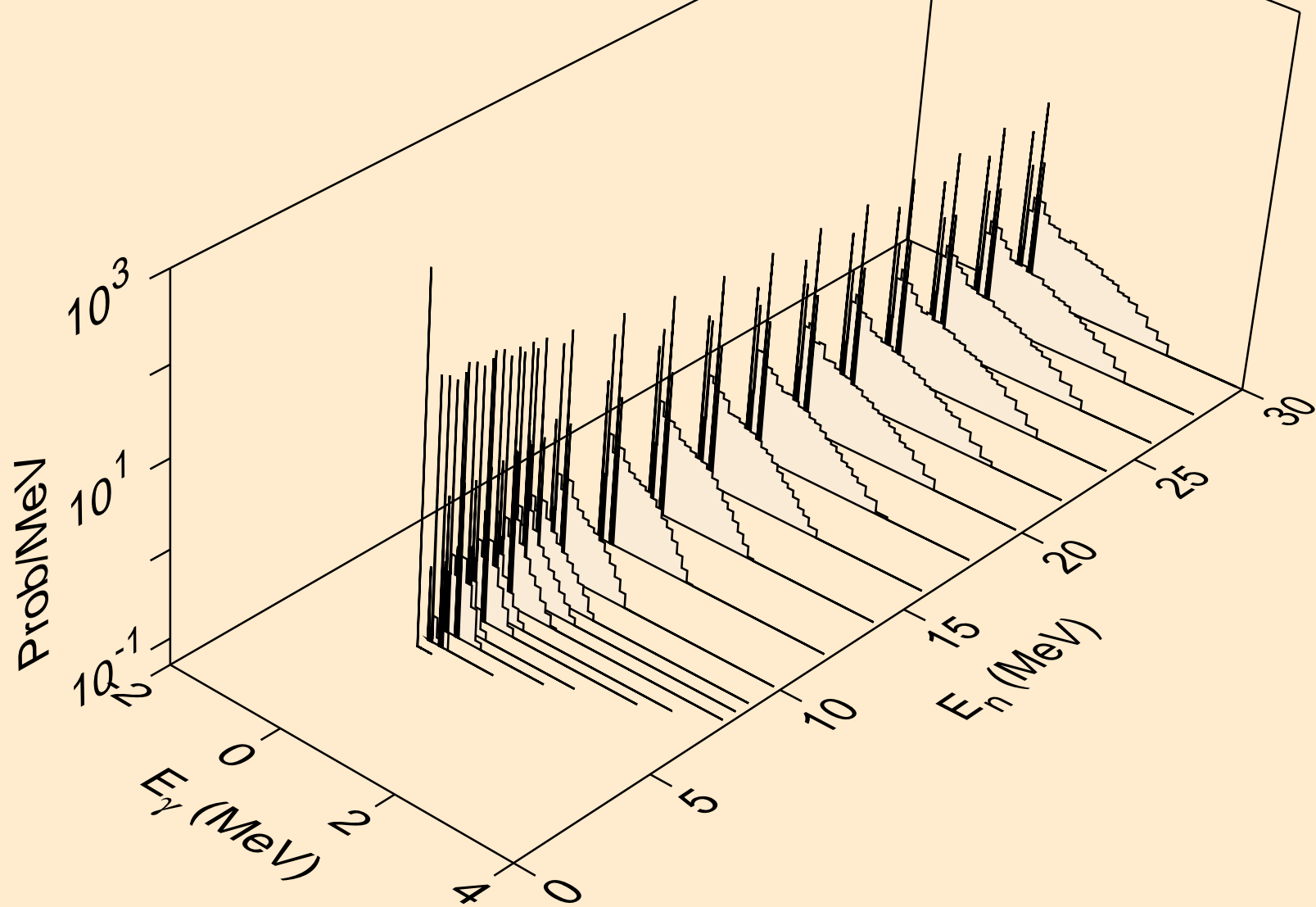

FM246 NEUTRON ACER TENDL-2024 LIBRARY; T=0.K  
Photon emission for (n,t)

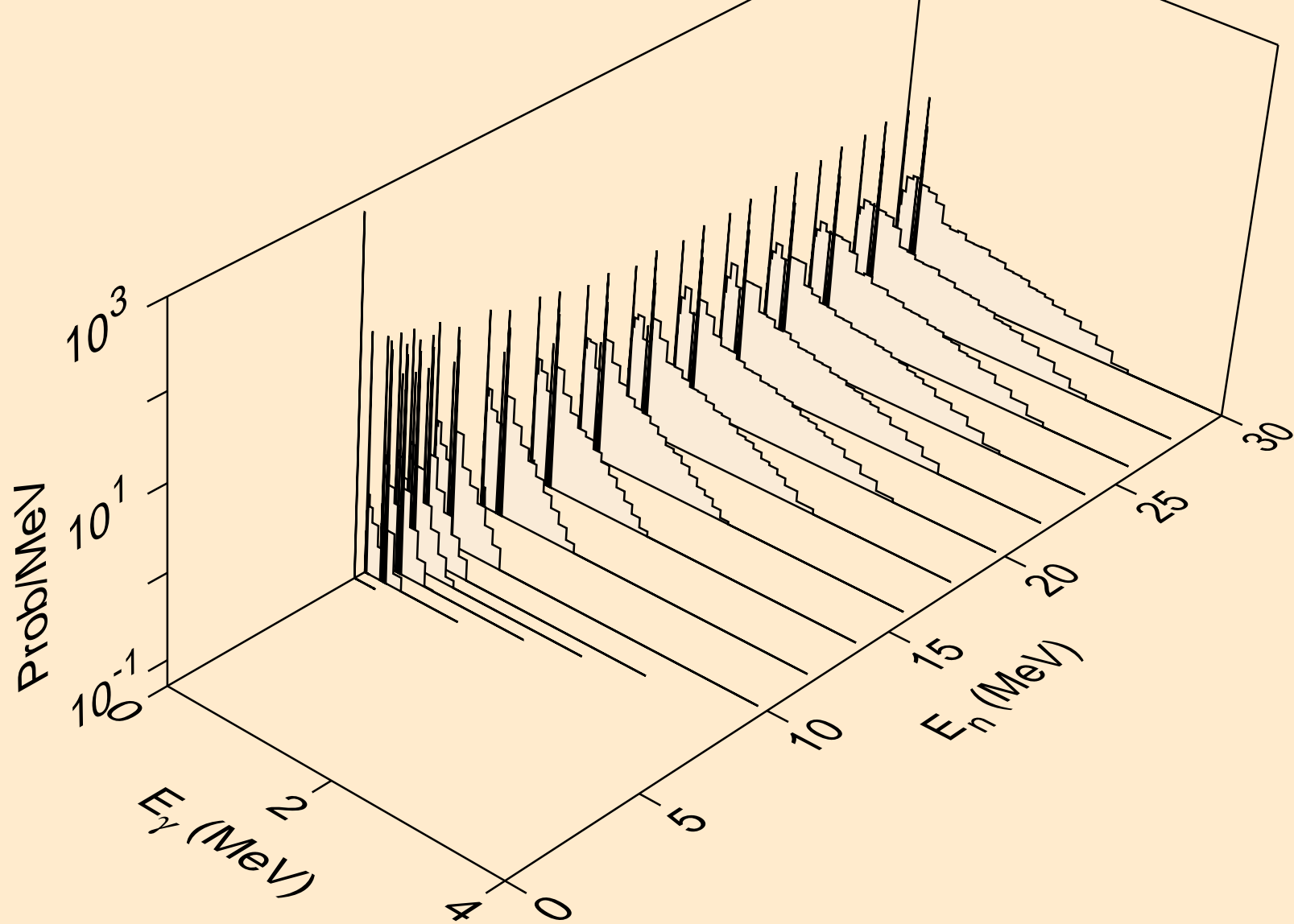

FM246 NEUTRON ACER TENDL-2024 LIBRARY; T=0.K  
Photon emission for (n,he3)

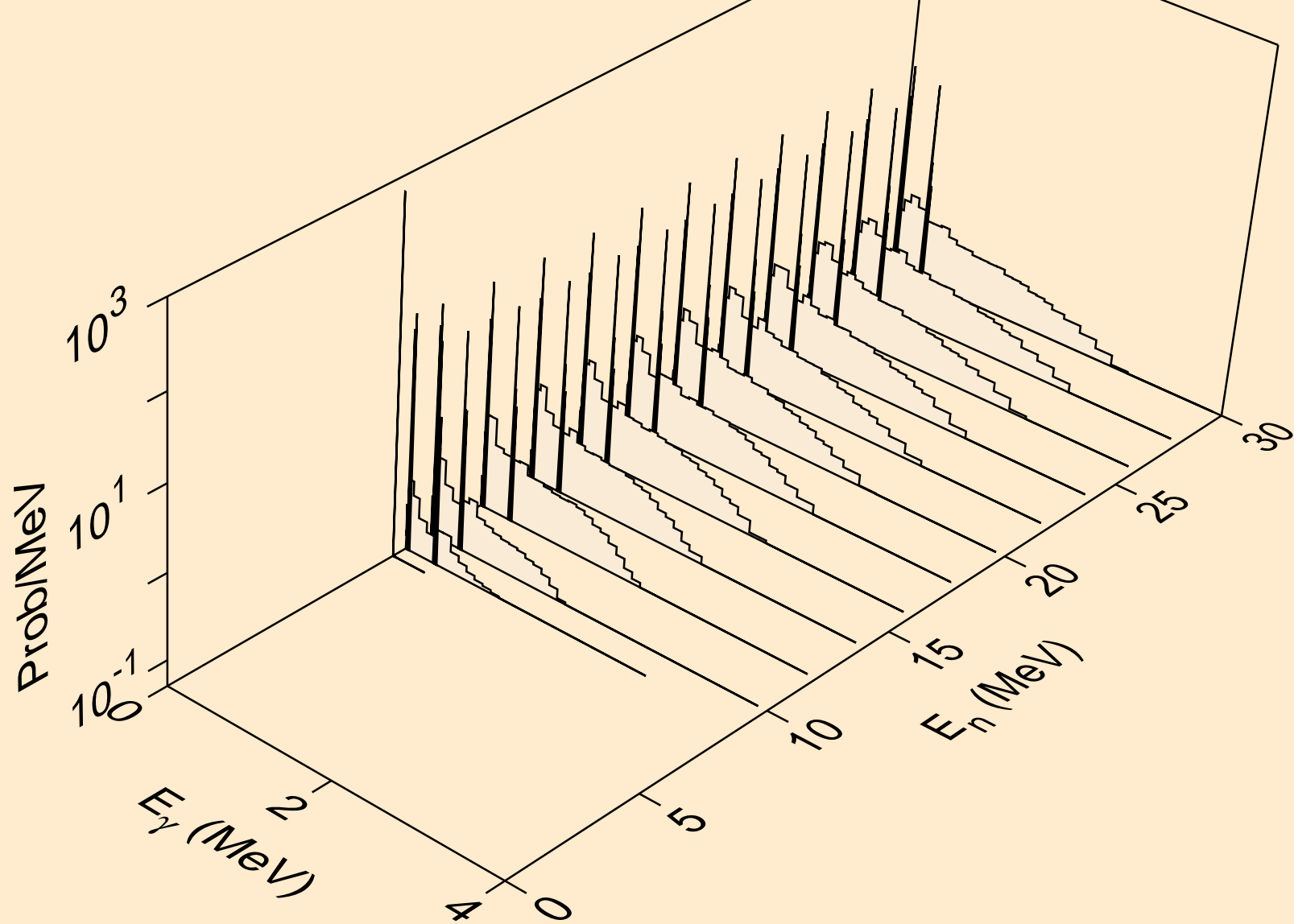

FM246 NEUTRON ACER TENDL-2024 LIBRARY; T=0.K  
Photon emission for (n,a)

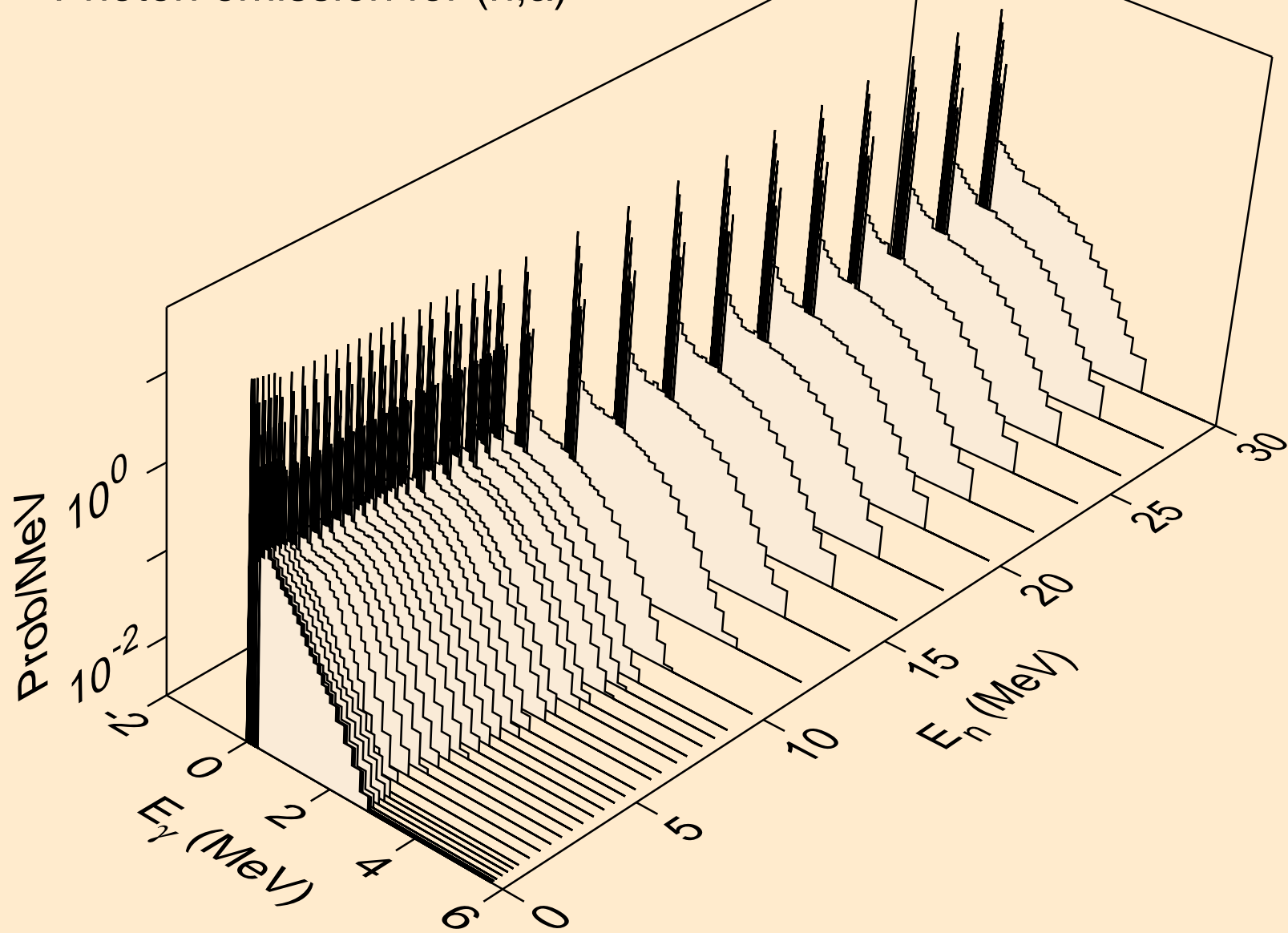

FM246 NEUTRON ACER TENDL-2024 LIBRARY; T=0.K  
Photon emission for (n,2a)

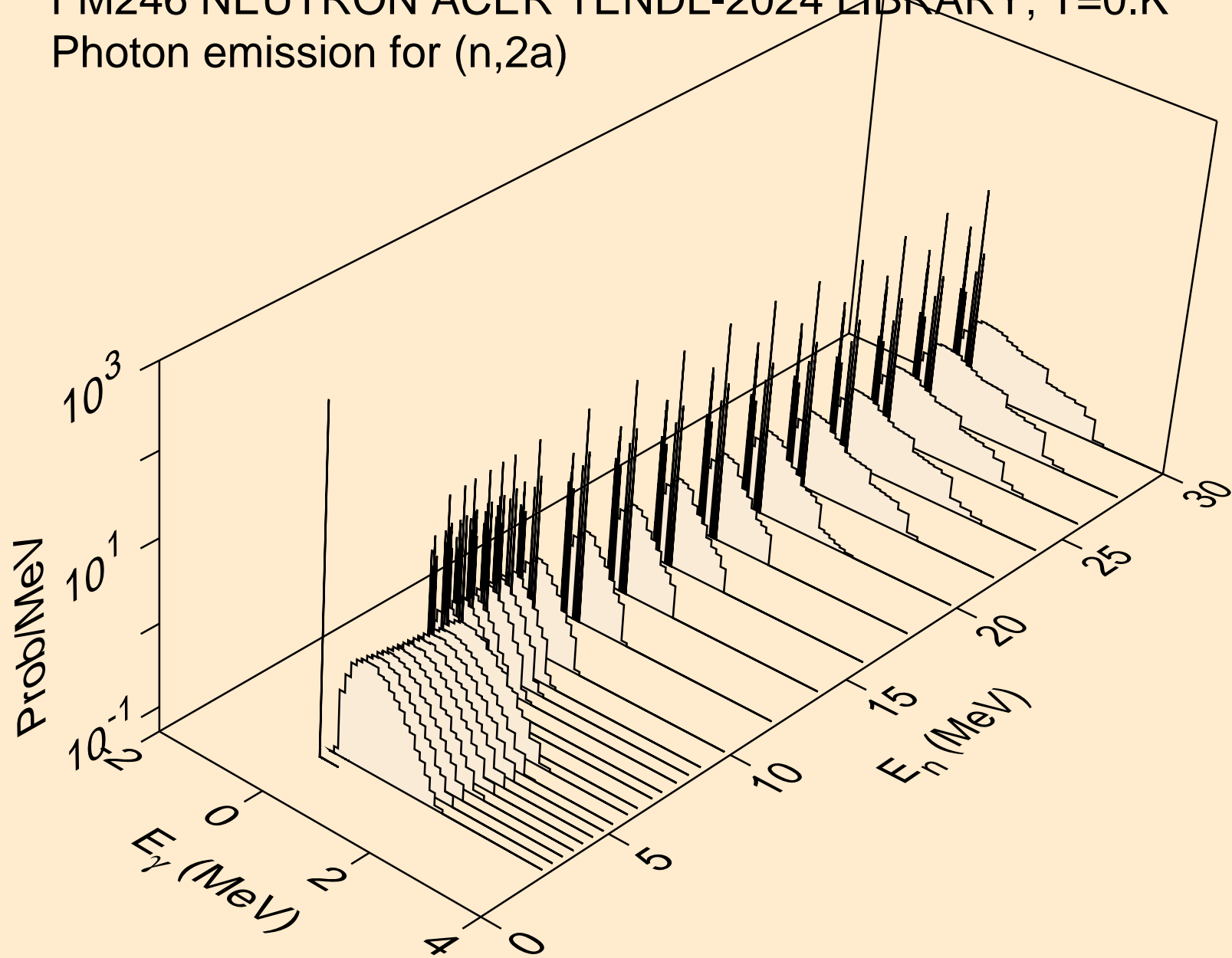



FM246 NEUTRON ACER TENDL-2024 LIBRARY; T=0.K  
Photon emission for (n,2p)

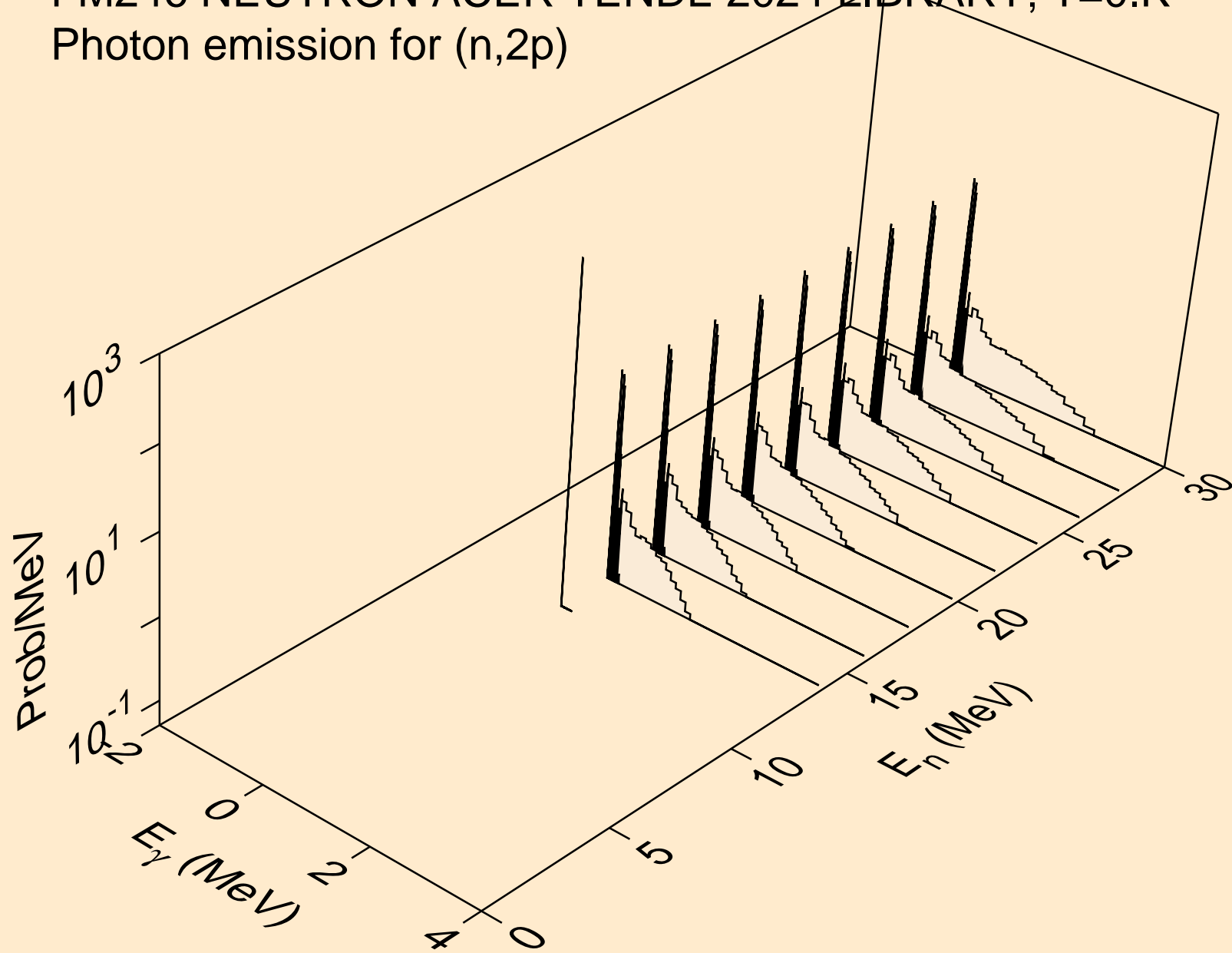

FM246 NEUTRON ACER TENDL-2024 LIBRARY; T=0.K  
Photon emission for (n,p $\alpha$ )

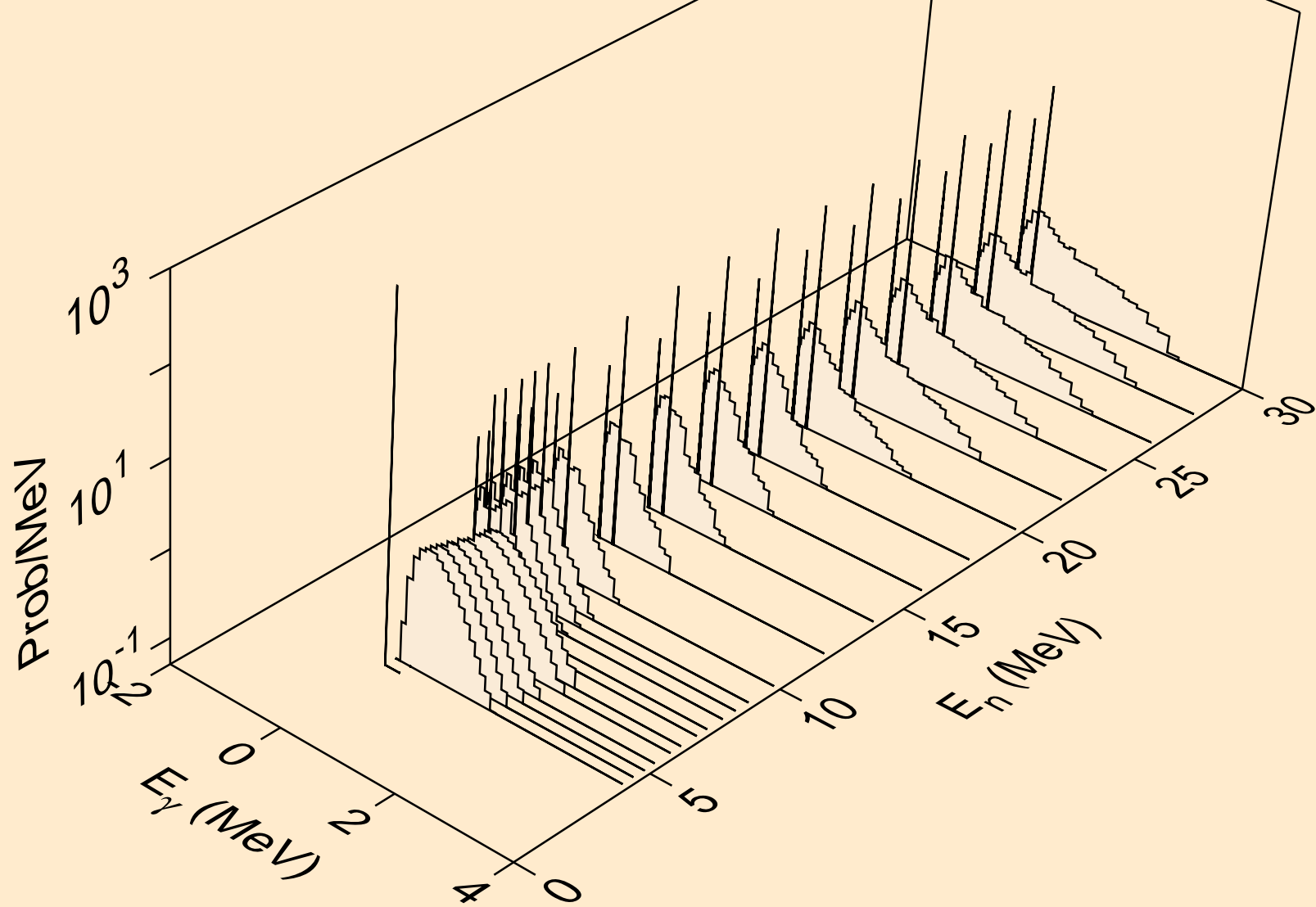

FM246 NEUTRON ACER TENDL-2024 LIBRARY; T=0.K  
Photon emission for (n,pd)

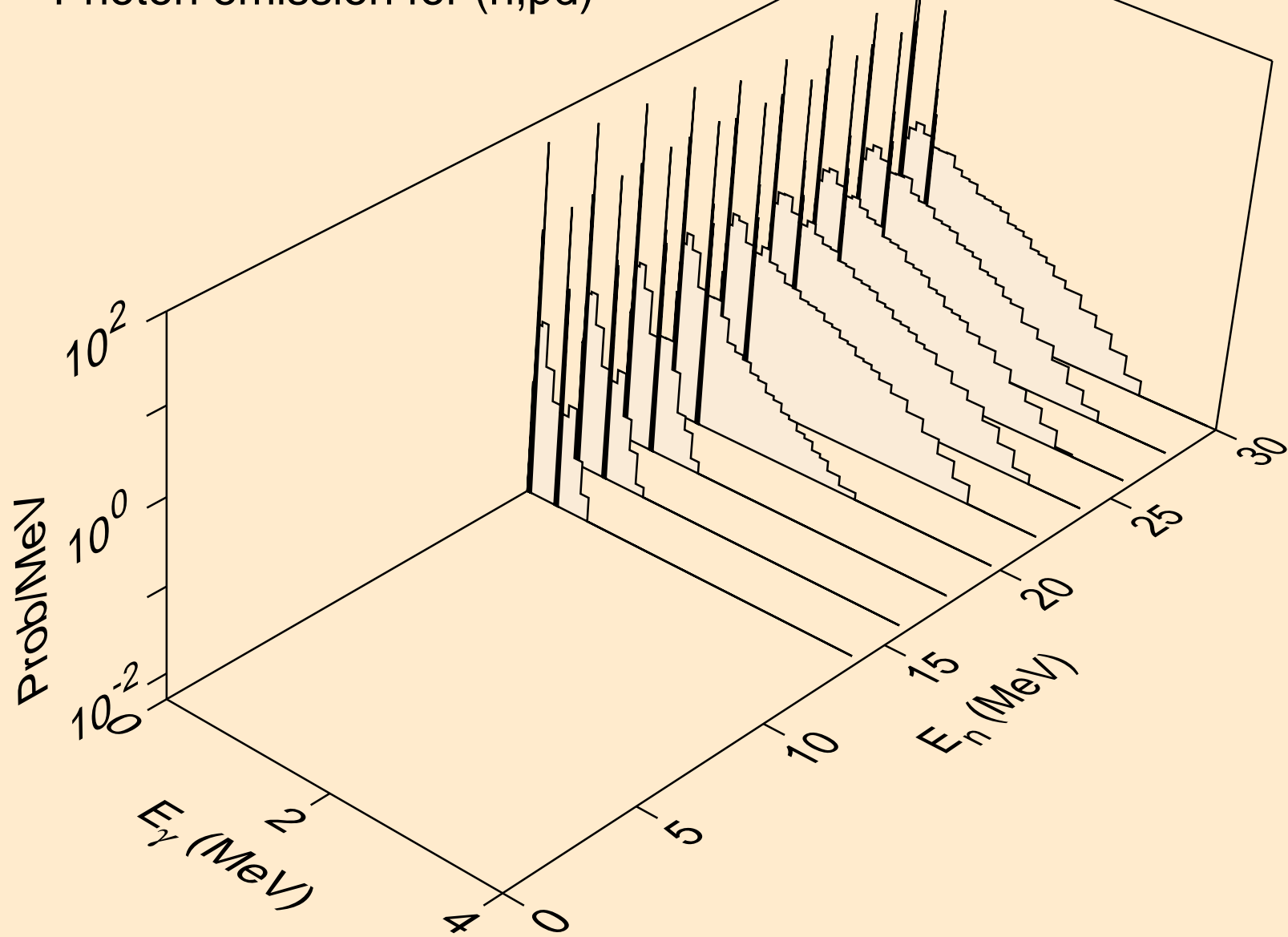

FM246 NEUTRON ACER TENDL-2024 LIBRARY; T=0.K  
Photon emission for (n,pt)

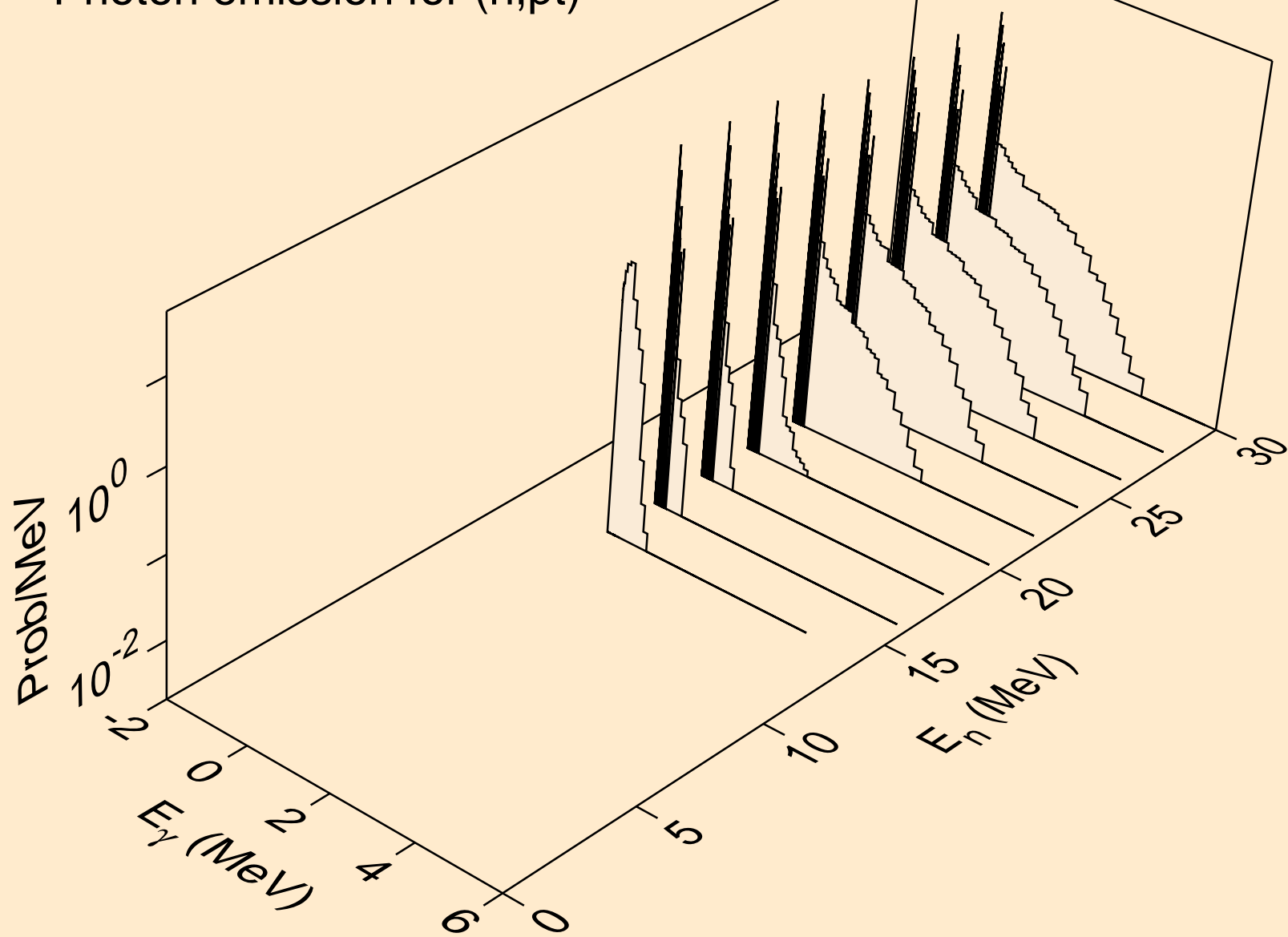

FM246 NEUTRON ACER TENDL-2024 LIBRARY; T=0.K  
thermal capture photon spectrum

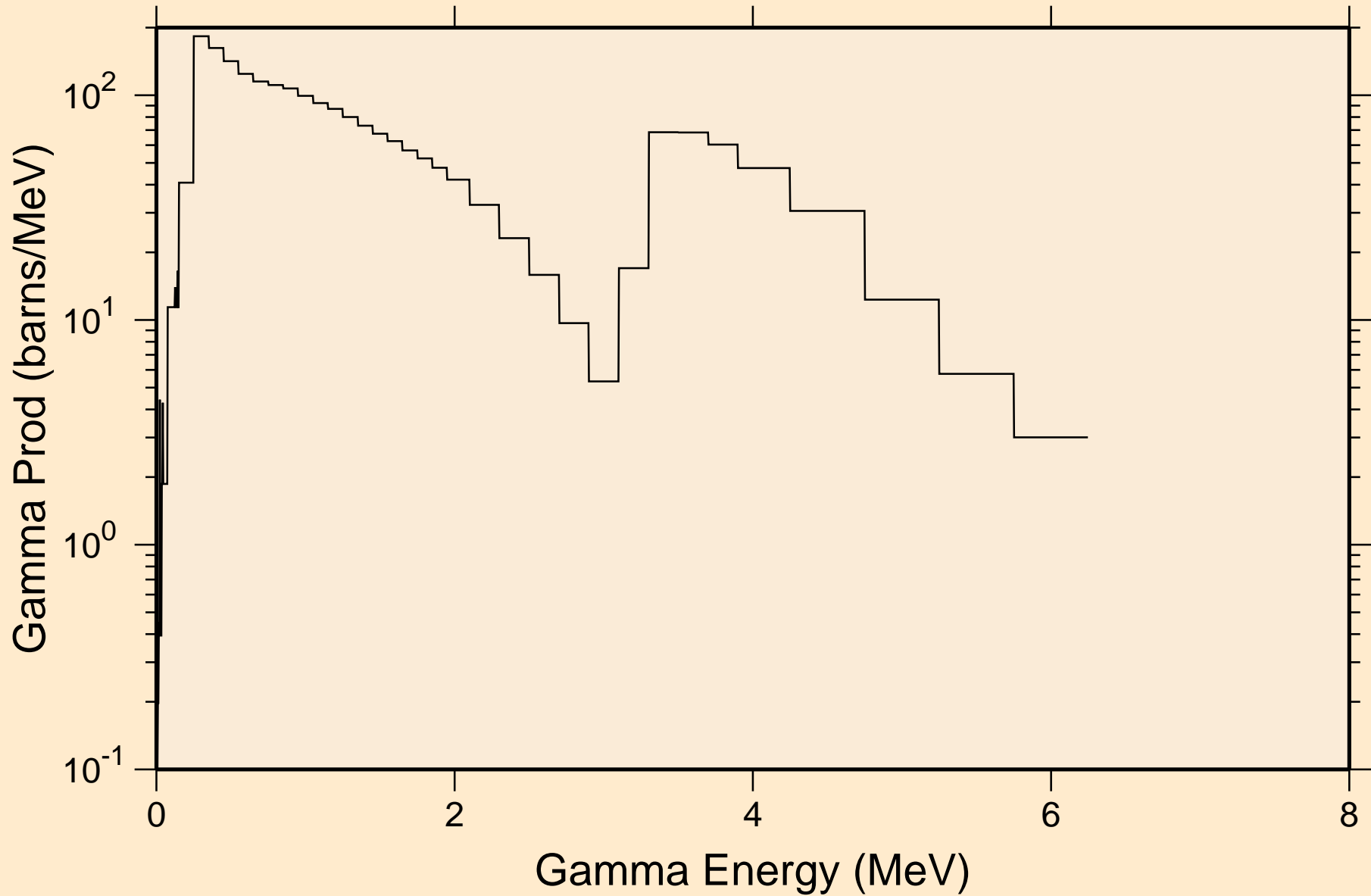

FM246 NEUTRON ACER TENDL-2024 LIBRARY; T=0.K  
14 MeV photon spectrum

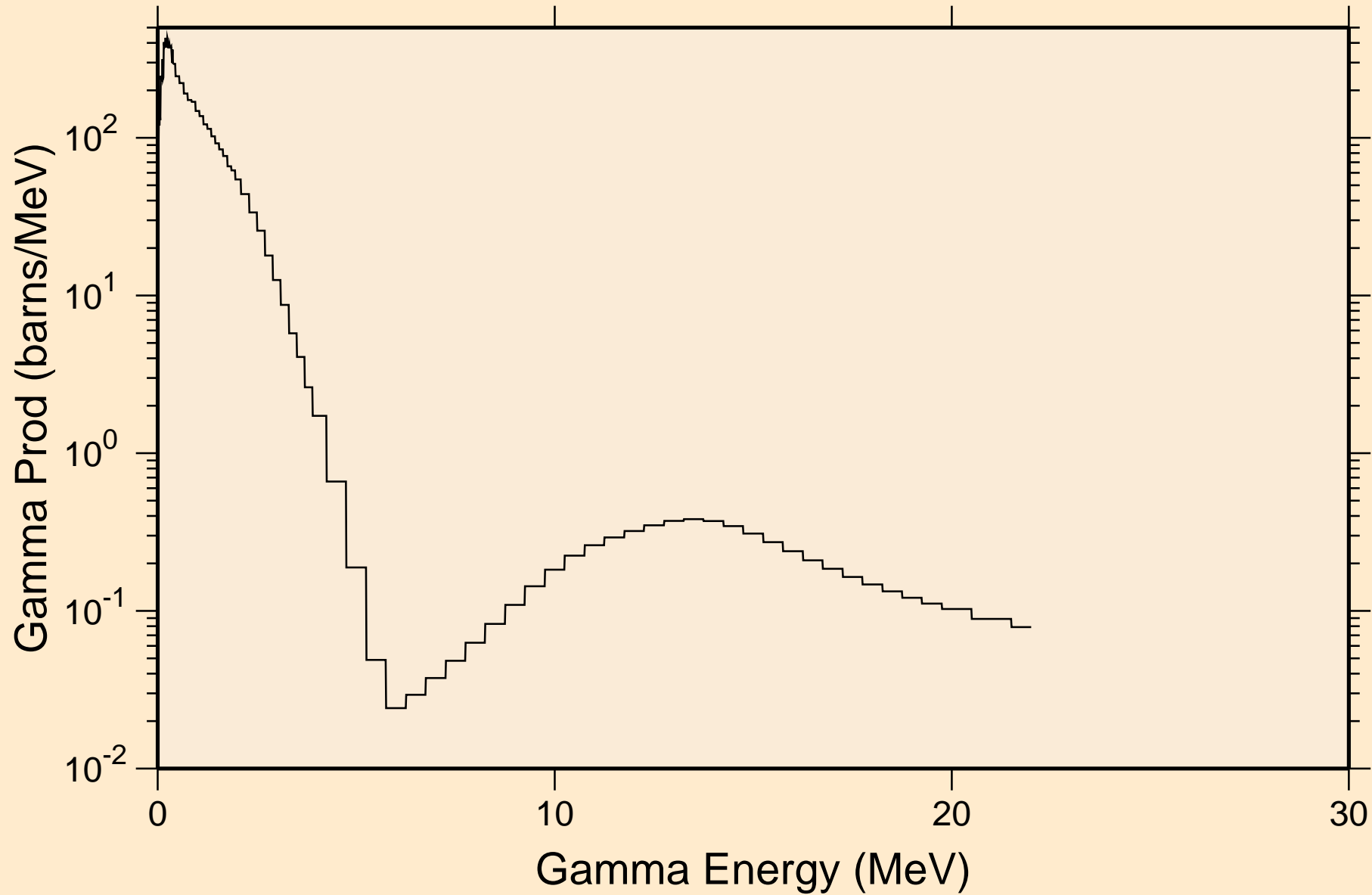

# FM246 NEUTRON ACER TENDL-2024 LIBRARY; T=0.K

## Particle heating contributions

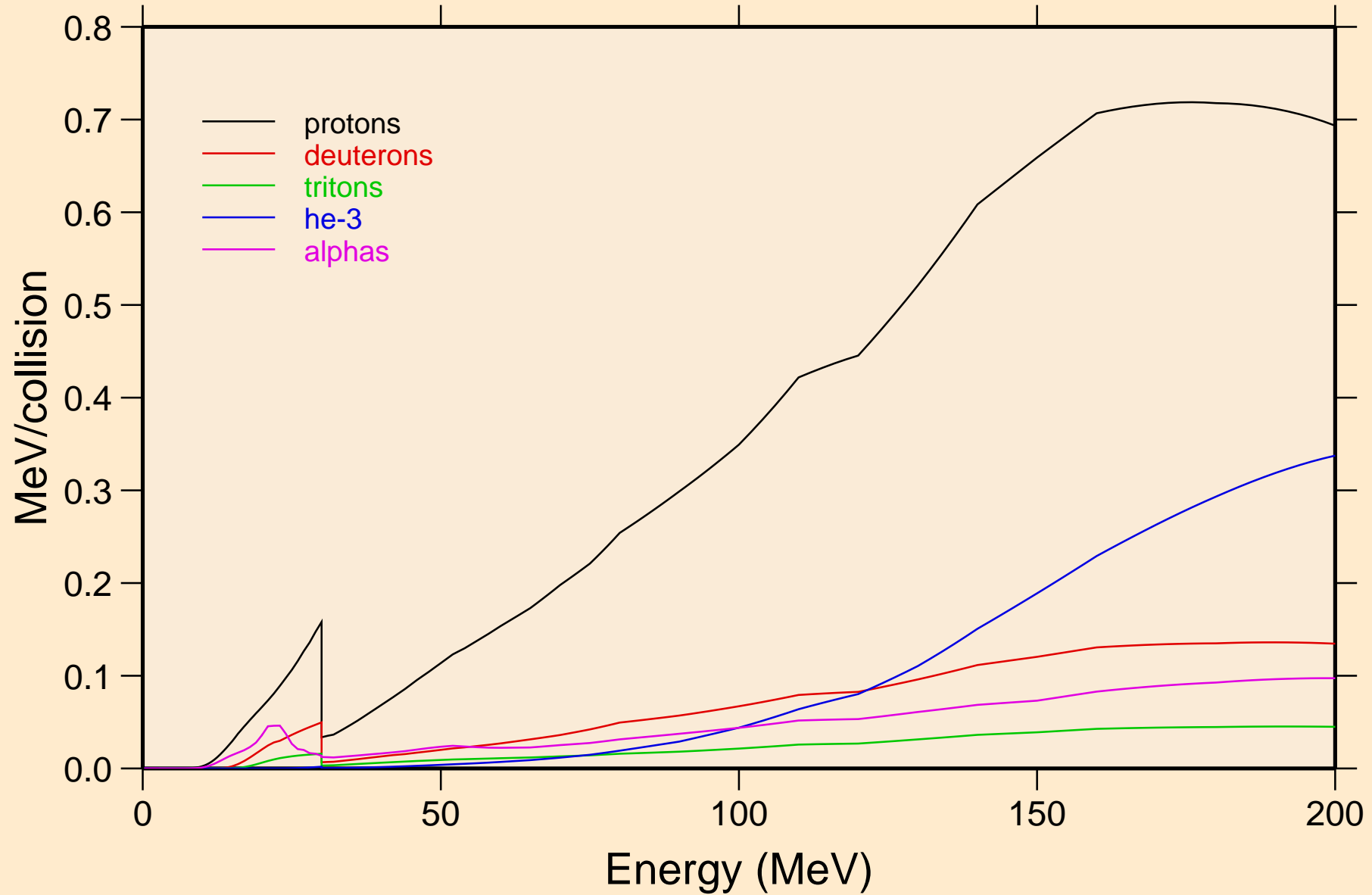

FM246 NEUTRON ACER TENDL-2024 LIBRARY; T=0.K  
Recoil Heating

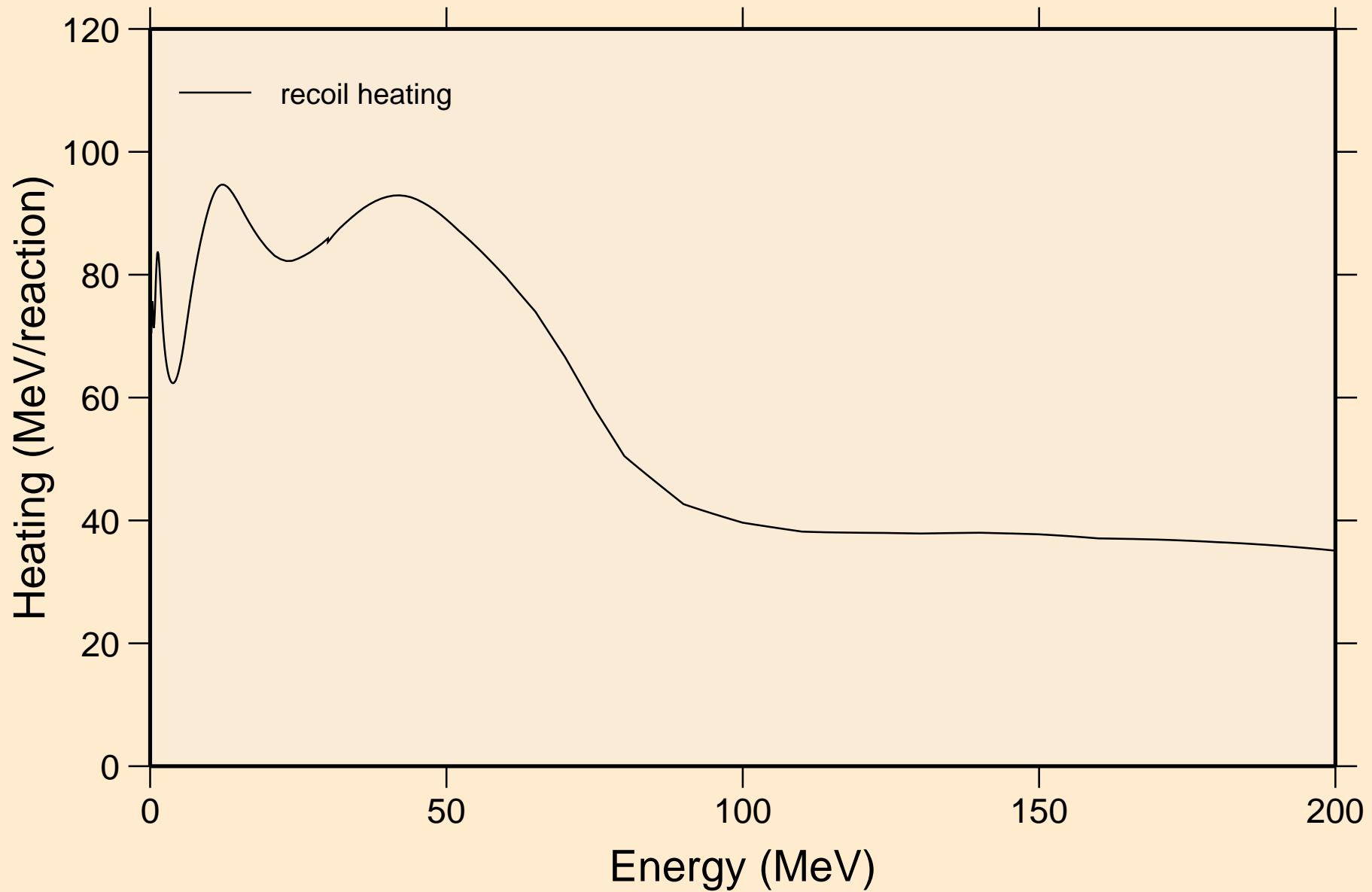



# FM246 NEUTRON ACER TENDL-2024 LIBRARY; T=0.K

## Particle production cross sections

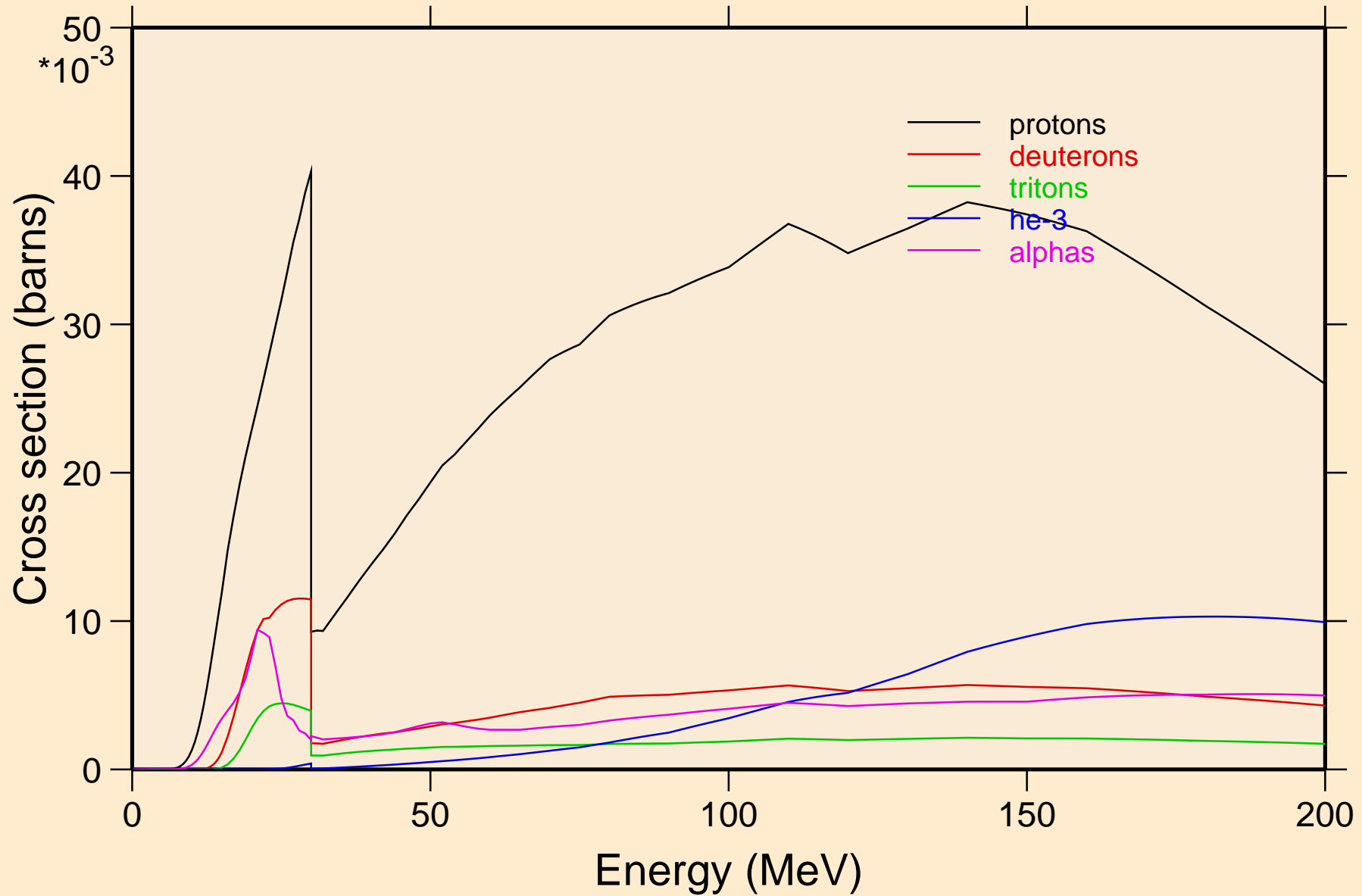

FM246 NEUTRON ACER TENDL-2024 LIBRARY; T=0.K  
protons from (n,x)

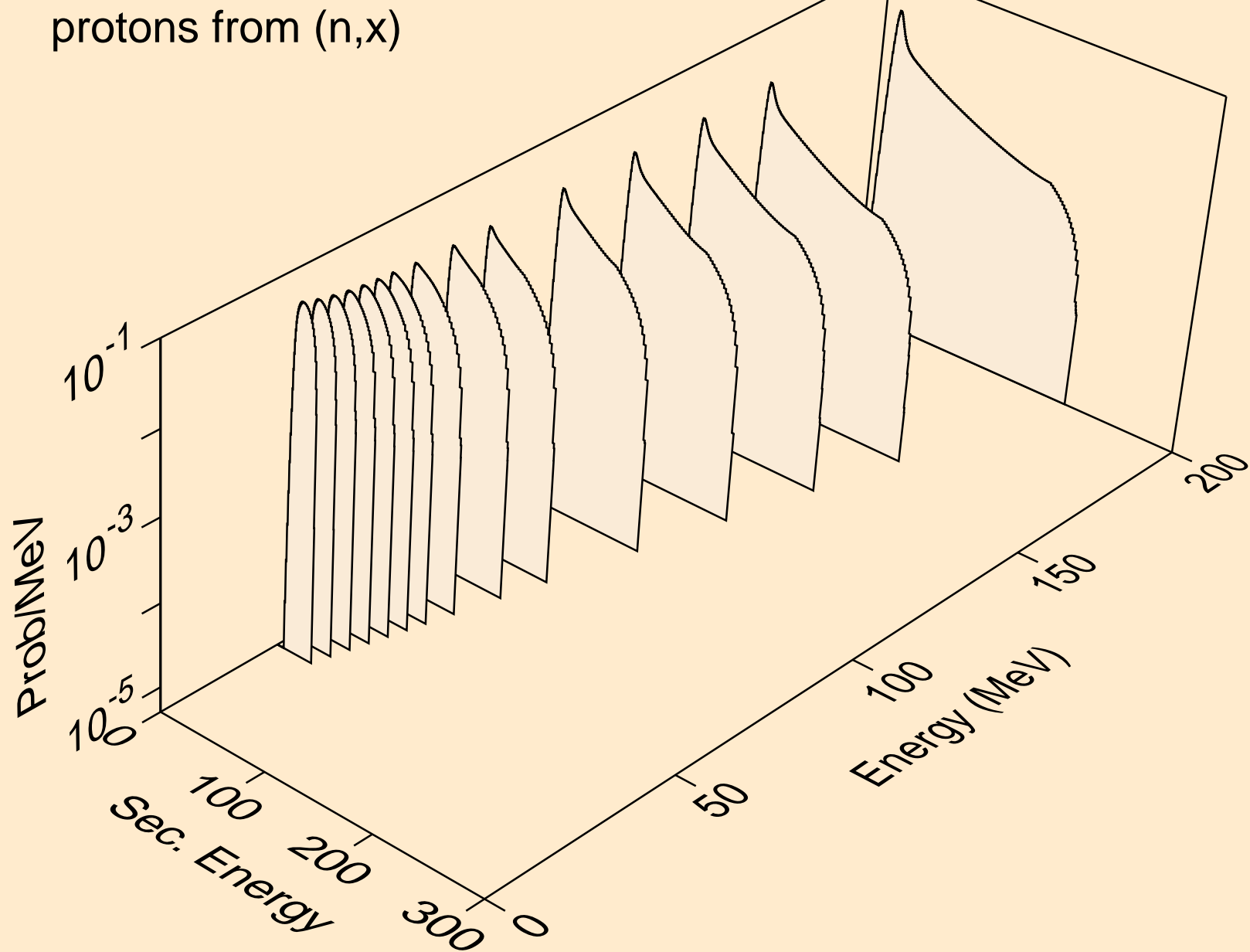

FM246 NEUTRON ACER TENDL-2024 LIBRARY; T=0.K  
protons from (n,n\*)p

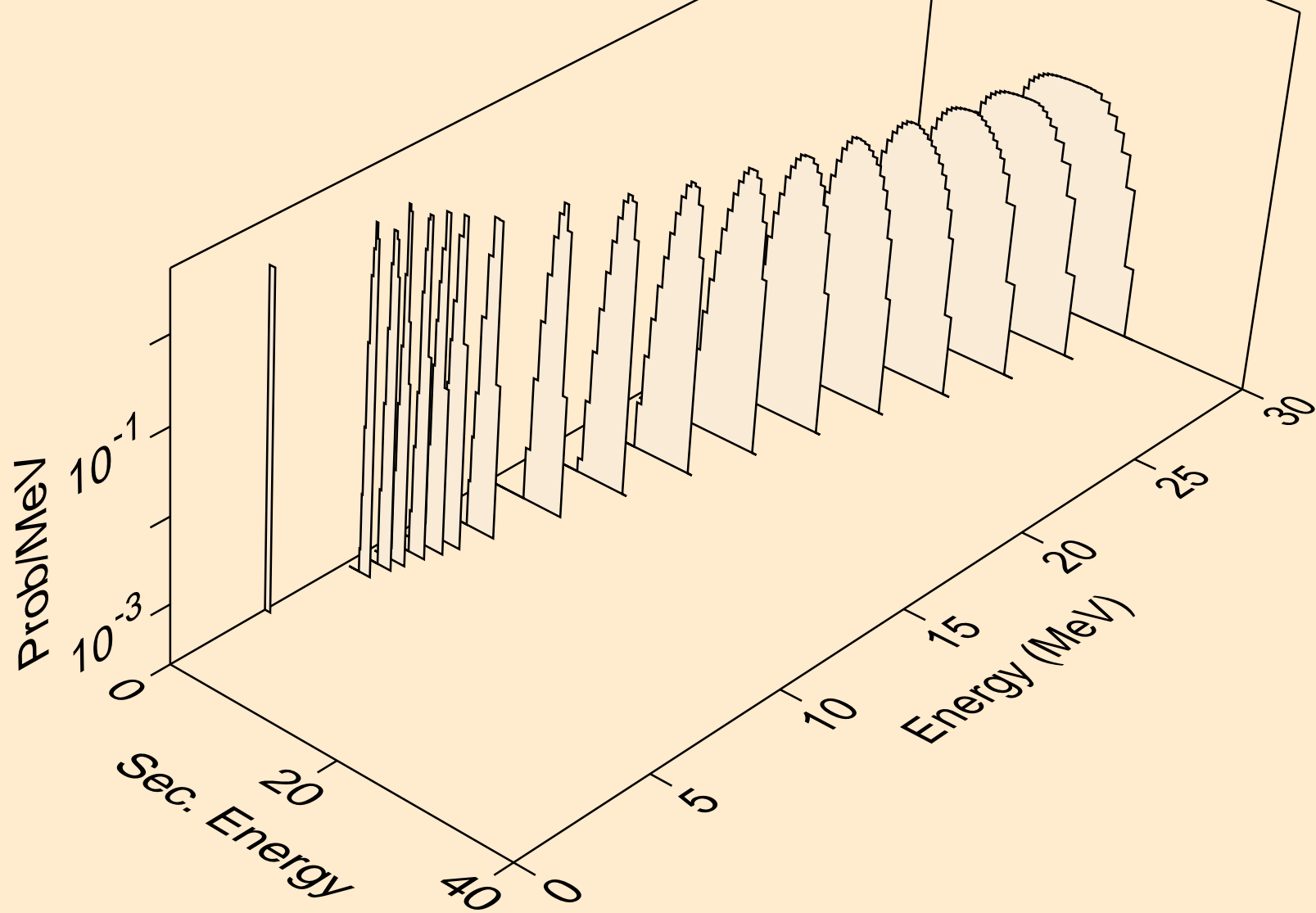

FM246 NEUTRON ACER TENDL-2024 LIBRARY; T=0.K  
protons from (n,2np)

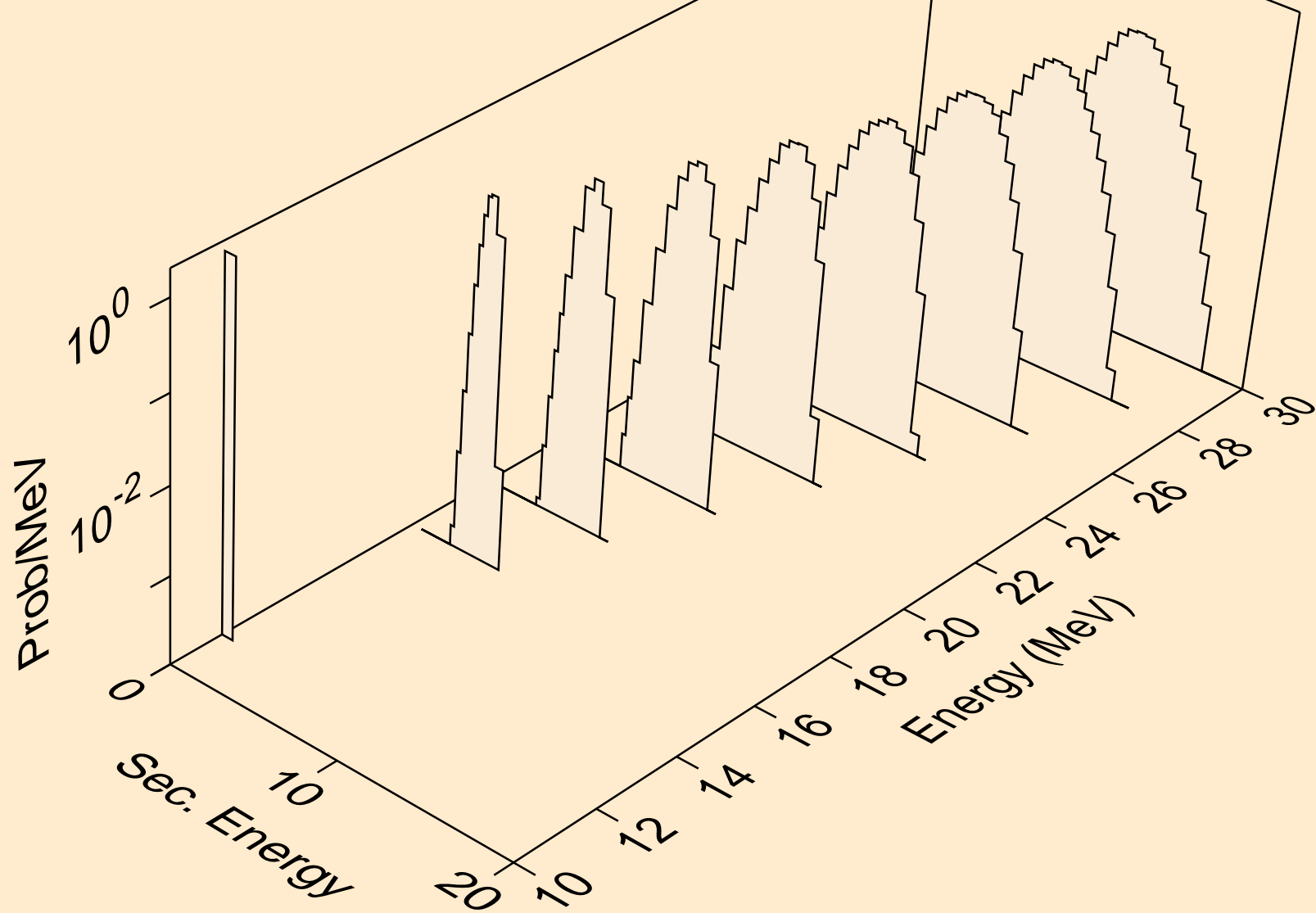

FM246 NEUTRON ACER TENDL-2024 LIBRARY; T=0.K  
protons from (n,n2p)

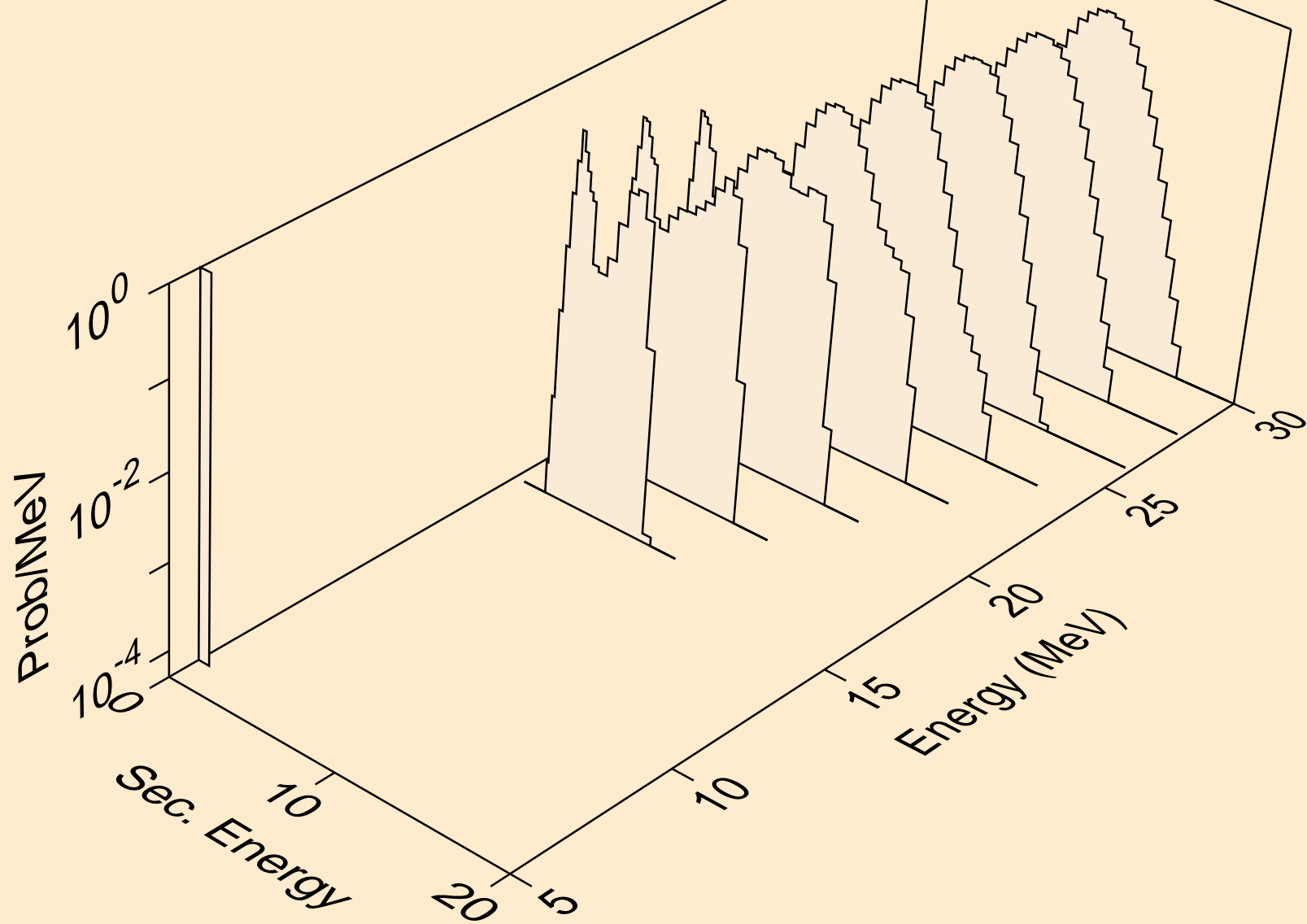

FM246 NEUTRON ACER TENDL-2024 LIBRARY; T=0.K  
protons from (n,p)

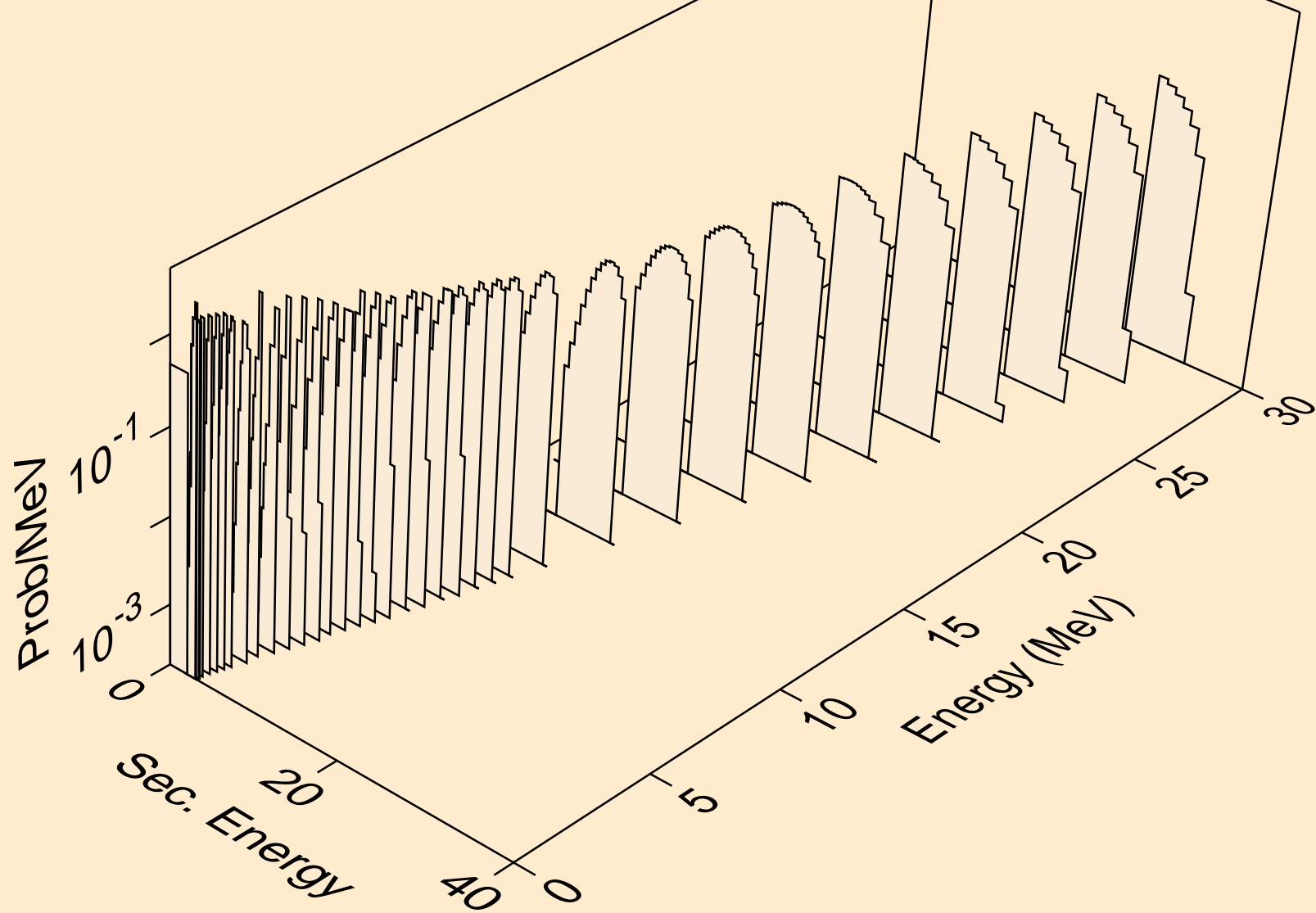

FM246 NEUTRON ACER TENDL-2024 LIBRARY; T=0.K  
protons from (n,2p)

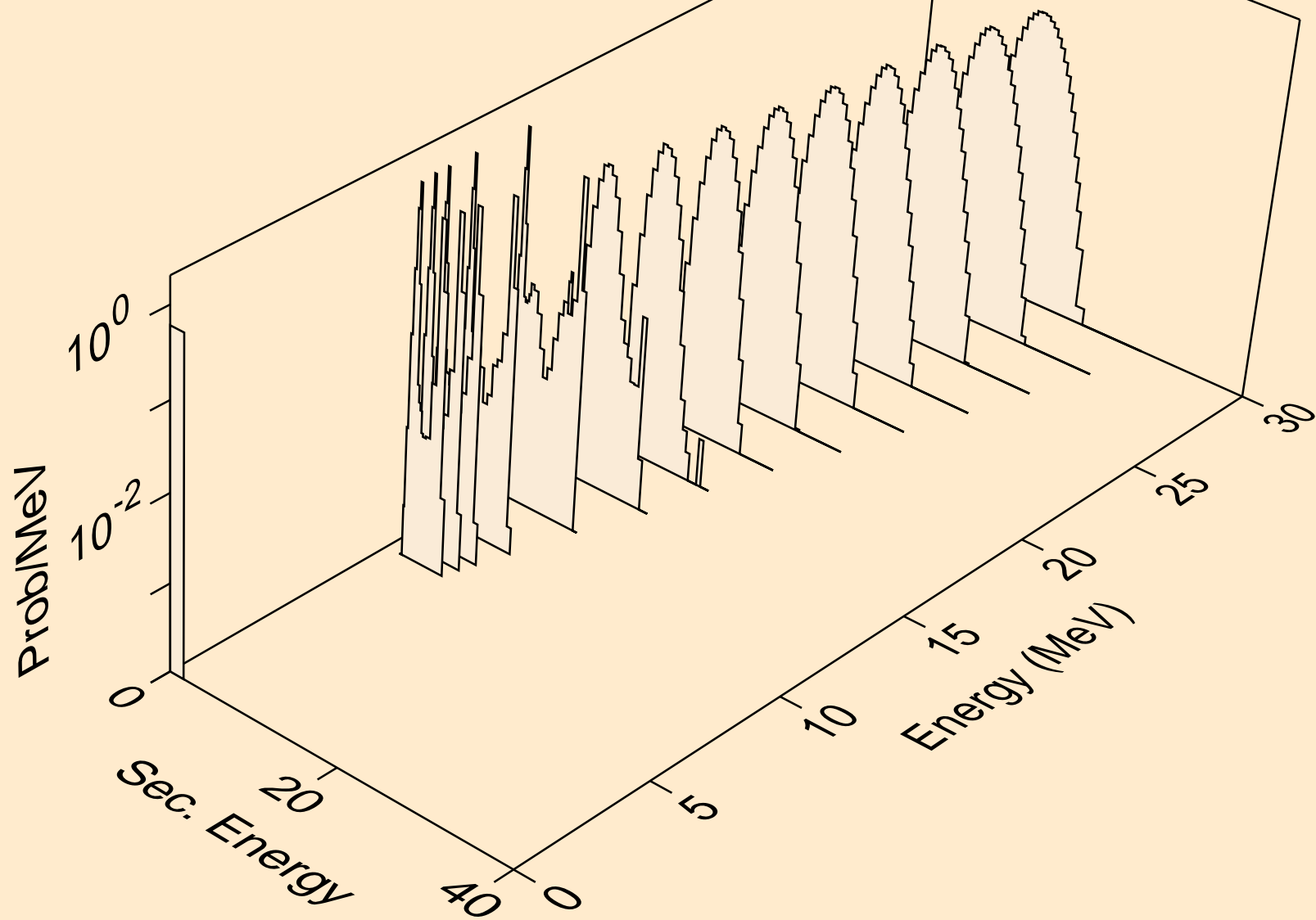

FM246 NEUTRON ACER TENDL-2024 LIBRARY; T=0.K  
protons from (n,p)

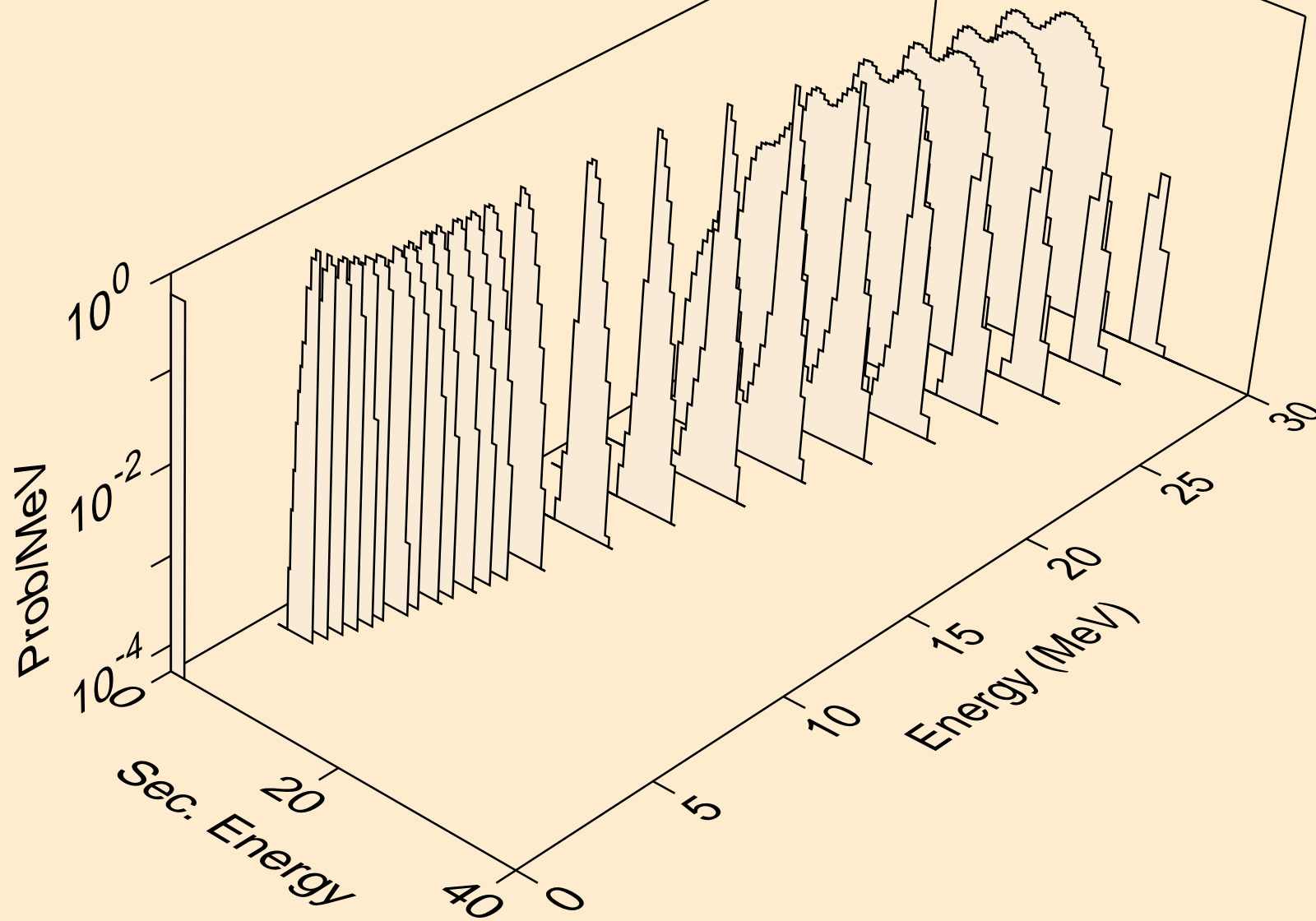



FM246 NEUTRON ACER TENDL-2024 LIBRARY; T=0.K  
protons from (n,pd)

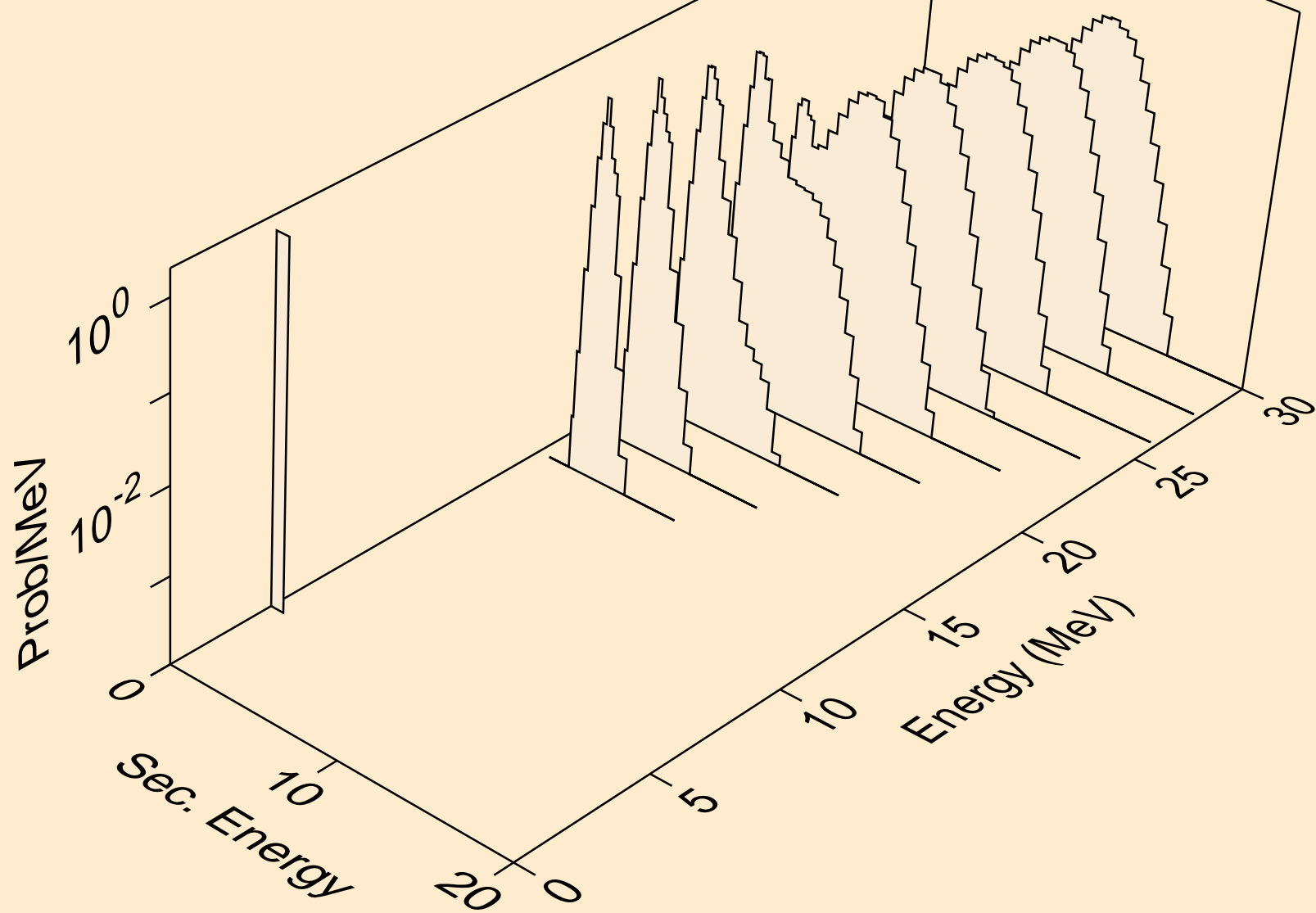

FM246 NEUTRON ACER TENDL-2024 LIBRARY; T=0.K  
protons from (n,pt)

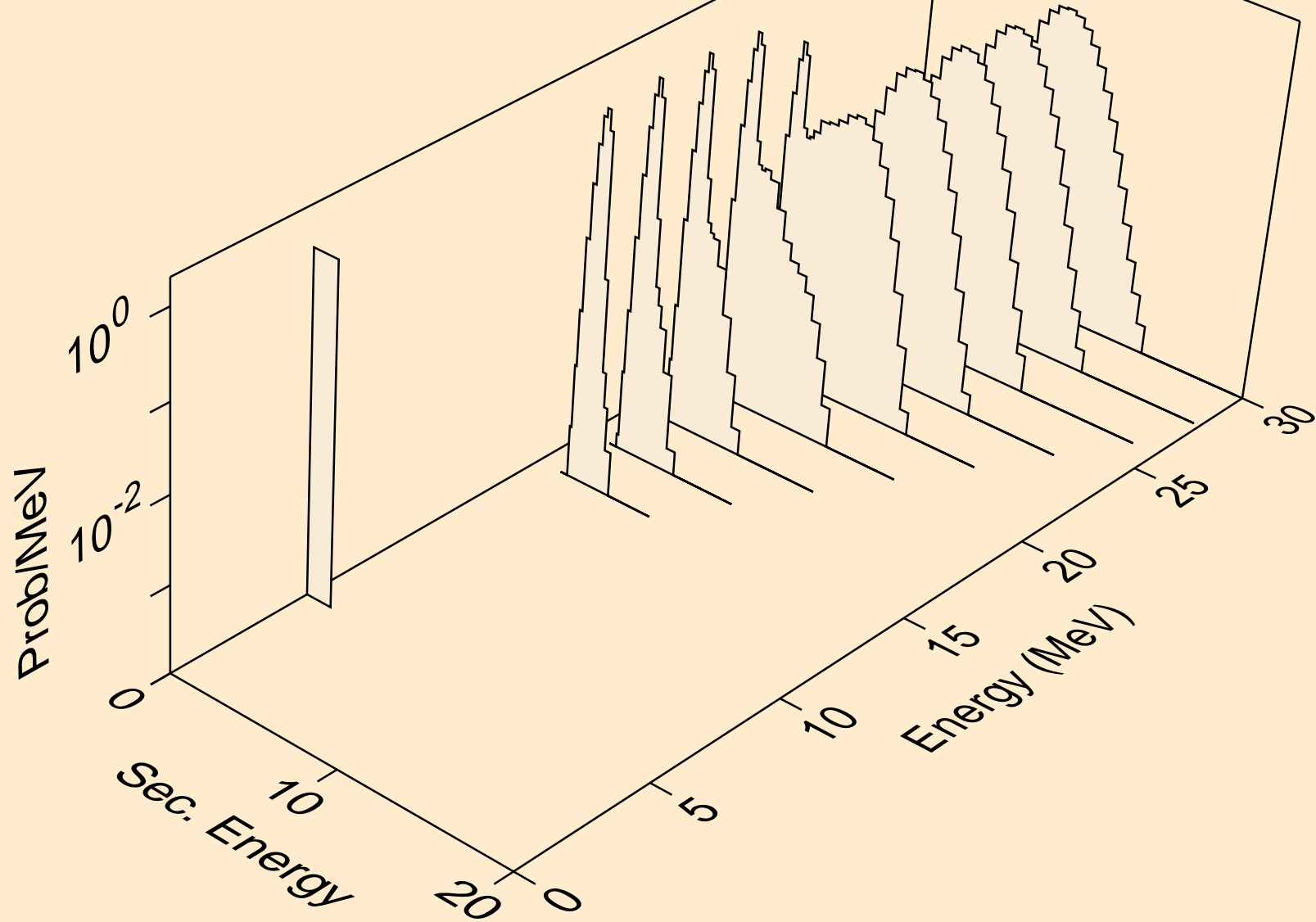

FM246 NEUTRON ACER TENDL-2024 LIBRARY; T=0.K  
deuterons from (n,x)

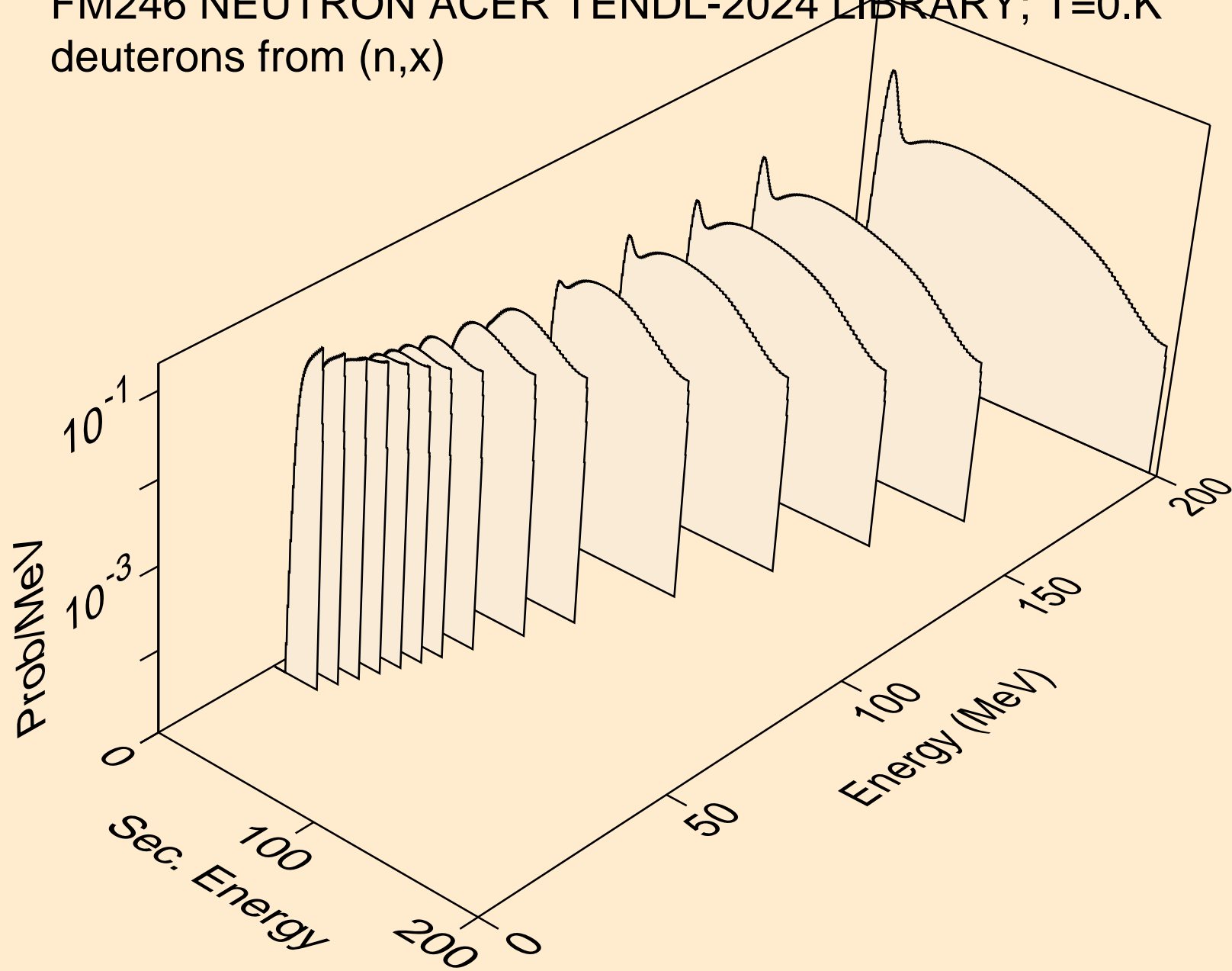

FM246 NEUTRON ACER TENDL-2024 LIBRARY; T=0.K  
deuterons from (n,n\*)d

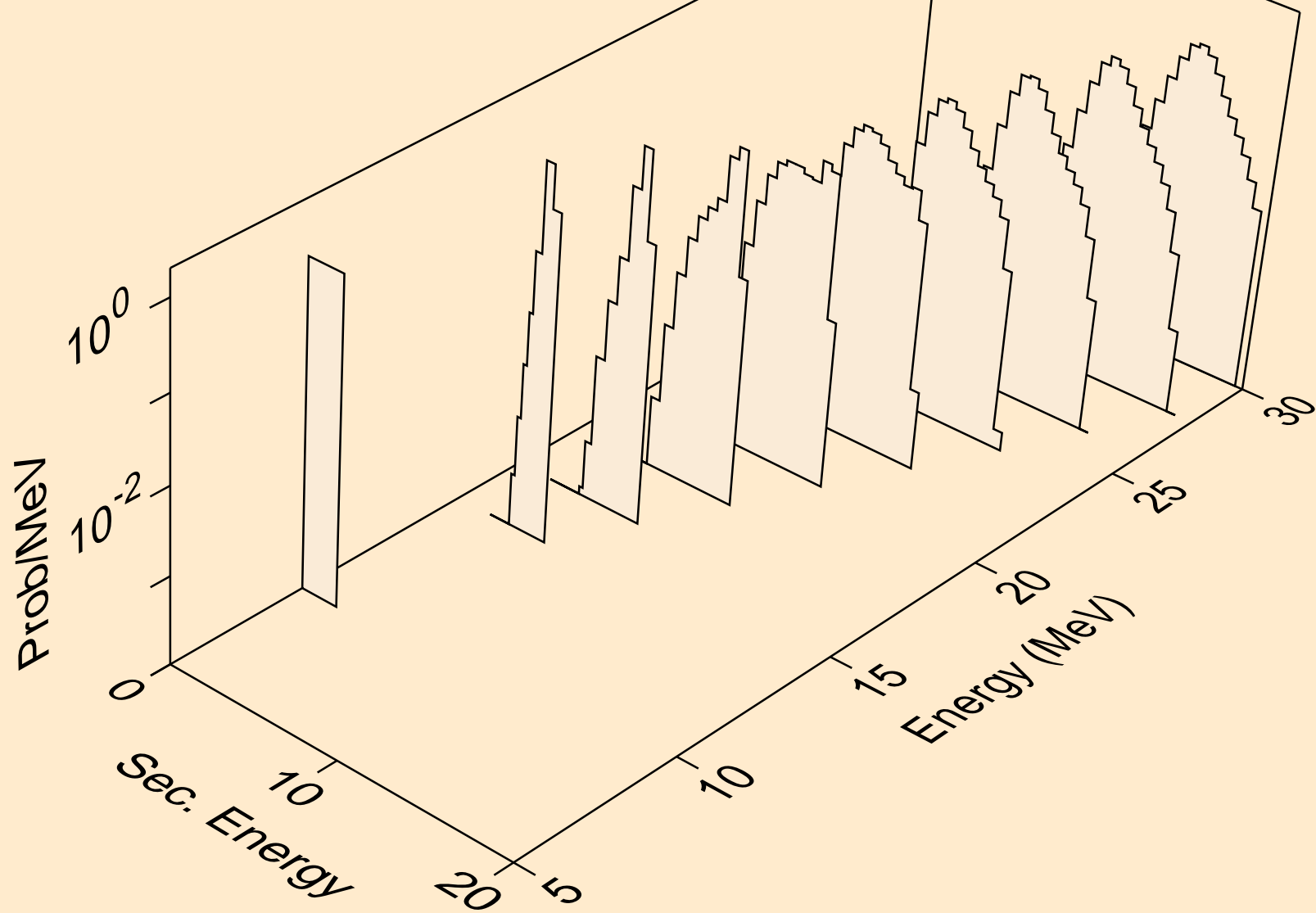

FM246 NEUTRON ACER TENDL-2024 LIBRARY; T=0.K  
deuterons from (n,d)

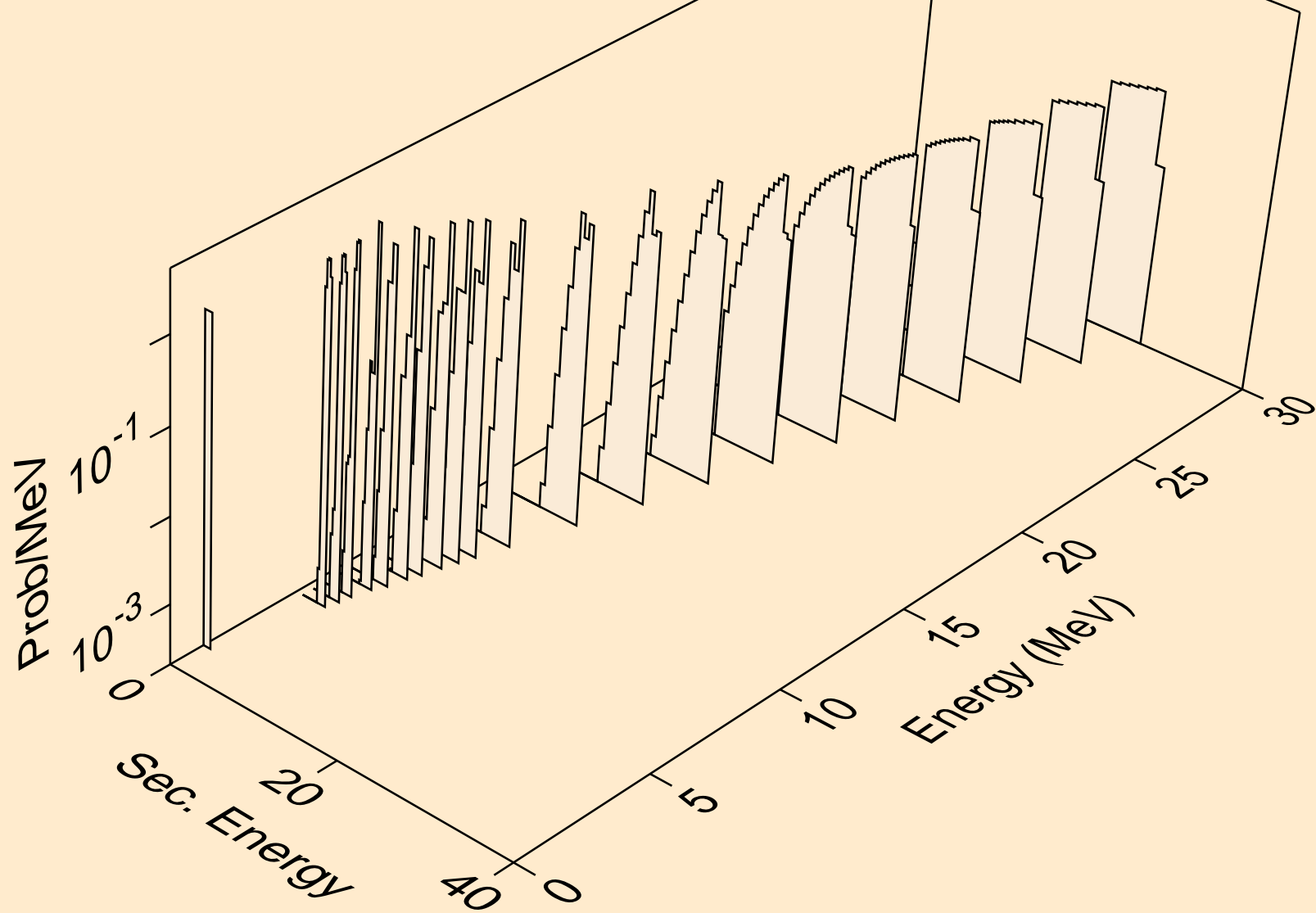

FM246 NEUTRON ACER TENDL-2024 LIBRARY; T=0.K  
deuterons from (n,pd)

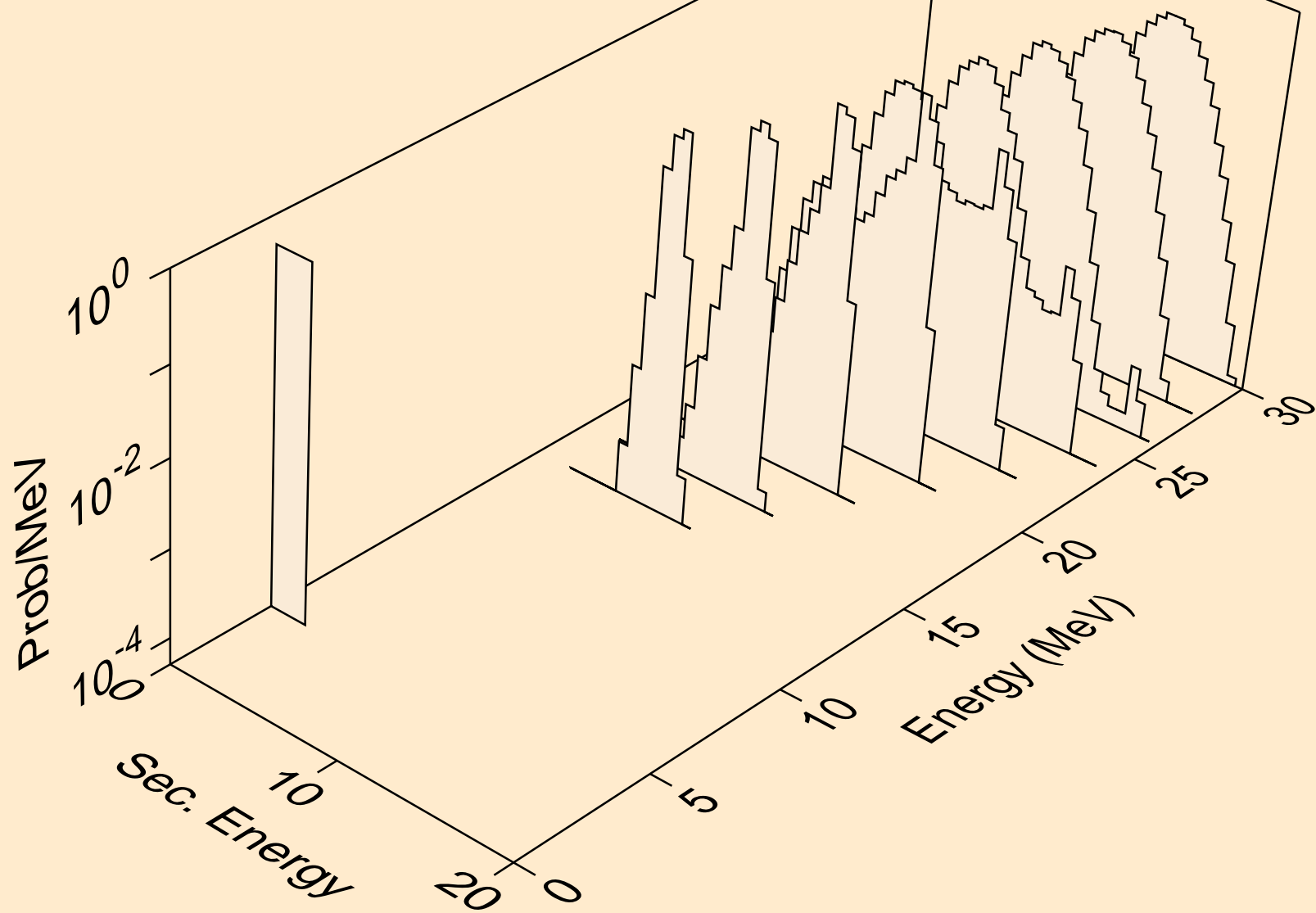

FM246 NEUTRON ACER TENDL-2024 LIBRARY; T=0.K  
tritons from (n,x)

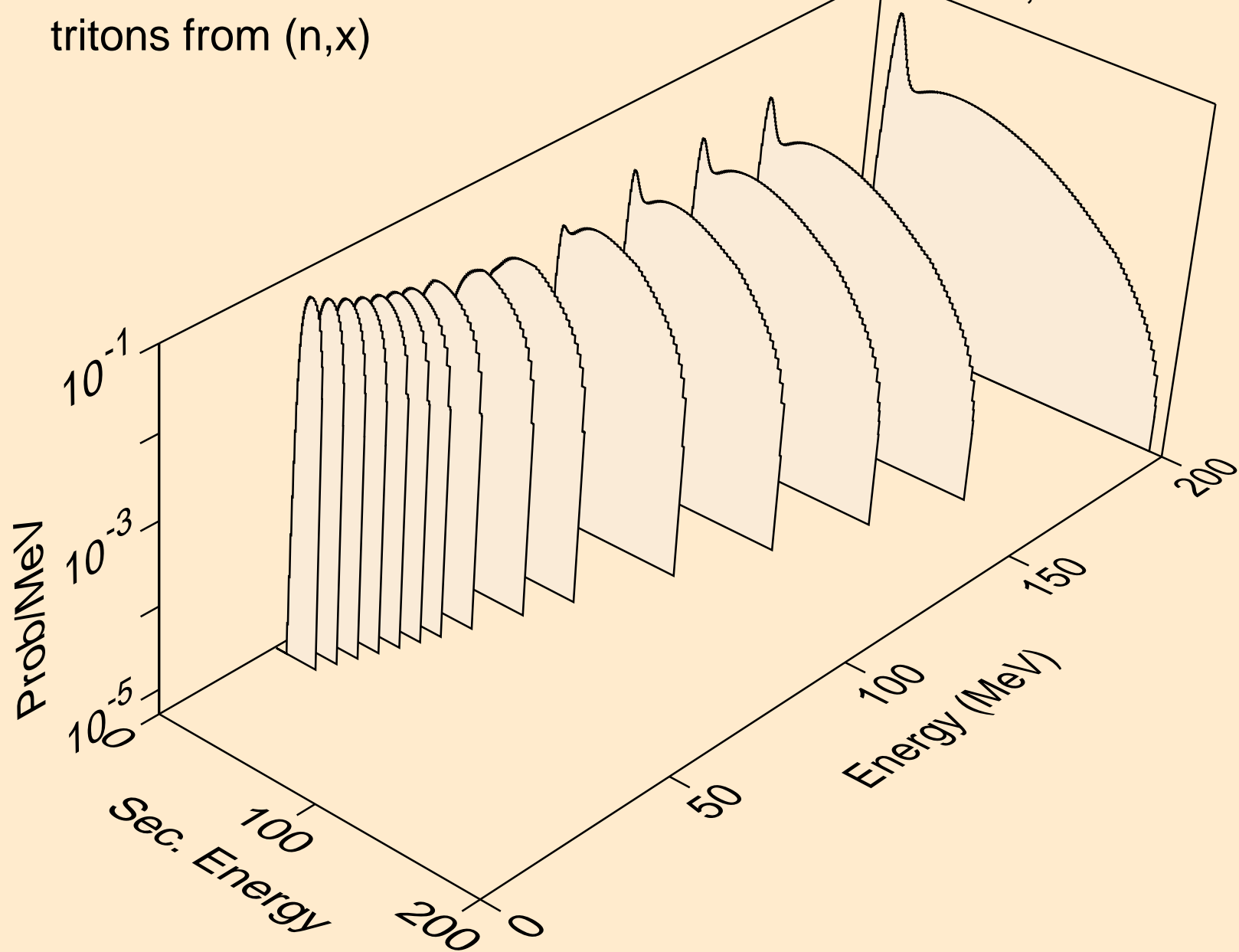

FM246 NEUTRON ACER TENDL-2024 LIBRARY; T=0.K  
tritons from (n,n\*)t

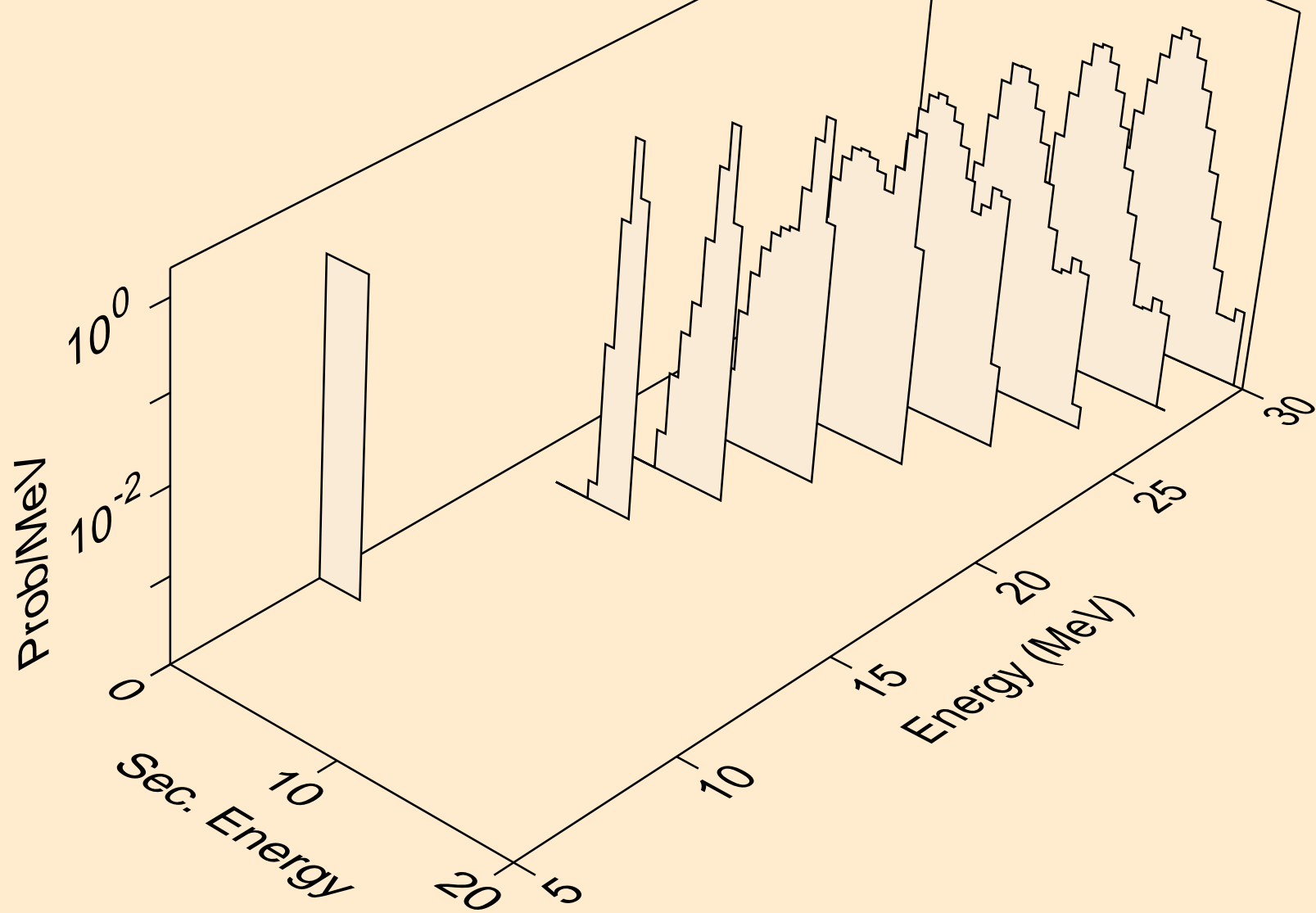



FM246 NEUTRON ACER TENDL-2024 LIBRARY; T=0.K  
tritons from (n,t)

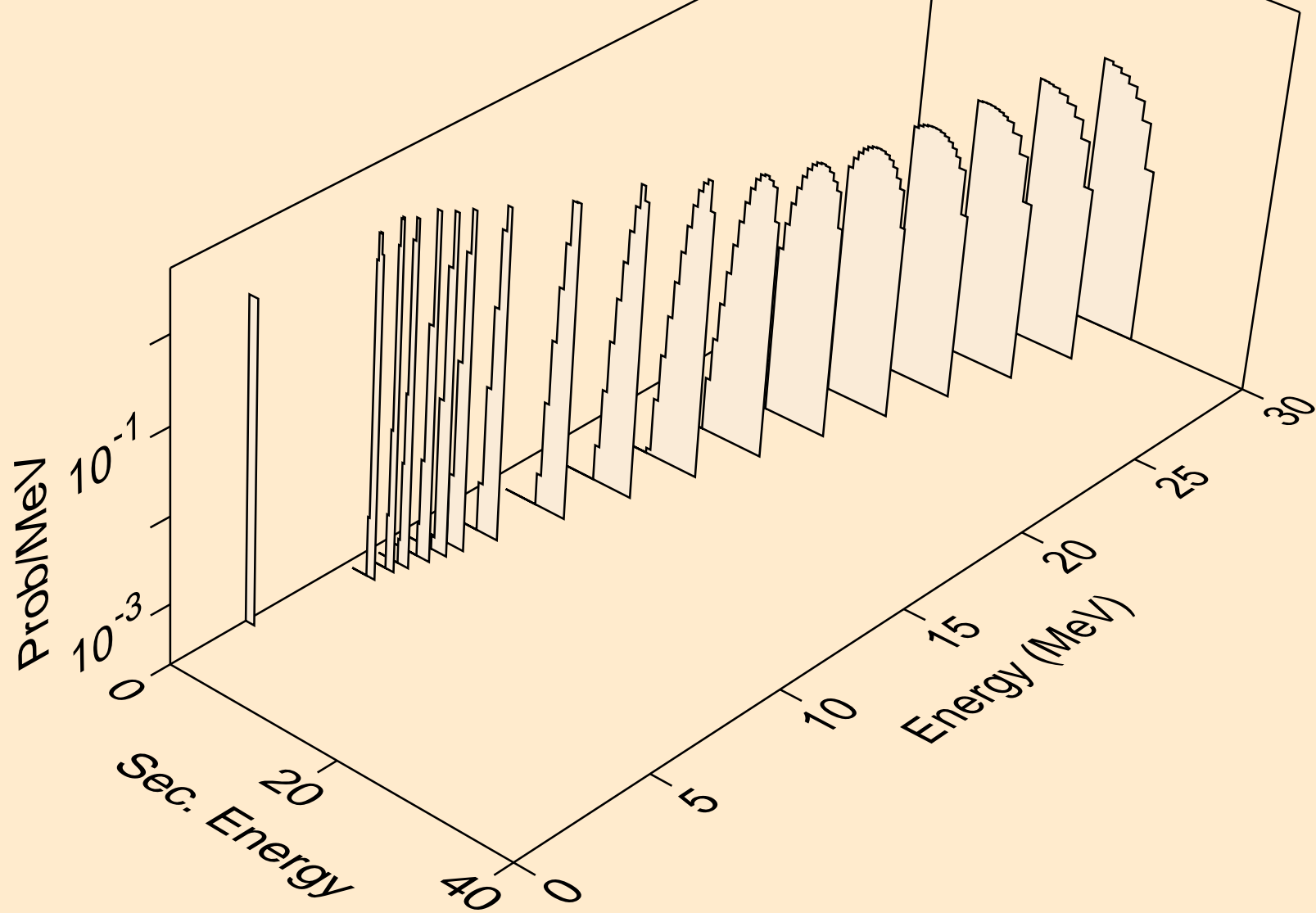

FM246 NEUTRON ACER TENDL-2024 LIBRARY; T=0.K  
tritons from (n,pt)

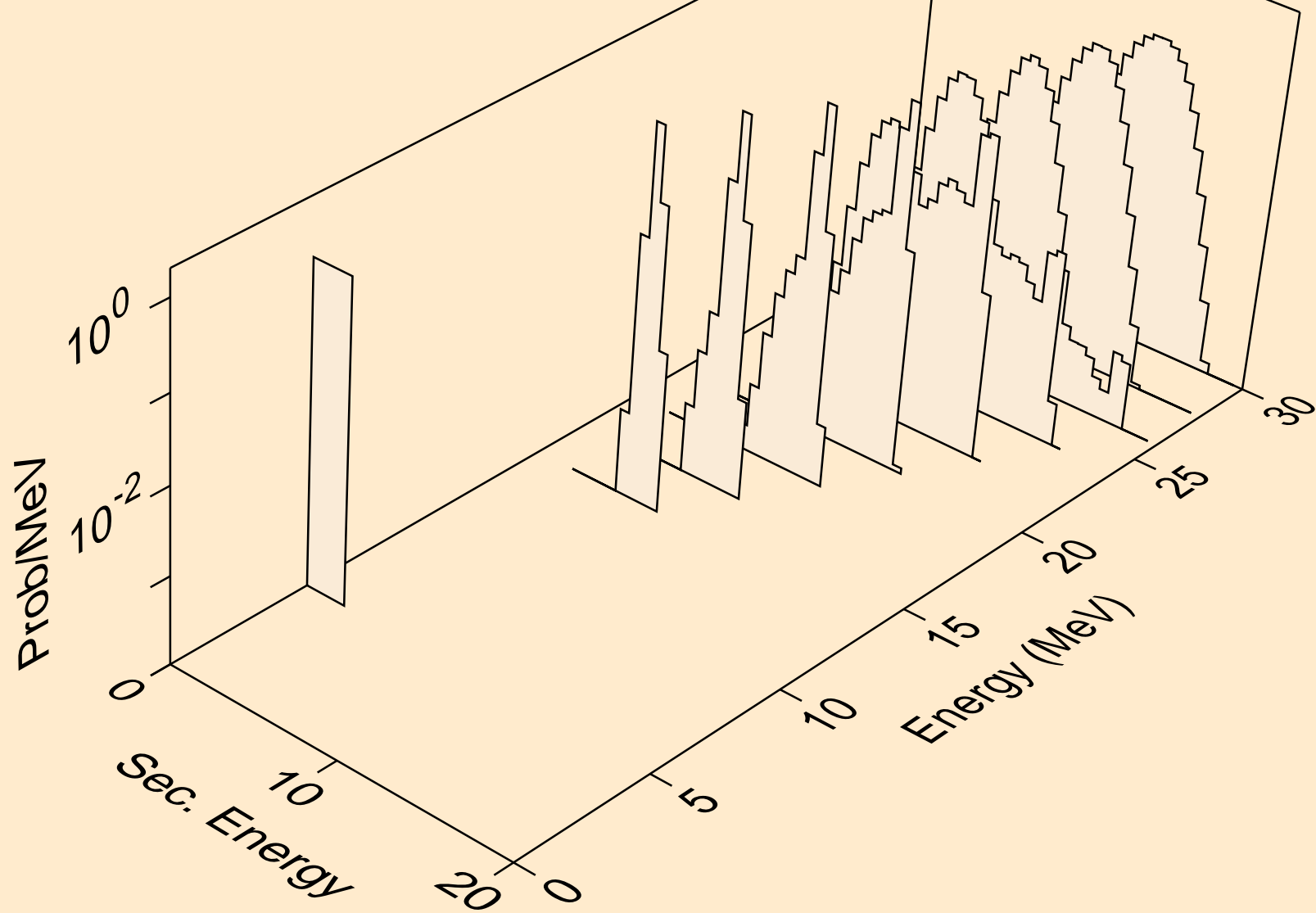

FM246 NEUTRON ACER TENDL-2024 LIBRARY; T=0.K  
he3s from (n,x)

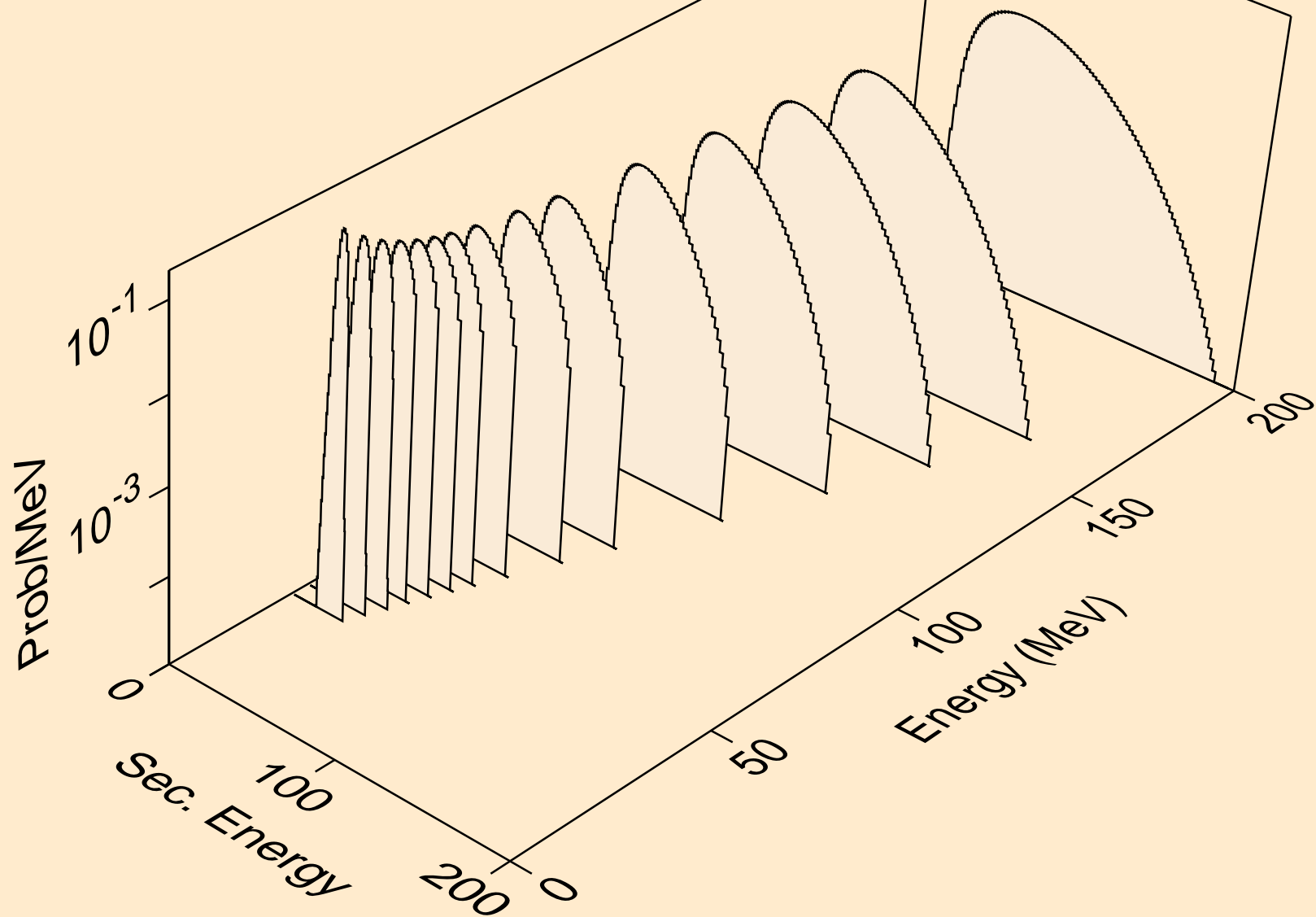

FM246 NEUTRON ACER TENDL-2024 LIBRARY; T=0.K  
he3s from (n,n\*)he3

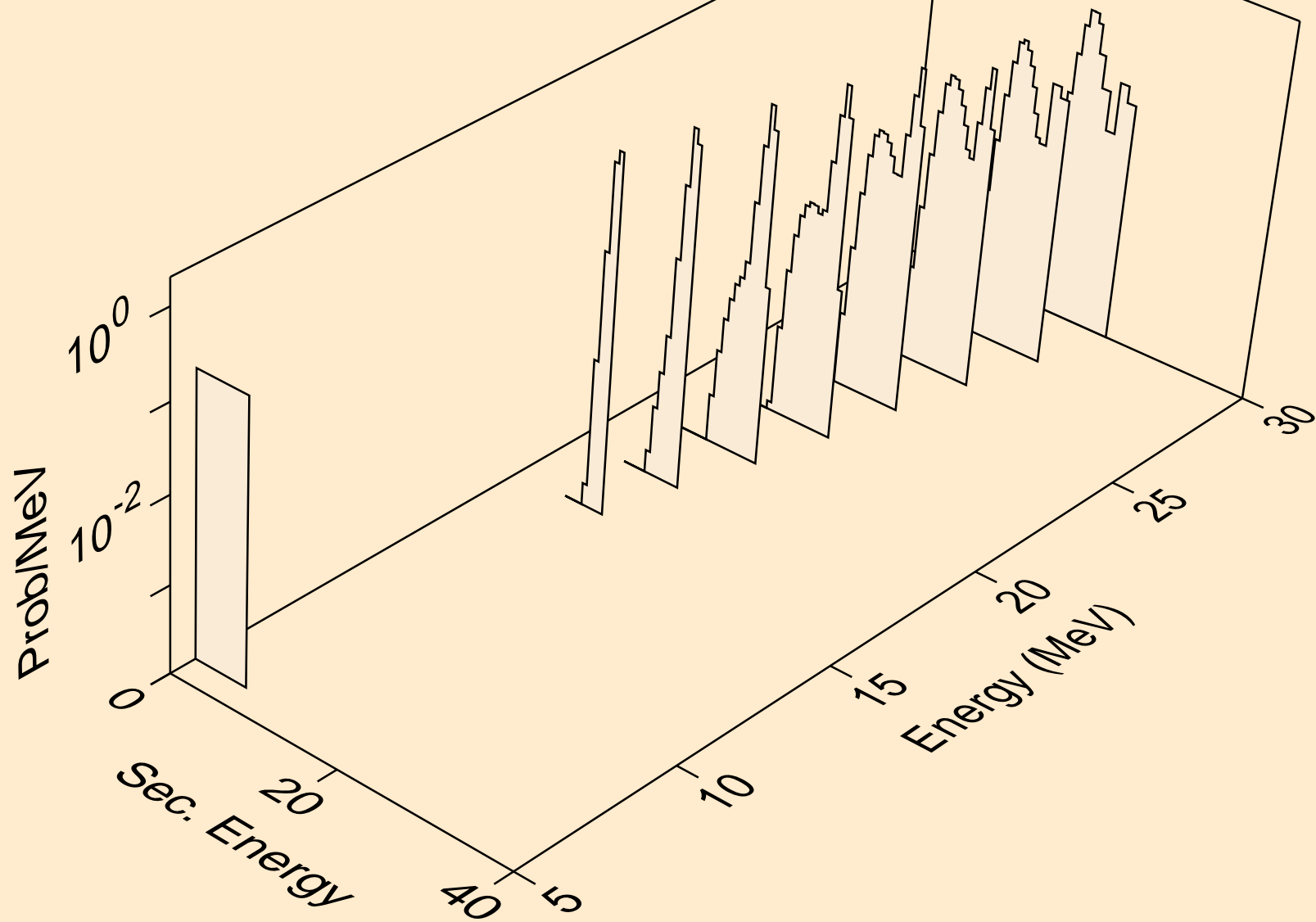

FM246 NEUTRON ACER TENDL-2024 LIBRARY; T=0.K  
he3s from (n,he3)

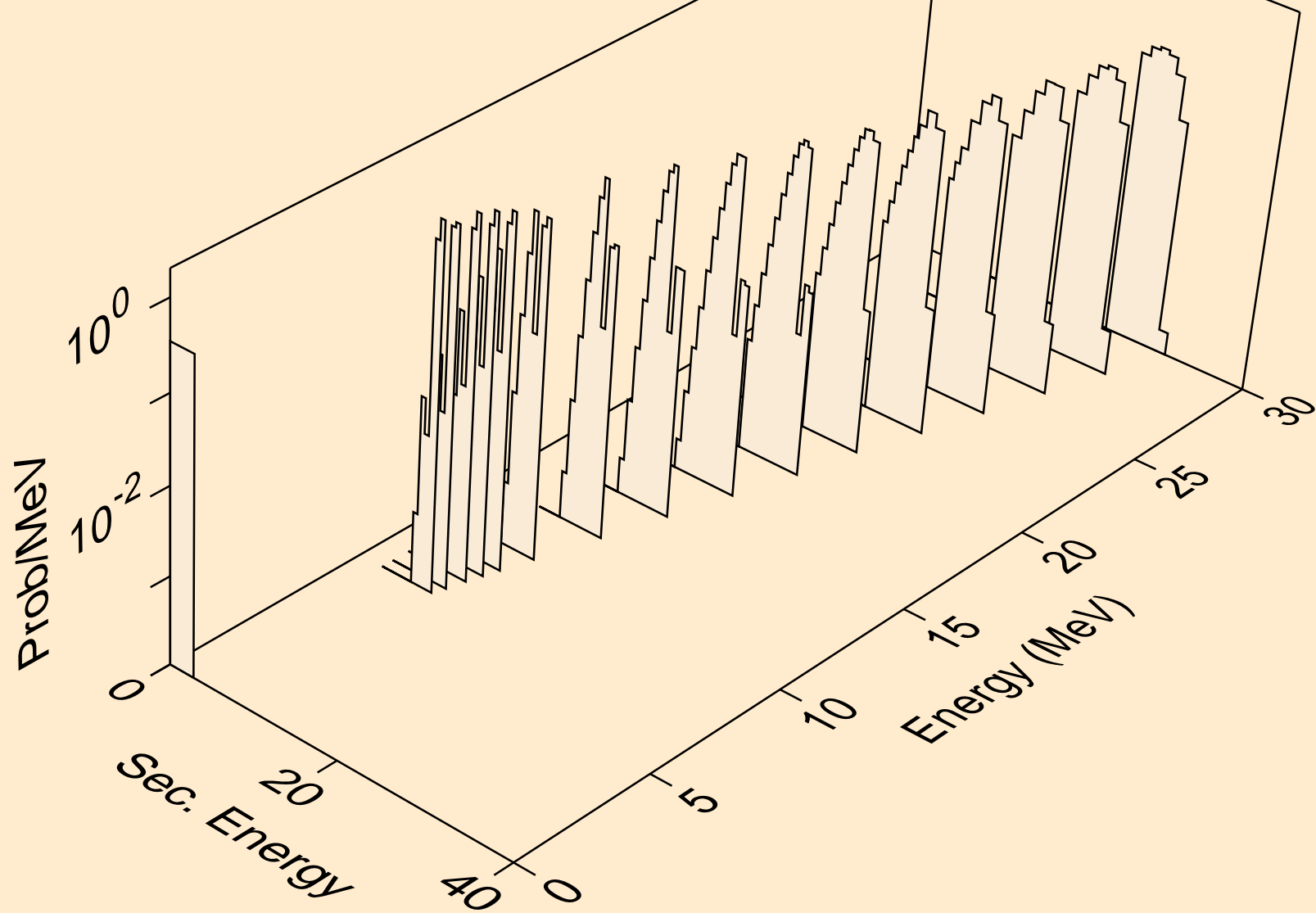

FM246 NEUTRON ACER TENDL-2024 LIBRARY; T=0.K  
alphas from (n,x)

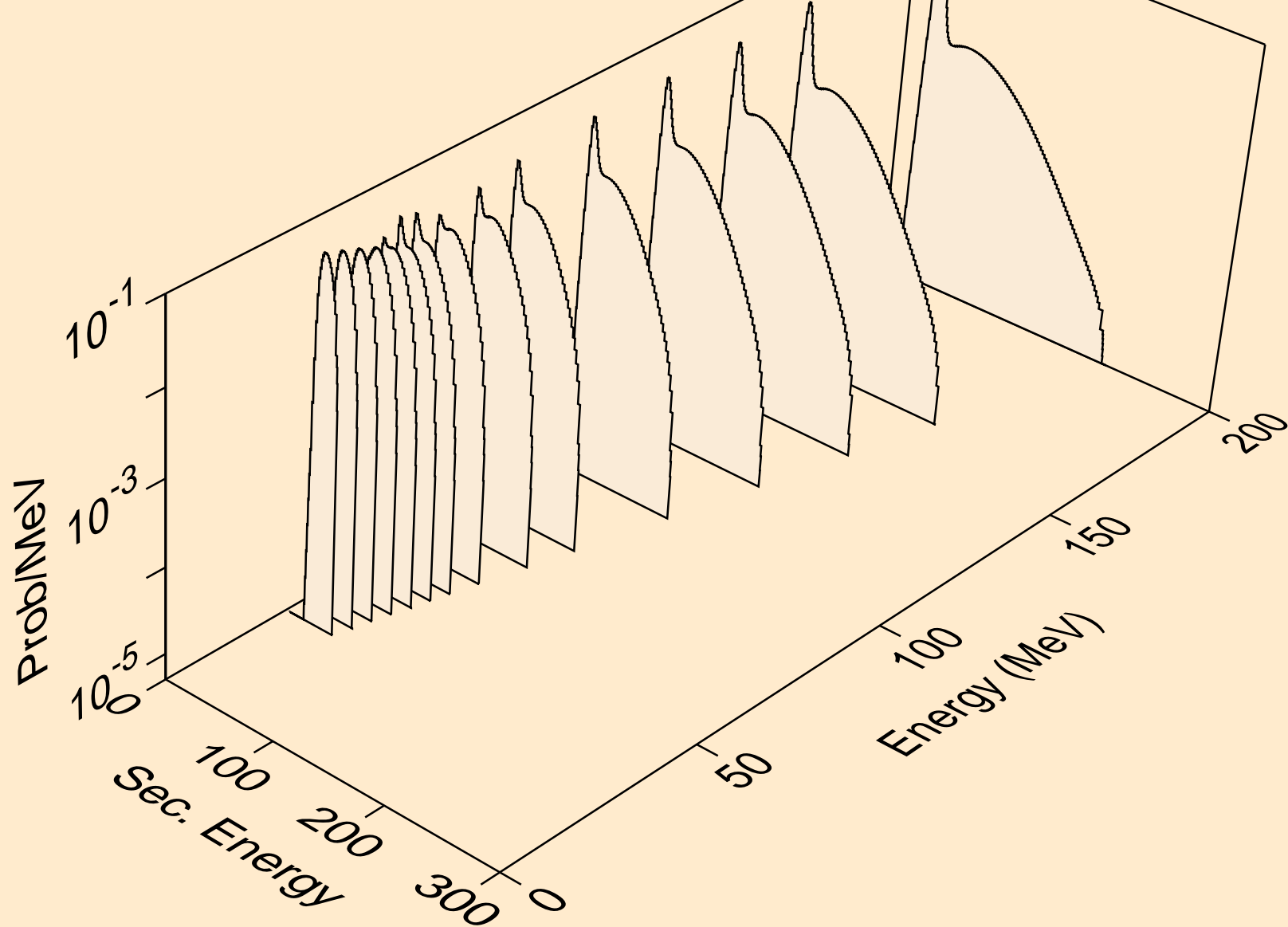

FM246 NEUTRON ACER TENDL-2024 LIBRARY; T=0.K  
alphas from (n,n\*)a

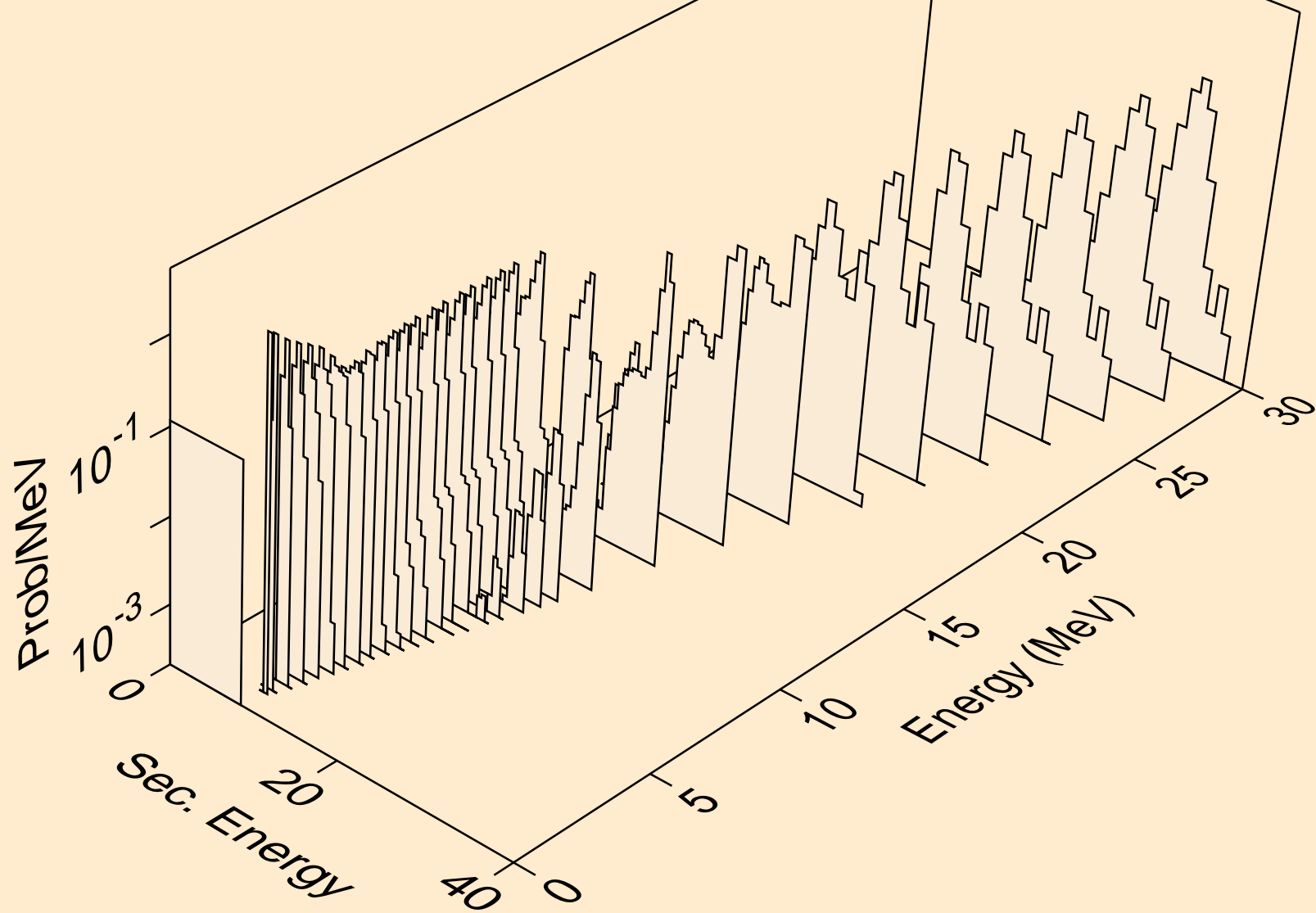

FM246 NEUTRON ACER TENDL-2024 LIBRARY; T=0.K  
alphas from (n,2n)a

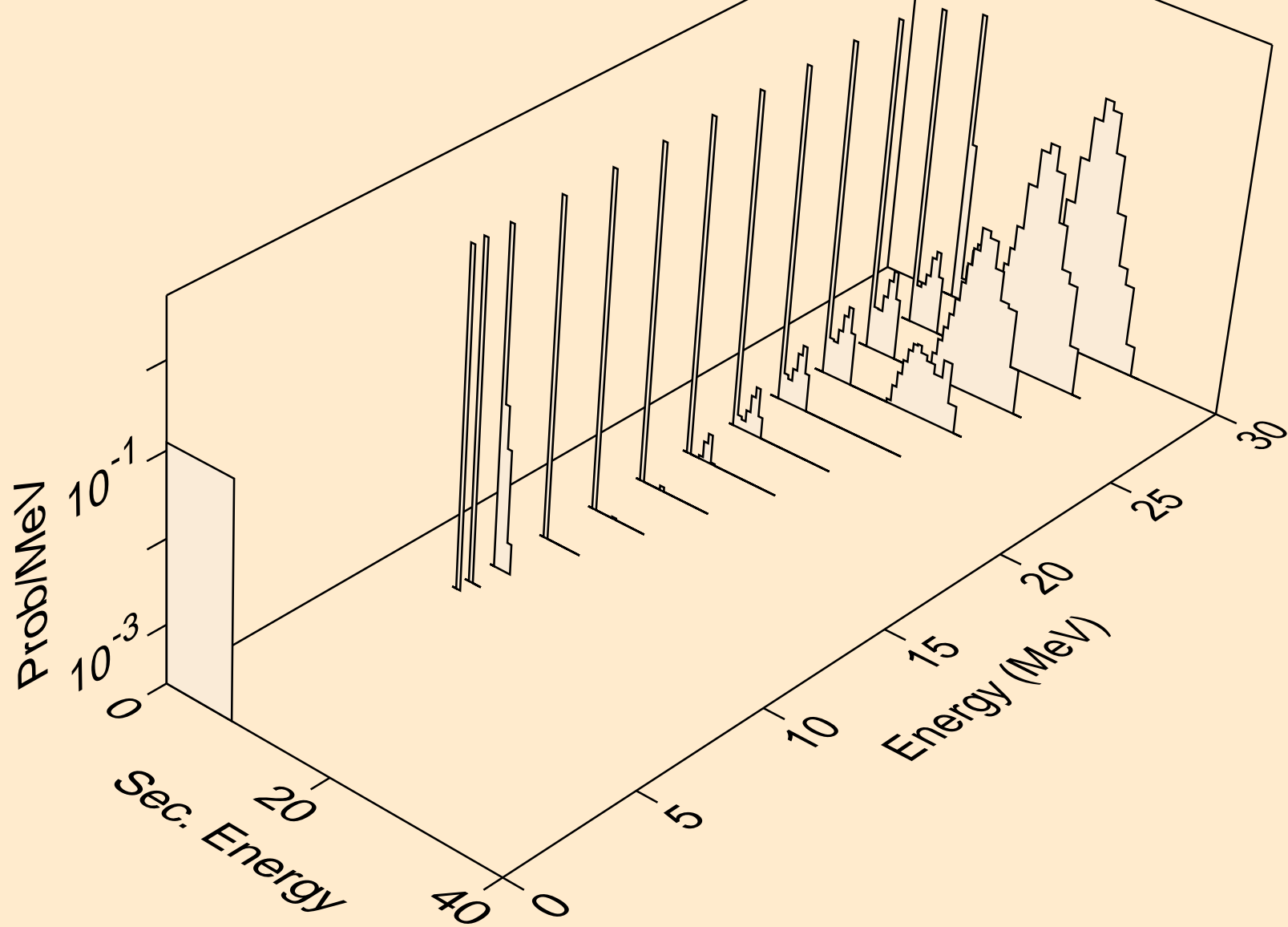



FM246 NEUTRON ACER TENDL-2024 LIBRARY; T=0.K  
alphas from (n,a)

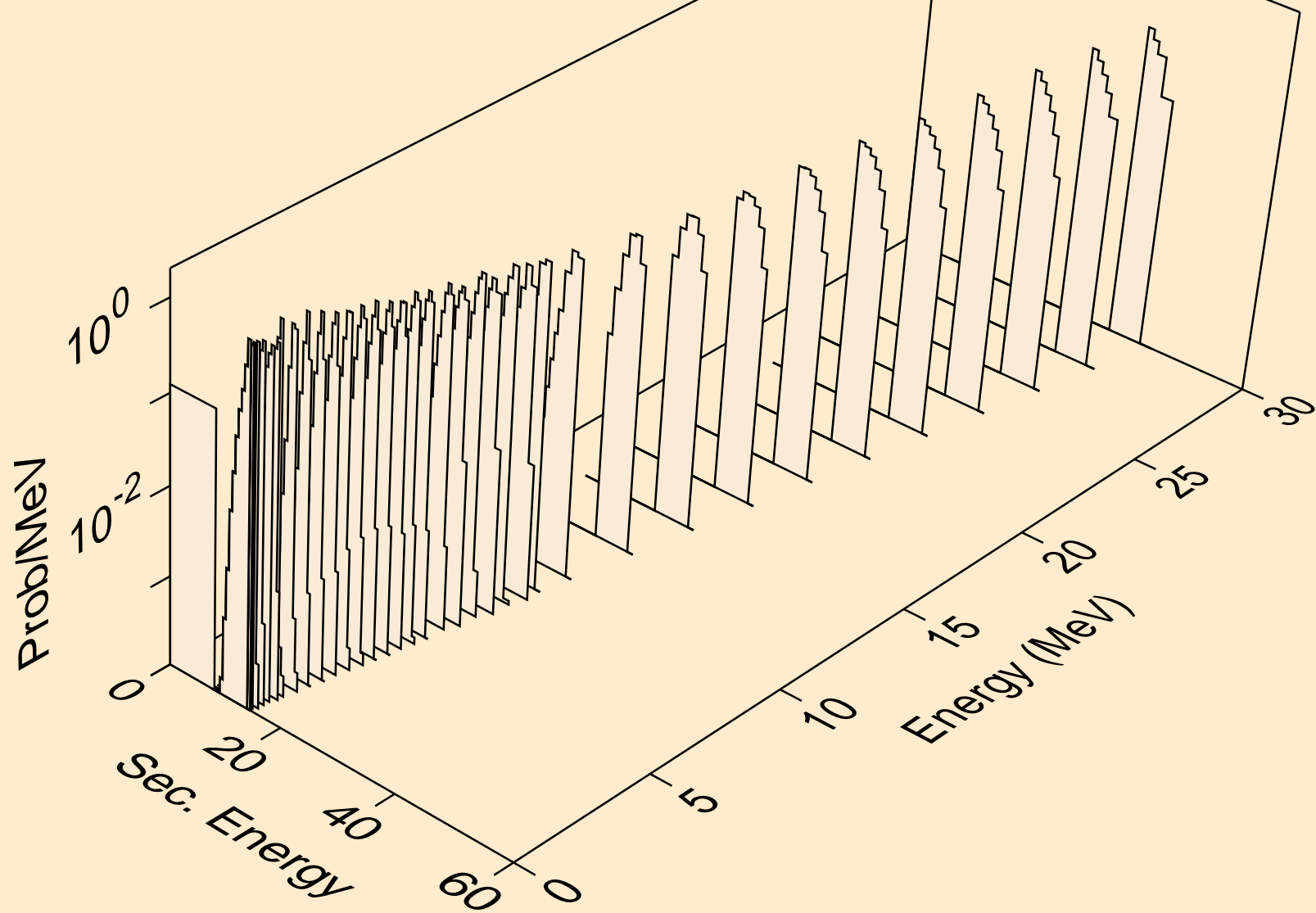

FM246 NEUTRON ACER TENDL-2024 LIBRARY; T=0.K  
alphas from (n,2a)

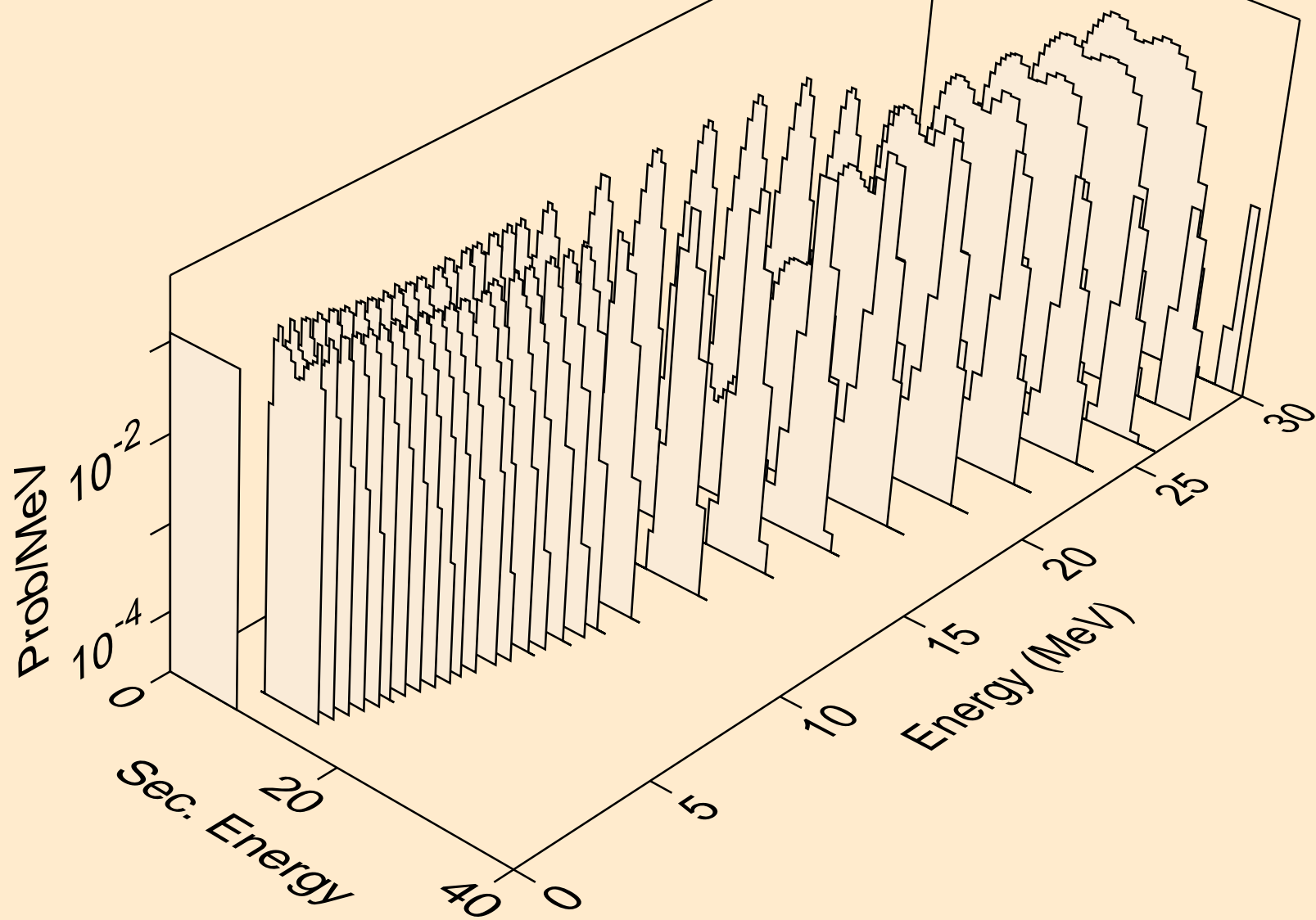

FM246 NEUTRON ACER TENDL-2024 LIBRARY; T=0.K  
alphas from (n,pa)

