

FR211 NEUTRON ACER TENDL-2024 LIBRARY; T=0.K

Principal cross sections

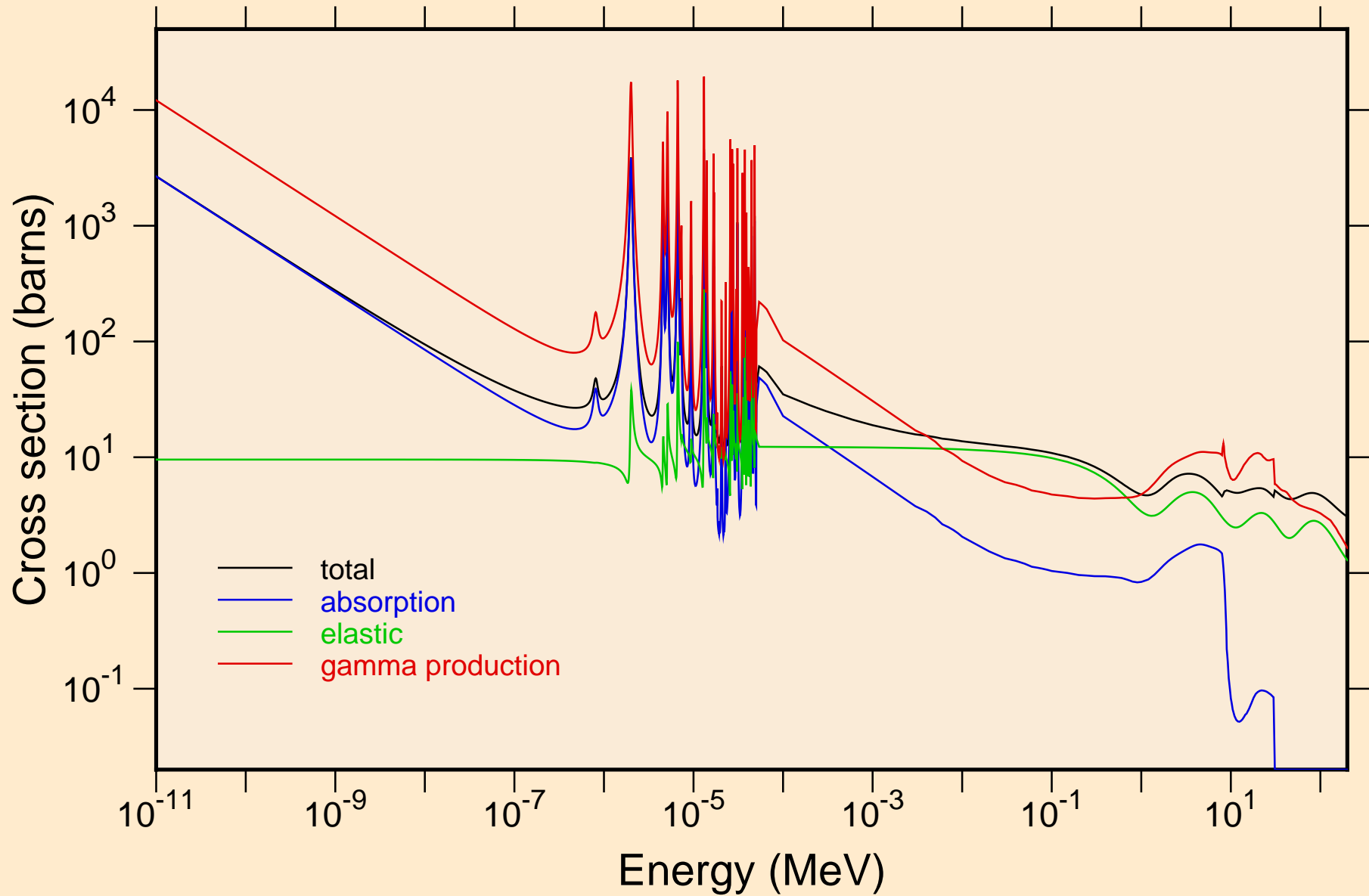

FR211 NEUTRON ACER TENDL-2024 LIBRARY; T=0.K
resonance total cross section

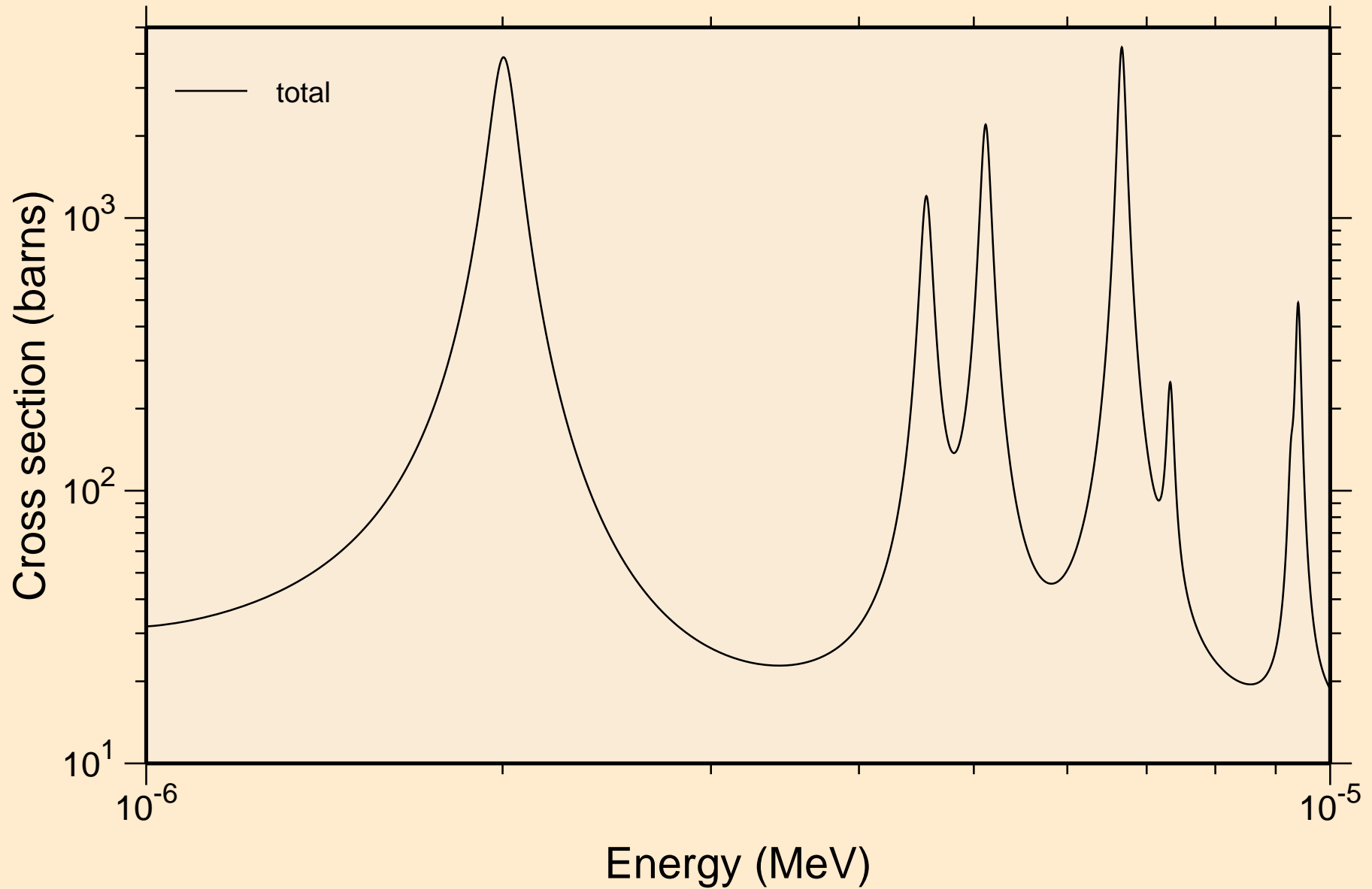

FR211 NEUTRON ACER TENDL-2024 LIBRARY; T=0.K
resonance total cross section

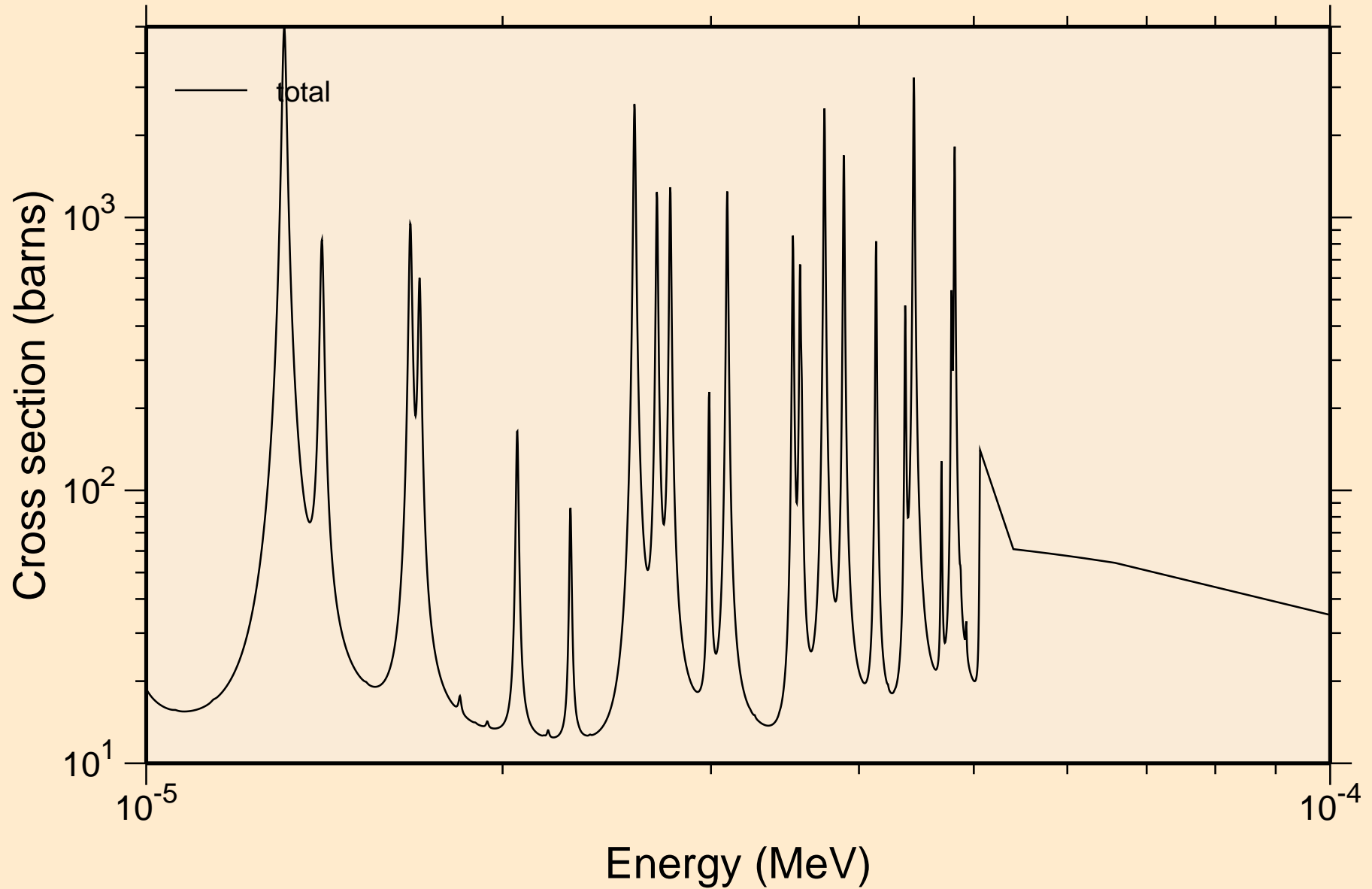

FR211 NEUTRON ACER TENDL-2024 LIBRARY; T=0.K
resonance total cross section

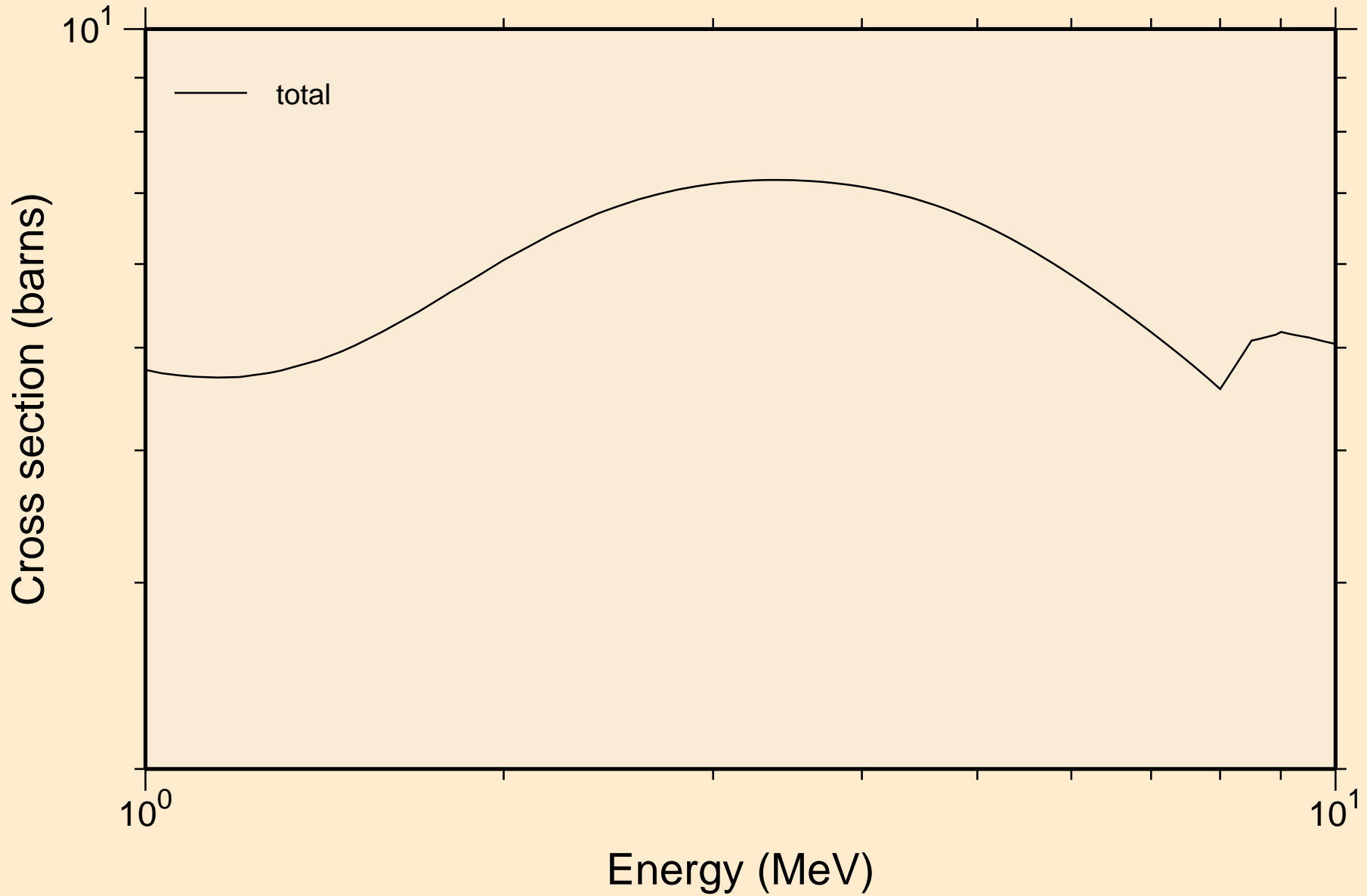

FR211 NEUTRON ACER TENDL-2024 LIBRARY; T=0.K
resonance absorption cross sections

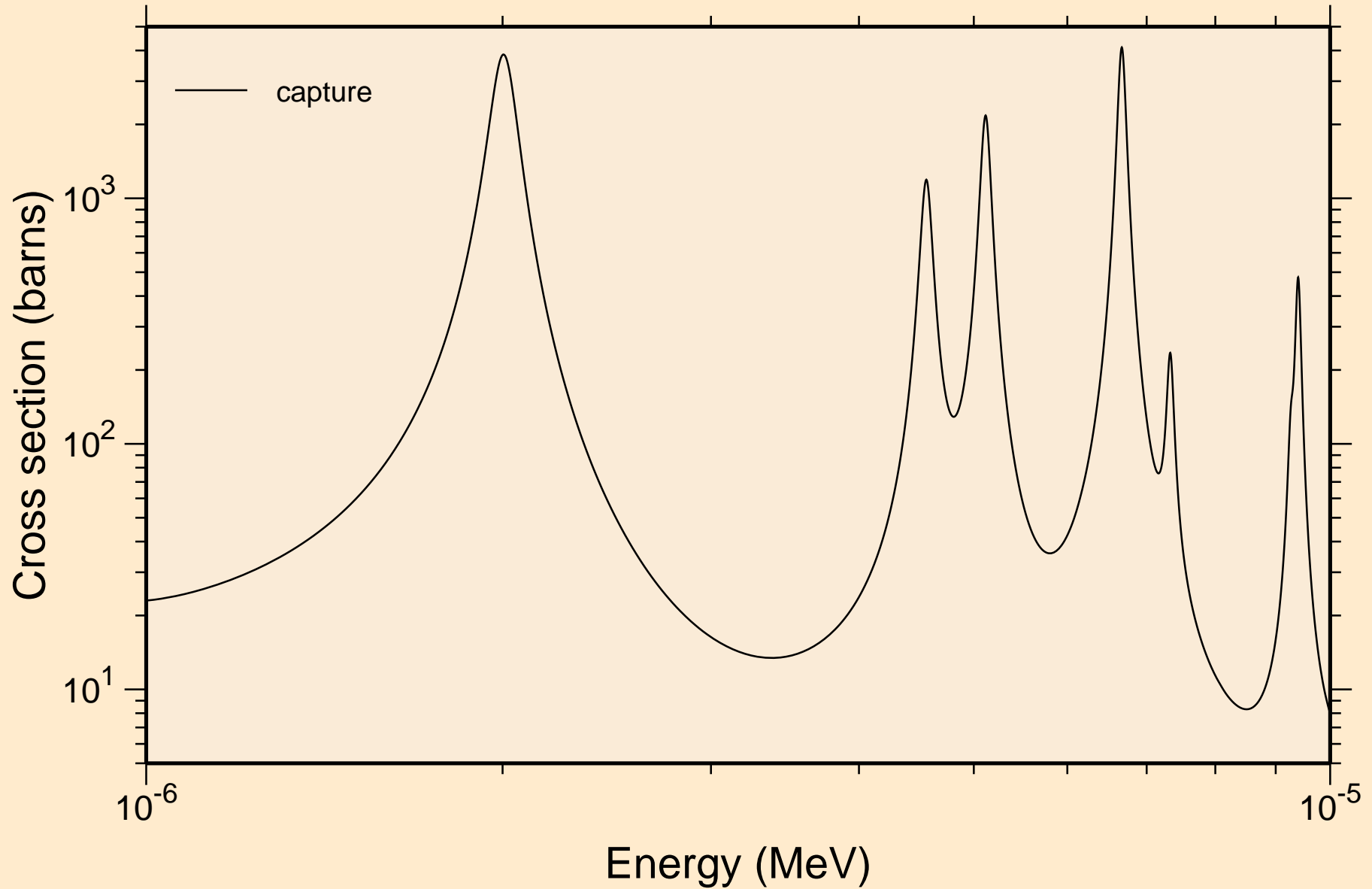

FR211 NEUTRON ACER TENDL-2024 LIBRARY; T=0.K
resonance absorption cross sections

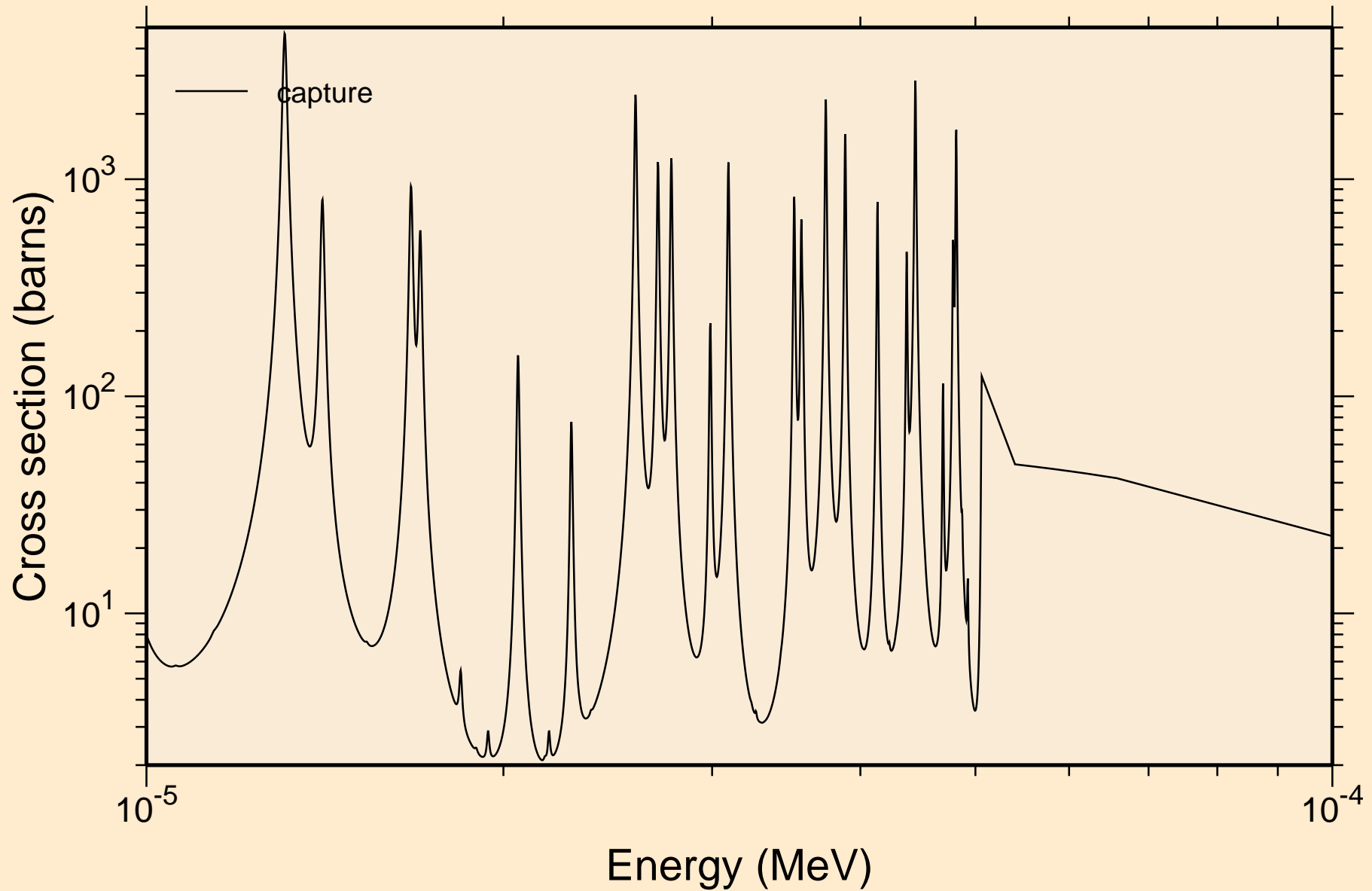

FR211 NEUTRON ACER TENDL-2024 LIBRARY; T=0.K
resonance absorption cross sections

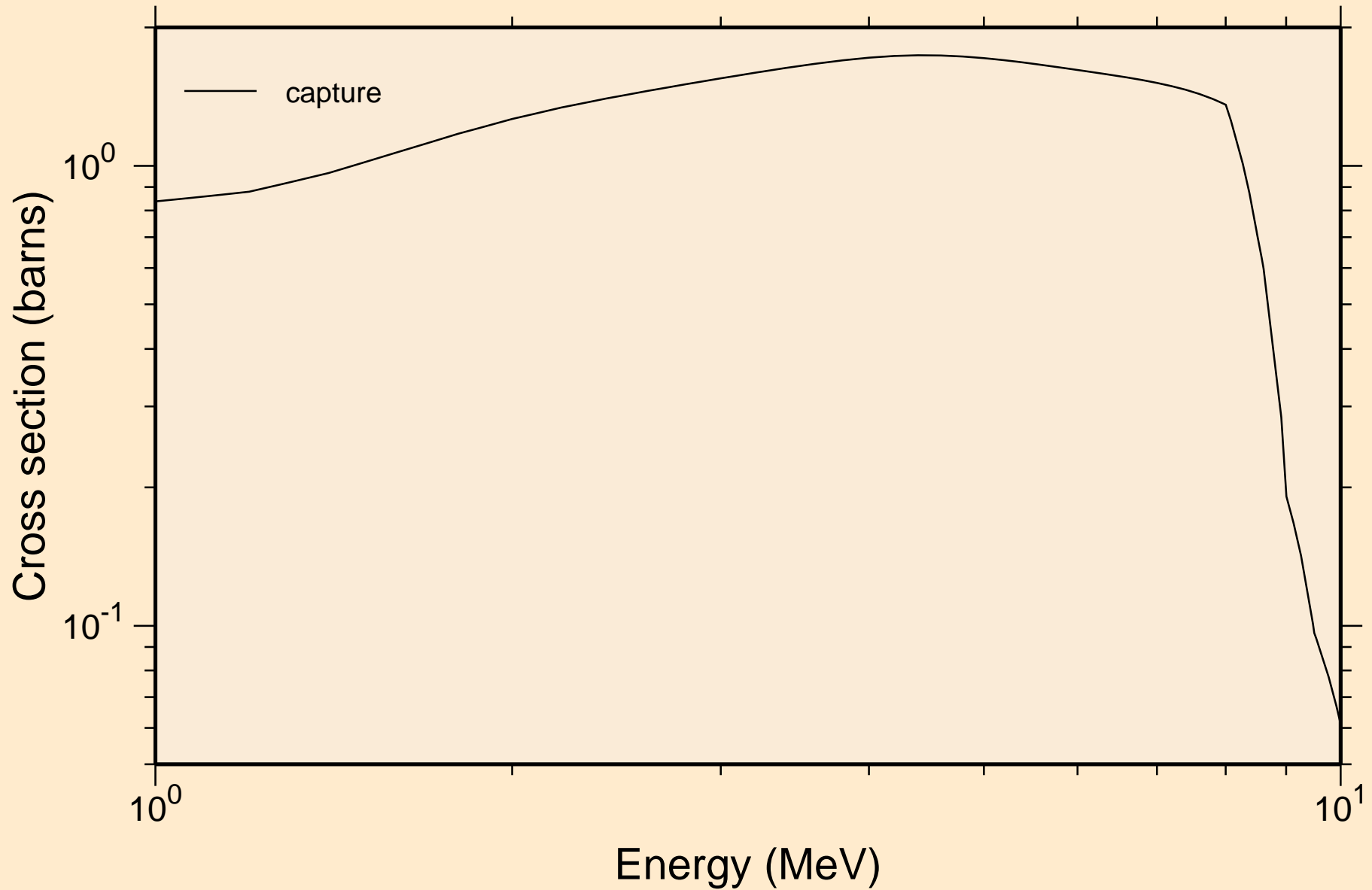

FR211 NEUTRON ACER TENDL-2024 LIBRARY; T=0.K

Heating

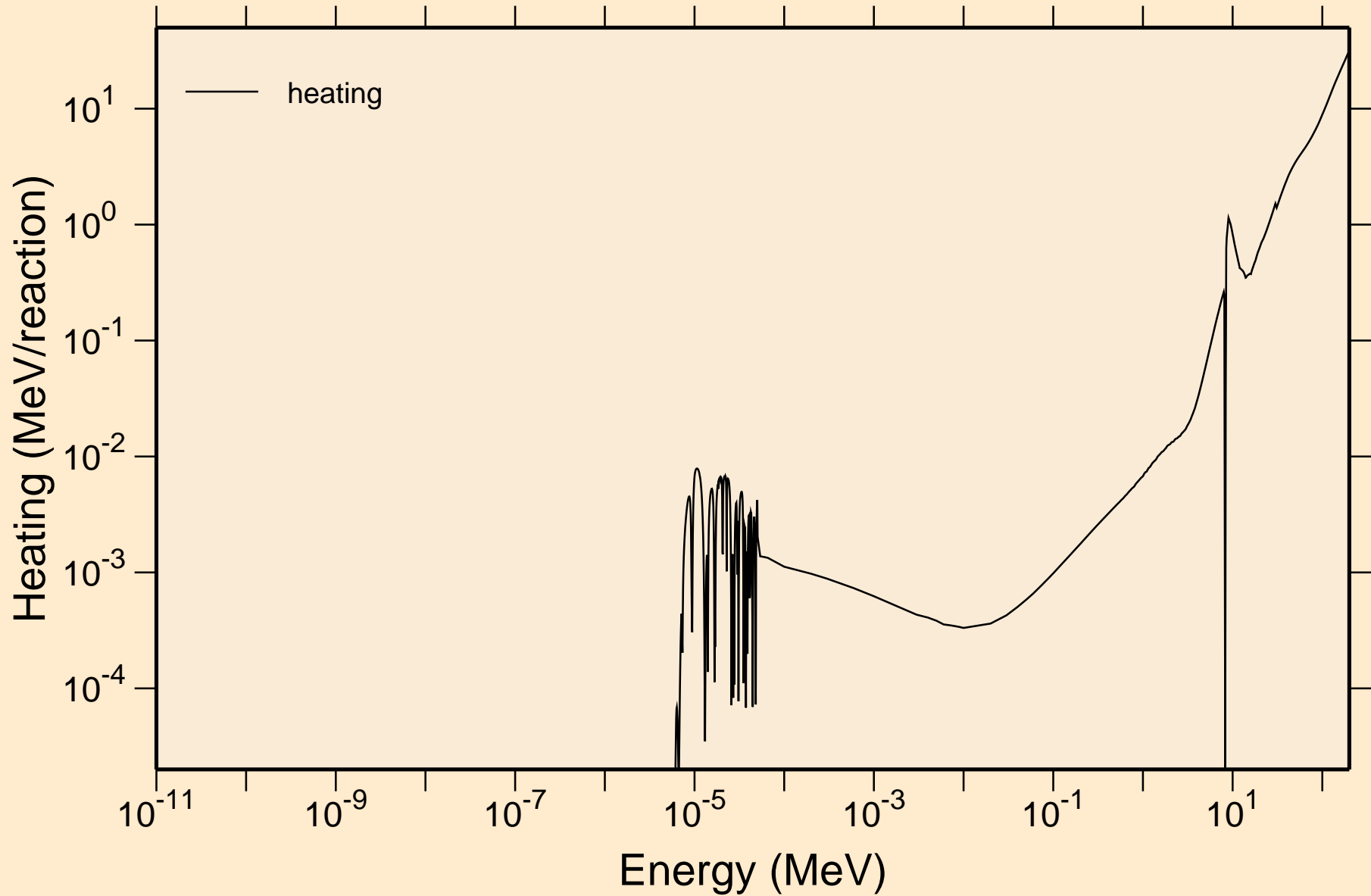

FR211 NEUTRON ACER TENDL-2024 LIBRARY; T=0.K
Damage

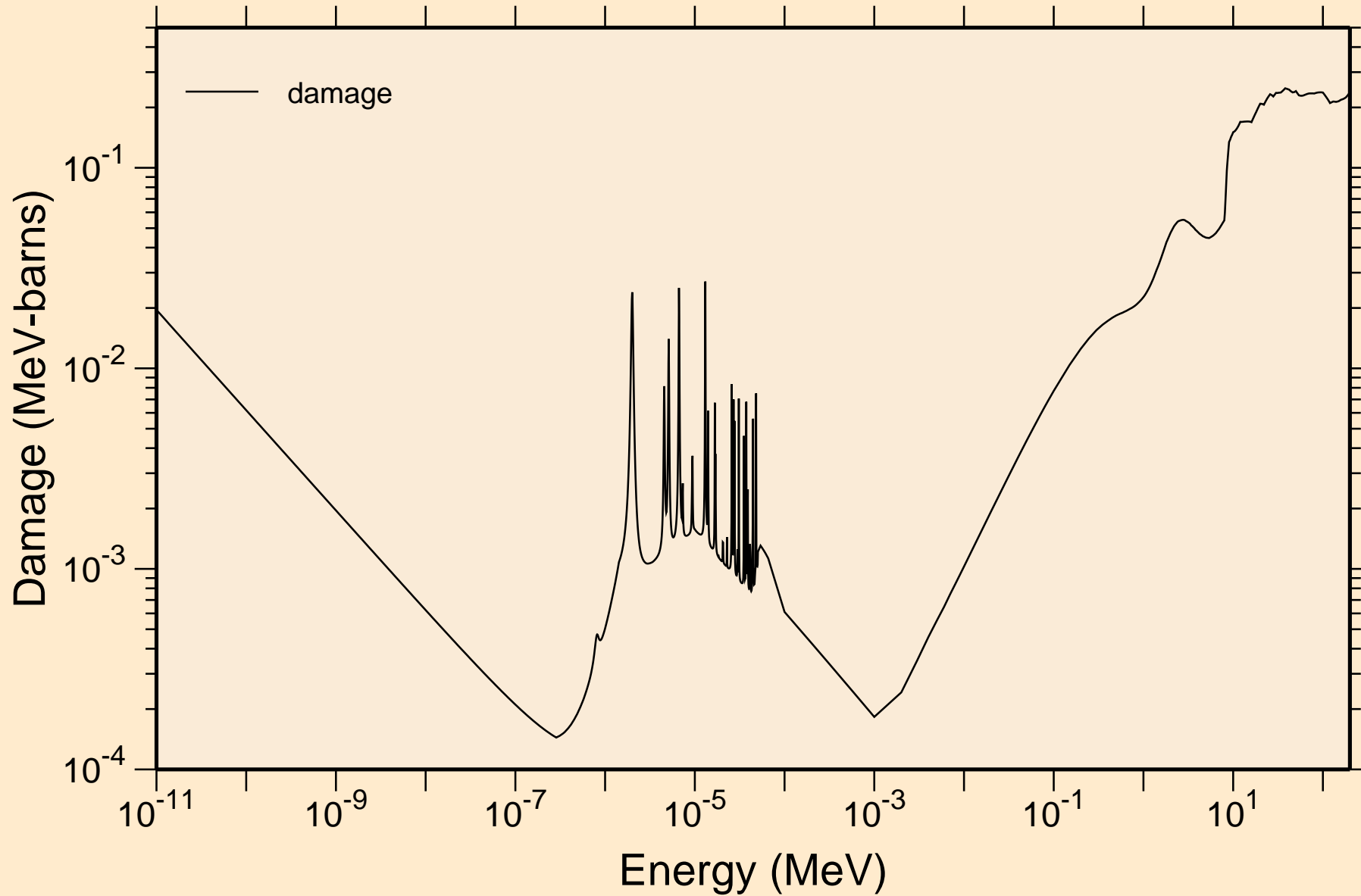

FR211 NEUTRON ACER TENDL-2024 LIBRARY; T=0.K
Non-threshold reactions

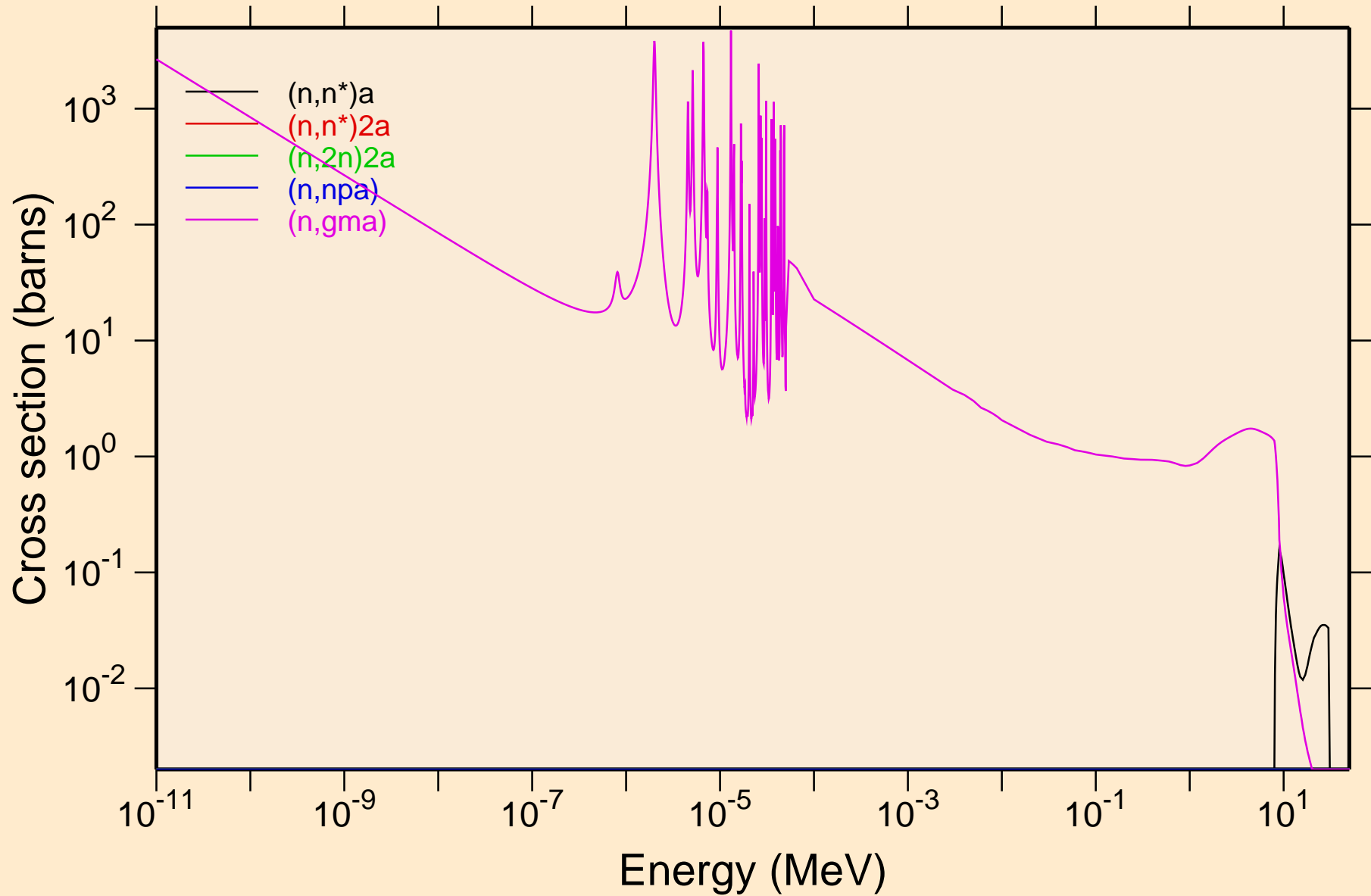

FR211 NEUTRON ACER TENDL-2024 LIBRARY; T=0.K
Non-threshold reactions

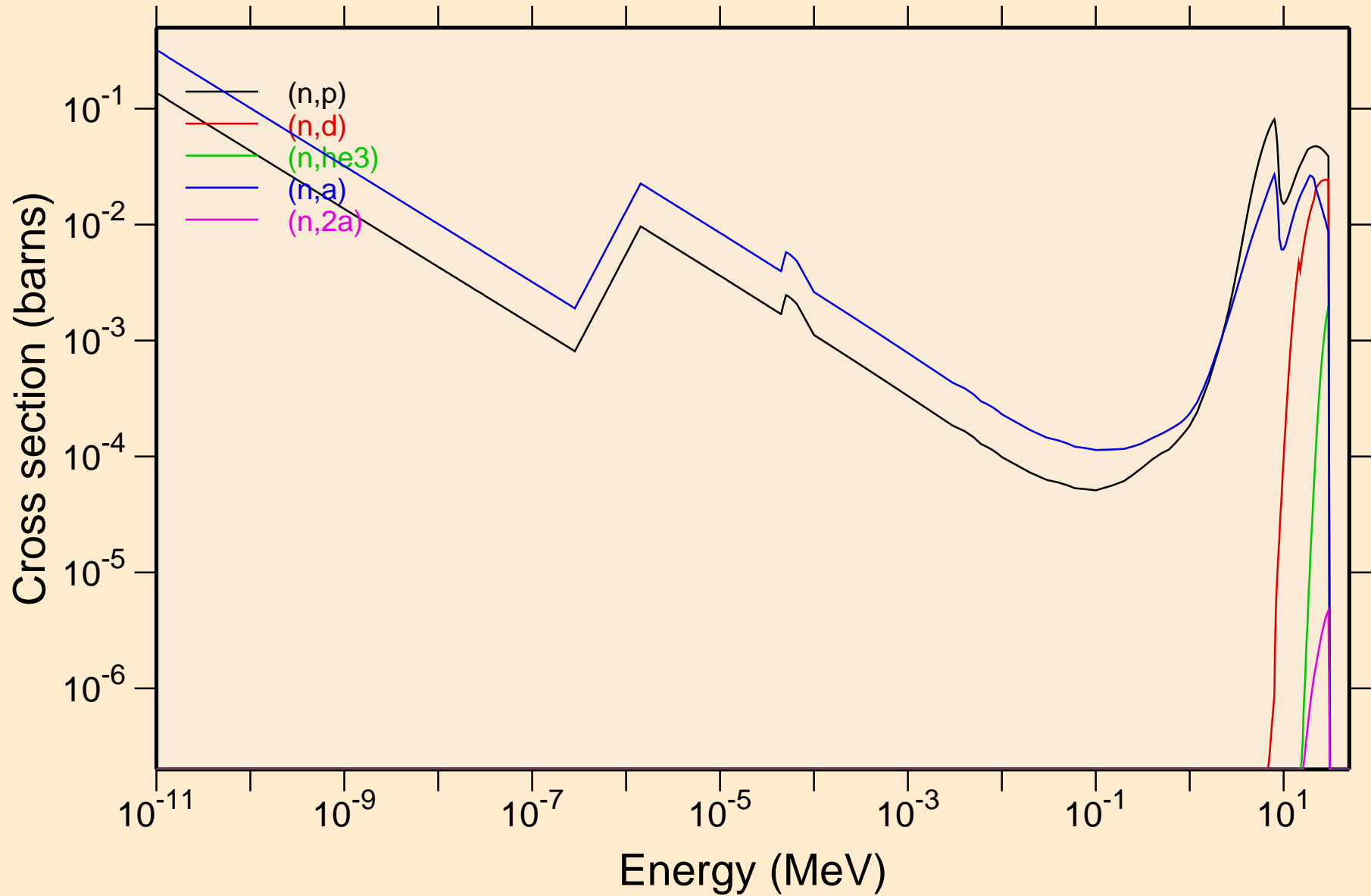

FR211 NEUTRON ACER TENDL-2024 LIBRARY; T=0.K
Non-threshold reactions

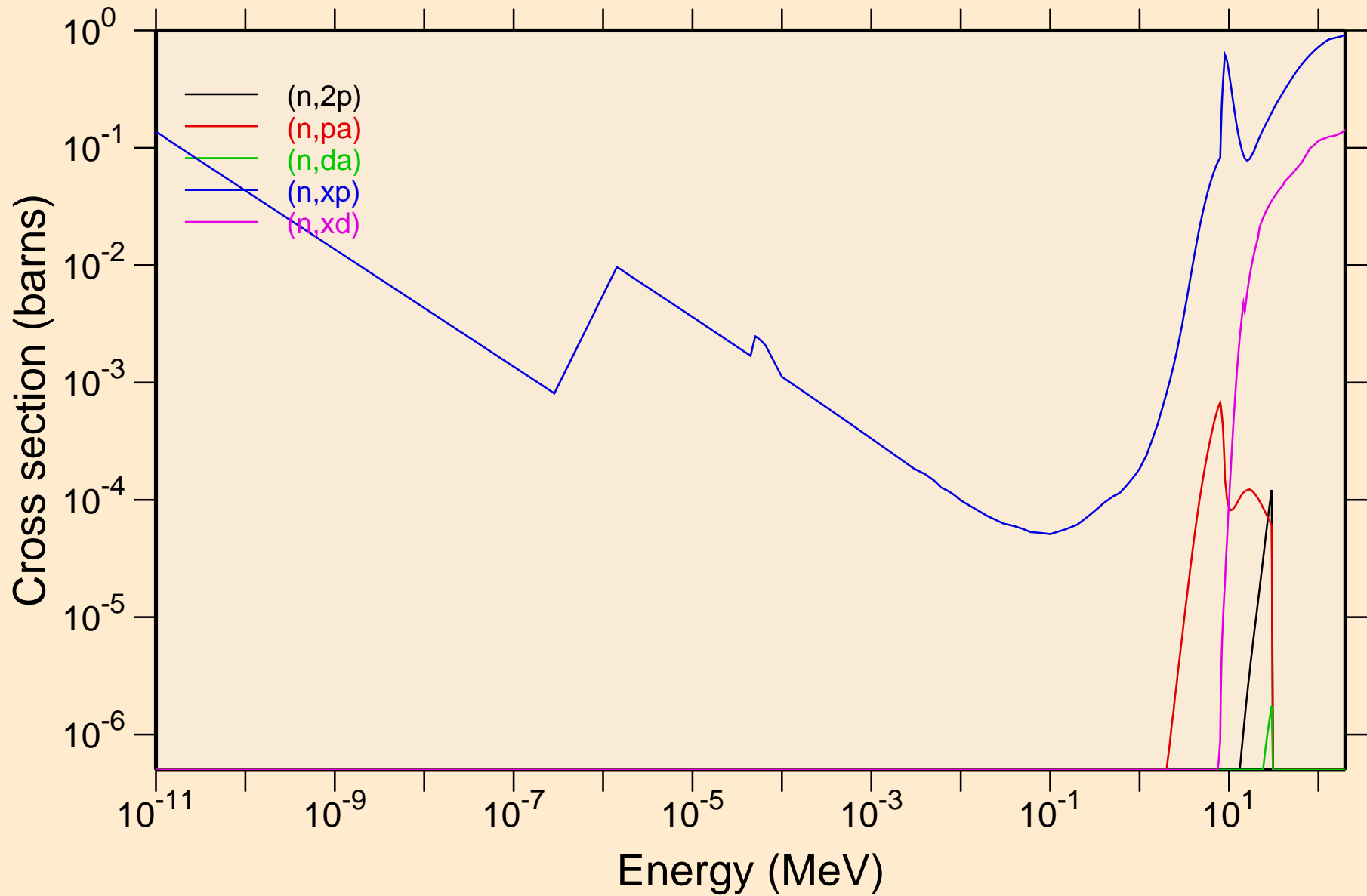

FR211 NEUTRON ACER TENDL-2024 LIBRARY; T=0.K
Non-threshold reactions

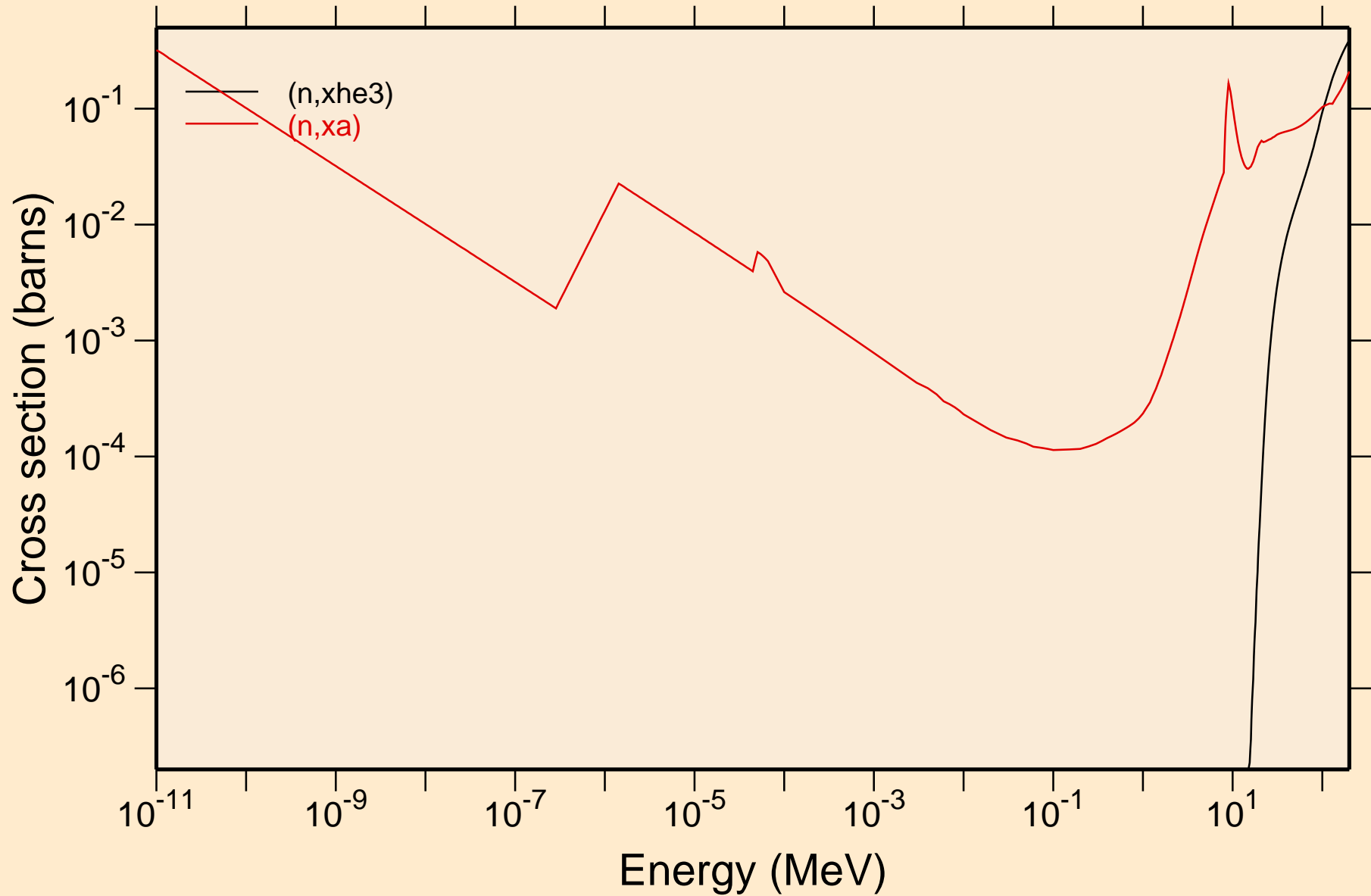

FR211 NEUTRON ACER TENDL-2024 LIBRARY; T=0.K

Principal cross sections

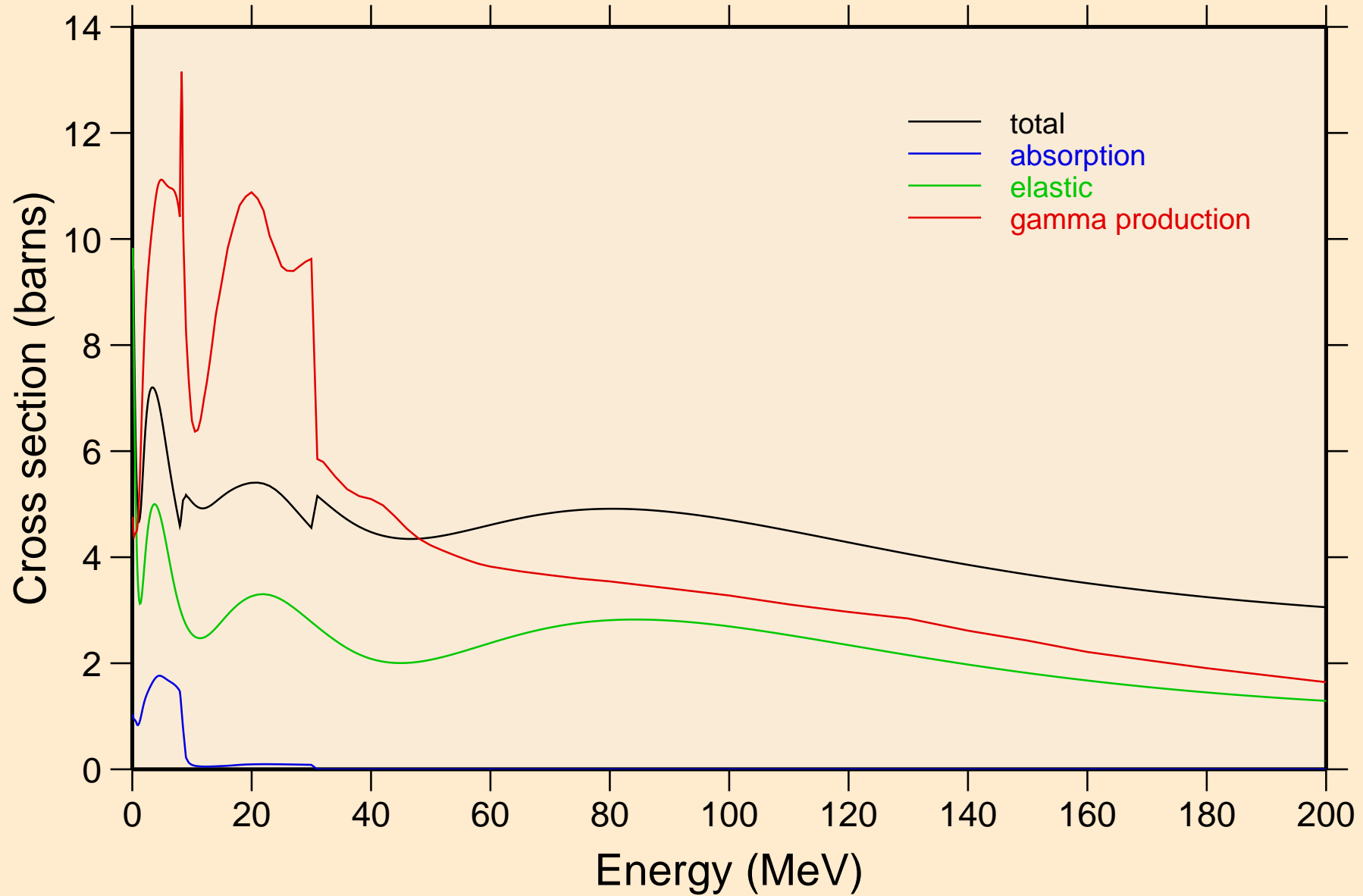

FR211 NEUTRON ACER TENDL-2024 LIBRARY; T=0.K

Heating

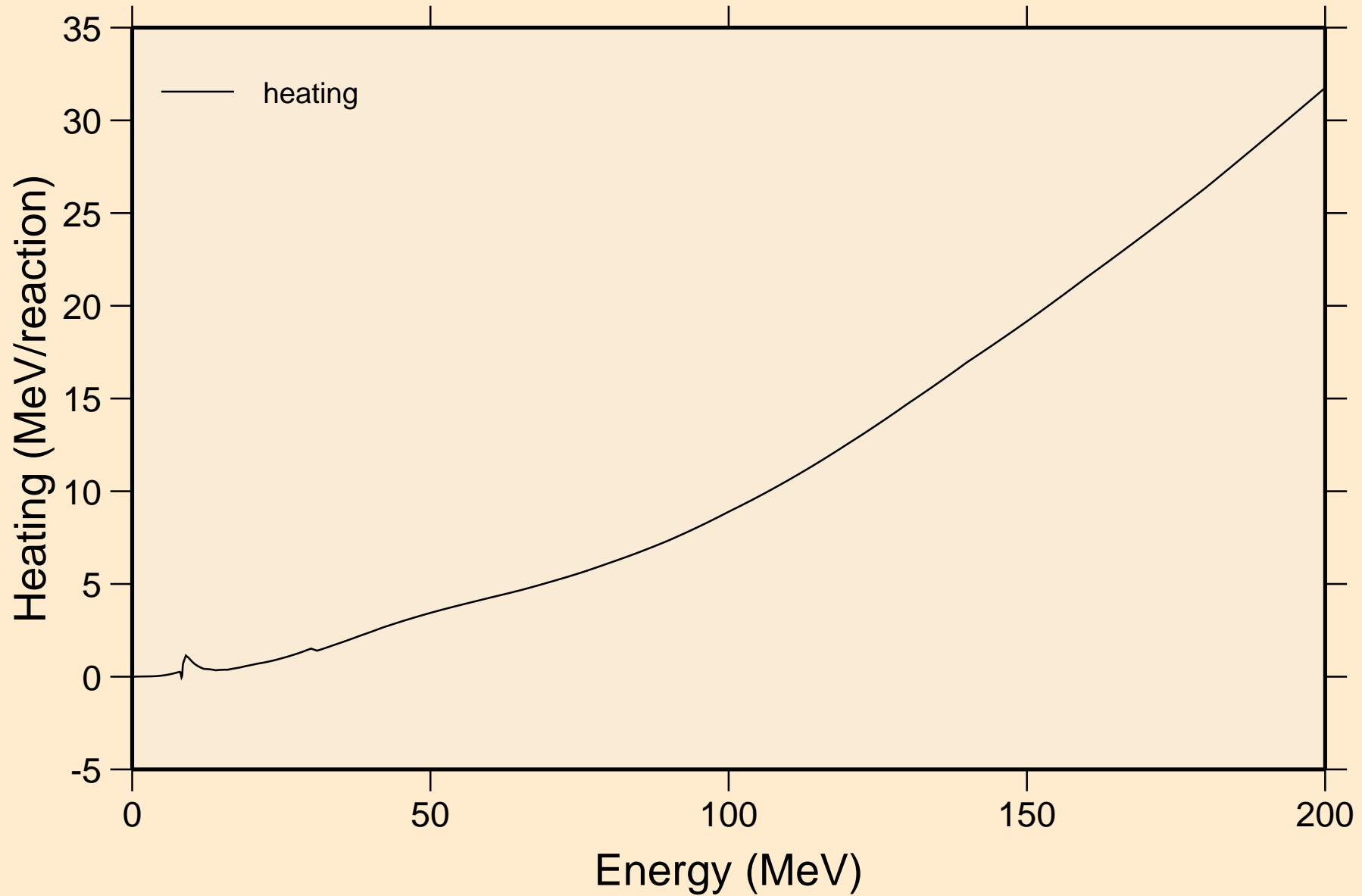

FR211 NEUTRON ACER TENDL-2024 LIBRARY; T=0.K

Damage

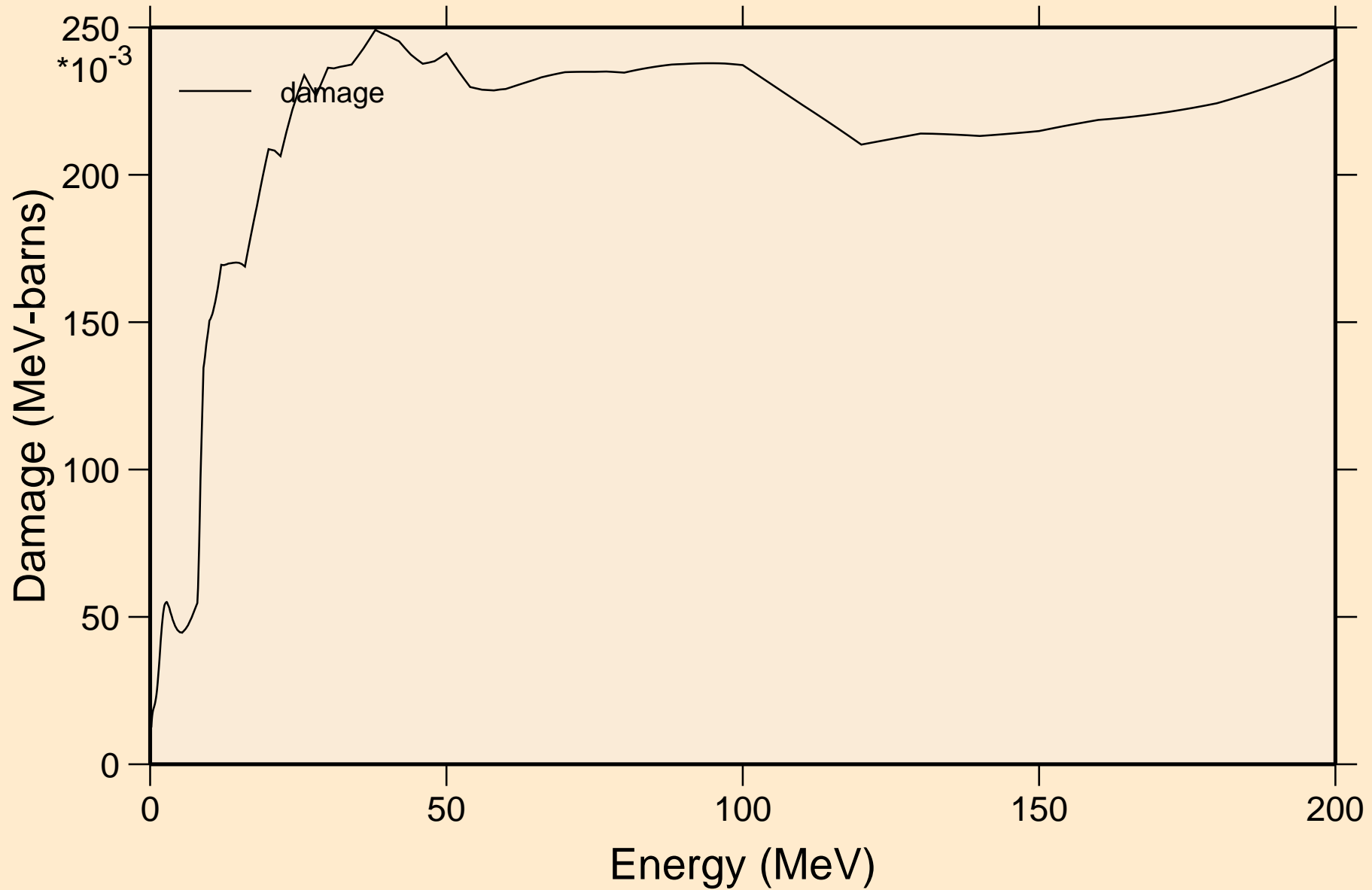

FR211 NEUTRON ACER TENDL-2024 LIBRARY; T=0.K

Non-threshold reactions

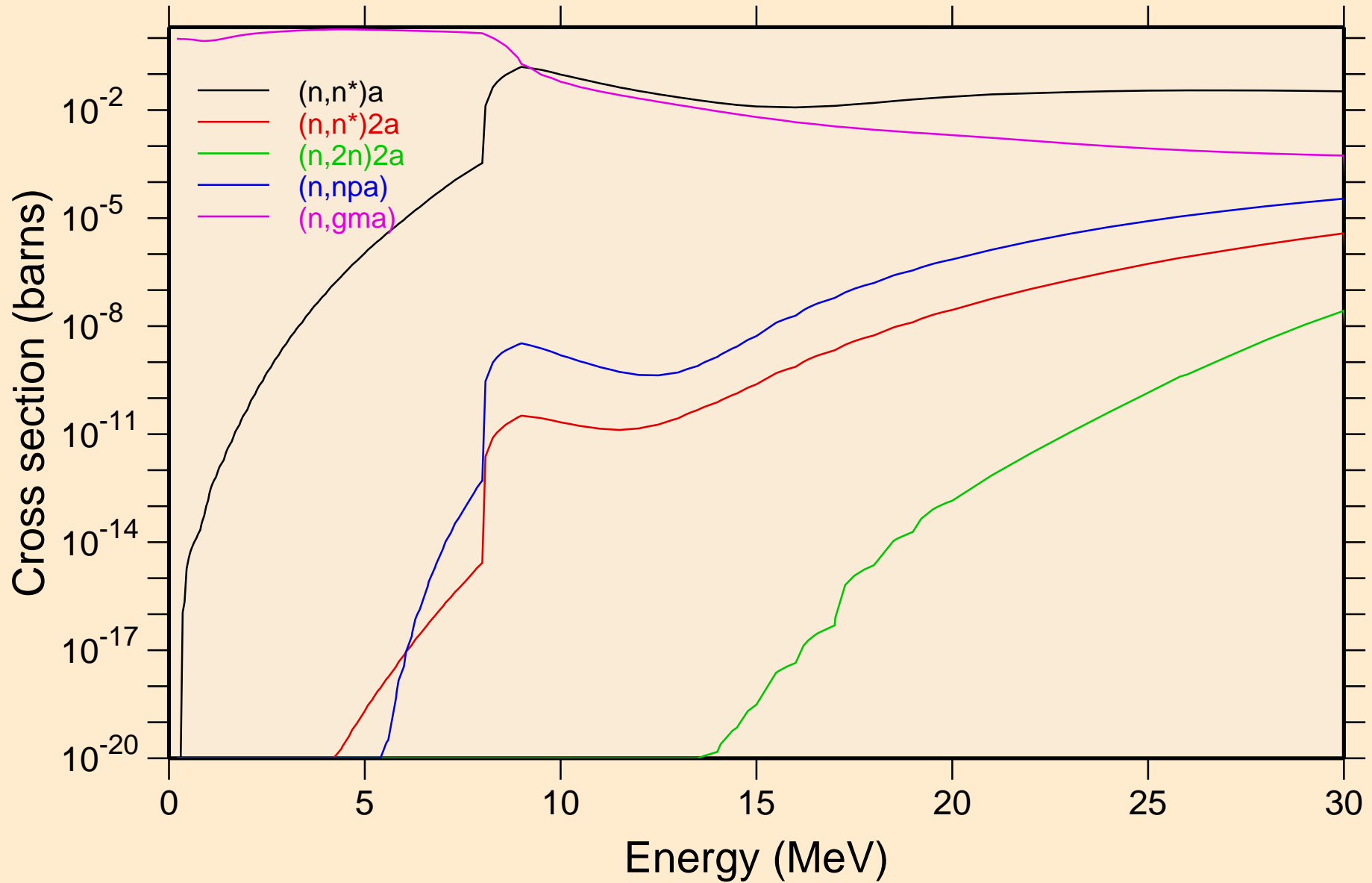

FR211 NEUTRON ACER TENDL-2024 LIBRARY; T=0.K
Non-threshold reactions

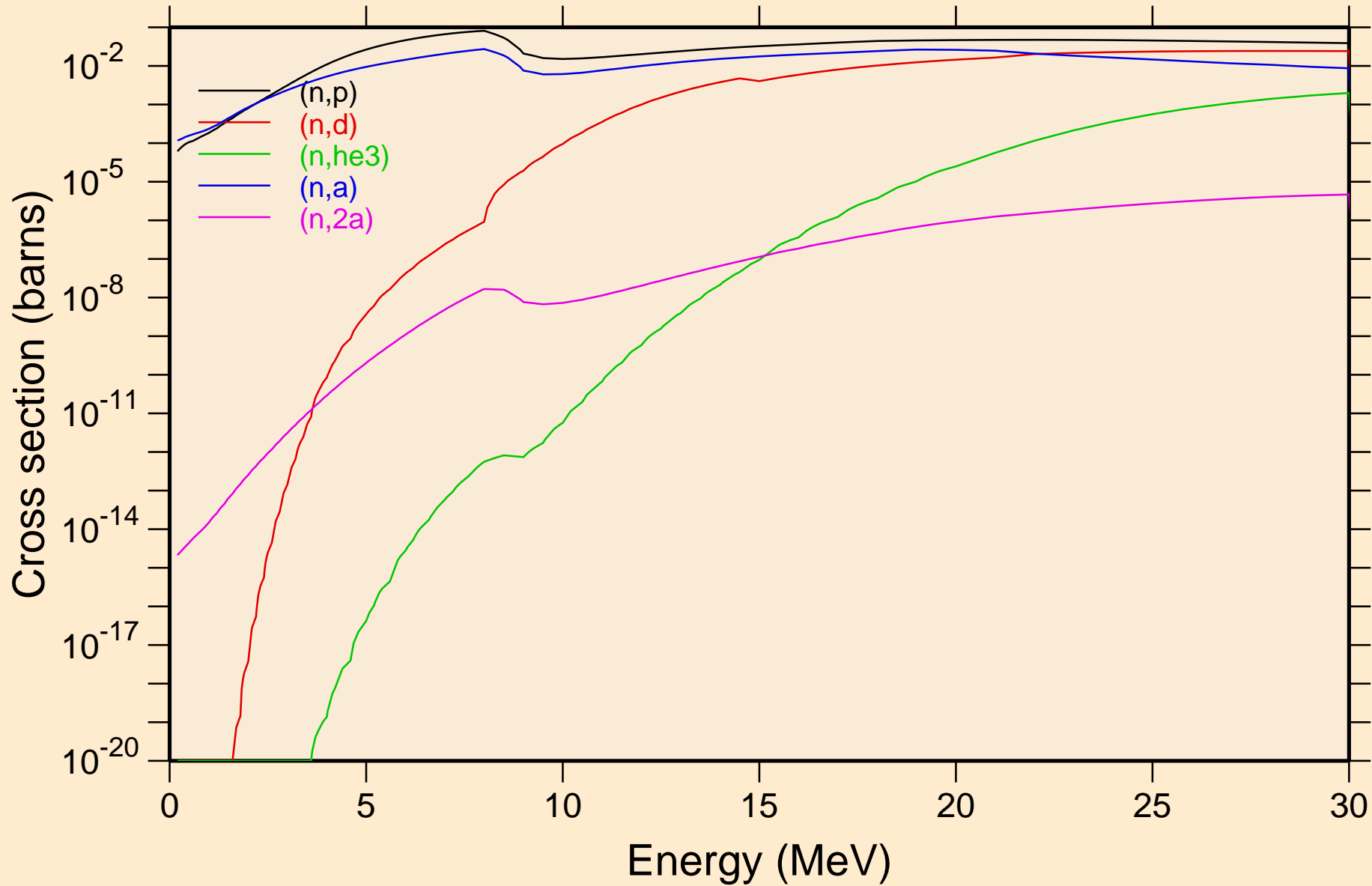

FR211 NEUTRON ACER TENDL-2024 LIBRARY; T=0.K
Non-threshold reactions

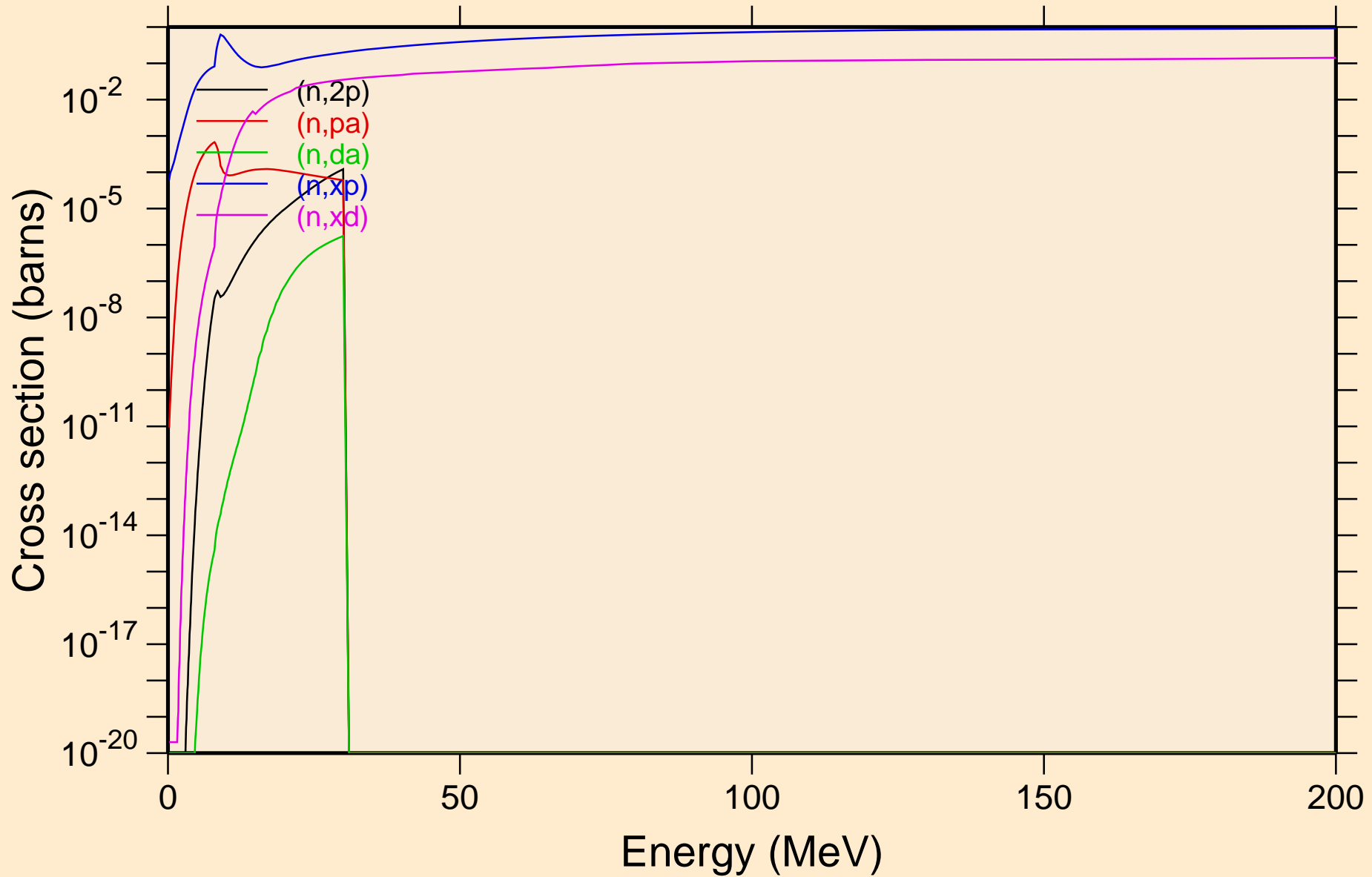

FR211 NEUTRON ACER TENDL-2024 LIBRARY; T=0.K
Non-threshold reactions

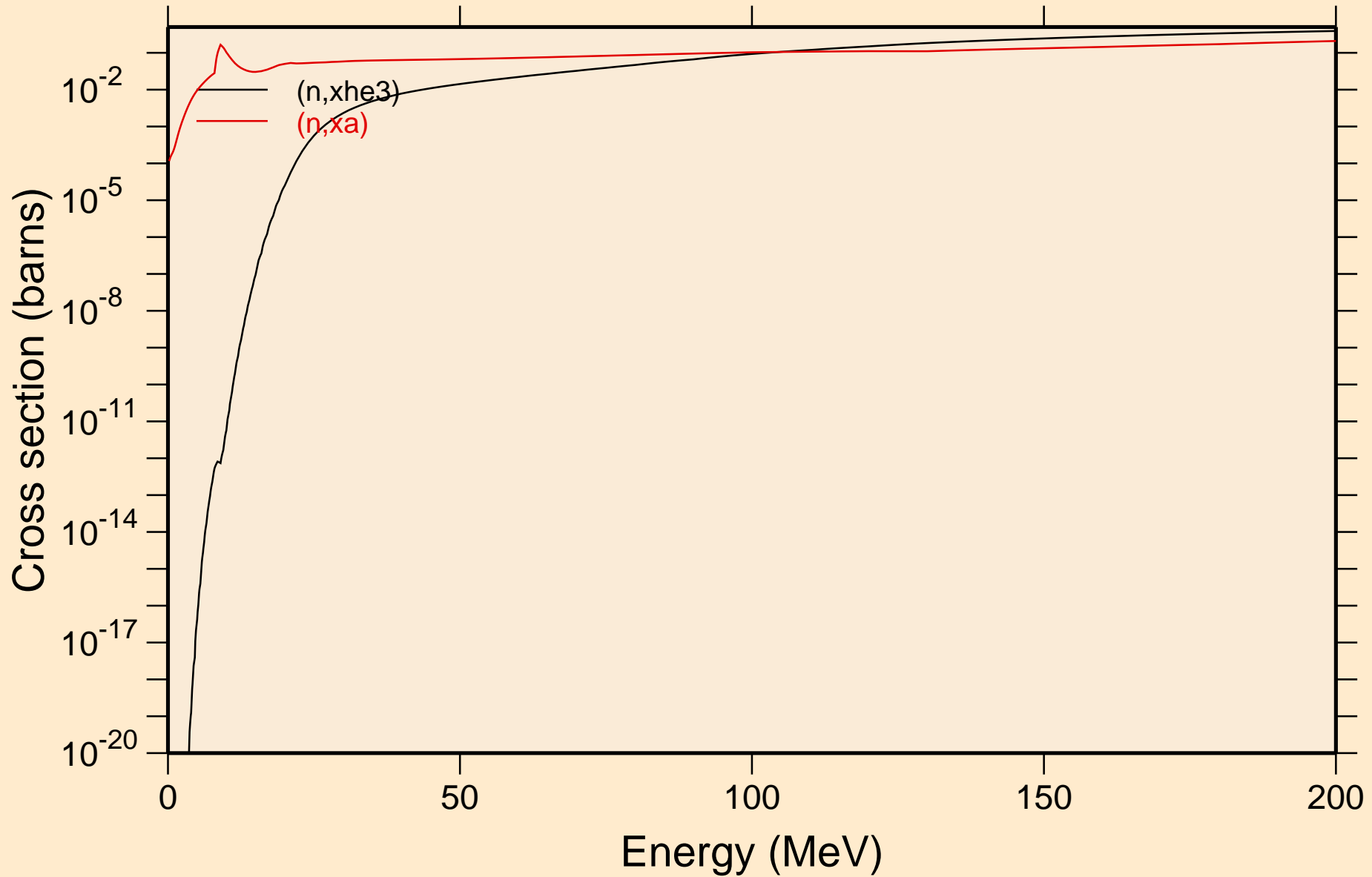

FR211 NEUTRON ACER TENDL-2024 LIBRARY; T=0.K
Inelastic levels

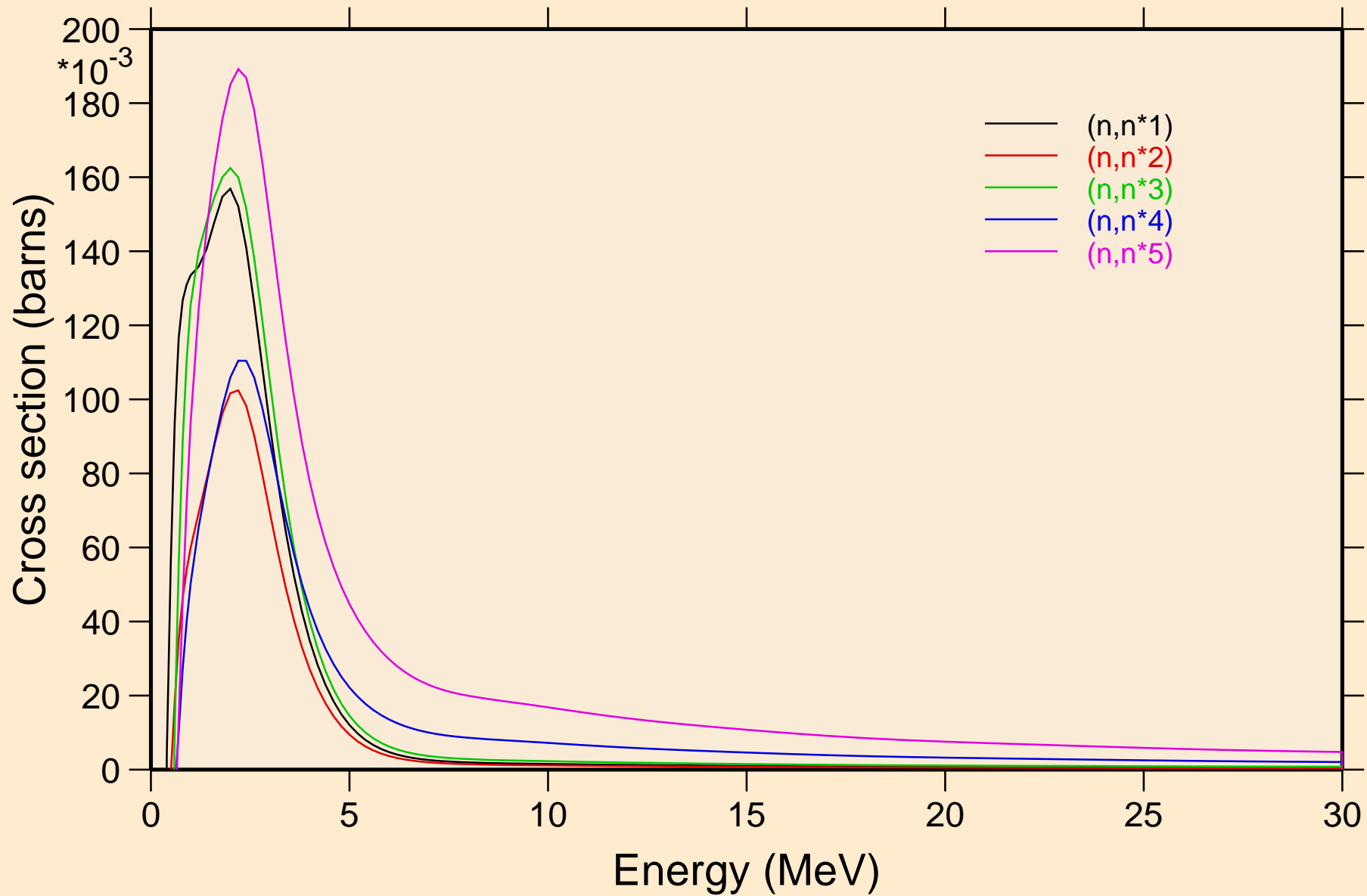

FR211 NEUTRON ACER TENDL-2024 LIBRARY; T=0.K
Inelastic levels

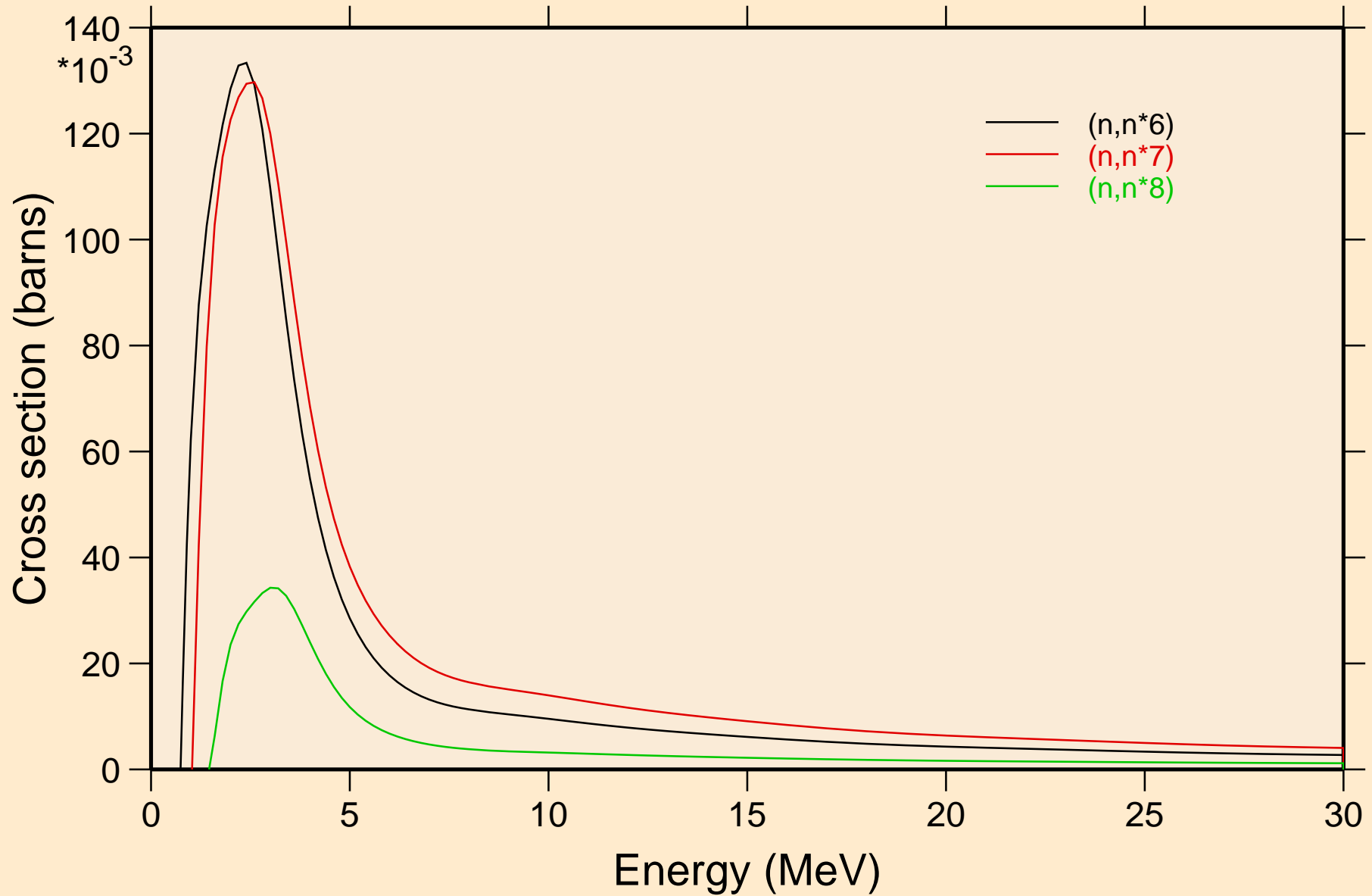

FR211 NEUTRON ACER TENDL-2024 LIBRARY; T=0.K

Threshold reactions

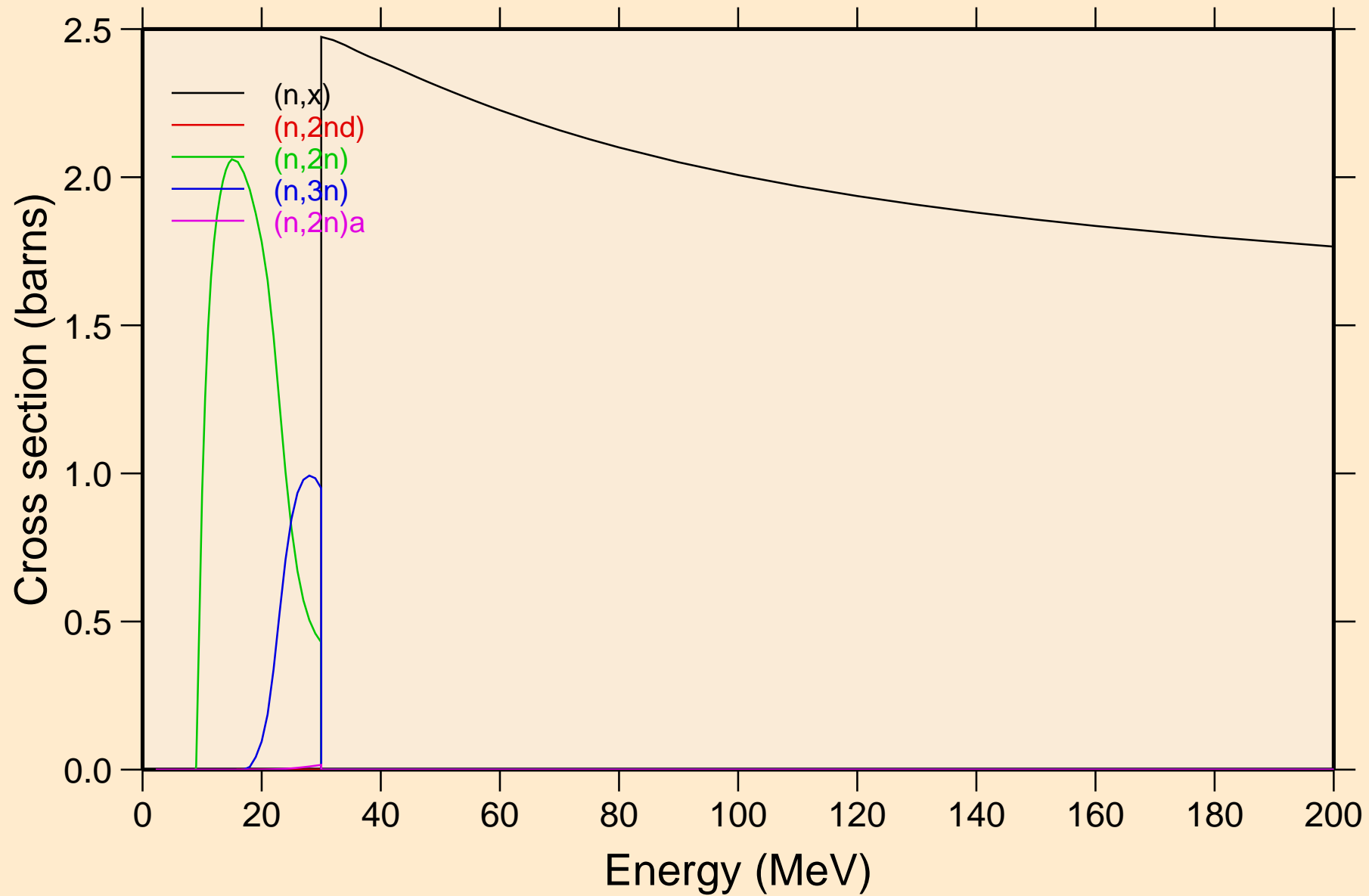

FR211 NEUTRON ACER TENDL-2024 LIBRARY; T=0.K
Threshold reactions

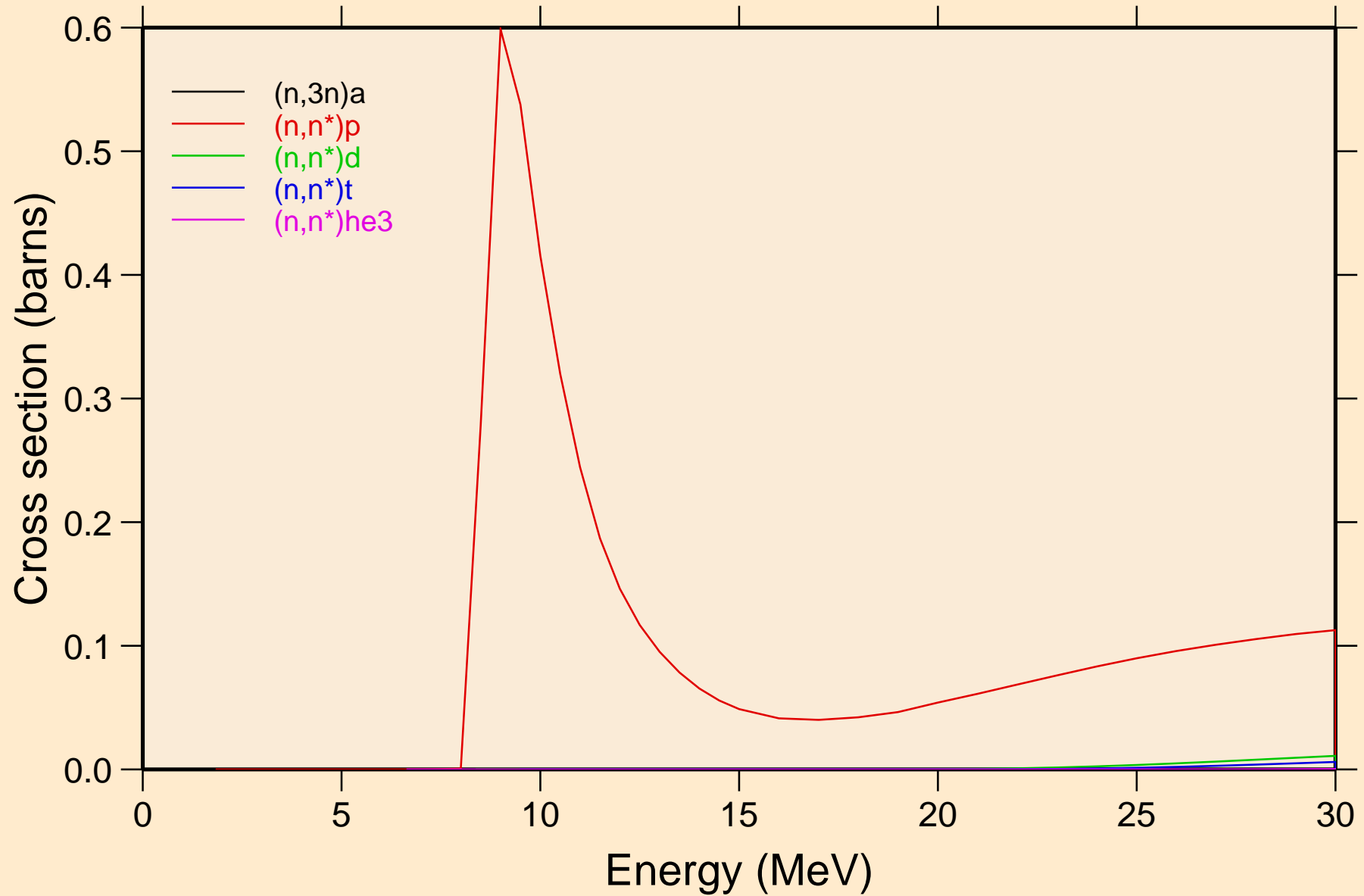

FR211 NEUTRON ACER TENDL-2024 LIBRARY; T=0.K
Threshold reactions

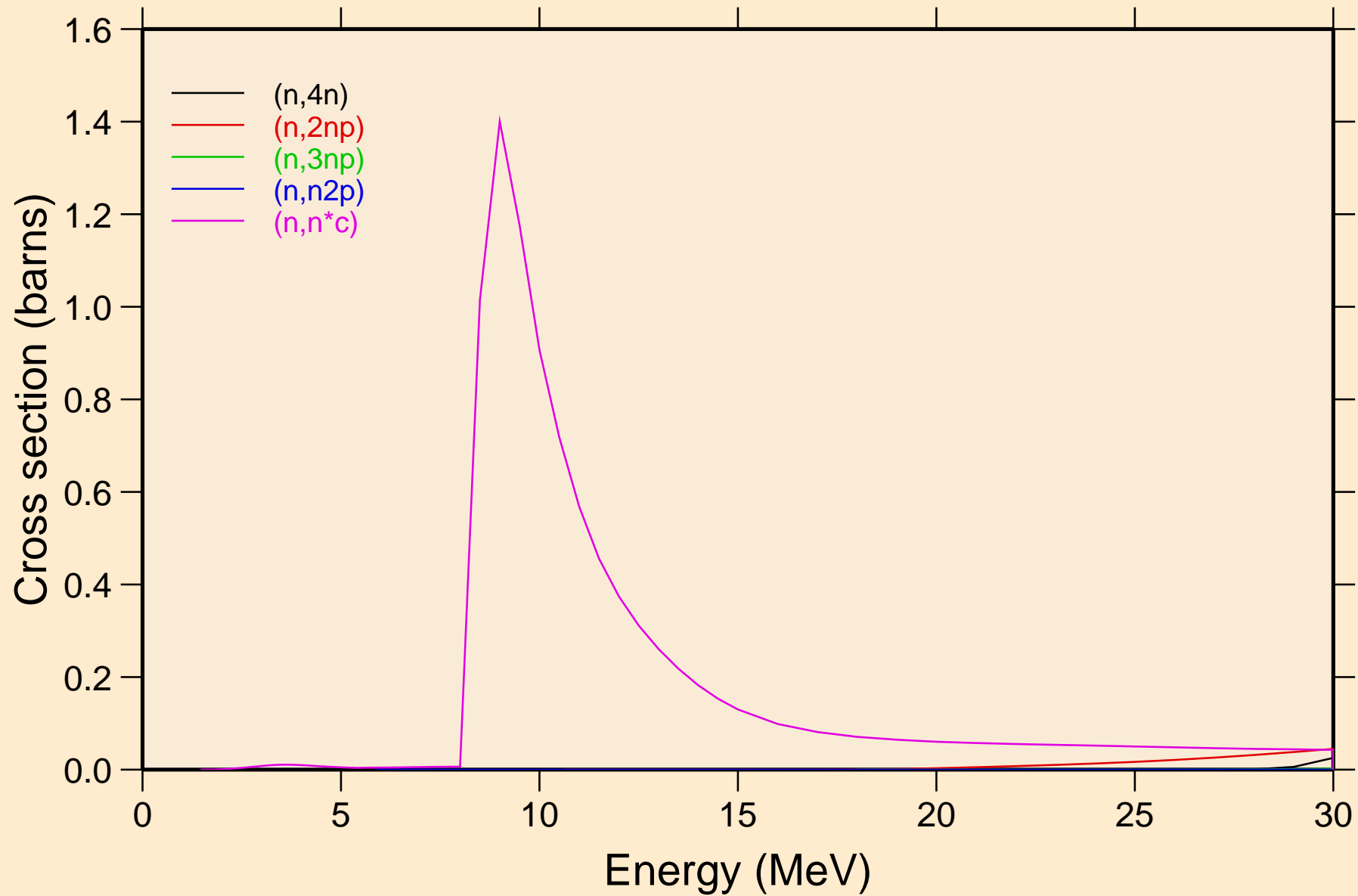

FR211 NEUTRON ACER TENDL-2024 LIBRARY; T=0.K
Threshold reactions

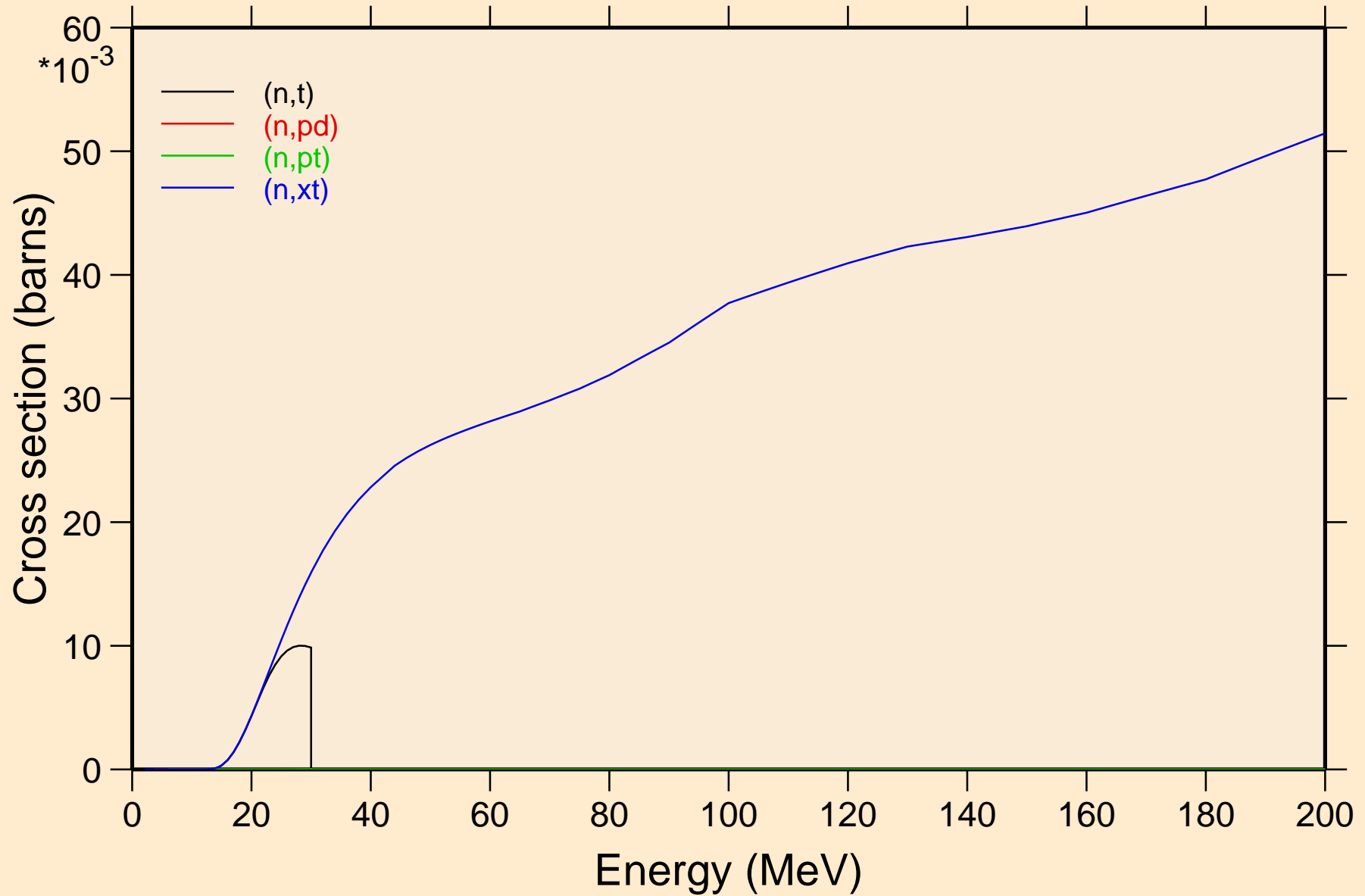

FR211 NEUTRON ACER TENDL-2024 LIBRARY; T=0.K
angular distribution for elastic

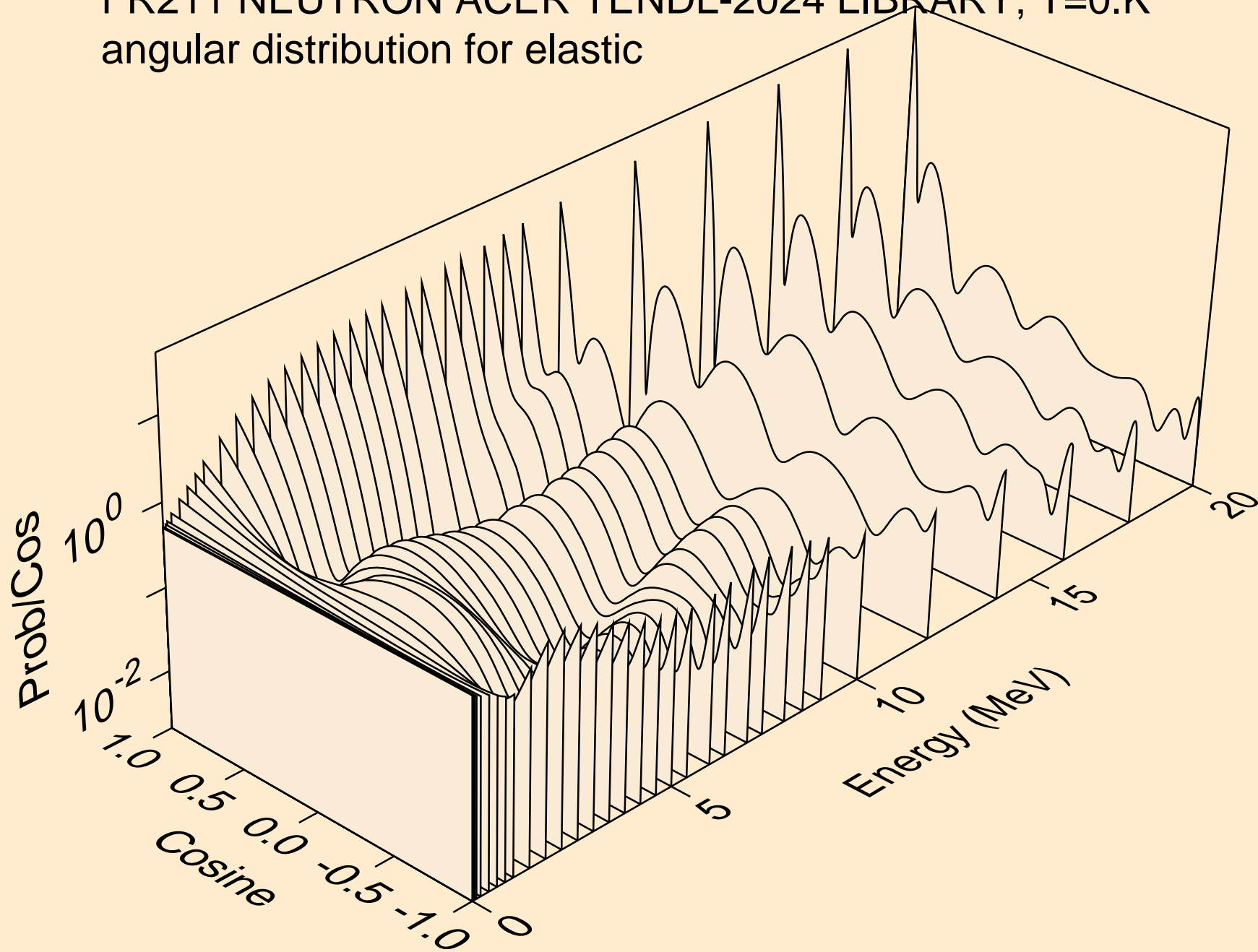

FR211 NEUTRON ACER TENDL-2024 LIBRARY; T=0.K
angular distribution for elastic

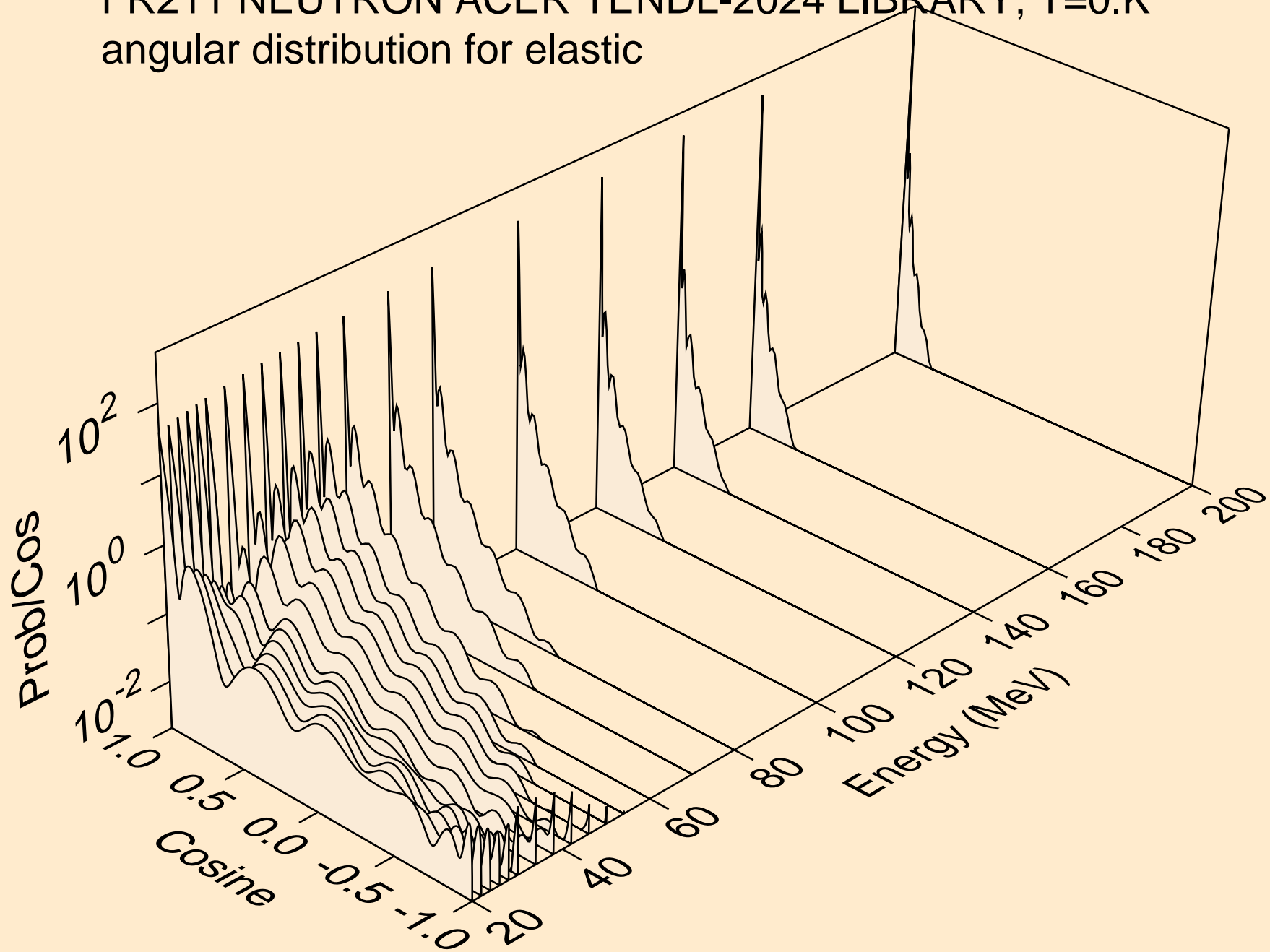

FR211 NEUTRON ACER TENDL-2024 LIBRARY; T=0.K
angular distribution for (n,n*1)

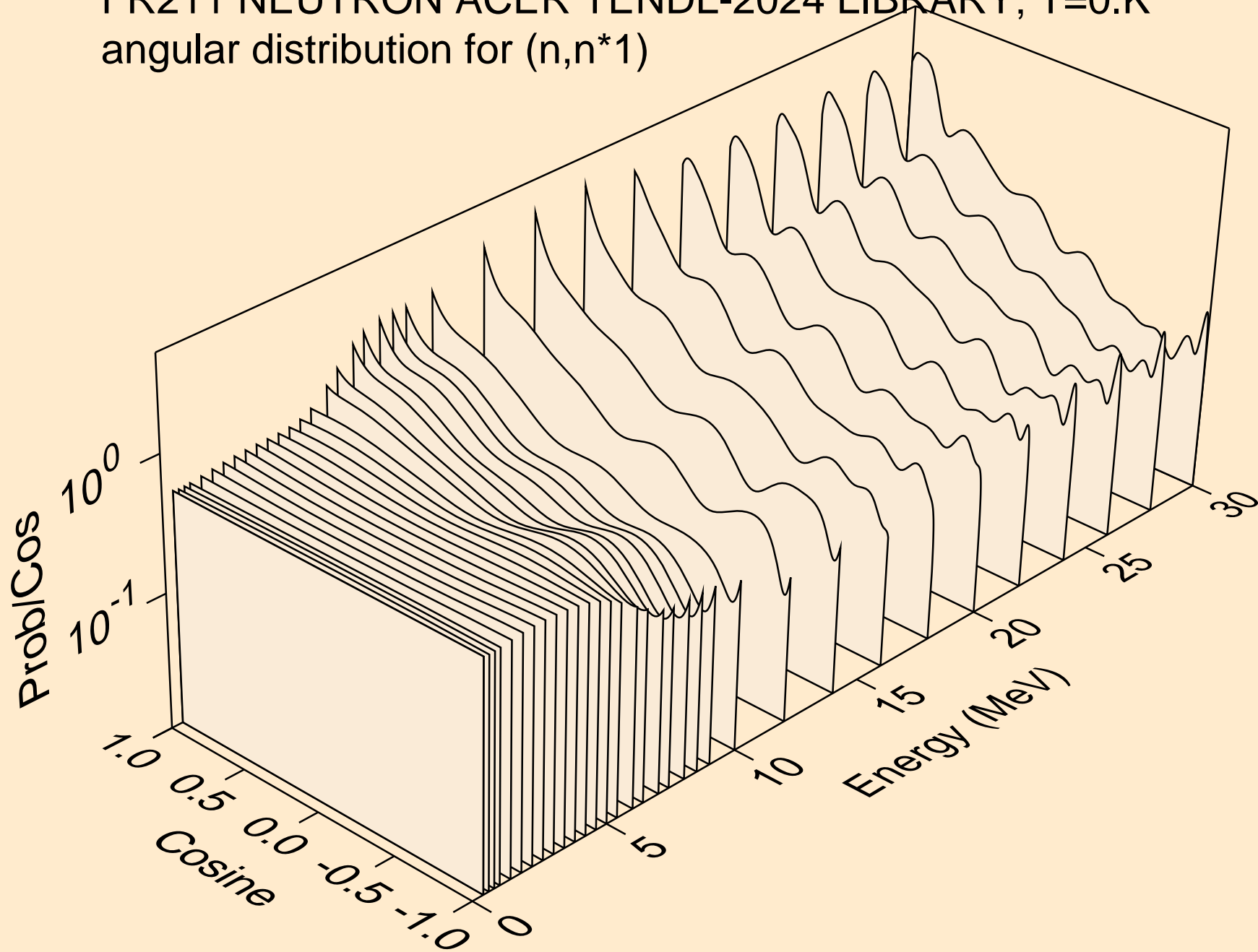

FR211 NEUTRON ACER TENDL-2024 LIBRARY; T=0.K
angular distribution for (n,n*2)

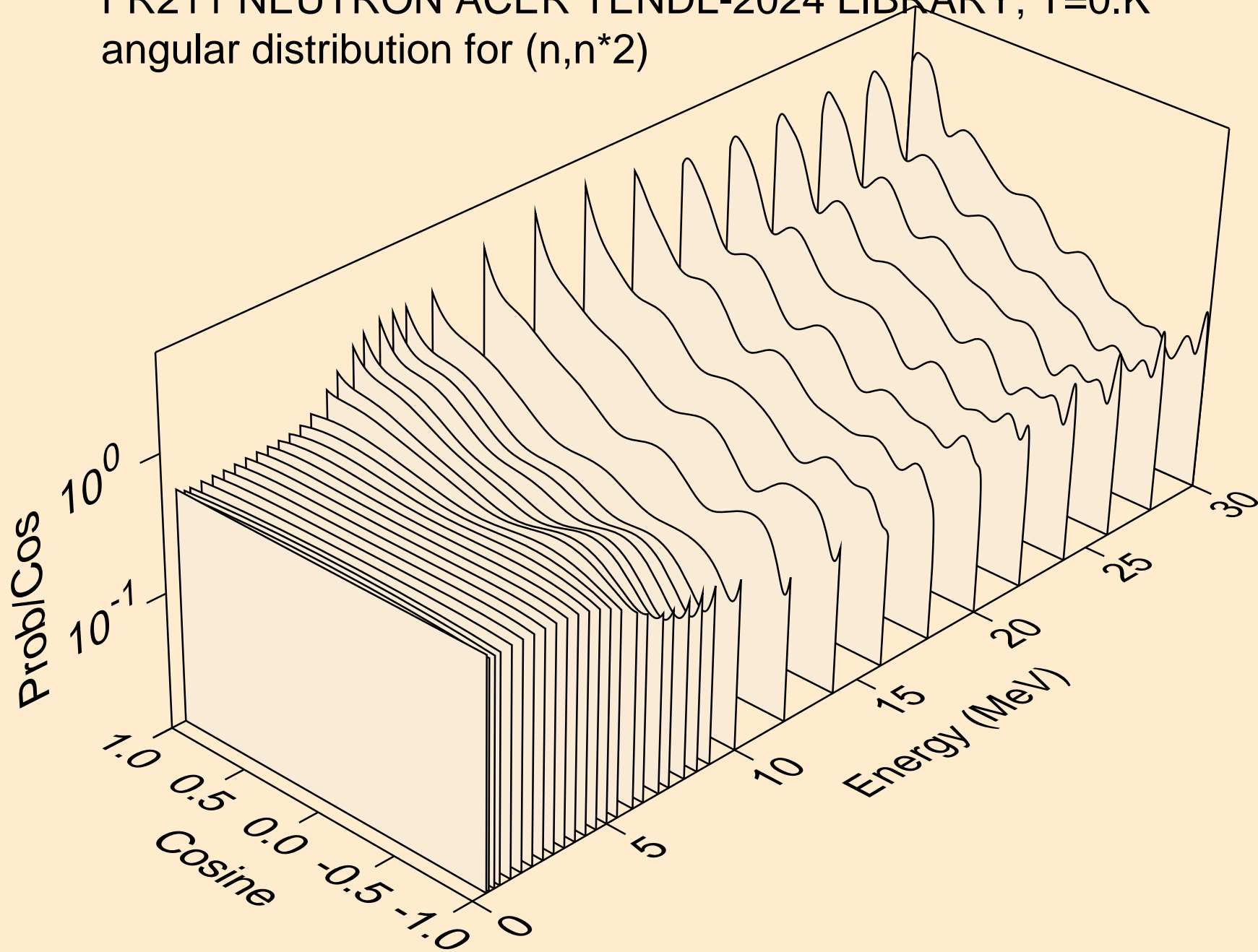

FR211 NEUTRON ACER TENDL-2024 LIBRARY; T=0.K
angular distribution for (n,n*3)

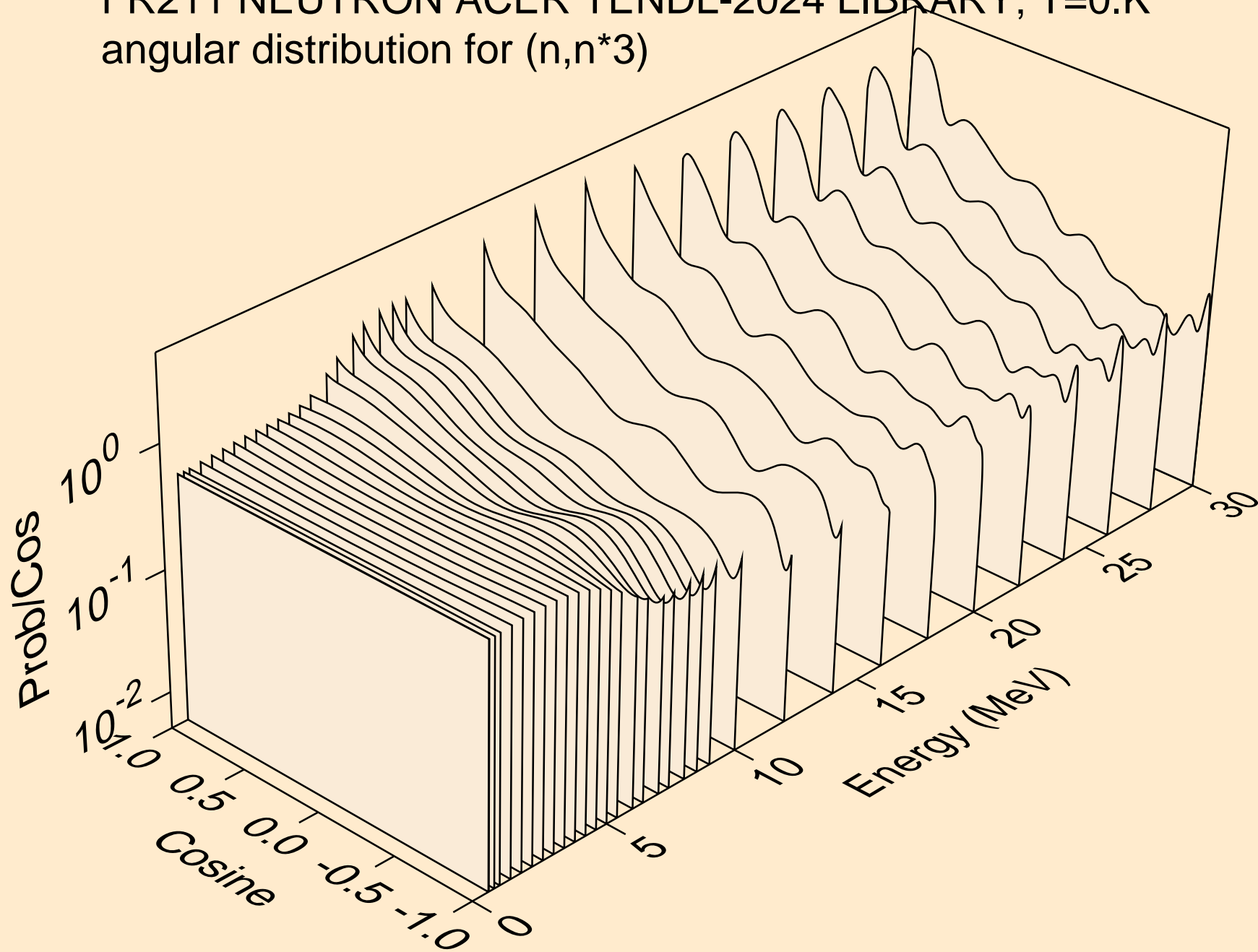

FR211 NEUTRON ACER TENDL-2024 LIBRARY; T=0.K
angular distribution for (n,n*4)

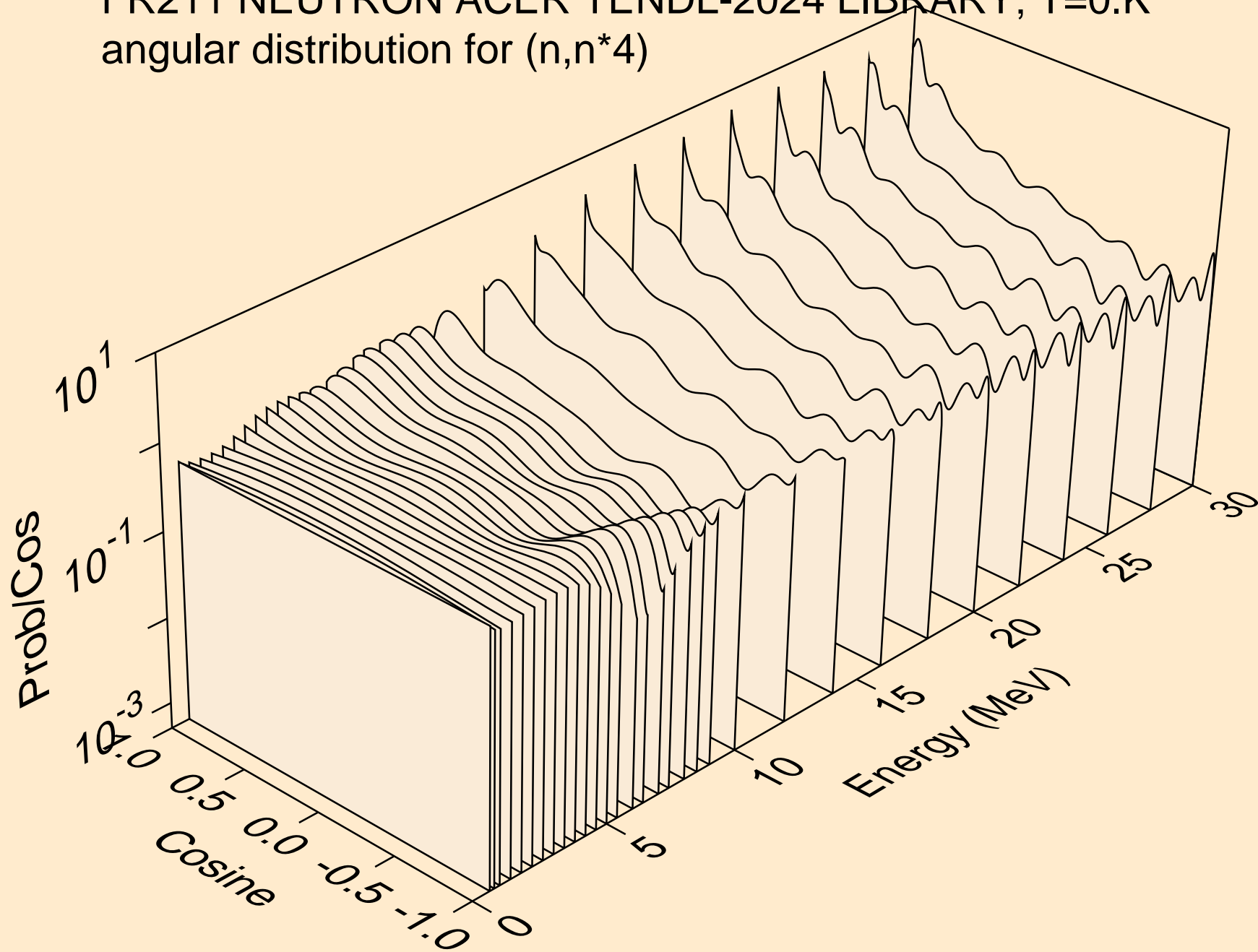

FR211 NEUTRON ACER TENDL-2024 LIBRARY; T=0.K
angular distribution for (n,n*5)

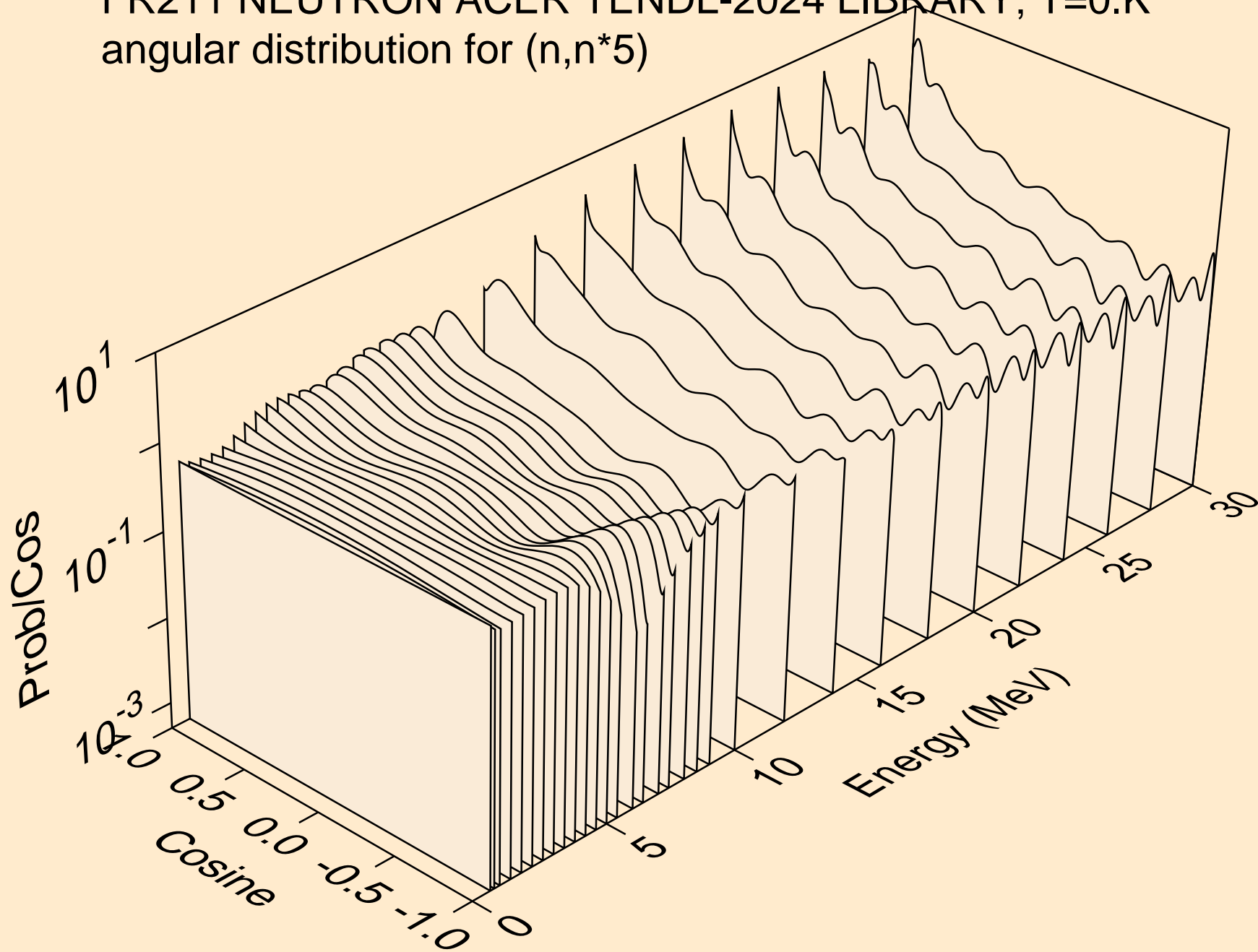

FR211 NEUTRON ACER TENDL-2024 LIBRARY; T=0.K
angular distribution for (n,n*6)

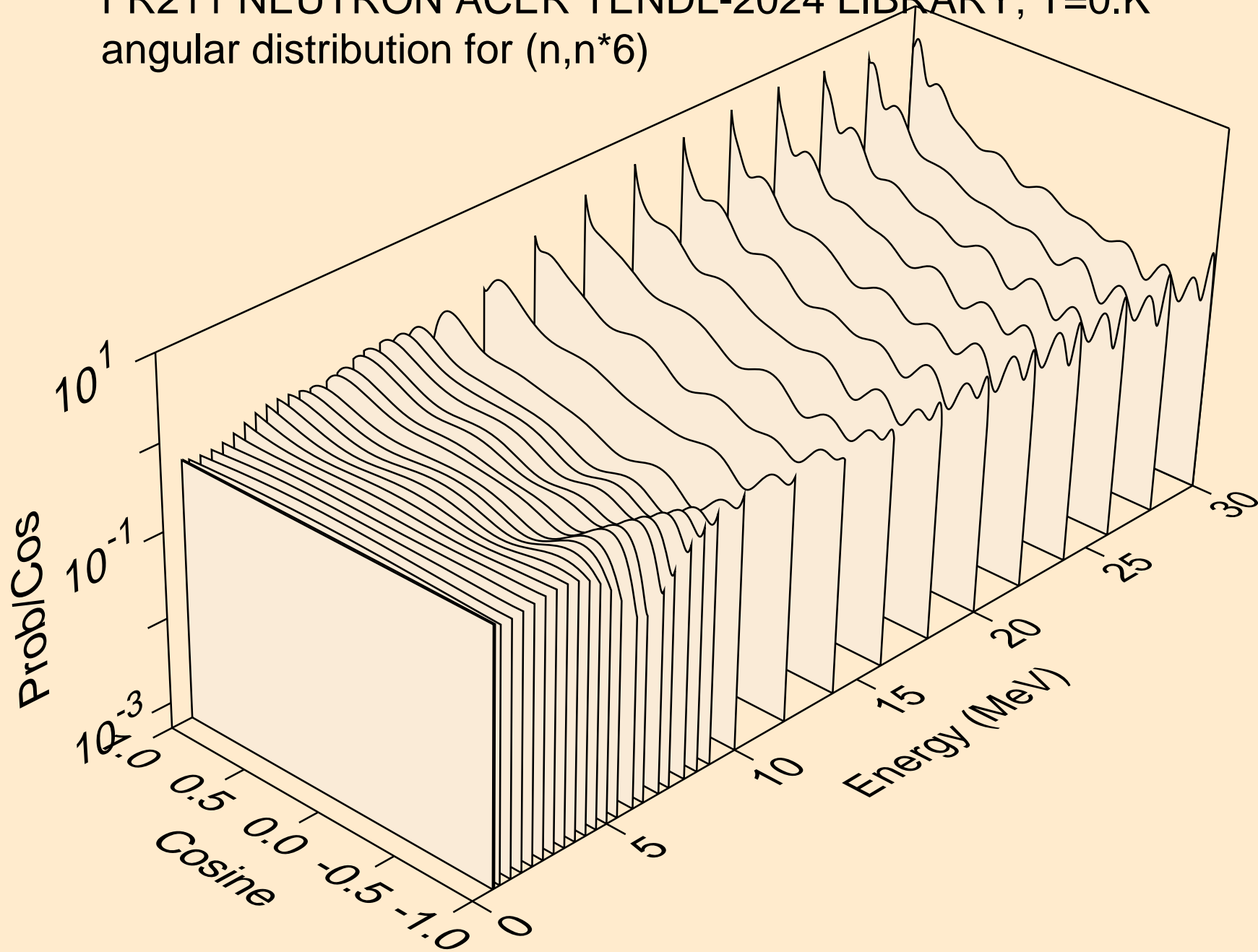

FR211 NEUTRON ACER TENDL-2024 LIBRARY; T=0.K
angular distribution for (n,n*7)

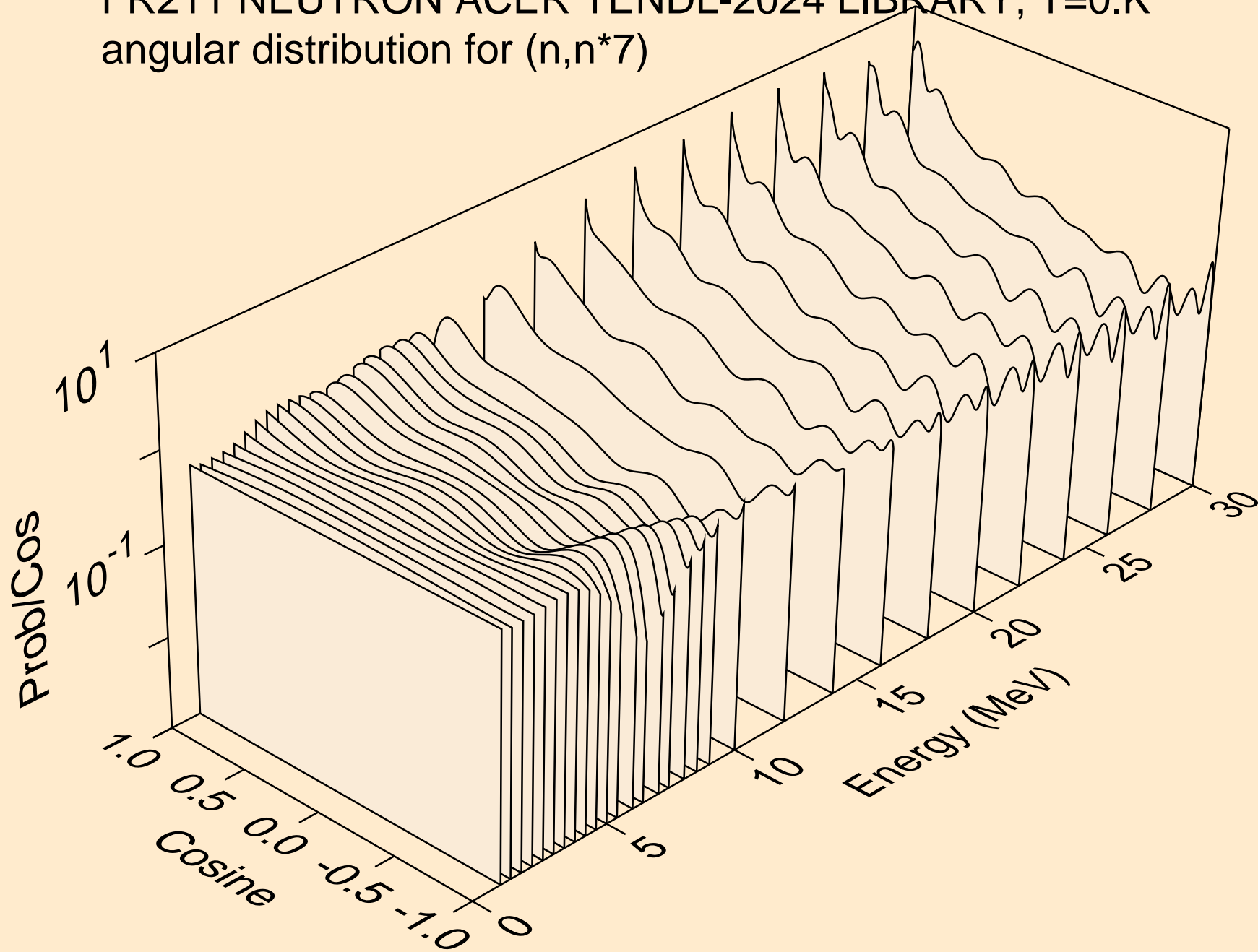

FR211 NEUTRON ACER TENDL-2024 LIBRARY; T=0.K
angular distribution for (n,n*8)

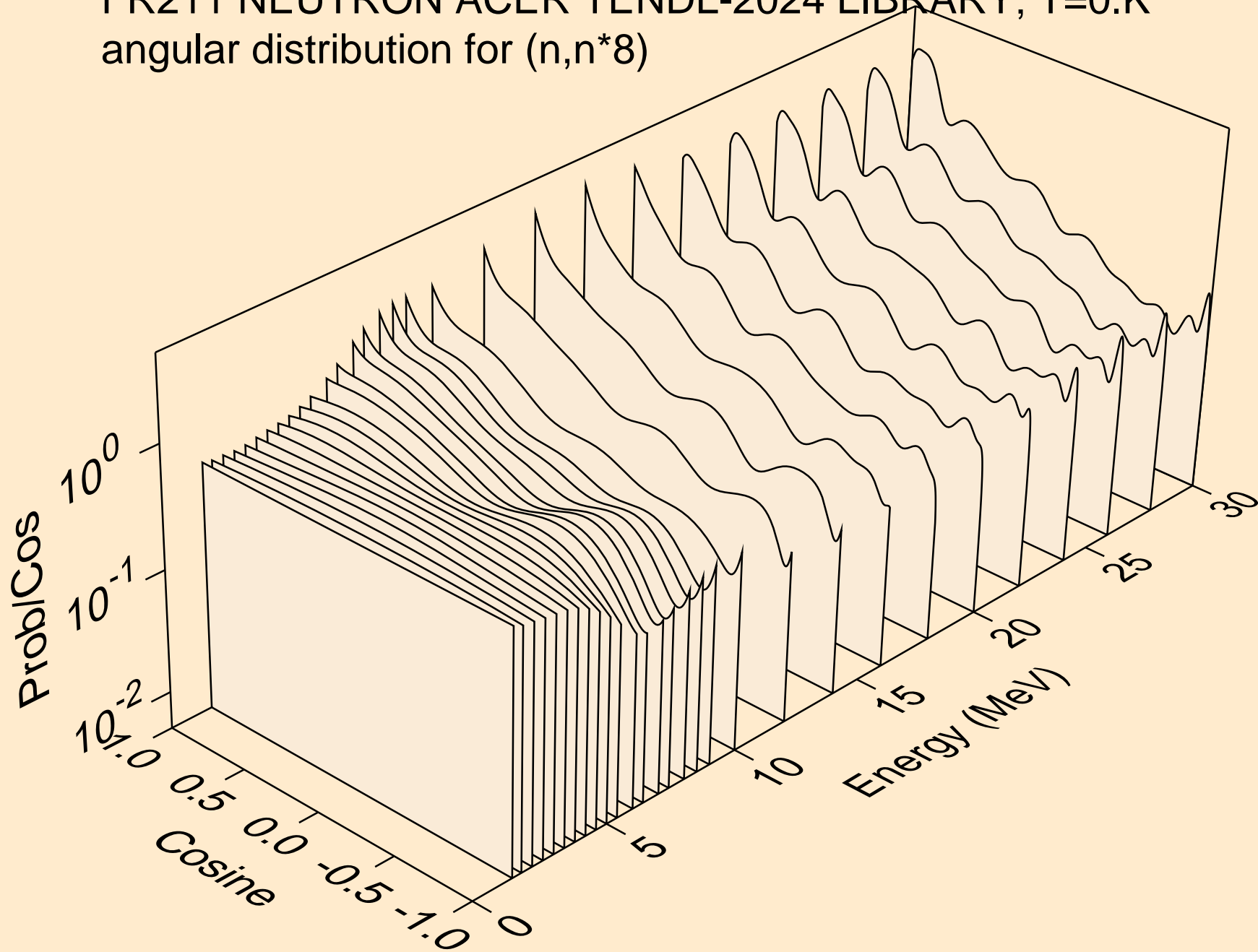

FR211 NEUTRON ACER TENDL-2024 LIBRARY; T=0.K
Neutron emission for (n,x)

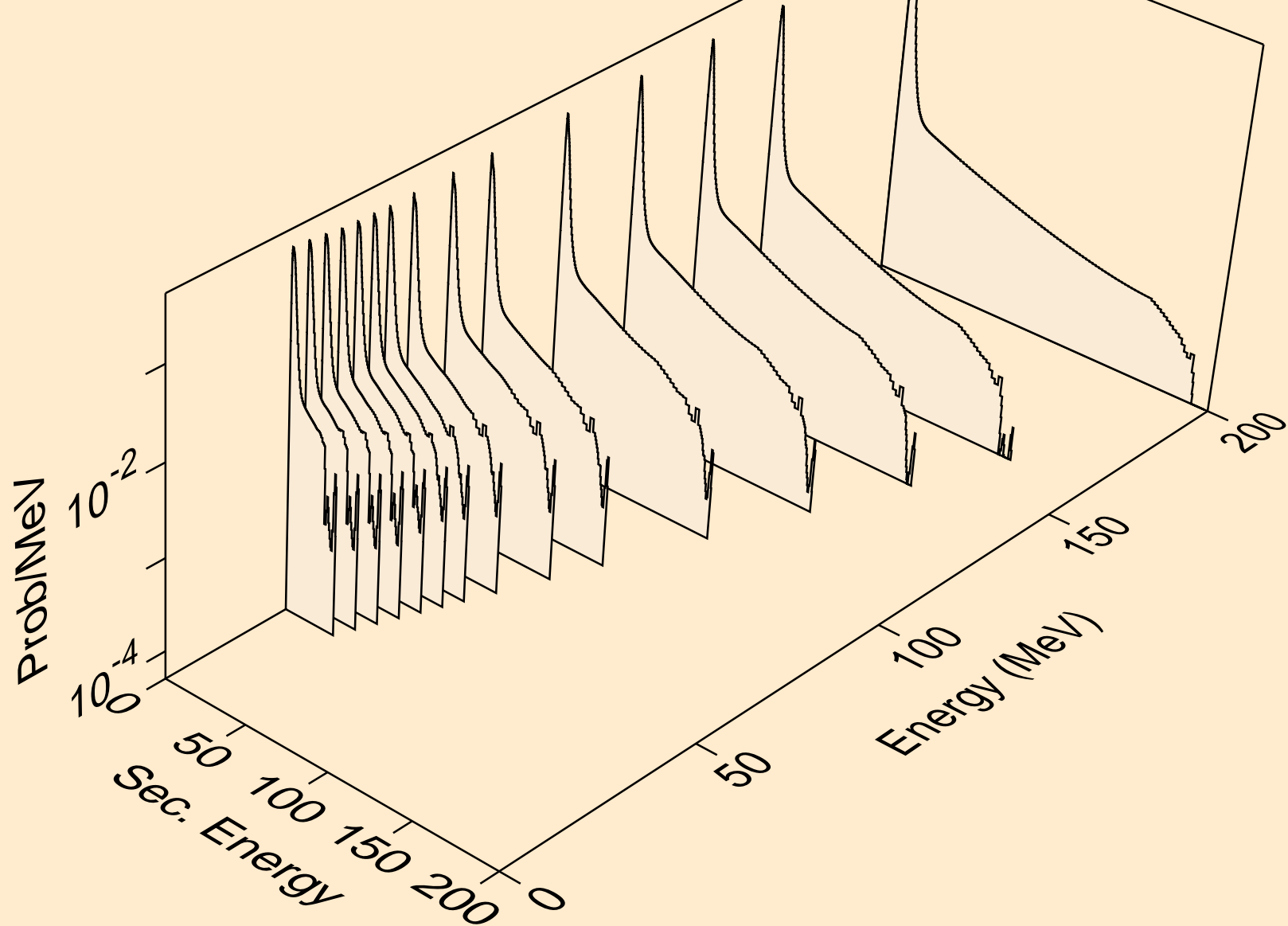

FR211 NEUTRON ACER TENDL-2024 LIBRARY; T=0.K
Neutron emission for (n,2nd)

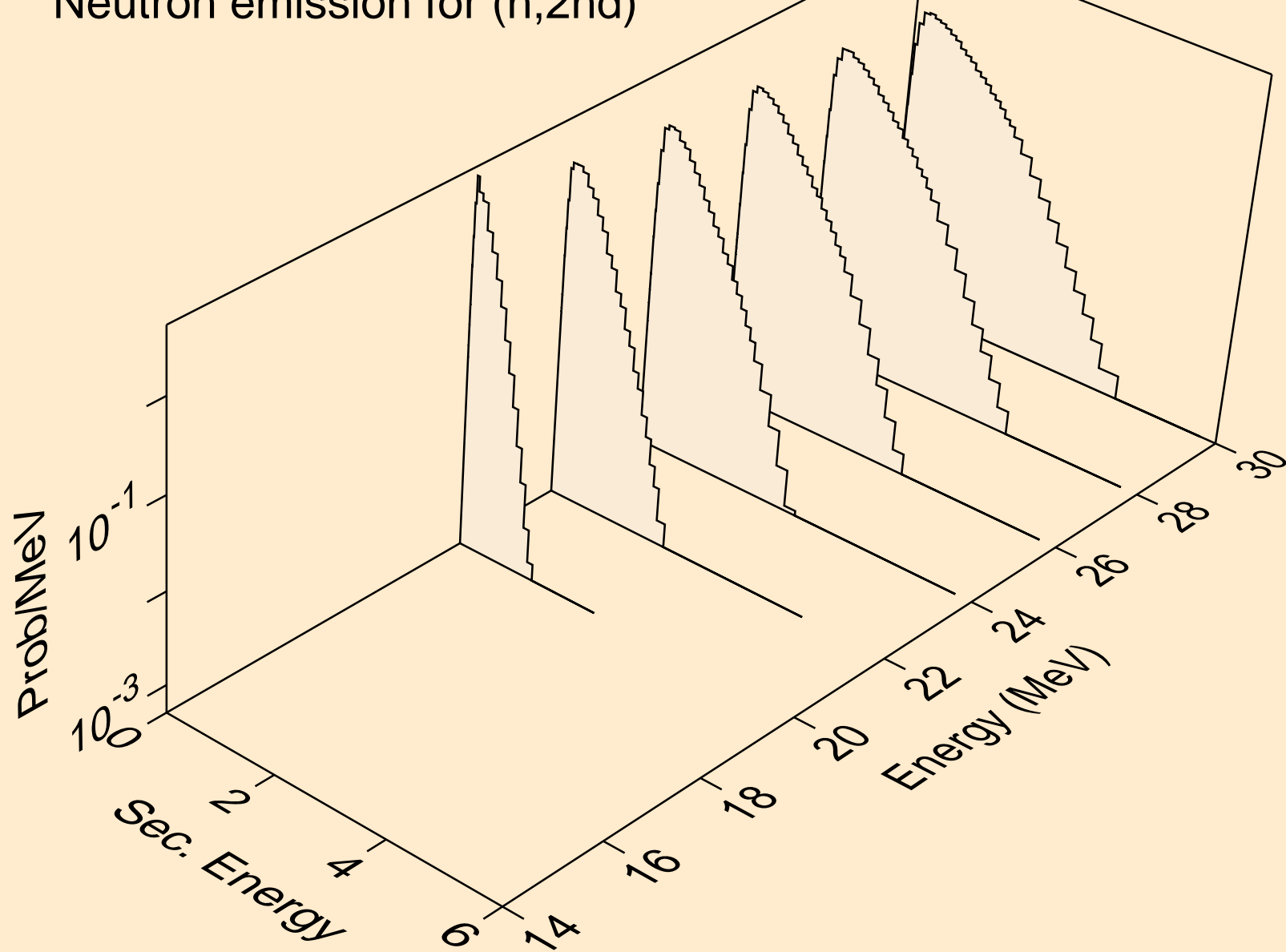

FR211 NEUTRON ACER TENDL-2024 LIBRARY; T=0.K
Neutron emission for (n,2n)

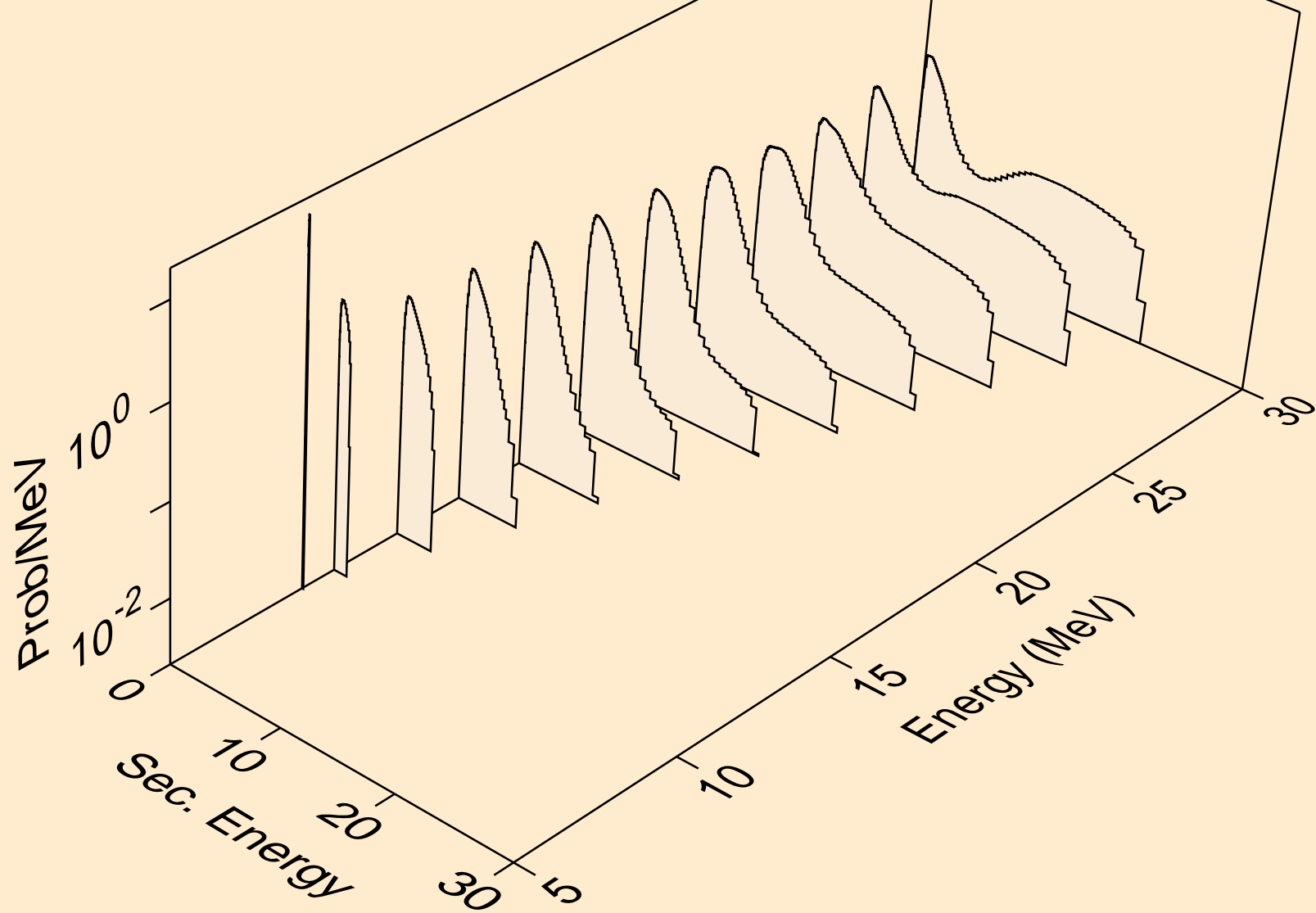

FR211 NEUTRON ACER TENDL-2024 LIBRARY; T=0.K
Neutron emission for (n,3n)

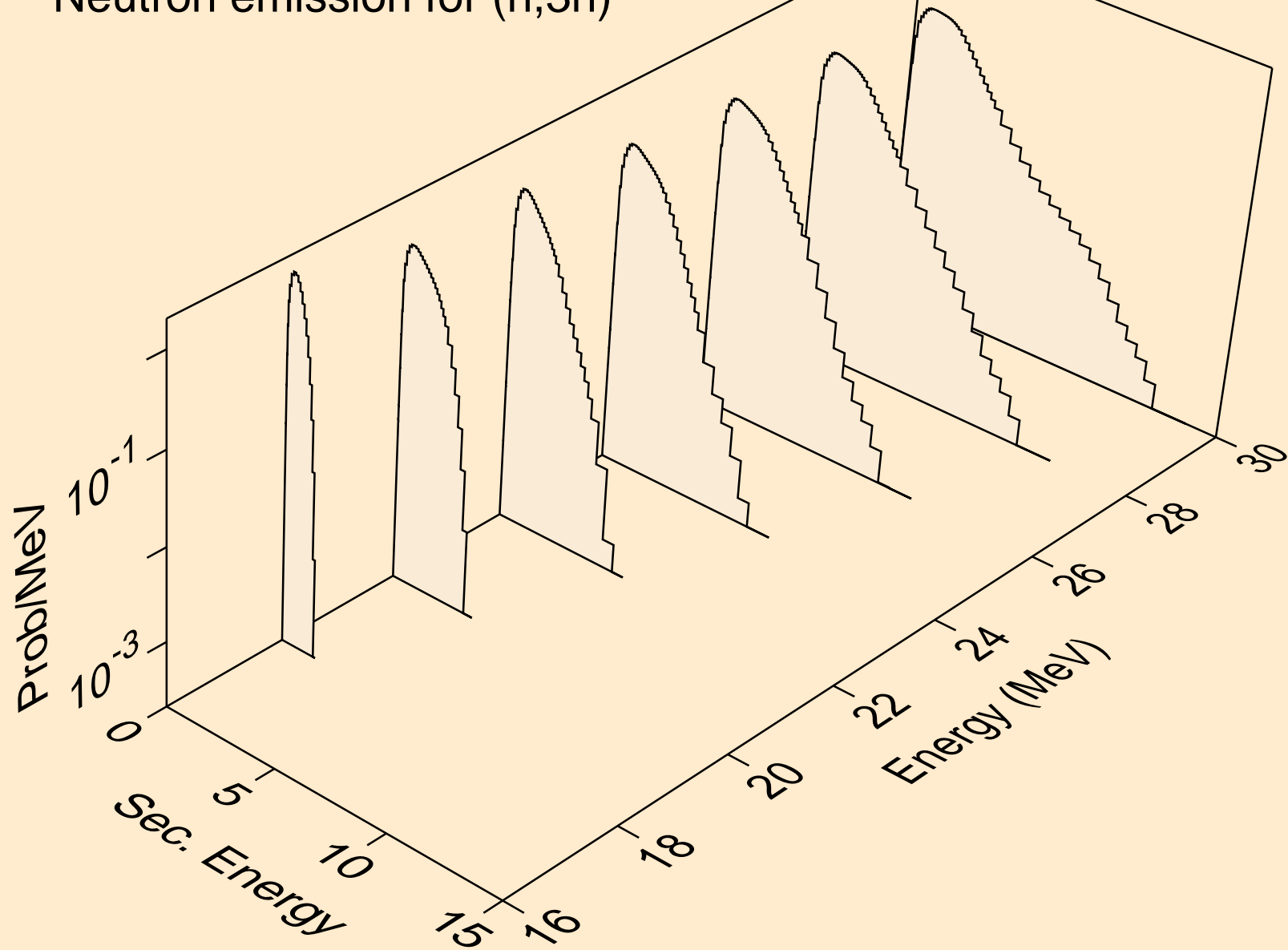

FR211 NEUTRON ACER TENDL-2024 LIBRARY; T=0.K
Neutron emission for (n,n*)a

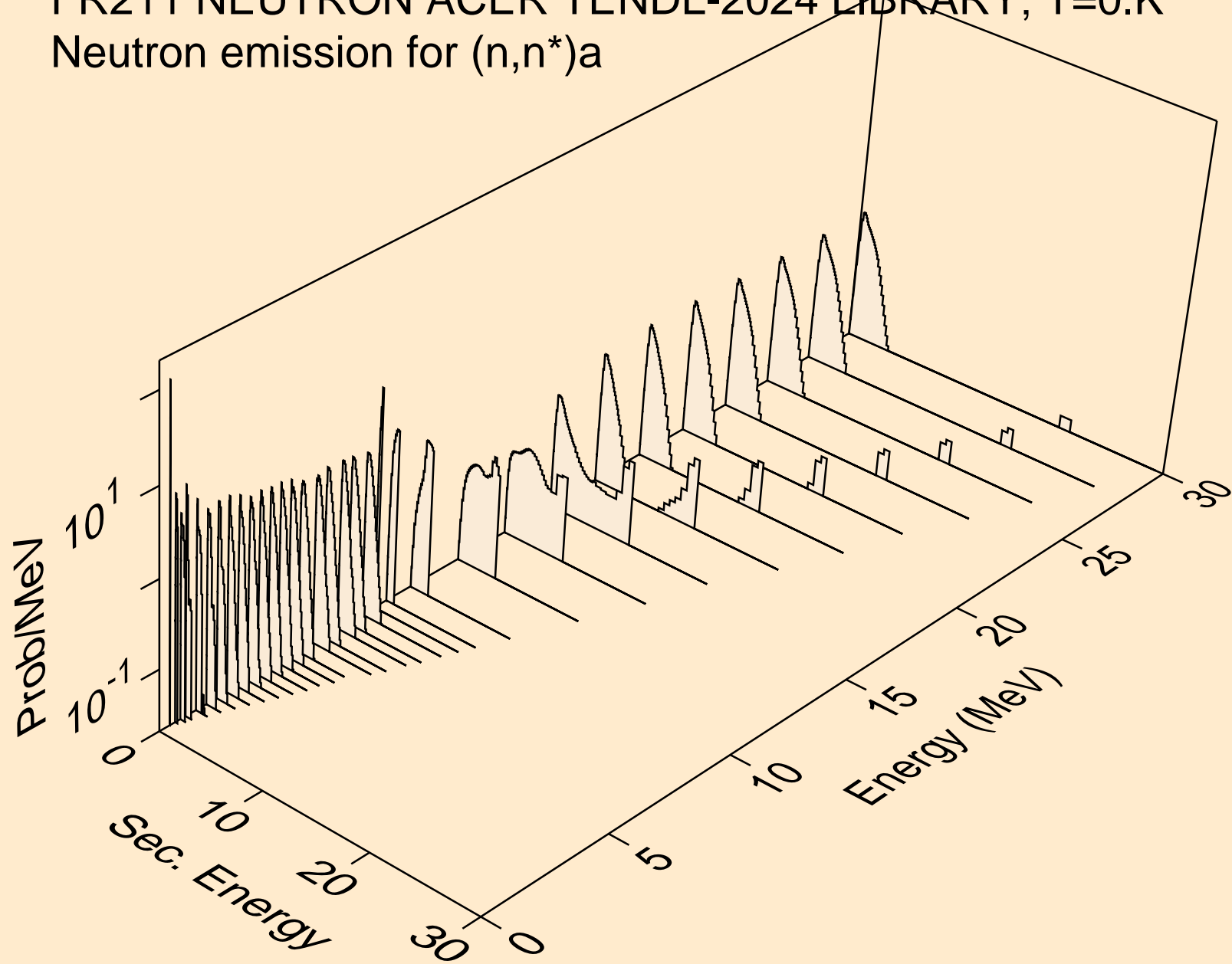

FR211 NEUTRON ACER TENDL-2024 LIBRARY; T=0.K
Neutron emission for (n,2n)a

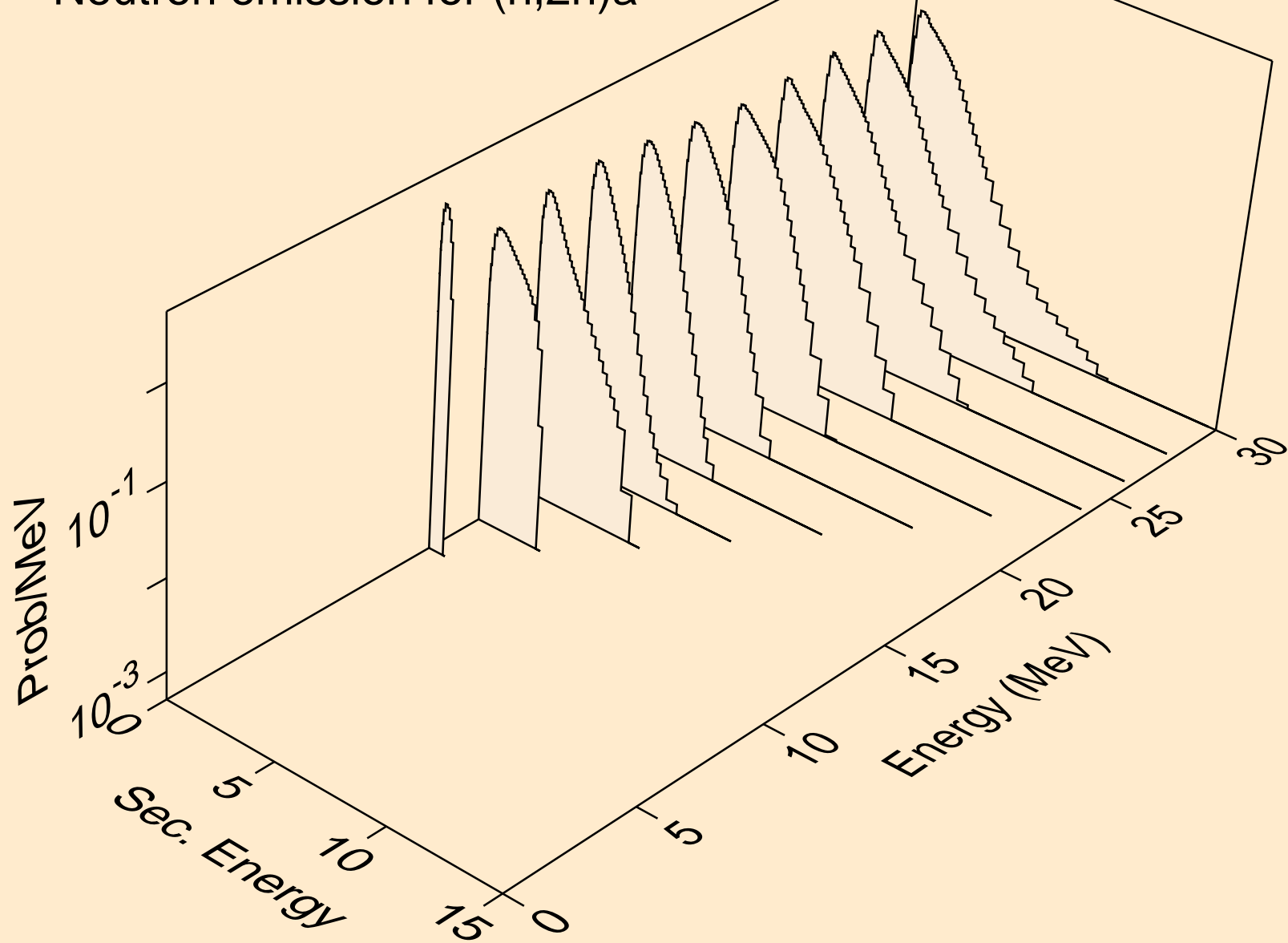

FR211 NEUTRON ACER TENDL-2024 LIBRARY; T=0.K
Neutron emission for (n,3n)a

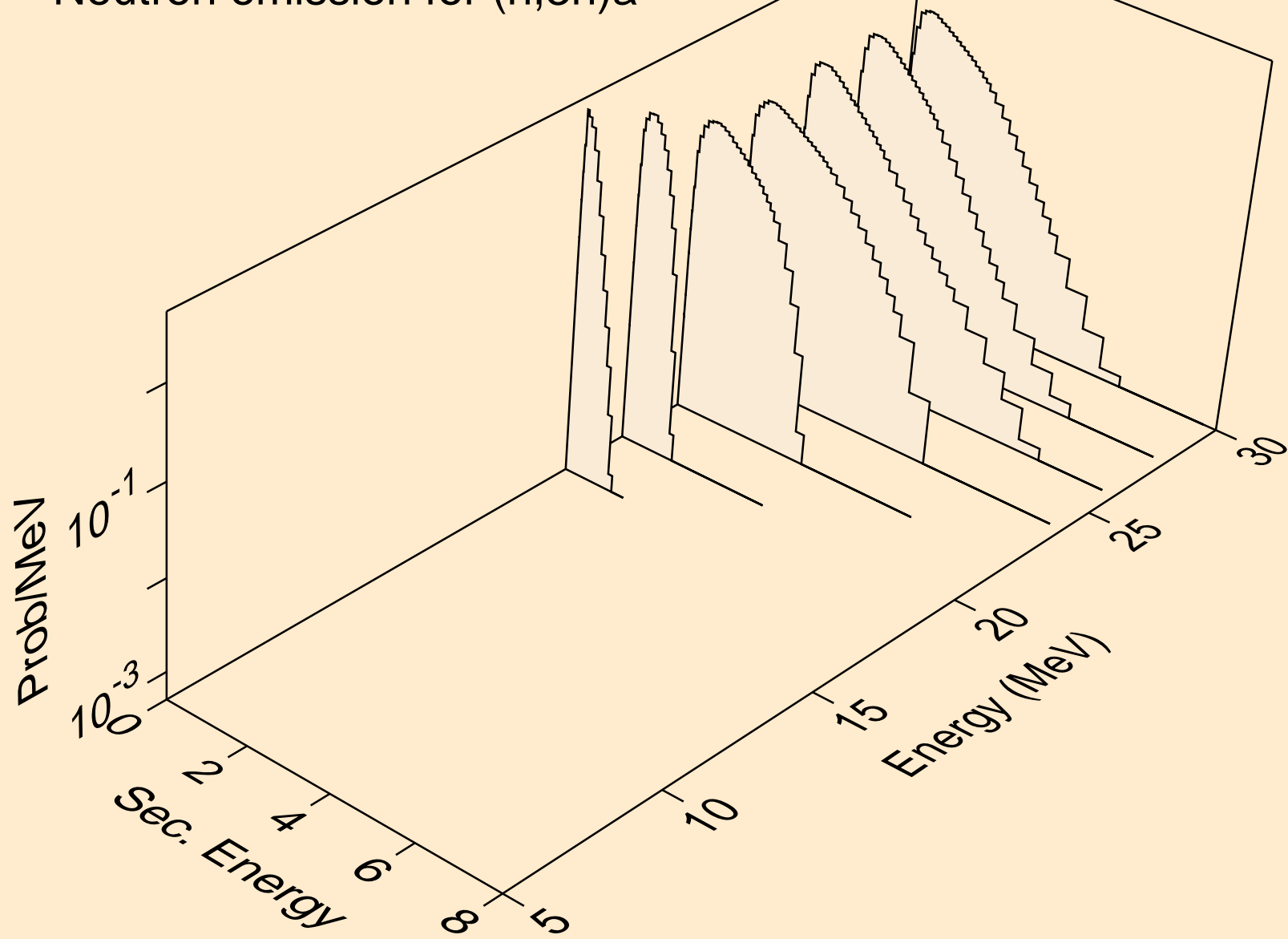

FR211 NEUTRON ACER TENDL-2024 LIBRARY; T=0.K
Neutron emission for (n,n*)p

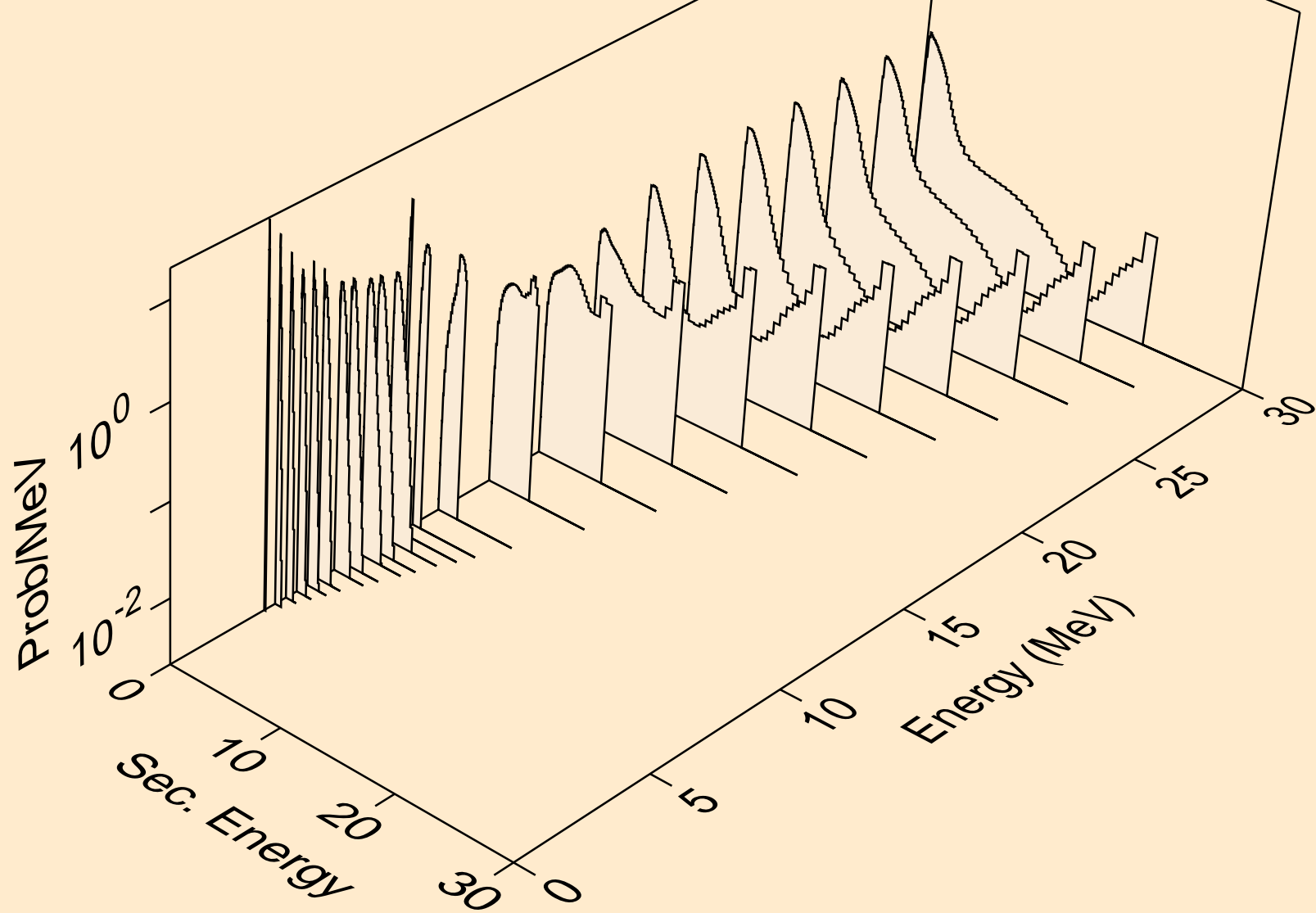

FR211 NEUTRON ACER TENDL-2024 LIBRARY; T=0.K
Neutron emission for (n,n*)2a

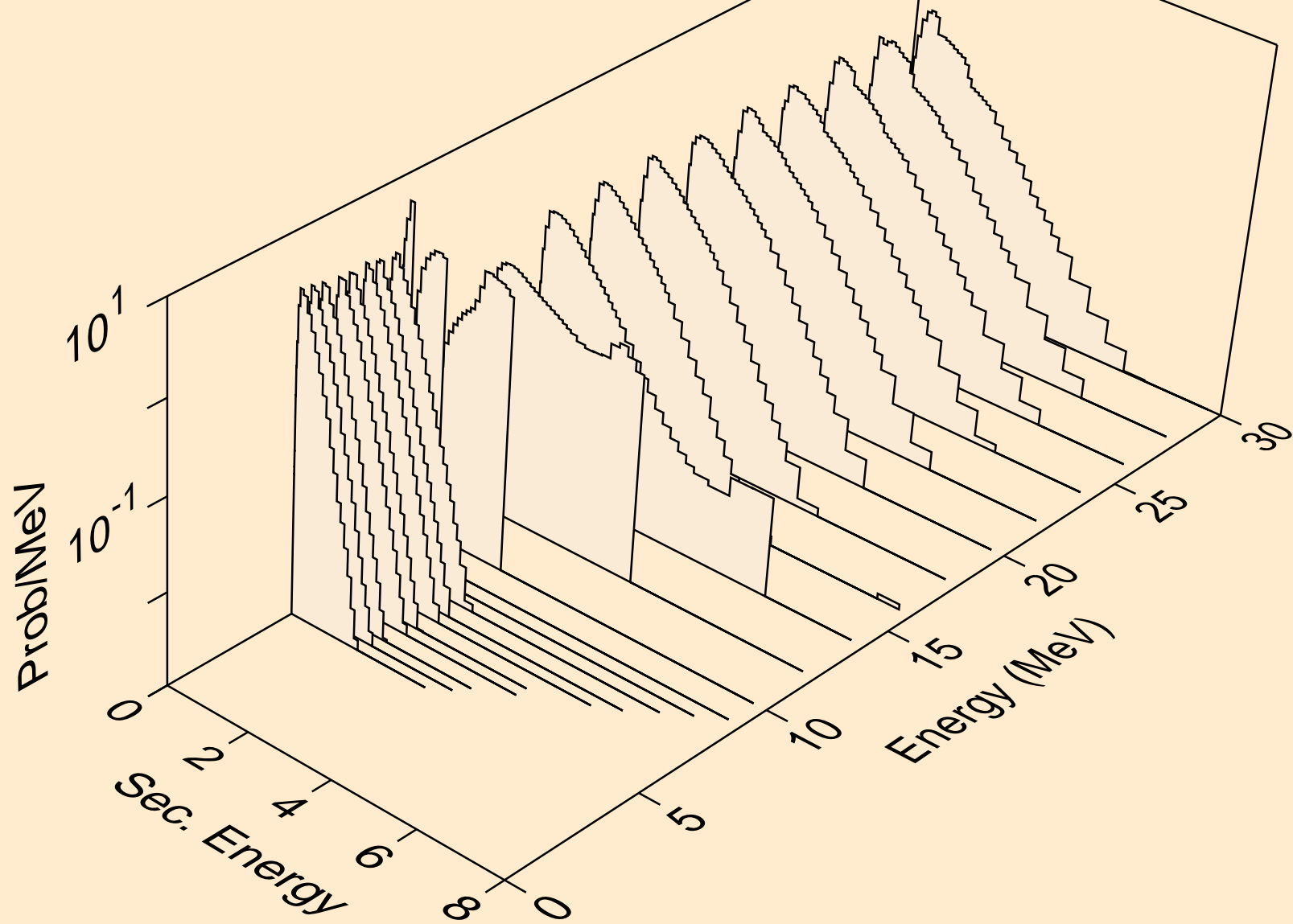

FR211 NEUTRON ACER TENDL-2024 LIBRARY; T=0.K
Neutron emission for (n,2n)_{2a}

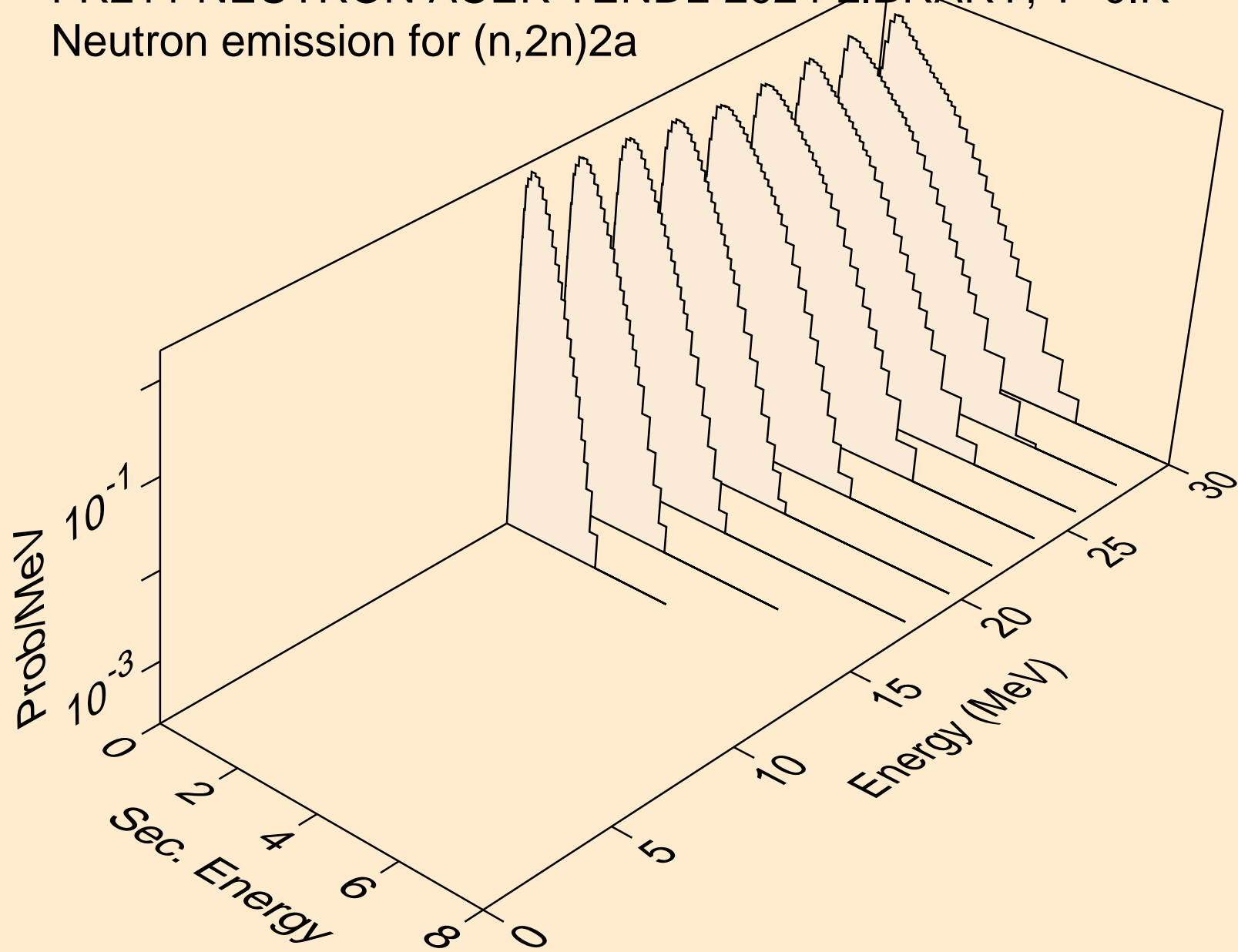

FR211 NEUTRON ACER TENDL-2024 LIBRARY; T=0.K
Neutron emission for (n,n*)d

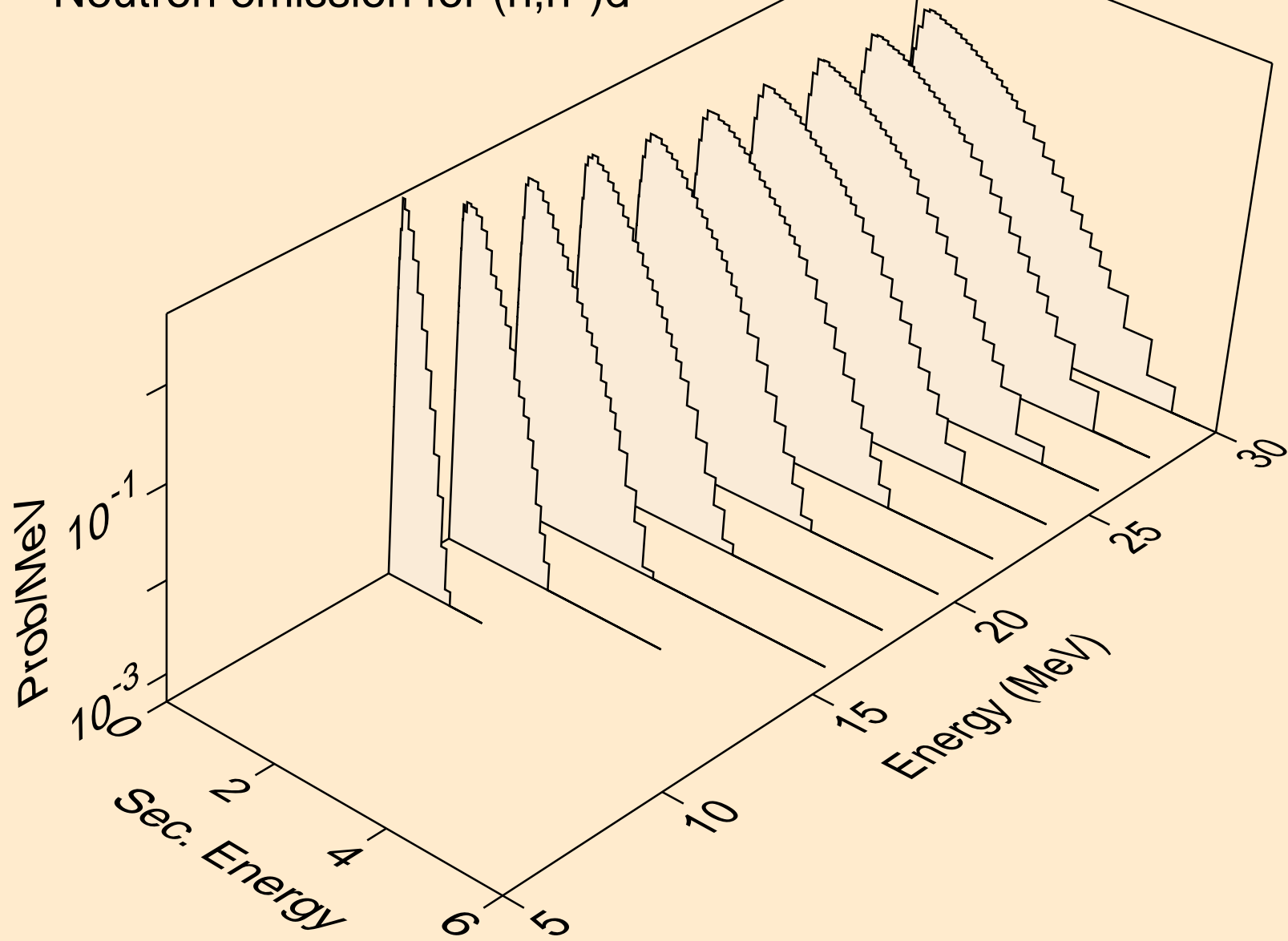

FR211 NEUTRON ACER TENDL-2024 LIBRARY; T=0.K
Neutron emission for (n,n*)t

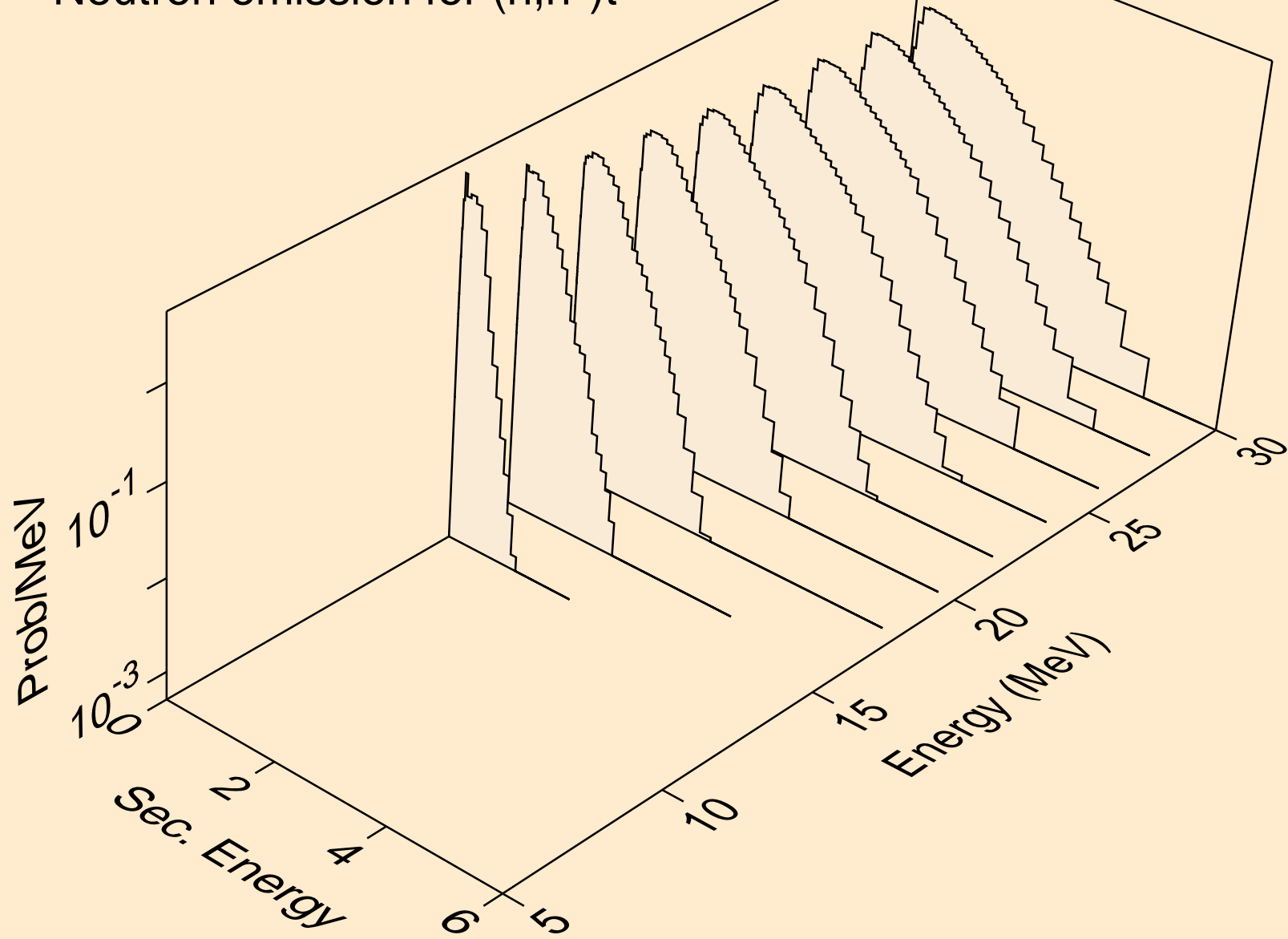

FR211 NEUTRON ACER TENDL-2024 LIBRARY; T=0.K
Neutron emission for (n,n*)he3

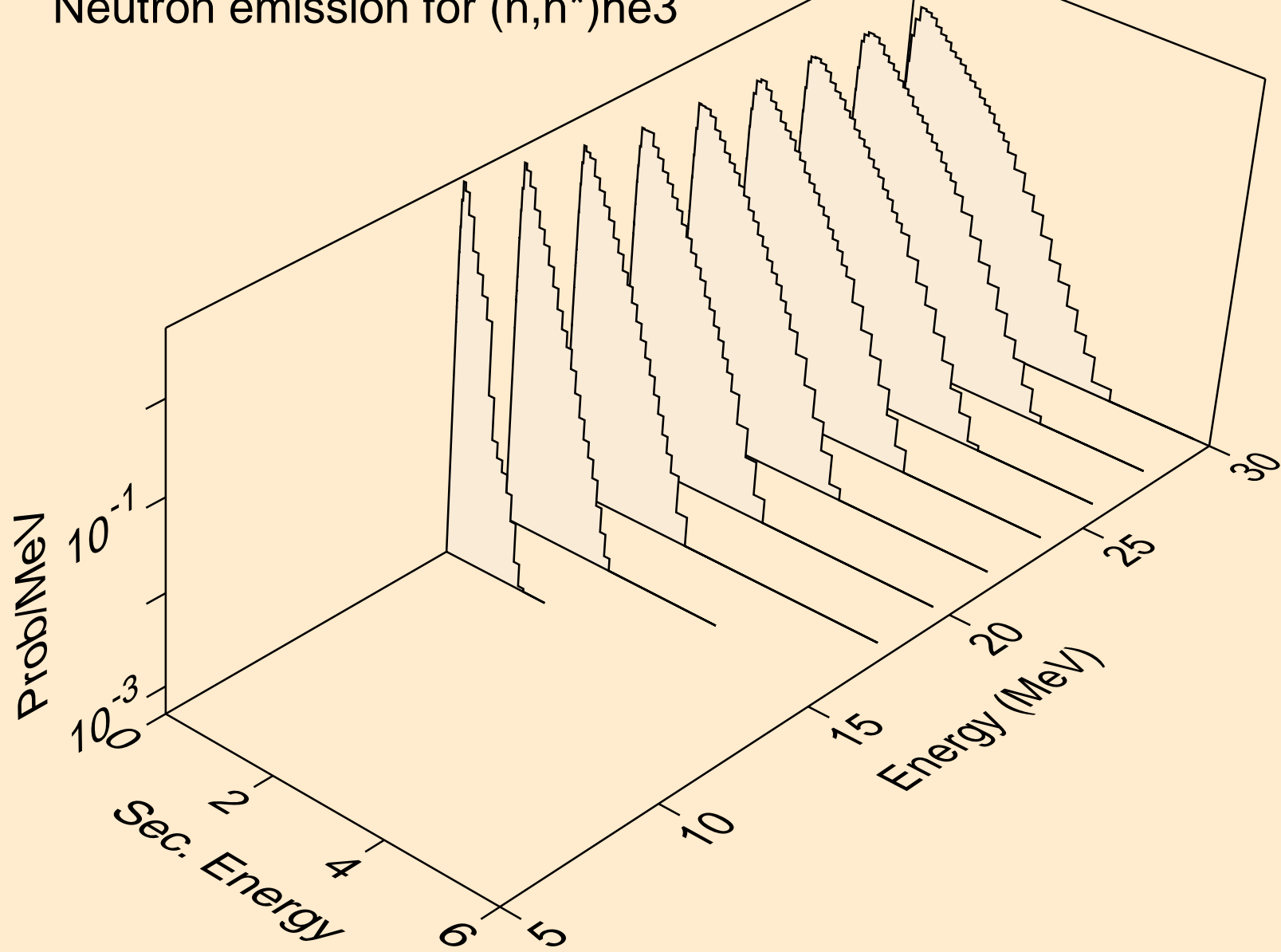

FR211 NEUTRON ACER TENDL-2024 LIBRARY; T=0.K
Neutron emission for (n,4n)

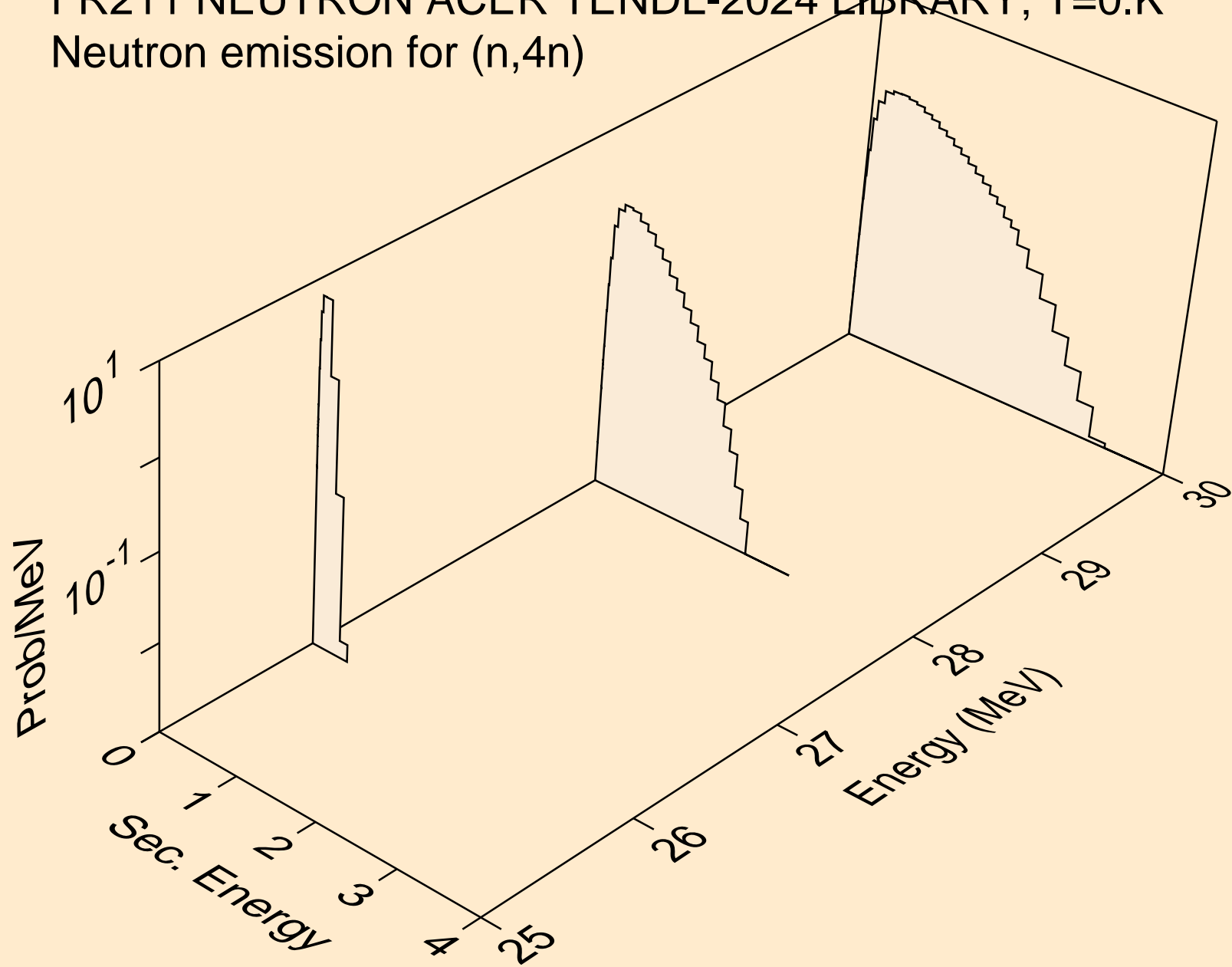

FR211 NEUTRON ACER TENDL-2024 LIBRARY; T=0.K
Neutron emission for (n,2np)

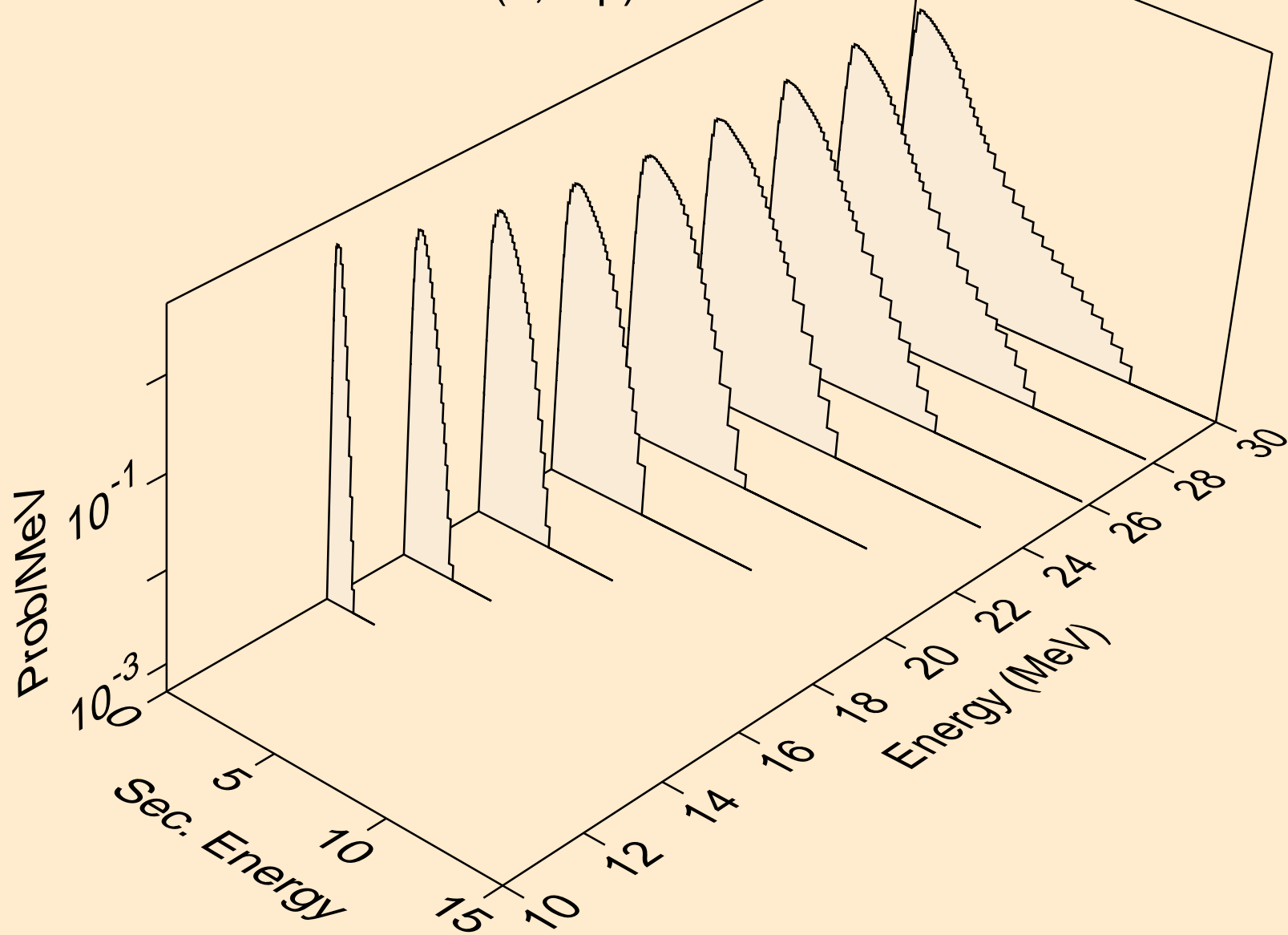

FR211 NEUTRON ACER TENDL-2024 LIBRARY; T=0.K
Neutron emission for (n,3np)

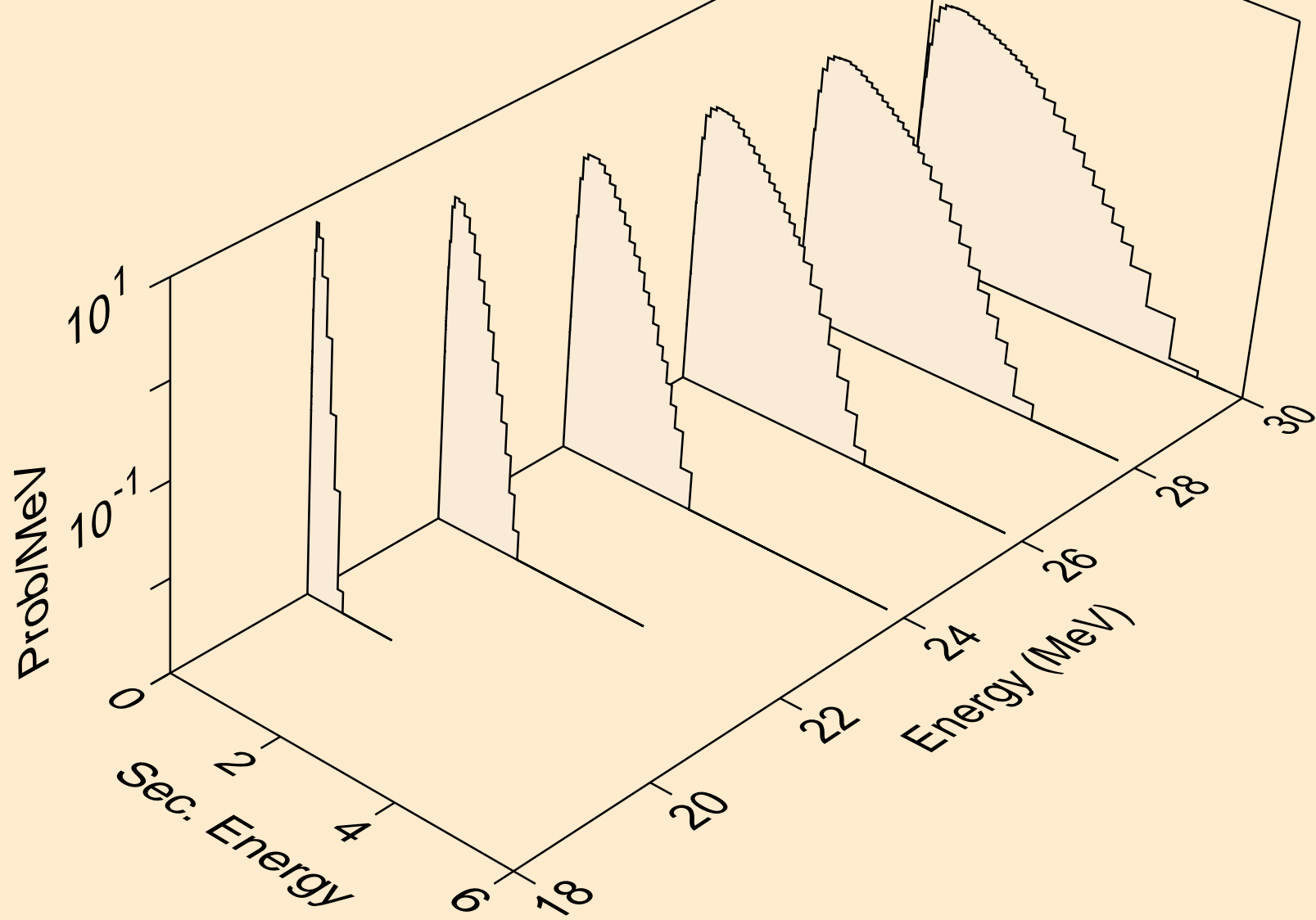

FR211 NEUTRON ACER TENDL-2024 LIBRARY; T=0.K
Neutron emission for (n,n2p)

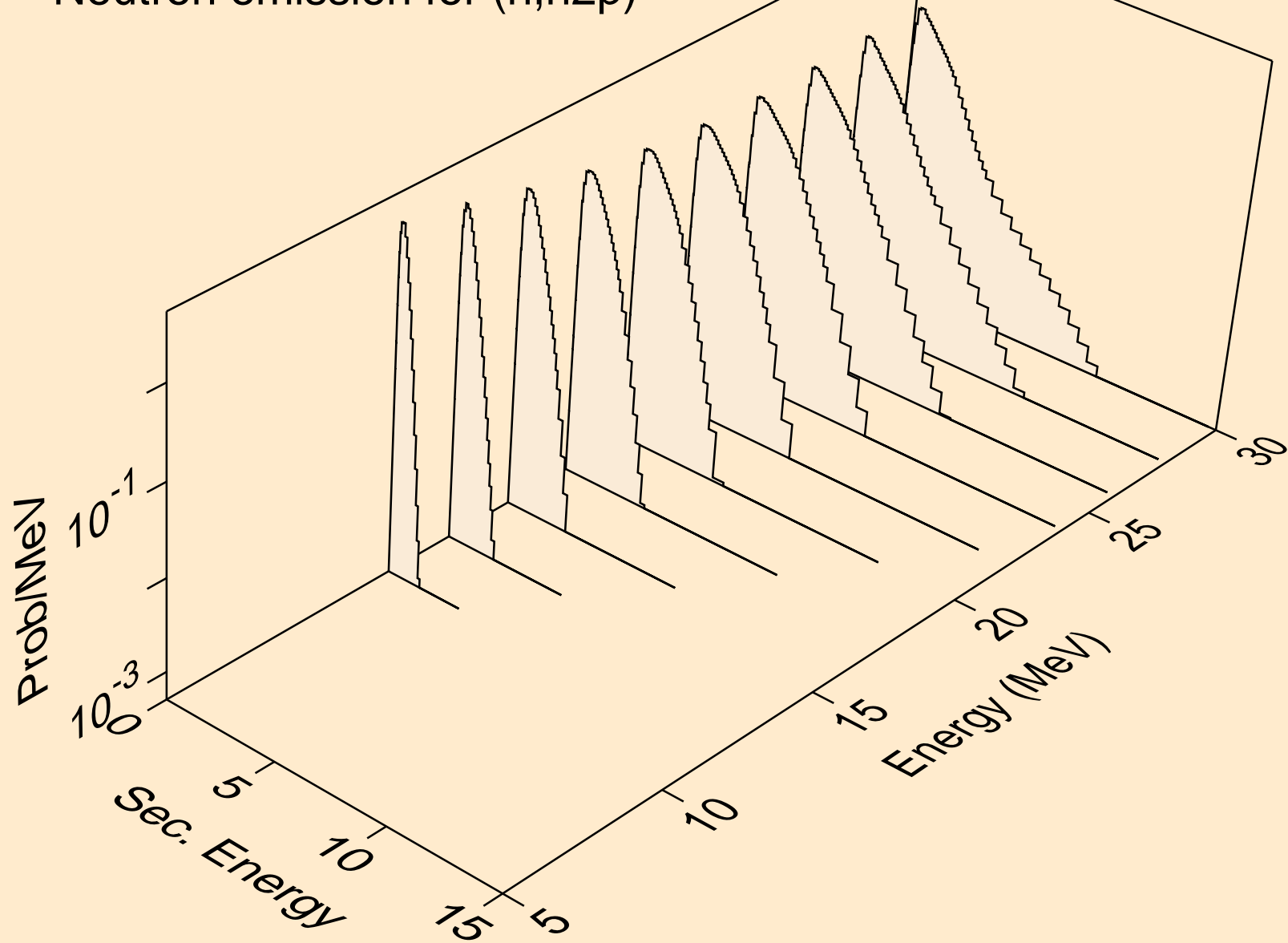

FR211 NEUTRON ACER TENDL-2024 LIBRARY; T=0.K
Neutron emission for (n,npa)

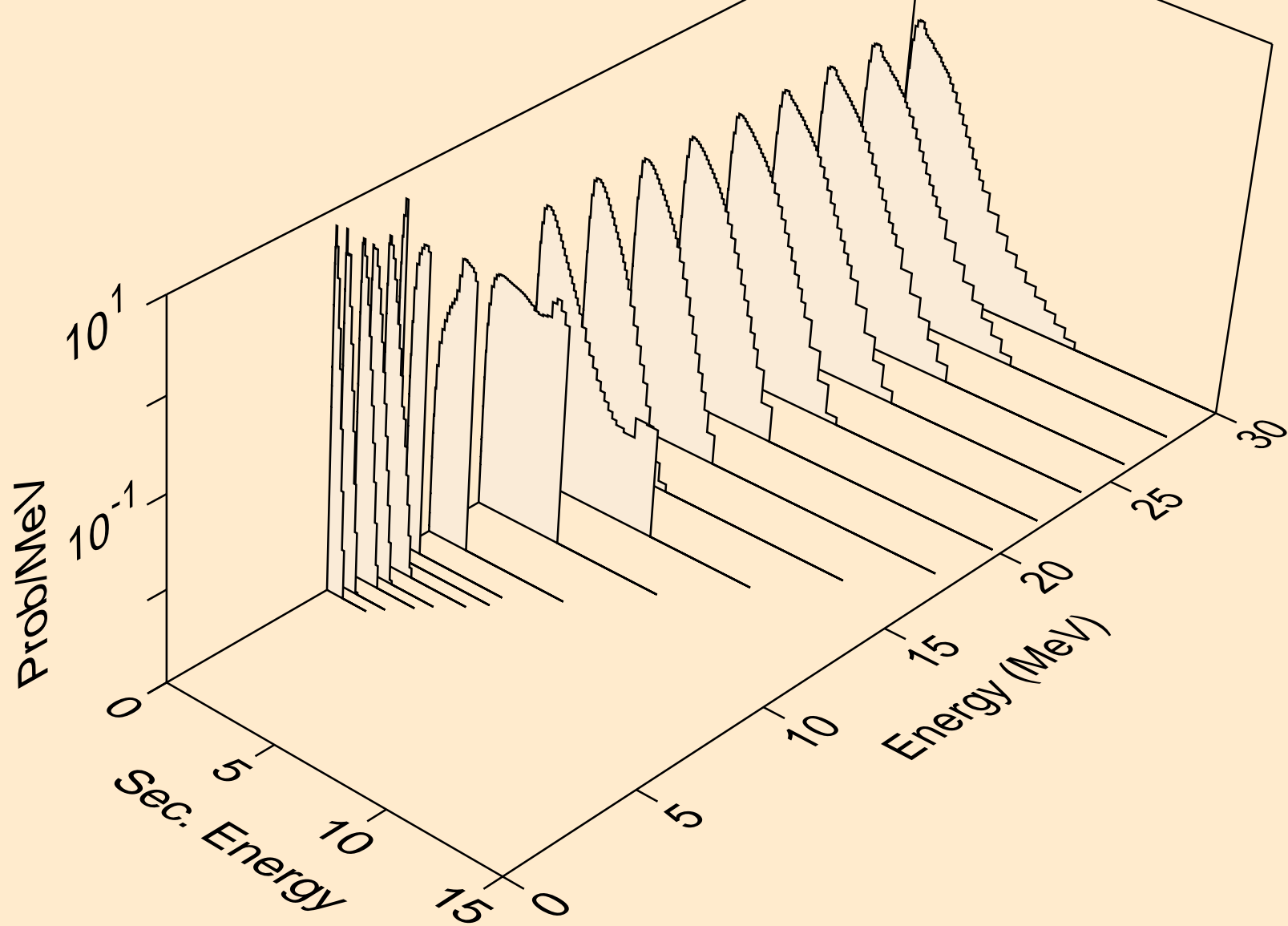

FR211 NEUTRON ACER TENDL-2024 LIBRARY; T=0.K
Neutron emission for (n,n*c)

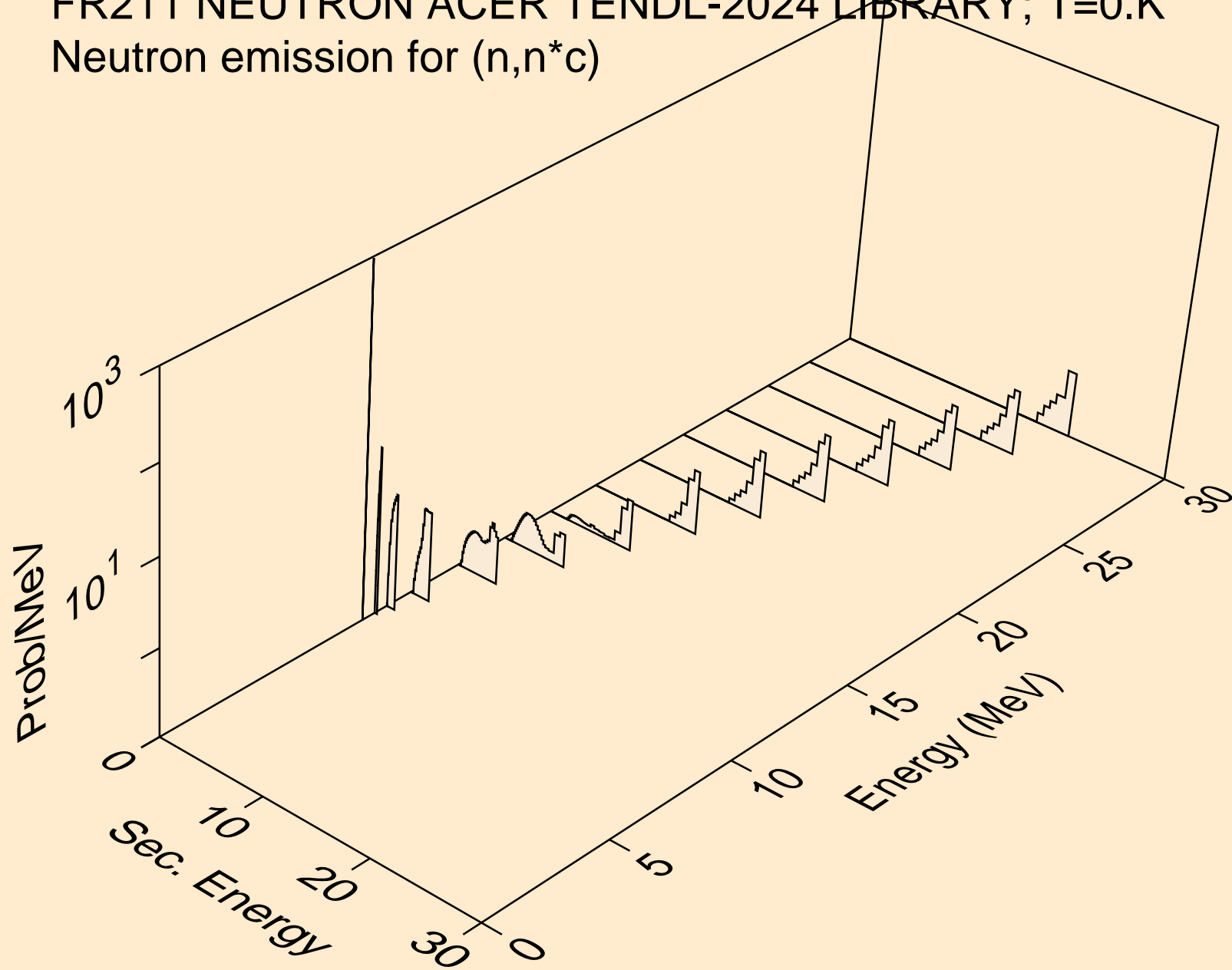

FR211 NEUTRON ACER TENDL-2024 LIBRARY; T=0.K
Photon emission for (n,x)

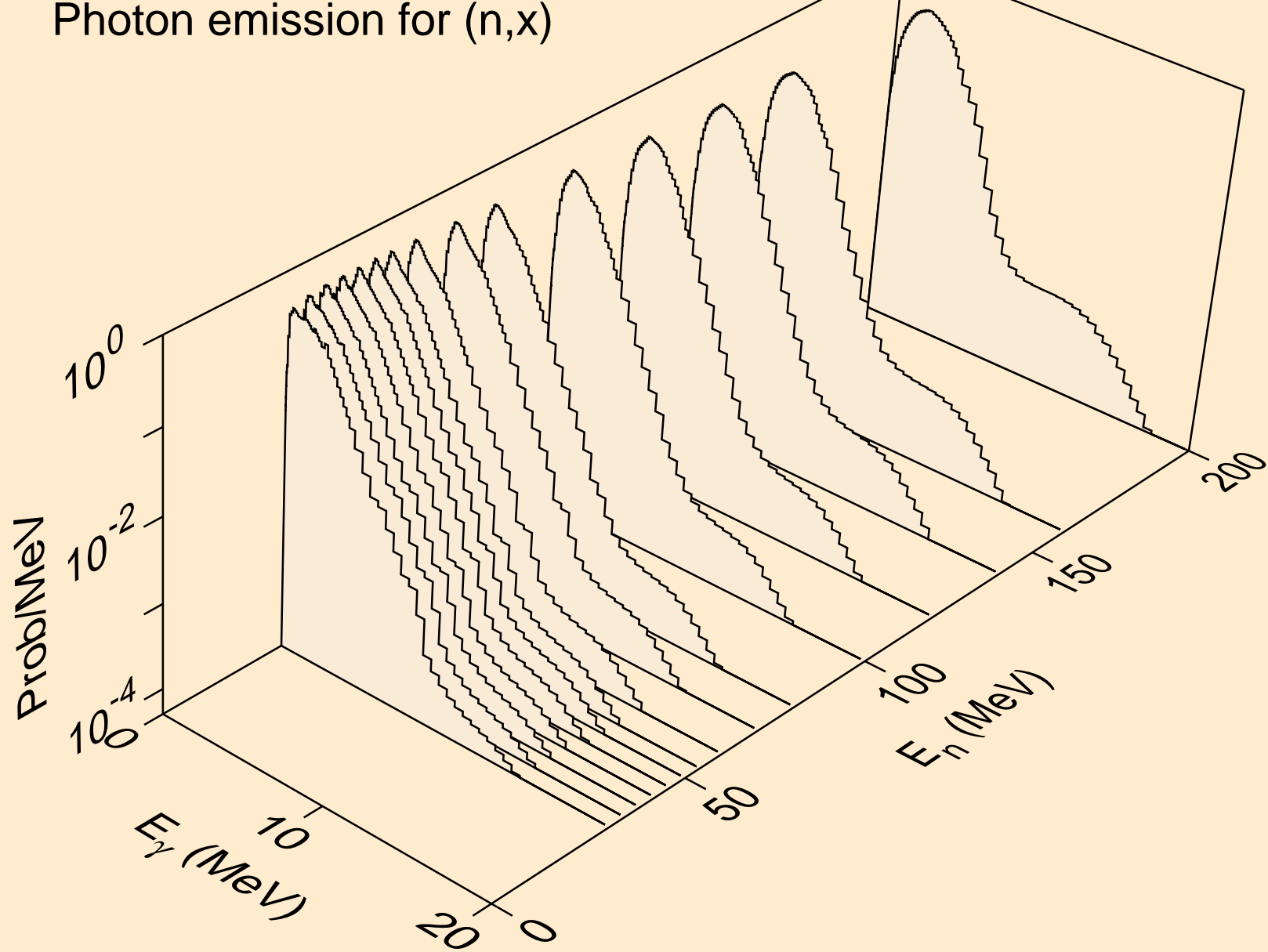

FR211 NEUTRON ACER TENDL-2024 LIBRARY; T=0.K
Photon emission for (n,2nd)

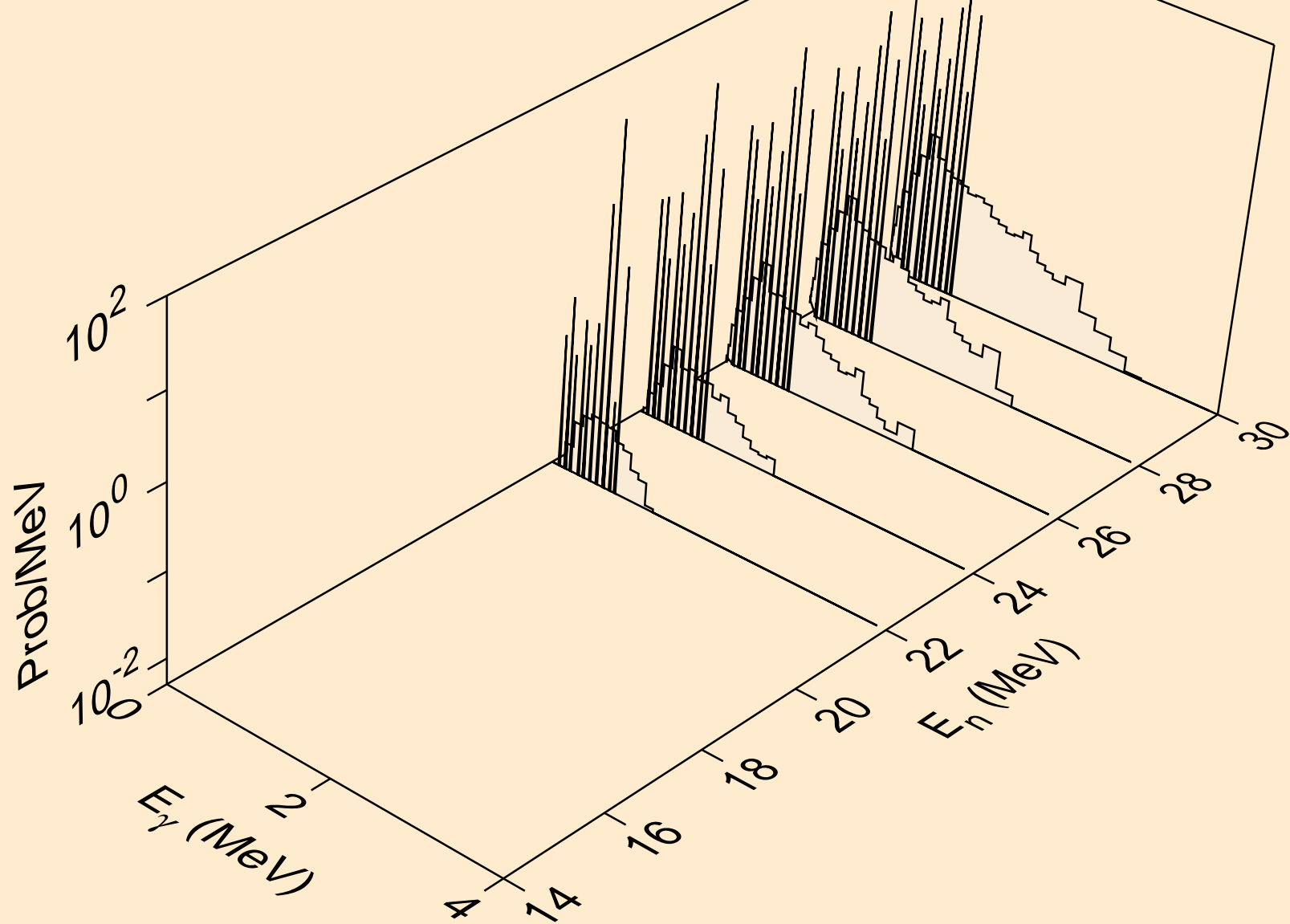

FR211 NEUTRON ACER TENDL-2024 LIBRARY; T=0.K
Photon emission for (n,2n)

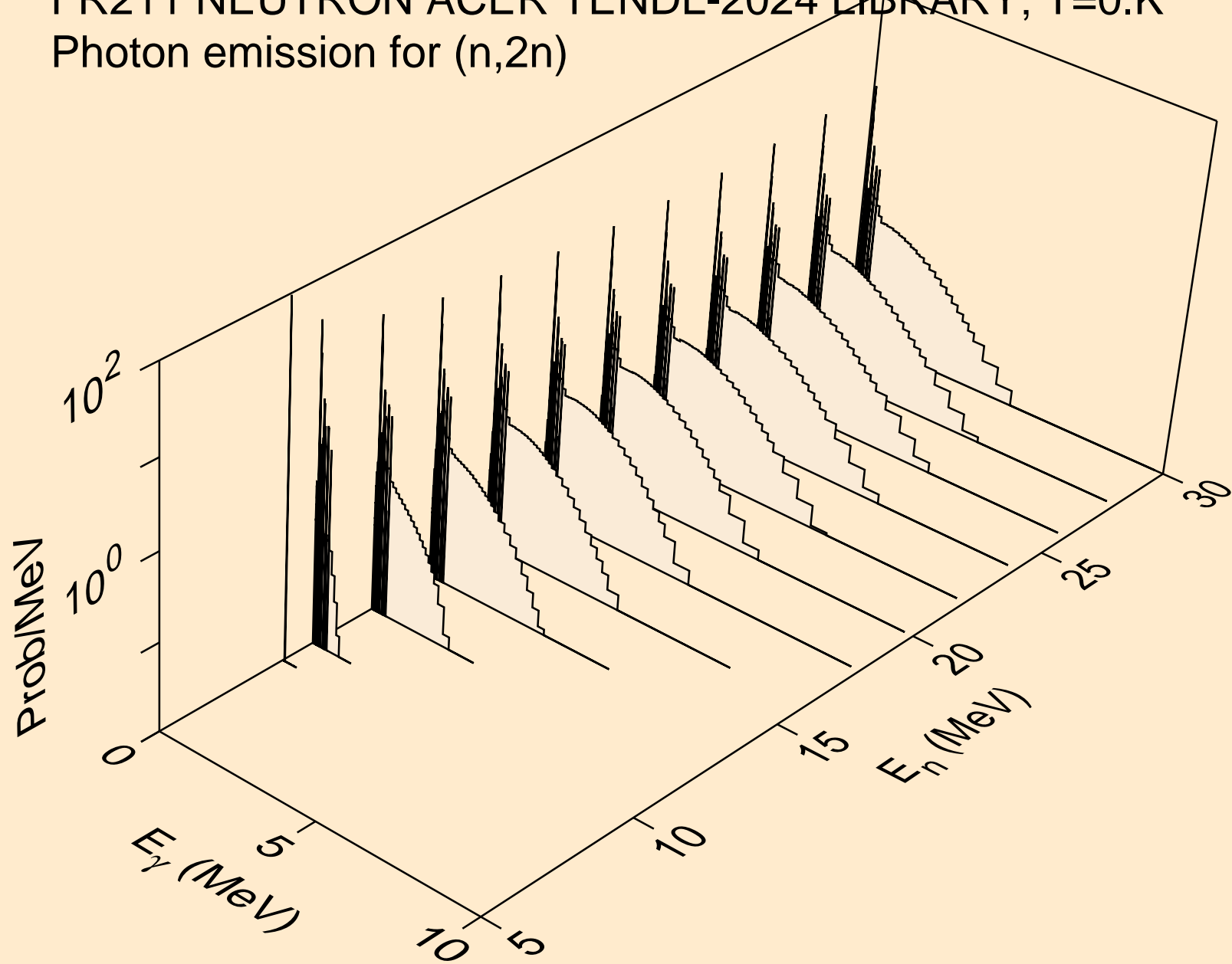

FR211 NEUTRON ACER TENDL-2024 LIBRARY; T=0.K
Photon emission for (n,3n)

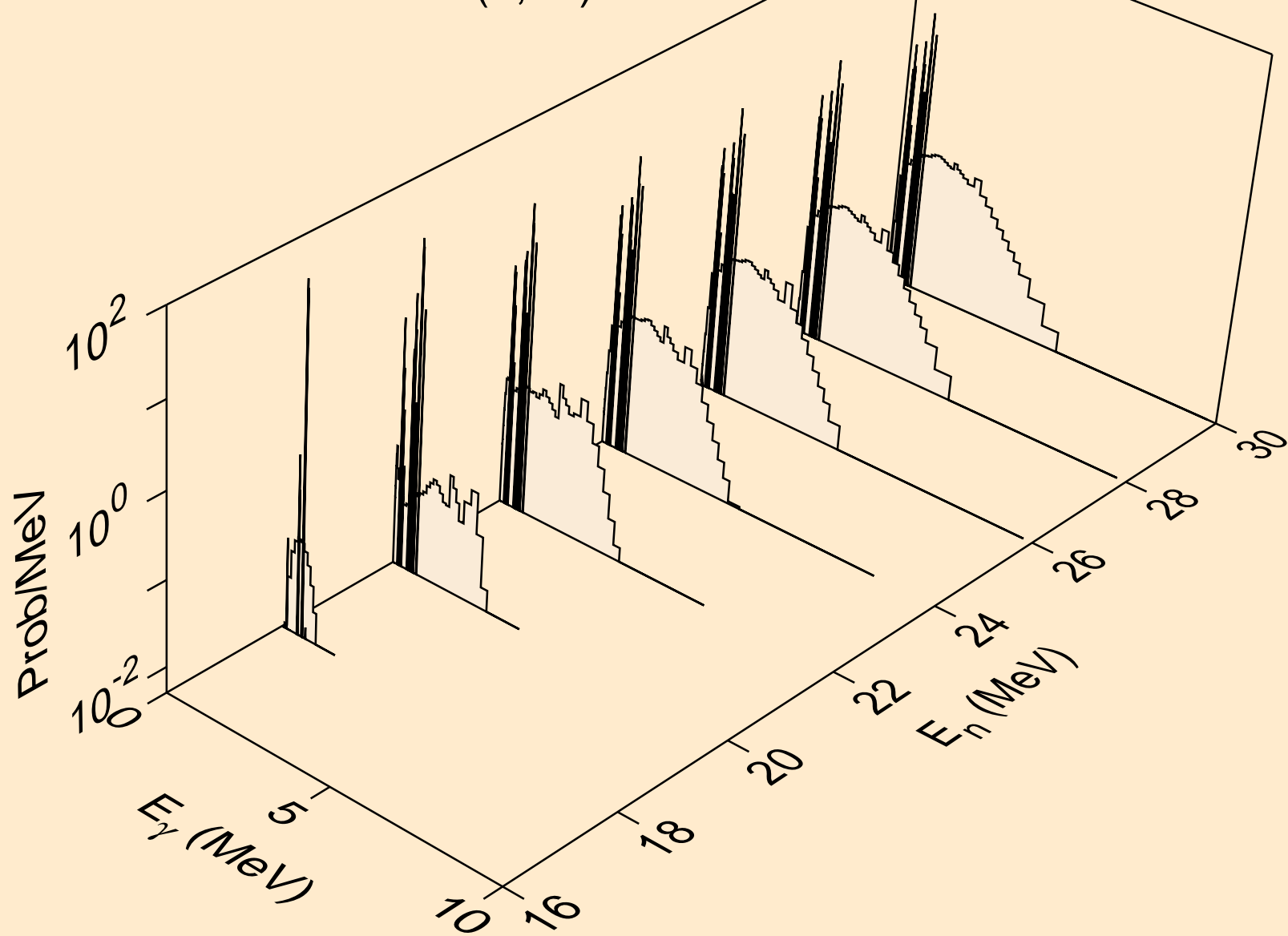

FR211 NEUTRON ACER TENDL-2024 LIBRARY; T=0.K
Photon emission for (n,n*)a

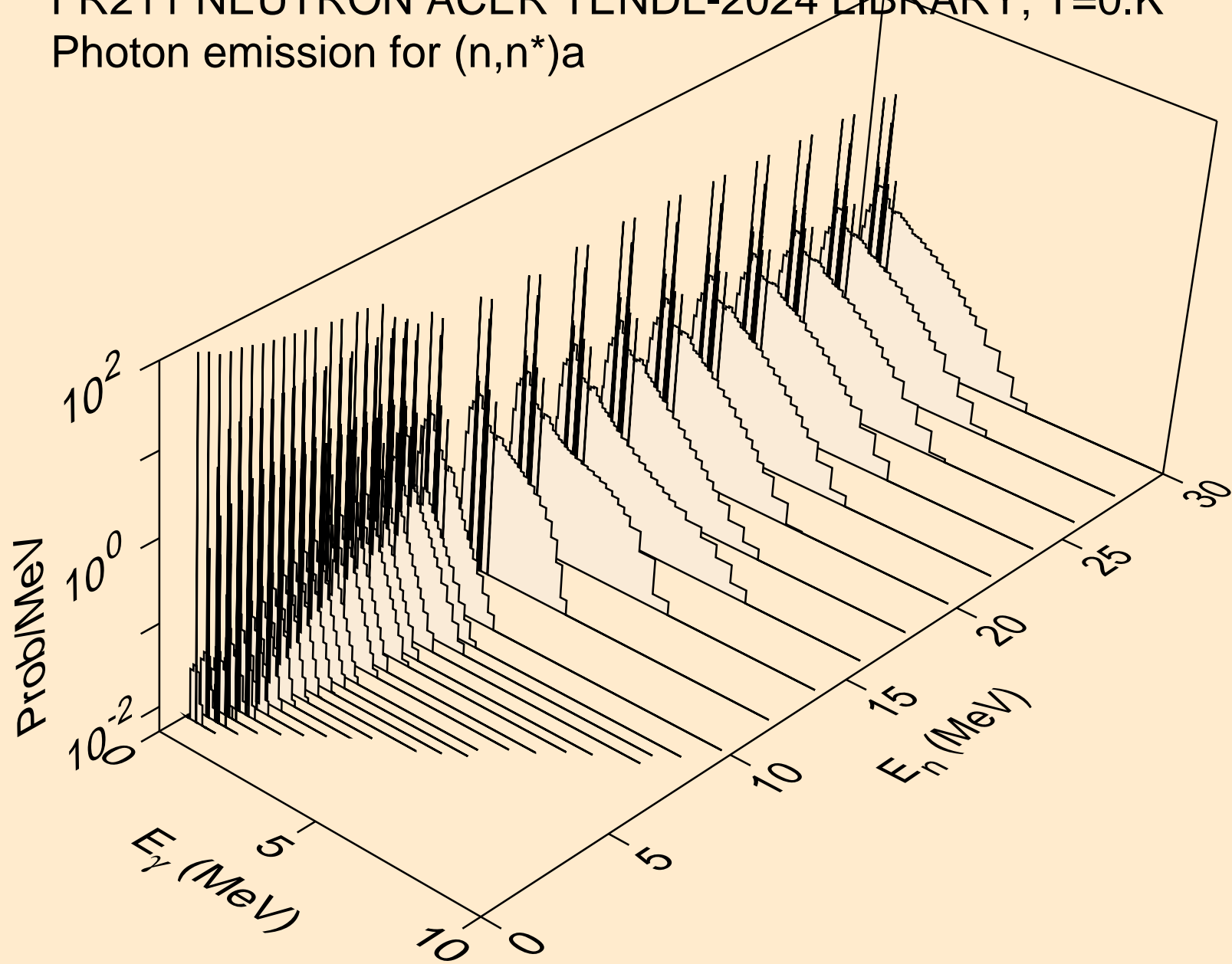

FR211 NEUTRON ACER TENDL-2024 LIBRARY; T=0.K
Photon emission for (n,2n)a

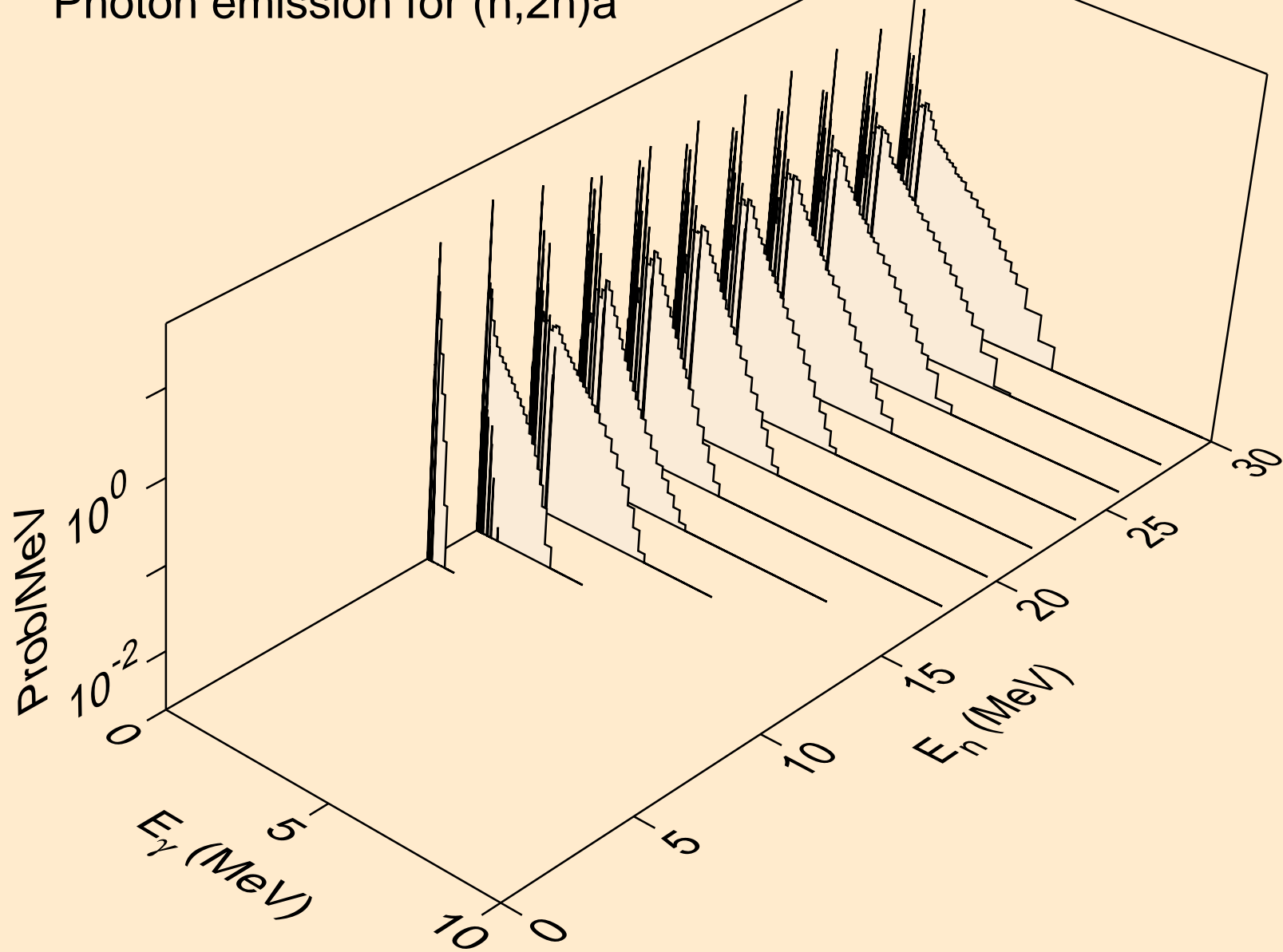

FR211 NEUTRON ACER TENDL-2024 LIBRARY; T=0.K
Photon emission for (n,3n)a

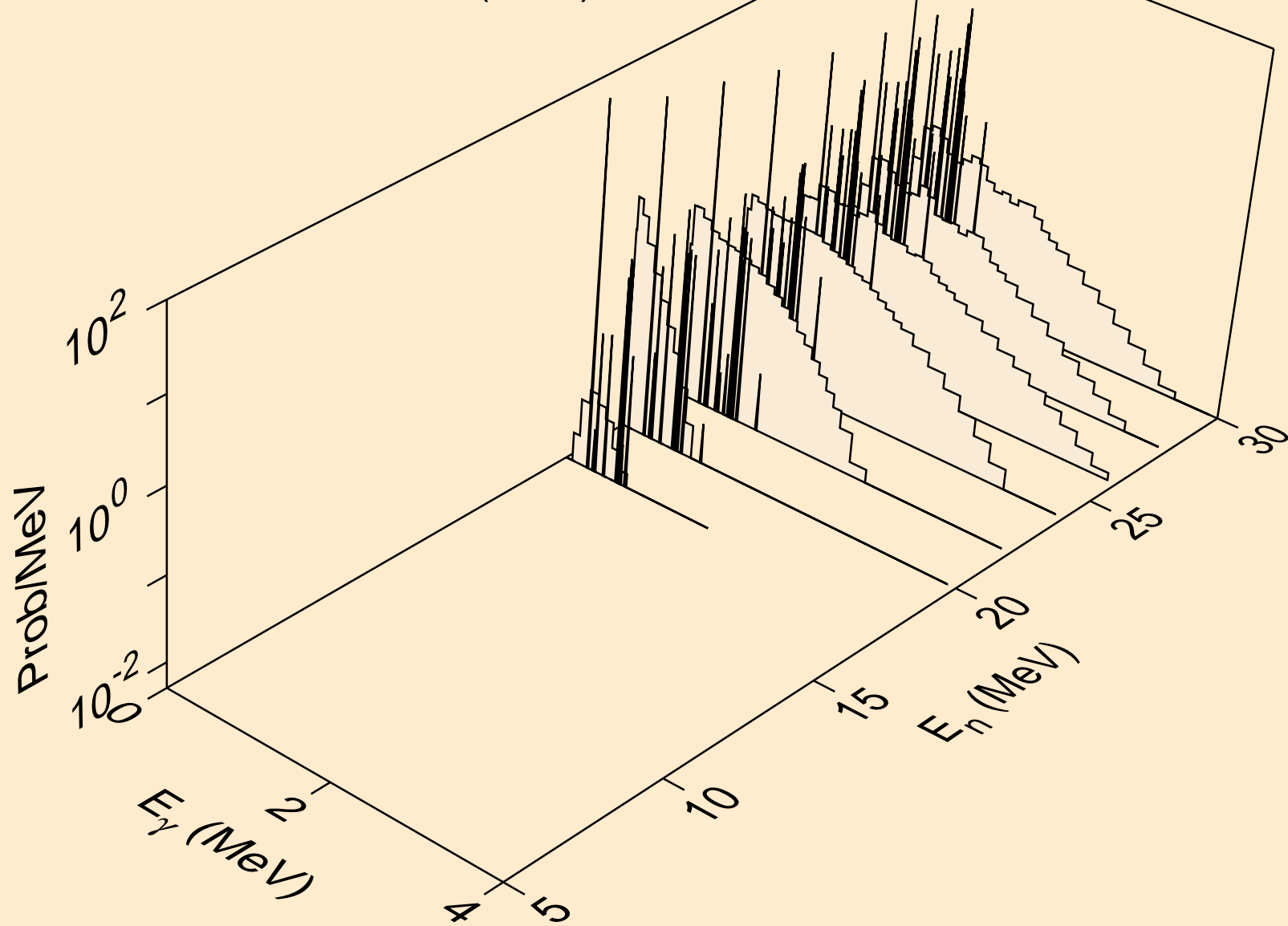

FR211 NEUTRON ACER TENDL-2024 LIBRARY; T=0.K
Photon emission for (n,n*)p

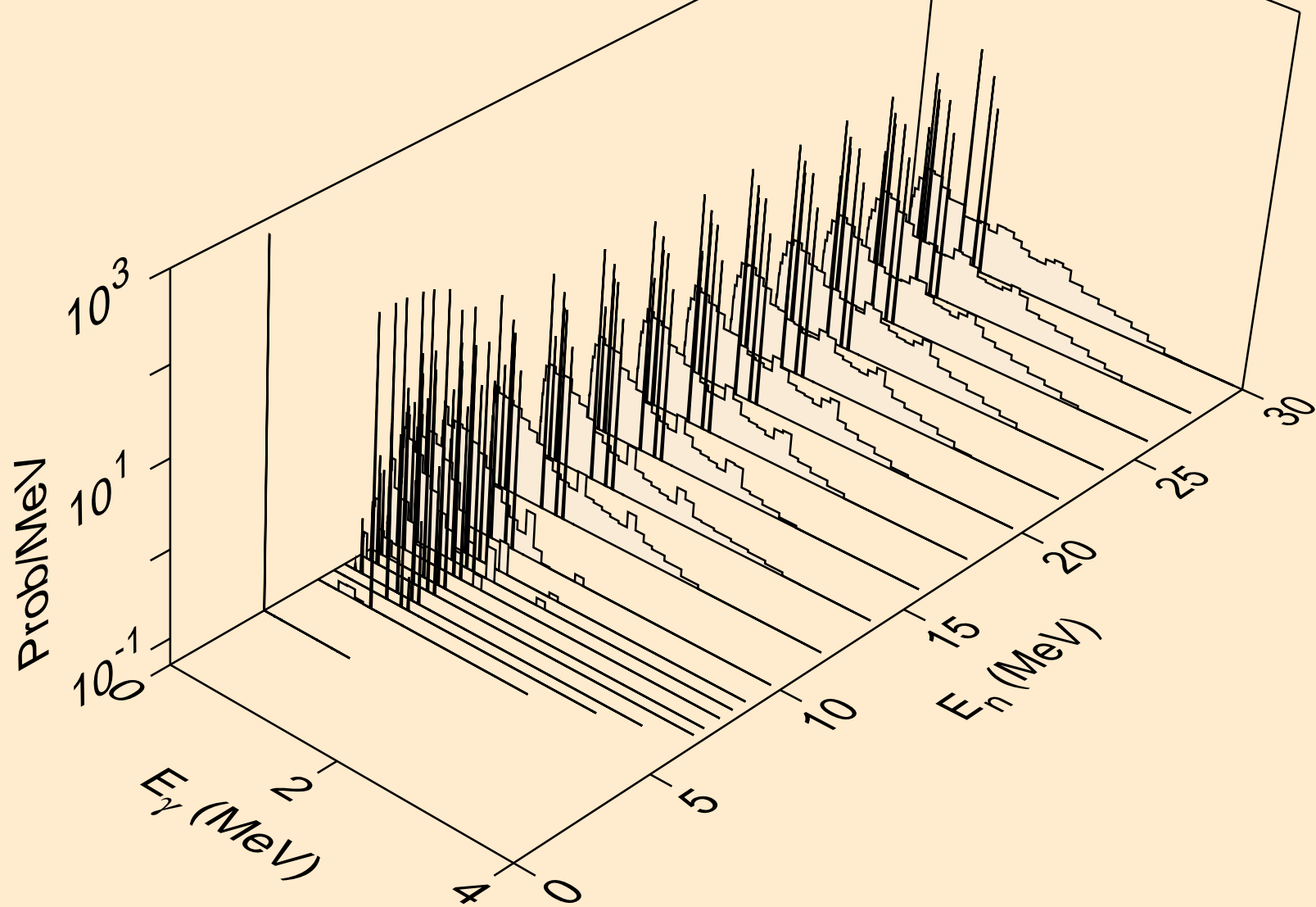

FR211 NEUTRON ACER TENDL-2024 LIBRARY; T=0.K
Photon emission for (n,n*)2a

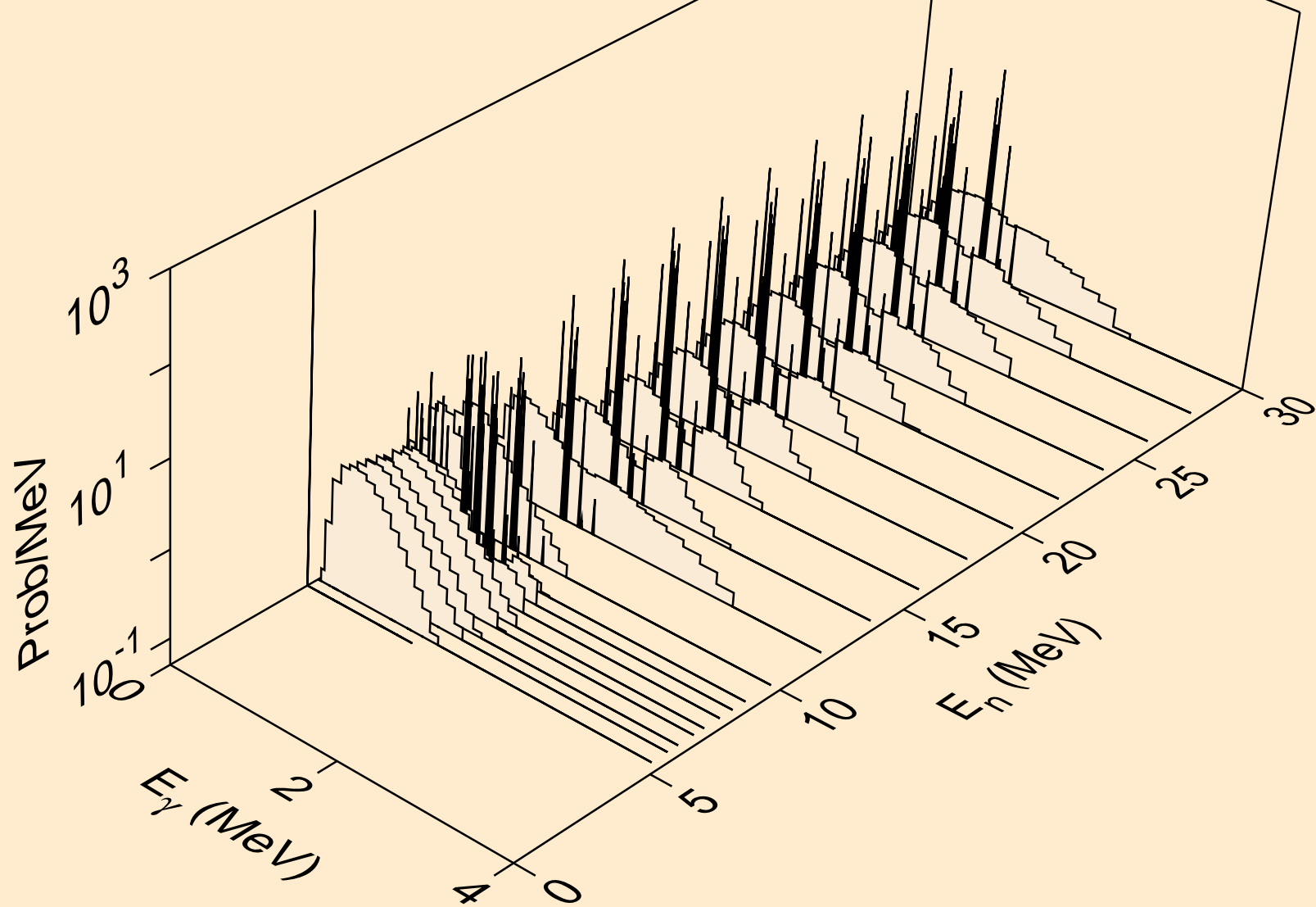

FR211 NEUTRON ACER TENDL-2024 LIBRARY; T=0.K
Photon emission for (n,2n)2a

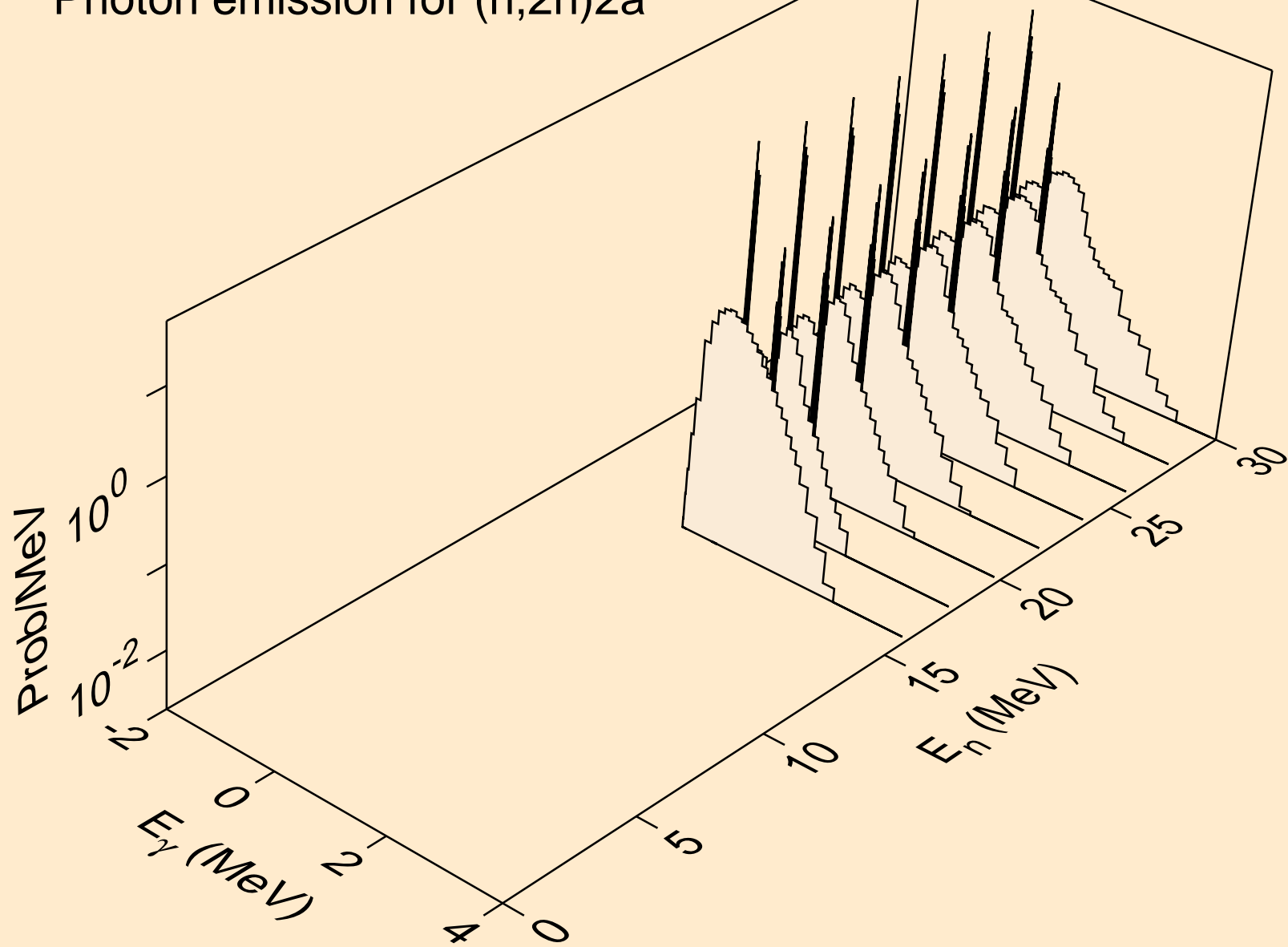

FR211 NEUTRON ACER TENDL-2024 LIBRARY; T=0.K
Photon emission for (n,n*)d

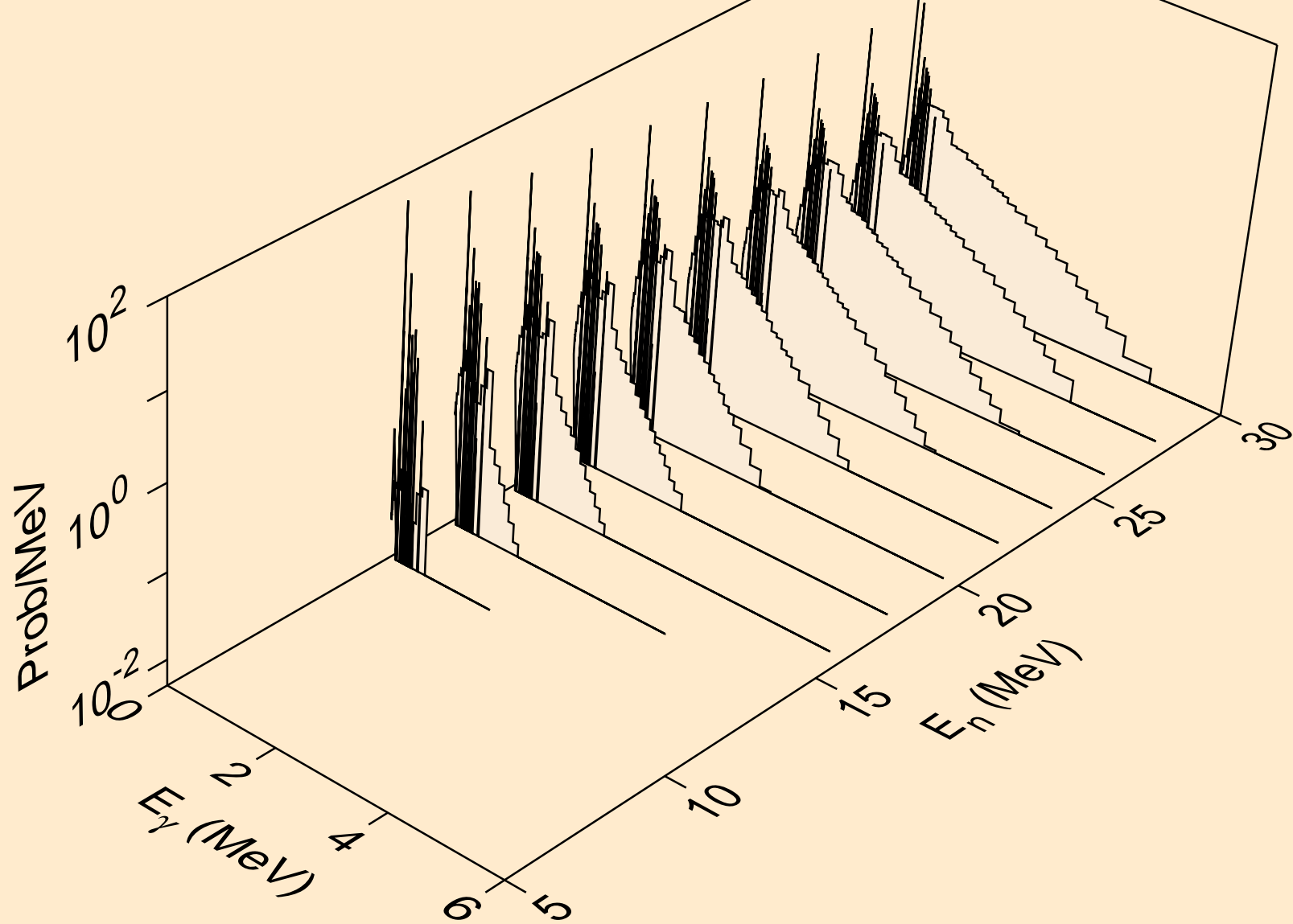

FR211 NEUTRON ACER TENDL-2024 LIBRARY; T=0.K
Photon emission for (n,n*)t

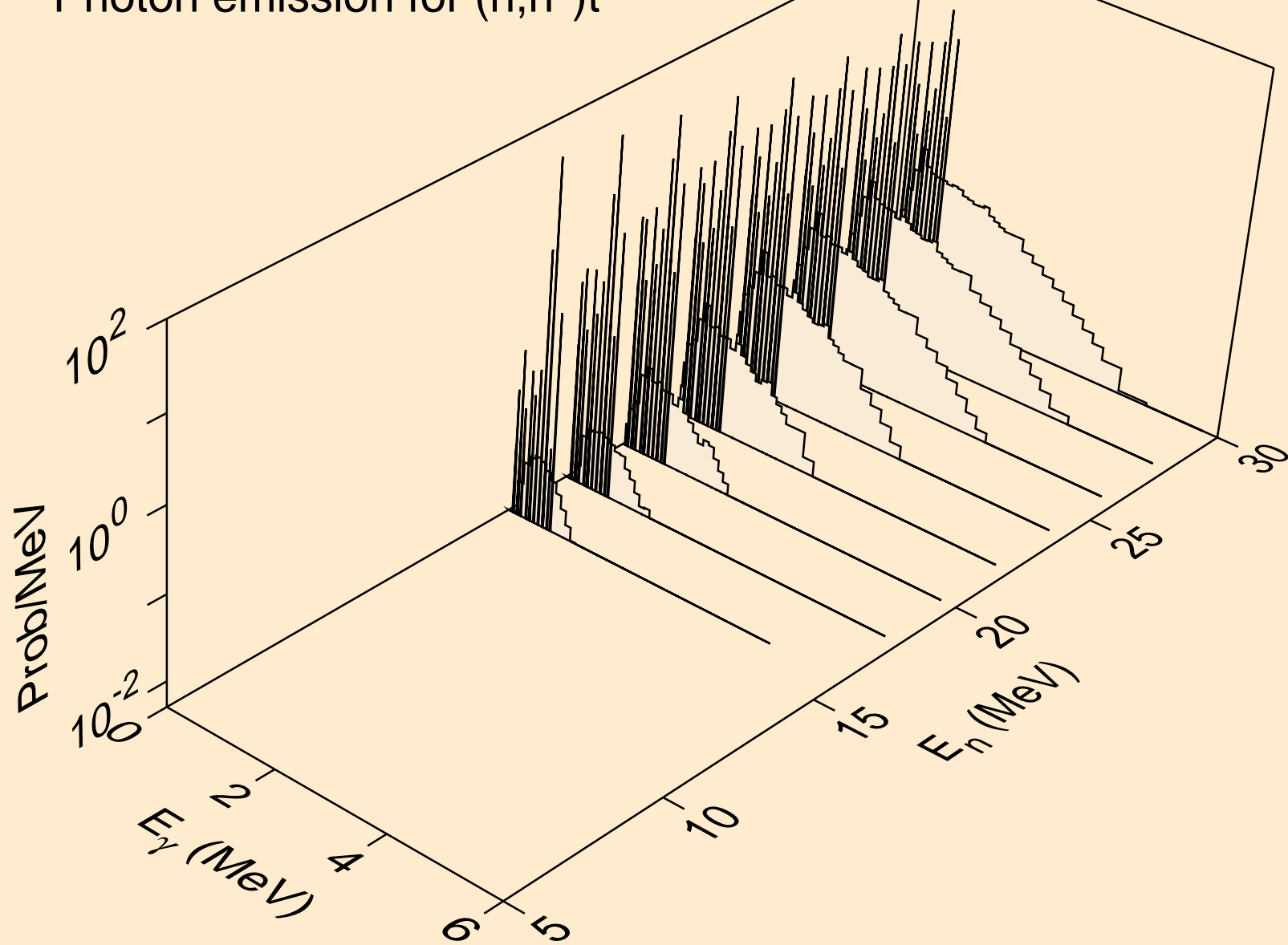

FR211 NEUTRON ACER TENDL-2024 LIBRARY; T=0.K
Photon emission for (n,n*)he3

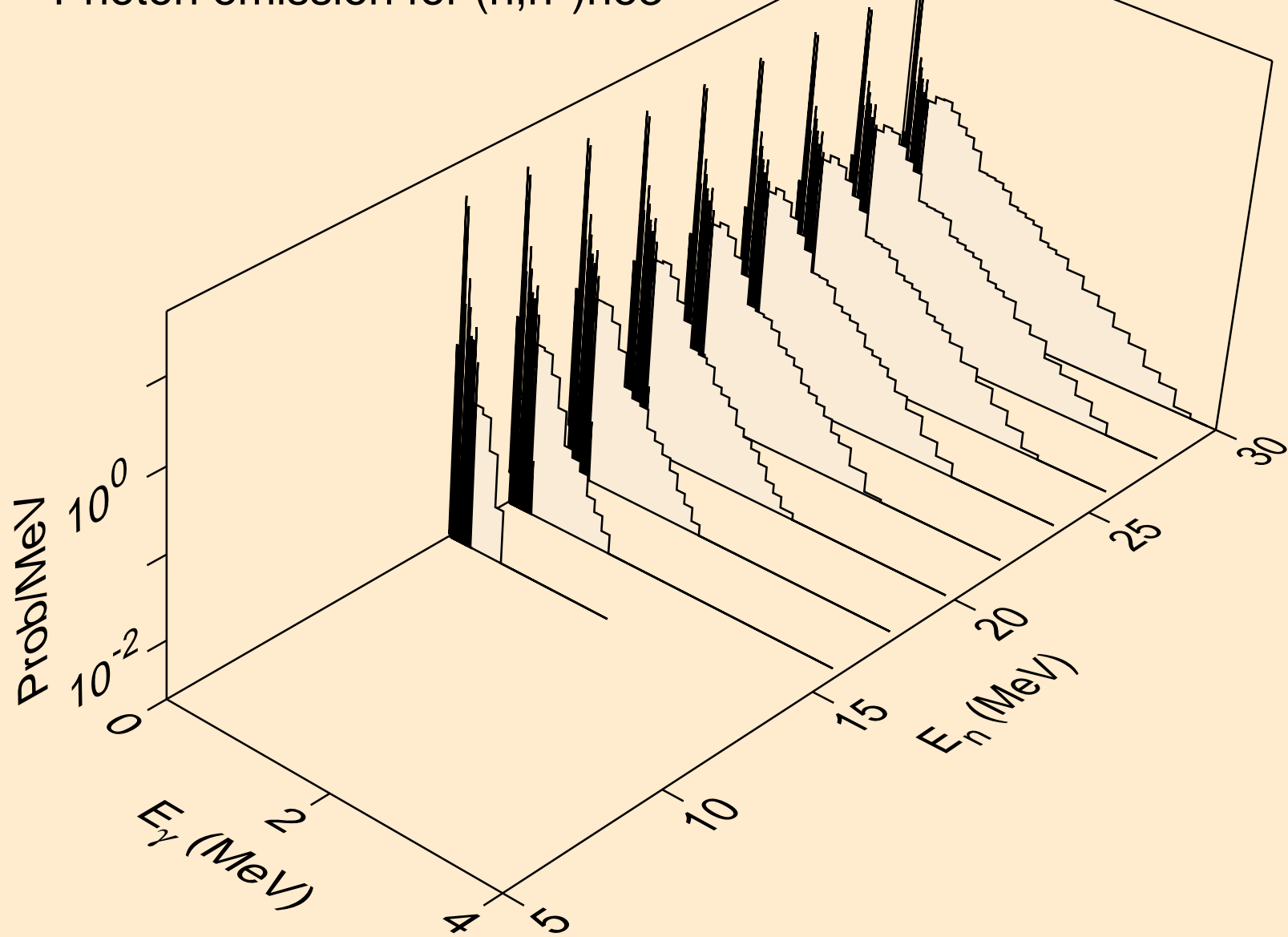

FR211 NEUTRON ACER TENDL-2024 LIBRARY; T=0.K
Photon emission for (n,4n)

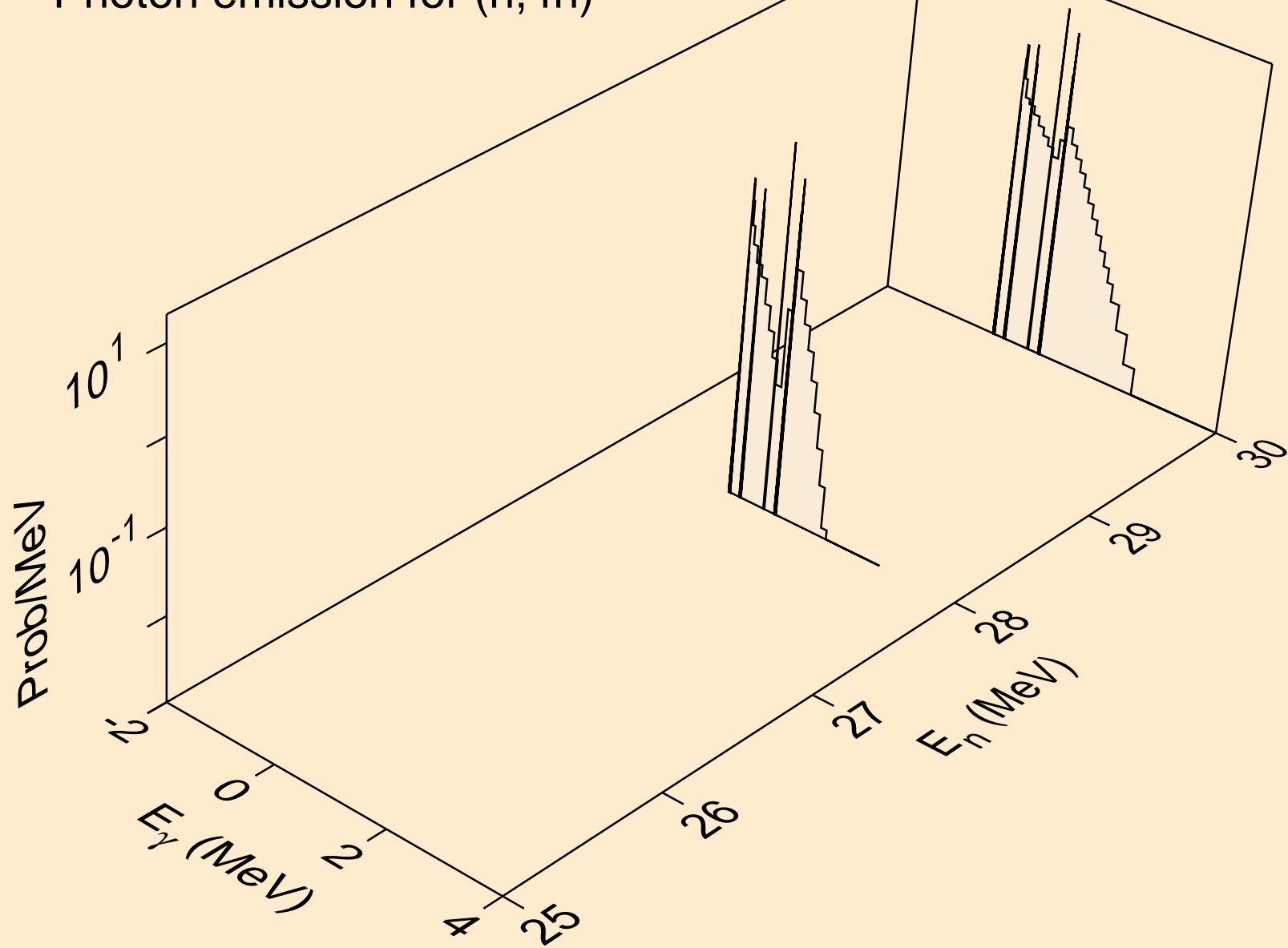

FR211 NEUTRON ACER TENDL-2024 LIBRARY; T=0.K
Photon emission for (n,2np)

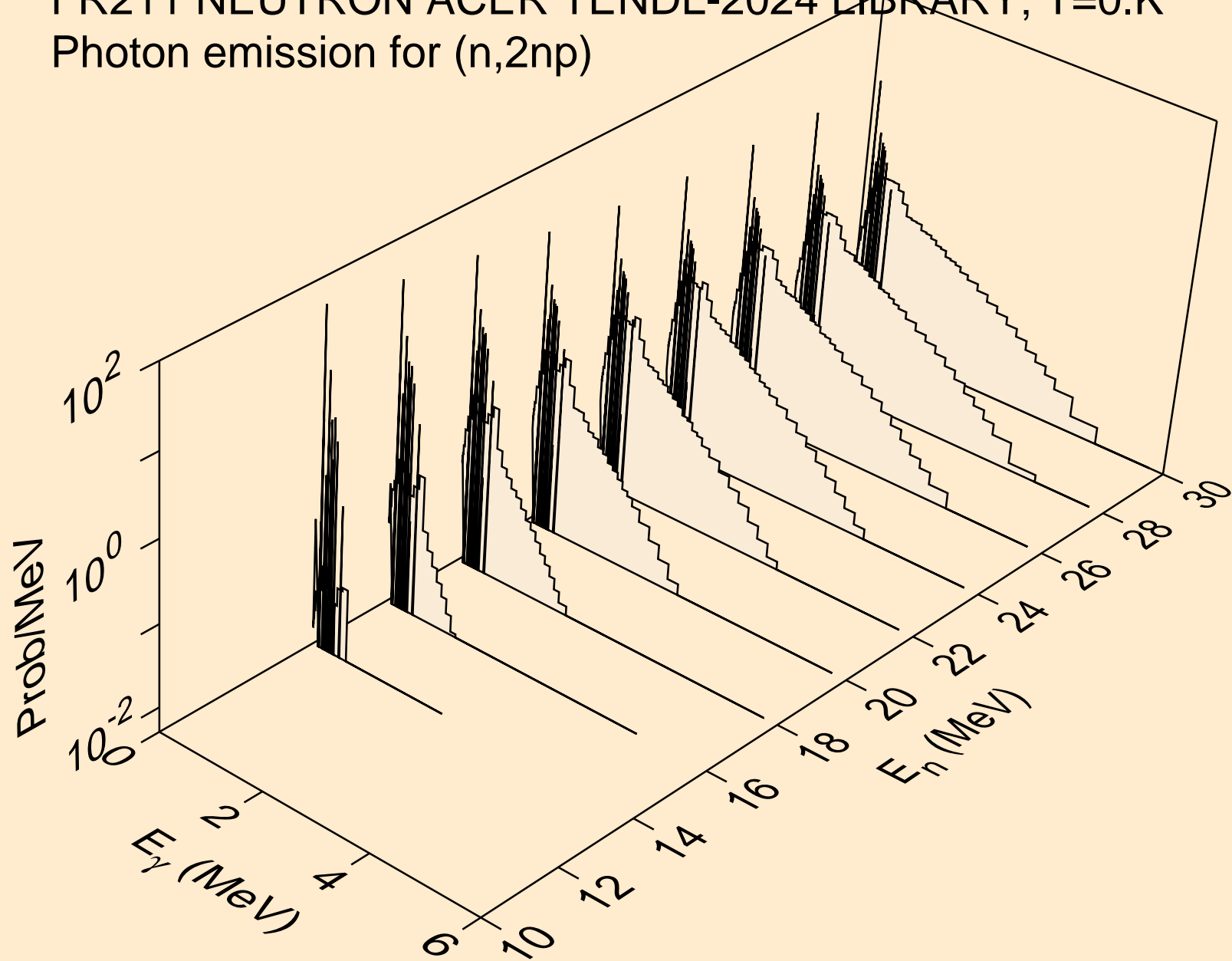

FR211 NEUTRON ACER TENDL-2024 LIBRARY; T=0.K
Photon emission for (n,3np)

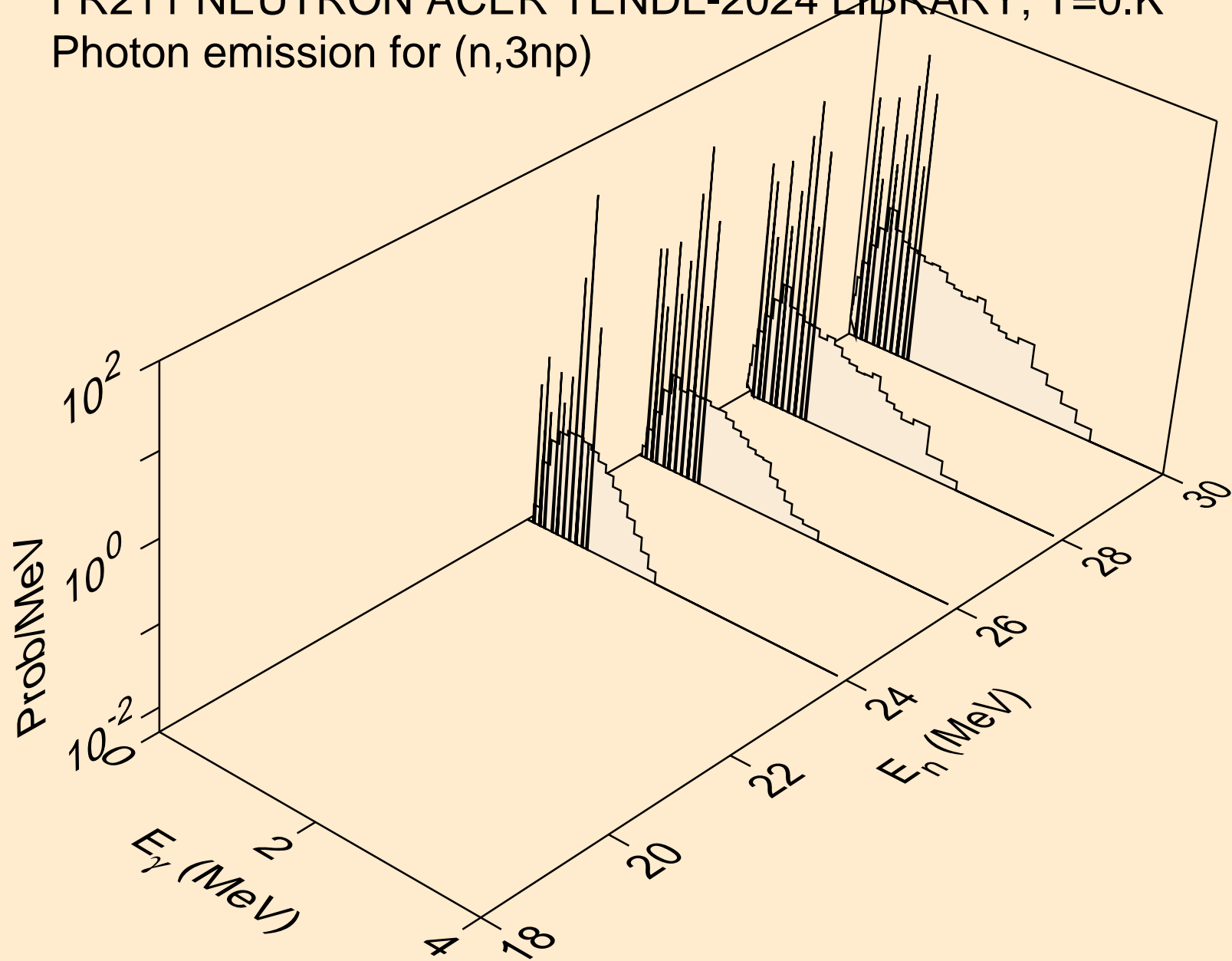

FR211 NEUTRON ACER TENDL-2024 LIBRARY; T=0.K
Photon emission for (n,n2p)

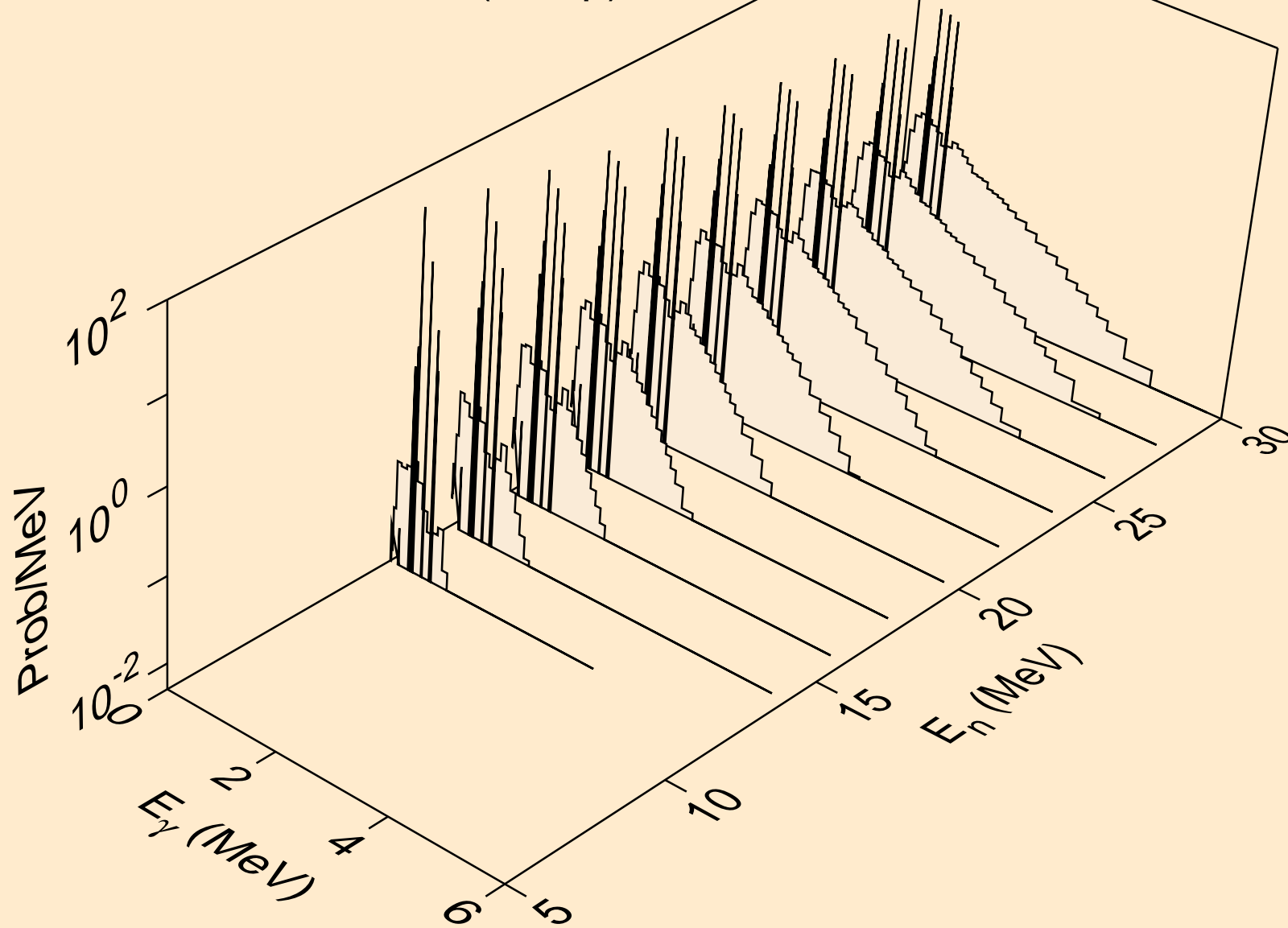

FR211 NEUTRON ACER TENDL-2024 LIBRARY; T=0.K
Photon emission for (n,npa)

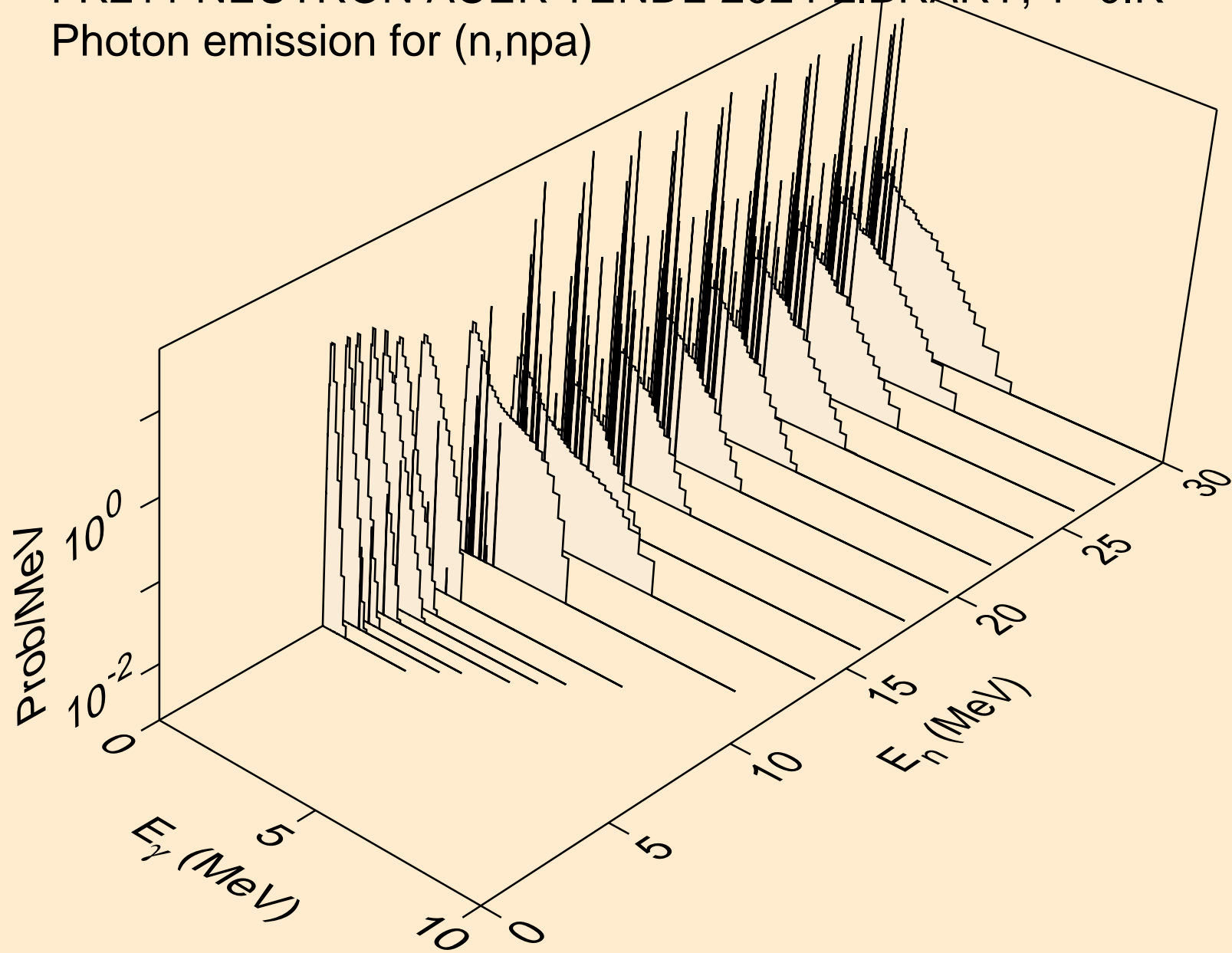

FR211 NEUTRON ACER TENDL-2024 LIBRARY; T=0.K
Photon emission for (n,n*c)

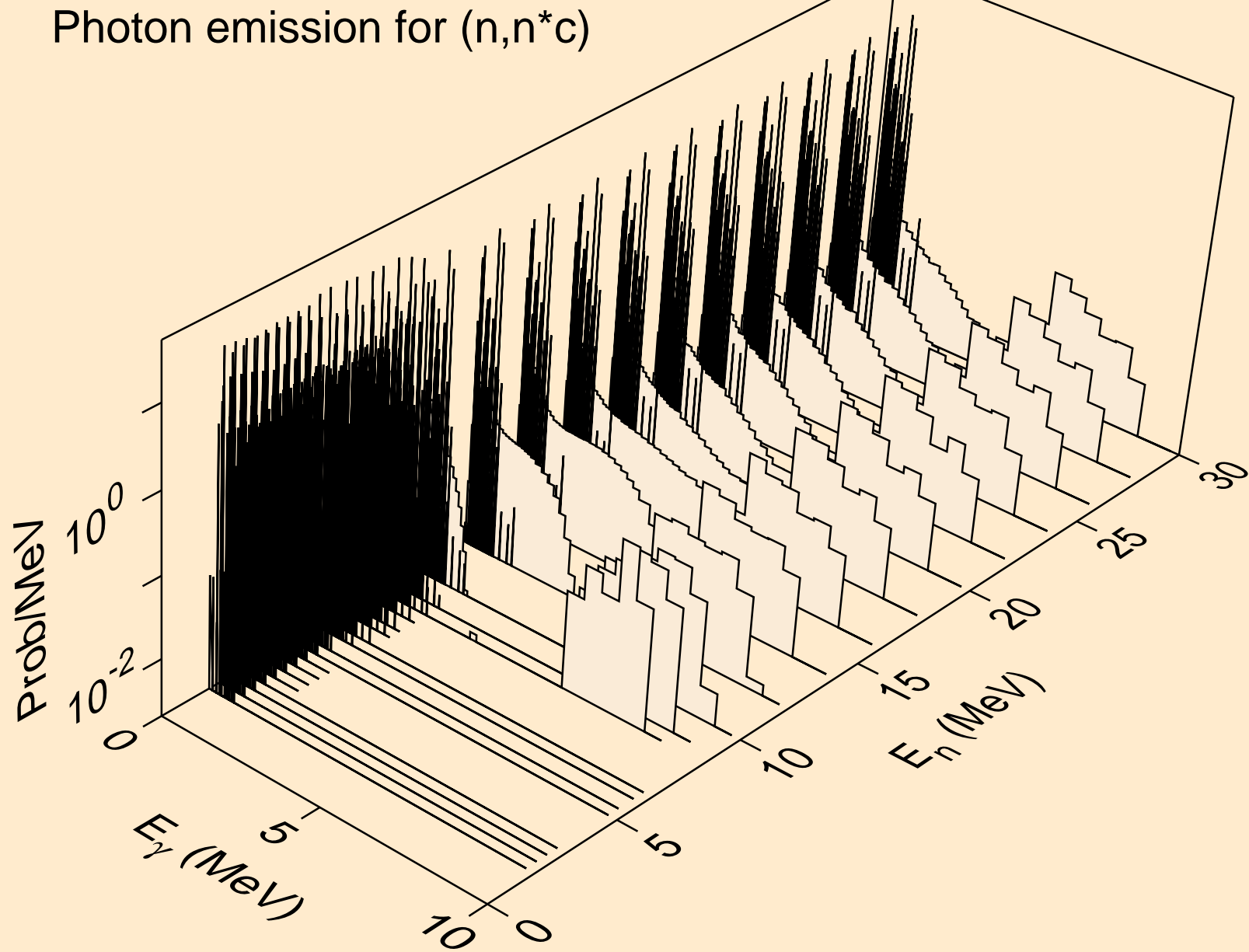

FR211 NEUTRON ACER TENDL-2024 LIBRARY; T=0.K
Photon emission for (n,gma)

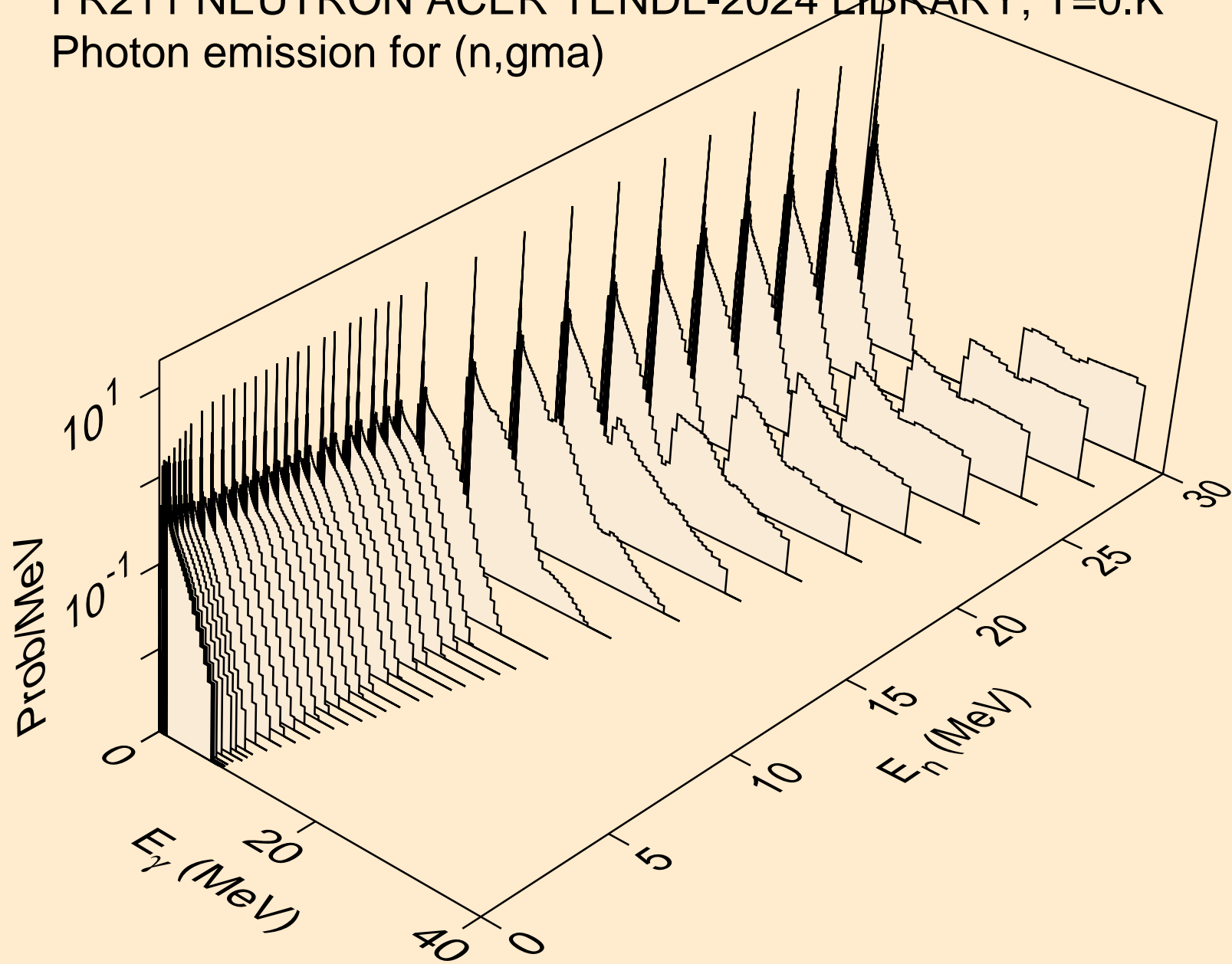

FR211 NEUTRON ACER TENDL-2024 LIBRARY; T=0.K
Photon emission for (n,p)

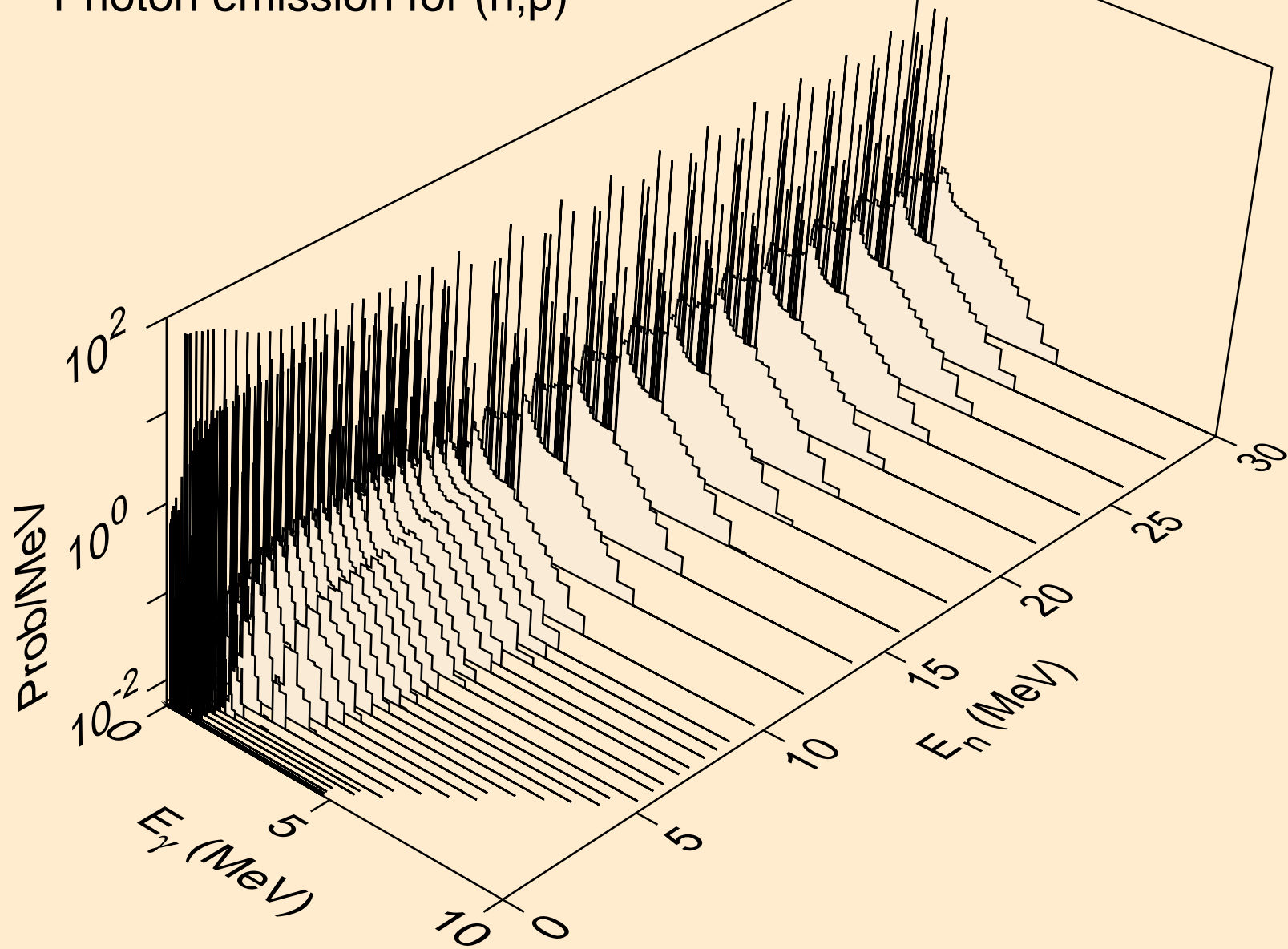

FR211 NEUTRON ACER TENDL-2024 LIBRARY; T=0.K
Photon emission for (n,d)

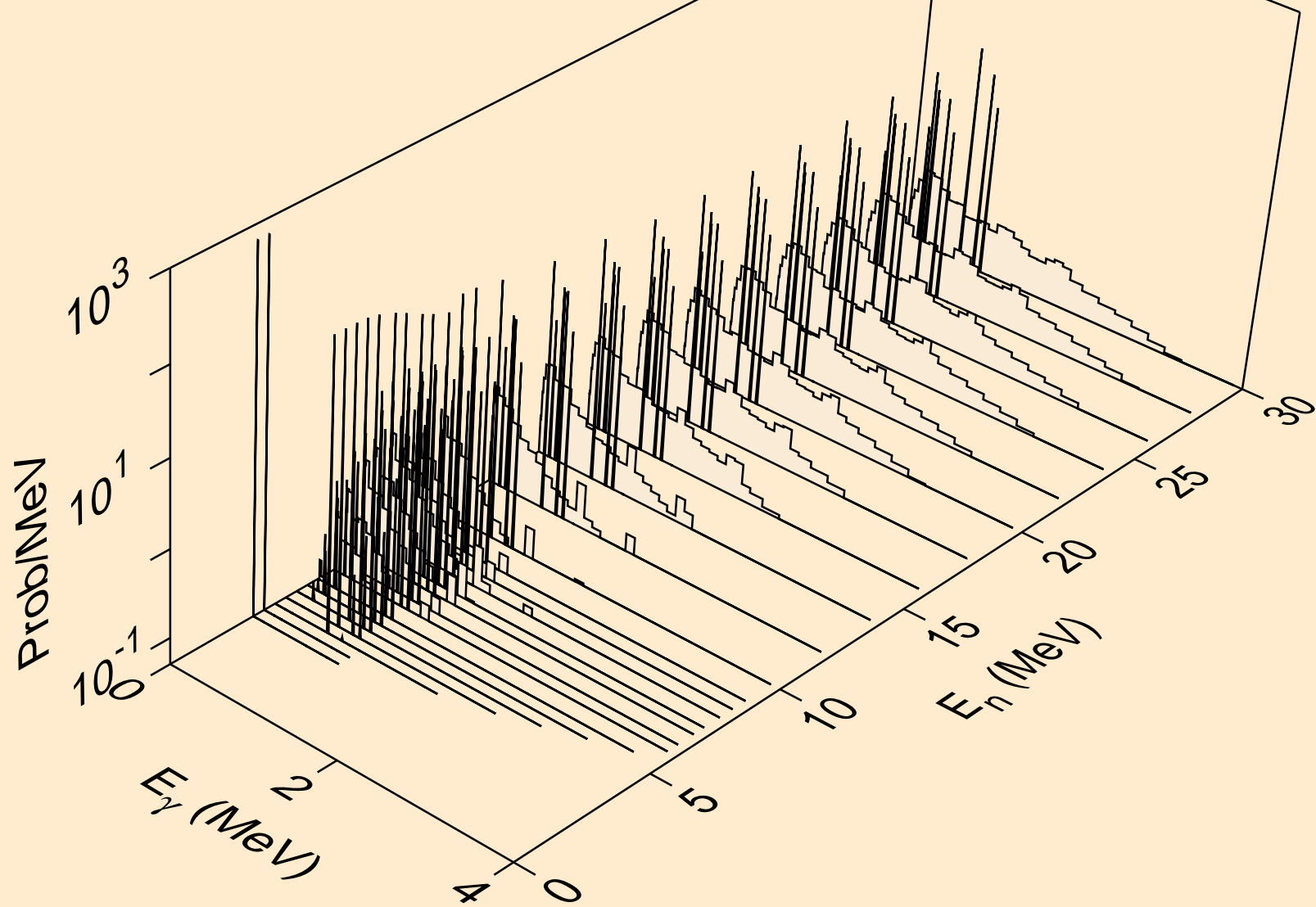

FR211 NEUTRON ACER TENDL-2024 LIBRARY; T=0.K
Photon emission for (n,t)

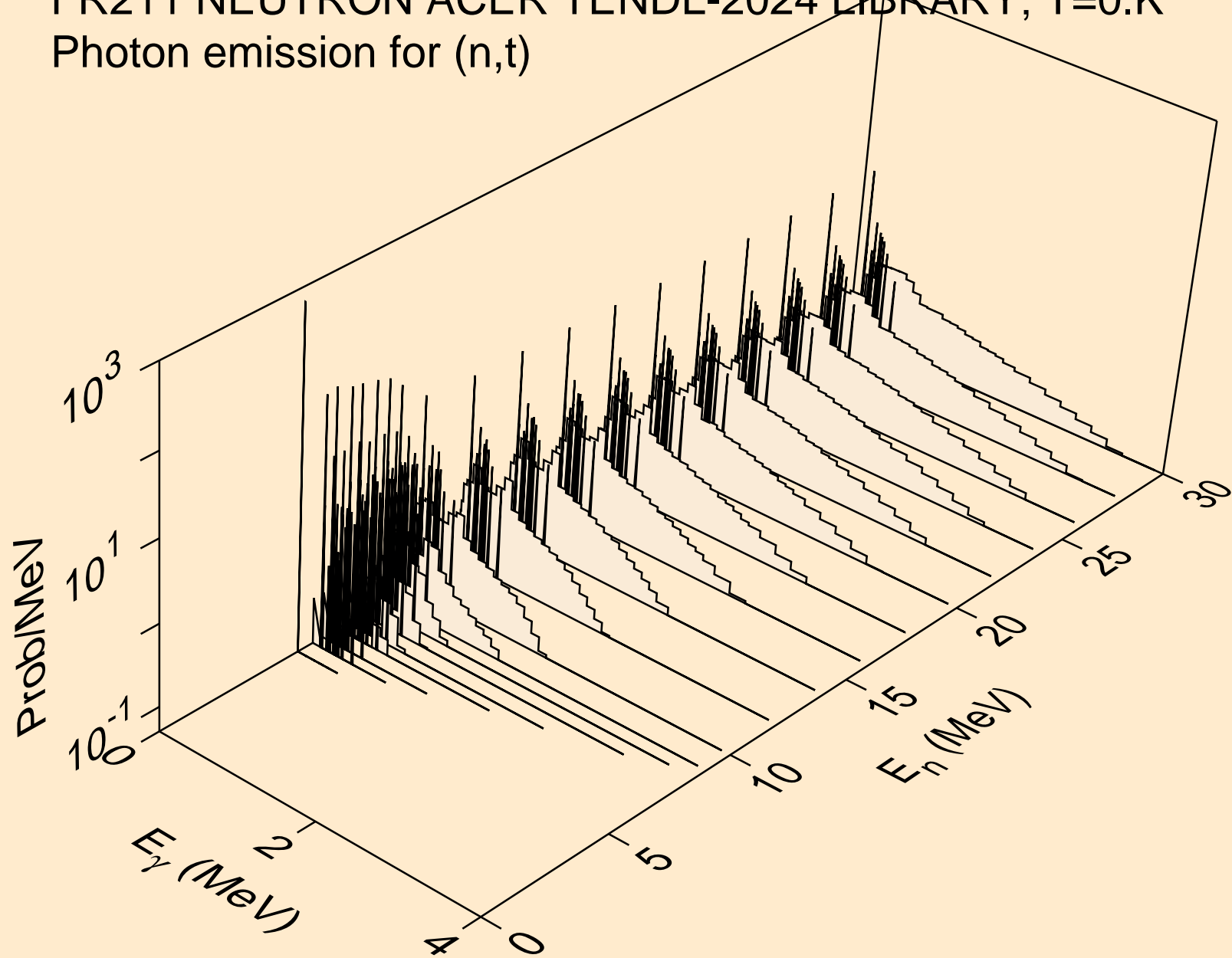

FR211 NEUTRON ACER TENDL-2024 LIBRARY; T=0.K
Photon emission for (n,he3)

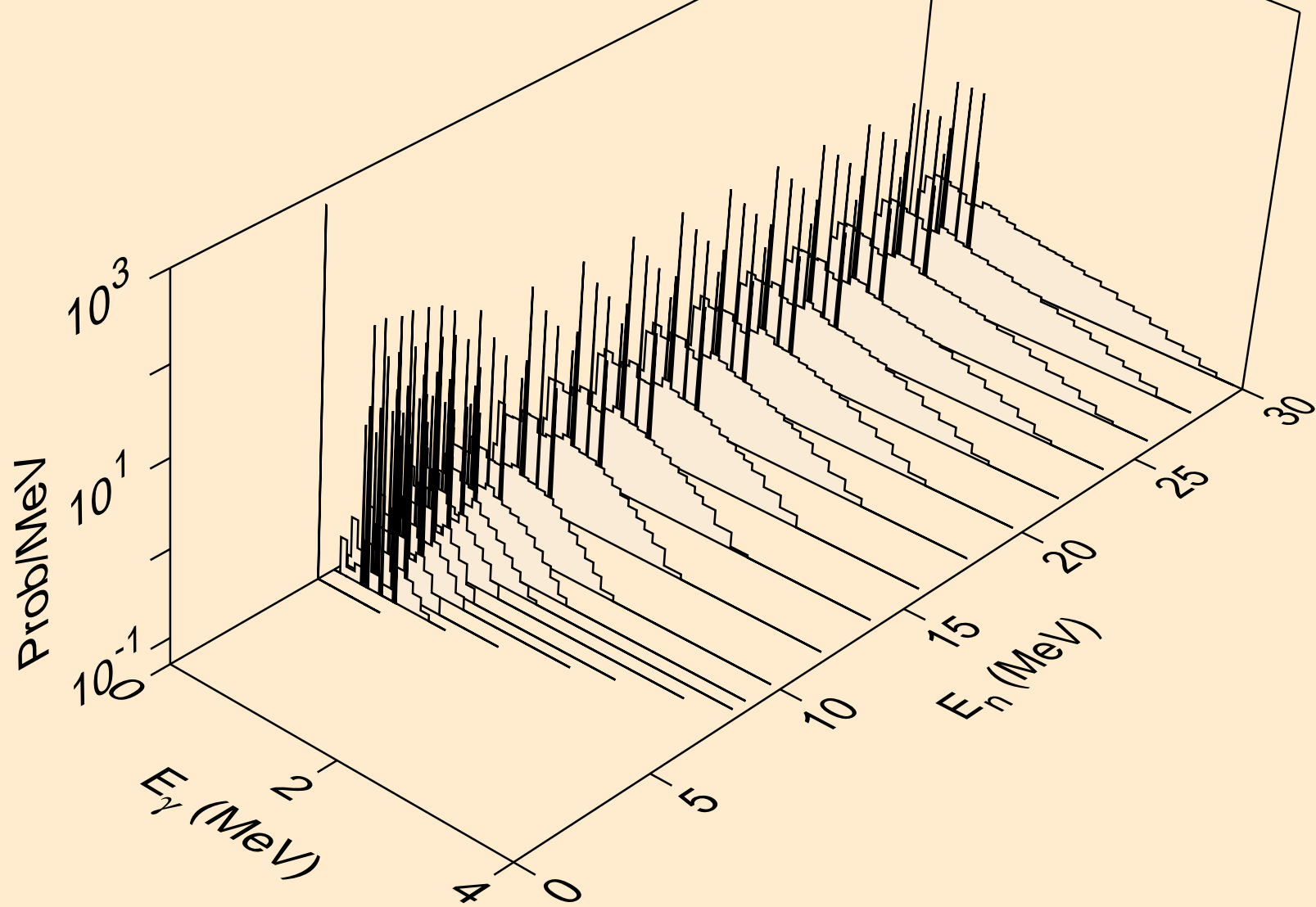

FR211 NEUTRON ACER TENDL-2024 LIBRARY; T=0.K
Photon emission for (n,a)

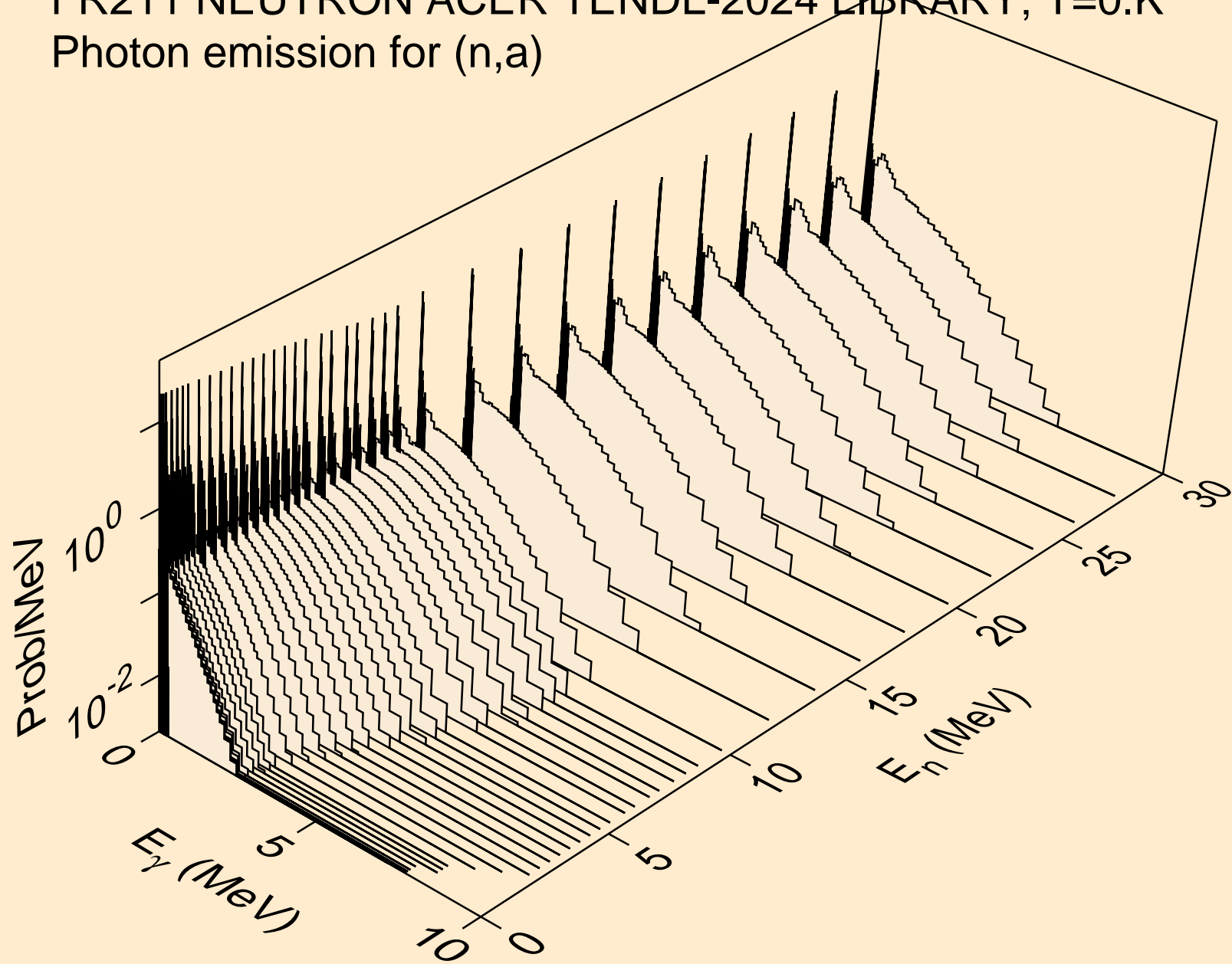

FR211 NEUTRON ACER TENDL-2024 LIBRARY; T=0.K
Photon emission for (n,2a)

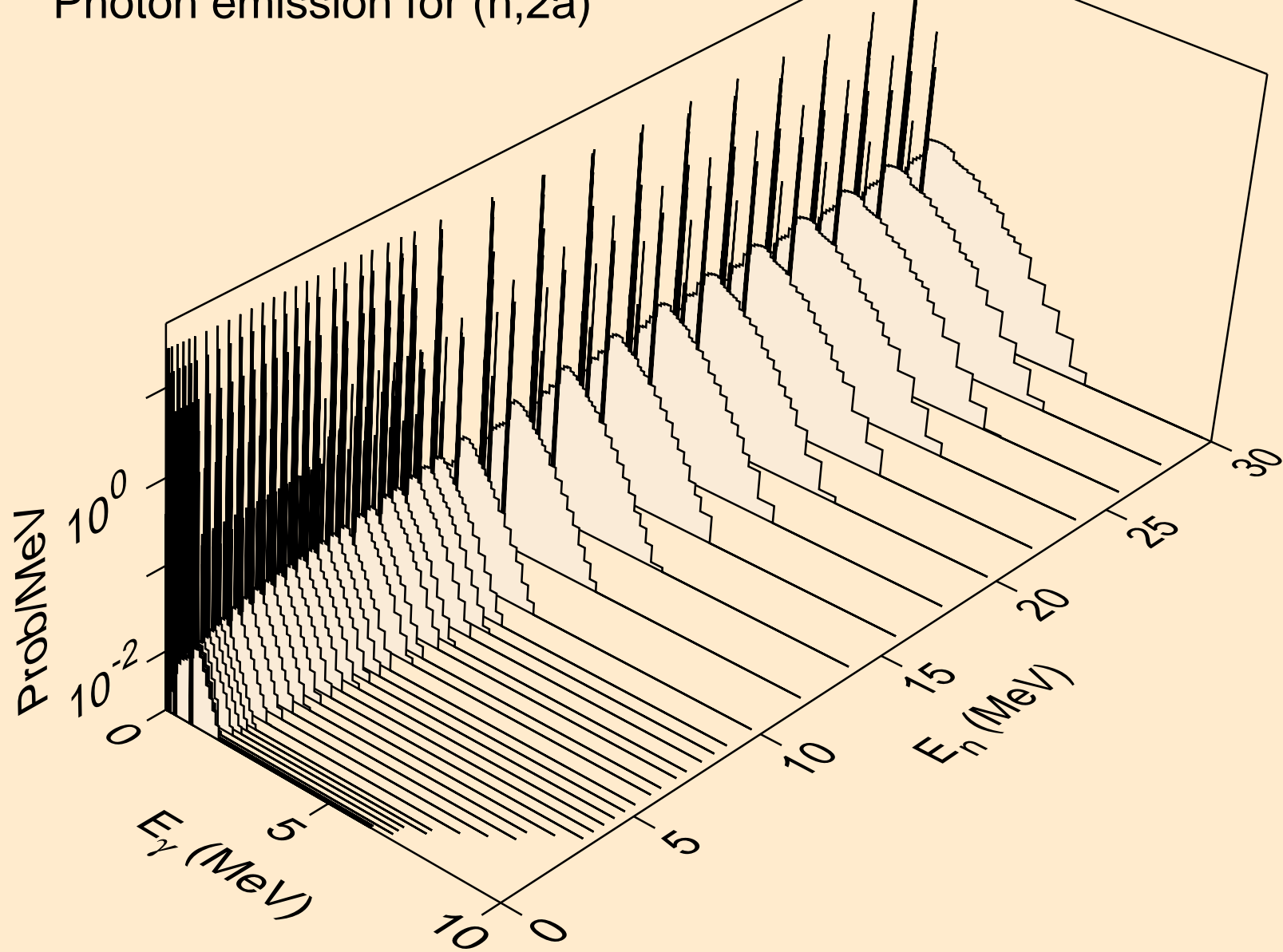

FR211 NEUTRON ACER TENDL-2024 LIBRARY; T=0.K
Photon emission for (n,2p)

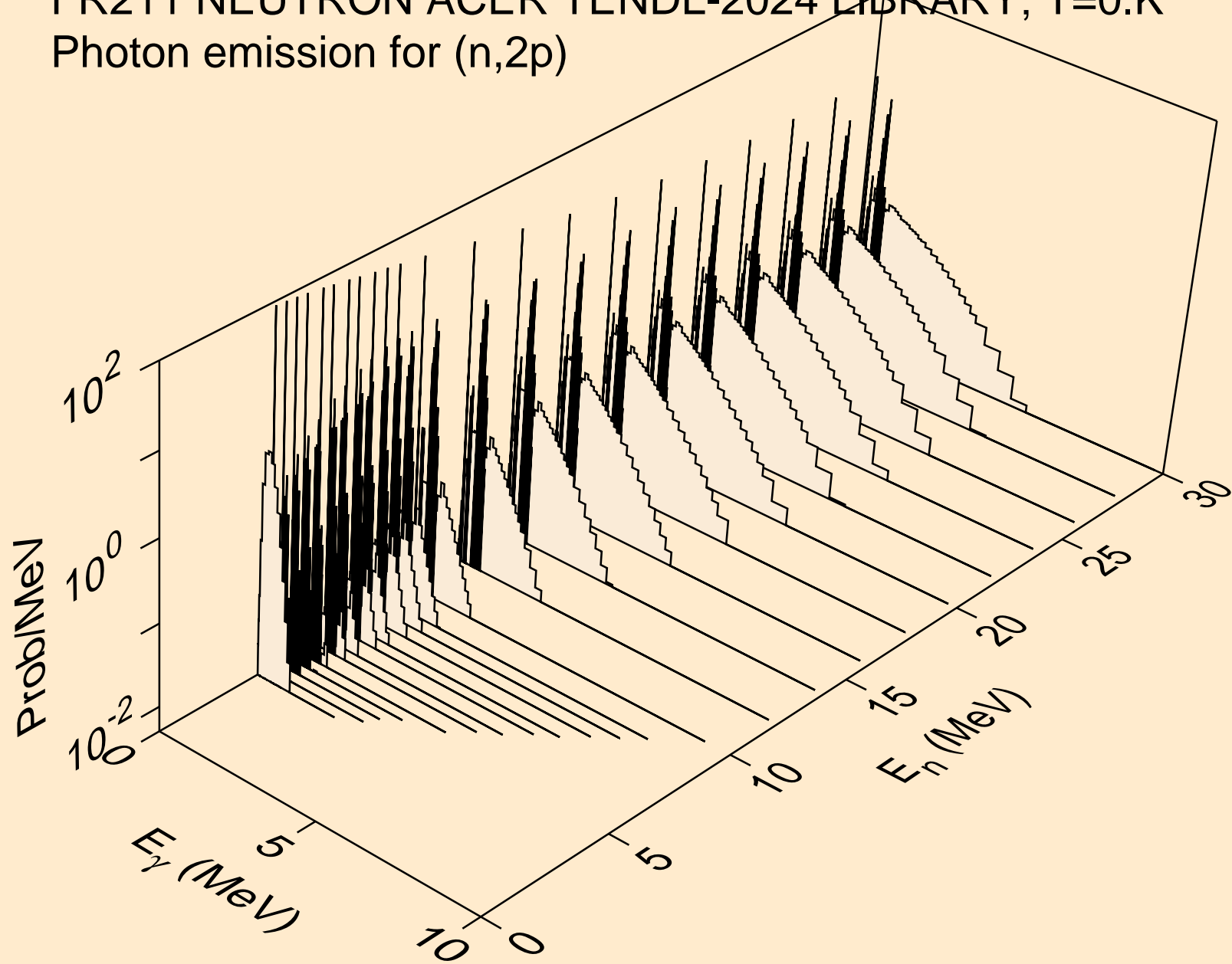

FR211 NEUTRON ACER TENDL-2024 LIBRARY; T=0.K
Photon emission for (n,p α)

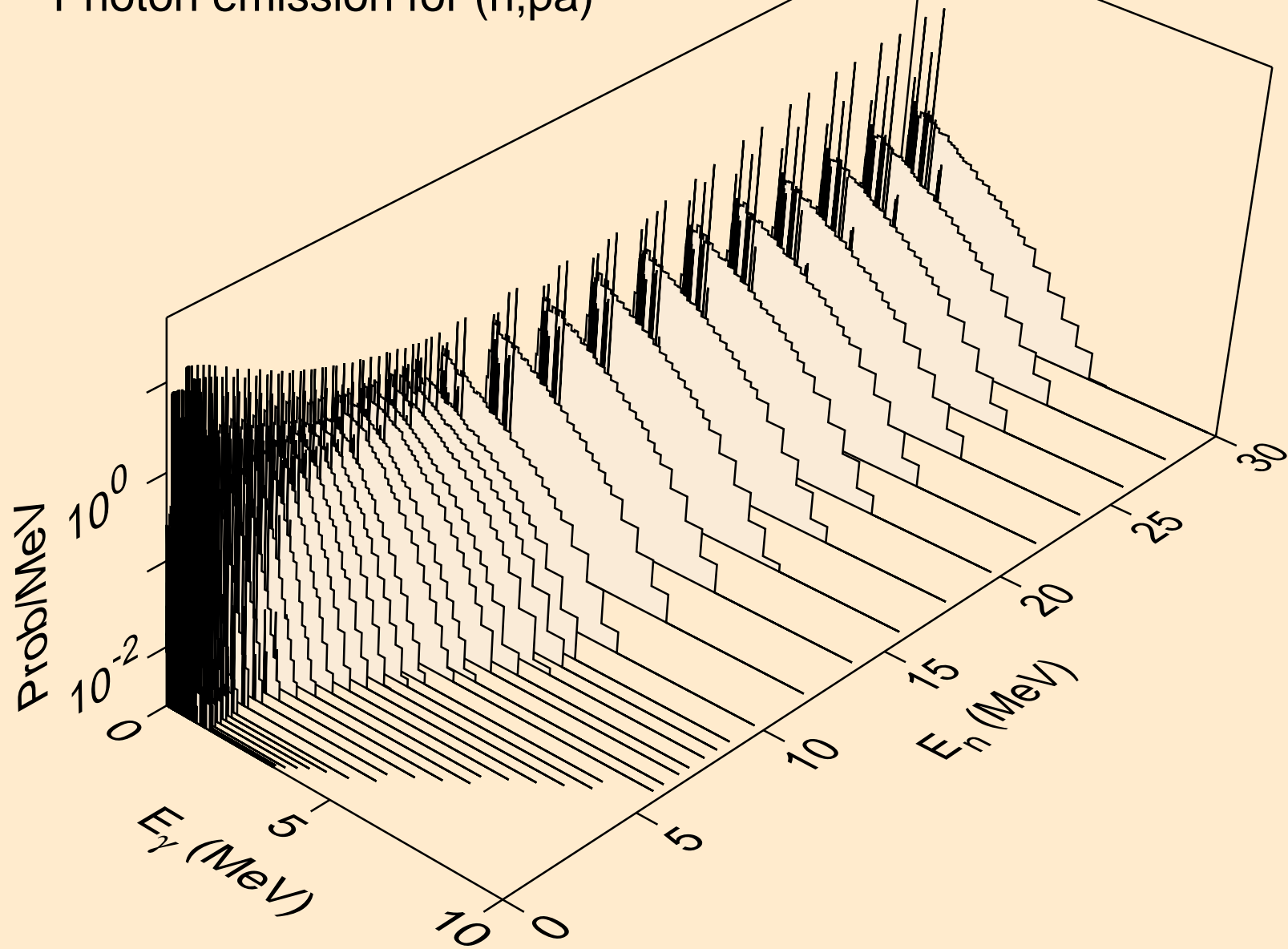

FR211 NEUTRON ACER TENDL-2024 LIBRARY; T=0.K
Photon emission for (n,pd)

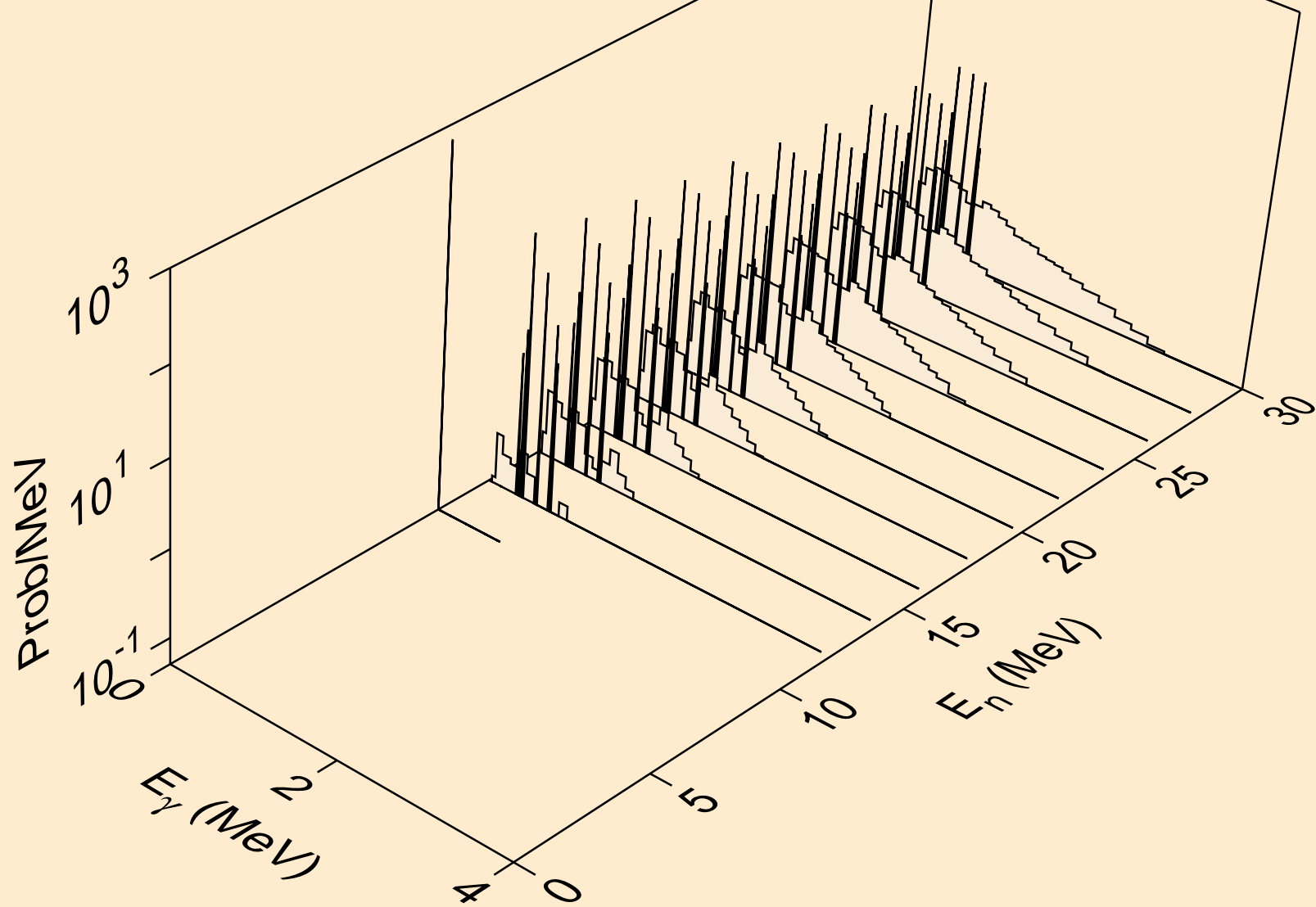

FR211 NEUTRON ACER TENDL-2024 LIBRARY; T=0.K
Photon emission for (n,pt)

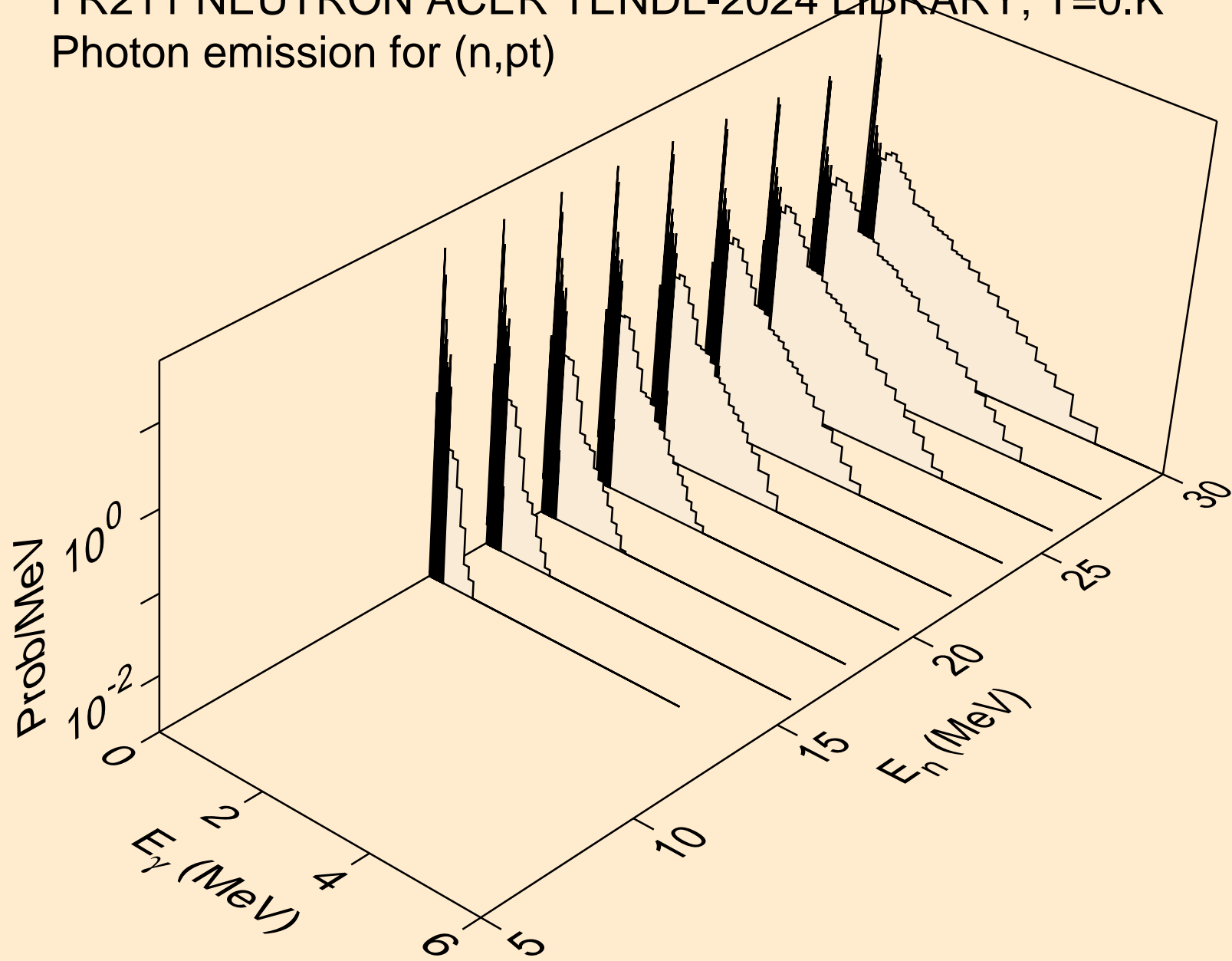

FR211 NEUTRON ACER TENDL-2024 LIBRARY; T=0.K
Photon emission for (n,da)

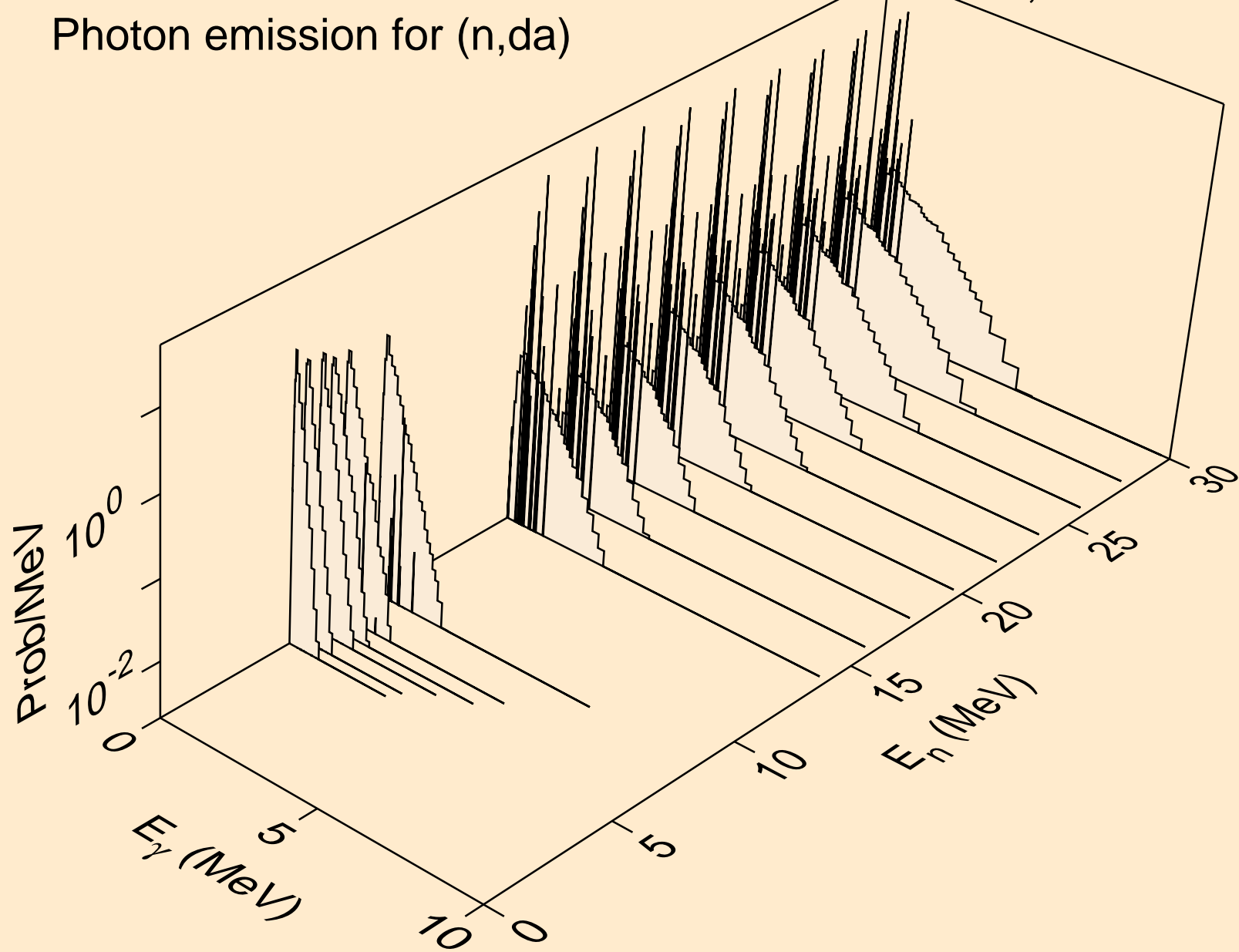

FR211 NEUTRON ACER TENDL-2024 LIBRARY; T=0.K
thermal capture photon spectrum

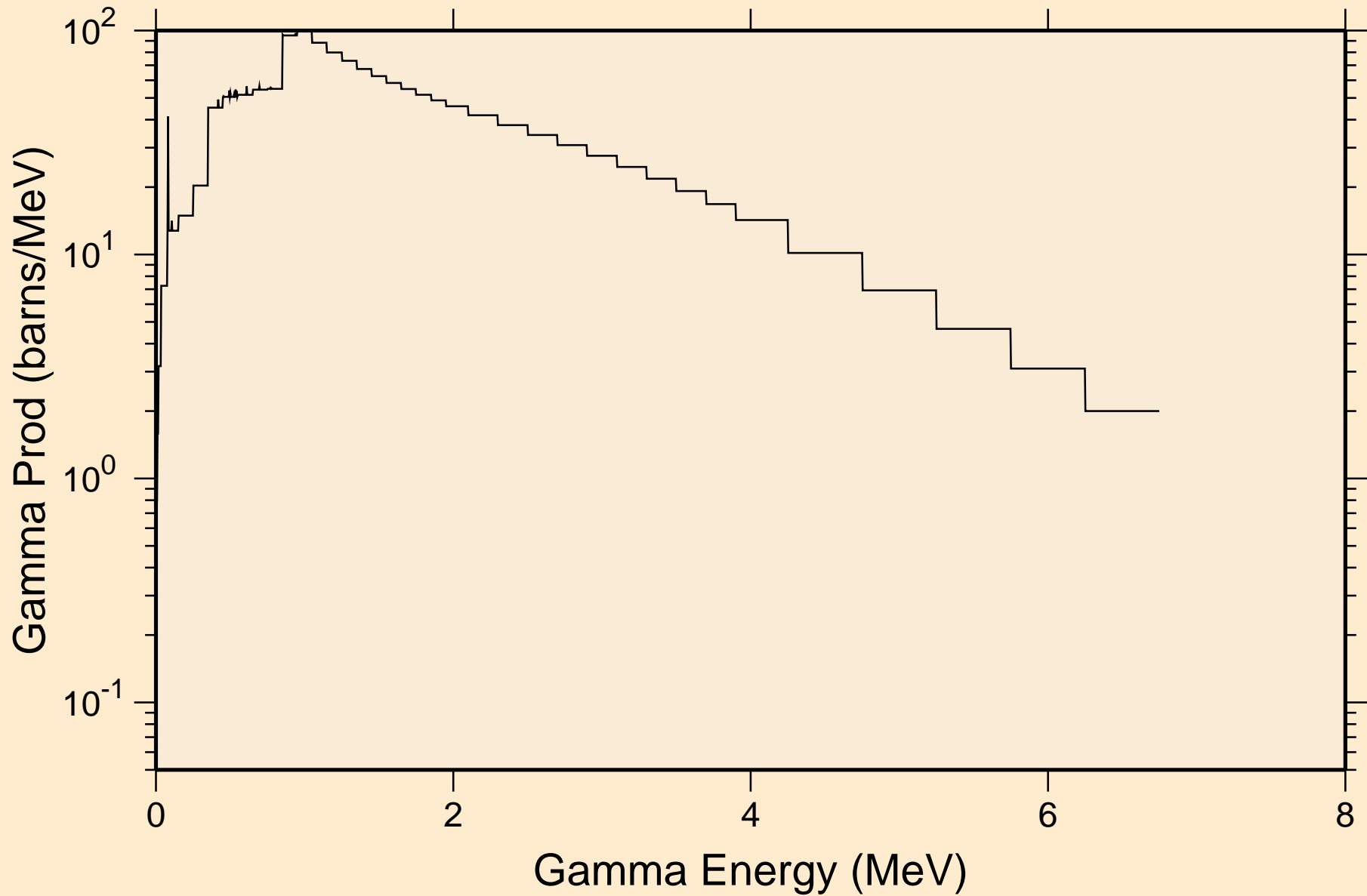

FR211 NEUTRON ACER TENDL-2024 LIBRARY; T=0.K
14 MeV photon spectrum

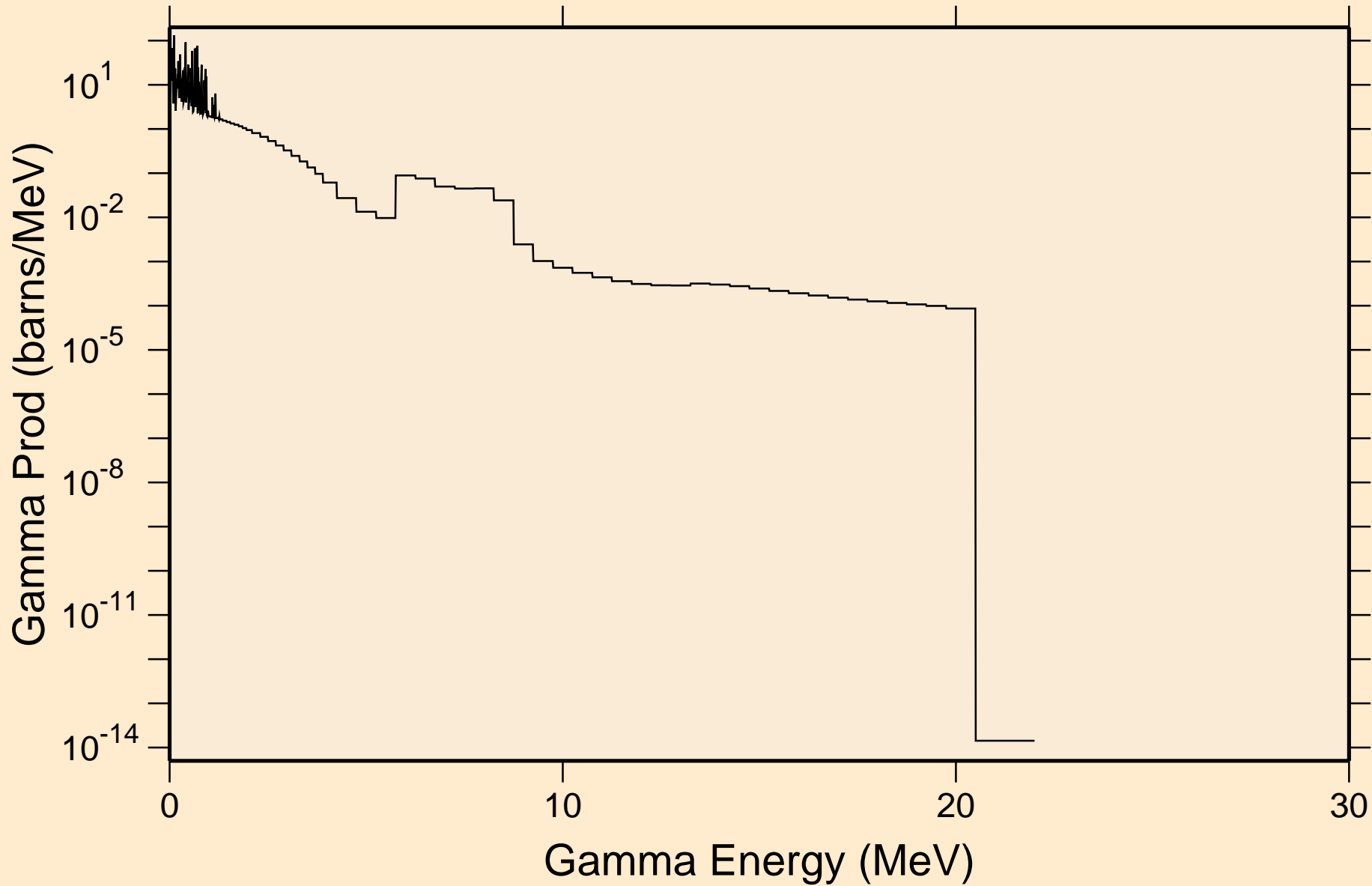

FR211 NEUTRON ACER TENDL-2024 LIBRARY; T=0.K
Particle heating contributions

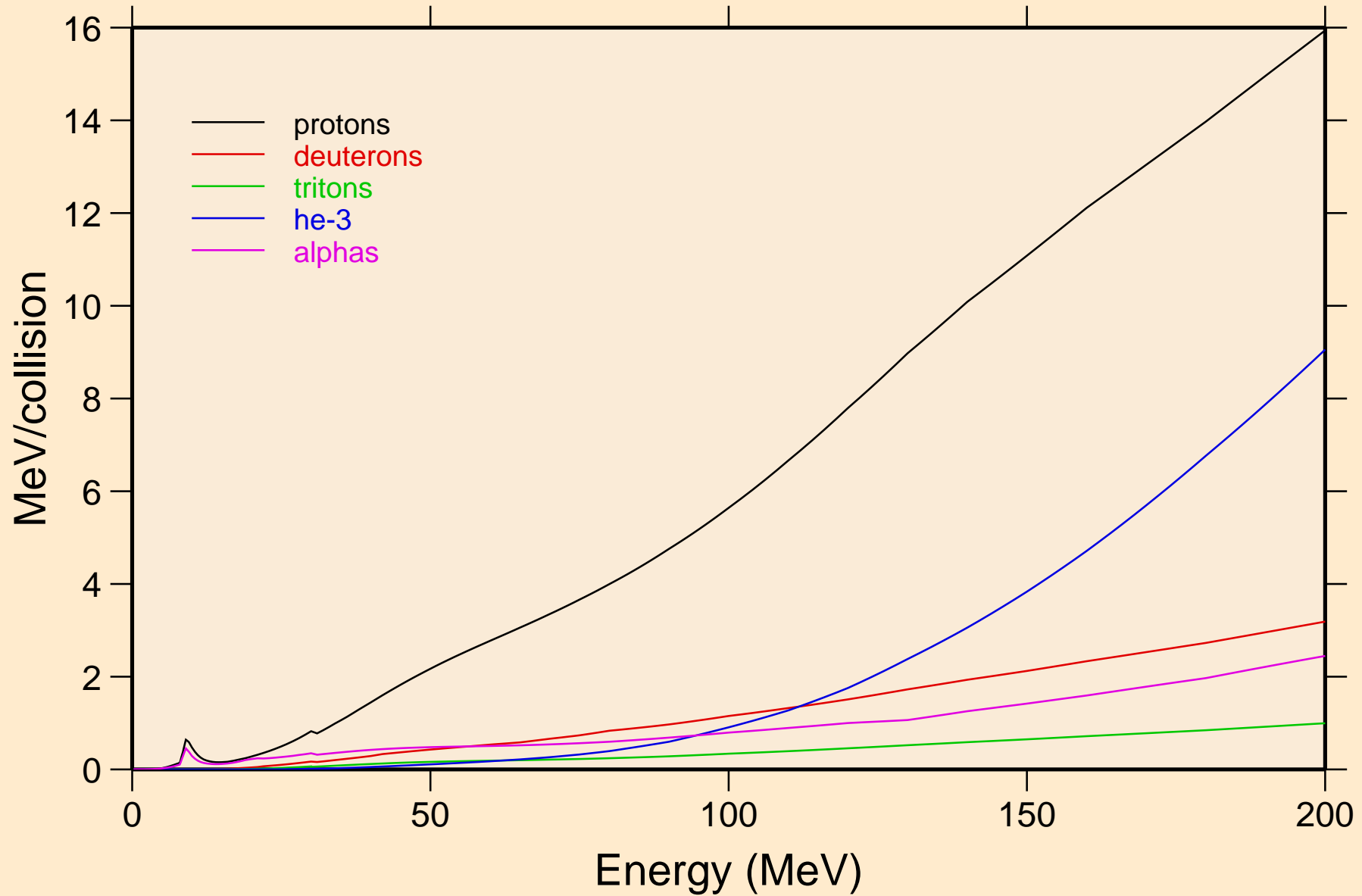

FR211 NEUTRON ACER TENDL-2024 LIBRARY; T=0.K
Recoil Heating

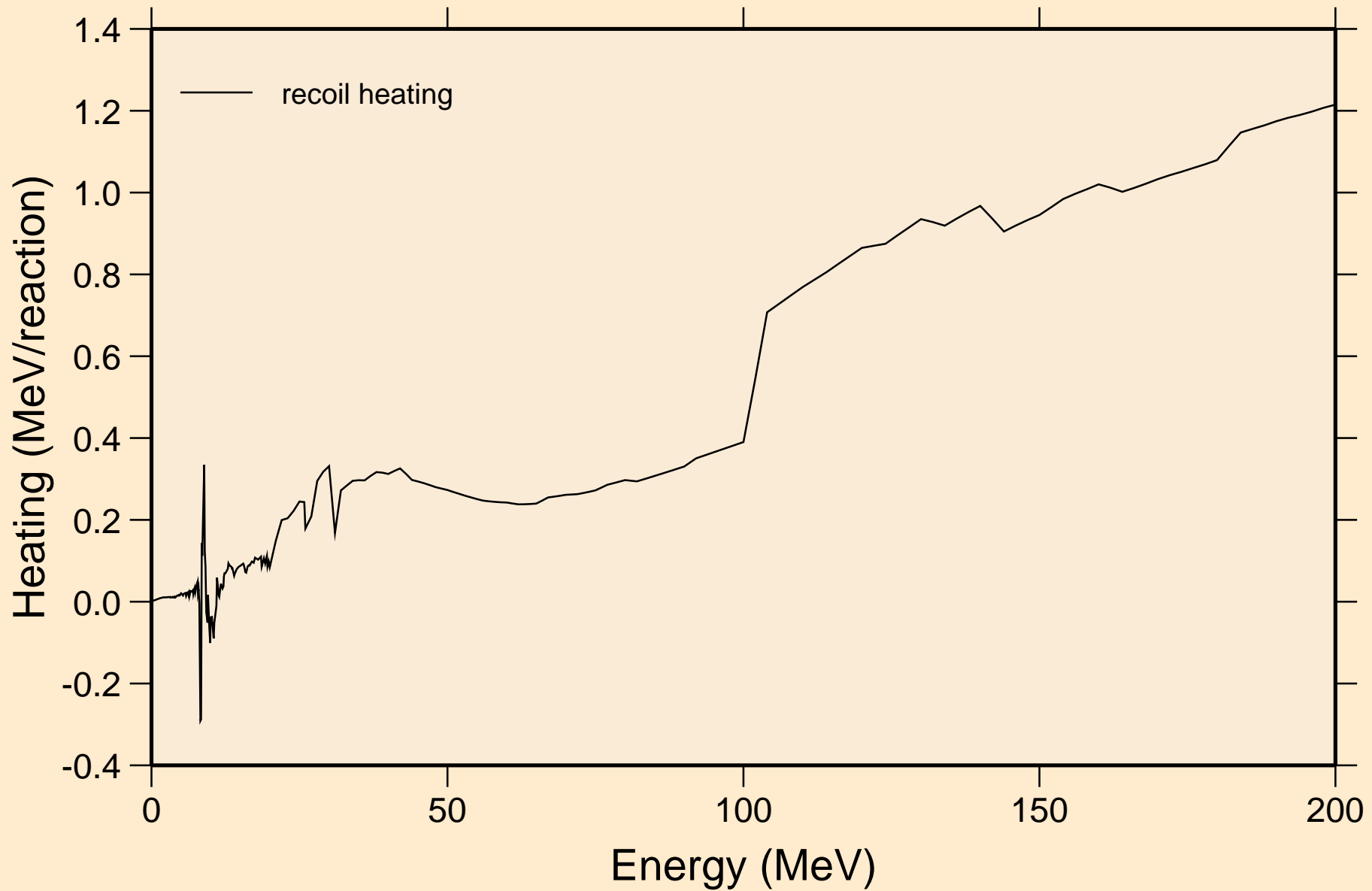

FR211 NEUTRON ACER TENDL-2024 LIBRARY; T=0.K
Particle production cross sections

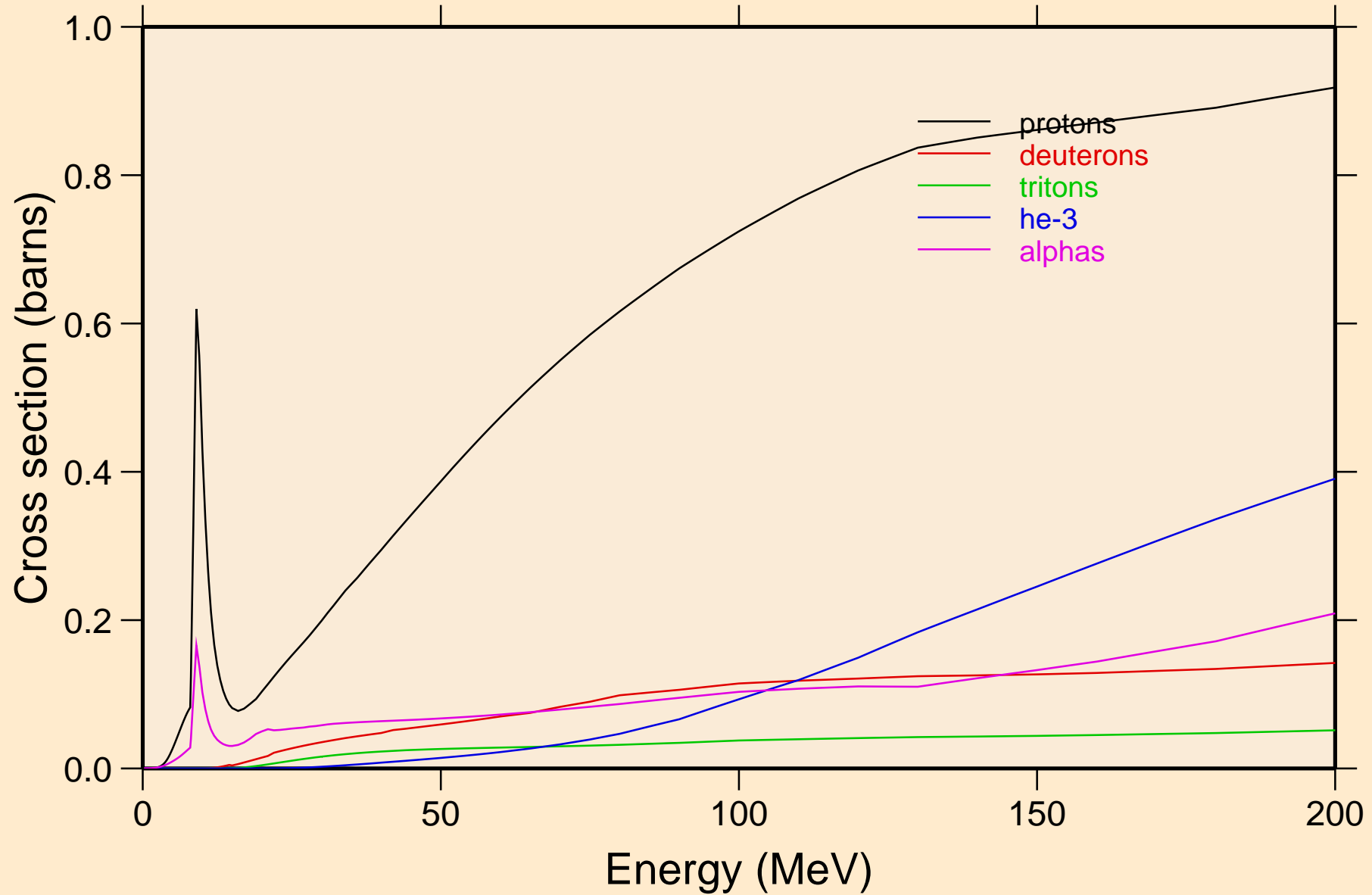

FR211 NEUTRON ACER TENDL-2024 LIBRARY; T=0.K
protons from (n,x)

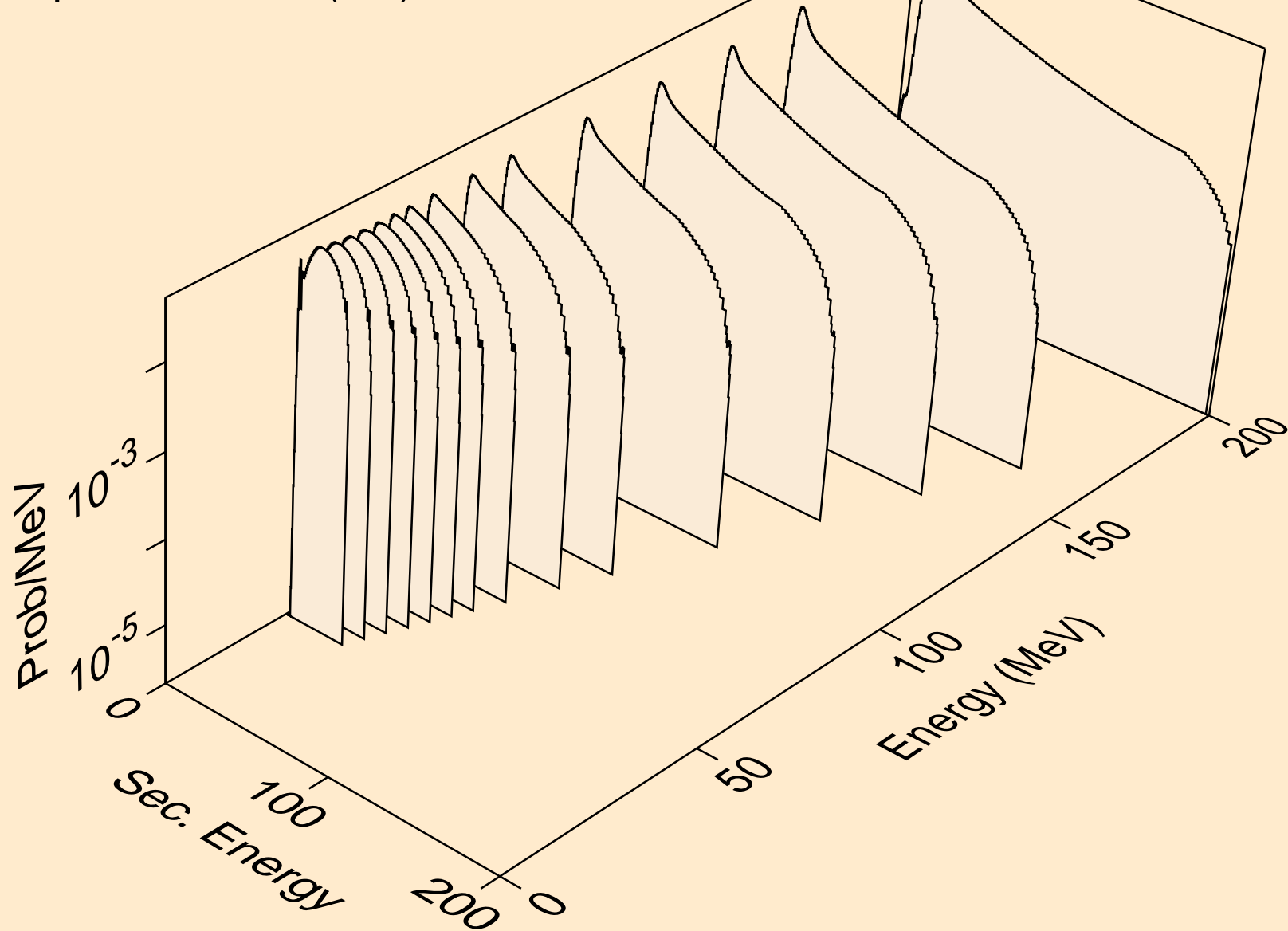

FR211 NEUTRON ACER TENDL-2024 LIBRARY; T=0.K
protons from (n,n*)p

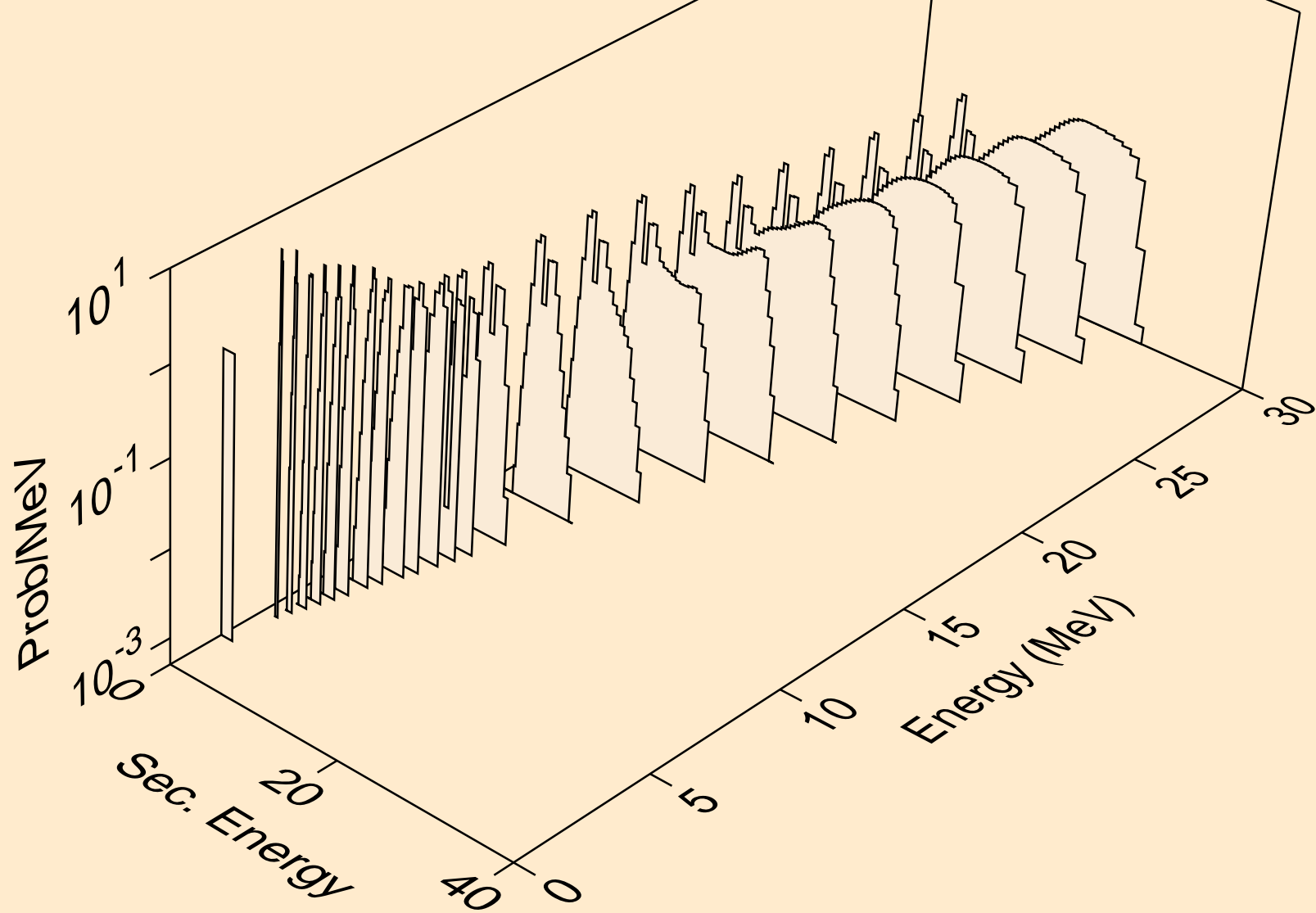

FR211 NEUTRON ACER TENDL-2024 LIBRARY; T=0.K
protons from (n,2np)

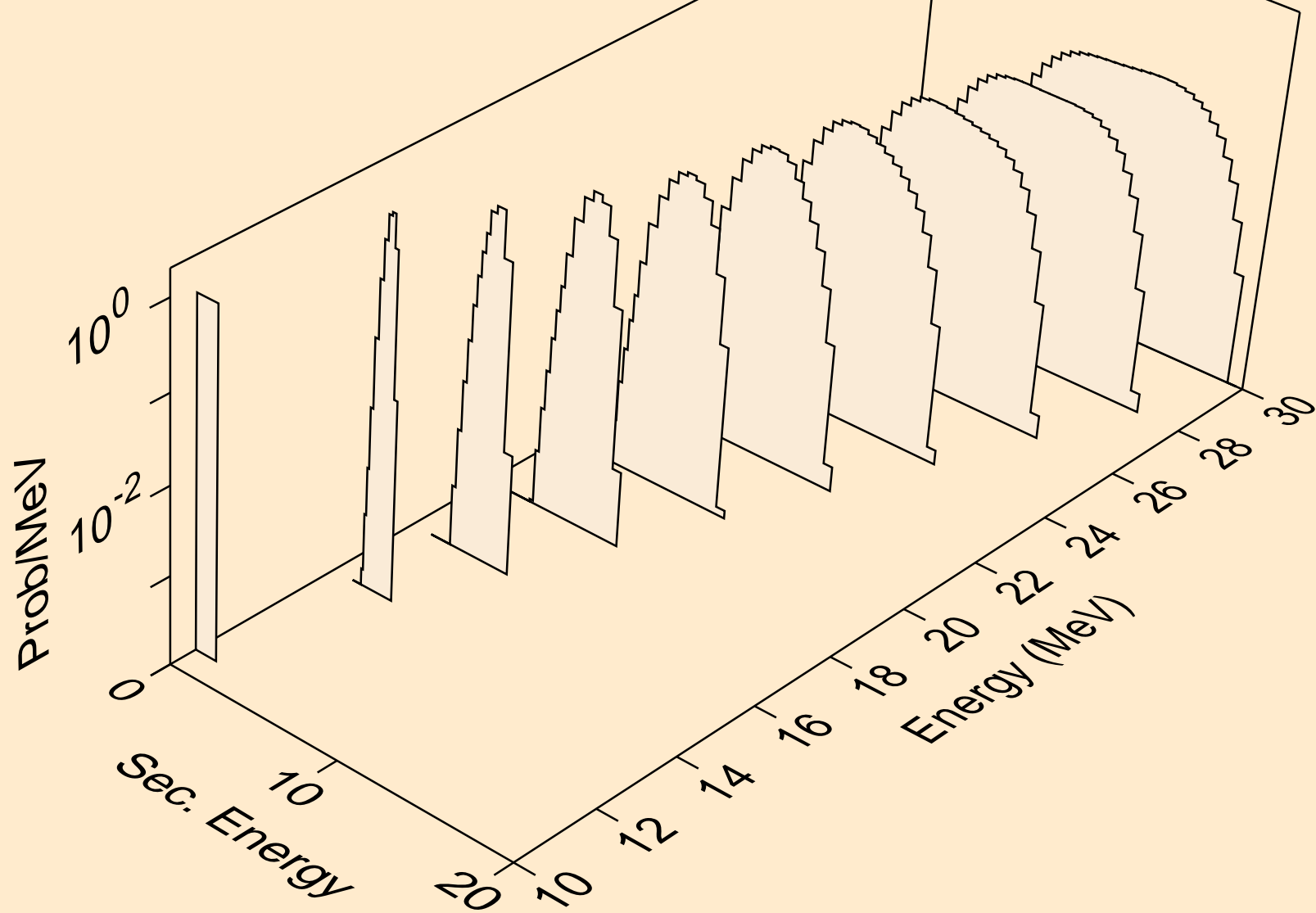

FR211 NEUTRON ACER TENDL-2024 LIBRARY; T=0.K
protons from (n,3np)

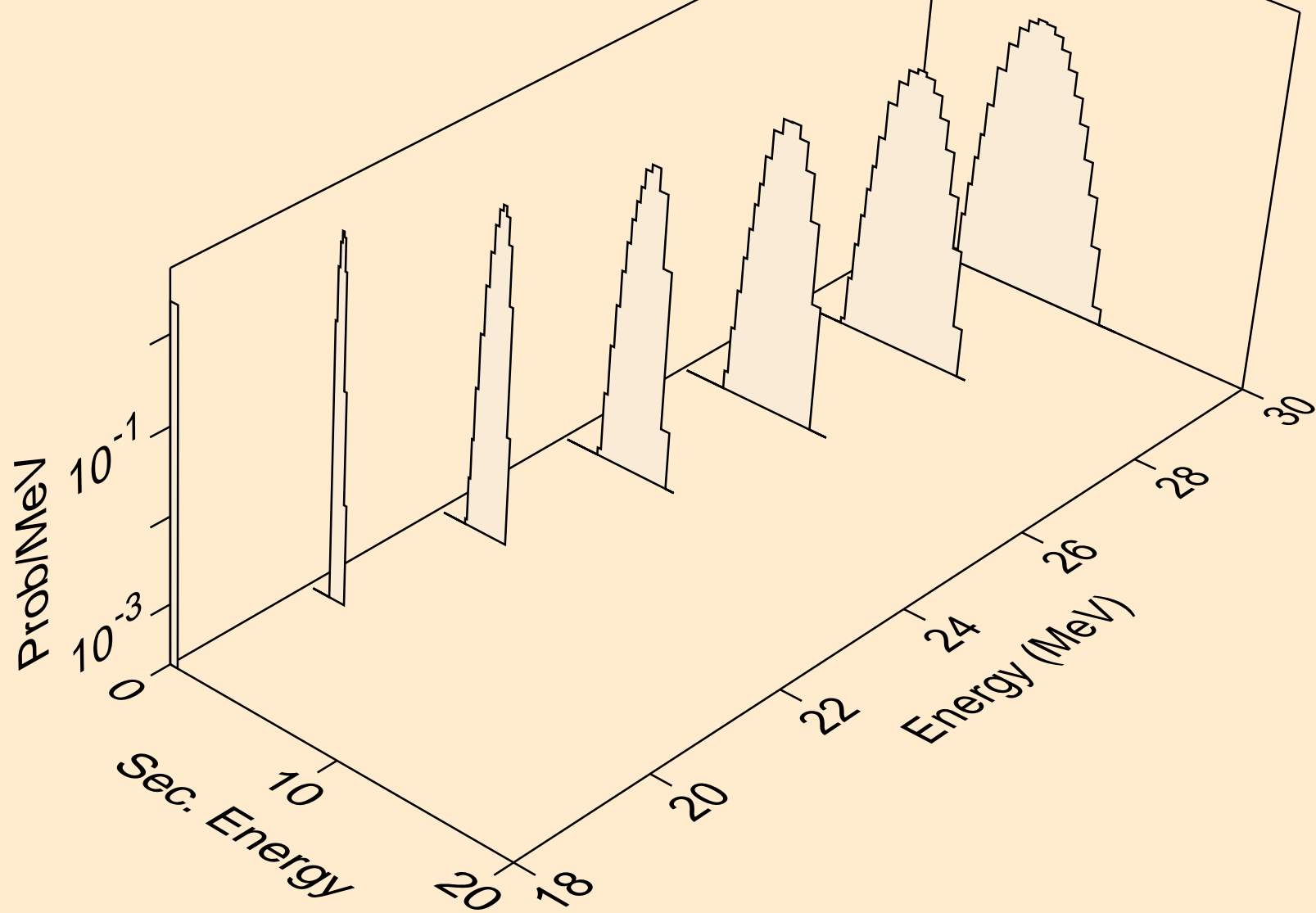

FR211 NEUTRON ACER TENDL-2024 LIBRARY; T=0.K
protons from (n,n2p)

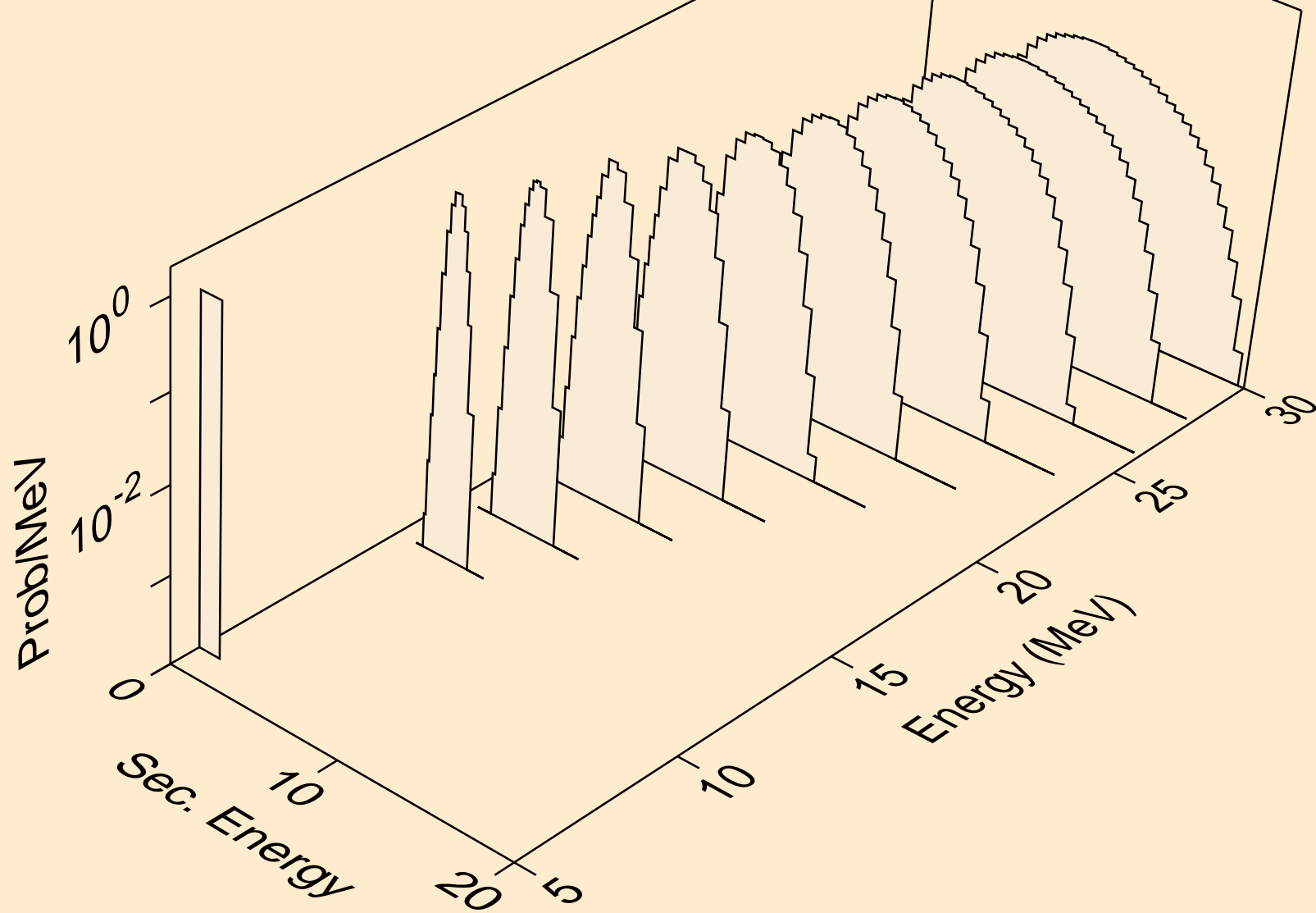

FR211 NEUTRON ACER TENDL-2024 LIBRARY; T=0.K
protons from (n,npa)

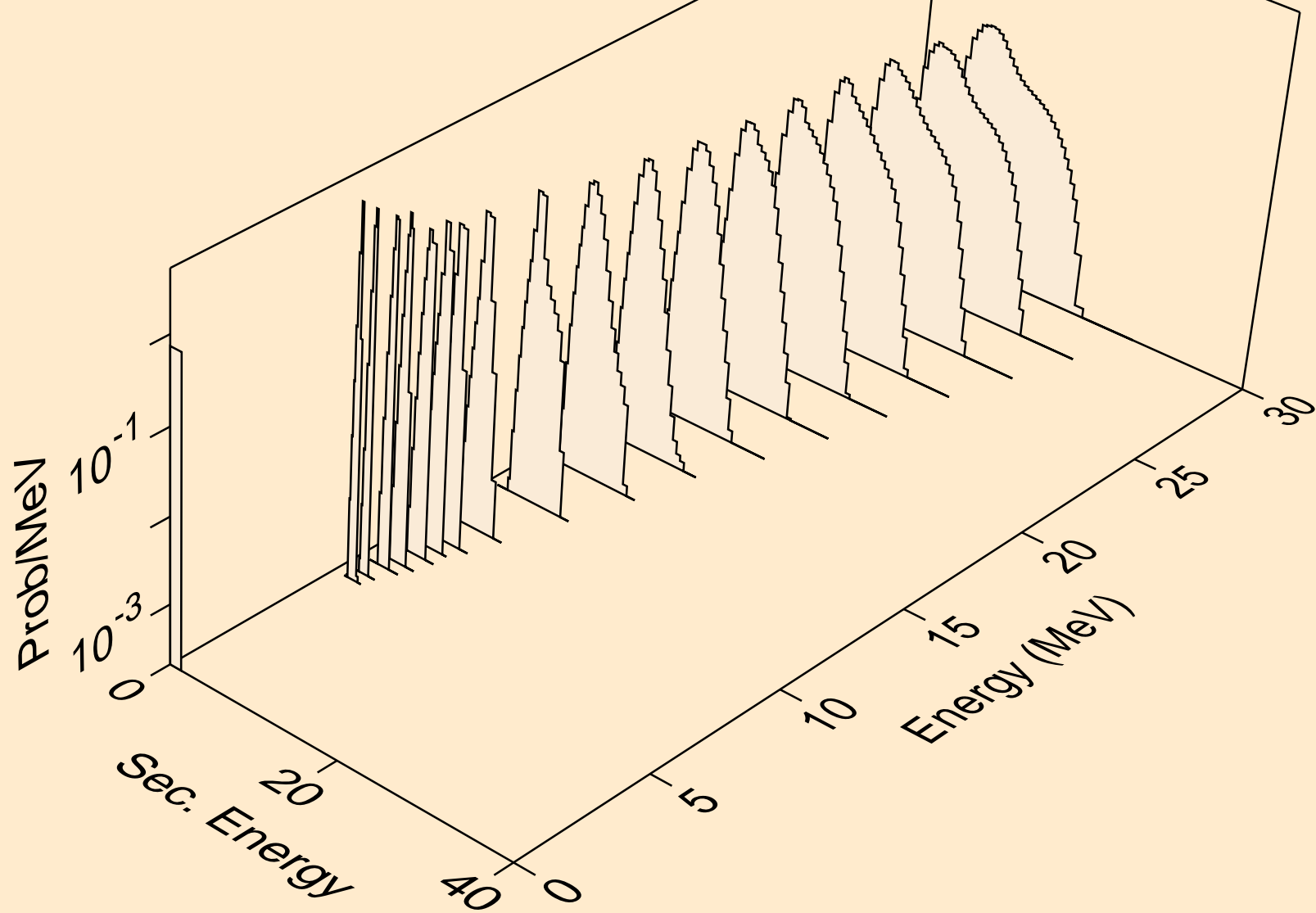

FR211 NEUTRON ACER TENDL-2024 LIBRARY; T=0.K
protons from (n,p)

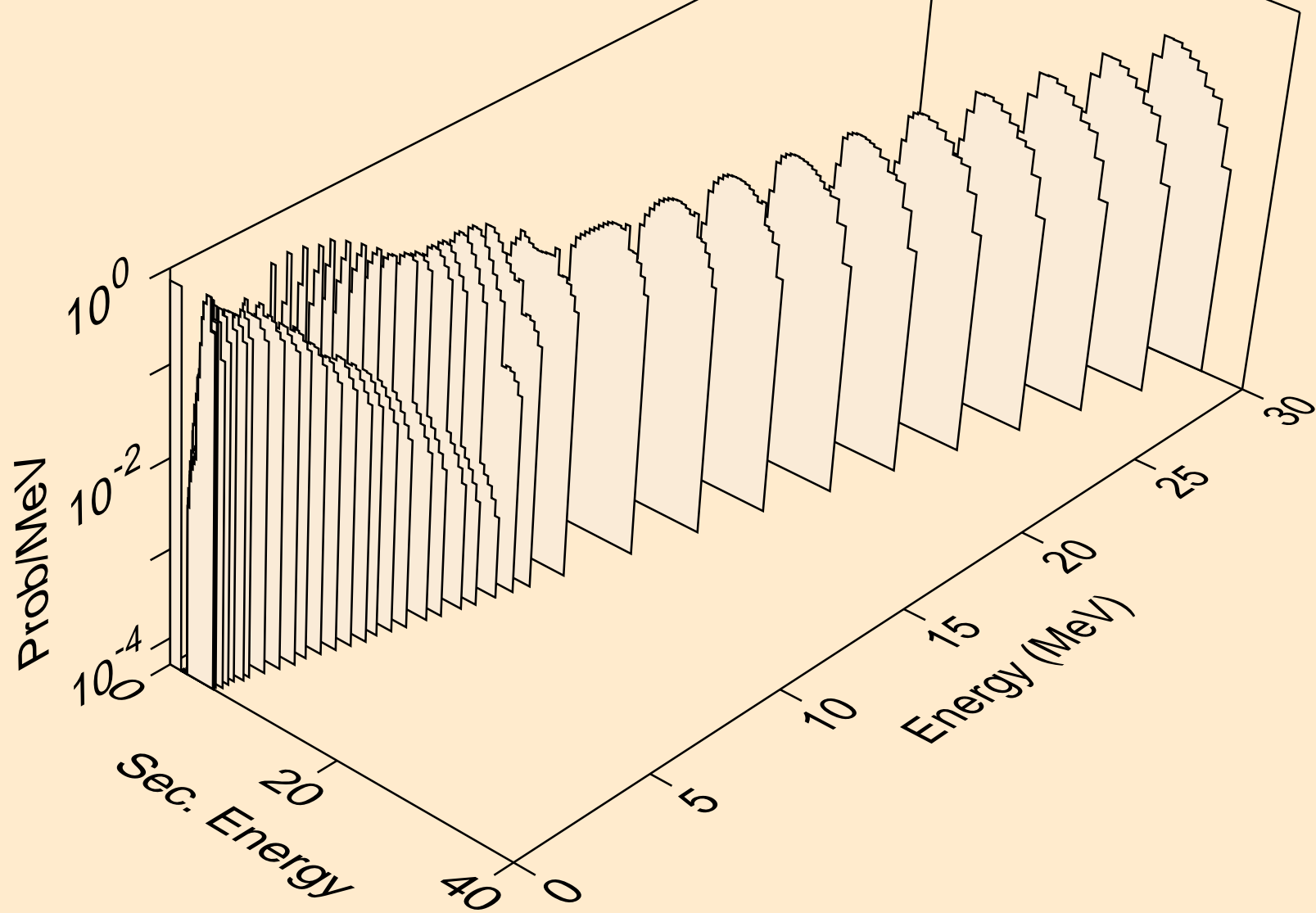

FR211 NEUTRON ACER TENDL-2024 LIBRARY; T=0.K
protons from (n,2p)

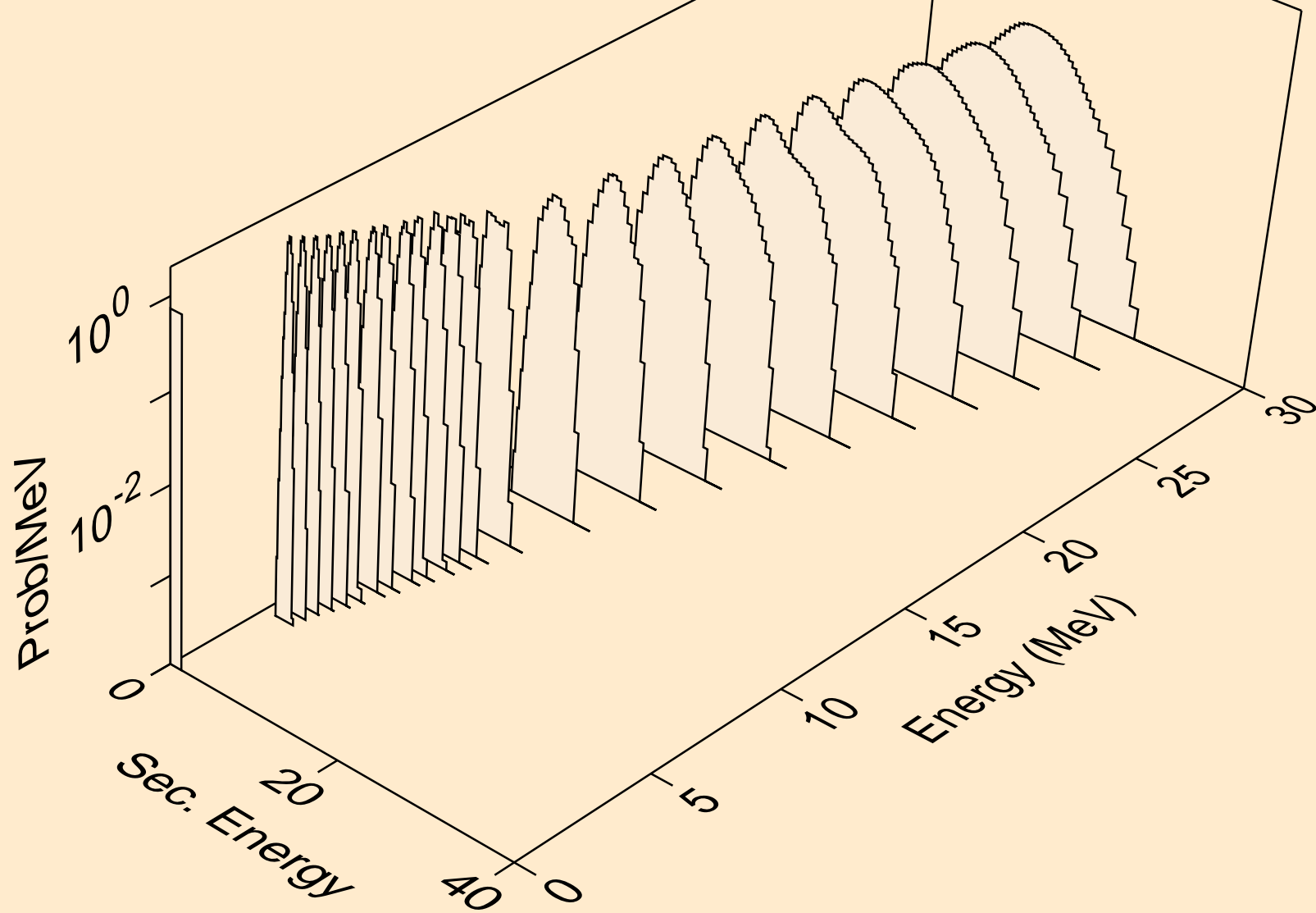

FR211 NEUTRON ACER TENDL-2024 LIBRARY; T=0.K
protons from (n,p)

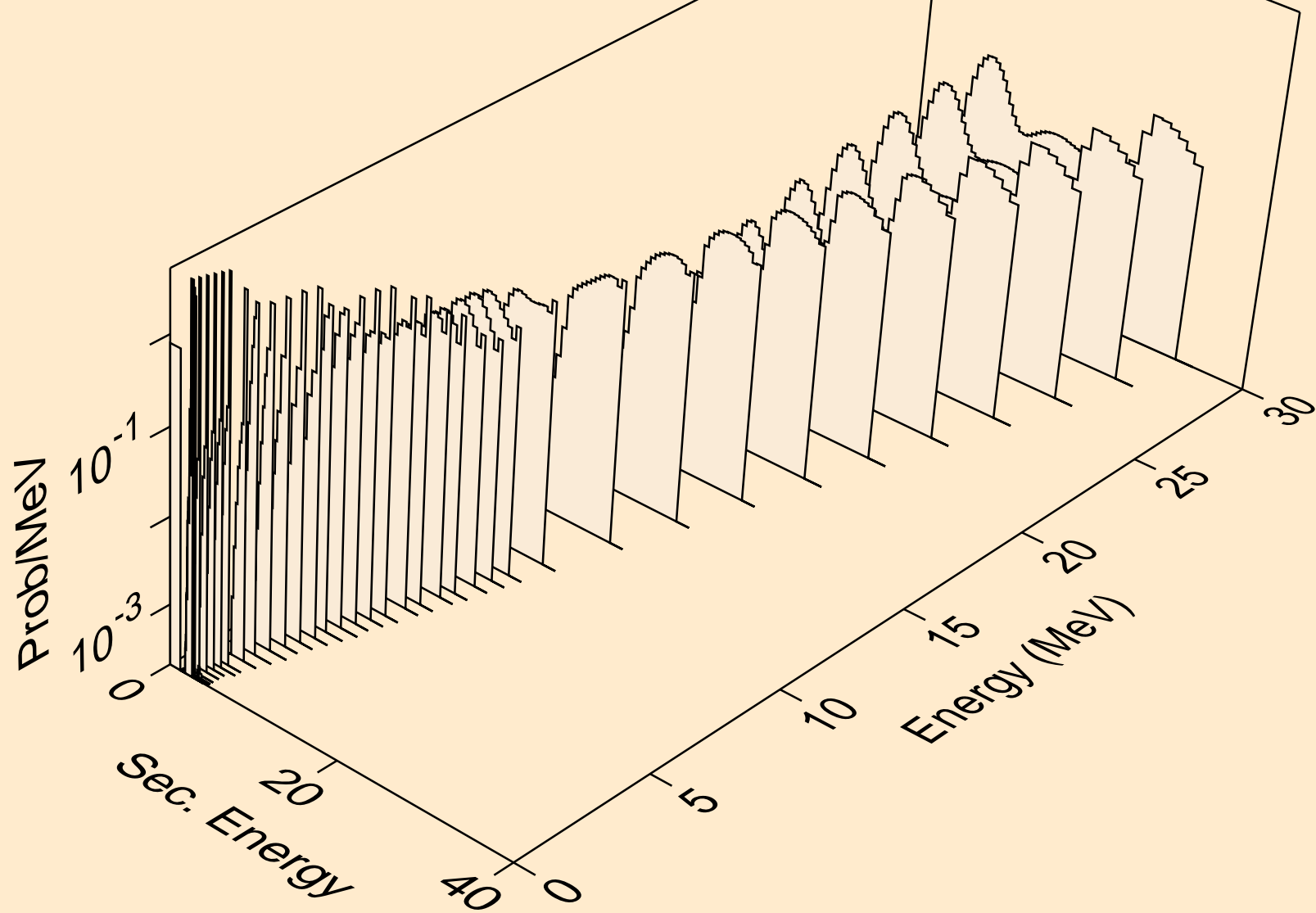

FR211 NEUTRON ACER TENDL-2024 LIBRARY; T=0.K
protons from (n,pd)

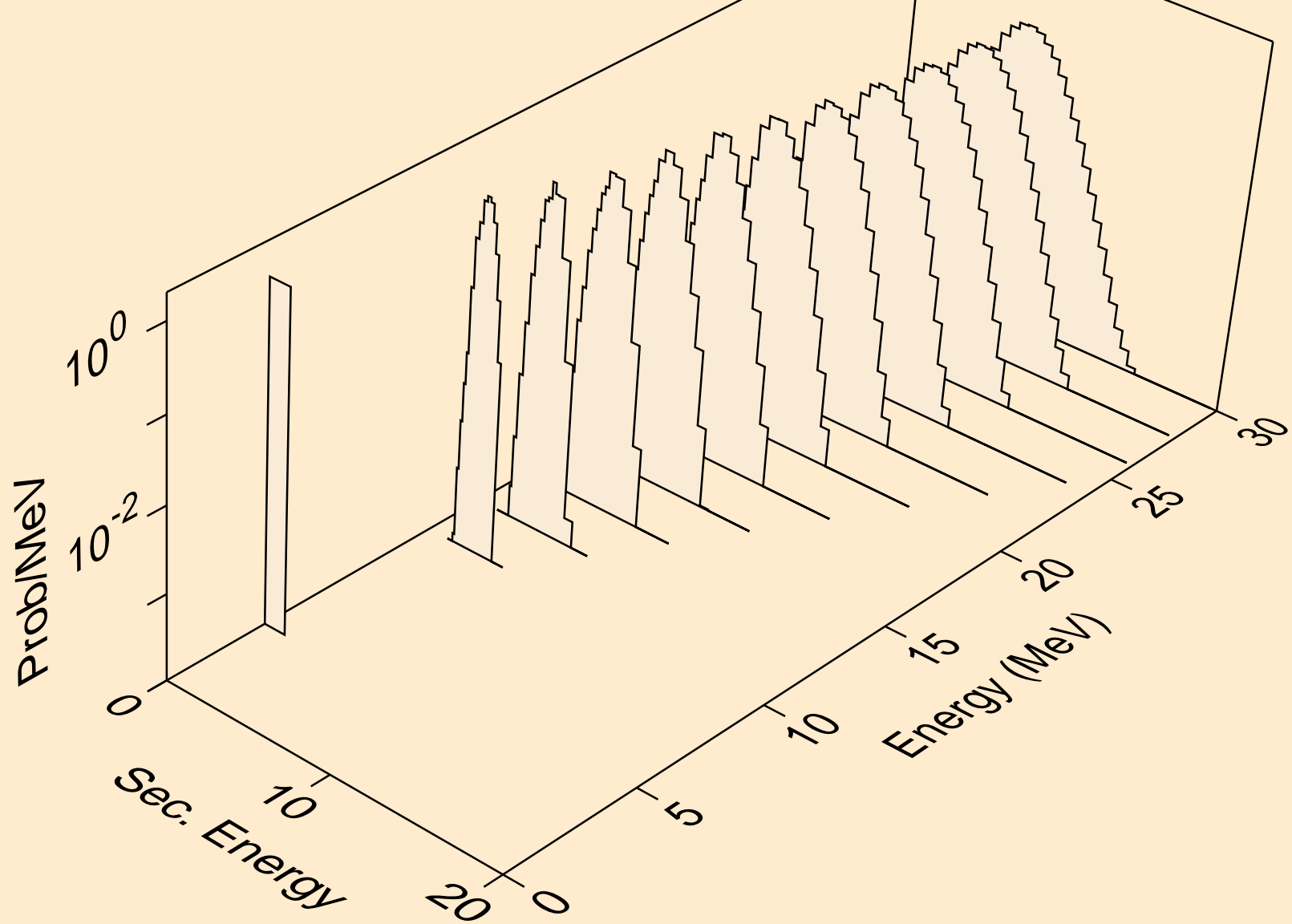

FR211 NEUTRON ACER TENDL-2024 LIBRARY; T=0.K
protons from (n,pt)

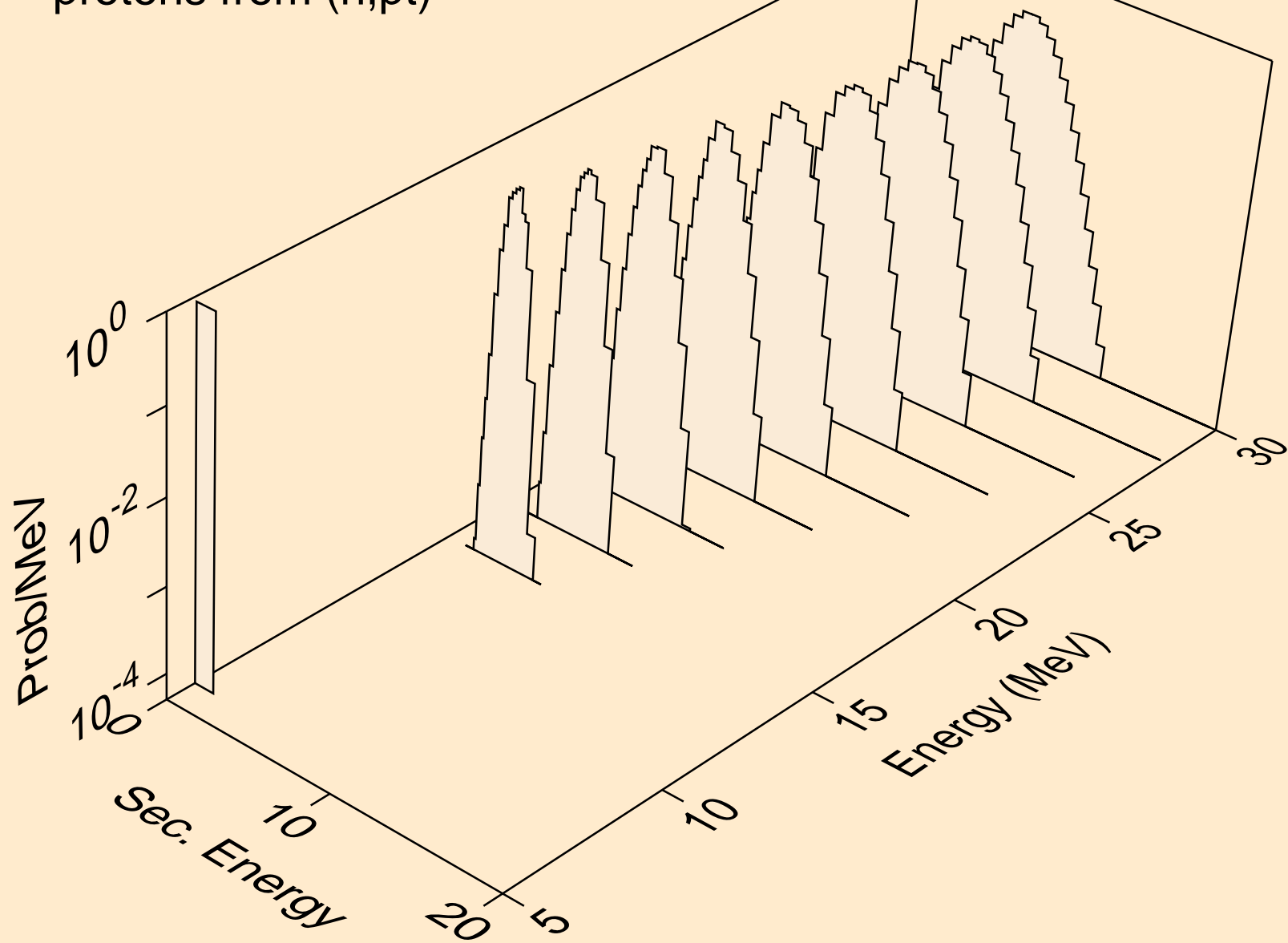

FR211 NEUTRON ACER TENDL-2024 LIBRARY; T=0.K
deuterons from (n,x)

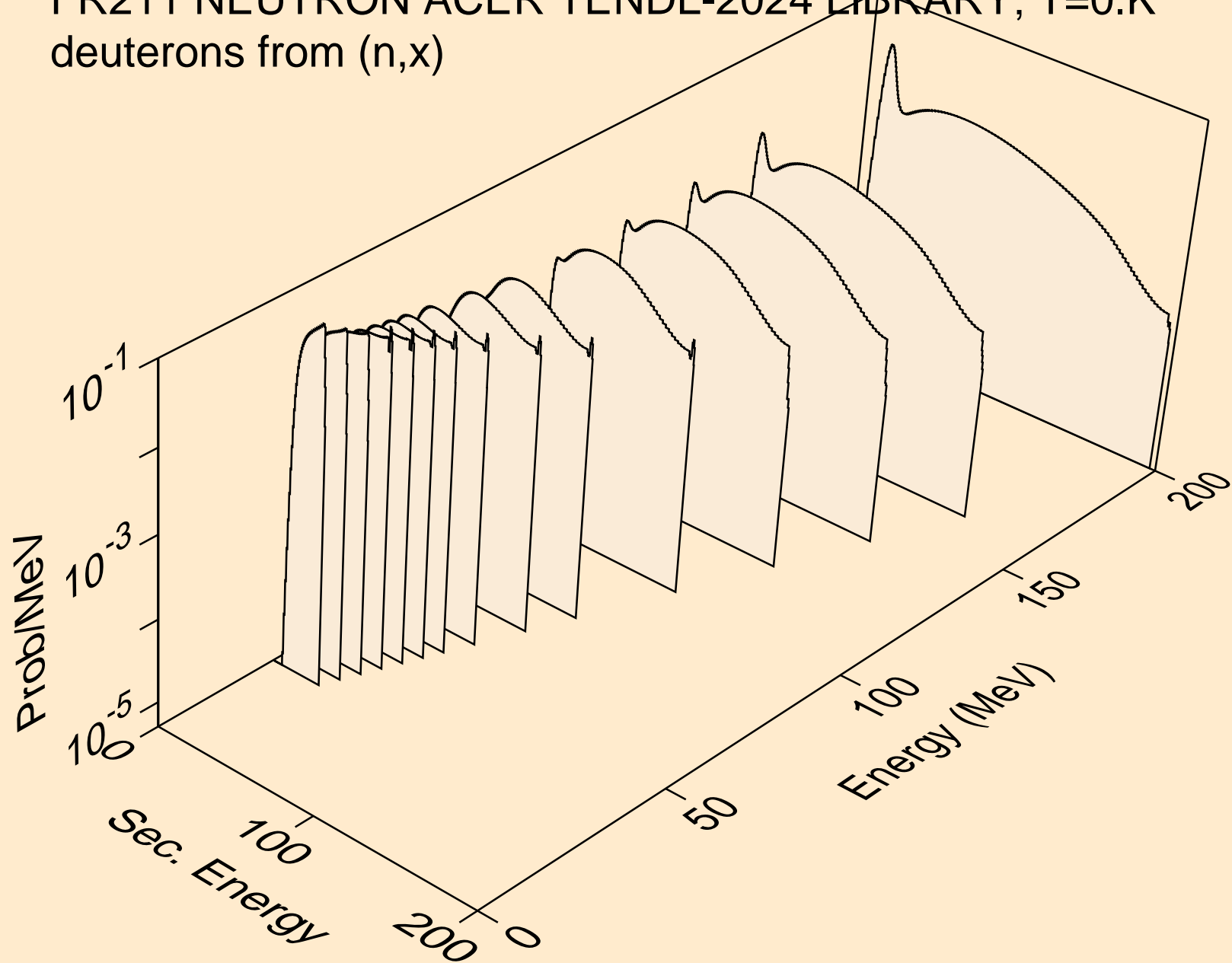

FR211 NEUTRON ACER TENDL-2024 LIBRARY; T=0.K
deuterons from (n,2nd)

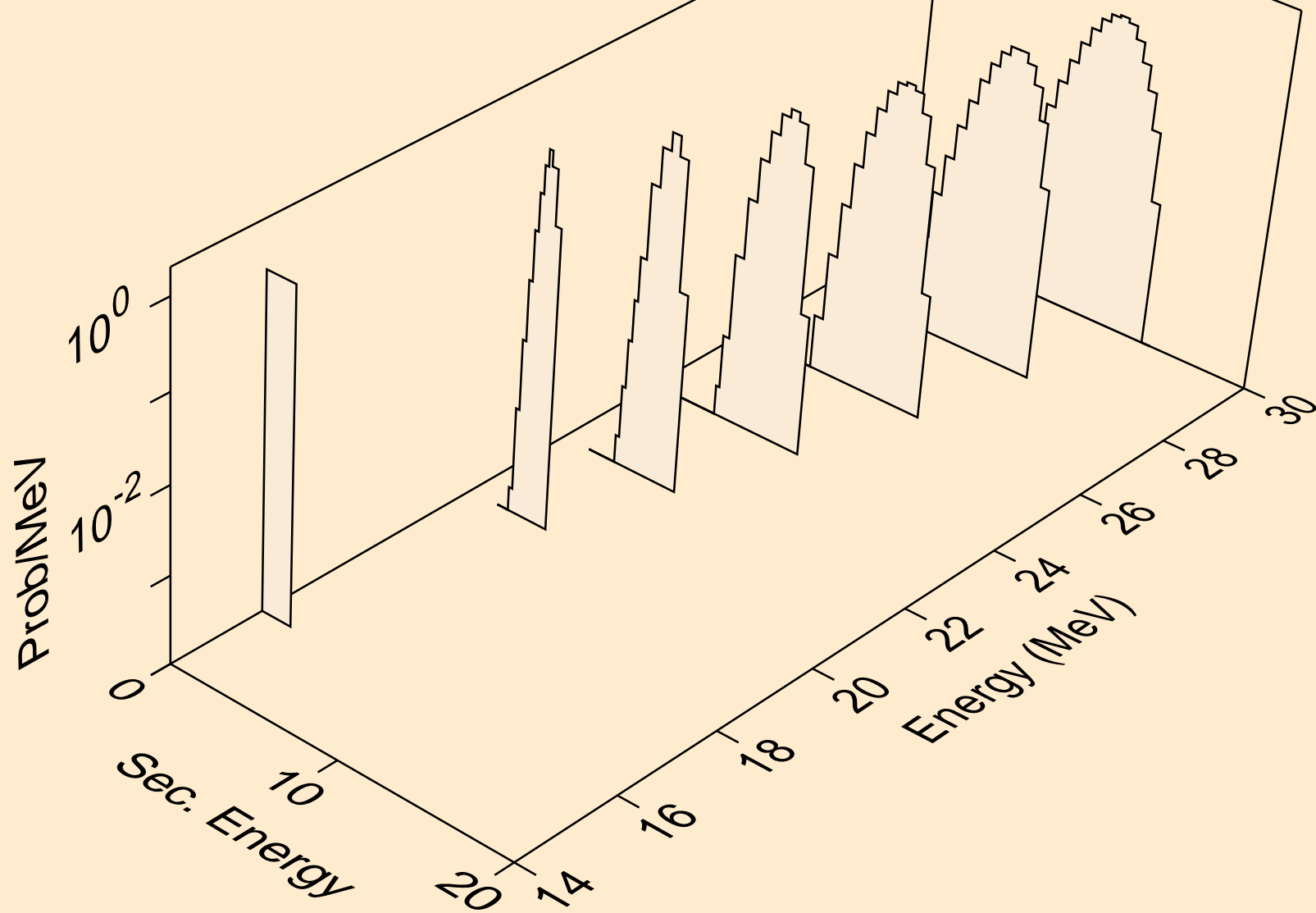

FR211 NEUTRON ACER TENDL-2024 LIBRARY; T=0.K
deuterons from (n,n*)d

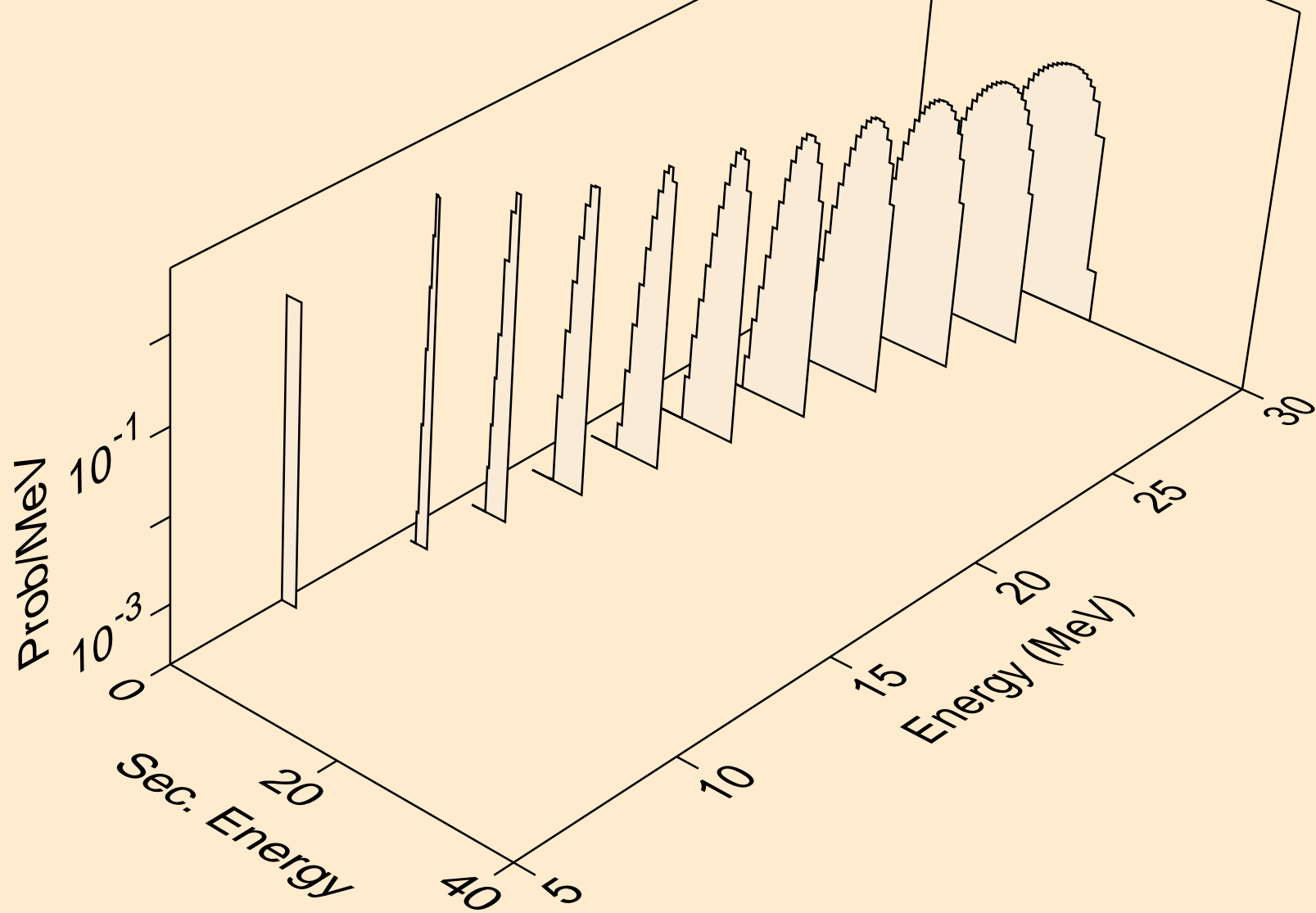

FR211 NEUTRON ACER TENDL-2024 LIBRARY; T=0.K
deuterons from (n,d)

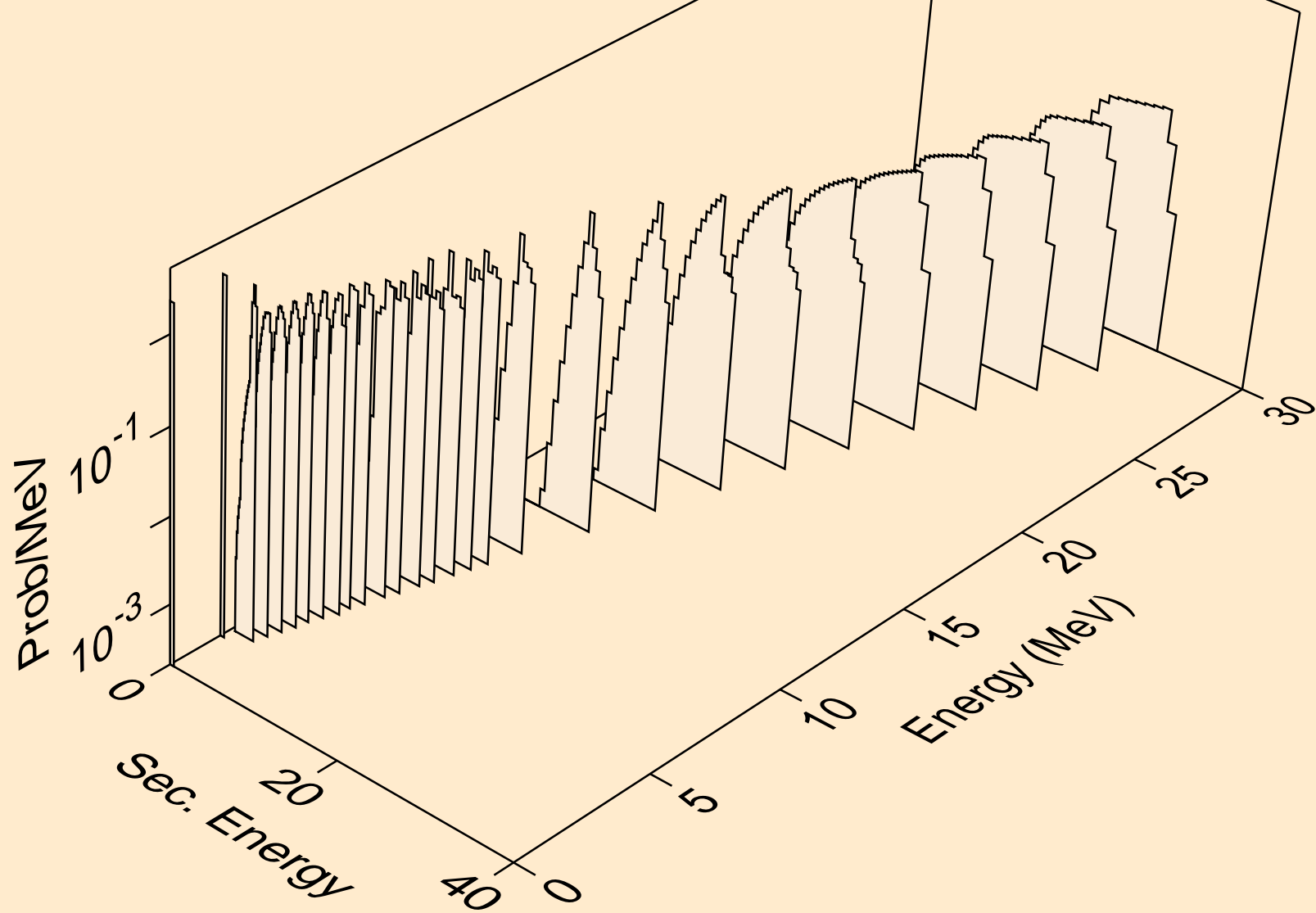

FR211 NEUTRON ACER TENDL-2024 LIBRARY; T=0.K
deuterons from (n,pd)

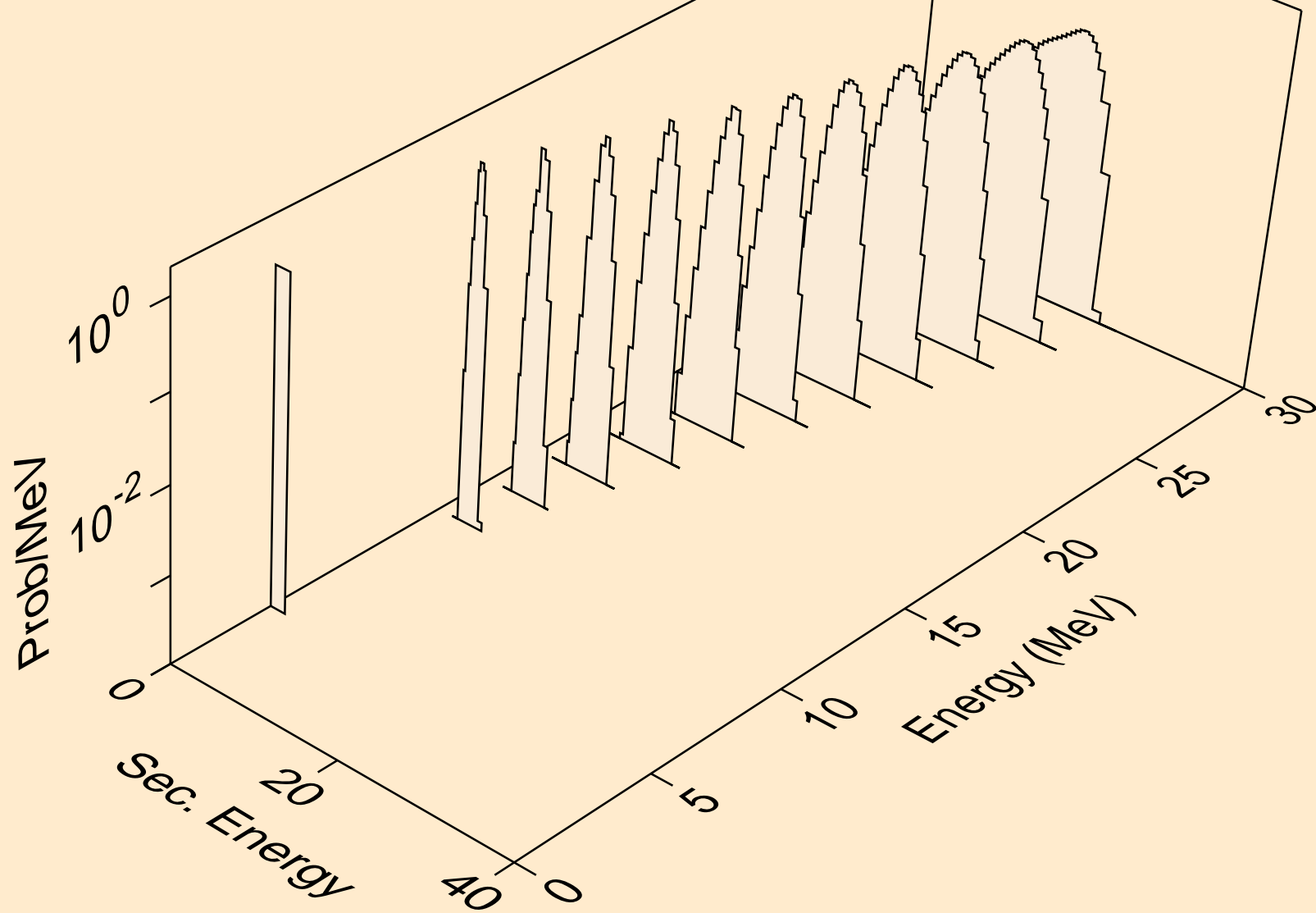

FR211 NEUTRON ACER TENDL-2024 LIBRARY; T=0.K
deuterons from (n,da)

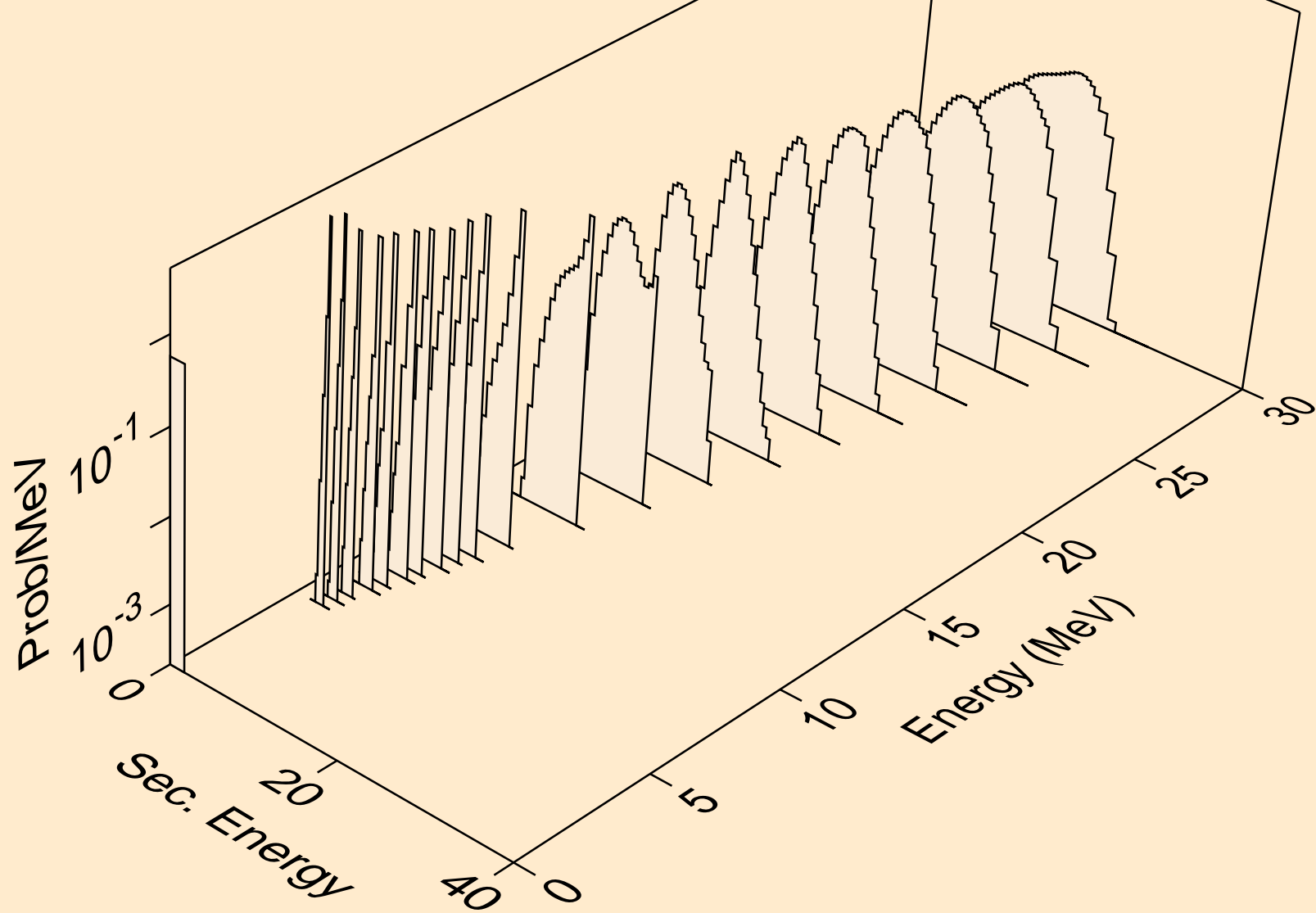

FR211 NEUTRON ACER TENDL-2024 LIBRARY; T=0.K
tritons from (n,x)

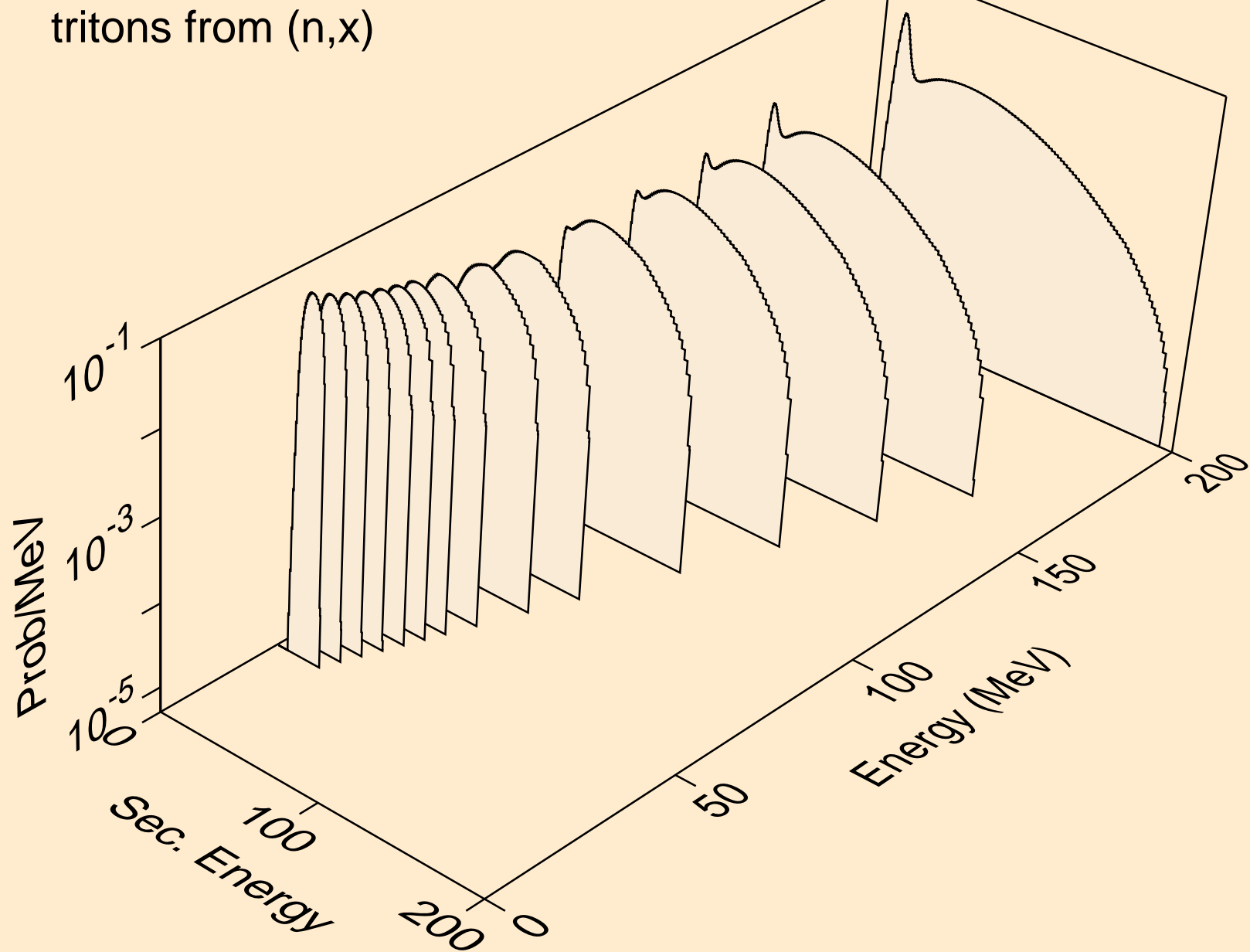

FR211 NEUTRON ACER TENDL-2024 LIBRARY; T=0.K
tritons from (n,n*)t

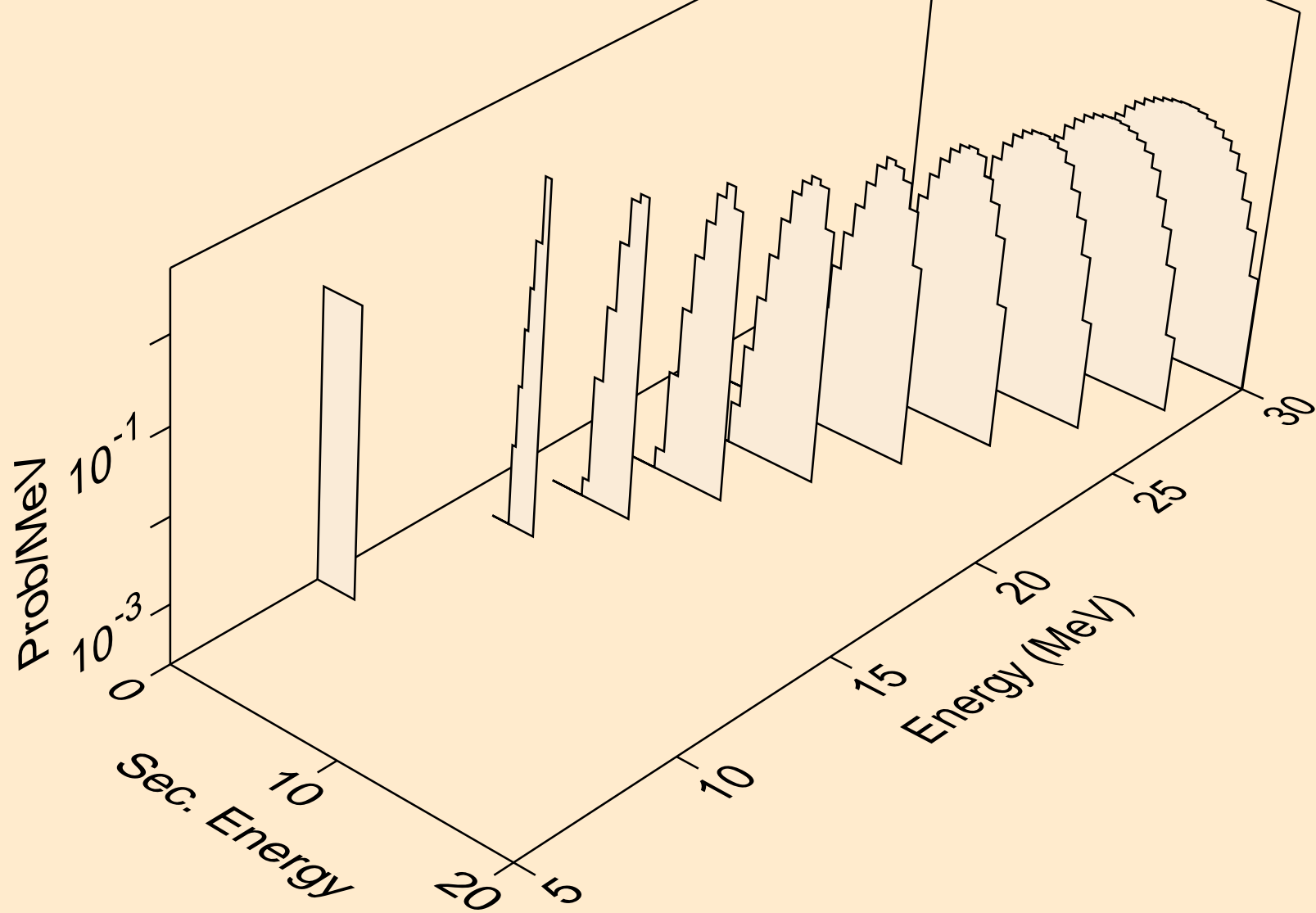

FR211 NEUTRON ACER TENDL-2024 LIBRARY; T=0.K
tritons from (n,t)

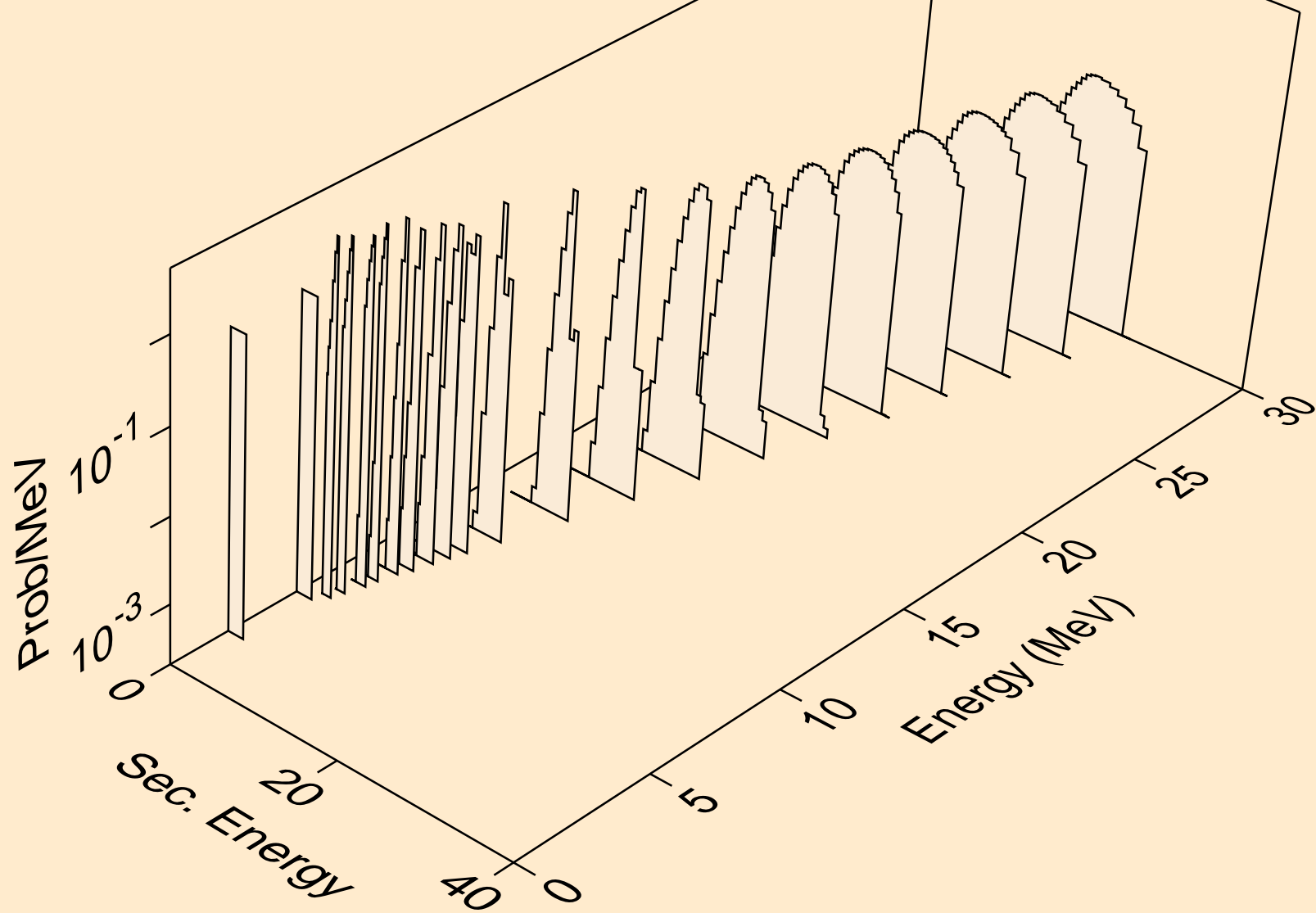

FR211 NEUTRON ACER TENDL-2024 LIBRARY; T=0.K
tritons from (n,pt)

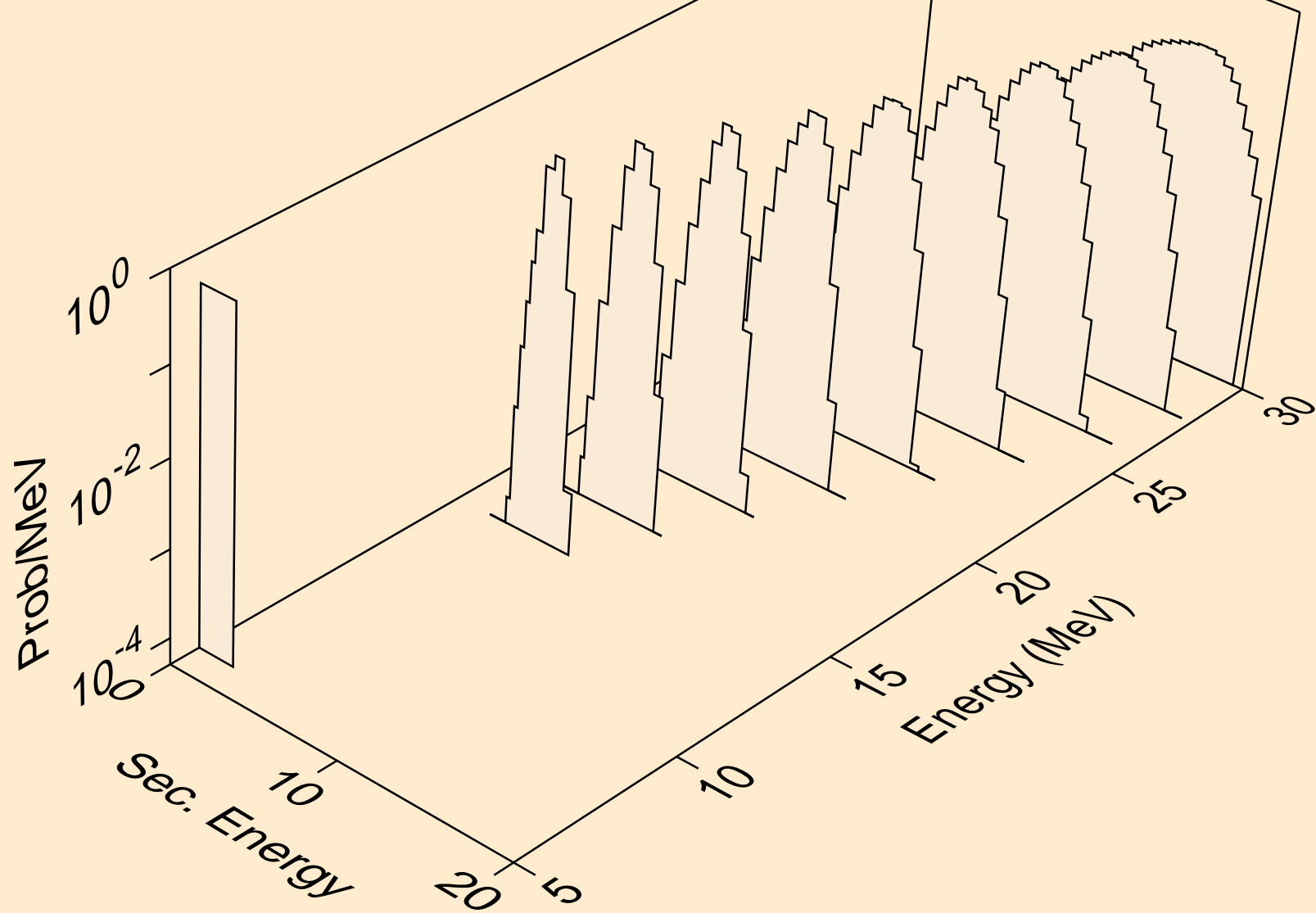

FR211 NEUTRON ACER TENDL-2024 LIBRARY; T=0.K
he3s from (n,x)

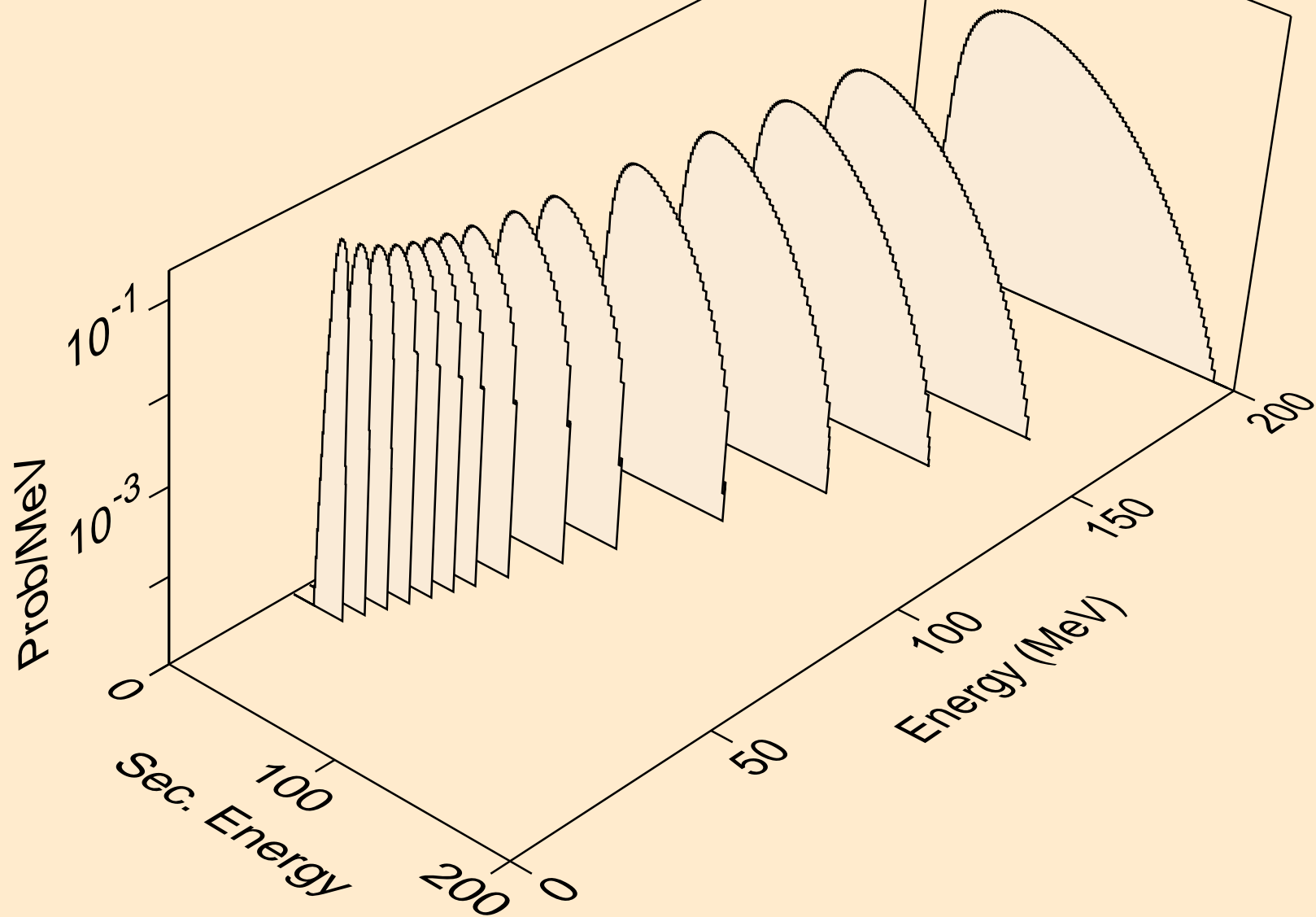

FR211 NEUTRON ACER TENDL-2024 LIBRARY; T=0.K
he3s from (n,n*)he3

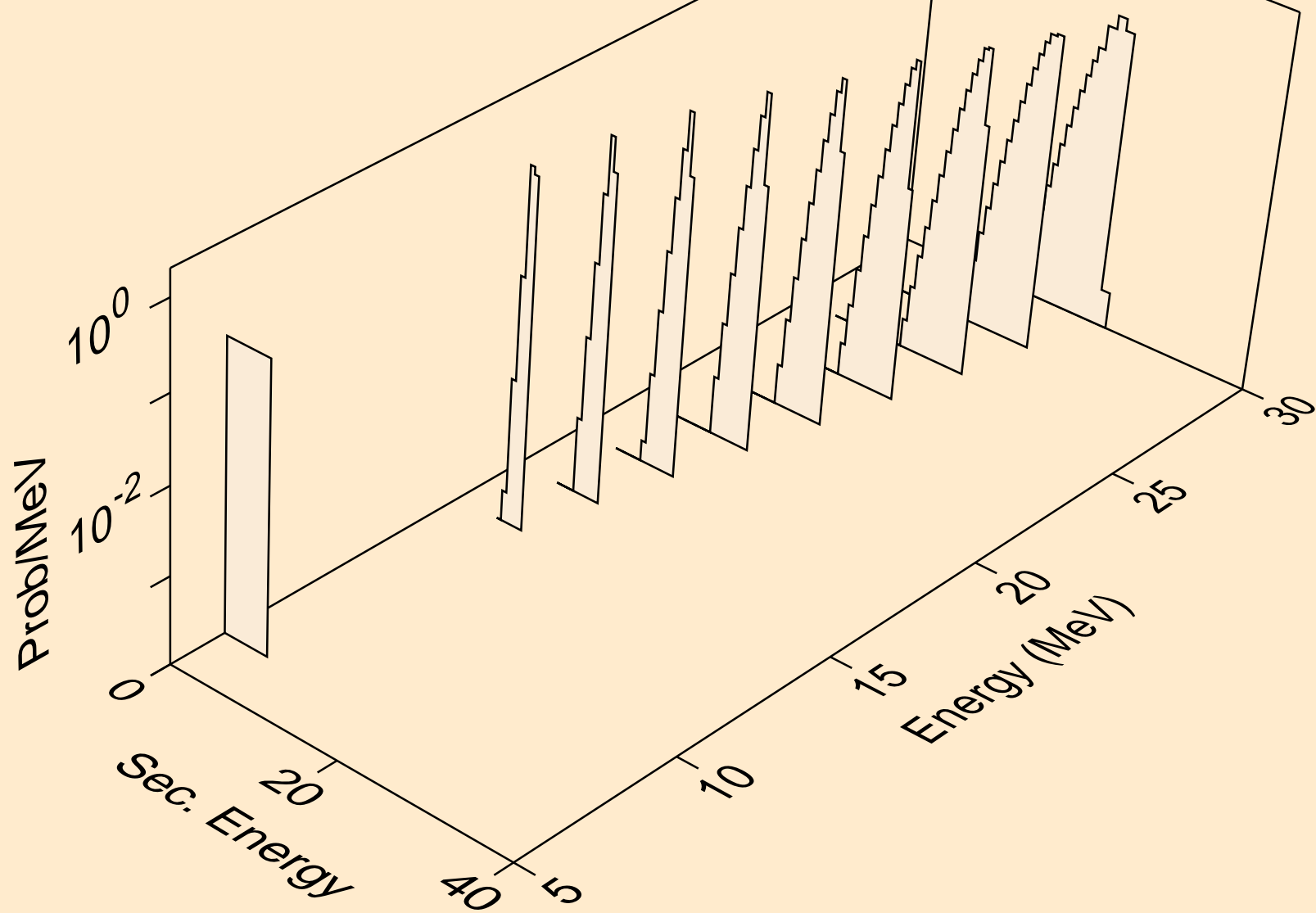

FR211 NEUTRON ACER TENDL-2024 LIBRARY; T=0.K
he3s from (n,he3)

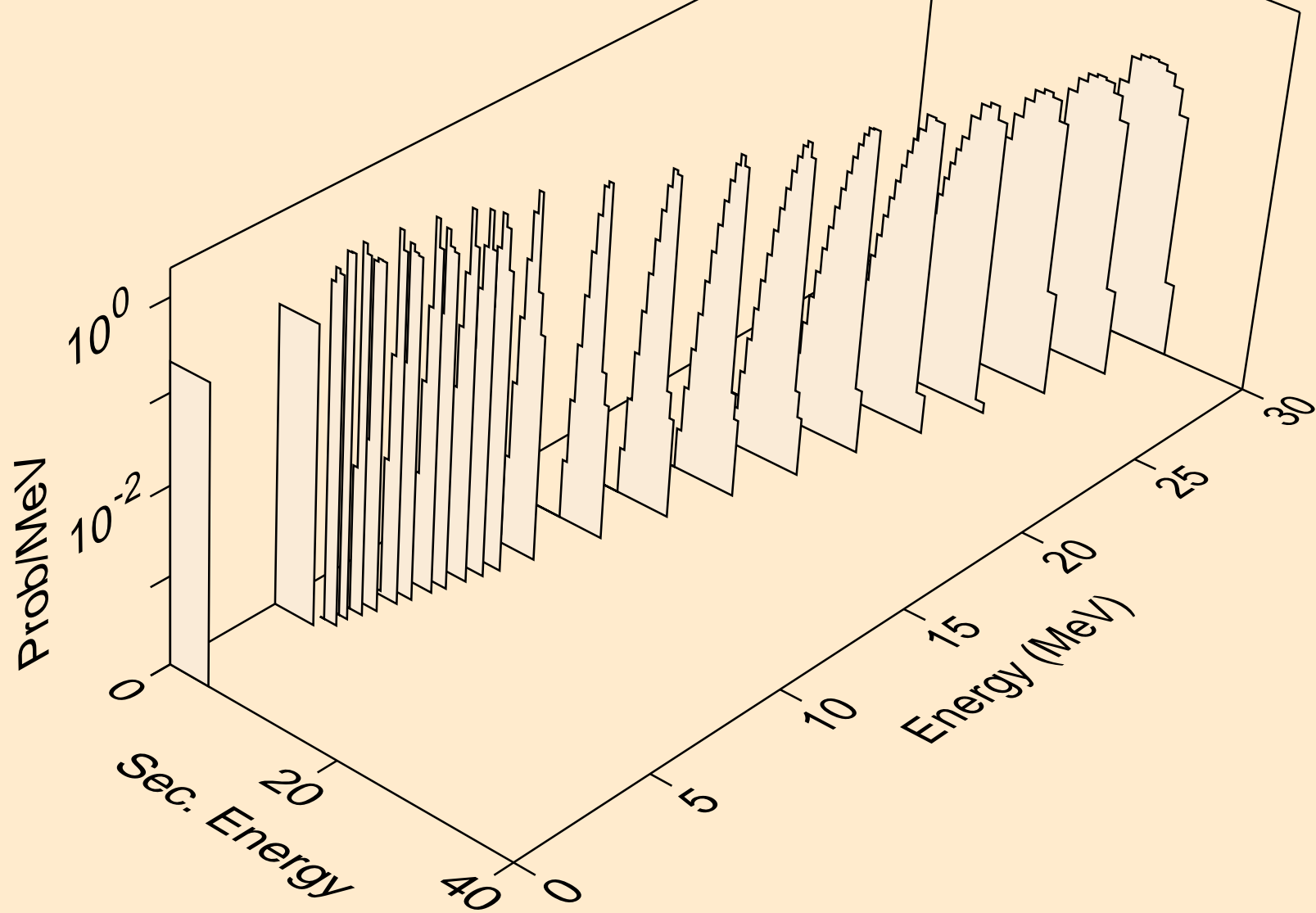

FR211 NEUTRON ACER TENDL-2024 LIBRARY; T=0.K
alphas from (n,x)

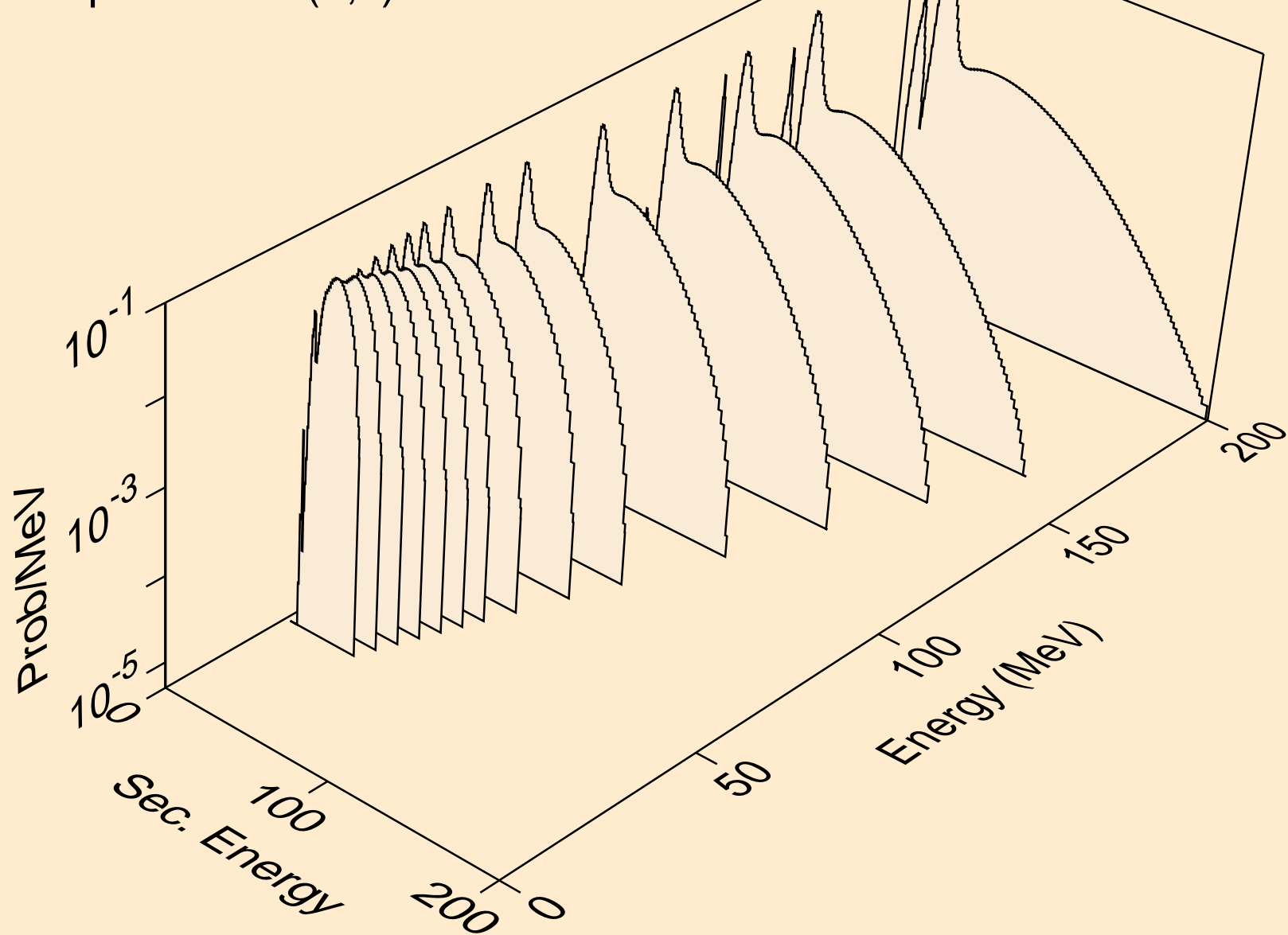

FR211 NEUTRON ACER TENDL-2024 LIBRARY; T=0.K
alphas from (n,n*)a

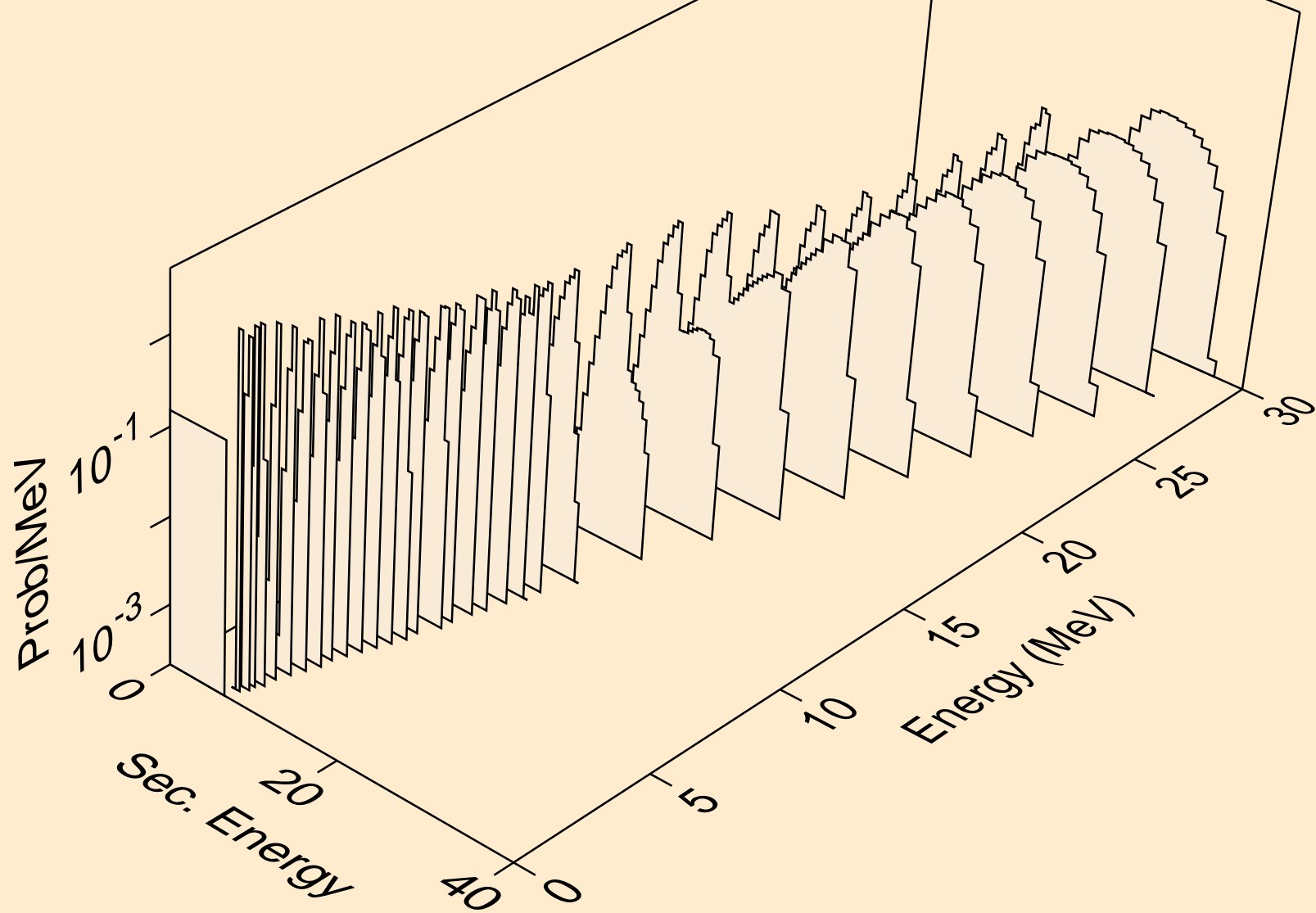

FR211 NEUTRON ACER TENDL-2024 LIBRARY; T=0.K
alphas from (n,2n)a

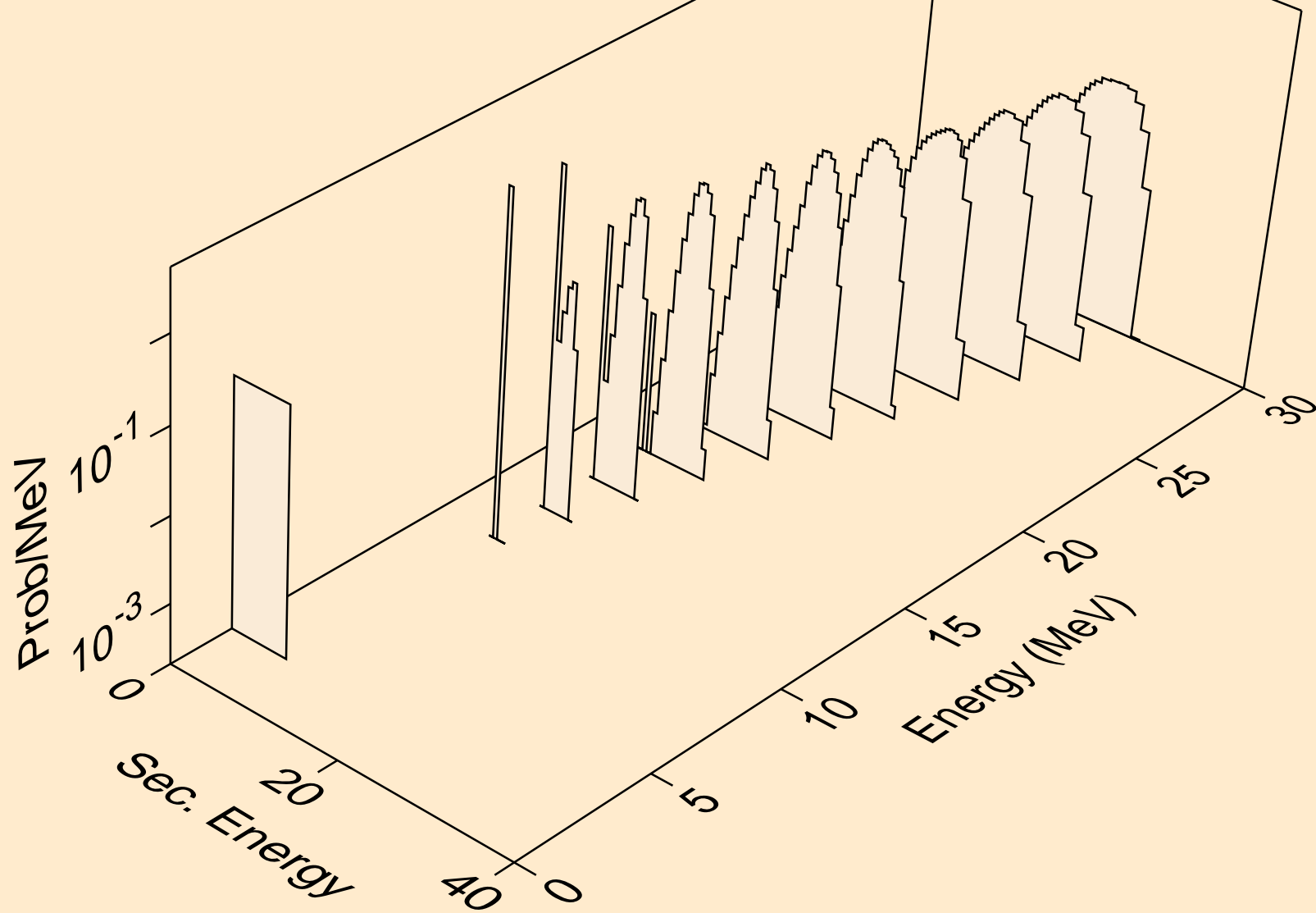

FR211 NEUTRON ACER TENDL-2024 LIBRARY; T=0.K
alphas from (n,3n)a

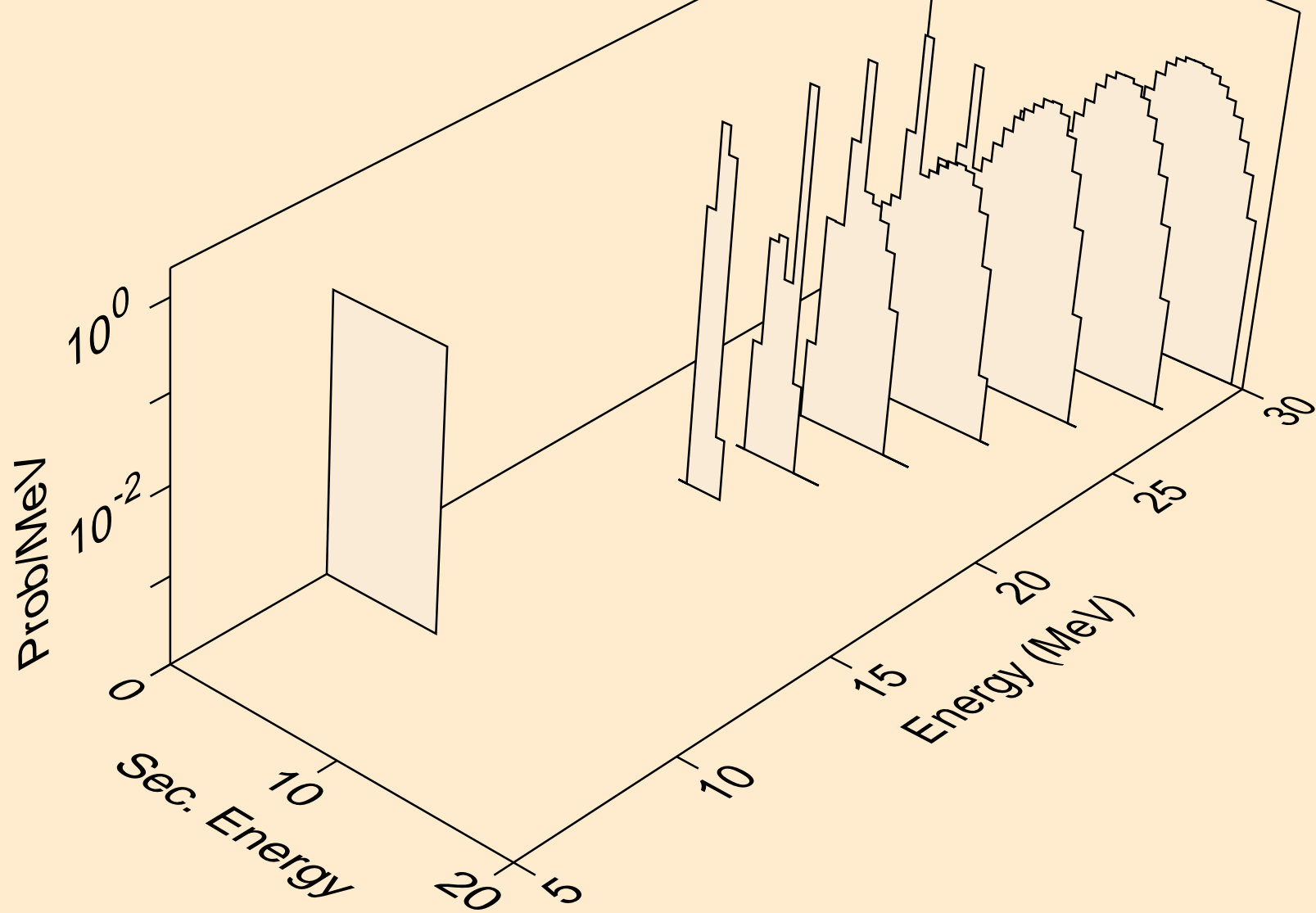

FR211 NEUTRON ACER TENDL-2024 LIBRARY; T=0.K
alphas from (n,n*)2a

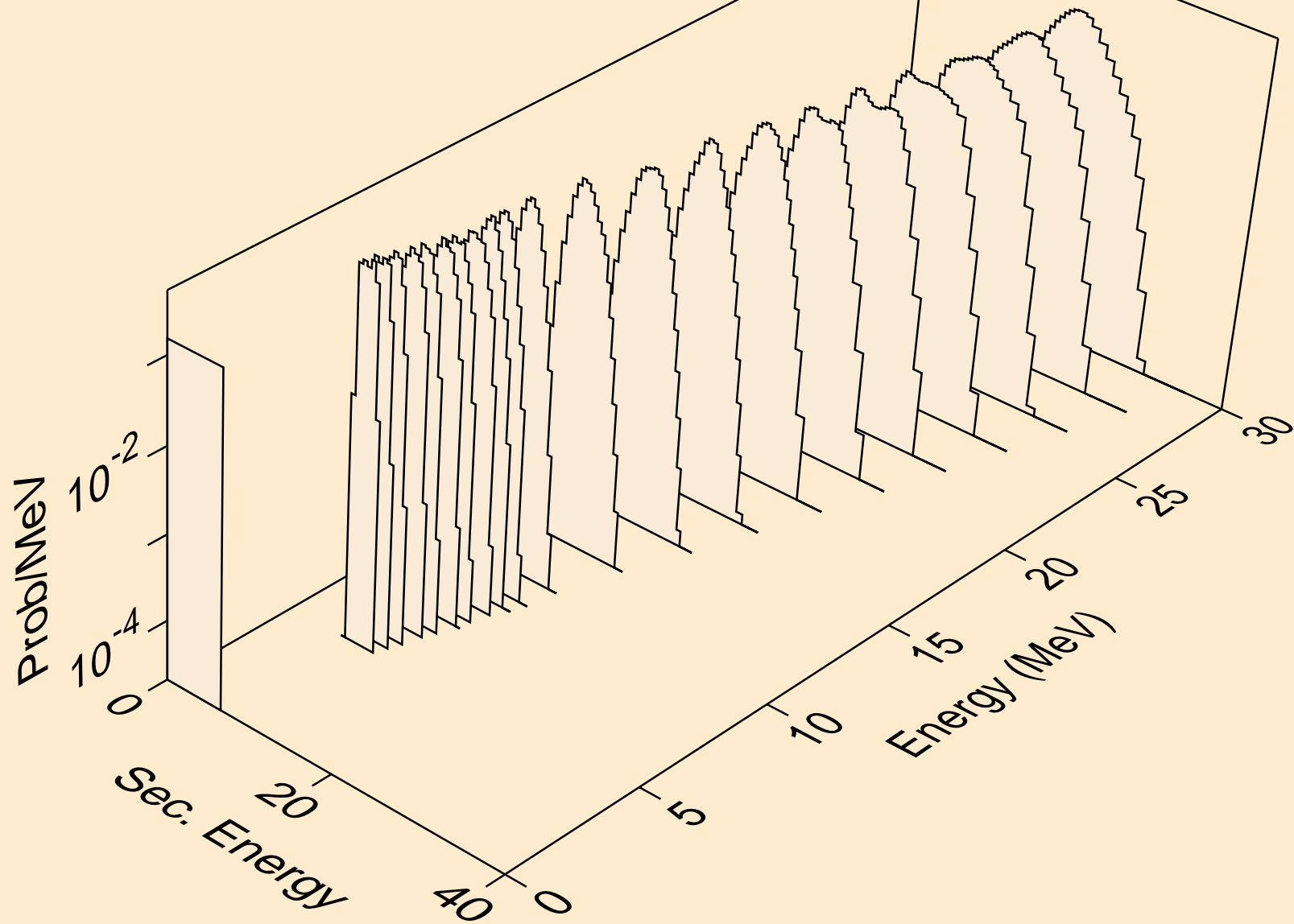

FR211 NEUTRON ACER TENDL-2024 LIBRARY; T=0.K
alphas from (n,2n)2a

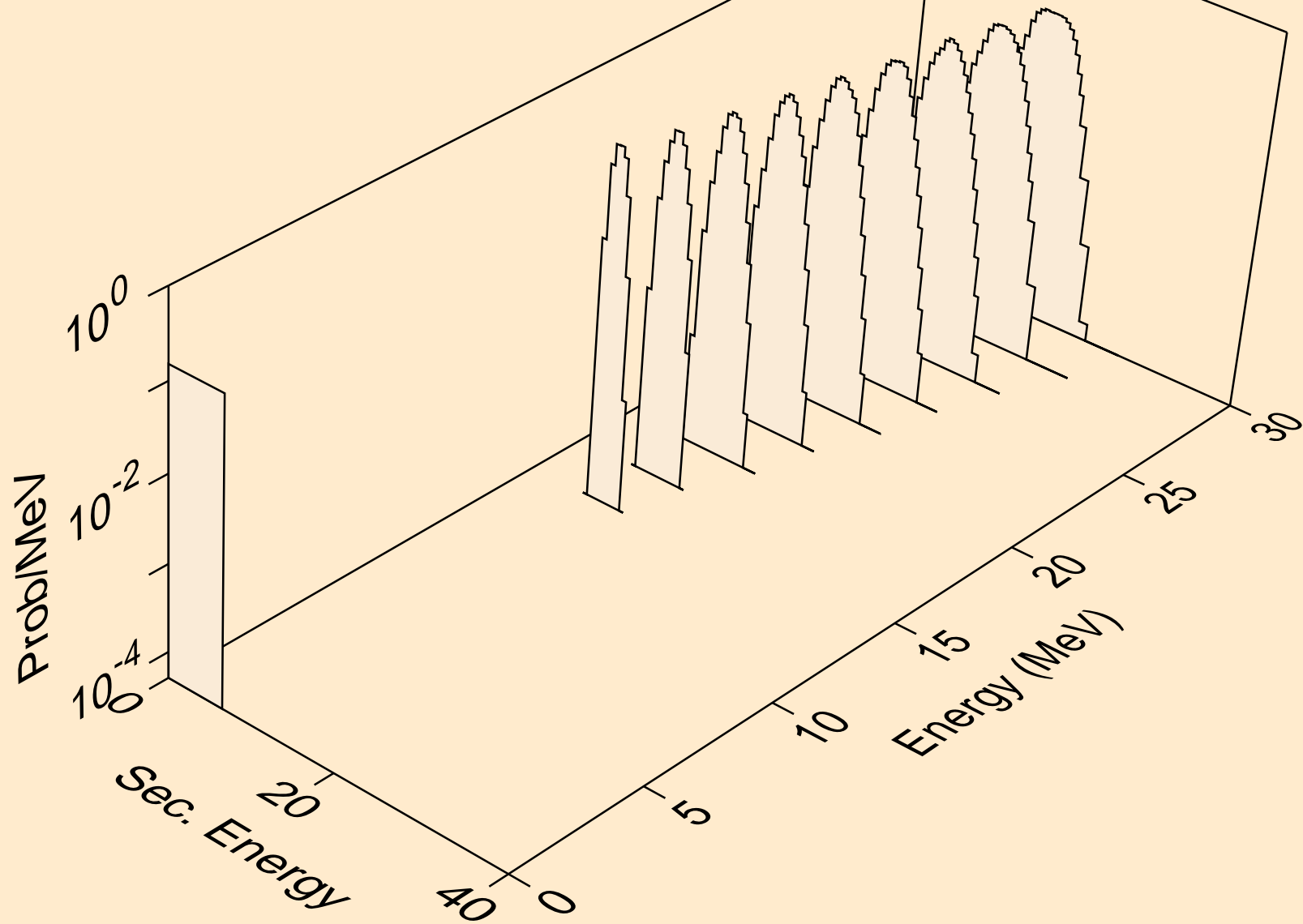

FR211 NEUTRON ACER TENDL-2024 LIBRARY; T=0.K
alphas from (n,npa)

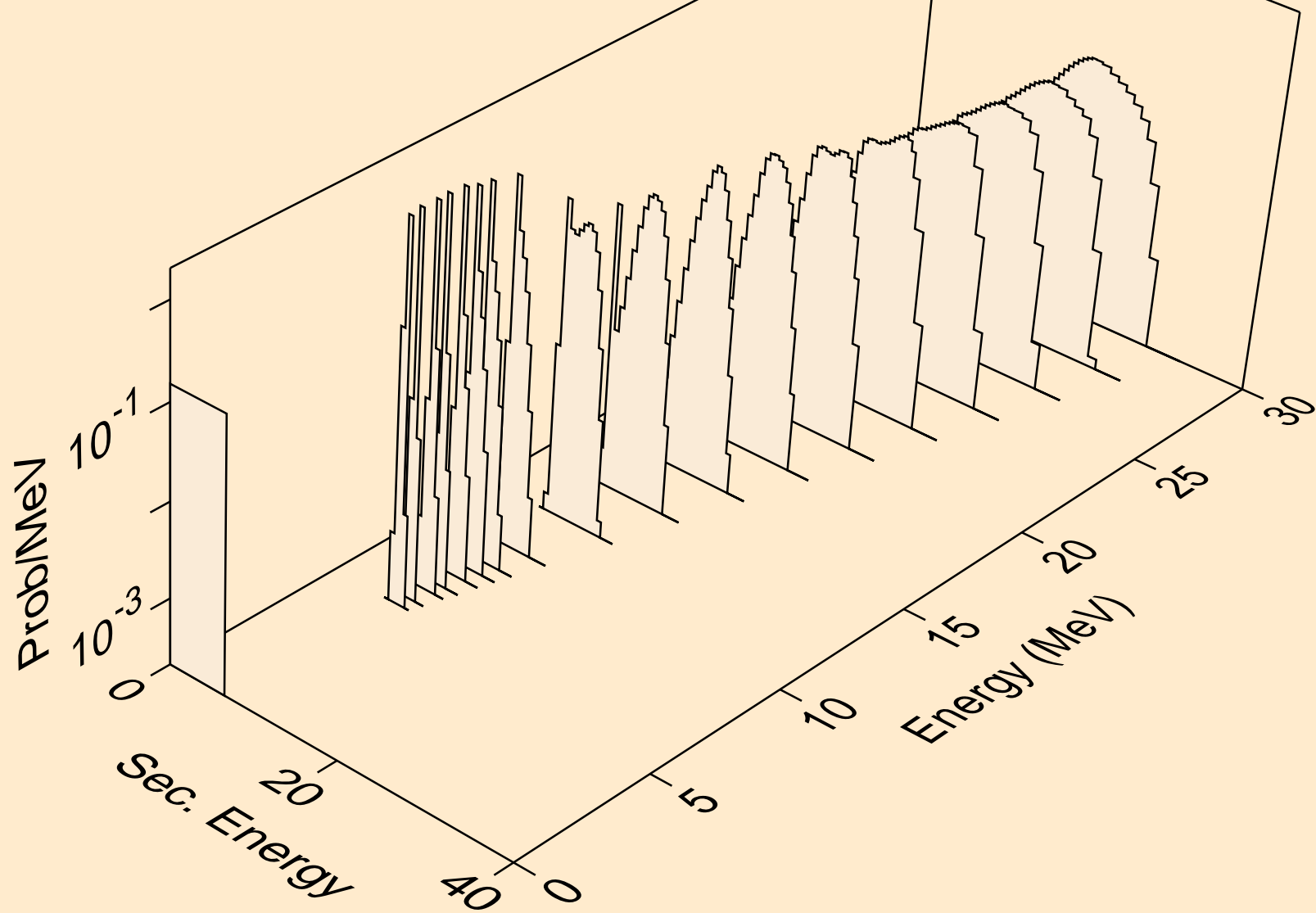

FR211 NEUTRON ACER TENDL-2024 LIBRARY; T=0.K
alphas from (n,a)

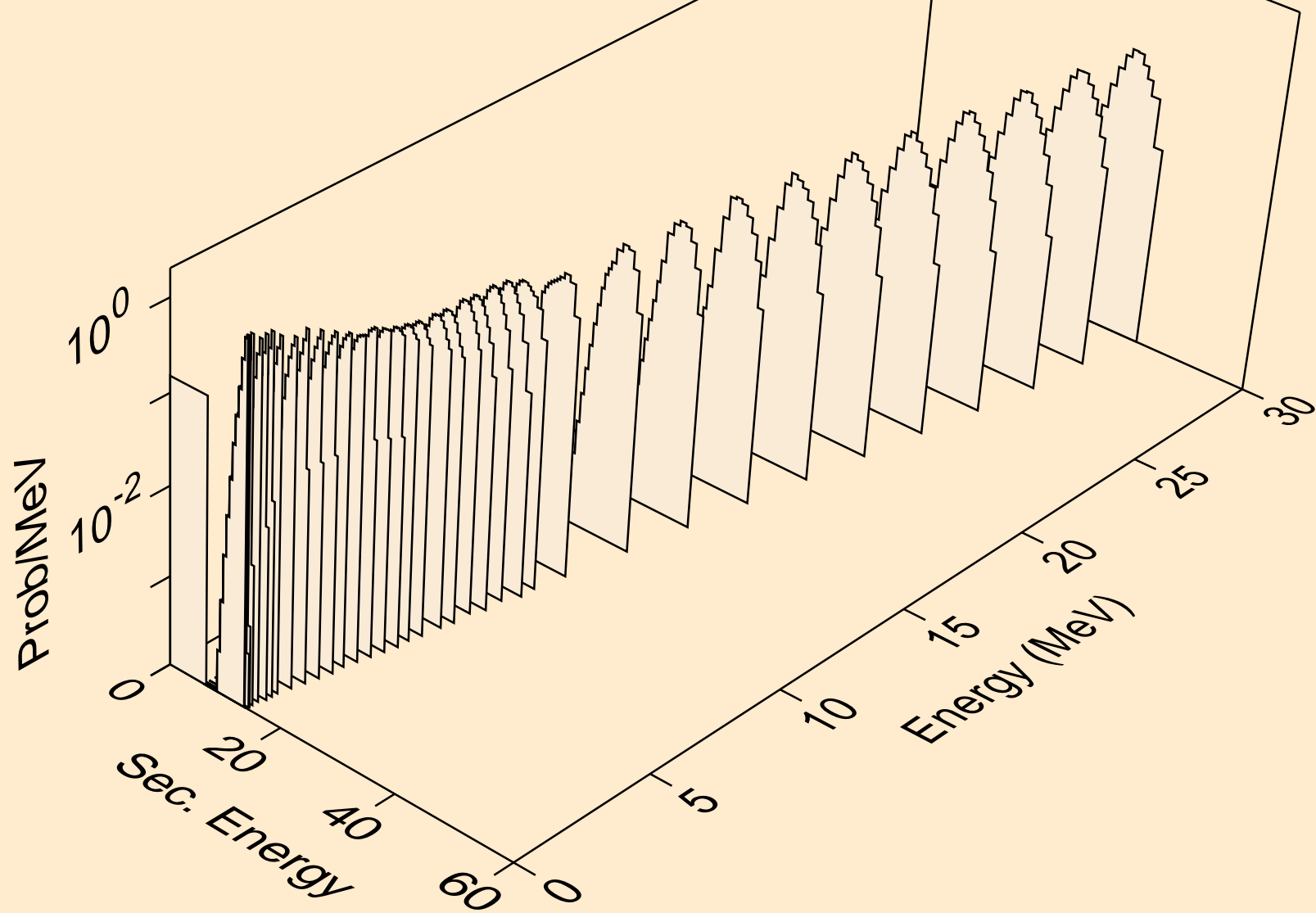

FR211 NEUTRON ACER TENDL-2024 LIBRARY; T=0.K
alphas from (n,2a)

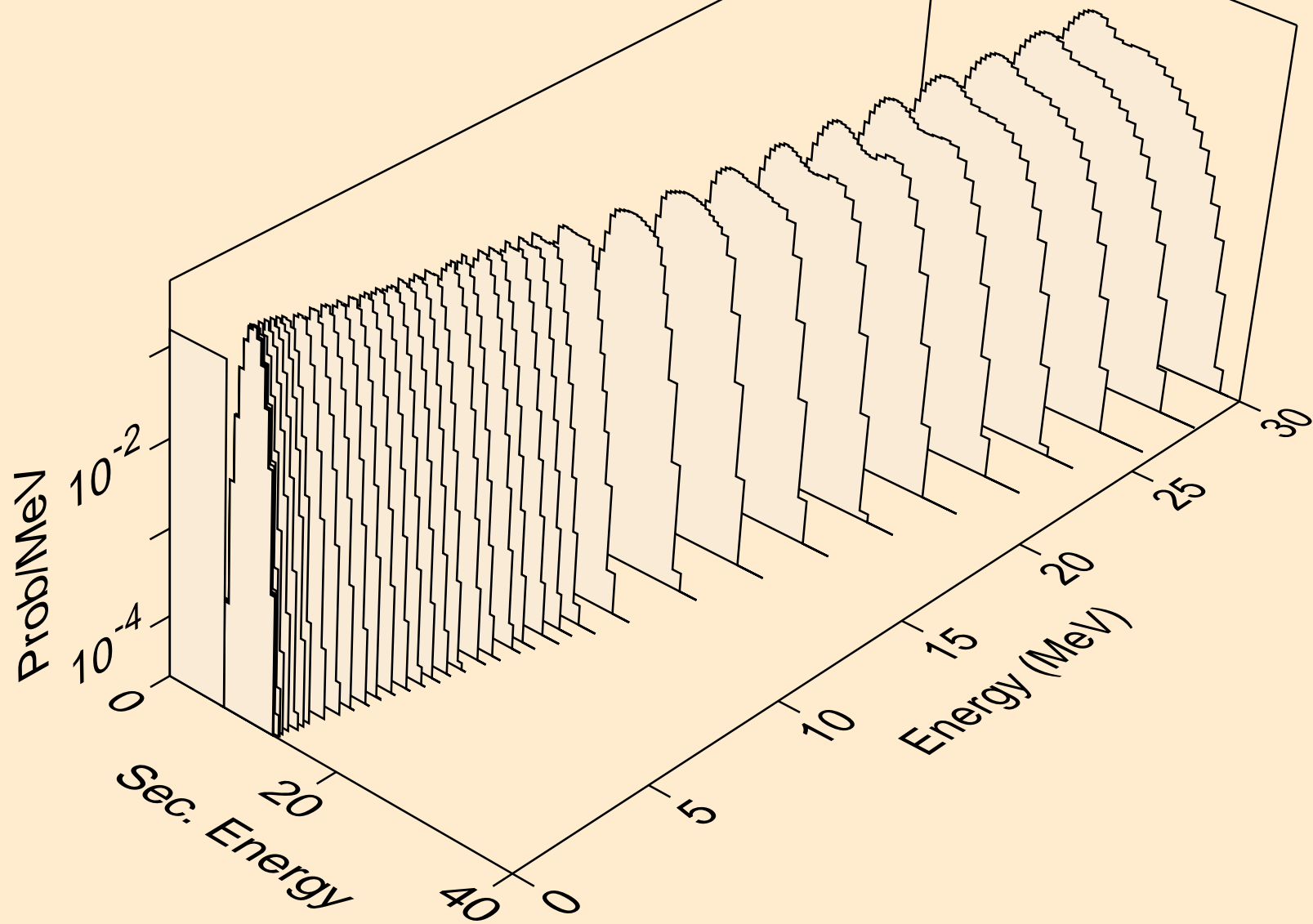

FR211 NEUTRON ACER TENDL-2024 LIBRARY; T=0.K
alphas from (n,pa)

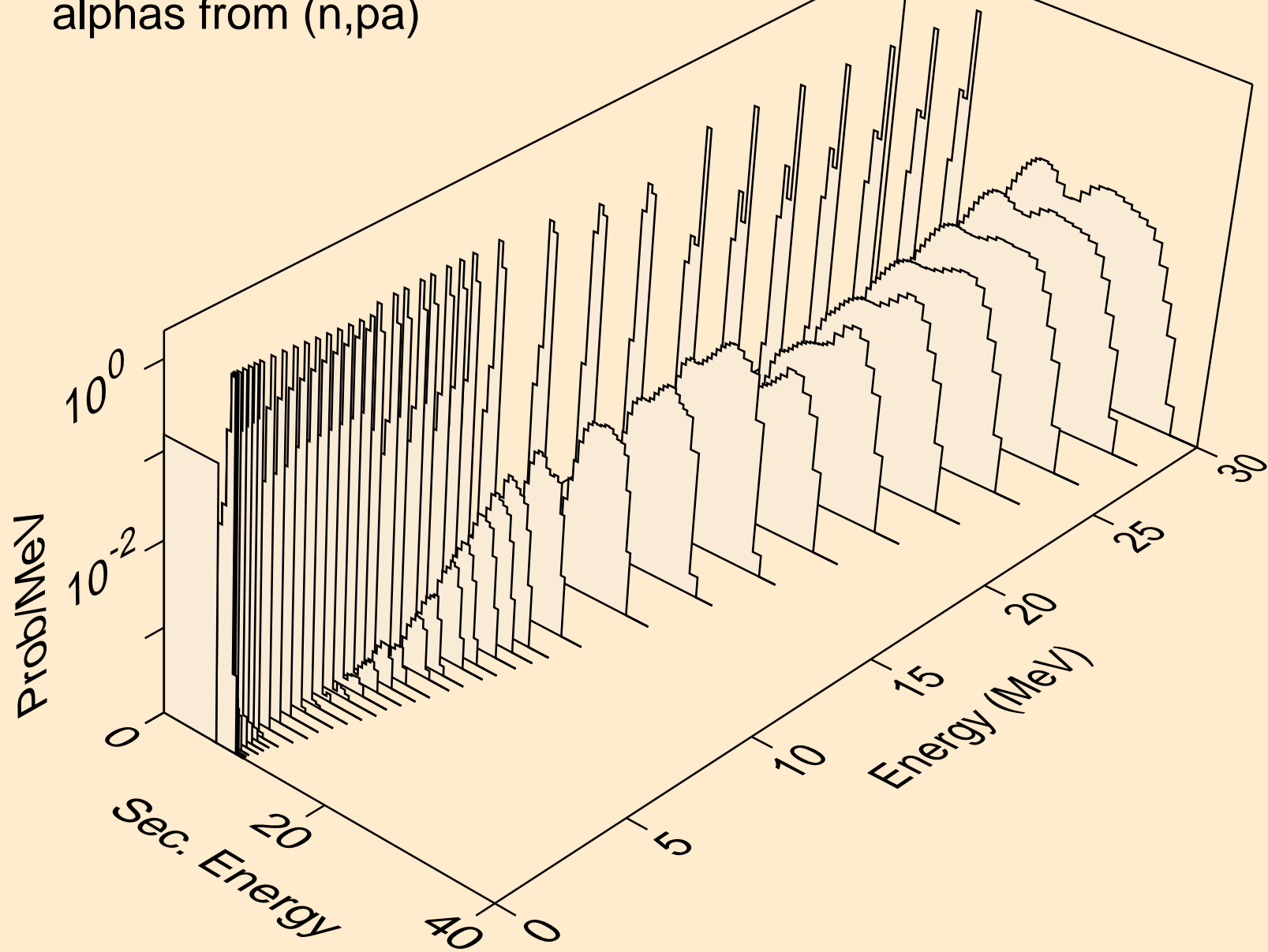

FR211 NEUTRON ACER TENDL-2024 LIBRARY; T=0.K
alphas from (n,da)

