

# GD153 NEUTRON ACER TENDL-2024 LIBRARY; T=0.K

## Principal cross sections

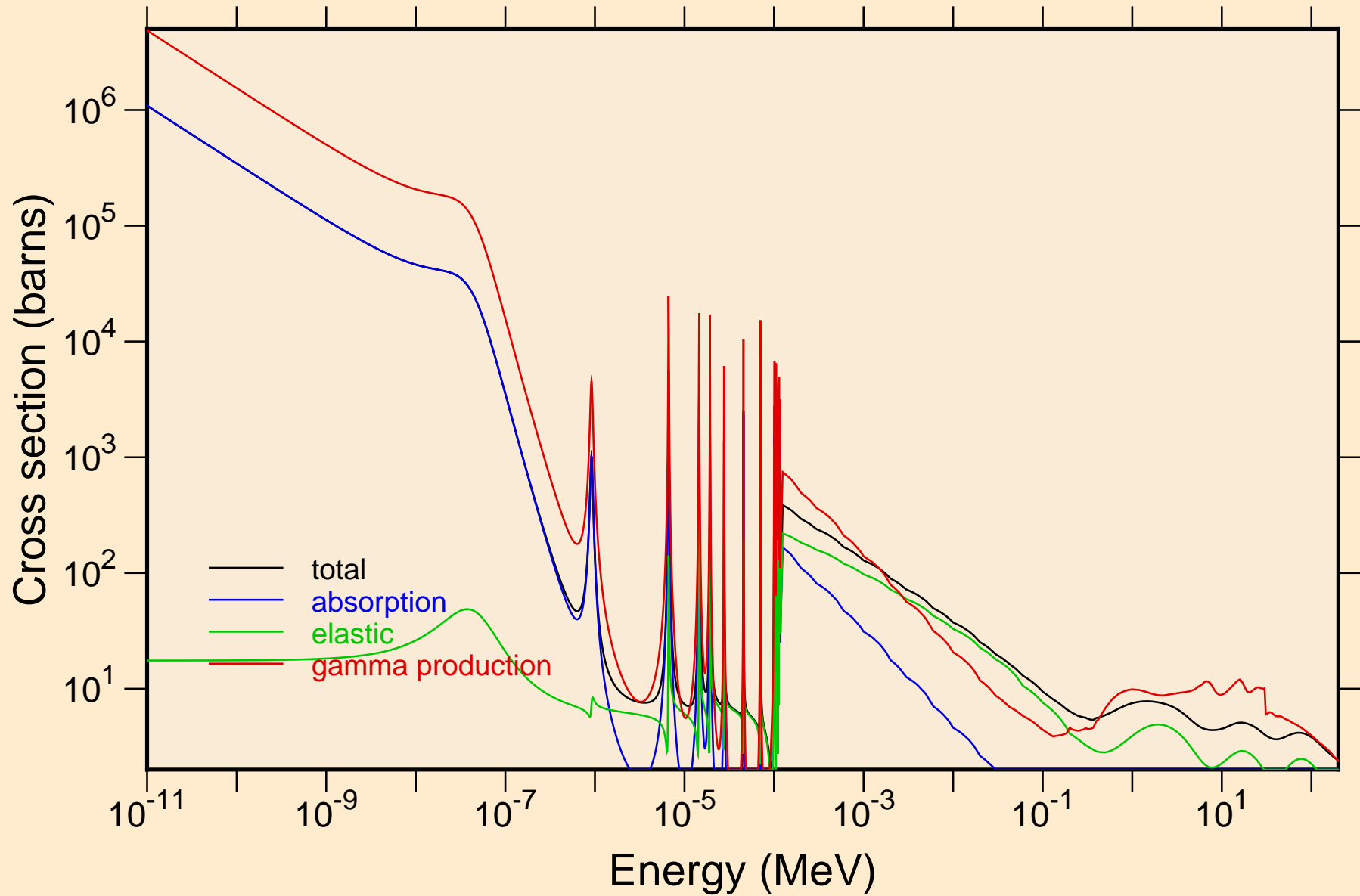

GD153 NEUTRON ACER TENDL-2024 LIBRARY; T=0.K  
resonance total cross section

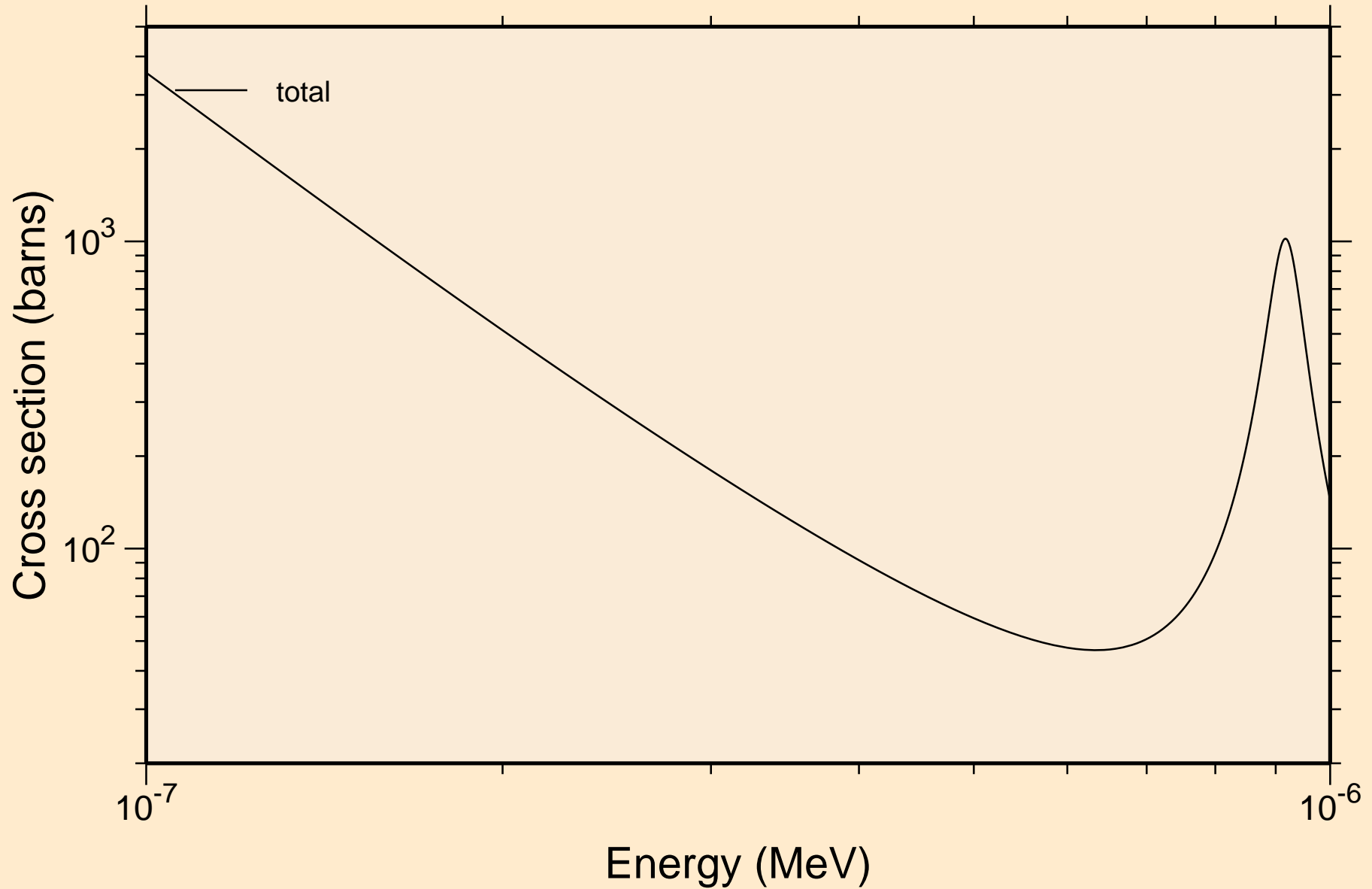

GD153 NEUTRON ACER TENDL-2024 LIBRARY; T=0.K  
resonance total cross section

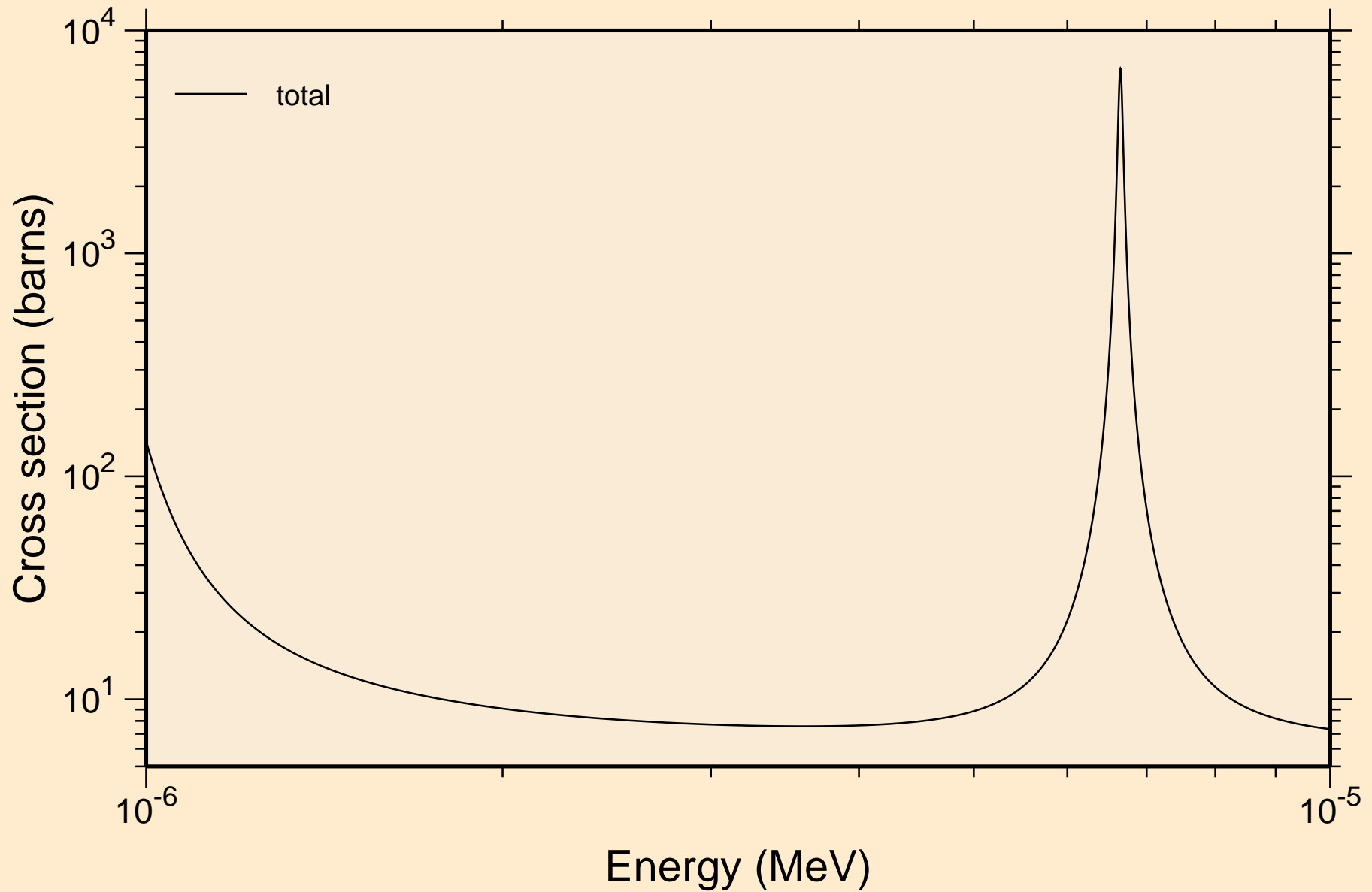

GD153 NEUTRON ACER TENDL-2024 LIBRARY; T=0.K  
resonance total cross section

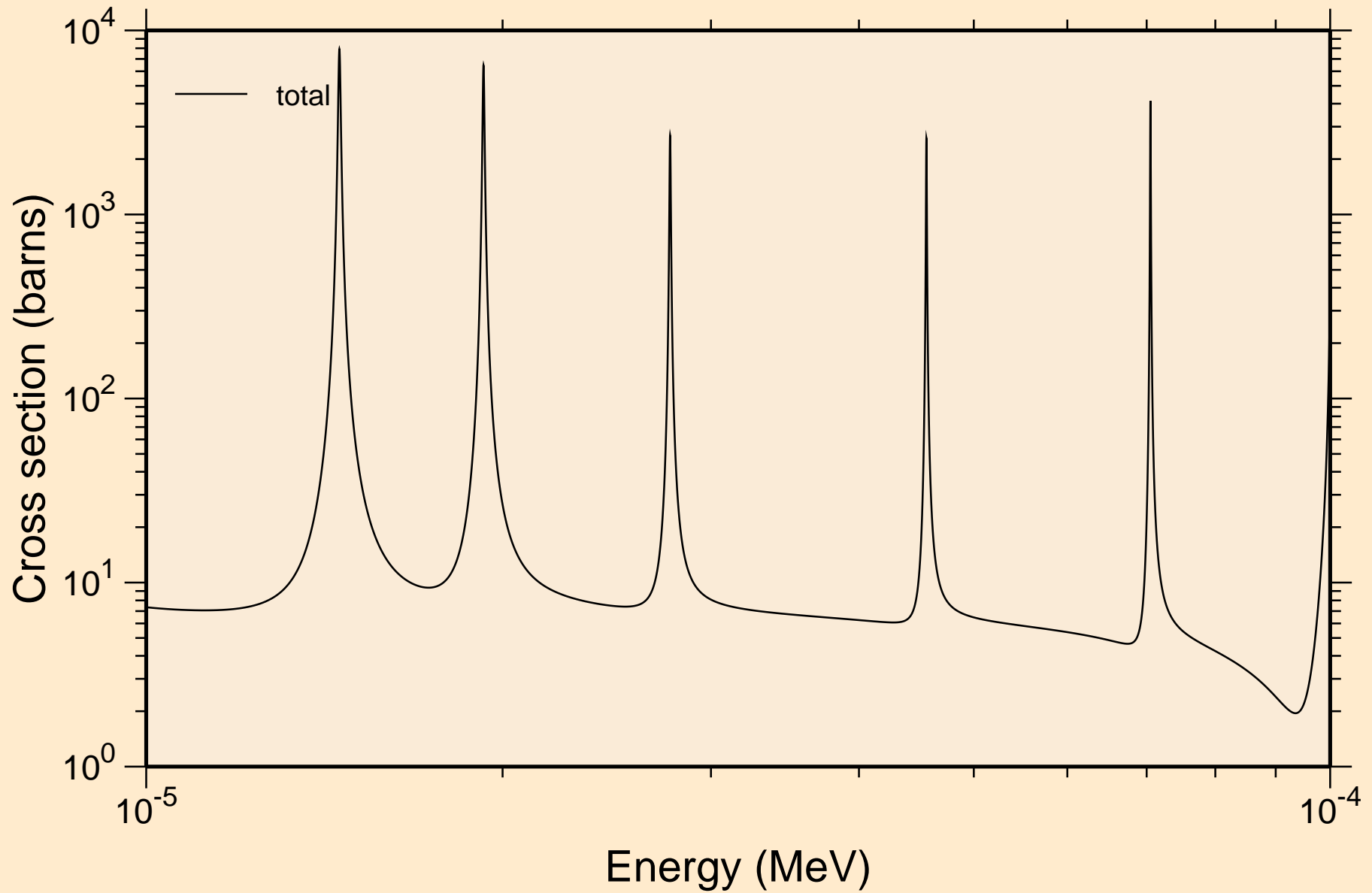

GD153 NEUTRON ACER TENDL-2024 LIBRARY; T=0.K  
resonance total cross section

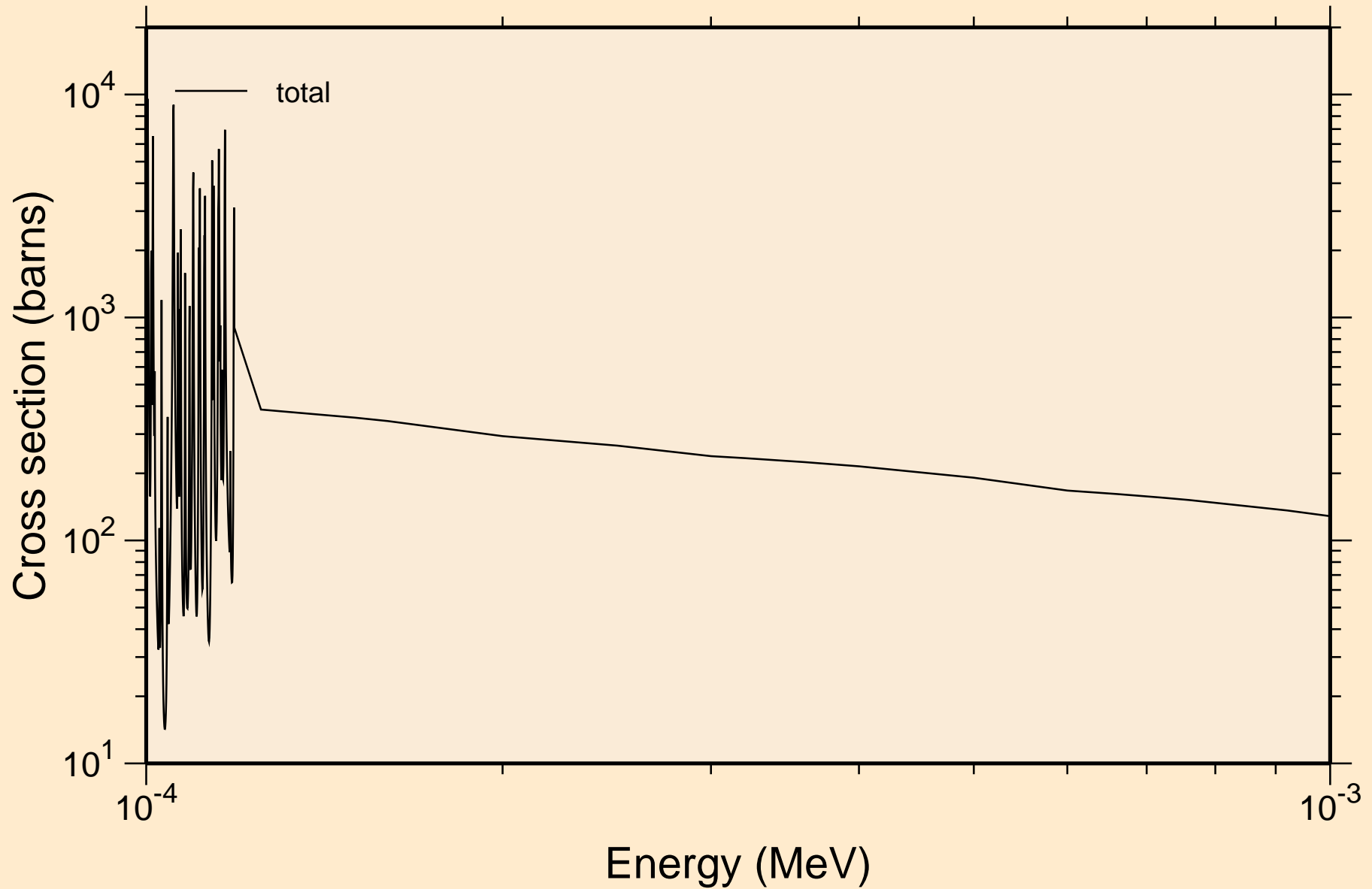

GD153 NEUTRON ACER TENDL-2024 LIBRARY; T=0.K  
resonance total cross section

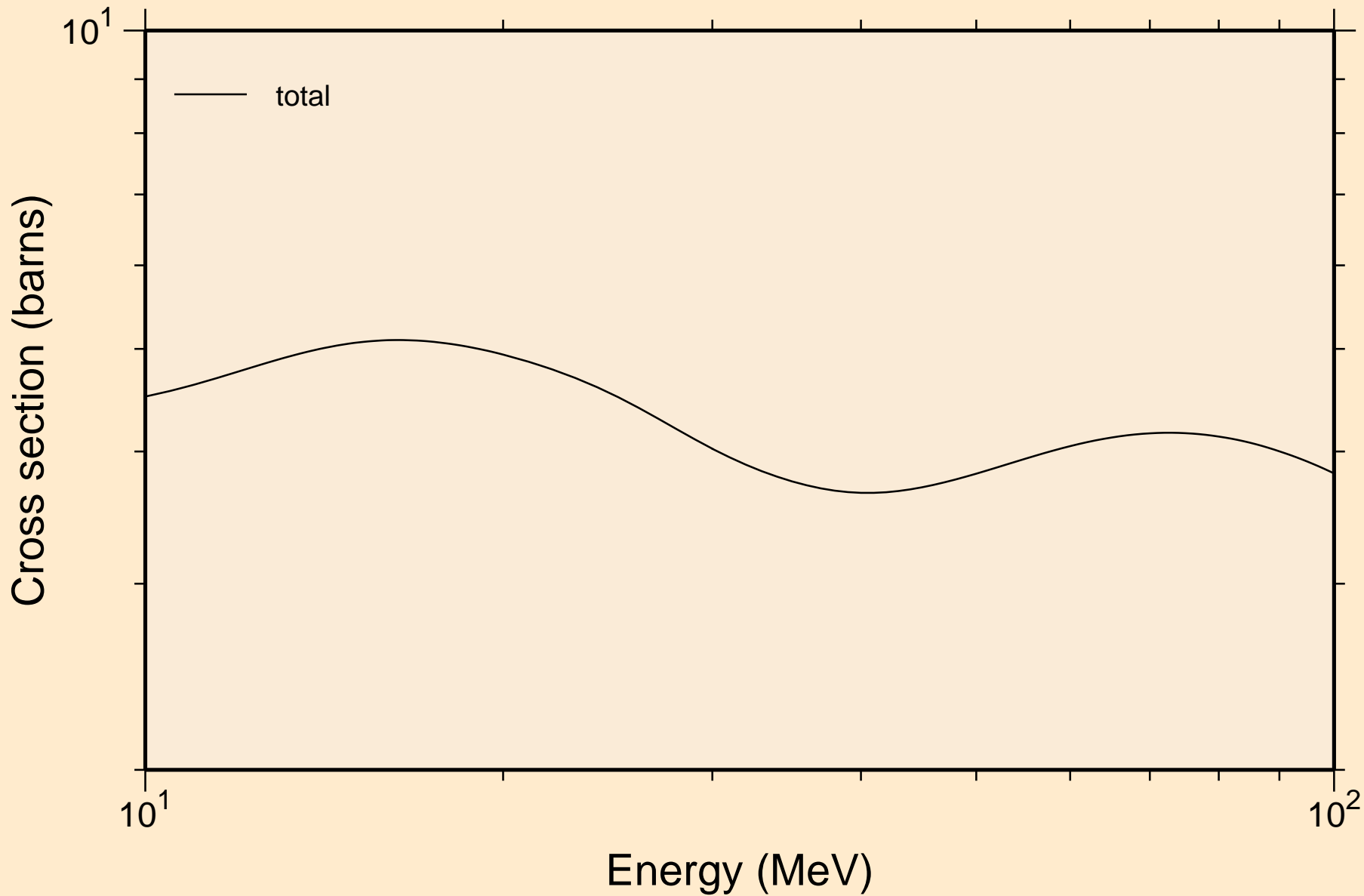

GD153 NEUTRON ACER TENDL-2024 LIBRARY; T=0.K  
resonance absorption cross sections

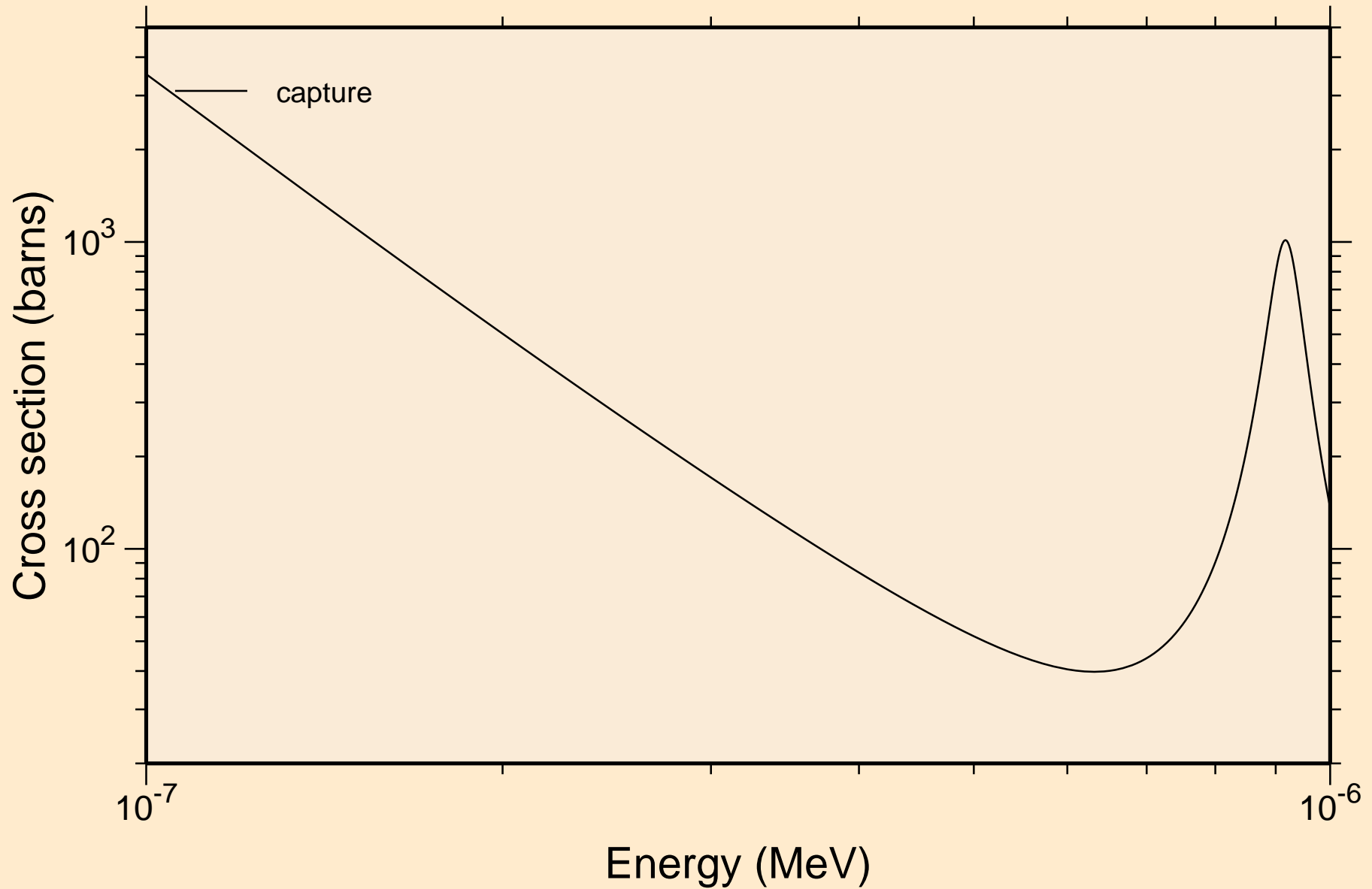

GD153 NEUTRON ACER TENDL-2024 LIBRARY; T=0.K  
resonance absorption cross sections

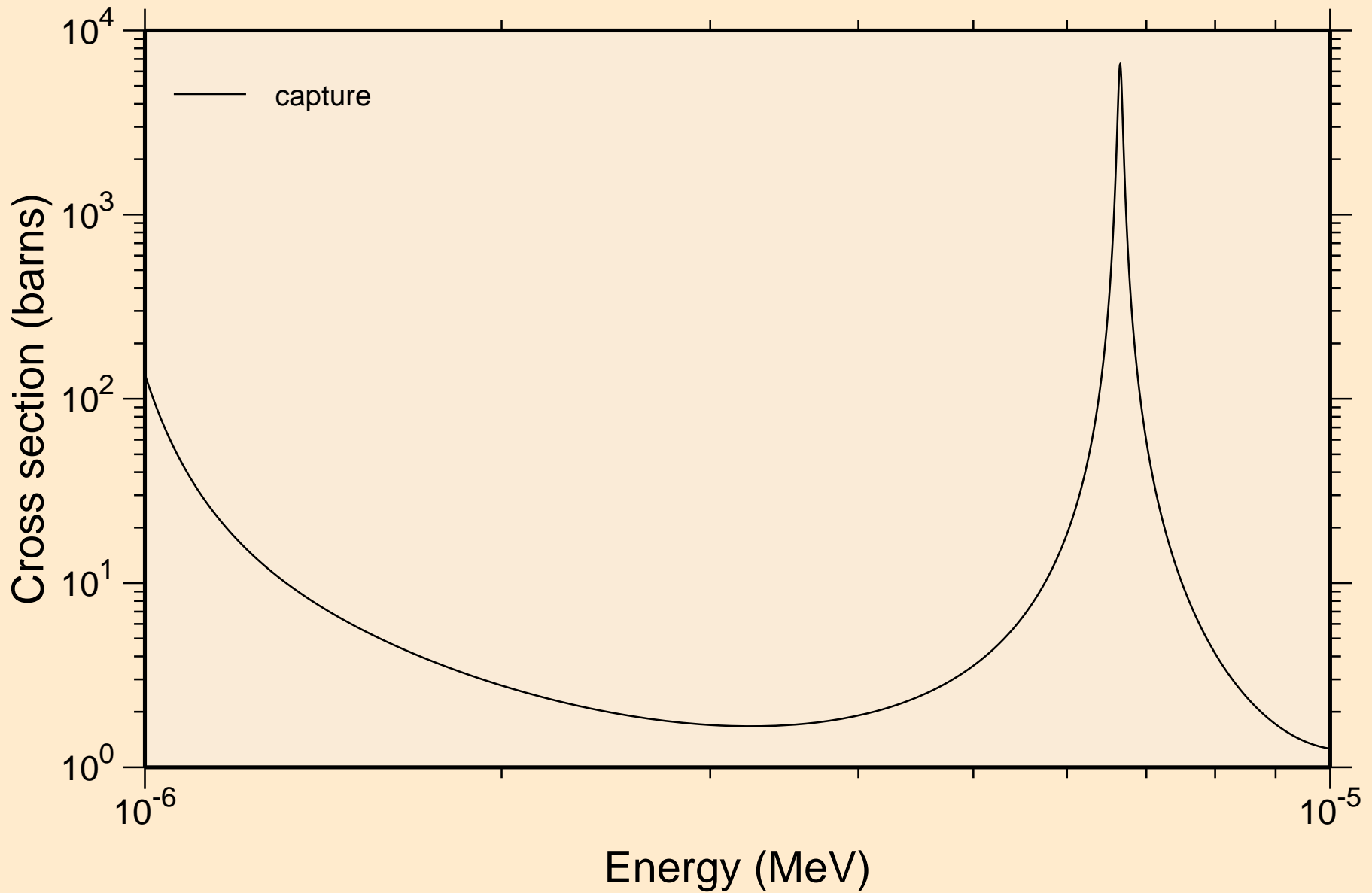



GD153 NEUTRON ACER TENDL-2024 LIBRARY; T=0.K  
resonance absorption cross sections

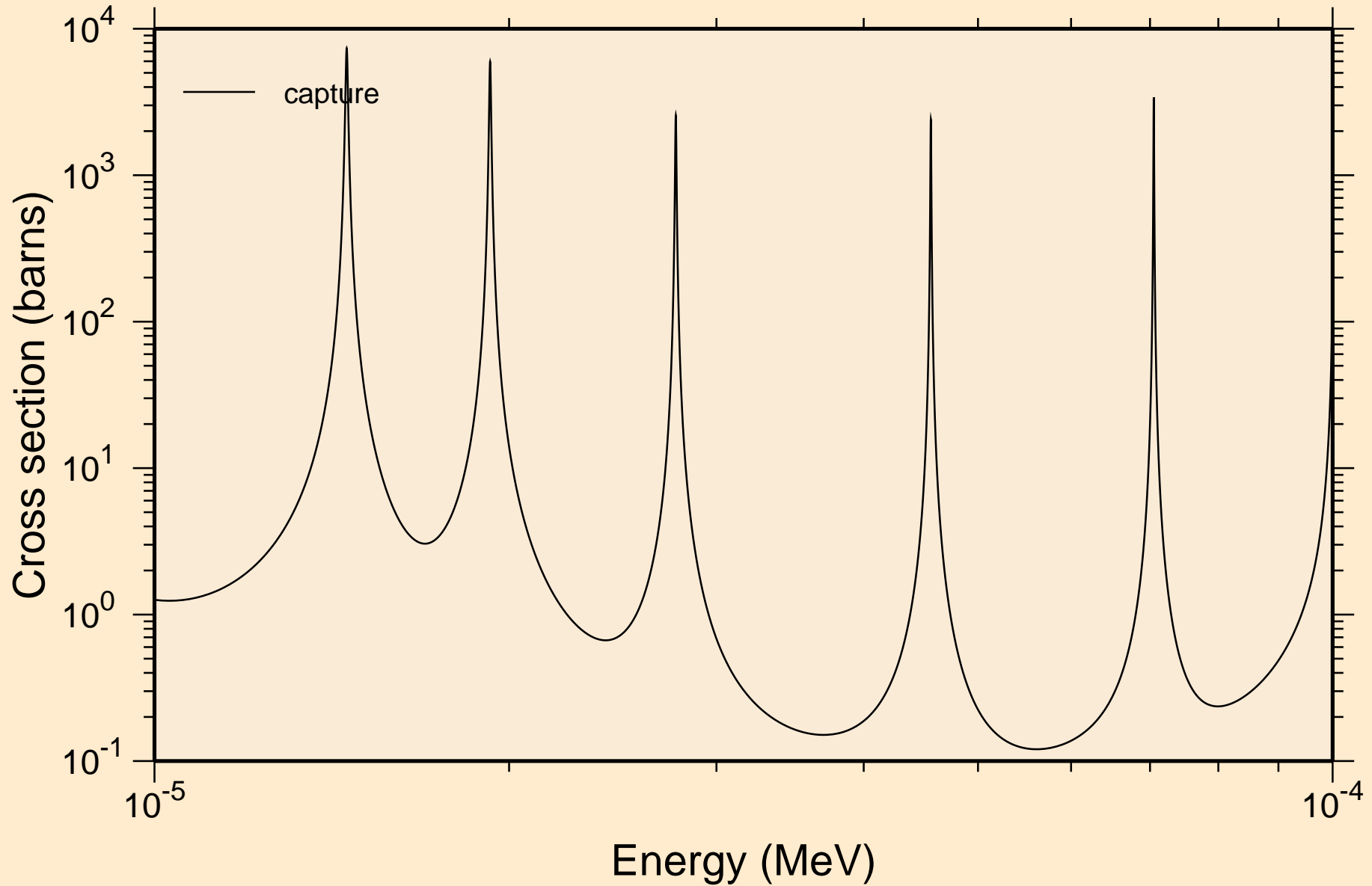

GD153 NEUTRON ACER TENDL-2024 LIBRARY; T=0.K  
resonance absorption cross sections

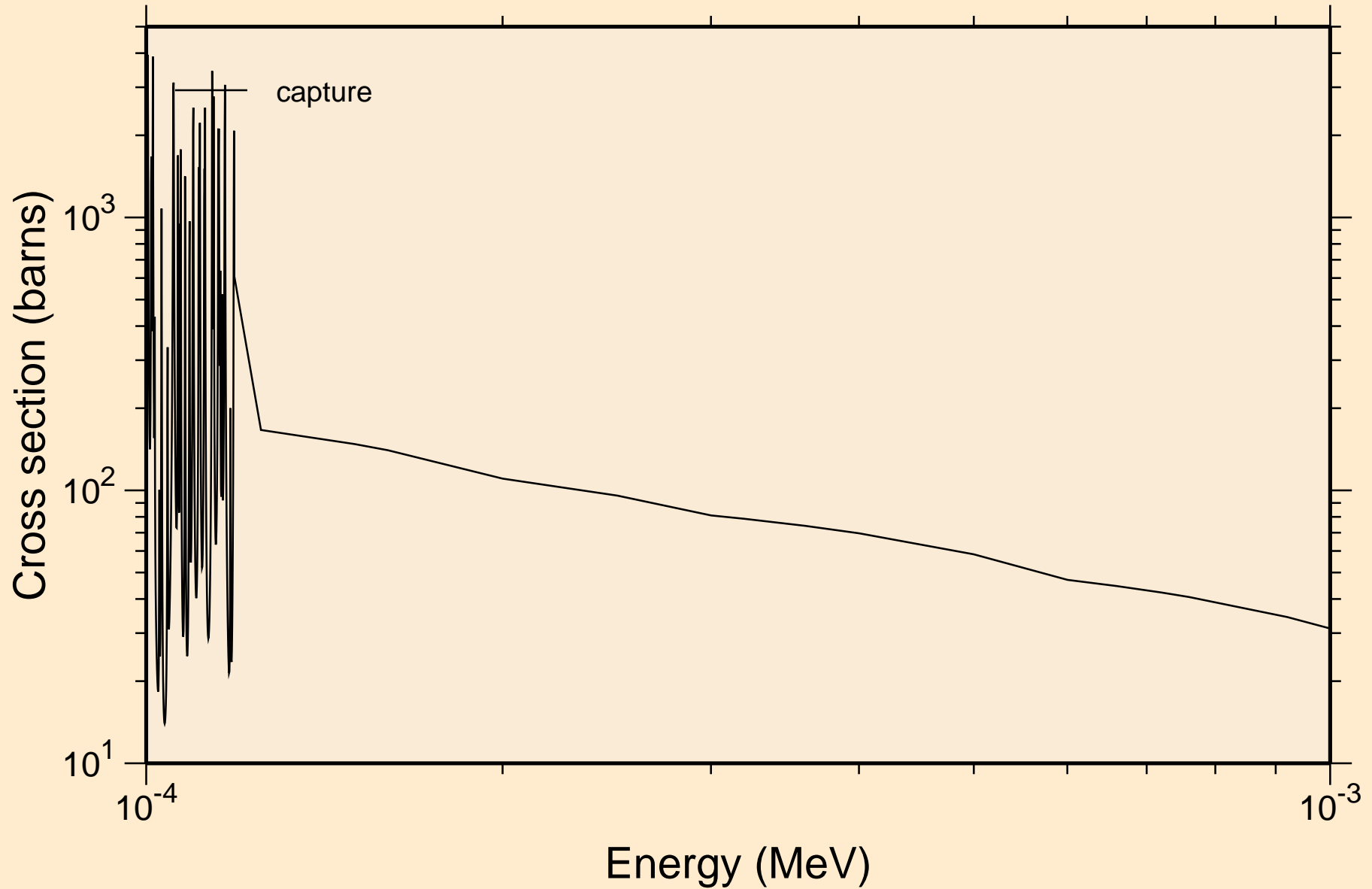

GD153 NEUTRON ACER TENDL-2024 LIBRARY; T=0.K  
resonance absorption cross sections

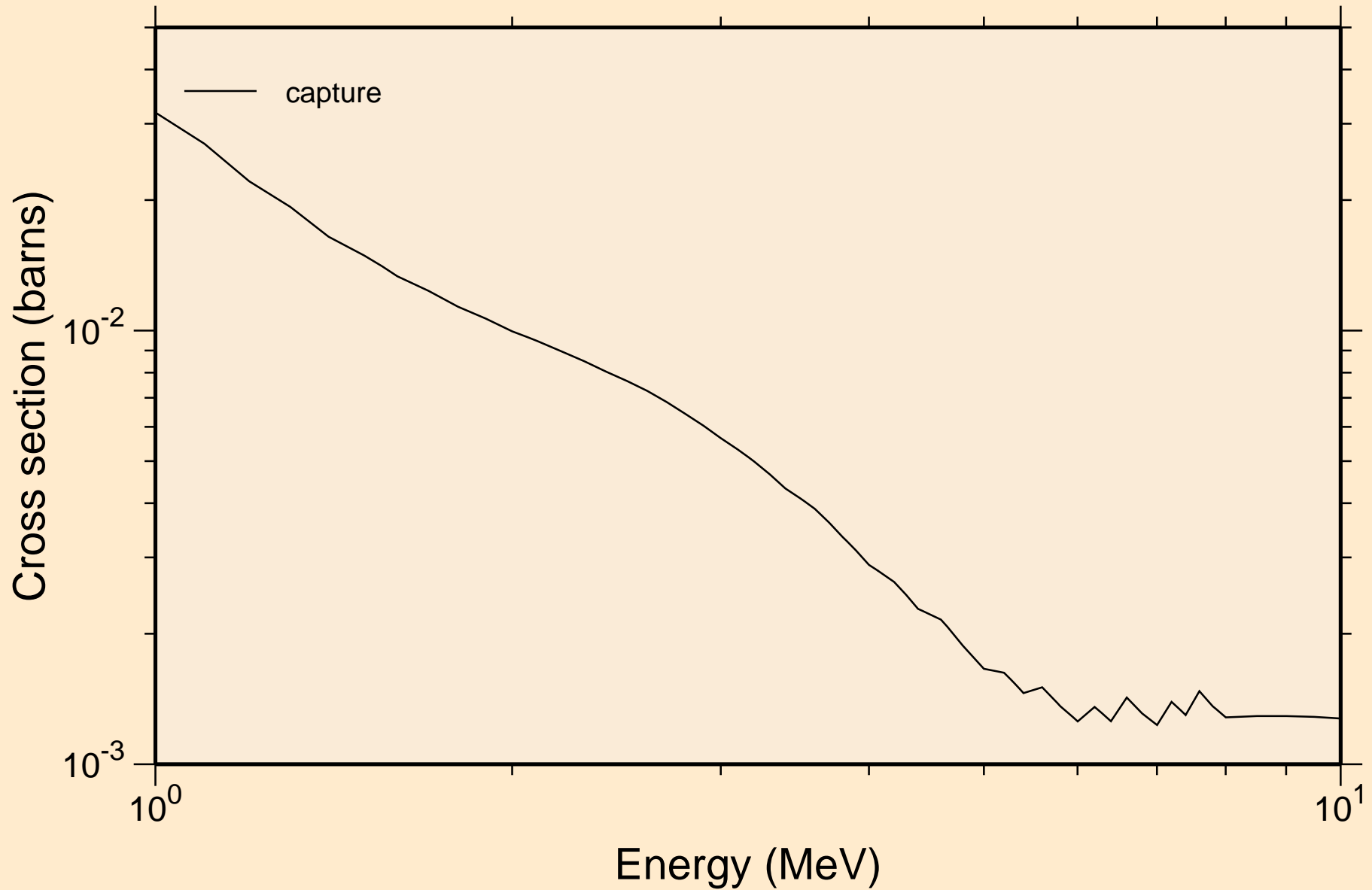

# GD153 NEUTRON ACER TENDL-2024 LIBRARY; T=0.K

## Heating

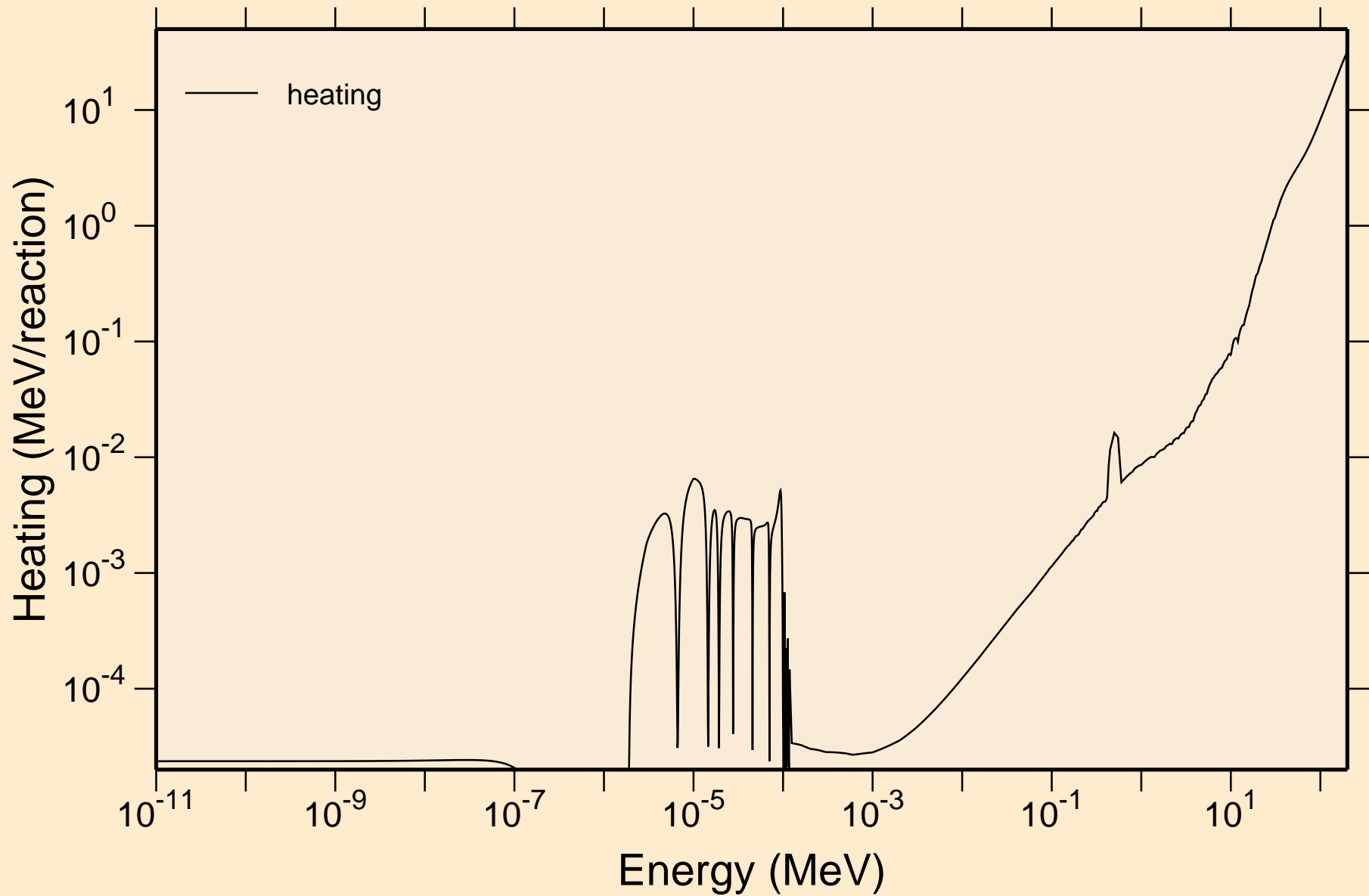

# GD153 NEUTRON ACER TENDL-2024 LIBRARY; T=0.K

## Damage

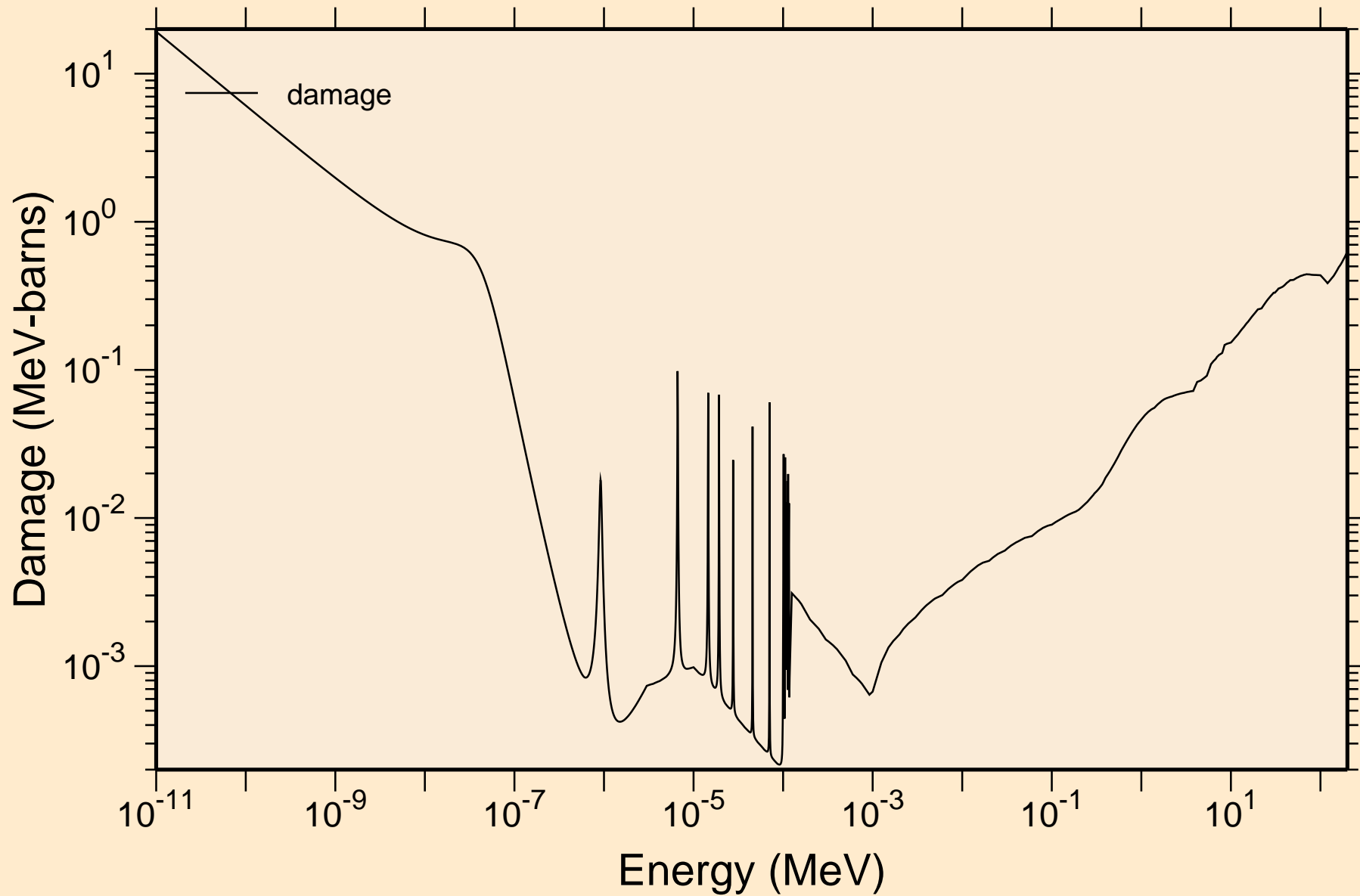

# GD153 NEUTRON ACER TENDL-2024 LIBRARY; T=0.K

## Non-threshold reactions

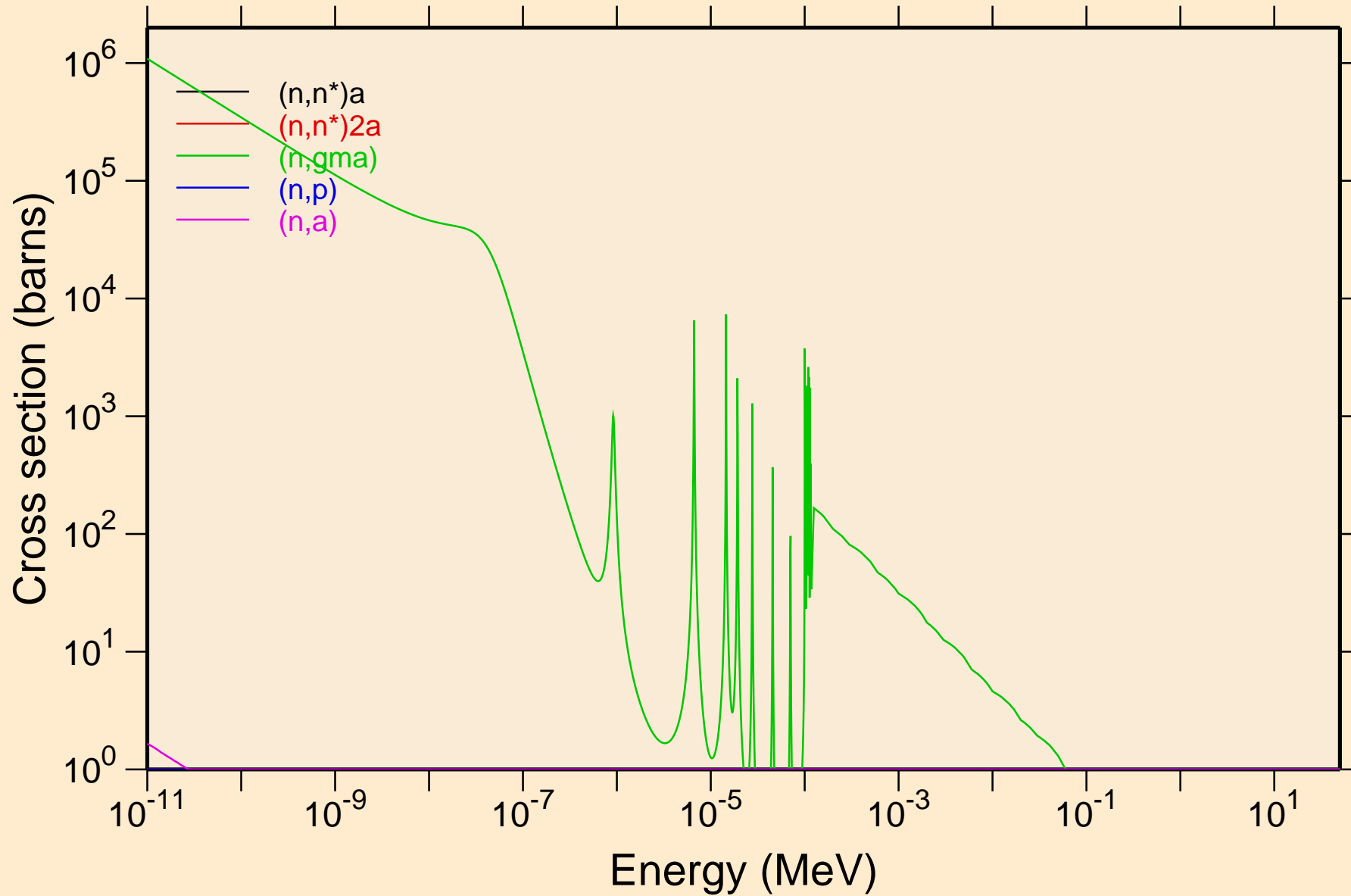

# GD153 NEUTRON ACER TENDL-2024 LIBRARY; T=0.K

## Non-threshold reactions

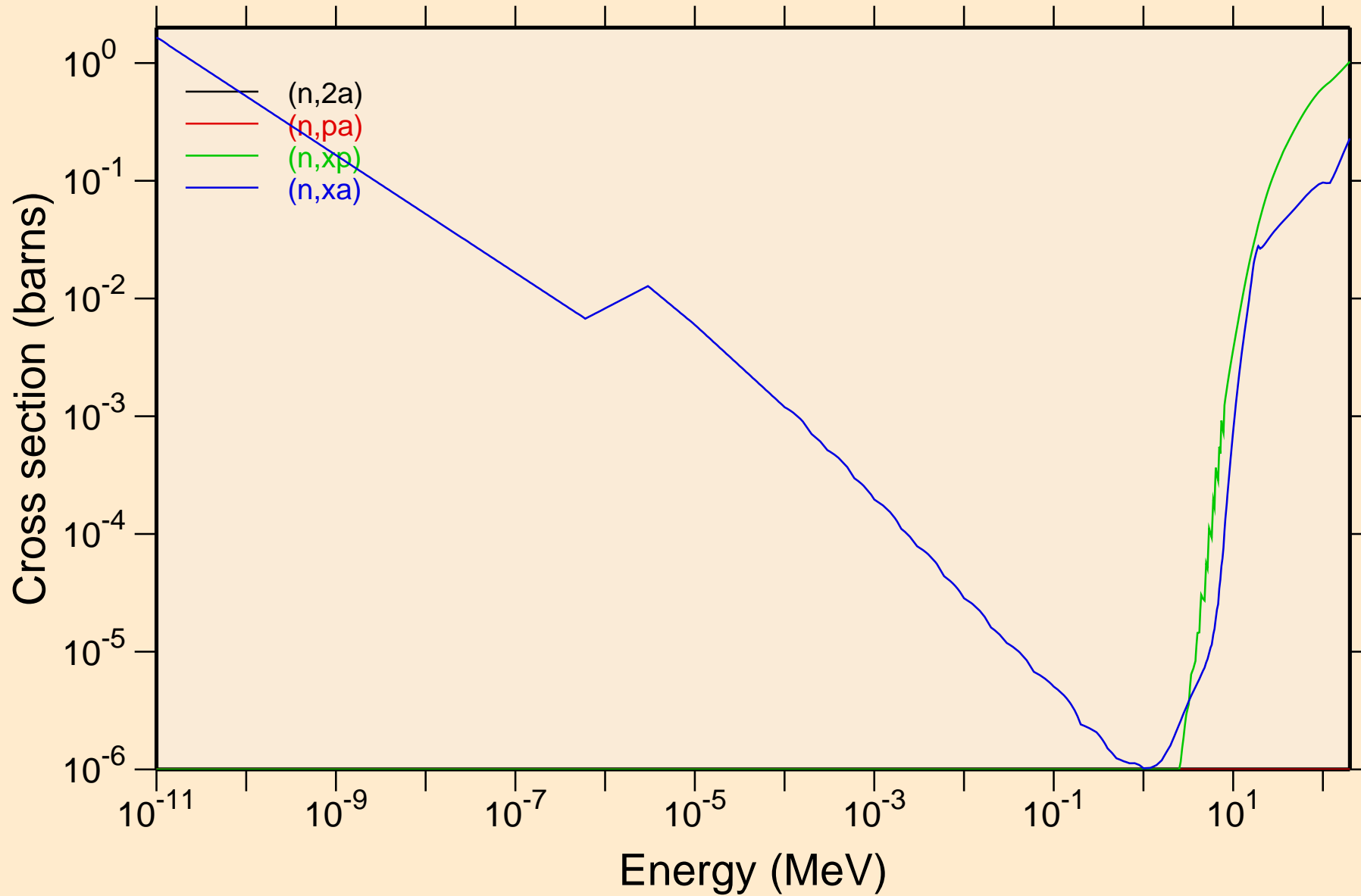

# GD153 NEUTRON ACER TENDL-2024 LIBRARY; T=0.K

## Principal cross sections

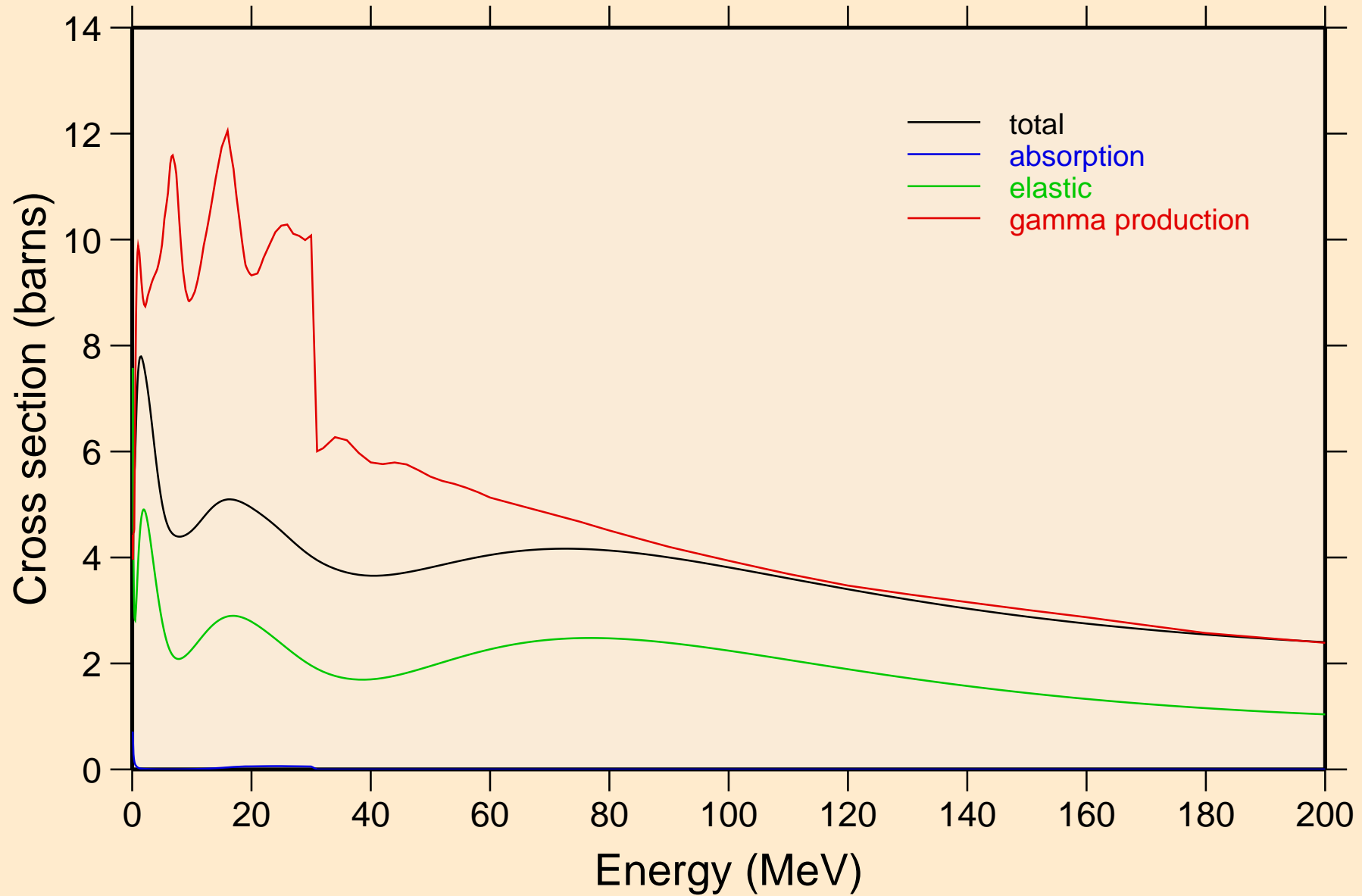



# GD153 NEUTRON ACER TENDL-2024 LIBRARY; T=0.K

## Heating

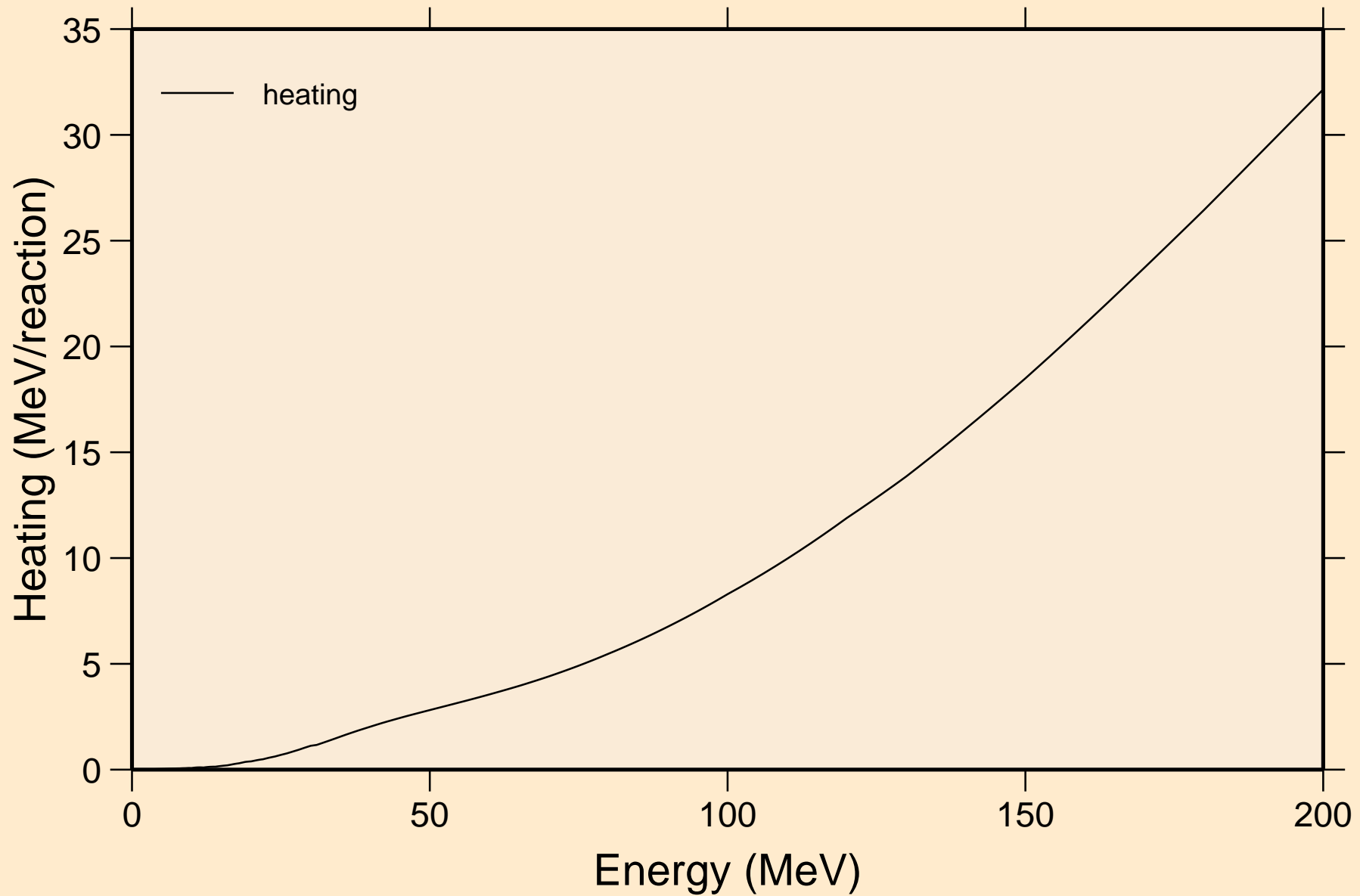

# GD153 NEUTRON ACER TENDL-2024 LIBRARY; T=0.K

## Damage

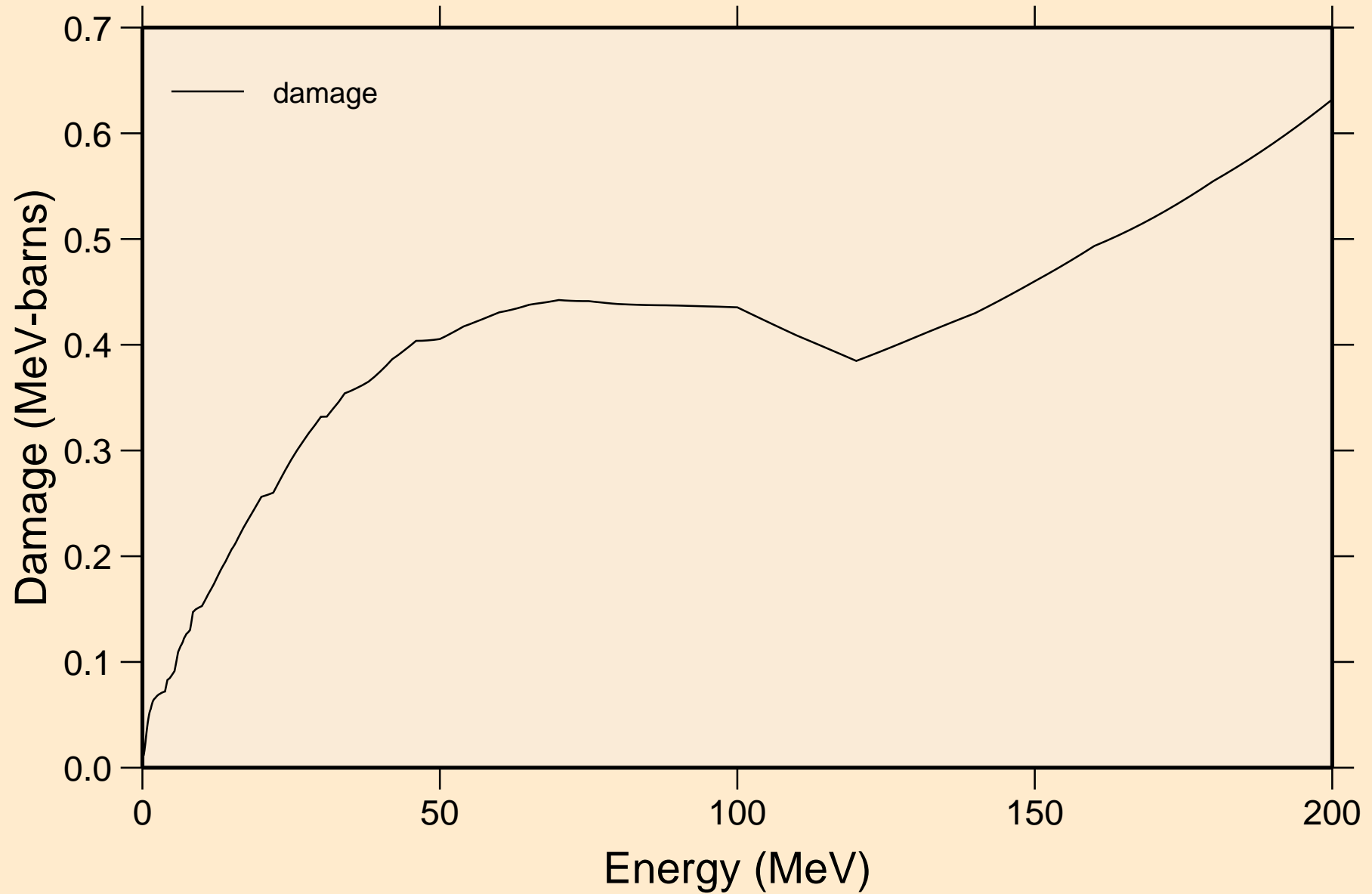

# GD153 NEUTRON ACER TENDL-2024 LIBRARY; T=0.K

## Non-threshold reactions

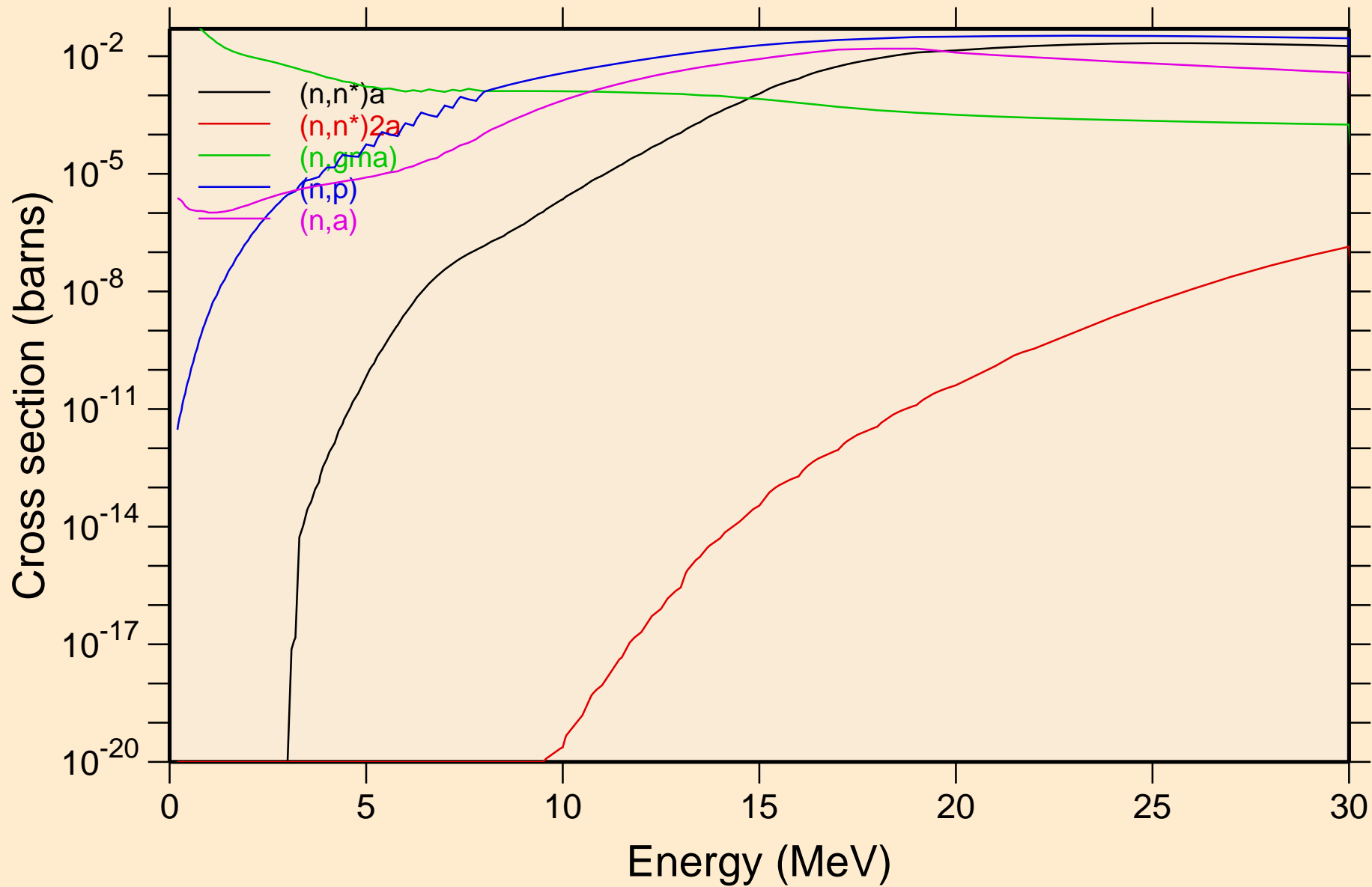

# GD153 NEUTRON ACER TENDL-2024 LIBRARY; T=0.K

## Non-threshold reactions

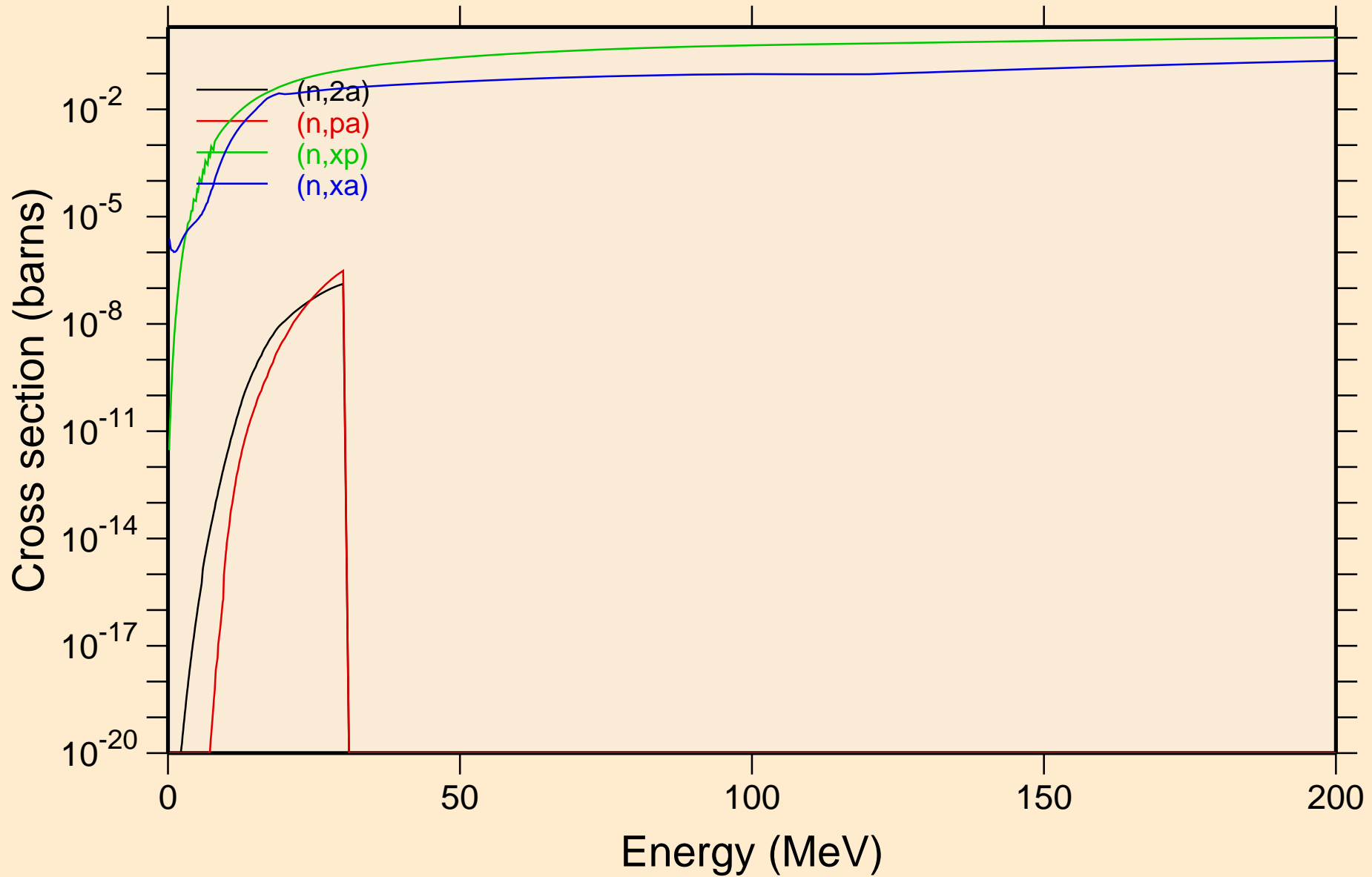

# GD153 NEUTRON ACER TENDL-2024 LIBRARY; T=0.K

## Inelastic levels

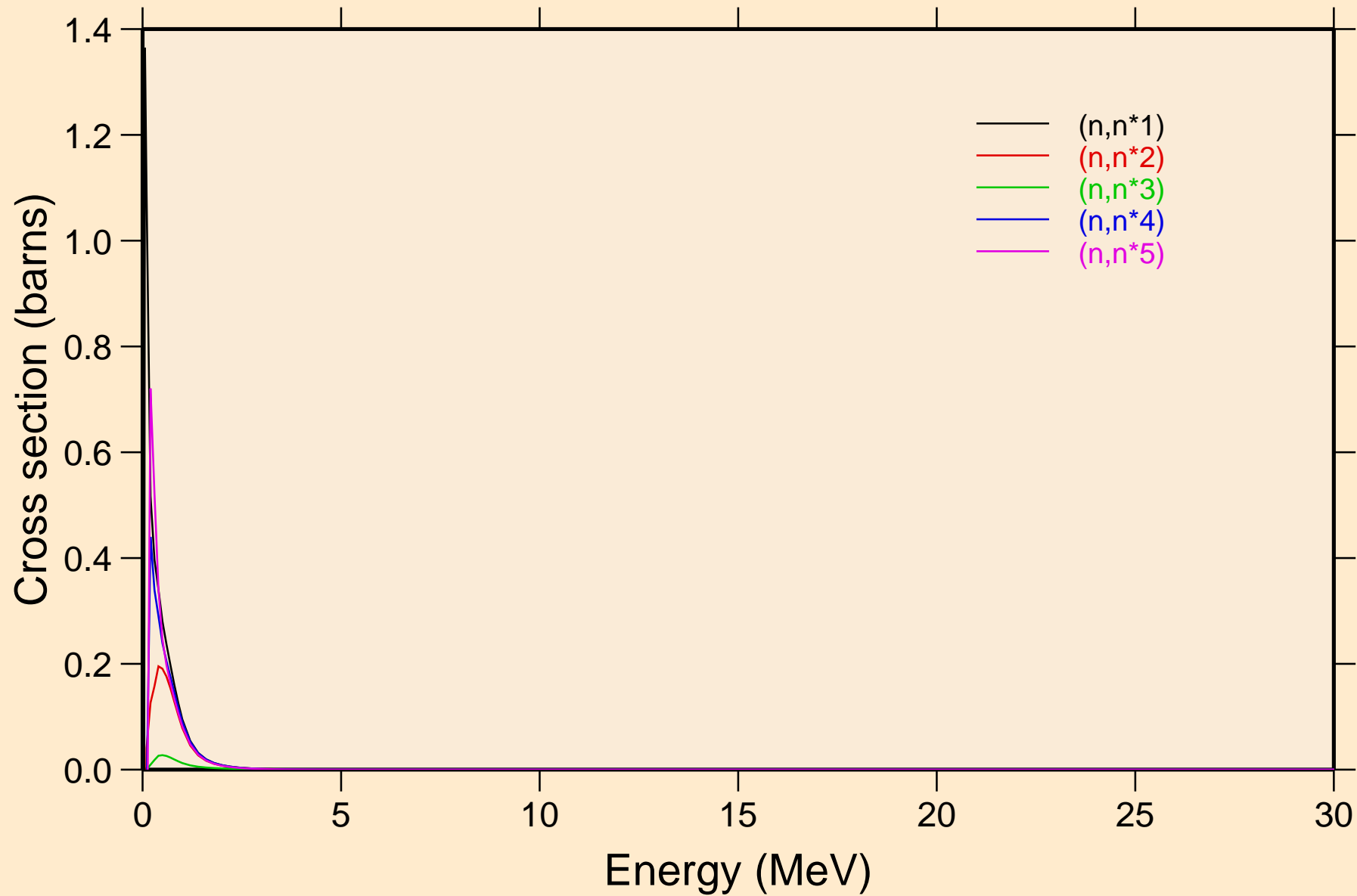

GD153 NEUTRON ACER TENDL-2024 LIBRARY; T=0.K  
Inelastic levels

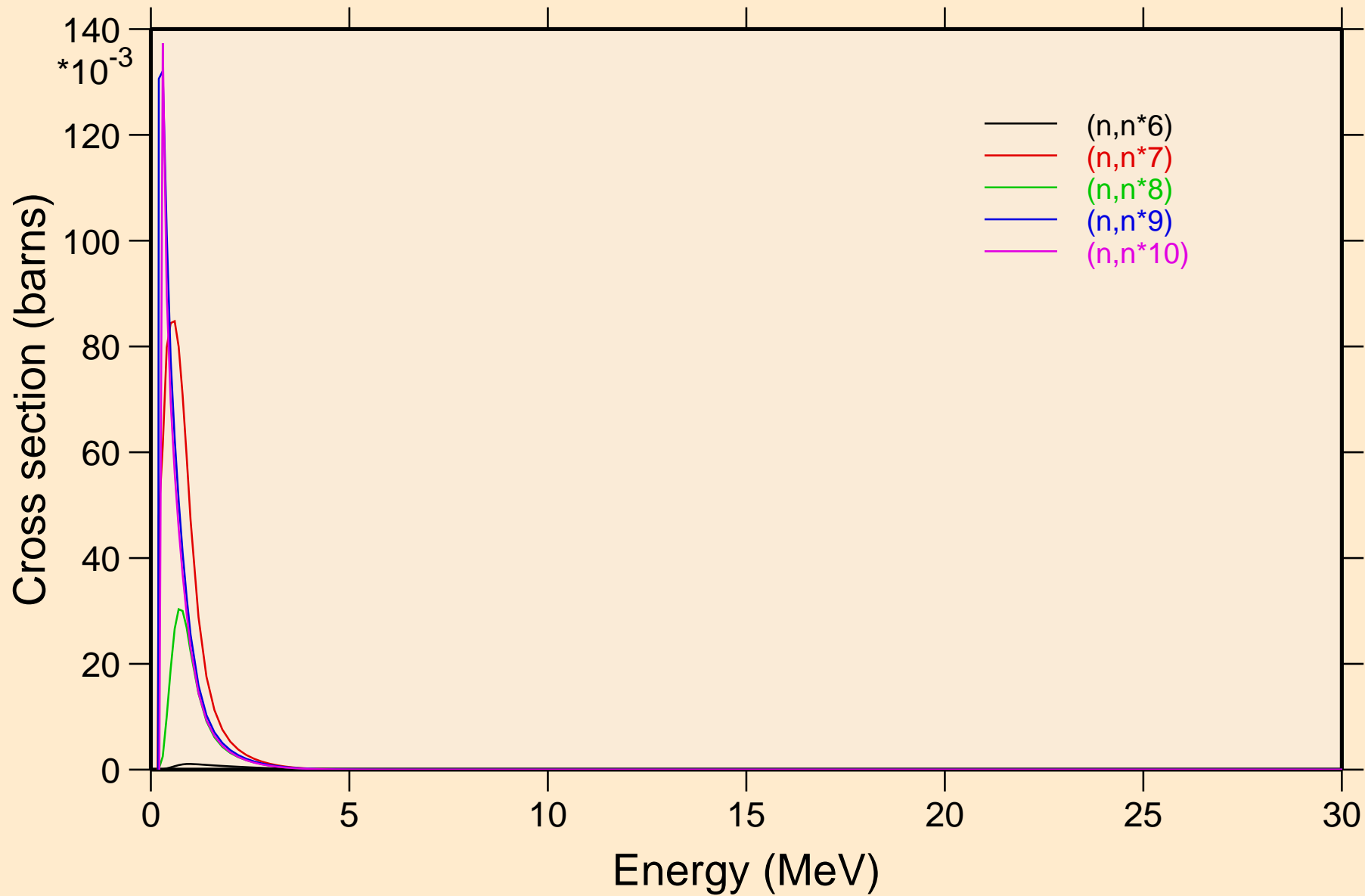

# GD153 NEUTRON ACER TENDL-2024 LIBRARY; T=0.K

## Inelastic levels

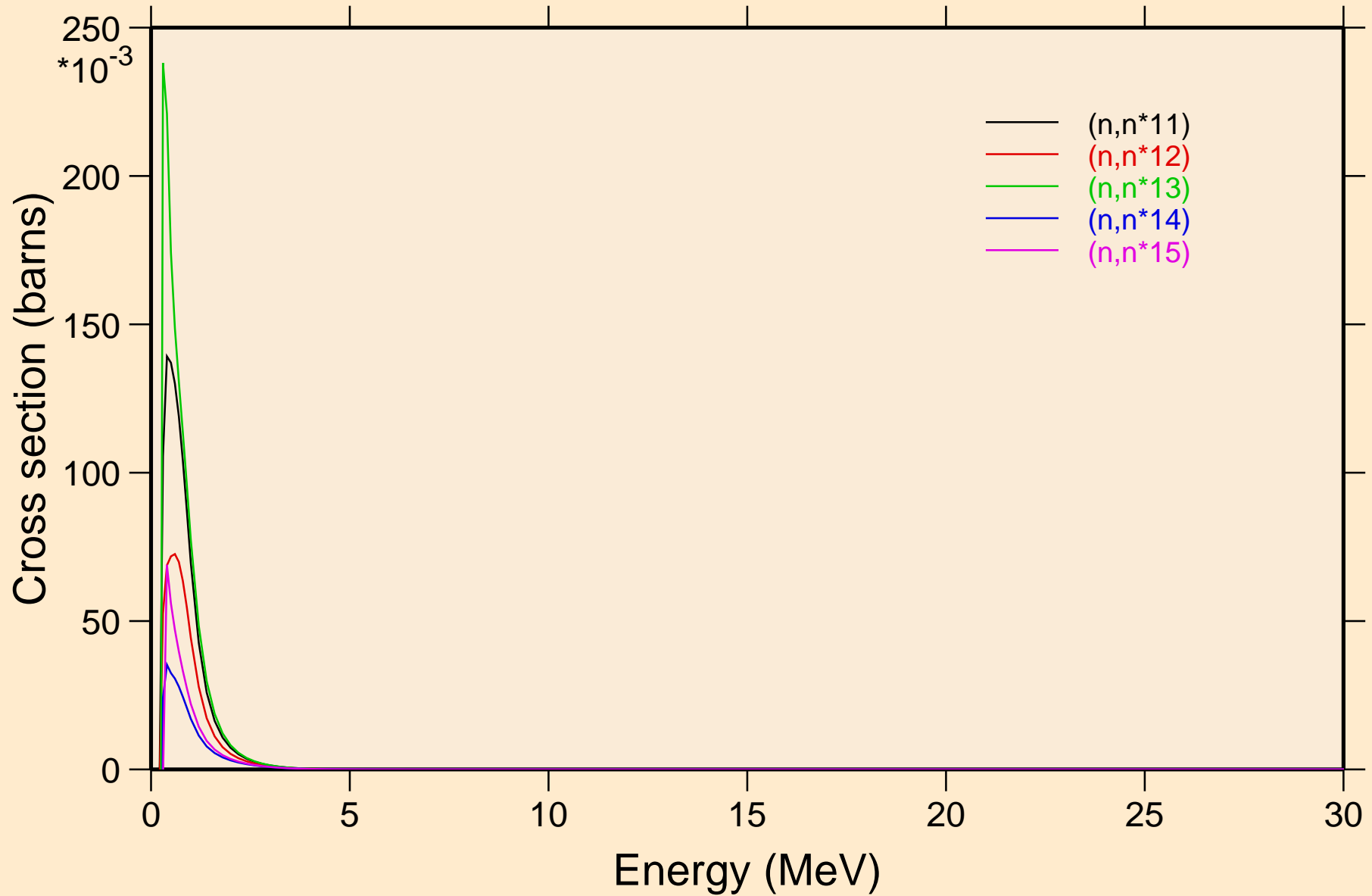

GD153 NEUTRON ACER TENDL-2024 LIBRARY; T=0.K  
Inelastic levels

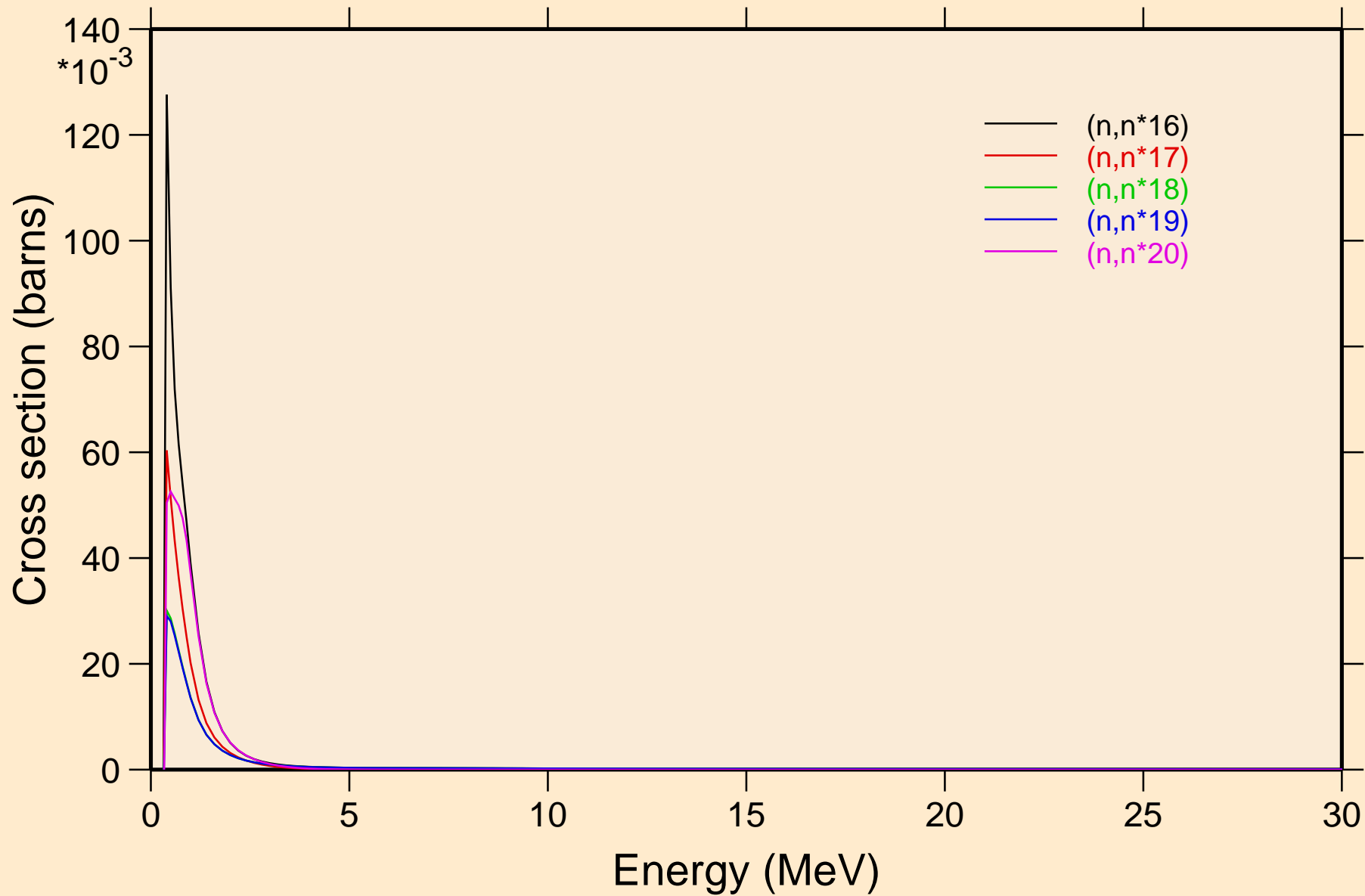



GD153 NEUTRON ACER TENDL-2024 LIBRARY; T=0.K  
Inelastic levels

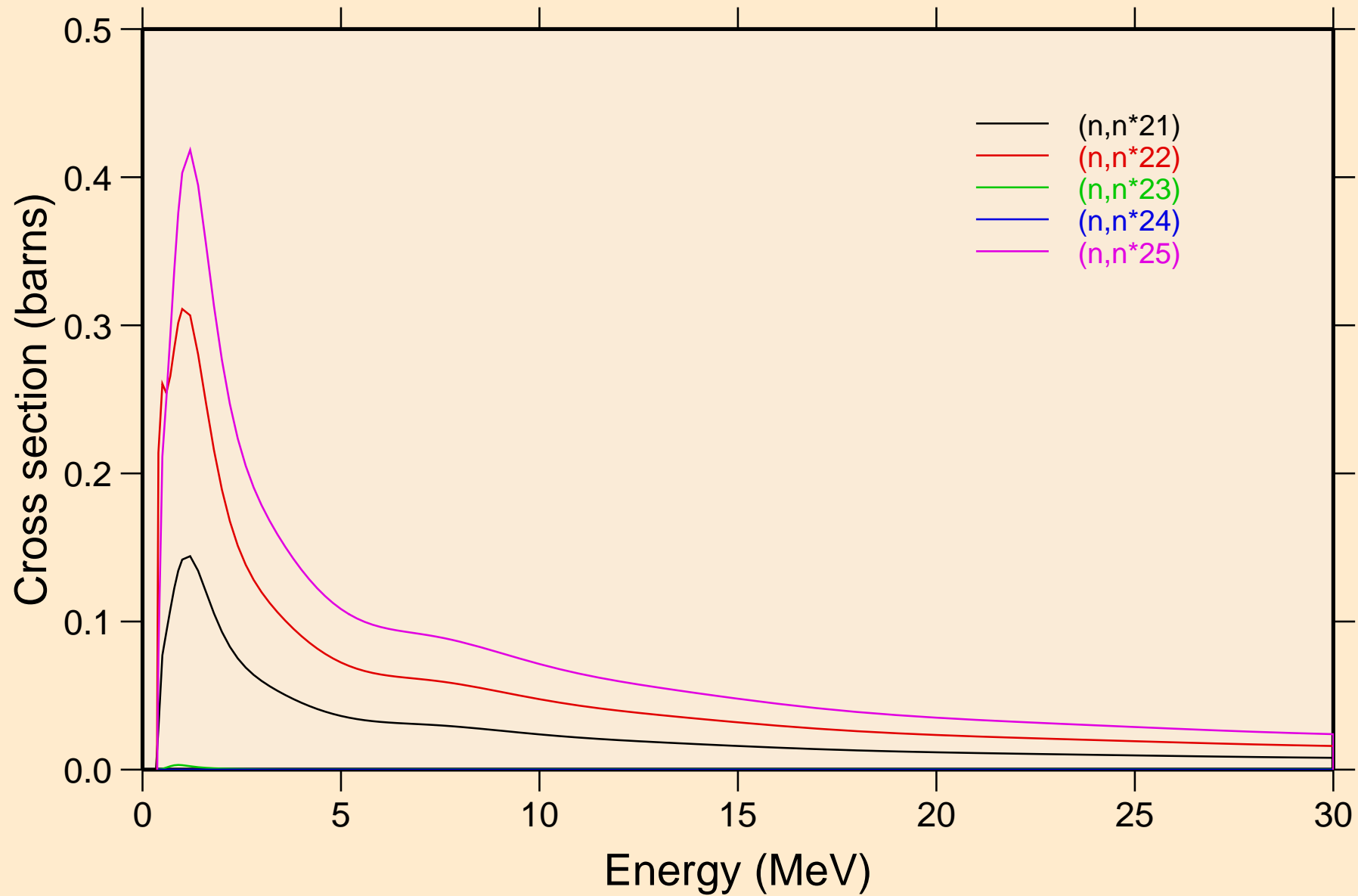

GD153 NEUTRON ACER TENDL-2024 LIBRARY; T=0.K  
Inelastic levels

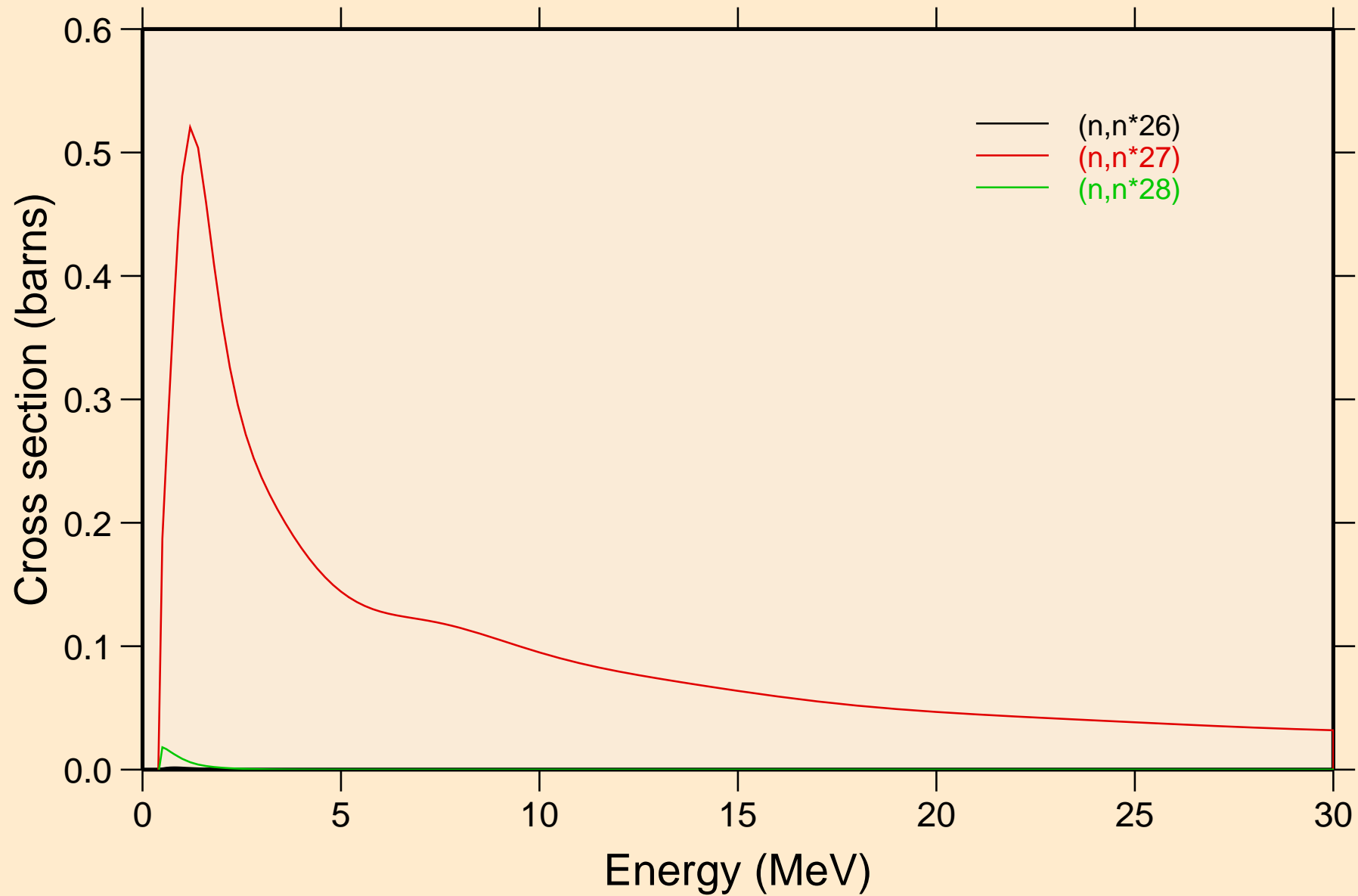

# GD153 NEUTRON ACER TENDL-2024 LIBRARY; T=0.K

## Threshold reactions

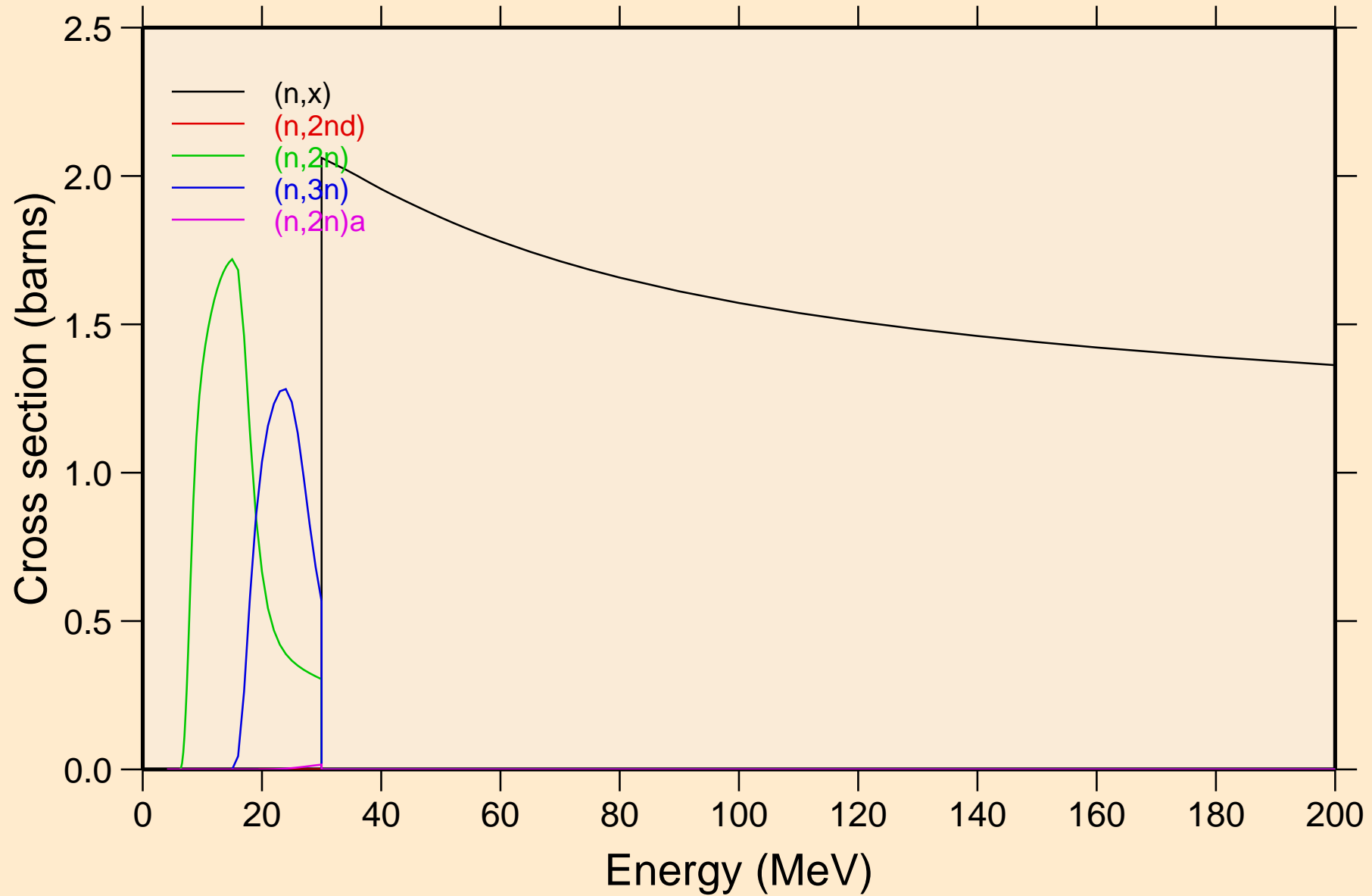

# GD153 NEUTRON ACER TENDL-2024 LIBRARY; T=0.K

## Threshold reactions

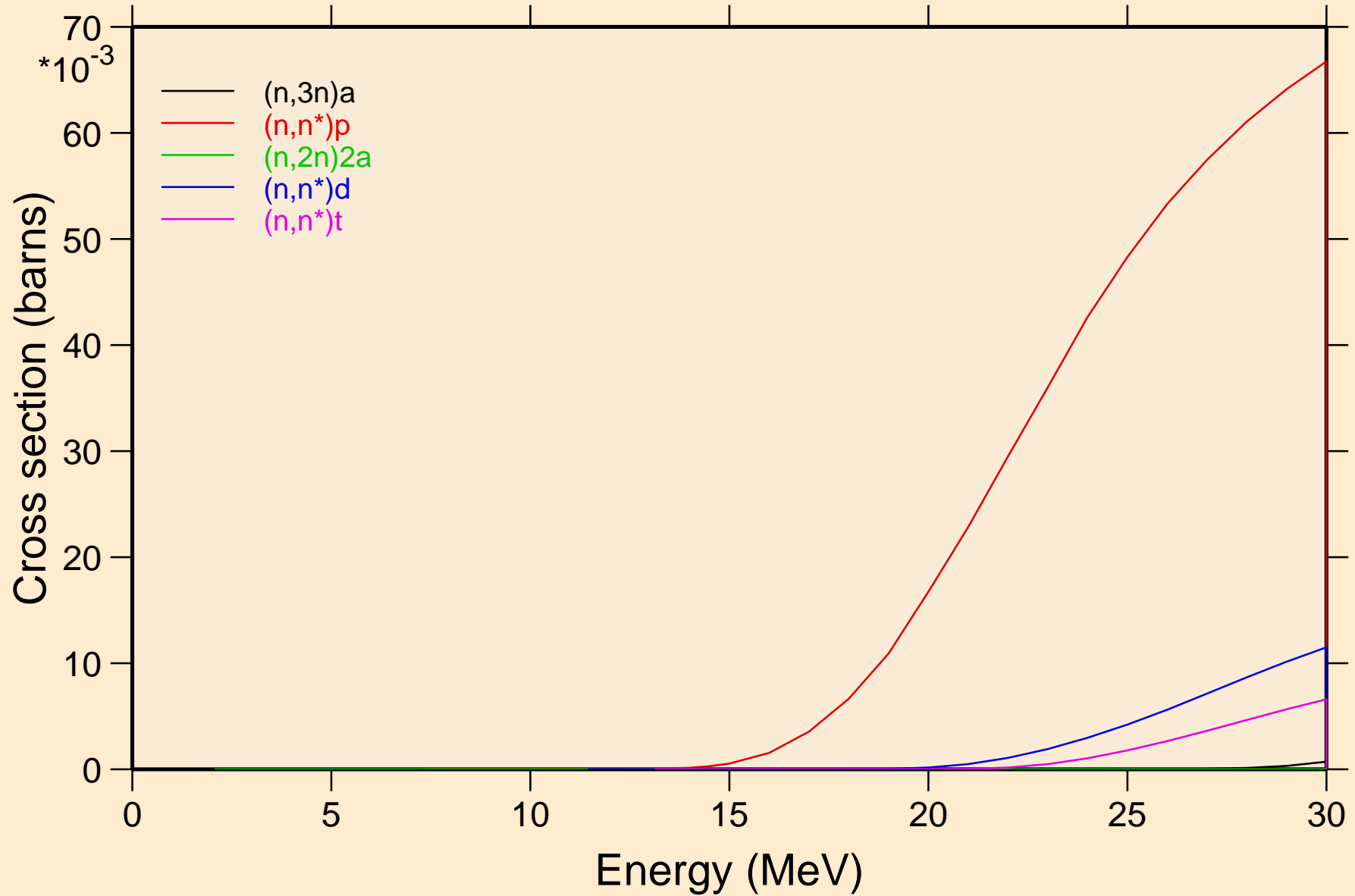

# GD153 NEUTRON ACER TENDL-2024 LIBRARY; T=0.K

## Threshold reactions

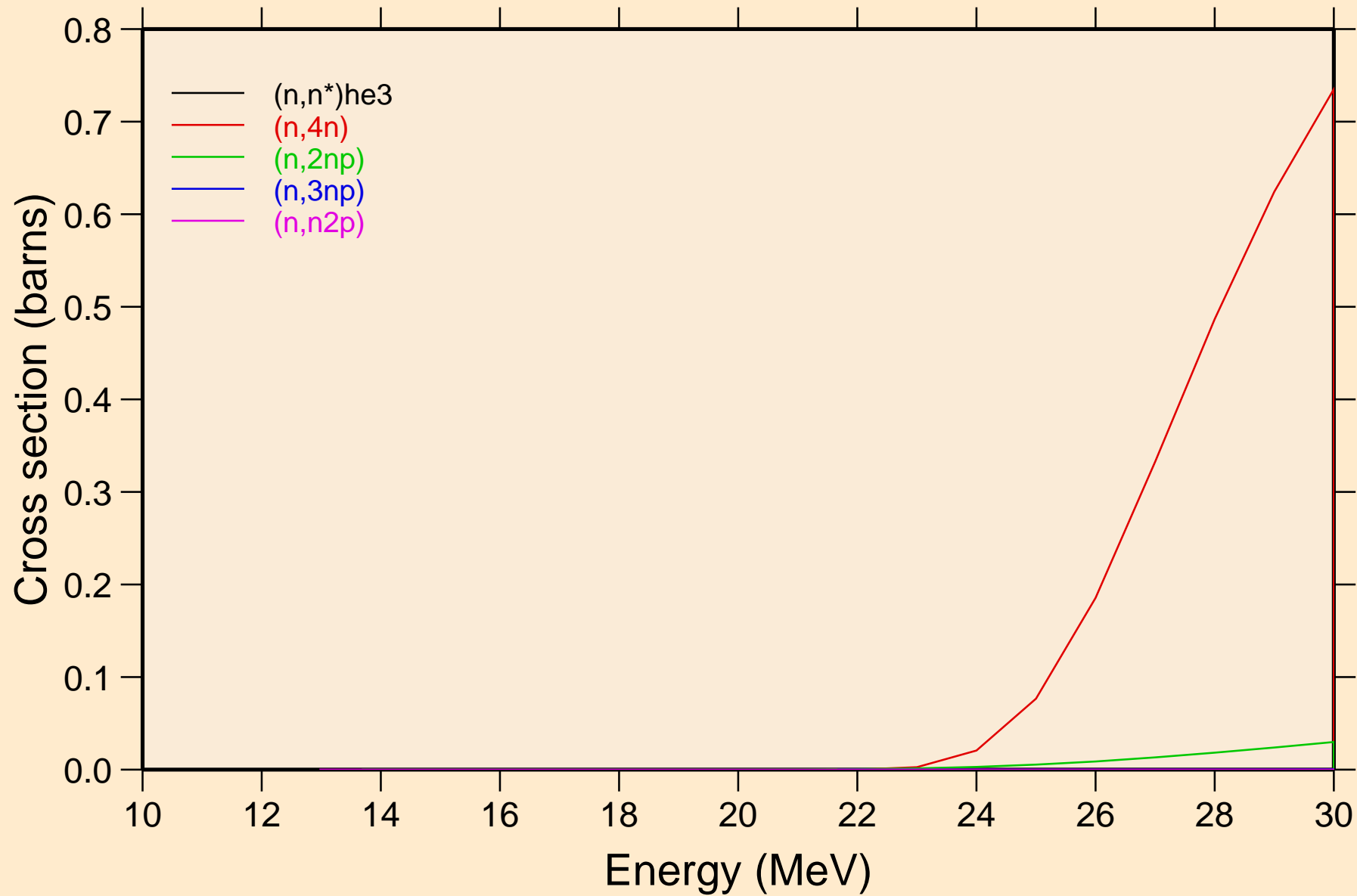

GD153 NEUTRON ACER TENDL-2024 LIBRARY; T=0.K  
Threshold reactions

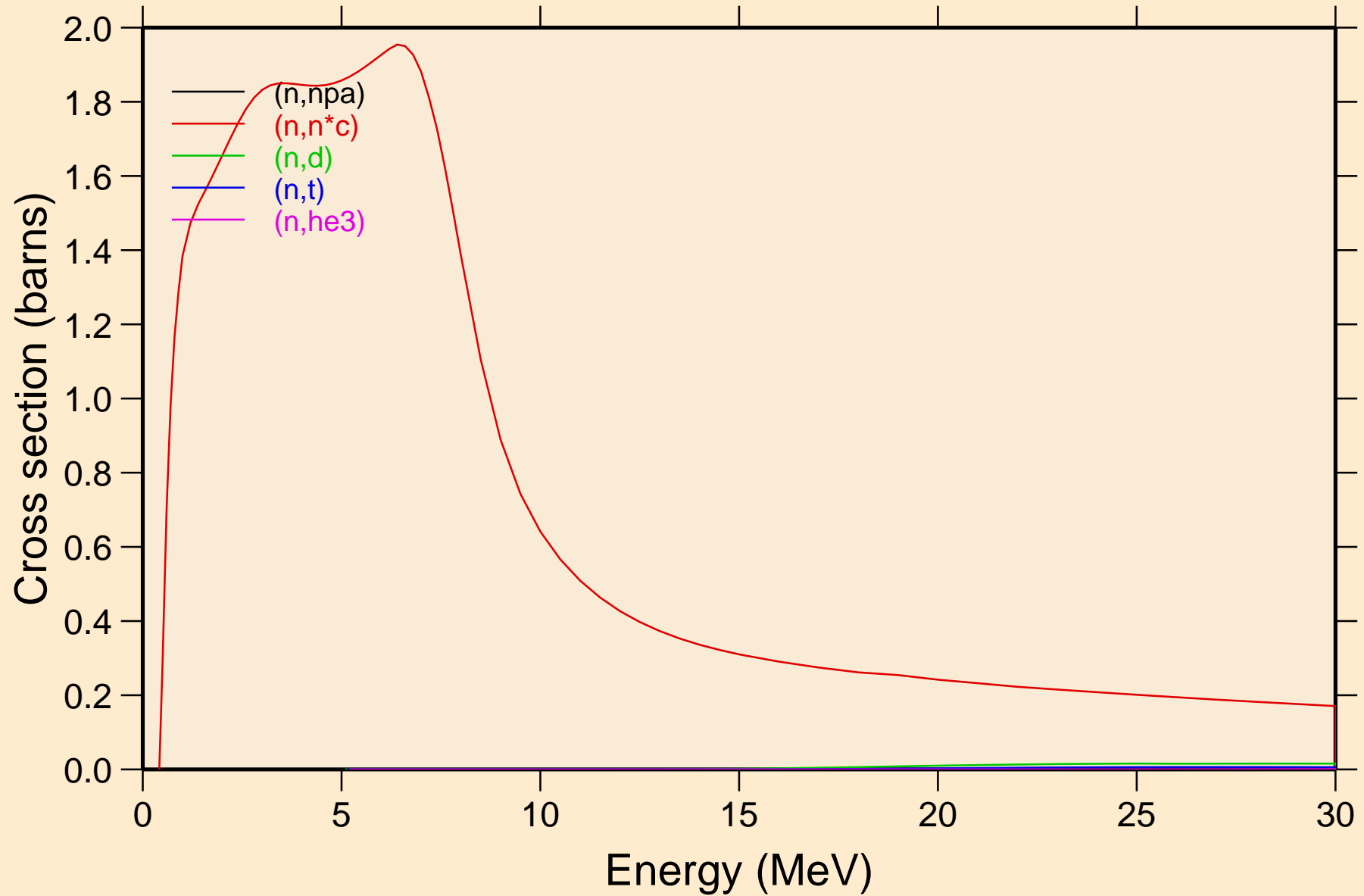

GD153 NEUTRON ACER TENDL-2024 LIBRARY; T=0.K  
Threshold reactions

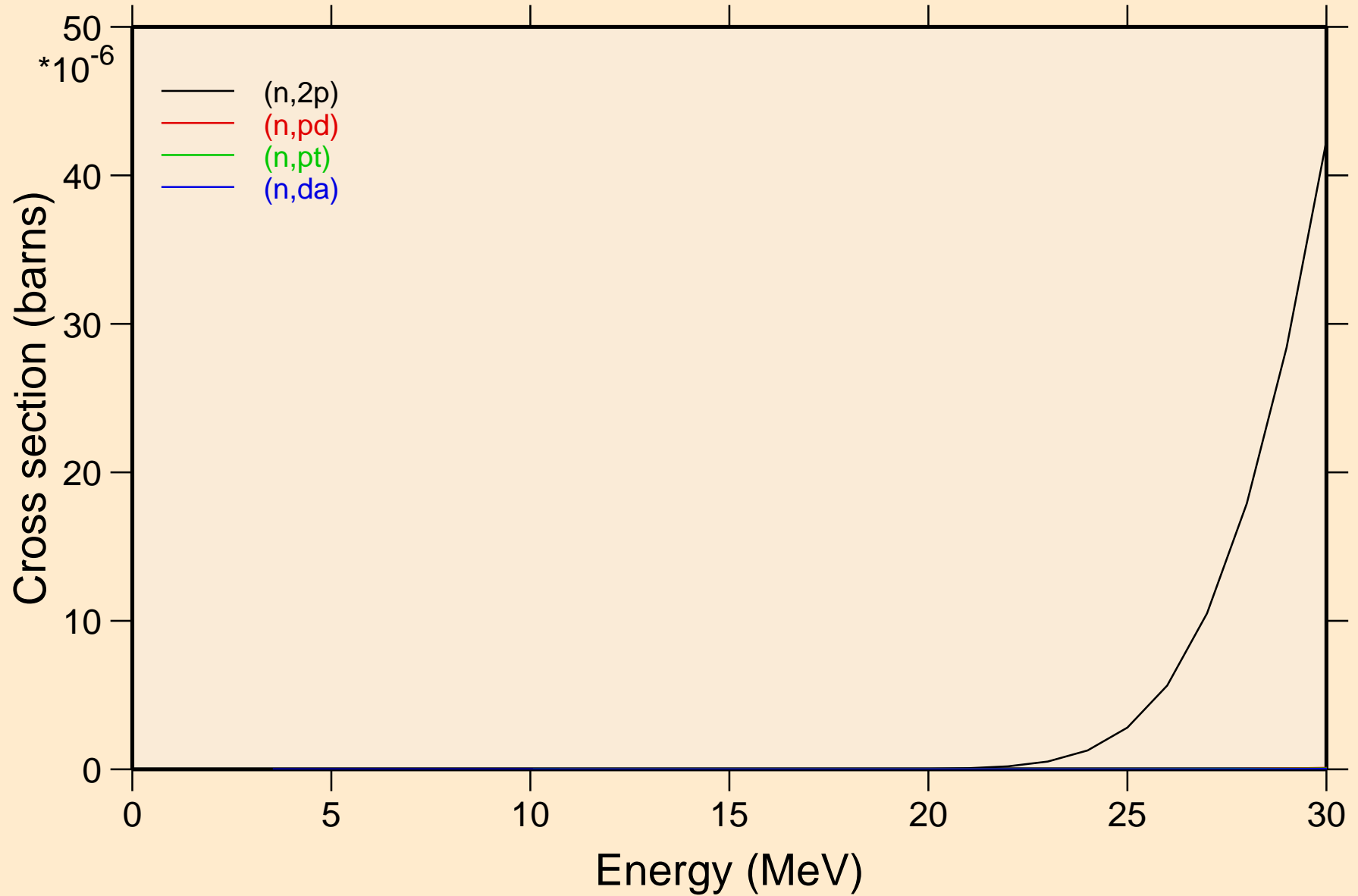

# GD153 NEUTRON ACER TENDL-2024 LIBRARY; T=0.K

## Threshold reactions

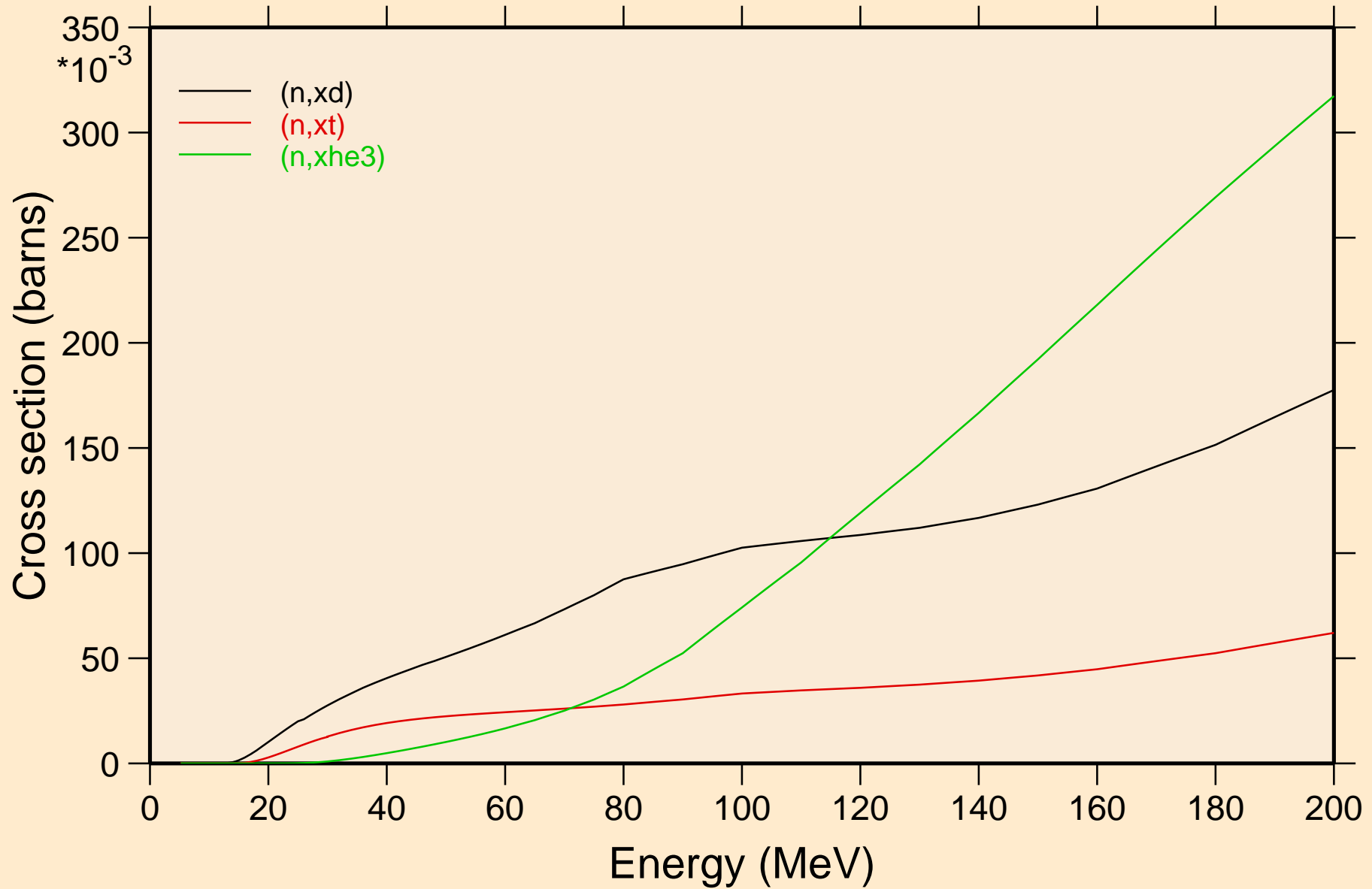



GD153 NEUTRON ACER TENDL-2024 LIBRARY; T=0.K  
angular distribution for elastic

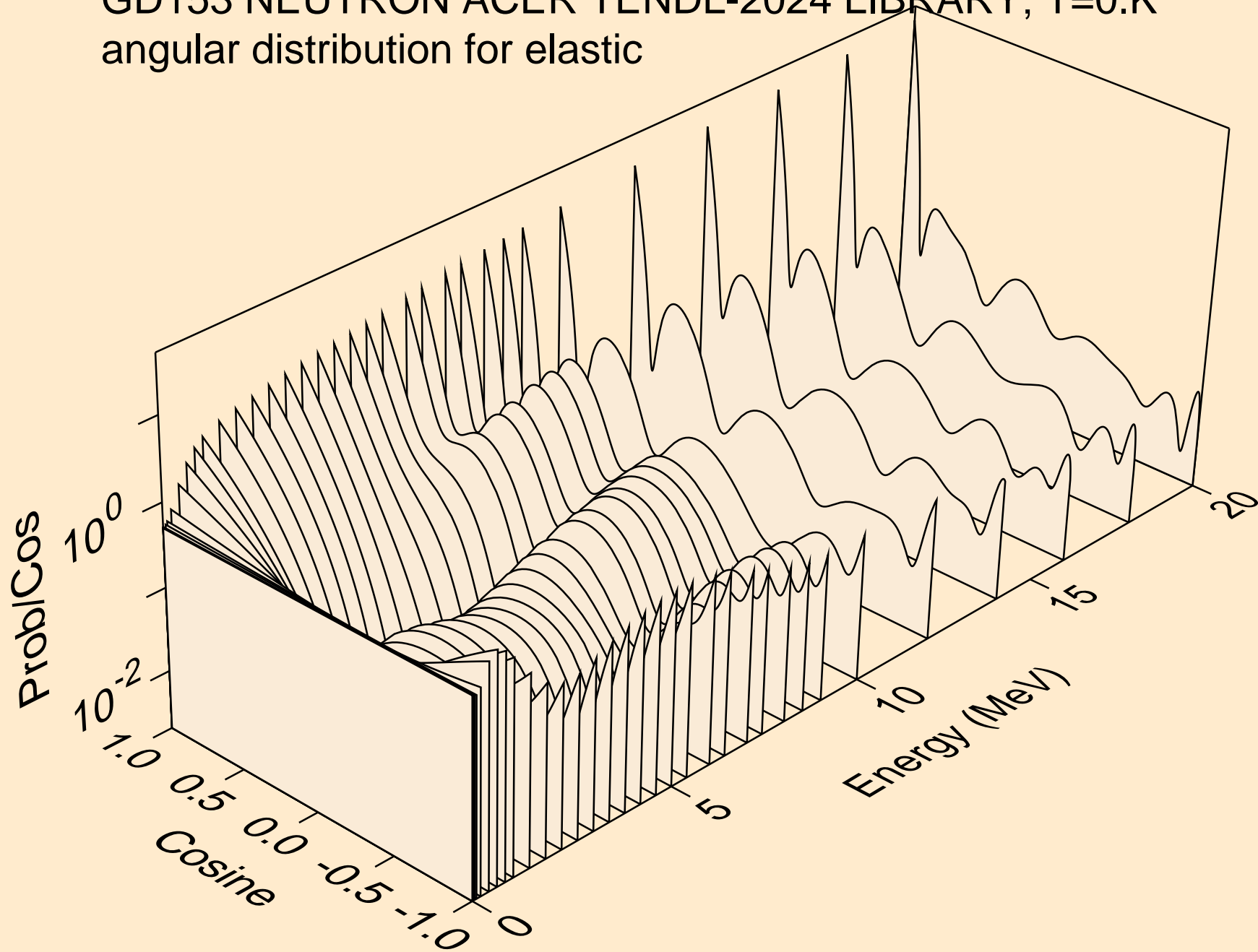

GD153 NEUTRON ACER TENDL-2024 LIBRARY; T=0.K  
angular distribution for elastic

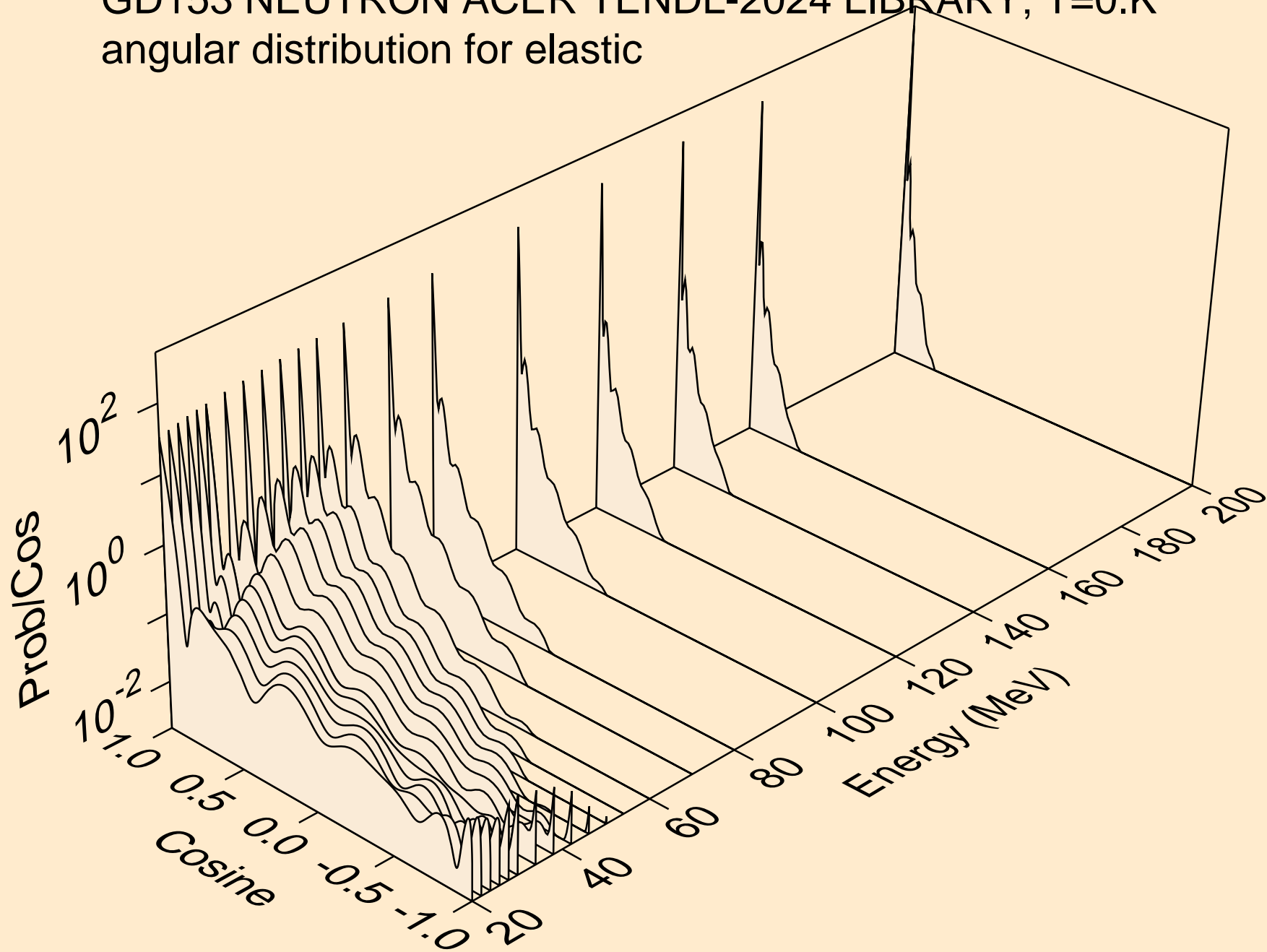

GD153 NEUTRON ACER TENDL-2024 LIBRARY; T=0.K  
angular distribution for (n,n\*1)

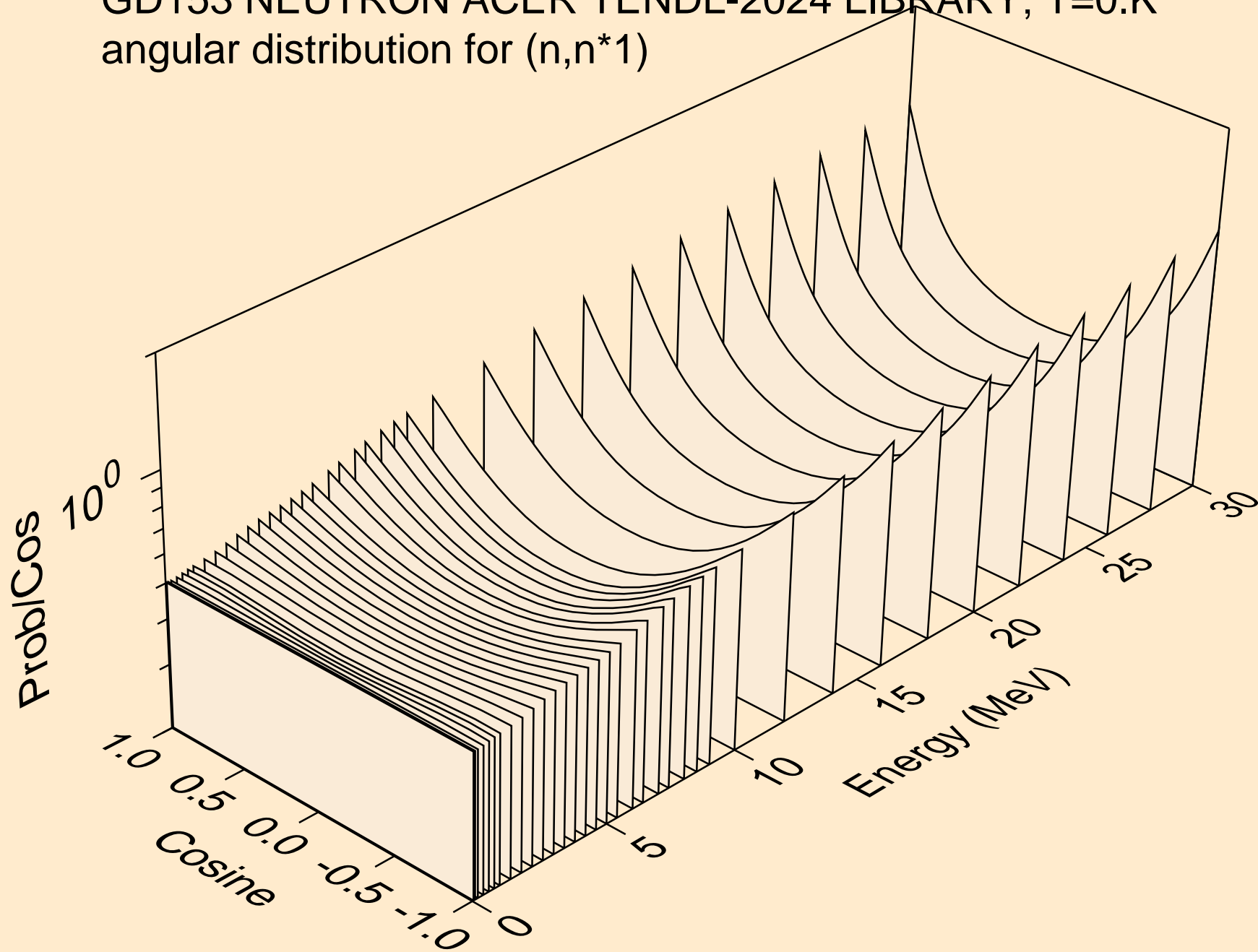

GD153 NEUTRON ACER TENDL-2024 LIBRARY; T=0.K  
angular distribution for (n,n\*2)

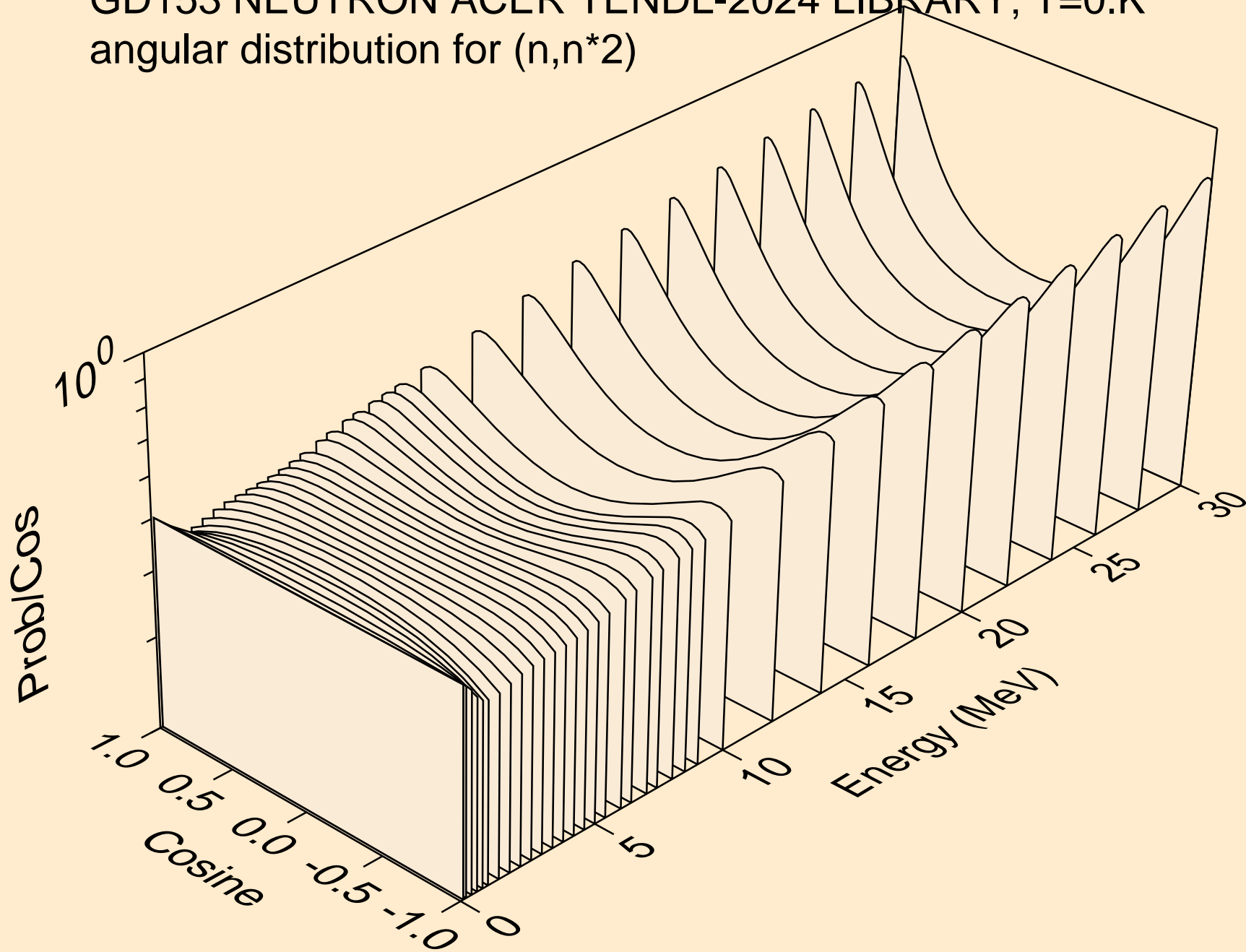

GD153 NEUTRON ACER TENDL-2024 LIBRARY; T=0.K  
angular distribution for (n,n\*3)

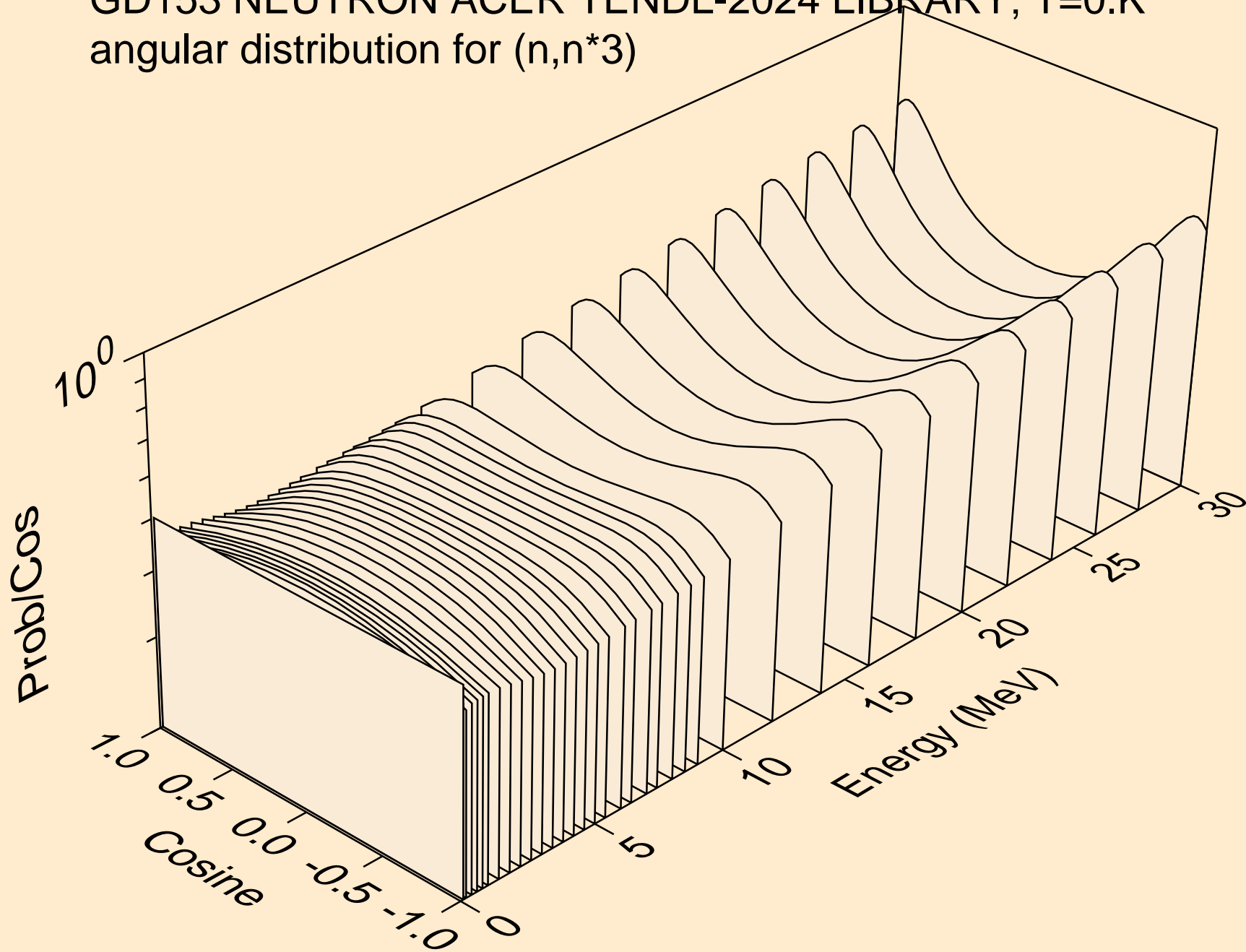

GD153 NEUTRON ACER TENDL-2024 LIBRARY; T=0.K  
angular distribution for (n,n\*4)

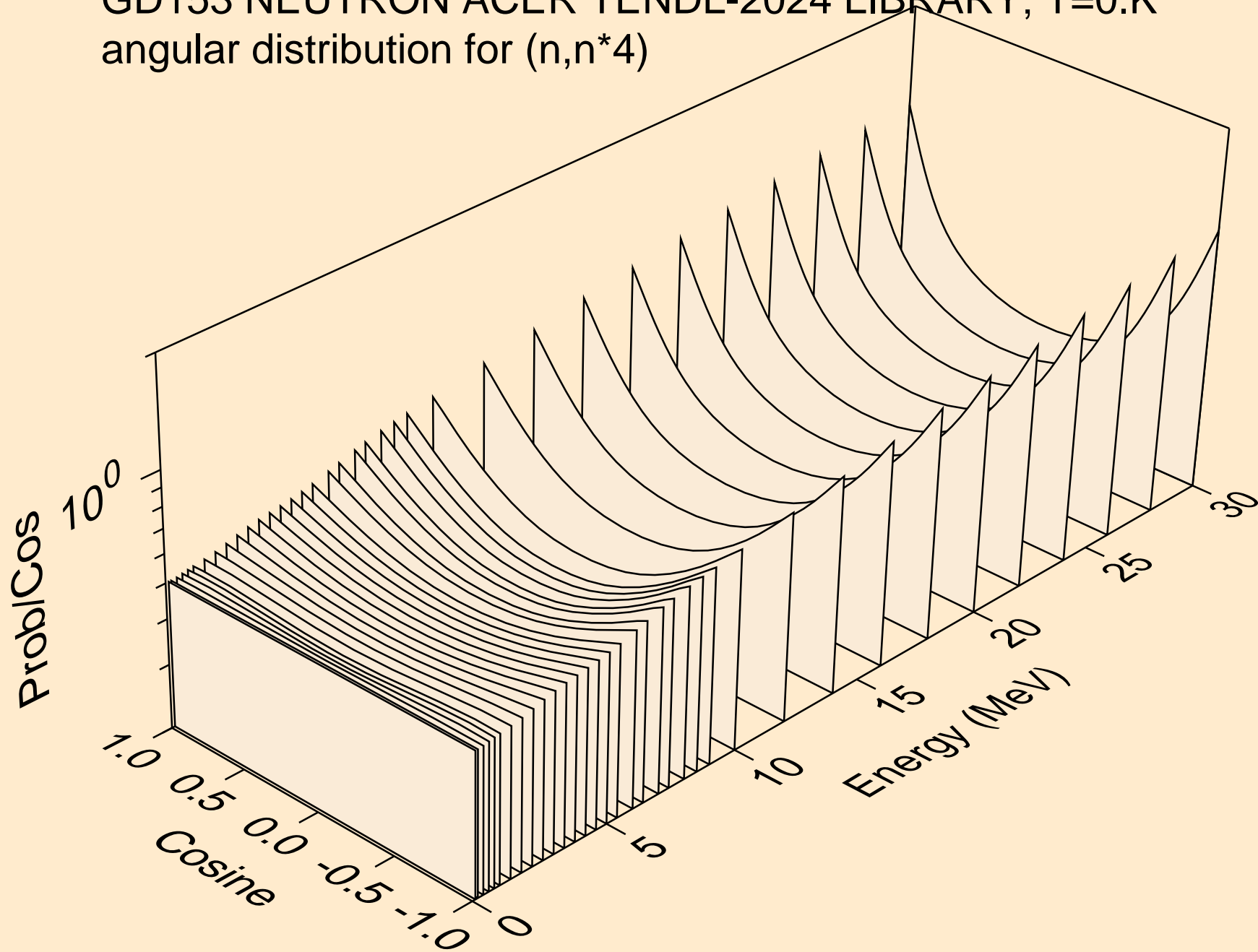

GD153 NEUTRON ACER TENDL-2024 LIBRARY; T=0.K  
angular distribution for (n,n\*5)

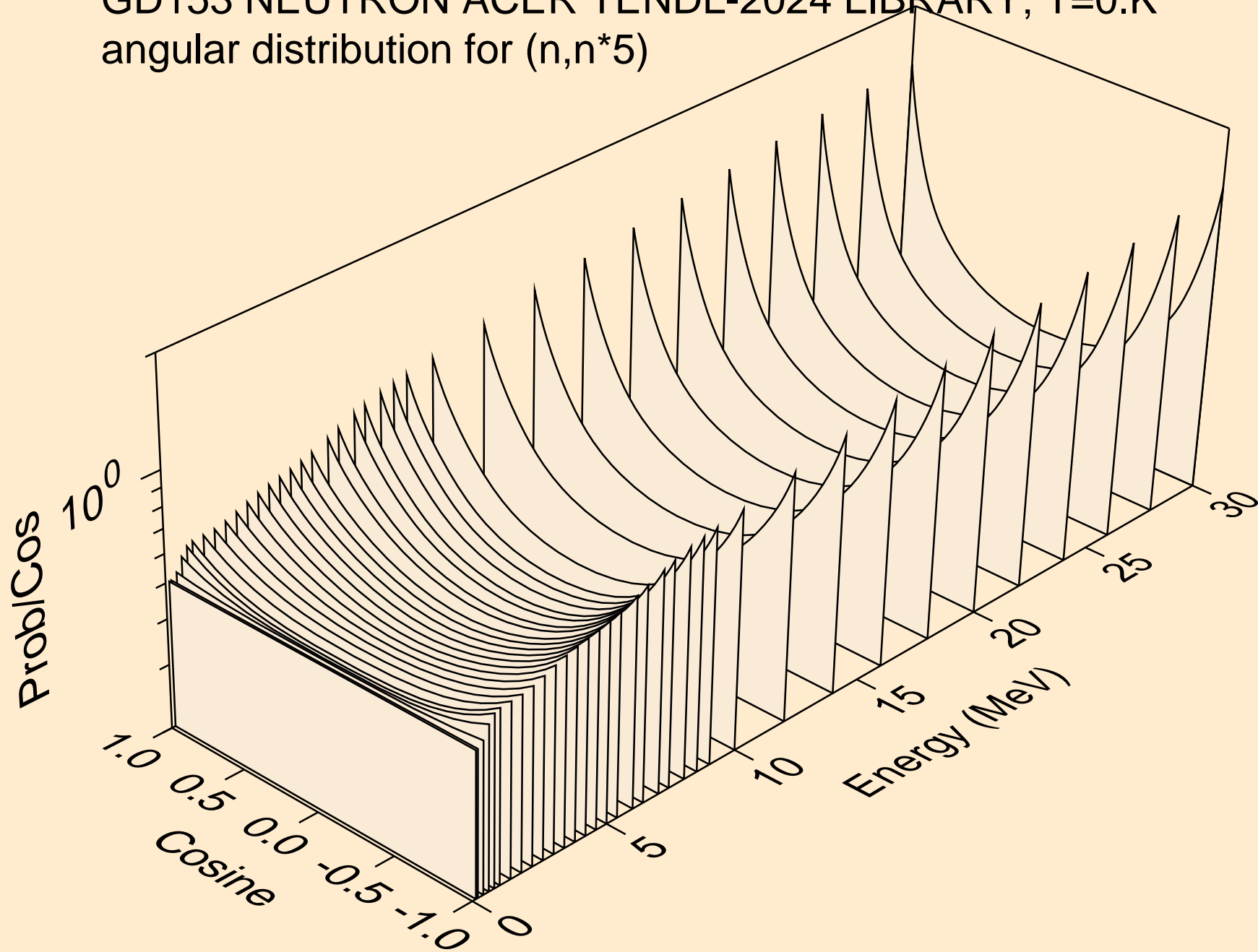

GD153 NEUTRON ACER TENDL-2024 LIBRARY; T=0.K  
angular distribution for (n,n\*6)

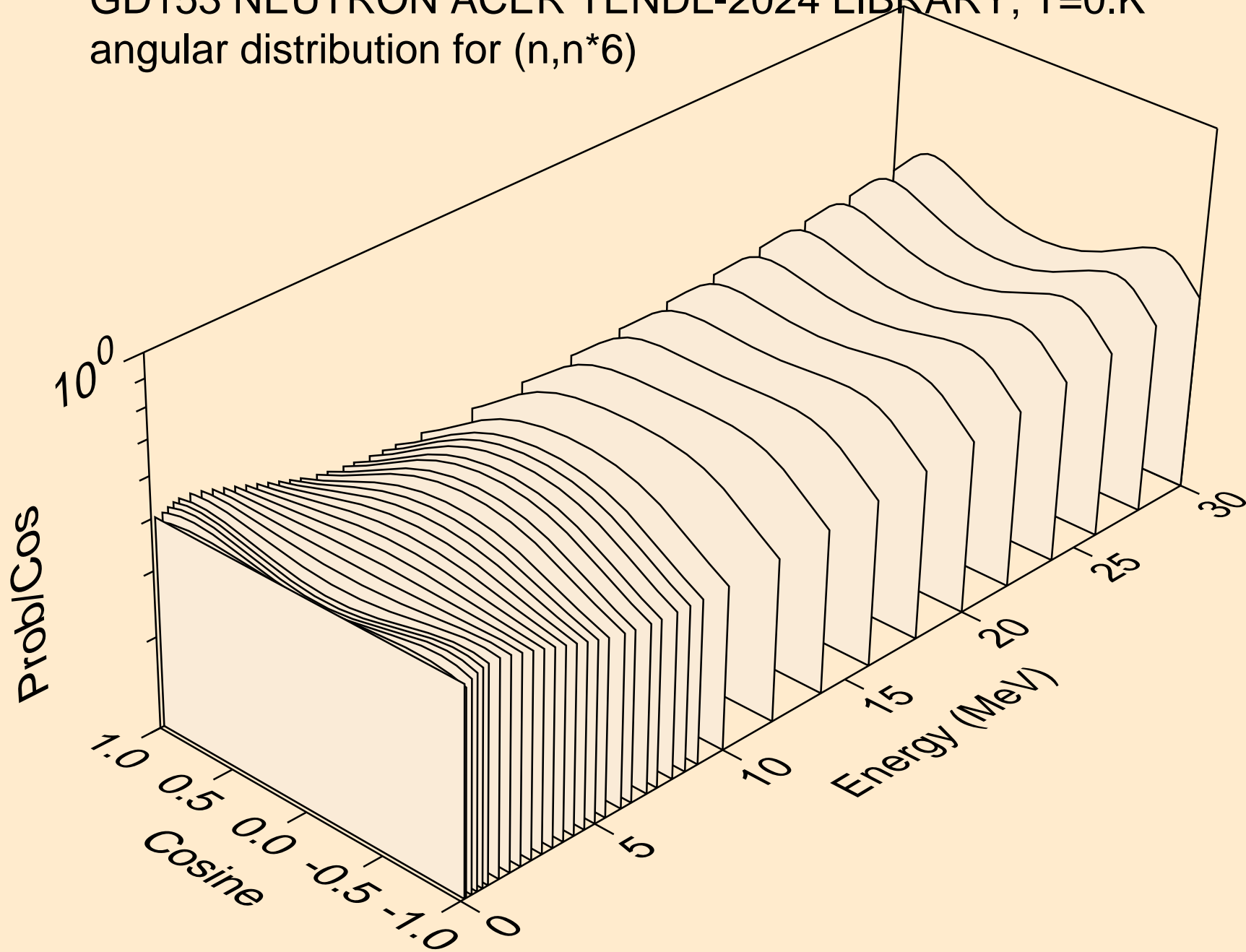



GD153 NEUTRON ACER TENDL-2024 LIBRARY; T=0.K  
angular distribution for (n,n\*7)

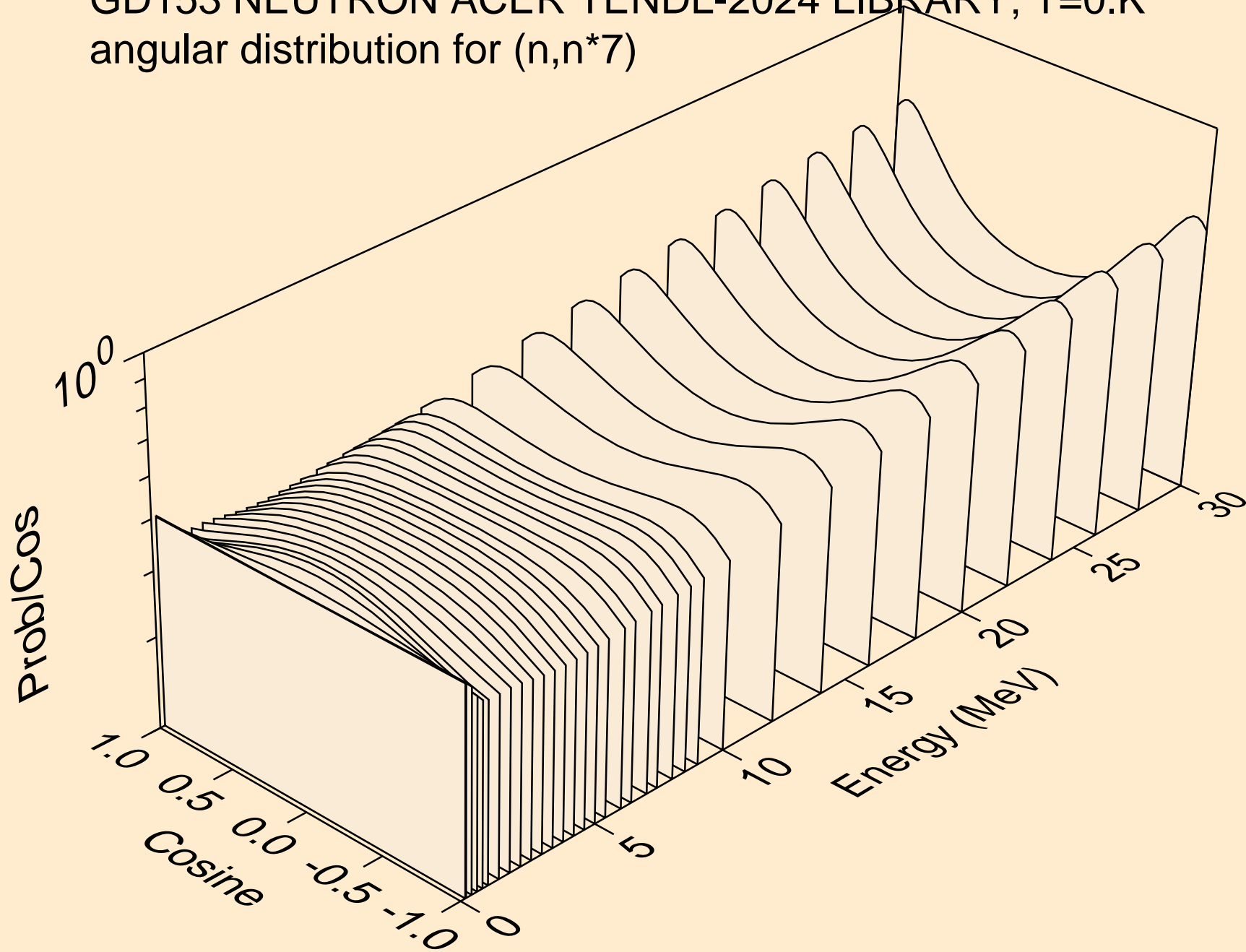

GD153 NEUTRON ACER TENDL-2024 LIBRARY; T=0.K  
angular distribution for (n,n\*8)

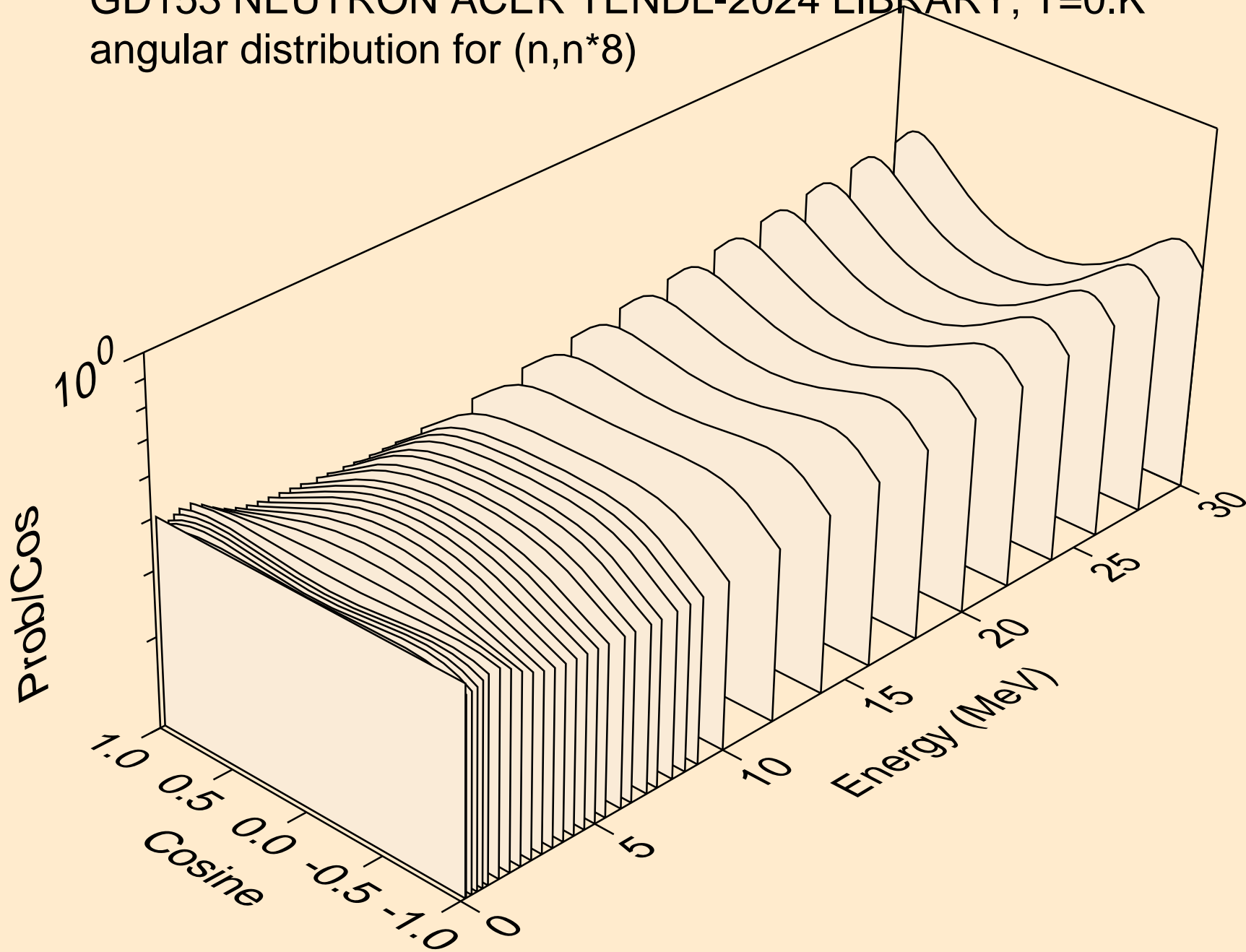

GD153 NEUTRON ACER TENDL-2024 LIBRARY; T=0.K  
angular distribution for (n,n\*9)

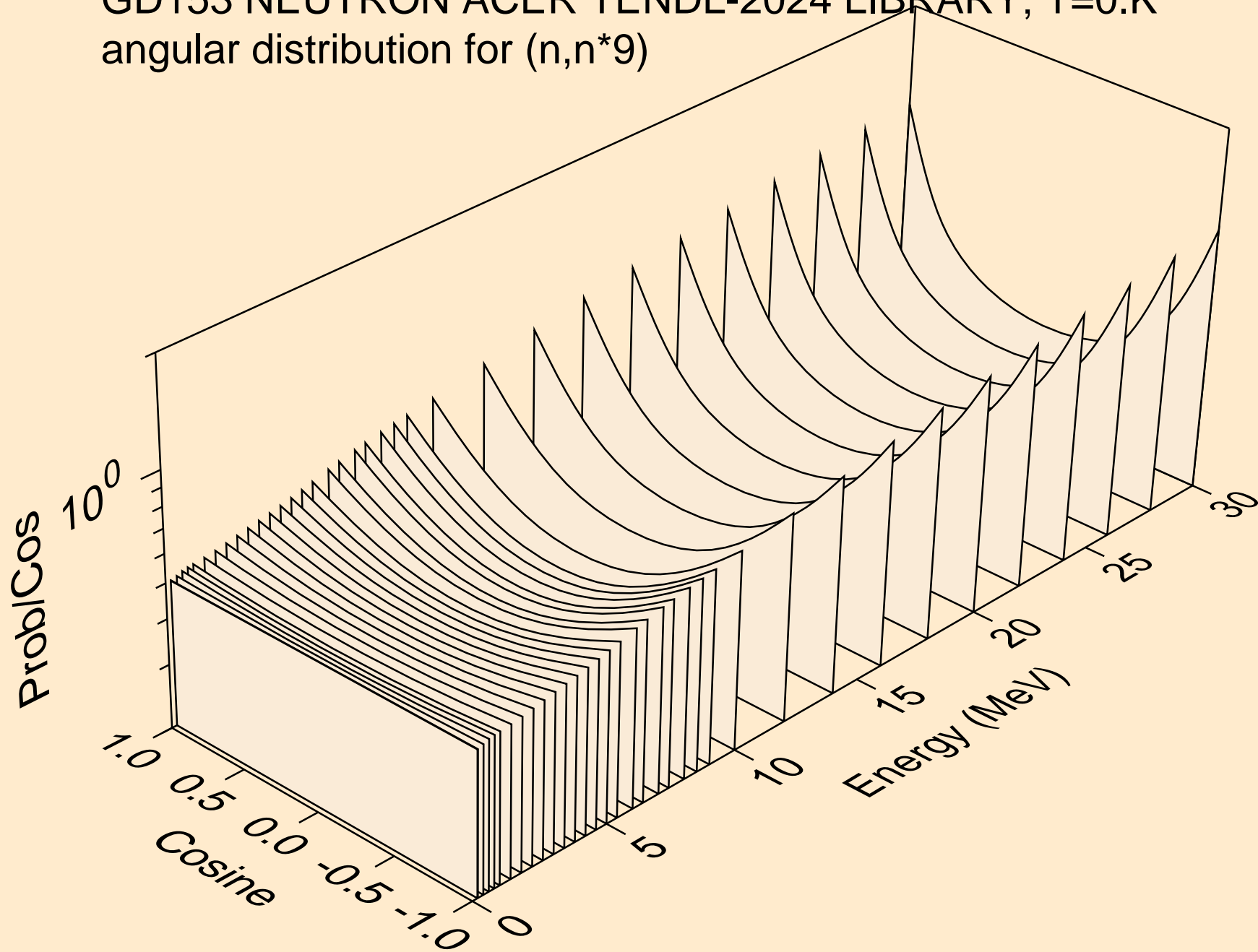

GD153 NEUTRON ACER TENDL-2024 LIBRARY; T=0.K  
angular distribution for (n,n\*10)

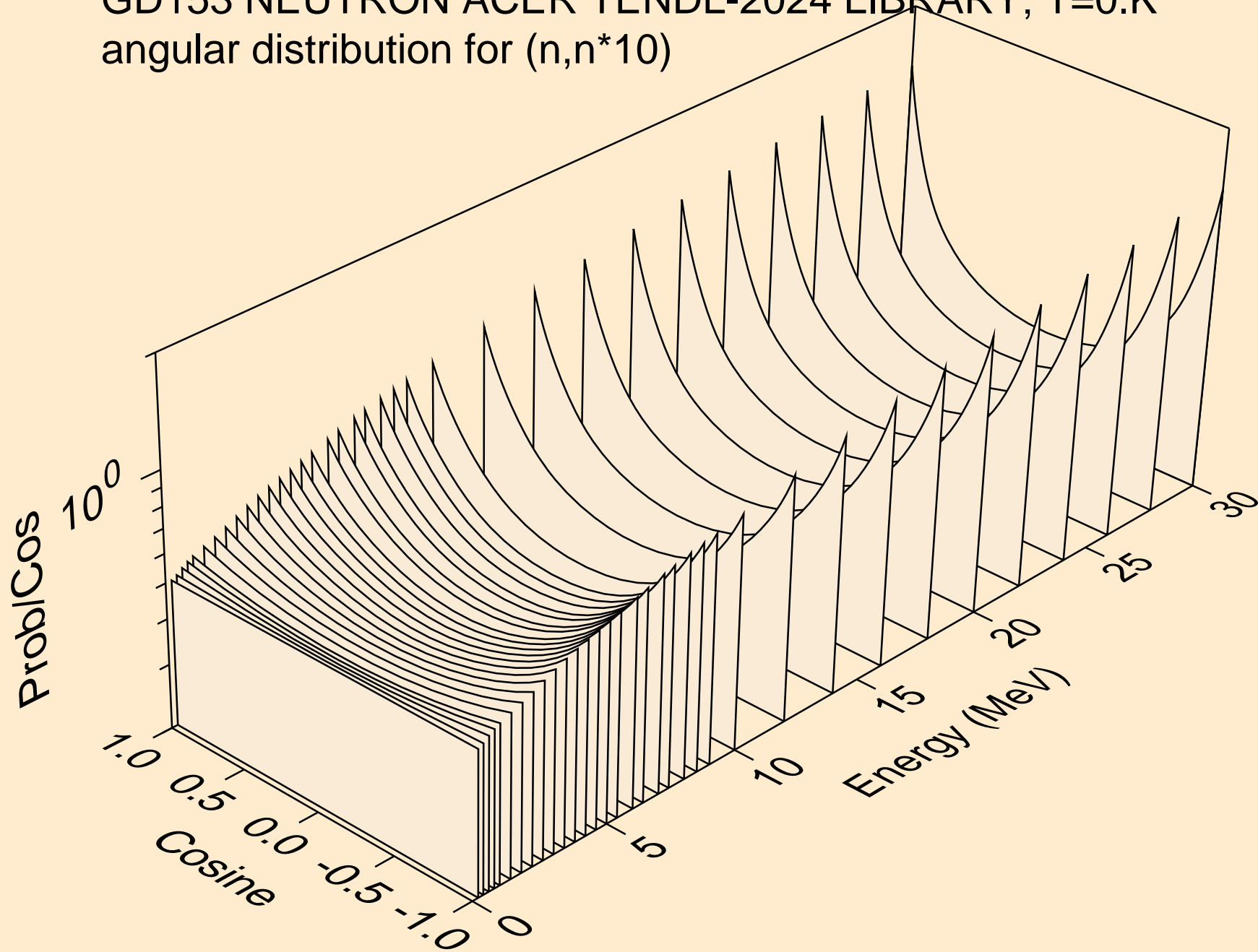

GD153 NEUTRON ACER TENDL-2024 LIBRARY; T=0.K  
angular distribution for (n,n\*11)

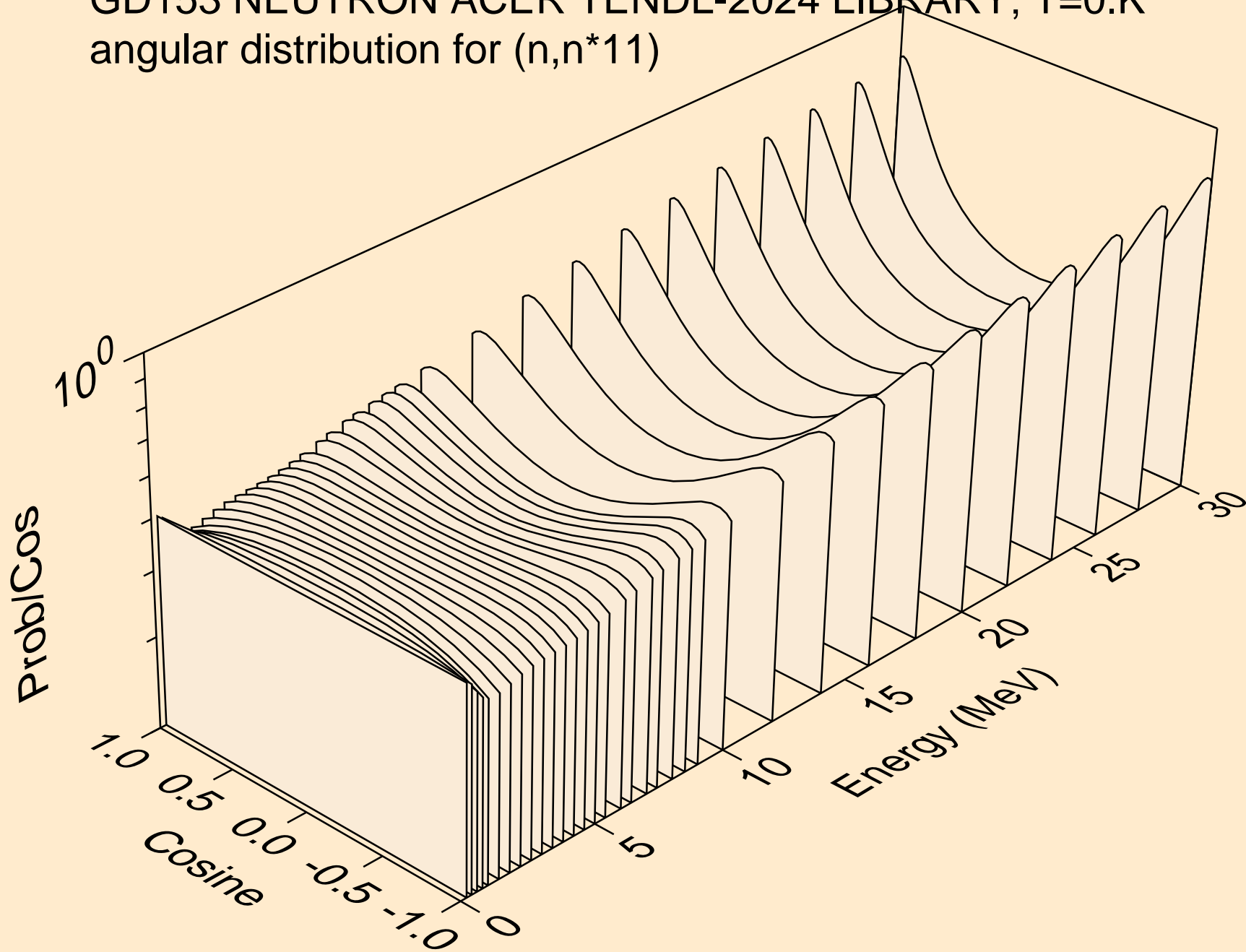

GD153 NEUTRON ACER TENDL-2024 LIBRARY; T=0.K  
angular distribution for (n,n\*12)

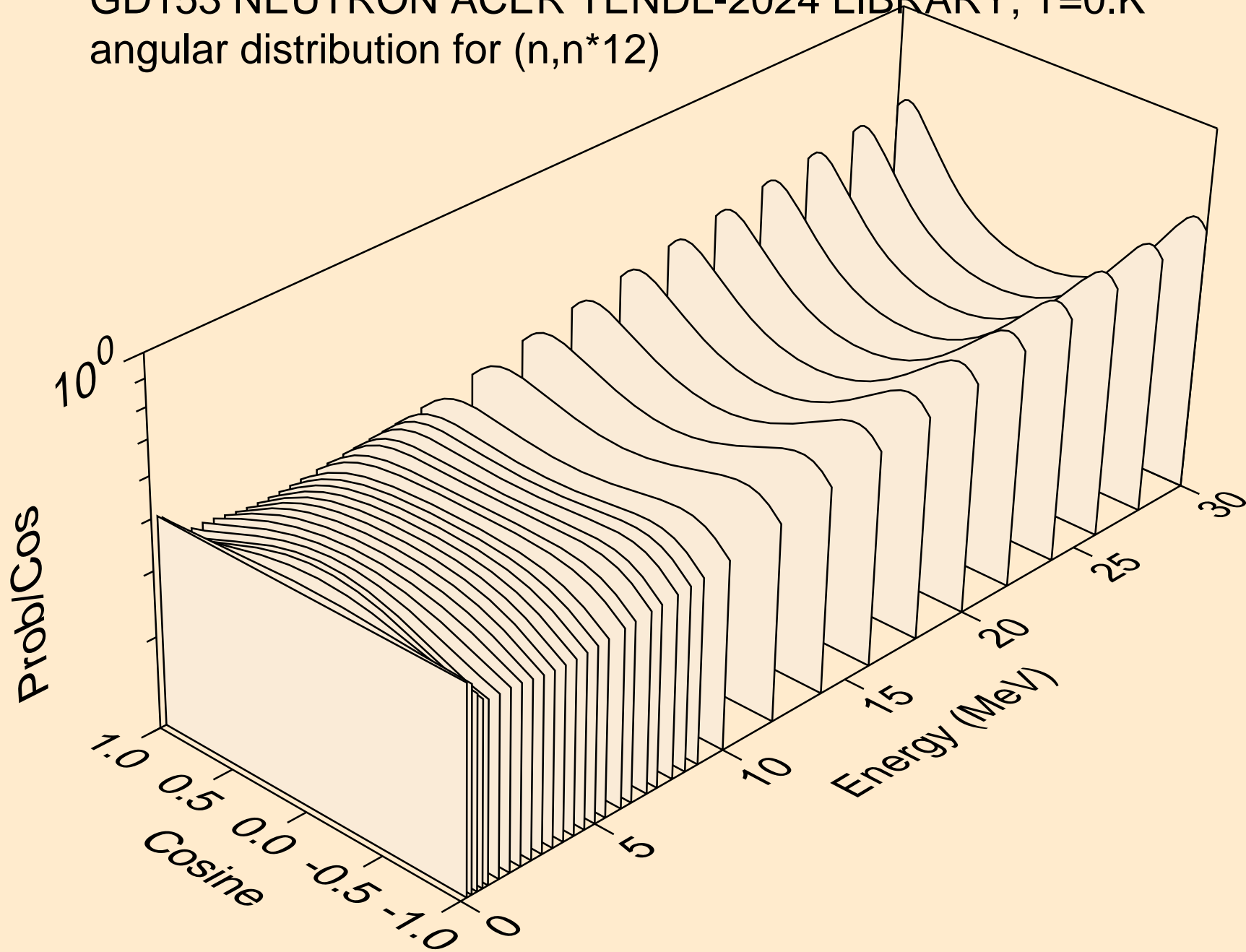

GD153 NEUTRON ACER TENDL-2024 LIBRARY; T=0.K  
angular distribution for (n,n\*13)

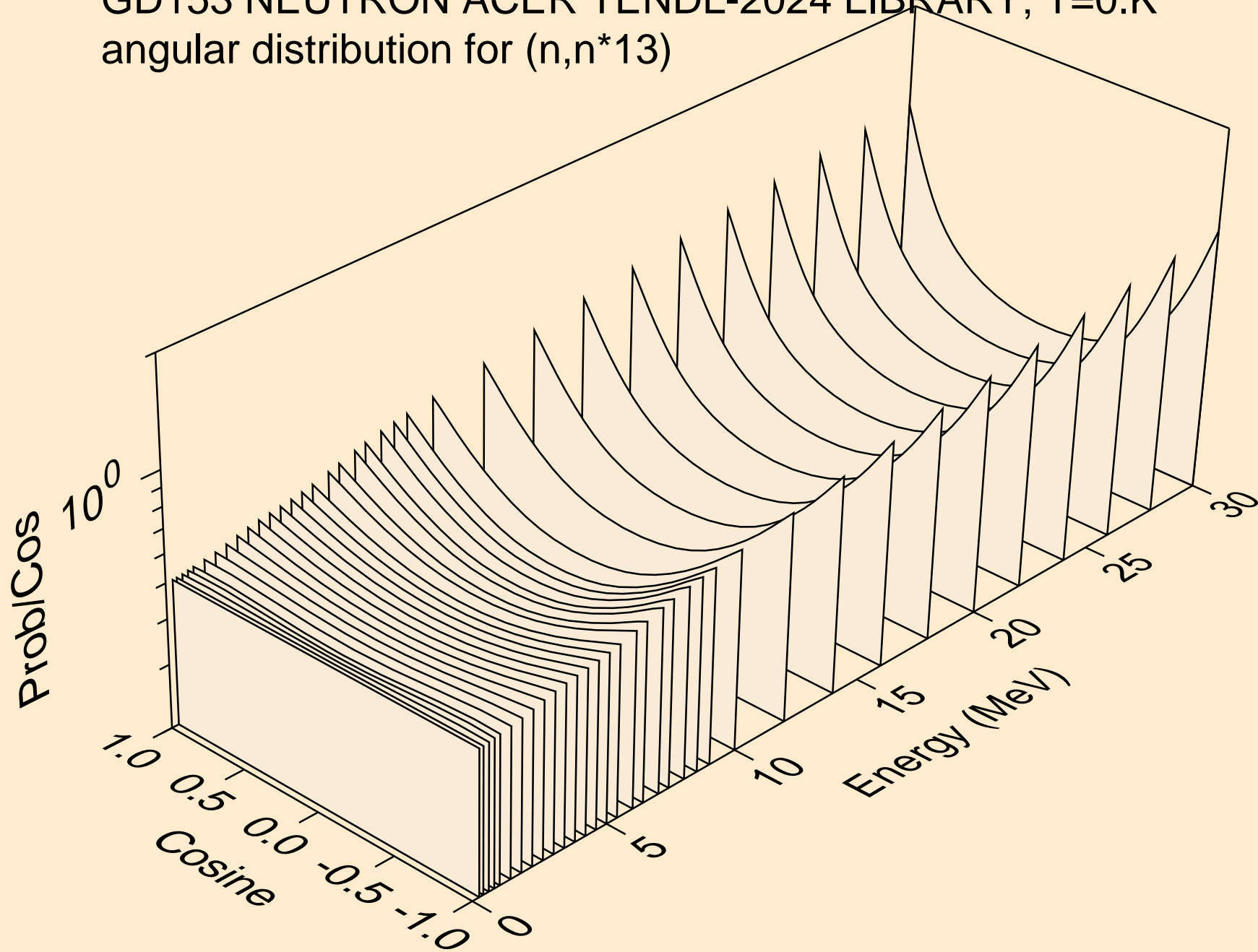

GD153 NEUTRON ACER TENDL-2024 LIBRARY; T=0.K  
angular distribution for (n,n\*14)

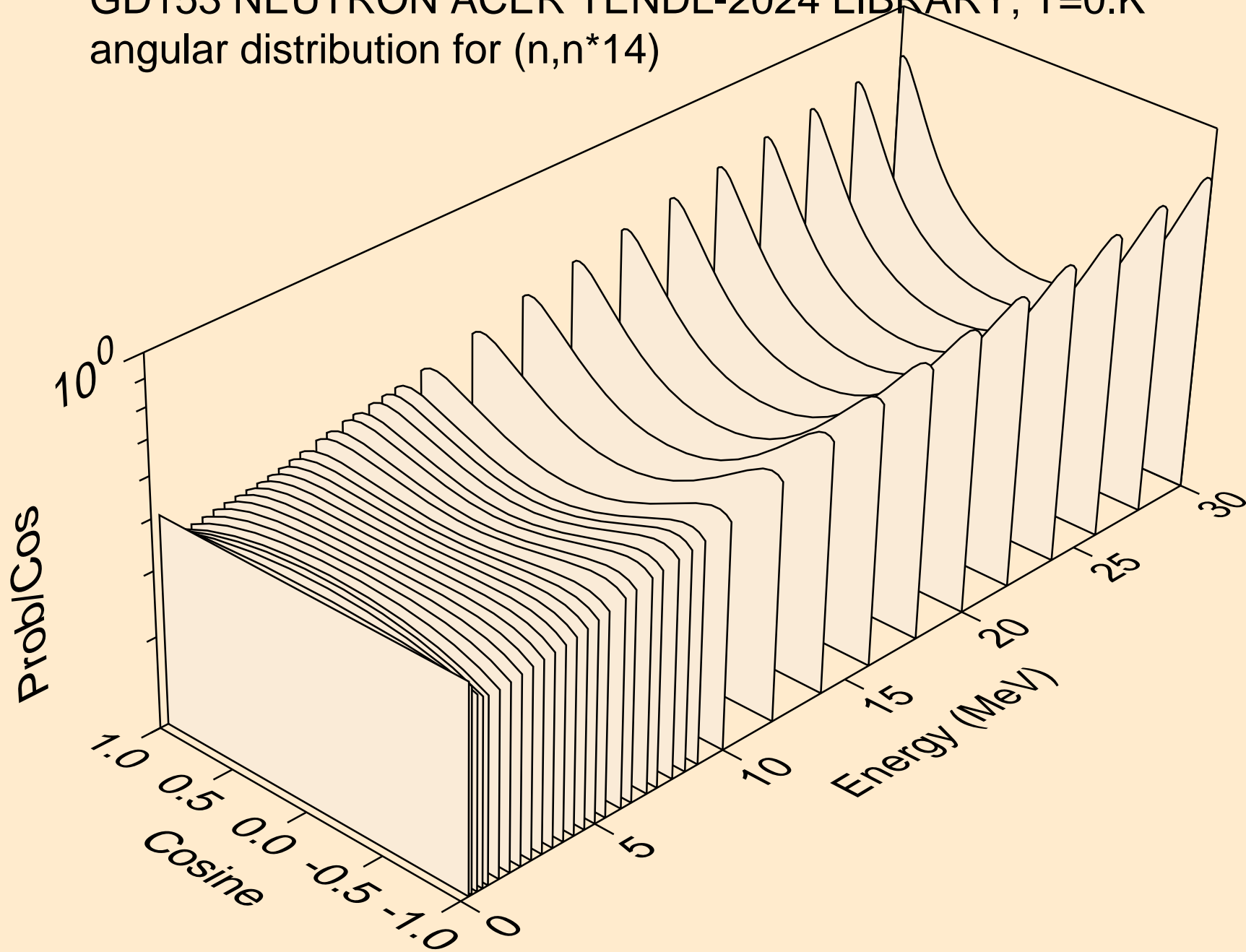



GD153 NEUTRON ACER TENDL-2024 LIBRARY; T=0.K  
angular distribution for (n,n\*15)

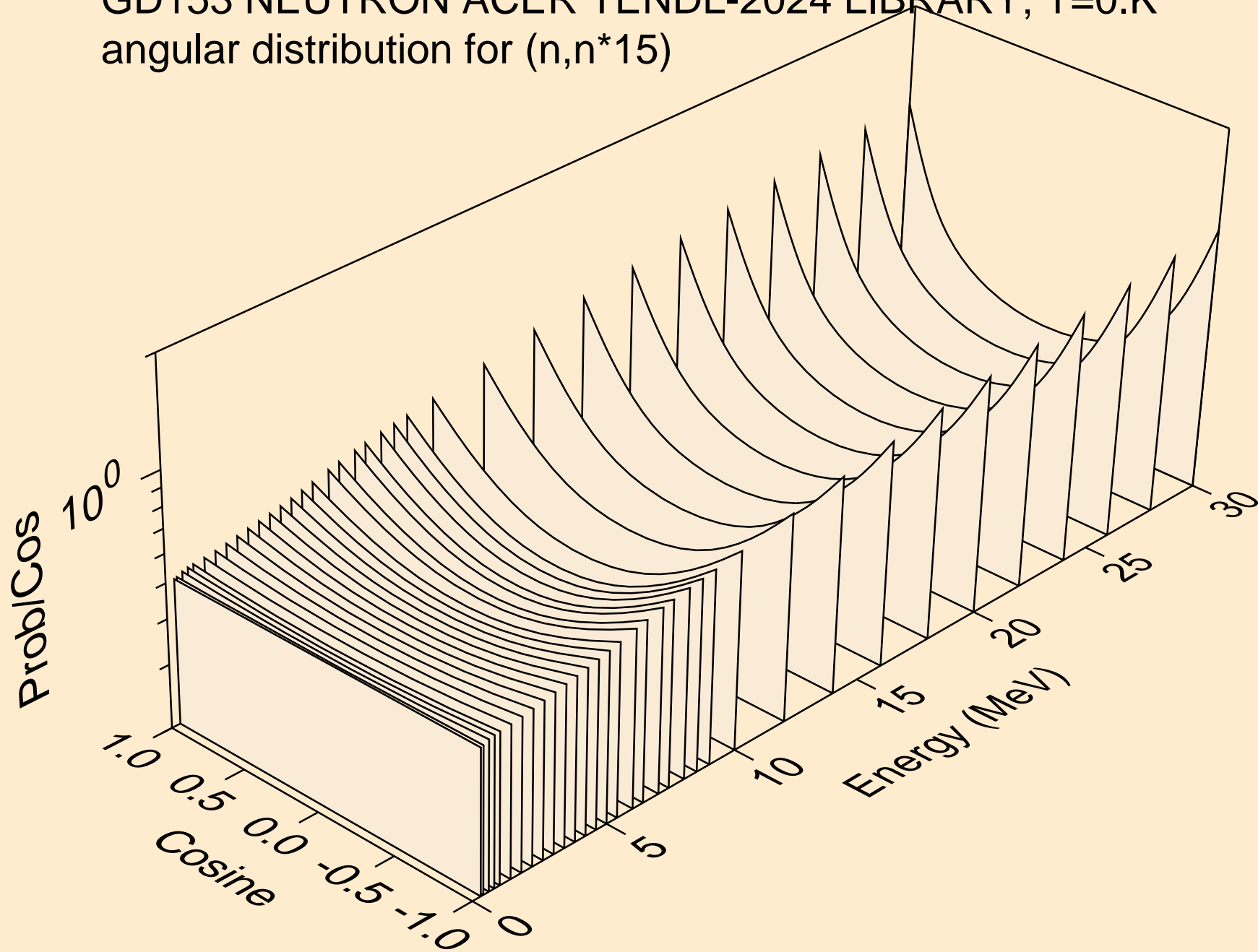

GD153 NEUTRON ACER TENDL-2024 LIBRARY; T=0.K  
angular distribution for (n,n\*16)

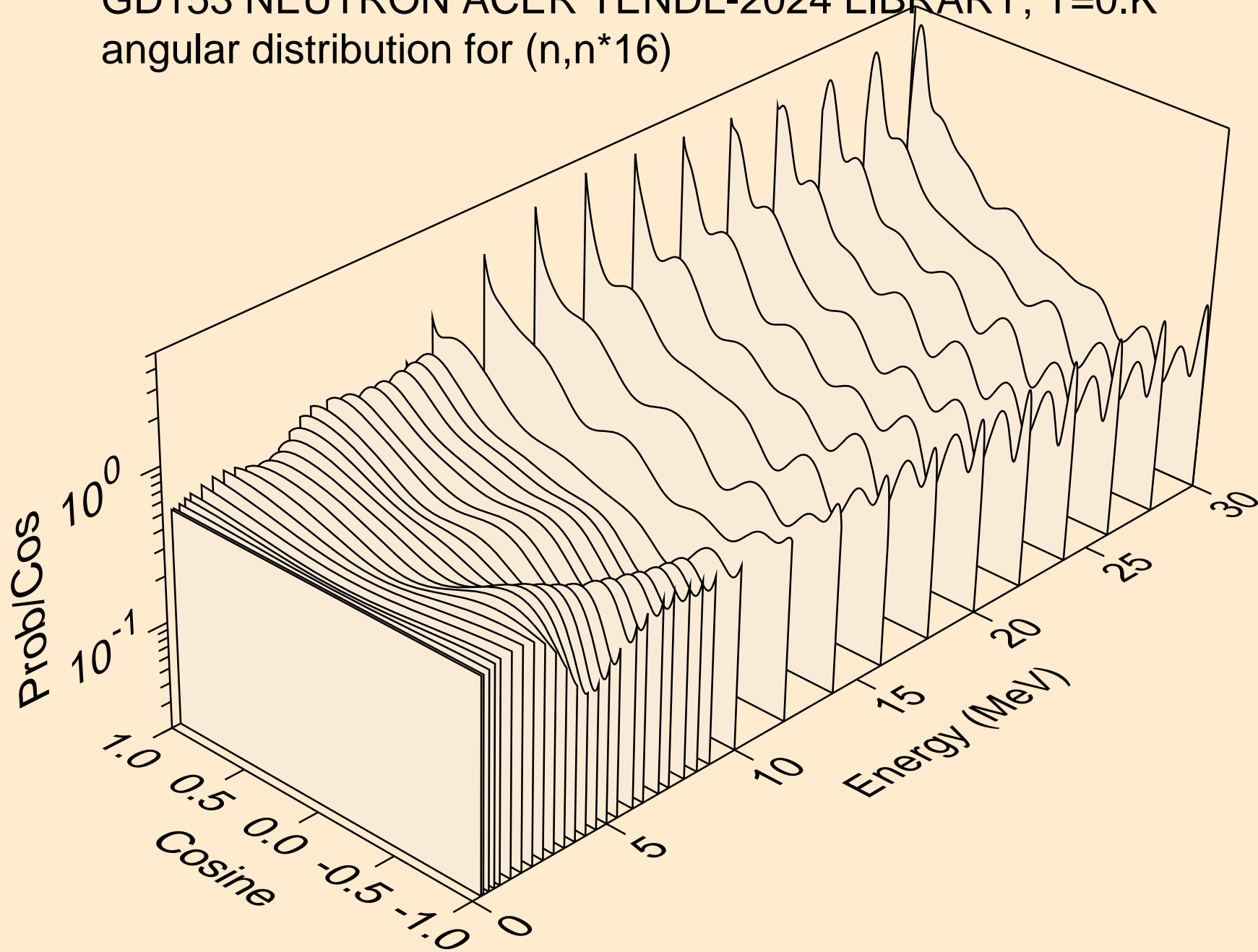

GD153 NEUTRON ACER TENDL-2024 LIBRARY; T=0.K  
angular distribution for (n,n\*17)

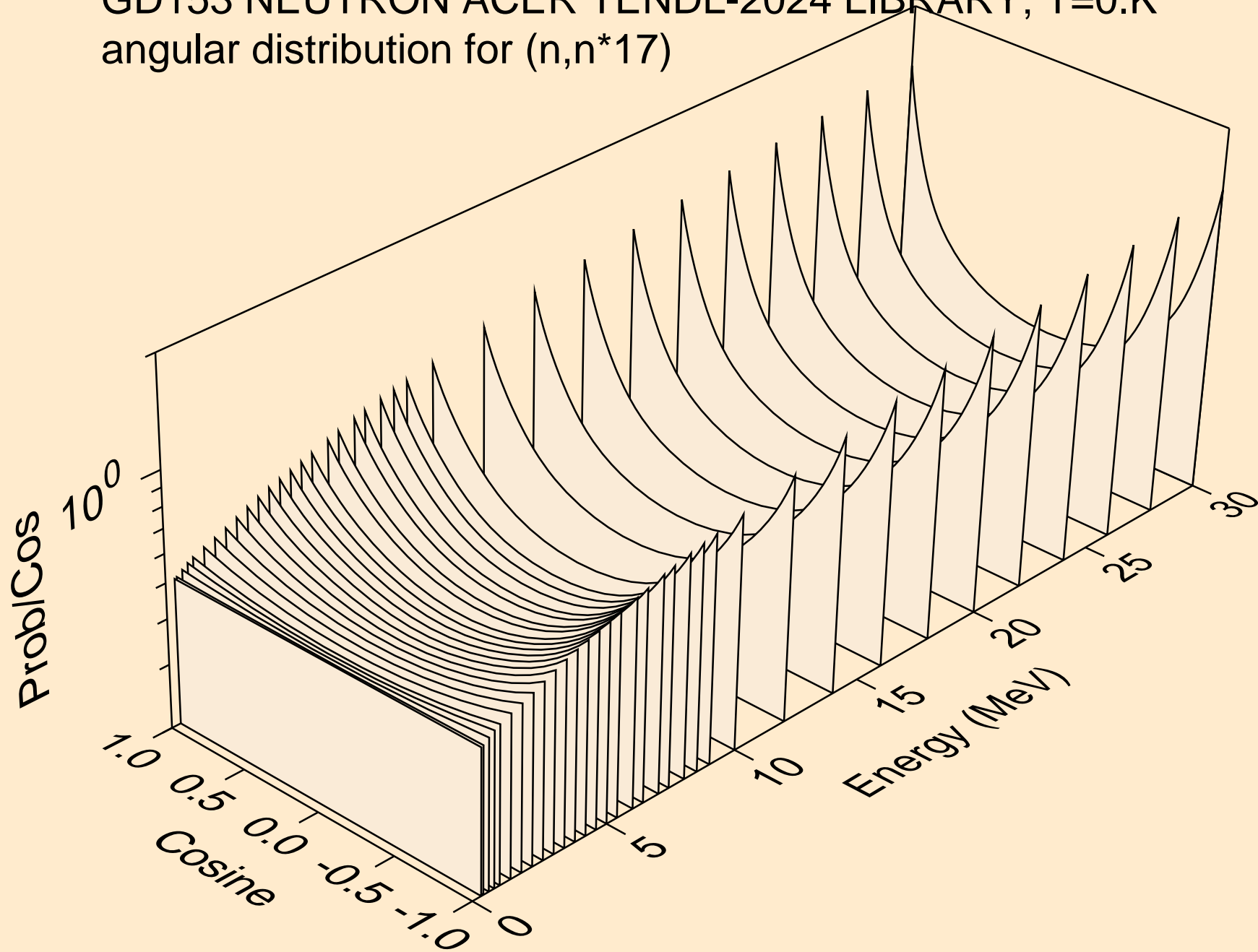

GD153 NEUTRON ACER TENDL-2024 LIBRARY; T=0.K  
angular distribution for (n,n\*18)

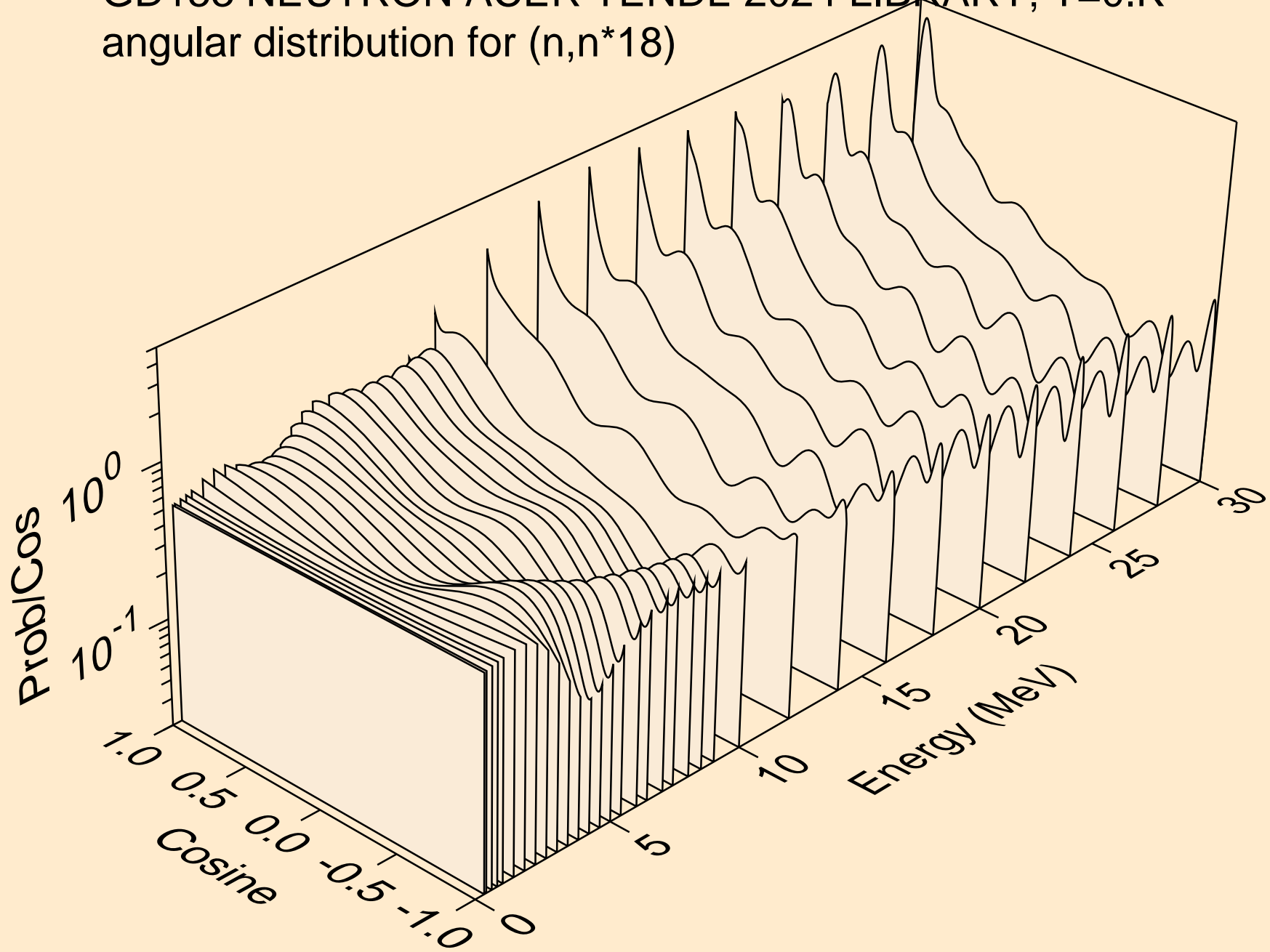

GD153 NEUTRON ACER TENDL-2024 LIBRARY; T=0.K  
angular distribution for (n,n\*19)

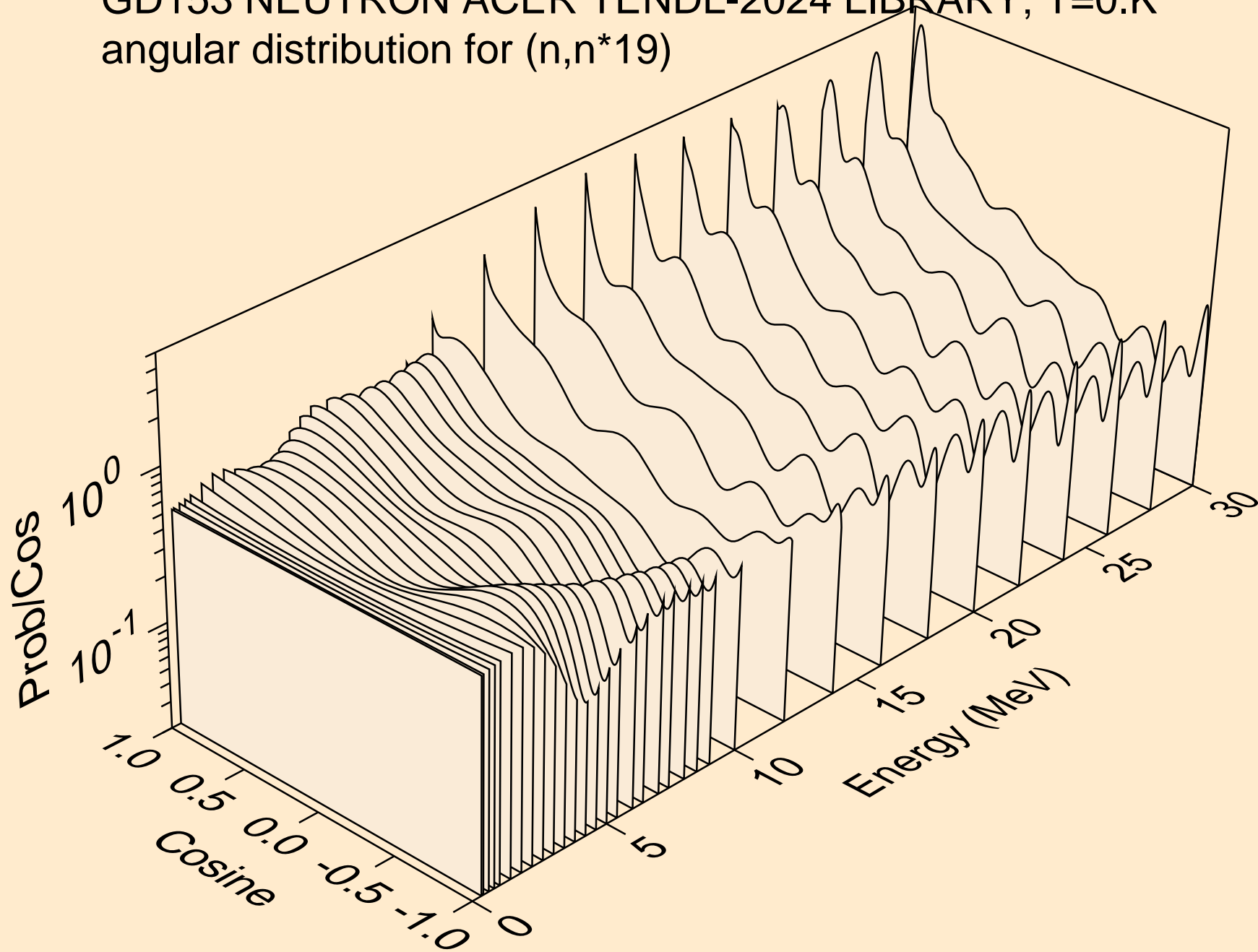

GD153 NEUTRON ACER TENDL-2024 LIBRARY; T=0.K  
angular distribution for (n,n\*20)

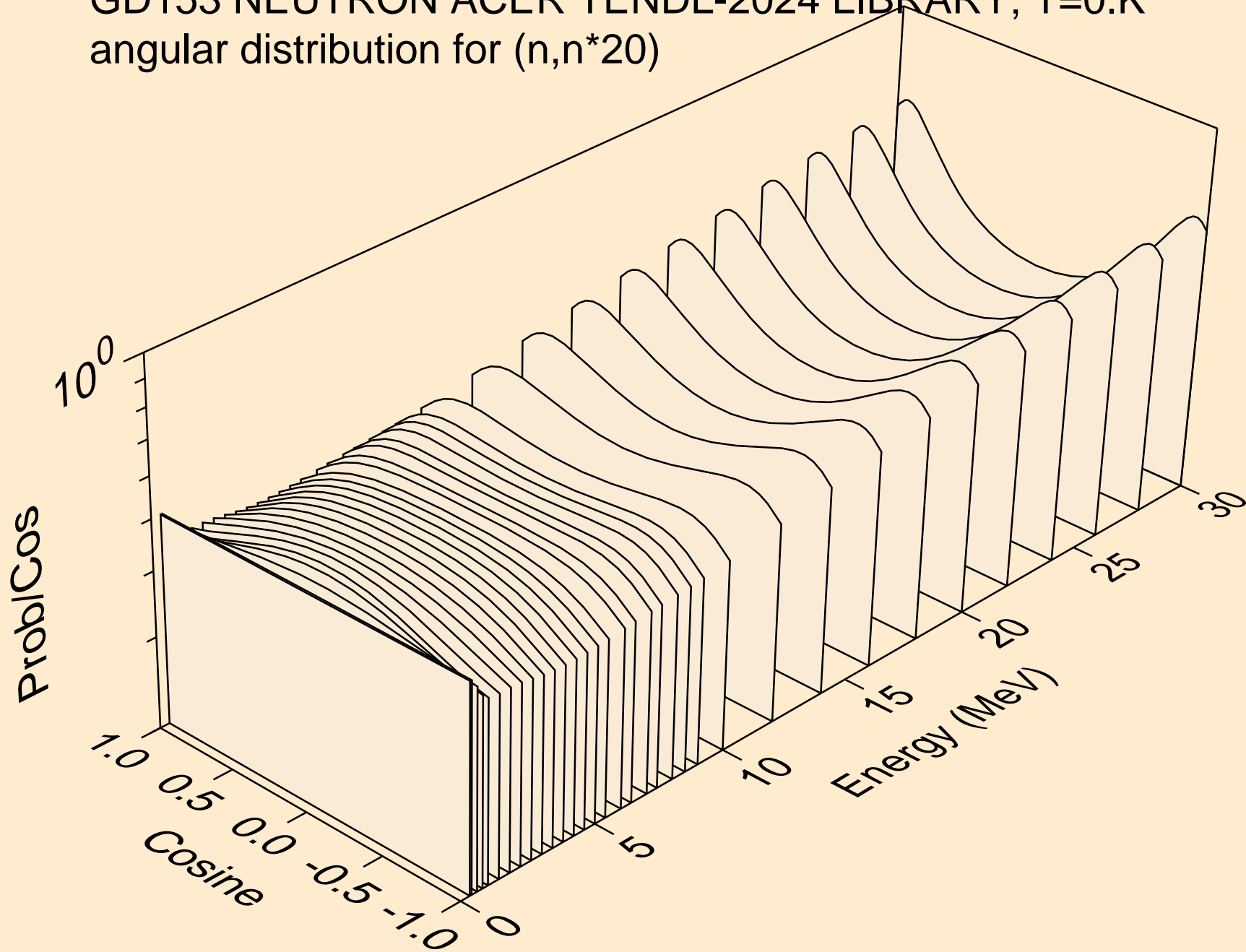

GD153 NEUTRON ACER TENDL-2024 LIBRARY; T=0.K  
angular distribution for (n,n\*21)

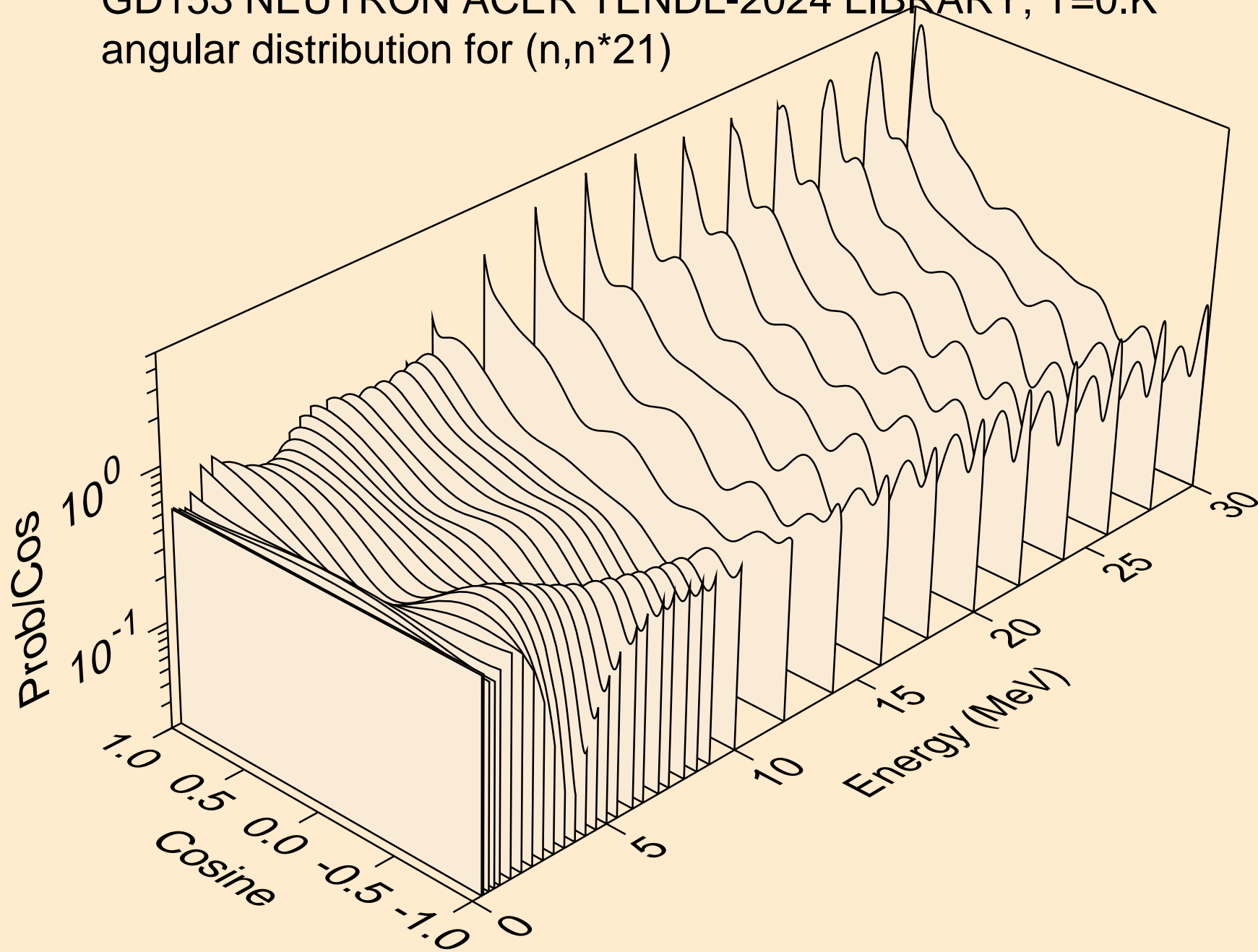



GD153 NEUTRON ACER TENDL-2024 LIBRARY; T=0.K  
angular distribution for (n,n\*22)

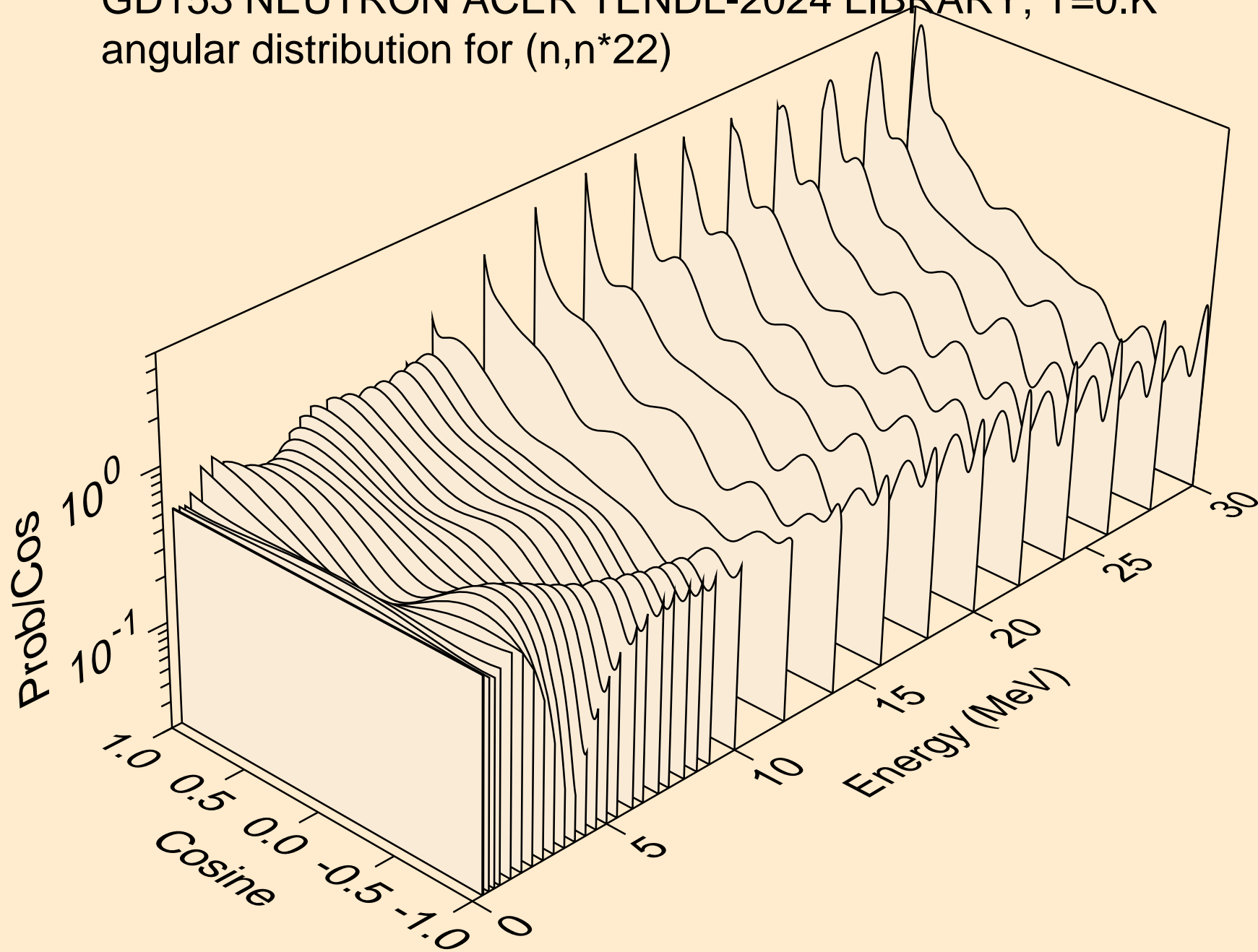



GD153 NEUTRON ACER TENDL-2024 LIBRARY; T=0.K  
angular distribution for (n,n\*23)

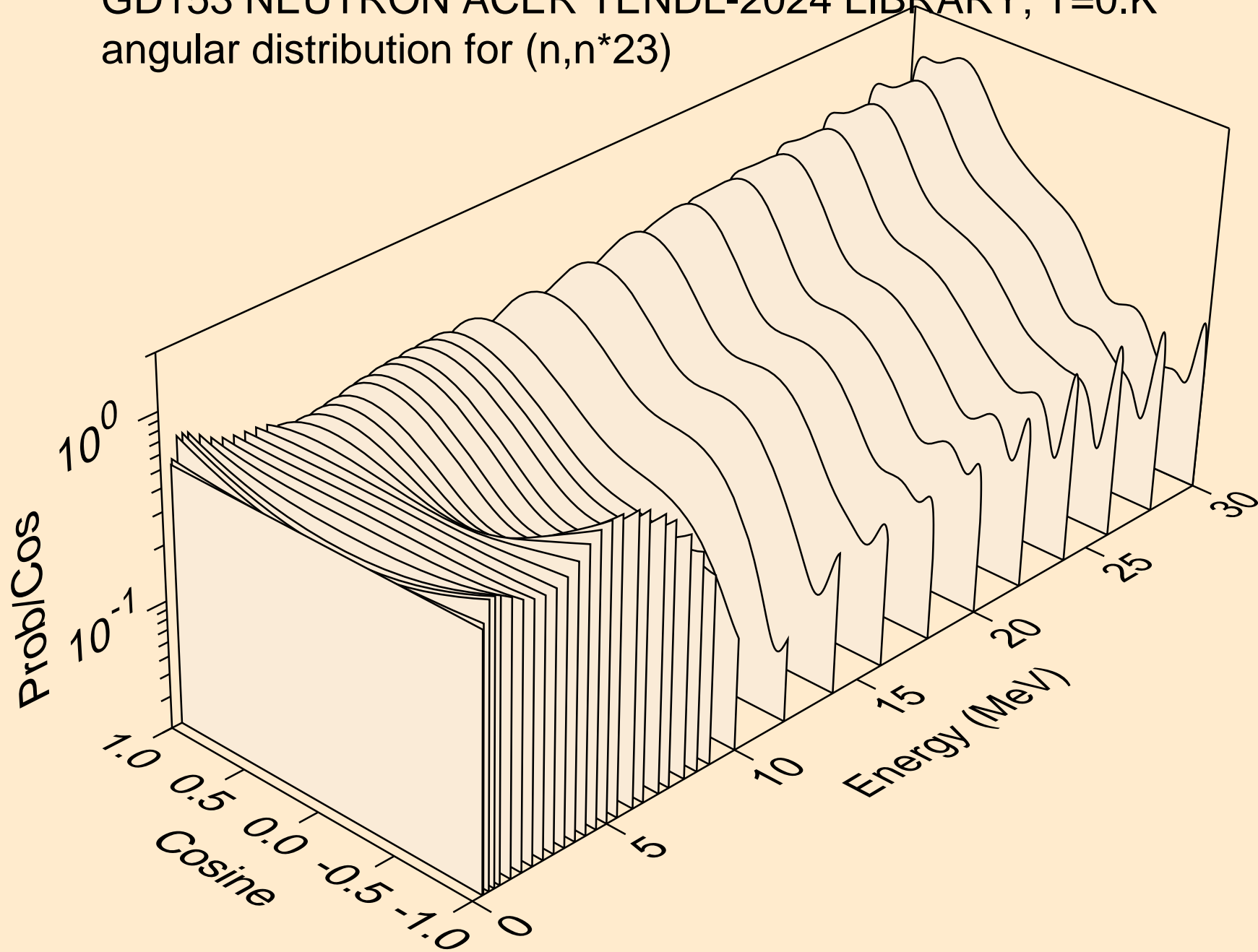

GD153 NEUTRON ACER TENDL-2024 LIBRARY; T=0.K  
angular distribution for (n,n\*24)

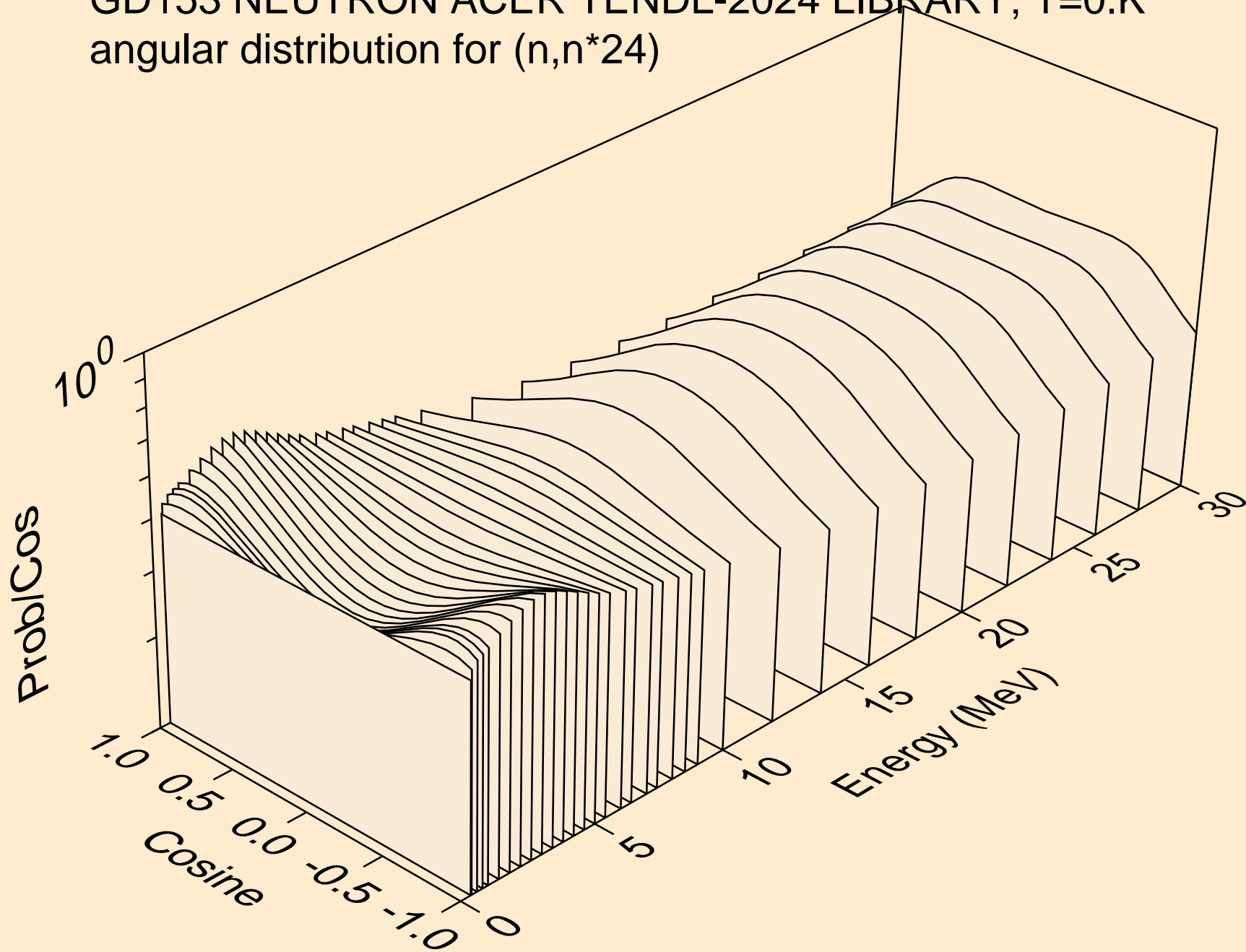

GD153 NEUTRON ACER TENDL-2024 LIBRARY; T=0.K  
angular distribution for (n,n\*25)

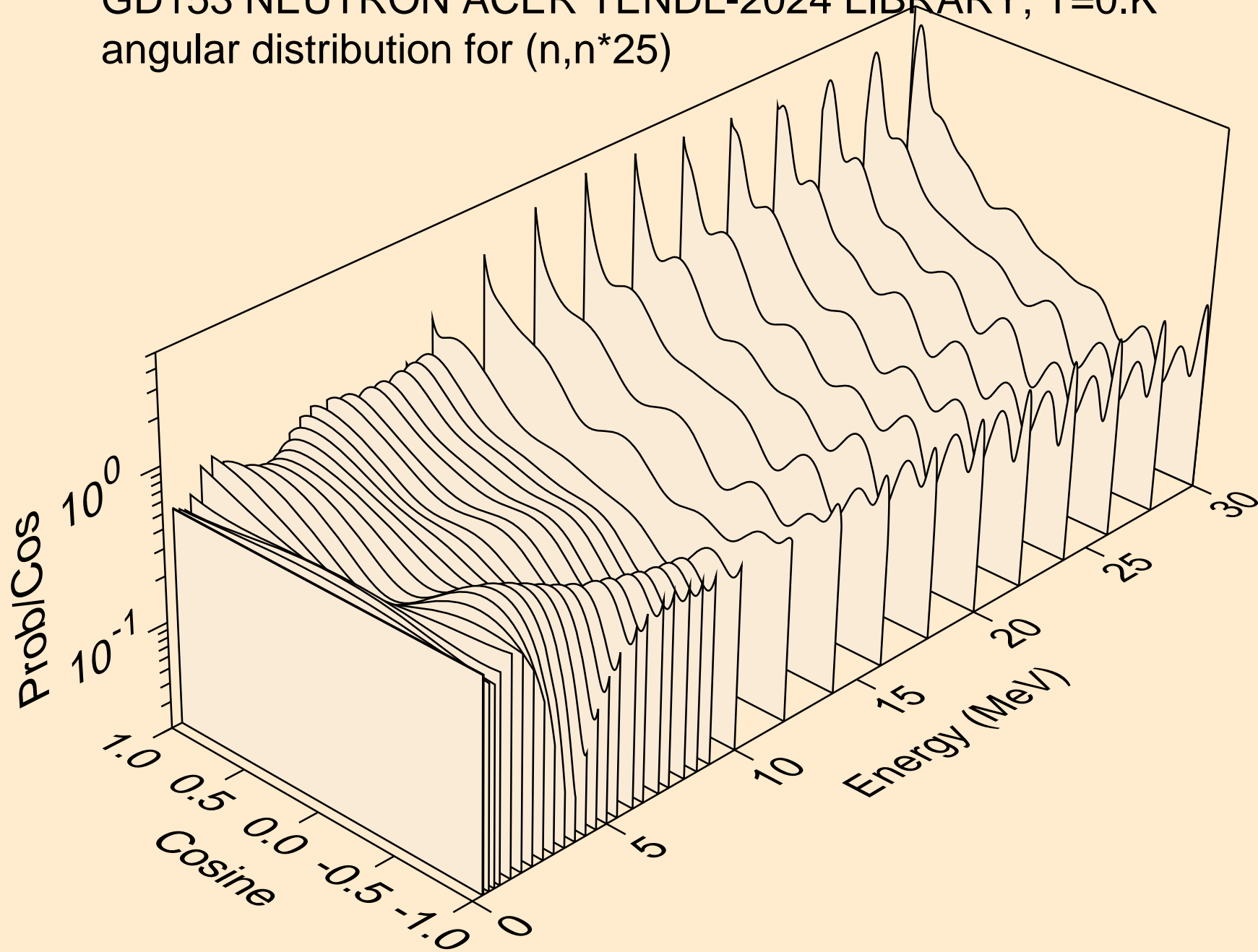

GD153 NEUTRON ACER TENDL-2024 LIBRARY; T=0.K  
angular distribution for (n,n\*26)

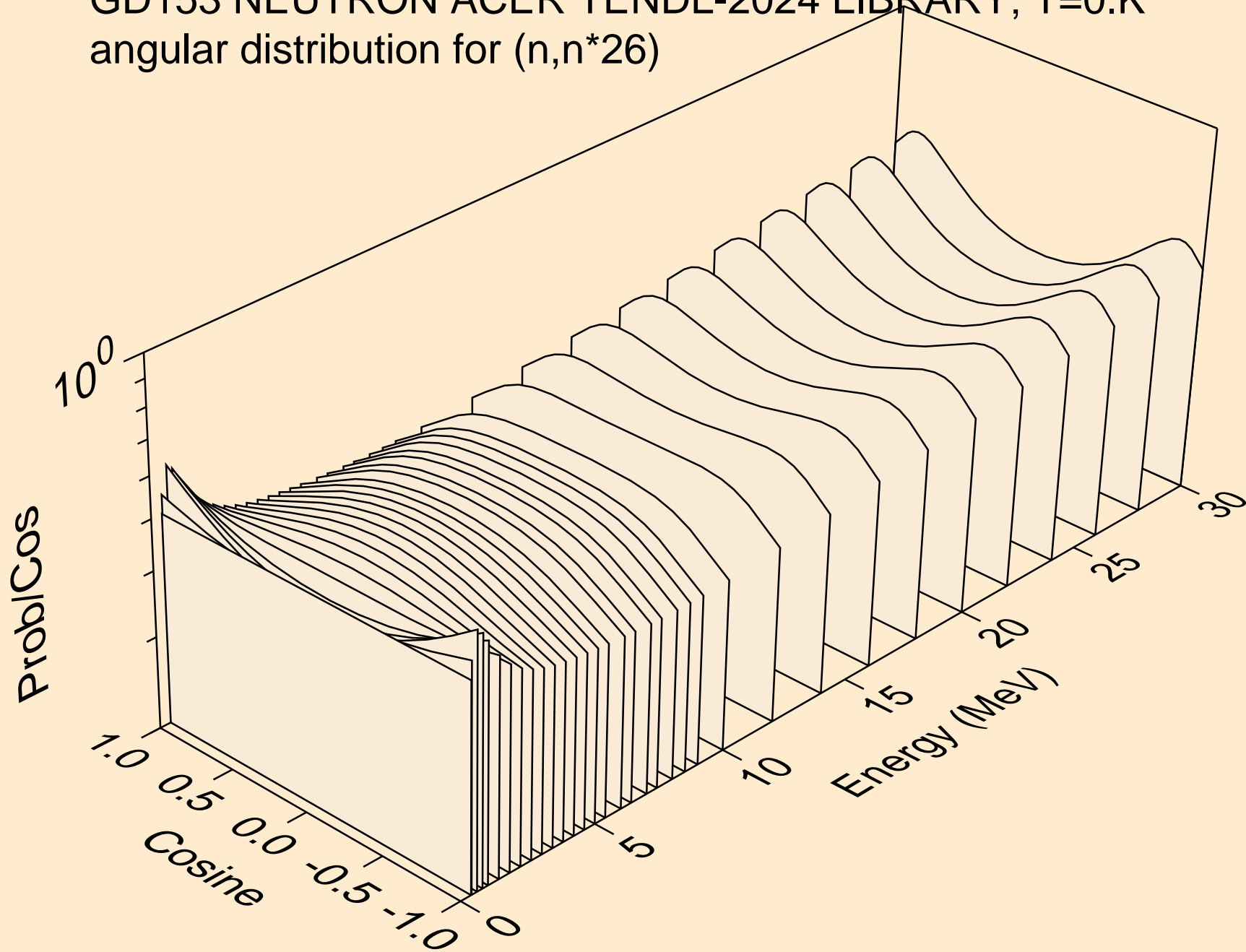

GD153 NEUTRON ACER TENDL-2024 LIBRARY; T=0.K  
angular distribution for (n,n\*27)

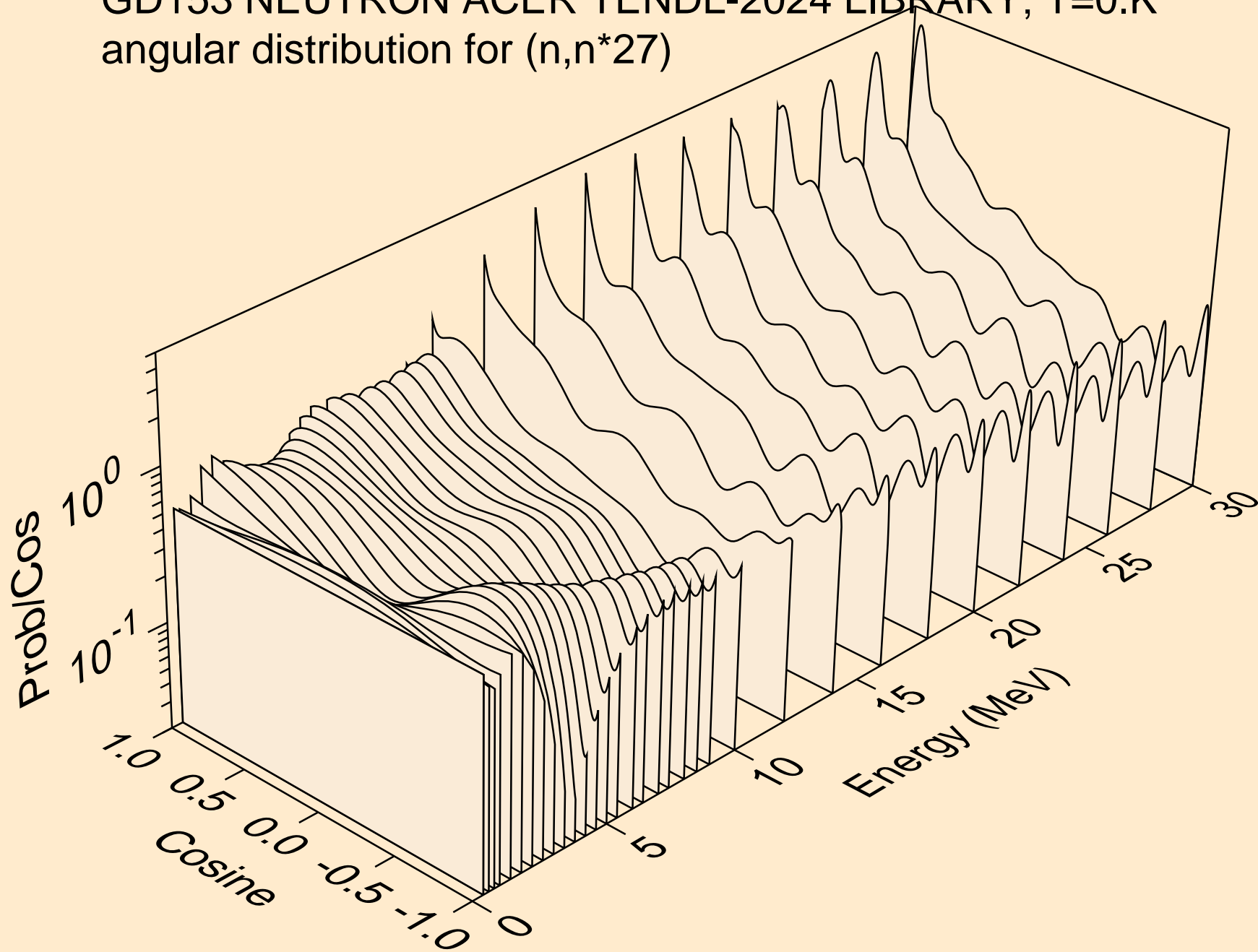

GD153 NEUTRON ACER TENDL-2024 LIBRARY; T=0.K  
angular distribution for (n,n\*28)

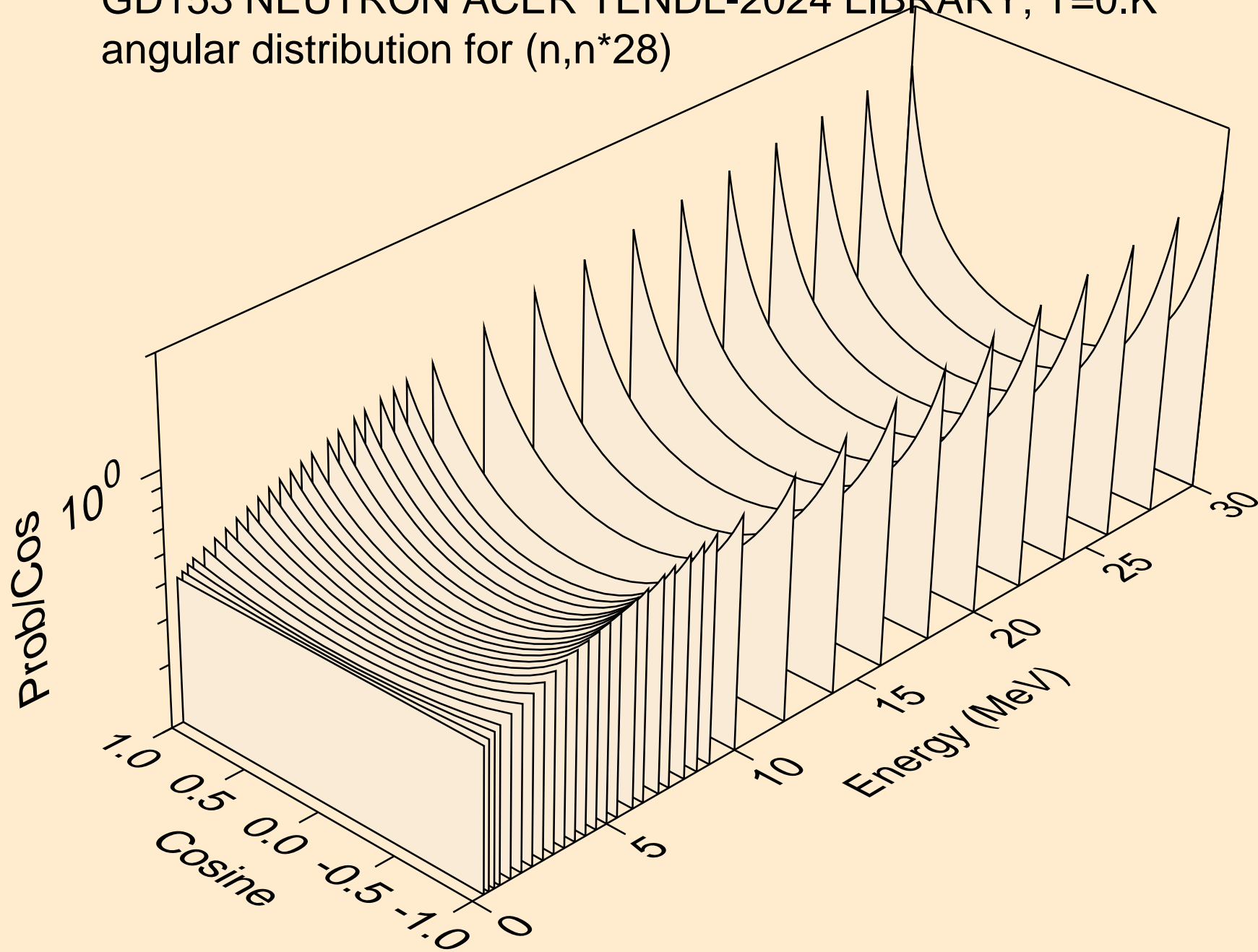

GD153 NEUTRON ACER TENDL-2024 LIBRARY; T=0.K  
Neutron emission for (n,x)

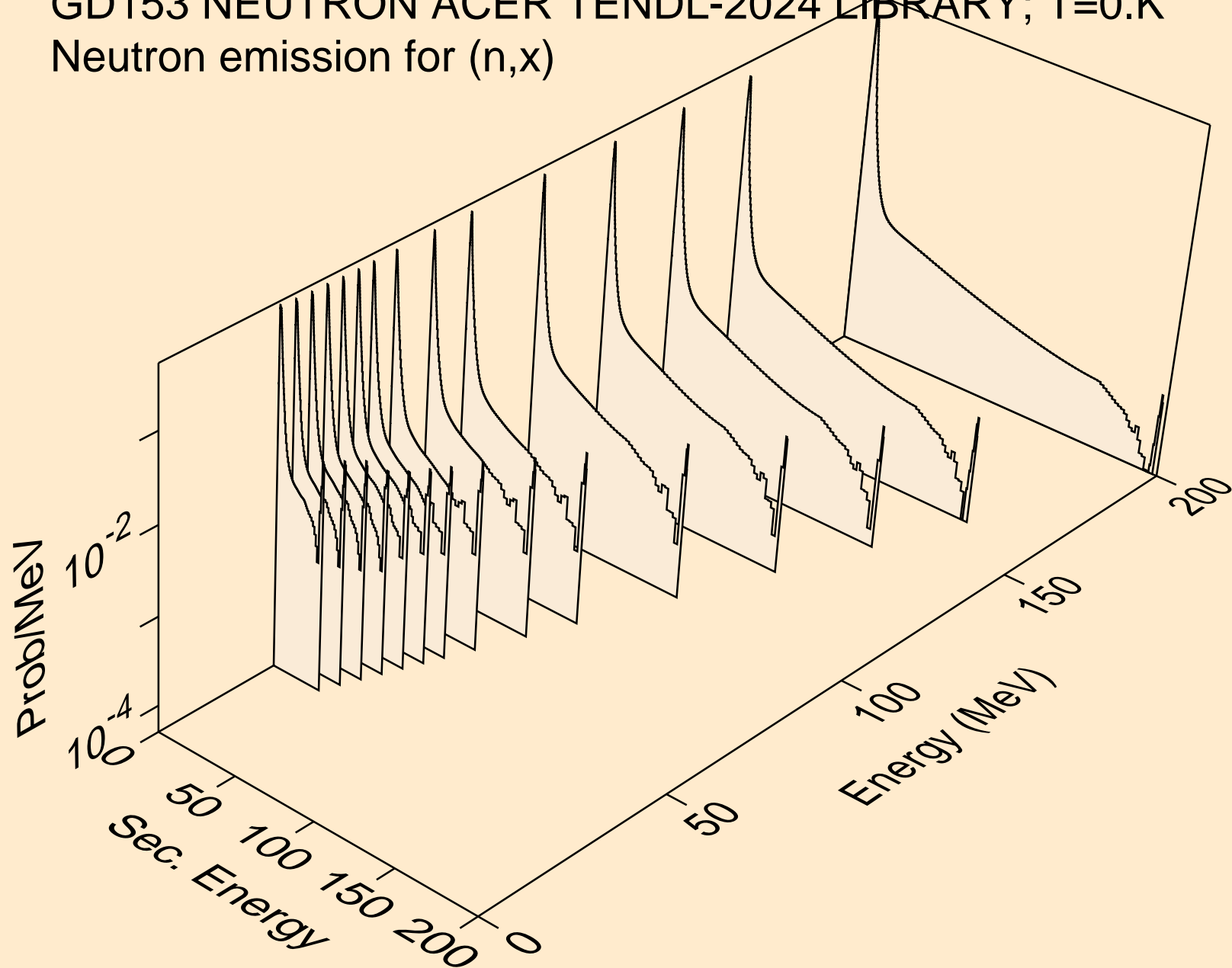

GD153 NEUTRON ACER TENDL-2024 LIBRARY; T=0.K  
Neutron emission for (n,2nd)

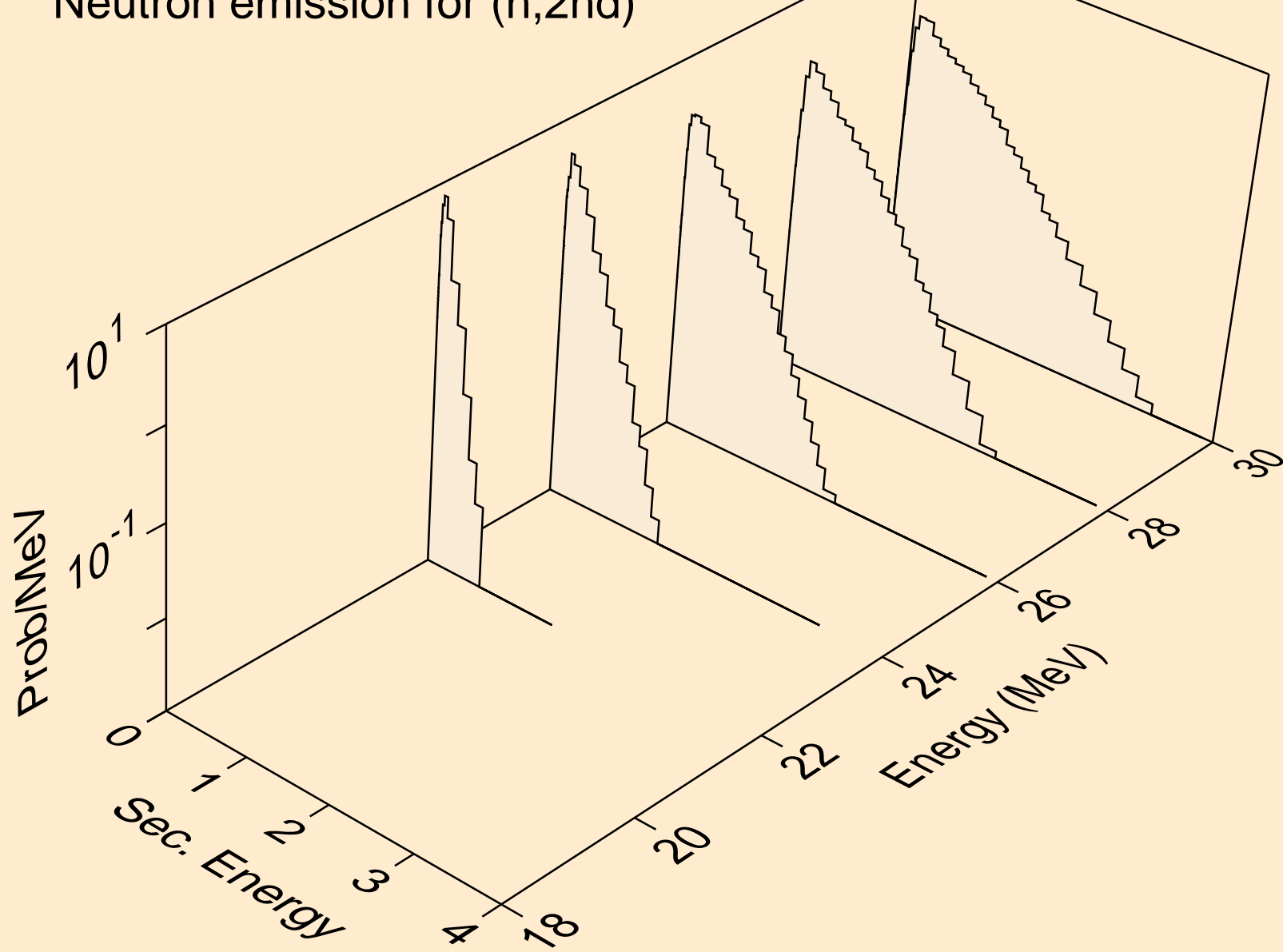



GD153 NEUTRON ACER TENDL-2024 LIBRARY; T=0.K  
Neutron emission for (n,2n)

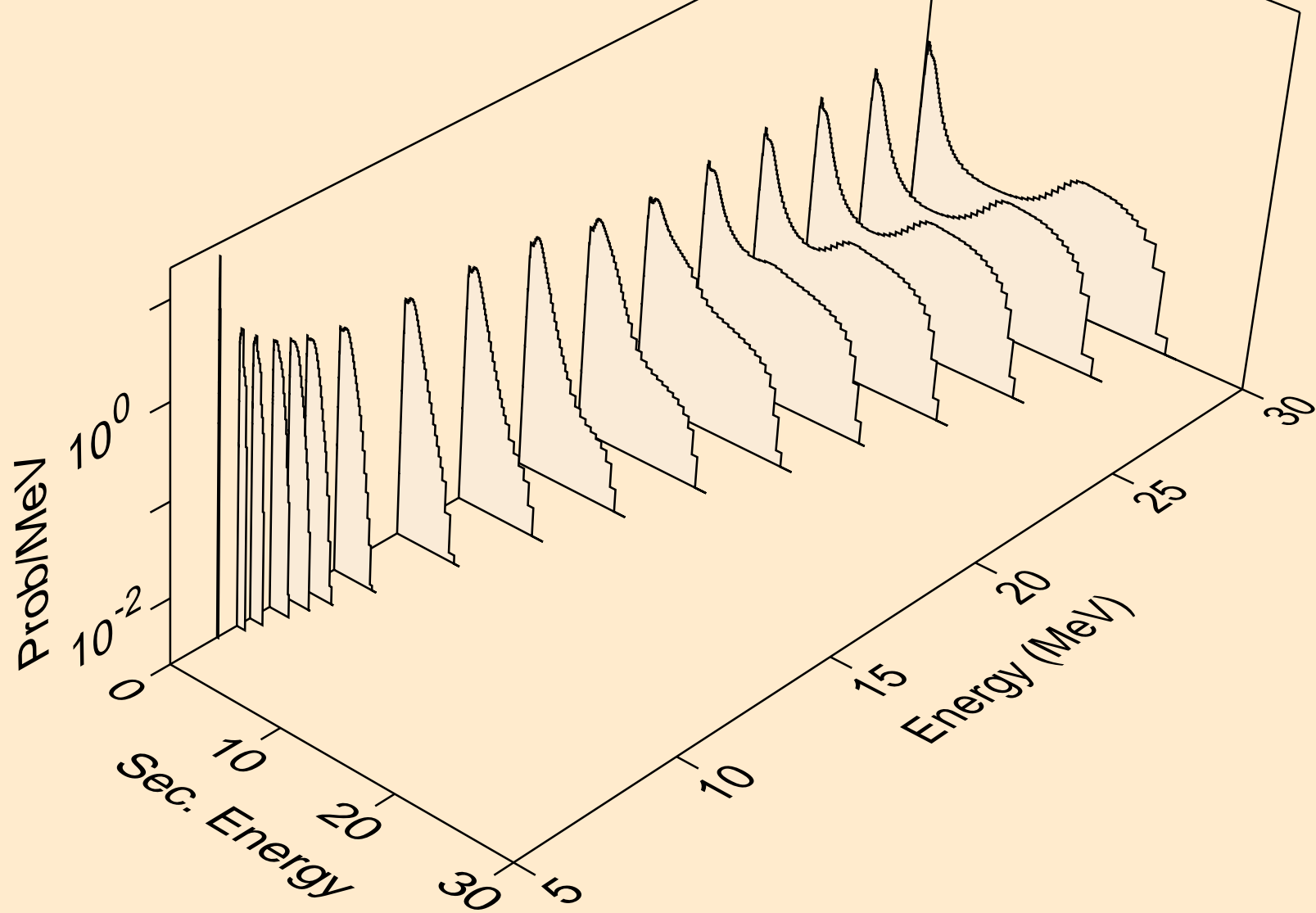

GD153 NEUTRON ACER TENDL-2024 LIBRARY; T=0.K  
Neutron emission for (n,3n)

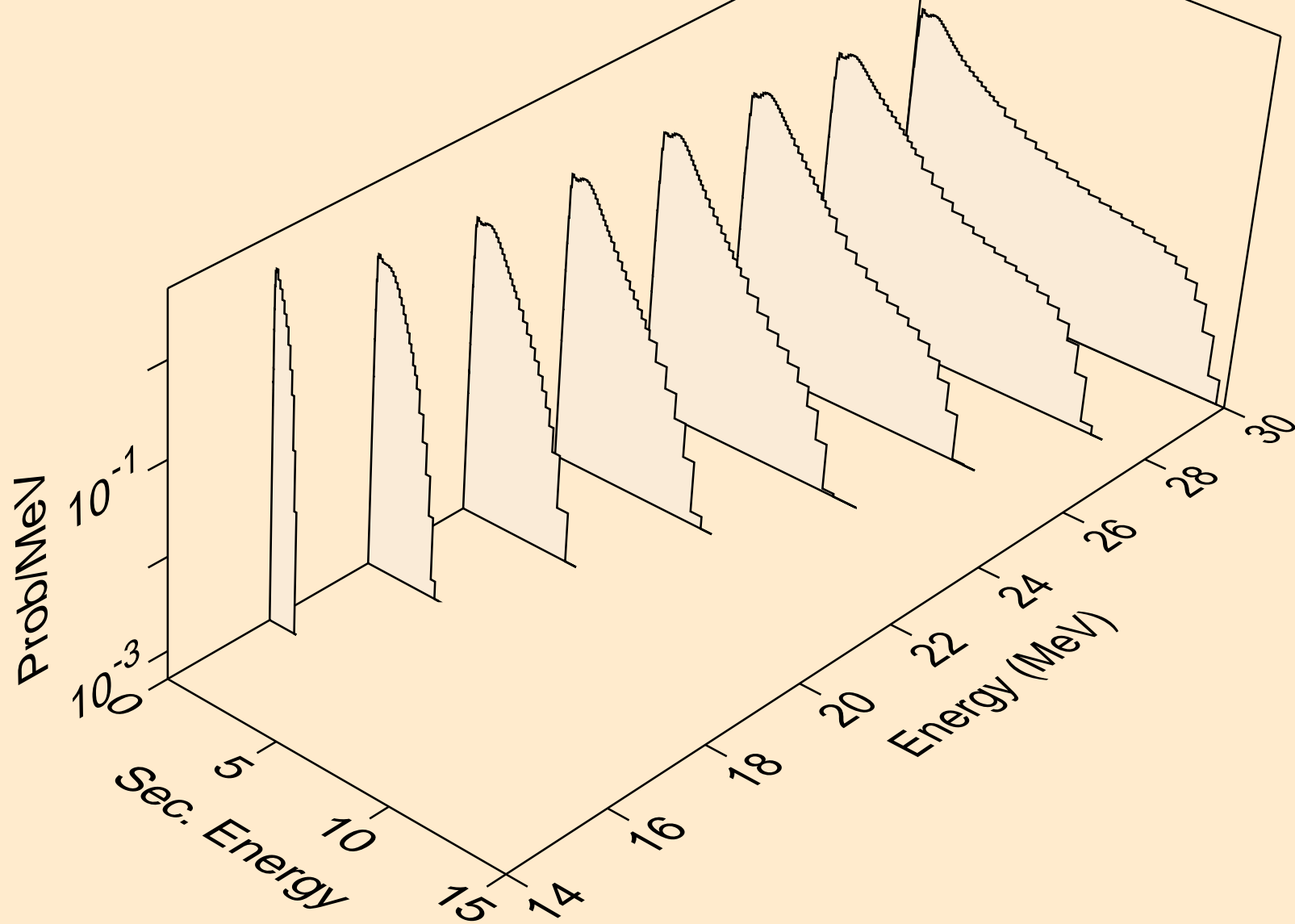

GD153 NEUTRON ACER TENDL-2024 LIBRARY; T=0.K  
Neutron emission for (n,n\*)a

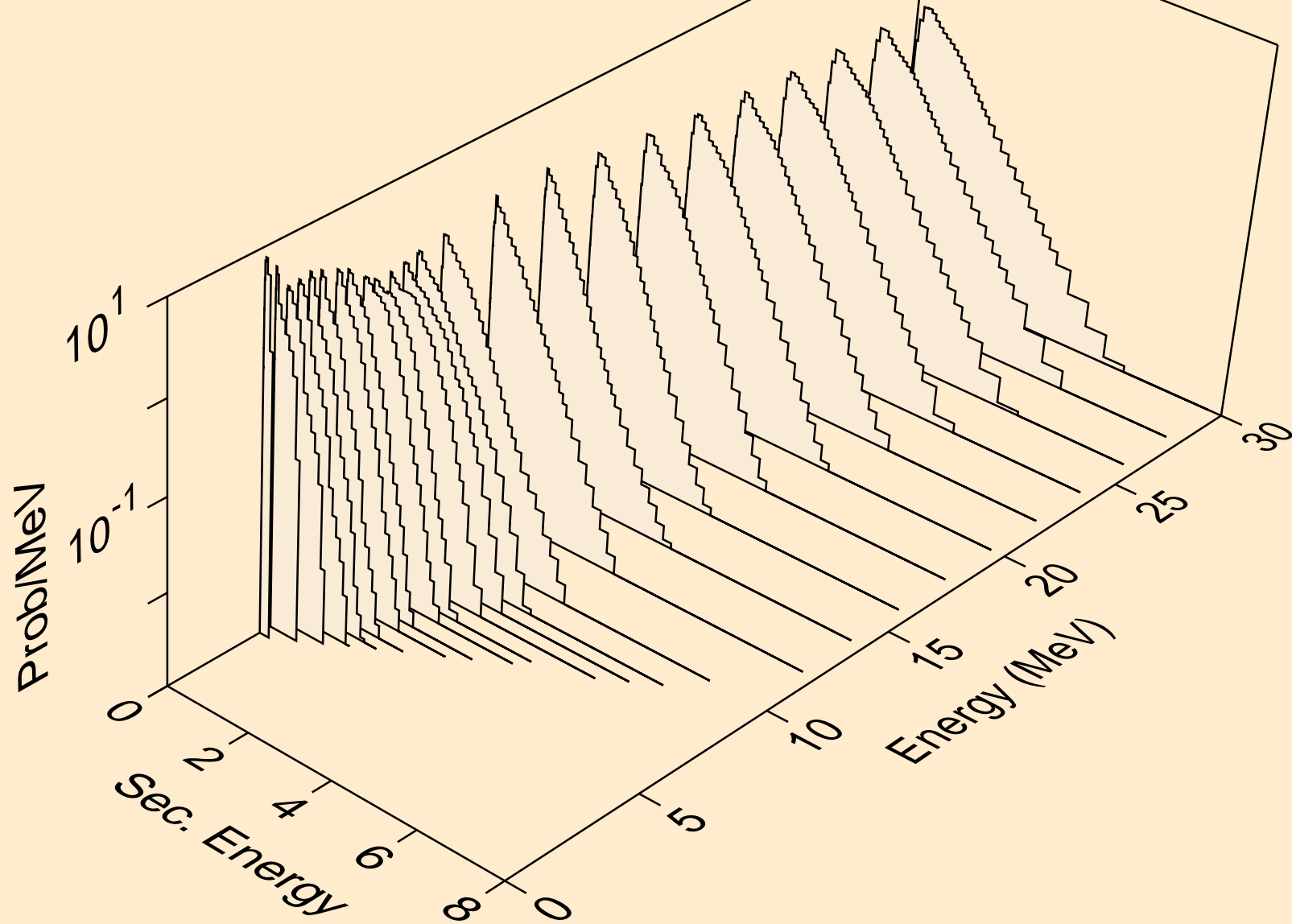

GD153 NEUTRON ACER TENDL-2024 LIBRARY; T=0.K  
Neutron emission for (n,2n)a

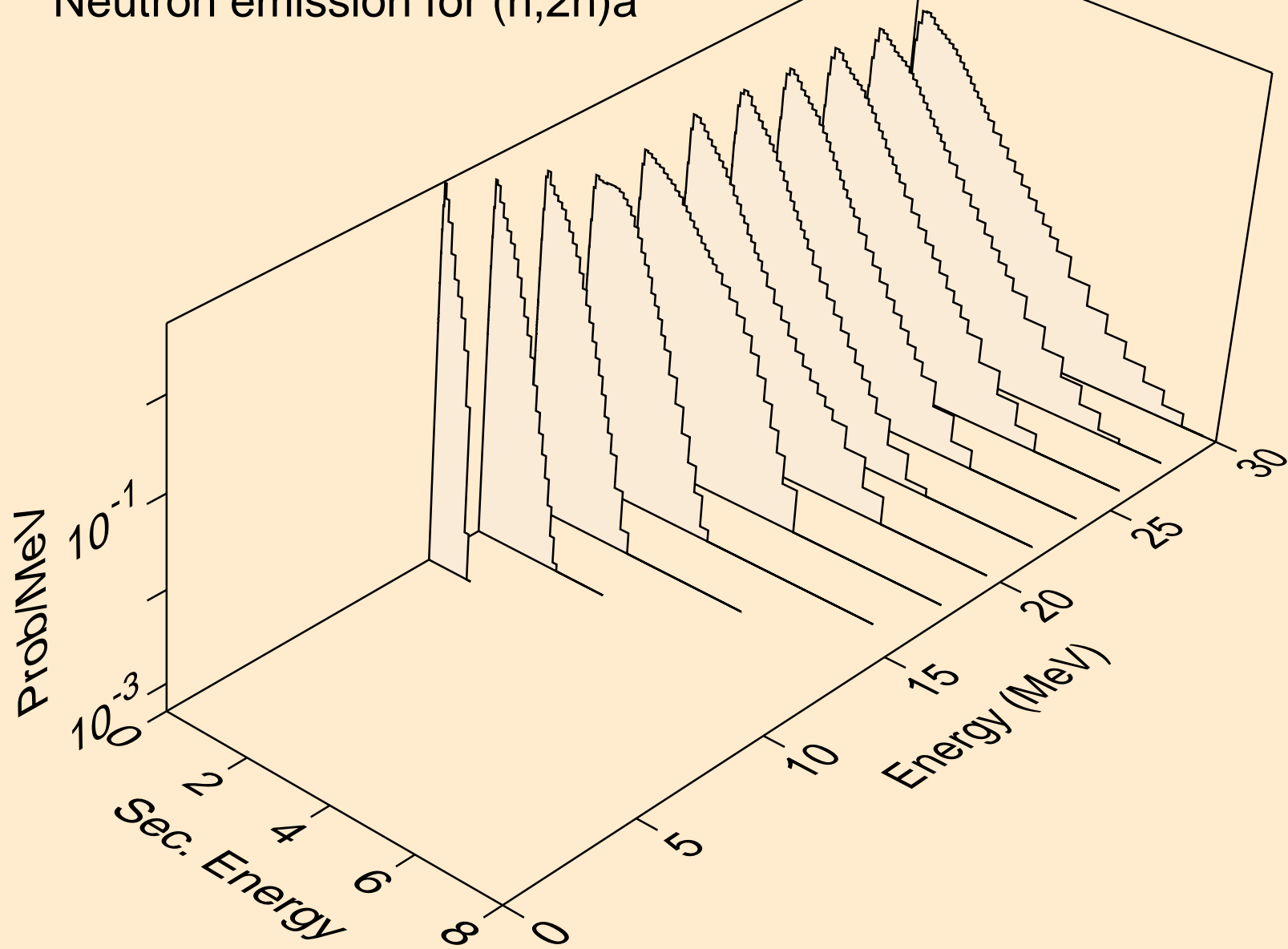

GD153 NEUTRON ACER TENDL-2024 LIBRARY; T=0.K  
Neutron emission for (n,3n)a

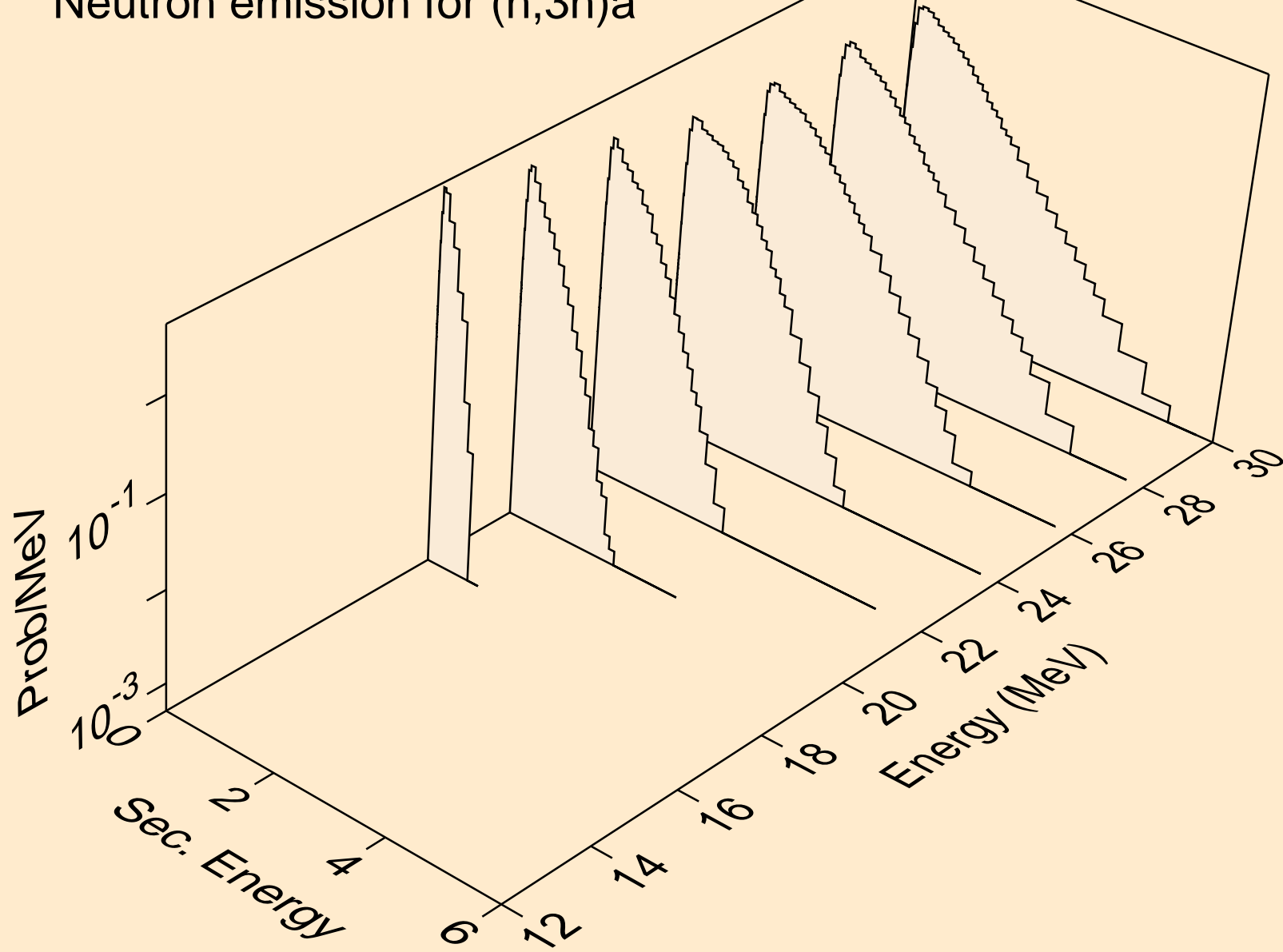

GD153 NEUTRON ACER TENDL-2024 LIBRARY; T=0.K  
Neutron emission for (n,n\*)p

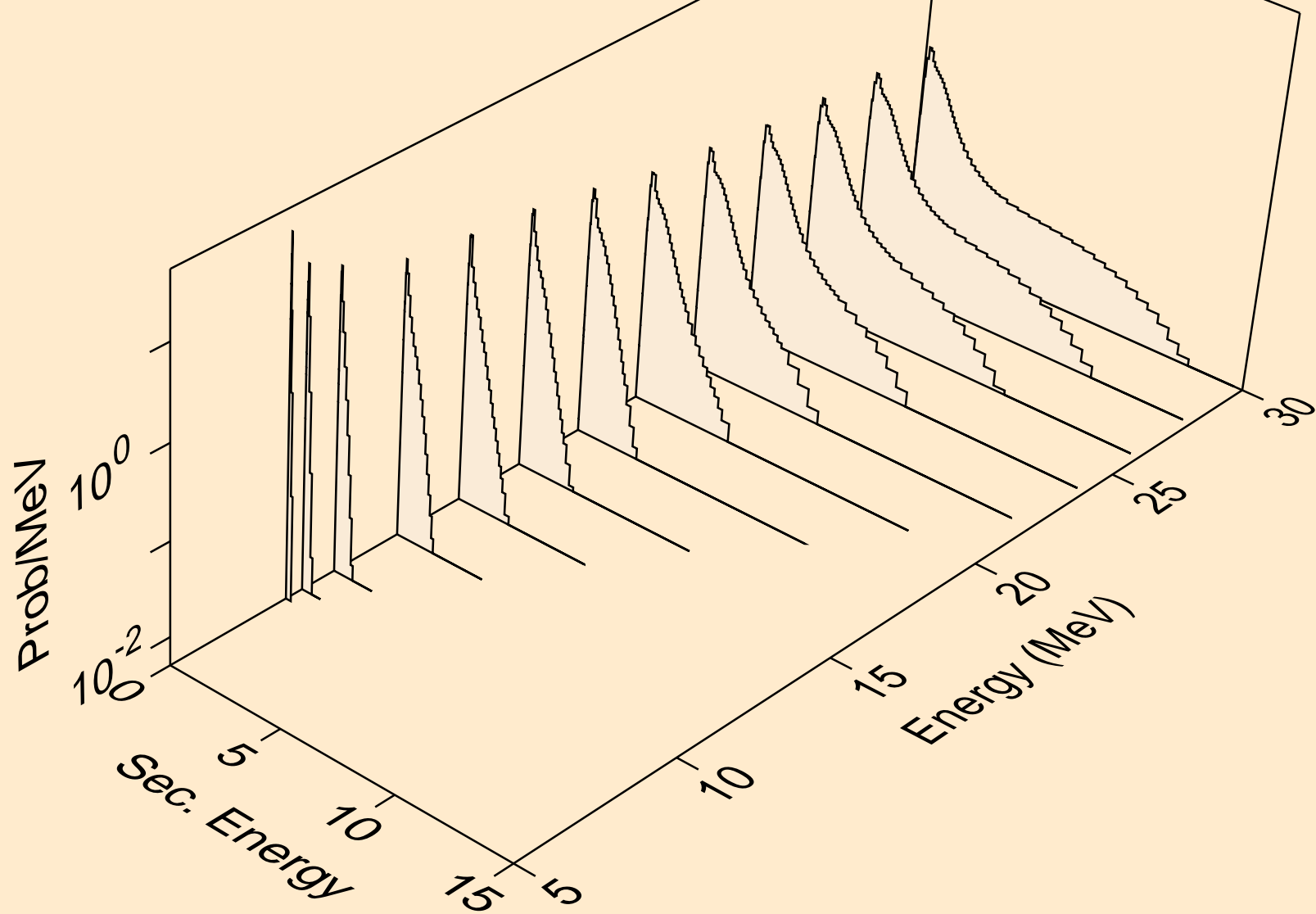

GD153 NEUTRON ACER TENDL-2024 LIBRARY; T=0.K  
Neutron emission for (n,n\*)2a

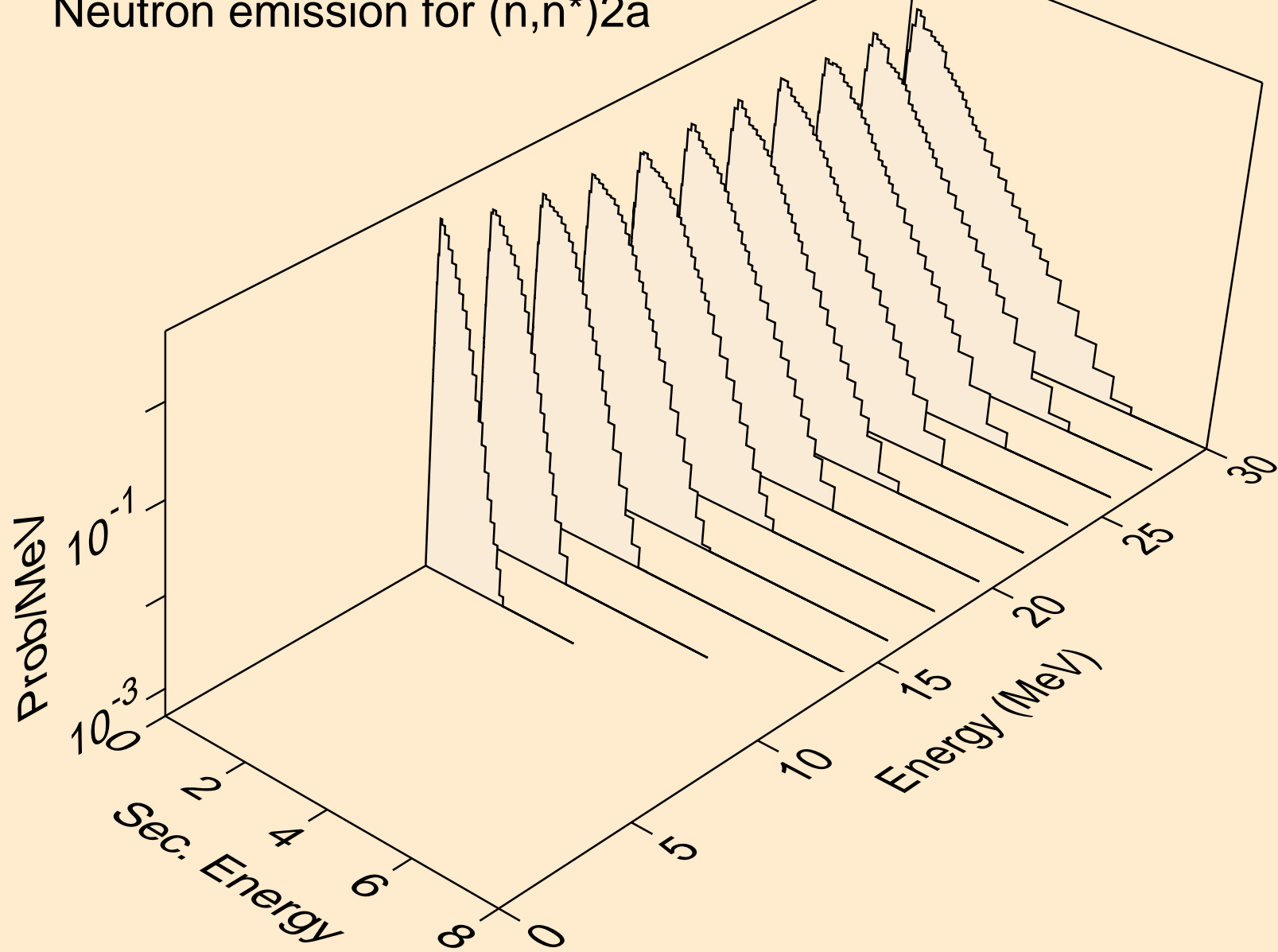

GD153 NEUTRON ACER TENDL-2024 LIBRARY; T=0.K  
Neutron emission for (n,2n)2a

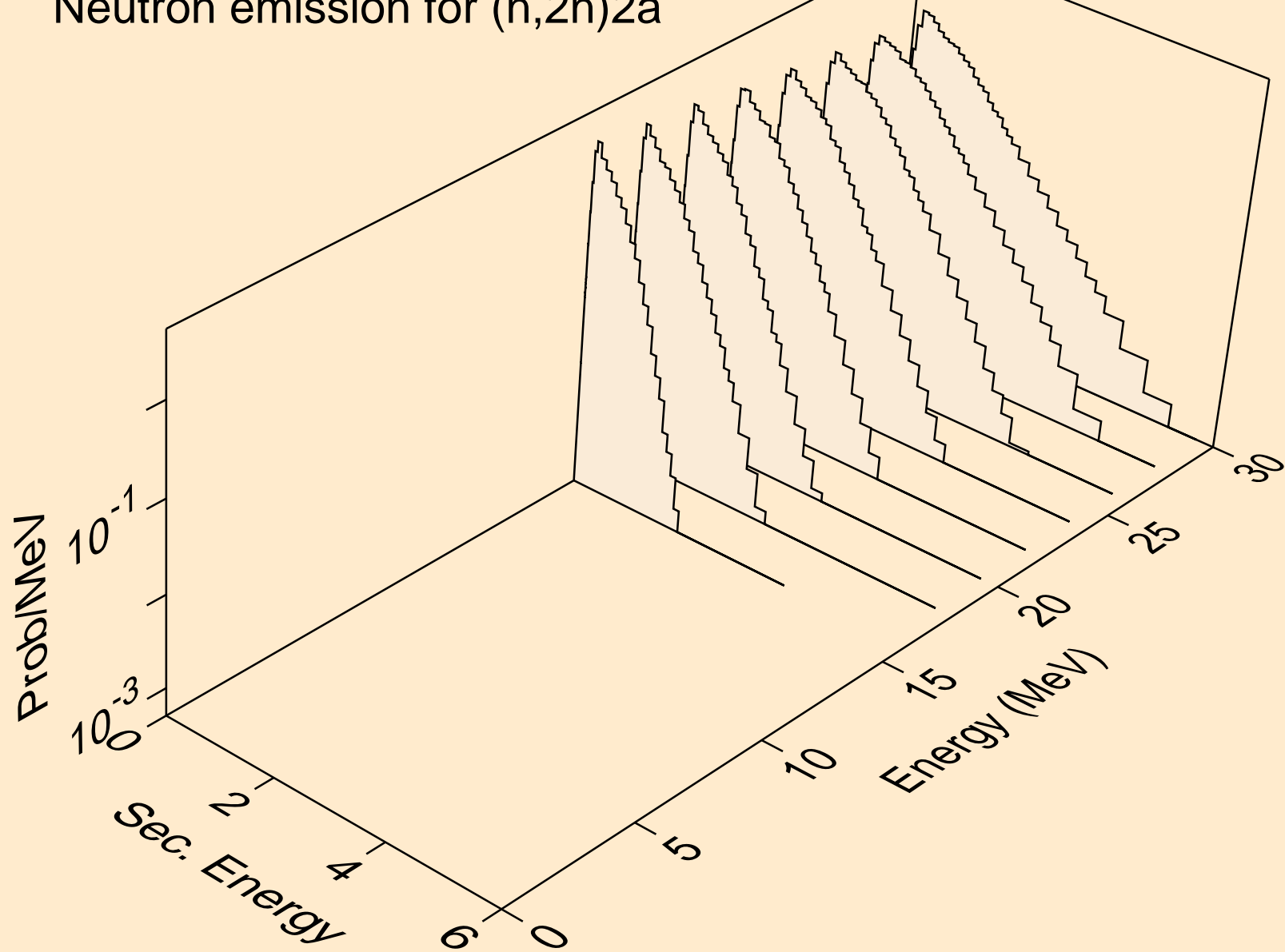



GD153 NEUTRON ACER TENDL-2024 LIBRARY; T=0.K  
Neutron emission for (n,n\*)d

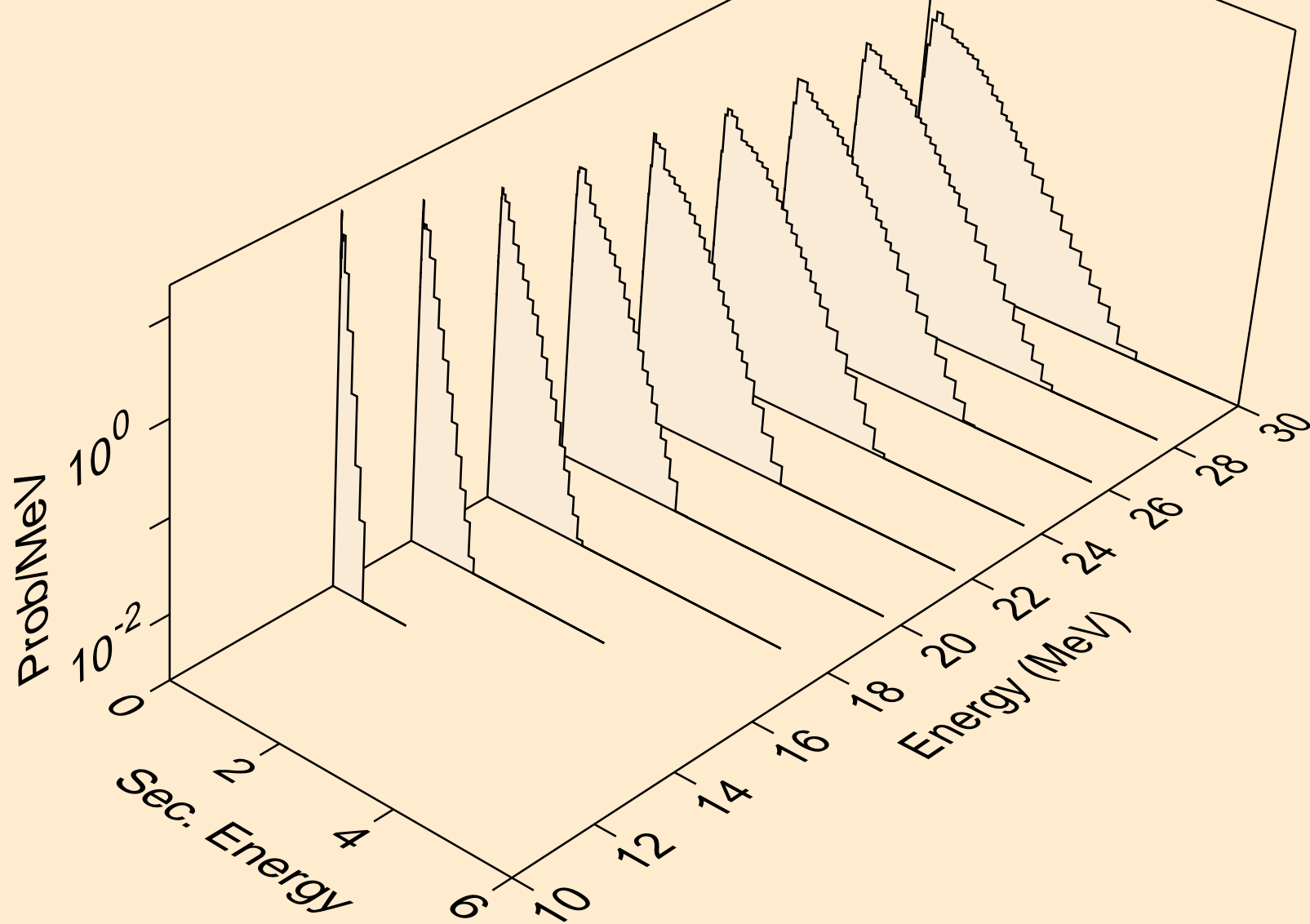

GD153 NEUTRON ACER TENDL-2024 LIBRARY; T=0.K  
Neutron emission for (n,n\*)t

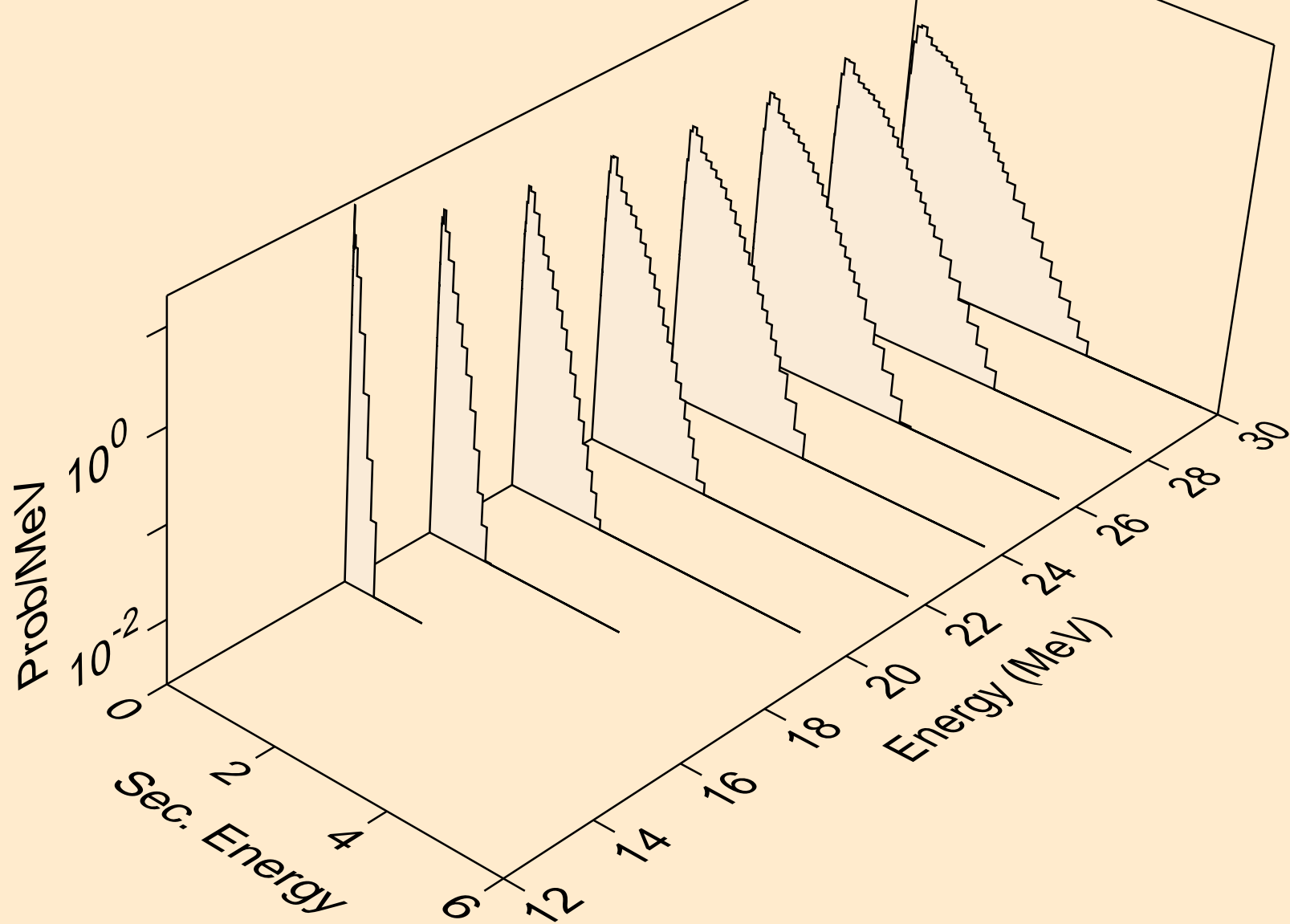

GD153 NEUTRON ACER TENDL-2024 LIBRARY; T=0.K  
Neutron emission for (n,n\*)he3

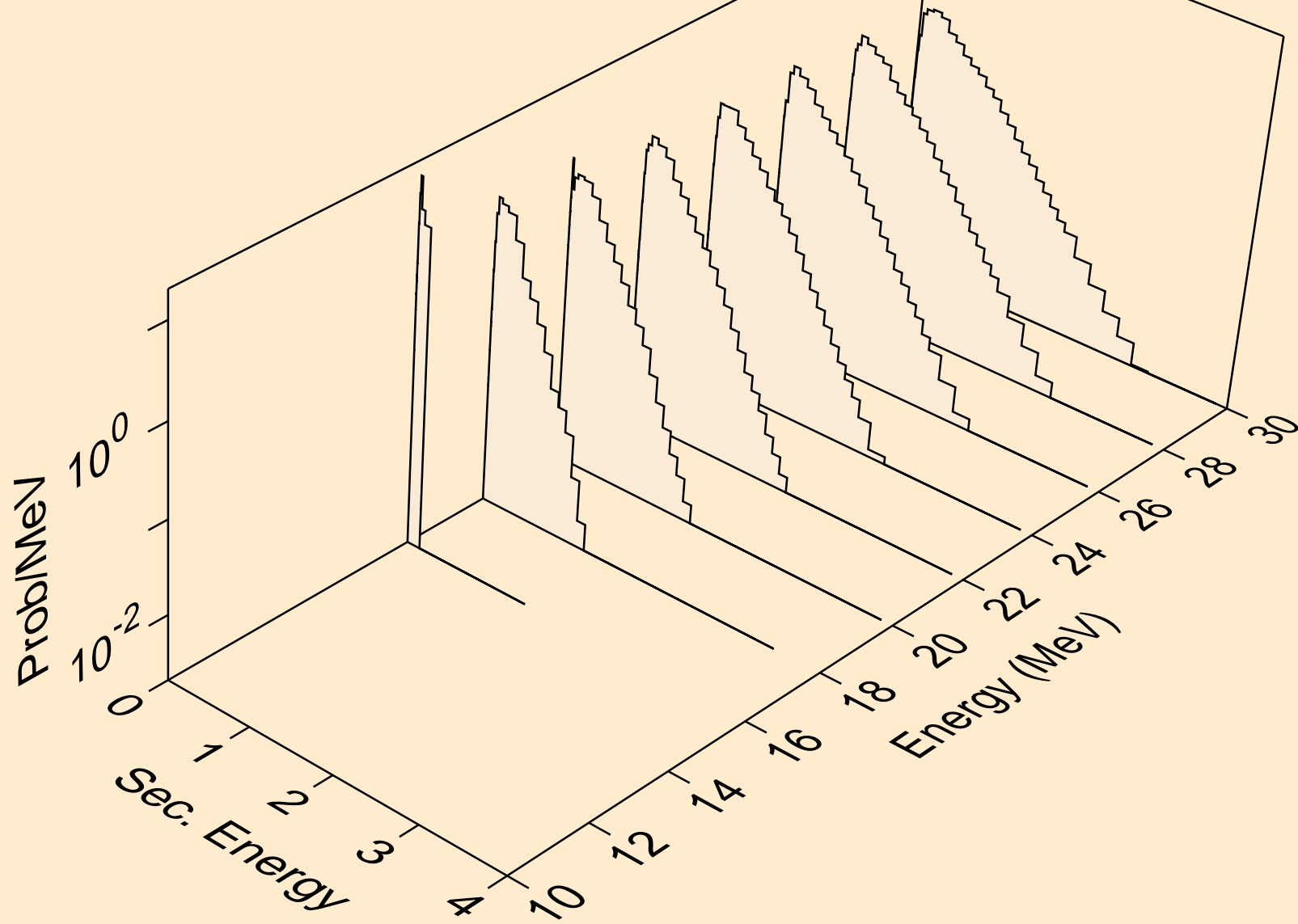

GD153 NEUTRON ACER TENDL-2024 LIBRARY; T=0.K  
Neutron emission for (n,4n)

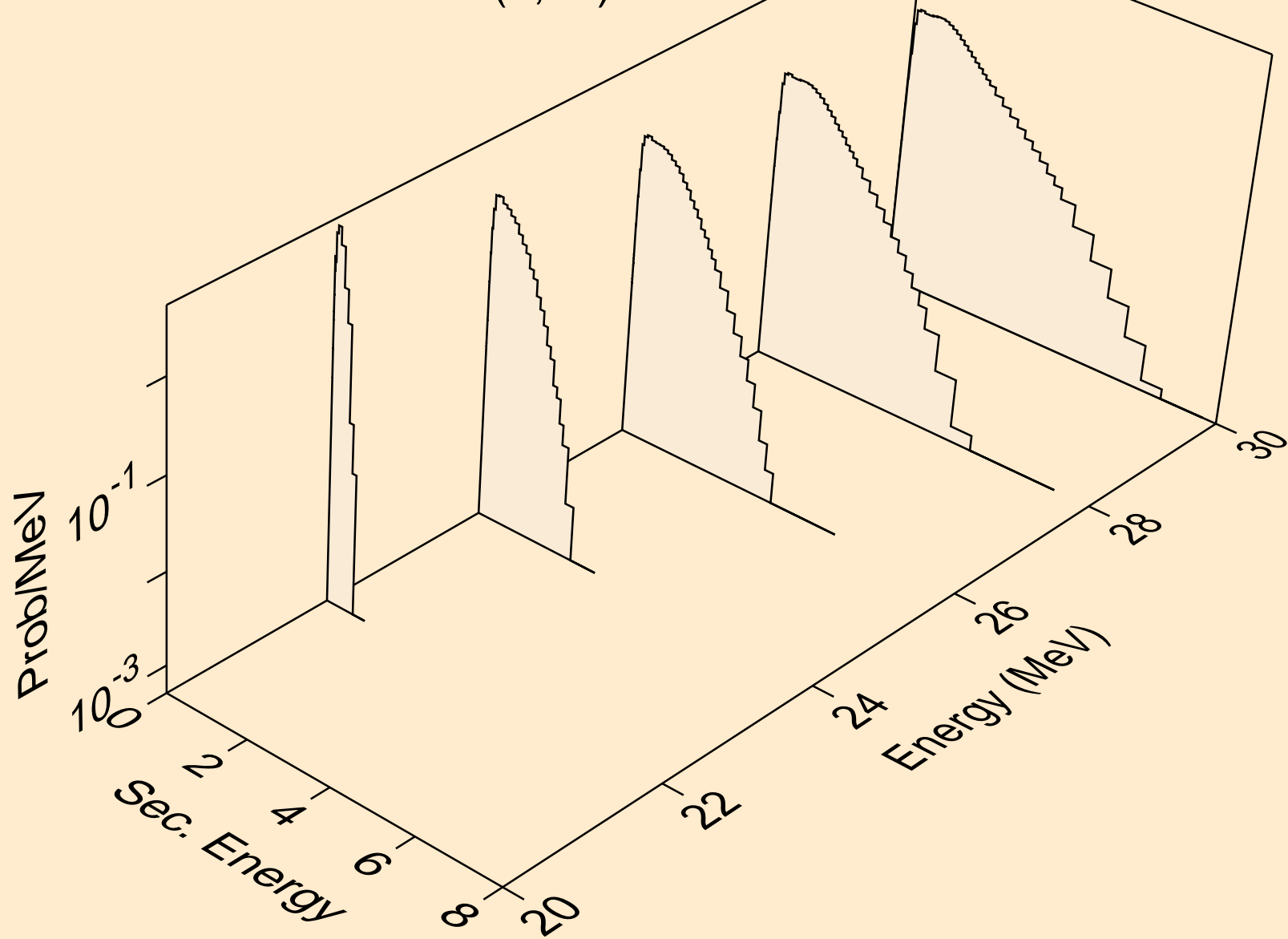

GD153 NEUTRON ACER TENDL-2024 LIBRARY; T=0.K  
Neutron emission for (n,2np)

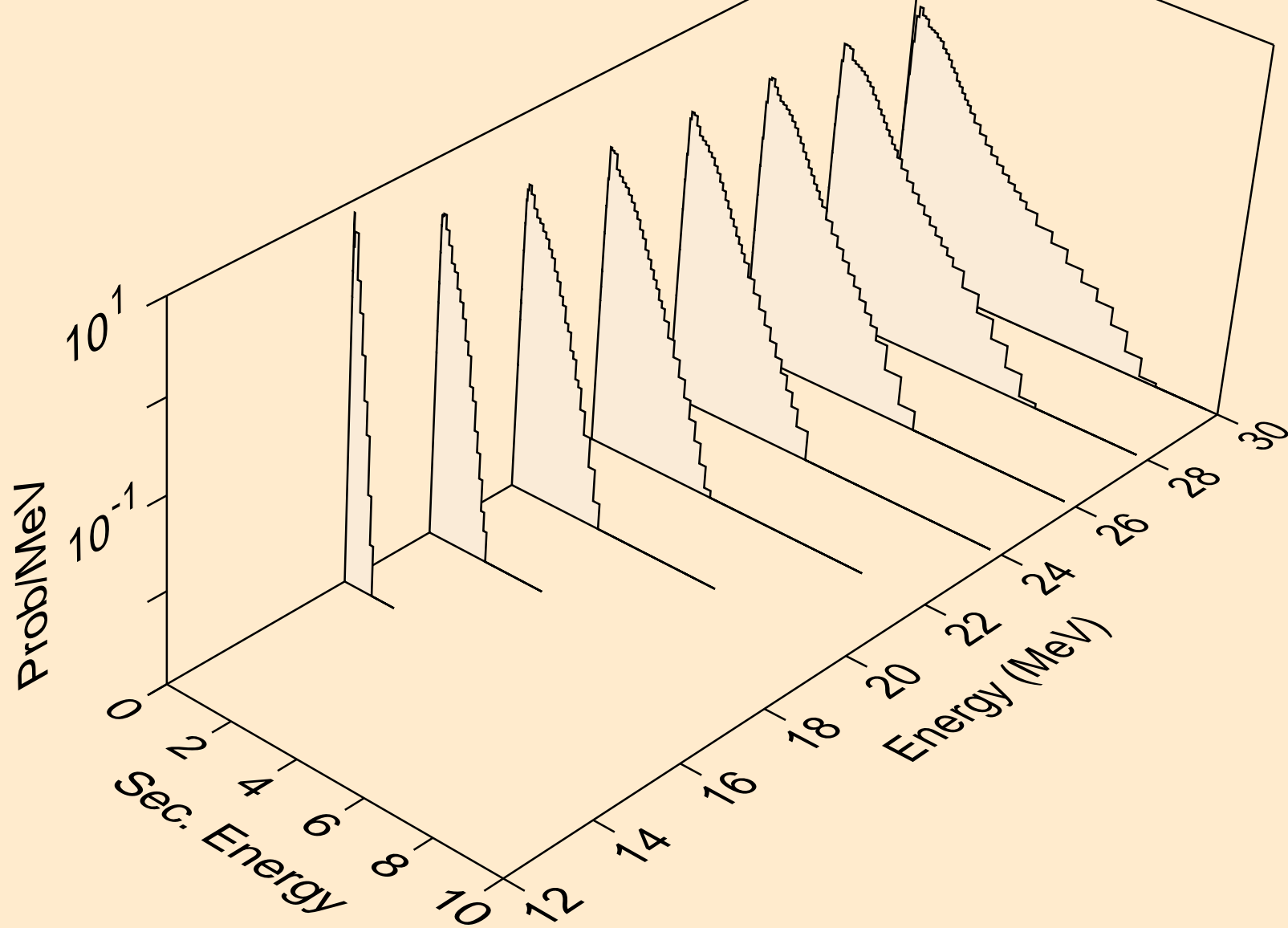

GD153 NEUTRON ACER TENDL-2024 LIBRARY; T=0.K  
Neutron emission for (n,3np)

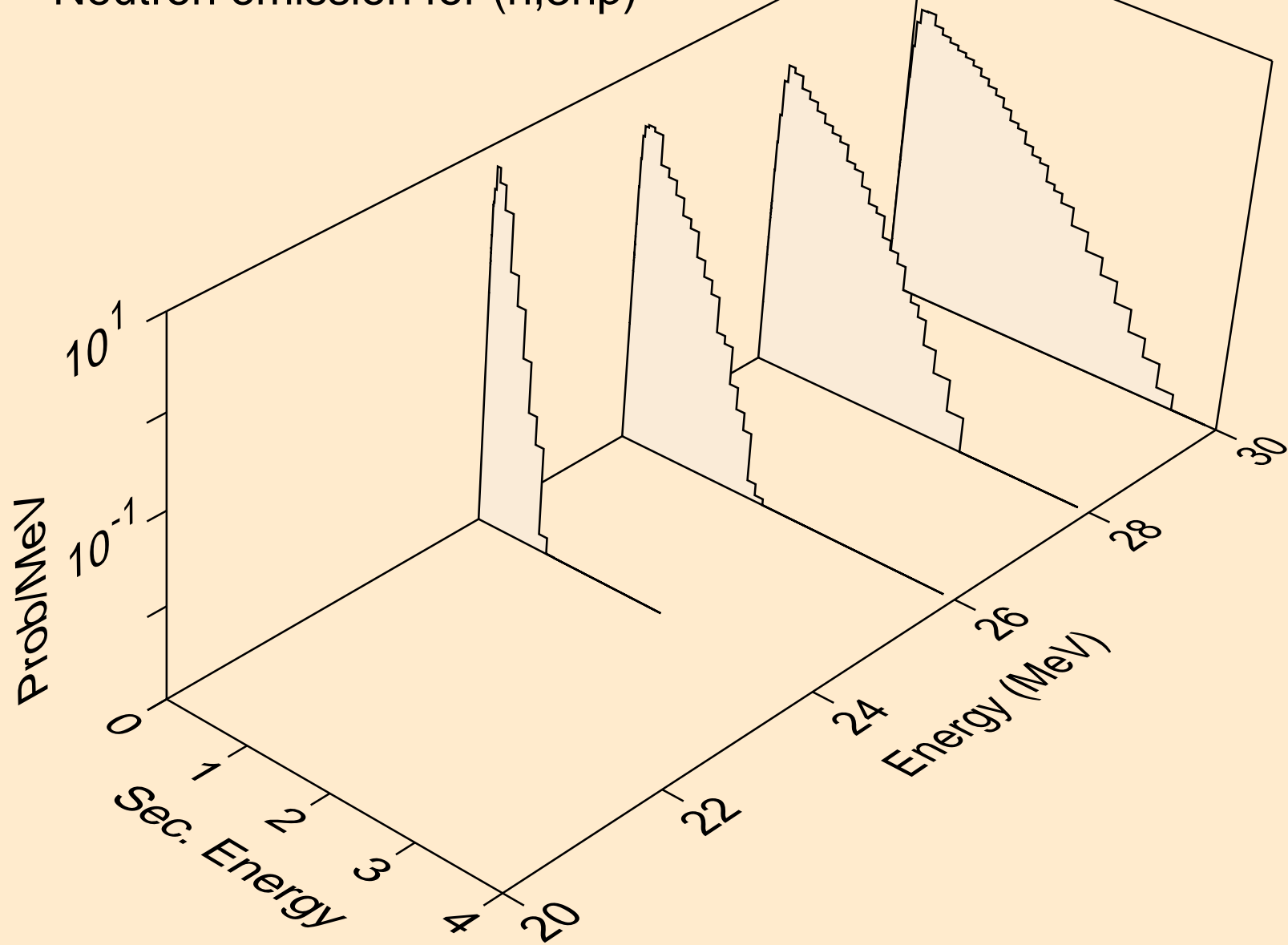

GD153 NEUTRON ACER TENDL-2024 LIBRARY; T=0.K  
Neutron emission for (n,n2p)

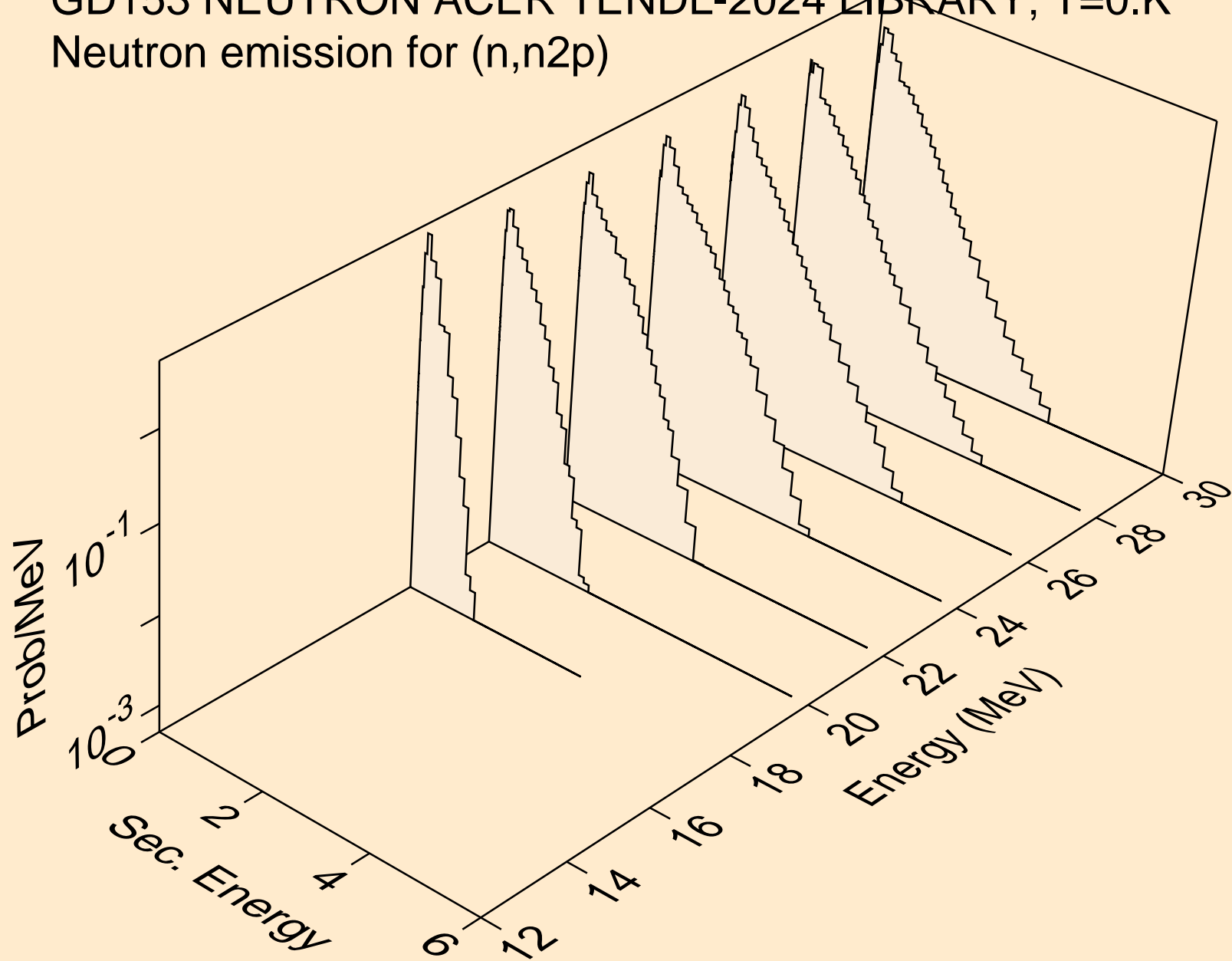

GD153 NEUTRON ACER TENDL-2024 LIBRARY; T=0.K  
Neutron emission for (n,npa)

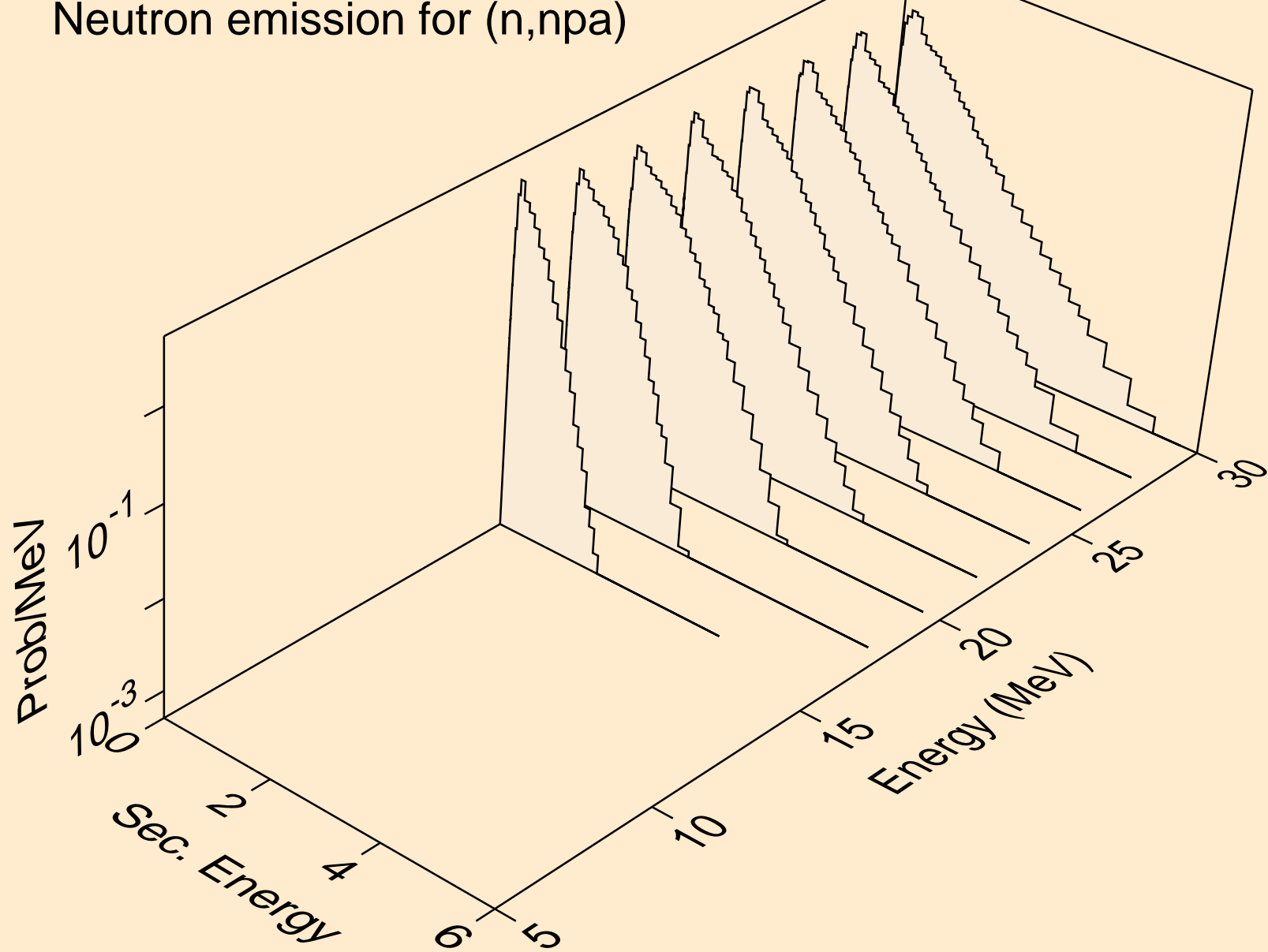



GD153 NEUTRON ACER TENDL-2024 LIBRARY; T=0.K  
Neutron emission for (n,n\*c)

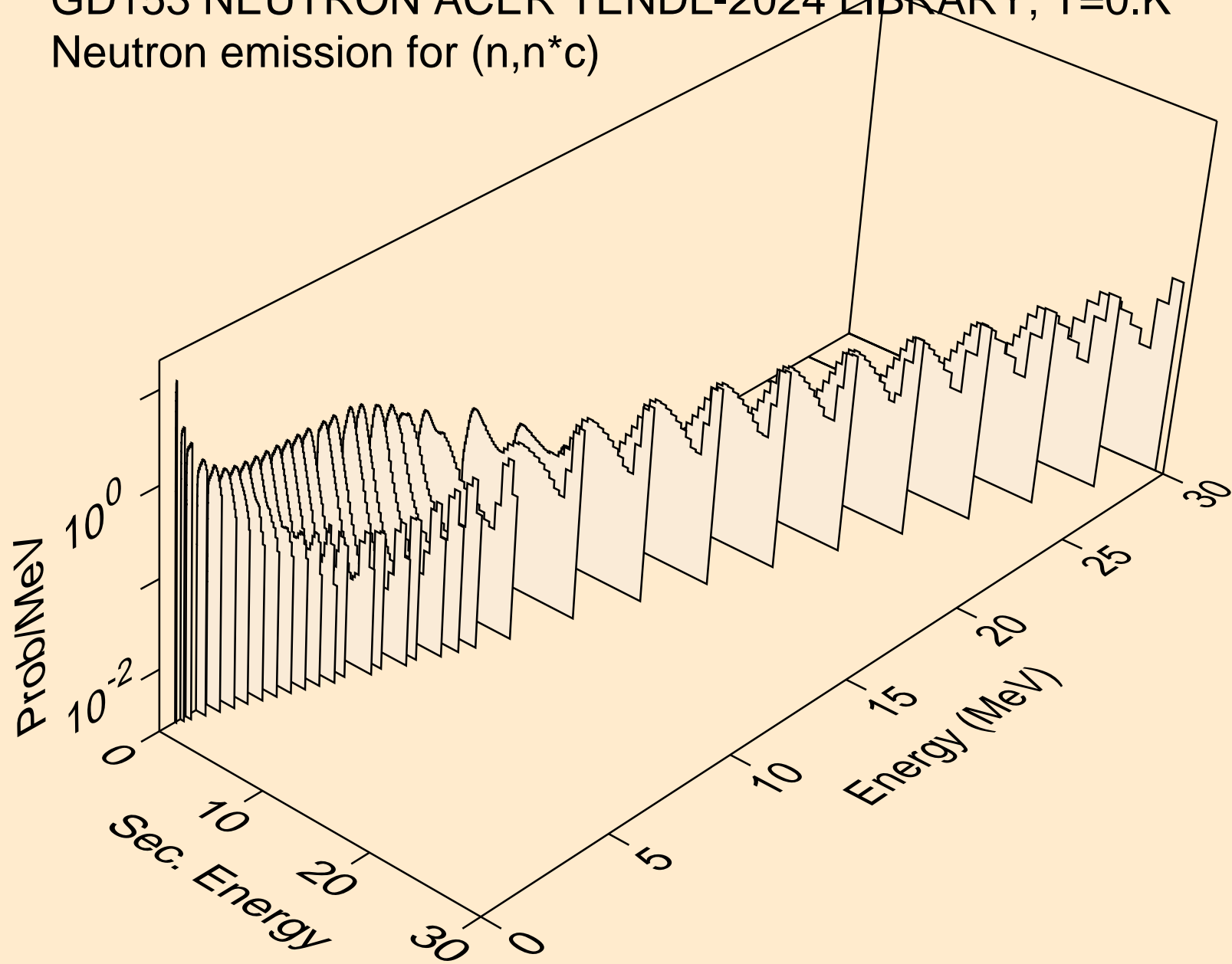

GD153 NEUTRON ACER TENDL-2024 LIBRARY; T=0.K  
Photon emission for (n,x)

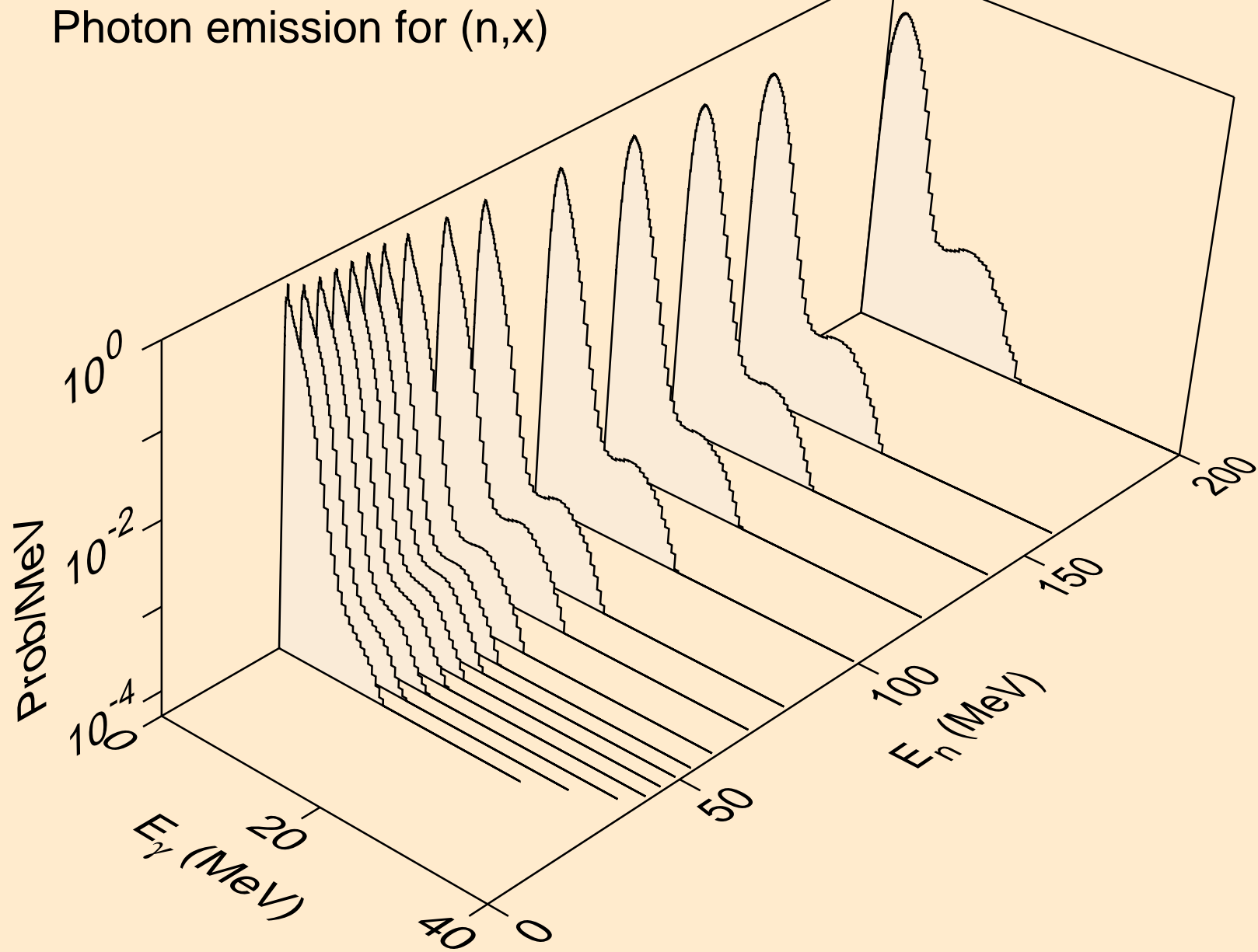

GD153 NEUTRON ACER TENDL-2024 LIBRARY; T=0.K  
Photon emission for (n,2nd)

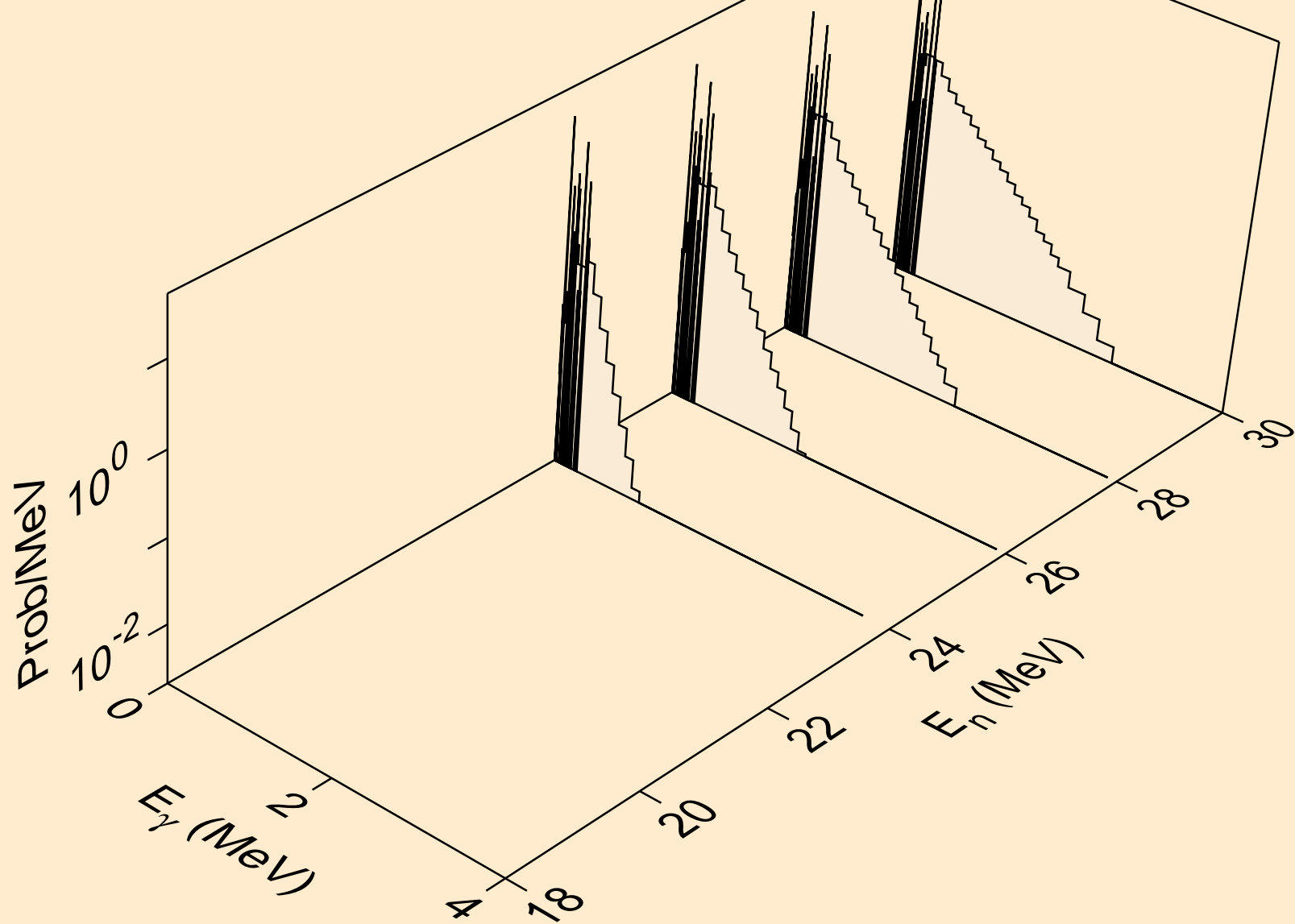

GD153 NEUTRON ACER TENDL-2024 LIBRARY; T=0.K  
Photon emission for (n,2n)

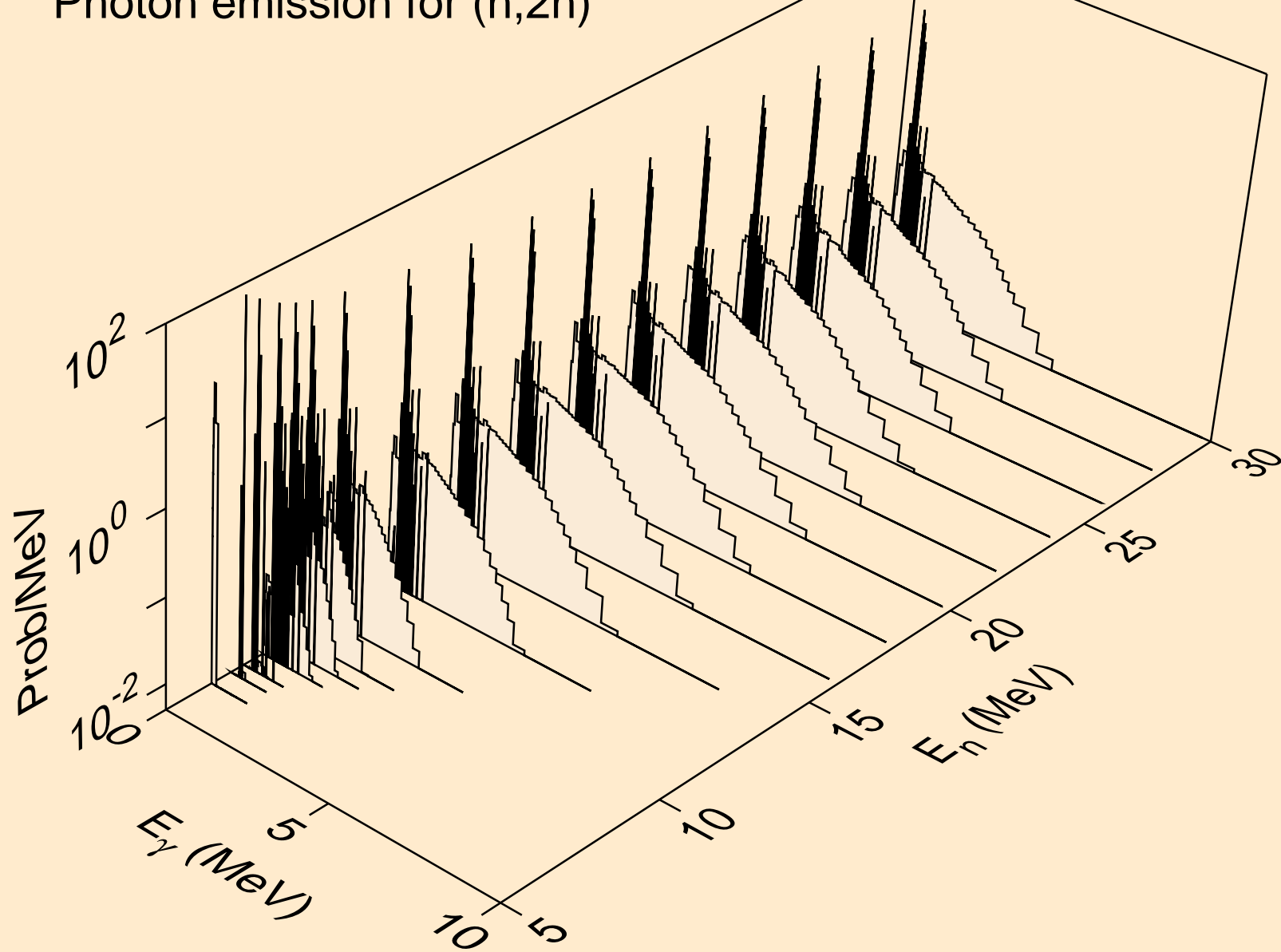

GD153 NEUTRON ACER TENDL-2024 LIBRARY; T=0.K  
Photon emission for (n,3n)

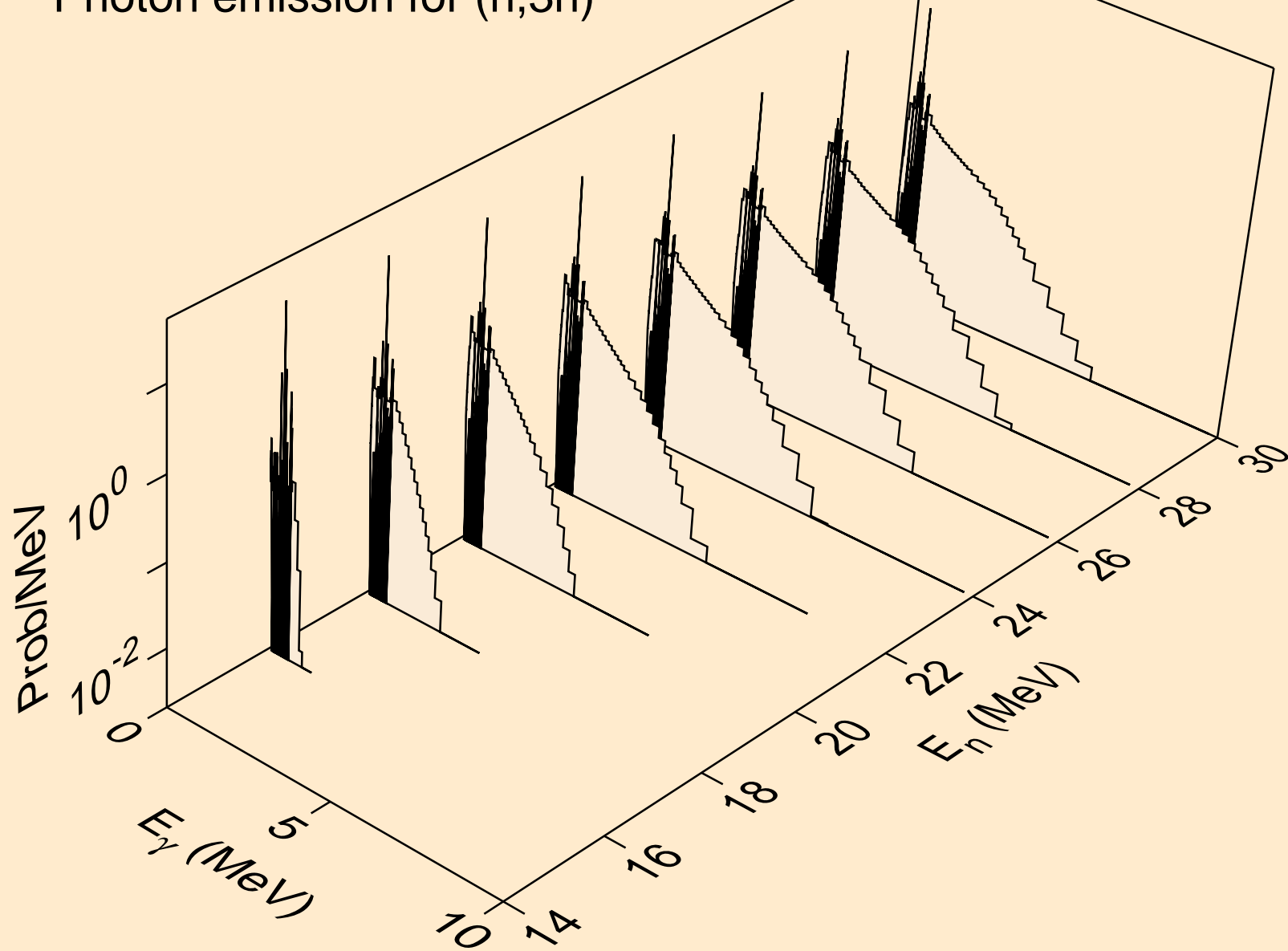

GD153 NEUTRON ACER TENDL-2024 LIBRARY; T=0.K  
Photon emission for (n,n\*)a

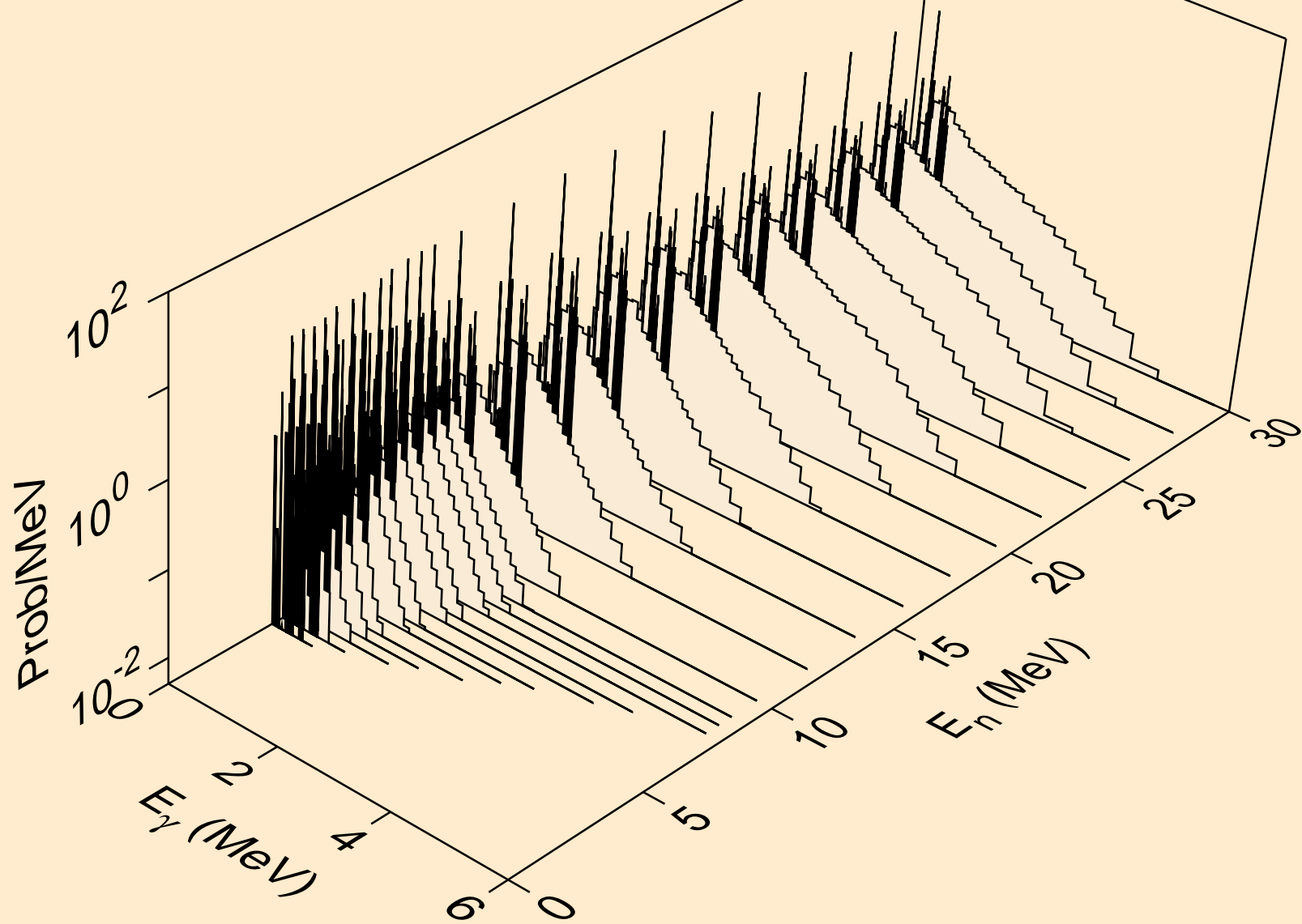

GD153 NEUTRON ACER TENDL-2024 LIBRARY; T=0.K  
Photon emission for (n,2n)a

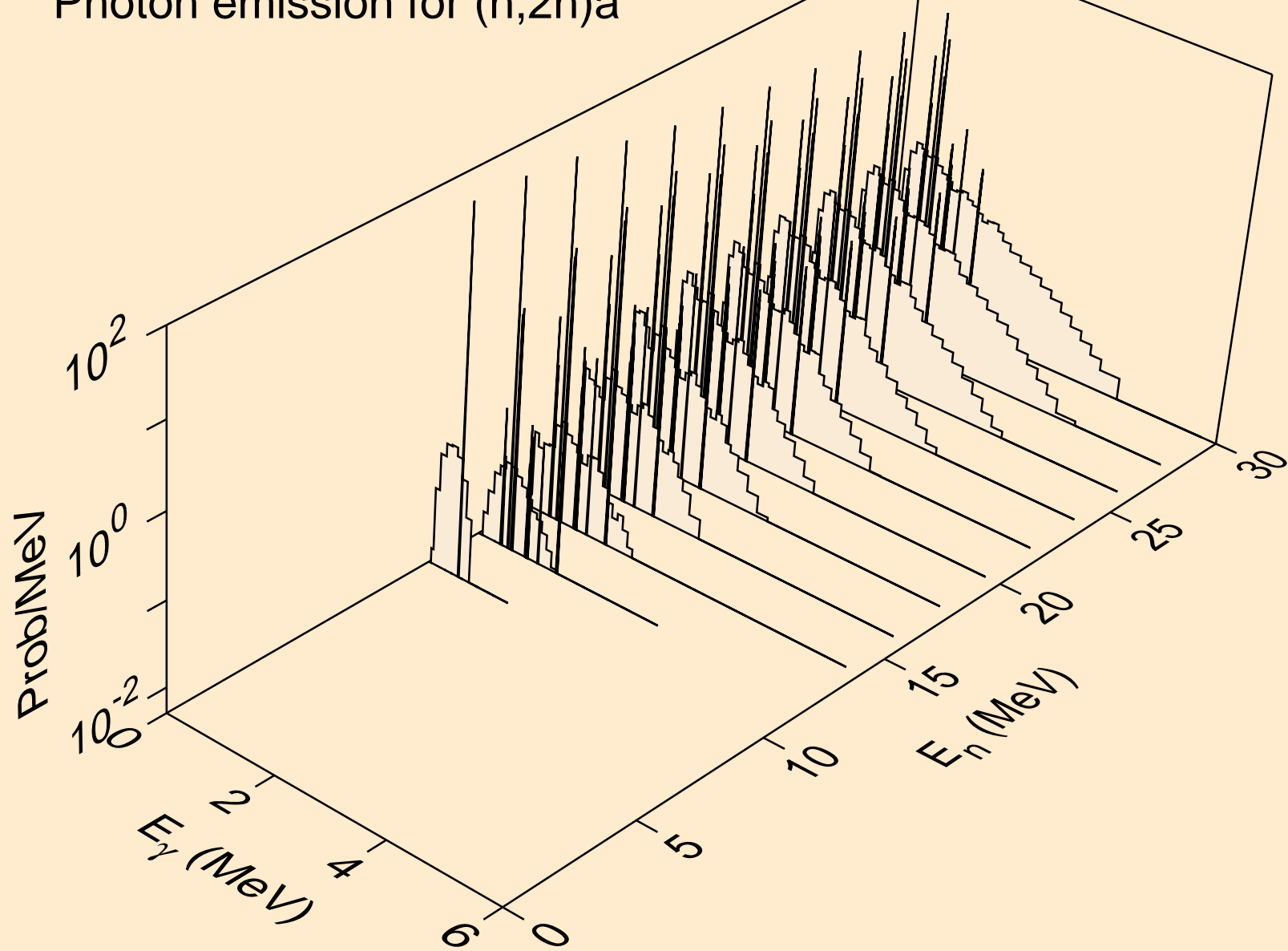

GD153 NEUTRON ACER TENDL-2024 LIBRARY; T=0.K  
Photon emission for (n,3n)a

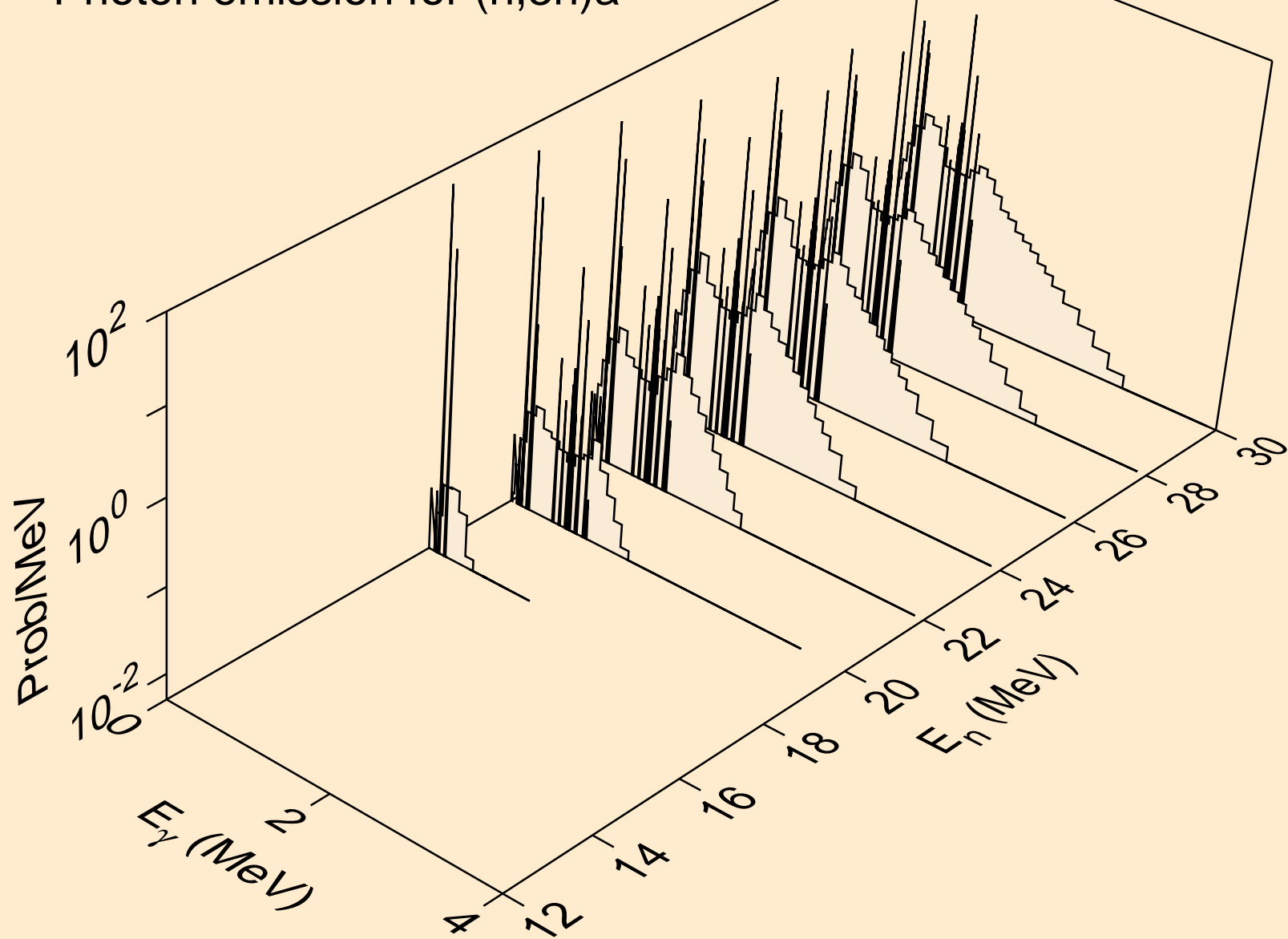



GD153 NEUTRON ACER TENDL-2024 LIBRARY; T=0.K  
Photon emission for (n,n\*)p

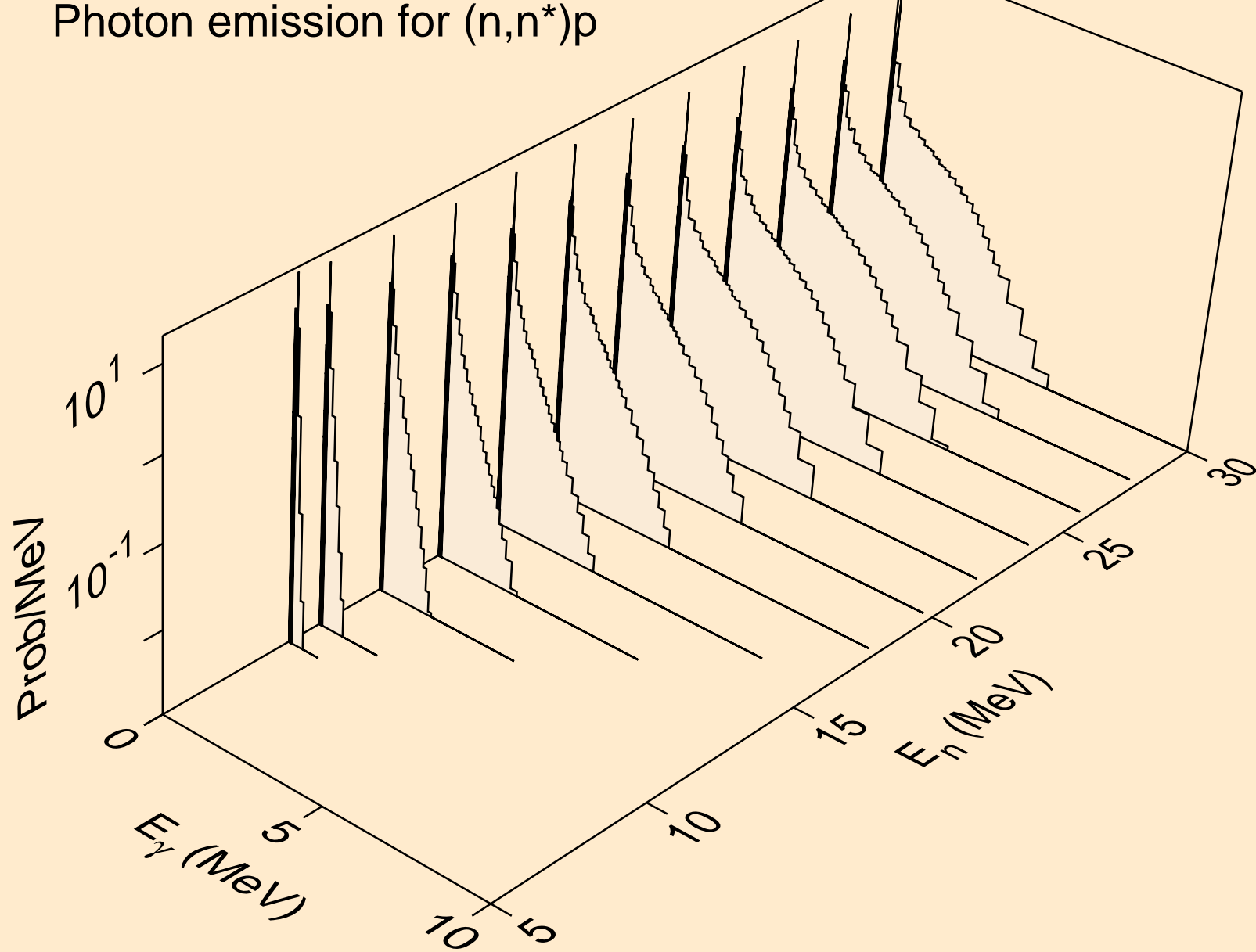

GD153 NEUTRON ACER TENDL-2024 LIBRARY; T=0.K  
Photon emission for (n,n\*)2a

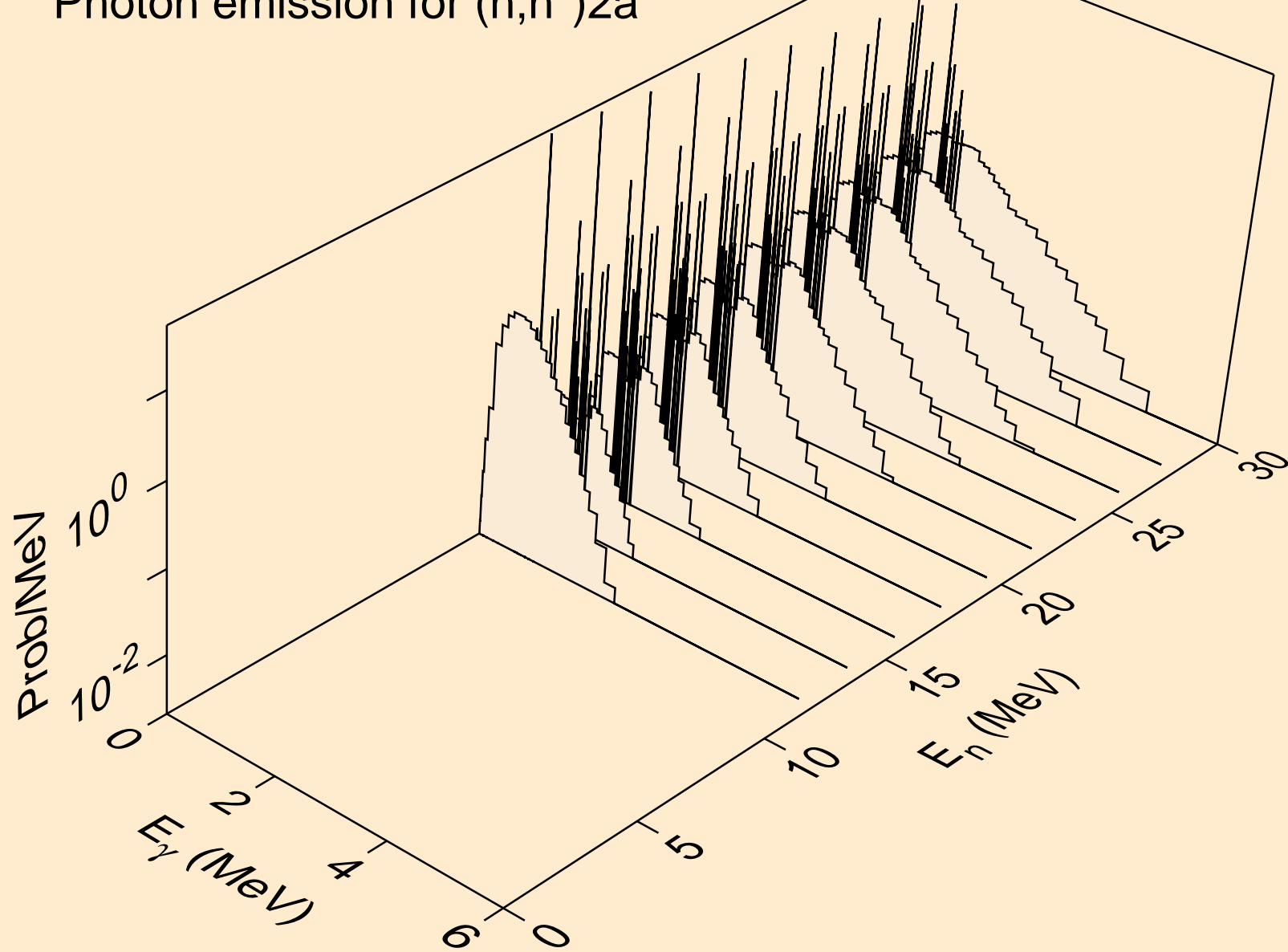

GD153 NEUTRON ACER TENDL-2024 LIBRARY; T=0.K  
Photon emission for (n,2n)2a

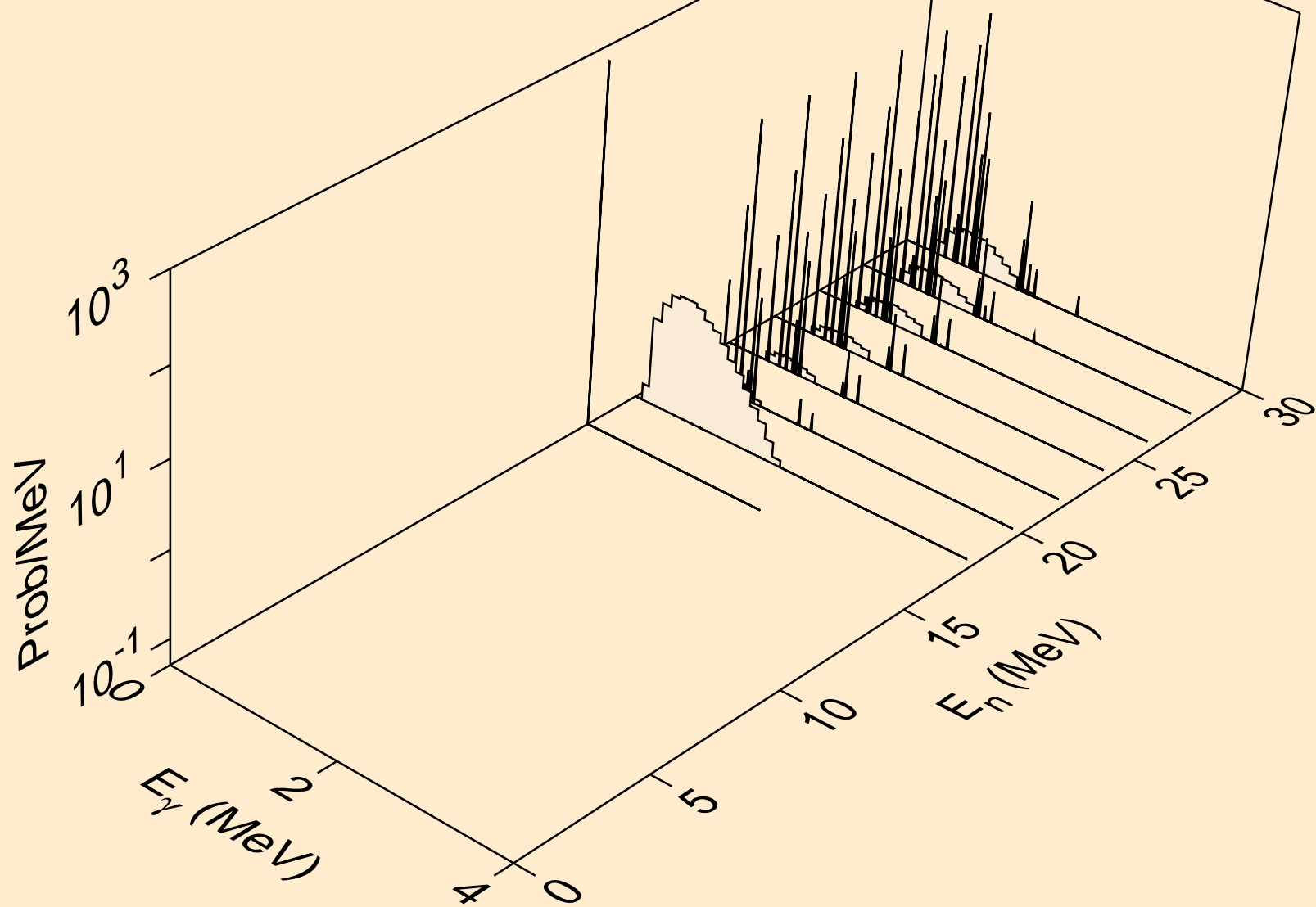

GD153 NEUTRON ACER TENDL-2024 LIBRARY; T=0.K  
Photon emission for (n,n\*)d

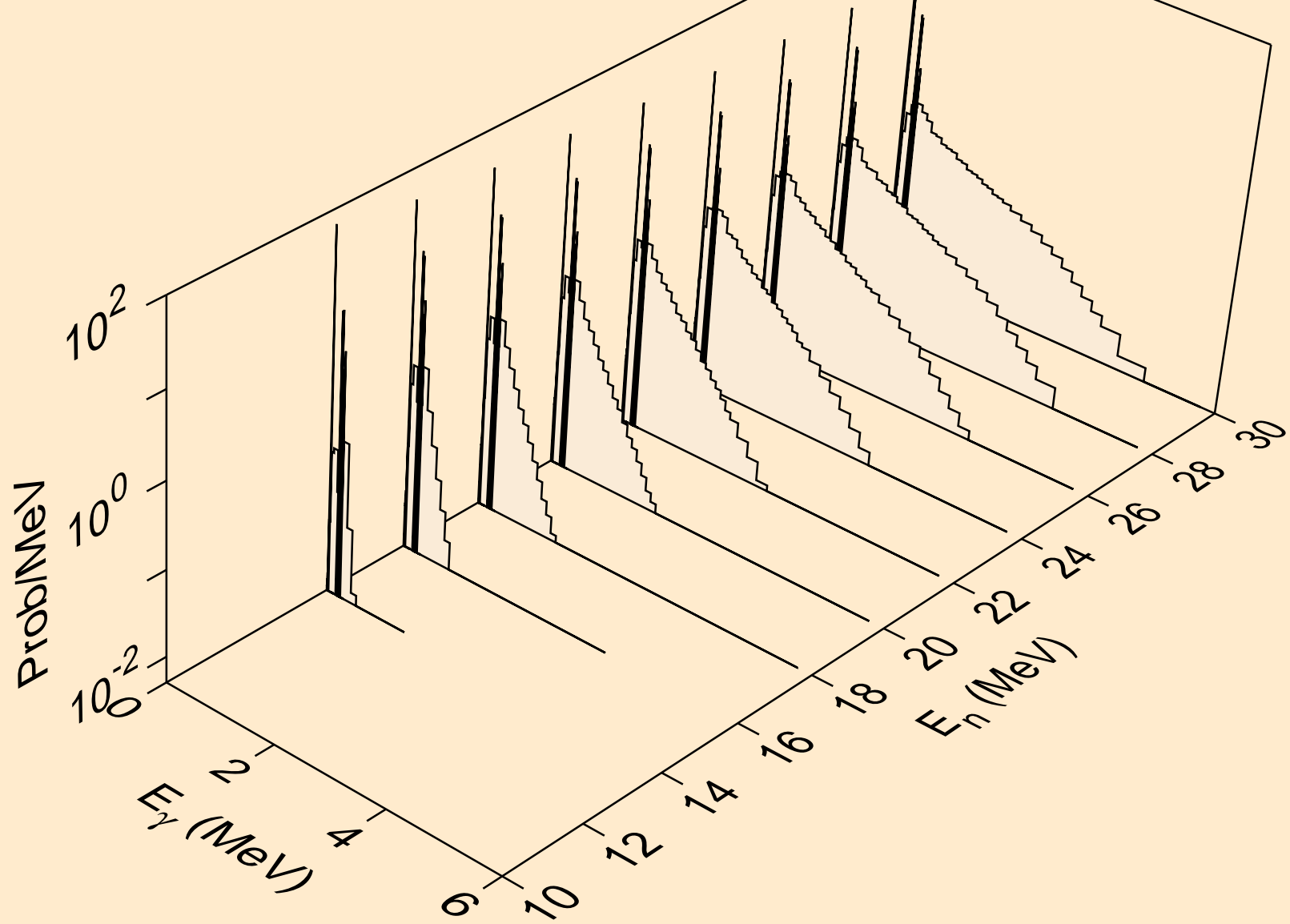

GD153 NEUTRON ACER TENDL-2024 LIBRARY; T=0.K  
Photon emission for (n,n\*)t

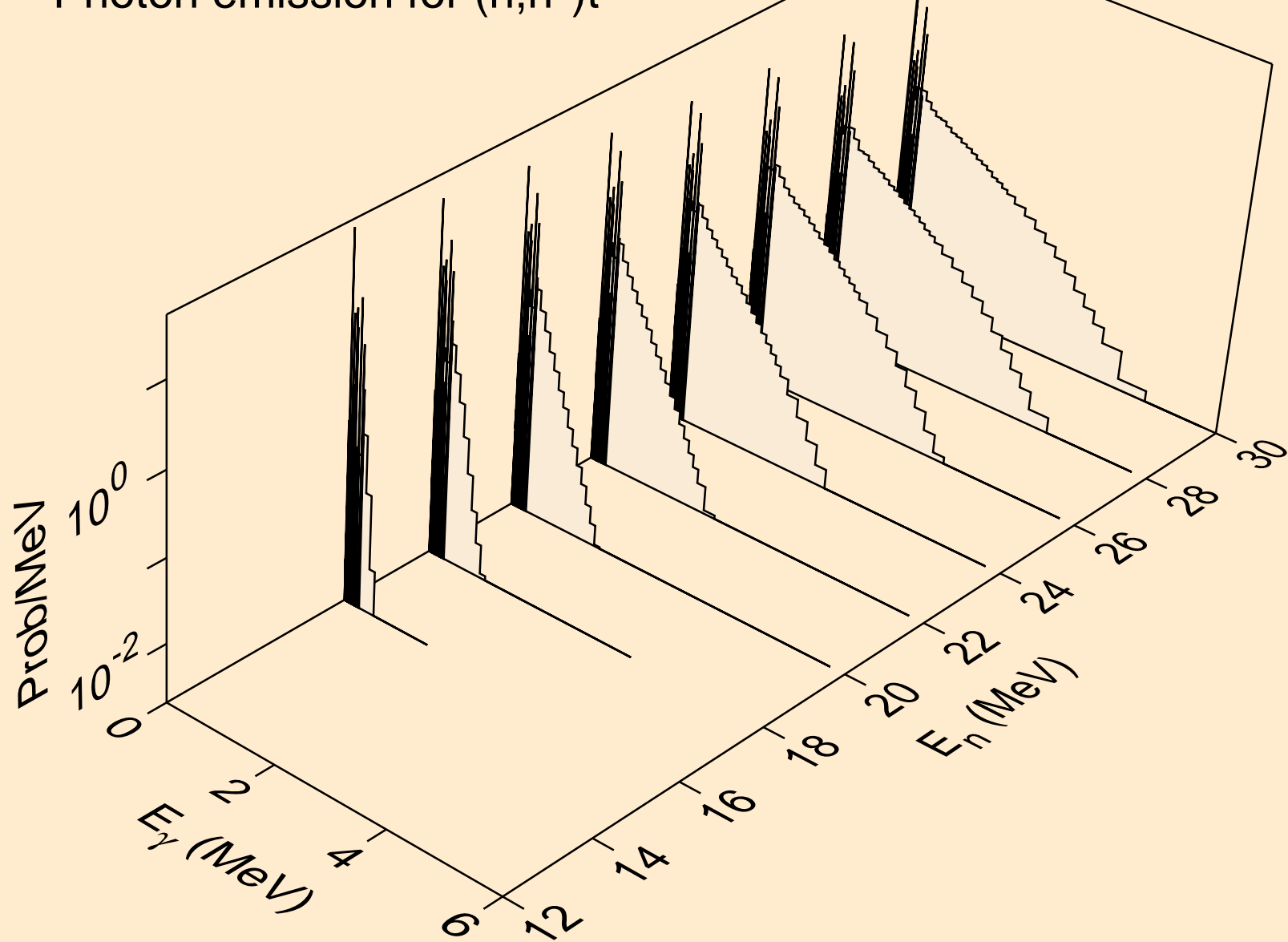

GD153 NEUTRON ACER TENDL-2024 LIBRARY; T=0.K  
Photon emission for (n,n\*)he3

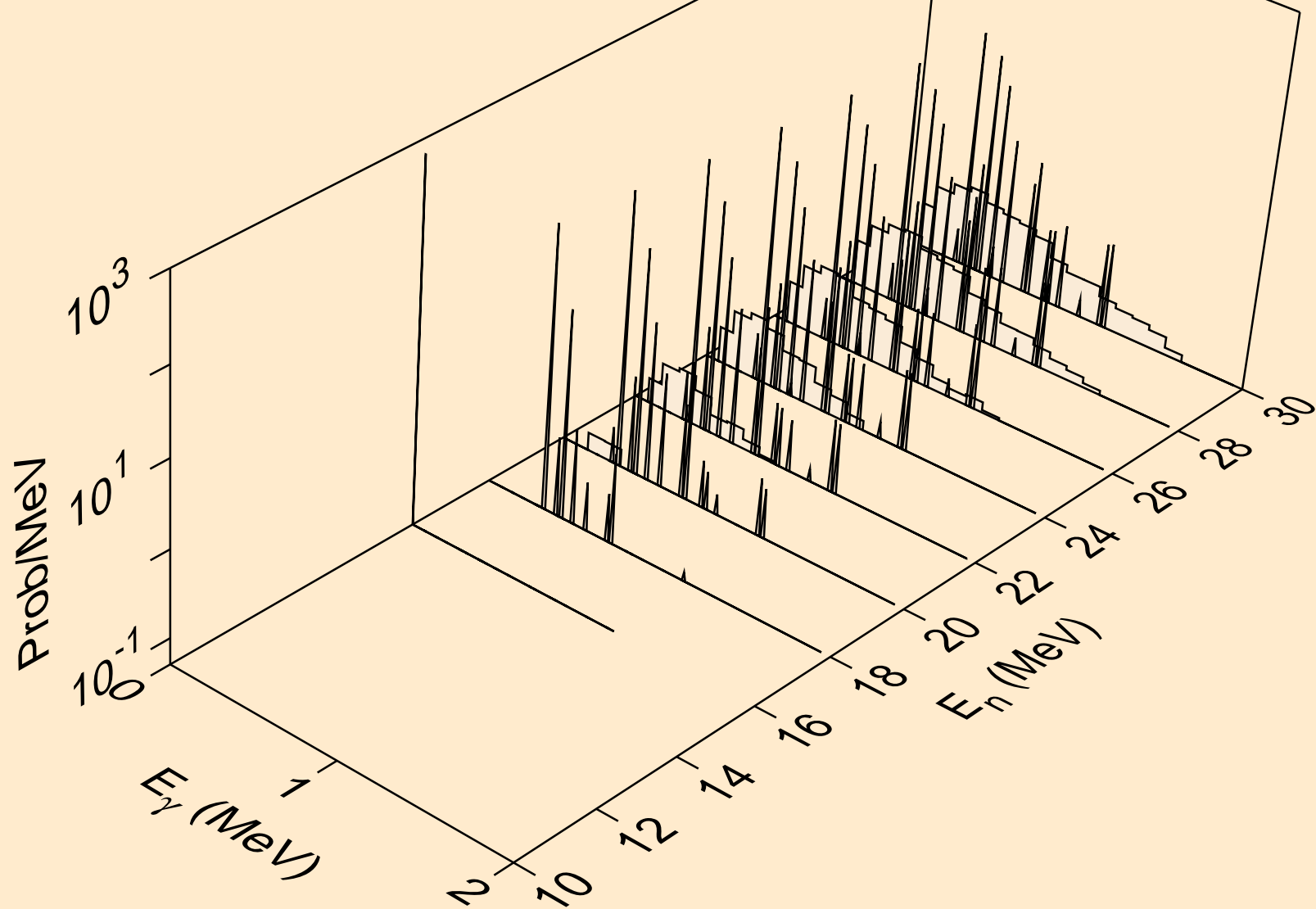

GD153 NEUTRON ACER TENDL-2024 LIBRARY; T=0.K  
Photon emission for (n,4n)

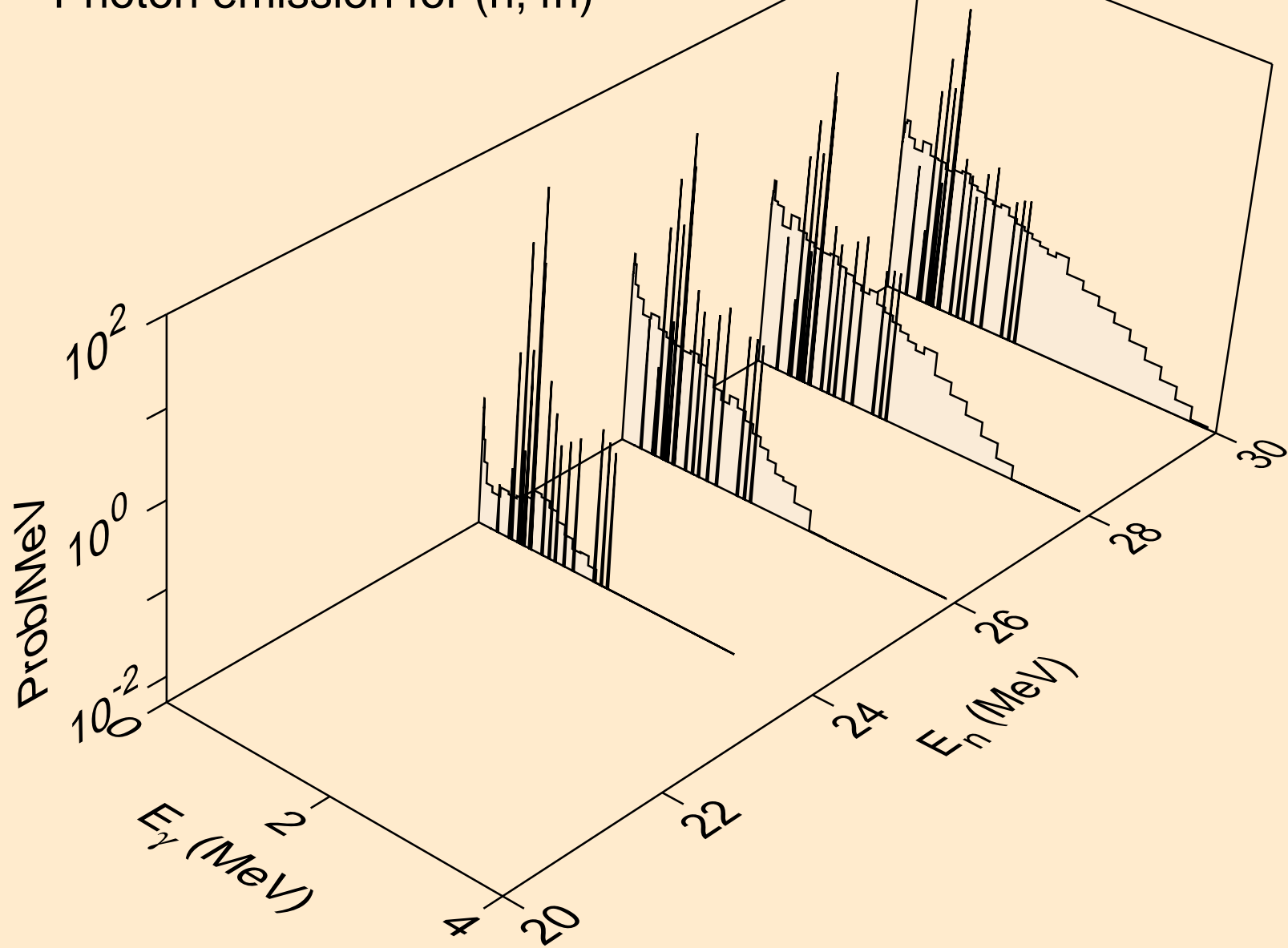

GD153 NEUTRON ACER TENDL-2024 LIBRARY; T=0.K  
Photon emission for (n,2np)

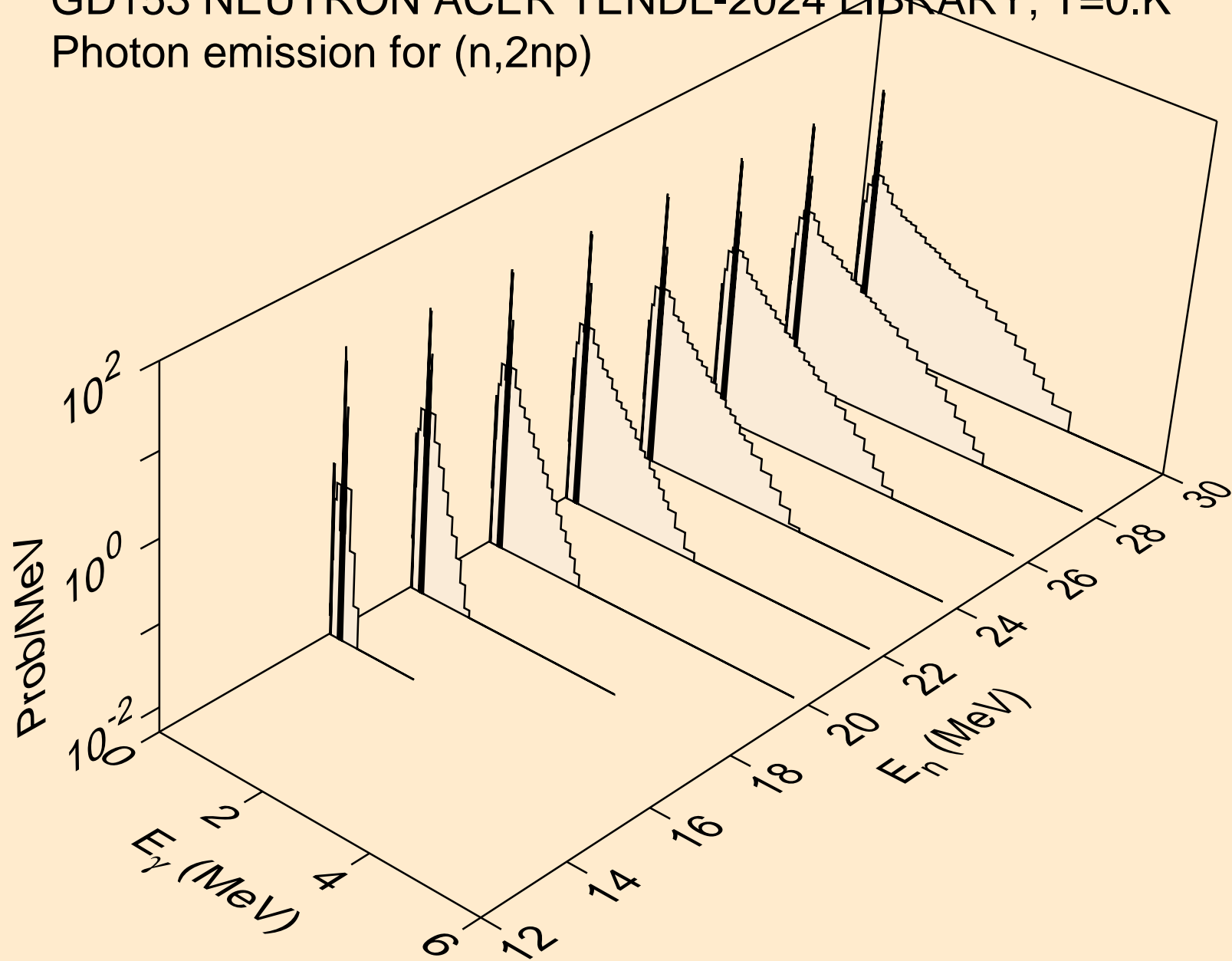



GD153 NEUTRON ACER TENDL-2024 LIBRARY; T=0.K  
Photon emission for (n,3np)

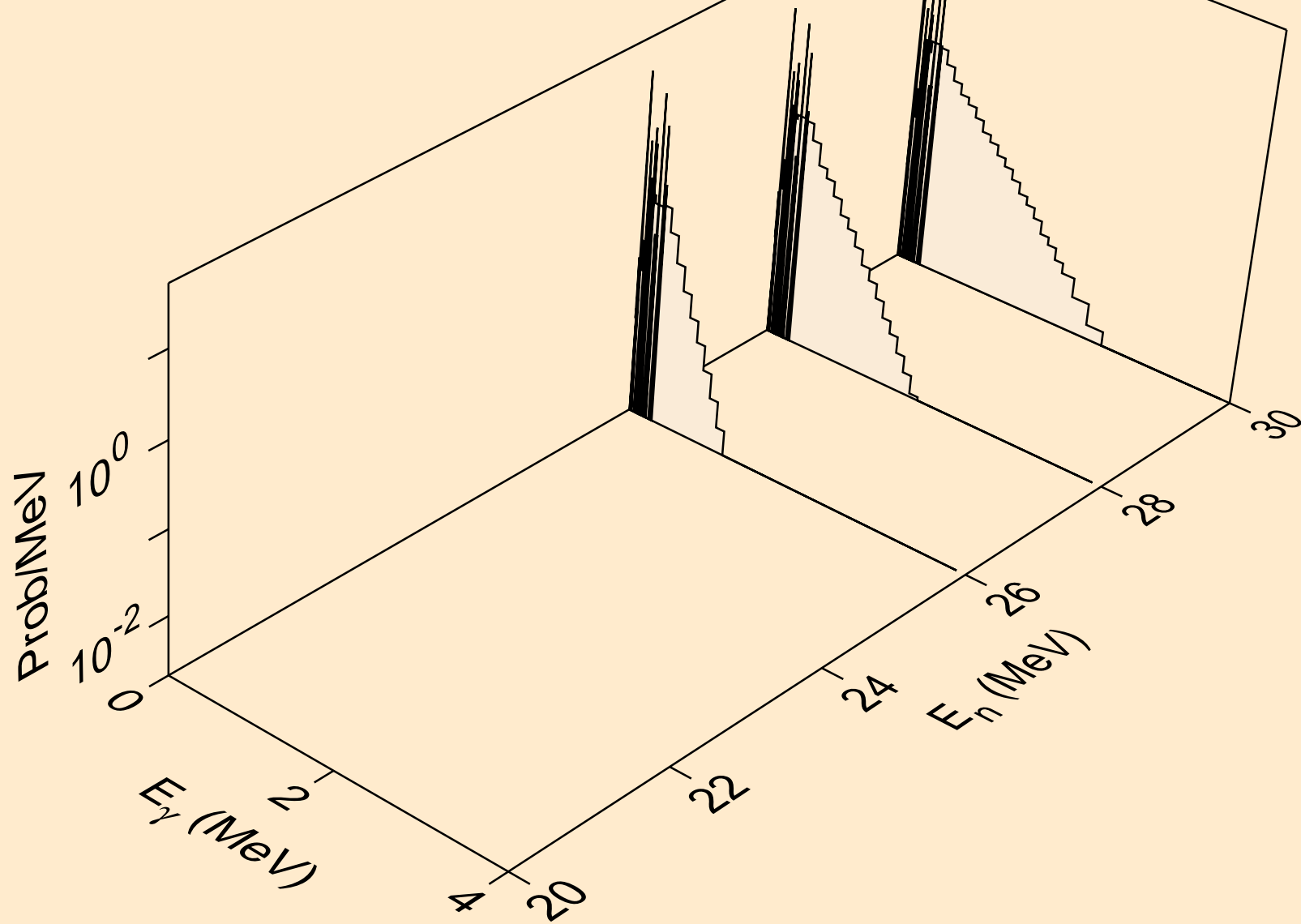

GD153 NEUTRON ACER TENDL-2024 LIBRARY; T=0.K  
Photon emission for (n,n2p)

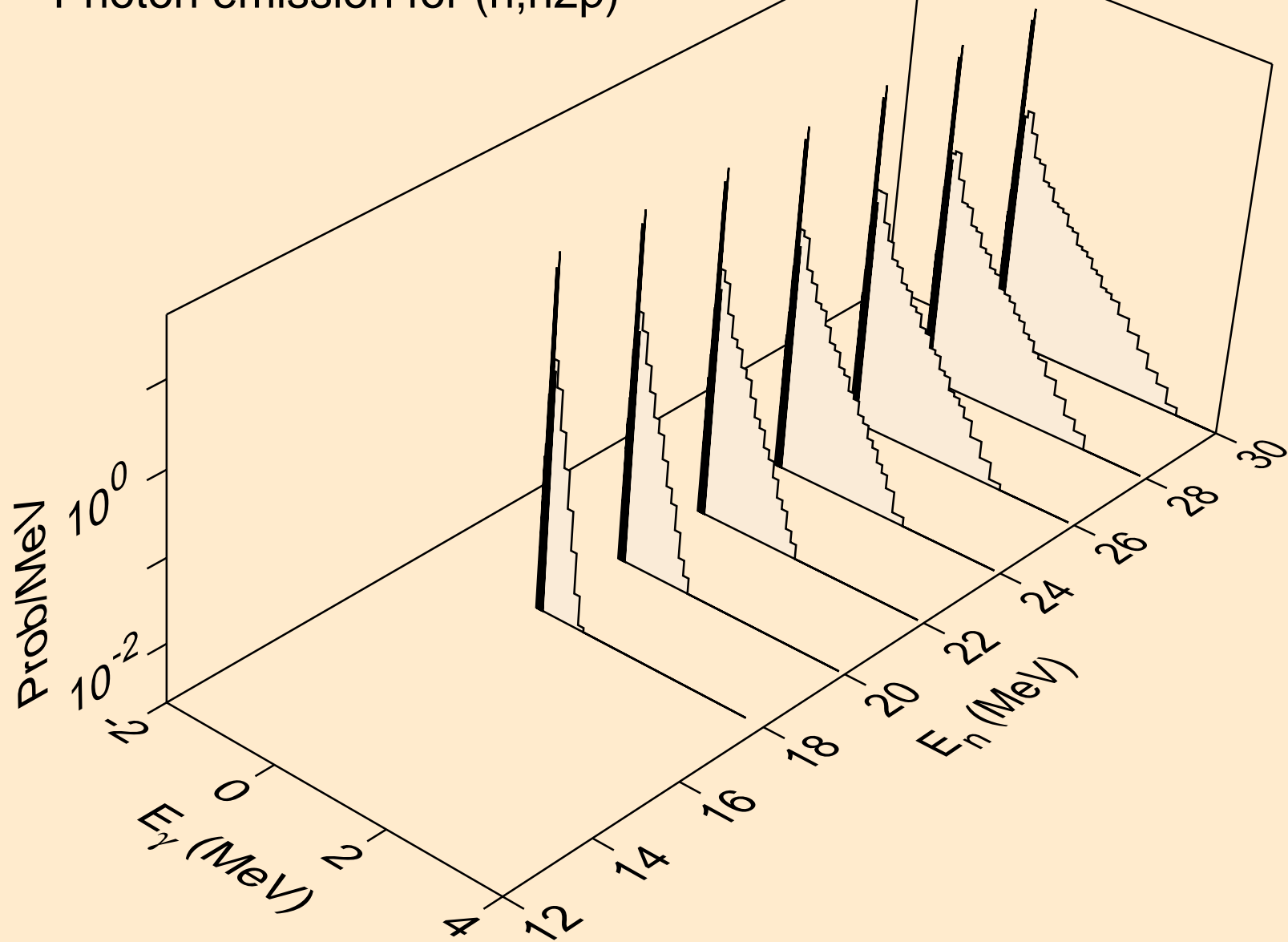

GD153 NEUTRON ACER TENDL-2024 LIBRARY; T=0.K  
Photon emission for (n,npa)

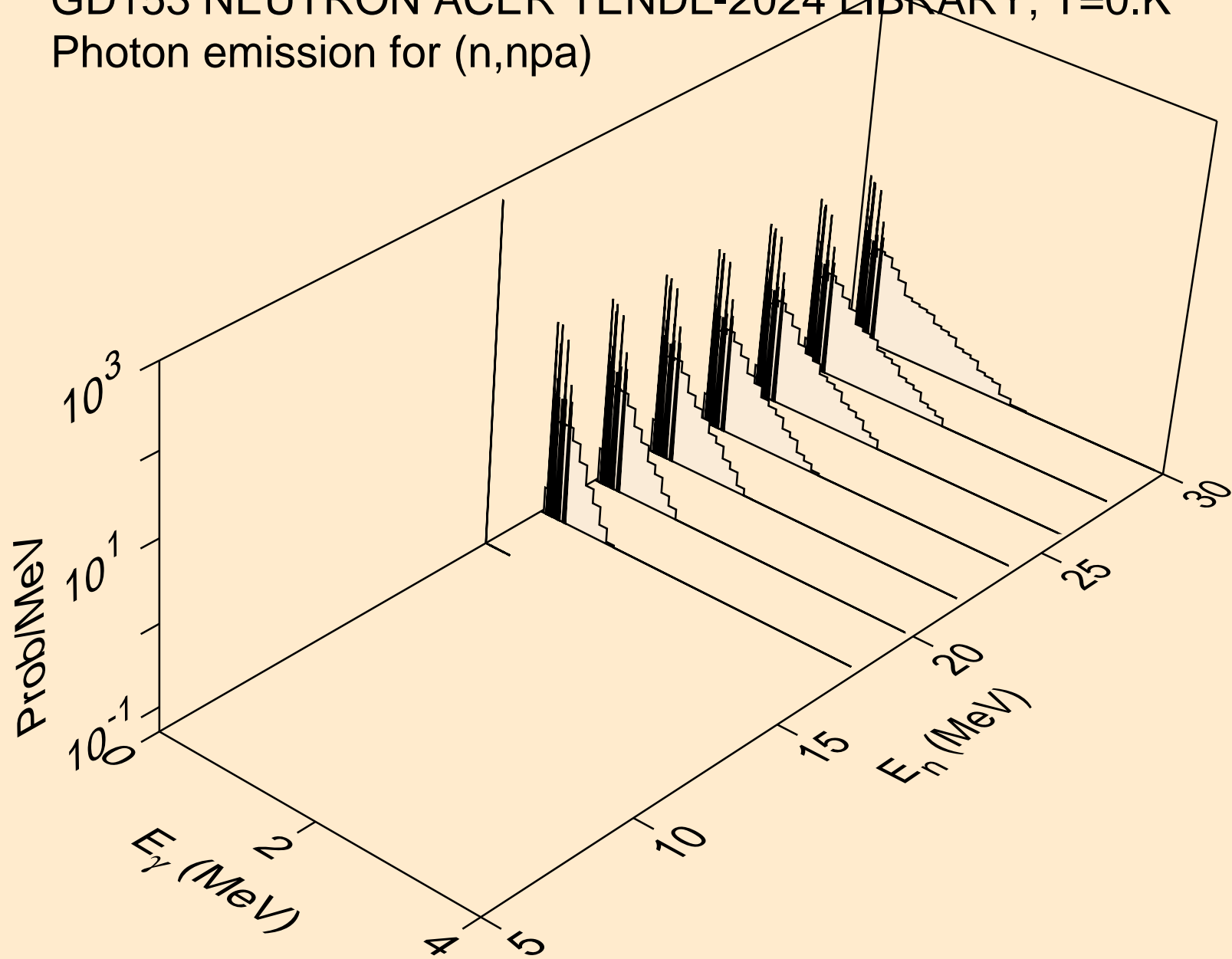

GD153 NEUTRON ACER TENDL-2024 LIBRARY; T=0.K  
Photon emission for (n,n\*c)

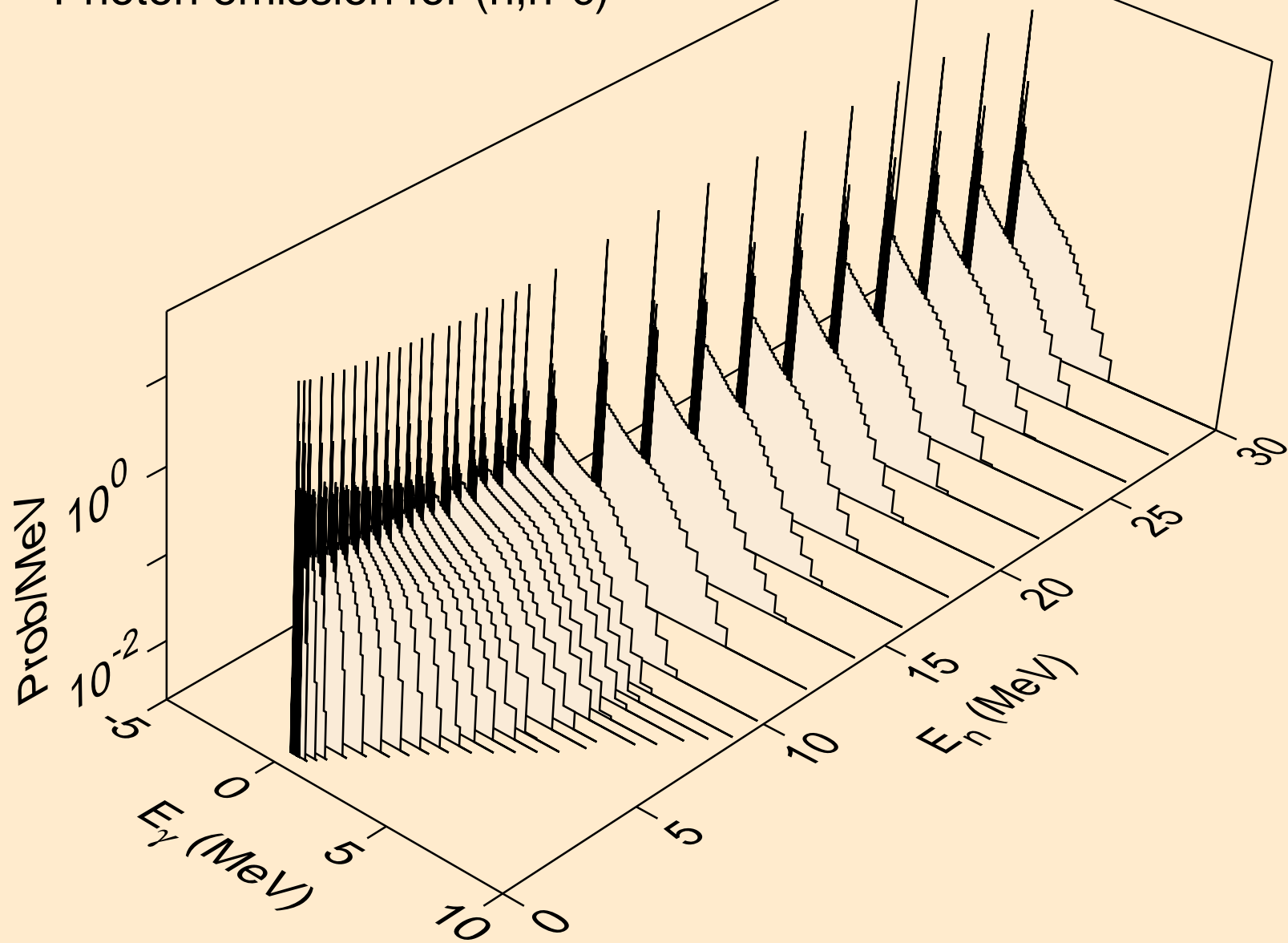

GD153 NEUTRON ACER TENDL-2024 LIBRARY; T=0.K  
Photon emission for (n,gma)

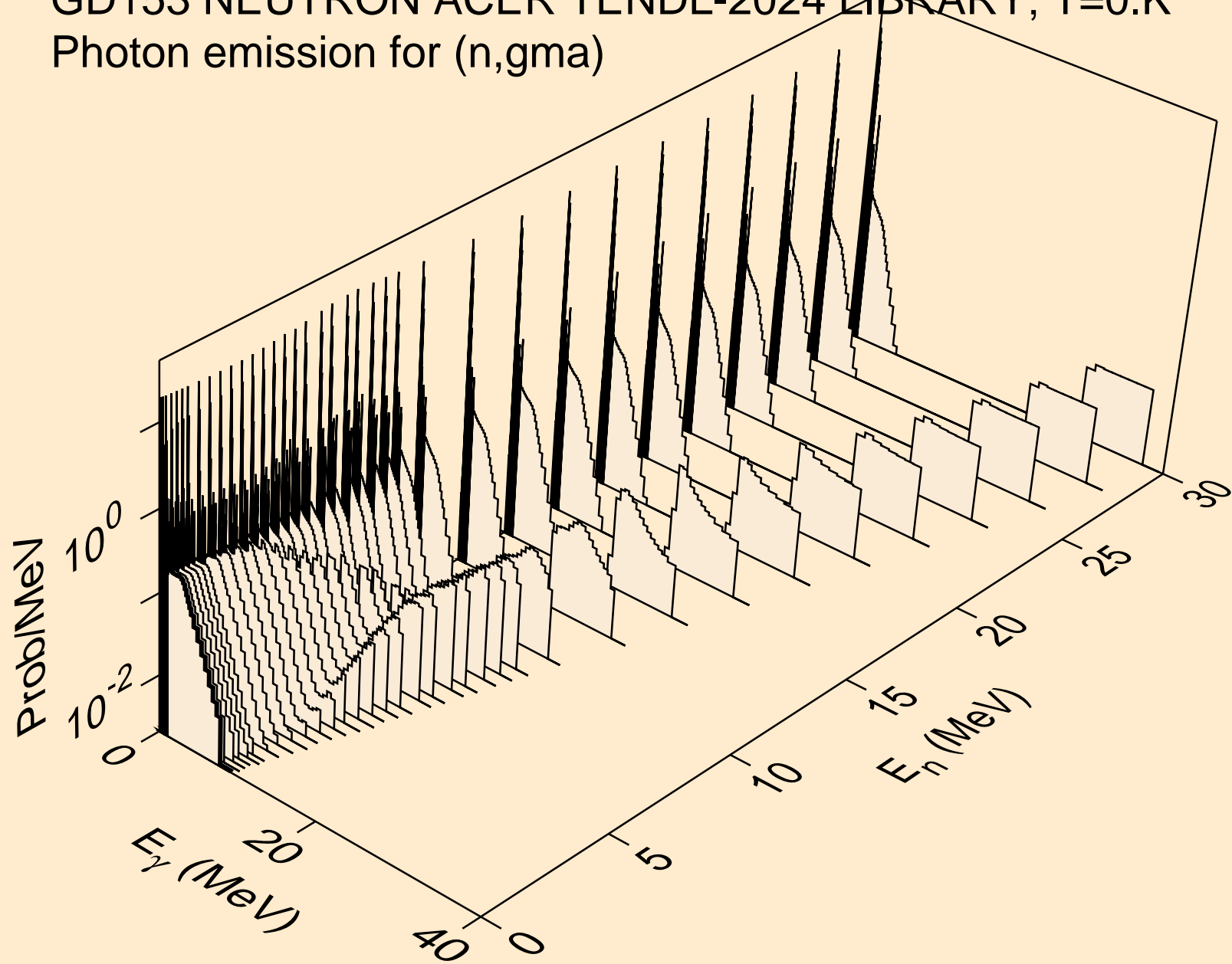

GD153 NEUTRON ACER TENDL-2024 LIBRARY; T=0.K  
Photon emission for (n,p)

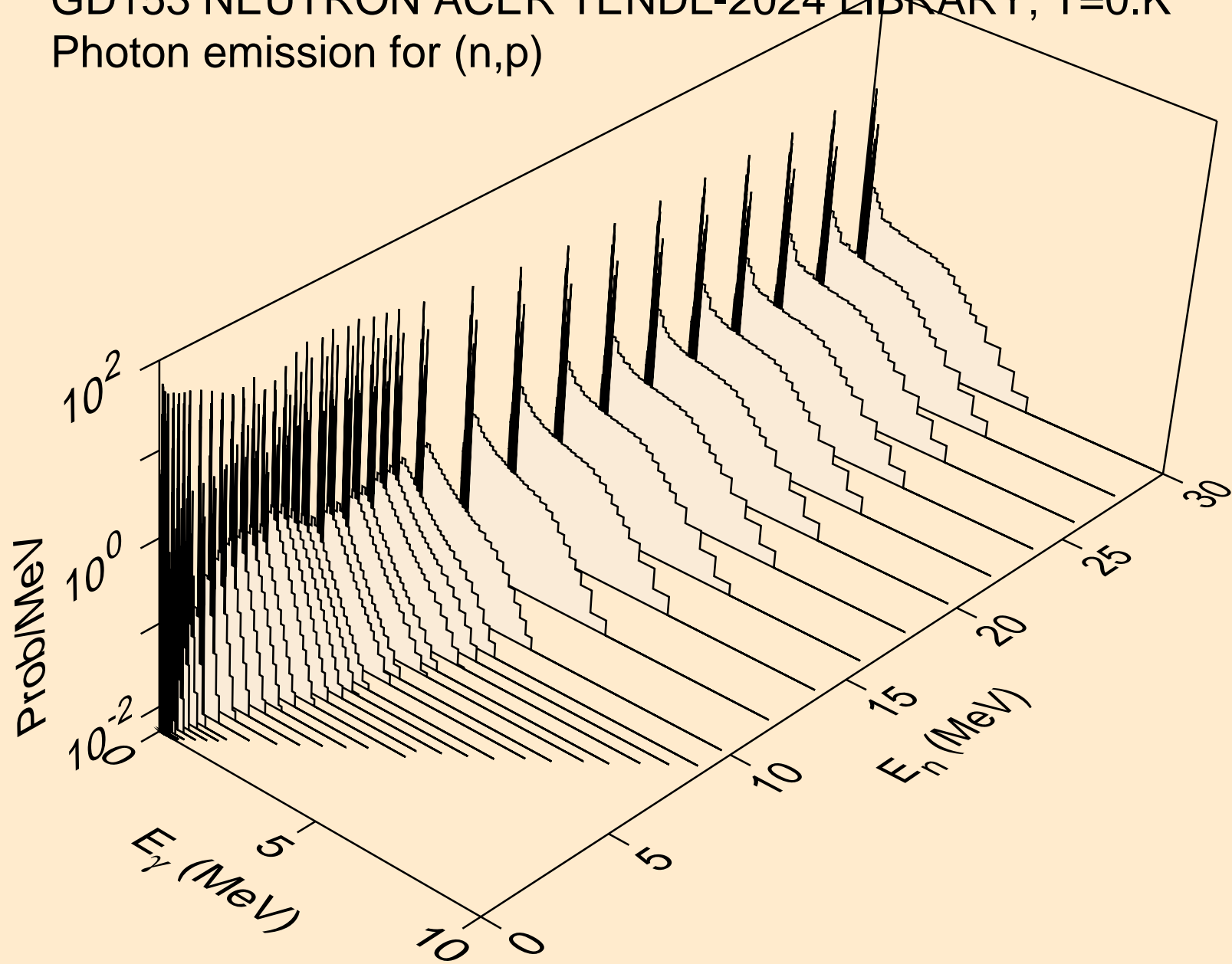

GD153 NEUTRON ACER TENDL-2024 LIBRARY; T=0.K  
Photon emission for (n,d)

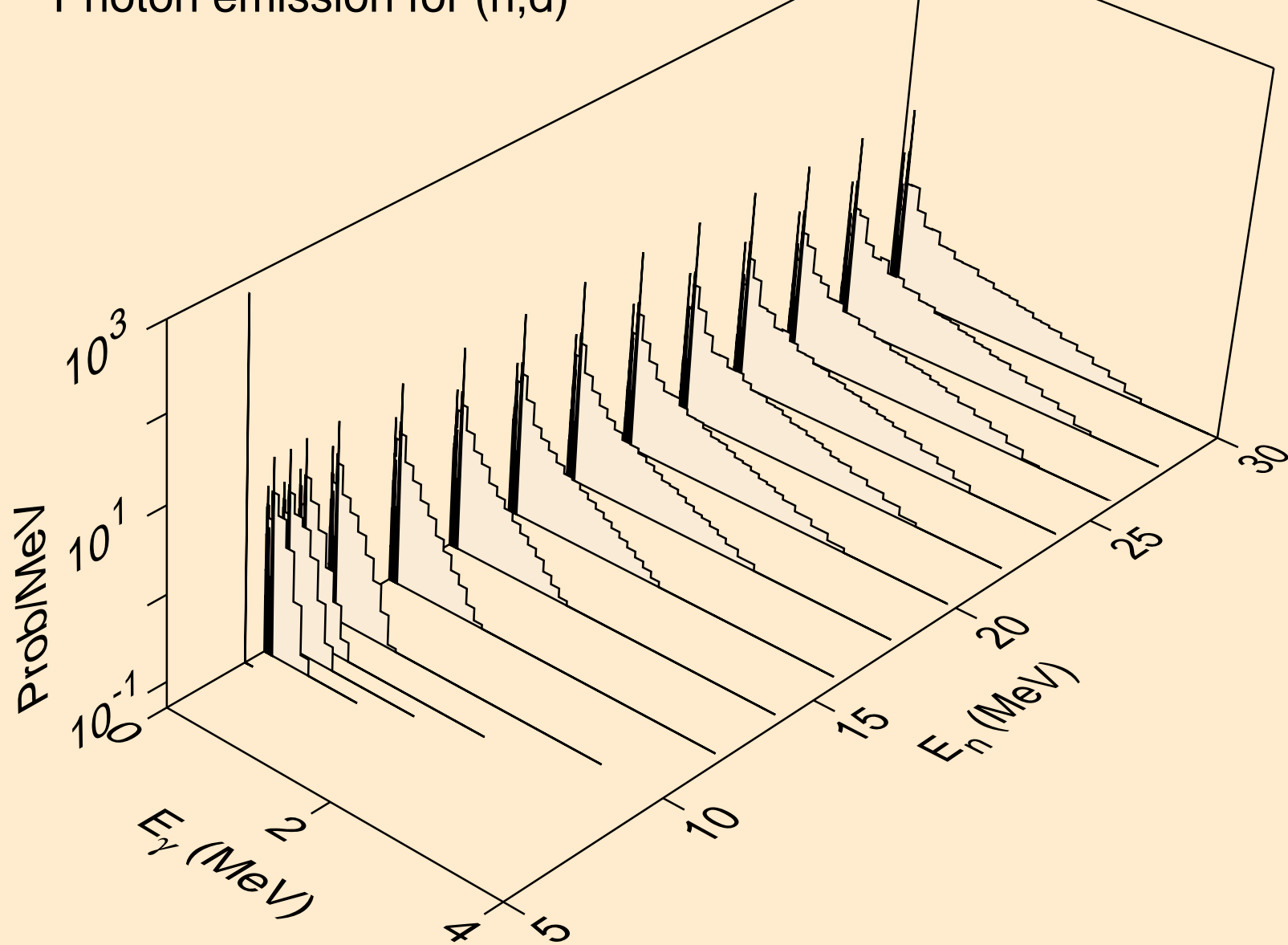

GD153 NEUTRON ACER TENDL-2024 LIBRARY; T=0.K  
Photon emission for (n,t)

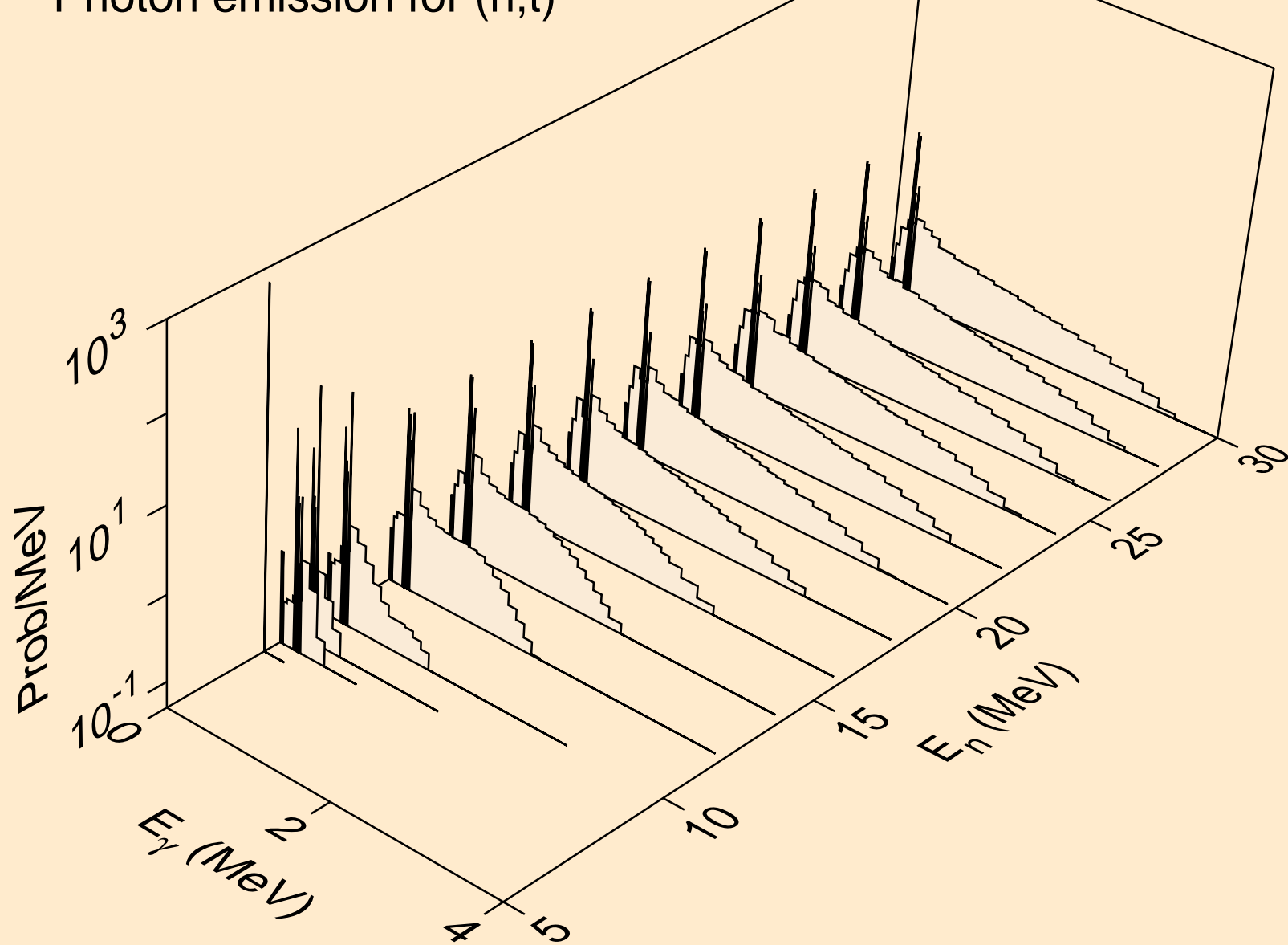



GD153 NEUTRON ACER TENDL-2024 LIBRARY; T=0.K  
Photon emission for (n,he3)

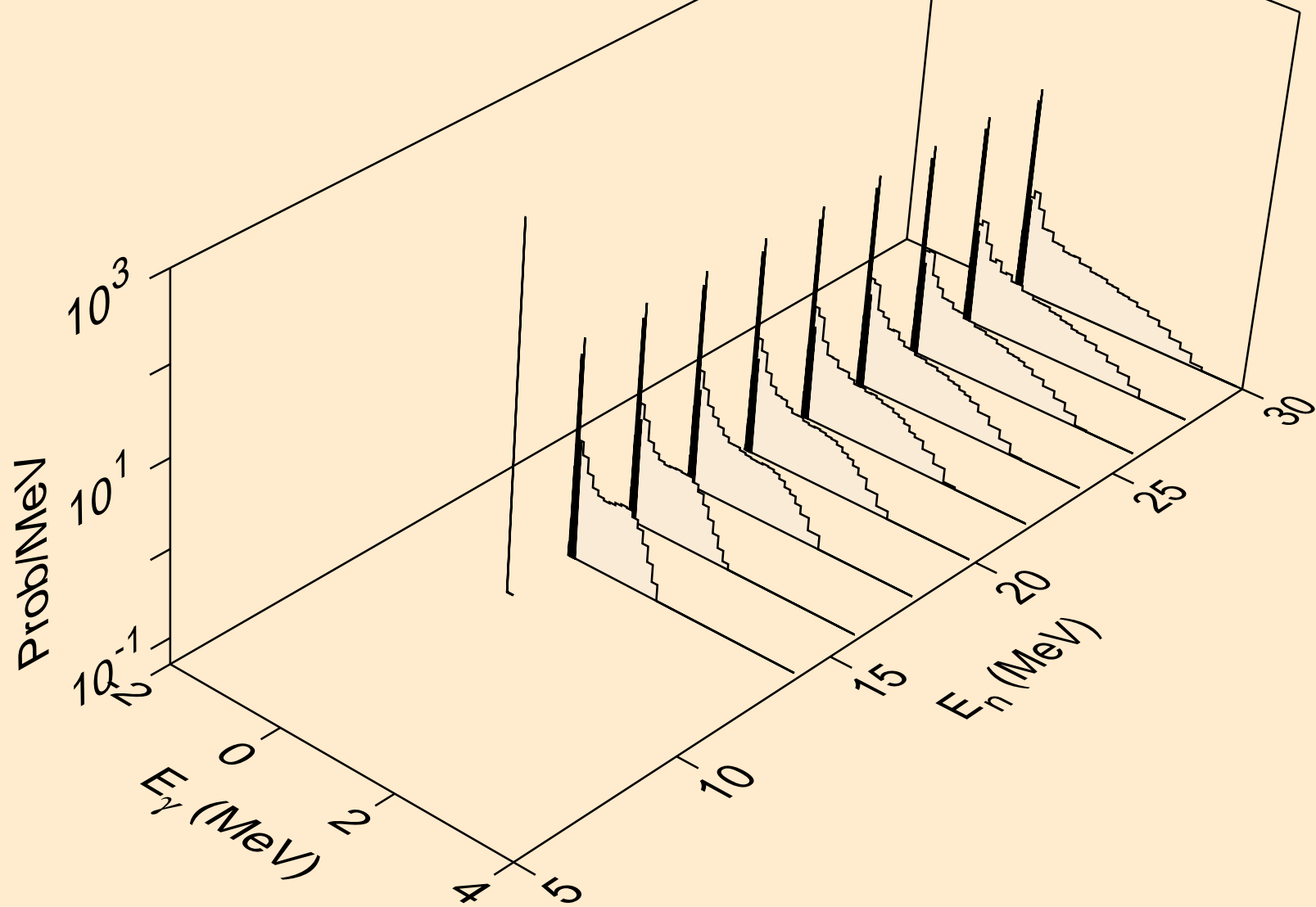

GD153 NEUTRON ACER TENDL-2024 LIBRARY; T=0.K  
Photon emission for (n,a)

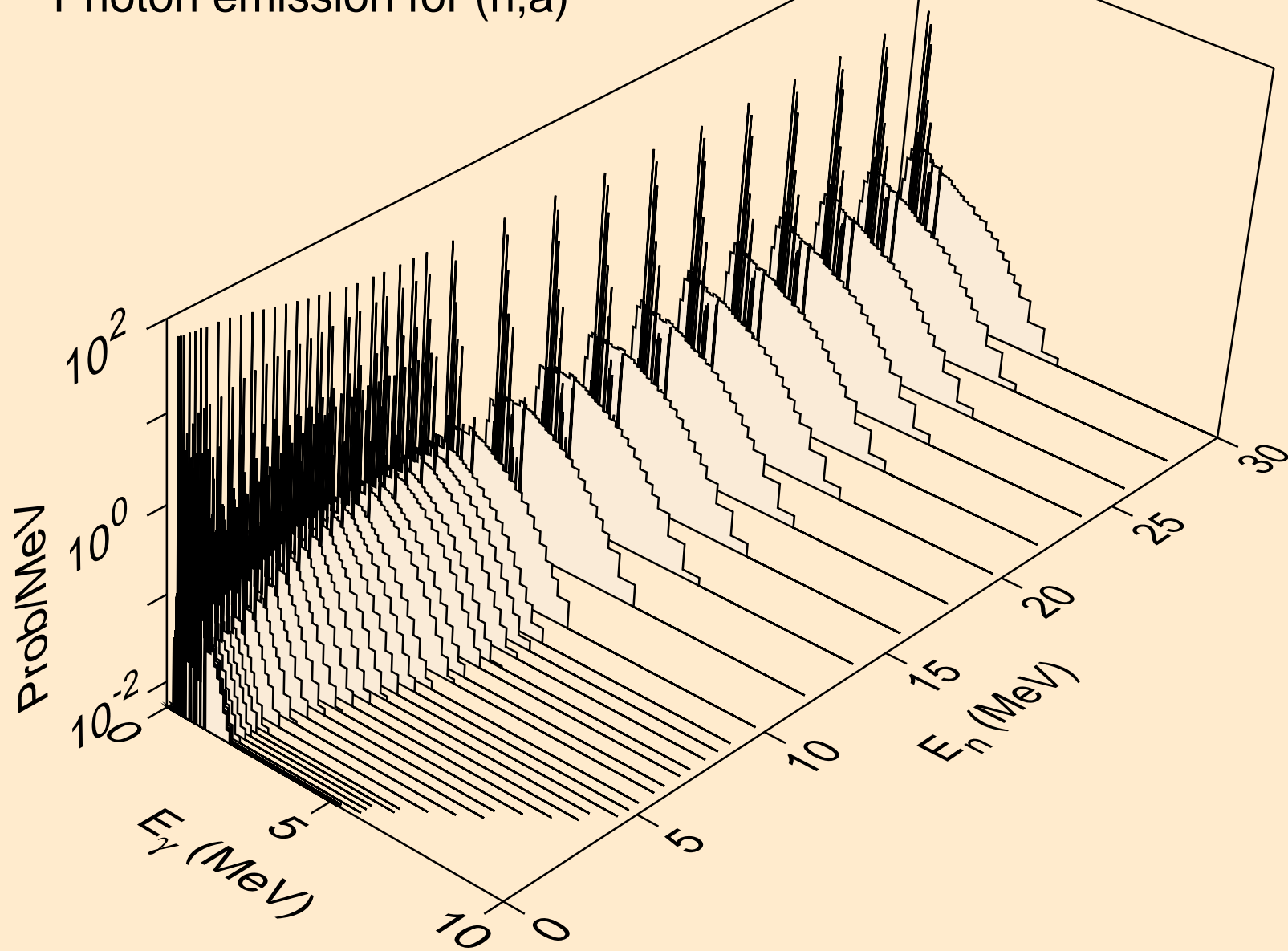

GD153 NEUTRON ACER TENDL-2024 LIBRARY; T=0.K  
Photon emission for (n,2a)

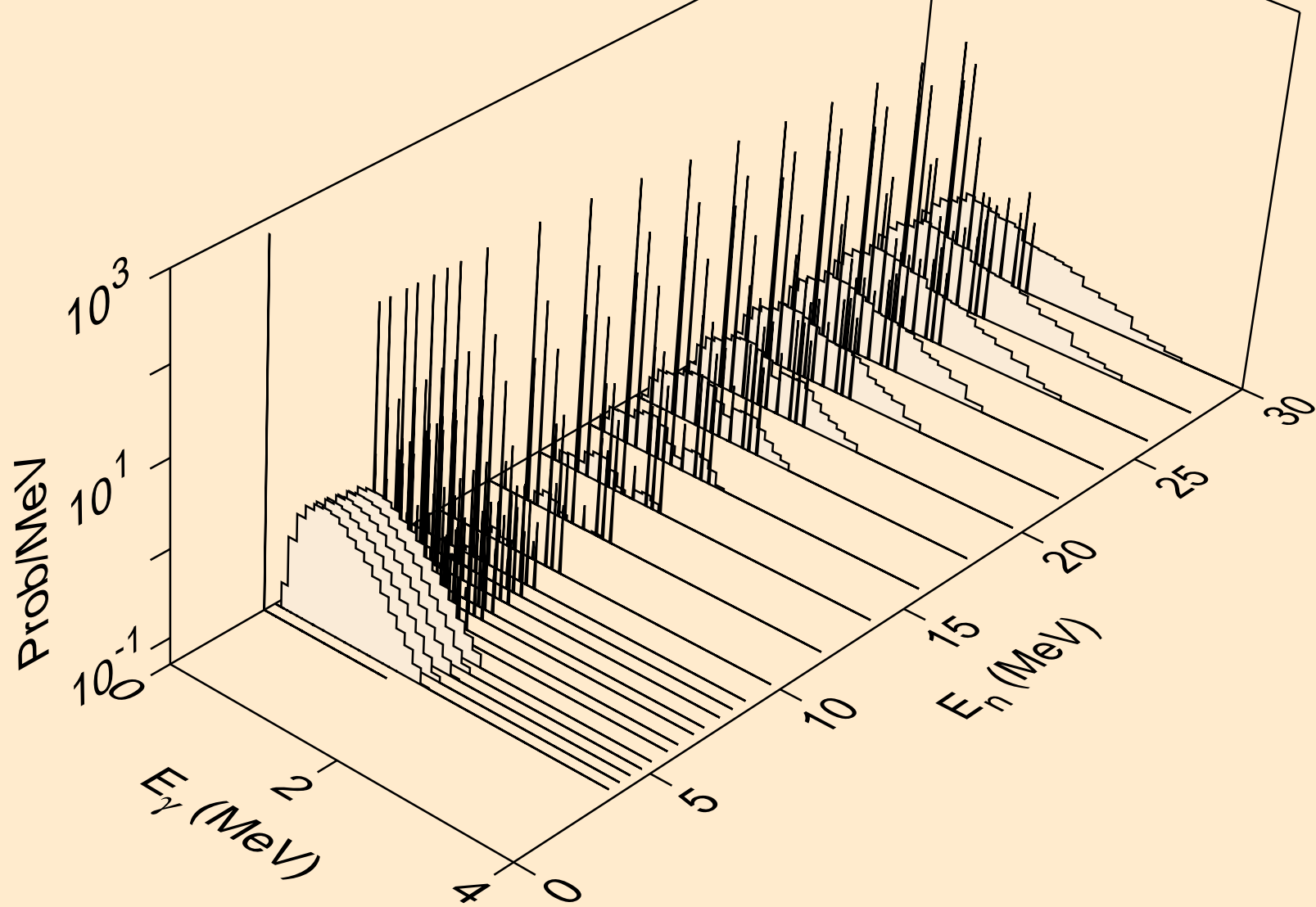

GD153 NEUTRON ACER TENDL-2024 LIBRARY; T=0.K  
Photon emission for (n,2p)

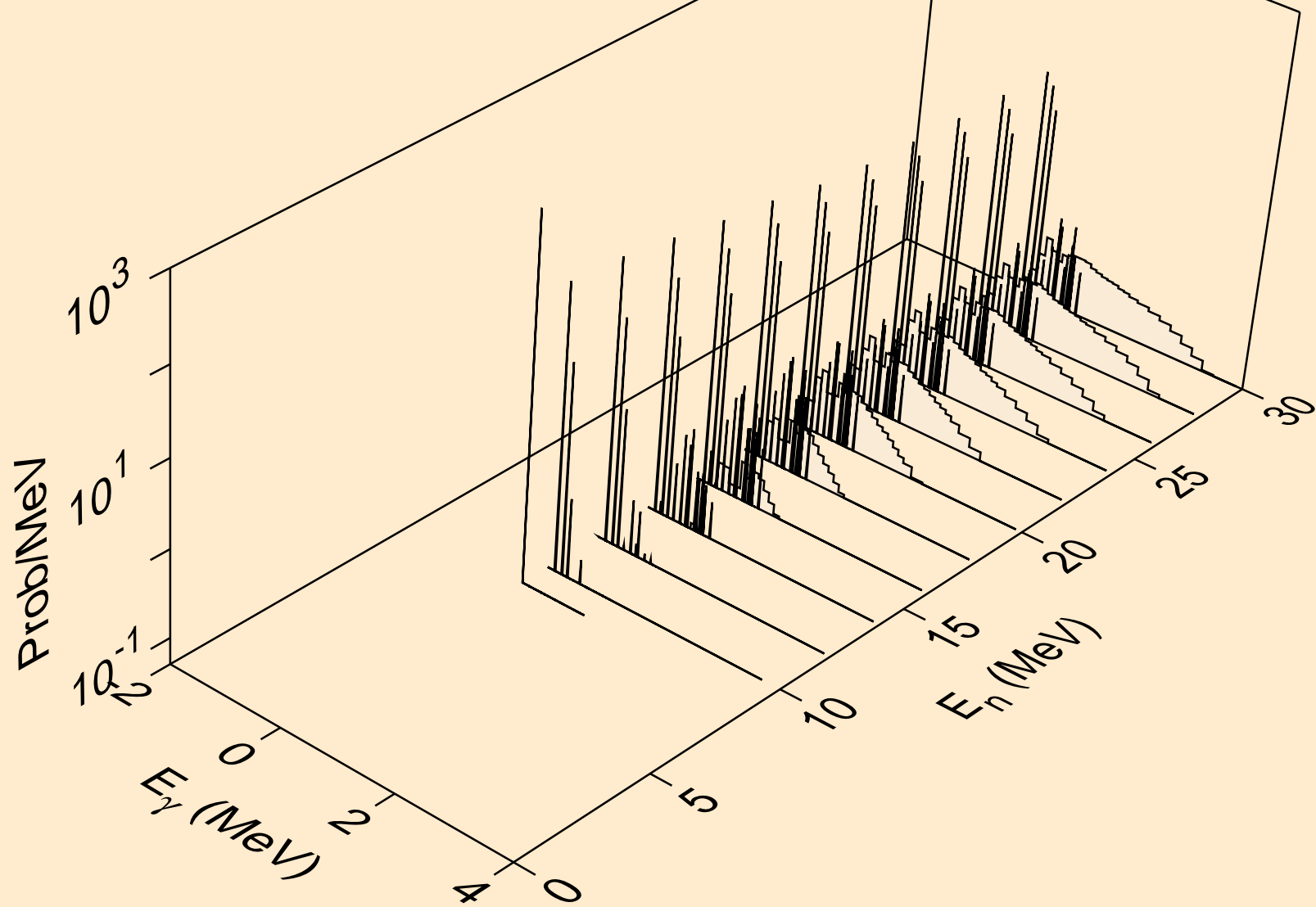

GD153 NEUTRON ACER TENDL-2024 LIBRARY; T=0.K  
Photon emission for (n,p $\alpha$ )

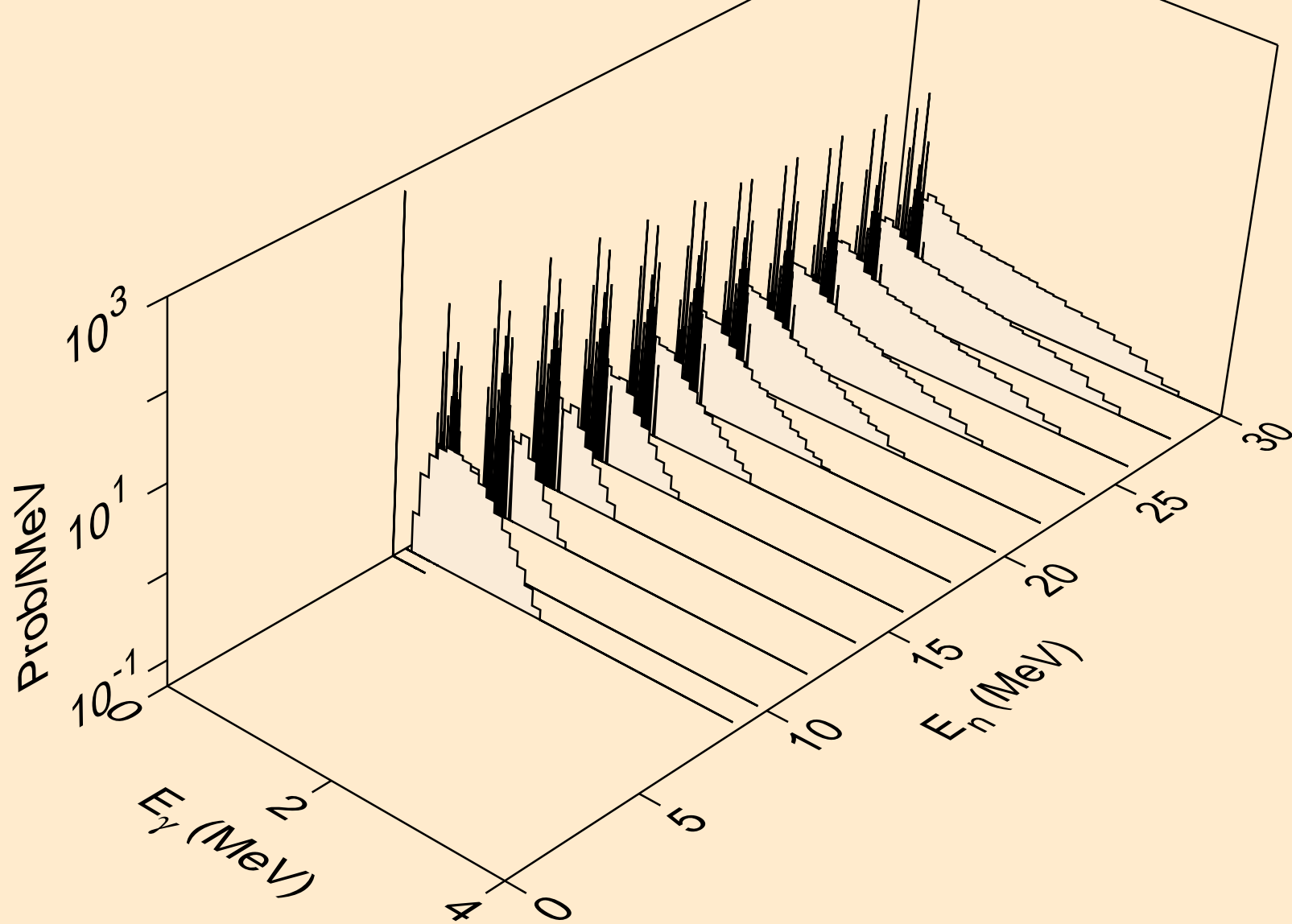

GD153 NEUTRON ACER TENDL-2024 LIBRARY; T=0.K  
Photon emission for (n,pd)

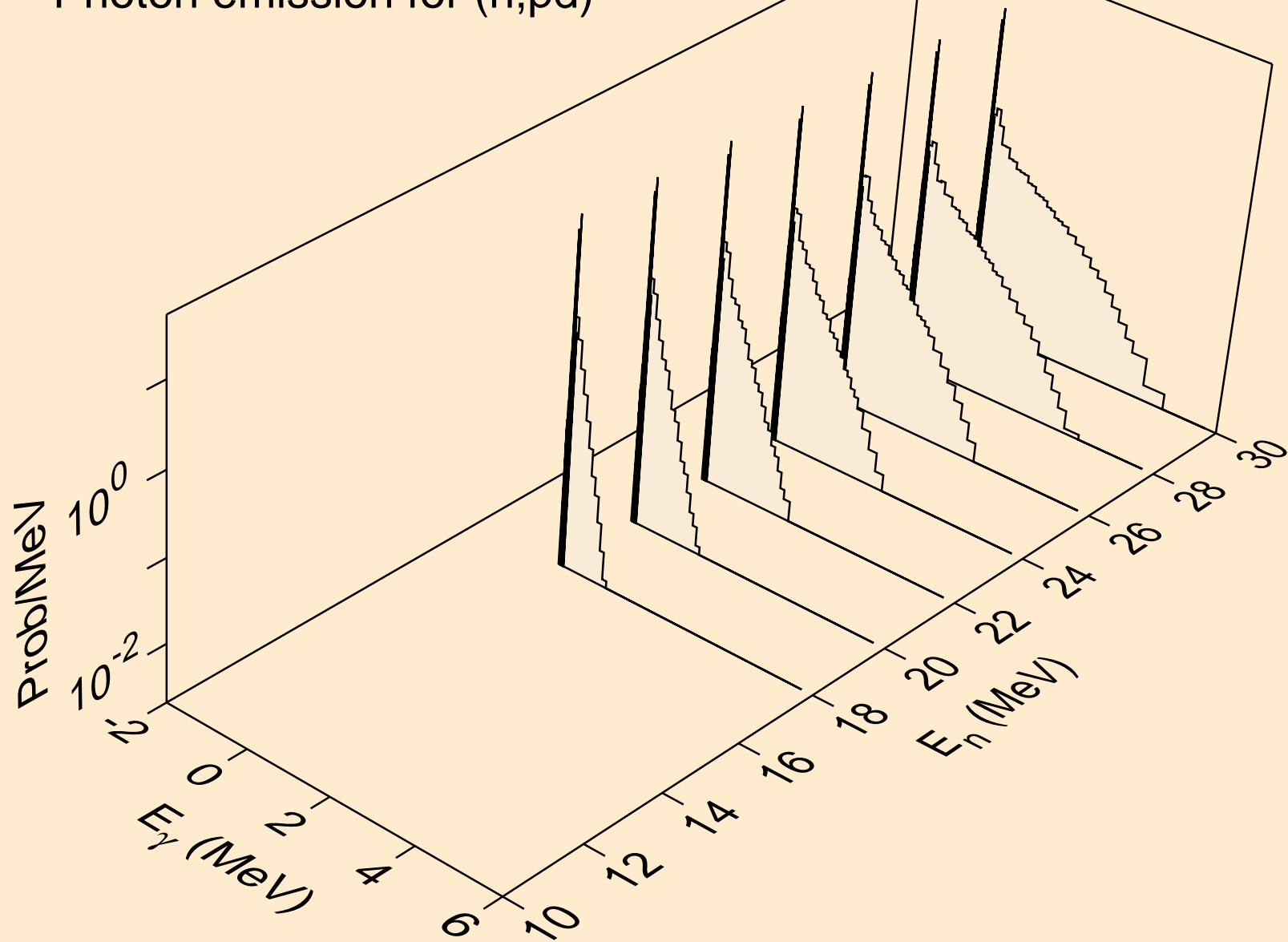

GD153 NEUTRON ACER TENDL-2024 LIBRARY; T=0.K  
Photon emission for (n,pt)

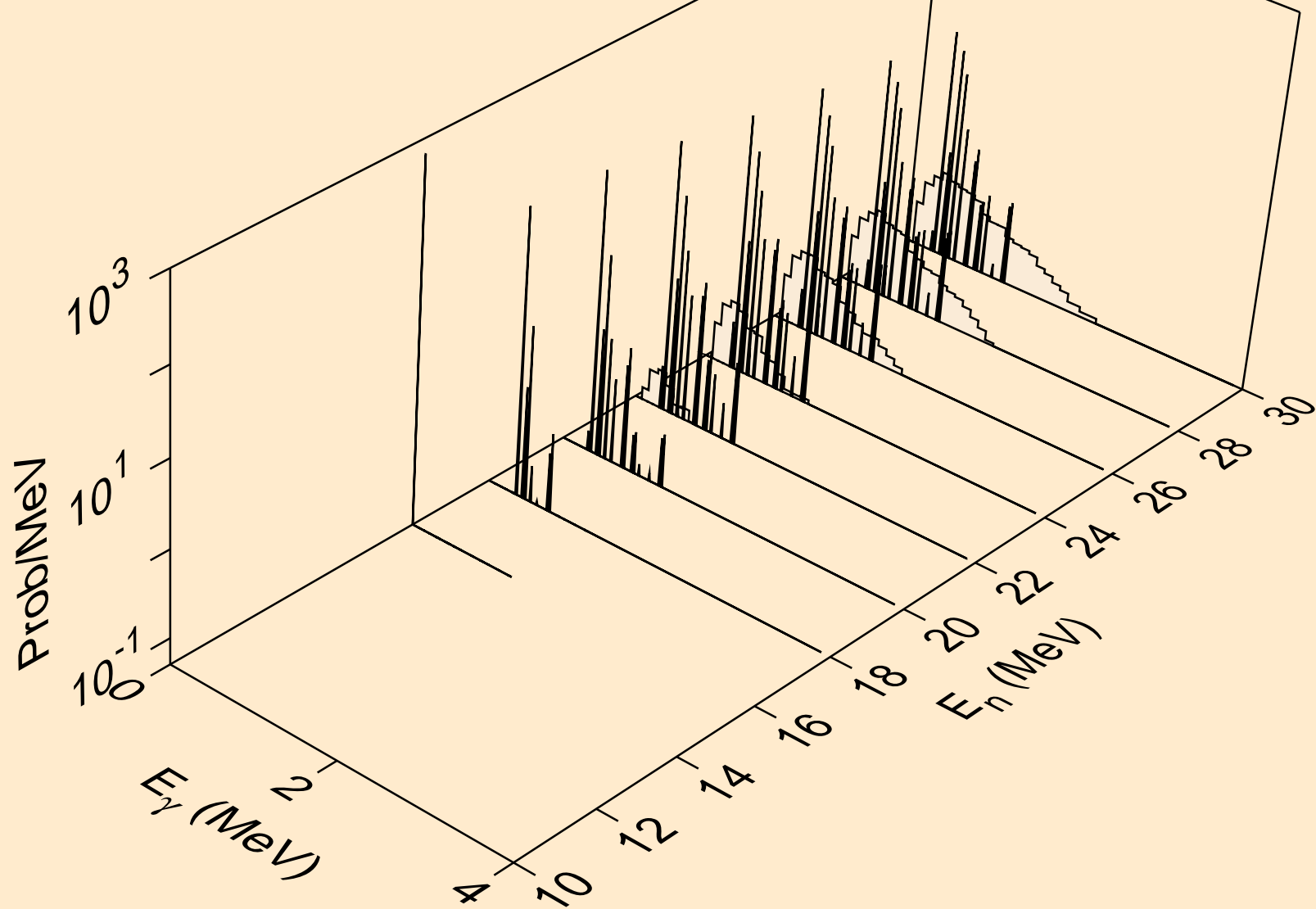

GD153 NEUTRON ACER TENDL-2024 LIBRARY; T=0.K  
Photon emission for (n,da)

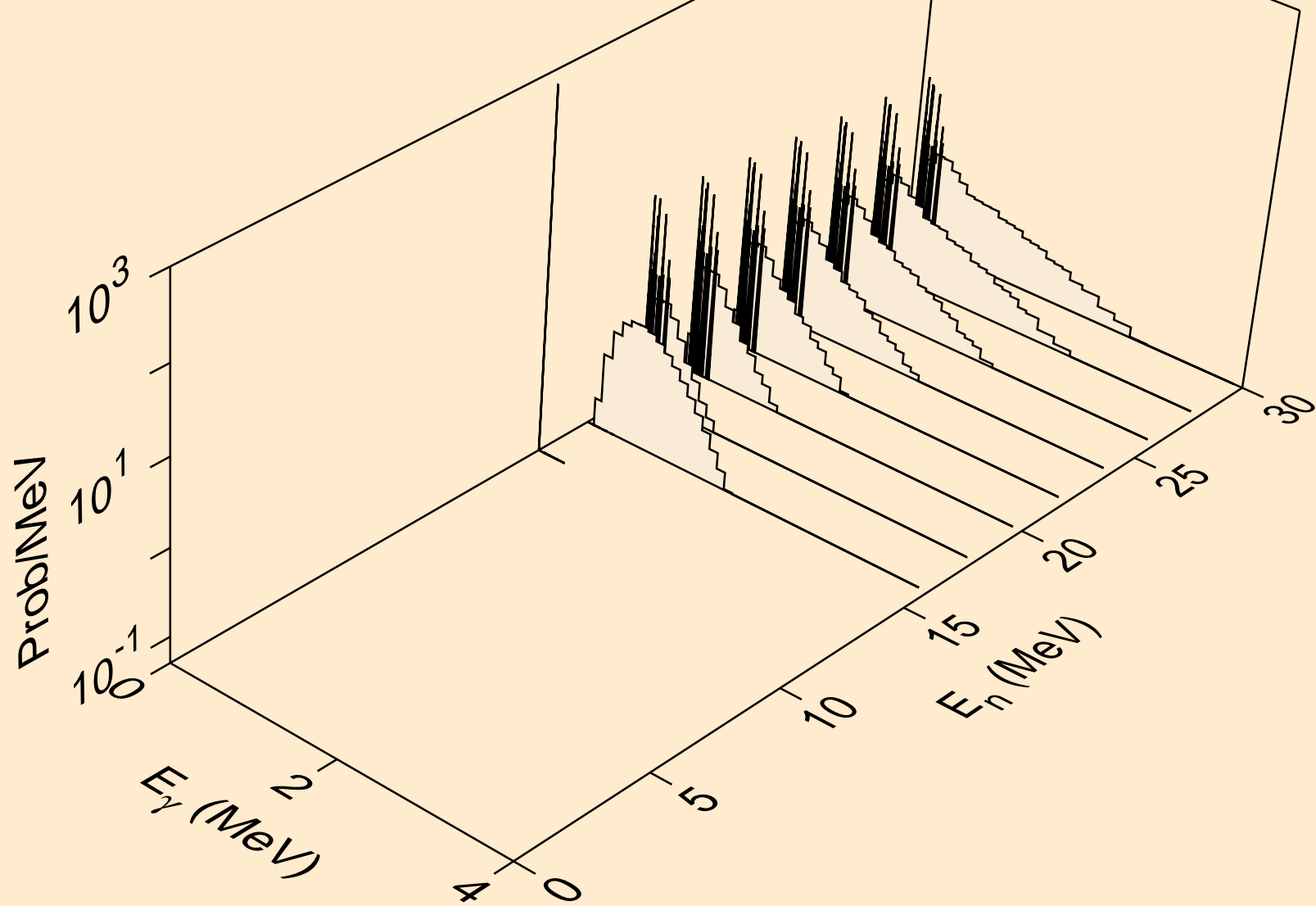



GD153 NEUTRON ACER TENDL-2024 LIBRARY; T=0.K  
thermal capture photon spectrum

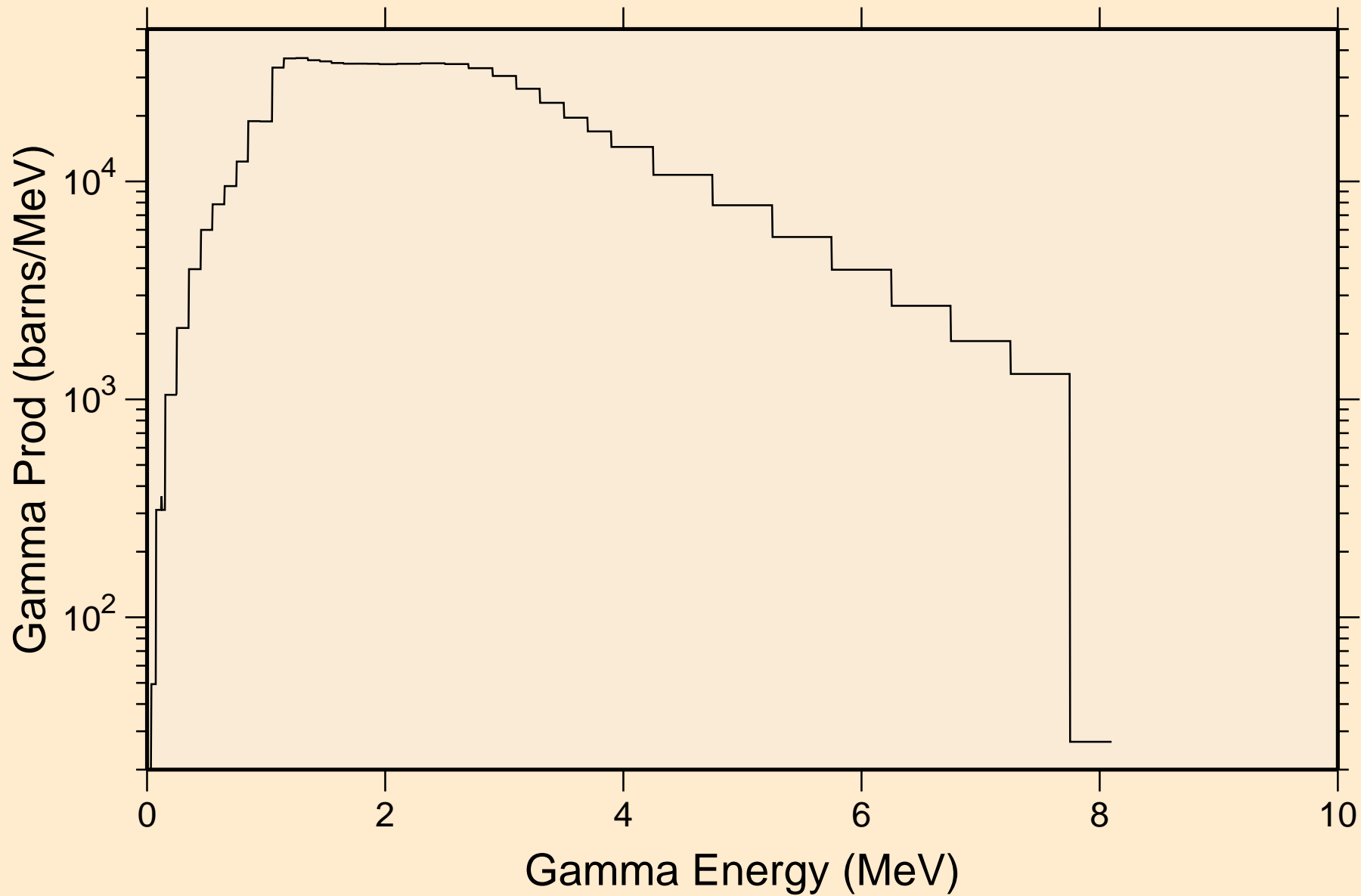

GD153 NEUTRON ACER TENDL-2024 LIBRARY; T=0.K  
14 MeV photon spectrum

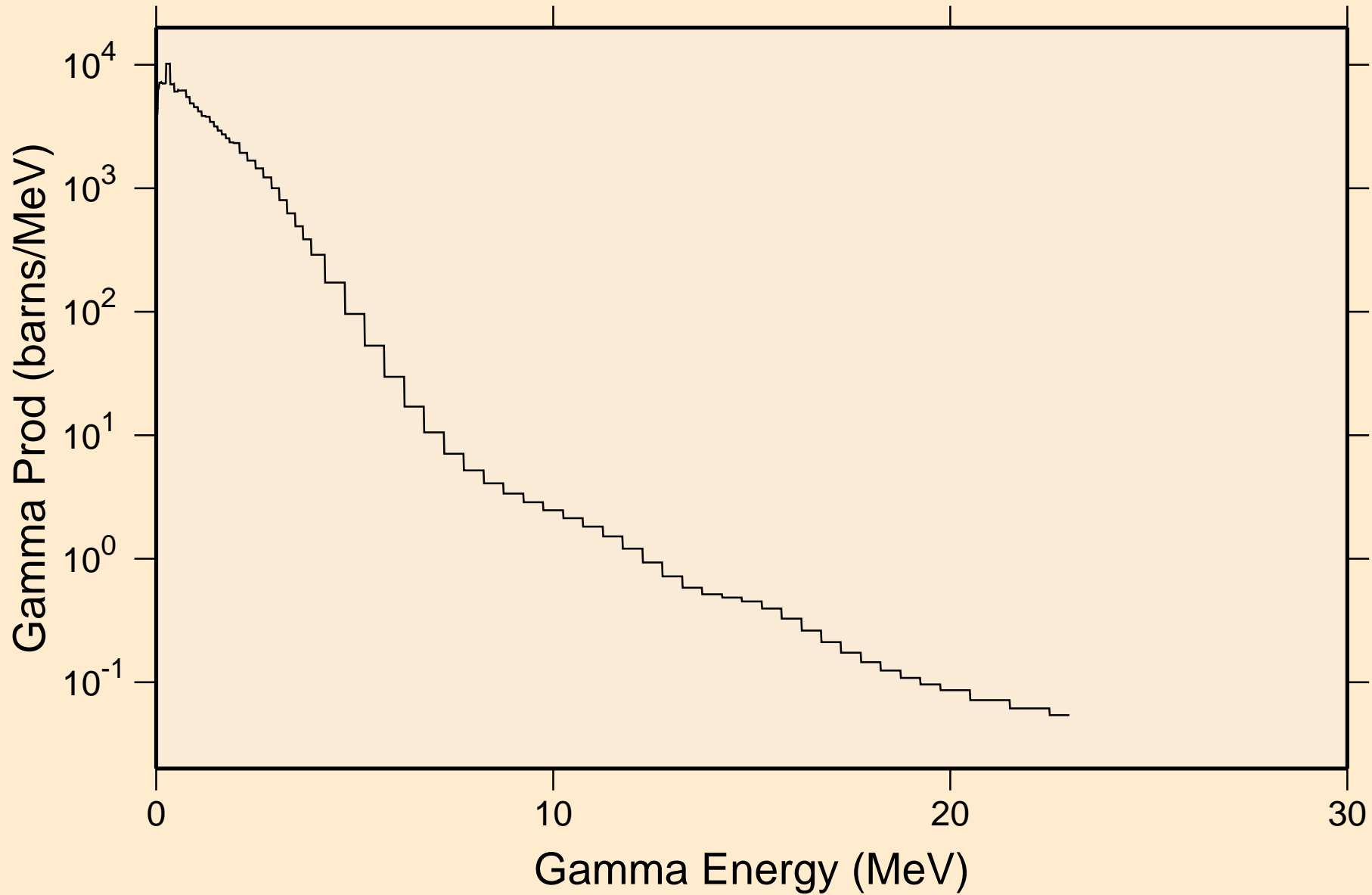

# GD153 NEUTRON ACER TENDL-2024 LIBRARY; T=0.K

## Particle heating contributions

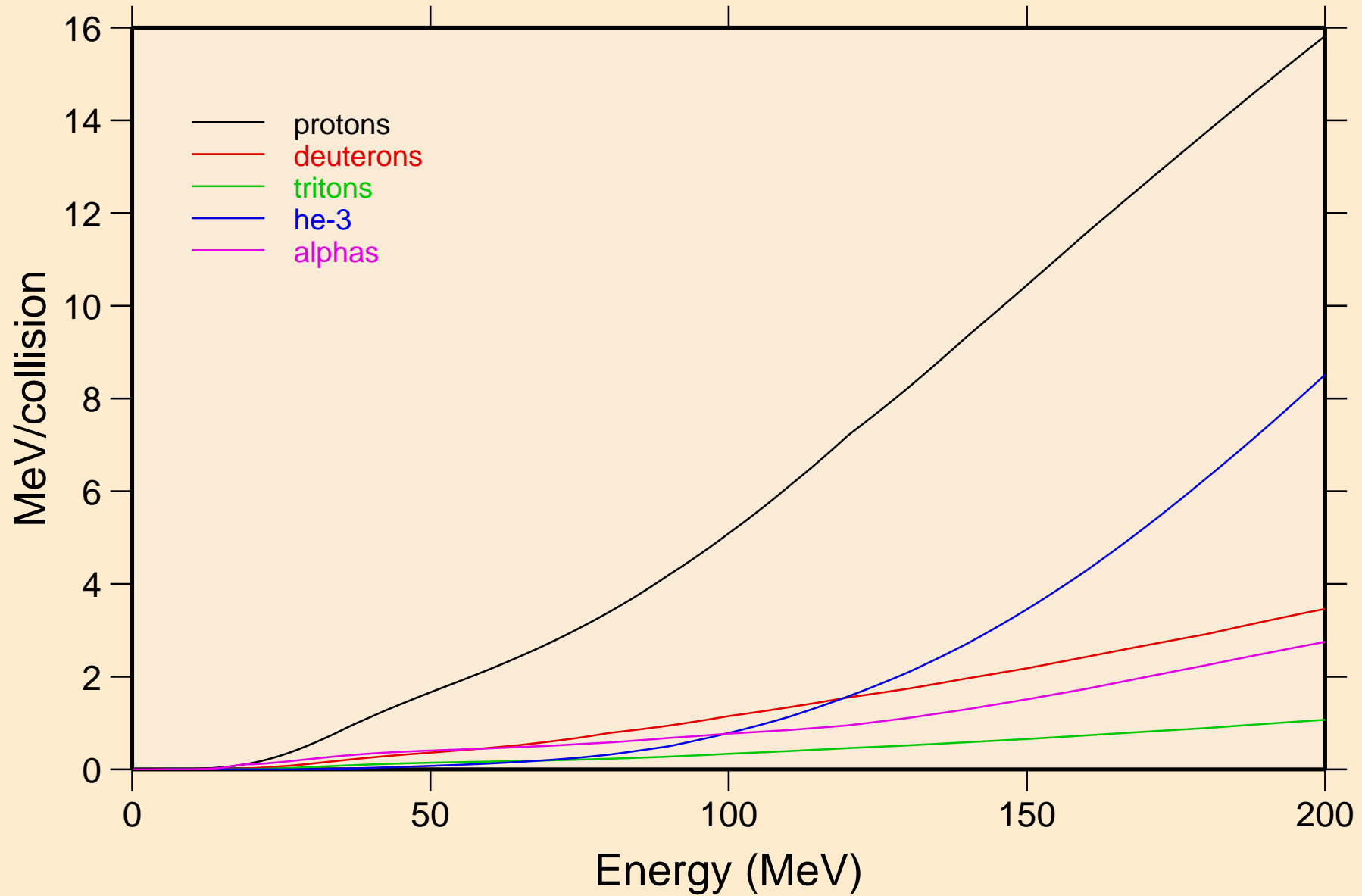

# GD153 NEUTRON ACER TENDL-2024 LIBRARY; T=0.K

## Recoil Heating

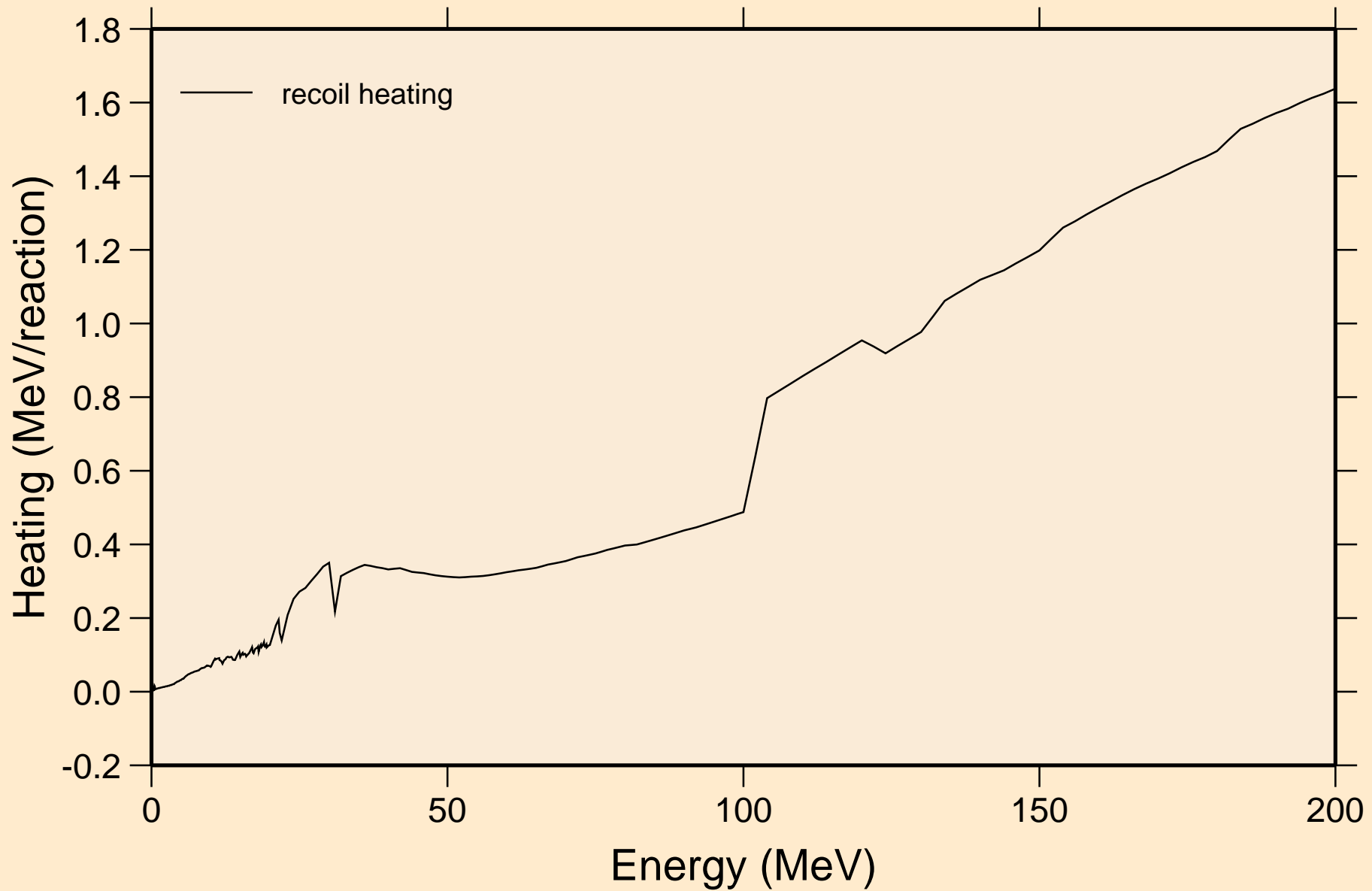

# GD153 NEUTRON ACER TENDL-2024 LIBRARY; T=0.K

## Particle production cross sections

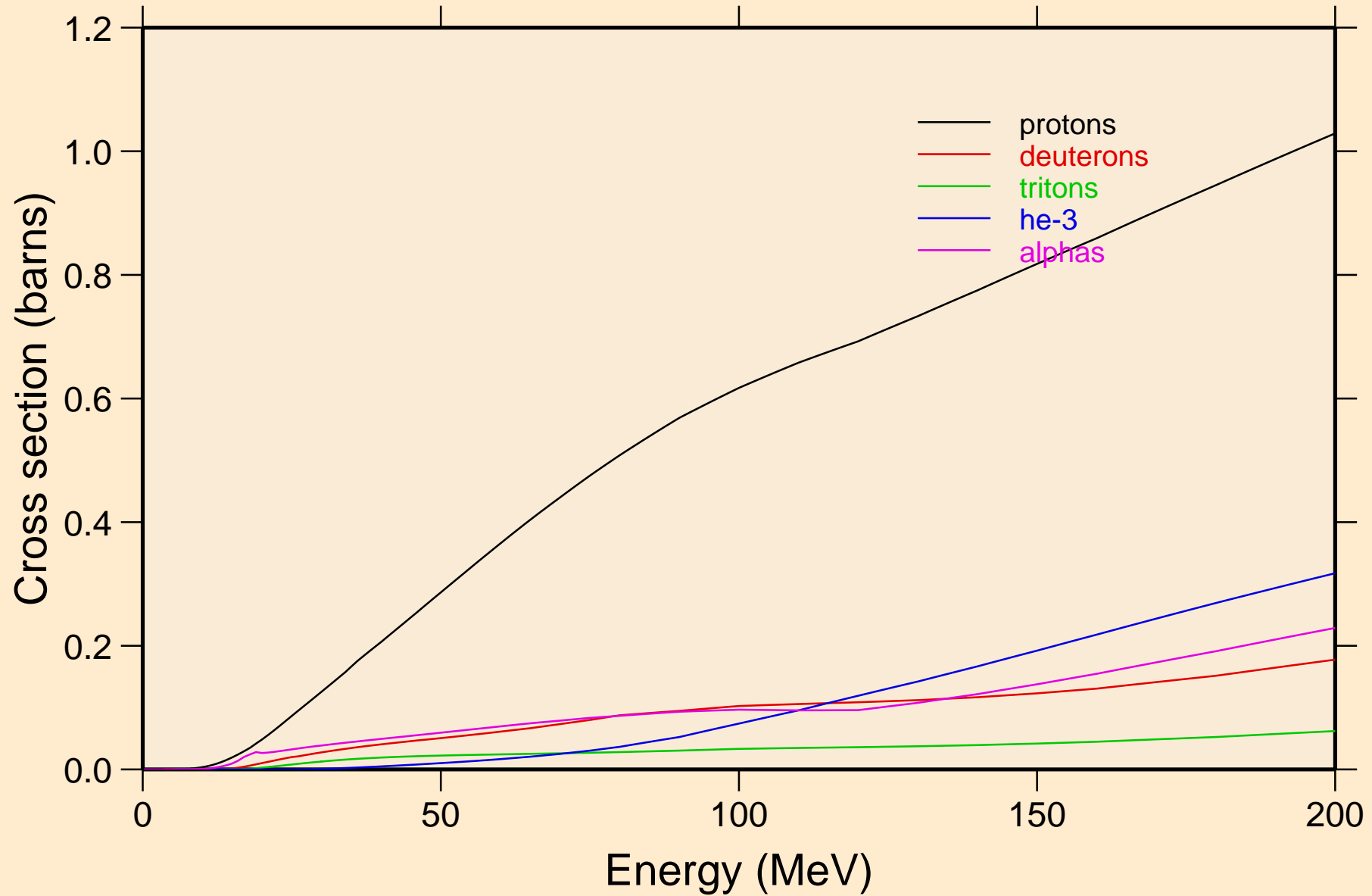

GD153 NEUTRON ACER TENDL-2024 LIBRARY; T=0.K  
protons from (n,x)

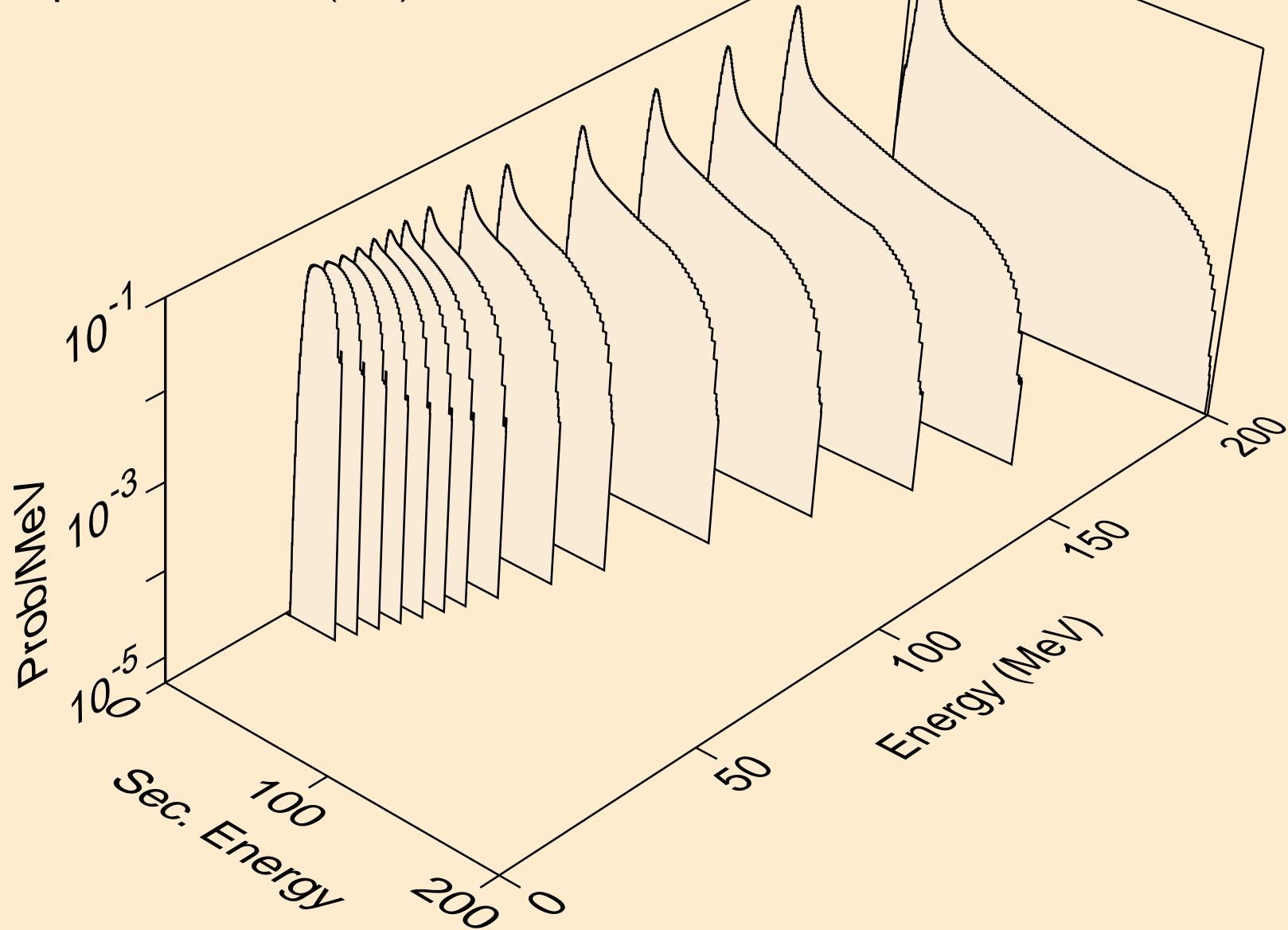

GD153 NEUTRON ACER TENDL-2024 LIBRARY; T=0.K  
protons from (n,n\*)p

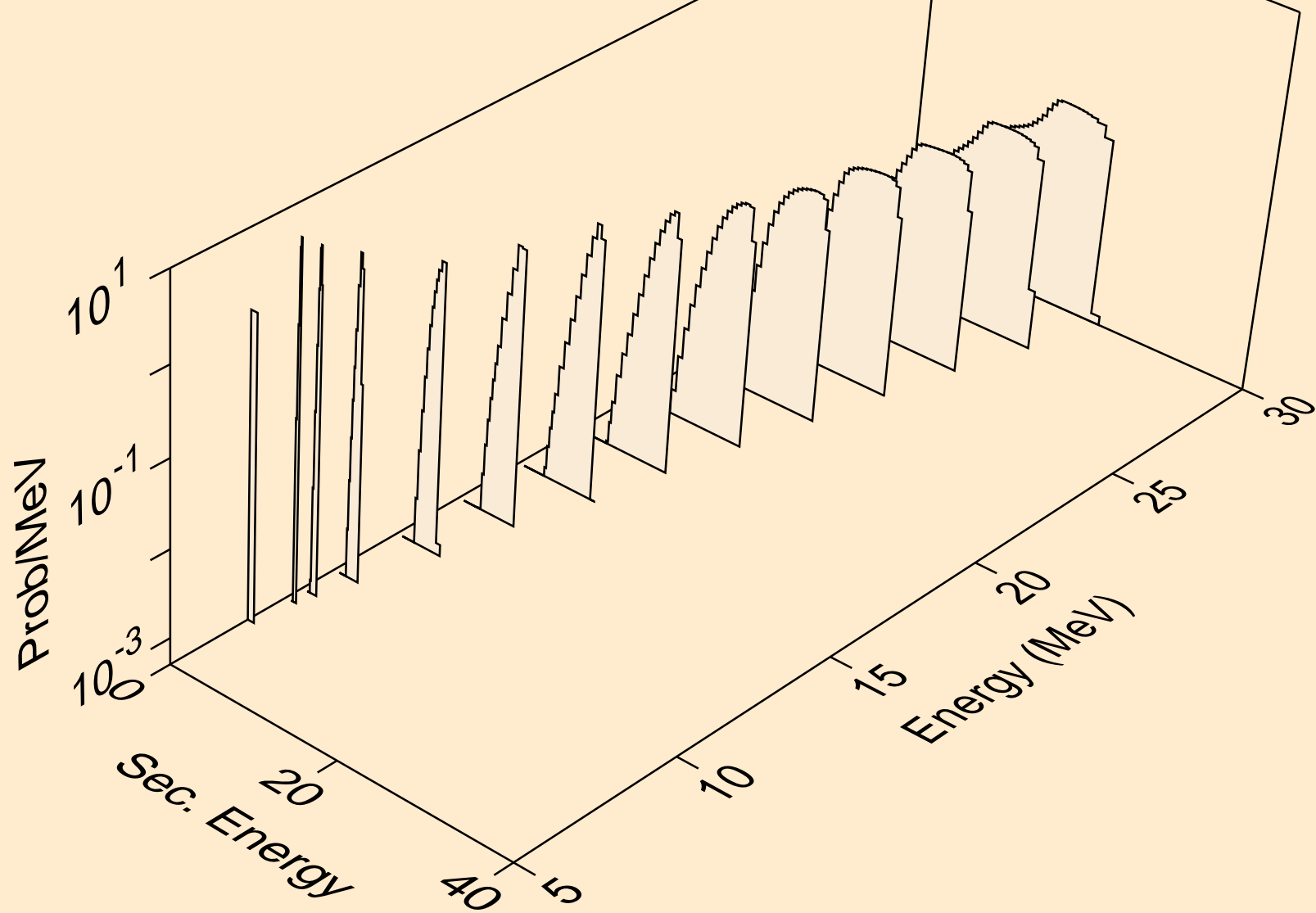

GD153 NEUTRON ACER TENDL-2024 LIBRARY; T=0.K  
protons from (n,2np)

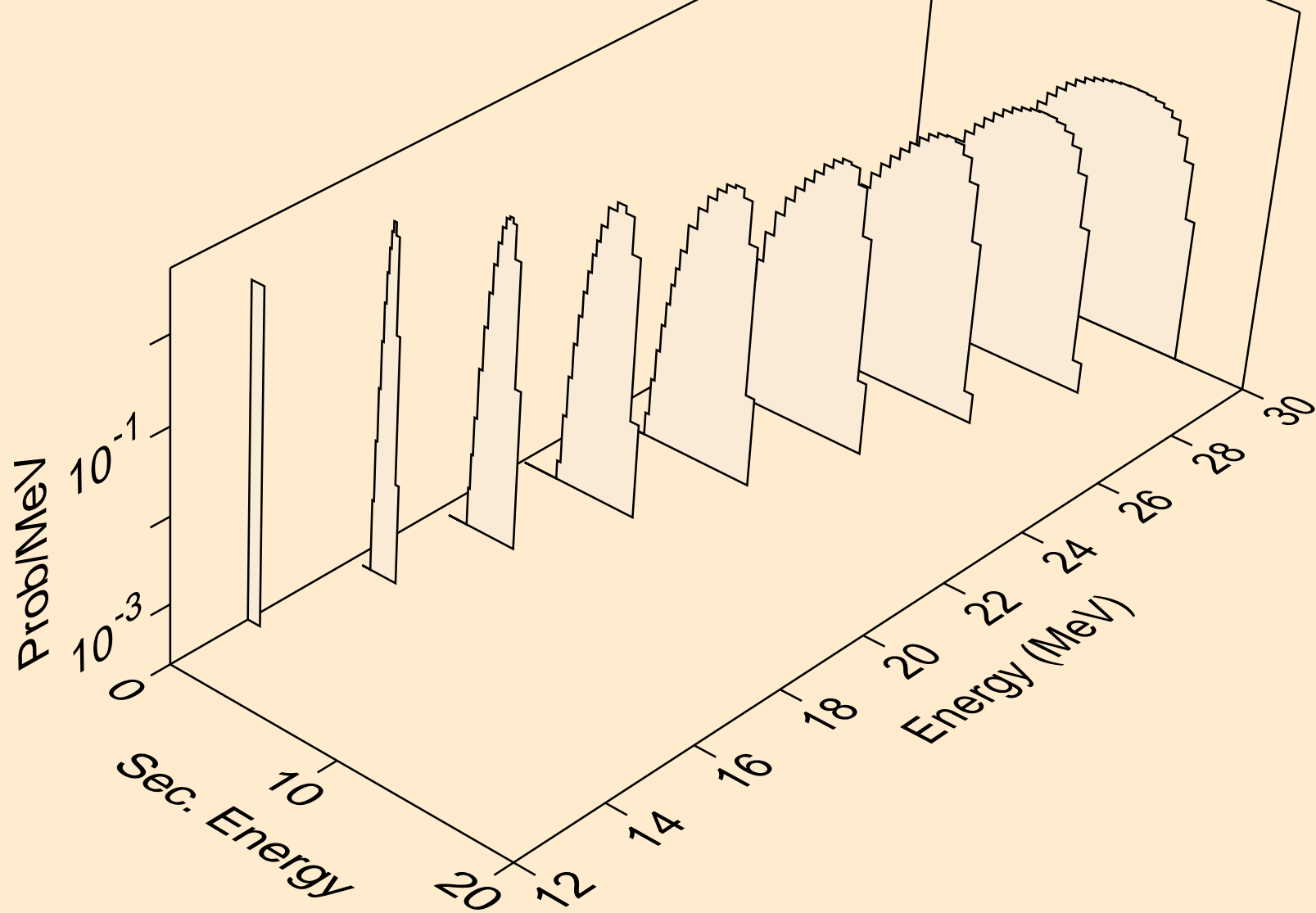



GD153 NEUTRON ACER TENDL-2024 LIBRARY; T=0.K  
protons from (n,3np)

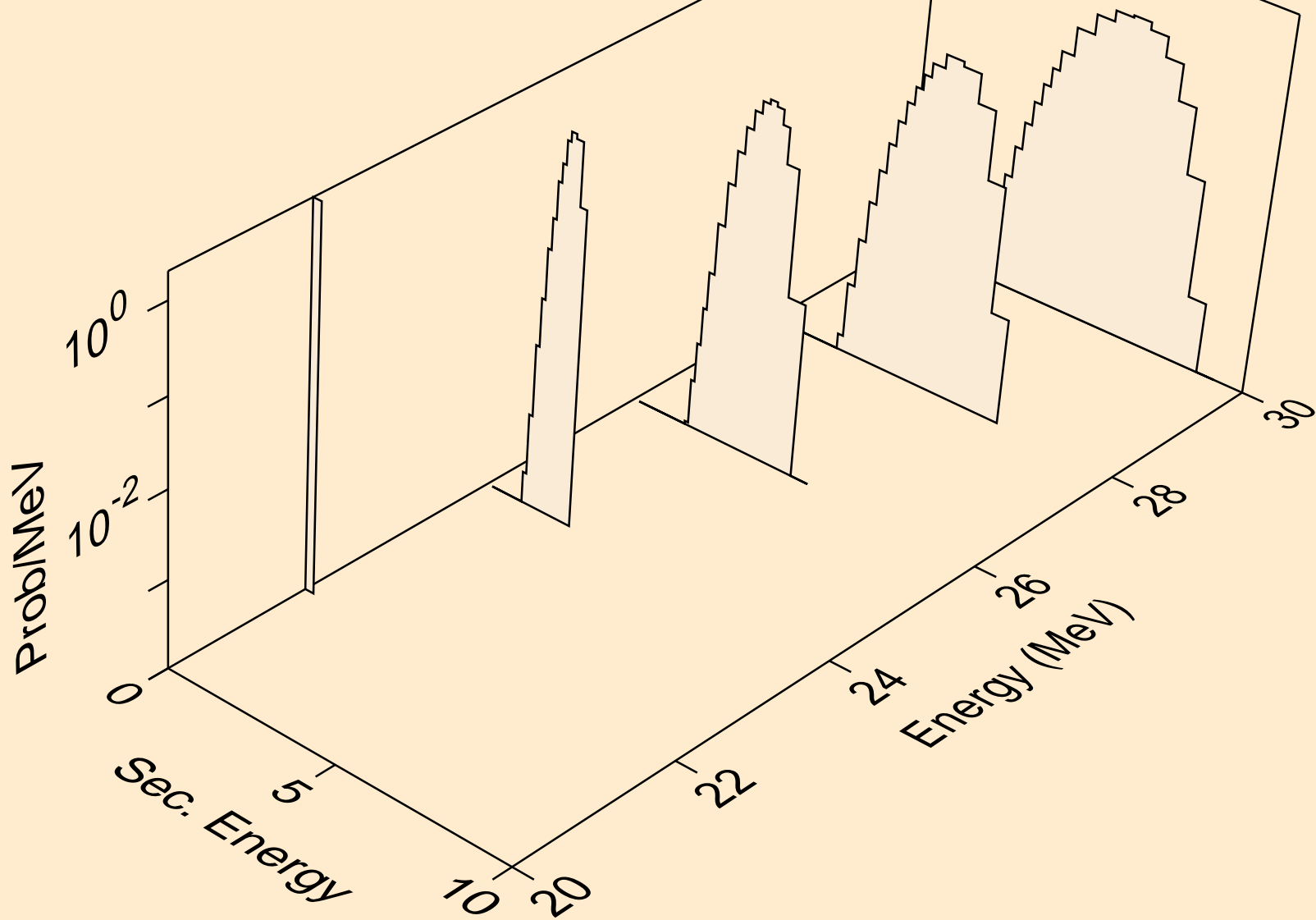

GD153 NEUTRON ACER TENDL-2024 LIBRARY; T=0.K  
protons from (n,n2p)

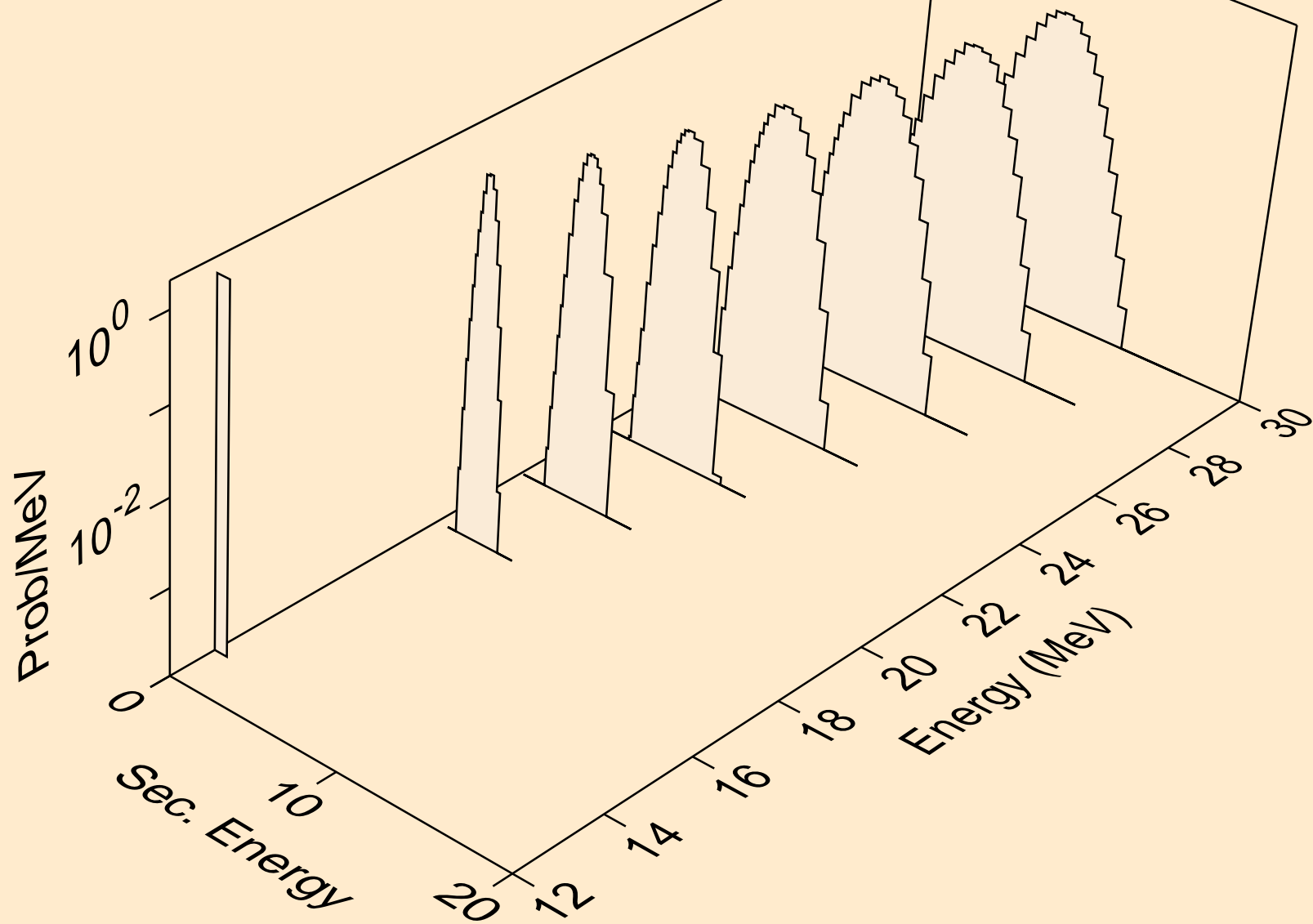

GD153 NEUTRON ACER TENDL-2024 LIBRARY; T=0.K  
protons from (n,npa)

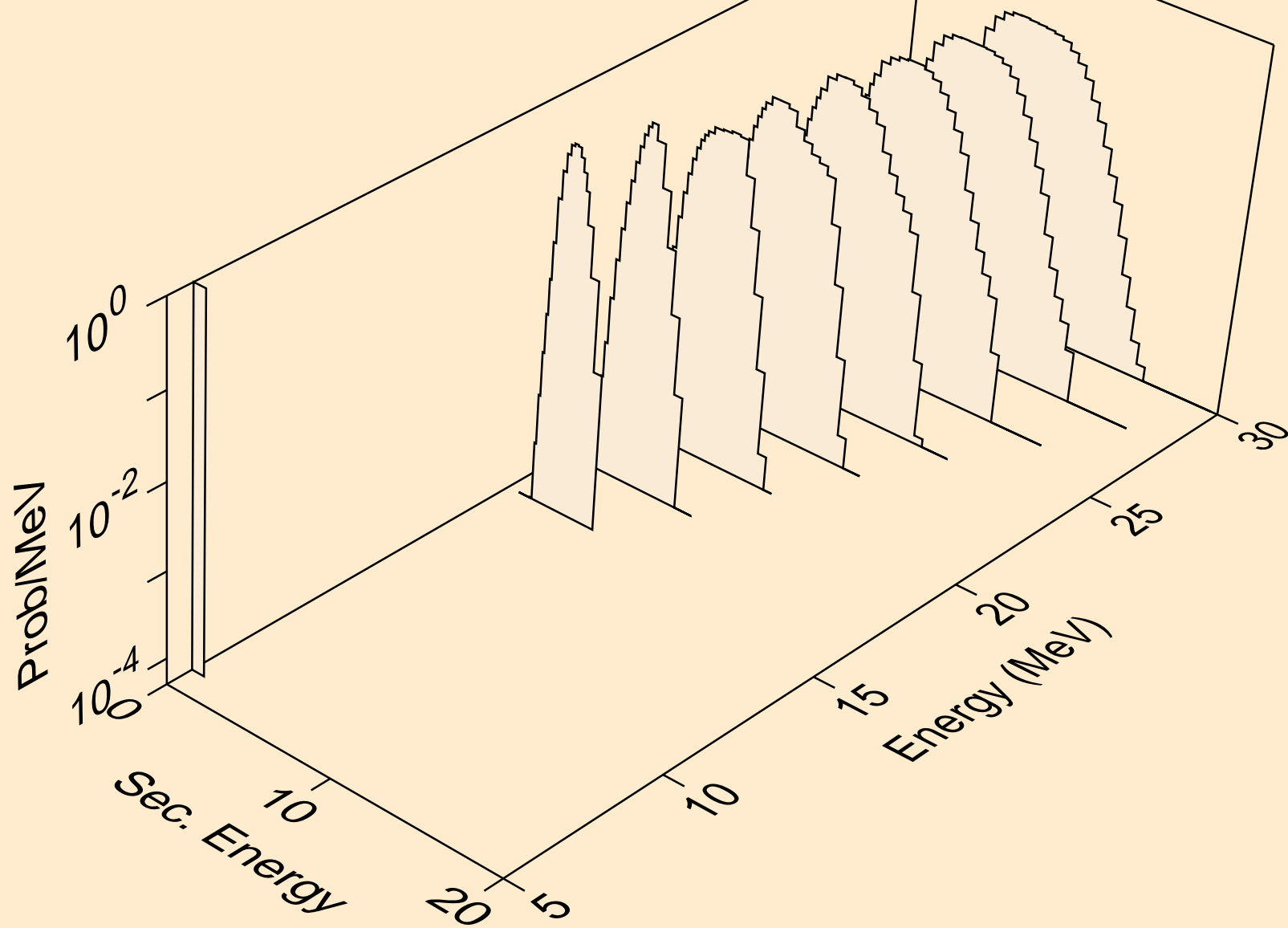

GD153 NEUTRON ACER TENDL-2024 LIBRARY; T=0.K  
protons from (n,p)

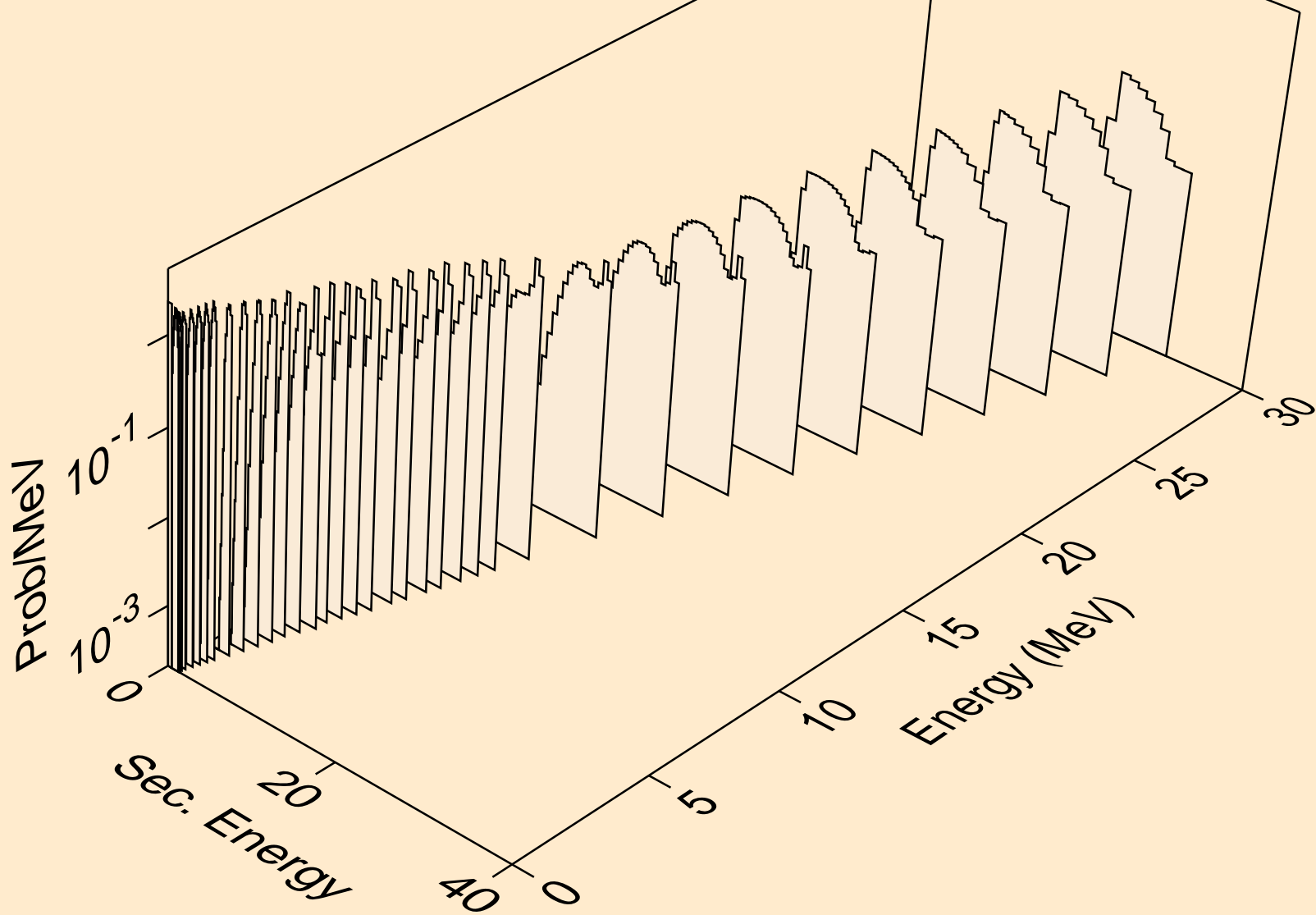

GD153 NEUTRON ACER TENDL-2024 LIBRARY; T=0.K  
protons from (n,2p)

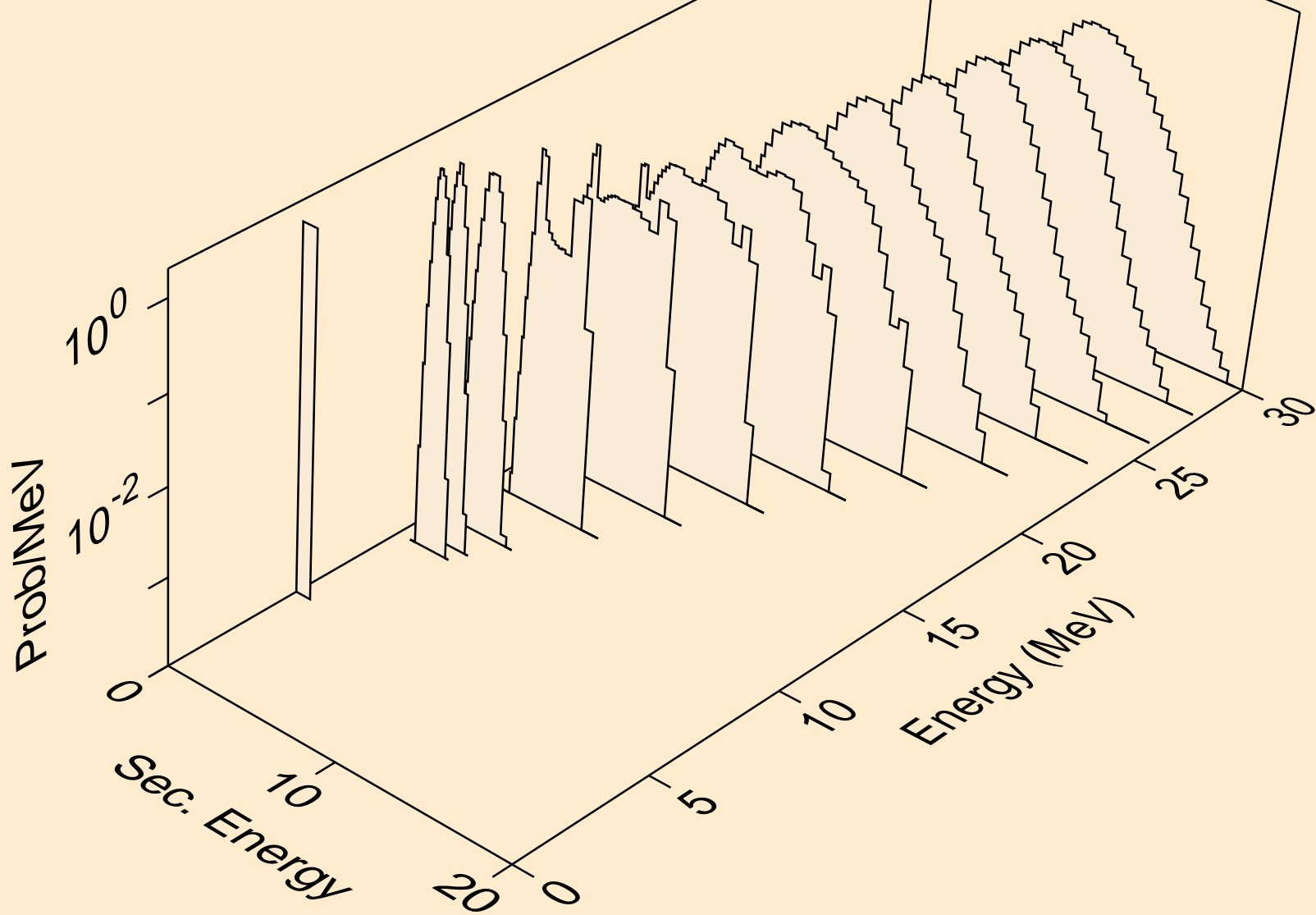

GD153 NEUTRON ACER TENDL-2024 LIBRARY; T=0.K  
protons from (n,pa)

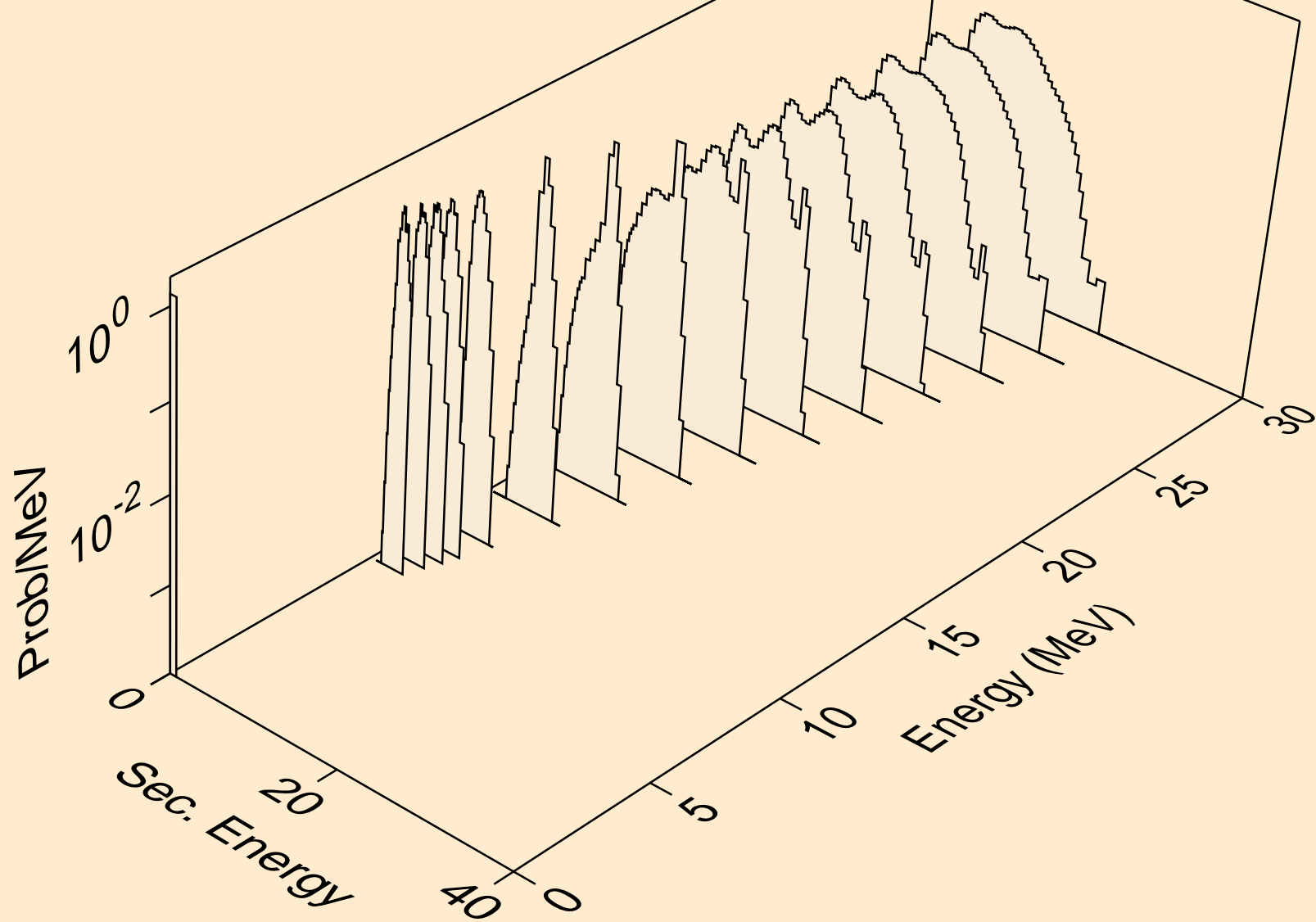

GD153 NEUTRON ACER TENDL-2024 LIBRARY; T=0.K  
protons from (n,pd)

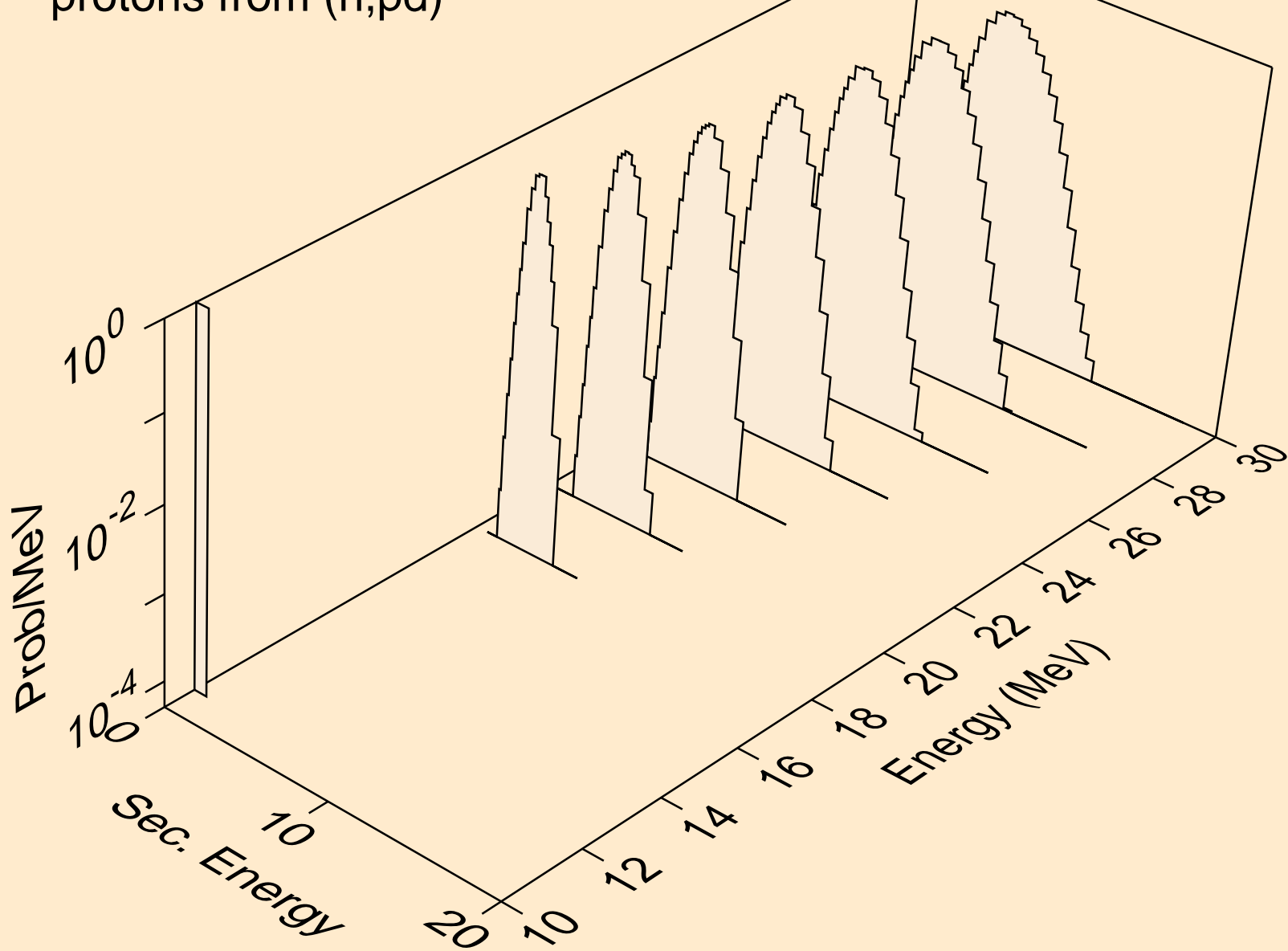

GD153 NEUTRON ACER TENDL-2024 LIBRARY; T=0.K  
protons from (n,pt)

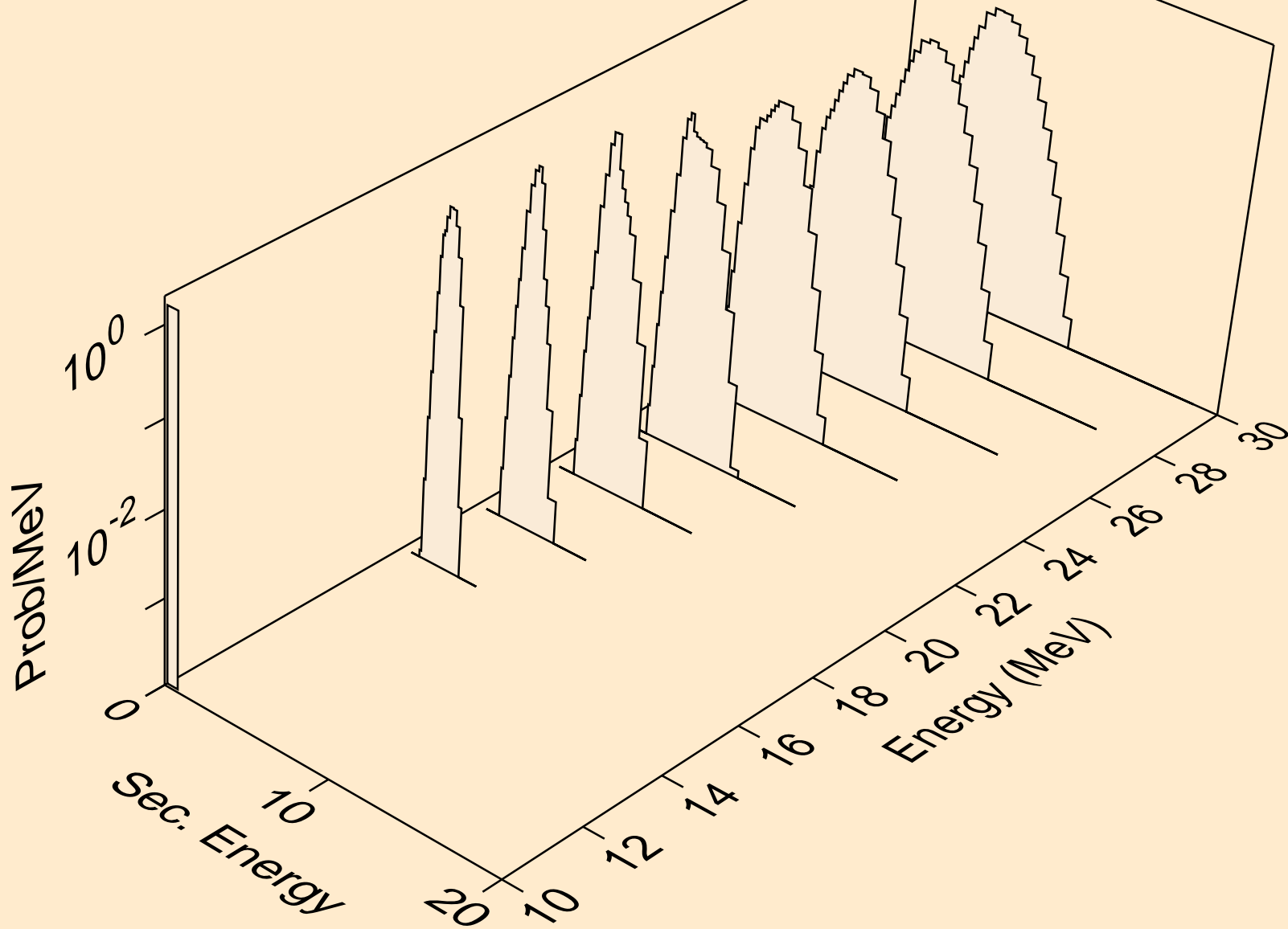



GD153 NEUTRON ACER TENDL-2024 LIBRARY; T=0.K  
deuterons from (n,x)

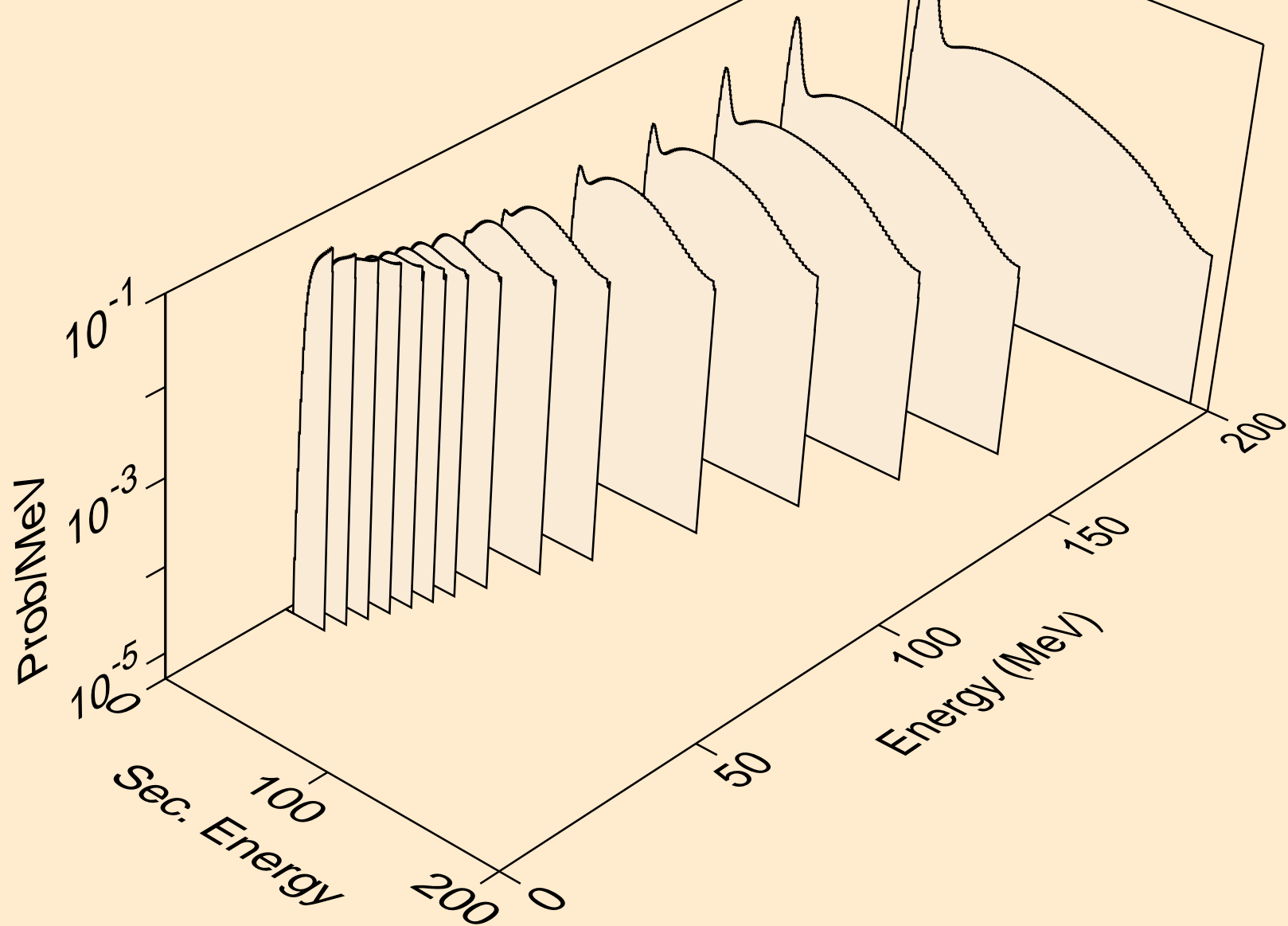

GD153 NEUTRON ACER TENDL-2024 LIBRARY; T=0.K  
deuterons from (n,2nd)

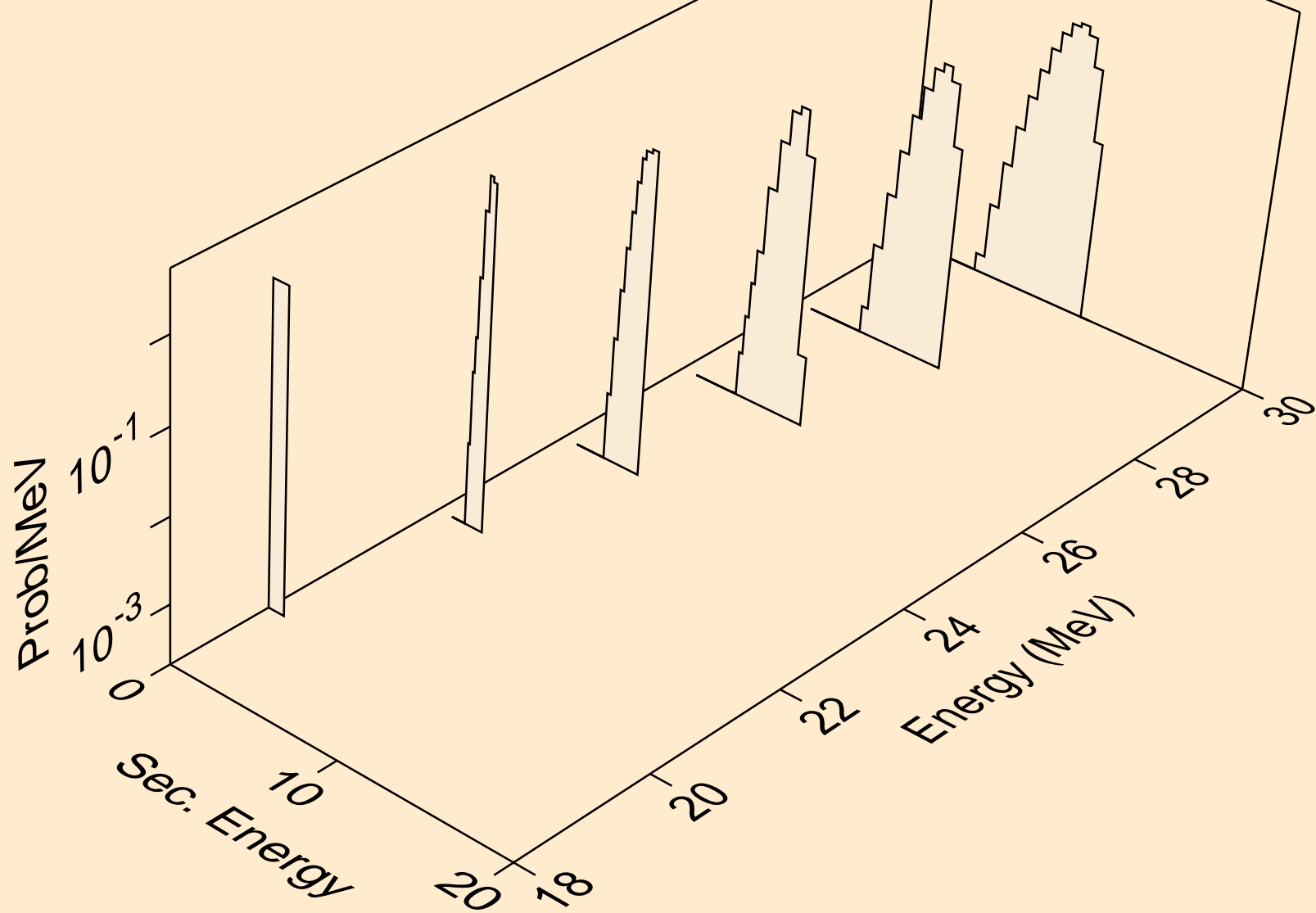

GD153 NEUTRON ACER TENDL-2024 LIBRARY; T=0.K  
deuterons from (n,n\*)d

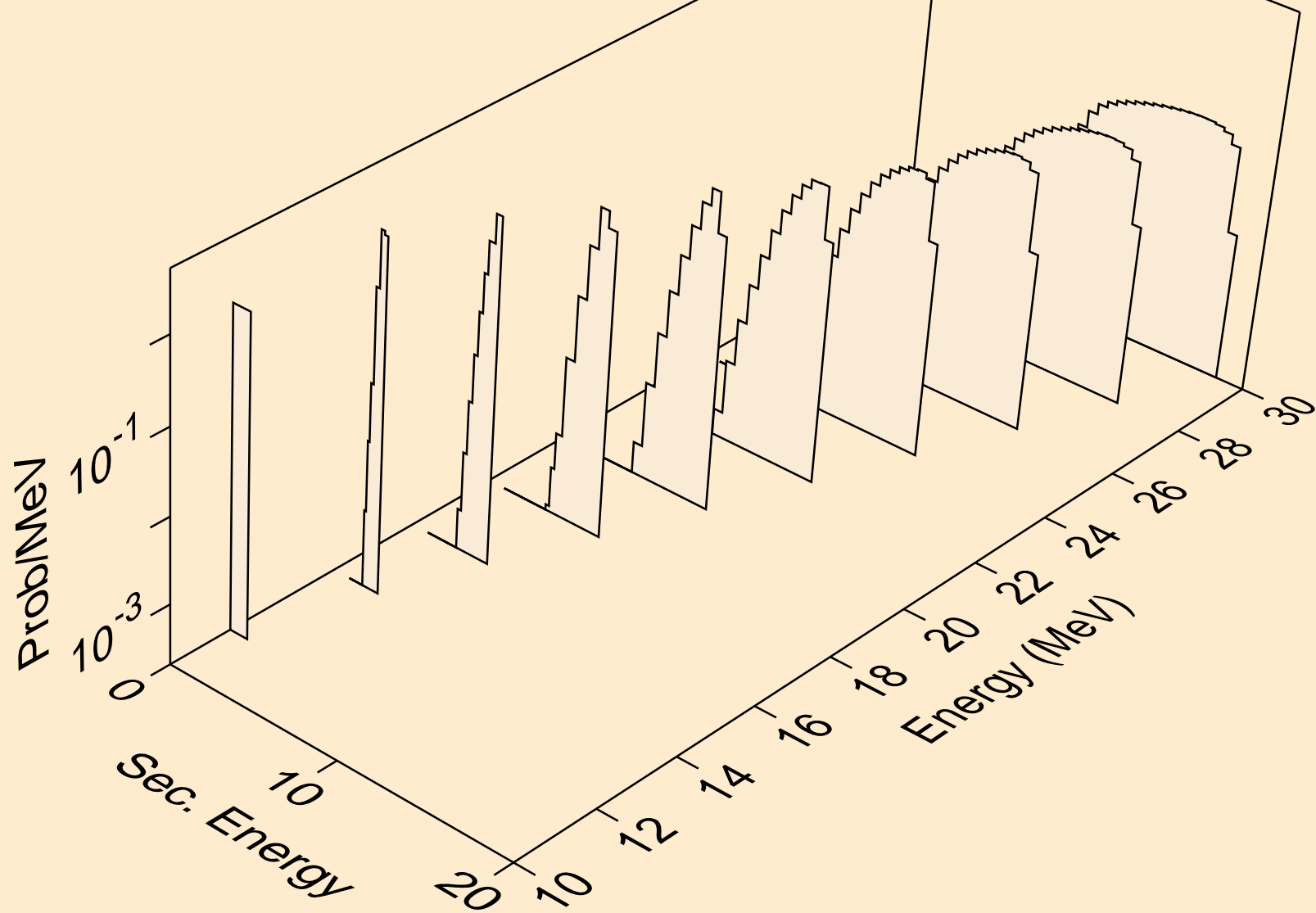

GD153 NEUTRON ACER TENDL-2024 LIBRARY; T=0.K  
deuterons from (n,d)

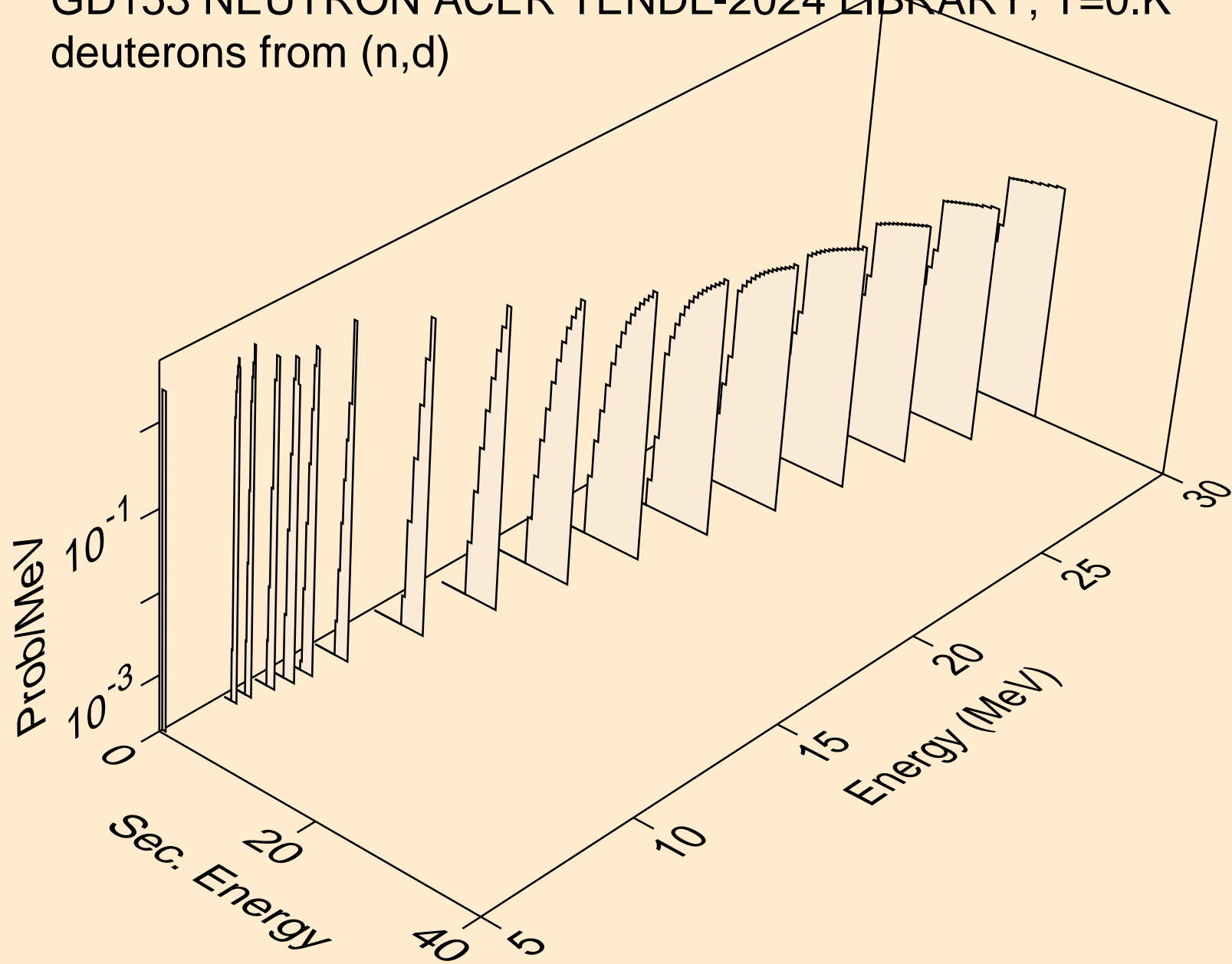

GD153 NEUTRON ACER TENDL-2024 LIBRARY; T=0.K  
deuterons from (n,pd)

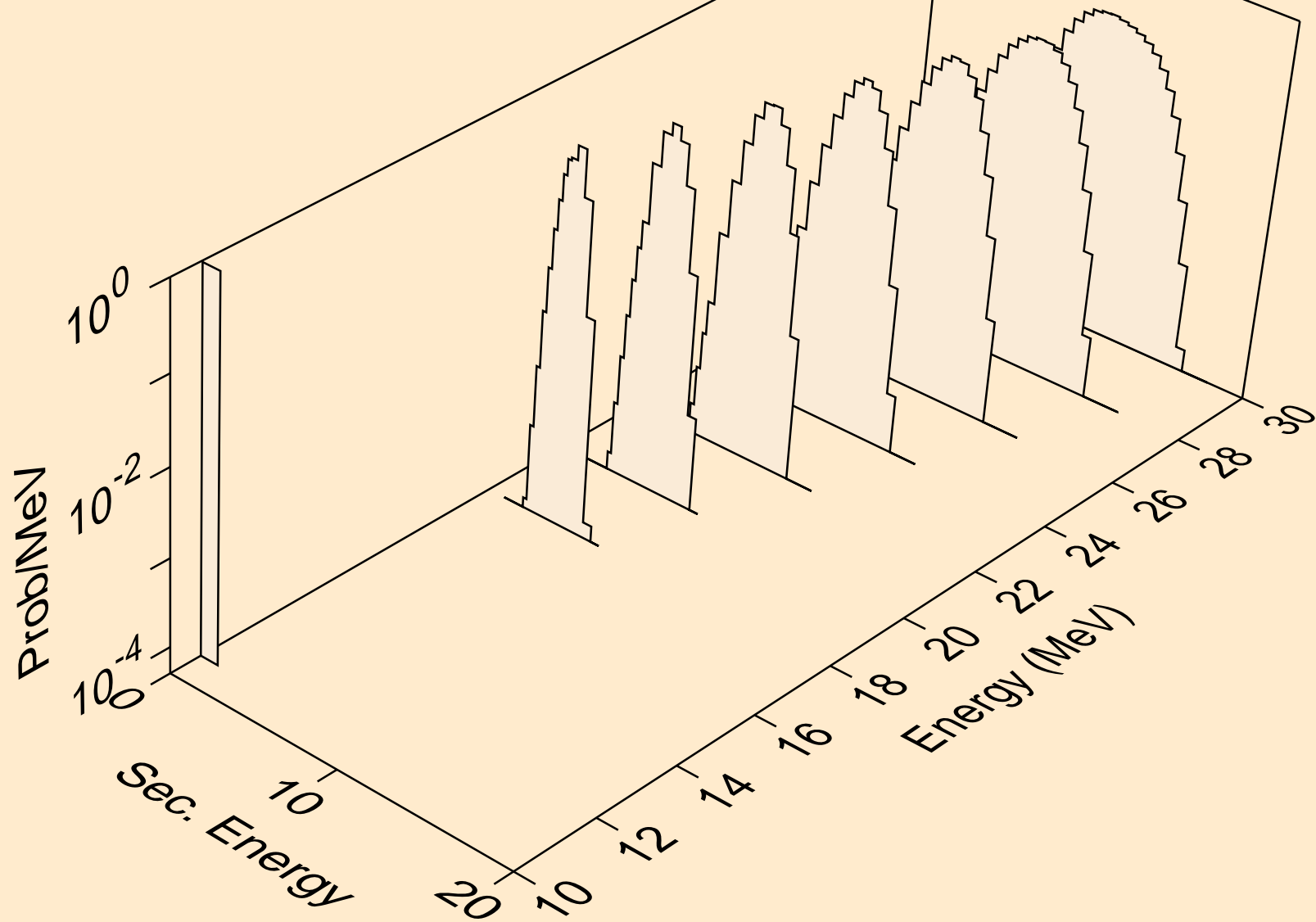

GD153 NEUTRON ACER TENDL-2024 LIBRARY; T=0.K  
deuterons from (n,da)

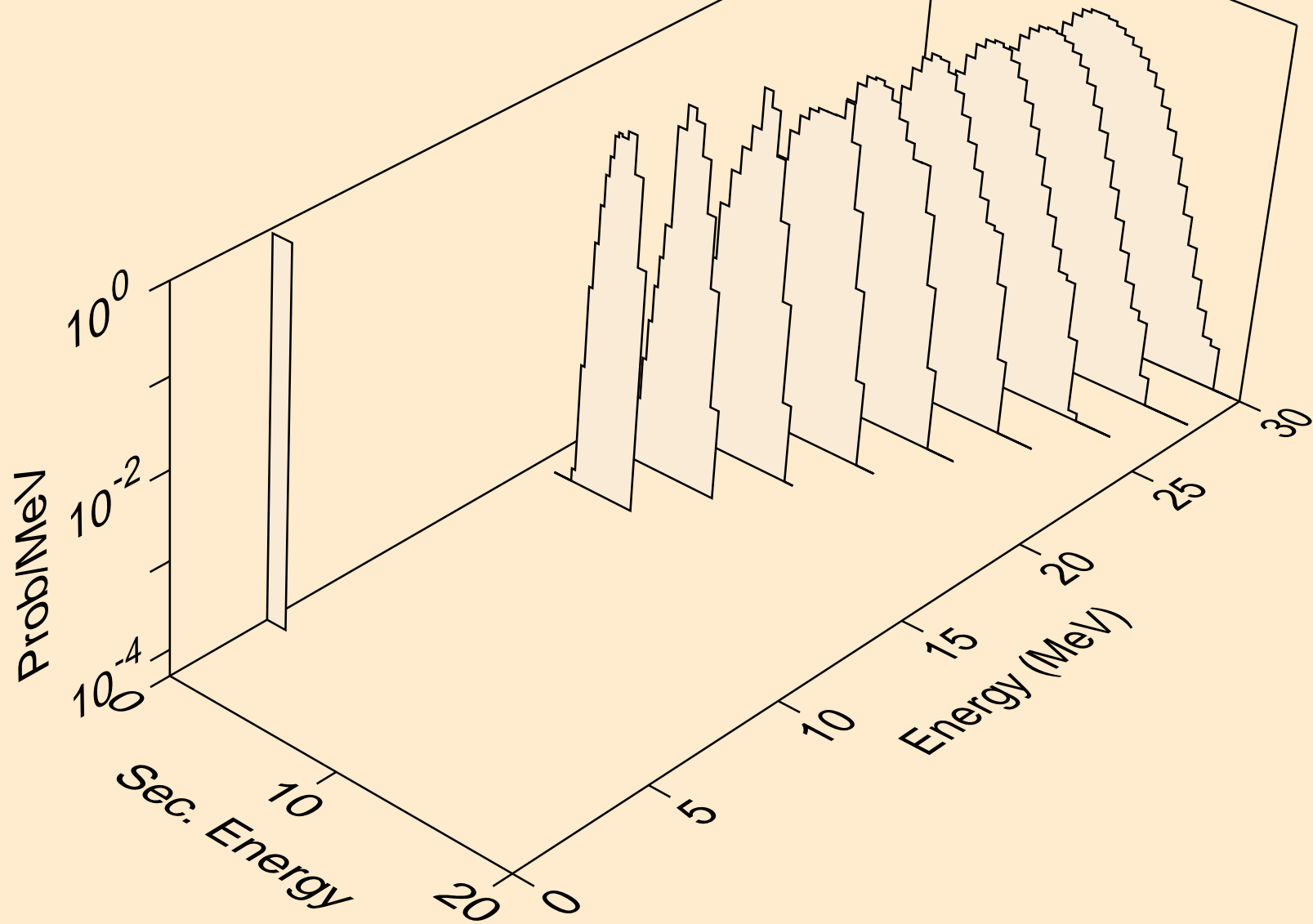

GD153 NEUTRON ACER TENDL-2024 LIBRARY; T=0.K  
tritons from (n,x)

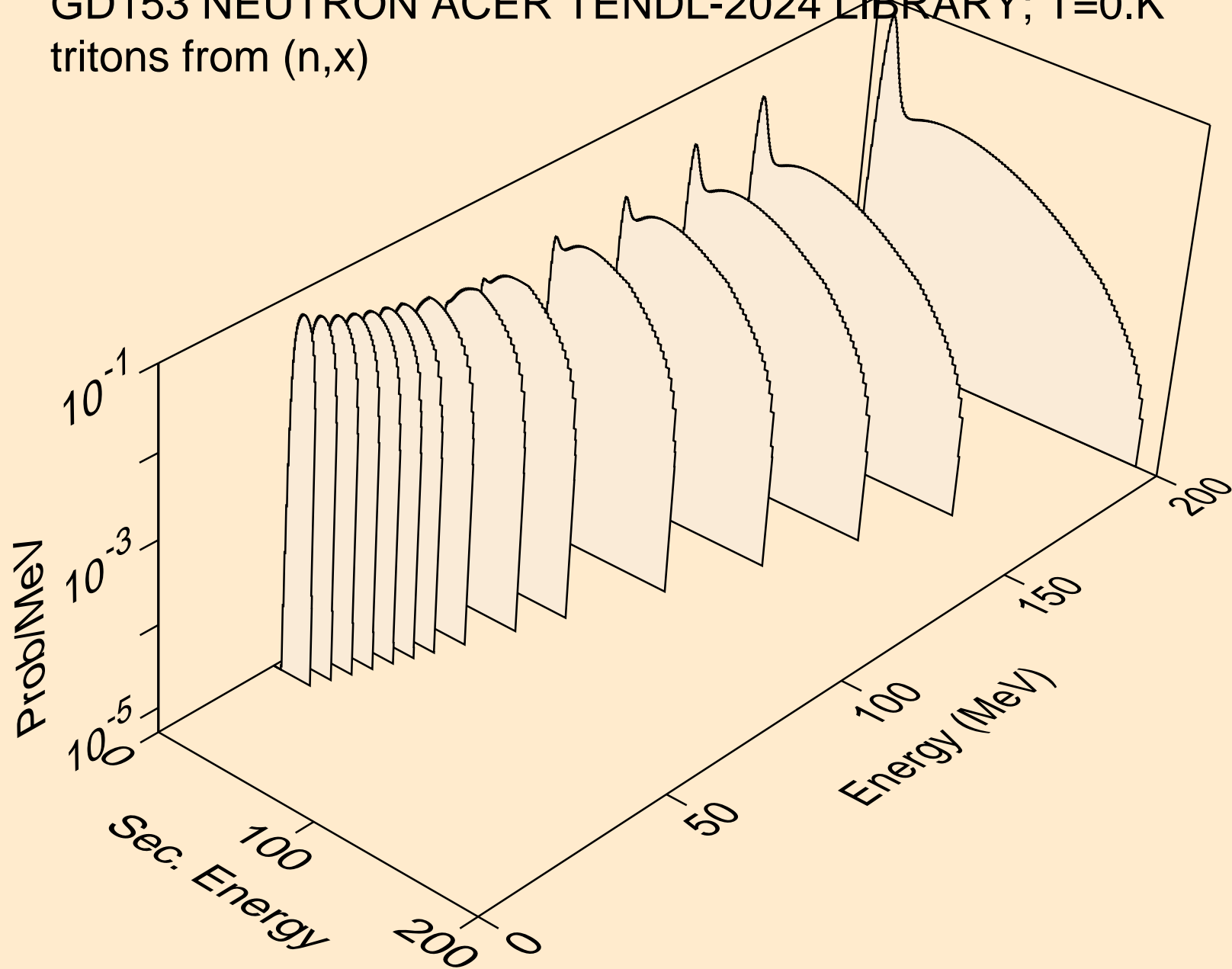

GD153 NEUTRON ACER TENDL-2024 LIBRARY; T=0.K  
tritons from (n,n\*)t

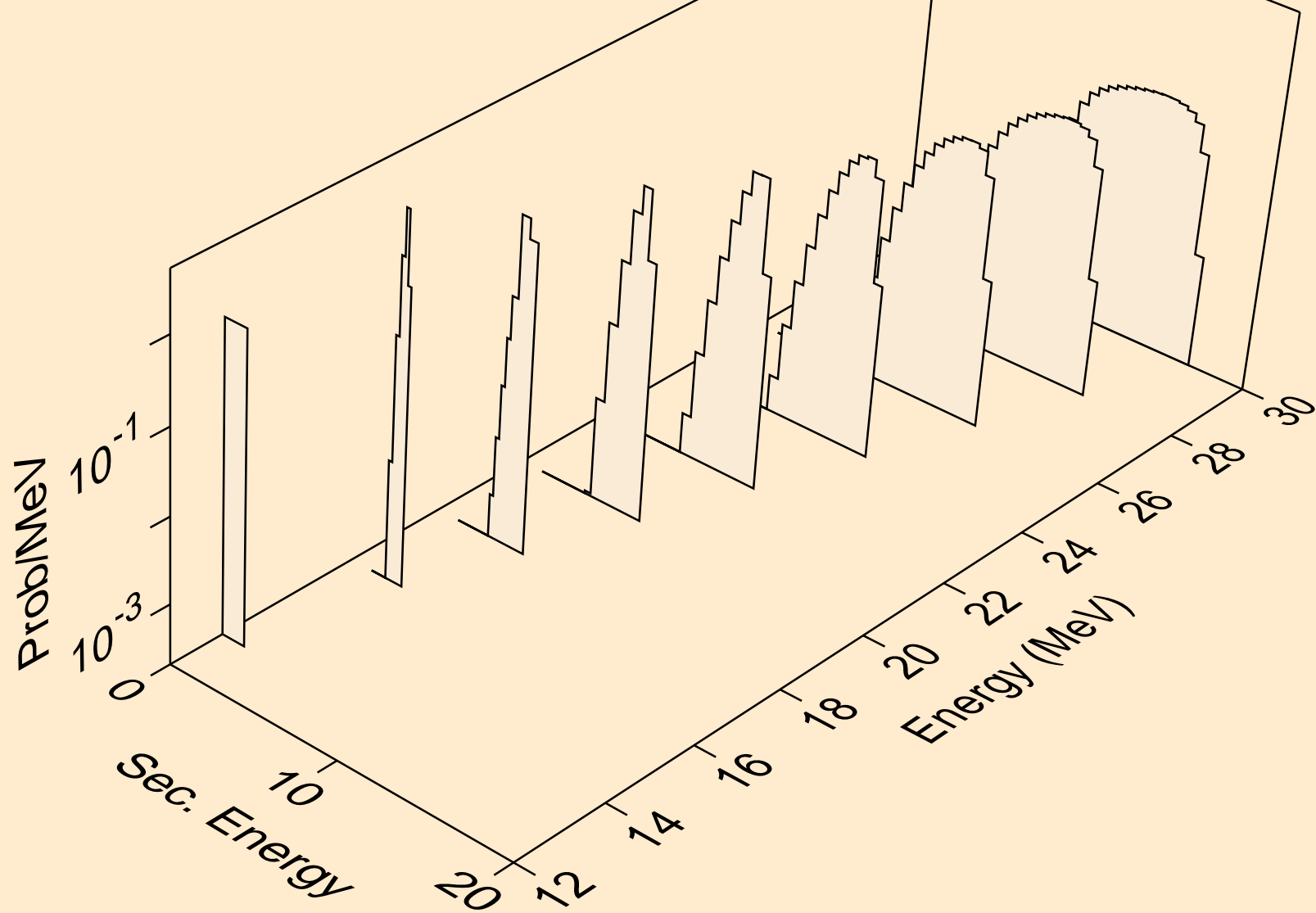



GD153 NEUTRON ACER TENDL-2024 LIBRARY; T=0.K  
tritons from (n,t)

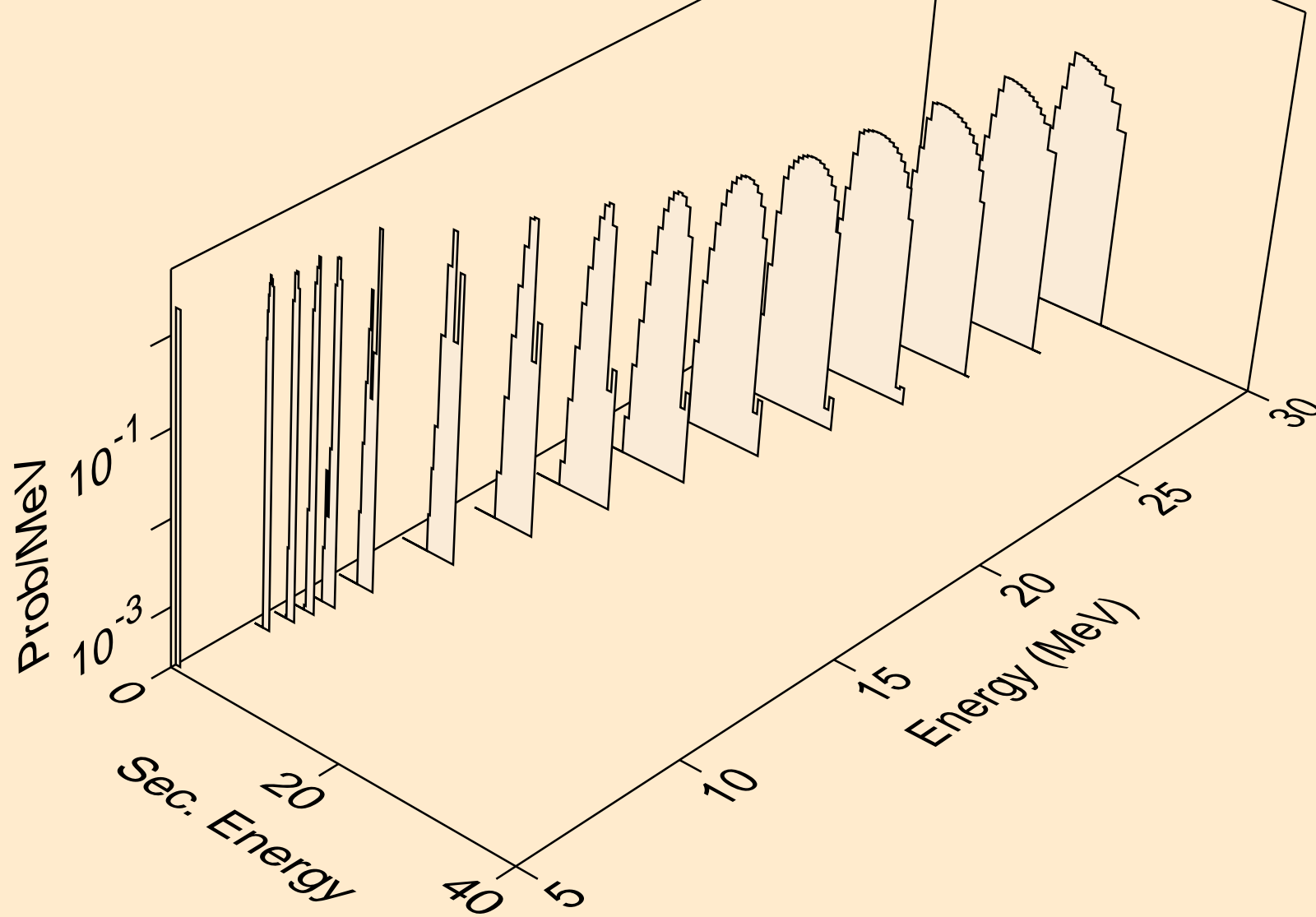

GD153 NEUTRON ACER TENDL-2024 LIBRARY; T=0.K  
tritons from (n,pt)

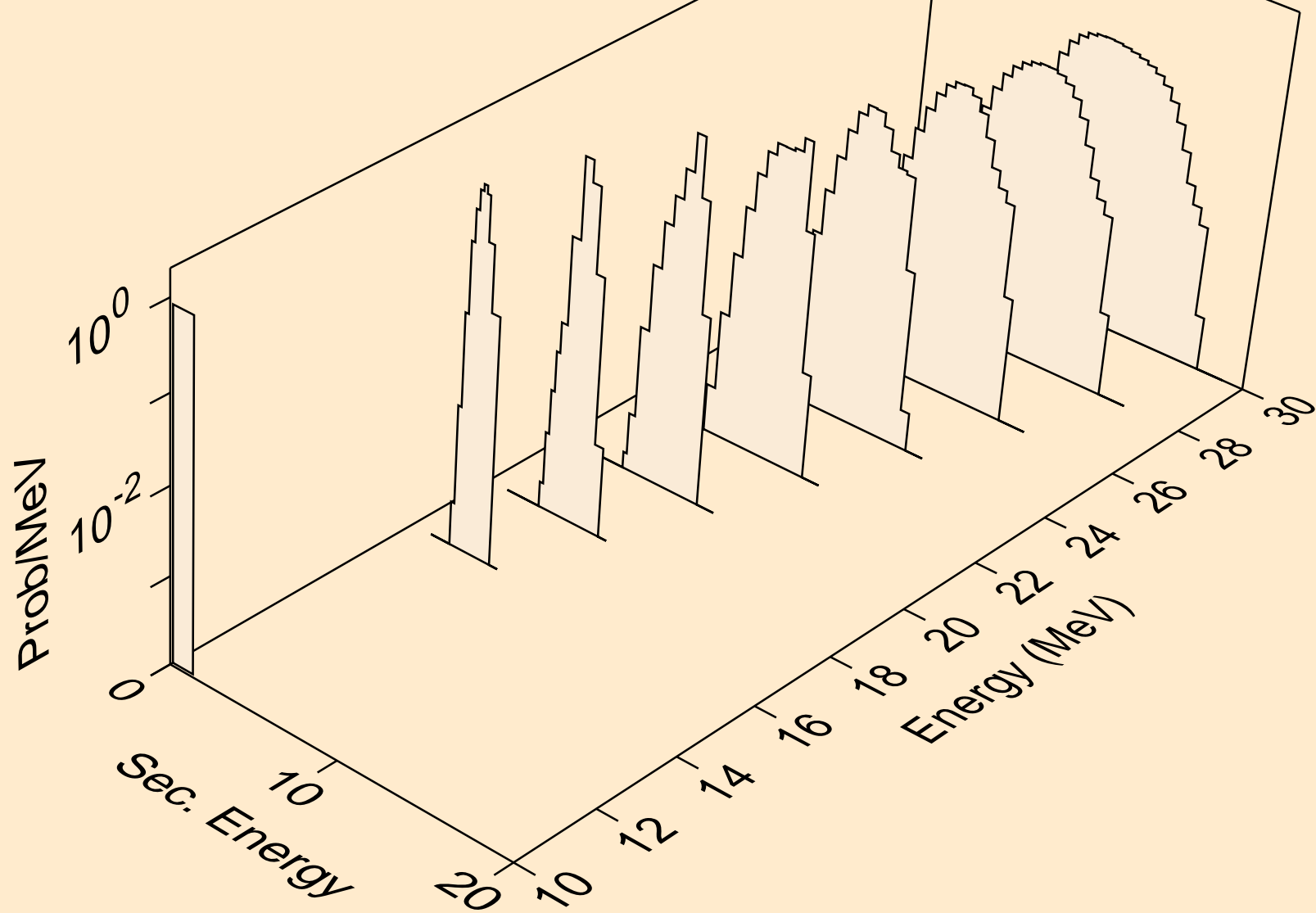

GD153 NEUTRON ACER TENDL-2024 LIBRARY; T=0.K  
he3s from (n,x)

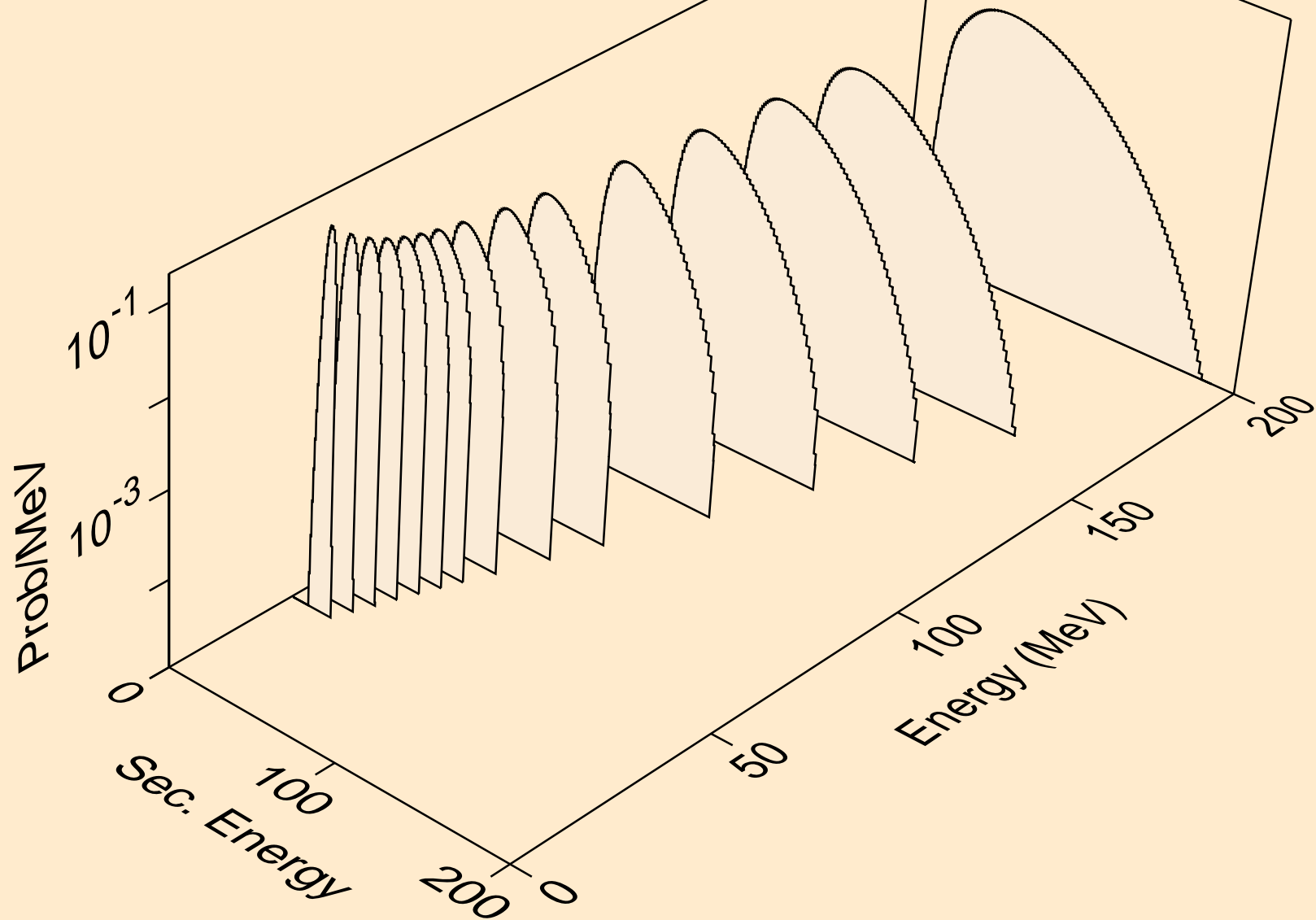

GD153 NEUTRON ACER TENDL-2024 LIBRARY; T=0.K  
he3s from (n,n\*)he3

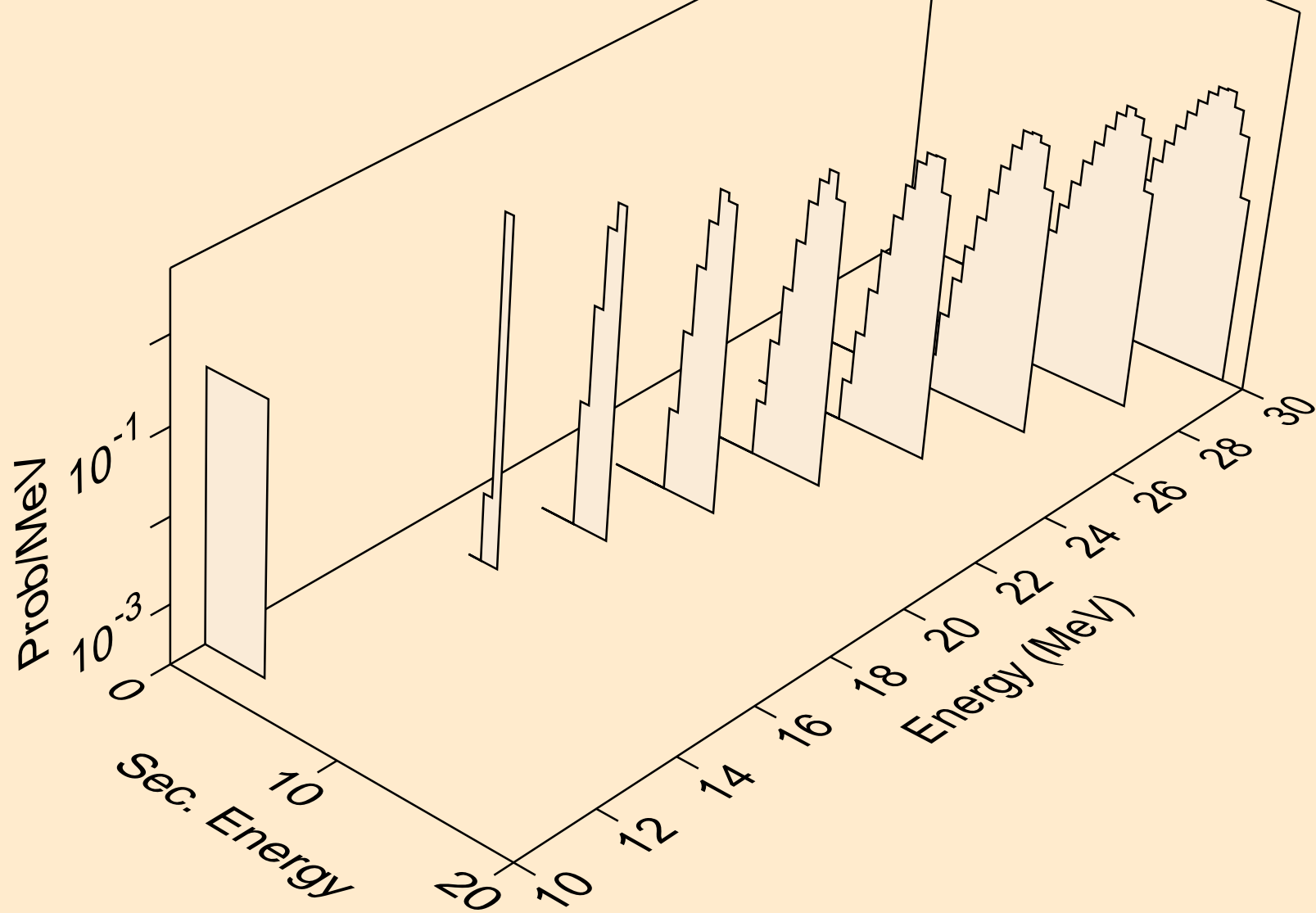

GD153 NEUTRON ACER TENDL-2024 LIBRARY; T=0.K  
he3s from (n,he3)

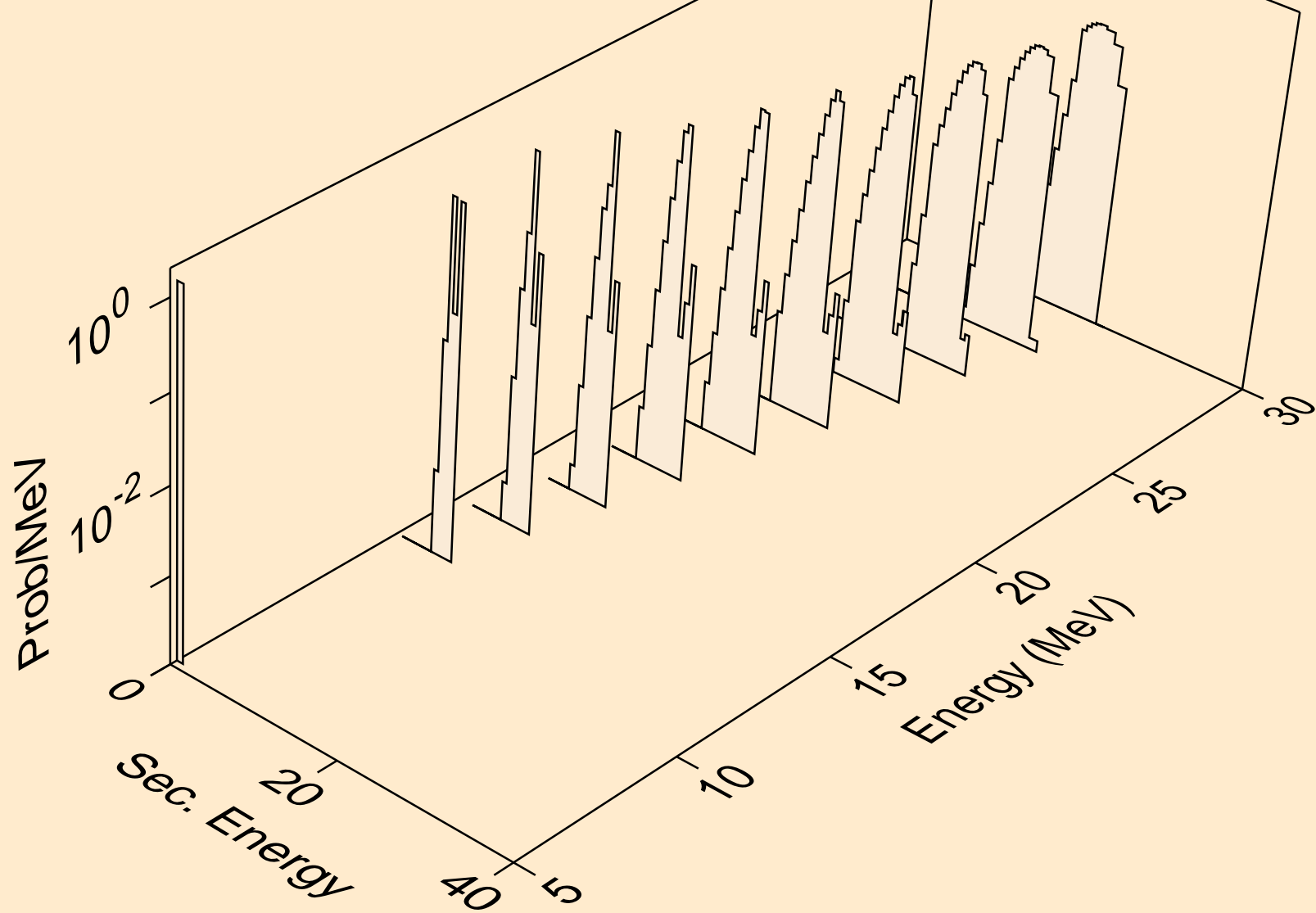

GD153 NEUTRON ACER TENDL-2024 LIBRARY; T=0.K  
alphas from (n,x)

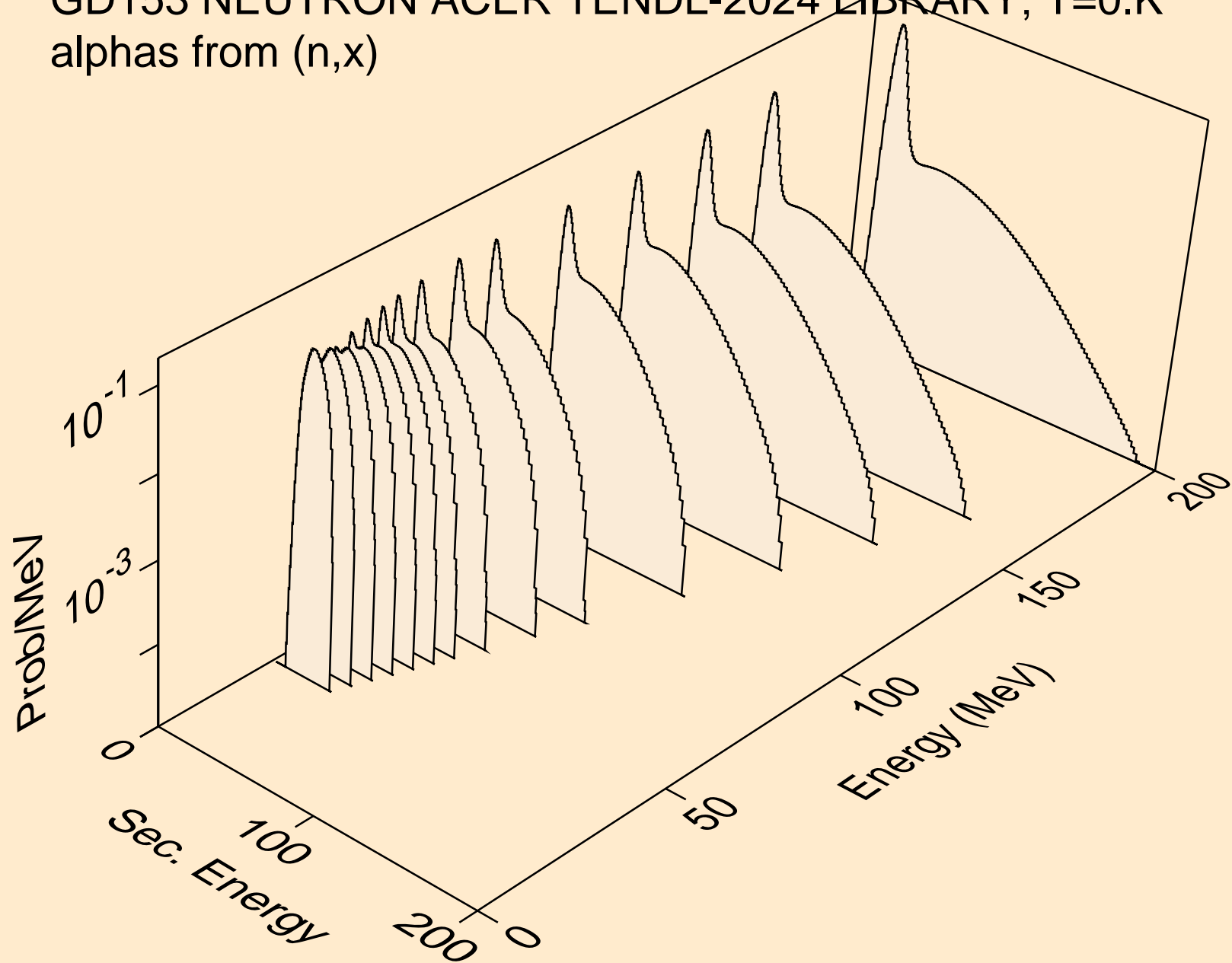

GD153 NEUTRON ACER TENDL-2024 LIBRARY; T=0.K  
alphas from (n,n\*)a

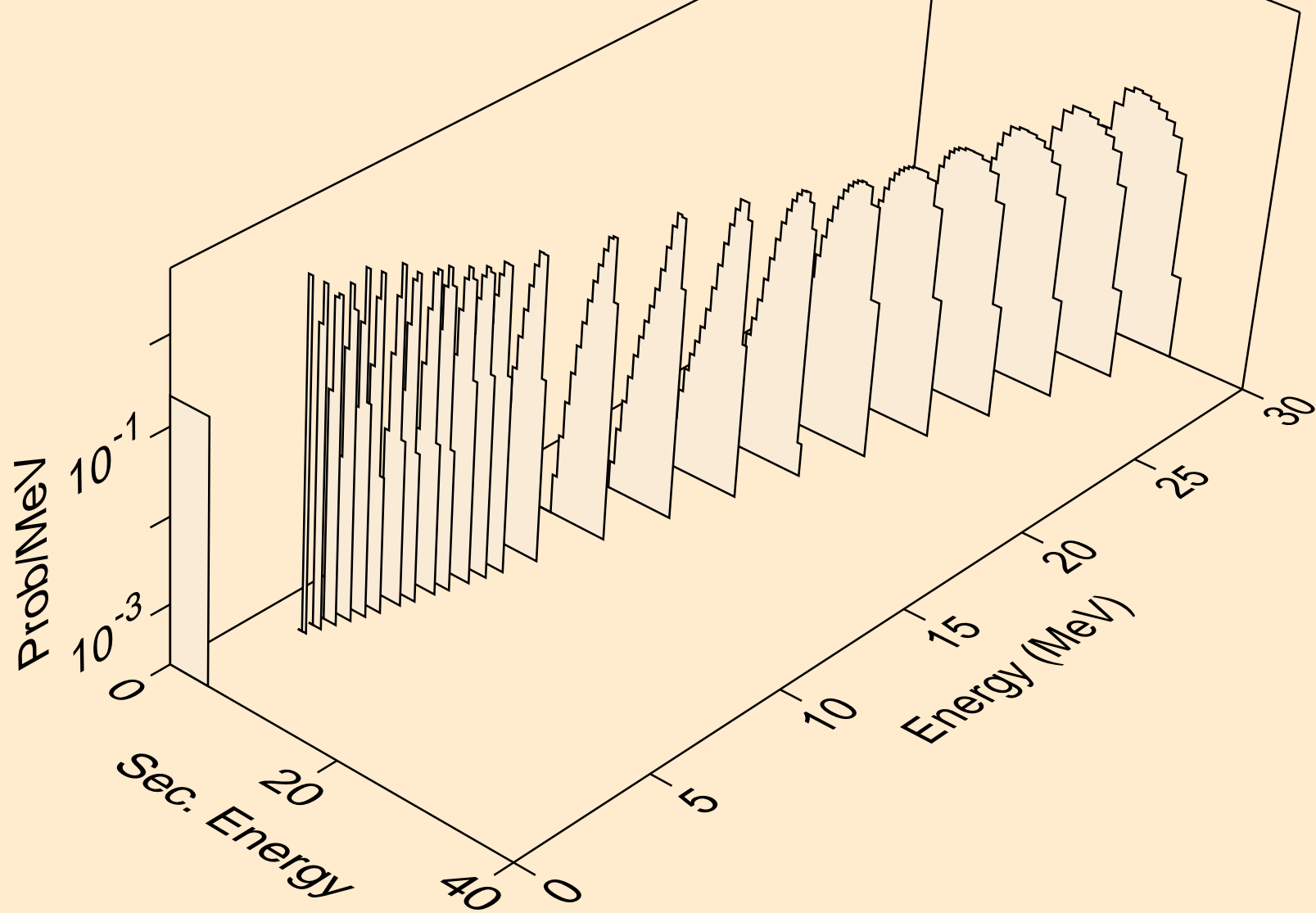

GD153 NEUTRON ACER TENDL-2024 LIBRARY; T=0.K  
alphas from (n,2n)a

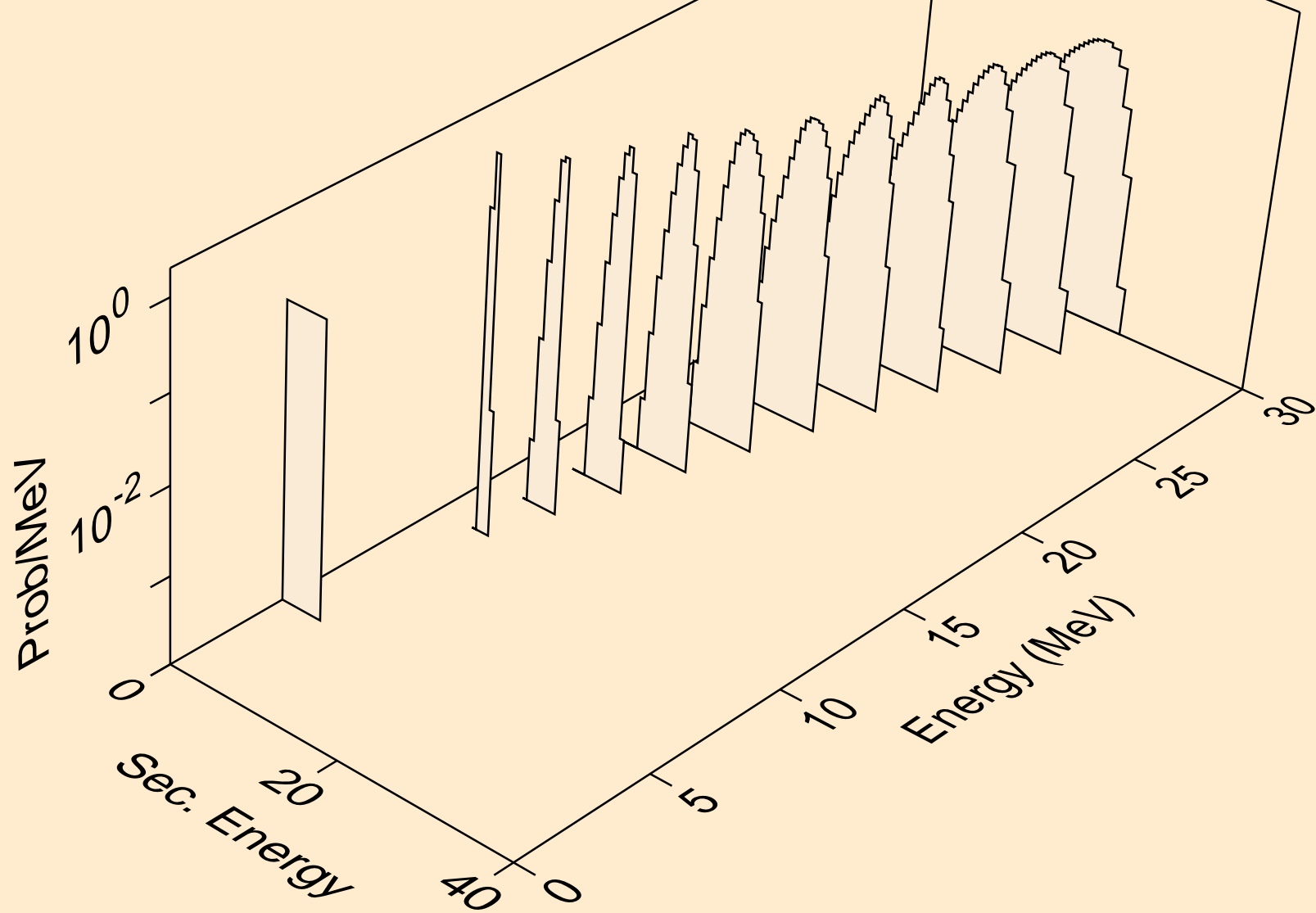



GD153 NEUTRON ACER TENDL-2024 LIBRARY; T=0.K  
alphas from (n,3n)a

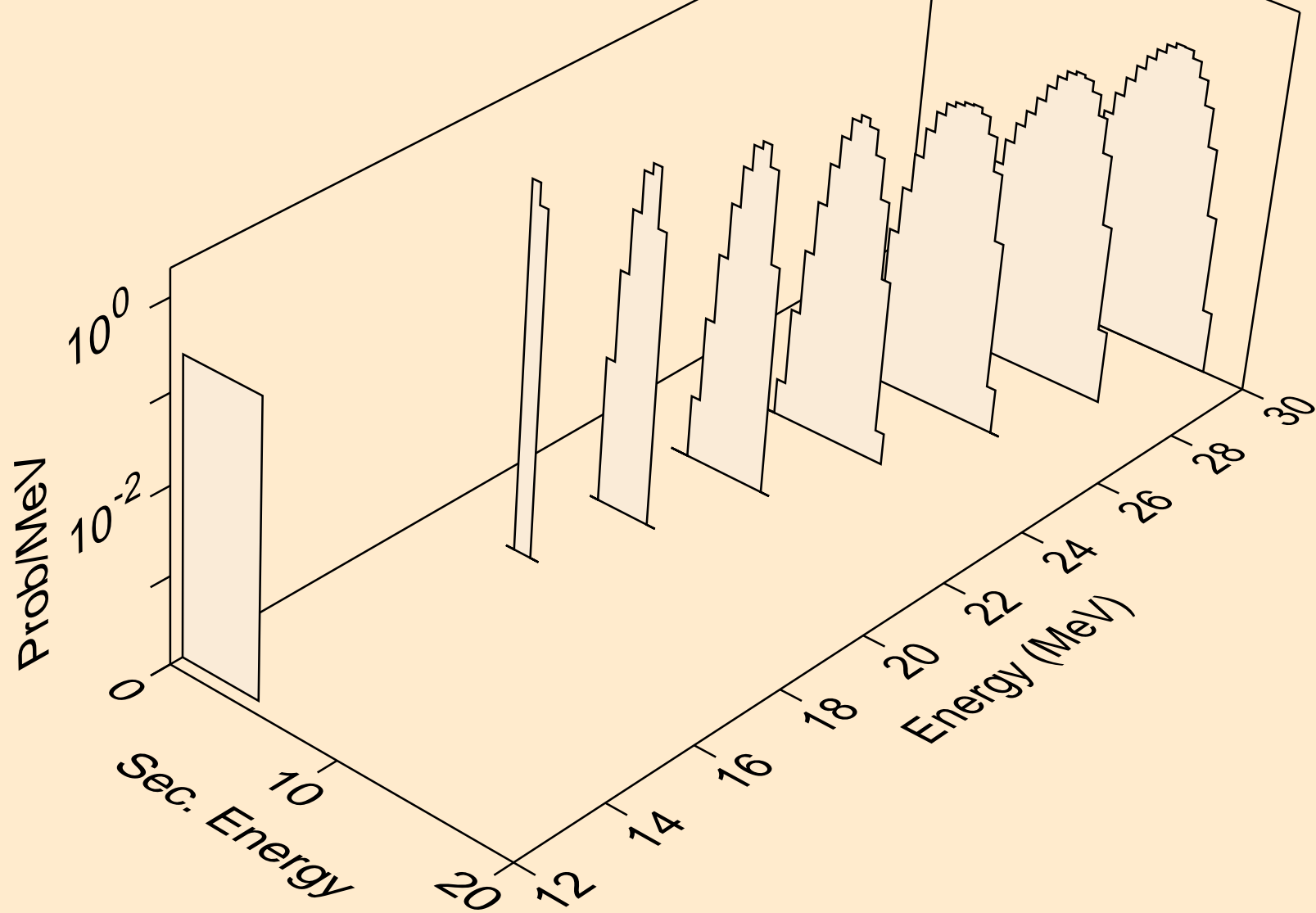

GD153 NEUTRON ACER TENDL-2024 LIBRARY; T=0.K  
alphas from (n,n\*)2a

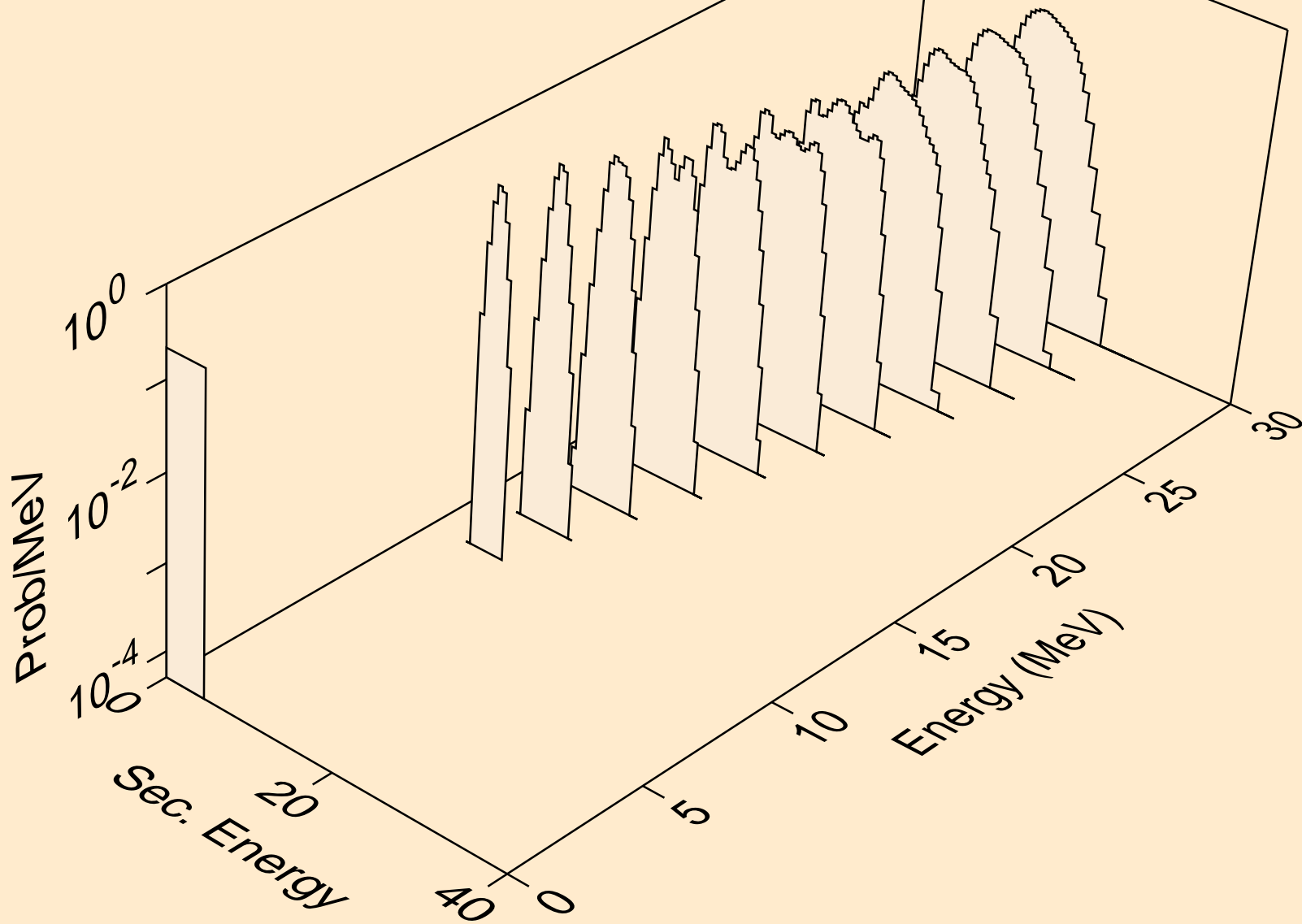

GD153 NEUTRON ACER TENDL-2024 LIBRARY; T=0.K  
alphas from (n,2n)2a

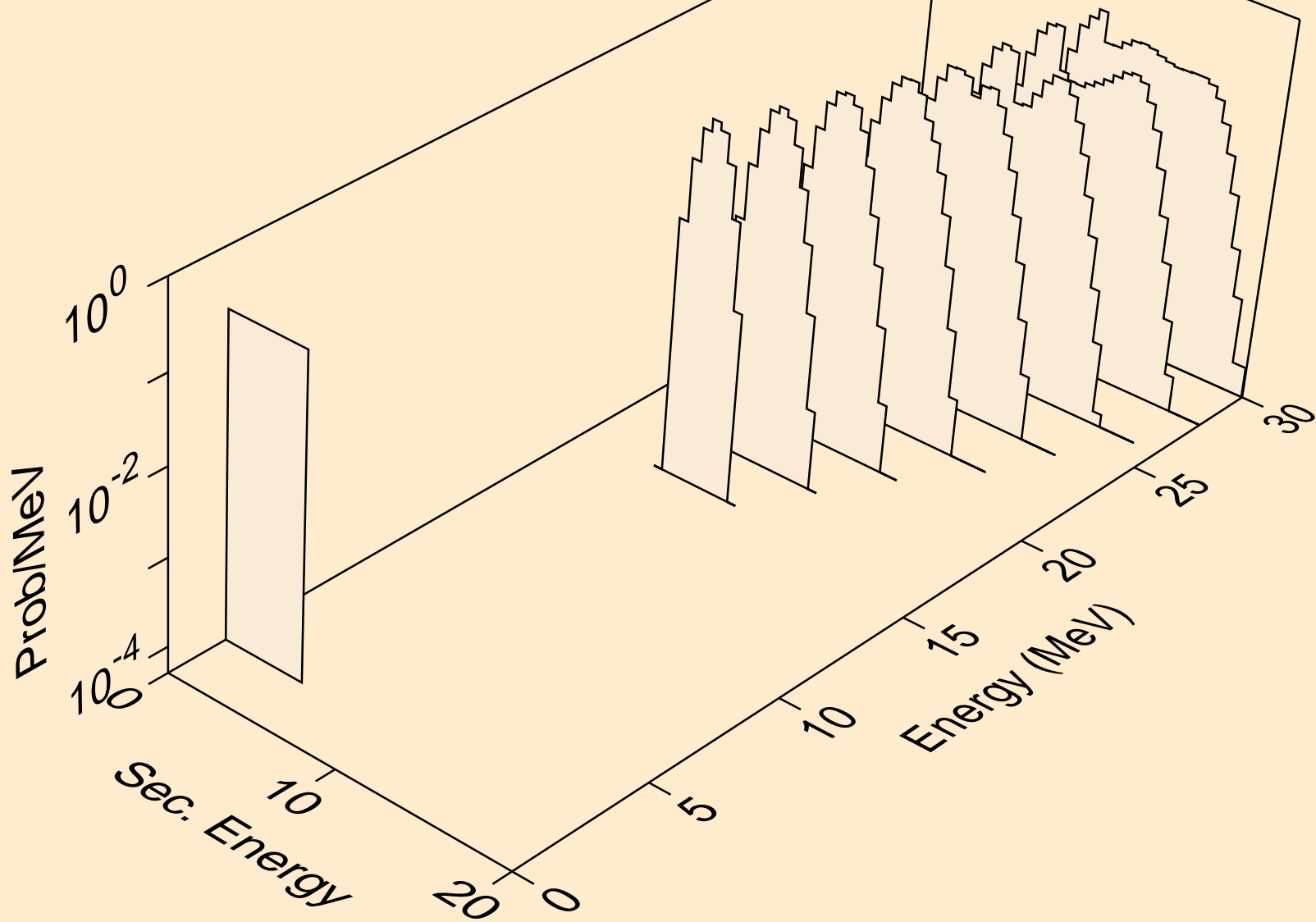

GD153 NEUTRON ACER TENDL-2024 LIBRARY; T=0.K  
alphas from (n,npa)

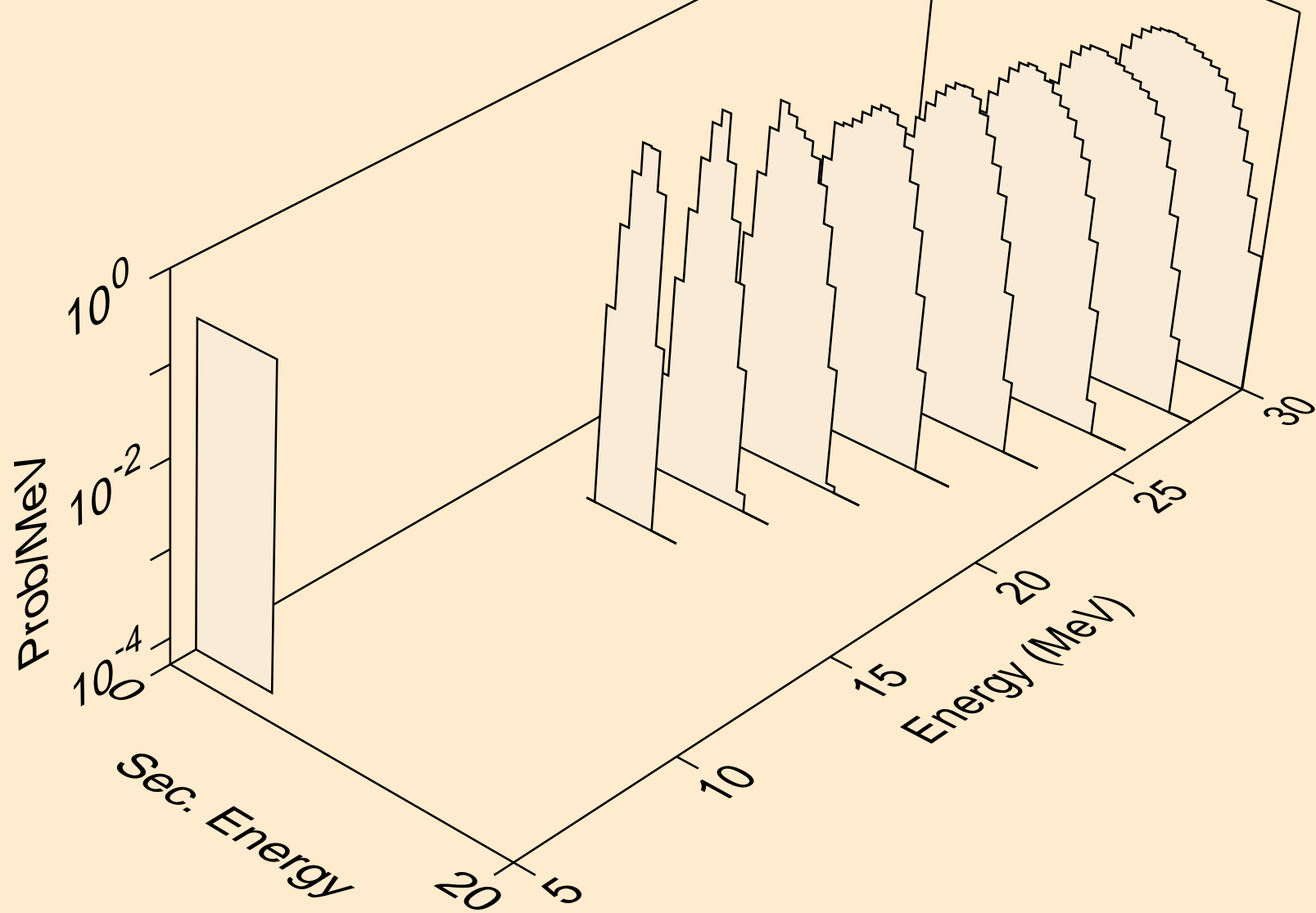

GD153 NEUTRON ACER TENDL-2024 LIBRARY; T=0.K  
alphas from (n,a)

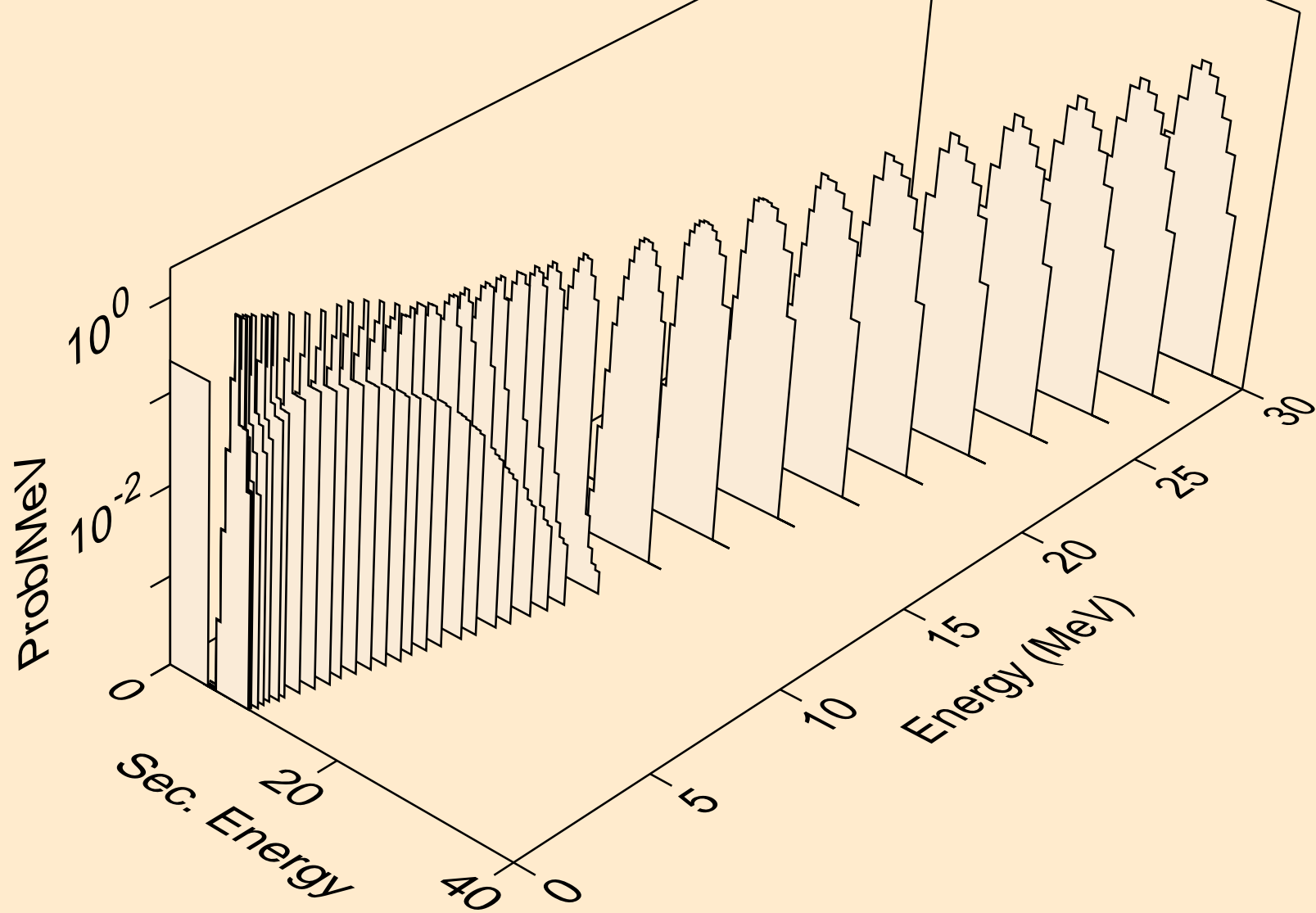

GD153 NEUTRON ACER TENDL-2024 LIBRARY; T=0.K  
alphas from (n,2a)

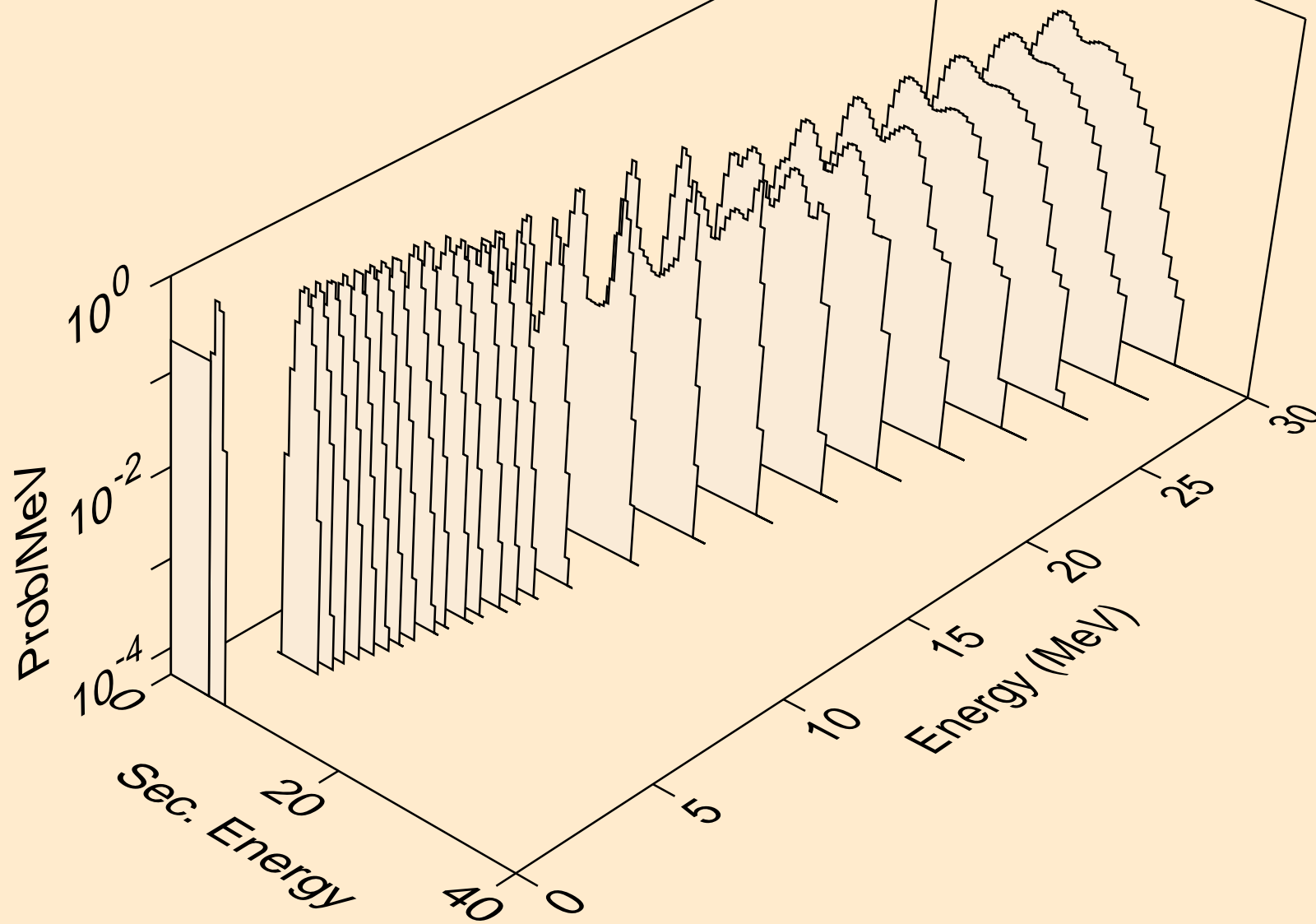

GD153 NEUTRON ACER TENDL-2024 LIBRARY; T=0.K  
alphas from (n,pa)

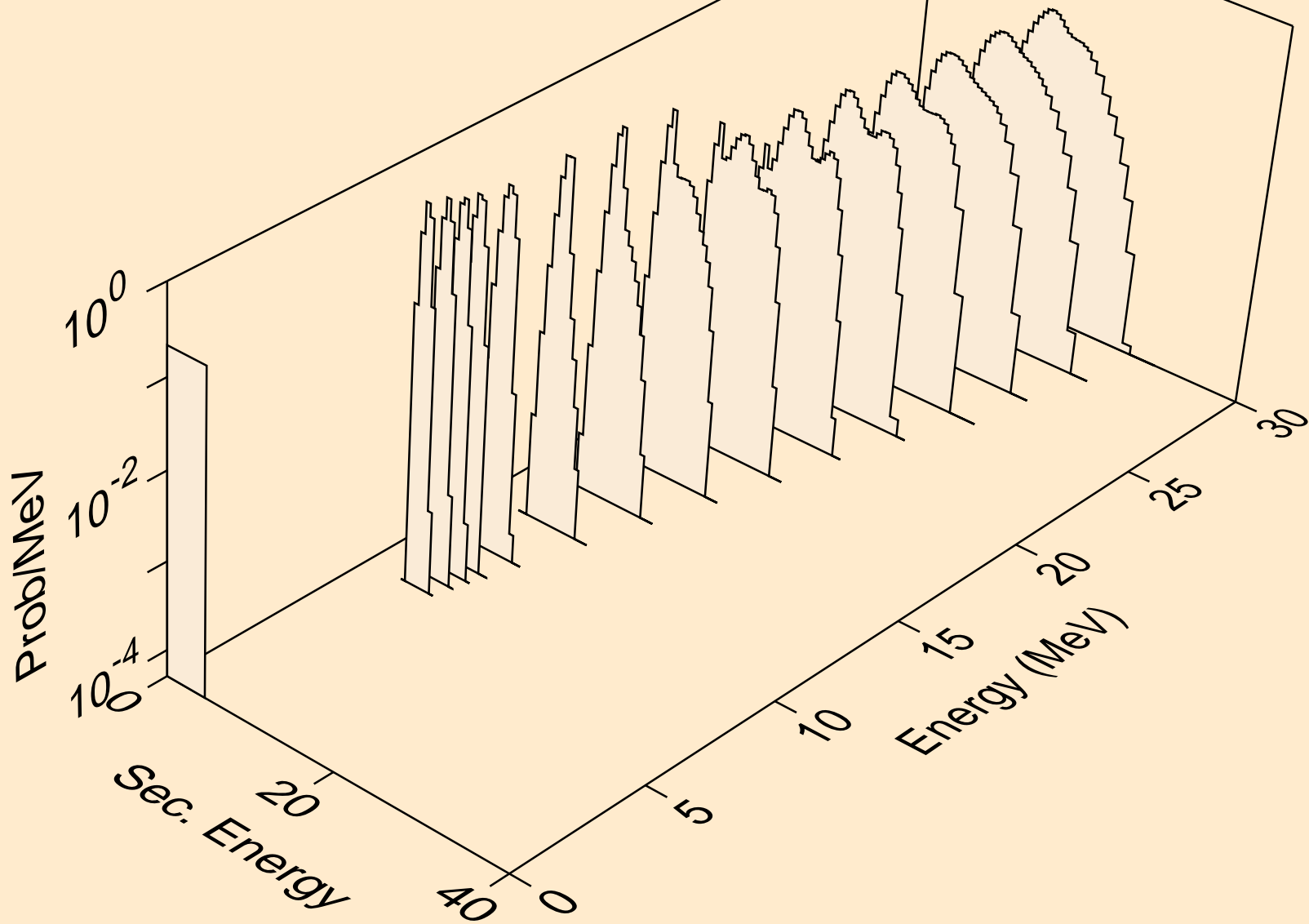

GD153 NEUTRON ACER TENDL-2024 LIBRARY; T=0.K  
alphas from (n,da)

