

# GD157 NEUTRON ACER TENDL-2024 LIBRARY; T=0.K

## Principal cross sections

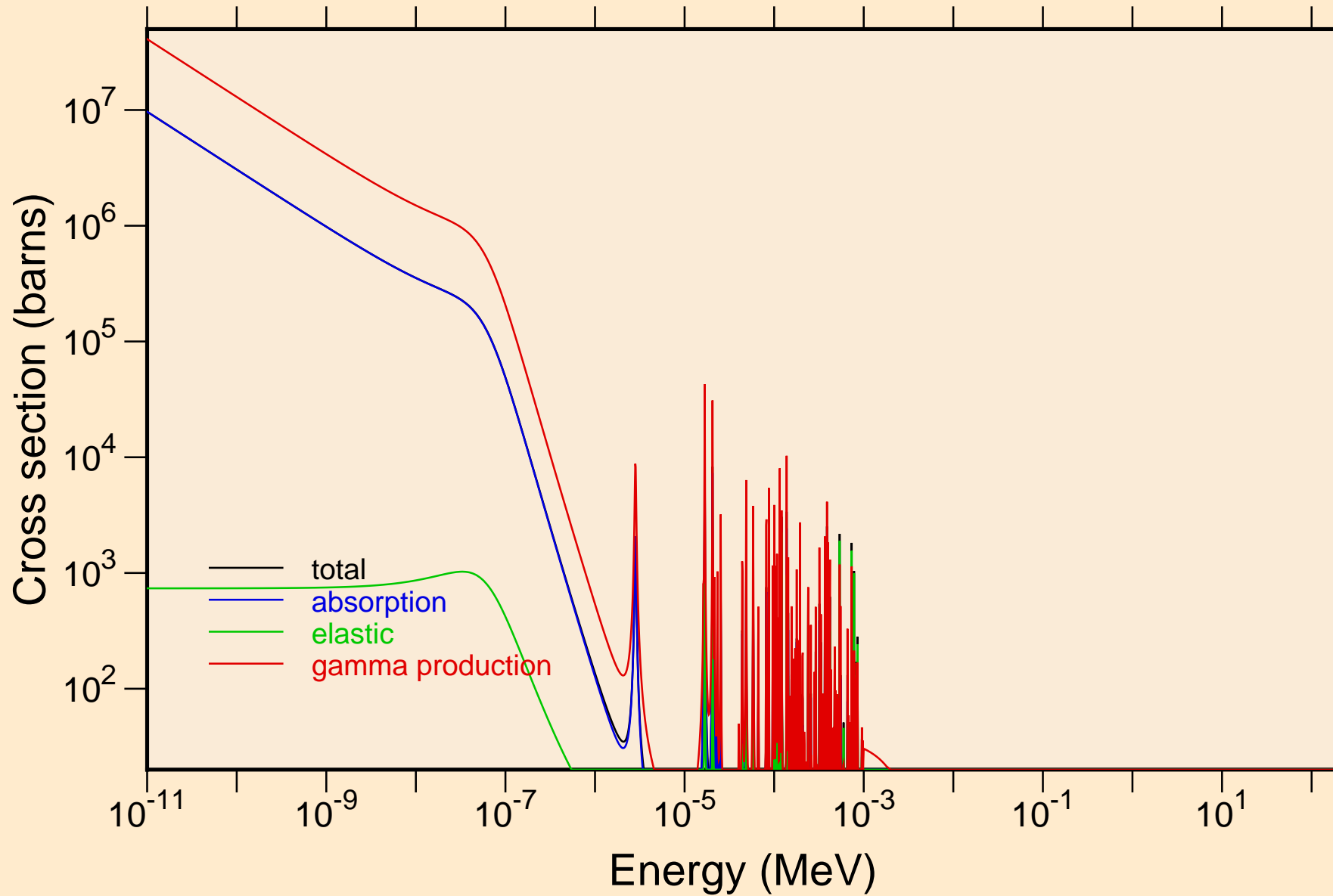

GD157 NEUTRON ACER TENDL-2024 LIBRARY; T=0.K  
resonance total cross section

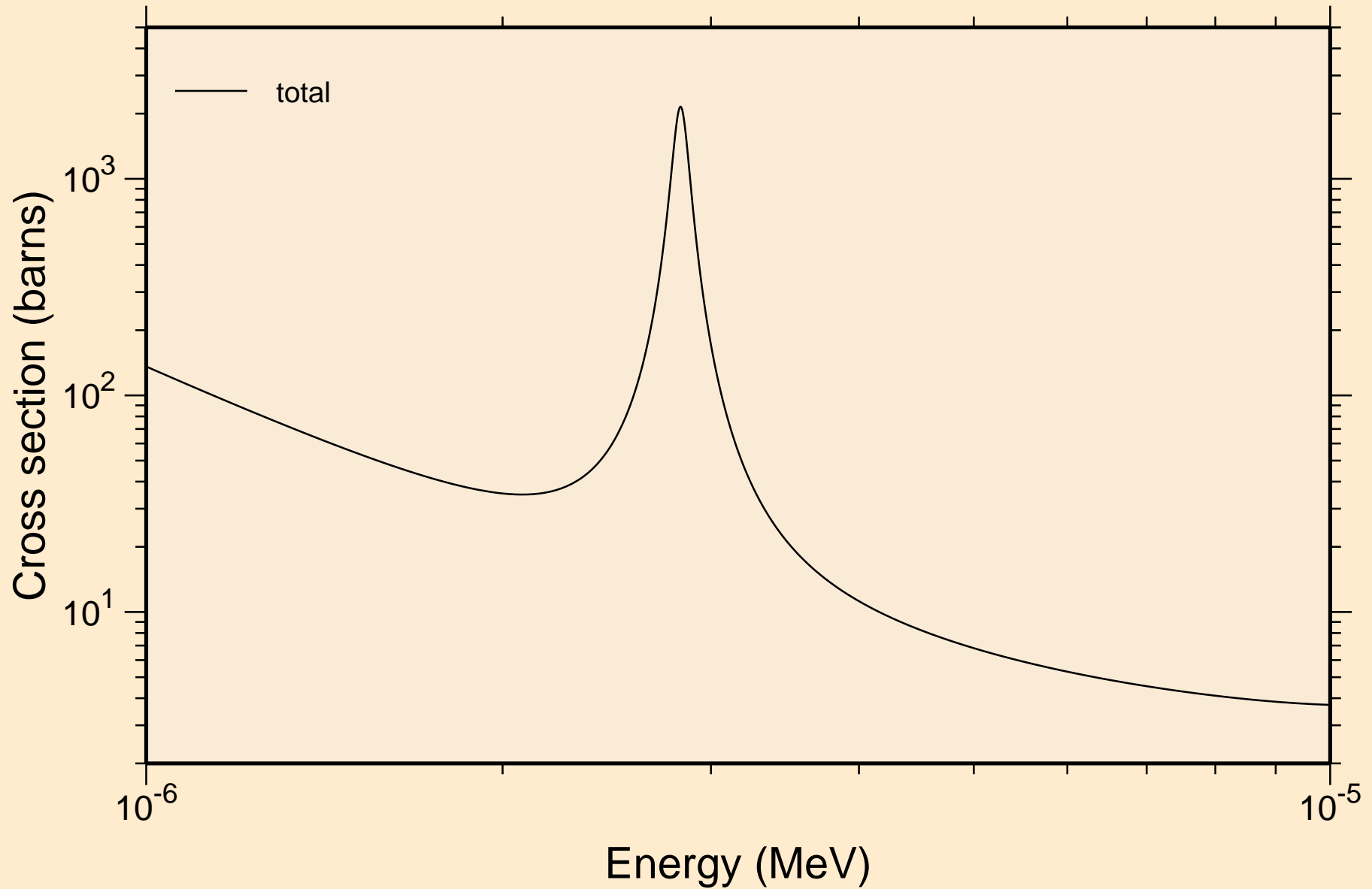

GD157 NEUTRON ACER TENDL-2024 LIBRARY; T=0.K  
resonance total cross section

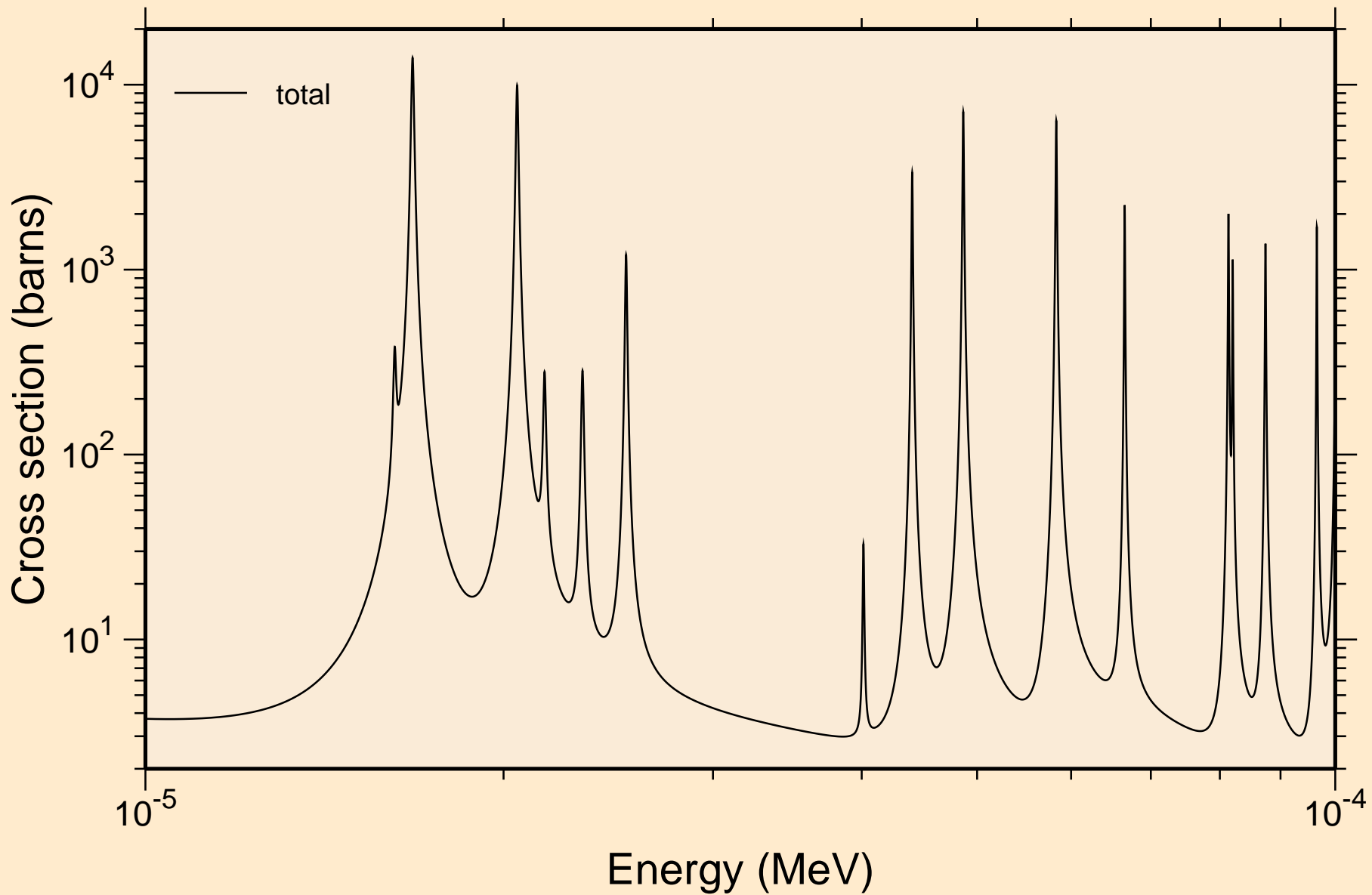

GD157 NEUTRON ACER TENDL-2024 LIBRARY; T=0.K  
resonance total cross section

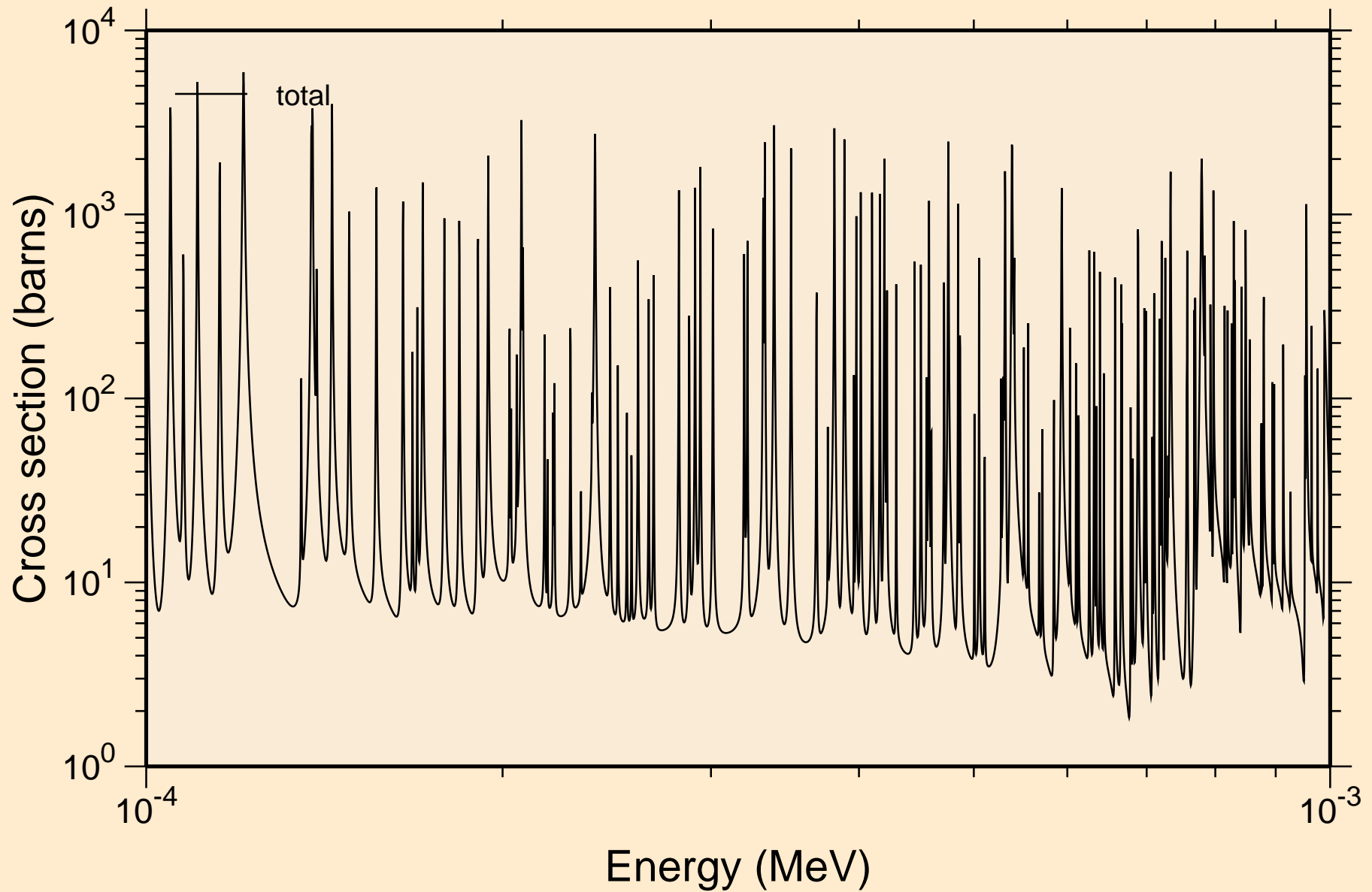

GD157 NEUTRON ACER TENDL-2024 LIBRARY; T=0.K  
resonance total cross section

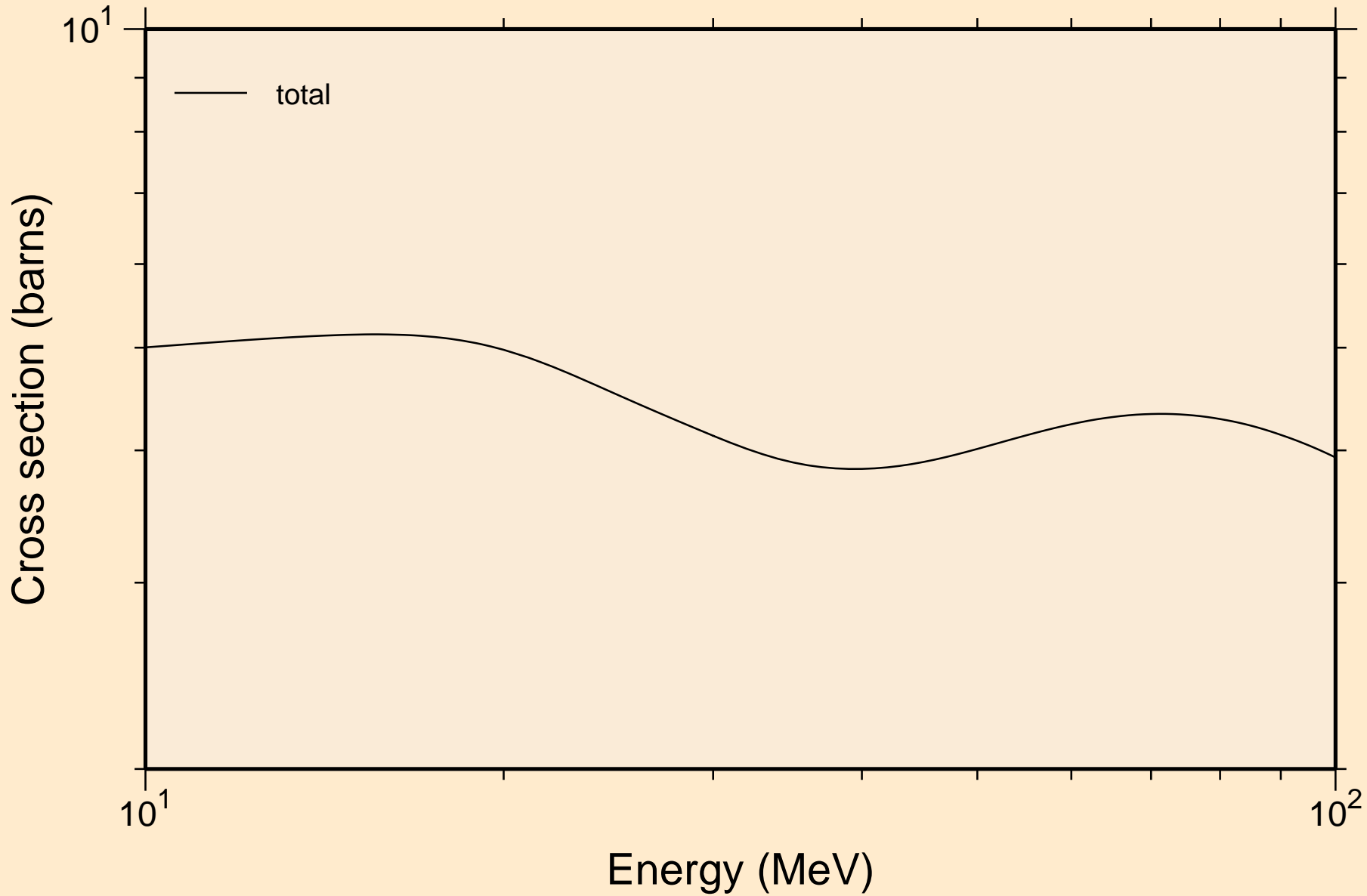

GD157 NEUTRON ACER TENDL-2024 LIBRARY; T=0.K  
resonance absorption cross sections

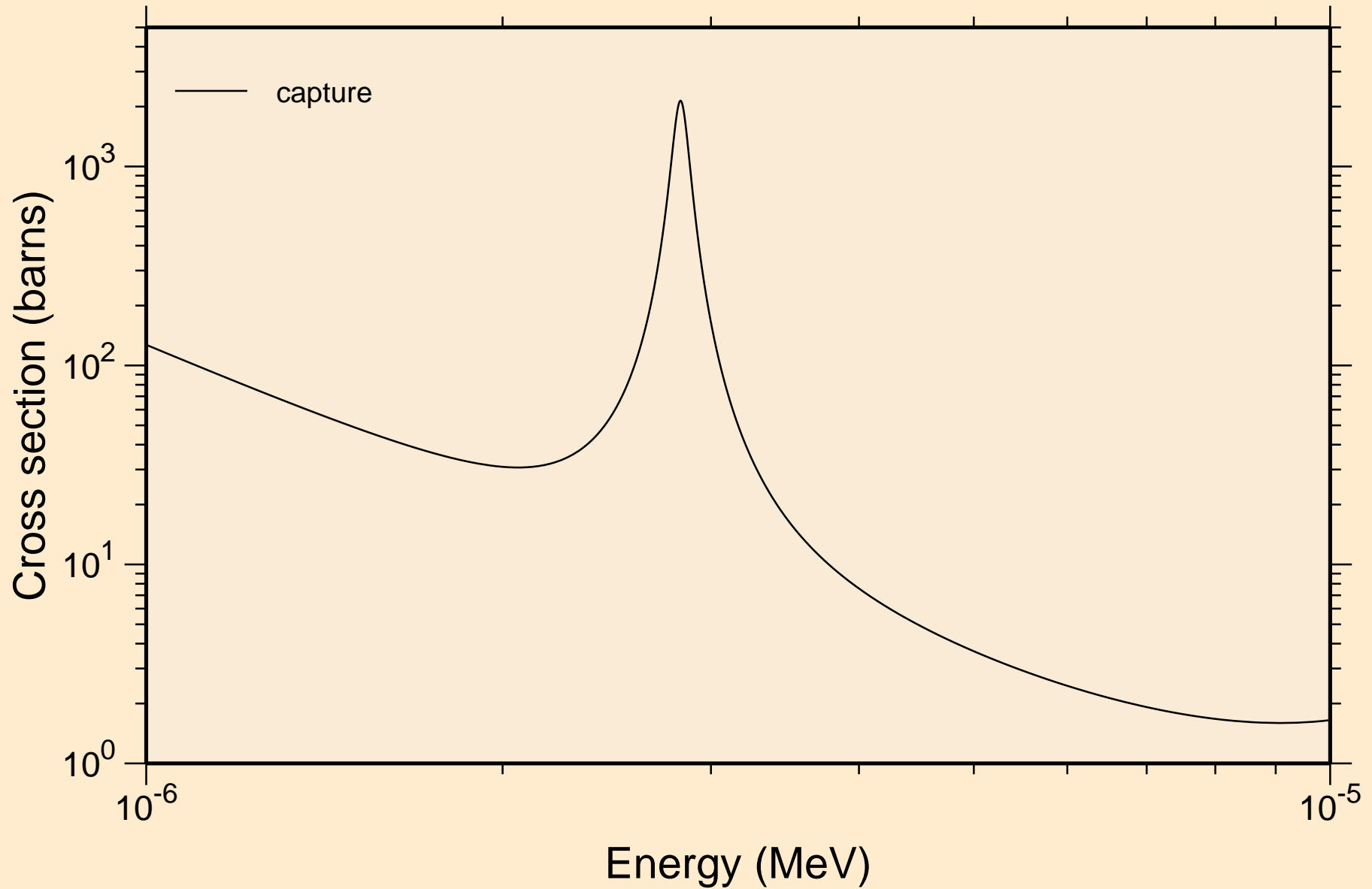

GD157 NEUTRON ACER TENDL-2024 LIBRARY; T=0.K  
resonance absorption cross sections

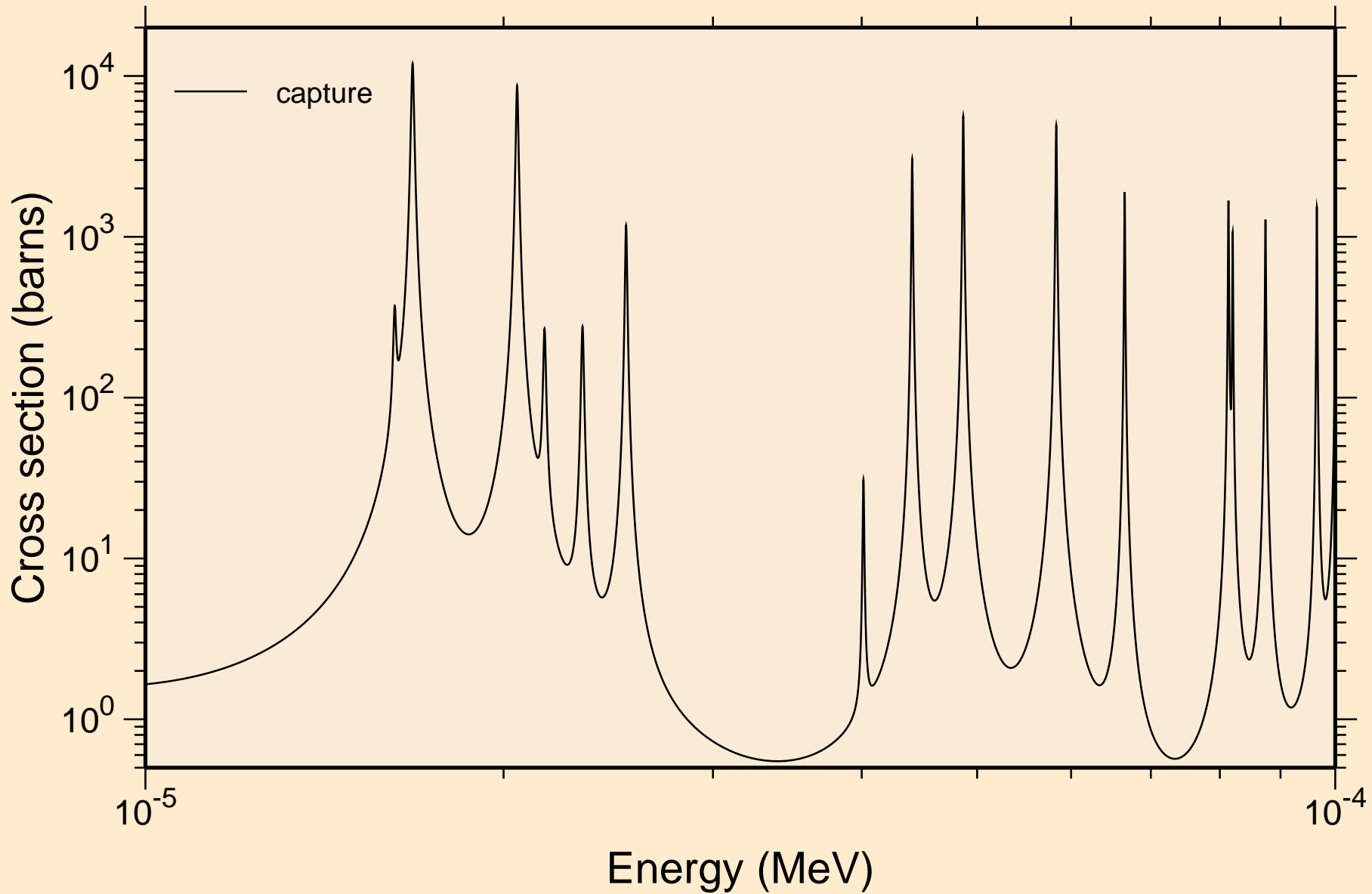

GD157 NEUTRON ACER TENDL-2024 LIBRARY; T=0.K  
resonance absorption cross sections

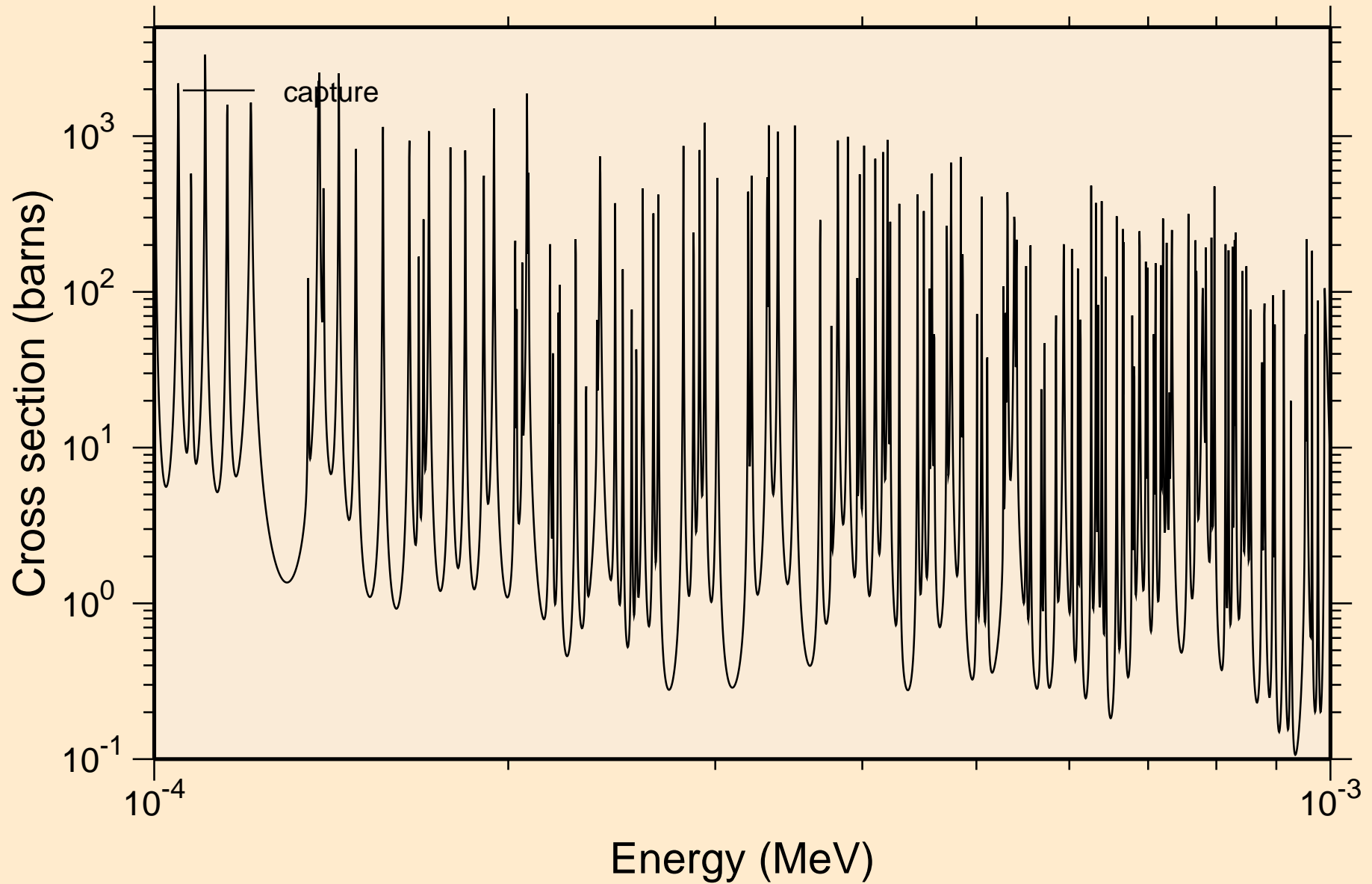



GD157 NEUTRON ACER TENDL-2024 LIBRARY; T=0.K  
resonance absorption cross sections

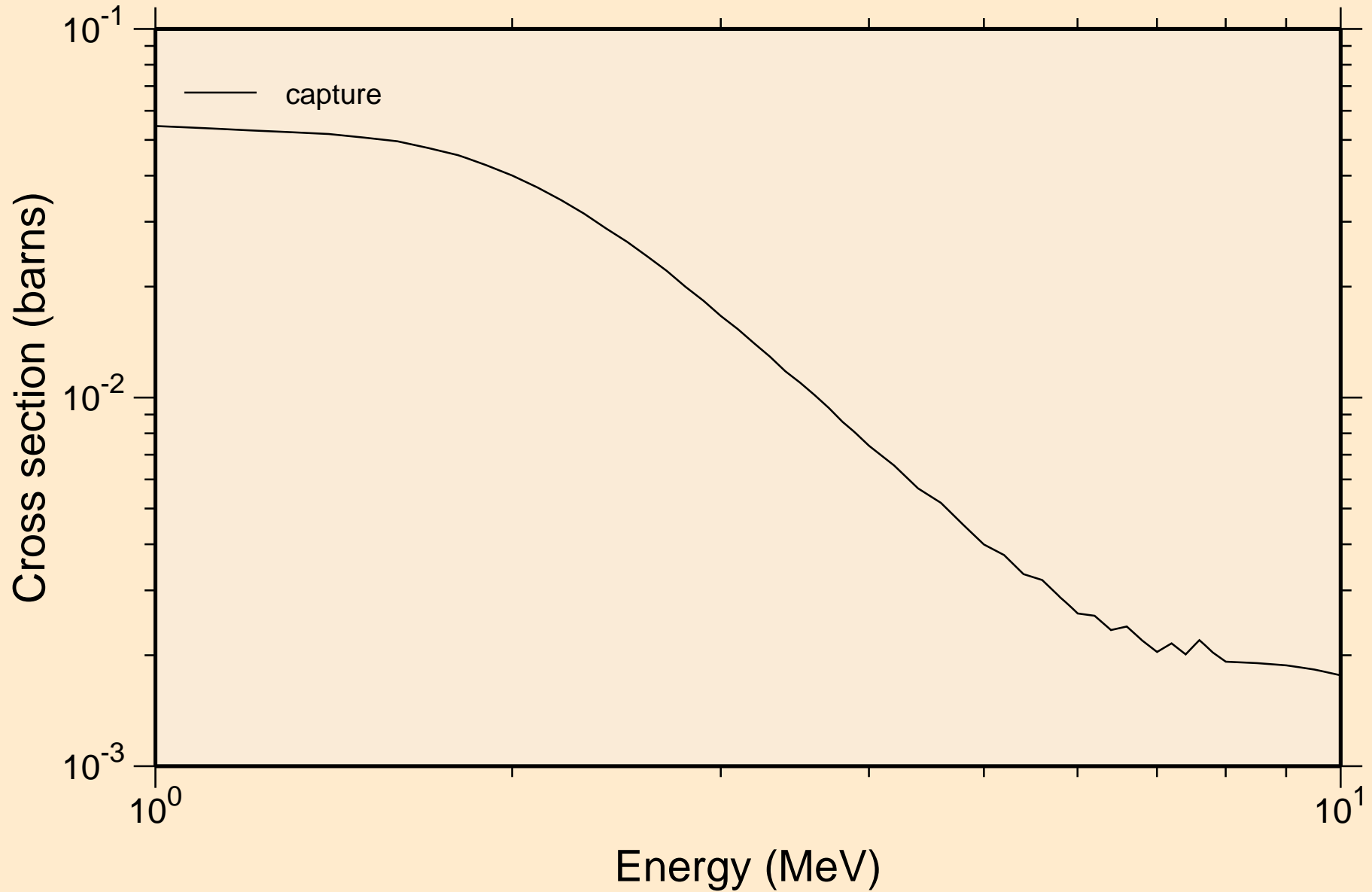

# GD157 NEUTRON ACER TENDL-2024 LIBRARY; T=0.K

## Heating

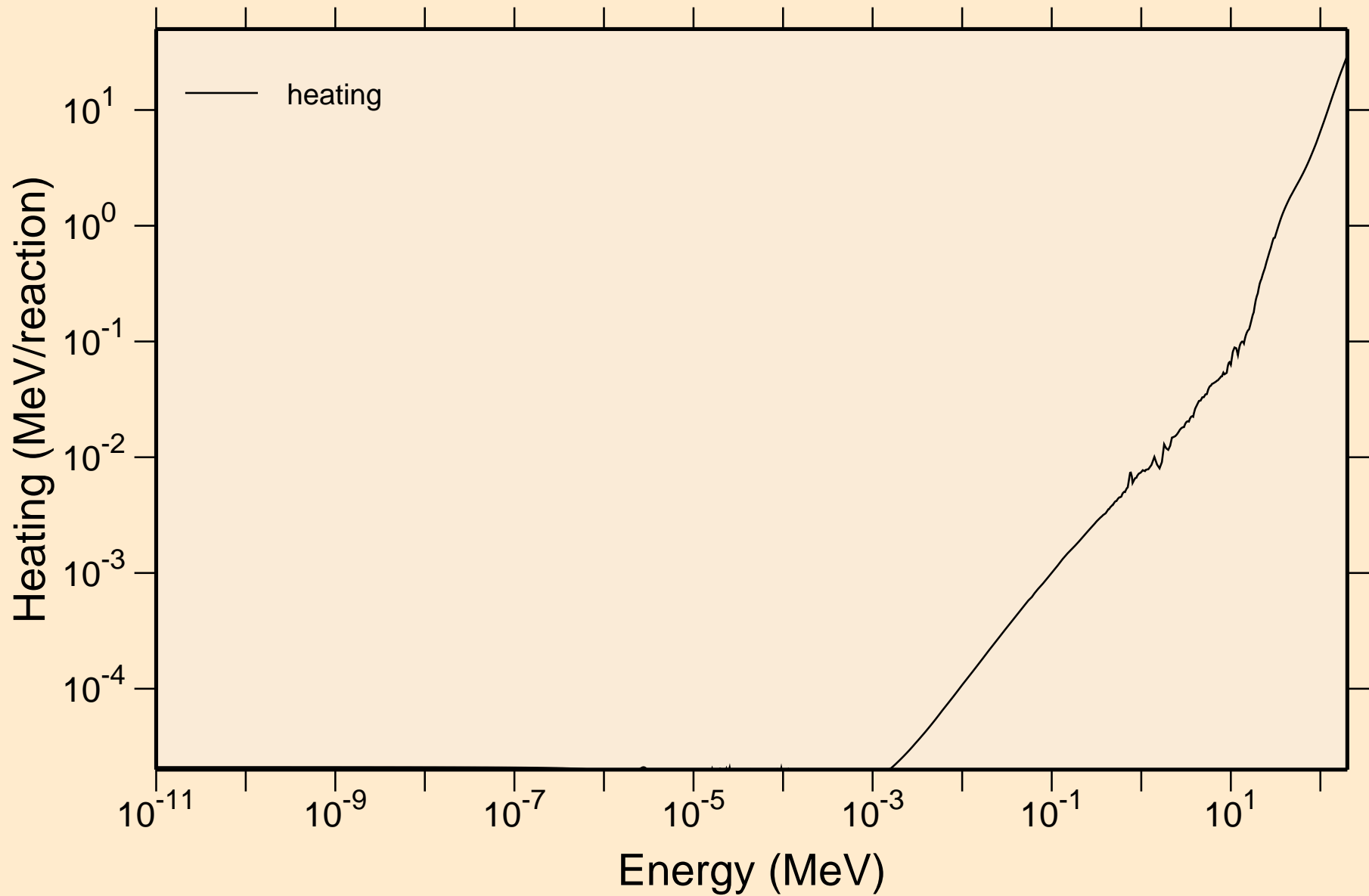

# GD157 NEUTRON ACER TENDL-2024 LIBRARY; T=0.K

## Damage

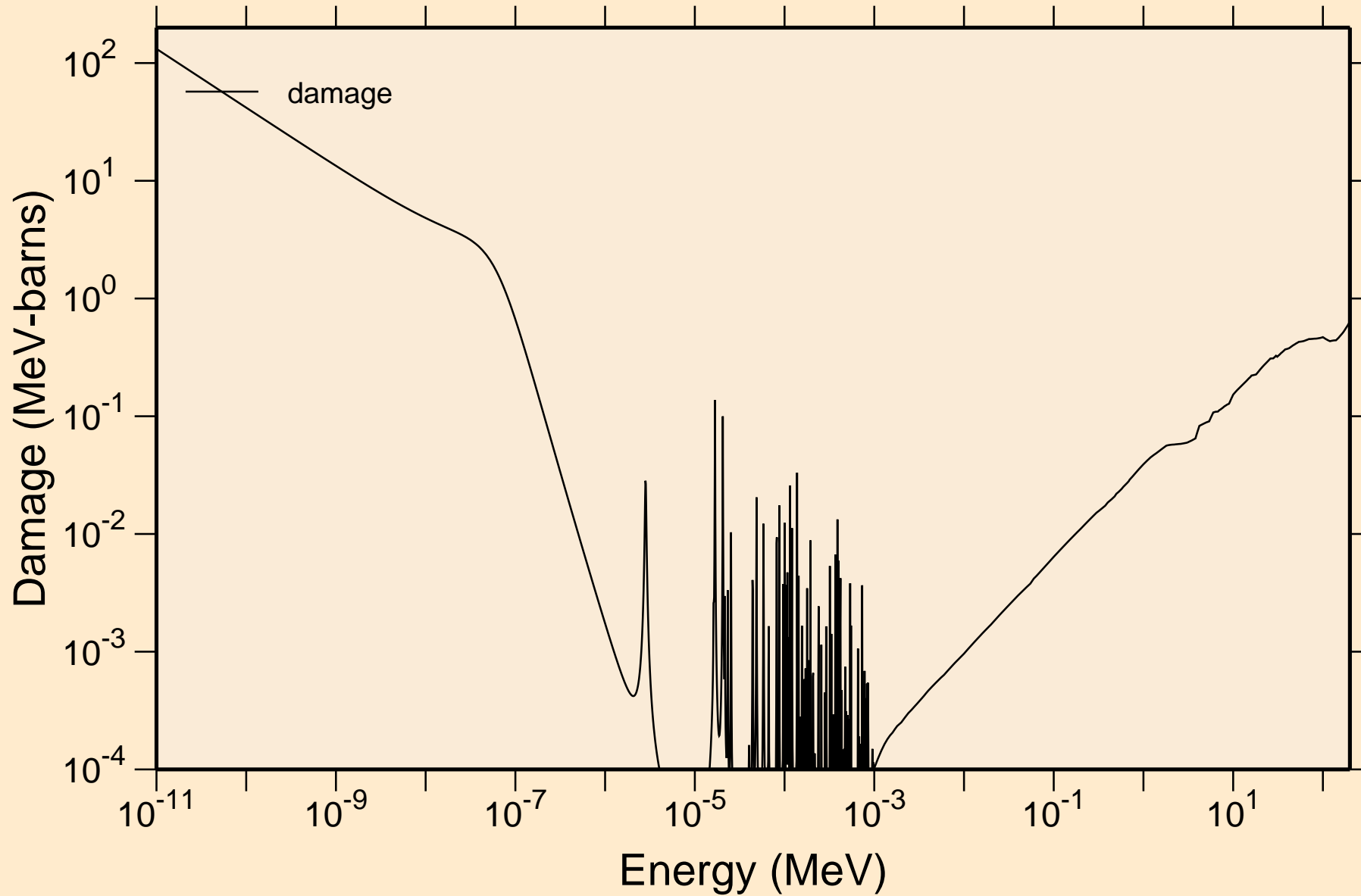

# GD157 NEUTRON ACER TENDL-2024 LIBRARY; T=0.K

## Non-threshold reactions

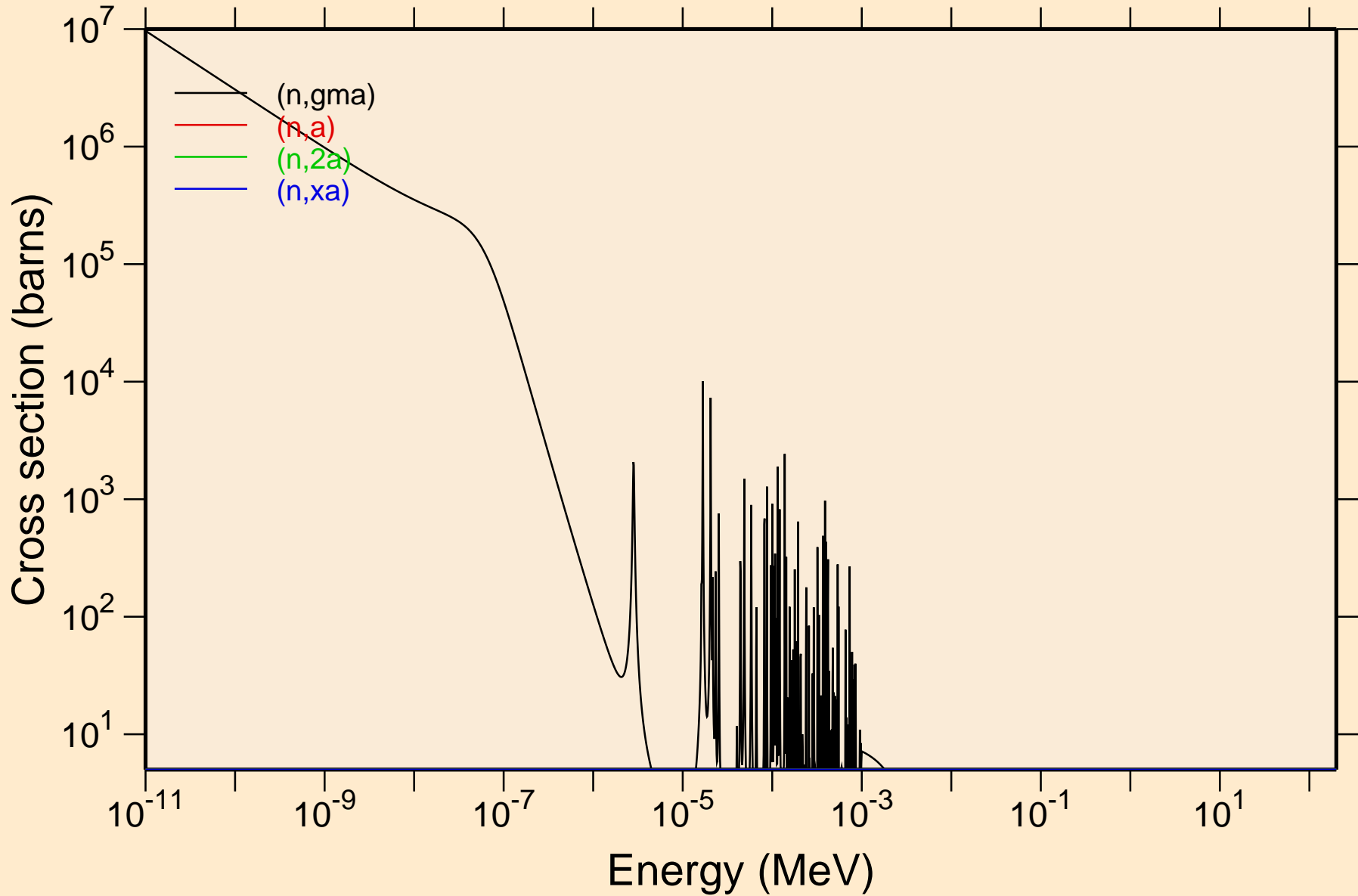

# GD157 NEUTRON ACER TENDL-2024 LIBRARY; T=0.K

## Principal cross sections

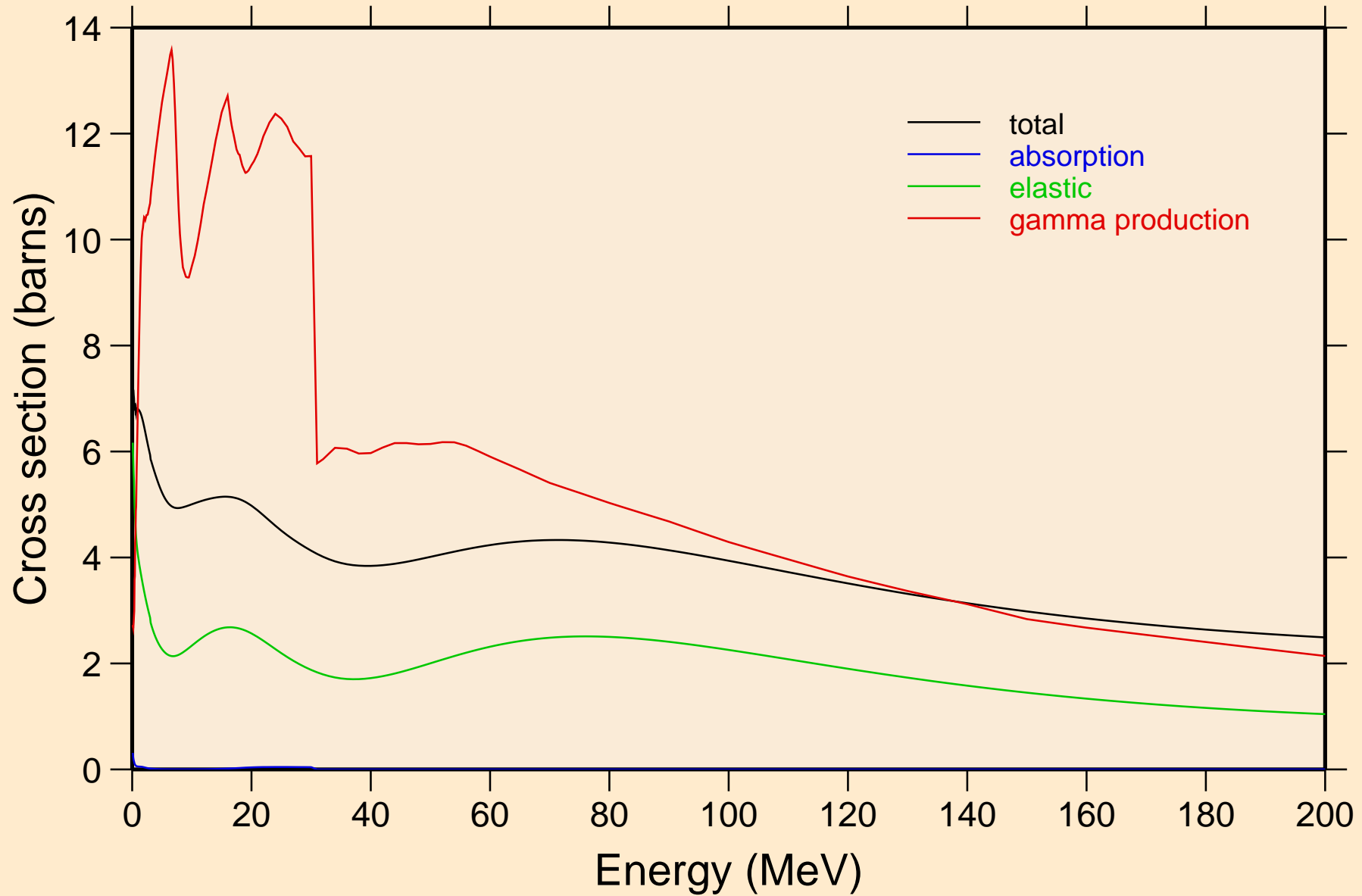

# GD157 NEUTRON ACER TENDL-2024 LIBRARY; T=0.K

## Heating

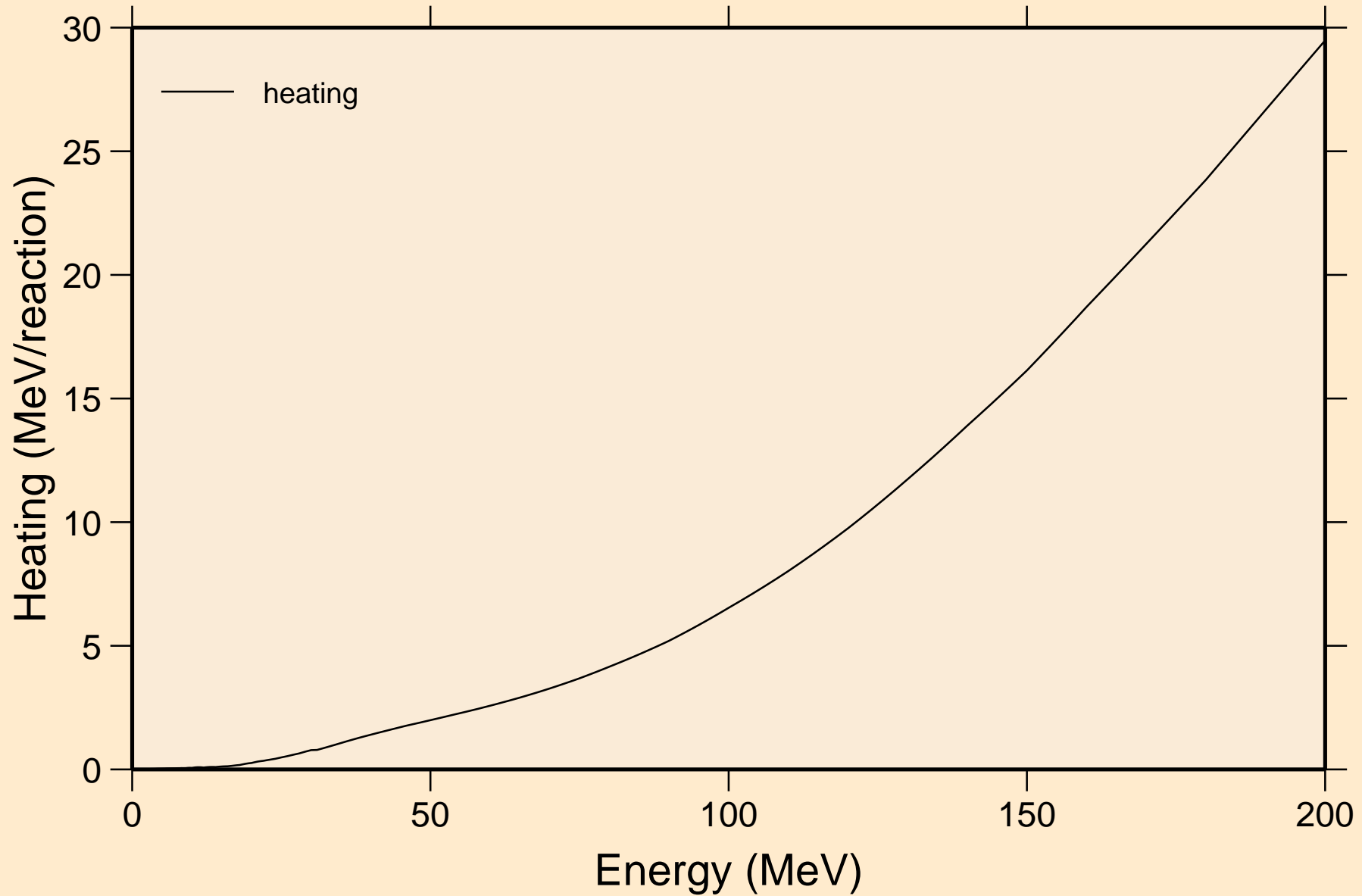

# GD157 NEUTRON ACER TENDL-2024 LIBRARY; T=0.K

## Damage

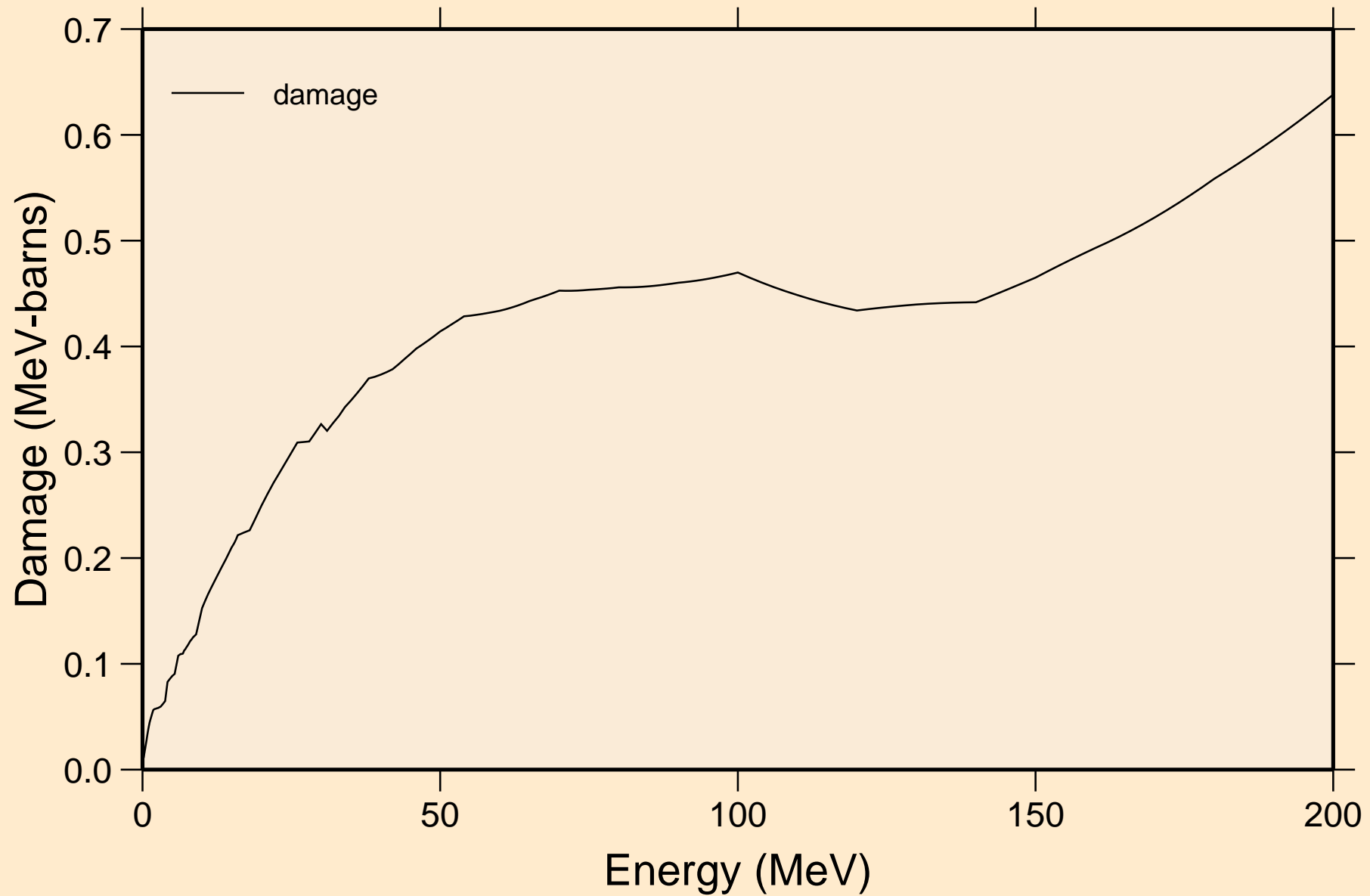

# GD157 NEUTRON ACER TENDL-2024 LIBRARY; T=0.K

## Non-threshold reactions

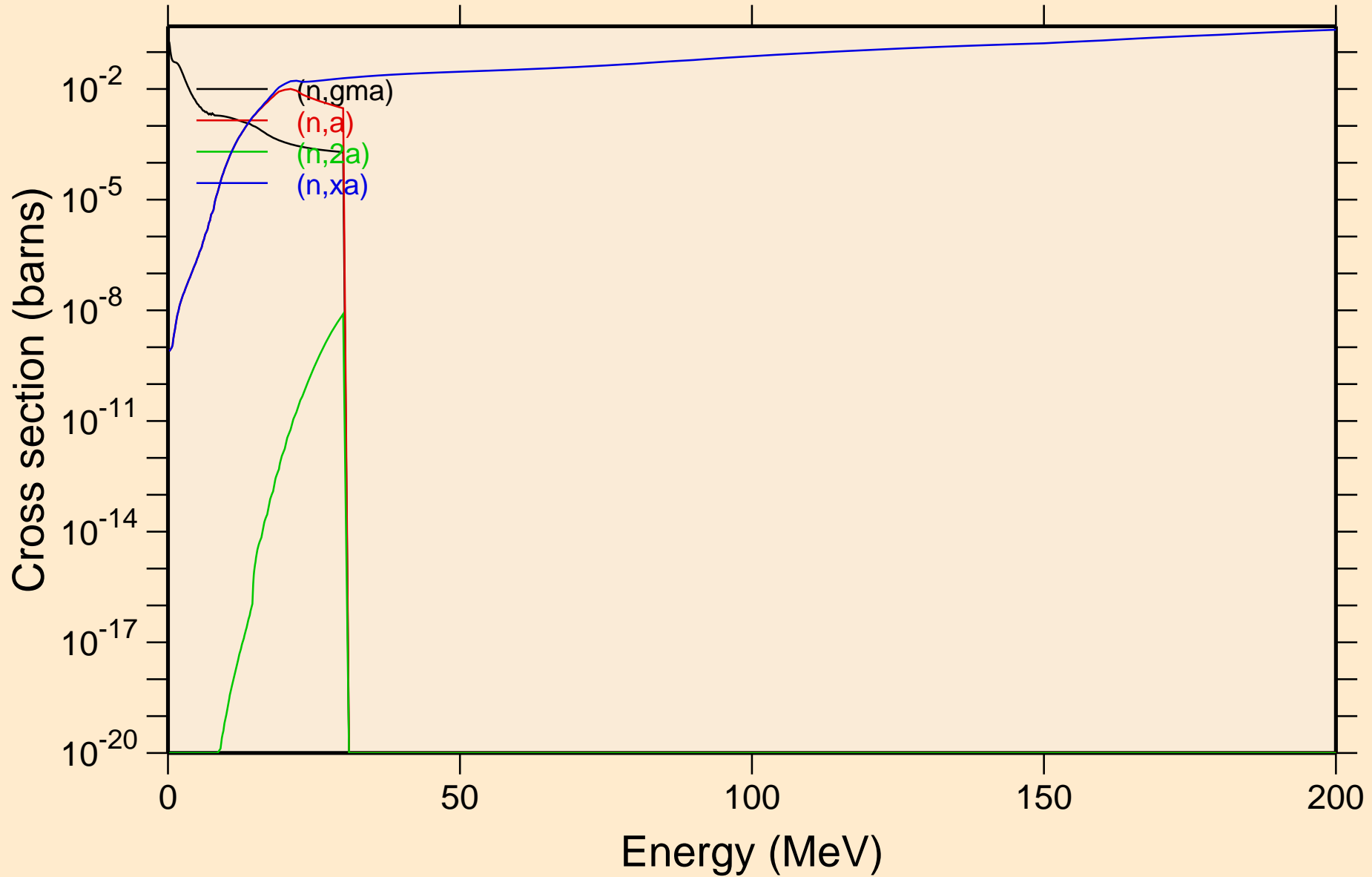



GD157 NEUTRON ACER TENDL-2024 LIBRARY; T=0.K  
Inelastic levels

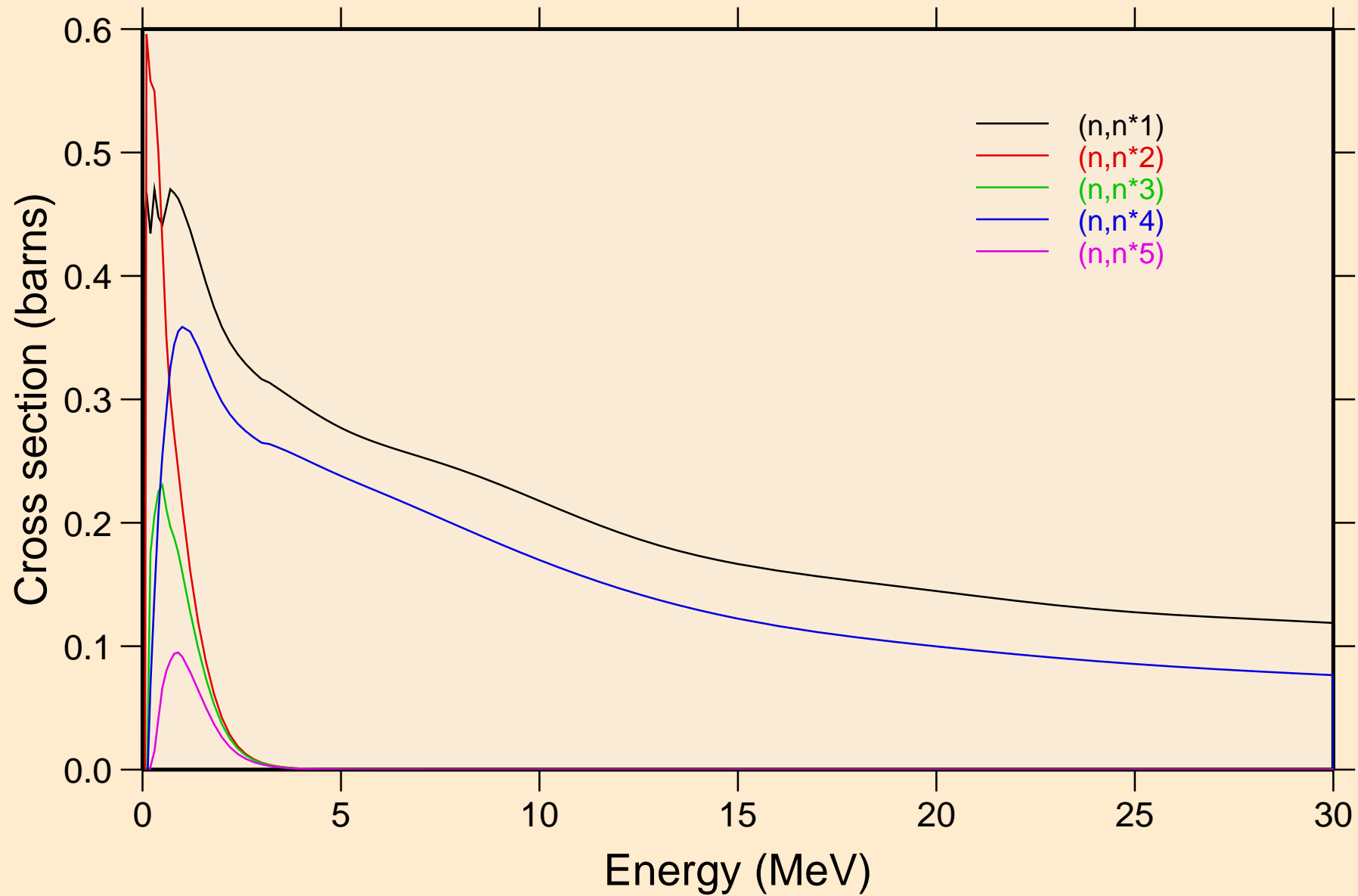

# GD157 NEUTRON ACER TENDL-2024 LIBRARY; T=0.K

## Inelastic levels

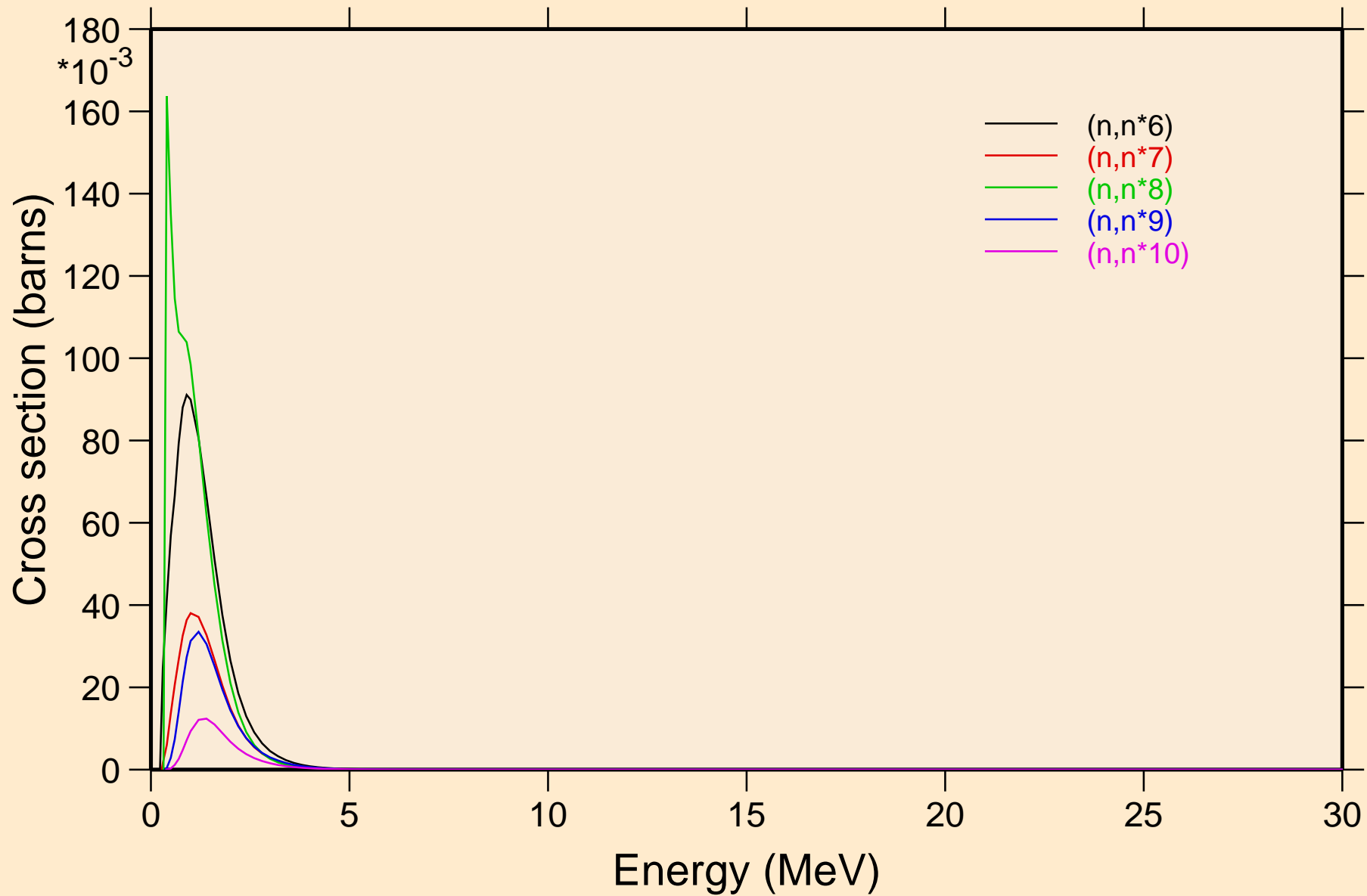

# GD157 NEUTRON ACER TENDL-2024 LIBRARY; T=0.K

## Inelastic levels

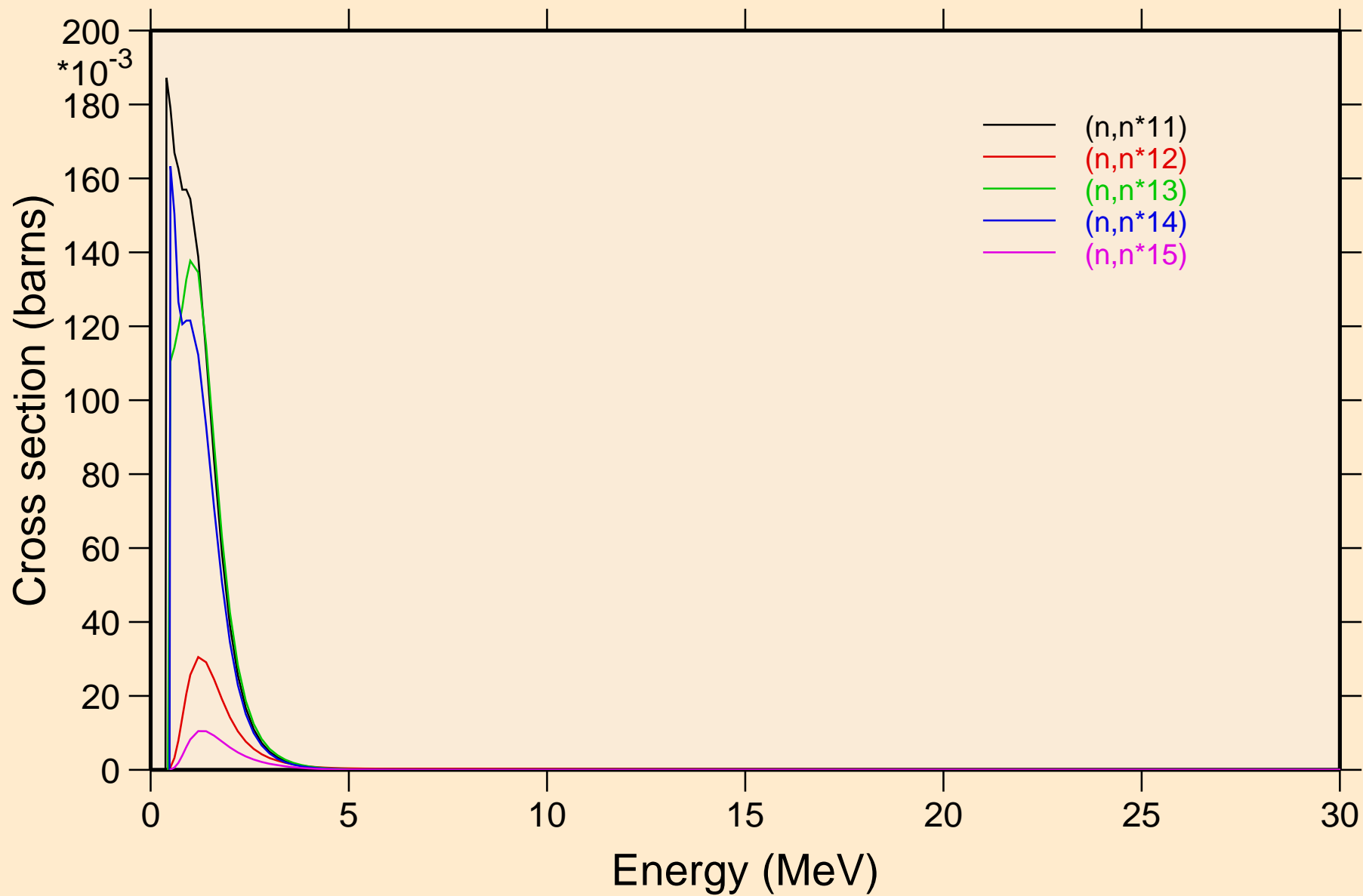

# GD157 NEUTRON ACER TENDL-2024 LIBRARY; T=0.K

## Inelastic levels

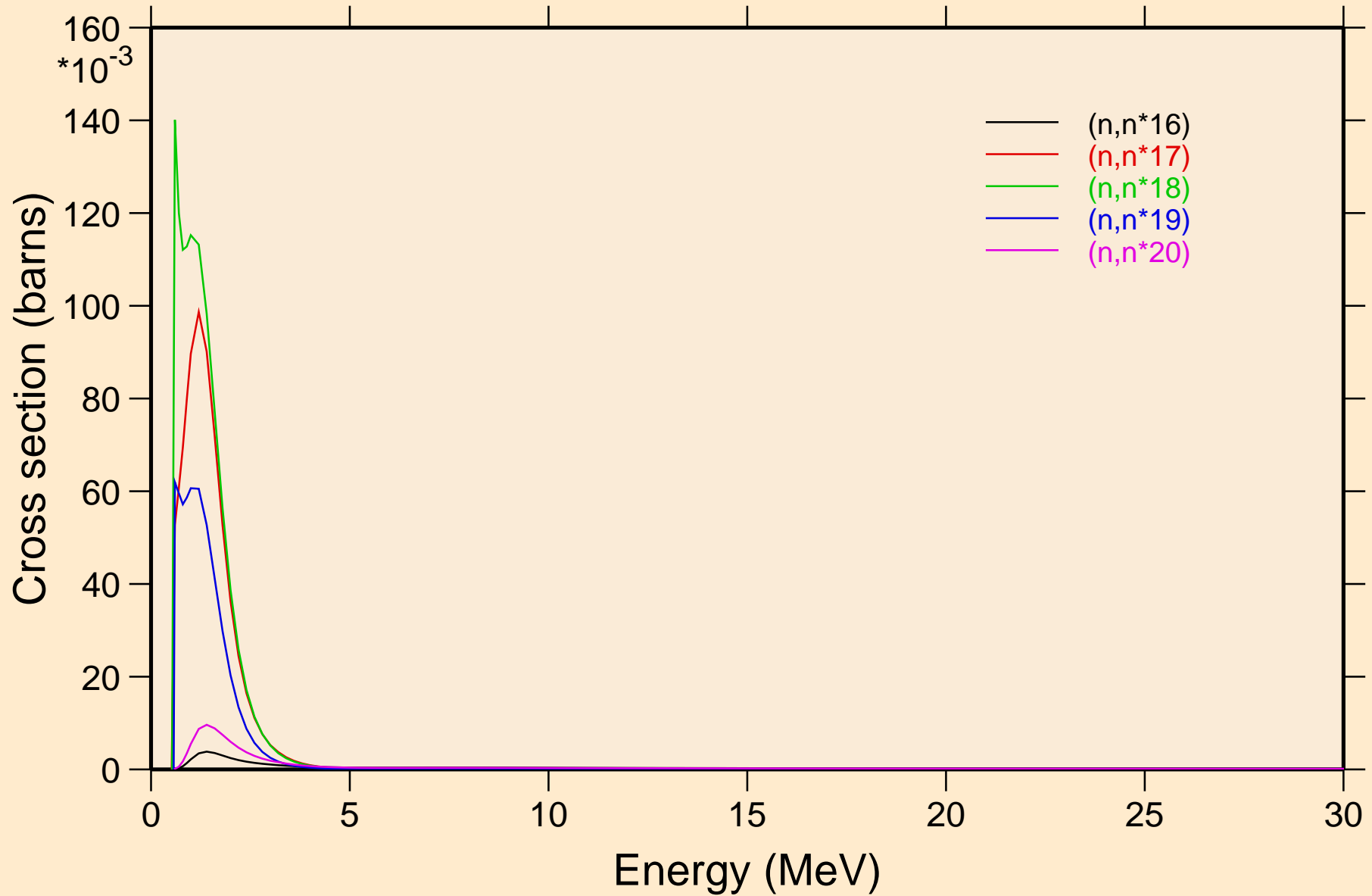

GD157 NEUTRON ACER TENDL-2024 LIBRARY; T=0.K  
Inelastic levels

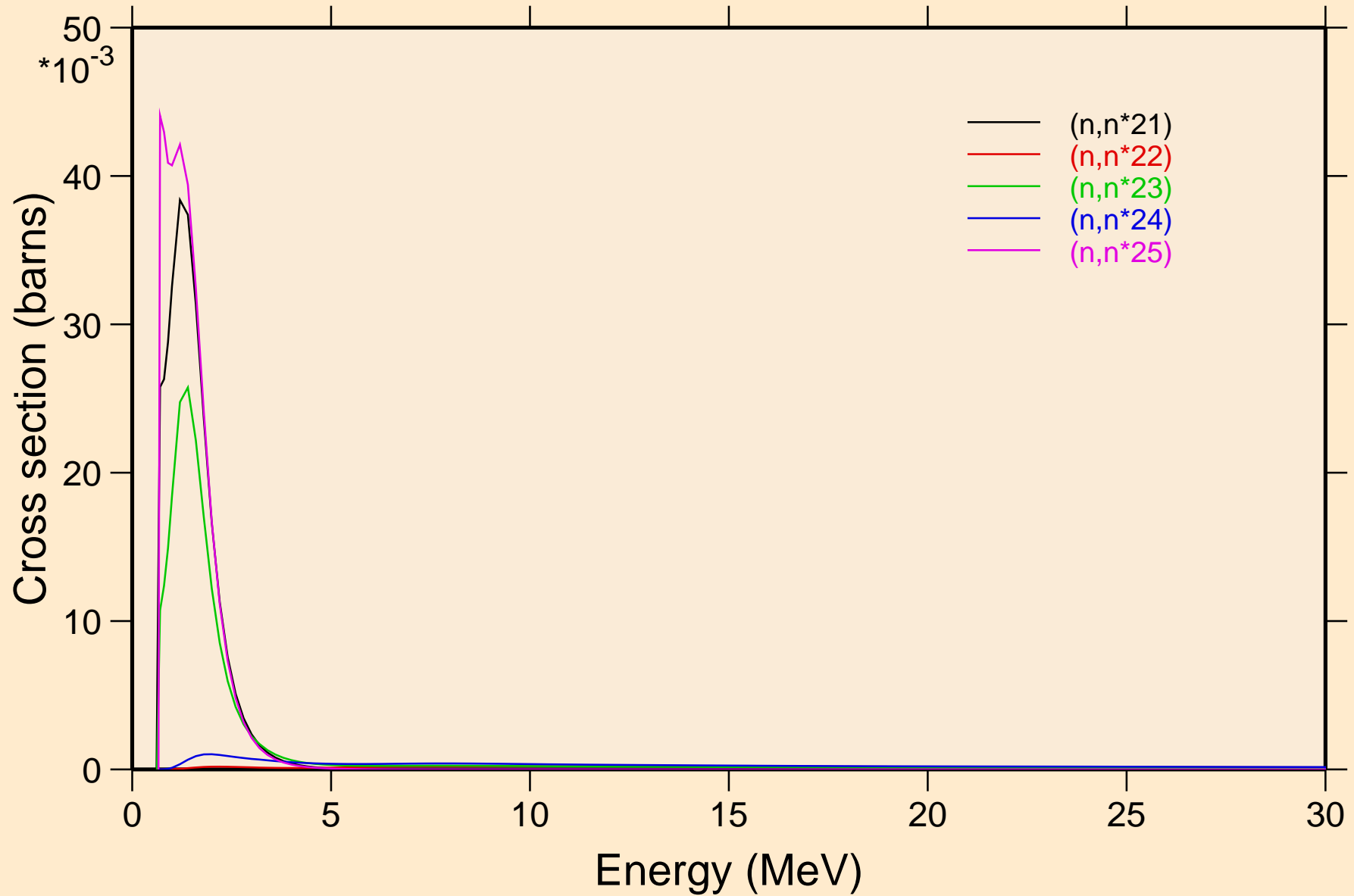

GD157 NEUTRON ACER TENDL-2024 LIBRARY; T=0.K  
Inelastic levels

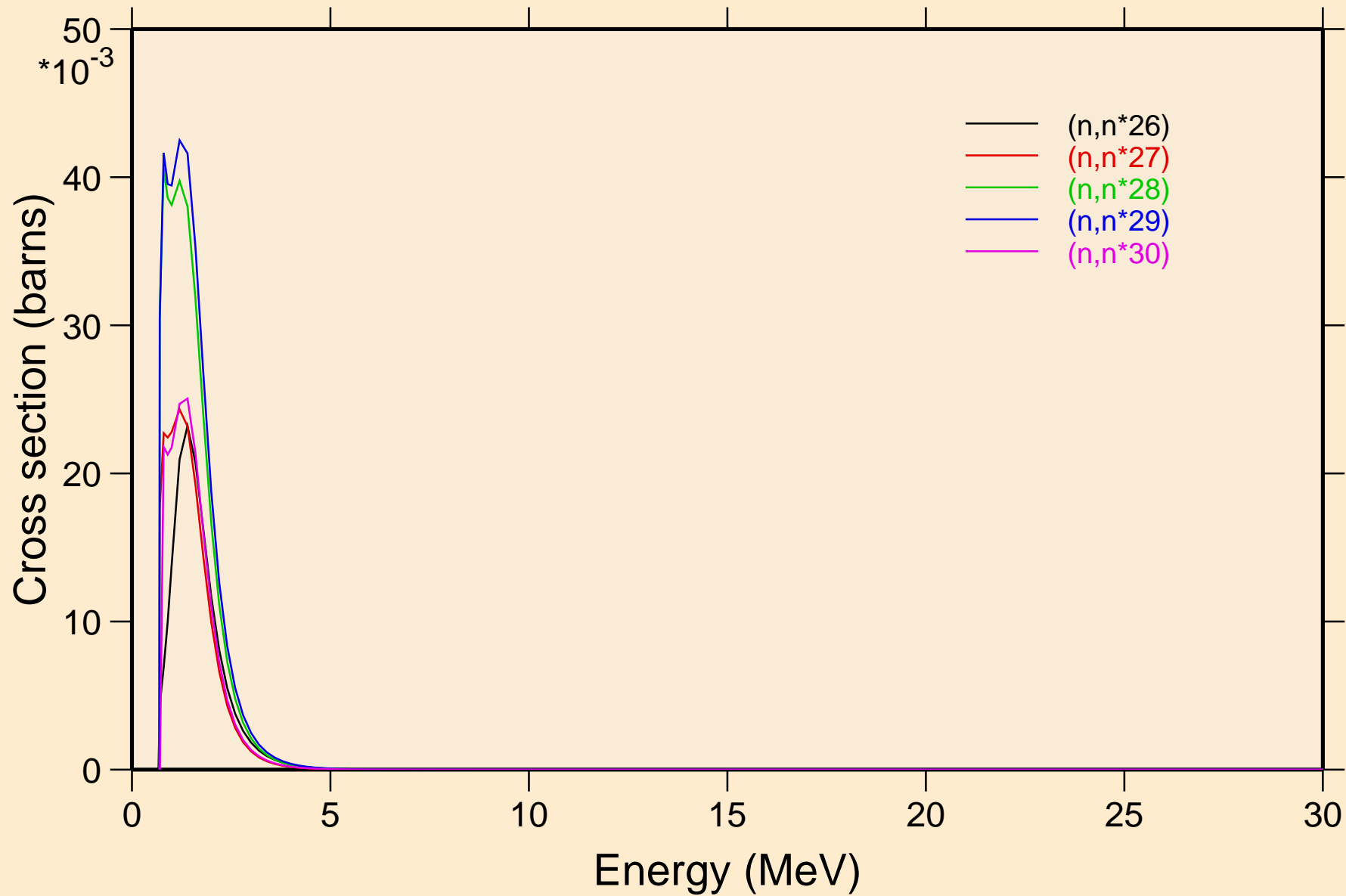

# GD157 NEUTRON ACER TENDL-2024 LIBRARY; T=0.K

## Threshold reactions

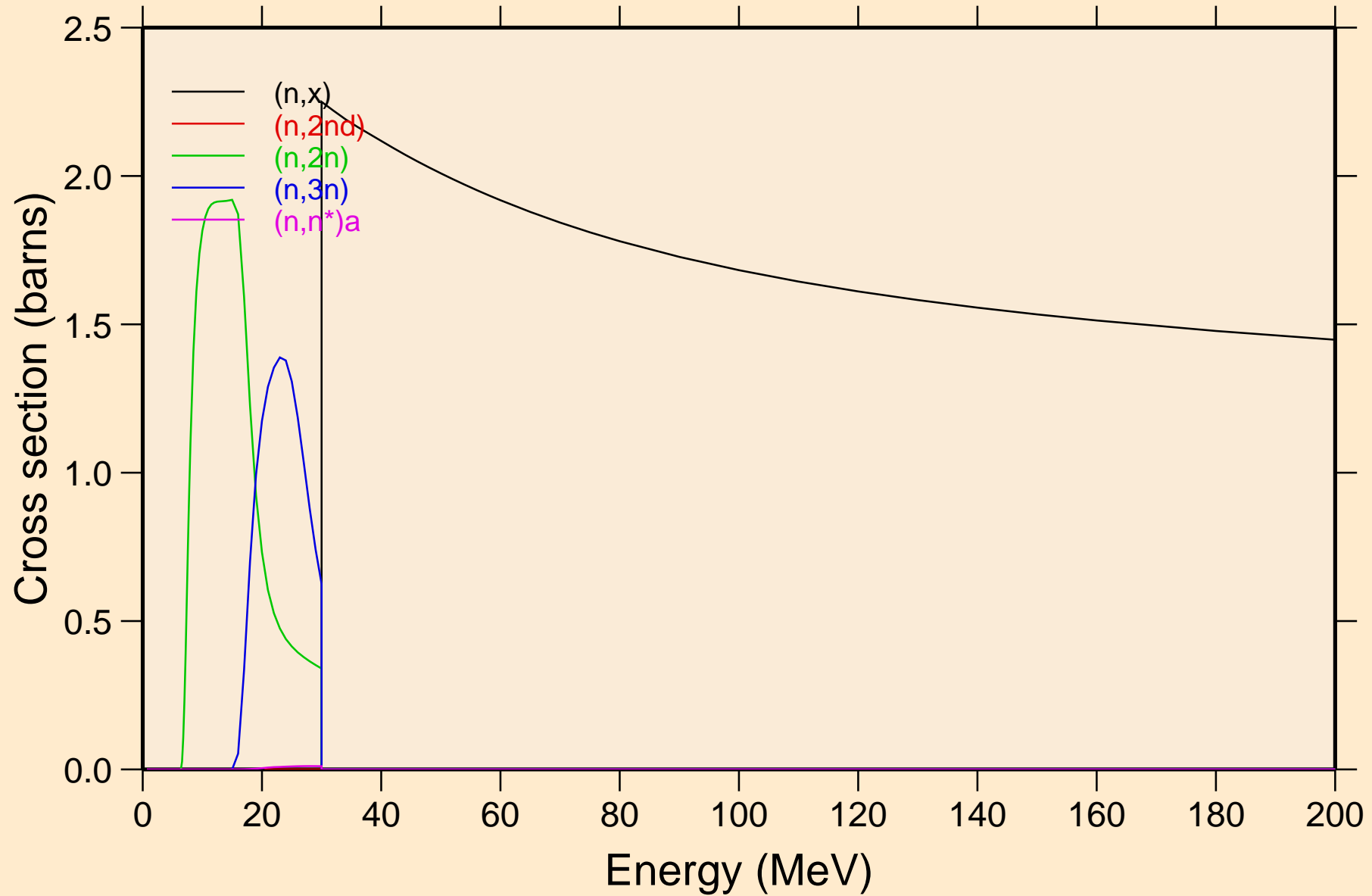

GD157 NEUTRON ACER TENDL-2024 LIBRARY; T=0.K  
Threshold reactions

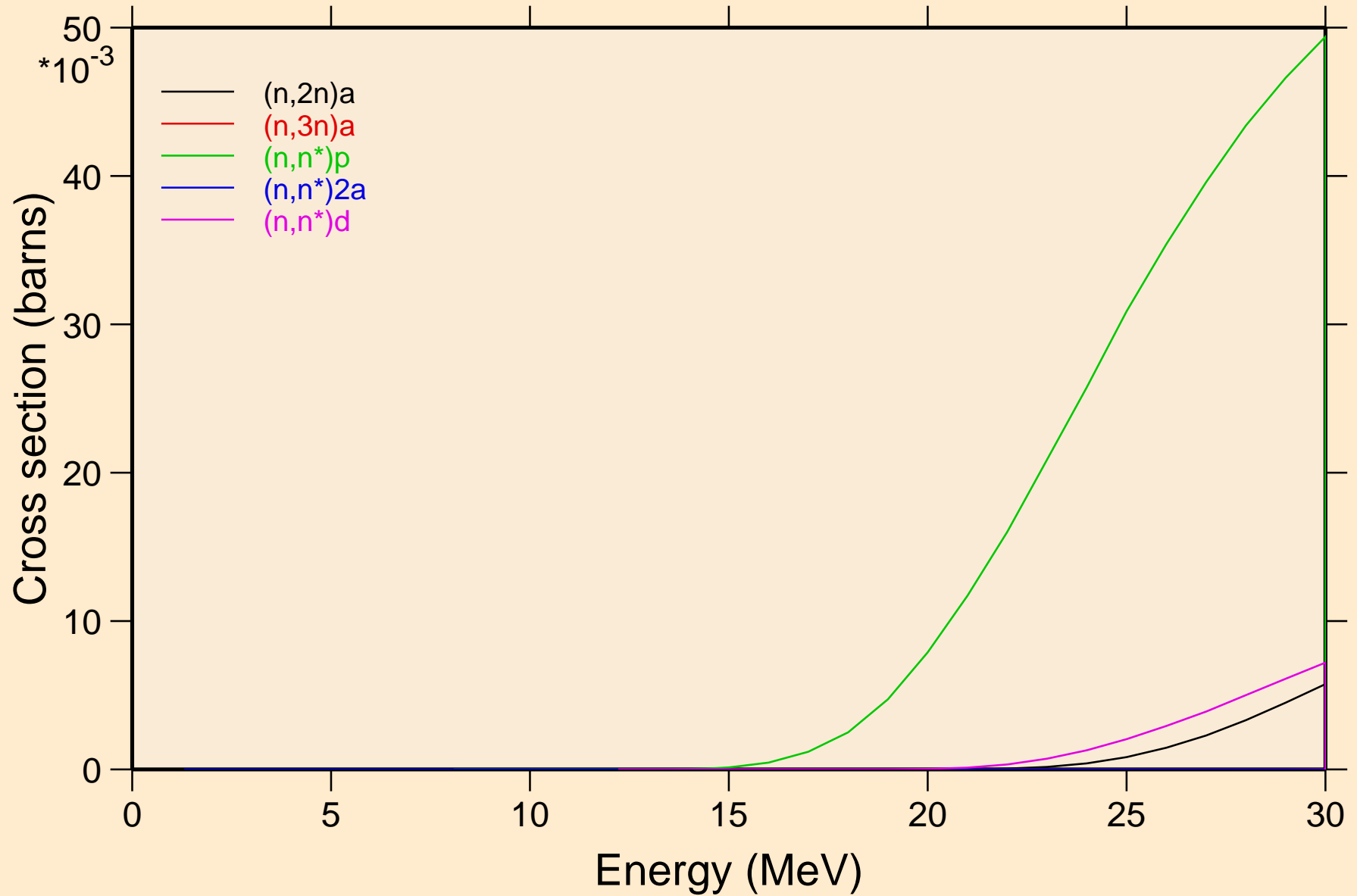



GD157 NEUTRON ACER TENDL-2024 LIBRARY; T=0.K  
Threshold reactions

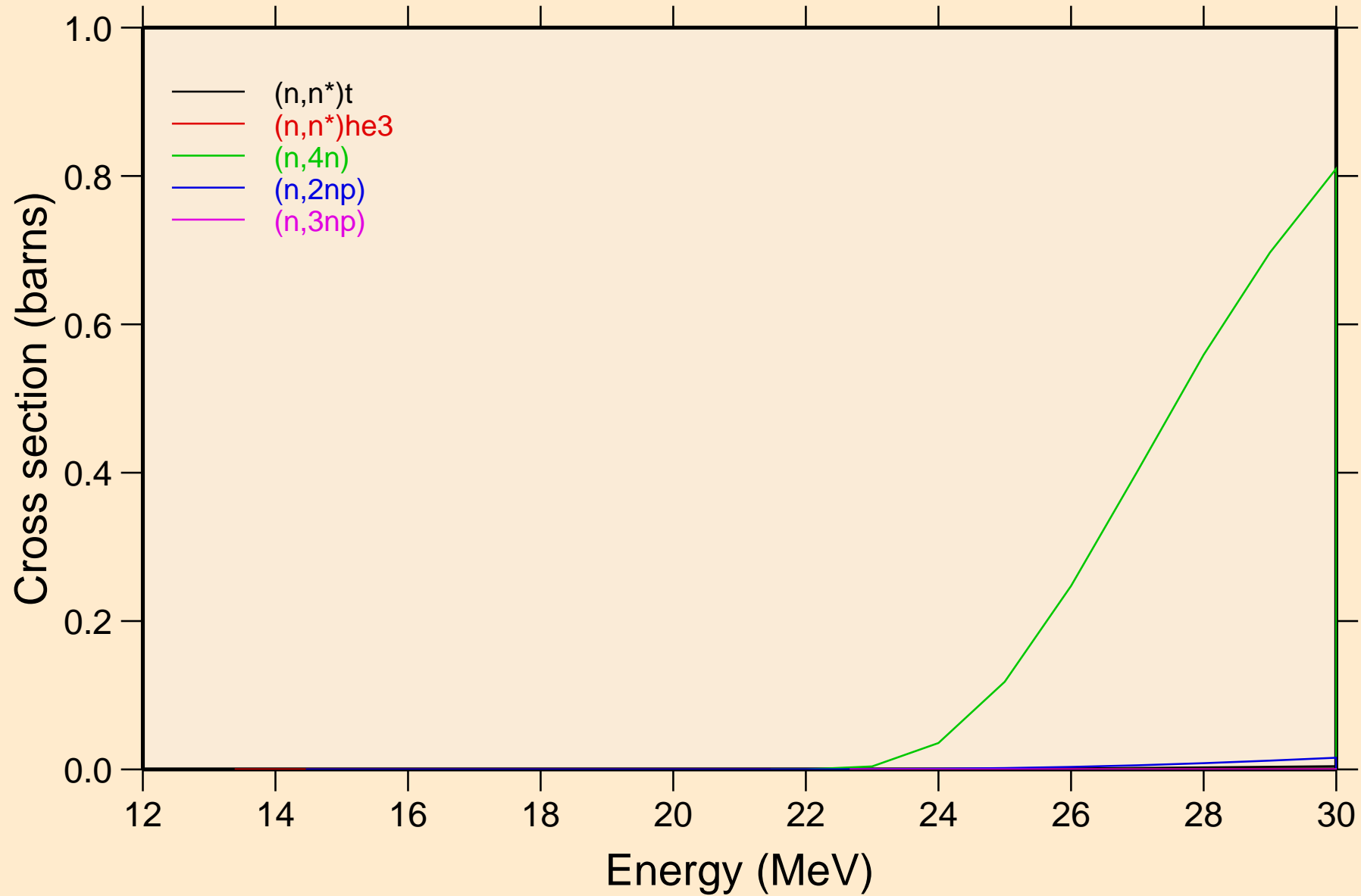

# GD157 NEUTRON ACER TENDL-2024 LIBRARY; T=0.K

## Threshold reactions

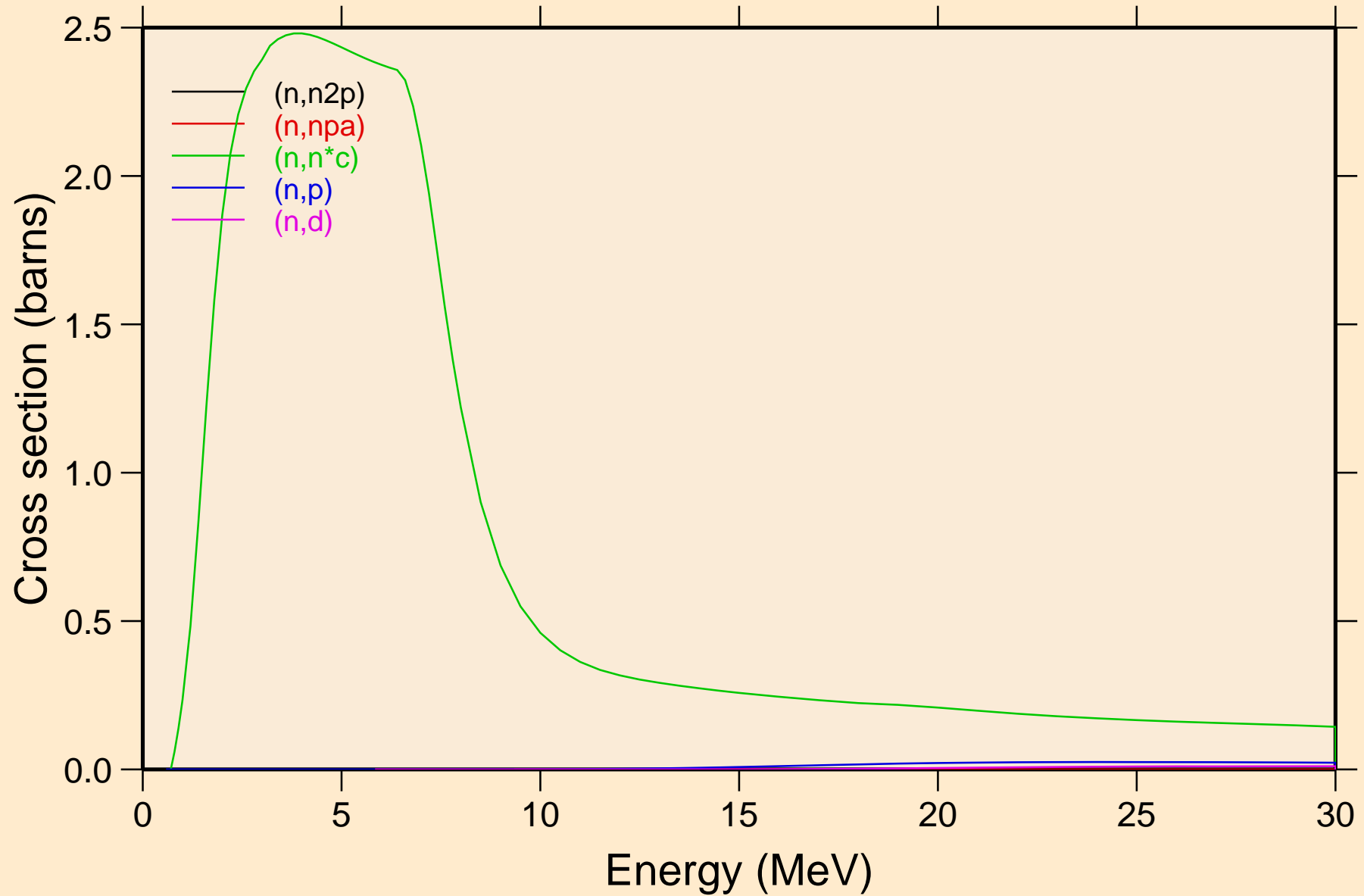

GD157 NEUTRON ACER TENDL-2024 LIBRARY; T=0.K  
Threshold reactions

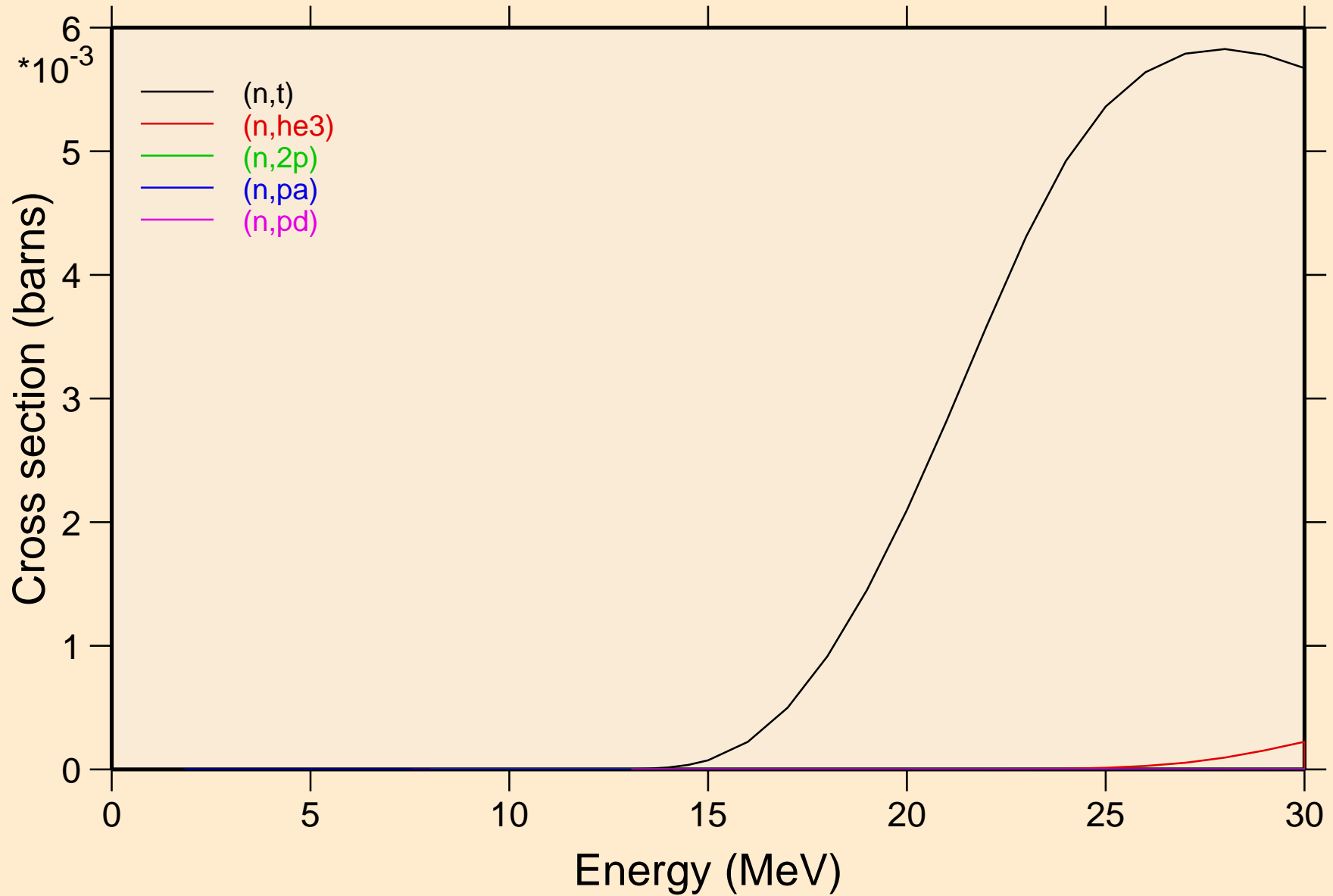

# GD157 NEUTRON ACER TENDL-2024 LIBRARY; T=0.K

## Threshold reactions

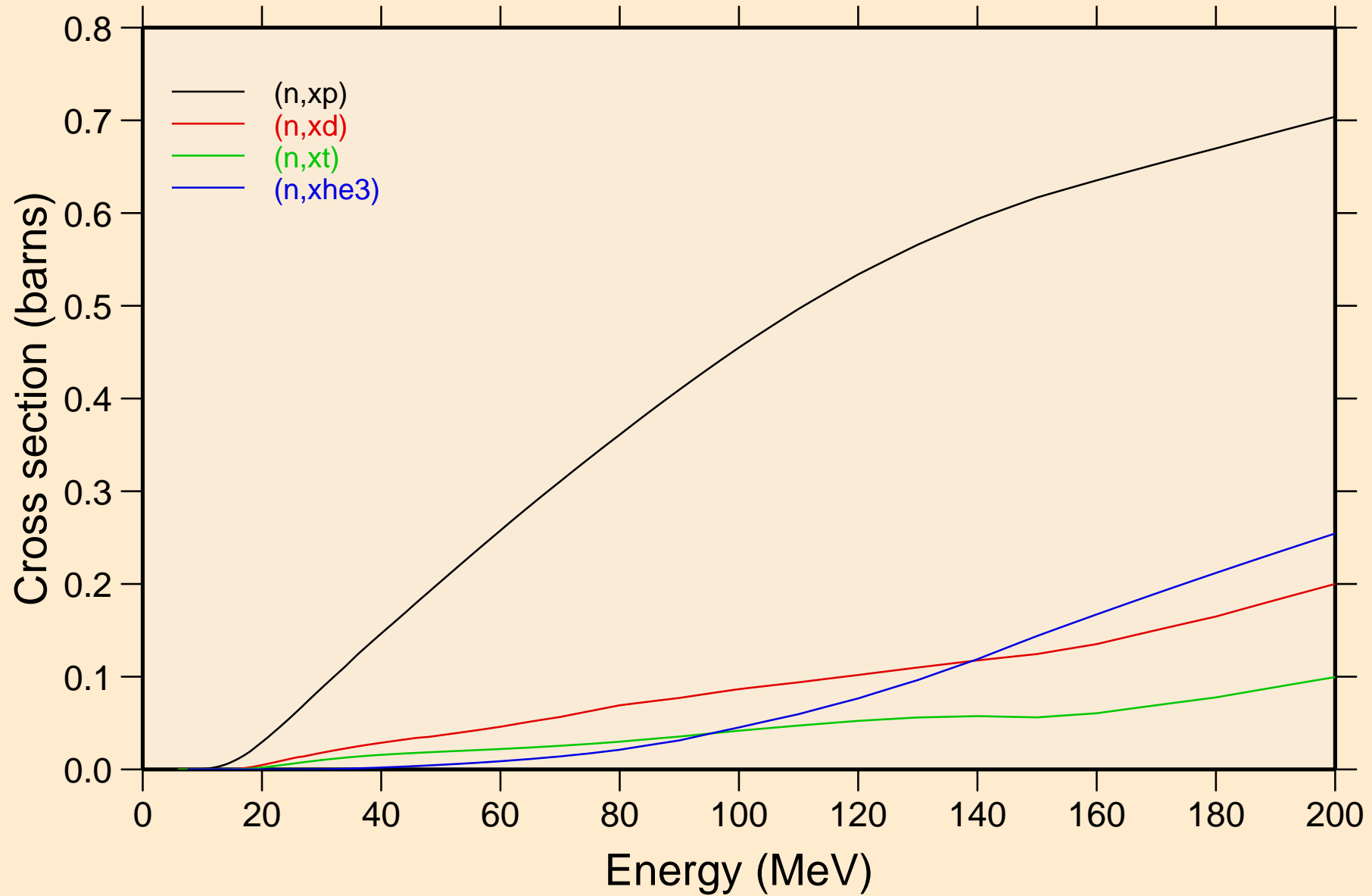

GD157 NEUTRON ACER TENDL-2024 LIBRARY; T=0.K  
angular distribution for elastic

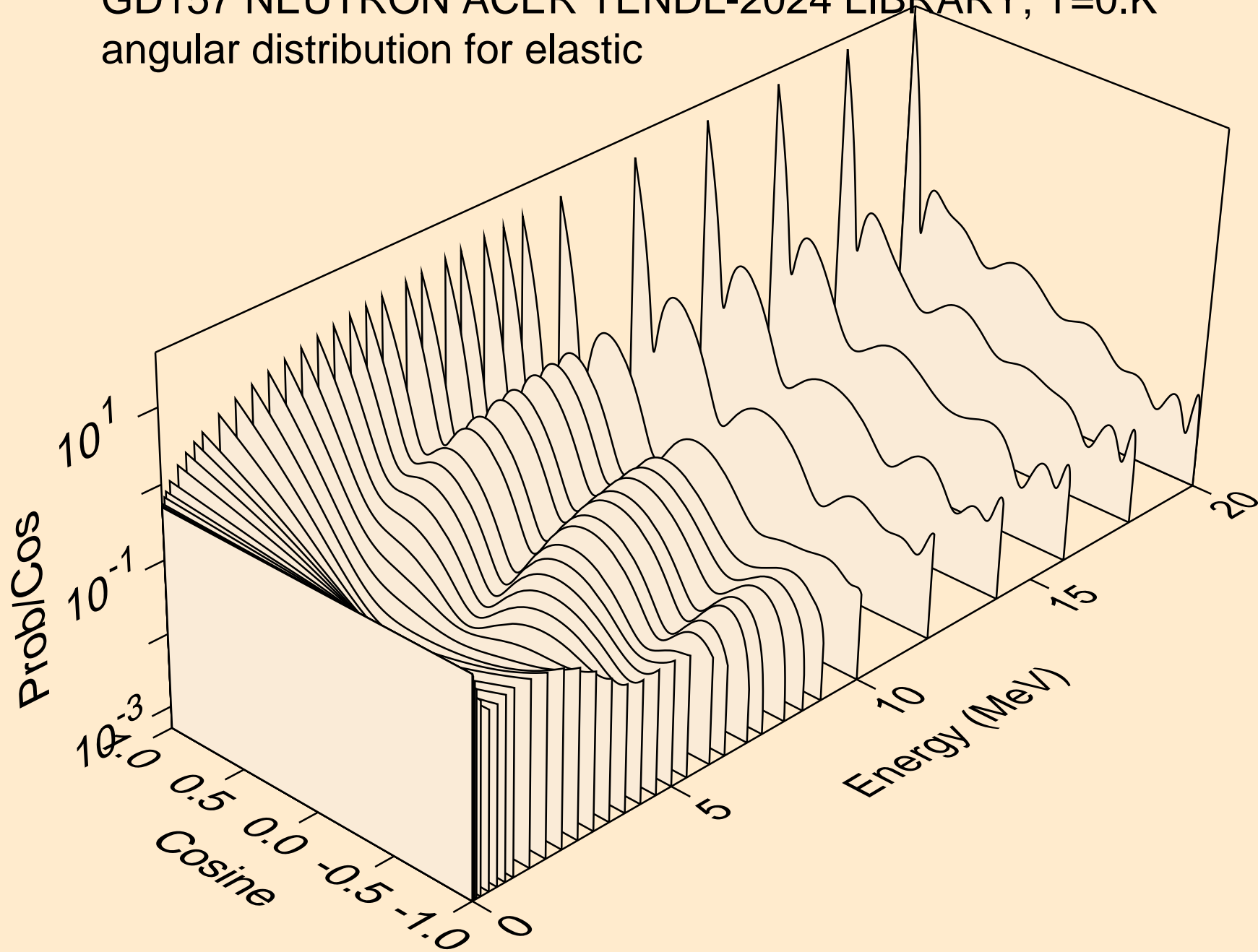

GD157 NEUTRON ACER TENDL-2024 LIBRARY; T=0.K  
angular distribution for elastic

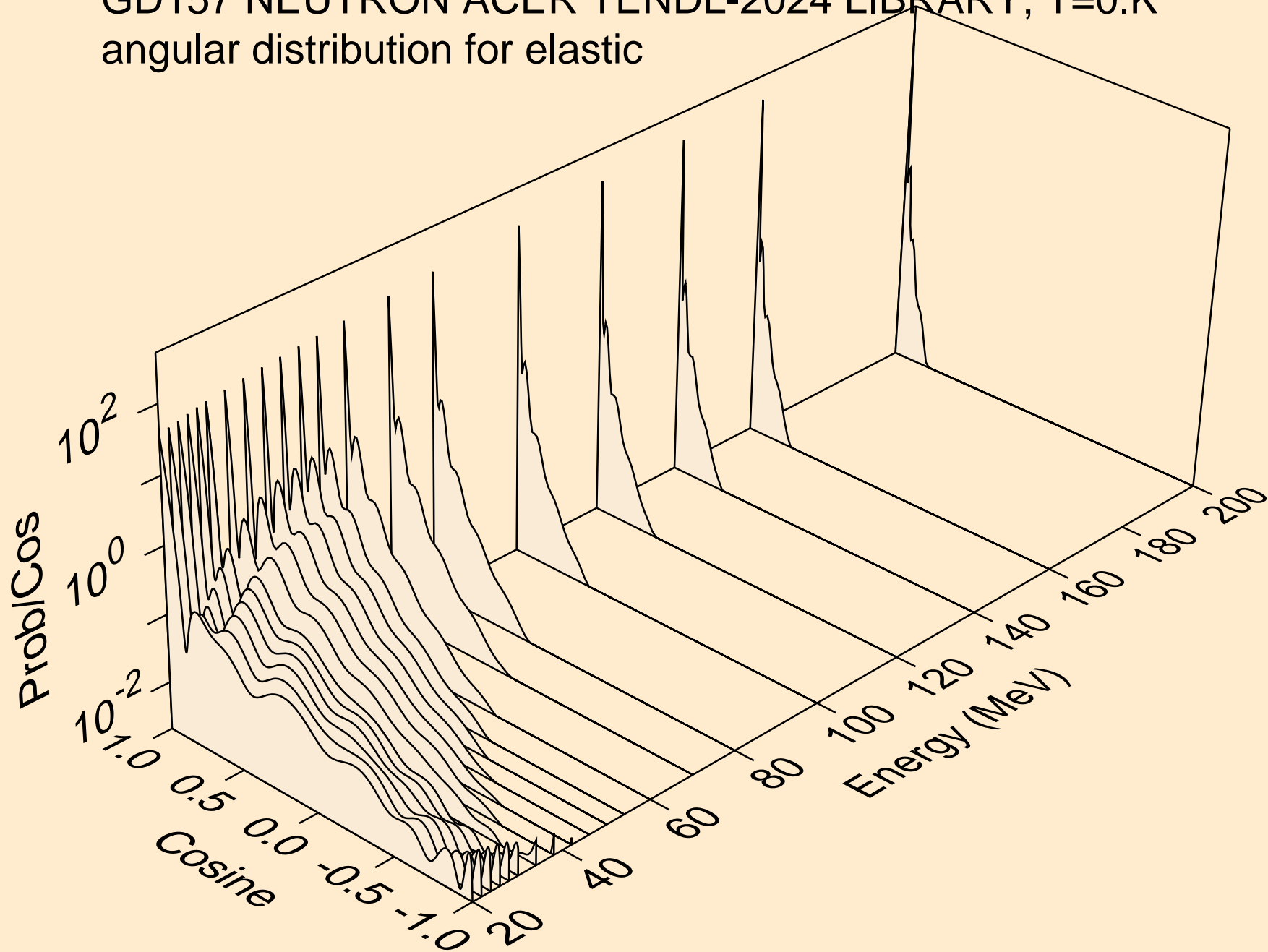

GD157 NEUTRON ACER TENDL-2024 LIBRARY; T=0.K  
angular distribution for (n,n\*1)

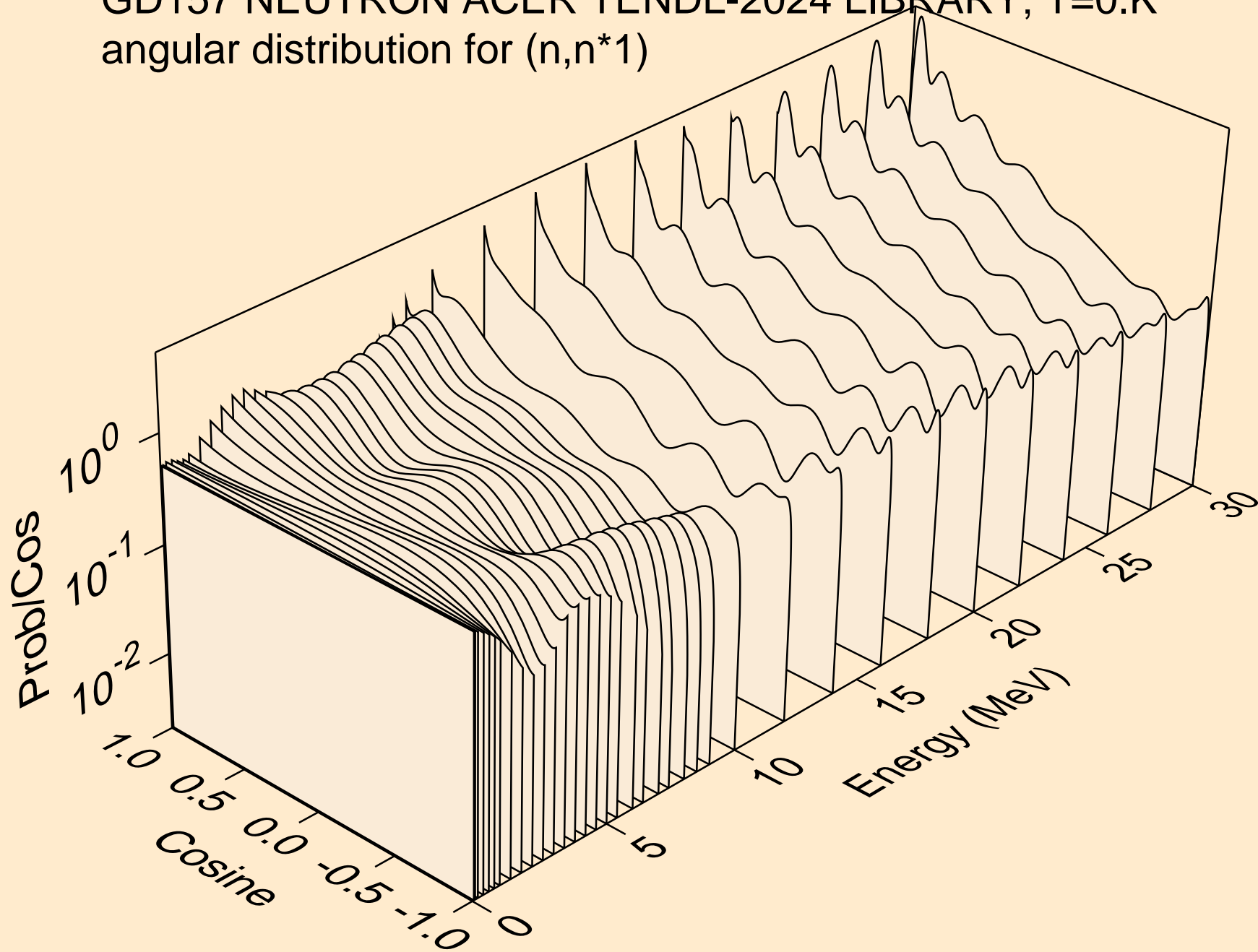

GD157 NEUTRON ACER TENDL-2024 LIBRARY; T=0.K  
angular distribution for (n,n\*2)

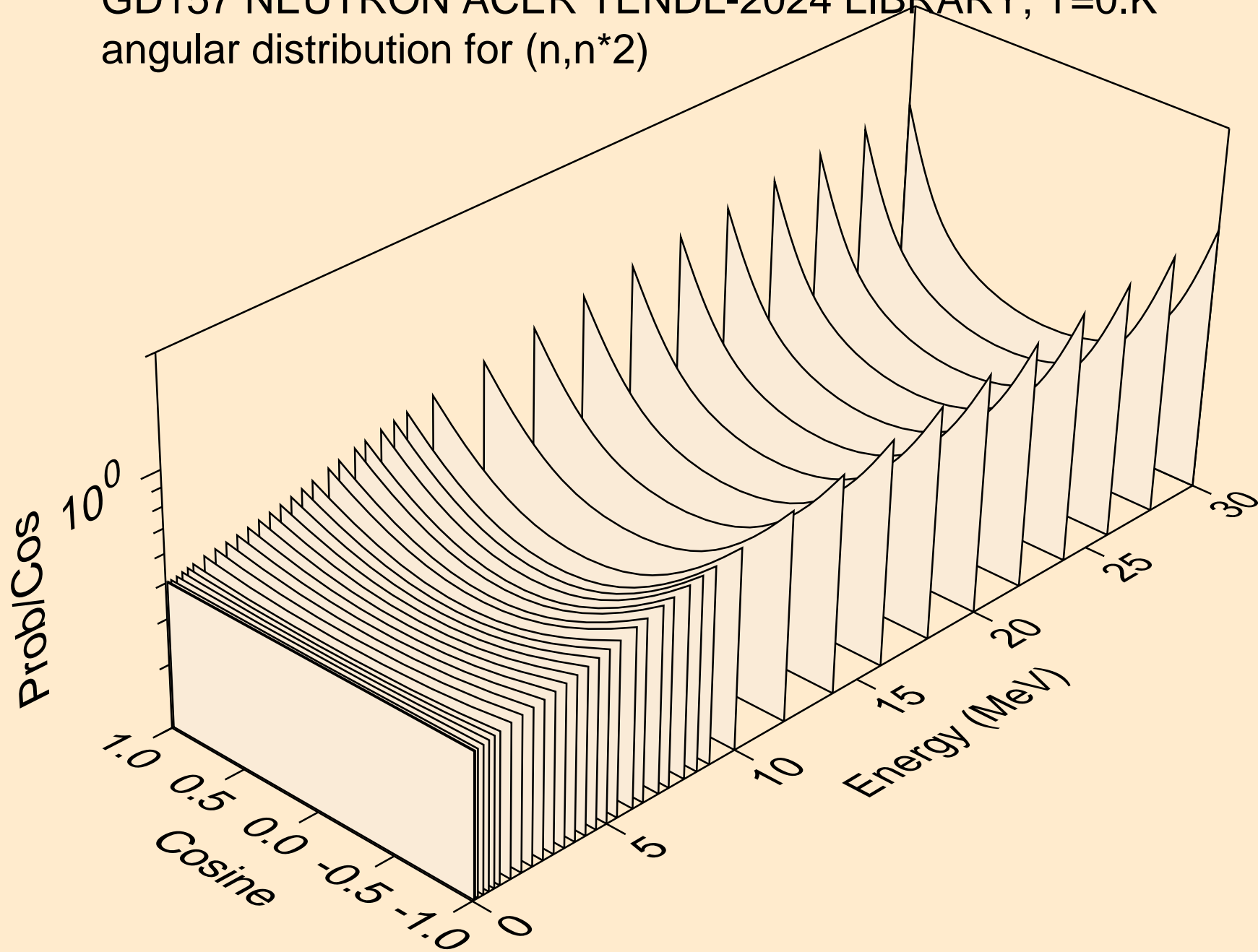



GD157 NEUTRON ACER TENDL-2024 LIBRARY; T=0.K  
angular distribution for (n,n\*3)

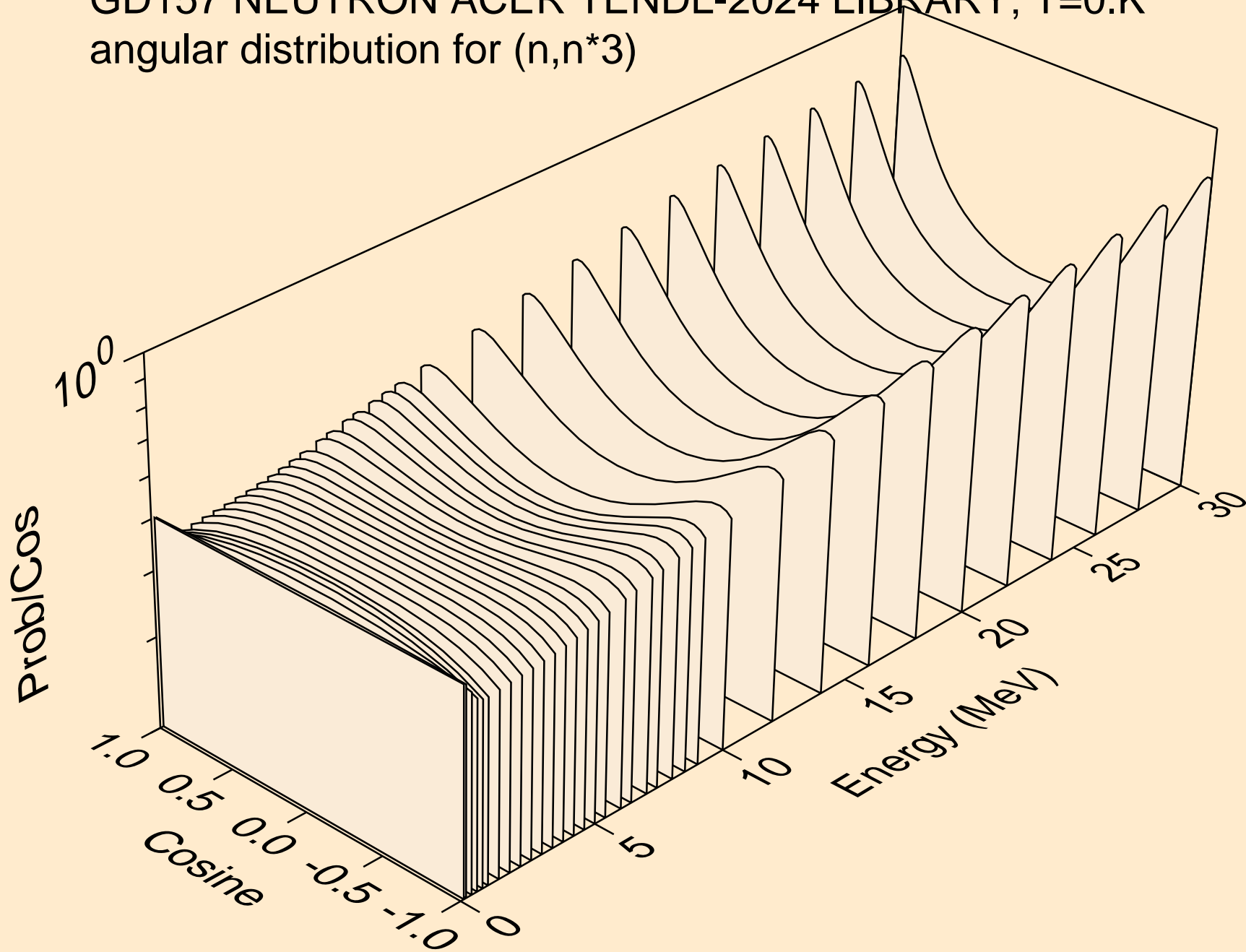

GD157 NEUTRON ACER TENDL-2024 LIBRARY; T=0.K  
angular distribution for (n,n\*4)

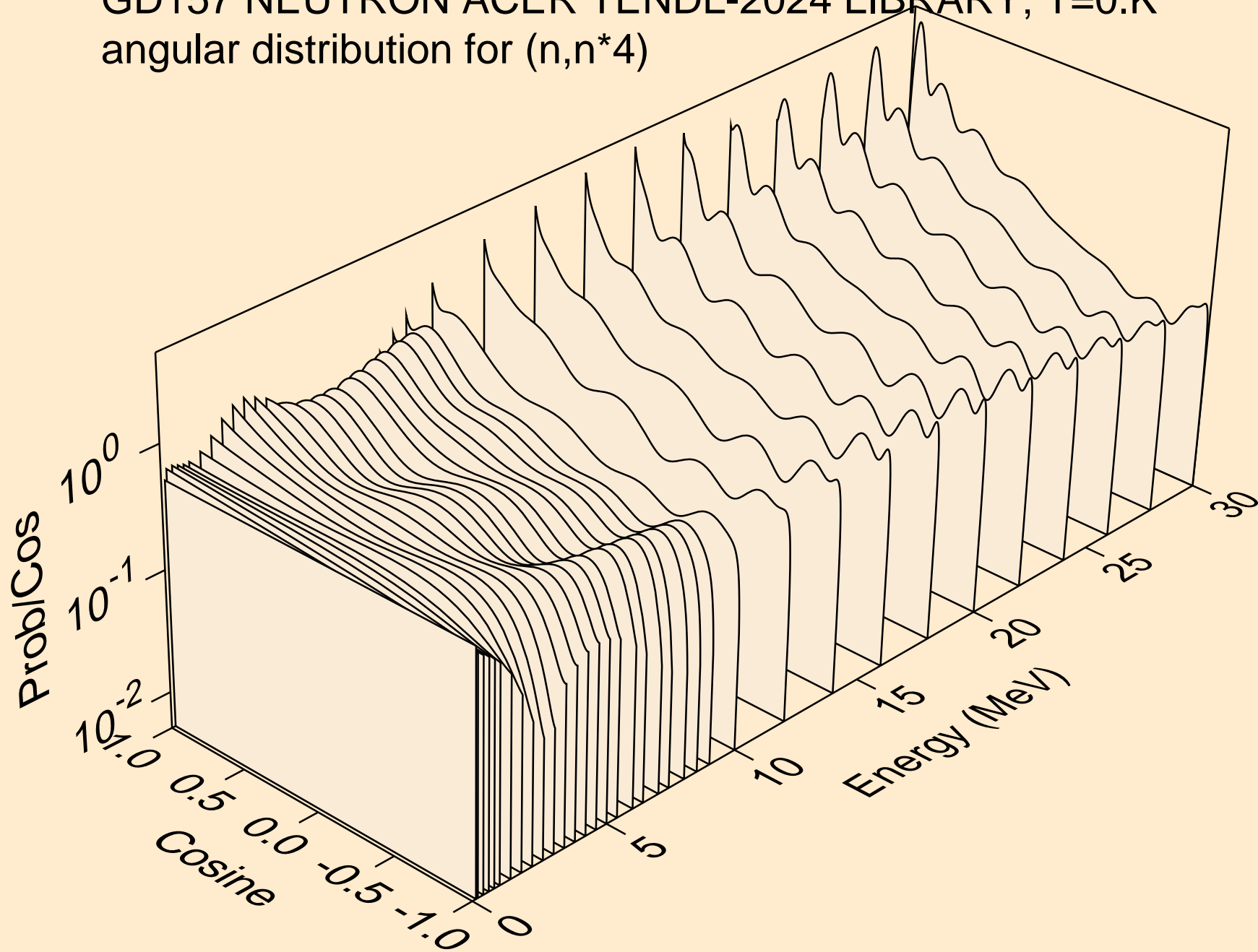

GD157 NEUTRON ACER TENDL-2024 LIBRARY; T=0.K  
angular distribution for (n,n\*5)

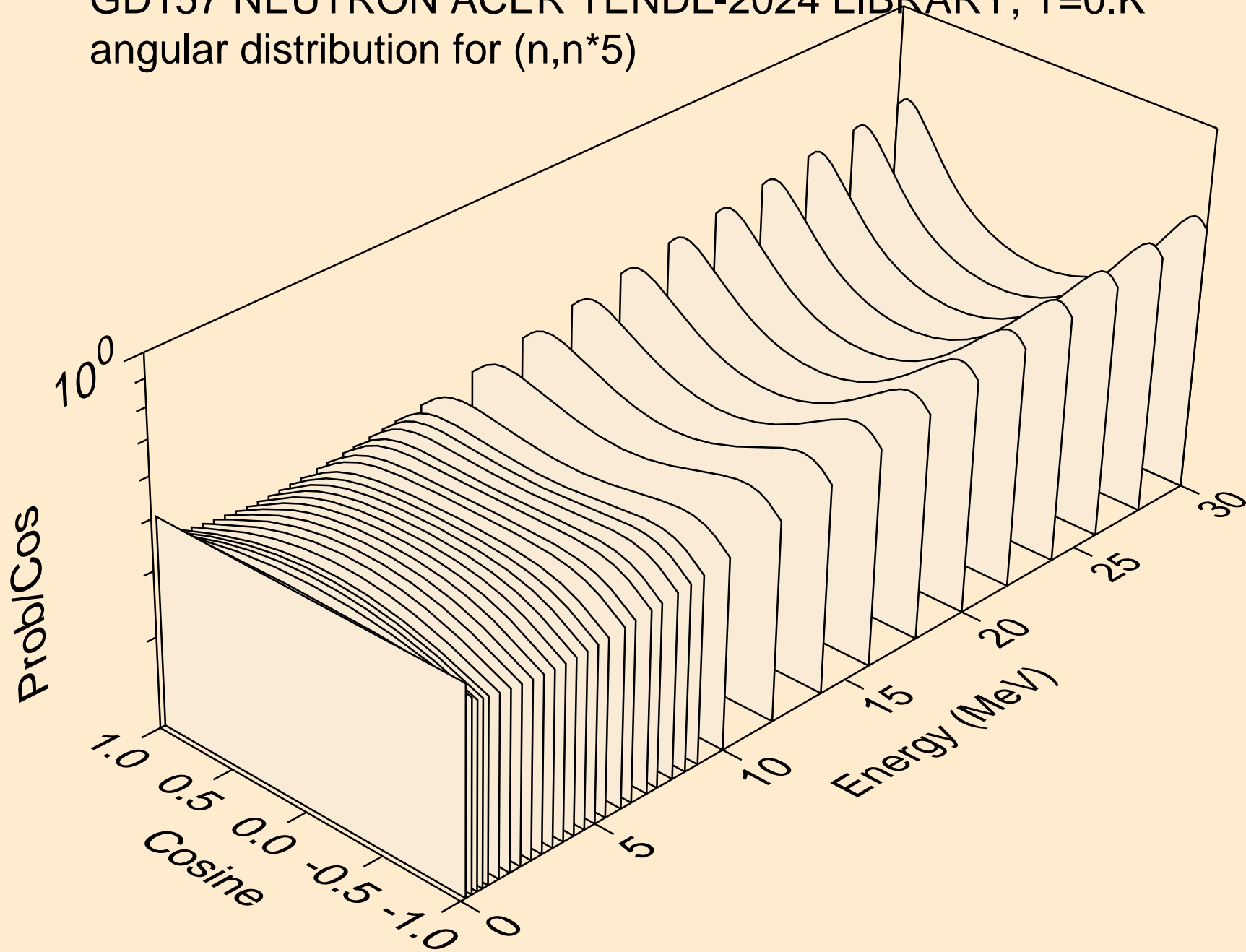

GD157 NEUTRON ACER TENDL-2024 LIBRARY; T=0.K  
angular distribution for (n,n\*6)

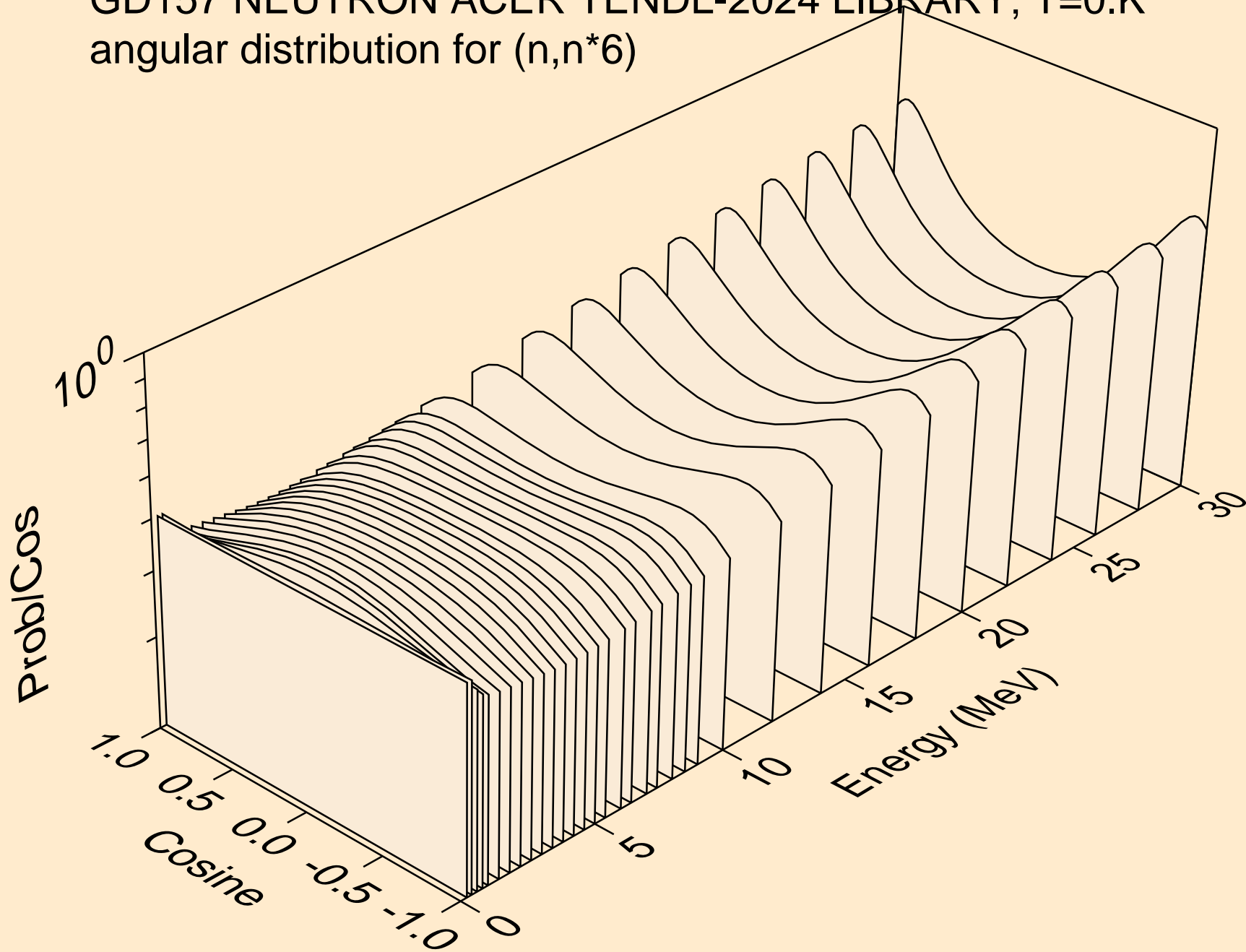

GD157 NEUTRON ACER TENDL-2024 LIBRARY; T=0.K  
angular distribution for (n,n\*7)

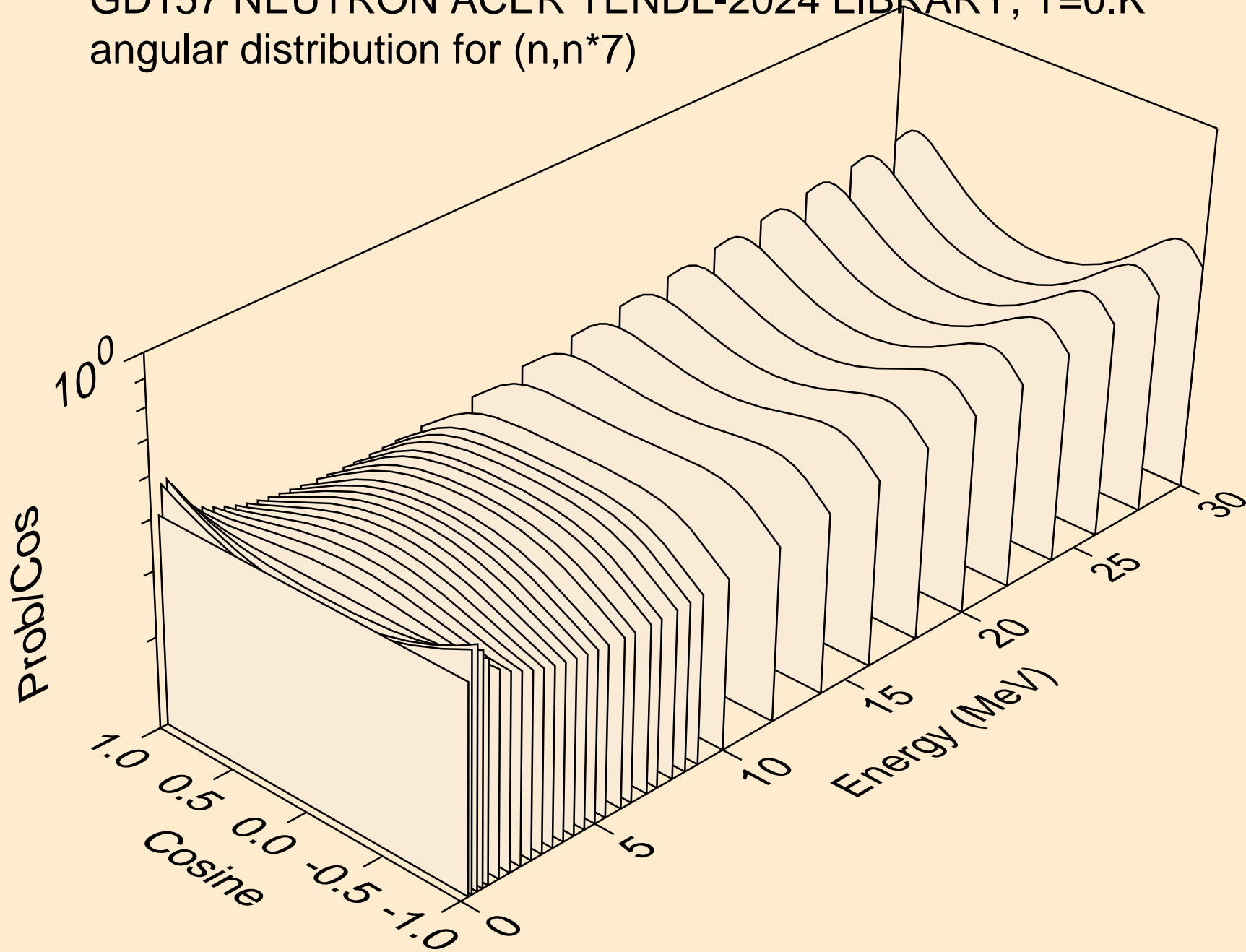

GD157 NEUTRON ACER TENDL-2024 LIBRARY; T=0.K  
angular distribution for (n,n\*8)

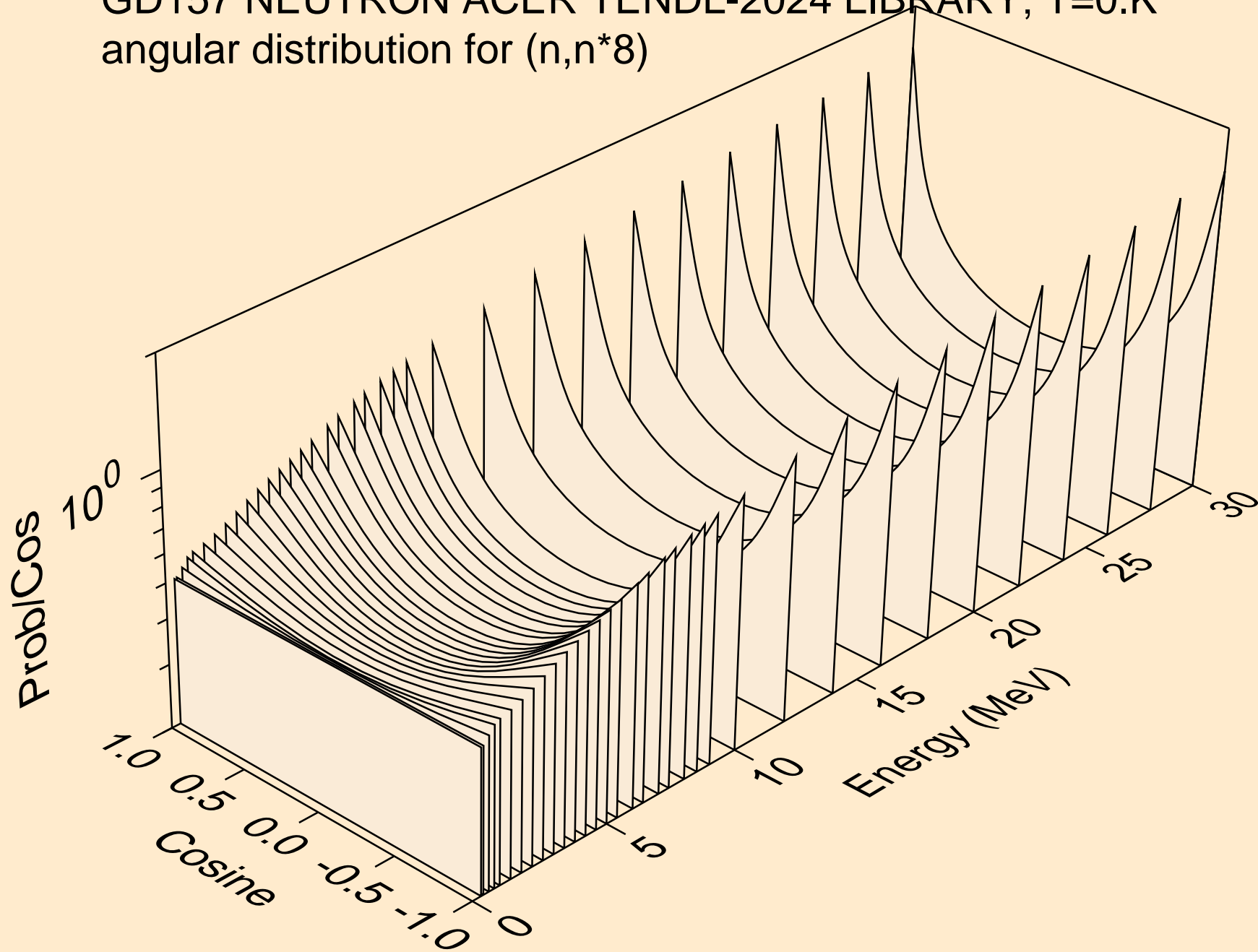

GD157 NEUTRON ACER TENDL-2024 LIBRARY; T=0.K  
angular distribution for (n,n\*9)

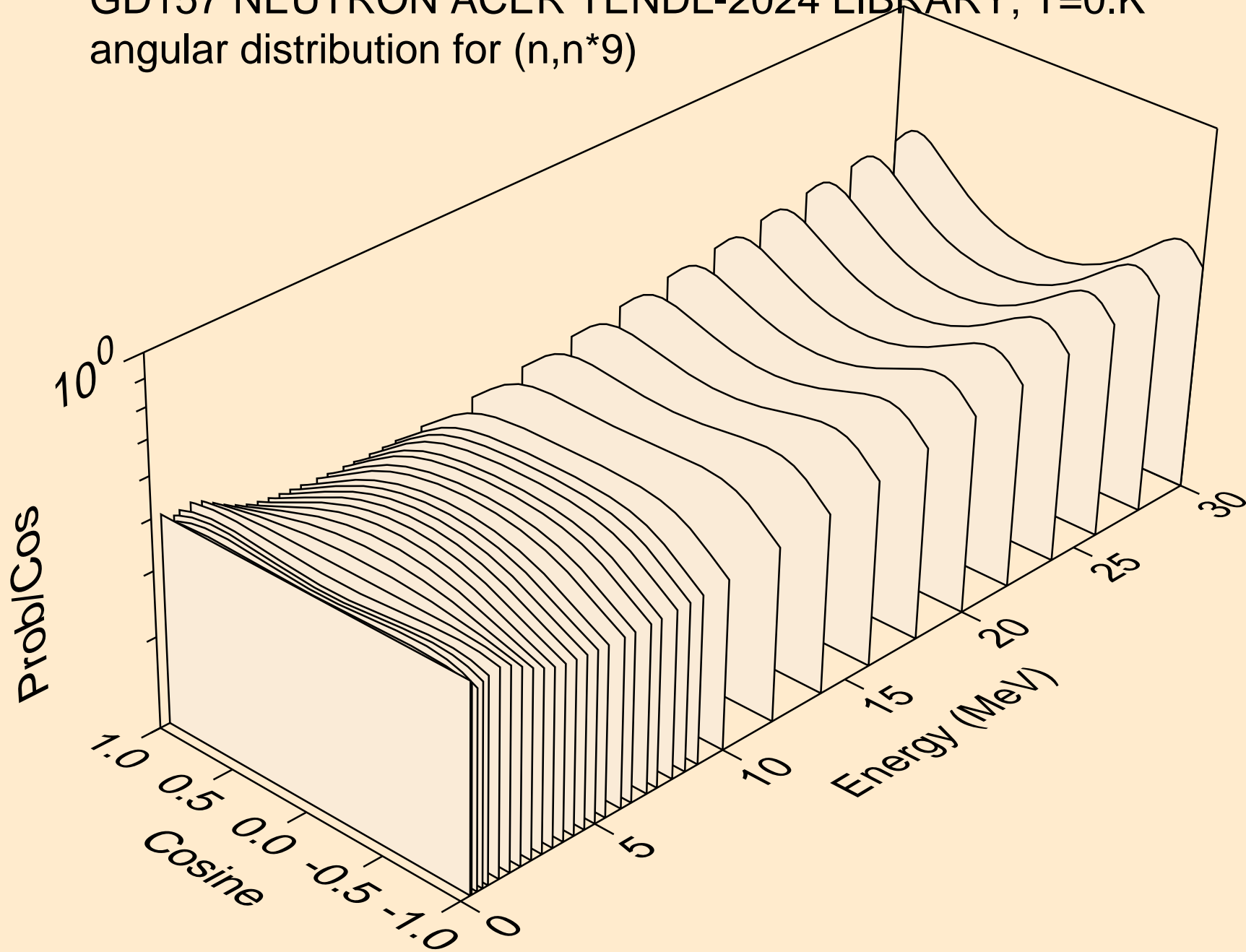

GD157 NEUTRON ACER TENDL-2024 LIBRARY; T=0.K  
angular distribution for (n,n\*10)

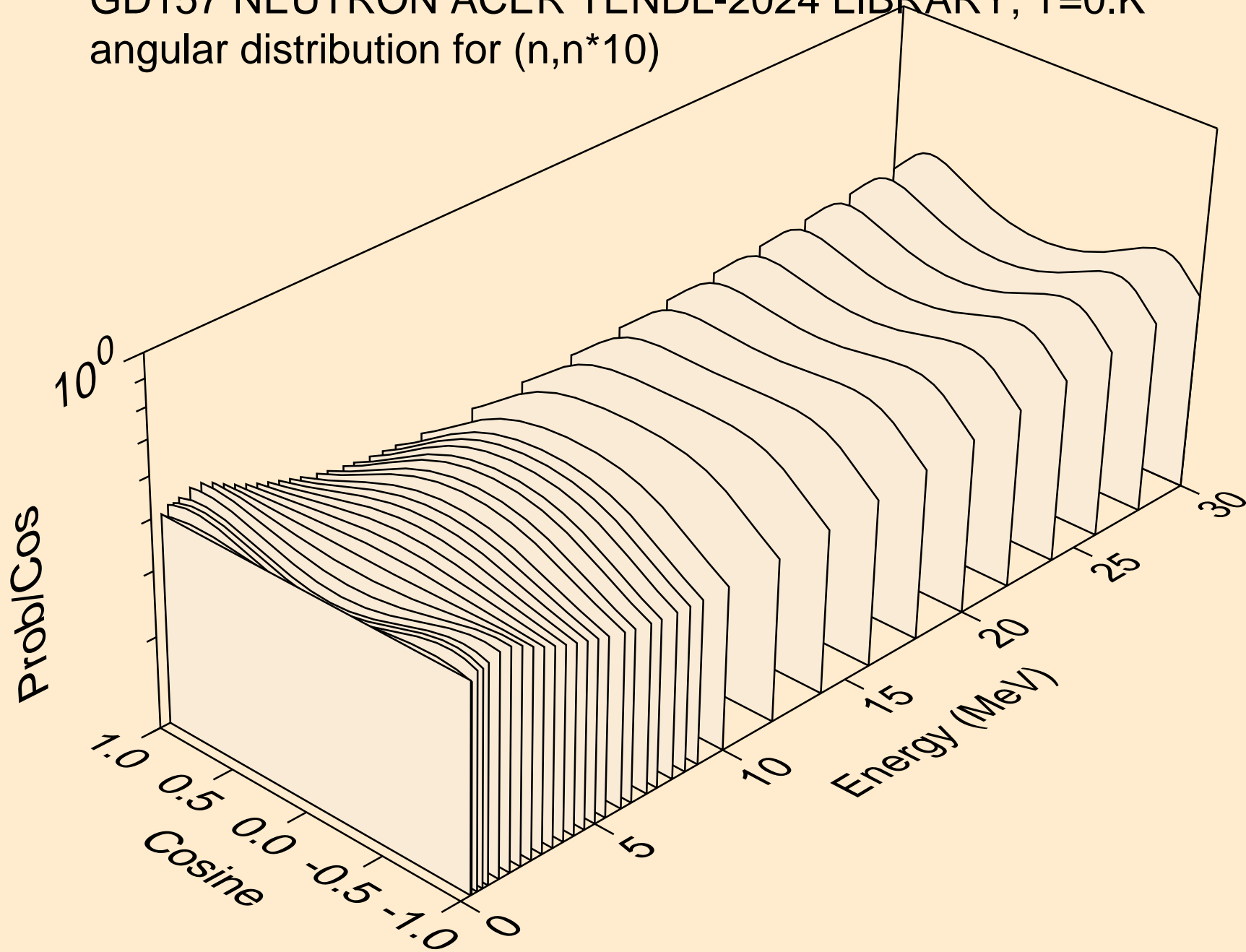



GD157 NEUTRON ACER TENDL-2024 LIBRARY; T=0.K  
angular distribution for (n,n\*11)

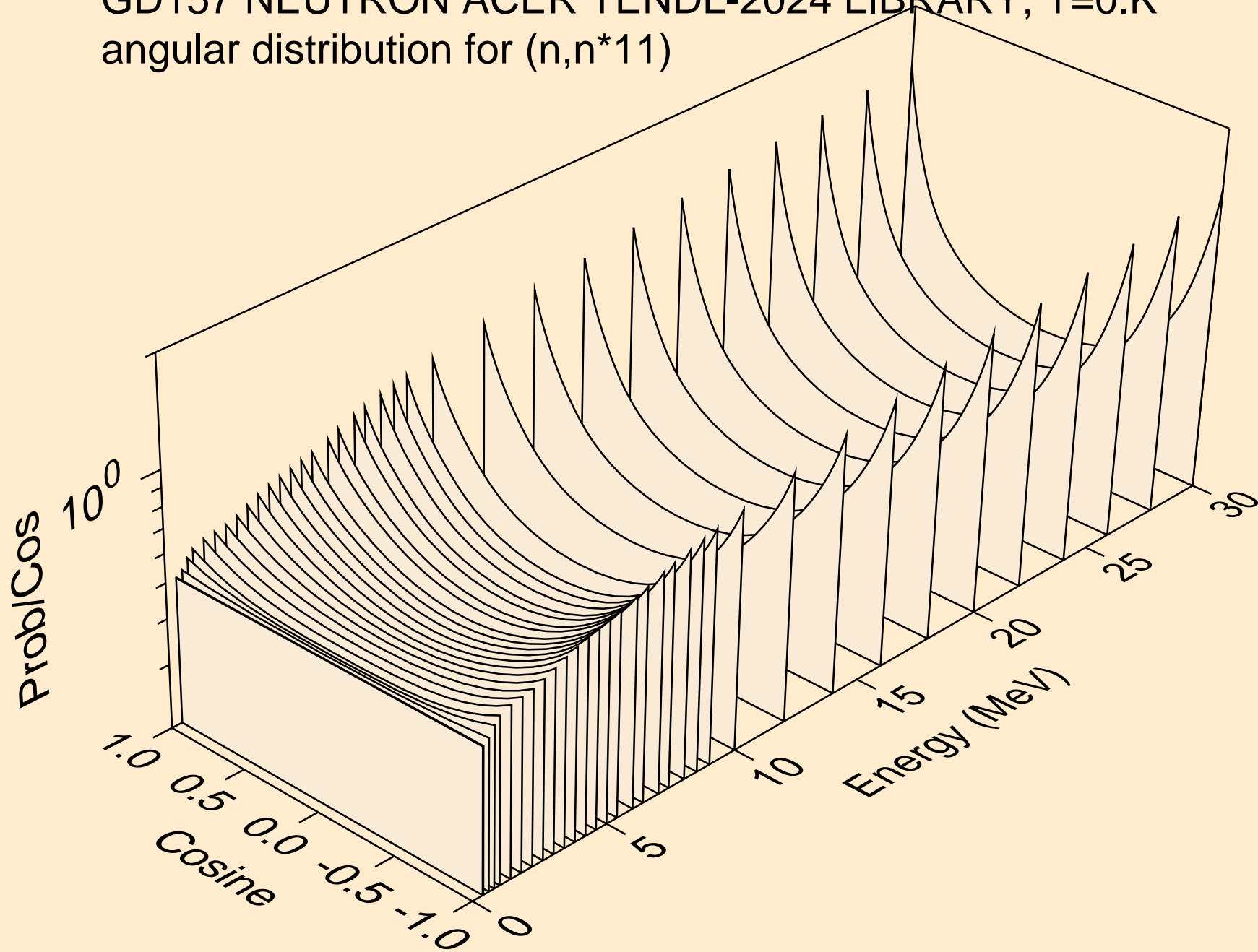

GD157 NEUTRON ACER TENDL-2024 LIBRARY; T=0.K  
angular distribution for (n,n\*12)

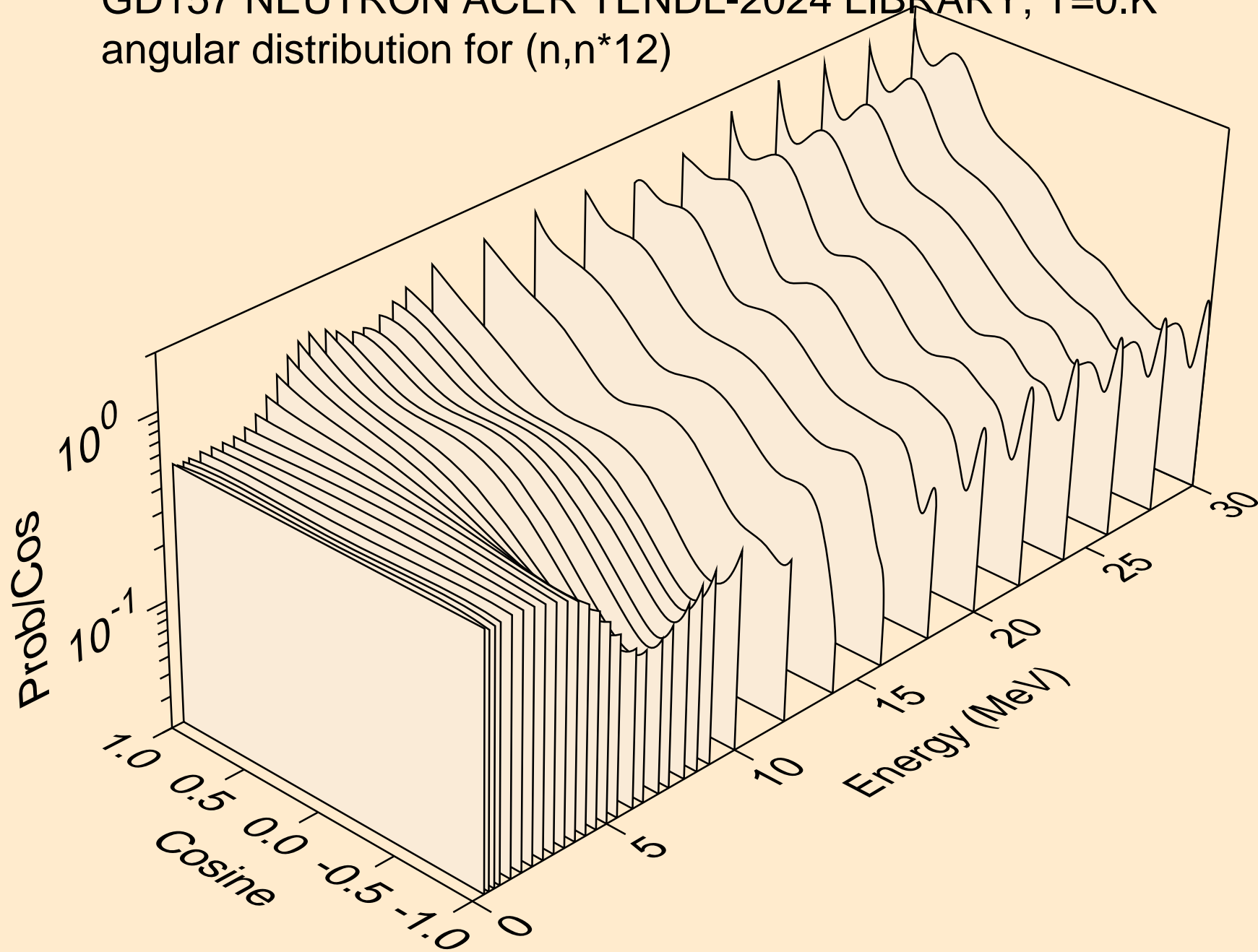

GD157 NEUTRON ACER TENDL-2024 LIBRARY; T=0.K  
angular distribution for (n,n\*13)

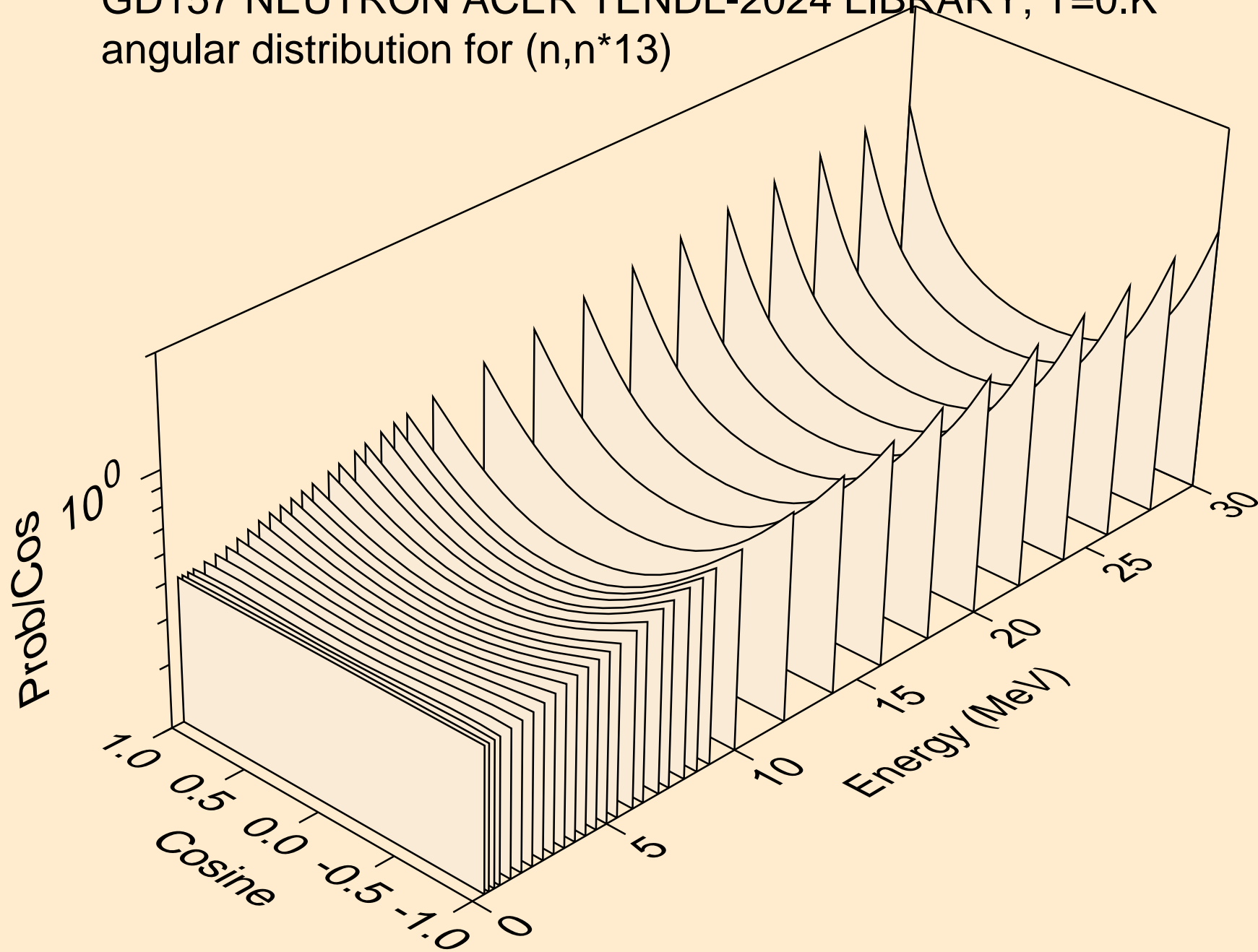

GD157 NEUTRON ACER TENDL-2024 LIBRARY; T=0.K  
angular distribution for (n,n\*14)

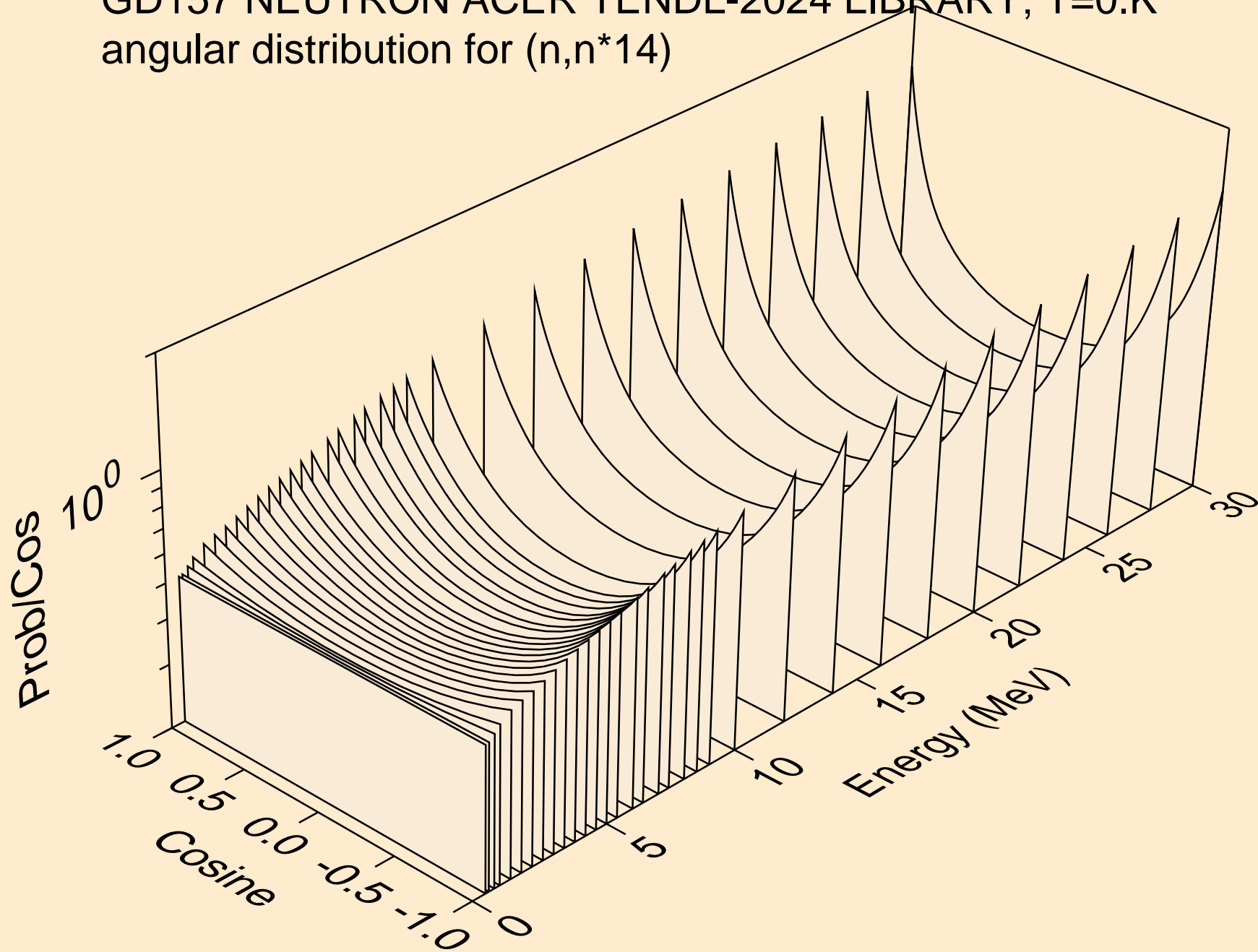

GD157 NEUTRON ACER TENDL-2024 LIBRARY; T=0.K  
angular distribution for (n,n\*15)

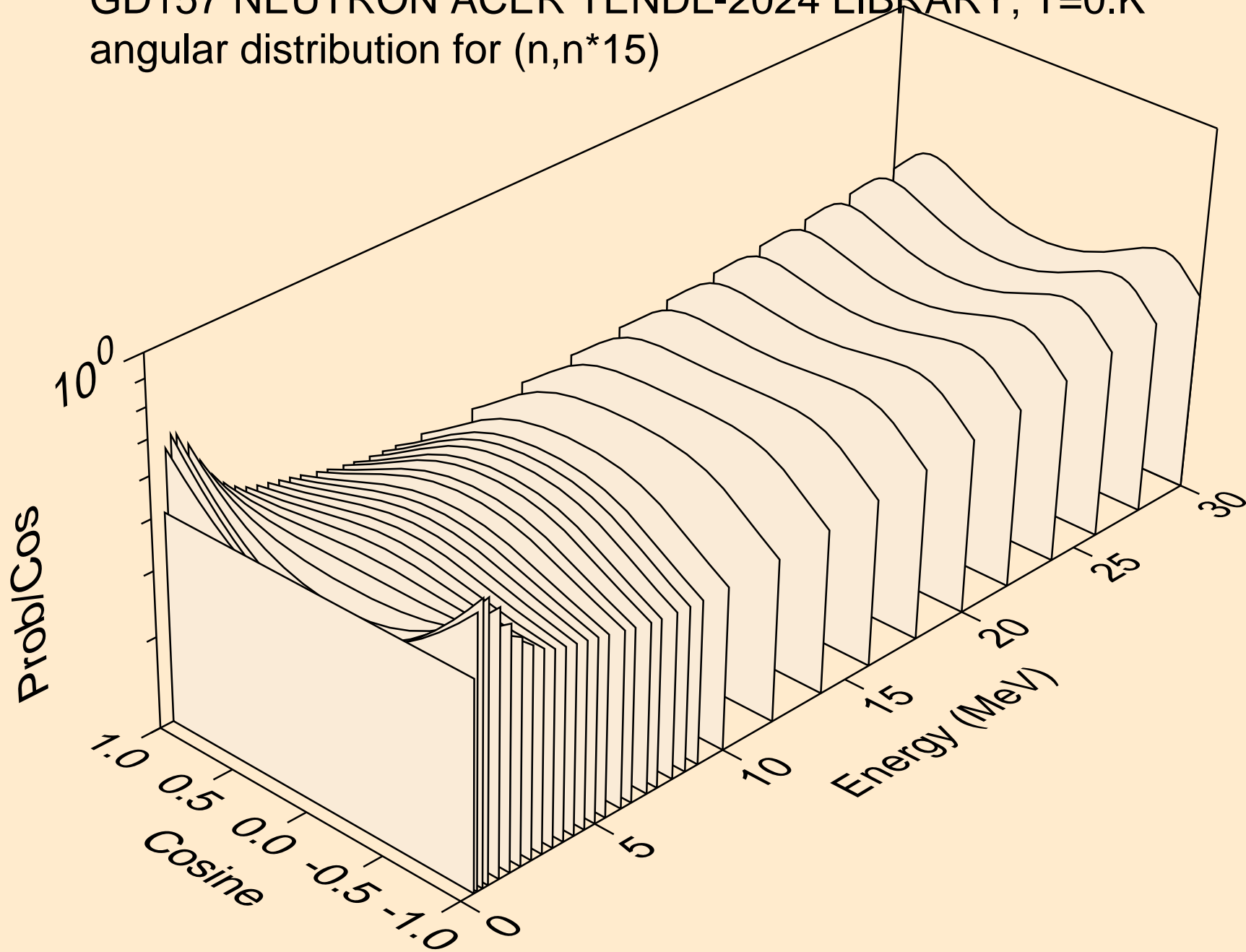

GD157 NEUTRON ACER TENDL-2024 LIBRARY; T=0.K  
angular distribution for (n,n\*16)

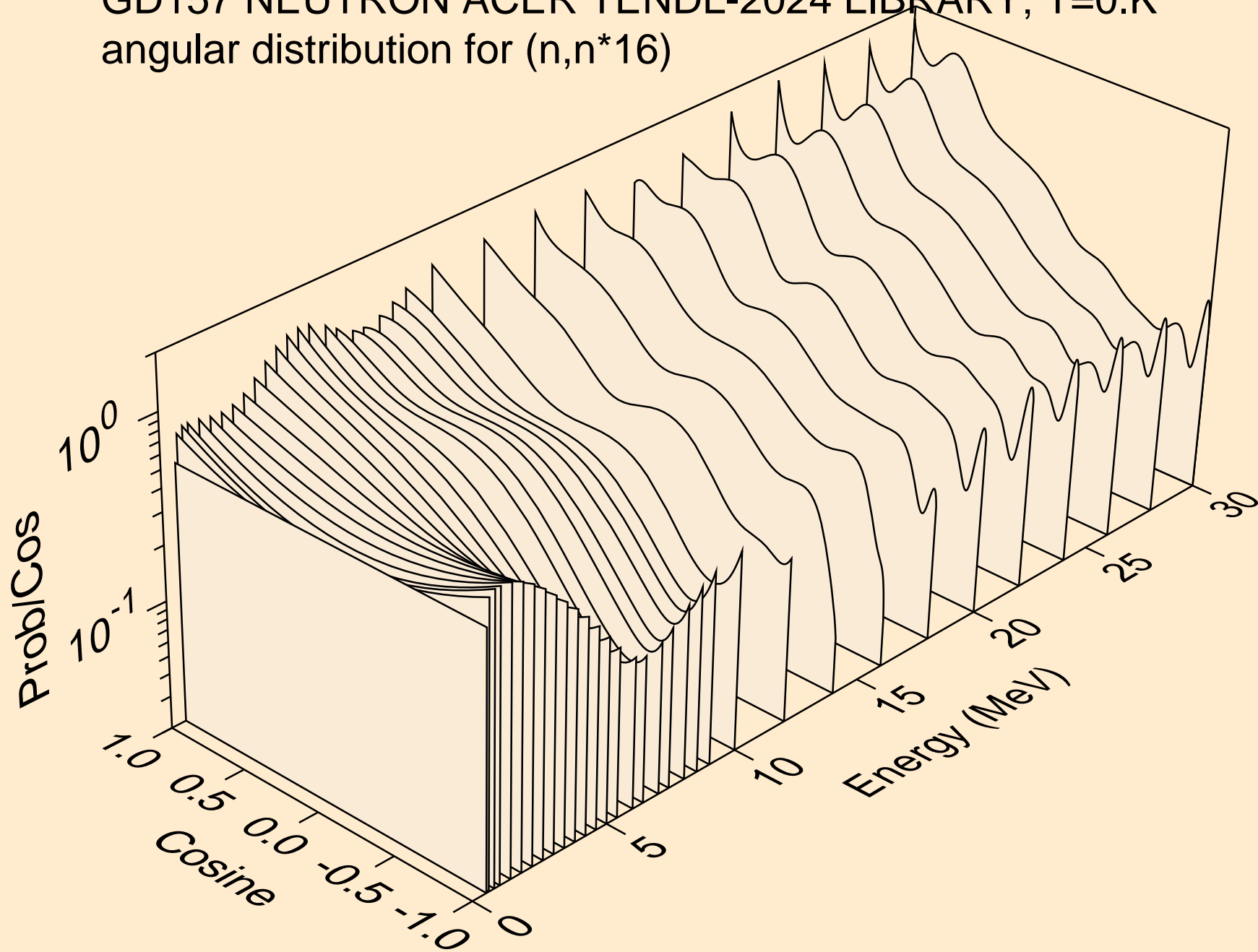

GD157 NEUTRON ACER TENDL-2024 LIBRARY; T=0.K  
angular distribution for (n,n\*17)

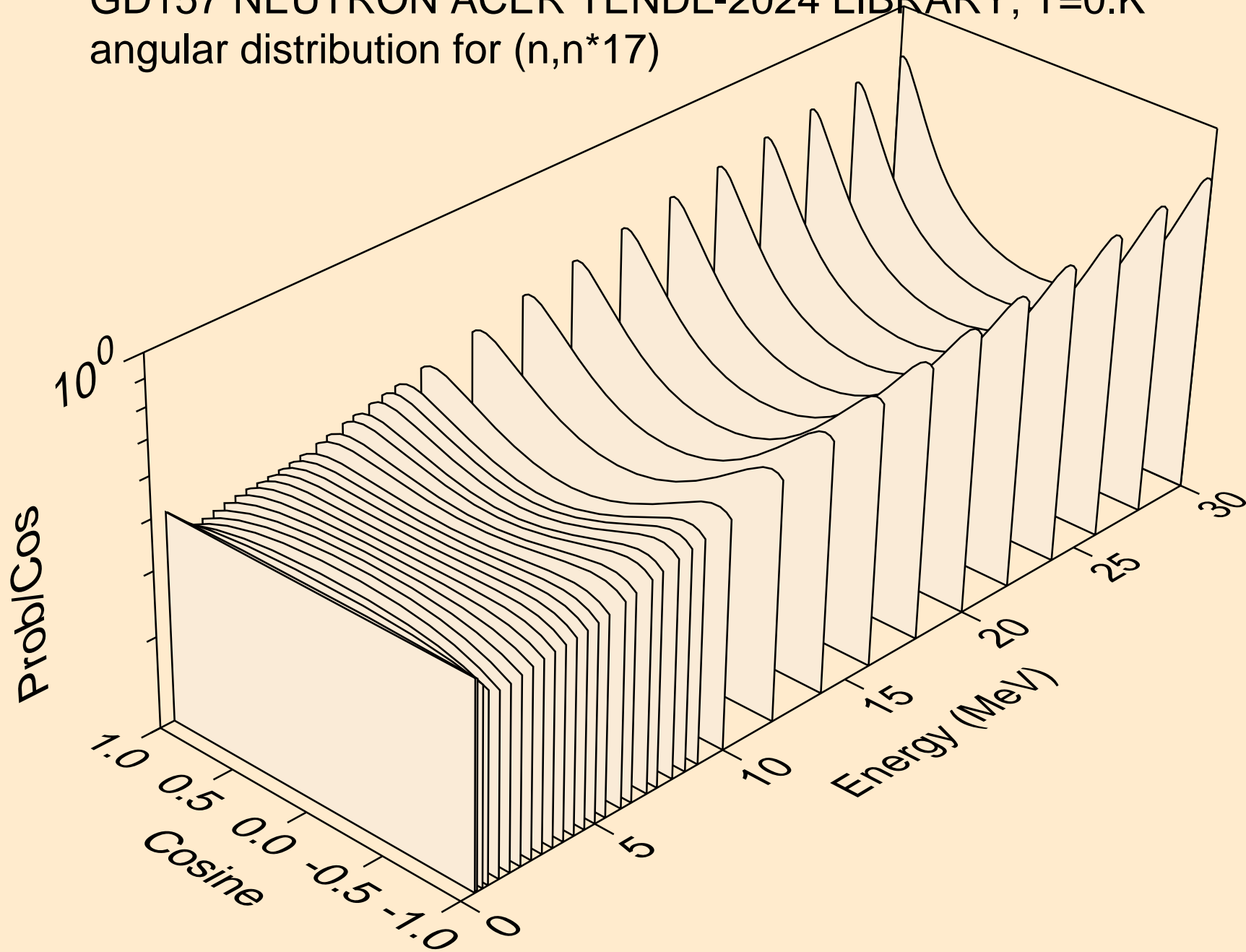

GD157 NEUTRON ACER TENDL-2024 LIBRARY; T=0.K  
angular distribution for (n,n\*18)

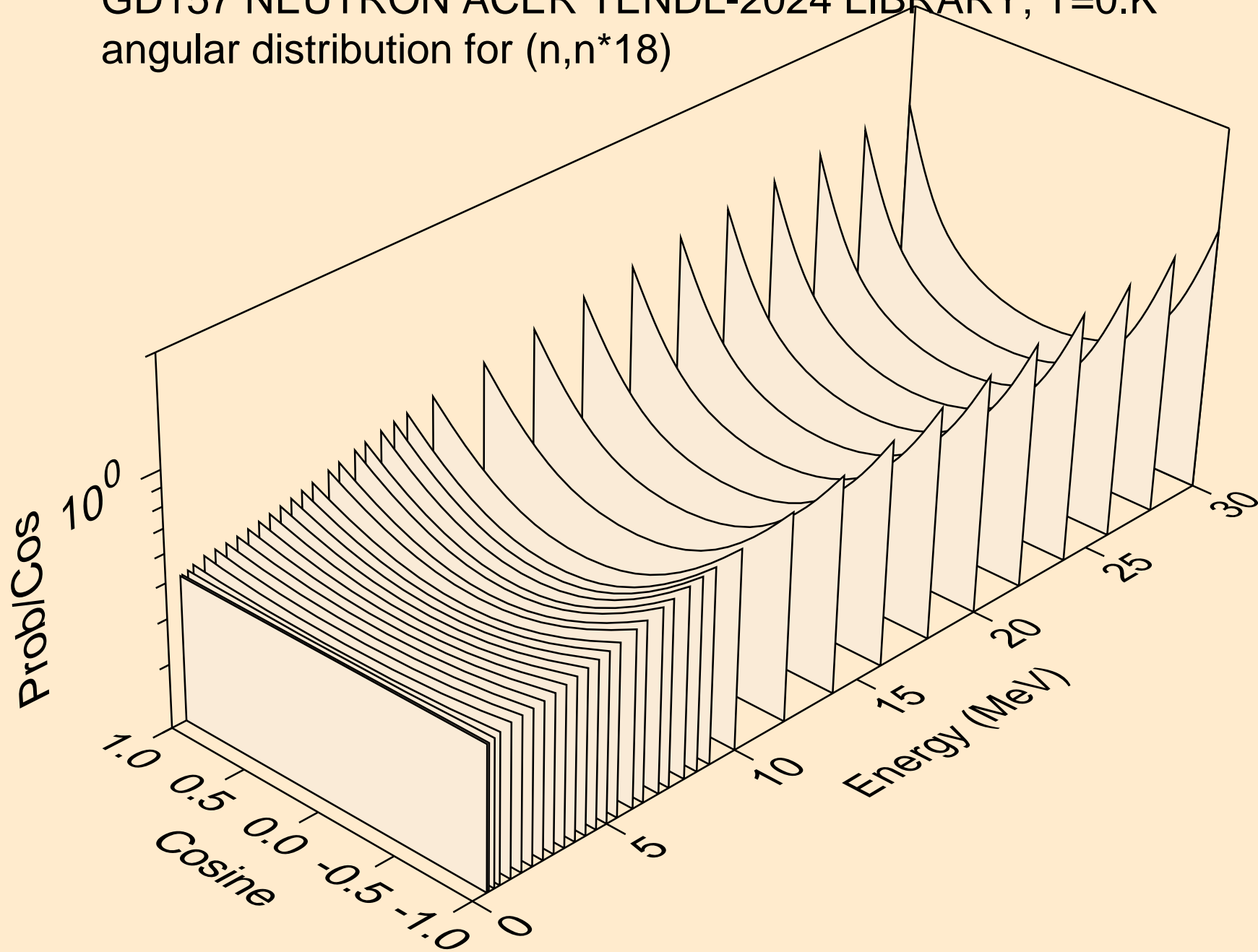



GD157 NEUTRON ACER TENDL-2024 LIBRARY; T=0.K  
angular distribution for (n,n\*19)

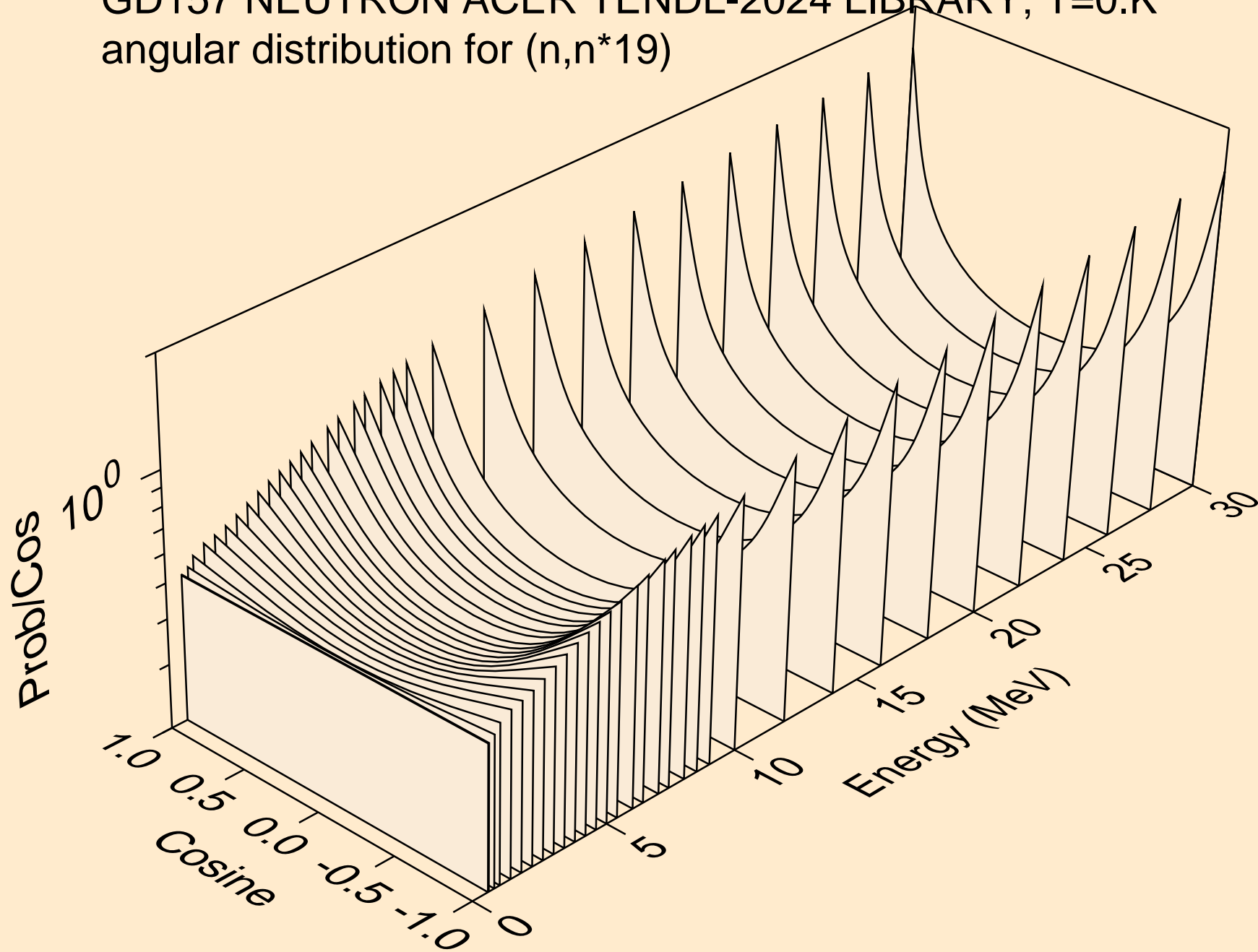

GD157 NEUTRON ACER TENDL-2024 LIBRARY; T=0.K  
angular distribution for (n,n\*20)

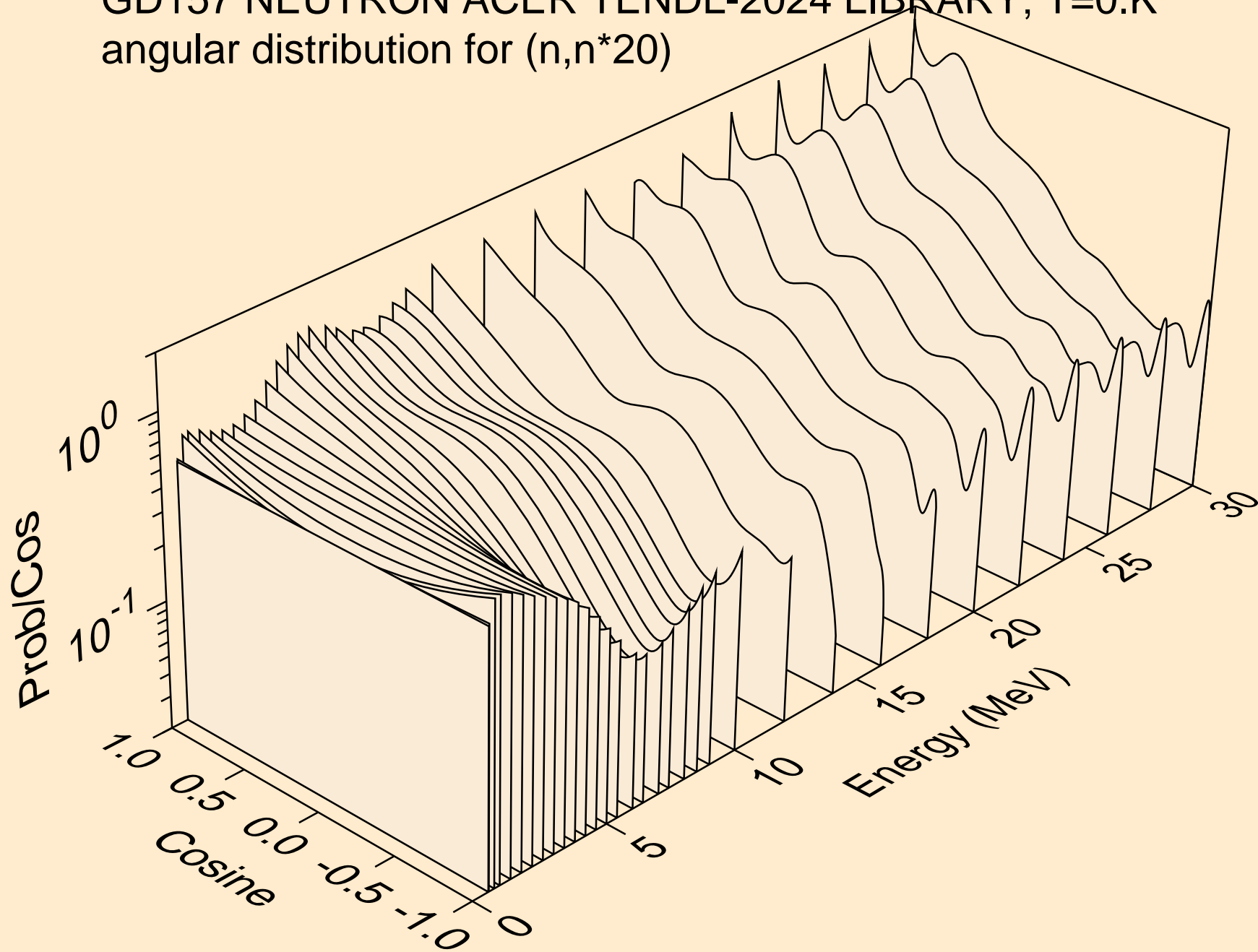

GD157 NEUTRON ACER TENDL-2024 LIBRARY; T=0.K  
angular distribution for (n,n\*21)

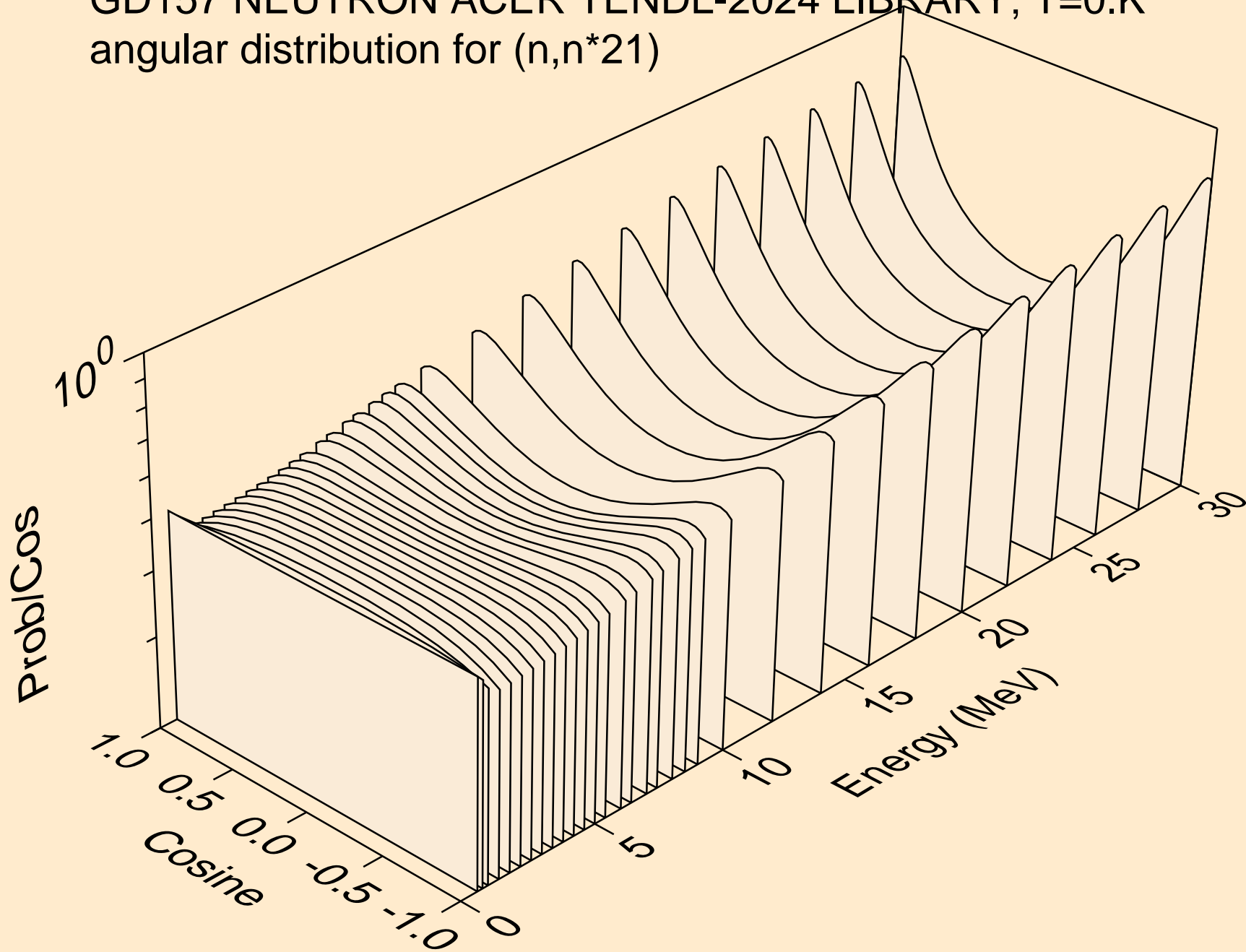

GD157 NEUTRON ACER TENDL-2024 LIBRARY; T=0.K  
angular distribution for (n,n\*22)

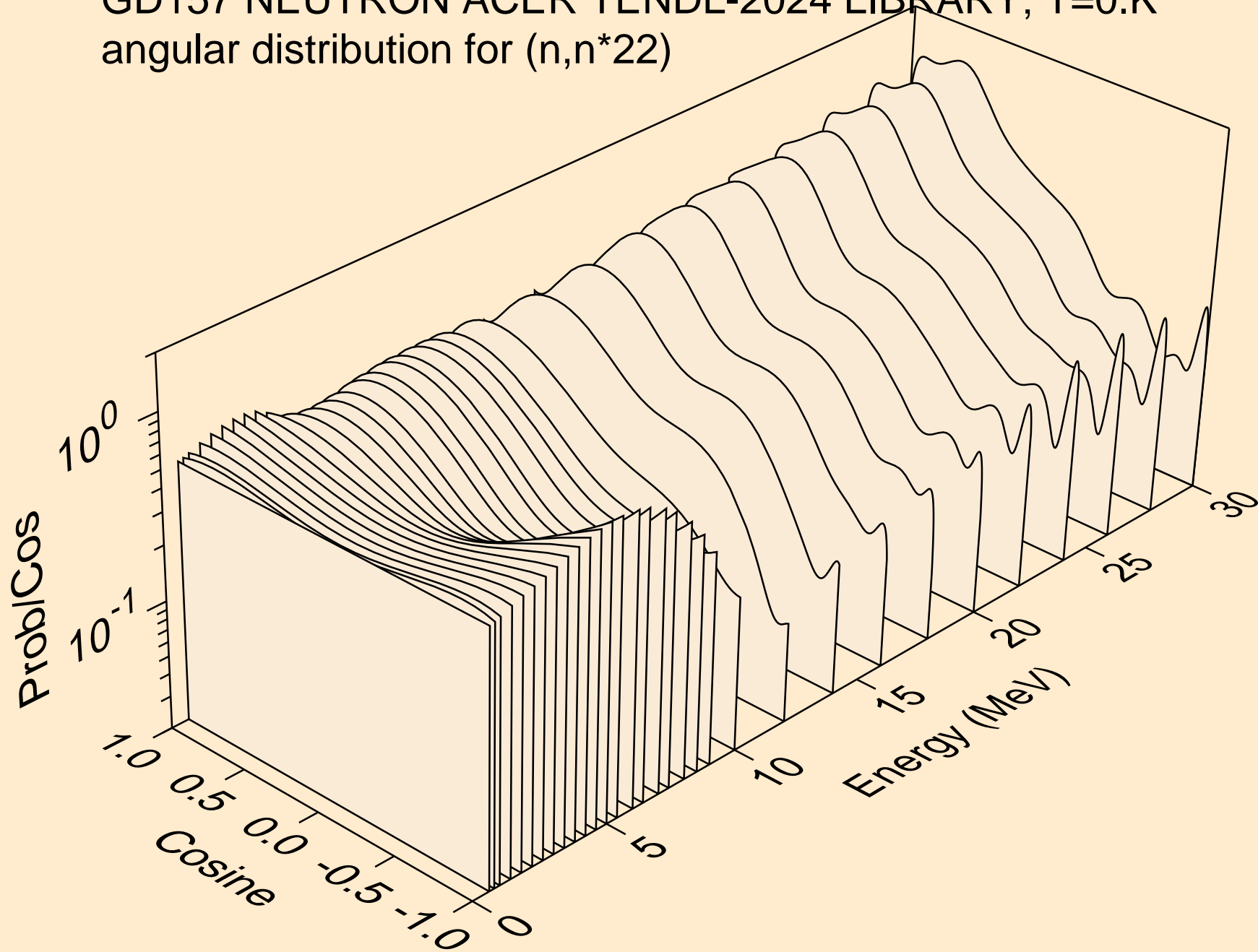

GD157 NEUTRON ACER TENDL-2024 LIBRARY; T=0.K  
angular distribution for (n,n\*23)

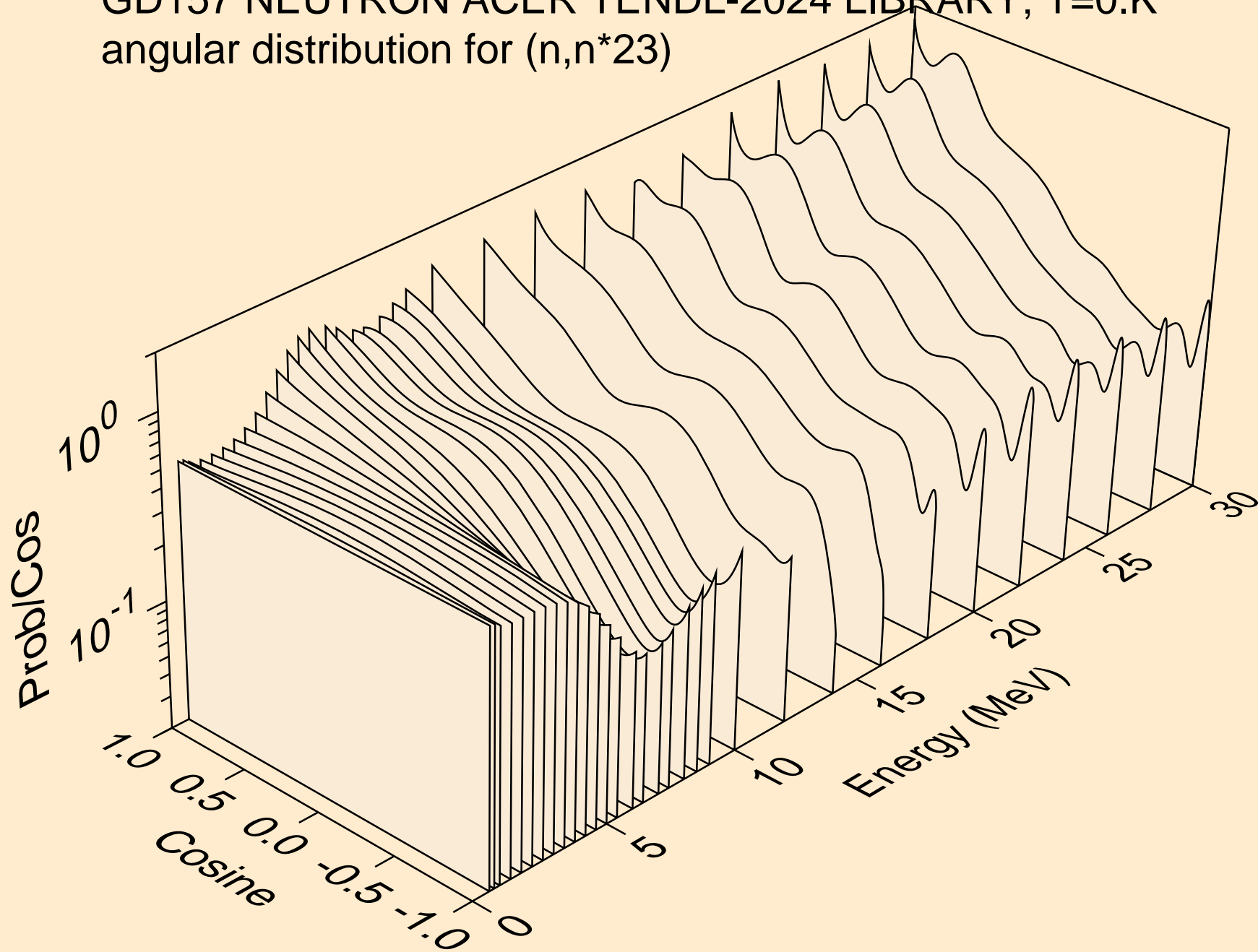

GD157 NEUTRON ACER TENDL-2024 LIBRARY; T=0.K  
angular distribution for (n,n\*24)

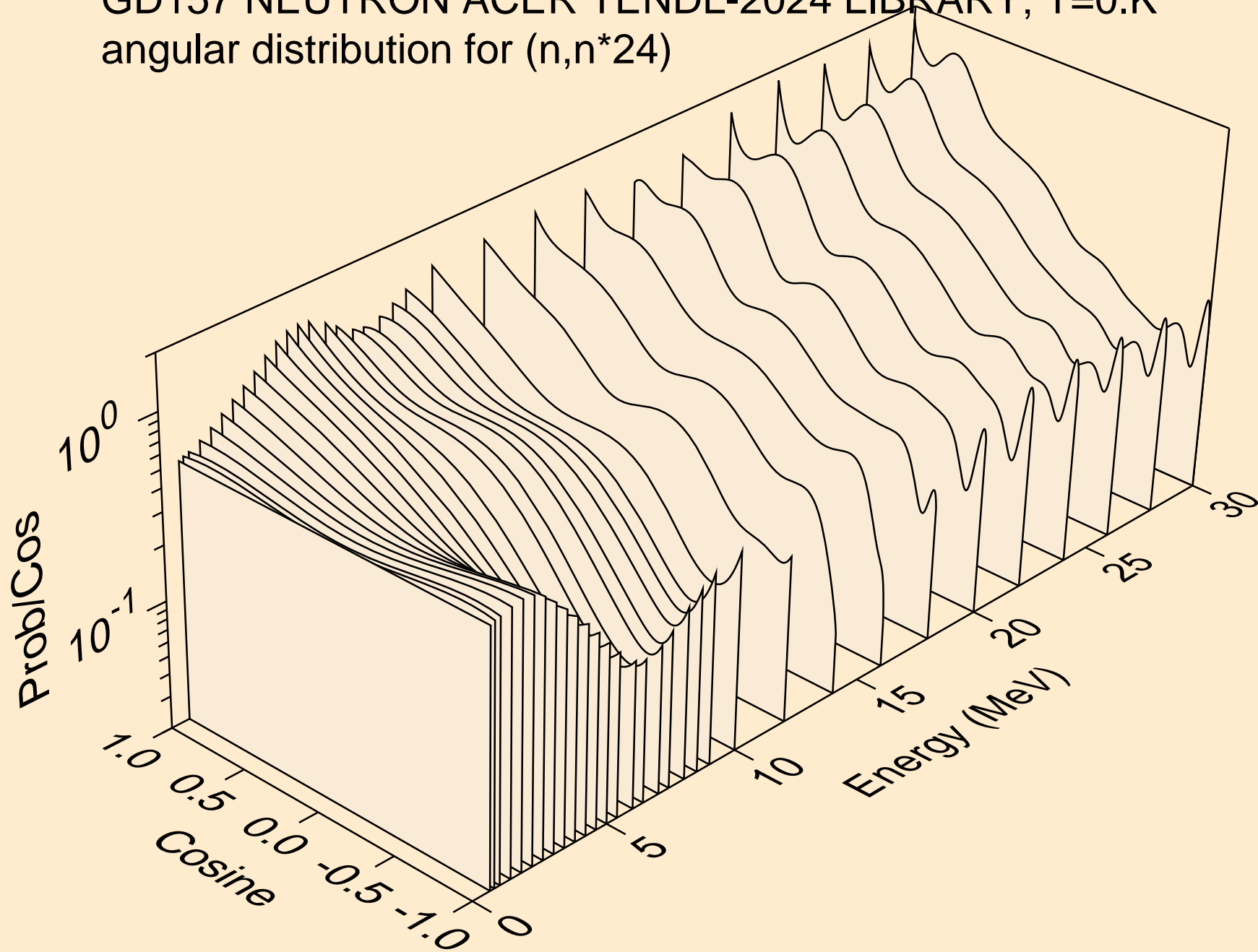

GD157 NEUTRON ACER TENDL-2024 LIBRARY; T=0.K  
angular distribution for (n,n\*25)

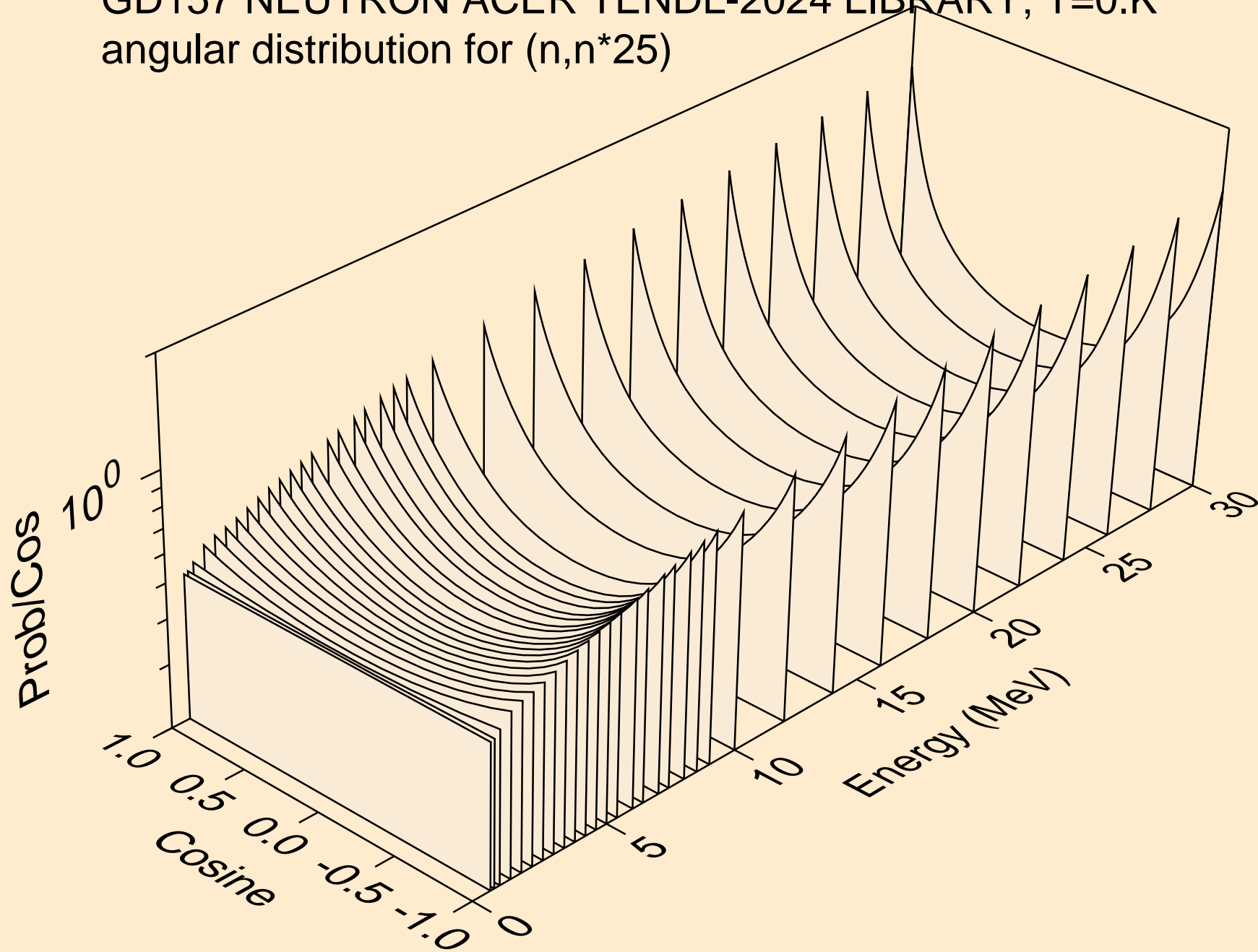

GD157 NEUTRON ACER TENDL-2024 LIBRARY; T=0.K  
angular distribution for (n,n\*26)

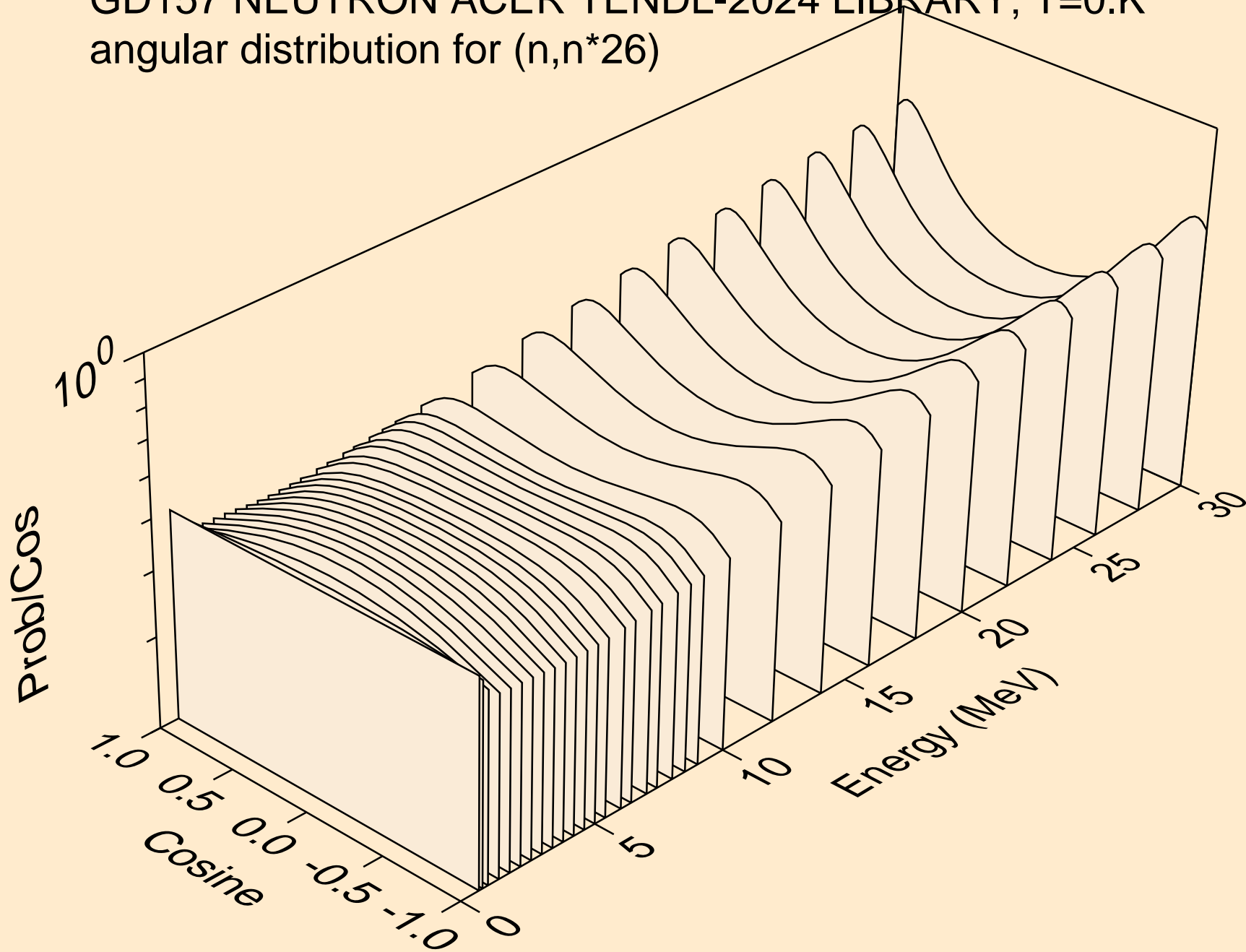



GD157 NEUTRON ACER TENDL-2024 LIBRARY; T=0.K  
angular distribution for (n,n\*27)

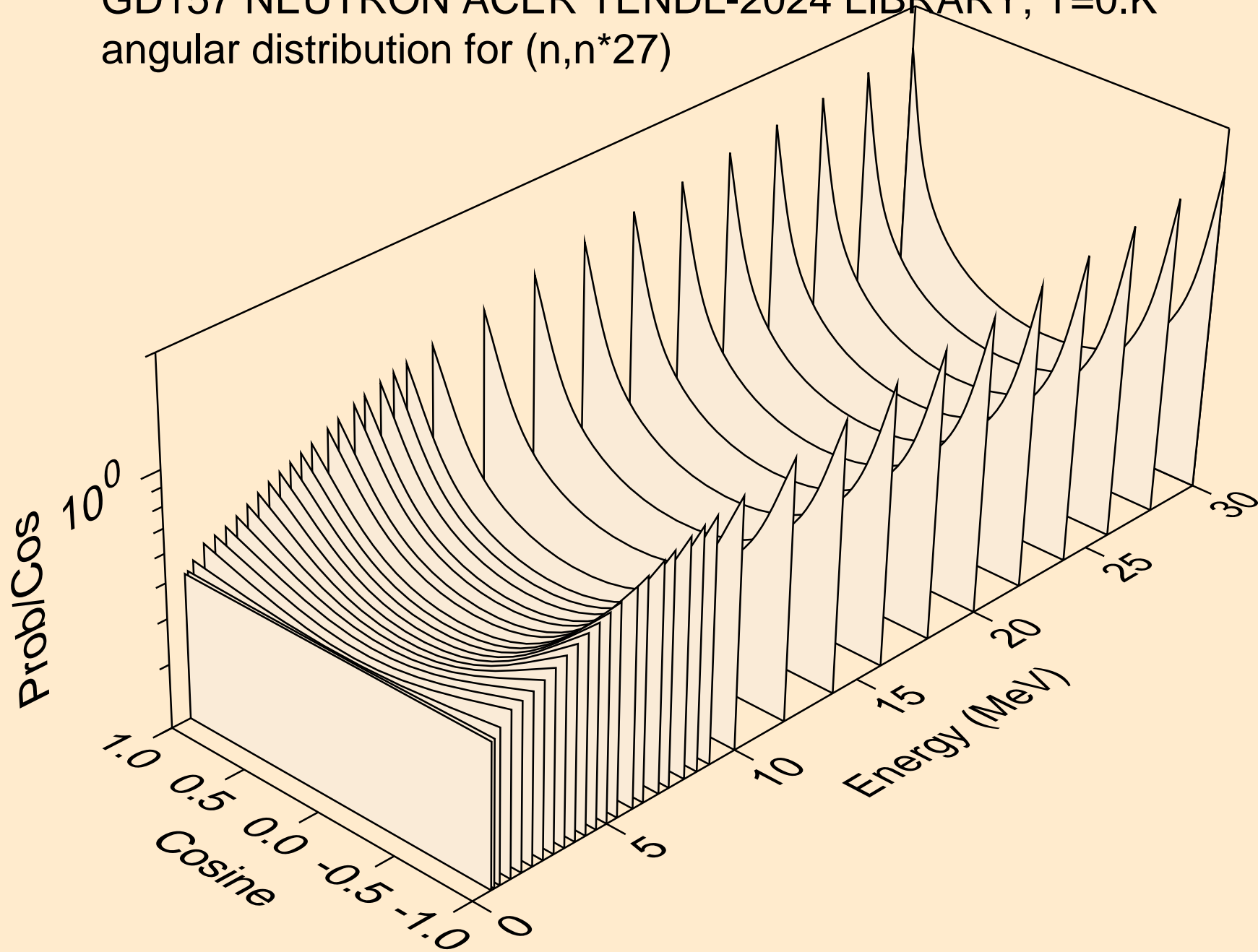

GD157 NEUTRON ACER TENDL-2024 LIBRARY; T=0.K  
angular distribution for (n,n\*28)

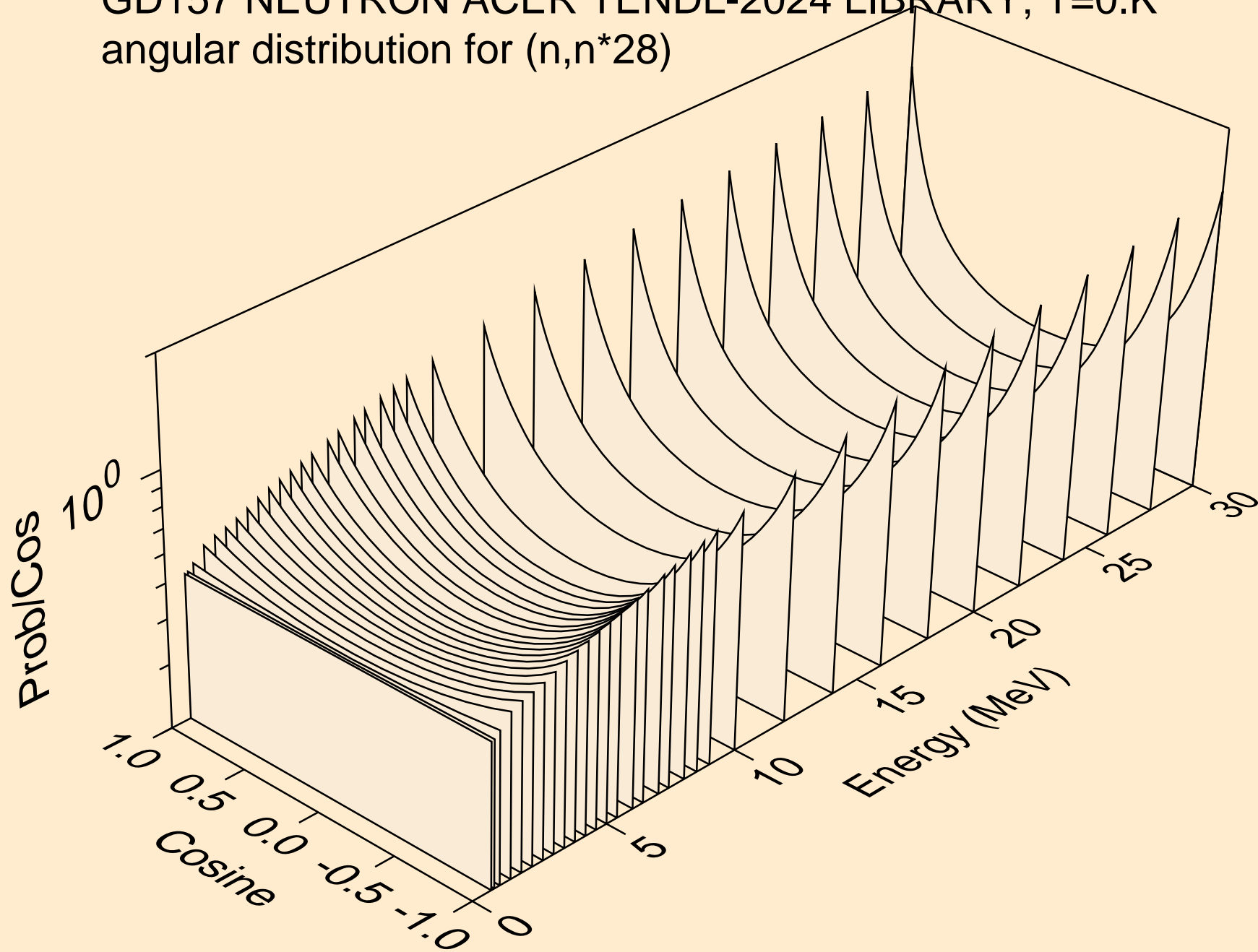

GD157 NEUTRON ACER TENDL-2024 LIBRARY; T=0.K  
angular distribution for (n,n\*29)

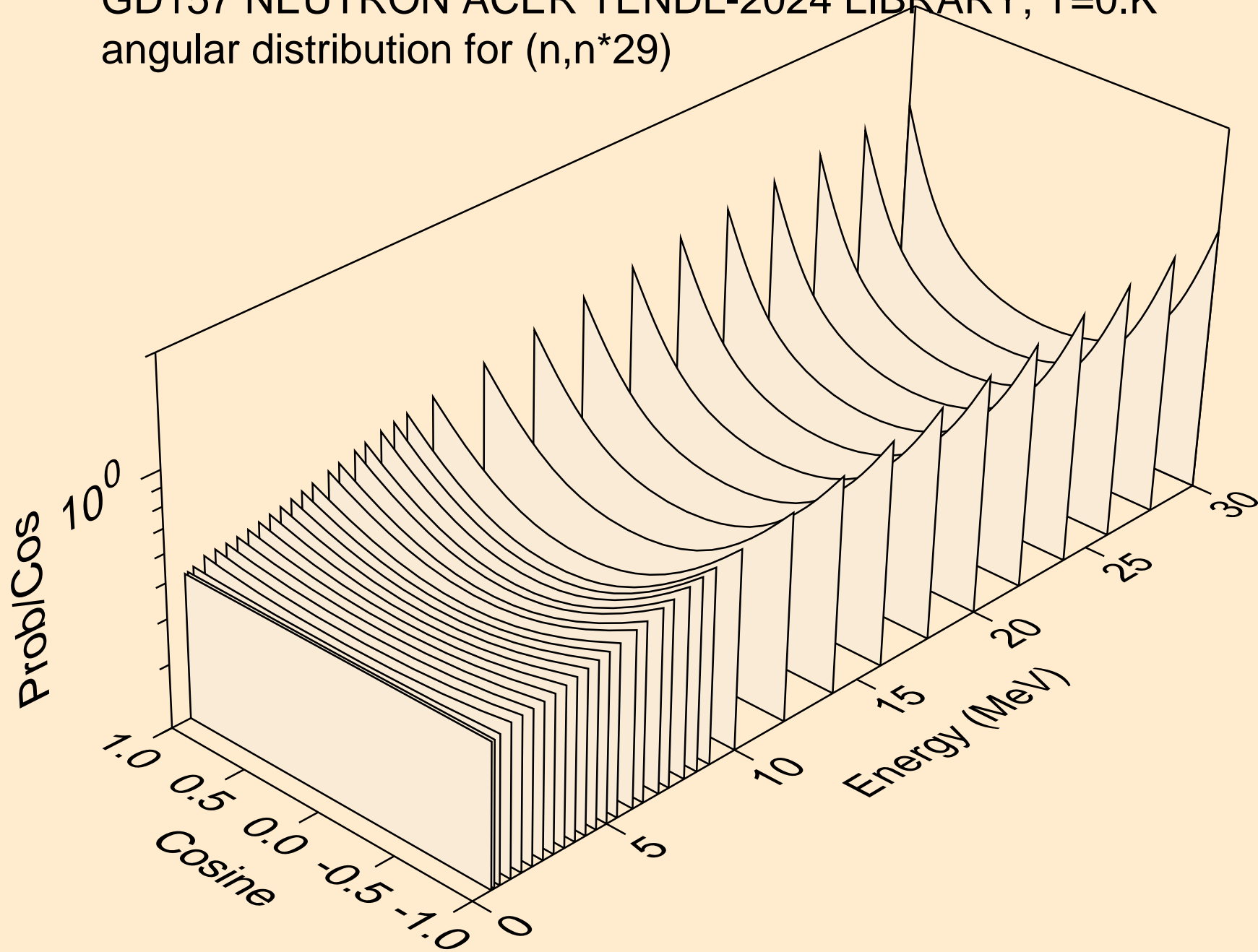

GD157 NEUTRON ACER TENDL-2024 LIBRARY; T=0.K  
angular distribution for (n,n\*30)

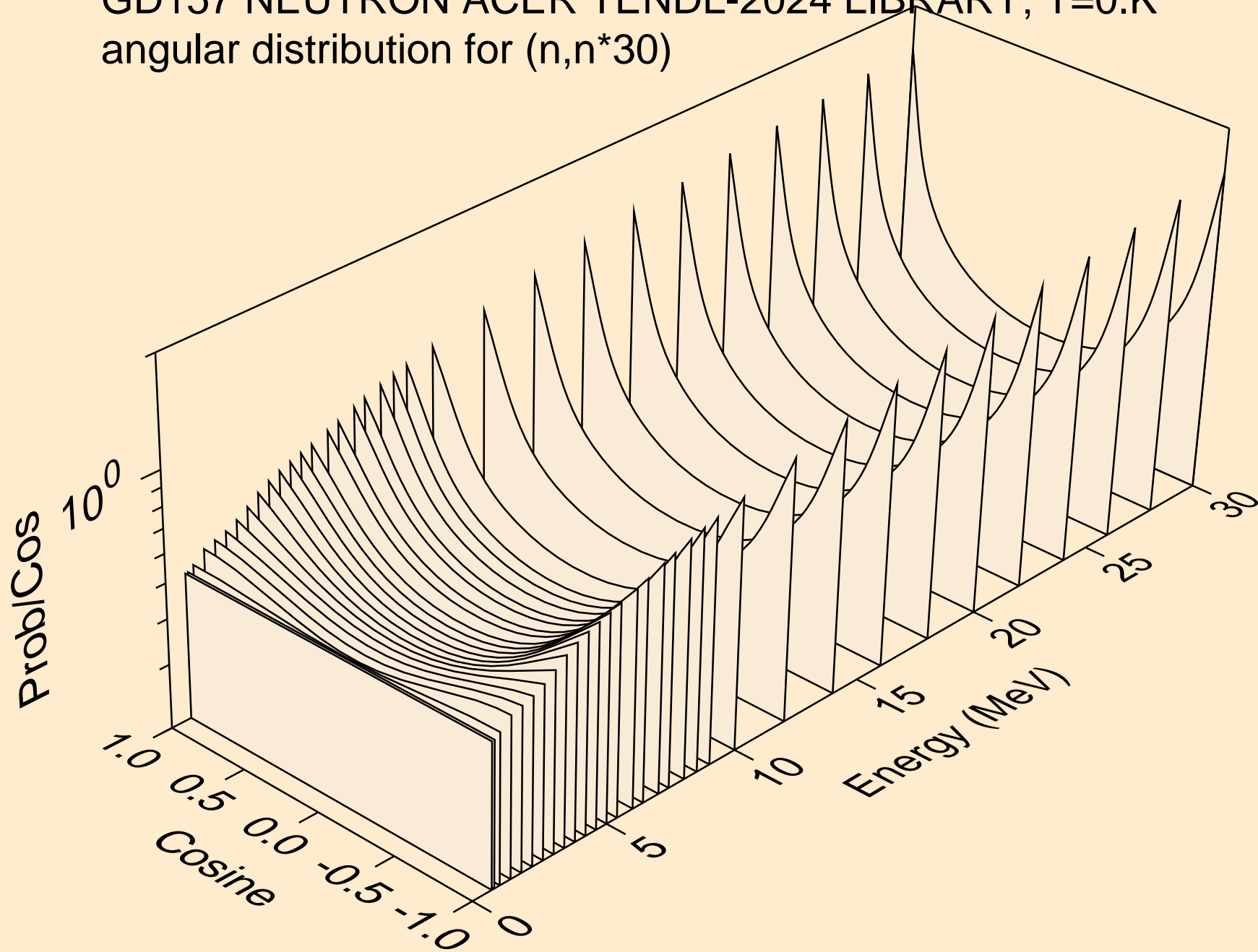

GD157 NEUTRON ACER TENDL-2024 LIBRARY; T=0.K  
Neutron emission for (n,x)

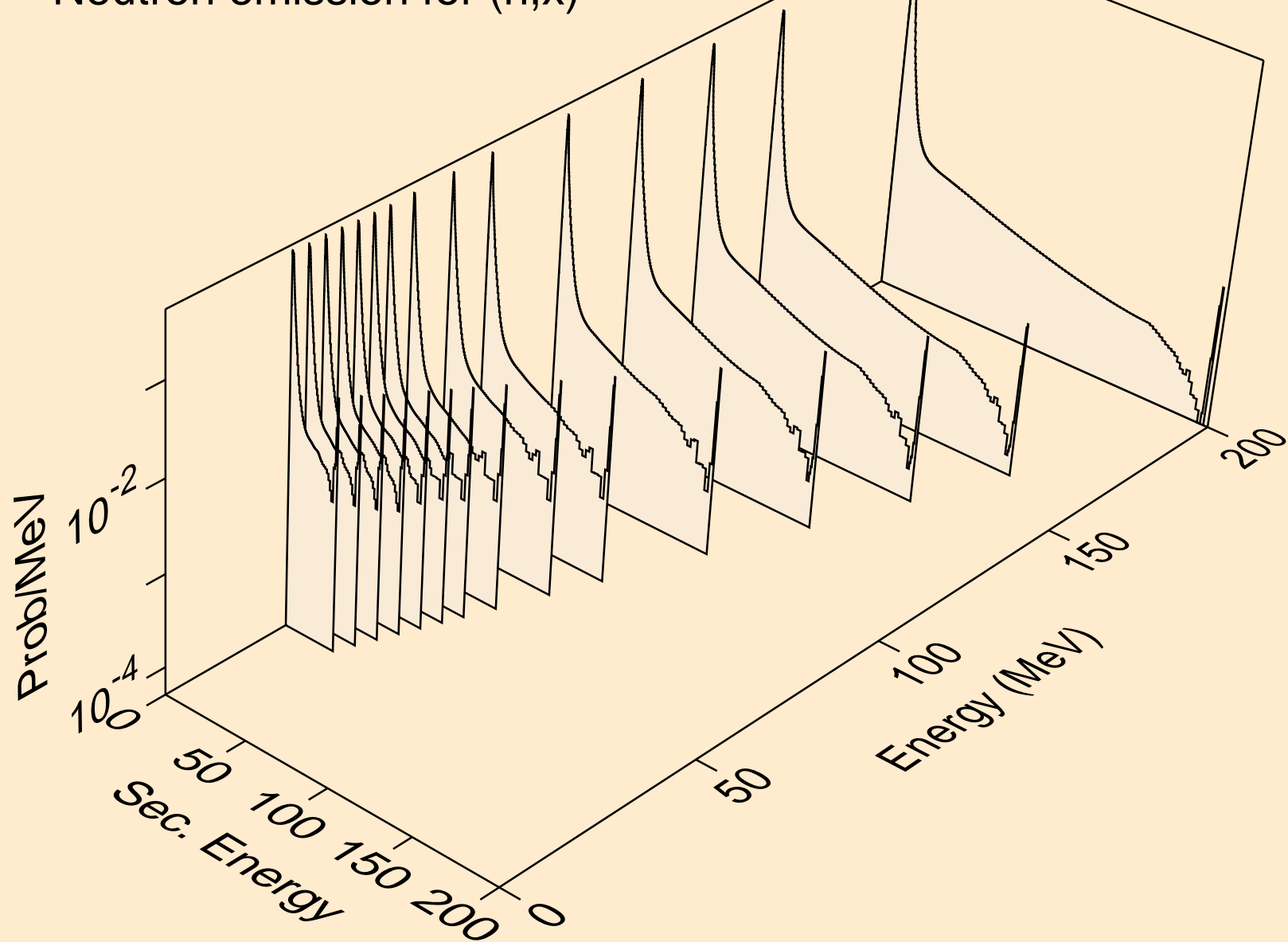

GD157 NEUTRON ACER TENDL-2024 LIBRARY; T=0.K  
Neutron emission for (n,2nd)

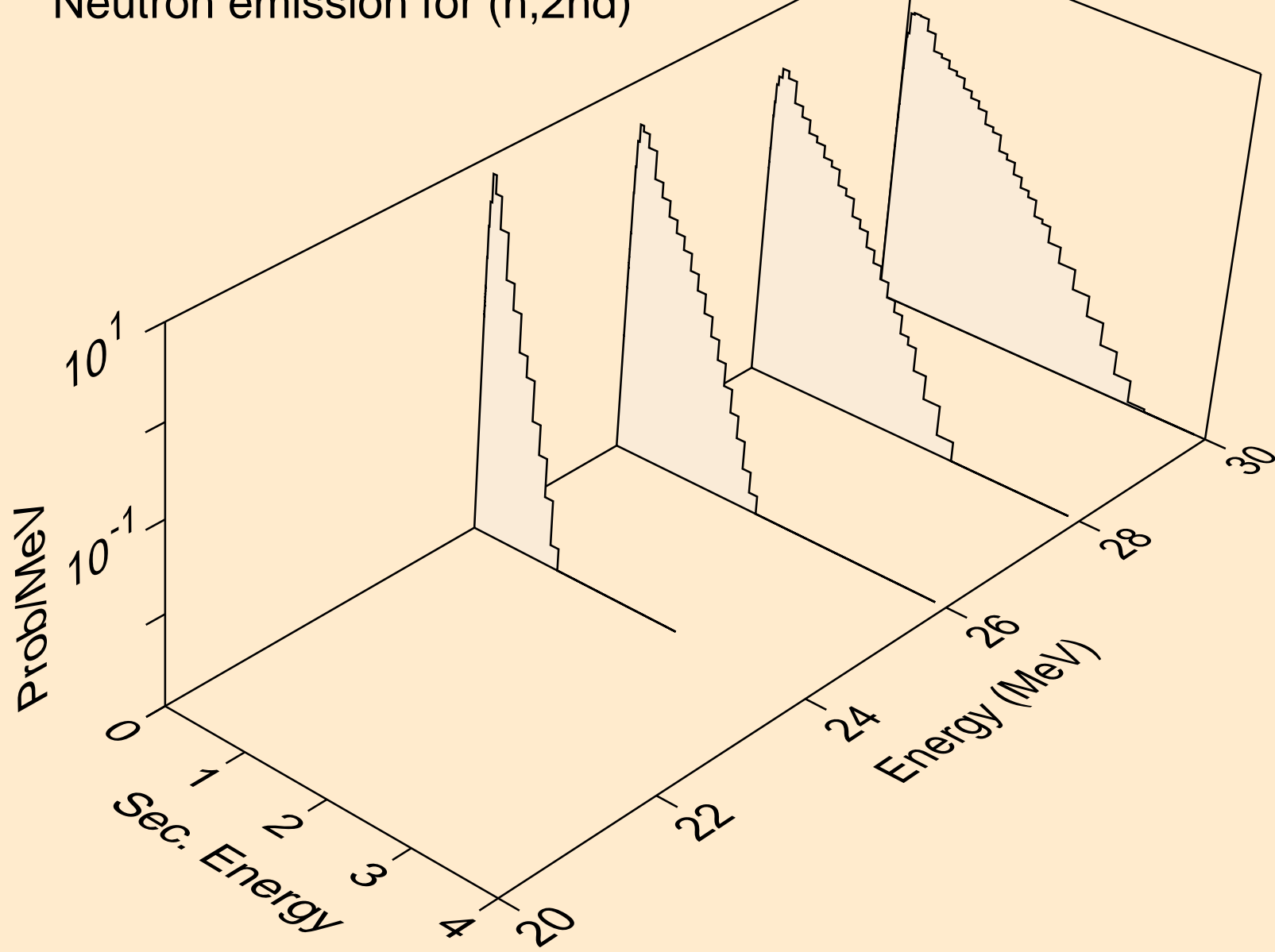

GD157 NEUTRON ACER TENDL-2024 LIBRARY; T=0.K  
Neutron emission for (n,2n)

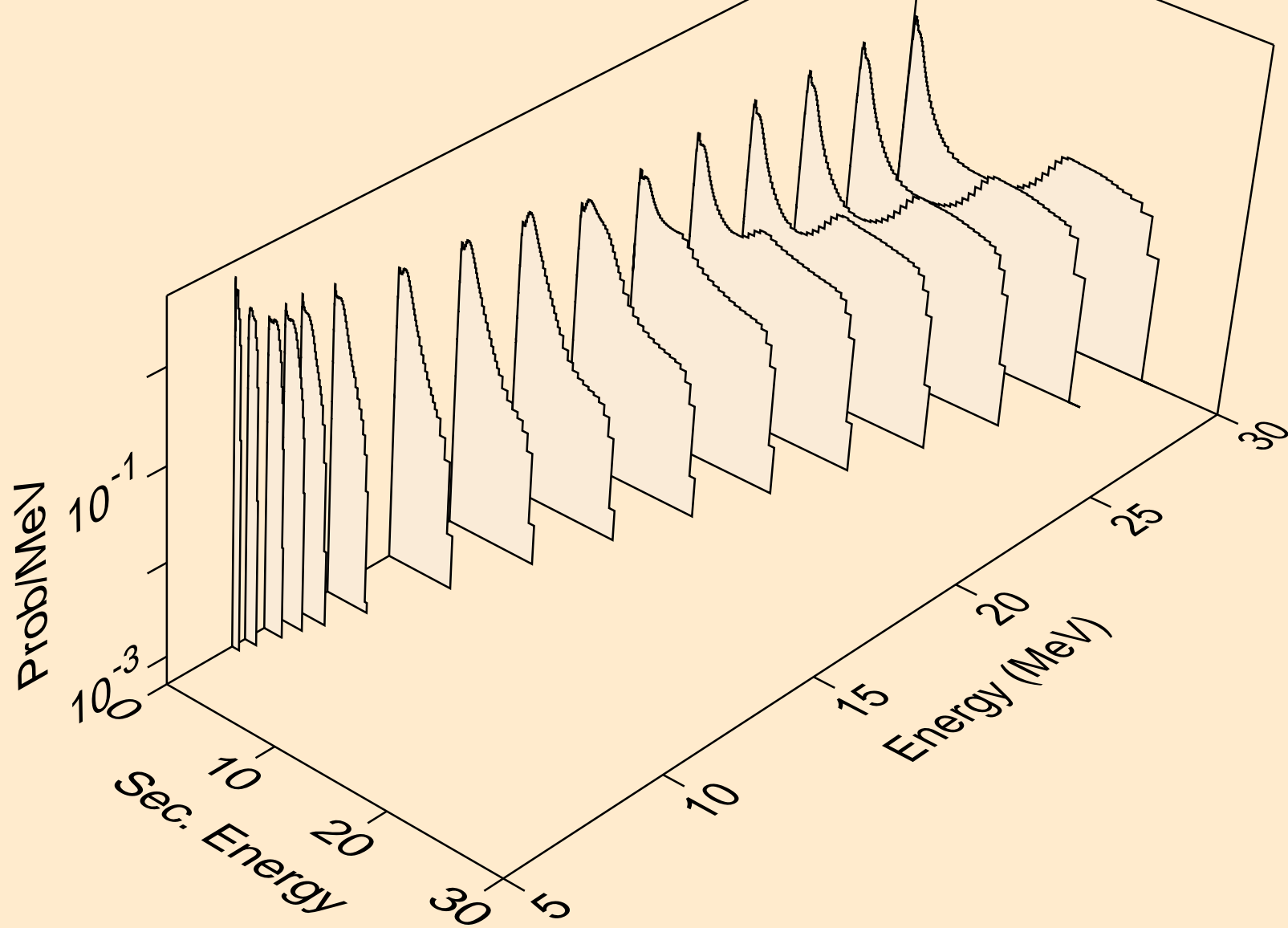

GD157 NEUTRON ACER TENDL-2024 LIBRARY; T=0.K  
Neutron emission for (n,3n)

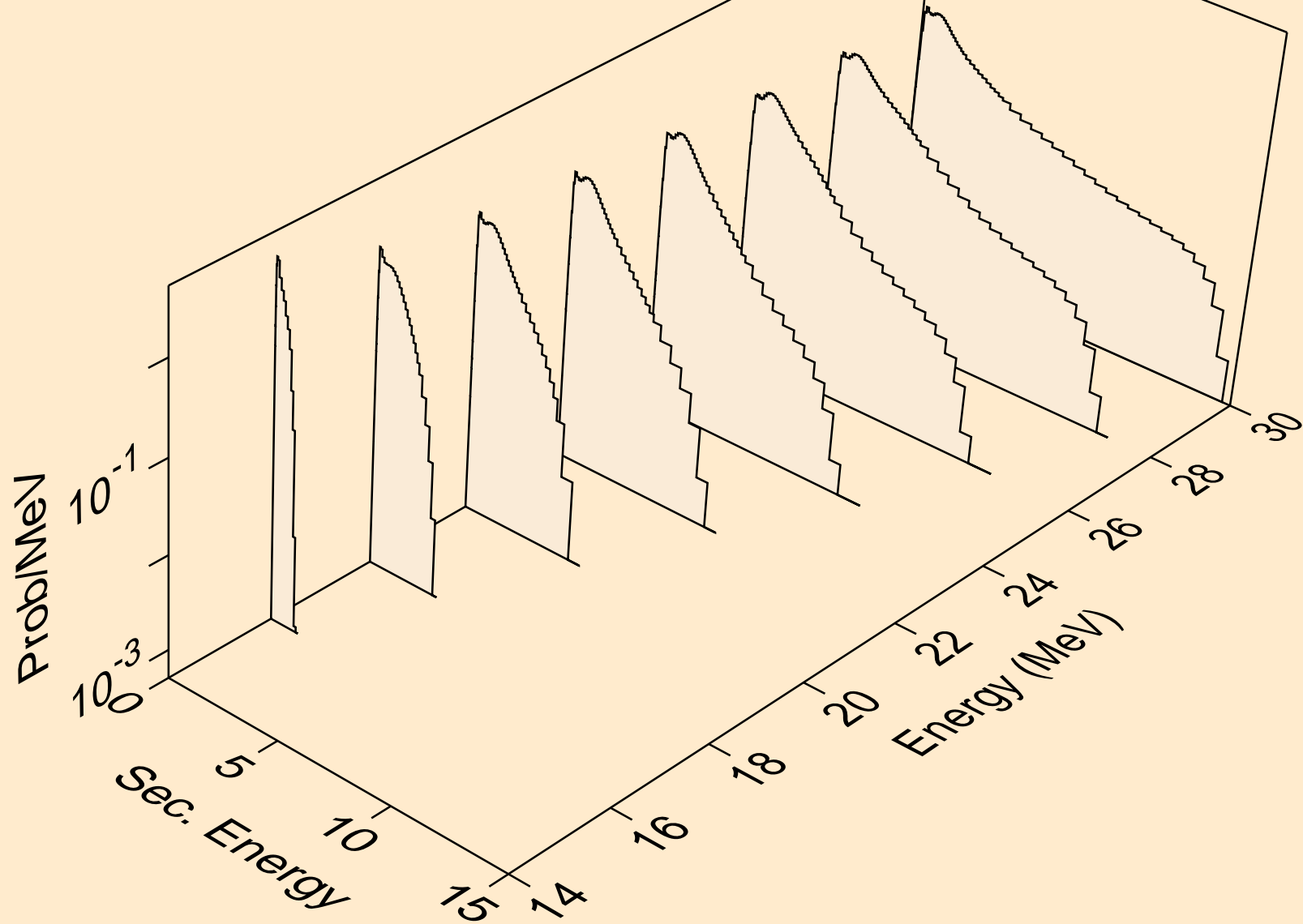



GD157 NEUTRON ACER TENDL-2024 LIBRARY; T=0.K  
Neutron emission for (n,n\*)a

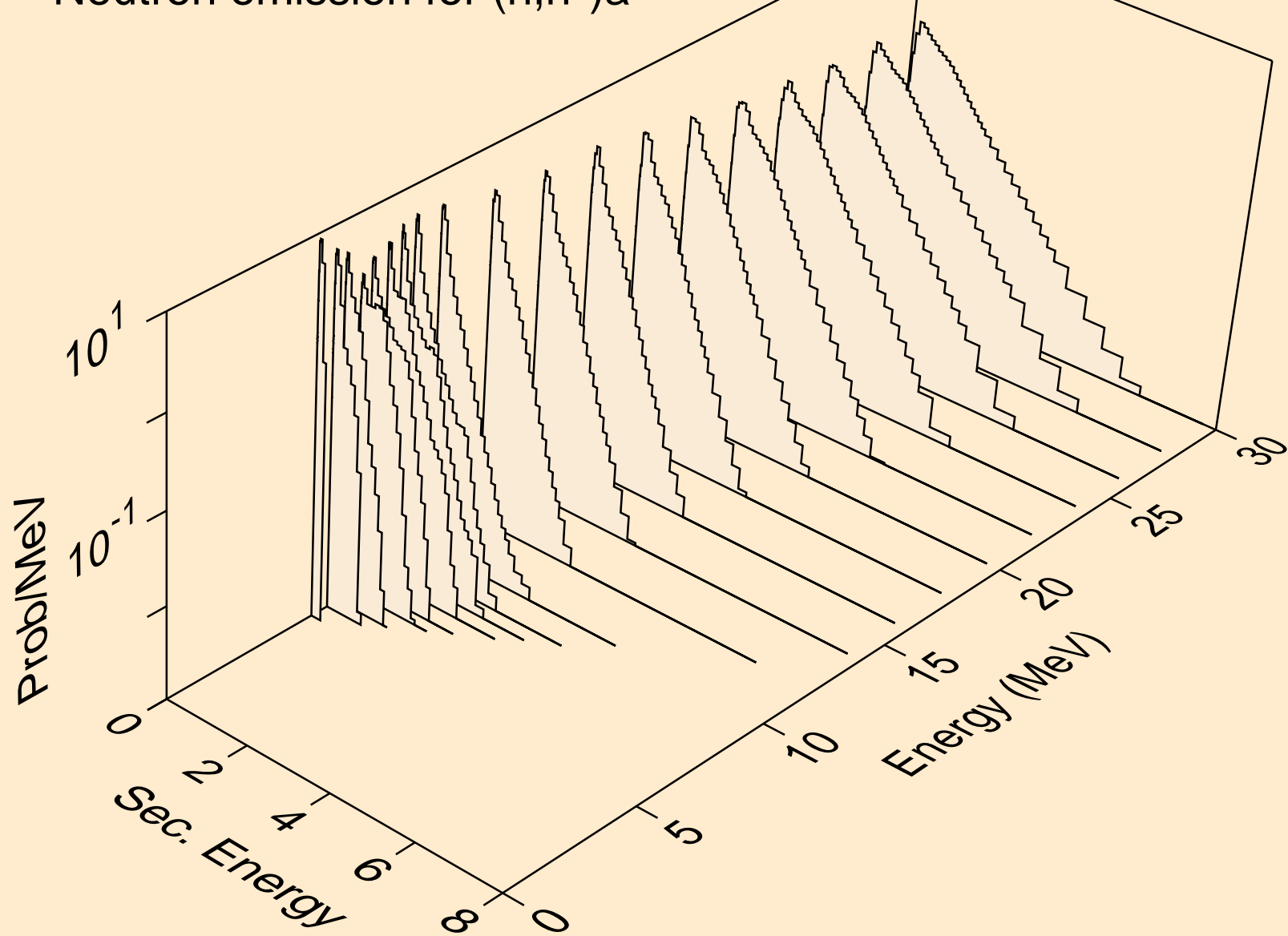

GD157 NEUTRON ACER TENDL-2024 LIBRARY; T=0.K  
Neutron emission for (n,2n)a

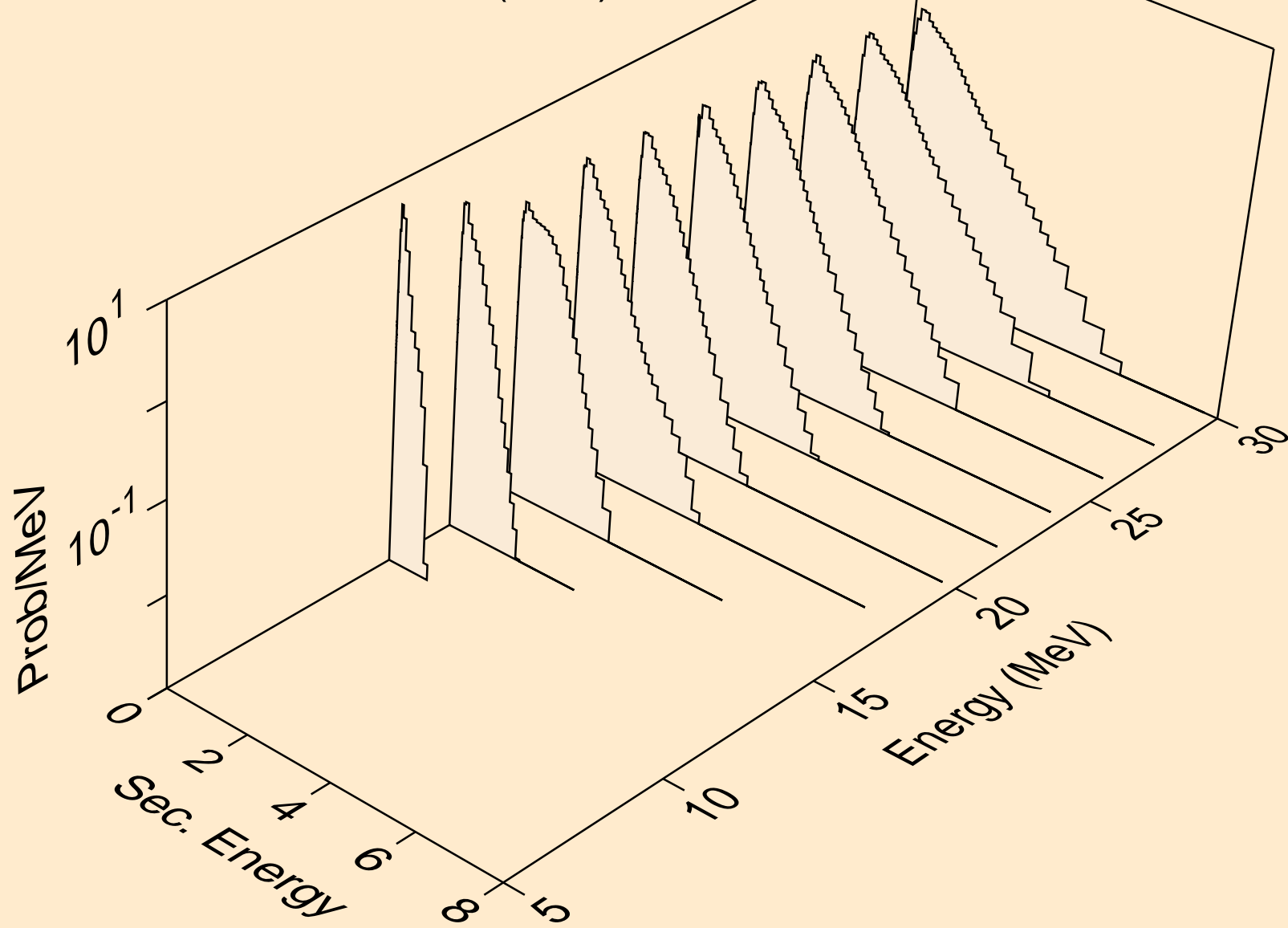

GD157 NEUTRON ACER TENDL-2024 LIBRARY; T=0.K  
Neutron emission for (n,3n)a

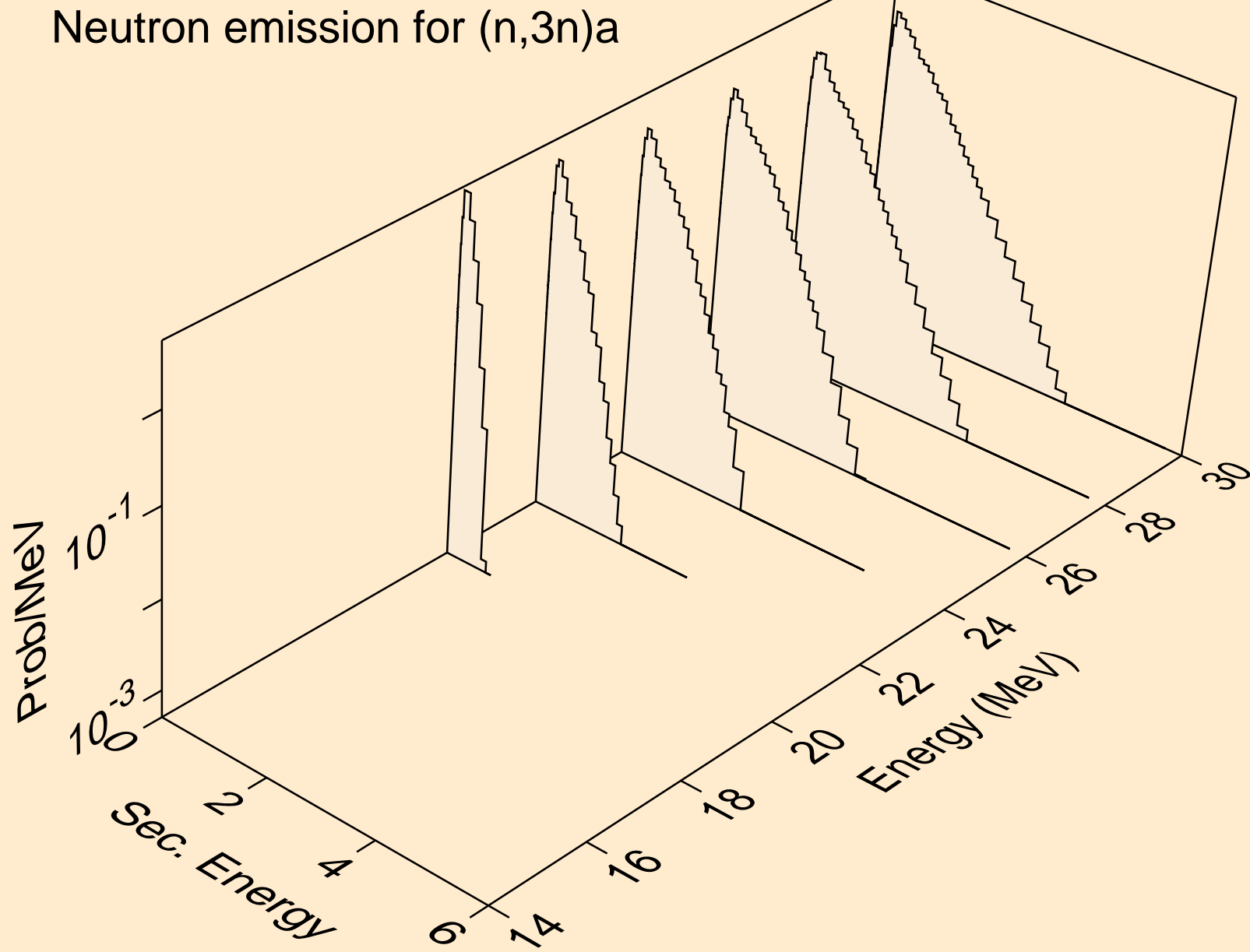

GD157 NEUTRON ACER TENDL-2024 LIBRARY; T=0.K  
Neutron emission for (n,n\*)p

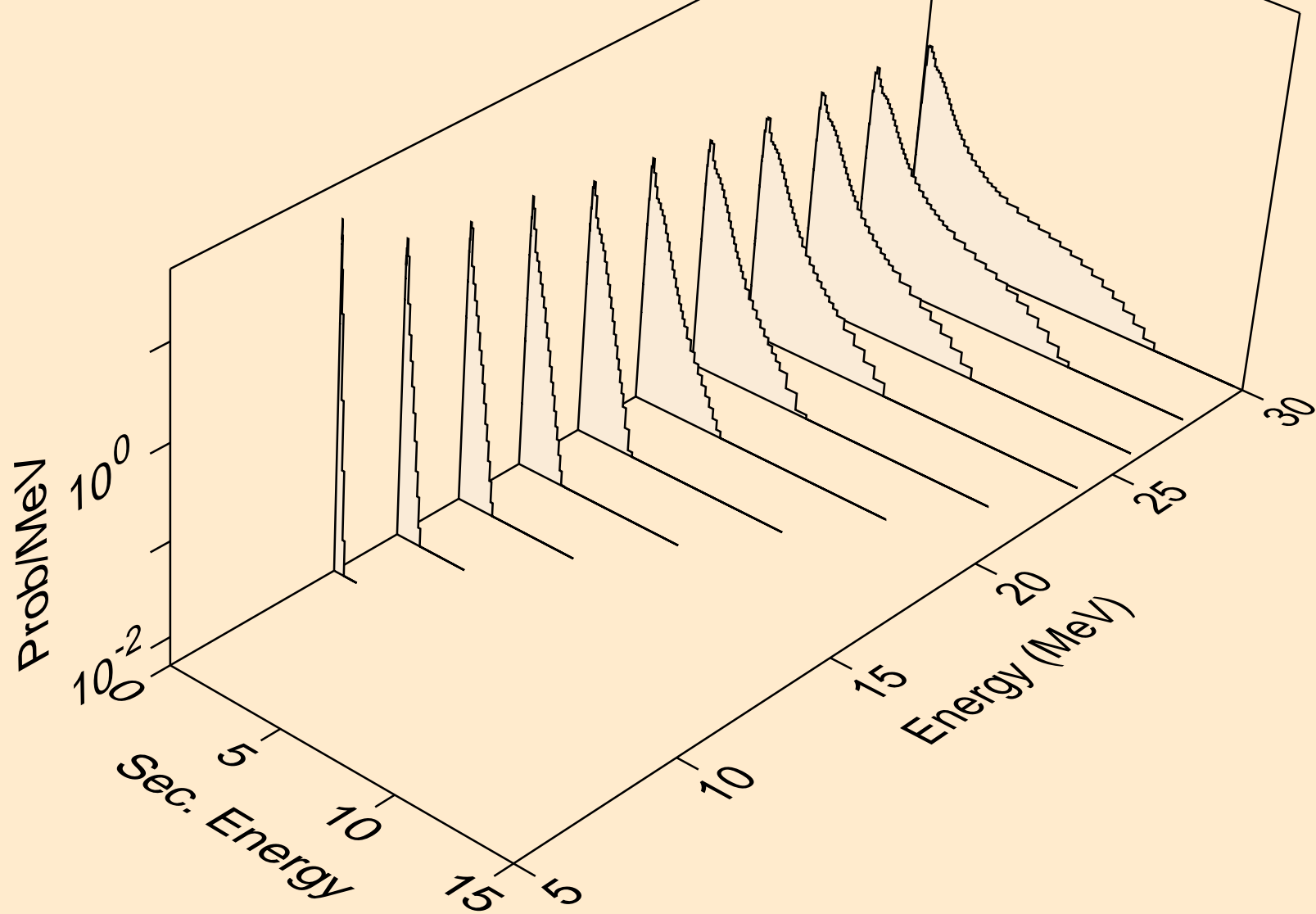

GD157 NEUTRON ACER TENDL-2024 LIBRARY; T=0.K  
Neutron emission for (n,n\*)2a

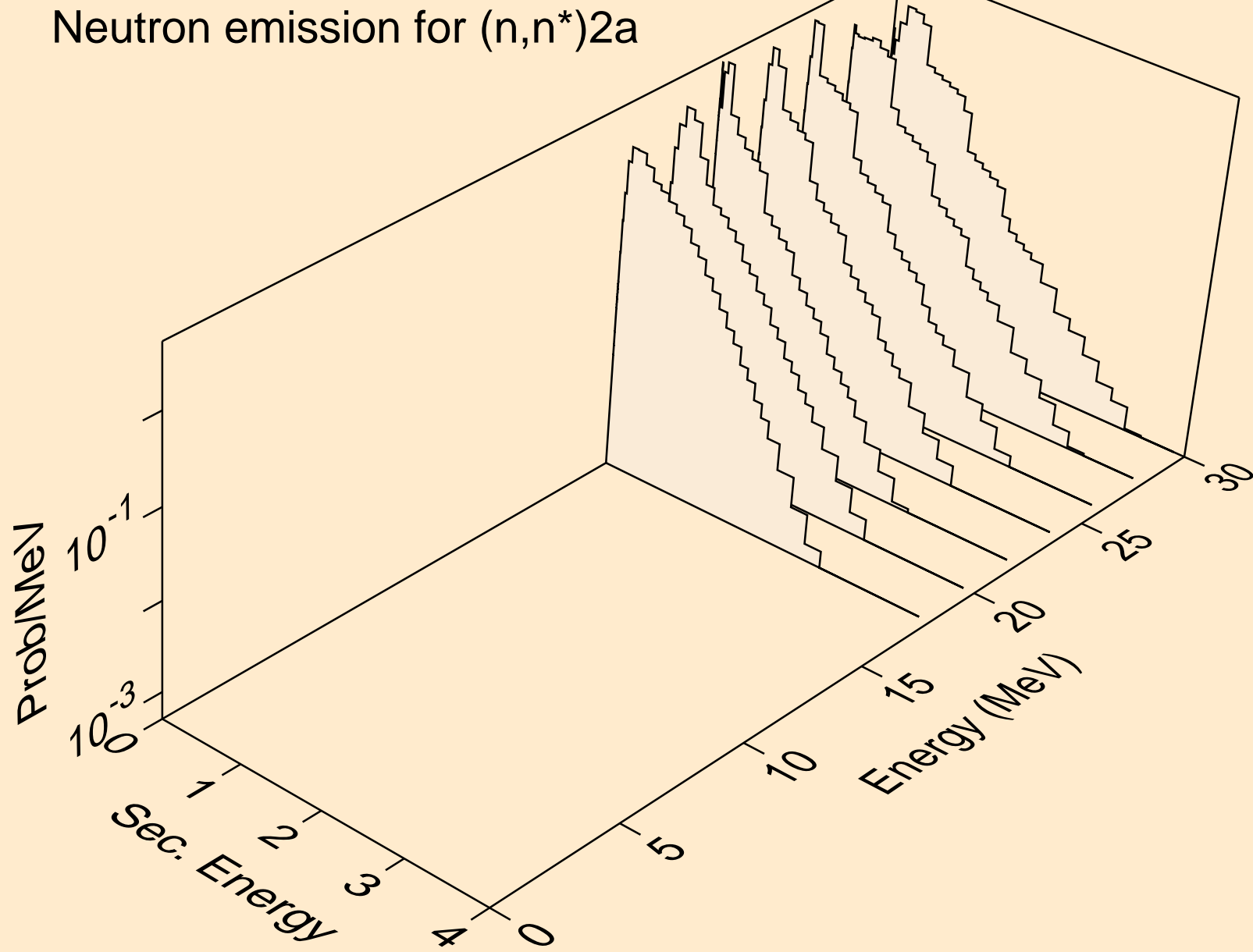

GD157 NEUTRON ACER TENDL-2024 LIBRARY; T=0.K  
Neutron emission for (n,n\*)d

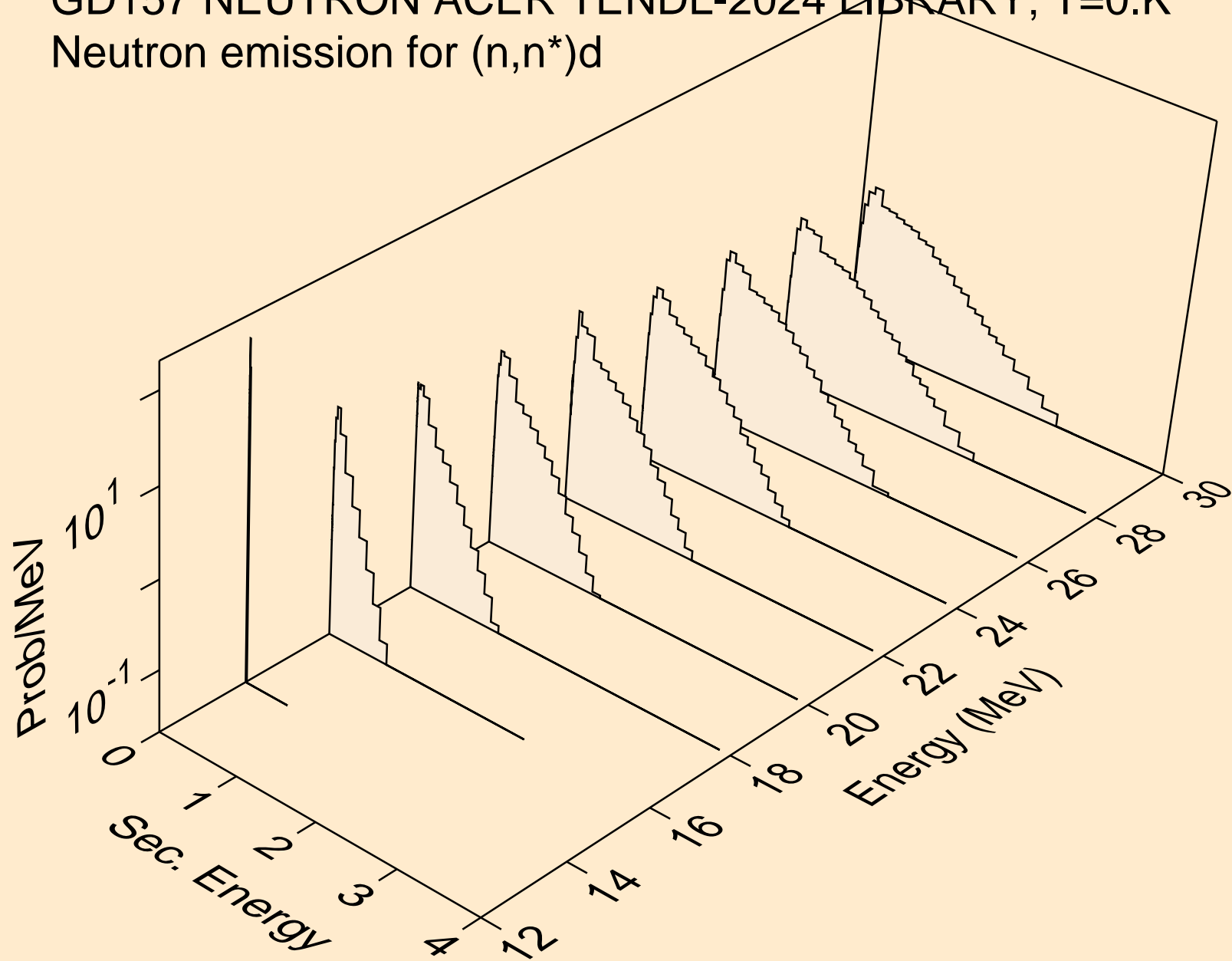

GD157 NEUTRON ACER TENDL-2024 LIBRARY; T=0.K  
Neutron emission for (n,n\*)t

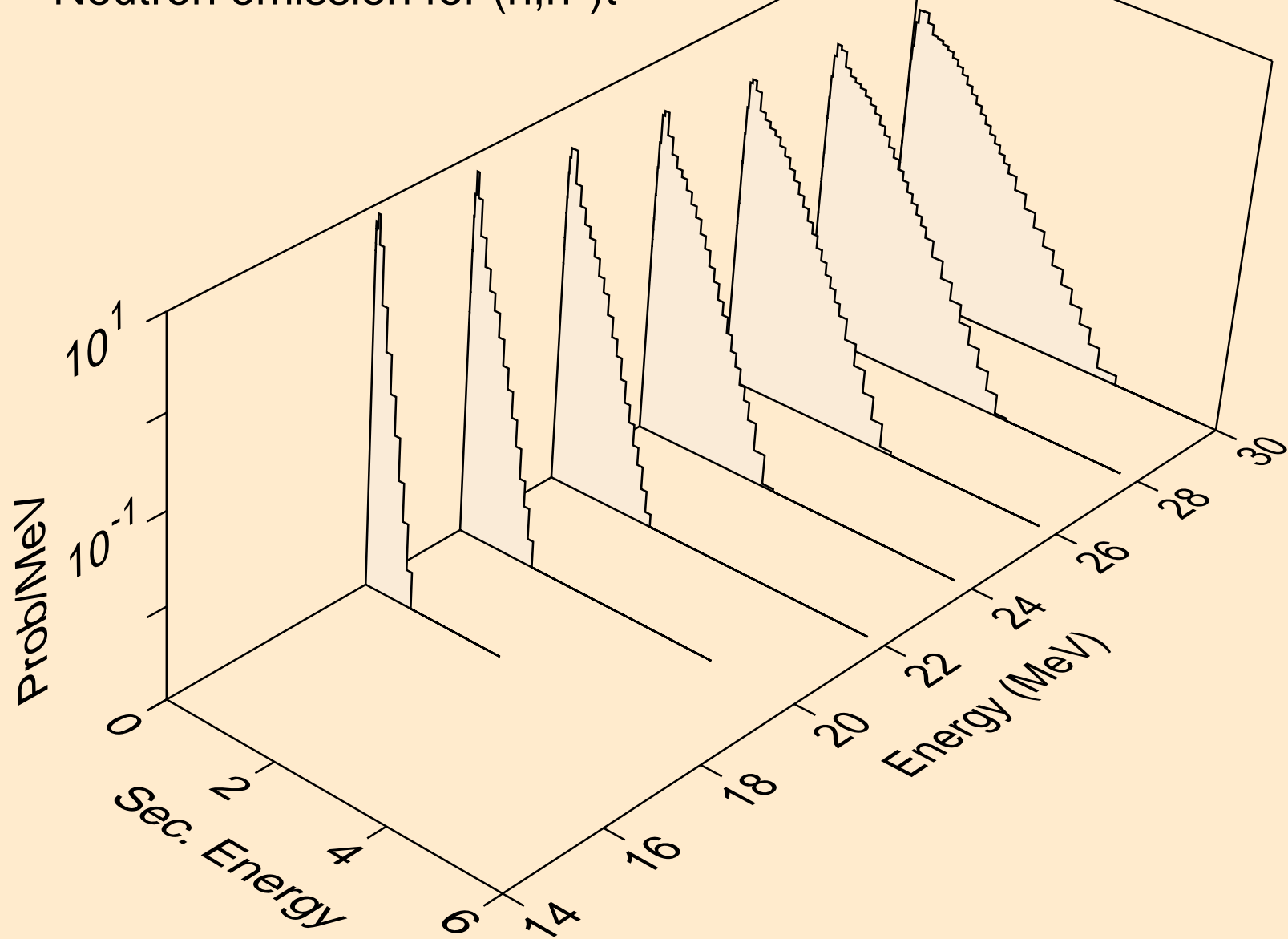

GD157 NEUTRON ACER TENDL-2024 LIBRARY; T=0.K  
Neutron emission for (n,n\*)he3

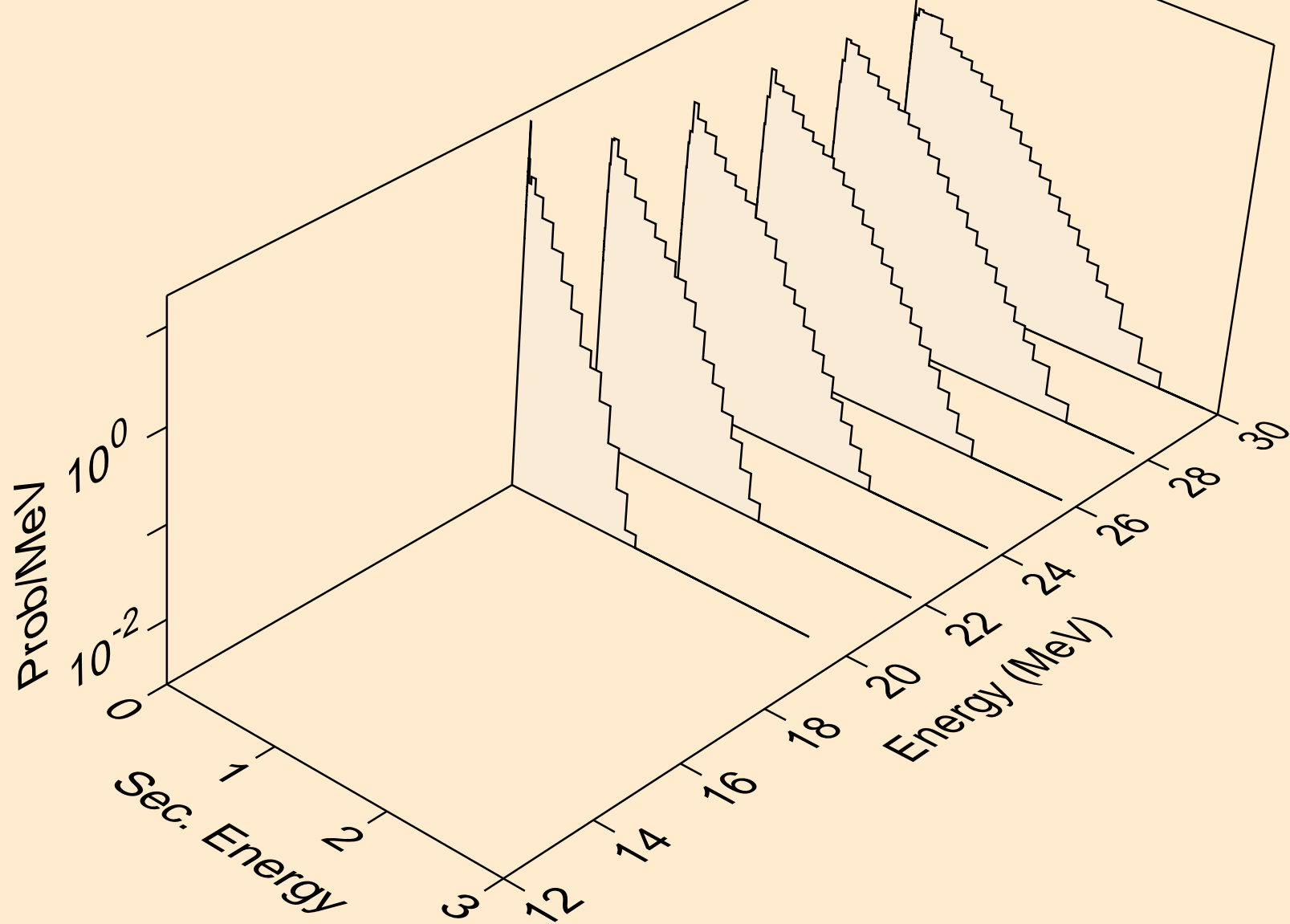



GD157 NEUTRON ACER TENDL-2024 LIBRARY; T=0.K  
Neutron emission for (n,4n)

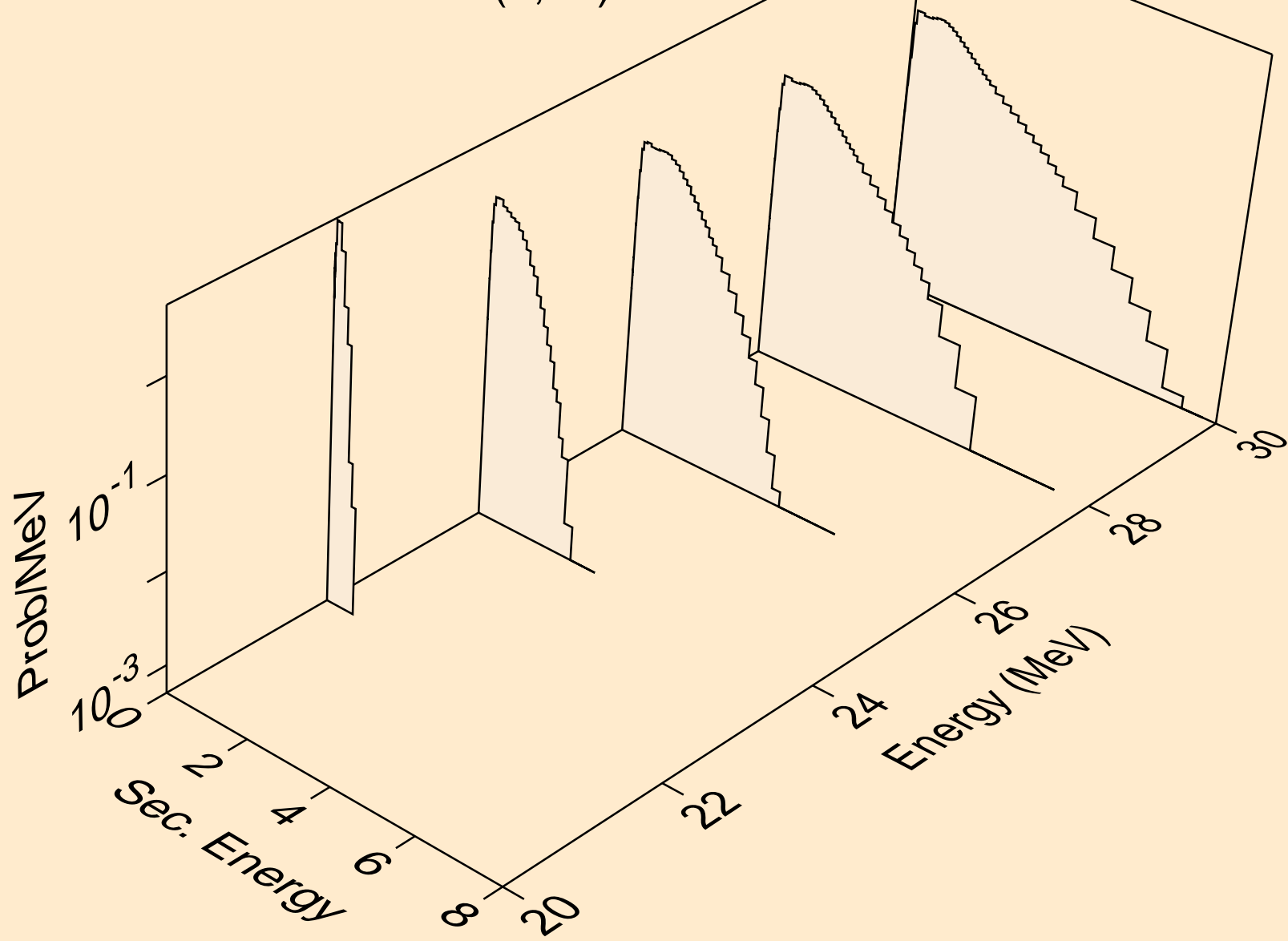

GD157 NEUTRON ACER TENDL-2024 LIBRARY; T=0.K  
Neutron emission for (n,2np)

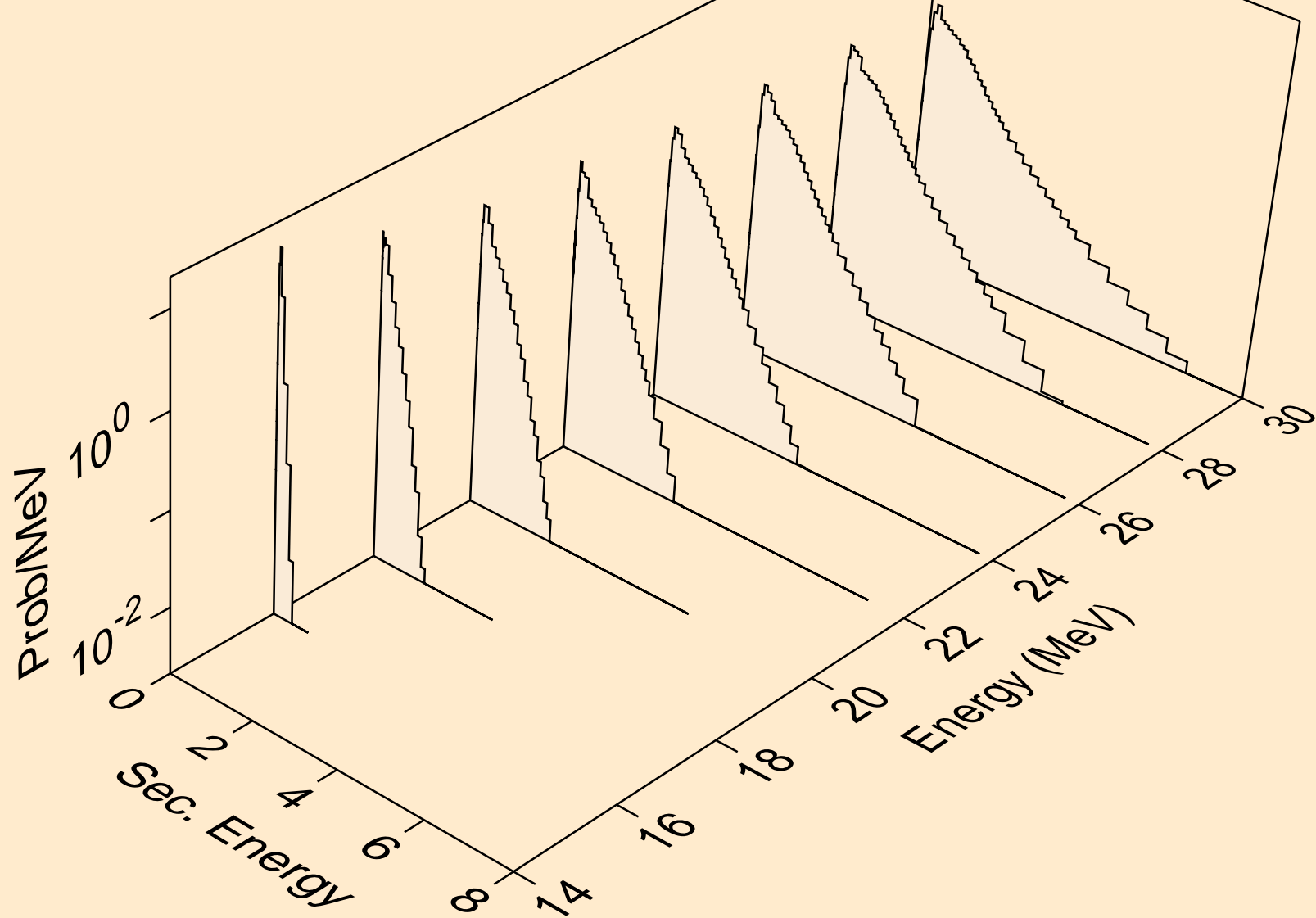

GD157 NEUTRON ACER TENDL-2024 LIBRARY; T=0.K  
Neutron emission for (n,3np)

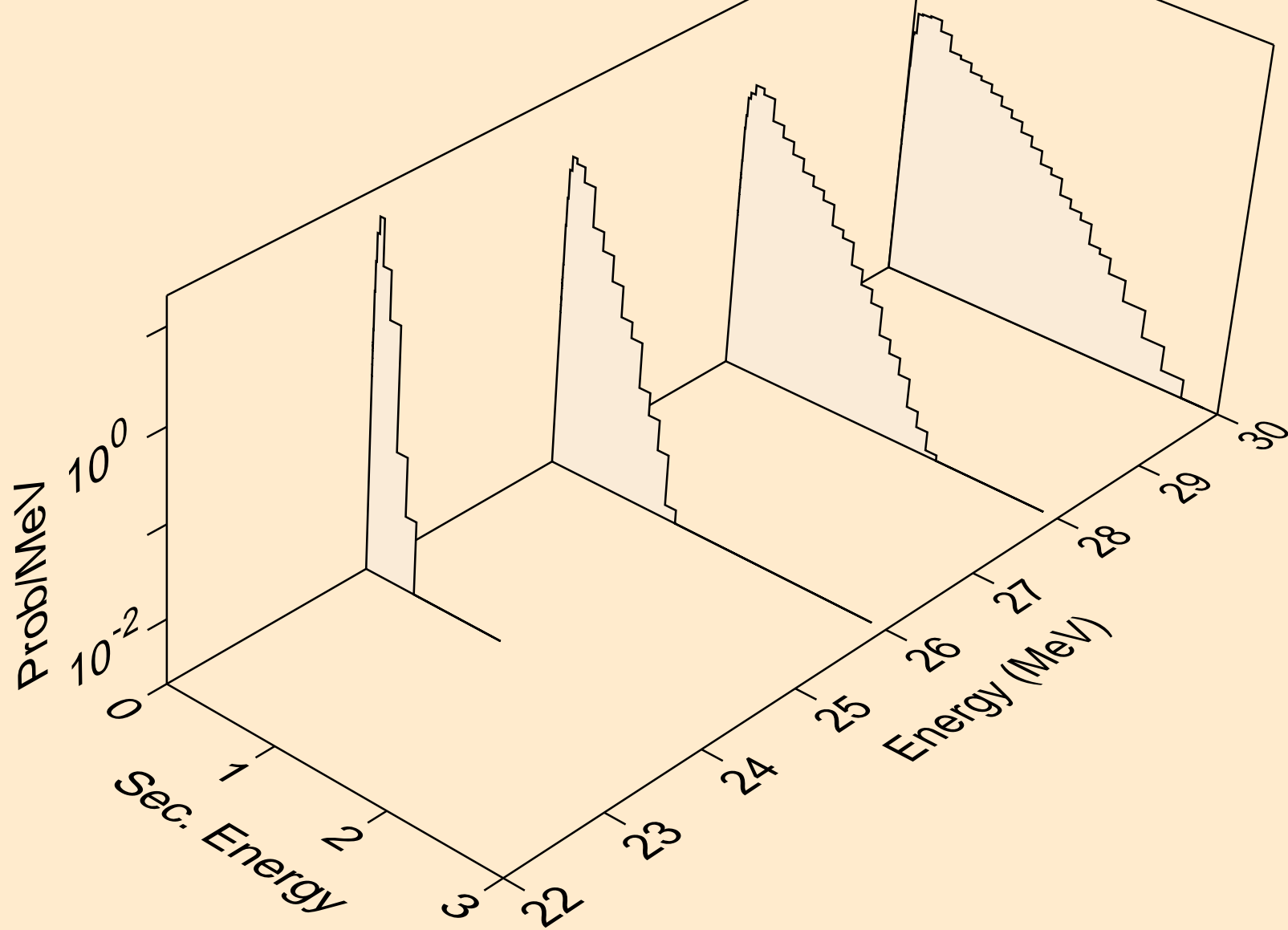

GD157 NEUTRON ACER TENDL-2024 LIBRARY; T=0.K  
Neutron emission for (n,n2p)

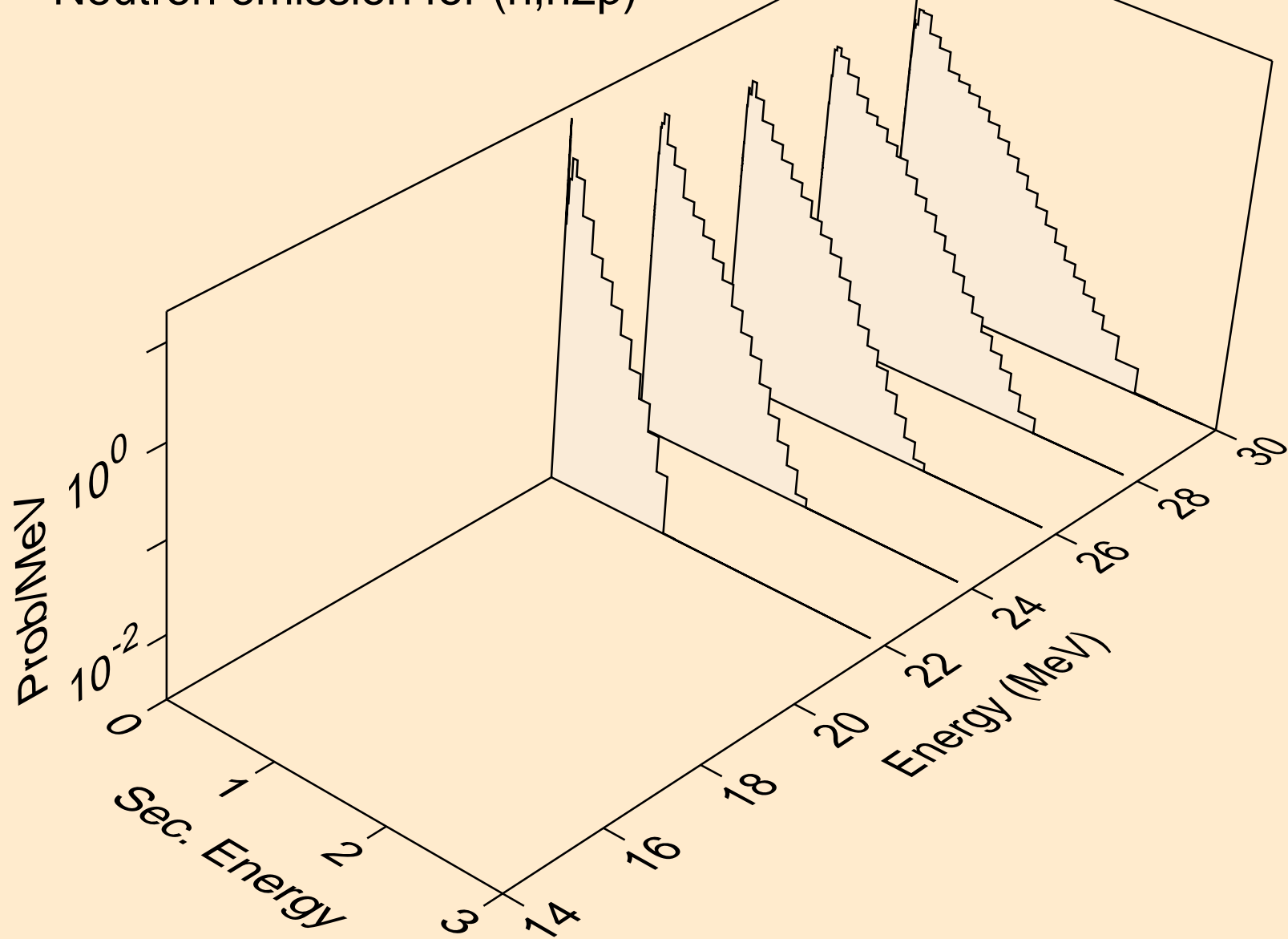

GD157 NEUTRON ACER TENDL-2024 LIBRARY; T=0.K  
Neutron emission for (n,npa)

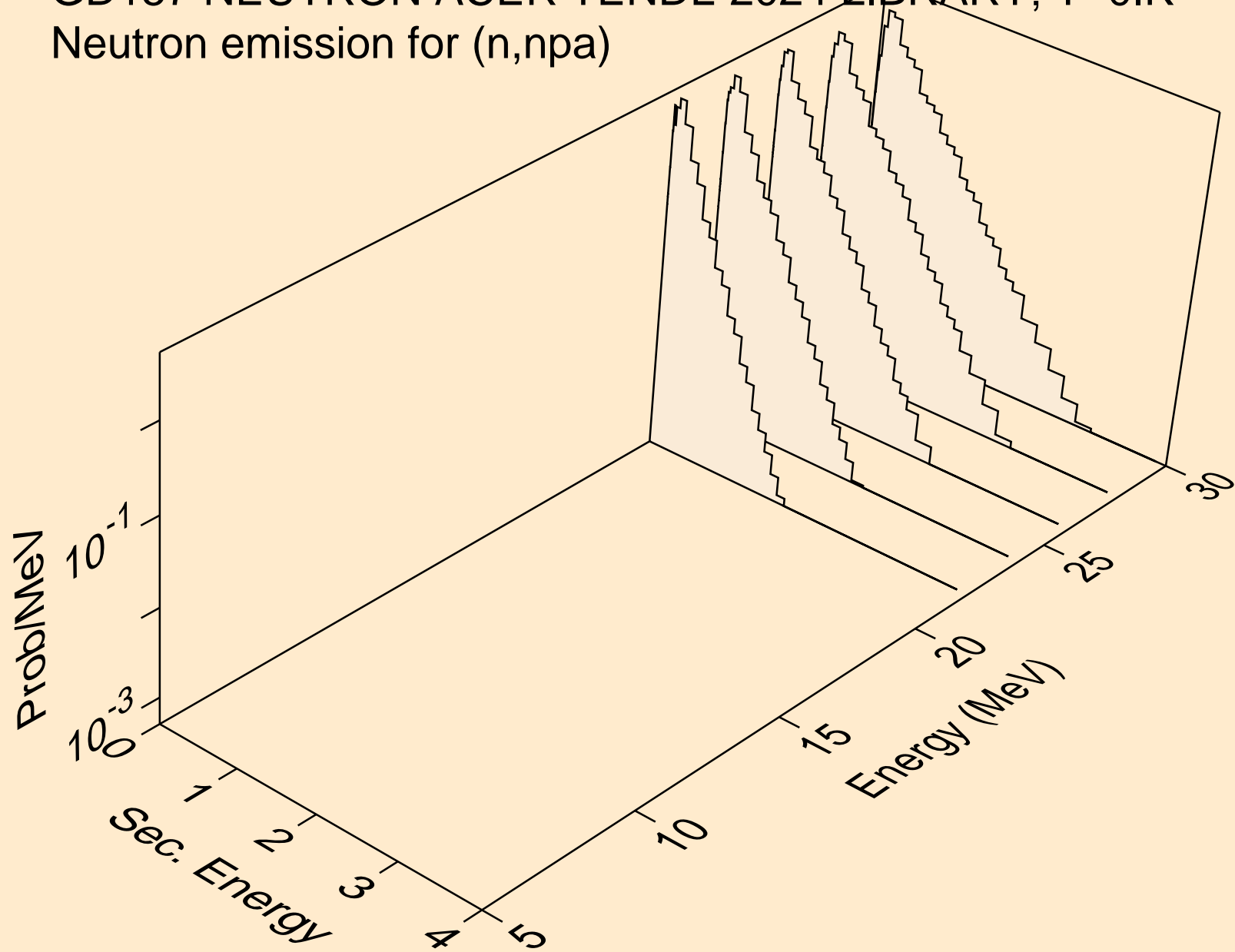

GD157 NEUTRON ACER TENDL-2024 LIBRARY; T=0.K  
Neutron emission for (n,n\*c)

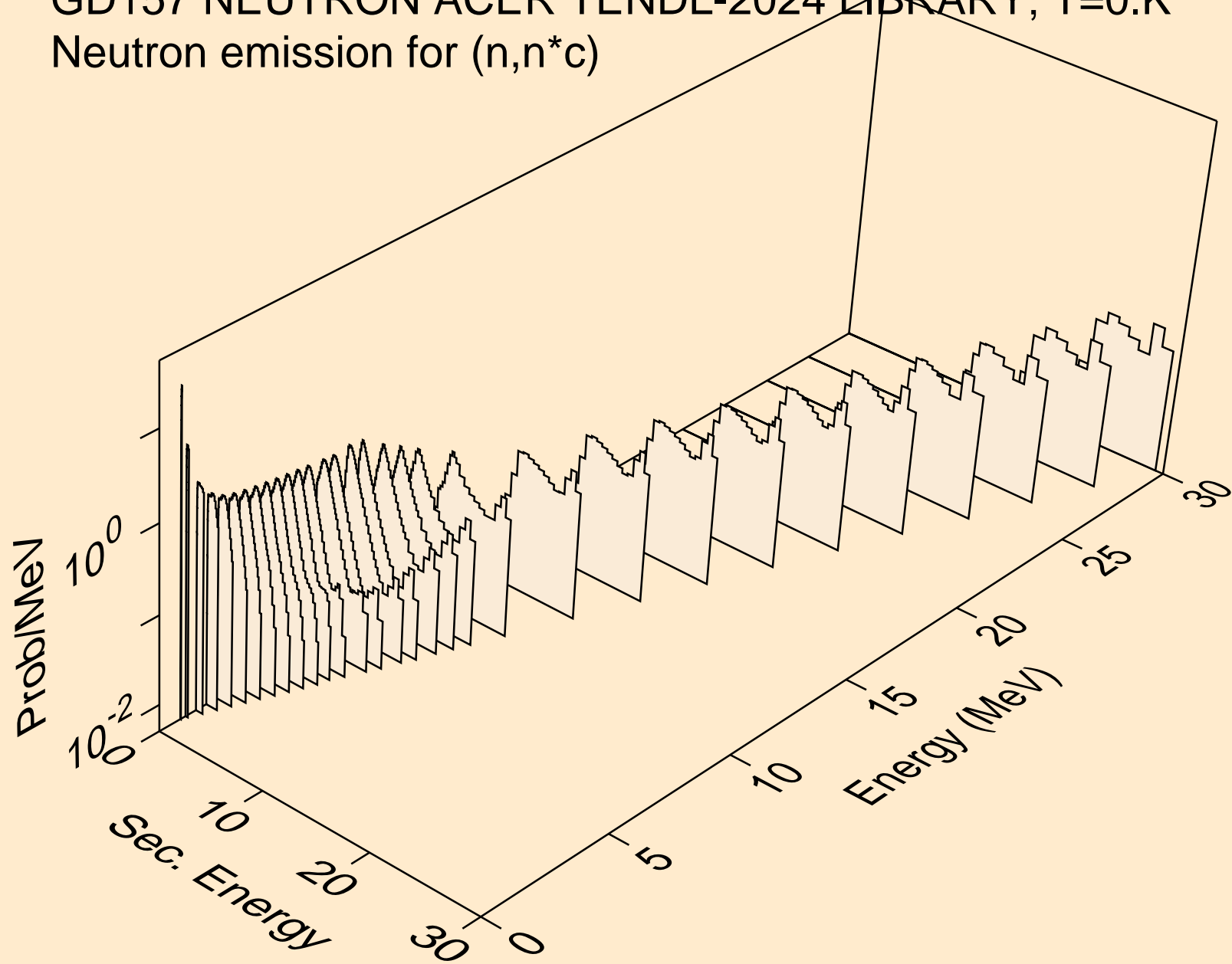

GD157 NEUTRON ACER TENDL-2024 LIBRARY; T=0.K  
Photon emission for (n,x)

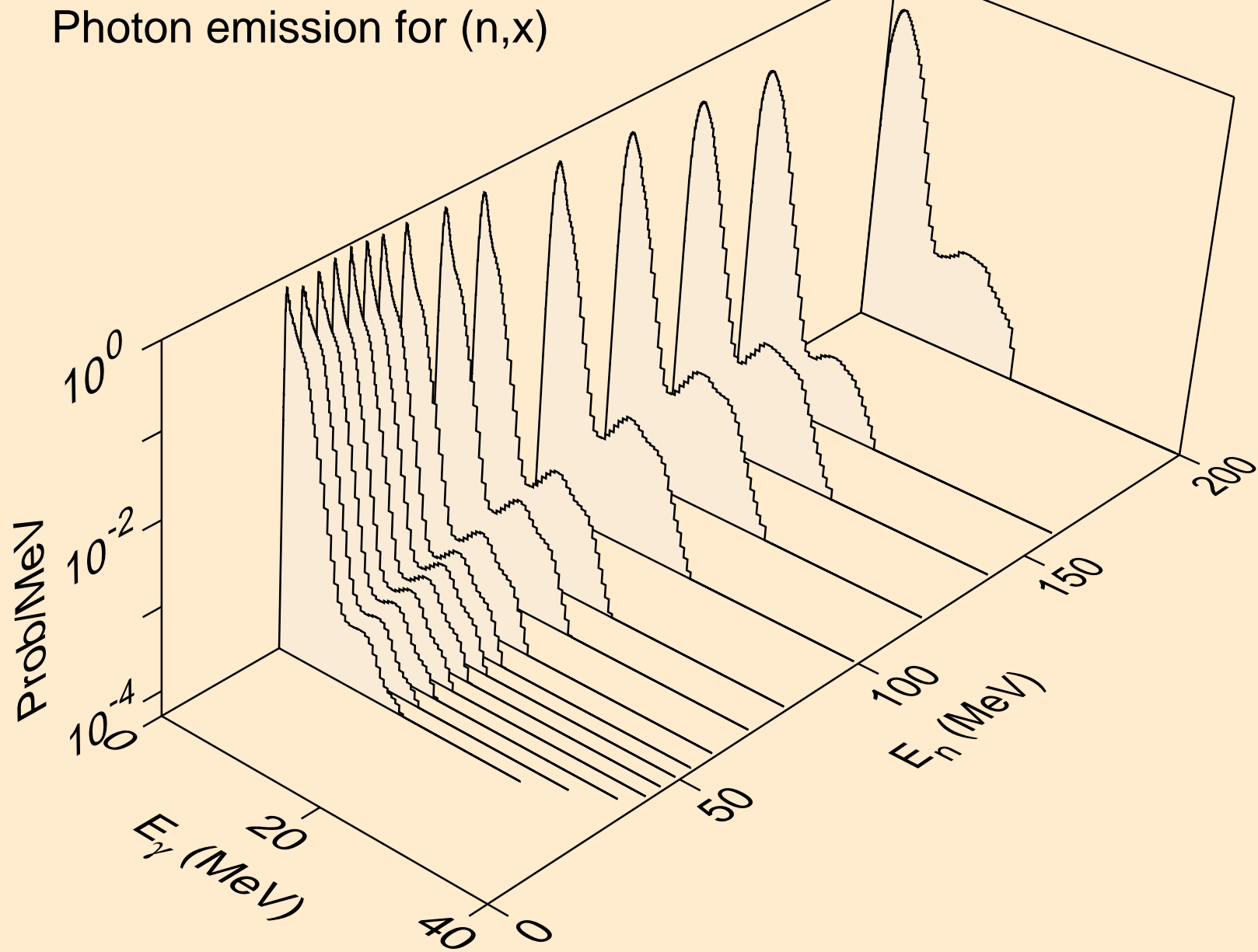

GD157 NEUTRON ACER TENDL-2024 LIBRARY; T=0.K  
Photon emission for (n,2nd)

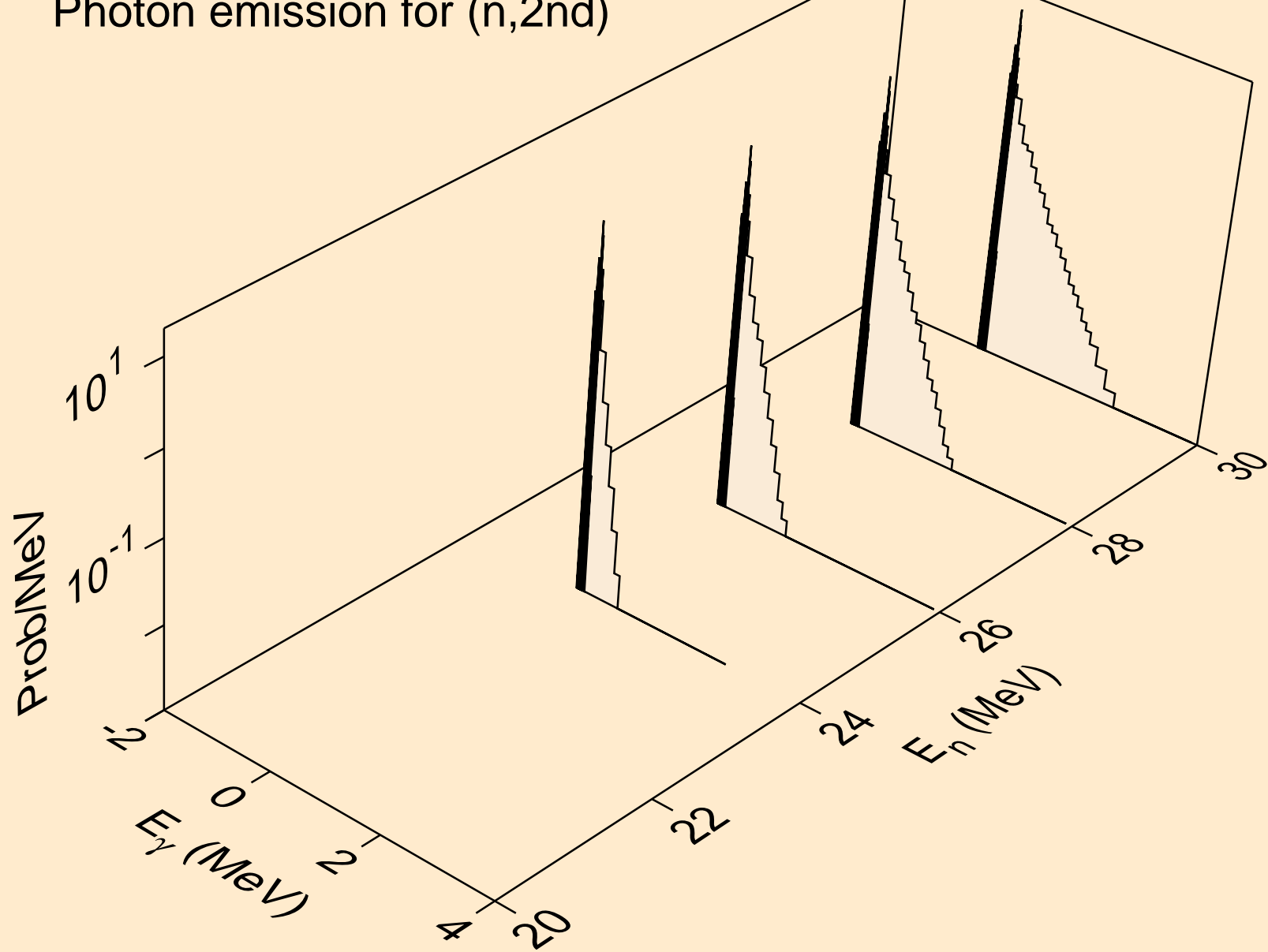



GD157 NEUTRON ACER TENDL-2024 LIBRARY; T=0.K  
Photon emission for (n,2n)

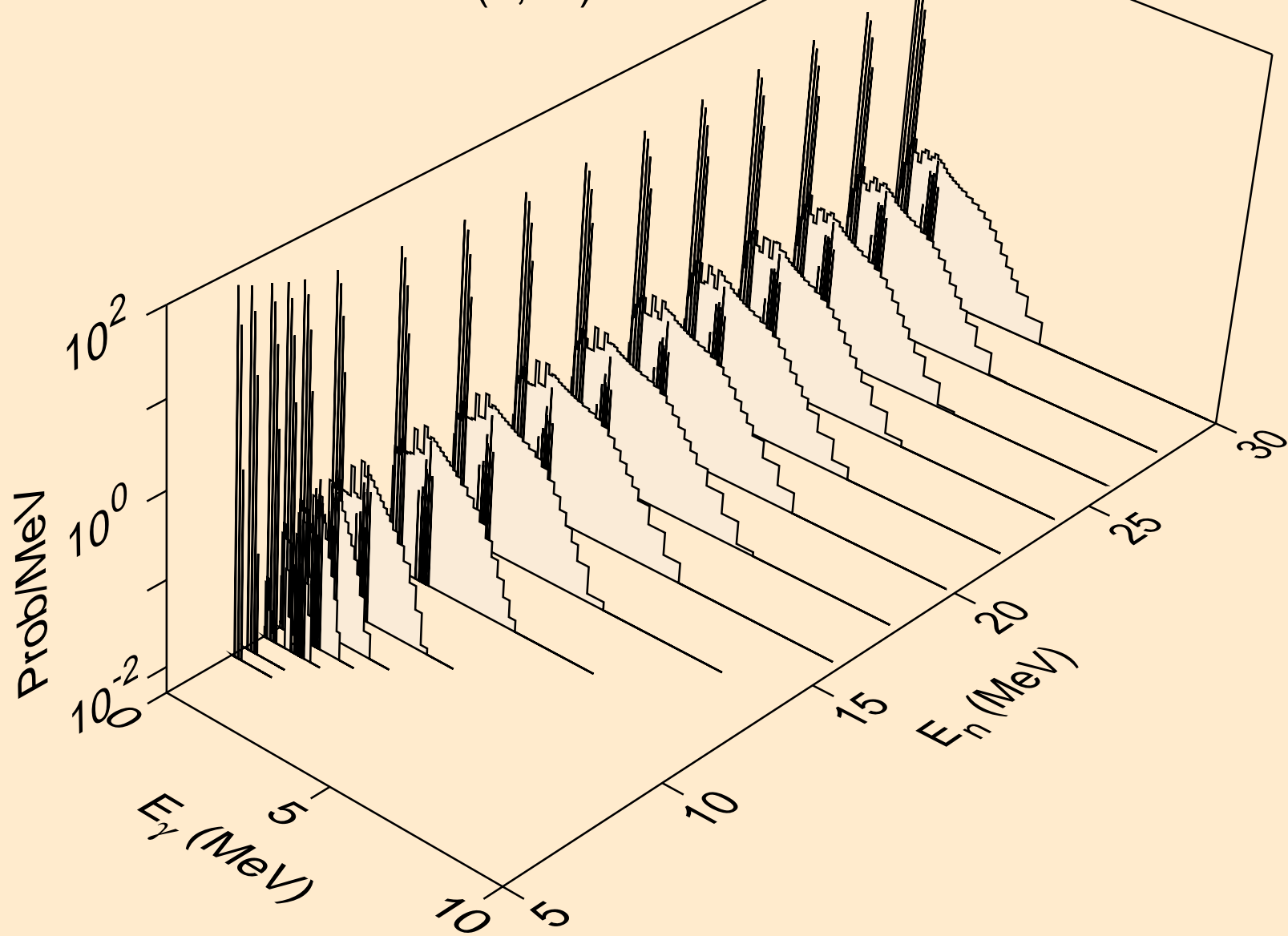

GD157 NEUTRON ACER TENDL-2024 LIBRARY; T=0.K  
Photon emission for (n,3n)

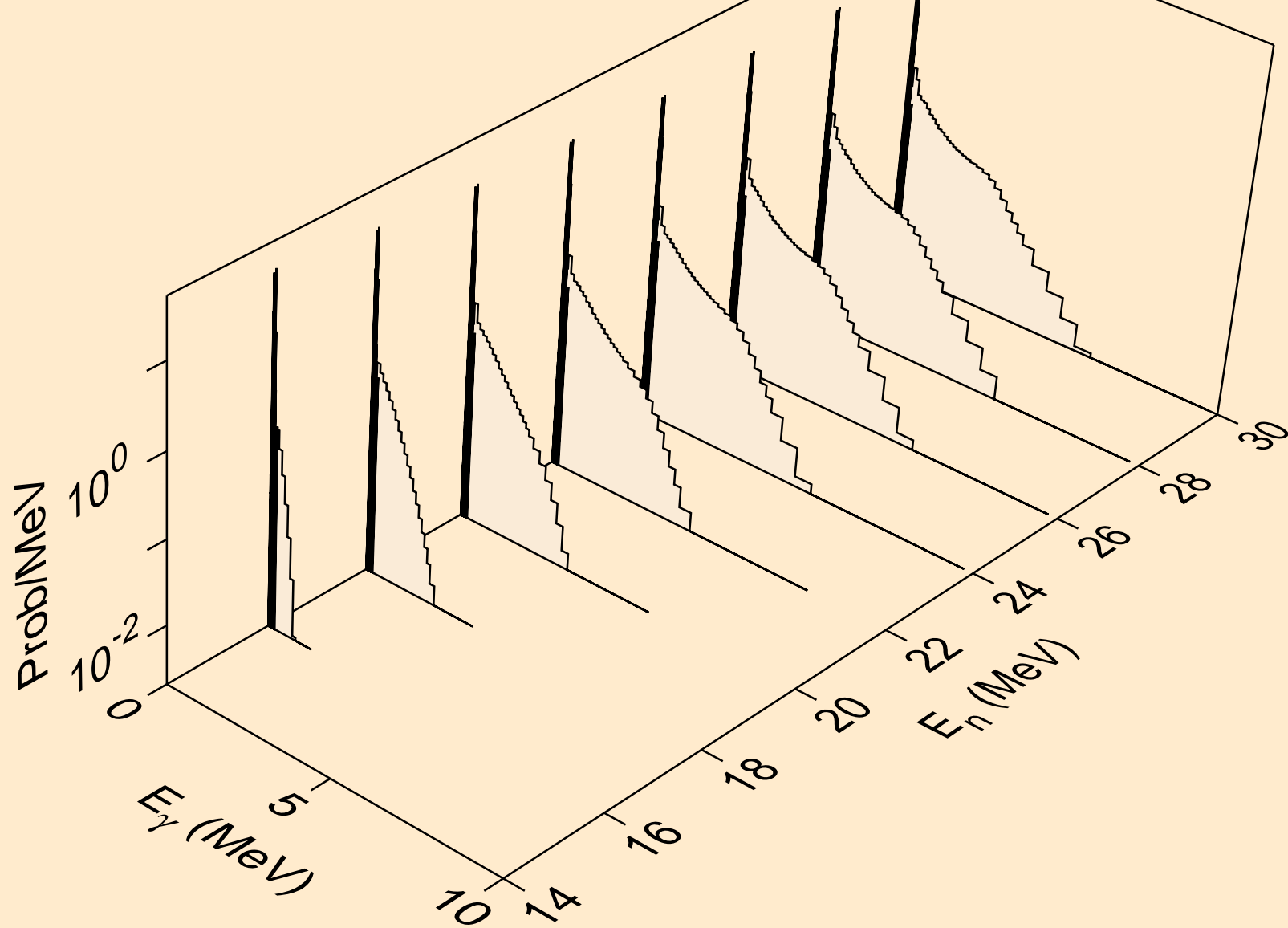

GD157 NEUTRON ACER TENDL-2024 LIBRARY; T=0.K  
Photon emission for (n,n\*)a

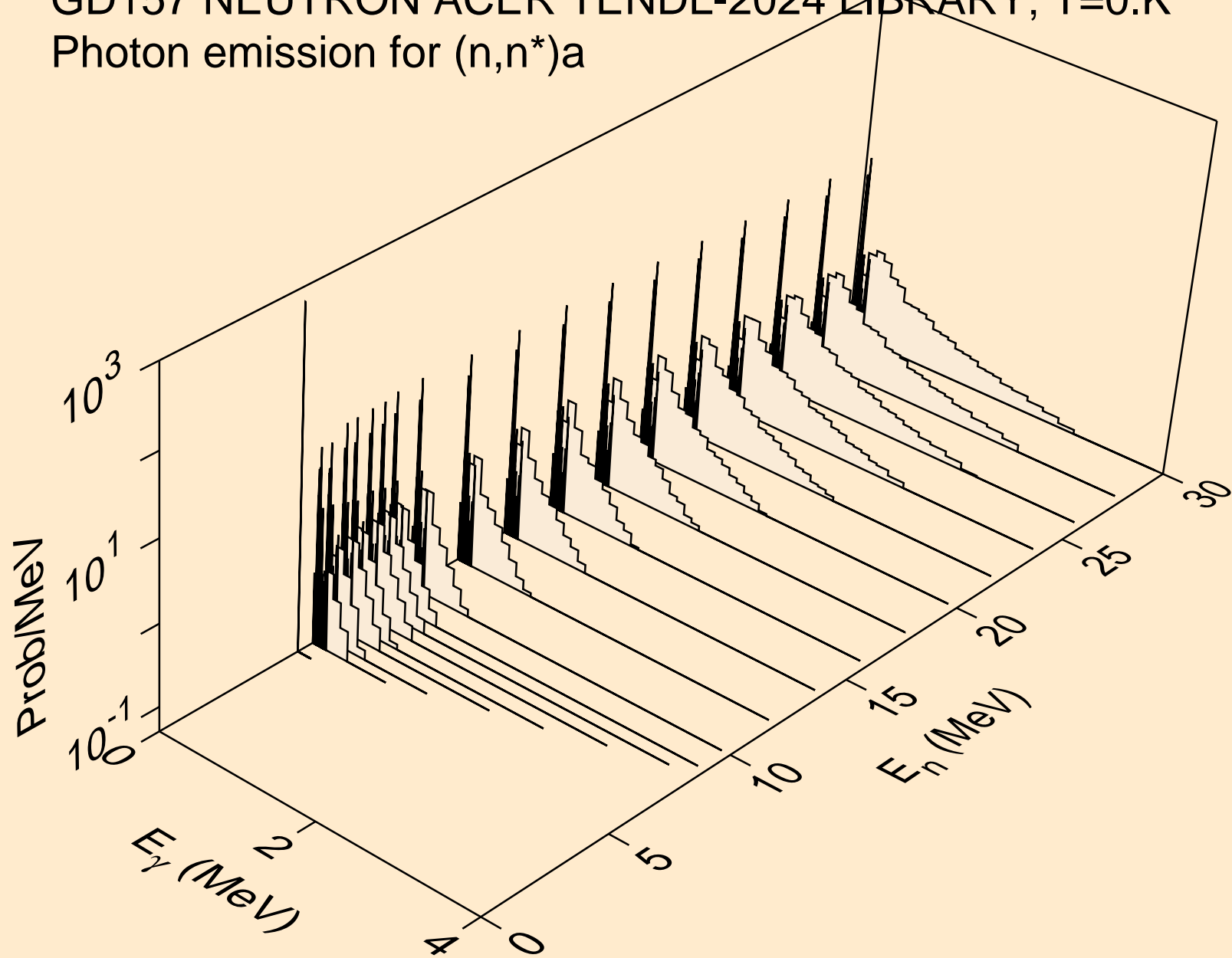

GD157 NEUTRON ACER TENDL-2024 LIBRARY; T=0.K  
Photon emission for (n,2n)a

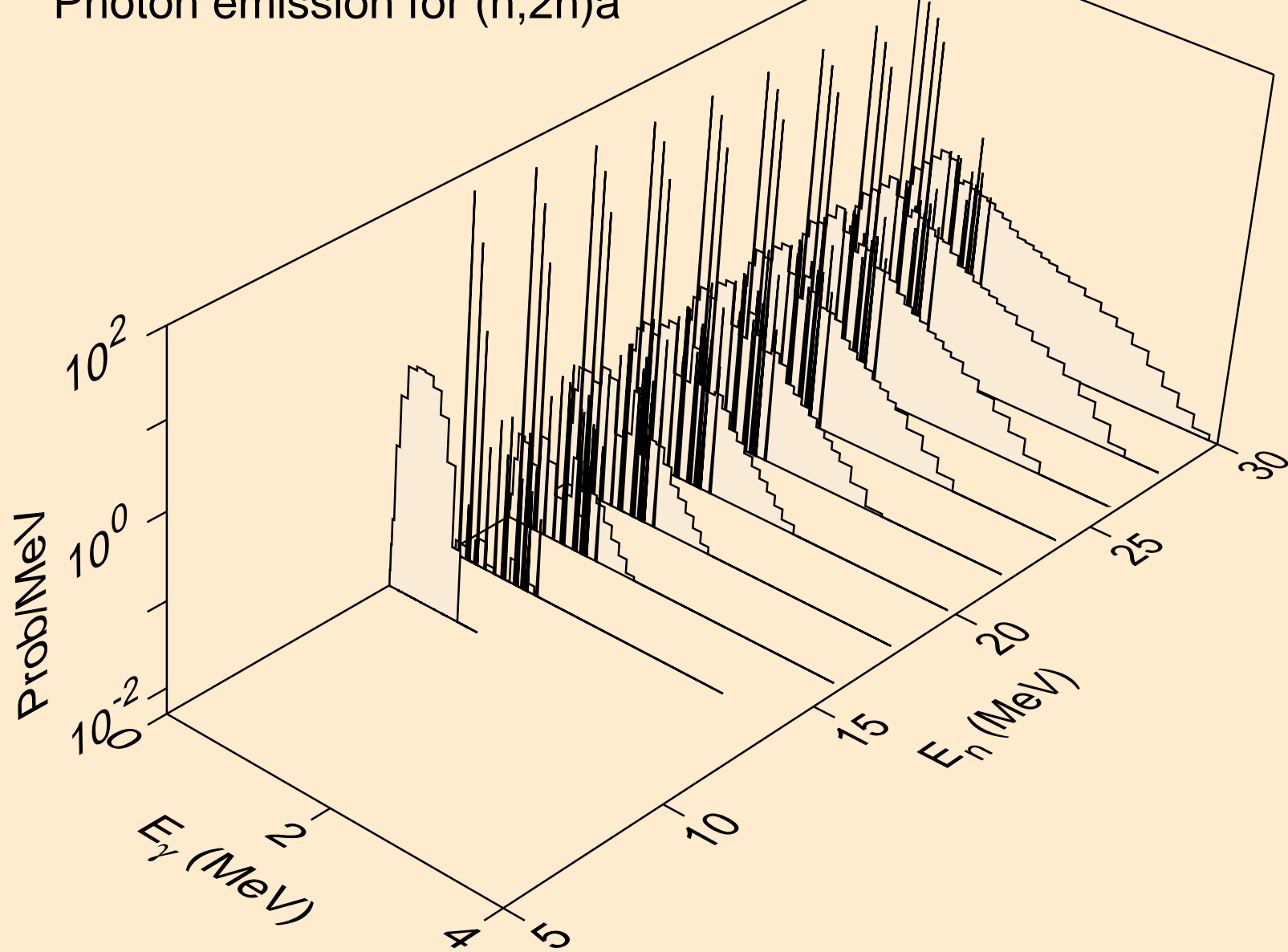

GD157 NEUTRON ACER TENDL-2024 LIBRARY; T=0.K  
Photon emission for (n,3n)a

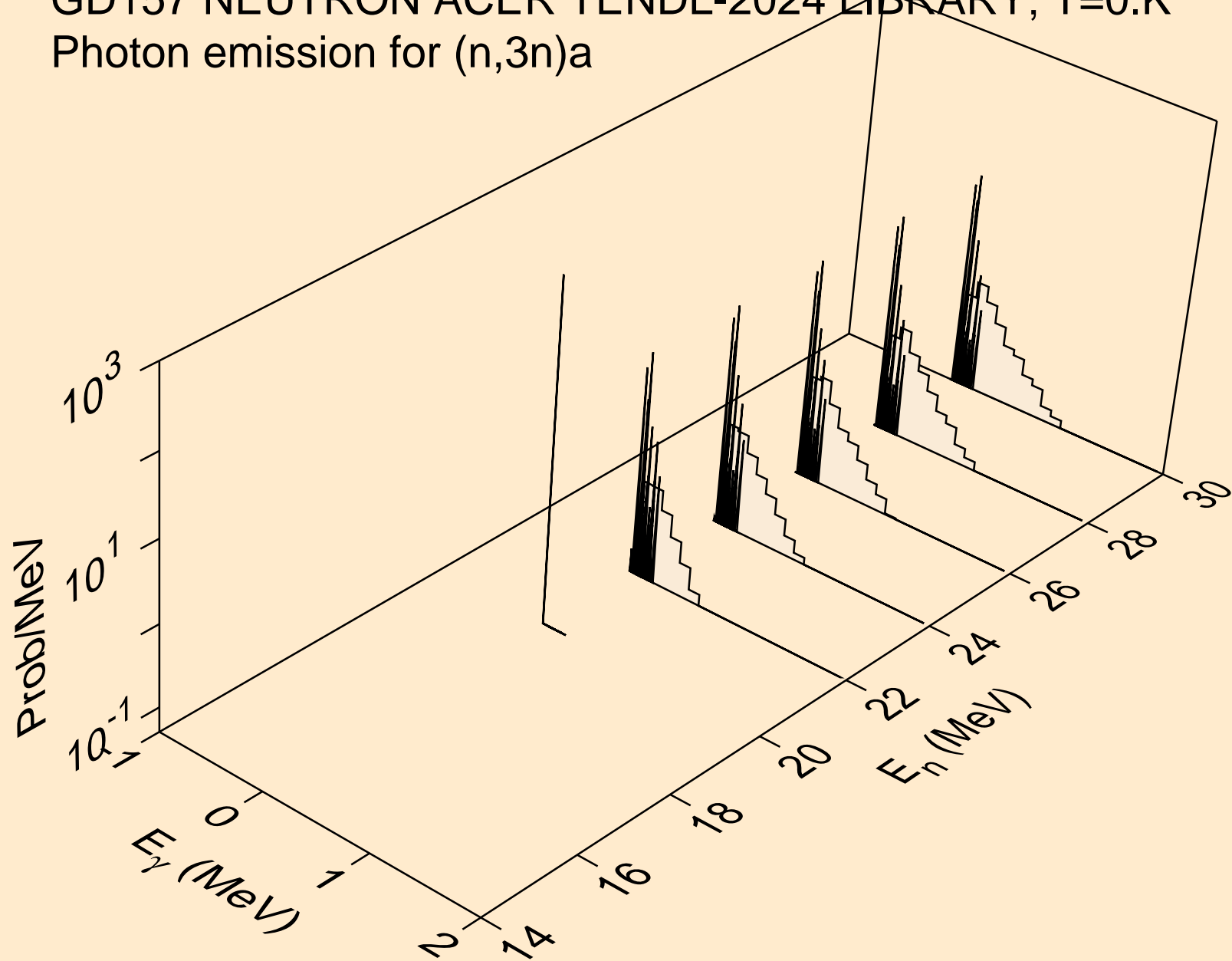

GD157 NEUTRON ACER TENDL-2024 LIBRARY; T=0.K  
Photon emission for (n,n\*)p

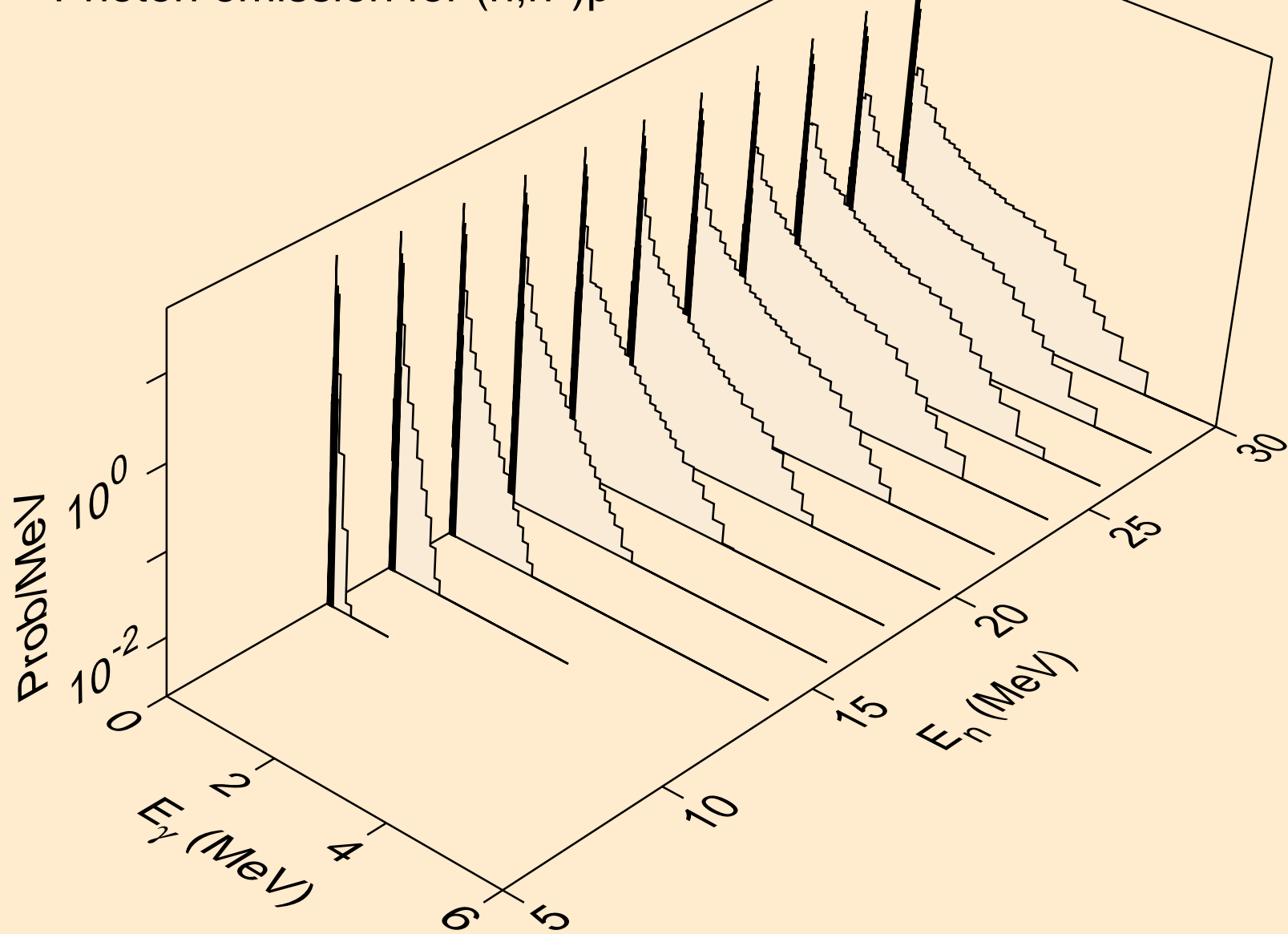

GD157 NEUTRON ACER TENDL-2024 LIBRARY; T=0.K  
Photon emission for (n,n\*)2a

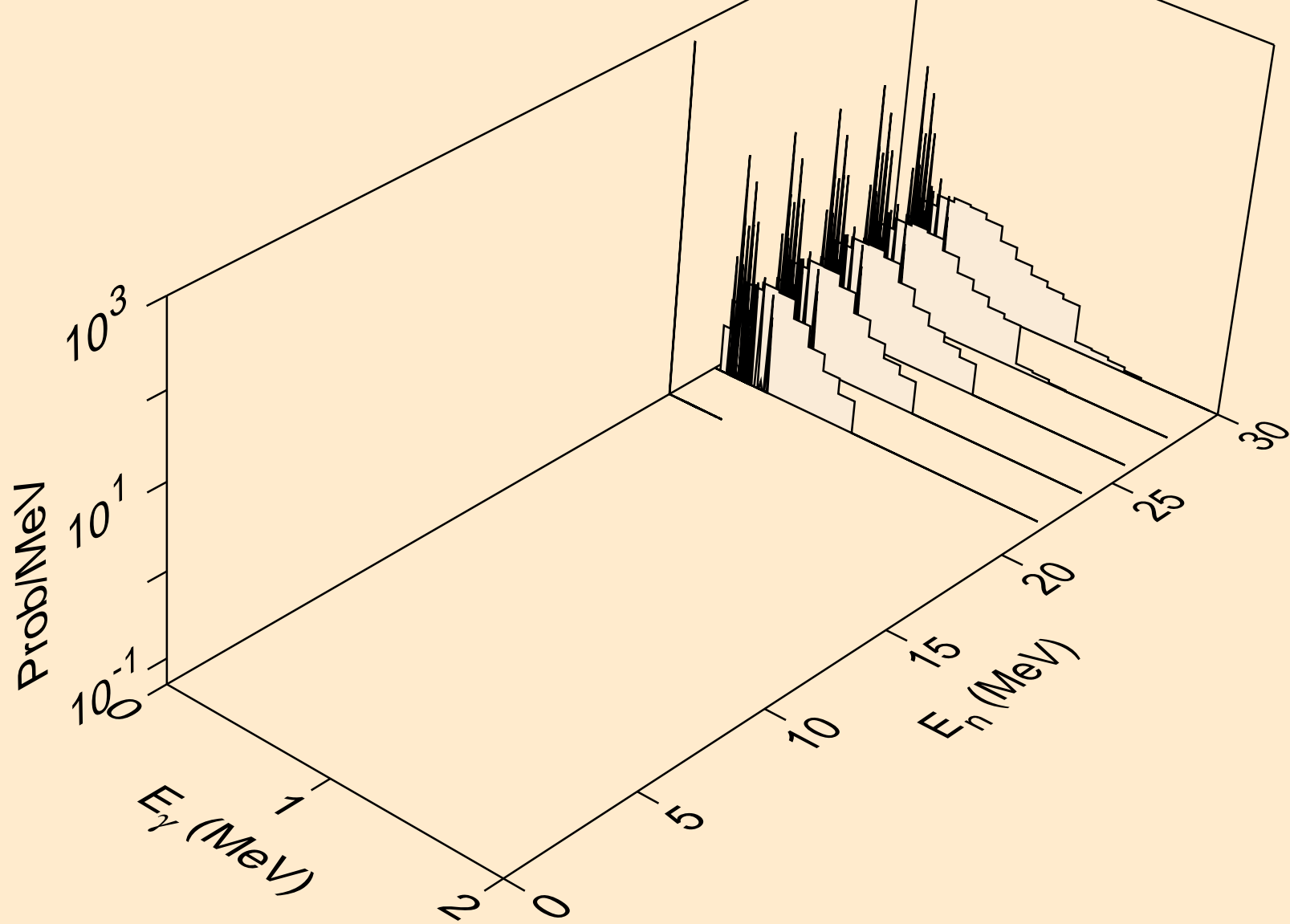

GD157 NEUTRON ACER TENDL-2024 LIBRARY; T=0.K  
Photon emission for (n,n\*)d

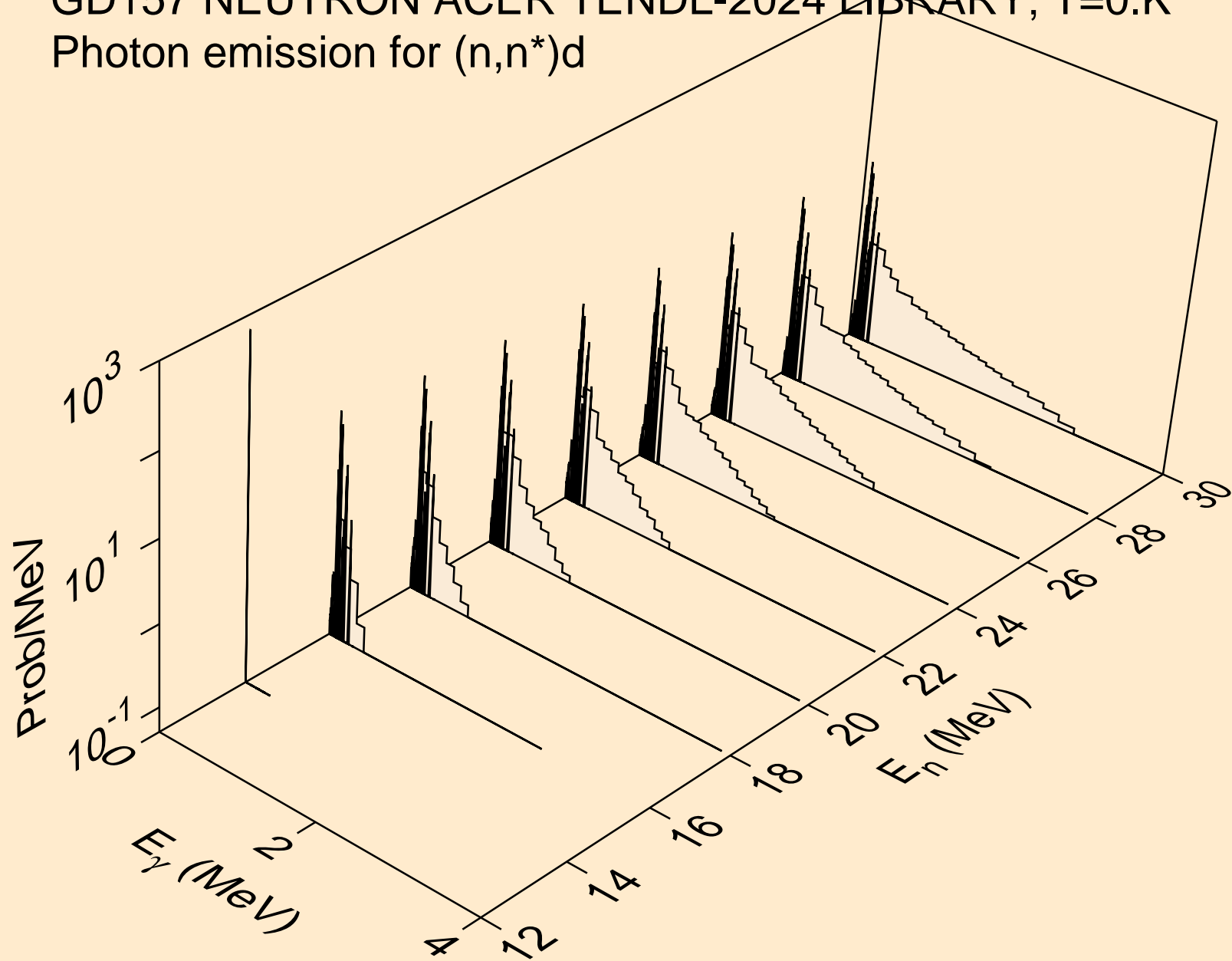



GD157 NEUTRON ACER TENDL-2024 LIBRARY; T=0.K  
Photon emission for (n,n\*)t

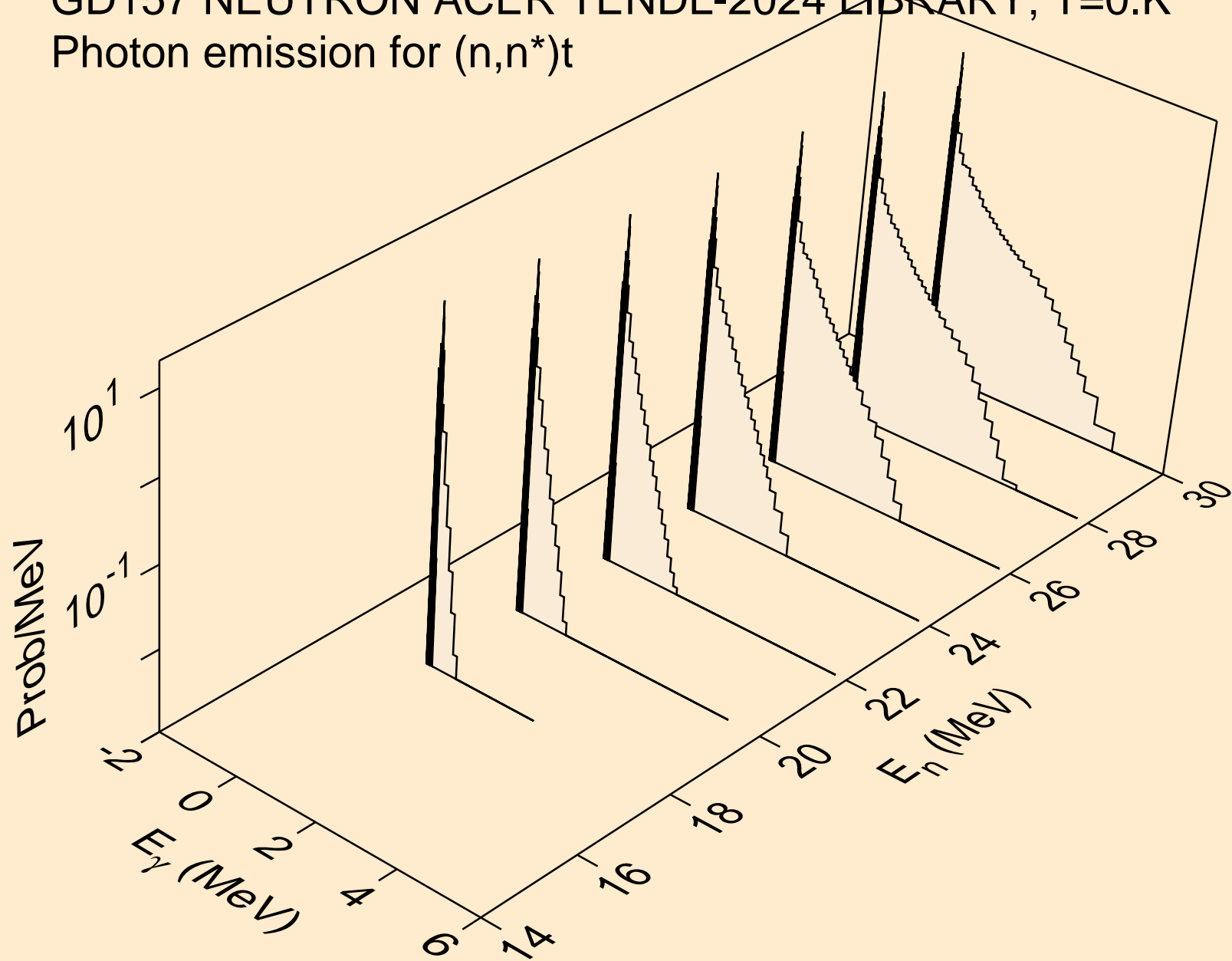

GD157 NEUTRON ACER TENDL-2024 LIBRARY; T=0.K  
Photon emission for (n,n\*)he3

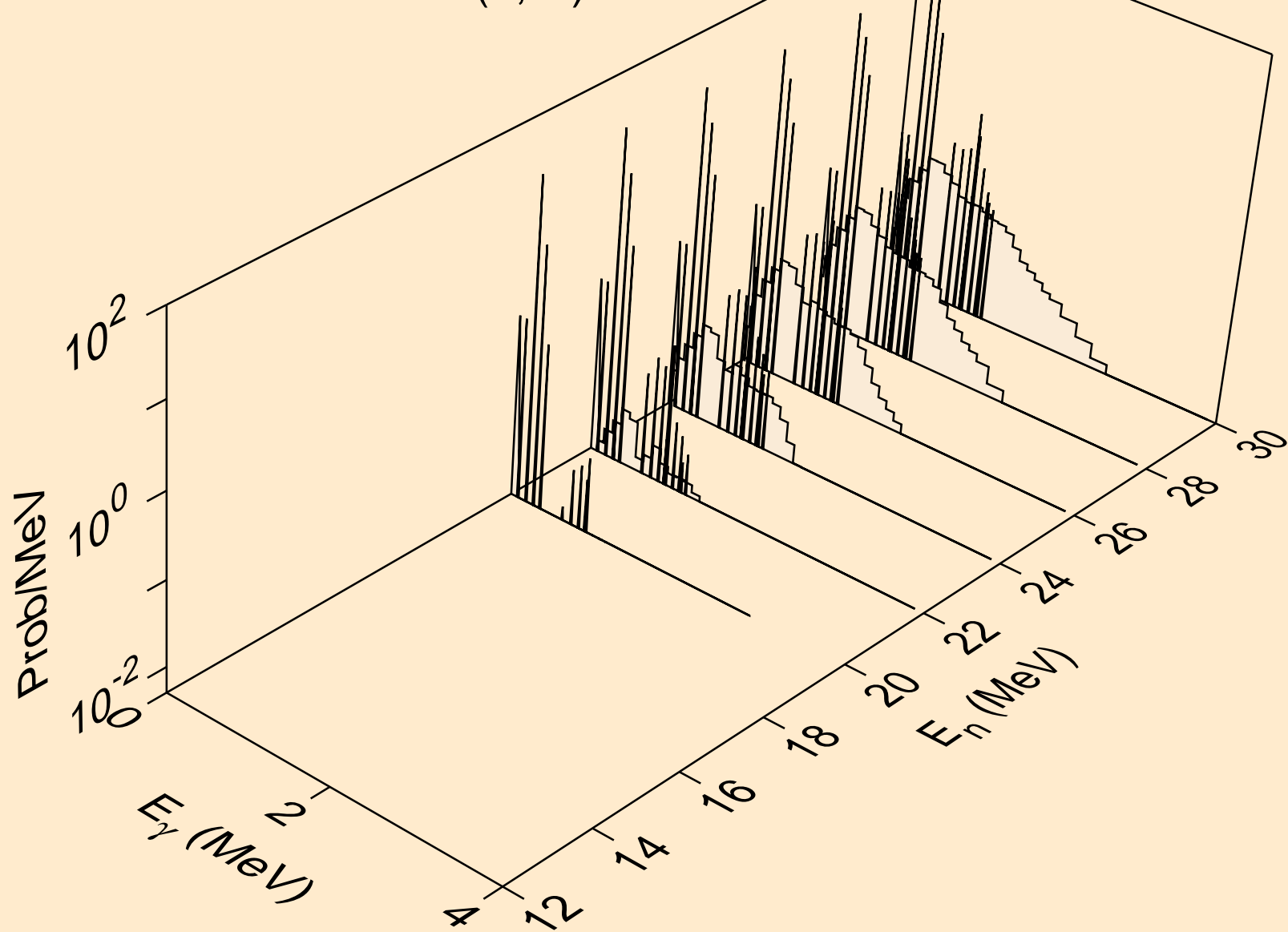

GD157 NEUTRON ACER TENDL-2024 LIBRARY; T=0.K  
Photon emission for (n,4n)

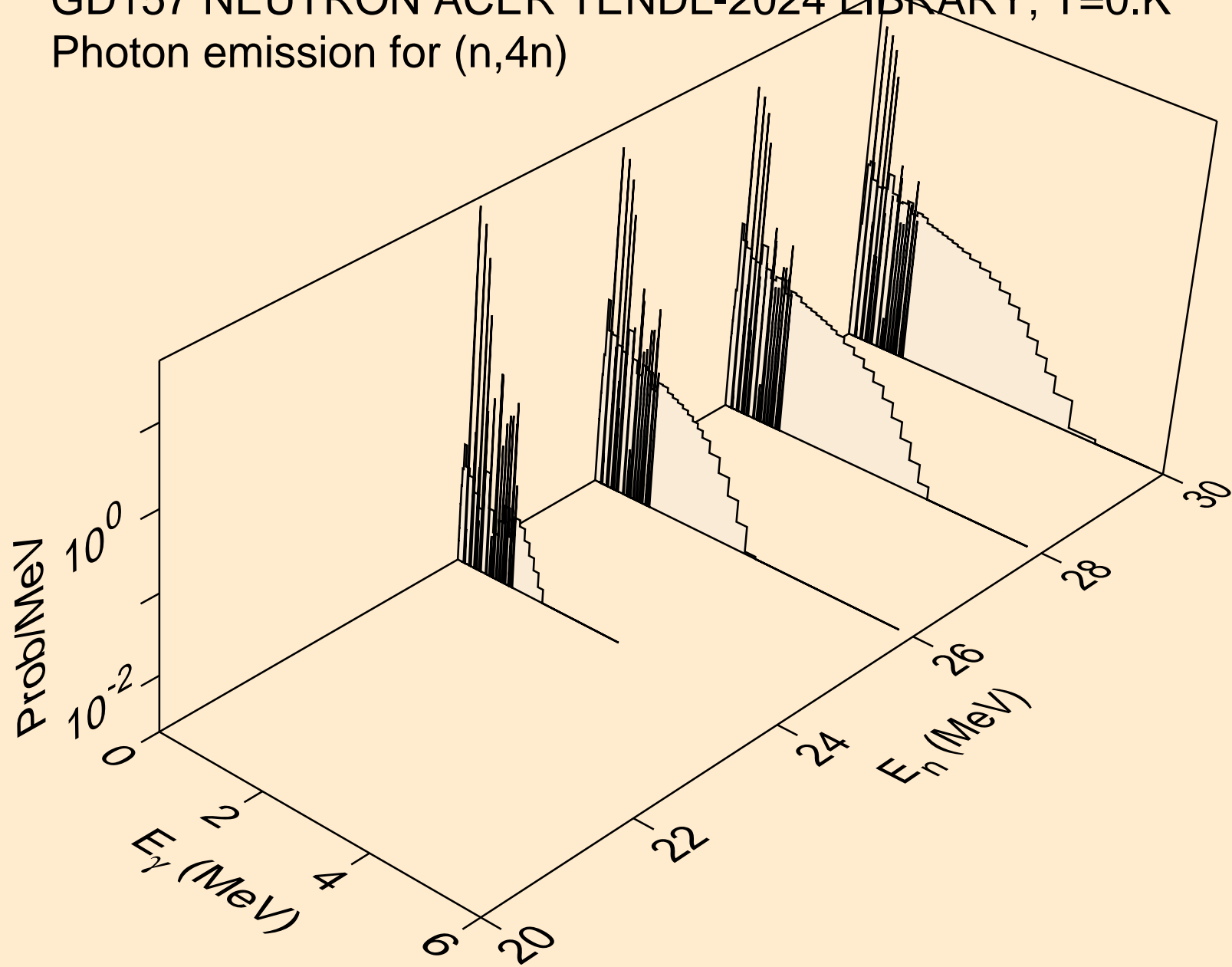

GD157 NEUTRON ACER TENDL-2024 LIBRARY; T=0.K  
Photon emission for (n,2np)

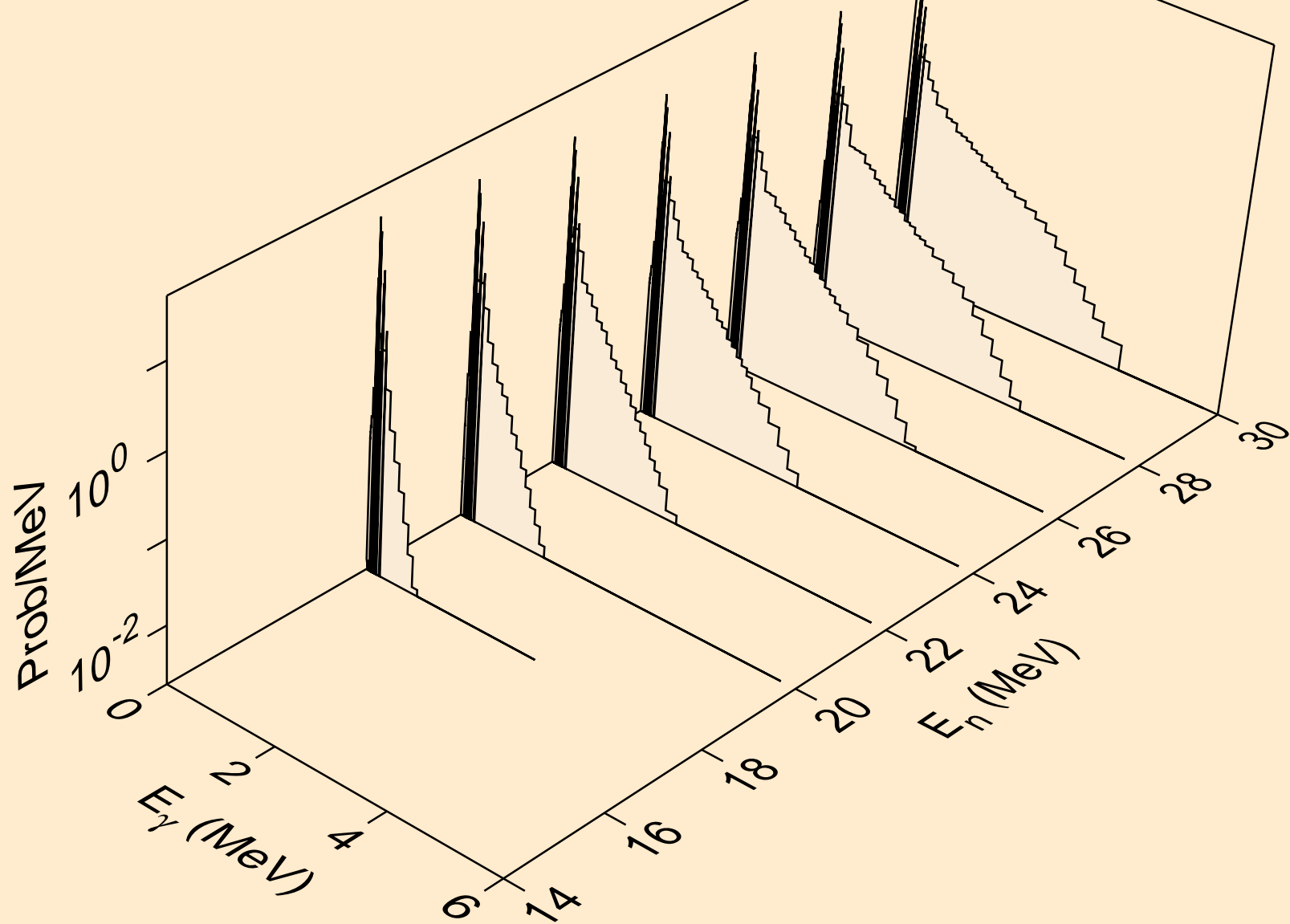

GD157 NEUTRON ACER TENDL-2024 LIBRARY; T=0.K  
Photon emission for (n,3np)

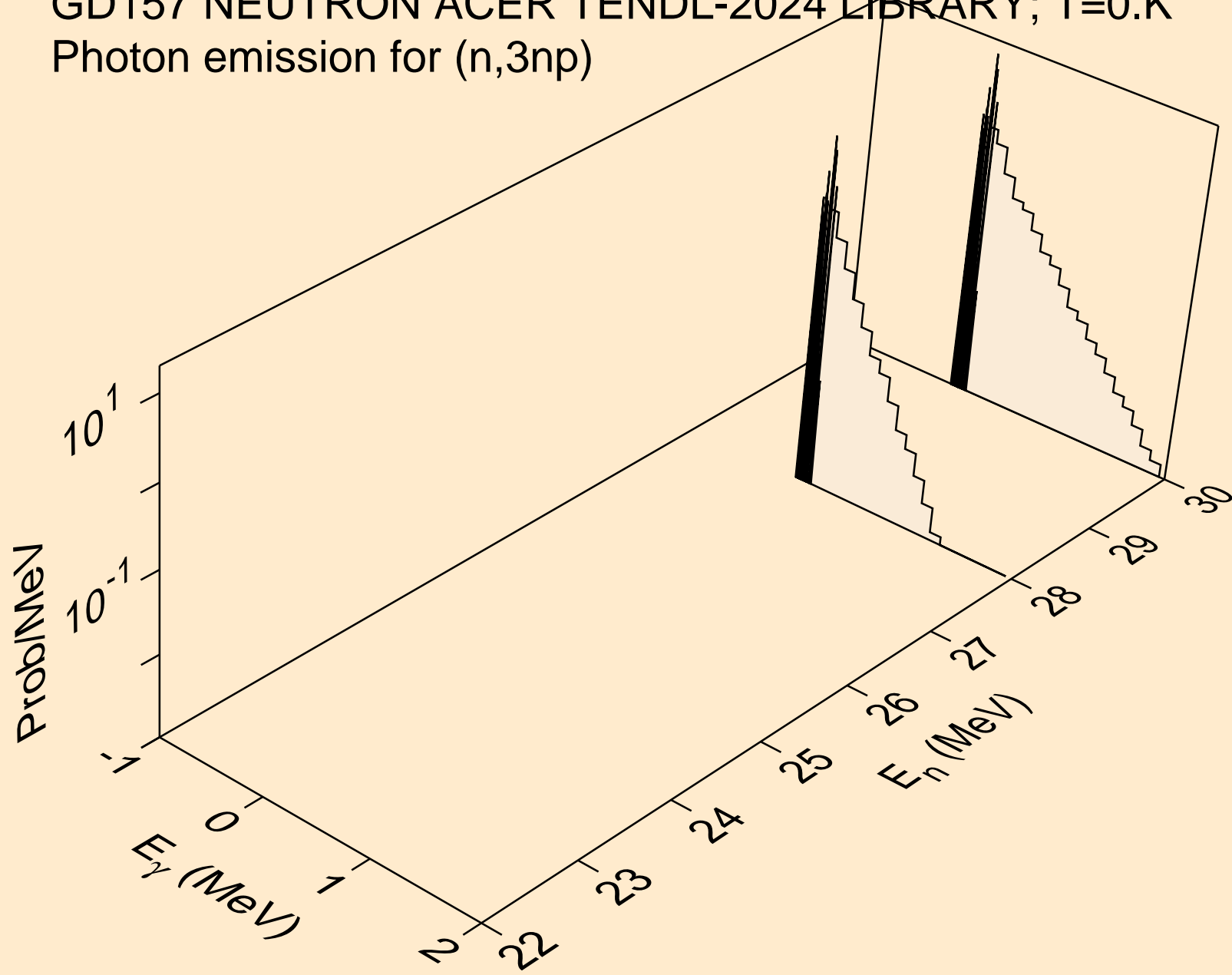

GD157 NEUTRON ACER TENDL-2024 LIBRARY; T=0.K  
Photon emission for (n,n2p)

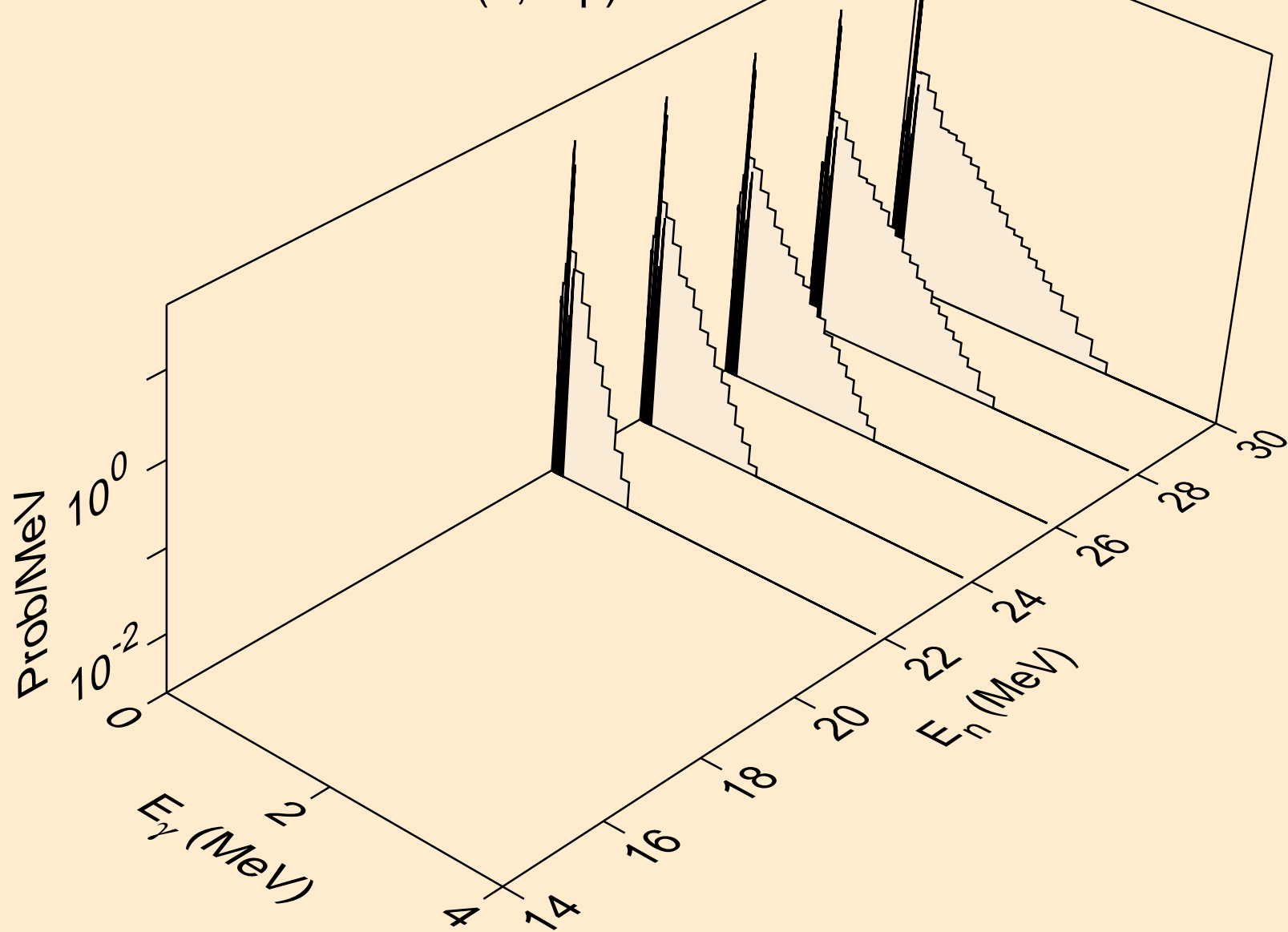

GD157 NEUTRON ACER TENDL-2024 LIBRARY; T=0.K  
Photon emission for (n,npa)

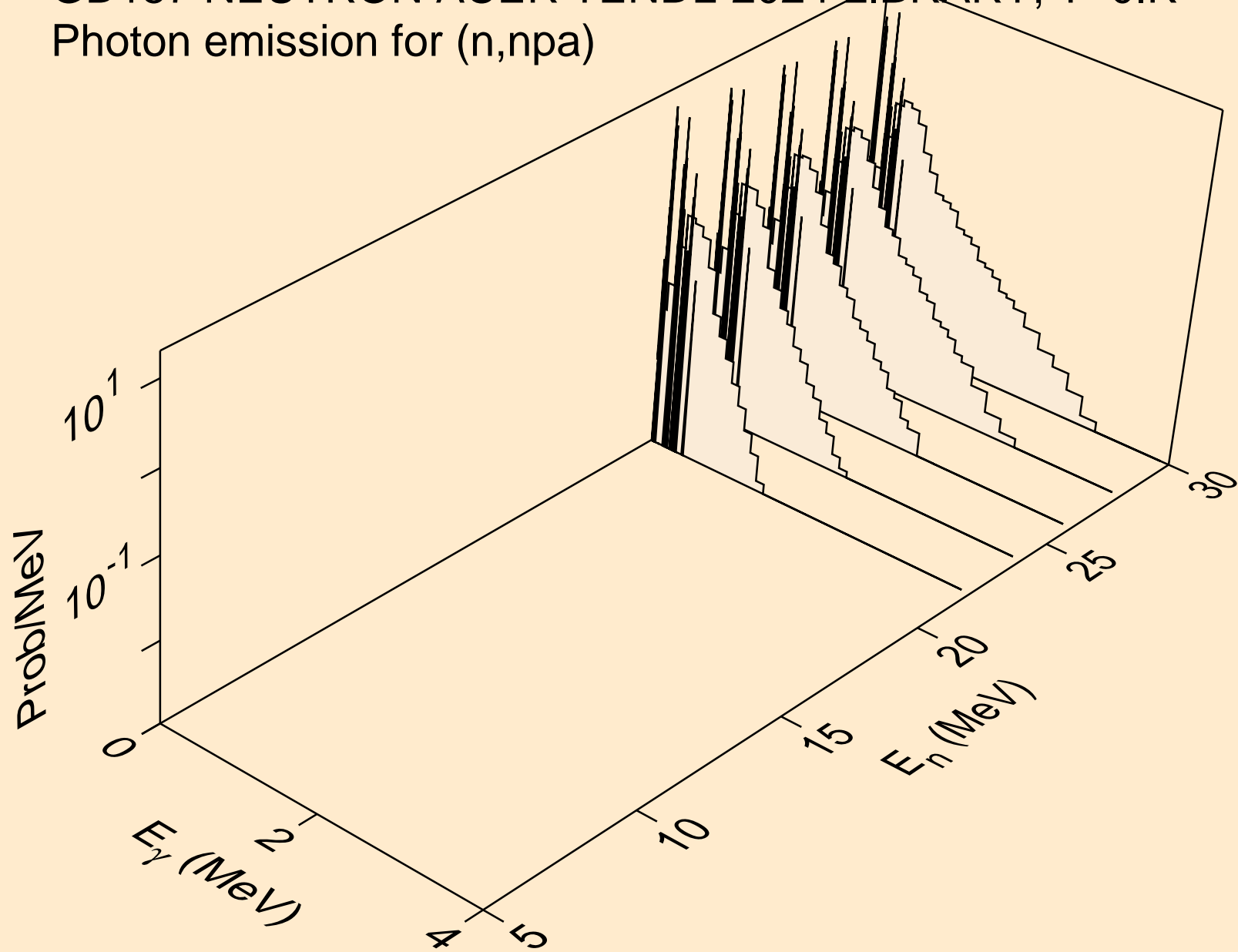

GD157 NEUTRON ACER TENDL-2024 LIBRARY; T=0.K  
Photon emission for (n,n\*c)

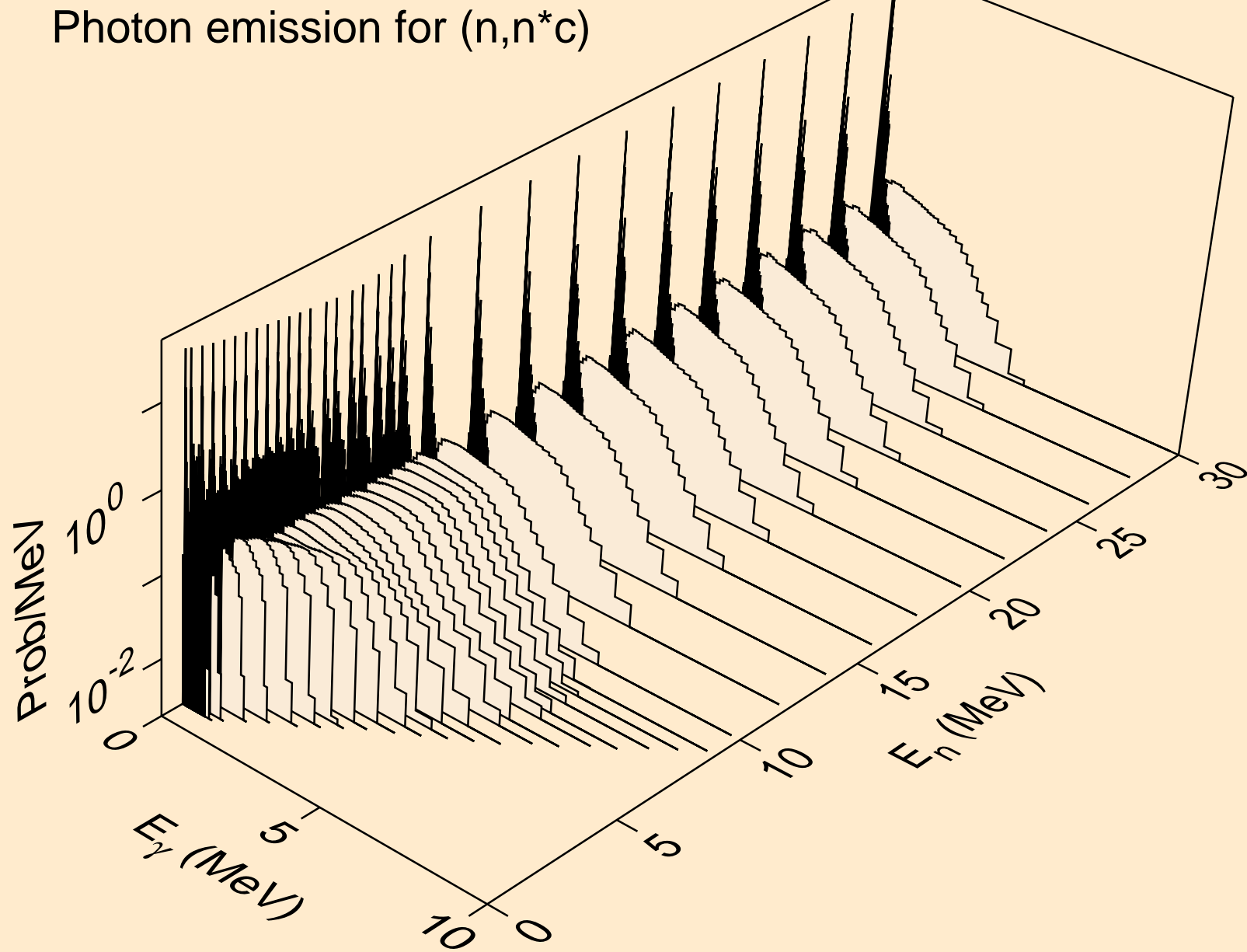



GD157 NEUTRON ACER TENDL-2024 LIBRARY; T=0.K  
Photon emission for (n,gma)

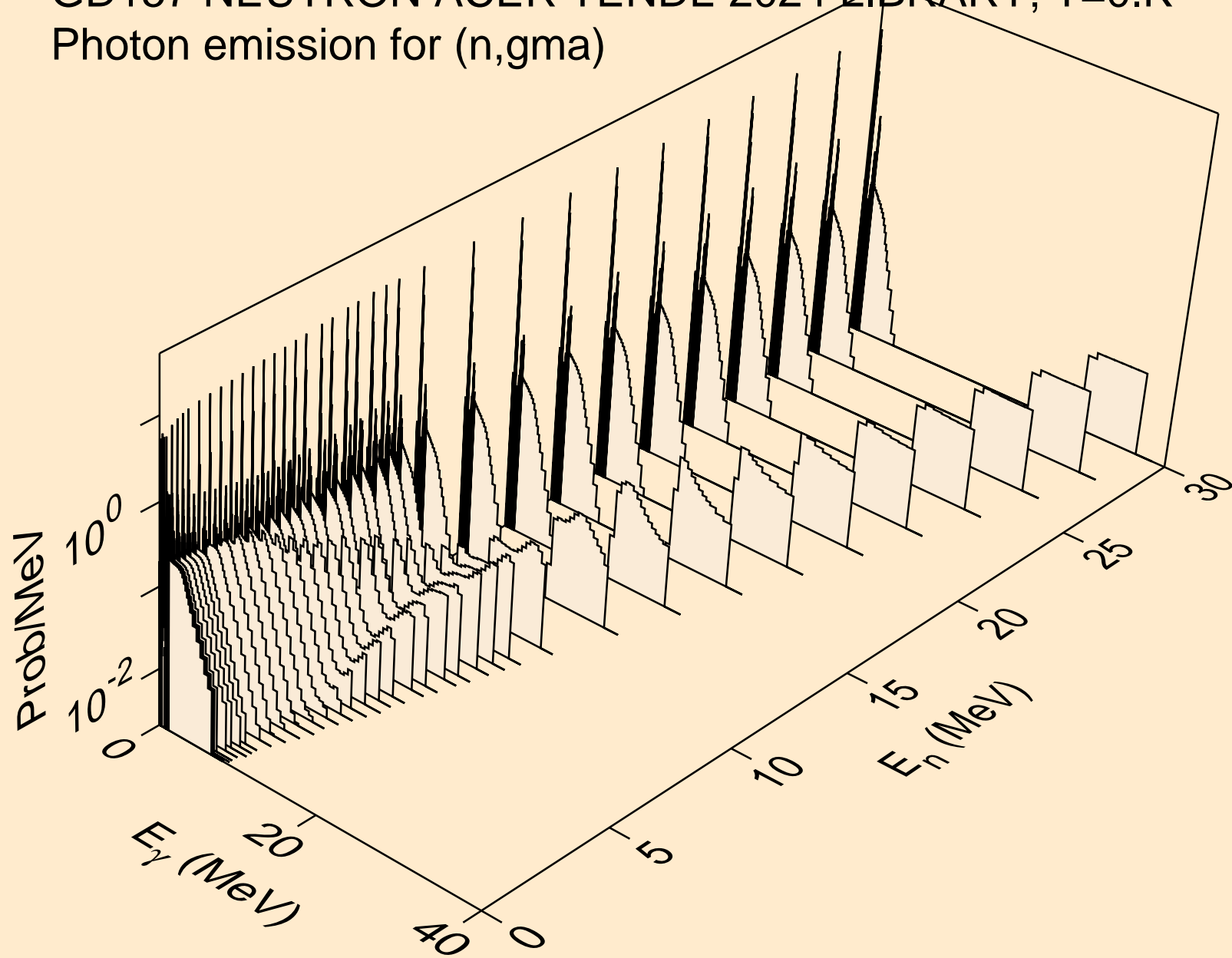

GD157 NEUTRON ACER TENDL-2024 LIBRARY; T=0.K  
Photon emission for (n,p)

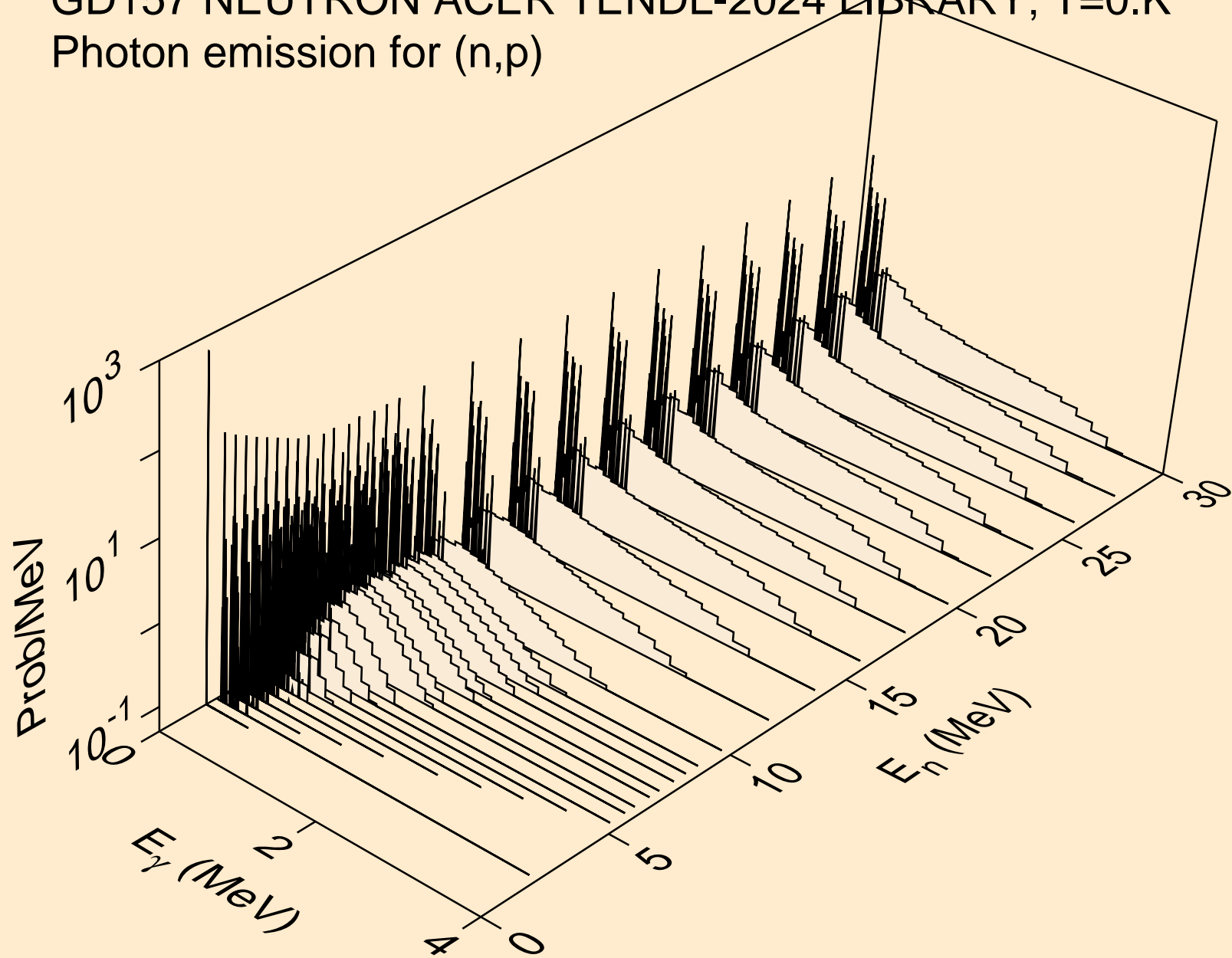

GD157 NEUTRON ACER TENDL-2024 LIBRARY; T=0.K  
Photon emission for (n,d)

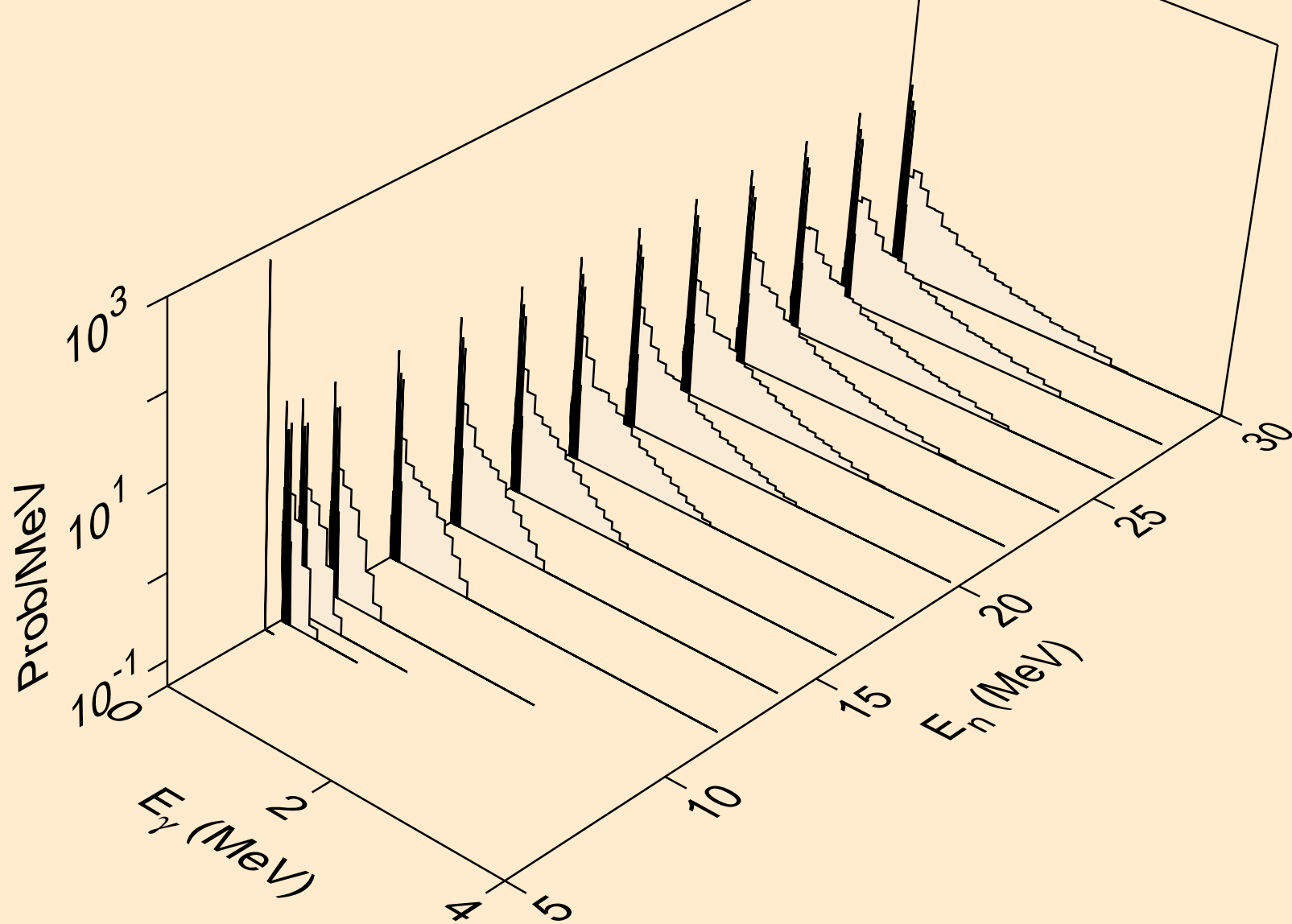

GD157 NEUTRON ACER TENDL-2024 LIBRARY; T=0.K  
Photon emission for (n,t)

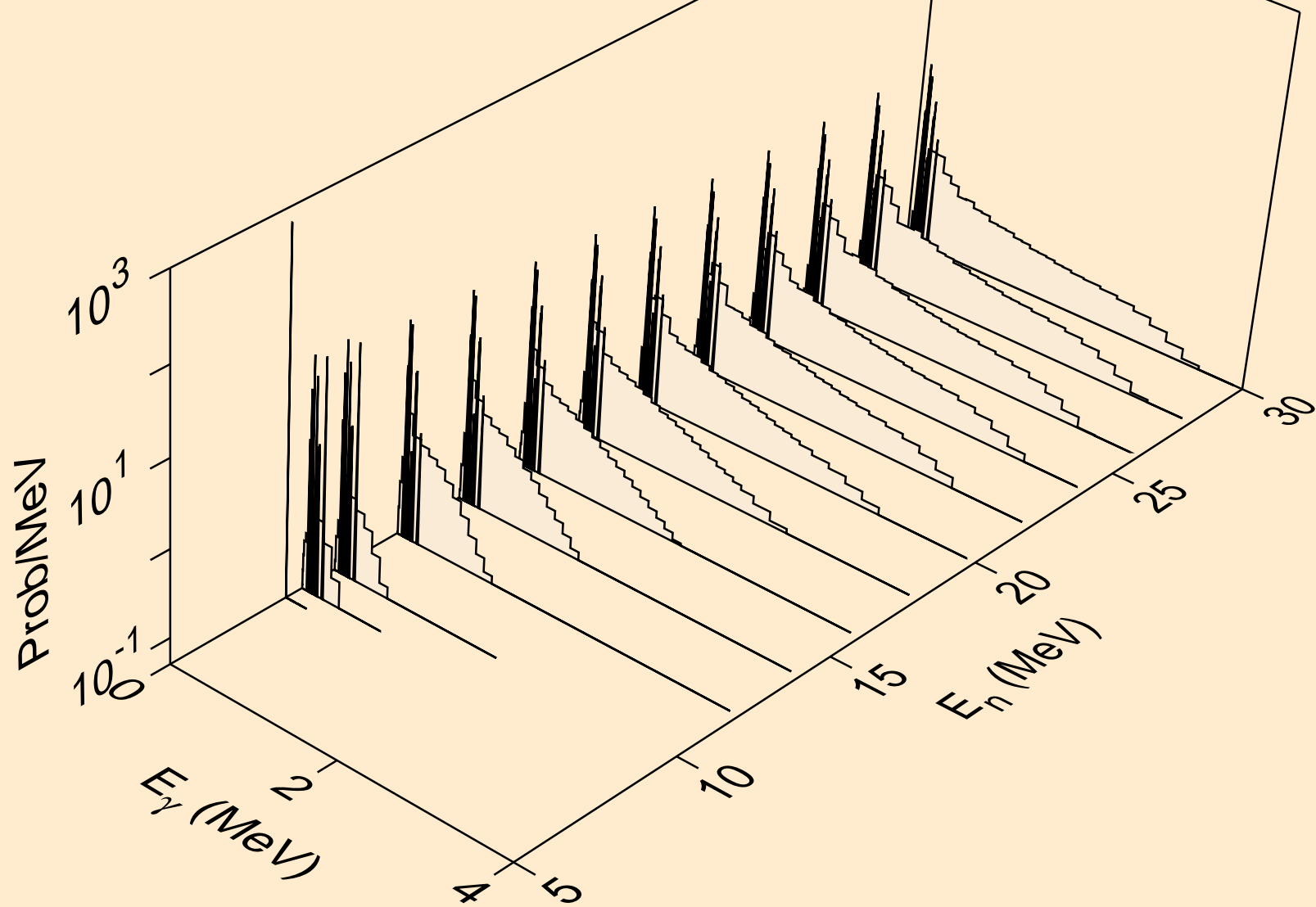

GD157 NEUTRON ACER TENDL-2024 LIBRARY; T=0.K  
Photon emission for (n,he3)

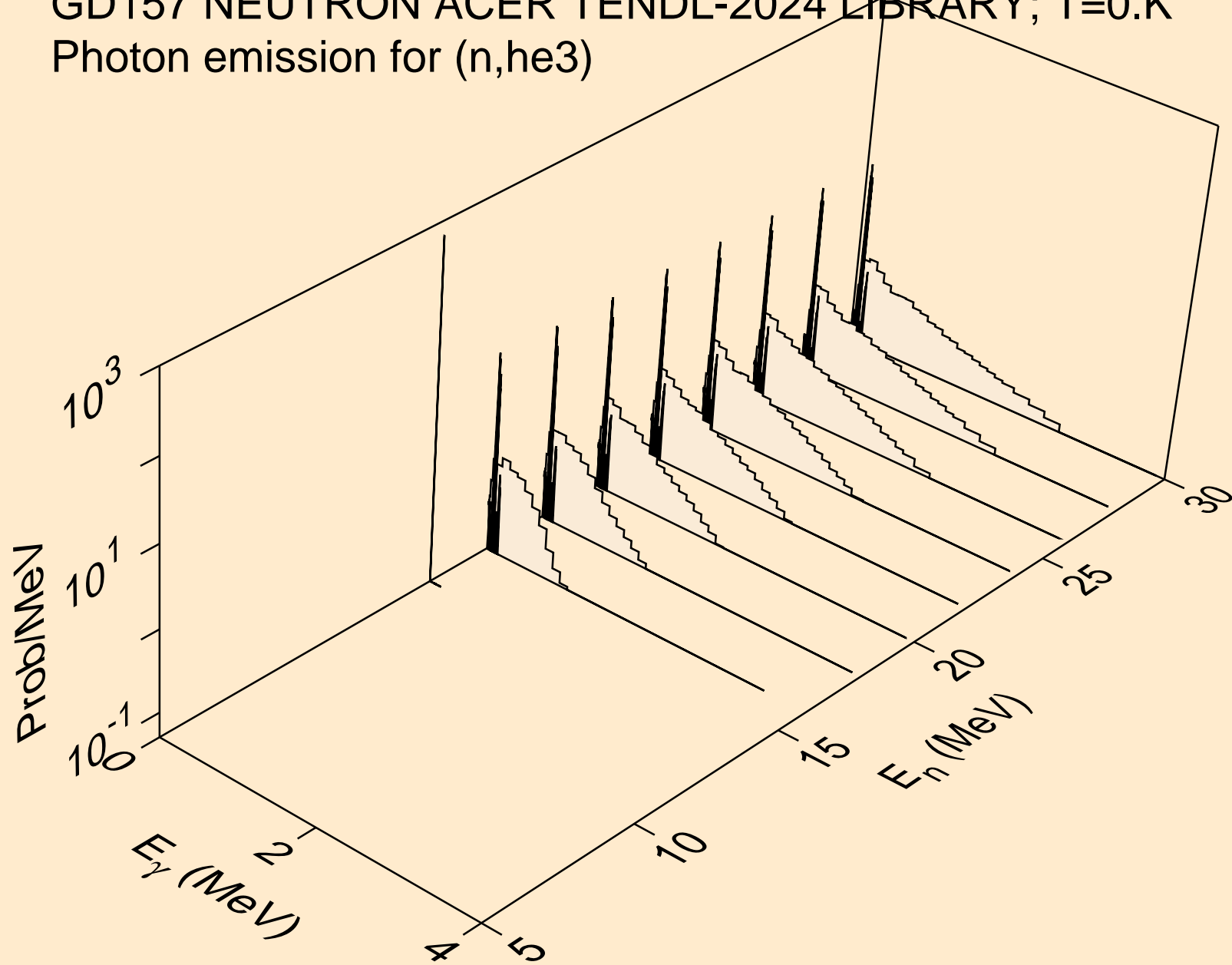

GD157 NEUTRON ACER TENDL-2024 LIBRARY; T=0.K  
Photon emission for (n,a)

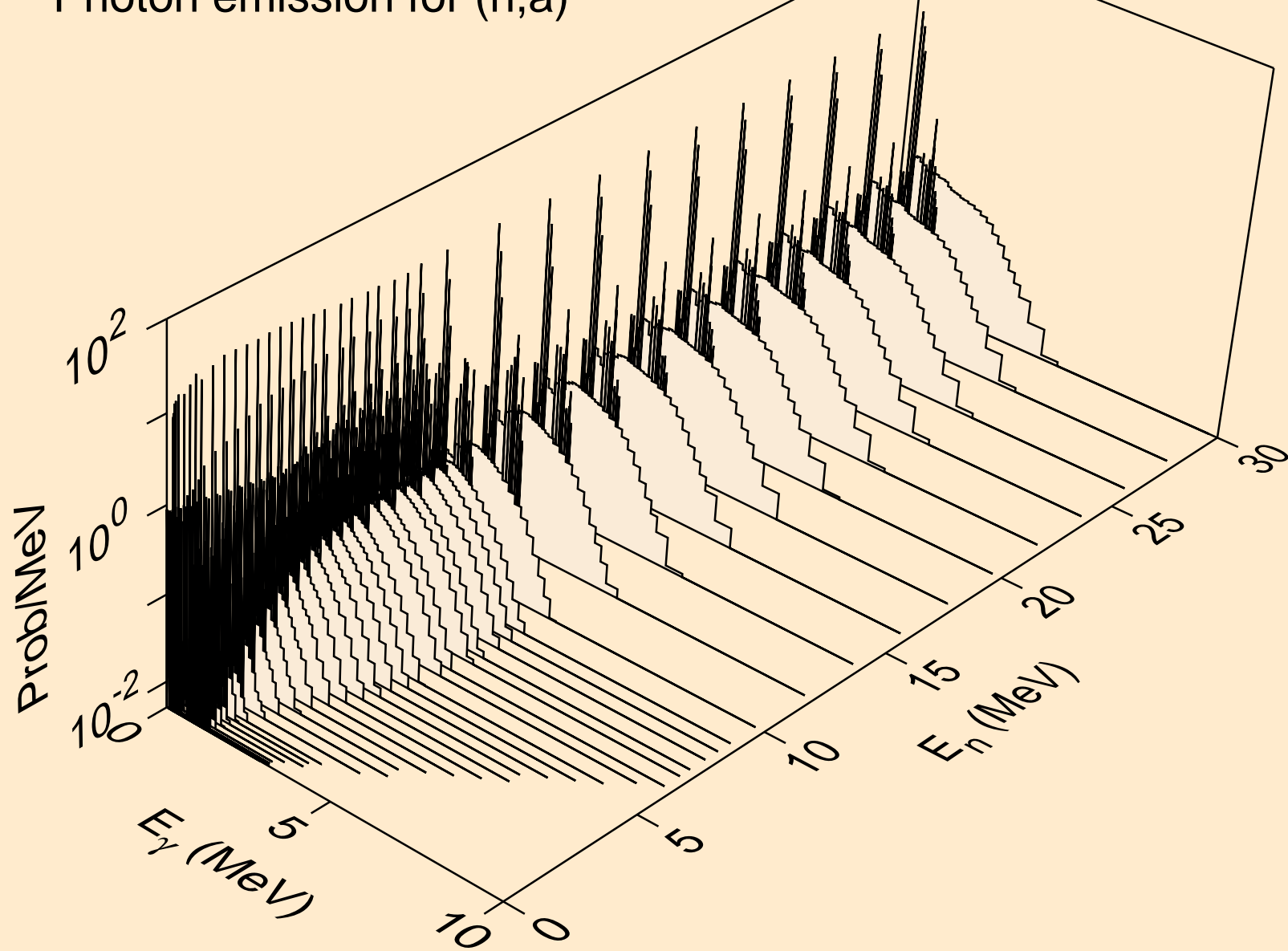

GD157 NEUTRON ACER TENDL-2024 LIBRARY; T=0.K  
Photon emission for (n,2a)

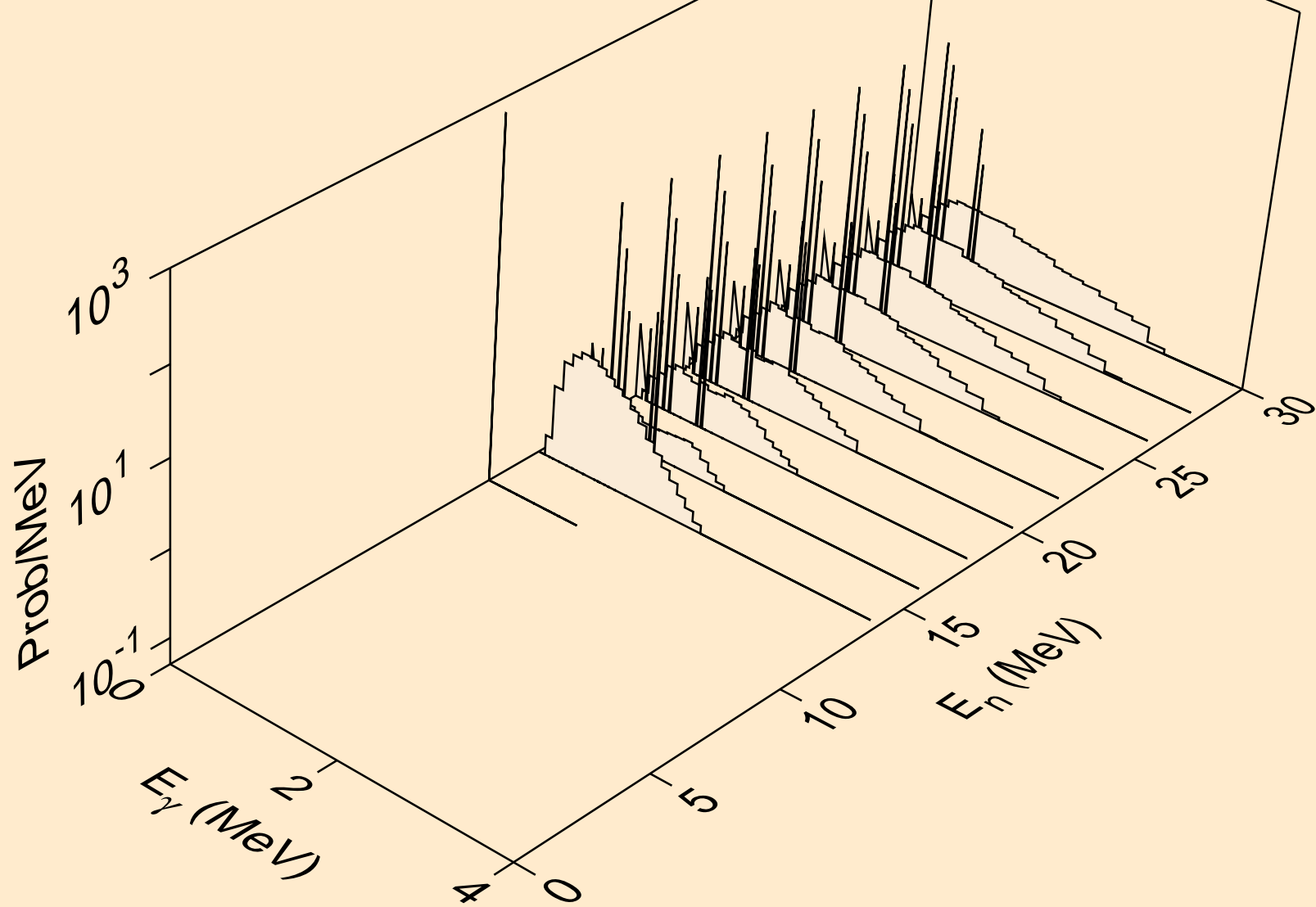

GD157 NEUTRON ACER TENDL-2024 LIBRARY; T=0.K  
Photon emission for (n,2p)

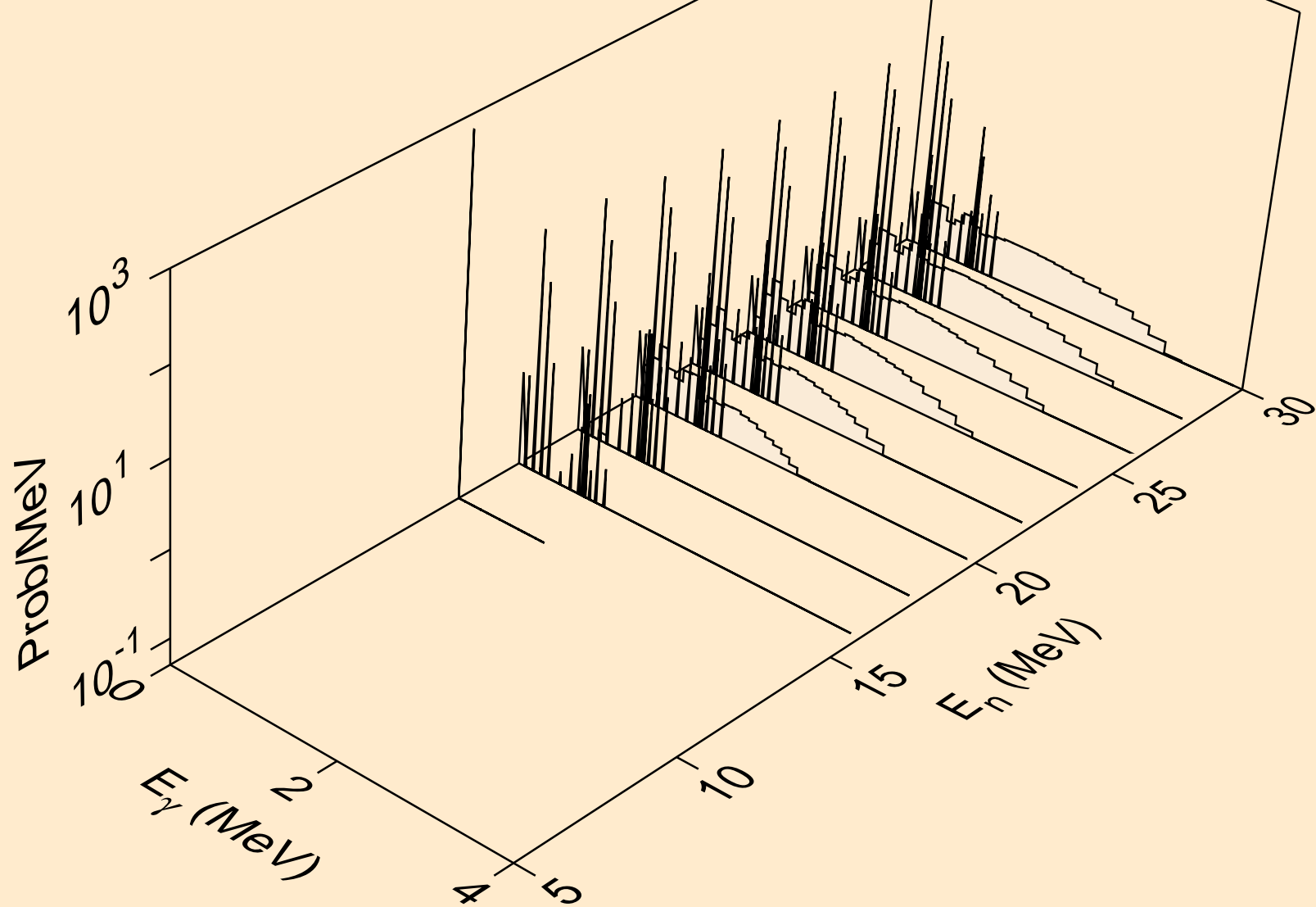



GD157 NEUTRON ACER TENDL-2024 LIBRARY; T=0.K  
Photon emission for (n,p)

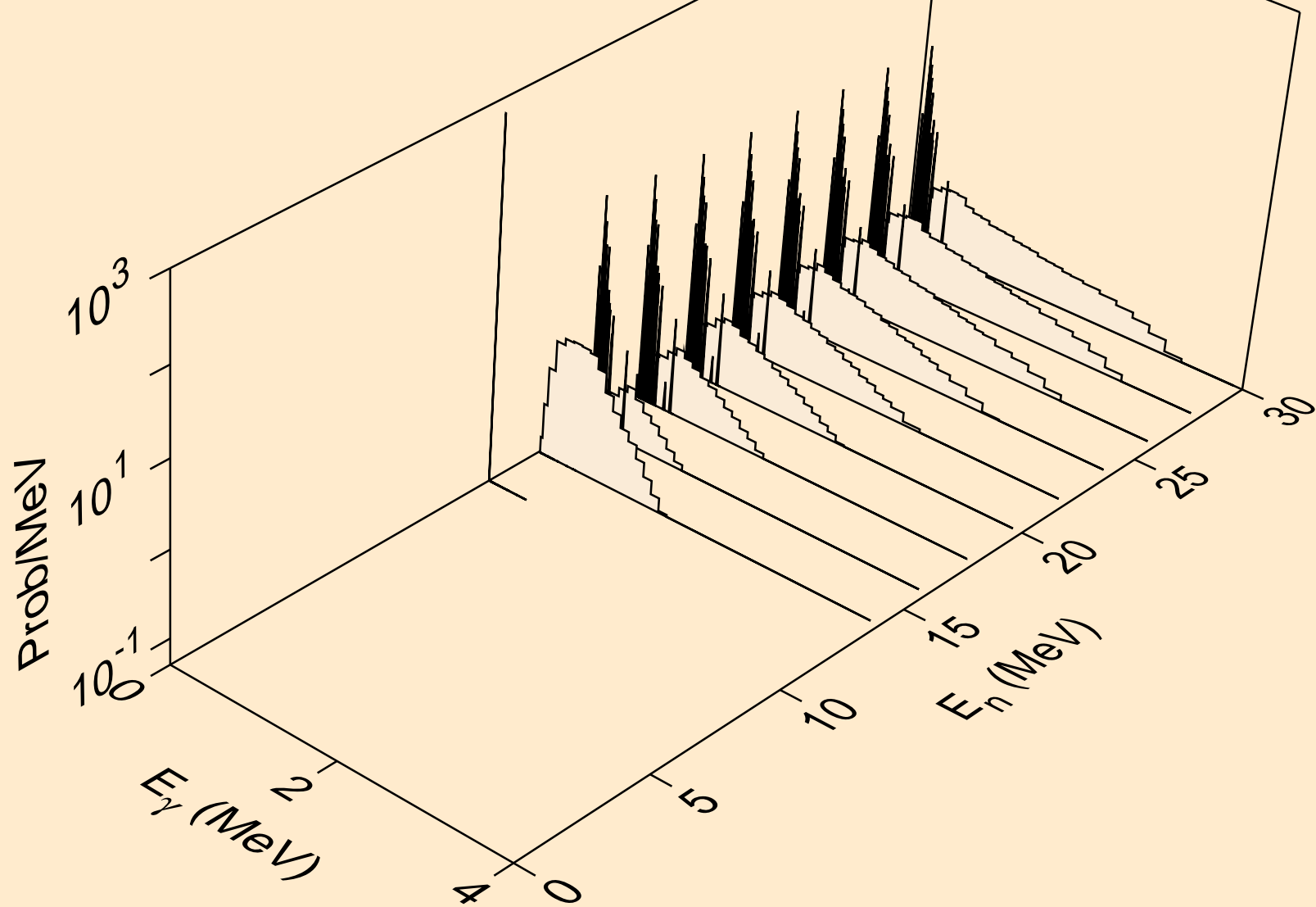

GD157 NEUTRON ACER TENDL-2024 LIBRARY; T=0.K  
Photon emission for (n,pd)

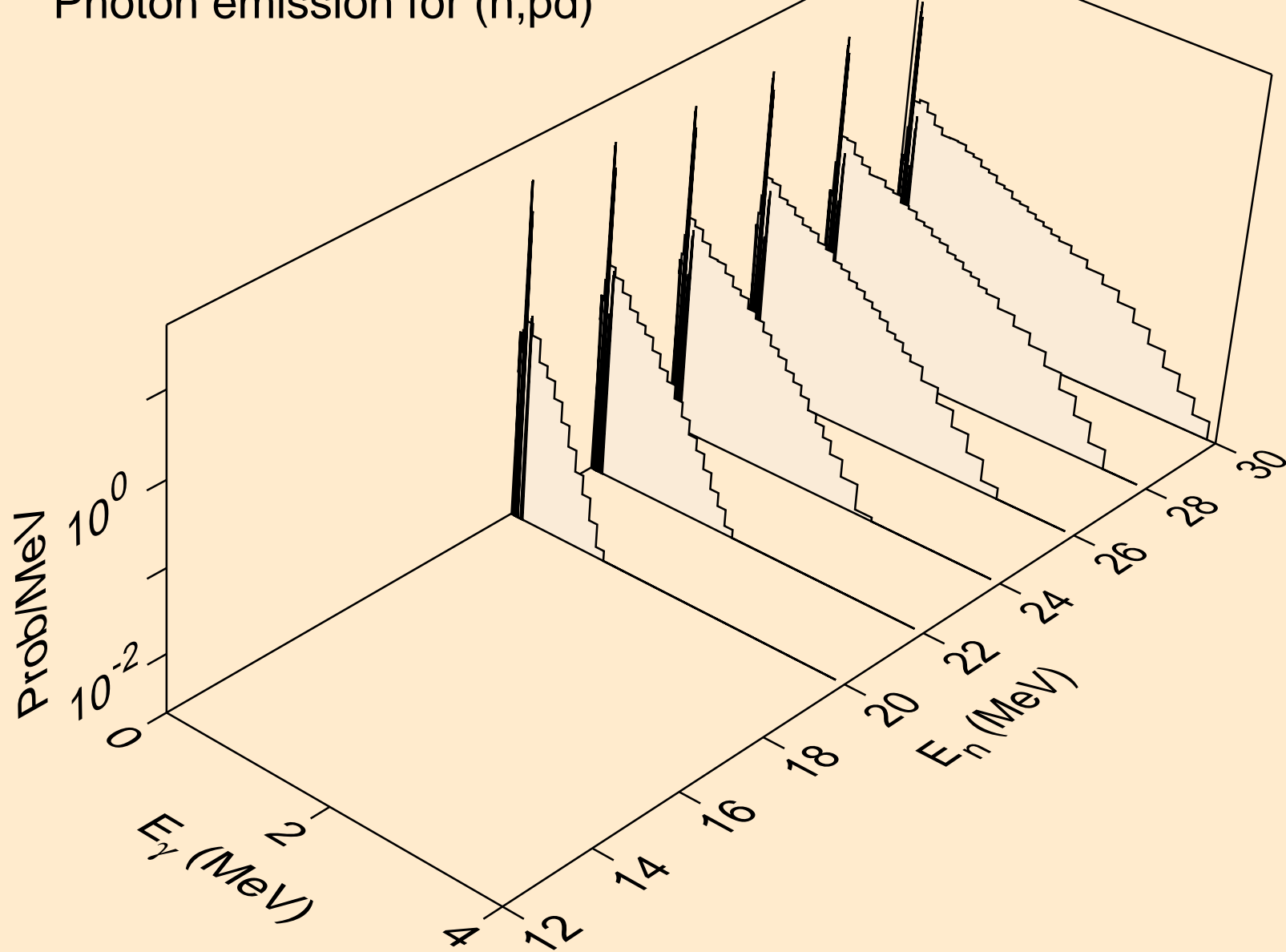

GD157 NEUTRON ACER TENDL-2024 LIBRARY; T=0.K  
thermal capture photon spectrum

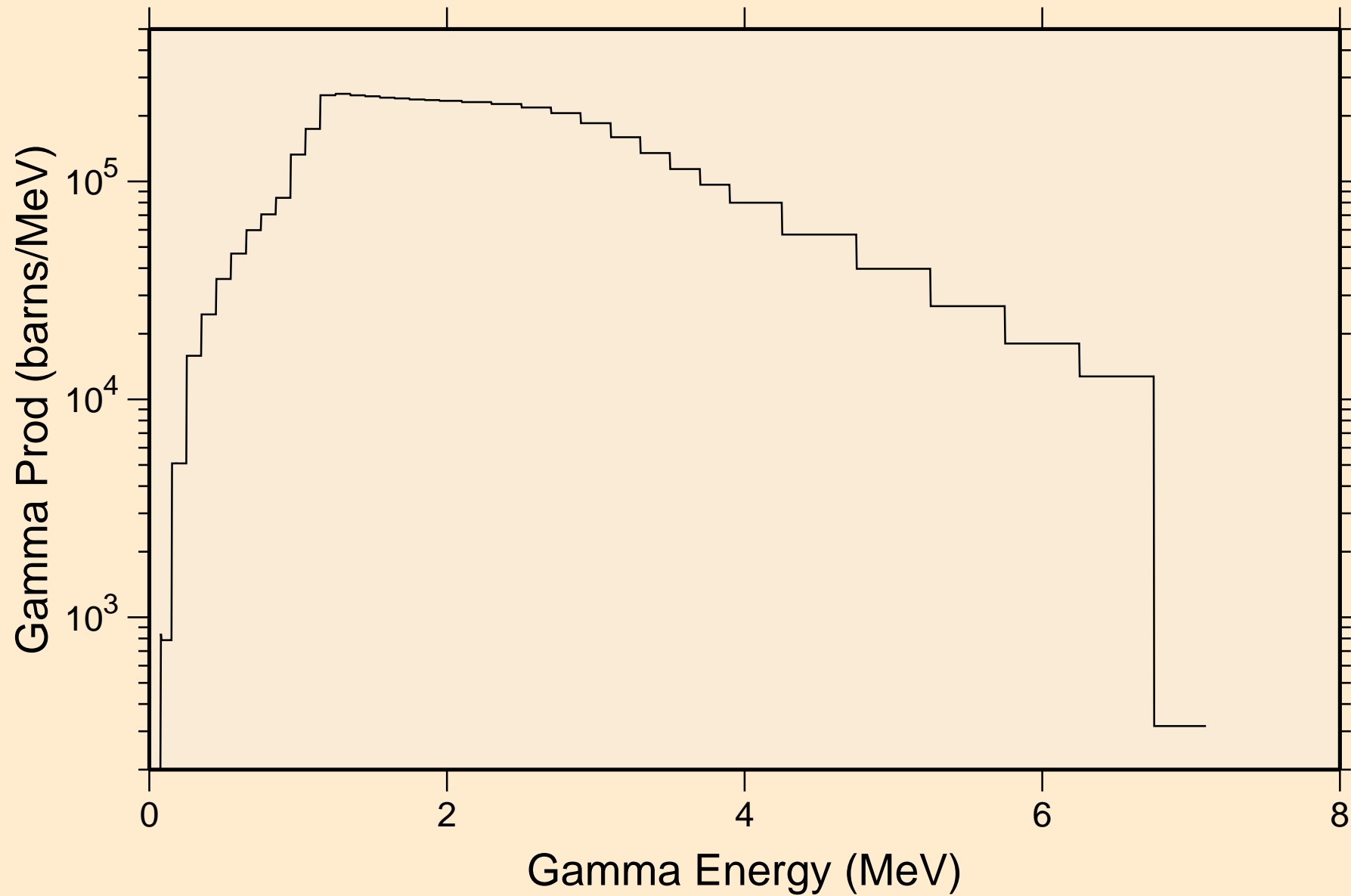

GD157 NEUTRON ACER TENDL-2024 LIBRARY; T=0.K  
14 MeV photon spectrum

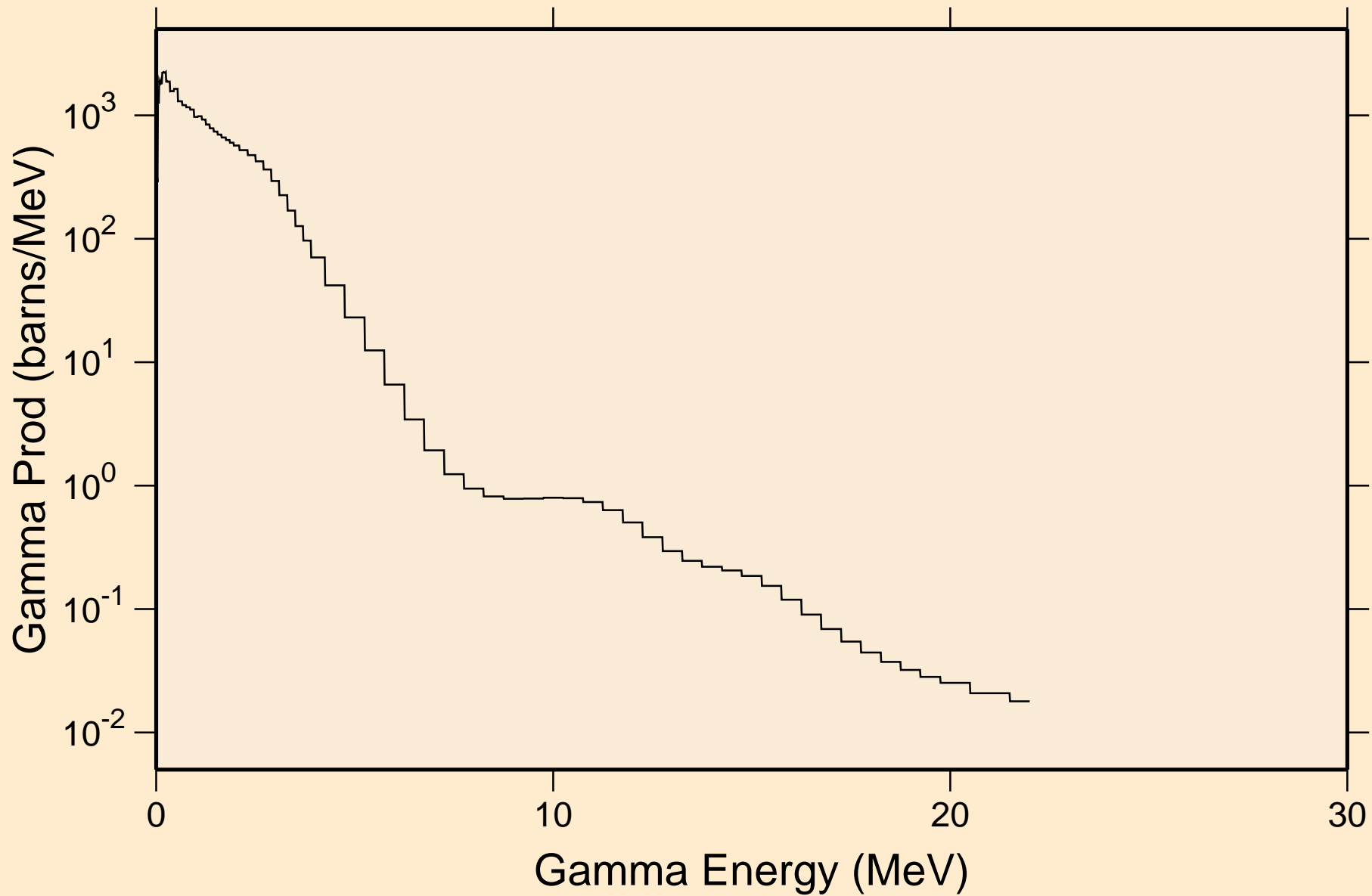

# GD157 NEUTRON ACER TENDL-2024 LIBRARY; T=0.K

## Particle heating contributions

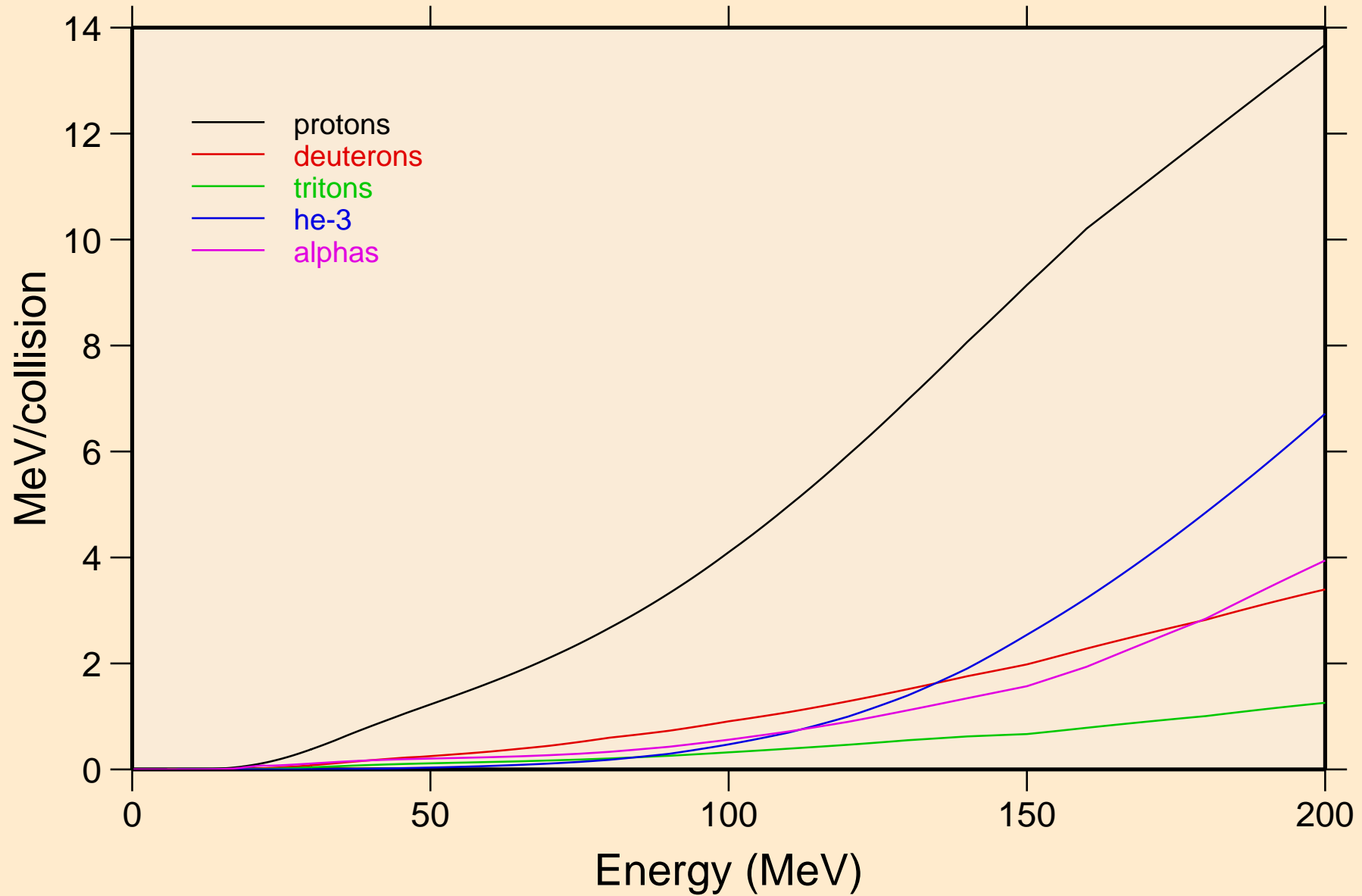

# GD157 NEUTRON ACER TENDL-2024 LIBRARY; T=0.K

## Recoil Heating

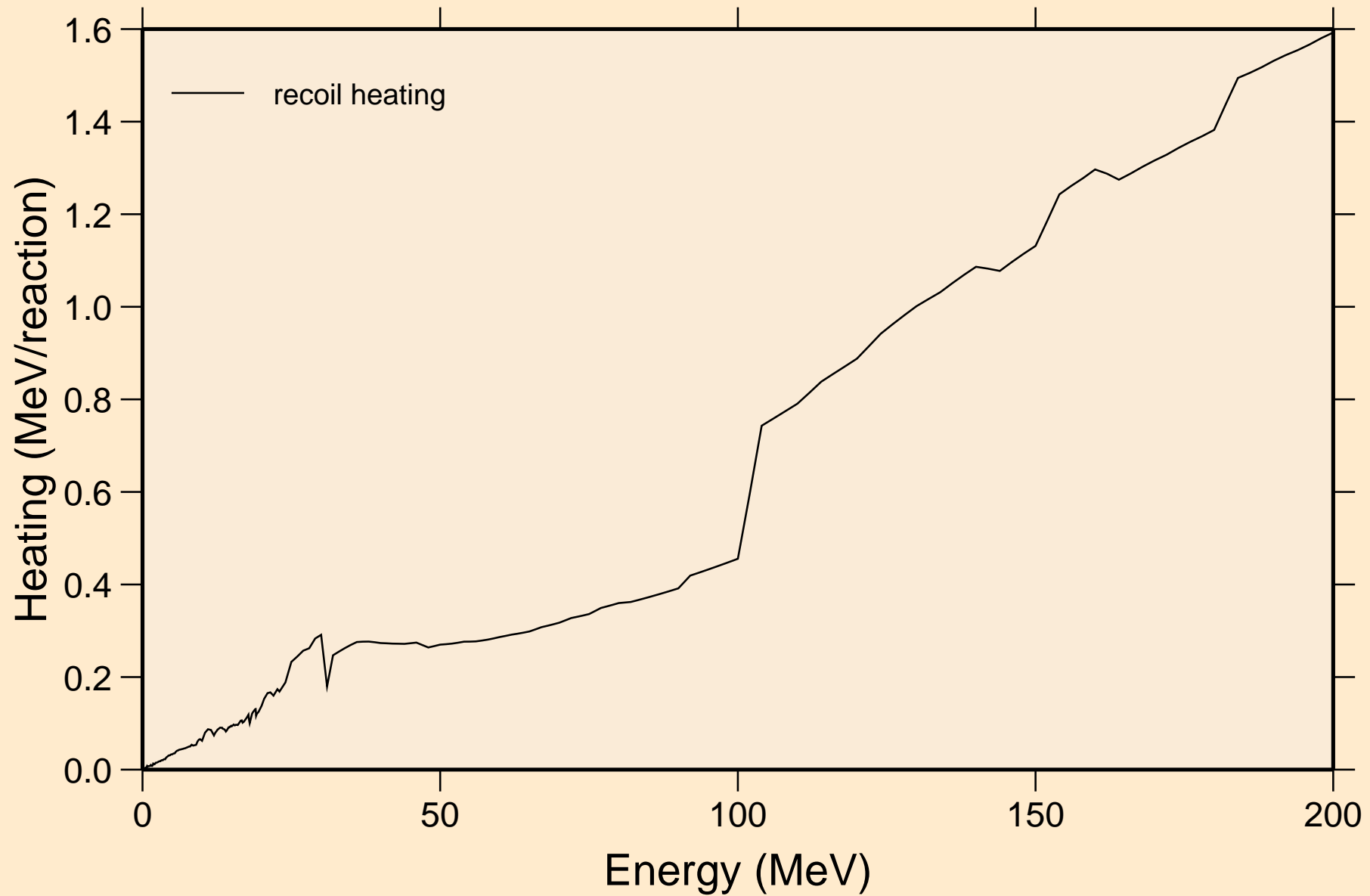

# GD157 NEUTRON ACER TENDL-2024 LIBRARY; T=0.K

## Particle production cross sections

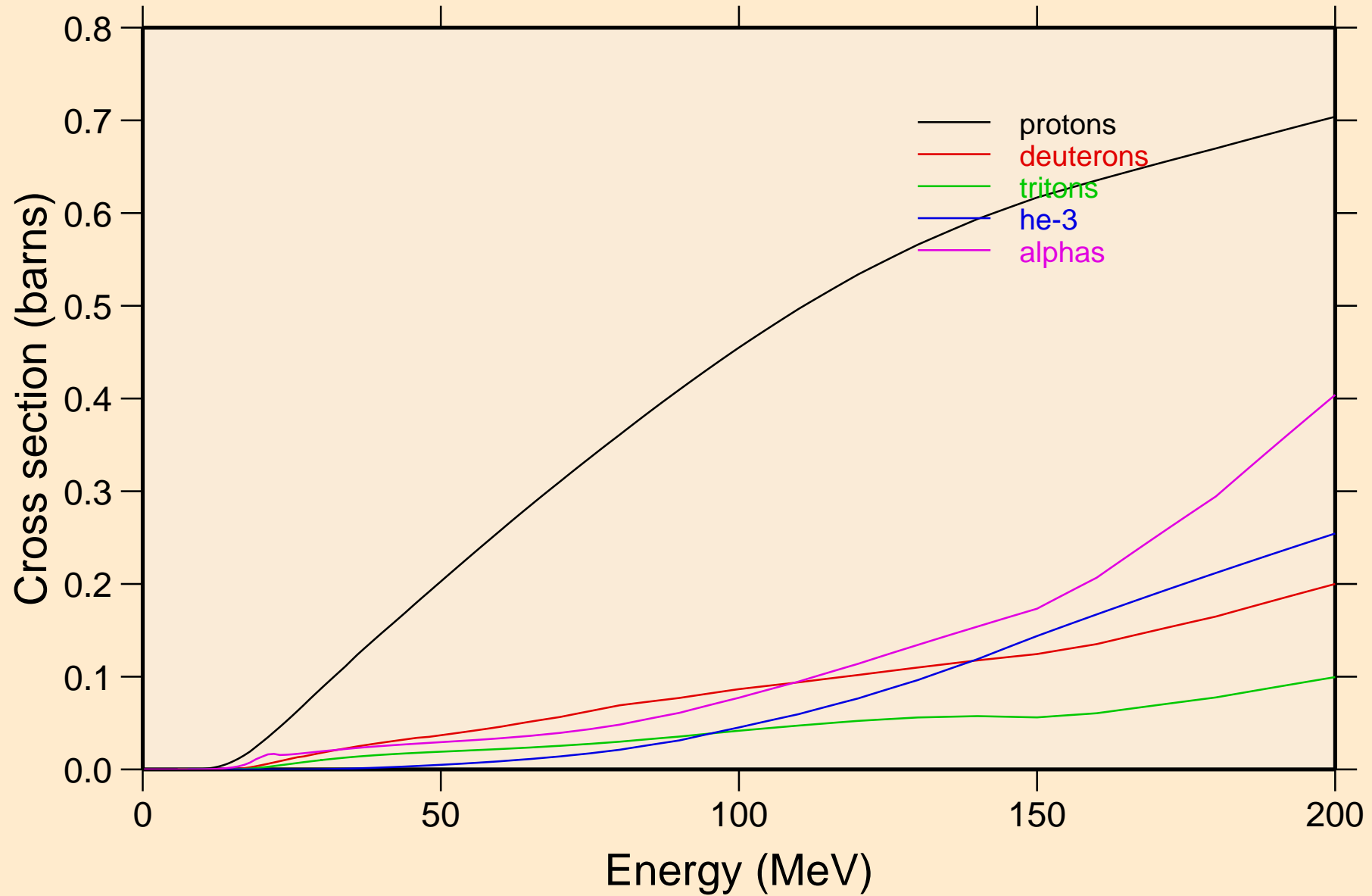

GD157 NEUTRON ACER TENDL-2024 LIBRARY; T=0.K  
protons from (n,x)

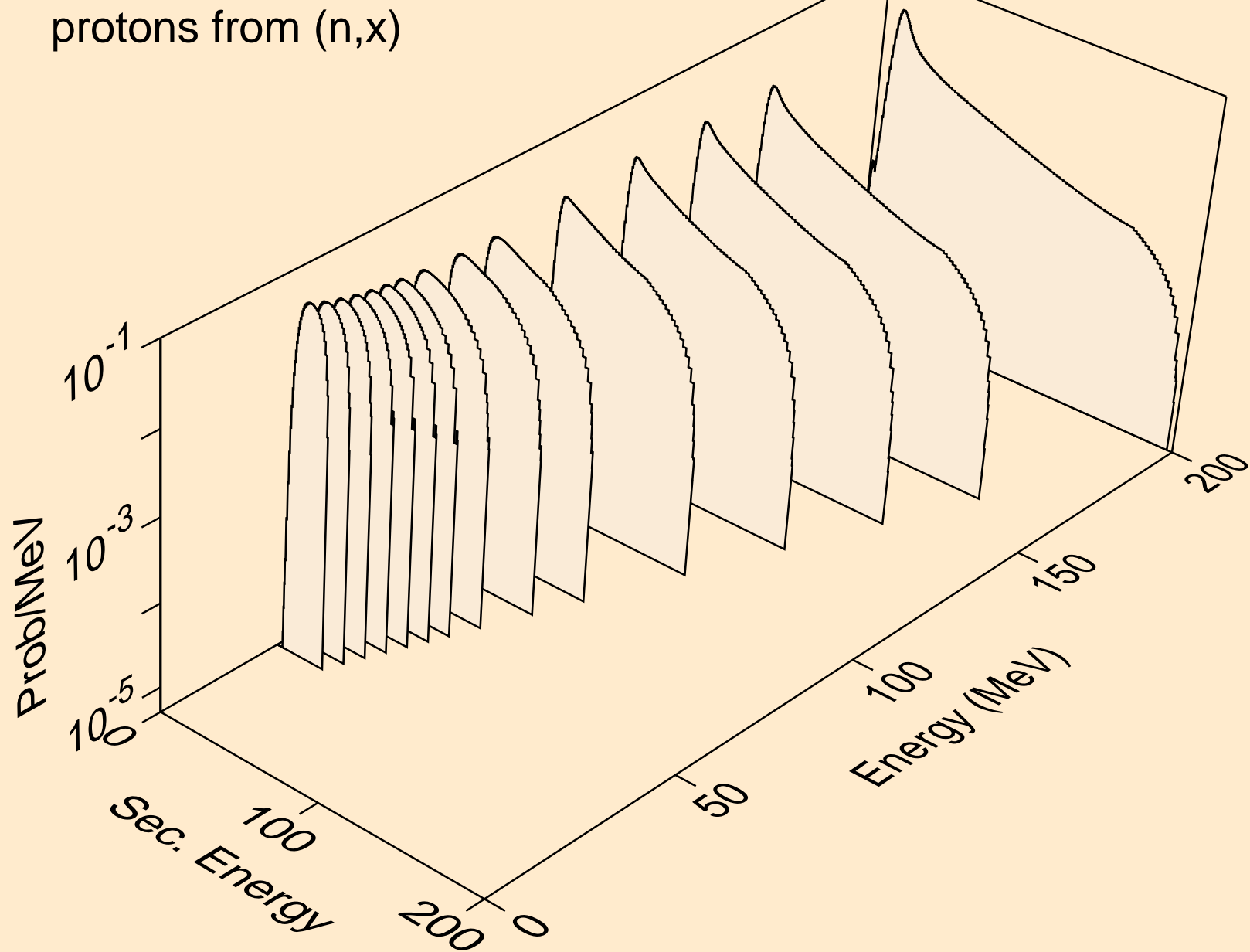



GD157 NEUTRON ACER TENDL-2024 LIBRARY; T=0.K  
protons from (n,n\*)p

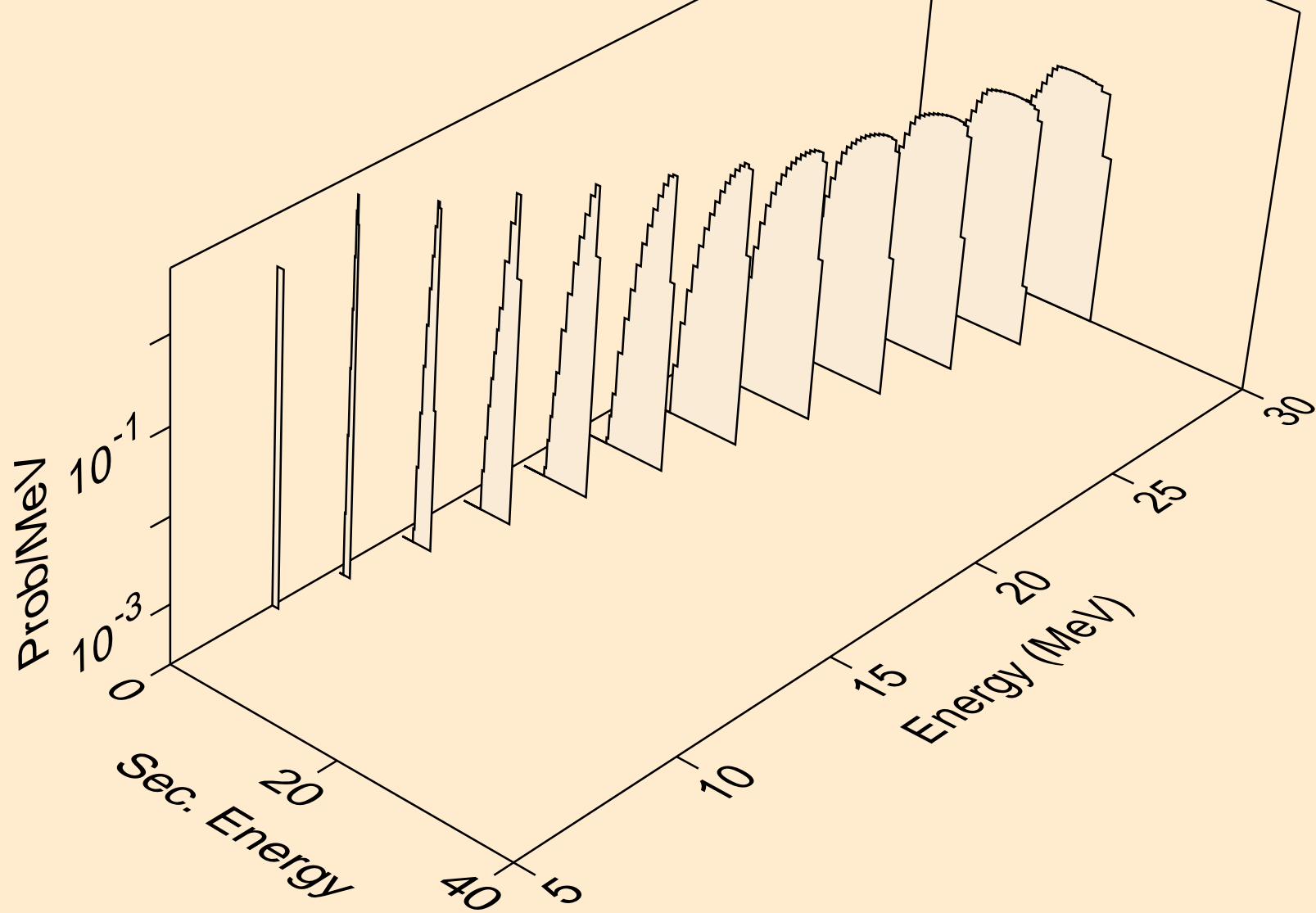

GD157 NEUTRON ACER TENDL-2024 LIBRARY; T=0.K  
protons from (n,2np)

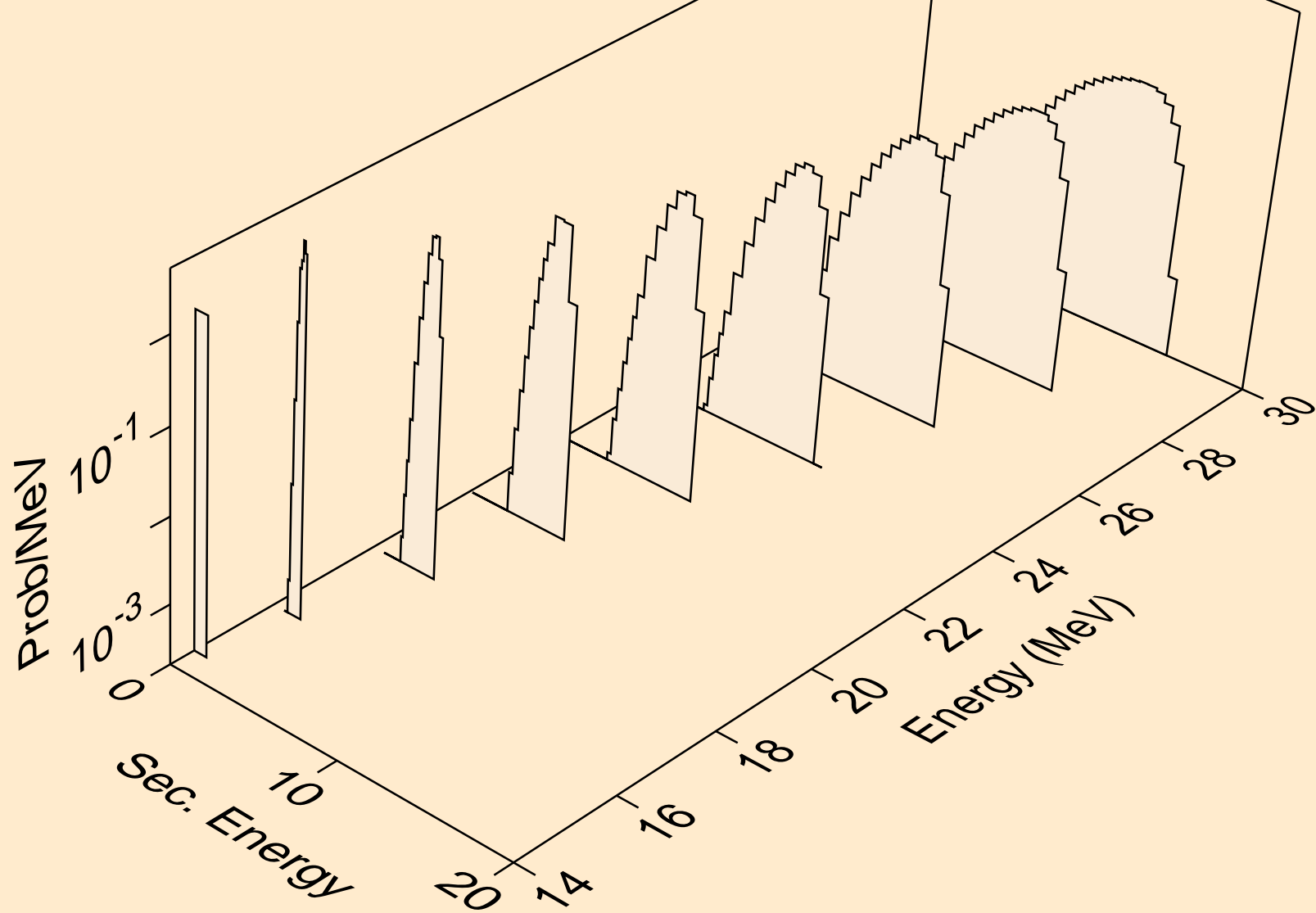

GD157 NEUTRON ACER TENDL-2024 LIBRARY; T=0.K  
protons from (n,3np)

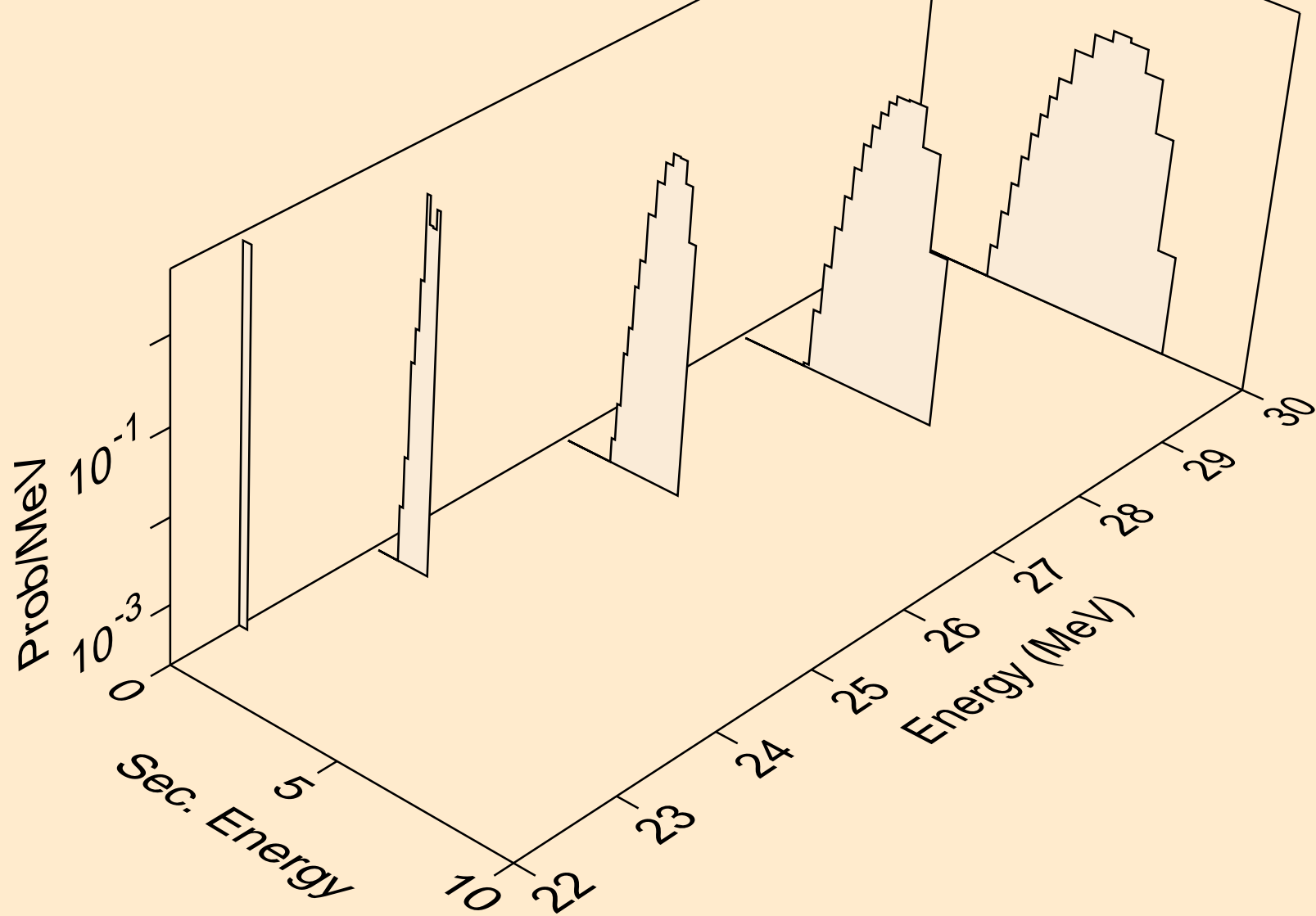

GD157 NEUTRON ACER TENDL-2024 LIBRARY; T=0.K  
protons from (n,n2p)

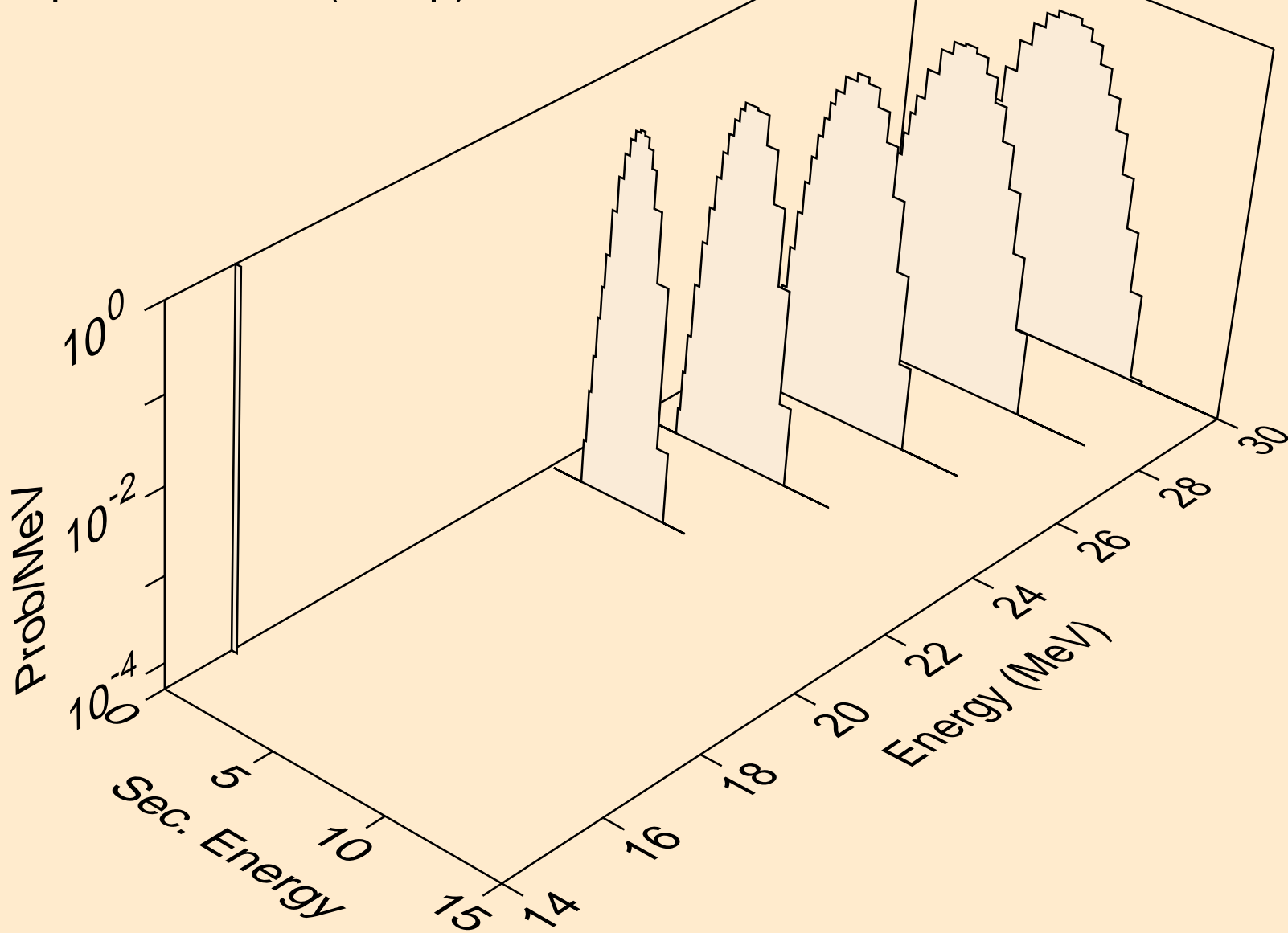

GD157 NEUTRON ACER TENDL-2024 LIBRARY; T=0.K  
protons from (n,npa)

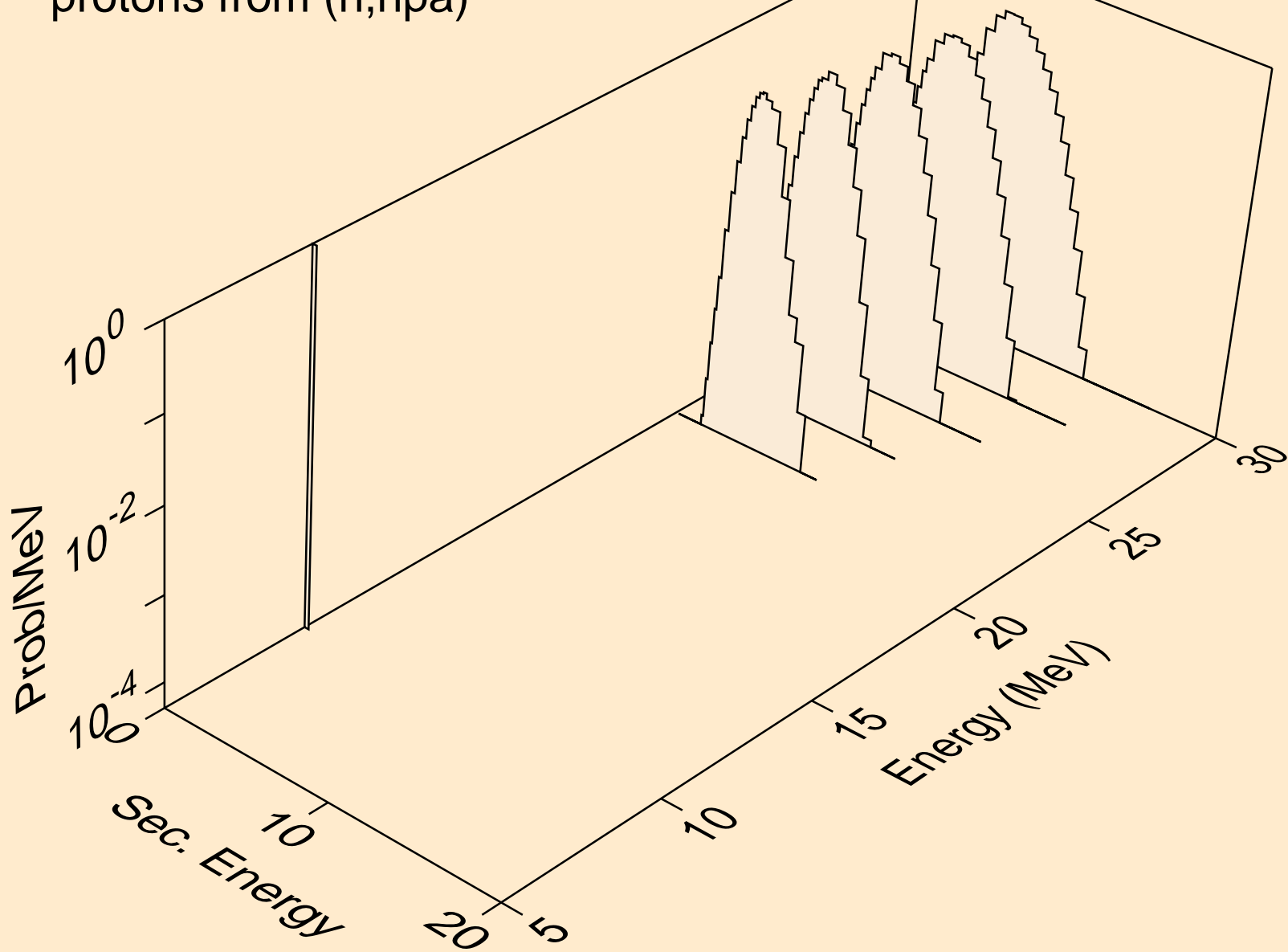

GD157 NEUTRON ACER TENDL-2024 LIBRARY; T=0.K  
protons from (n,p)

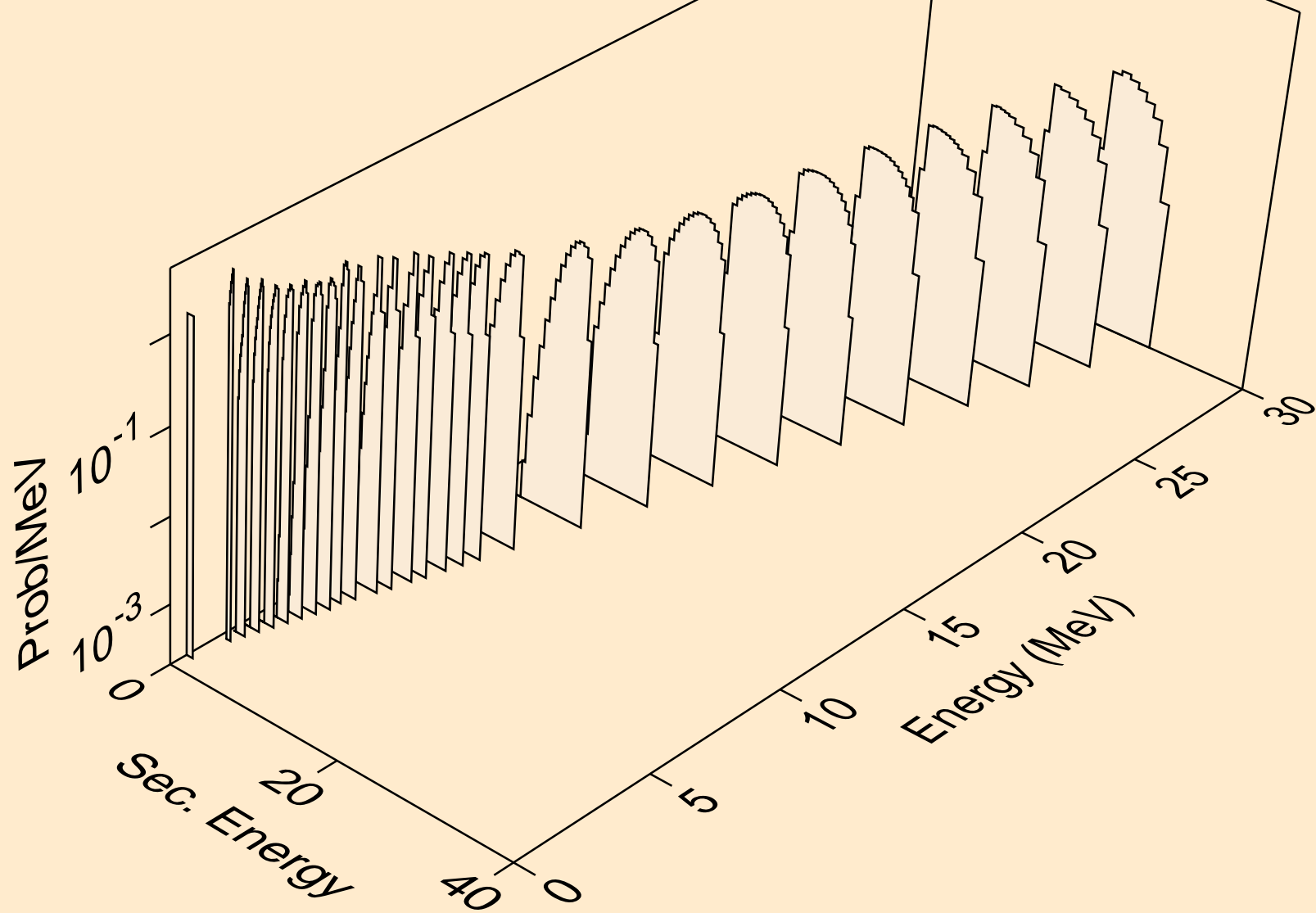

GD157 NEUTRON ACER TENDL-2024 LIBRARY; T=0.K  
protons from (n,2p)

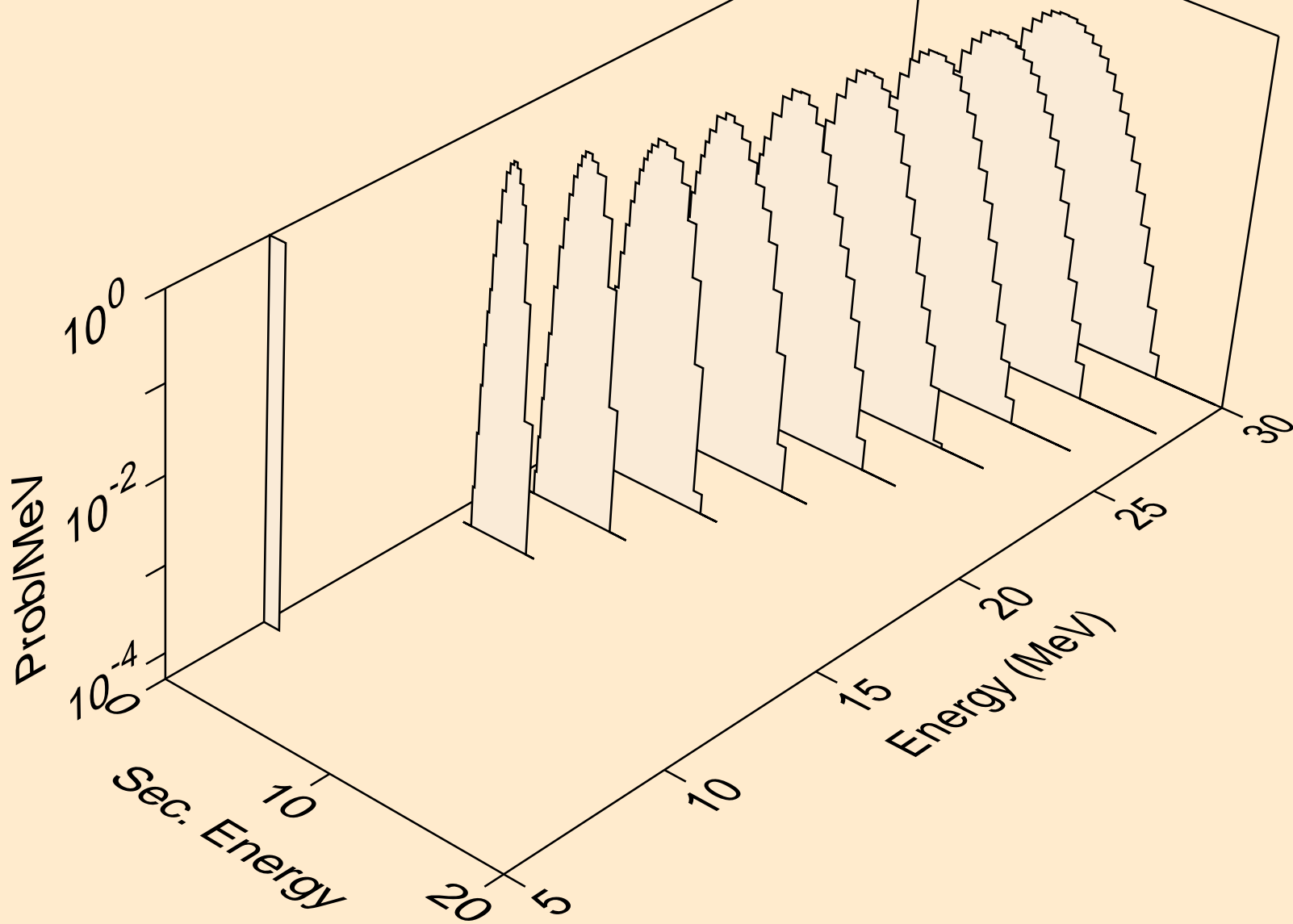

GD157 NEUTRON ACER TENDL-2024 LIBRARY; T=0.K  
protons from (n,pa)

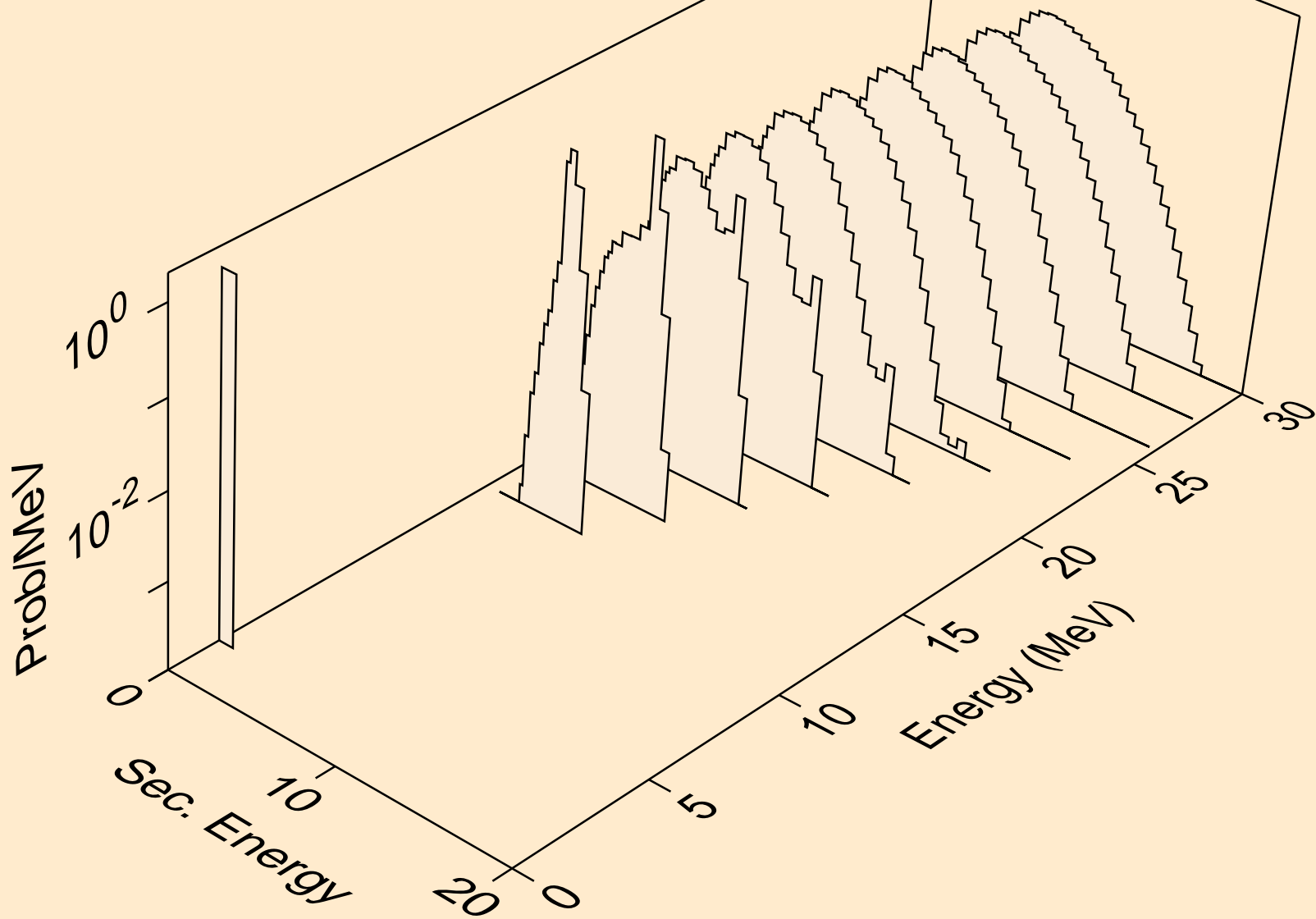



GD157 NEUTRON ACER TENDL-2024 LIBRARY; T=0.K  
protons from (n,pd)

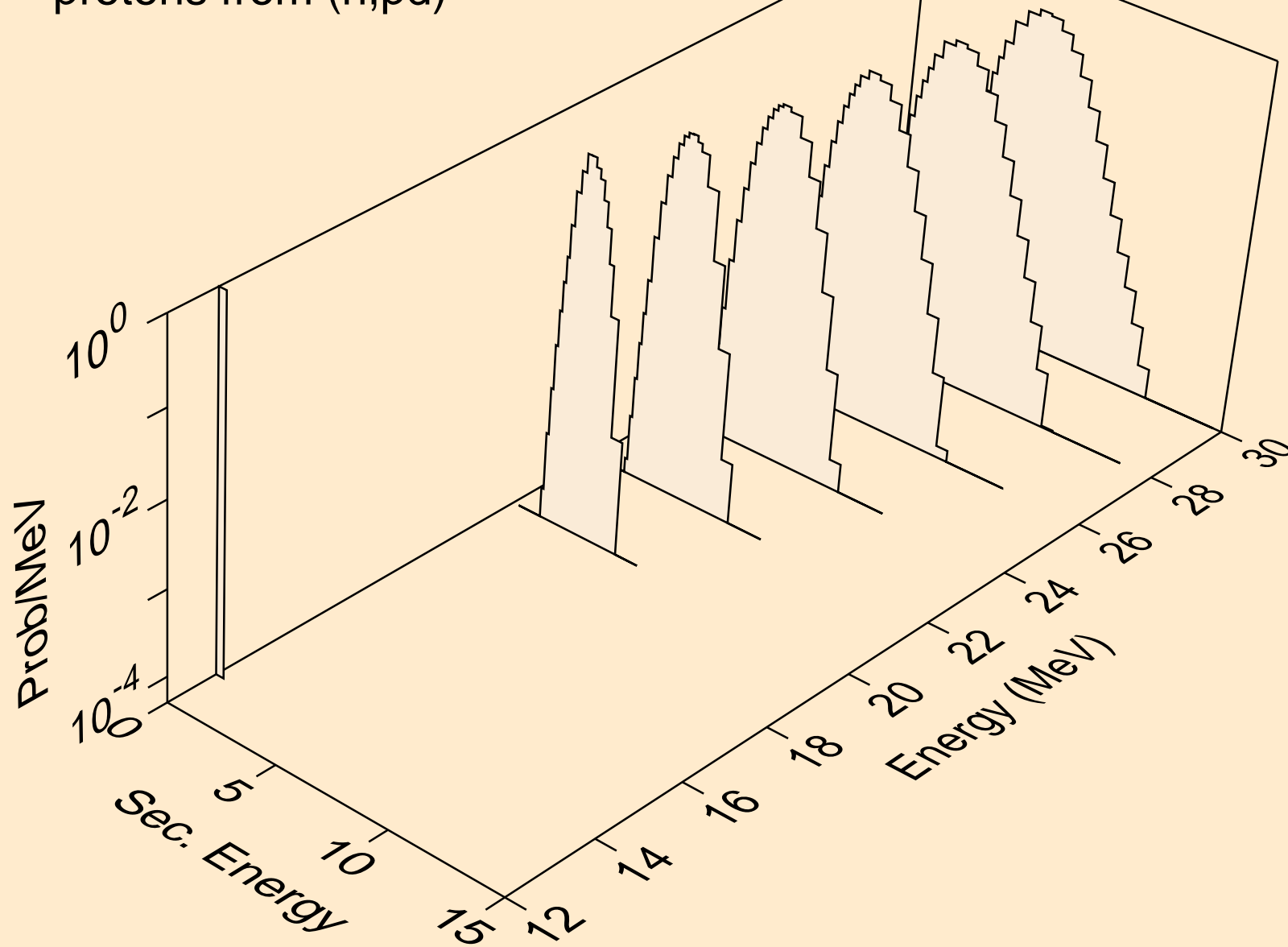

GD157 NEUTRON ACER TENDL-2024 LIBRARY; T=0.K  
deuterons from (n,x)

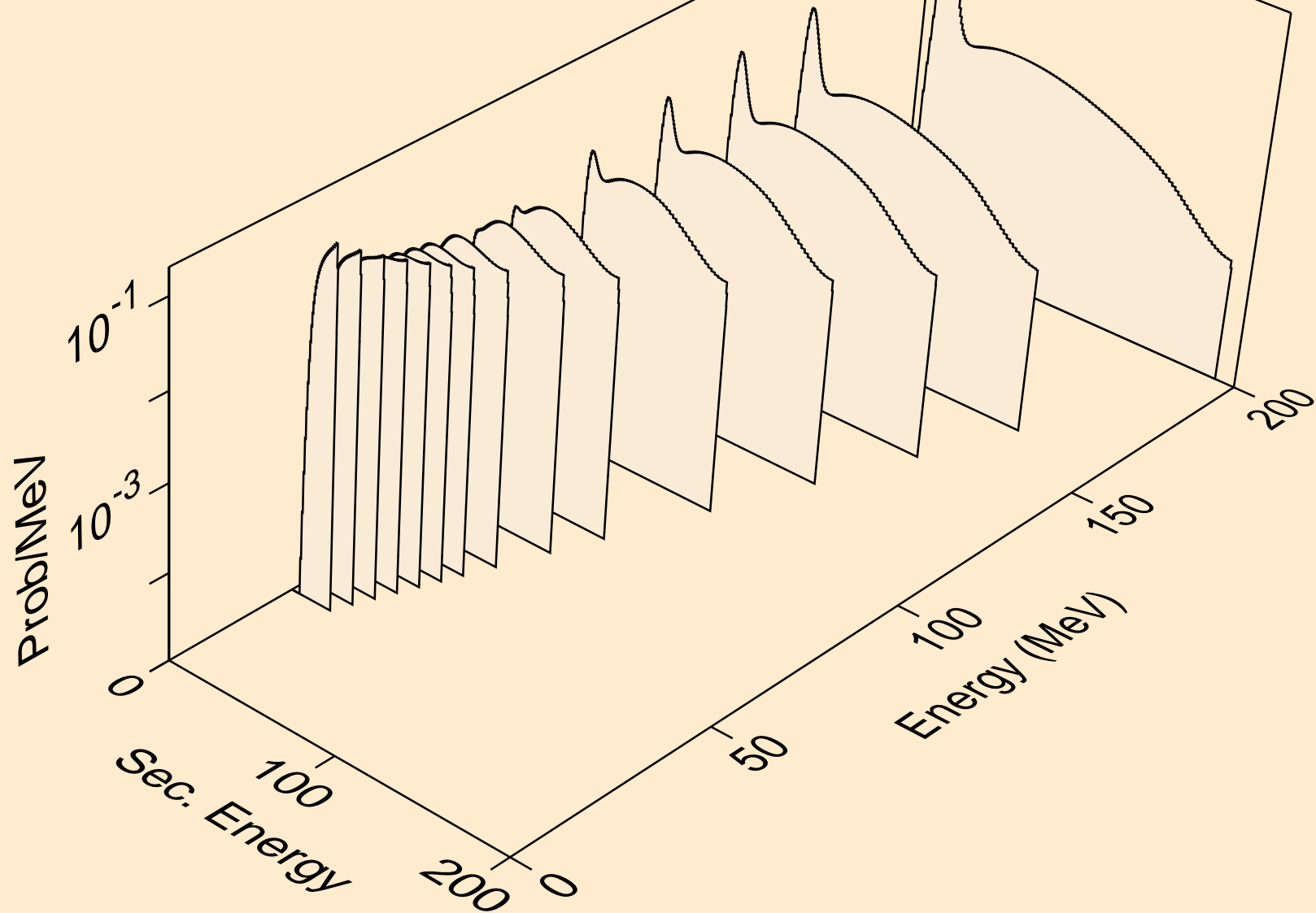

GD157 NEUTRON ACER TENDL-2024 LIBRARY; T=0.K  
deuterons from (n,2nd)

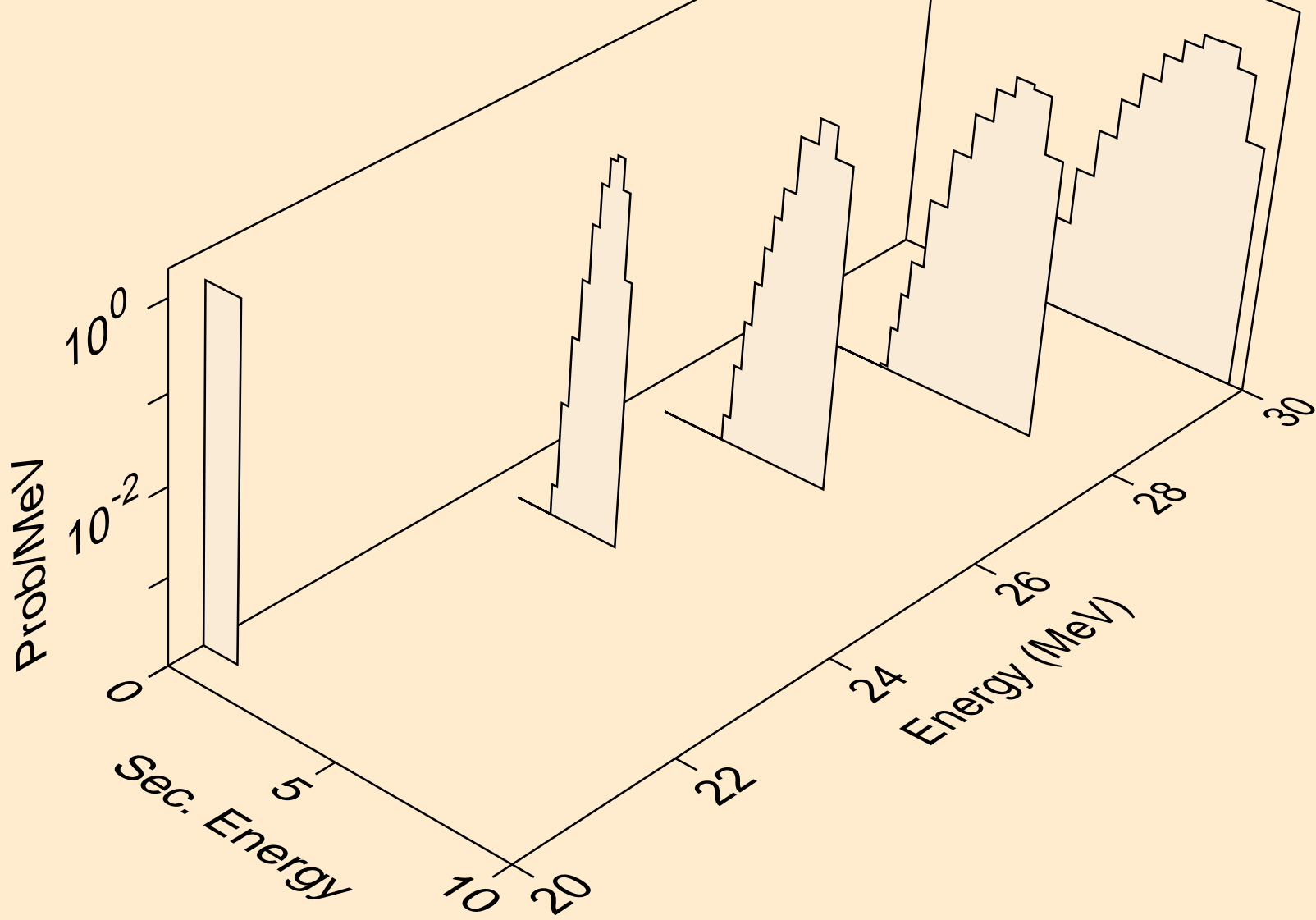

GD157 NEUTRON ACER TENDL-2024 LIBRARY; T=0.K  
deuterons from (n,n\*)d

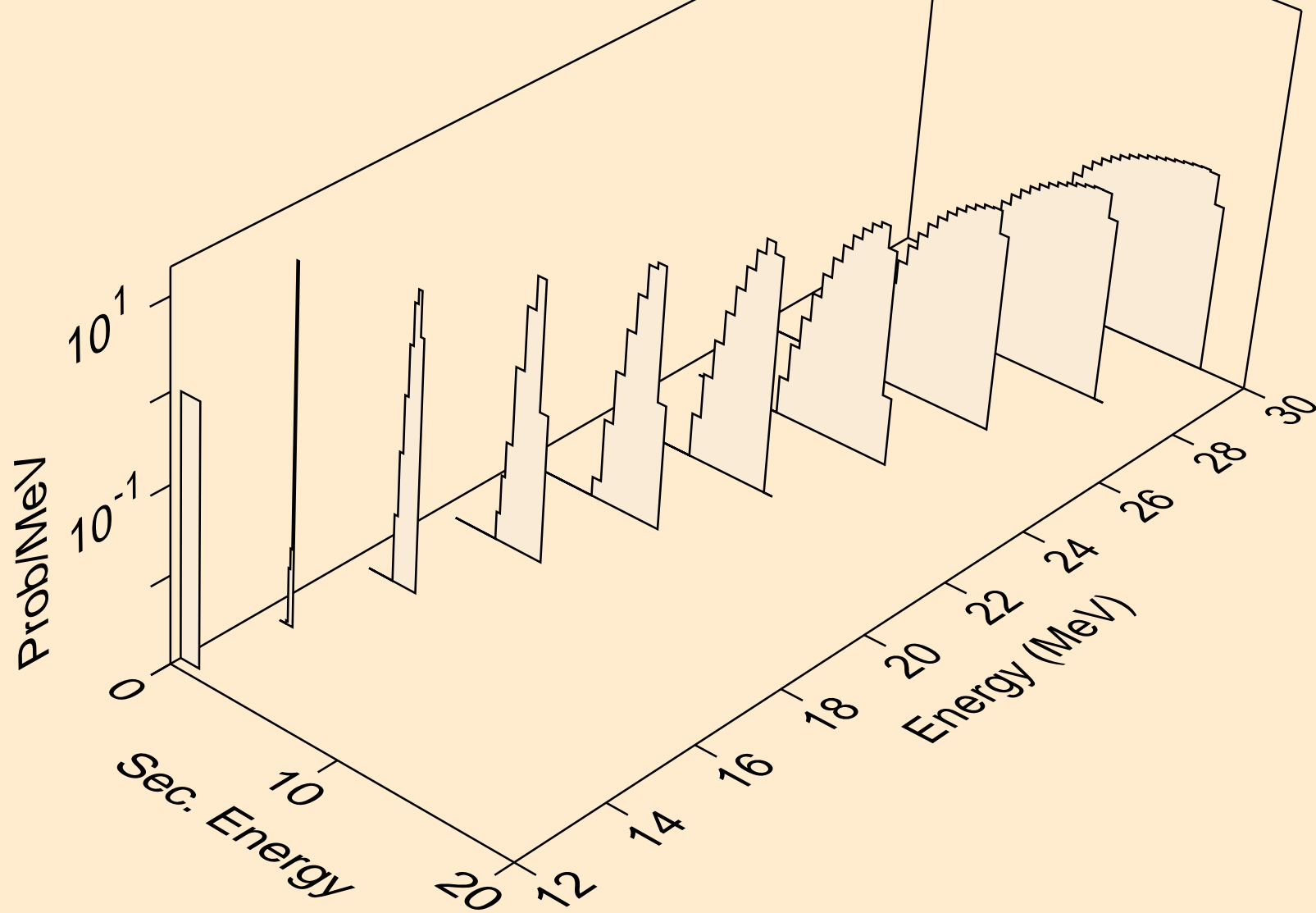

GD157 NEUTRON ACER TENDL-2024 LIBRARY; T=0.K  
deuterons from (n,d)

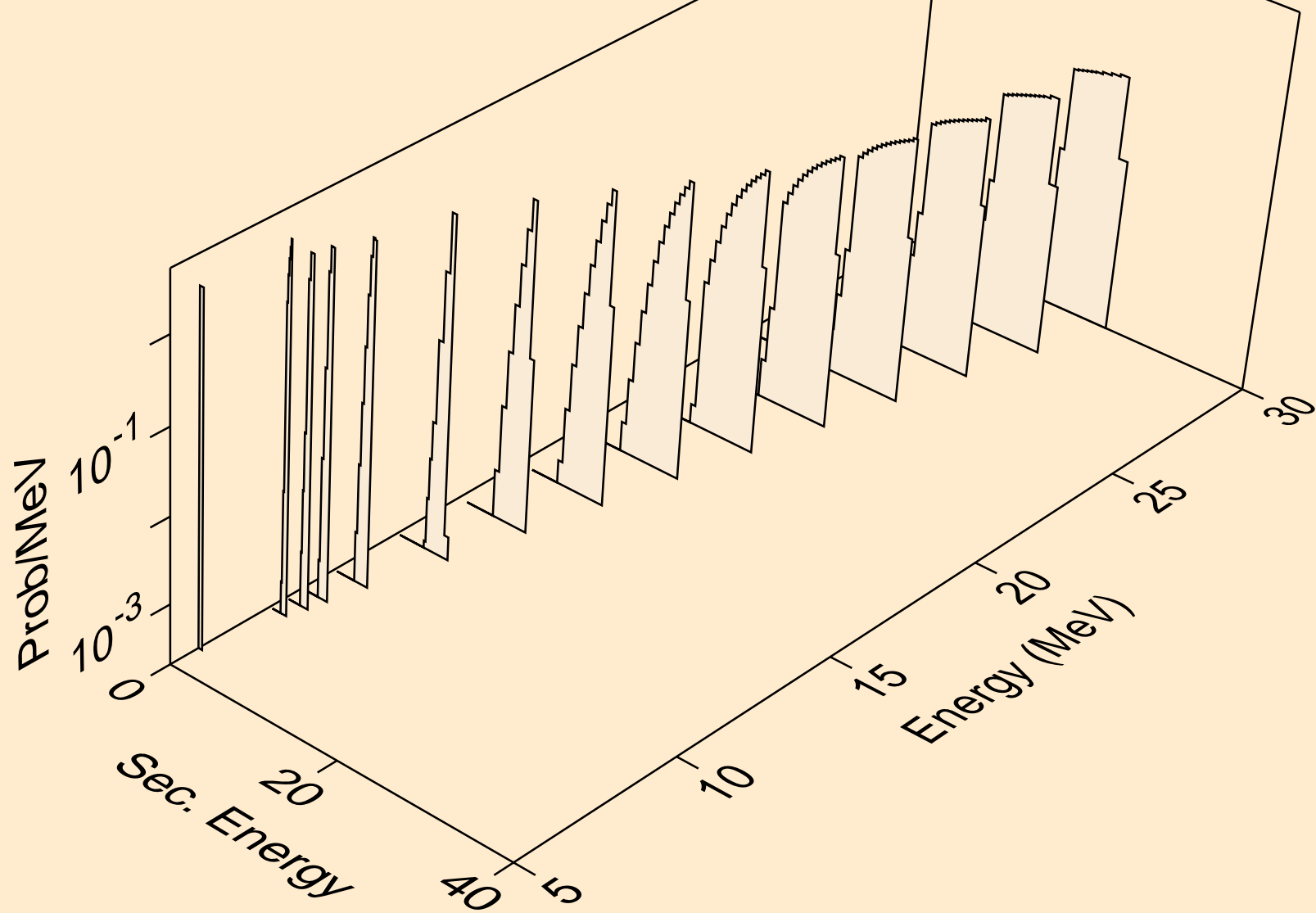

GD157 NEUTRON ACER TENDL-2024 LIBRARY; T=0.K  
deuterons from (n,pd)

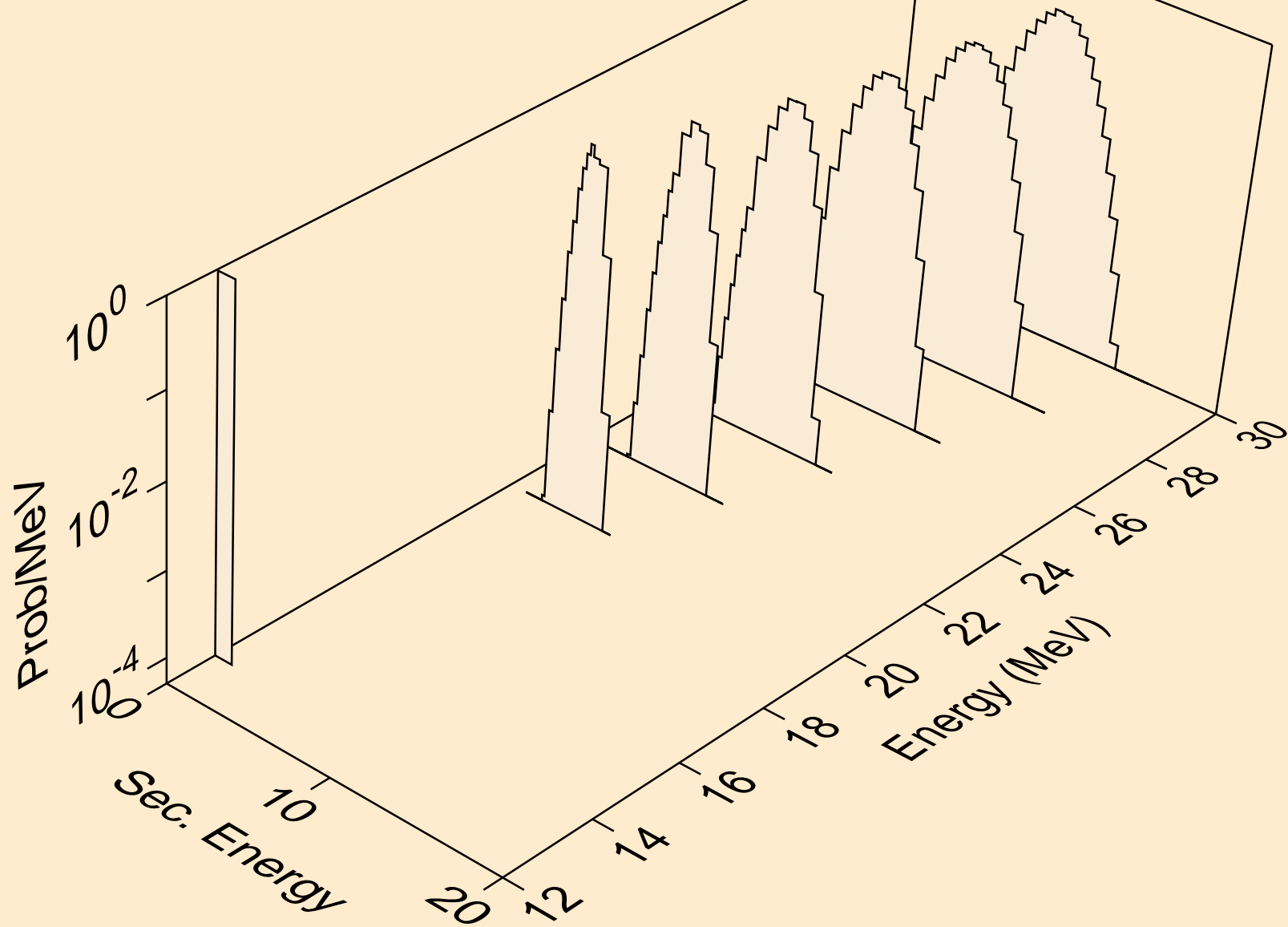

GD157 NEUTRON ACER TENDL-2024 LIBRARY; T=0.K  
tritons from (n,x)

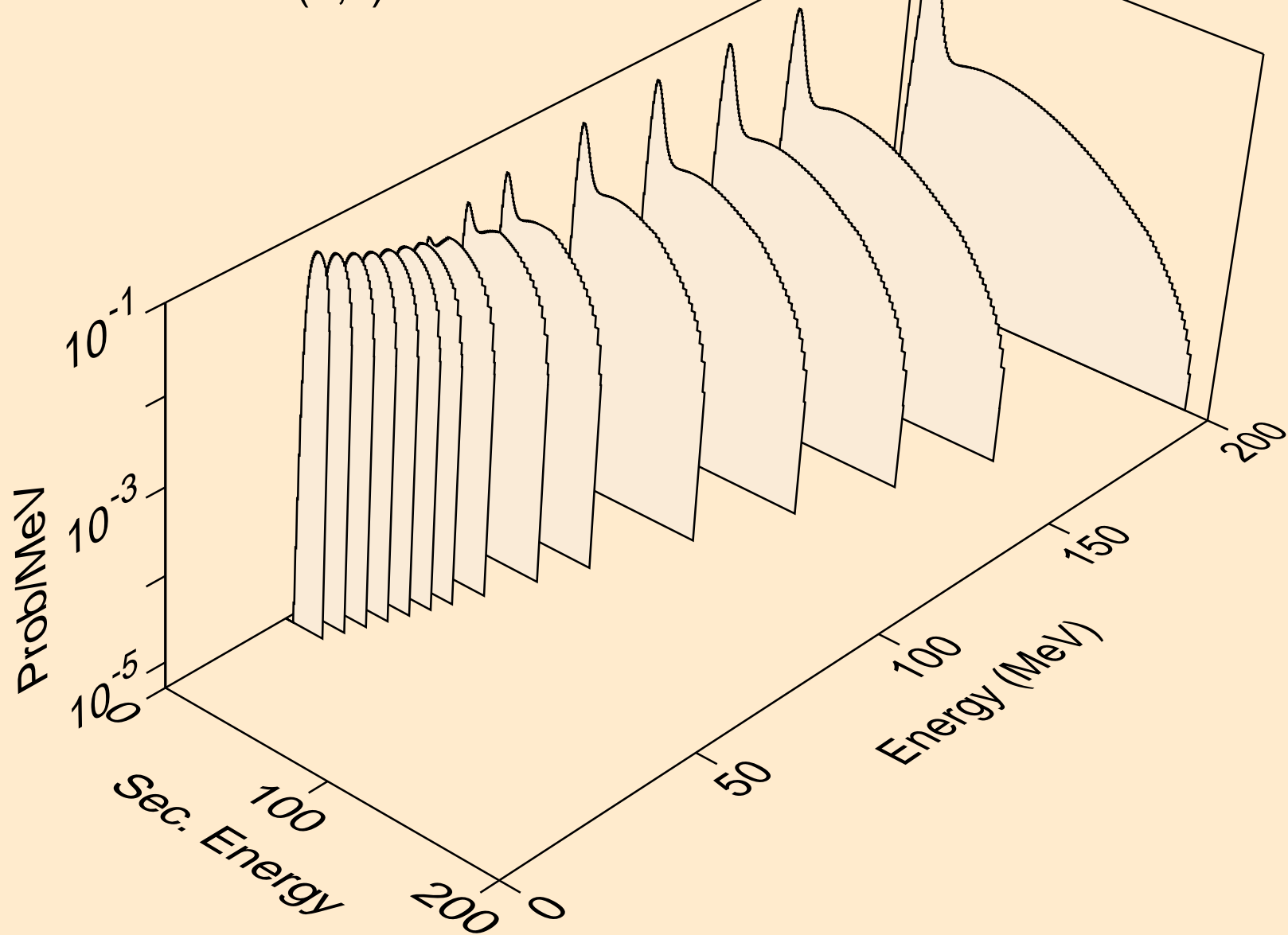

GD157 NEUTRON ACER TENDL-2024 LIBRARY; T=0.K  
tritons from (n,n\*)t

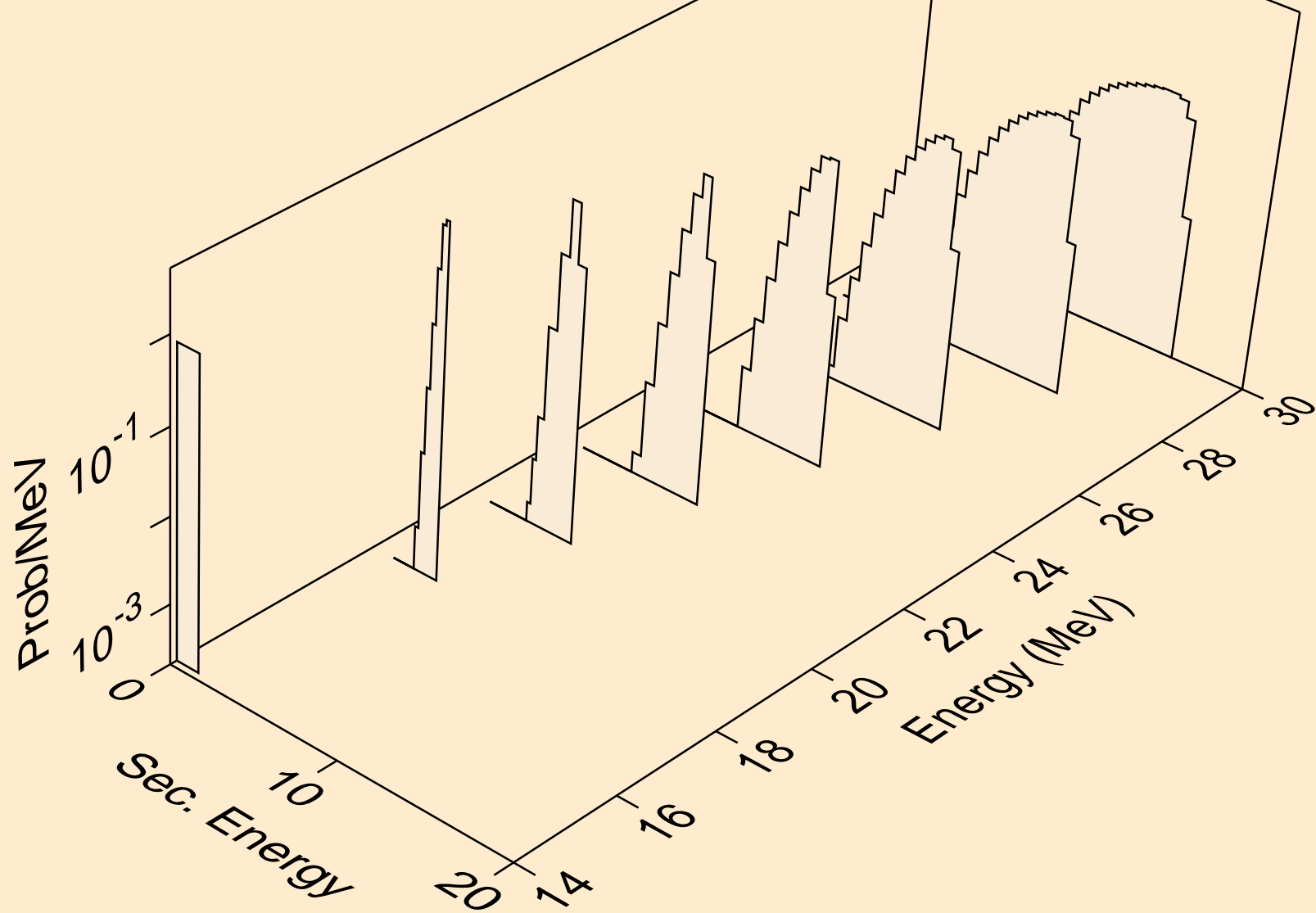



GD157 NEUTRON ACER TENDL-2024 LIBRARY; T=0.K  
tritons from (n,t)

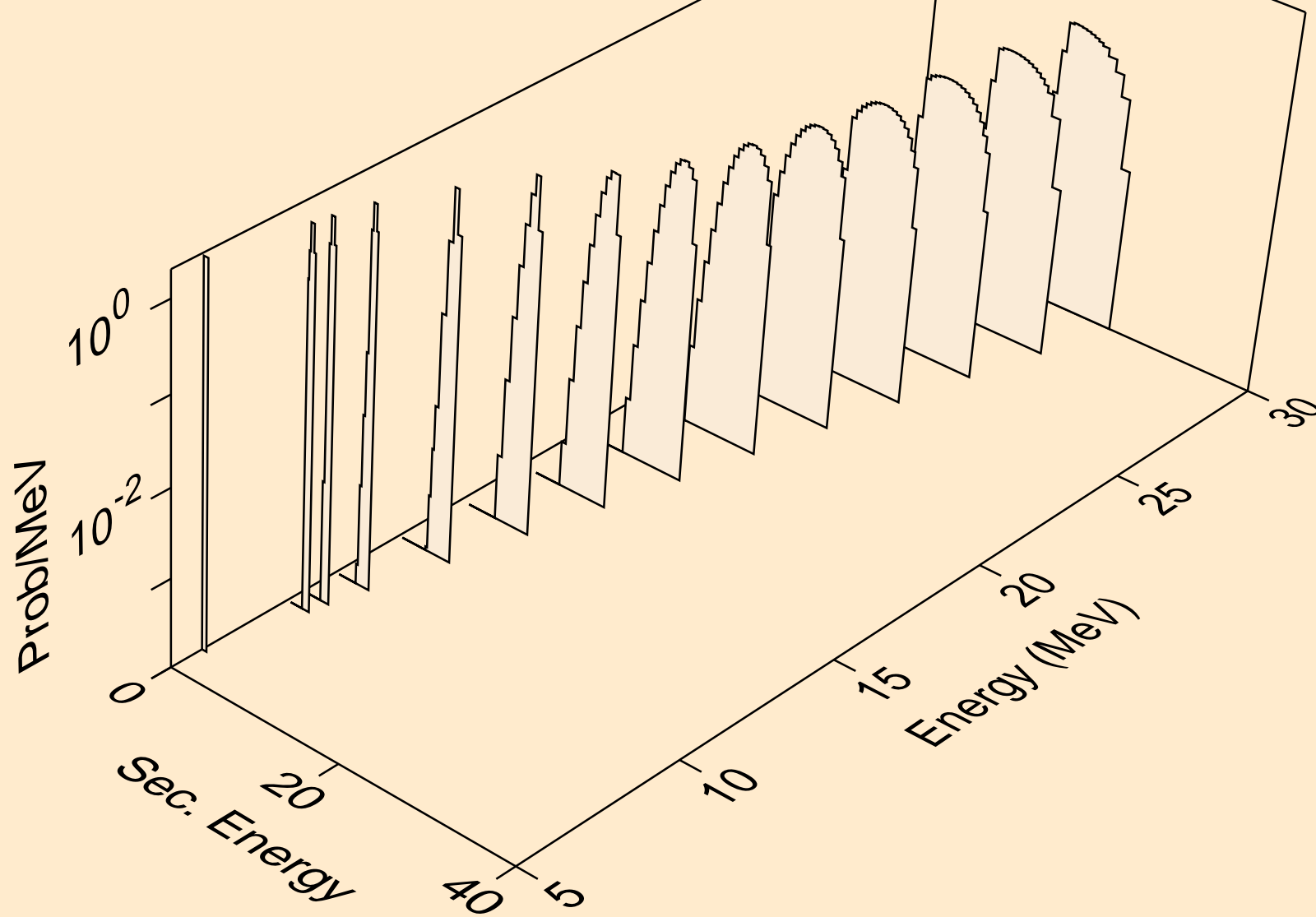

GD157 NEUTRON ACER TENDL-2024 LIBRARY; T=0.K  
he3s from (n,x)

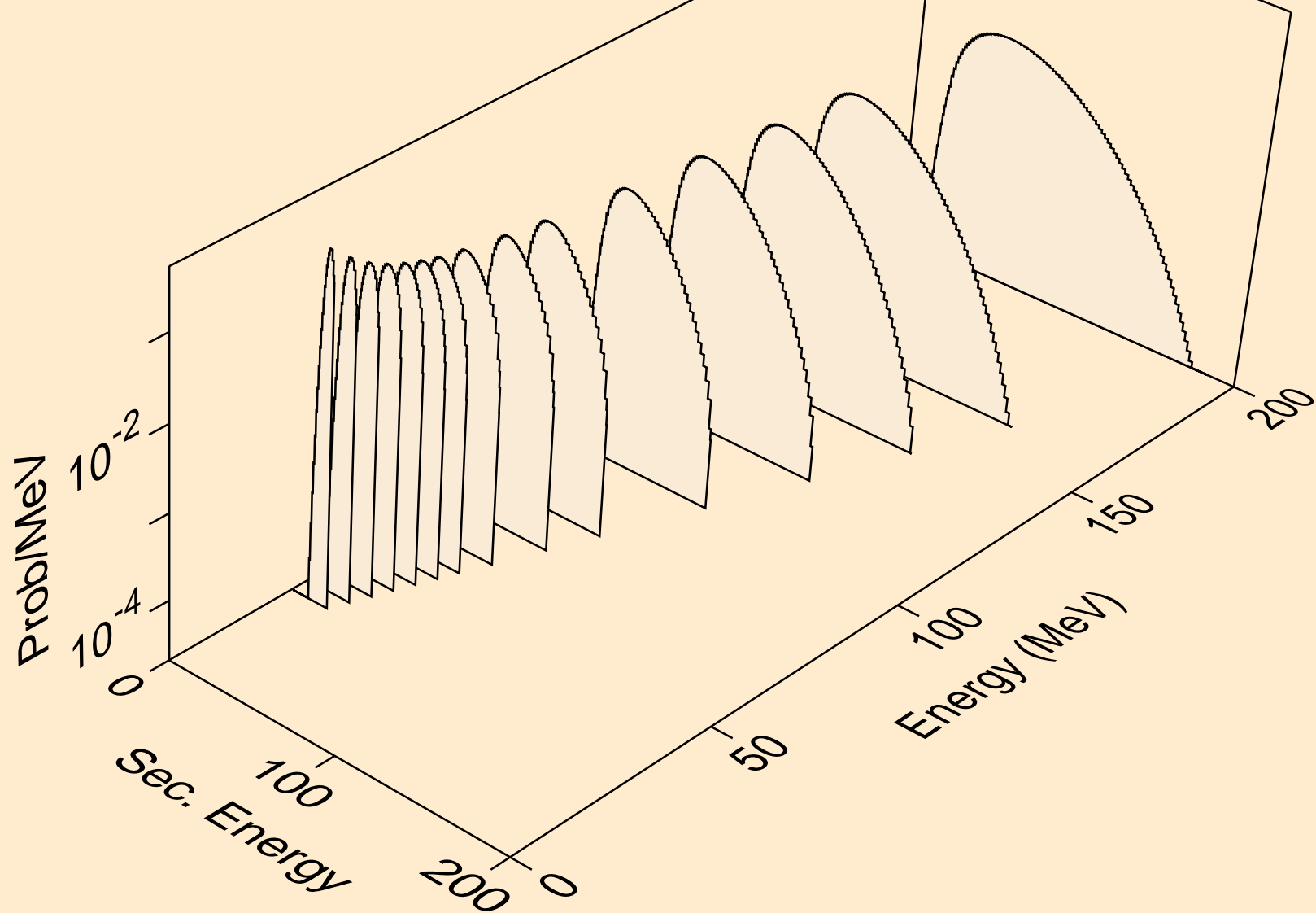

GD157 NEUTRON ACER TENDL-2024 LIBRARY; T=0.K  
he3s from (n,n\*)he3

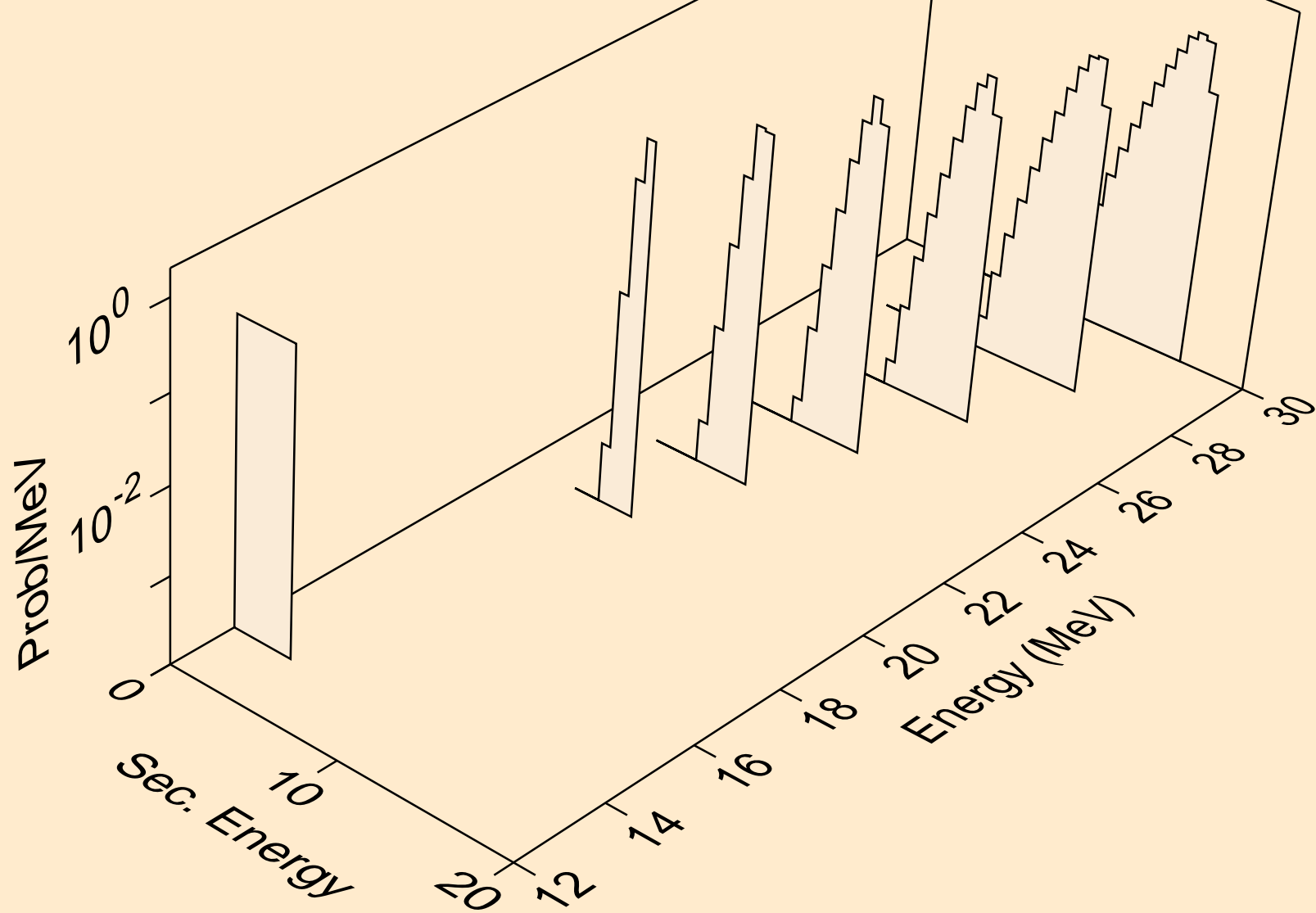

GD157 NEUTRON ACER TENDL-2024 LIBRARY; T=0.K  
he3s from (n,he3)

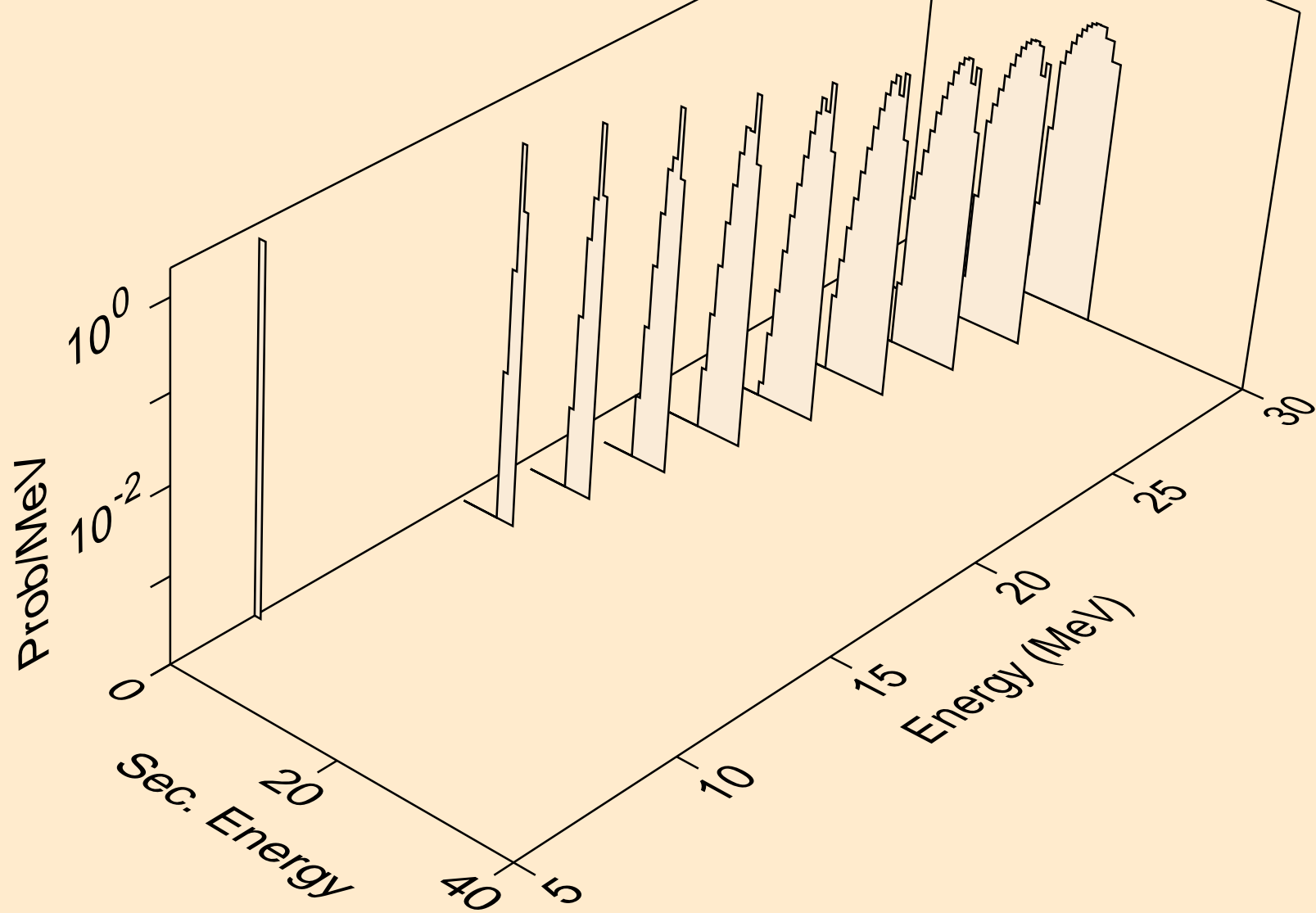

GD157 NEUTRON ACER TENDL-2024 LIBRARY; T=0.K  
alphas from (n,x)

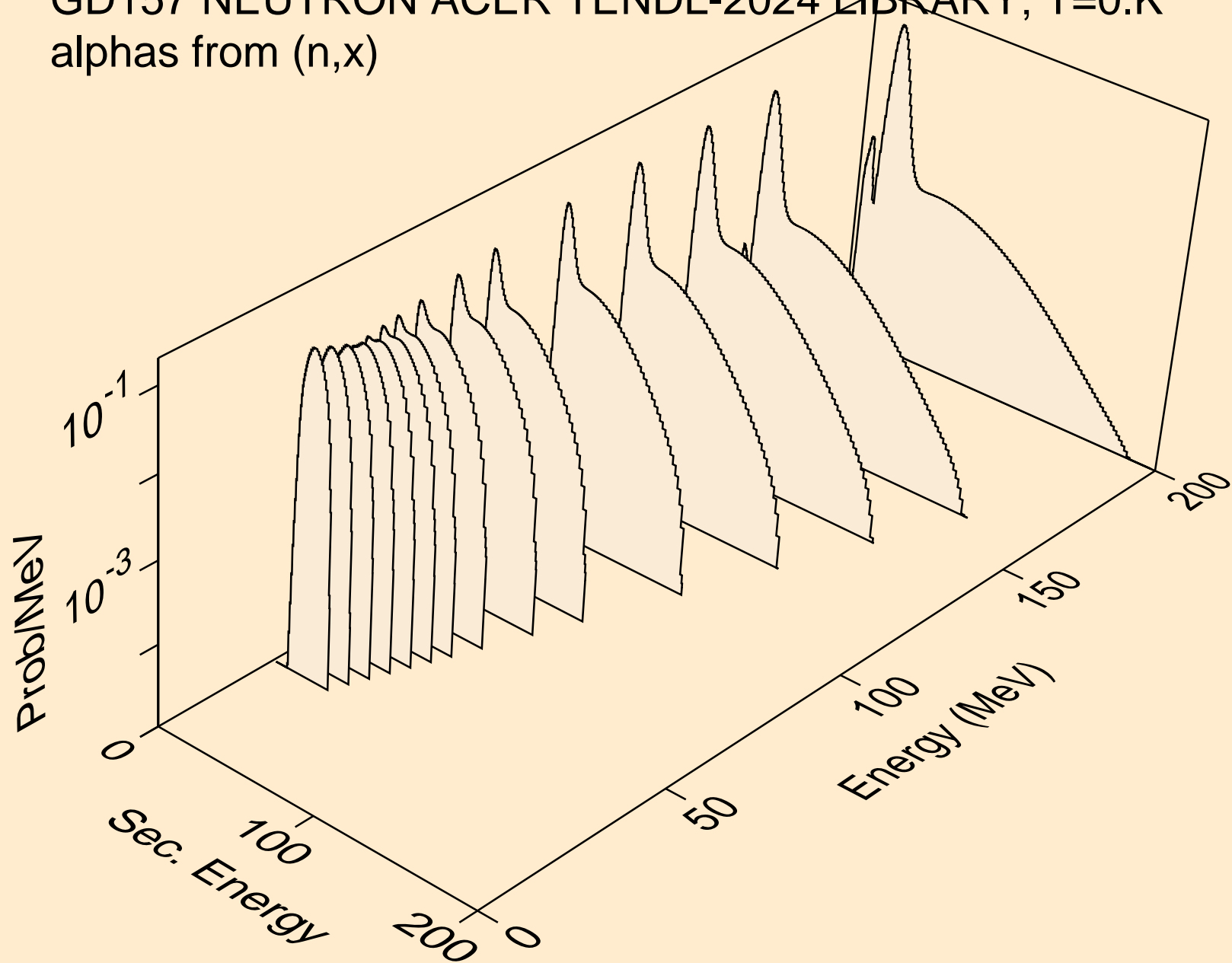

GD157 NEUTRON ACER TENDL-2024 LIBRARY; T=0.K  
alphas from (n,n\*)a

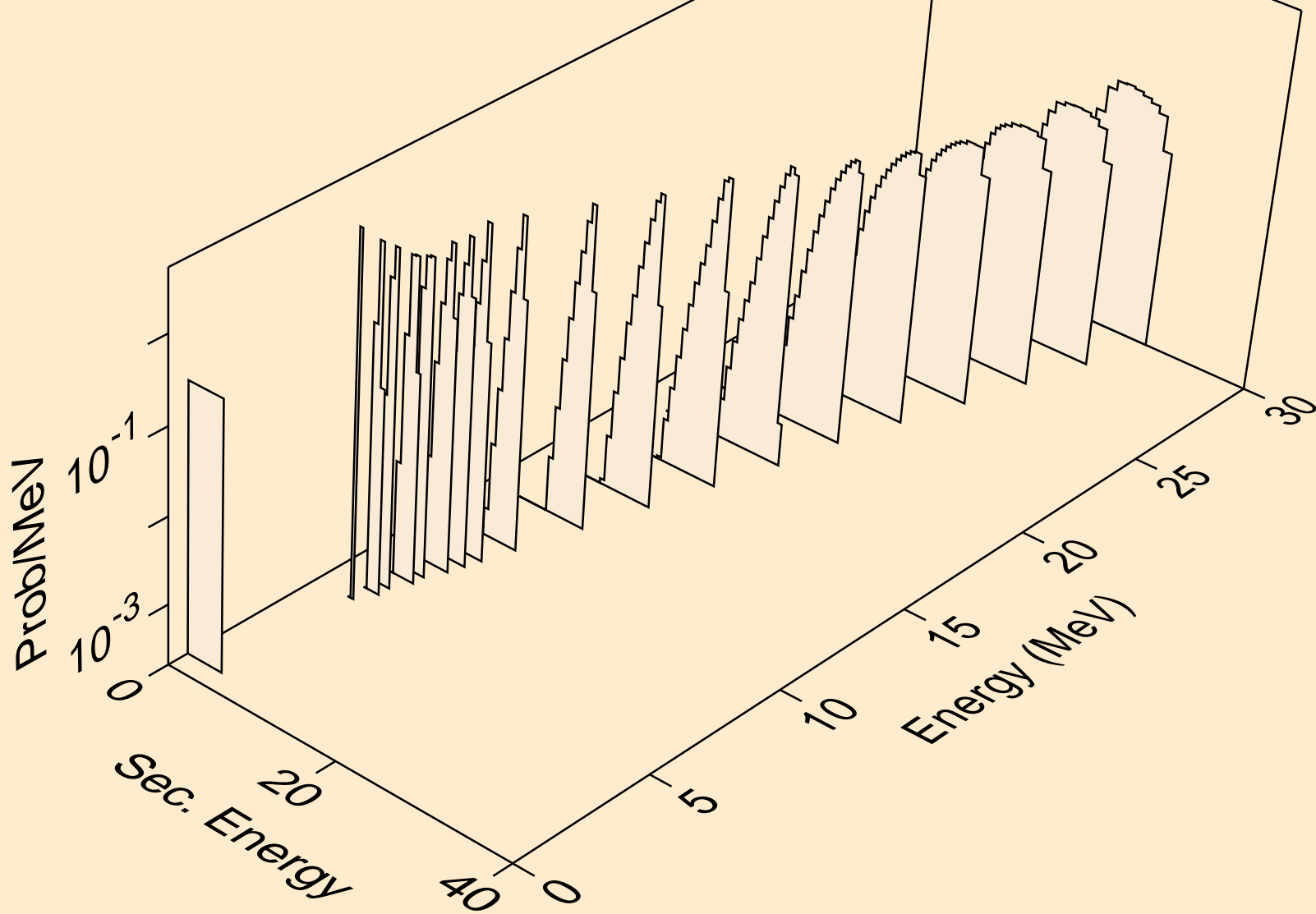

GD157 NEUTRON ACER TENDL-2024 LIBRARY; T=0.K  
alphas from (n,2n)a

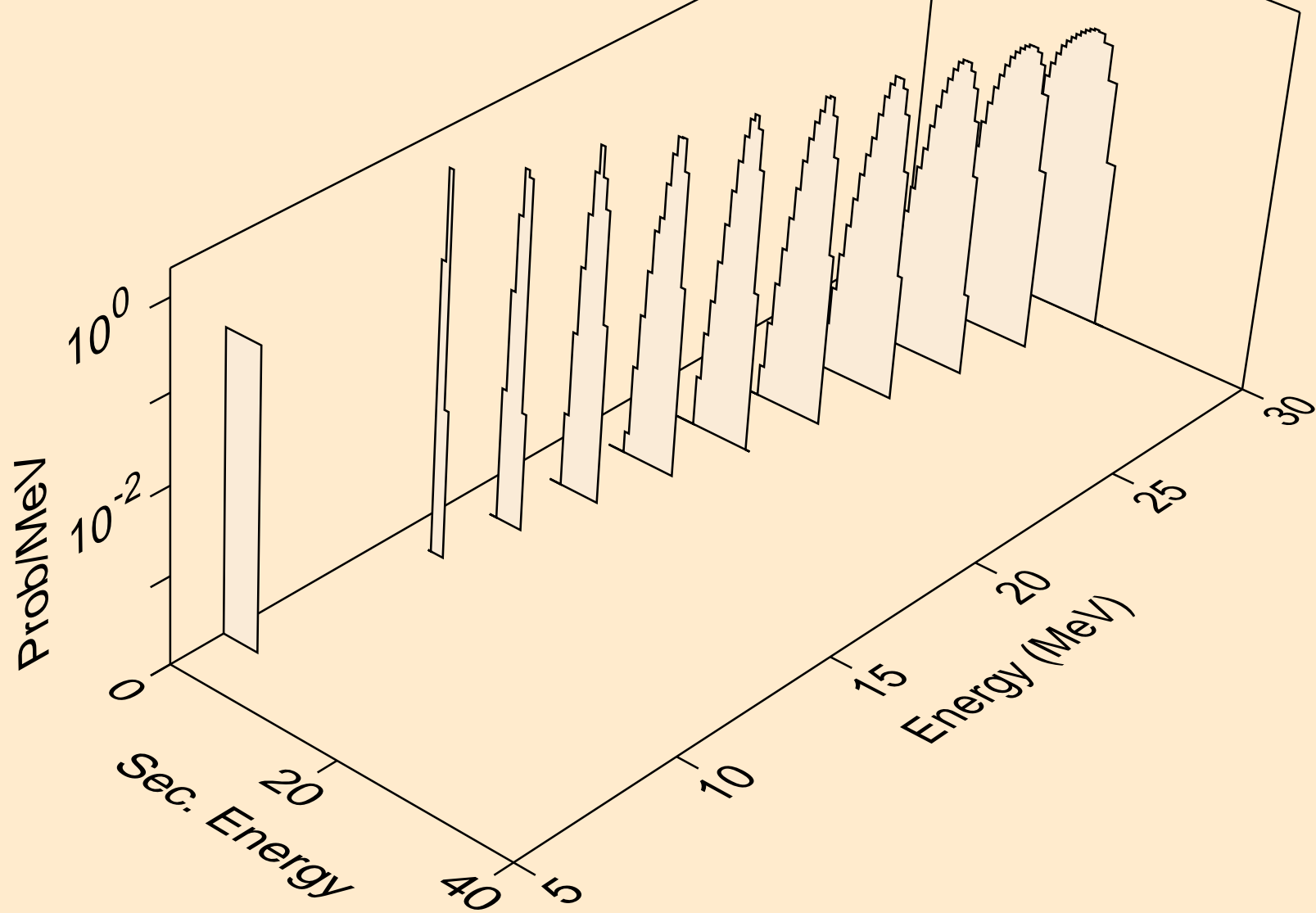

GD157 NEUTRON ACER TENDL-2024 LIBRARY; T=0.K  
alphas from (n,3n)a

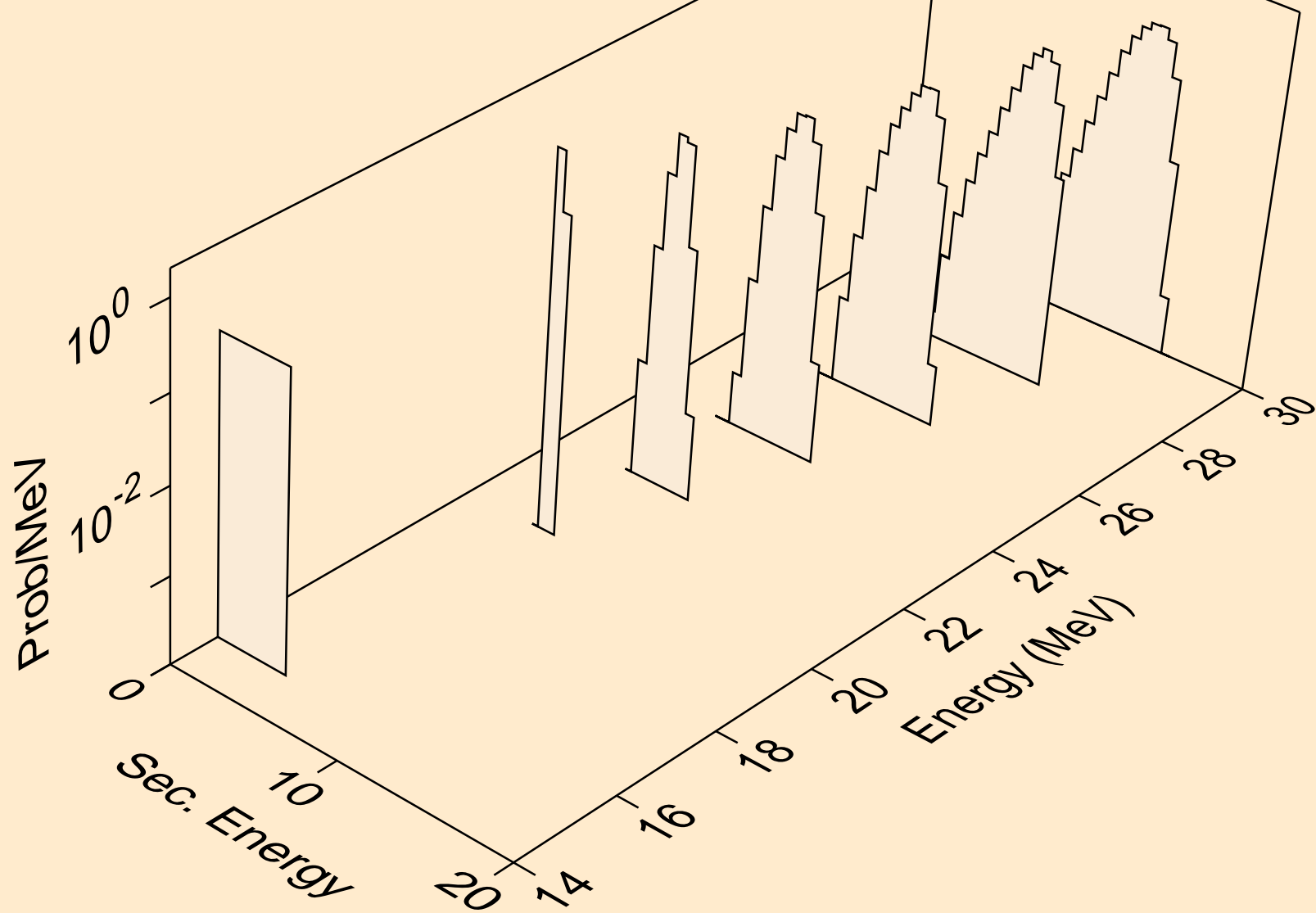



GD157 NEUTRON ACER TENDL-2024 LIBRARY; T=0.K  
alphas from (n,n\*)2a

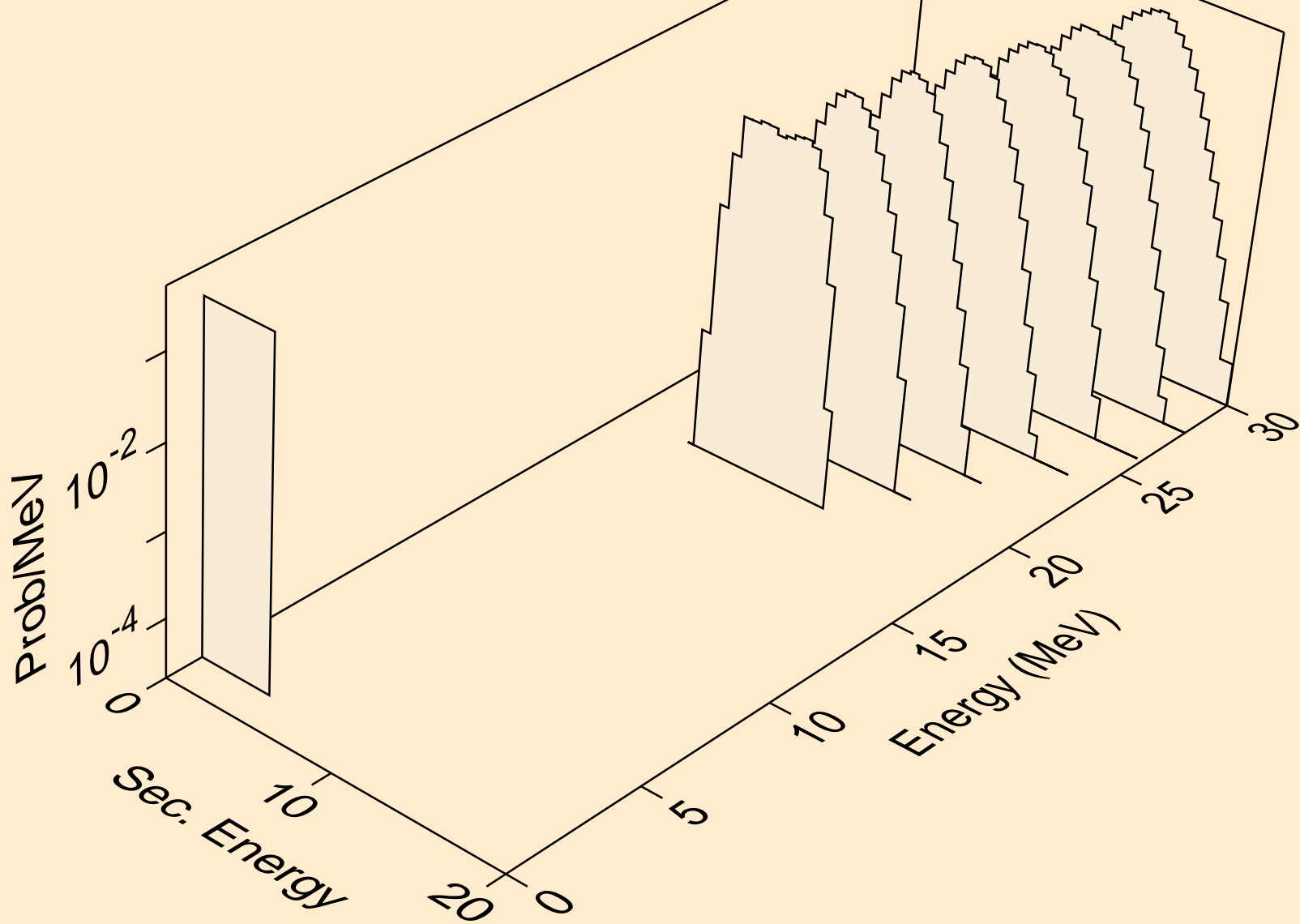

GD157 NEUTRON ACER TENDL-2024 LIBRARY; T=0.K  
alphas from (n,npa)

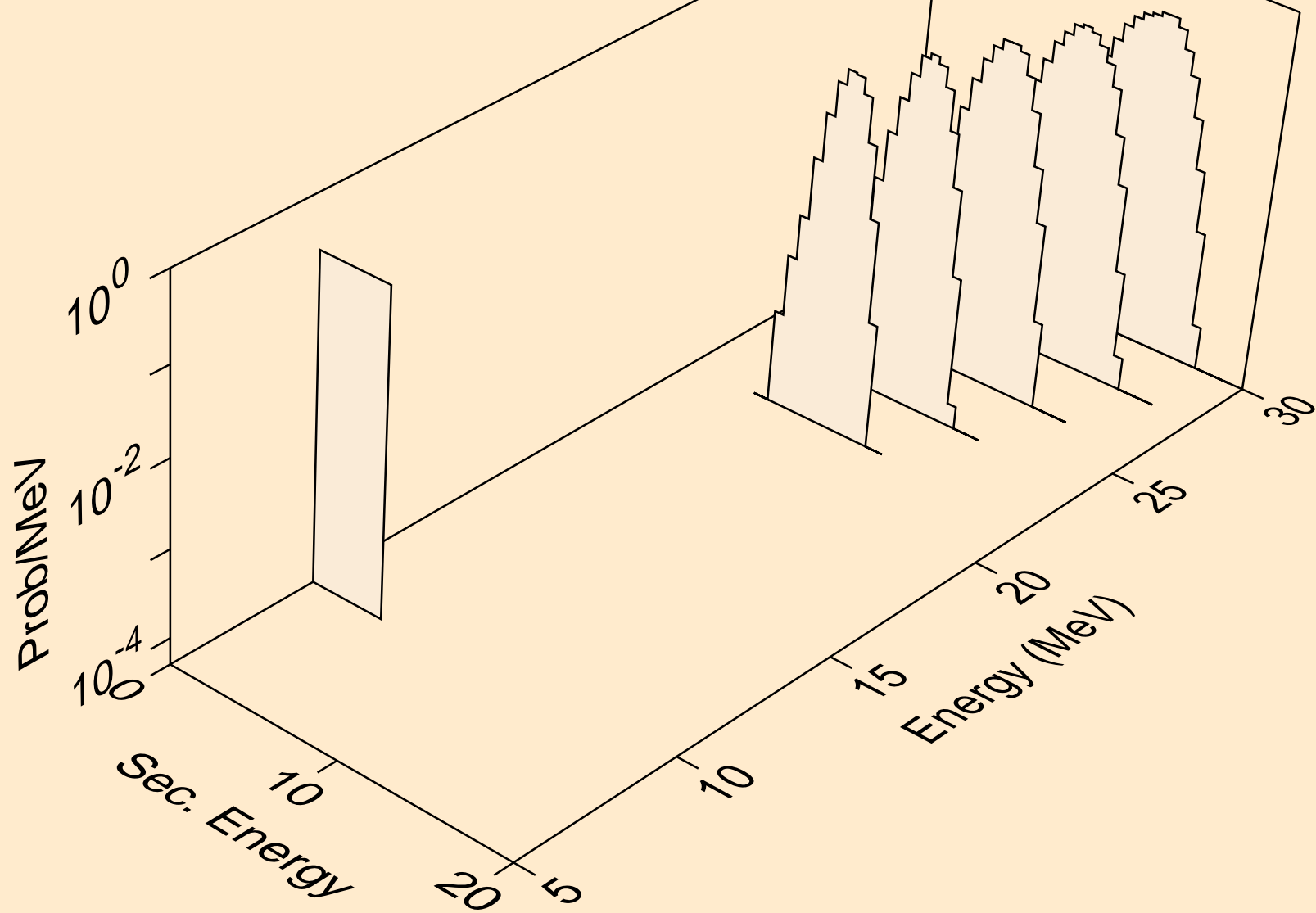

GD157 NEUTRON ACER TENDL-2024 LIBRARY; T=0.K  
alphas from (n,a)

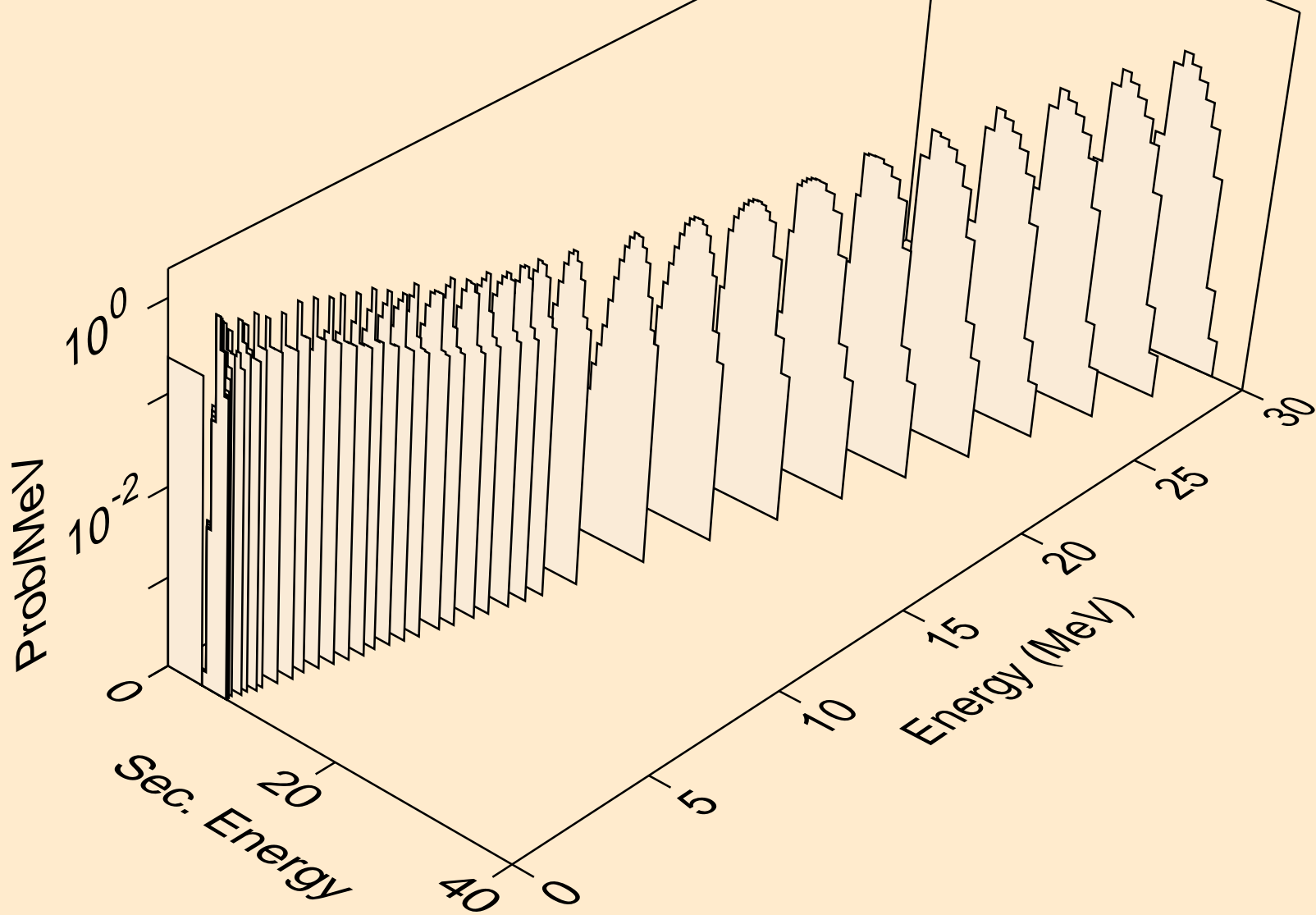

GD157 NEUTRON ACER TENDL-2024 LIBRARY; T=0.K  
alphas from (n,2a)

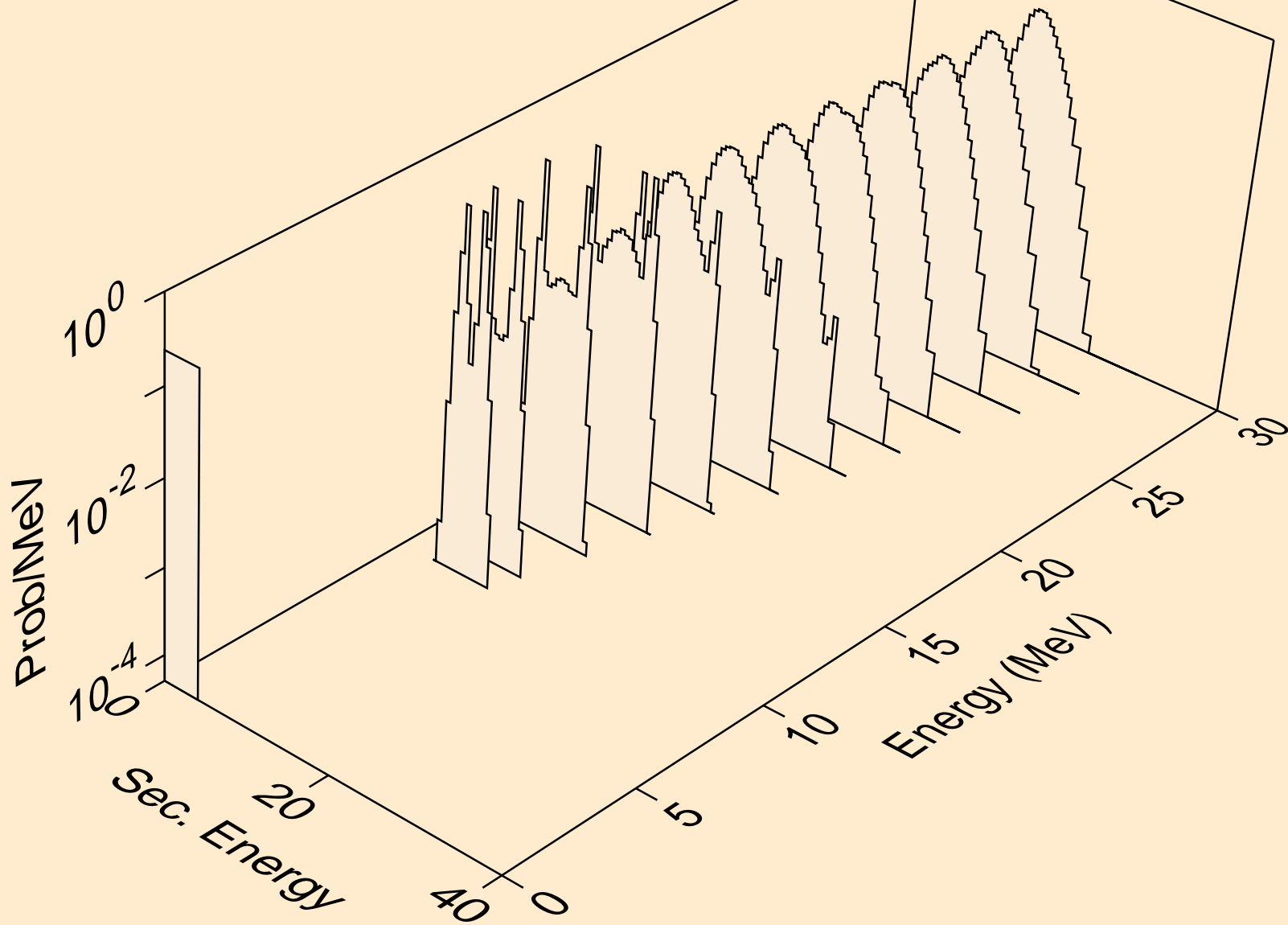

GD157 NEUTRON ACER TENDL-2024 LIBRARY; T=0.K  
alphas from (n,pa)

