

HG192 NEUTRON ACER TENDL-2024 LIBRARY; T=0.K

Principal cross sections

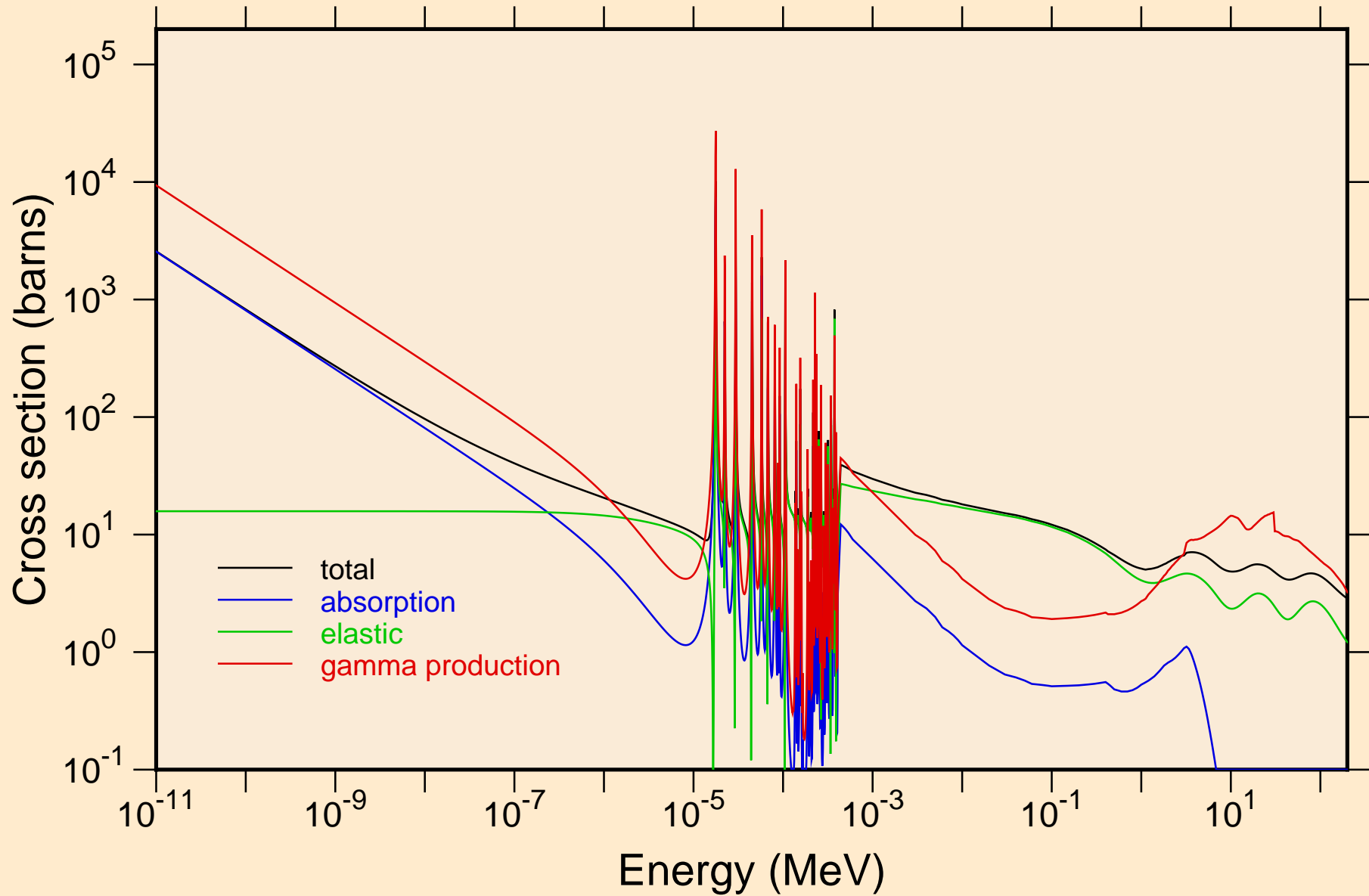

HG192 NEUTRON ACER TENDL-2024 LIBRARY; T=0.K
resonance total cross section

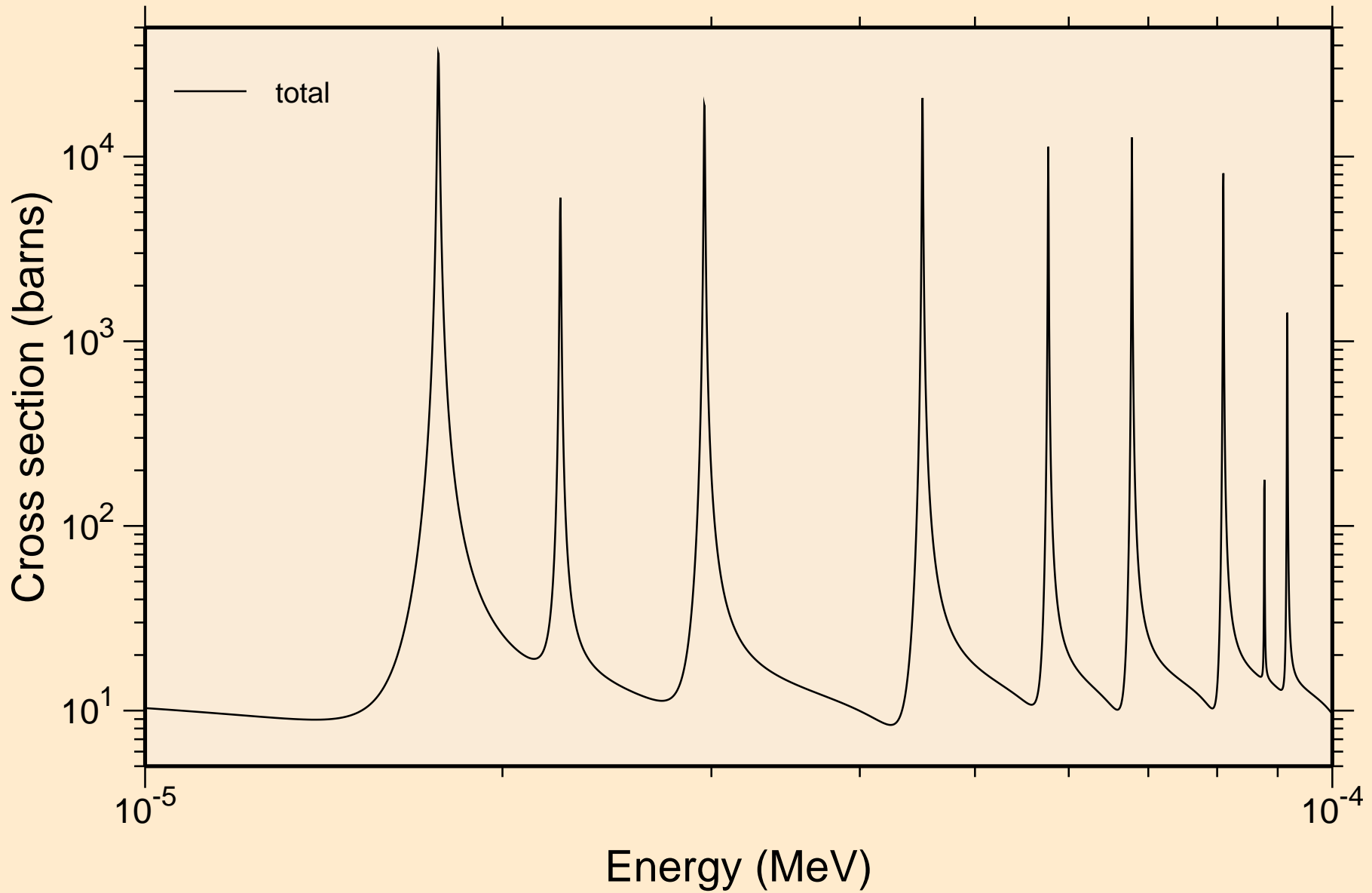

HG192 NEUTRON ACER TENDL-2024 LIBRARY; T=0.K
resonance total cross section

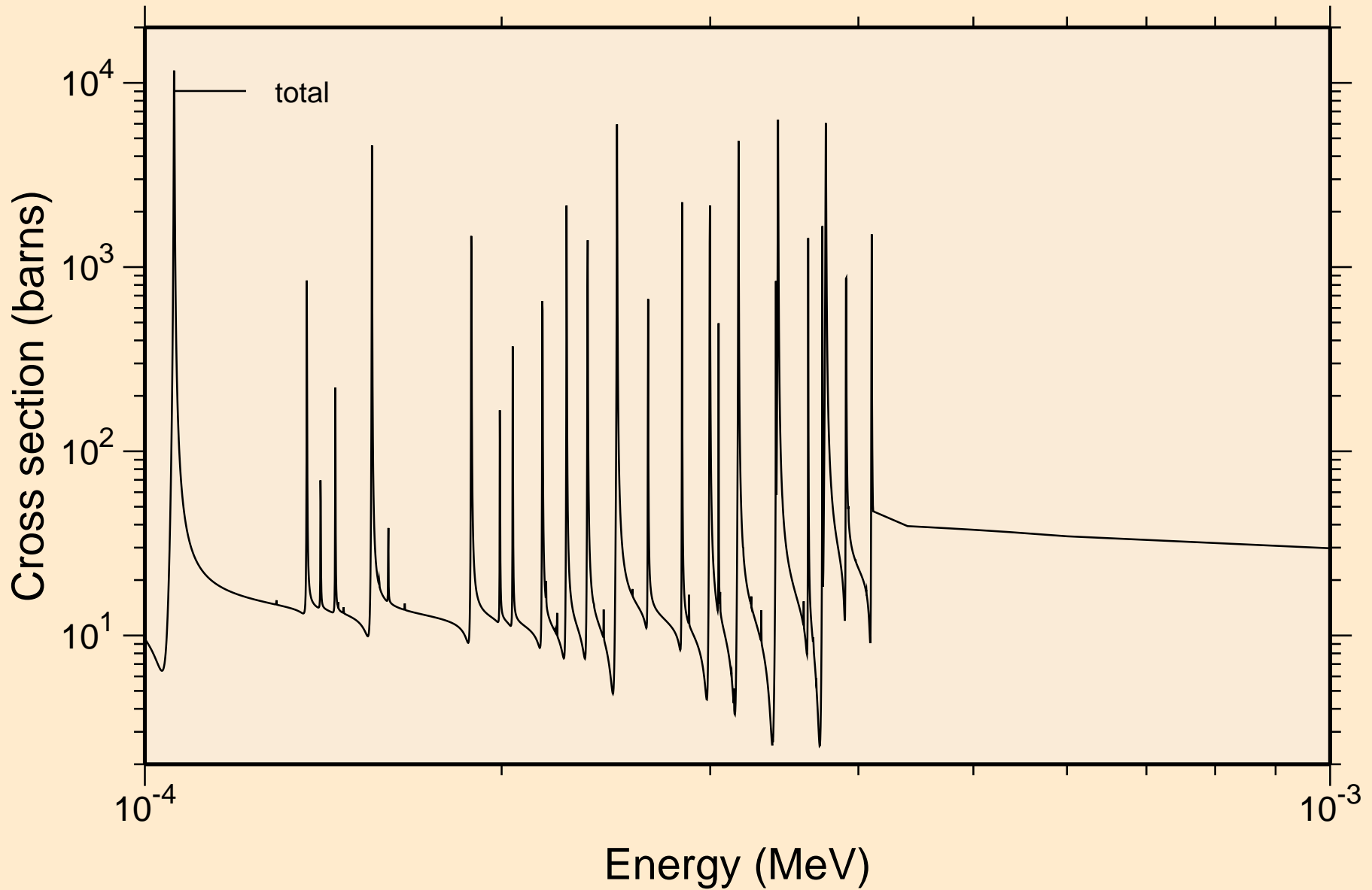

HG192 NEUTRON ACER TENDL-2024 LIBRARY; T=0.K
resonance total cross section

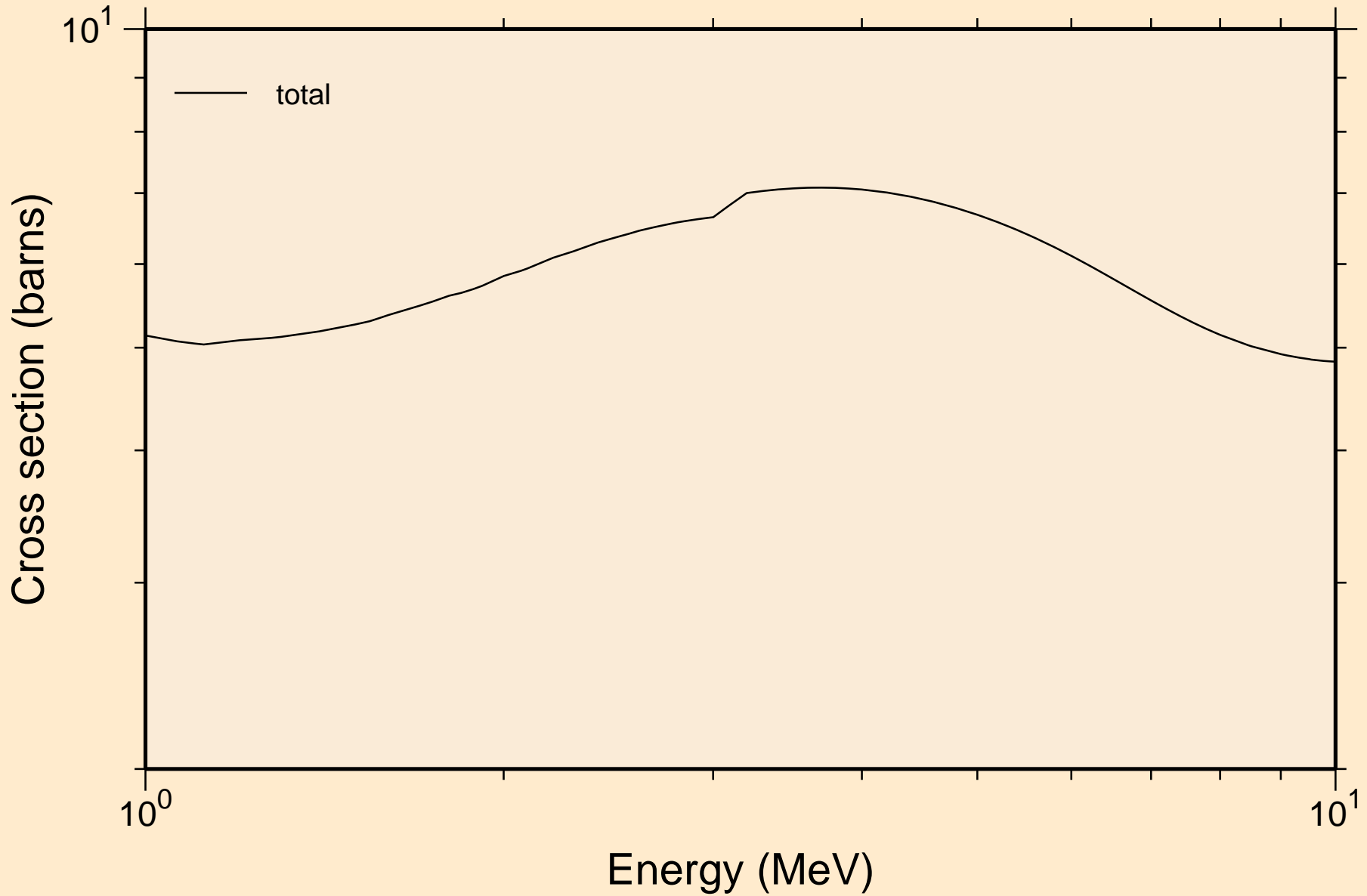

HG192 NEUTRON ACER TENDL-2024 LIBRARY; T=0.K
resonance absorption cross sections

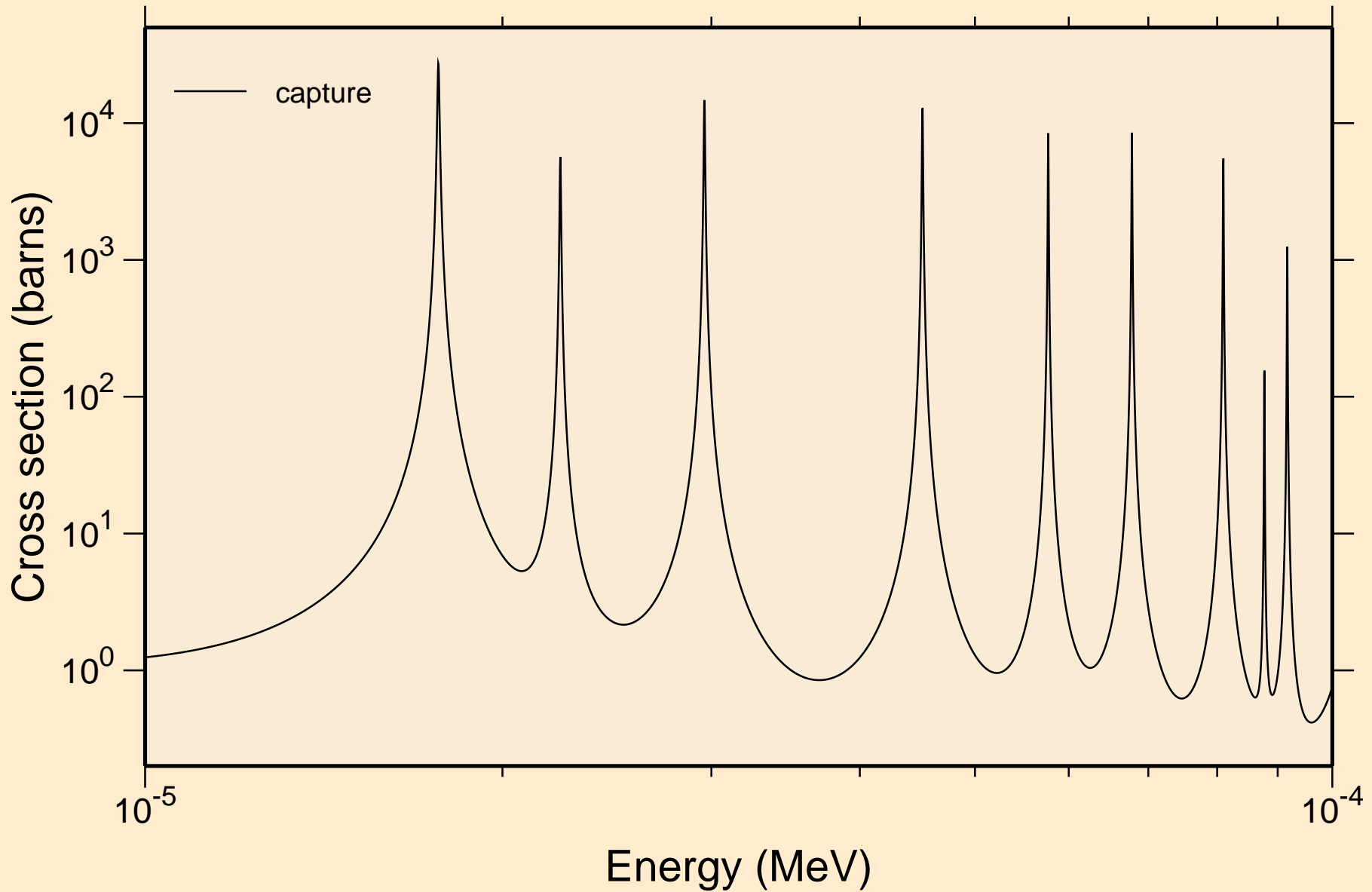

HG192 NEUTRON ACER TENDL-2024 LIBRARY; T=0.K

resonance absorption cross sections

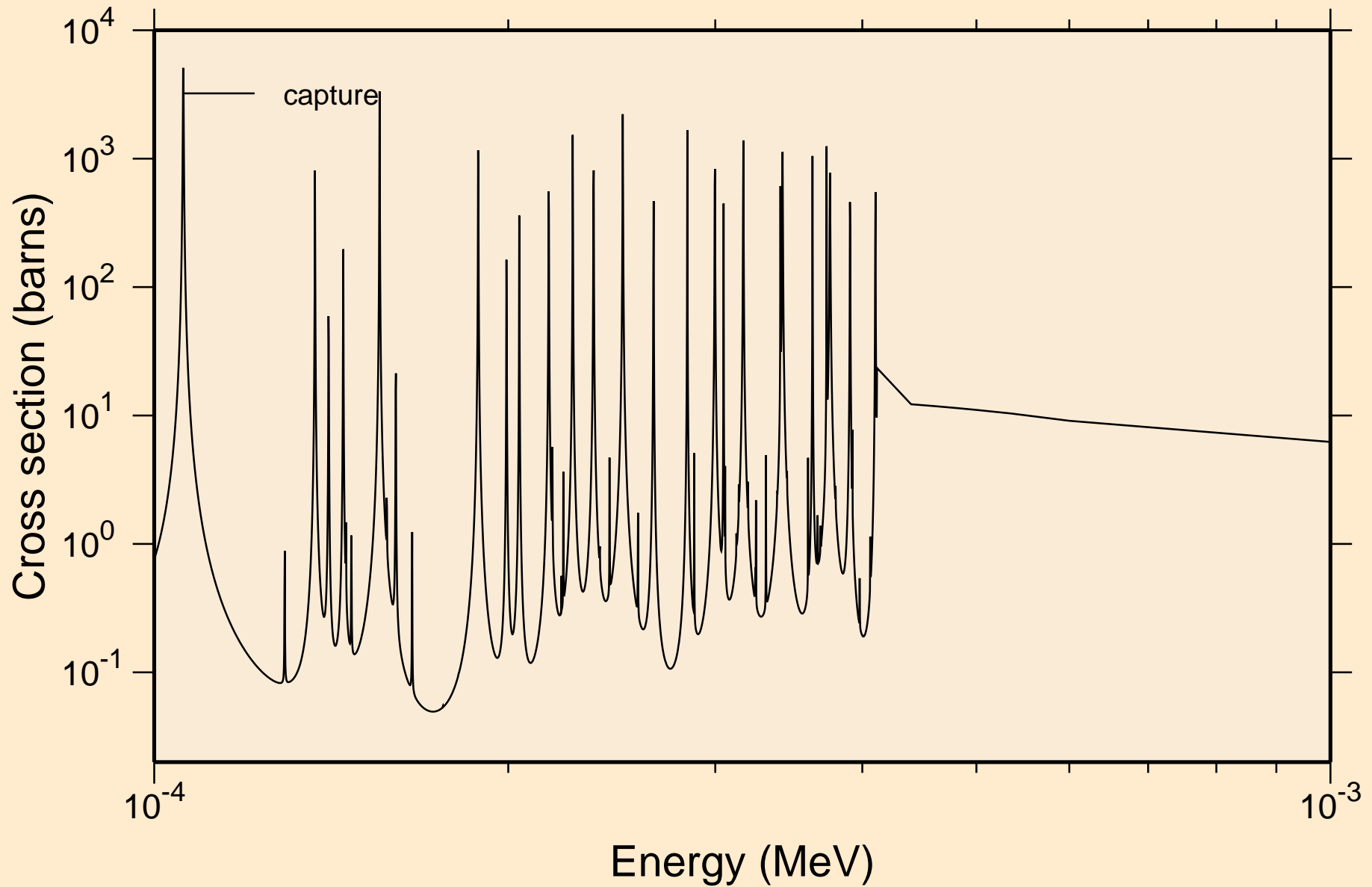

HG192 NEUTRON ACER TENDL-2024 LIBRARY; T=0.K
resonance absorption cross sections

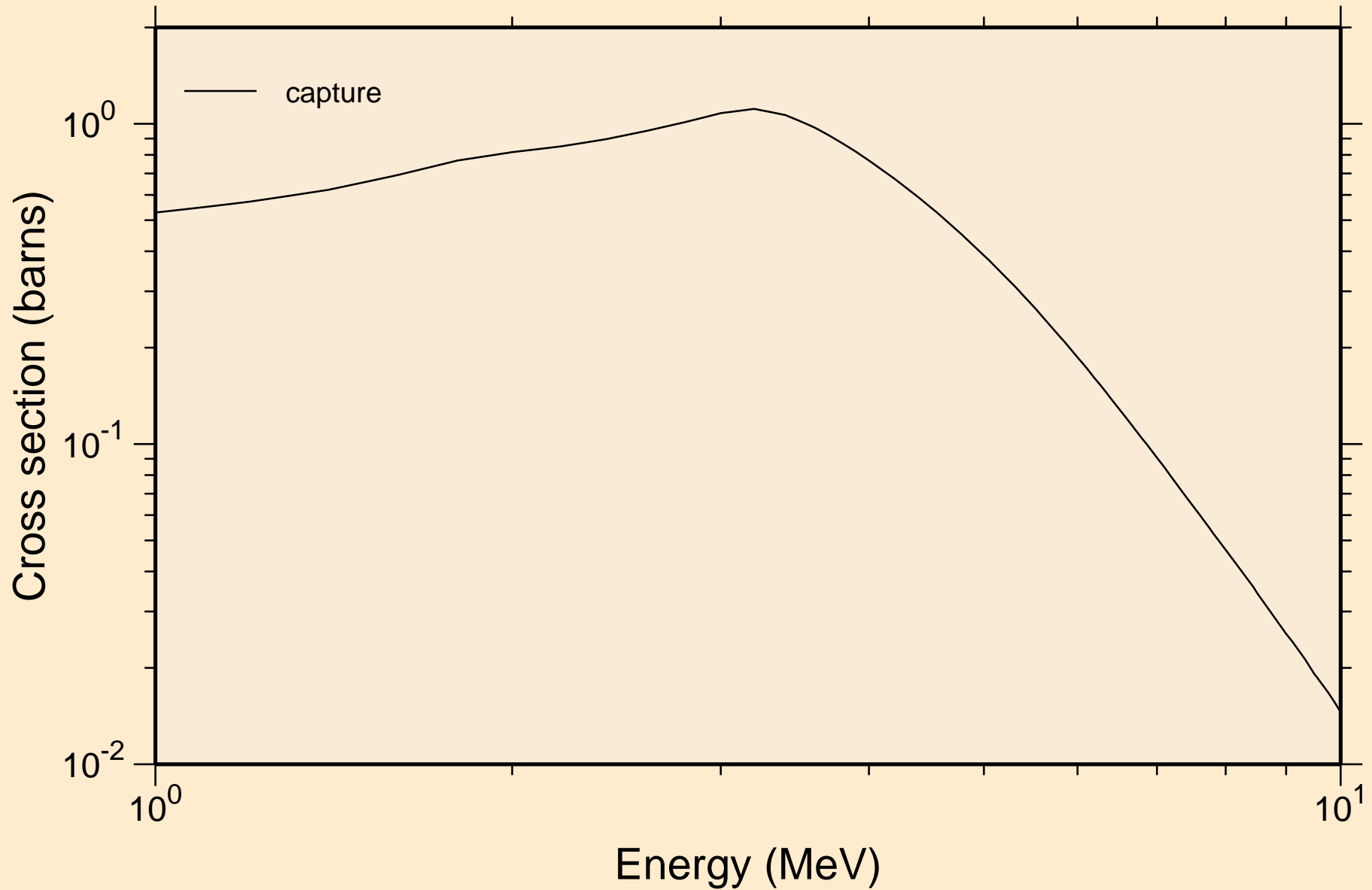

HG192 NEUTRON ACER TENDL-2024 LIBRARY; T=0.K
Heating

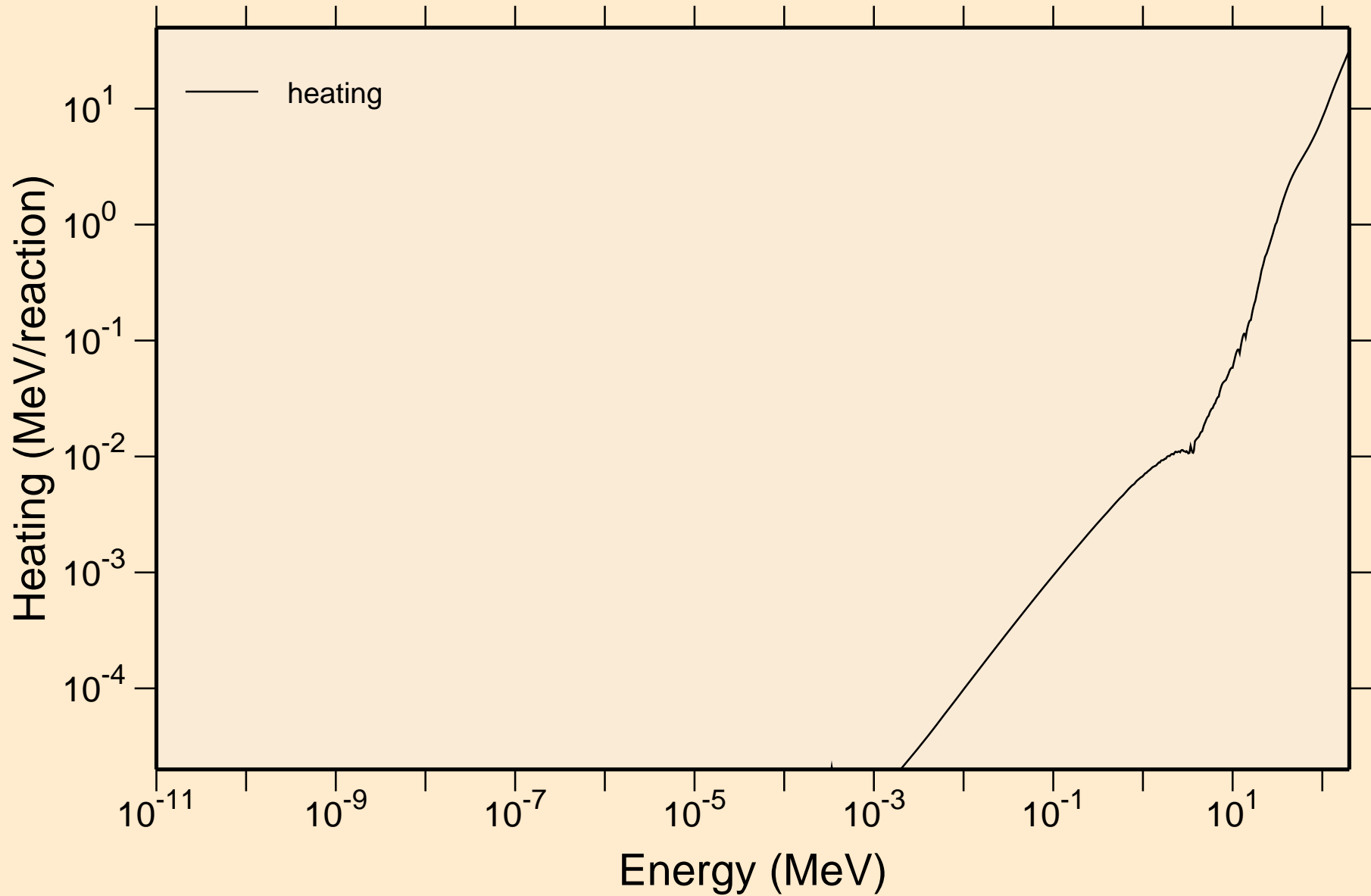

HG192 NEUTRON ACER TENDL-2024 LIBRARY; T=0.K

Damage

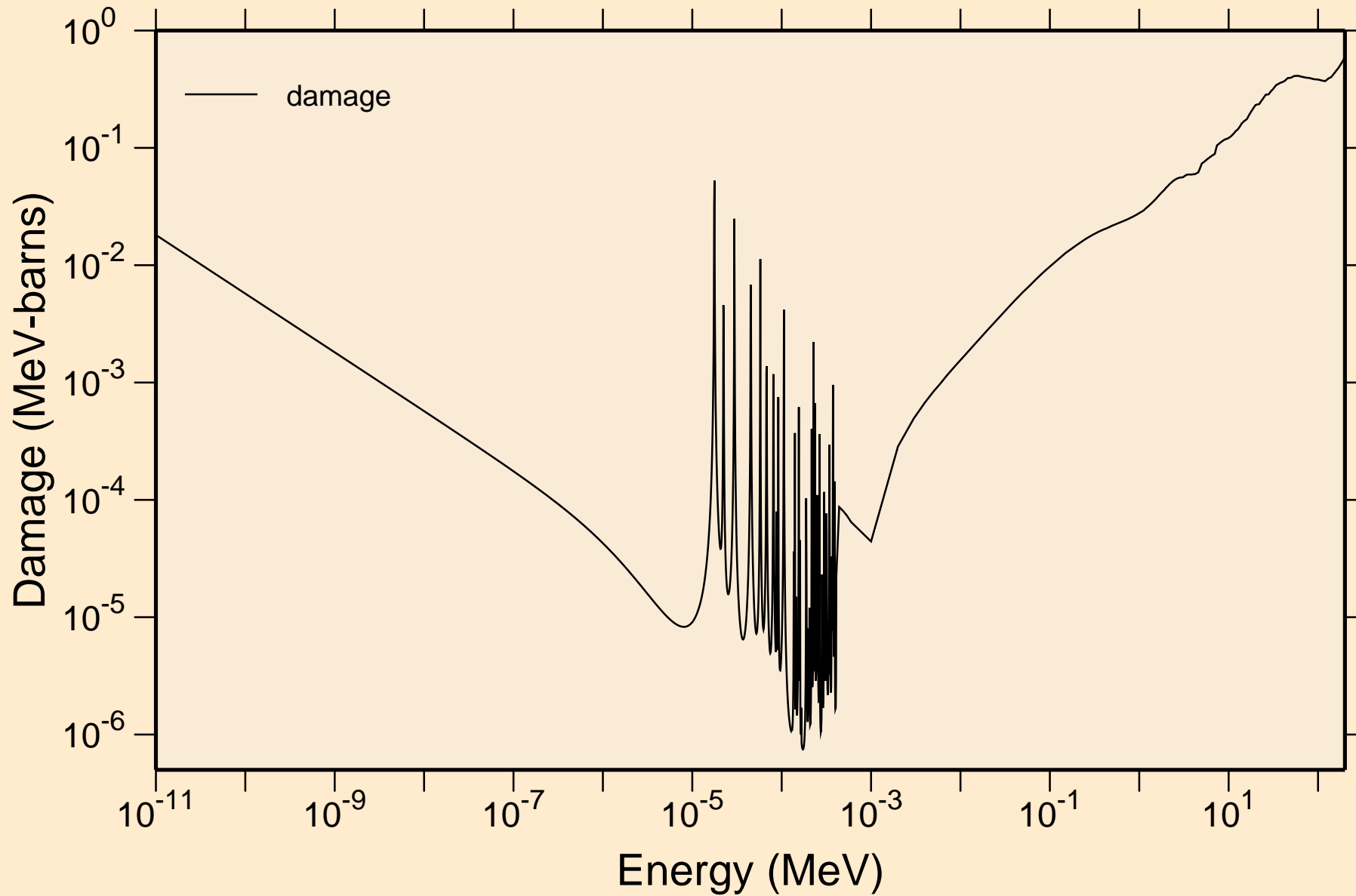

HG192 NEUTRON ACER TENDL-2024 LIBRARY; T=0.K

Non-threshold reactions

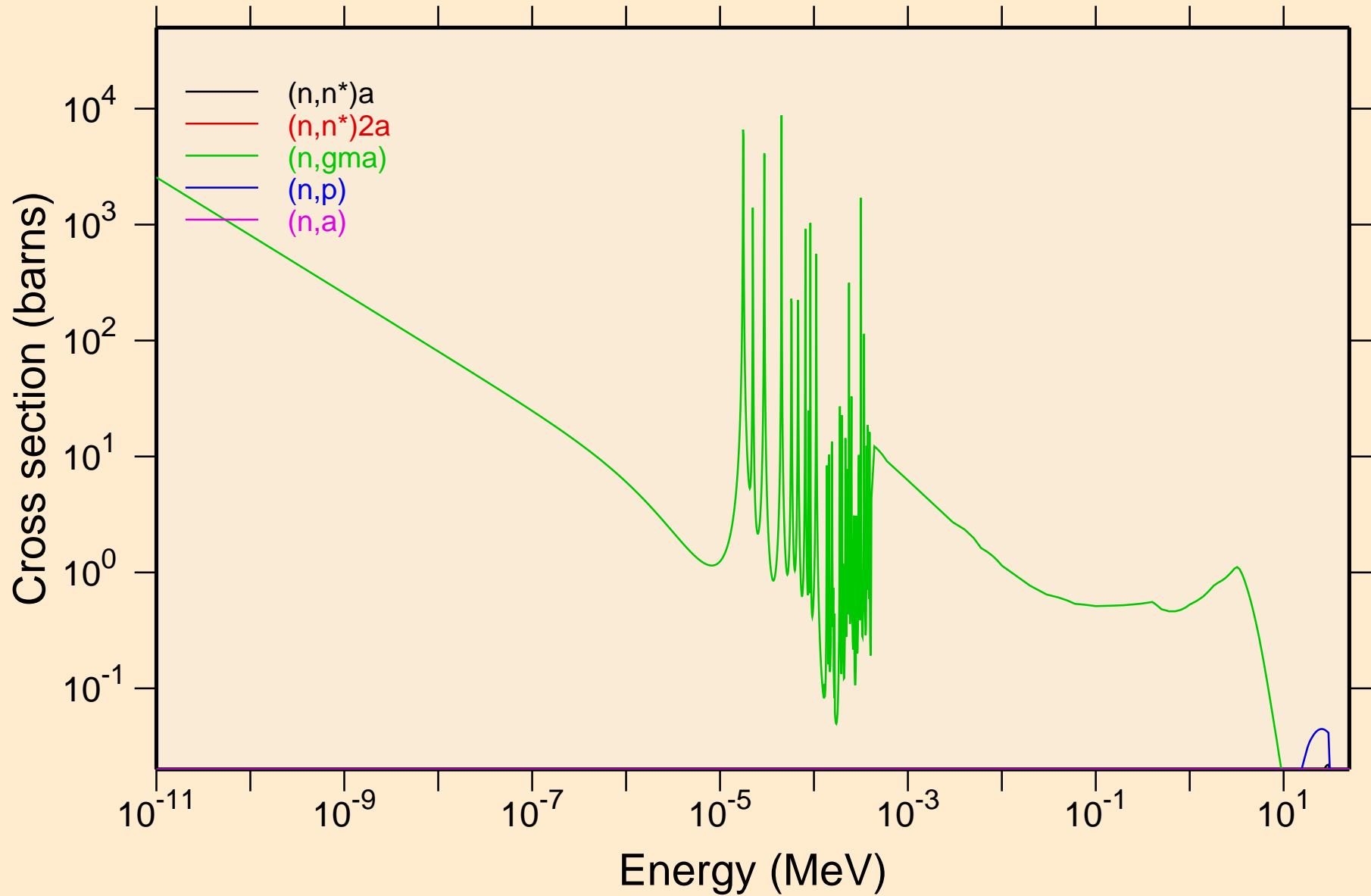

HG192 NEUTRON ACER TENDL-2024 LIBRARY; T=0.K

Non-threshold reactions

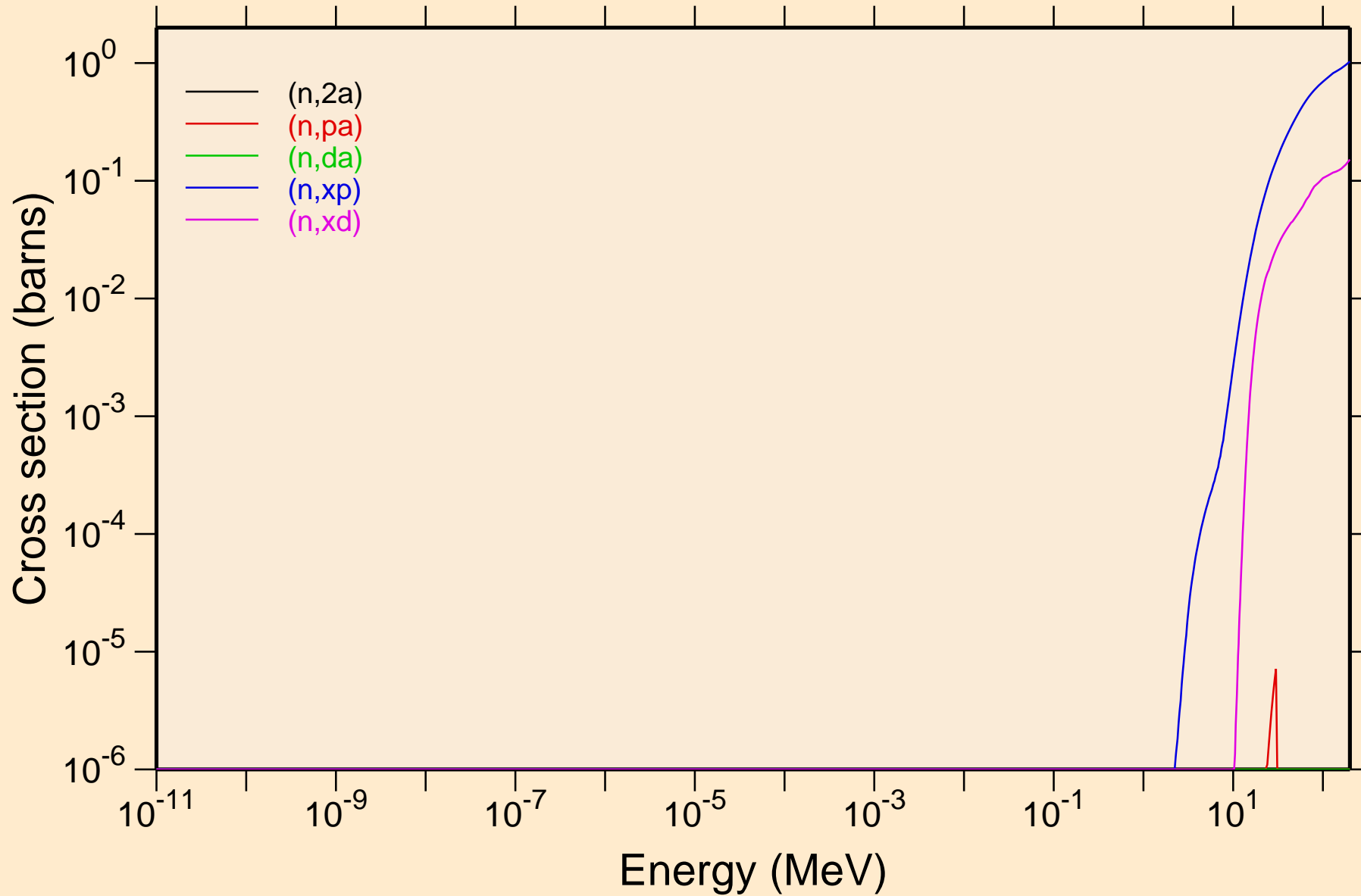

HG192 NEUTRON ACER TENDL-2024 LIBRARY; T=0.K
Non-threshold reactions

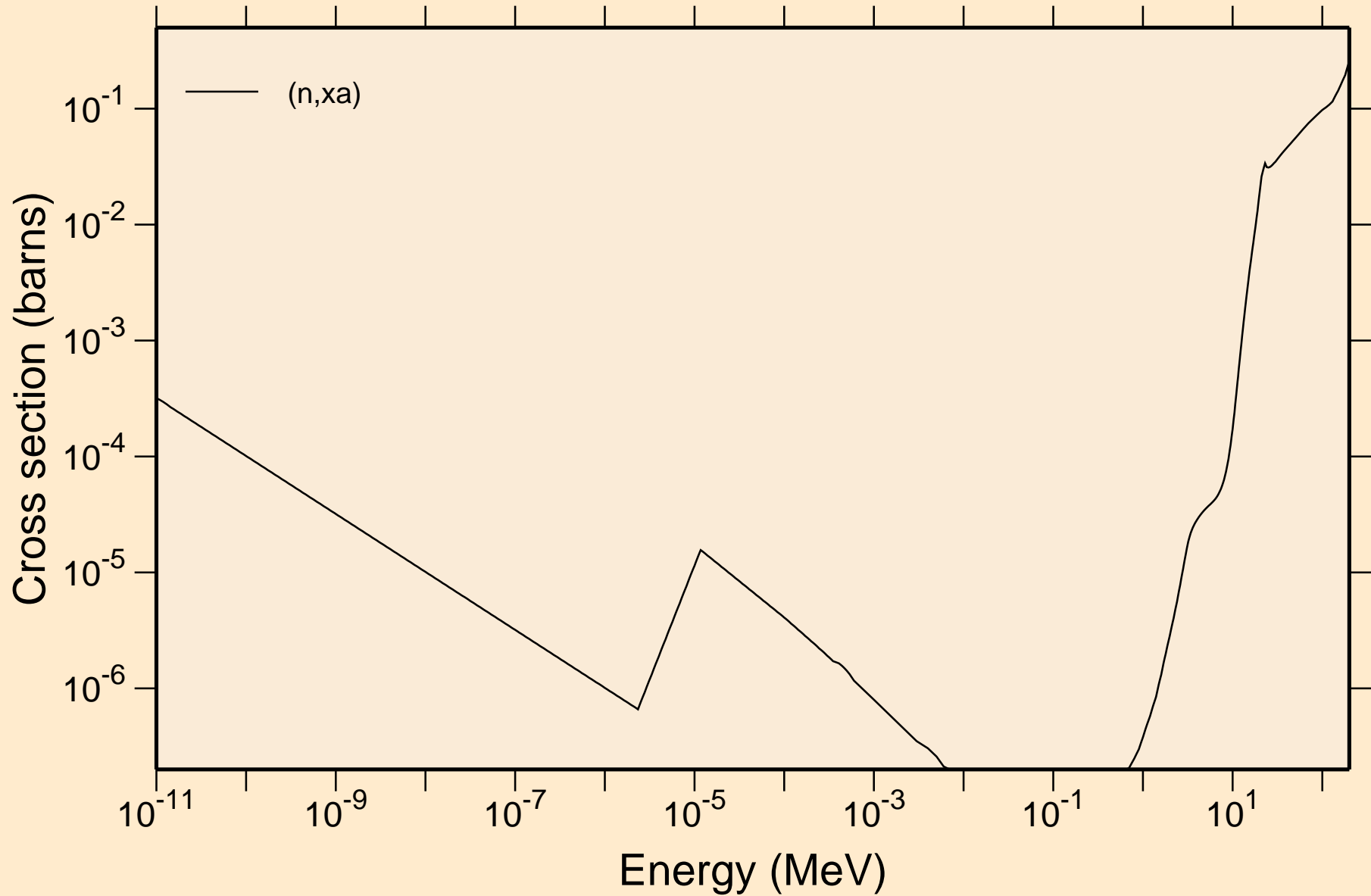

HG192 NEUTRON ACER TENDL-2024 LIBRARY; T=0.K

Principal cross sections

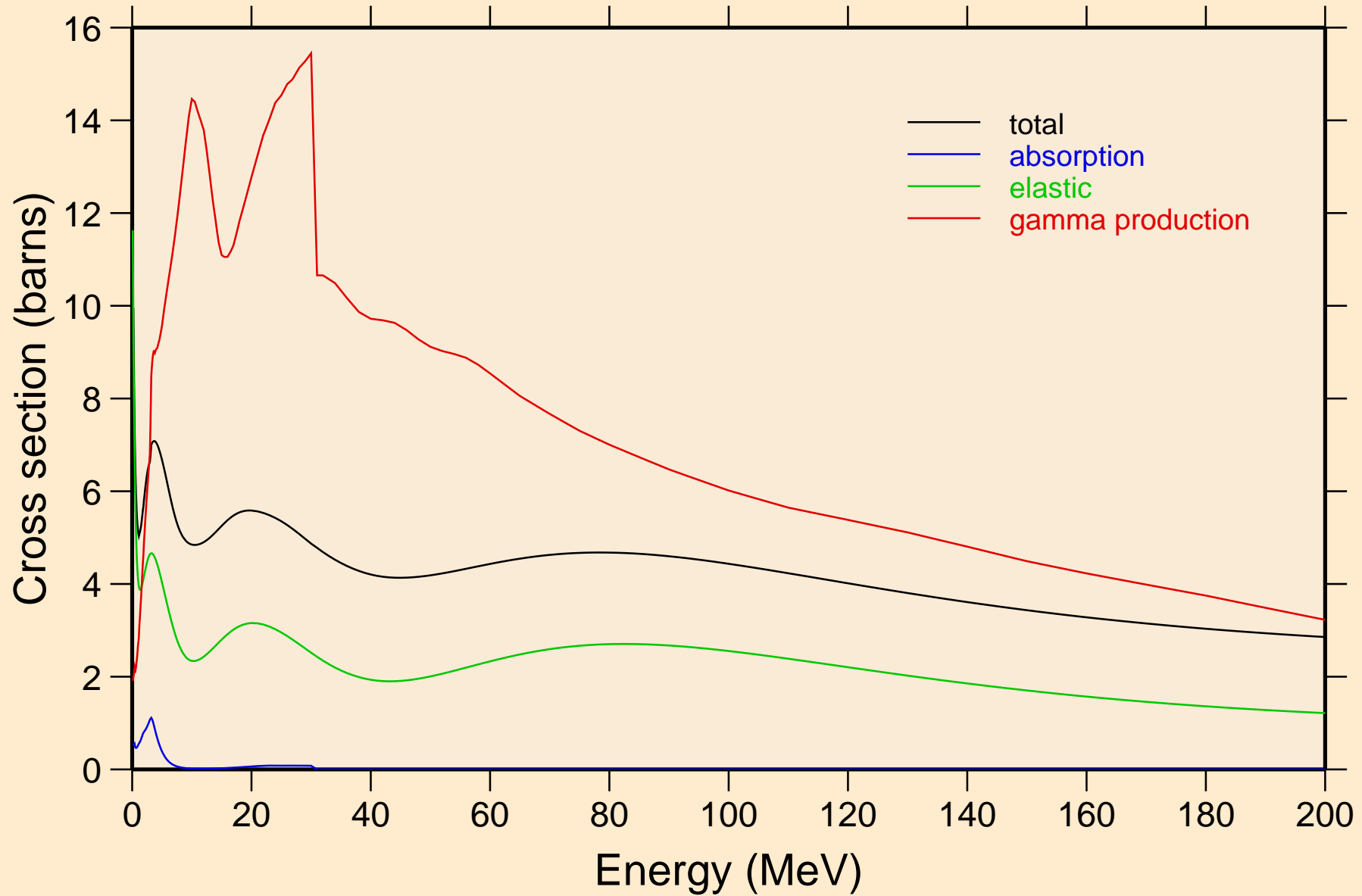

HG192 NEUTRON ACER TENDL-2024 LIBRARY; T=0.K

Heating

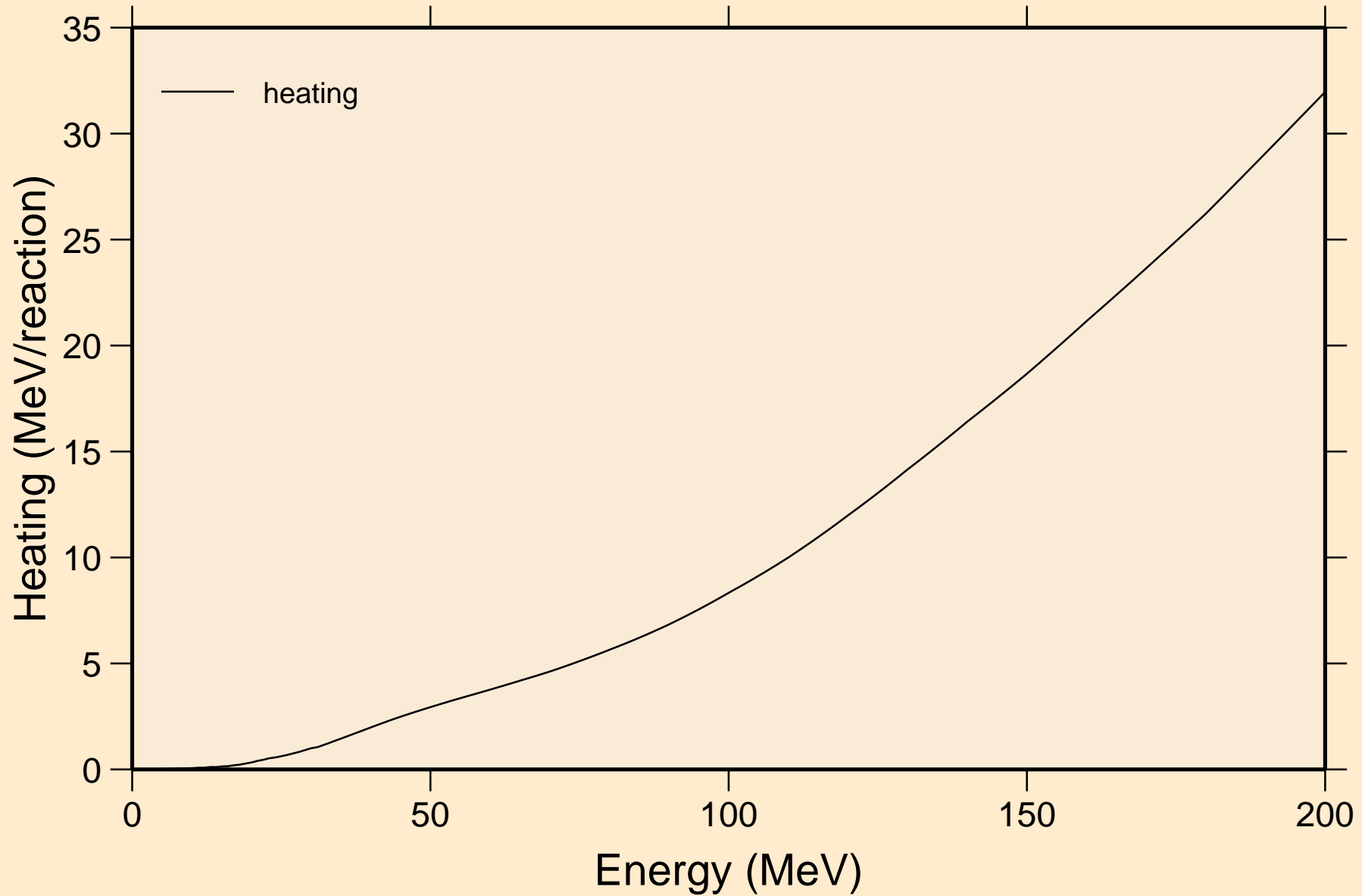

HG192 NEUTRON ACER TENDL-2024 LIBRARY; T=0.K

Damage

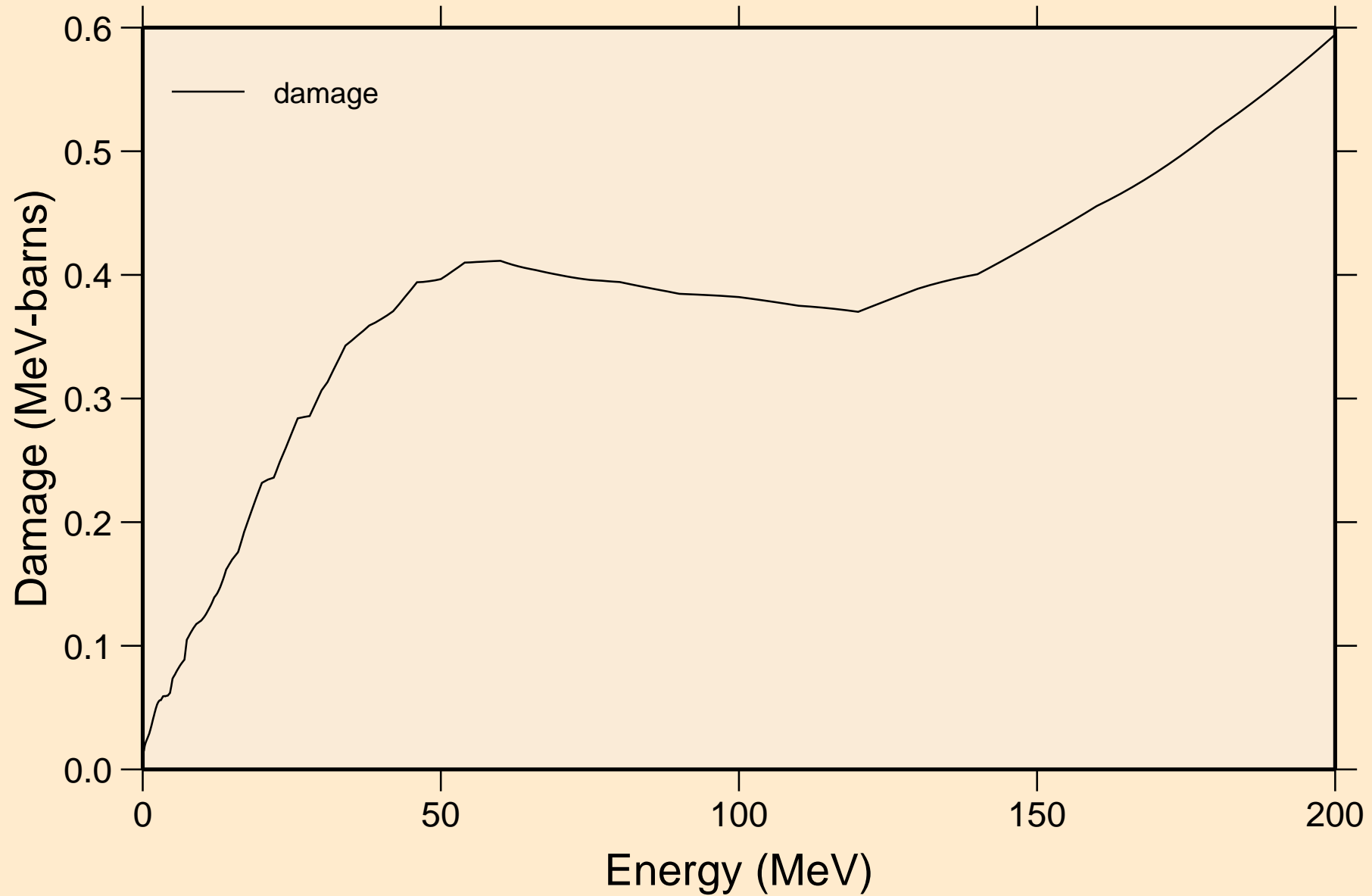

HG192 NEUTRON ACER TENDL-2024 LIBRARY; T=0.K

Non-threshold reactions

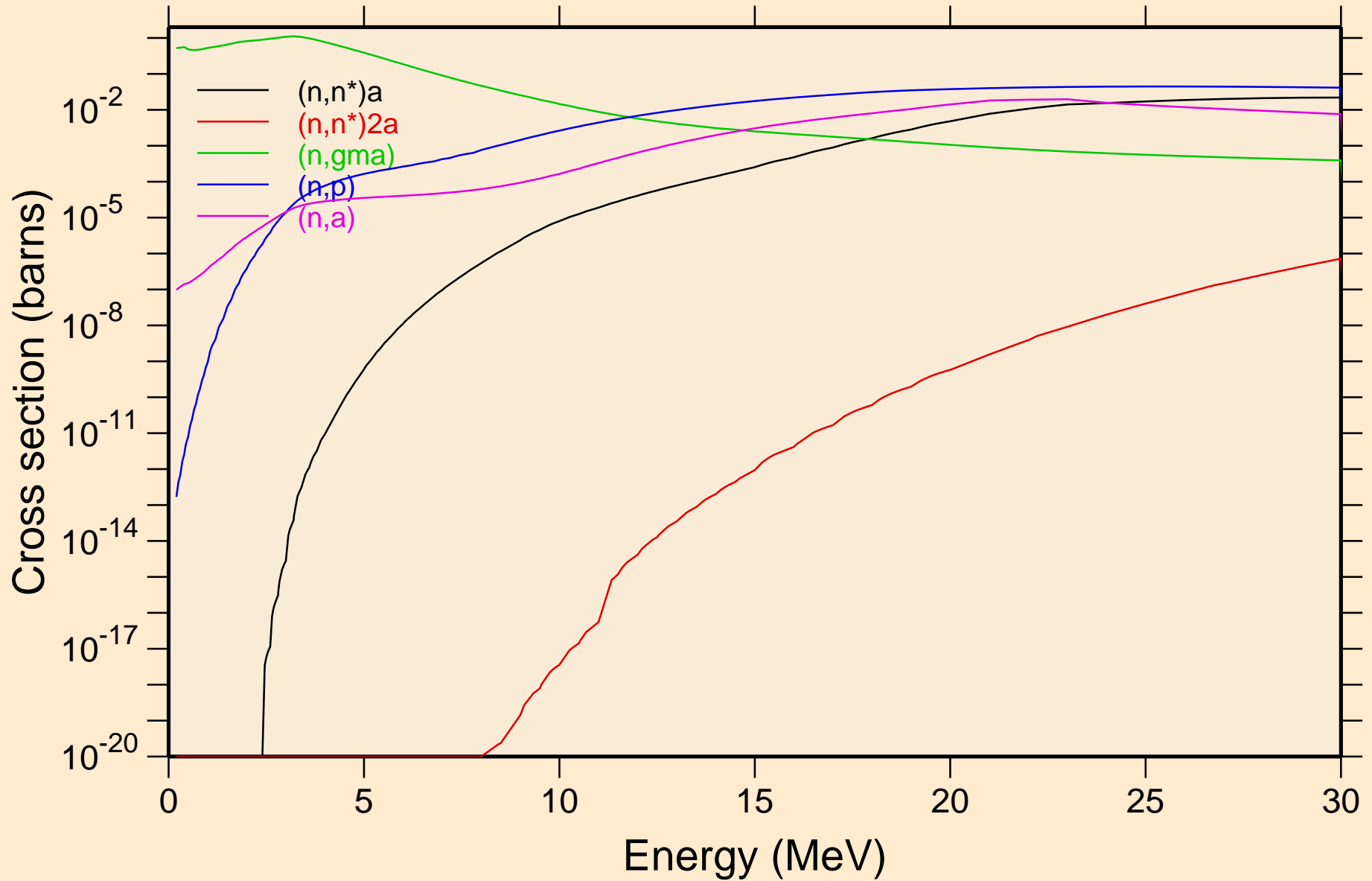

HG192 NEUTRON ACER TENDL-2024 LIBRARY; T=0.K

Non-threshold reactions

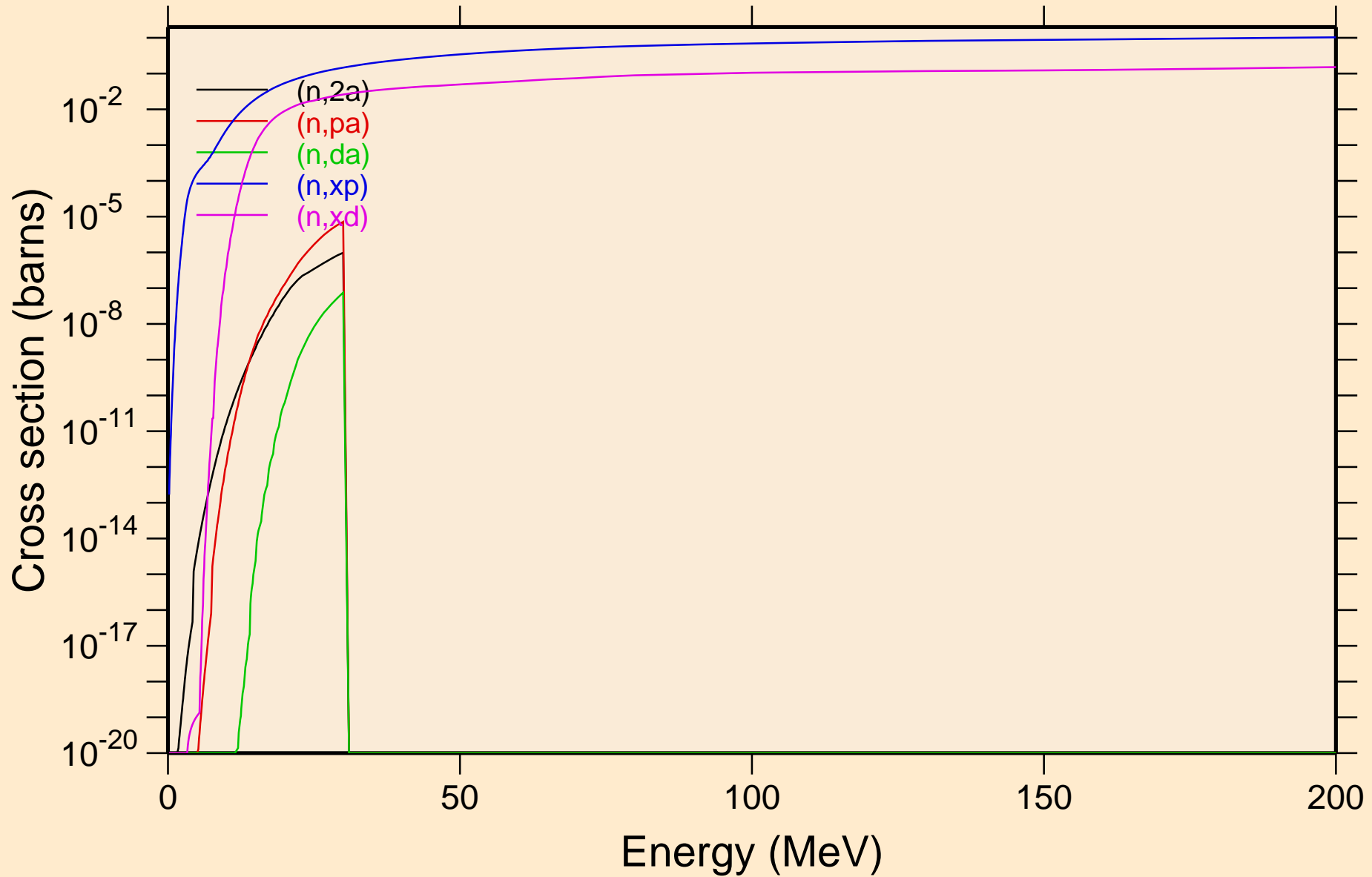

HG192 NEUTRON ACER TENDL-2024 LIBRARY; T=0.K
Non-threshold reactions

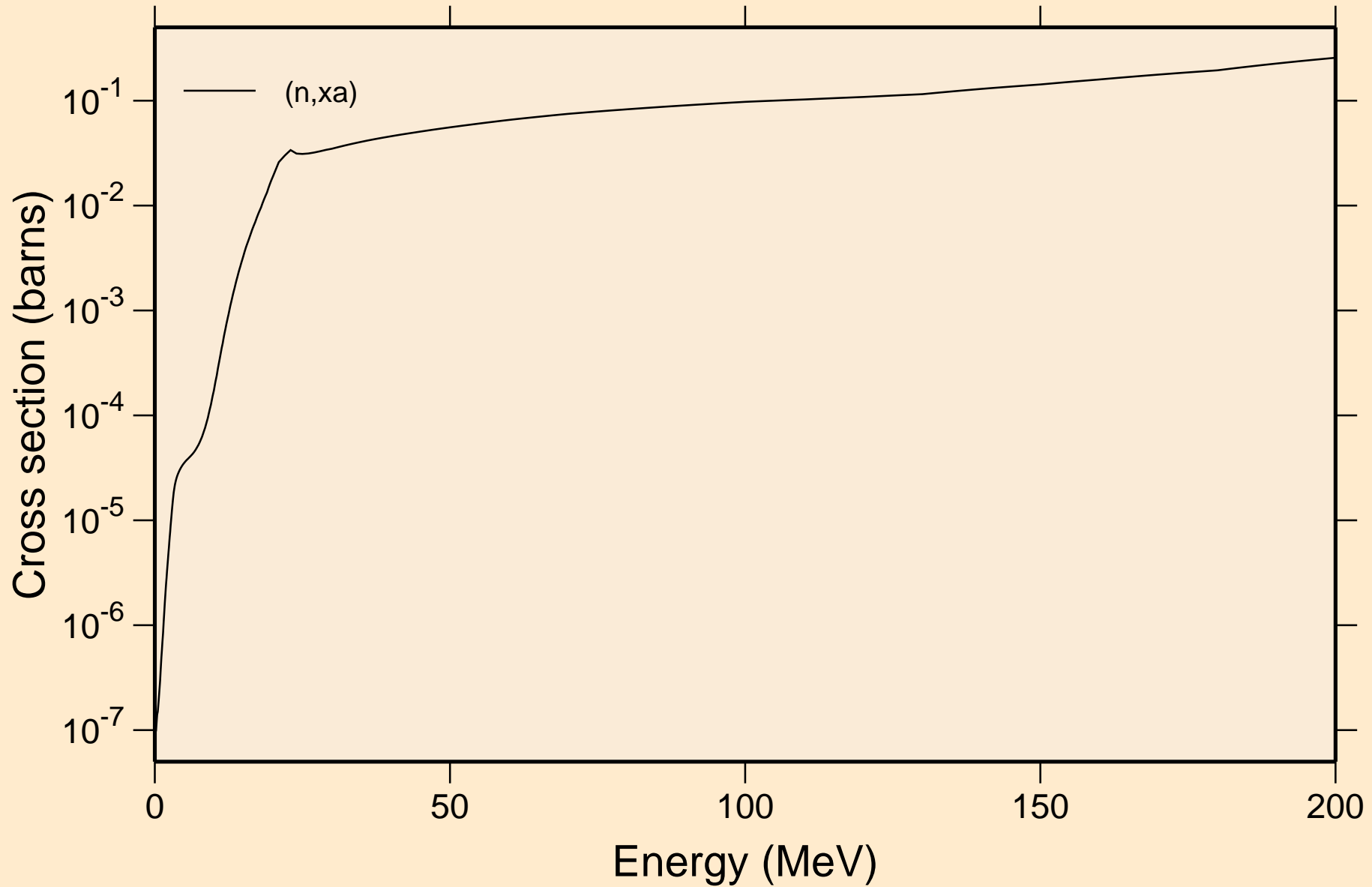

HG192 NEUTRON ACER TENDL-2024 LIBRARY; T=0.K
Inelastic levels

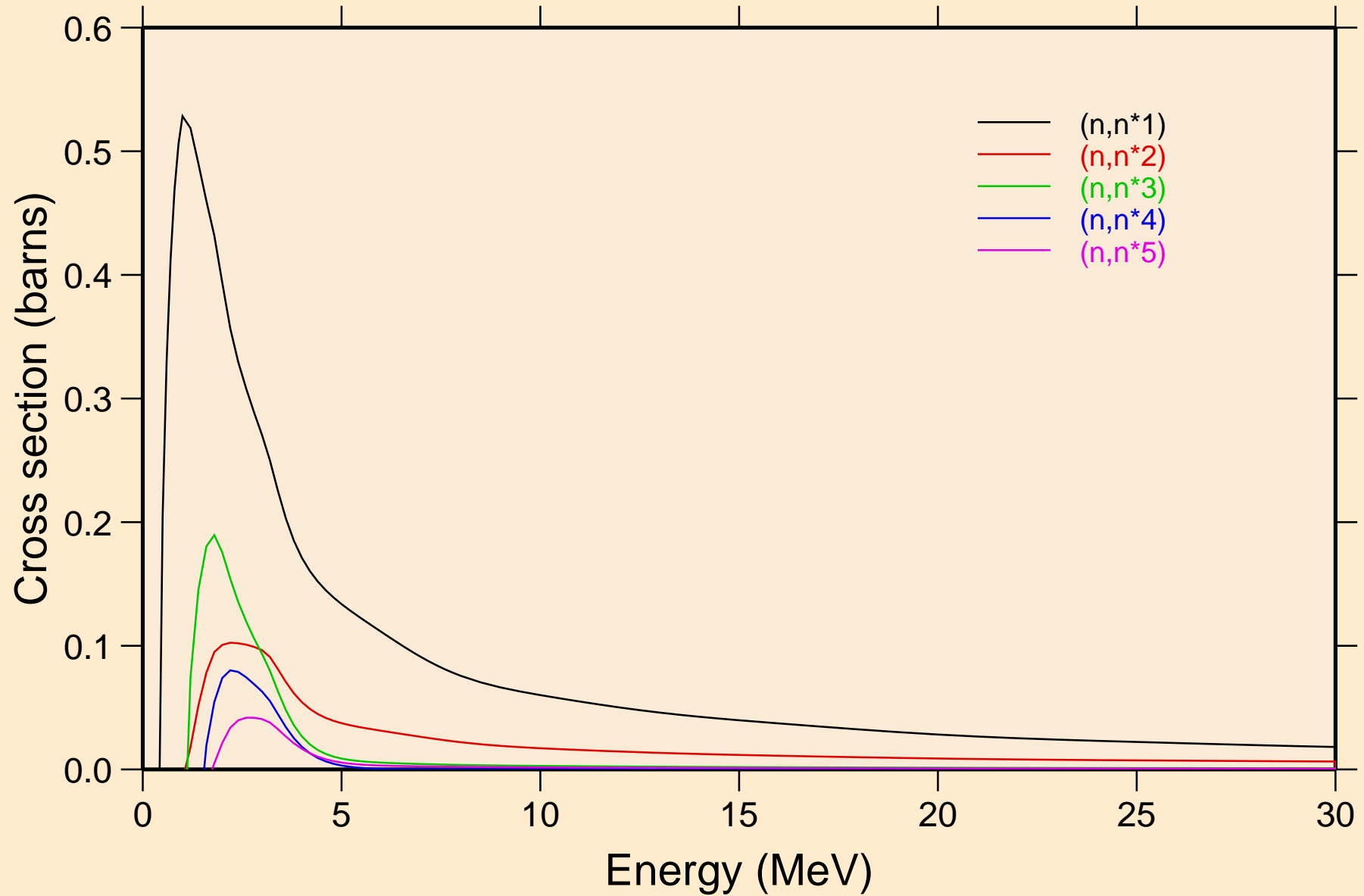

HG192 NEUTRON ACER TENDL-2024 LIBRARY; T=0.K
Inelastic levels

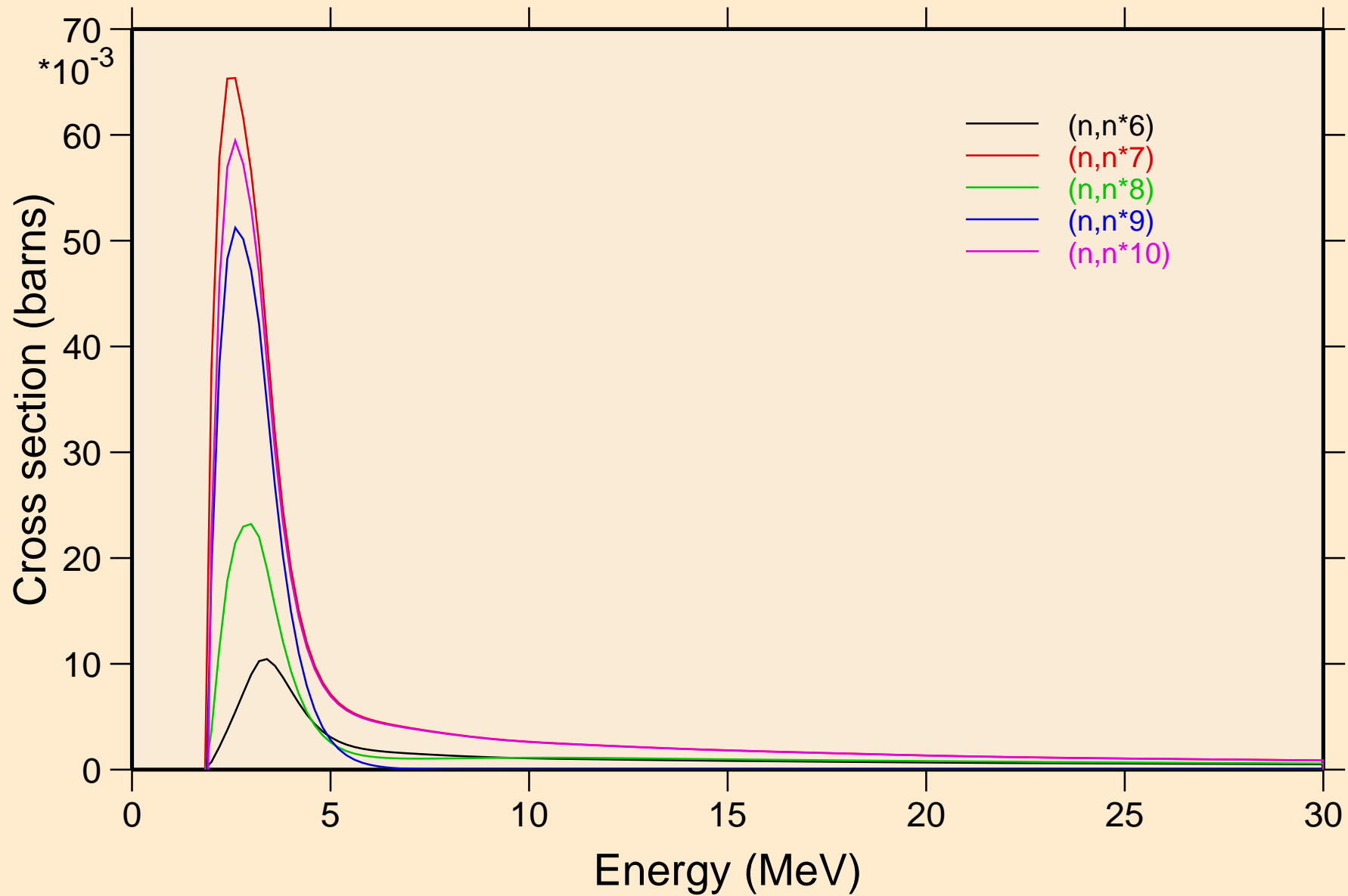

HG192 NEUTRON ACER TENDL-2024 LIBRARY; T=0.K
Inelastic levels

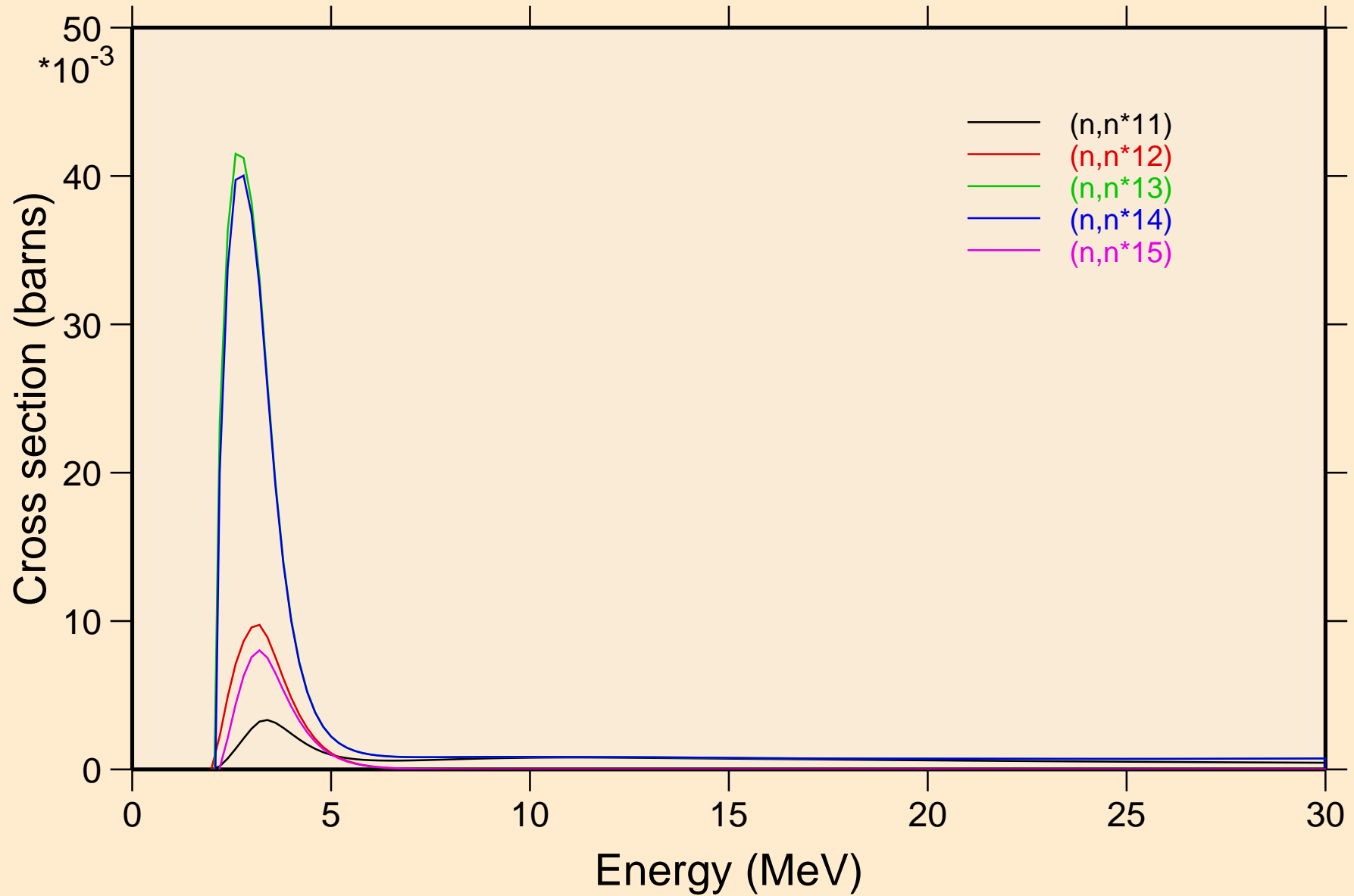

HG192 NEUTRON ACER TENDL-2024 LIBRARY; T=0.K

Inelastic levels

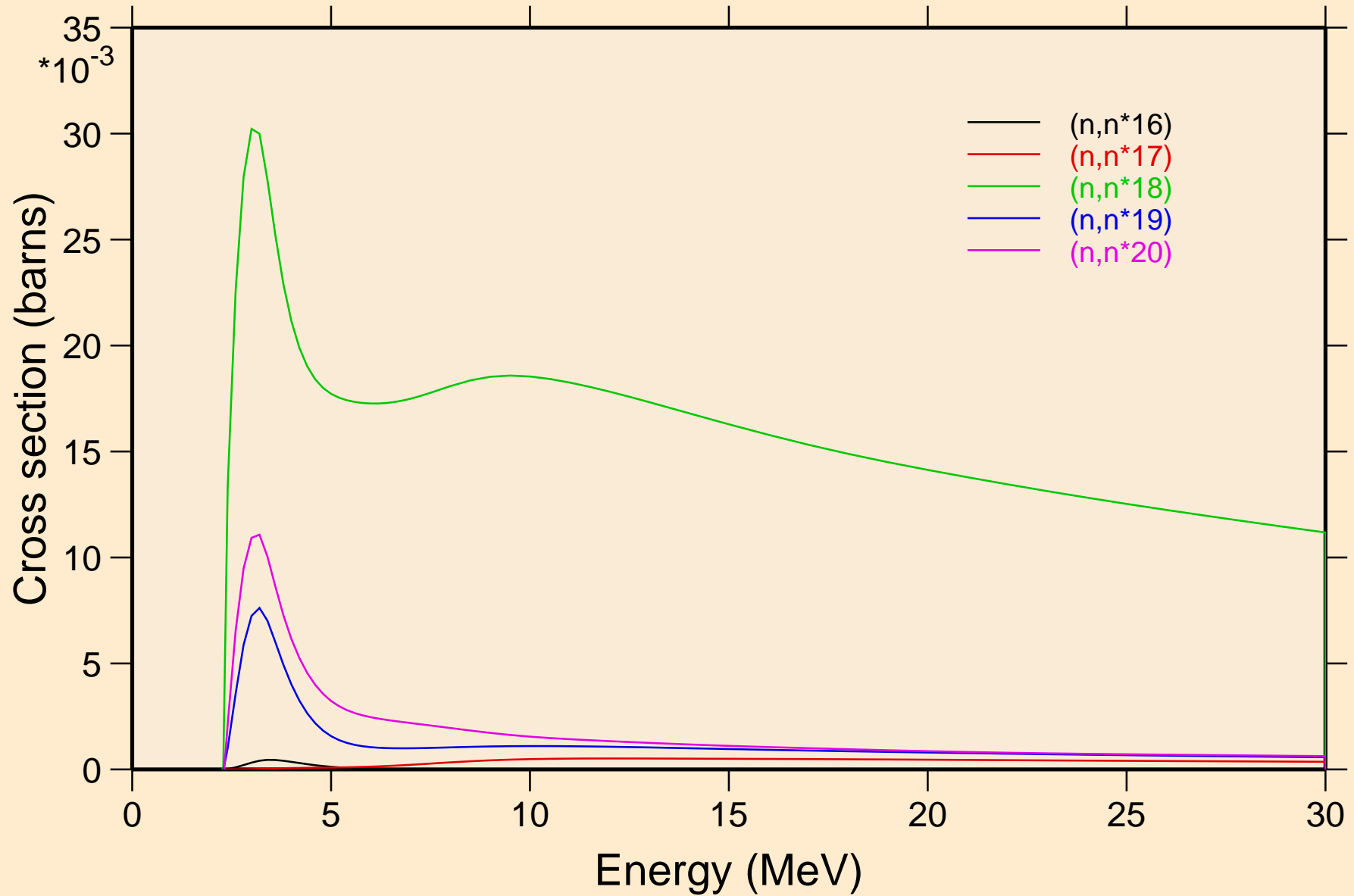

HG192 NEUTRON ACER TENDL-2024 LIBRARY; T=0.K
Inelastic levels

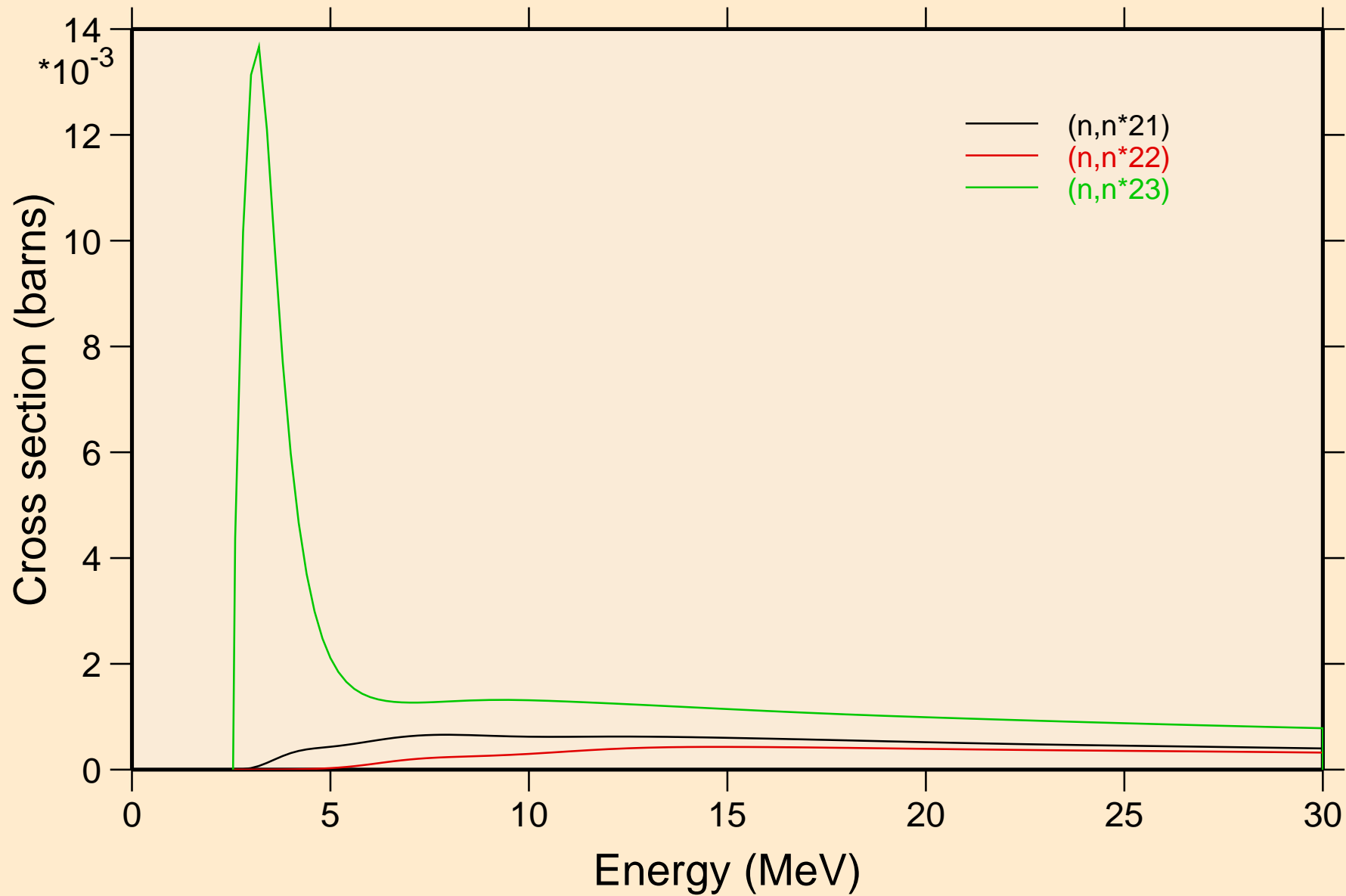

HG192 NEUTRON ACER TENDL-2024 LIBRARY; T=0.K

Threshold reactions

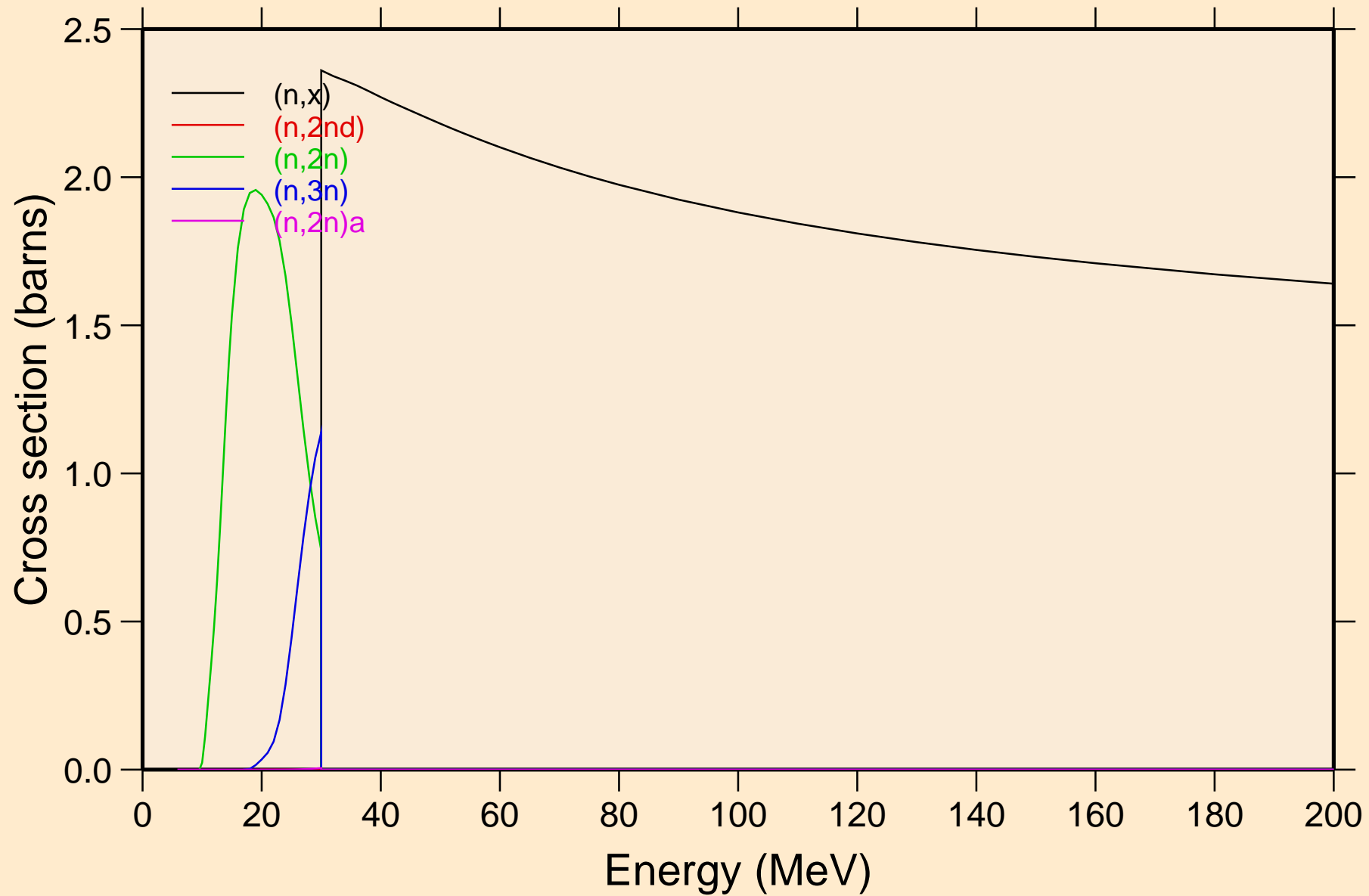

HG192 NEUTRON ACER TENDL-2024 LIBRARY; T=0.K

Threshold reactions

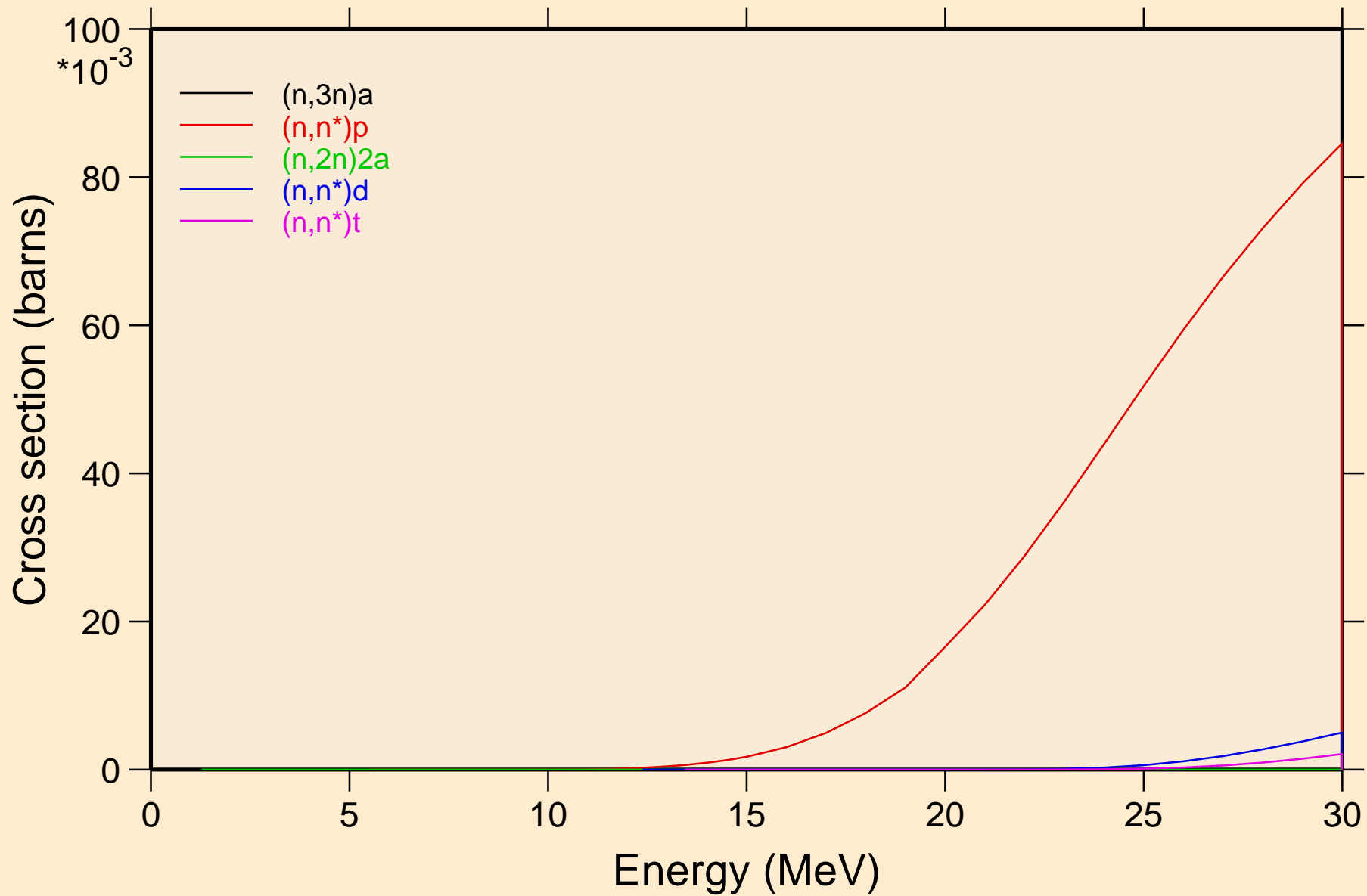

HG192 NEUTRON ACER TENDL-2024 LIBRARY; T=0.K

Threshold reactions

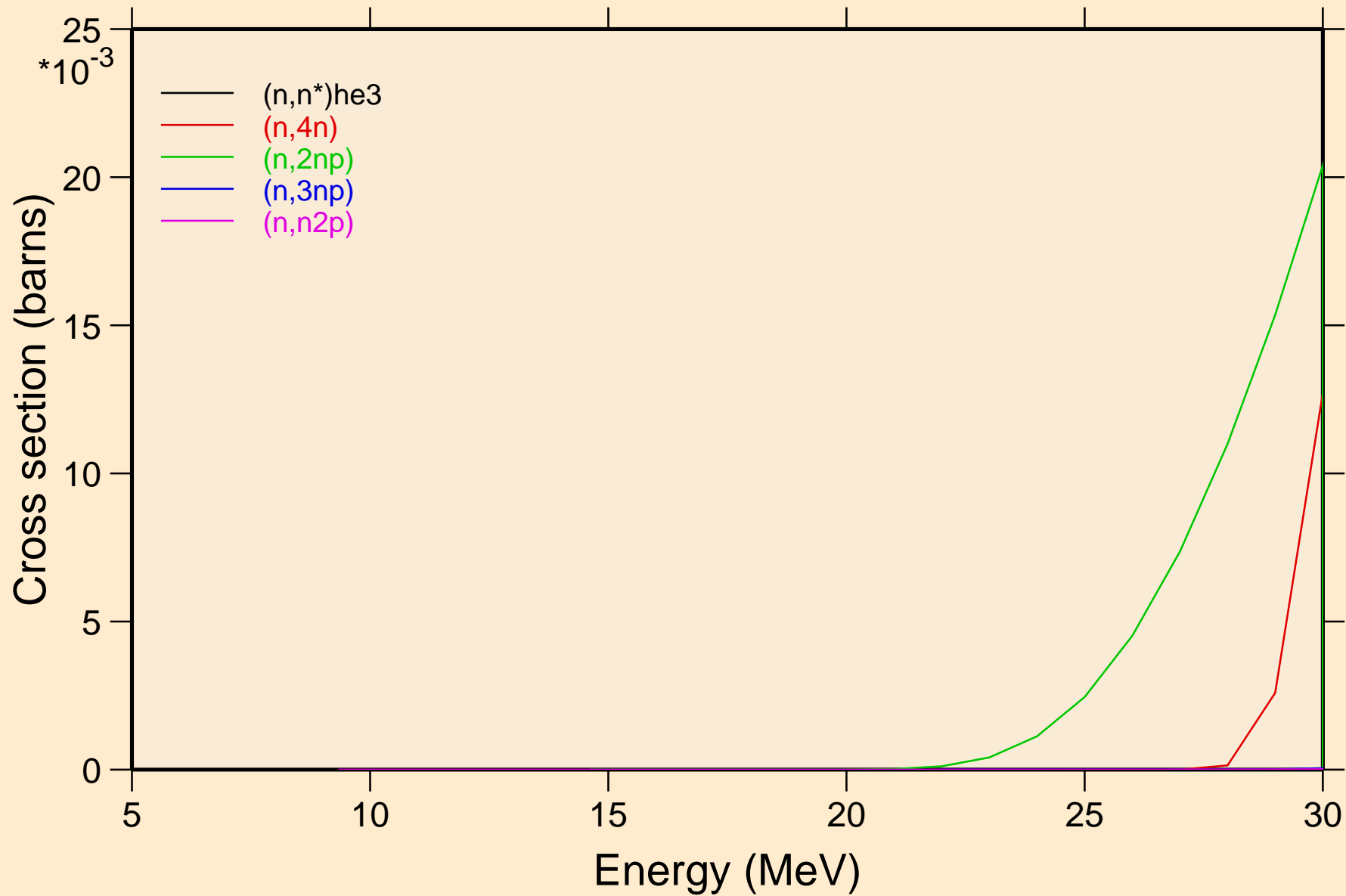

HG192 NEUTRON ACER TENDL-2024 LIBRARY; T=0.K

Threshold reactions

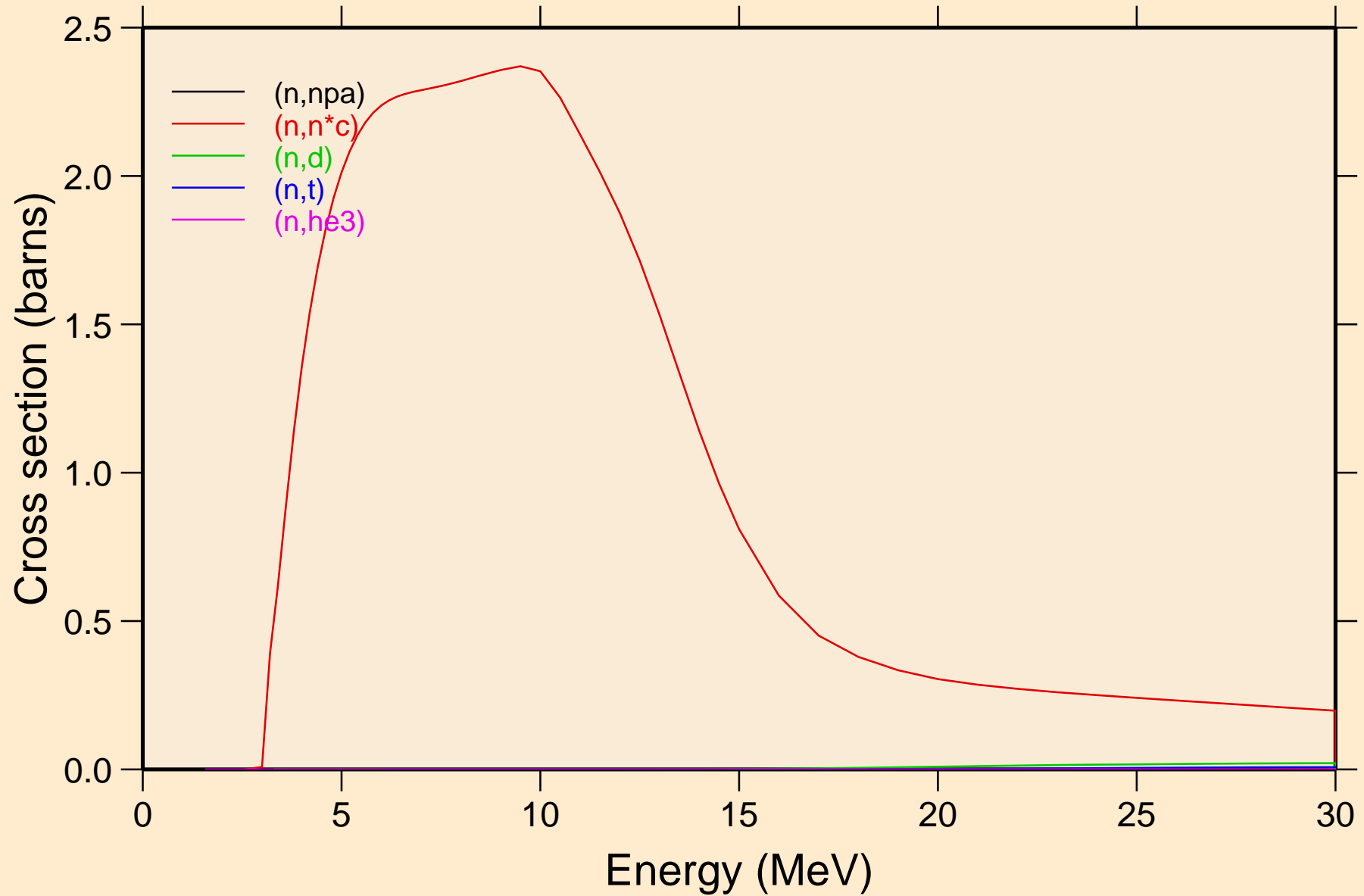

HG192 NEUTRON ACER TENDL-2024 LIBRARY; T=0.K

Threshold reactions

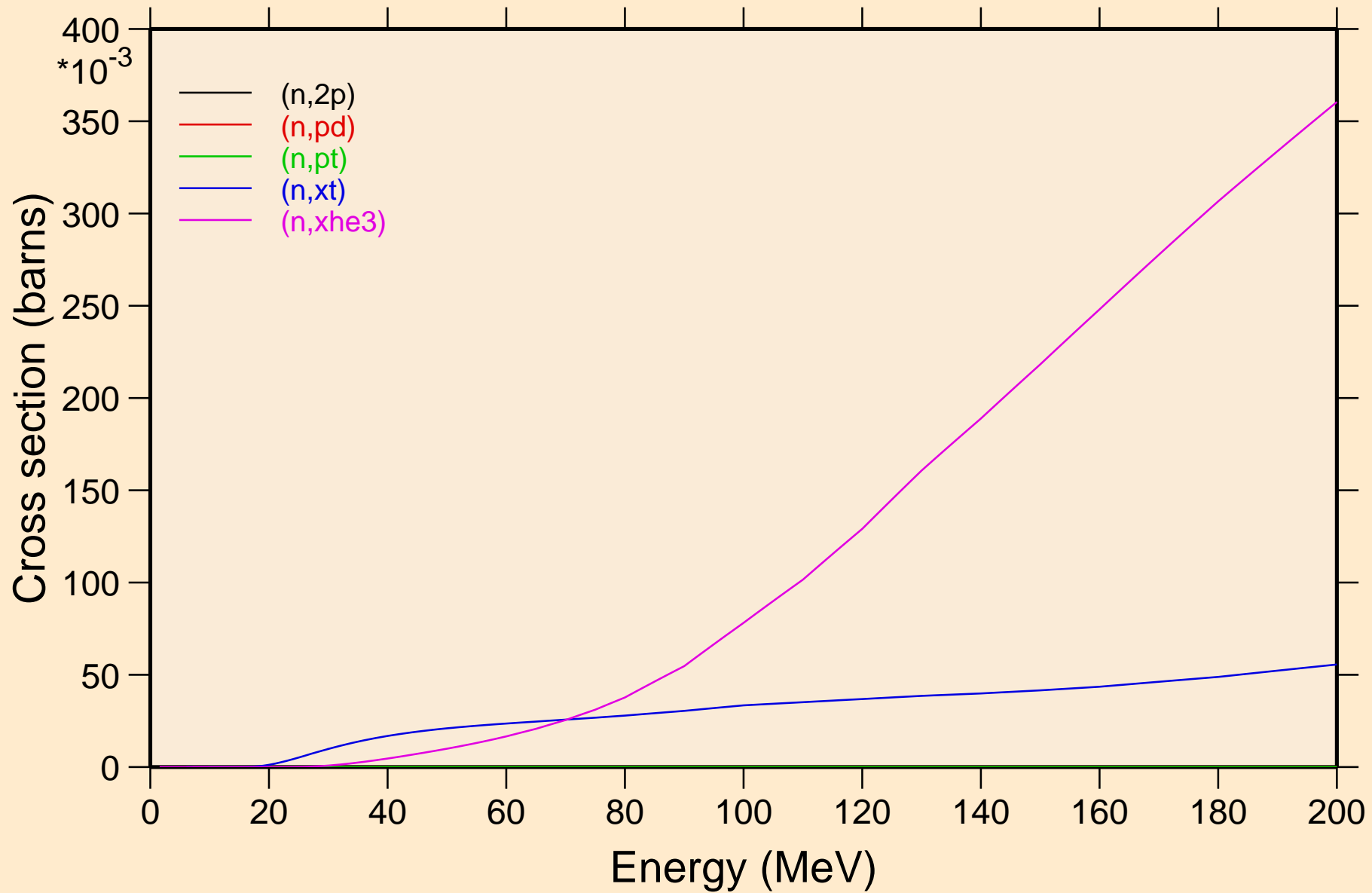

HG192 NEUTRON ACER TENDL-2024 LIBRARY; T=0.K
angular distribution for elastic

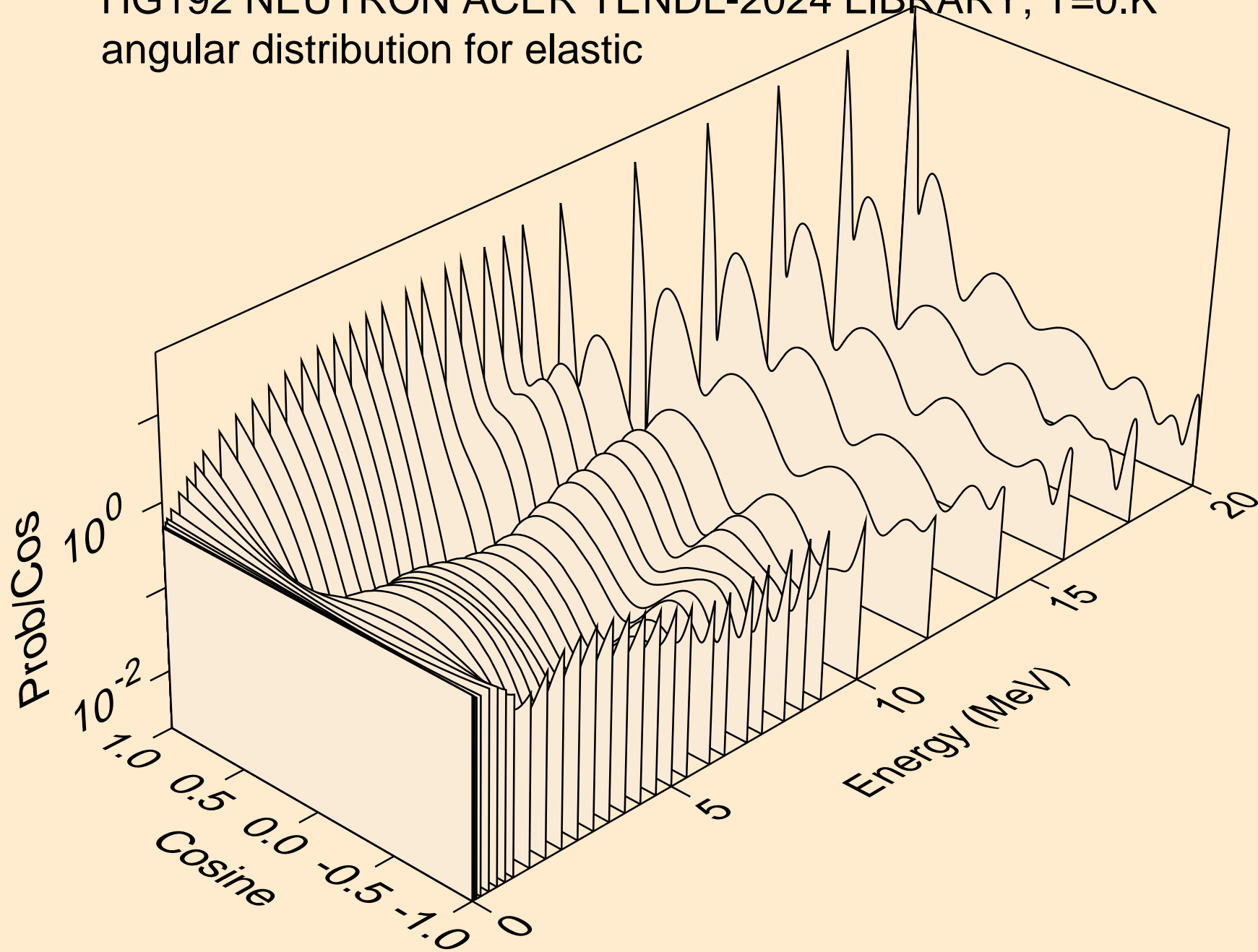

HG192 NEUTRON ACER TENDL-2024 LIBRARY; T=0.K
angular distribution for elastic

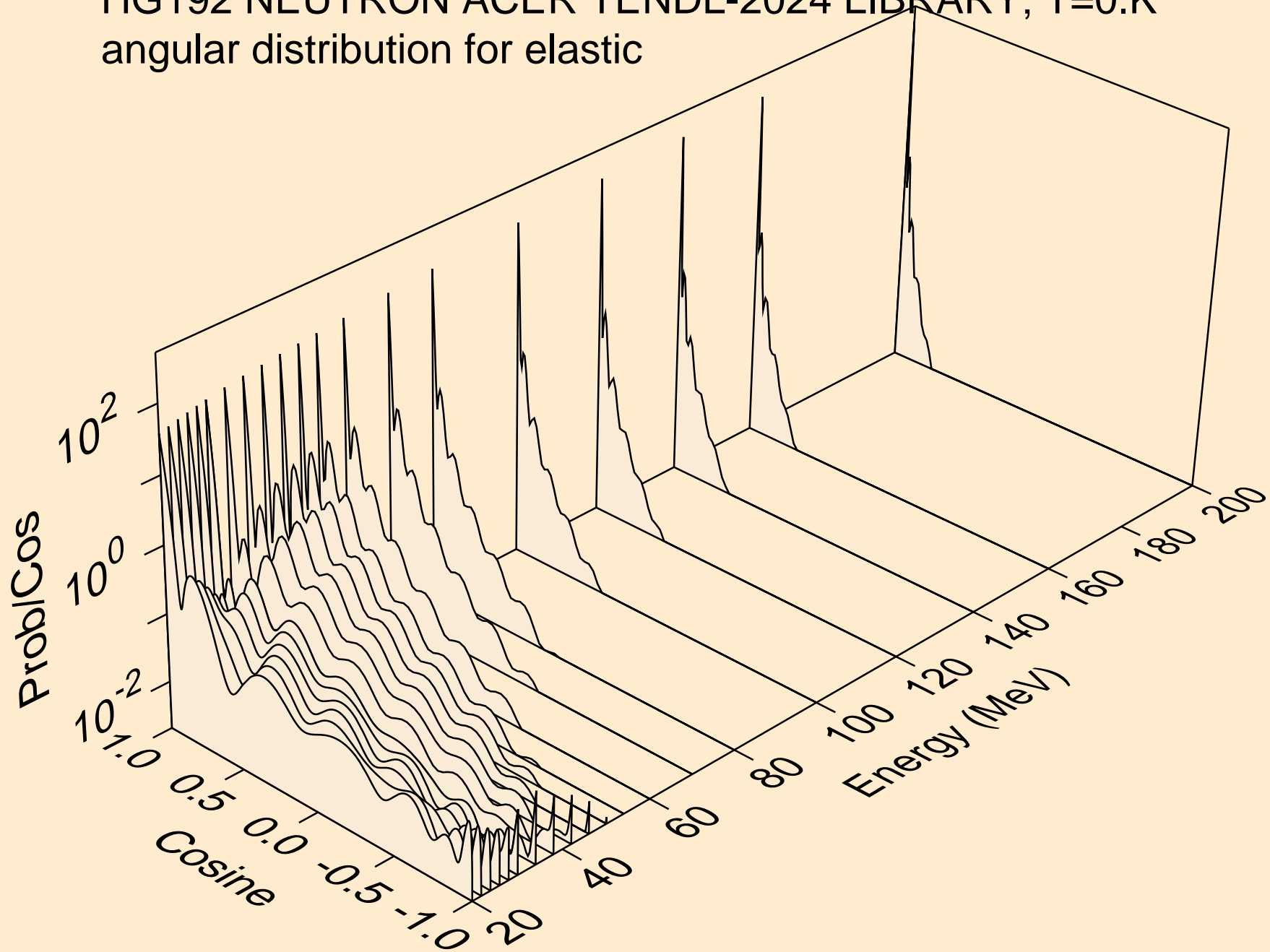

HG192 NEUTRON ACER TENDL-2024 LIBRARY; T=0.K
angular distribution for (n,n*1)

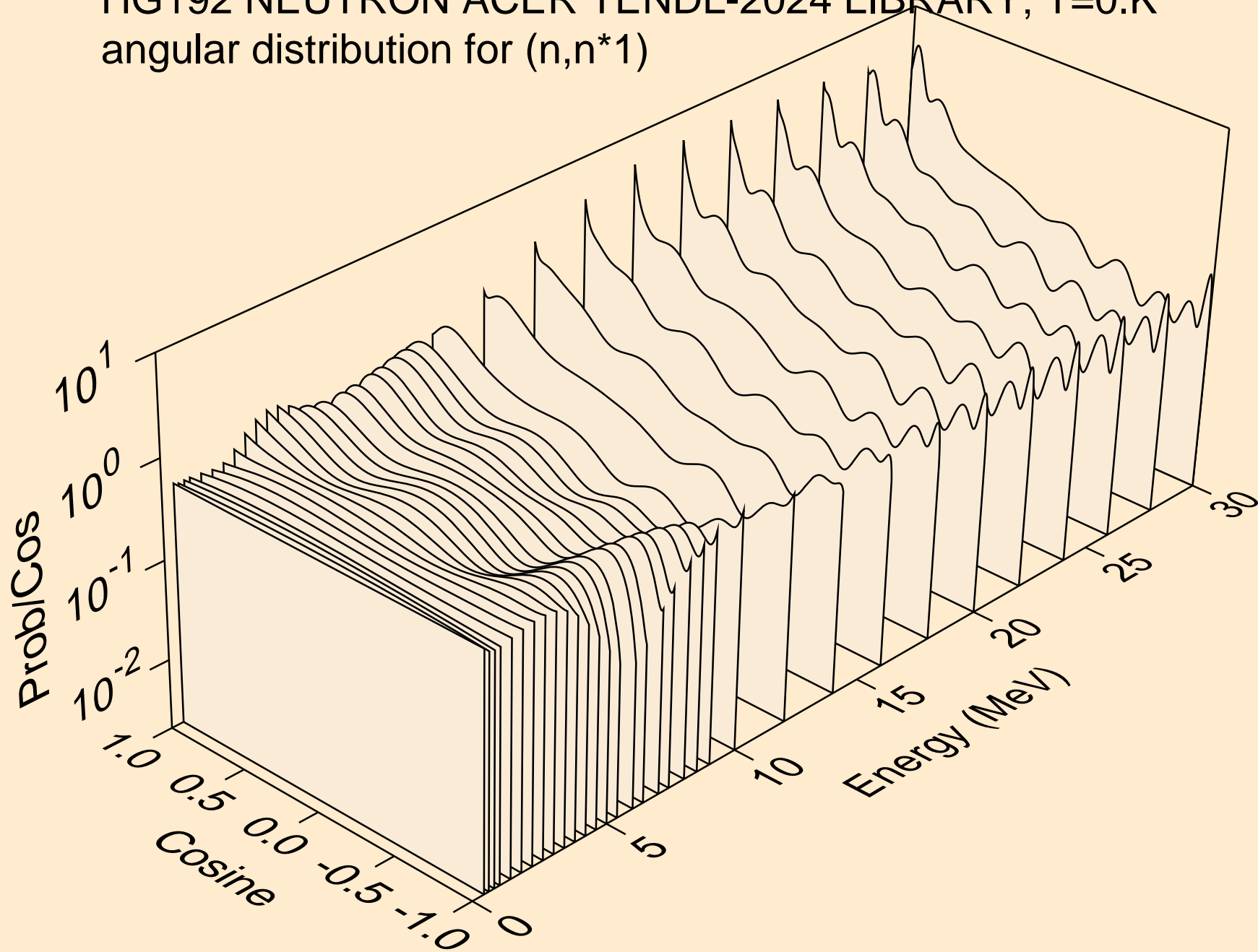

HG192 NEUTRON ACER TENDL-2024 LIBRARY; T=0.K
angular distribution for (n,n*2)

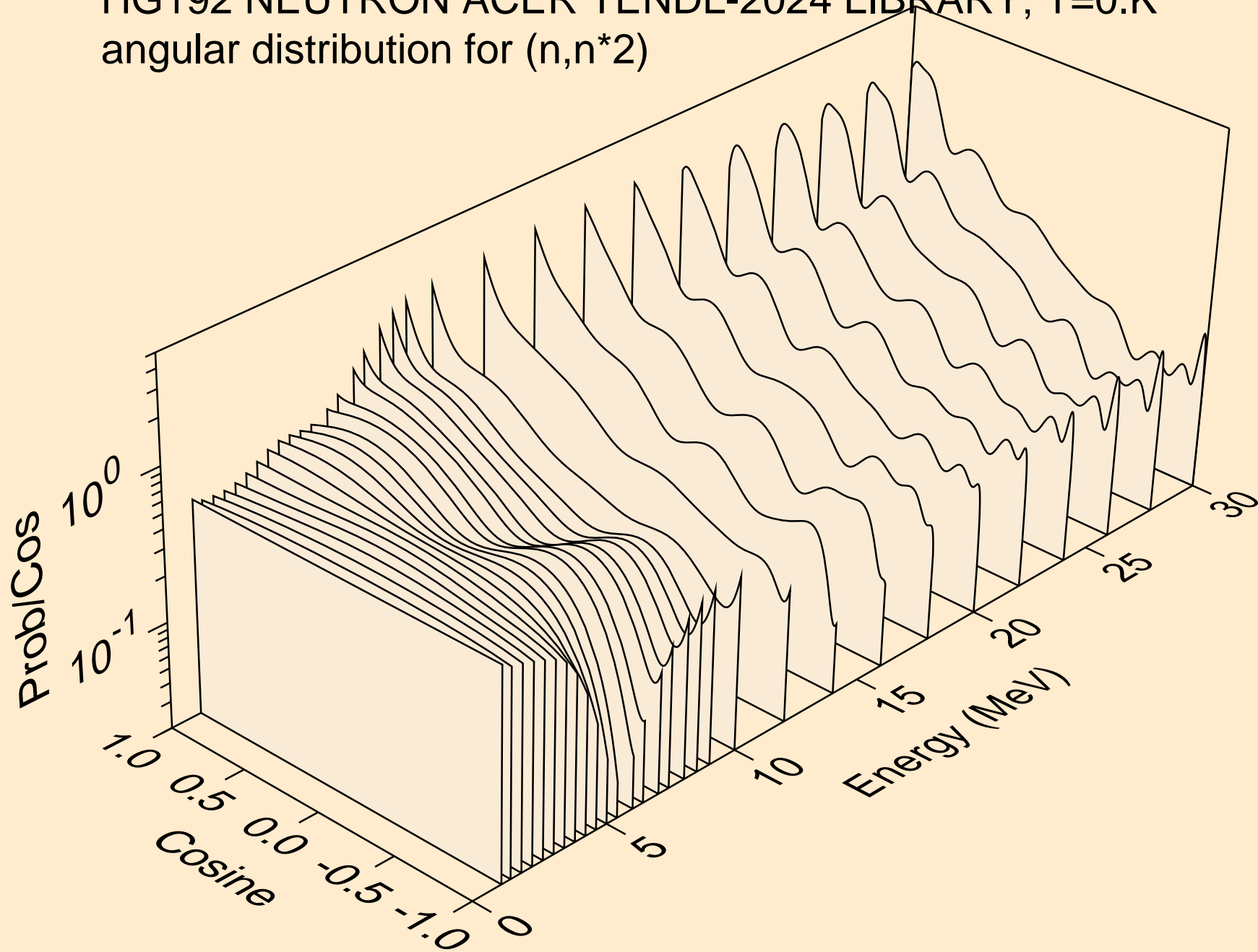

HG192 NEUTRON ACER TENDL-2024 LIBRARY; T=0.K
angular distribution for (n,n*3)

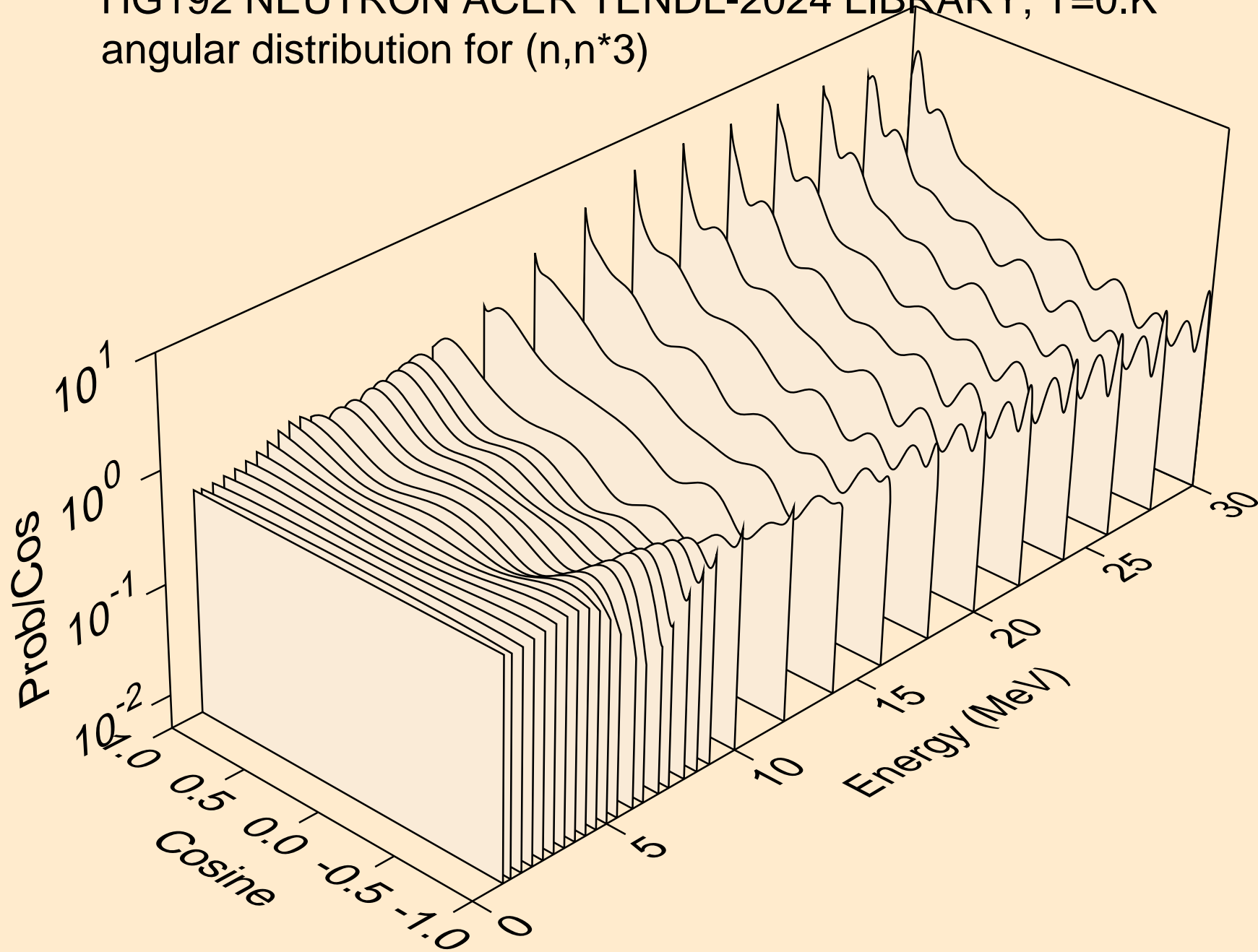

HG192 NEUTRON ACER TENDL-2024 LIBRARY; T=0.K
angular distribution for (n,n*4)

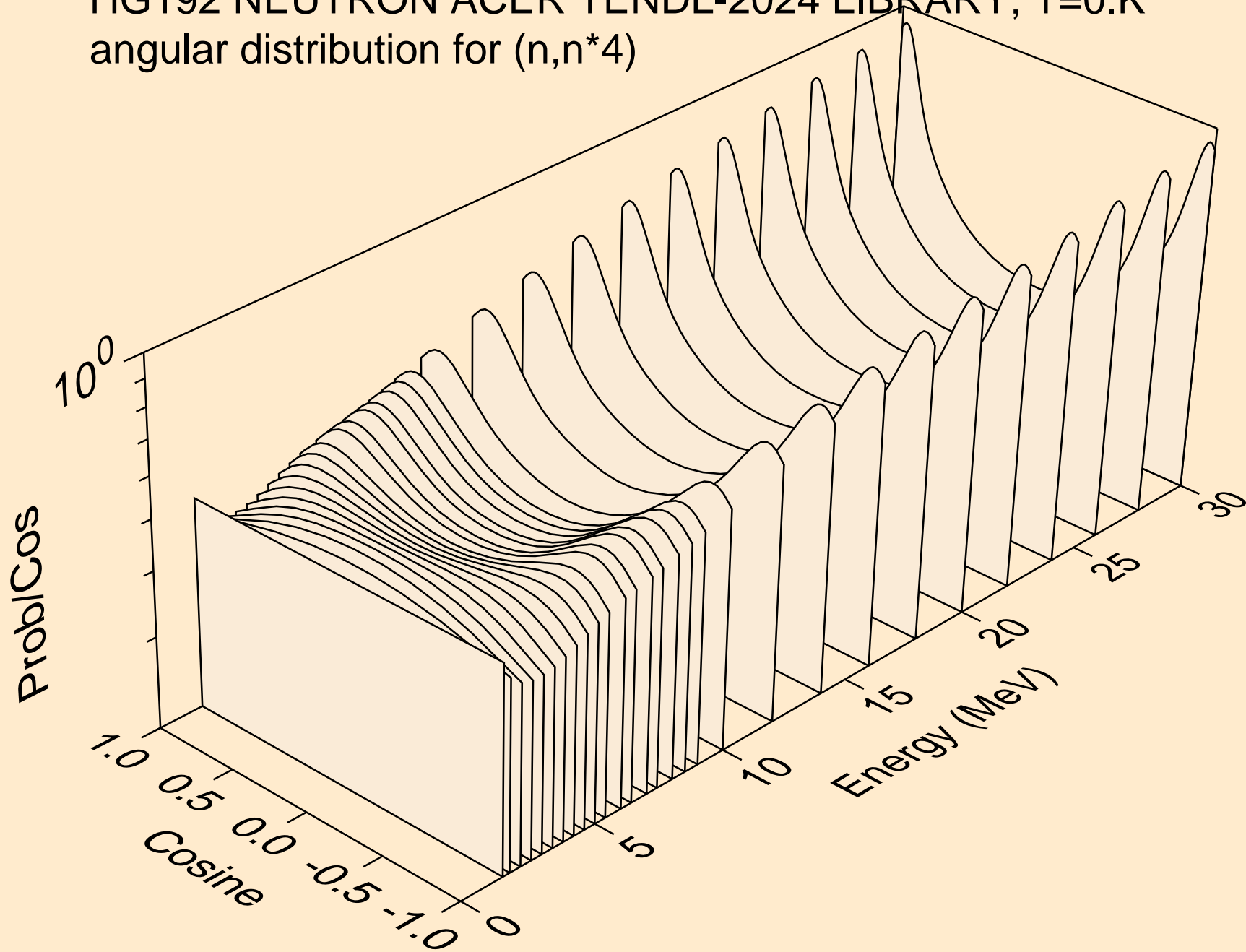

HG192 NEUTRON ACER TENDL-2024 LIBRARY; T=0.K
angular distribution for (n,n*5)

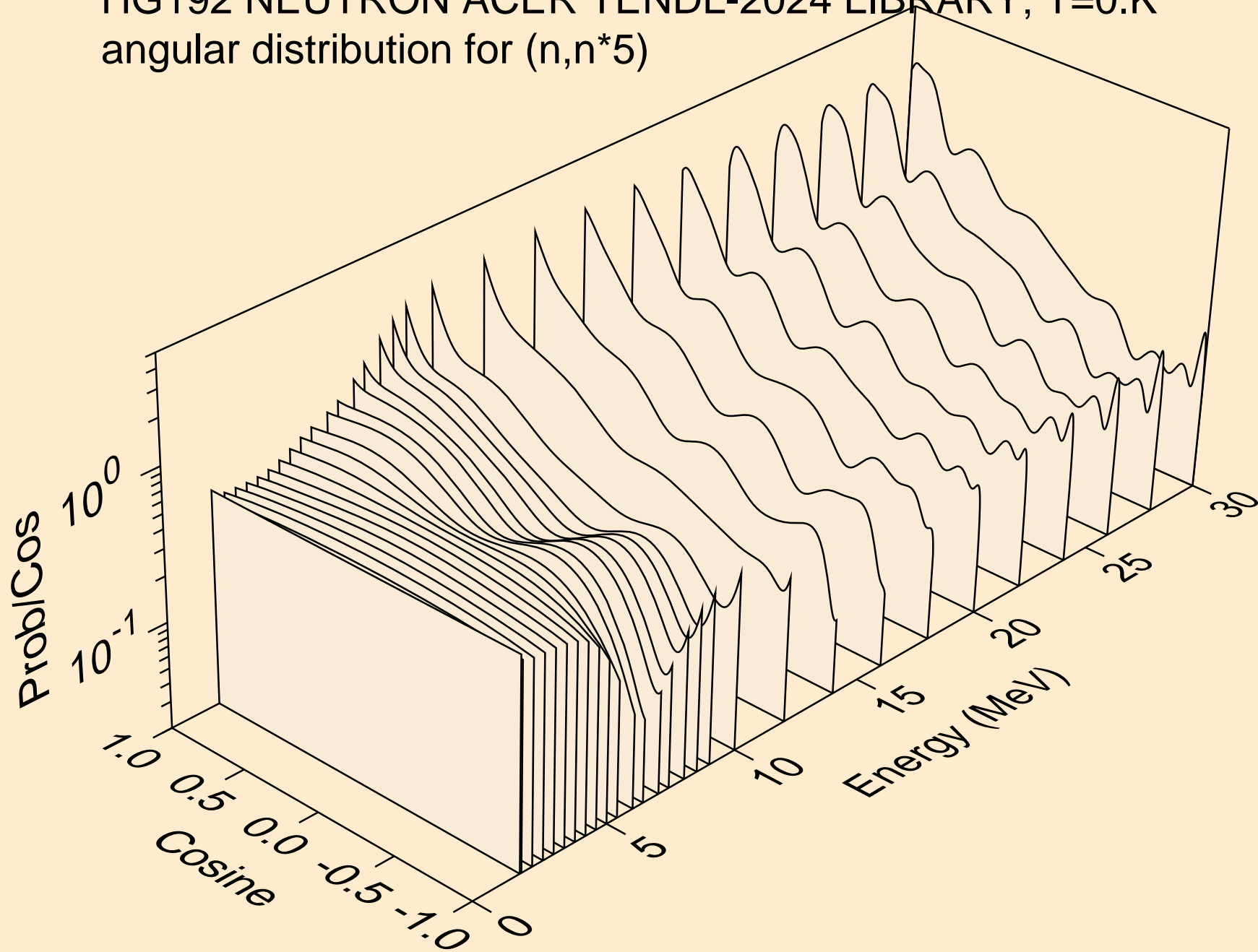

HG192 NEUTRON ACER TENDL-2024 LIBRARY; T=0.K
angular distribution for (n,n*6)

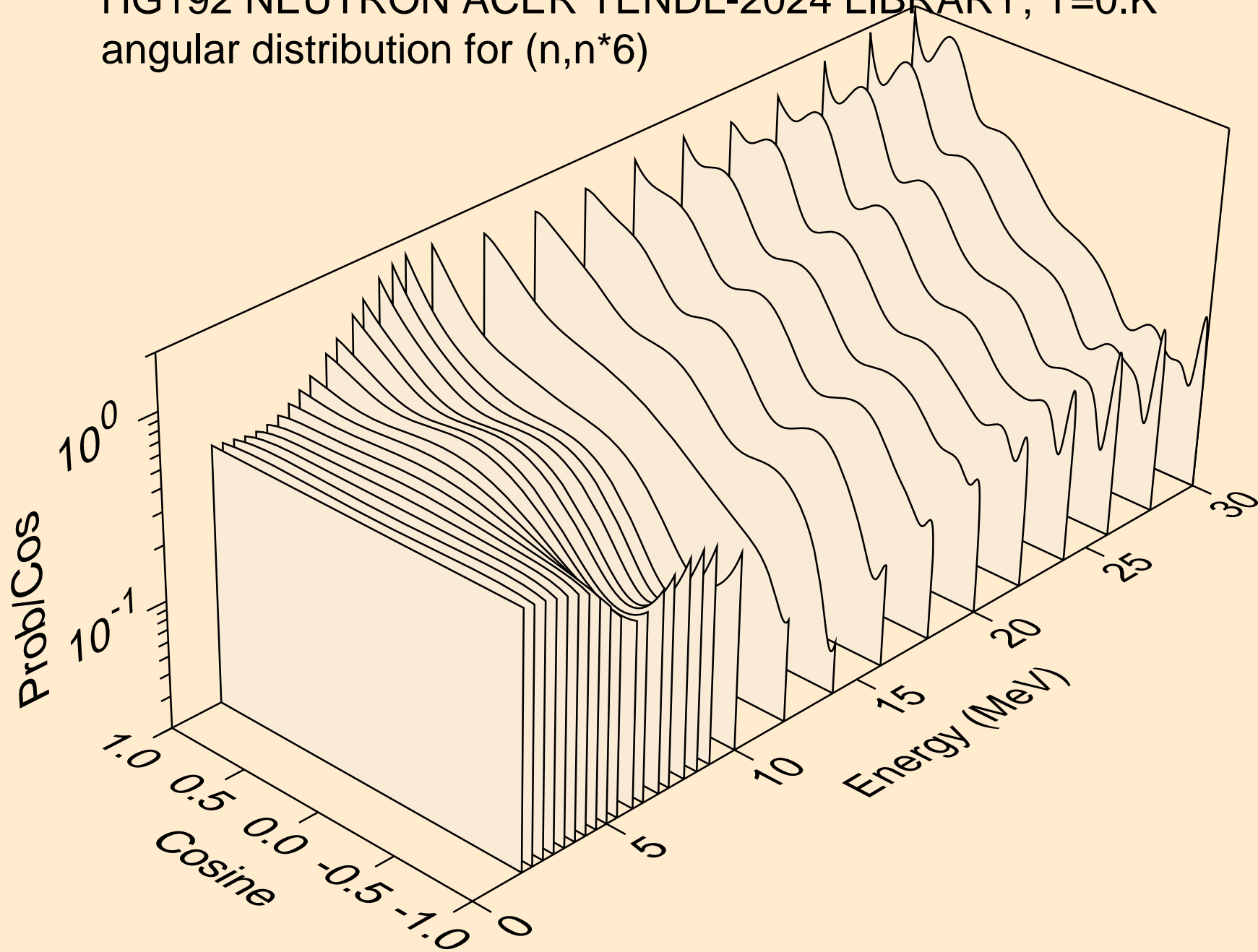

HG192 NEUTRON ACER TENDL-2024 LIBRARY; T=0.K
angular distribution for (n,n*7)

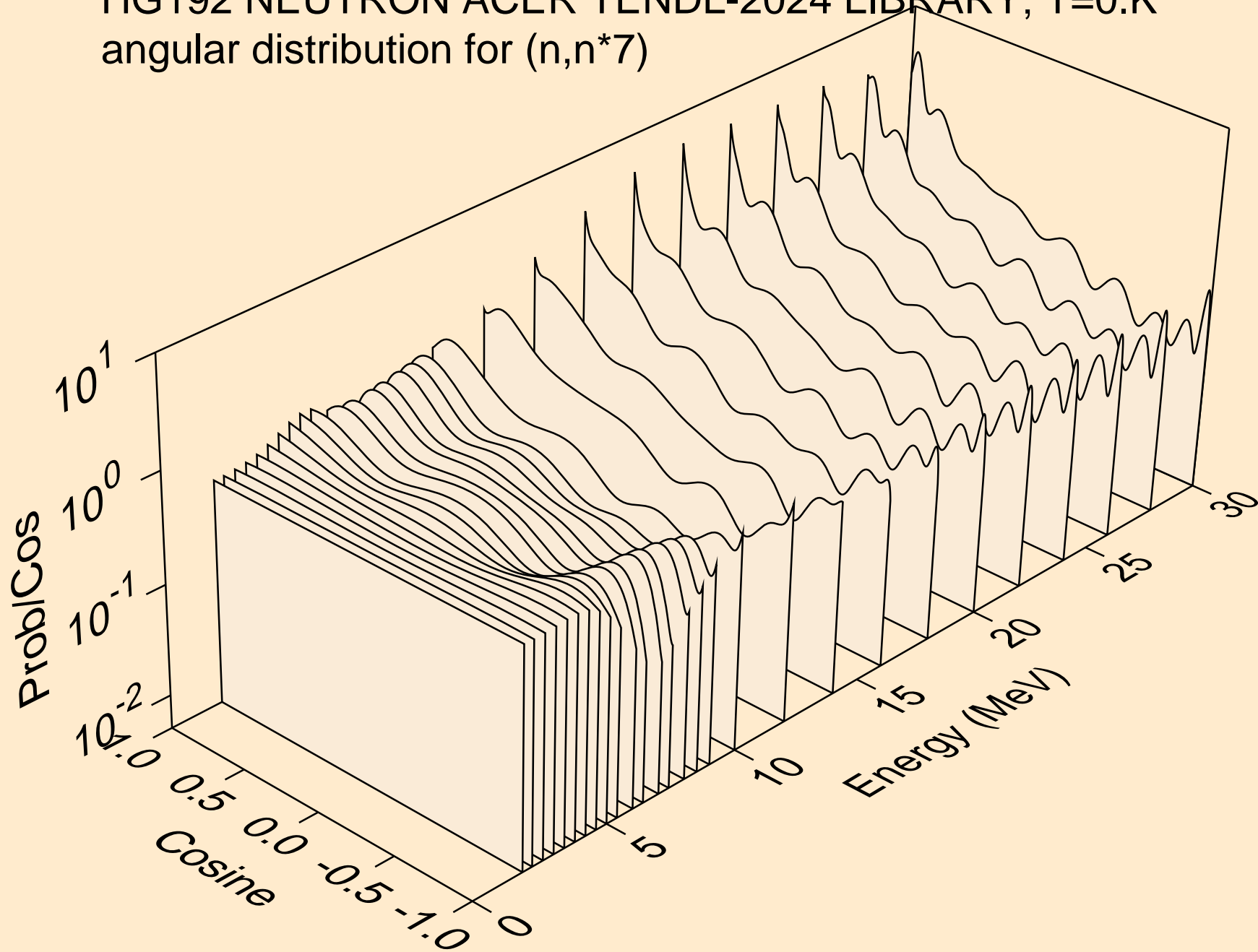

HG192 NEUTRON ACER TENDL-2024 LIBRARY; T=0.K
angular distribution for (n,n*8)

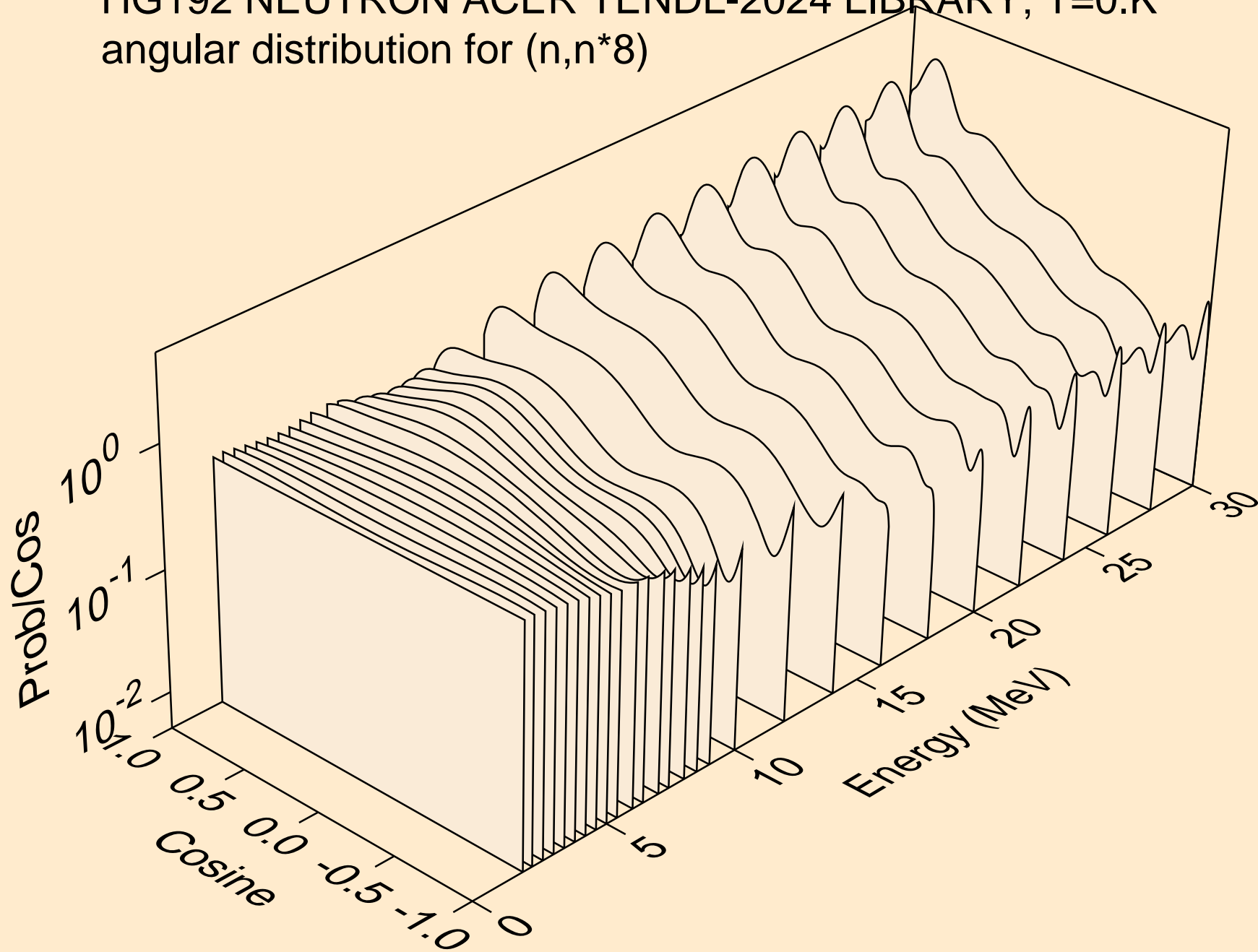

HG192 NEUTRON ACER TENDL-2024 LIBRARY; T=0.K
angular distribution for (n,n*9)

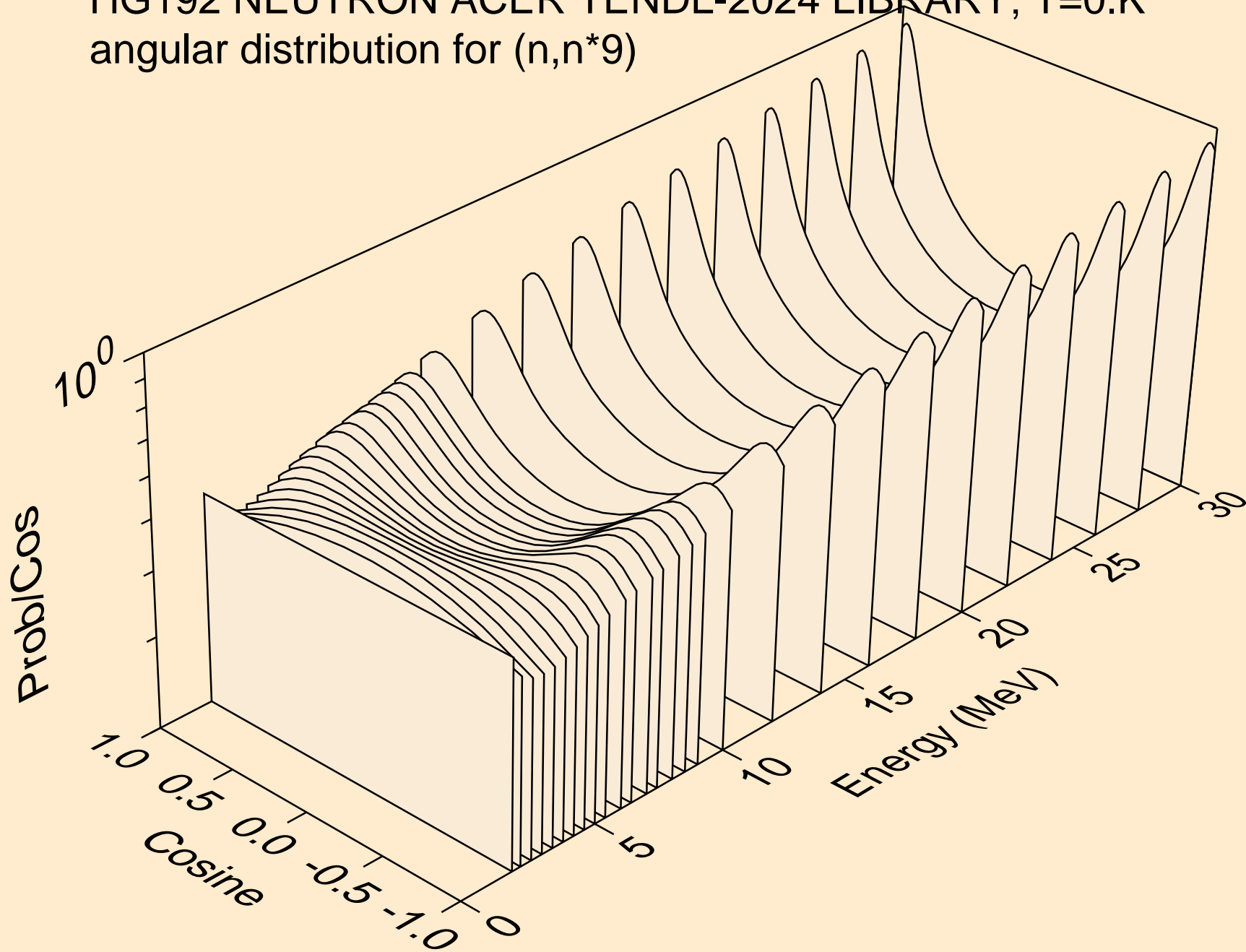

HG192 NEUTRON ACER TENDL-2024 LIBRARY; T=0.K
angular distribution for (n,n*10)

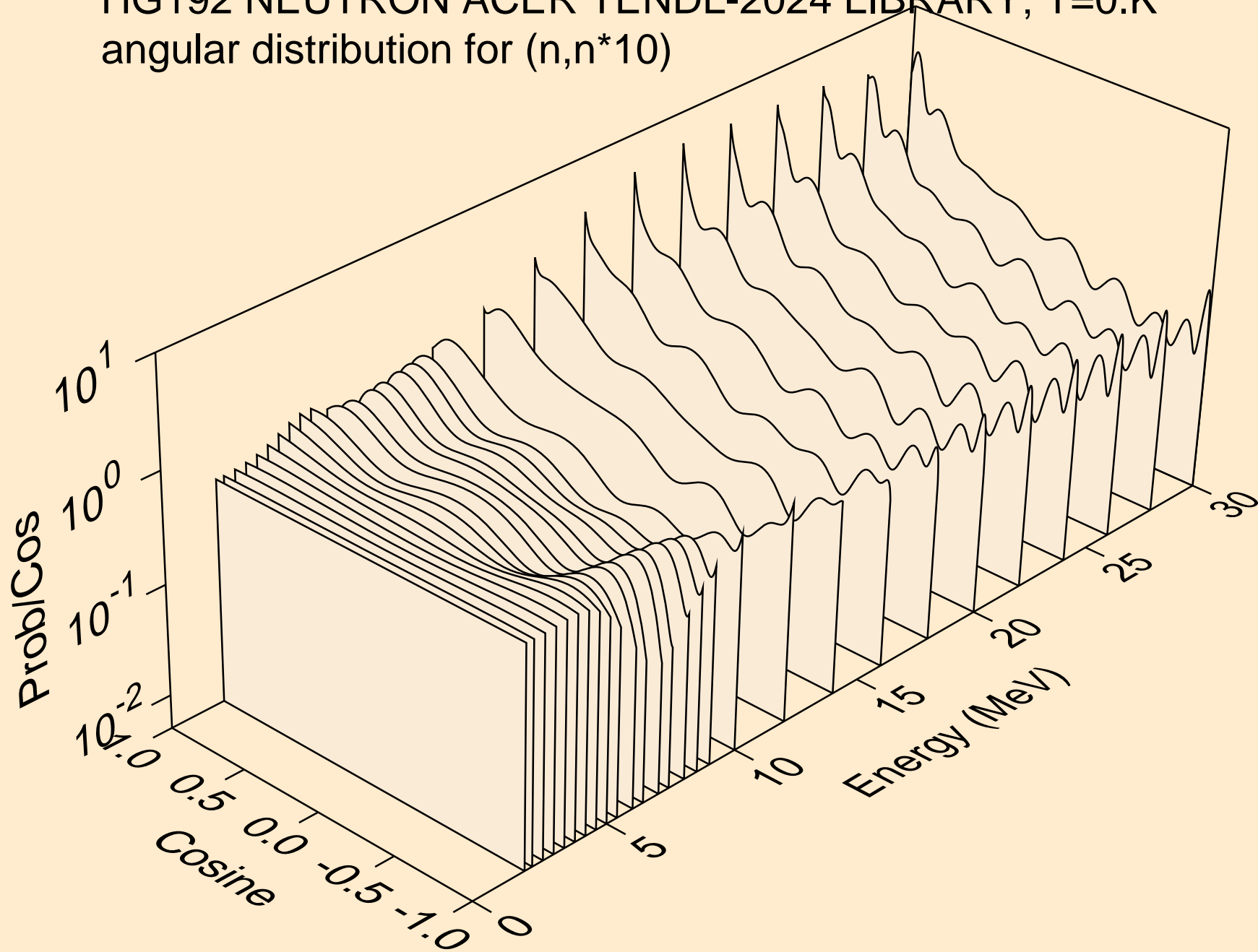

HG192 NEUTRON ACER TENDL-2024 LIBRARY; T=0.K
angular distribution for (n,n*11)

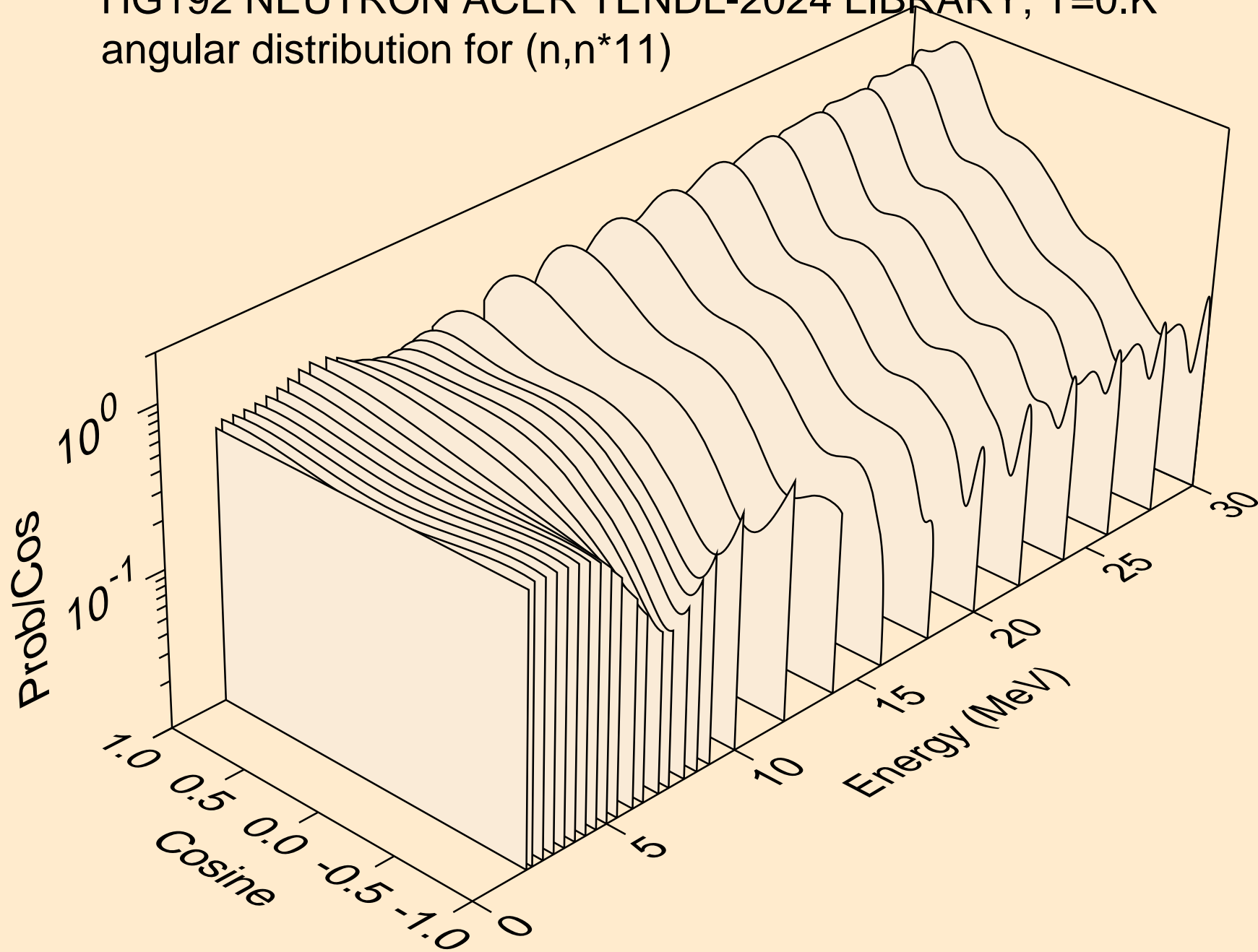

HG192 NEUTRON ACER TENDL-2024 LIBRARY; T=0.K
angular distribution for (n,n*12)

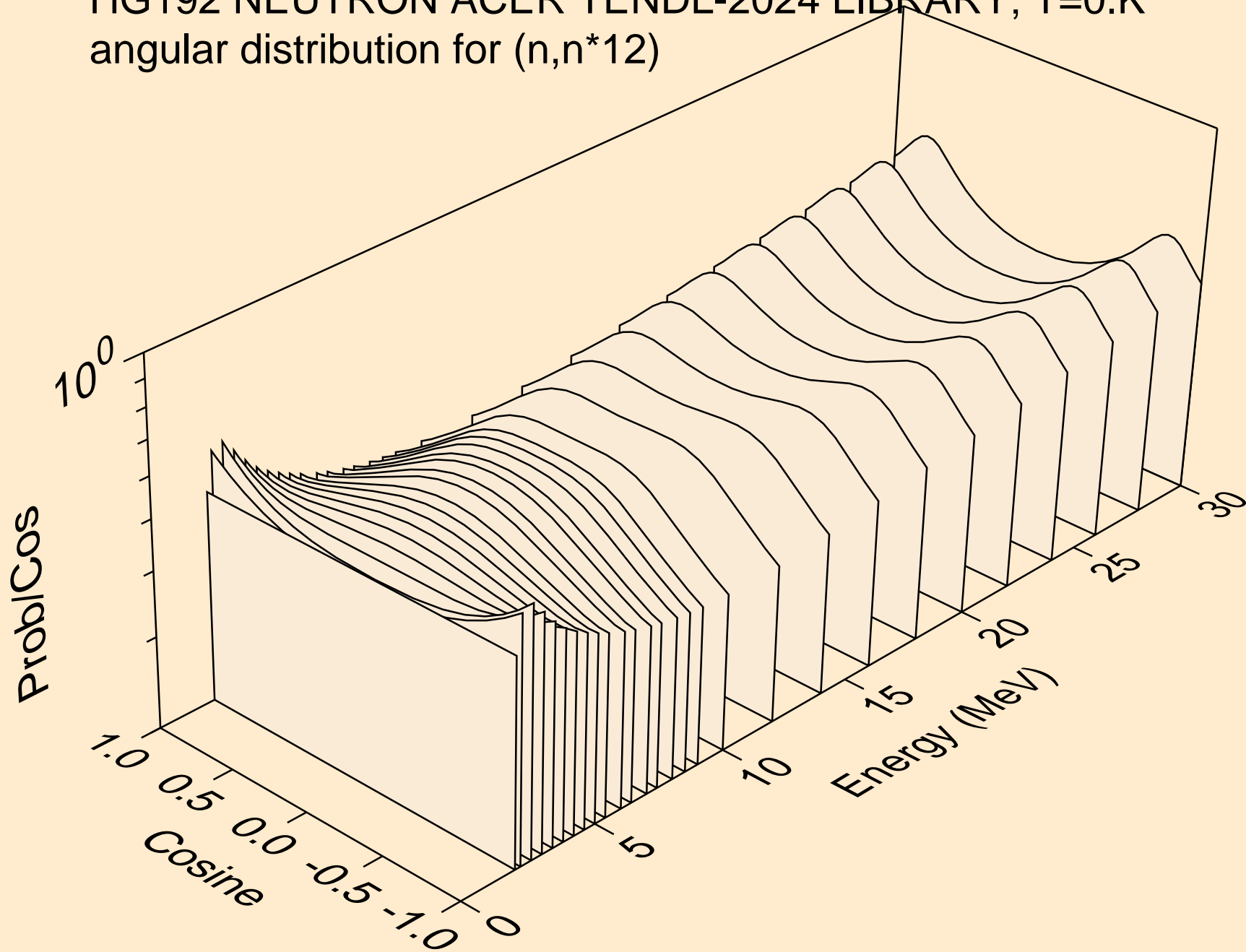

HG192 NEUTRON ACER TENDL-2024 LIBRARY; T=0.K
angular distribution for (n,n*13)

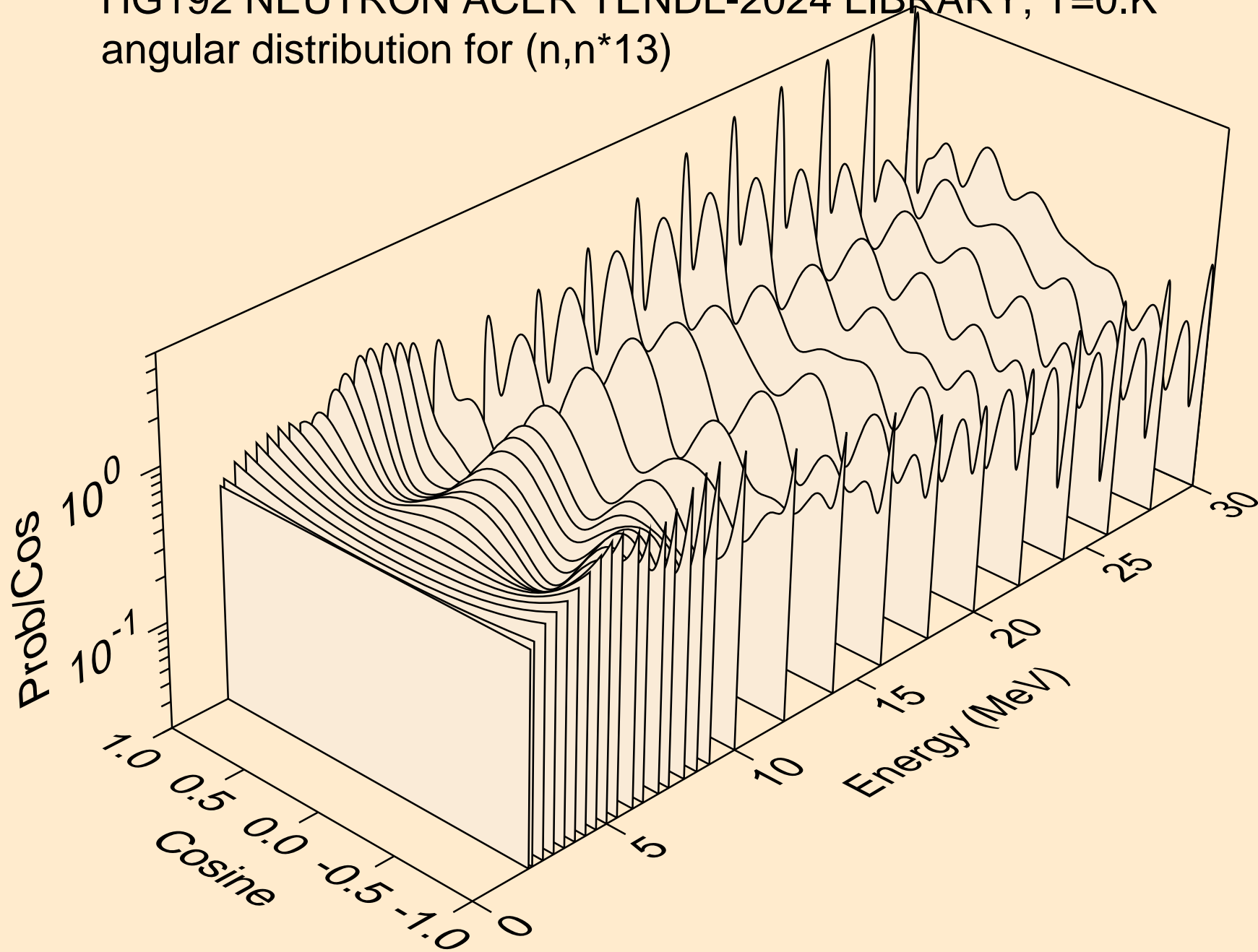

HG192 NEUTRON ACER TENDL-2024 LIBRARY; T=0.K
angular distribution for (n,n*14)

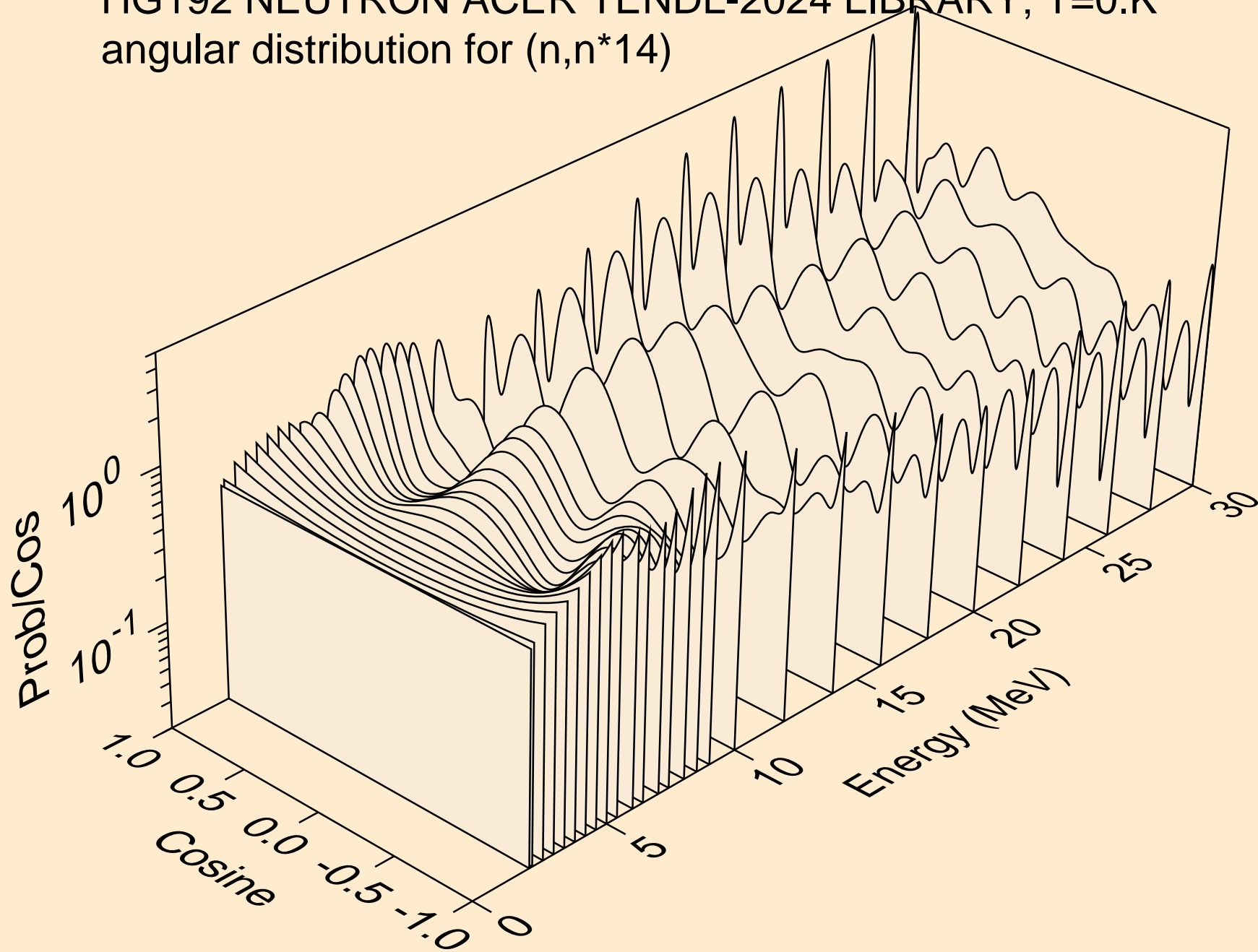

HG192 NEUTRON ACER TENDL-2024 LIBRARY; T=0.K
angular distribution for (n,n*15)

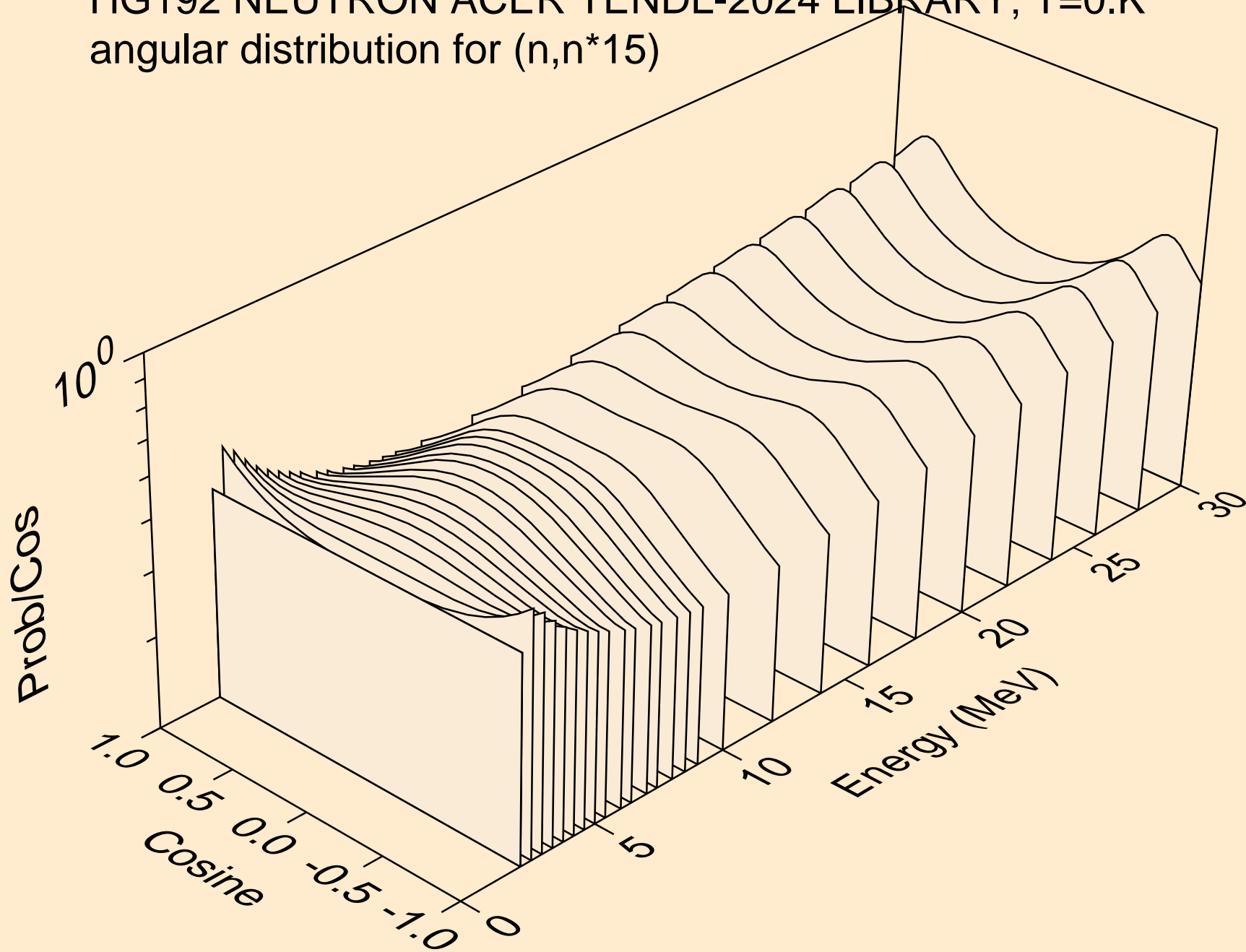

HG192 NEUTRON ACER TENDL-2024 LIBRARY; T=0.K
angular distribution for (n,n*16)

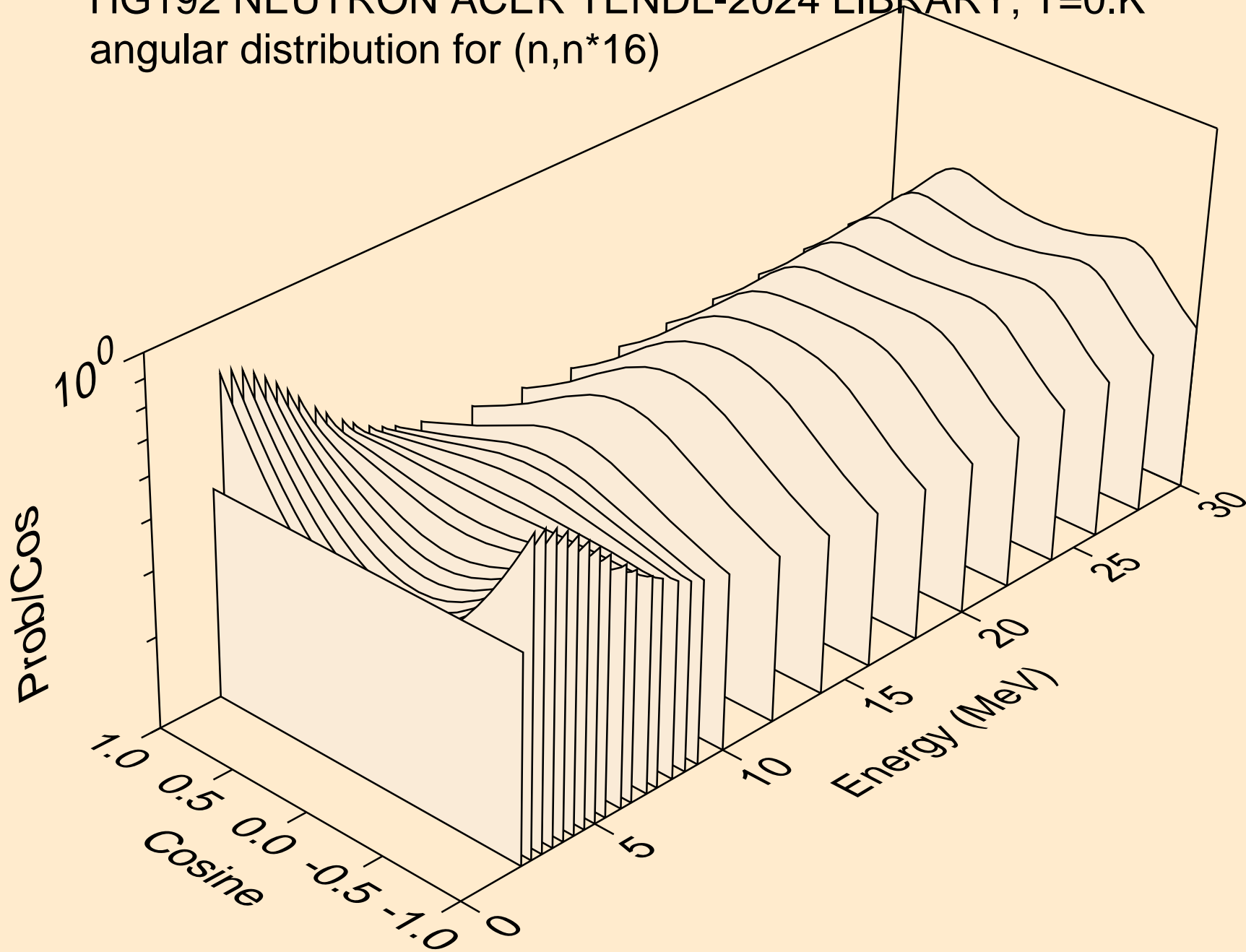

HG192 NEUTRON ACER TENDL-2024 LIBRARY; T=0.K
angular distribution for (n,n*17)

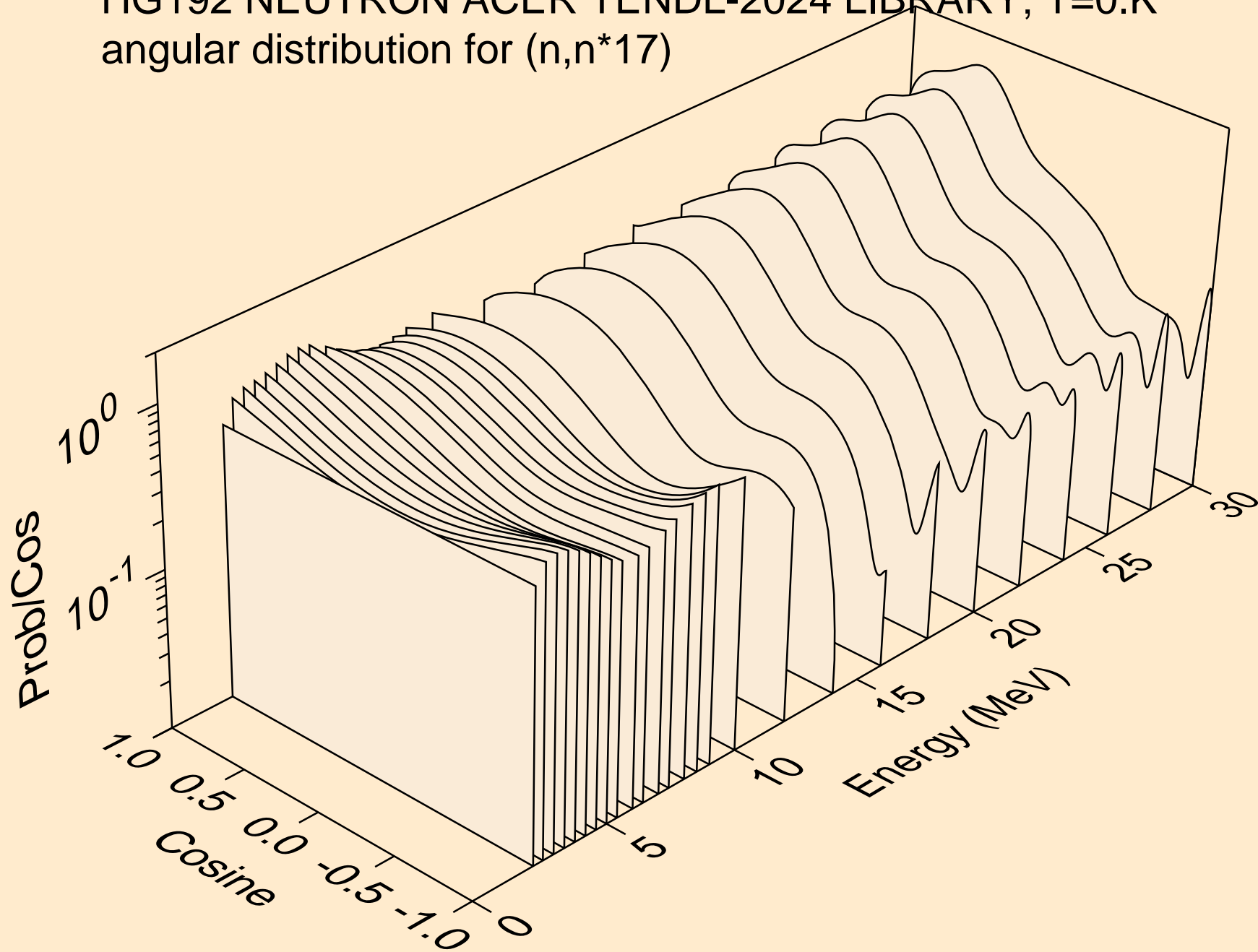

HG192 NEUTRON ACER TENDL-2024 LIBRARY; T=0.K
angular distribution for (n,n*18)

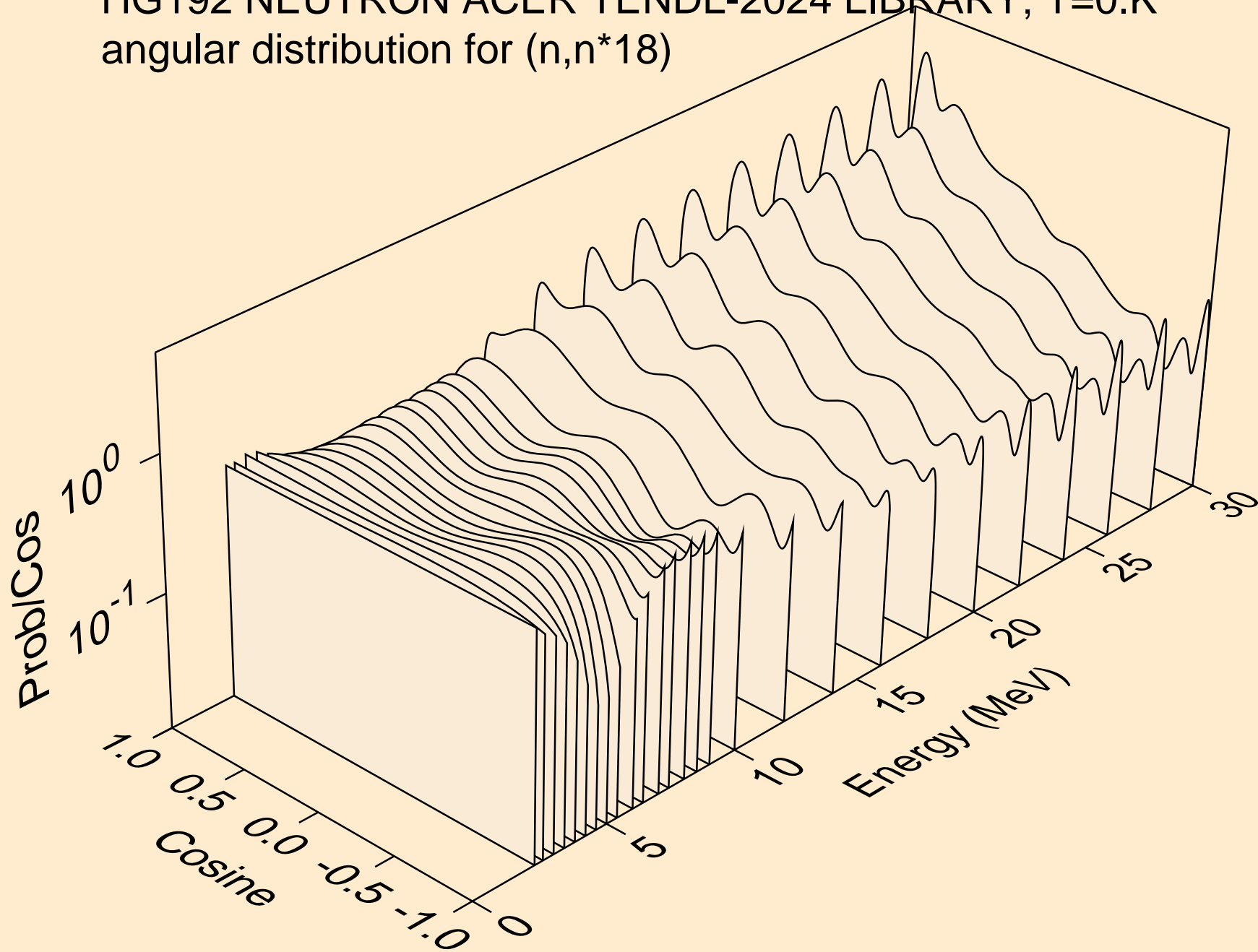

HG192 NEUTRON ACER TENDL-2024 LIBRARY; T=0.K
angular distribution for (n,n*19)

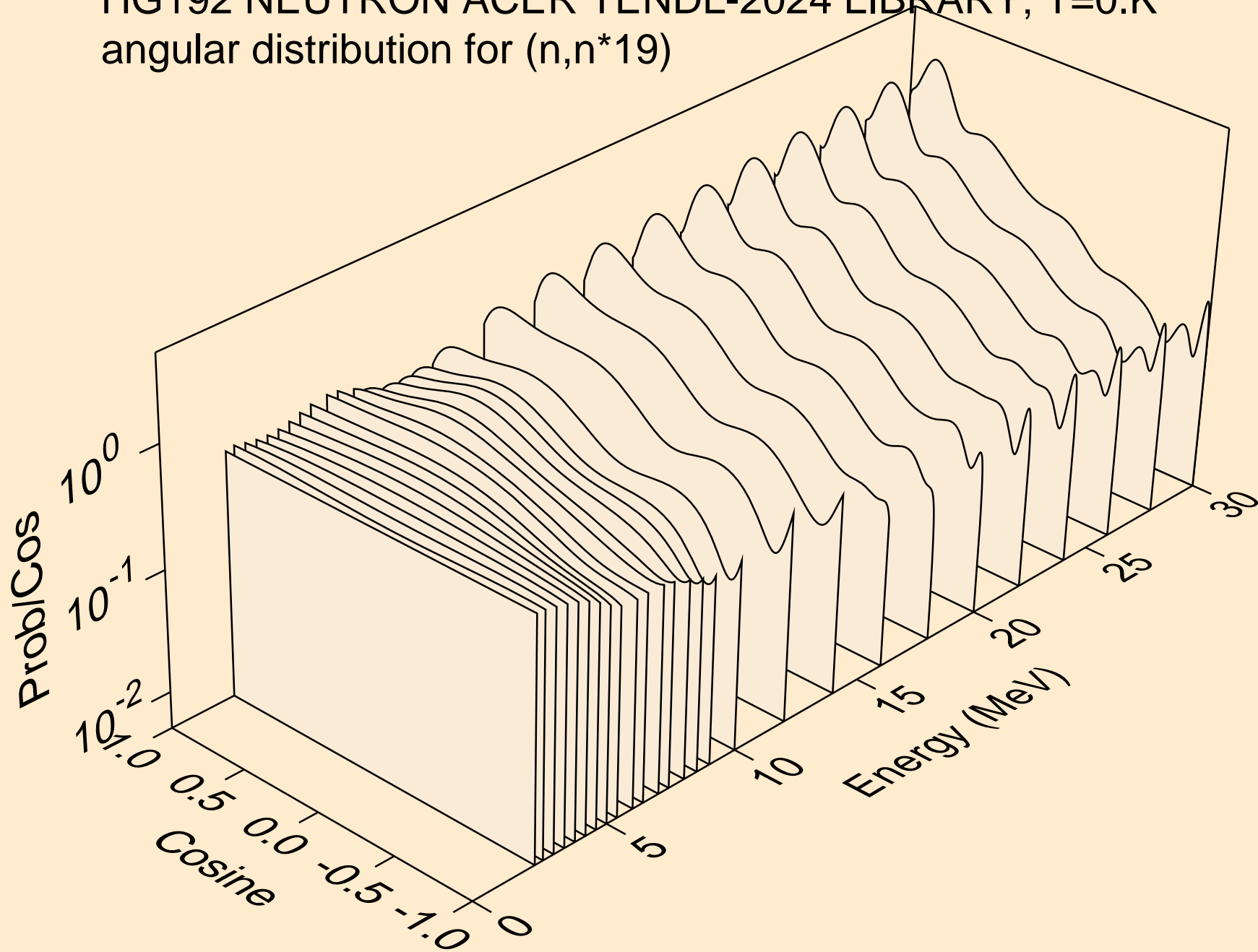

HG192 NEUTRON ACER TENDL-2024 LIBRARY; T=0.K
angular distribution for (n,n*20)

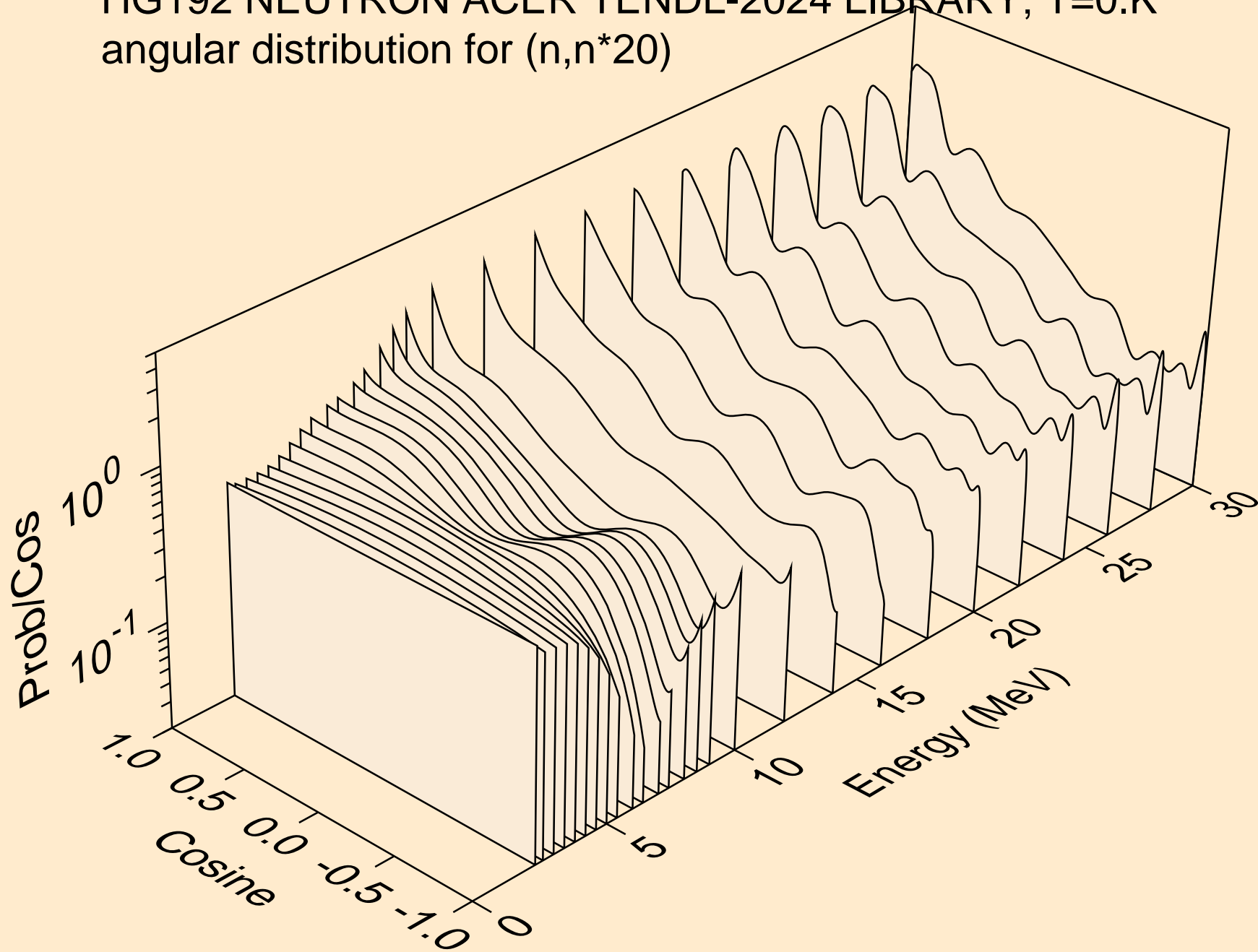

HG192 NEUTRON ACER TENDL-2024 LIBRARY; T=0.K
angular distribution for (n,n*21)

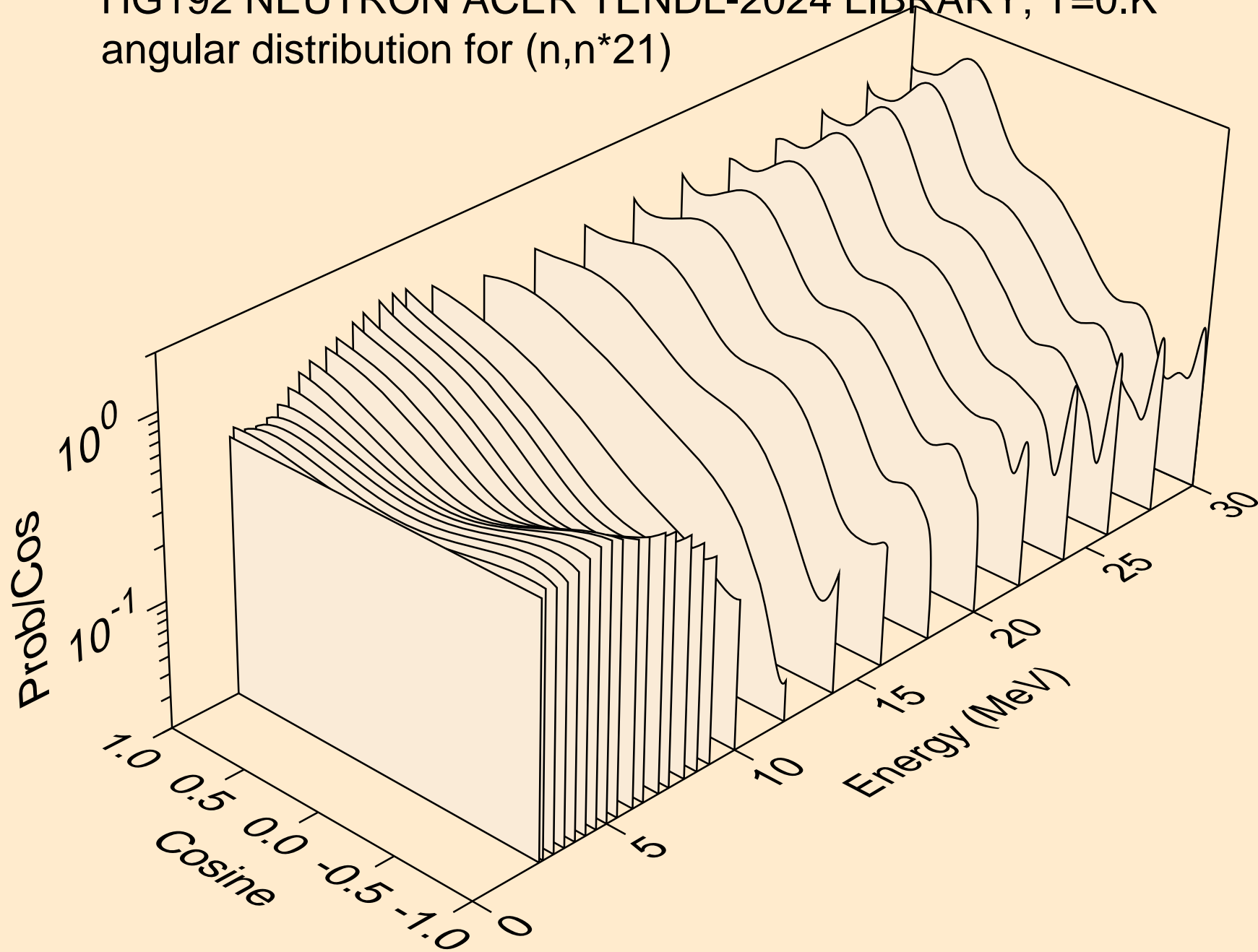

HG192 NEUTRON ACER TENDL-2024 LIBRARY; T=0.K
angular distribution for (n,n*22)

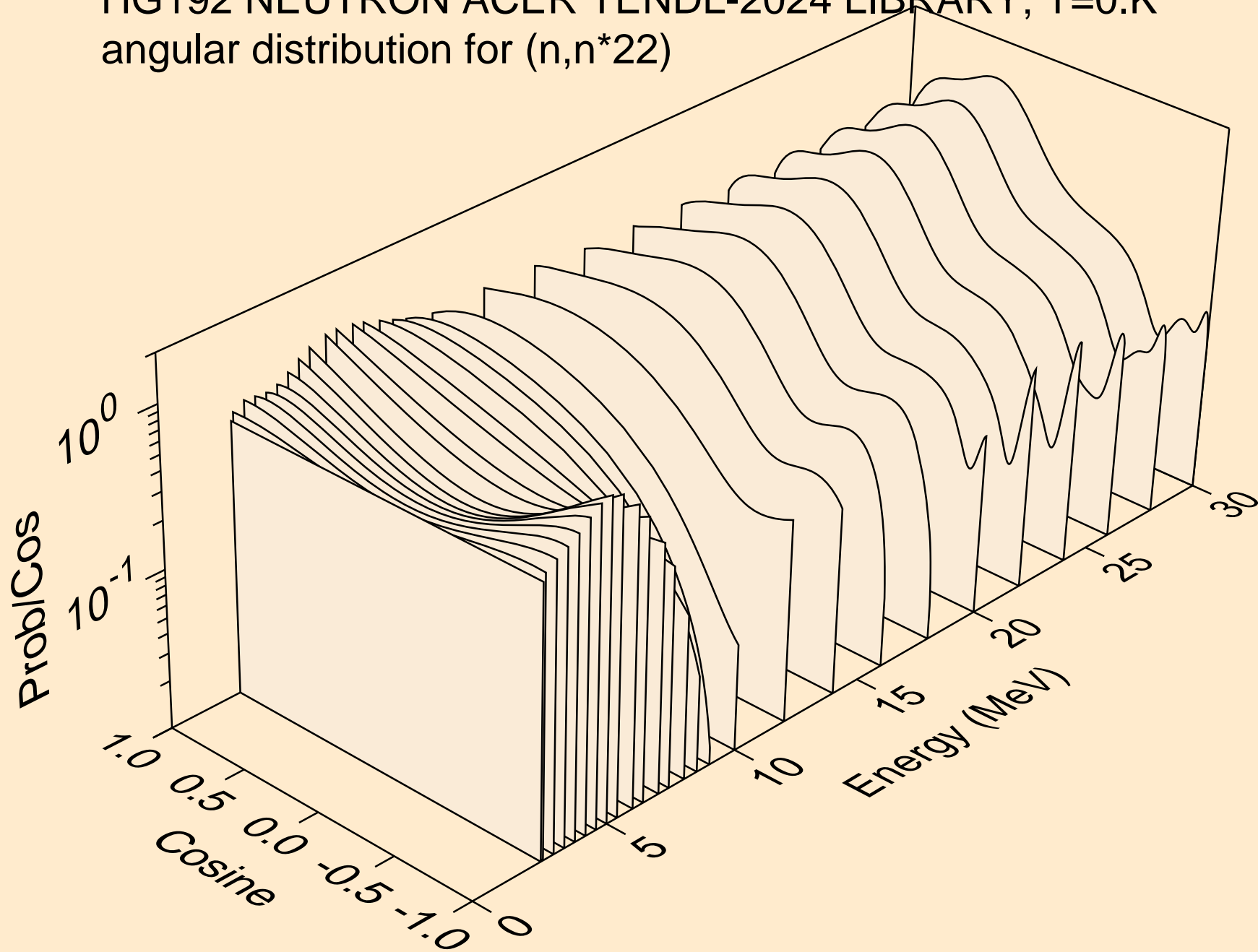

HG192 NEUTRON ACER TENDL-2024 LIBRARY; T=0.K
angular distribution for (n,n*23)

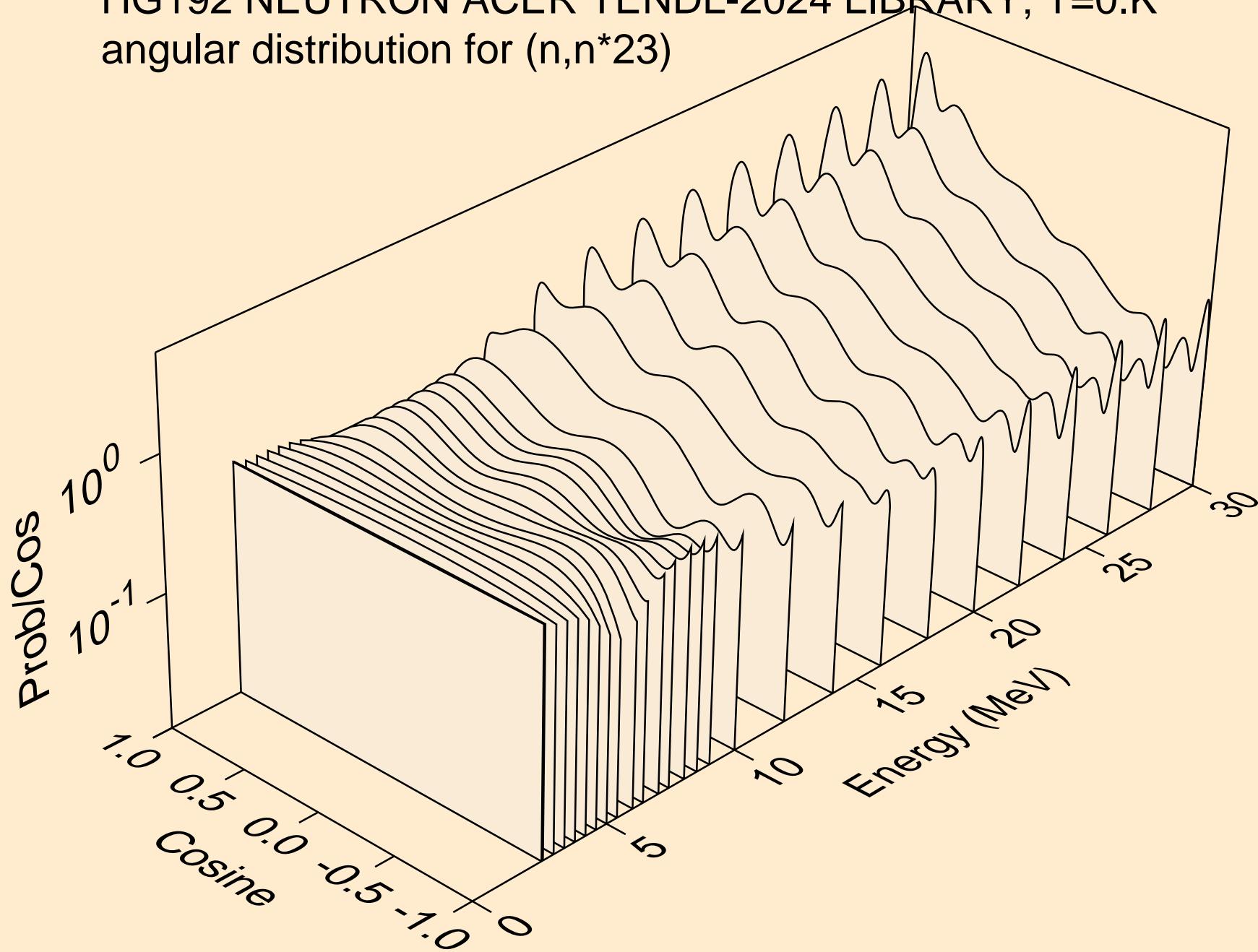

HG192 NEUTRON ACER TENDL-2024 LIBRARY; T=0.K
Neutron emission for (n,x)

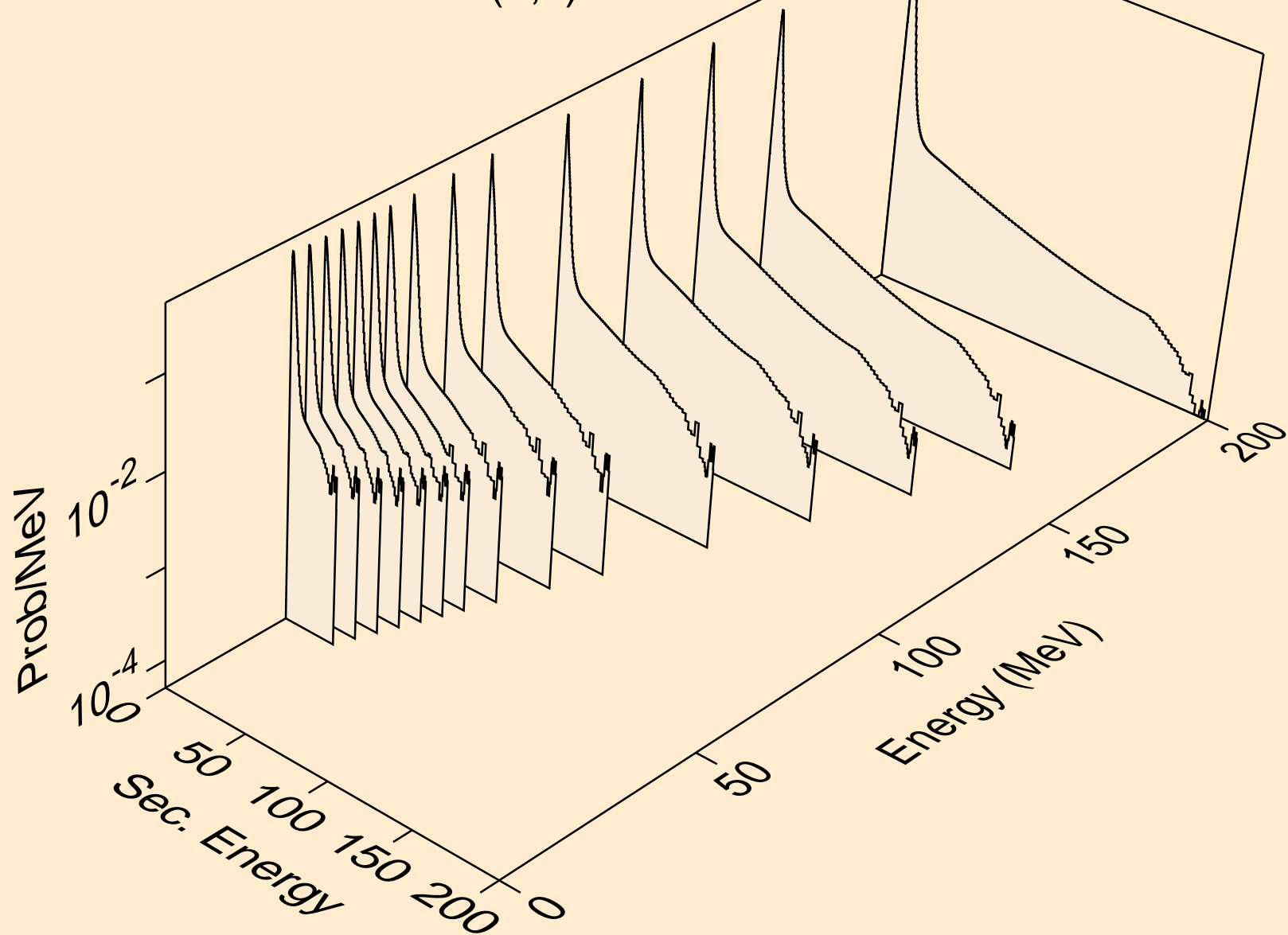

HG192 NEUTRON ACER TENDL-2024 LIBRARY; T=0.K
Neutron emission for (n,2nd)

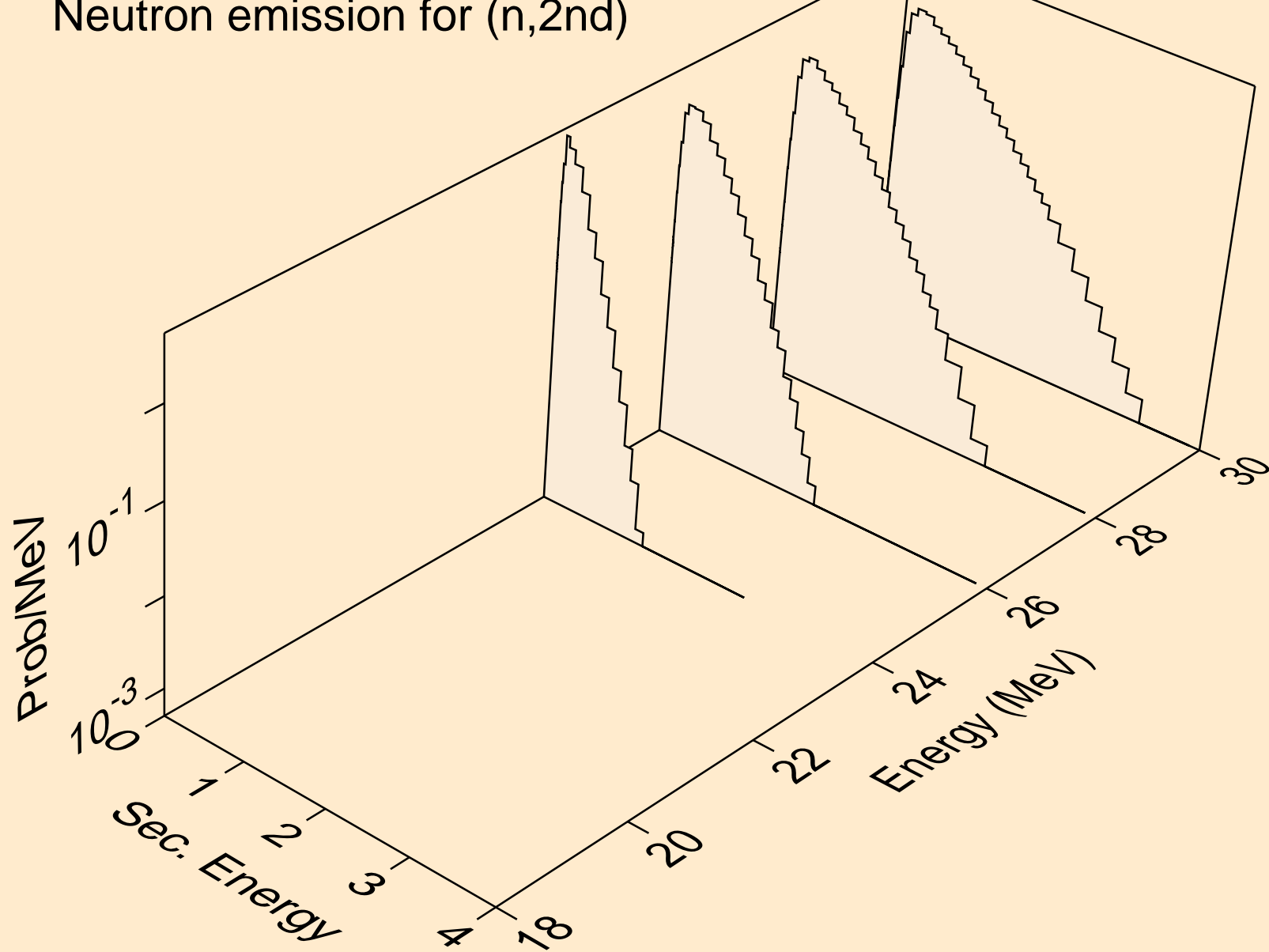

HG192 NEUTRON ACER TENDL-2024 LIBRARY; T=0.K
Neutron emission for (n,2n)

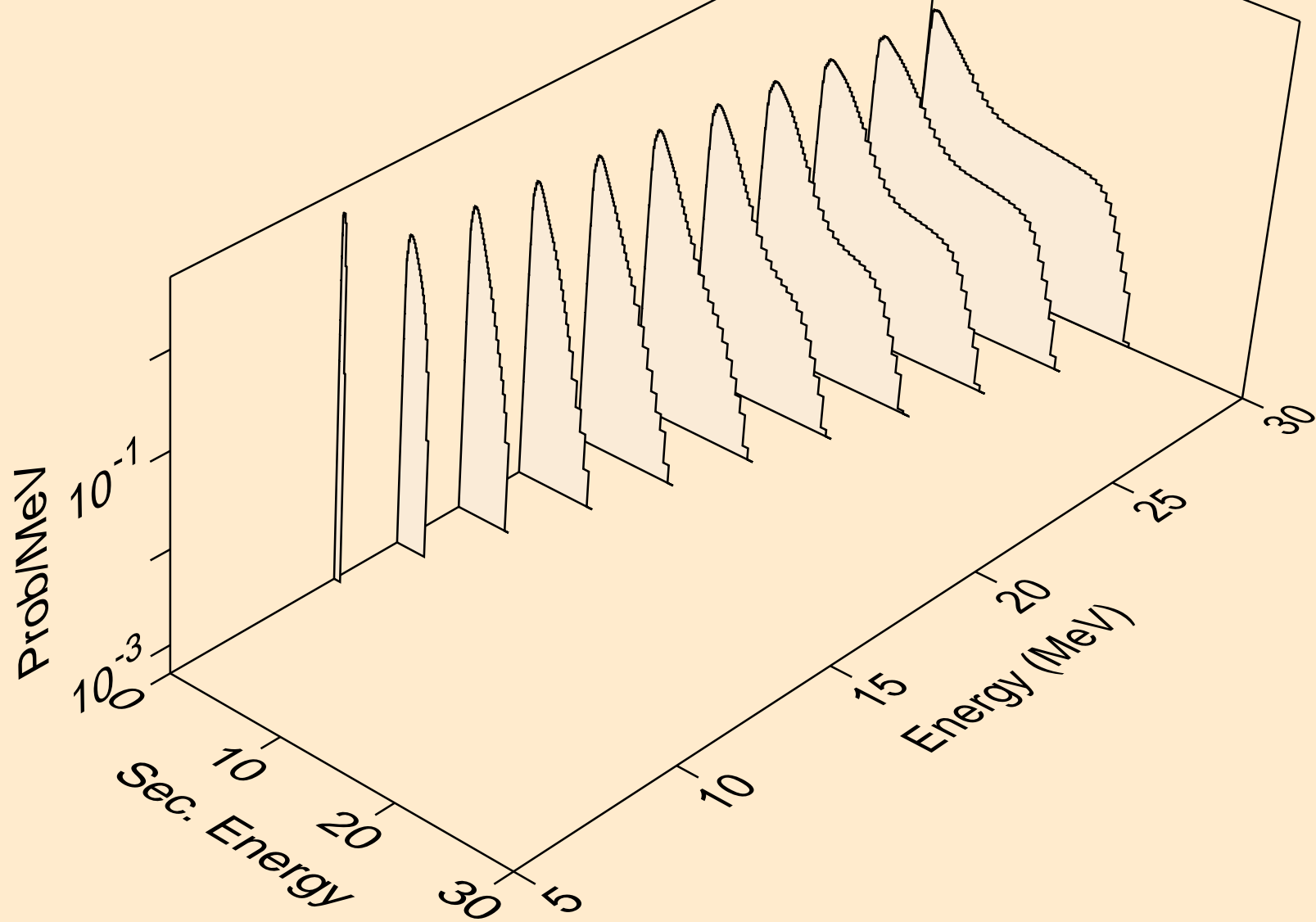

HG192 NEUTRON ACER TENDL-2024 LIBRARY; T=0.K
Neutron emission for (n,3n)

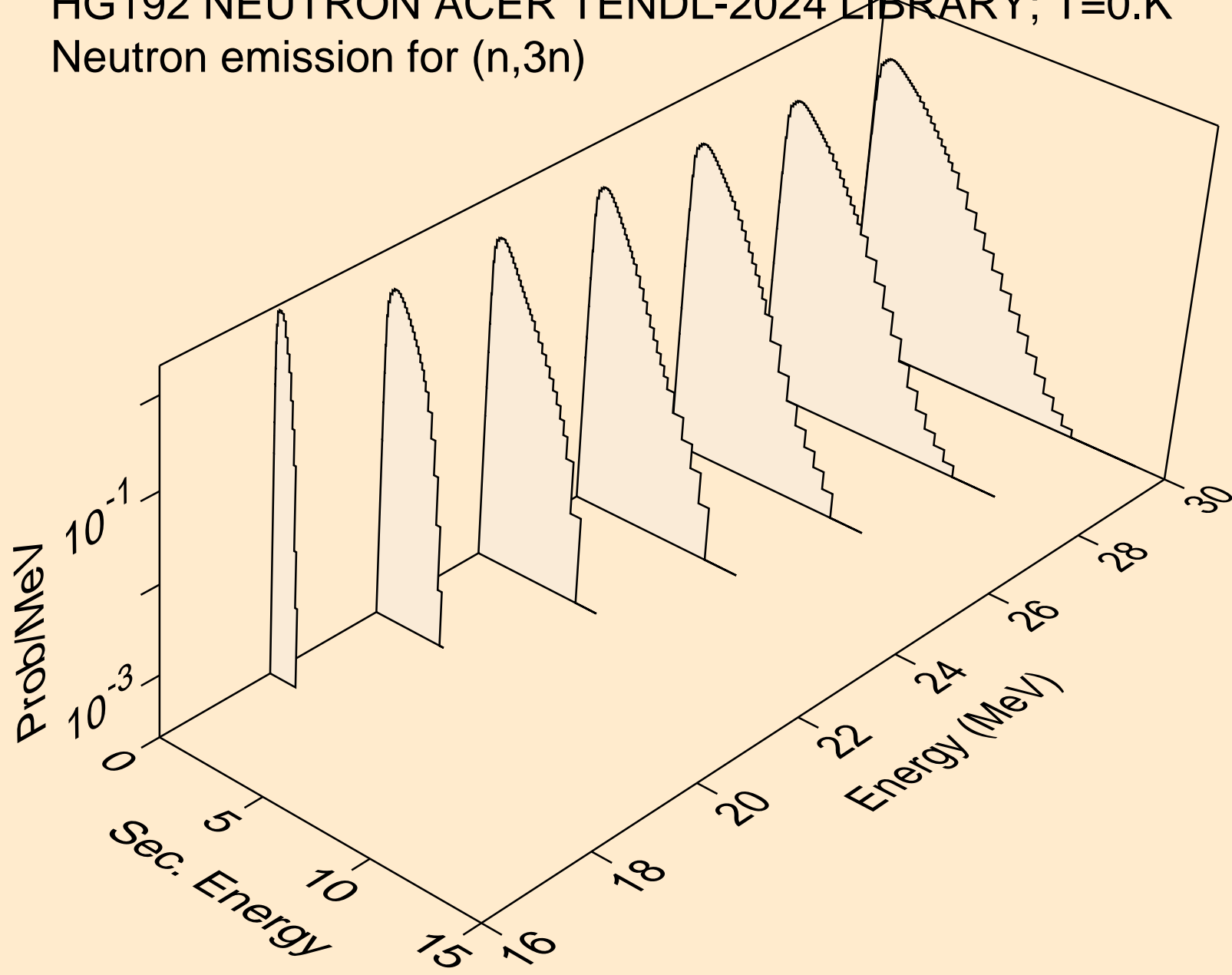

HG192 NEUTRON ACER TENDL-2024 LIBRARY; T=0.K
Neutron emission for (n,n*)a

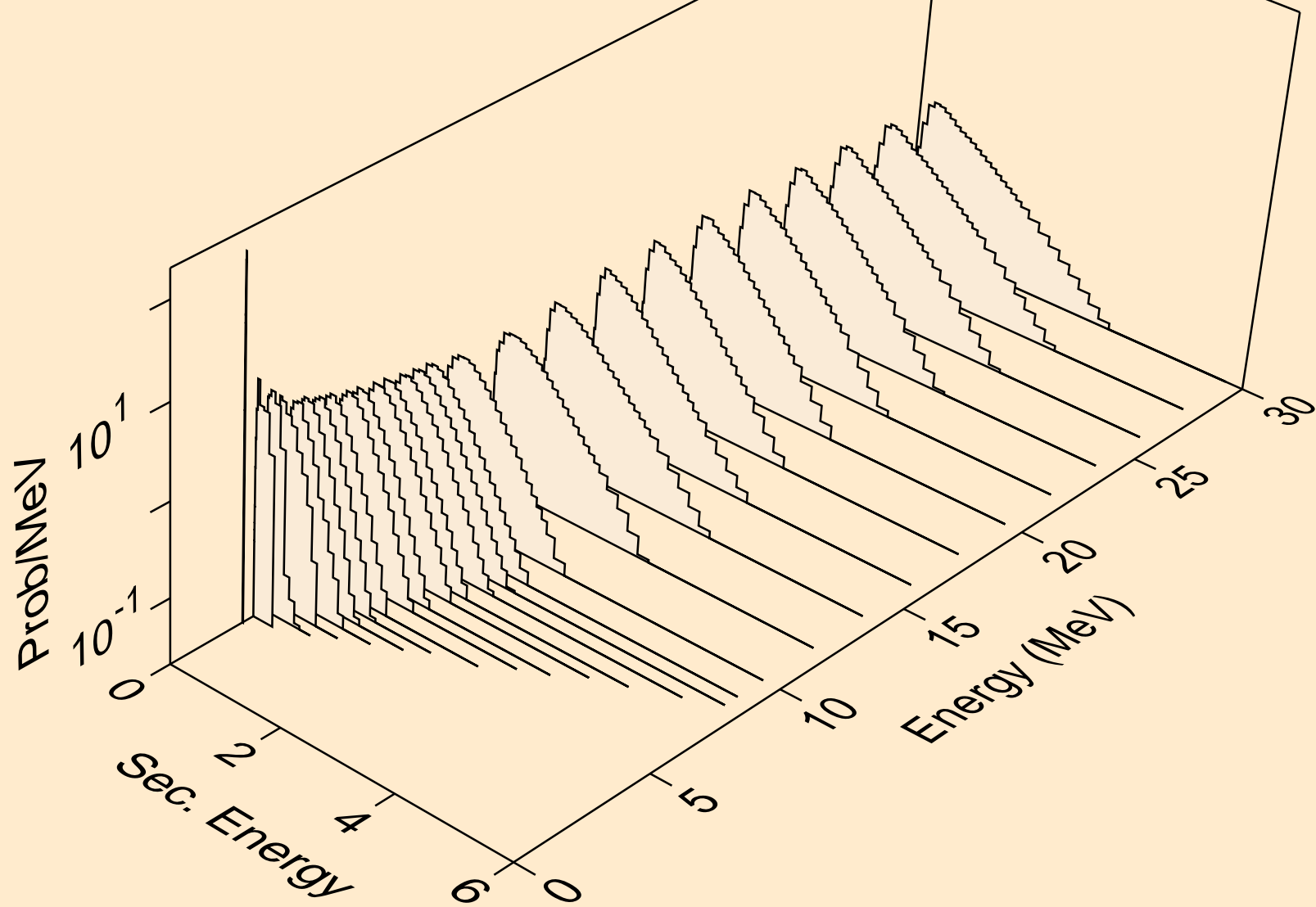

HG192 NEUTRON ACER TENDL-2024 LIBRARY; T=0.K
Neutron emission for (n,2n)a

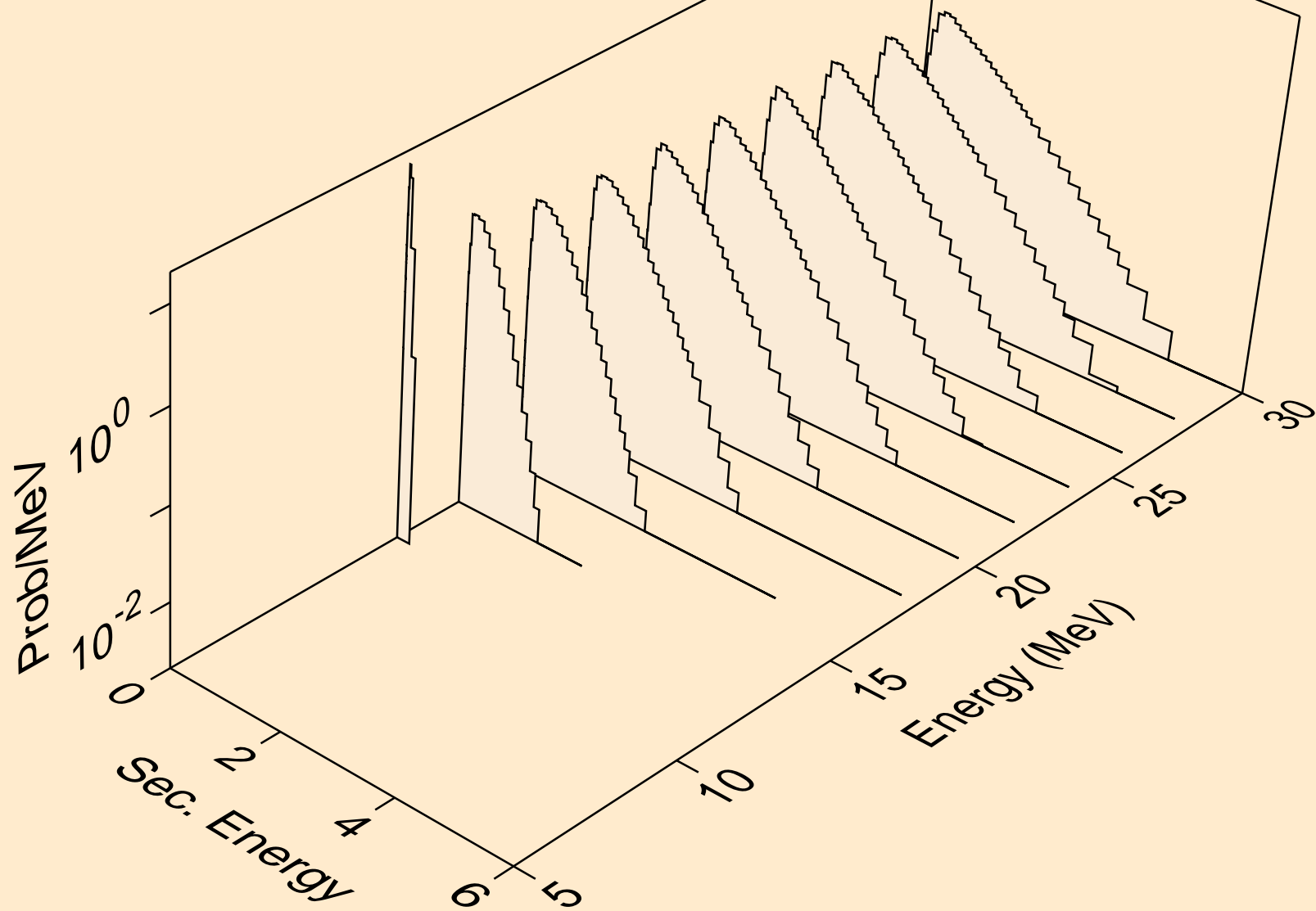

HG192 NEUTRON ACER TENDL-2024 LIBRARY; T=0.K
Neutron emission for (n,3n)a

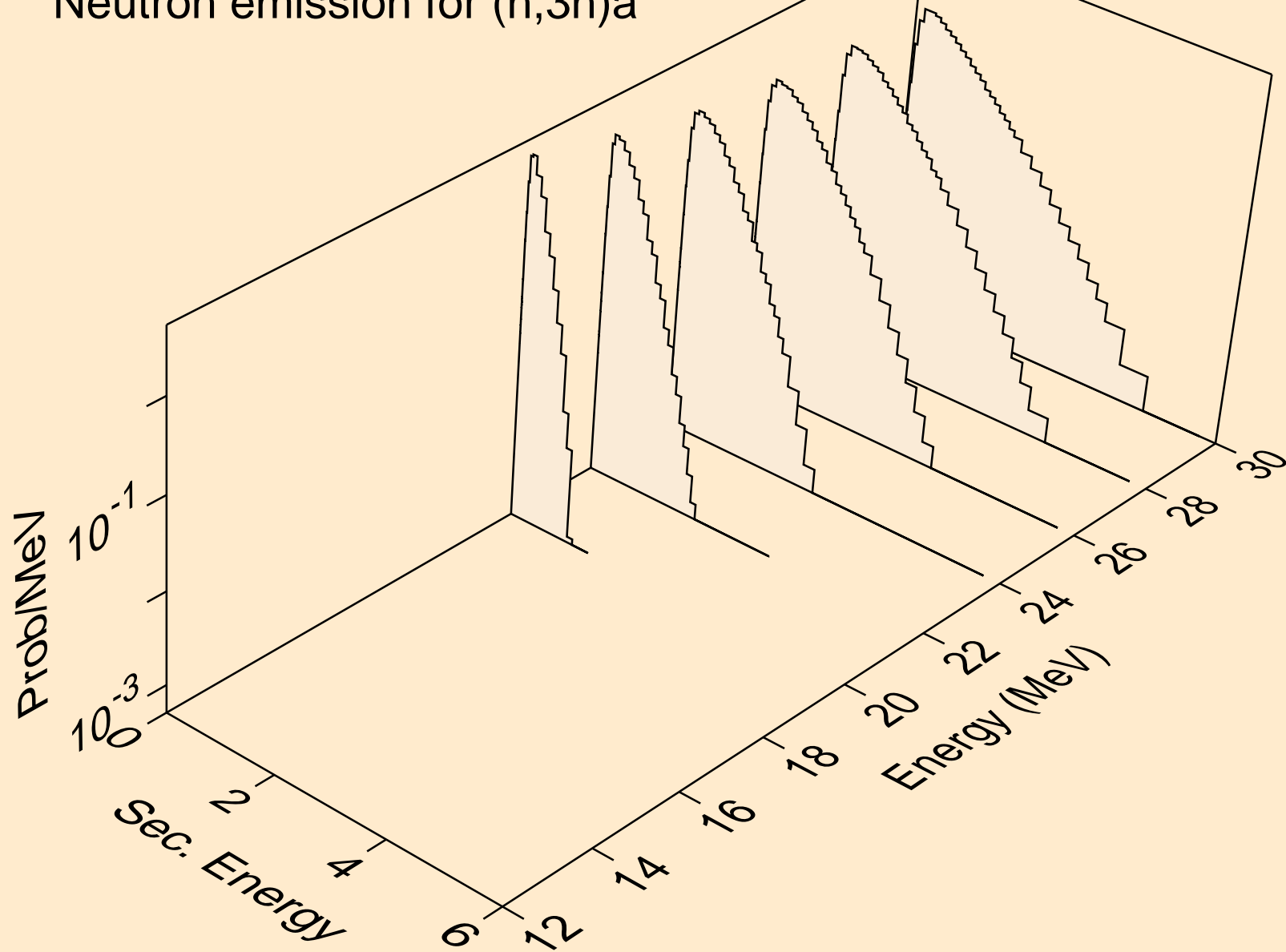

HG192 NEUTRON ACER TENDL-2024 LIBRARY; T=0.K
Neutron emission for (n,n*)p

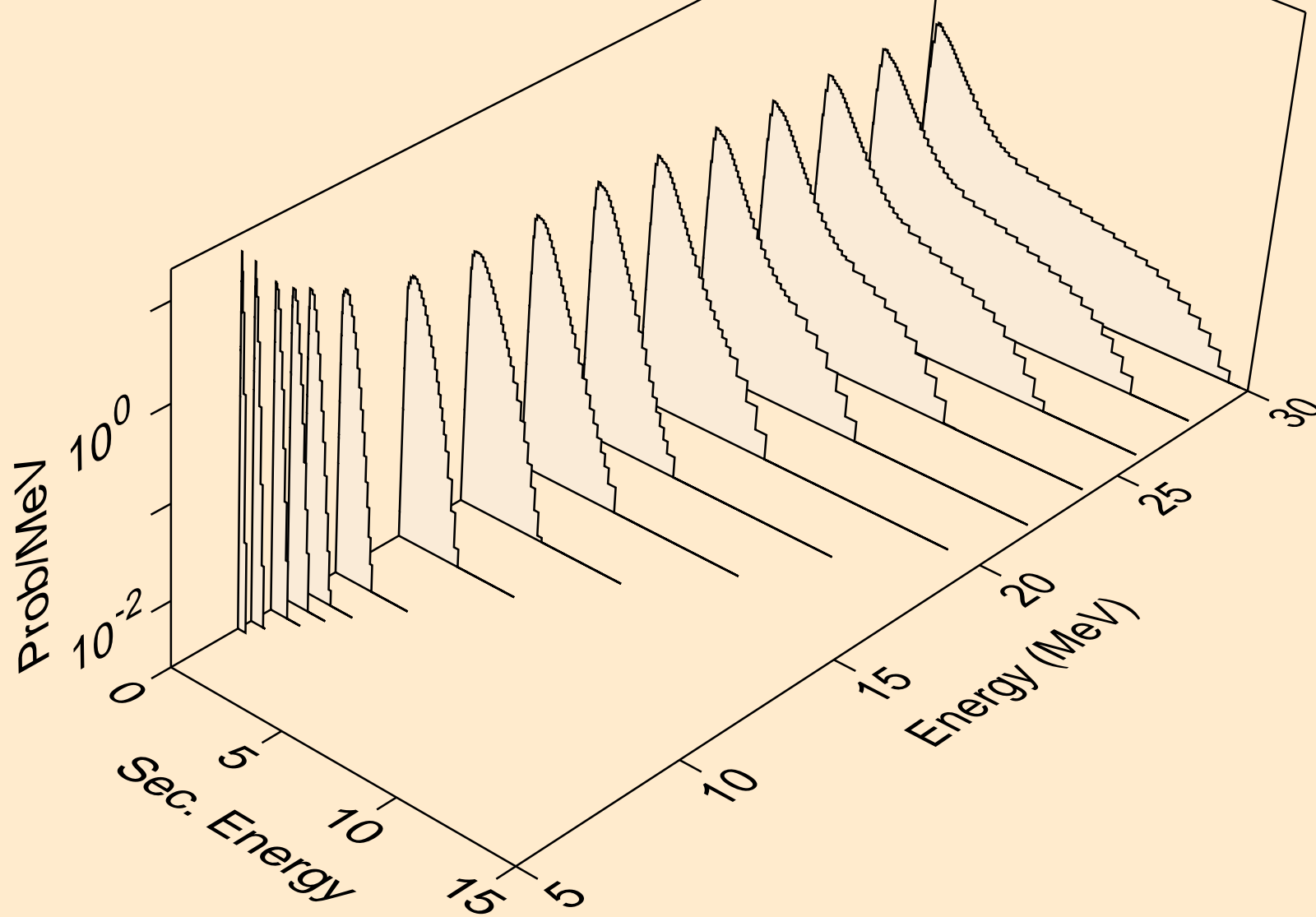

HG192 NEUTRON ACER TENDL-2024 LIBRARY; T=0.K
Neutron emission for (n,n*)2a

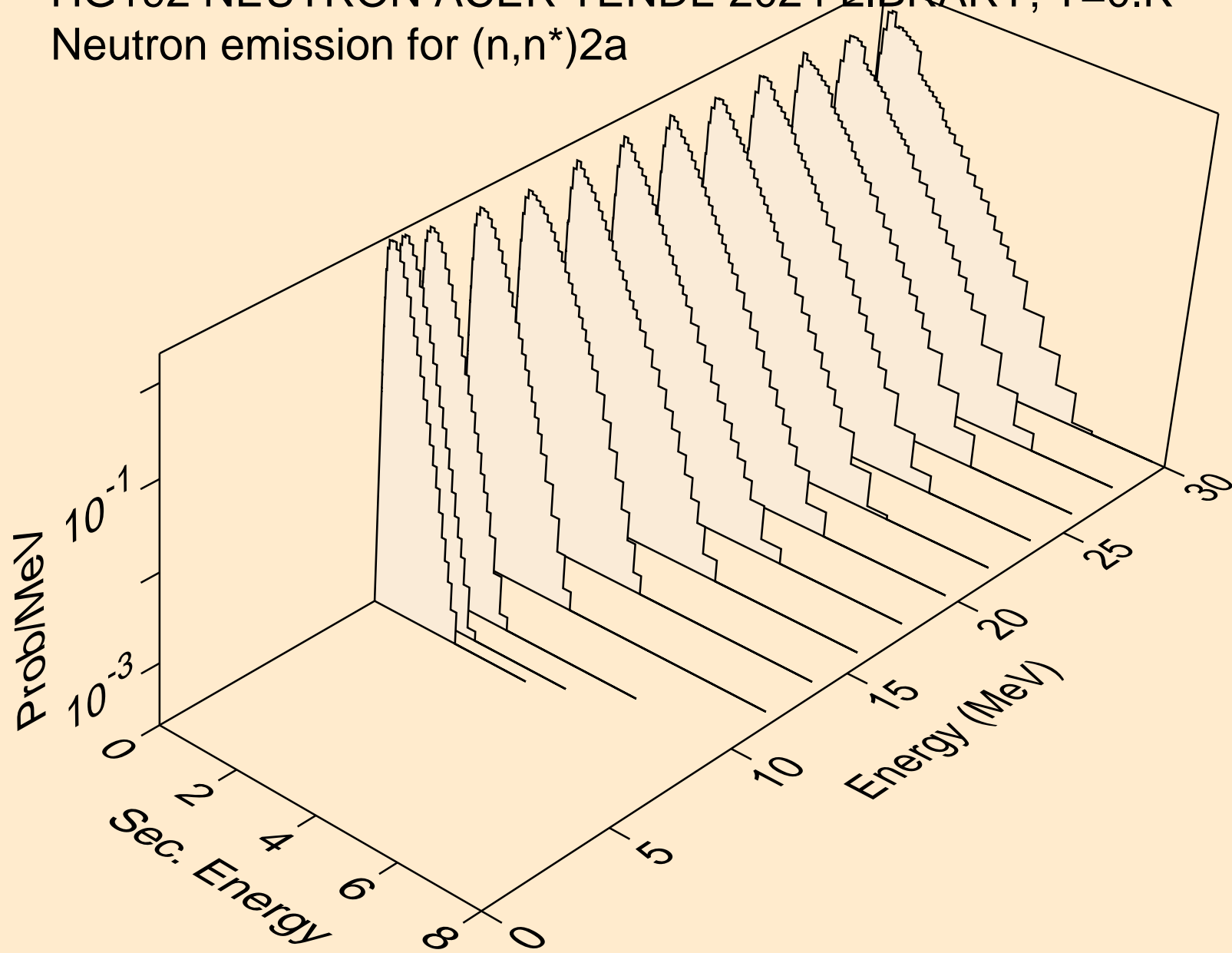

HG192 NEUTRON ACER TENDL-2024 LIBRARY; T=0.K
Neutron emission for (n,2n)2a

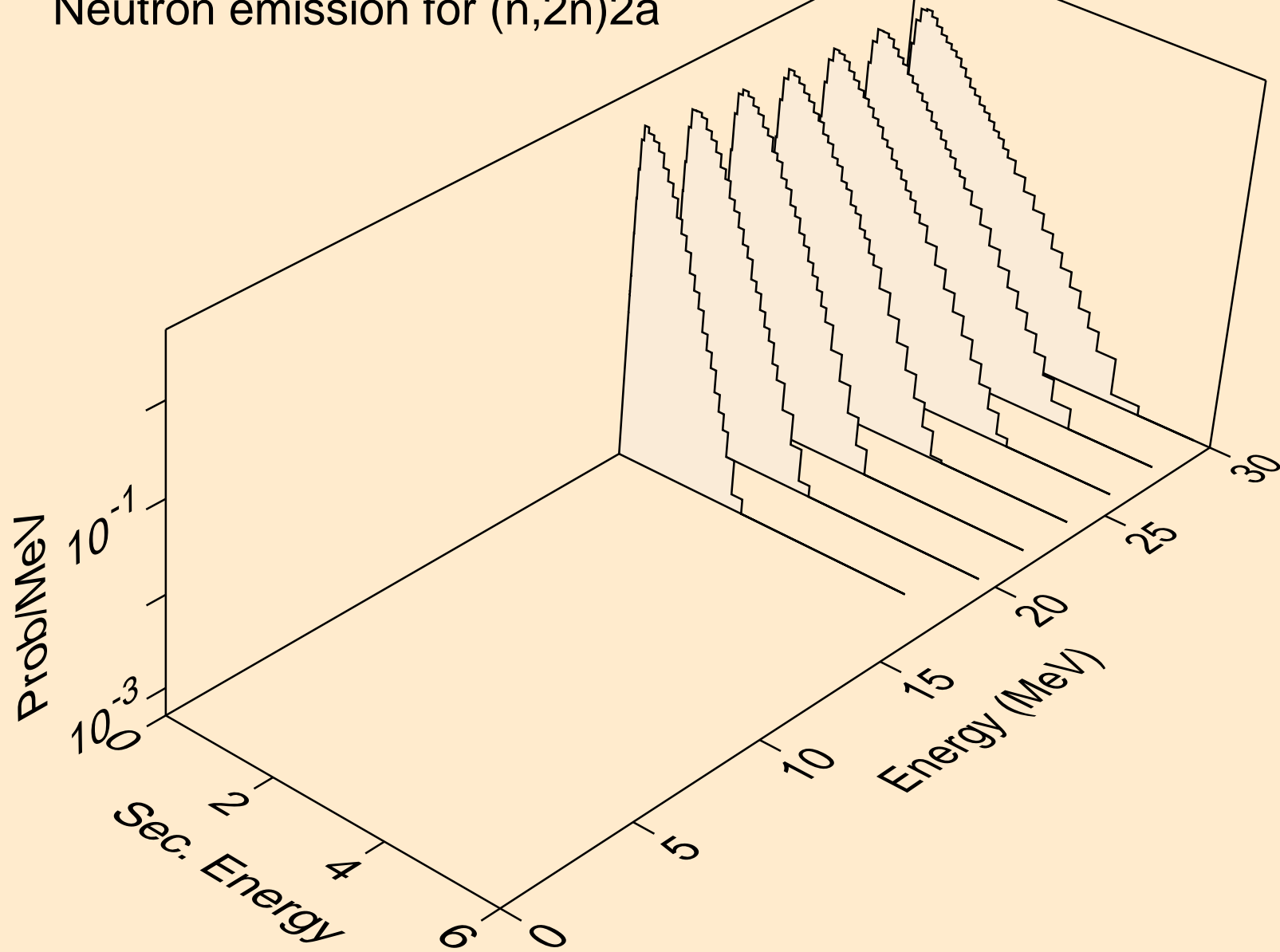

HG192 NEUTRON ACER TENDL-2024 LIBRARY; T=0.K
Neutron emission for (n,n*)d

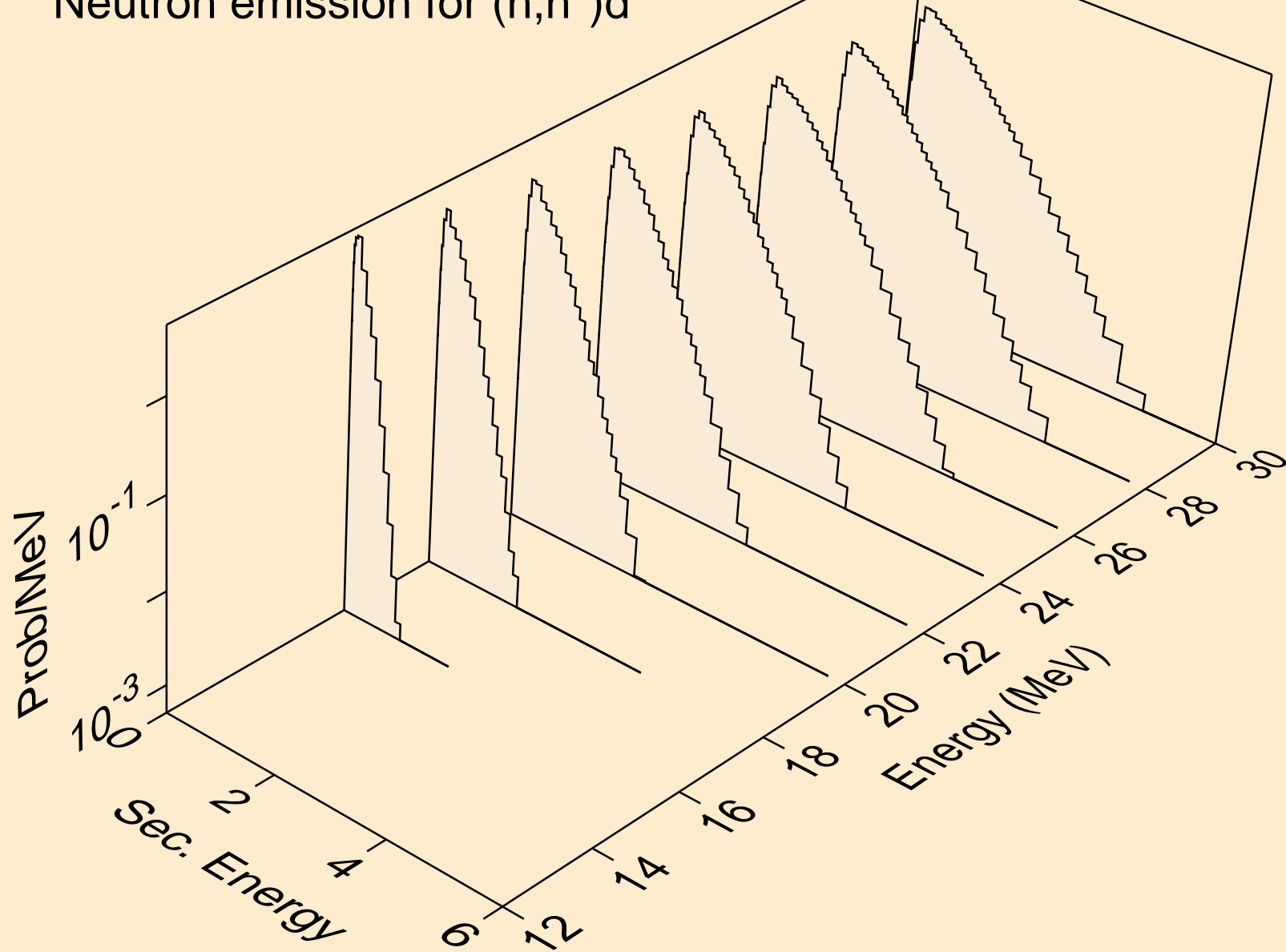

HG192 NEUTRON ACER TENDL-2024 LIBRARY; T=0.K
Neutron emission for (n,n*)t

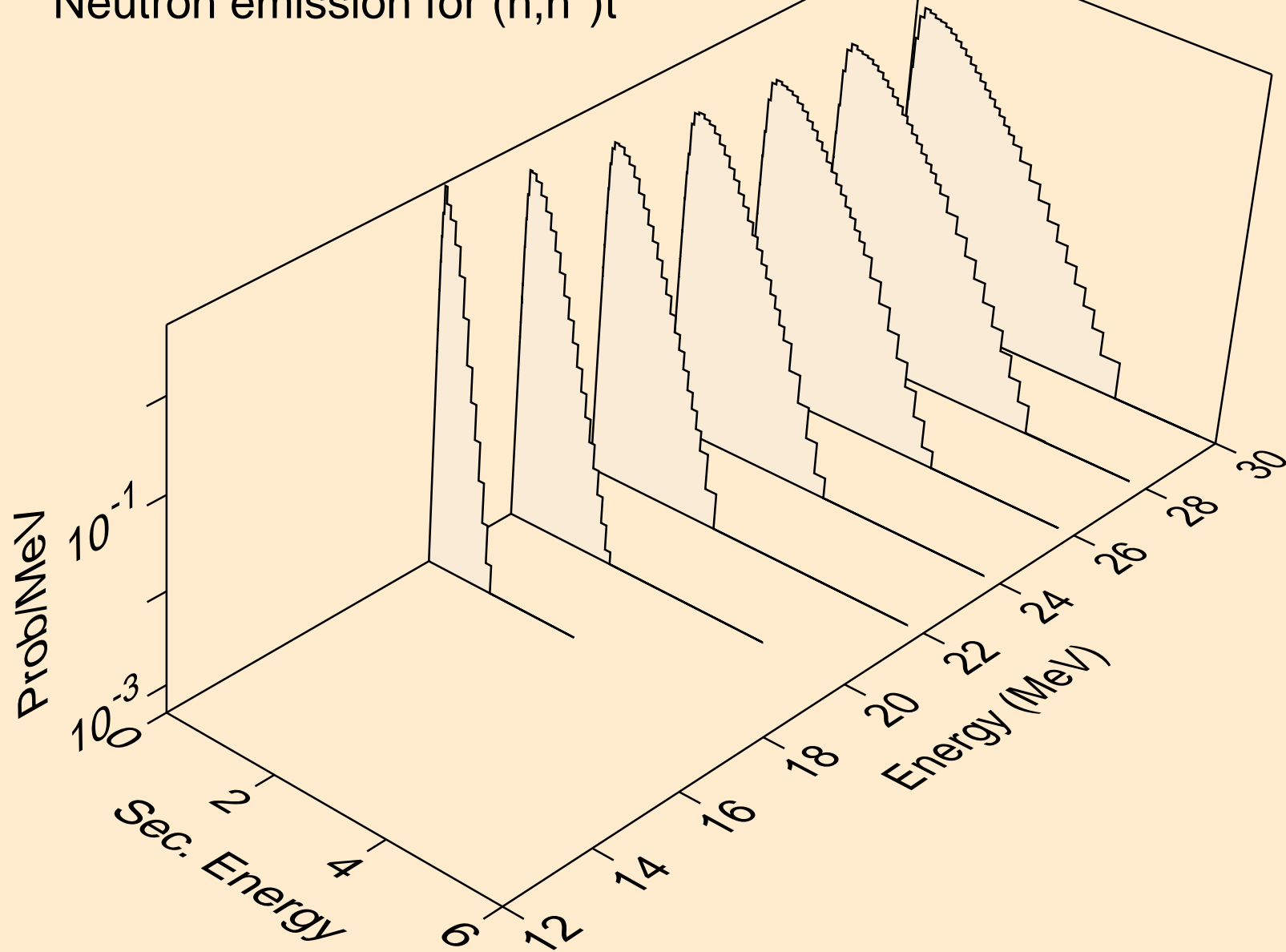

HG192 NEUTRON ACER TENDL-2024 LIBRARY; T=0.K
Neutron emission for (n,n*)he3

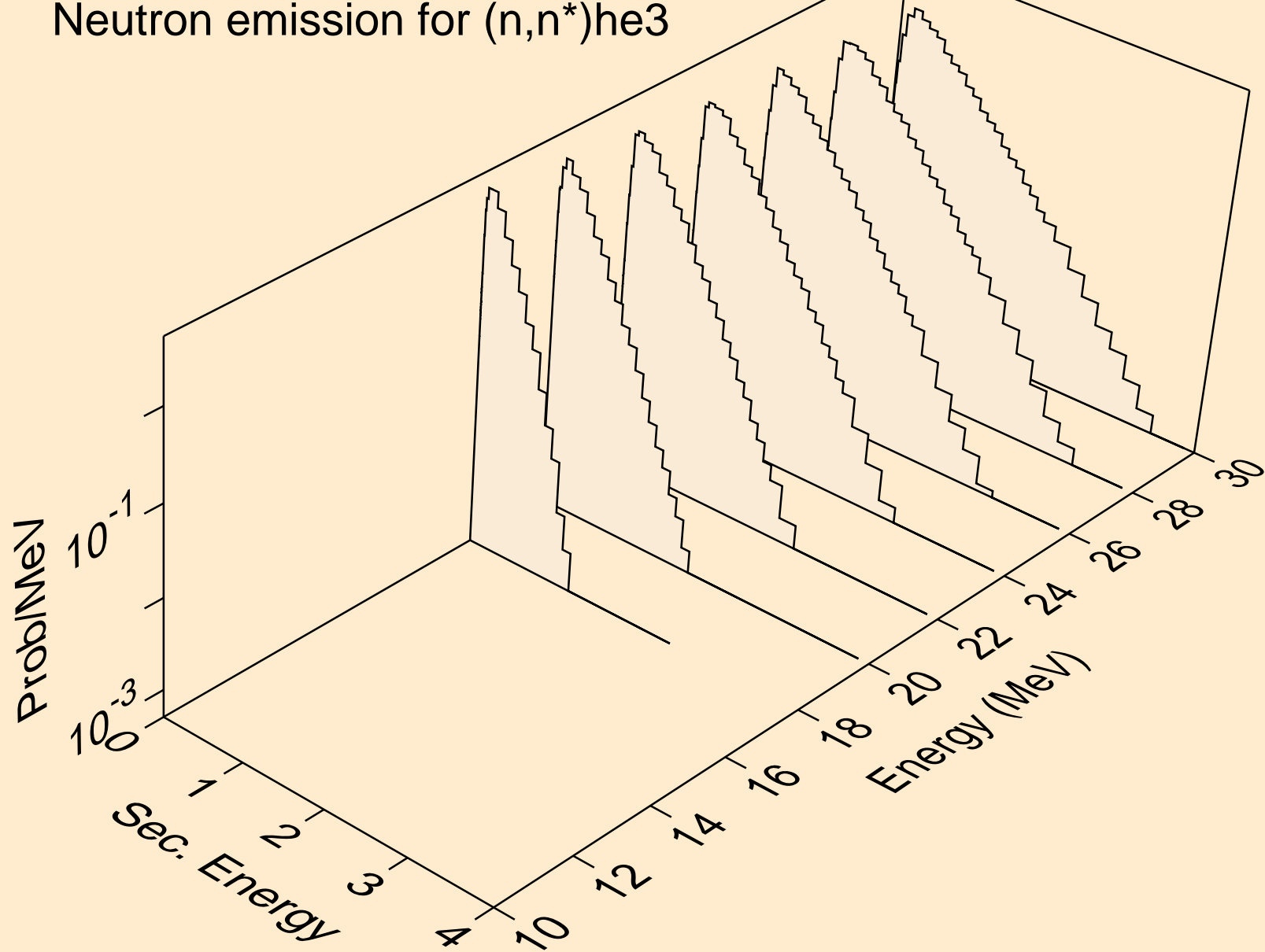

HG192 NEUTRON ACER TENDL-2024 LIBRARY; T=0.K
Neutron emission for (n,4n)

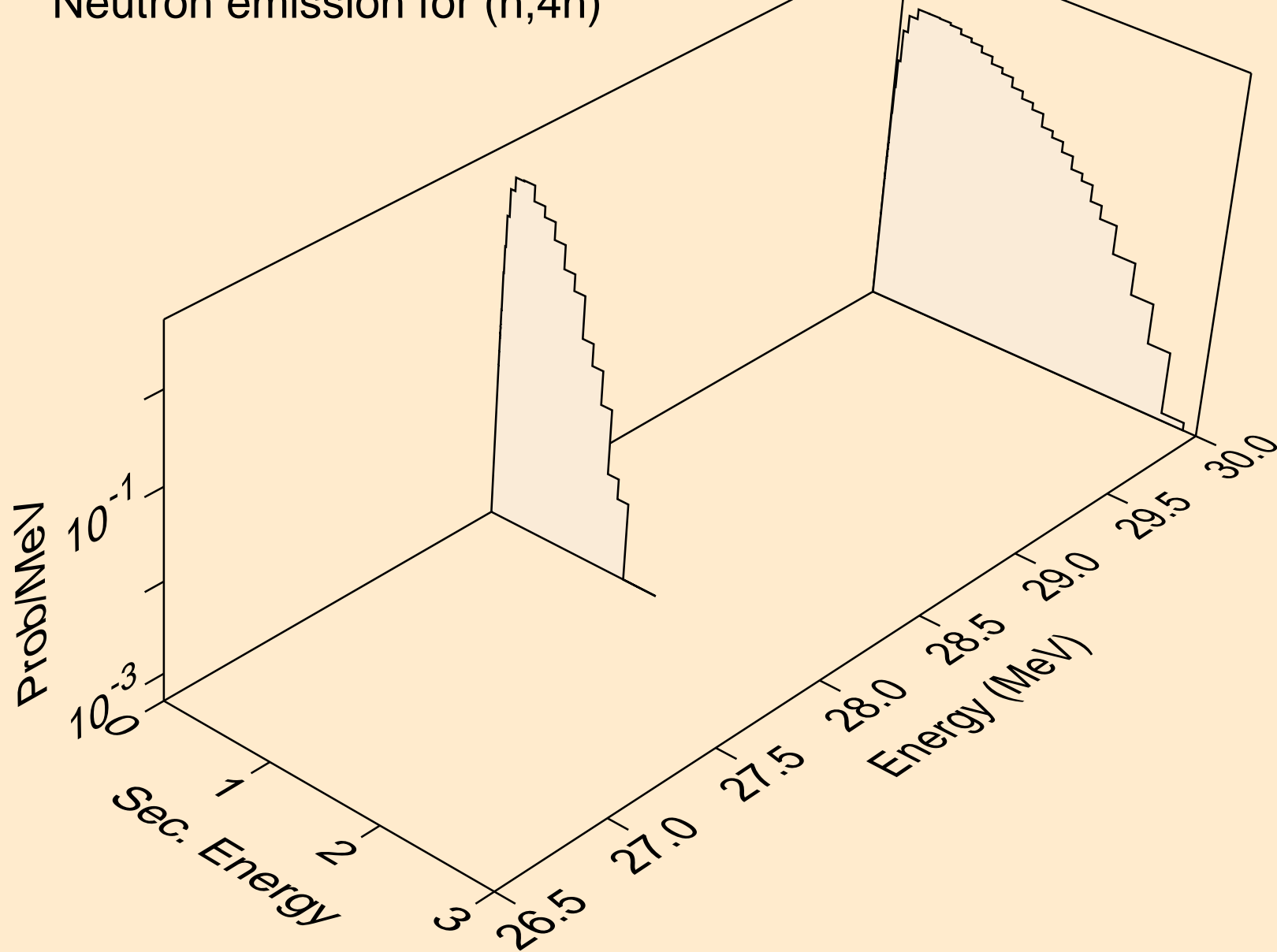

HG192 NEUTRON ACER TENDL-2024 LIBRARY; T=0.K
Neutron emission for (n,2np)

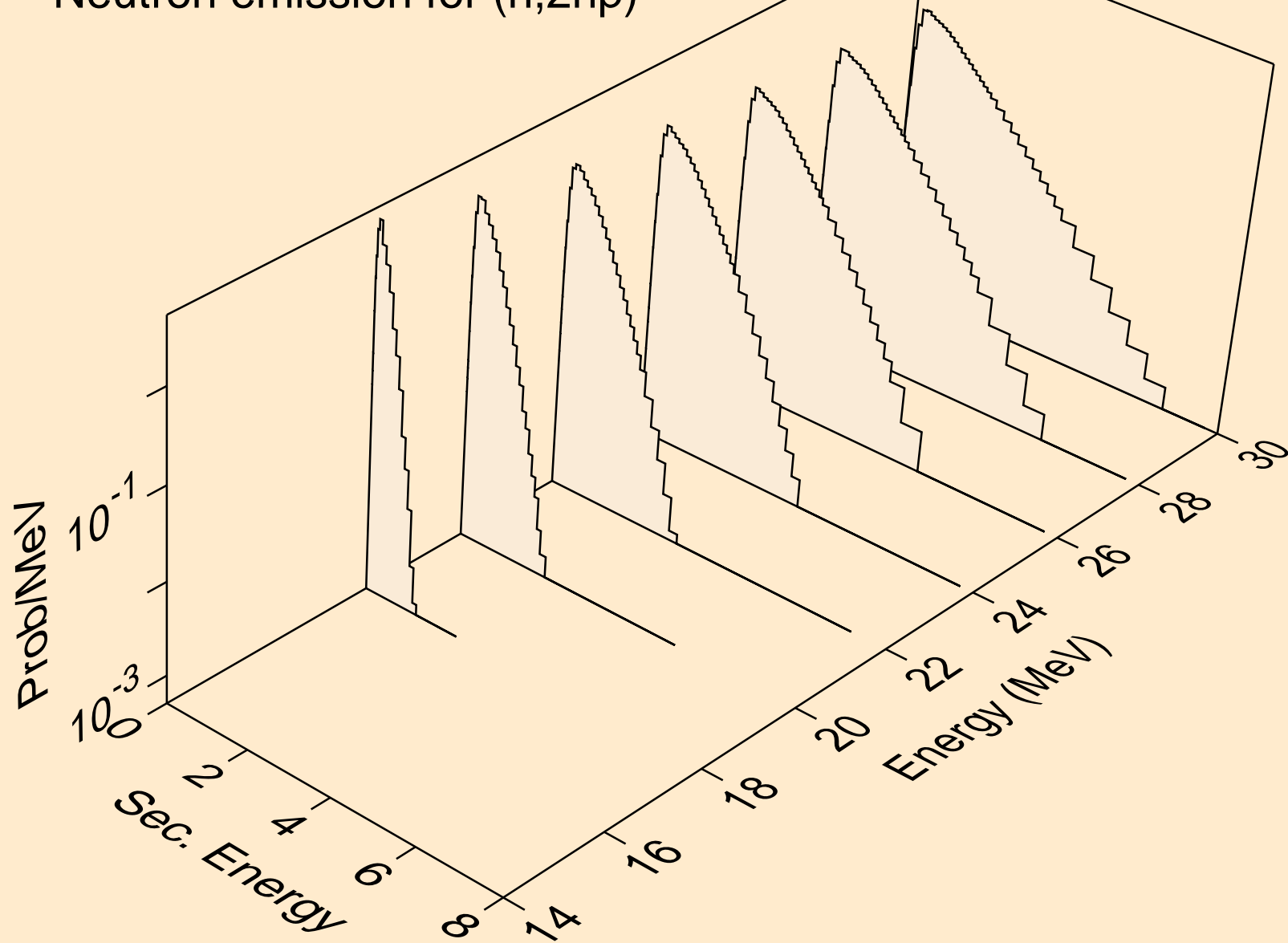

HG192 NEUTRON ACER TENDL-2024 LIBRARY; T=0.K
Neutron emission for (n,3np)

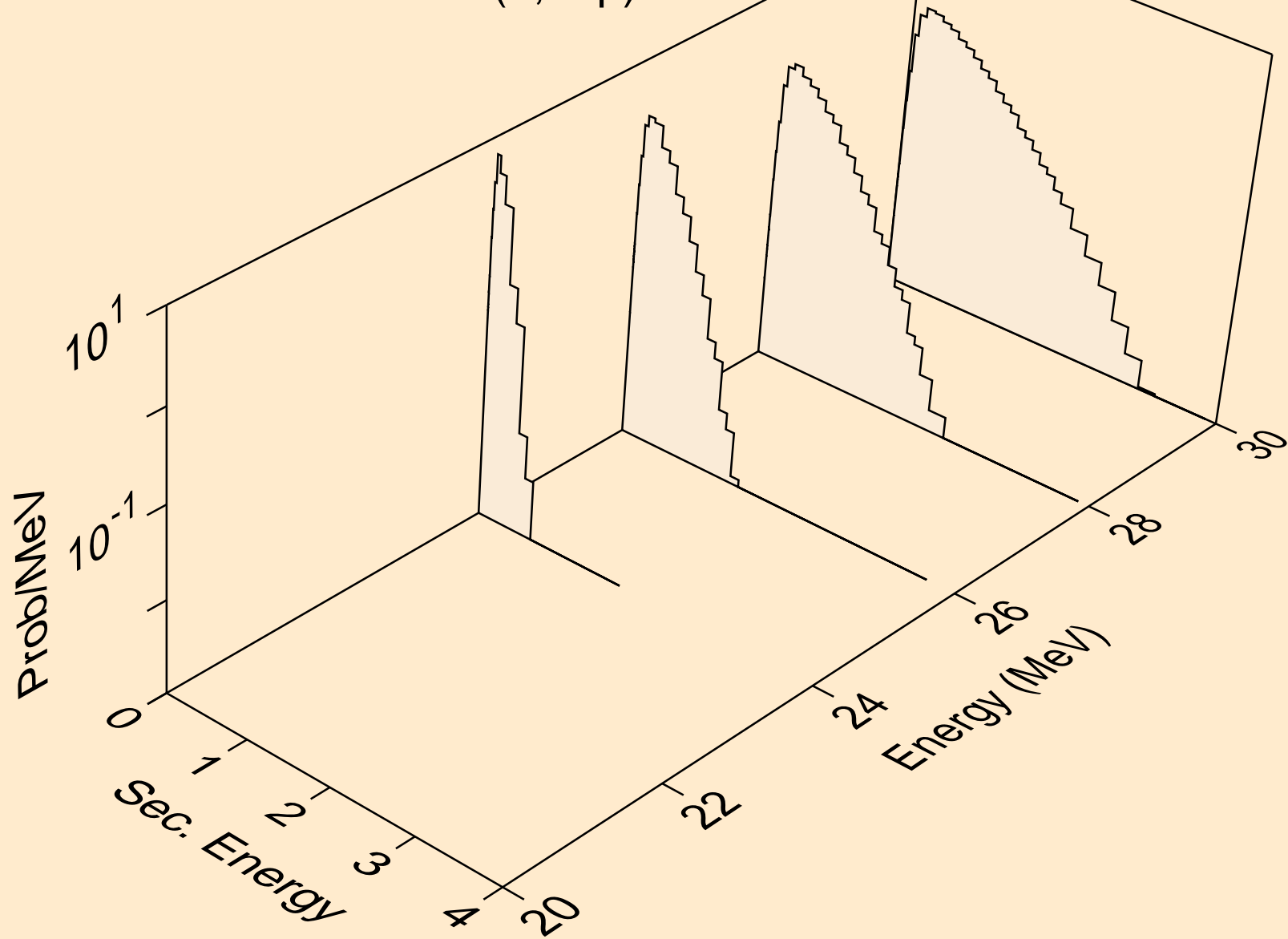

HG192 NEUTRON ACER TENDL-2024 LIBRARY; T=0.K
Neutron emission for (n,n2p)

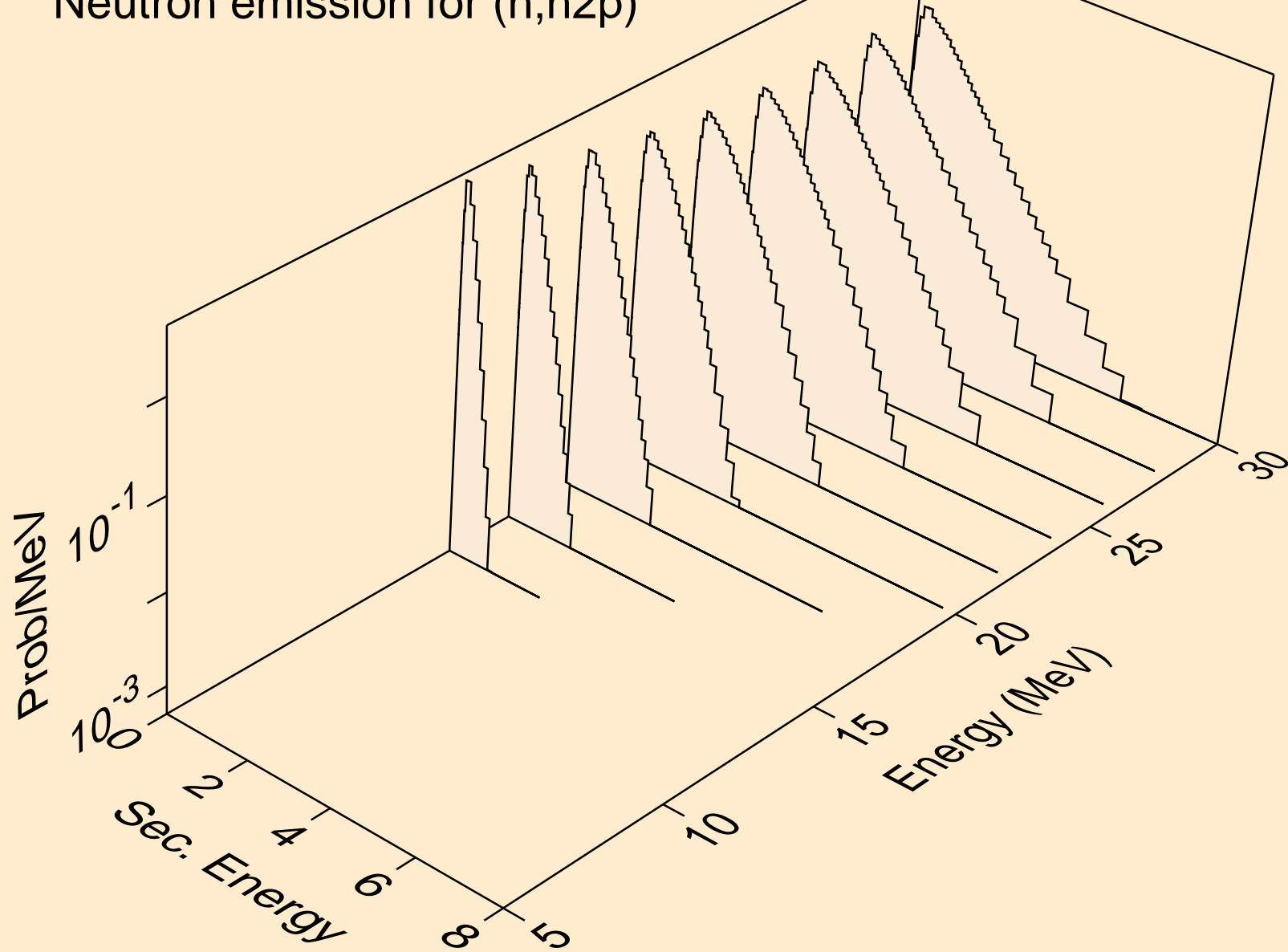

HG192 NEUTRON ACER TENDL-2024 LIBRARY; T=0.K
Neutron emission for (n,npa)

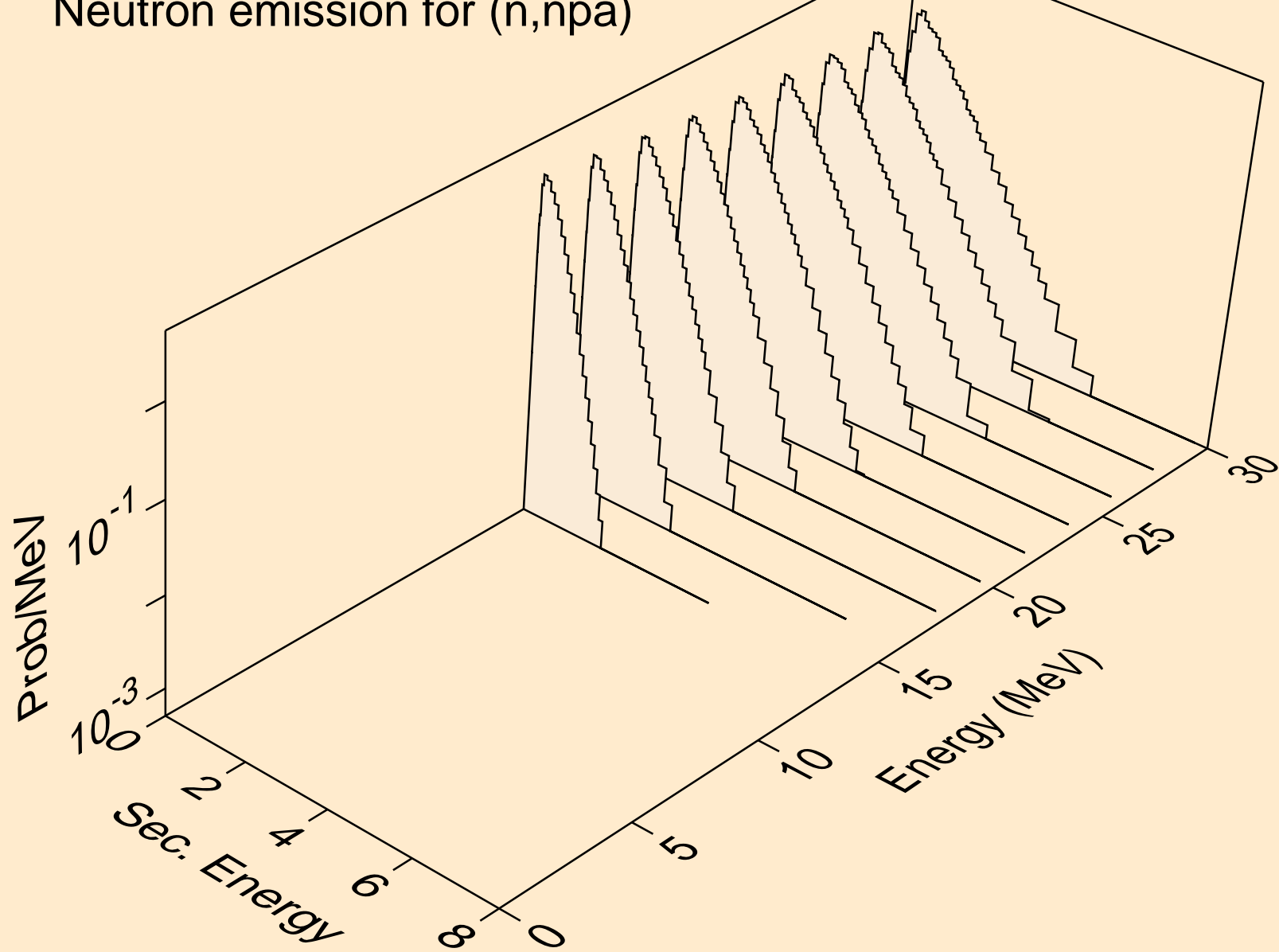

HG192 NEUTRON ACER TENDL-2024 LIBRARY; T=0.K
Neutron emission for (n,n*c)

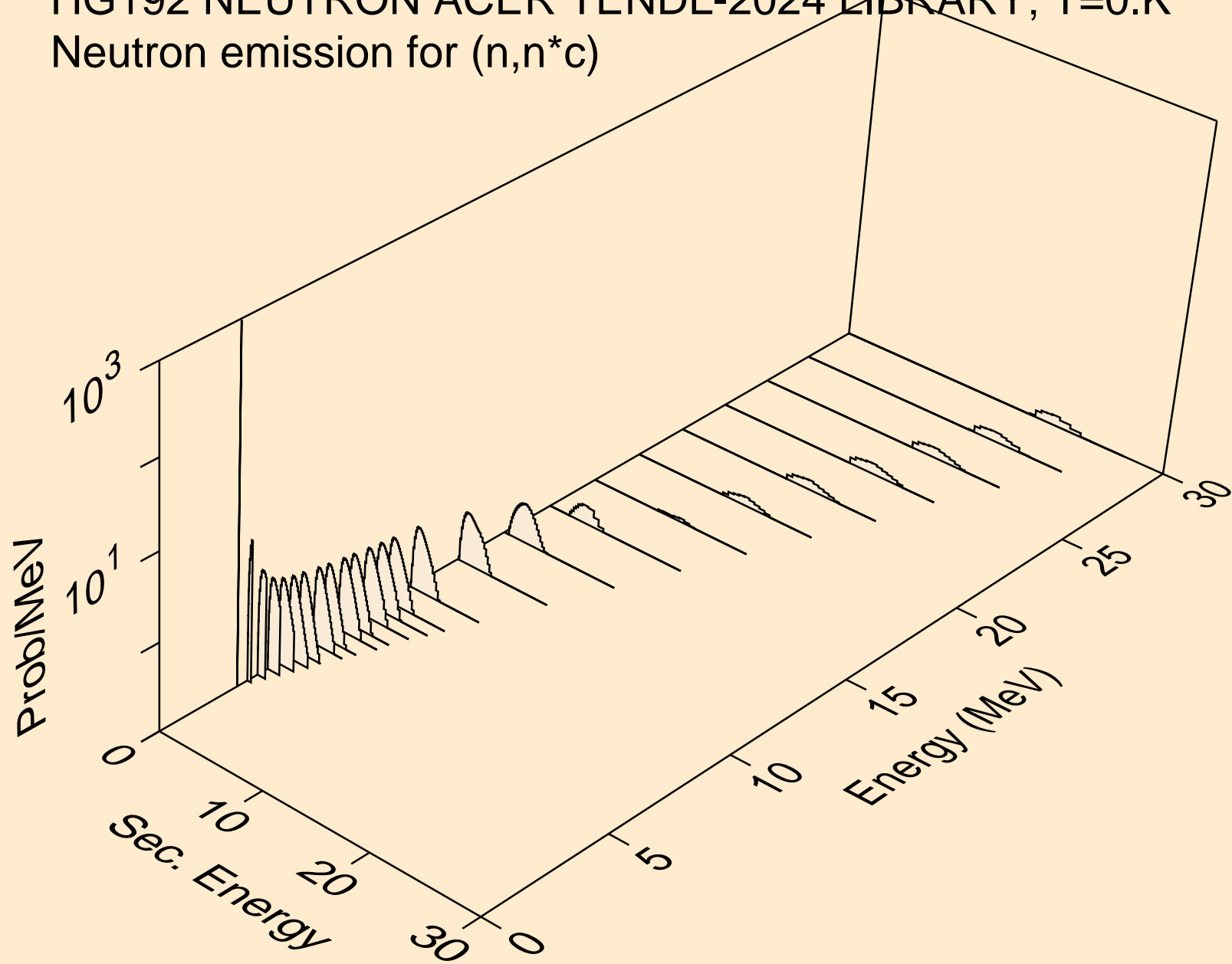

HG192 NEUTRON ACER TENDL-2024 LIBRARY; T=0.K
Photon emission for (n,x)

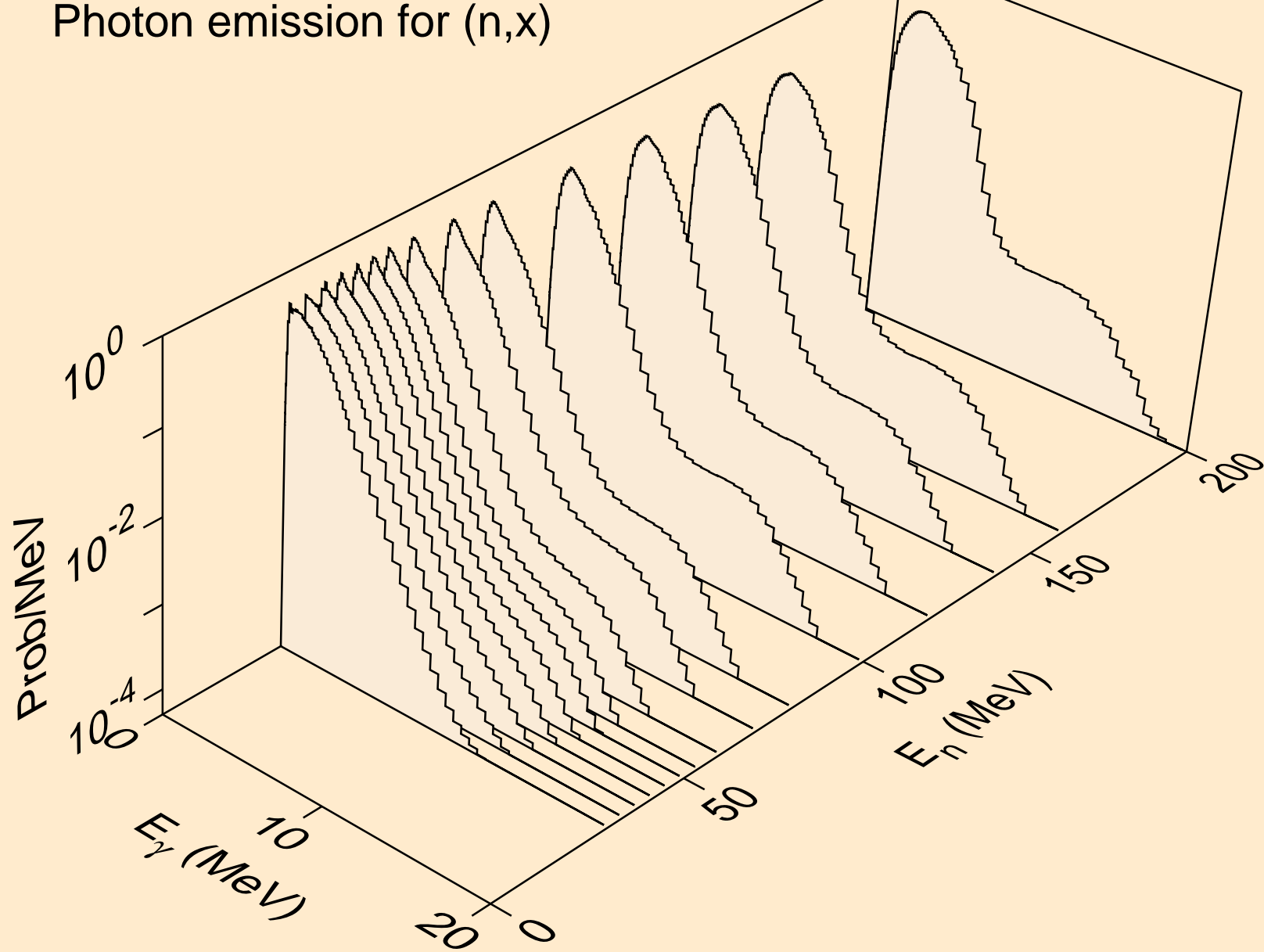

HG192 NEUTRON ACER TENDL-2024 LIBRARY; T=0.K
Photon emission for (n,2nd)

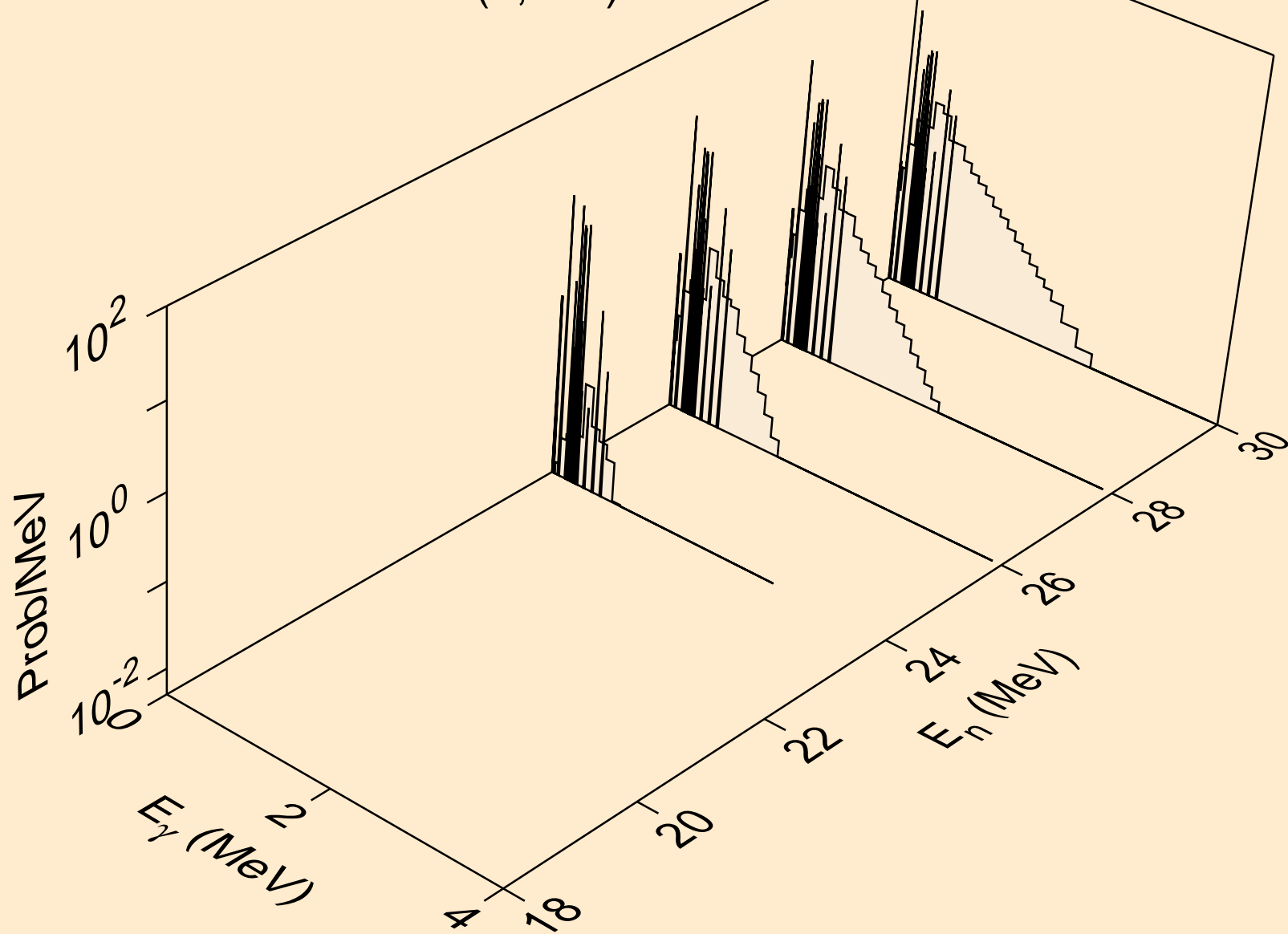

HG192 NEUTRON ACER TENDL-2024 LIBRARY; T=0.K
Photon emission for (n,2n)

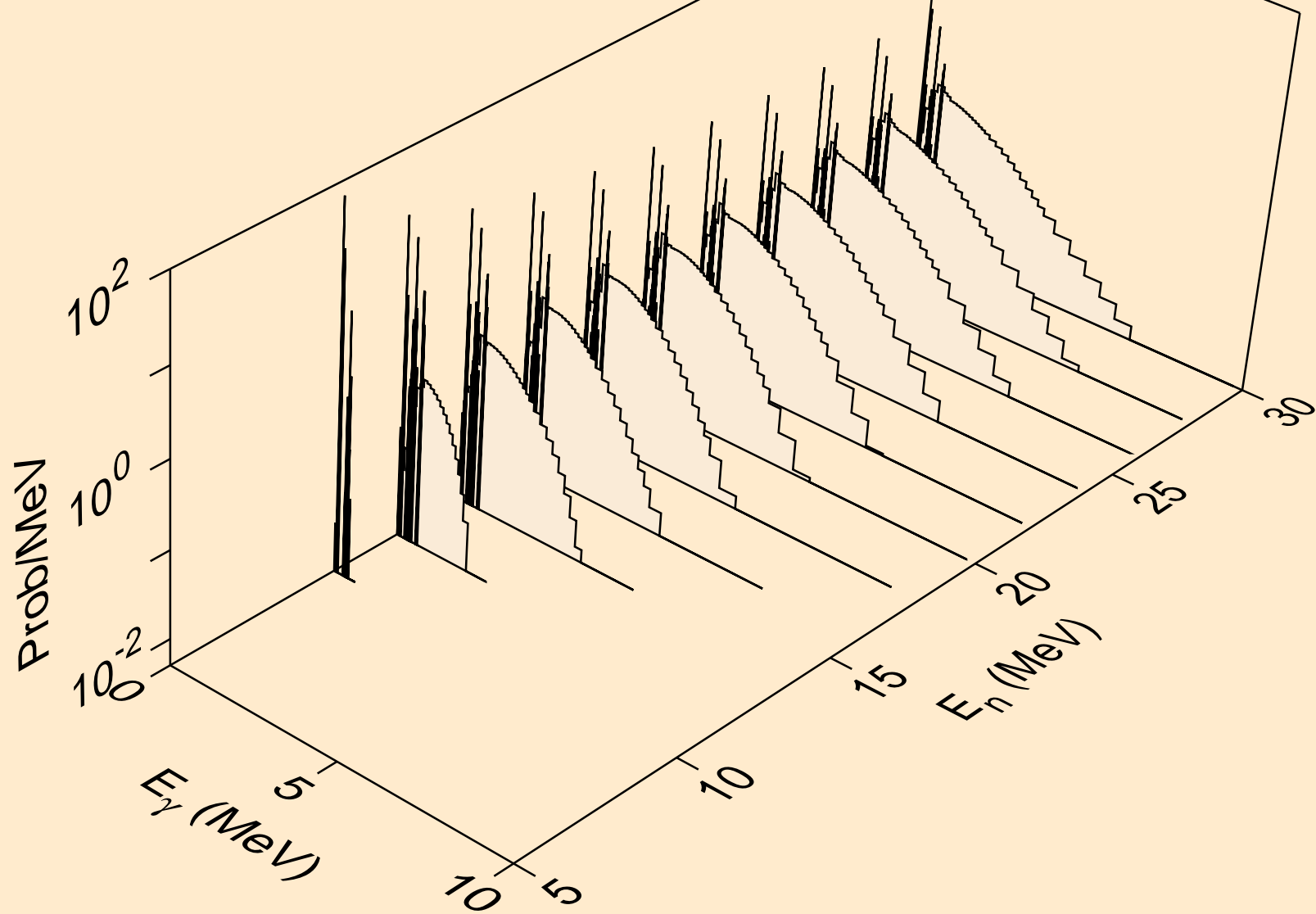

HG192 NEUTRON ACER TENDL-2024 LIBRARY; T=0.K
Photon emission for (n,3n)

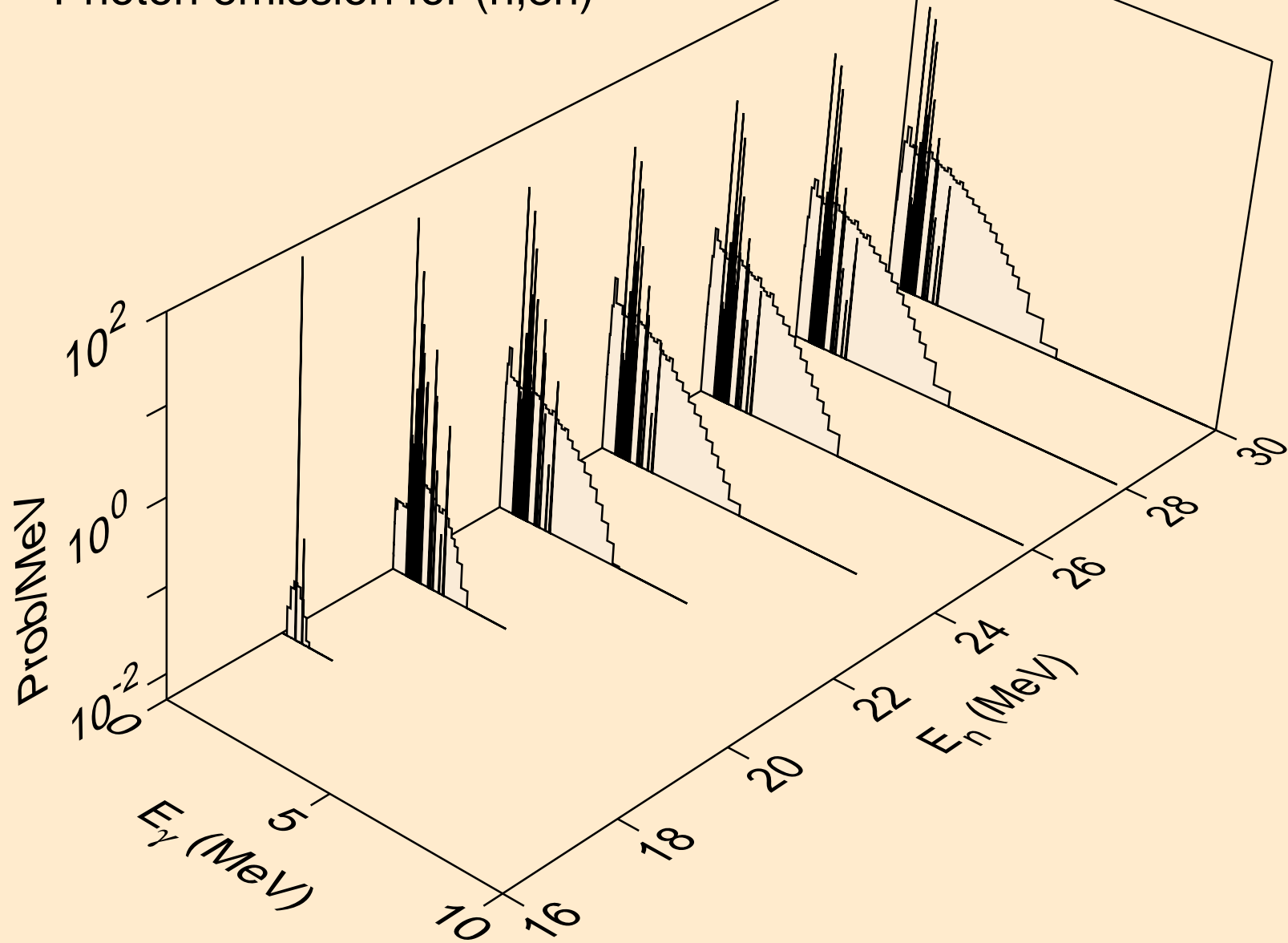

HG192 NEUTRON ACER TENDL-2024 LIBRARY; T=0.K
Photon emission for (n,n*)a

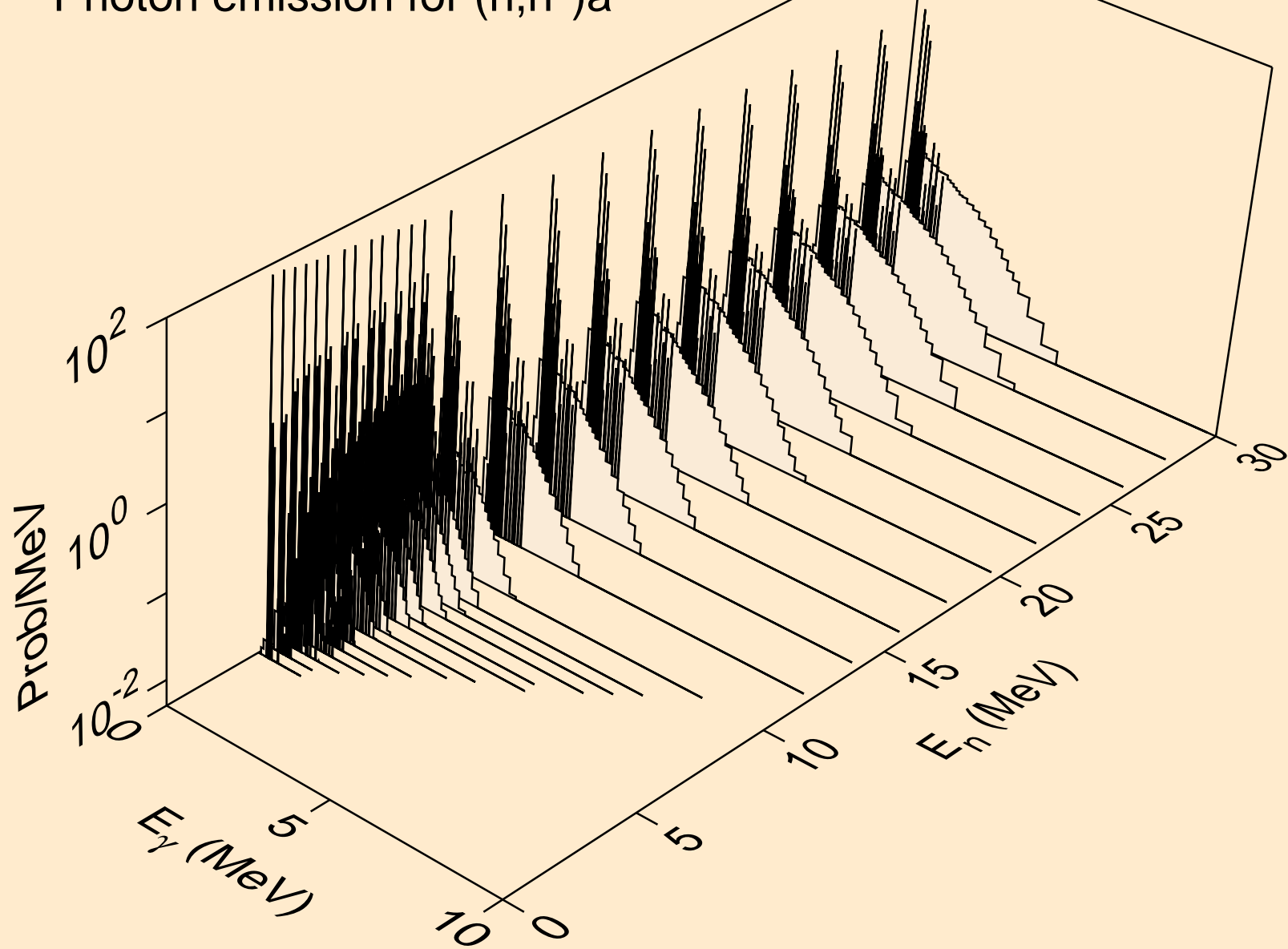

HG192 NEUTRON ACER TENDL-2024 LIBRARY; T=0.K
Photon emission for (n,2n)a

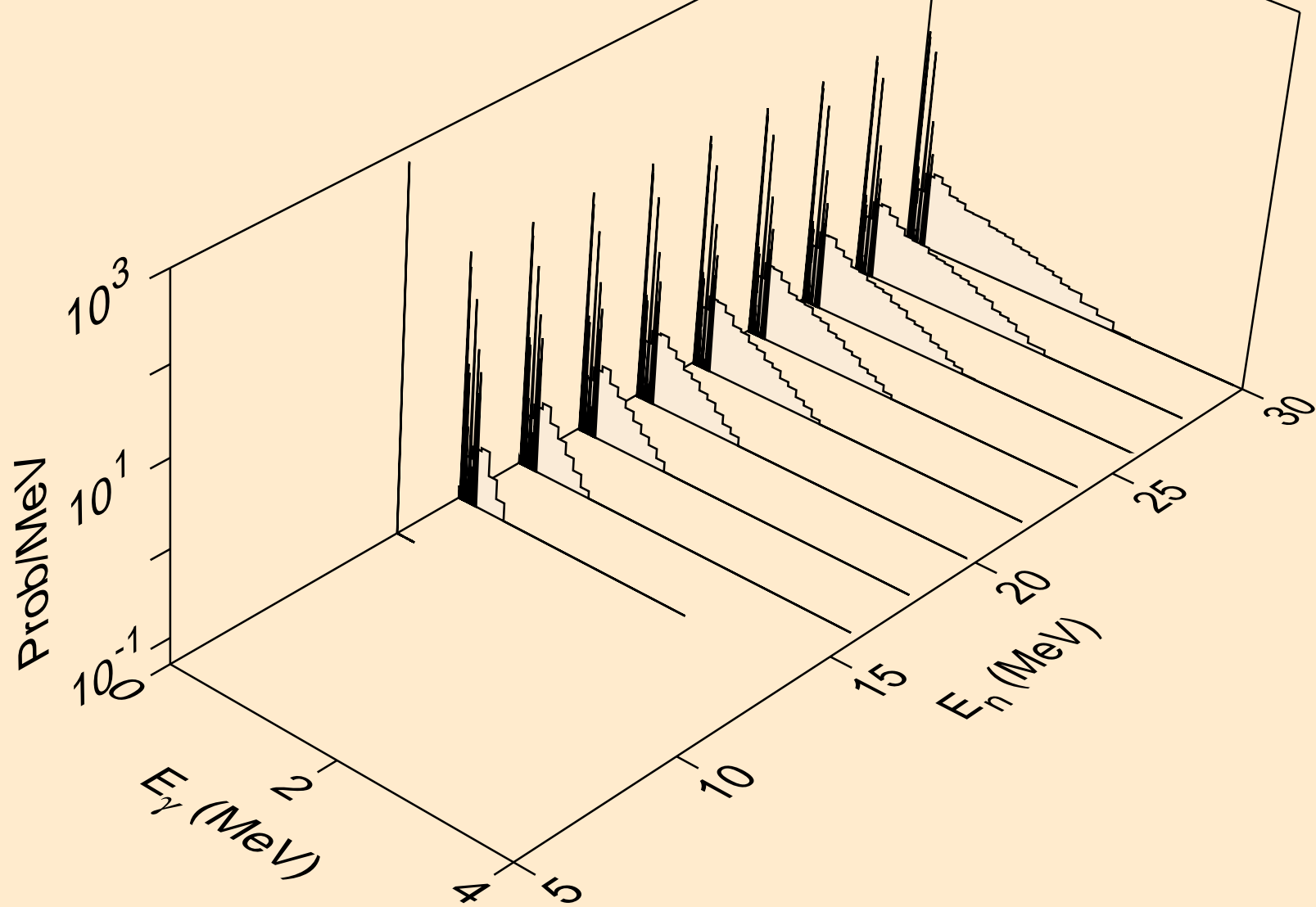

HG192 NEUTRON ACER TENDL-2024 LIBRARY; T=0.K
Photon emission for (n,3n)a

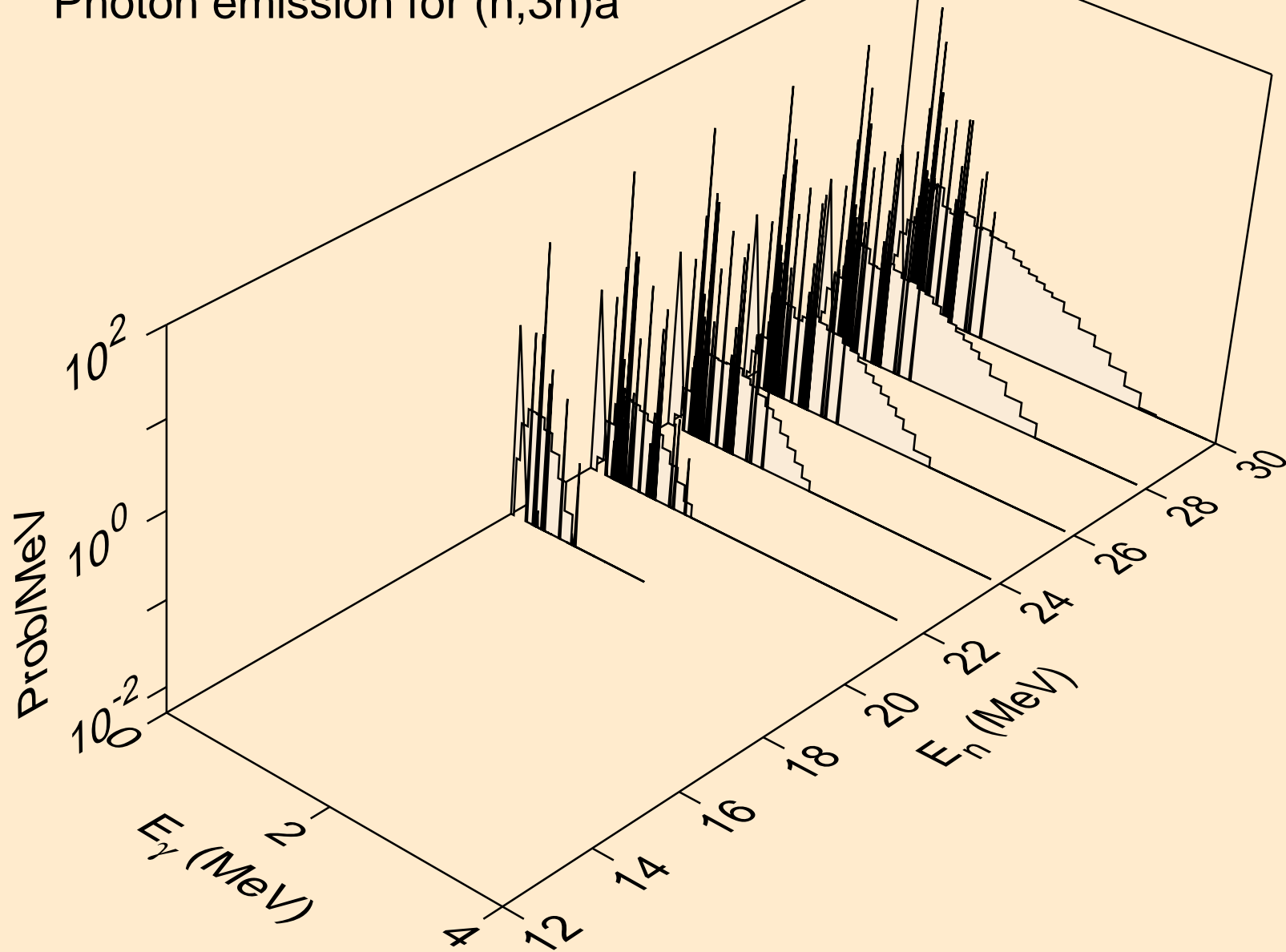

HG192 NEUTRON ACER TENDL-2024 LIBRARY; T=0.K
Photon emission for (n,n*)p

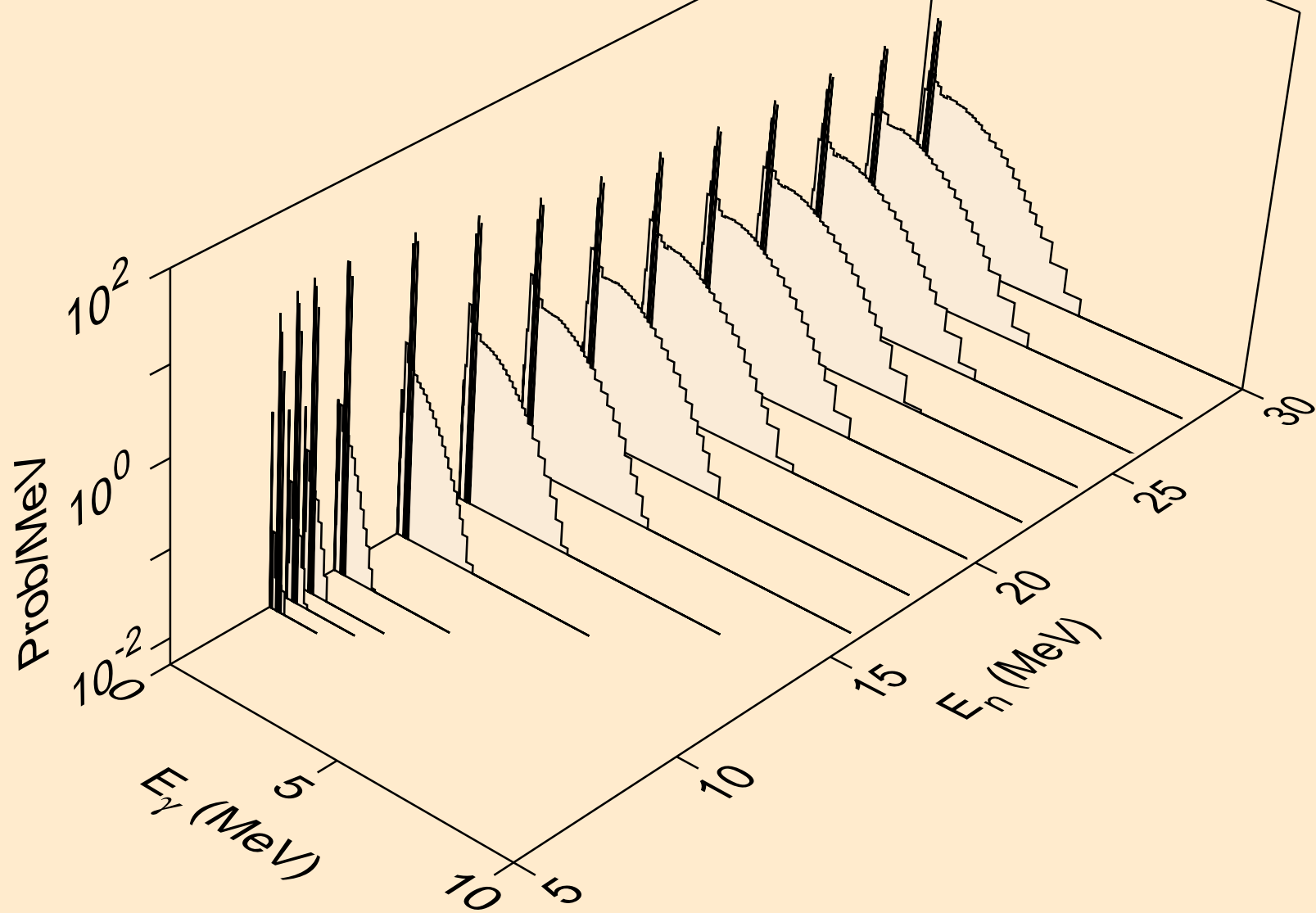

HG192 NEUTRON ACER TENDL-2024 LIBRARY; T=0.K
Photon emission for (n,n*)2a

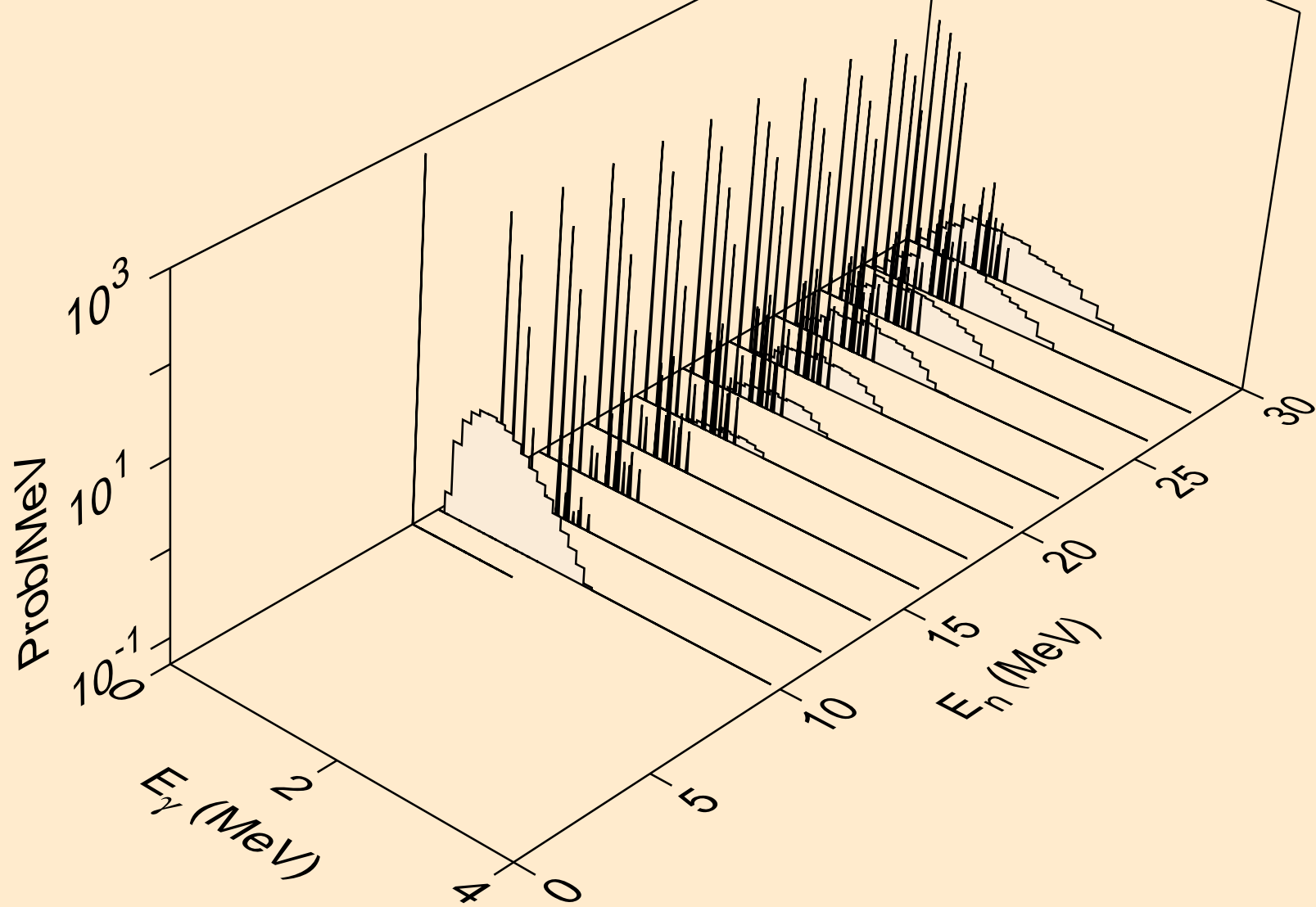

HG192 NEUTRON ACER TENDL-2024 LIBRARY; T=0.K
Photon emission for (n,2n)2a

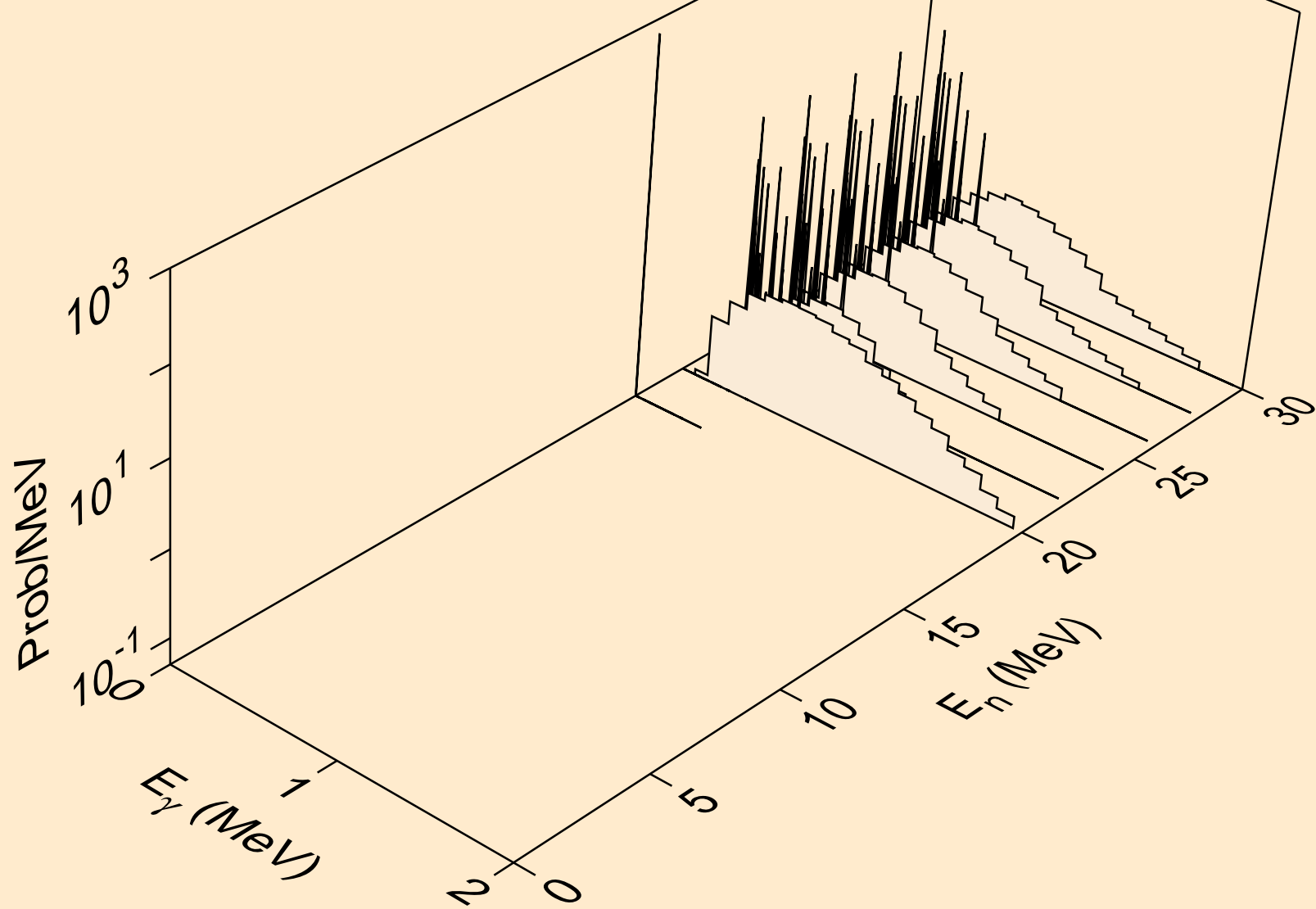

HG192 NEUTRON ACER TENDL-2024 LIBRARY; T=0.K
Photon emission for (n,n*)d

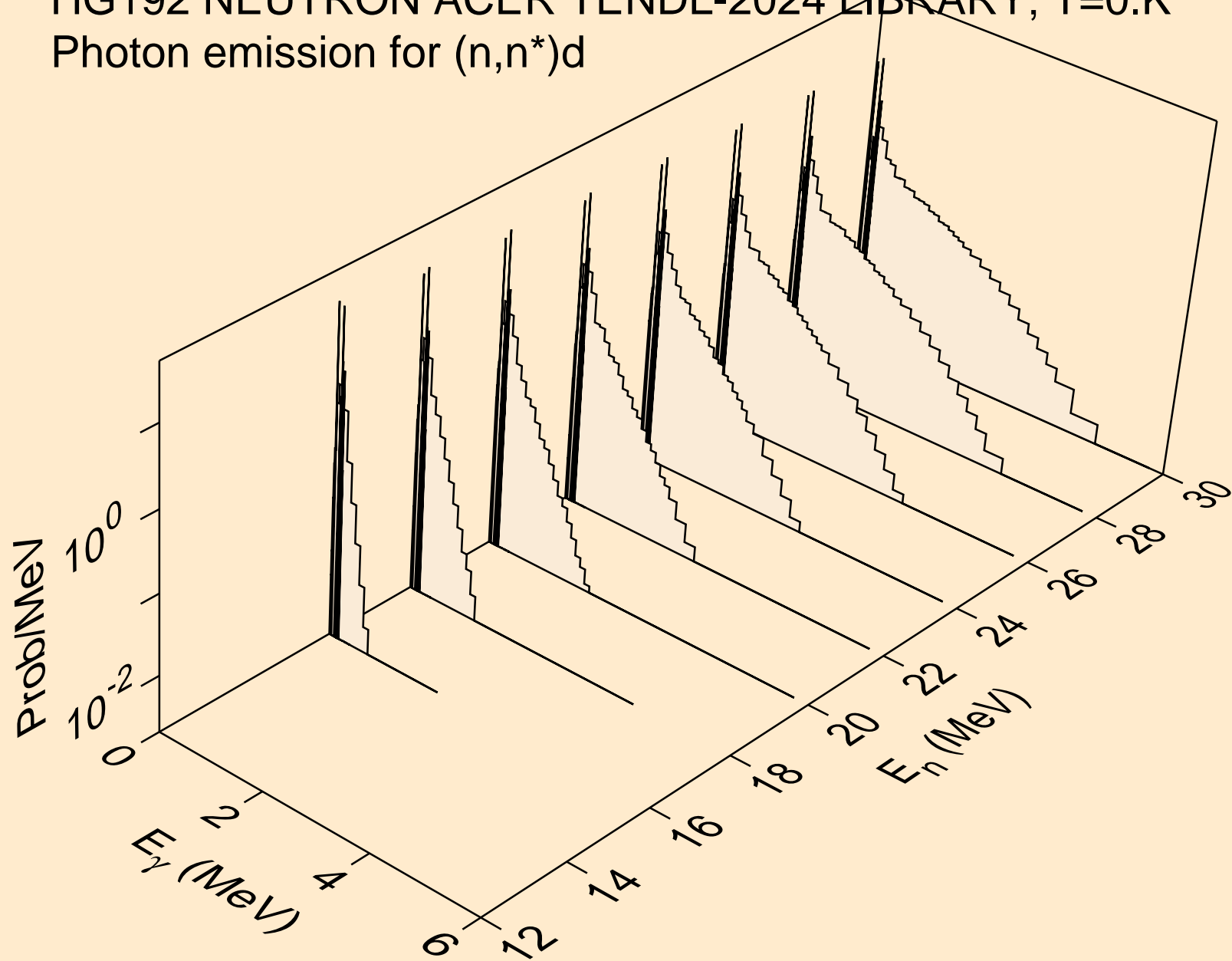

HG192 NEUTRON ACER TENDL-2024 LIBRARY; T=0.K
Photon emission for (n,n*)t

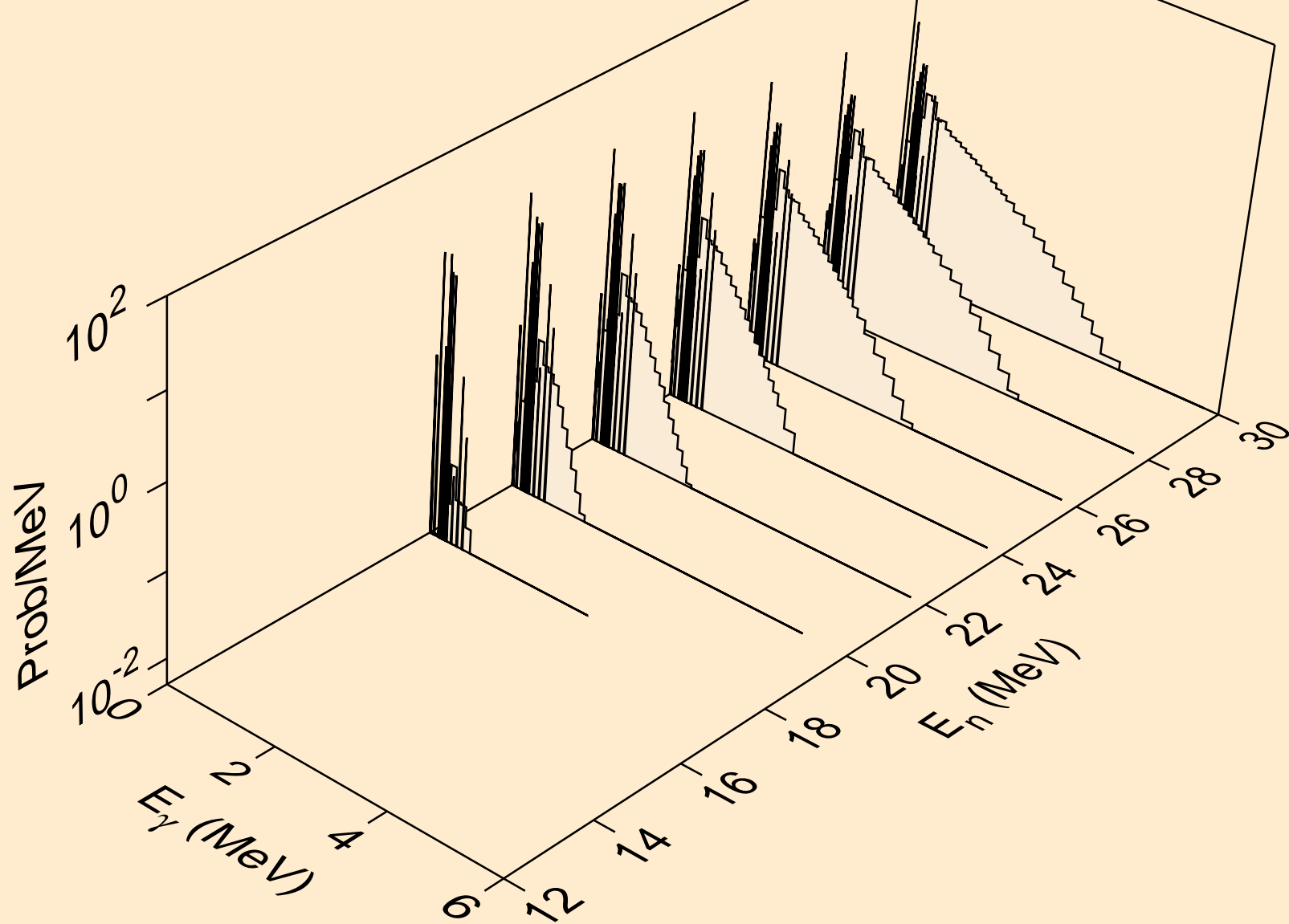

HG192 NEUTRON ACER TENDL-2024 LIBRARY; T=0.K
Photon emission for (n,n*)he3

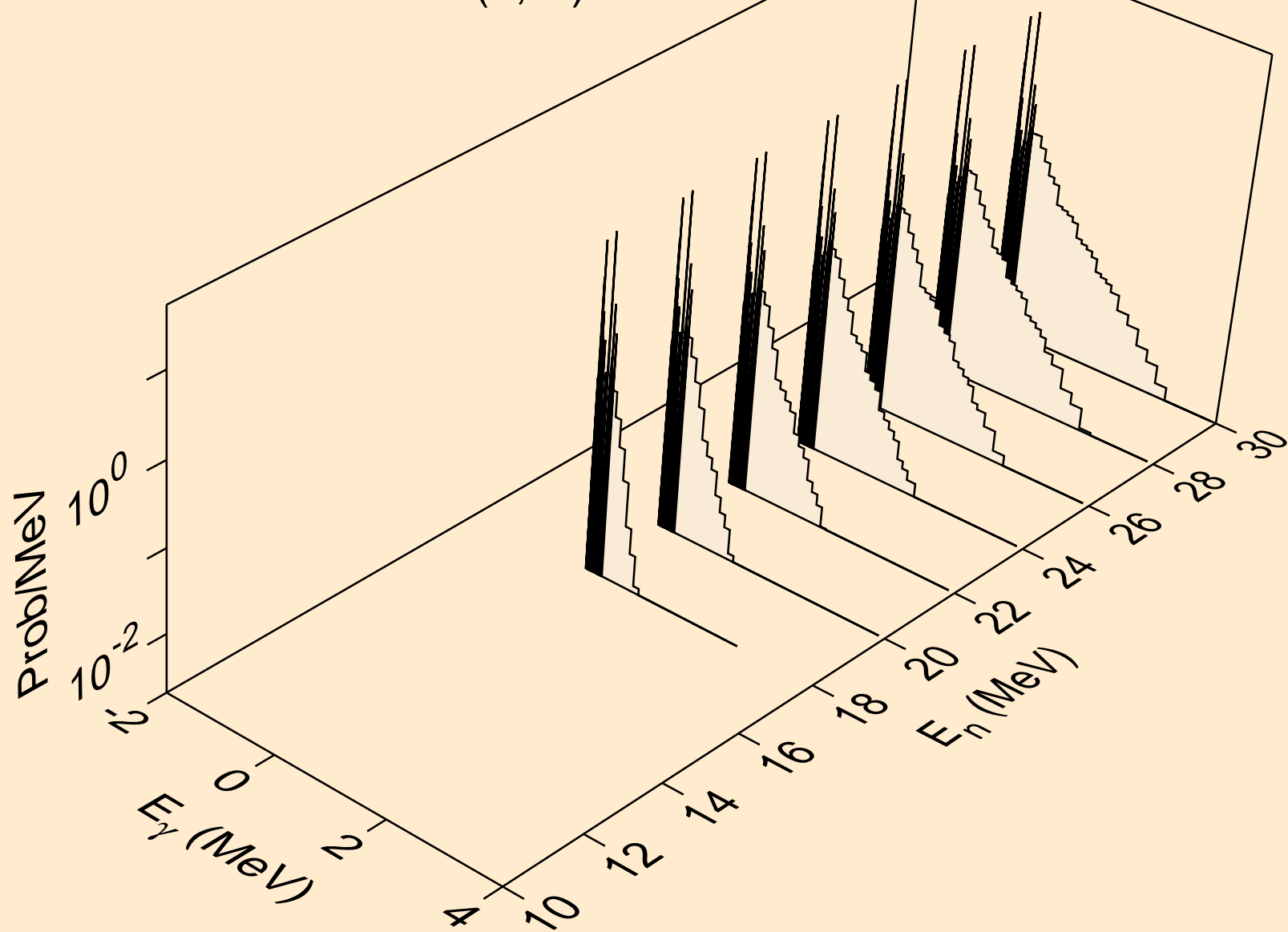

HG192 NEUTRON ACER TENDL-2024 LIBRARY; T=0.K
Photon emission for (n,4n)

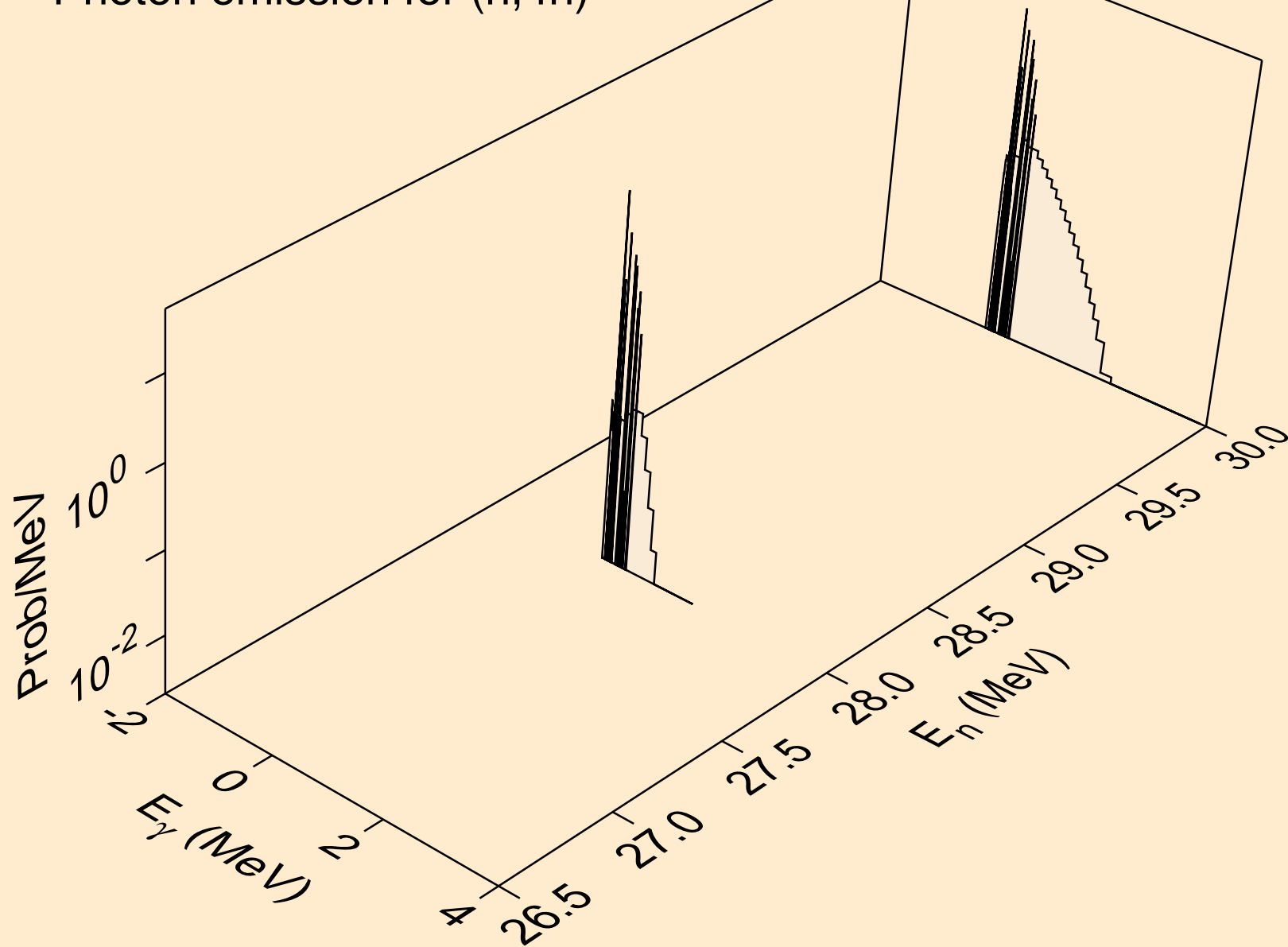

HG192 NEUTRON ACER TENDL-2024 LIBRARY; T=0.K
Photon emission for (n,2np)

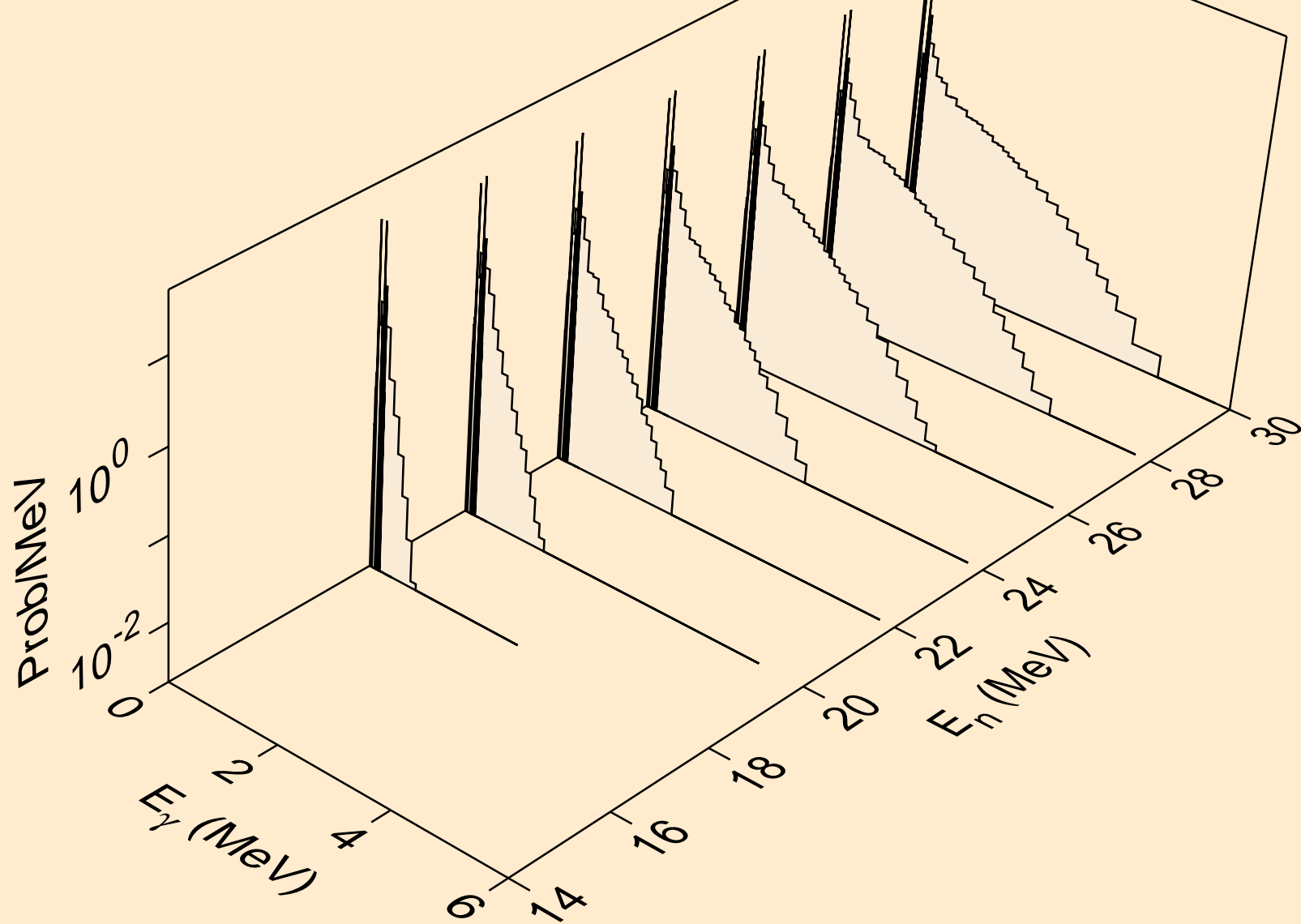

HG192 NEUTRON ACER TENDL-2024 LIBRARY; T=0.K
Photon emission for (n,3np)

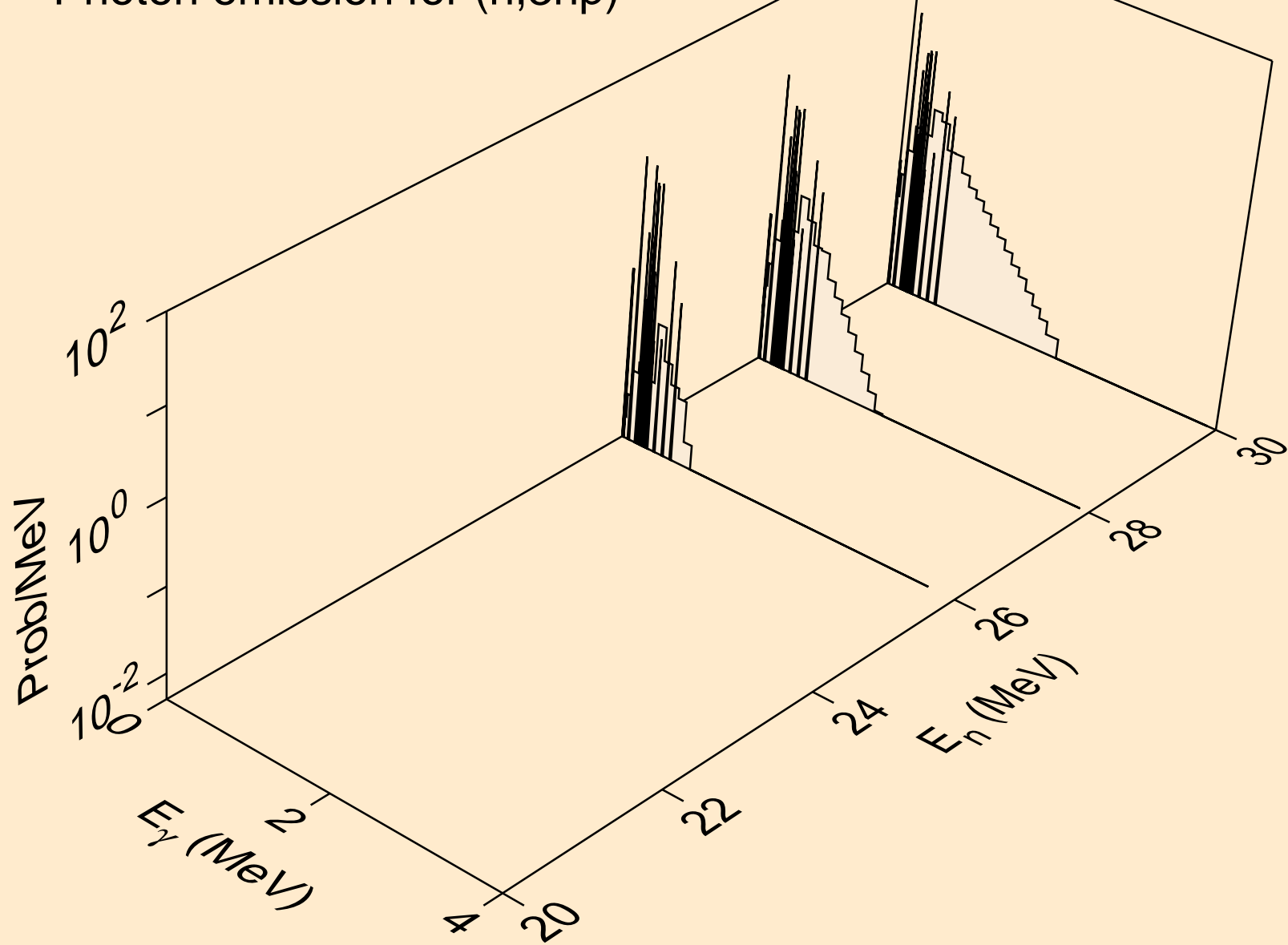

HG192 NEUTRON ACER TENDL-2024 LIBRARY; T=0.K
Photon emission for (n,n2p)

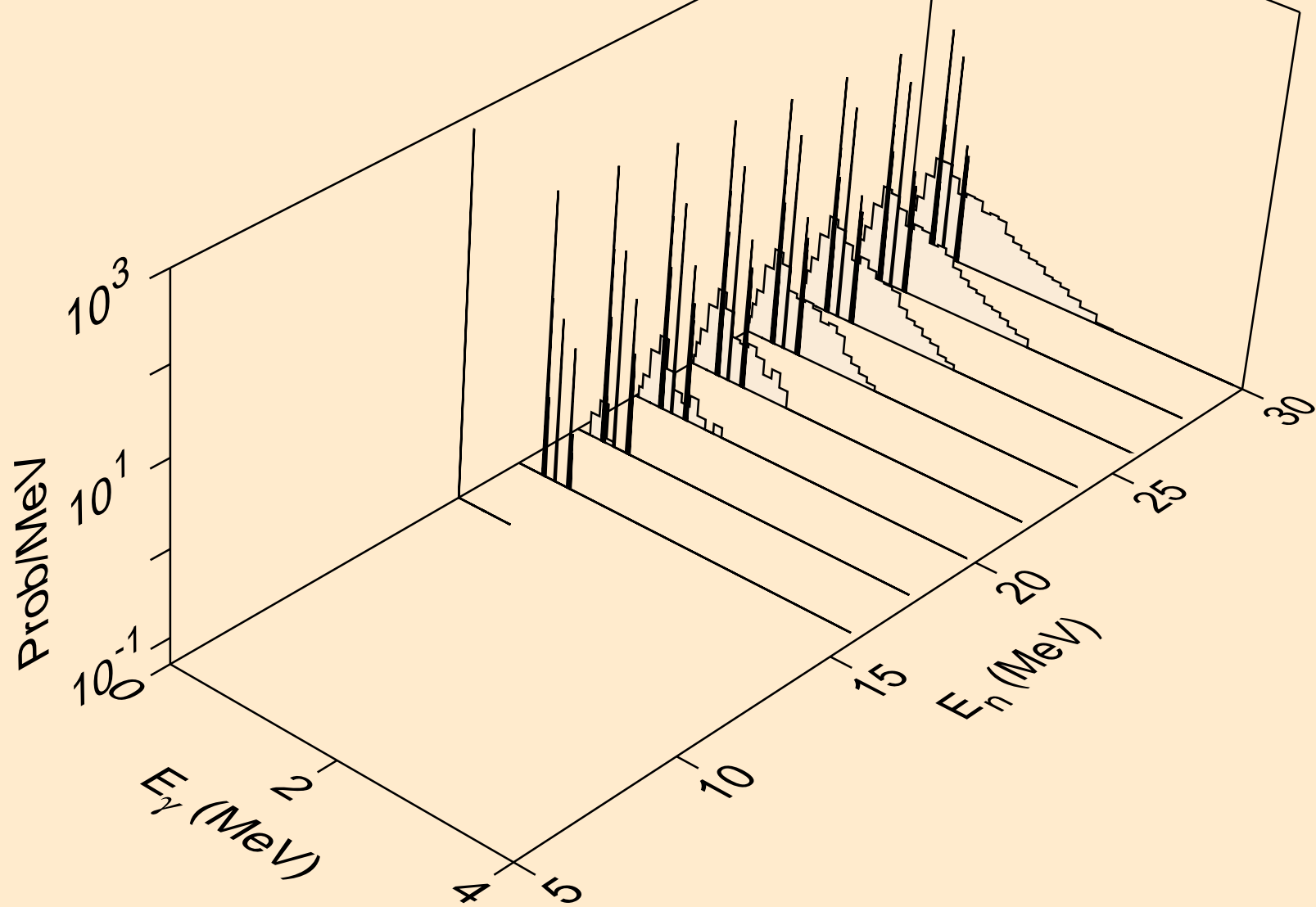

HG192 NEUTRON ACER TENDL-2024 LIBRARY; T=0.K
Photon emission for (n,npa)

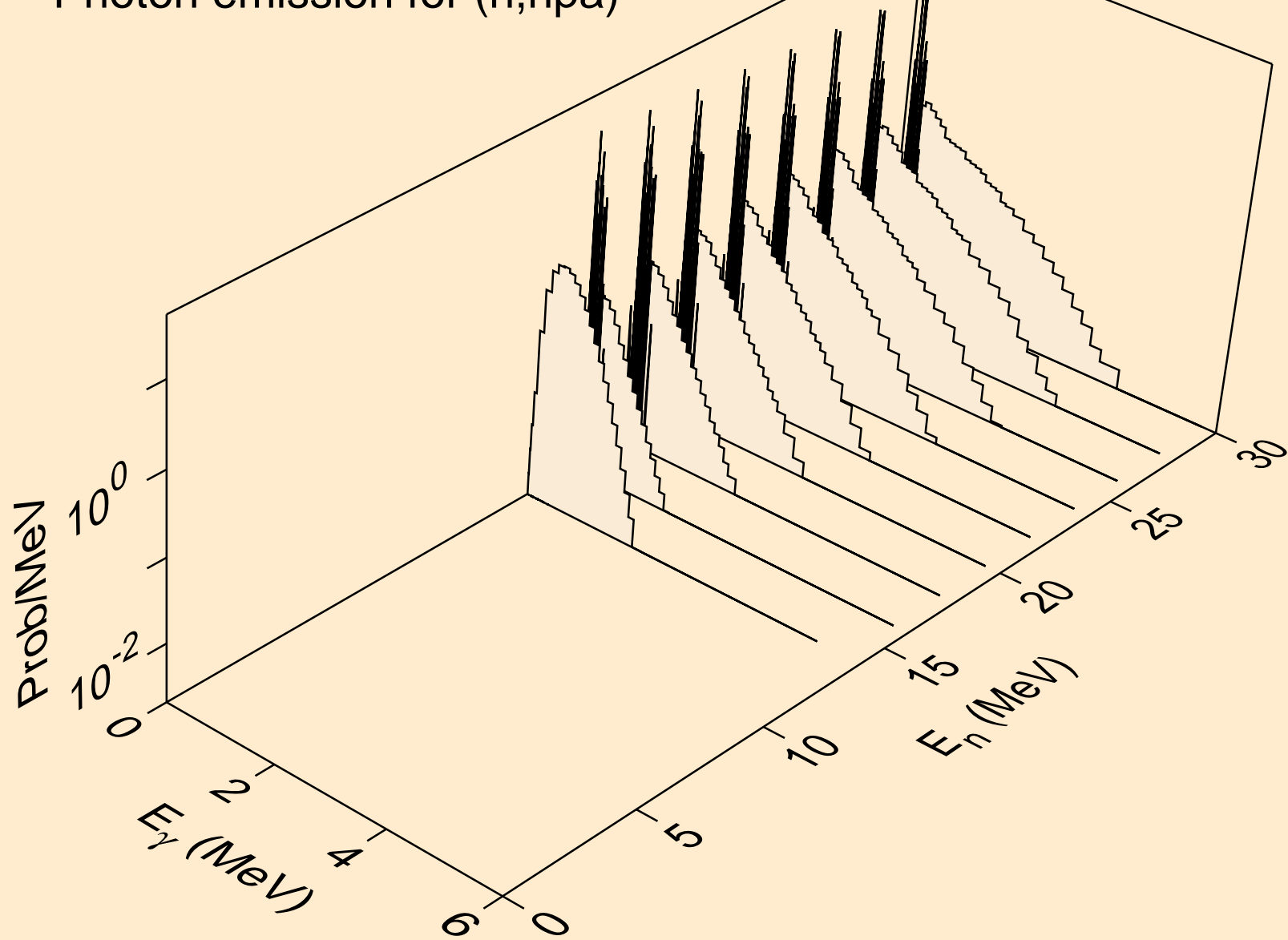

HG192 NEUTRON ACER TENDL-2024 LIBRARY; T=0.K
Photon emission for (n,n*c)

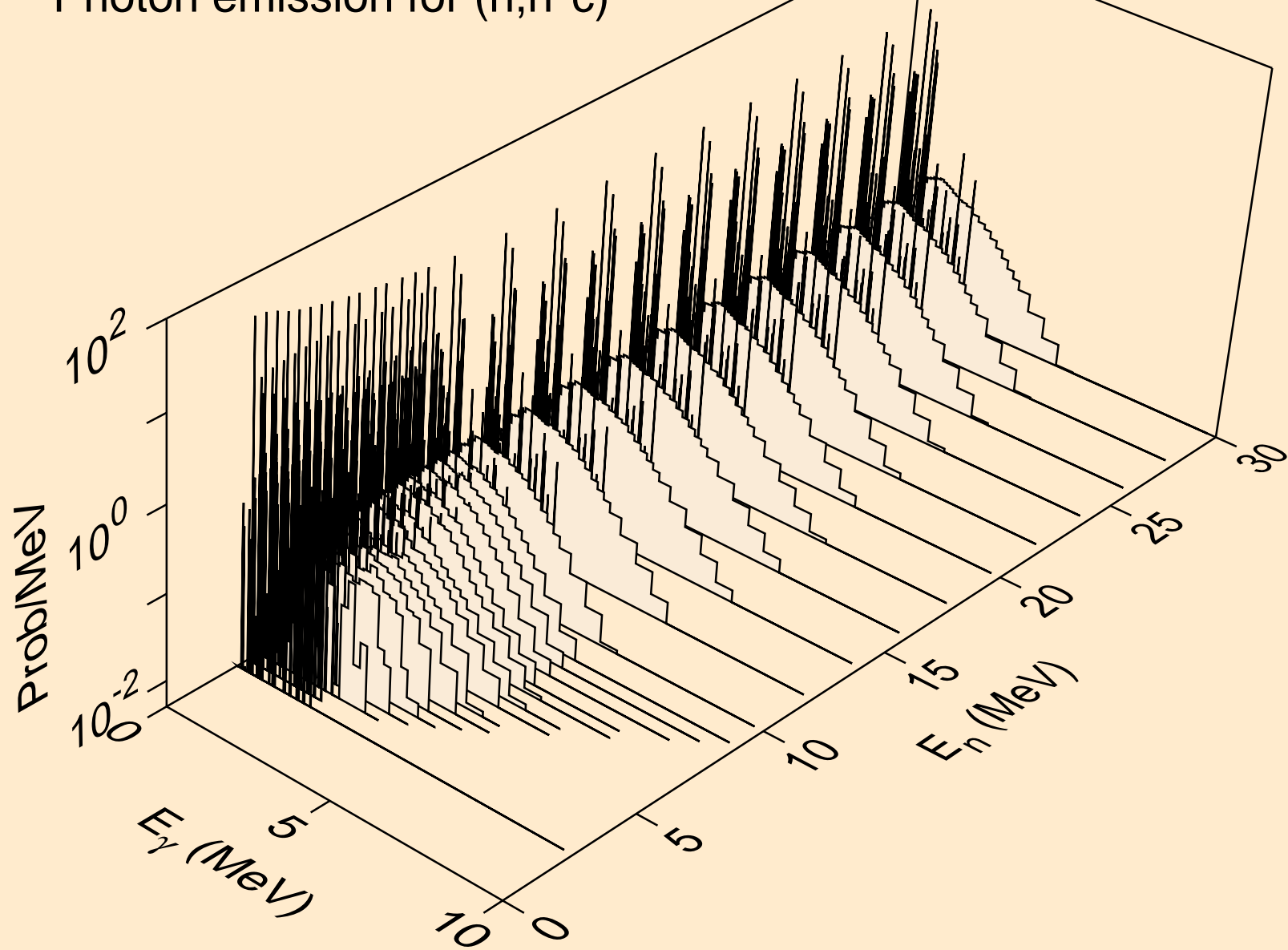

HG192 NEUTRON ACER TENDL-2024 LIBRARY; T=0.K
Photon emission for (n,gma)

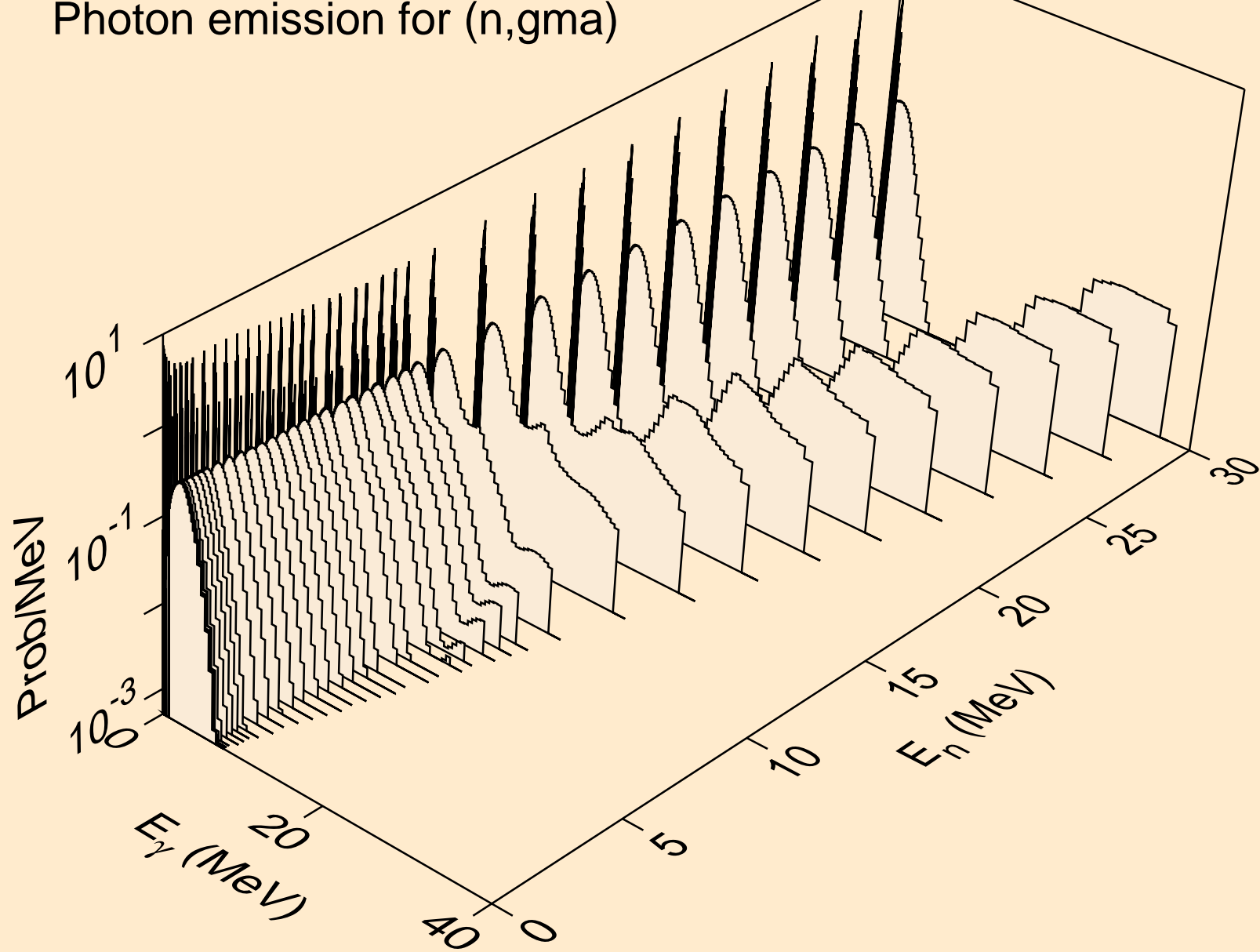

HG192 NEUTRON ACER TENDL-2024 LIBRARY; T=0.K
Photon emission for (n,p)

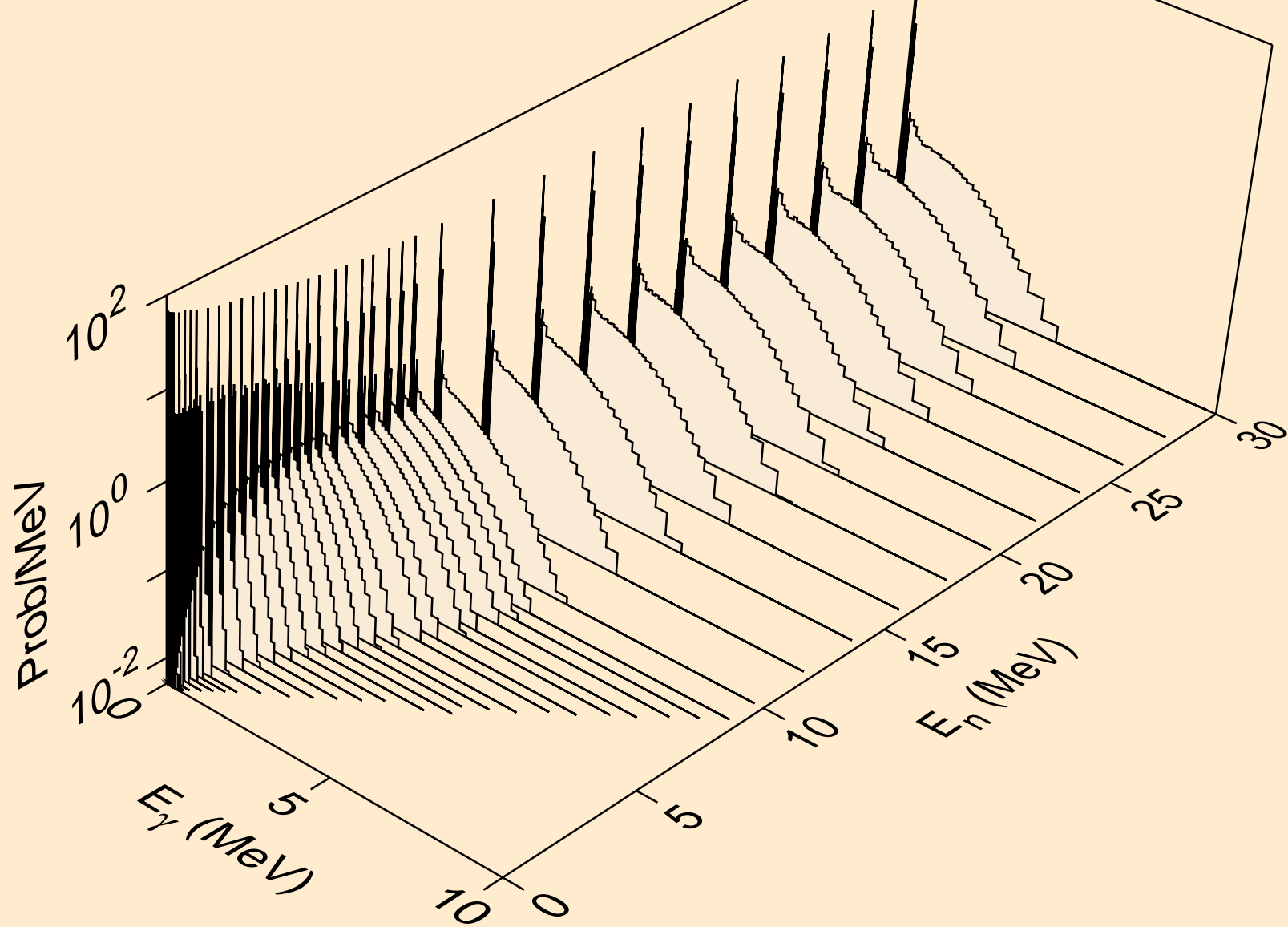

HG192 NEUTRON ACER TENDL-2024 LIBRARY; T=0.K
Photon emission for (n,d)

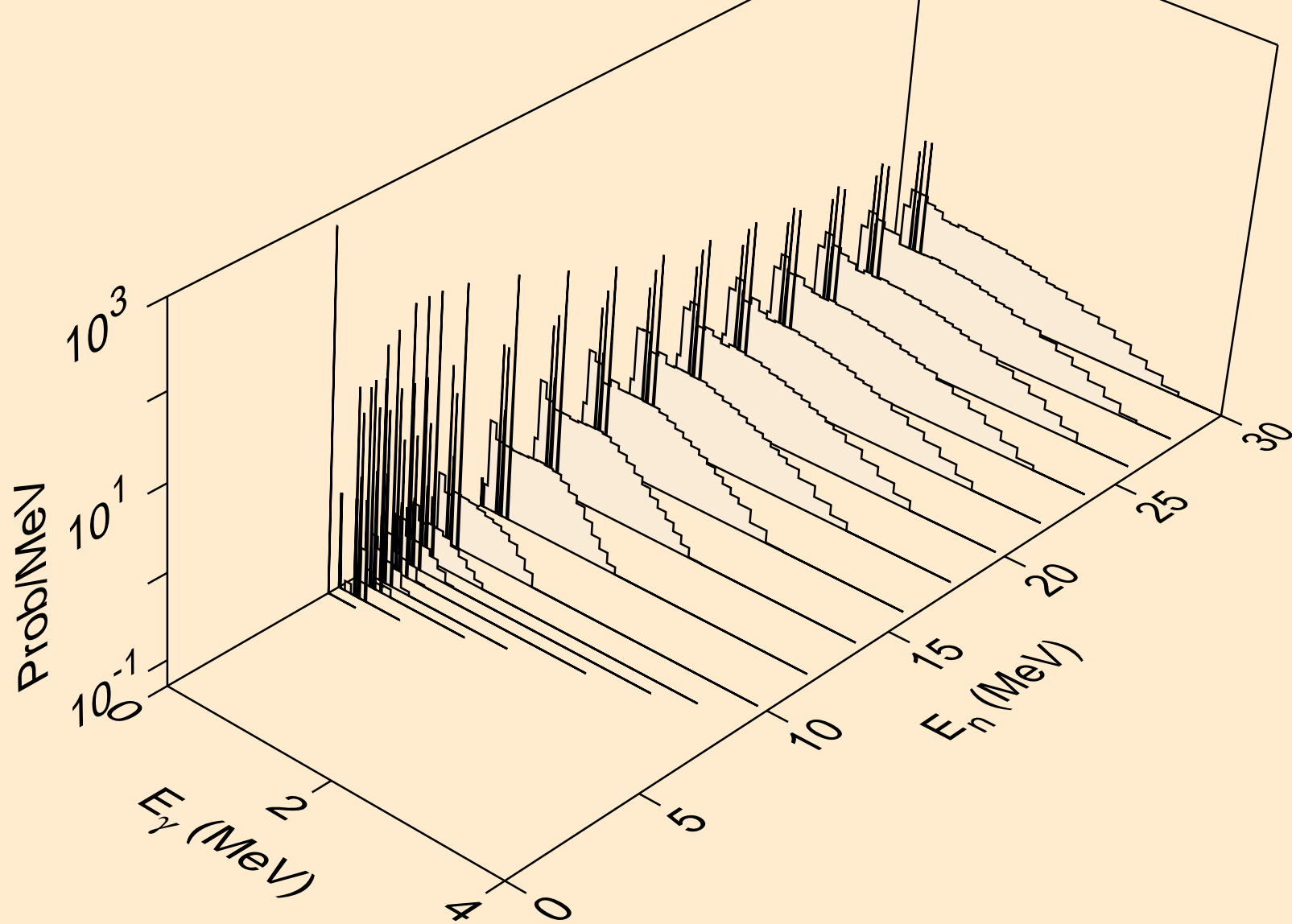

HG192 NEUTRON ACER TENDL-2024 LIBRARY; T=0.K
Photon emission for (n,t)

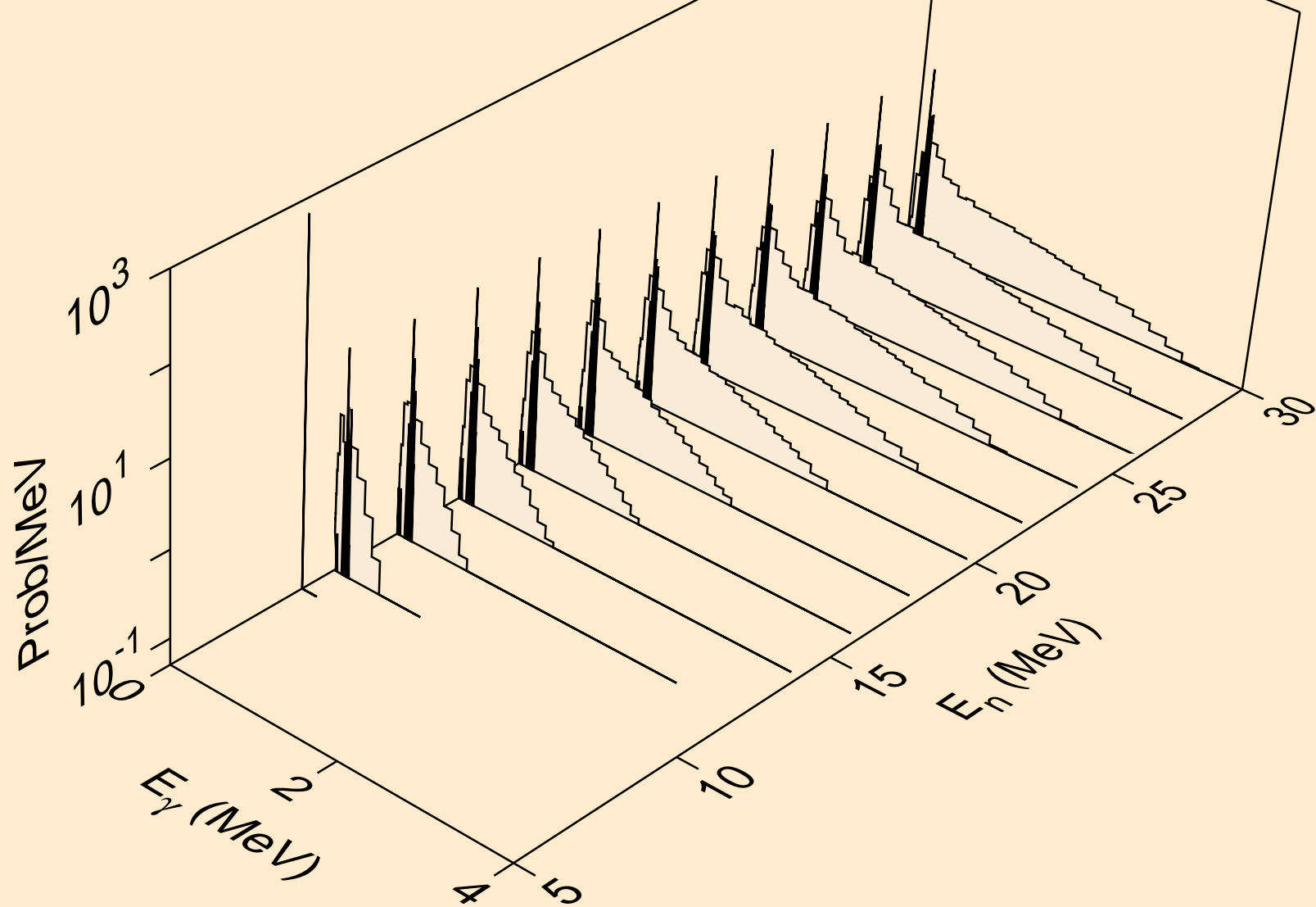

HG192 NEUTRON ACER TENDL-2024 LIBRARY; T=0.K
Photon emission for (n,he3)

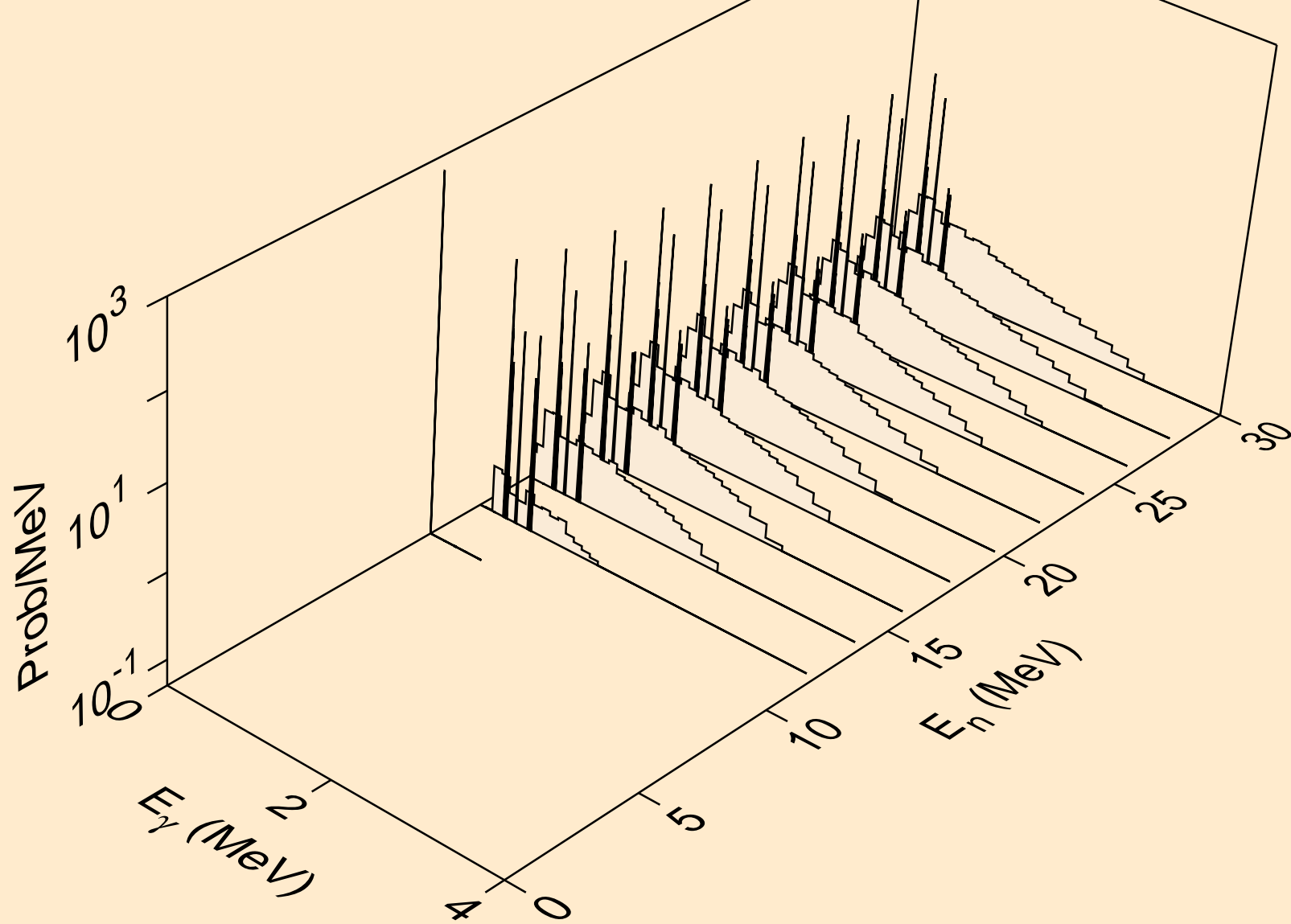

HG192 NEUTRON ACER TENDL-2024 LIBRARY; T=0.K
Photon emission for (n,a)

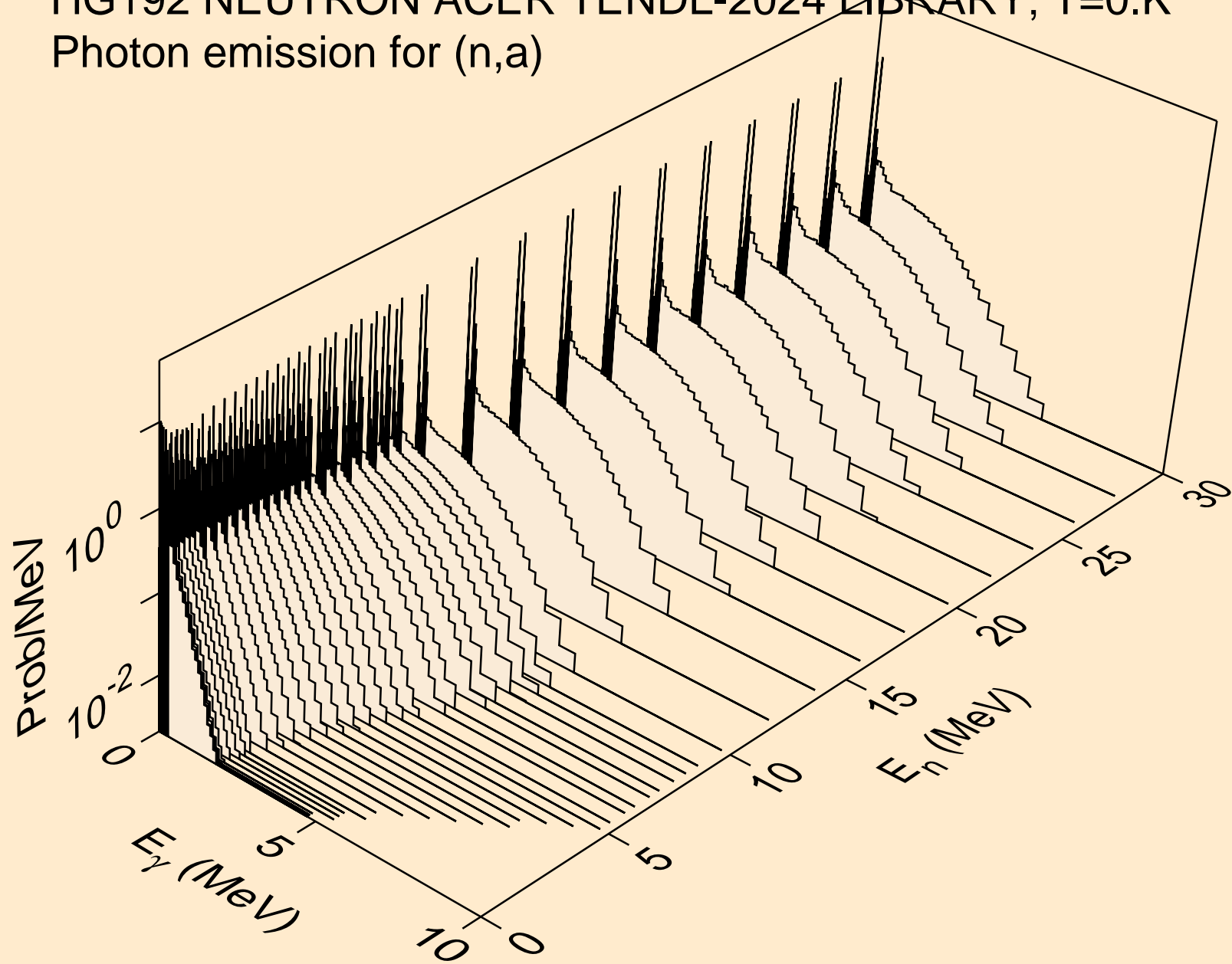

HG192 NEUTRON ACER TENDL-2024 LIBRARY; T=0.K
Photon emission for (n,2a)

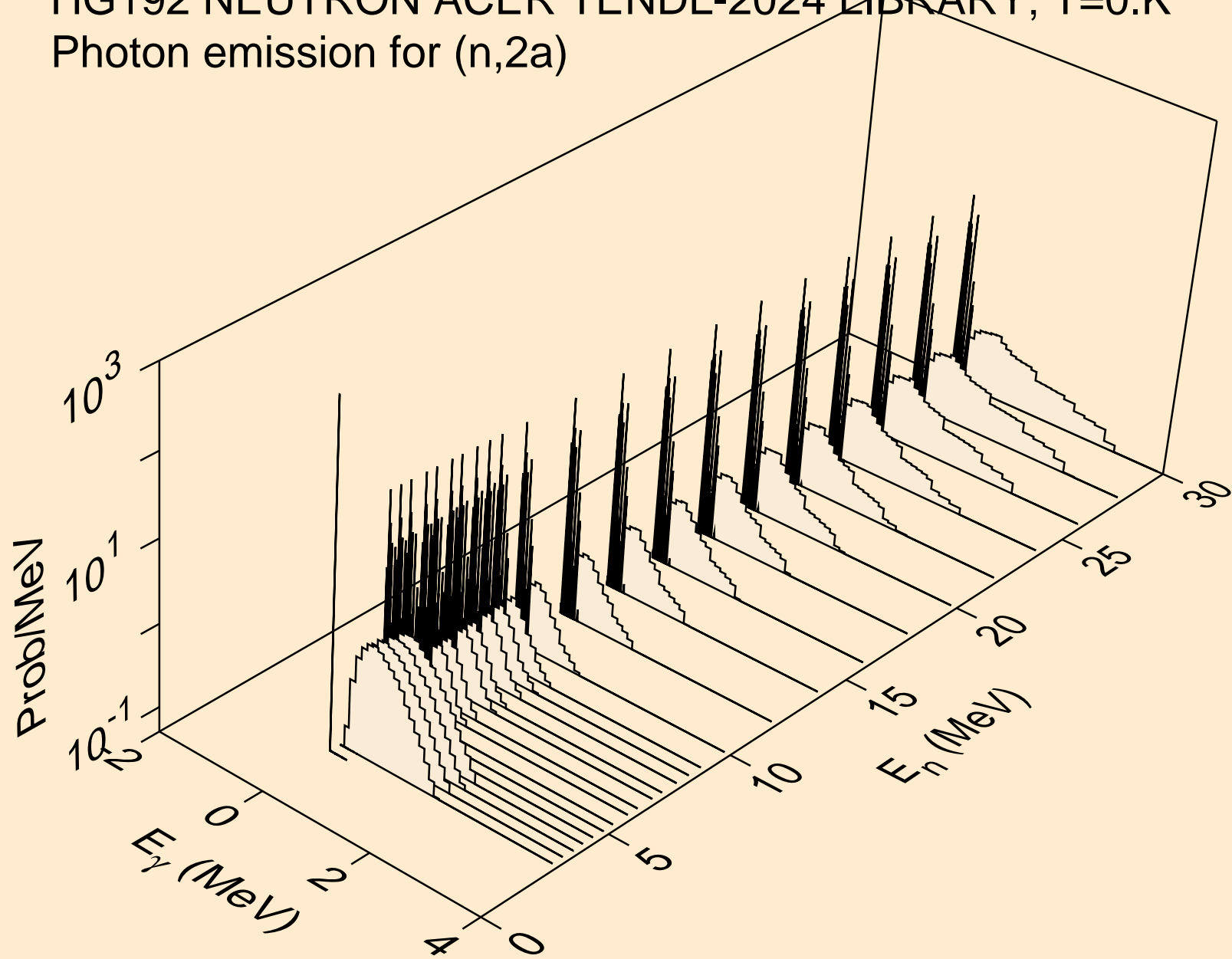

HG192 NEUTRON ACER TENDL-2024 LIBRARY; T=0.K
Photon emission for (n,2p)

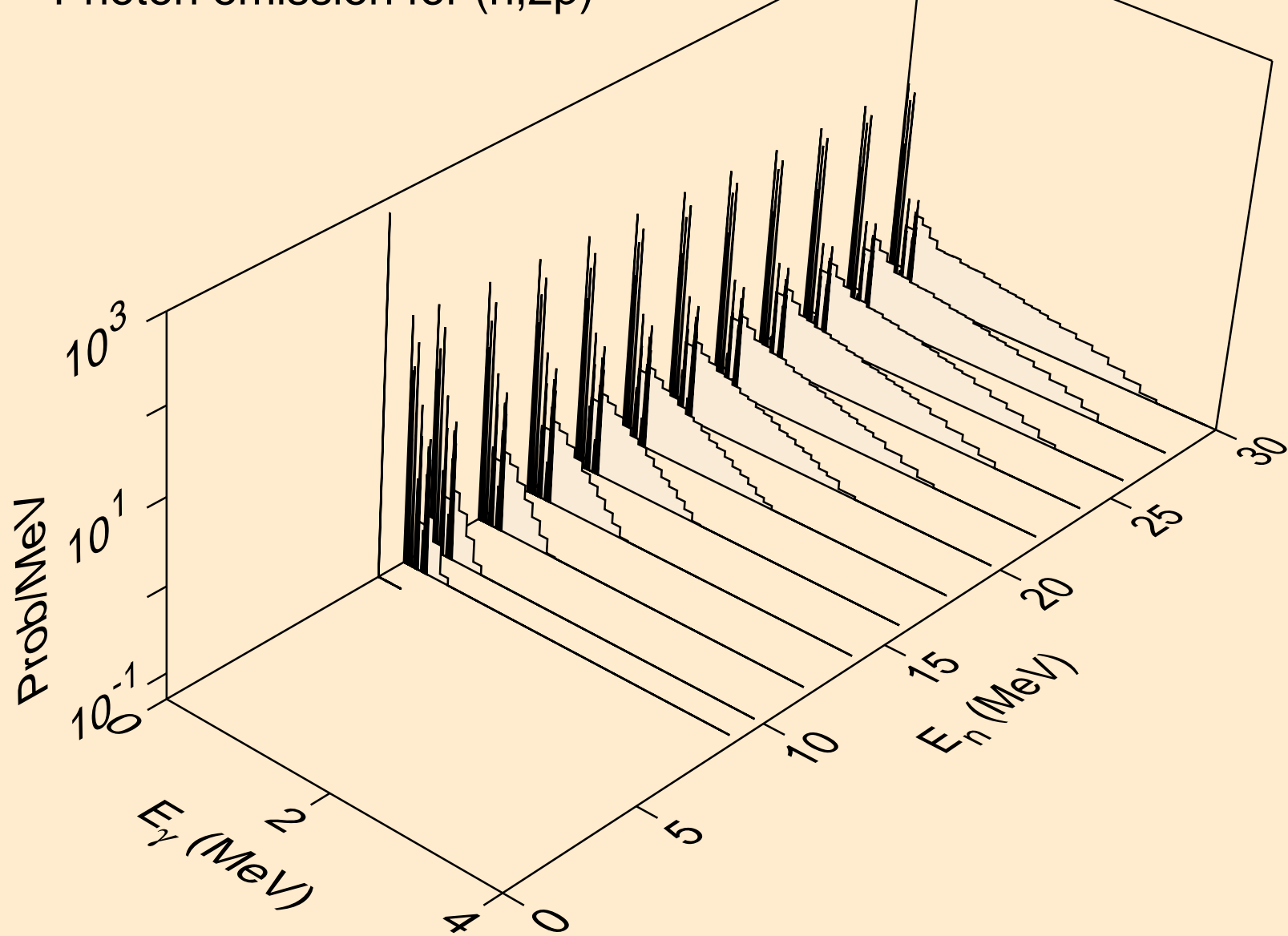

HG192 NEUTRON ACER TENDL-2024 LIBRARY; T=0.K
Photon emission for (n,p α)

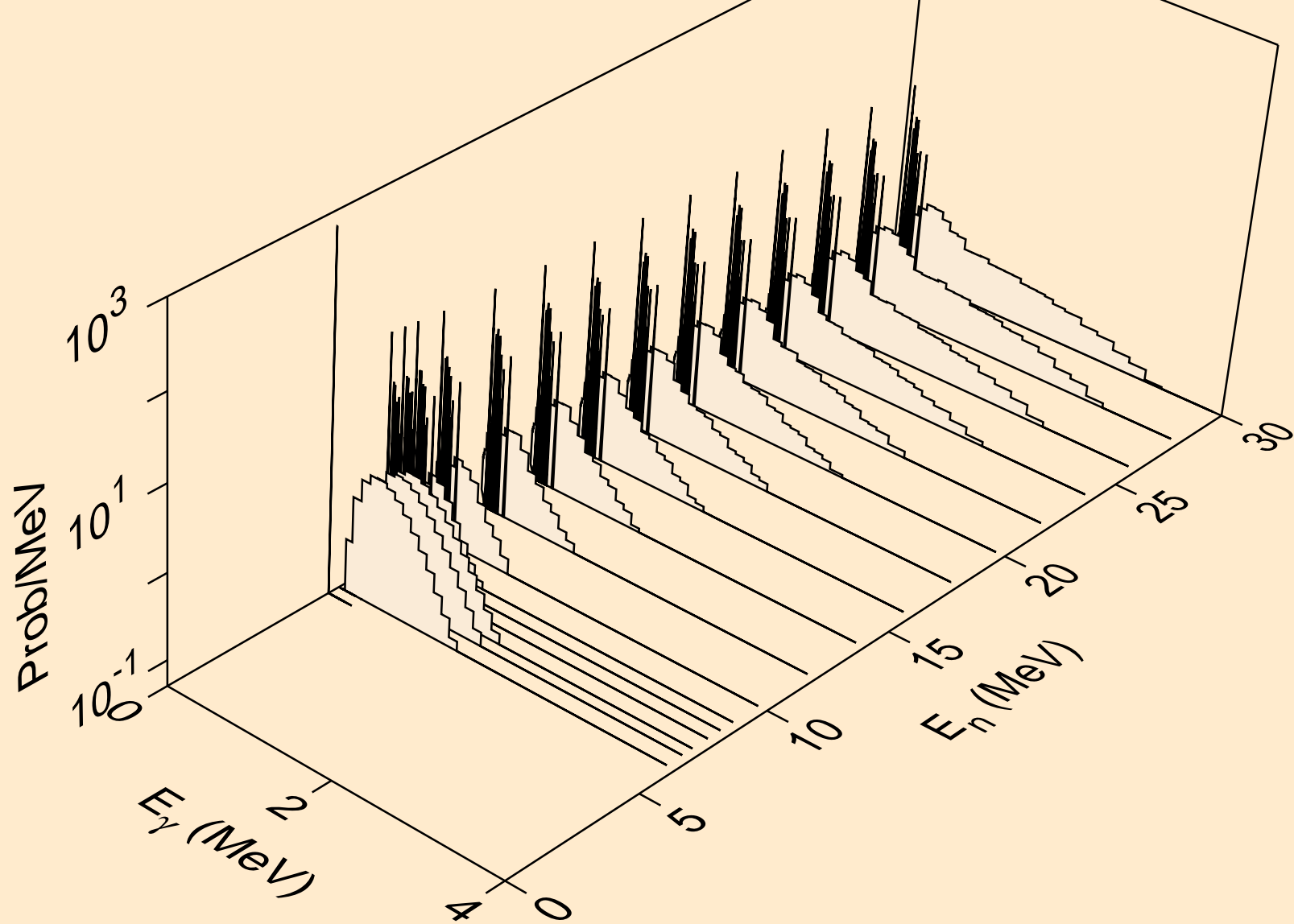

HG192 NEUTRON ACER TENDL-2024 LIBRARY; T=0.K
Photon emission for (n,pd)

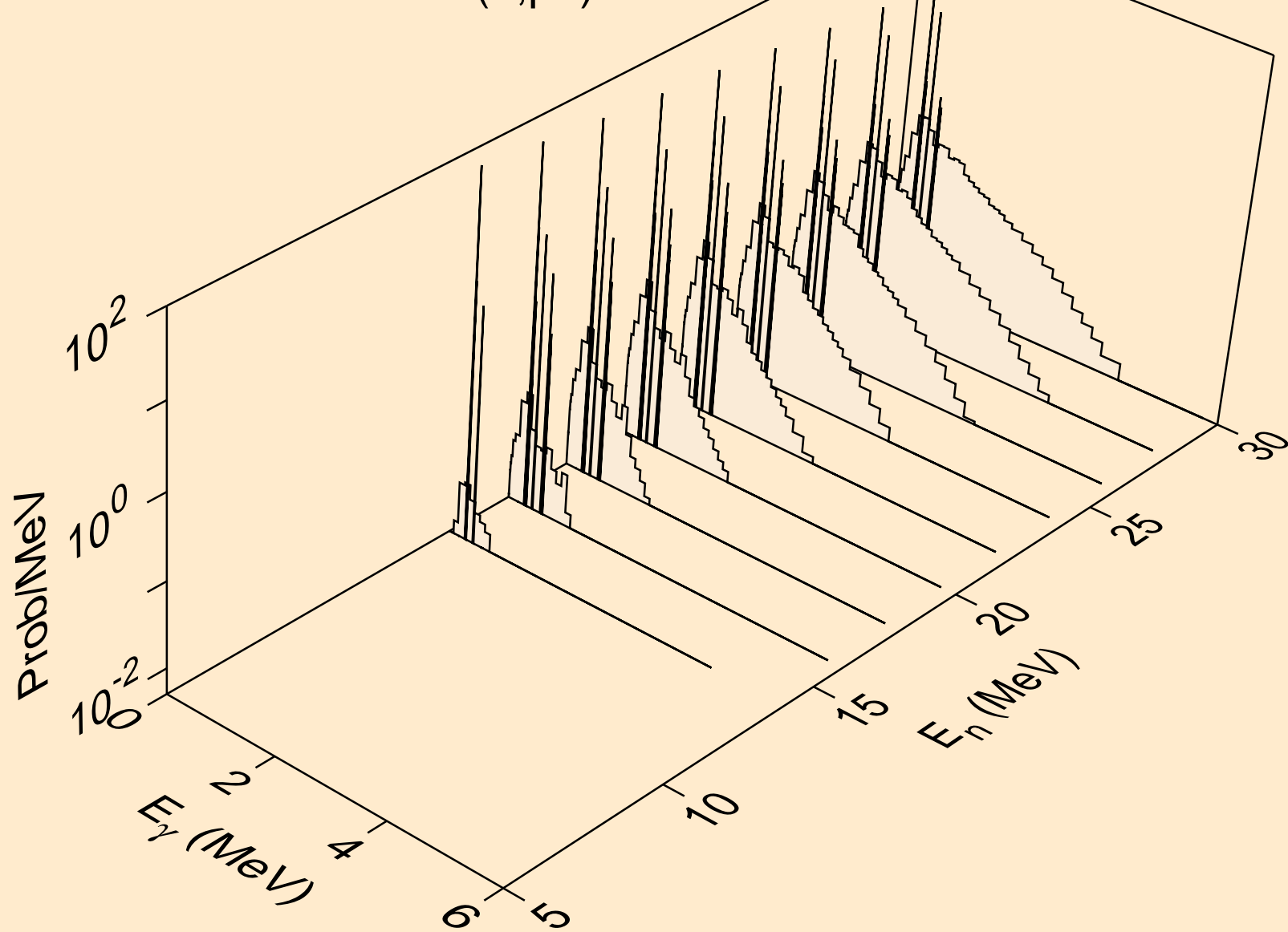

HG192 NEUTRON ACER TENDL-2024 LIBRARY; T=0.K
Photon emission for (n,pt)

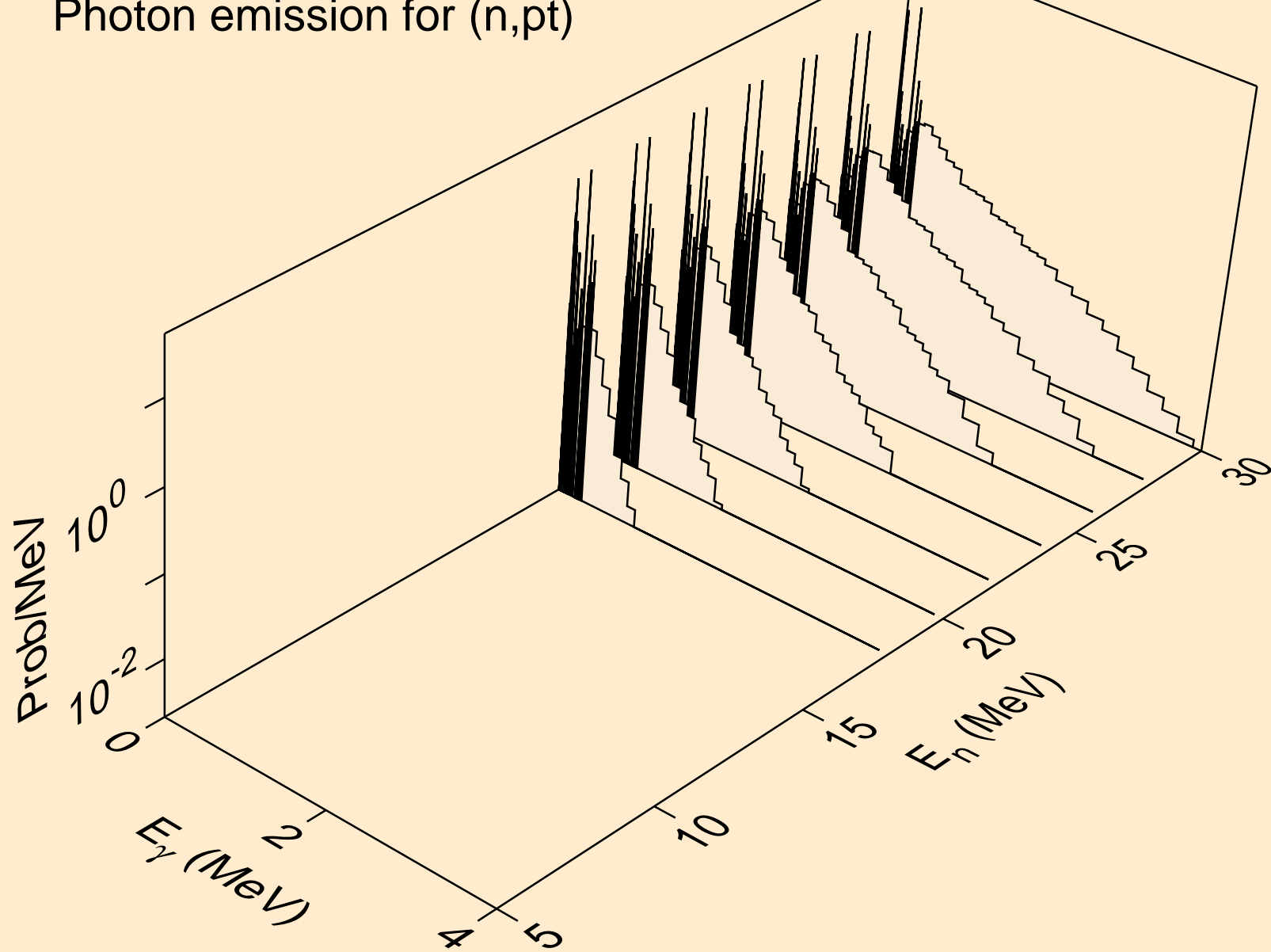

HG192 NEUTRON ACER TENDL-2024 LIBRARY; T=0.K
Photon emission for (n,da)

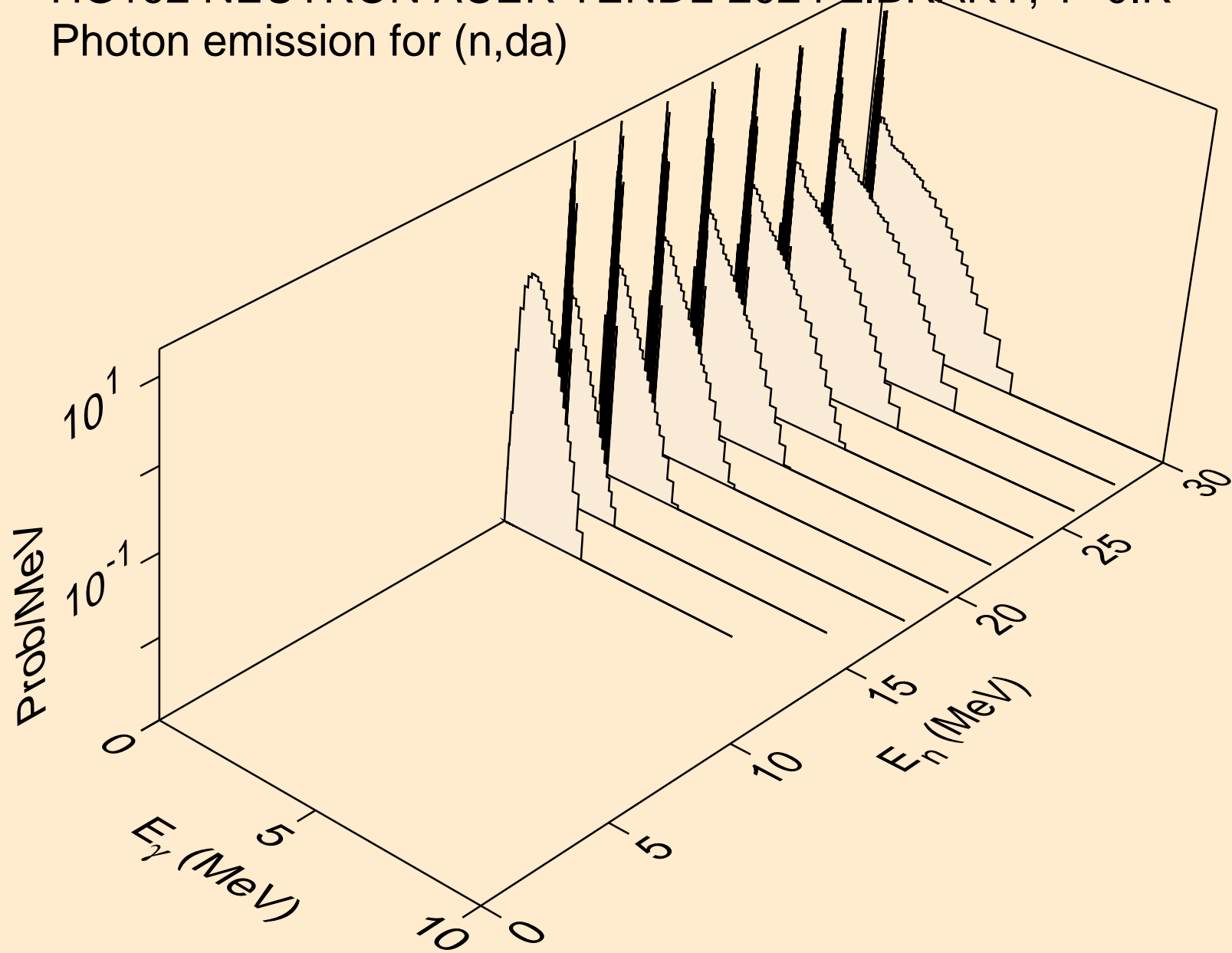

HG192 NEUTRON ACER TENDL-2024 LIBRARY; T=0.K
thermal capture photon spectrum

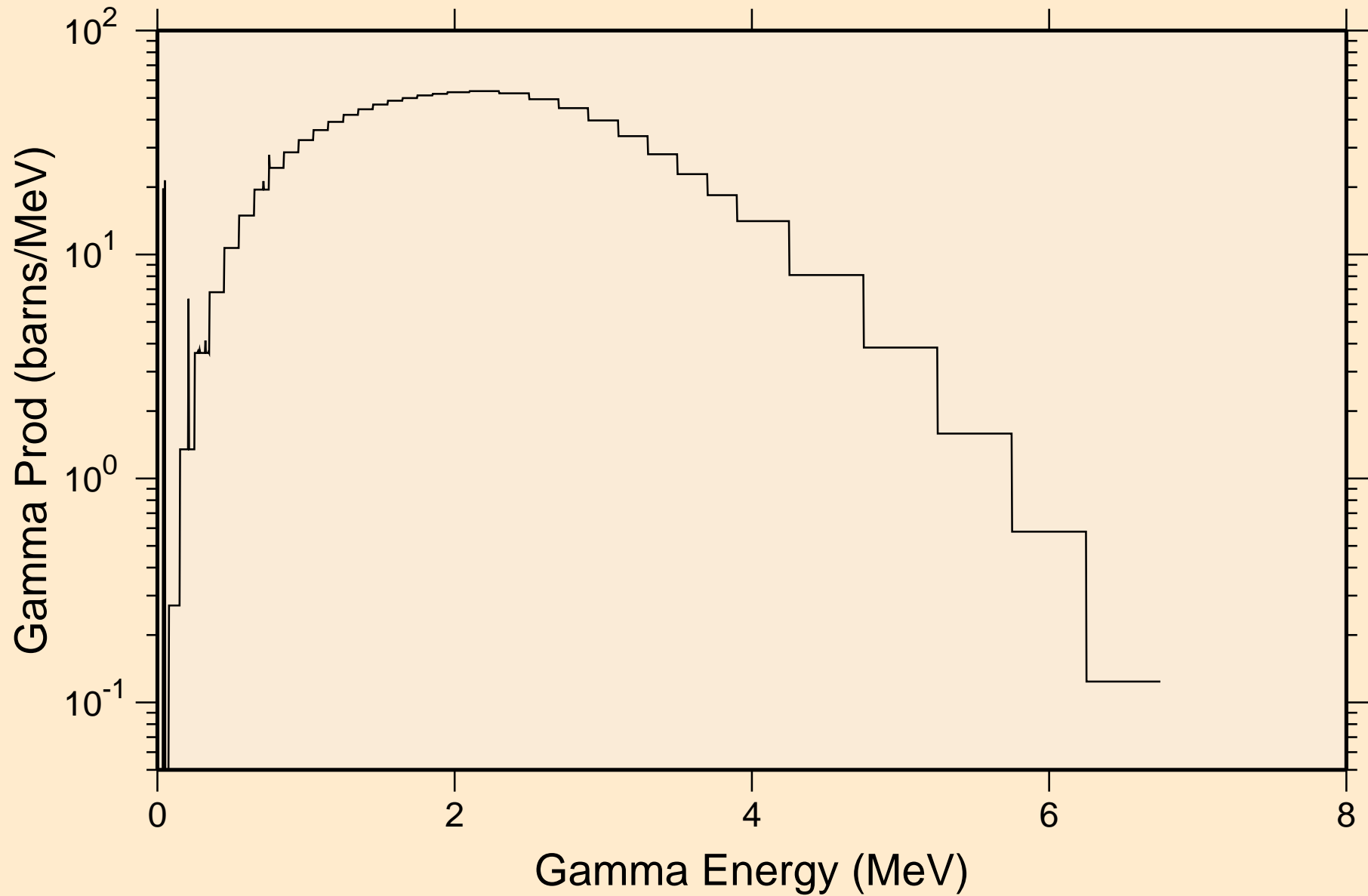

HG192 NEUTRON ACER TENDL-2024 LIBRARY; T=0.K
14 MeV photon spectrum

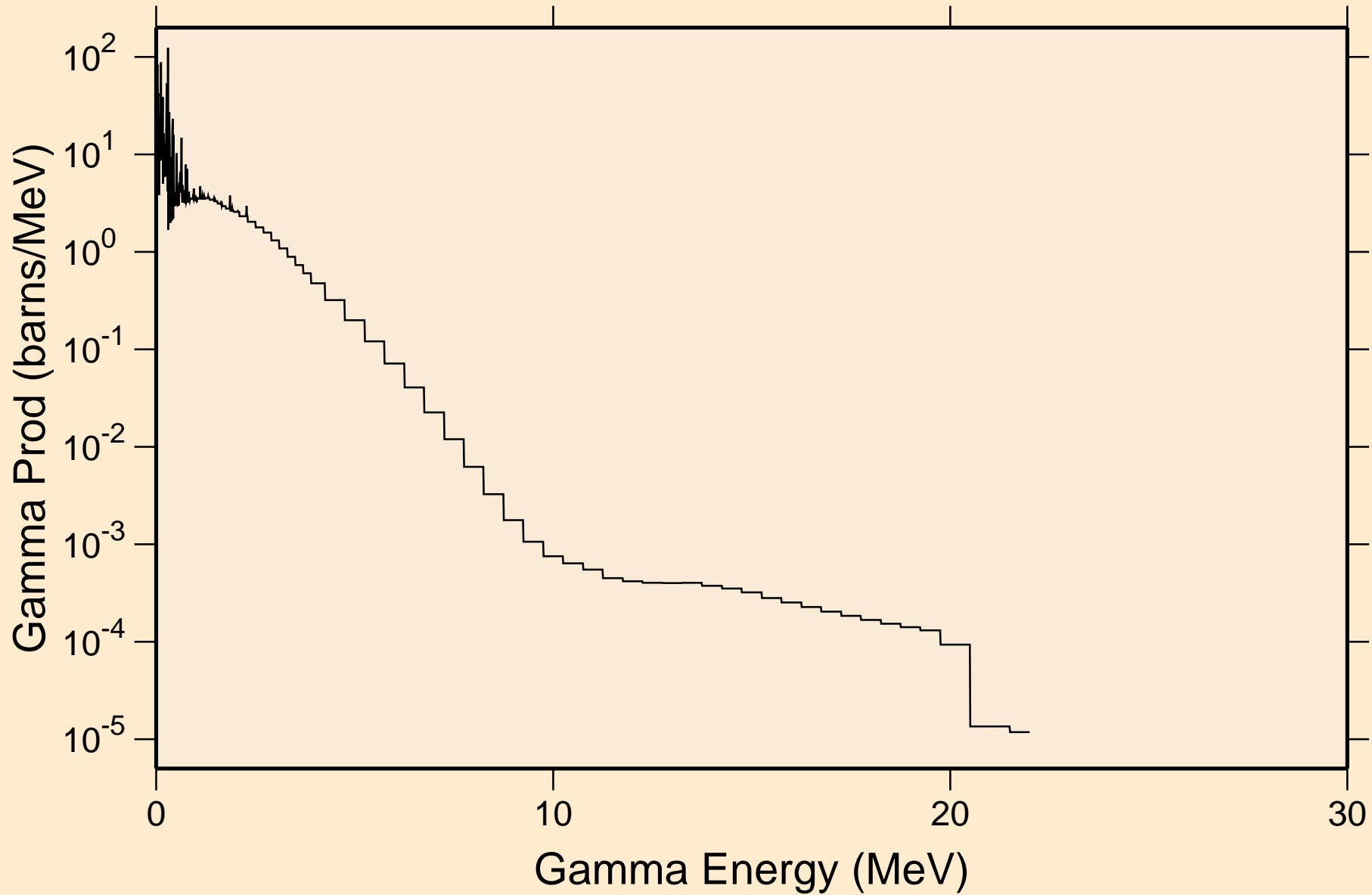

HG192 NEUTRON ACER TENDL-2024 LIBRARY; T=0.K

Particle heating contributions

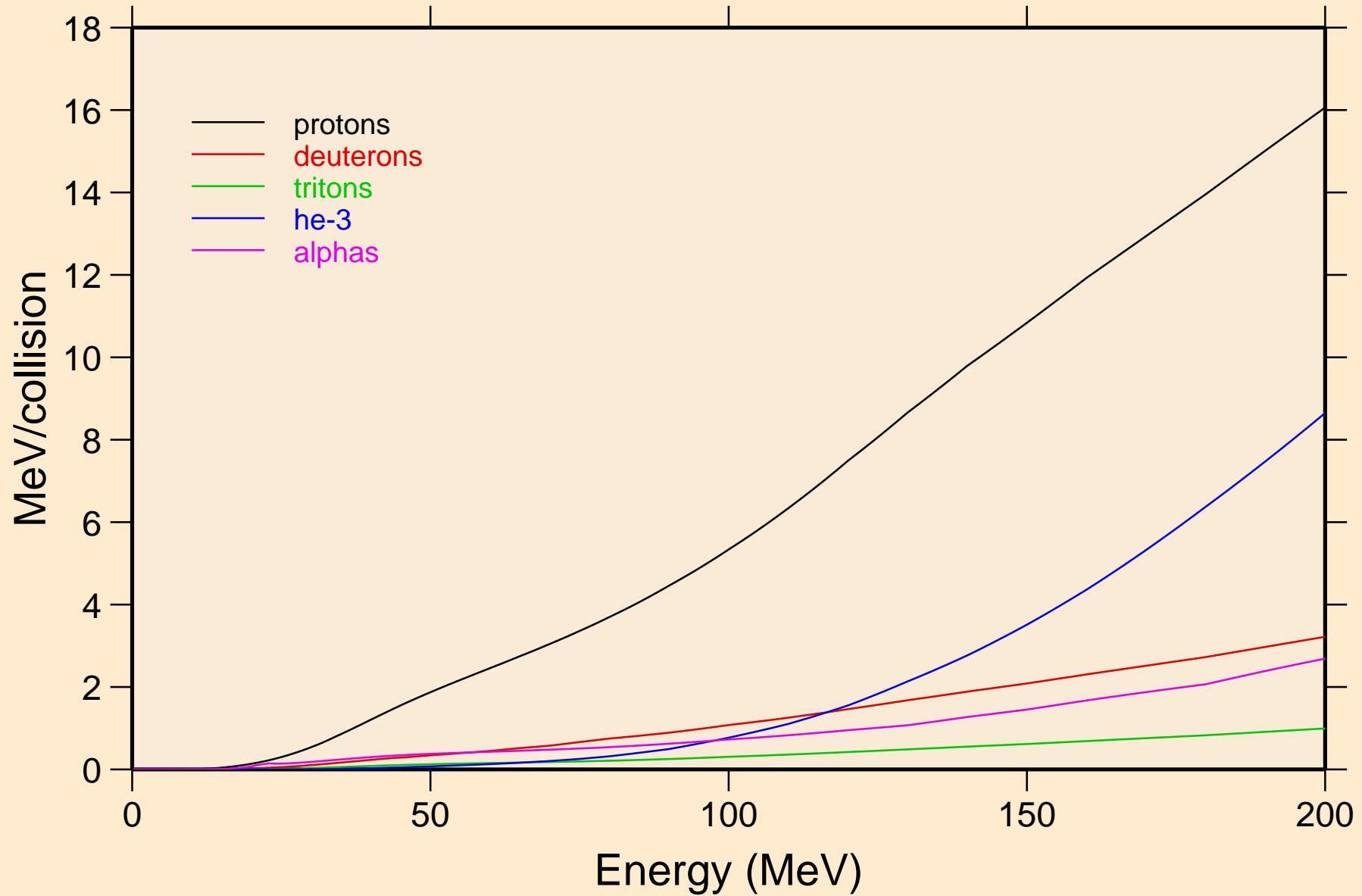

HG192 NEUTRON ACER TENDL-2024 LIBRARY; T=0.K

Recoil Heating

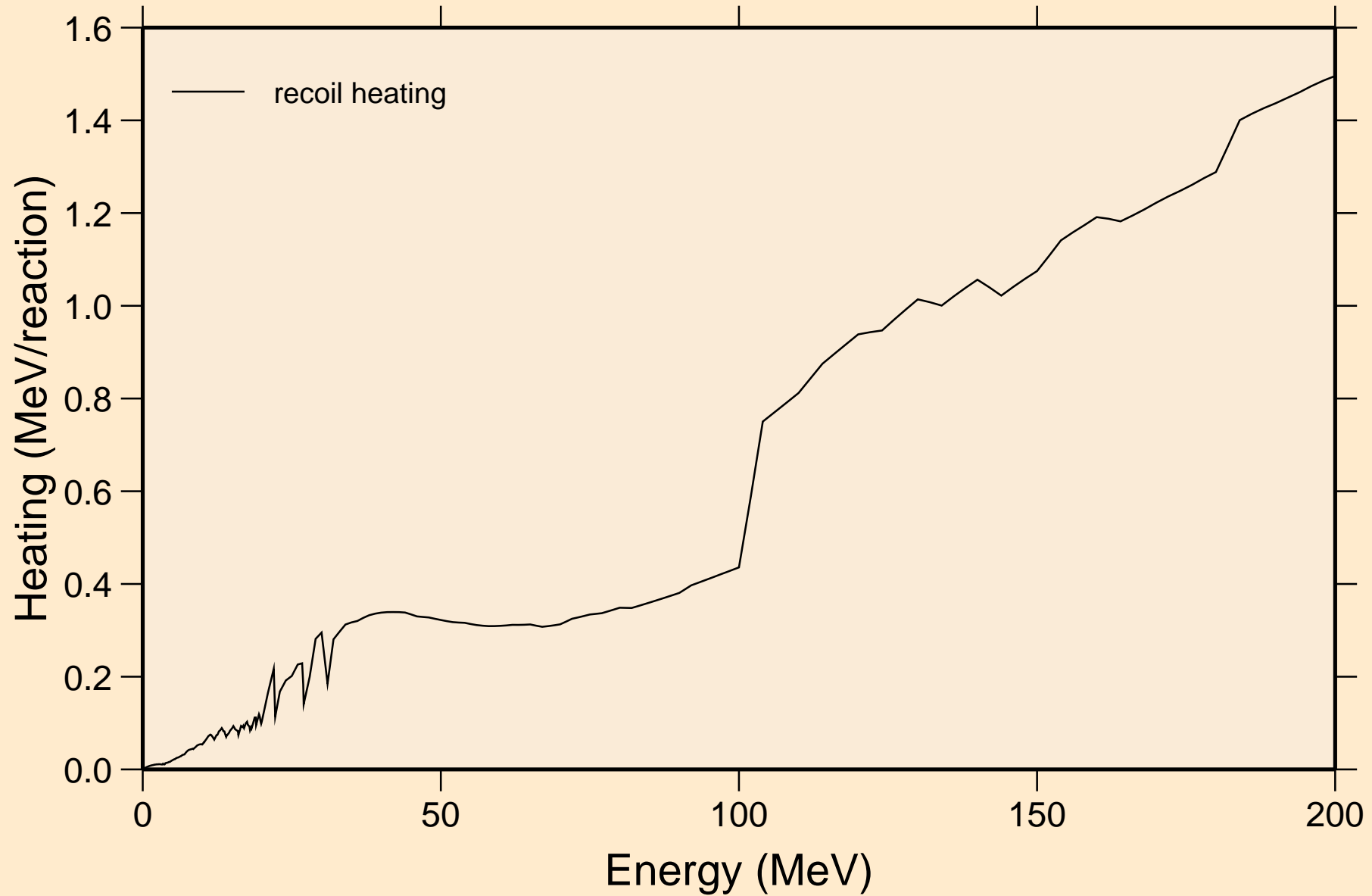

HG192 NEUTRON ACER TENDL-2024 LIBRARY; T=0.K
Particle production cross sections

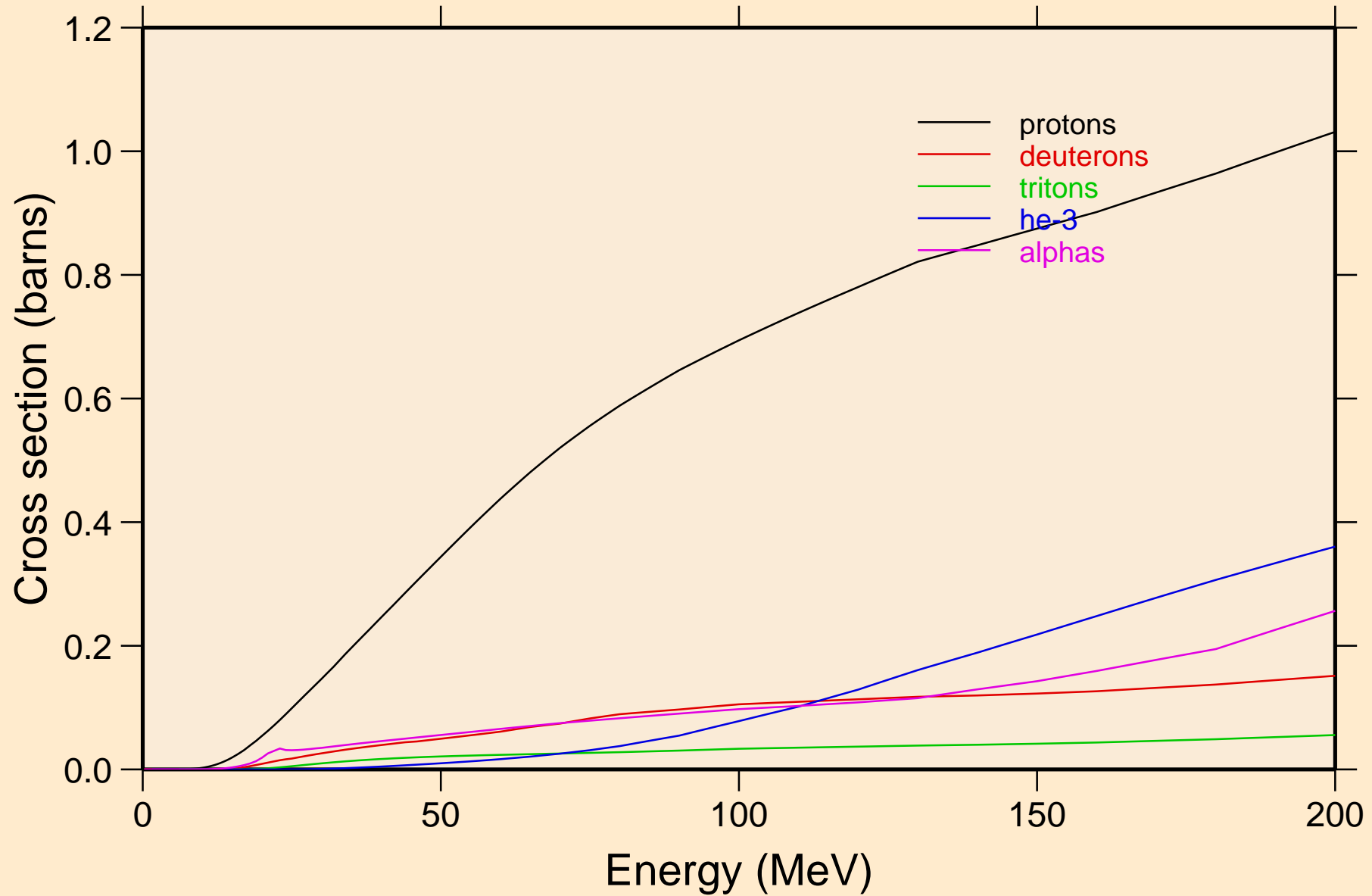

HG192 NEUTRON ACER TENDL-2024 LIBRARY; T=0.K
protons from (n,x)

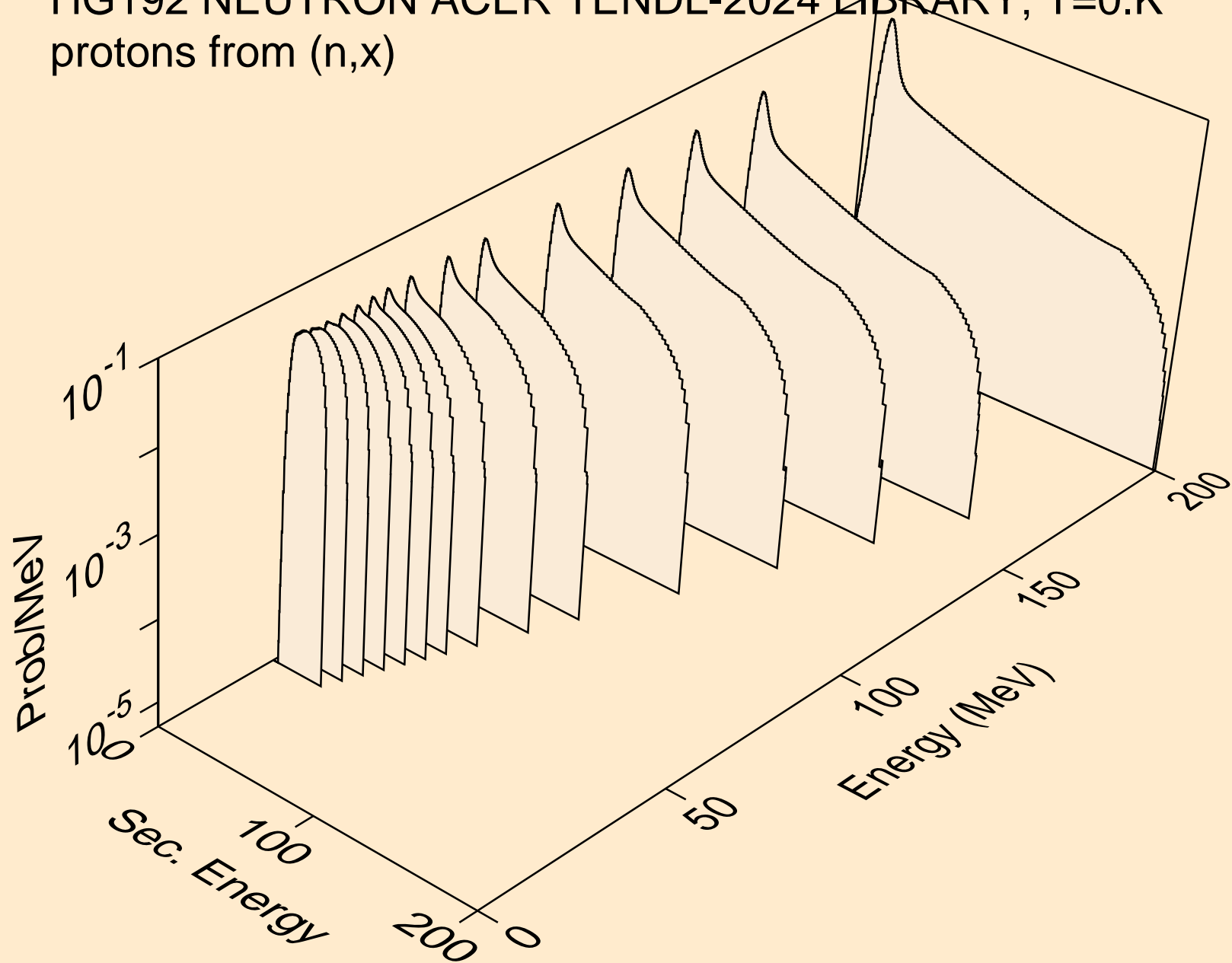

HG192 NEUTRON ACER TENDL-2024 LIBRARY; T=0.K
protons from (n,n*)p

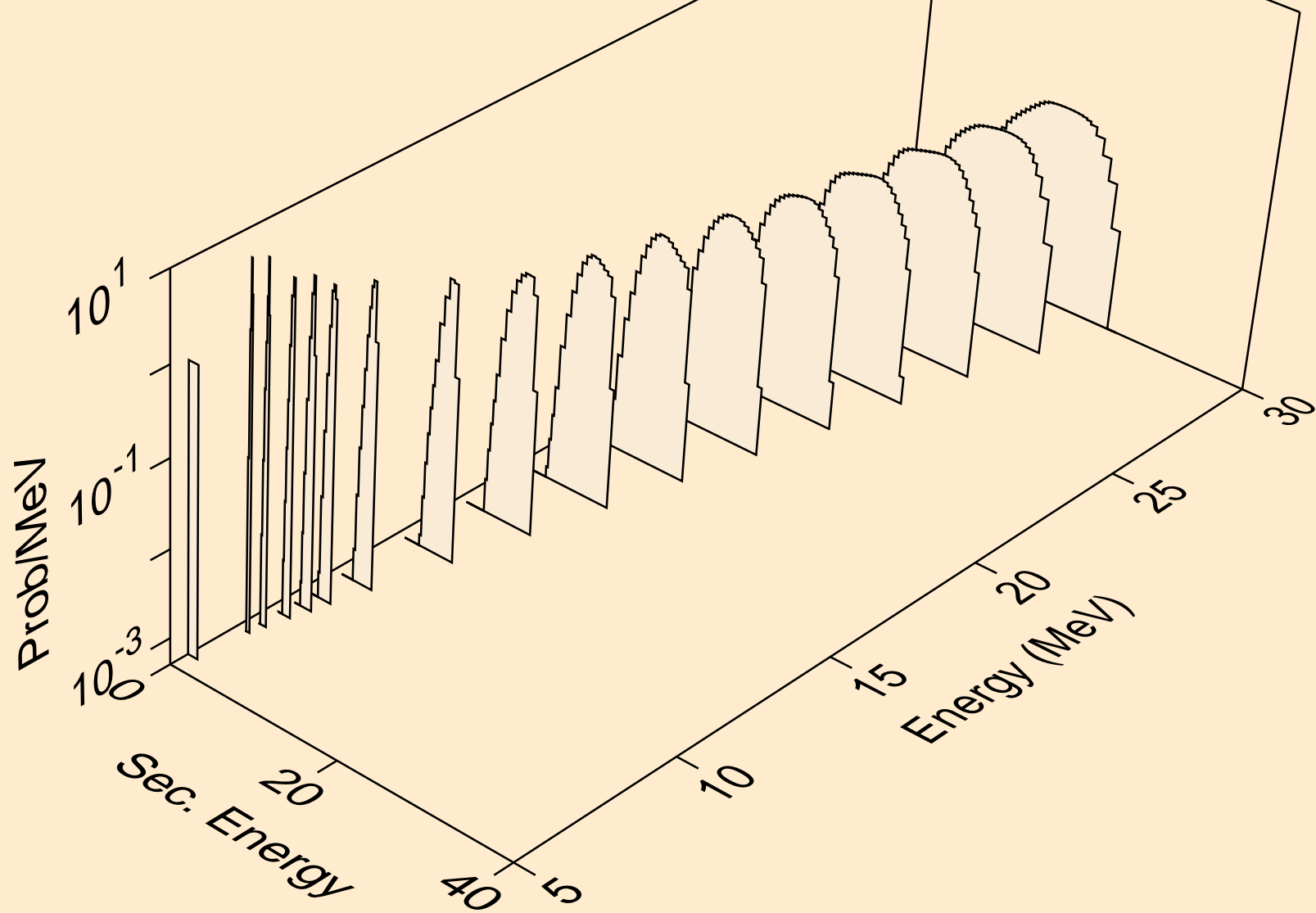

HG192 NEUTRON ACER TENDL-2024 LIBRARY; T=0.K
protons from (n,2np)

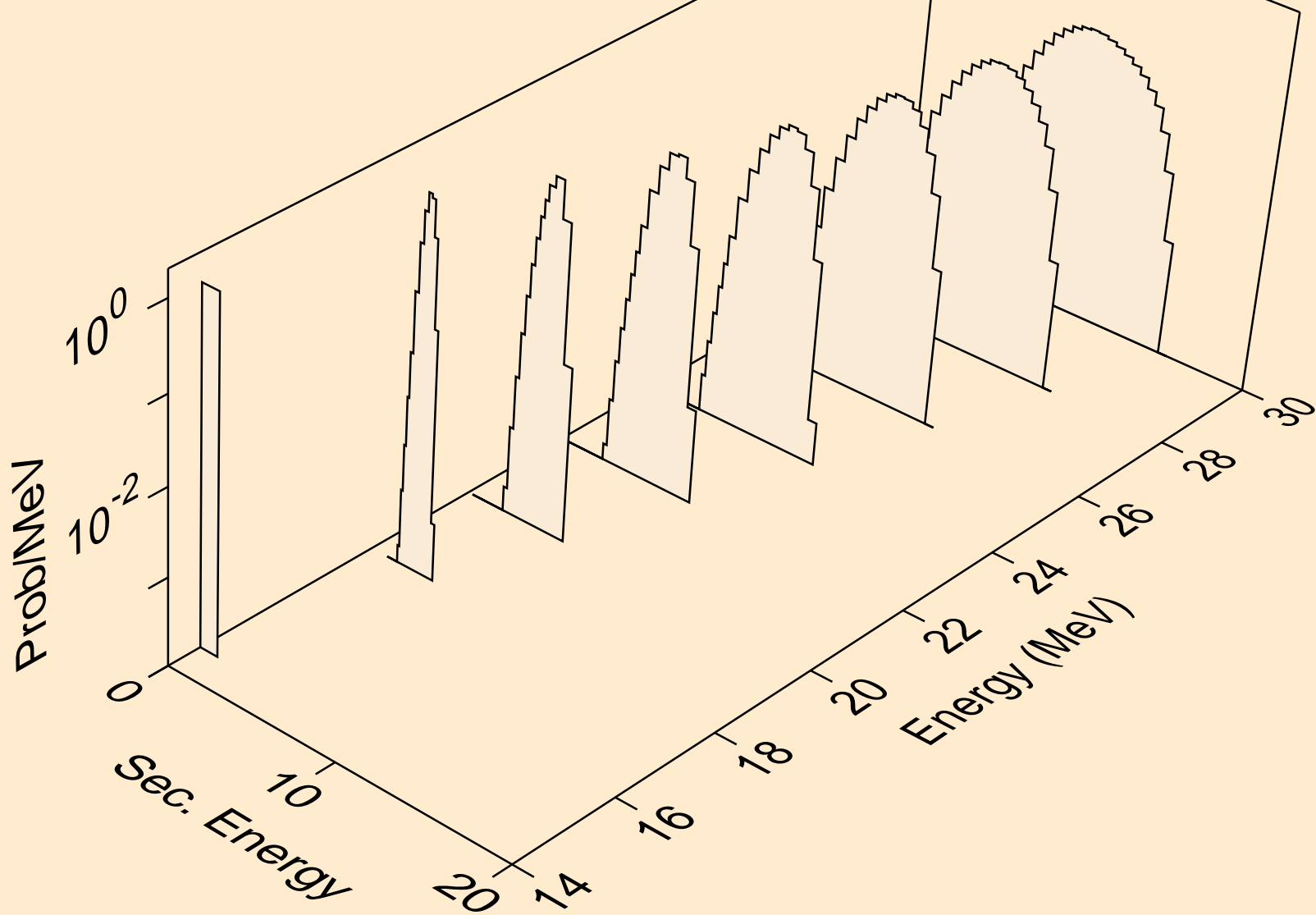

HG192 NEUTRON ACER TENDL-2024 LIBRARY; T=0.K
protons from (n,3np)

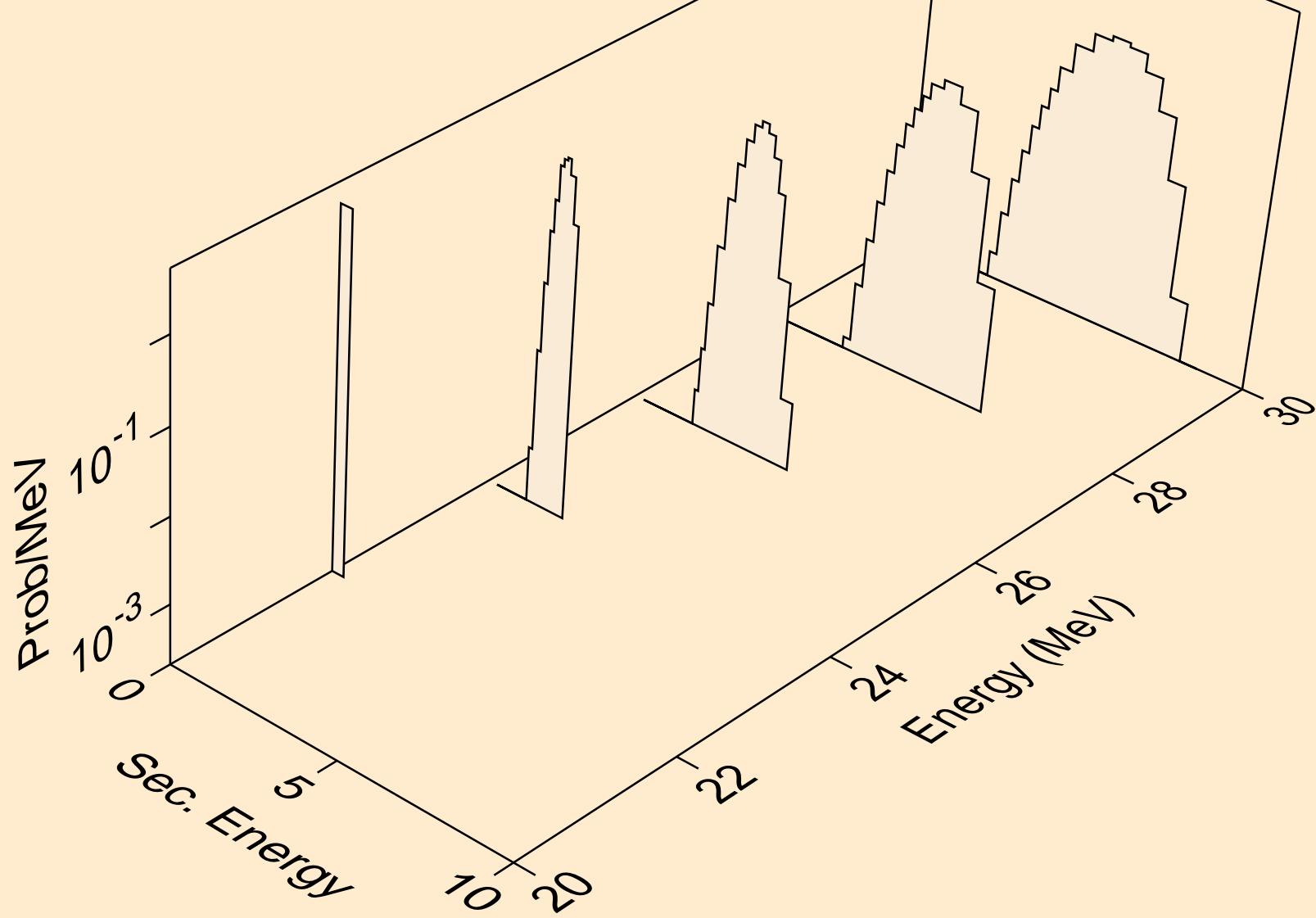

HG192 NEUTRON ACER TENDL-2024 LIBRARY; T=0.K
protons from (n,n2p)

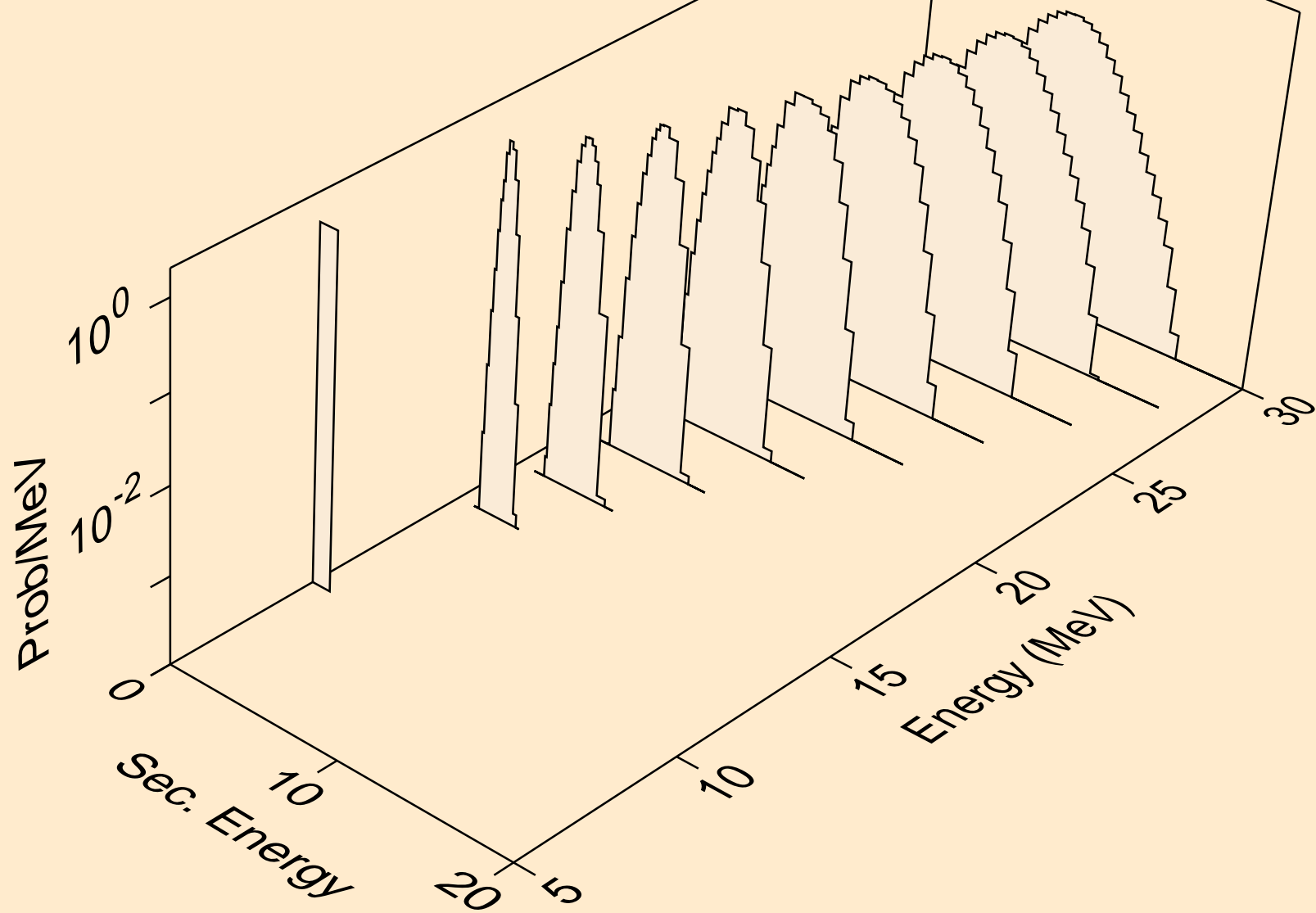

HG192 NEUTRON ACER TENDL-2024 LIBRARY; T=0.K
protons from (n,npa)

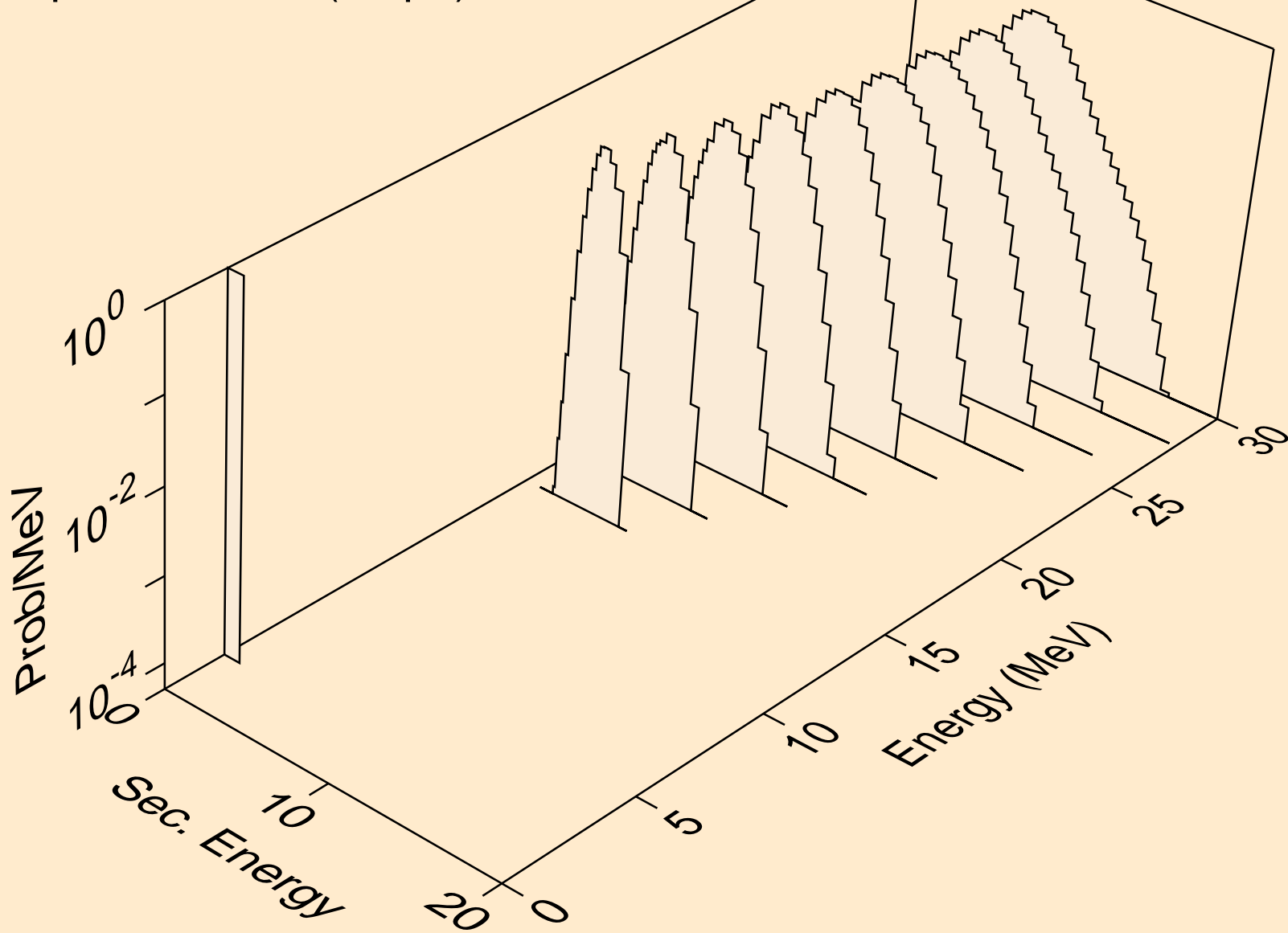

HG192 NEUTRON ACER TENDL-2024 LIBRARY; T=0.K
protons from (n,p)

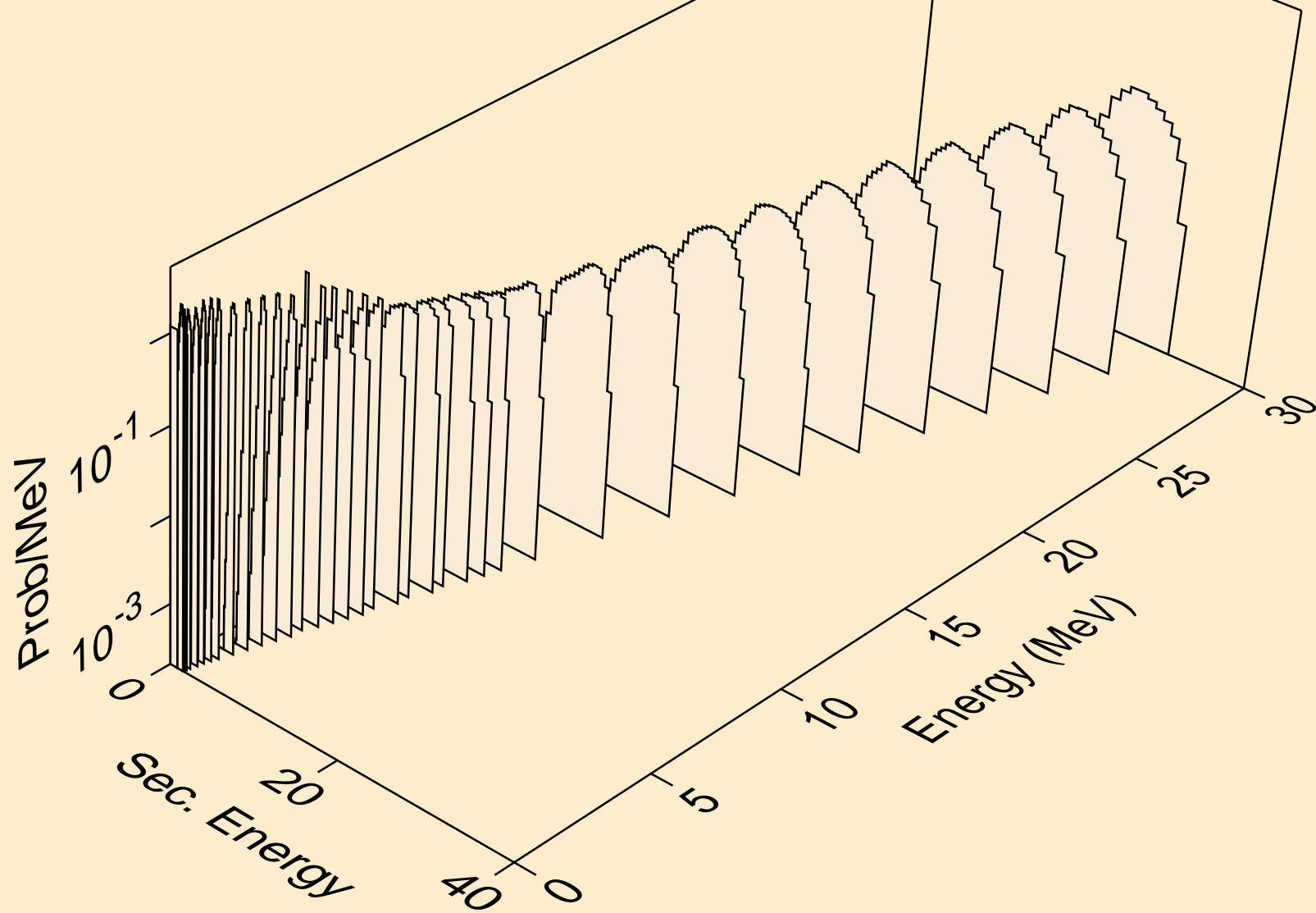

HG192 NEUTRON ACER TENDL-2024 LIBRARY; T=0.K
protons from (n,2p)

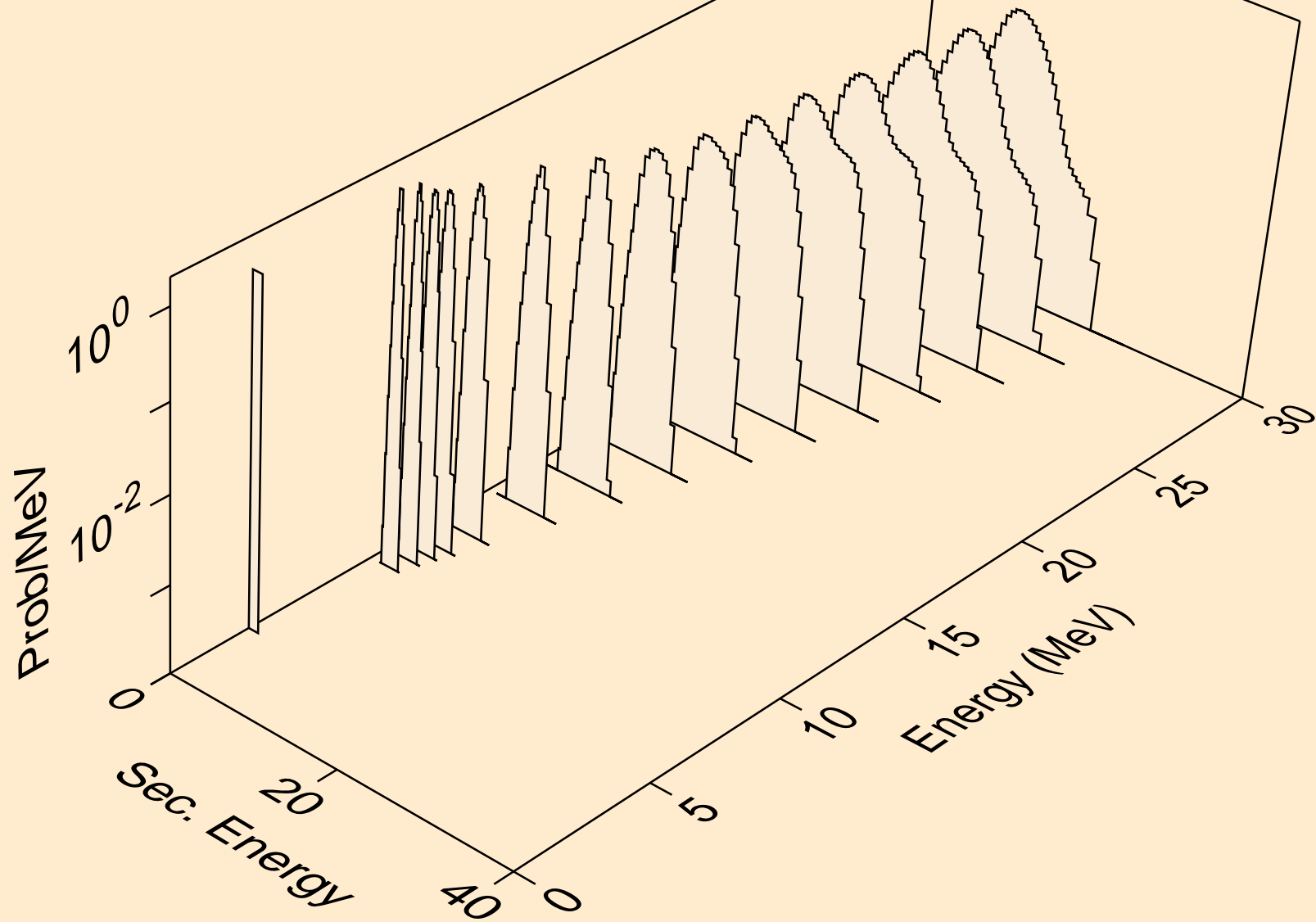

HG192 NEUTRON ACER TENDL-2024 LIBRARY; T=0.K
protons from (n,p)

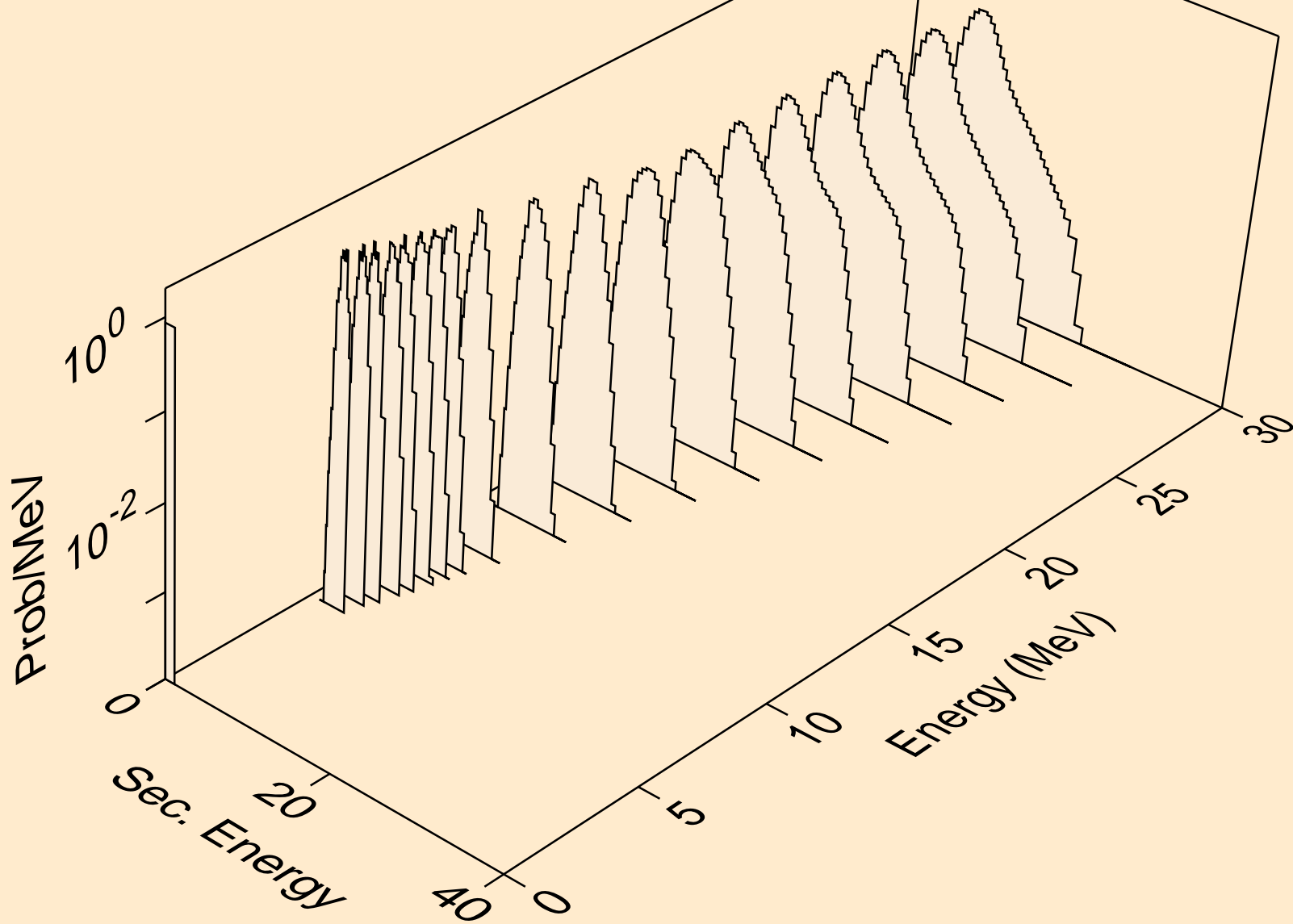

HG192 NEUTRON ACER TENDL-2024 LIBRARY; T=0.K
protons from (n,pd)

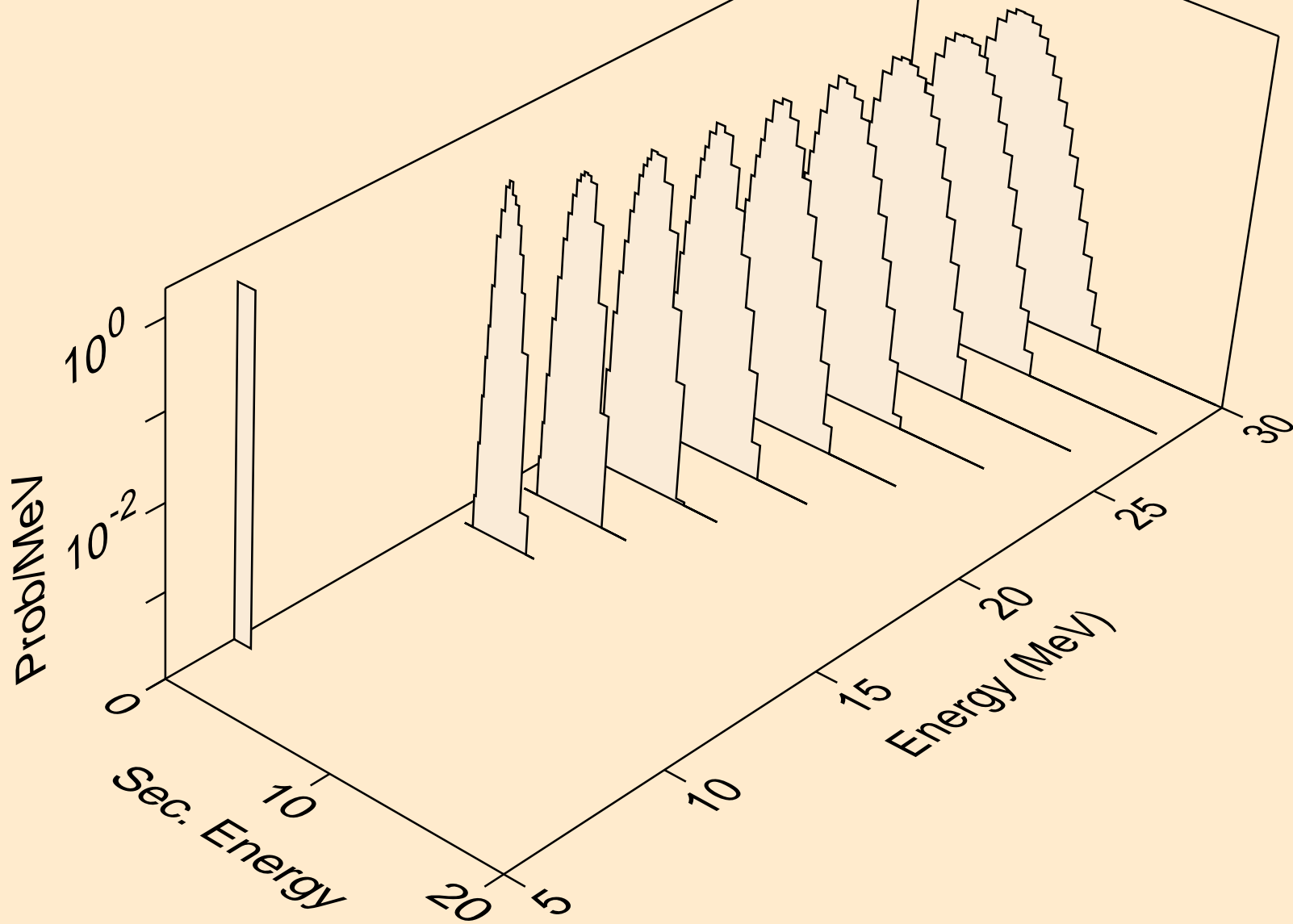

HG192 NEUTRON ACER TENDL-2024 LIBRARY; T=0.K
protons from (n,pt)

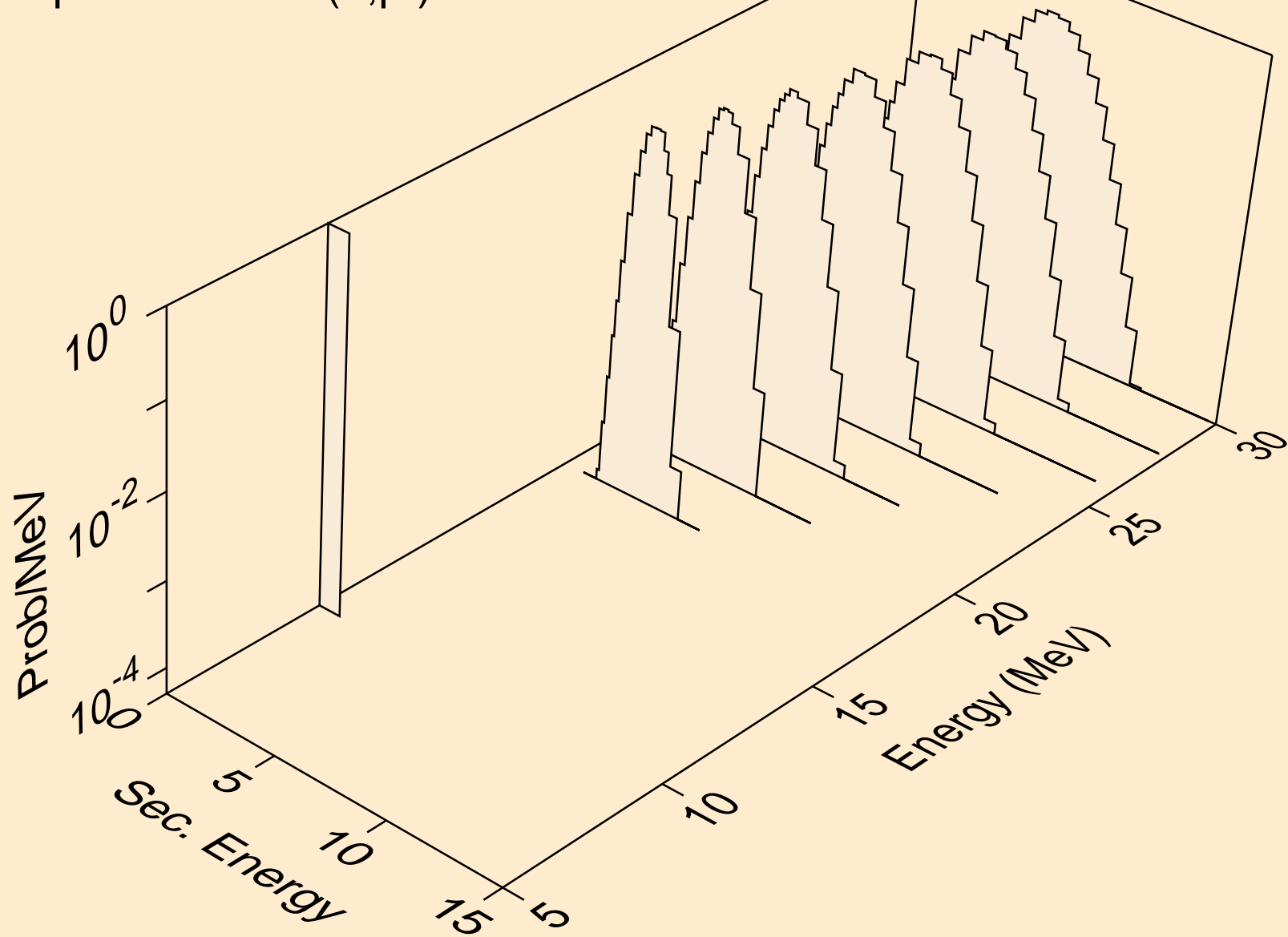

HG192 NEUTRON ACER TENDL-2024 LIBRARY; T=0.K
deuterons from (n,x)

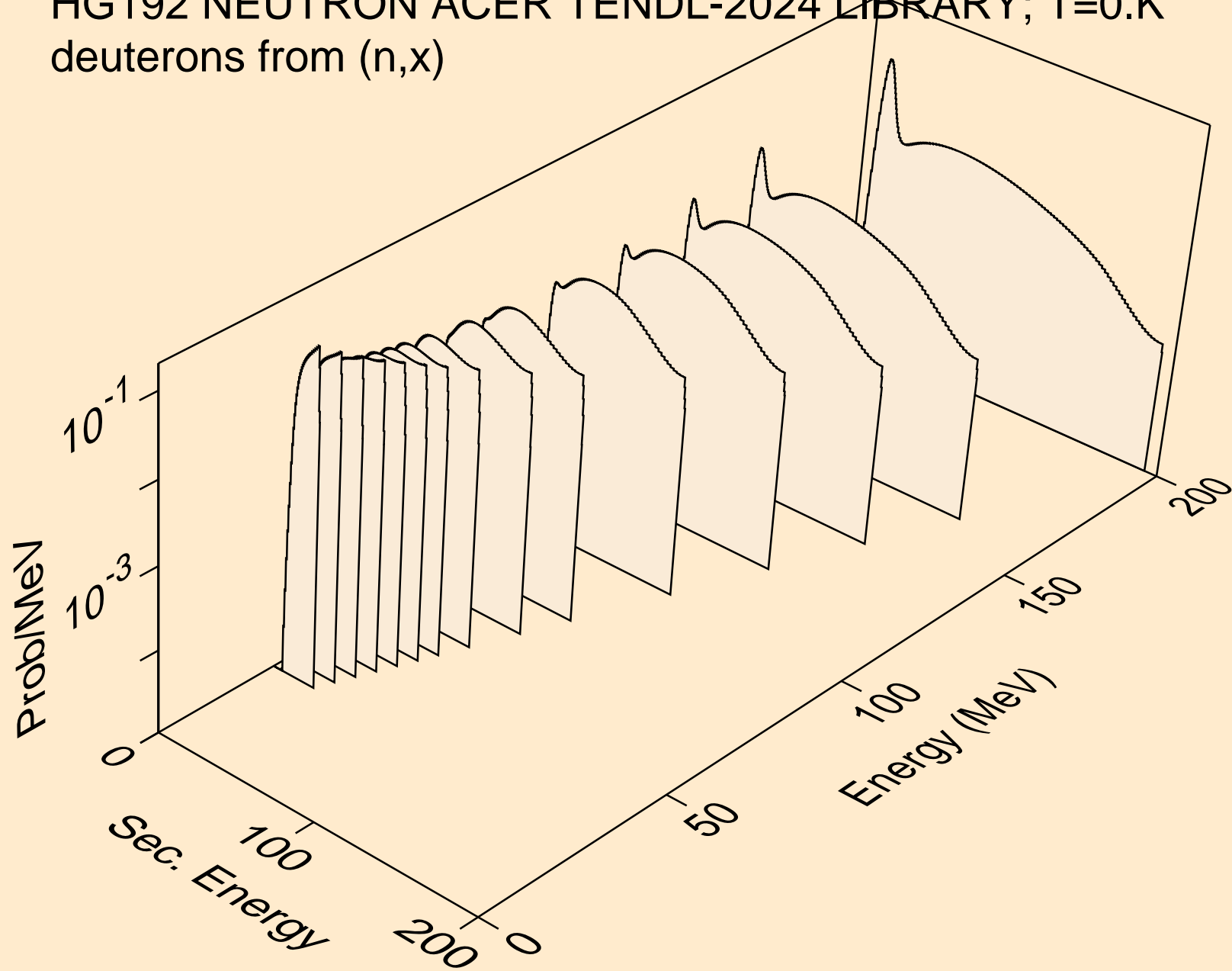

HG192 NEUTRON ACER TENDL-2024 LIBRARY; T=0.K
deuterons from (n,2nd)

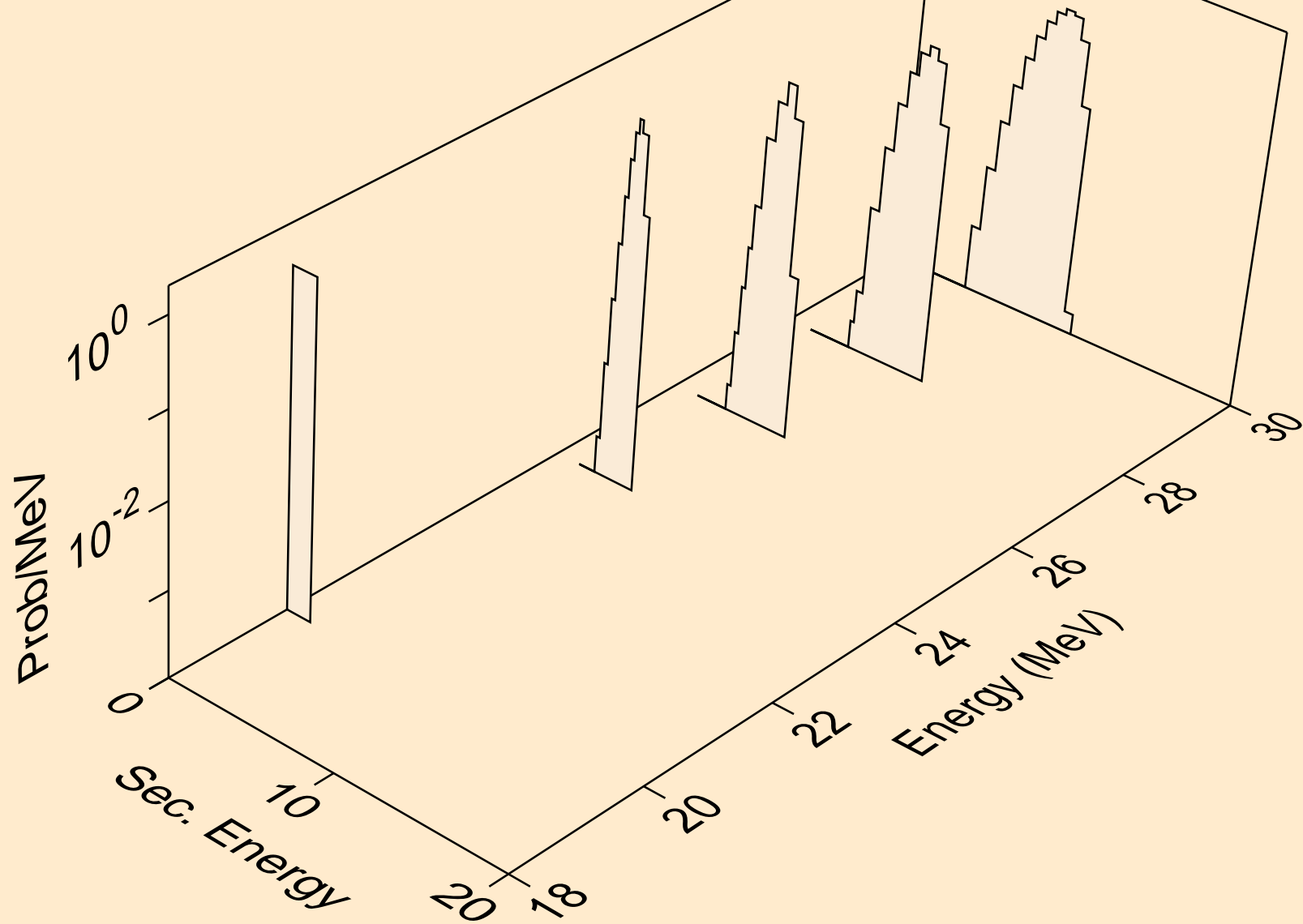

HG192 NEUTRON ACER TENDL-2024 LIBRARY; T=0.K
deuterons from (n,n*)d

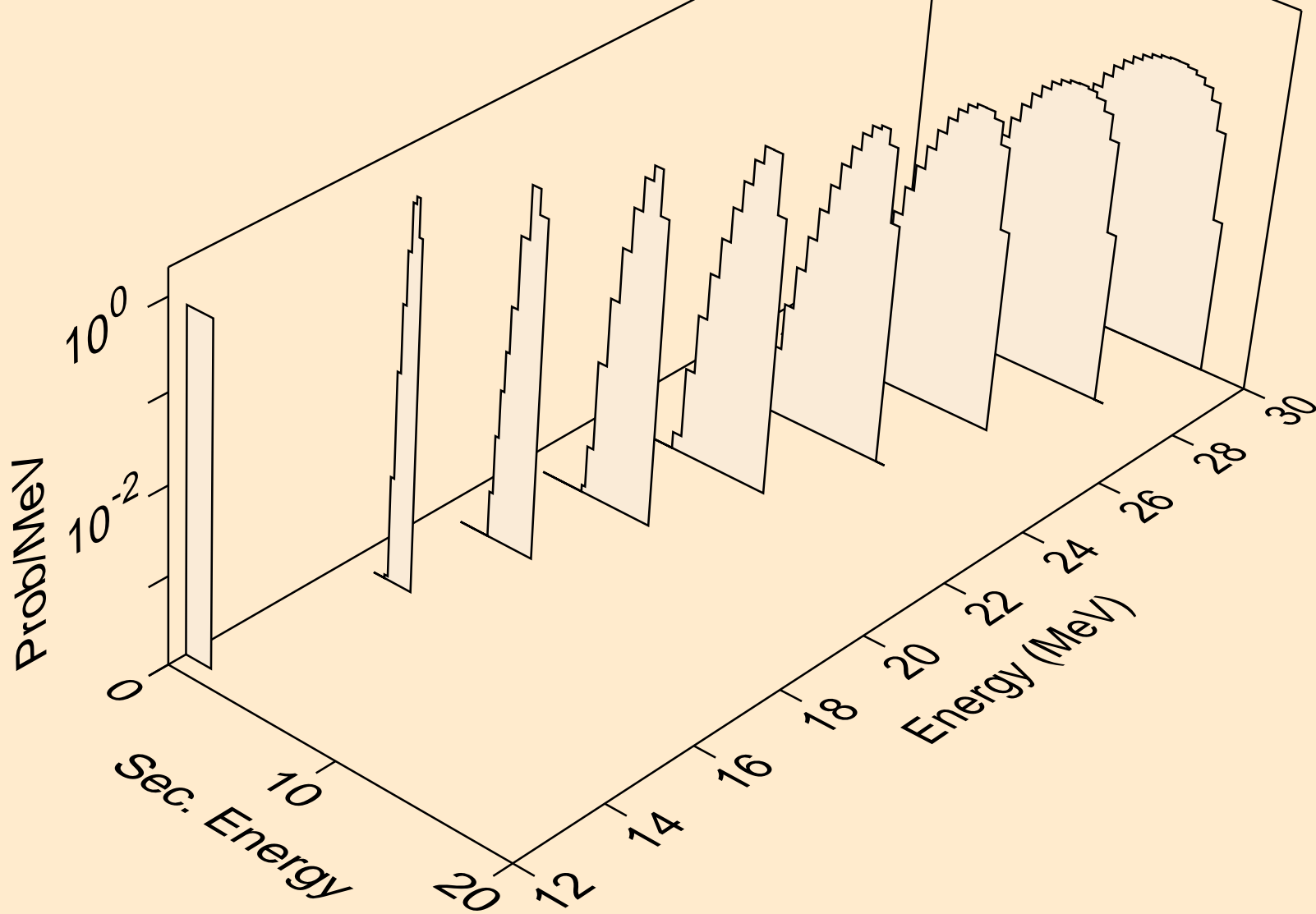

HG192 NEUTRON ACER TENDL-2024 LIBRARY; T=0.K
deuterons from (n,d)

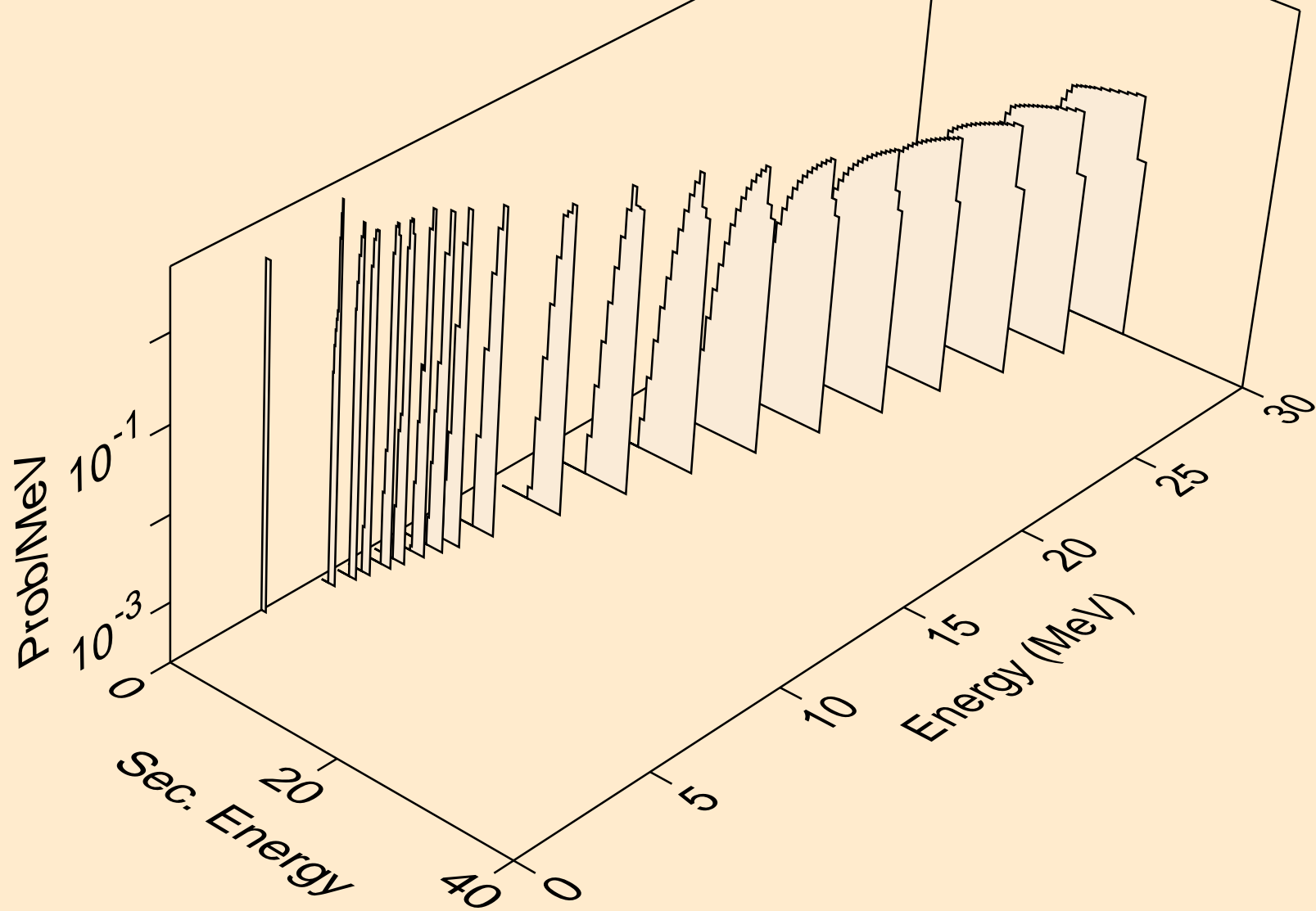

HG192 NEUTRON ACER TENDL-2024 LIBRARY; T=0.K
deuterons from (n,pd)

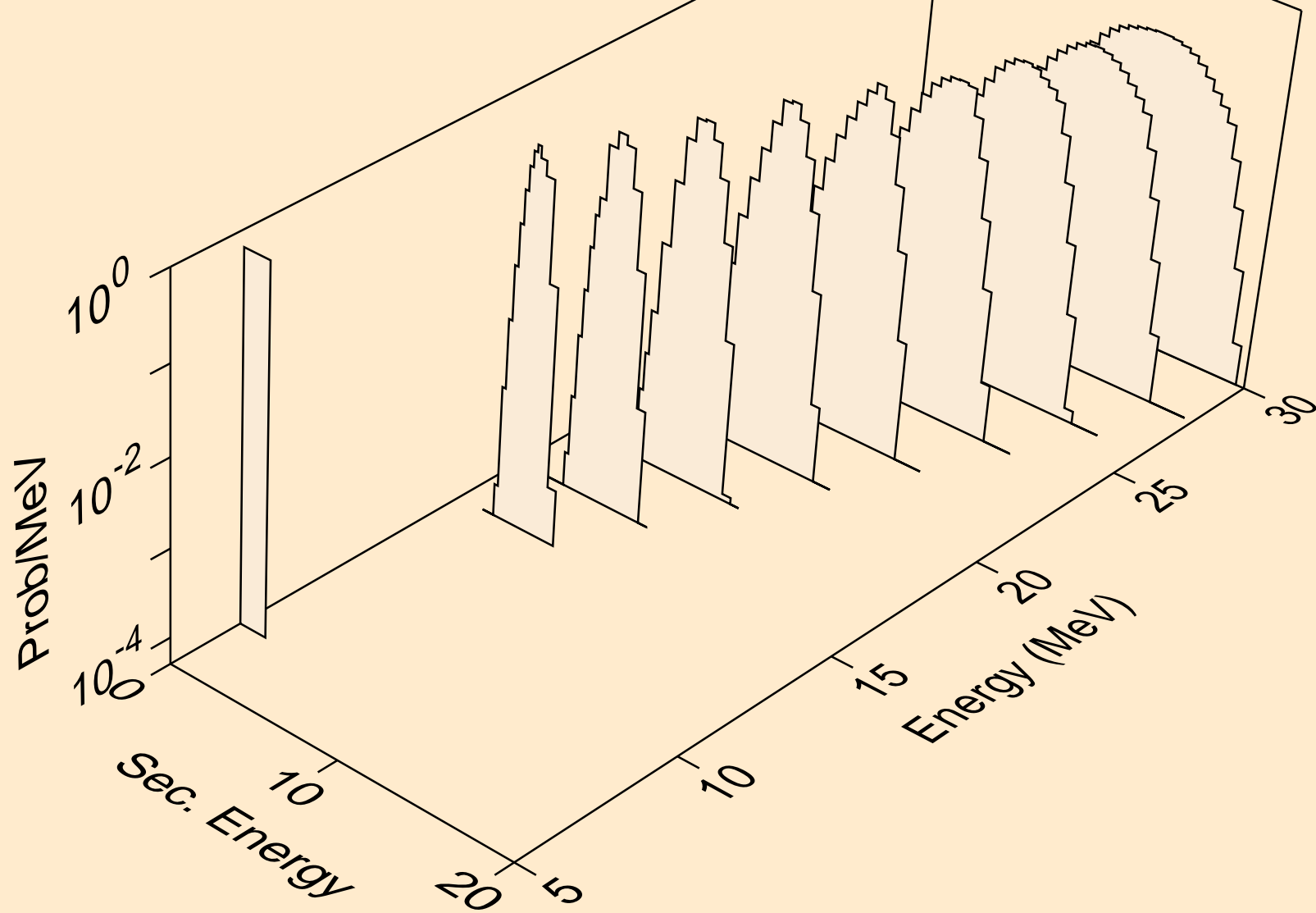

HG192 NEUTRON ACER TENDL-2024 LIBRARY; T=0.K
deuterons from (n,da)

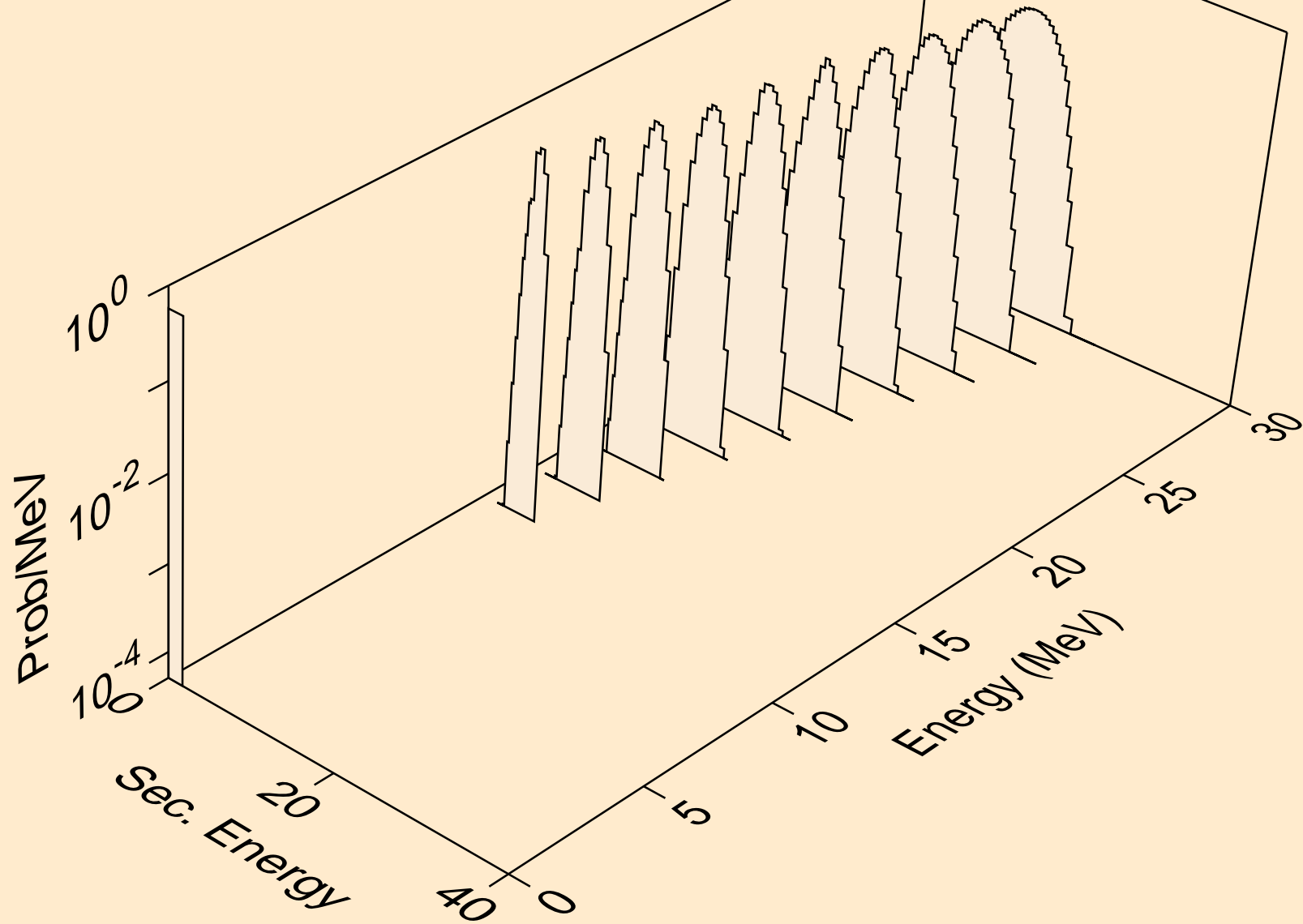

HG192 NEUTRON ACER TENDL-2024 LIBRARY; T=0.K
tritons from (n,x)

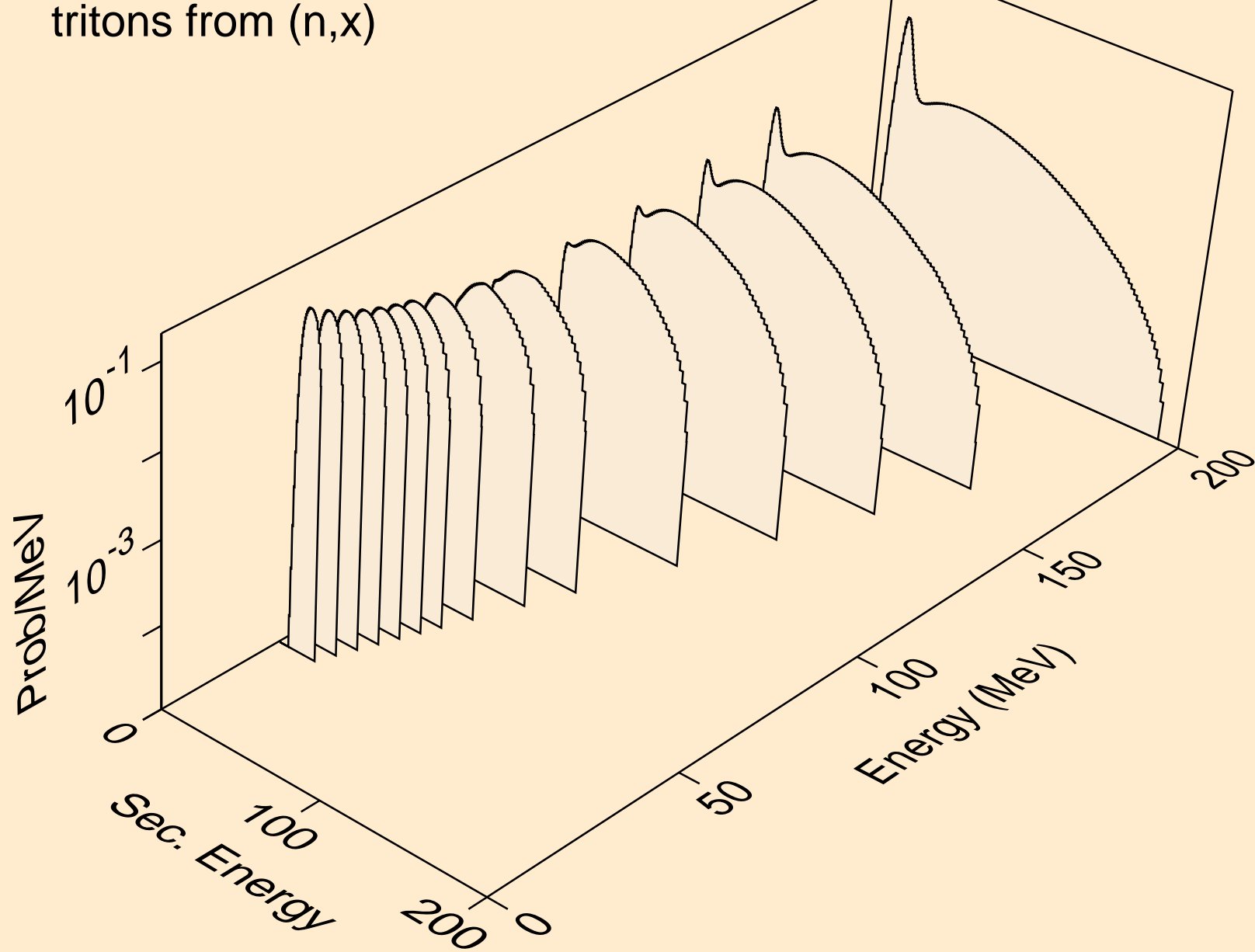

HG192 NEUTRON ACER TENDL-2024 LIBRARY; T=0.K
tritons from (n,n*)t

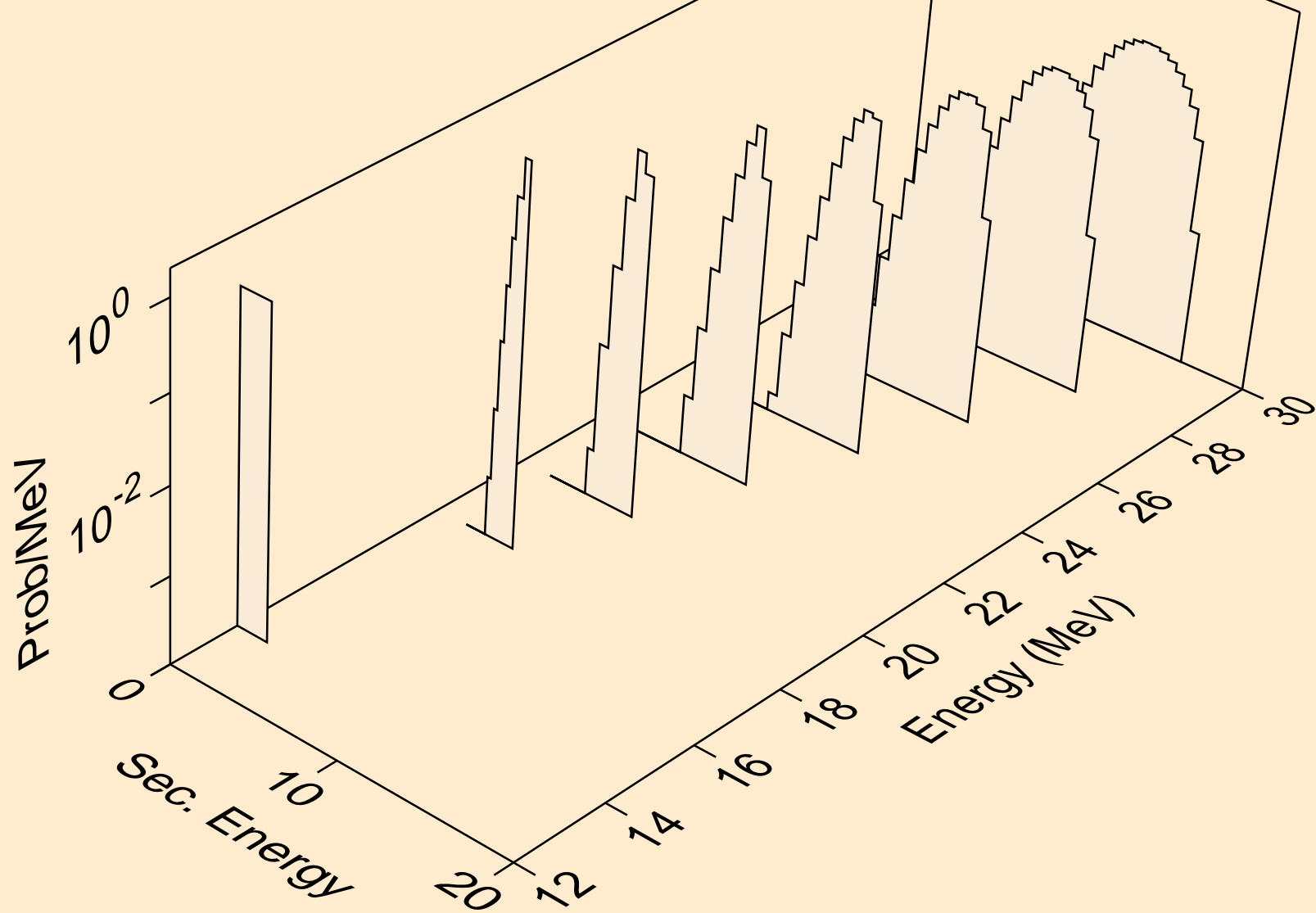

HG192 NEUTRON ACER TENDL-2024 LIBRARY; T=0.K
tritons from (n,t)

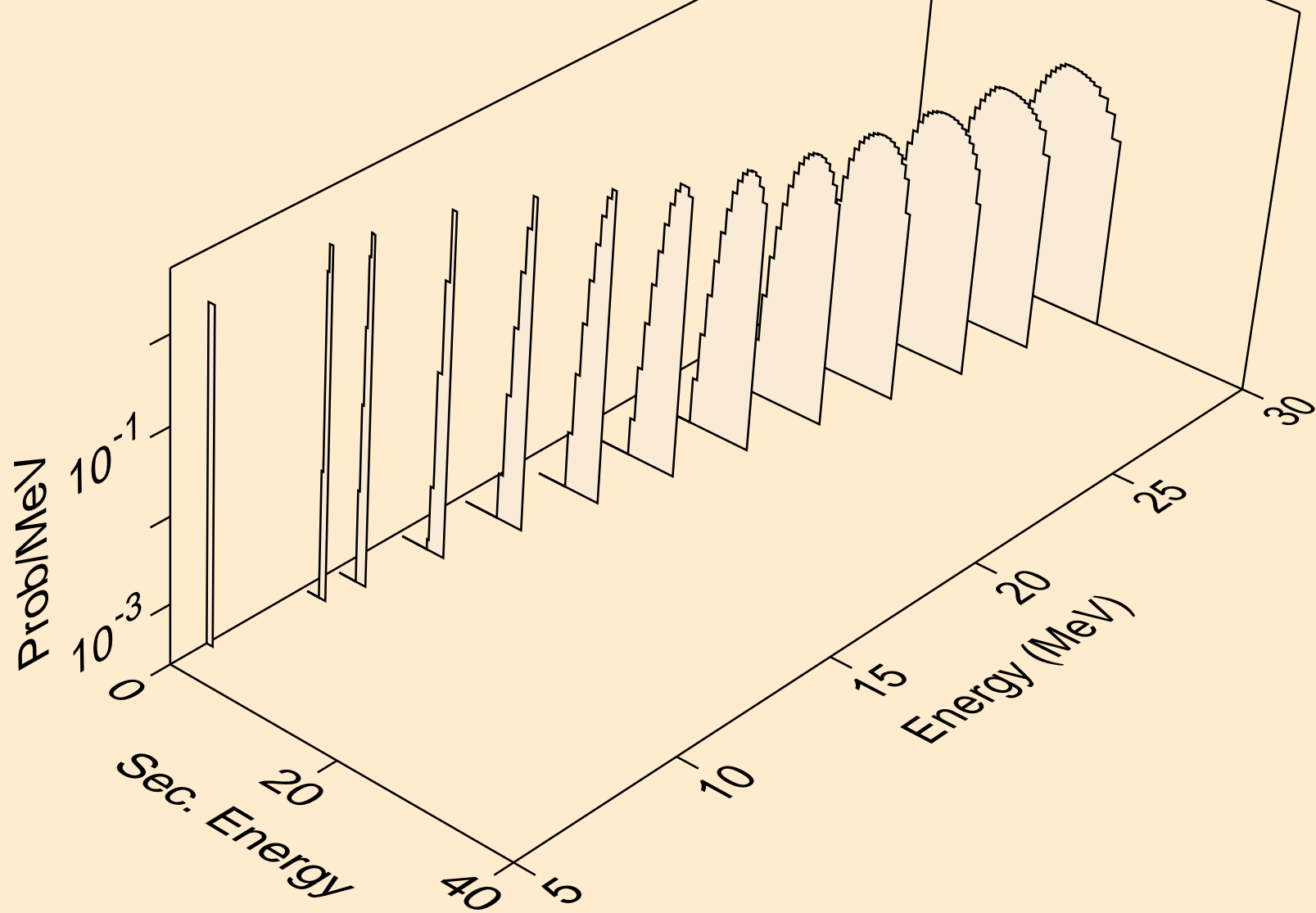

HG192 NEUTRON ACER TENDL-2024 LIBRARY; T=0.K
tritons from (n,pt)

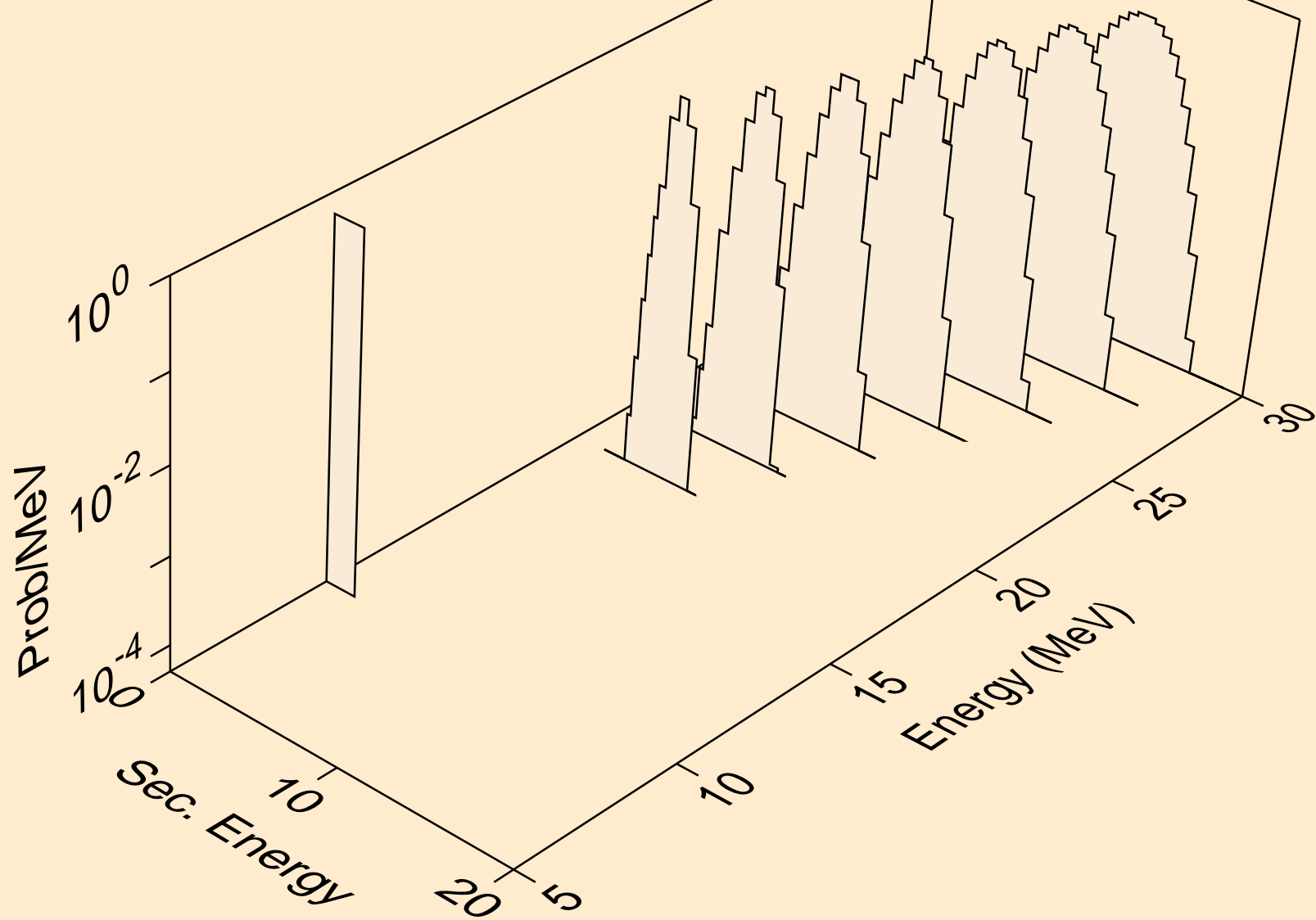

HG192 NEUTRON ACER TENDL-2024 LIBRARY; T=0.K
he3s from (n,x)

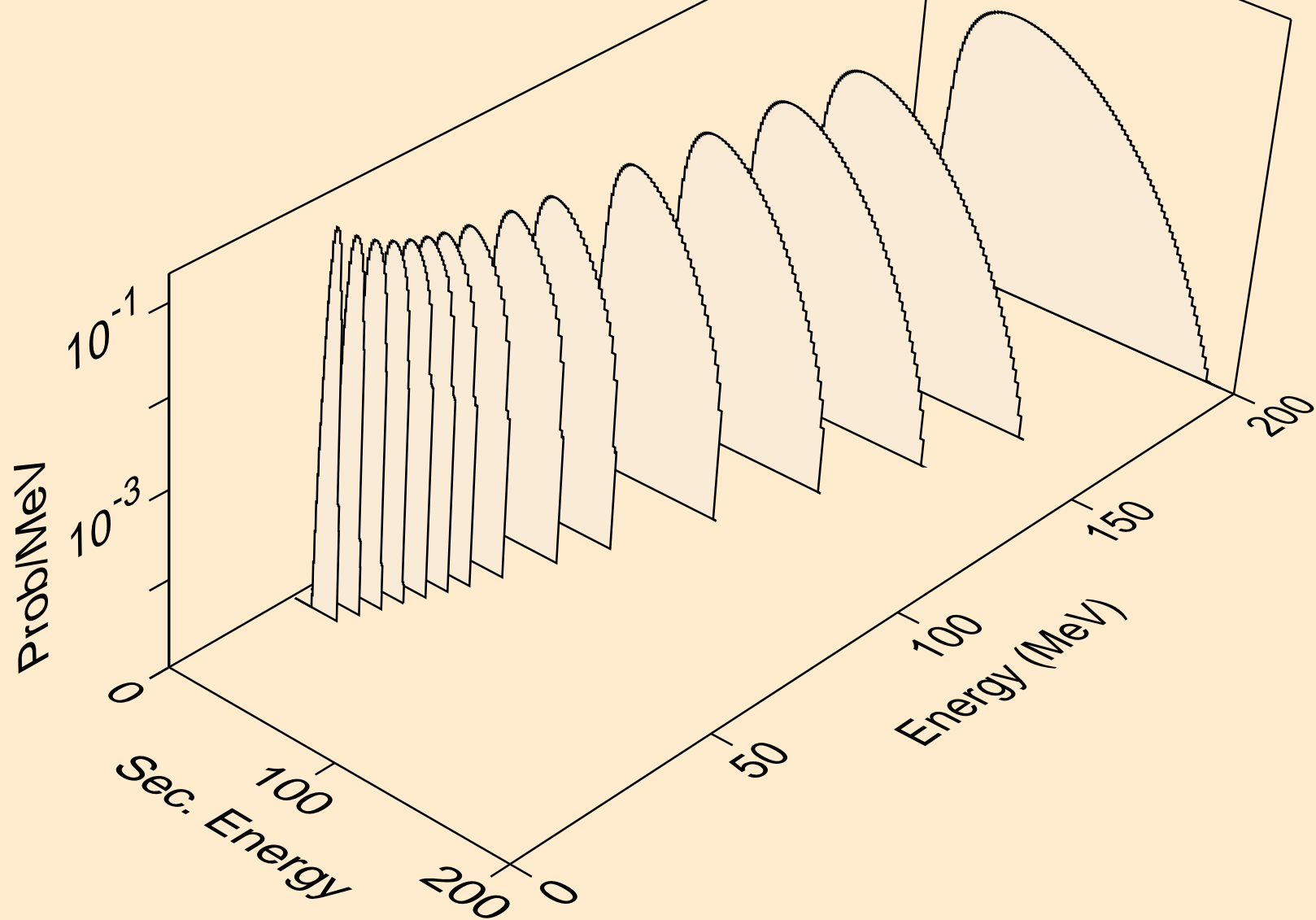

HG192 NEUTRON ACER TENDL-2024 LIBRARY; T=0.K
he3s from (n,n*)he3

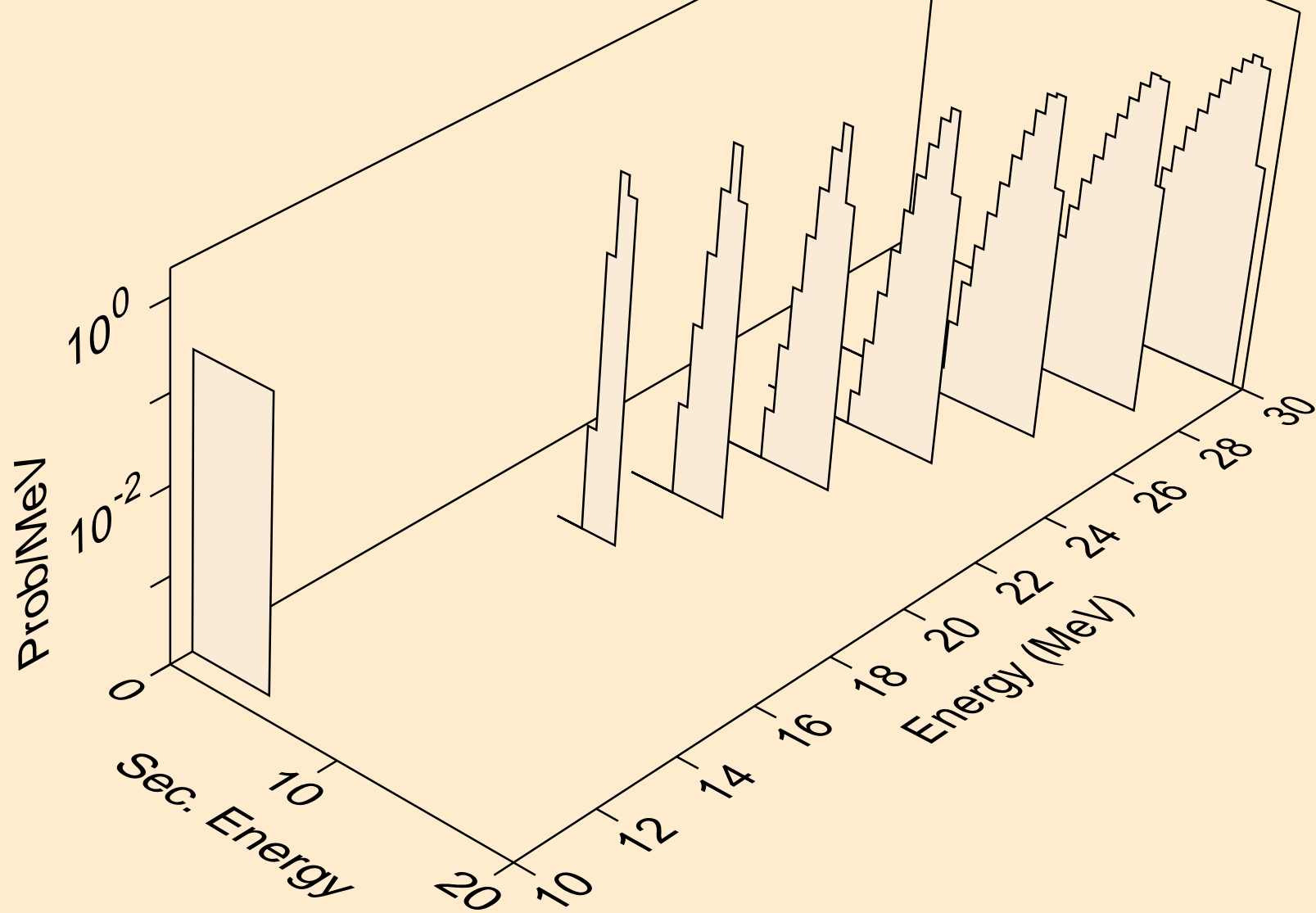

HG192 NEUTRON ACER TENDL-2024 LIBRARY; T=0.K
he3s from (n,he3)

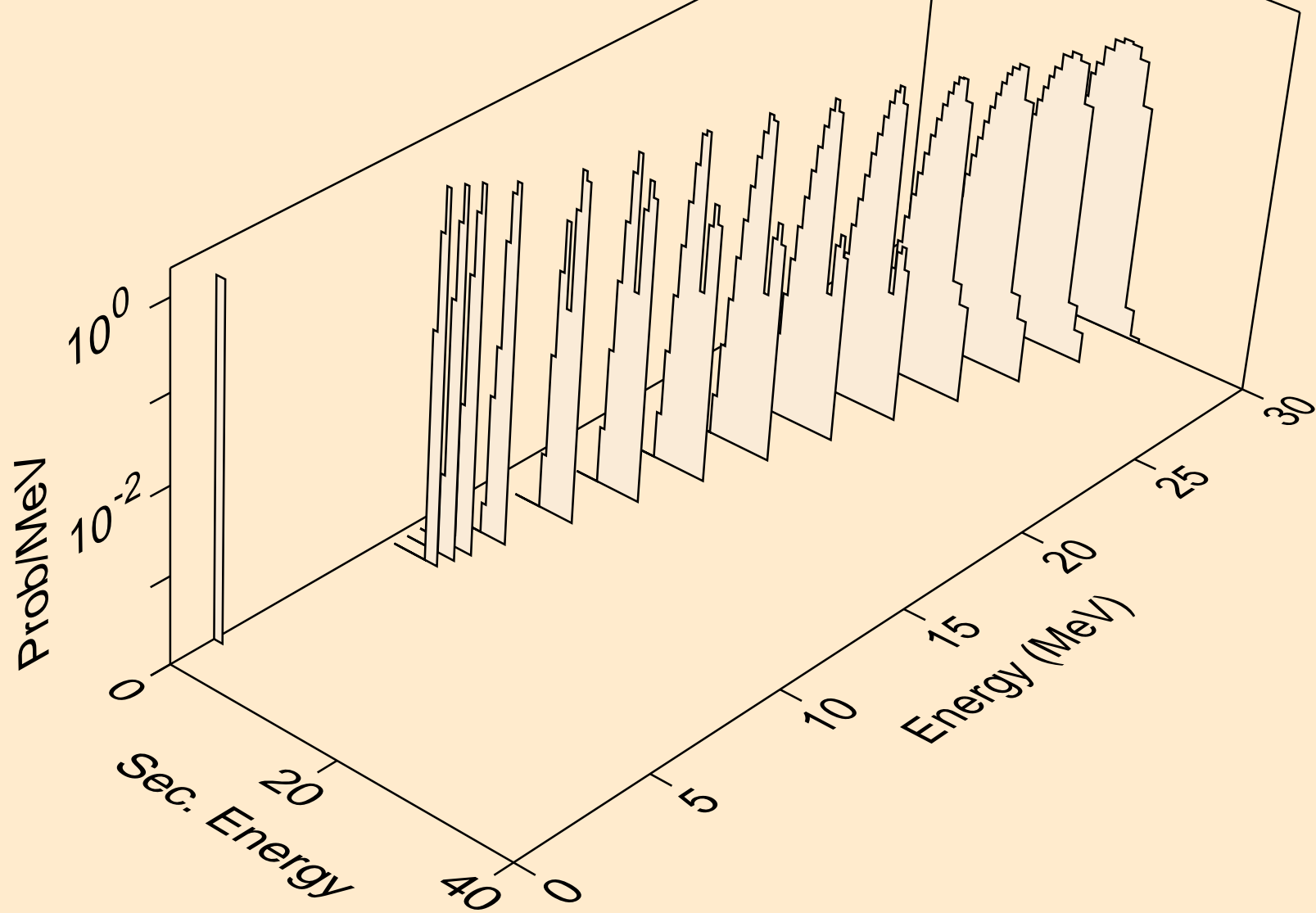

HG192 NEUTRON ACER TENDL-2024 LIBRARY; T=0.K
alphas from (n,x)

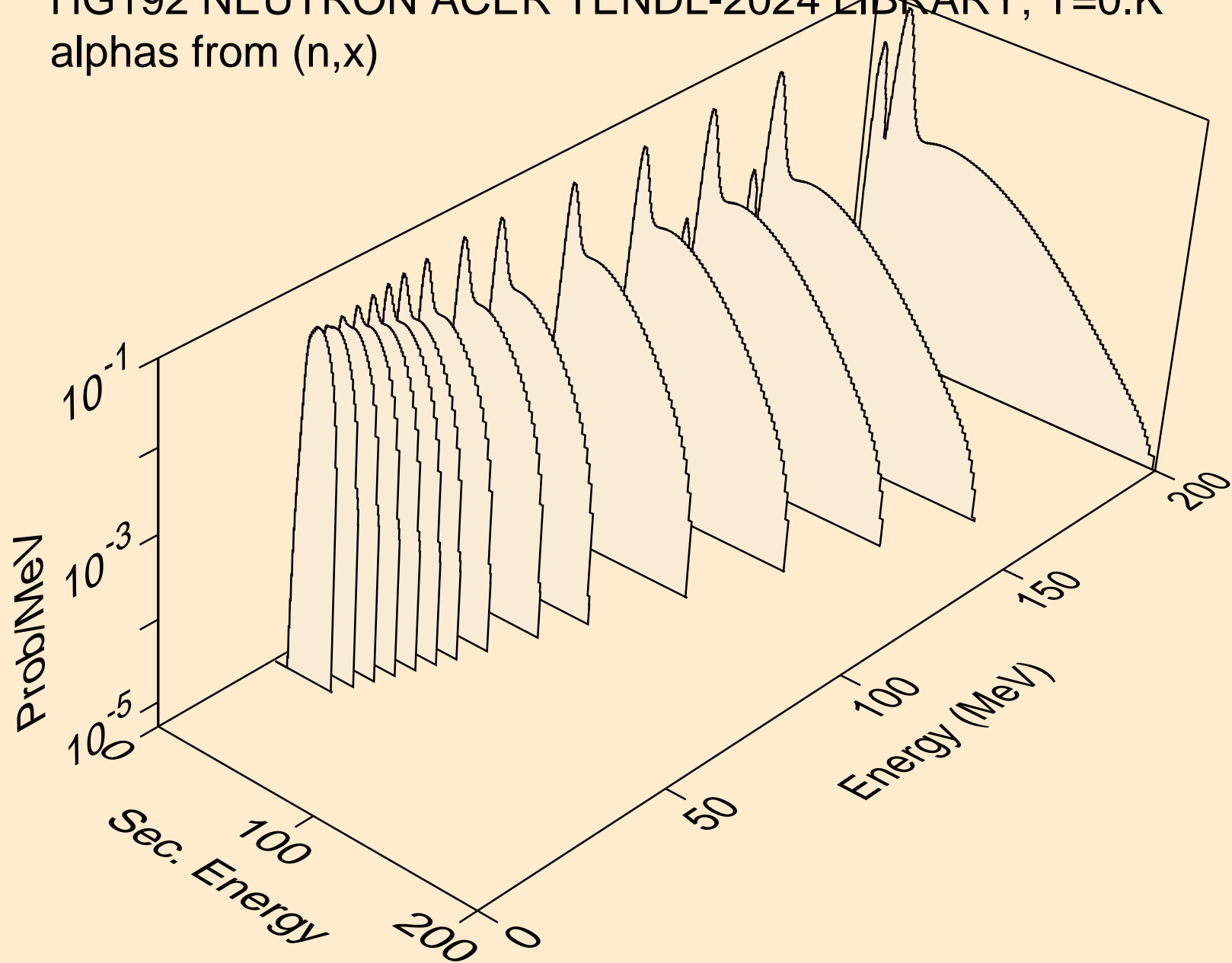

HG192 NEUTRON ACER TENDL-2024 LIBRARY; T=0.K
alphas from (n,n*)a

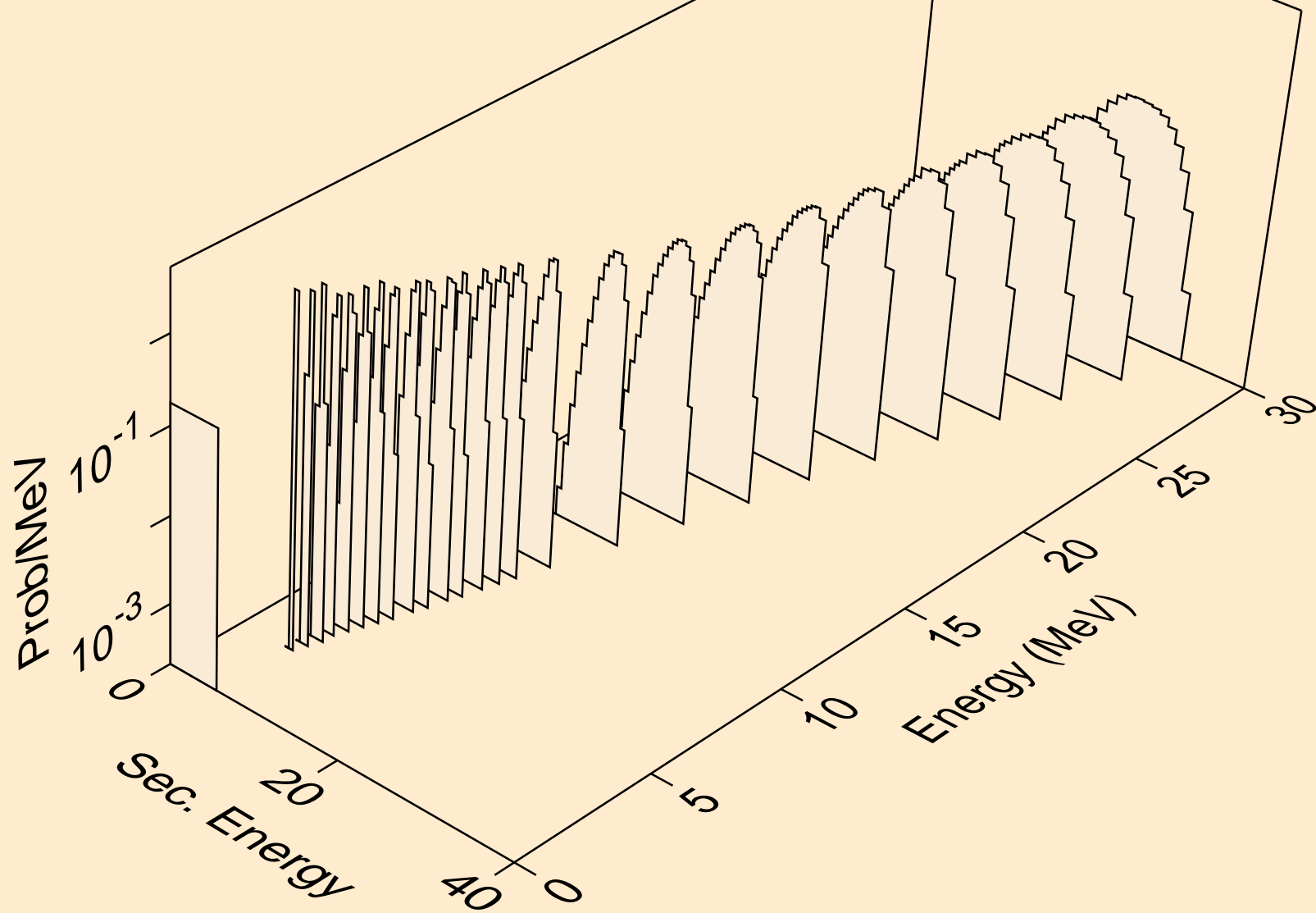

HG192 NEUTRON ACER TENDL-2024 LIBRARY; T=0.K
alphas from (n,2n)a

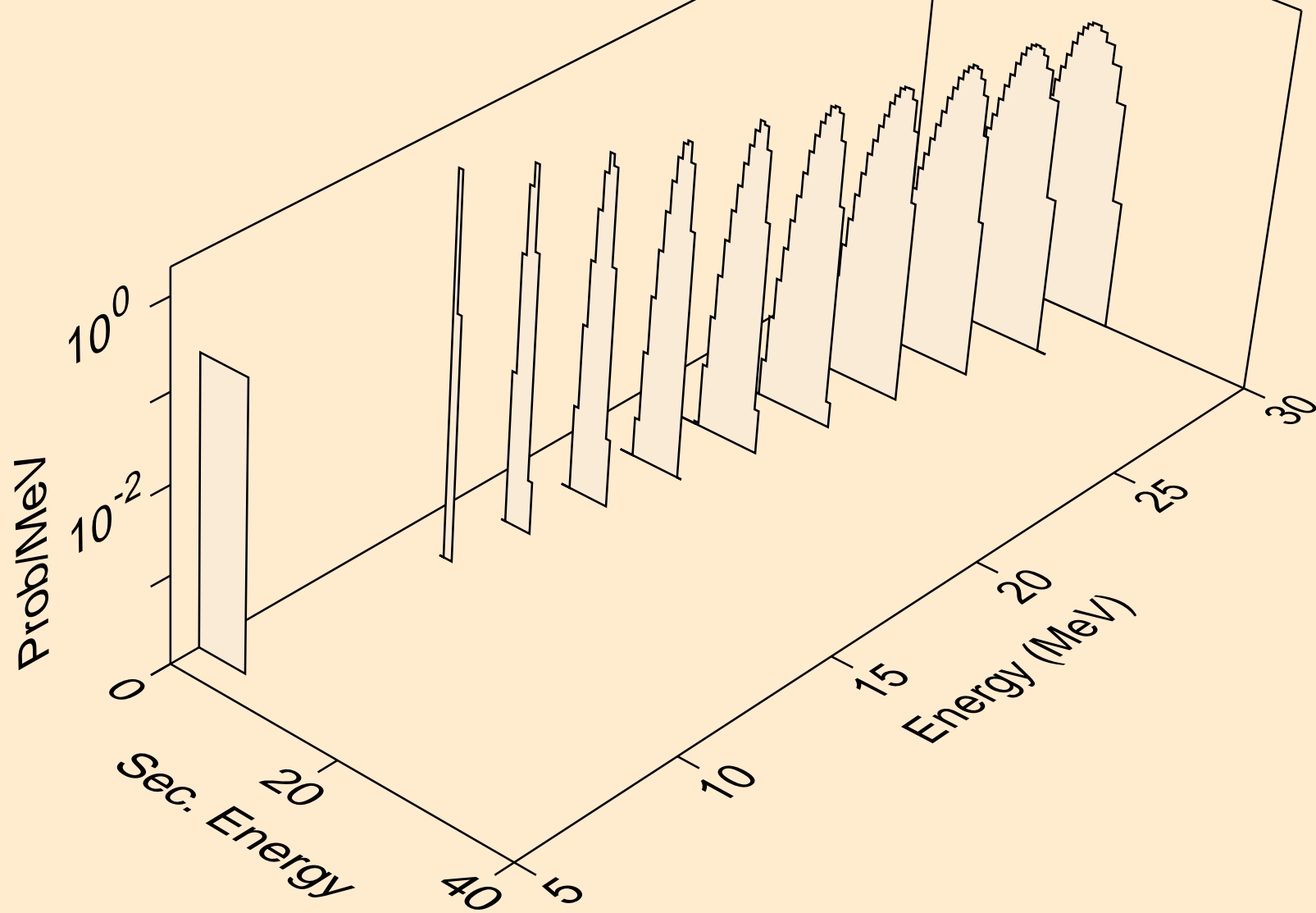

HG192 NEUTRON ACER TENDL-2024 LIBRARY; T=0.K
alphas from (n,3n)a

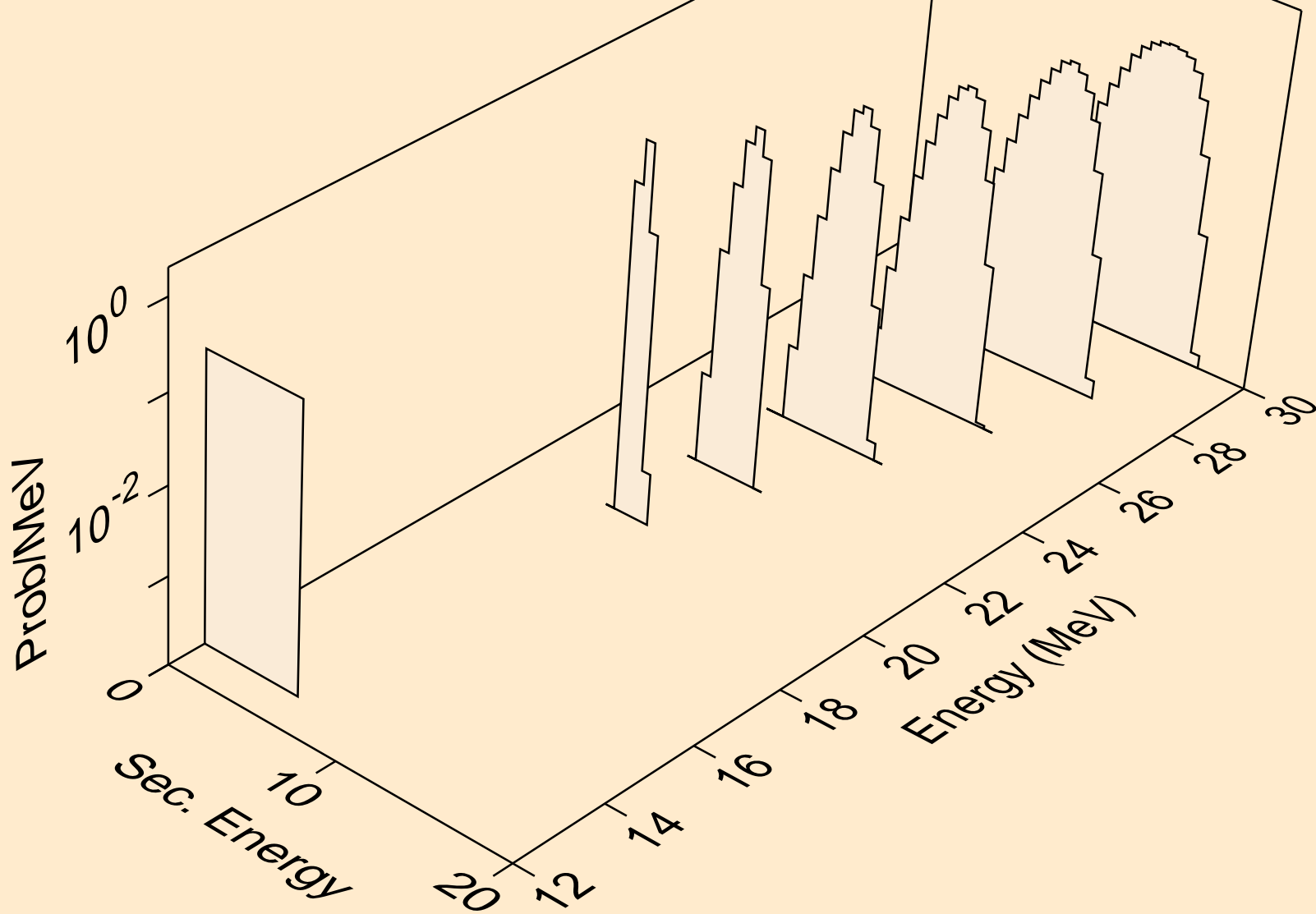

HG192 NEUTRON ACER TENDL-2024 LIBRARY; T=0.K
alphas from (n,n*)2a

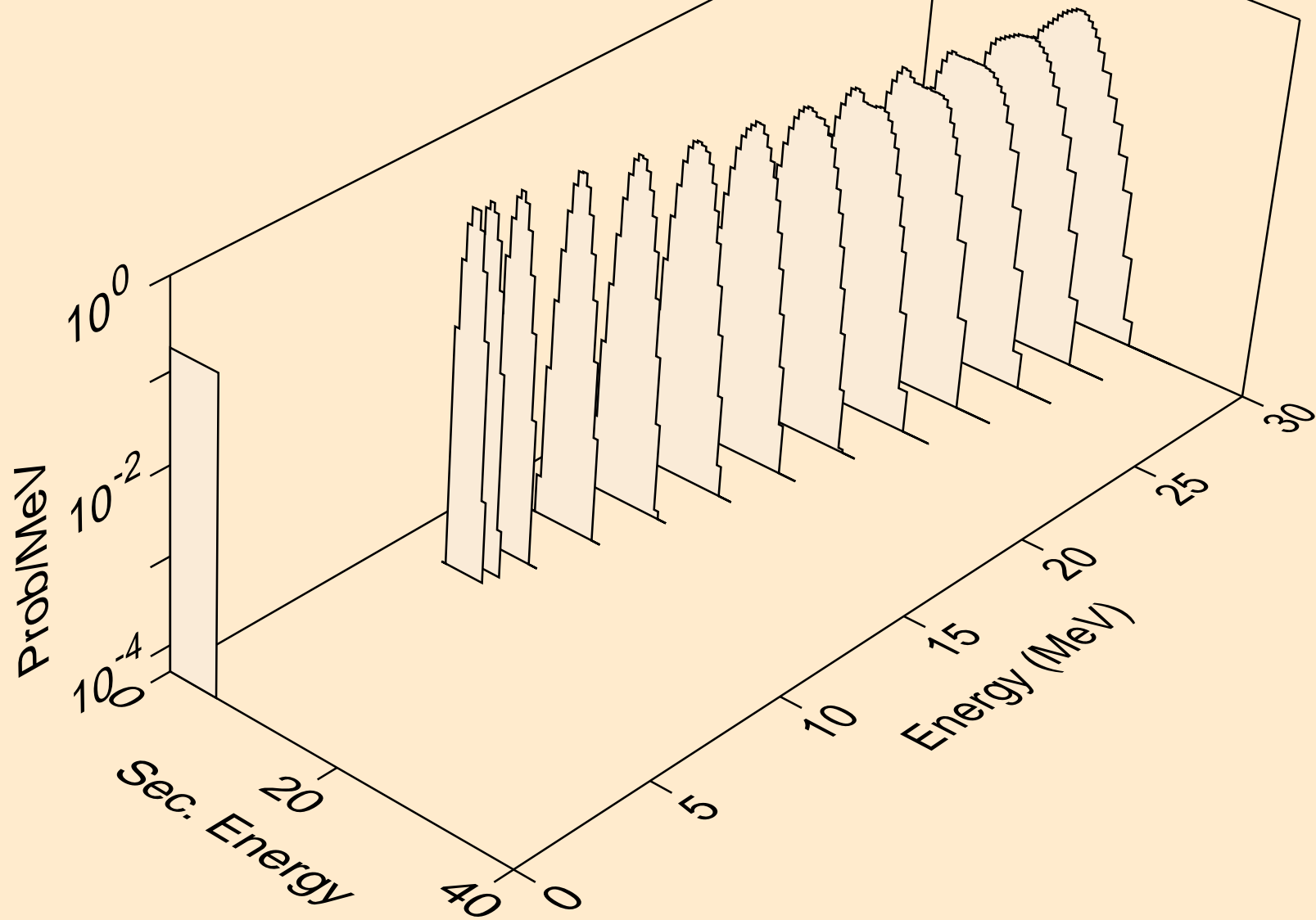

HG192 NEUTRON ACER TENDL-2024 LIBRARY; T=0.K
alphas from (n,2n)2a

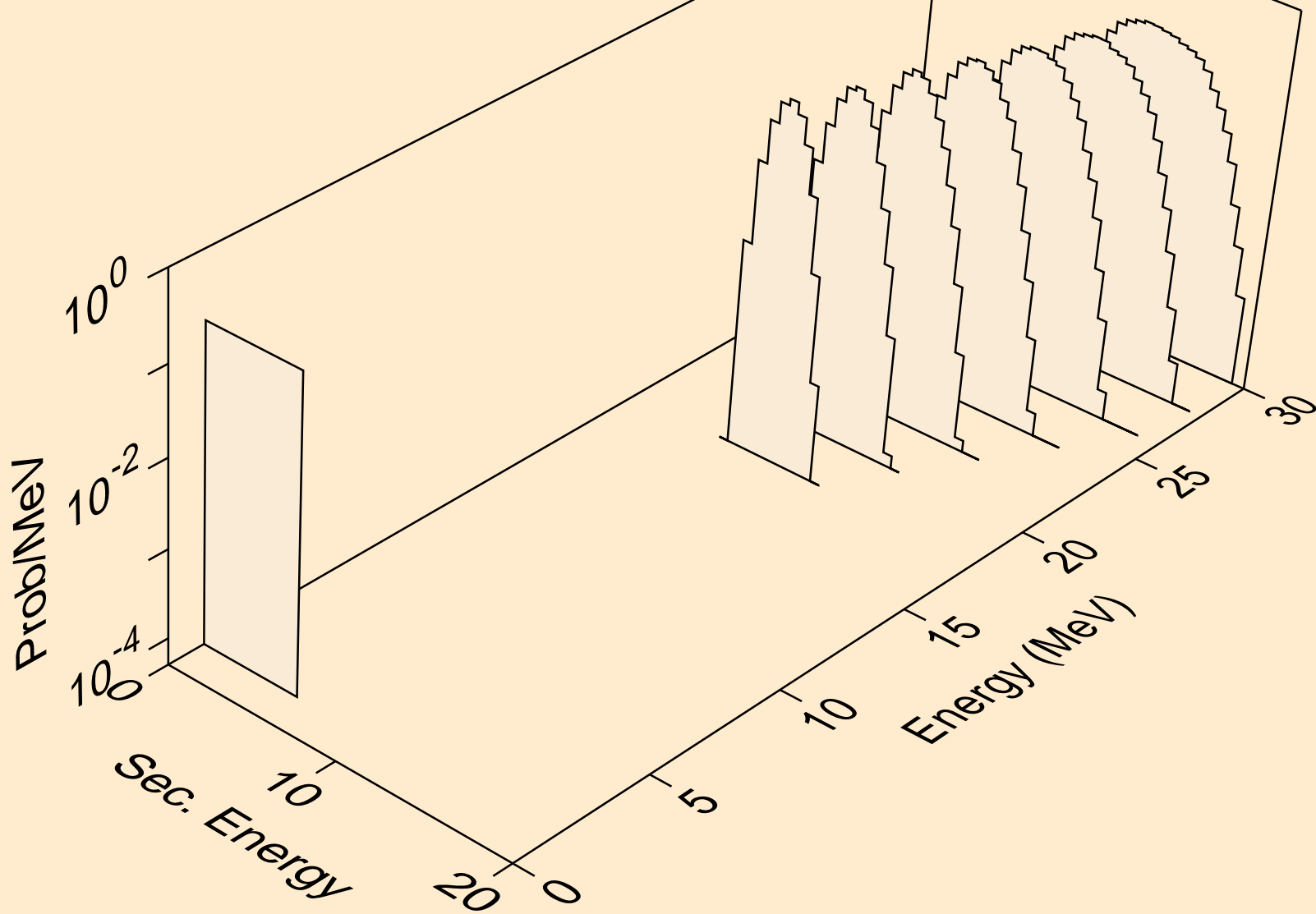

HG192 NEUTRON ACER TENDL-2024 LIBRARY; T=0.K
alphas from (n,npa)

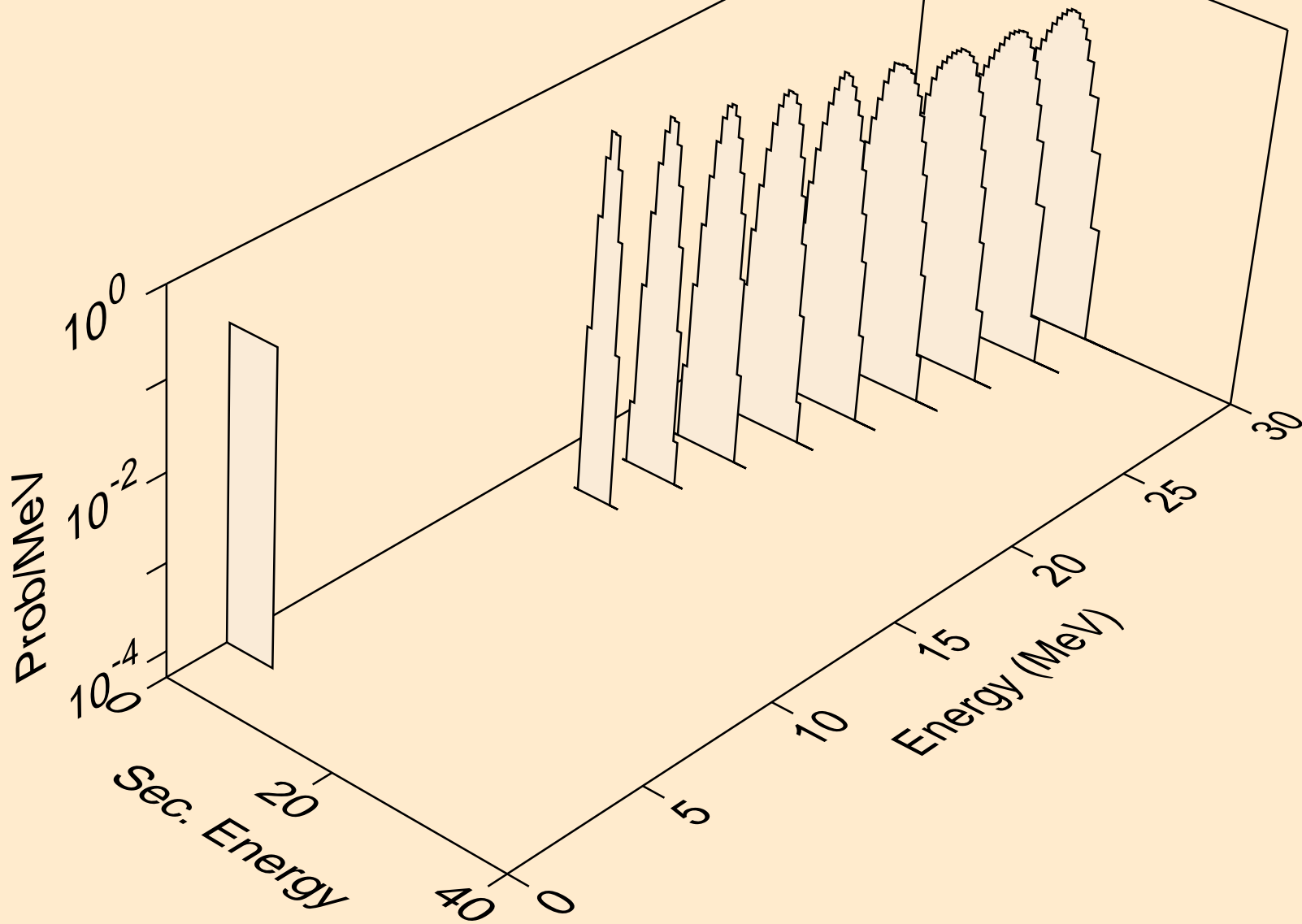

HG192 NEUTRON ACER TENDL-2024 LIBRARY; T=0.K
alphas from (n,a)

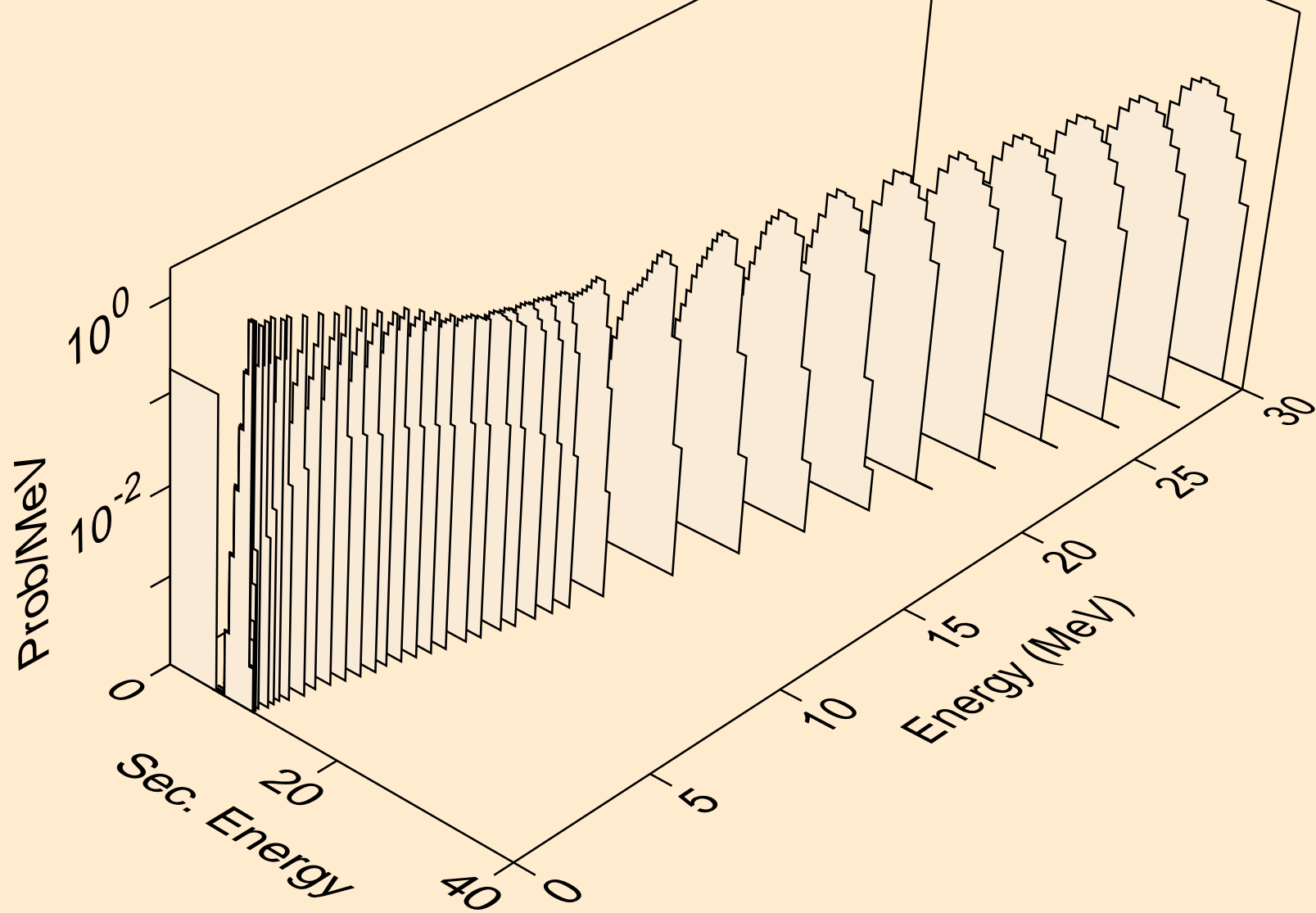

HG192 NEUTRON ACER TENDL-2024 LIBRARY; T=0.K
alphas from (n,2a)

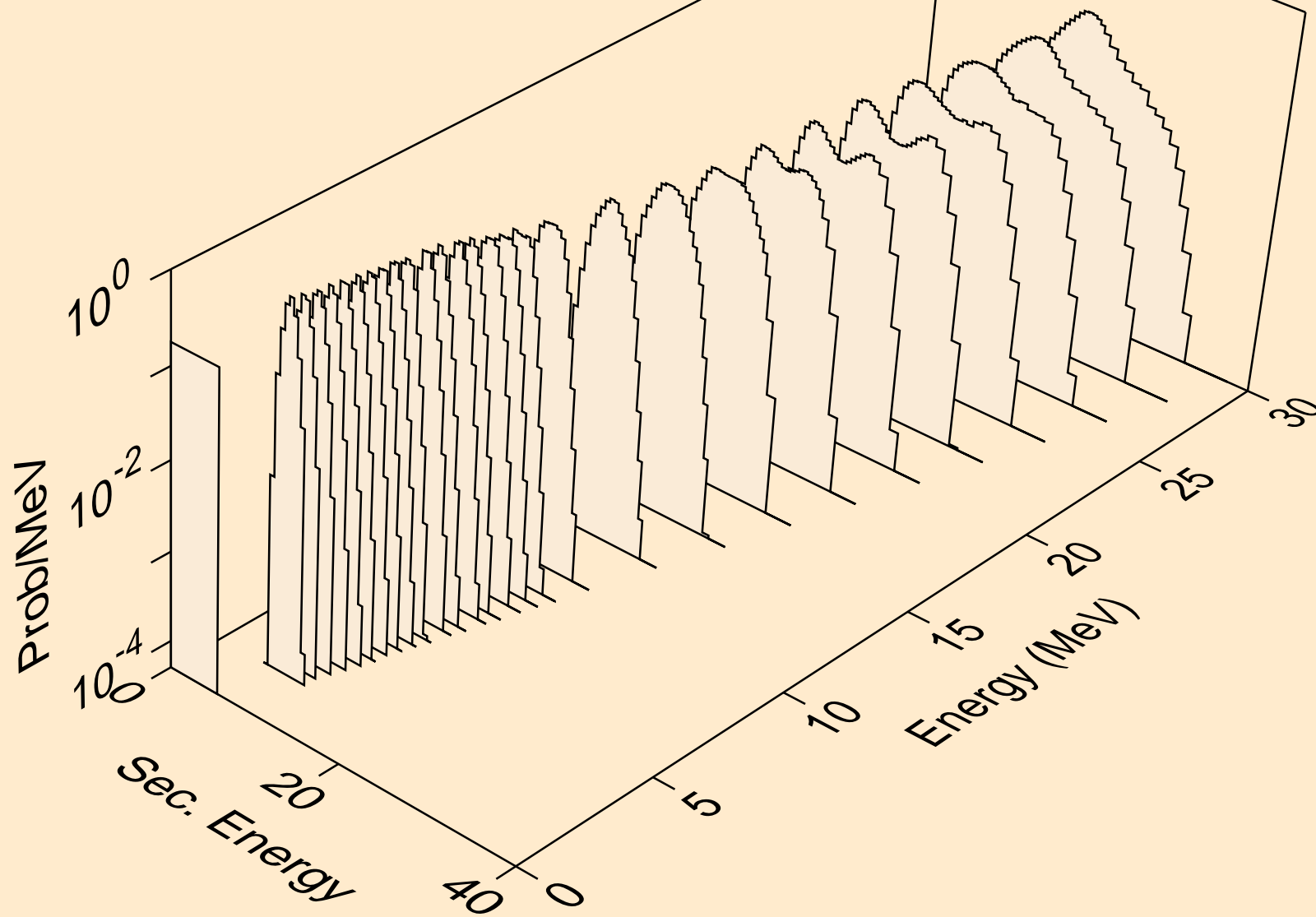

HG192 NEUTRON ACER TENDL-2024 LIBRARY; T=0.K
alphas from (n,pa)

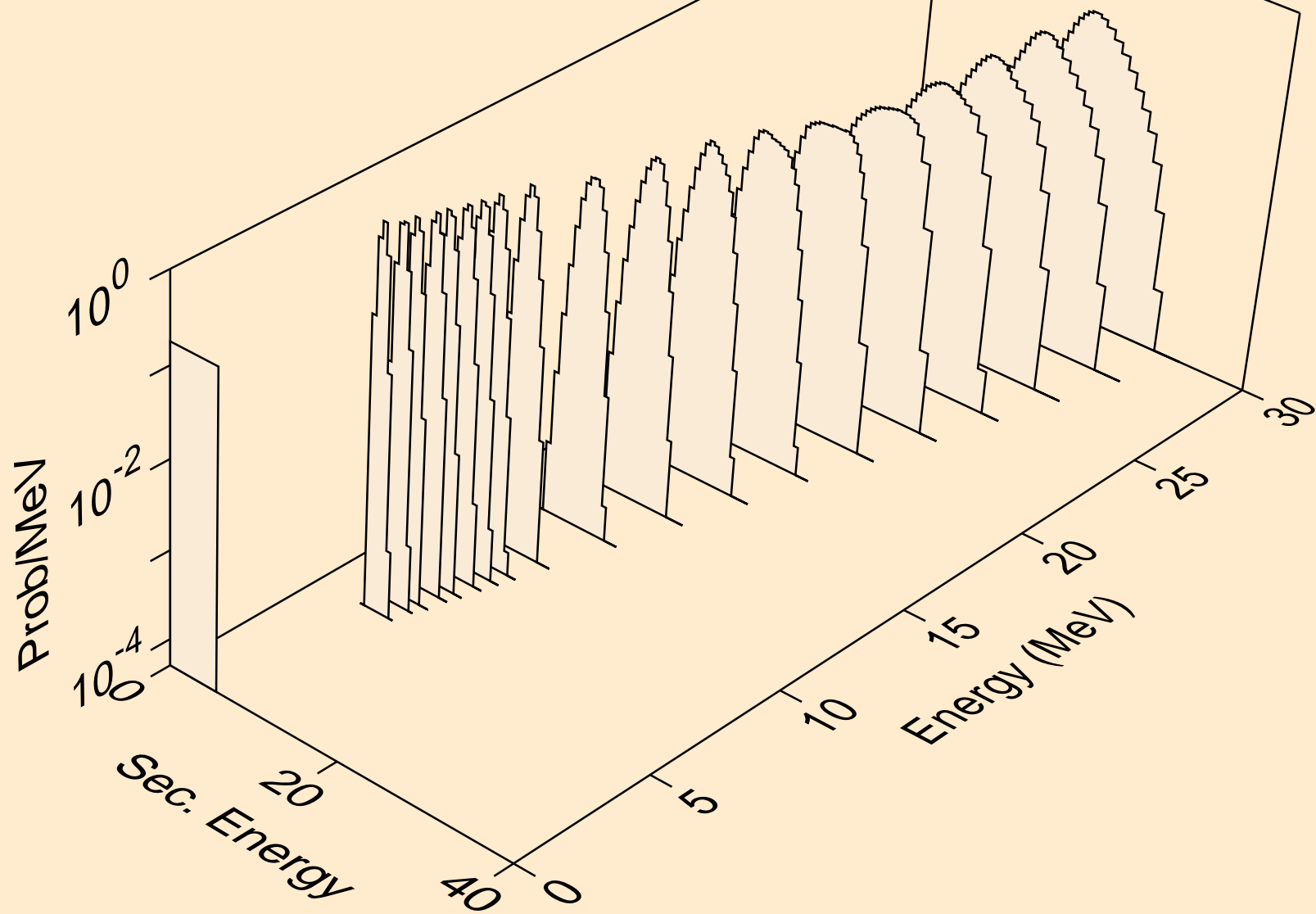

HG192 NEUTRON ACER TENDL-2024 LIBRARY; T=0.K
alphas from (n,da)

