

HO148 NEUTRON ACER TENDL-2024 LIBRARY; T=0.K

Principal cross sections

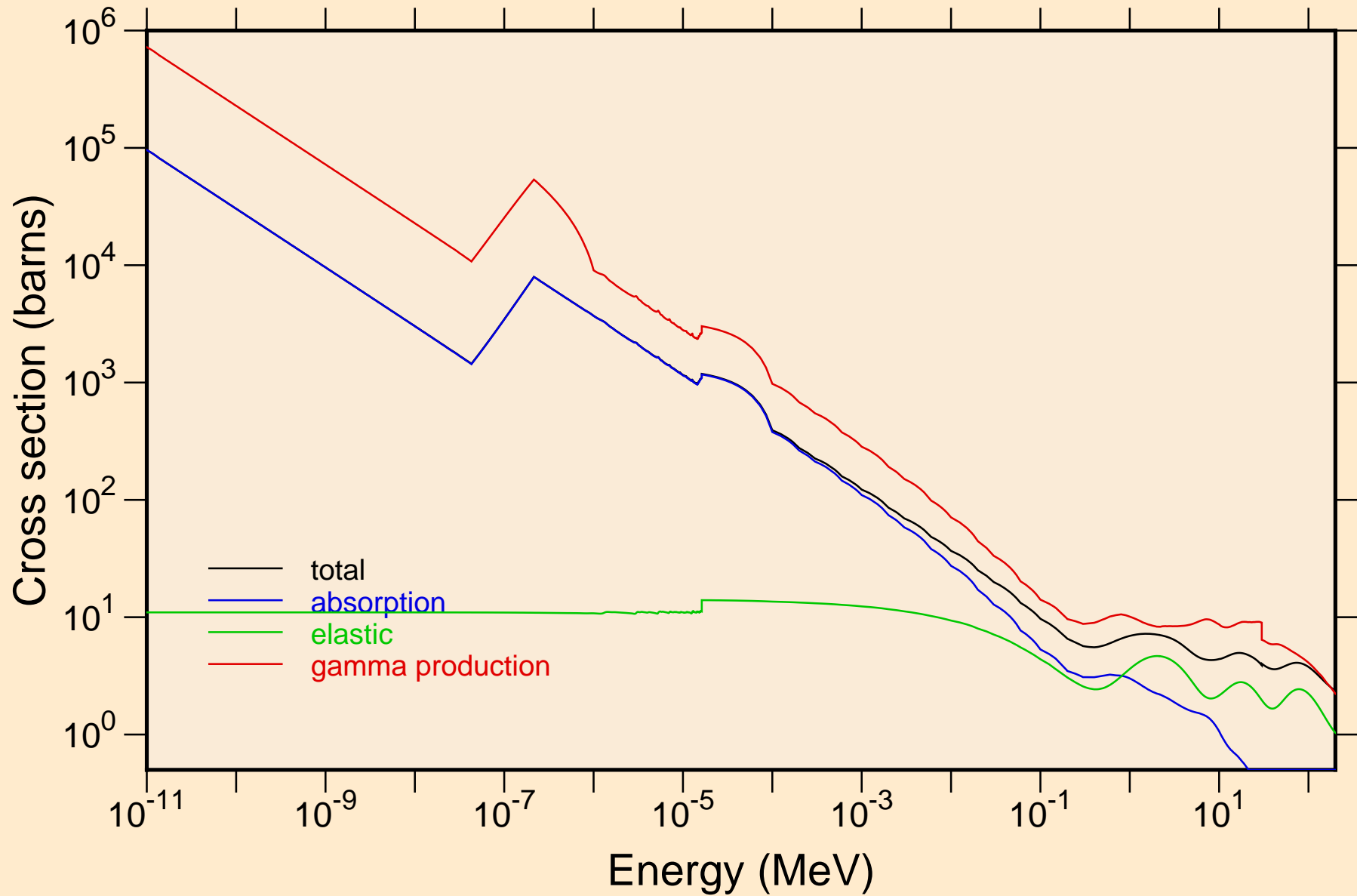

HO148 NEUTRON ACER TENDL-2024 LIBRARY; T=0.K
resonance total cross section

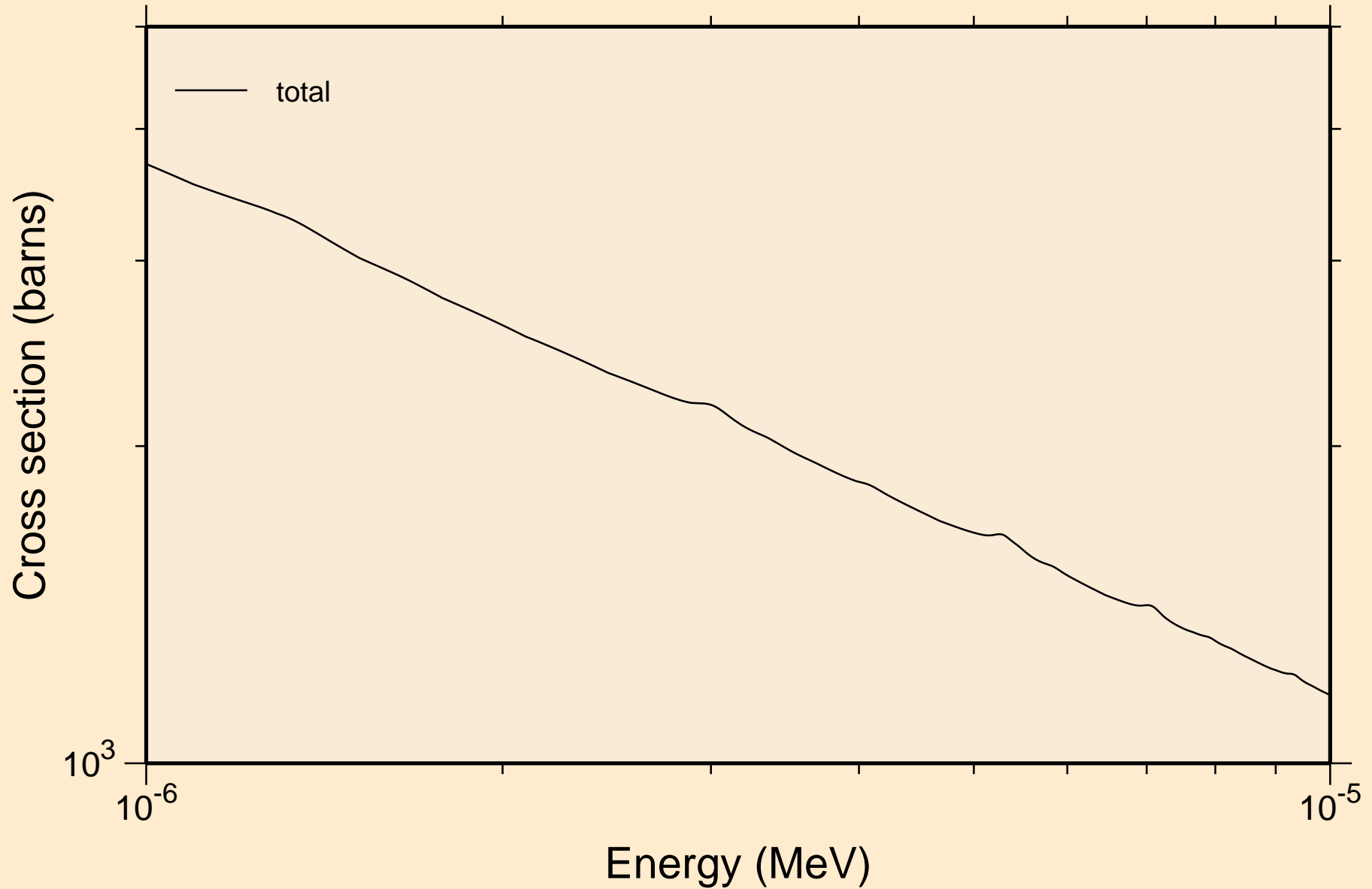

HO148 NEUTRON ACER TENDL-2024 LIBRARY; T=0.K
resonance total cross section

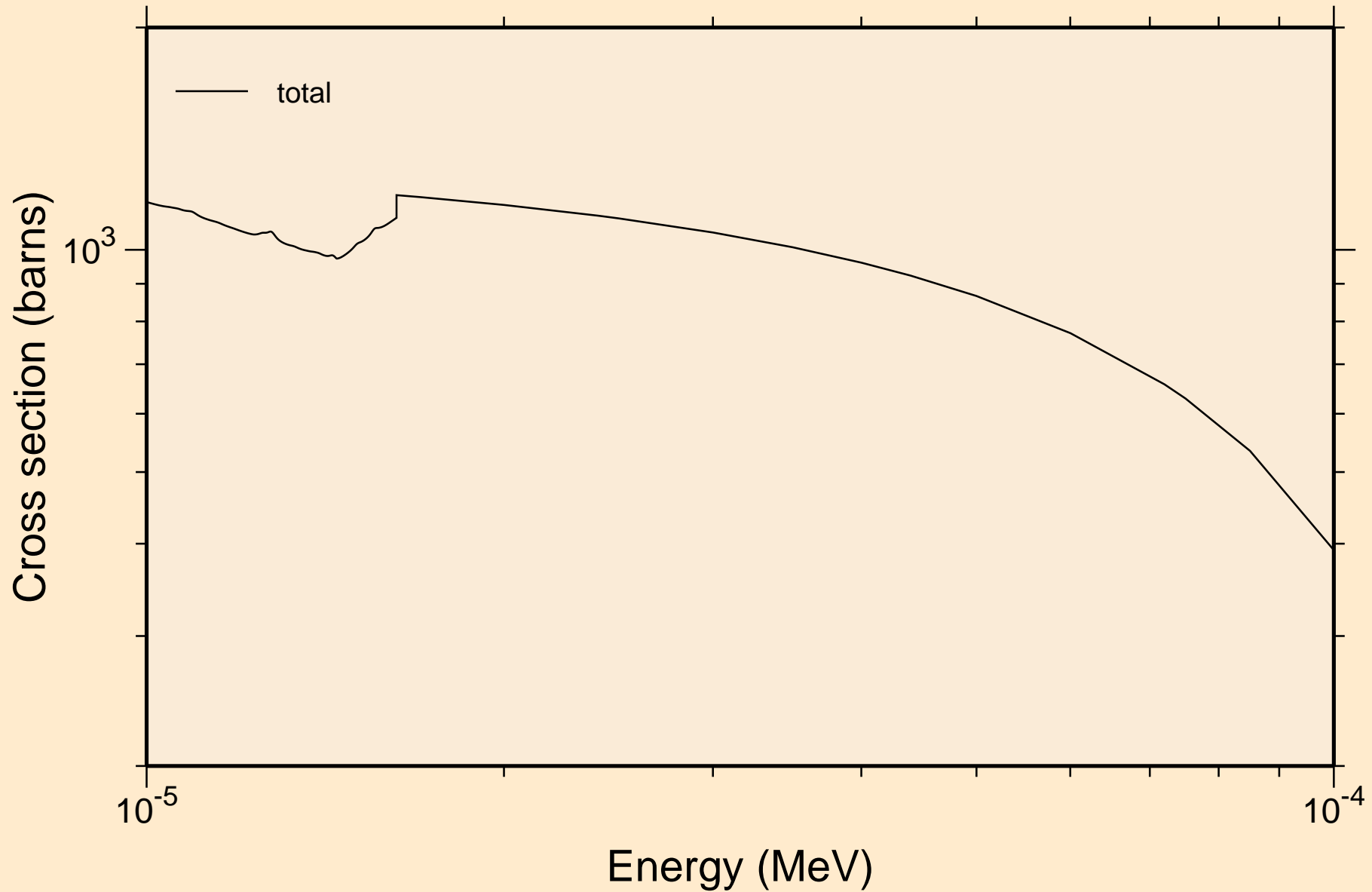

HO148 NEUTRON ACER TENDL-2024 LIBRARY; T=0.K
resonance total cross section

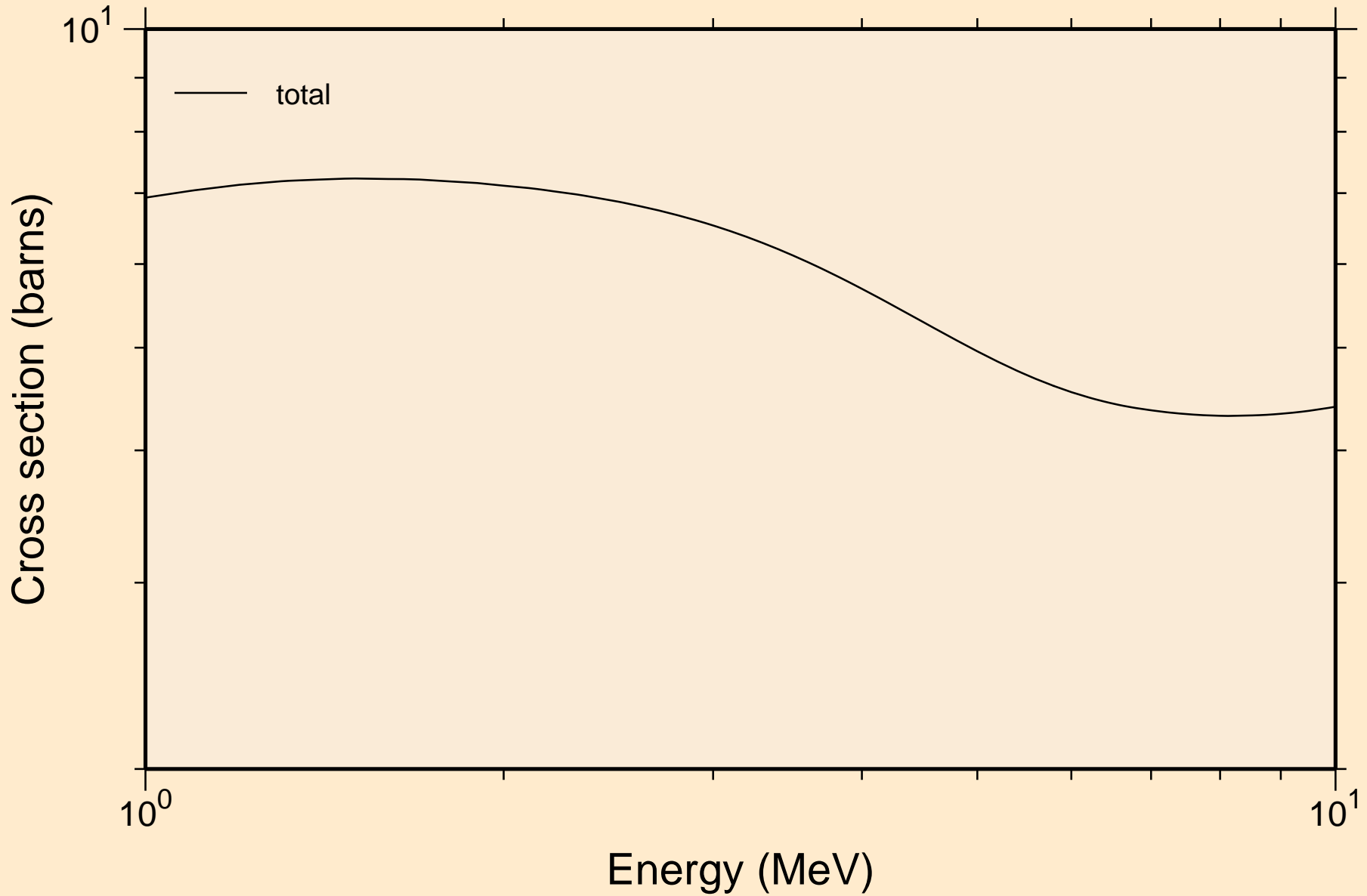

HO148 NEUTRON ACER TENDL-2024 LIBRARY; T=0.K
resonance absorption cross sections

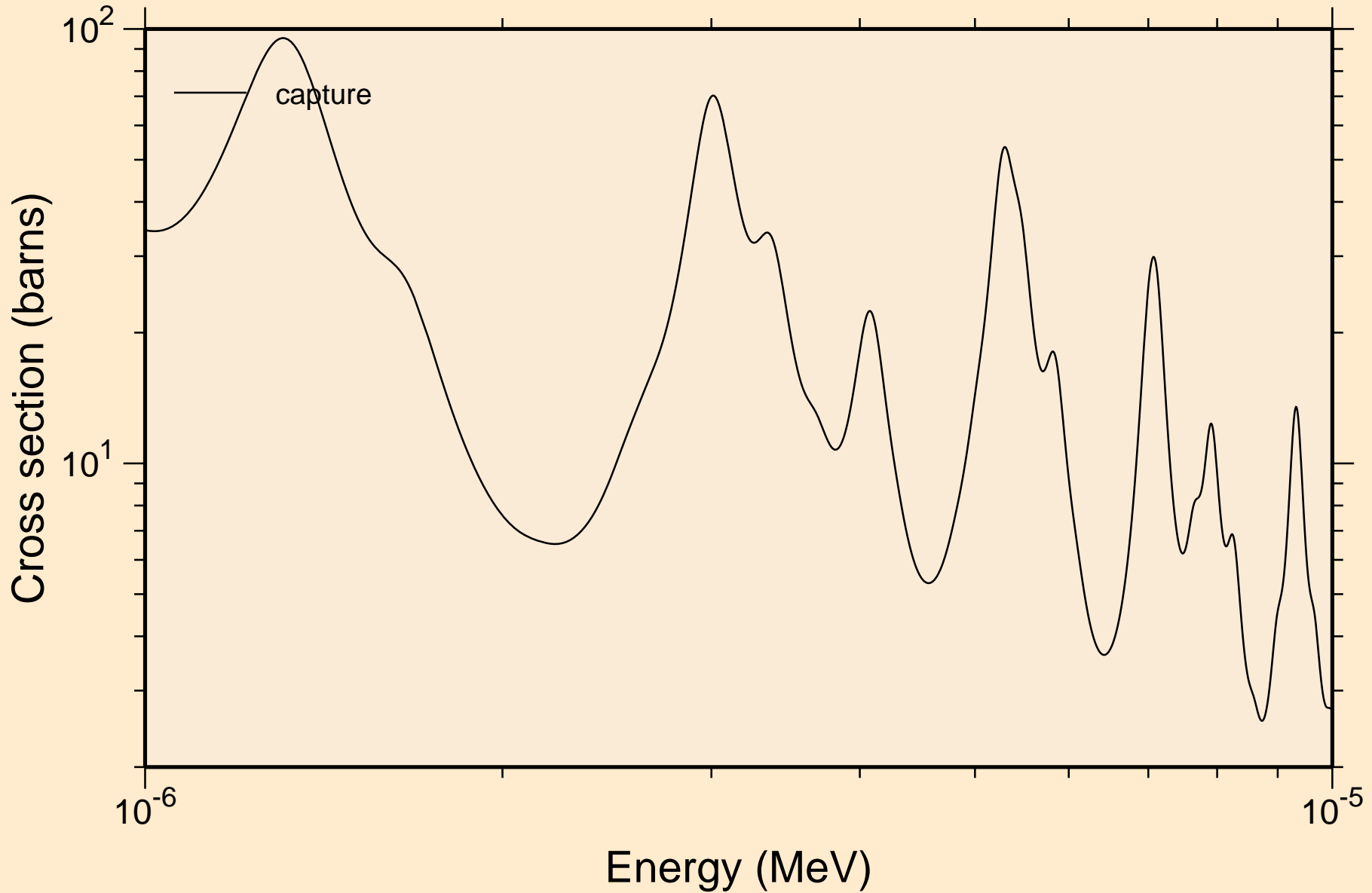

HO148 NEUTRON ACER TENDL-2024 LIBRARY; T=0.K
resonance absorption cross sections

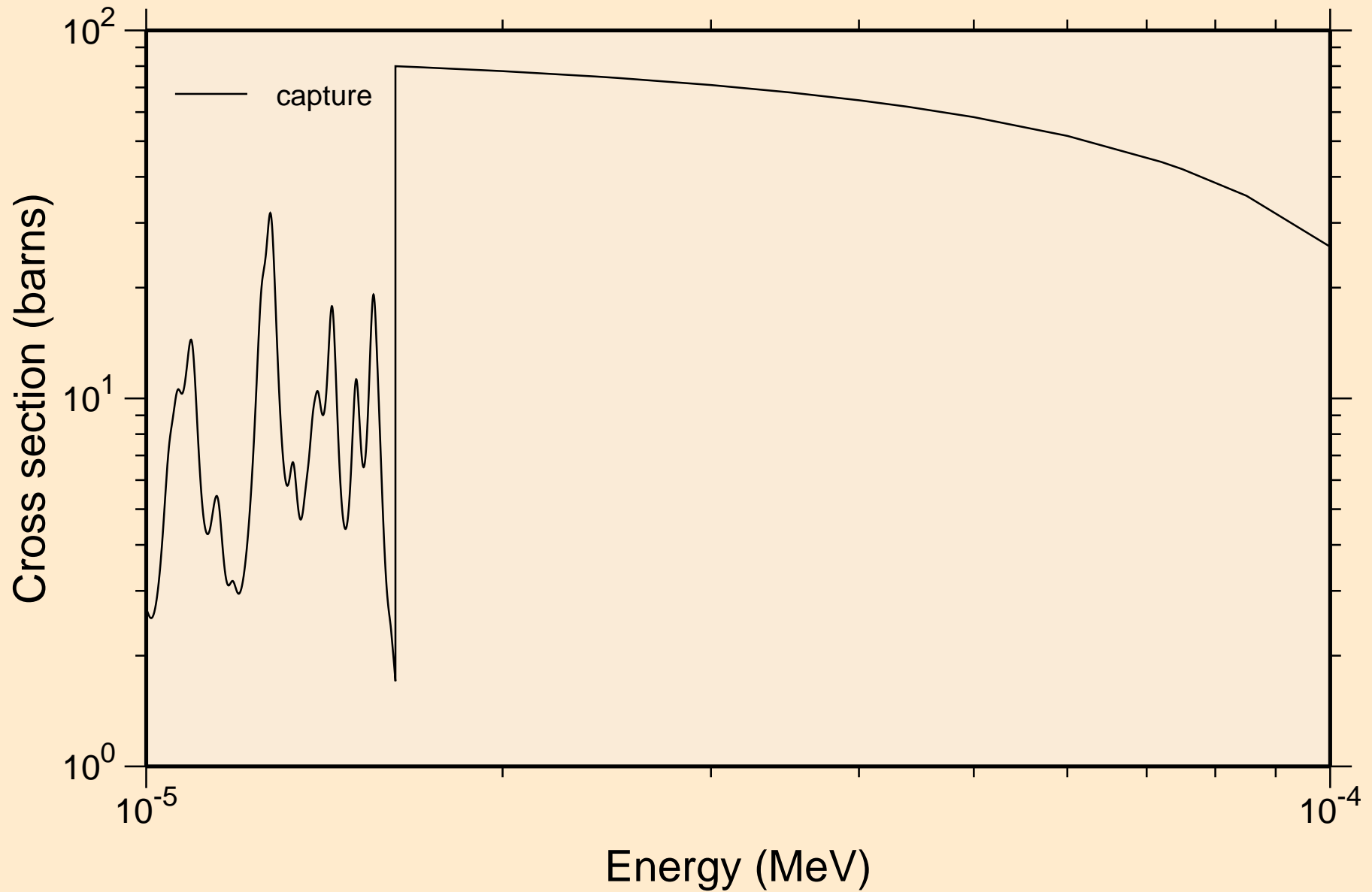

HO148 NEUTRON ACER TENDL-2024 LIBRARY; T=0.K
resonance absorption cross sections

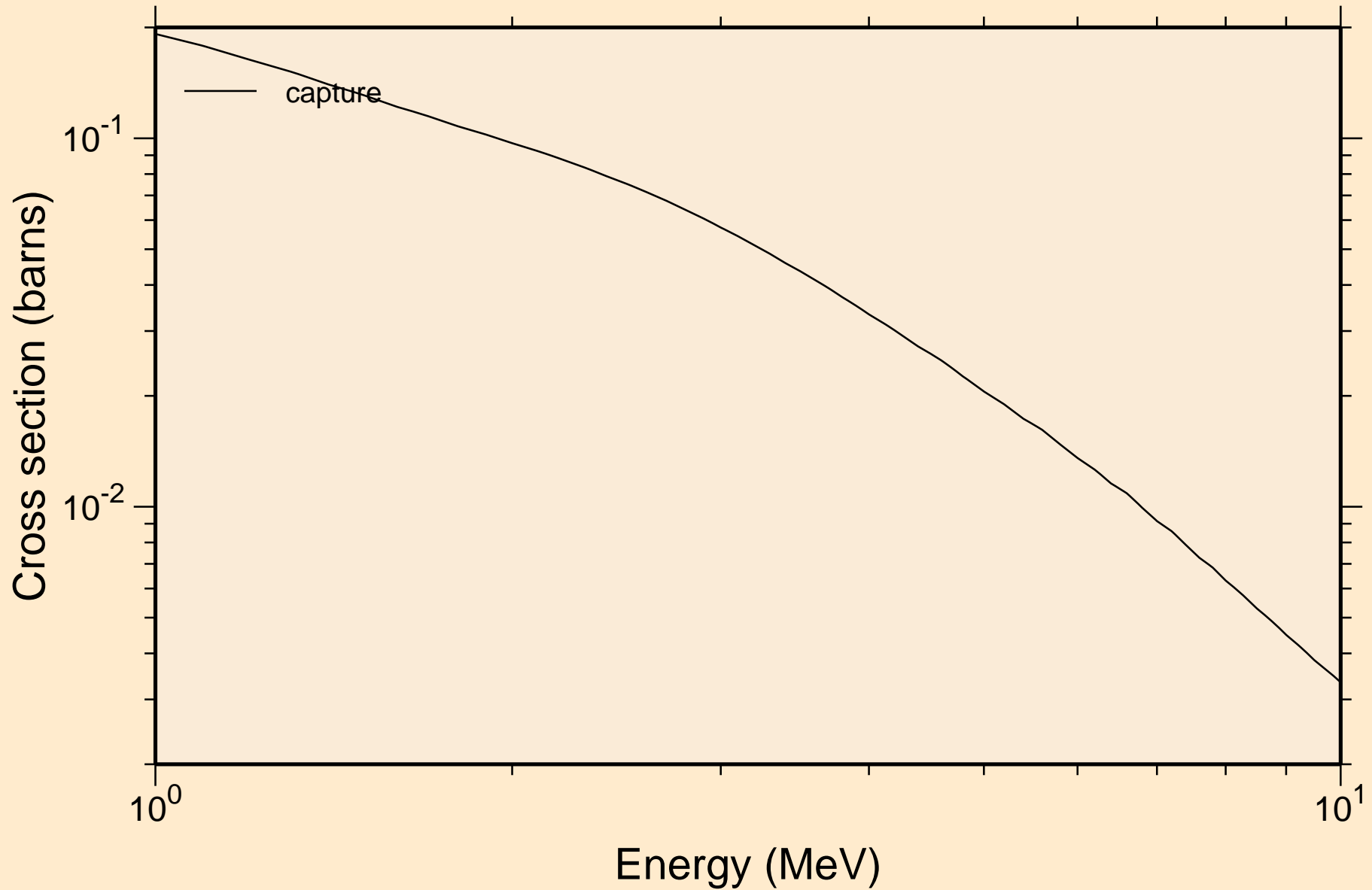

HO148 NEUTRON ACER TENDL-2024 LIBRARY; T=0.K

Heating

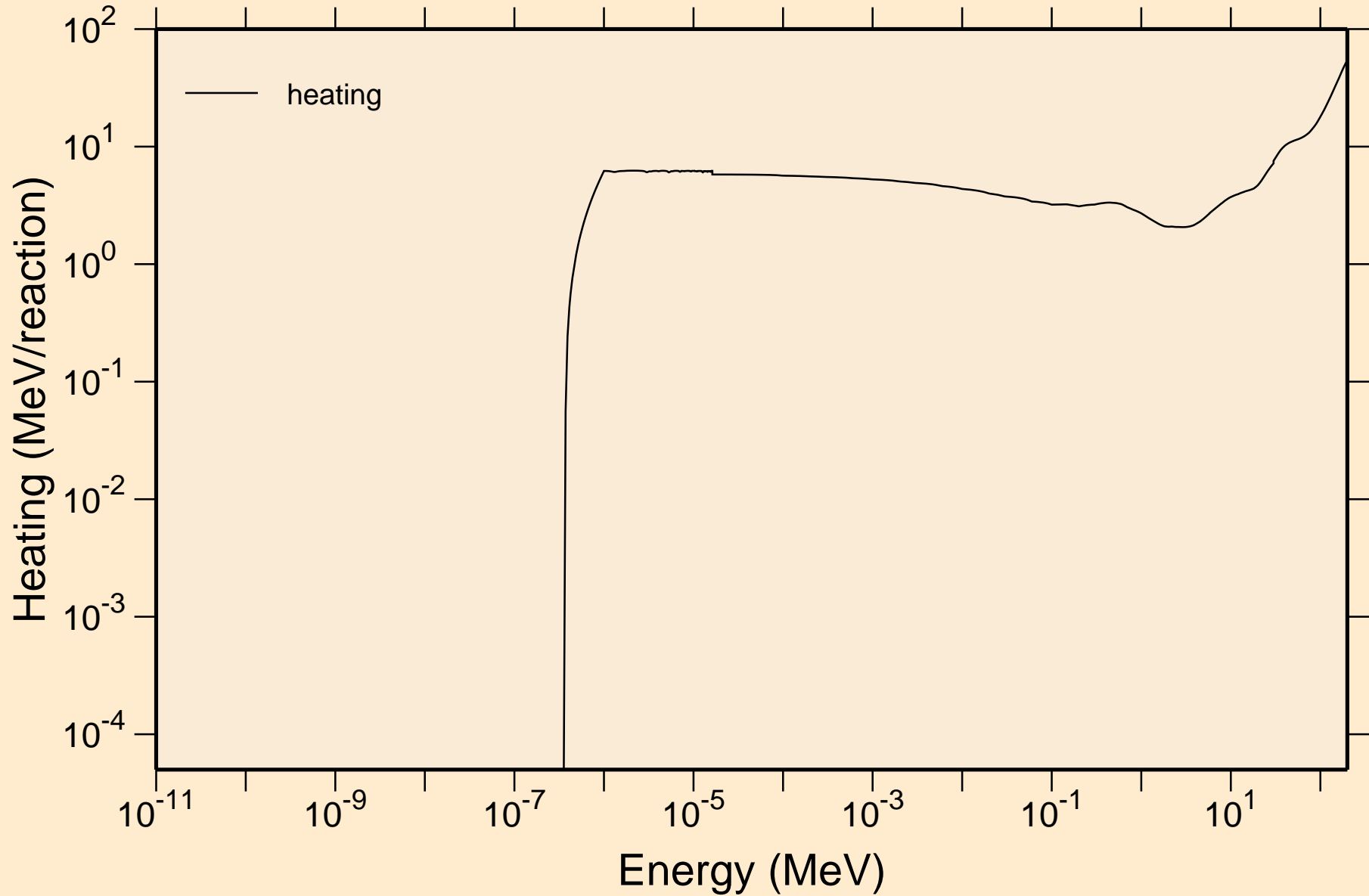

HO148 NEUTRON ACER TENDL-2024 LIBRARY; T=0.K

Damage

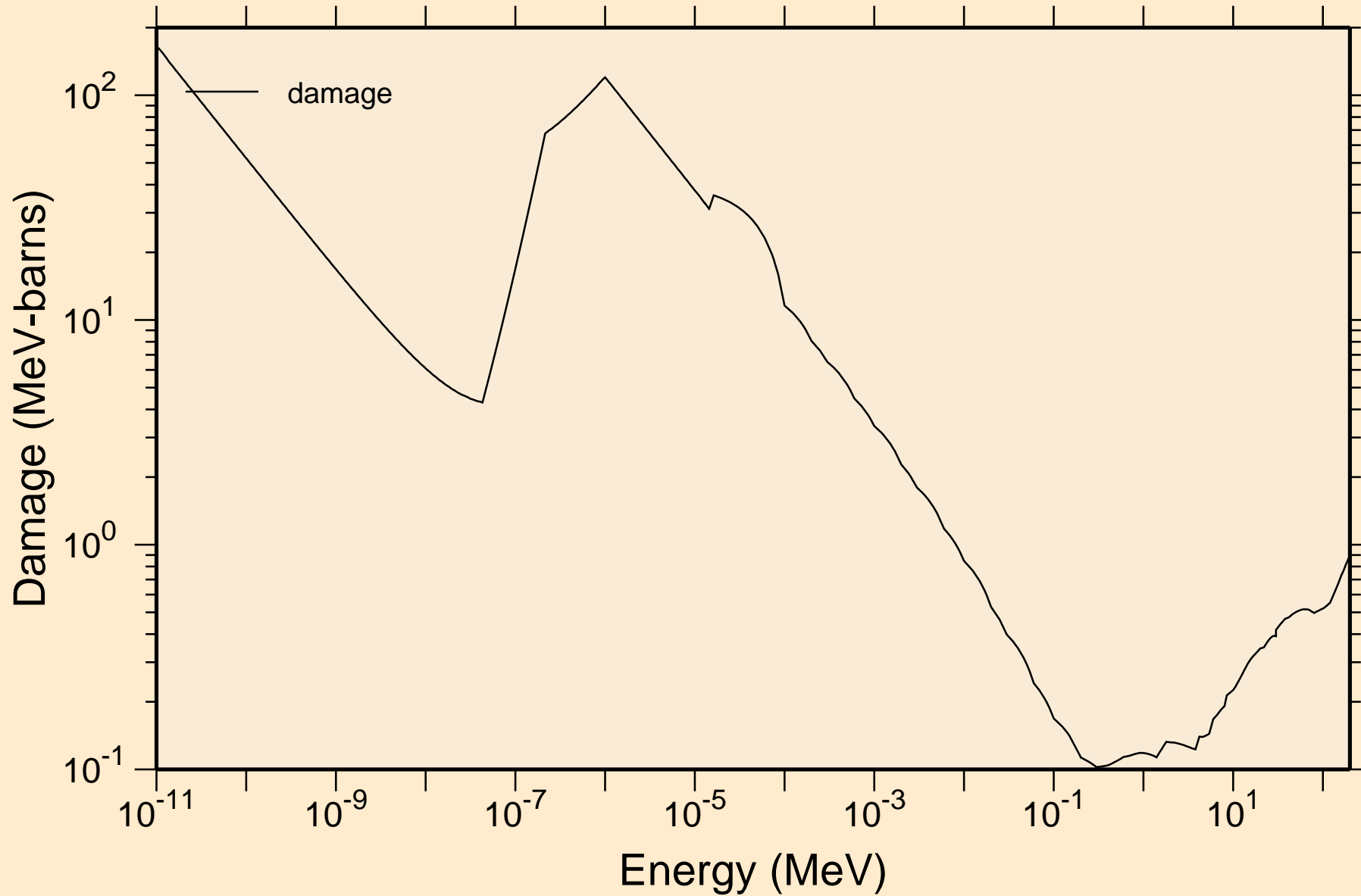

HO148 NEUTRON ACER TENDL-2024 LIBRARY; T=0.K

Non-threshold reactions

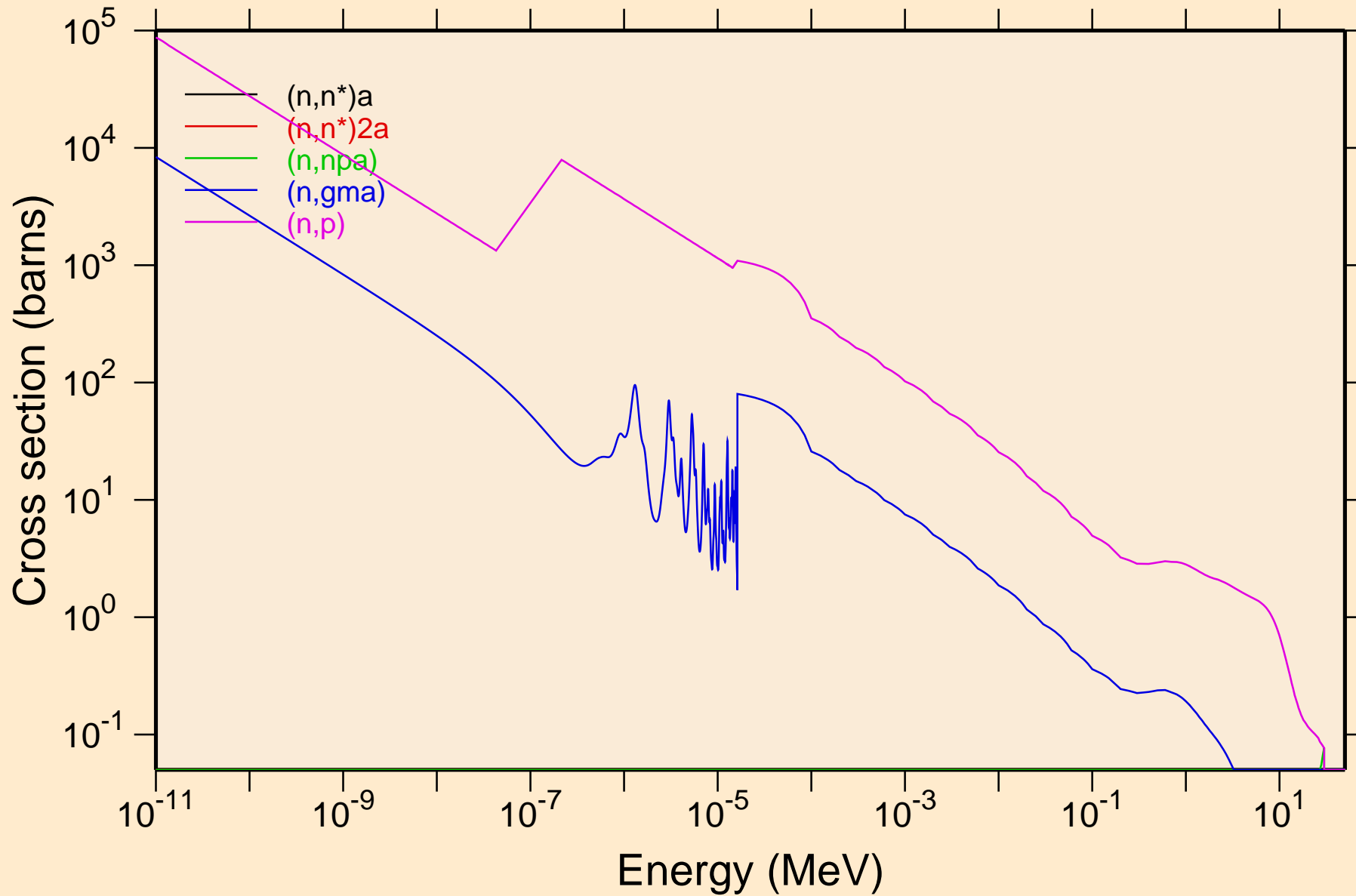

HO148 NEUTRON ACER TENDL-2024 LIBRARY; T=0.K

Non-threshold reactions

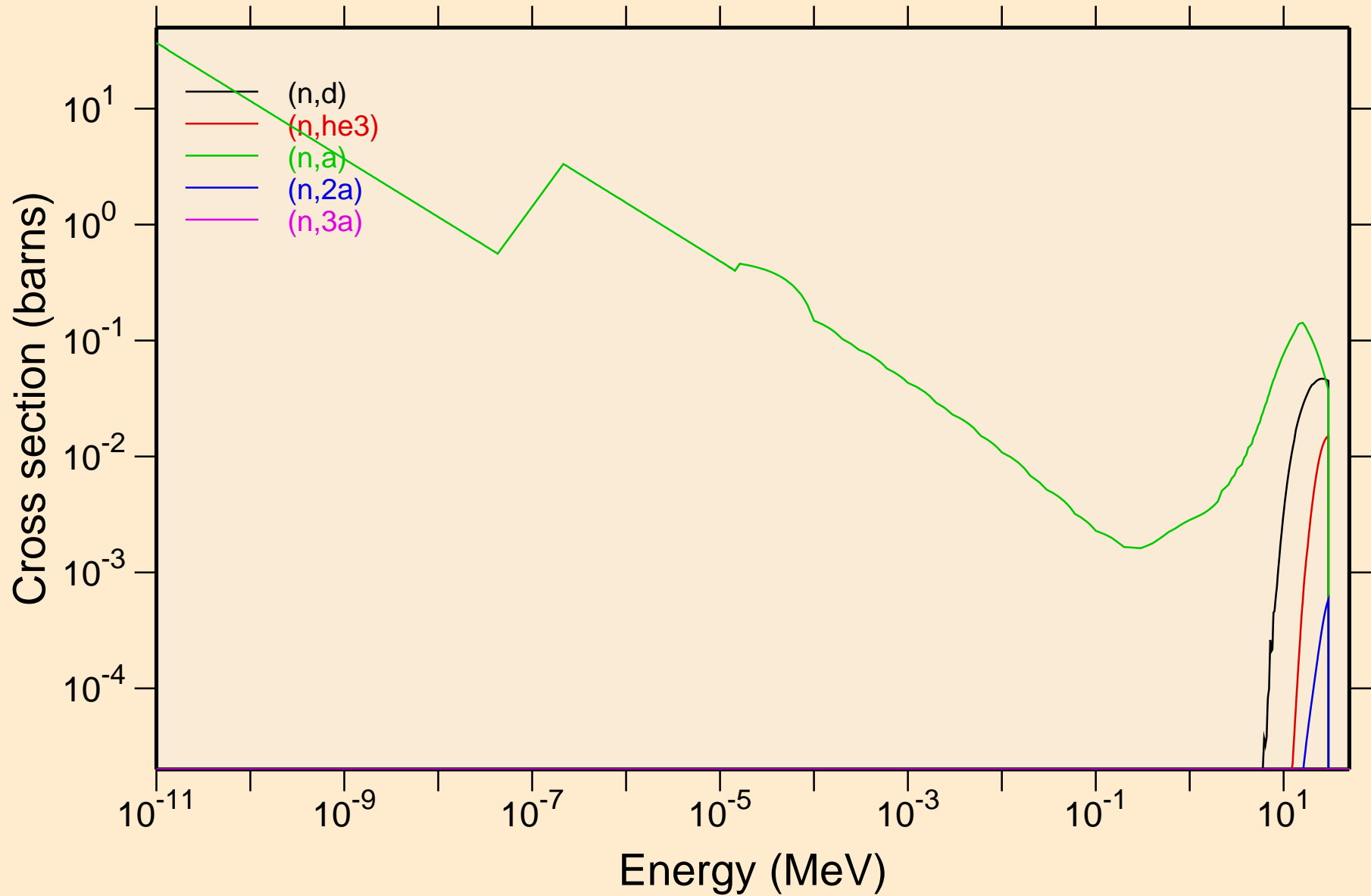

HO148 NEUTRON ACER TENDL-2024 LIBRARY; T=0.K

Non-threshold reactions

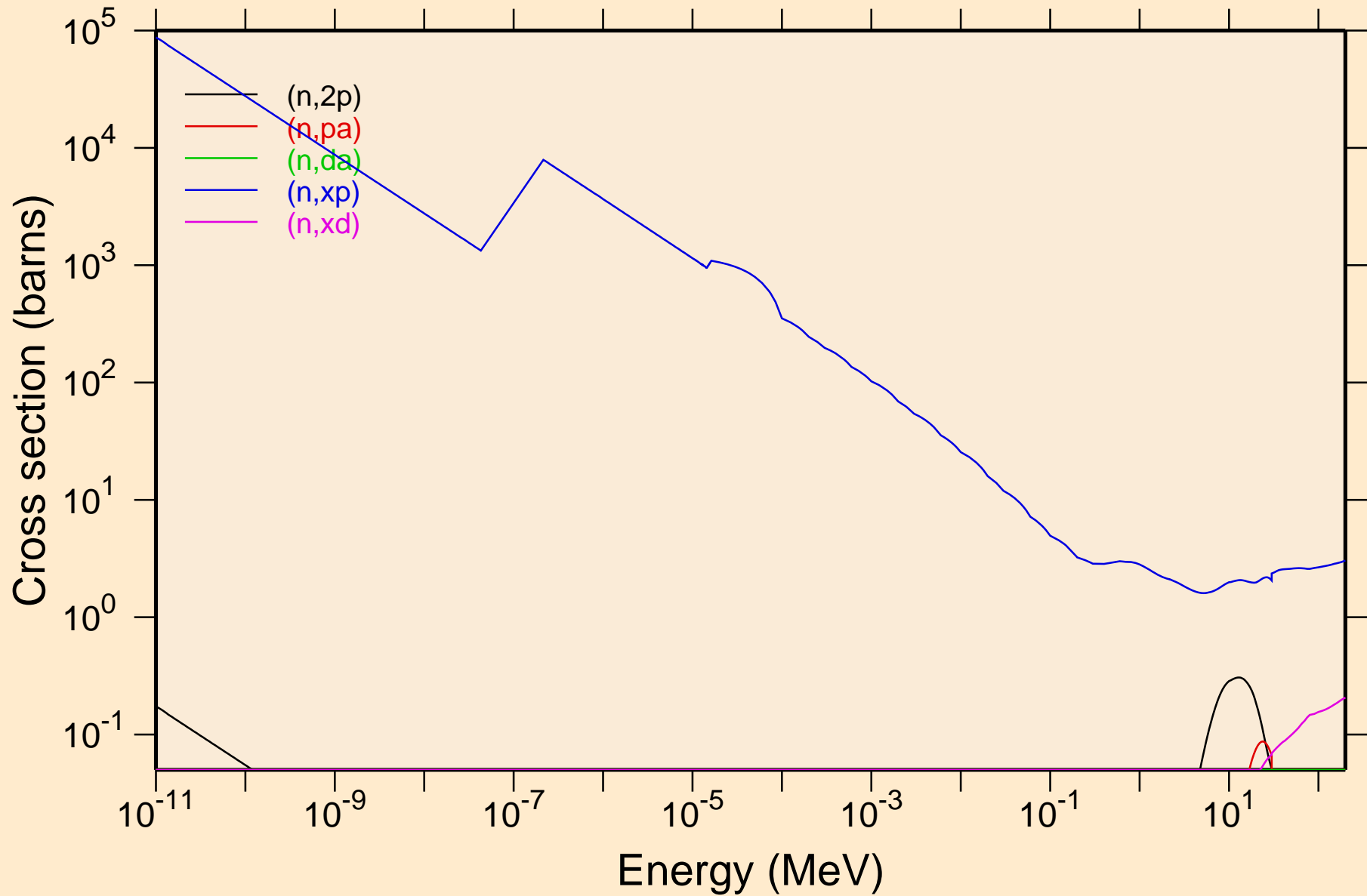

HO148 NEUTRON ACER TENDL-2024 LIBRARY; T=0.K
Non-threshold reactions

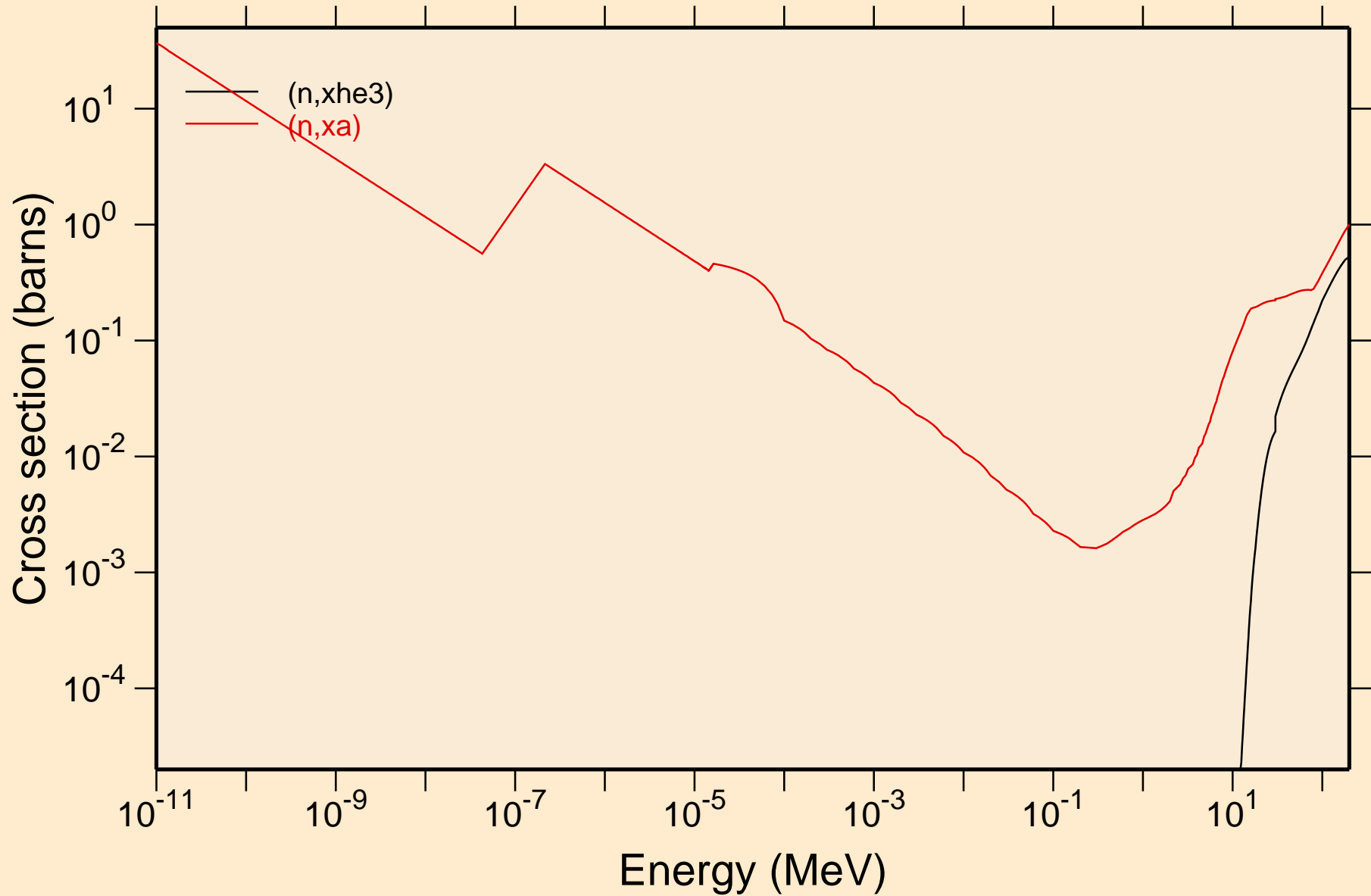

HO148 NEUTRON ACER TENDL-2024 LIBRARY; T=0.K

Principal cross sections

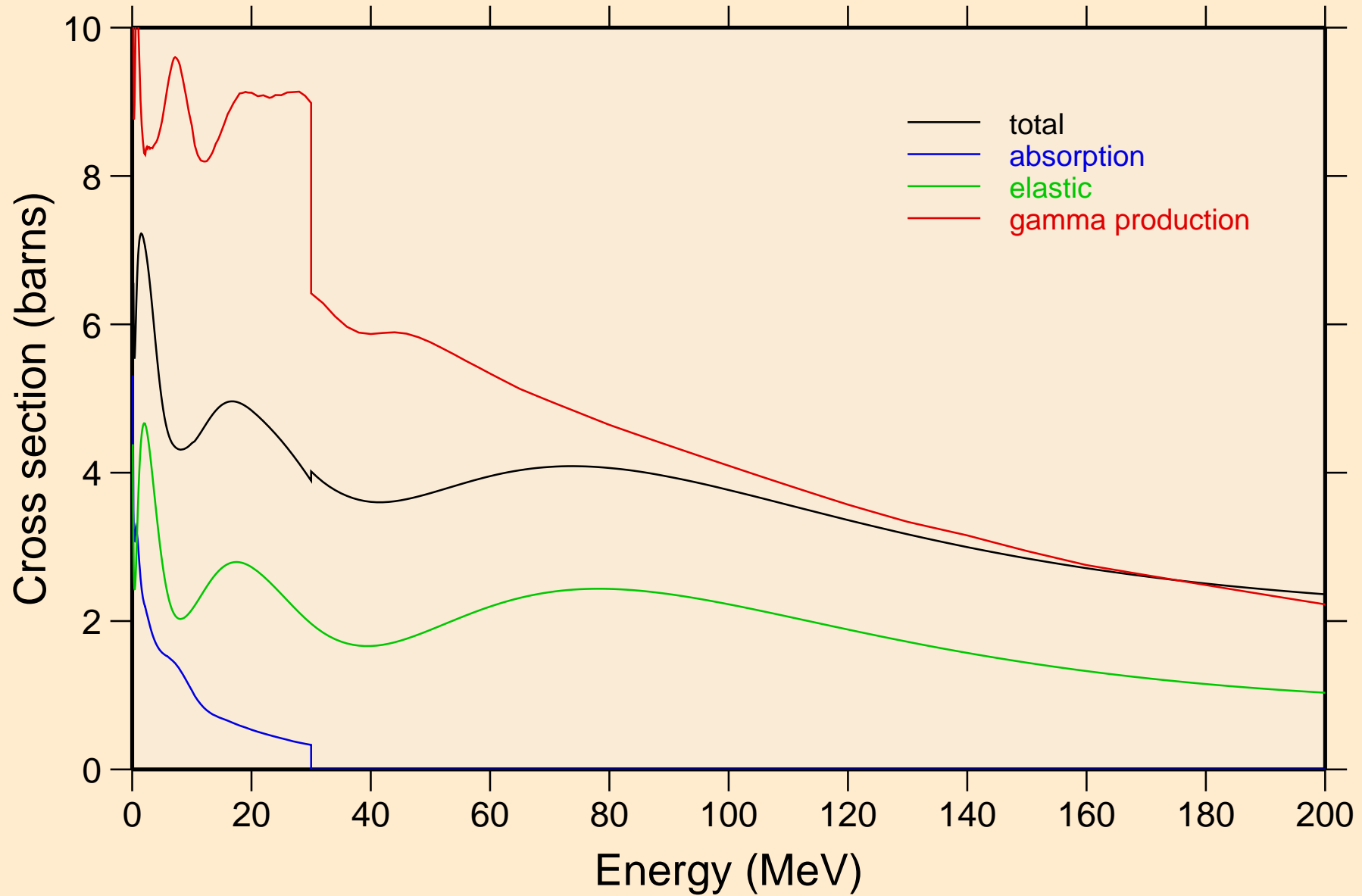

HO148 NEUTRON ACER TENDL-2024 LIBRARY; T=0.K

Heating

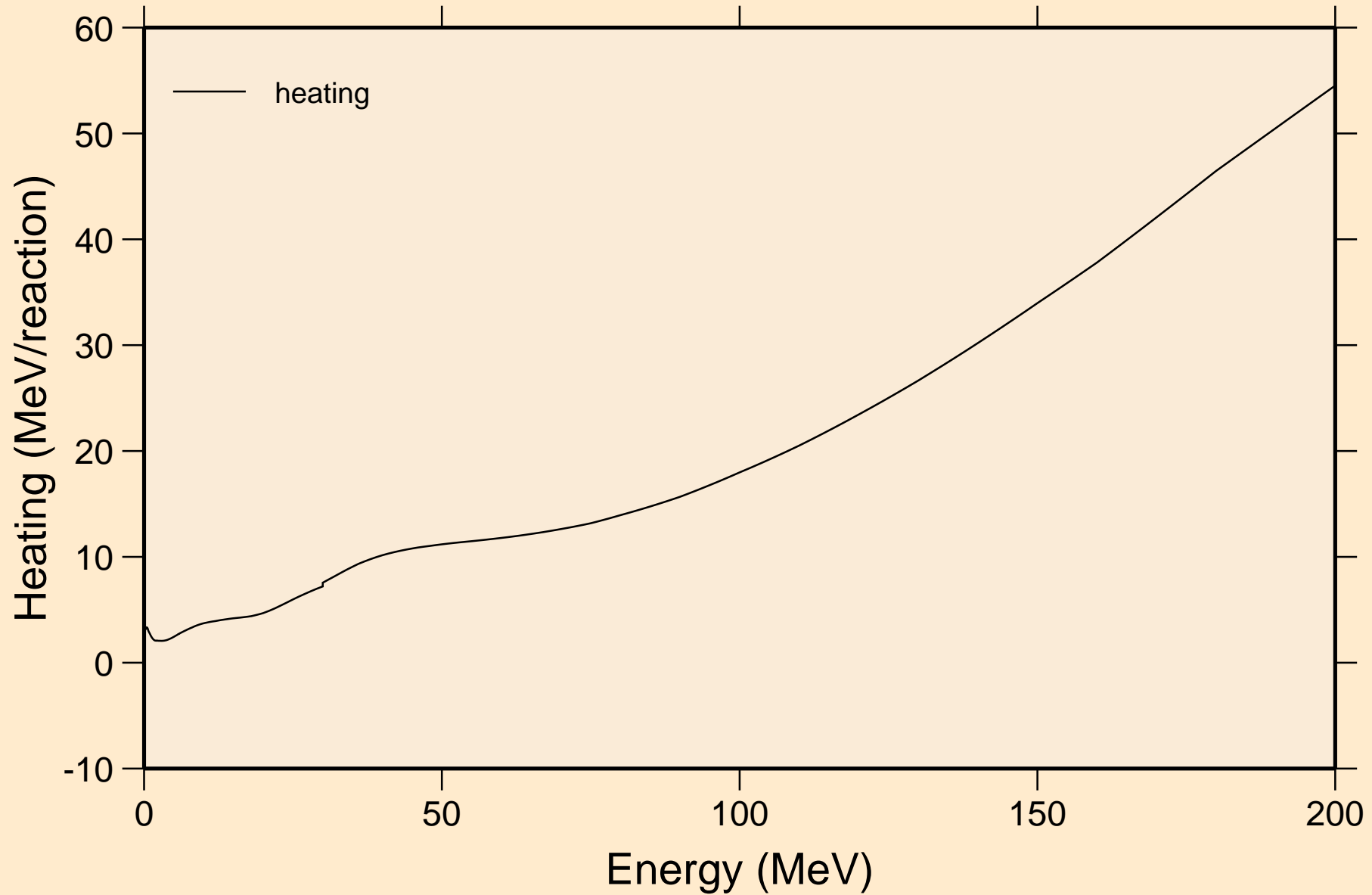

HO148 NEUTRON ACER TENDL-2024 LIBRARY; T=0.K
Damage

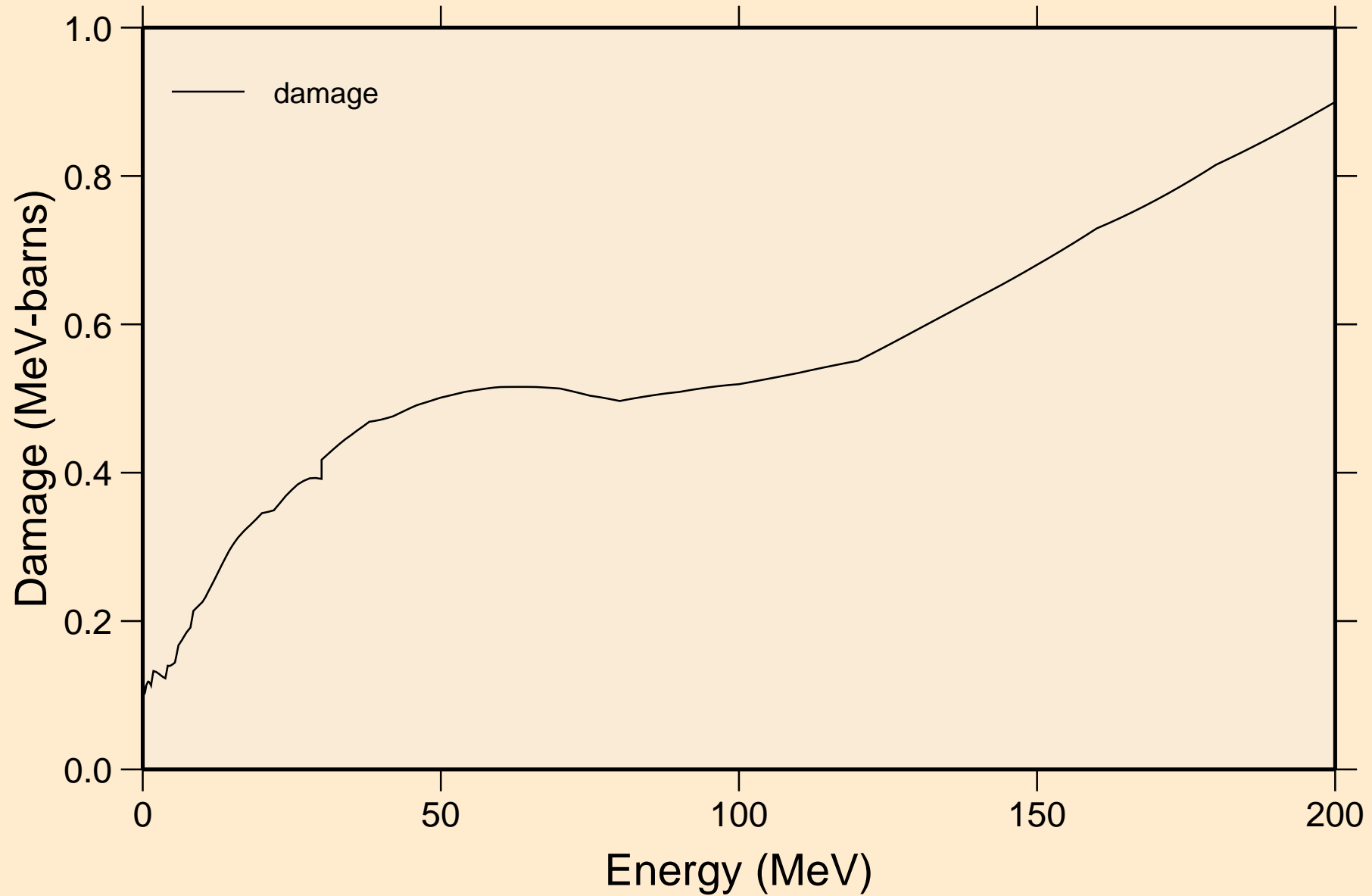

HO148 NEUTRON ACER TENDL-2024 LIBRARY; T=0.K

Non-threshold reactions

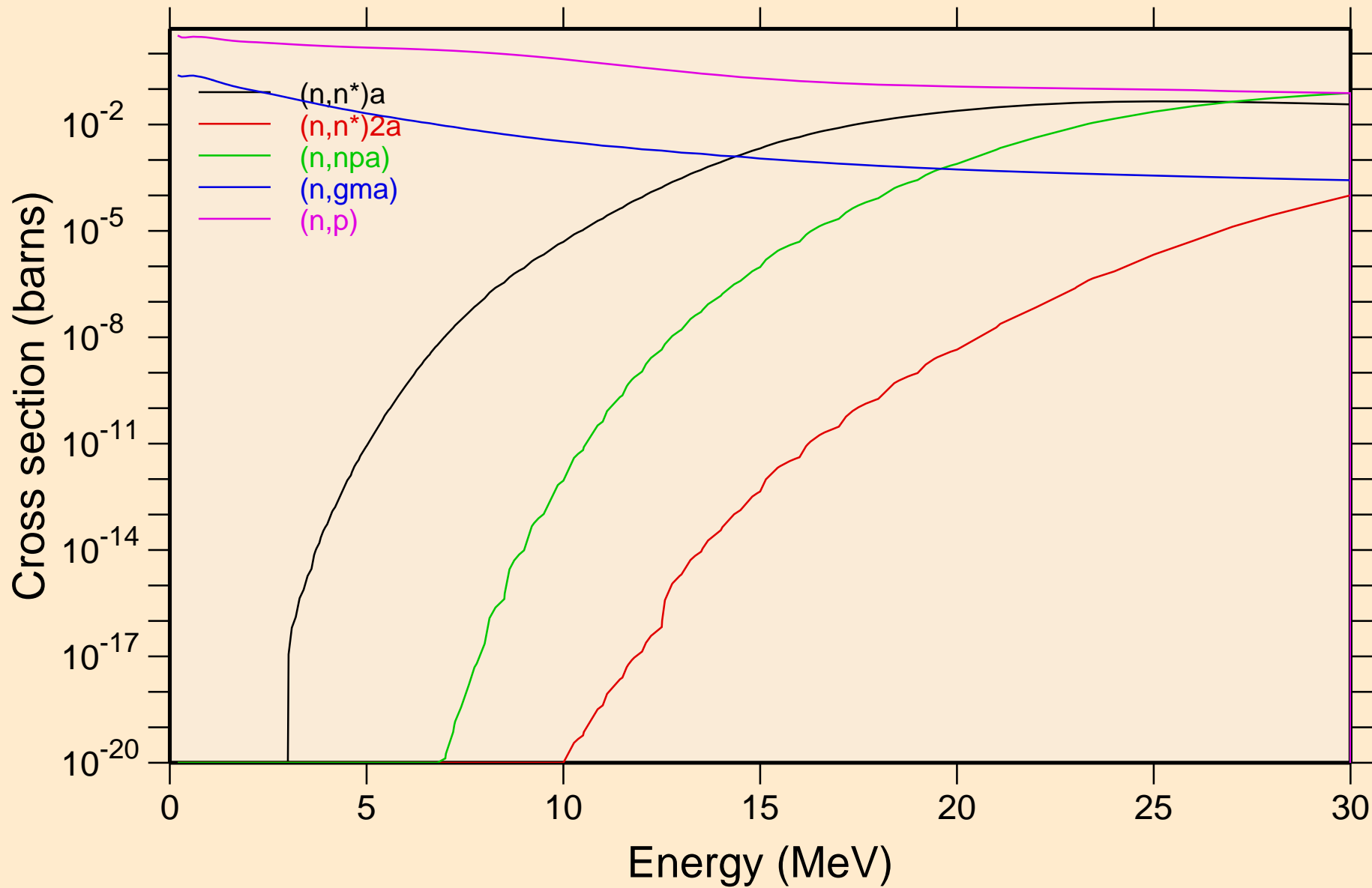

HO148 NEUTRON ACER TENDL-2024 LIBRARY; T=0.K

Non-threshold reactions

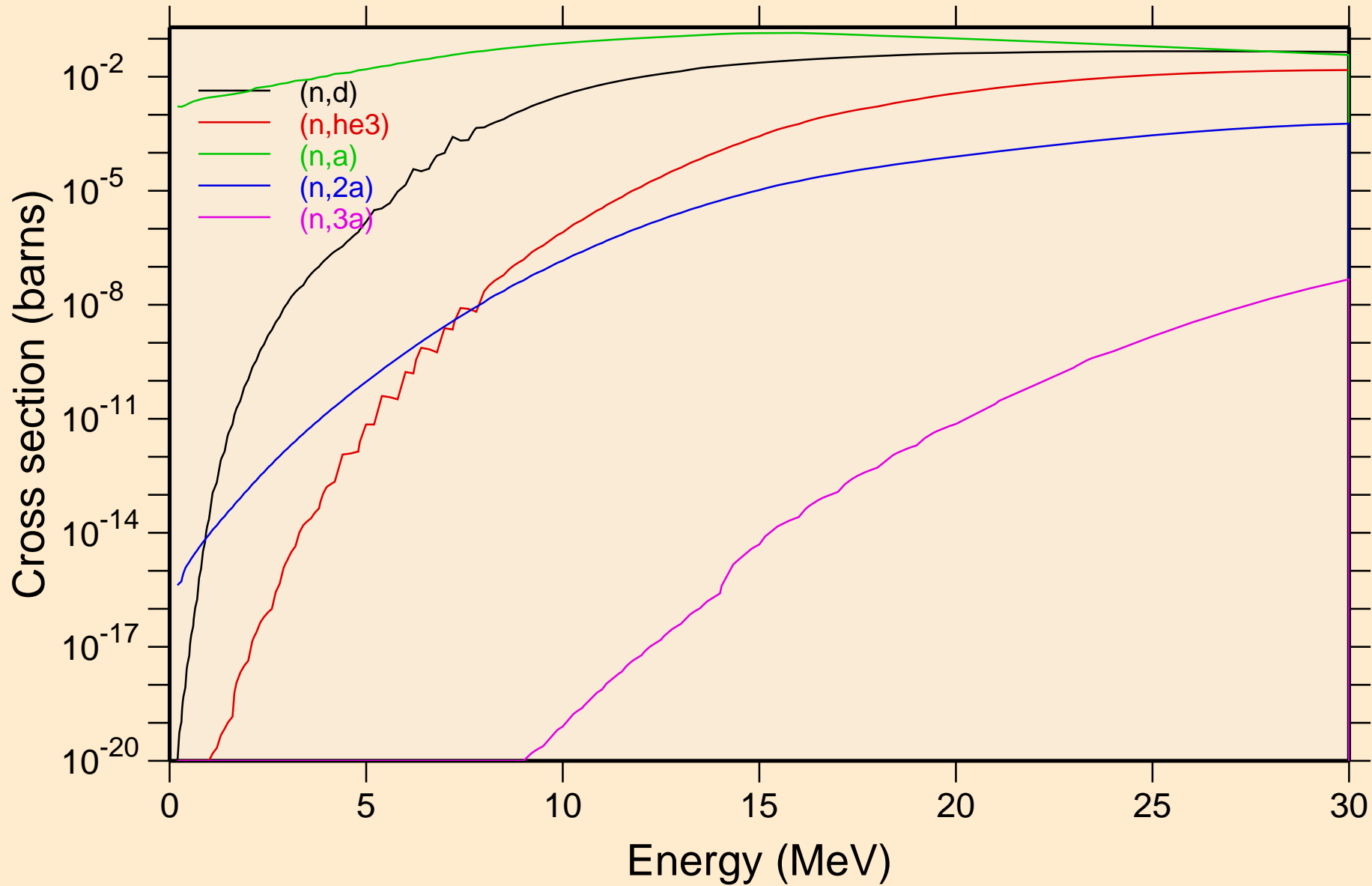

HO148 NEUTRON ACER TENDL-2024 LIBRARY; T=0.K

Non-threshold reactions

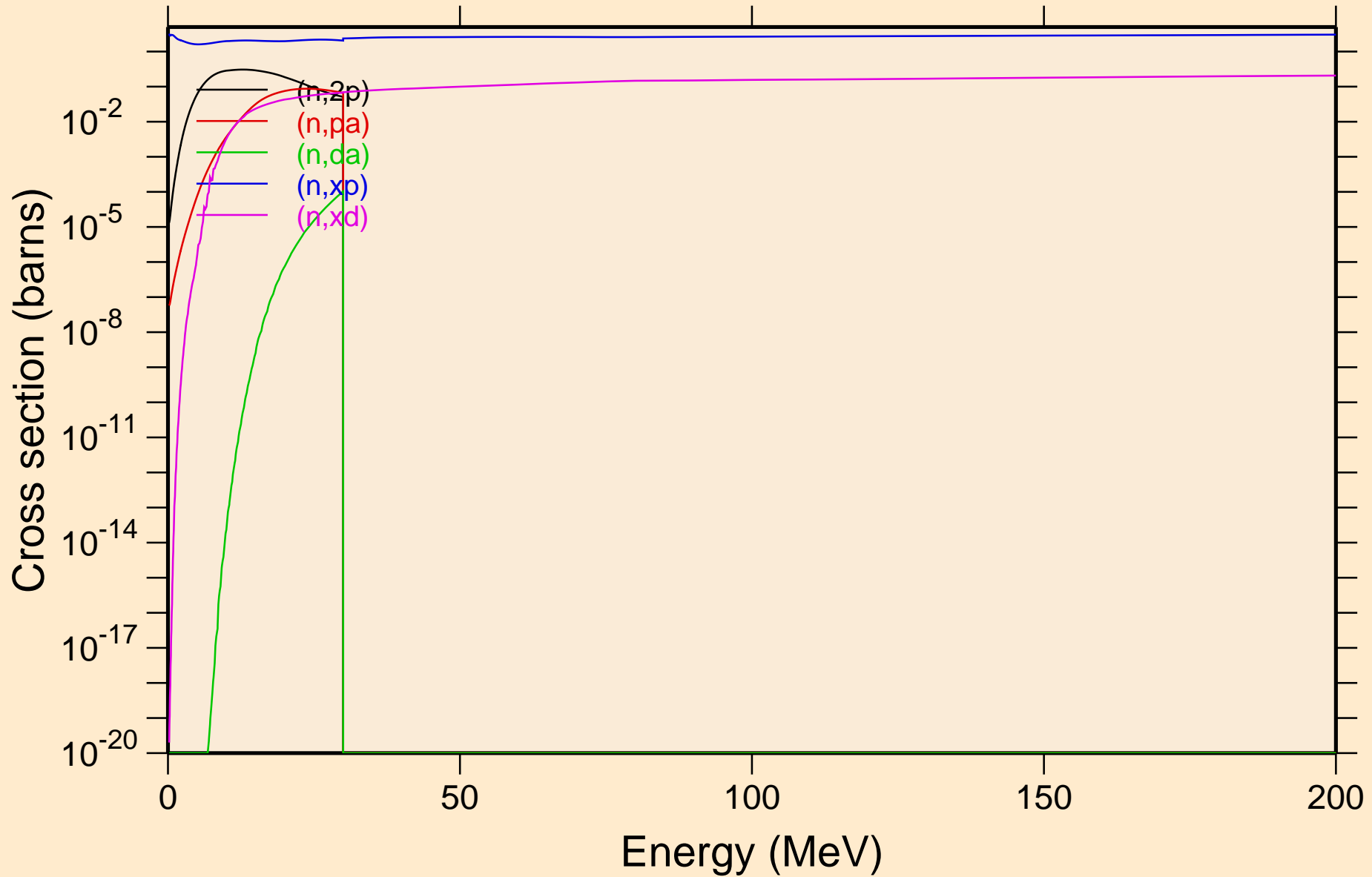

HO148 NEUTRON ACER TENDL-2024 LIBRARY; T=0.K
Non-threshold reactions

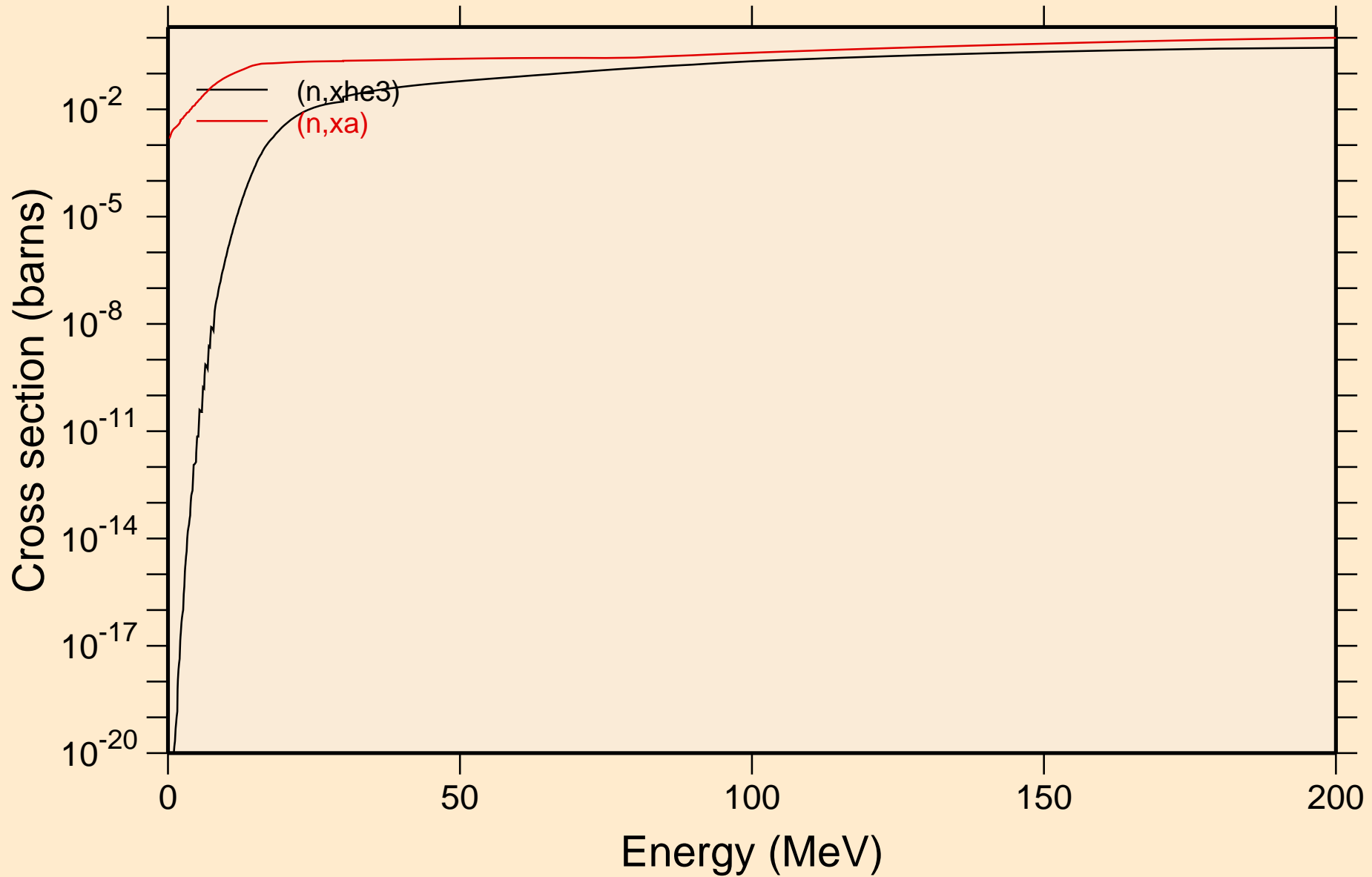

HO148 NEUTRON ACER TENDL-2024 LIBRARY; T=0.K
Inelastic levels

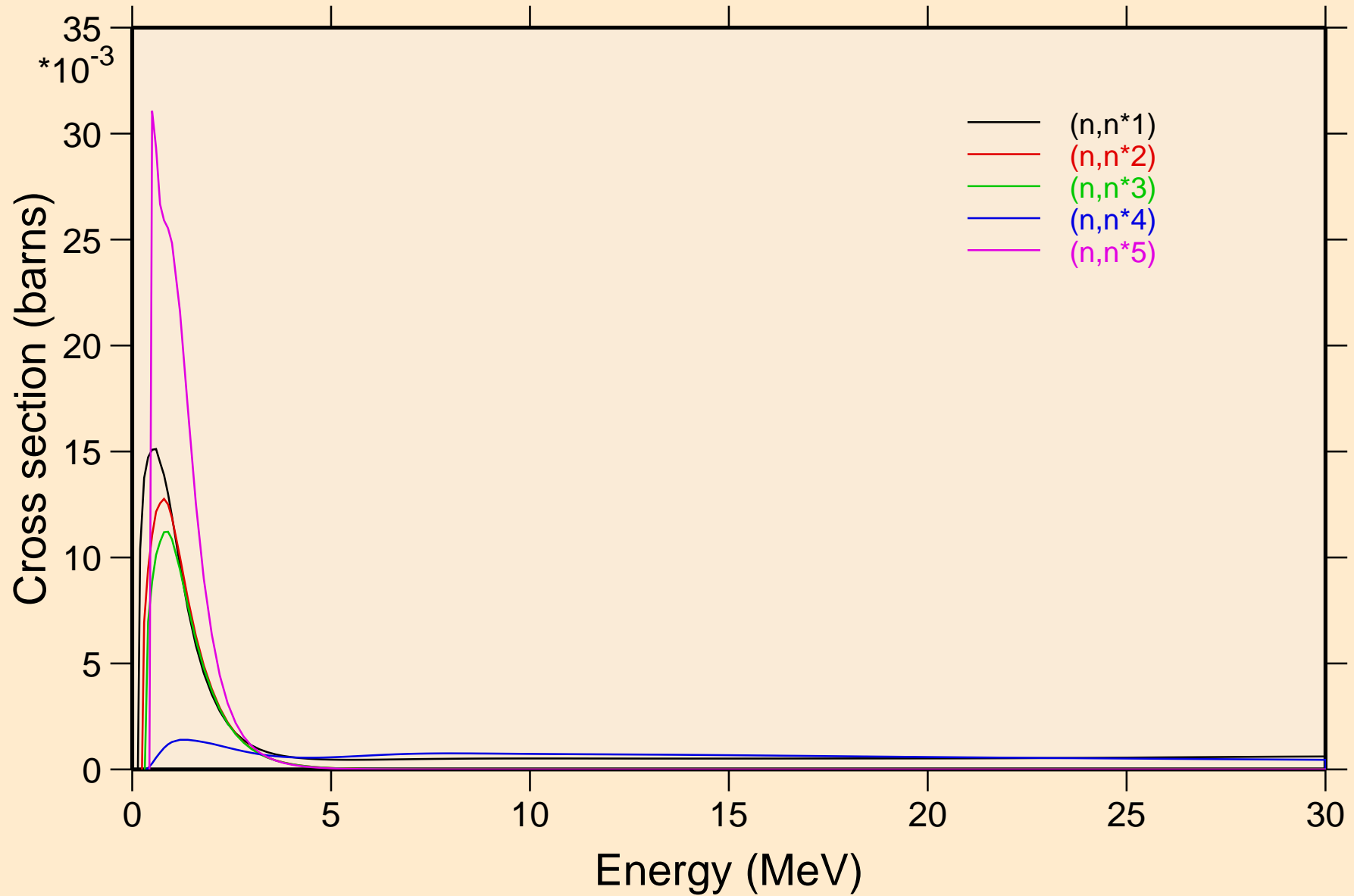

HO148 NEUTRON ACER TENDL-2024 LIBRARY; T=0.K
Inelastic levels

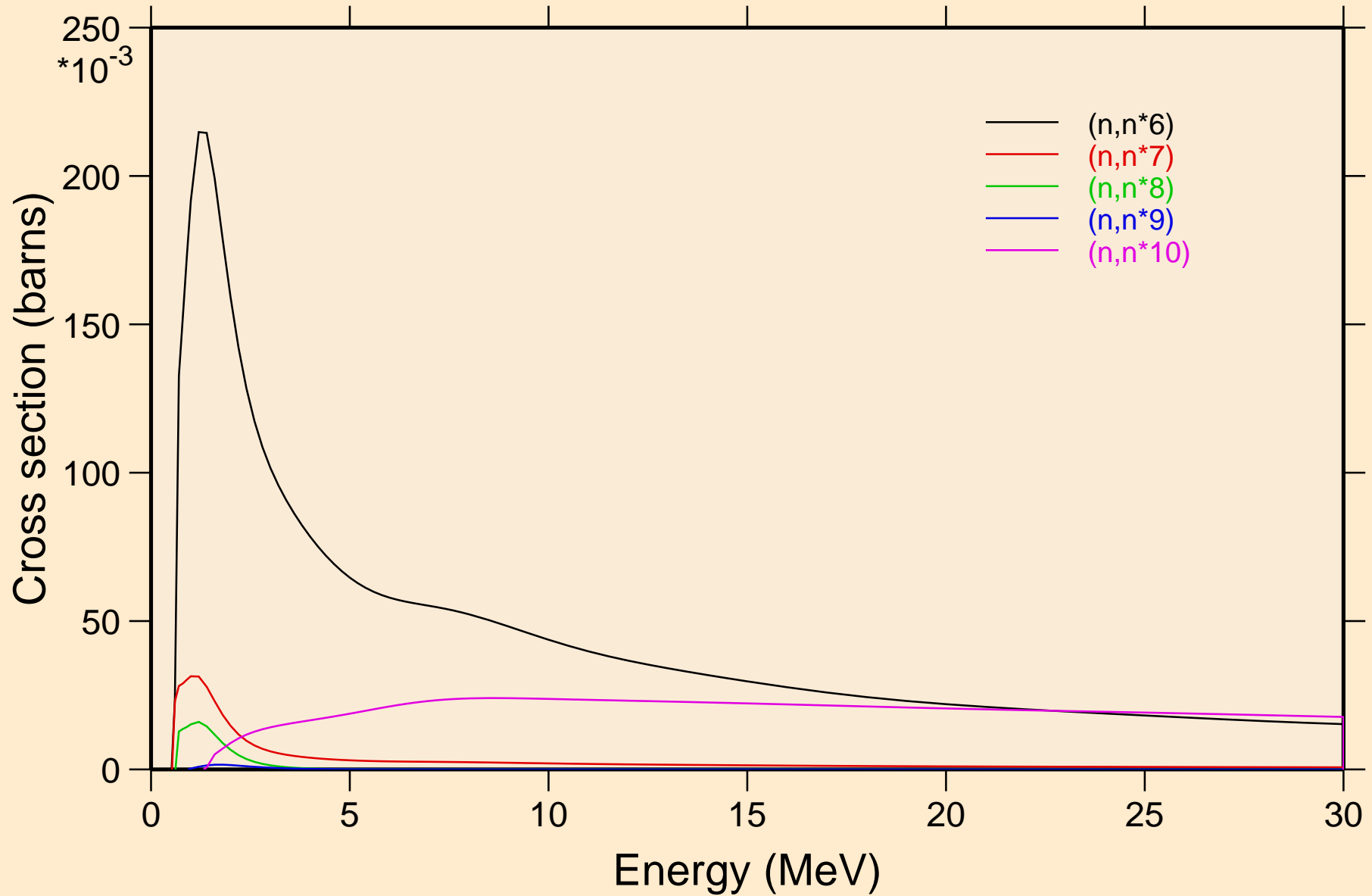

HO148 NEUTRON ACER TENDL-2024 LIBRARY; T=0.K

Threshold reactions

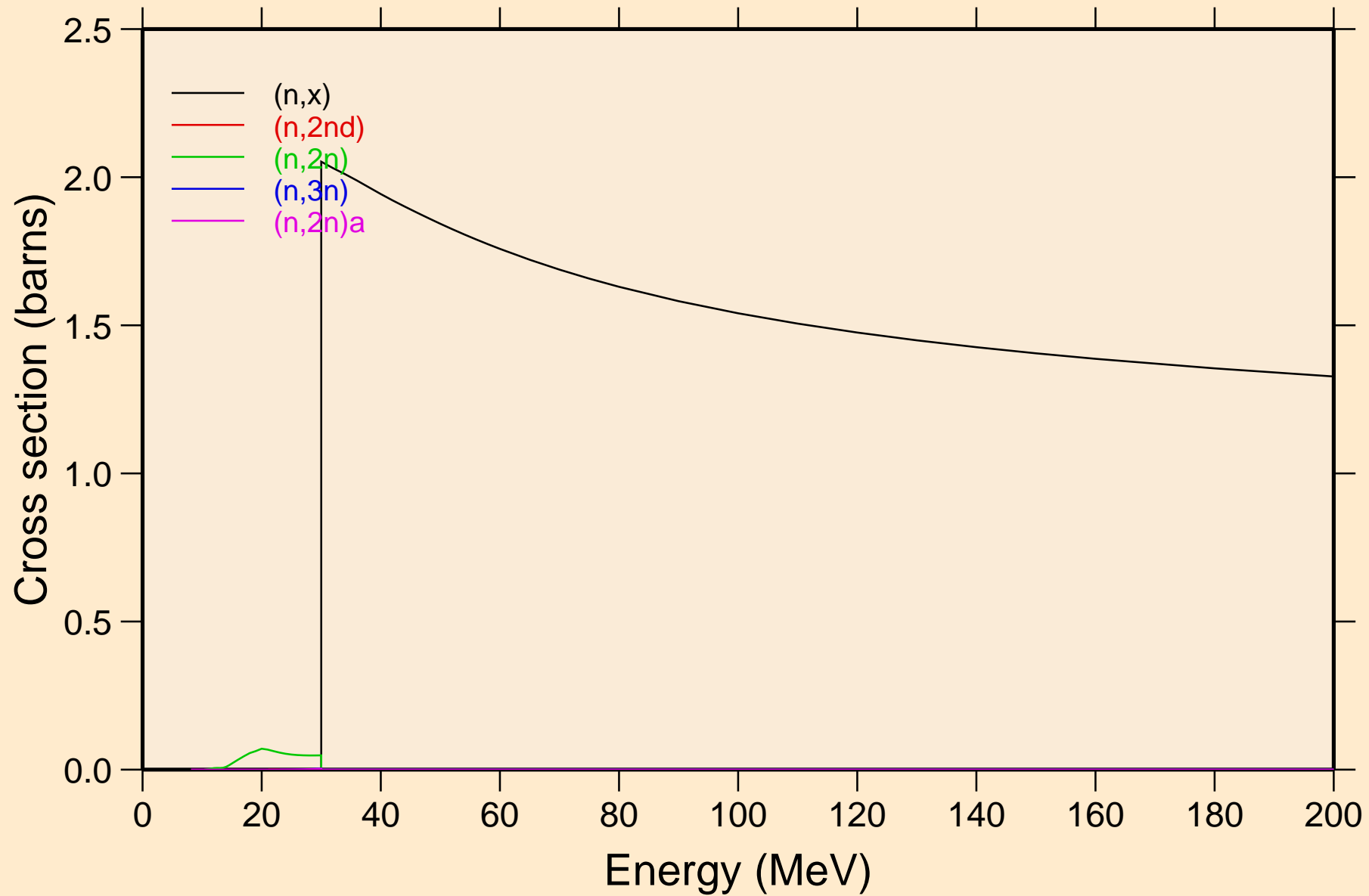

HO148 NEUTRON ACER TENDL-2024 LIBRARY; T=0.K

Threshold reactions

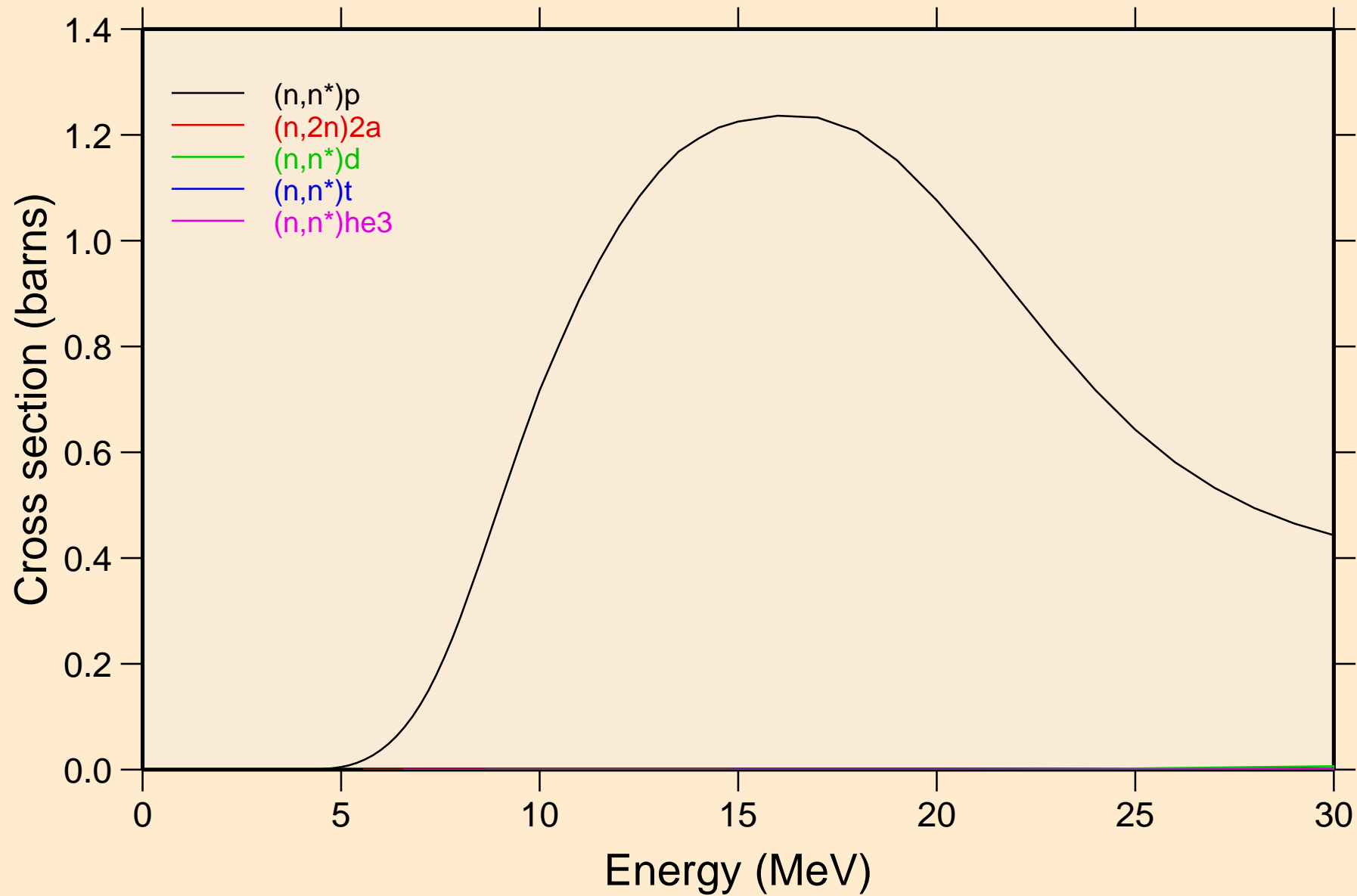

HO148 NEUTRON ACER TENDL-2024 LIBRARY; T=0.K

Threshold reactions

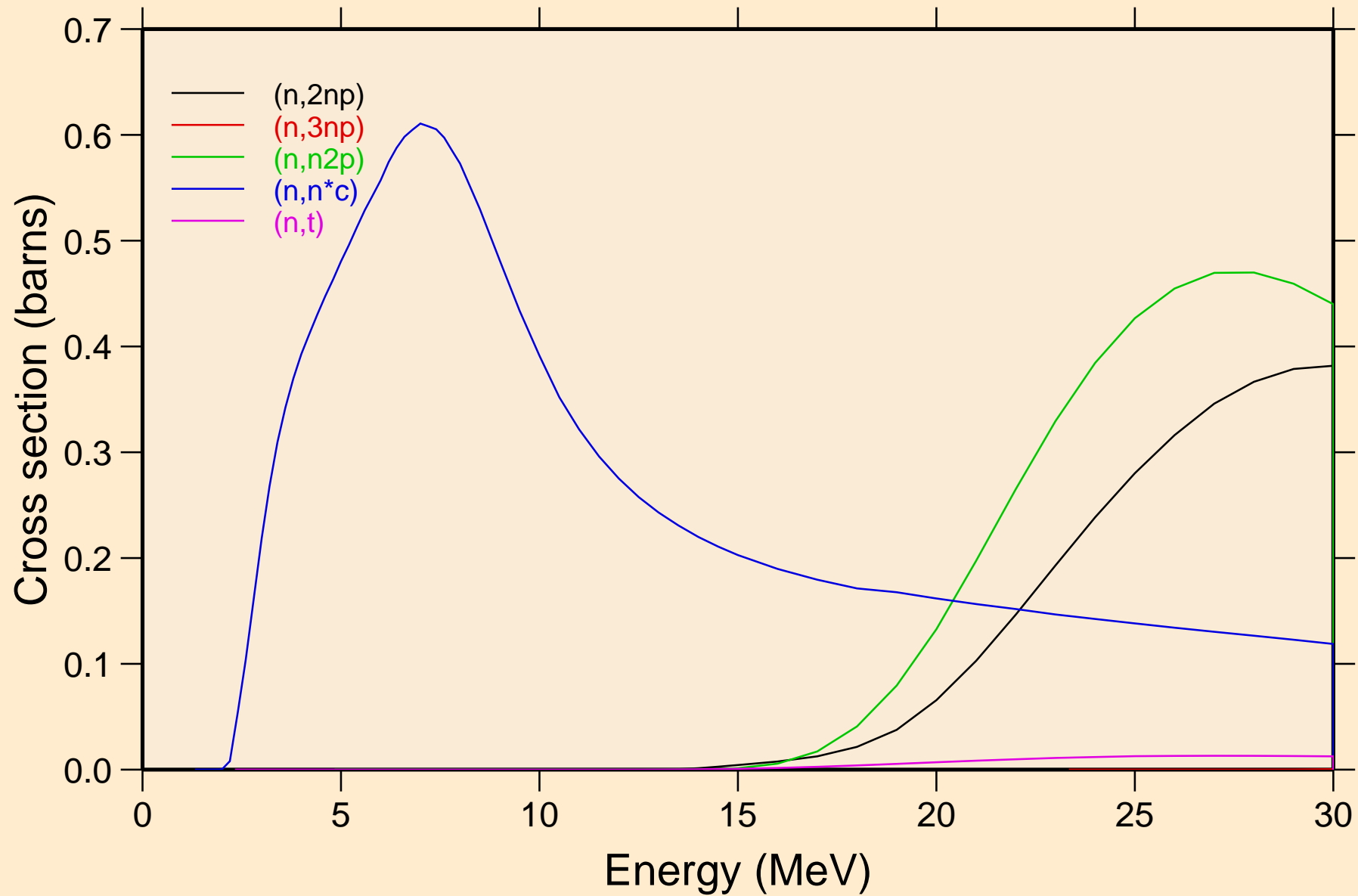

HO148 NEUTRON ACER TENDL-2024 LIBRARY; T=0.K

Threshold reactions

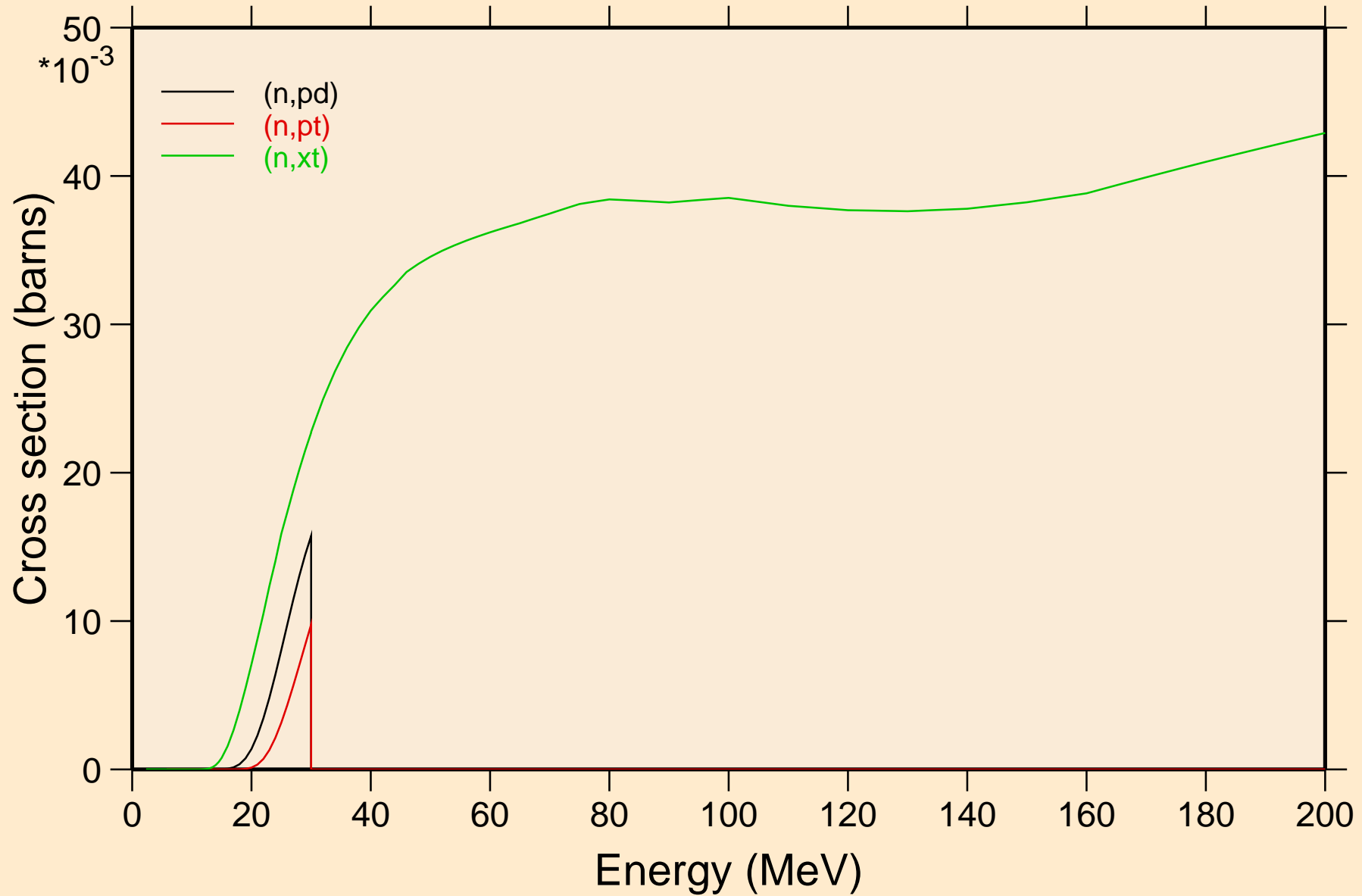

HO148 NEUTRON ACER TENDL-2024 LIBRARY; T=0.K
angular distribution for elastic

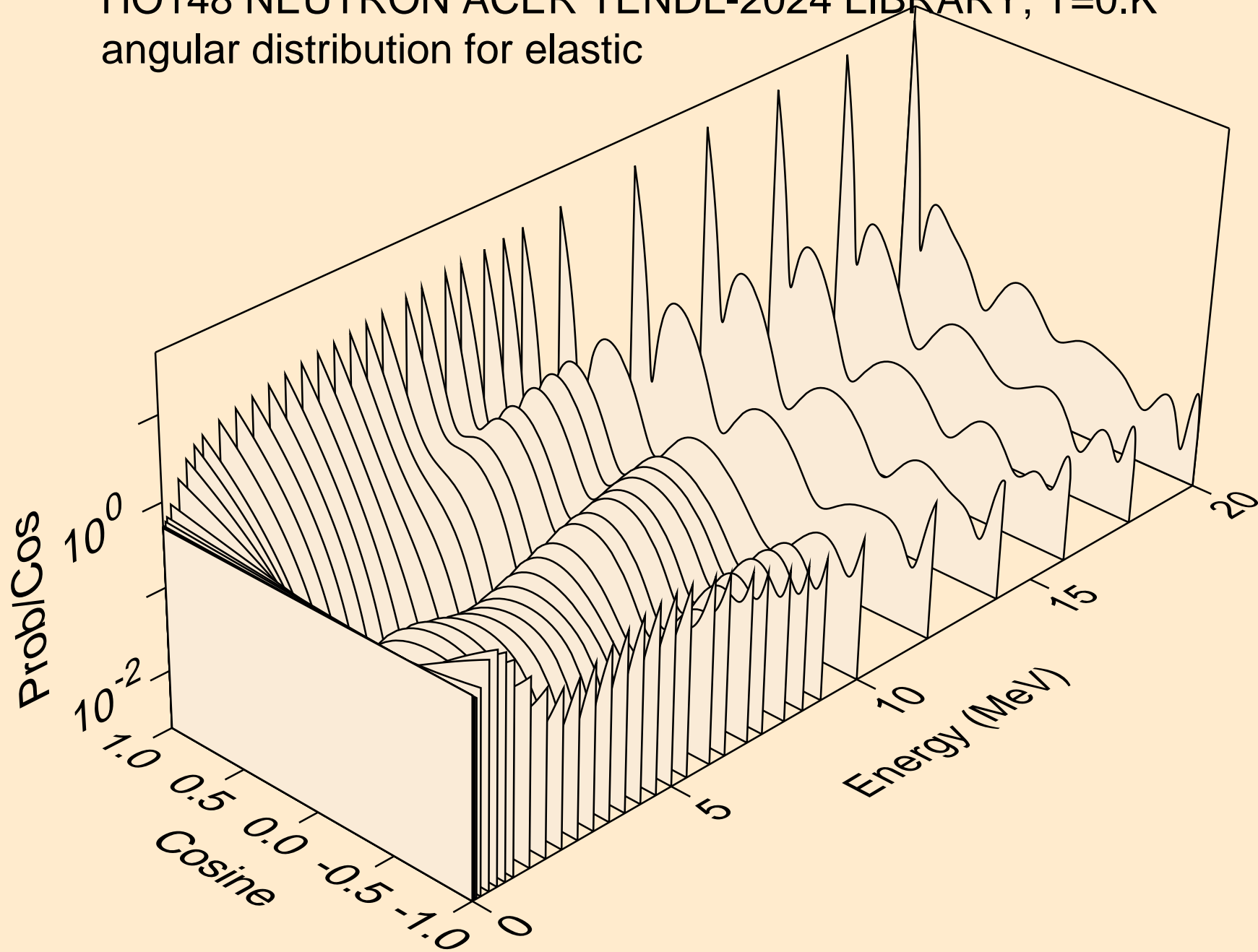

HO148 NEUTRON ACER TENDL-2024 LIBRARY; T=0.K
angular distribution for elastic

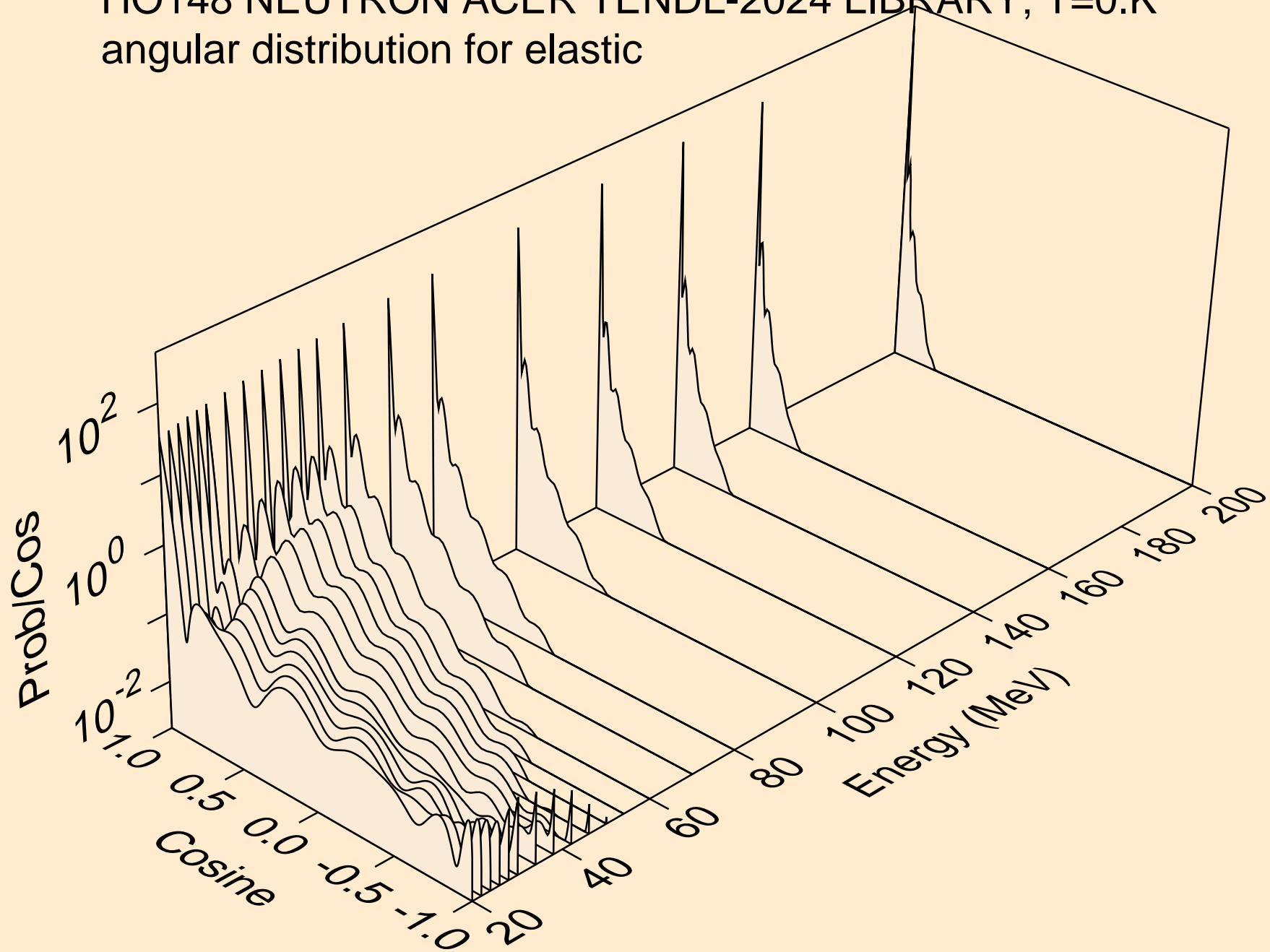

HO148 NEUTRON ACER TENDL-2024 LIBRARY; T=0.K
angular distribution for (n,n*1)

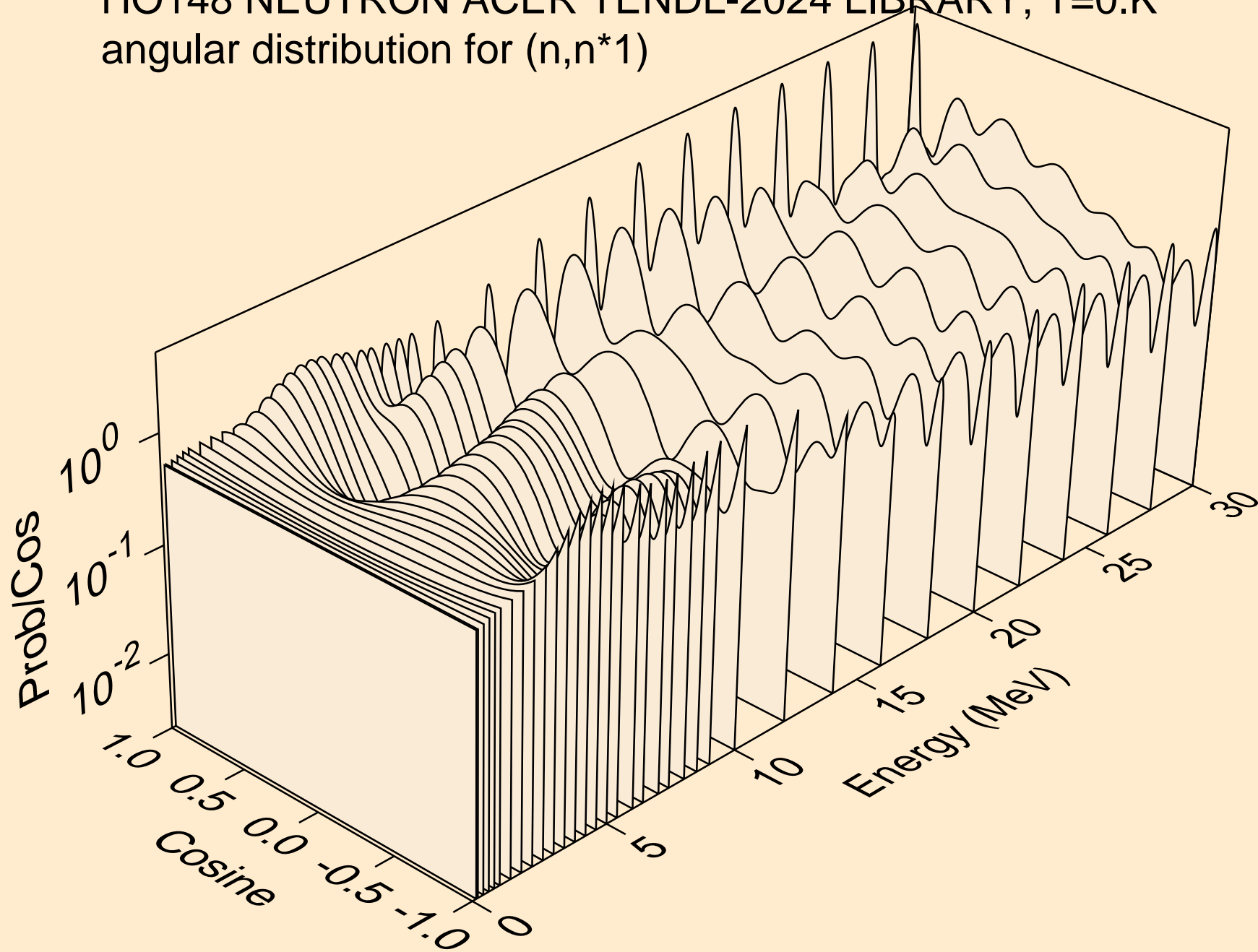

HO148 NEUTRON ACER TENDL-2024 LIBRARY; T=0.K
angular distribution for (n,n*2)

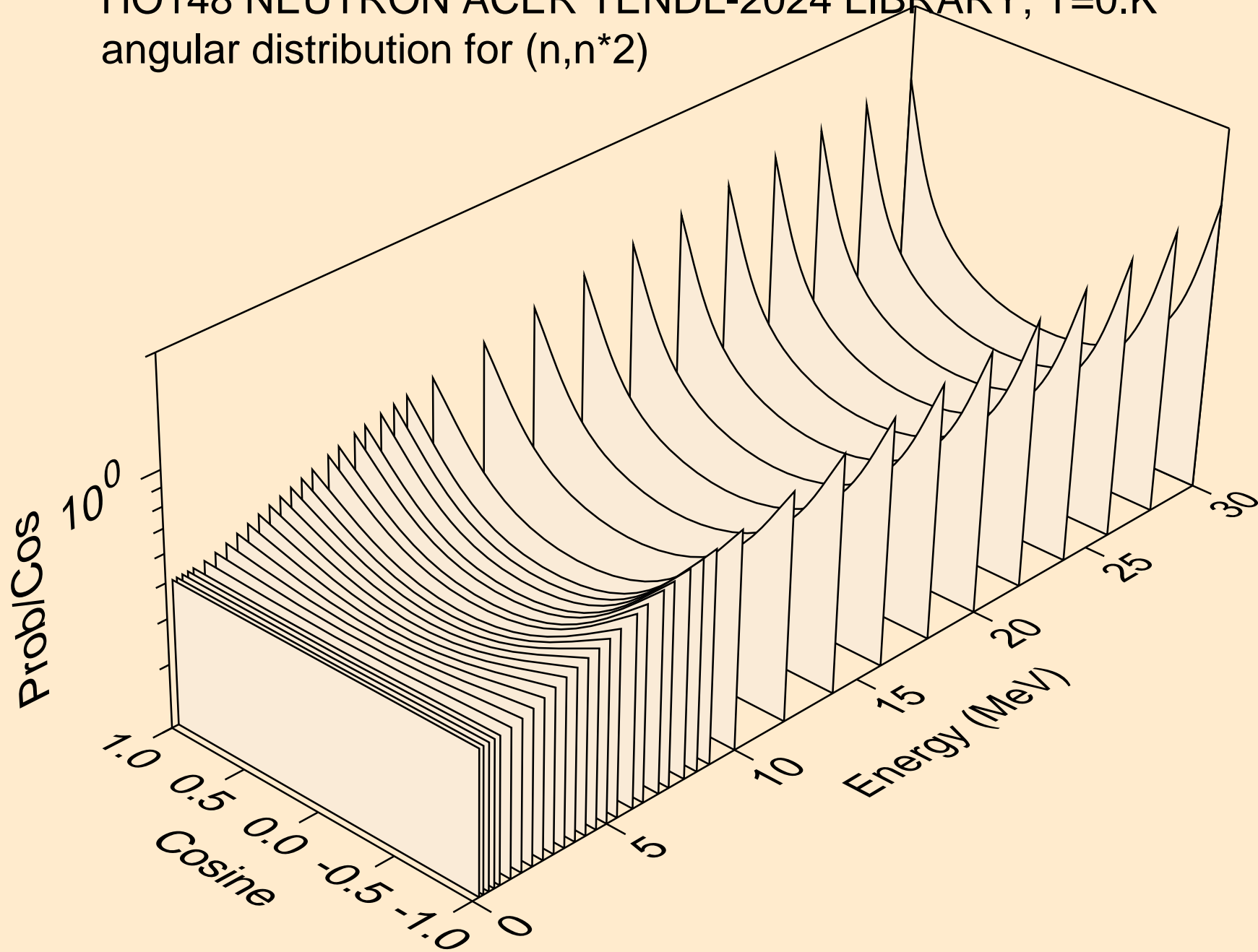

HO148 NEUTRON ACER TENDL-2024 LIBRARY; T=0.K
angular distribution for (n,n*3)

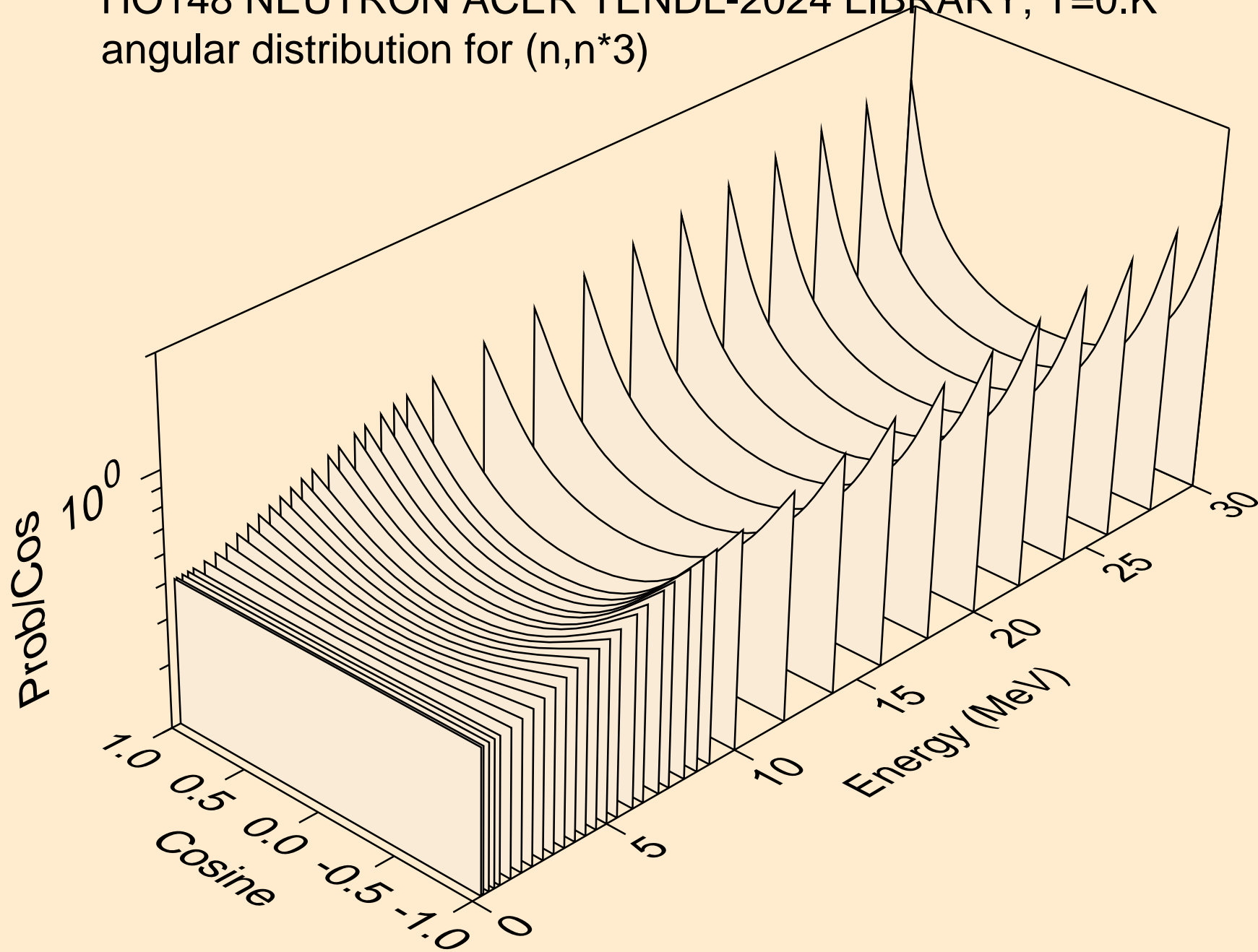

HO148 NEUTRON ACER TENDL-2024 LIBRARY; T=0.K
angular distribution for (n,n*4)

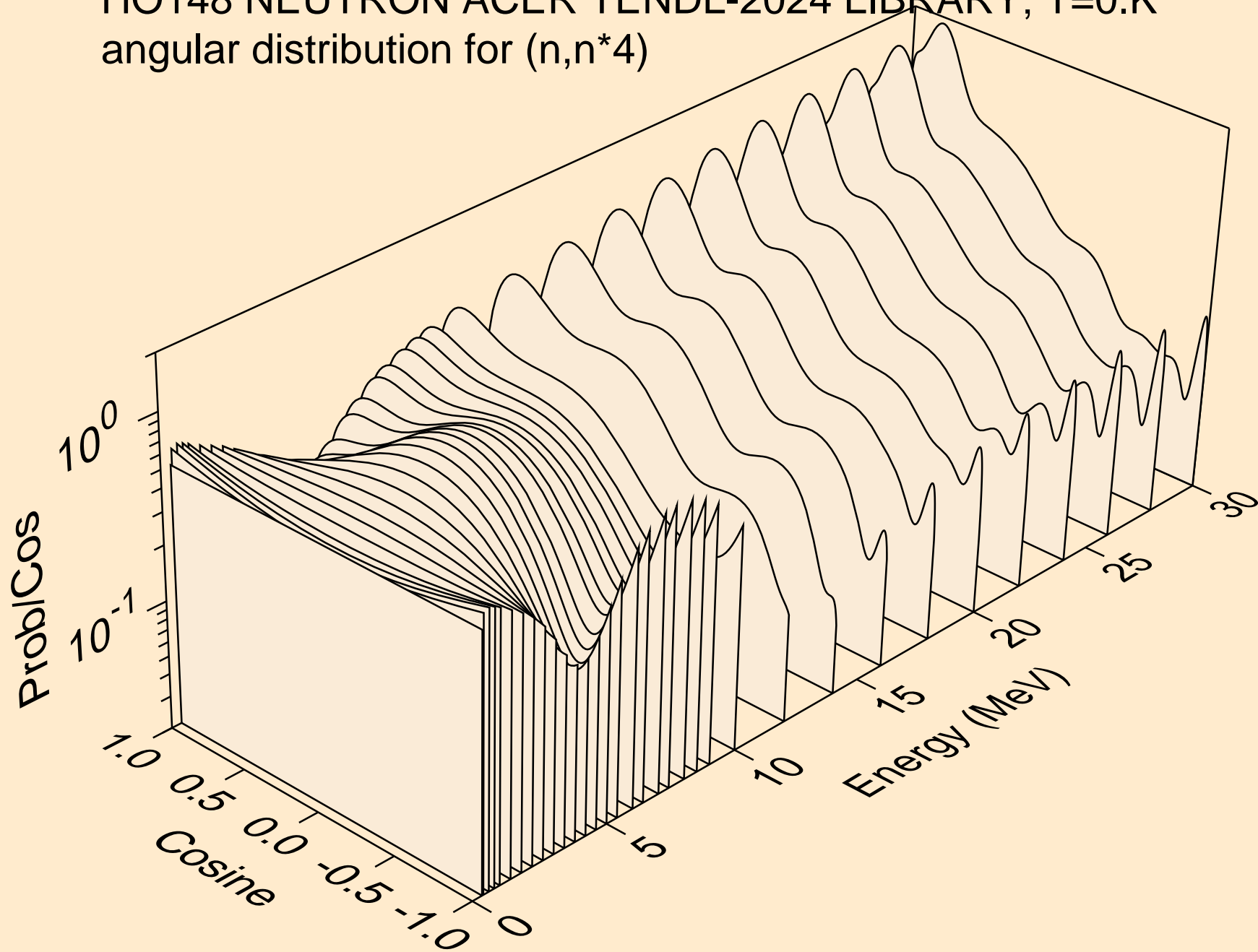

HO148 NEUTRON ACER TENDL-2024 LIBRARY; T=0.K
angular distribution for (n,n*5)

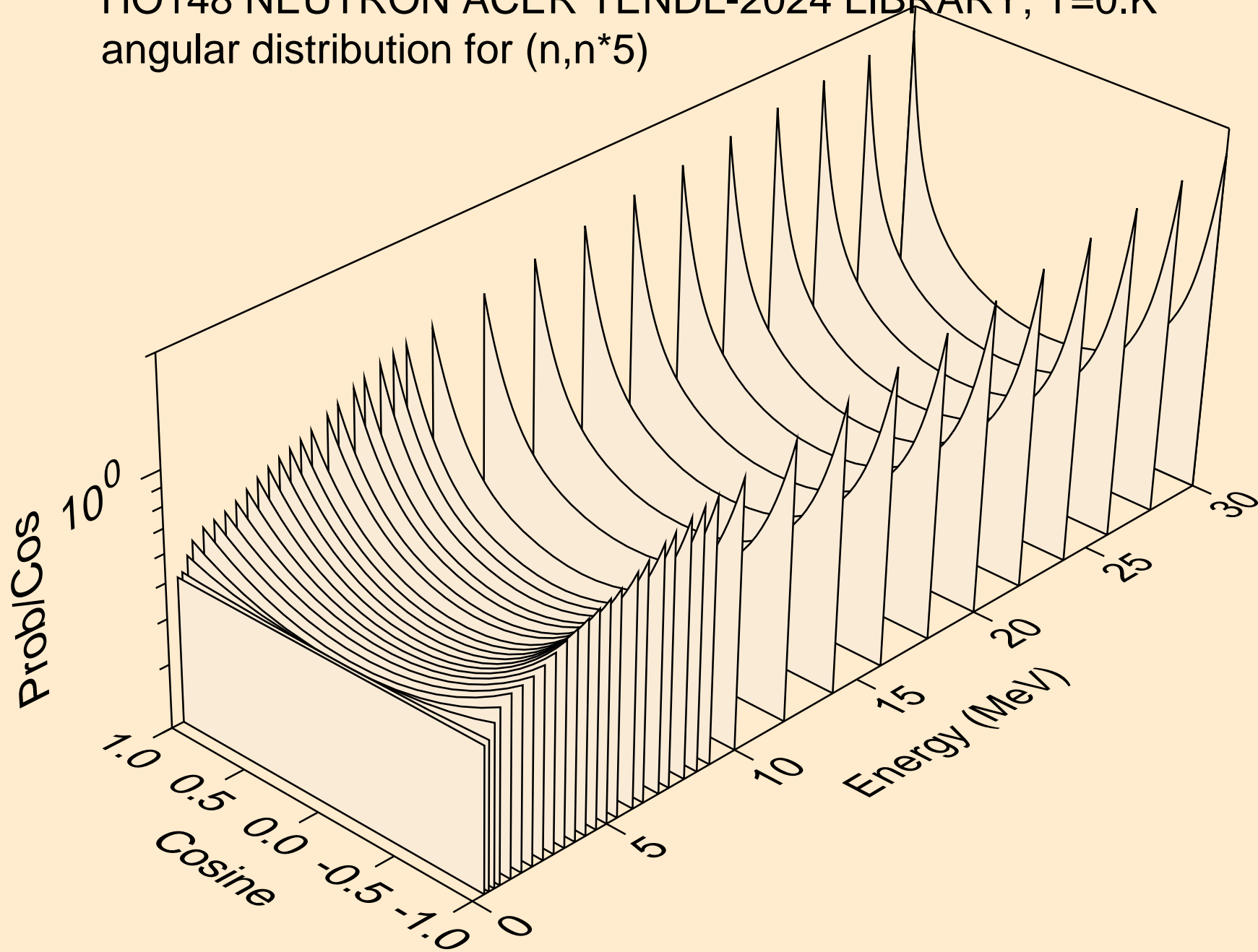

HO148 NEUTRON ACER TENDL-2024 LIBRARY; T=0.K
angular distribution for (n,n*6)

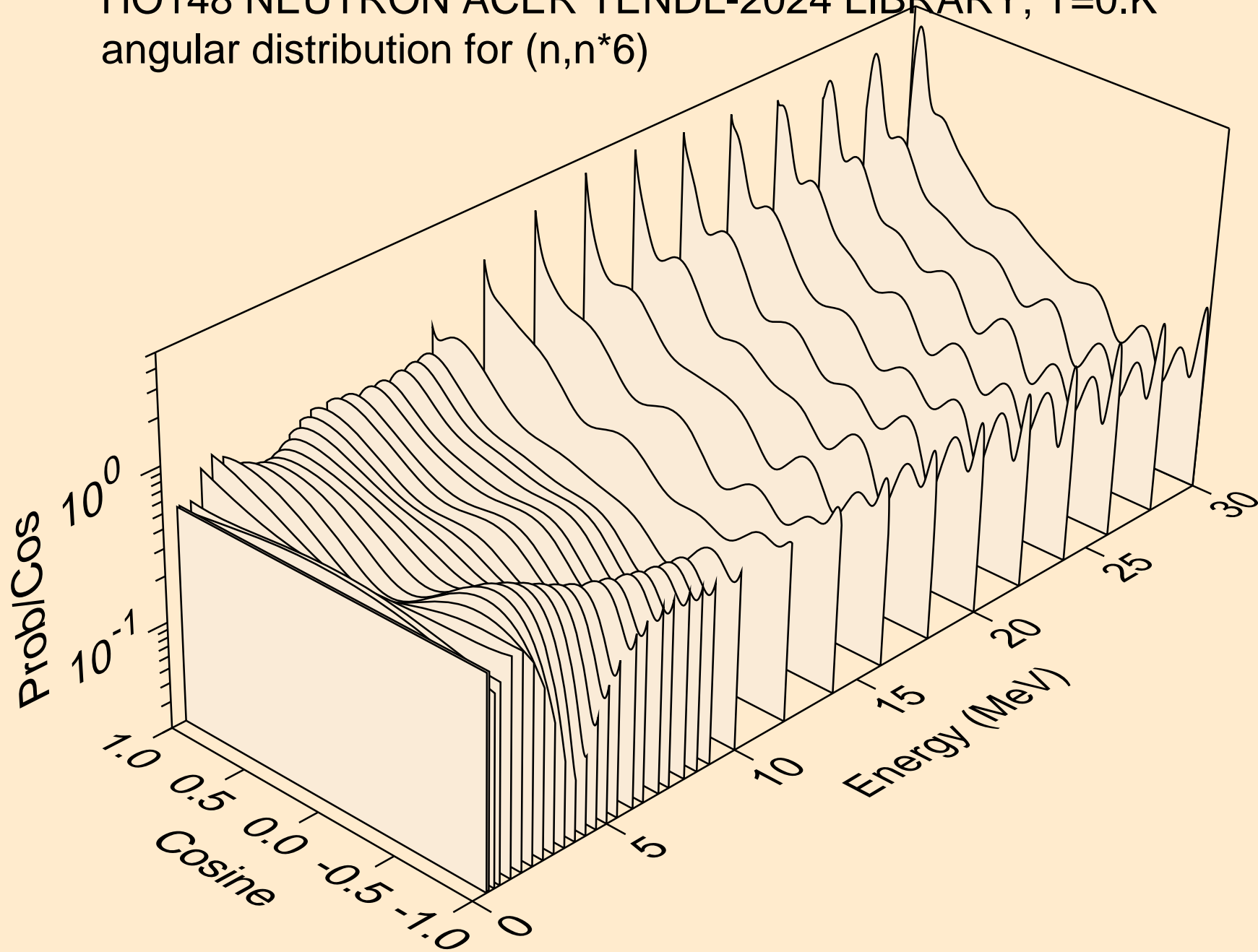

HO148 NEUTRON ACER TENDL-2024 LIBRARY; T=0.K
angular distribution for (n,n*7)

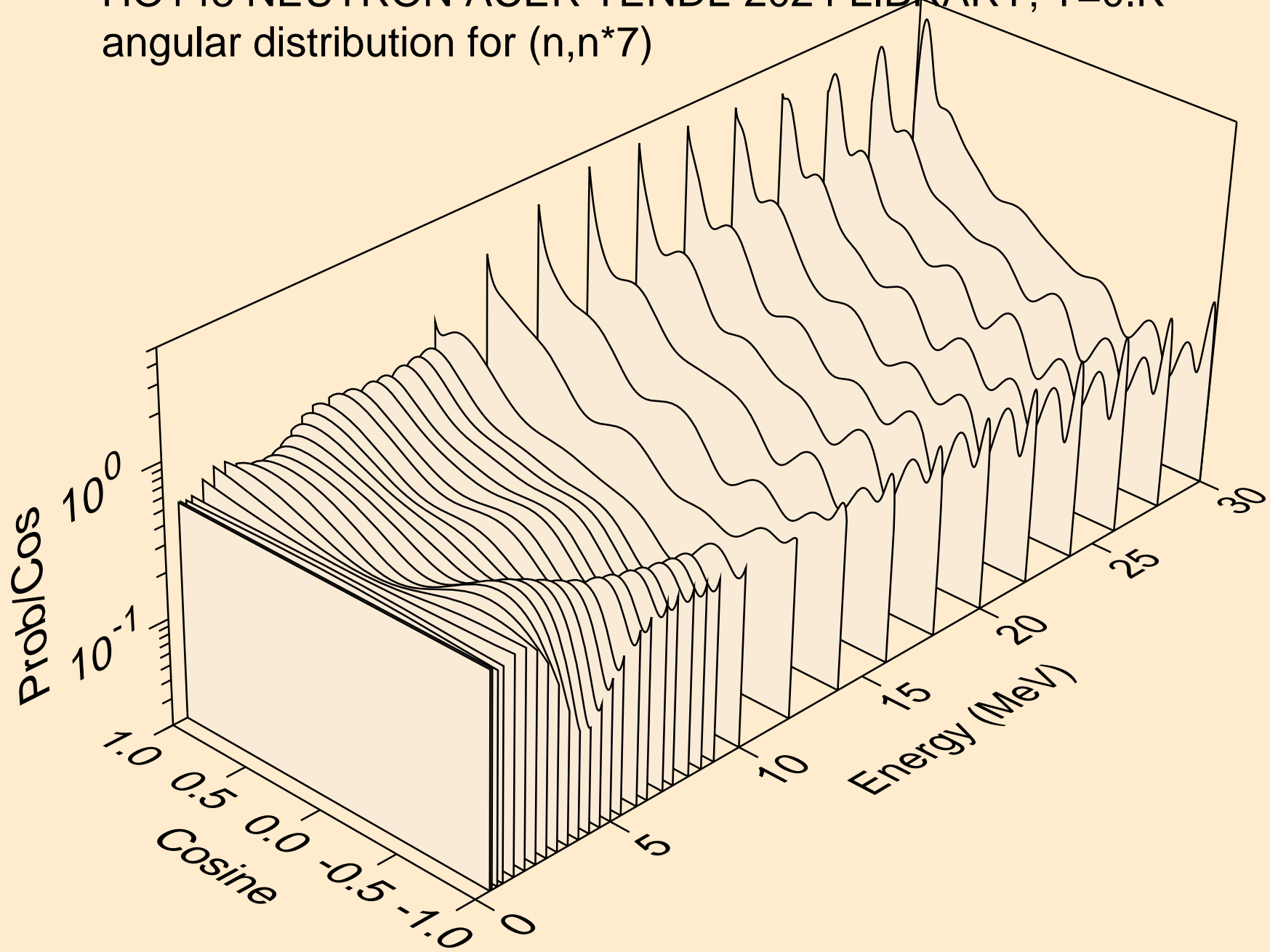

HO148 NEUTRON ACER TENDL-2024 LIBRARY; T=0.K
angular distribution for (n,n*8)

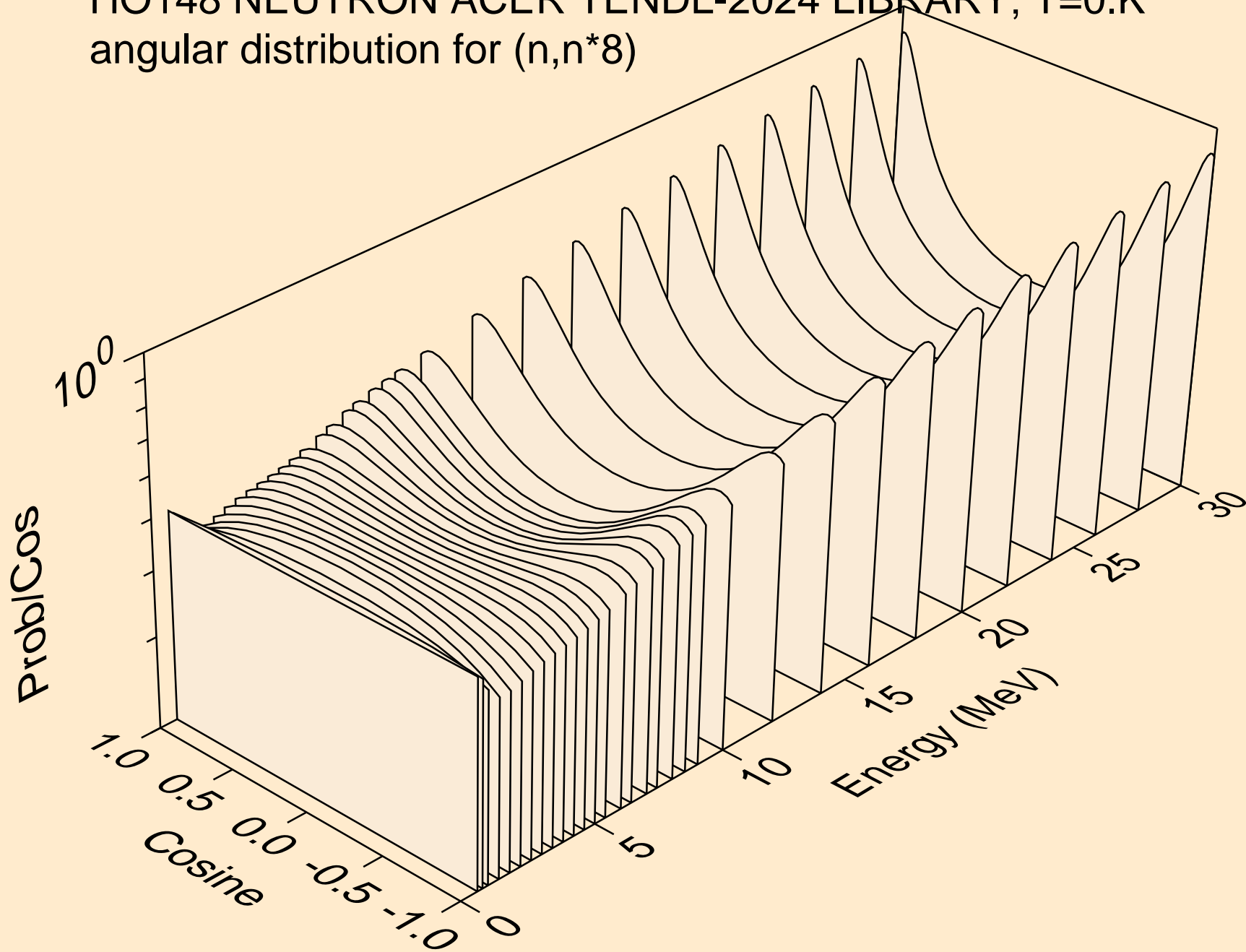

HO148 NEUTRON ACER TENDL-2024 LIBRARY; T=0.K
angular distribution for (n,n*9)

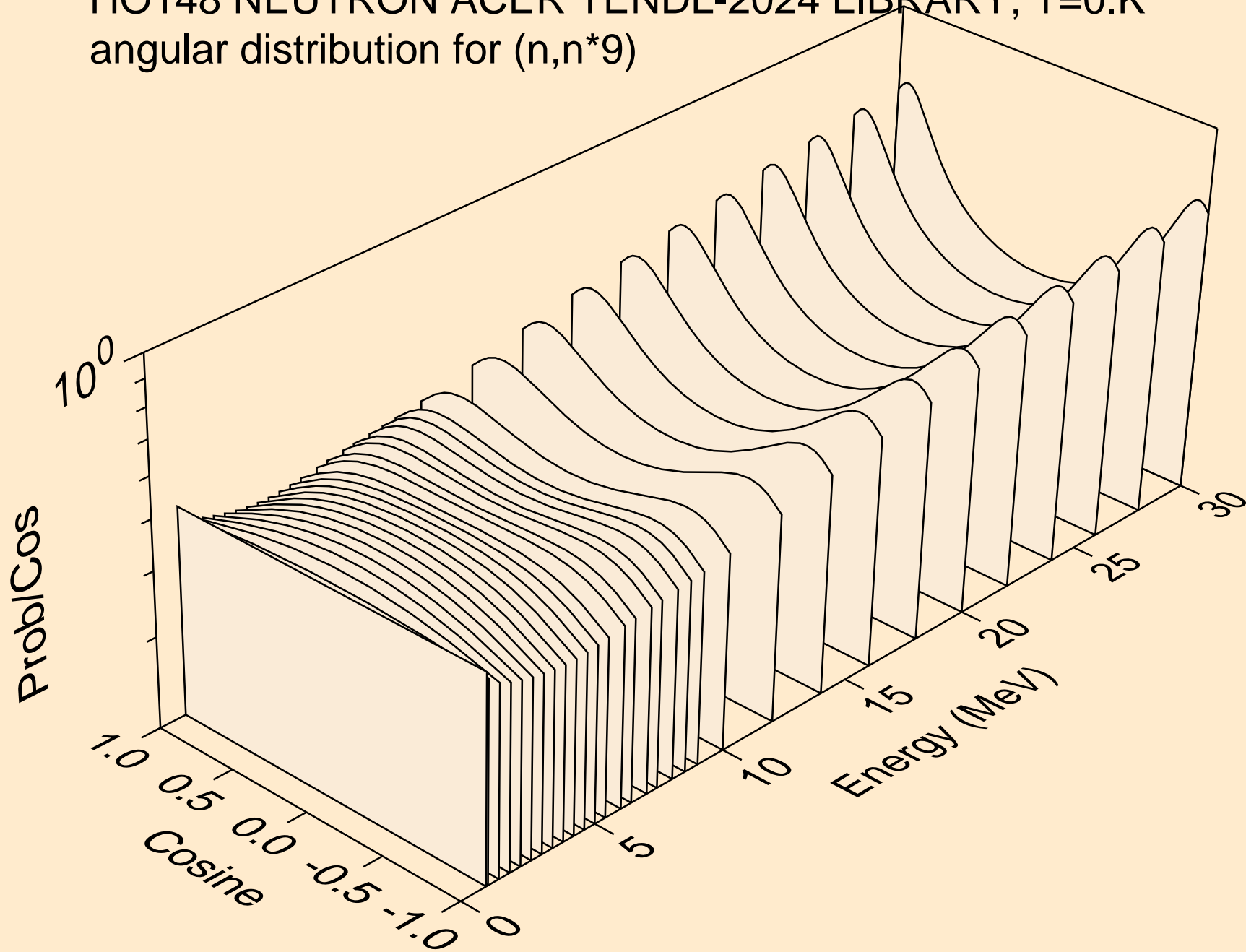

HO148 NEUTRON ACER TENDL-2024 LIBRARY; T=0.K
angular distribution for (n,n*10)

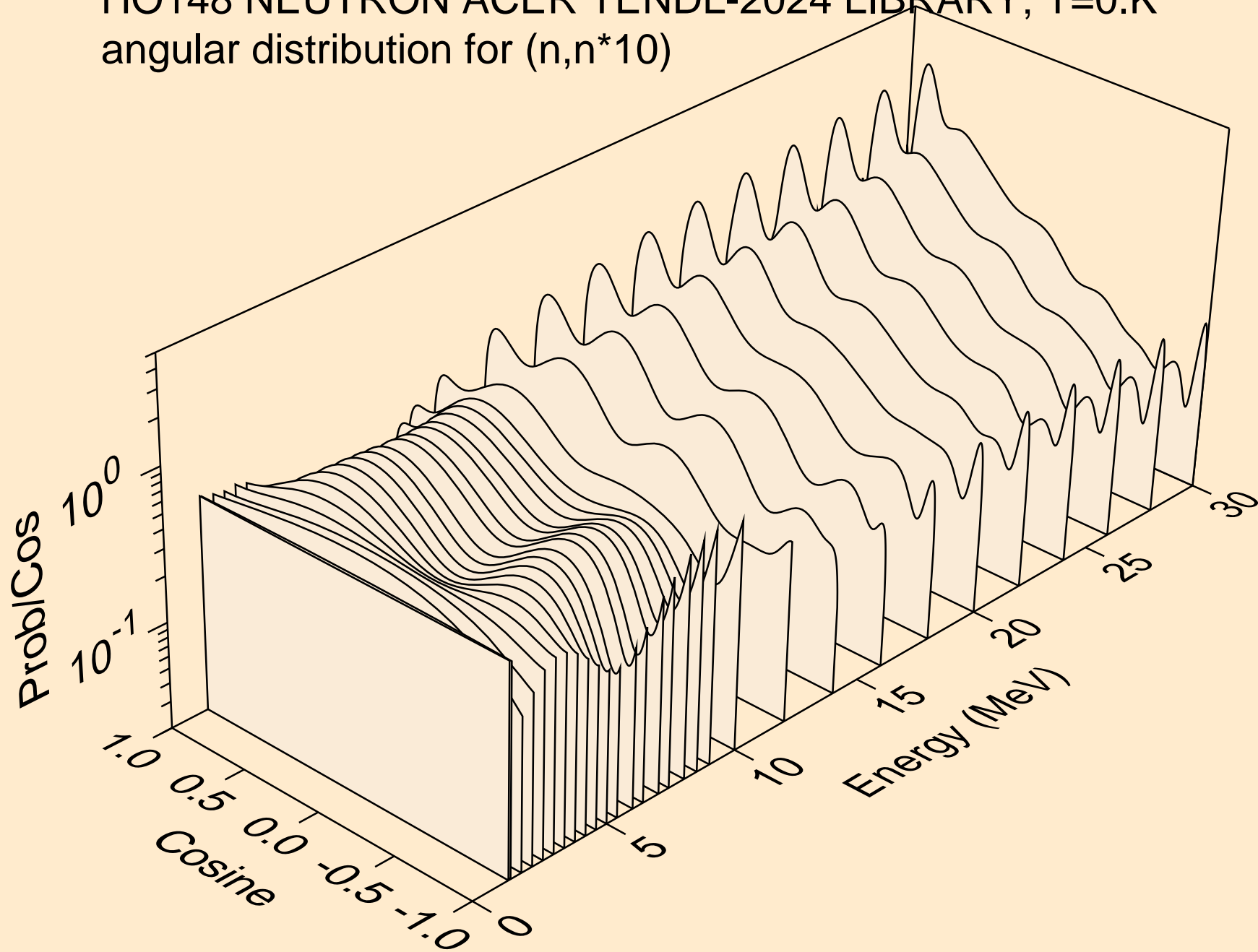

HO148 NEUTRON ACER TENDL-2024 LIBRARY; T=0.K
Neutron emission for (n,x)

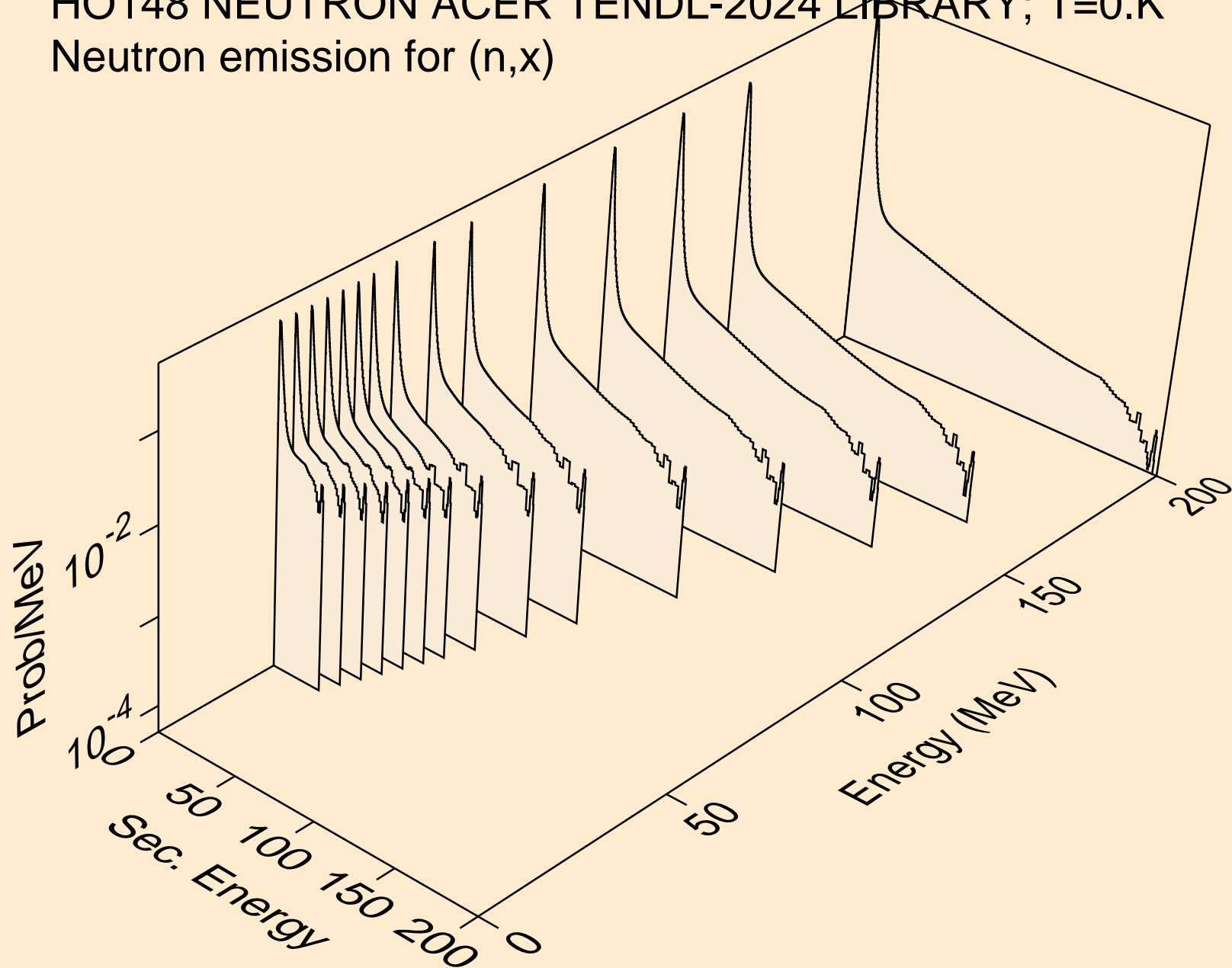

HO148 NEUTRON ACER TENDL-2024 LIBRARY; T=0.K
Neutron emission for (n,2nd)

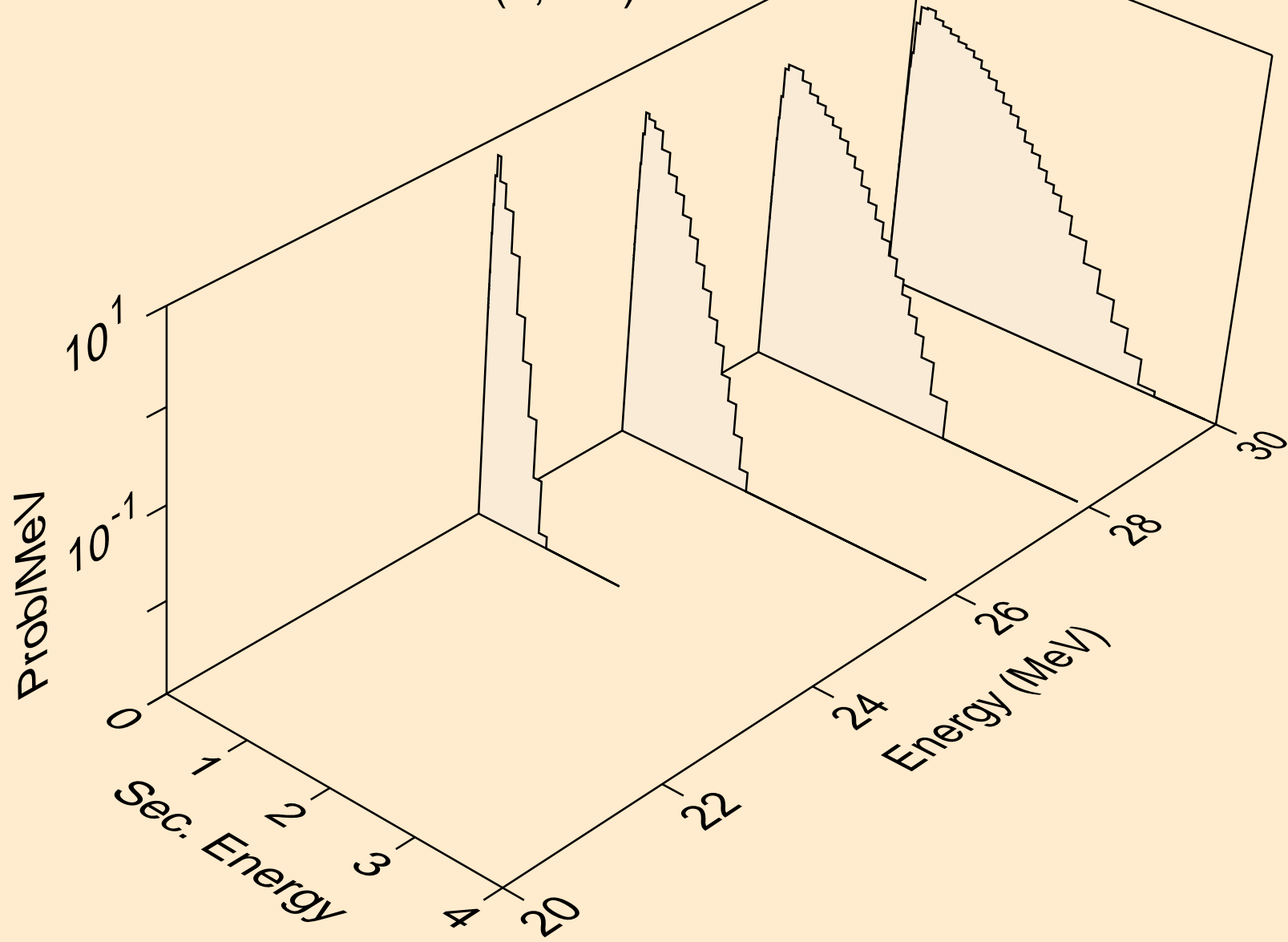

HO148 NEUTRON ACER TENDL-2024 LIBRARY; T=0.K
Neutron emission for (n,2n)

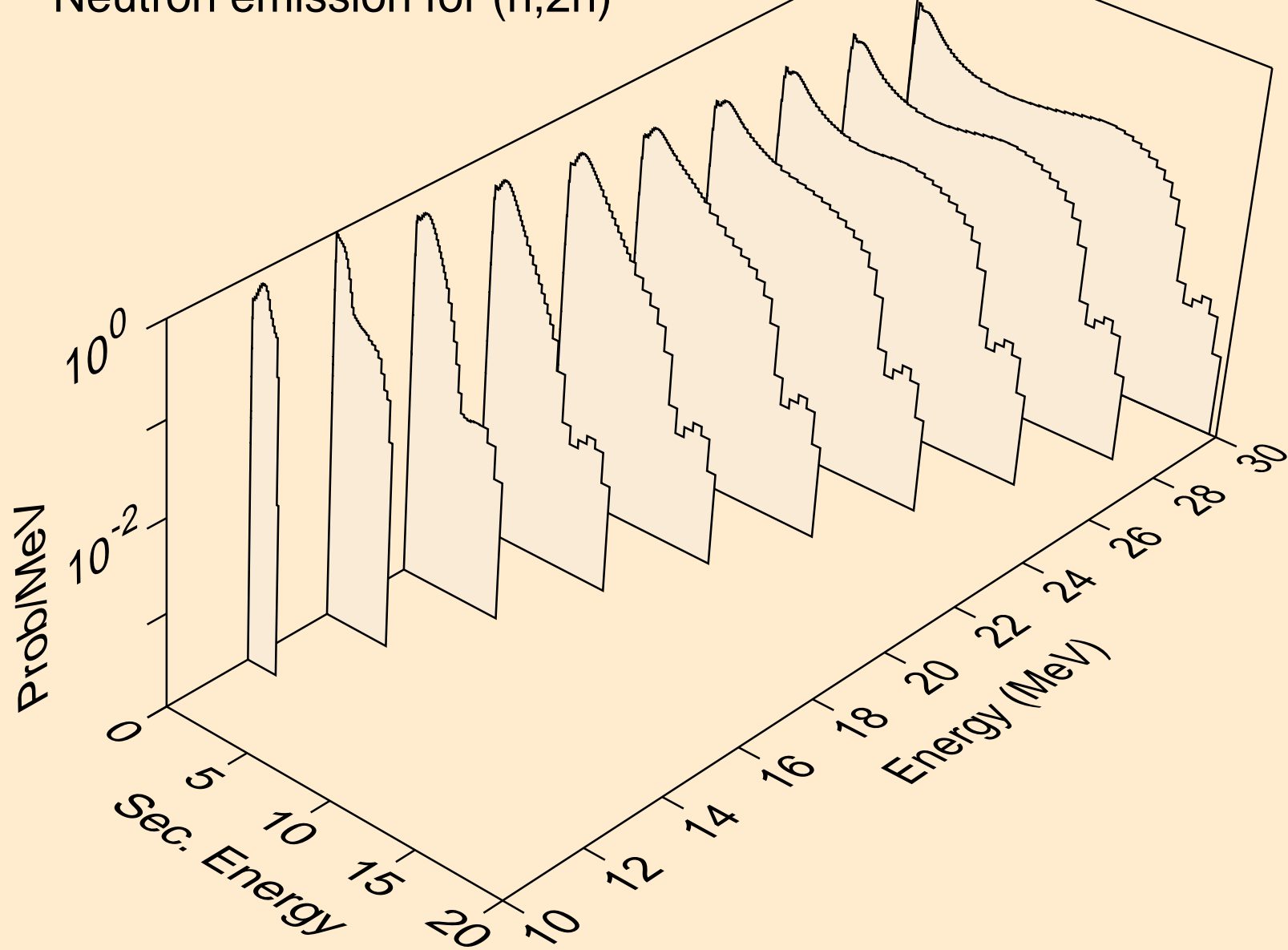

HO148 NEUTRON ACER TENDL-2024 LIBRARY; T=0.K
Neutron emission for (n,3n)

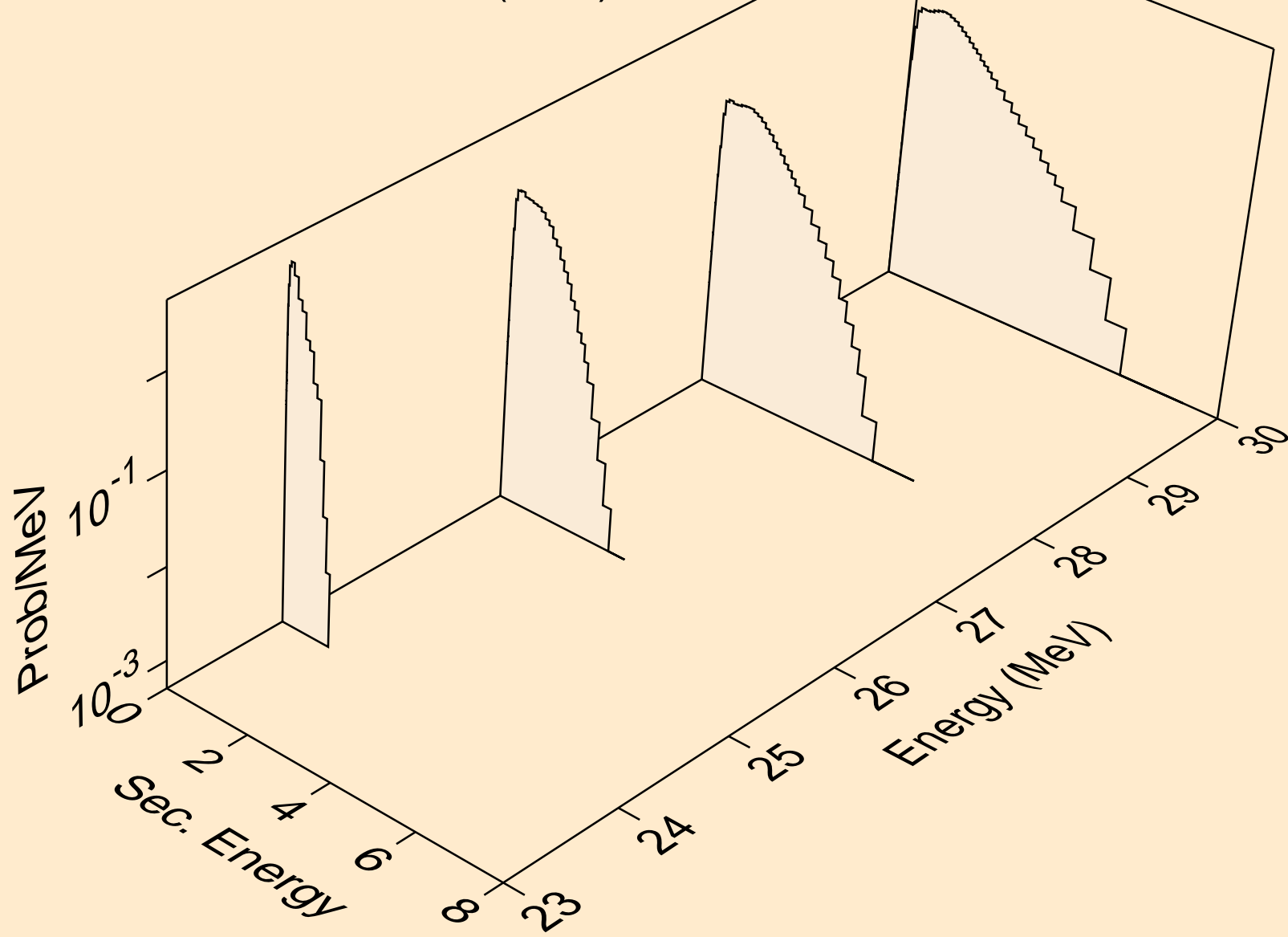

HO148 NEUTRON ACER TENDL-2024 LIBRARY; T=0.K
Neutron emission for (n,n*)a

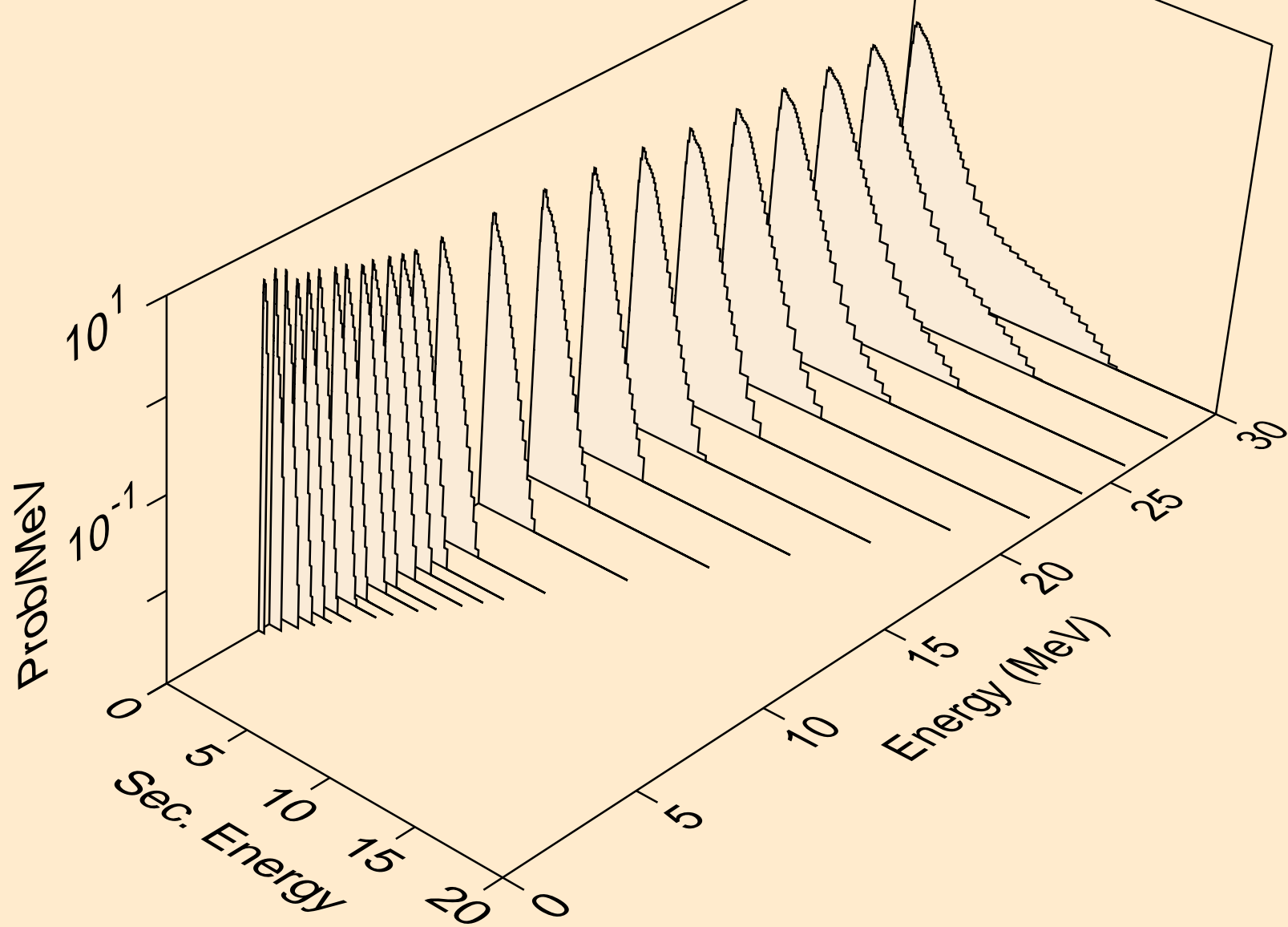

HO148 NEUTRON ACER TENDL-2024 LIBRARY; T=0.K
Neutron emission for (n,2n)a

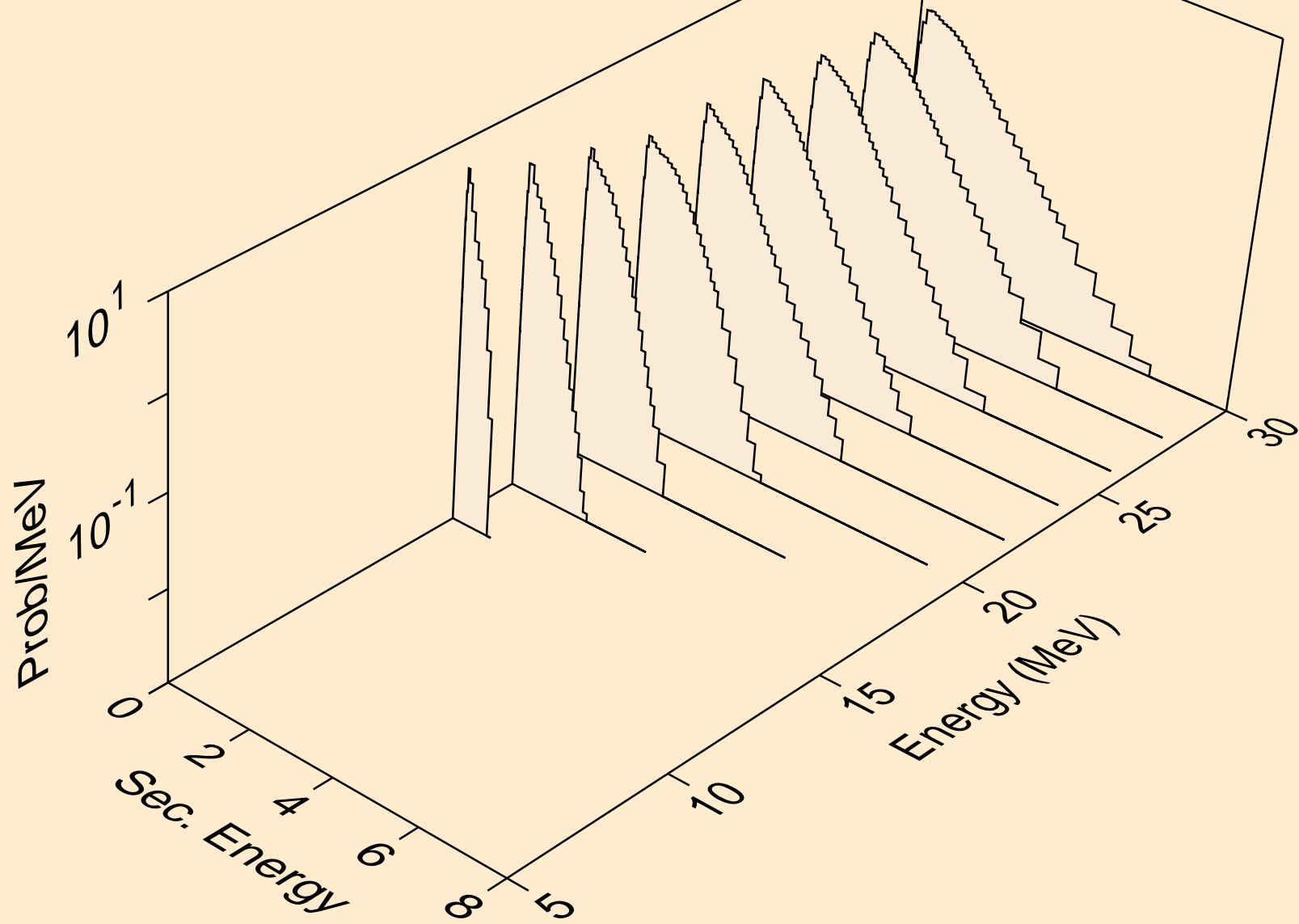

HO148 NEUTRON ACER TENDL-2024 LIBRARY; T=0.K
Neutron emission for (n,n*)p

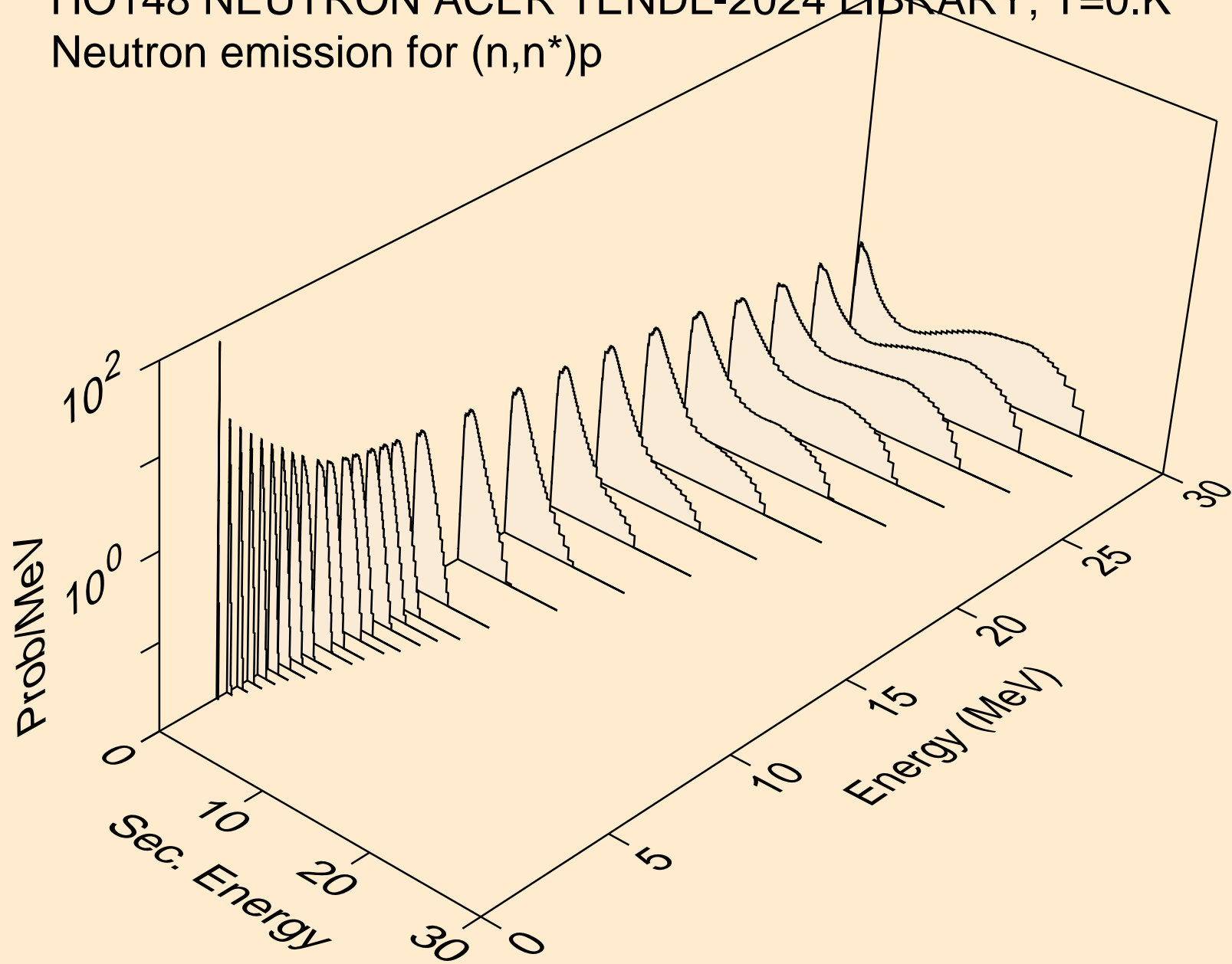

HO148 NEUTRON ACER TENDL-2024 LIBRARY; T=0.K
Neutron emission for (n,n*)2a

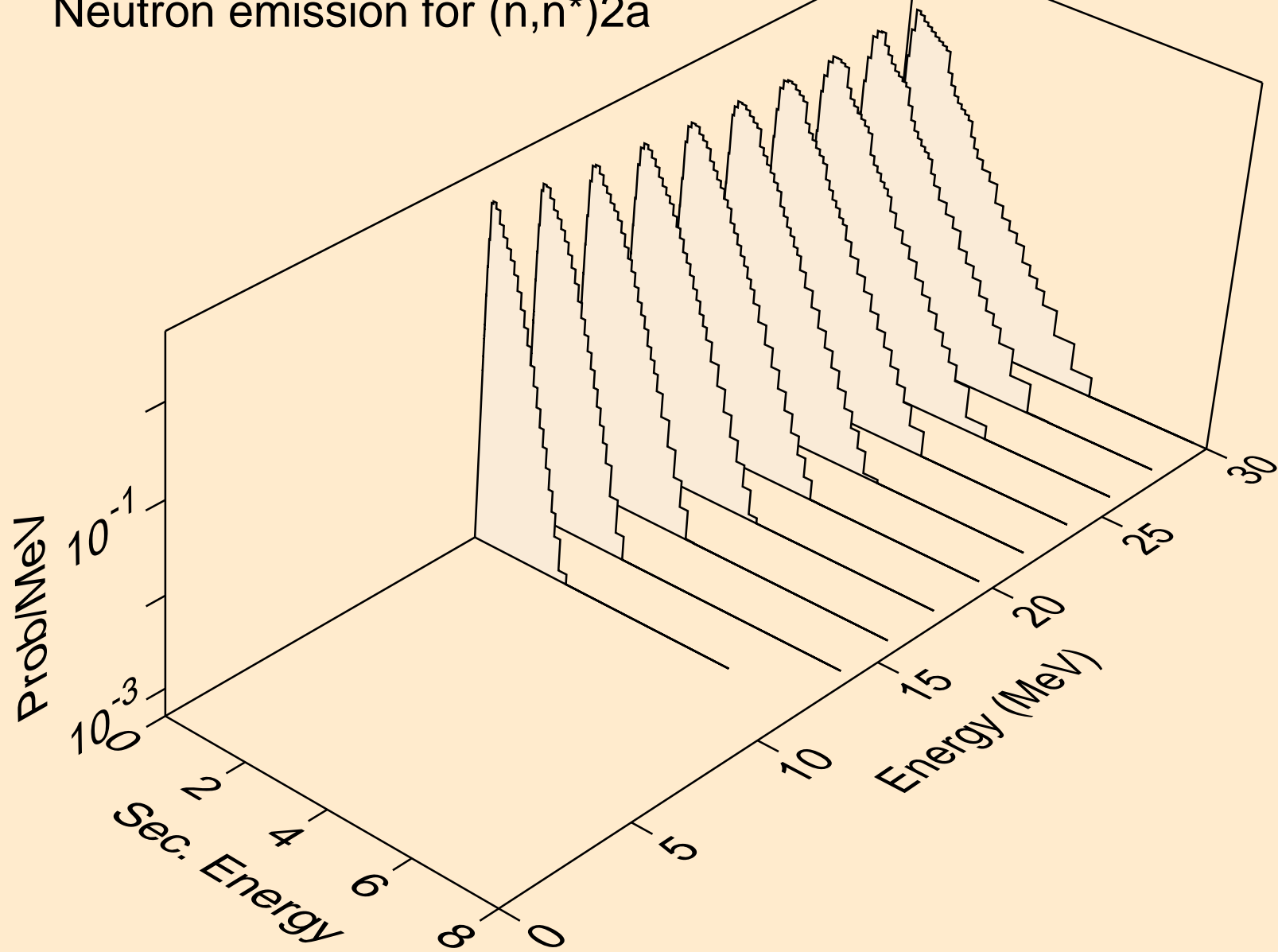

HO148 NEUTRON ACER TENDL-2024 LIBRARY; T=0.K
Neutron emission for (n,2n)2a

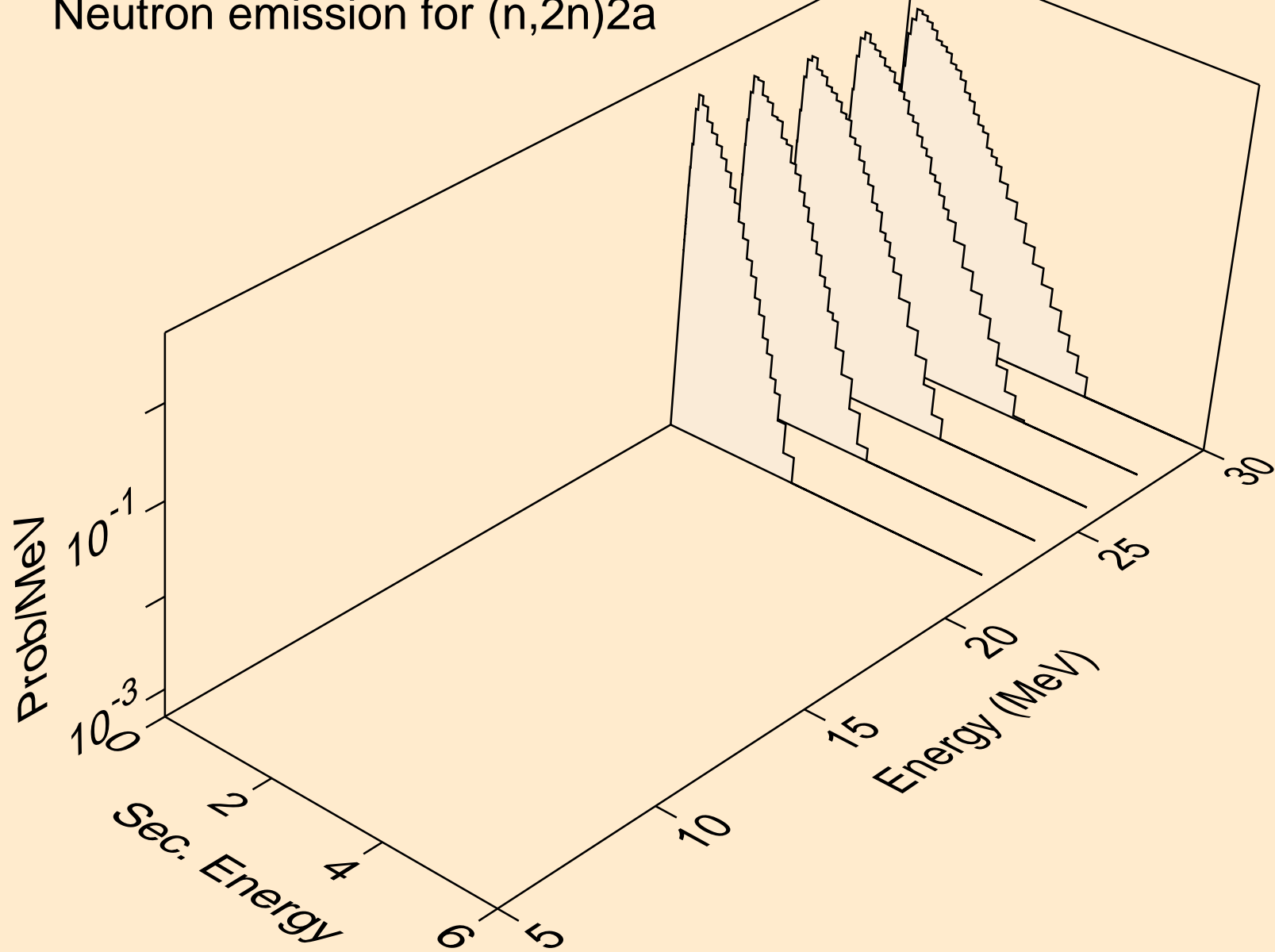

HO148 NEUTRON ACER TENDL-2024 LIBRARY; T=0.K
Neutron emission for (n,n*)d

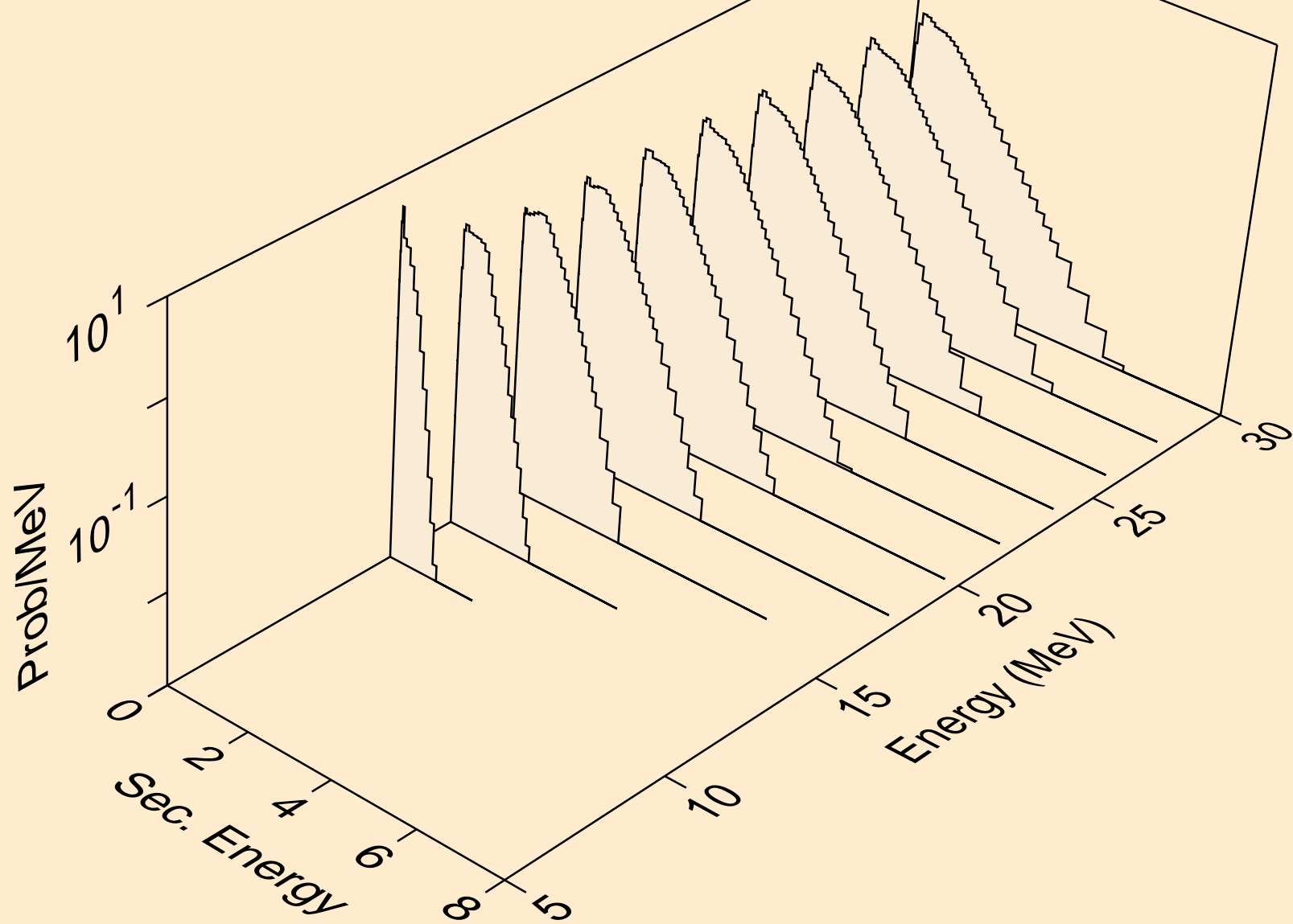

HO148 NEUTRON ACER TENDL-2024 LIBRARY; T=0.K
Neutron emission for (n,n*)t

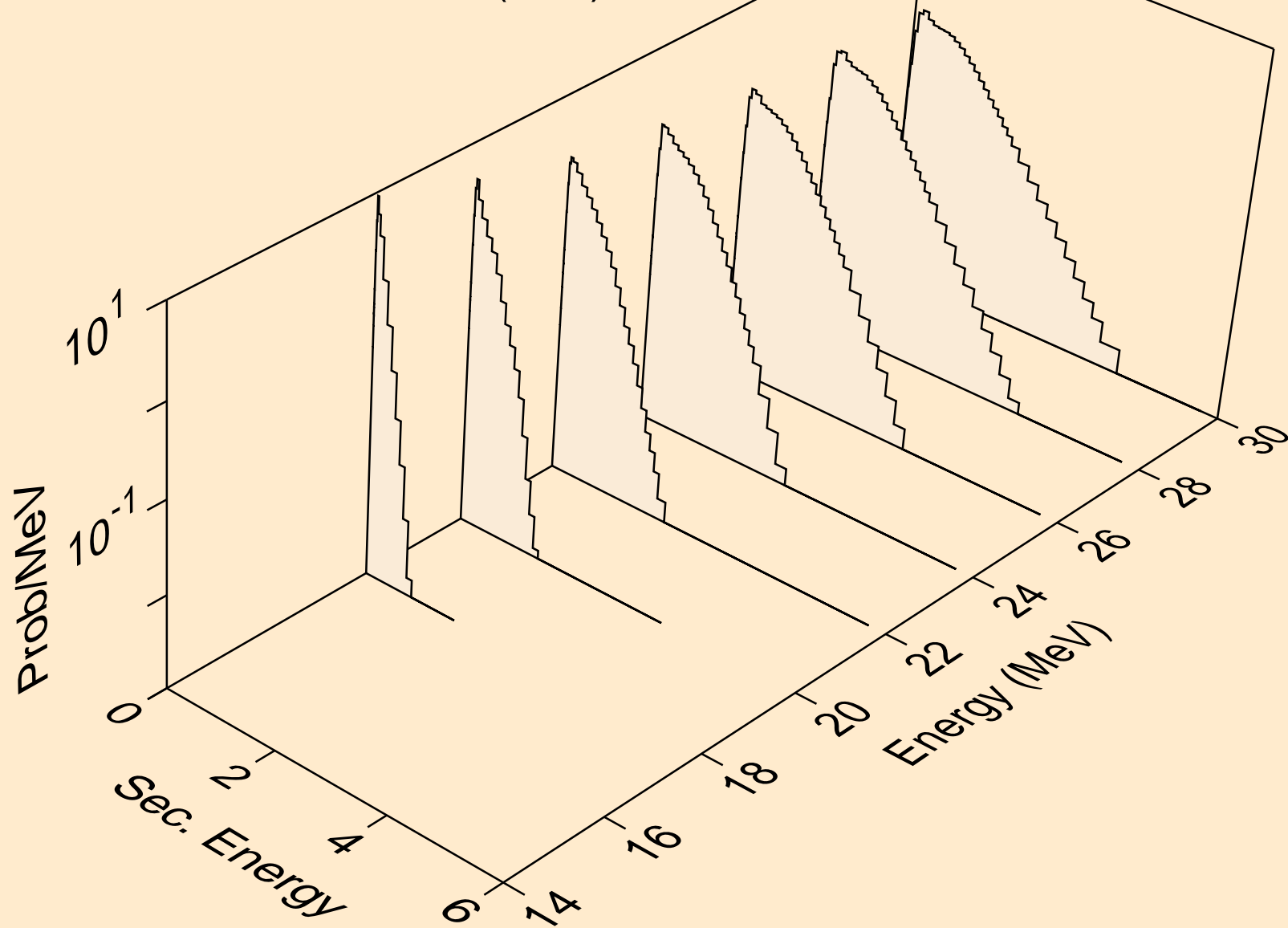

HO148 NEUTRON ACER TENDL-2024 LIBRARY; T=0.K
Neutron emission for (n,n*)he3

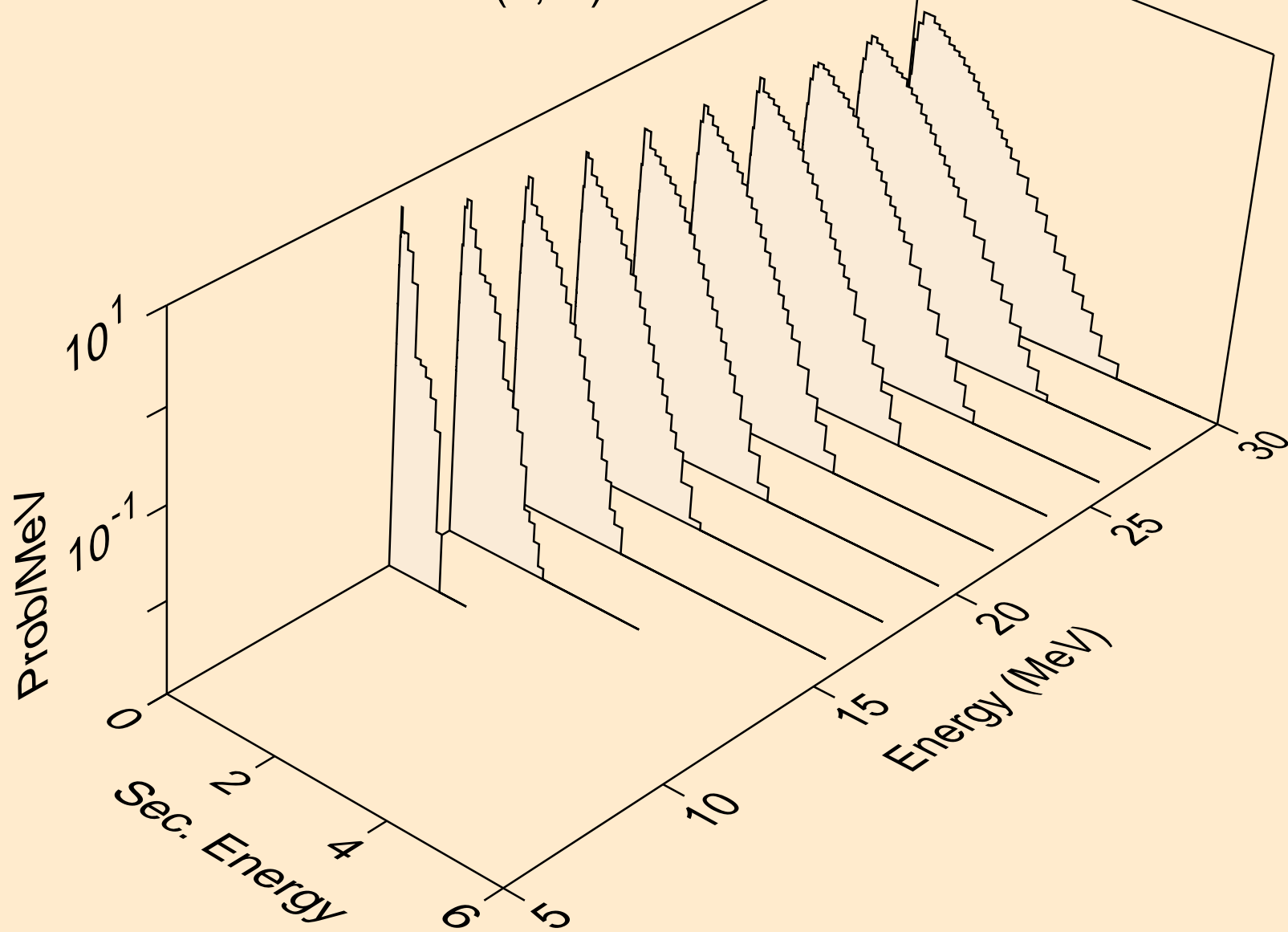

HO148 NEUTRON ACER TENDL-2024 LIBRARY; T=0.K
Neutron emission for (n,2np)

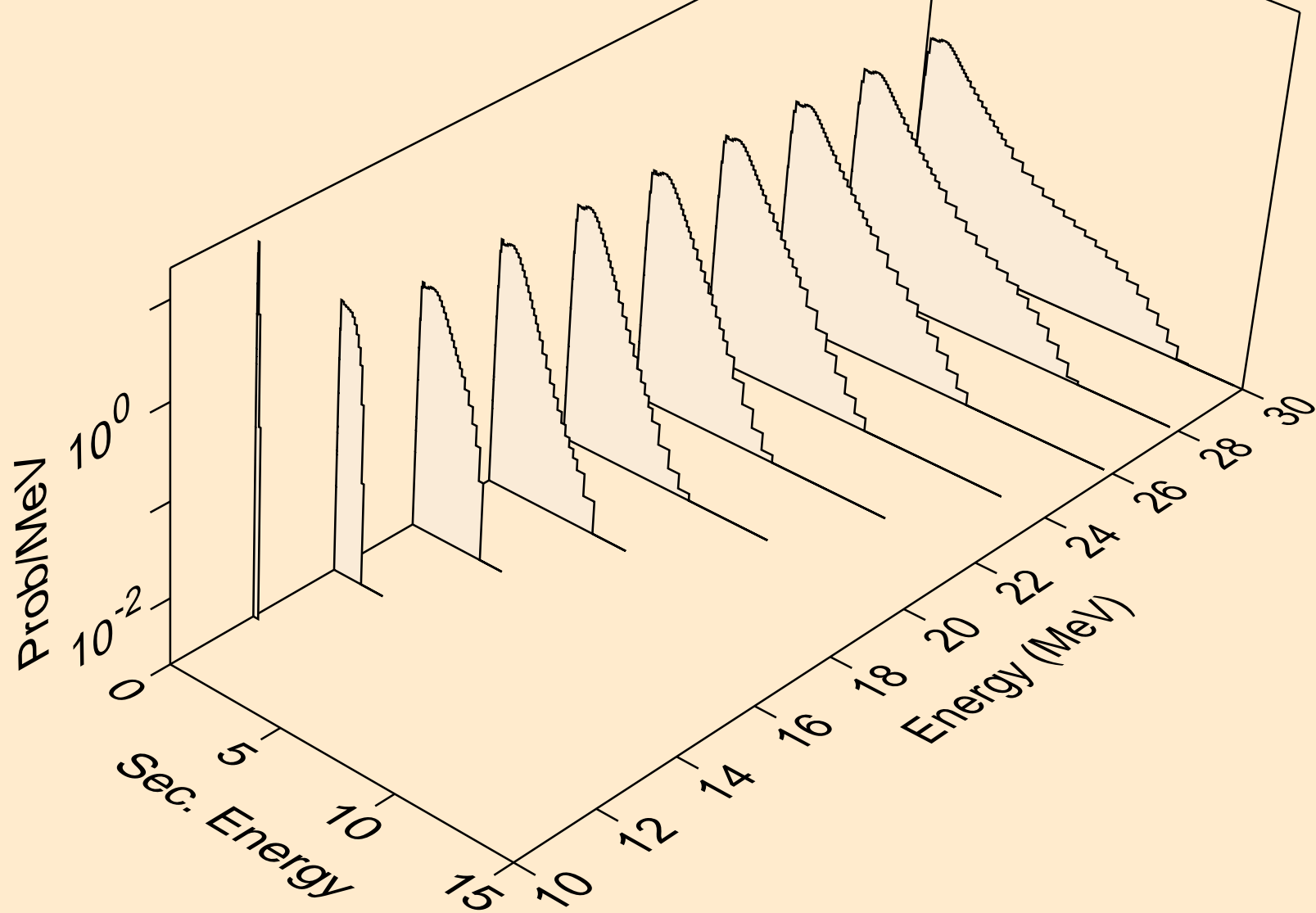

HO148 NEUTRON ACER TENDL-2024 LIBRARY; T=0.K
Neutron emission for (n,3np)

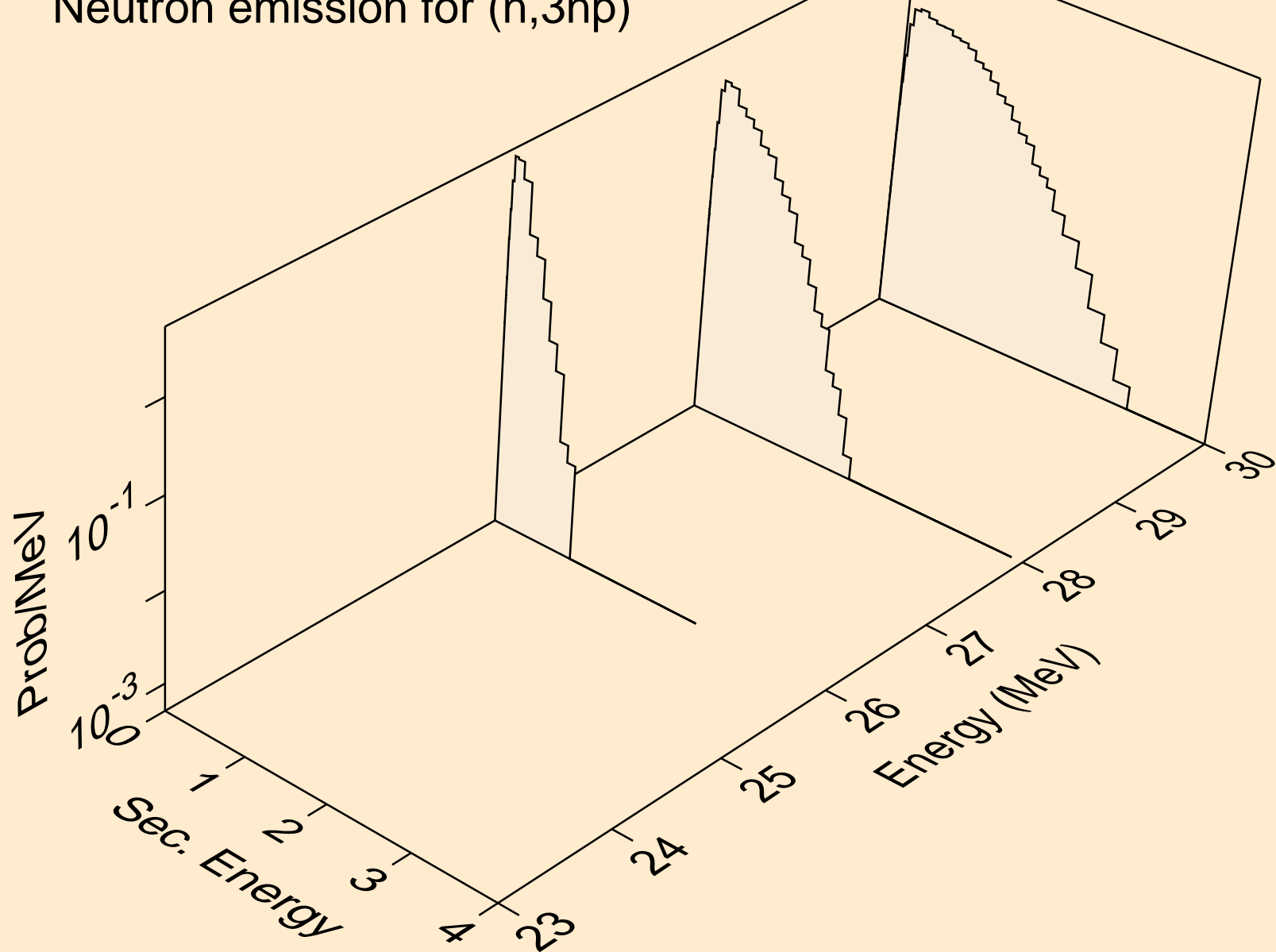

HO148 NEUTRON ACER TENDL-2024 LIBRARY; T=0.K
Neutron emission for (n,n2p)

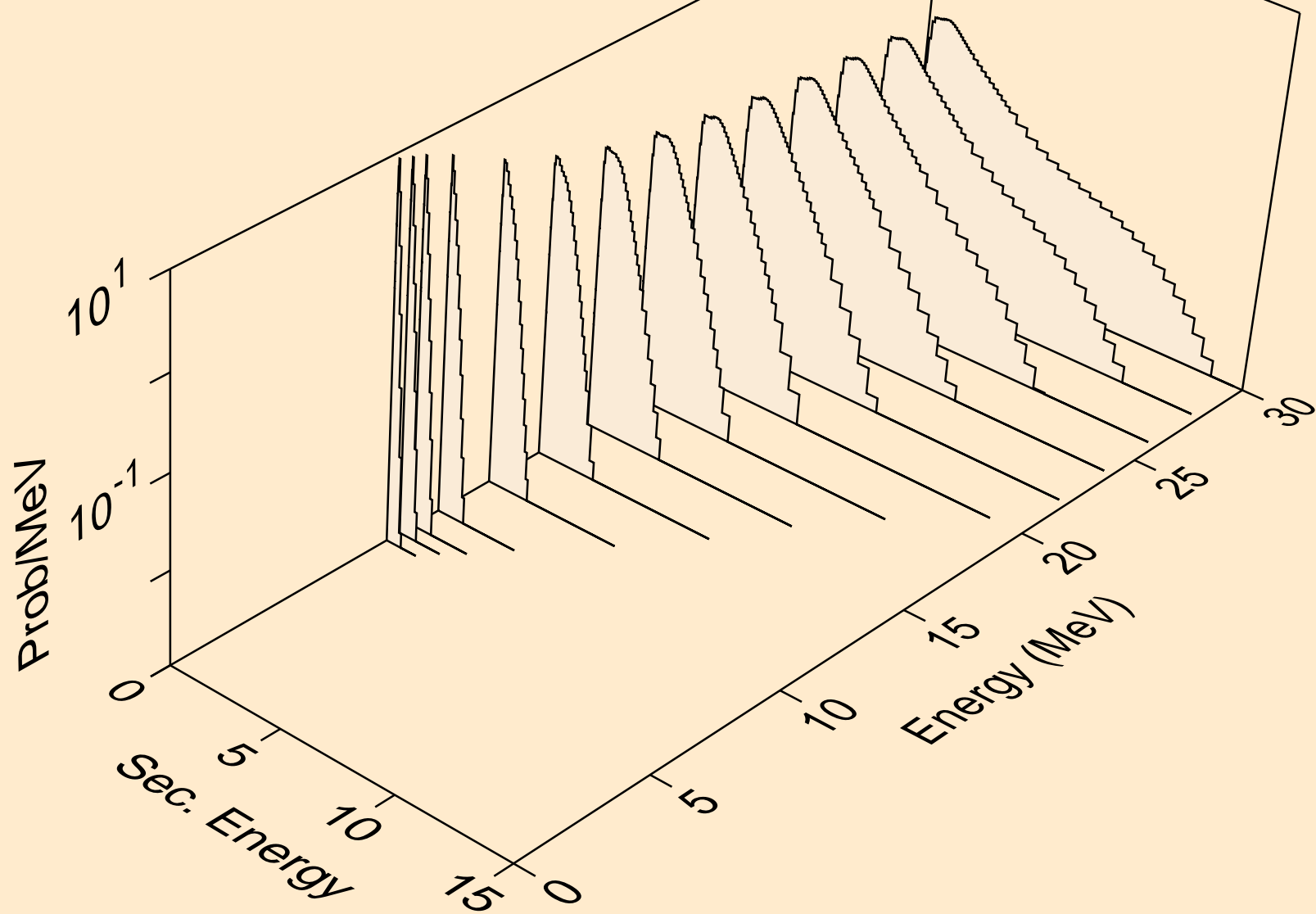

HO148 NEUTRON ACER TENDL-2024 LIBRARY; T=0.K
Neutron emission for (n,npa)

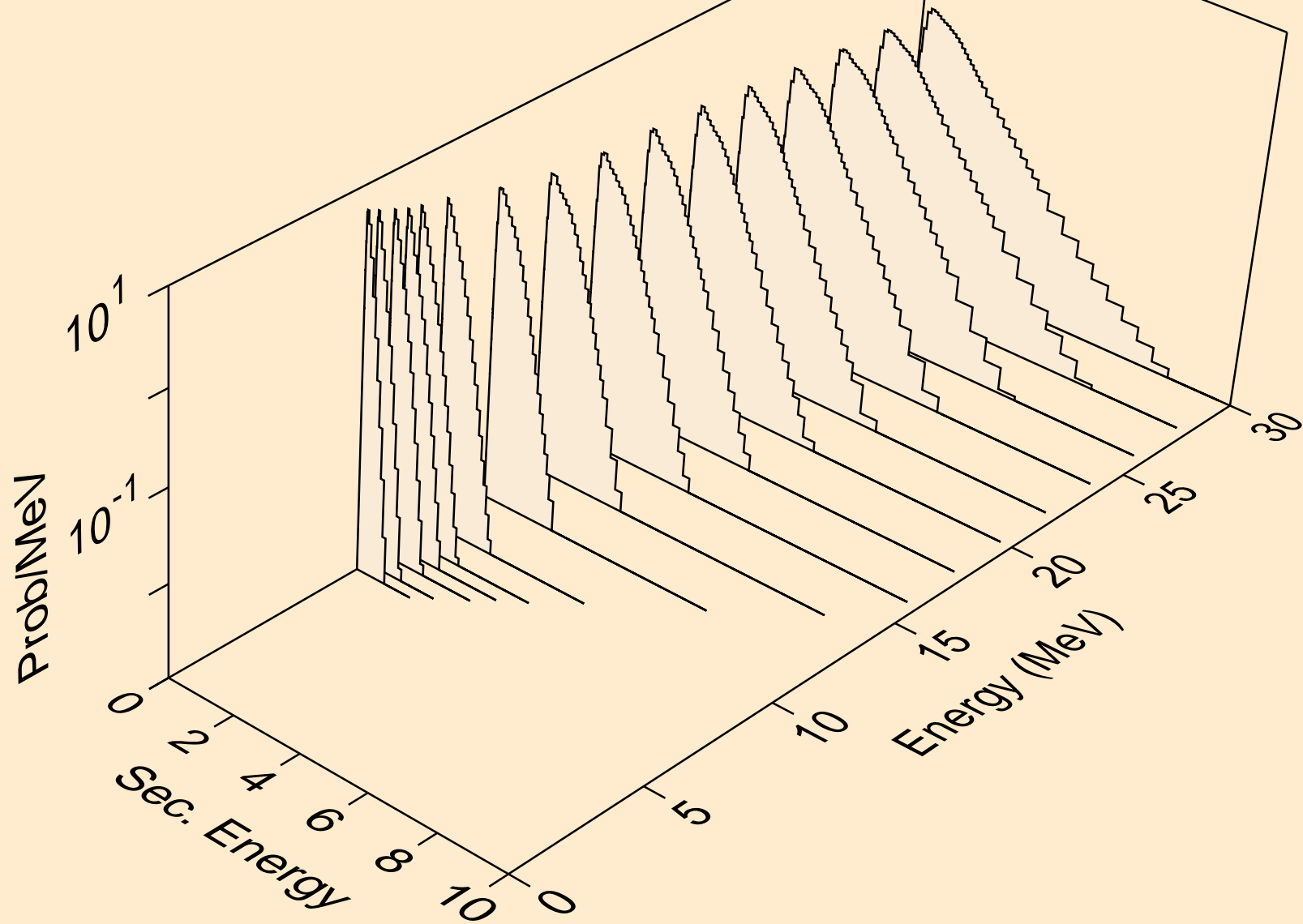

HO148 NEUTRON ACER TENDL-2024 LIBRARY; T=0.K
Neutron emission for (n,n*c)

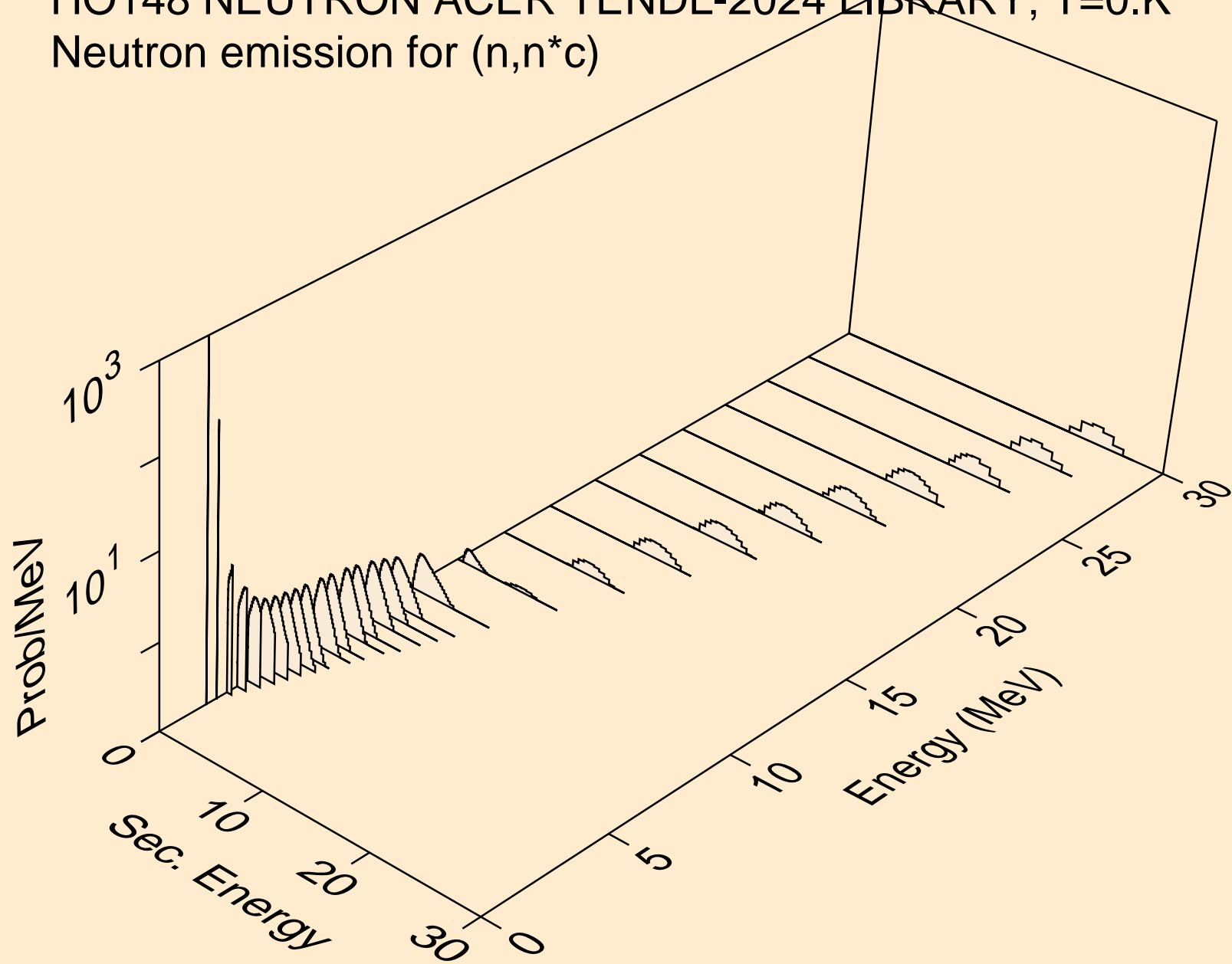

HO148 NEUTRON ACER TENDL-2024 LIBRARY; T=0.K
Photon emission for (n,x)

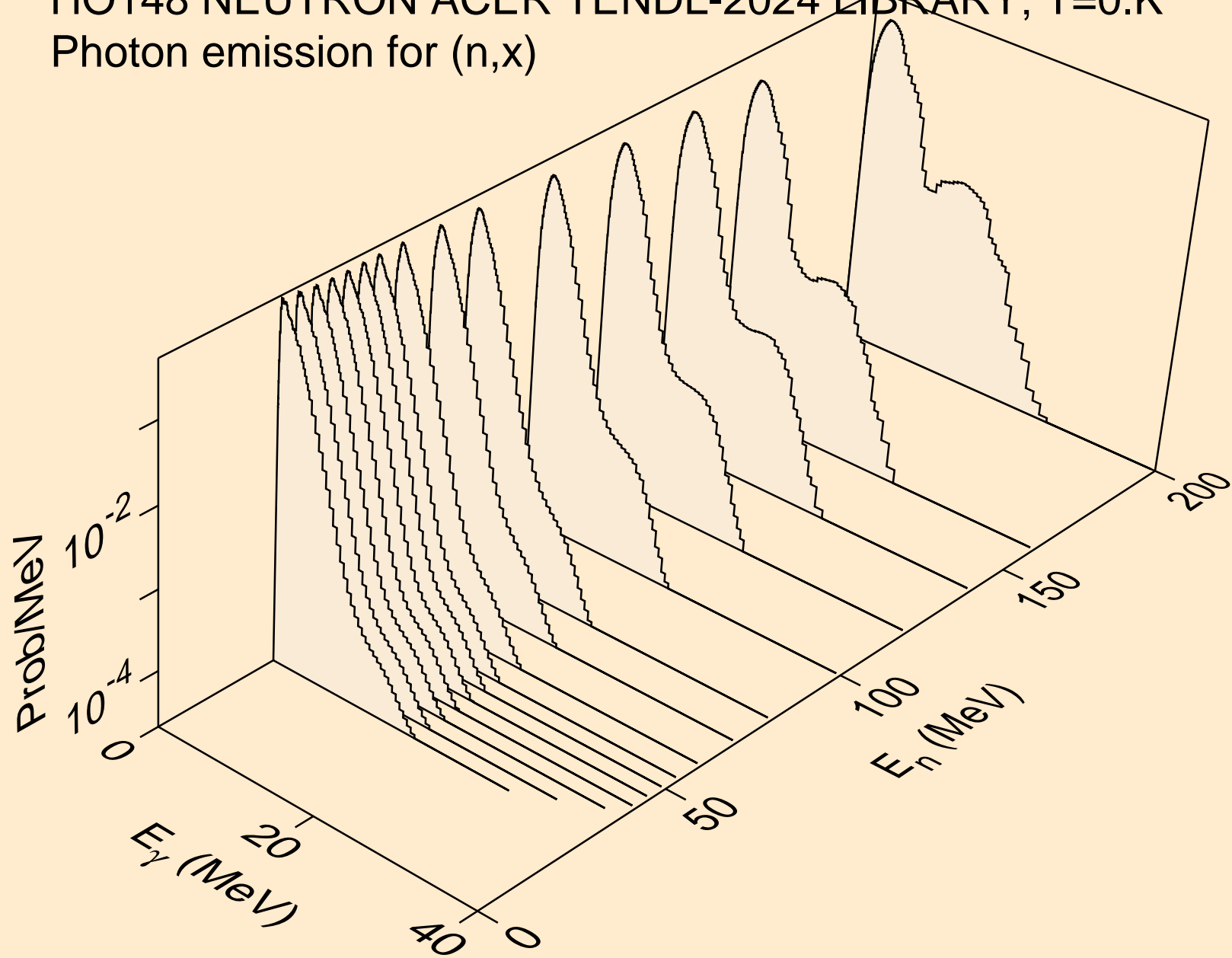

HO148 NEUTRON ACER TENDL-2024 LIBRARY; T=0.K
Photon emission for (n,2nd)

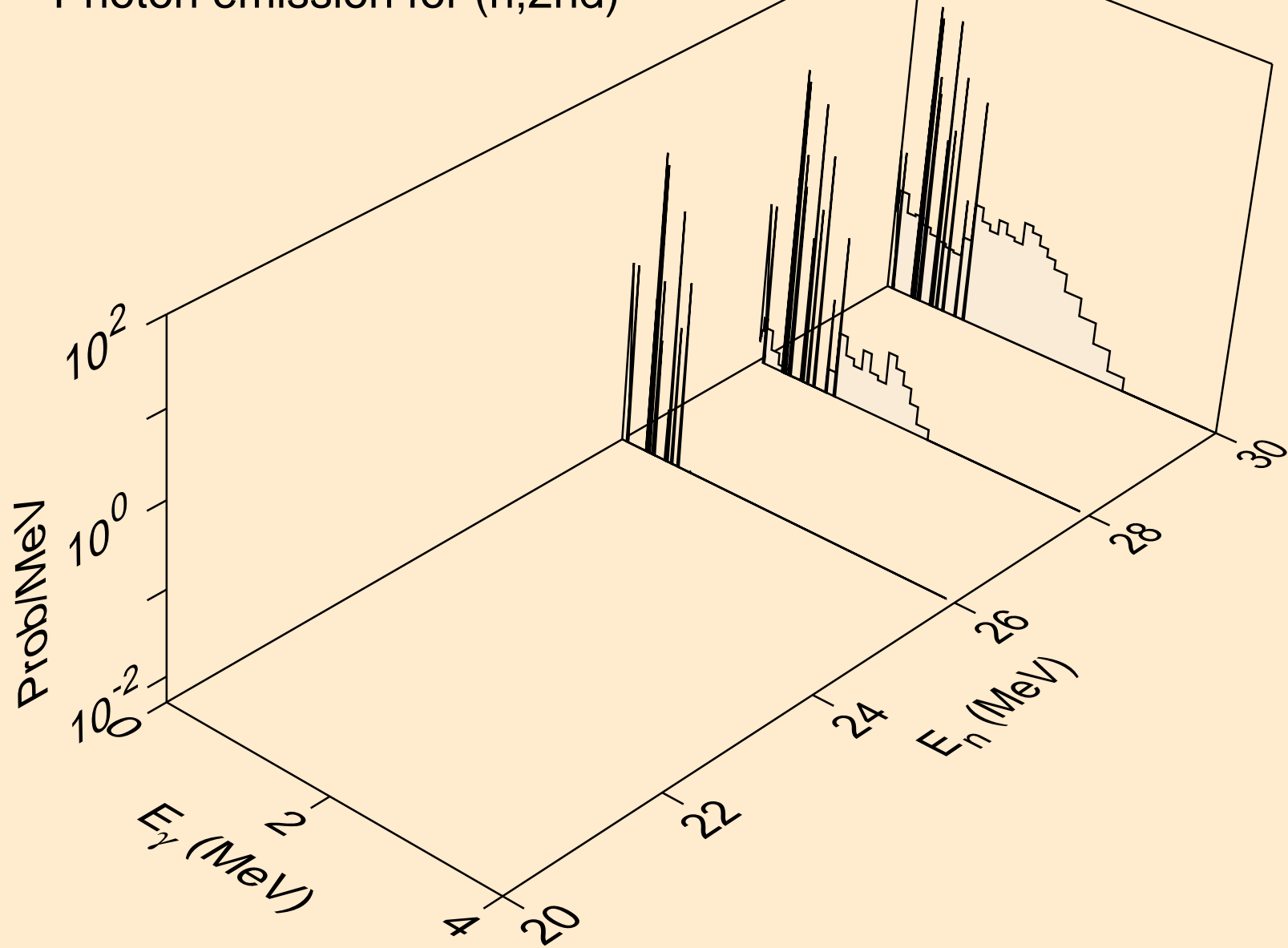

HO148 NEUTRON ACER TENDL-2024 LIBRARY; T=0.K
Photon emission for (n,2n)

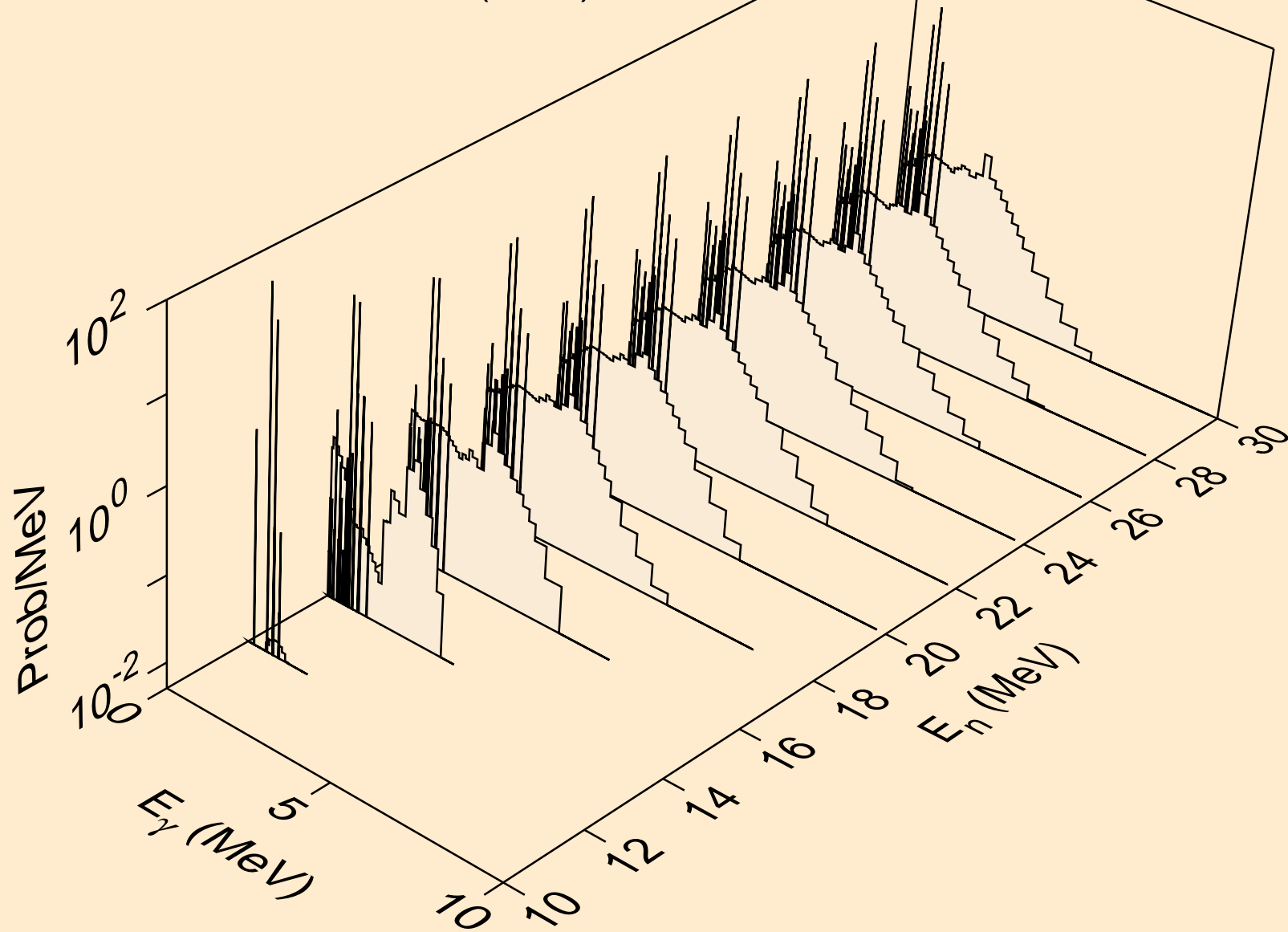

HO148 NEUTRON ACER TENDL-2024 LIBRARY; T=0.K
Photon emission for (n,3n)

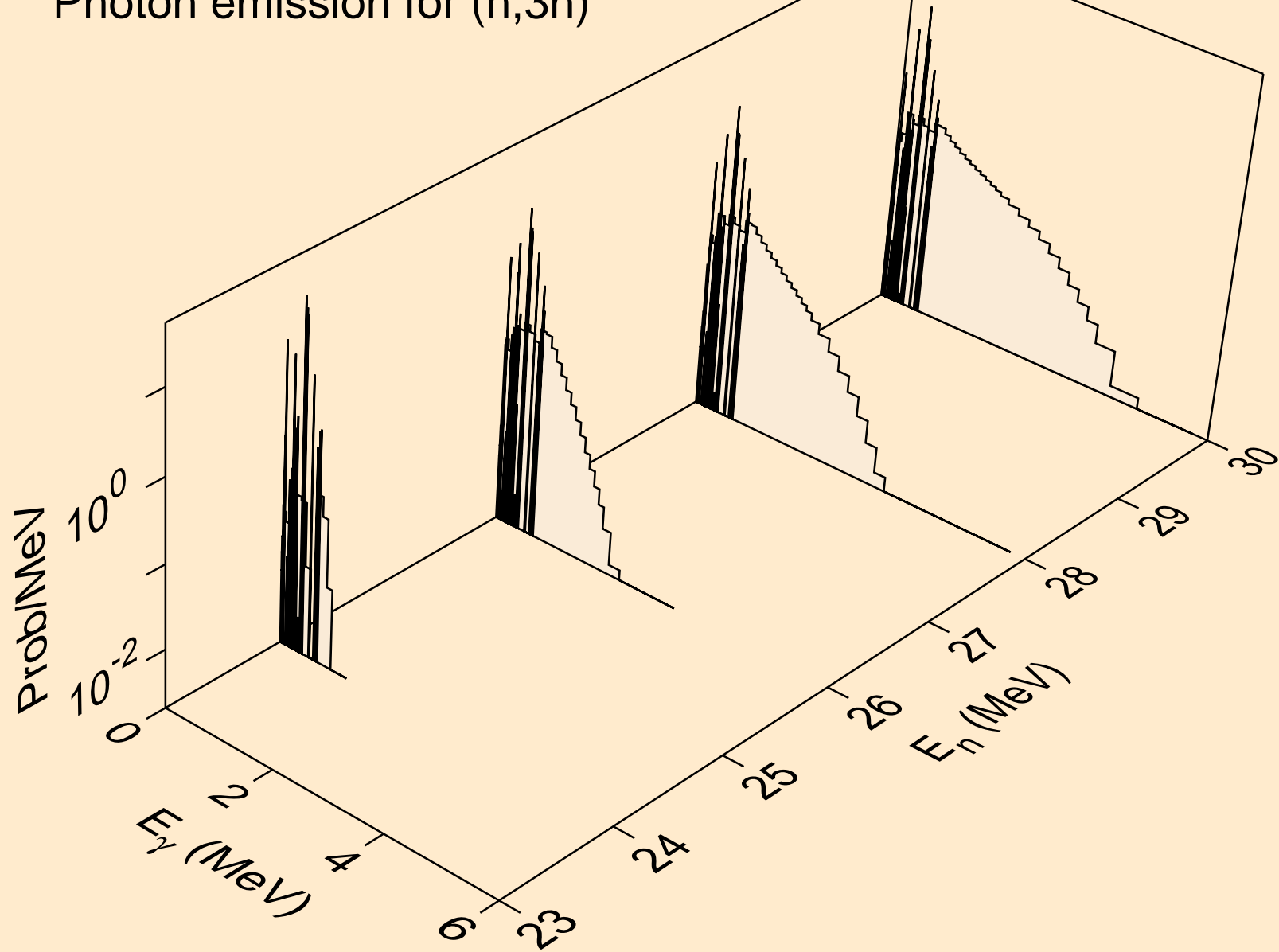

HO148 NEUTRON ACER TENDL-2024 LIBRARY; T=0.K
Photon emission for (n,n*)a

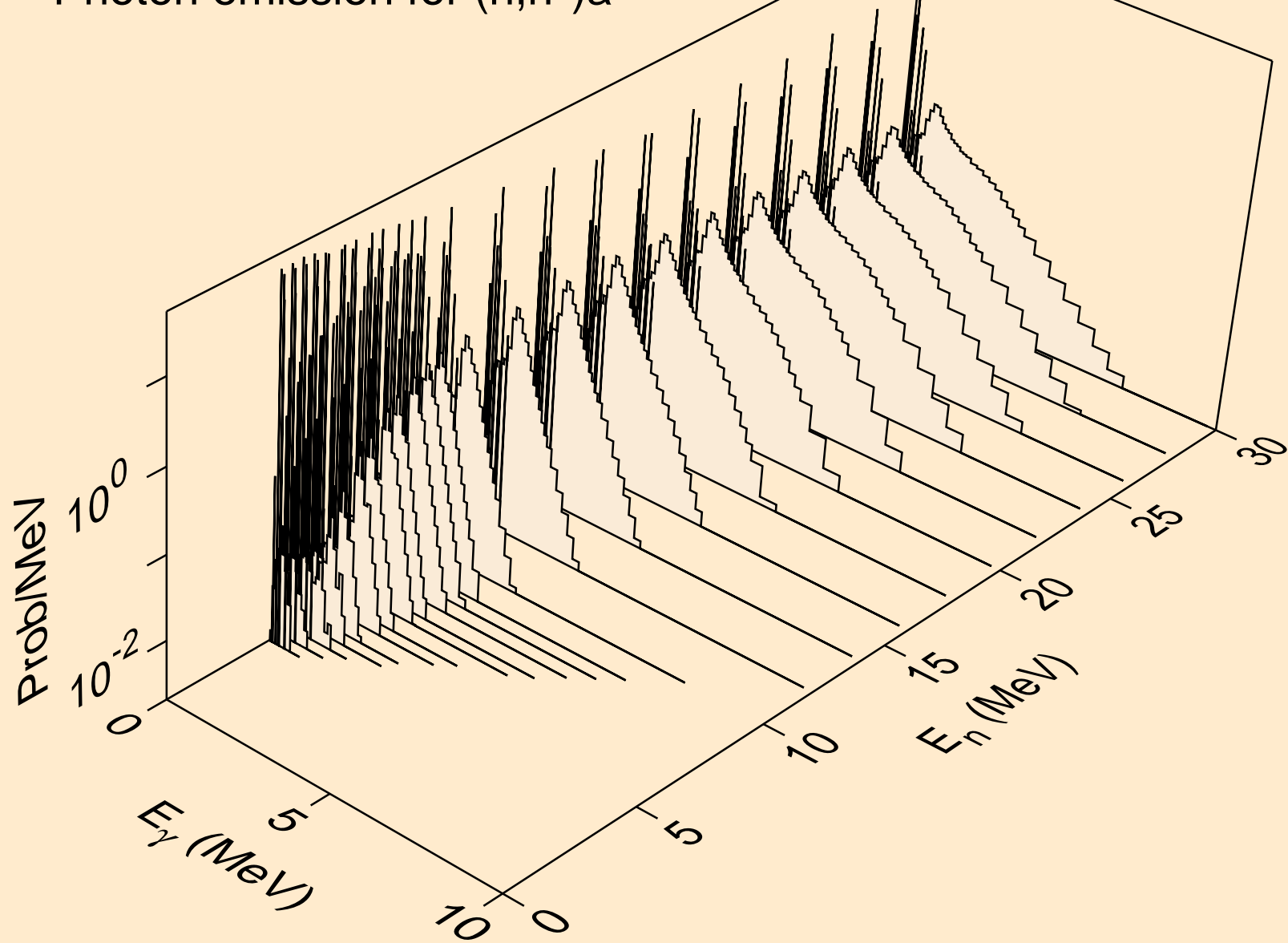

HO148 NEUTRON ACER TENDL-2024 LIBRARY; T=0.K
Photon emission for (n,2n)a

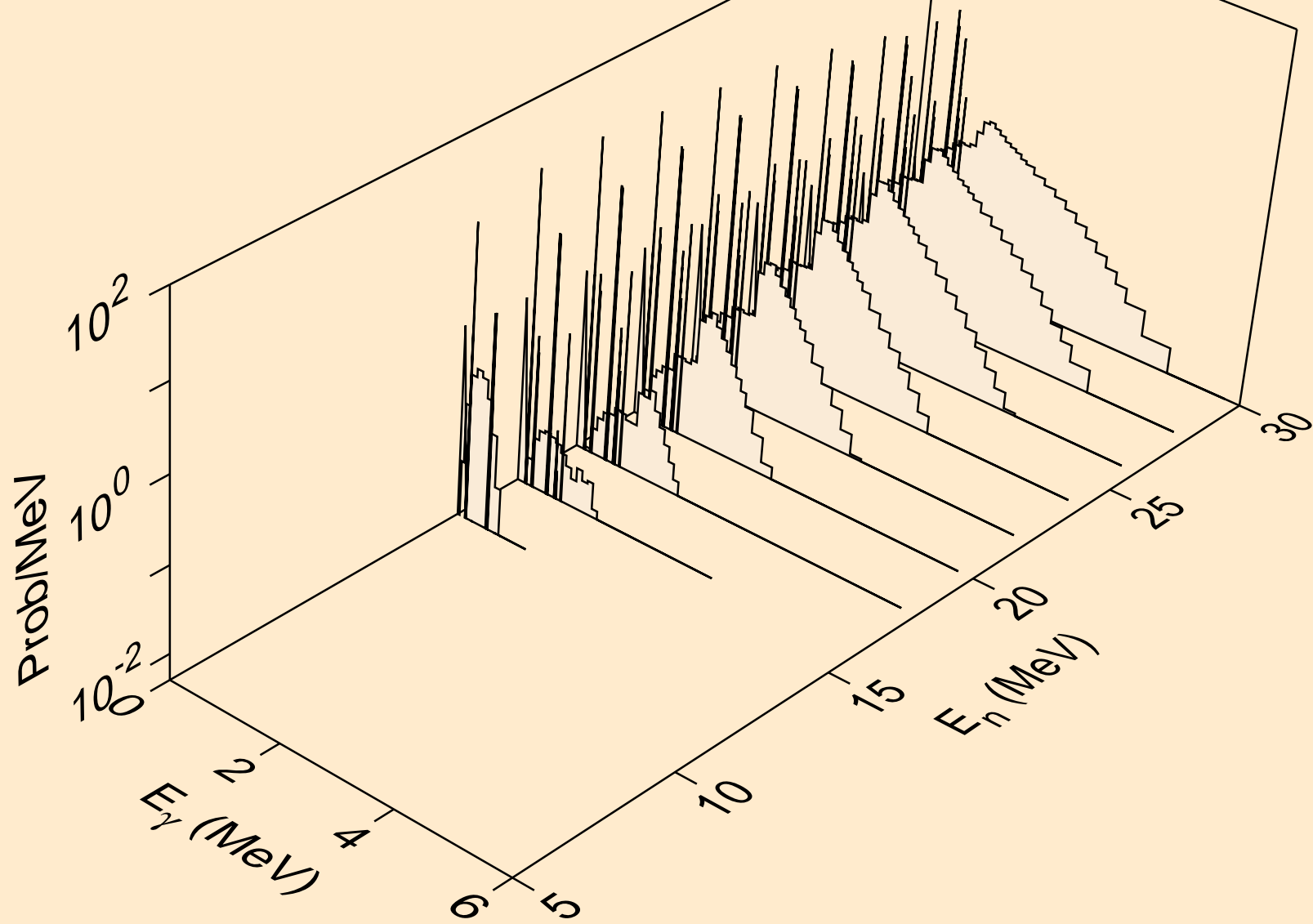

HO148 NEUTRON ACER TENDL-2024 LIBRARY; T=0.K
Photon emission for (n,n*)p

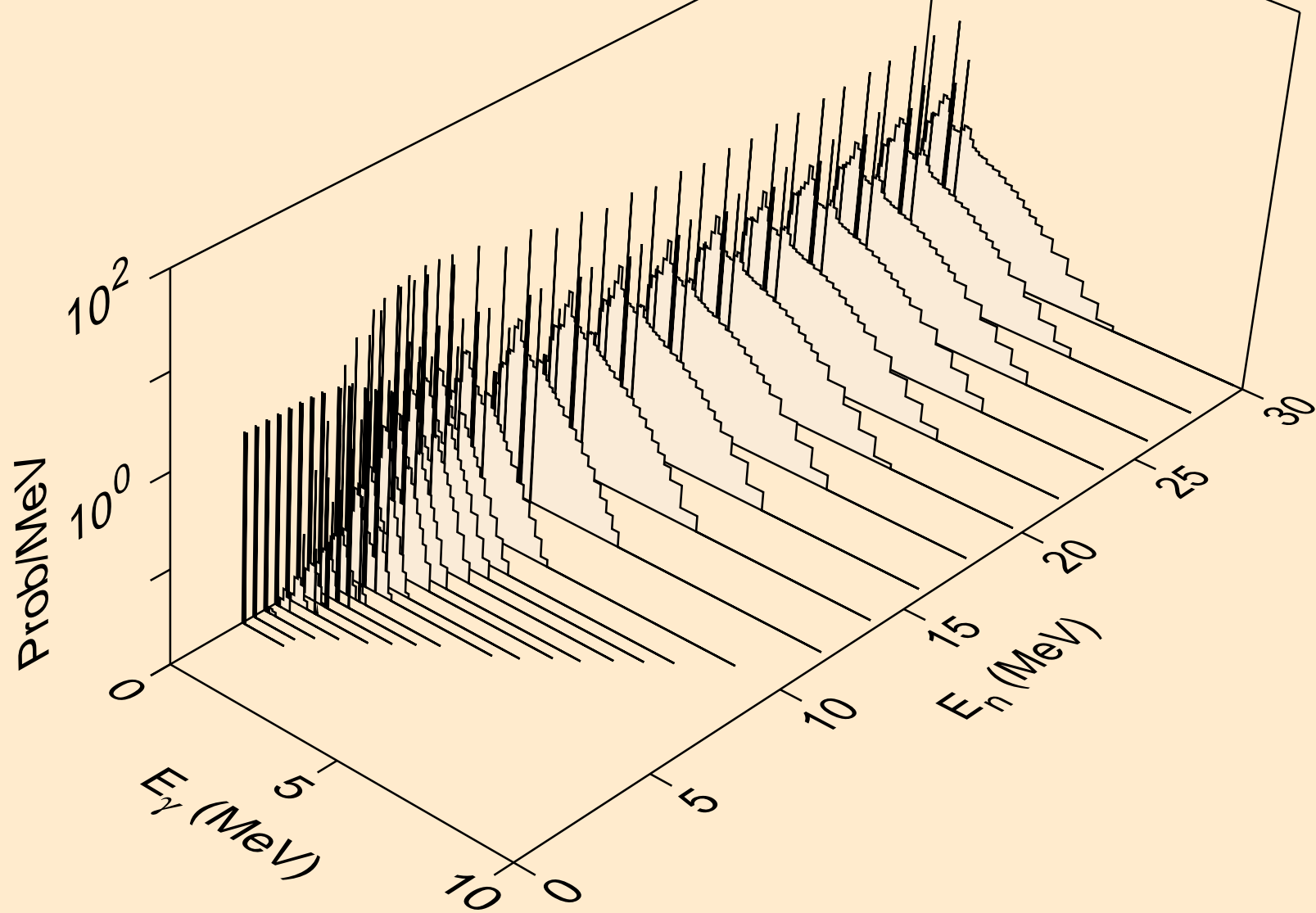

HO148 NEUTRON ACER TENDL-2024 LIBRARY; T=0.K
Photon emission for (n,n*)2a

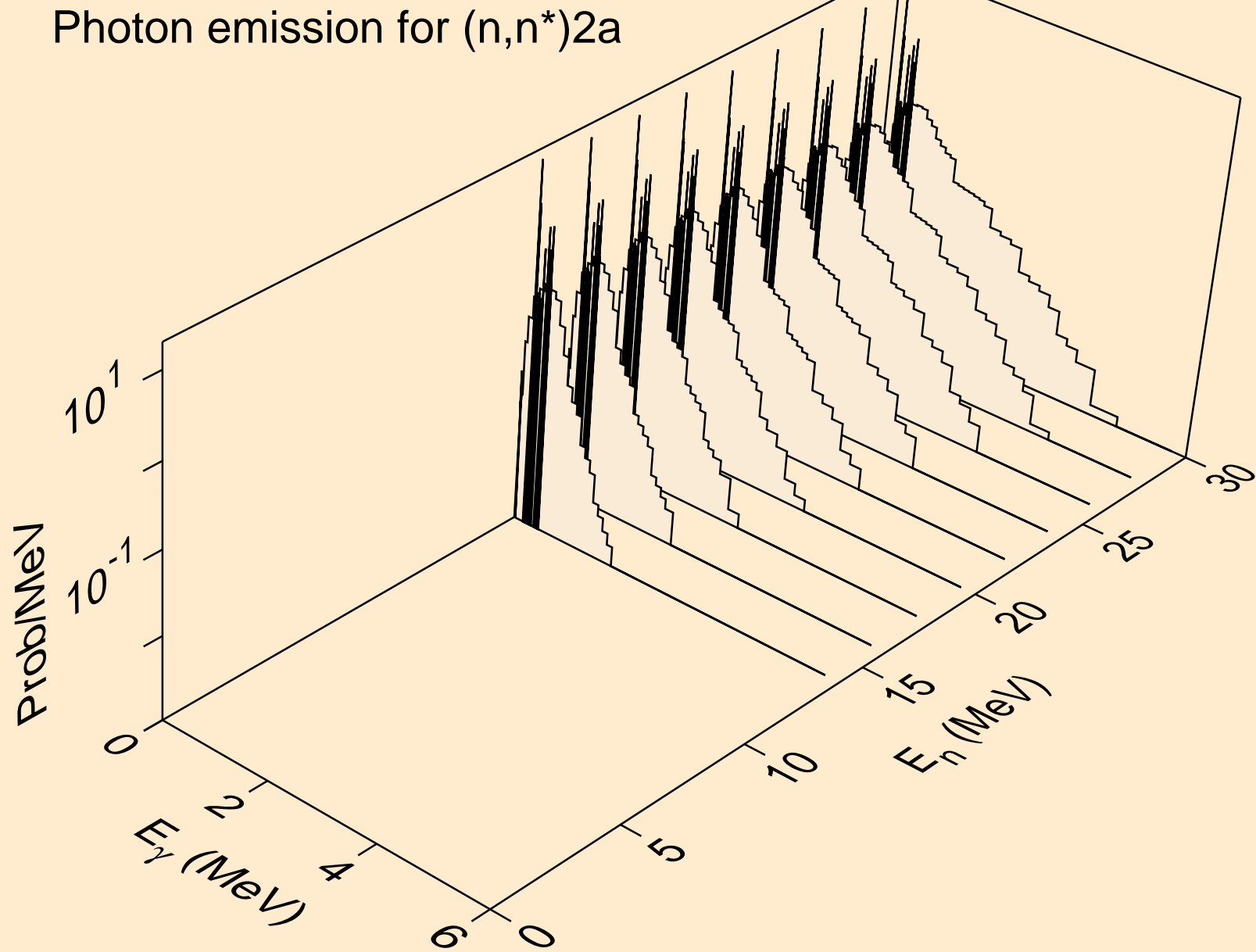

HO148 NEUTRON ACER TENDL-2024 LIBRARY; T=0.K
Photon emission for (n,2n)2a

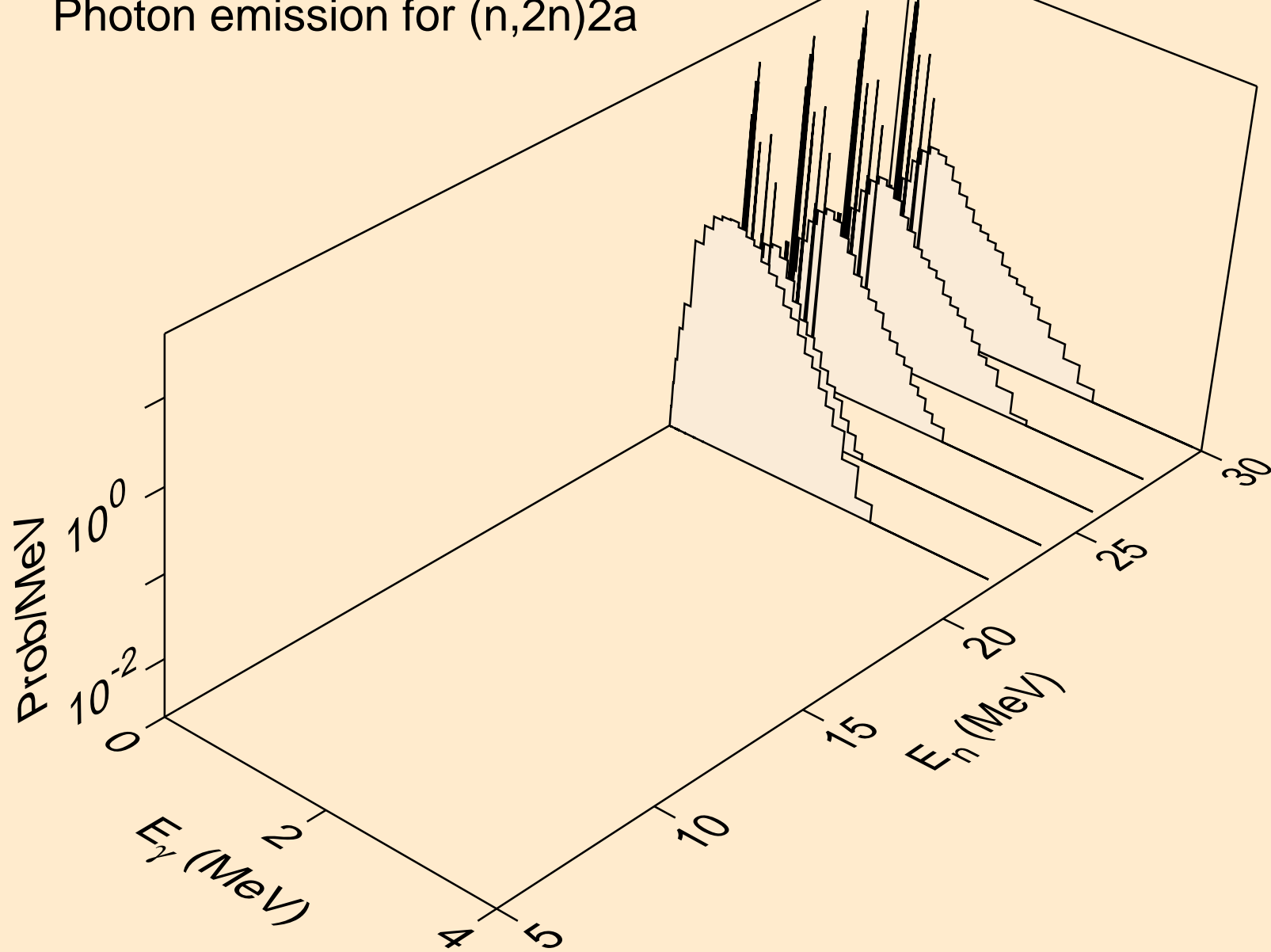

HO148 NEUTRON ACER TENDL-2024 LIBRARY; T=0.K
Photon emission for (n,n*)d

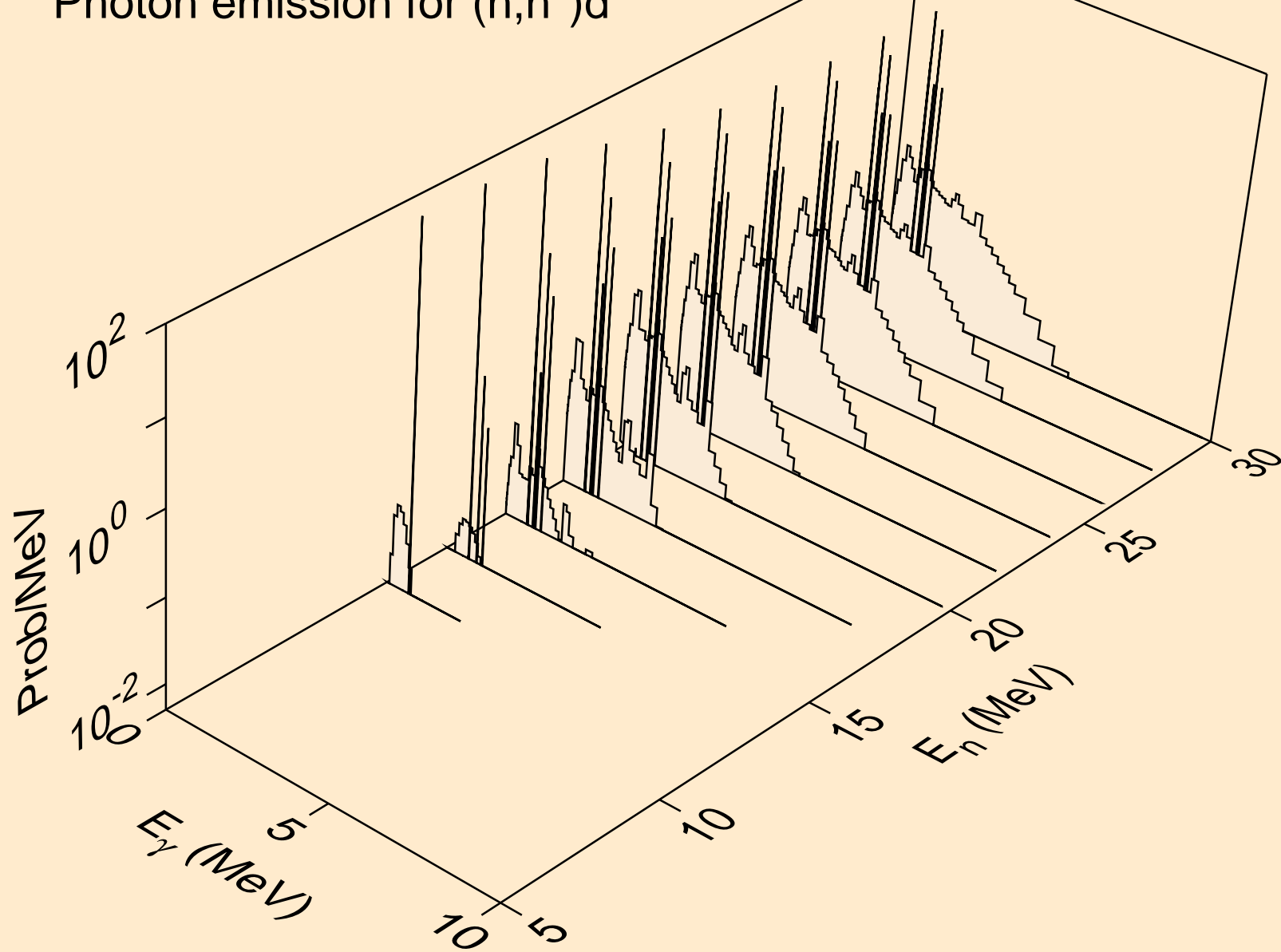

HO148 NEUTRON ACER TENDL-2024 LIBRARY; T=0.K
Photon emission for (n,n*)t

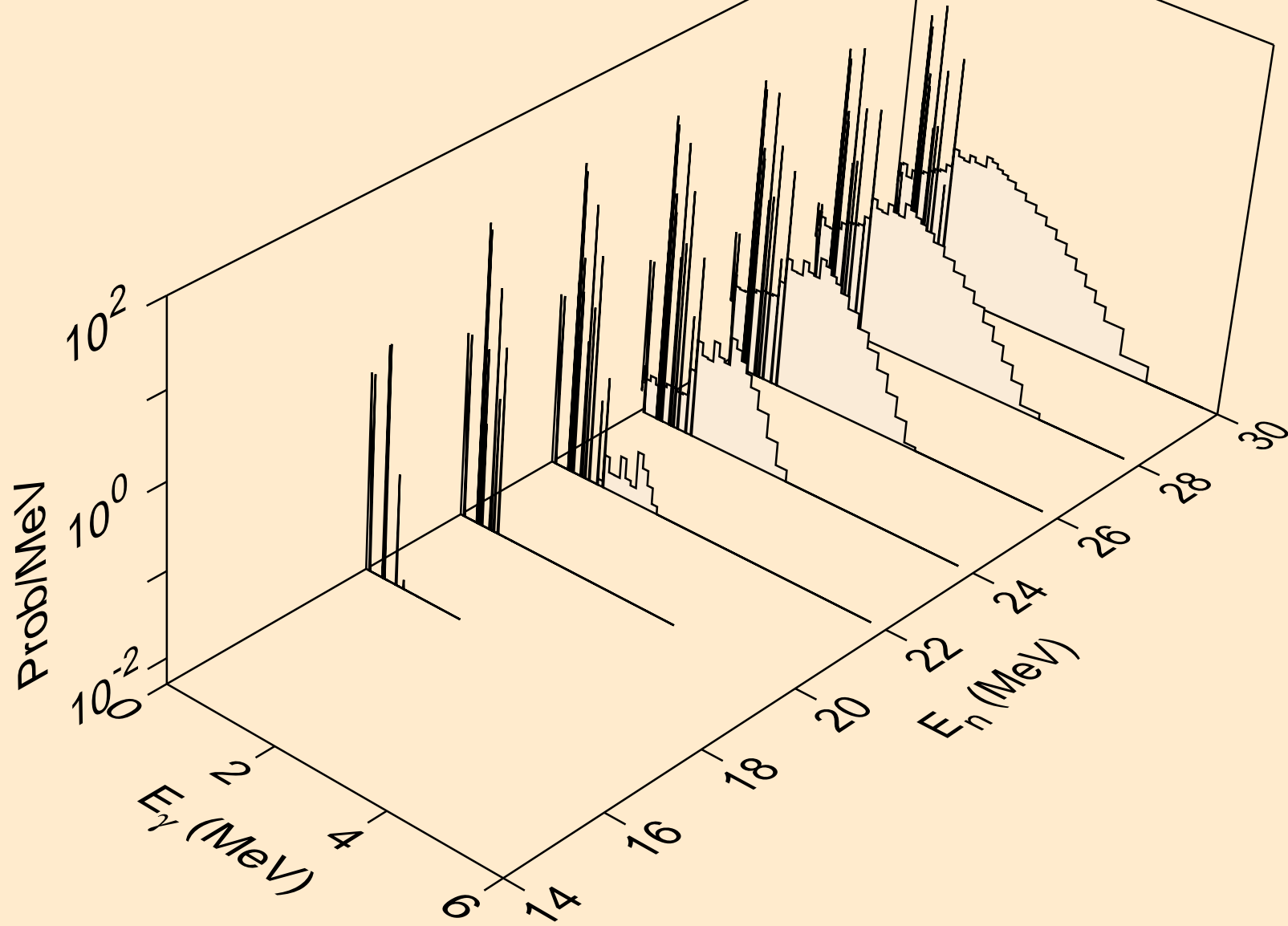

HO148 NEUTRON ACER TENDL-2024 LIBRARY; T=0.K
Photon emission for (n,n*)he3

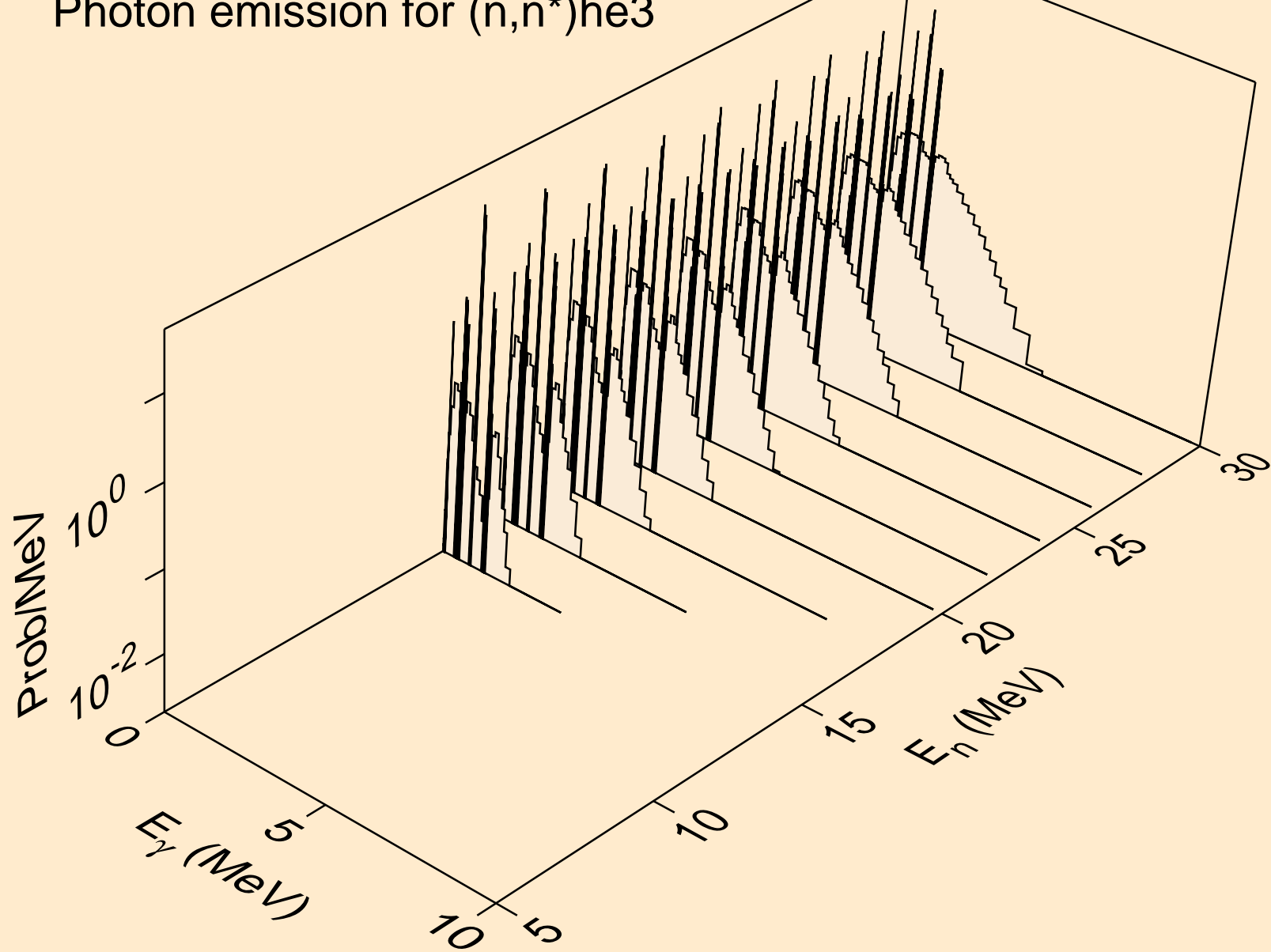

HO148 NEUTRON ACER TENDL-2024 LIBRARY; T=0.K
Photon emission for (n,2np)

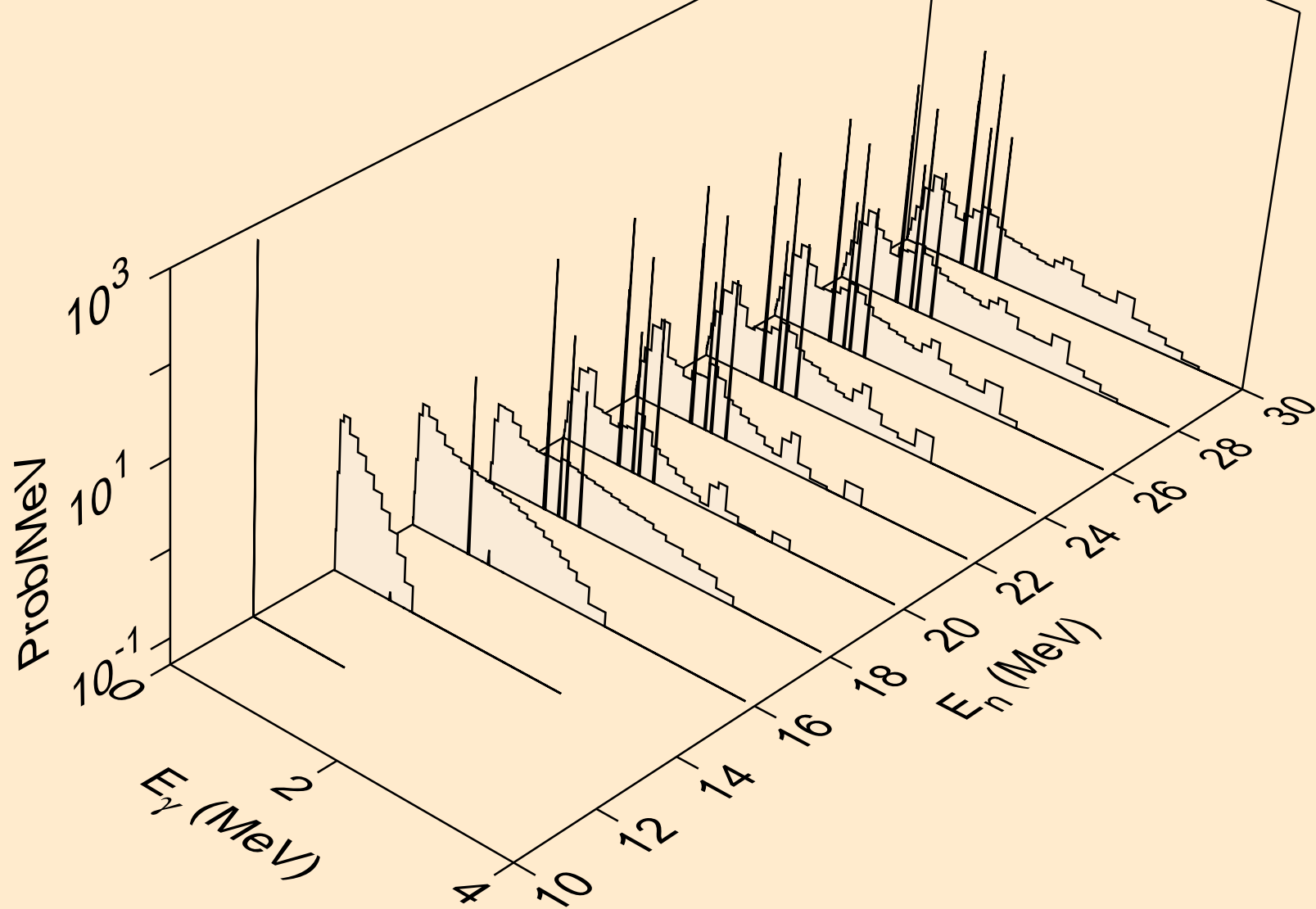

HO148 NEUTRON ACER TENDL-2024 LIBRARY; T=0.K
Photon emission for (n,3np)

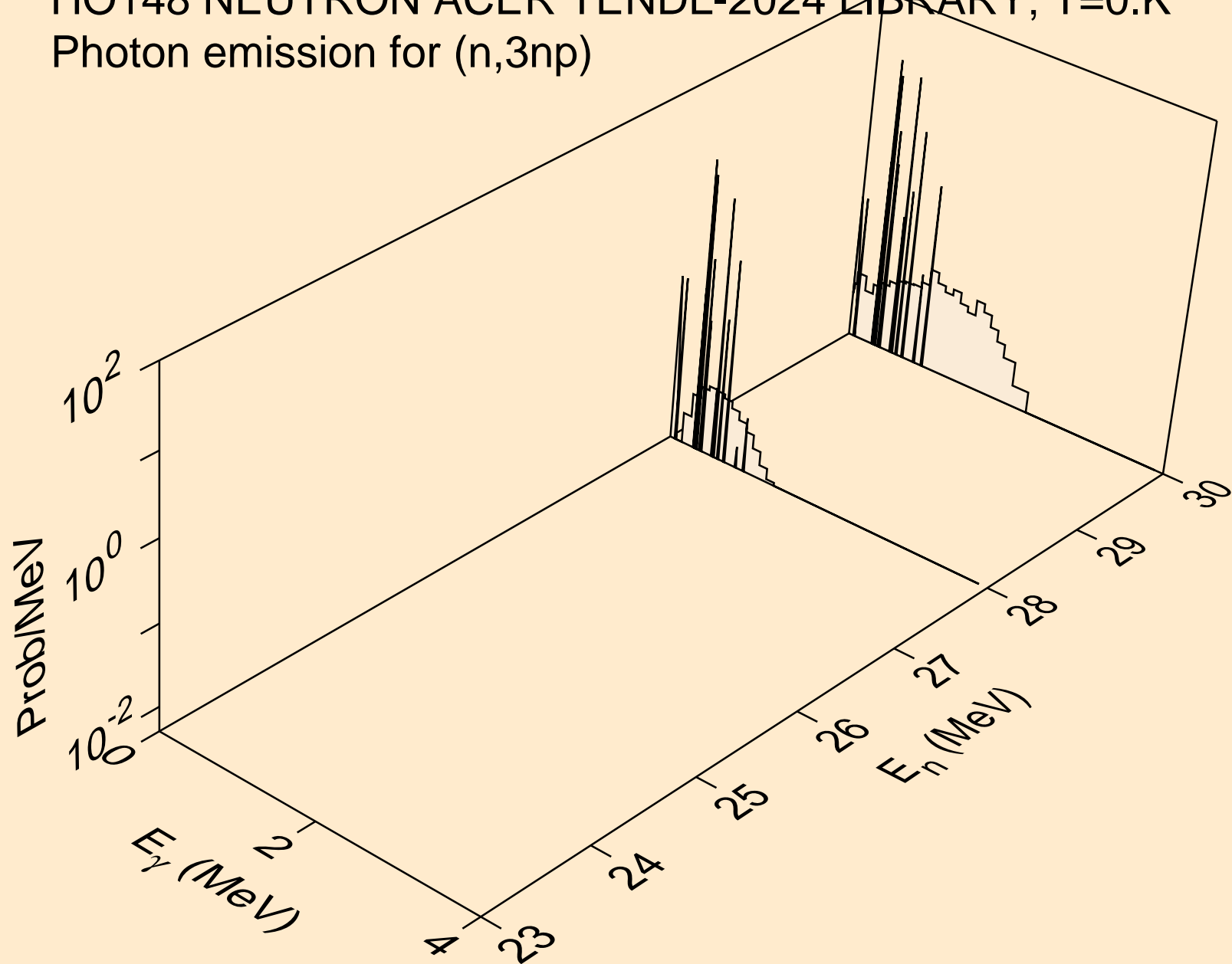

HO148 NEUTRON ACER TENDL-2024 LIBRARY; T=0.K
Photon emission for (n,n2p)

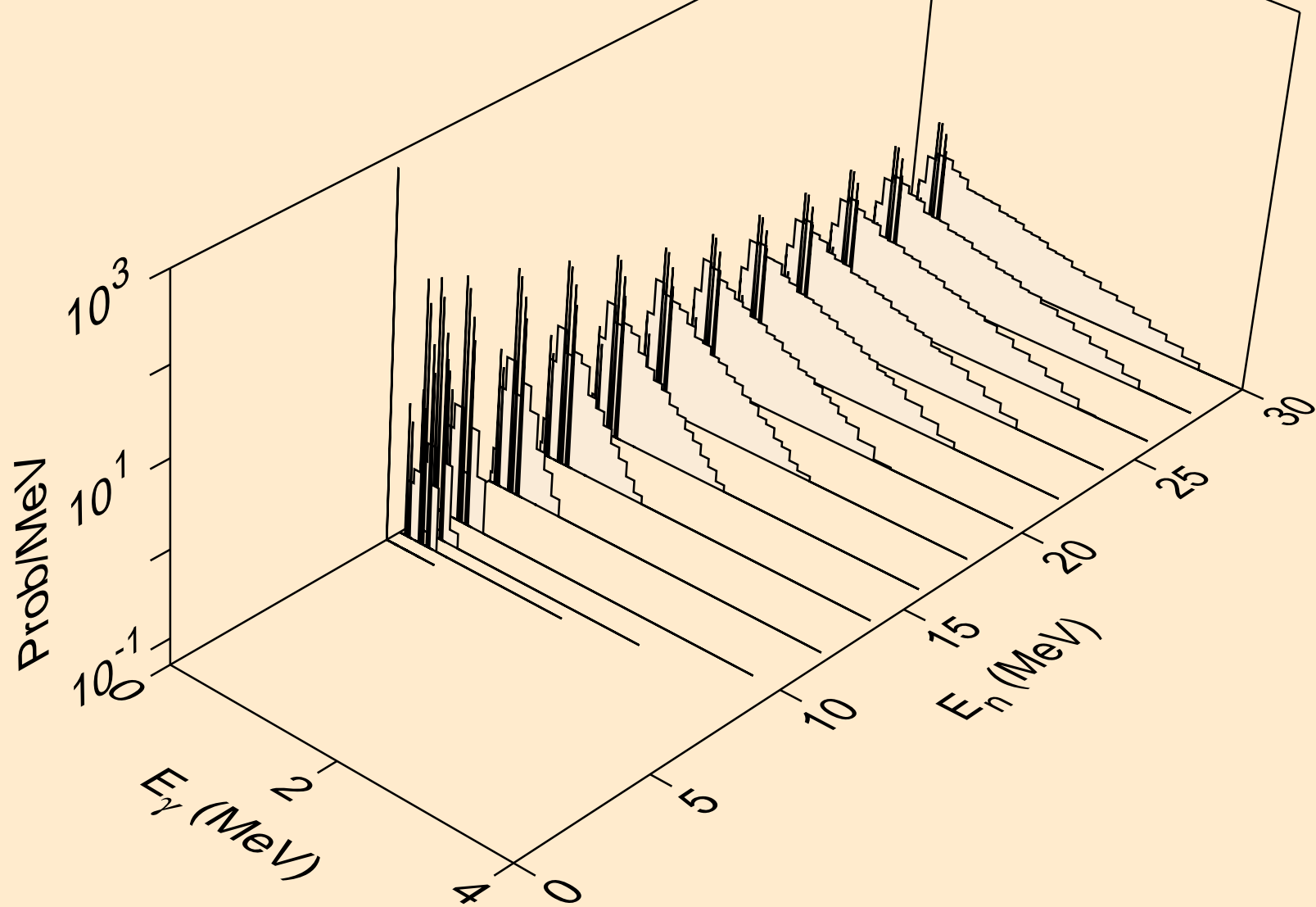

HO148 NEUTRON ACER TENDL-2024 LIBRARY; T=0.K
Photon emission for (n,npa)

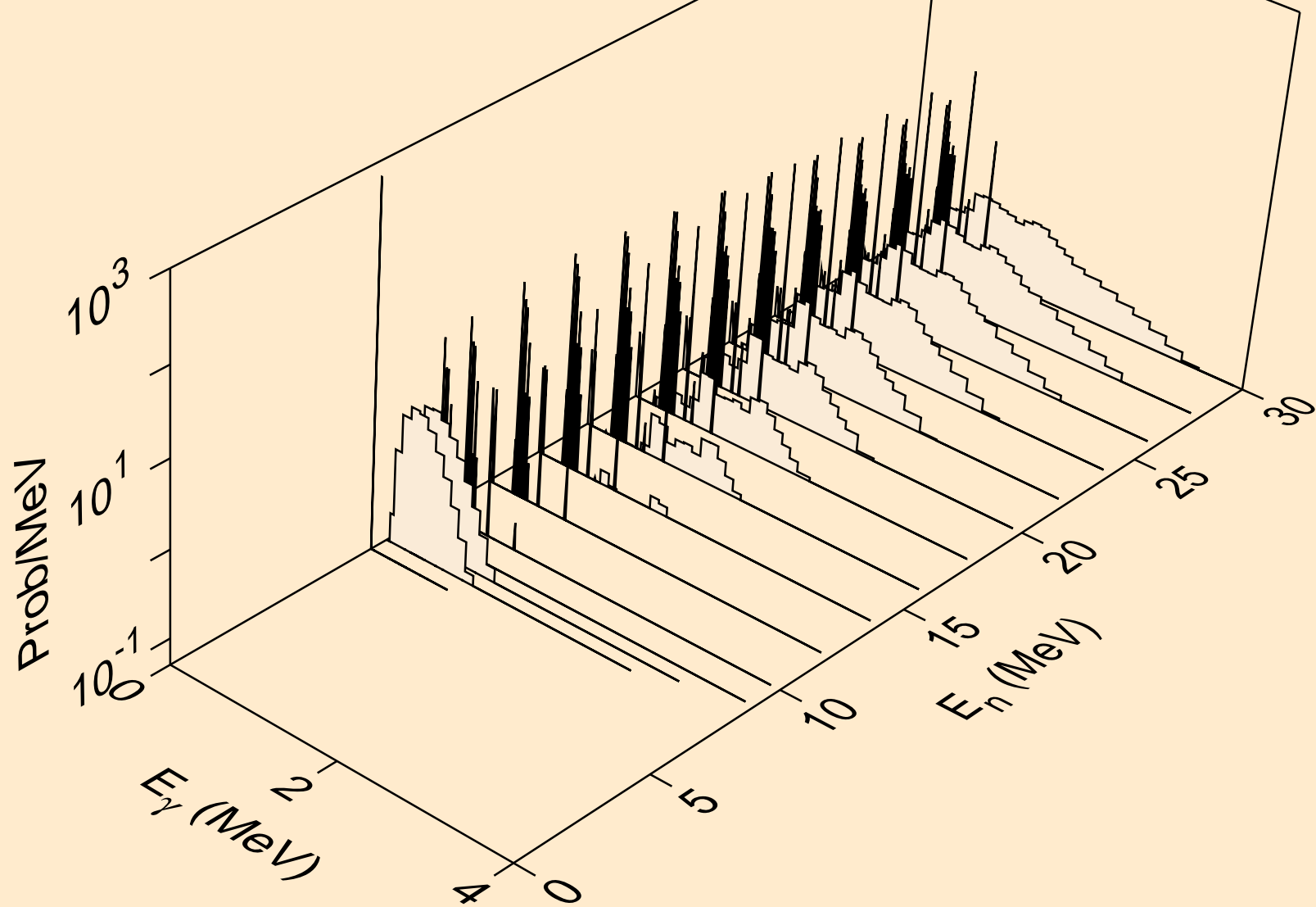

HO148 NEUTRON ACER TENDL-2024 LIBRARY; T=0.K
Photon emission for (n,n*c)

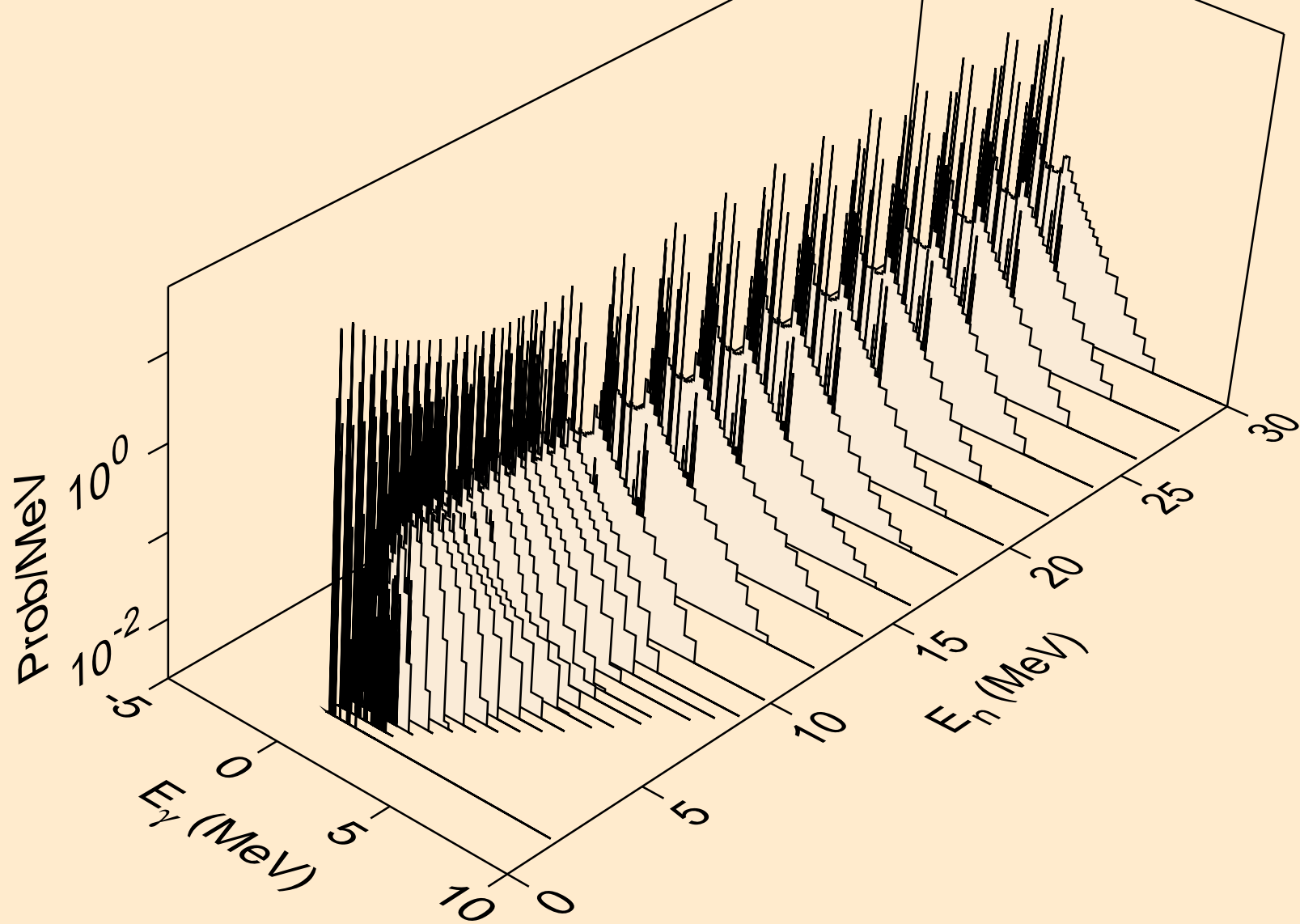

HO148 NEUTRON ACER TENDL-2024 LIBRARY; T=0.K
Photon emission for (n,gma)

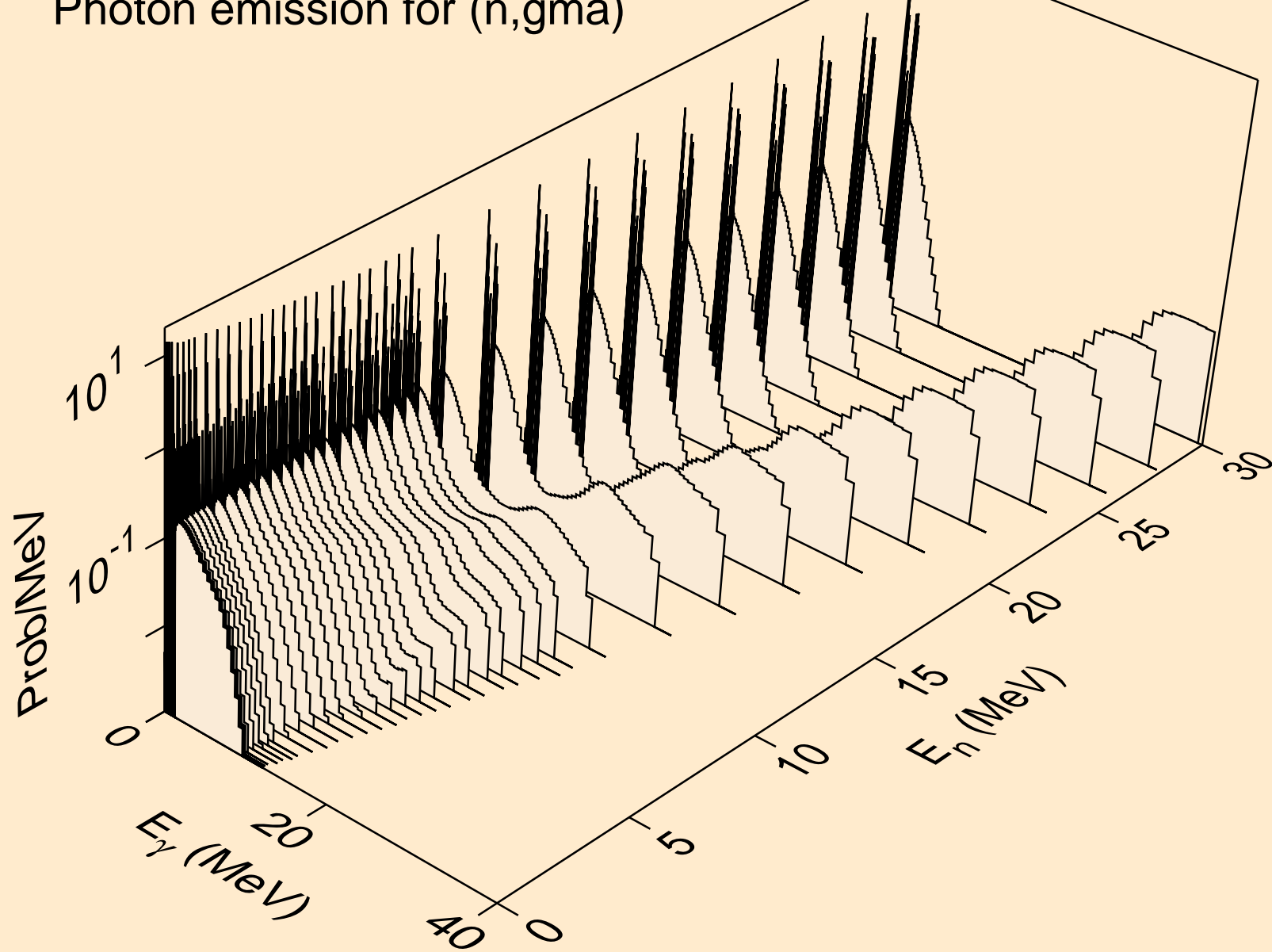

HO148 NEUTRON ACER TENDL-2024 LIBRARY; T=0.K
Photon emission for (n,p)

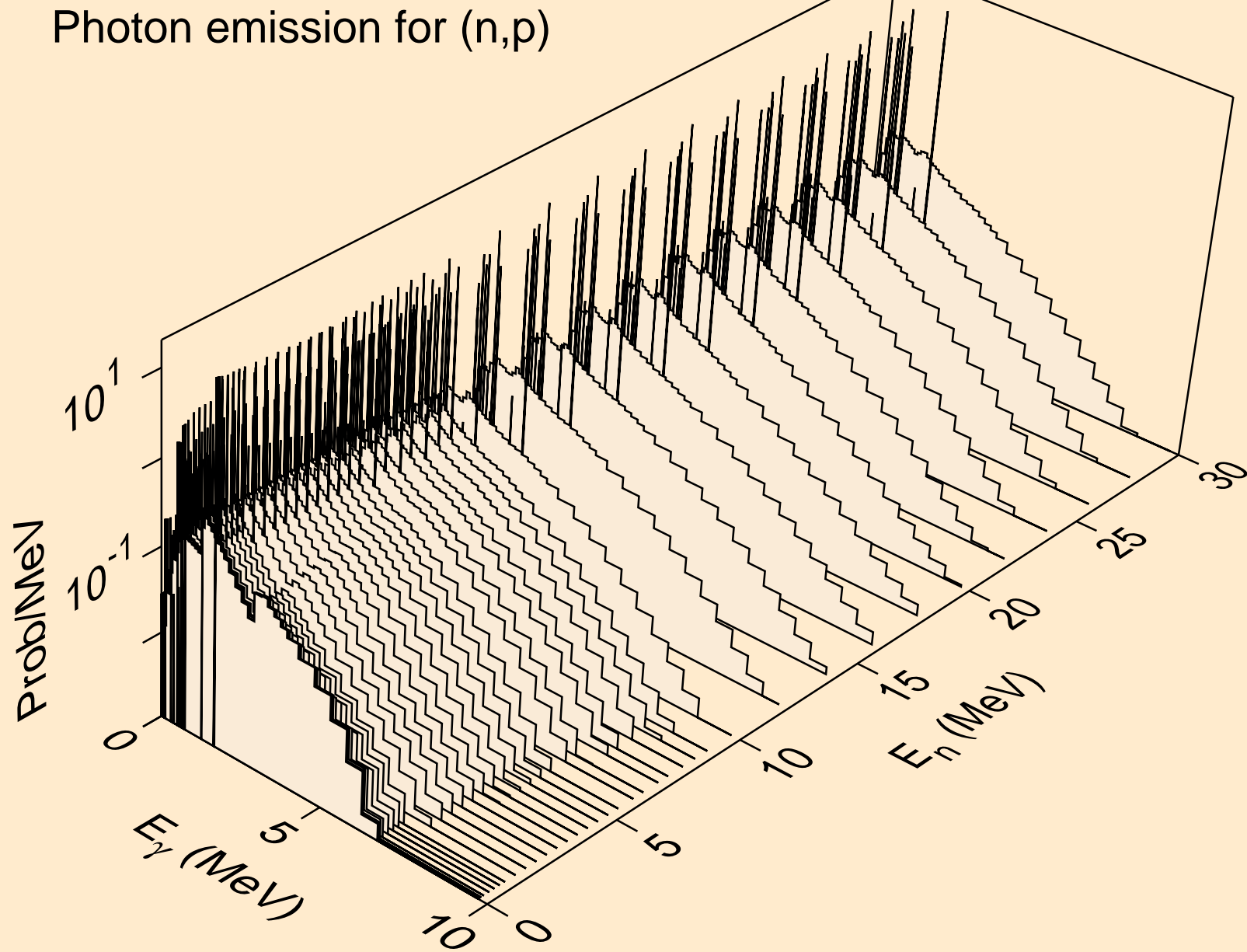

HO148 NEUTRON ACER TENDL-2024 LIBRARY; T=0.K
Photon emission for (n,d)

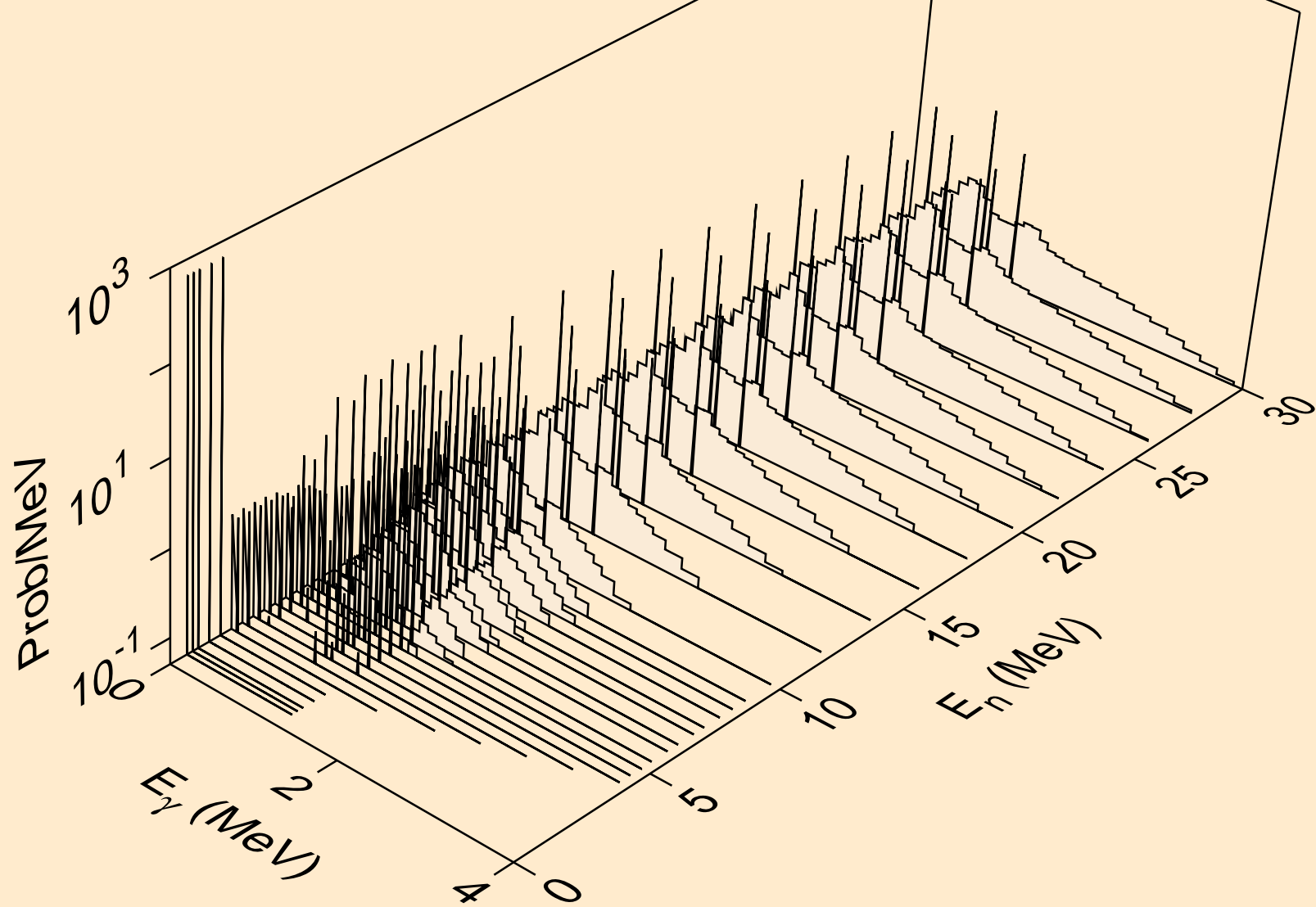

HO148 NEUTRON ACER TENDL-2024 LIBRARY; T=0.K
Photon emission for (n,t)

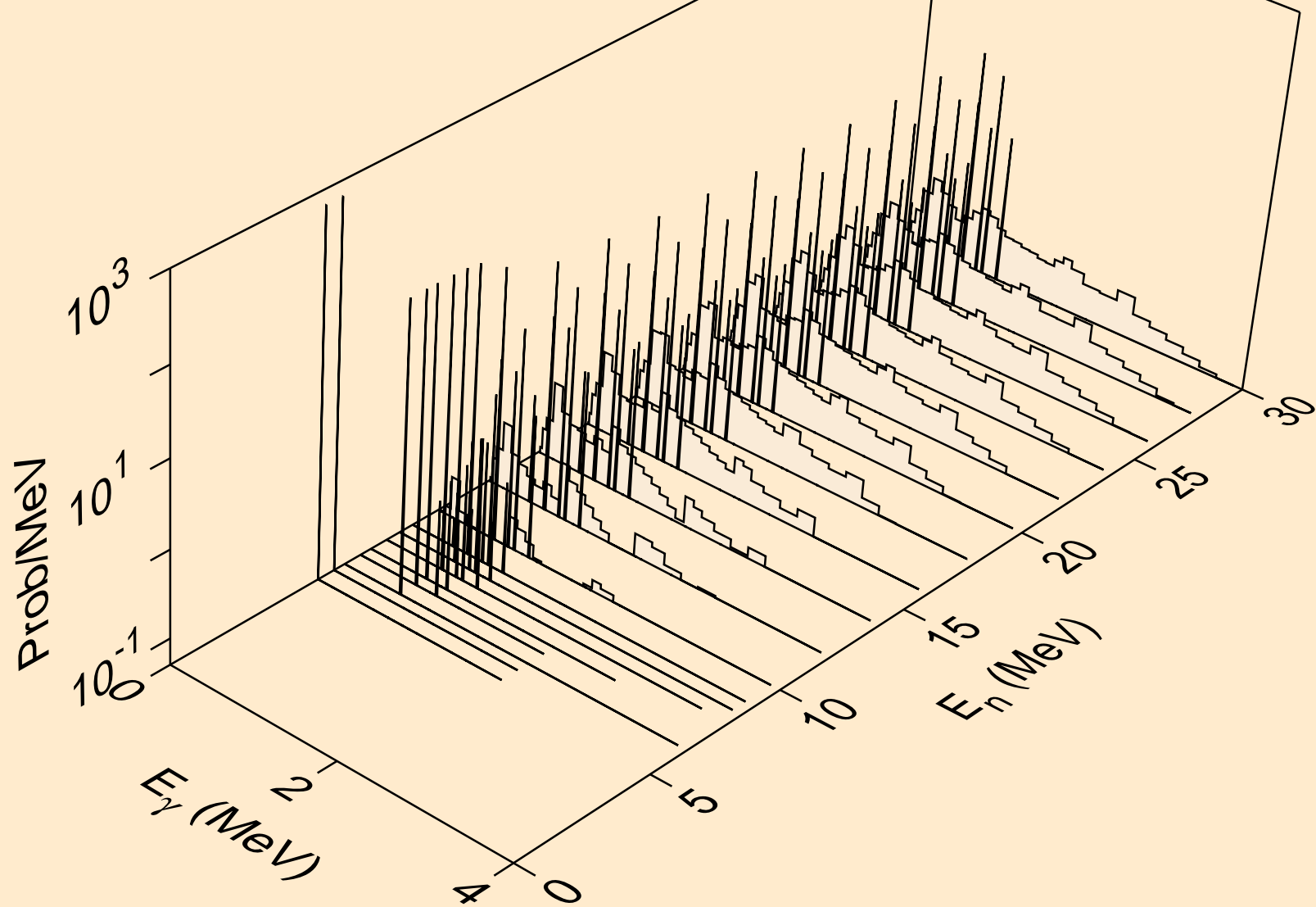

HO148 NEUTRON ACER TENDL-2024 LIBRARY; T=0.K
Photon emission for (n,he3)

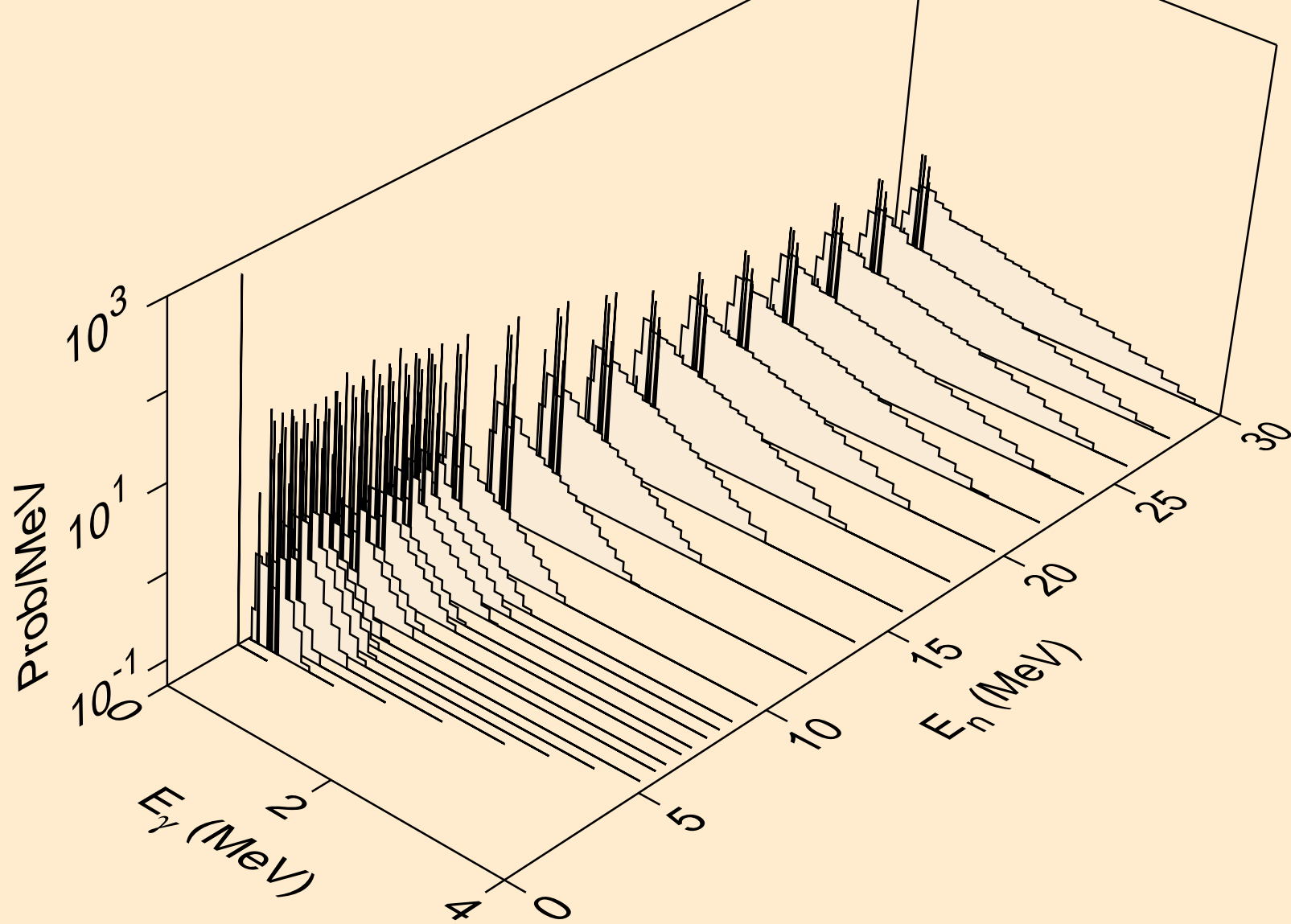

HO148 NEUTRON ACER TENDL-2024 LIBRARY; T=0.K
Photon emission for (n,a)

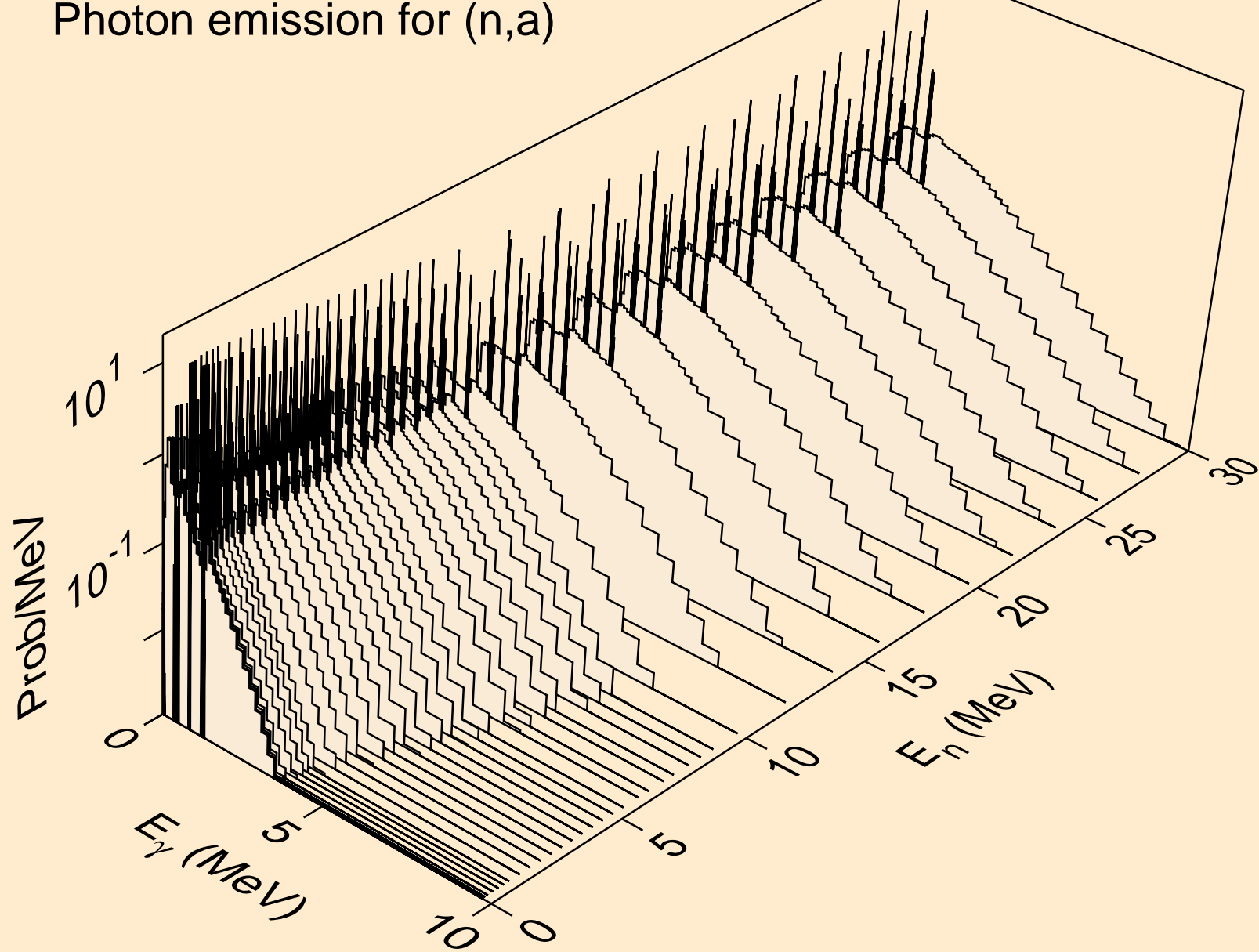

HO148 NEUTRON ACER TENDL-2024 LIBRARY; T=0.K
Photon emission for (n,2a)

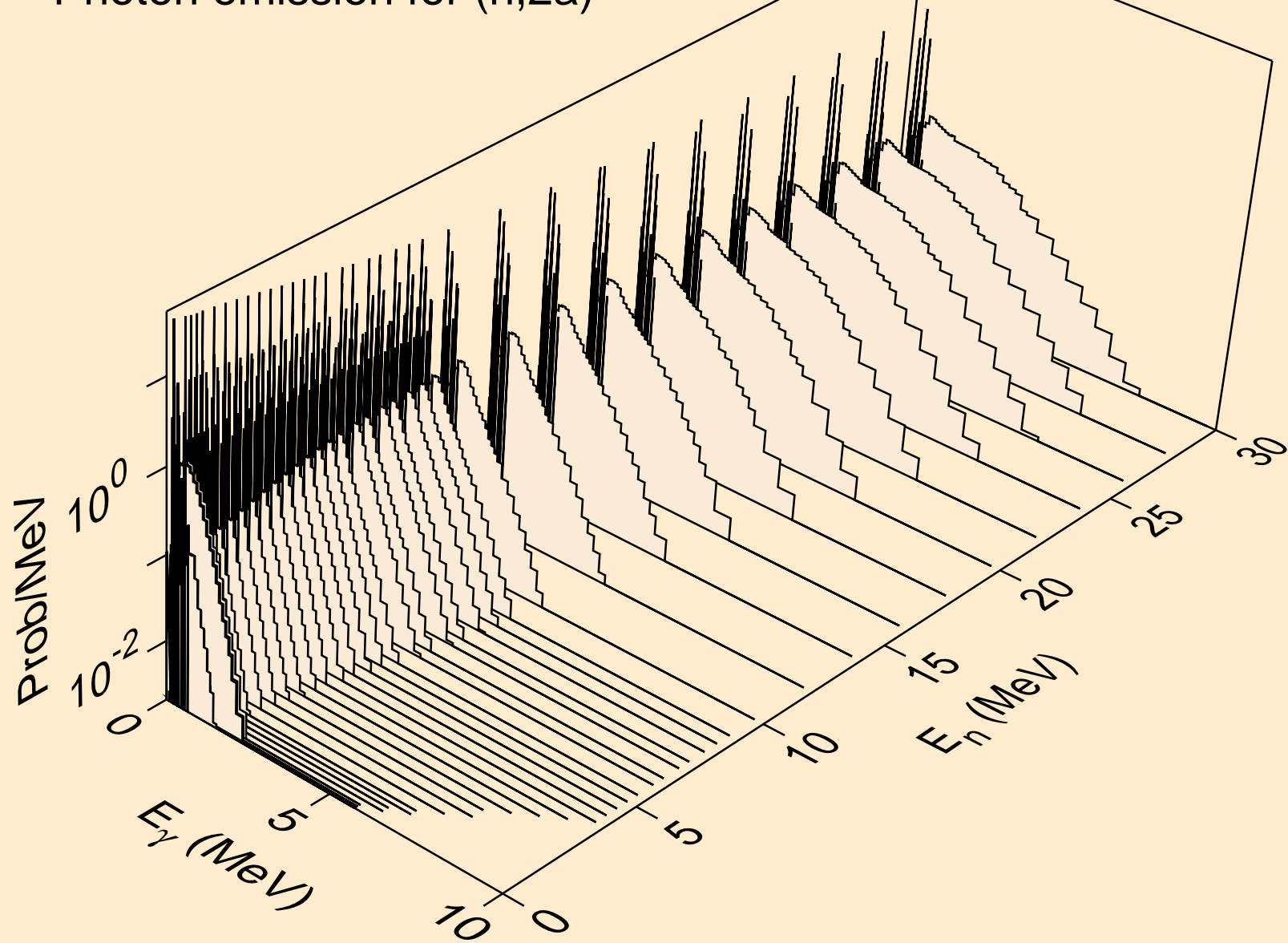

HO148 NEUTRON ACER TENDL-2024 LIBRARY; T=0.K
Photon emission for (n,3a)

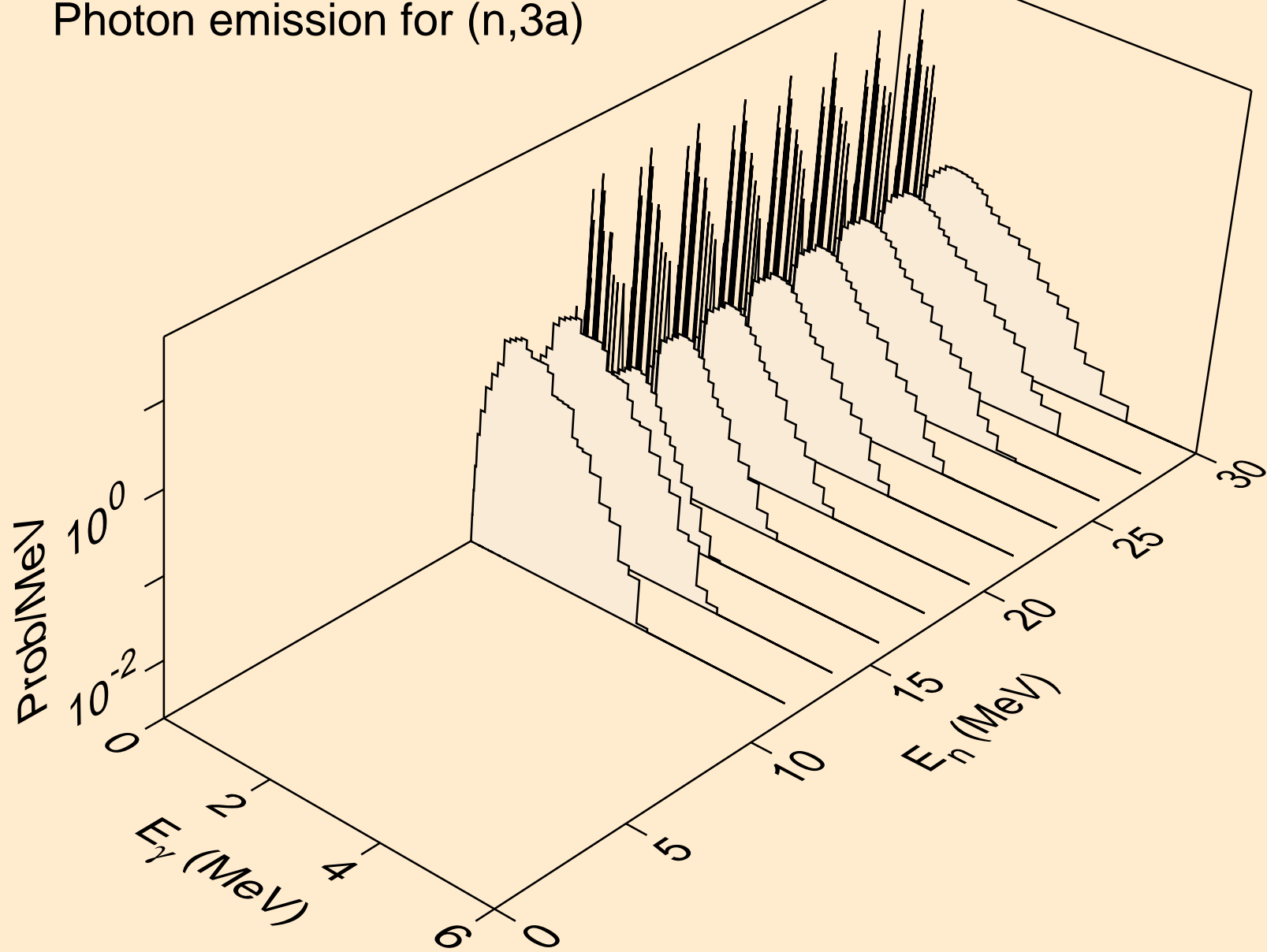

HO148 NEUTRON ACER TENDL-2024 LIBRARY; T=0.K
Photon emission for (n,2p)

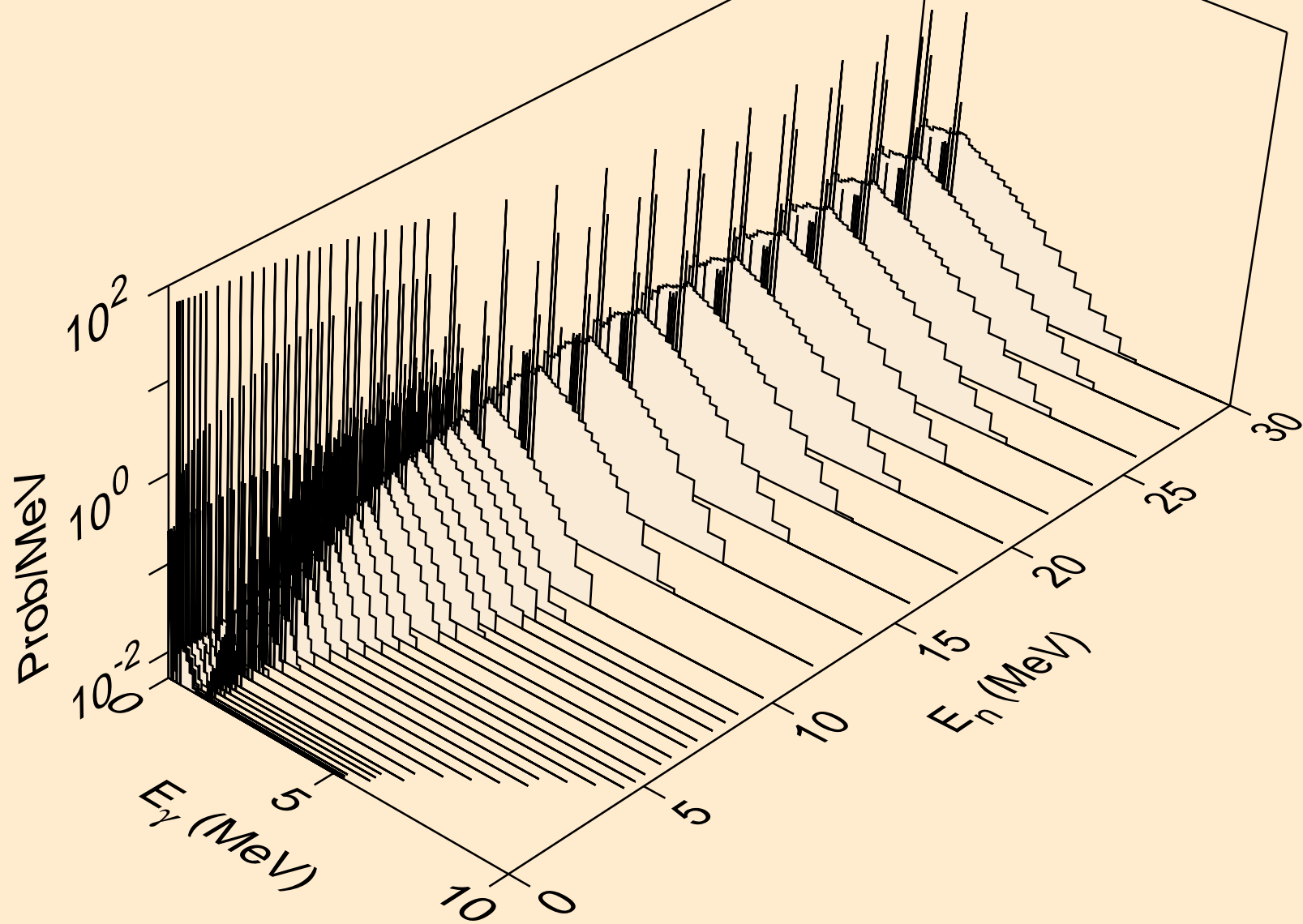

HO148 NEUTRON ACER TENDL-2024 LIBRARY; T=0.K
Photon emission for (n,p)

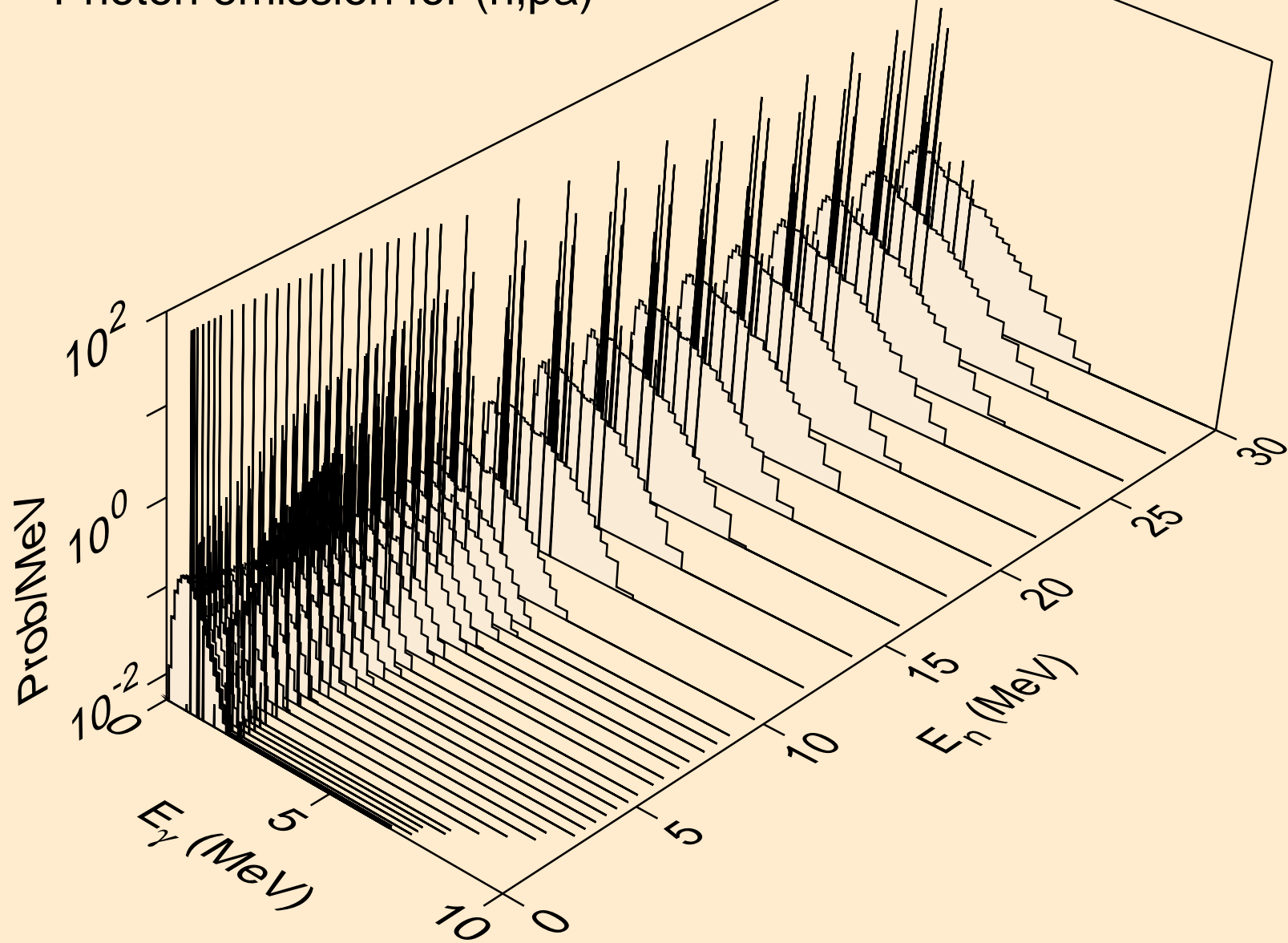

HO148 NEUTRON ACER TENDL-2024 LIBRARY; T=0.K
Photon emission for (n,pd)

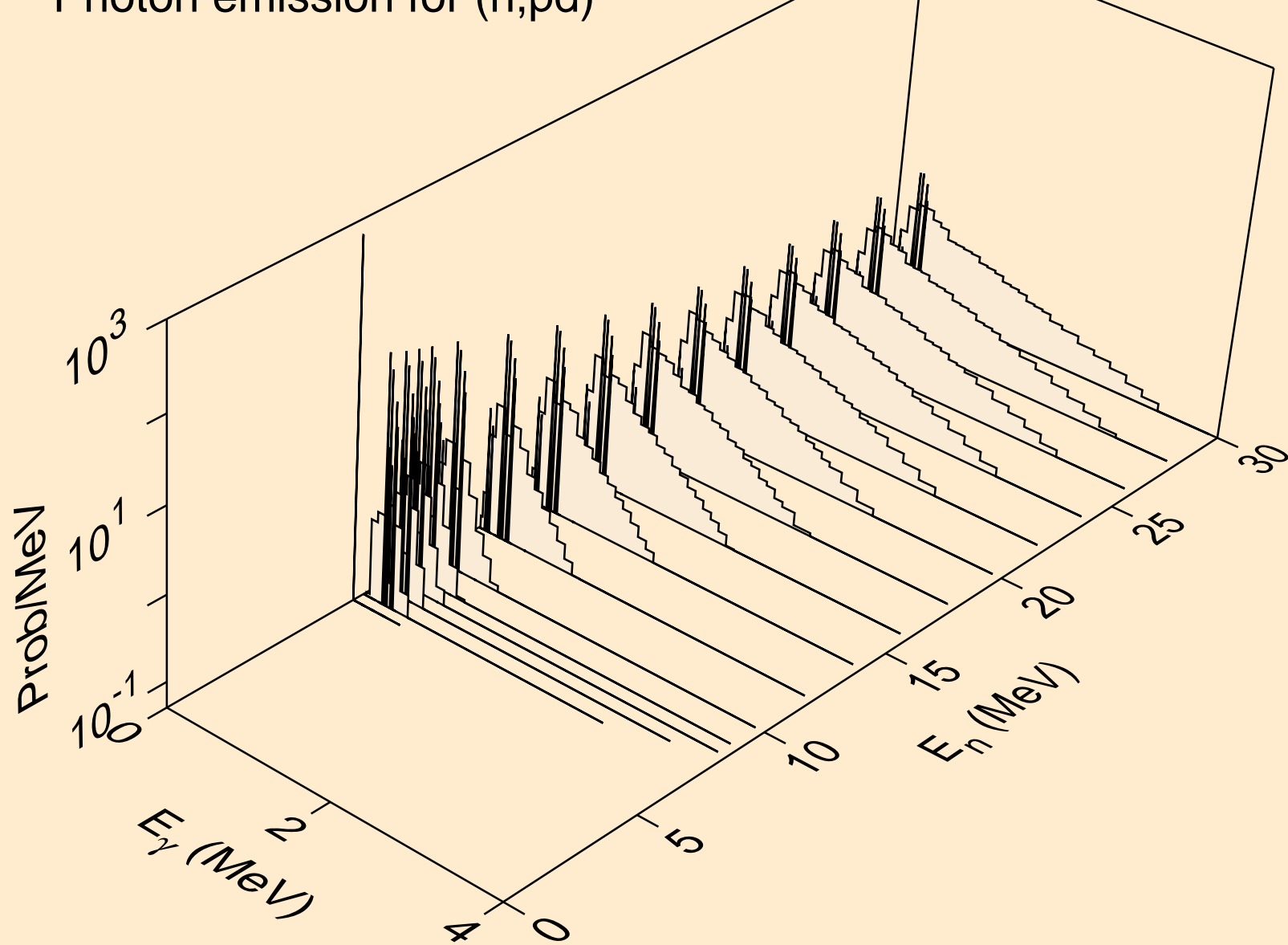

HO148 NEUTRON ACER TENDL-2024 LIBRARY; T=0.K
Photon emission for (n,pt)

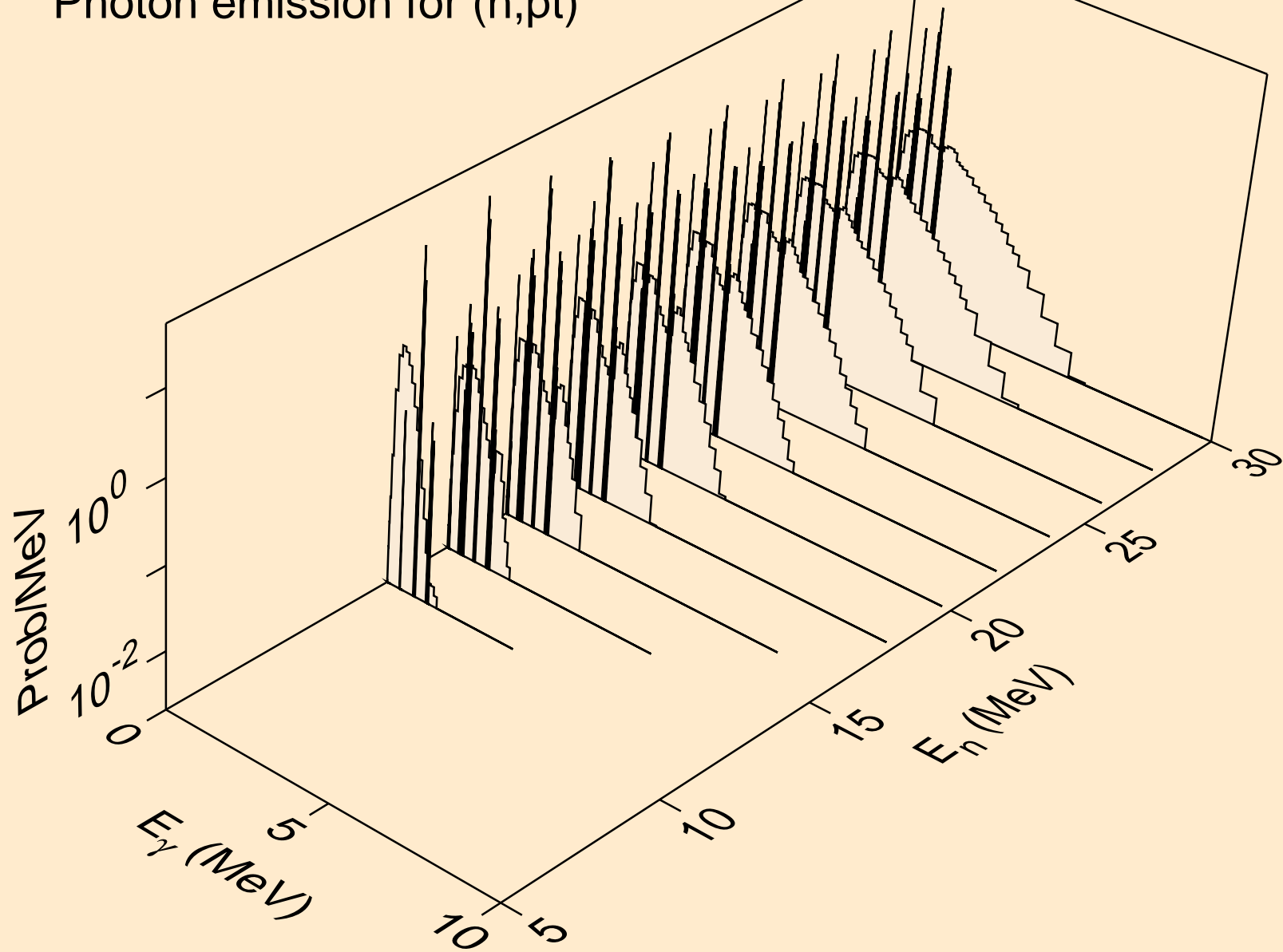

HO148 NEUTRON ACER TENDL-2024 LIBRARY; T=0.K
Photon emission for (n,da)

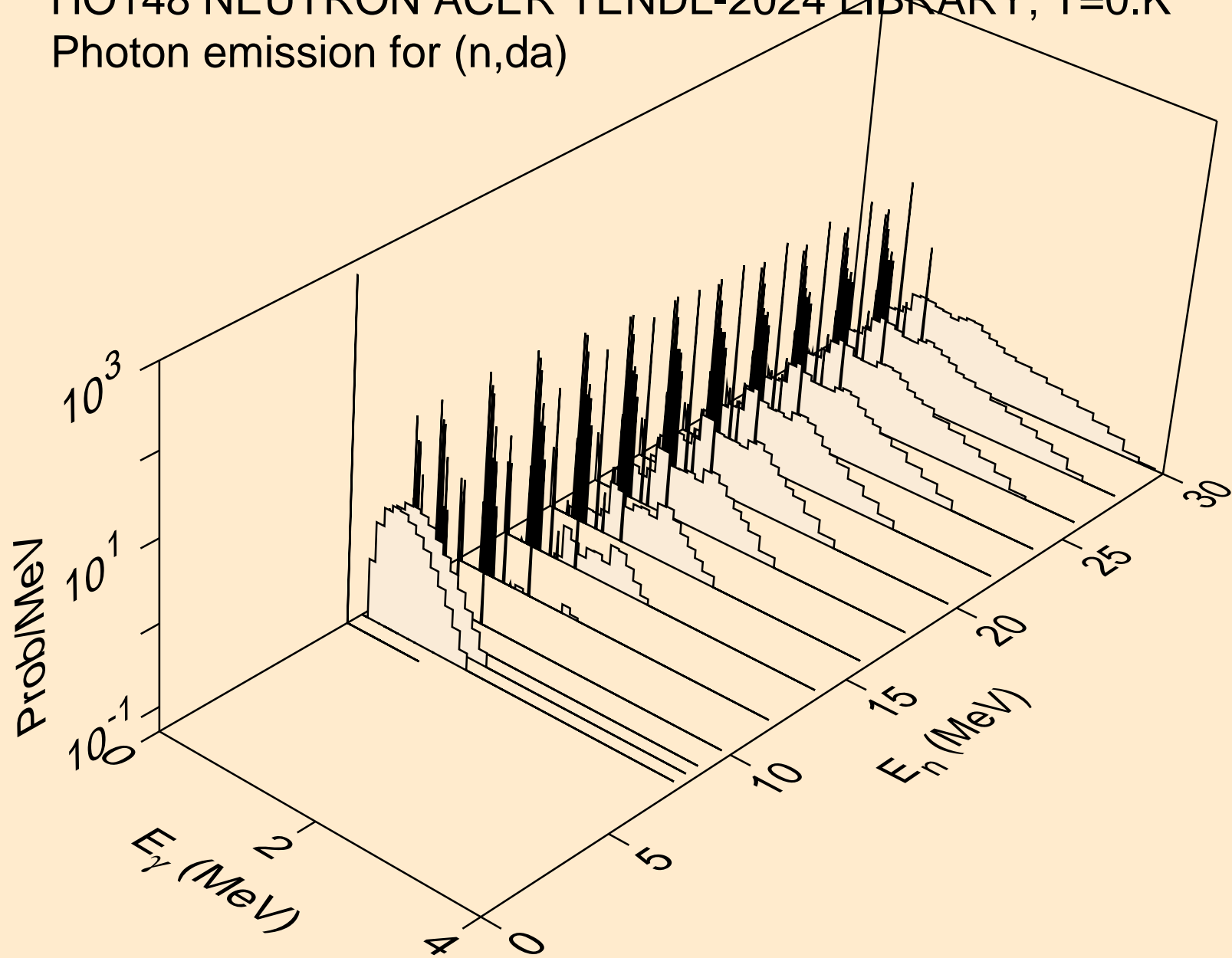

HO148 NEUTRON ACER TENDL-2024 LIBRARY; T=0.K
thermal capture photon spectrum

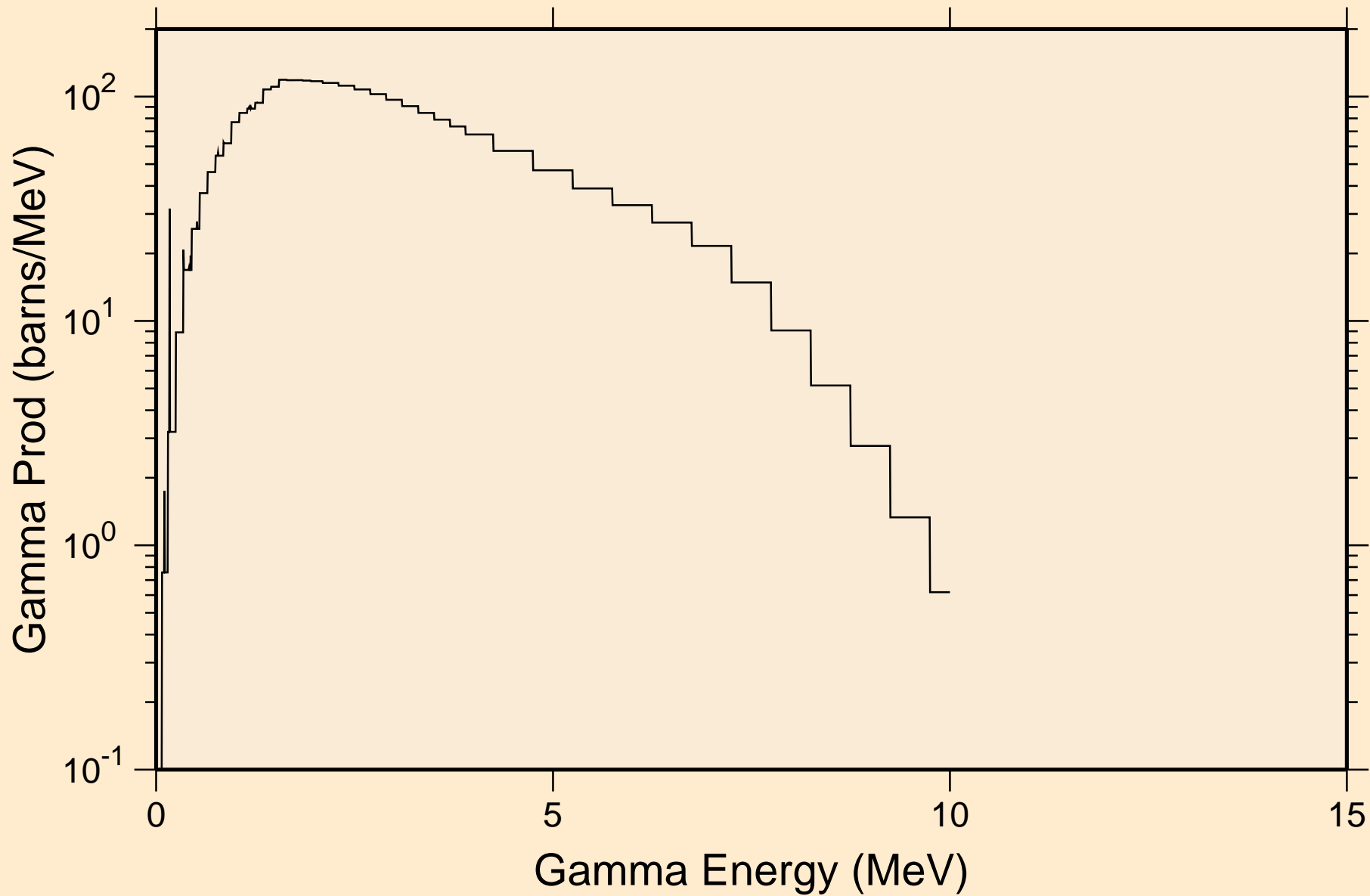

HO148 NEUTRON ACER TENDL-2024 LIBRARY; T=0.K
14 MeV photon spectrum

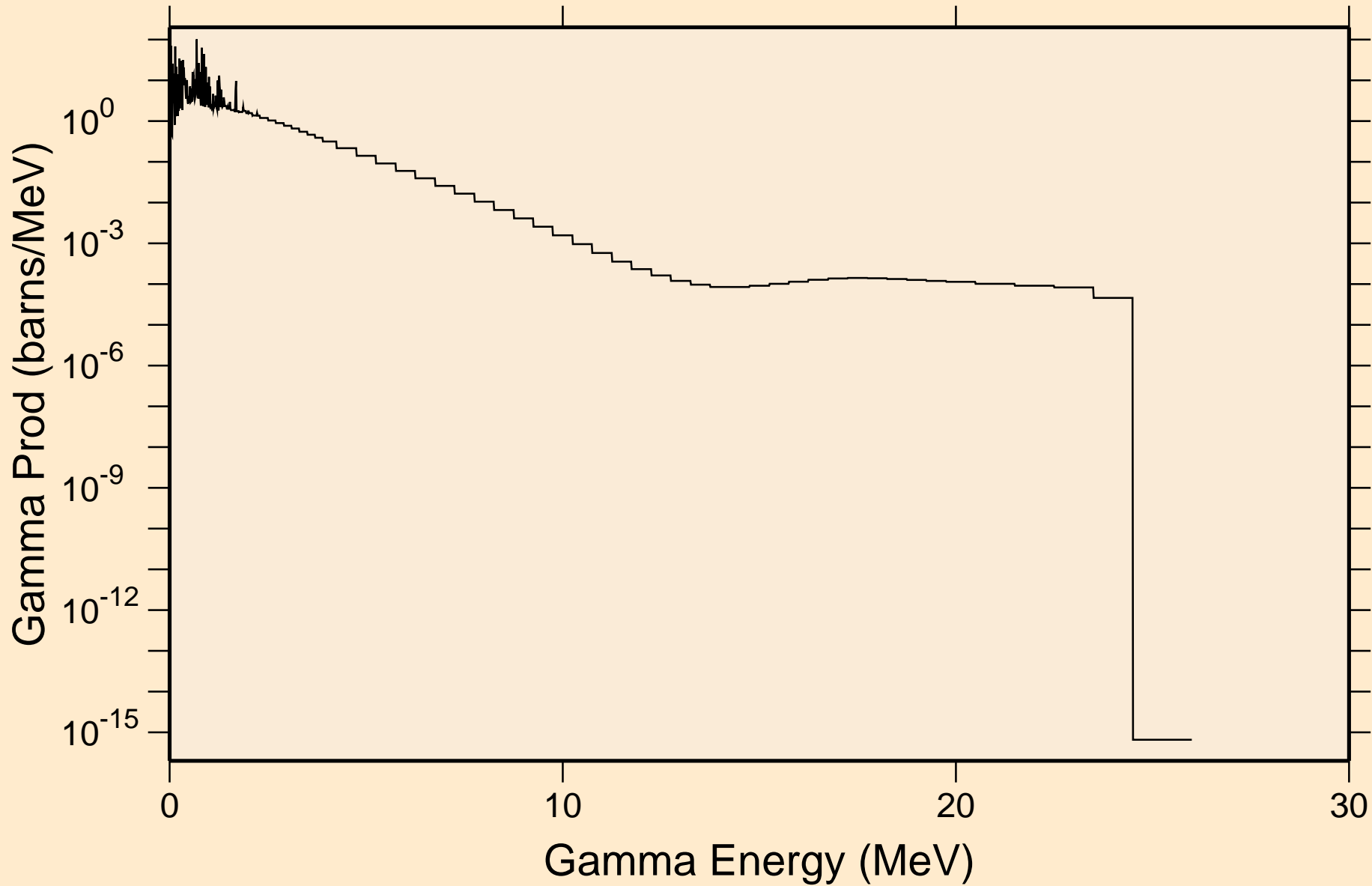

HO148 NEUTRON ACER TENDL-2024 LIBRARY; T=0.K

Particle heating contributions

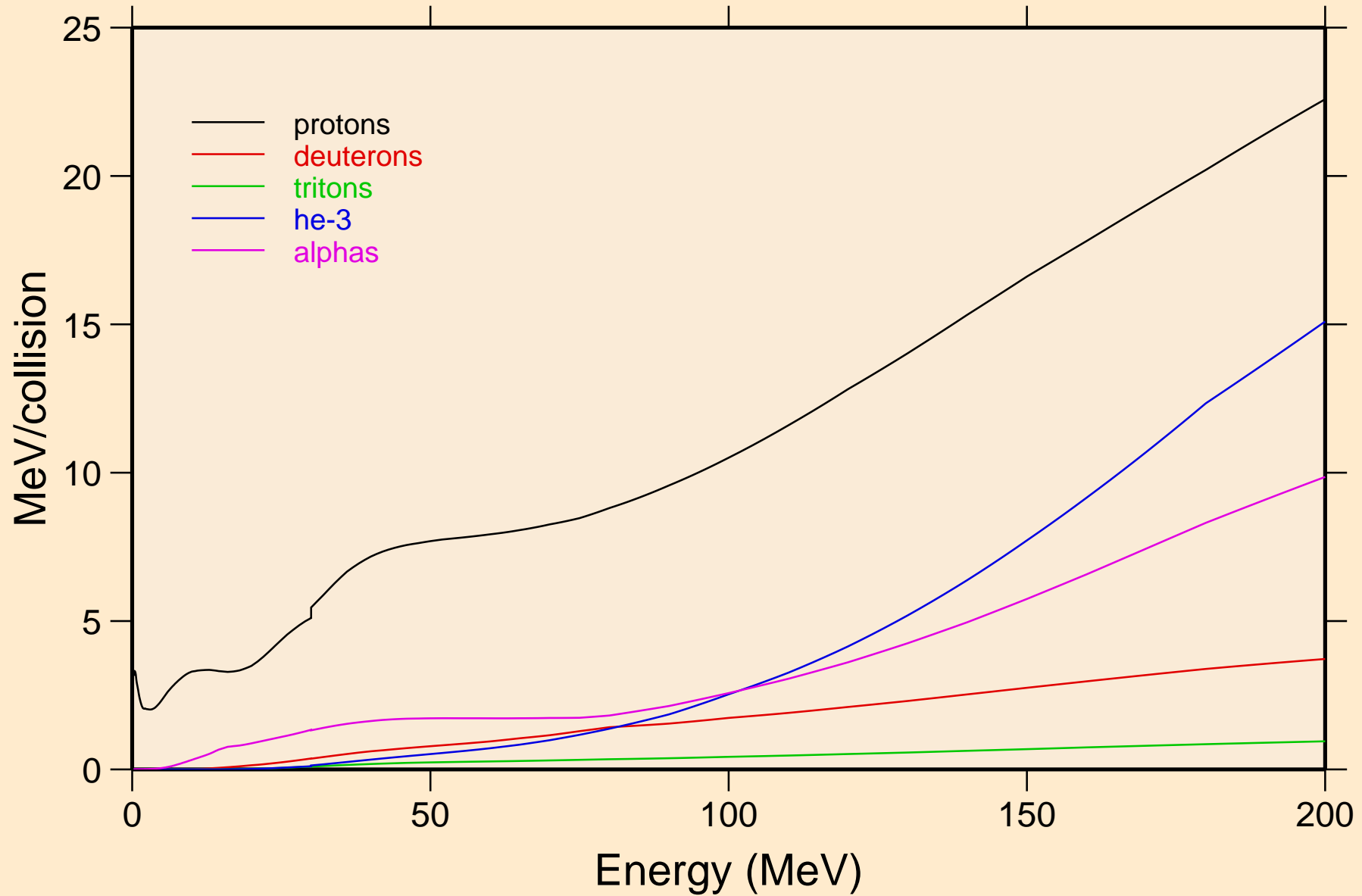

HO148 NEUTRON ACER TENDL-2024 LIBRARY; T=0.K
Recoil Heating

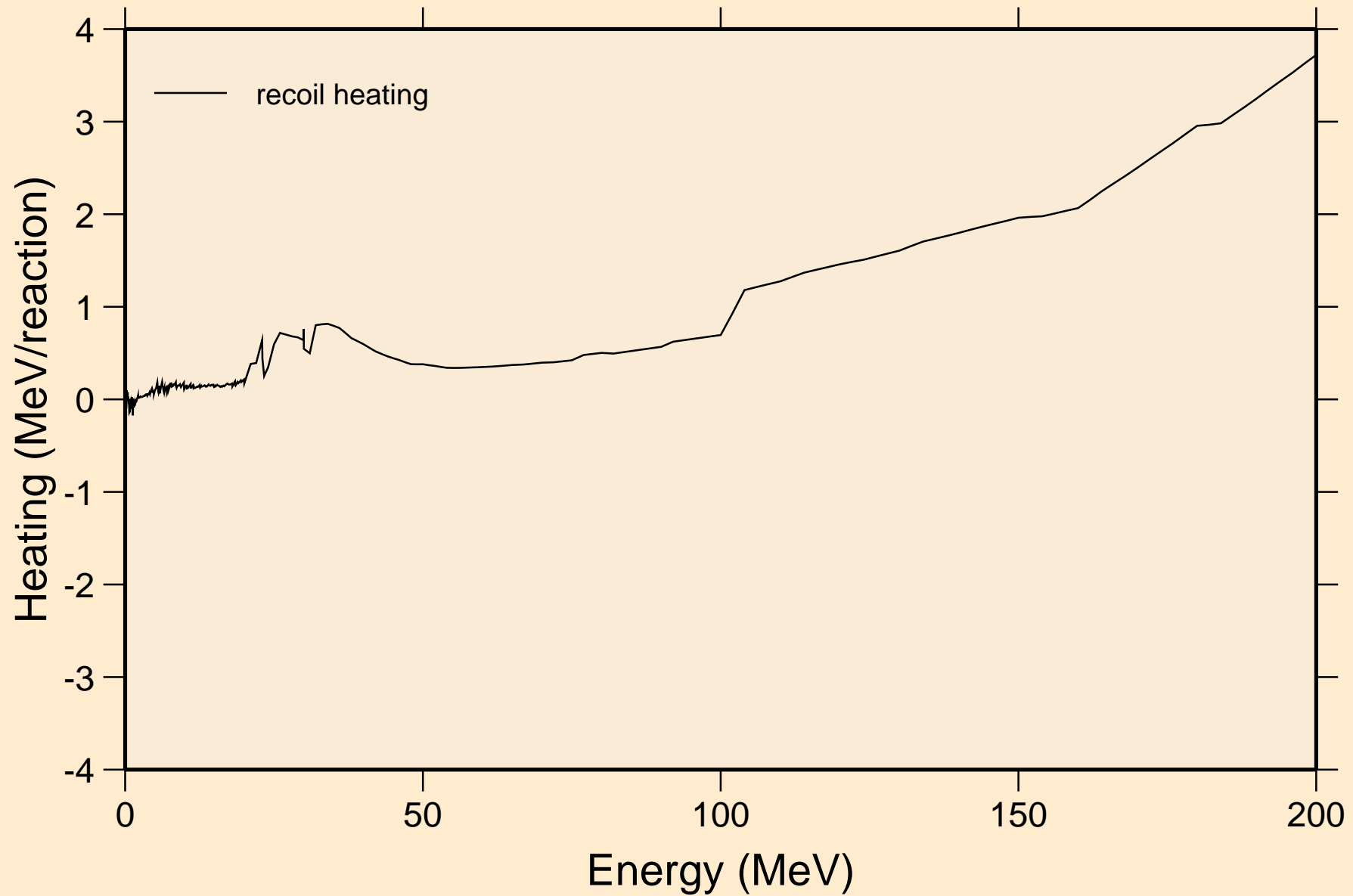

HO148 NEUTRON ACER TENDL-2024 LIBRARY; T=0.K

Particle production cross sections

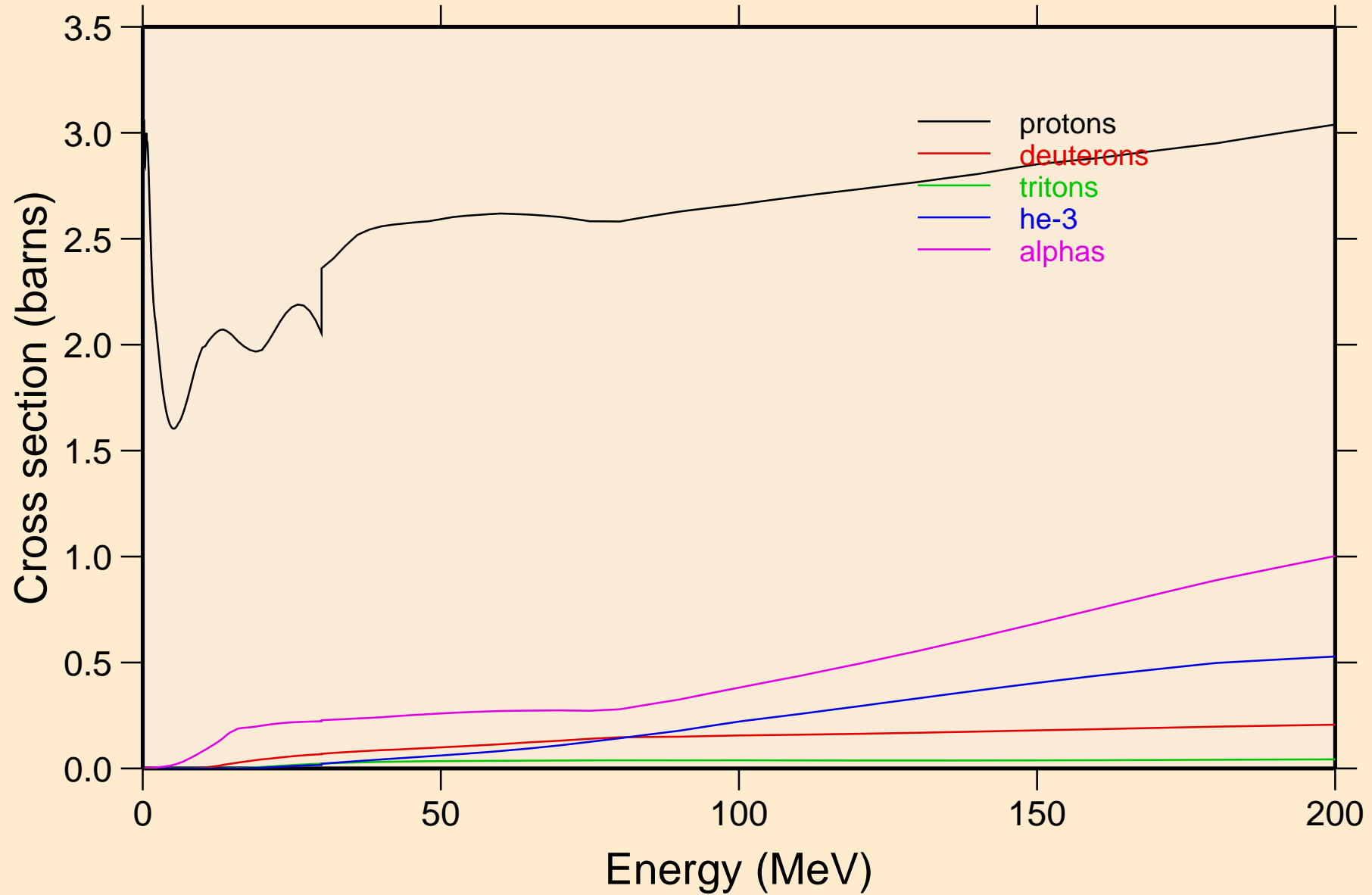

HO148 NEUTRON ACER TENDL-2024 LIBRARY; T=0.K
protons from (n,x)

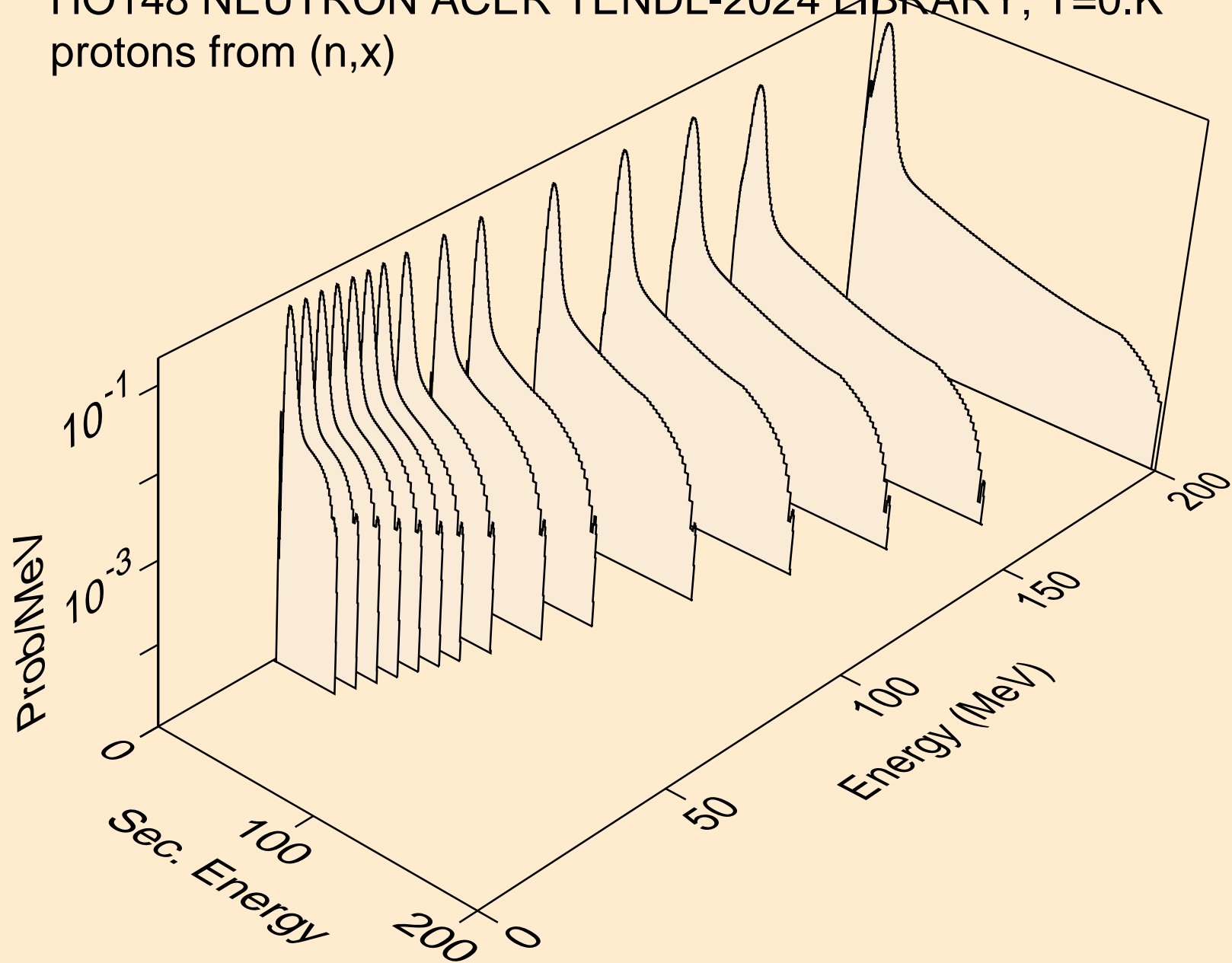

HO148 NEUTRON ACER TENDL-2024 LIBRARY; T=0.K
protons from (n,n*)p

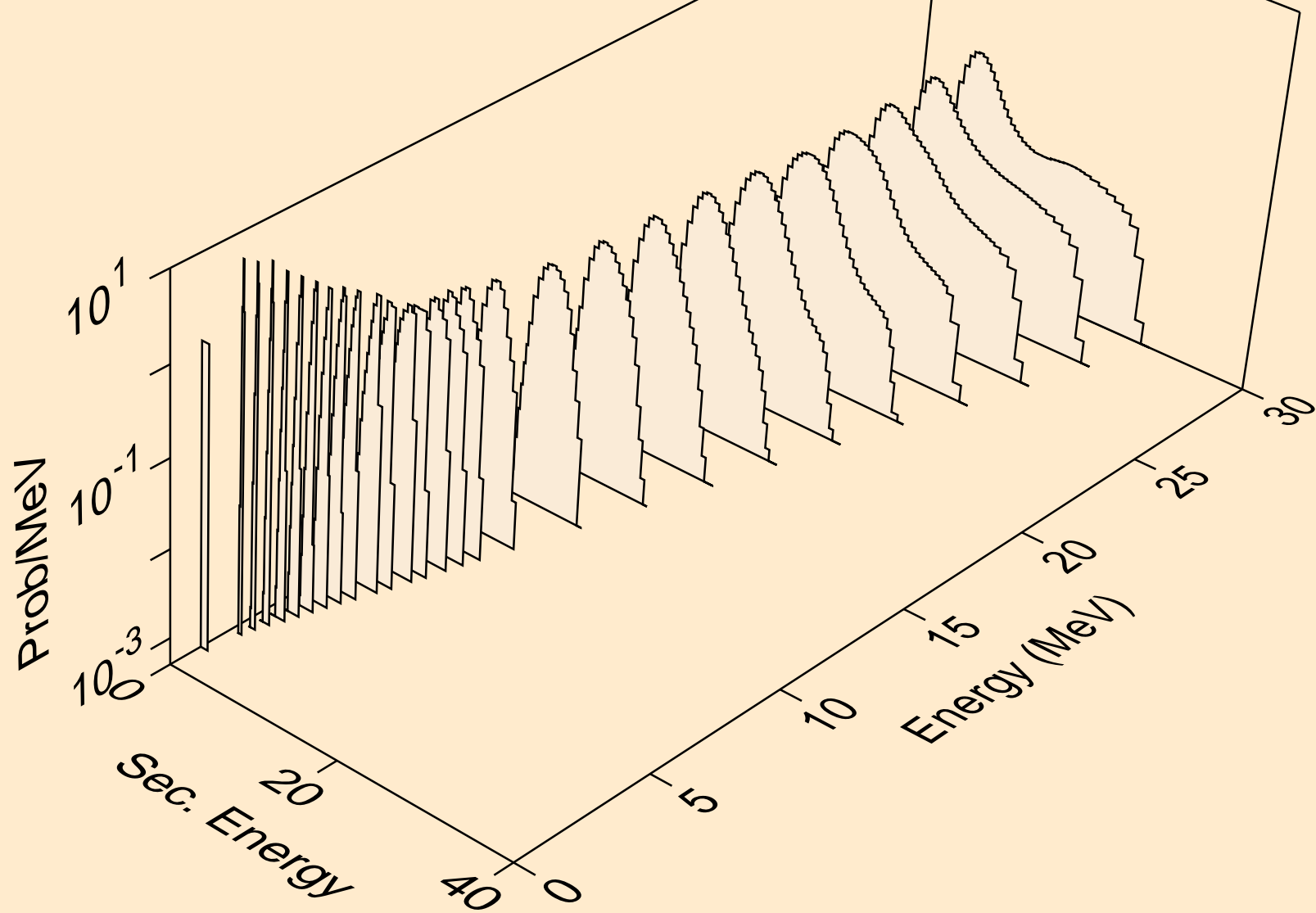

HO148 NEUTRON ACER TENDL-2024 LIBRARY; T=0.K
protons from (n,2np)

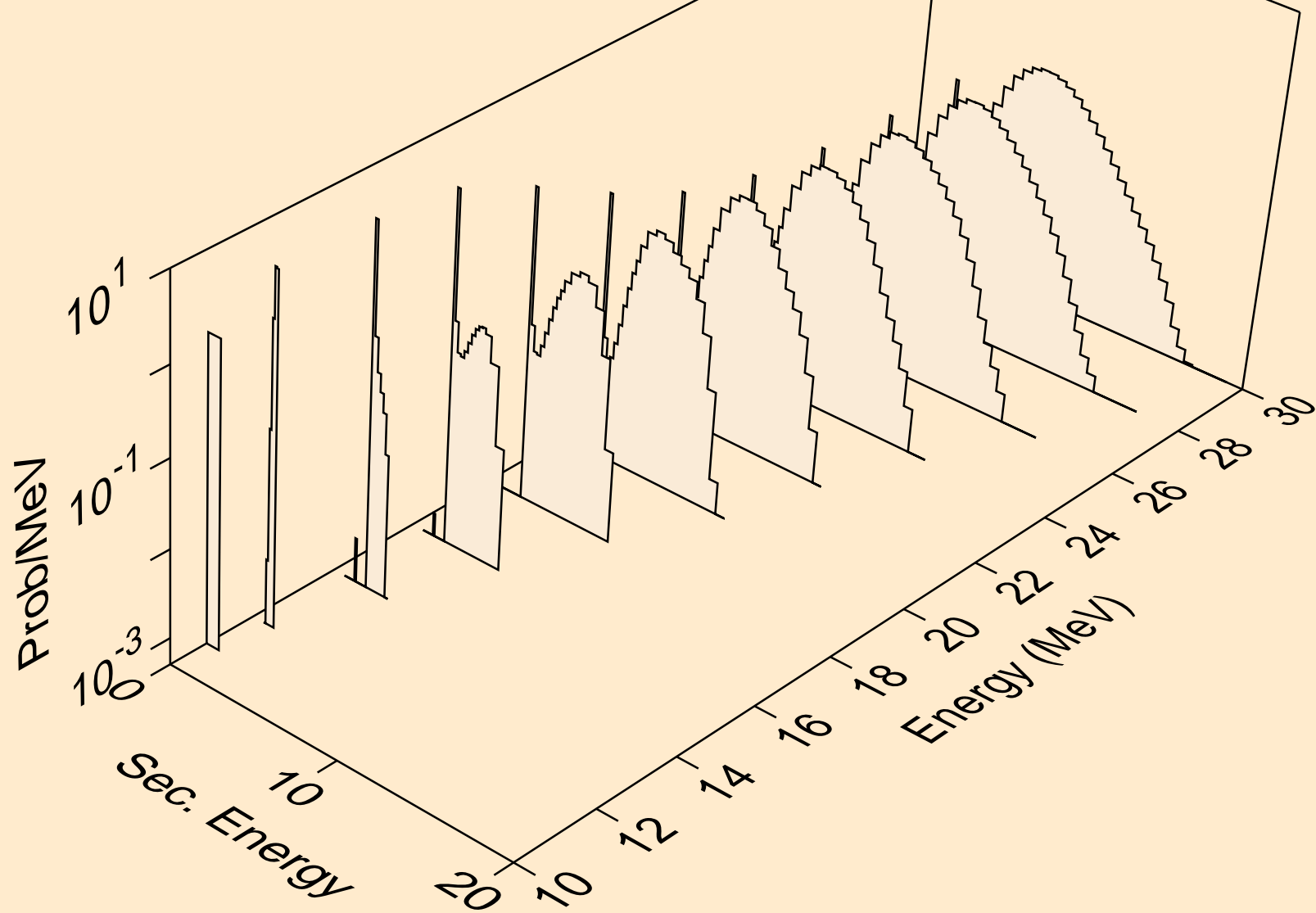

HO148 NEUTRON ACER TENDL-2024 LIBRARY; T=0.K
protons from (n,3np)

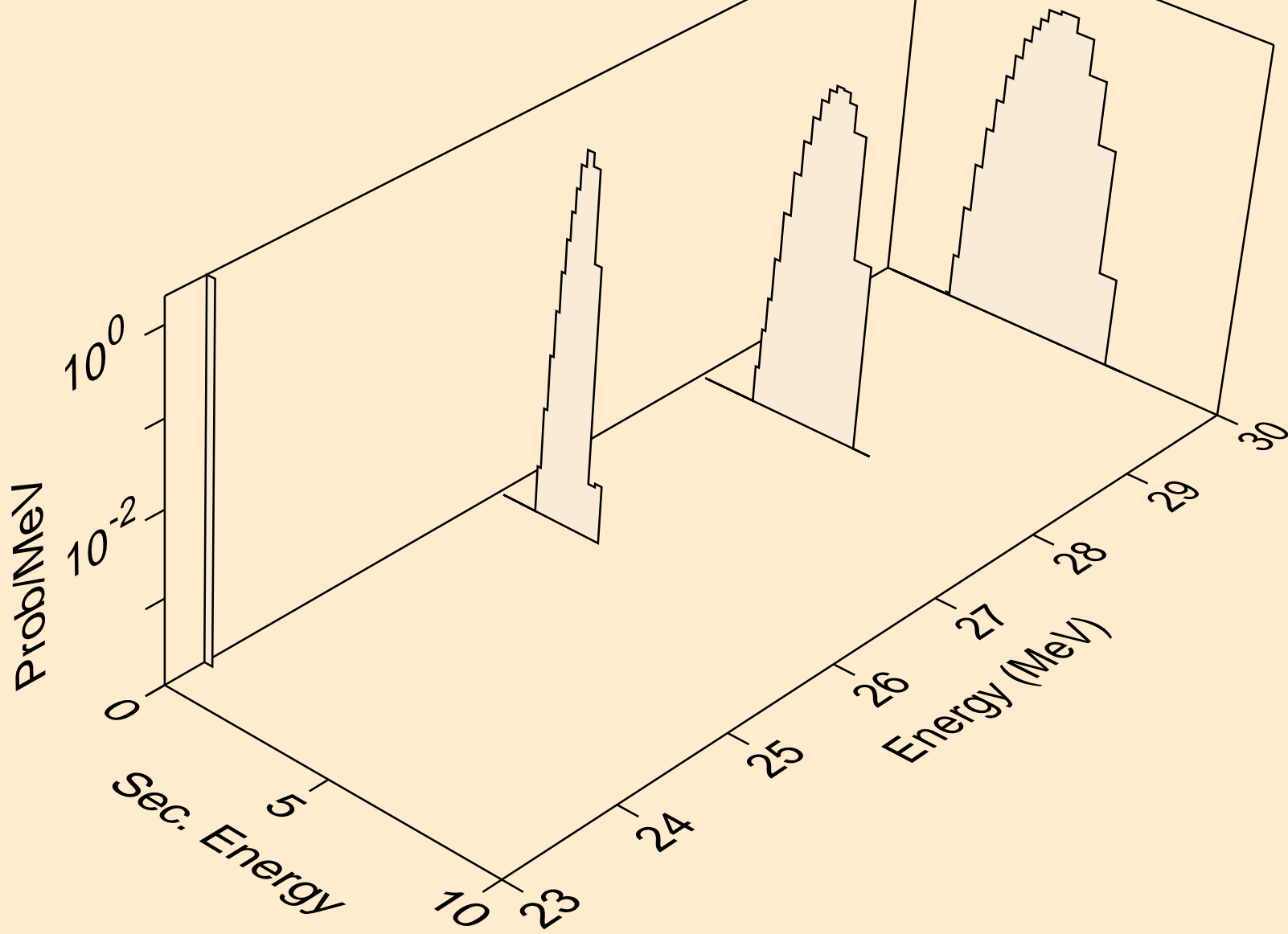

HO148 NEUTRON ACER TENDL-2024 LIBRARY; T=0.K
protons from (n,n2p)

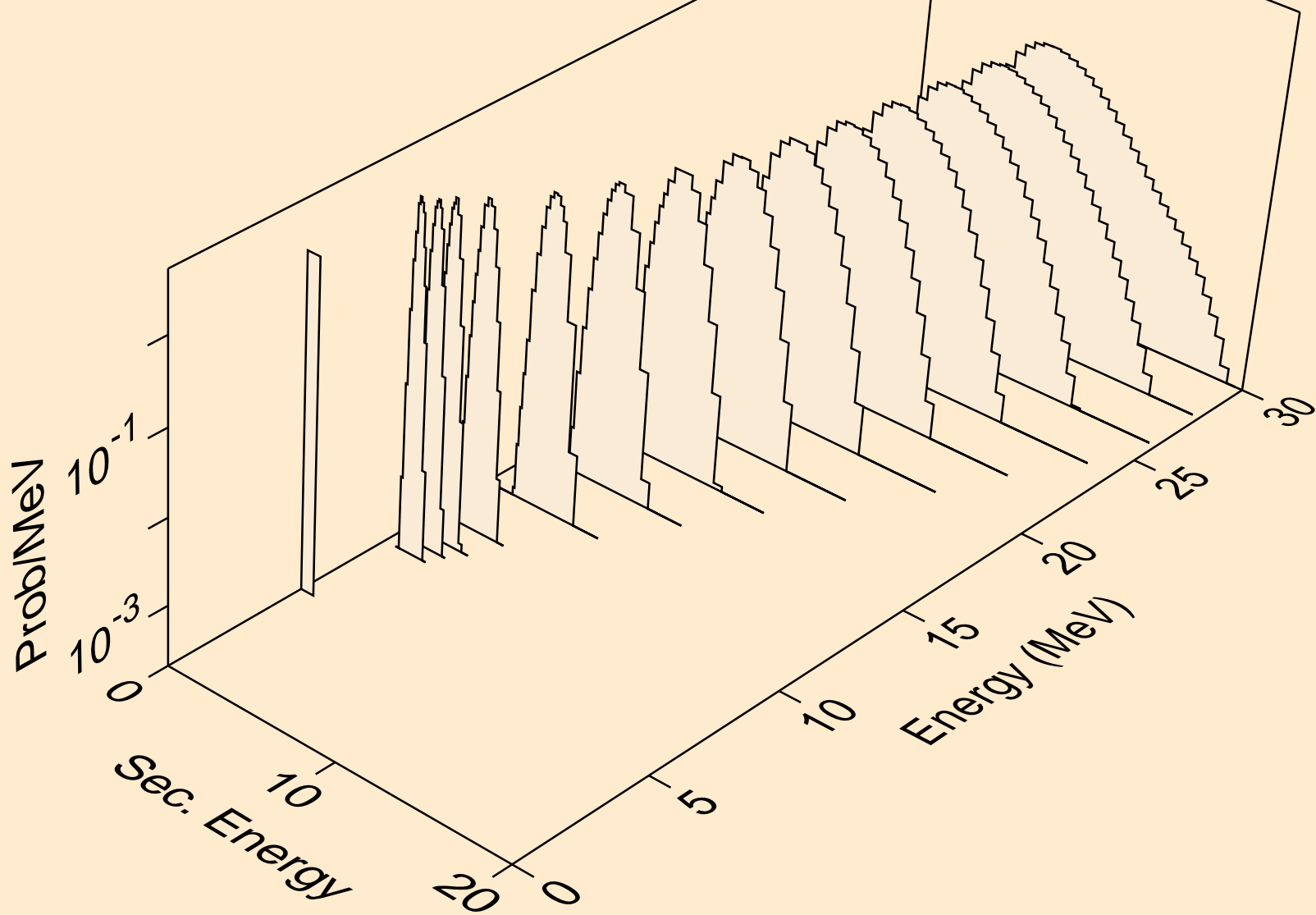

HO148 NEUTRON ACER TENDL-2024 LIBRARY; T=0.K
protons from (n,npa)

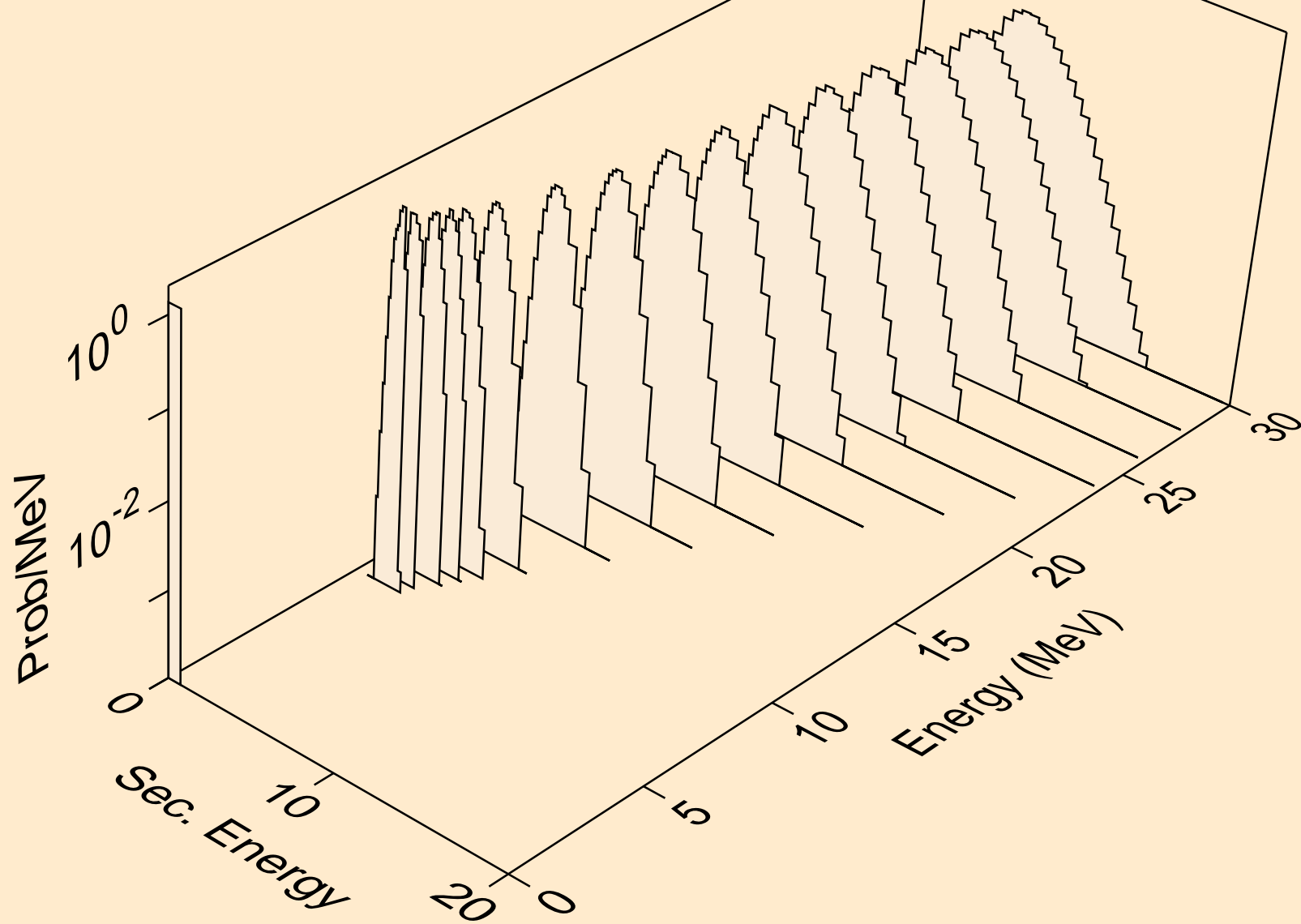

HO148 NEUTRON ACER TENDL-2024 LIBRARY; T=0.K
protons from (n,p)

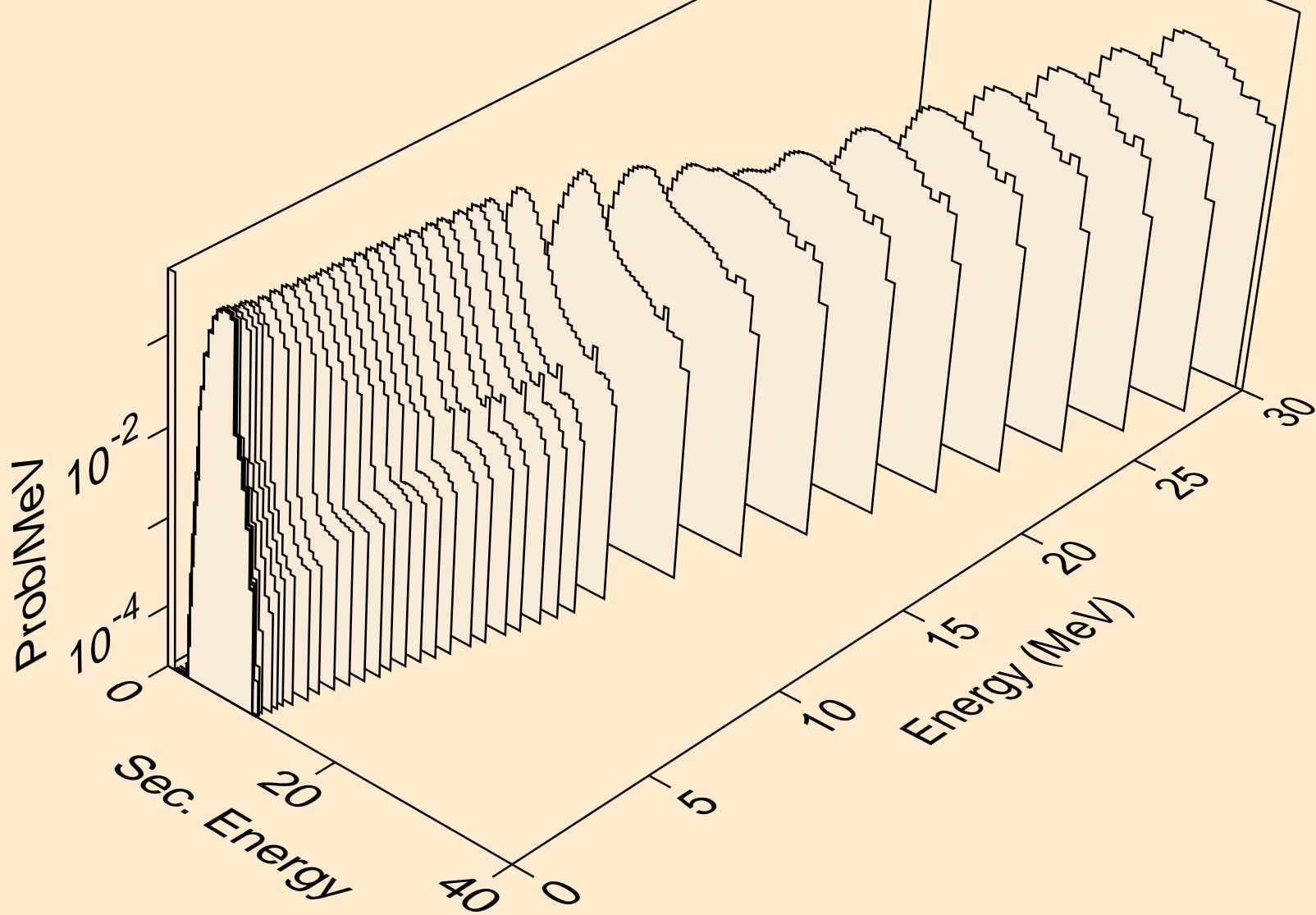

HO148 NEUTRON ACER TENDL-2024 LIBRARY; T=0.K
protons from (n,2p)

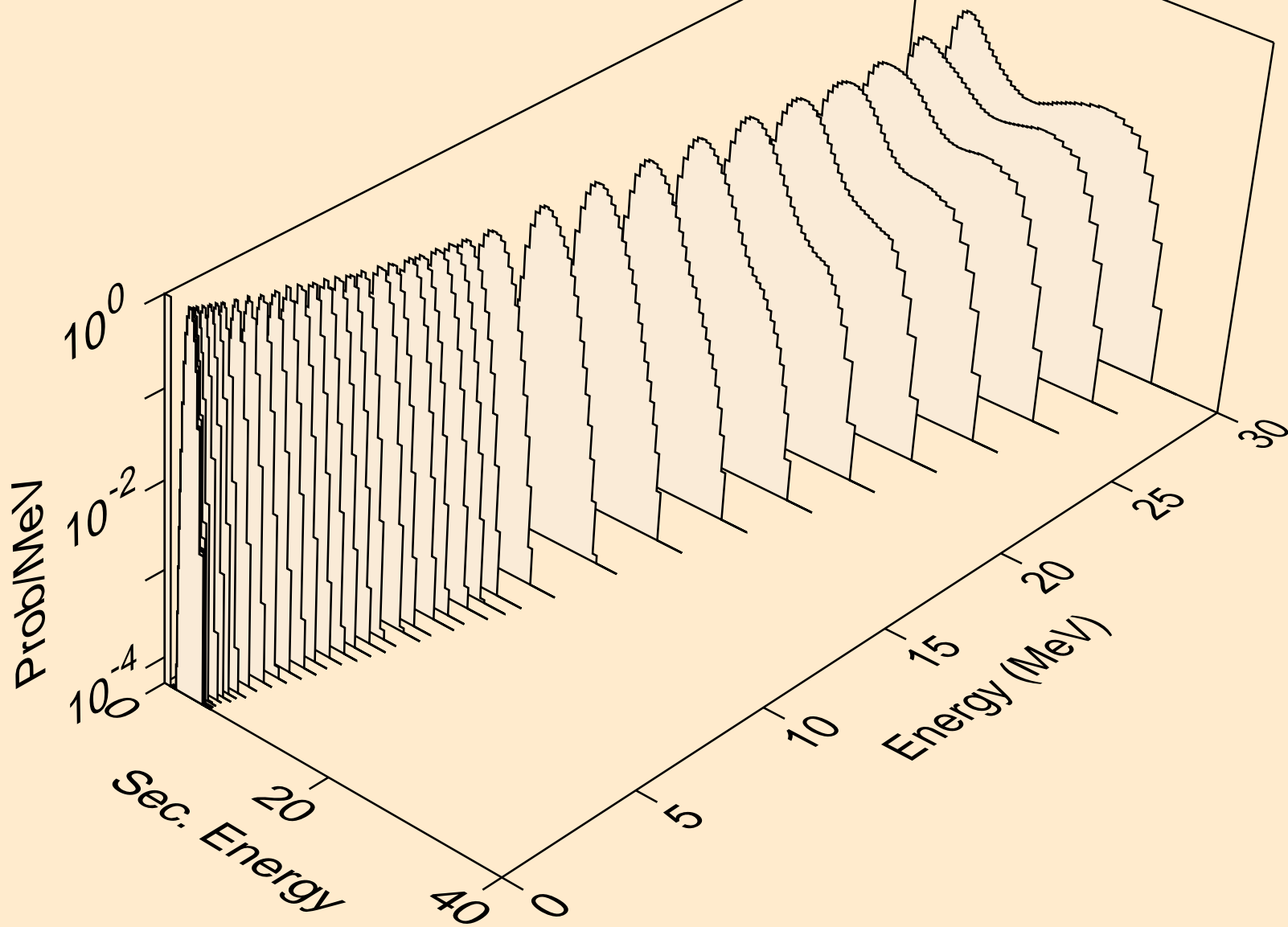

HO148 NEUTRON ACER TENDL-2024 LIBRARY; T=0.K
protons from (n,p)

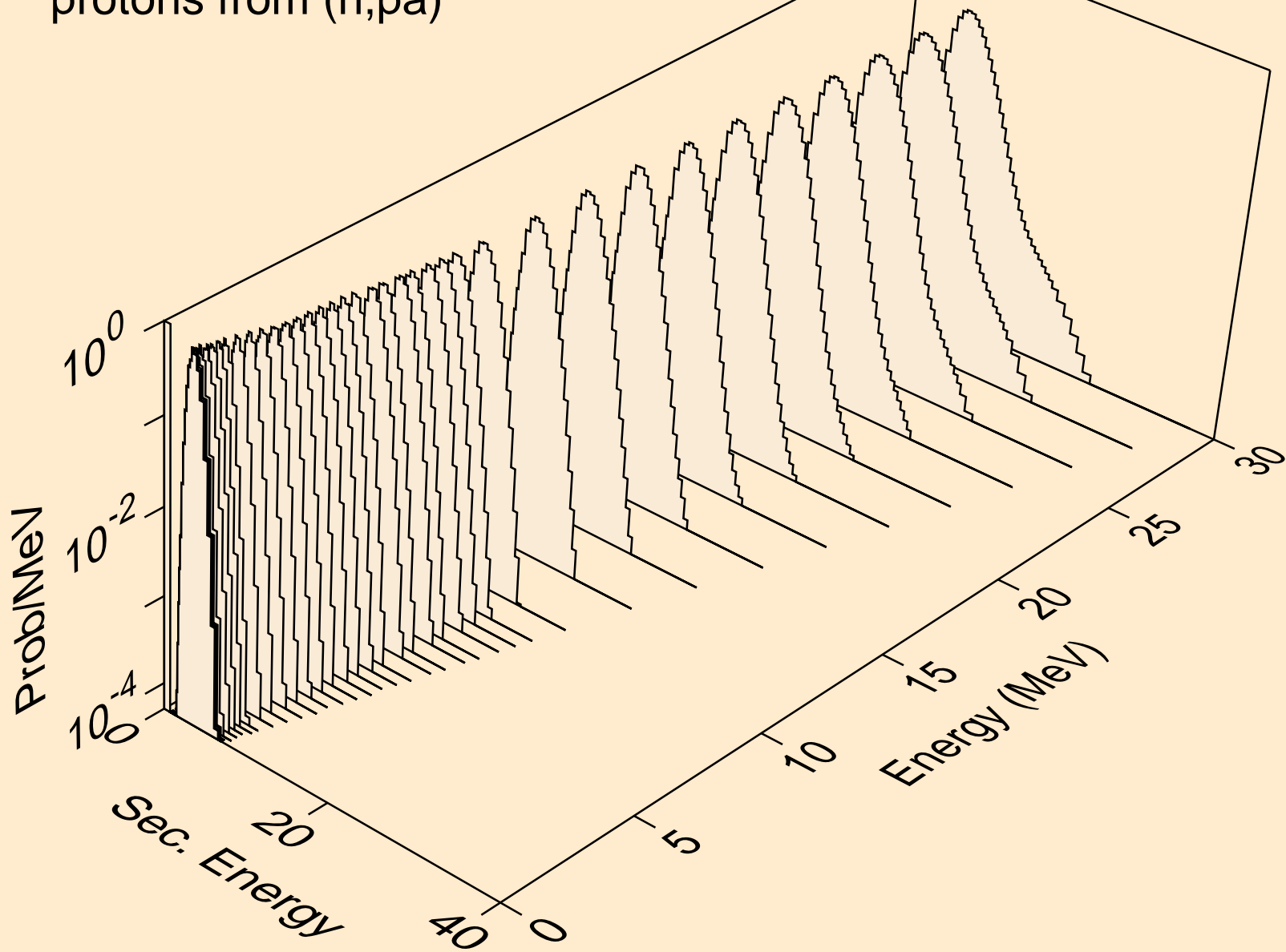

HO148 NEUTRON ACER TENDL-2024 LIBRARY; T=0.K
protons from (n,pd)

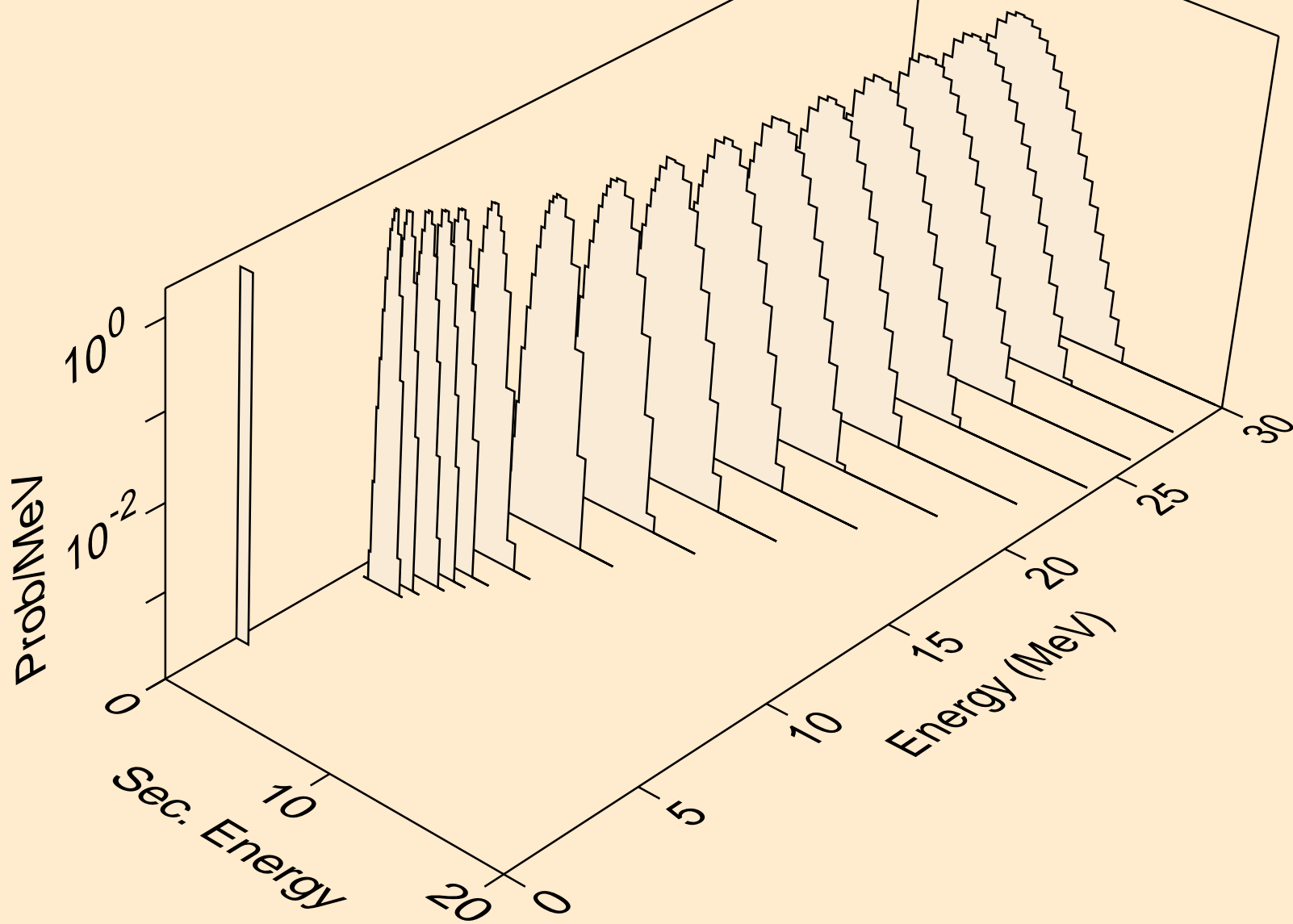

HO148 NEUTRON ACER TENDL-2024 LIBRARY; T=0.K
protons from (n,pt)

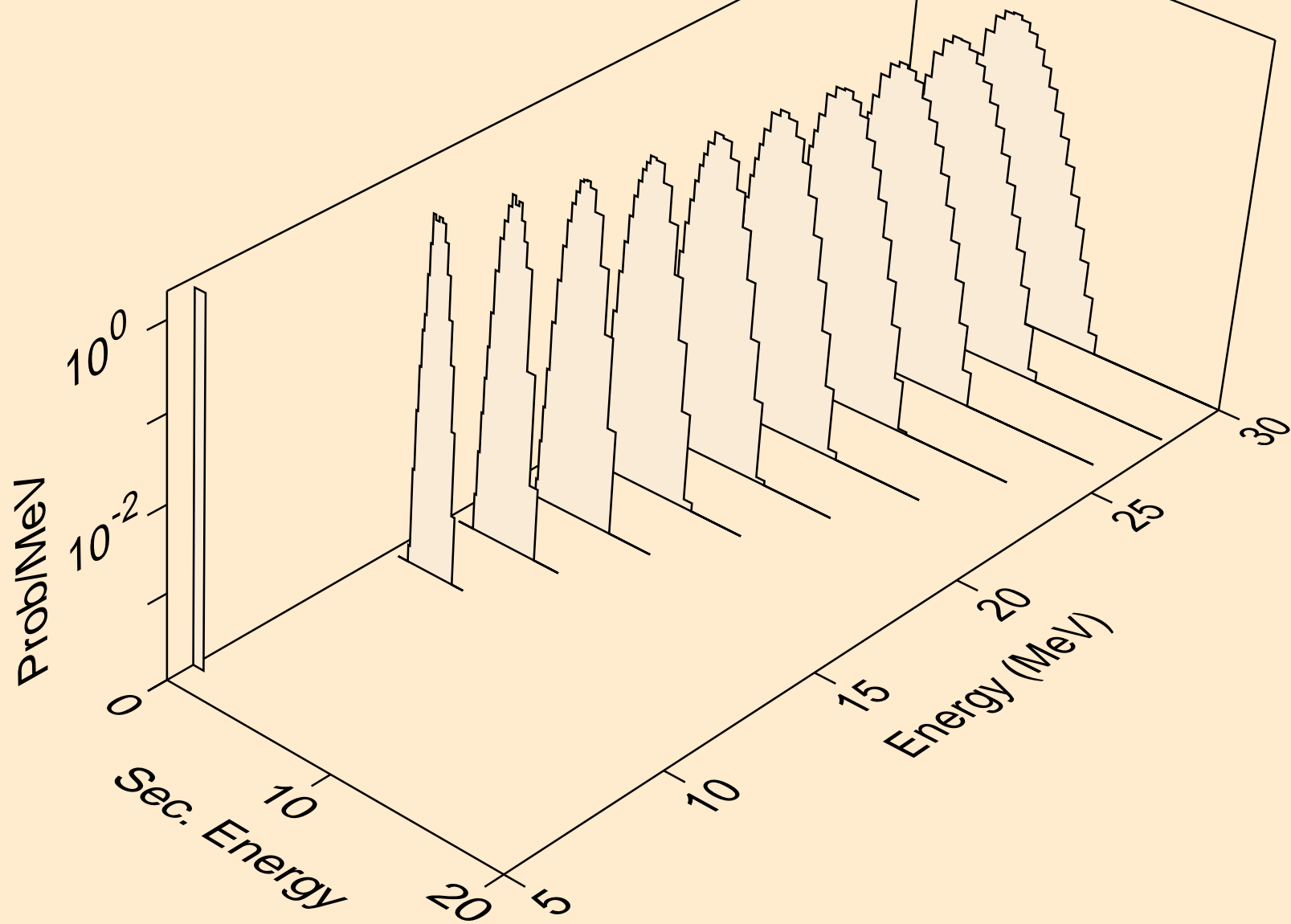

HO148 NEUTRON ACER TENDL-2024 LIBRARY; T=0.K
deuterons from (n,x)

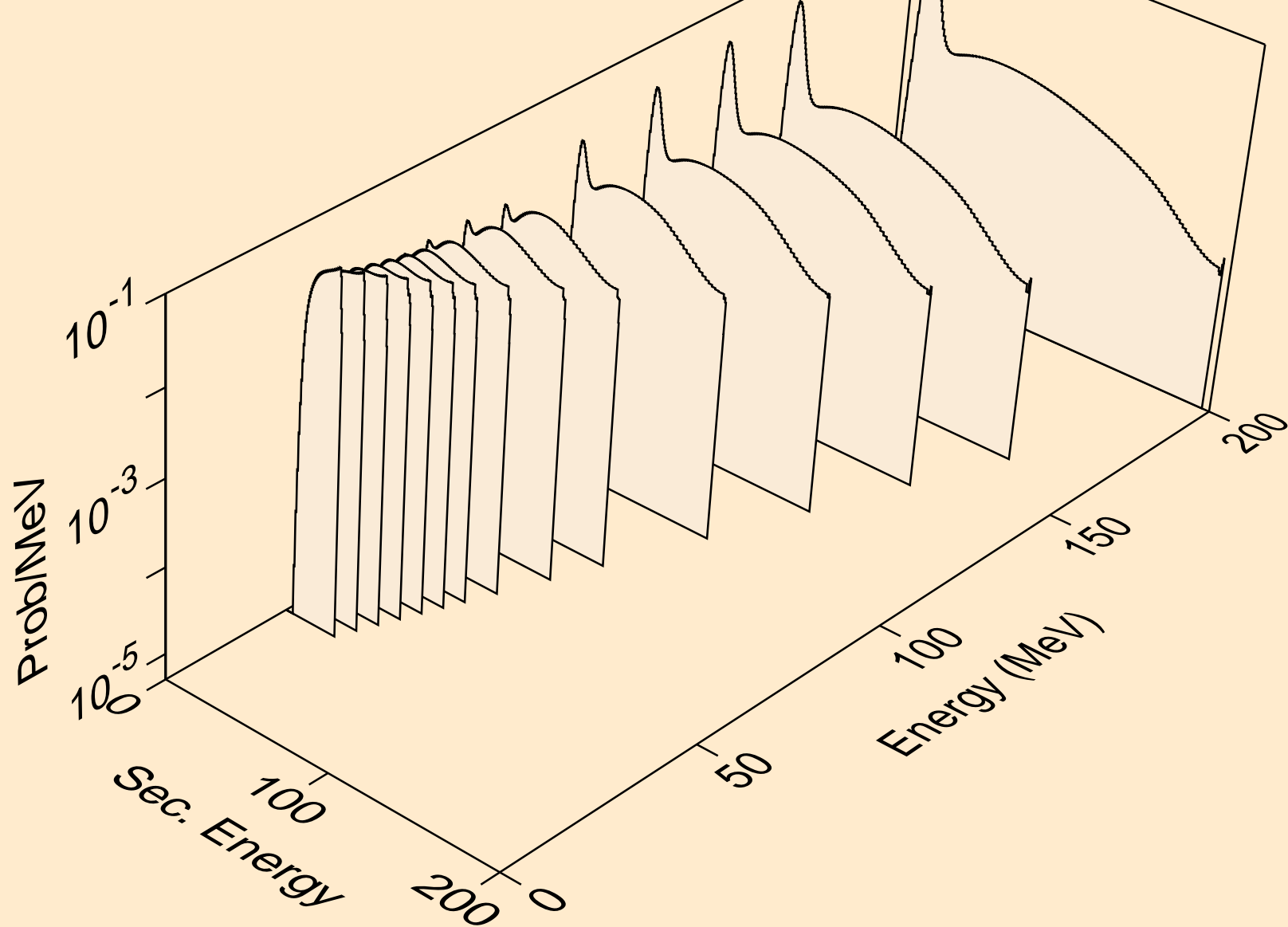

HO148 NEUTRON ACER TENDL-2024 LIBRARY; T=0.K
deuterons from (n,2nd)

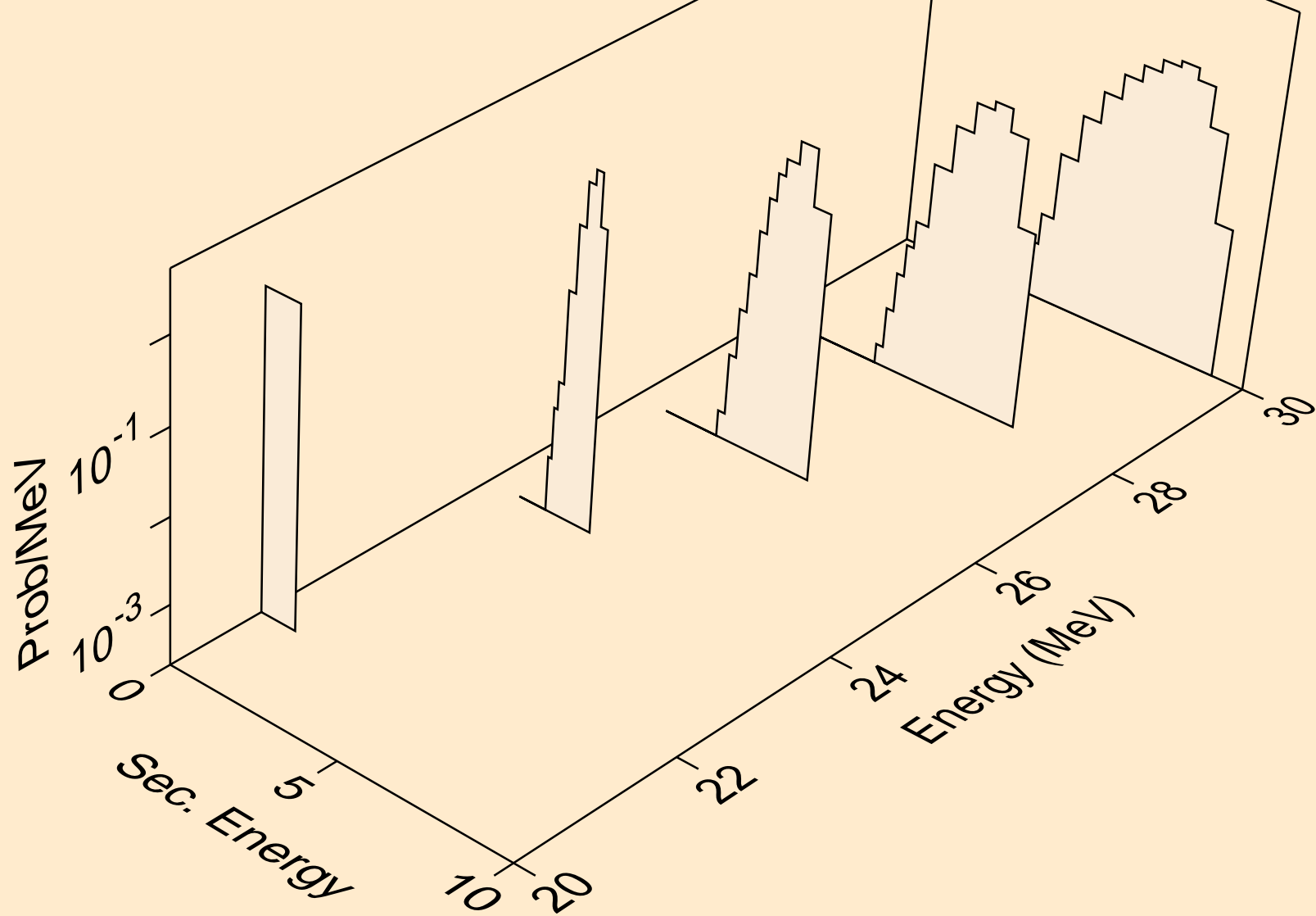

HO148 NEUTRON ACER TENDL-2024 LIBRARY; T=0.K
deuterons from (n,n*)d

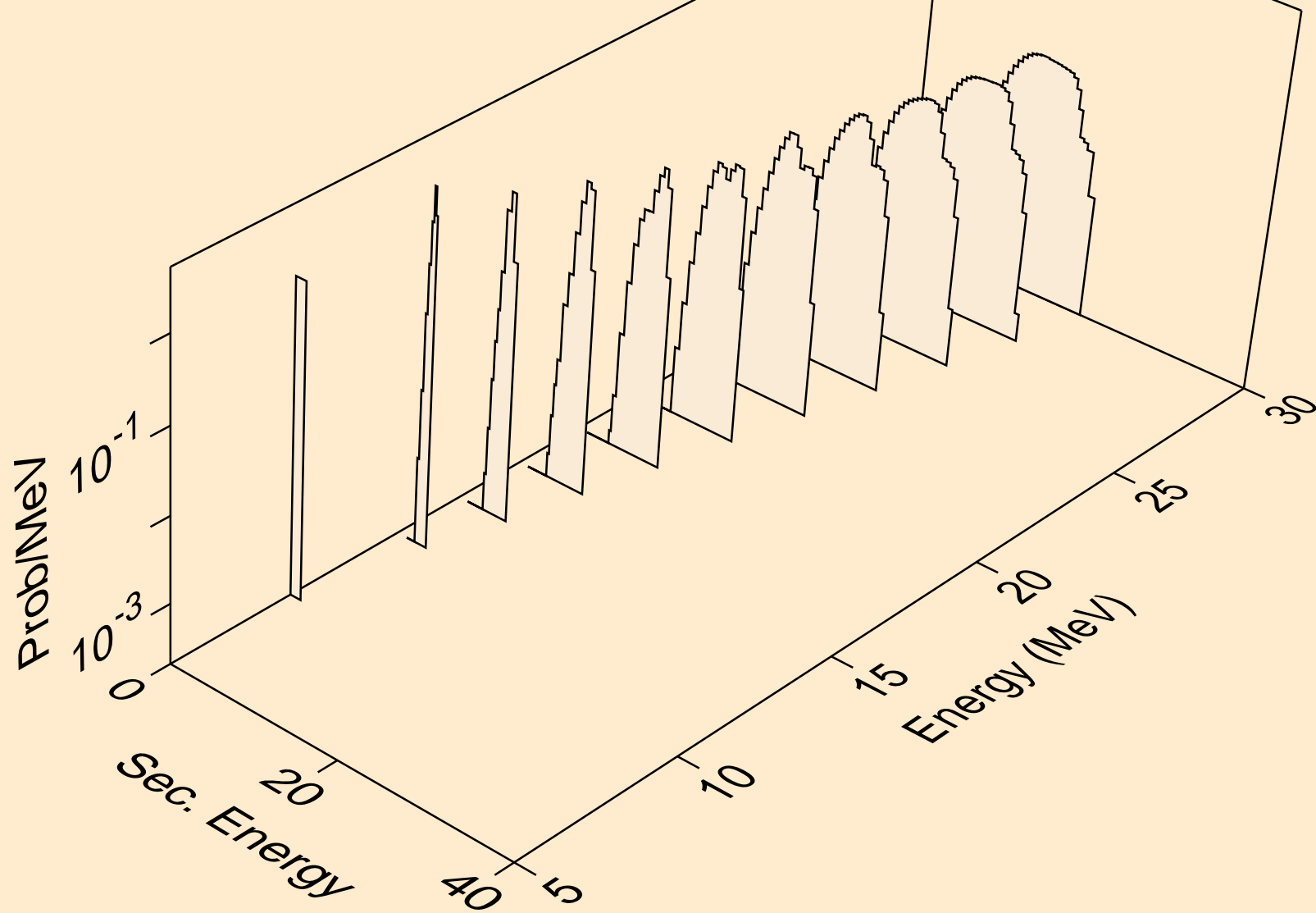

HO148 NEUTRON ACER TENDL-2024 LIBRARY; T=0.K
deuterons from (n,d)

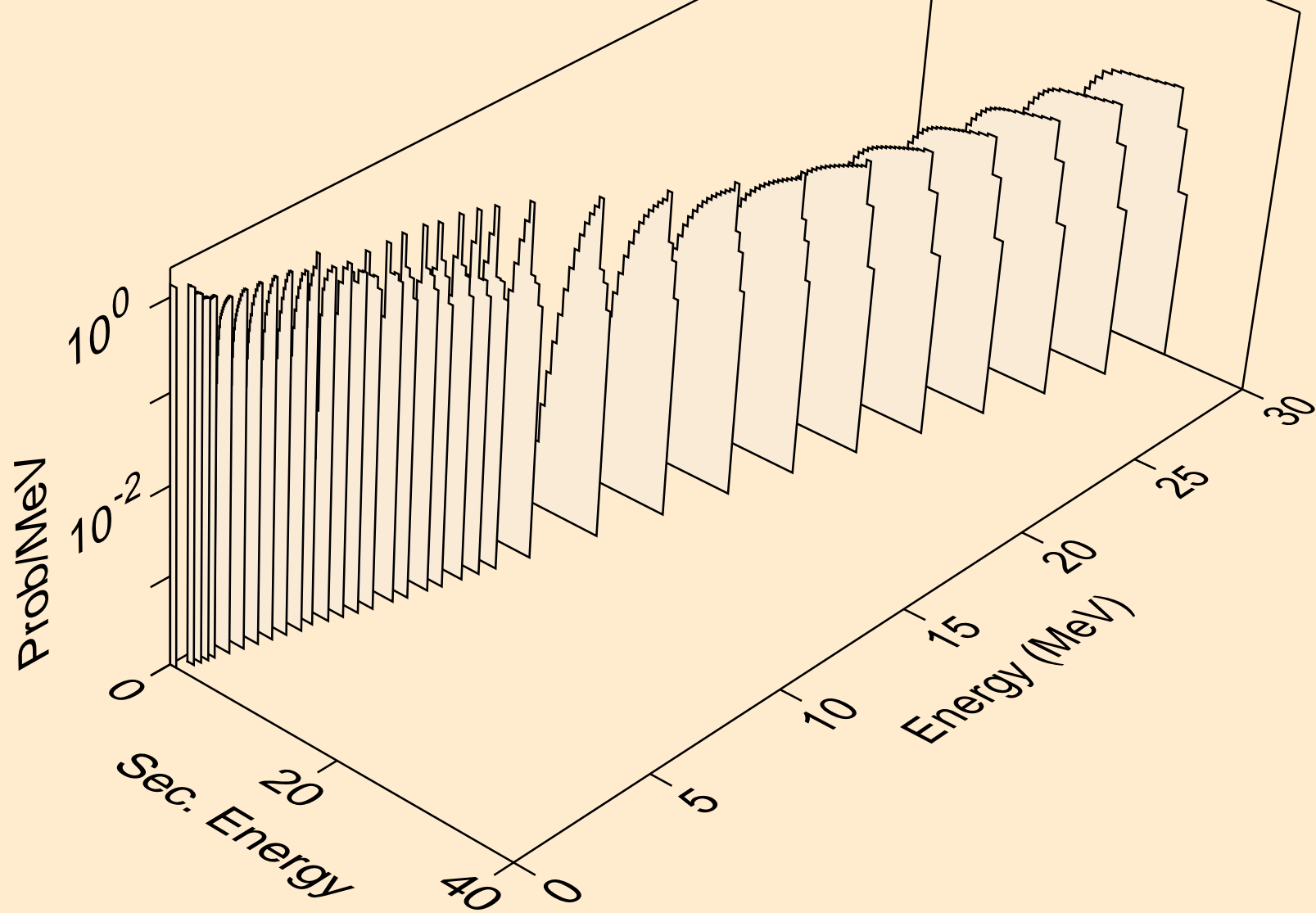

HO148 NEUTRON ACER TENDL-2024 LIBRARY; T=0.K
deuterons from (n,pd)

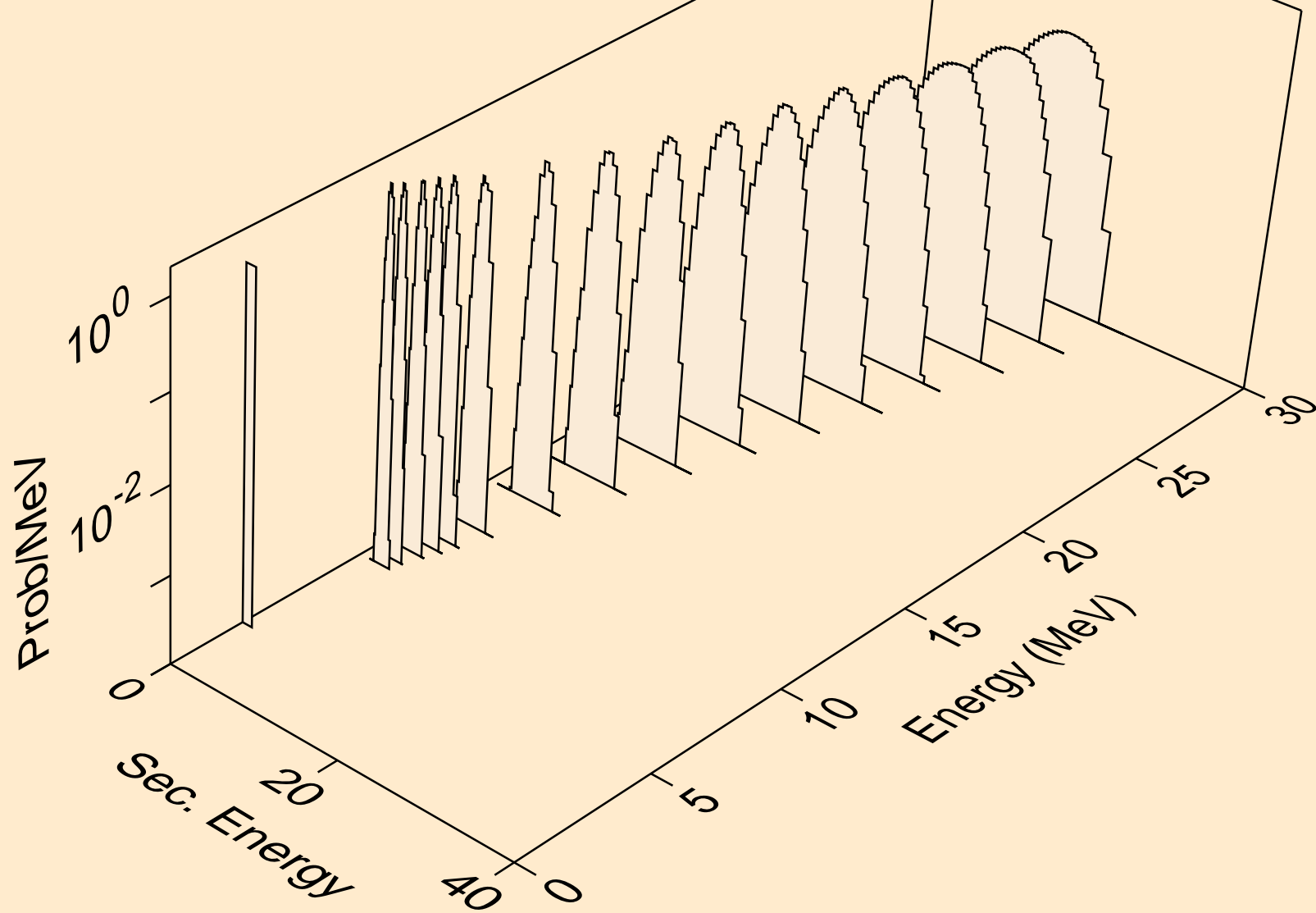

HO148 NEUTRON ACER TENDL-2024 LIBRARY; T=0.K
deuterons from (n,da)

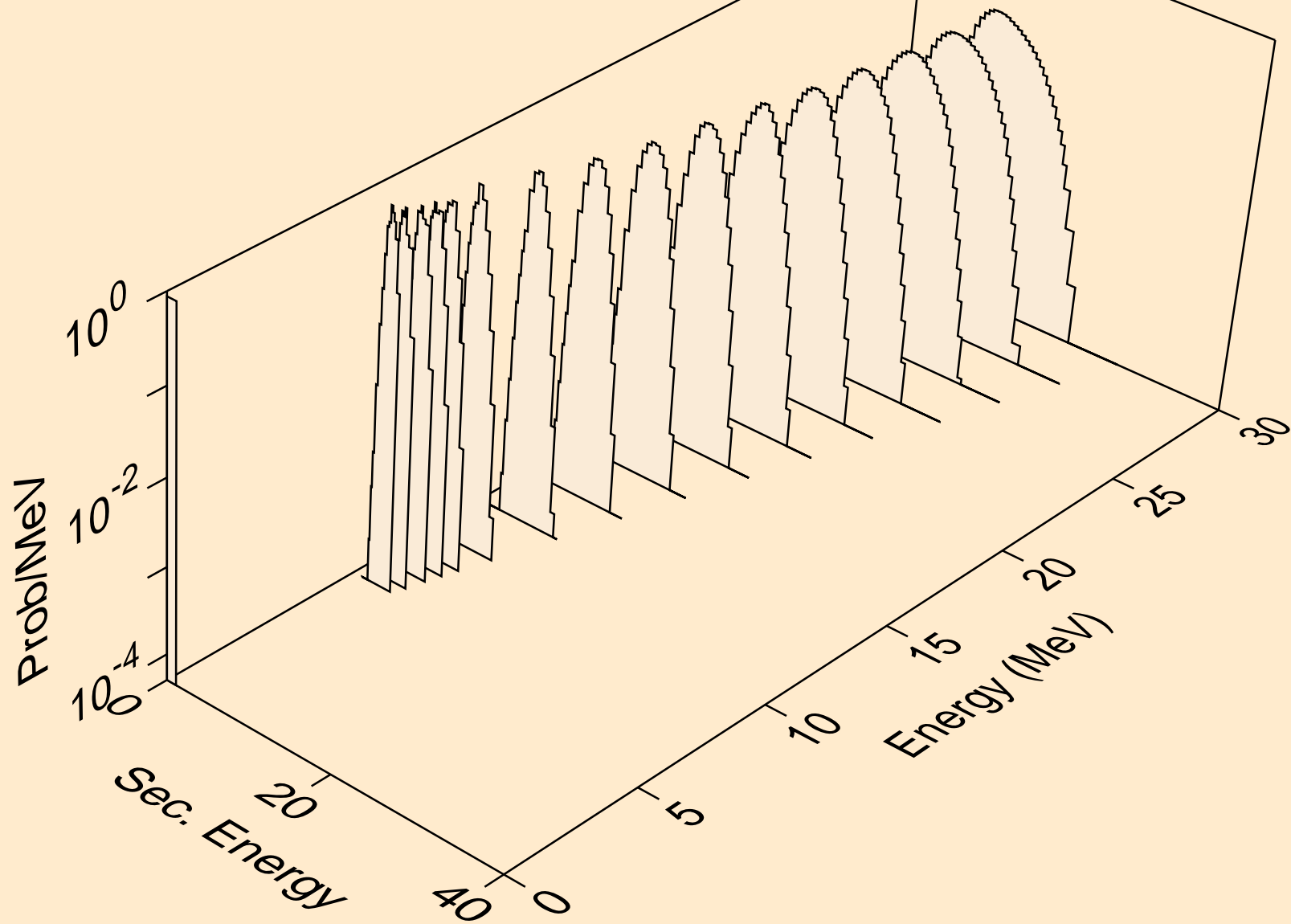

HO148 NEUTRON ACER TENDL-2024 LIBRARY; T=0.K
tritons from (n,x)

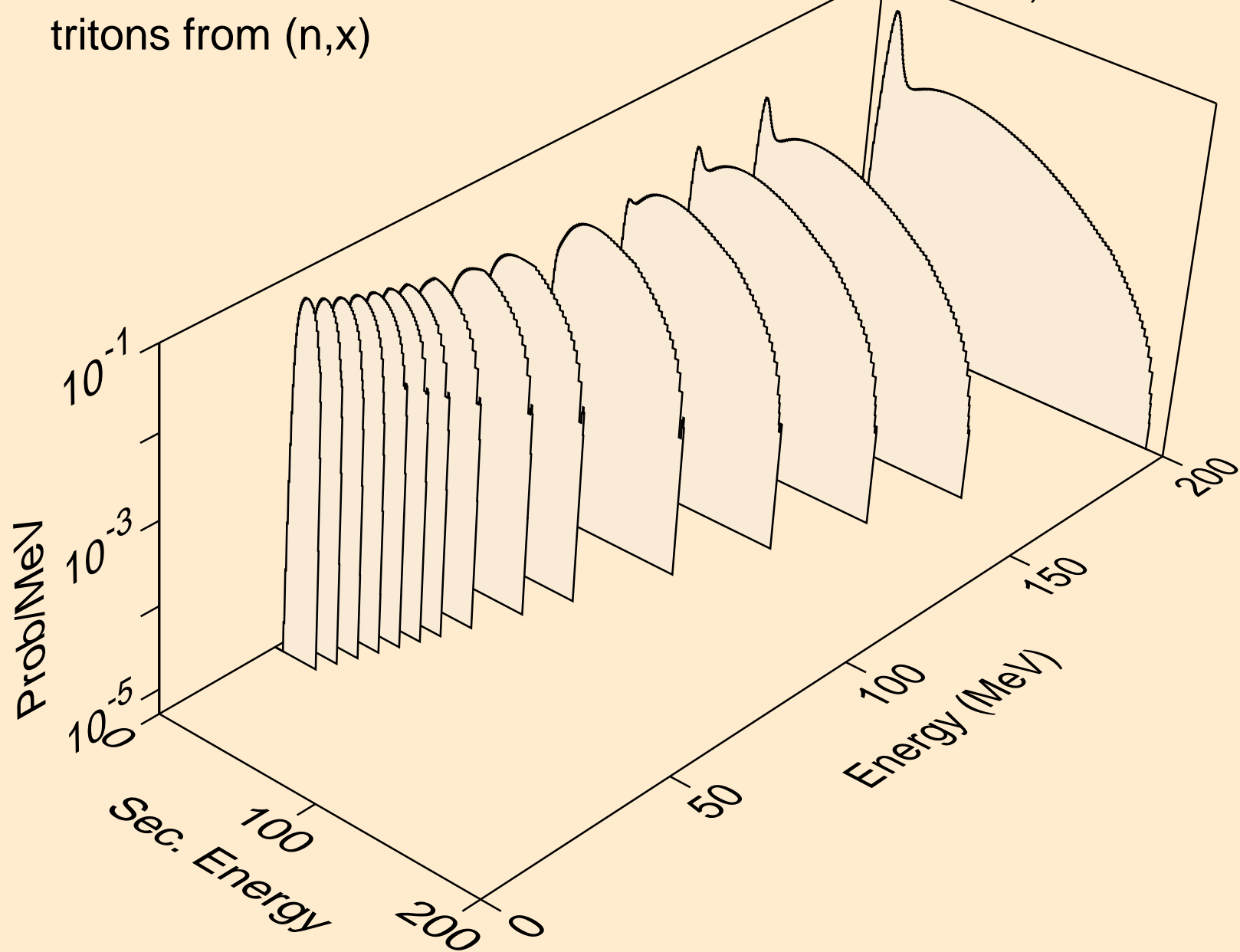

HO148 NEUTRON ACER TENDL-2024 LIBRARY; T=0.K
tritons from (n,n*)t

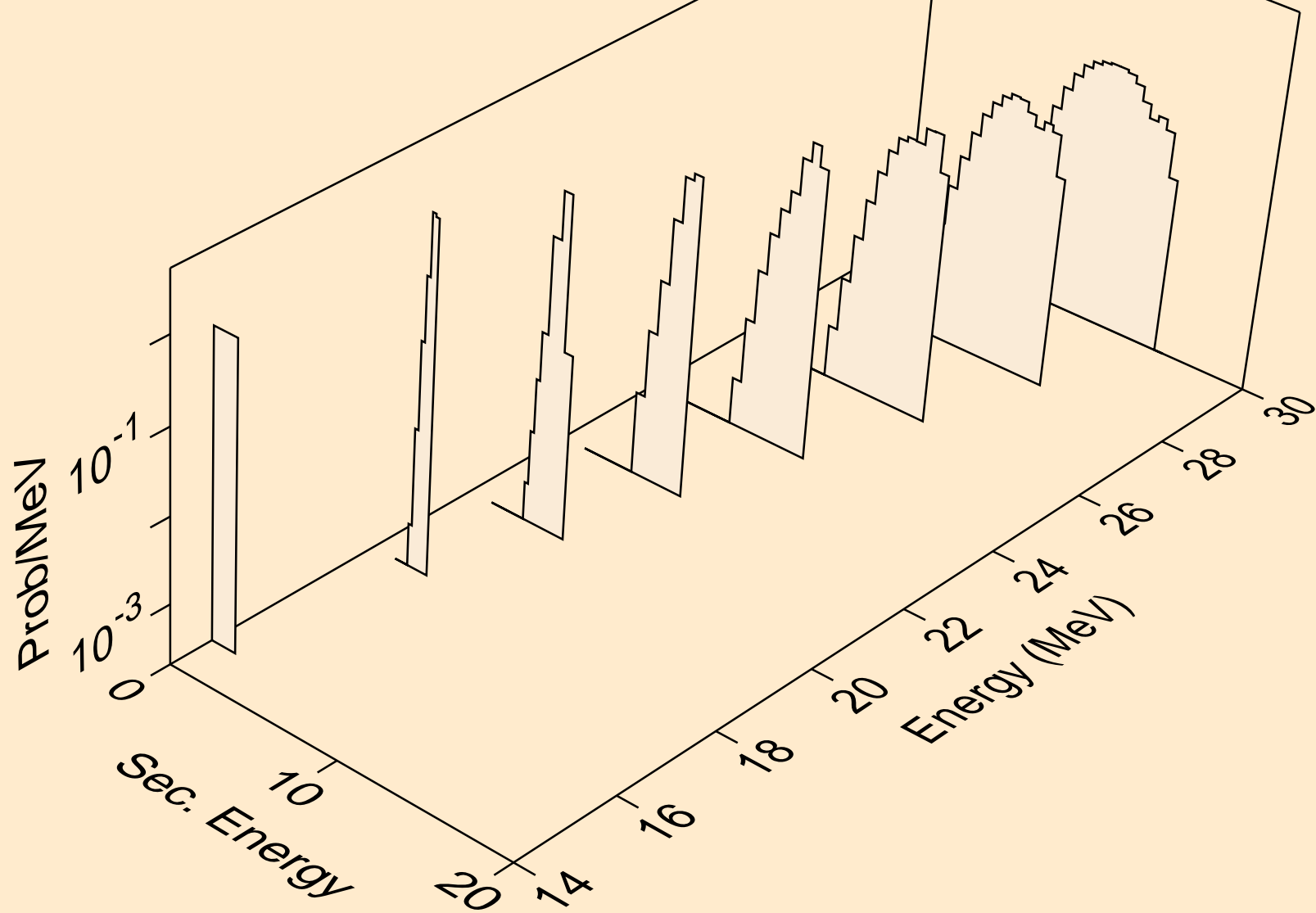

HO148 NEUTRON ACER TENDL-2024 LIBRARY; T=0.K
tritons from (n,t)

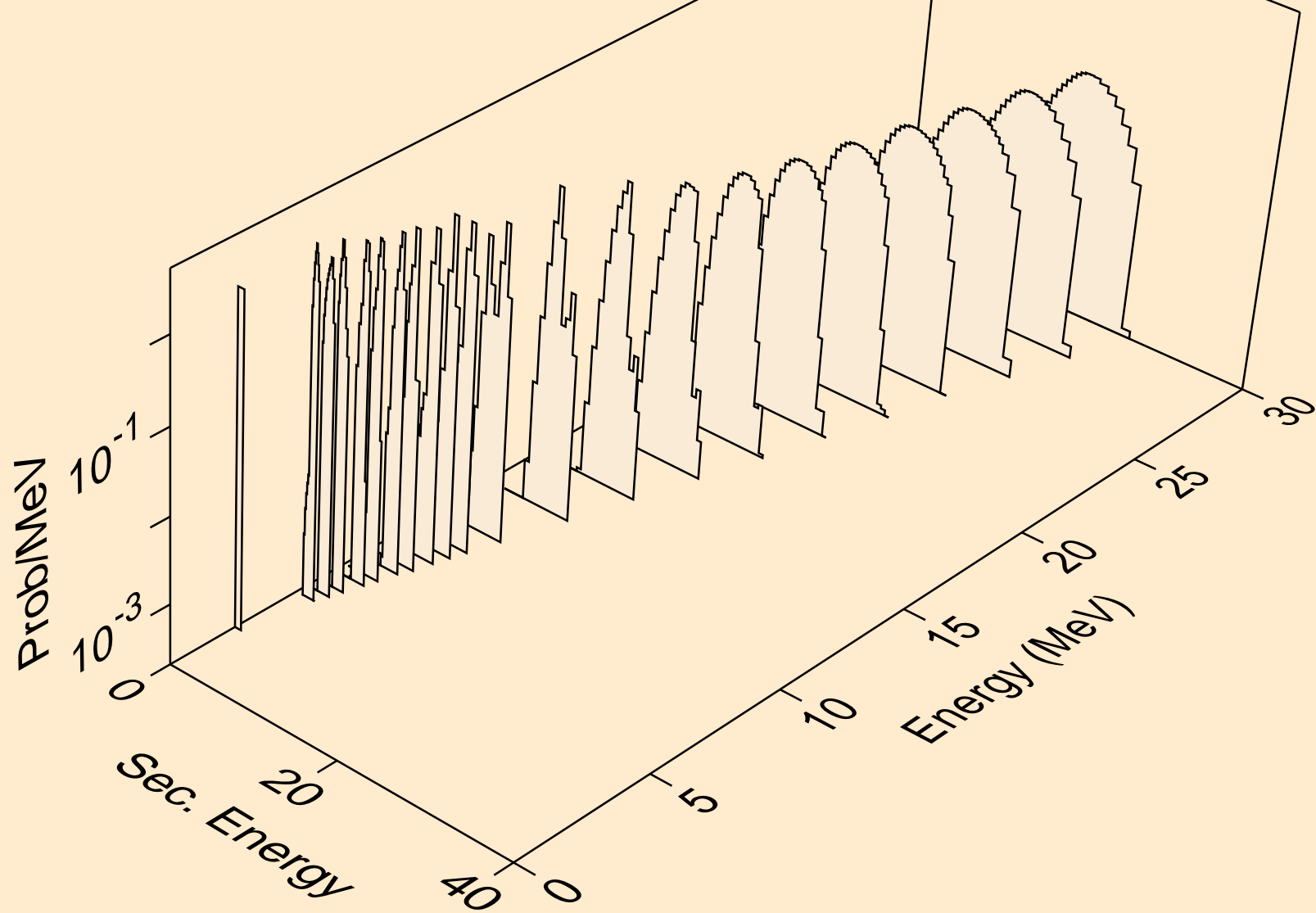

HO148 NEUTRON ACER TENDL-2024 LIBRARY; T=0.K
tritons from (n,pt)

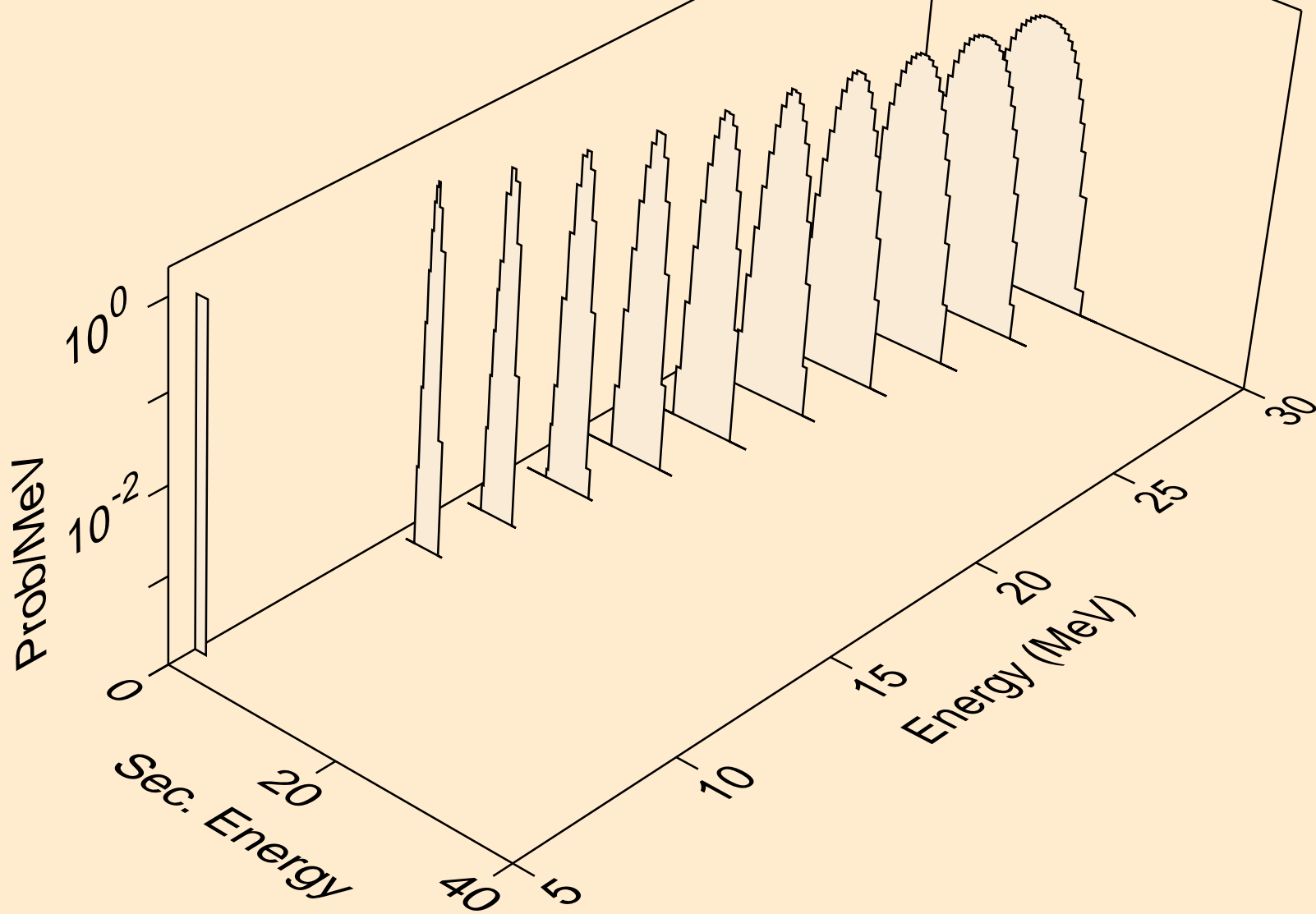

HO148 NEUTRON ACER TENDL-2024 LIBRARY; T=0.K
he3s from (n,x)

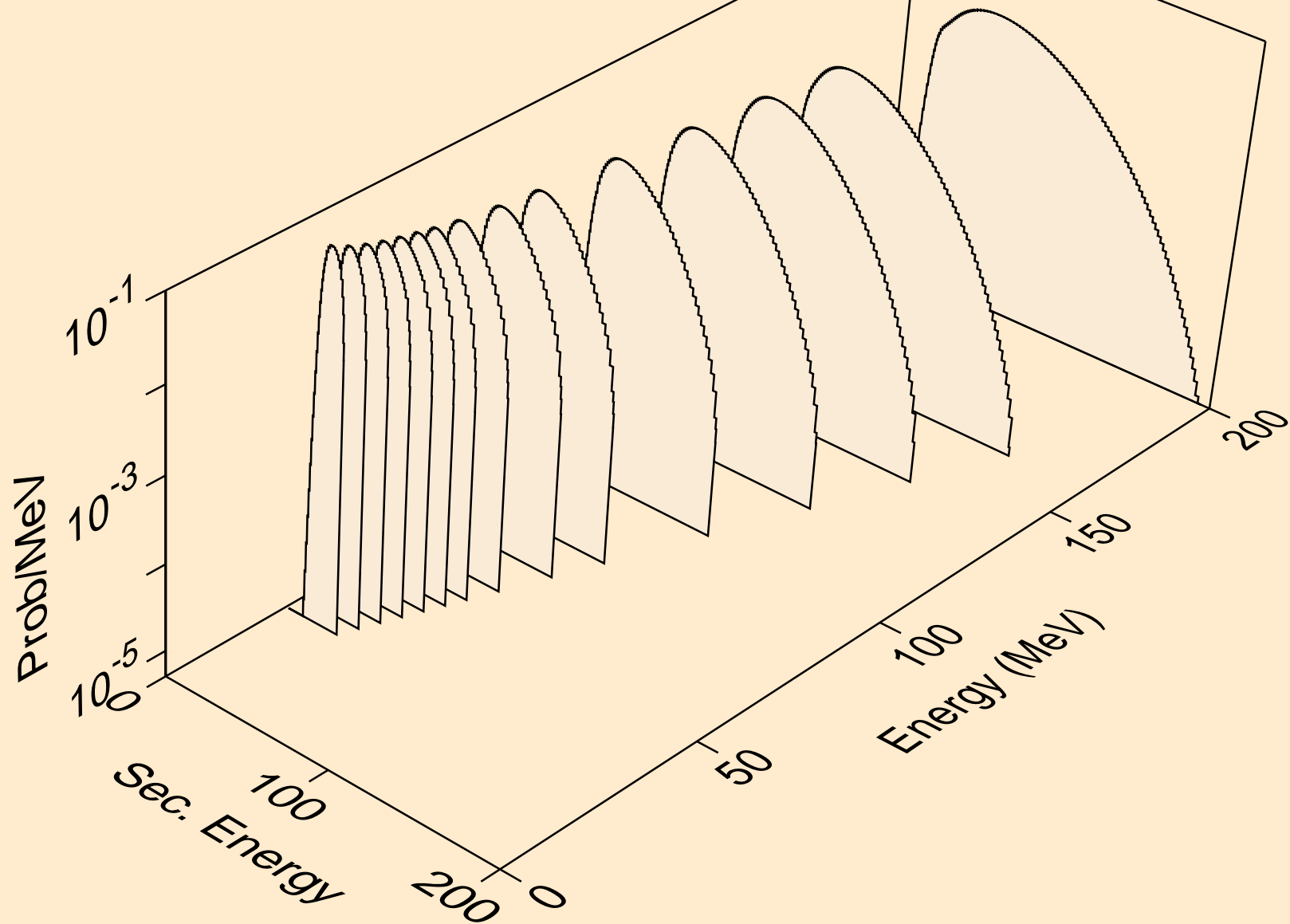

HO148 NEUTRON ACER TENDL-2024 LIBRARY; T=0.K
he3s from (n,n*)he3

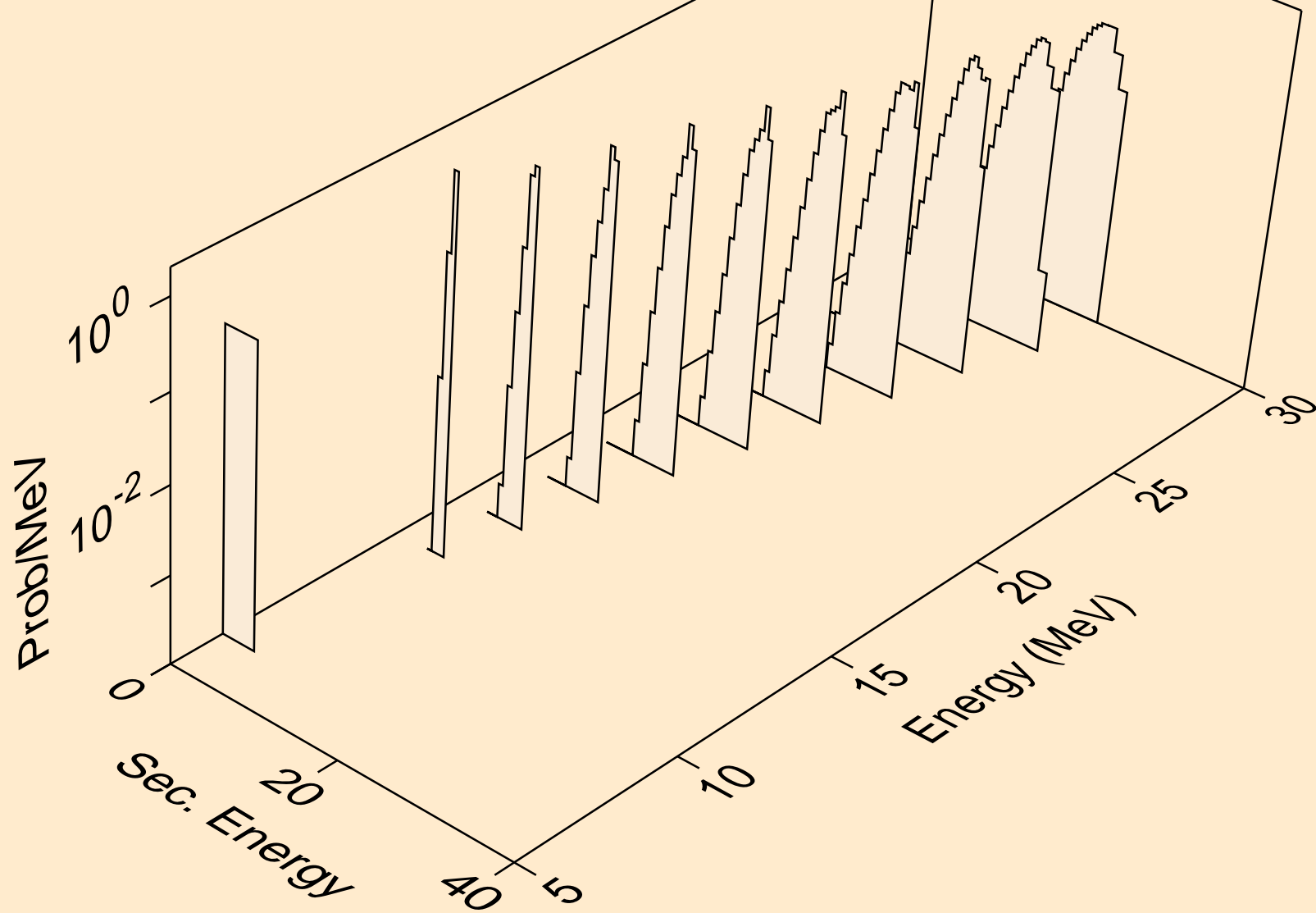

HO148 NEUTRON ACER TENDL-2024 LIBRARY; T=0.K
he3s from (n,he3)

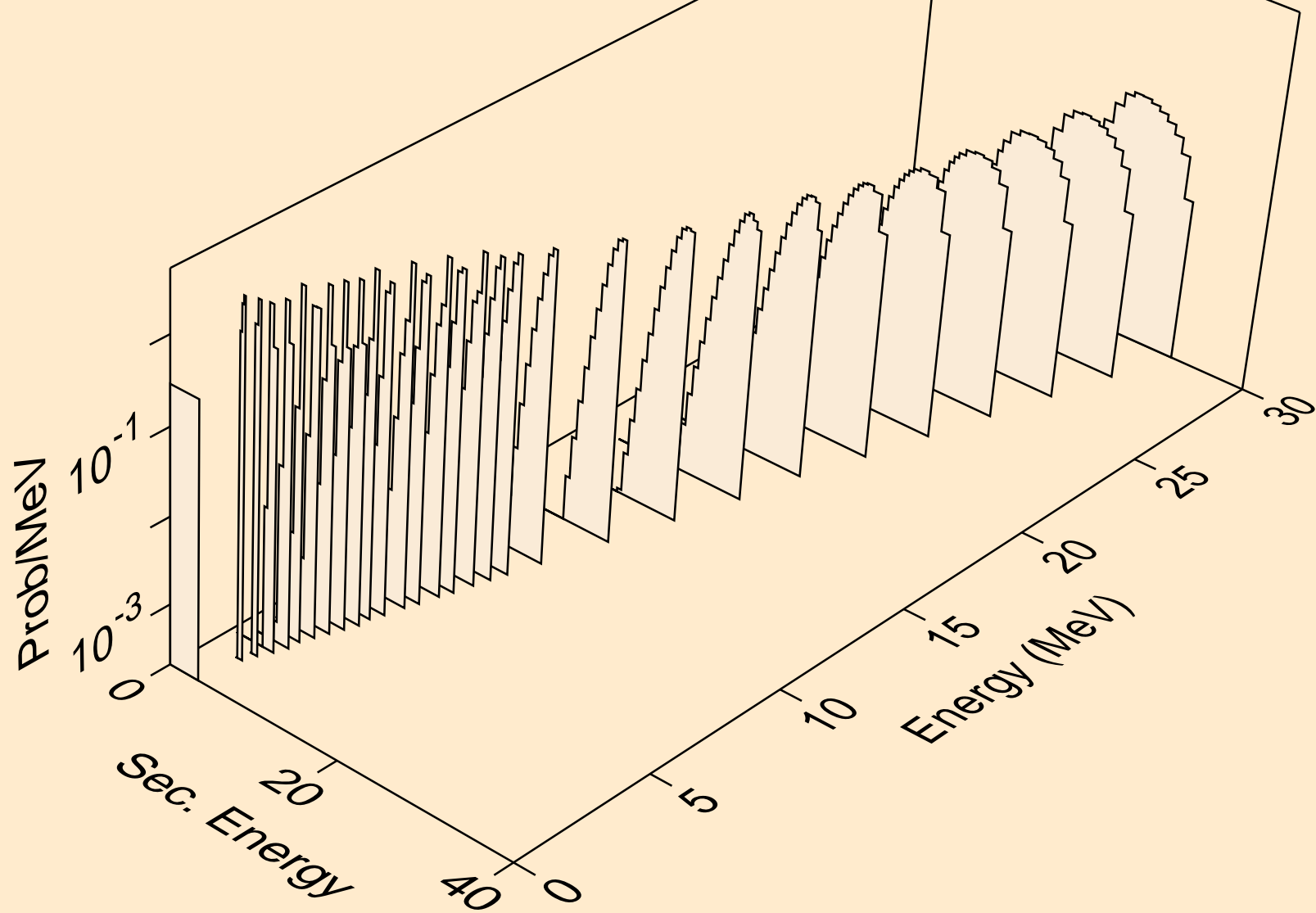

HO148 NEUTRON ACER TENDL-2024 LIBRARY; T=0.K
alphas from (n,x)

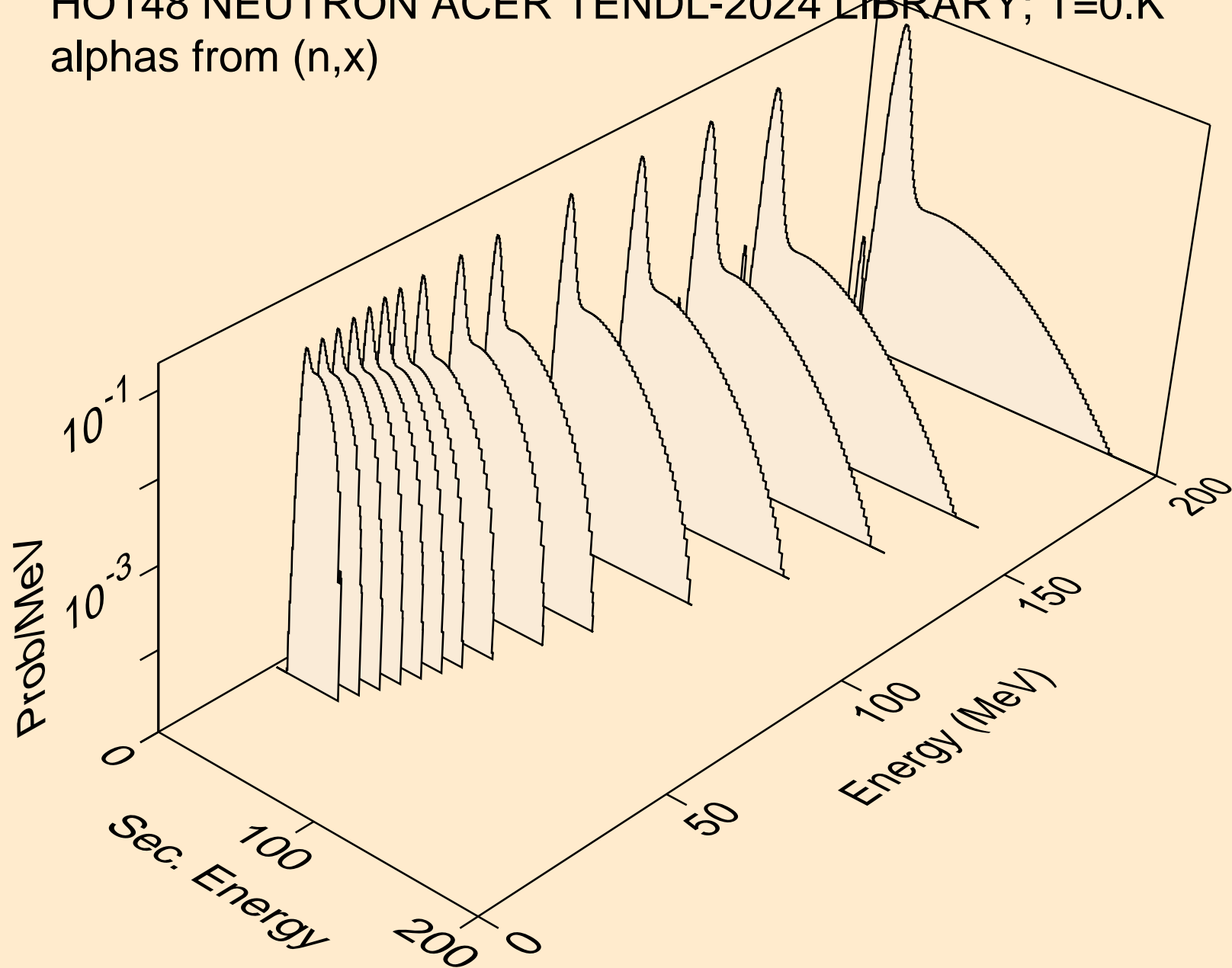

HO148 NEUTRON ACER TENDL-2024 LIBRARY; T=0.K
alphas from (n,n*)a

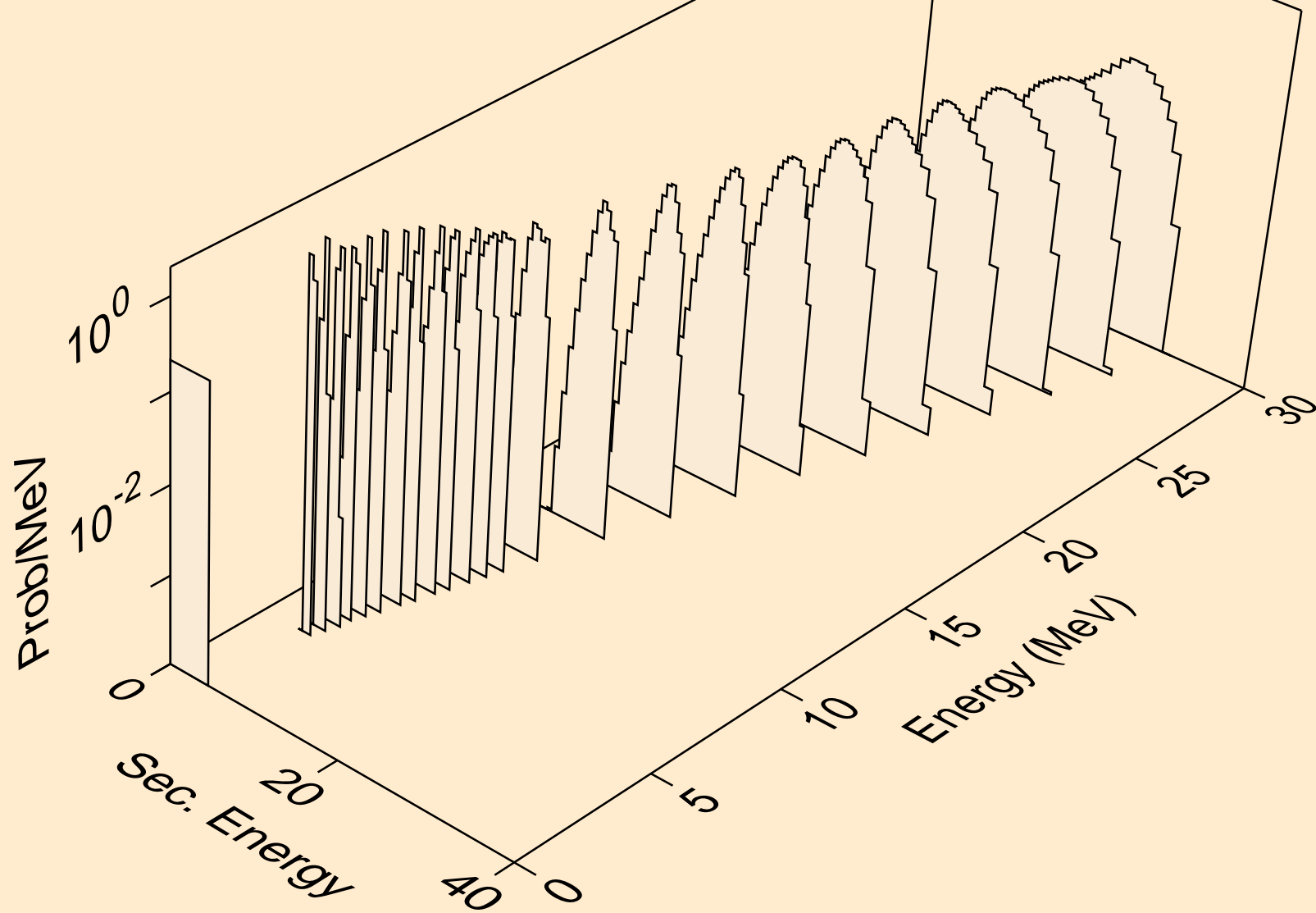

HO148 NEUTRON ACER TENDL-2024 LIBRARY; T=0.K
alphas from (n,2n)a

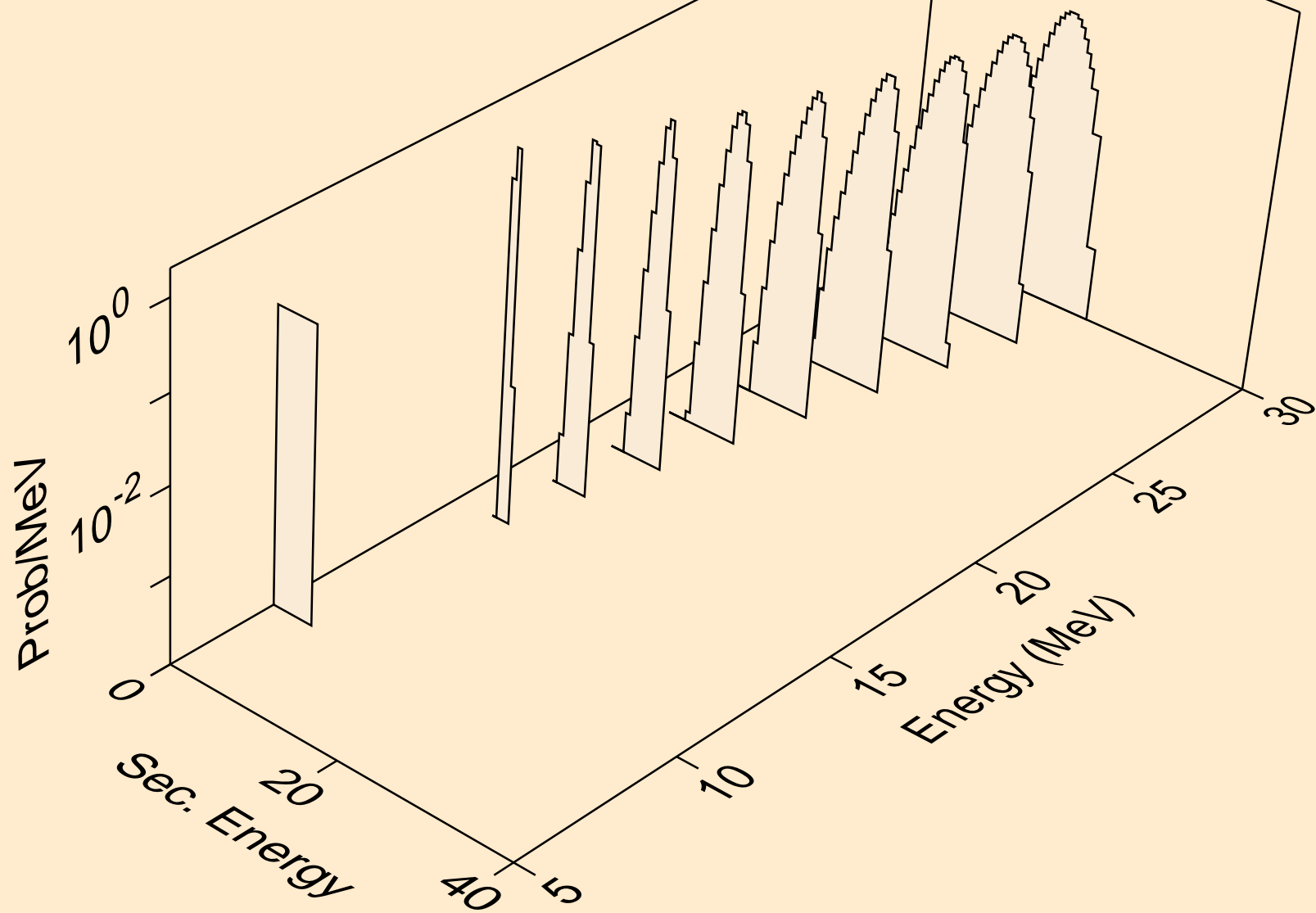

HO148 NEUTRON ACER TENDL-2024 LIBRARY; T=0.K
alphas from (n,n*)2a

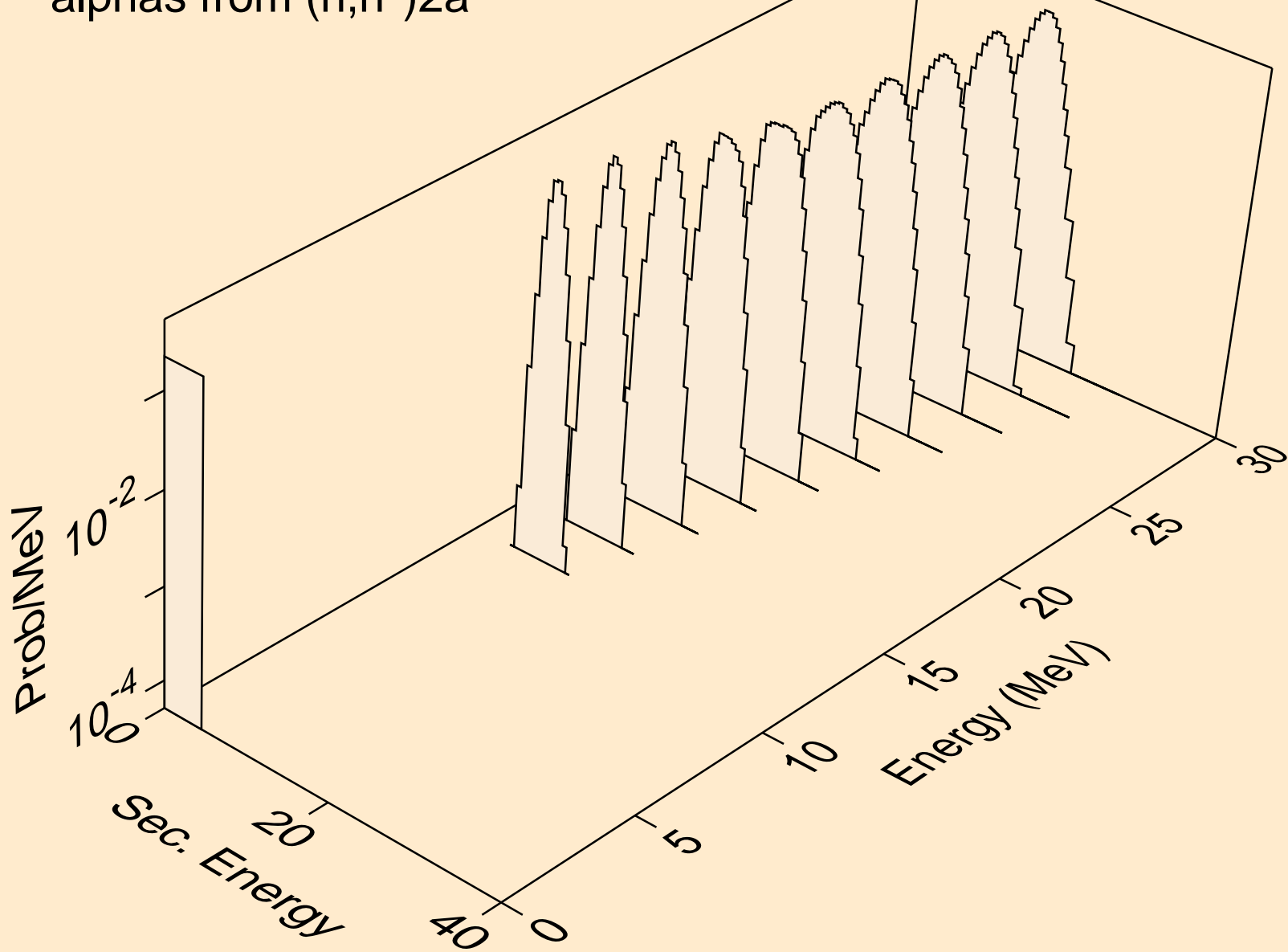

HO148 NEUTRON ACER TENDL-2024 LIBRARY; T=0.K
alphas from (n,2n)2a

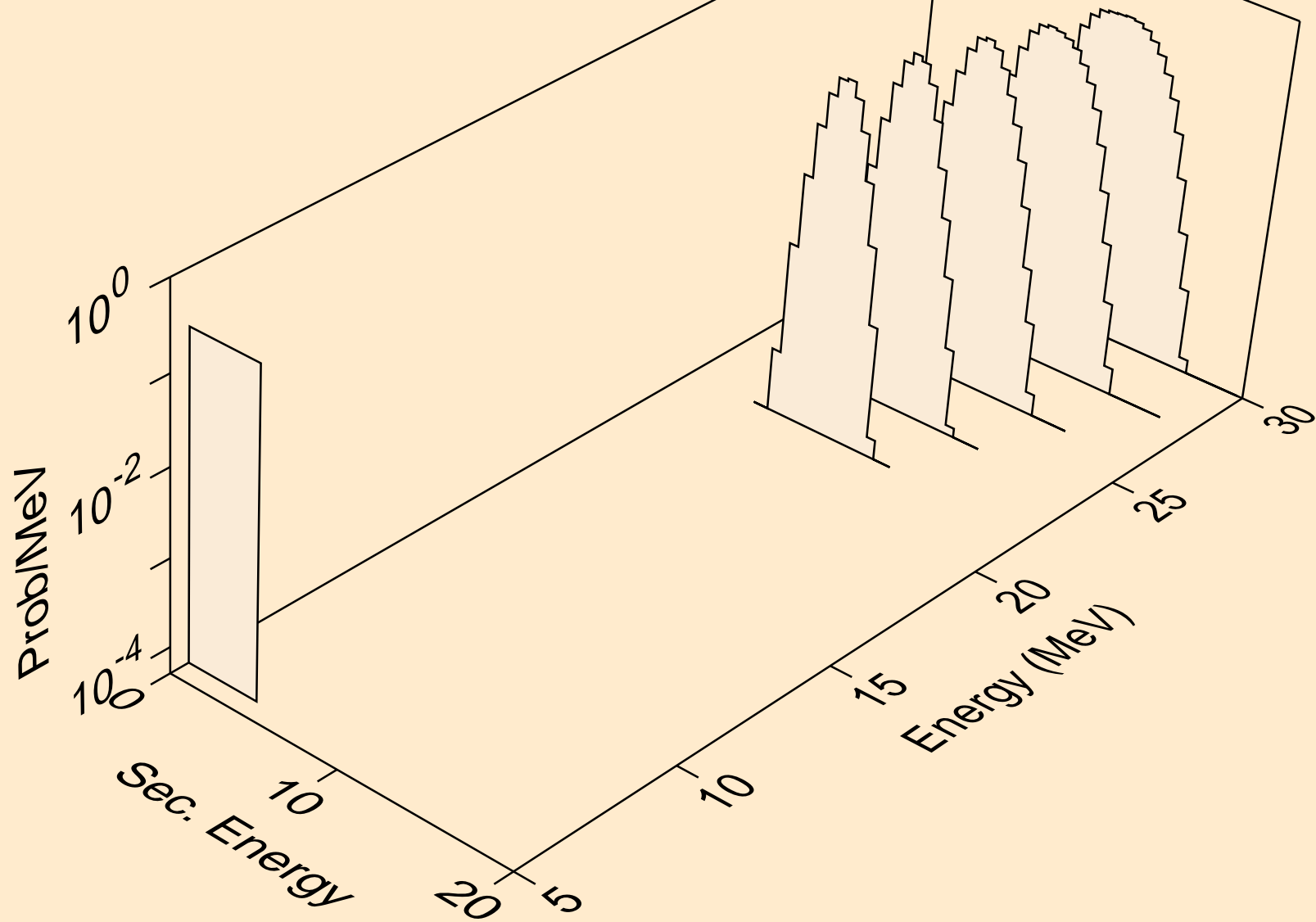

HO148 NEUTRON ACER TENDL-2024 LIBRARY; T=0.K
alphas from (n,npa)

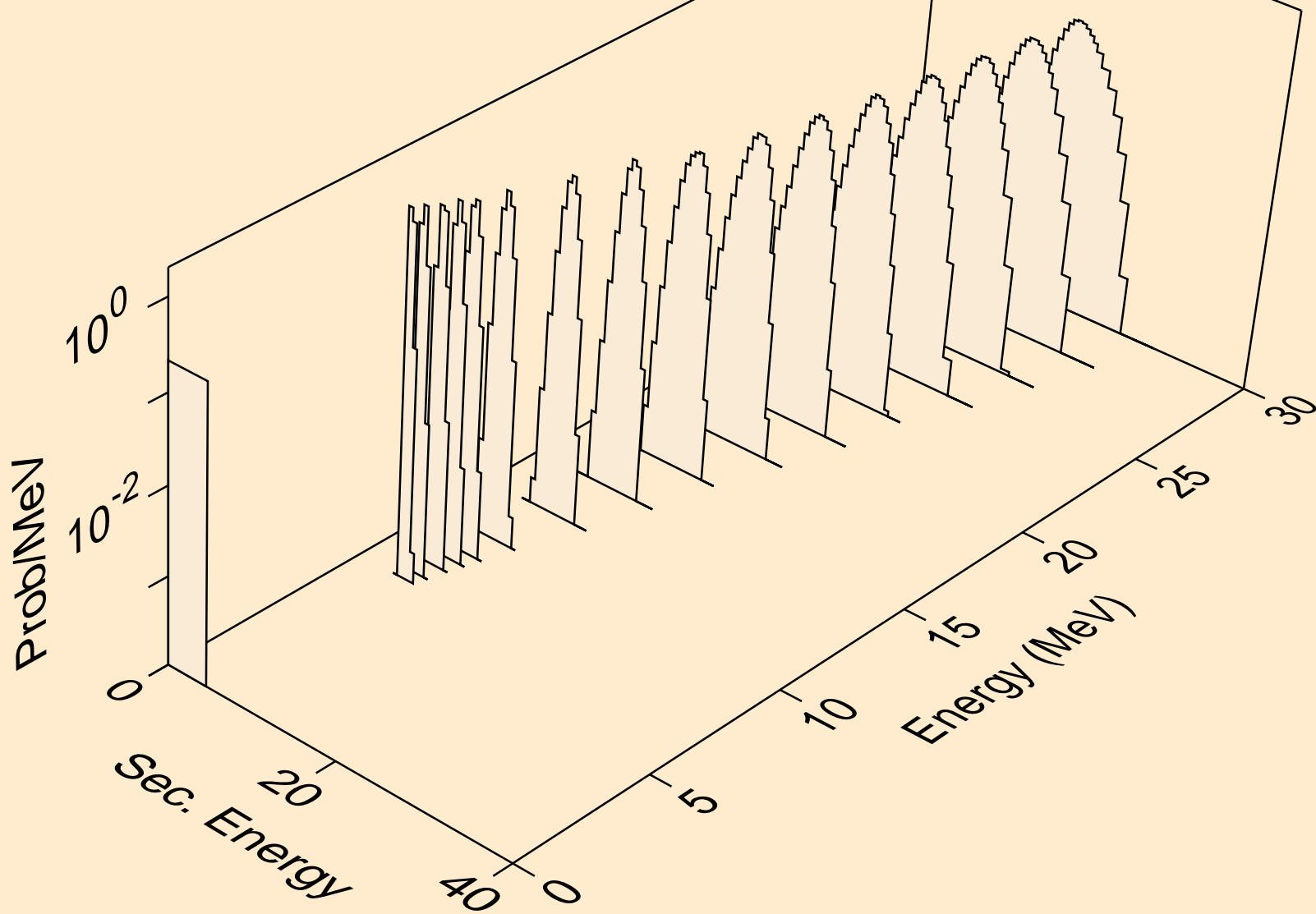

HO148 NEUTRON ACER TENDL-2024 LIBRARY; T=0.K
alphas from (n,a)

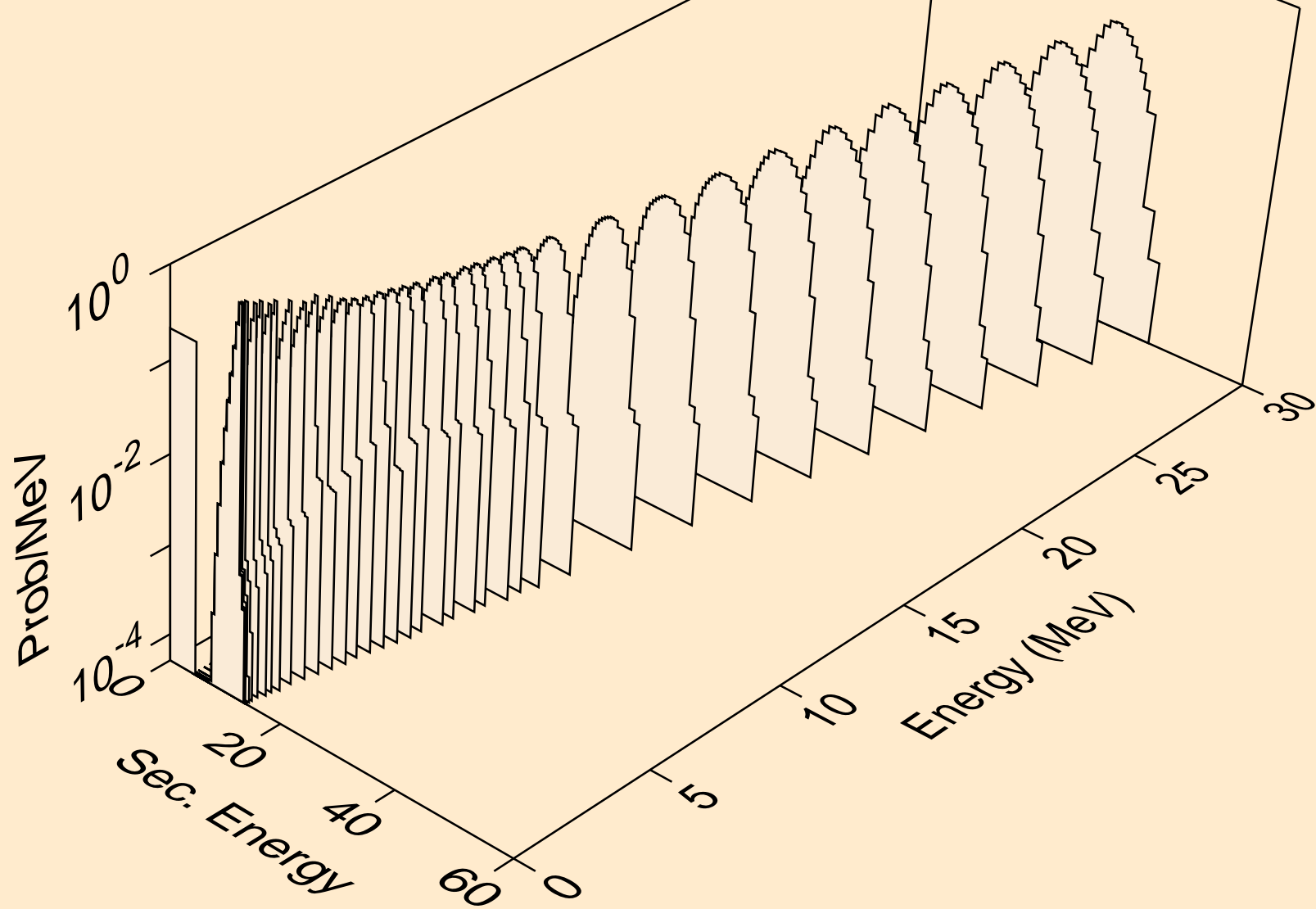

HO148 NEUTRON ACER TENDL-2024 LIBRARY; T=0.K
alphas from (n,2a)

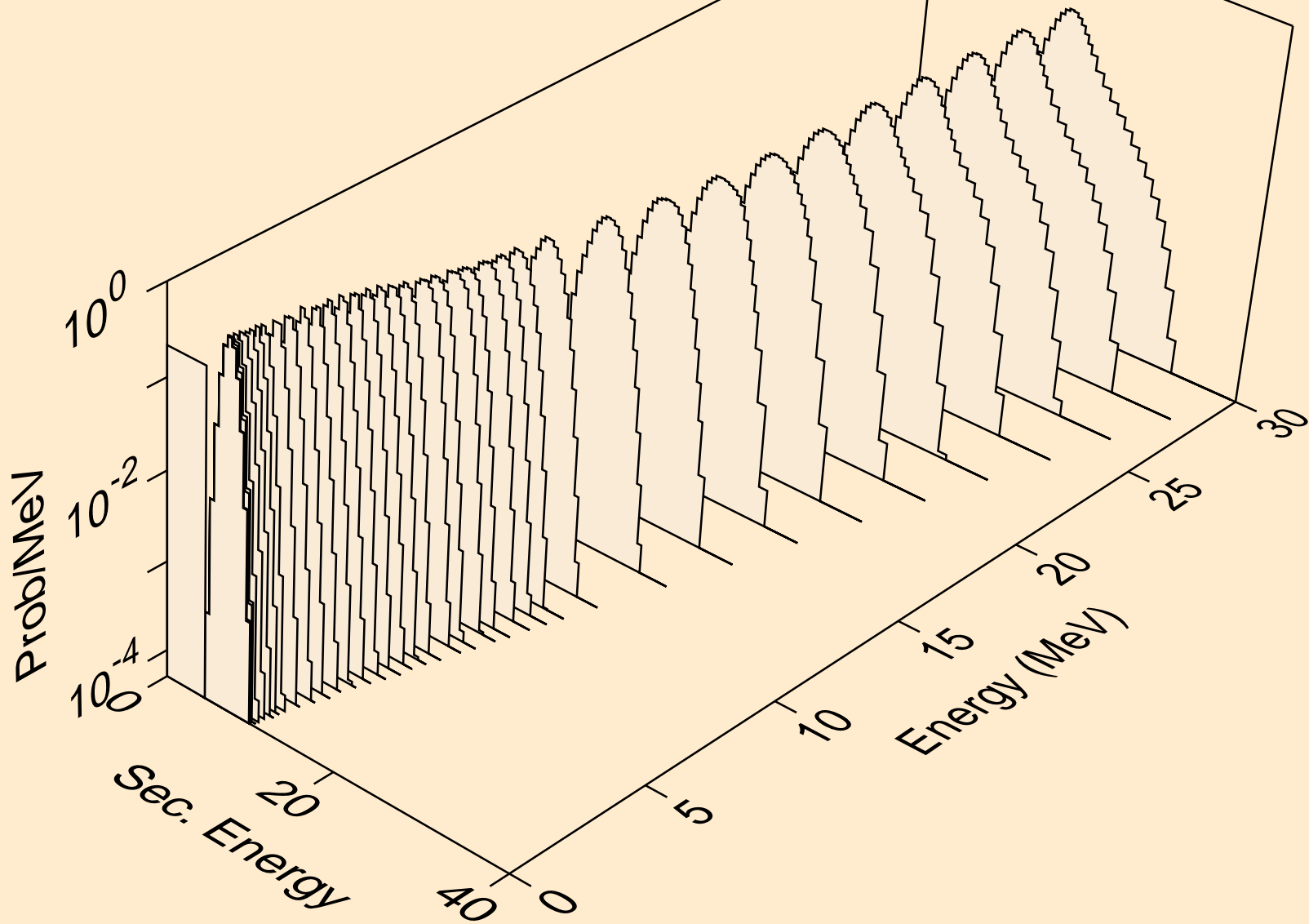

HO148 NEUTRON ACER TENDL-2024 LIBRARY; T=0.K
alphas from (n,3a)

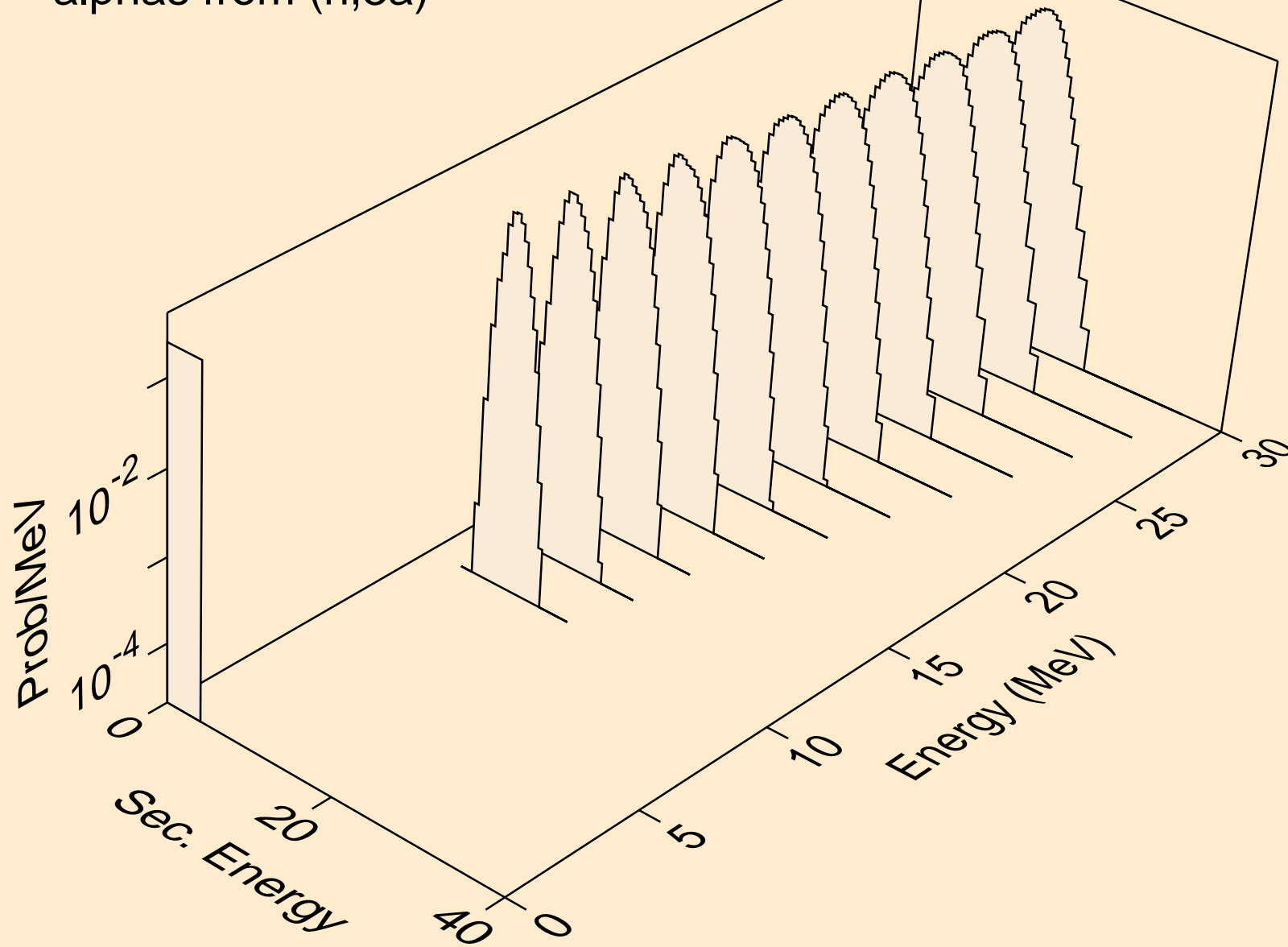

HO148 NEUTRON ACER TENDL-2024 LIBRARY; T=0.K
alphas from (n,pa)

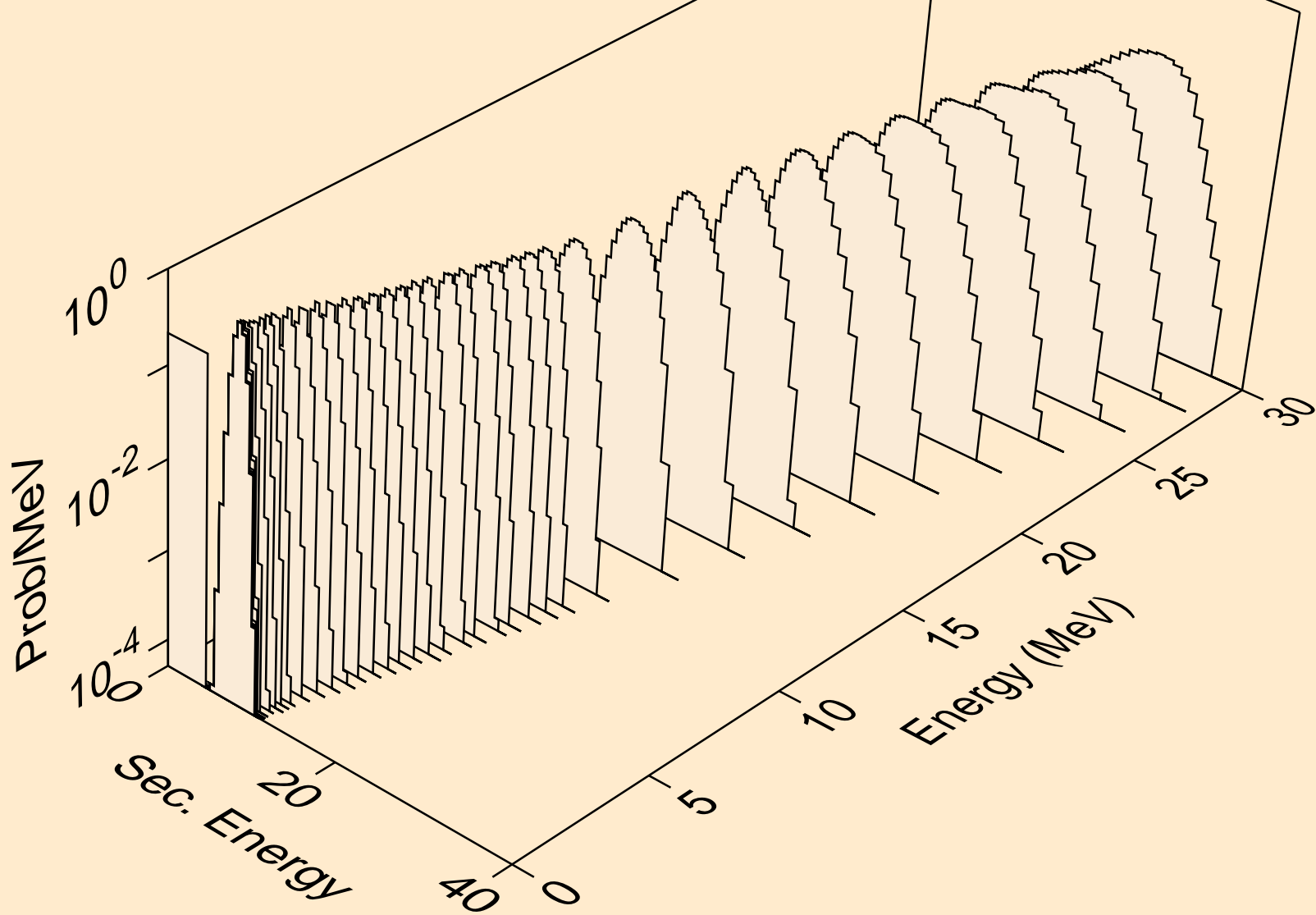

HO148 NEUTRON ACER TENDL-2024 LIBRARY; T=0.K
alphas from (n,da)

