

HS271 NEUTRON ACER TENDL-2024 LIBRARY; T=0.K

Principal cross sections

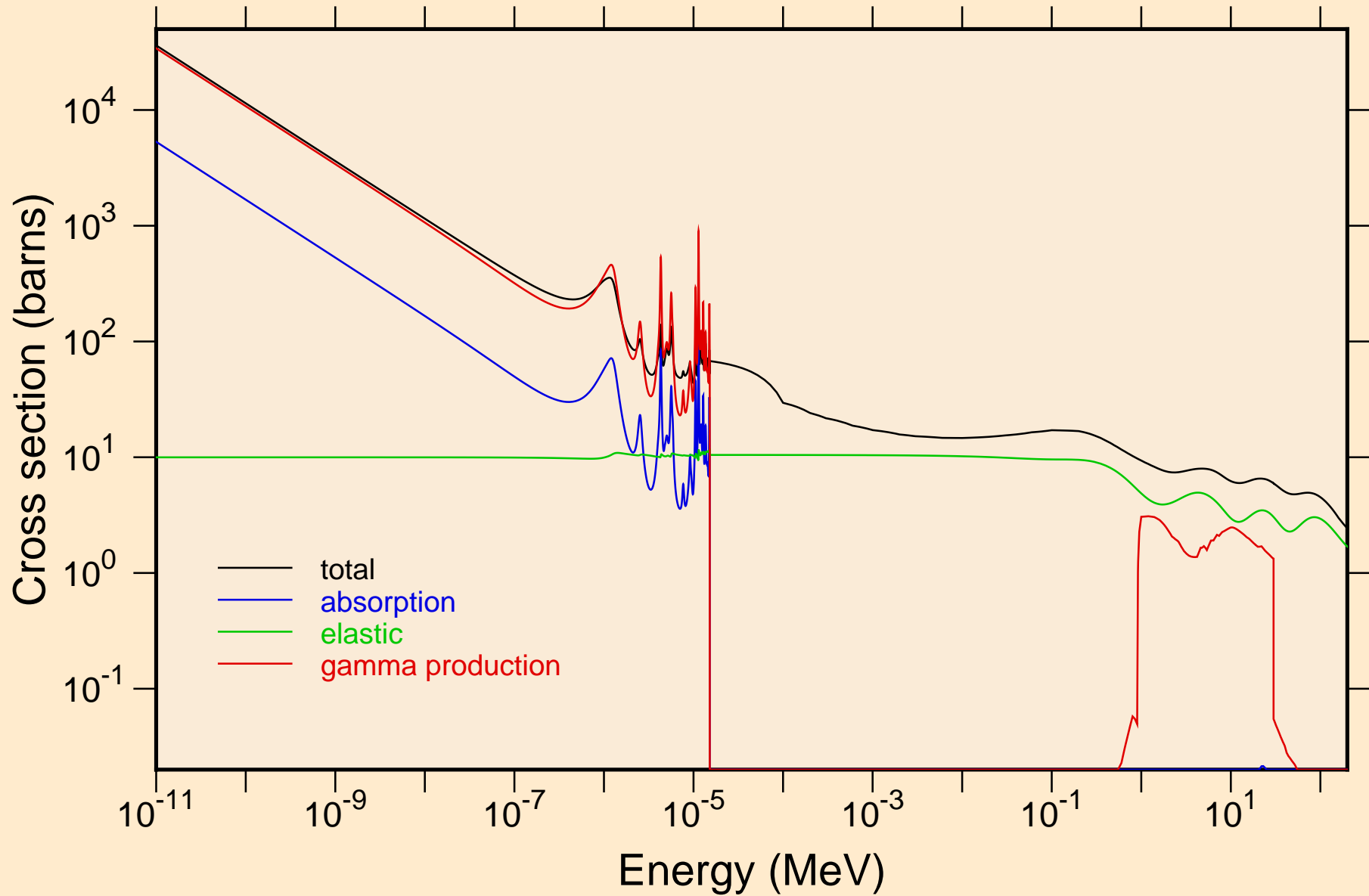

HS271 NEUTRON ACER TENDL-2024 LIBRARY; T=0.K
resonance total cross section

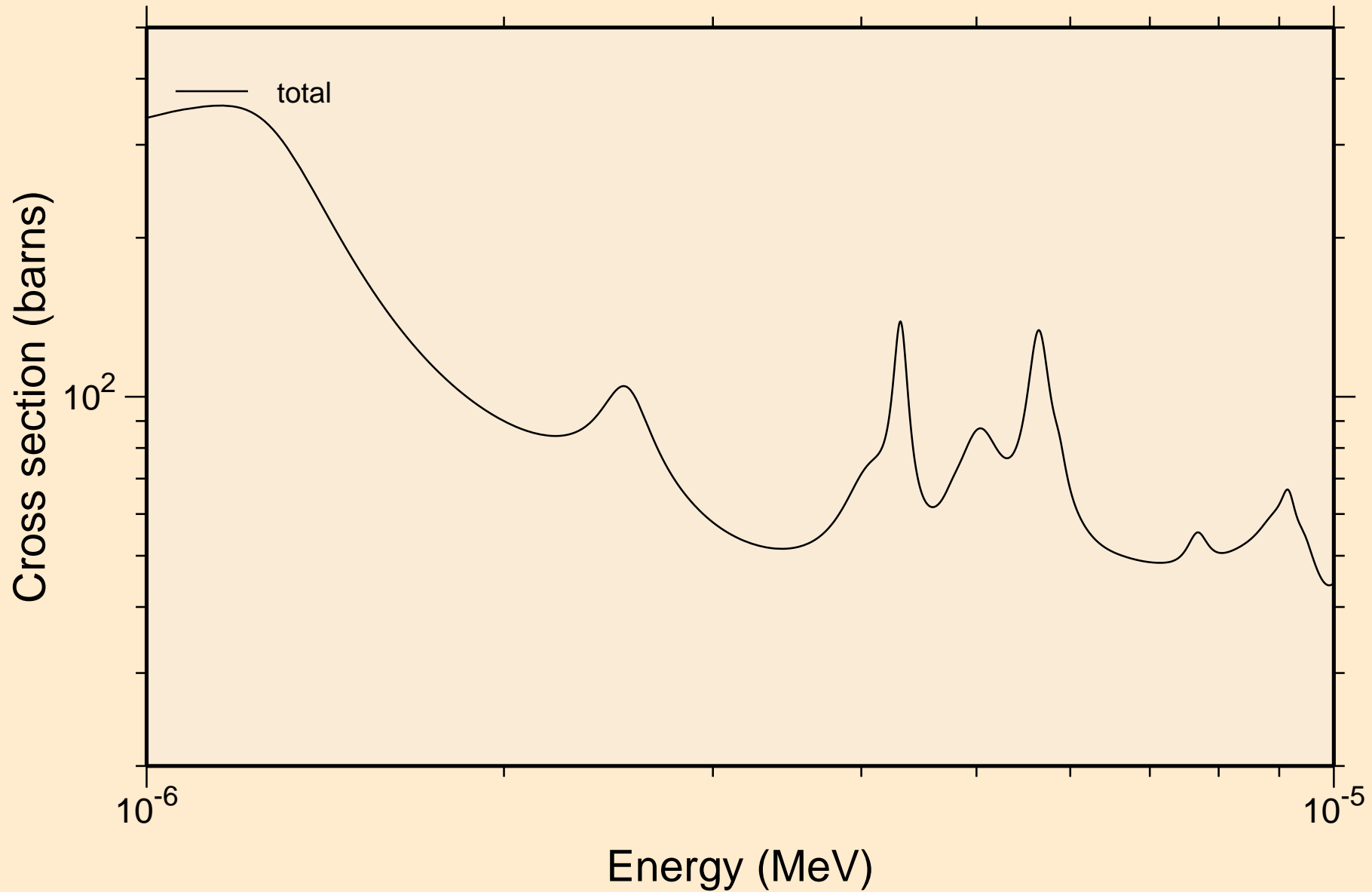

HS271 NEUTRON ACER TENDL-2024 LIBRARY; T=0.K
resonance total cross section

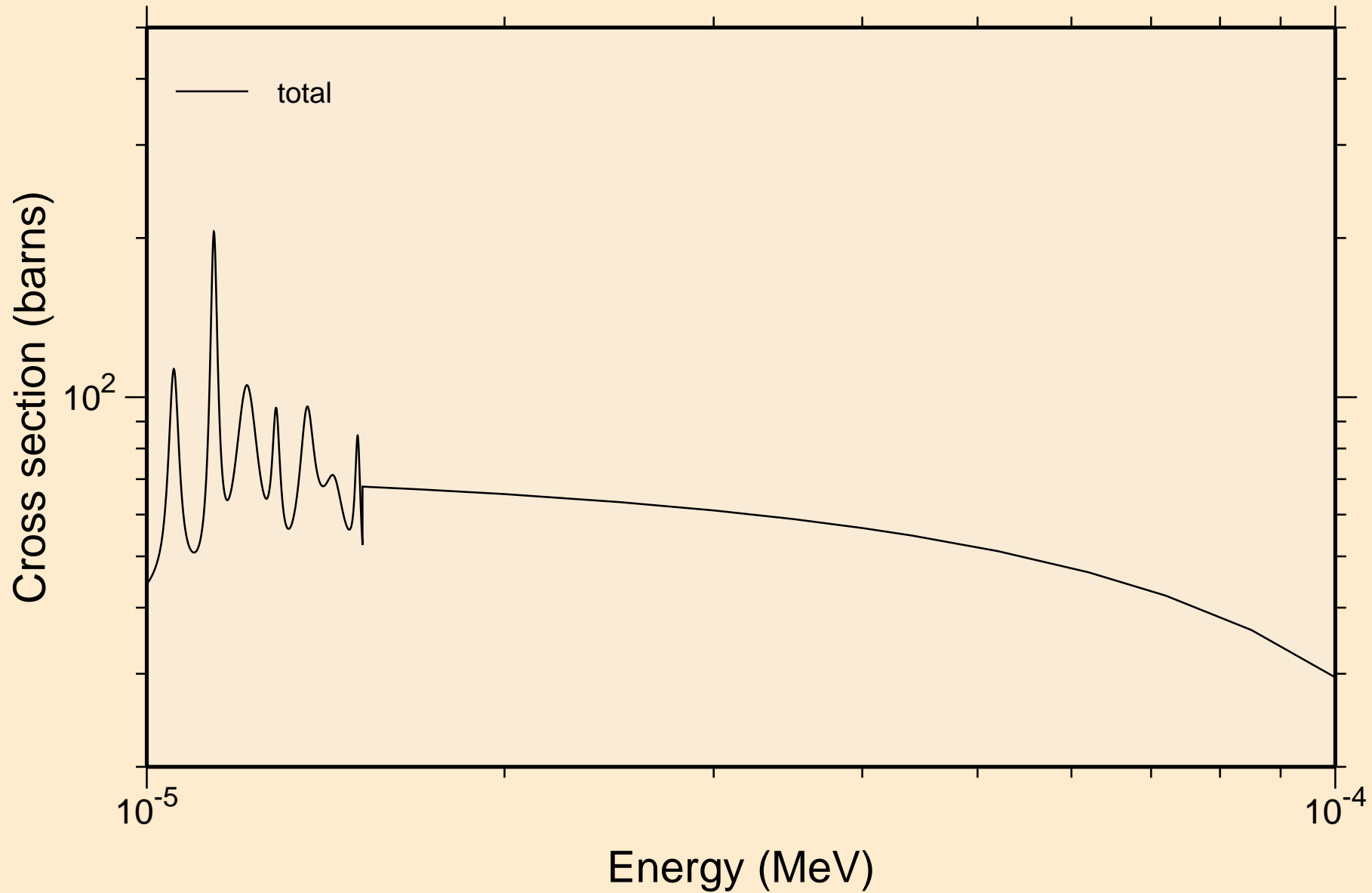

HS271 NEUTRON ACER TENDL-2024 LIBRARY; T=0.K
resonance total cross section

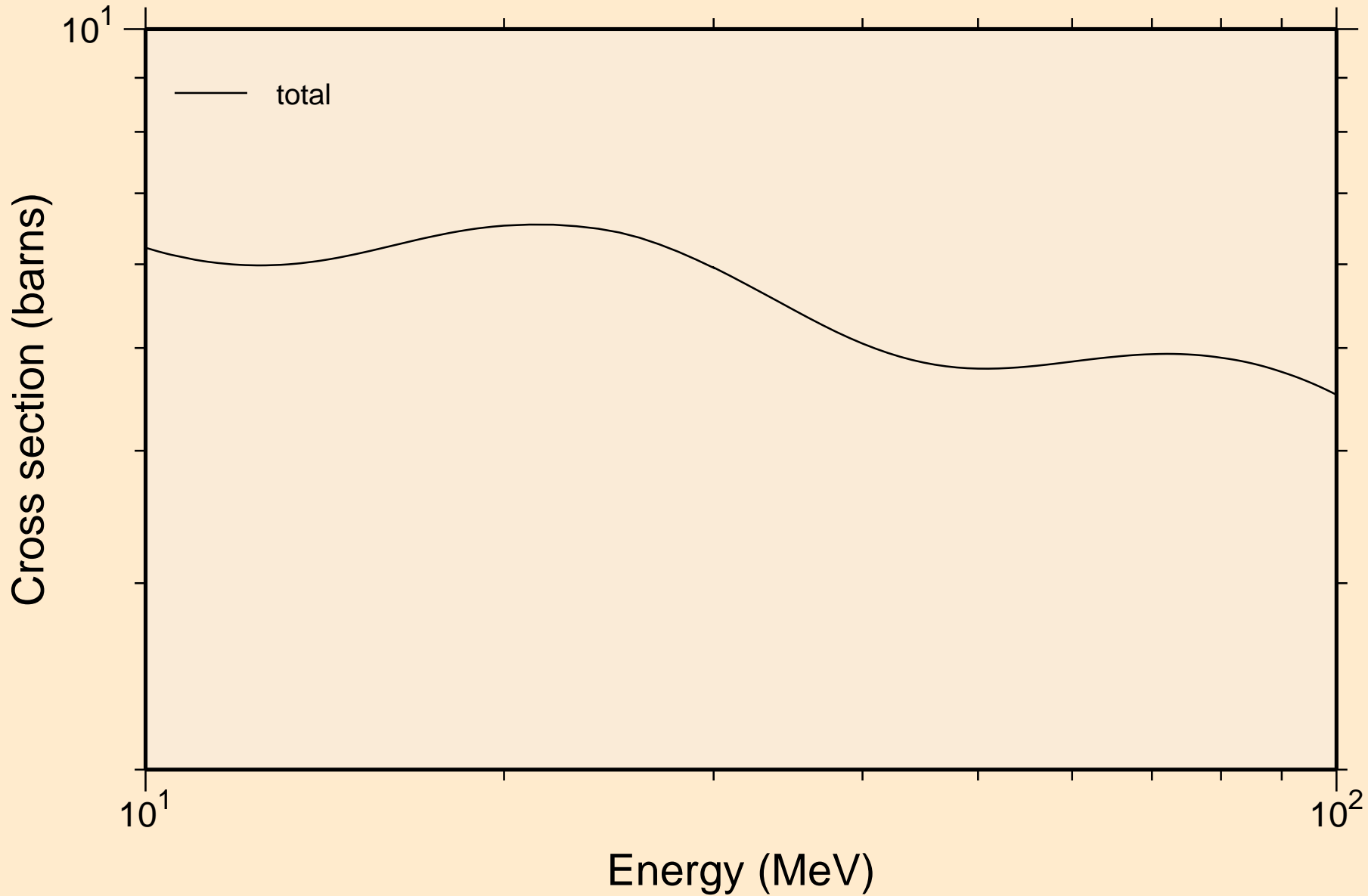

HS271 NEUTRON ACER TENDL-2024 LIBRARY; T=0.K
resonance absorption cross sections

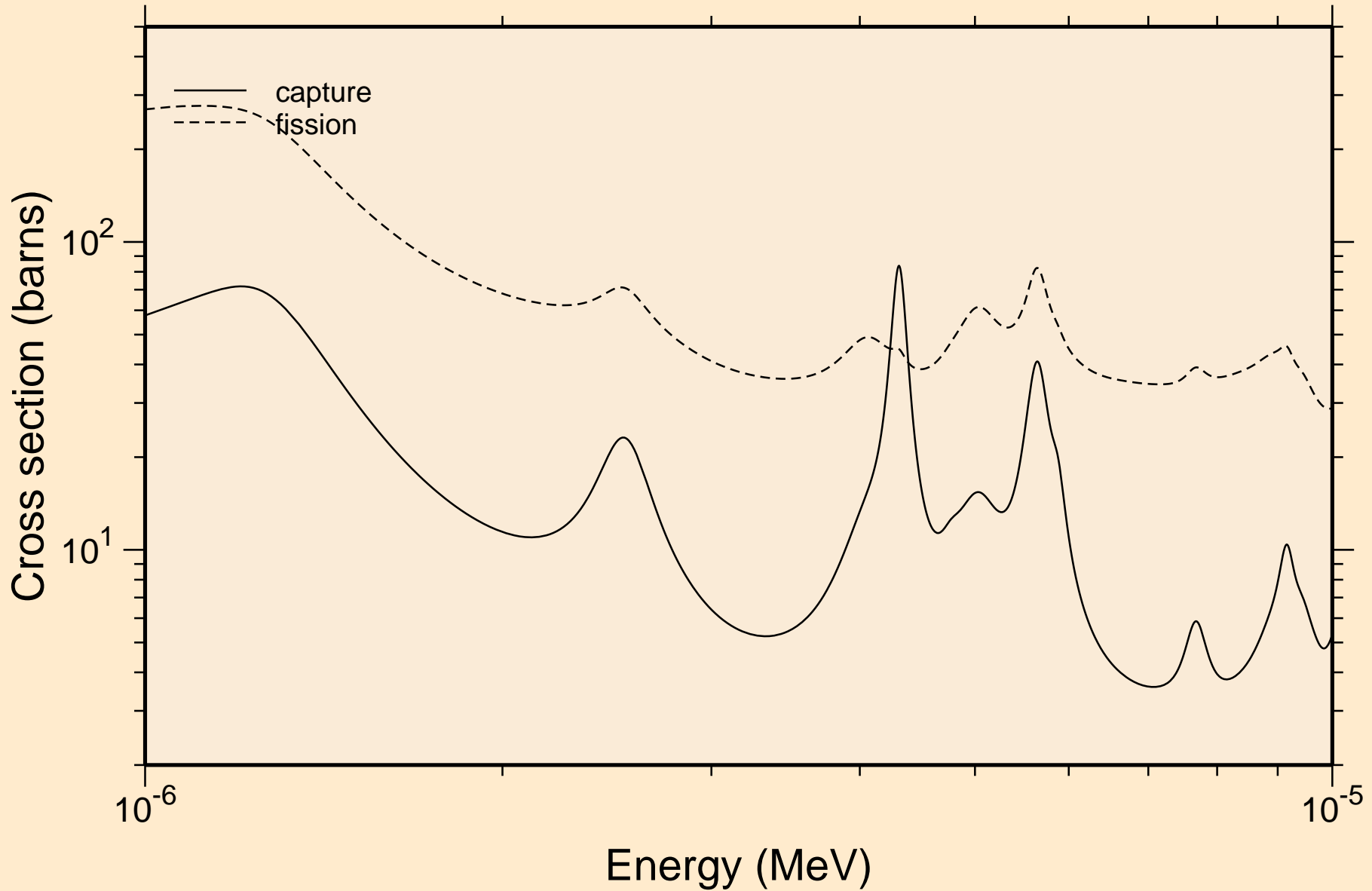

HS271 NEUTRON ACER TENDL-2024 LIBRARY; T=0.K
resonance absorption cross sections

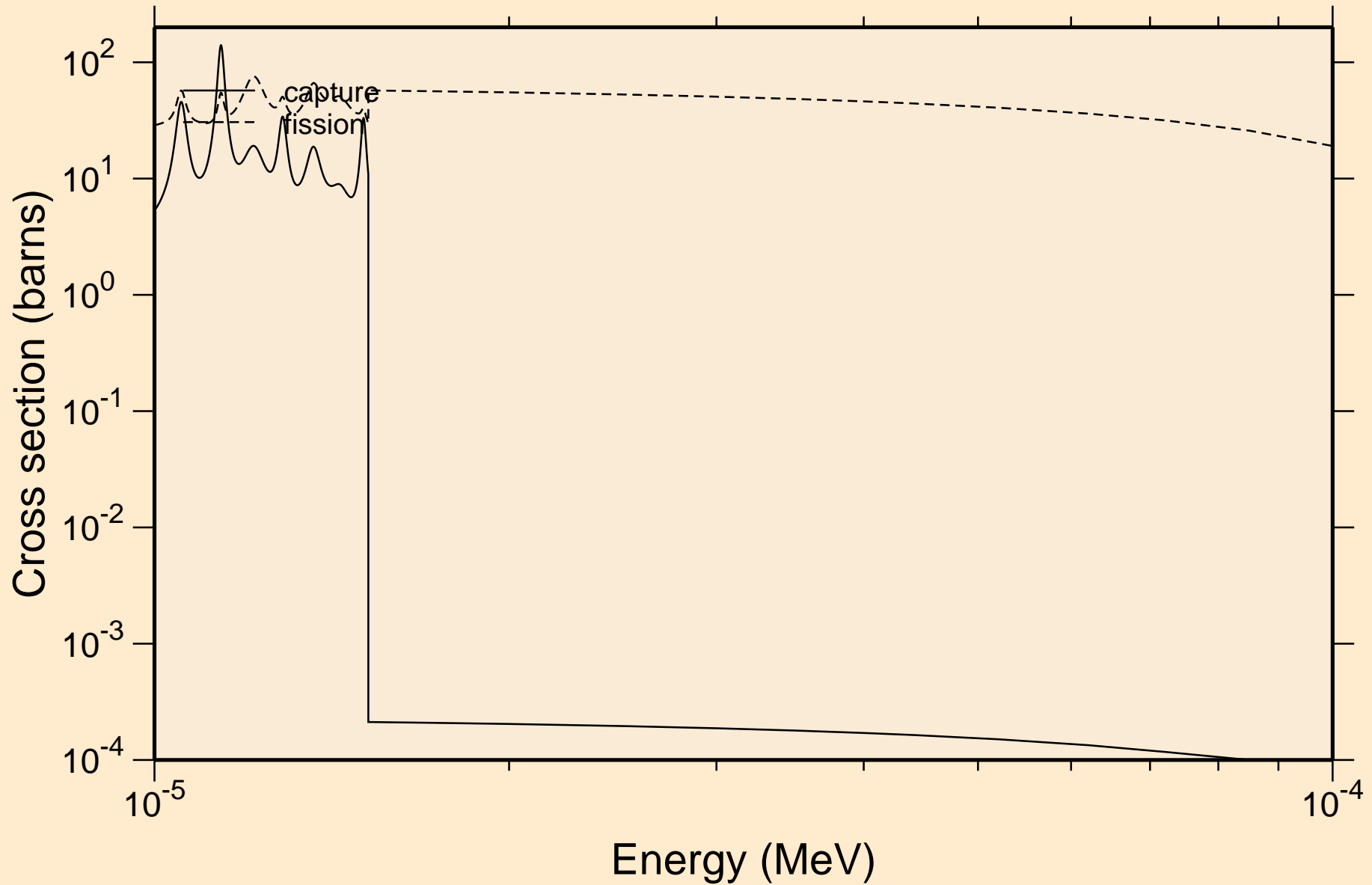

HS271 NEUTRON ACER TENDL-2024 LIBRARY; T=0.K

resonance absorption cross sections

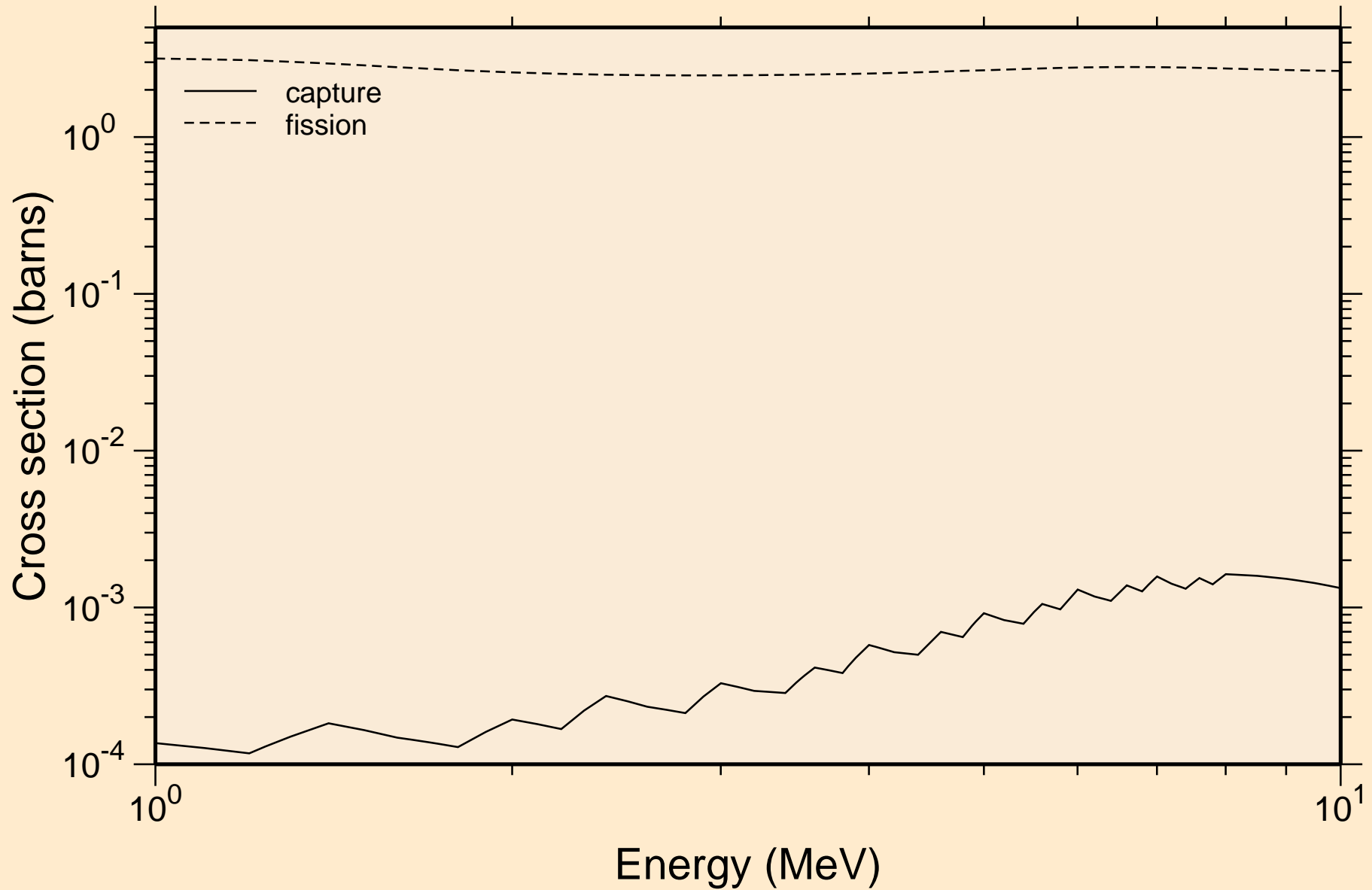

HS271 NEUTRON ACER TENDL-2024 LIBRARY; T=0.K

Heating

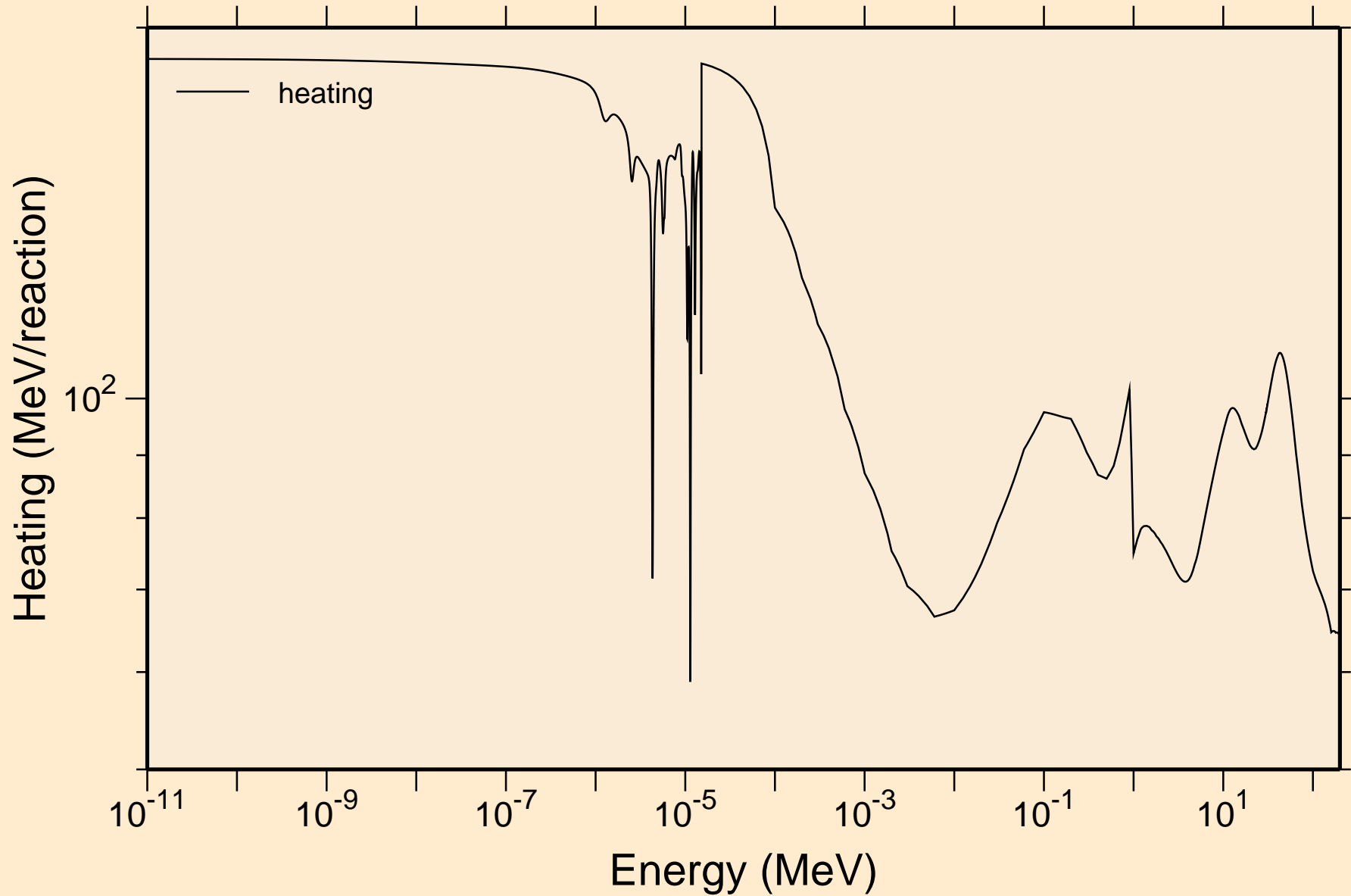

HS271 NEUTRON ACER TENDL-2024 LIBRARY; T=0.K
Damage

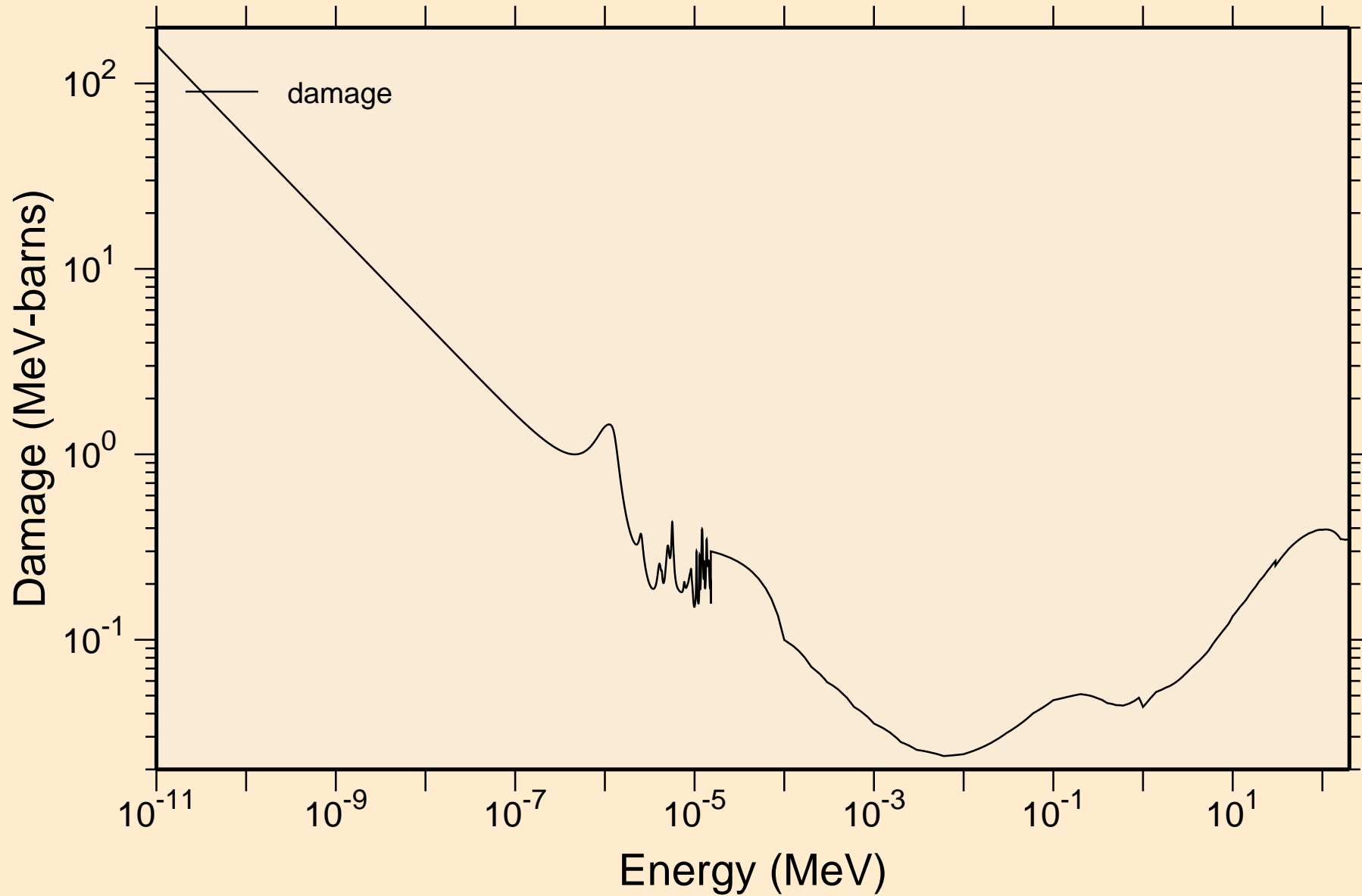

HS271 NEUTRON ACER TENDL-2024 LIBRARY; T=0.K

Non-threshold reactions

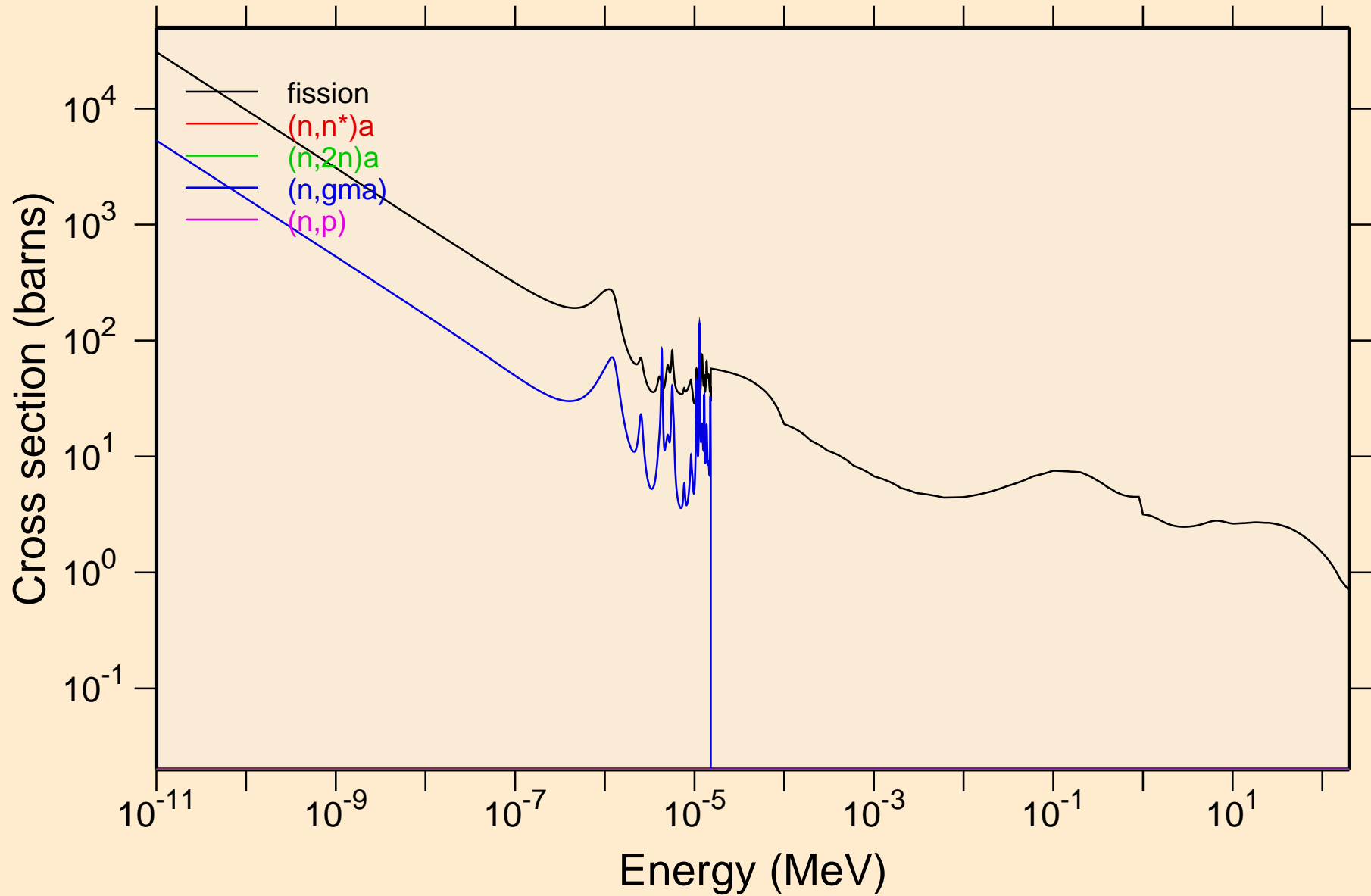

HS271 NEUTRON ACER TENDL-2024 LIBRARY; T=0.K

Non-threshold reactions

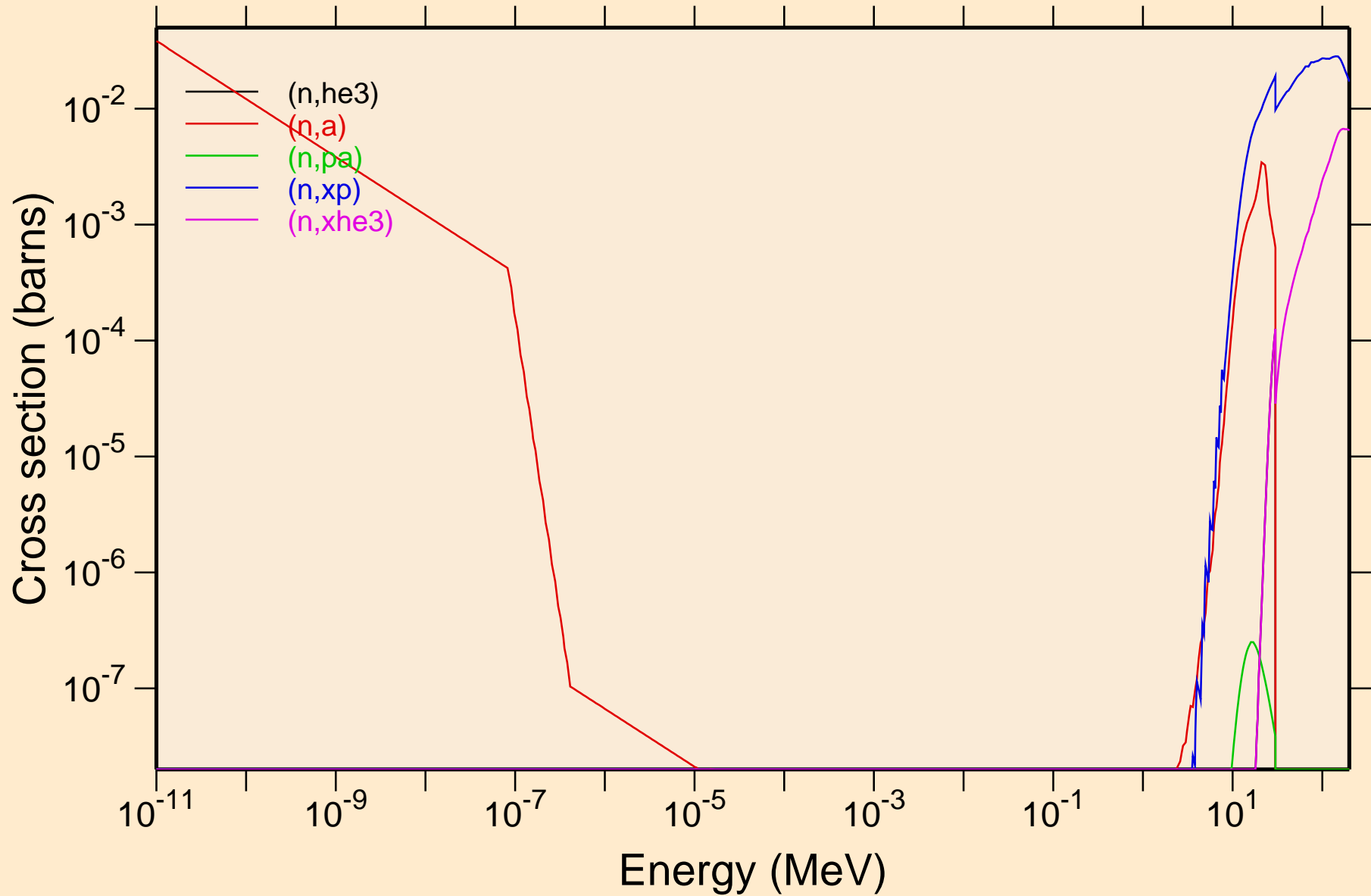

HS271 NEUTRON ACER TENDL-2024 LIBRARY; T=0.K
Non-threshold reactions

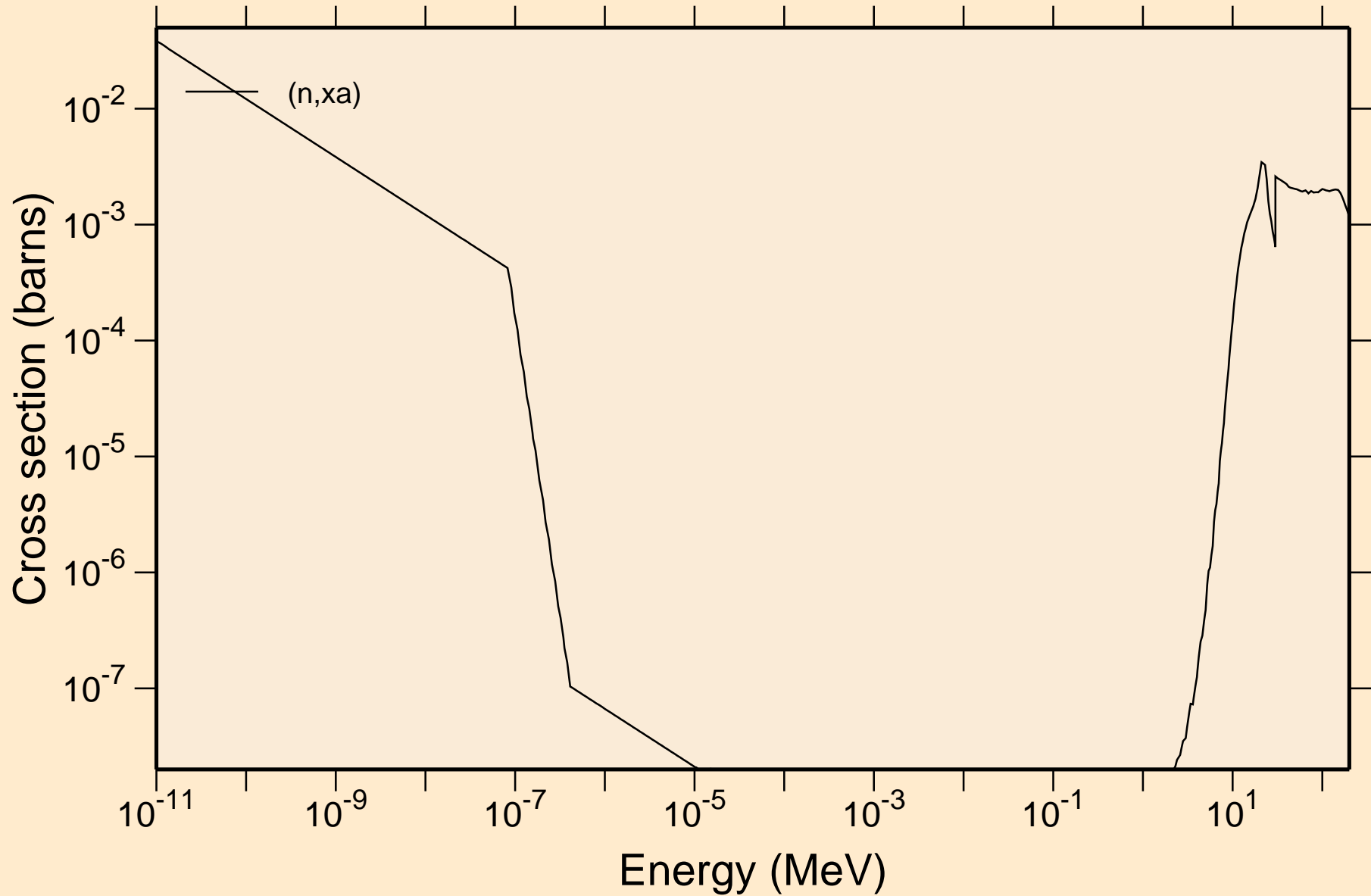

HS271 NEUTRON ACER TENDL-2024 LIBRARY; T=0.K

Principal cross sections

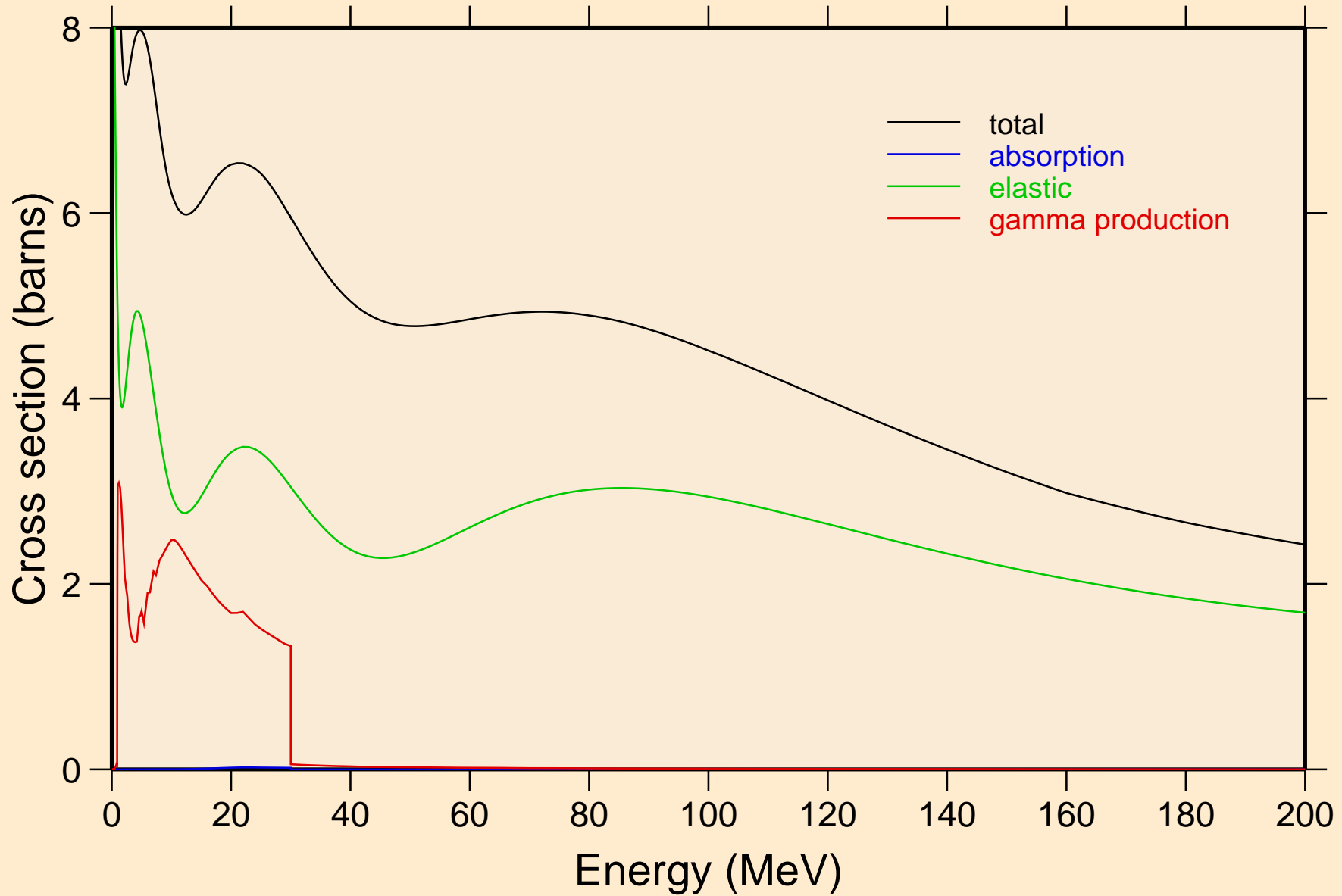

HS271 NEUTRON ACER TENDL-2024 LIBRARY; T=0.K

Heating

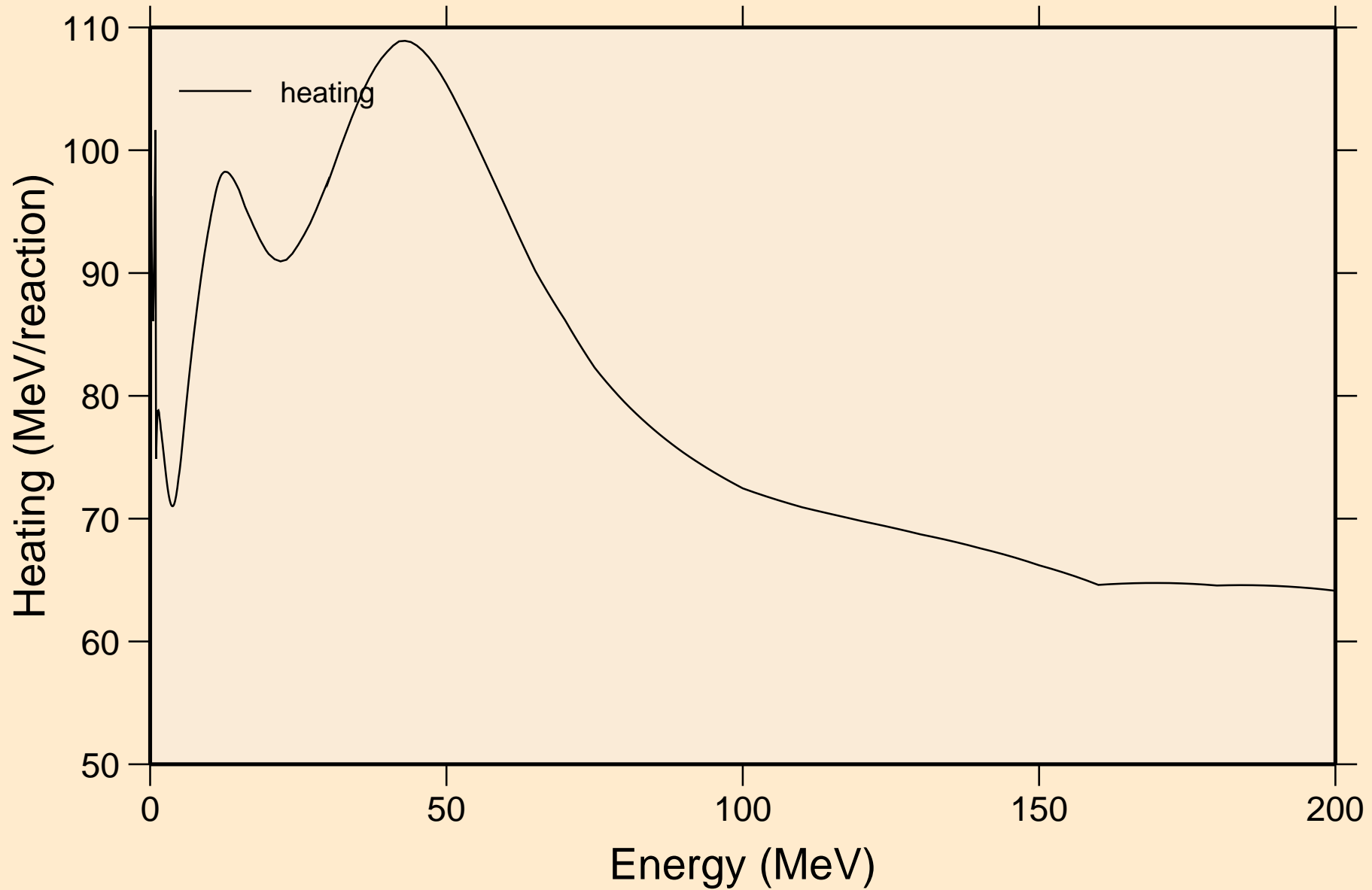

HS271 NEUTRON ACER TENDL-2024 LIBRARY; T=0.K

Damage

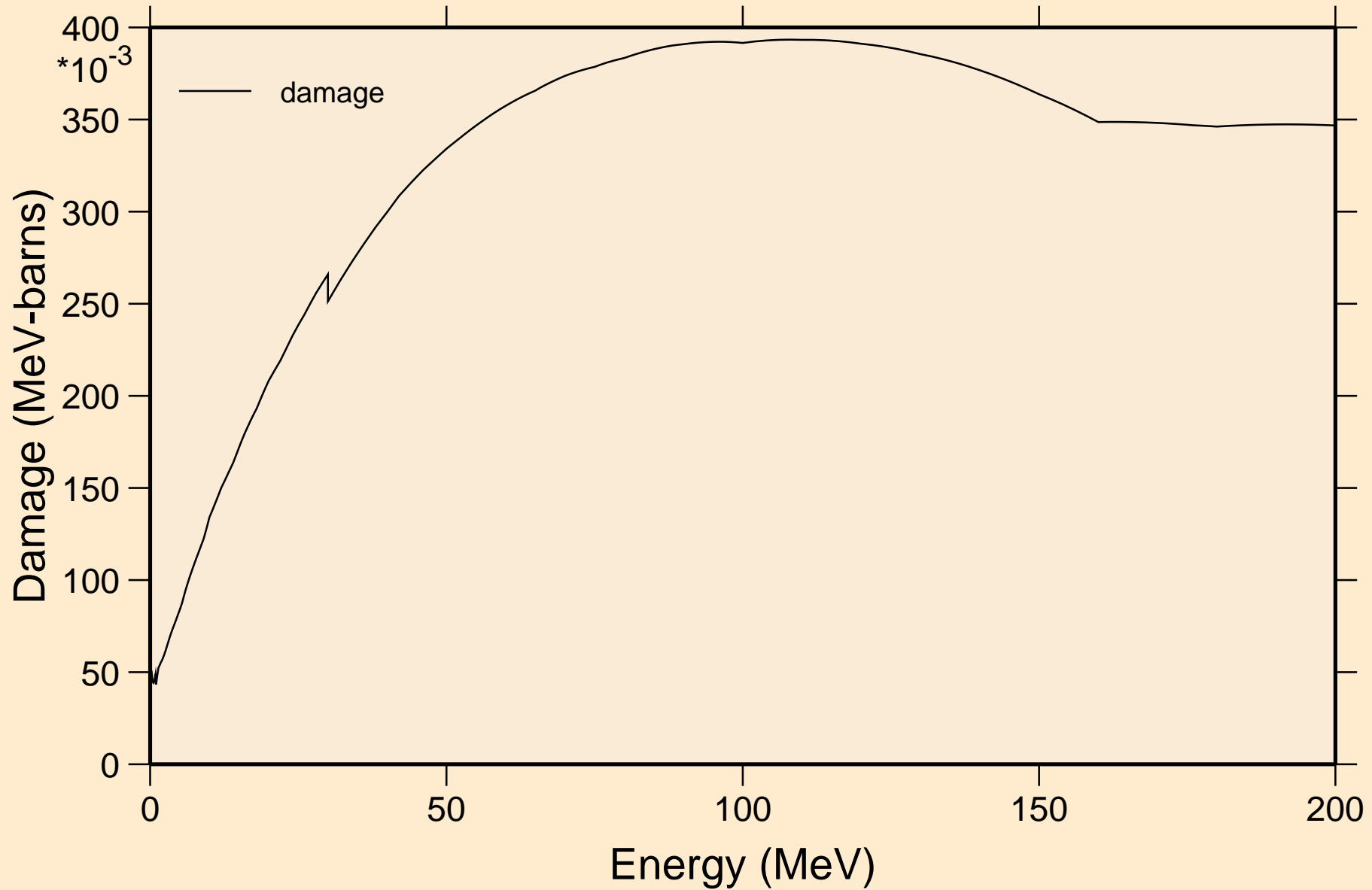

HS271 NEUTRON ACER TENDL-2024 LIBRARY; T=0.K

Non-threshold reactions

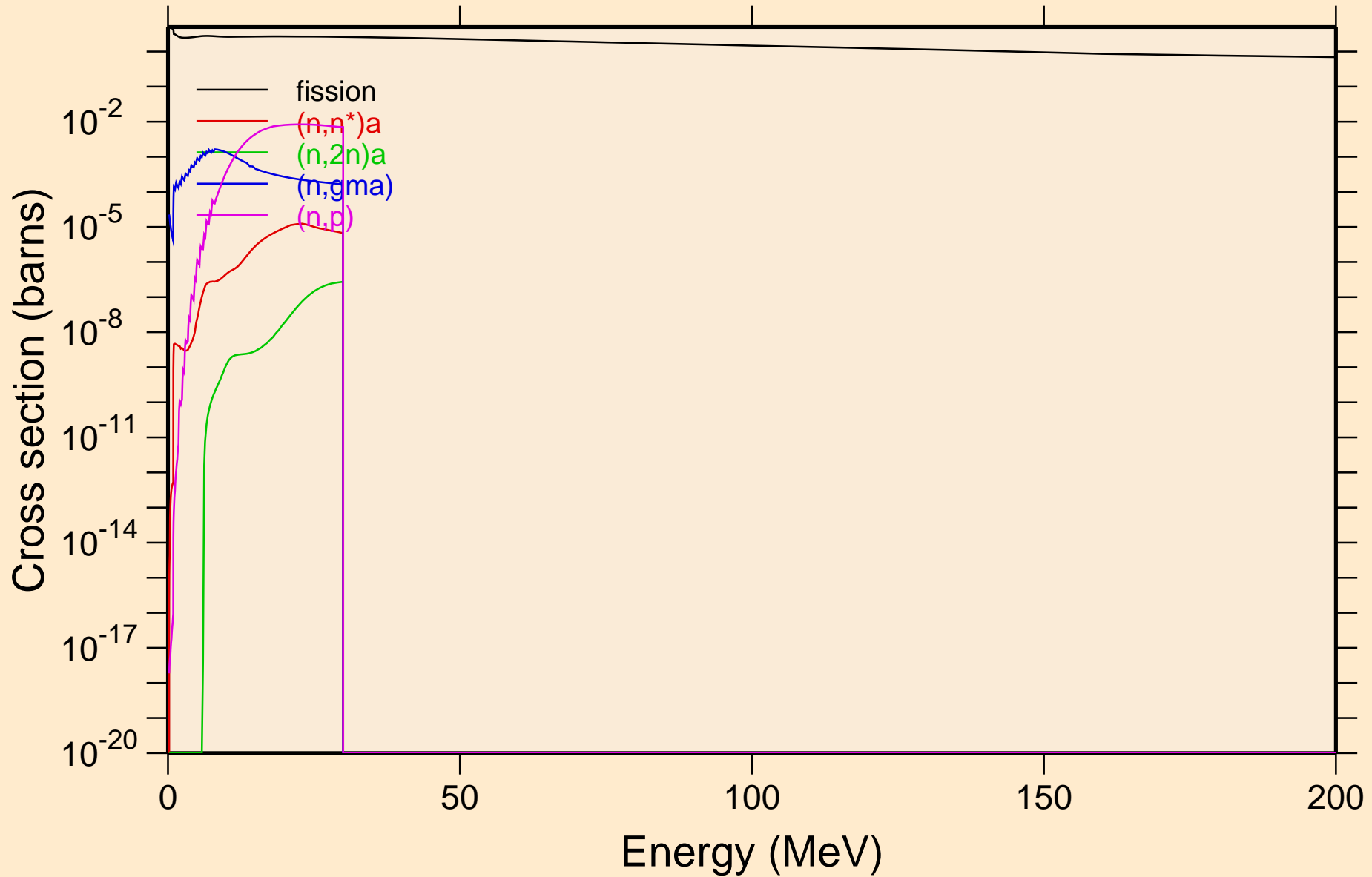

HS271 NEUTRON ACER TENDL-2024 LIBRARY; T=0.K

Non-threshold reactions

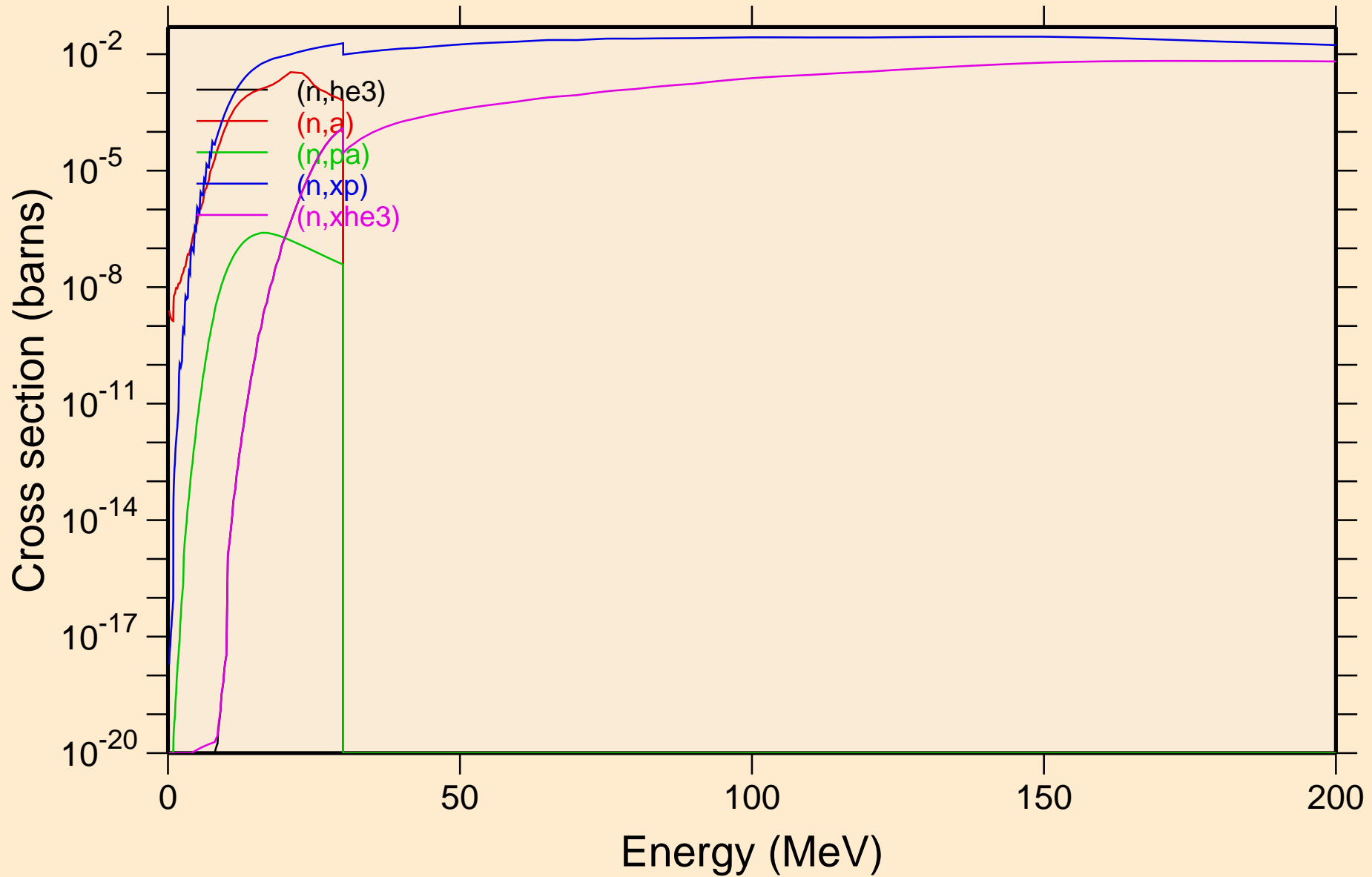

HS271 NEUTRON ACER TENDL-2024 LIBRARY; T=0.K
Non-threshold reactions

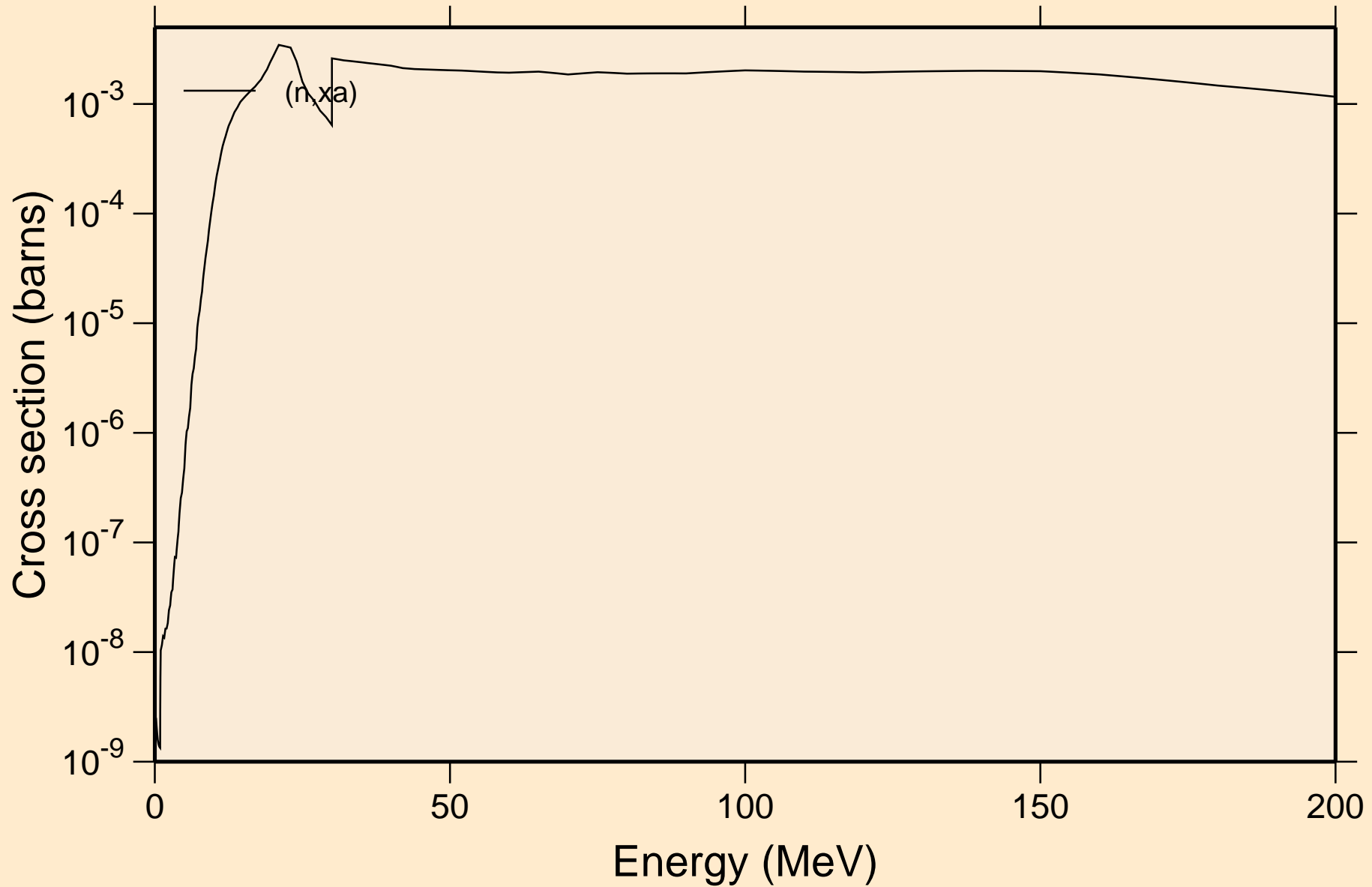

HS271 NEUTRON ACER TENDL-2024 LIBRARY; T=0.K
Inelastic levels

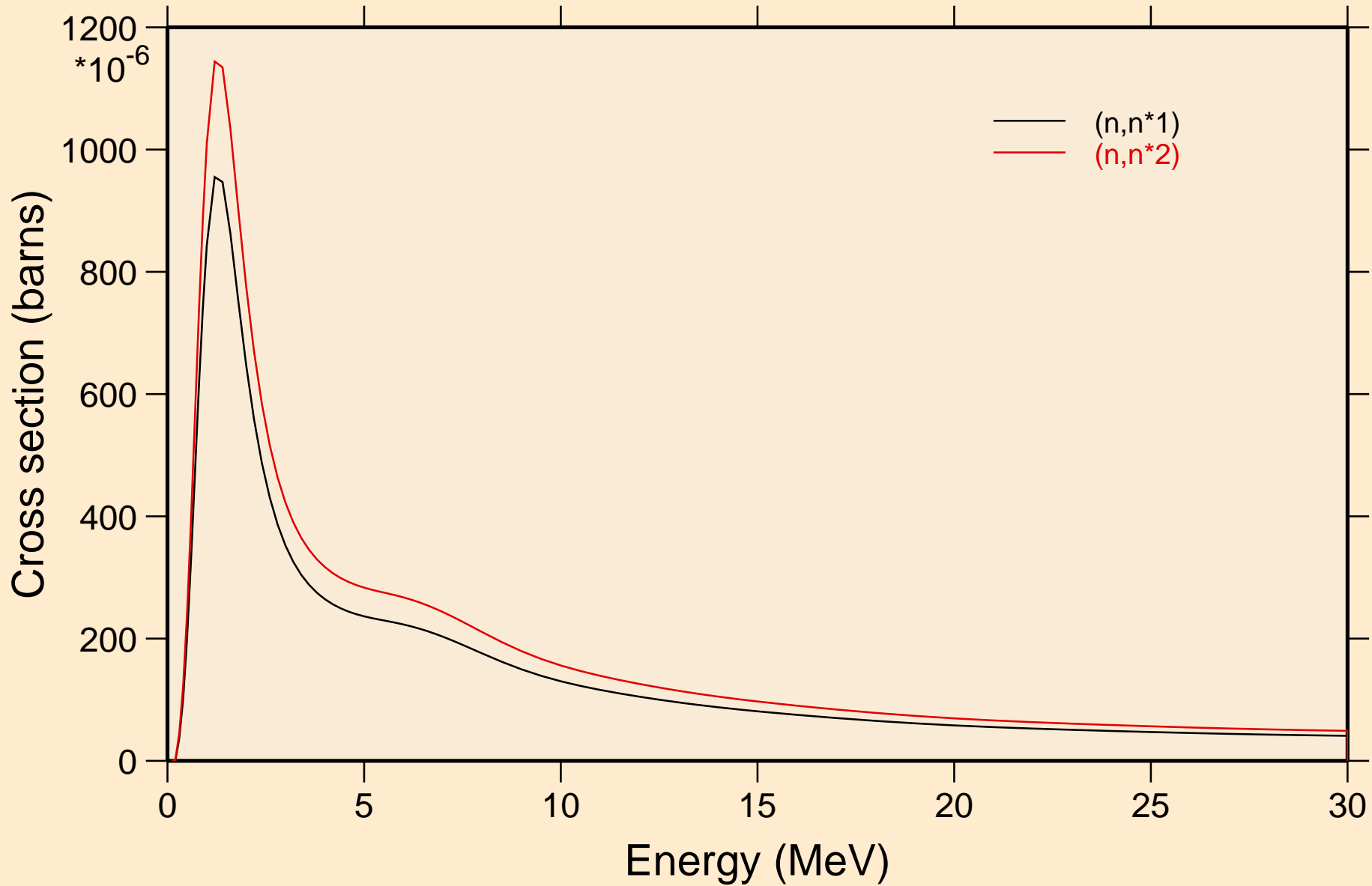

HS271 NEUTRON ACER TENDL-2024 LIBRARY; T=0.K

Threshold reactions

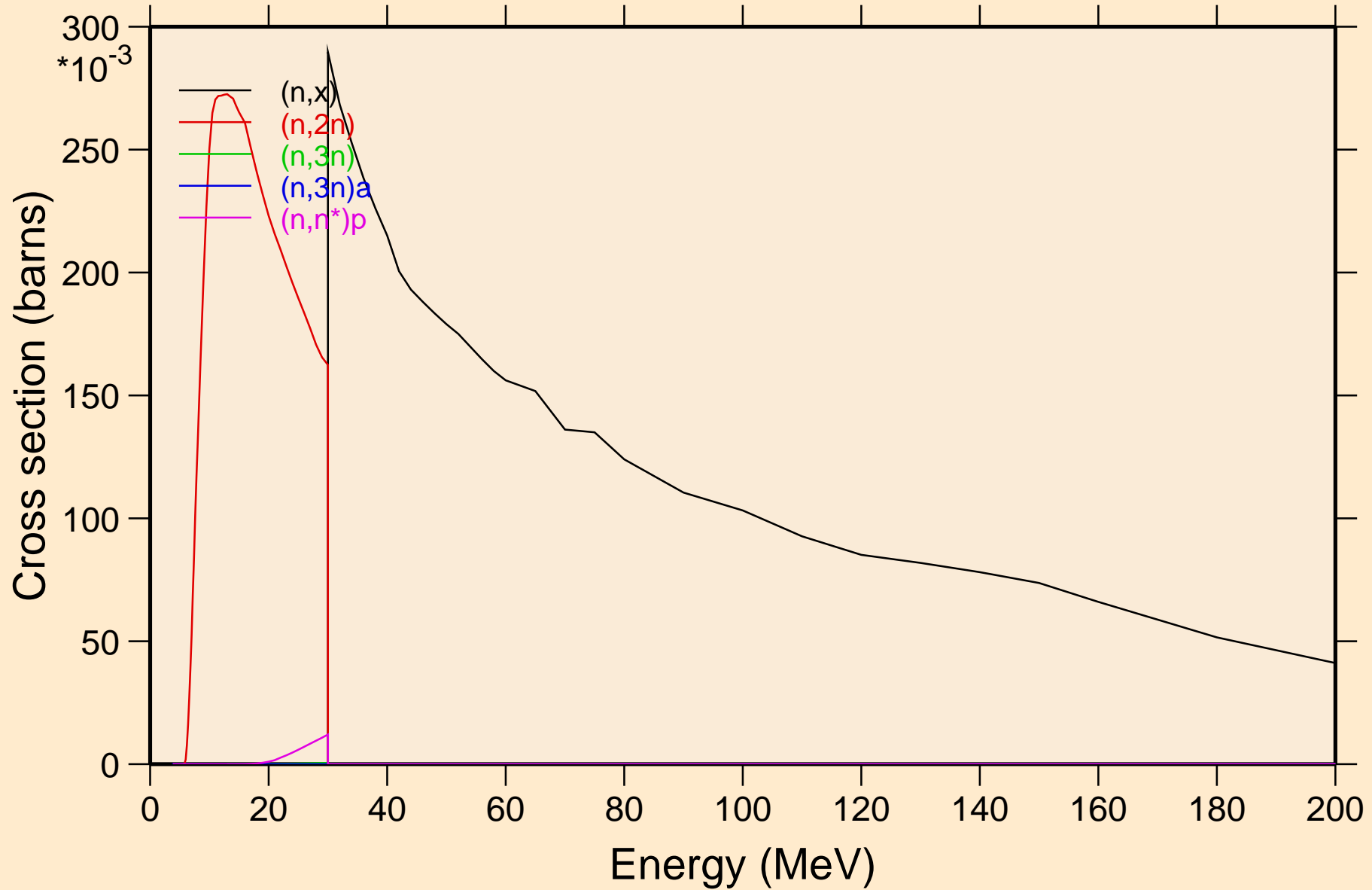

HS271 NEUTRON ACER TENDL-2024 LIBRARY; T=0.K

Threshold reactions

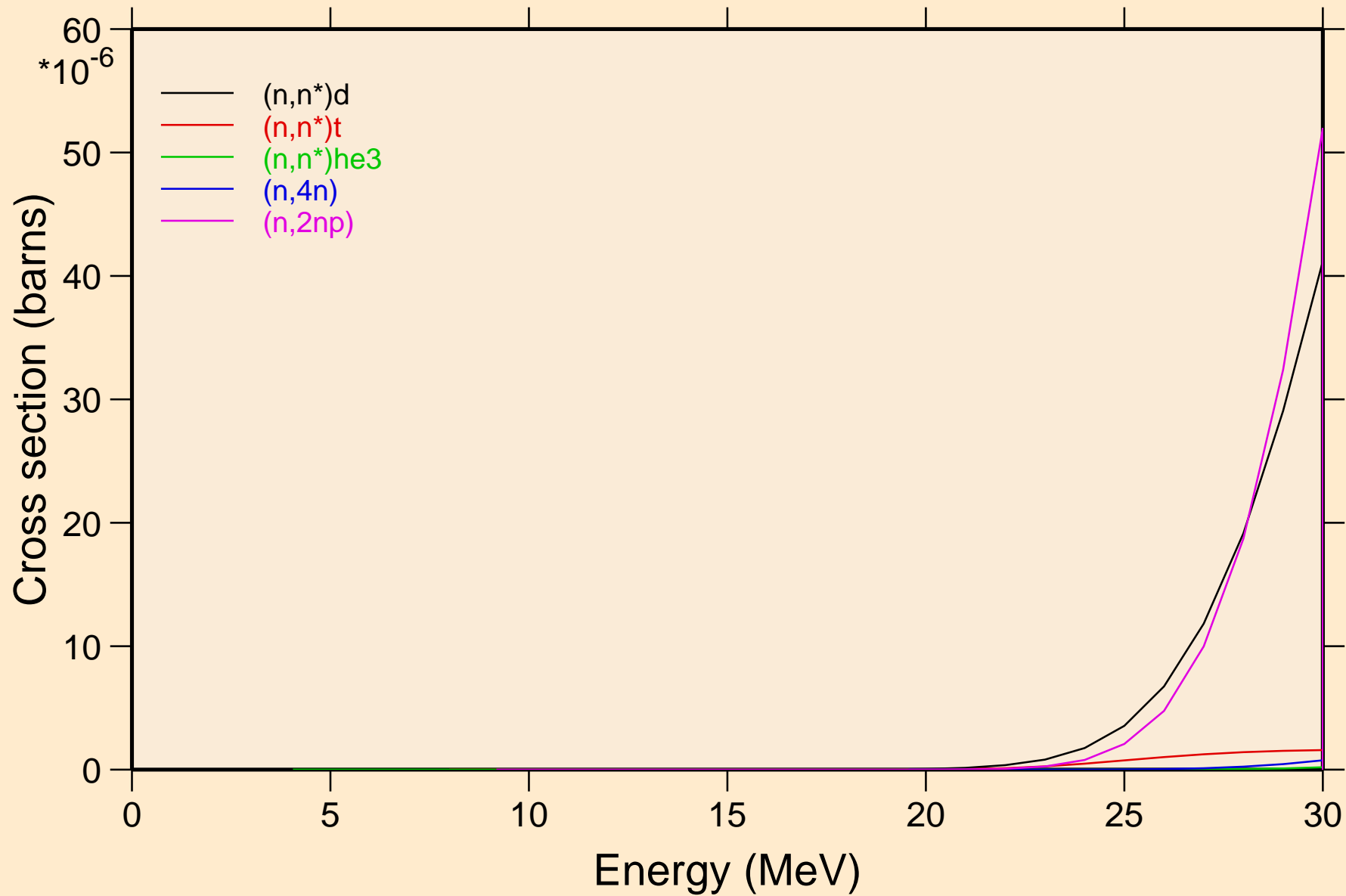

HS271 NEUTRON ACER TENDL-2024 LIBRARY; T=0.K

Threshold reactions

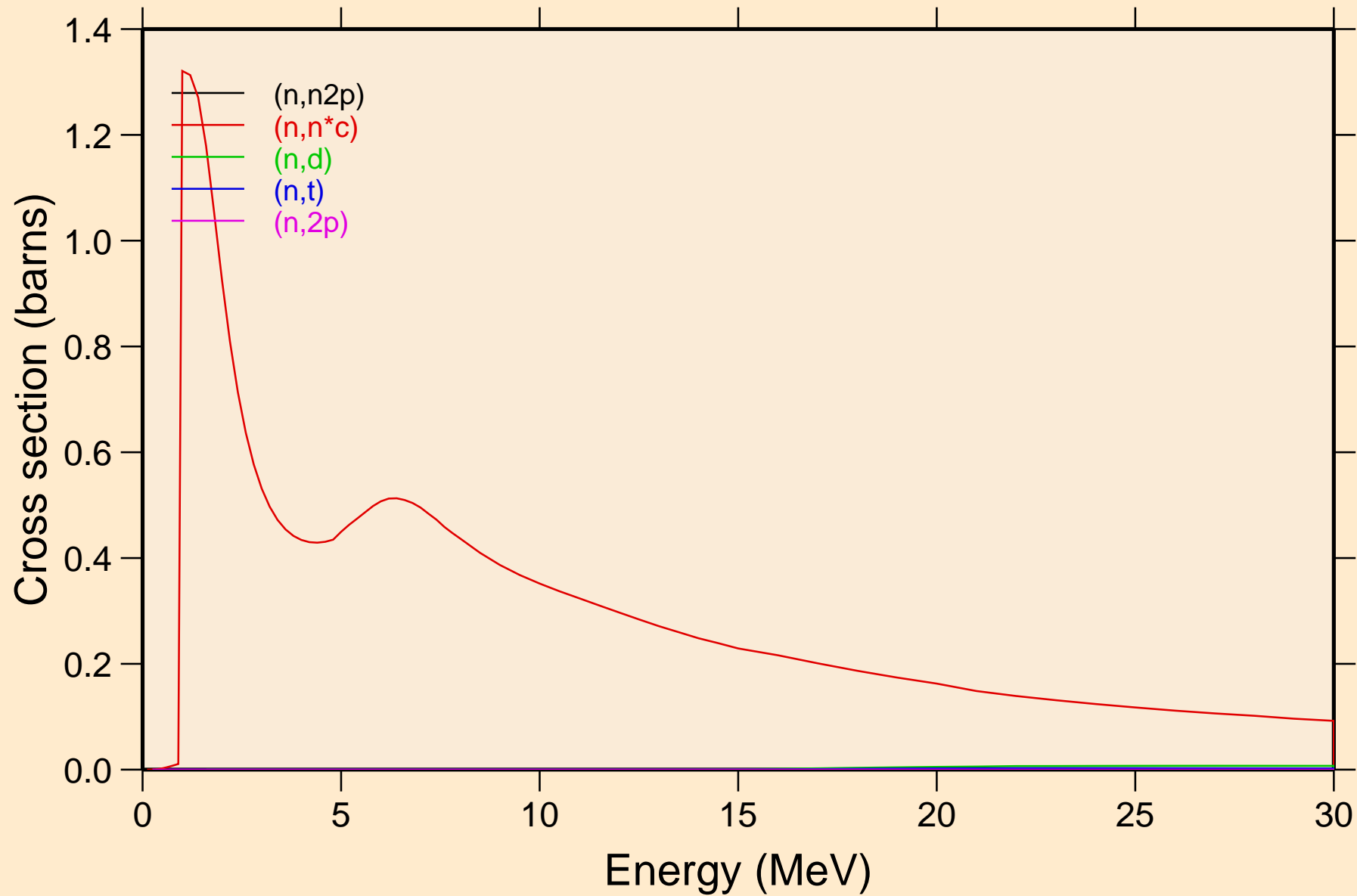

HS271 NEUTRON ACER TENDL-2024 LIBRARY; T=0.K
Threshold reactions

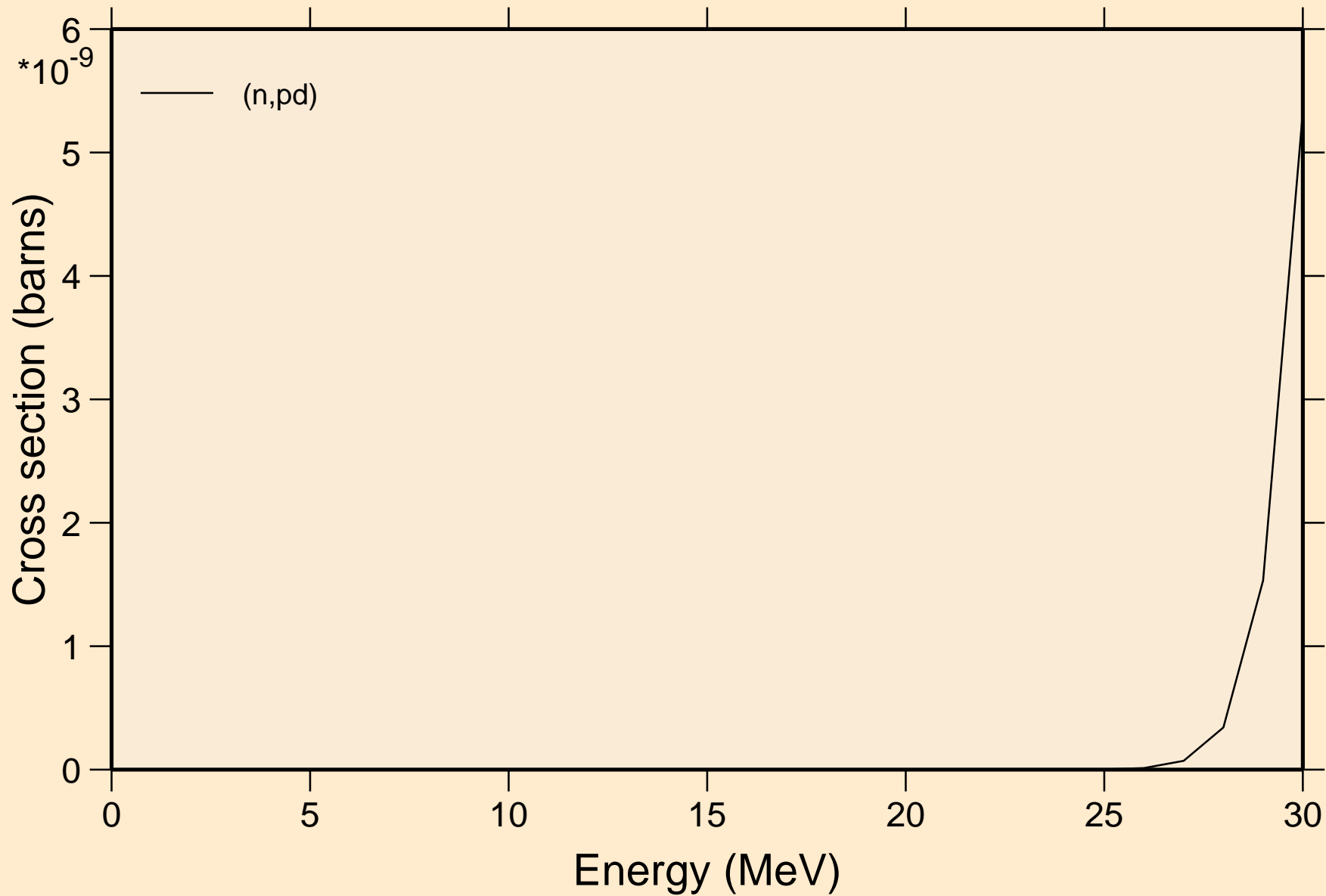

HS271 NEUTRON ACER TENDL-2024 LIBRARY; T=0.K

Threshold reactions

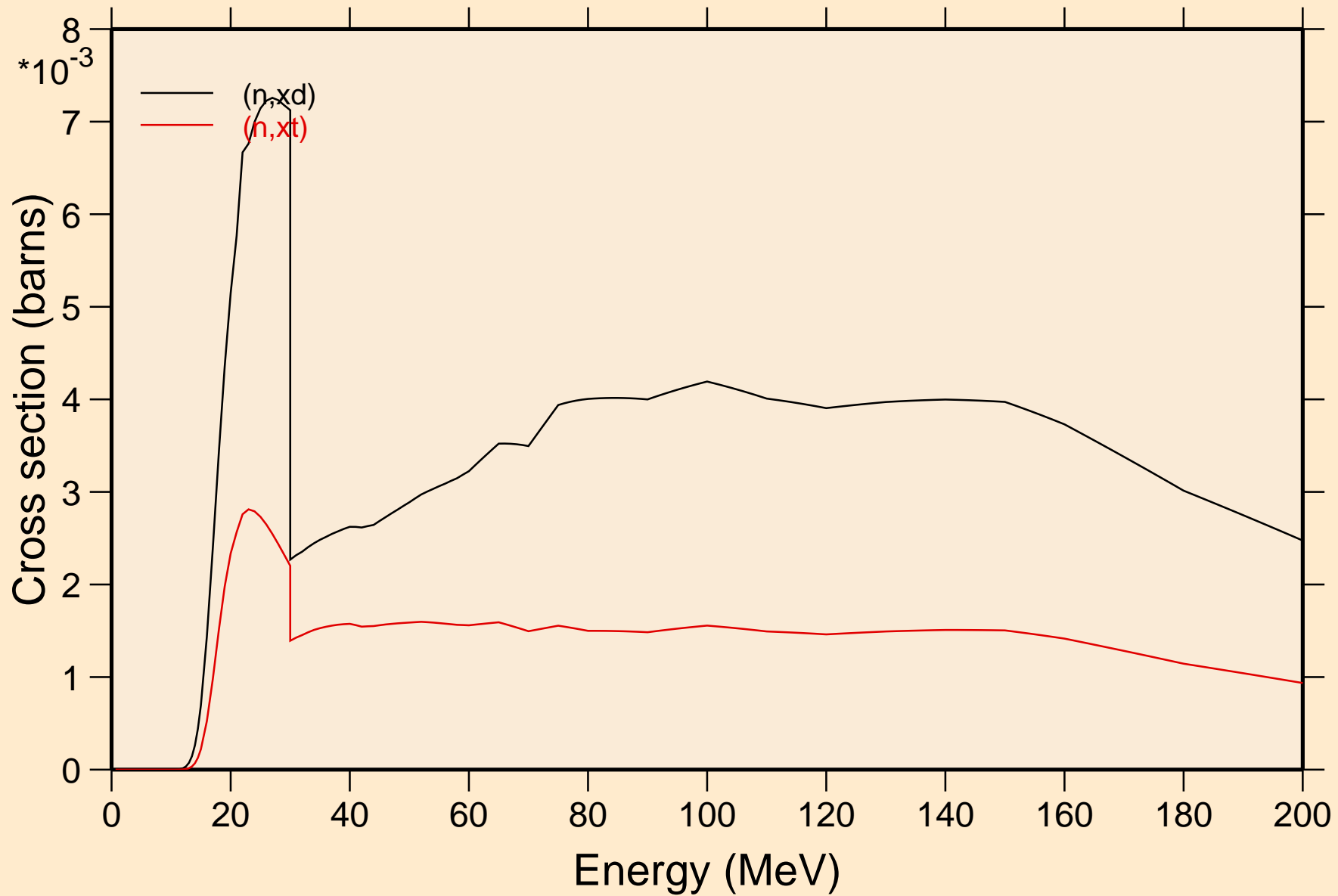

HS271 NEUTRON ACER TENDL-2024 LIBRARY; T=0.K
angular distribution for elastic

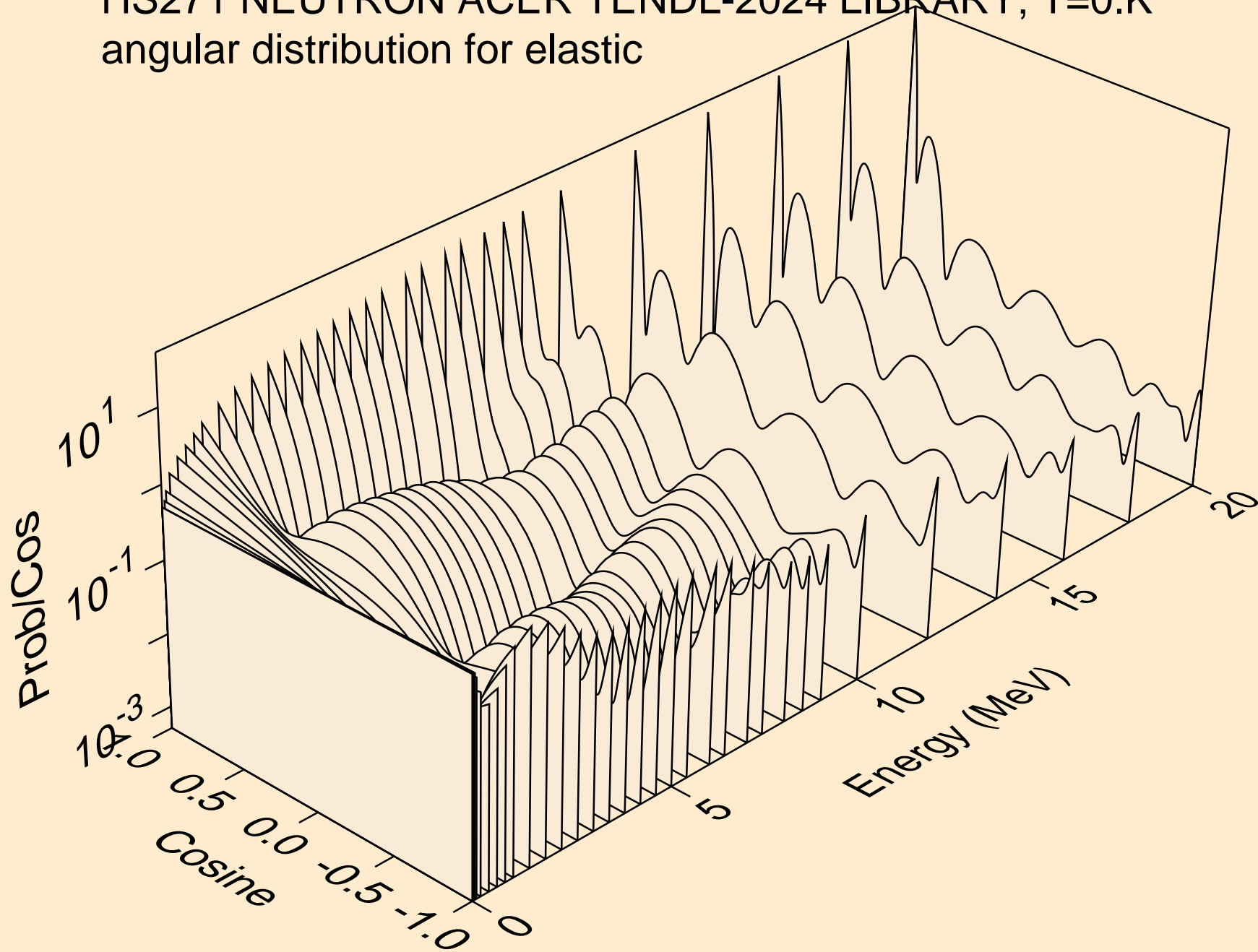

HS271 NEUTRON ACER TENDL-2024 LIBRARY; T=0.K
angular distribution for elastic

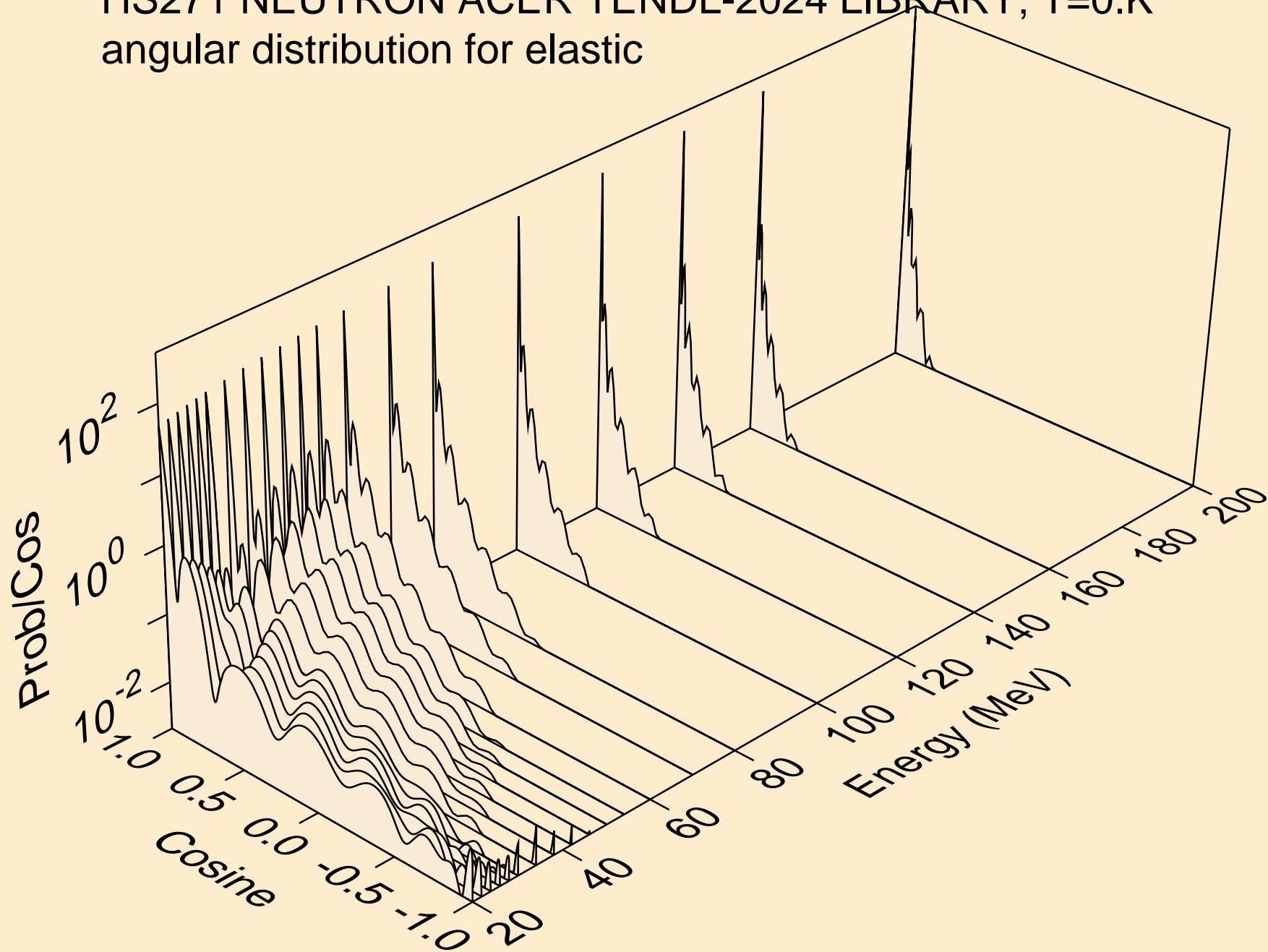

HS271 NEUTRON ACER TENDL-2024 LIBRARY; T=0.K
angular distribution for (n,n*1)

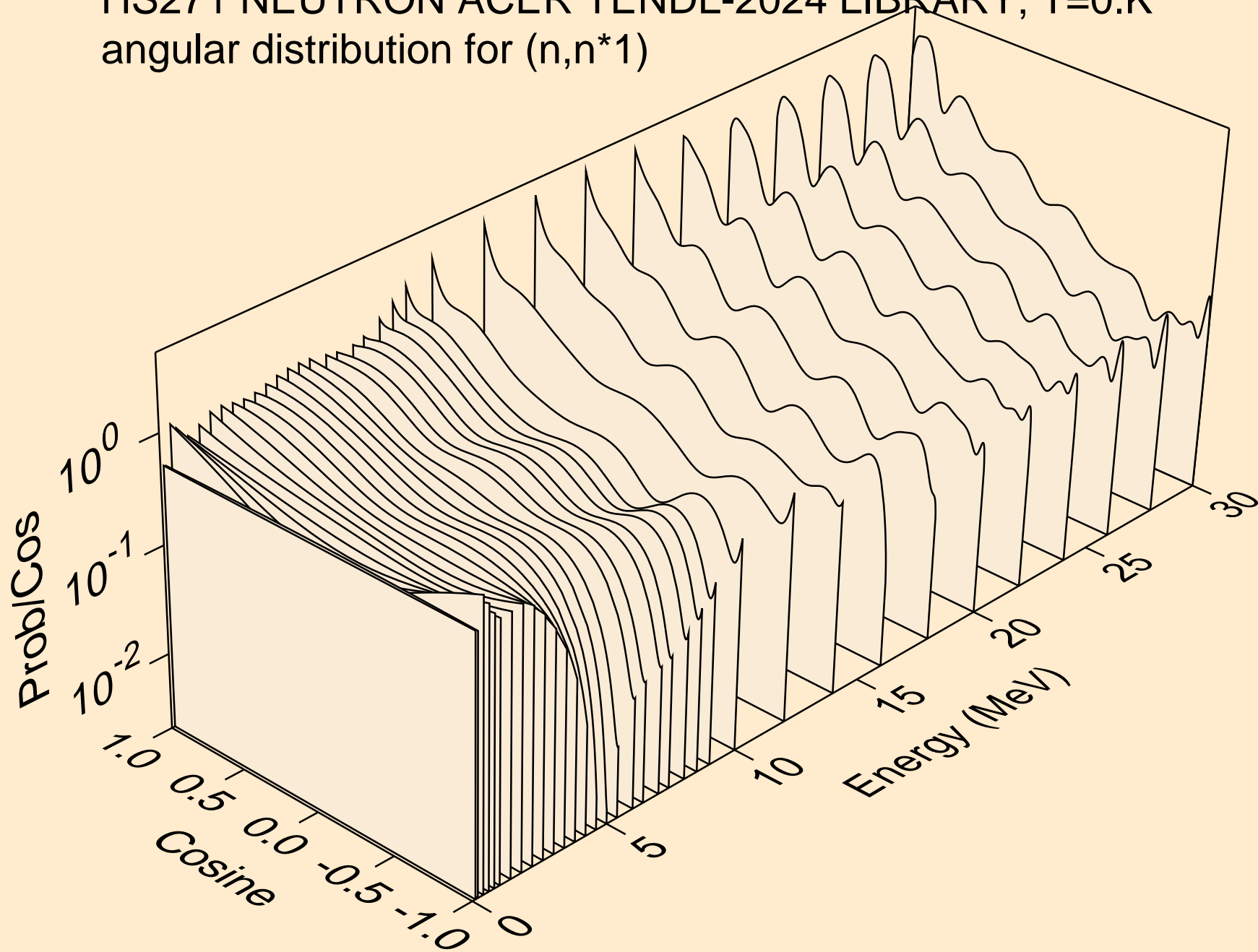

HS271 NEUTRON ACER TENDL-2024 LIBRARY; T=0.K
angular distribution for (n,n*2)

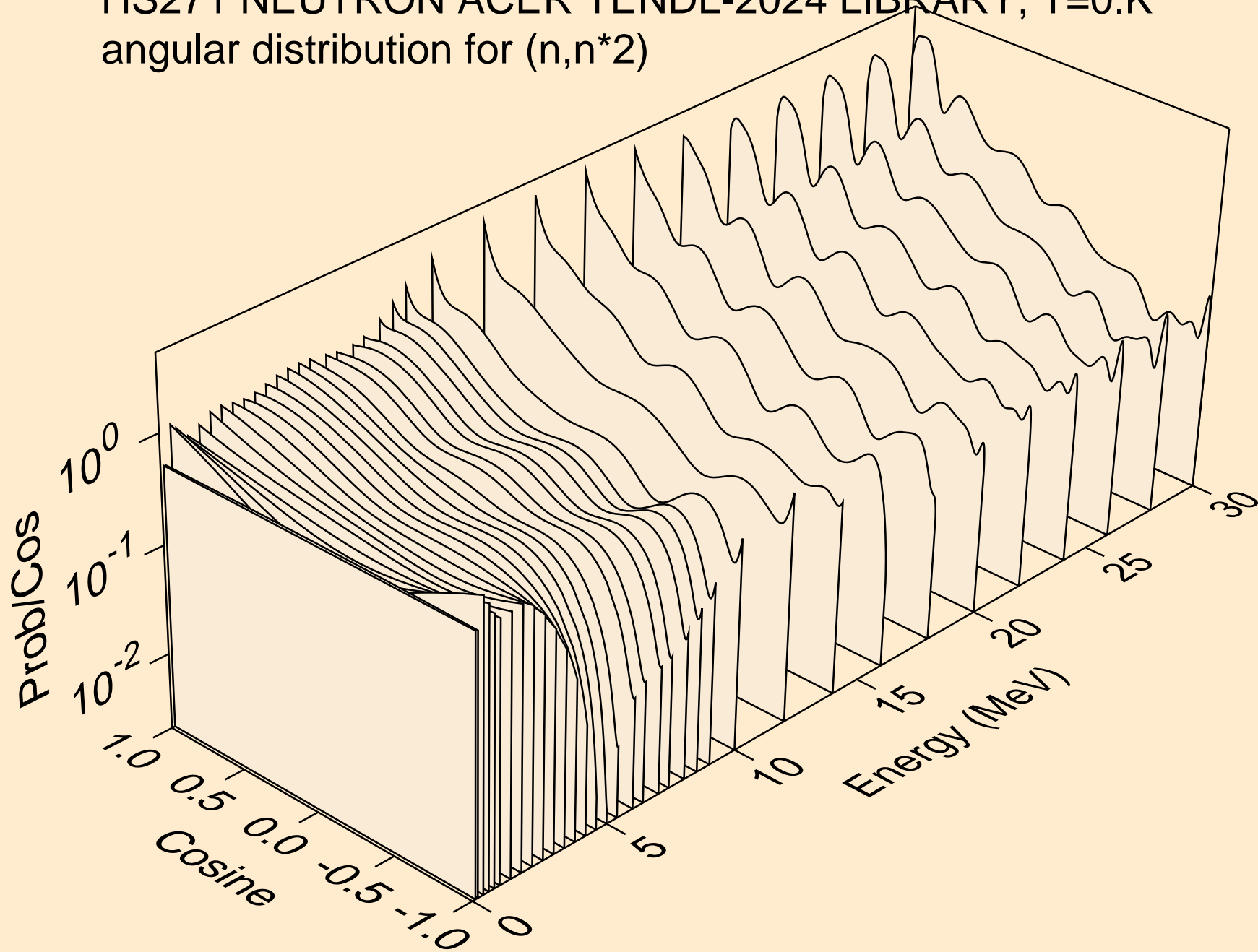

HS271 NEUTRON ACER TENDL-2024 LIBRARY; T=0.K

Total fission nubar

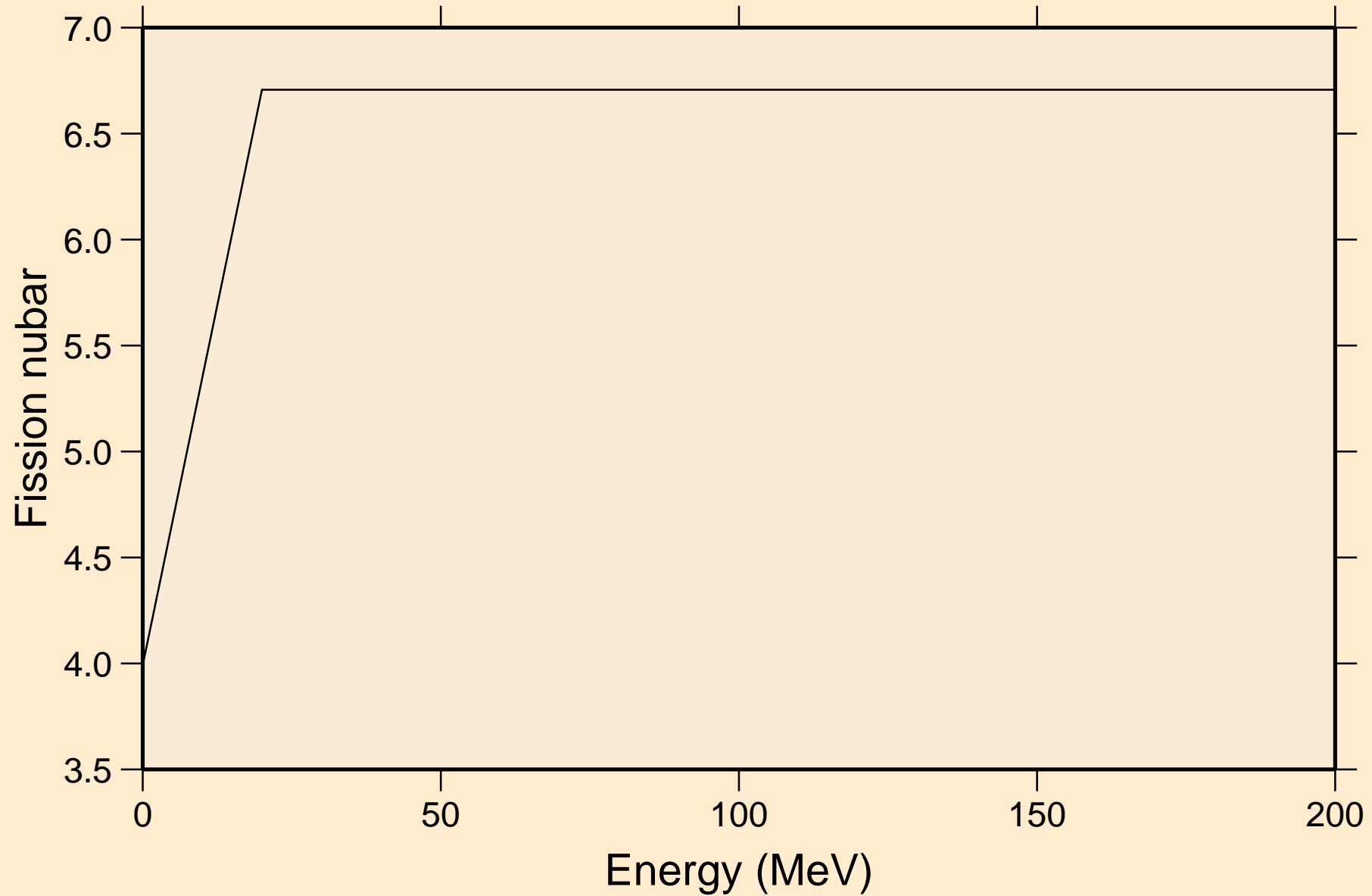

HS271 NEUTRON ACER TENDL-2024 LIBRARY; T=0.K
Neutron emission for (n,x)

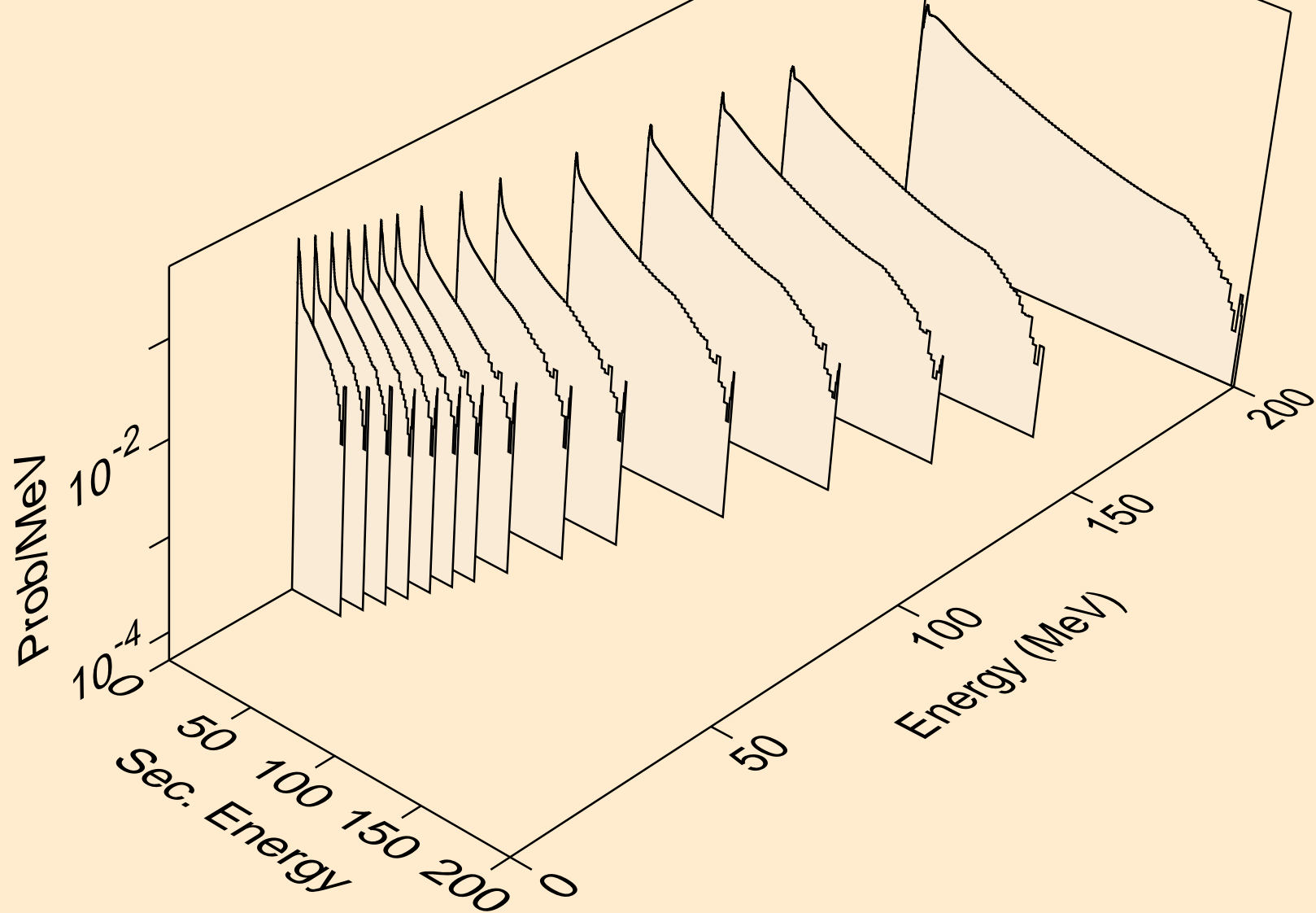

HS271 NEUTRON ACER TENDL-2024 LIBRARY; T=0.K
Neutron emission for (n,2n)

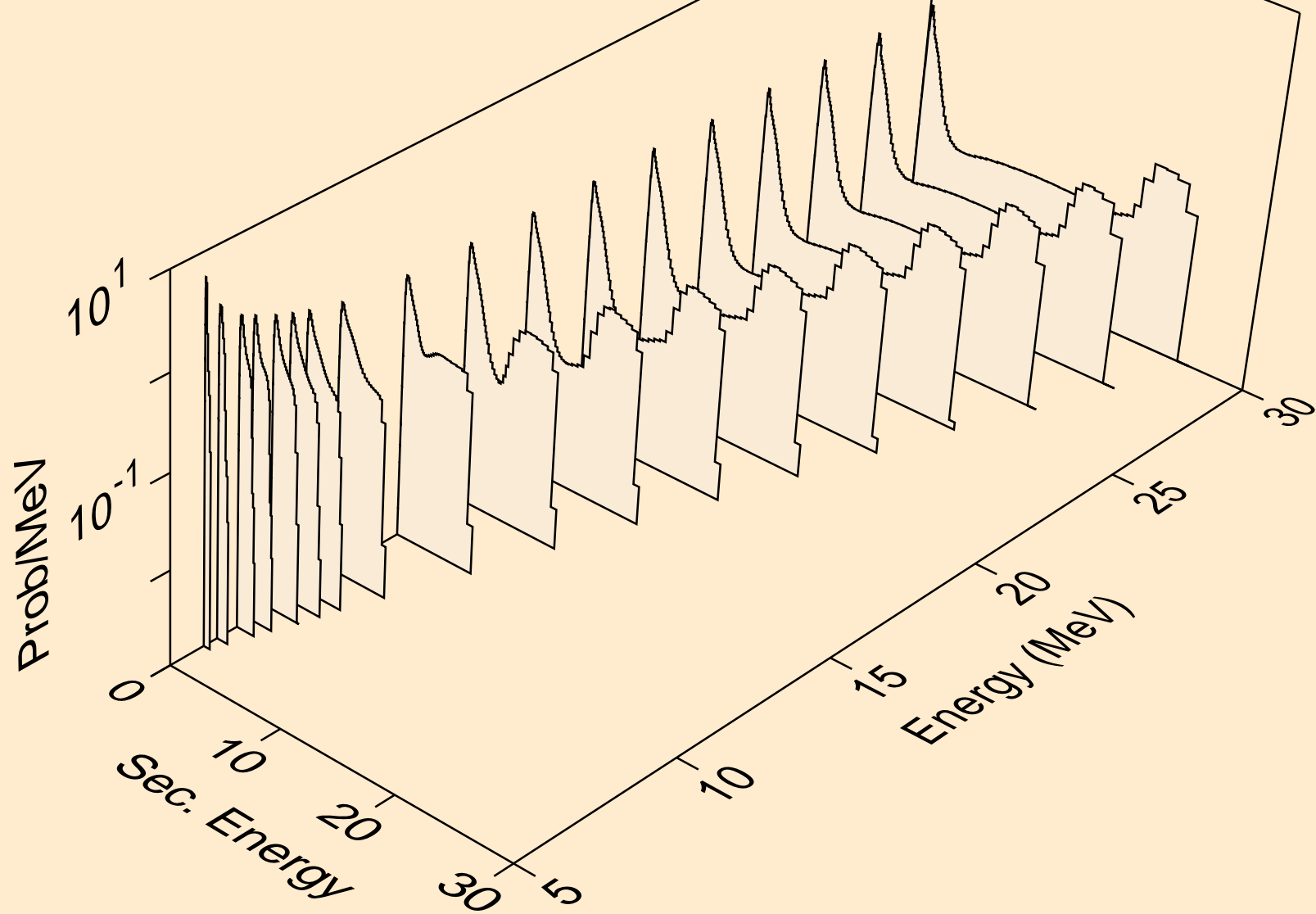

HS271 NEUTRON ACER TENDL-2024 LIBRARY; T=0.K
Neutron emission for (n,3n)

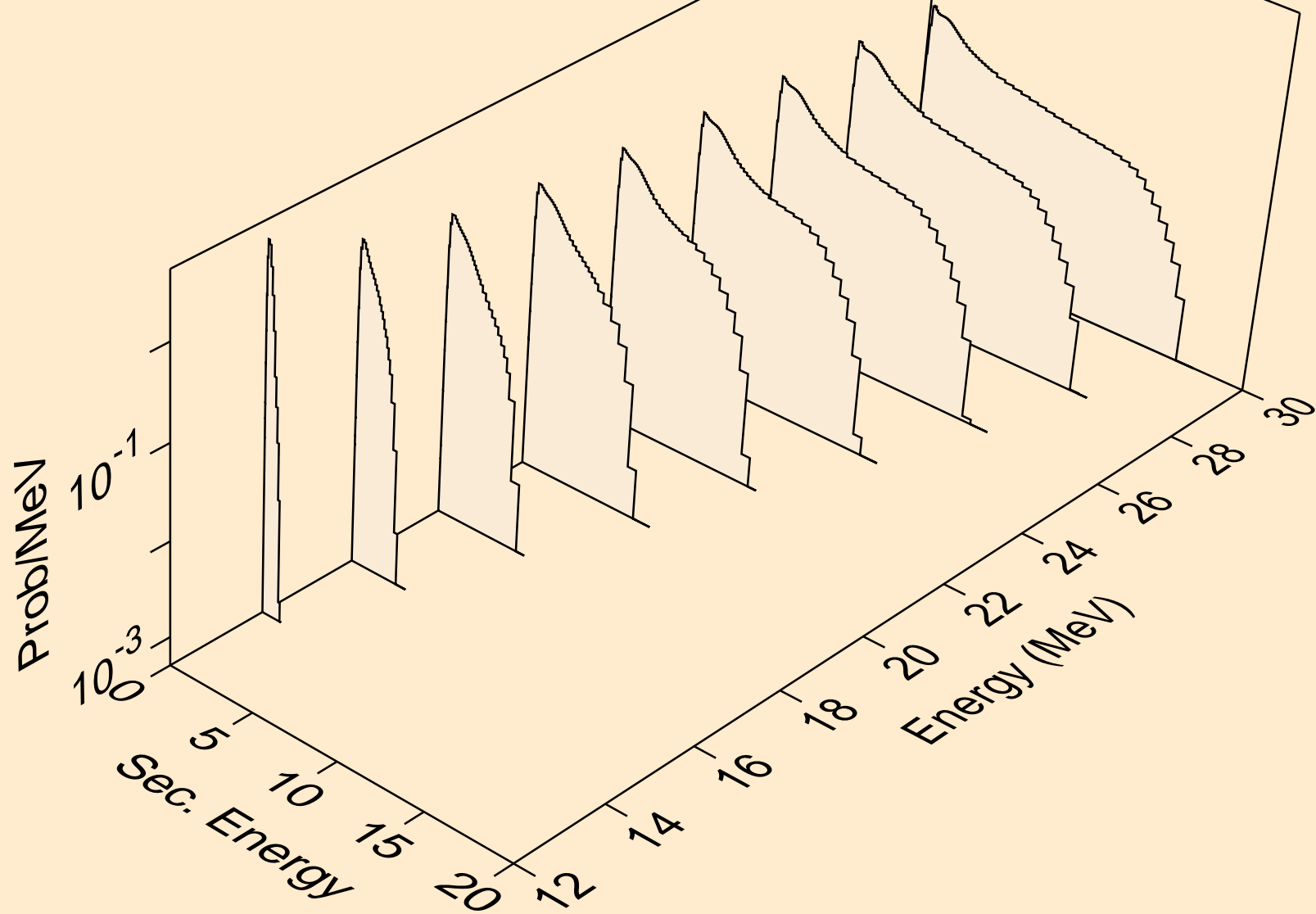

HS271 NEUTRON ACER TENDL-2024 LIBRARY; T=0.K
Neutron emission for fission

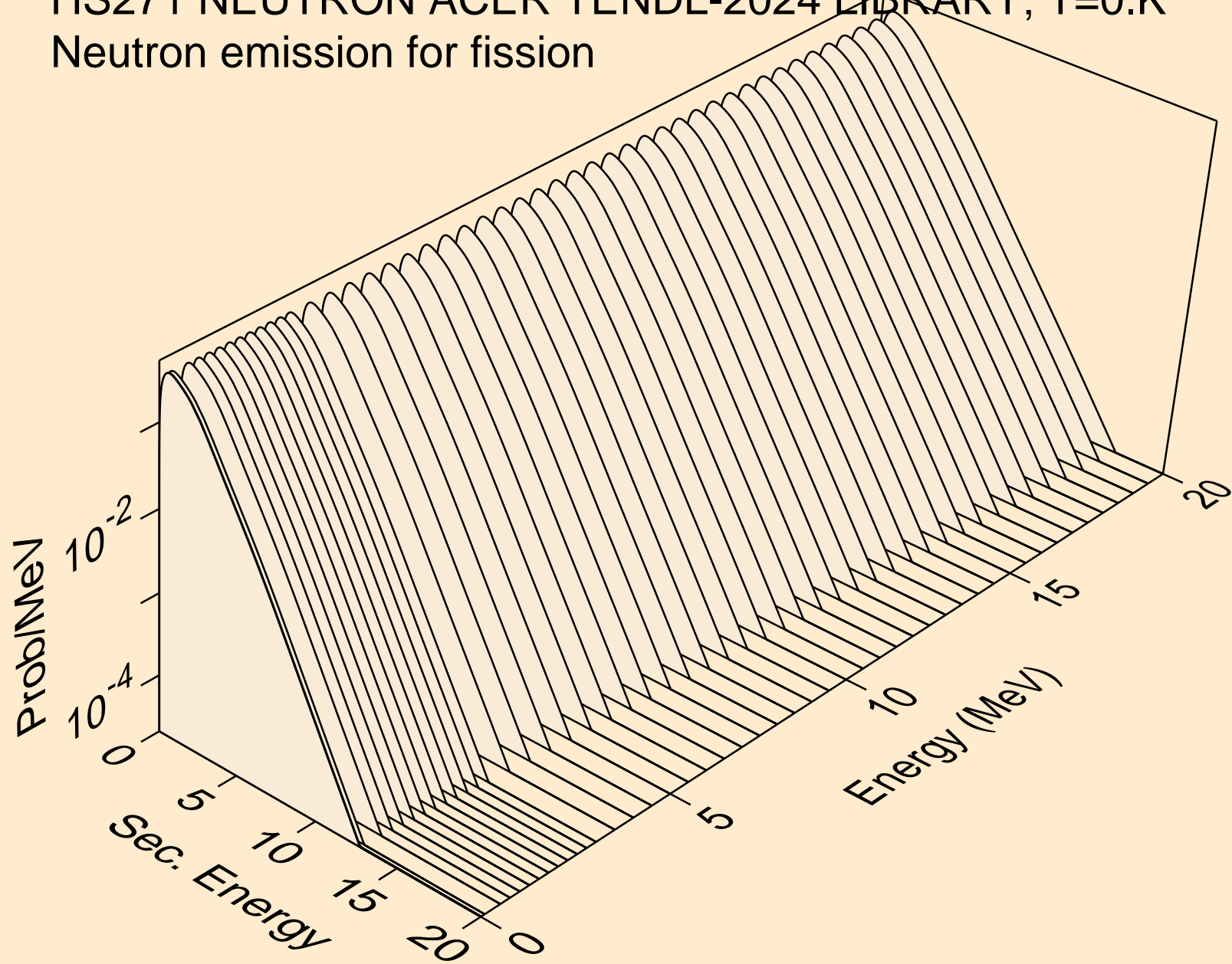

HS271 NEUTRON ACER TENDL-2024 LIBRARY; T=0.K
Neutron emission for (n,n*)a

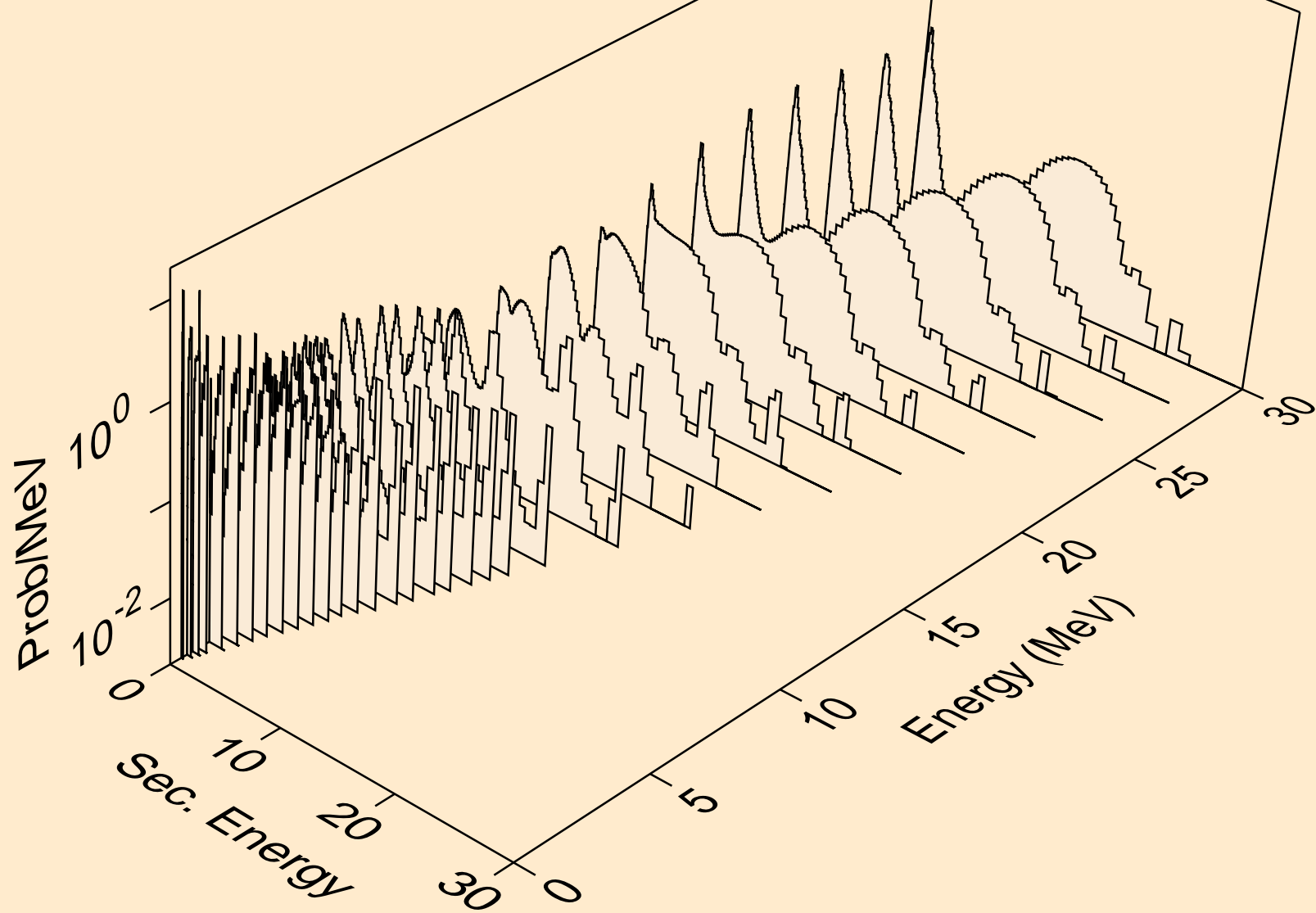

HS271 NEUTRON ACER TENDL-2024 LIBRARY; T=0.K
Neutron emission for (n,2n)a

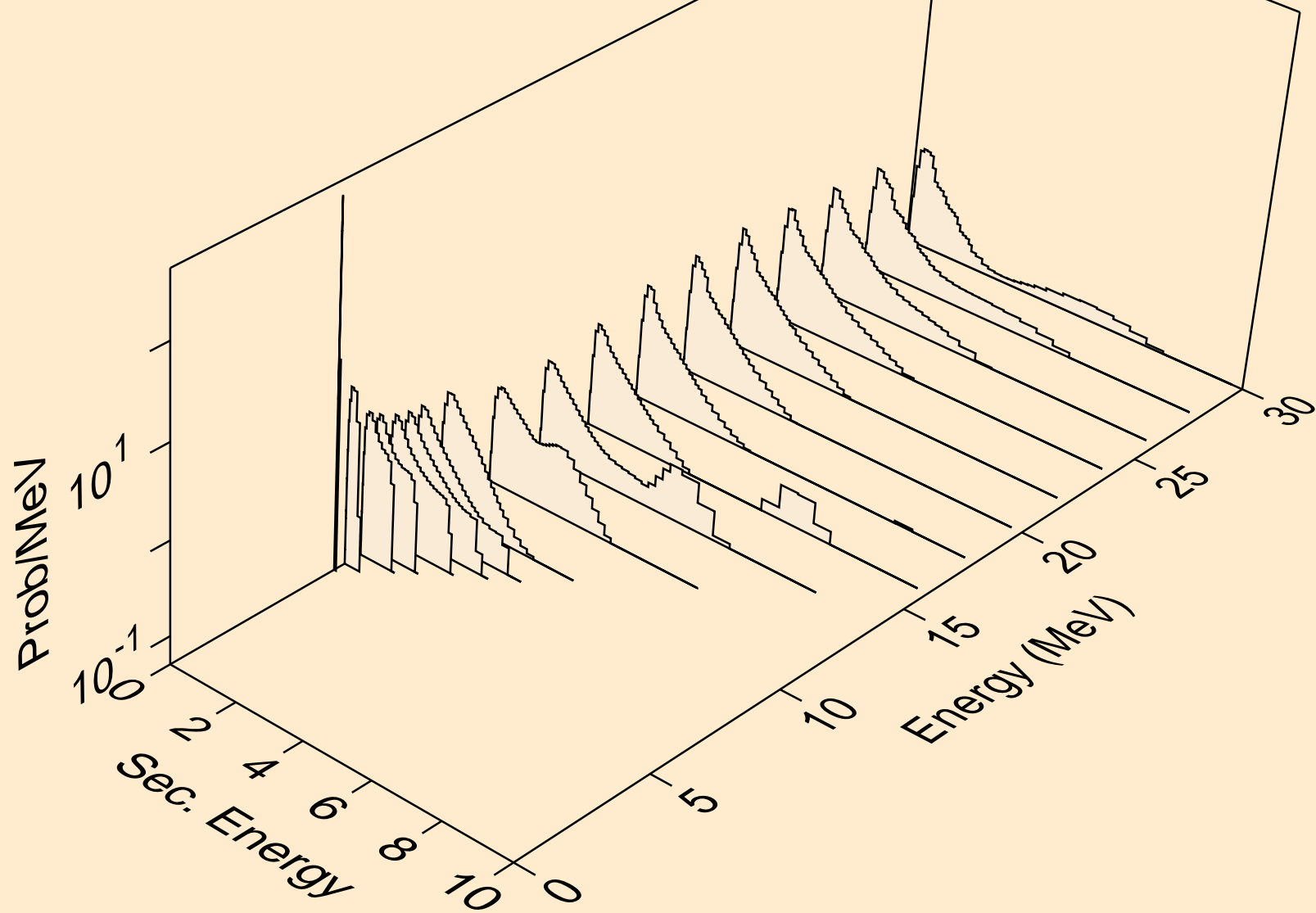

HS271 NEUTRON ACER TENDL-2024 LIBRARY; T=0.K
Neutron emission for (n,3n)a

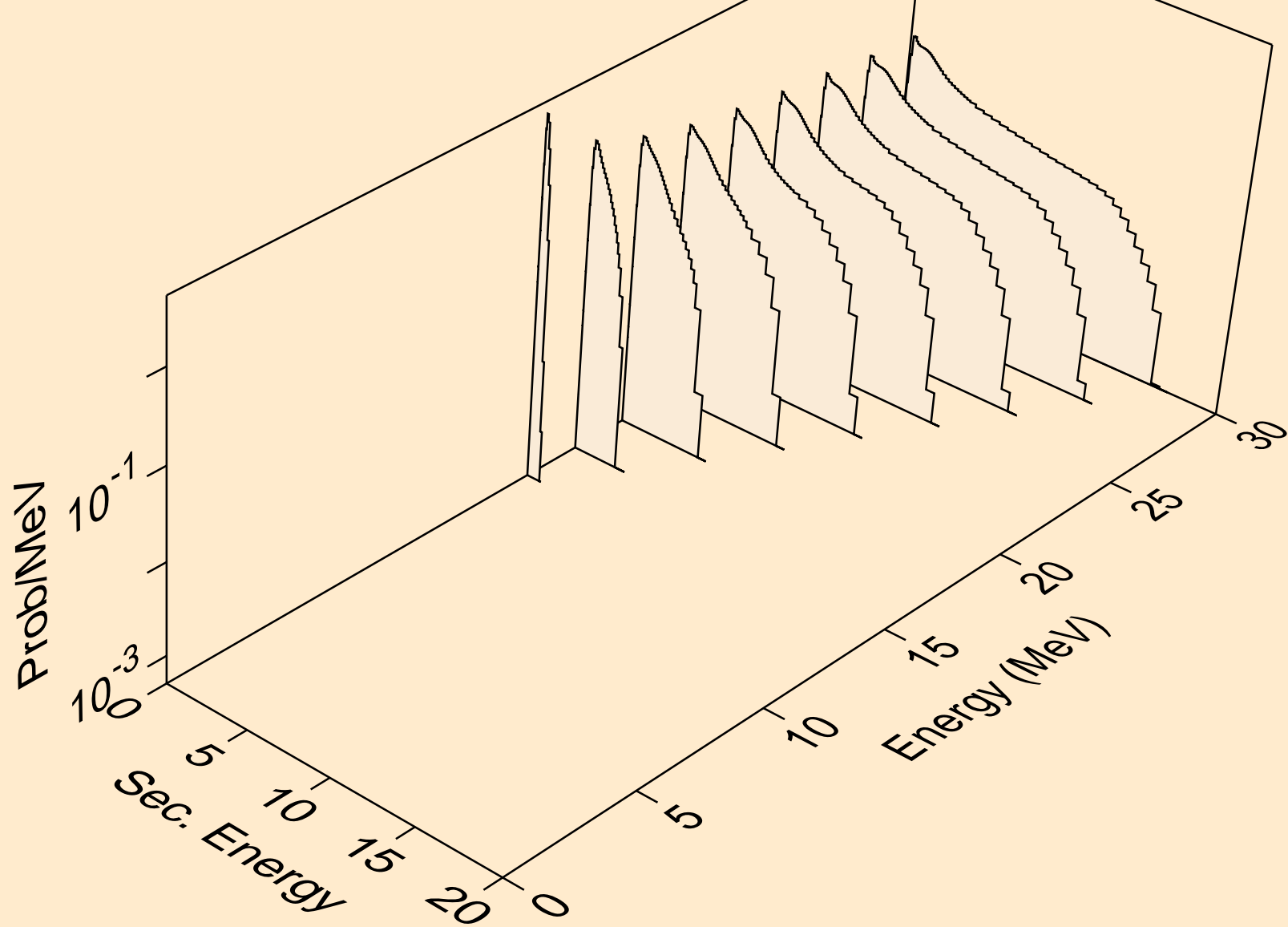

HS271 NEUTRON ACER TENDL-2024 LIBRARY; T=0.K
Neutron emission for (n,n*)p

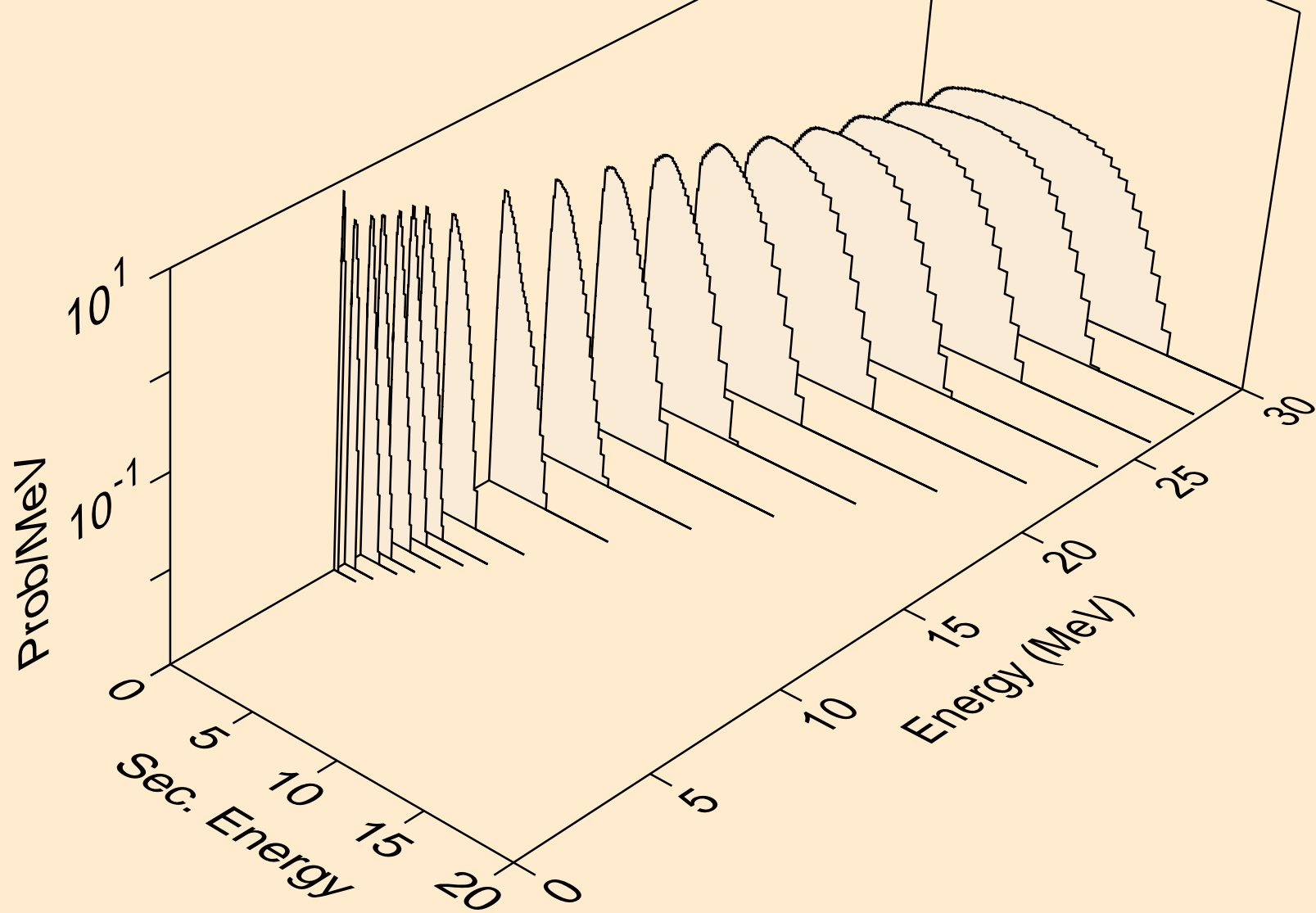

HS271 NEUTRON ACER TENDL-2024 LIBRARY; T=0.K
Neutron emission for (n,n*)d

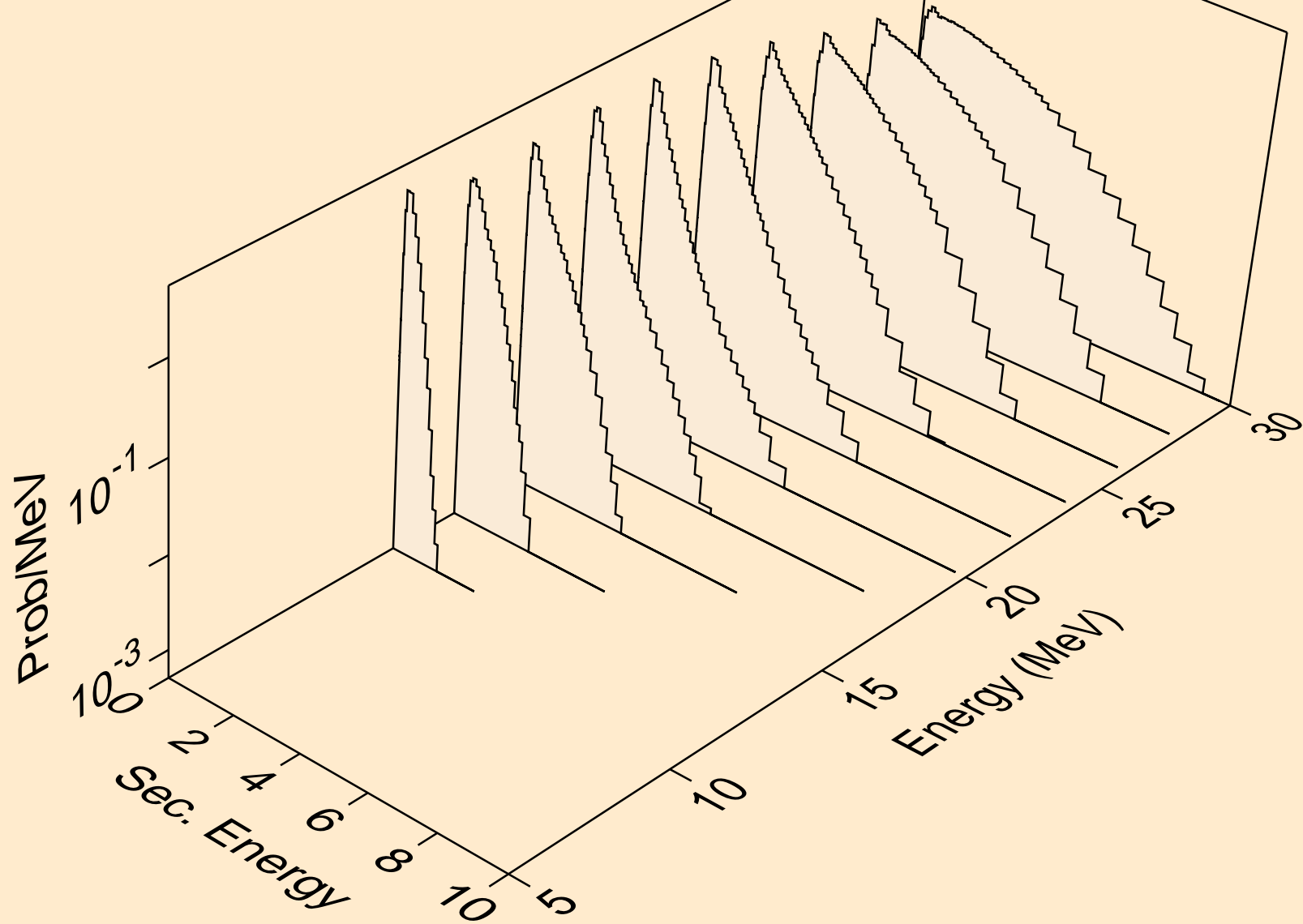

HS271 NEUTRON ACER TENDL-2024 LIBRARY; T=0.K
Neutron emission for (n,n*)t

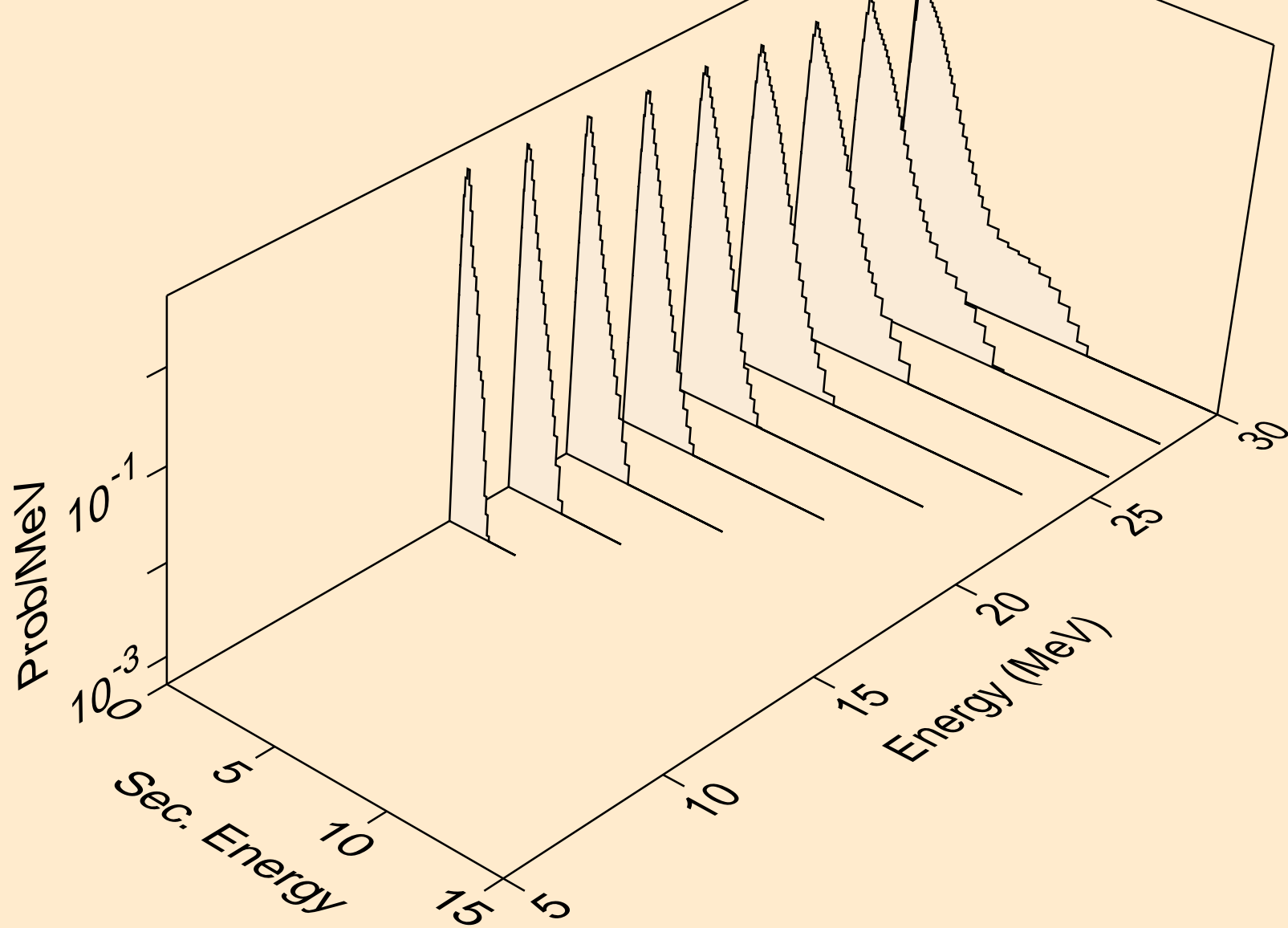

HS271 NEUTRON ACER TENDL-2024 LIBRARY; T=0.K
Neutron emission for (n,n*)he3

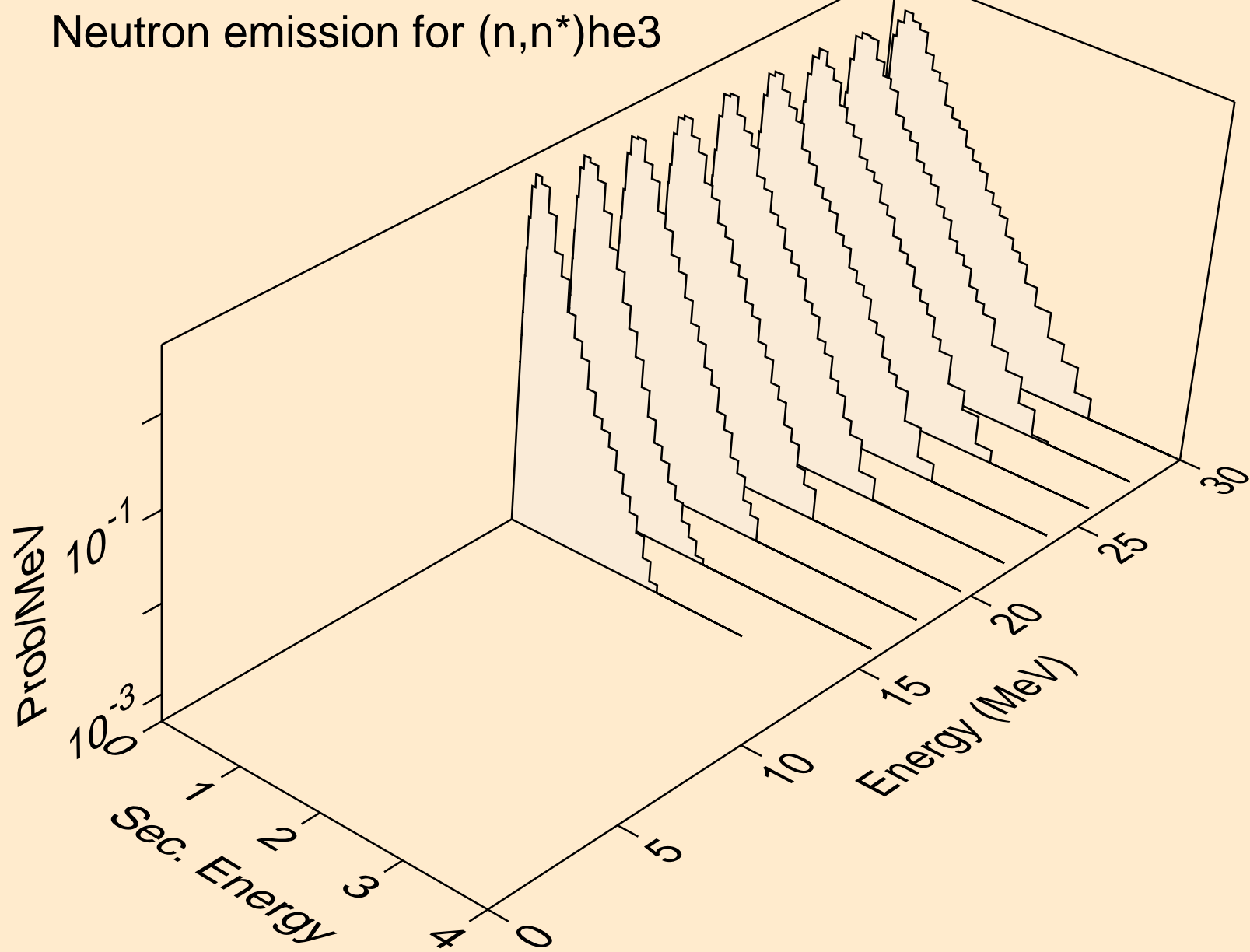

HS271 NEUTRON ACER TENDL-2024 LIBRARY; T=0.K
Neutron emission for (n,4n)

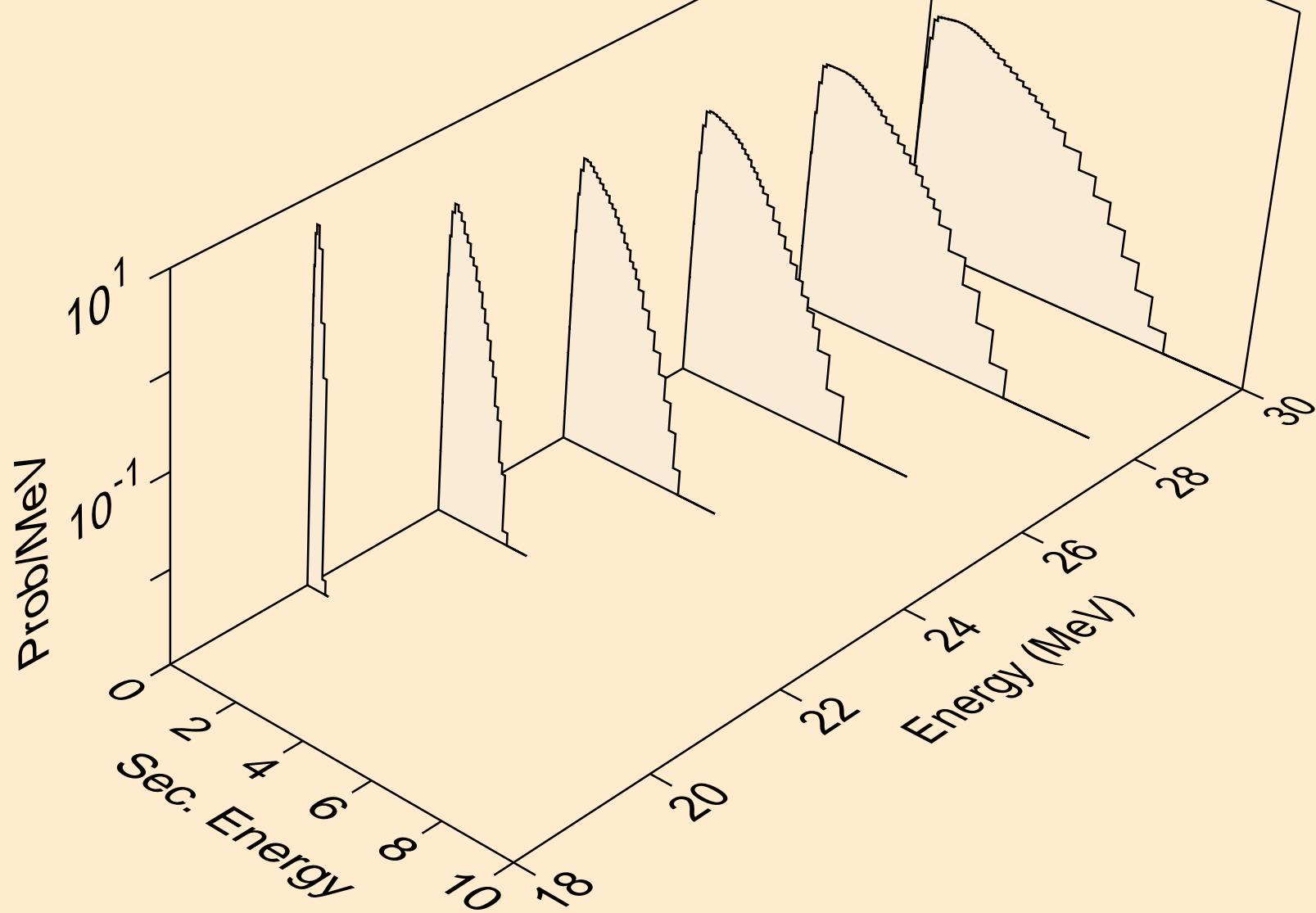

HS271 NEUTRON ACER TENDL-2024 LIBRARY; T=0.K
Neutron emission for (n,2np)

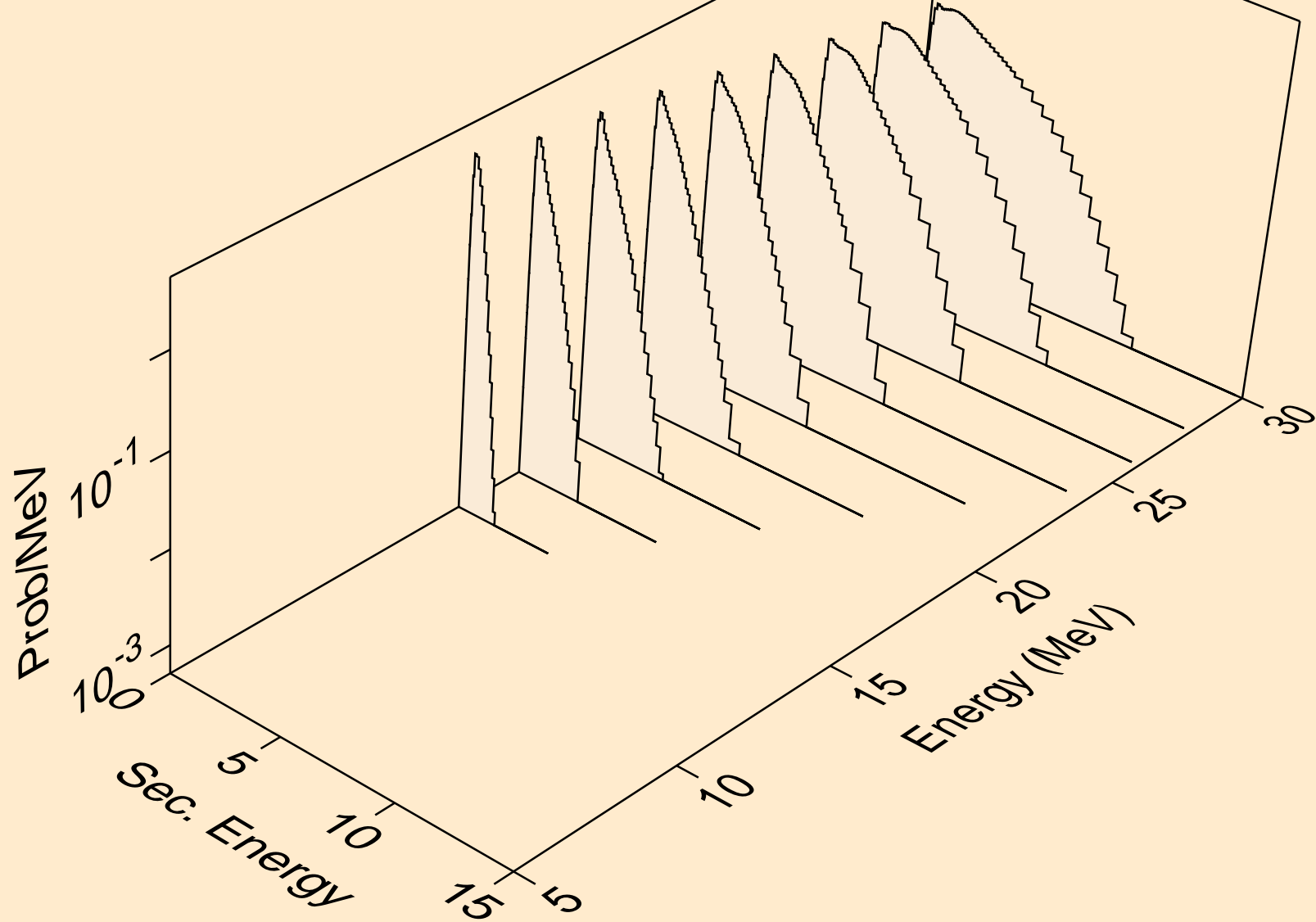

HS271 NEUTRON ACER TENDL-2024 LIBRARY; T=0.K
Neutron emission for (n,n2p)

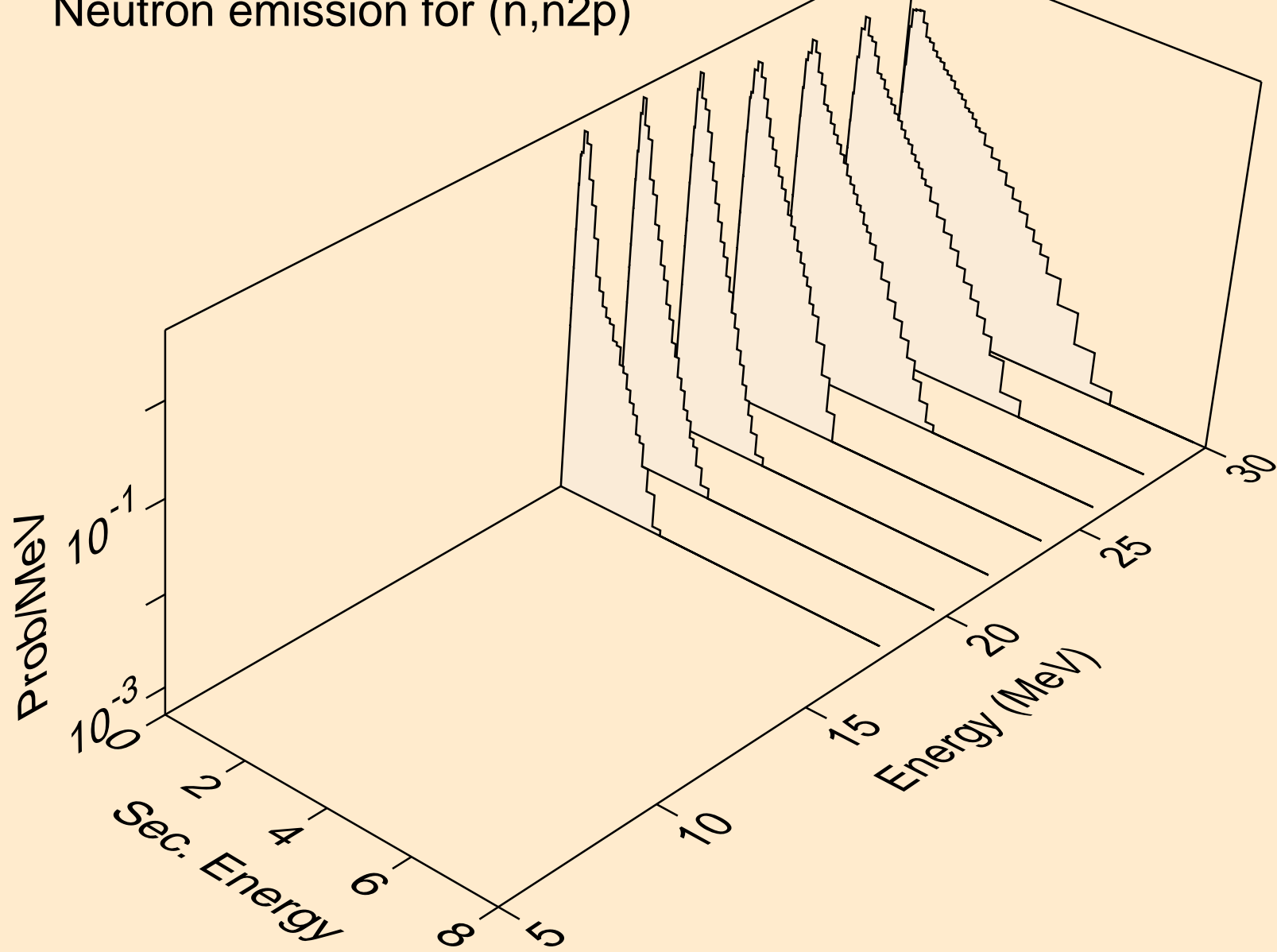

HS271 NEUTRON ACER TENDL-2024 LIBRARY; T=0.K
Neutron emission for (n,n*c)

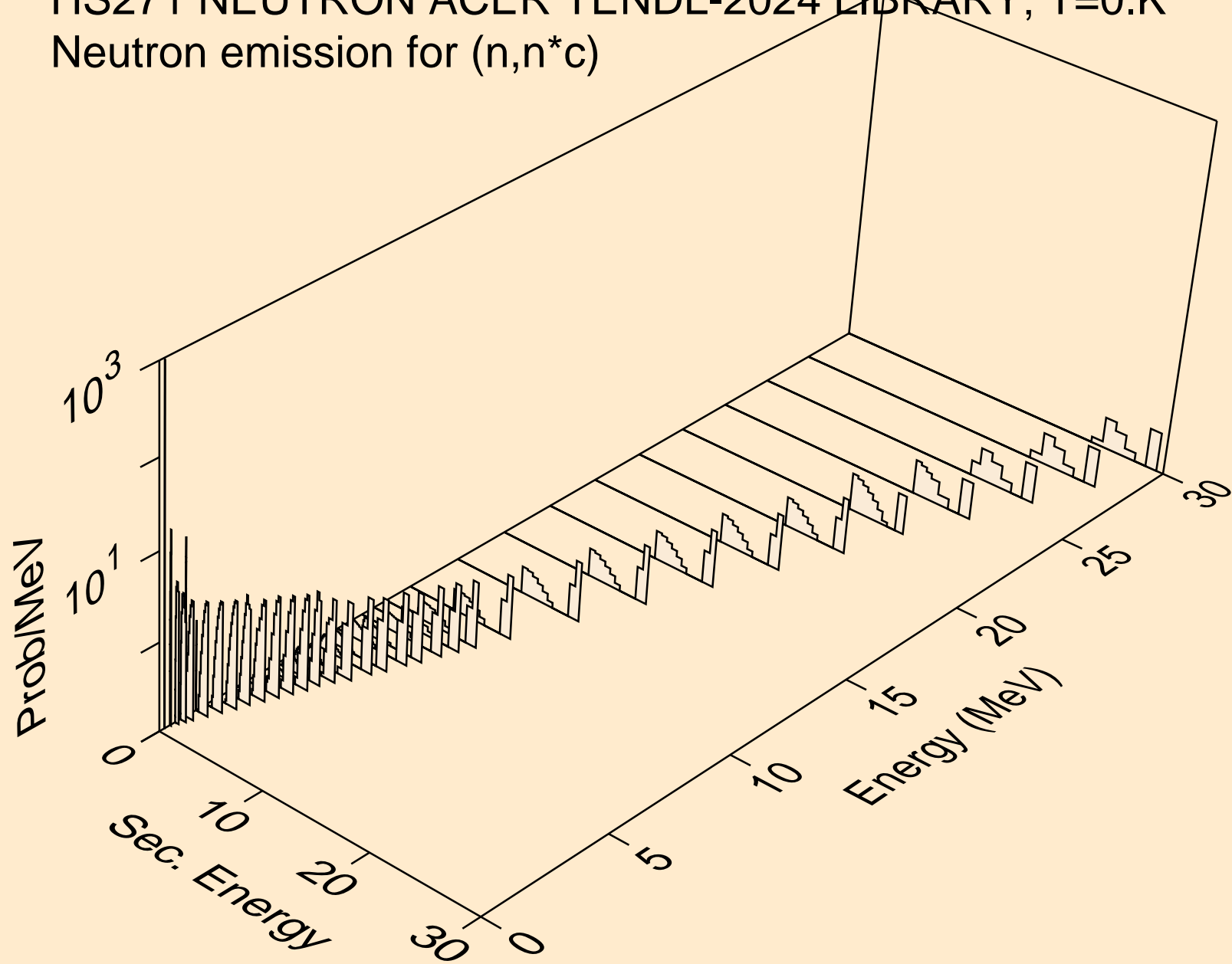

HS271 NEUTRON ACER TENDL-2024 LIBRARY; T=0.K

Delayed nubar

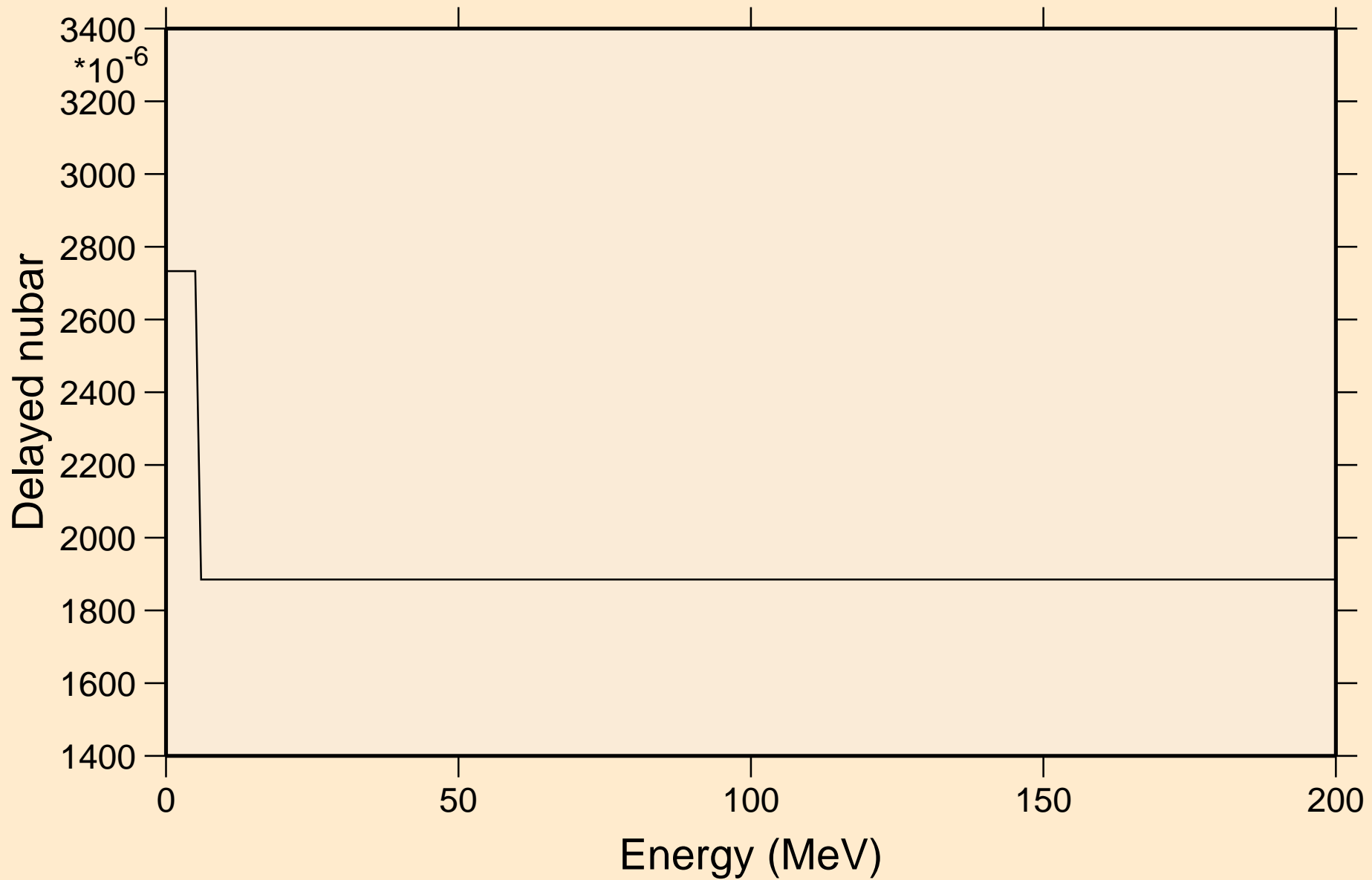

HS271 NEUTRON ACER TENDL-2024 LIBRARY; T=0.K

Delayed neutron spectra

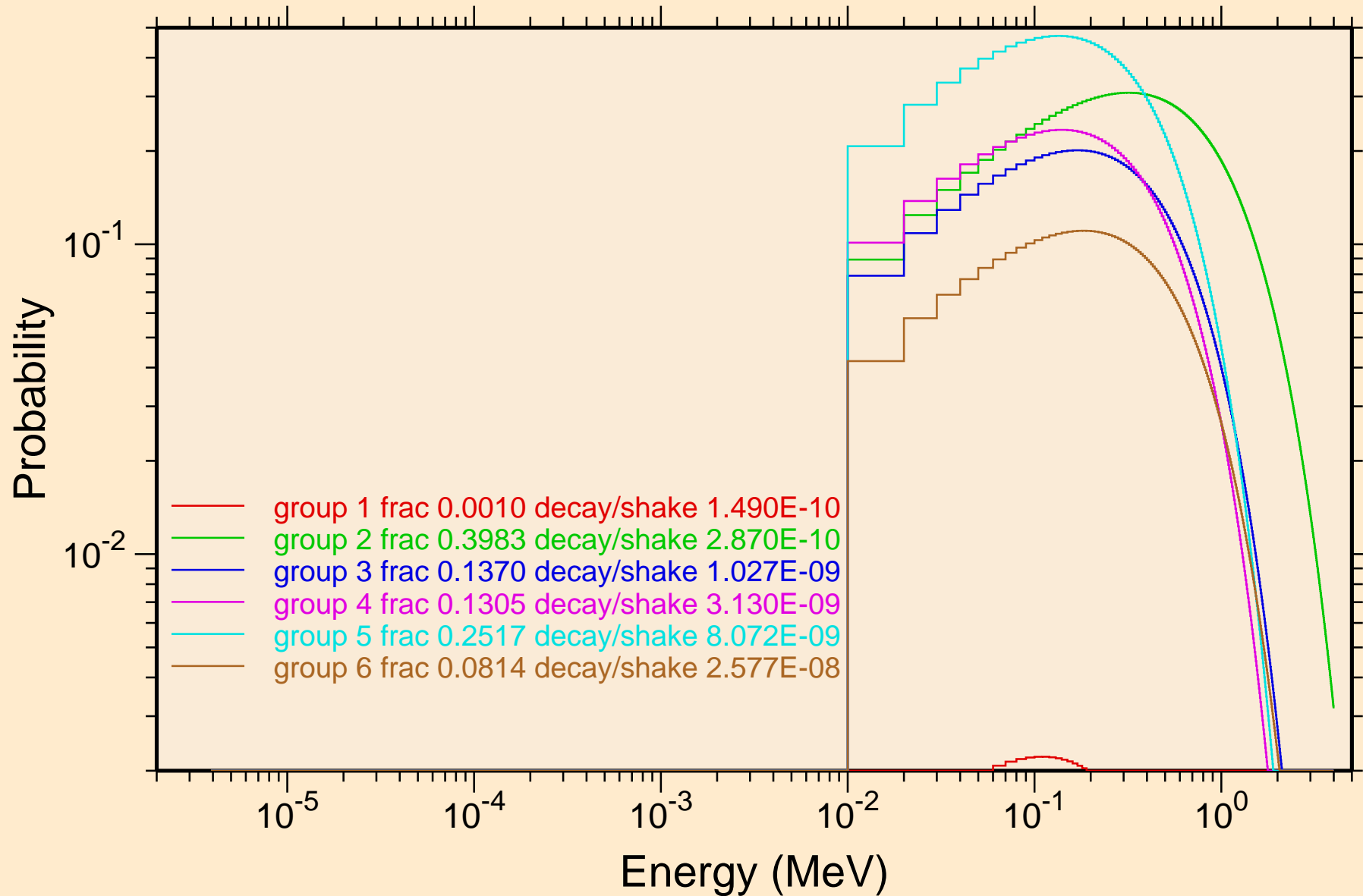

HS271 NEUTRON ACER TENDL-2024 LIBRARY; T=0.K
Photon emission for (n,x)

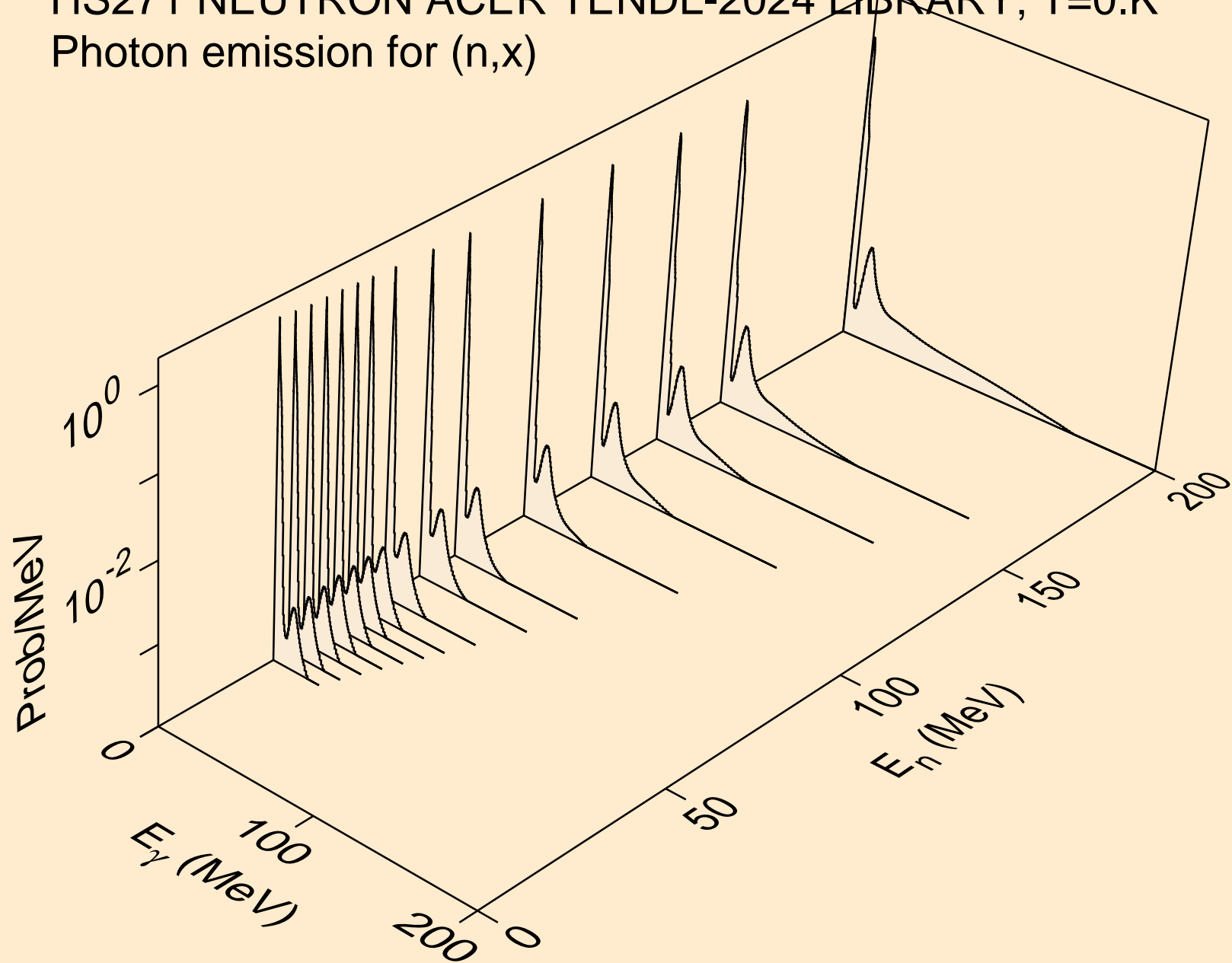

HS271 NEUTRON ACER TENDL-2024 LIBRARY; T=0.K
Photon emission for (n,2n)

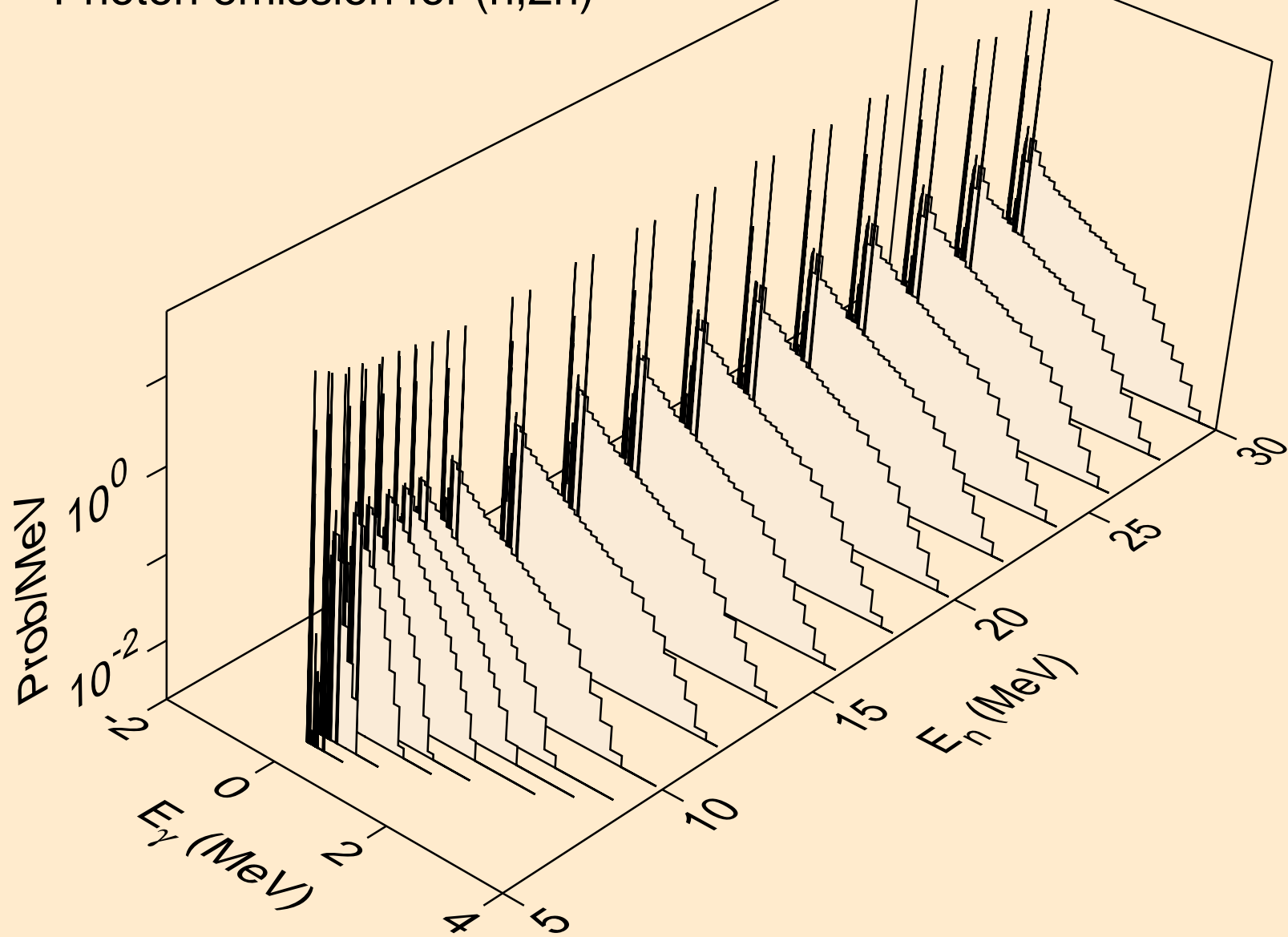

HS271 NEUTRON ACER TENDL-2024 LIBRARY; T=0.K
Photon emission for (n,3n)

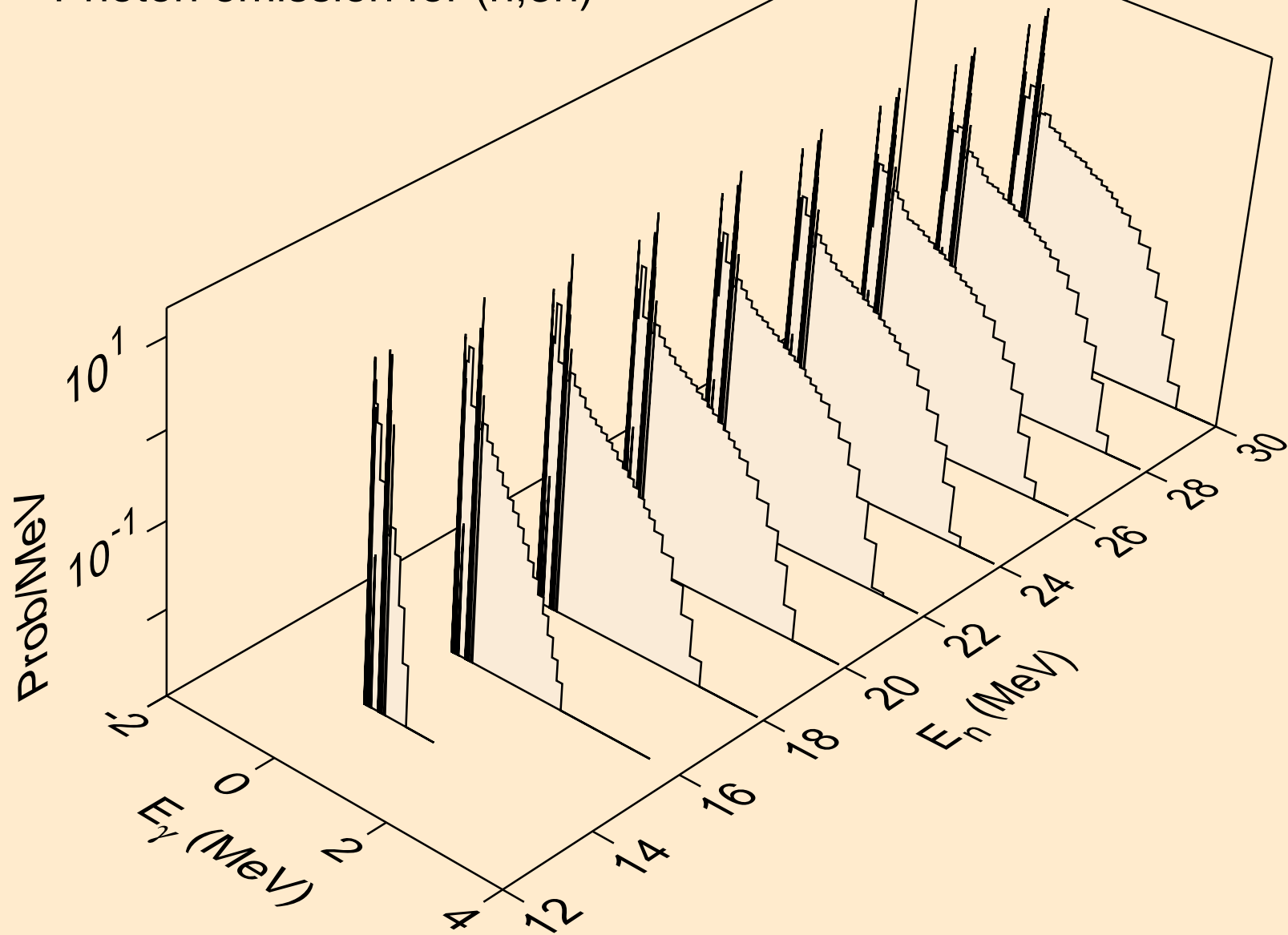

HS271 NEUTRON ACER TENDL-2024 LIBRARY; T=0.K
Photon emission for (n,n*)a

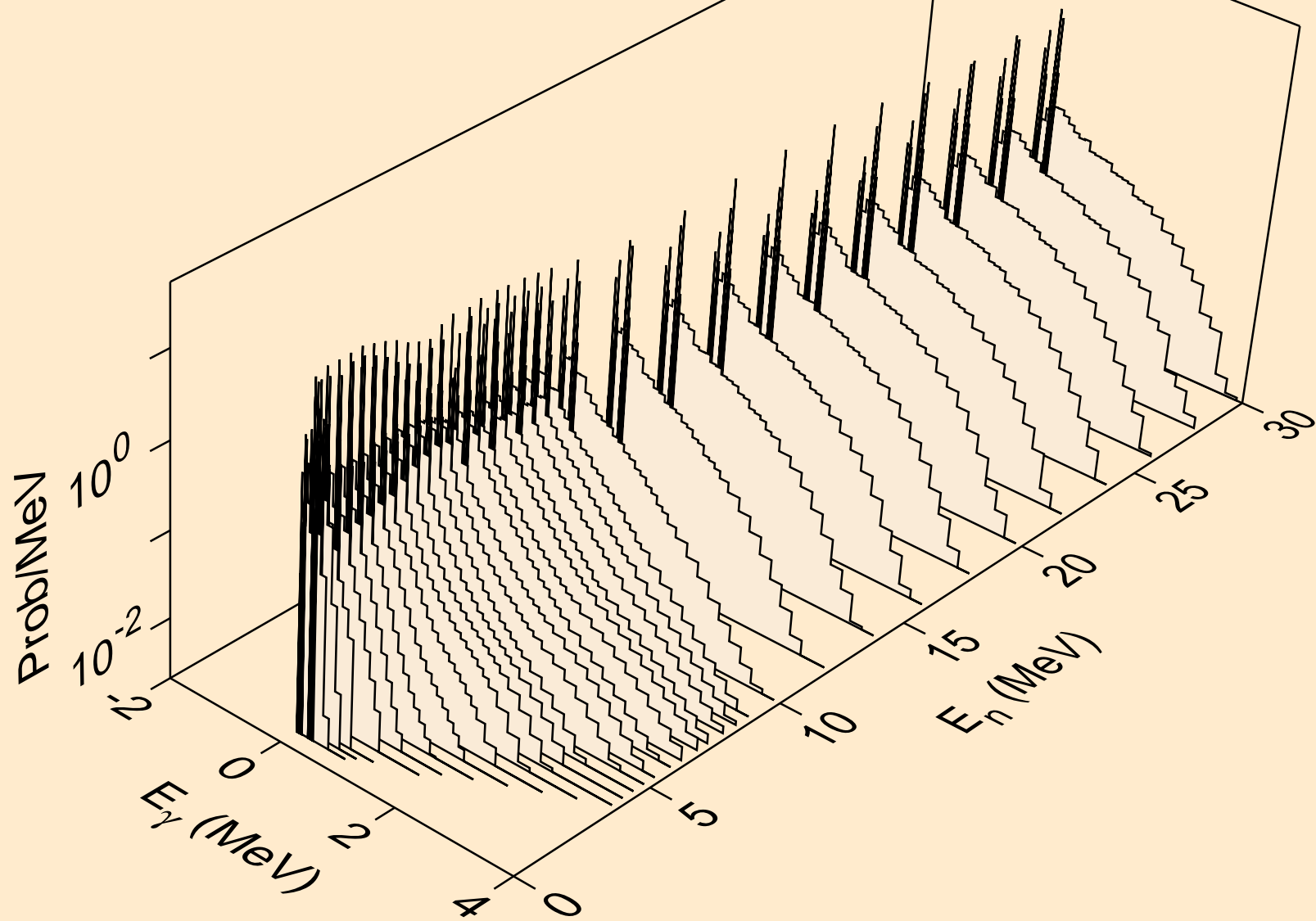

HS271 NEUTRON ACER TENDL-2024 LIBRARY; T=0.K
Photon emission for (n,2n)a

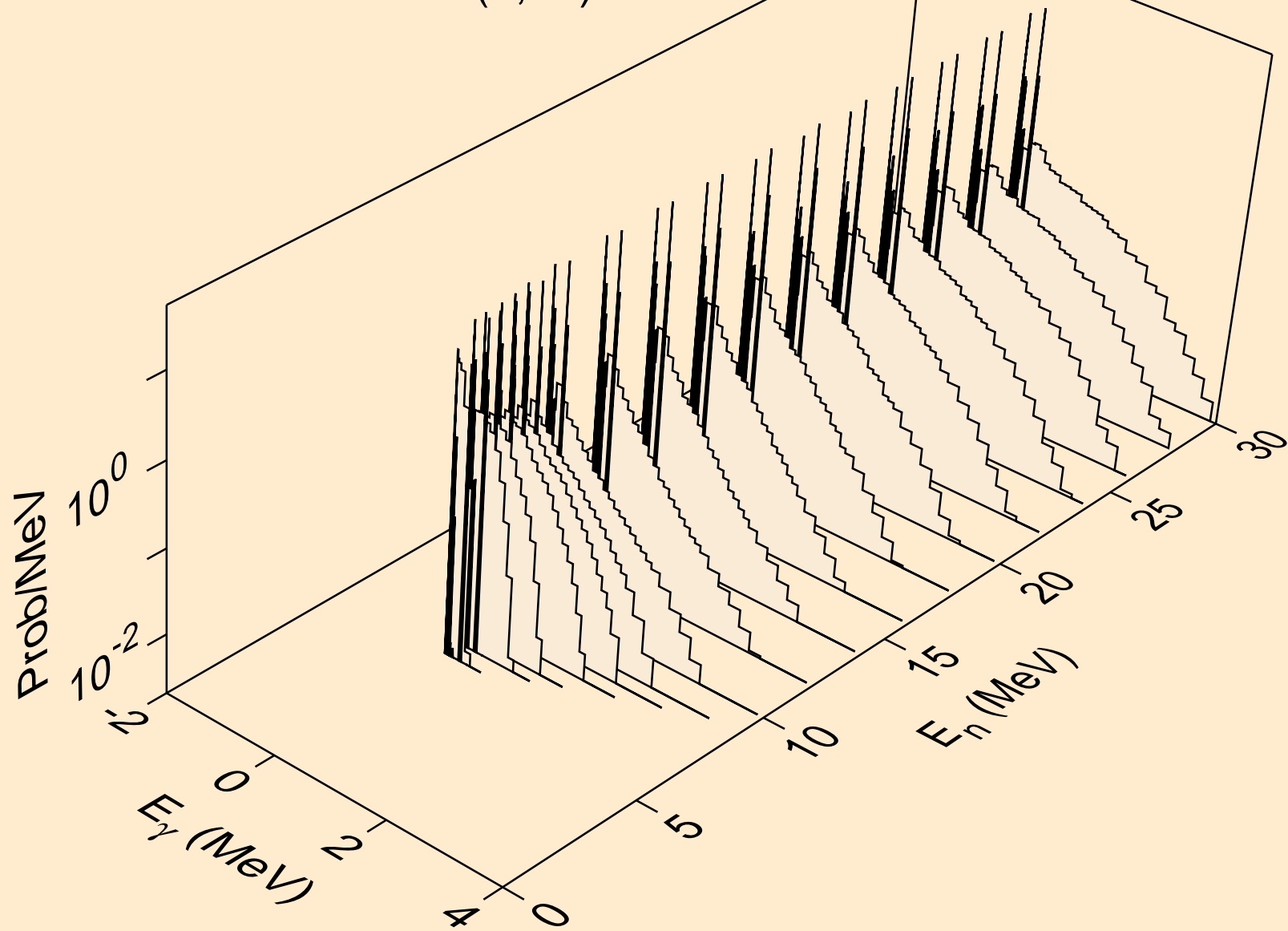

HS271 NEUTRON ACER TENDL-2024 LIBRARY; T=0.K
Photon emission for (n,3n)a

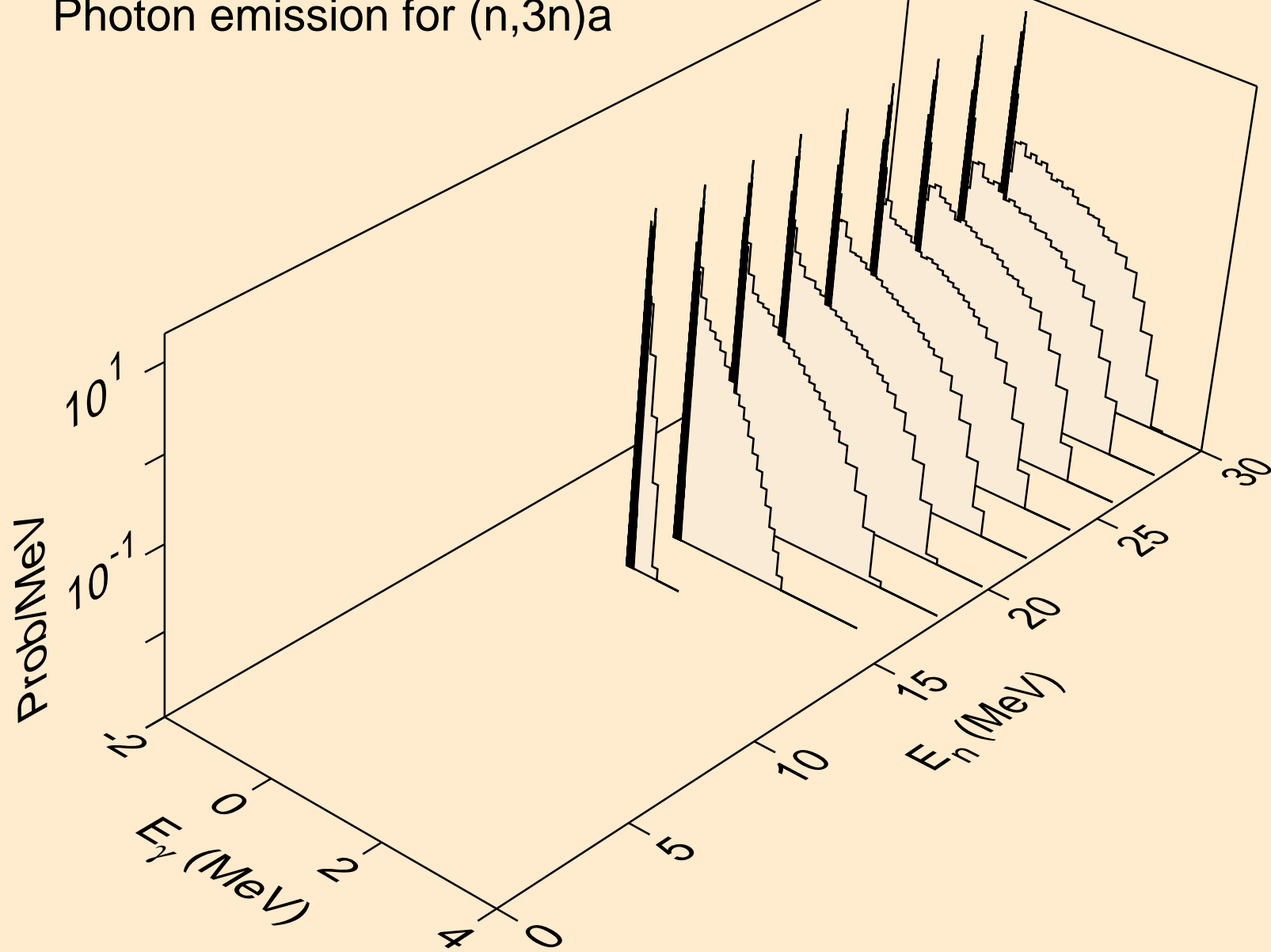

HS271 NEUTRON ACER TENDL-2024 LIBRARY; T=0.K
Photon emission for (n,n*)p

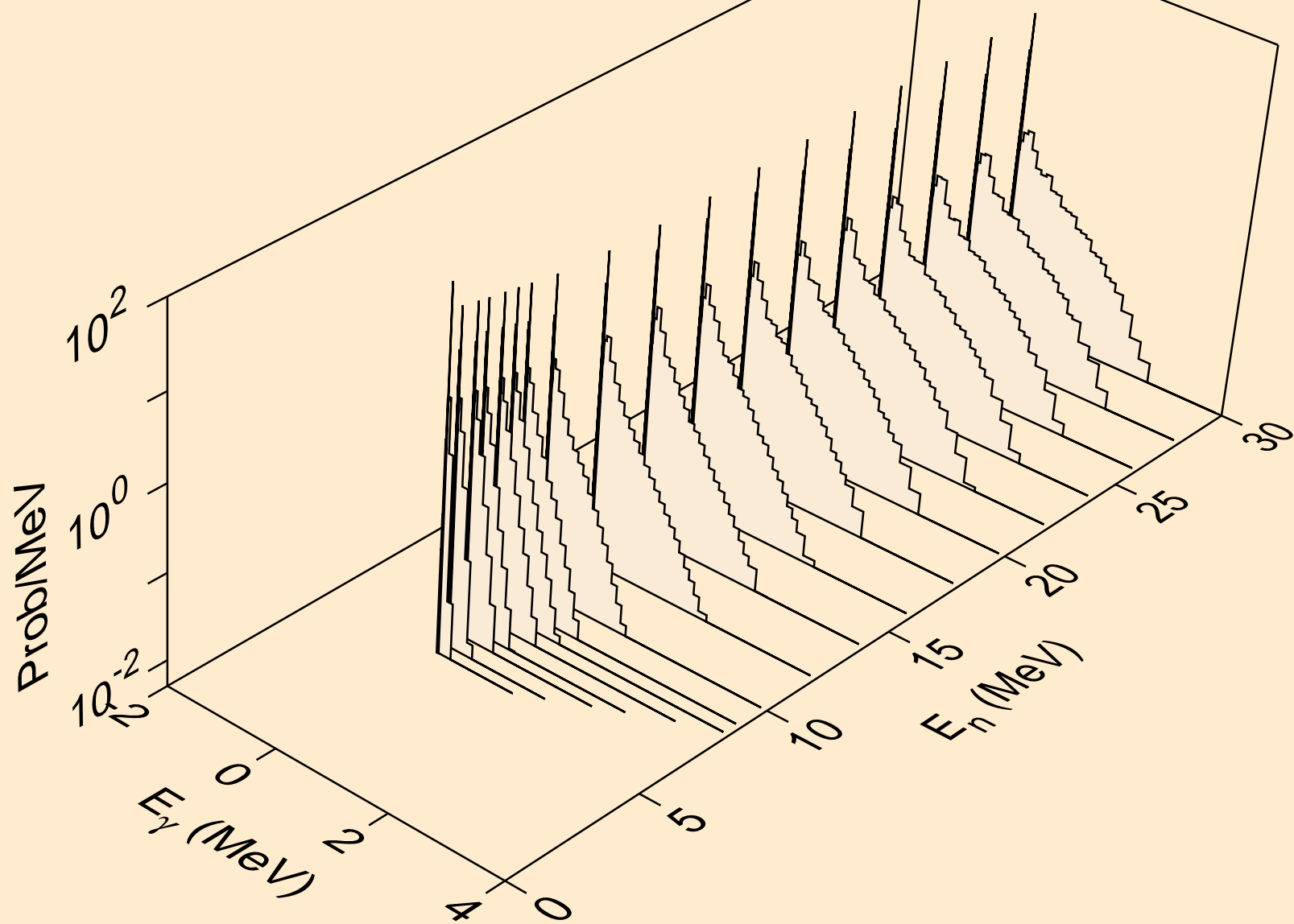

HS271 NEUTRON ACER TENDL-2024 LIBRARY; T=0.K
Photon emission for (n,n*)d

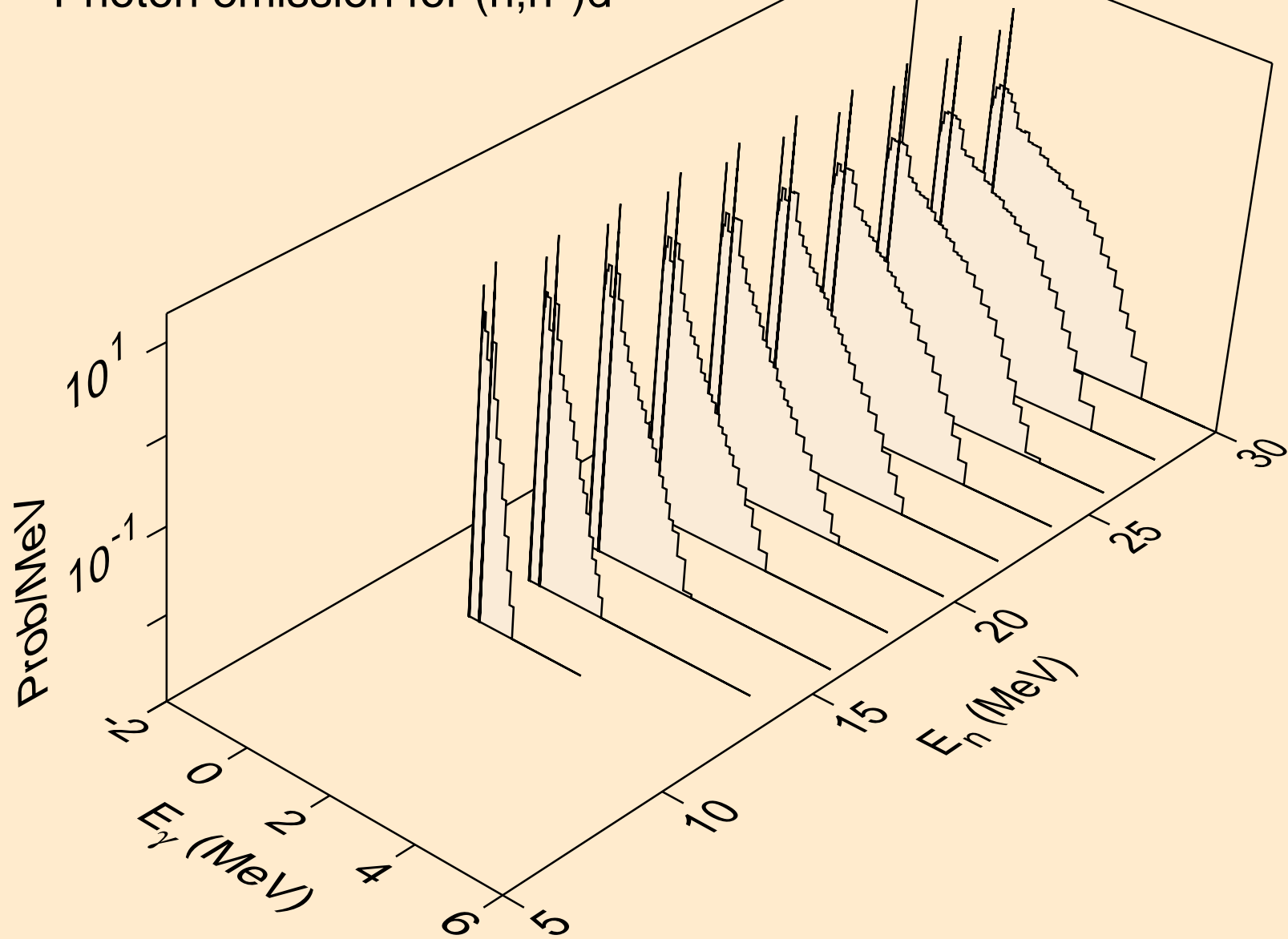

HS271 NEUTRON ACER TENDL-2024 LIBRARY; T=0.K
Photon emission for (n,n*)t

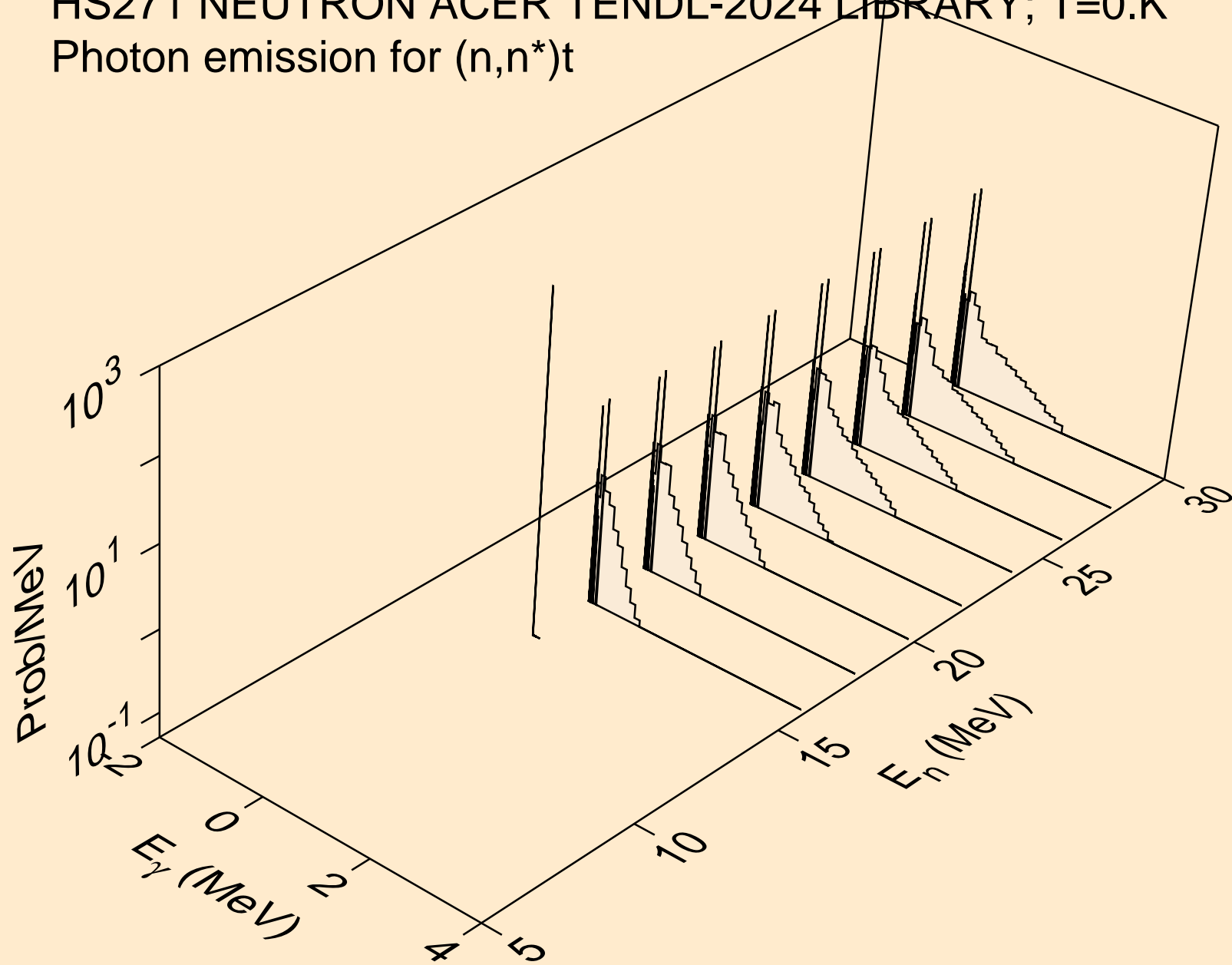

HS271 NEUTRON ACER TENDL-2024 LIBRARY; T=0.K
Photon emission for (n,n*)he3

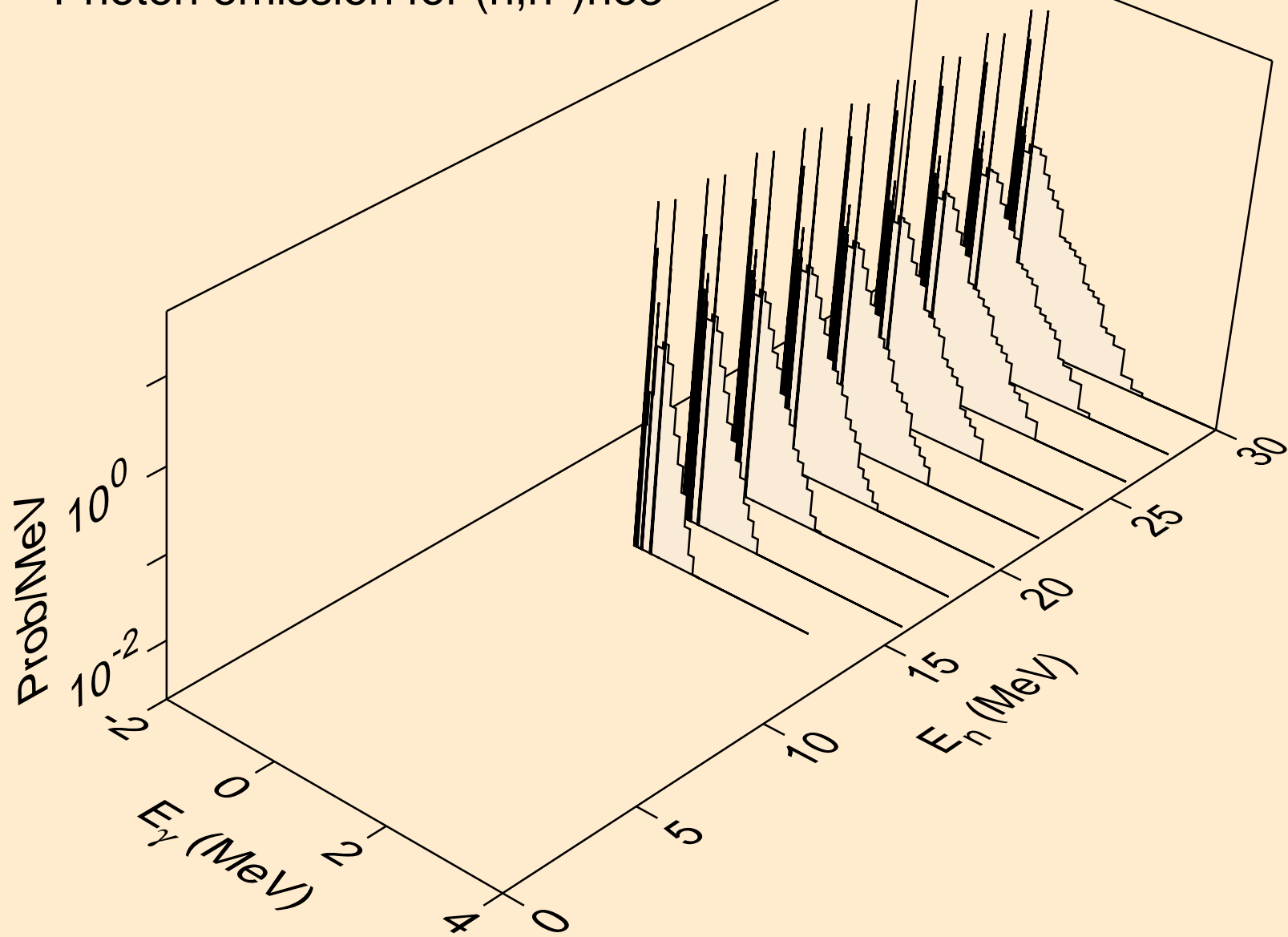

HS271 NEUTRON ACER TENDL-2024 LIBRARY; T=0.K
Photon emission for (n,4n)

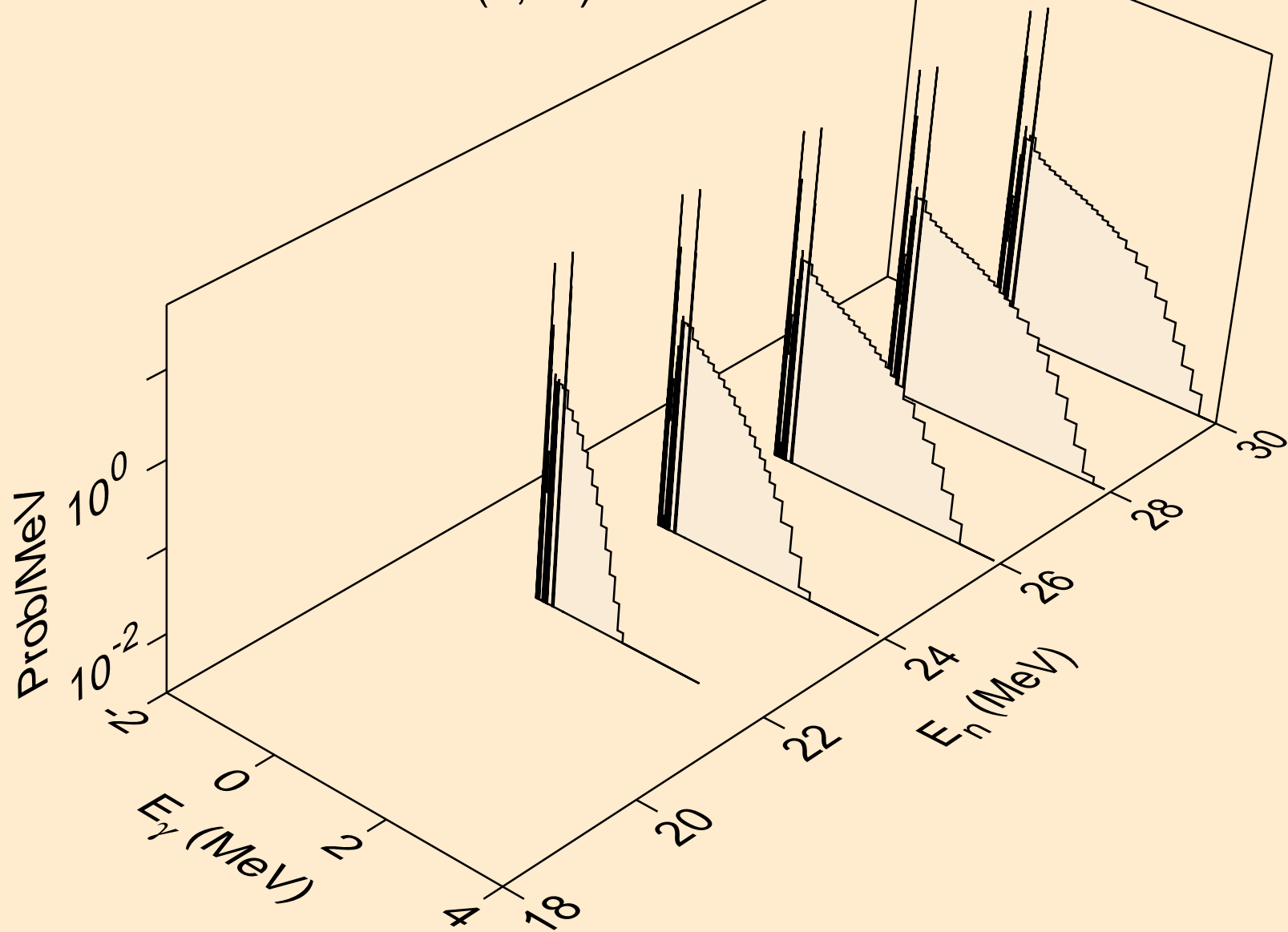

HS271 NEUTRON ACER TENDL-2024 LIBRARY; T=0.K
Photon emission for (n,2np)

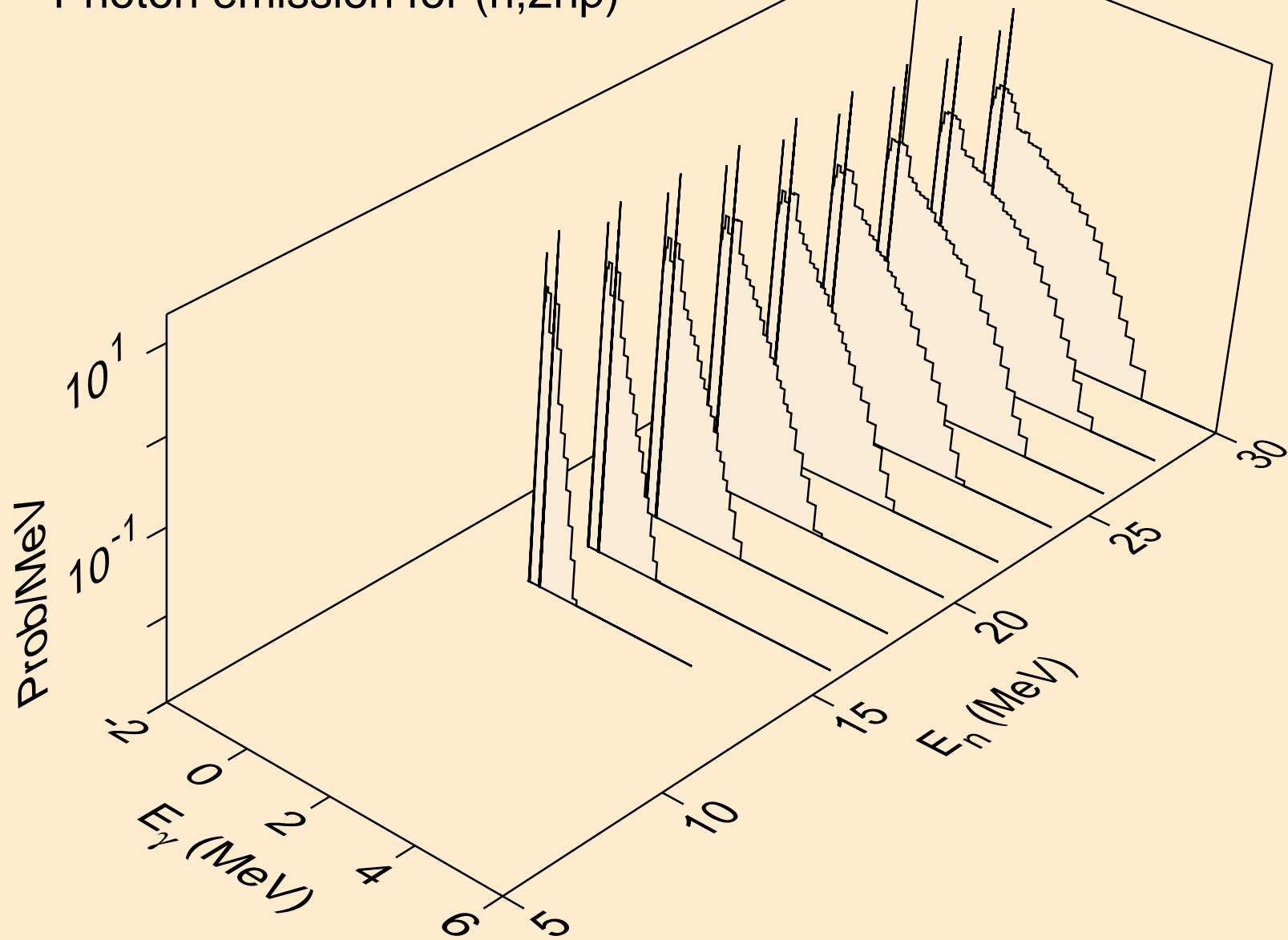

HS271 NEUTRON ACER TENDL-2024 LIBRARY; T=0.K
Photon emission for (n,n2p)

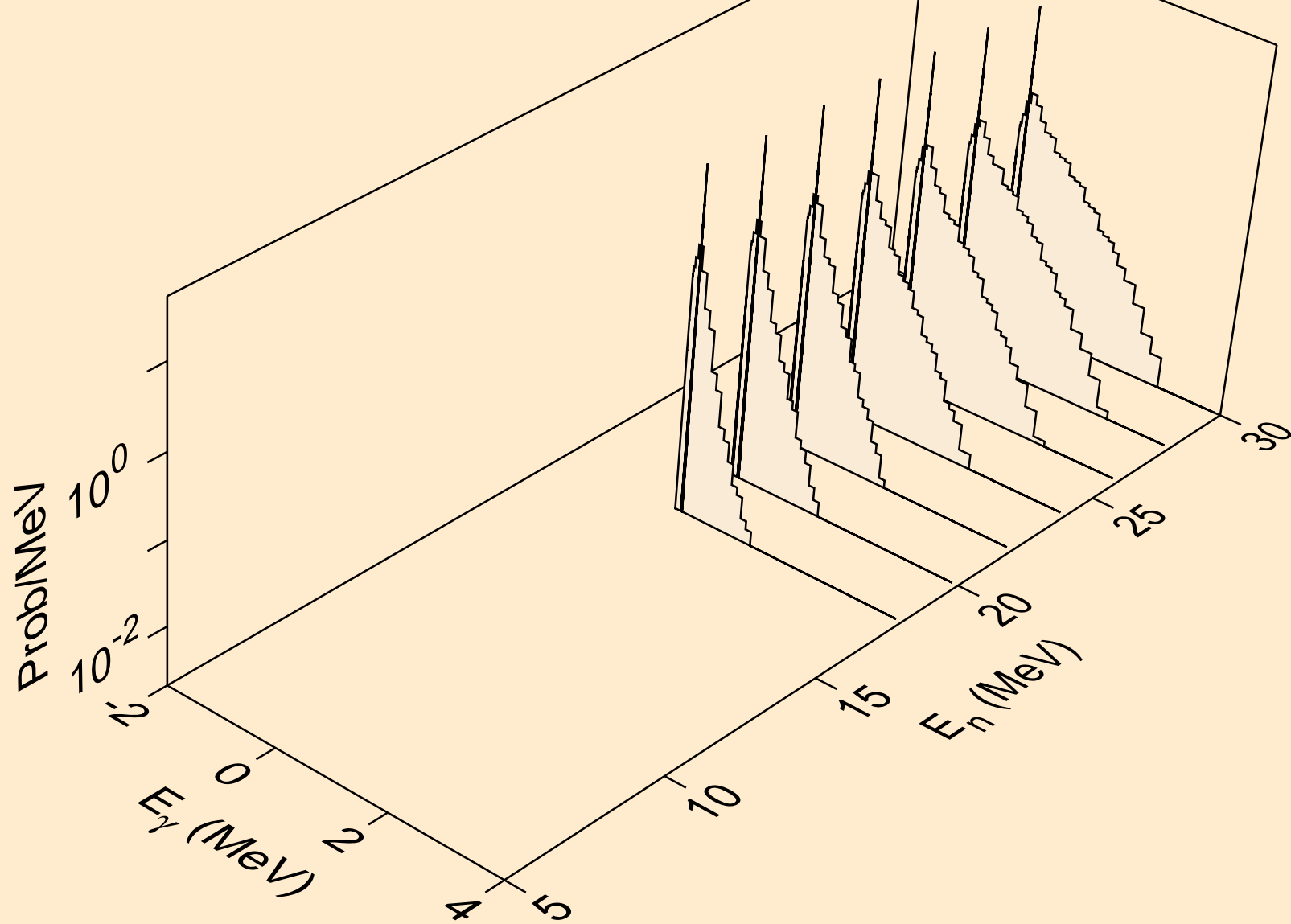

HS271 NEUTRON ACER TENDL-2024 LIBRARY; T=0.K
Photon emission for (n,n*c)

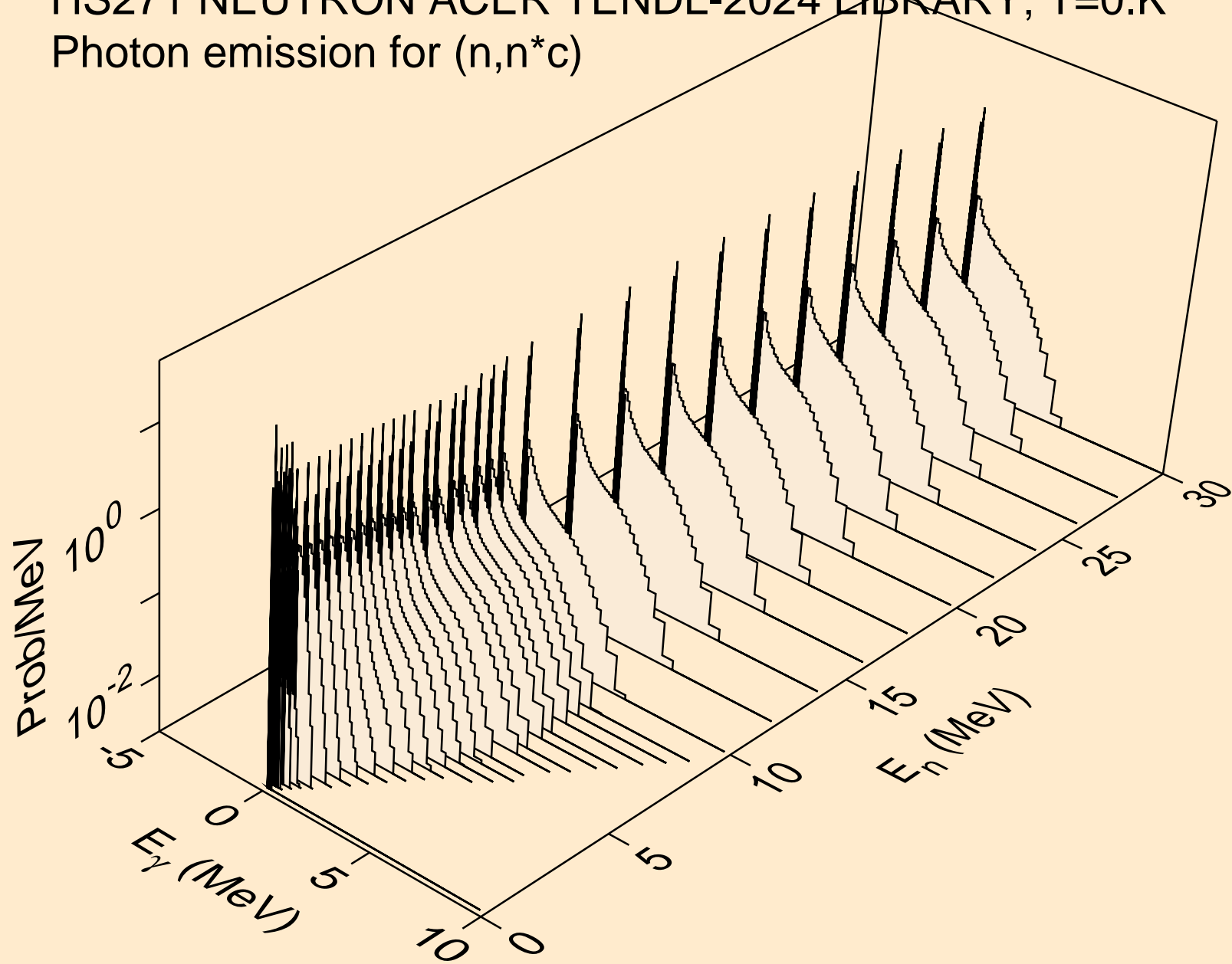

HS271 NEUTRON ACER TENDL-2024 LIBRARY; T=0.K
Photon emission for (n,gma)

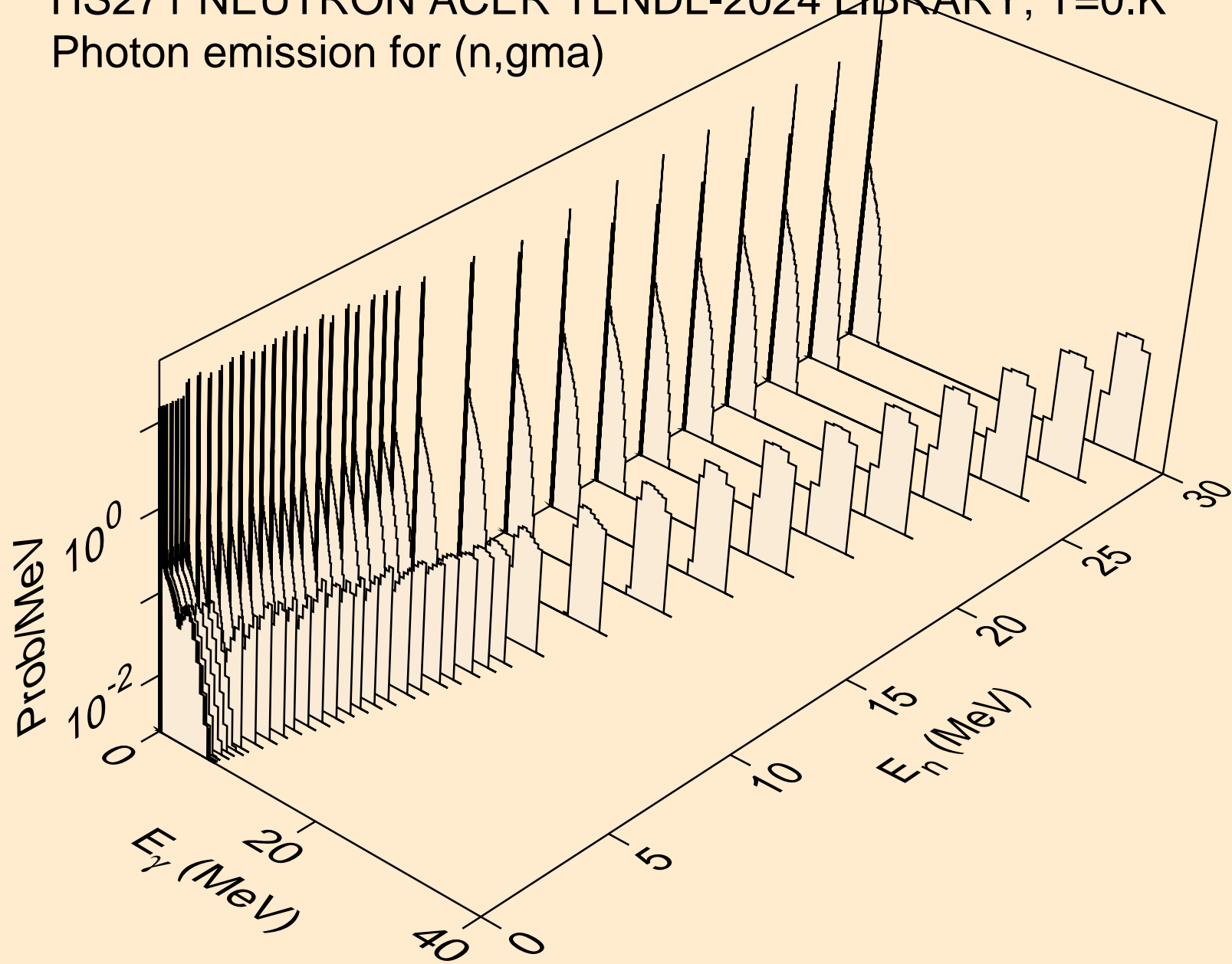

HS271 NEUTRON ACER TENDL-2024 LIBRARY; T=0.K
Photon emission for (n,p)

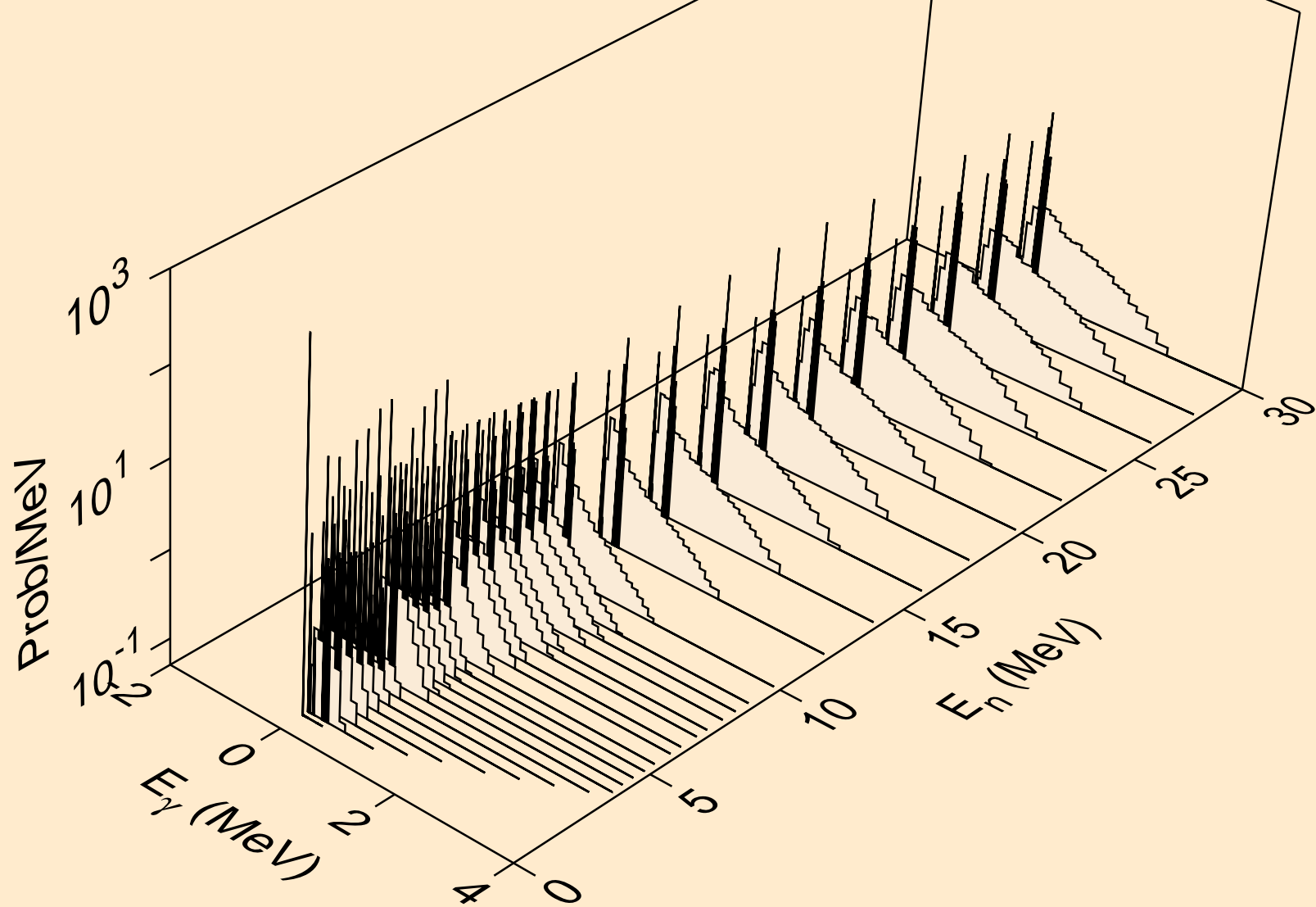

HS271 NEUTRON ACER TENDL-2024 LIBRARY; T=0.K
Photon emission for (n,d)

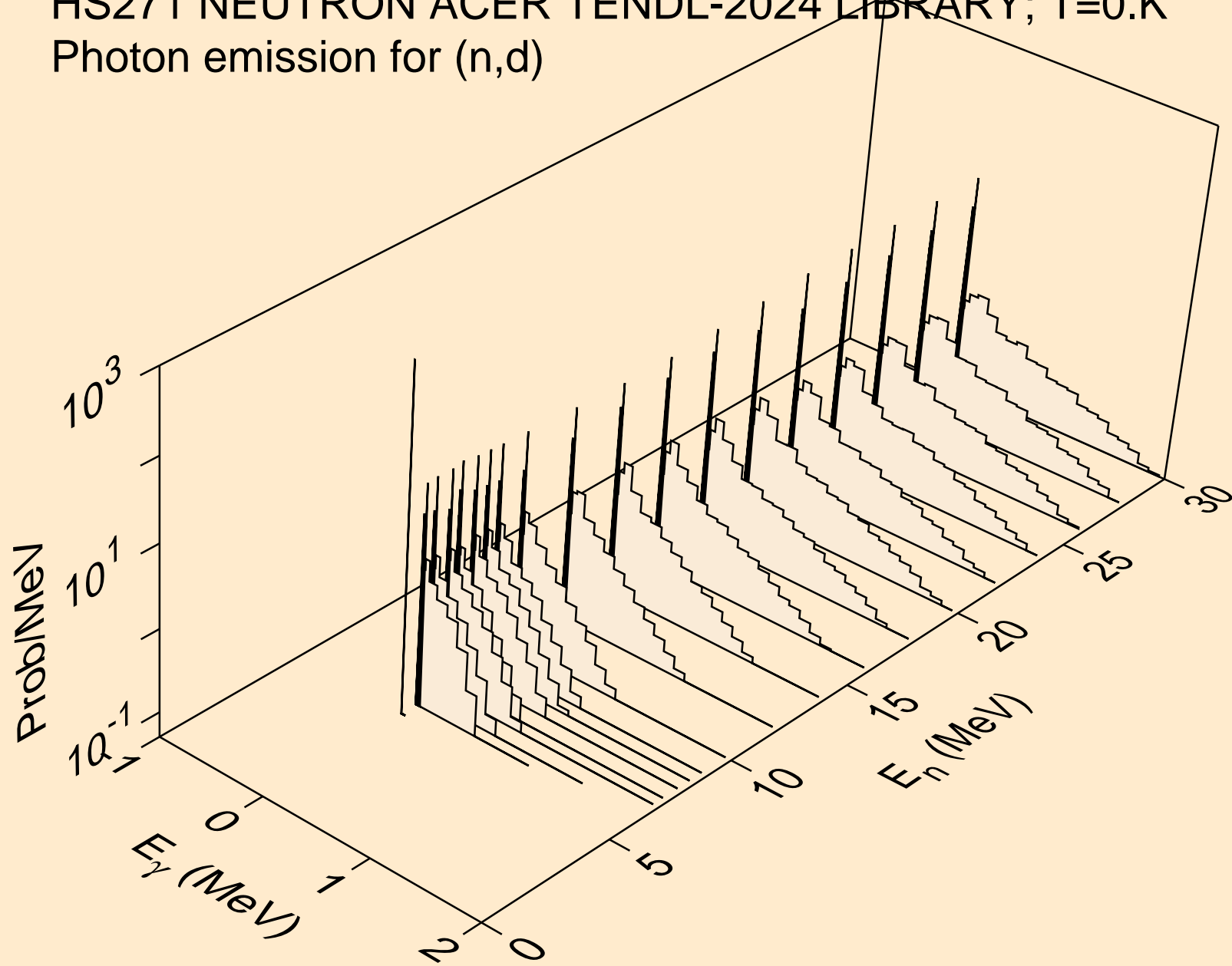

HS271 NEUTRON ACER TENDL-2024 LIBRARY; T=0.K
Photon emission for (n,t)

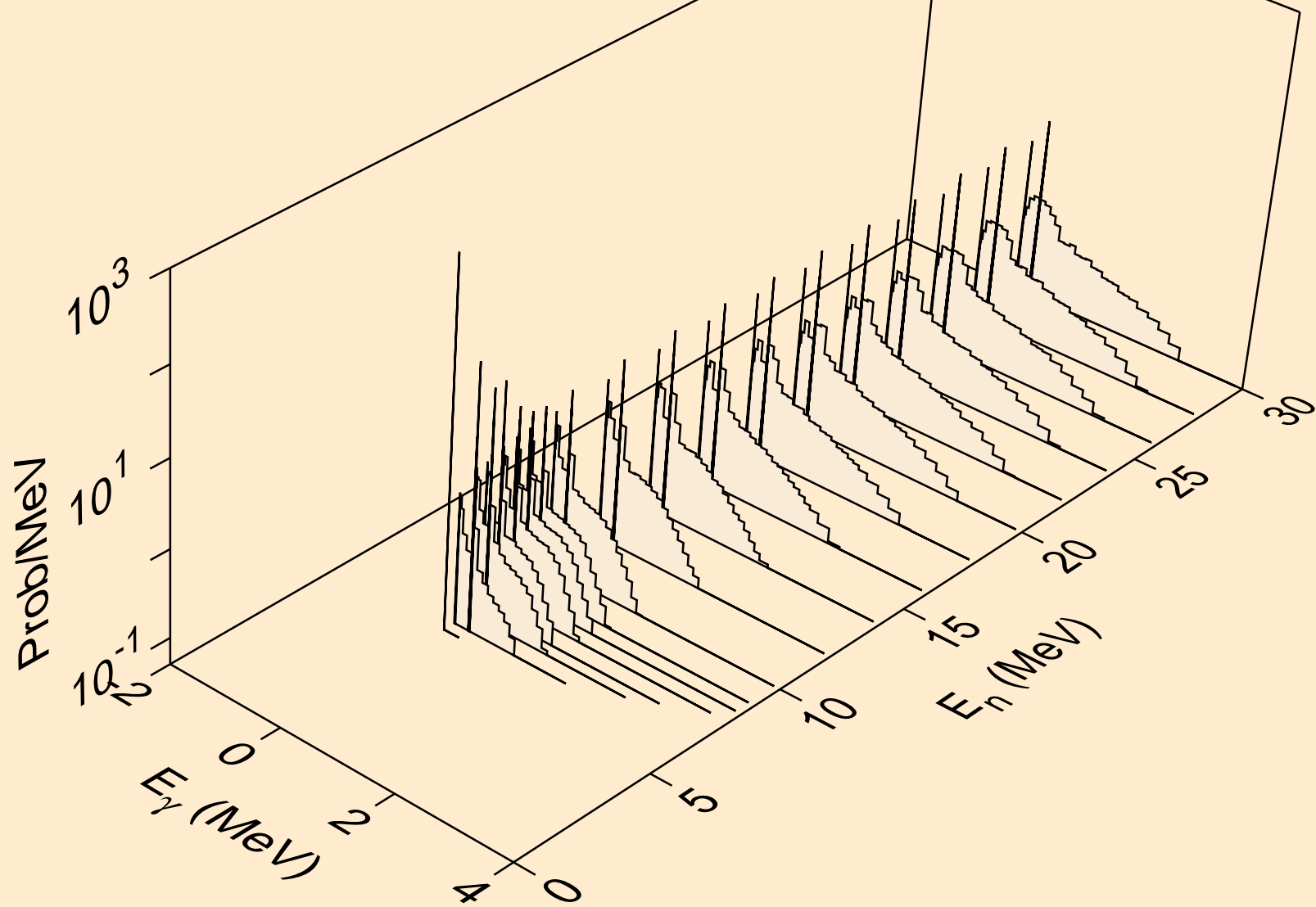

HS271 NEUTRON ACER TENDL-2024 LIBRARY; T=0.K
Photon emission for (n,he3)

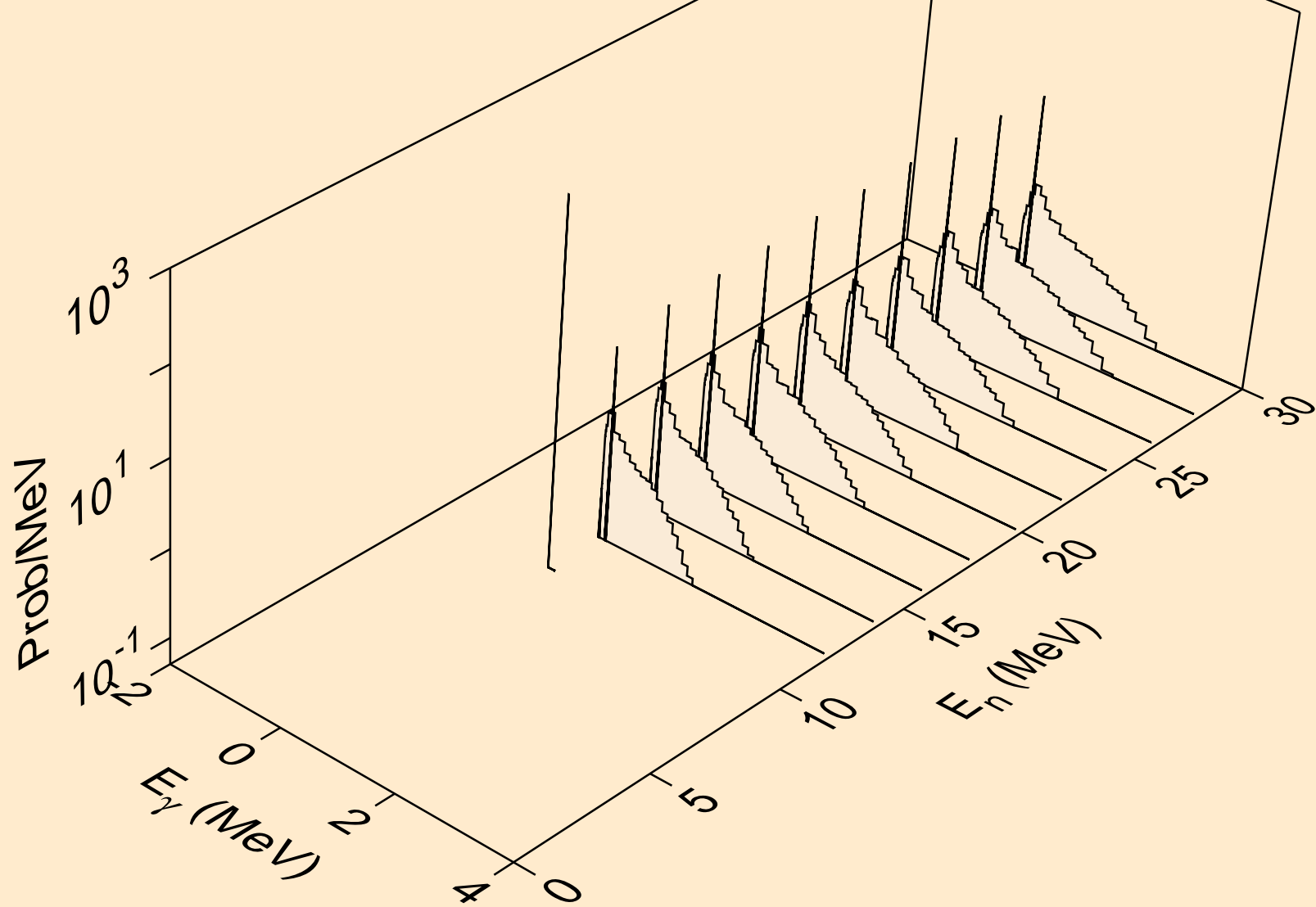

HS271 NEUTRON ACER TENDL-2024 LIBRARY; T=0.K
Photon emission for (n,a)

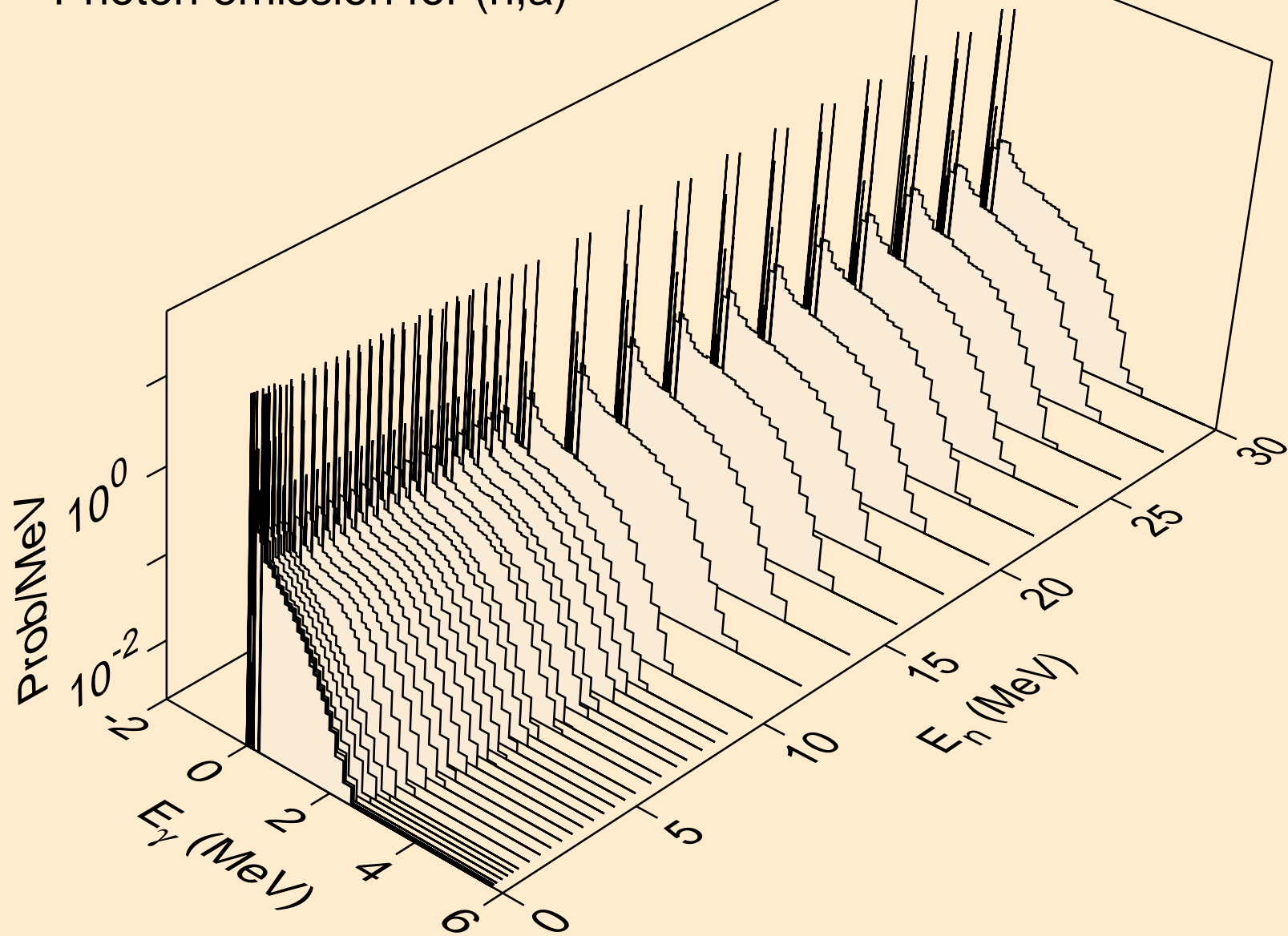

HS271 NEUTRON ACER TENDL-2024 LIBRARY; T=0.K
Photon emission for (n,2p)

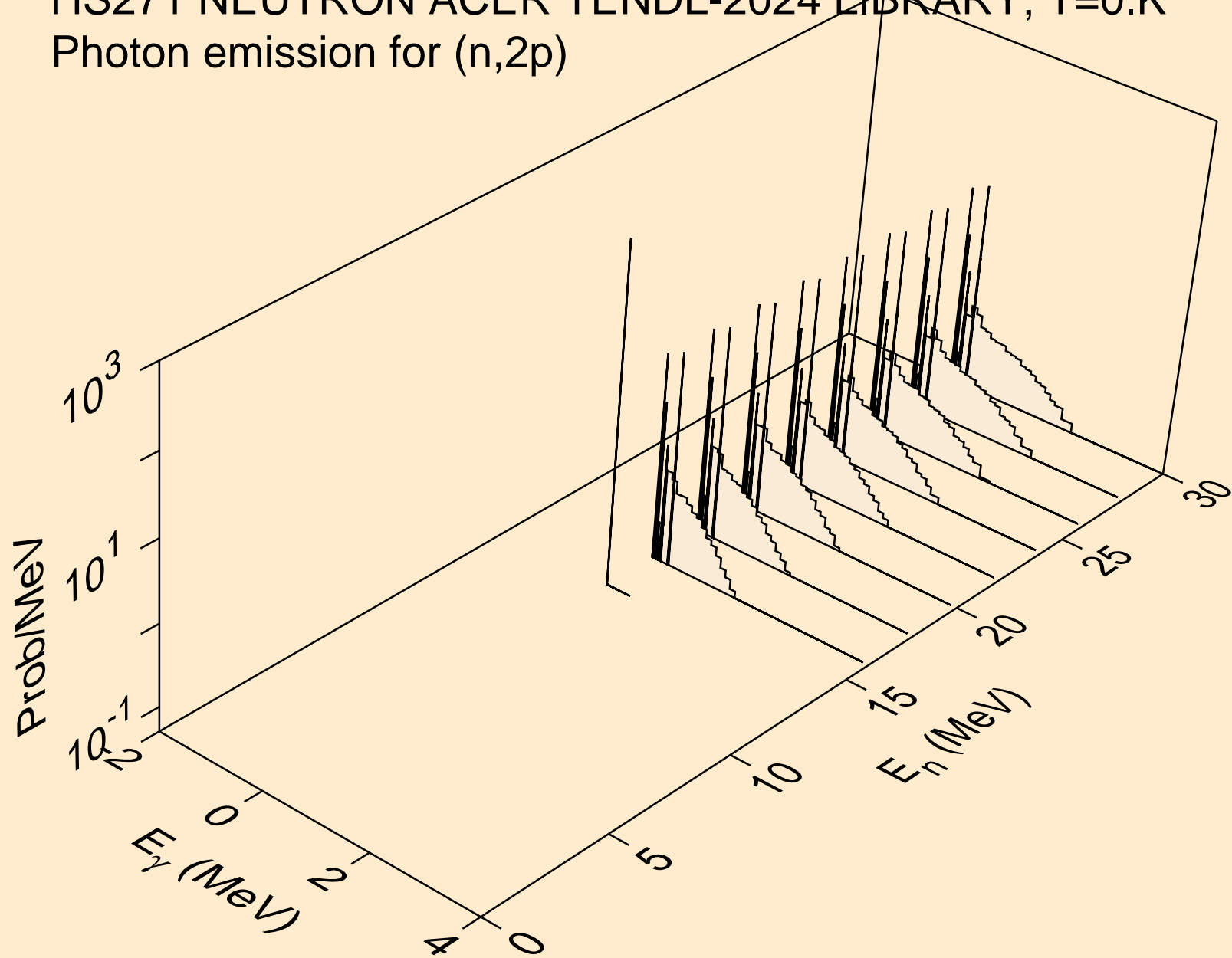

HS271 NEUTRON ACER TENDL-2024 LIBRARY; T=0.K
Photon emission for (n,p α)

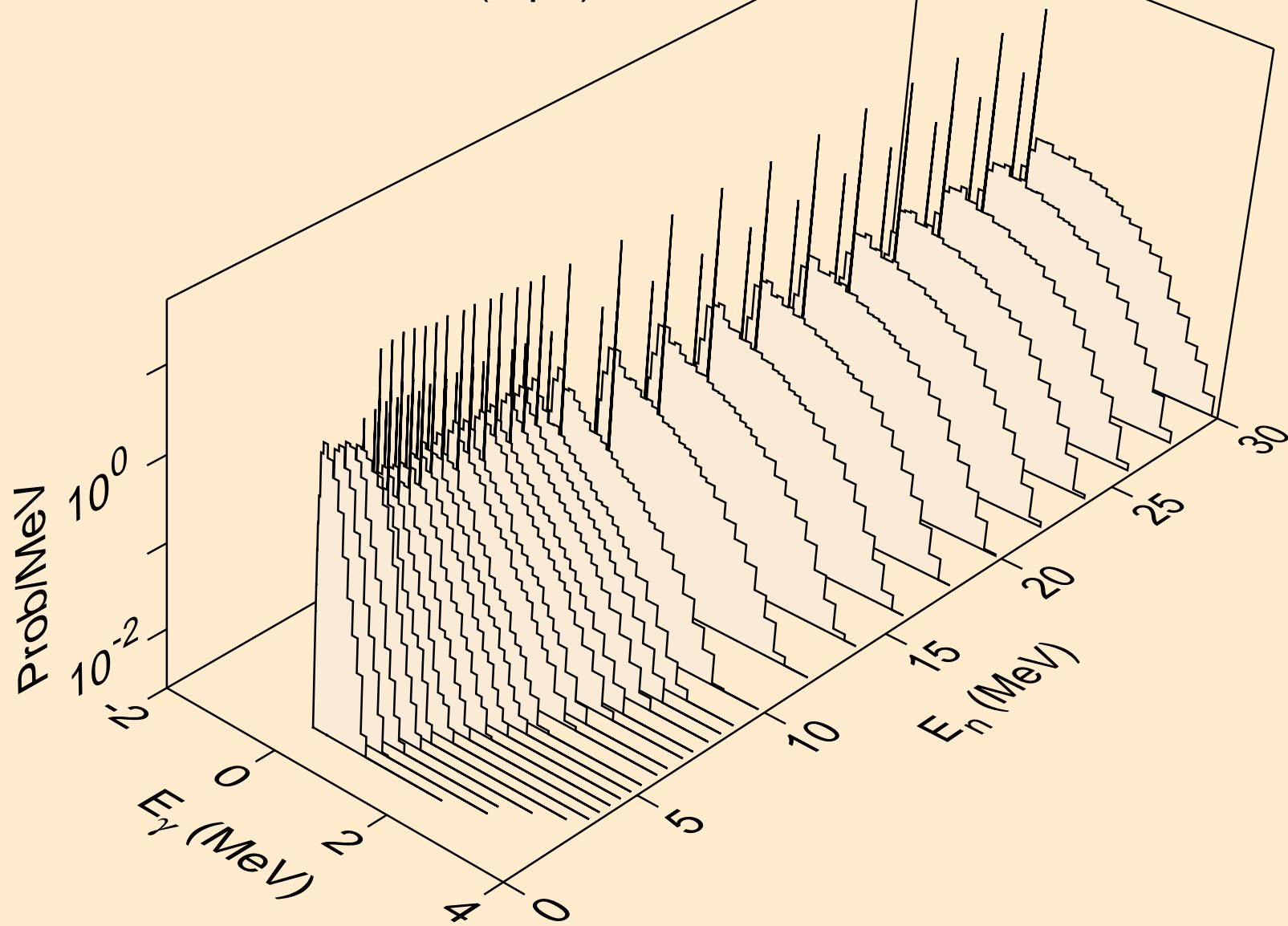

HS271 NEUTRON ACER TENDL-2024 LIBRARY; T=0.K
Photon emission for (n,pd)

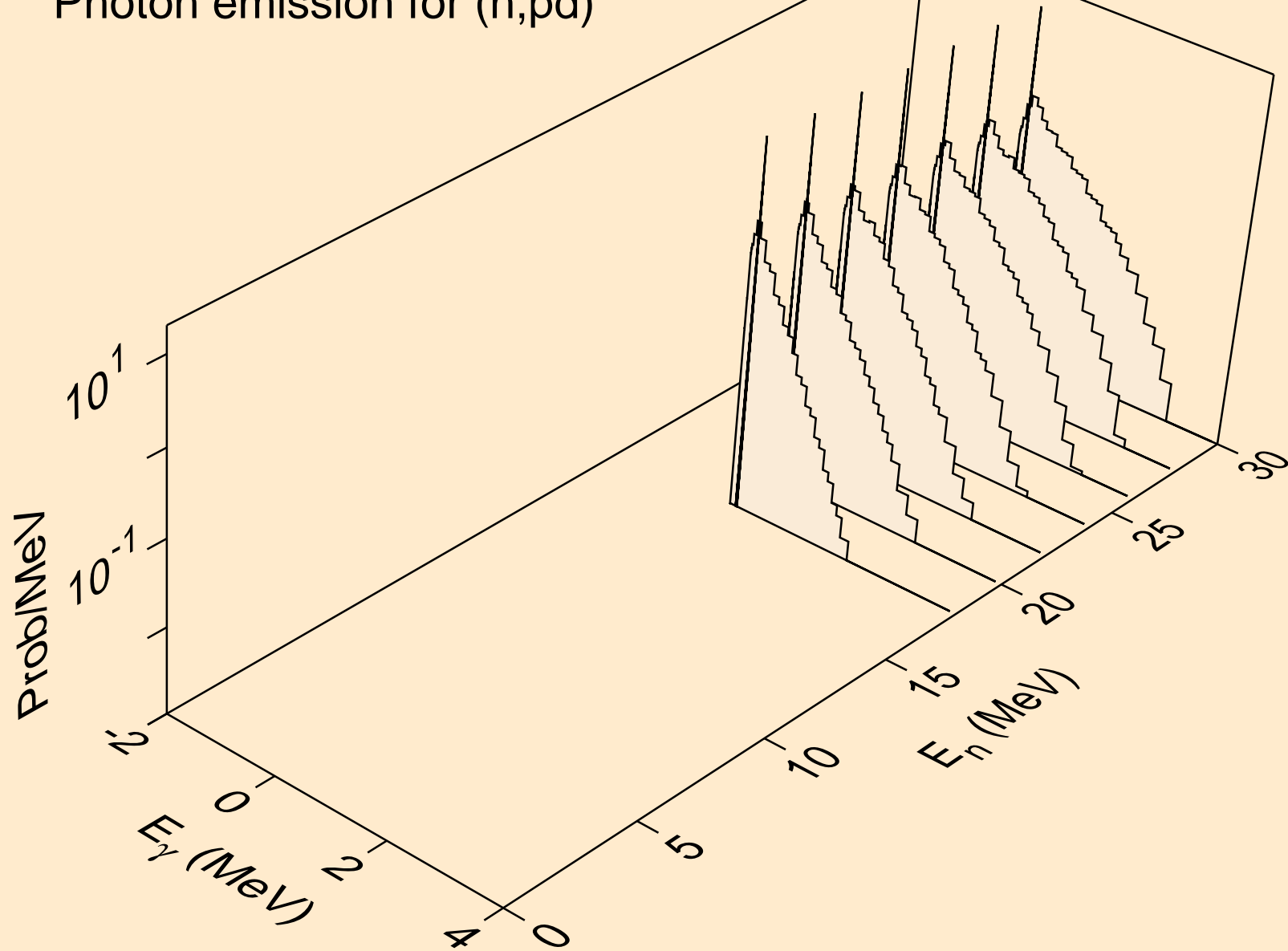

HS271 NEUTRON ACER TENDL-2024 LIBRARY; T=0.K
thermal capture photon spectrum

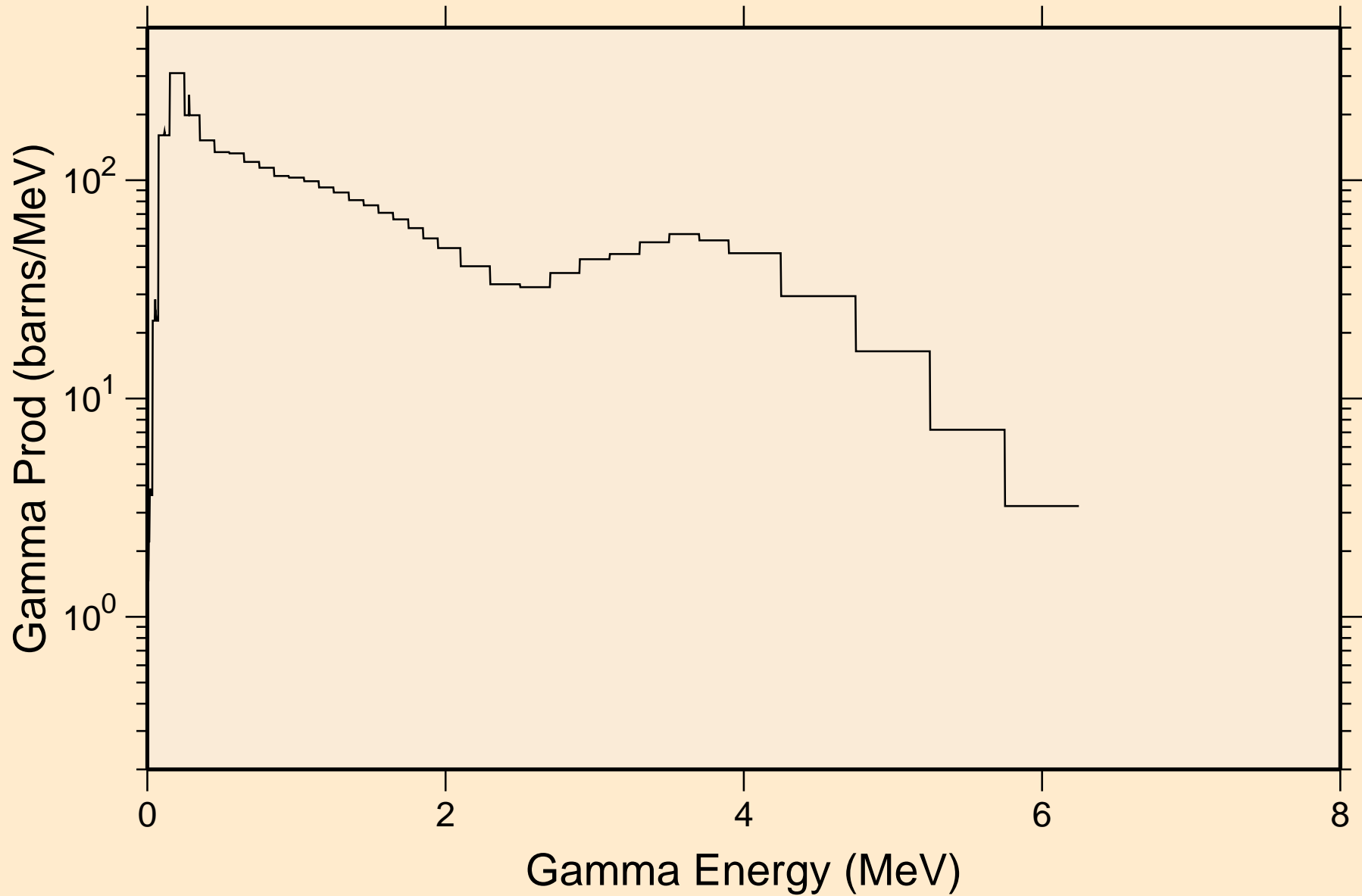

HS271 NEUTRON ACER TENDL-2024 LIBRARY; T=0.K
14 MeV photon spectrum

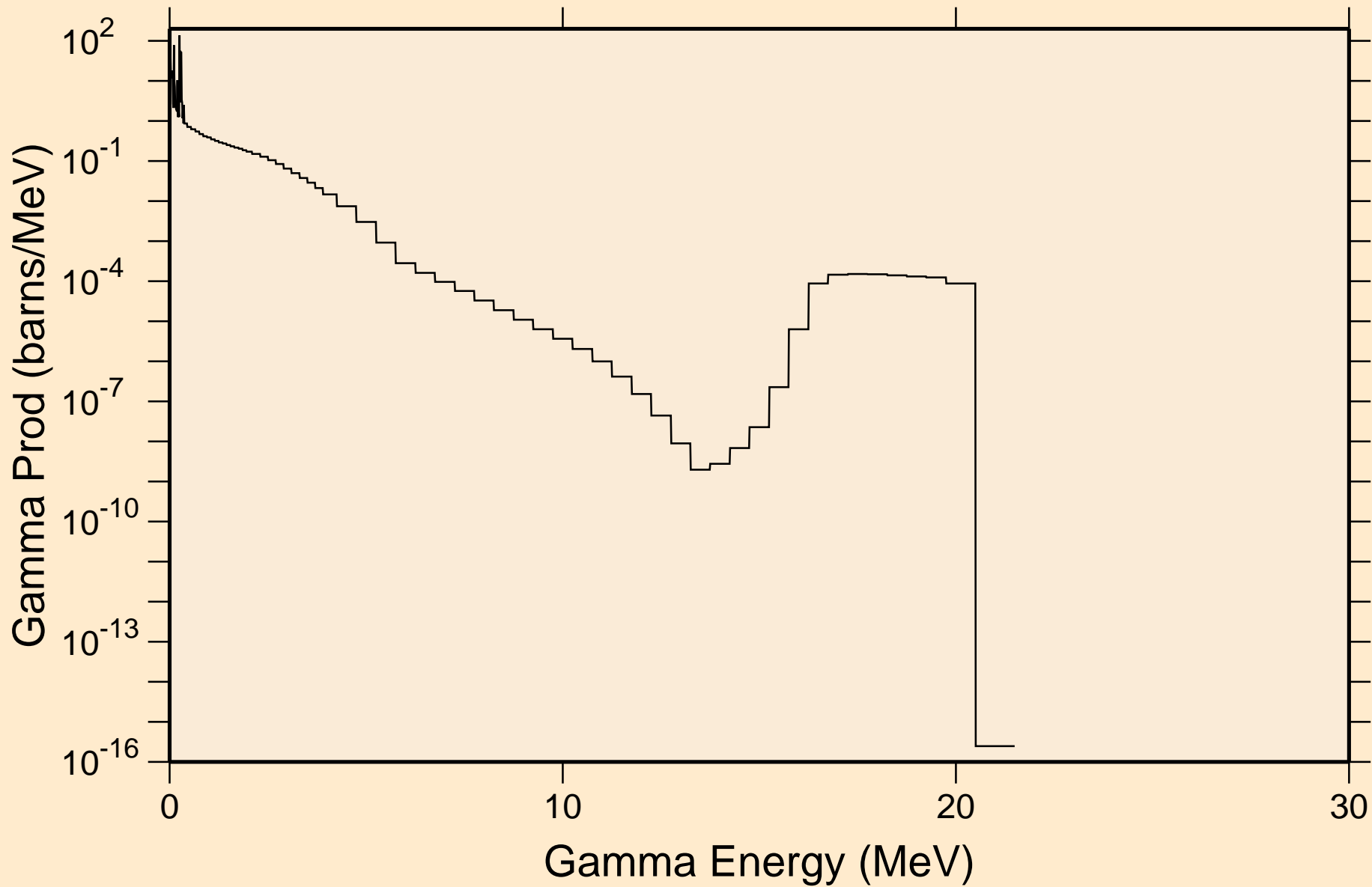

HS271 NEUTRON ACER TENDL-2024 LIBRARY; T=0.K

Particle heating contributions

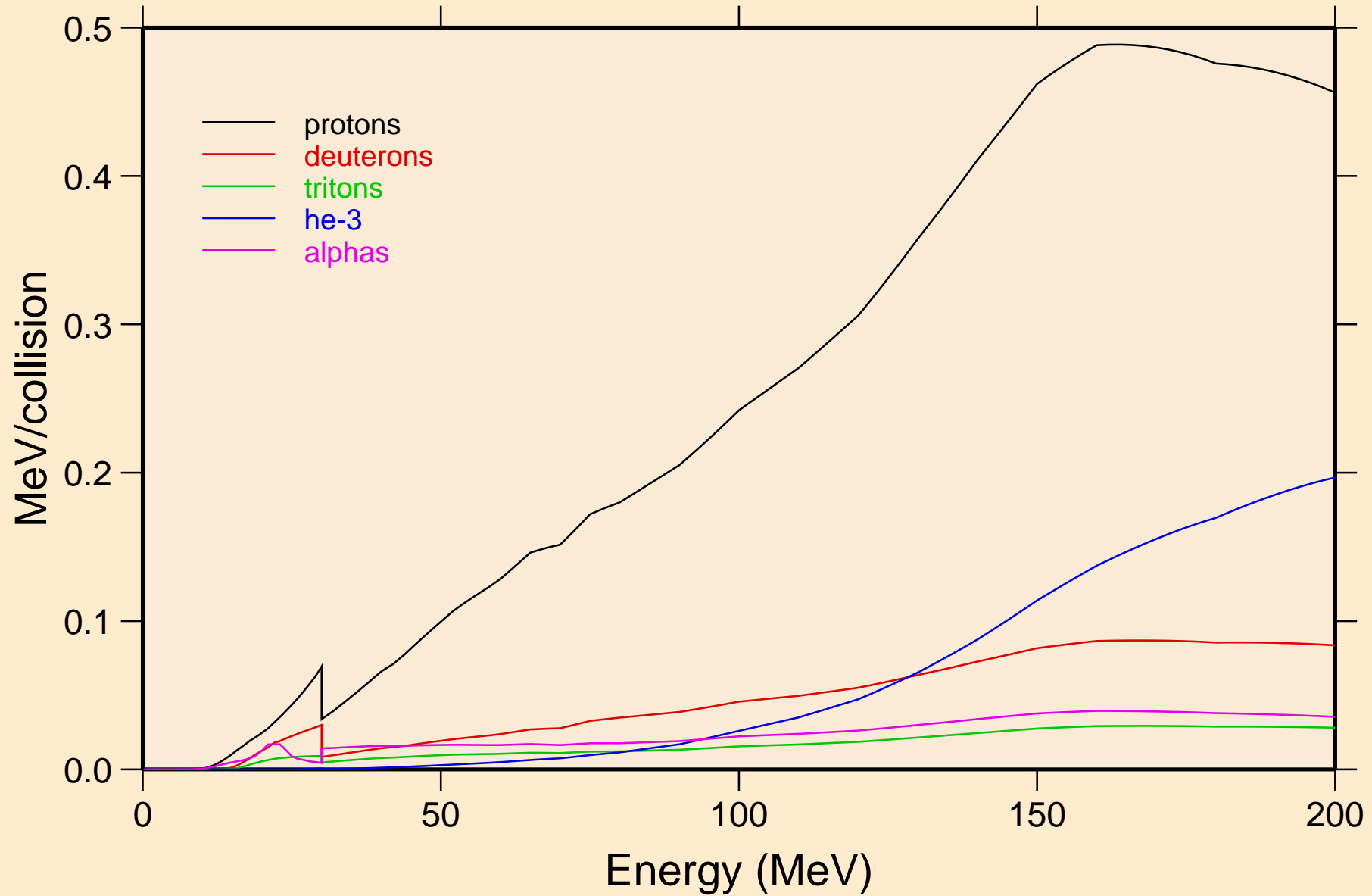

HS271 NEUTRON ACER TENDL-2024 LIBRARY; T=0.K

Recoil Heating

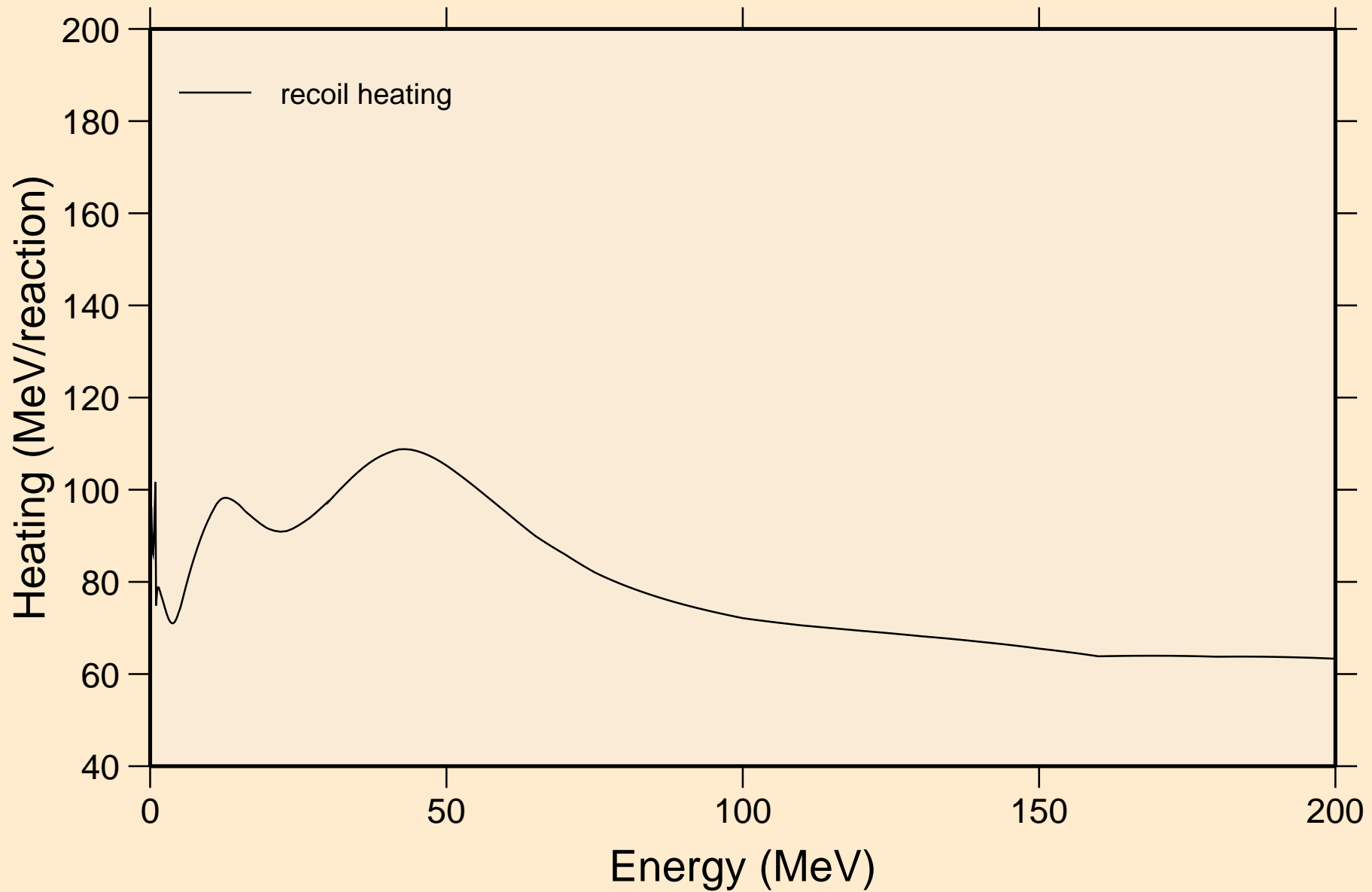

HS271 NEUTRON ACER TENDL-2024 LIBRARY; T=0.K

Particle production cross sections

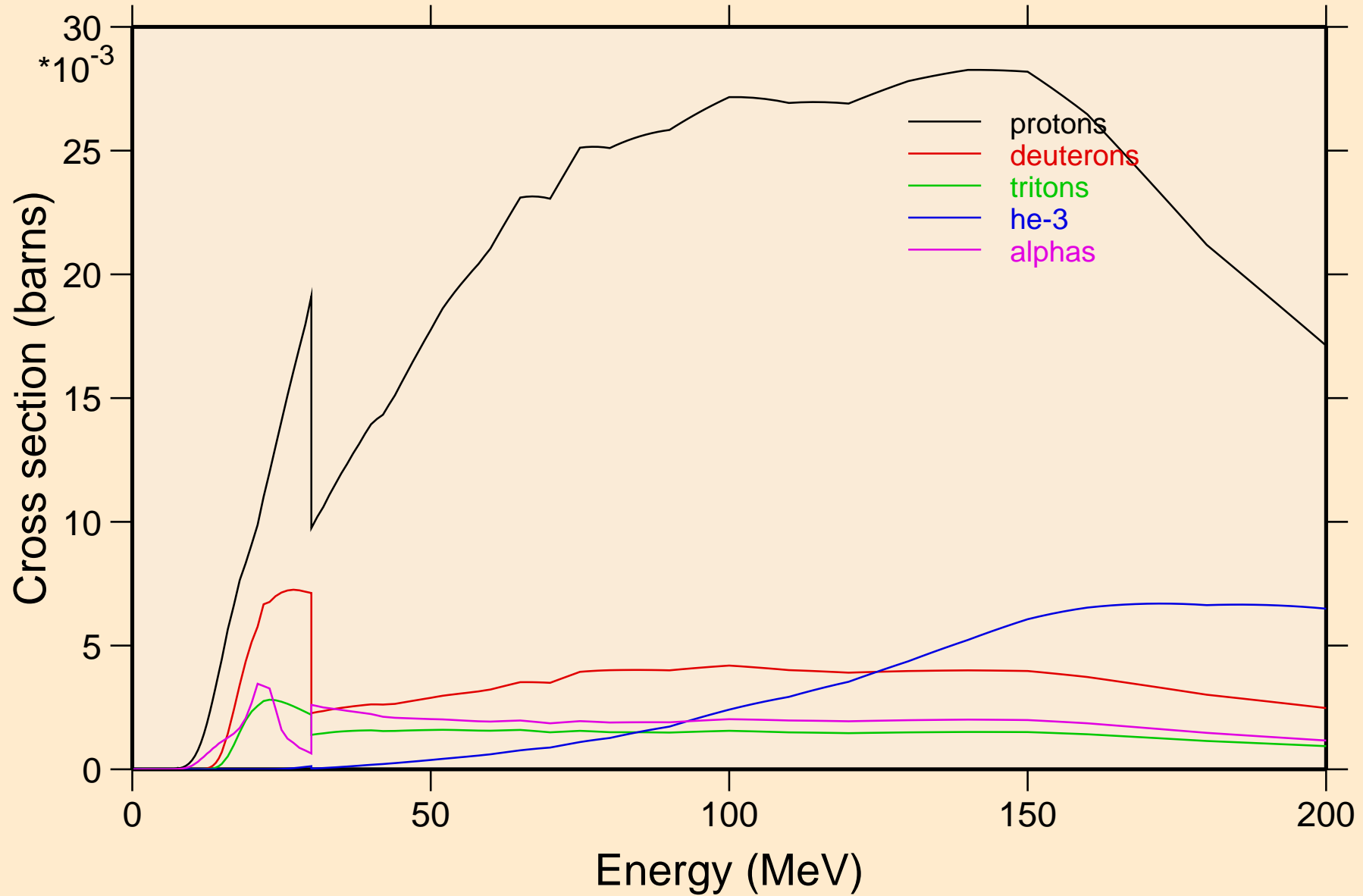

HS271 NEUTRON ACER TENDL-2024 LIBRARY; T=0.K
protons from (n,x)

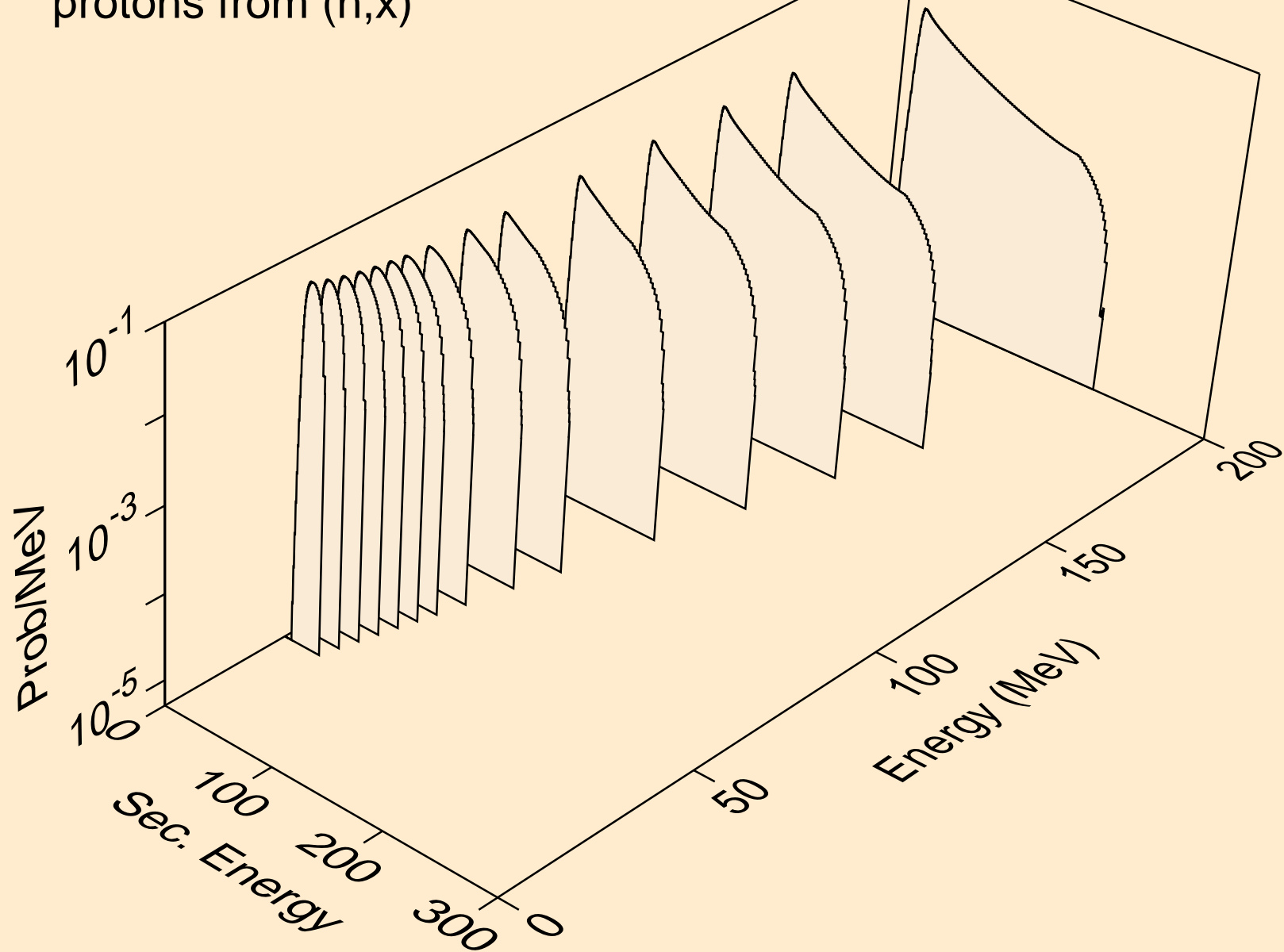

HS271 NEUTRON ACER TENDL-2024 LIBRARY; T=0.K
protons from (n,n*)p

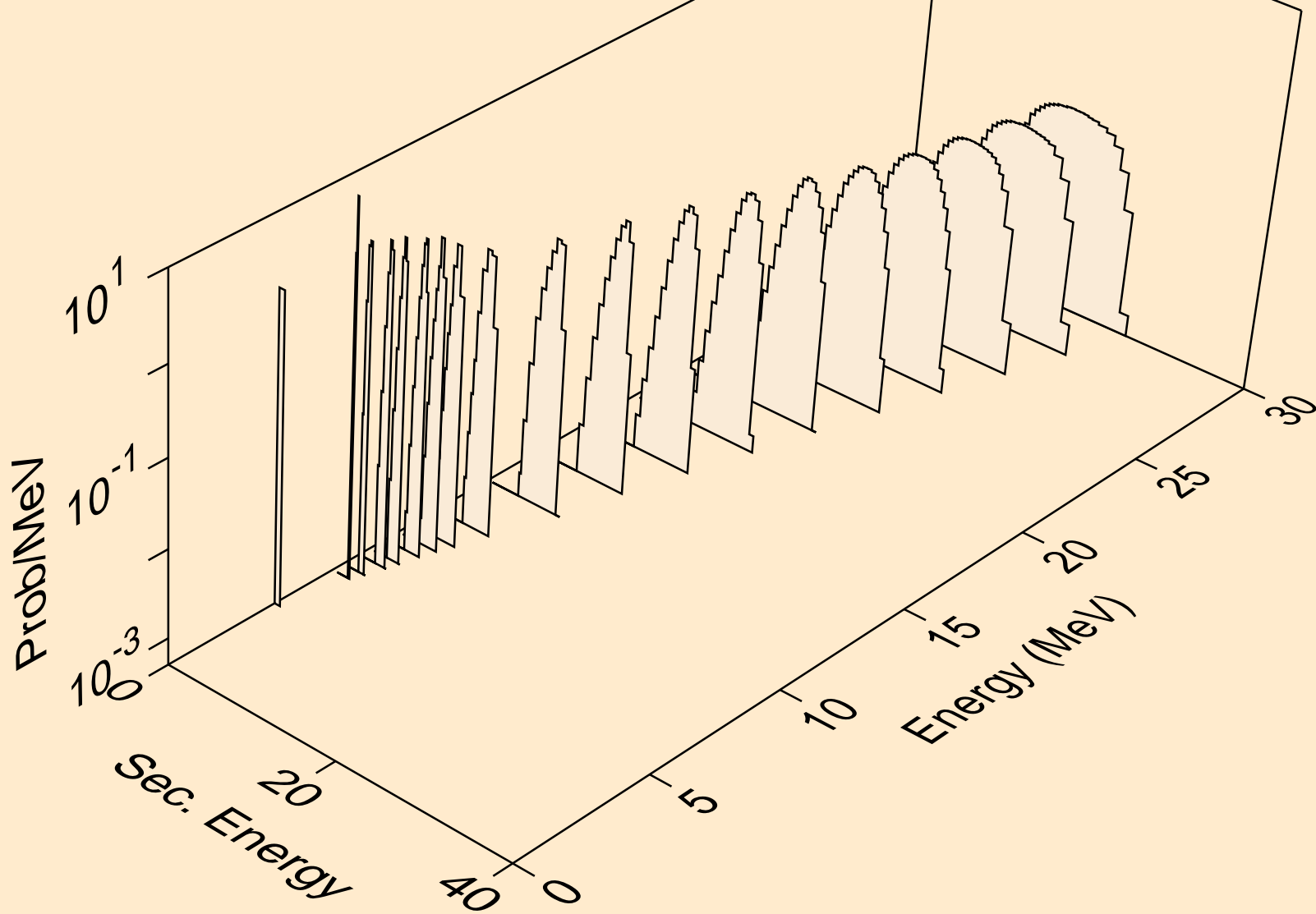

HS271 NEUTRON ACER TENDL-2024 LIBRARY; T=0.K
protons from (n,2np)

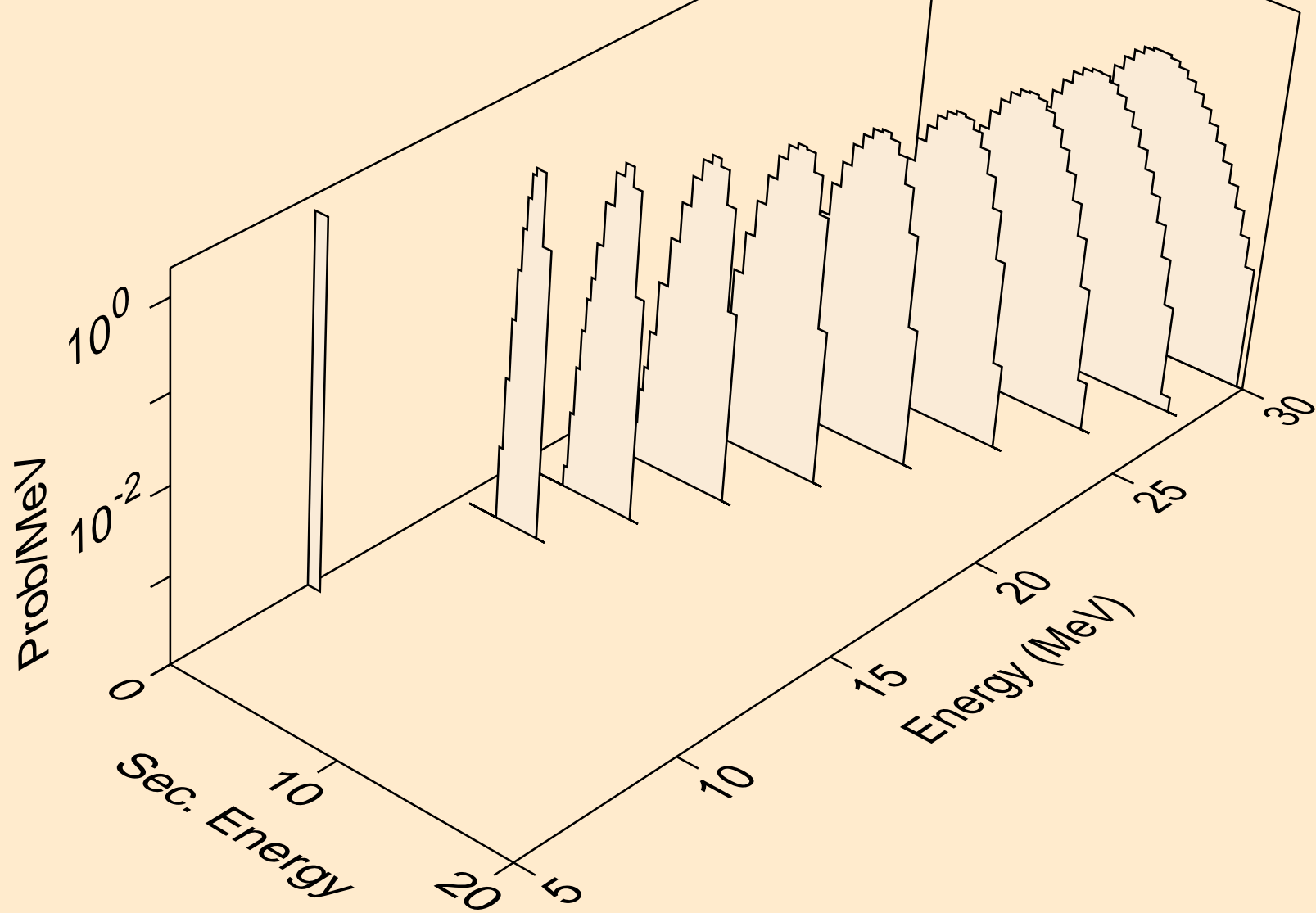

HS271 NEUTRON ACER TENDL-2024 LIBRARY; T=0.K
protons from (n,n2p)

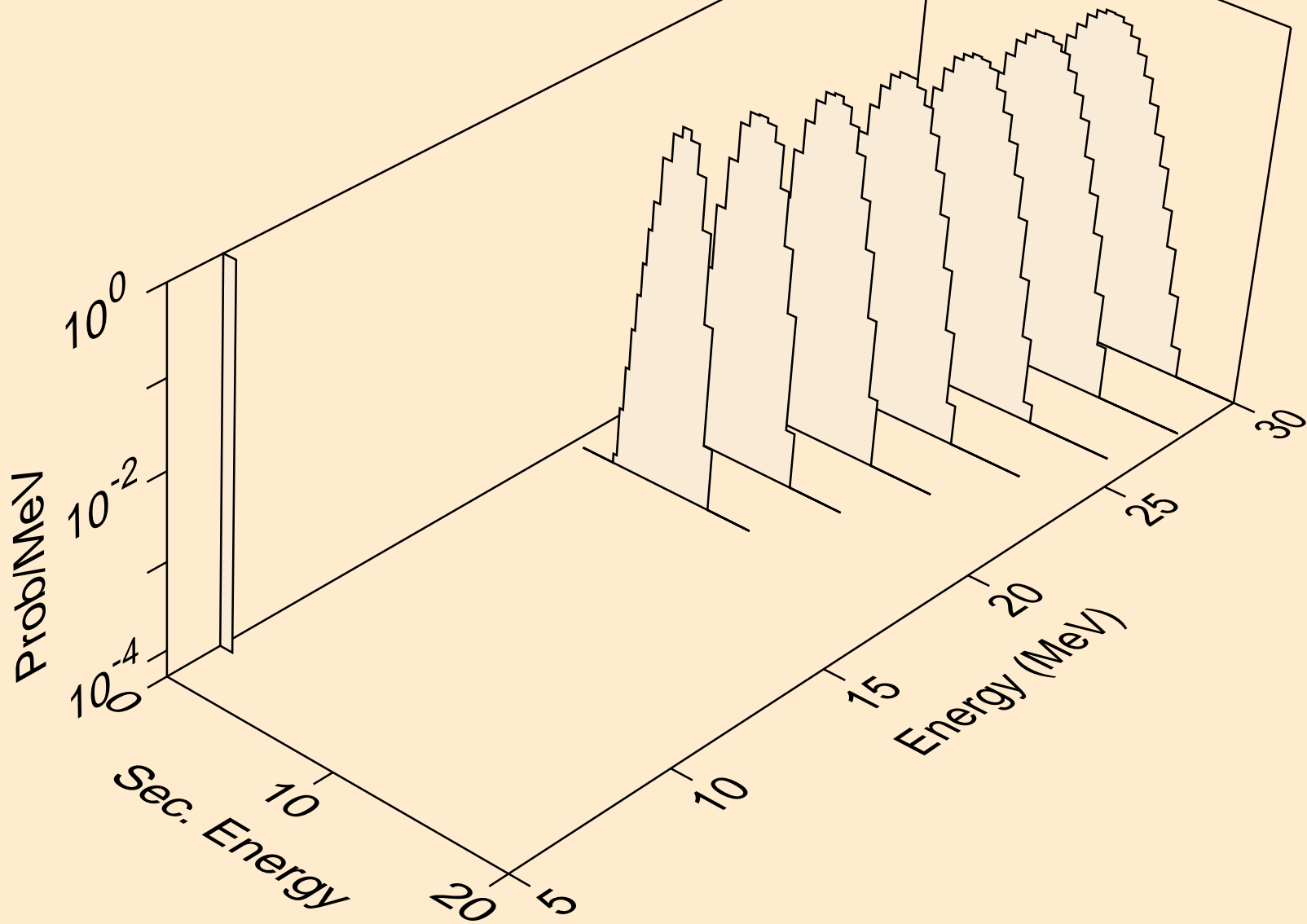

HS271 NEUTRON ACER TENDL-2024 LIBRARY; T=0.K
protons from (n,p)

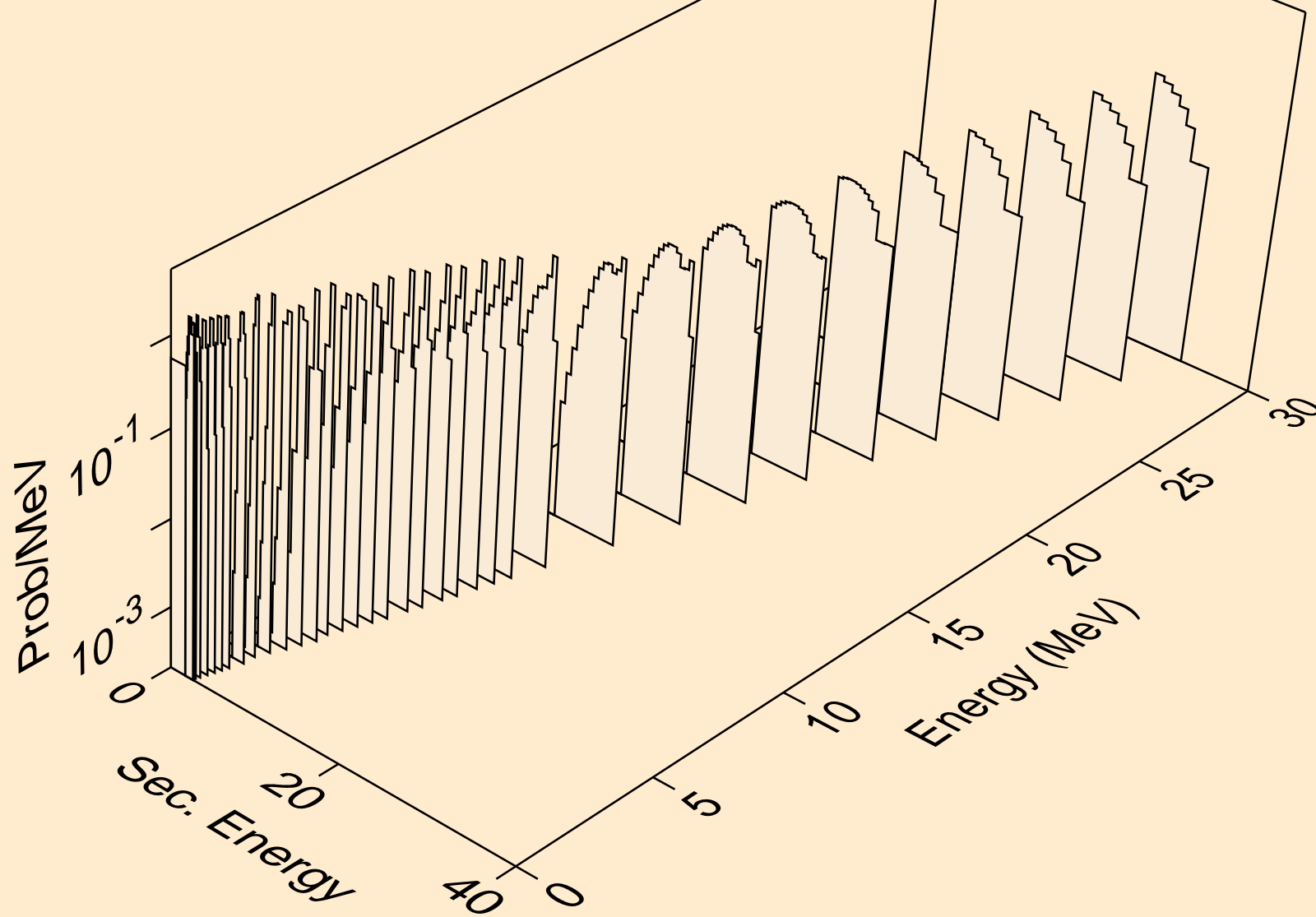

HS271 NEUTRON ACER TENDL-2024 LIBRARY; T=0.K
protons from (n,2p)

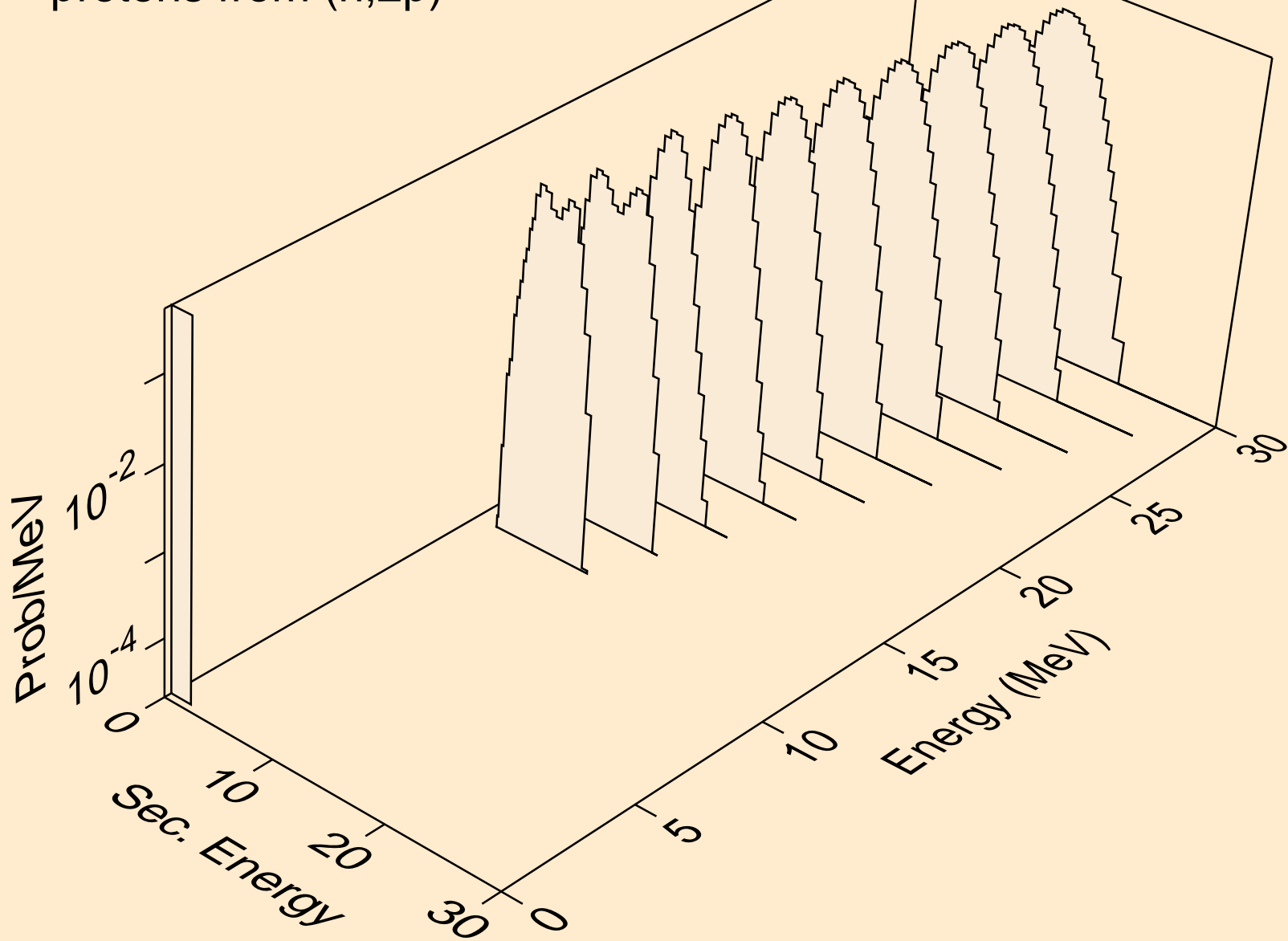

HS271 NEUTRON ACER TENDL-2024 LIBRARY; T=0.K
protons from (n,p)

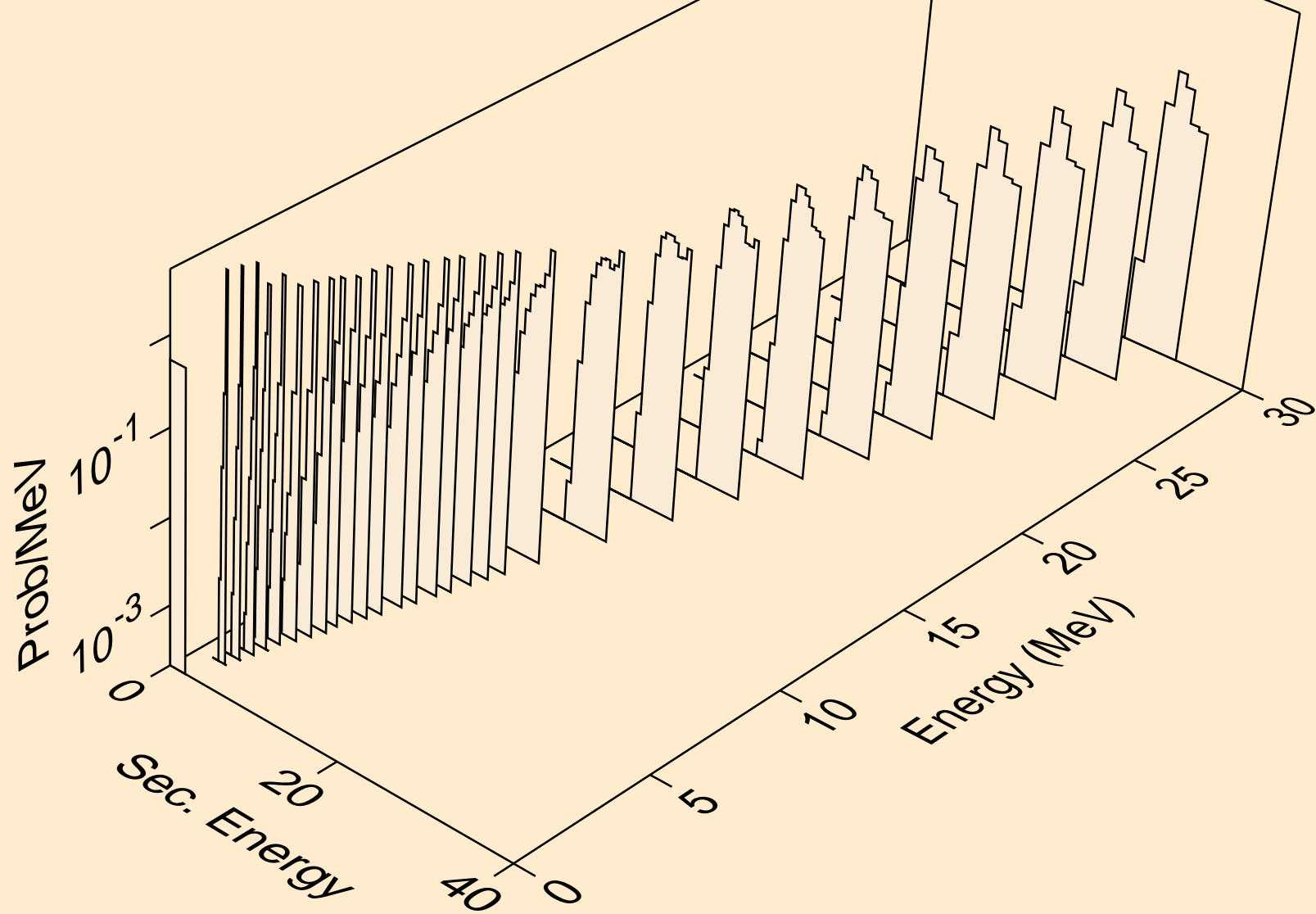

HS271 NEUTRON ACER TENDL-2024 LIBRARY; T=0.K
protons from (n,pd)

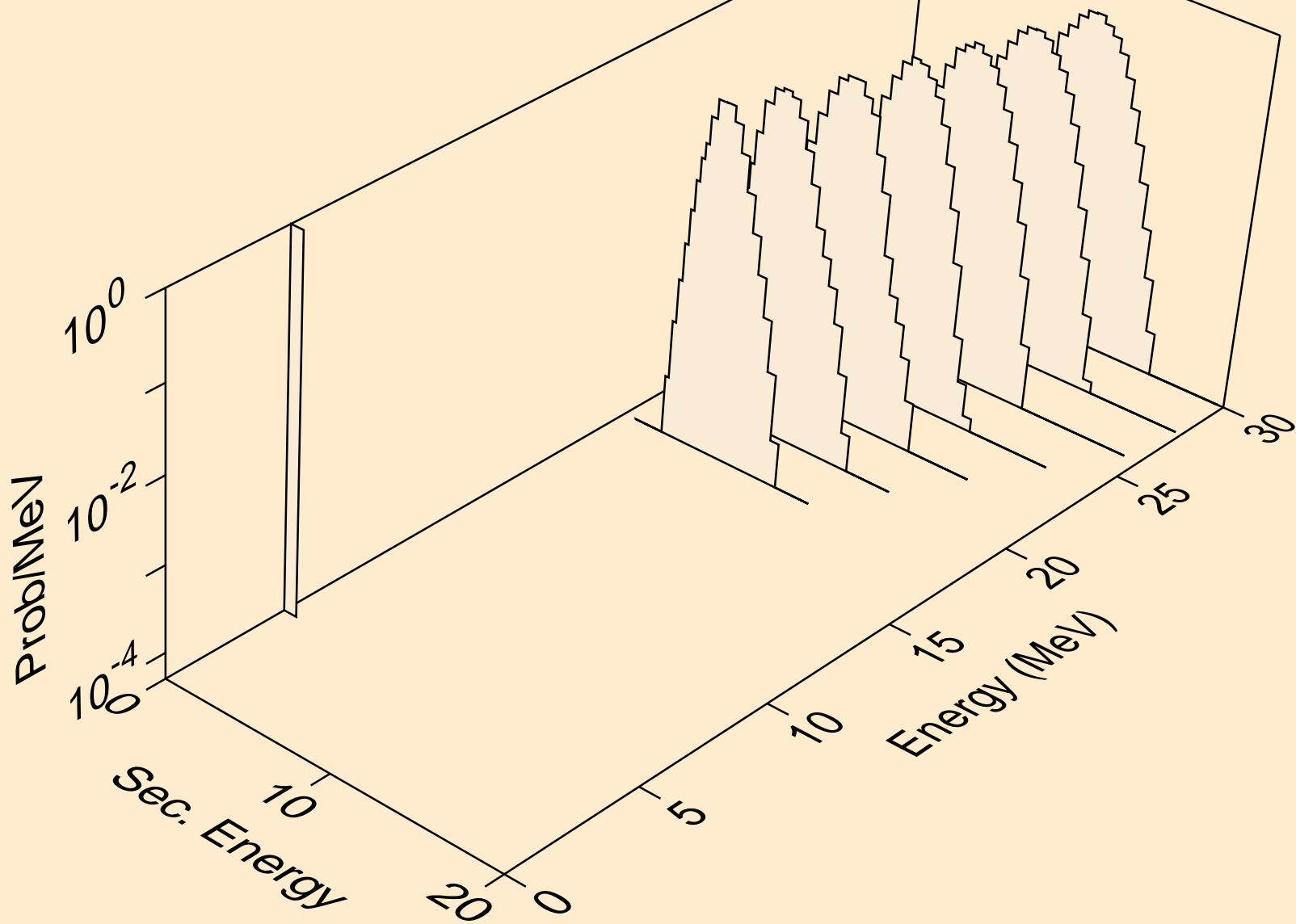

HS271 NEUTRON ACER TENDL-2024 LIBRARY; T=0.K
deuterons from (n,x)

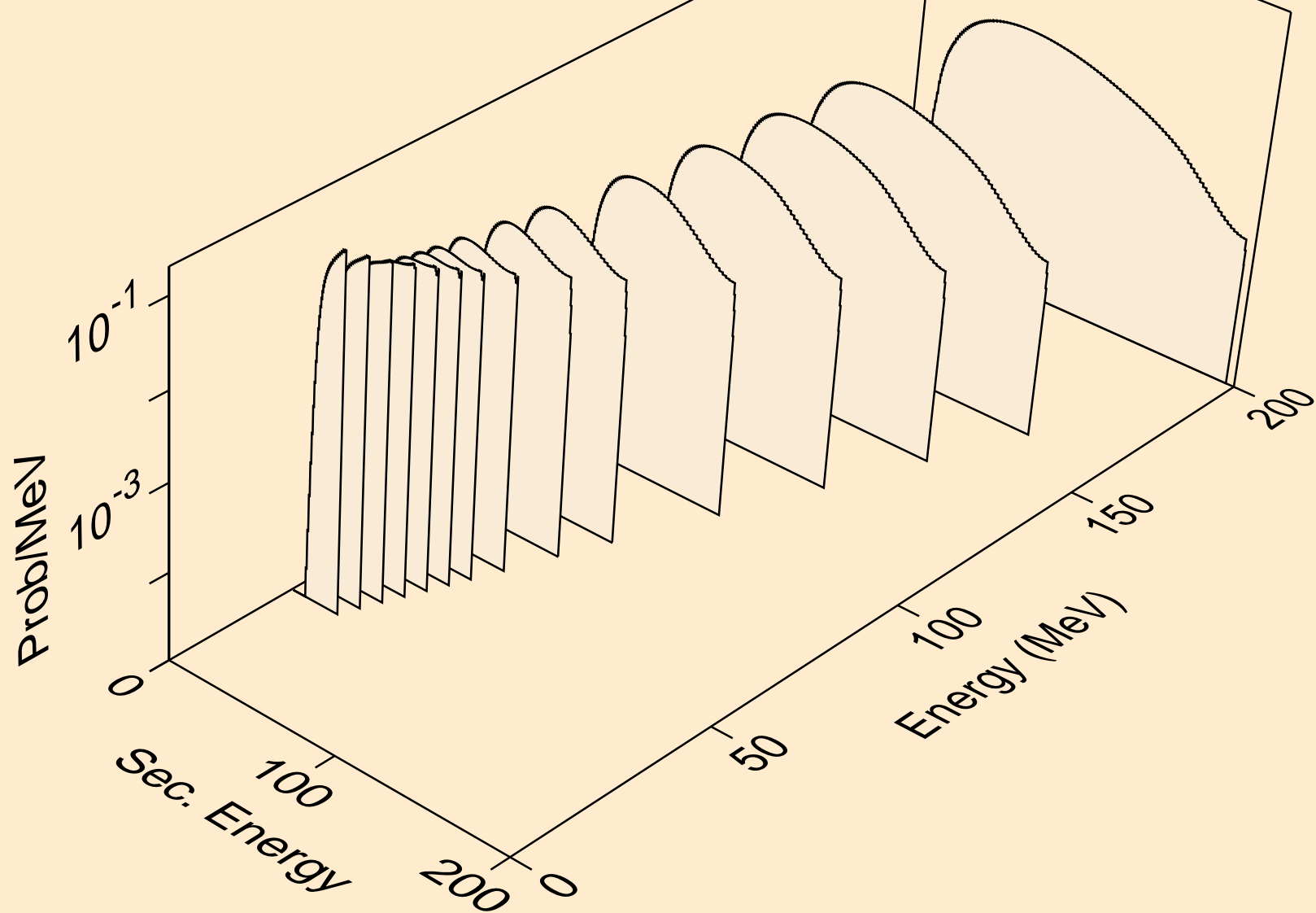

HS271 NEUTRON ACER TENDL-2024 LIBRARY; T=0.K
deuterons from (n,n*)d

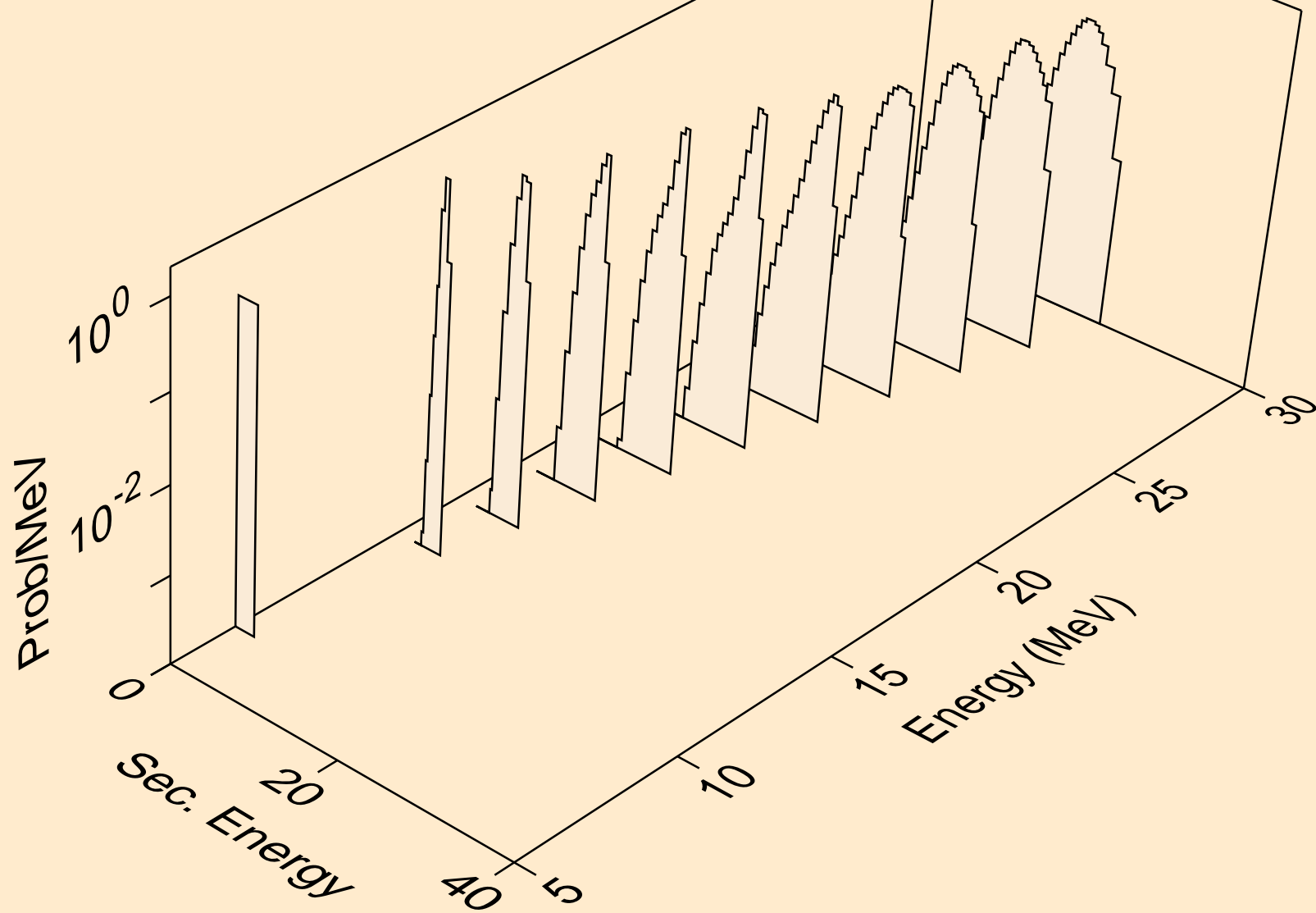

HS271 NEUTRON ACER TENDL-2024 LIBRARY; T=0.K
deuterons from (n,d)

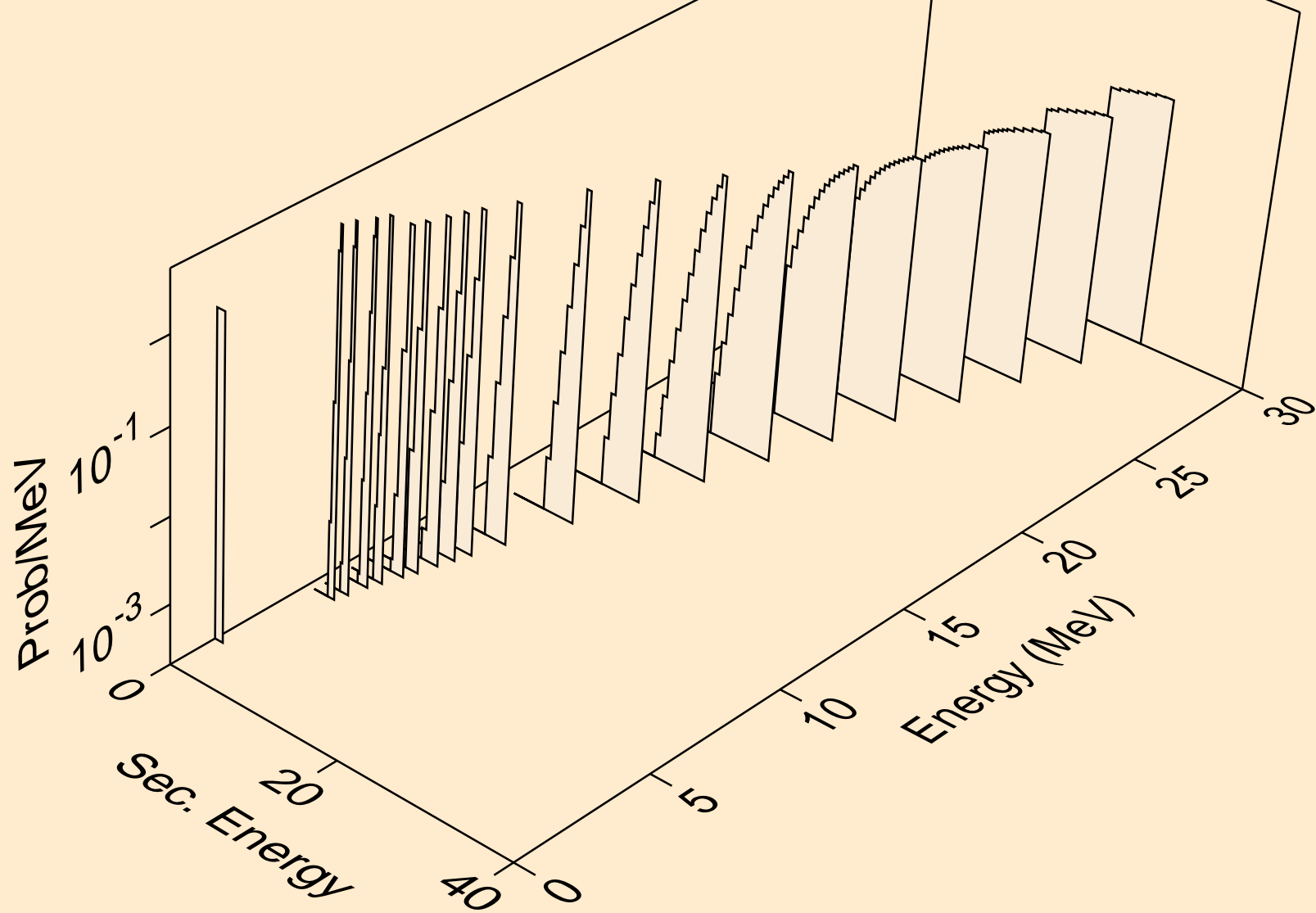

HS271 NEUTRON ACER TENDL-2024 LIBRARY; T=0.K
deuterons from (n,pd)

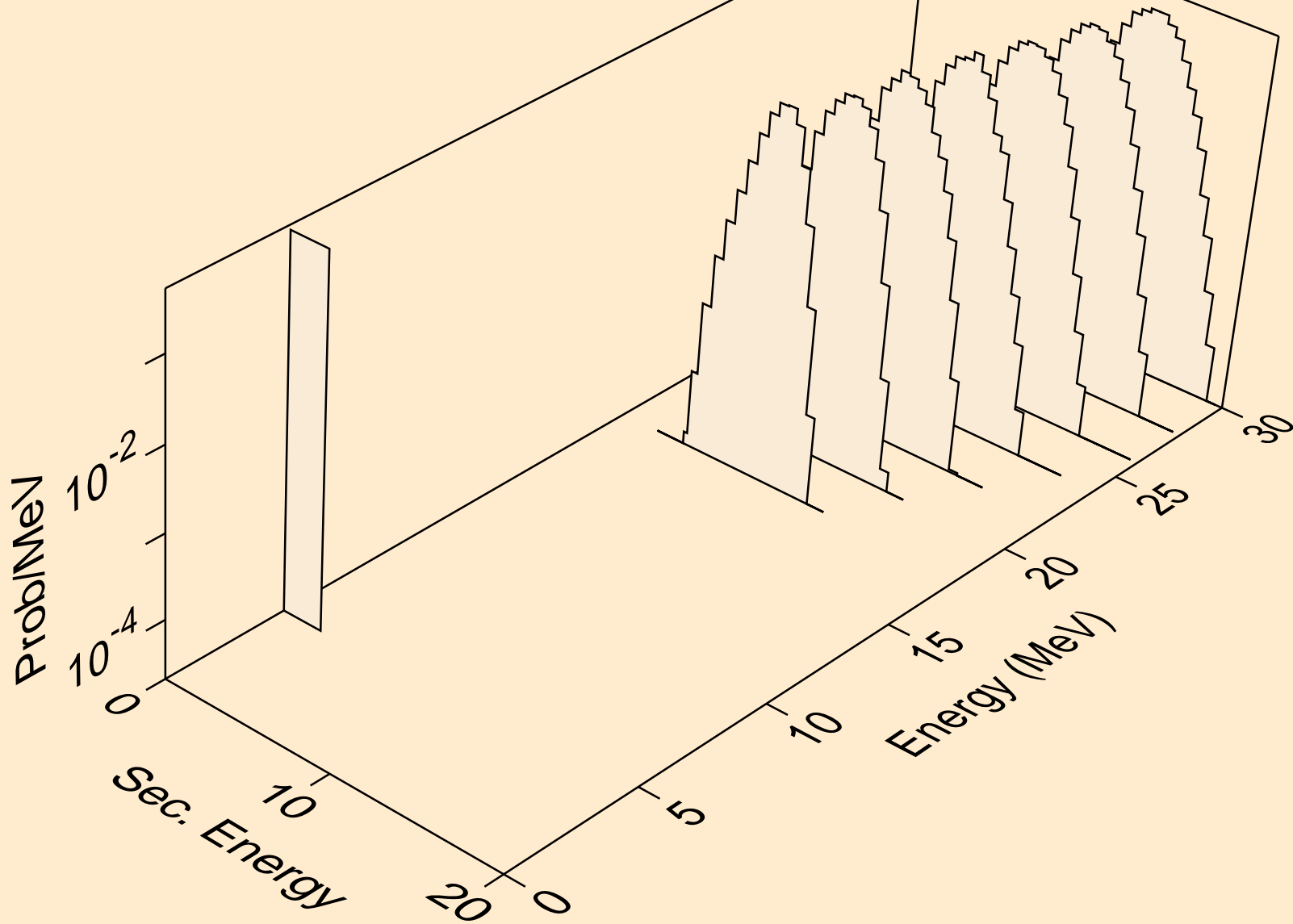

HS271 NEUTRON ACER TENDL-2024 LIBRARY; T=0.K
tritons from (n,x)

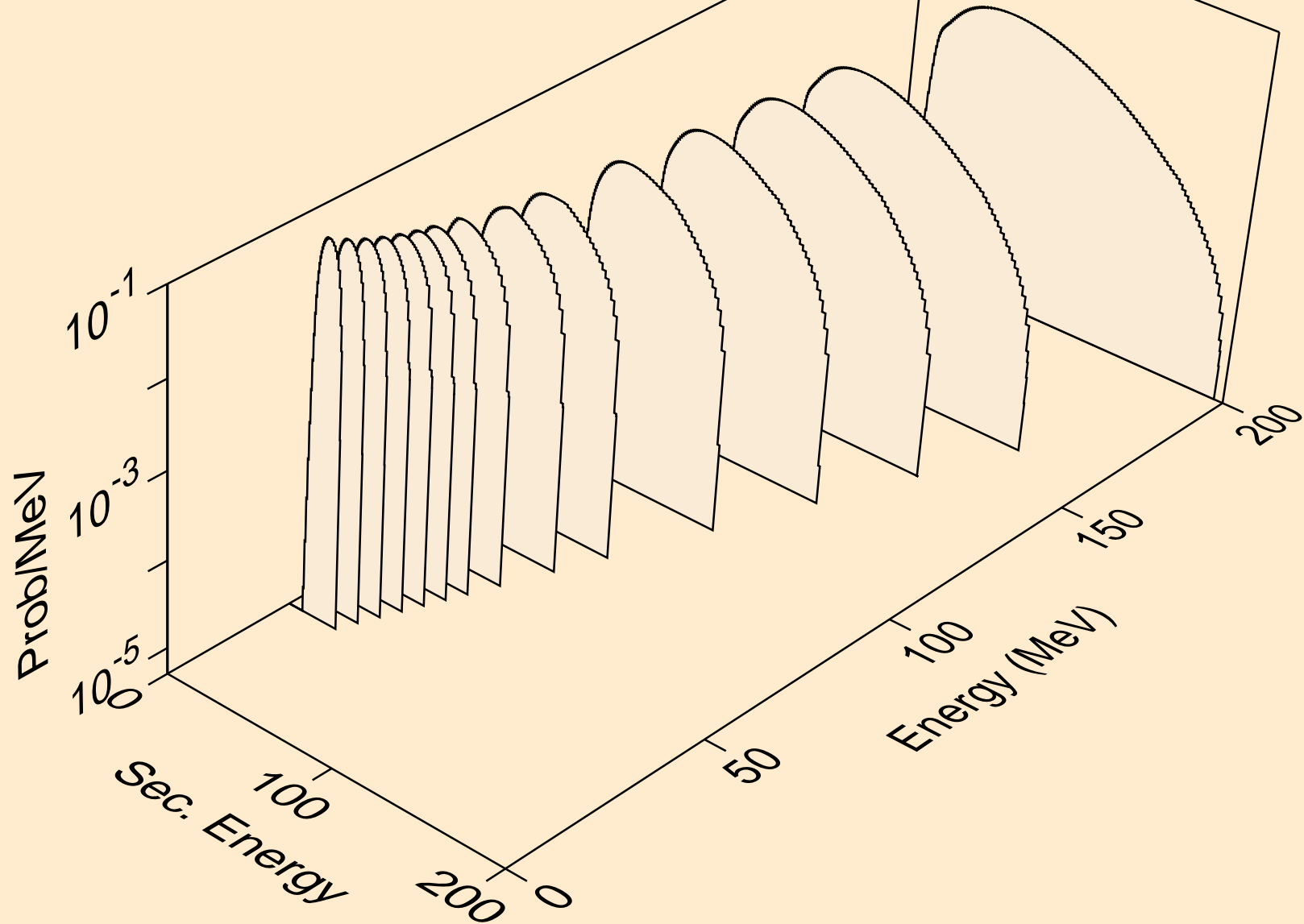

HS271 NEUTRON ACER TENDL-2024 LIBRARY; T=0.K
tritons from (n,n*)t

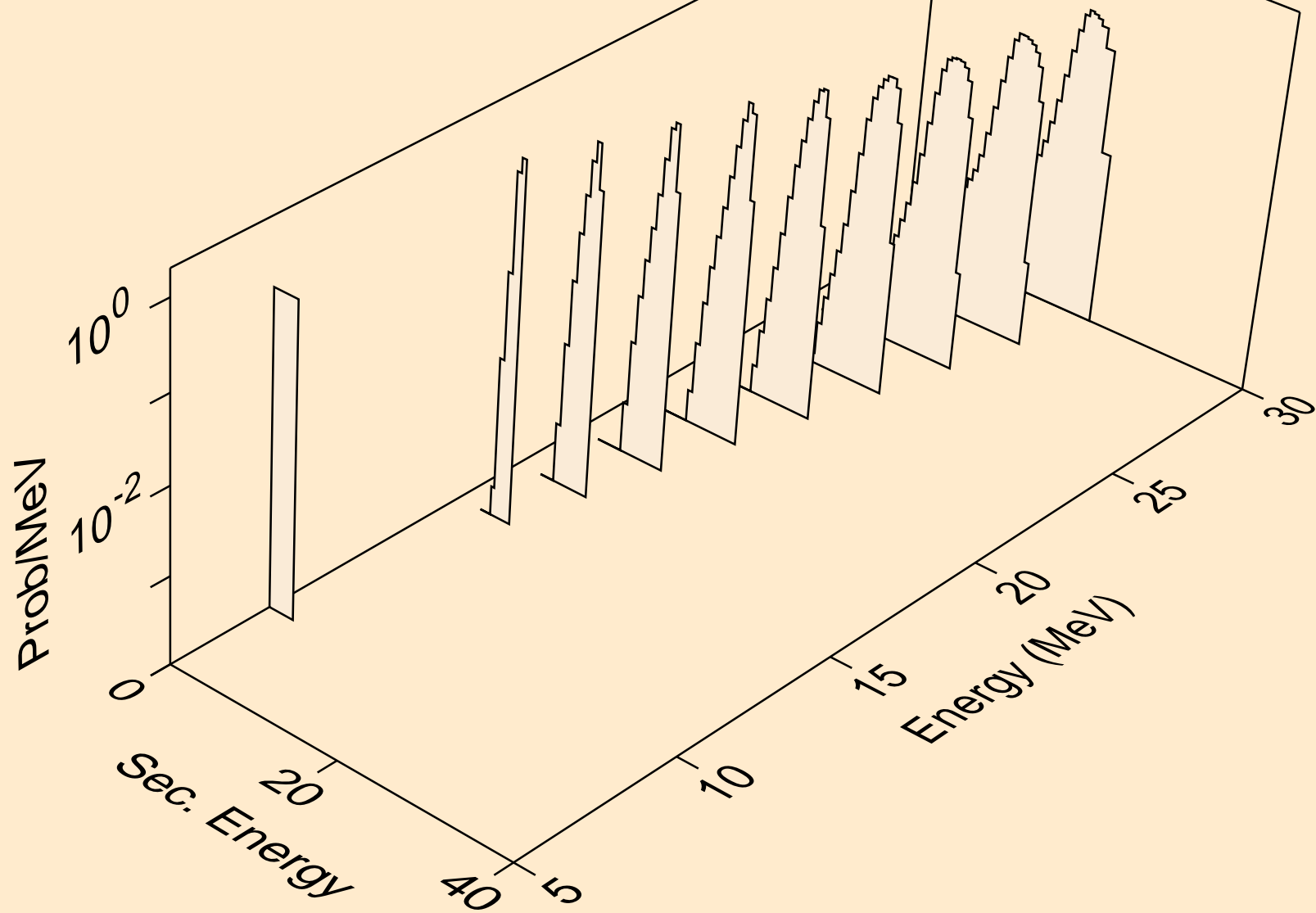

HS271 NEUTRON ACER TENDL-2024 LIBRARY; T=0.K
tritons from (n,t)

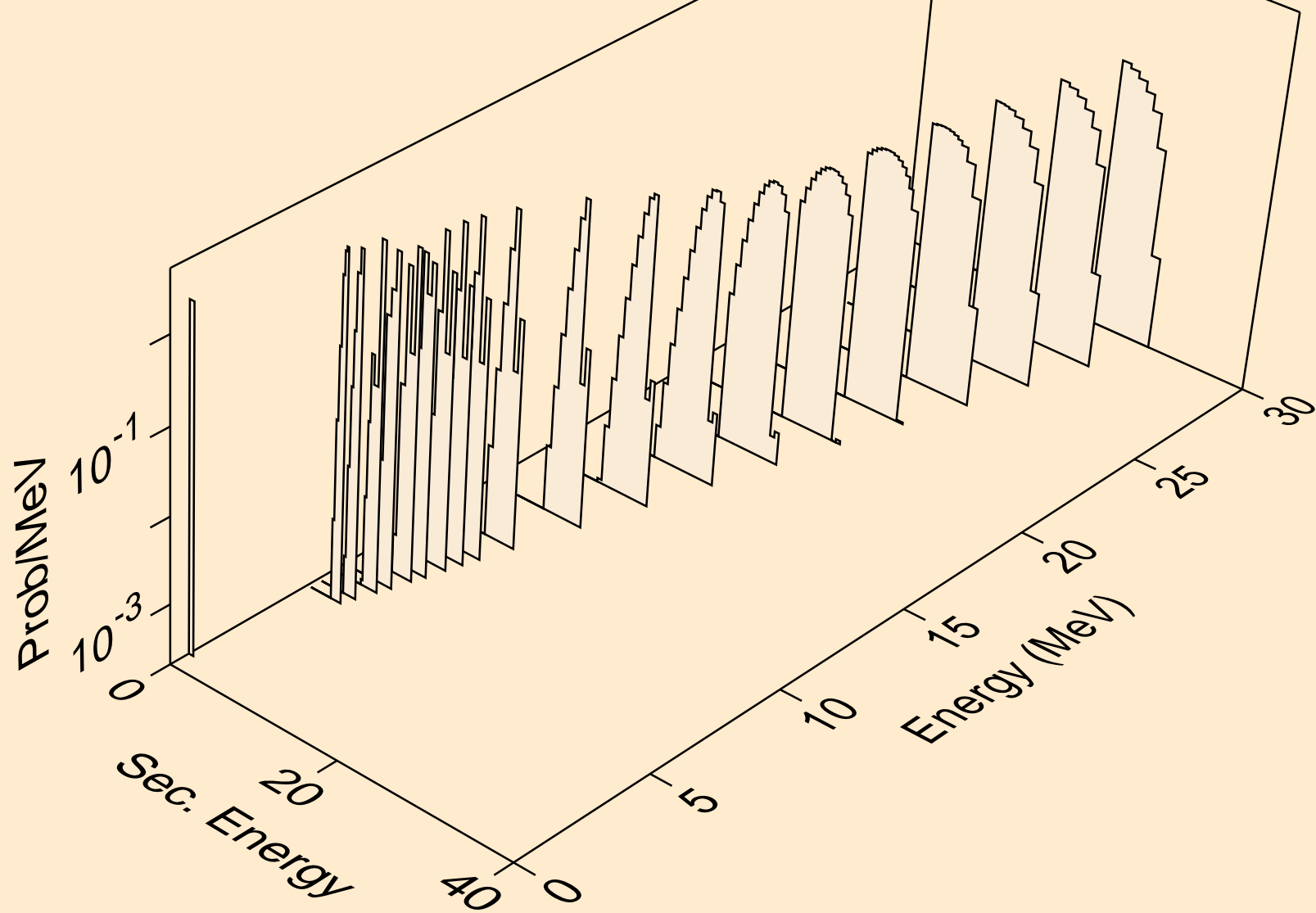

HS271 NEUTRON ACER TENDL-2024 LIBRARY; T=0.K
he3s from (n,x)

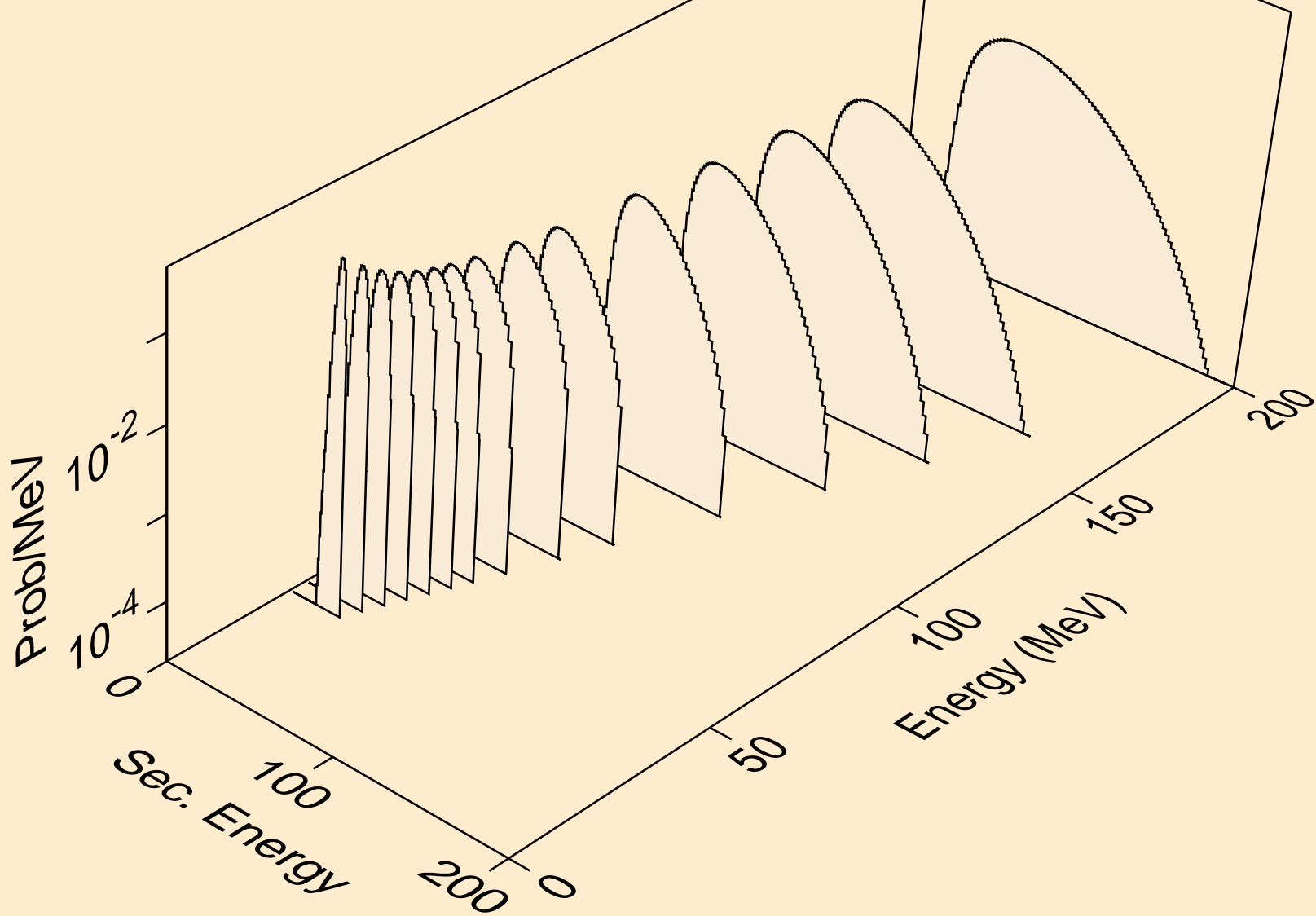

HS271 NEUTRON ACER TENDL-2024 LIBRARY; T=0.K
he3s from (n,n*)he3

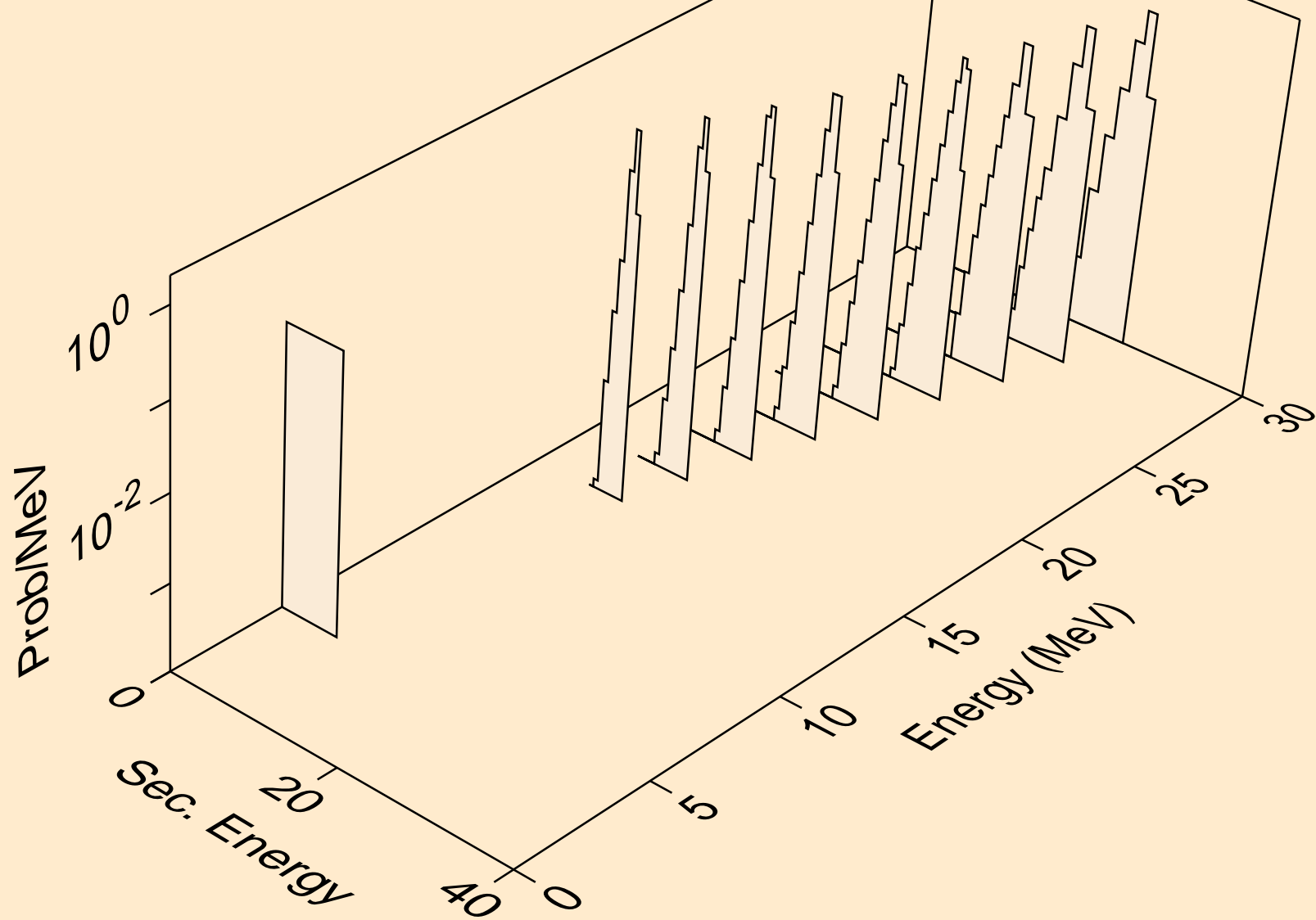

HS271 NEUTRON ACER TENDL-2024 LIBRARY; T=0.K
he3s from (n,he3)

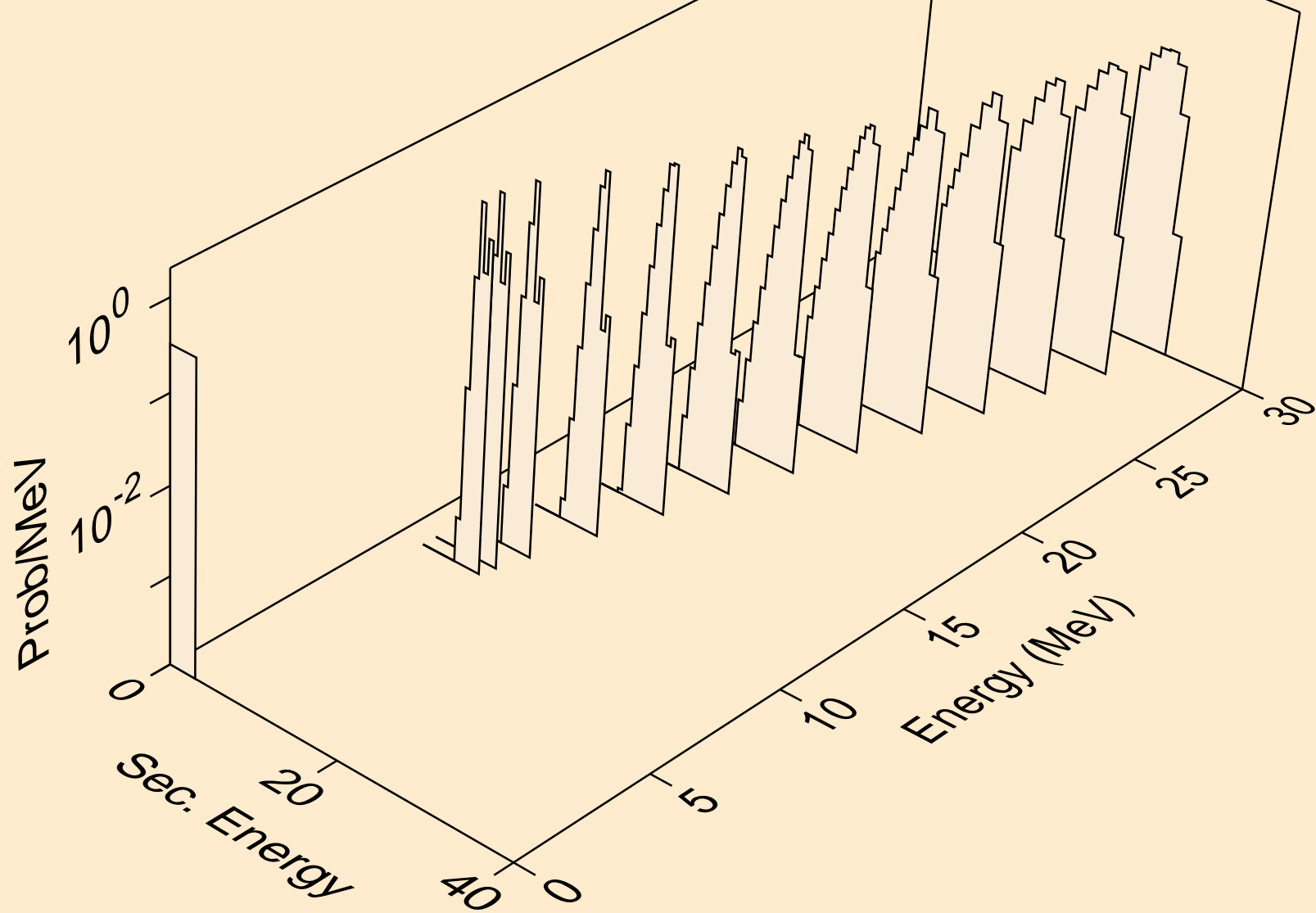

HS271 NEUTRON ACER TENDL-2024 LIBRARY; T=0.K
alphas from (n,x)

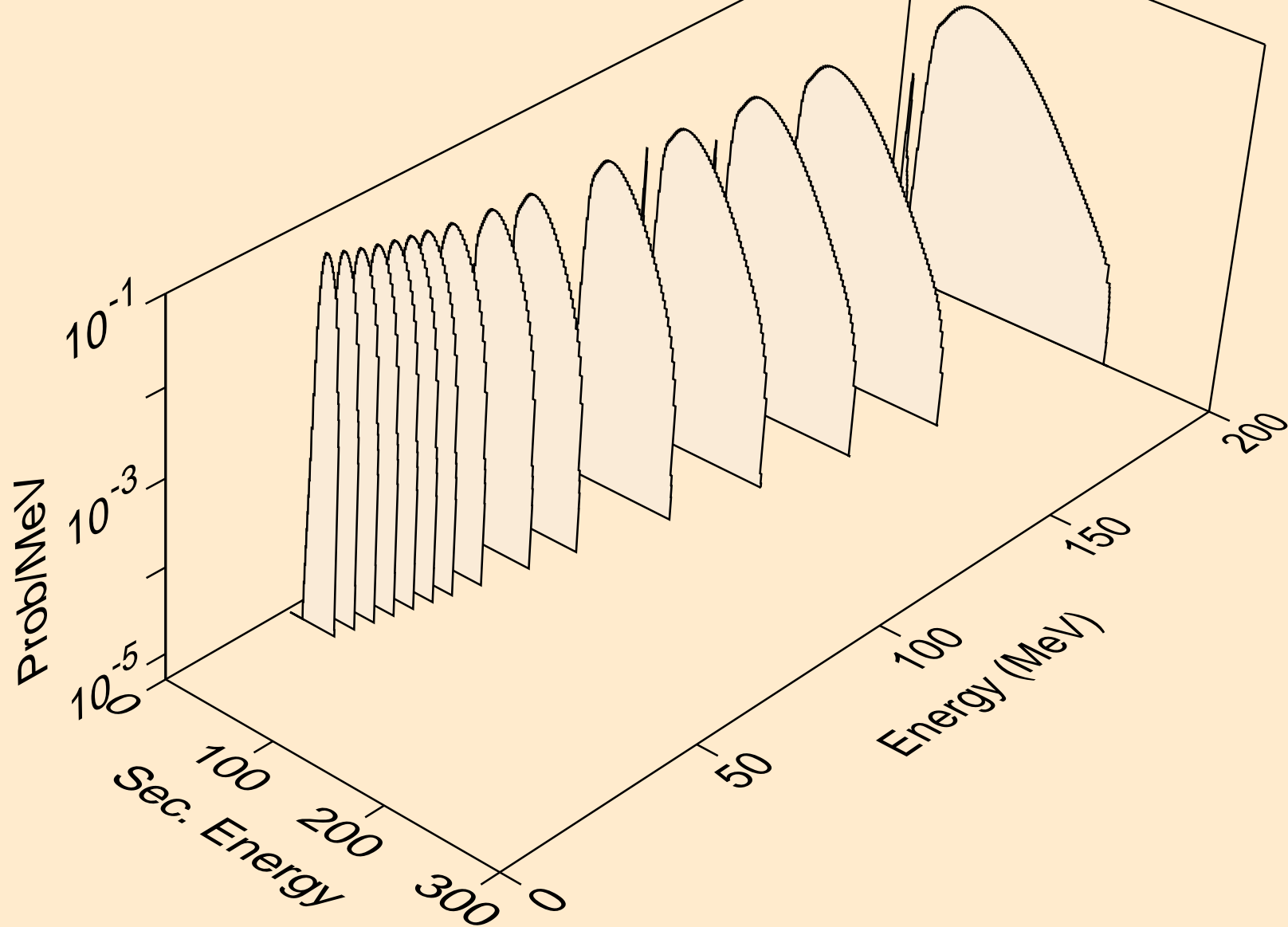

HS271 NEUTRON ACER TENDL-2024 LIBRARY; T=0.K
alphas from (n,n*)a

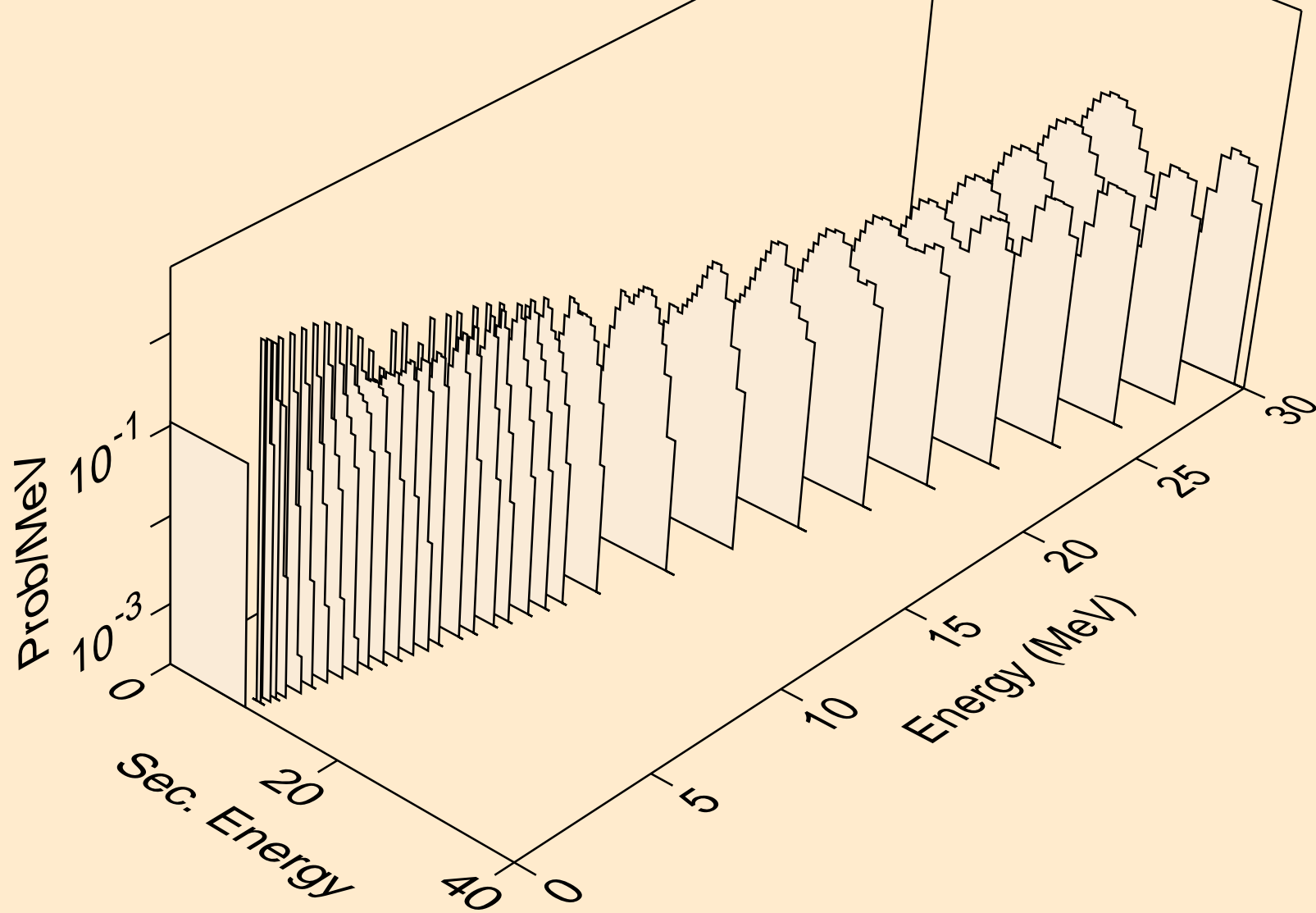

HS271 NEUTRON ACER TENDL-2024 LIBRARY; T=0.K
alphas from (n,2n)a

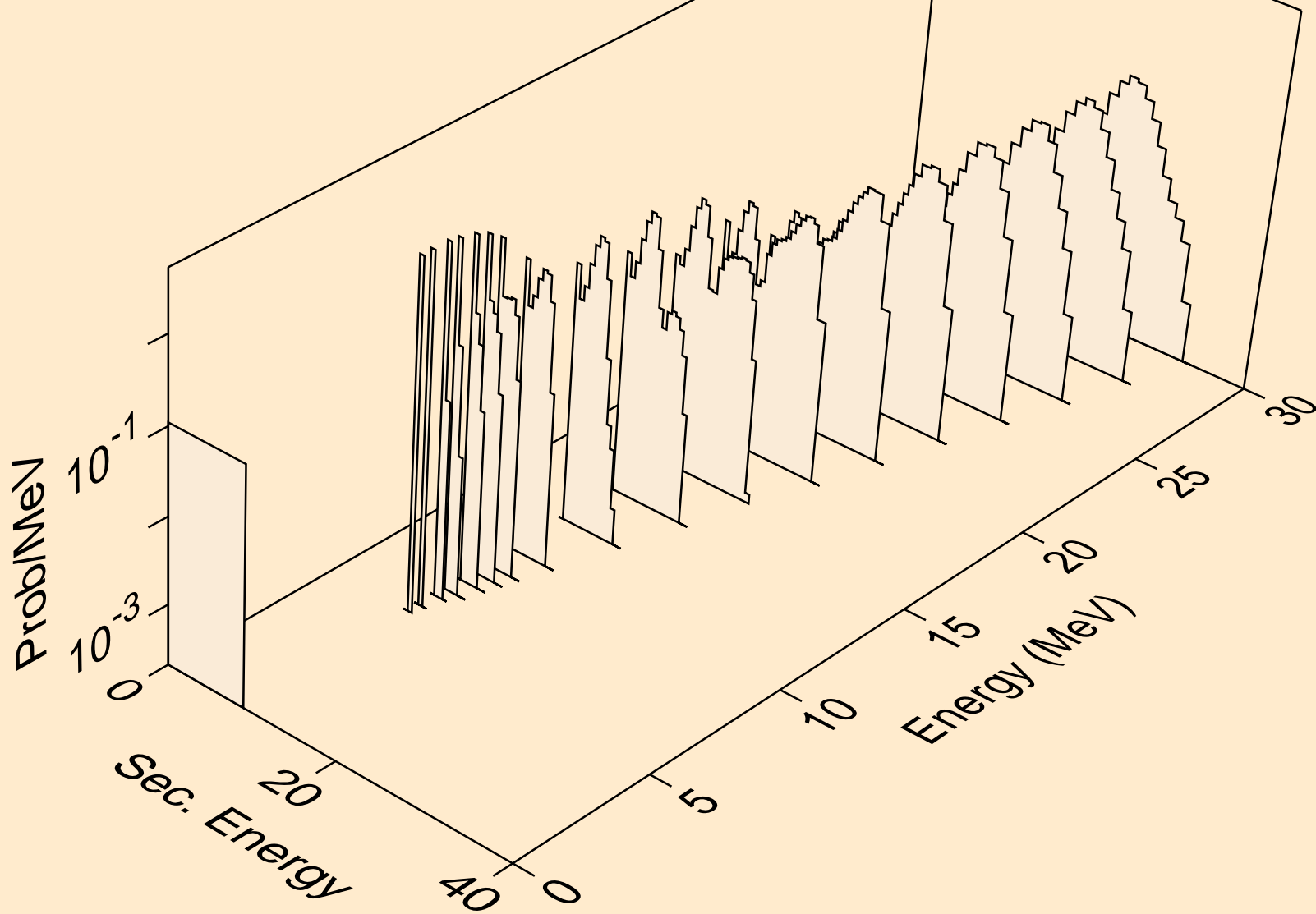

HS271 NEUTRON ACER TENDL-2024 LIBRARY; T=0.K
alphas from (n,3n)a

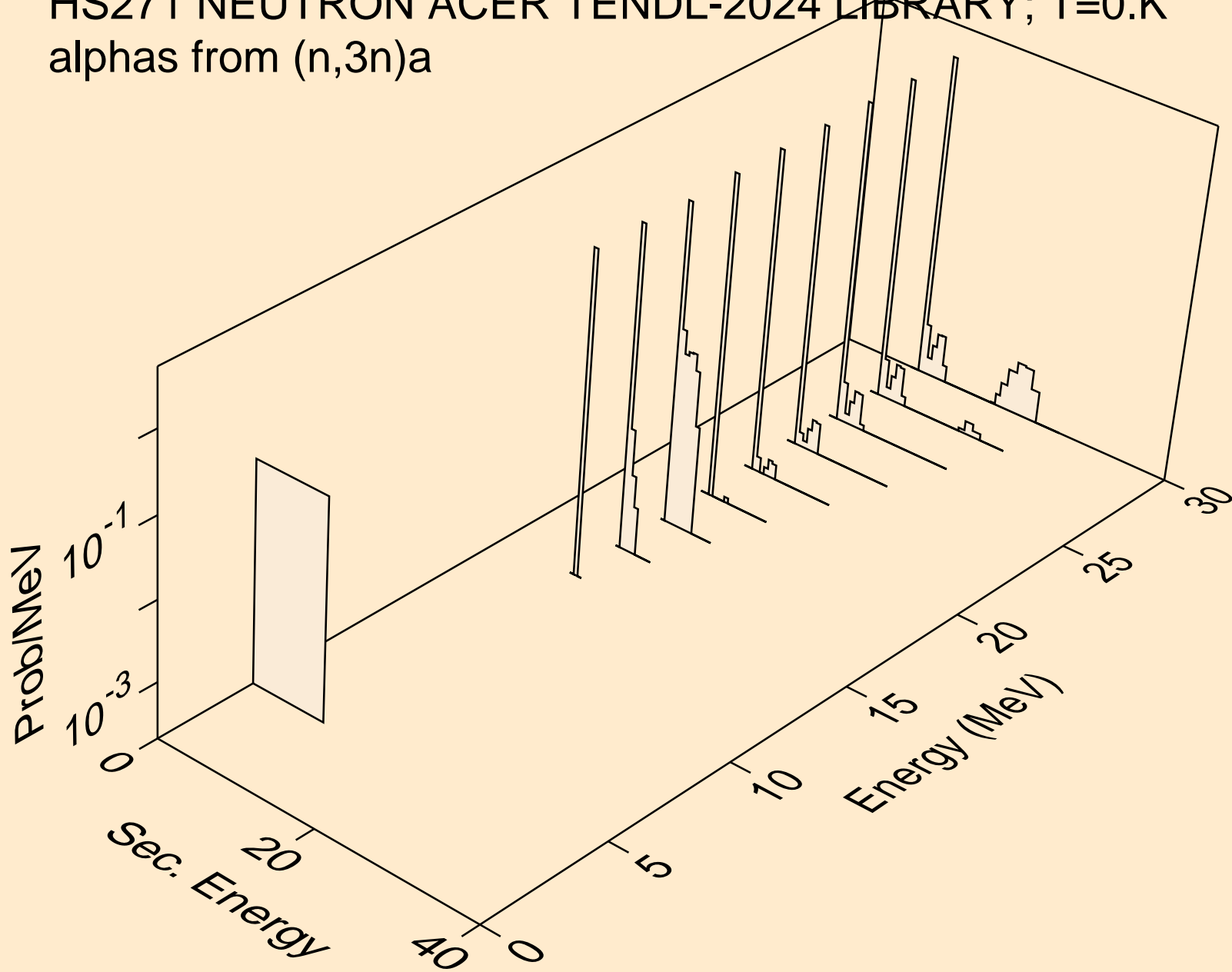

HS271 NEUTRON ACER TENDL-2024 LIBRARY; T=0.K
alphas from (n,a)

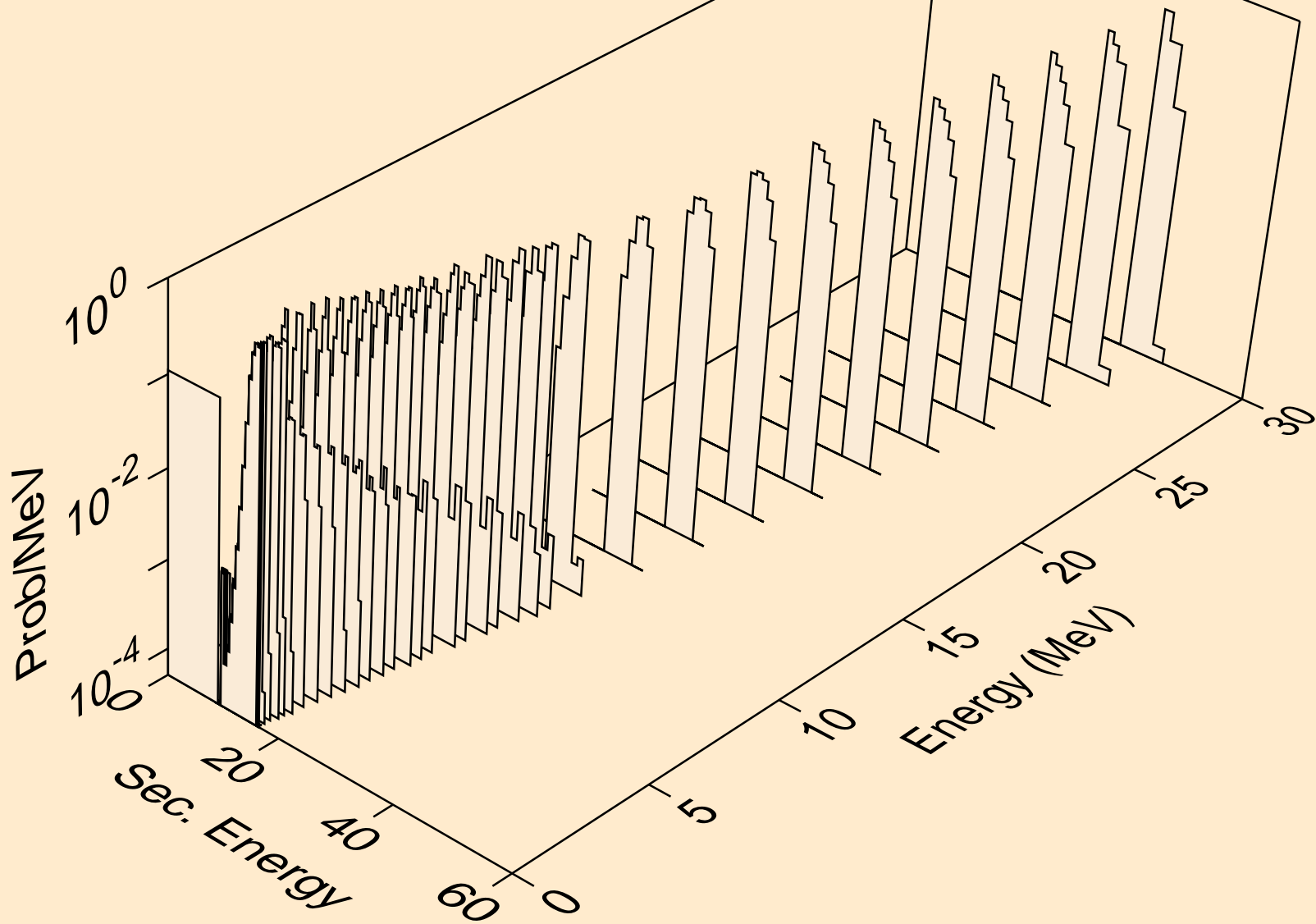

HS271 NEUTRON ACER TENDL-2024 LIBRARY; T=0.K
alphas from (n,pa)

