

I136 NEUTRON ACER TENDL-2024 LIBRARY; T=0.K

Principal cross sections

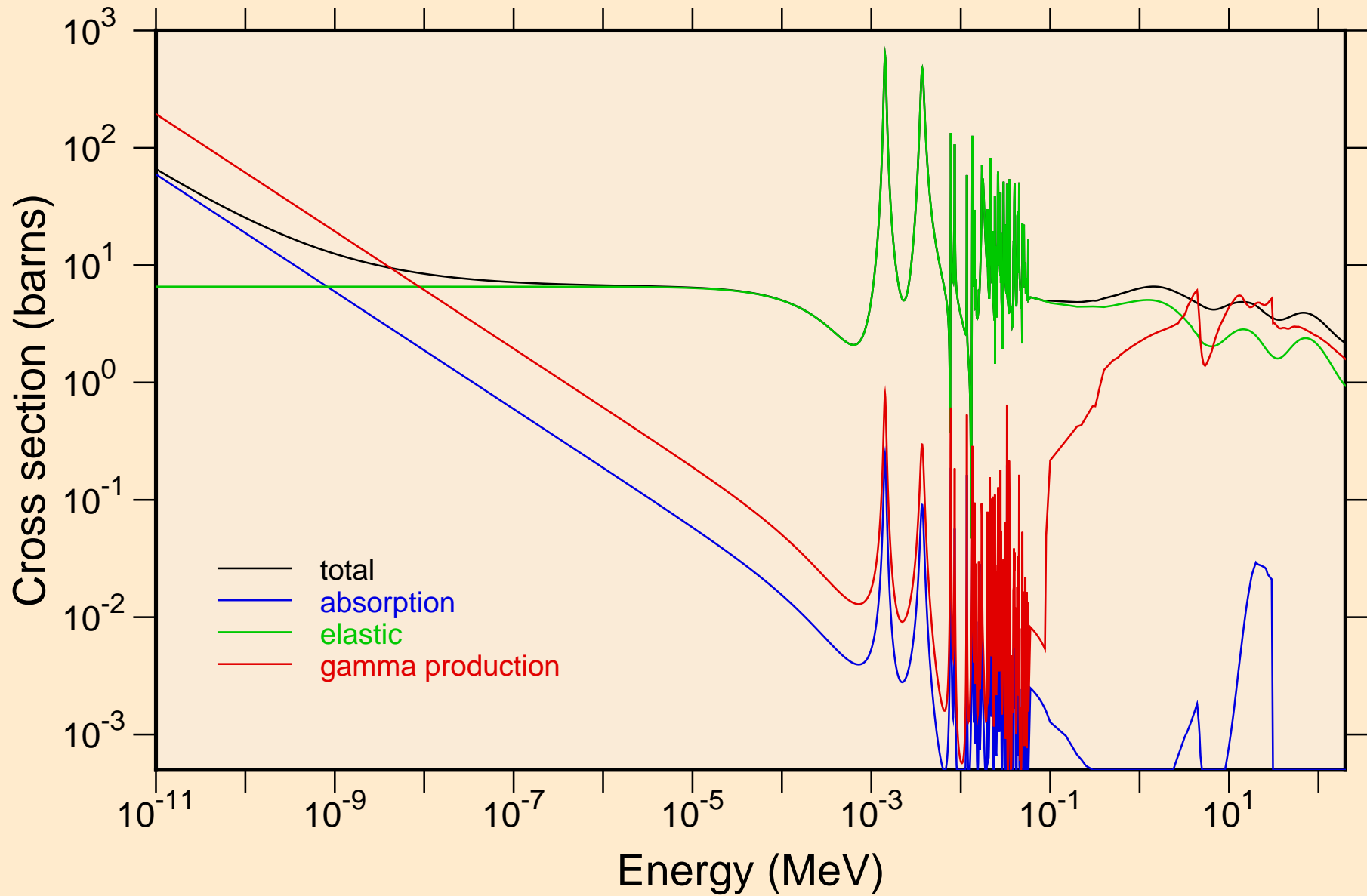

I136 NEUTRON ACER TENDL-2024 LIBRARY; T=0.K
resonance total cross section

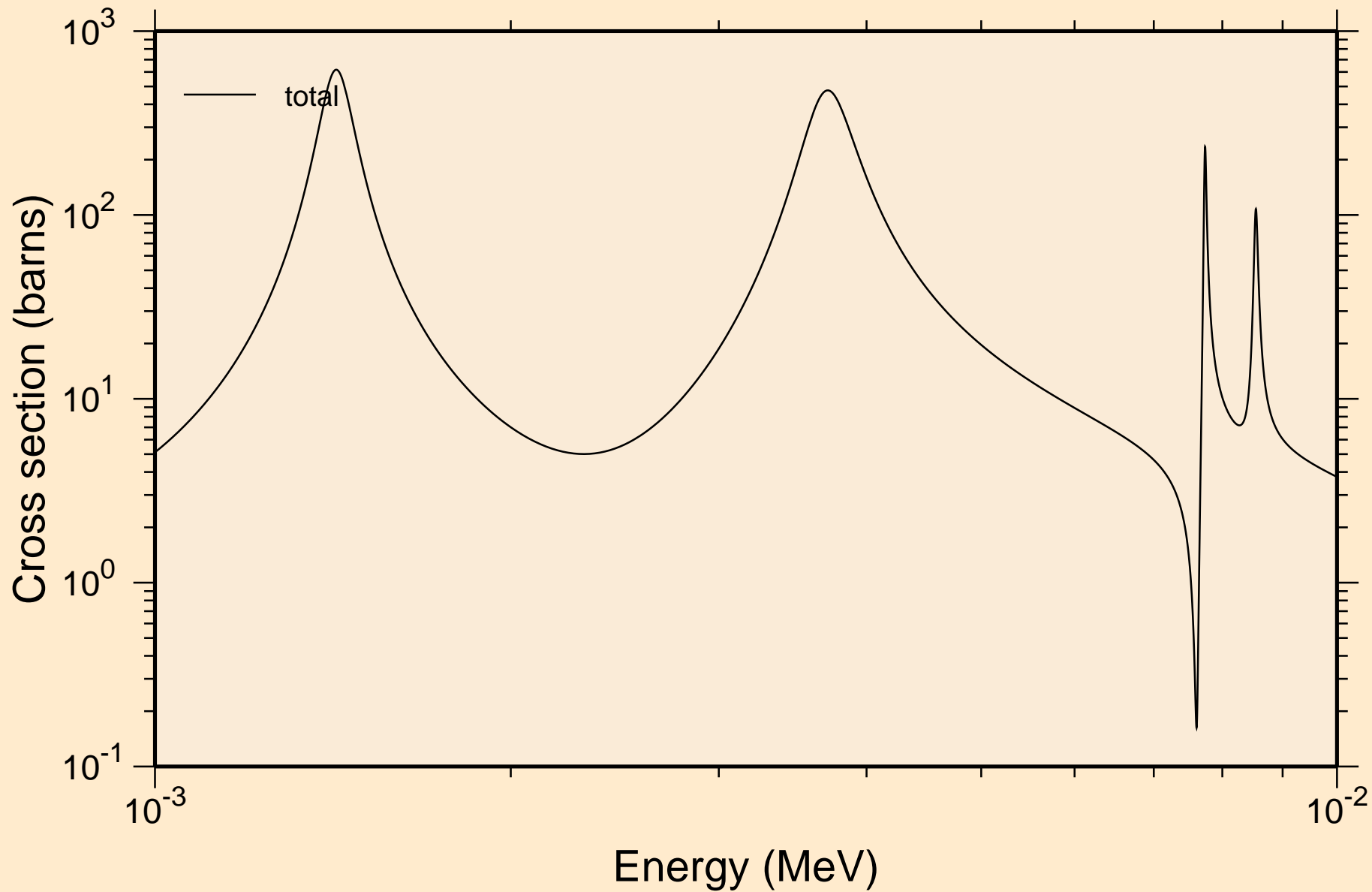

I136 NEUTRON ACER TENDL-2024 LIBRARY; T=0.K
resonance total cross section

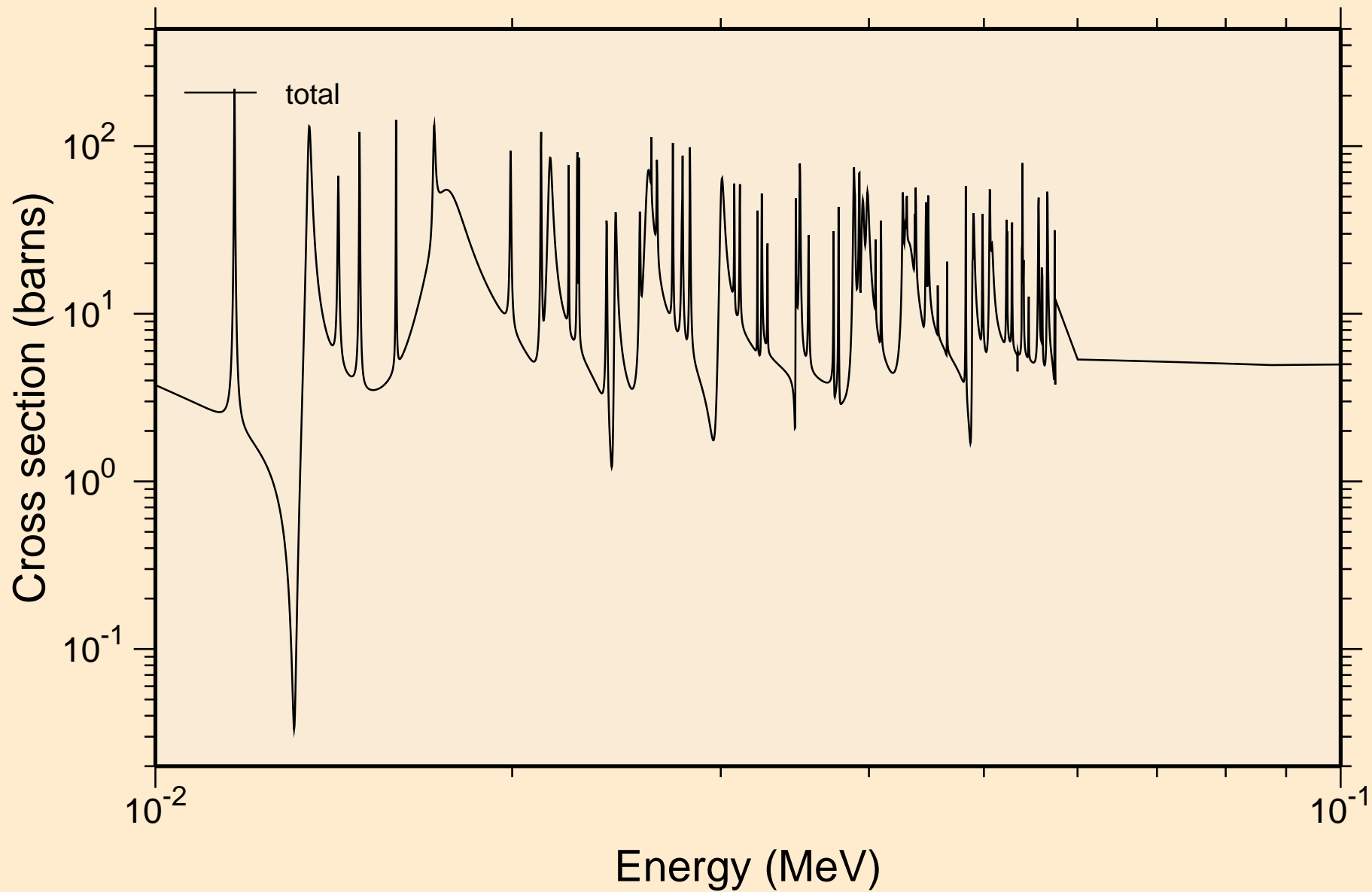

I136 NEUTRON ACER TENDL-2024 LIBRARY; T=0.K
resonance total cross section

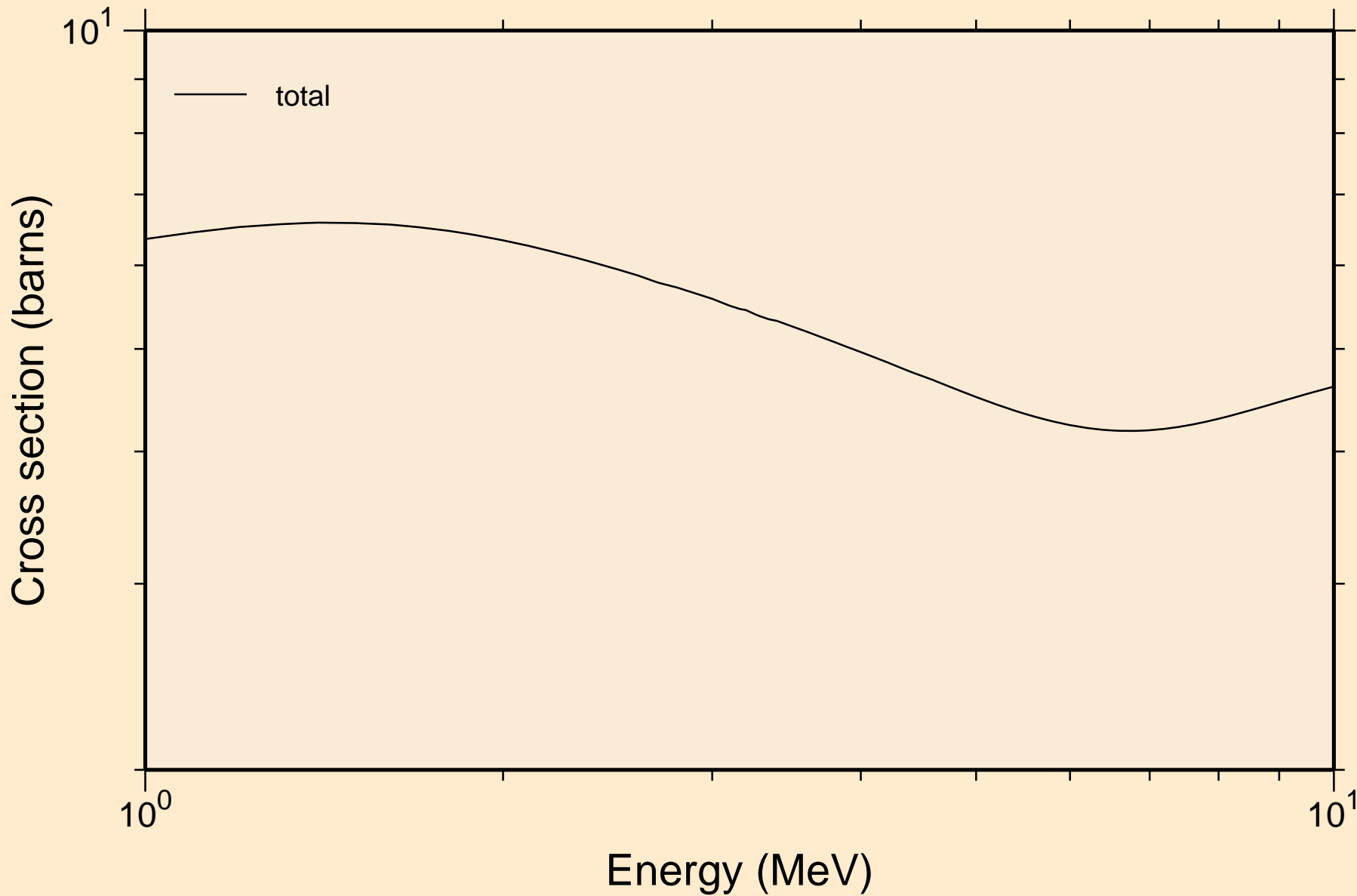

I136 NEUTRON ACER TENDL-2024 LIBRARY; T=0.K
resonance absorption cross sections

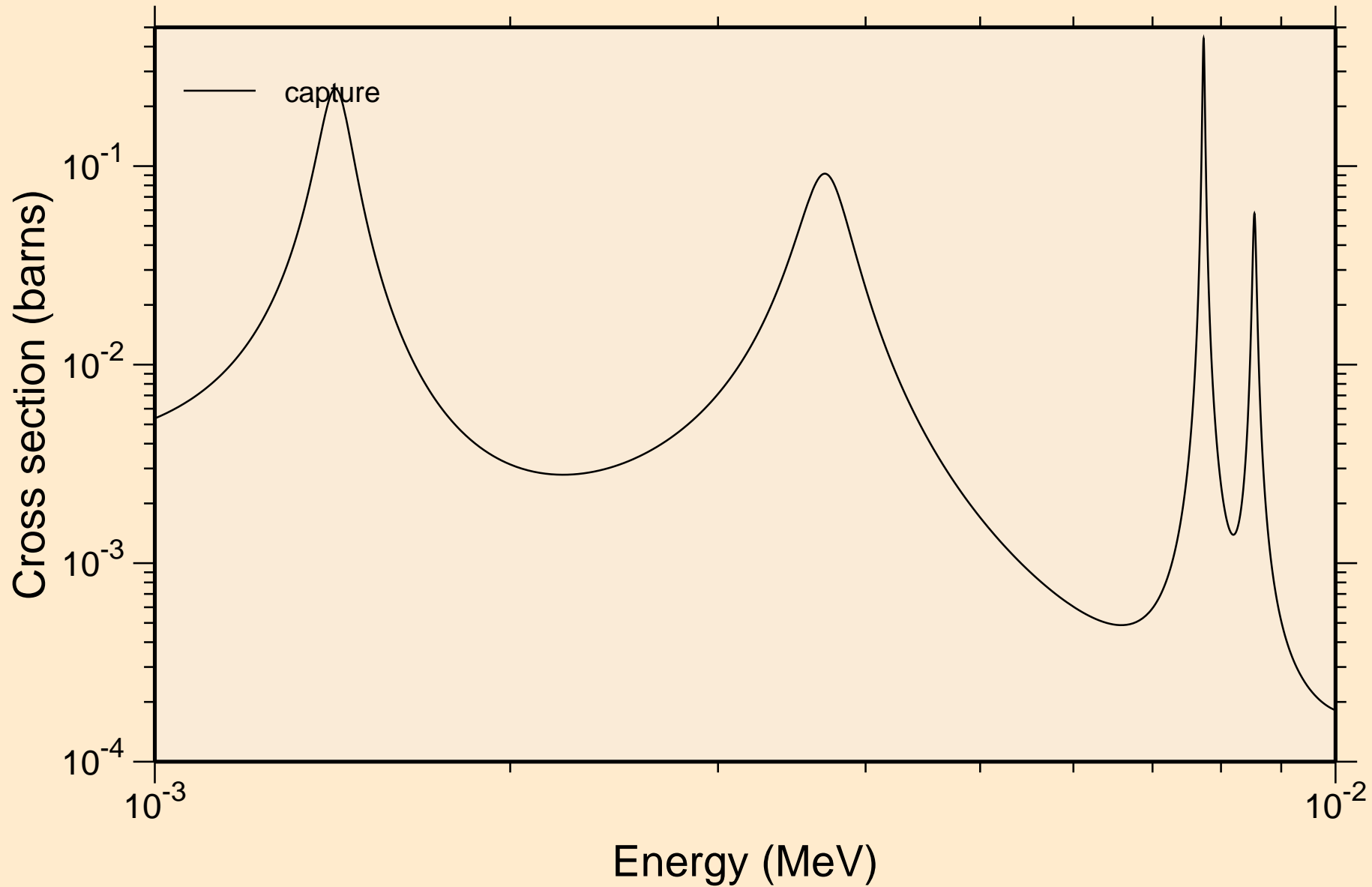

I136 NEUTRON ACER TENDL-2024 LIBRARY; T=0.K
resonance absorption cross sections

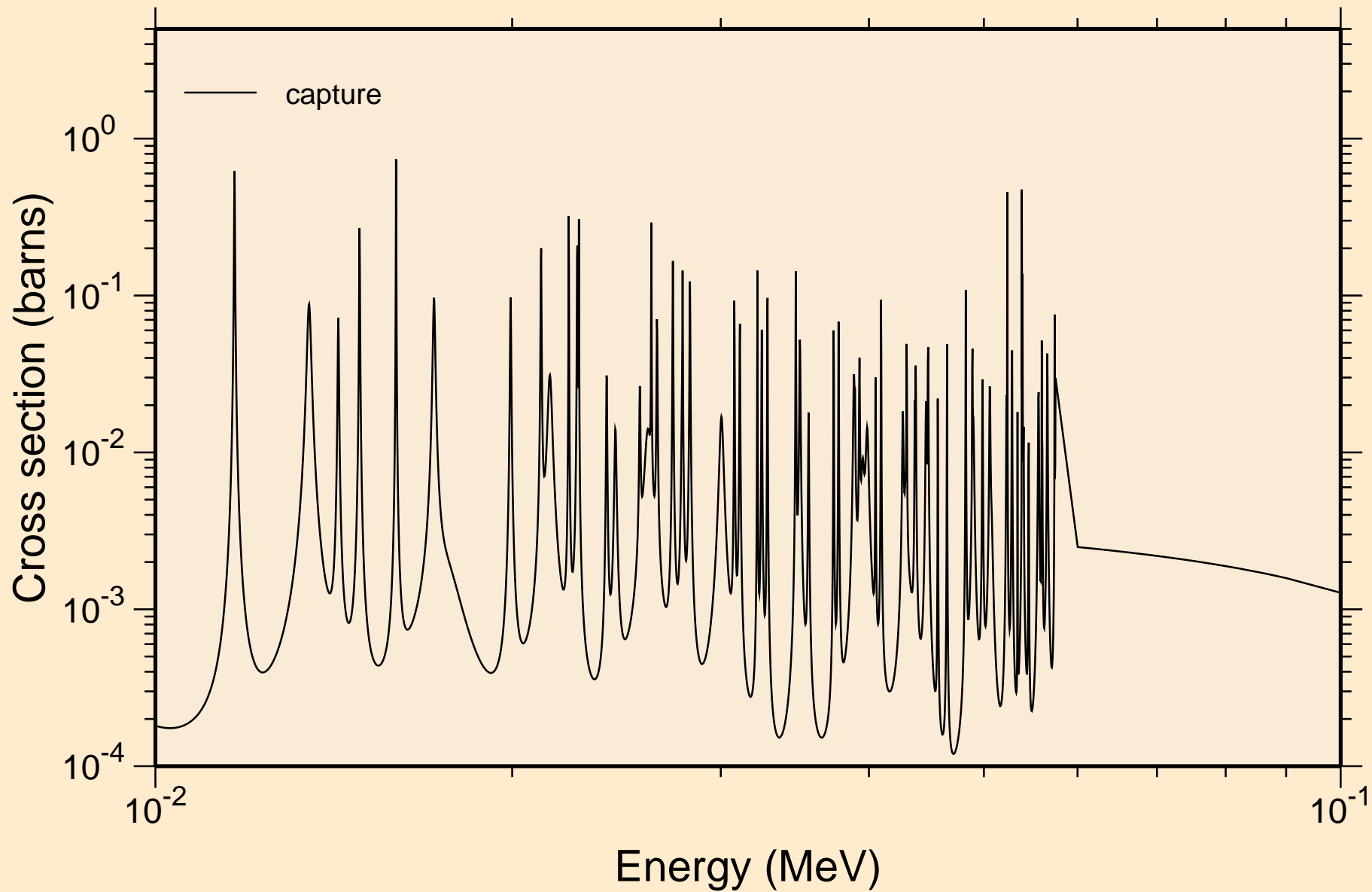

I136 NEUTRON ACER TENDL-2024 LIBRARY; T=0.K
resonance absorption cross sections

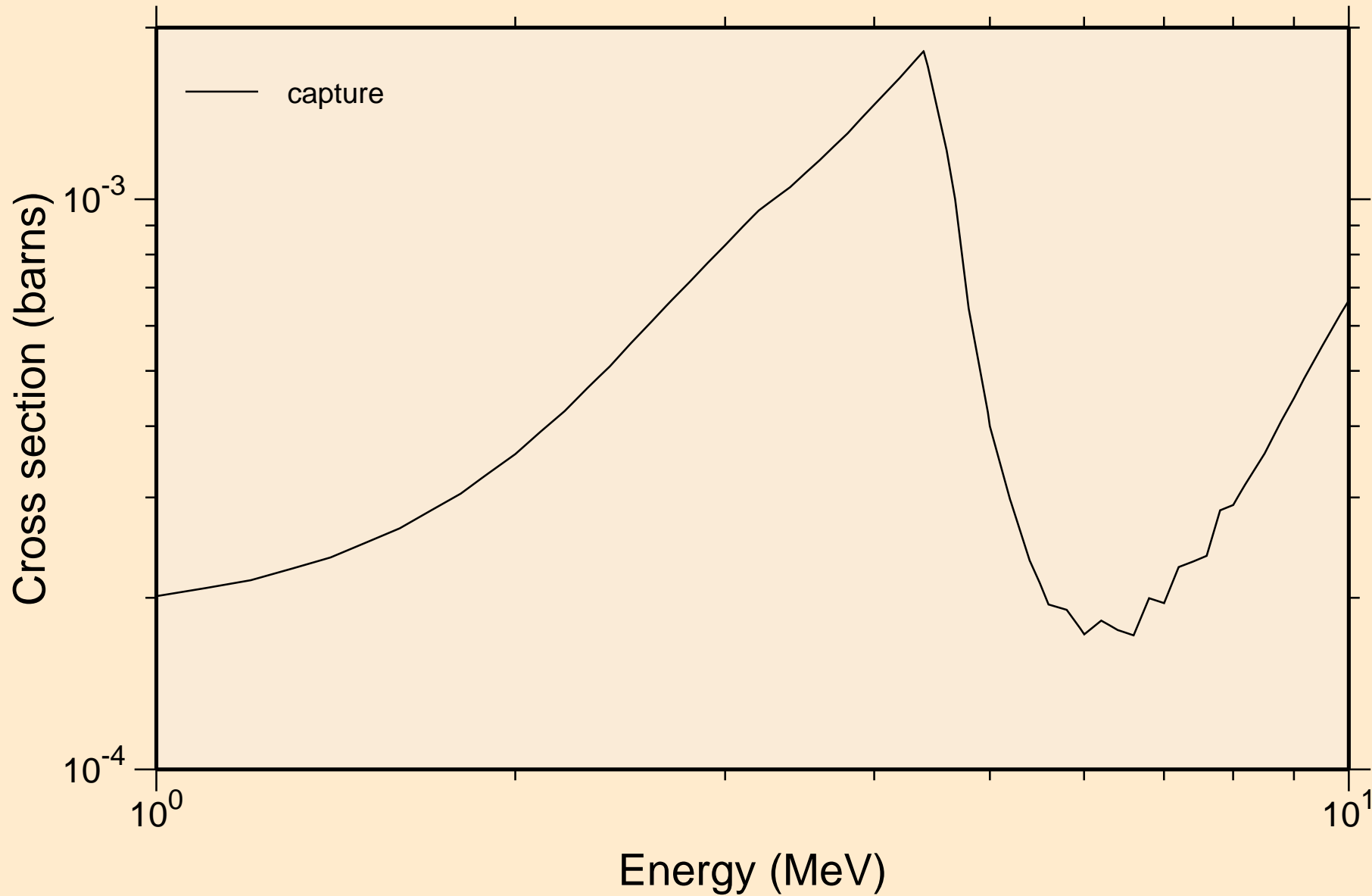

I136 NEUTRON ACER TENDL-2024 LIBRARY; T=0.K

Heating

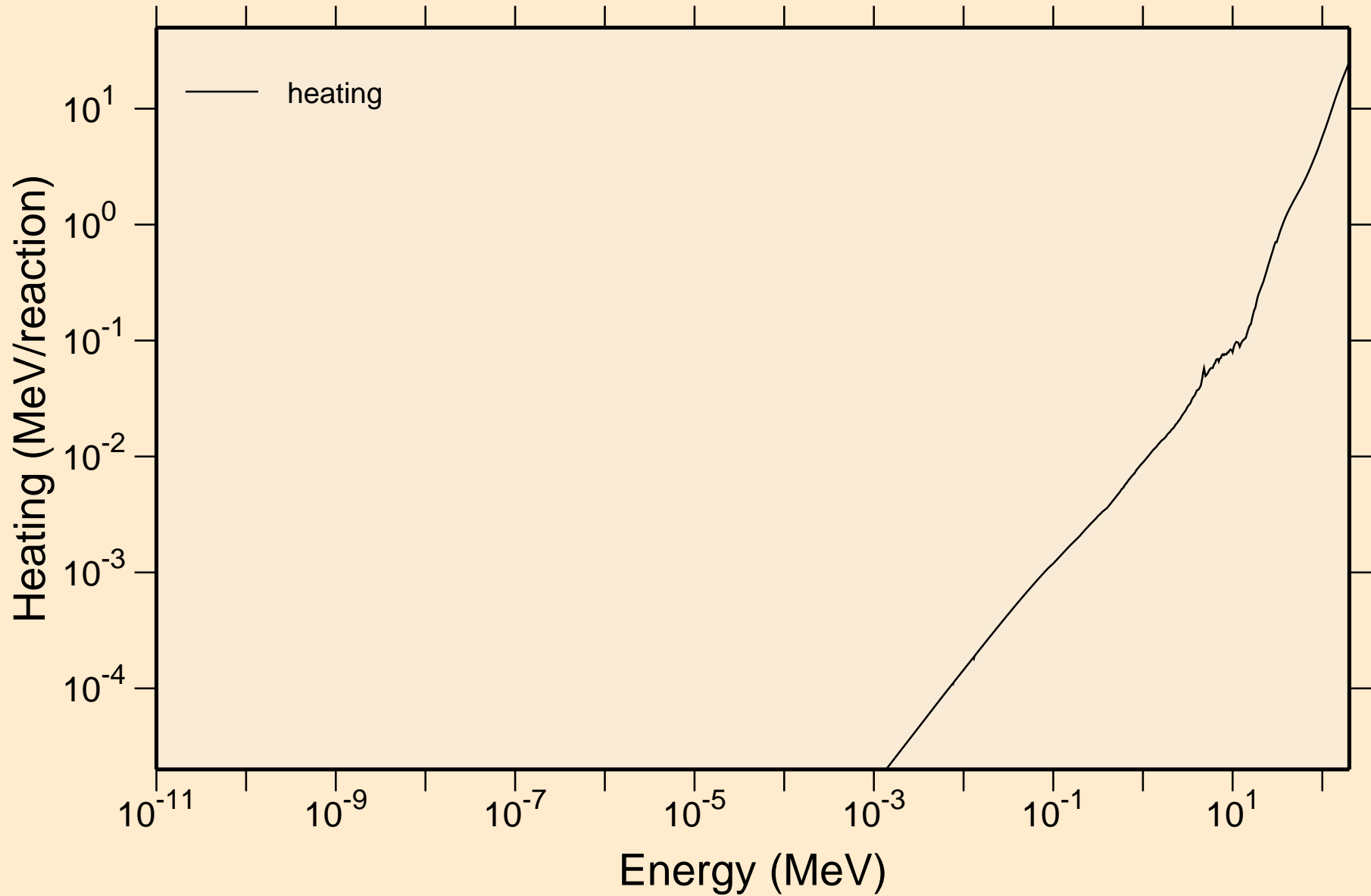

I136 NEUTRON ACER TENDL-2024 LIBRARY; T=0.K

Damage

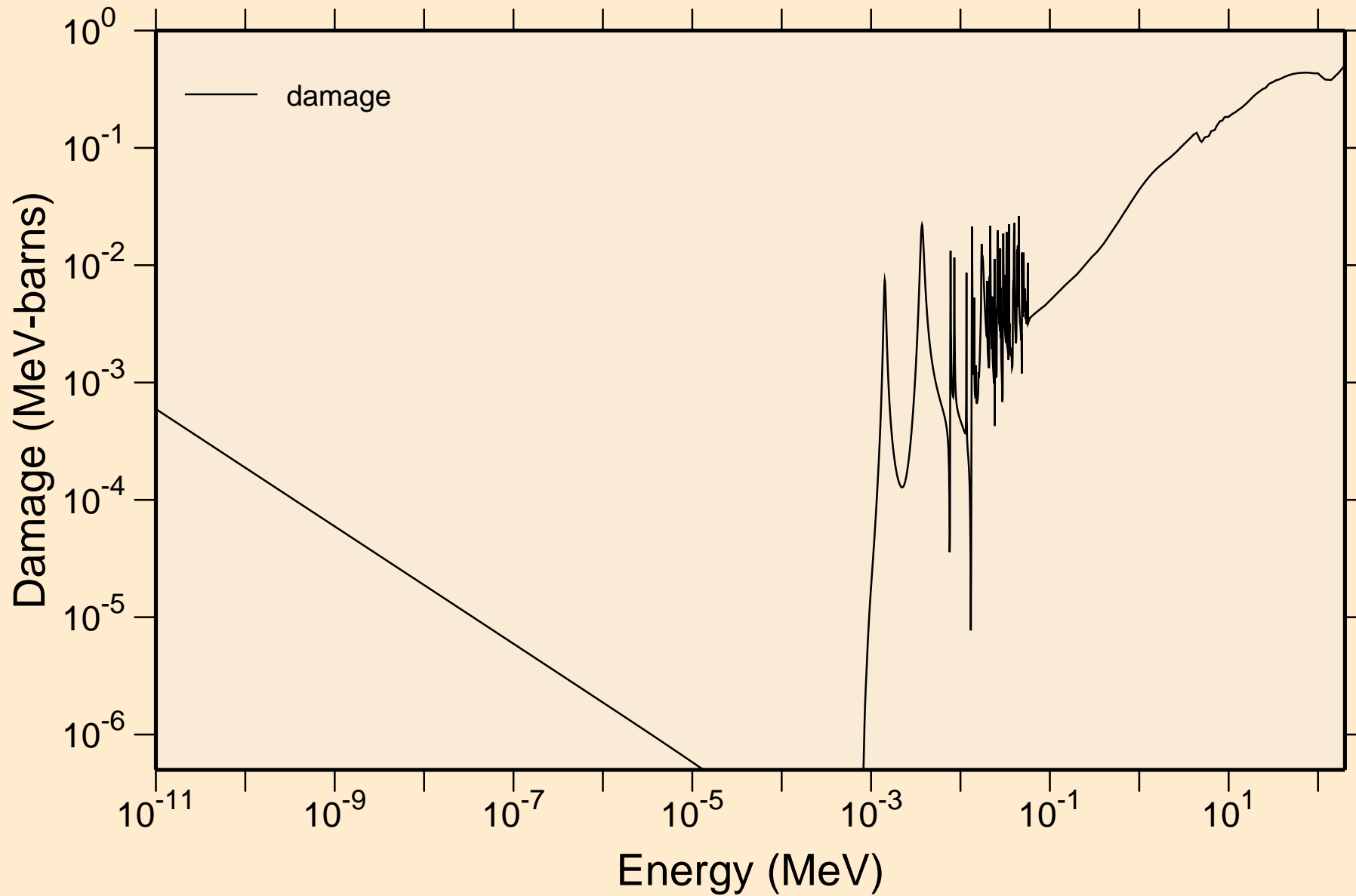

I136 NEUTRON ACER TENDL-2024 LIBRARY; T=0.K
Non-threshold reactions

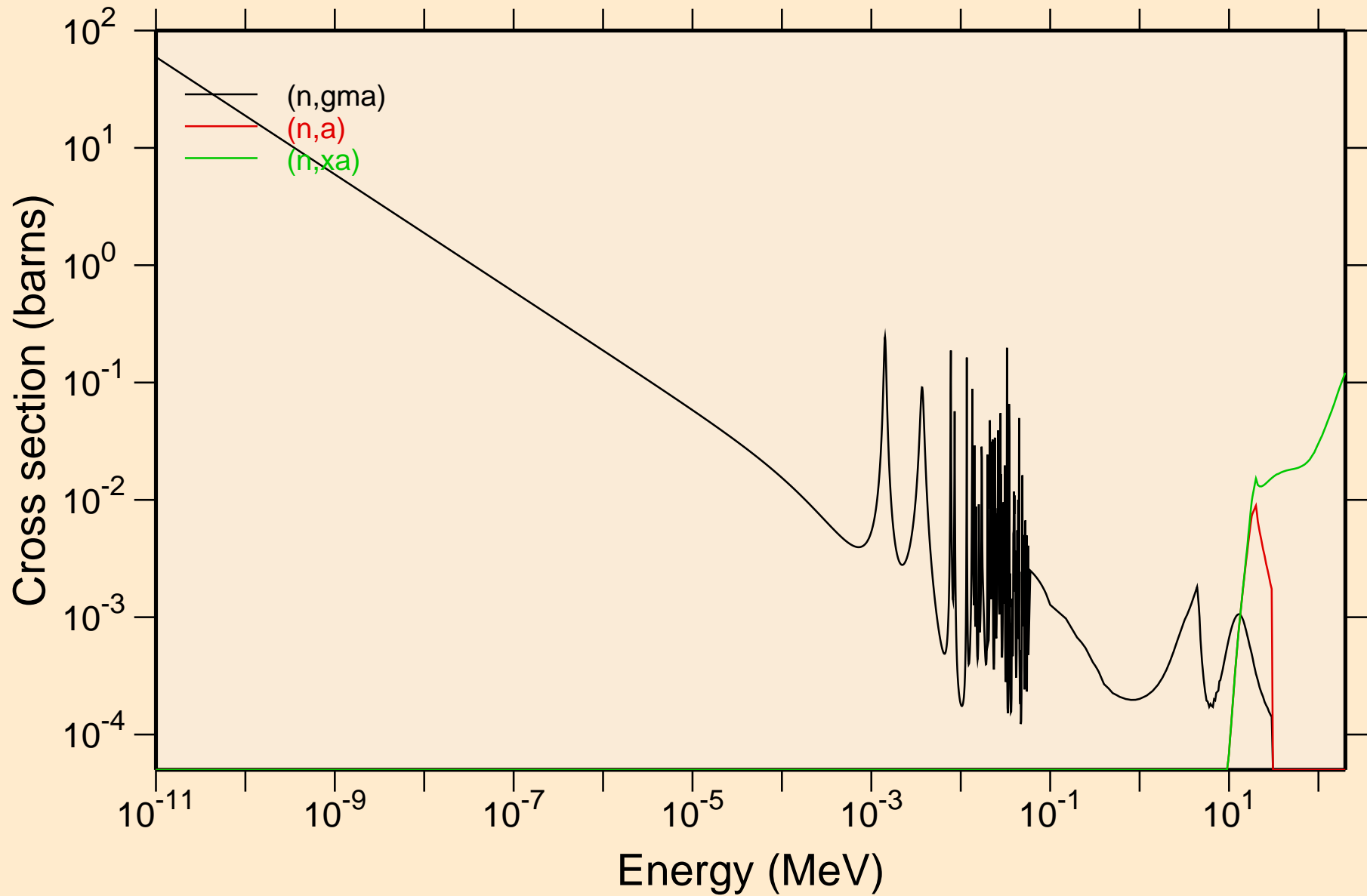

I136 NEUTRON ACER TENDL-2024 LIBRARY; T=0.K

Principal cross sections

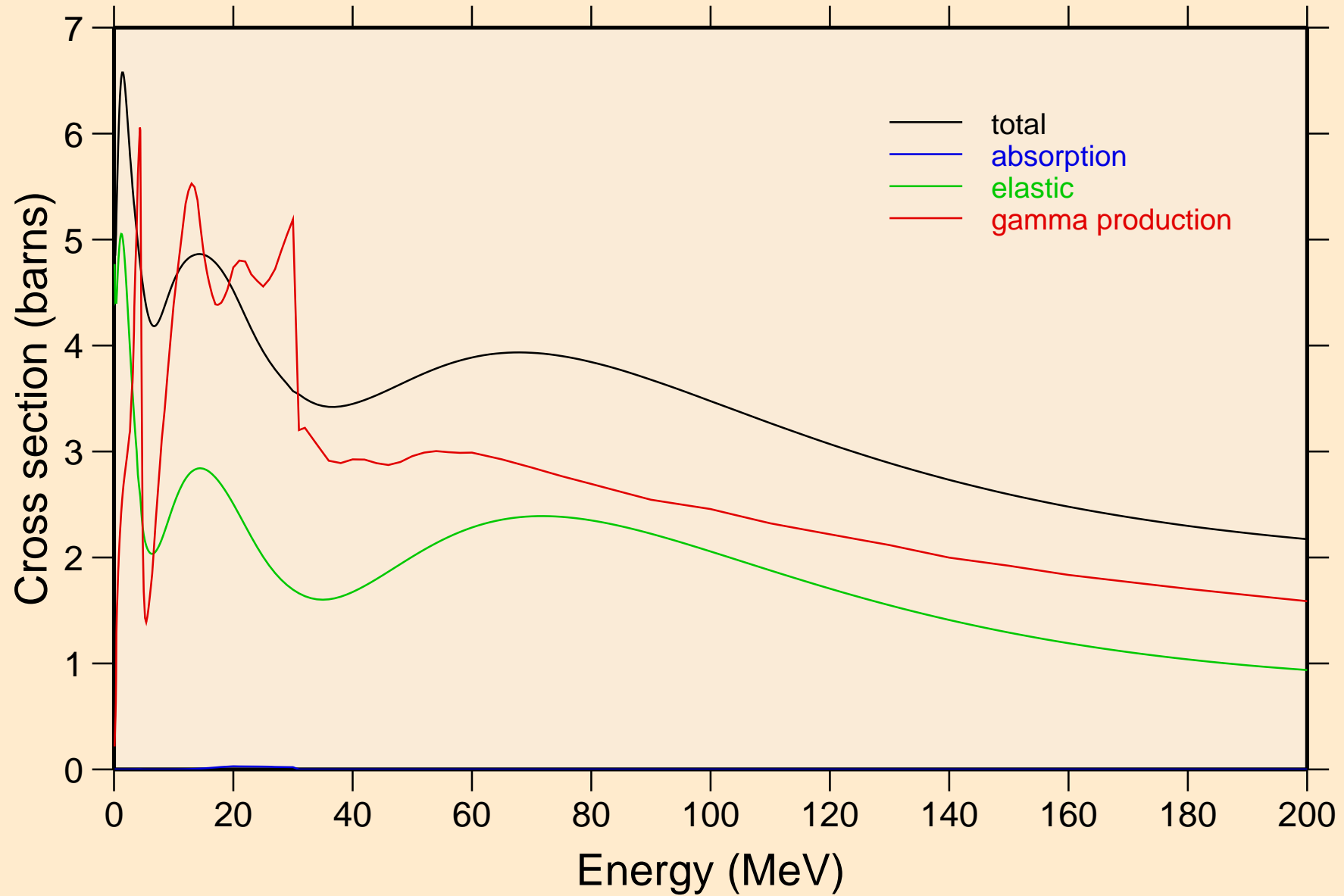

I136 NEUTRON ACER TENDL-2024 LIBRARY; T=0.K

Heating

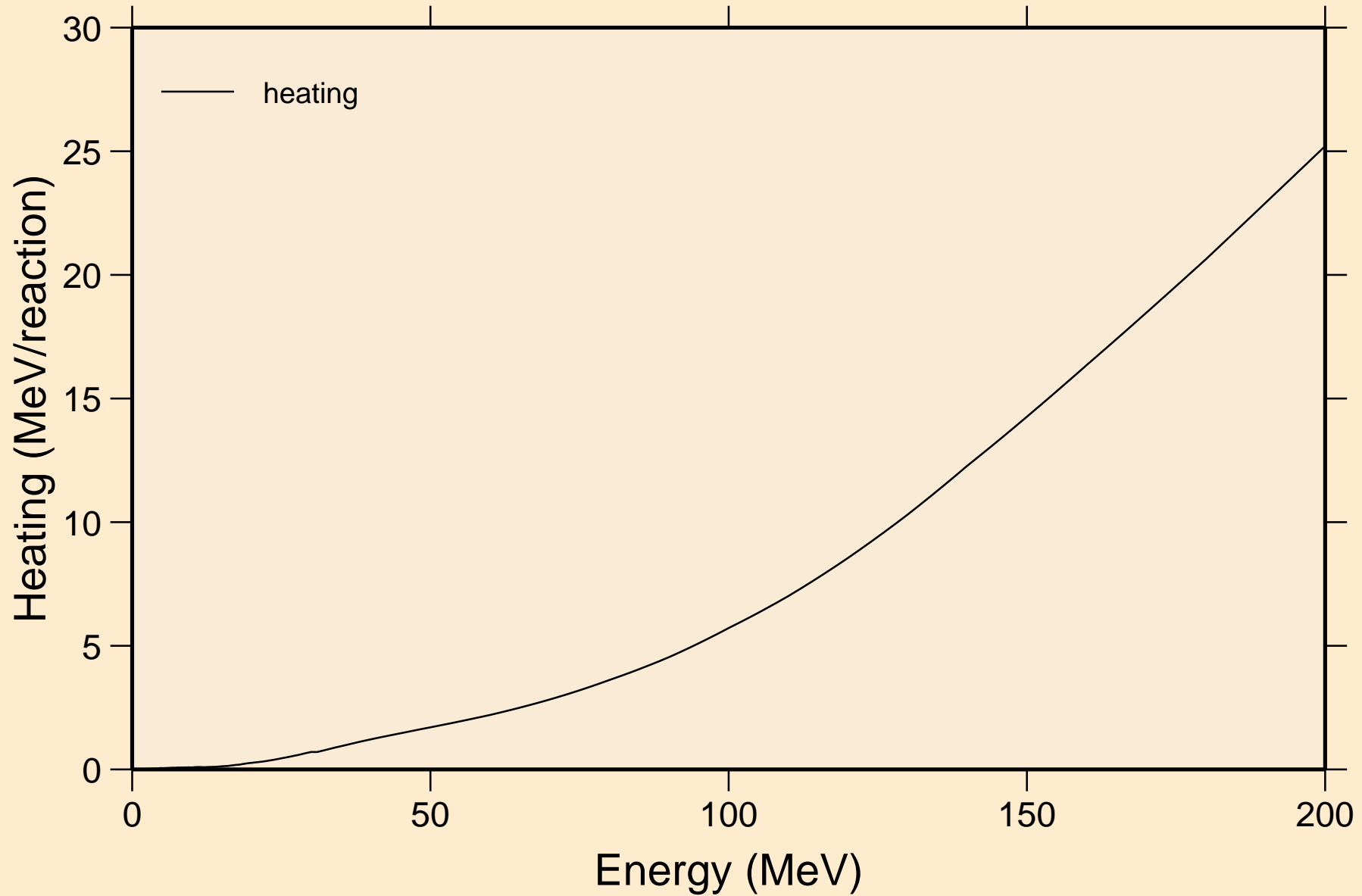

I136 NEUTRON ACER TENDL-2024 LIBRARY; T=0.K

Damage

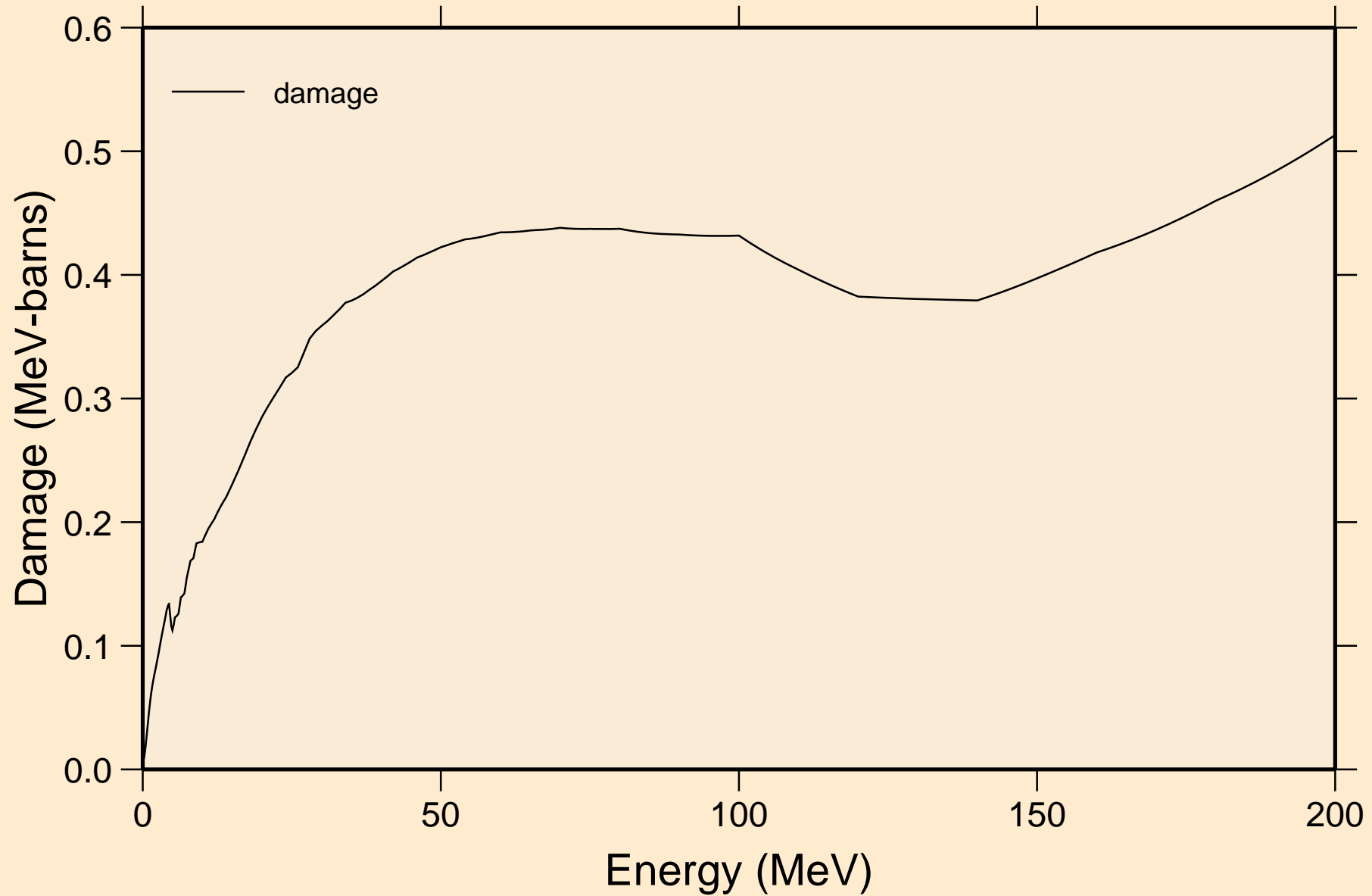

I136 NEUTRON ACER TENDL-2024 LIBRARY; T=0.K
Non-threshold reactions

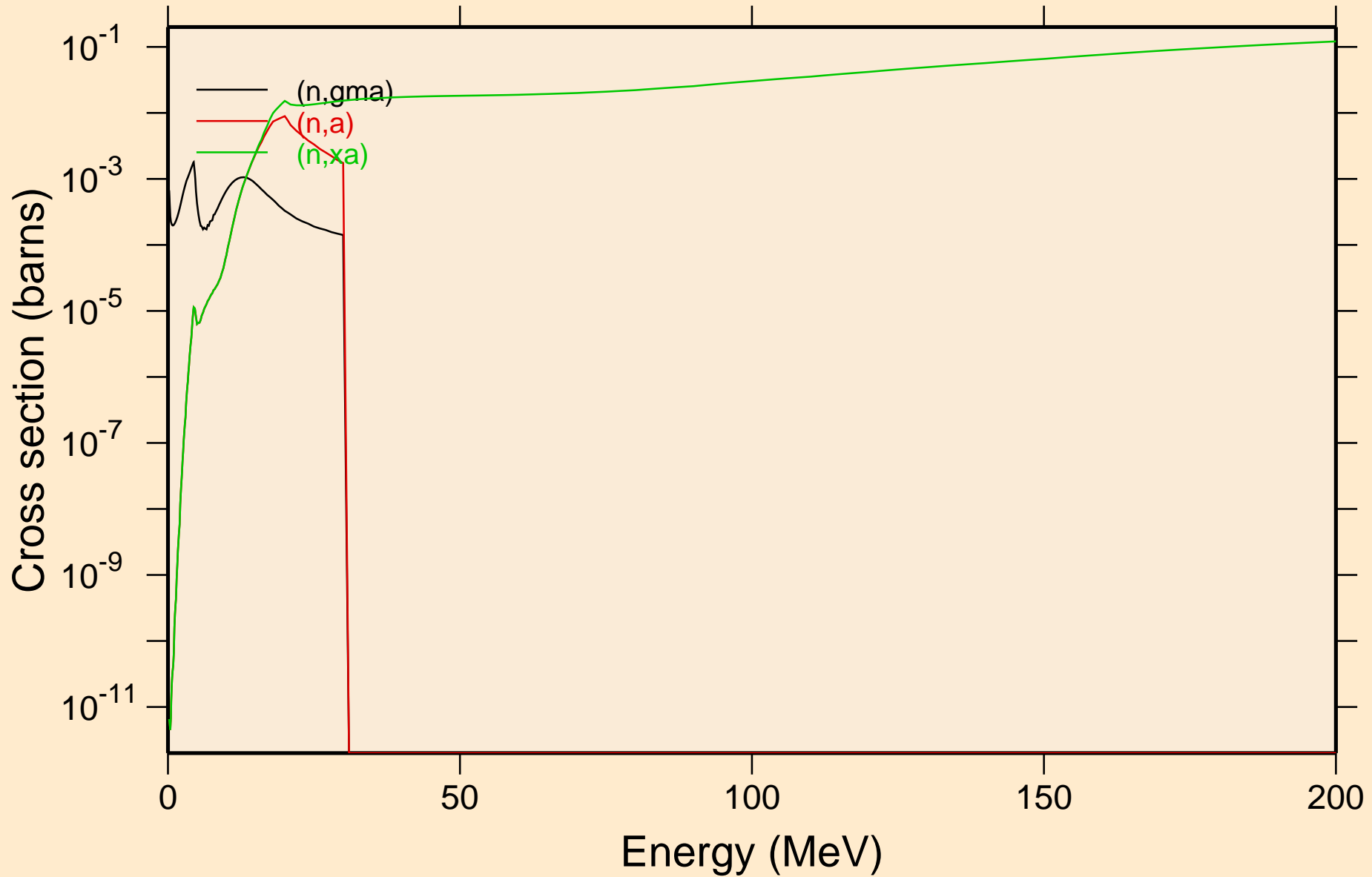

I136 NEUTRON ACER TENDL-2024 LIBRARY; T=0.K

Inelastic levels

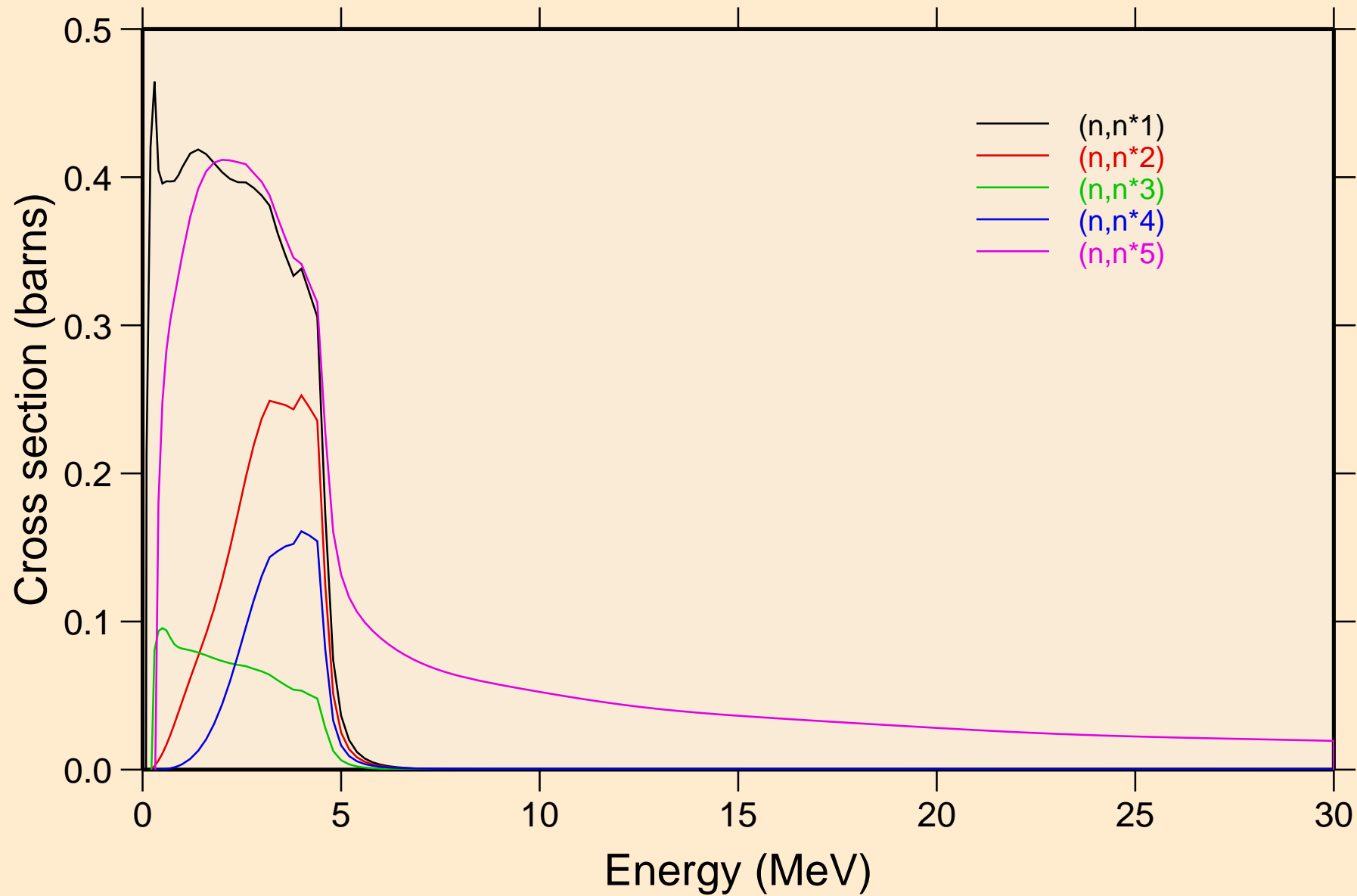

I136 NEUTRON ACER TENDL-2024 LIBRARY; T=0.K

Inelastic levels

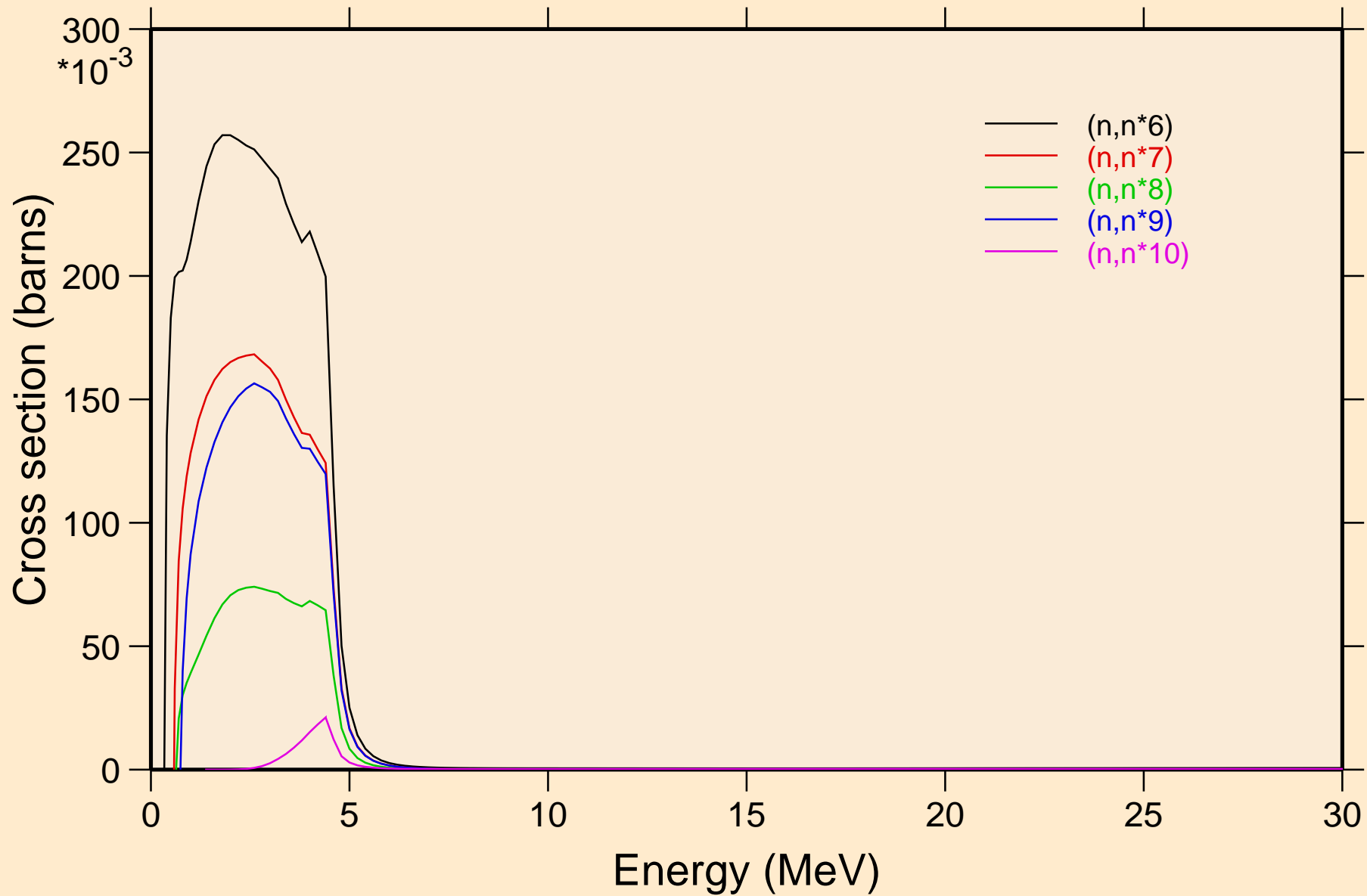

I136 NEUTRON ACER TENDL-2024 LIBRARY; T=0.K

Inelastic levels

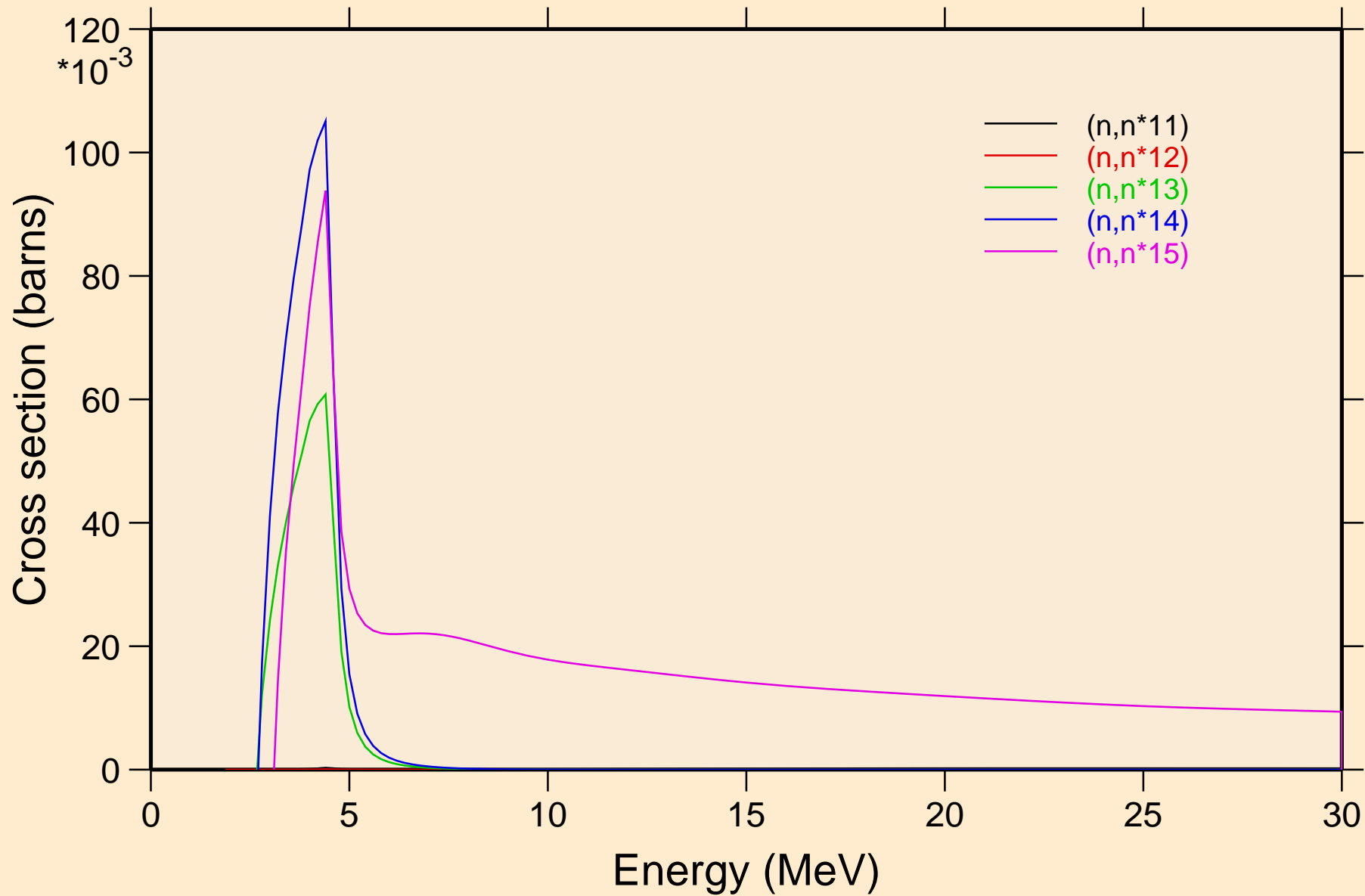

I136 NEUTRON ACER TENDL-2024 LIBRARY; T=0.K
Inelastic levels

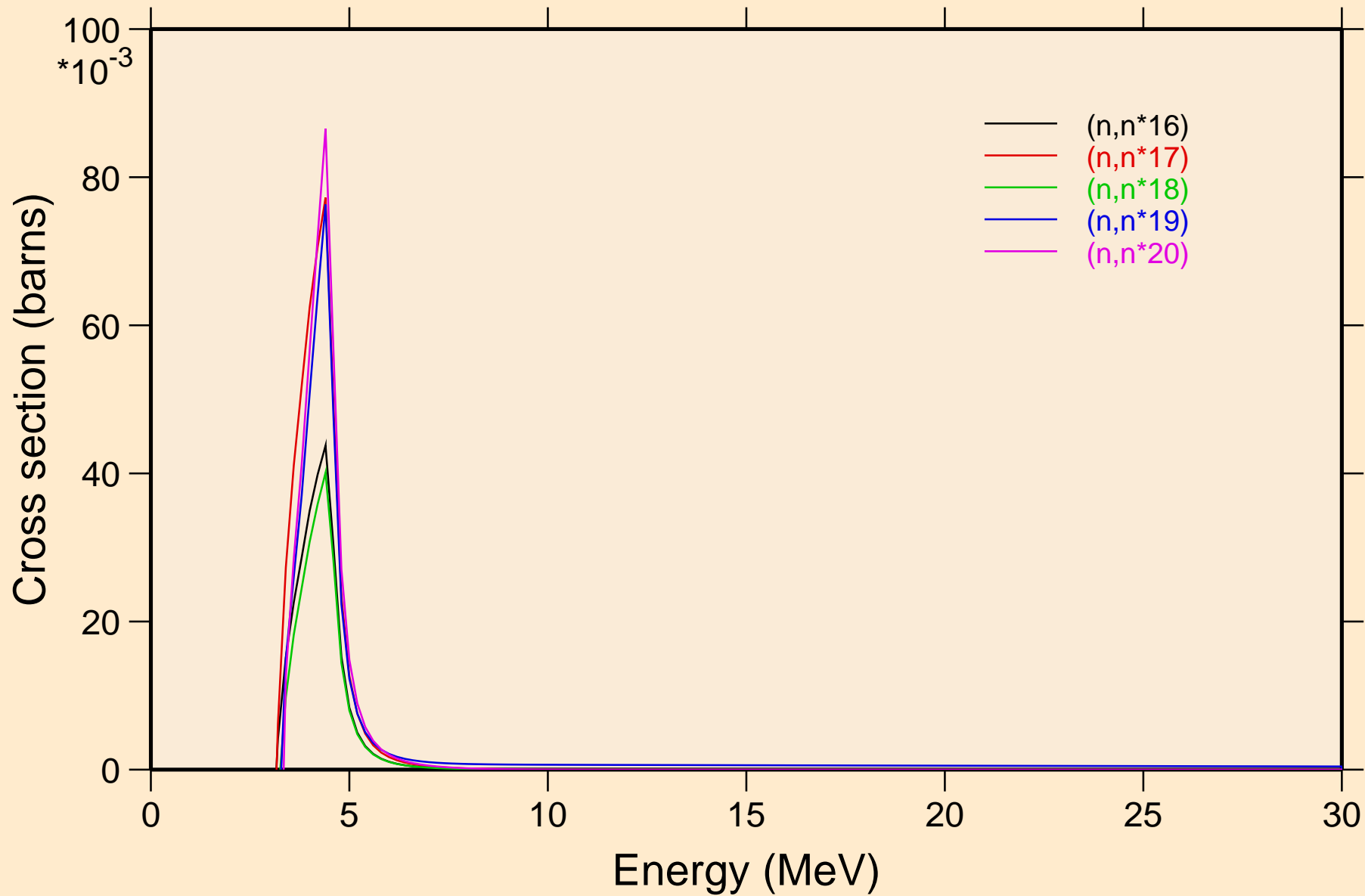

I136 NEUTRON ACER TENDL-2024 LIBRARY; T=0.K

Threshold reactions

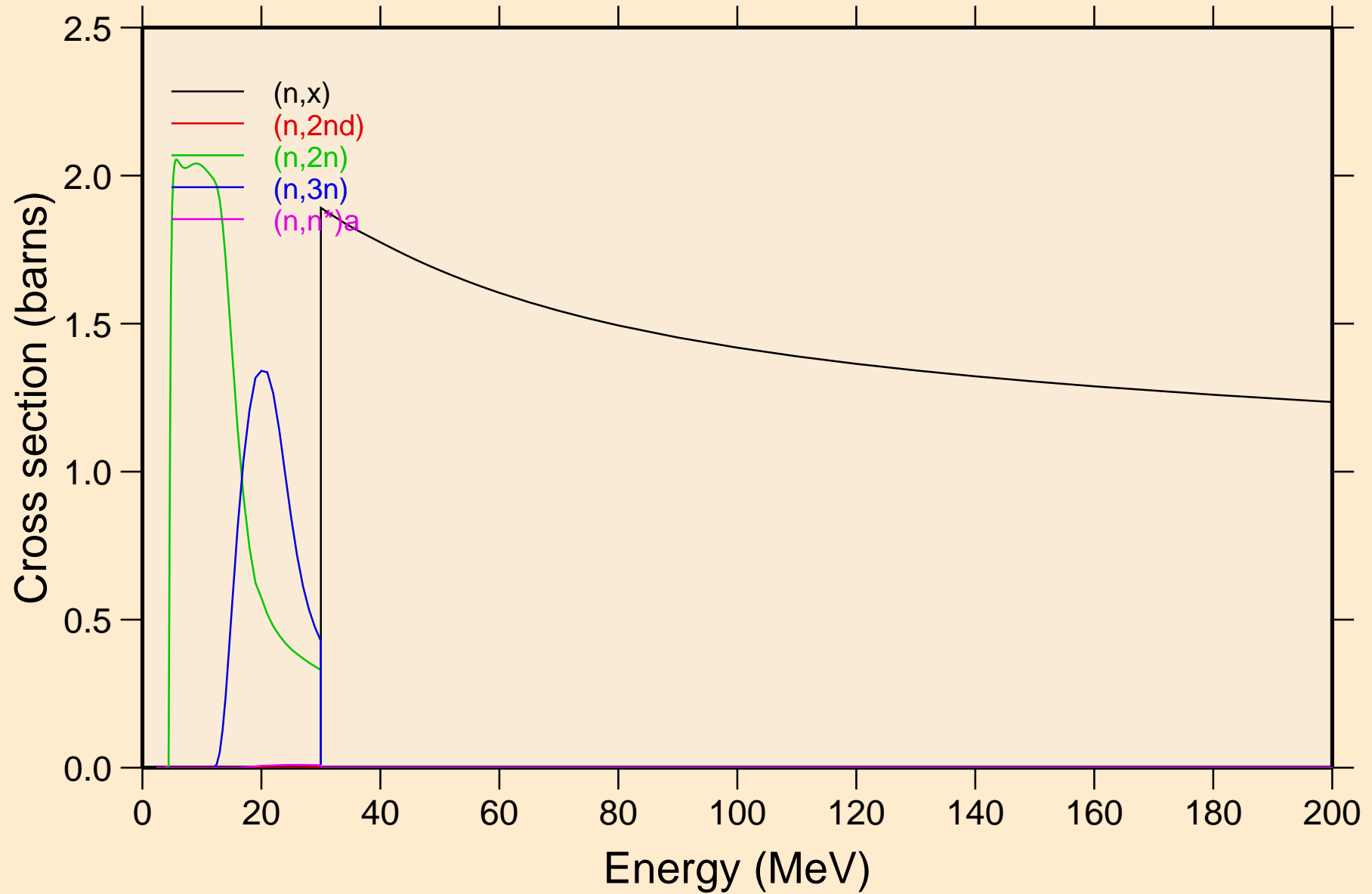

I136 NEUTRON ACER TENDL-2024 LIBRARY; T=0.K

Threshold reactions

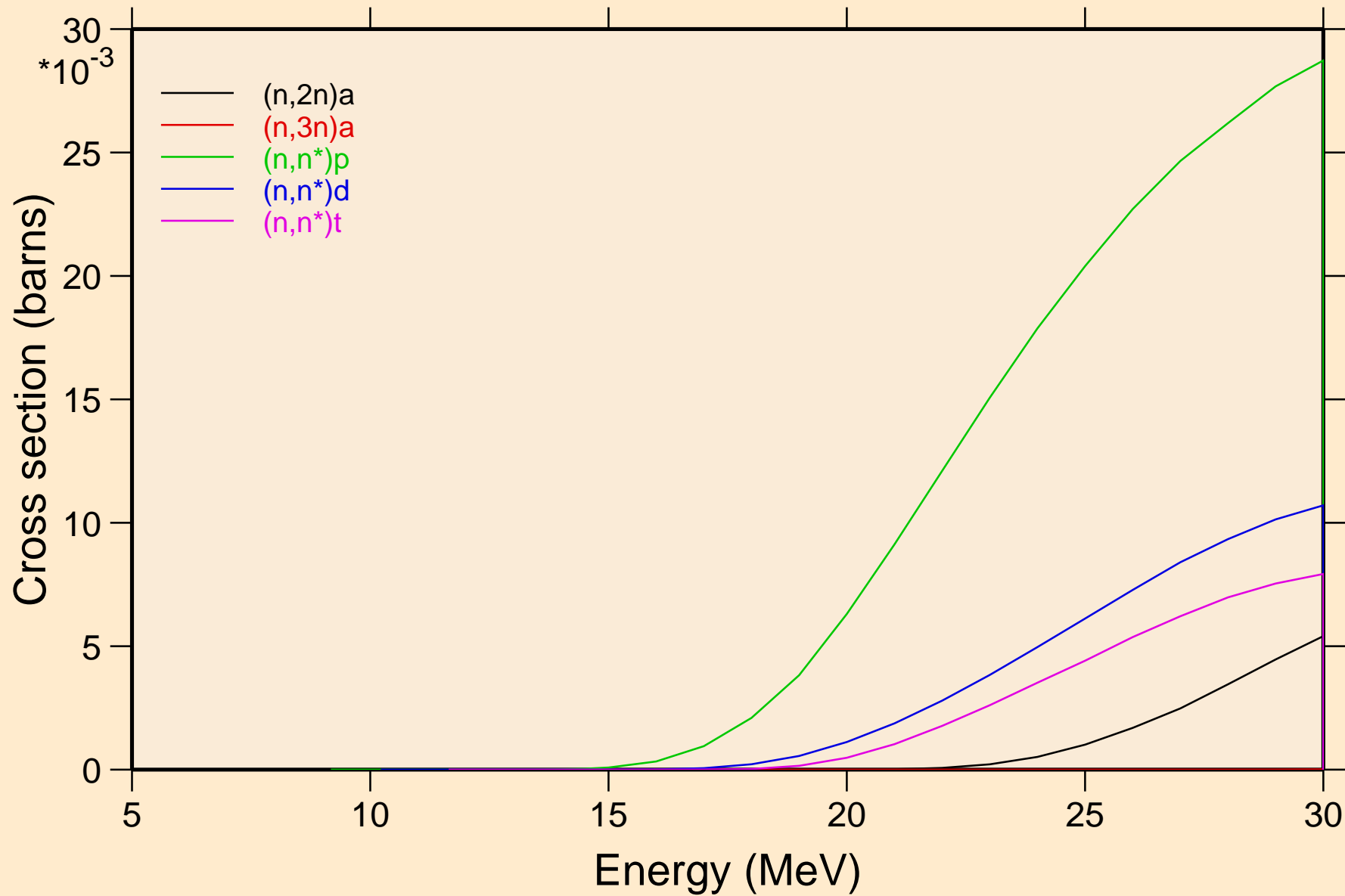

I136 NEUTRON ACER TENDL-2024 LIBRARY; T=0.K
Threshold reactions

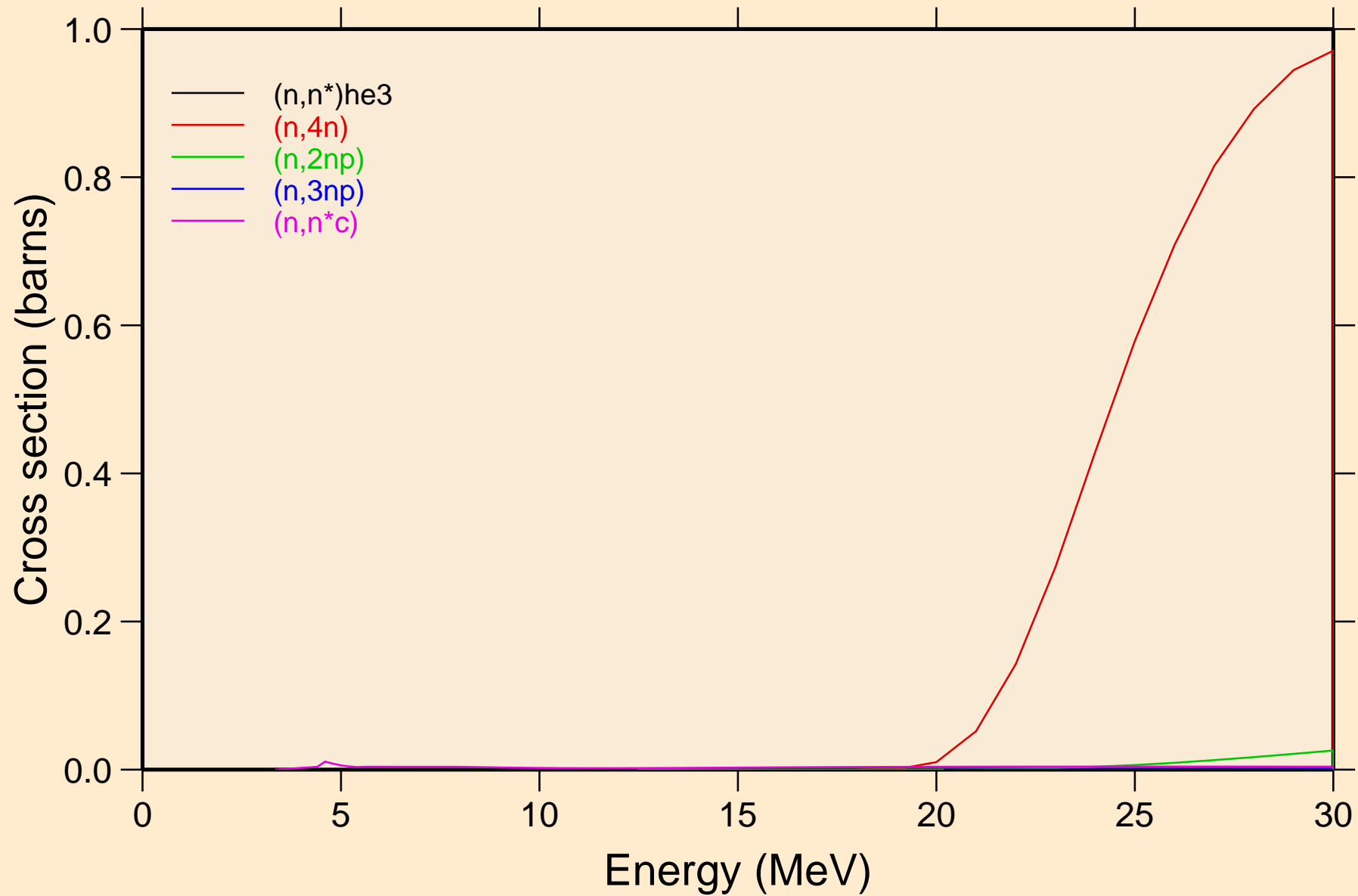

I136 NEUTRON ACER TENDL-2024 LIBRARY; T=0.K
Threshold reactions

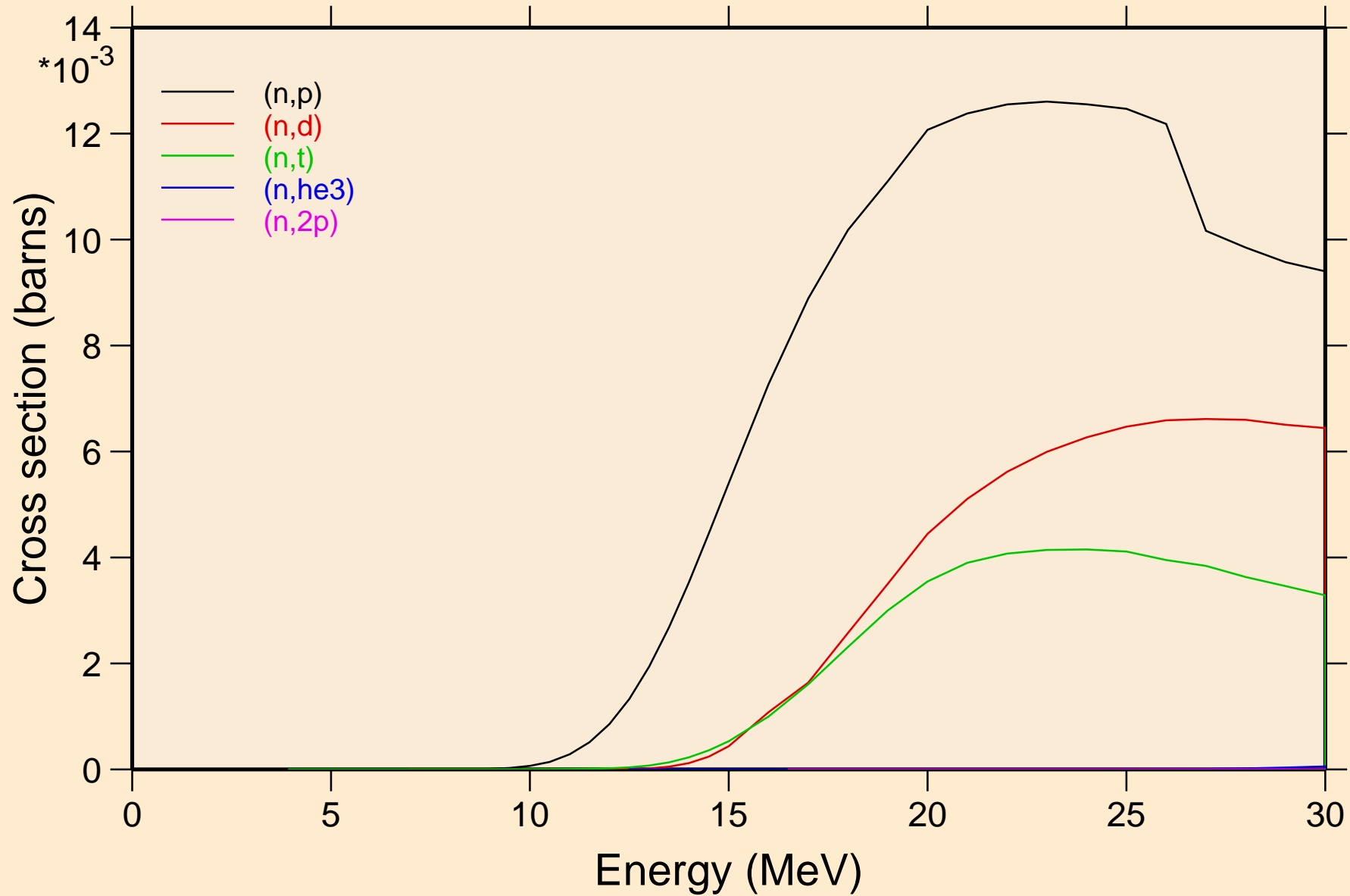

I136 NEUTRON ACER TENDL-2024 LIBRARY; T=0.K

Threshold reactions

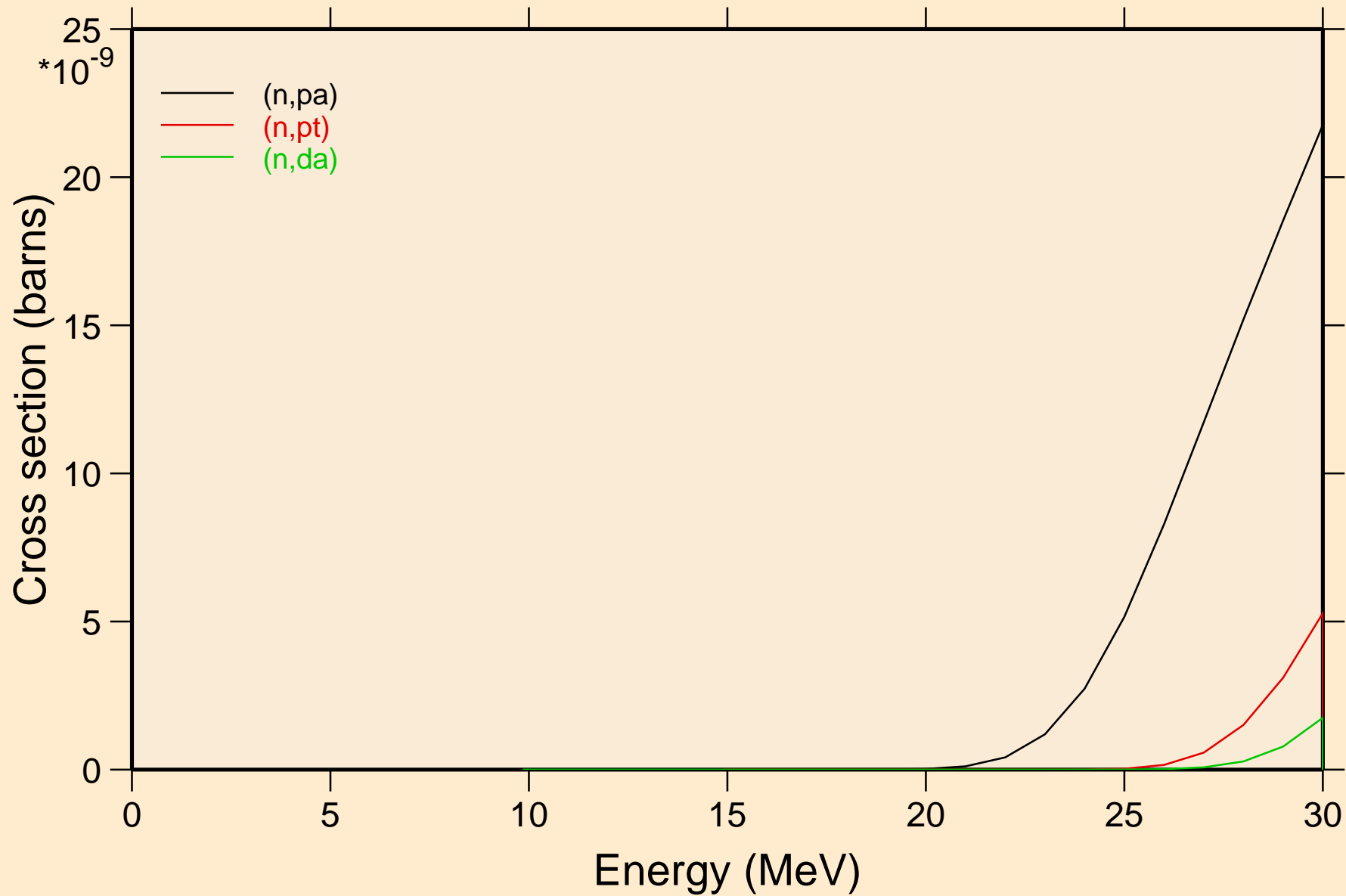

I136 NEUTRON ACER TENDL-2024 LIBRARY; T=0.K

Threshold reactions

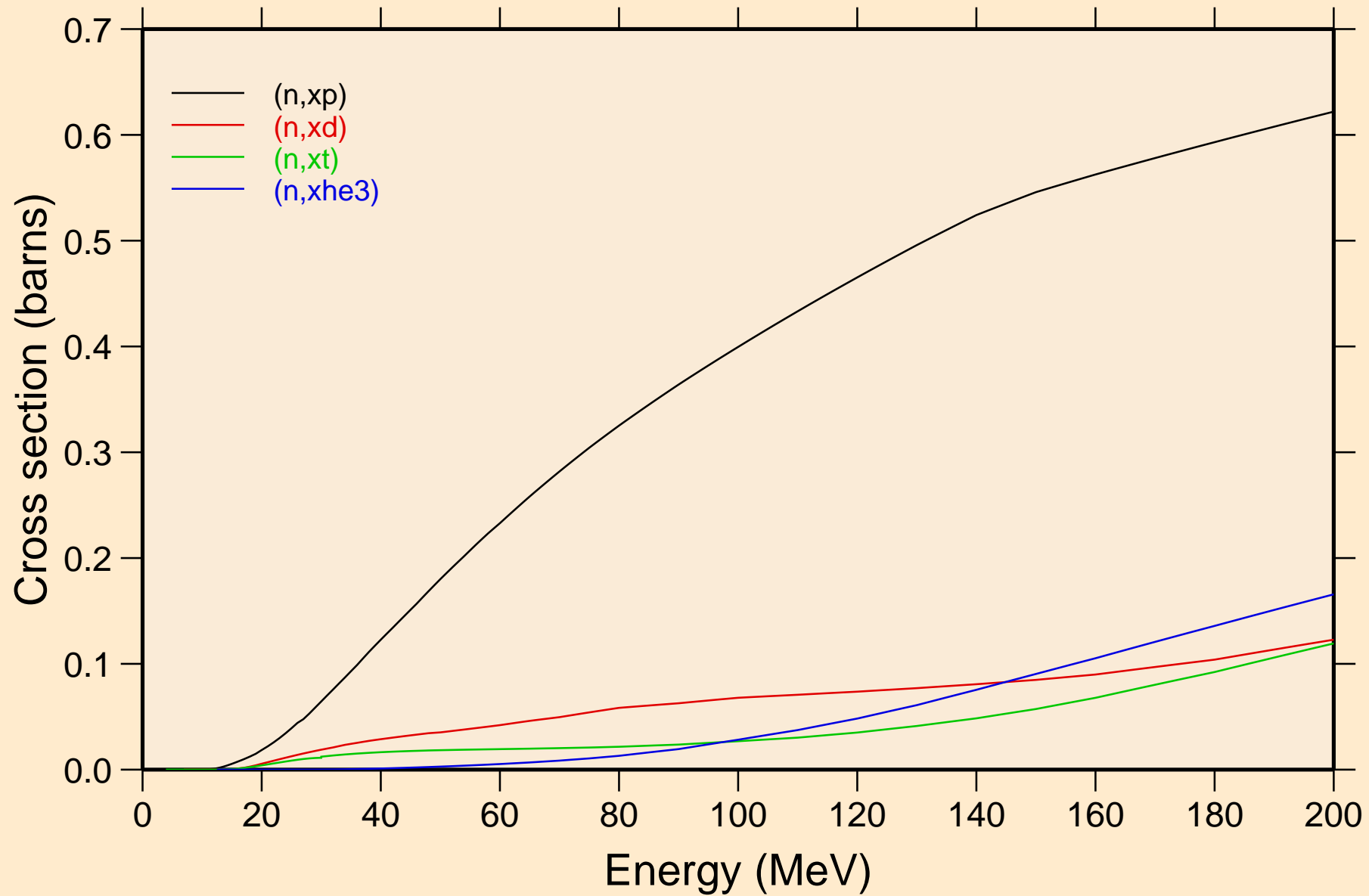

I136 NEUTRON ACER TENDL-2024 LIBRARY; T=0.K
angular distribution for elastic

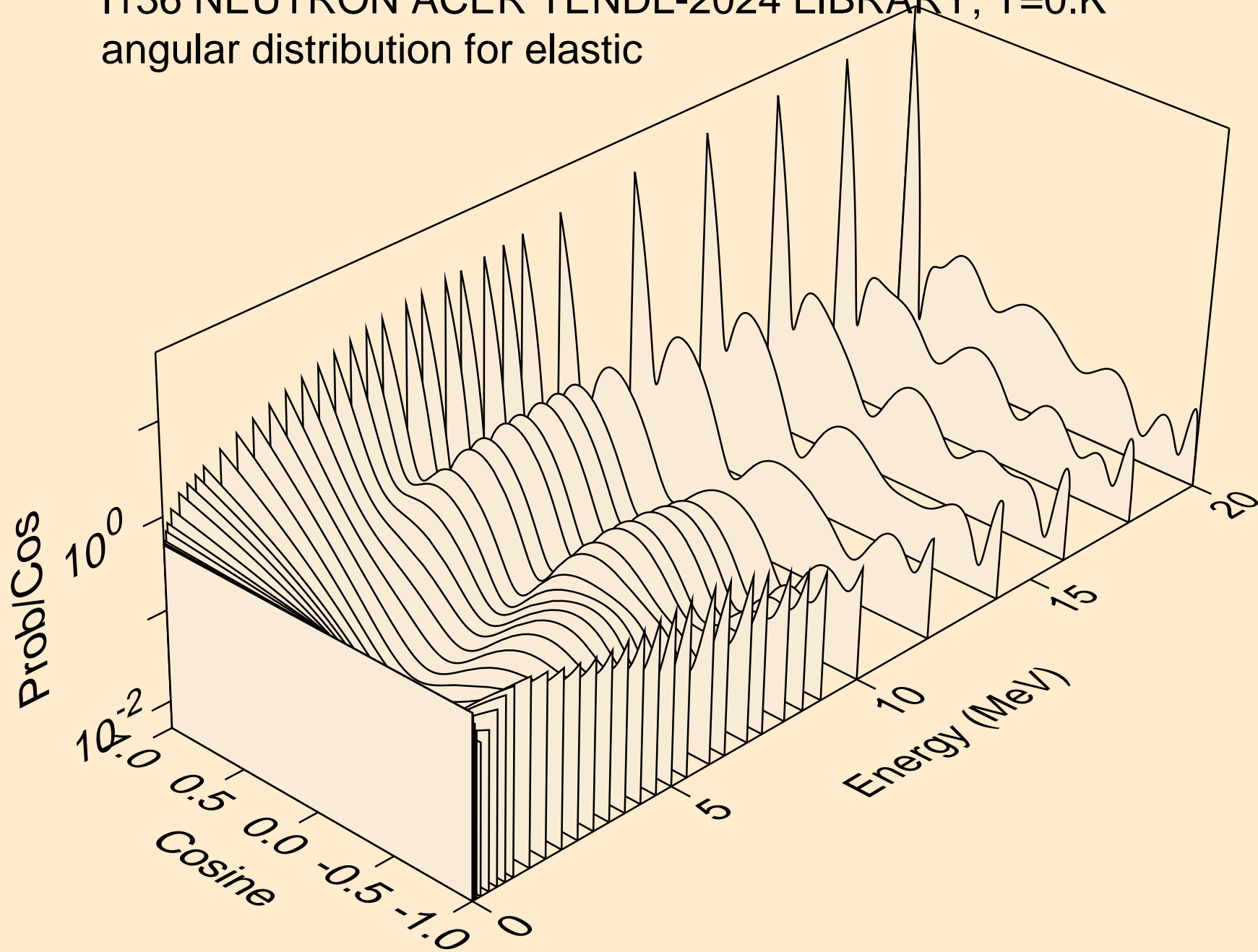

I136 NEUTRON ACER TENDL-2024 LIBRARY; T=0.K
angular distribution for elastic

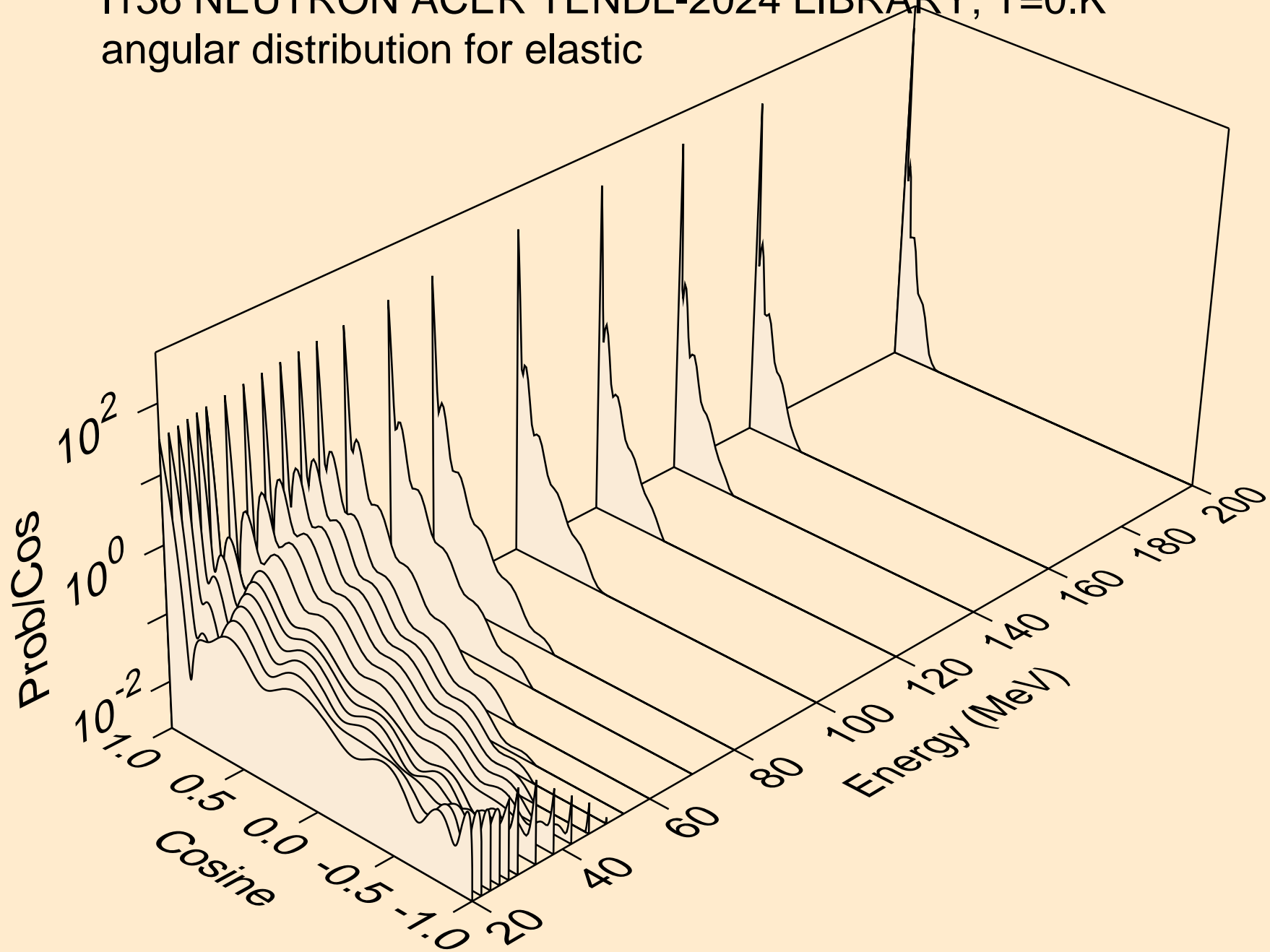

I136 NEUTRON ACER TENDL-2024 LIBRARY; T=0.K
angular distribution for (n,n*1)

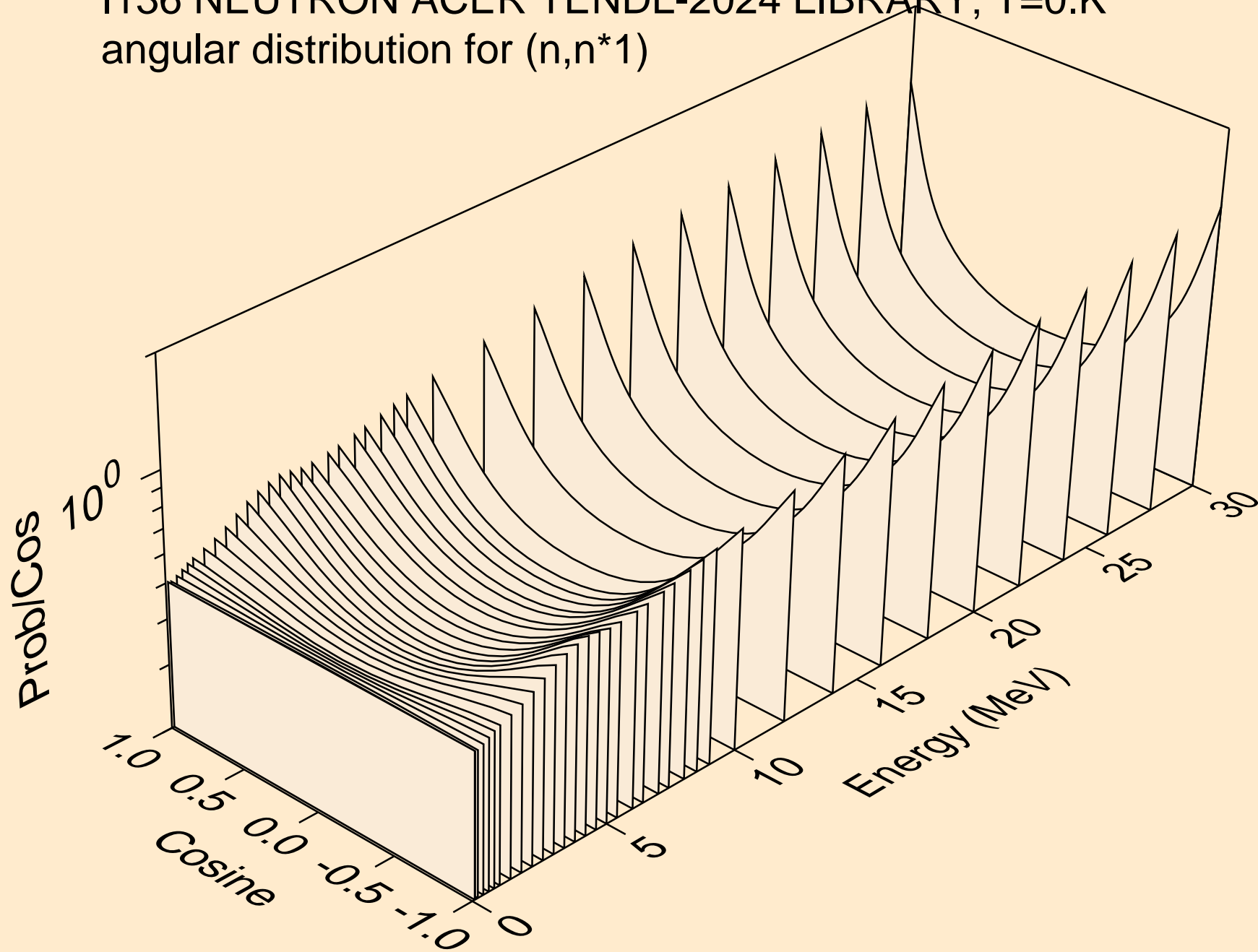

I136 NEUTRON ACER TENDL-2024 LIBRARY; T=0.K
angular distribution for (n,n*2)

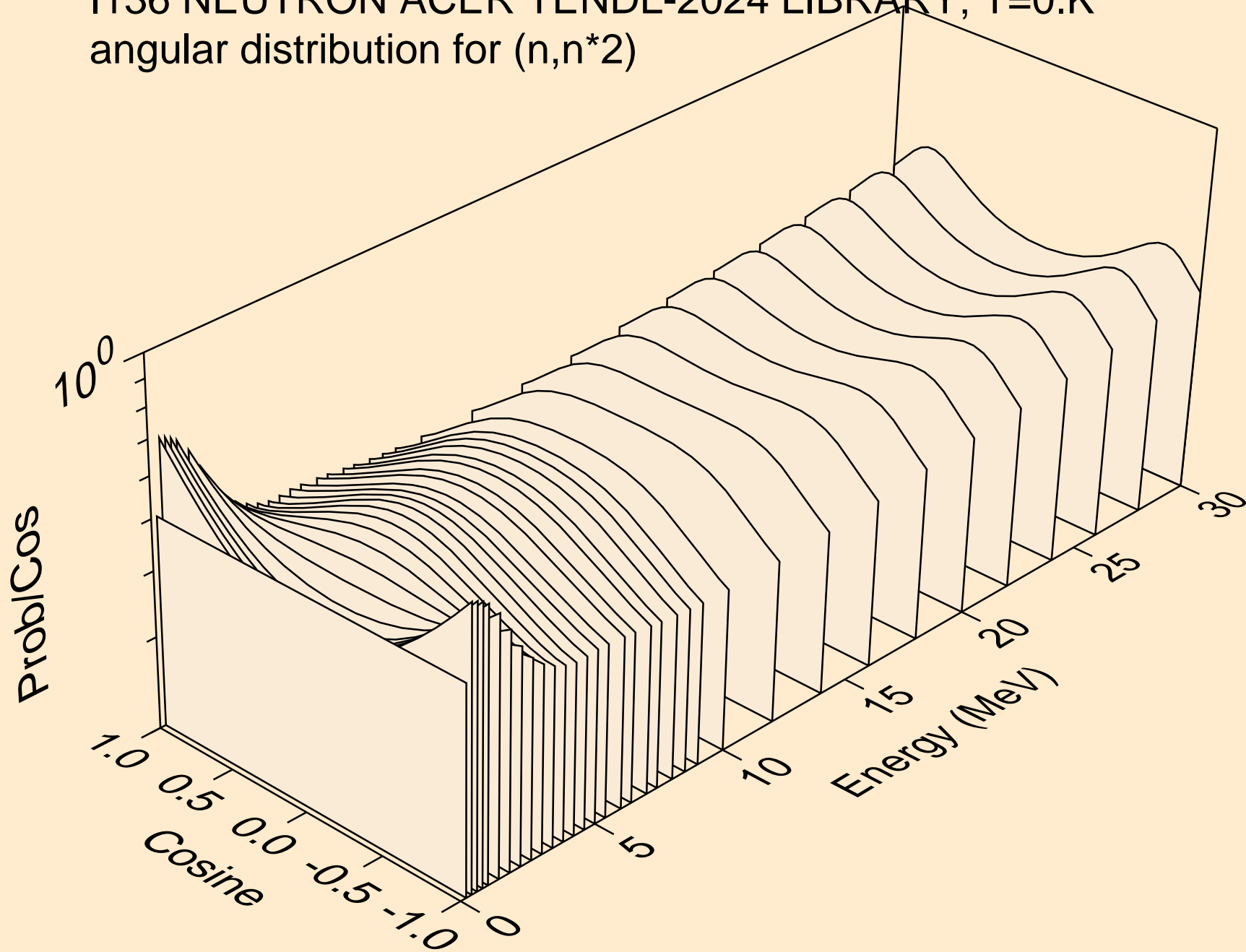

I136 NEUTRON ACER TENDL-2024 LIBRARY; T=0.K
angular distribution for (n,n*3)

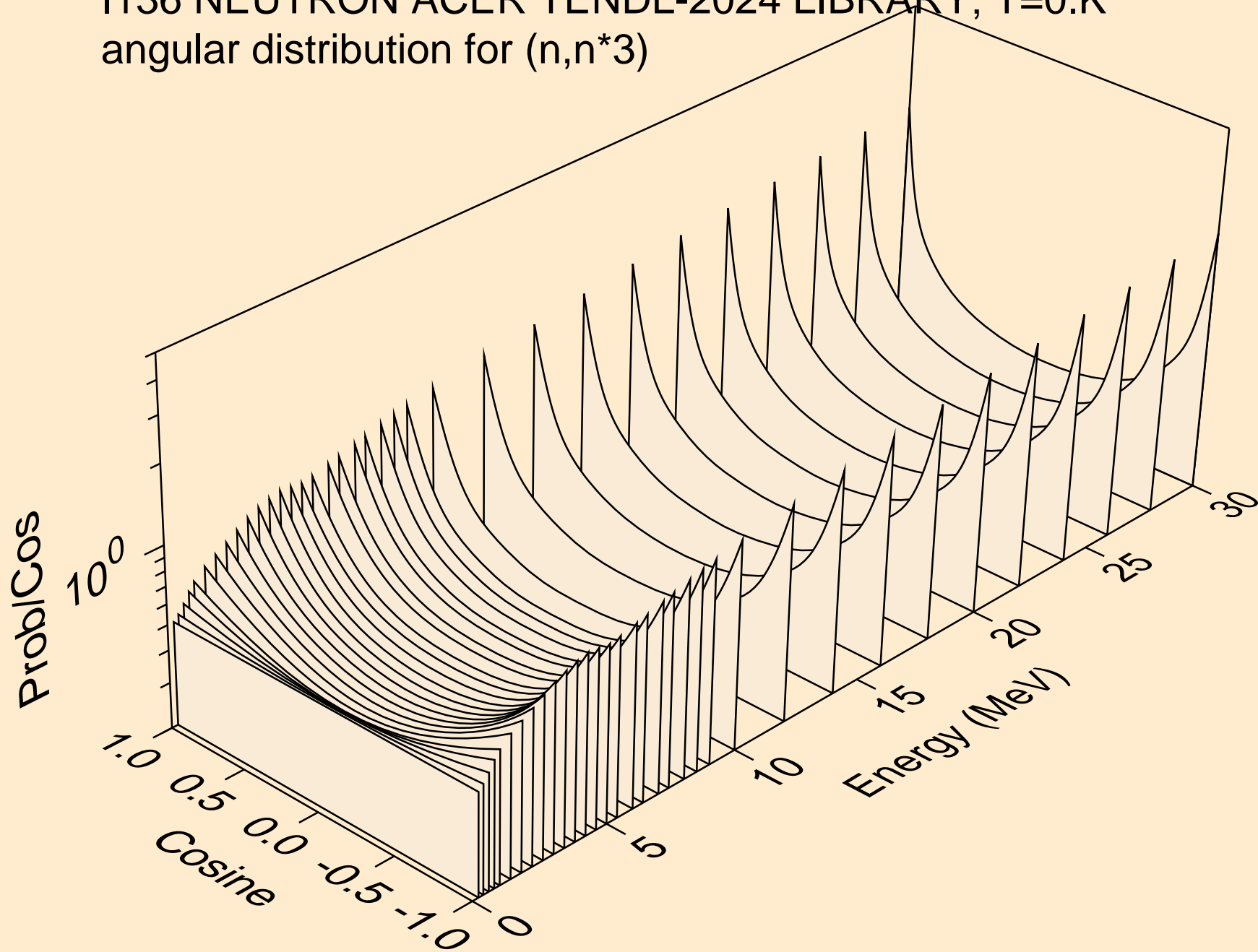

I136 NEUTRON ACER TENDL-2024 LIBRARY; T=0.K
angular distribution for (n,n*4)

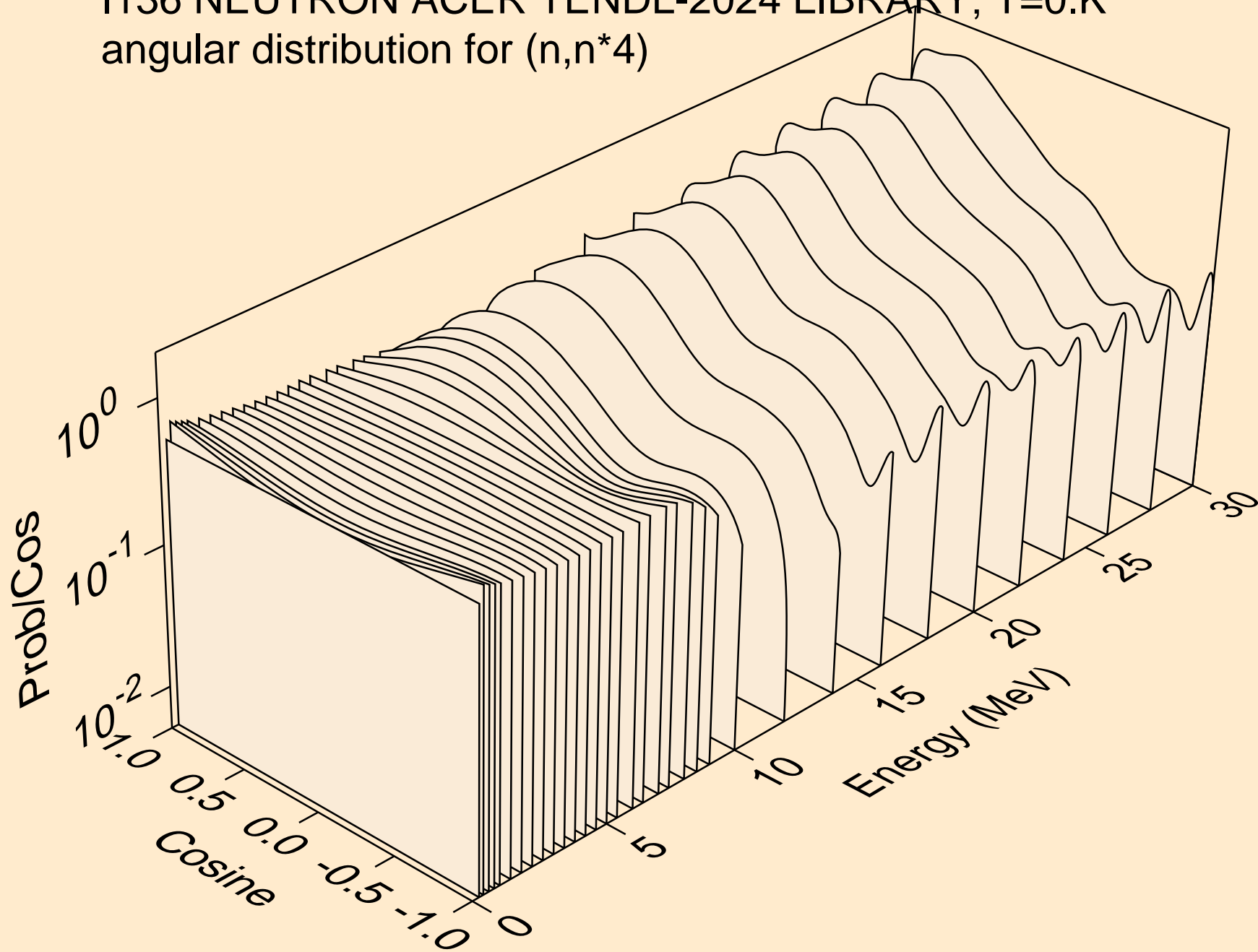

I136 NEUTRON ACER TENDL-2024 LIBRARY; T=0.K
angular distribution for (n,n*5)

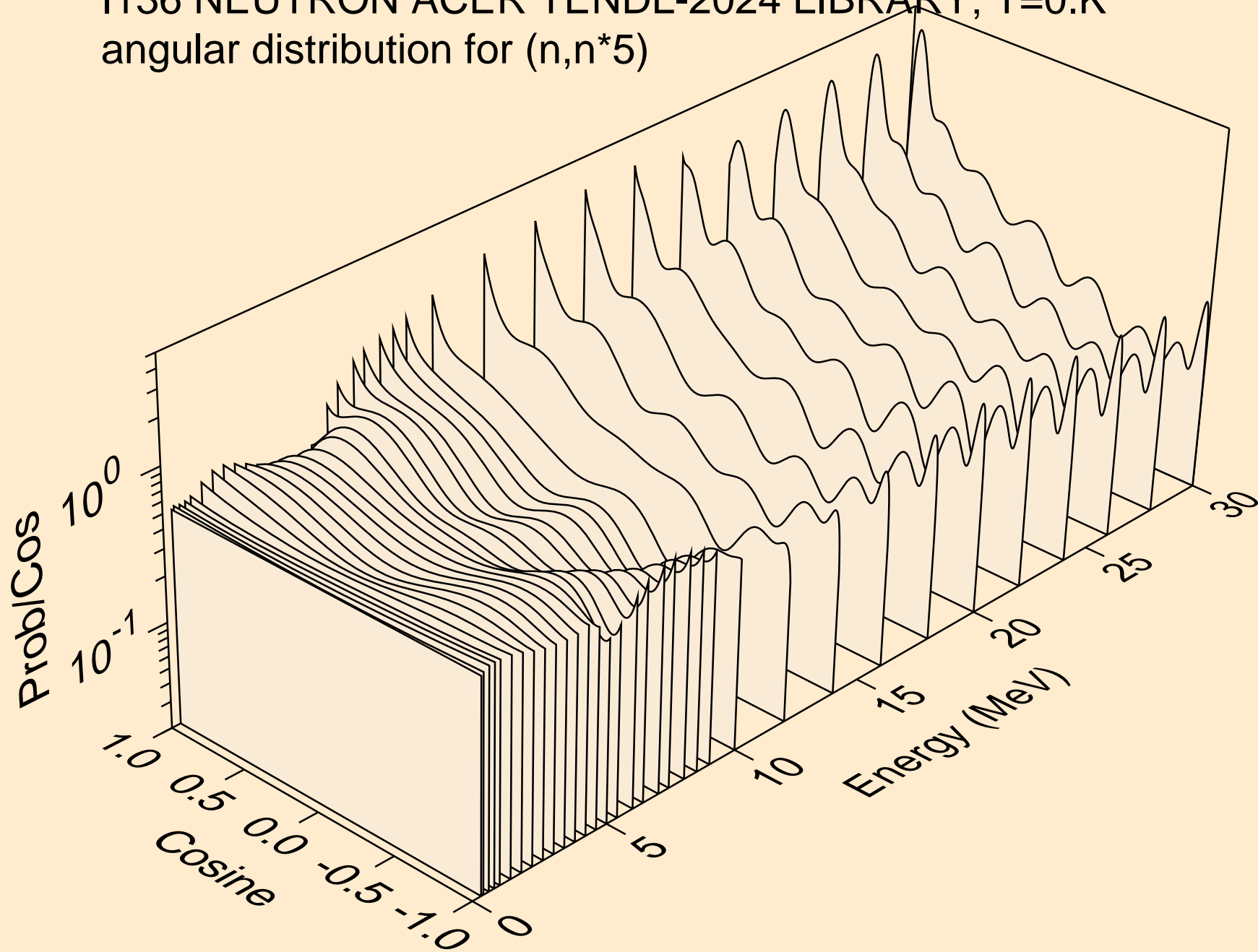

I136 NEUTRON ACER TENDL-2024 LIBRARY; T=0.K
angular distribution for (n,n*6)

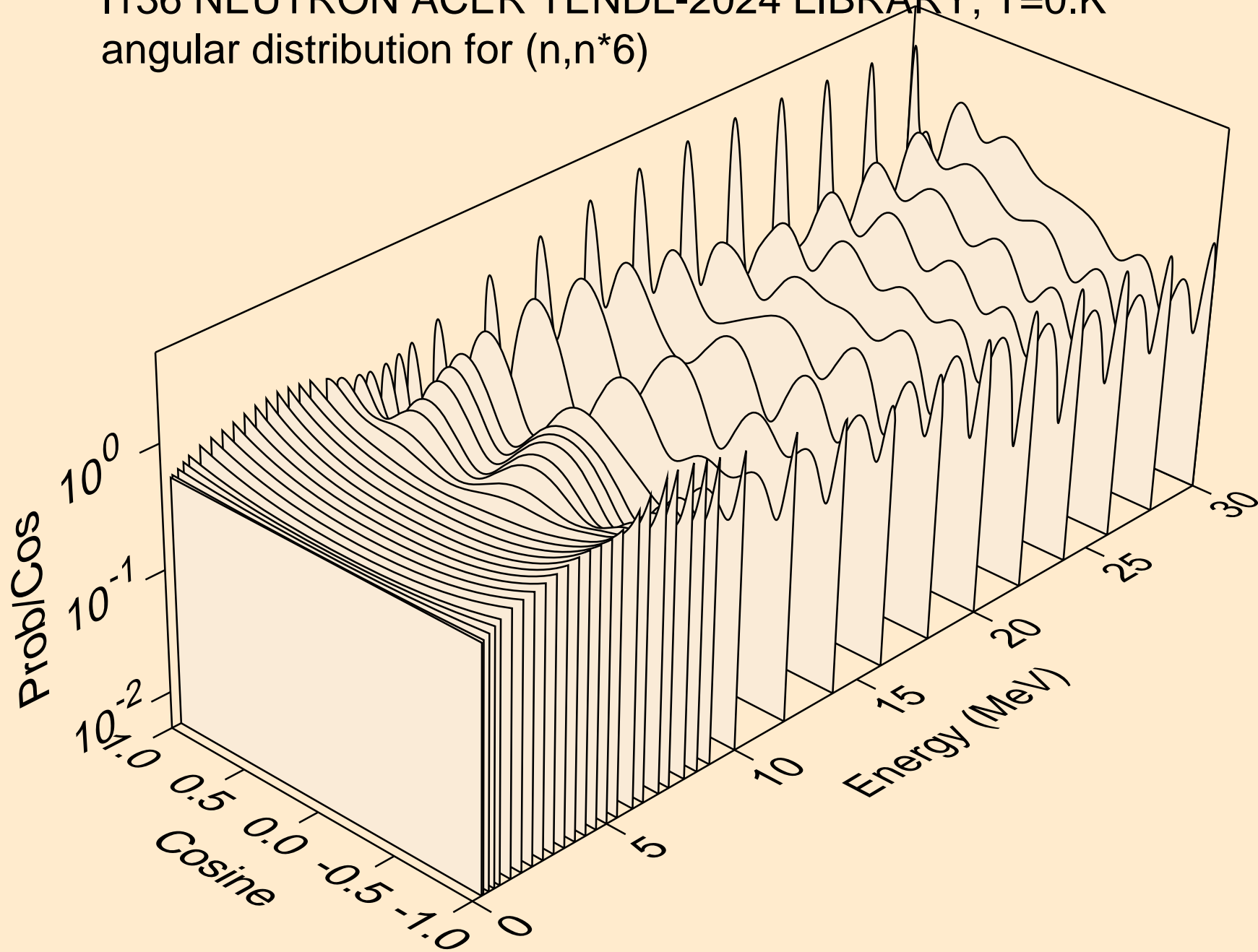

I136 NEUTRON ACER TENDL-2024 LIBRARY; T=0.K
angular distribution for (n,n*7)

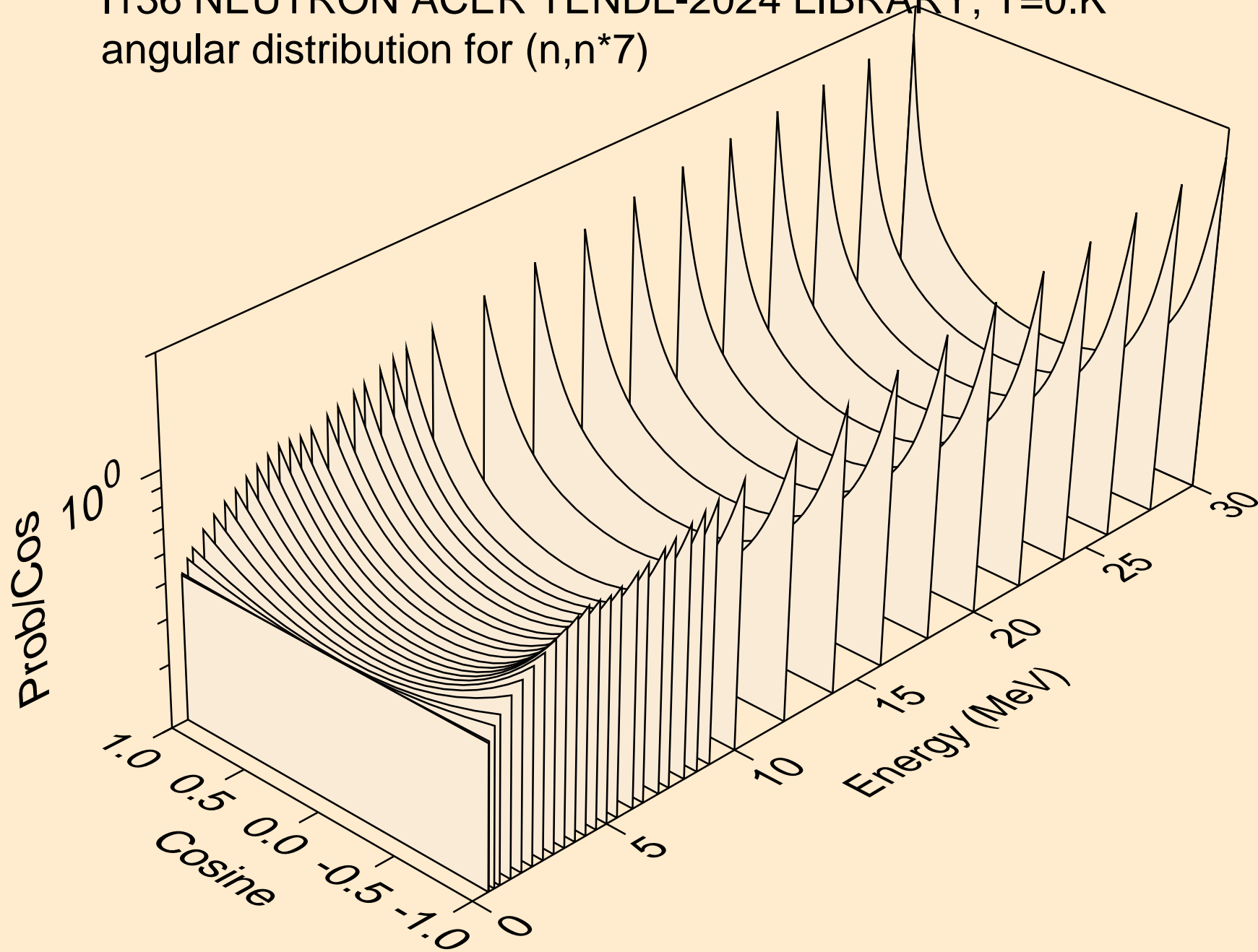

I136 NEUTRON ACER TENDL-2024 LIBRARY; T=0.K
angular distribution for (n,n*8)

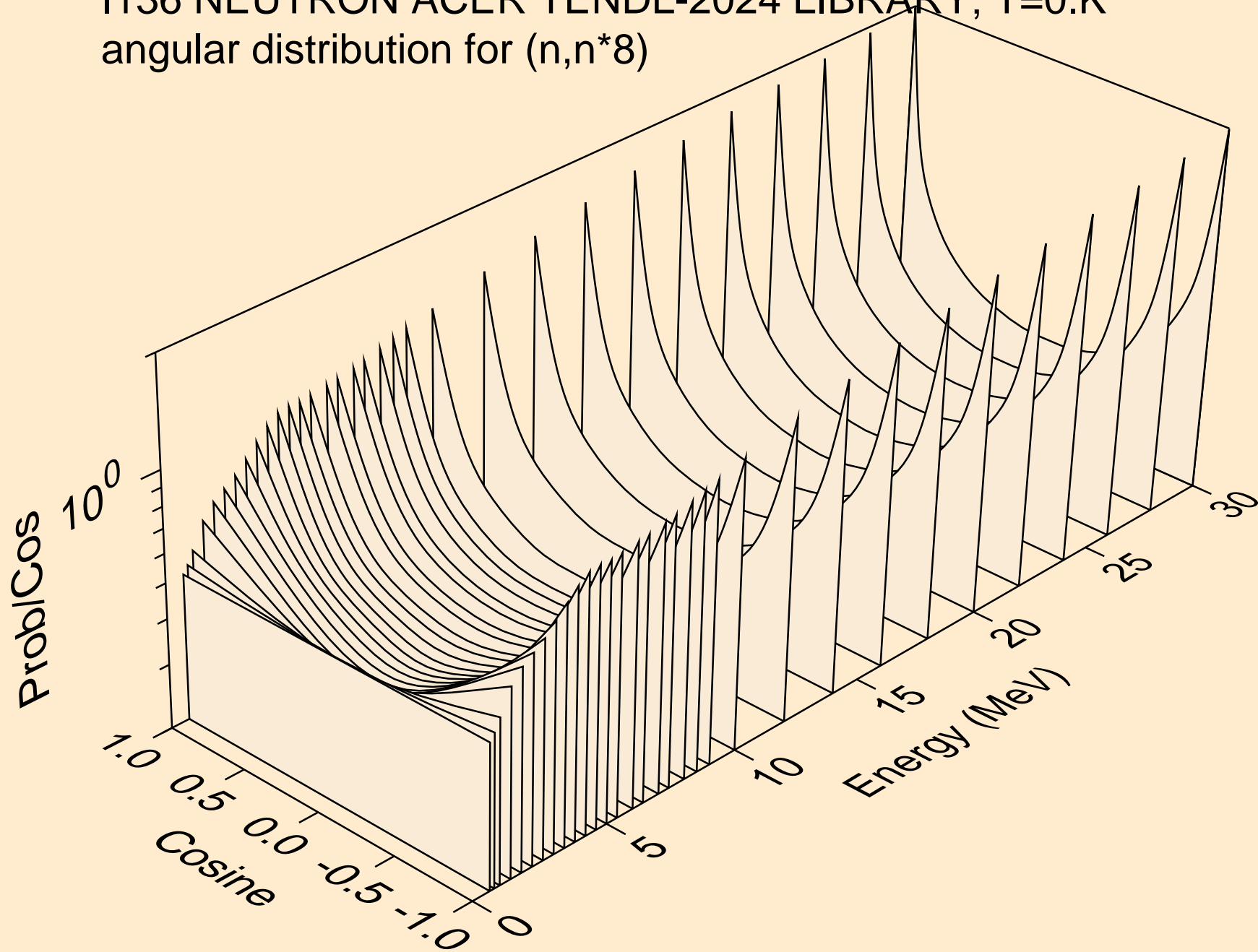

I136 NEUTRON ACER TENDL-2024 LIBRARY; T=0.K
angular distribution for (n,n*9)

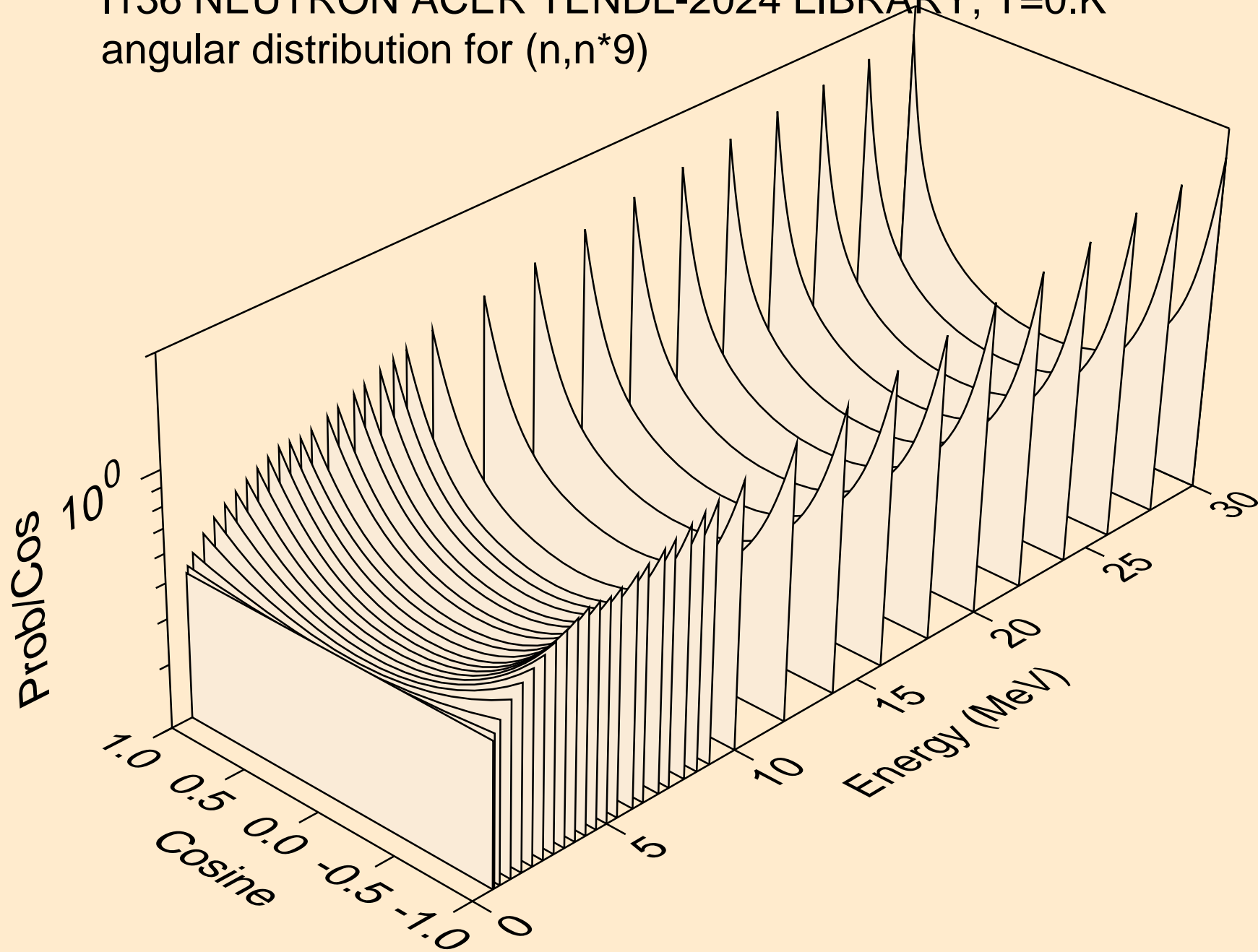

I136 NEUTRON ACER TENDL-2024 LIBRARY; T=0.K
angular distribution for (n,n*10)

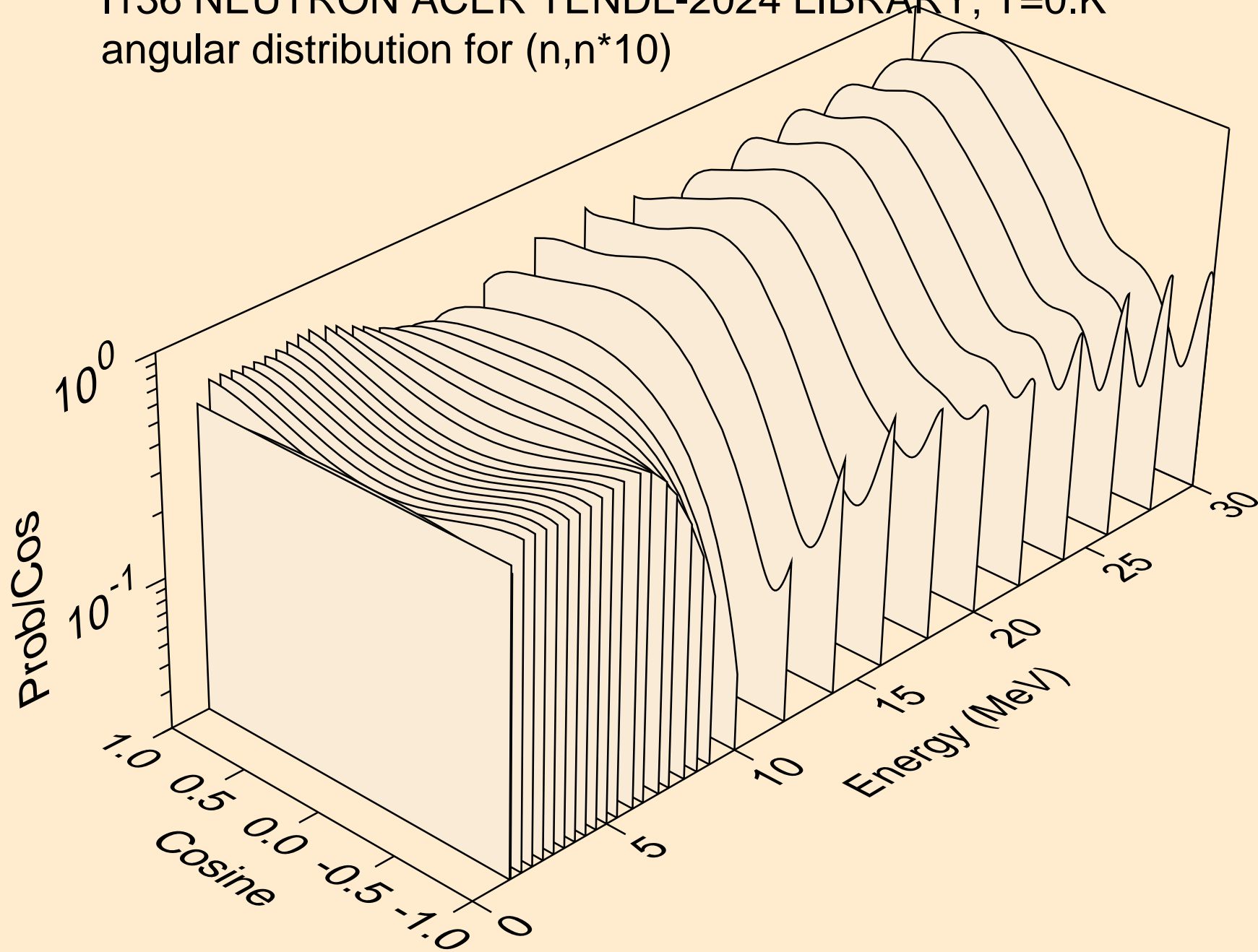

I136 NEUTRON ACER TENDL-2024 LIBRARY; T=0.K
angular distribution for (n,n*11)

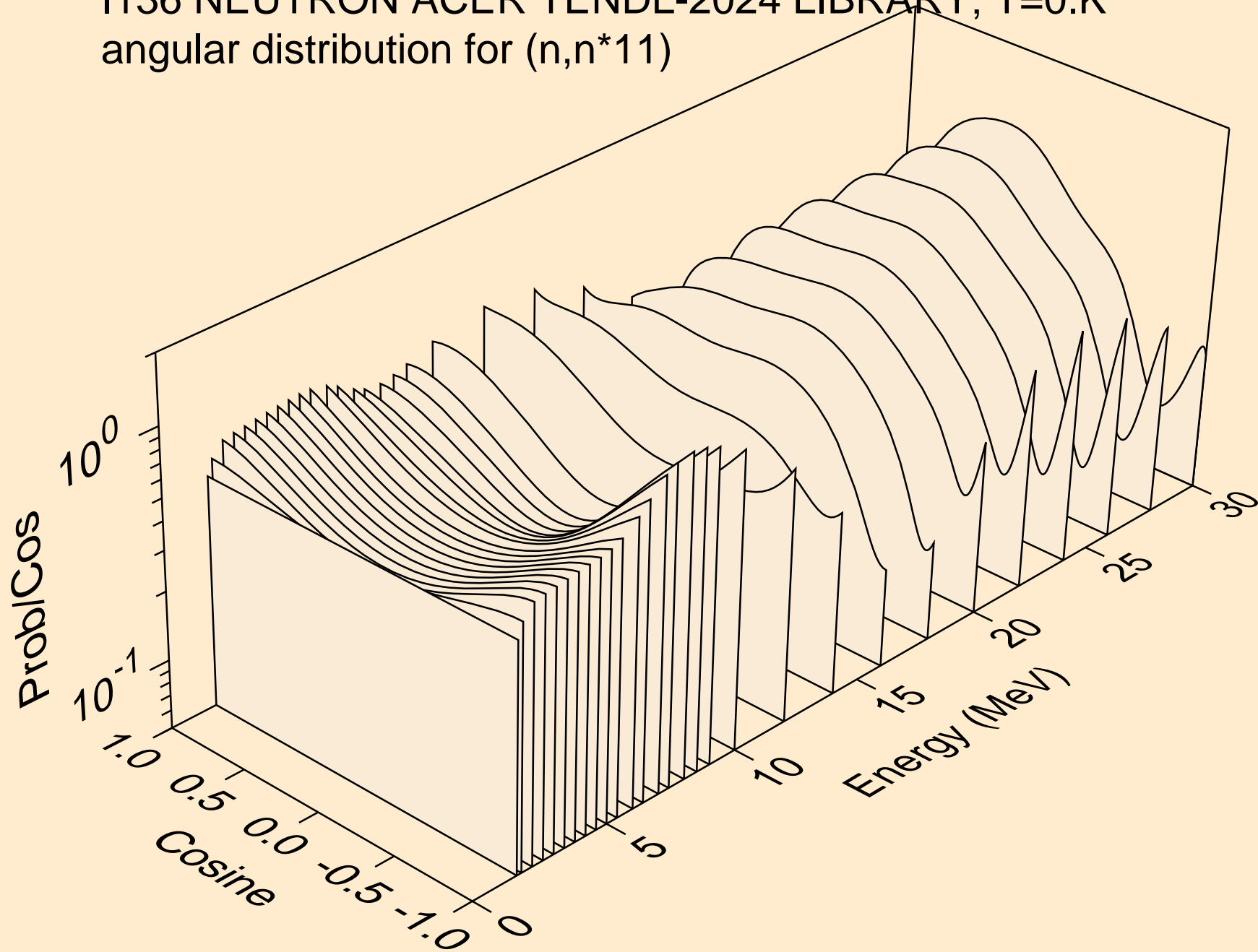

I136 NEUTRON ACER TENDL-2024 LIBRARY; T=0.K
angular distribution for (n,n*12)

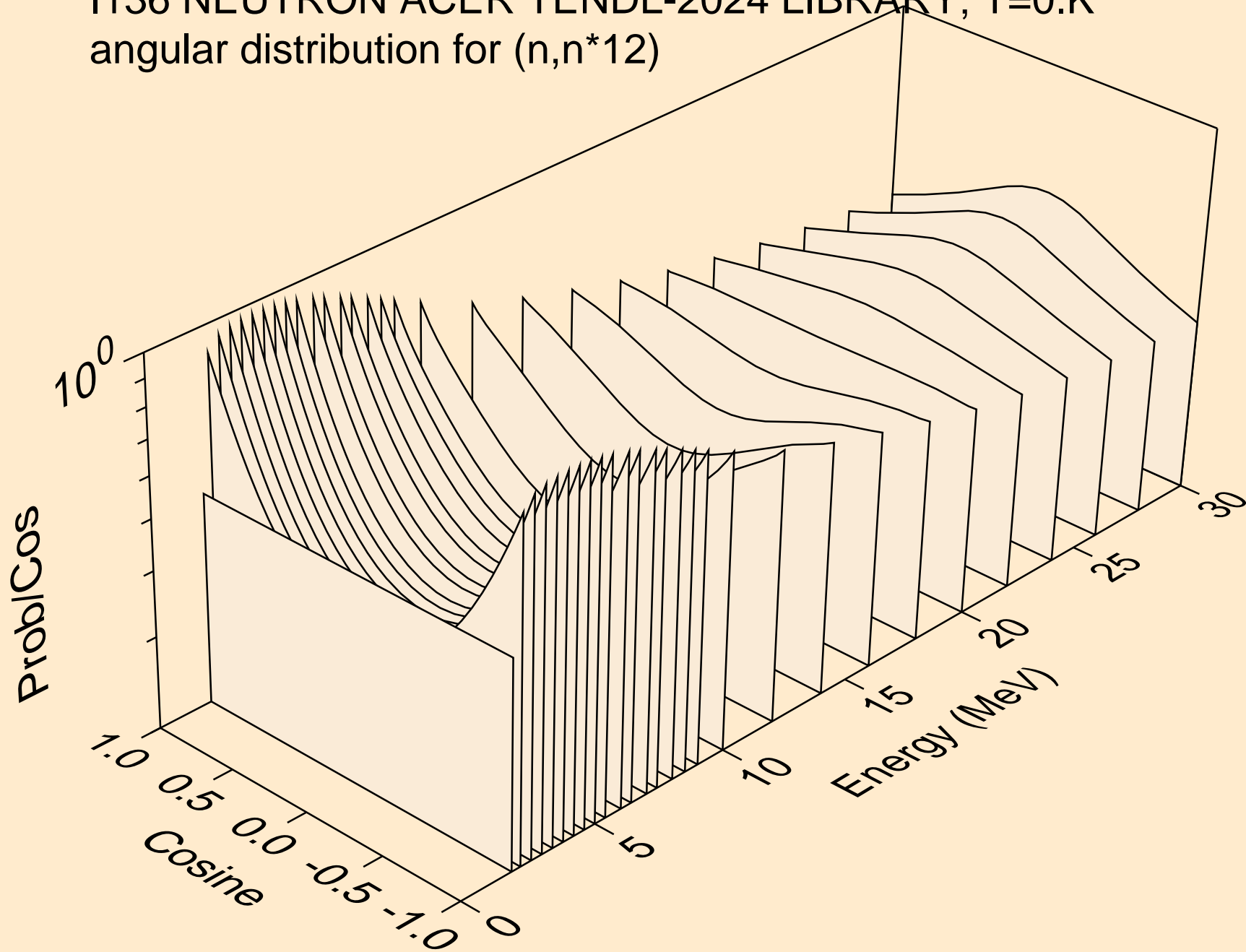

I136 NEUTRON ACER TENDL-2024 LIBRARY; T=0.K
angular distribution for (n,n*13)

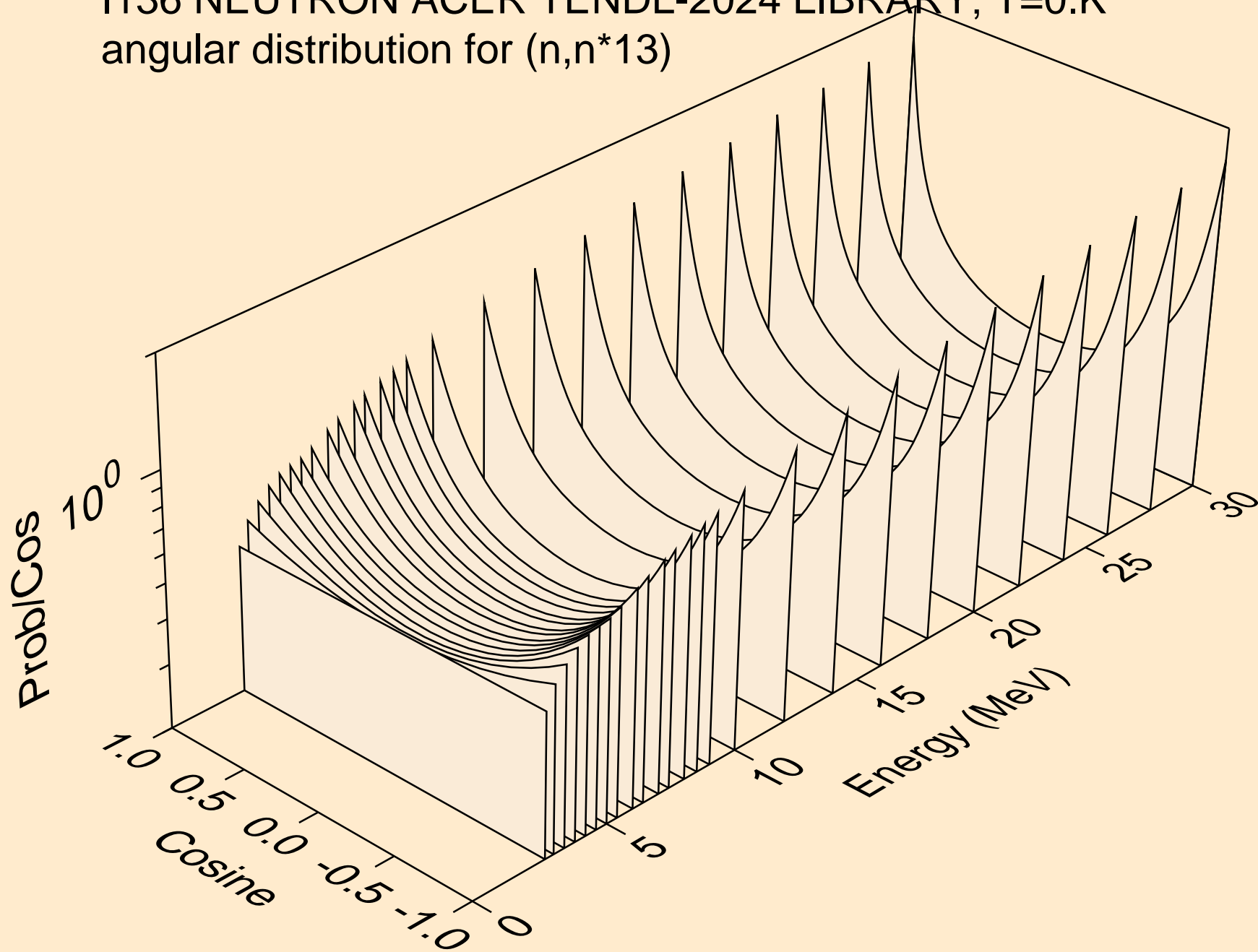

I136 NEUTRON ACER TENDL-2024 LIBRARY; T=0.K
angular distribution for (n,n*14)

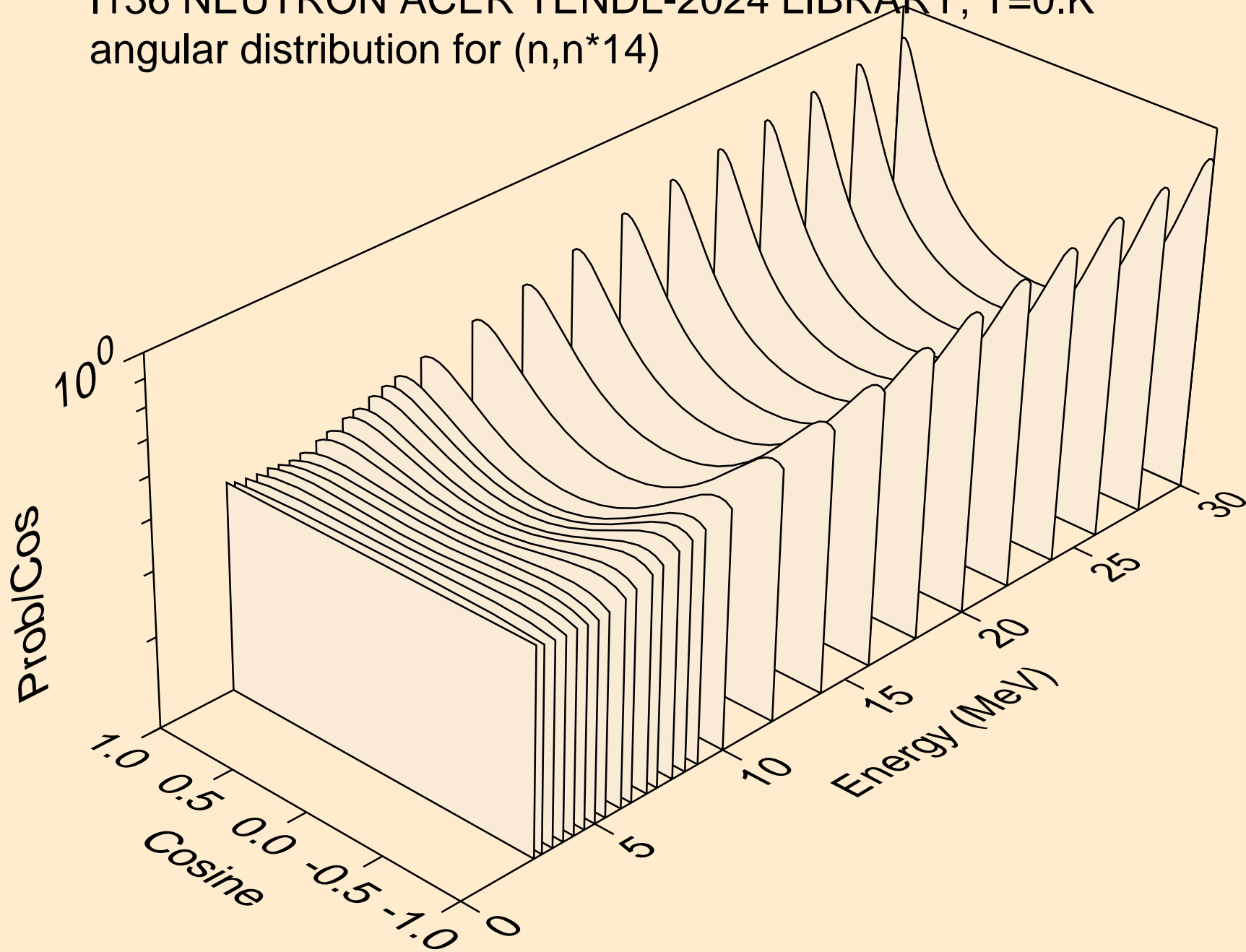

I136 NEUTRON ACER TENDL-2024 LIBRARY; T=0.K
angular distribution for (n,n*15)

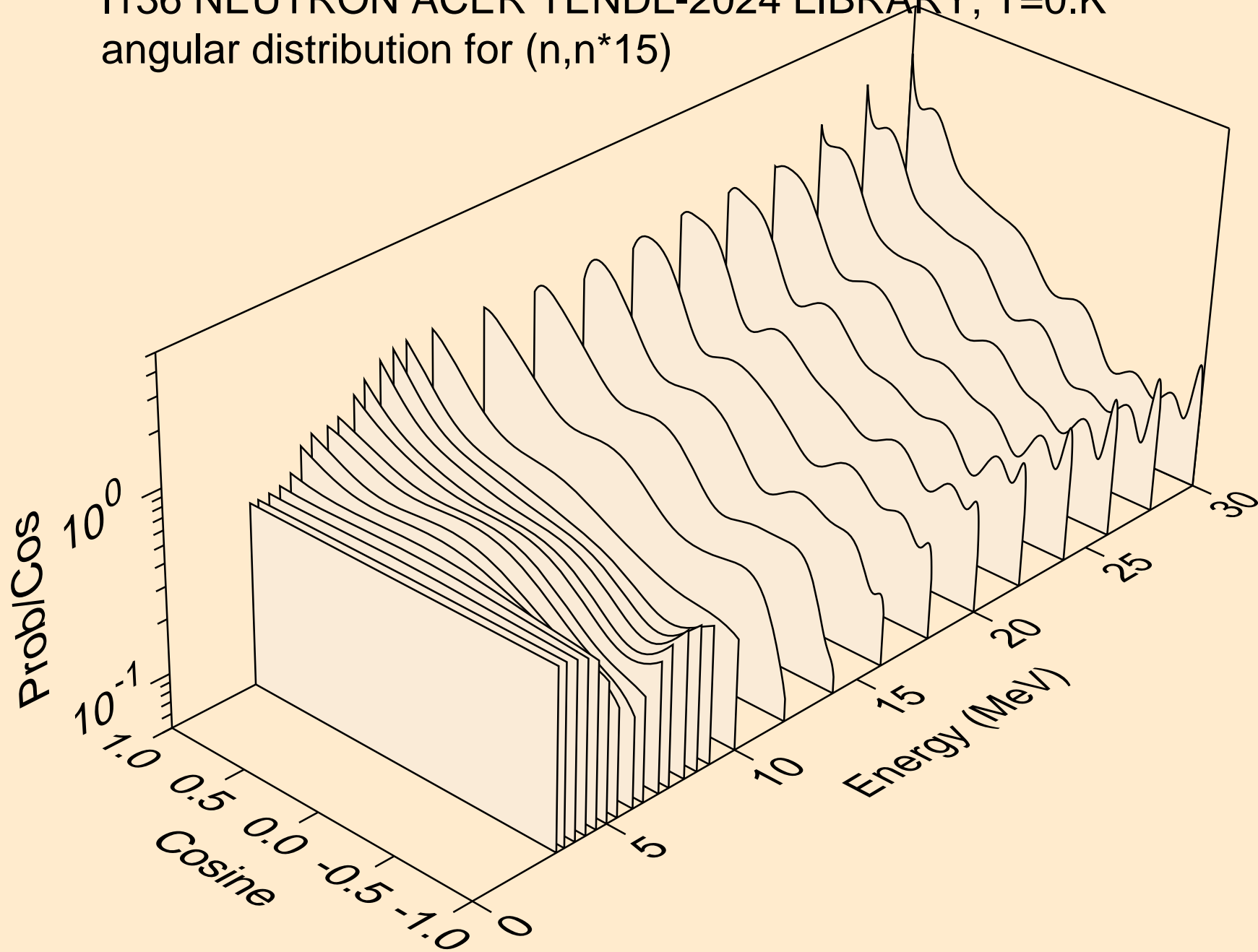

I136 NEUTRON ACER TENDL-2024 LIBRARY; T=0.K
angular distribution for (n,n*16)

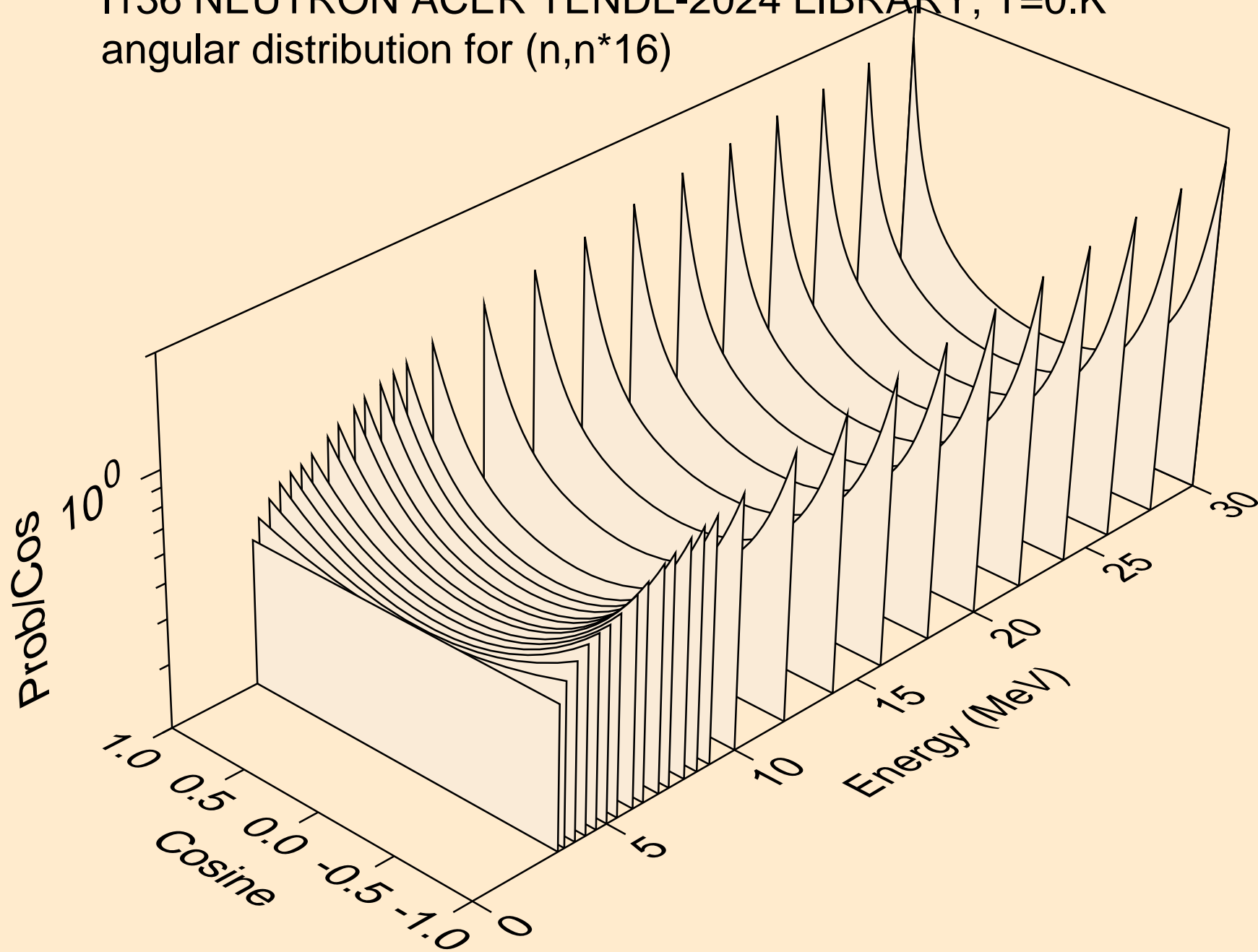

I136 NEUTRON ACER TENDL-2024 LIBRARY; T=0.K
angular distribution for (n,n*17)

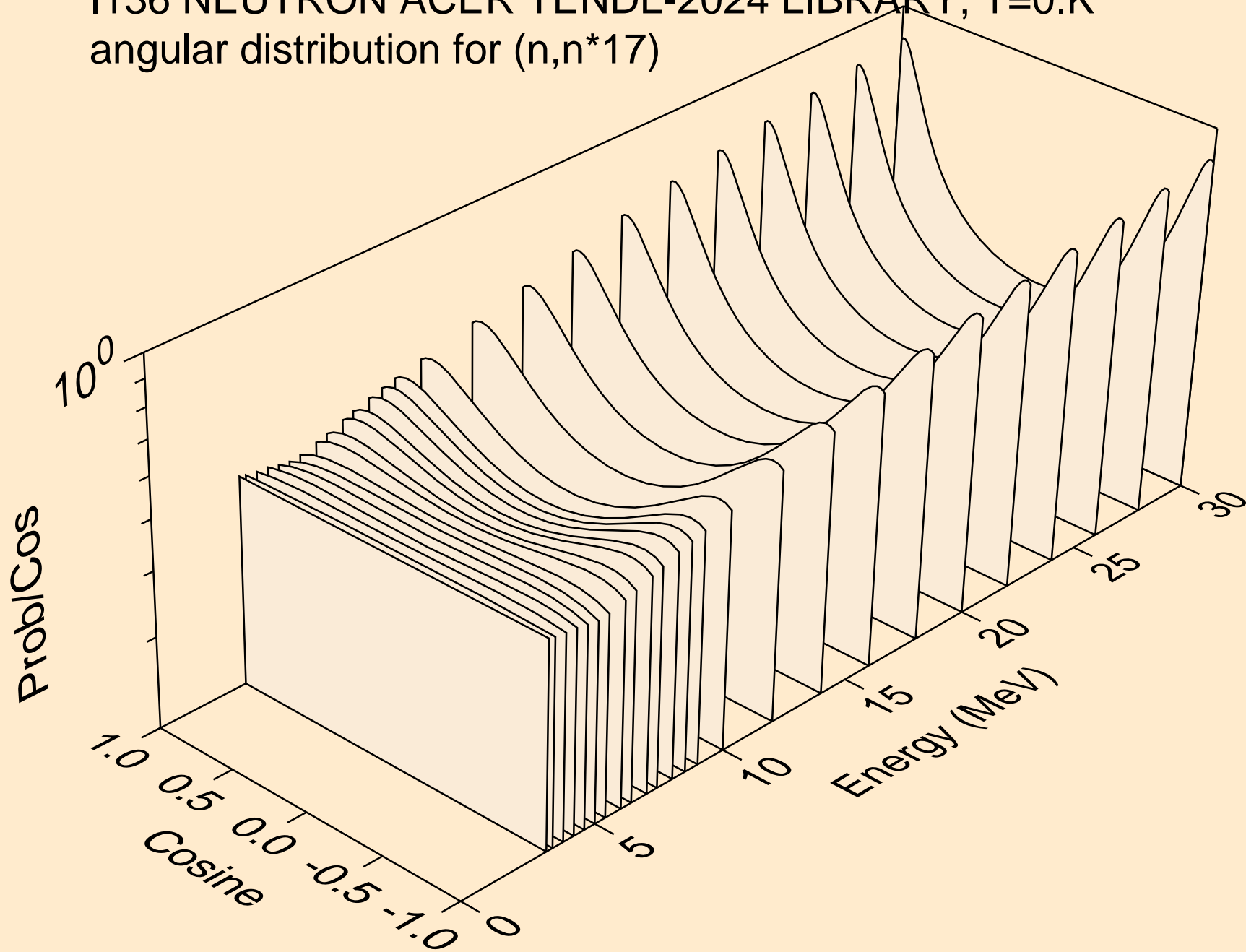

I136 NEUTRON ACER TENDL-2024 LIBRARY; T=0.K
angular distribution for (n,n*18)

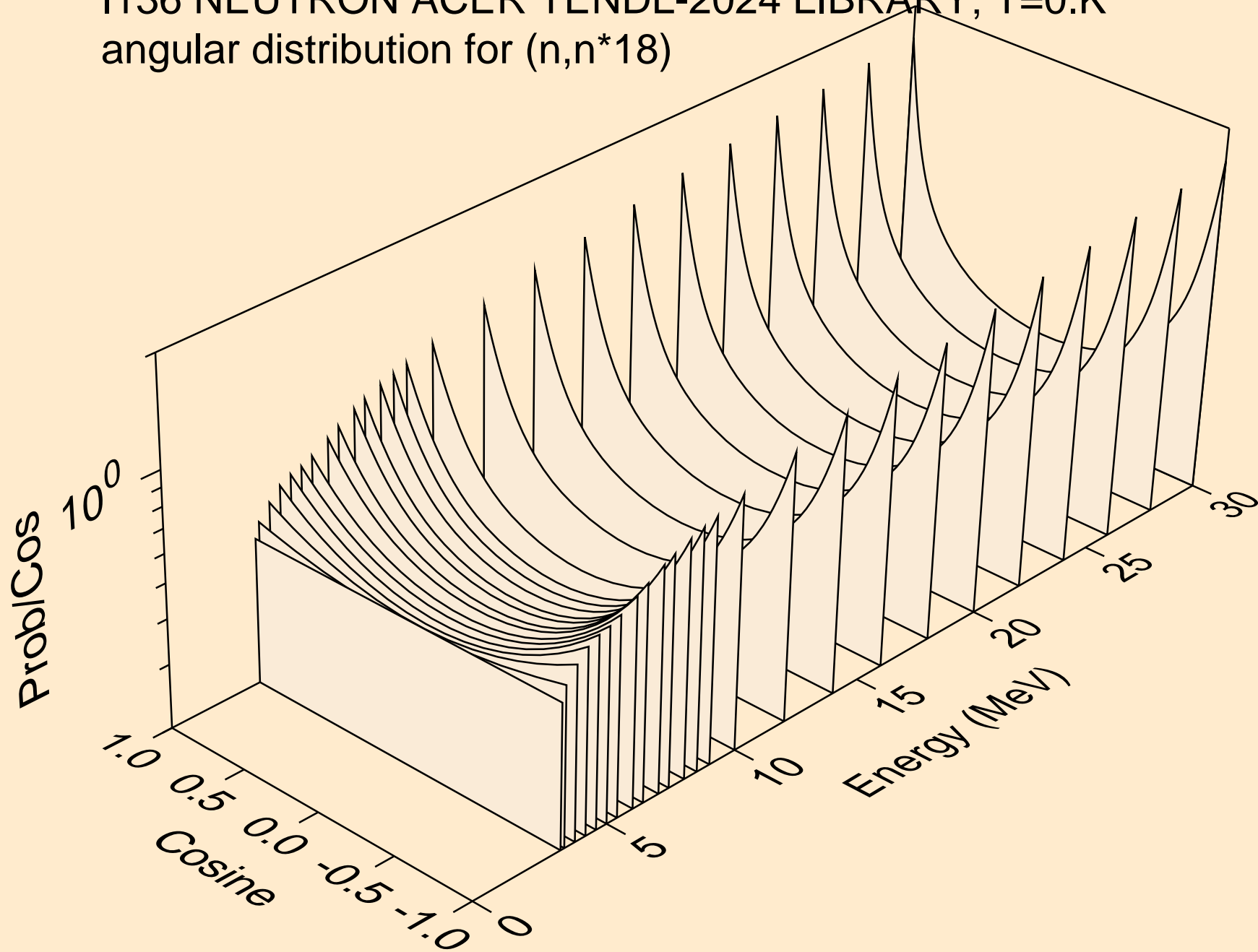

I136 NEUTRON ACER TENDL-2024 LIBRARY; T=0.K
angular distribution for (n,n*19)

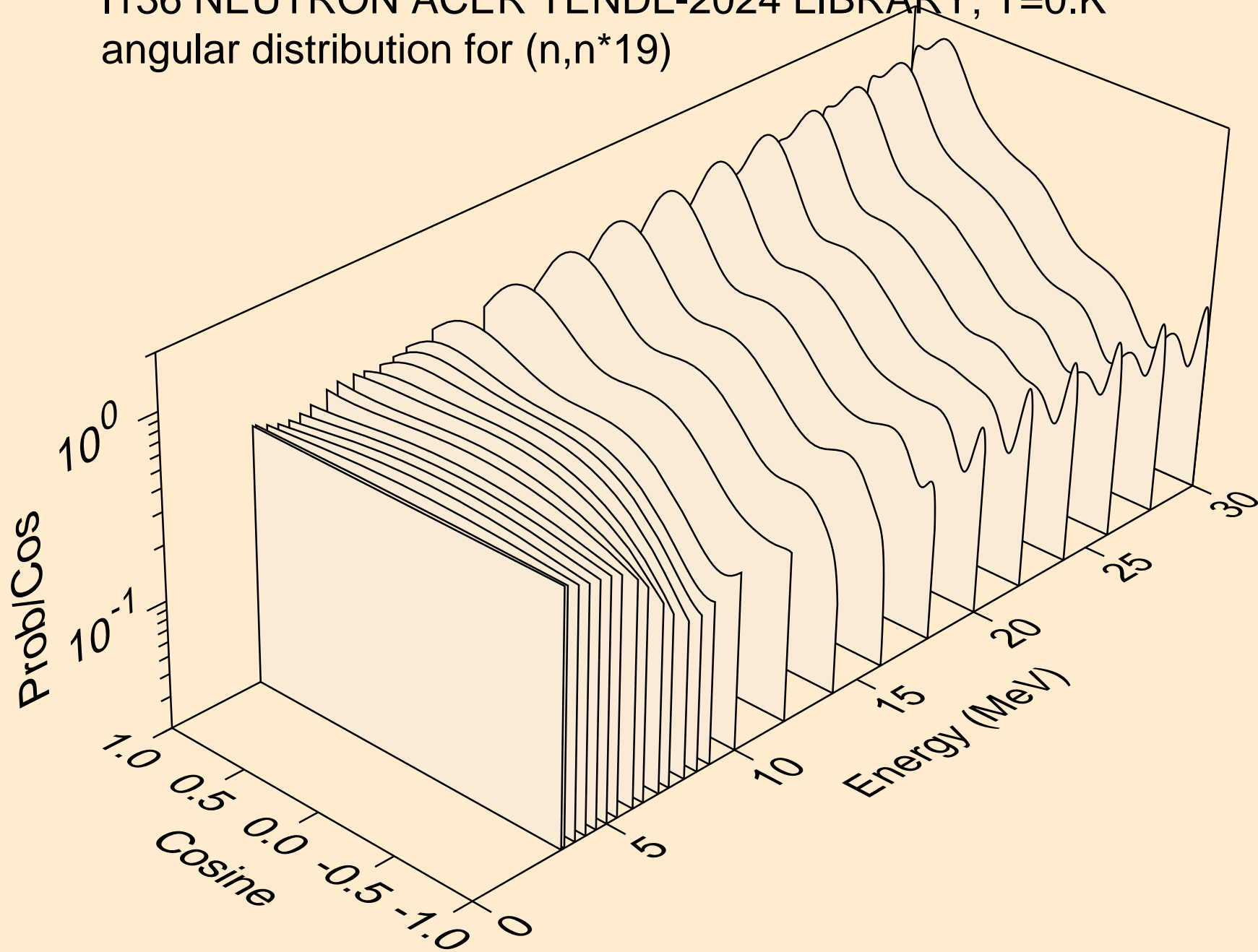

I136 NEUTRON ACER TENDL-2024 LIBRARY; T=0.K
angular distribution for (n,n*20)

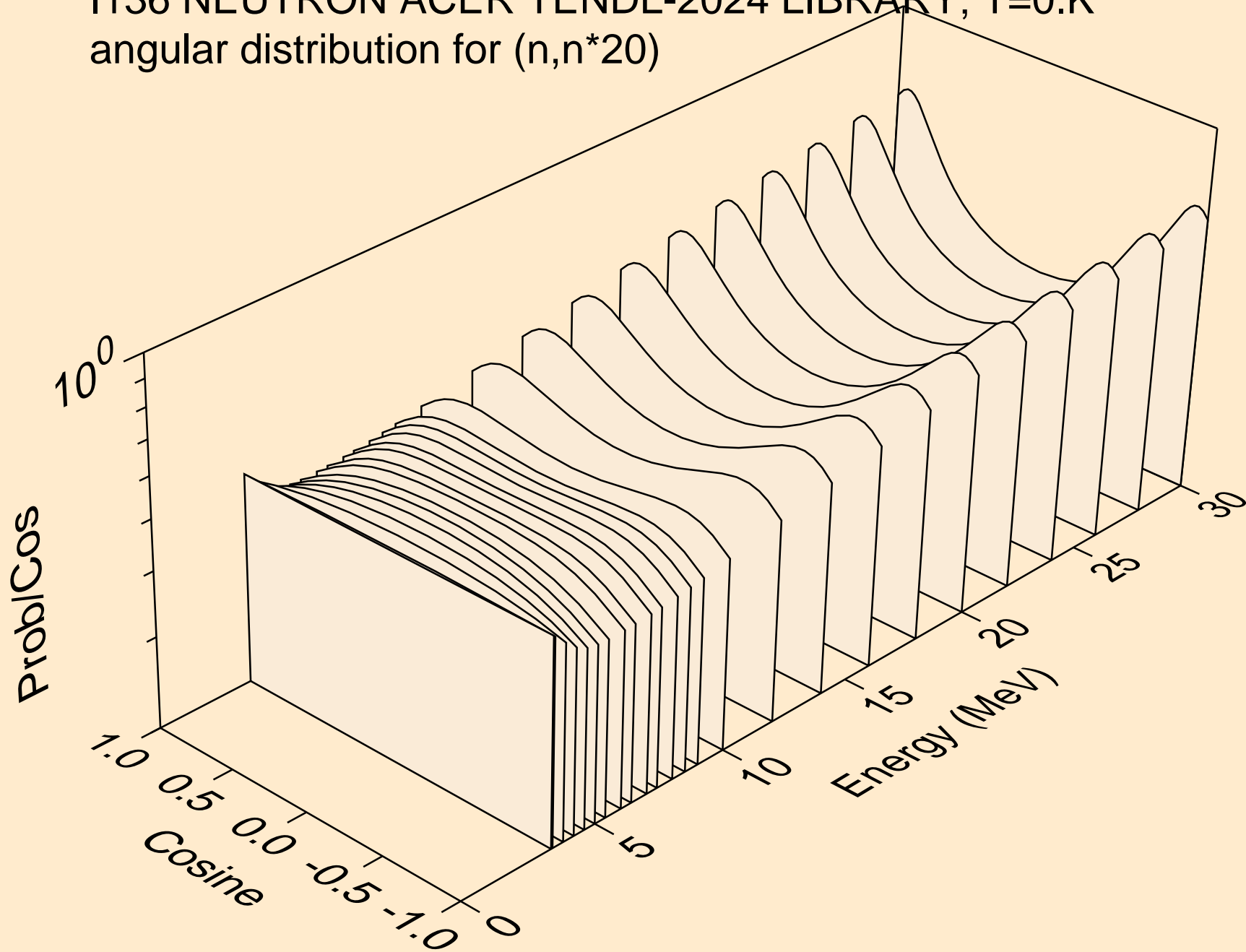

I136 NEUTRON ACER TENDL-2024 LIBRARY; T=0.K
Neutron emission for (n,x)

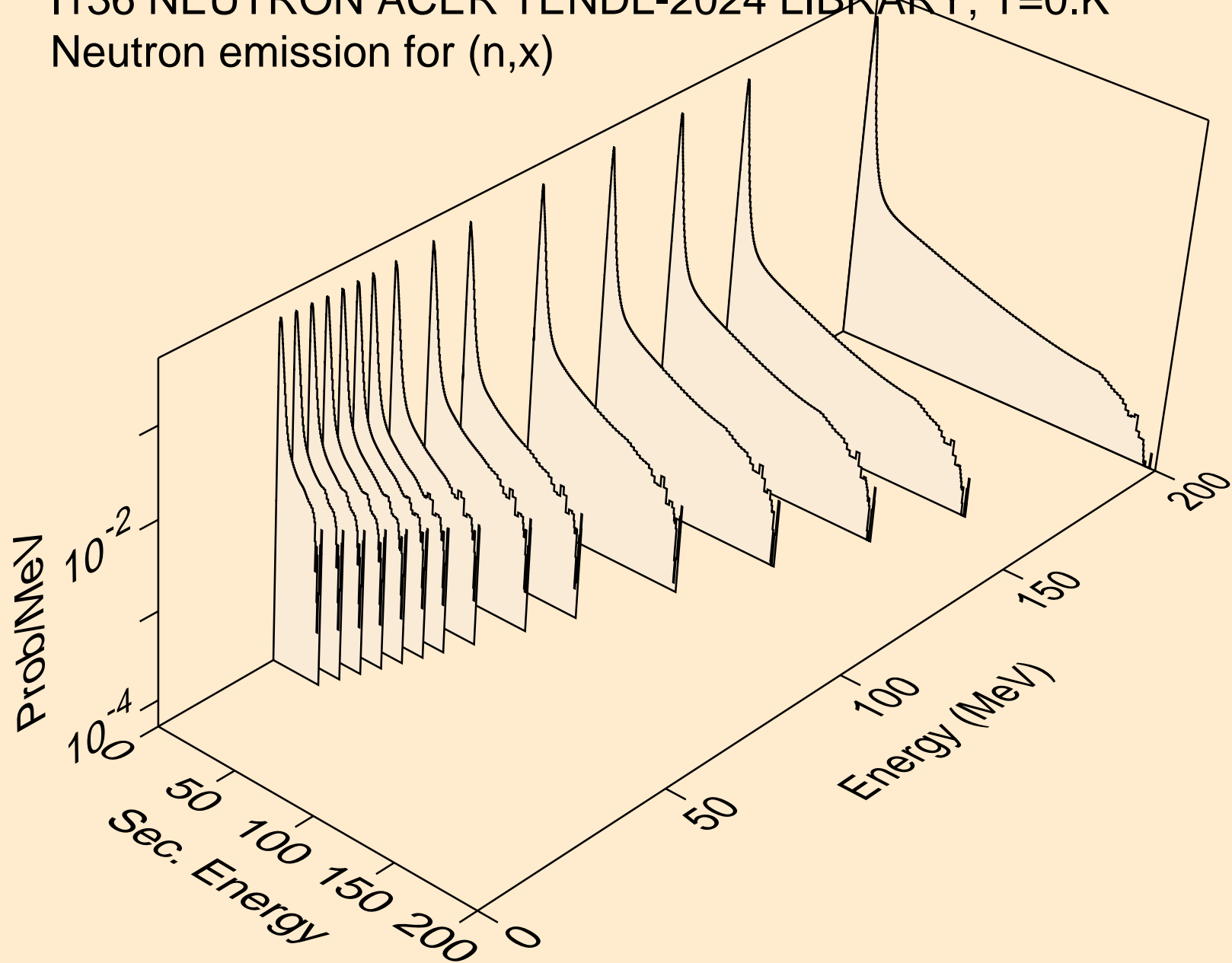

I136 NEUTRON ACER TENDL-2024 LIBRARY; T=0.K
Neutron emission for (n,2nd)

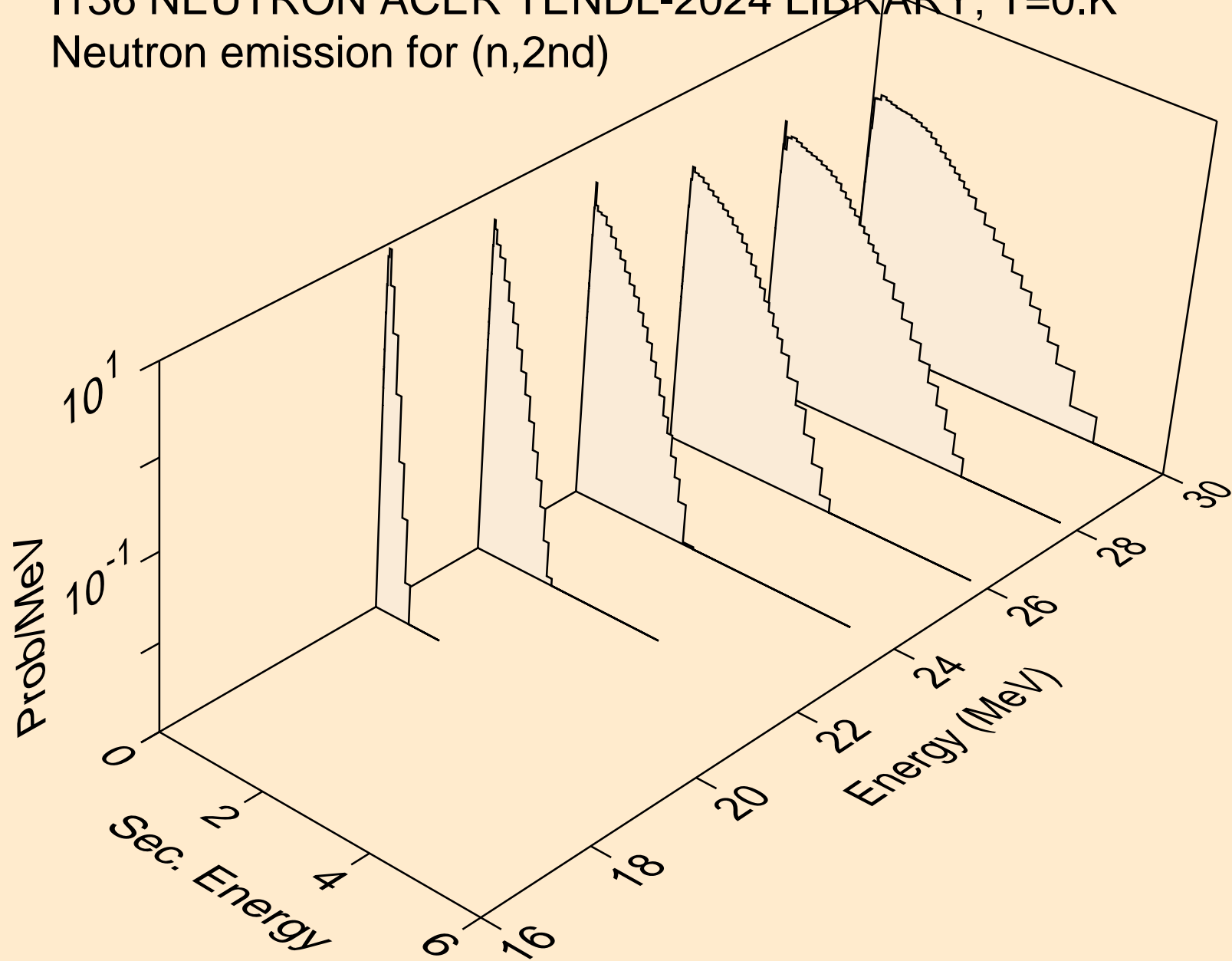

I136 NEUTRON ACER TENDL-2024 LIBRARY; T=0.K
Neutron emission for (n,2n)

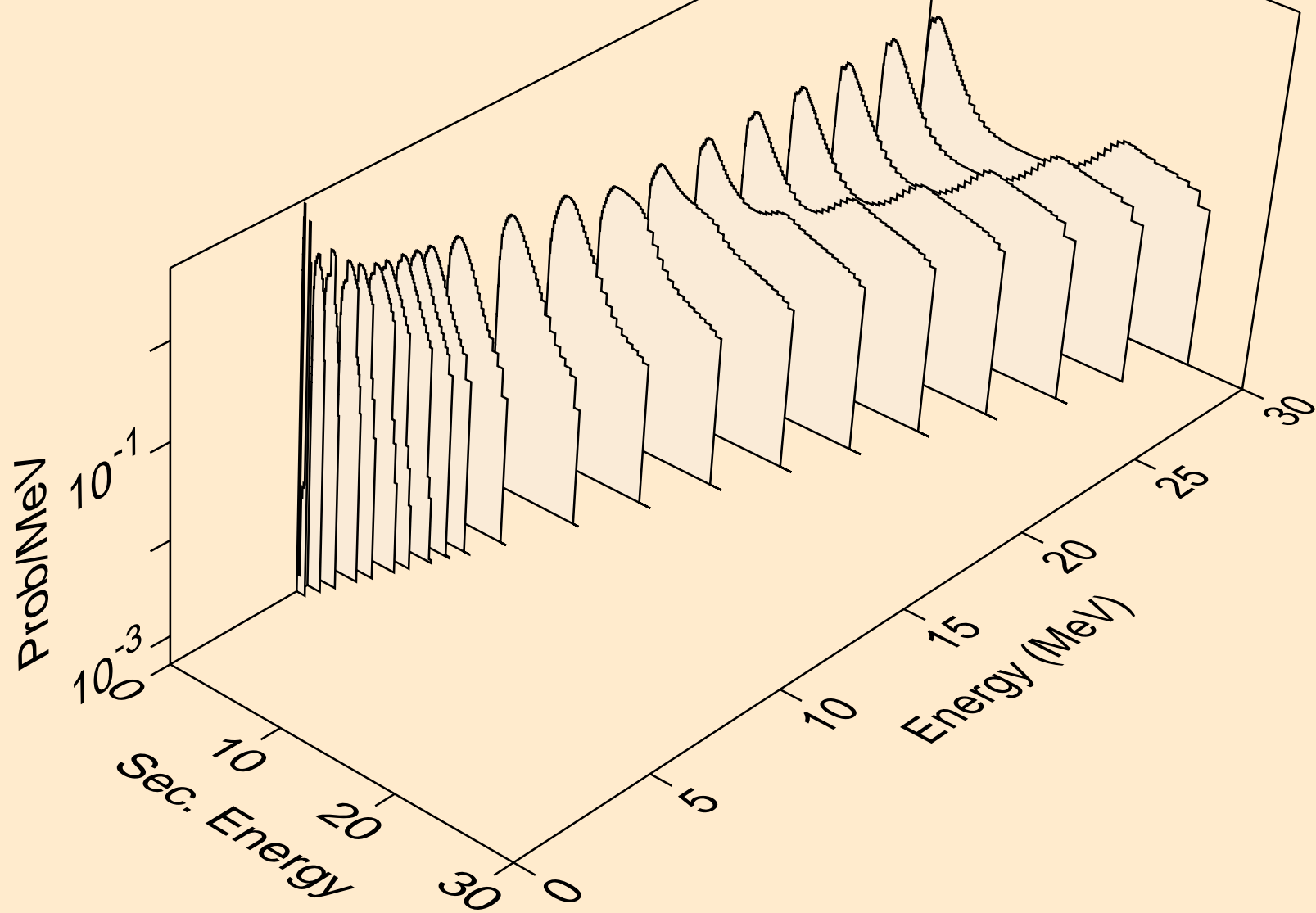

I136 NEUTRON ACER TENDL-2024 LIBRARY; T=0.K
Neutron emission for (n,3n)

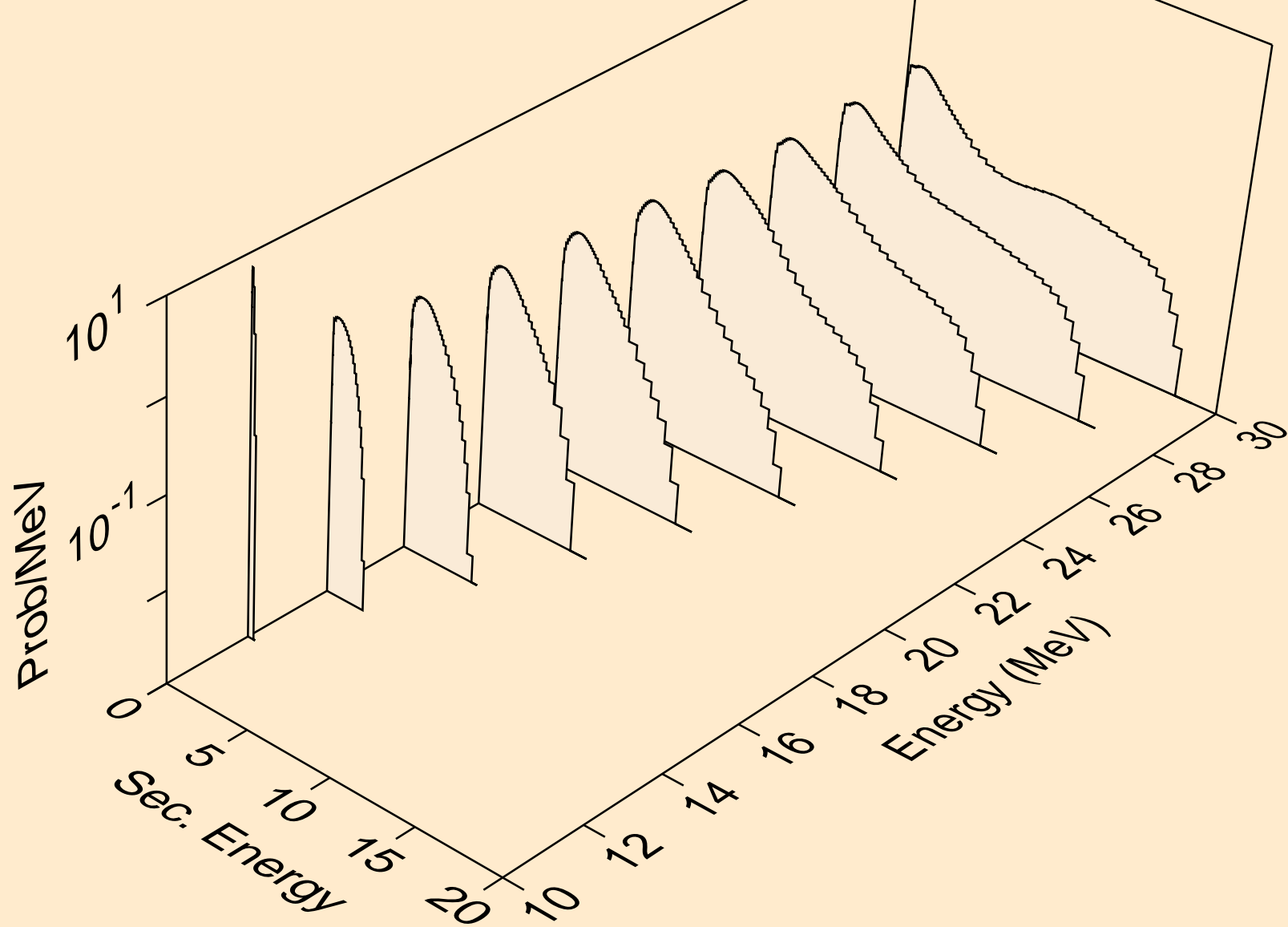

I136 NEUTRON ACER TENDL-2024 LIBRARY; T=0.K
Neutron emission for (n,n*)a

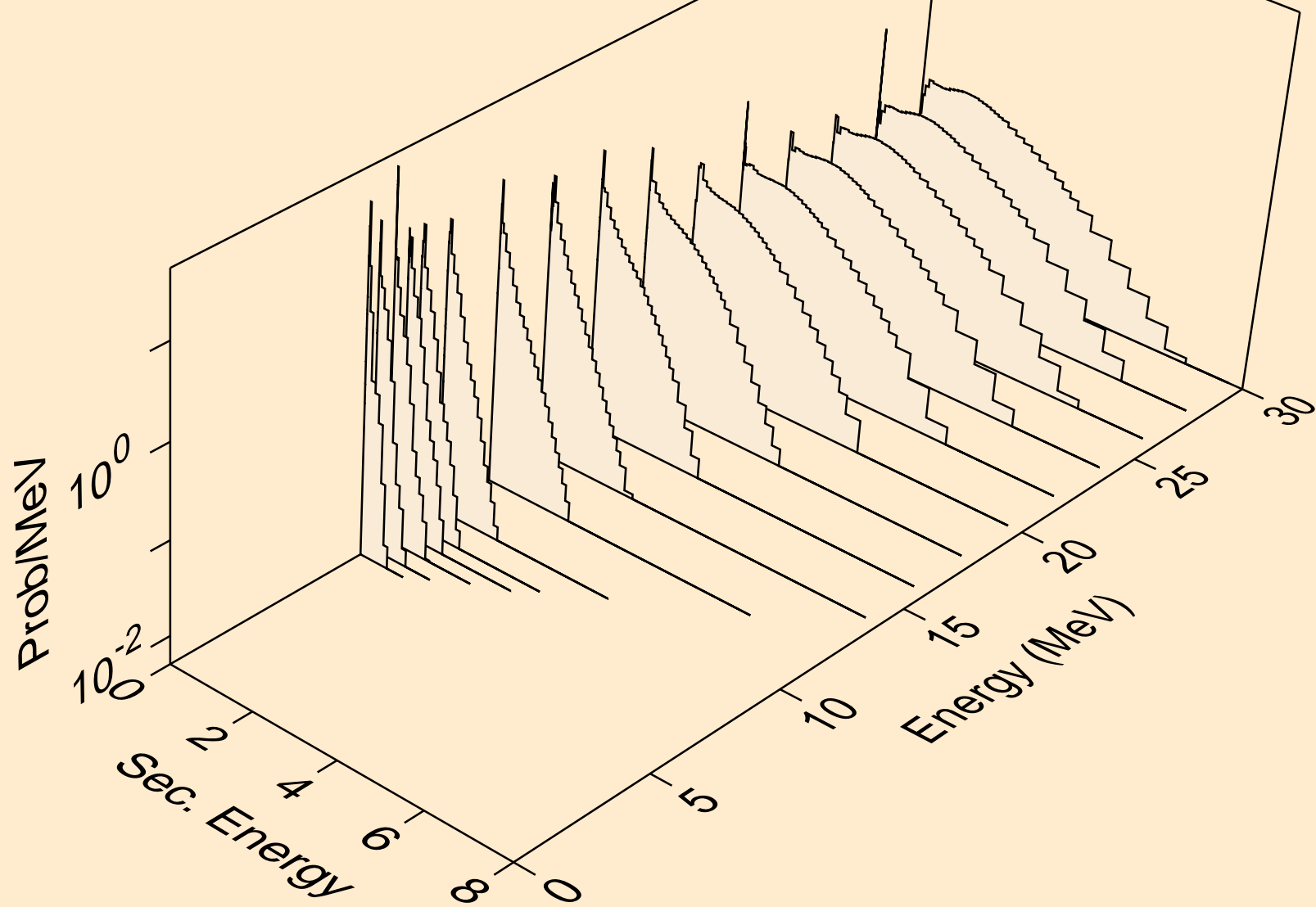

I136 NEUTRON ACER TENDL-2024 LIBRARY; T=0.K
Neutron emission for (n,2n)a

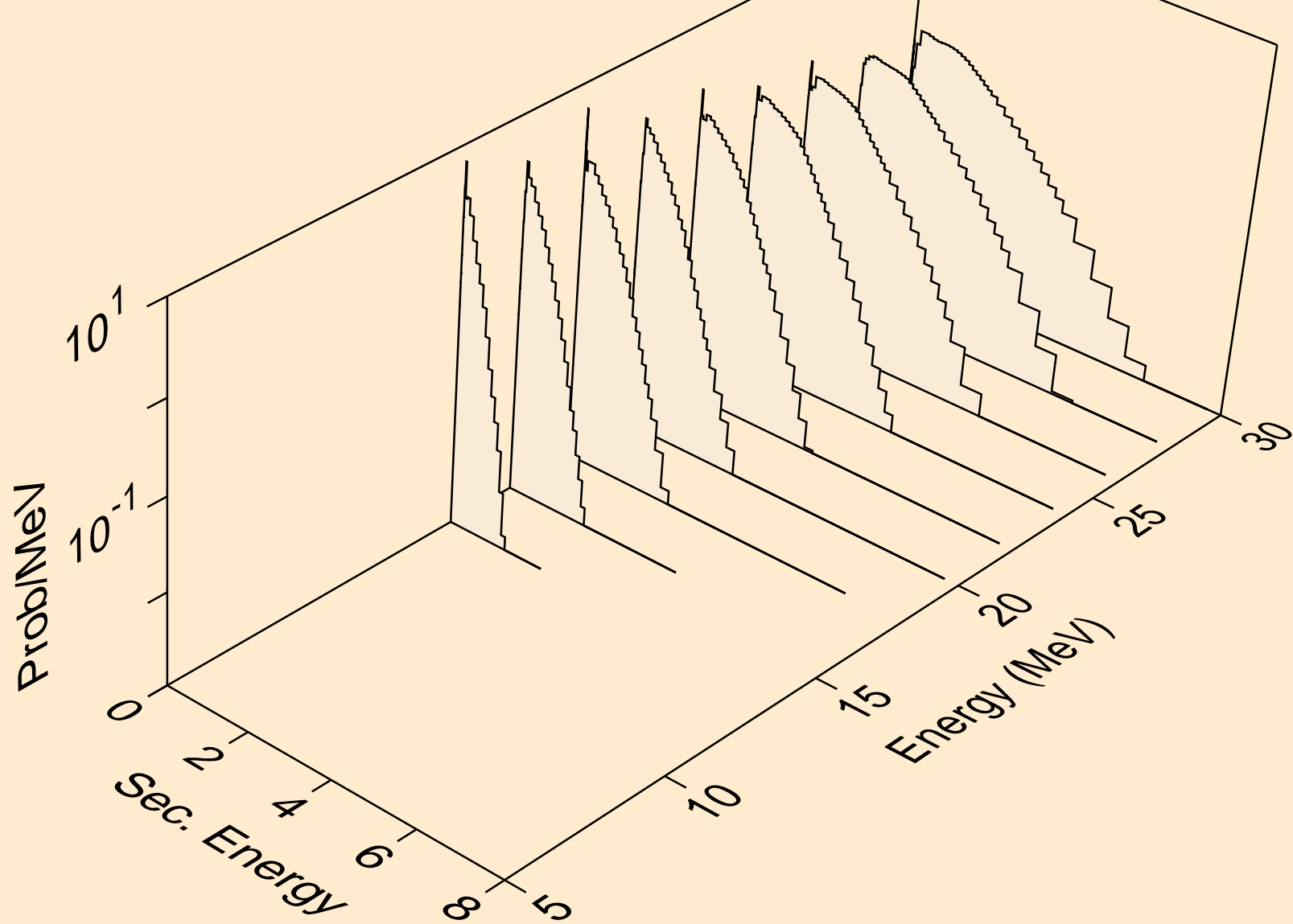

I136 NEUTRON ACER TENDL-2024 LIBRARY; T=0.K
Neutron emission for (n,3n)a

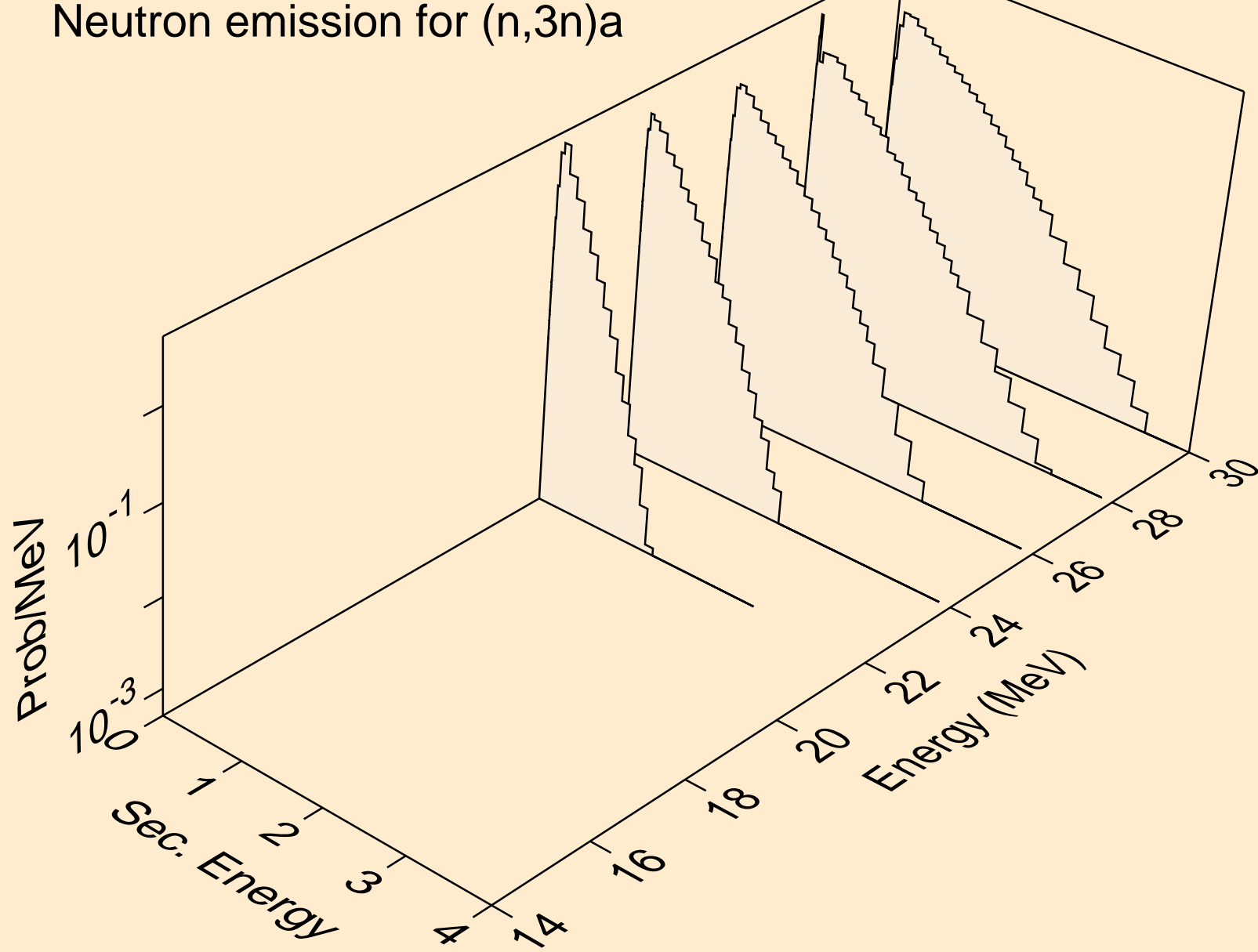

I136 NEUTRON ACER TENDL-2024 LIBRARY; T=0.K
Neutron emission for (n,n*)p

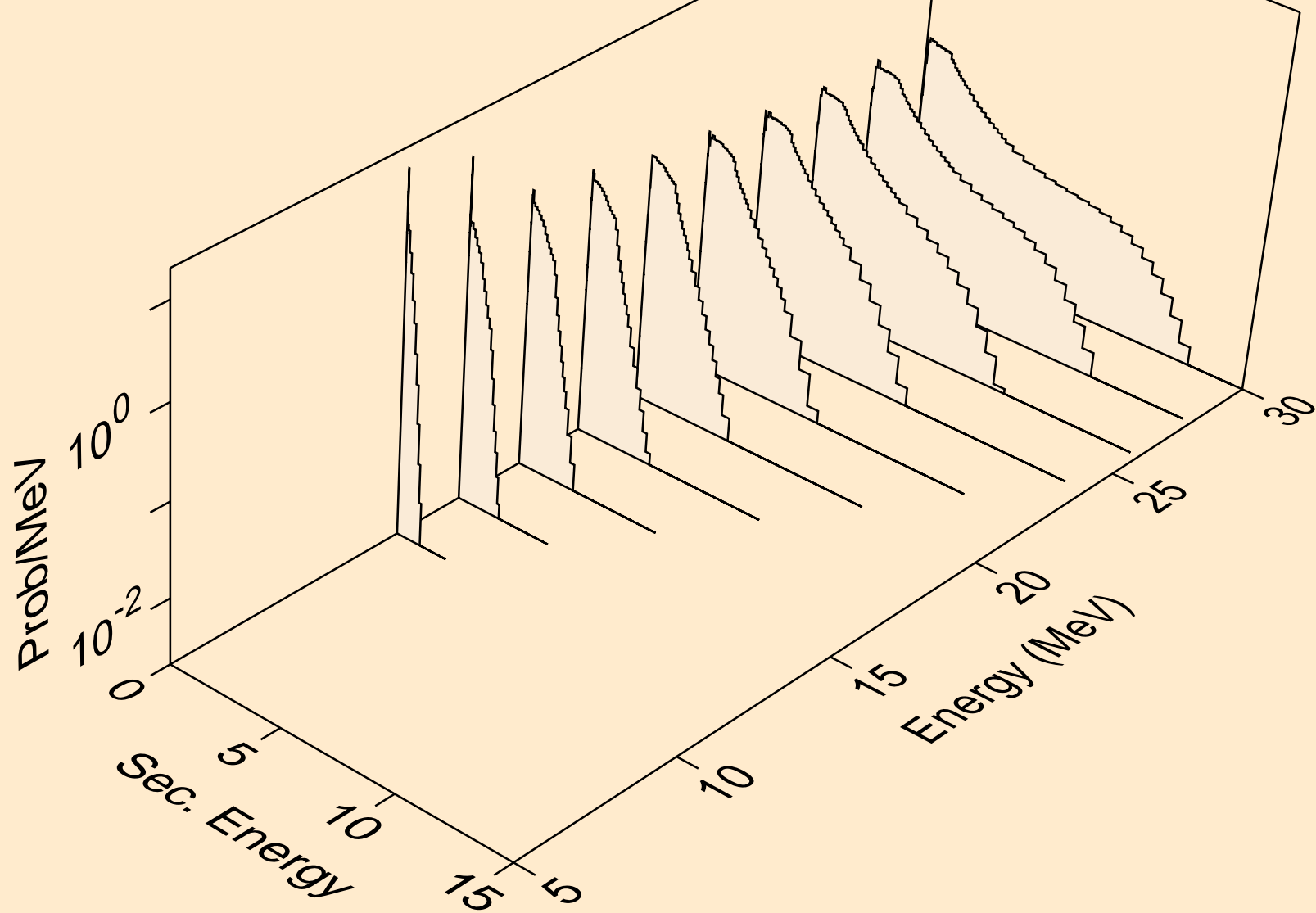

I136 NEUTRON ACER TENDL-2024 LIBRARY; T=0.K
Neutron emission for (n,n*)d

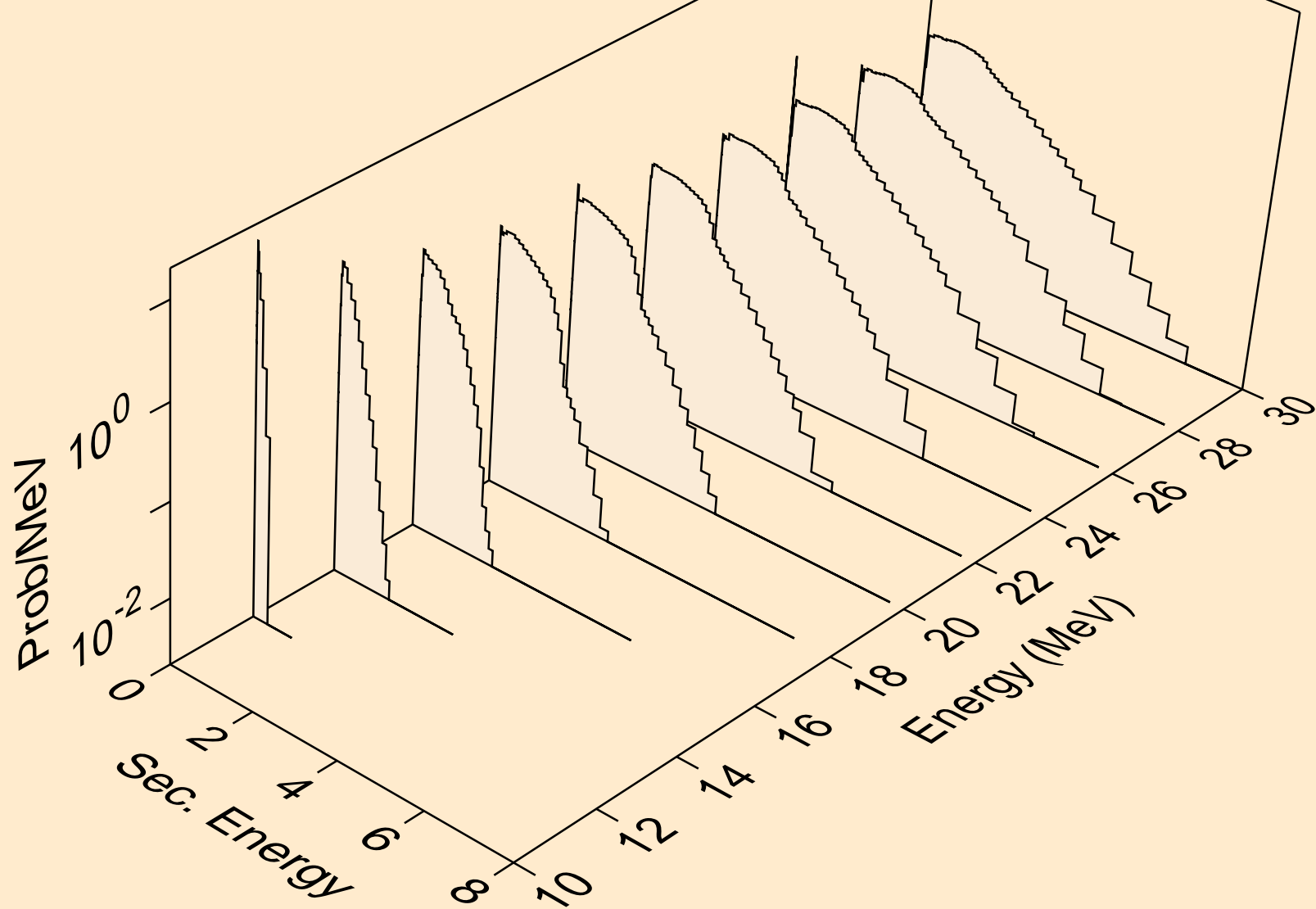

I136 NEUTRON ACER TENDL-2024 LIBRARY; T=0.K
Neutron emission for (n,n*)t

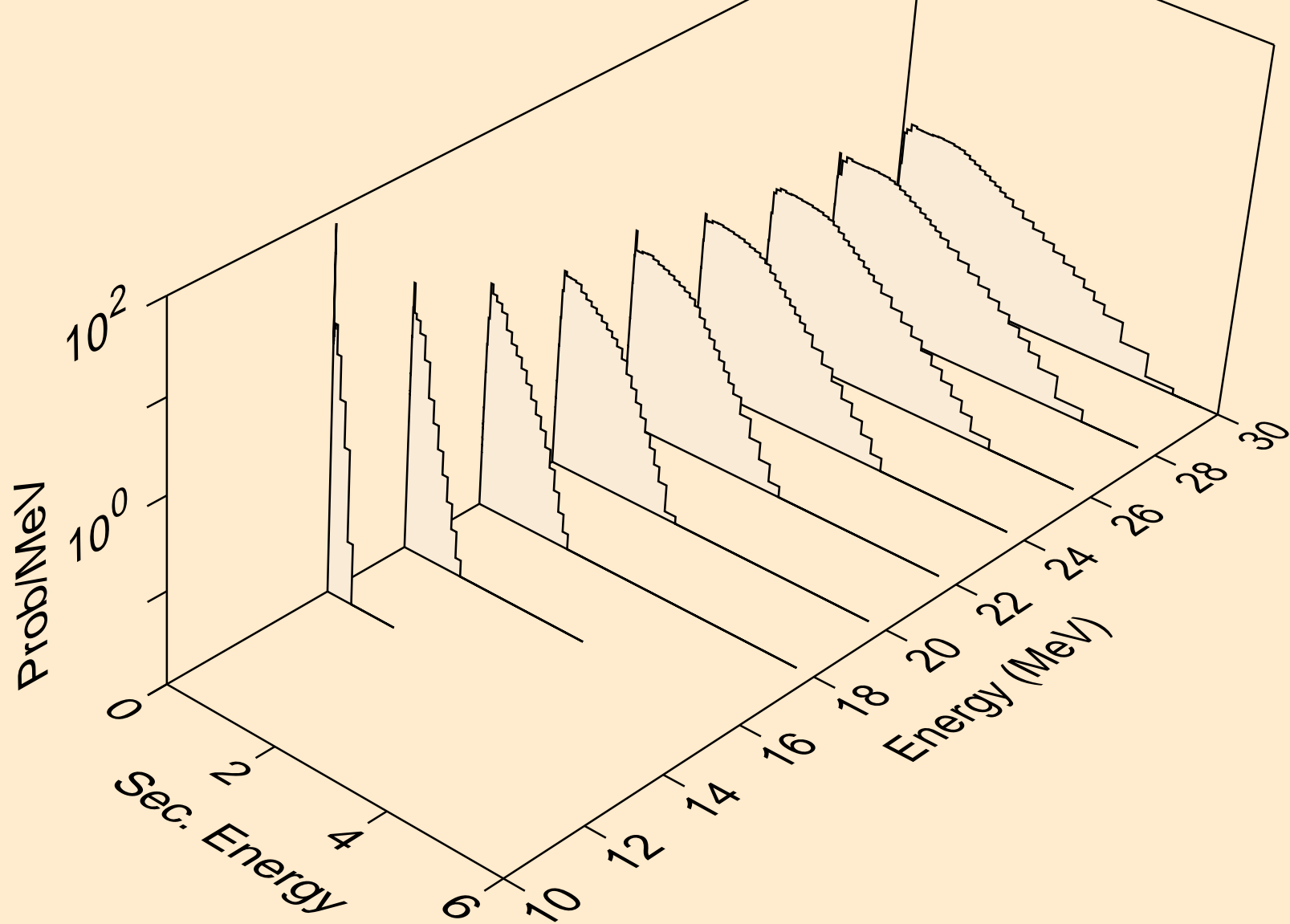

I136 NEUTRON ACER TENDL-2024 LIBRARY; T=0.K
Neutron emission for (n,n*)he3

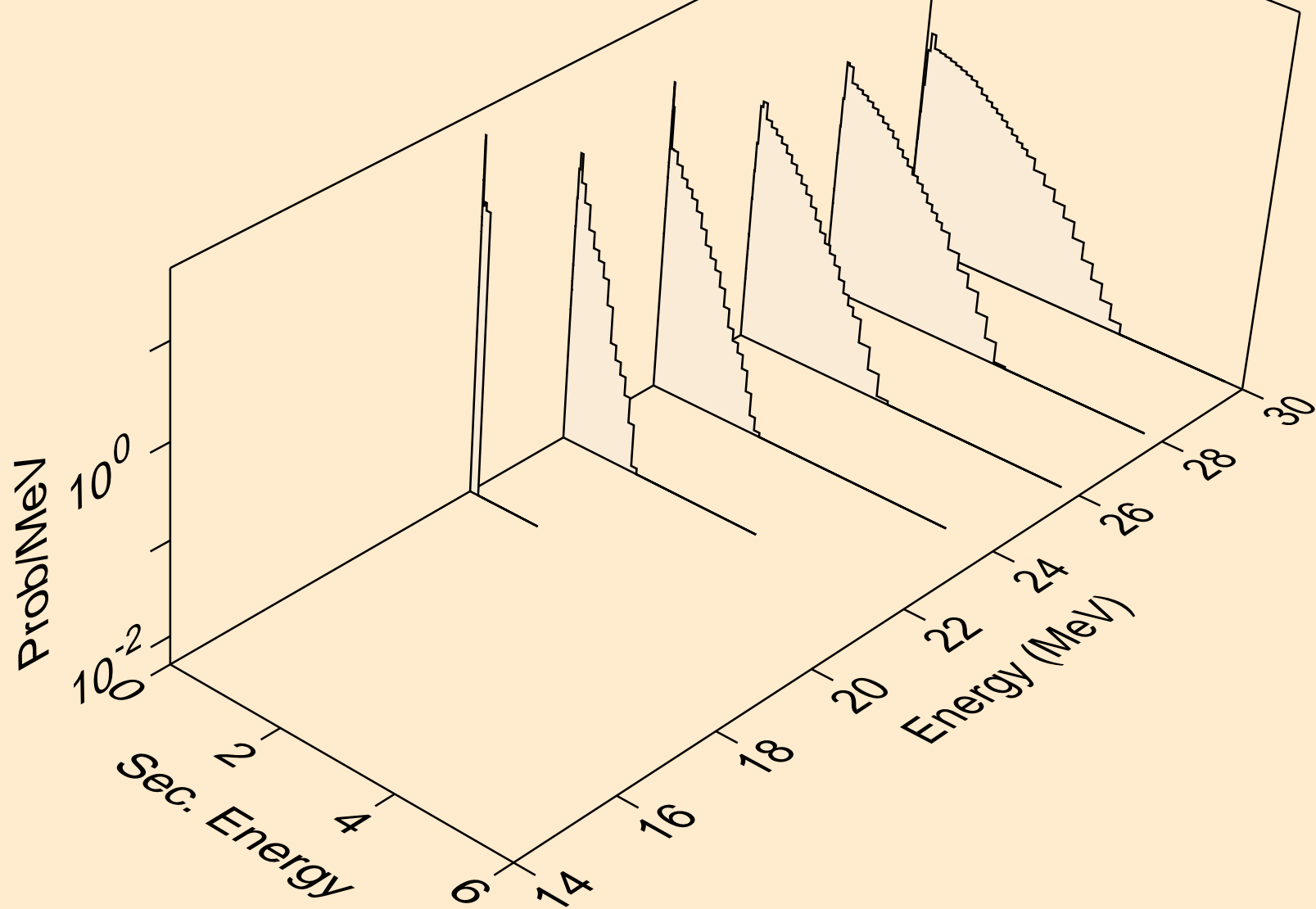

I136 NEUTRON ACER TENDL-2024 LIBRARY; T=0.K
Neutron emission for (n,4n)

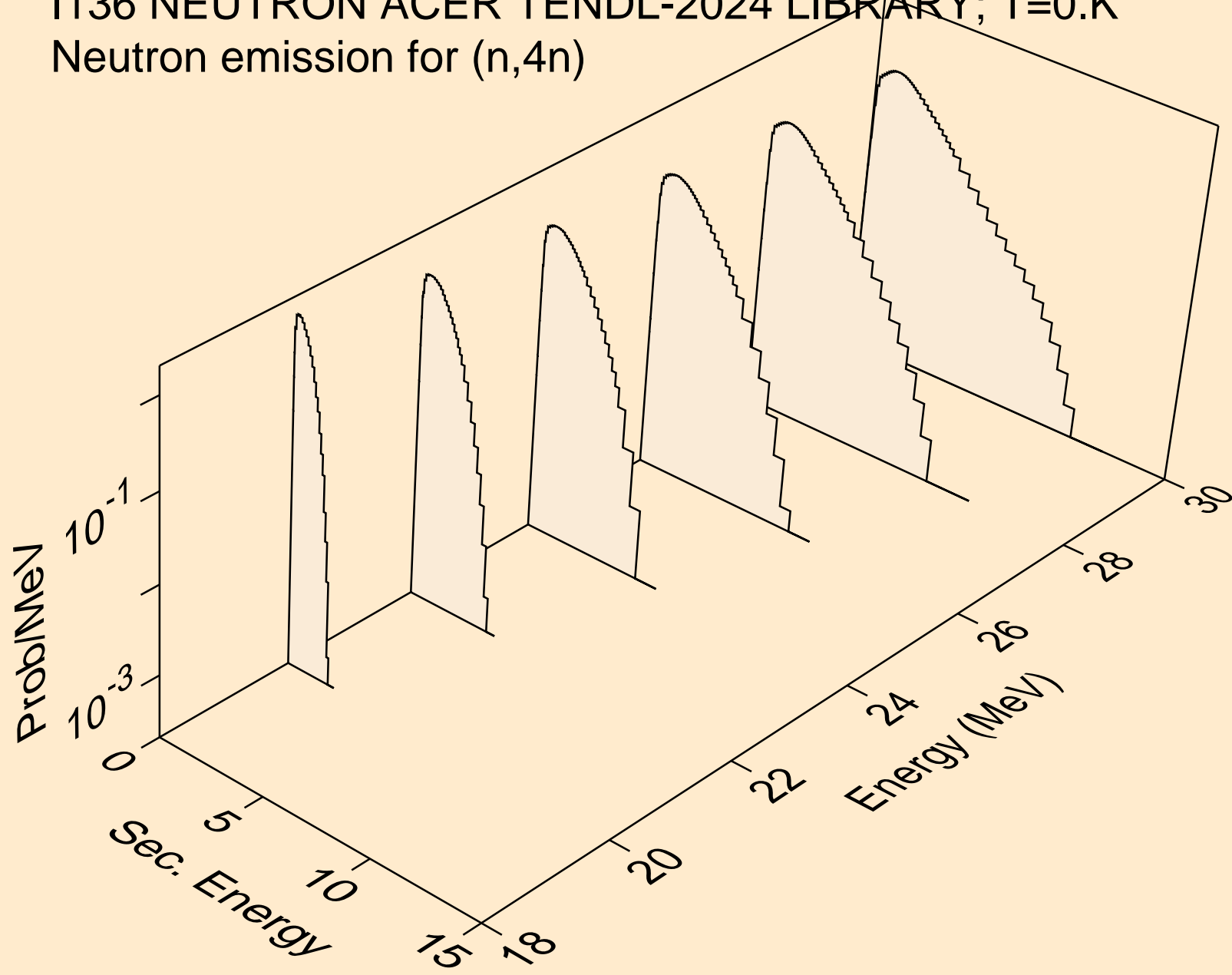

I136 NEUTRON ACER TENDL-2024 LIBRARY; T=0.K
Neutron emission for (n,2np)

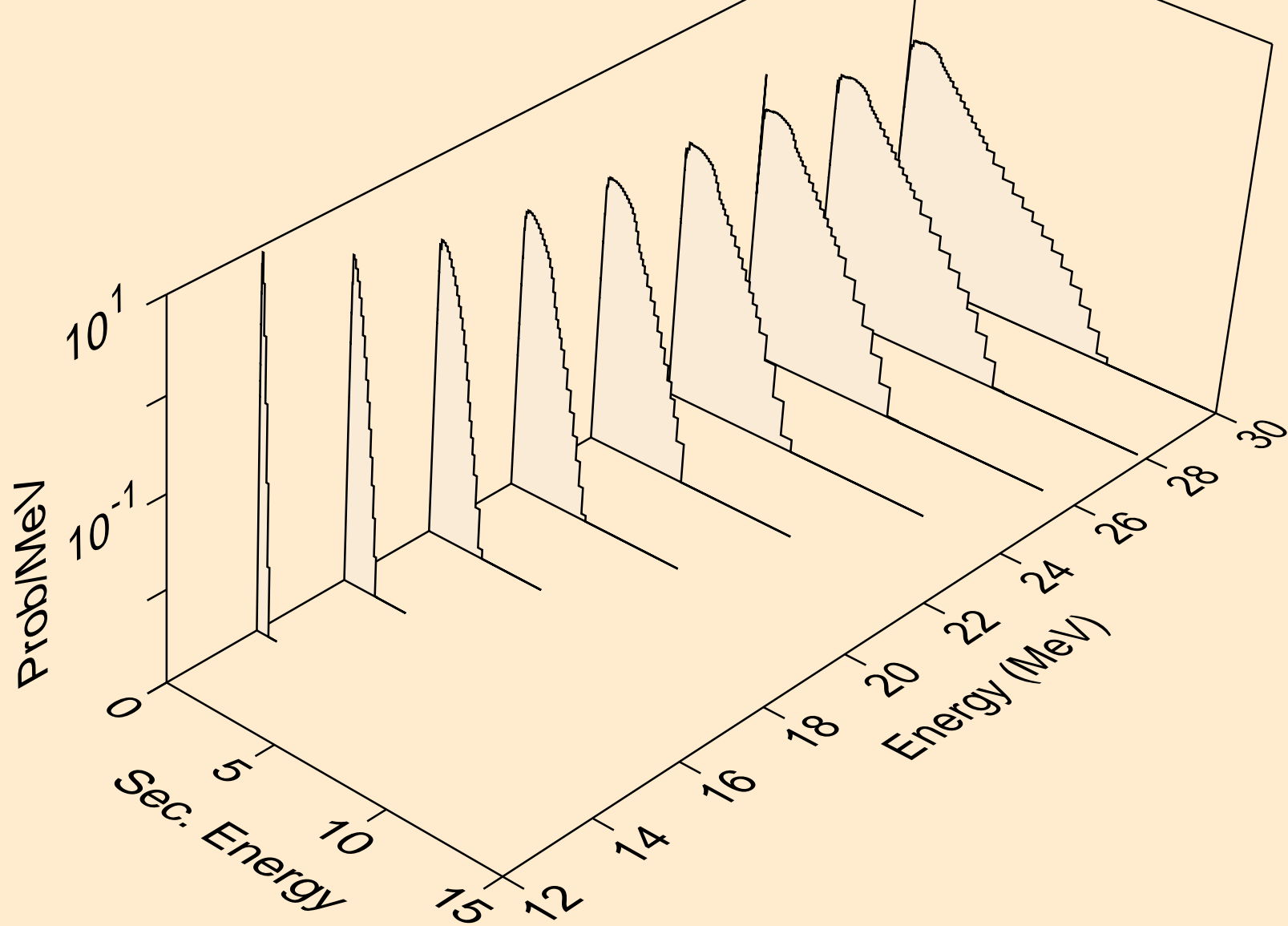

I136 NEUTRON ACER TENDL-2024 LIBRARY; T=0.K
Neutron emission for (n,3np)

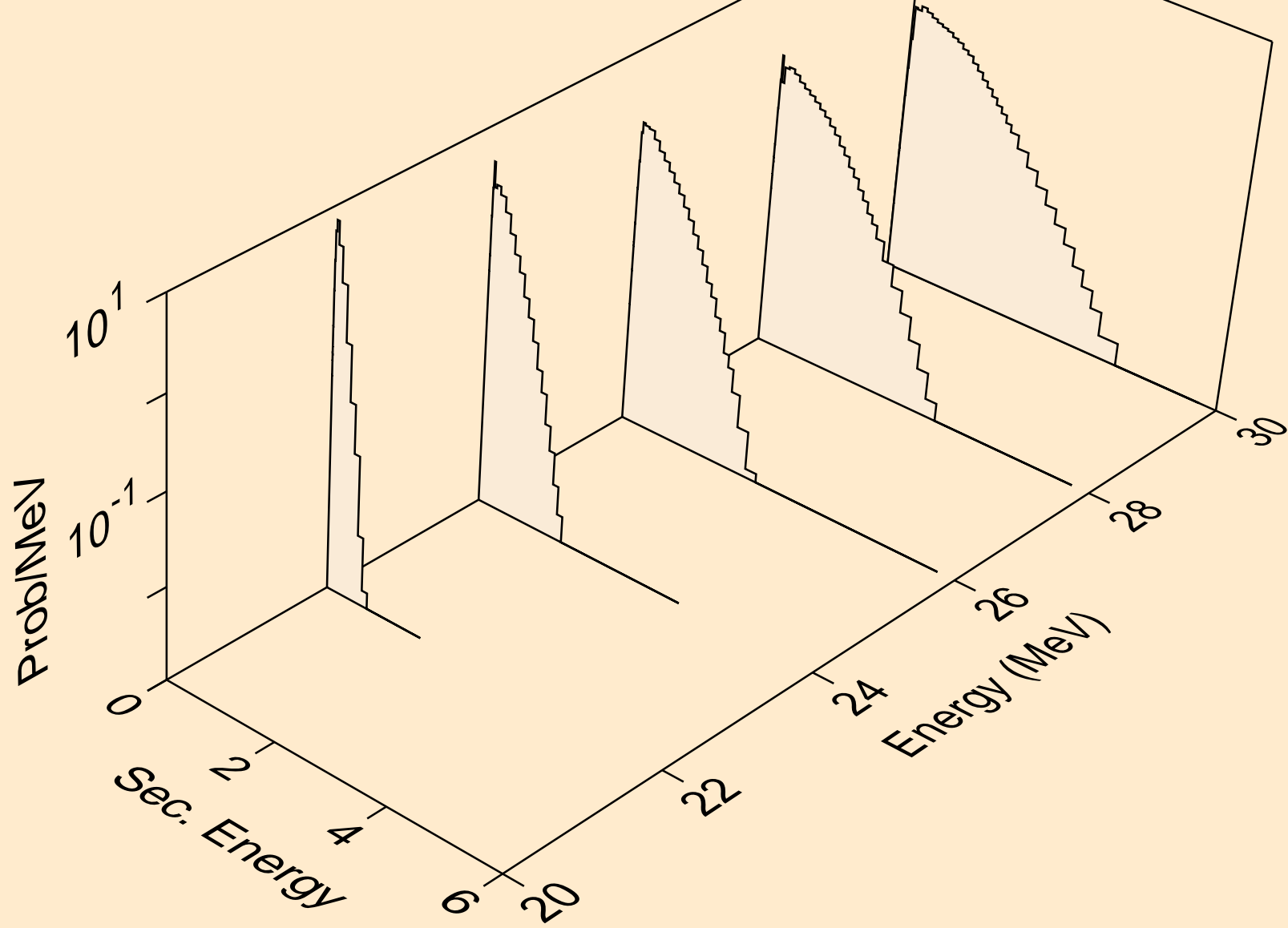

I136 NEUTRON ACER TENDL-2024 LIBRARY; T=0.K
Neutron emission for (n,n*c)

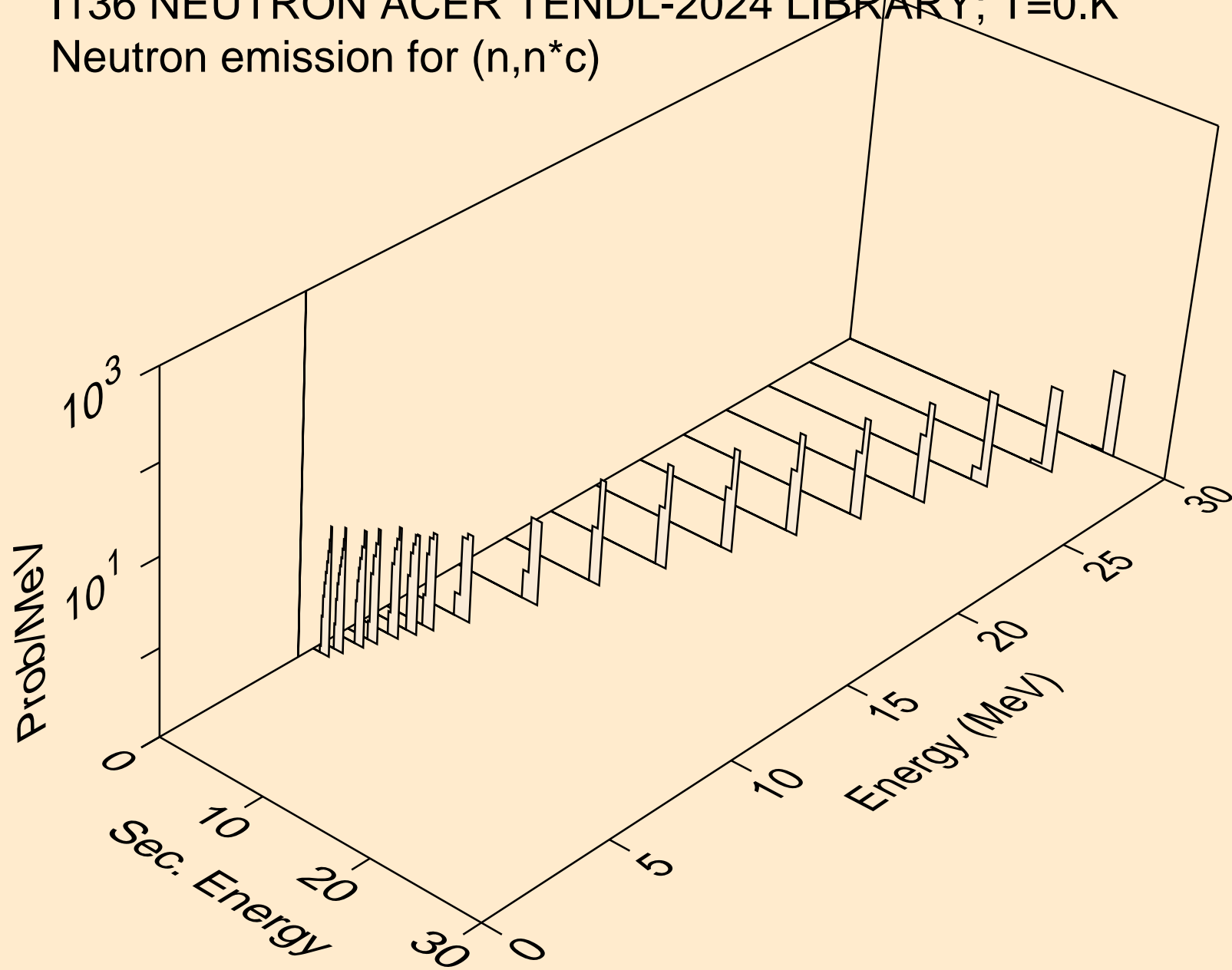

I136 NEUTRON ACER TENDL-2024 LIBRARY; T=0.K
Photon emission for (n,x)

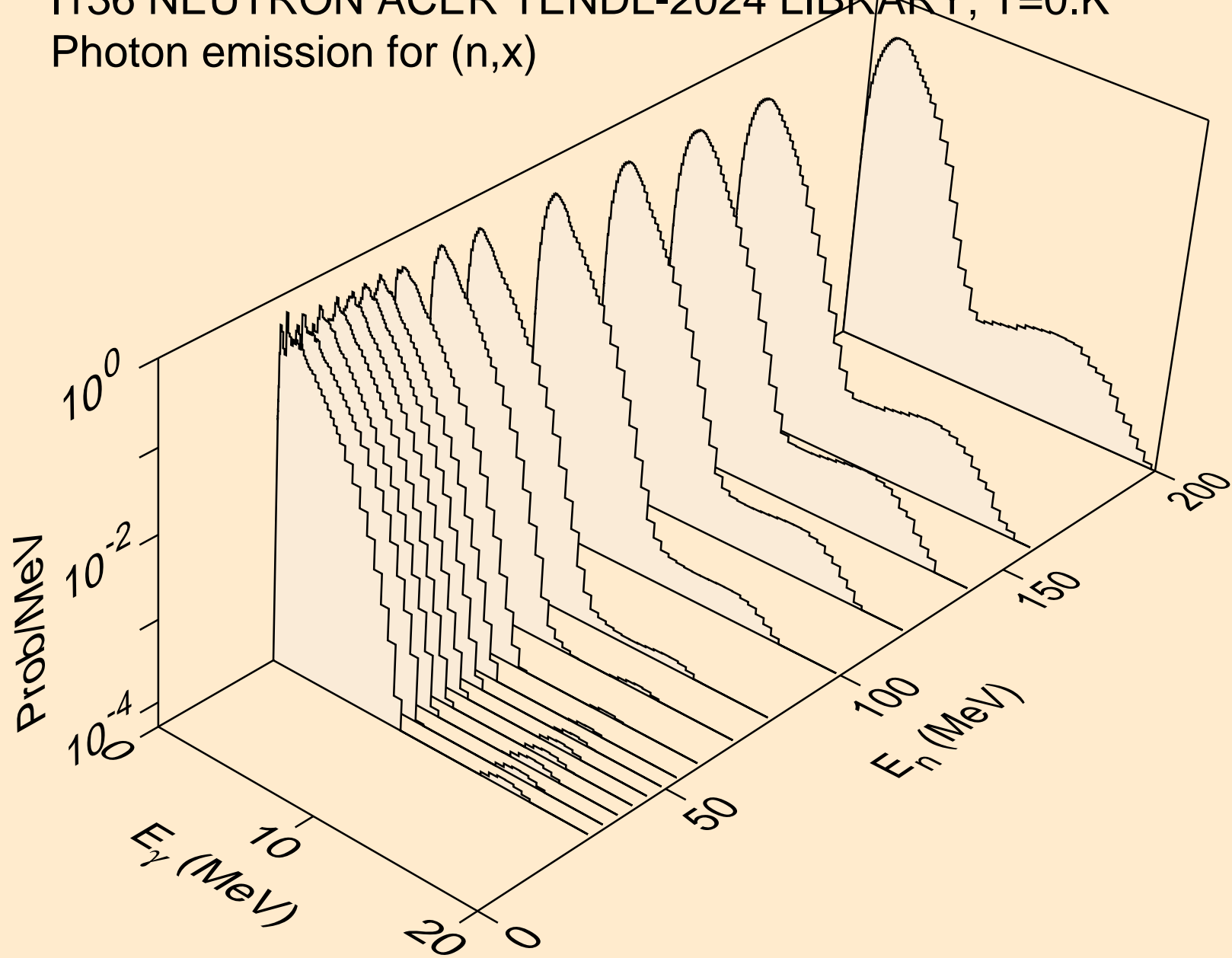

I136 NEUTRON ACER TENDL-2024 LIBRARY; T=0.K
Photon emission for (n,2nd)

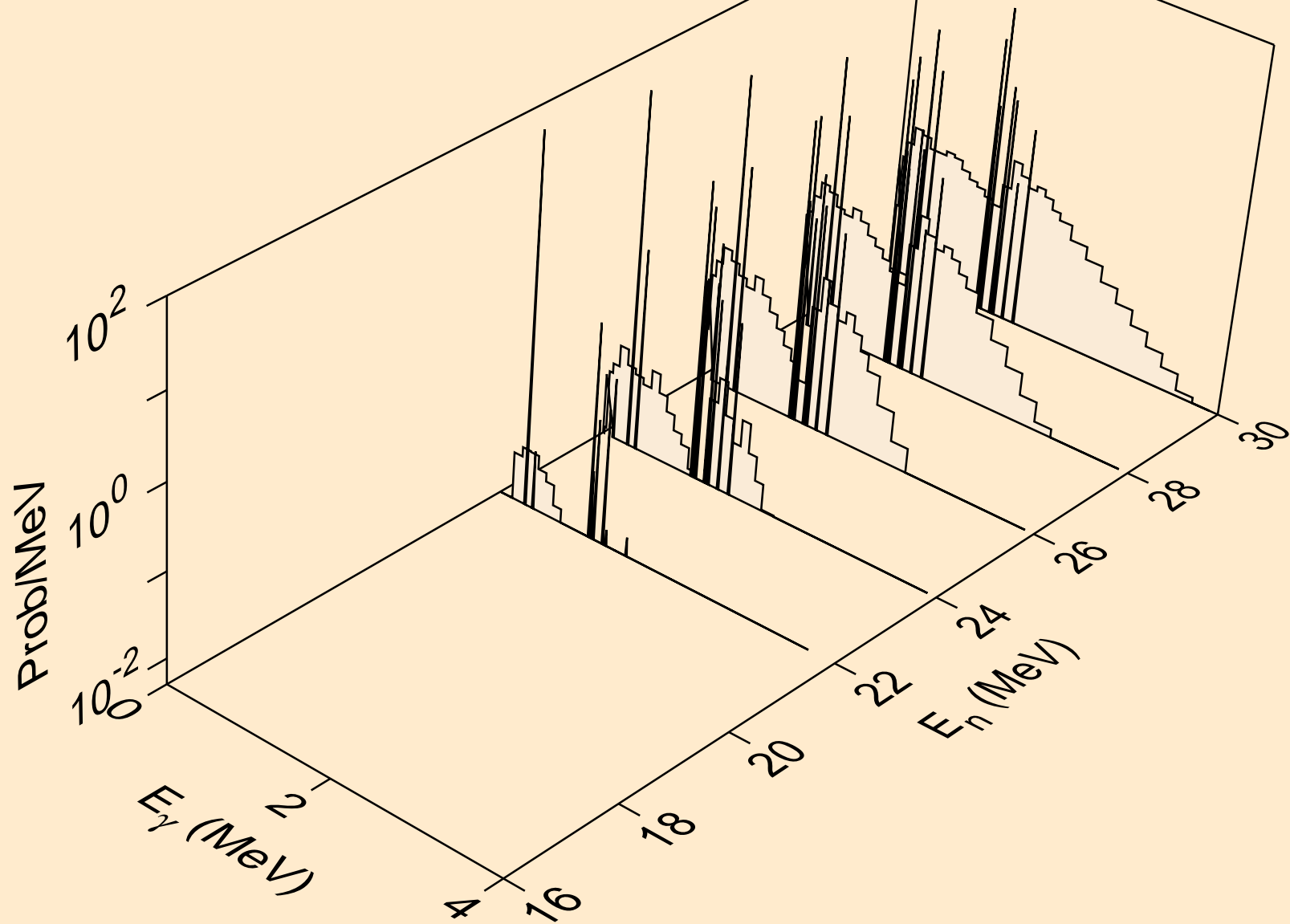

I136 NEUTRON ACER TENDL-2024 LIBRARY; T=0.K
Photon emission for (n,2n)

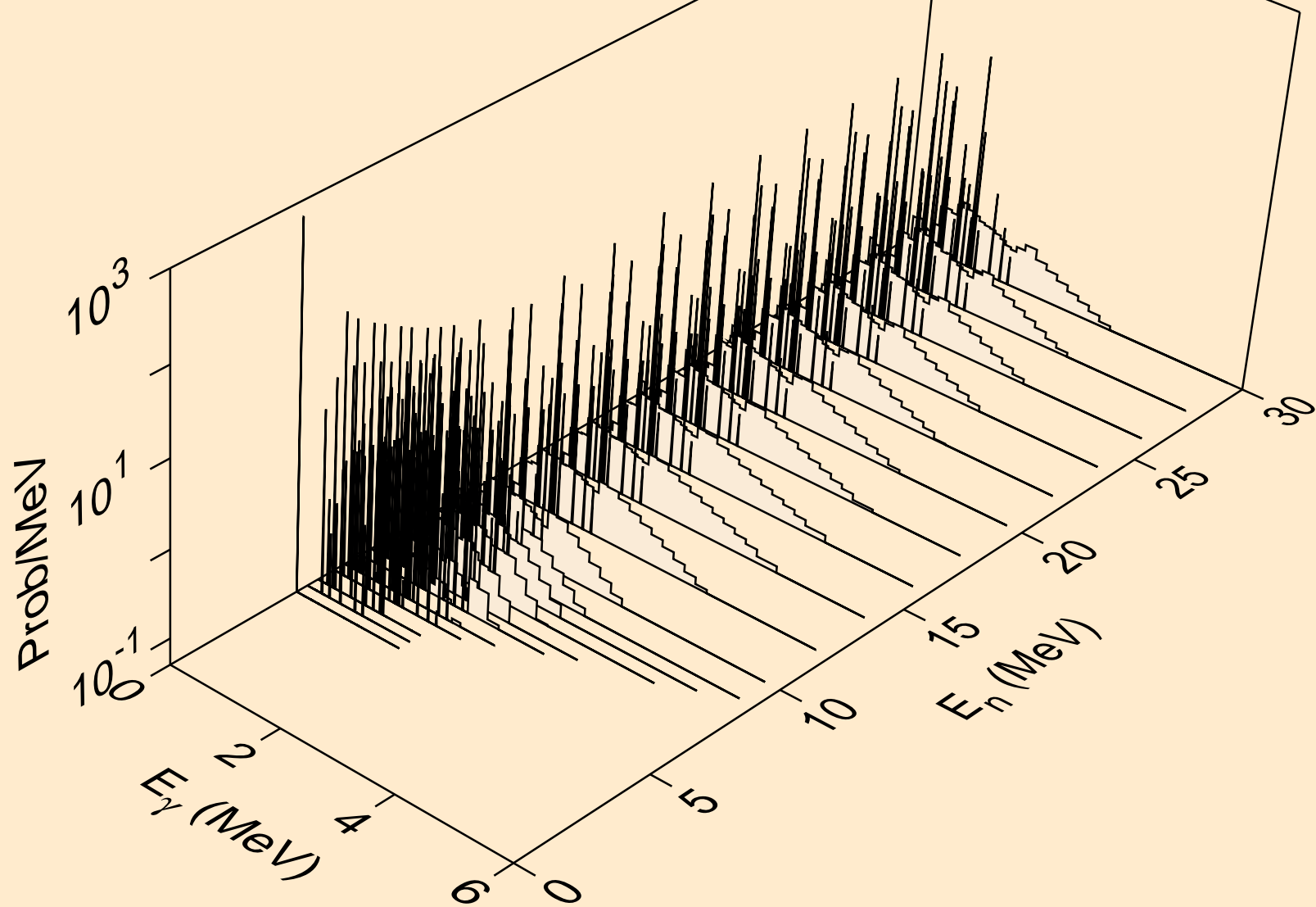

I136 NEUTRON ACER TENDL-2024 LIBRARY; T=0.K
Photon emission for (n,3n)

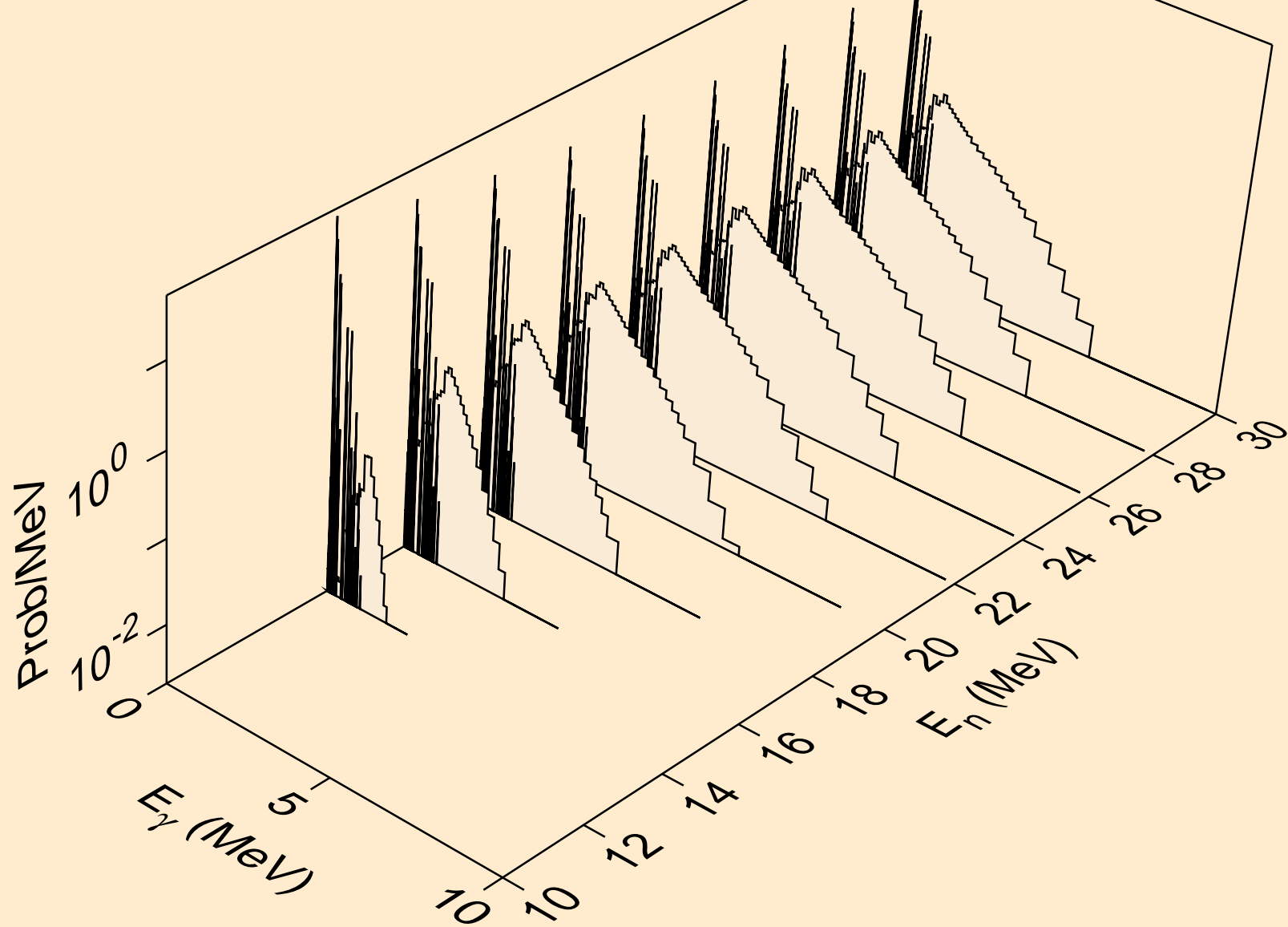

I136 NEUTRON ACER TENDL-2024 LIBRARY; T=0.K
Photon emission for (n,n*)a

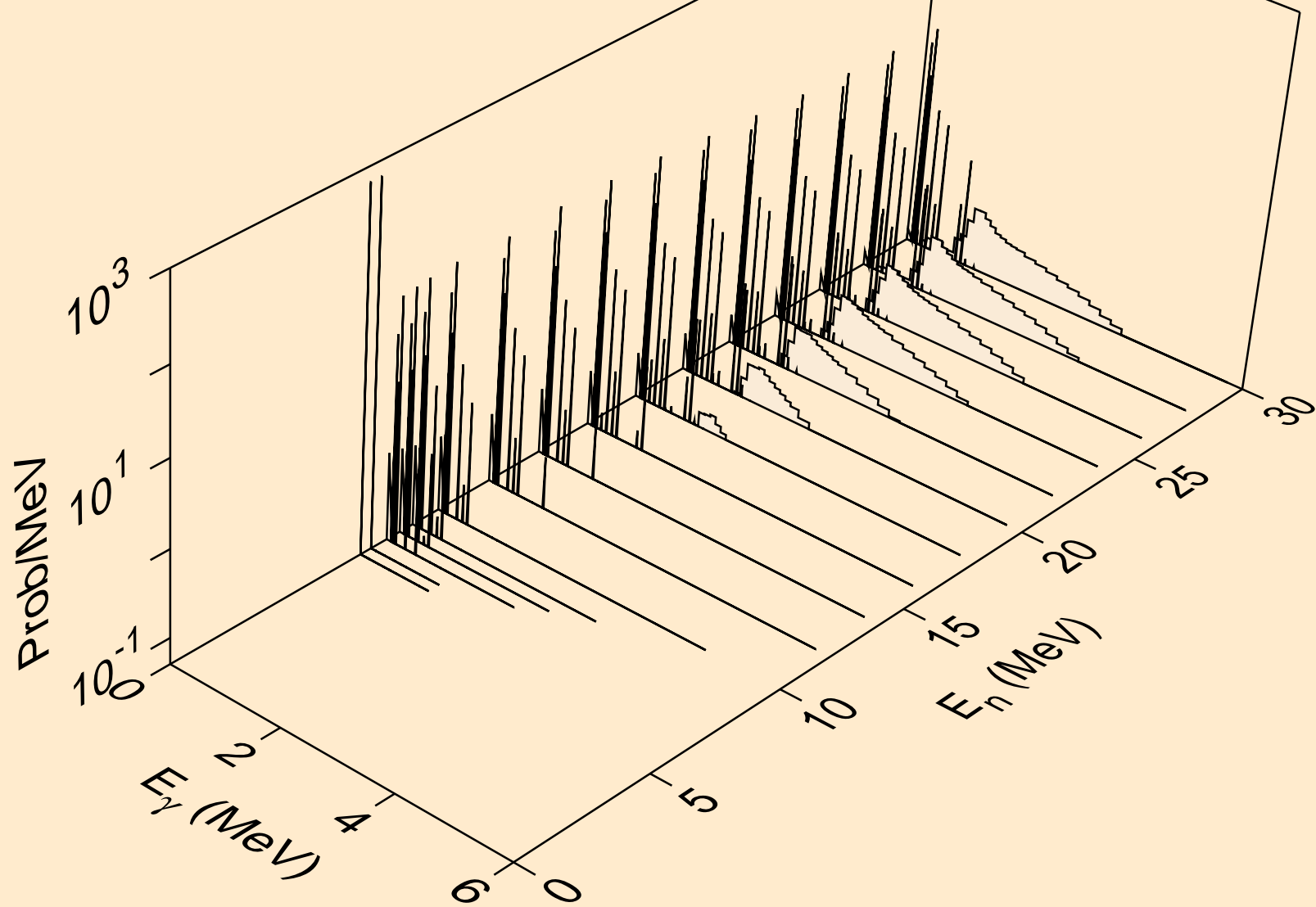

I136 NEUTRON ACER TENDL-2024 LIBRARY; T=0.K
Photon emission for (n,2n)a

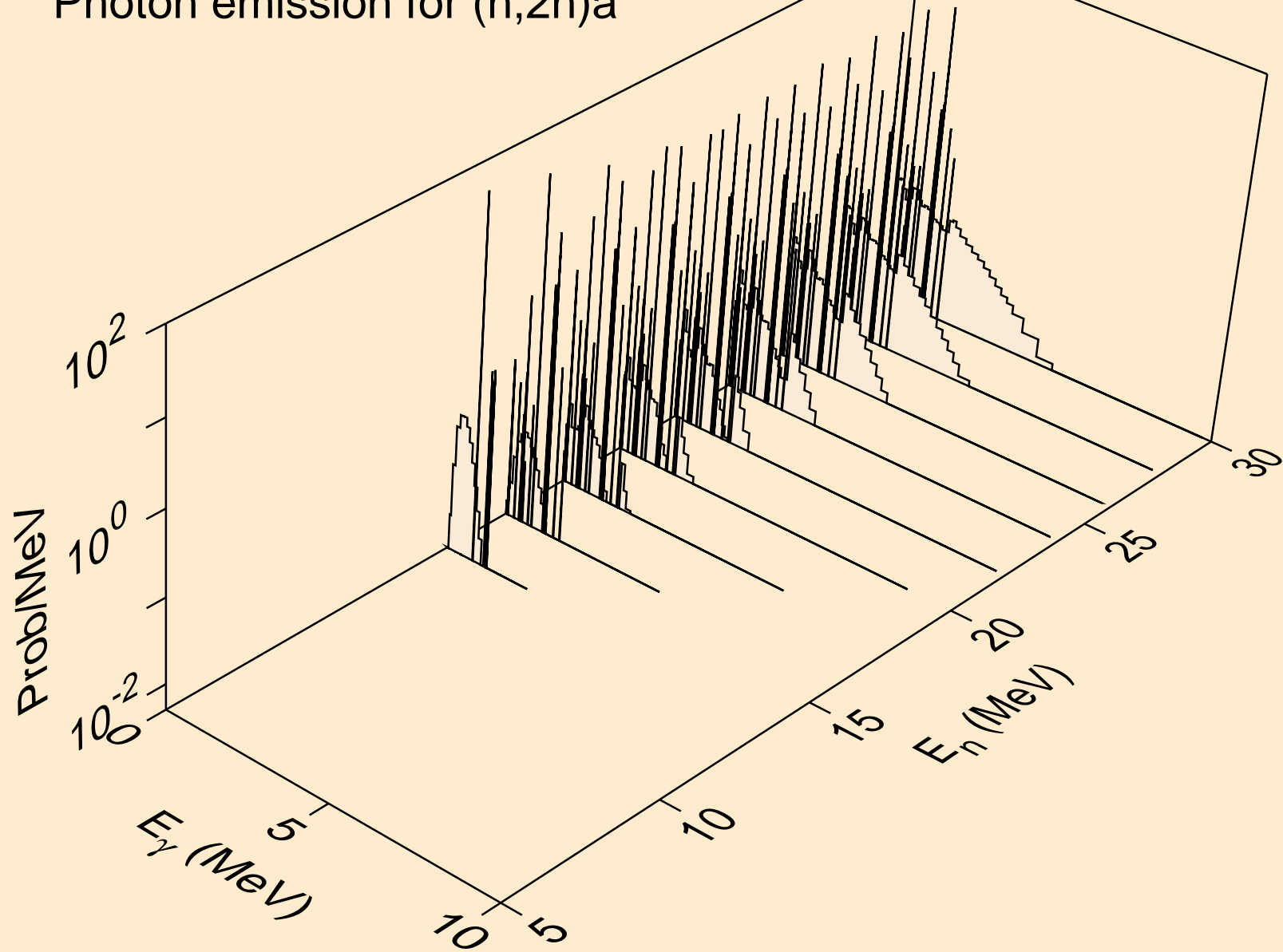

I136 NEUTRON ACER TENDL-2024 LIBRARY; T=0.K
Photon emission for (n,3n)a

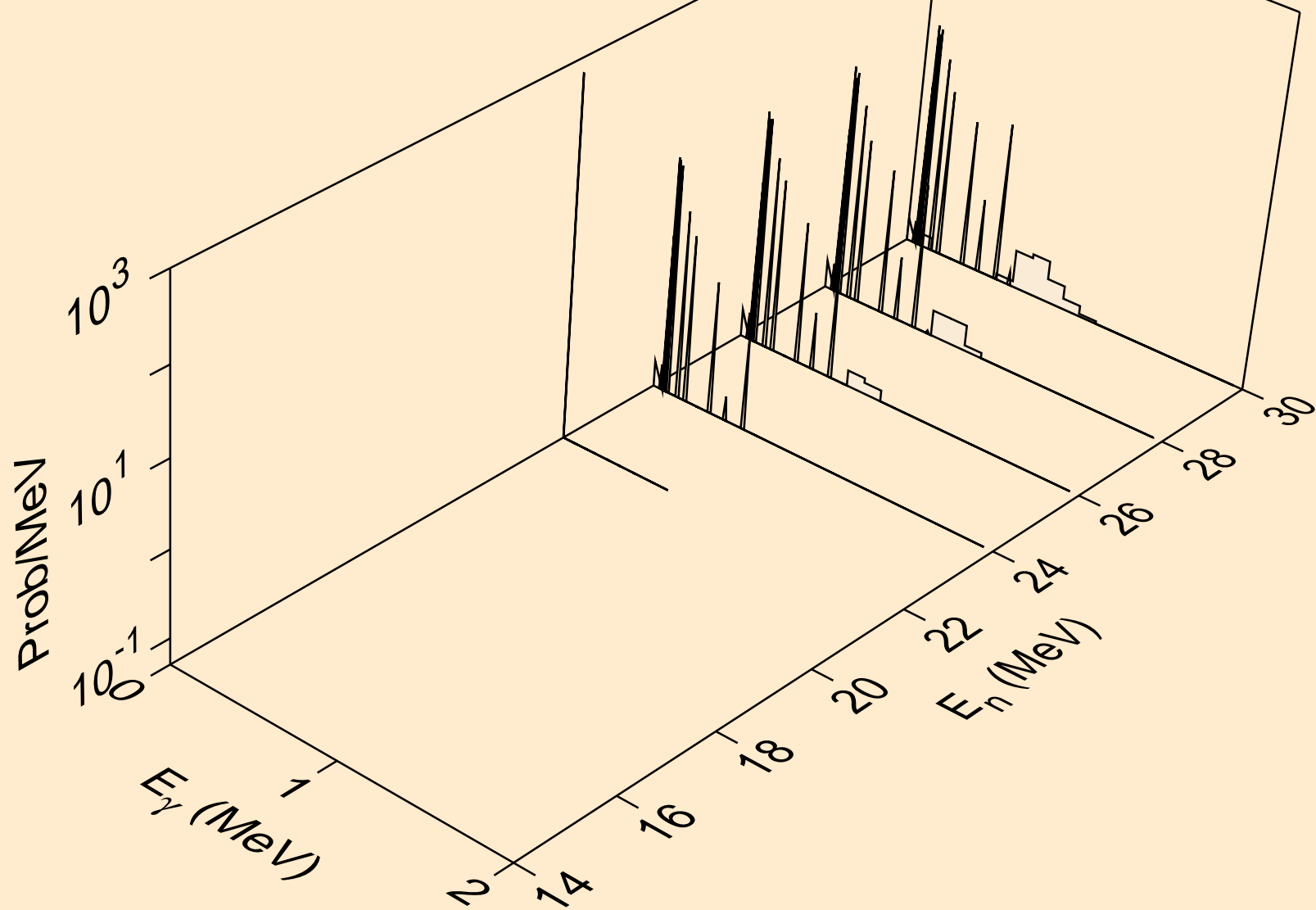

I136 NEUTRON ACER TENDL-2024 LIBRARY; T=0.K
Photon emission for (n,n*)p

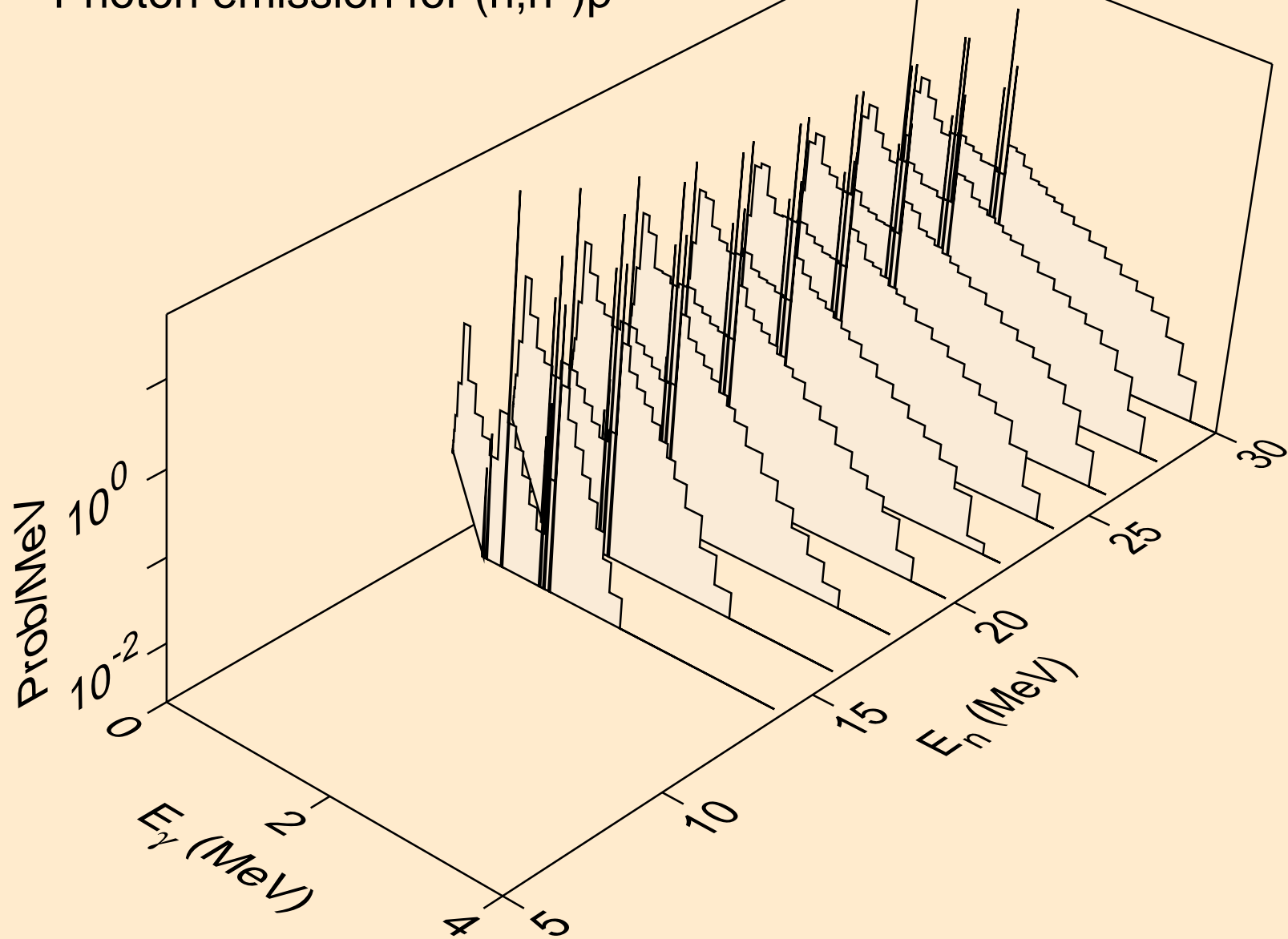

I136 NEUTRON ACER TENDL-2024 LIBRARY; T=0.K
Photon emission for (n,n*)d

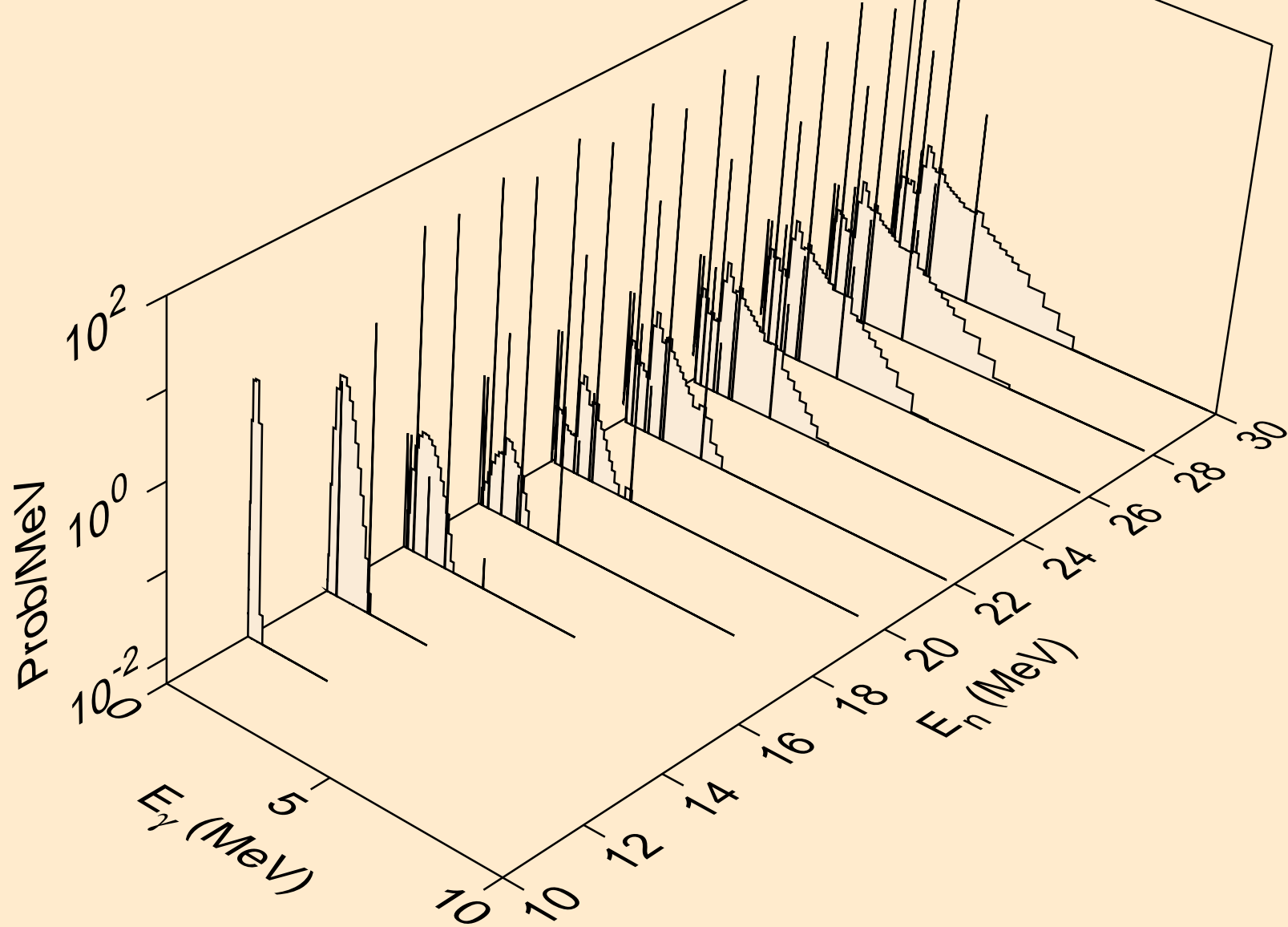

I136 NEUTRON ACER TENDL-2024 LIBRARY; T=0.K
Photon emission for (n,n*)t

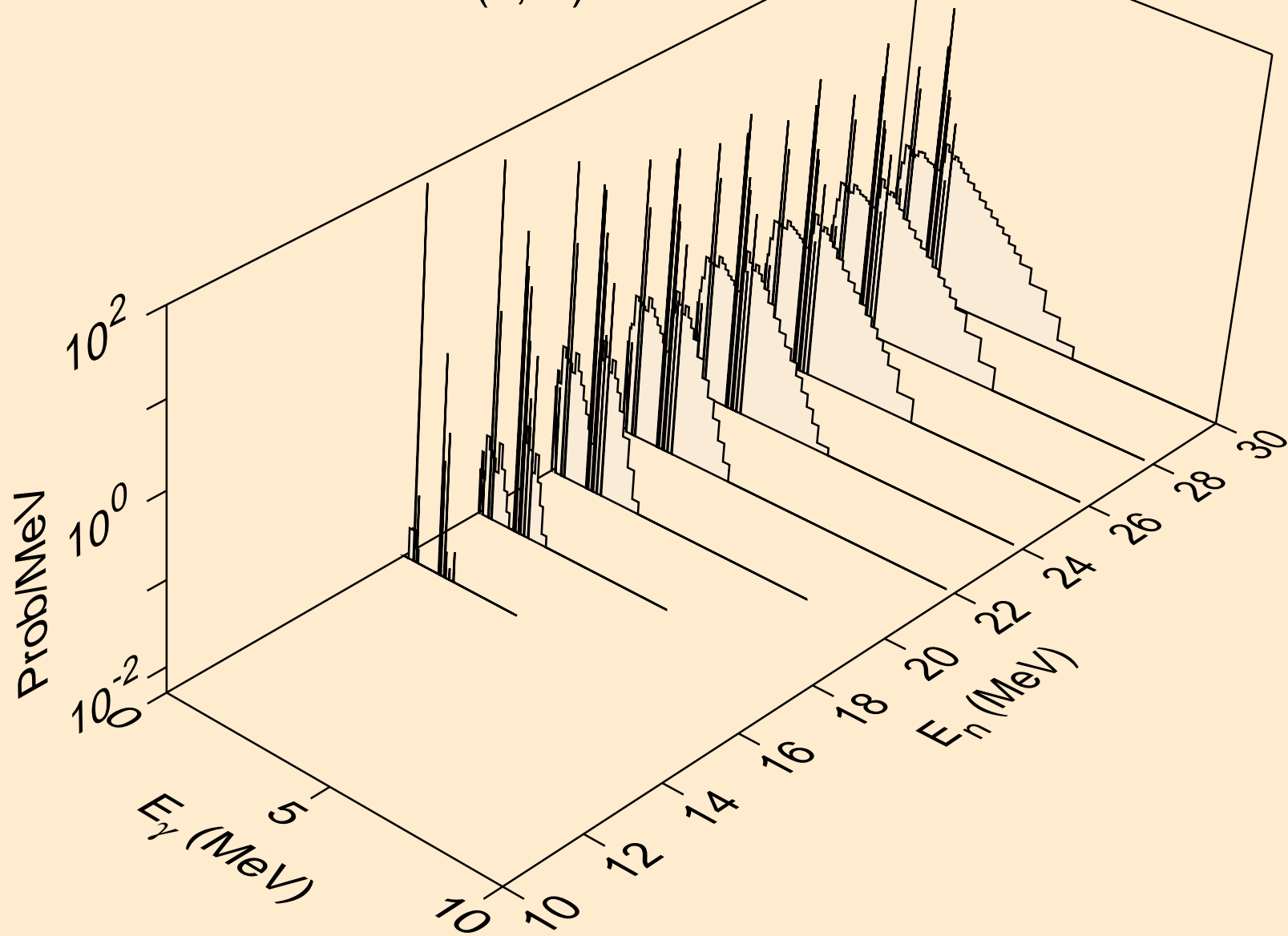

I136 NEUTRON ACER TENDL-2024 LIBRARY; T=0.K
Photon emission for (n,n*)he3

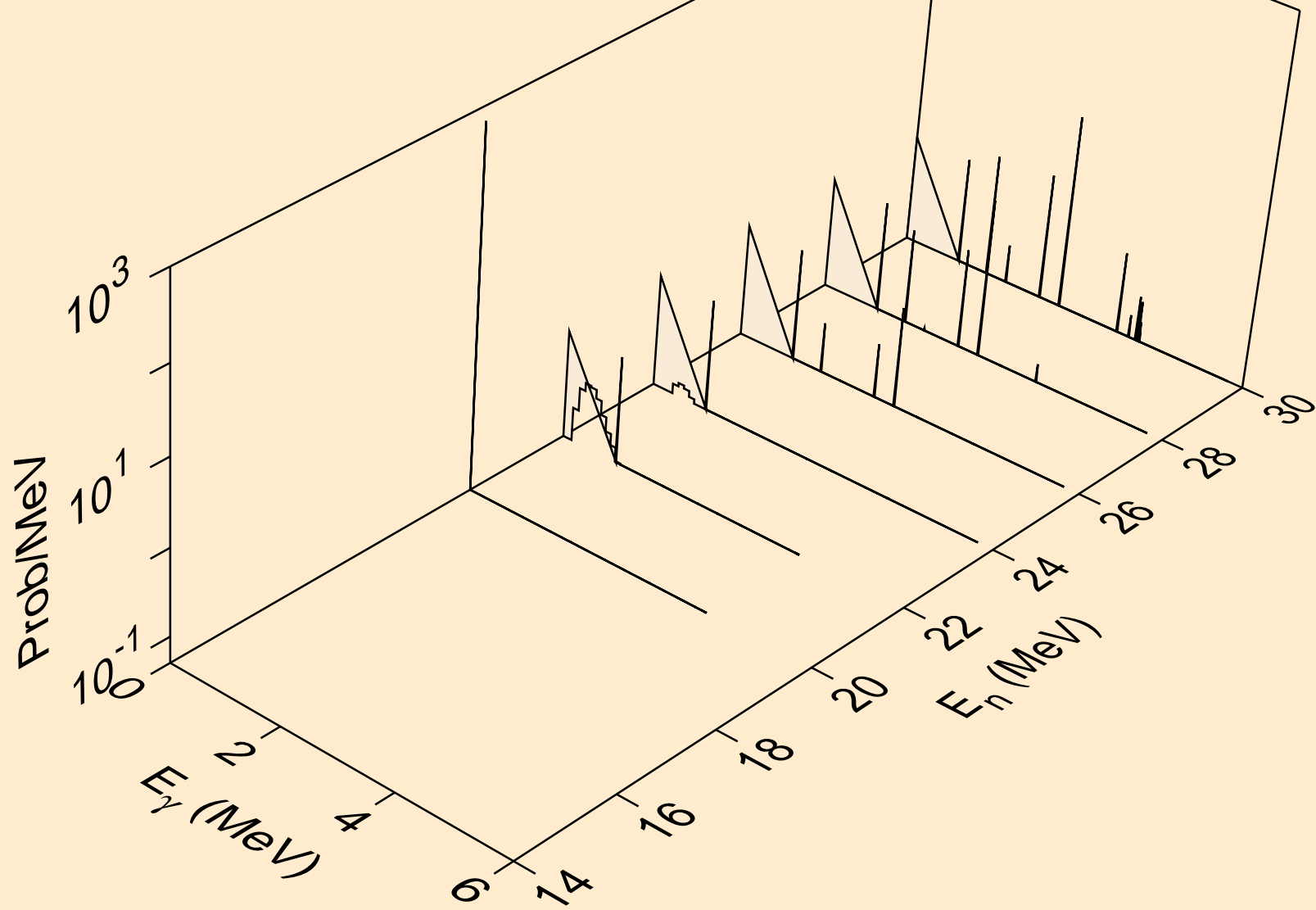

I136 NEUTRON ACER TENDL-2024 LIBRARY; T=0.K
Photon emission for (n,4n)

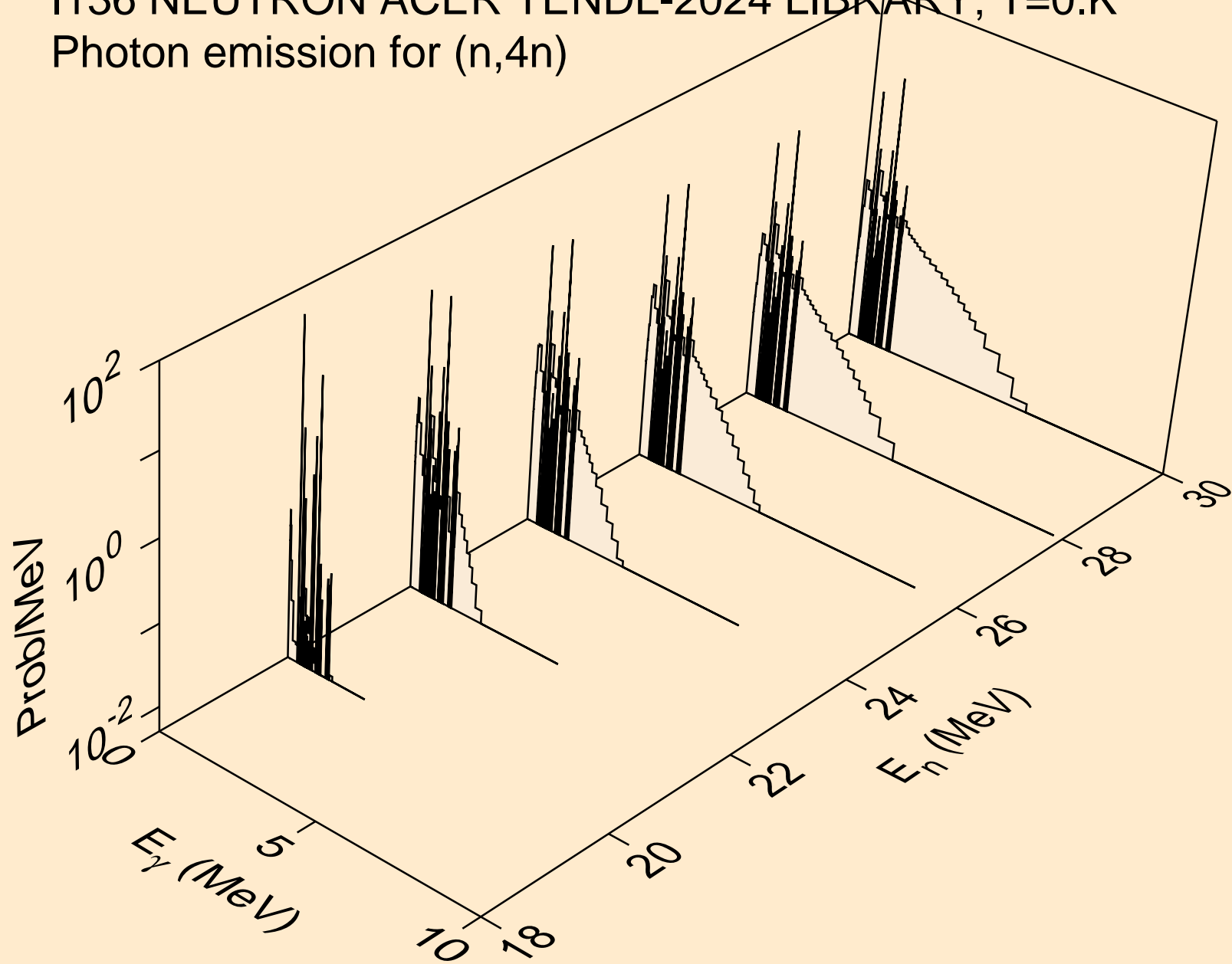

I136 NEUTRON ACER TENDL-2024 LIBRARY; T=0.K
Photon emission for (n,2np)

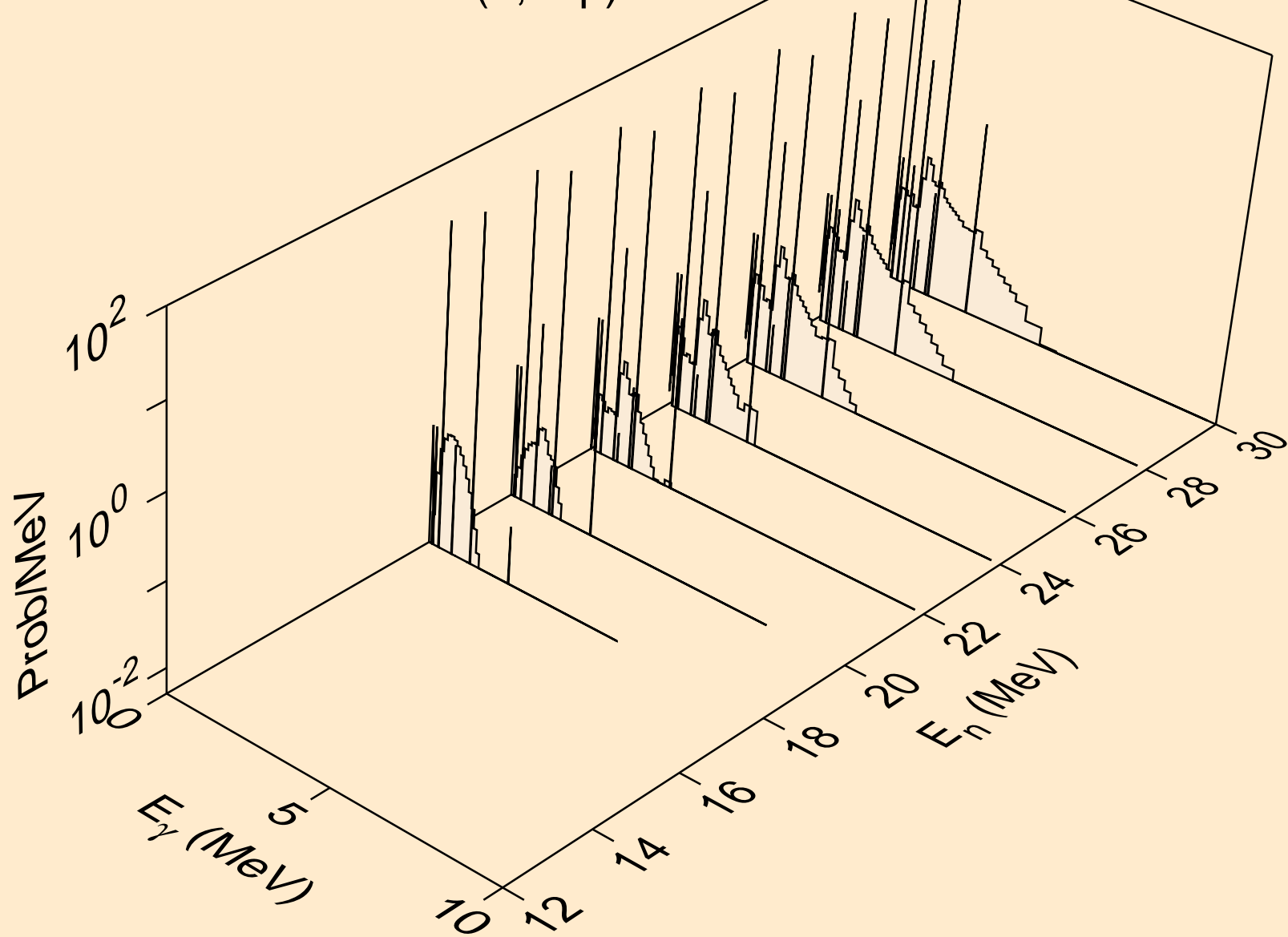

I136 NEUTRON ACER TENDL-2024 LIBRARY; T=0.K
Photon emission for (n,3np)

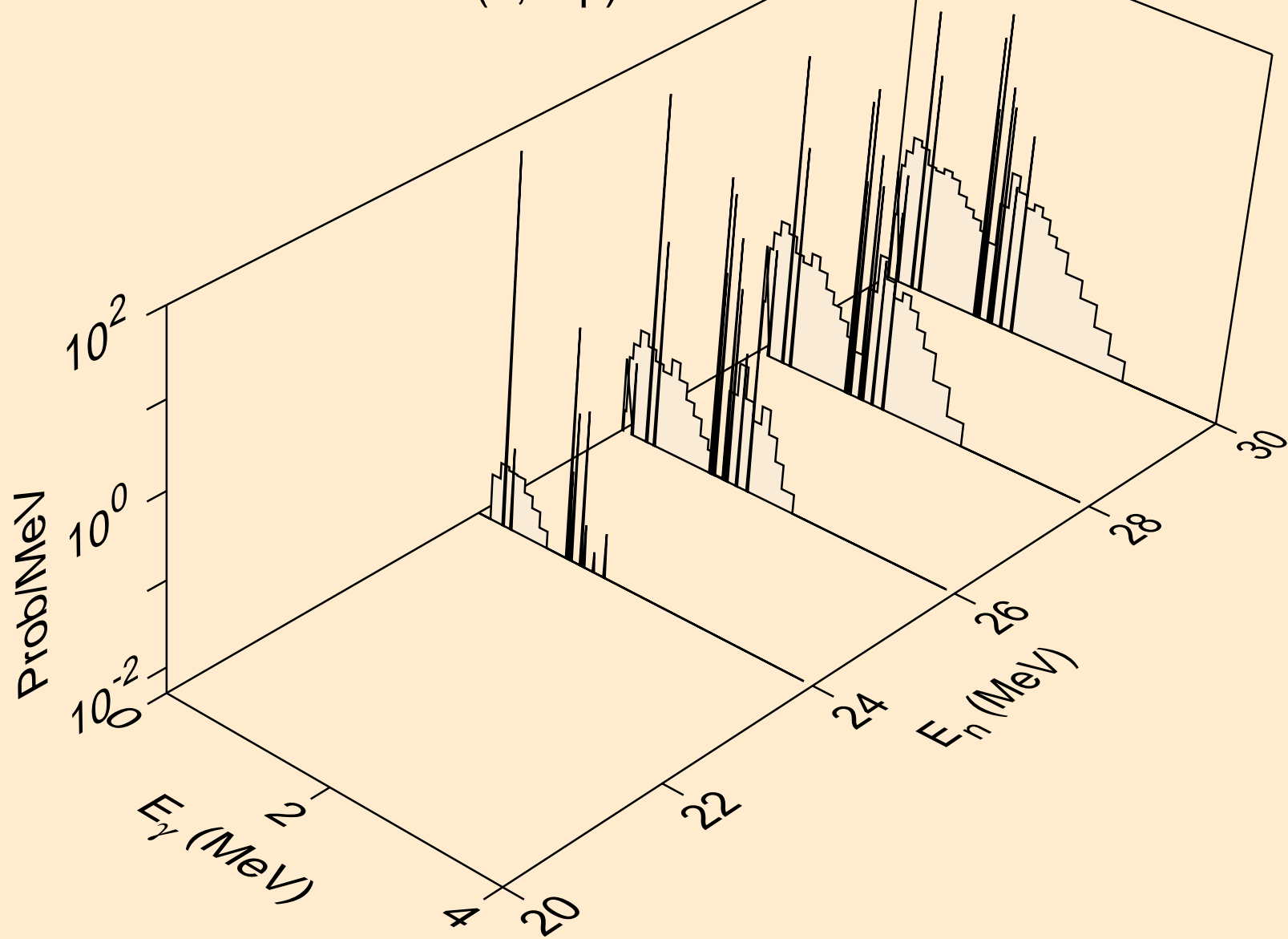

I136 NEUTRON ACER TENDL-2024 LIBRARY; T=0.K
Photon emission for (n,n*c)

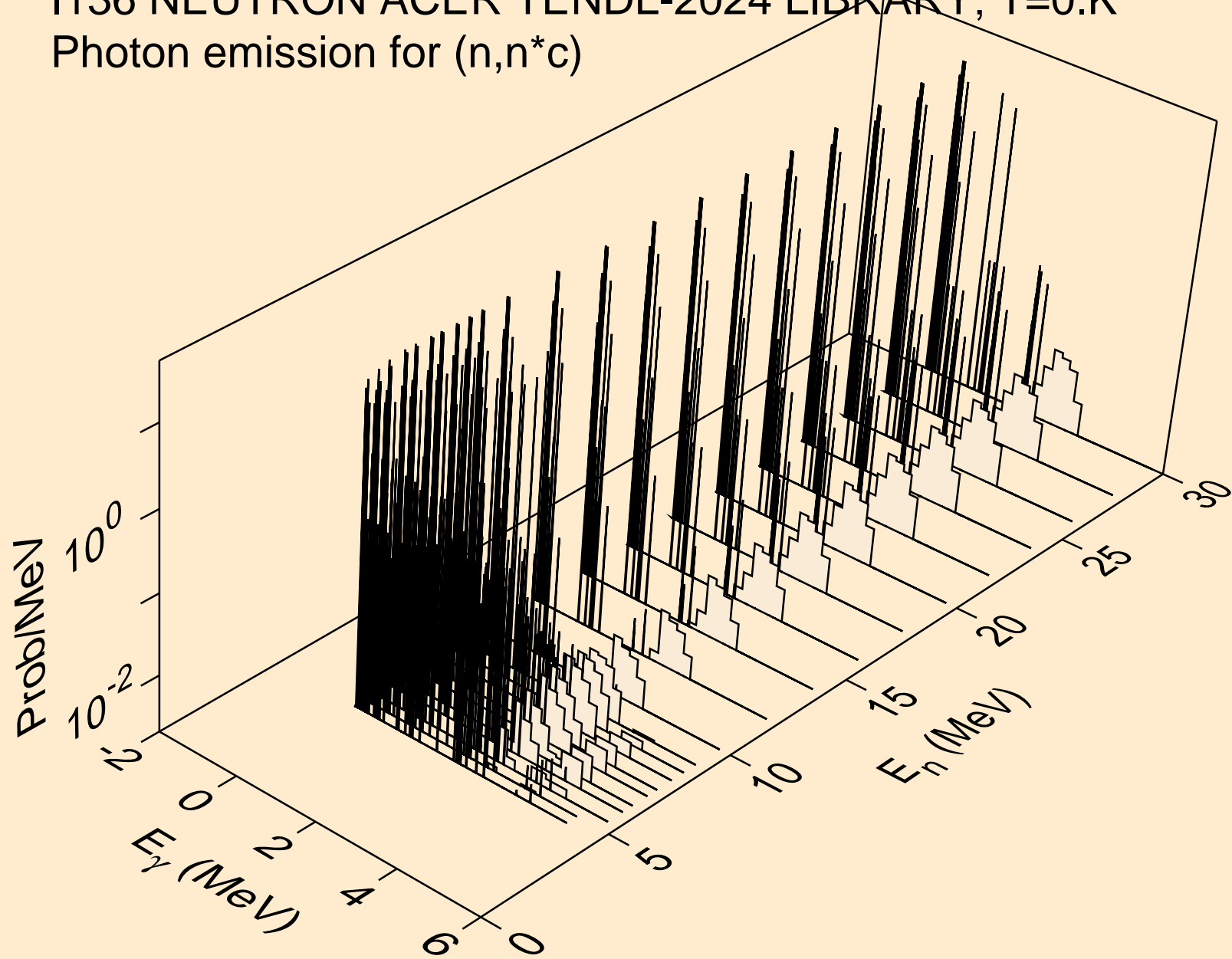

I136 NEUTRON ACER TENDL-2024 LIBRARY; T=0.K
Photon emission for (n,gma)

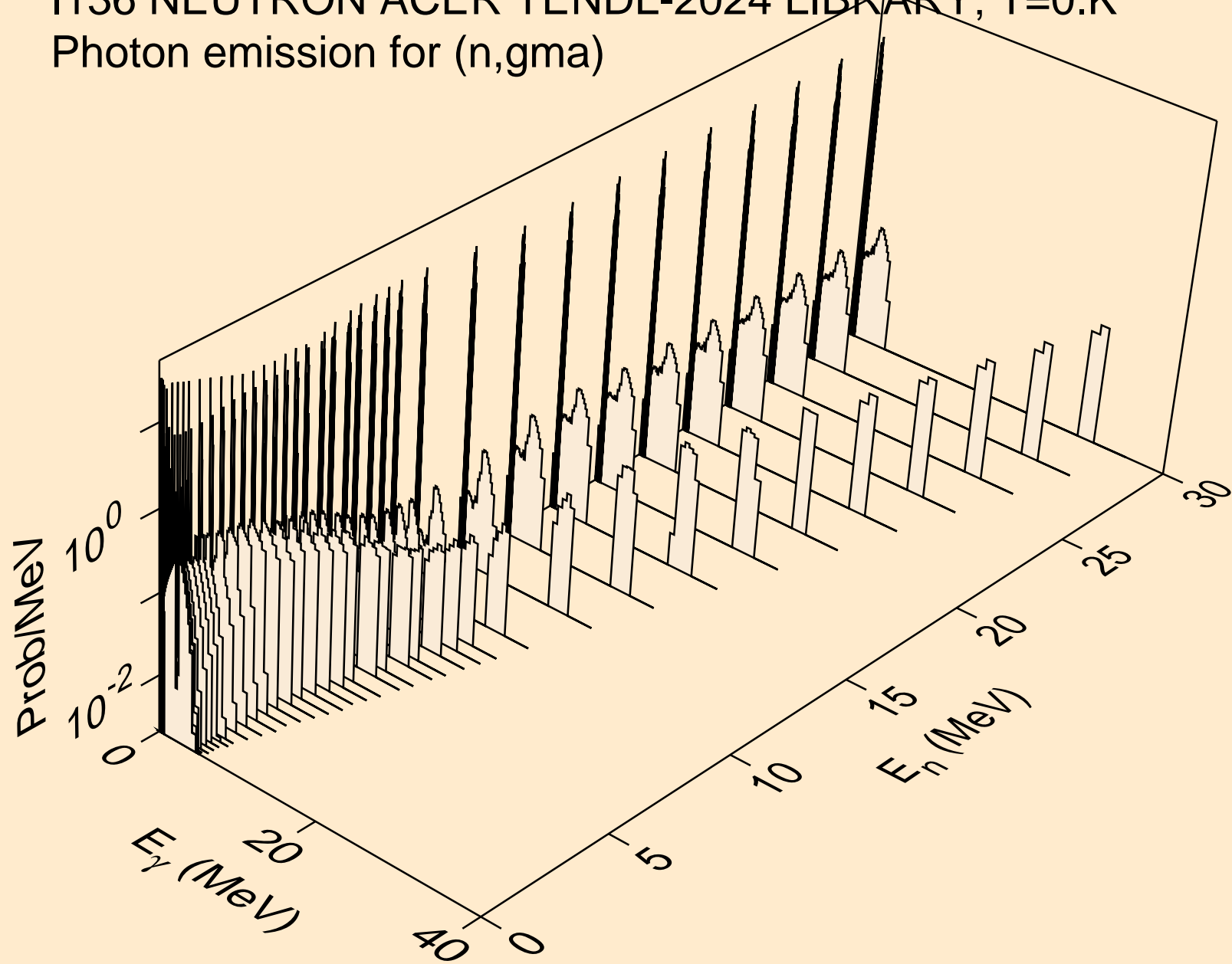

I136 NEUTRON ACER TENDL-2024 LIBRARY; T=0.K
Photon emission for (n,p)

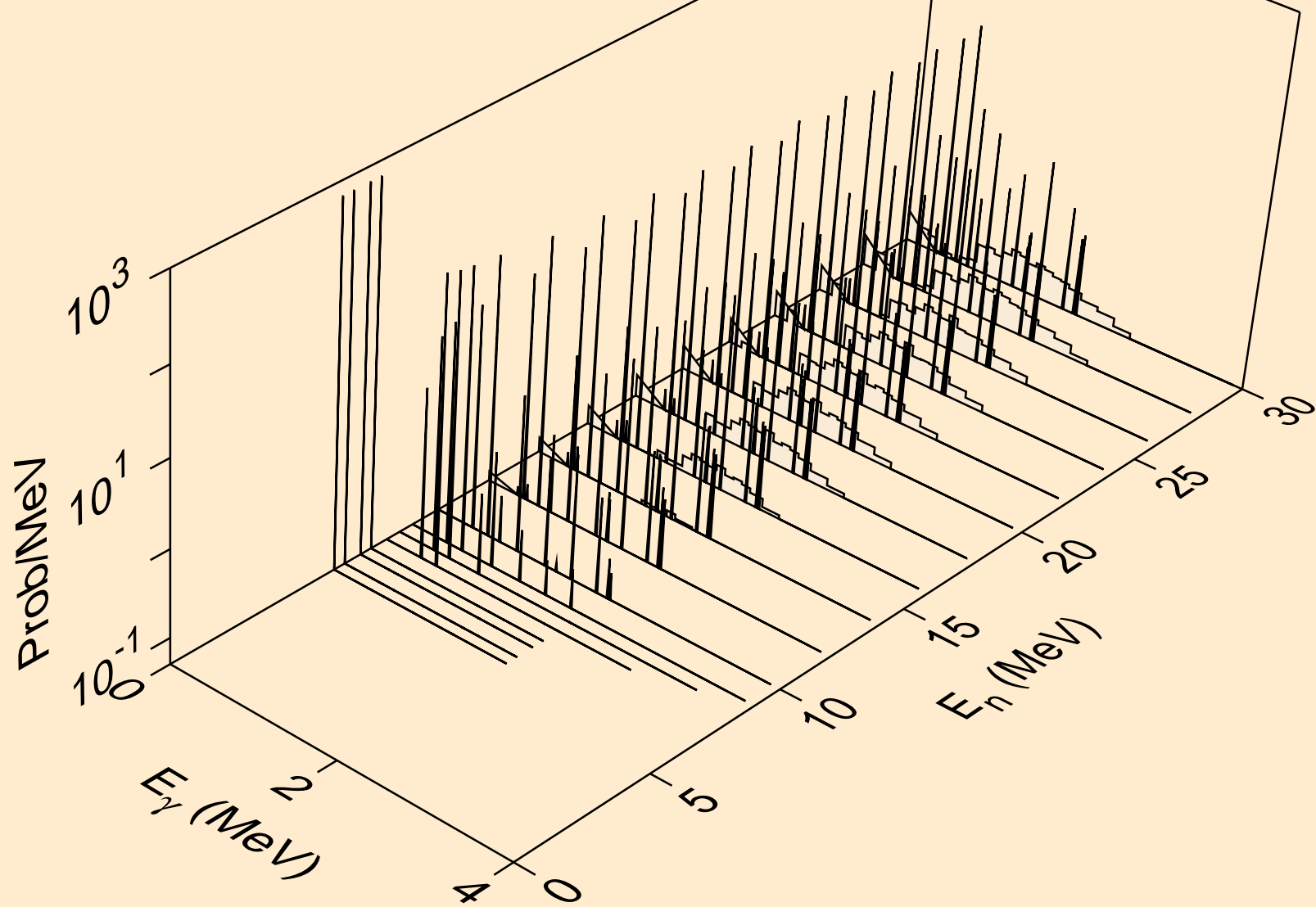

I136 NEUTRON ACER TENDL-2024 LIBRARY; T=0.K
Photon emission for (n,d)

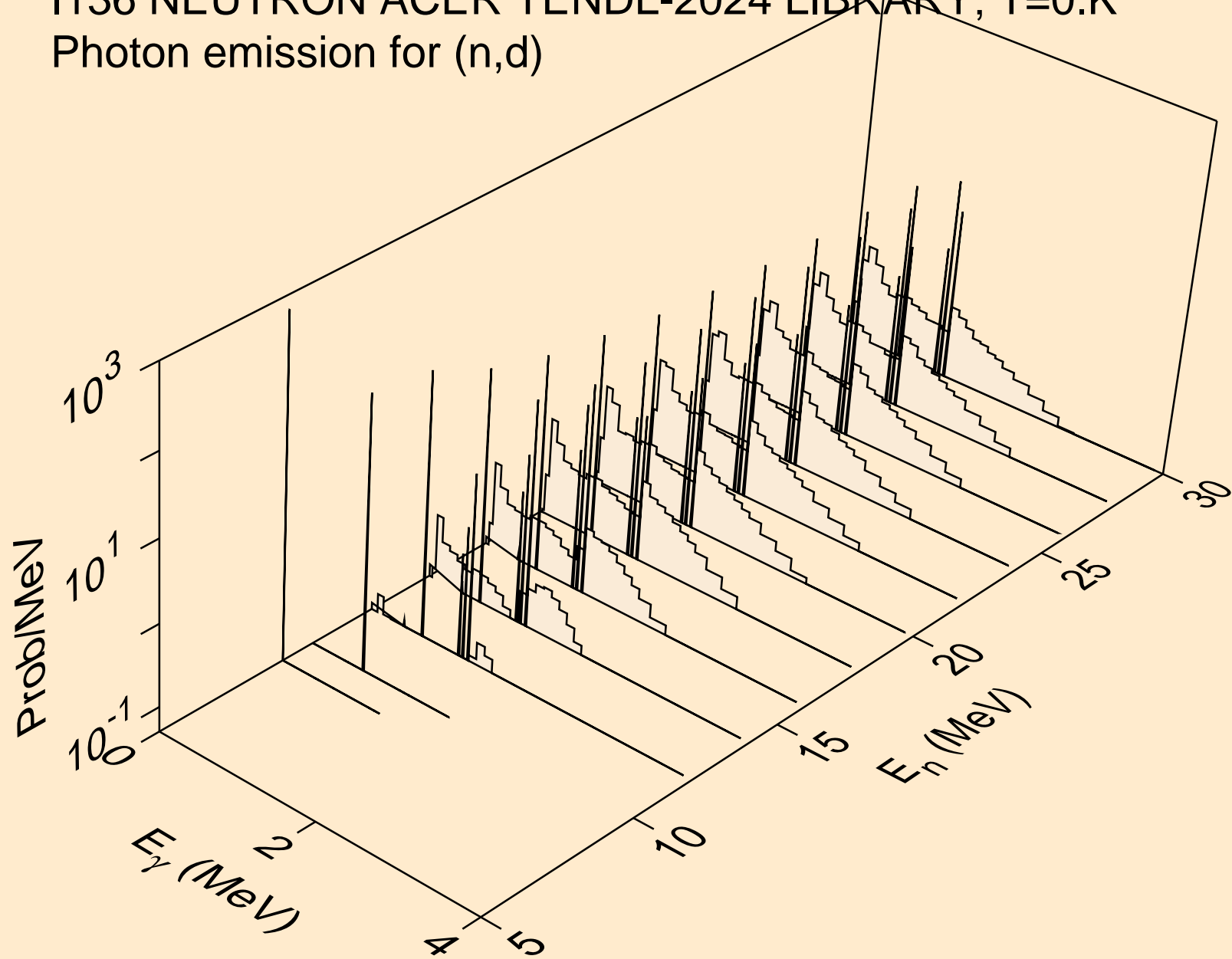

I136 NEUTRON ACER TENDL-2024 LIBRARY; T=0.K
Photon emission for (n,t)

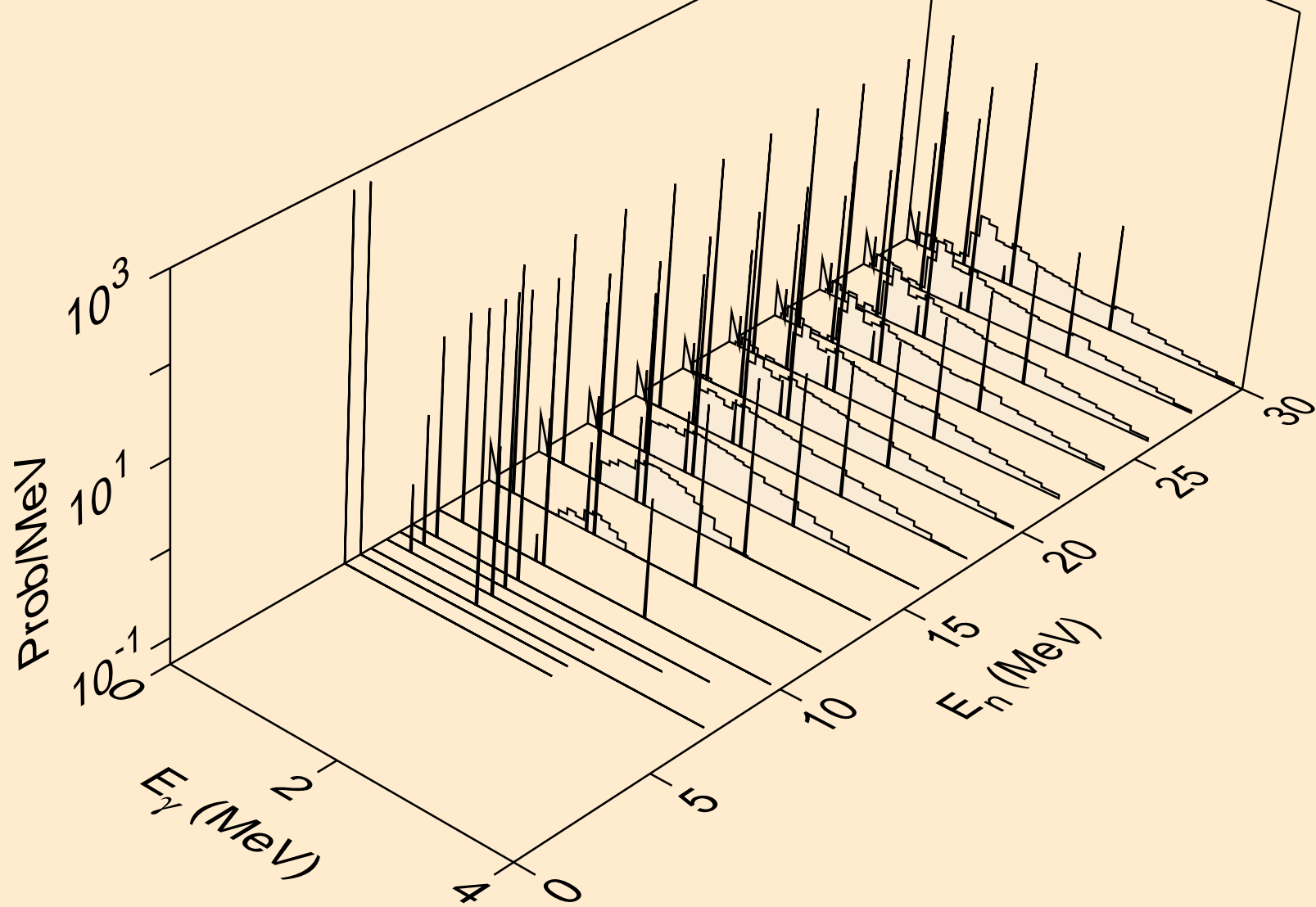

I136 NEUTRON ACER TENDL-2024 LIBRARY; T=0.K
Photon emission for (n,he3)

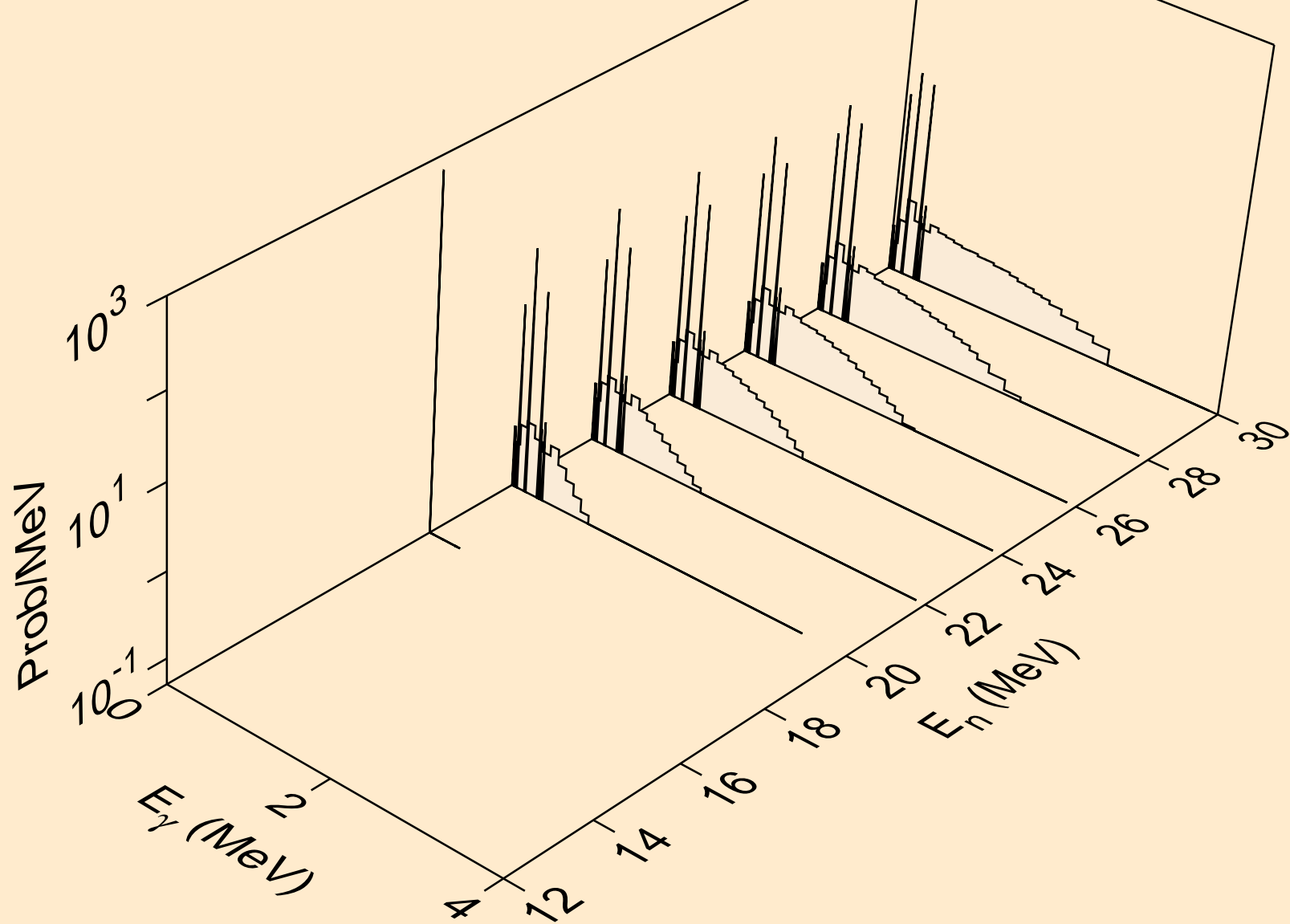

I136 NEUTRON ACER TENDL-2024 LIBRARY; T=0.K
Photon emission for (n,a)

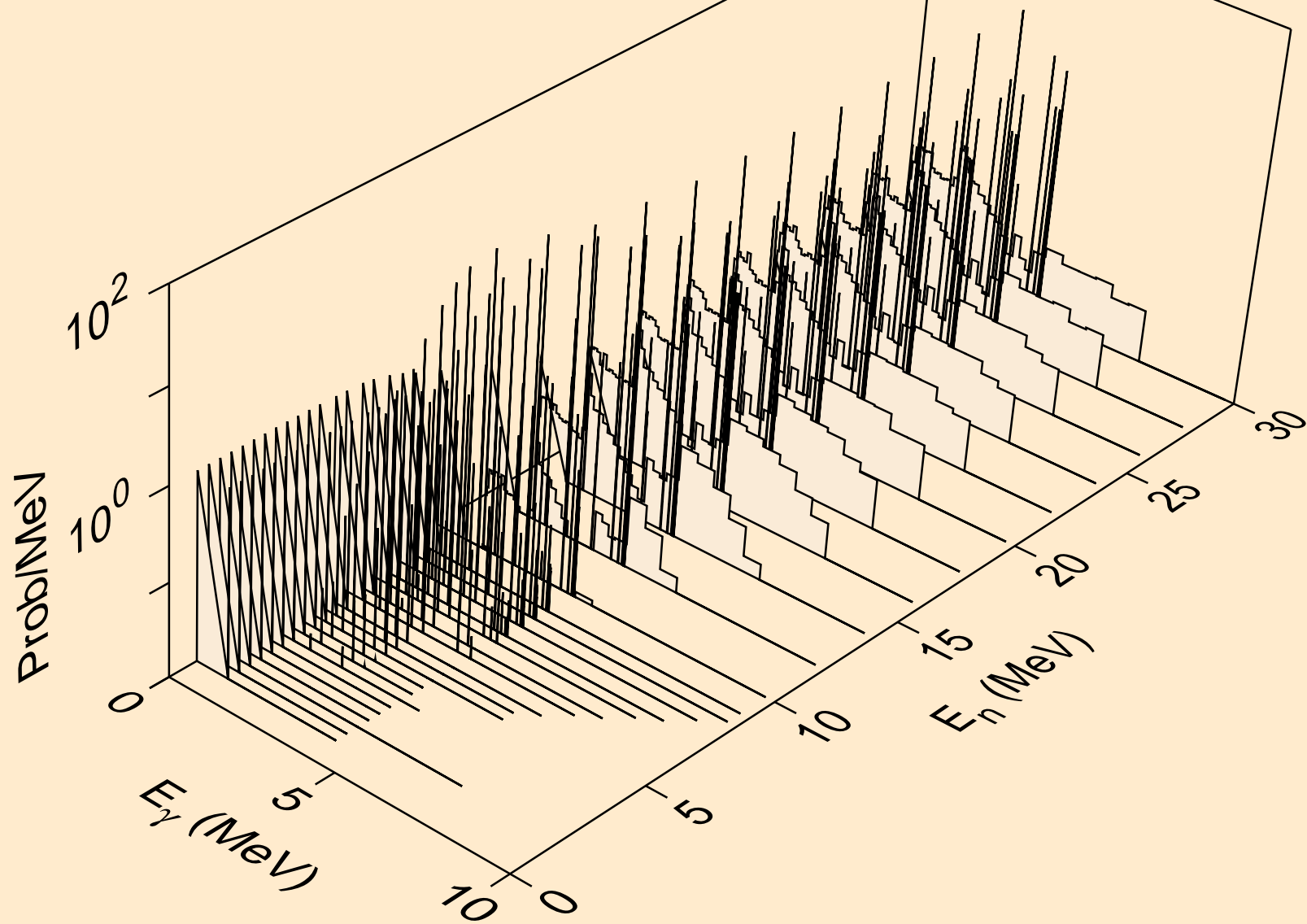

I136 NEUTRON ACER TENDL-2024 LIBRARY; T=0.K
Photon emission for (n,2p)

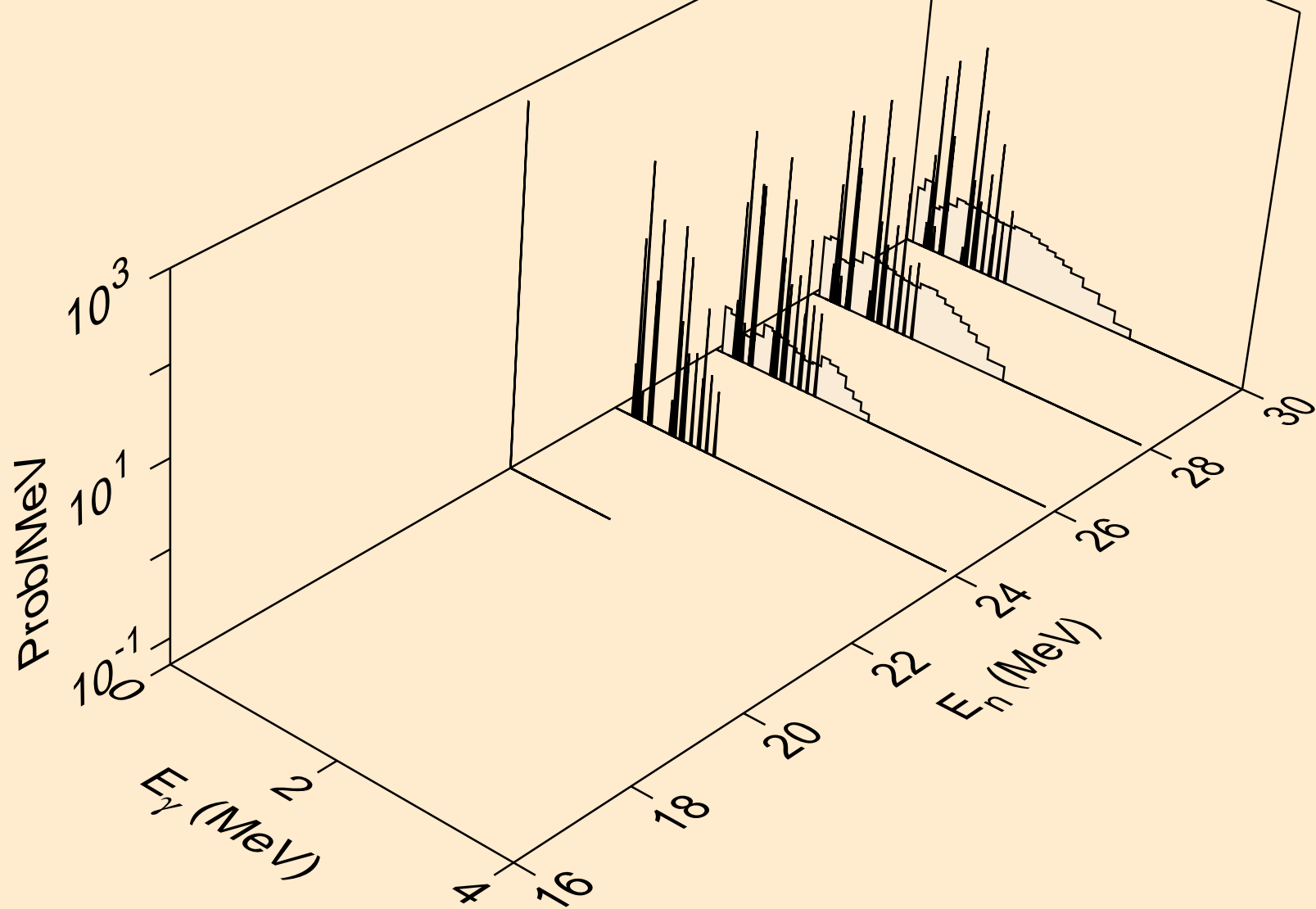

I136 NEUTRON ACER TENDL-2024 LIBRARY; T=0.K
Photon emission for (n,p α)

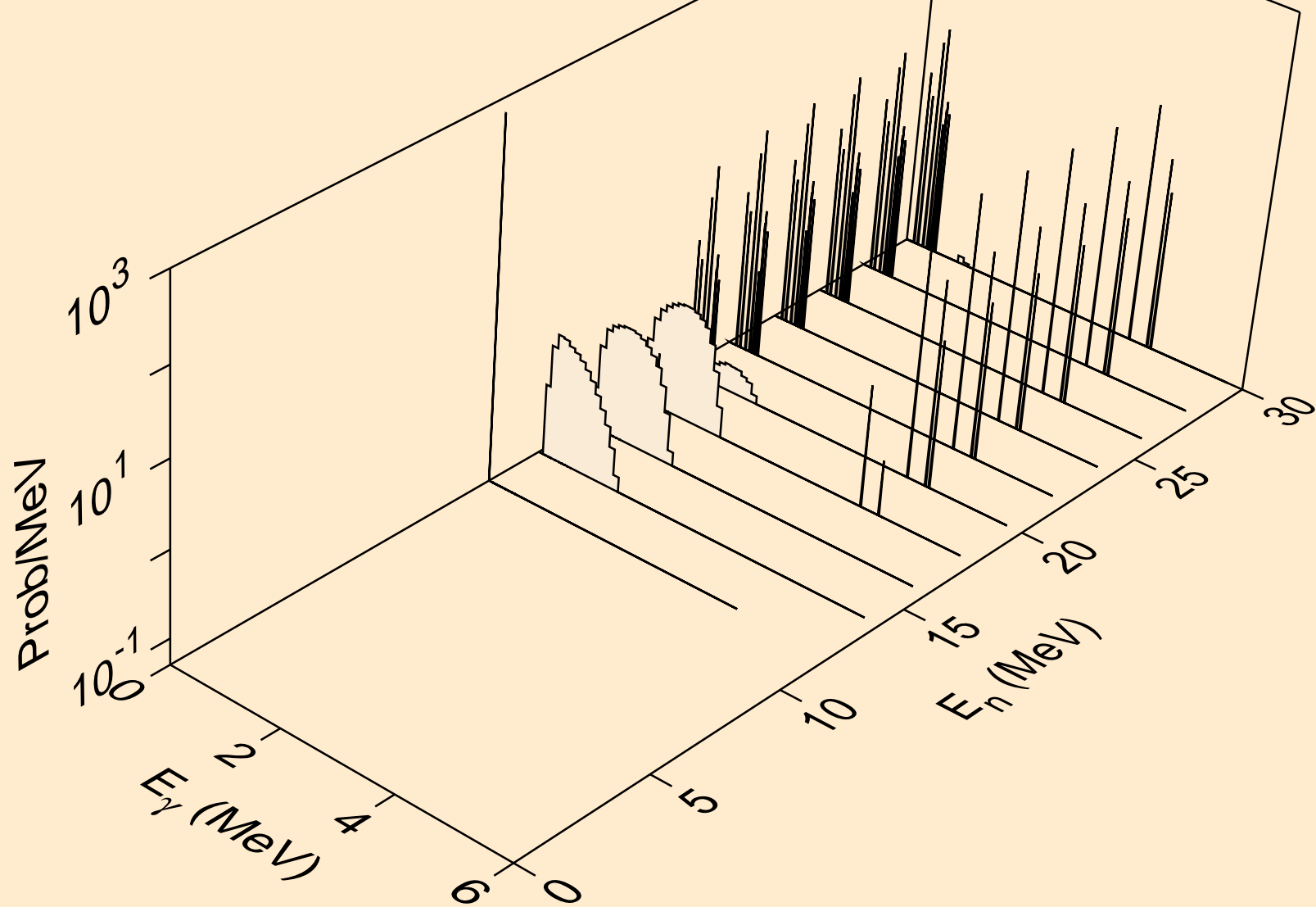

I136 NEUTRON ACER TENDL-2024 LIBRARY; T=0.K
Photon emission for (n,pt)

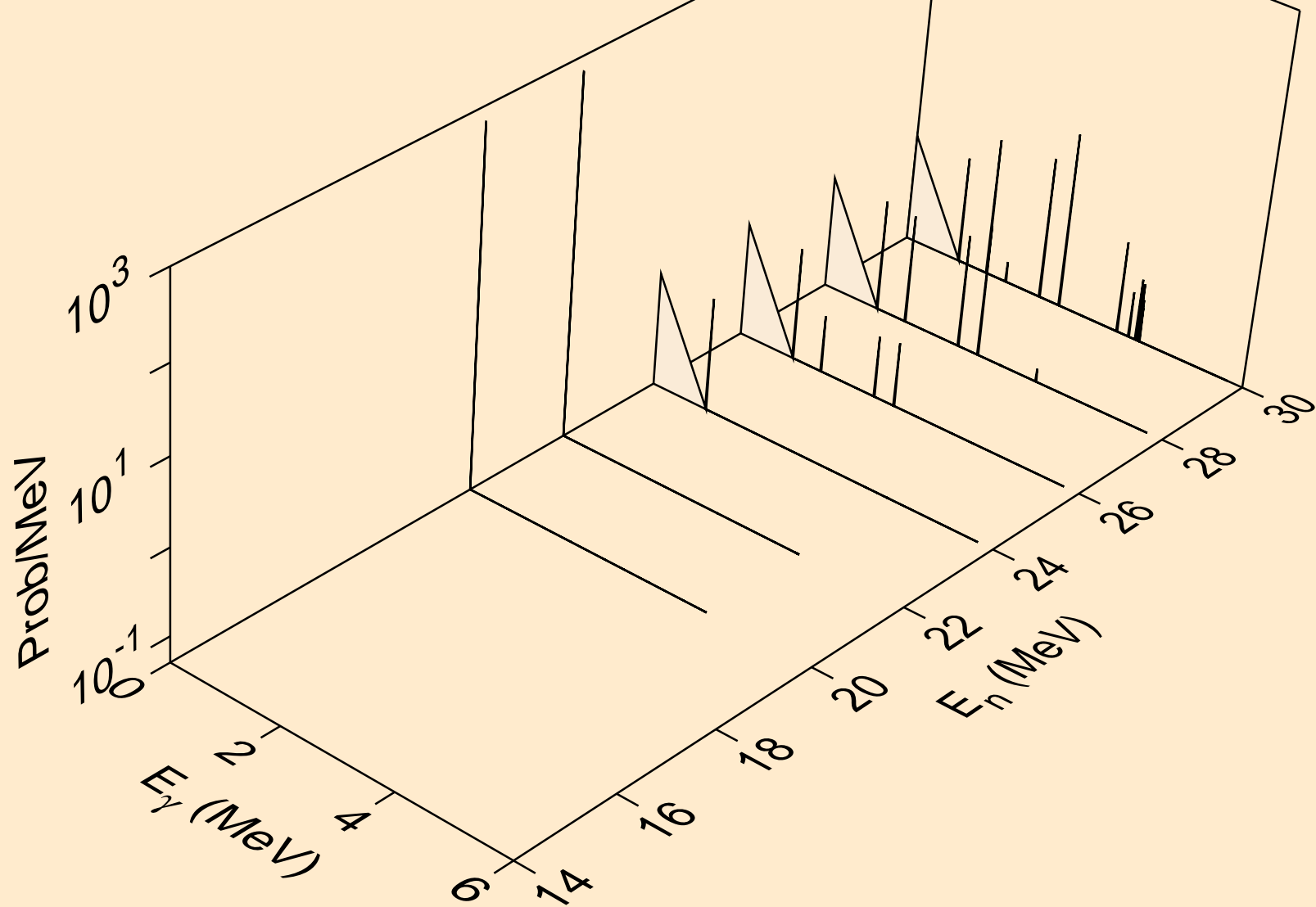

I136 NEUTRON ACER TENDL-2024 LIBRARY; T=0.K
Photon emission for (n,da)

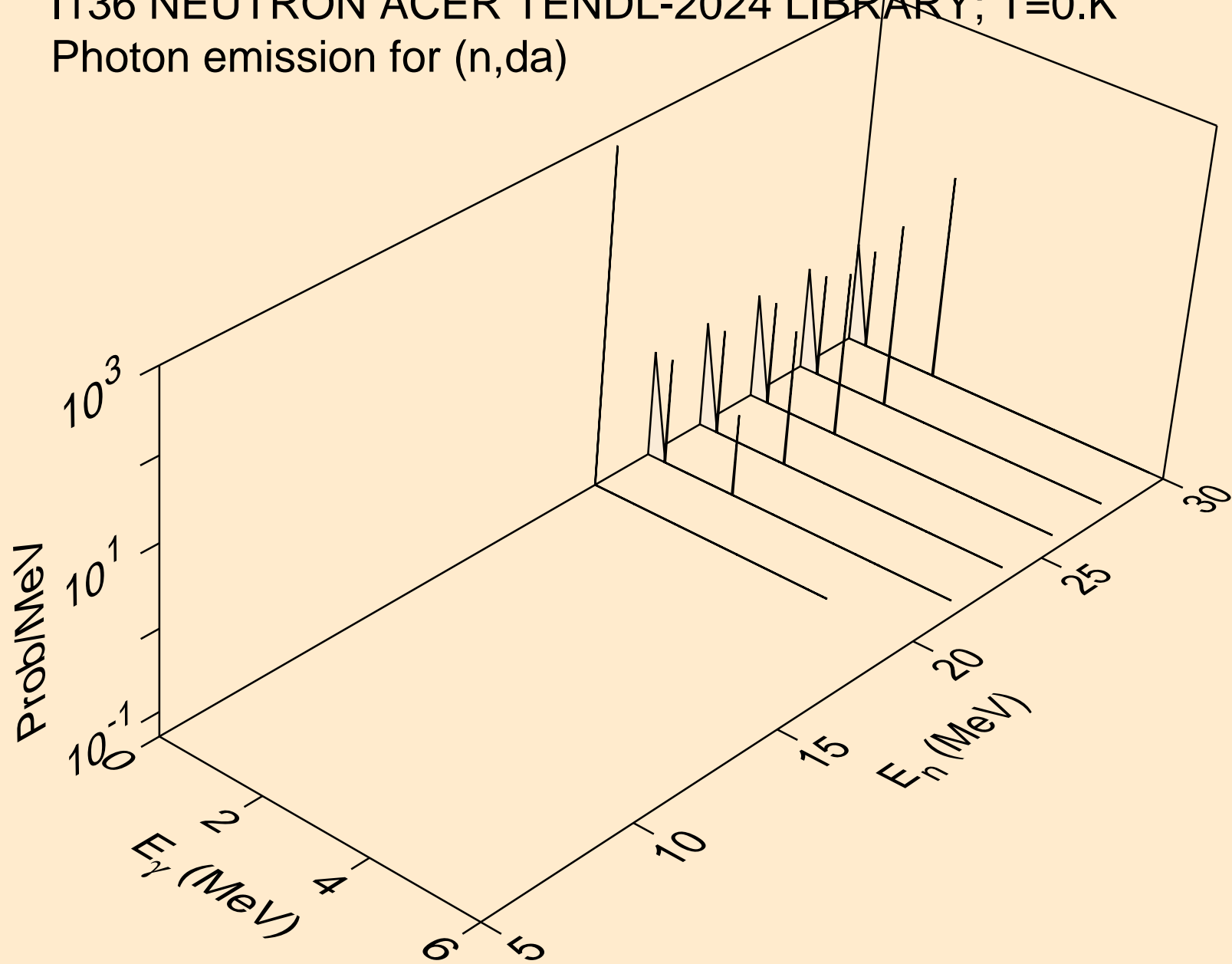

I136 NEUTRON ACER TENDL-2024 LIBRARY; T=0.K
thermal capture photon spectrum

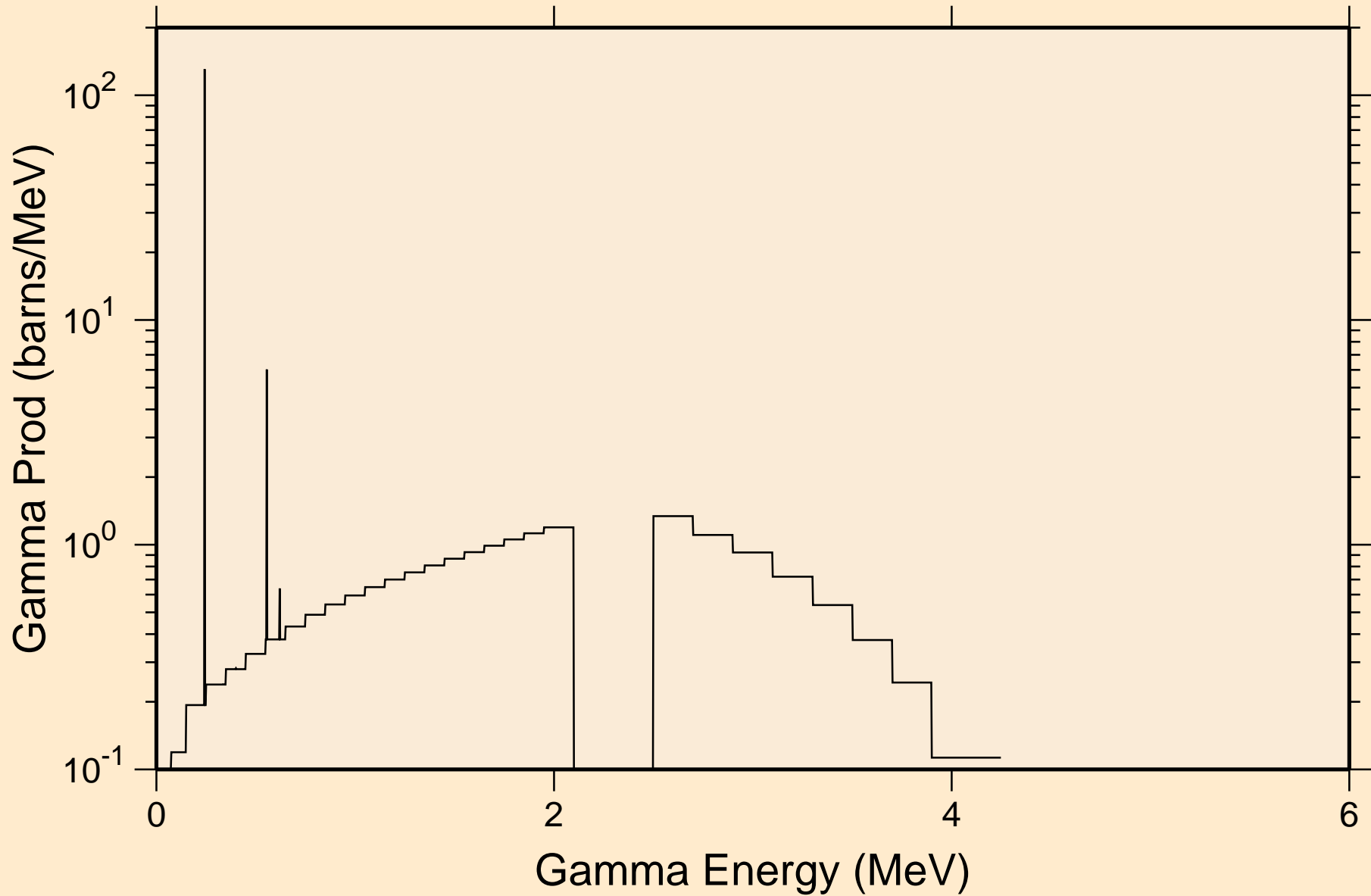

I136 NEUTRON ACER TENDL-2024 LIBRARY; T=0.K
14 MeV photon spectrum

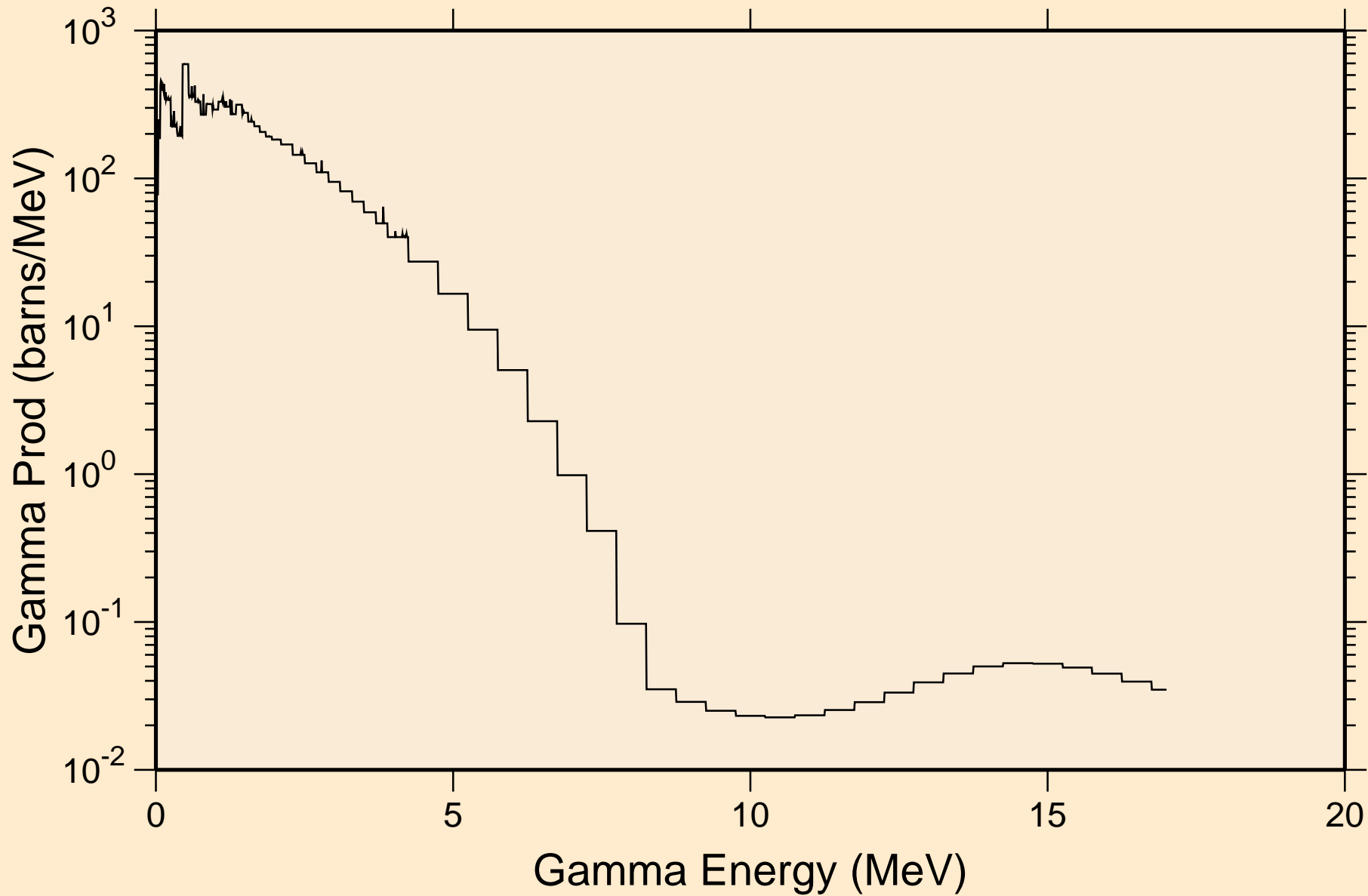

I136 NEUTRON ACER TENDL-2024 LIBRARY; T=0.K

Particle heating contributions

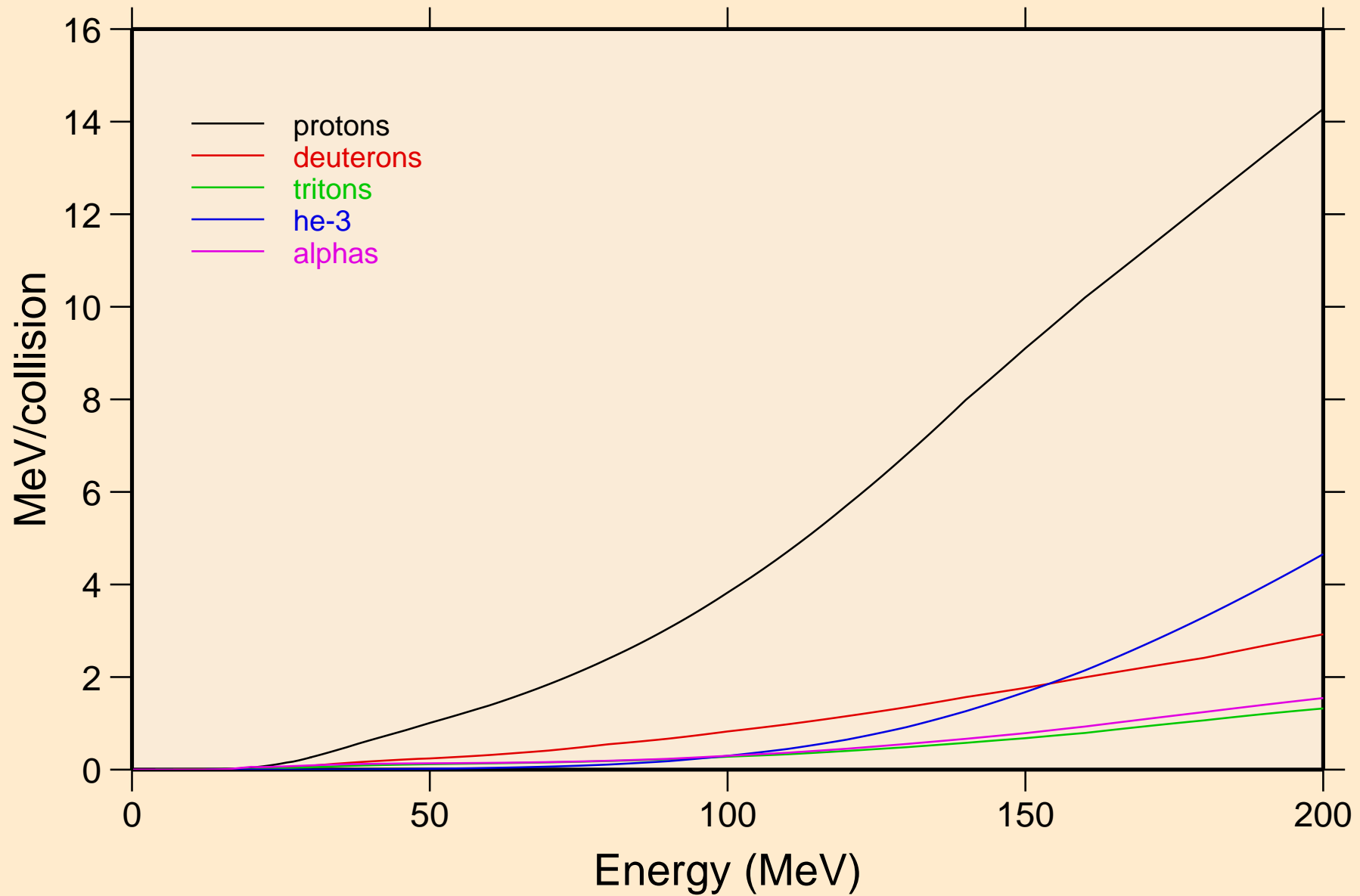

I136 NEUTRON ACER TENDL-2024 LIBRARY; T=0.K

Recoil Heating

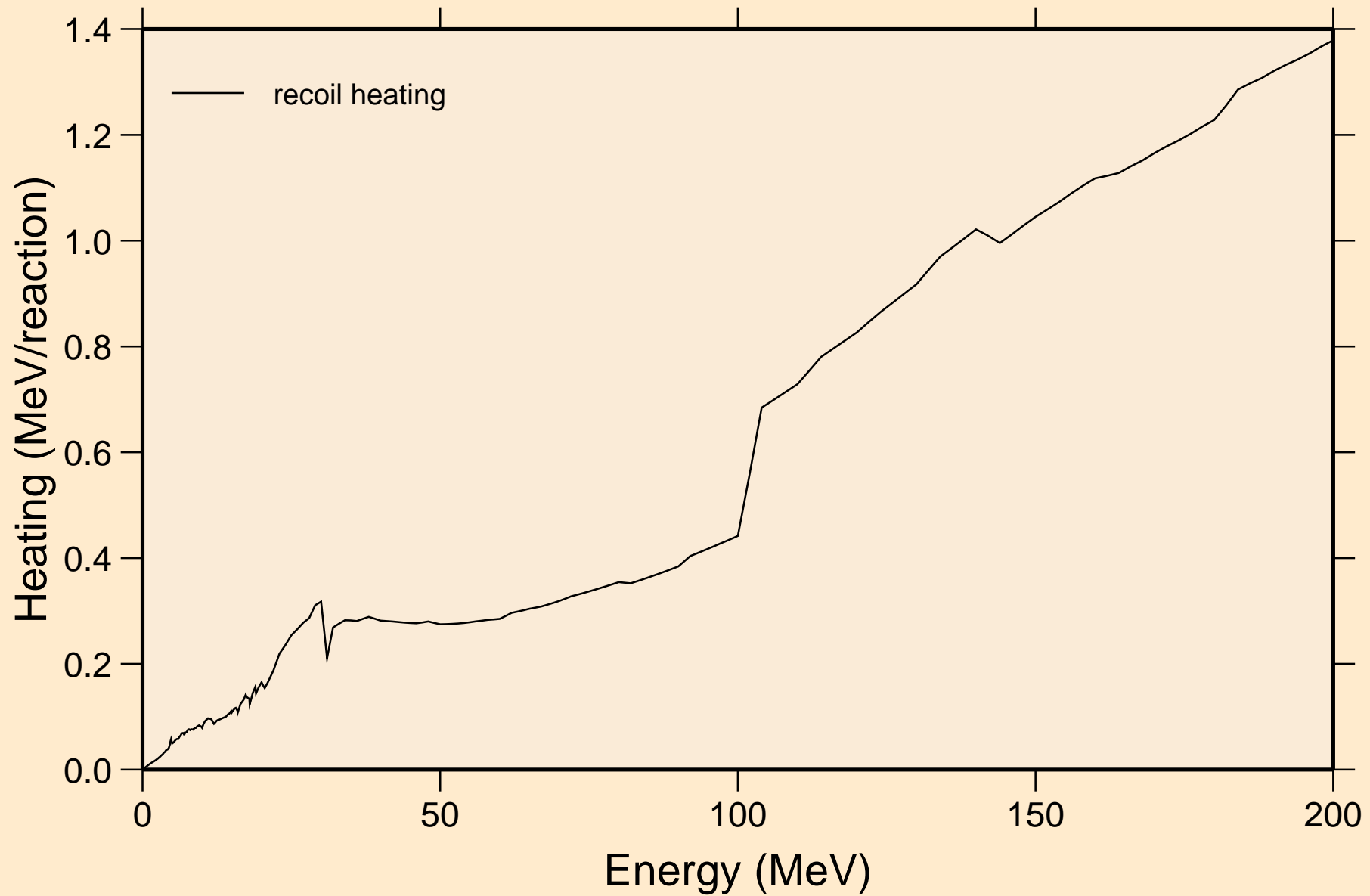

I136 NEUTRON ACER TENDL-2024 LIBRARY; T=0.K

Particle production cross sections

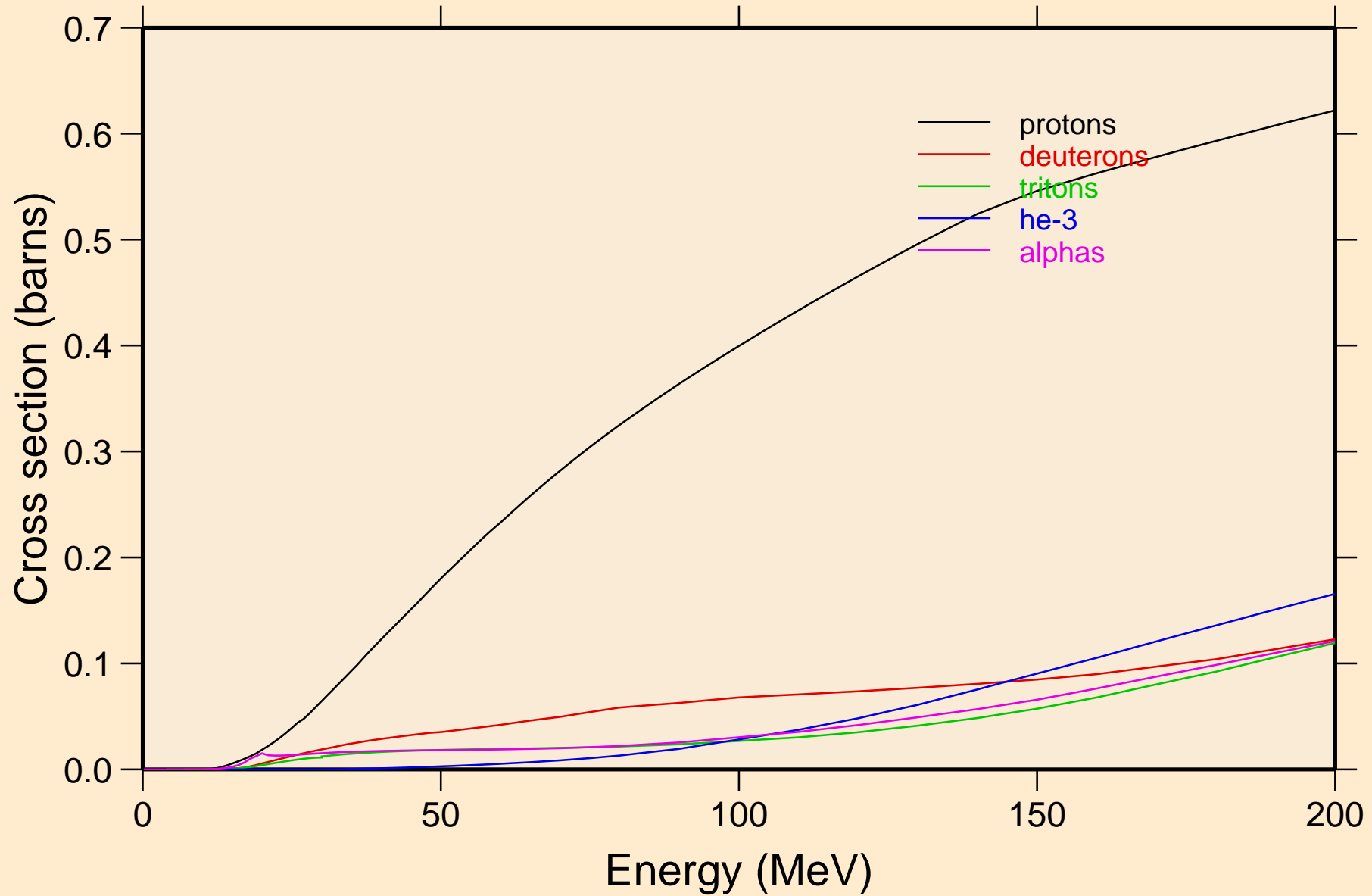

I136 NEUTRON ACER TENDL-2024 LIBRARY; T=0.K
protons from (n,x)

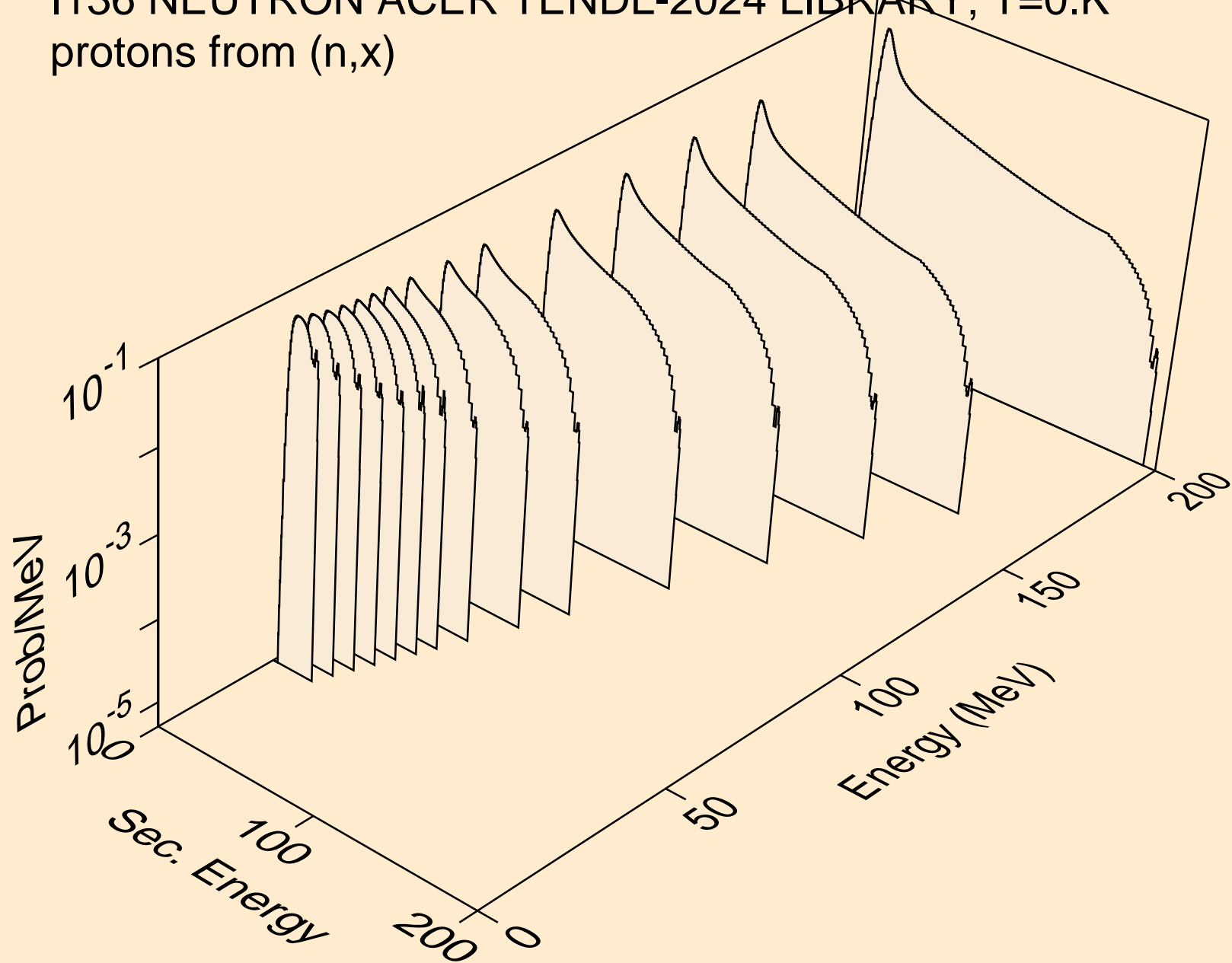

I136 NEUTRON ACER TENDL-2024 LIBRARY; T=0.K
protons from (n,n*)p

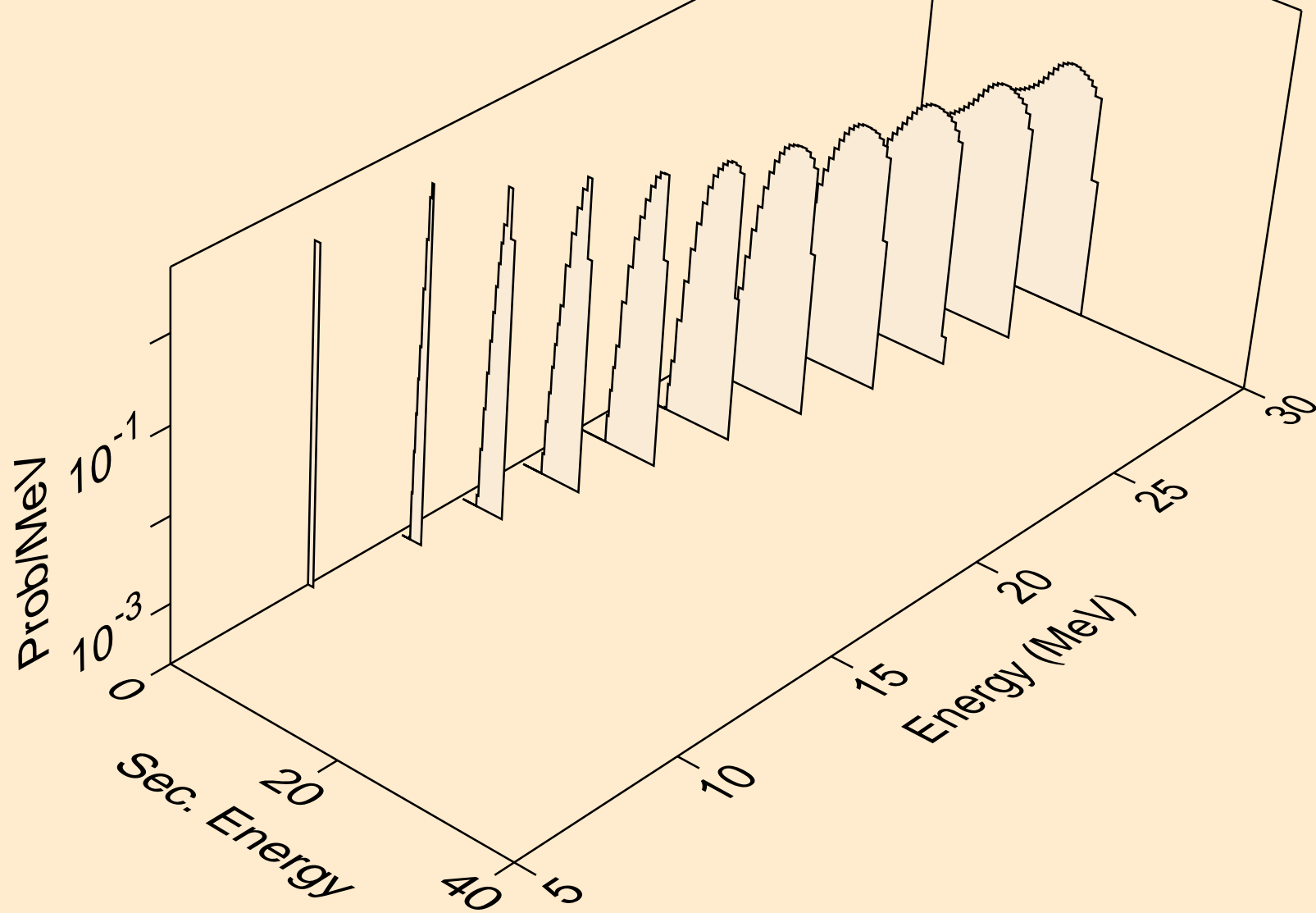

I136 NEUTRON ACER TENDL-2024 LIBRARY; T=0.K
protons from (n,2np)

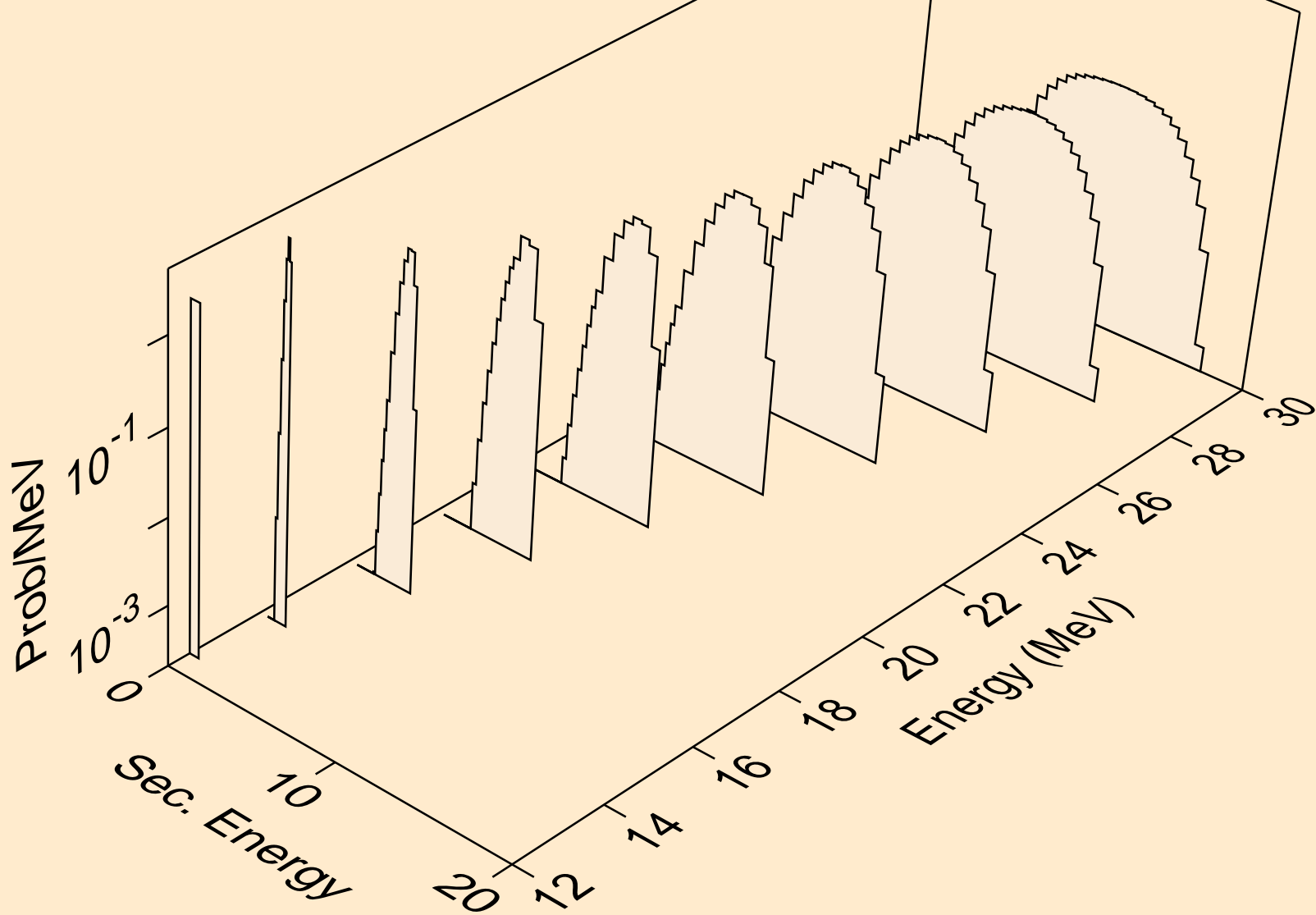

I136 NEUTRON ACER TENDL-2024 LIBRARY; T=0.K
protons from (n,3np)

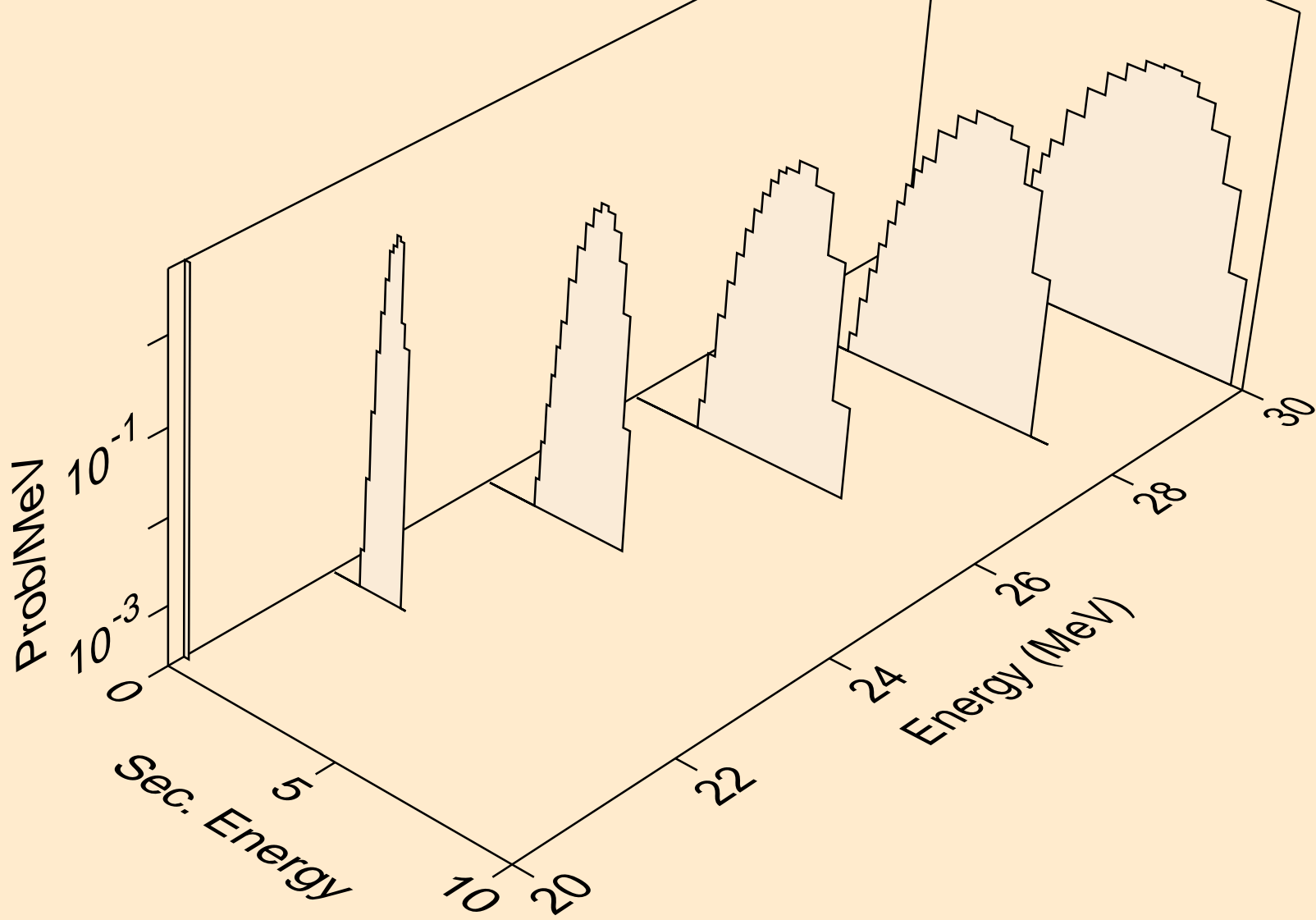

I136 NEUTRON ACER TENDL-2024 LIBRARY; T=0.K
protons from (n,p)

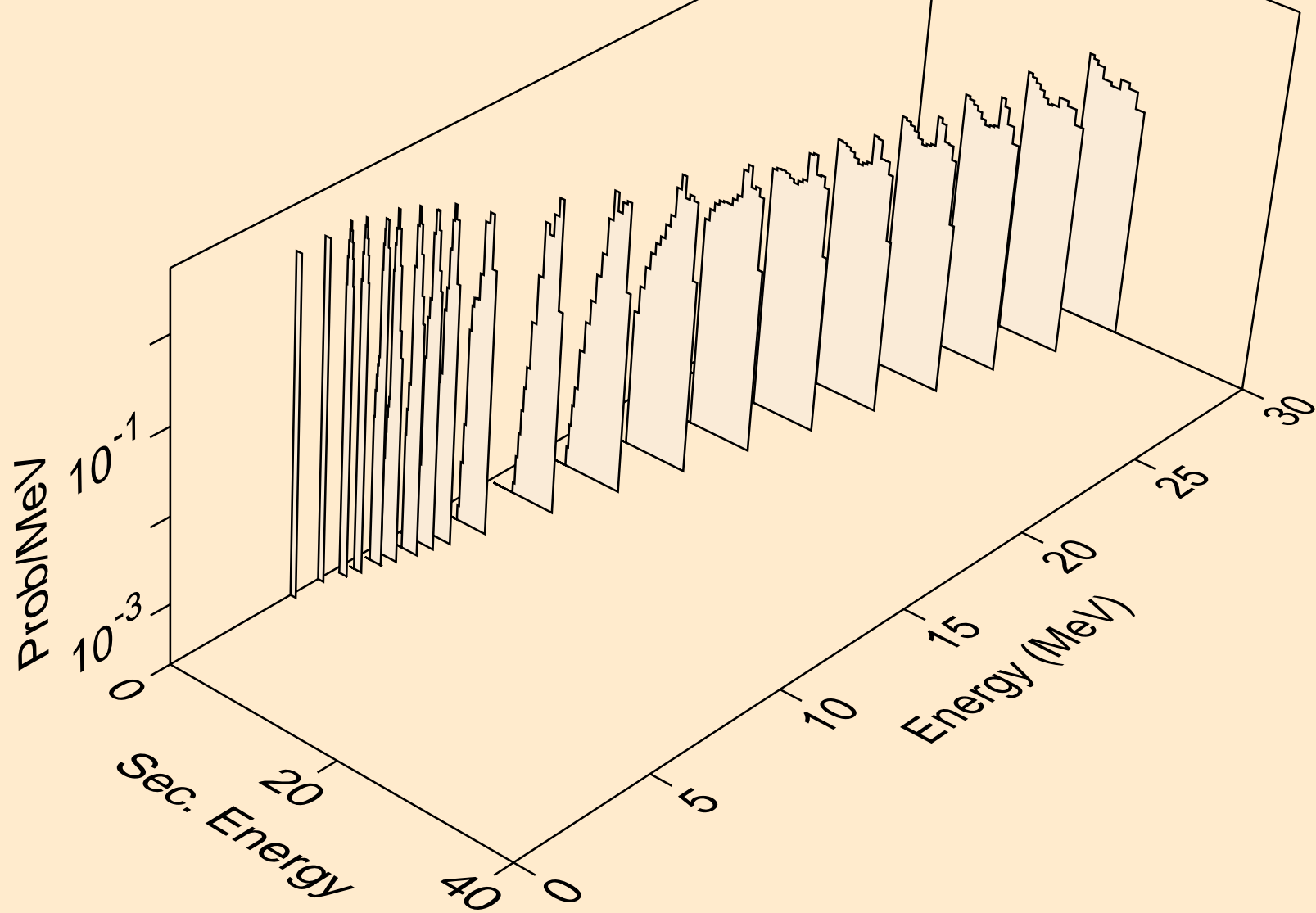

I136 NEUTRON ACER TENDL-2024 LIBRARY; T=0.K
protons from (n,2p)

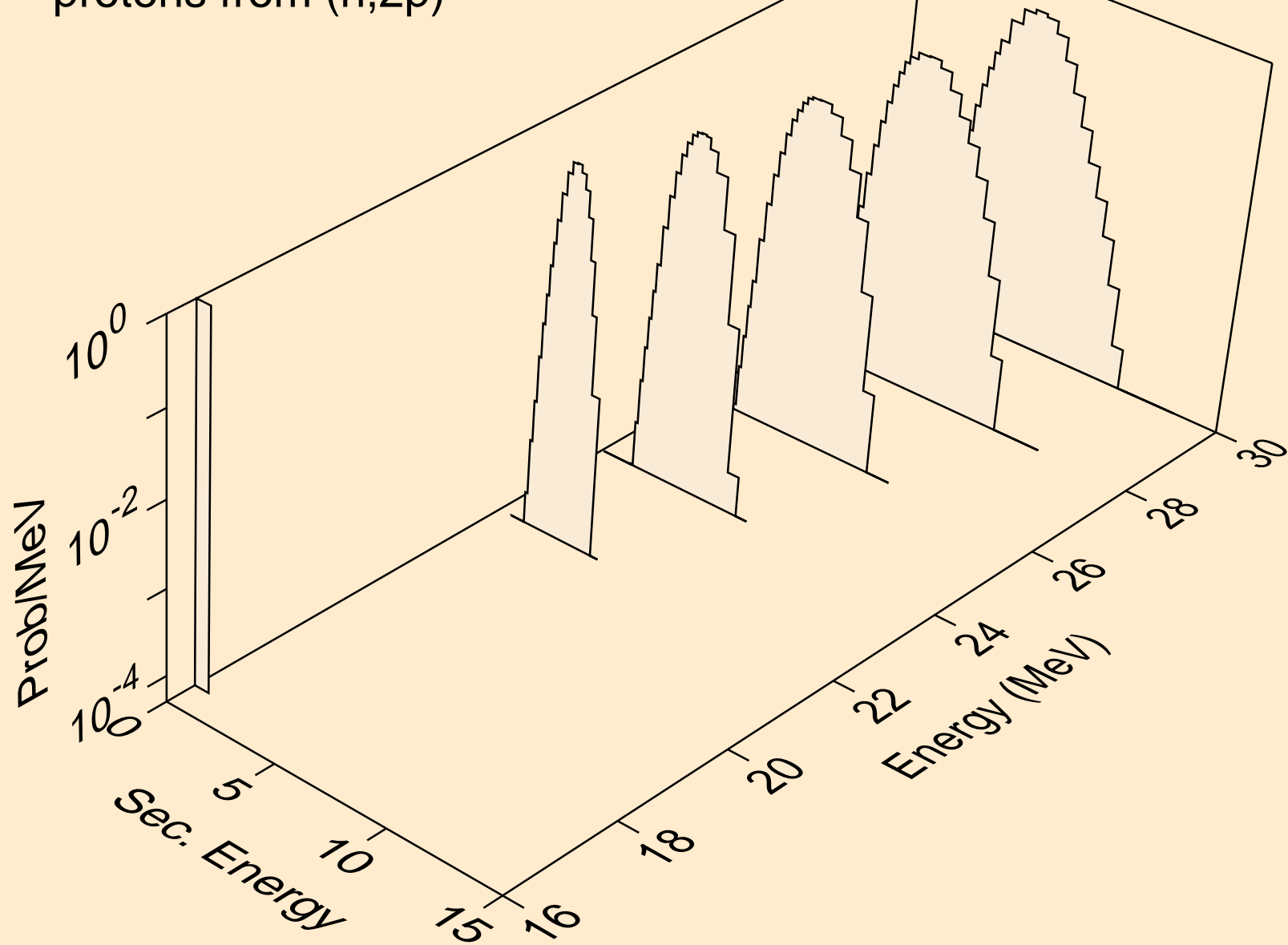

I136 NEUTRON ACER TENDL-2024 LIBRARY; T=0.K
protons from (n,p)

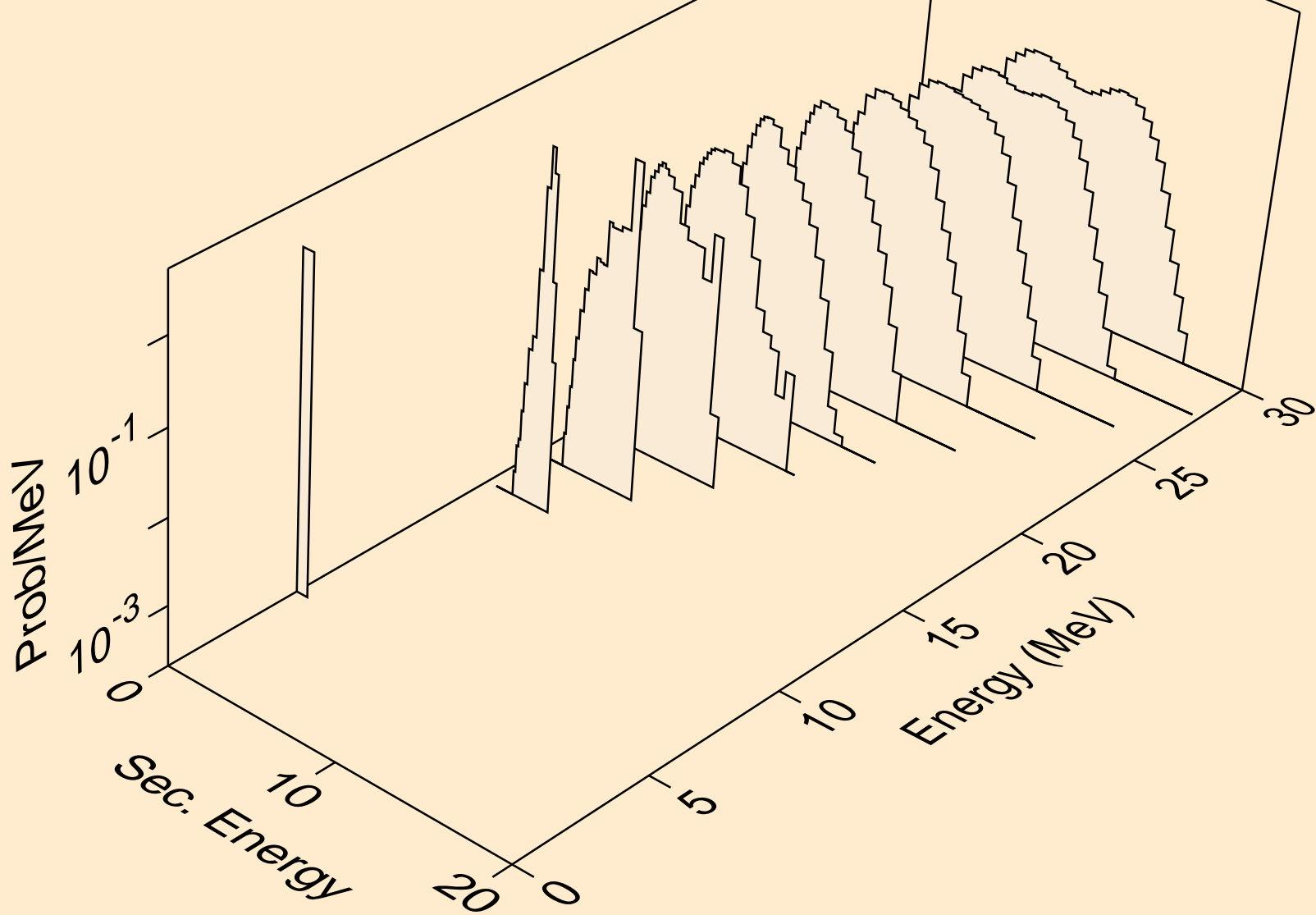

I136 NEUTRON ACER TENDL-2024 LIBRARY; T=0.K
protons from (n,pt)

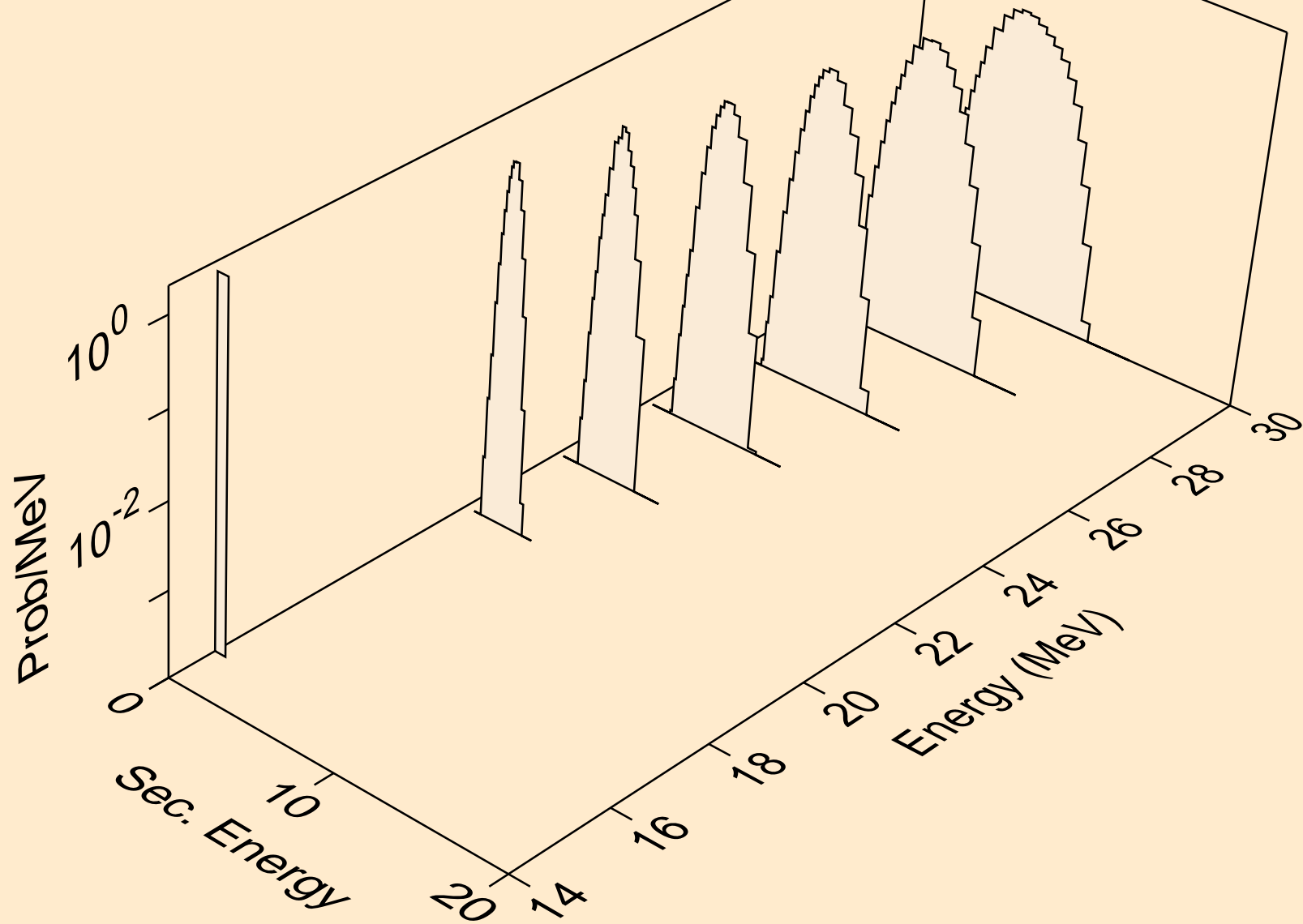

I136 NEUTRON ACER TENDL-2024 LIBRARY; T=0.K
deuterons from (n,x)

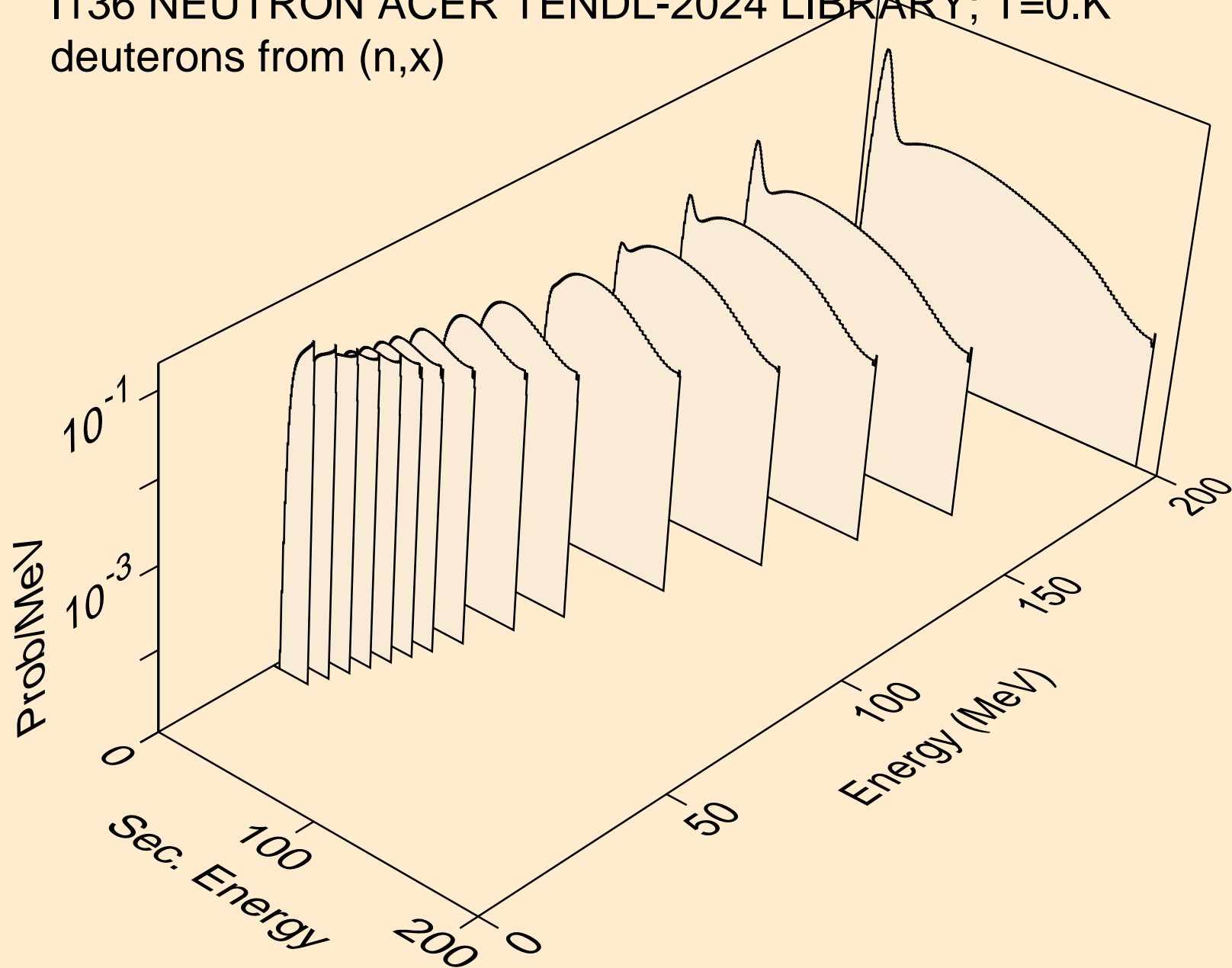

I136 NEUTRON ACER TENDL-2024 LIBRARY; T=0.K
deuterons from (n,2nd)

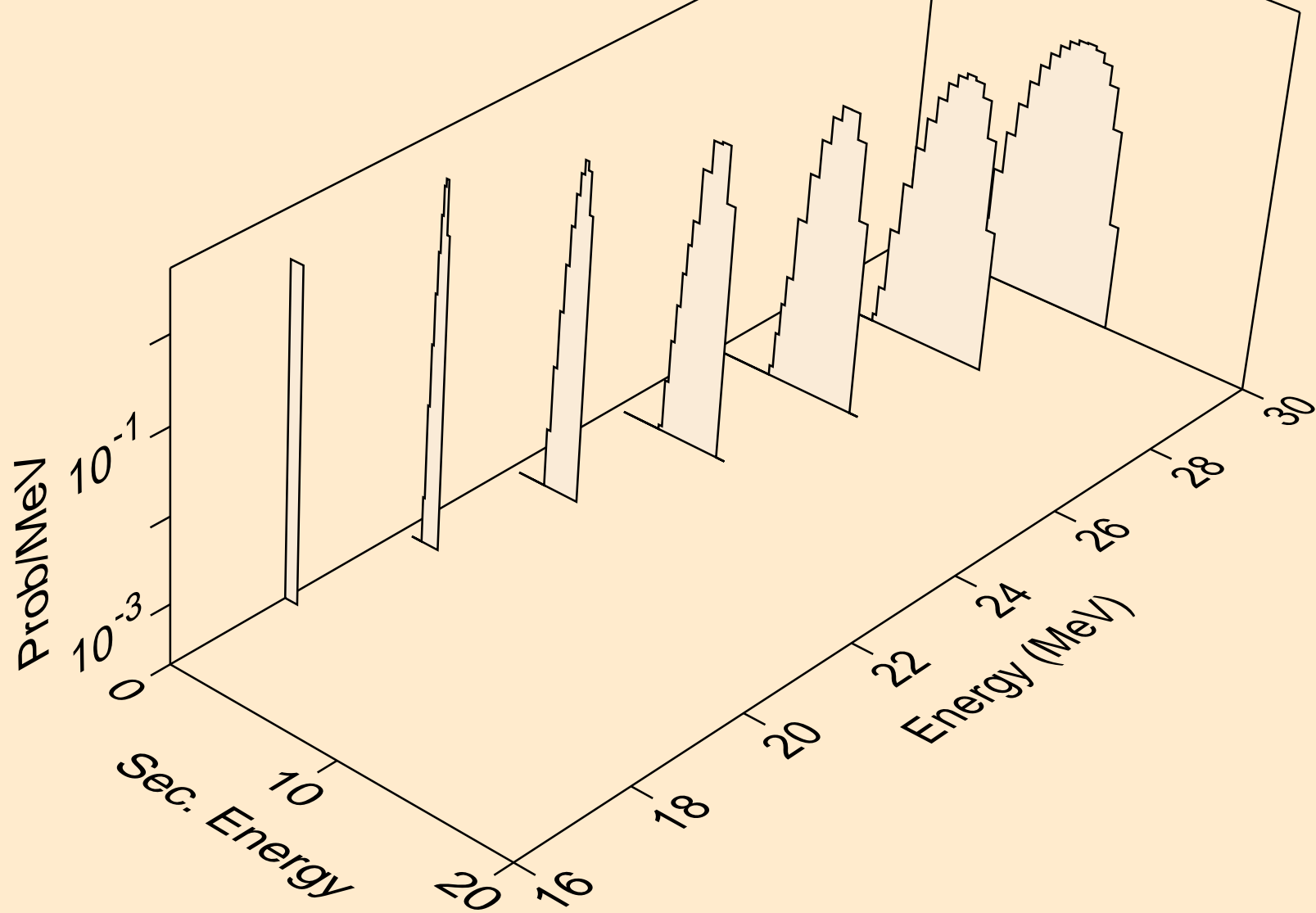

I136 NEUTRON ACER TENDL-2024 LIBRARY; T=0.K
deuterons from (n,n*)d

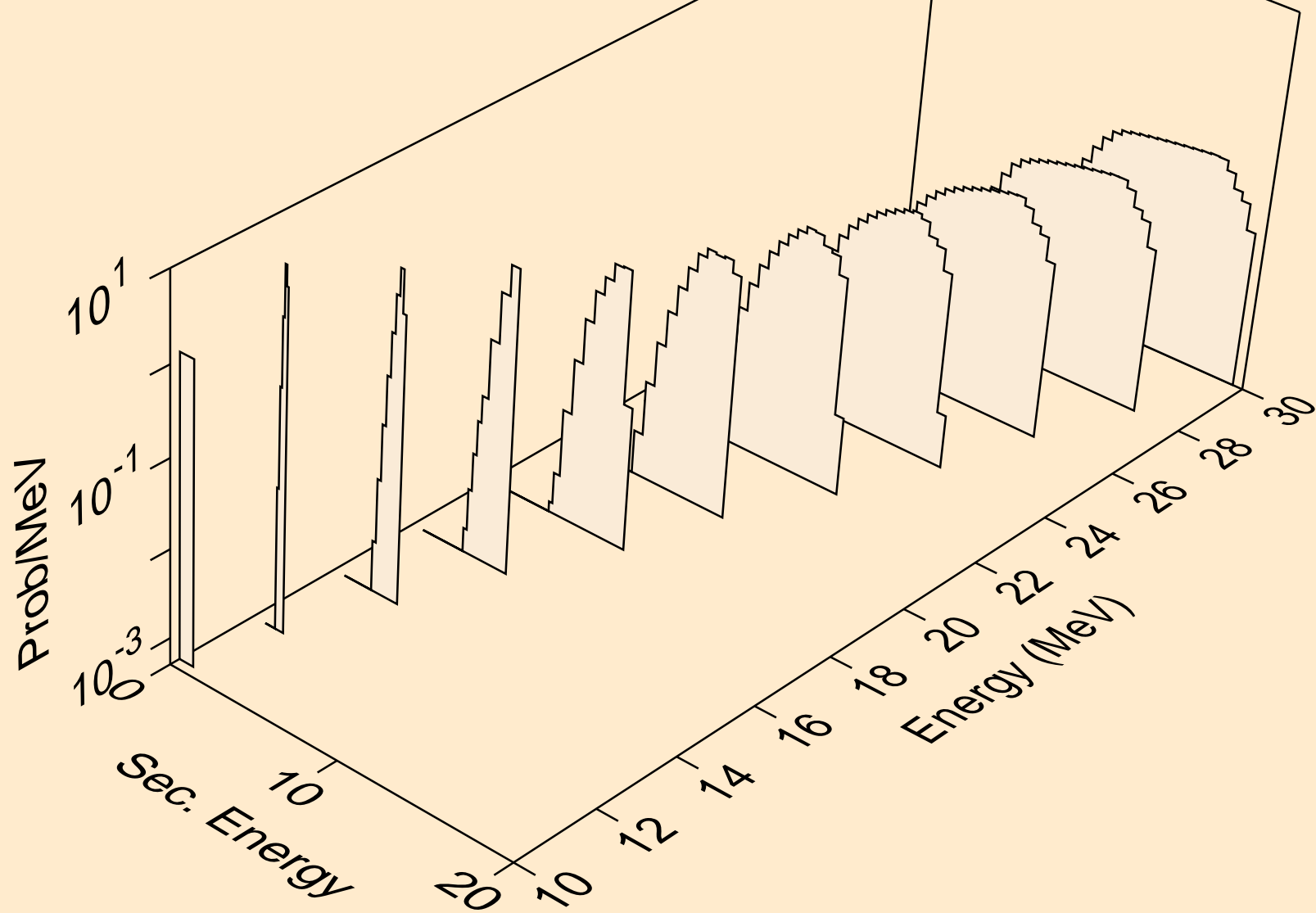

I136 NEUTRON ACER TENDL-2024 LIBRARY; T=0.K
deuterons from (n,d)

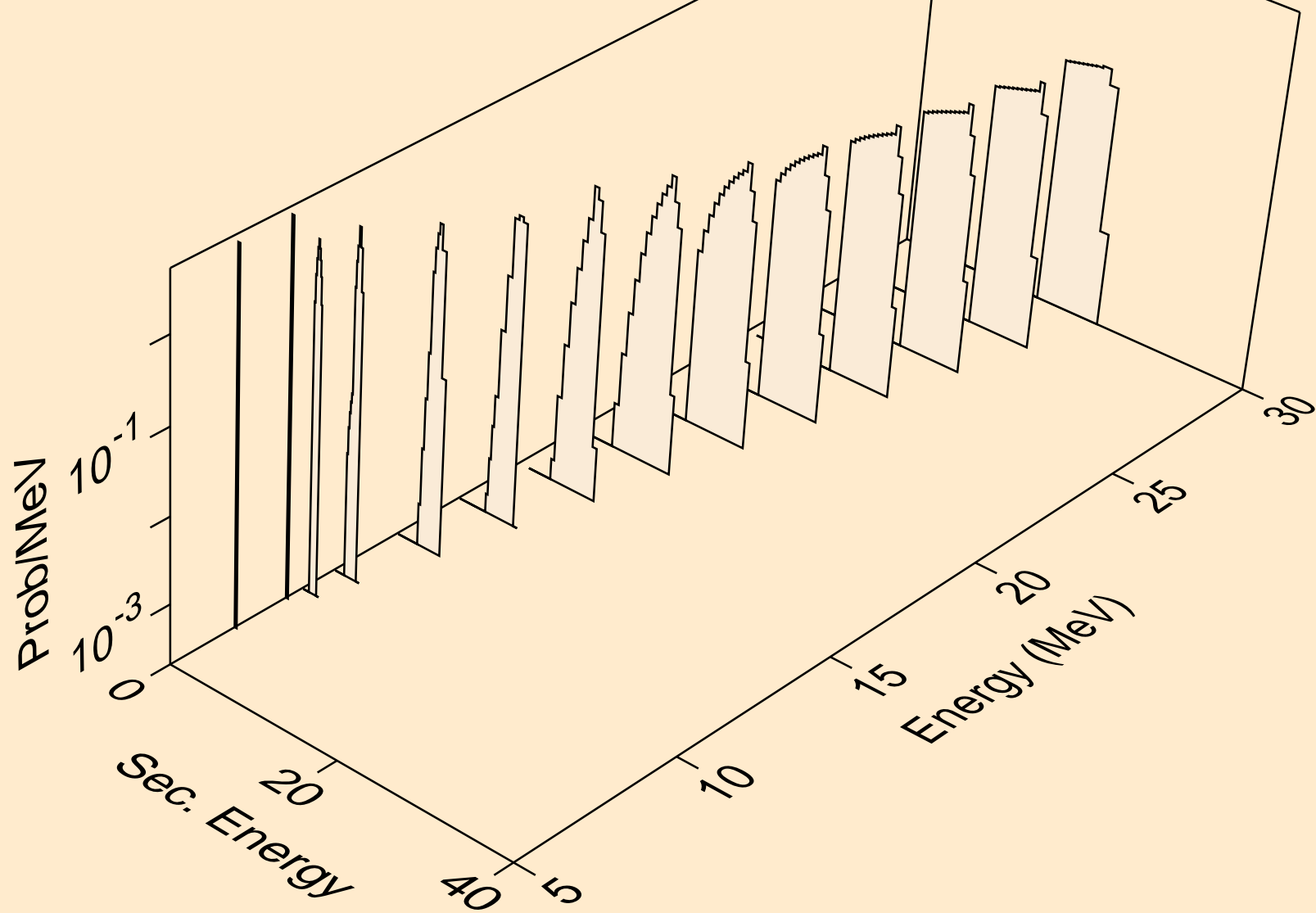

I136 NEUTRON ACER TENDL-2024 LIBRARY; T=0.K
deuterons from (n,da)

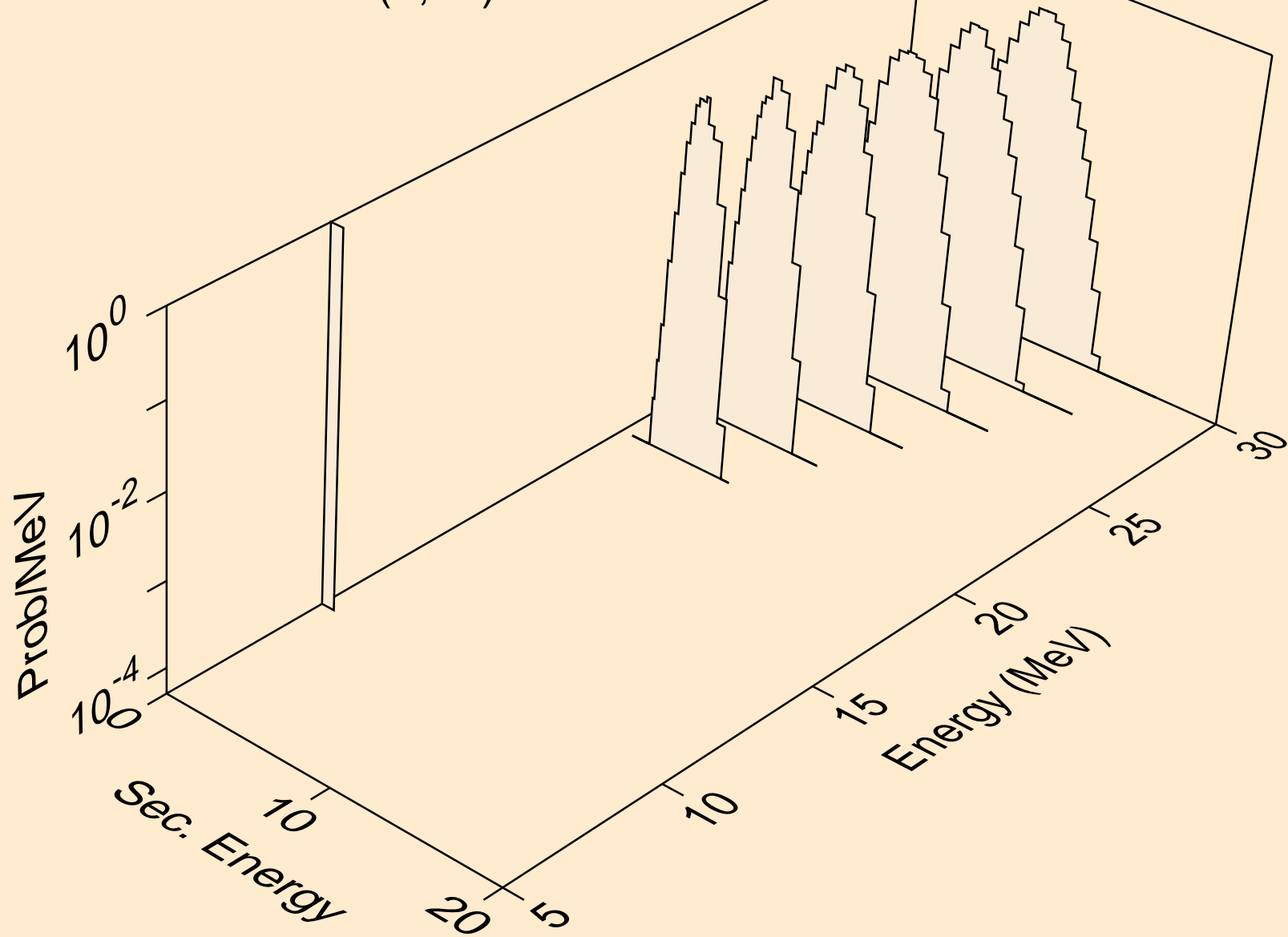

I136 NEUTRON ACER TENDL-2024 LIBRARY; T=0.K
tritons from (n,x)

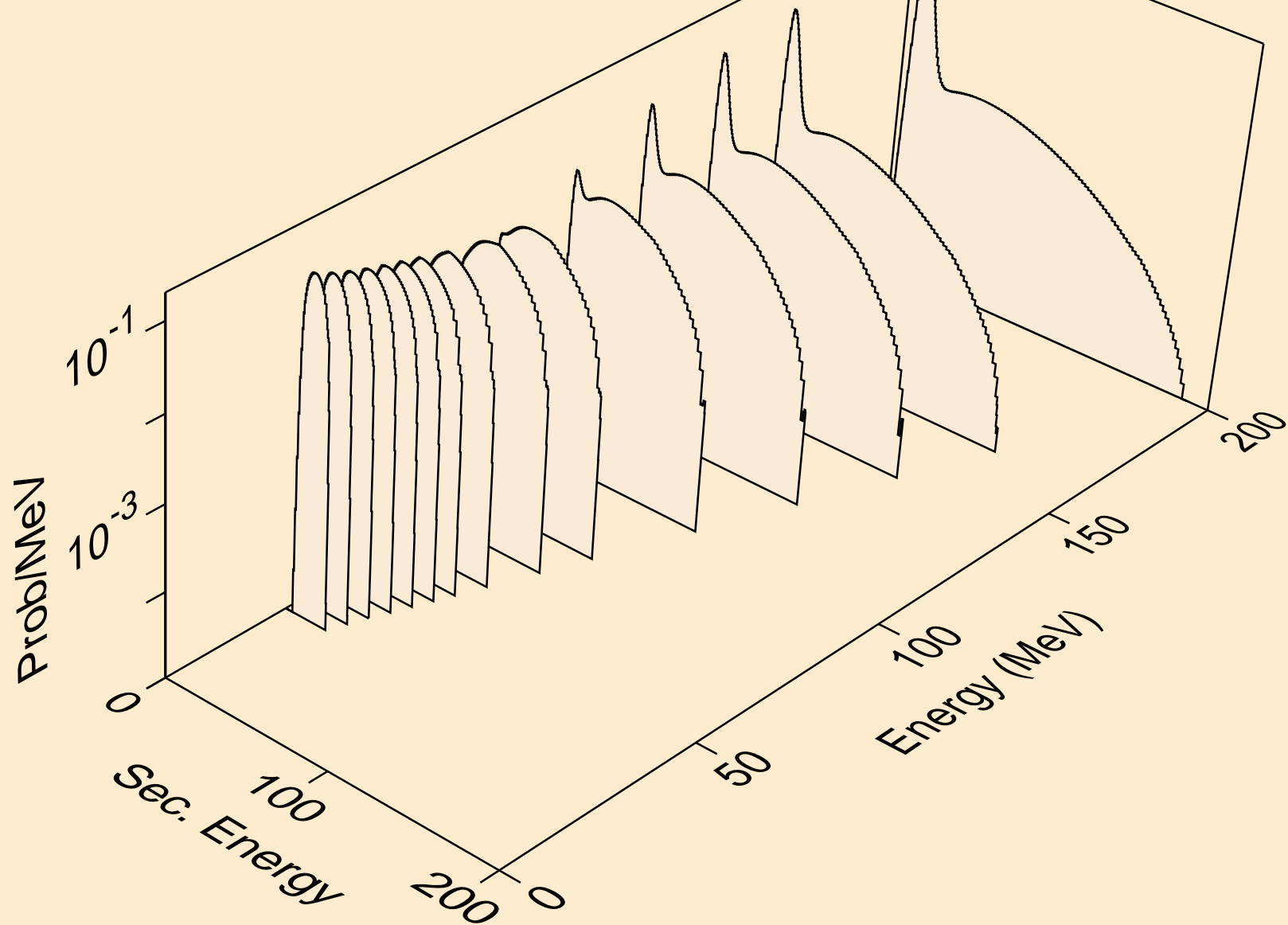

I136 NEUTRON ACER TENDL-2024 LIBRARY; T=0.K
tritons from (n,n*)t

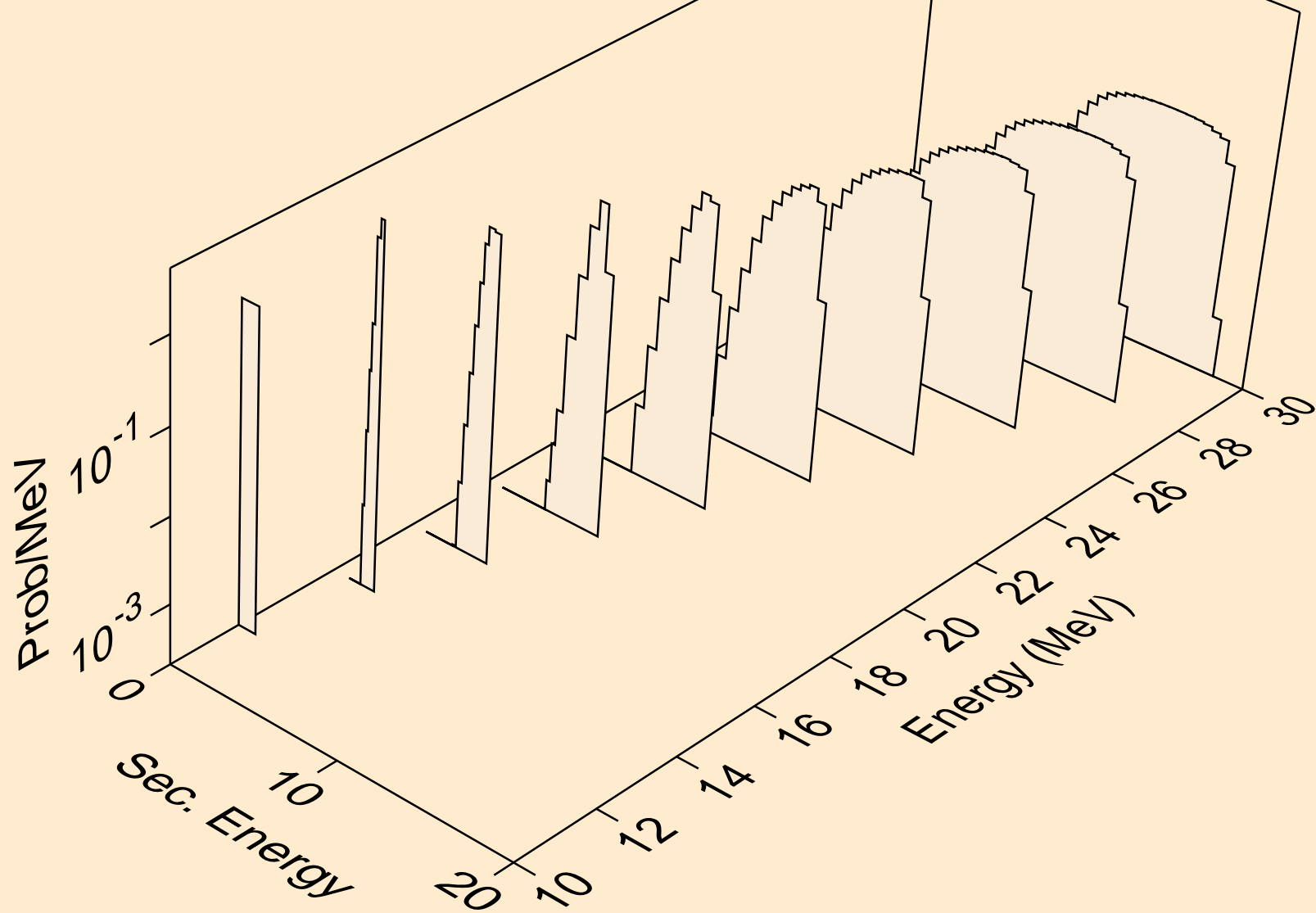

I136 NEUTRON ACER TENDL-2024 LIBRARY; T=0.K
tritons from (n,t)

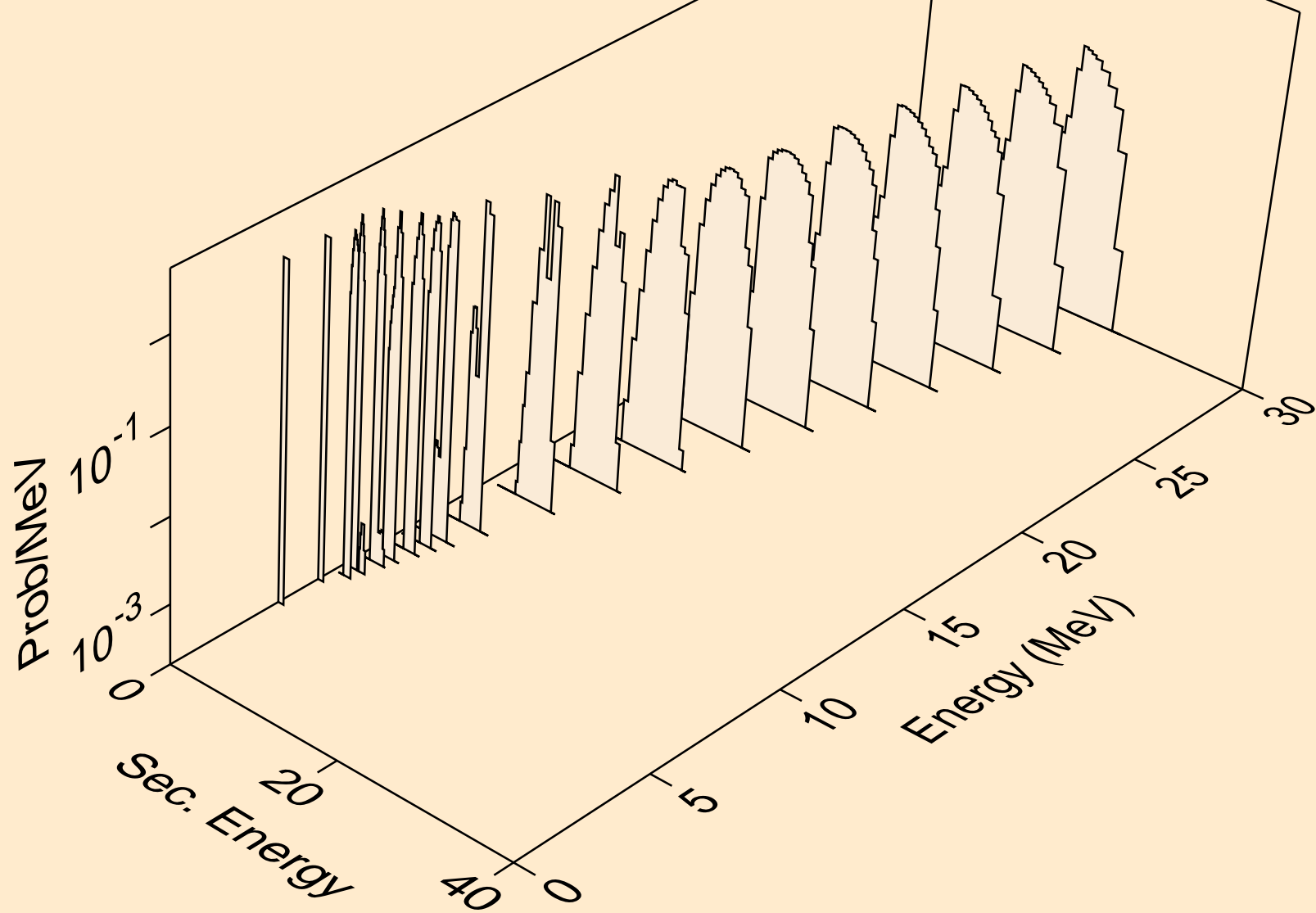

I136 NEUTRON ACER TENDL-2024 LIBRARY; T=0.K
tritons from (n,pt)

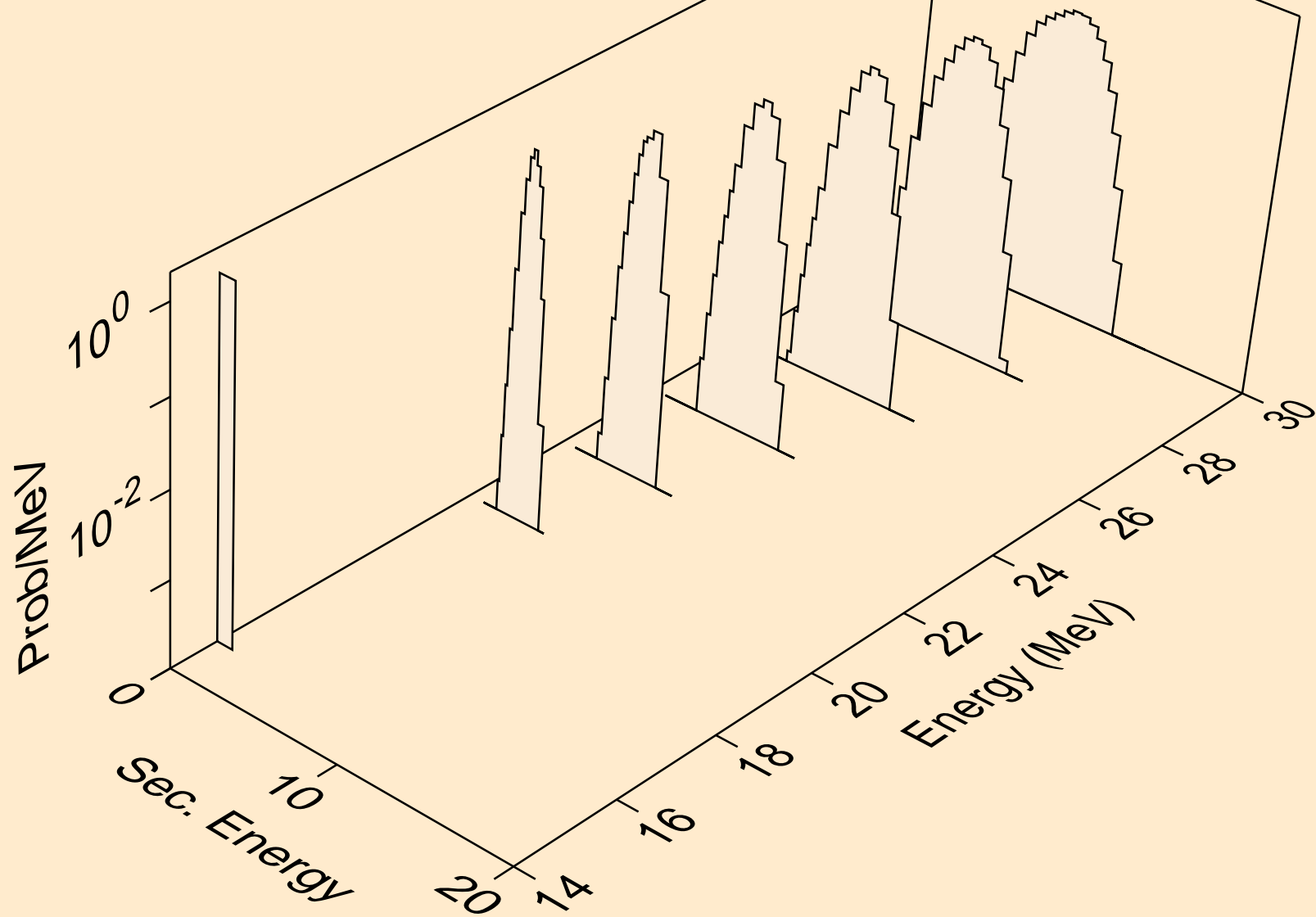

I136 NEUTRON ACER TENDL-2024 LIBRARY; T=0.K
he3s from (n,x)

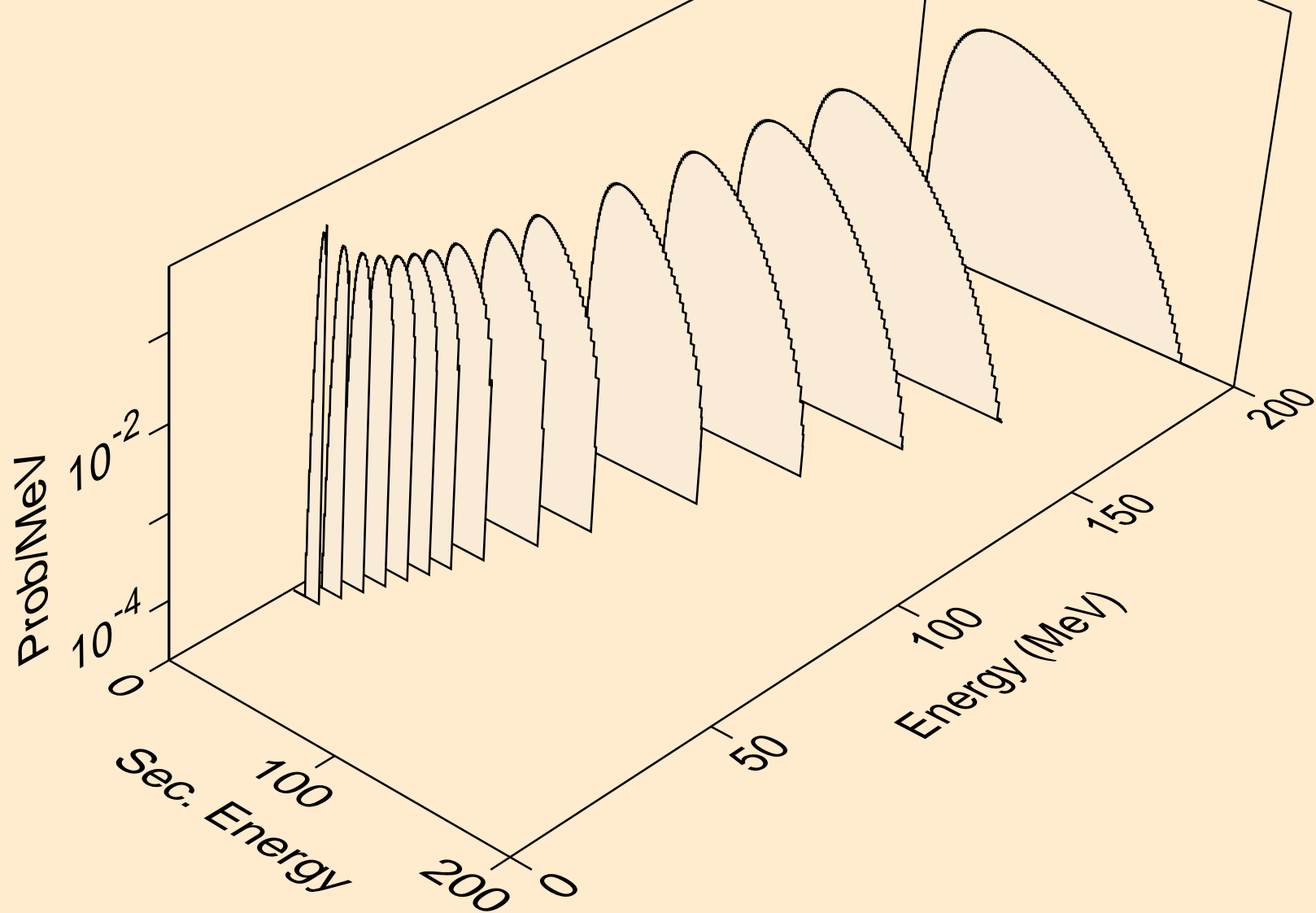

I136 NEUTRON ACER TENDL-2024 LIBRARY; T=0.K
he3s from (n,n*)he3

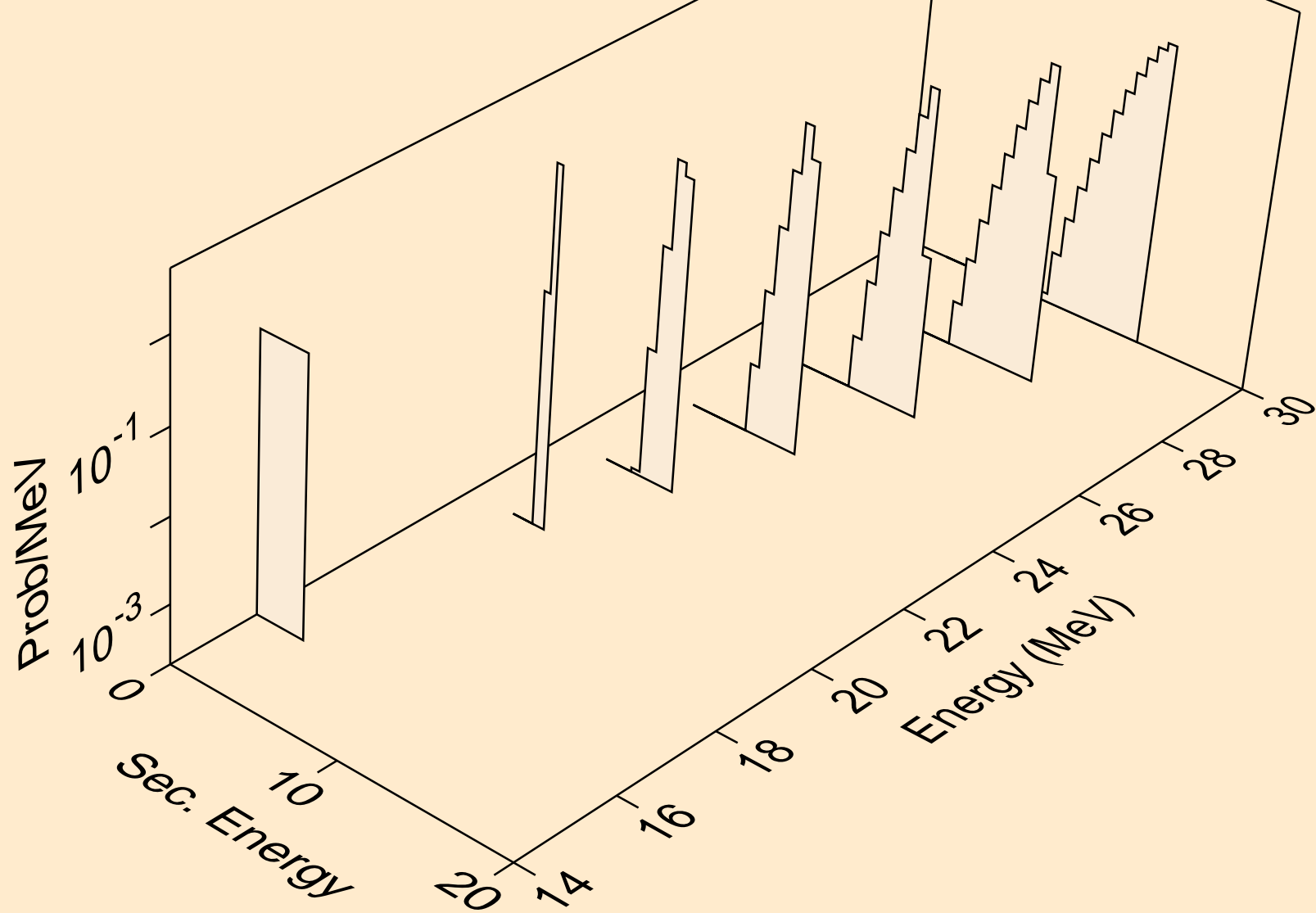

I136 NEUTRON ACER TENDL-2024 LIBRARY; T=0.K
he3s from (n,he3)

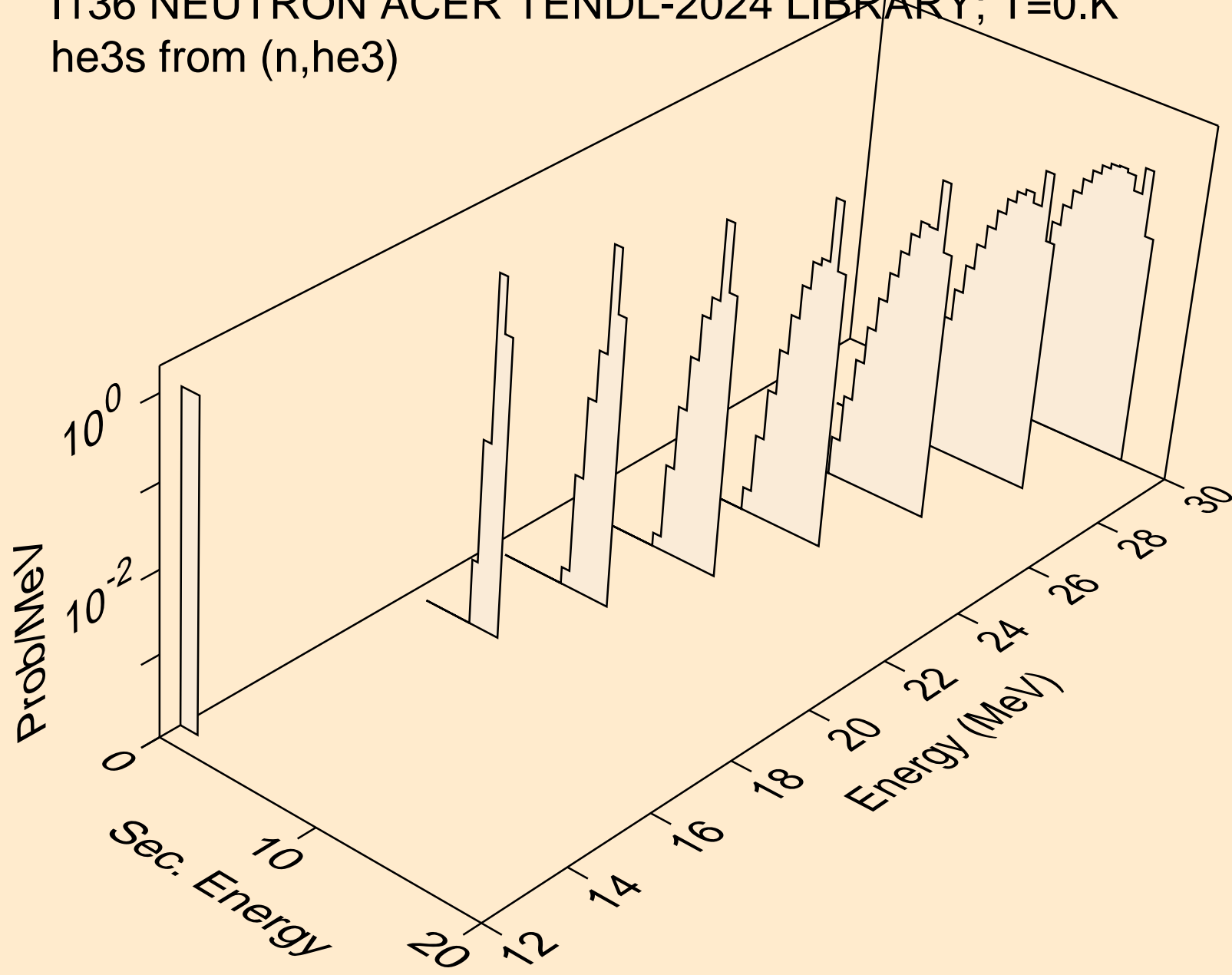

I136 NEUTRON ACER TENDL-2024 LIBRARY; T=0.K
alphas from (n,x)

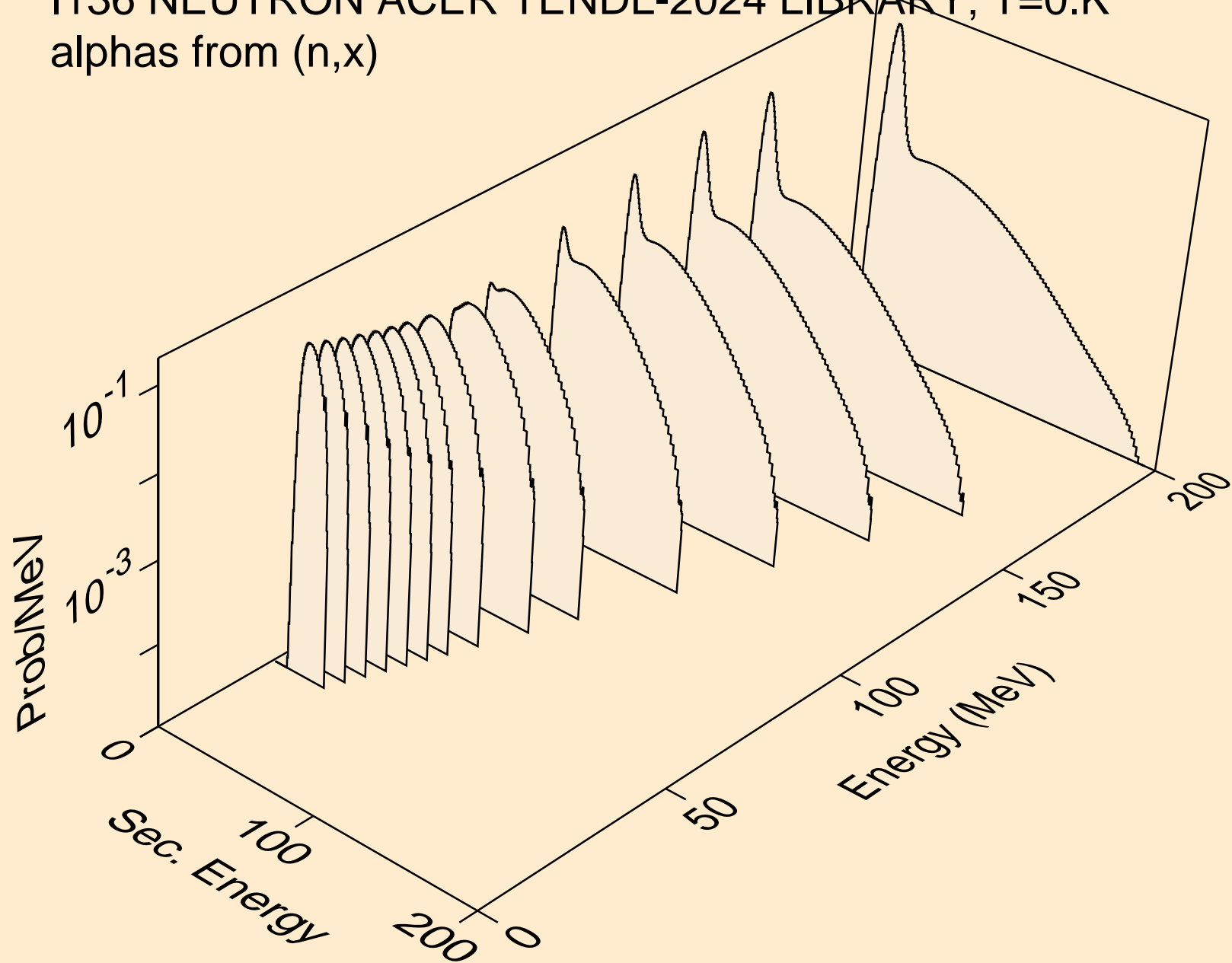

I136 NEUTRON ACER TENDL-2024 LIBRARY; T=0.K
alphas from (n,n*)a

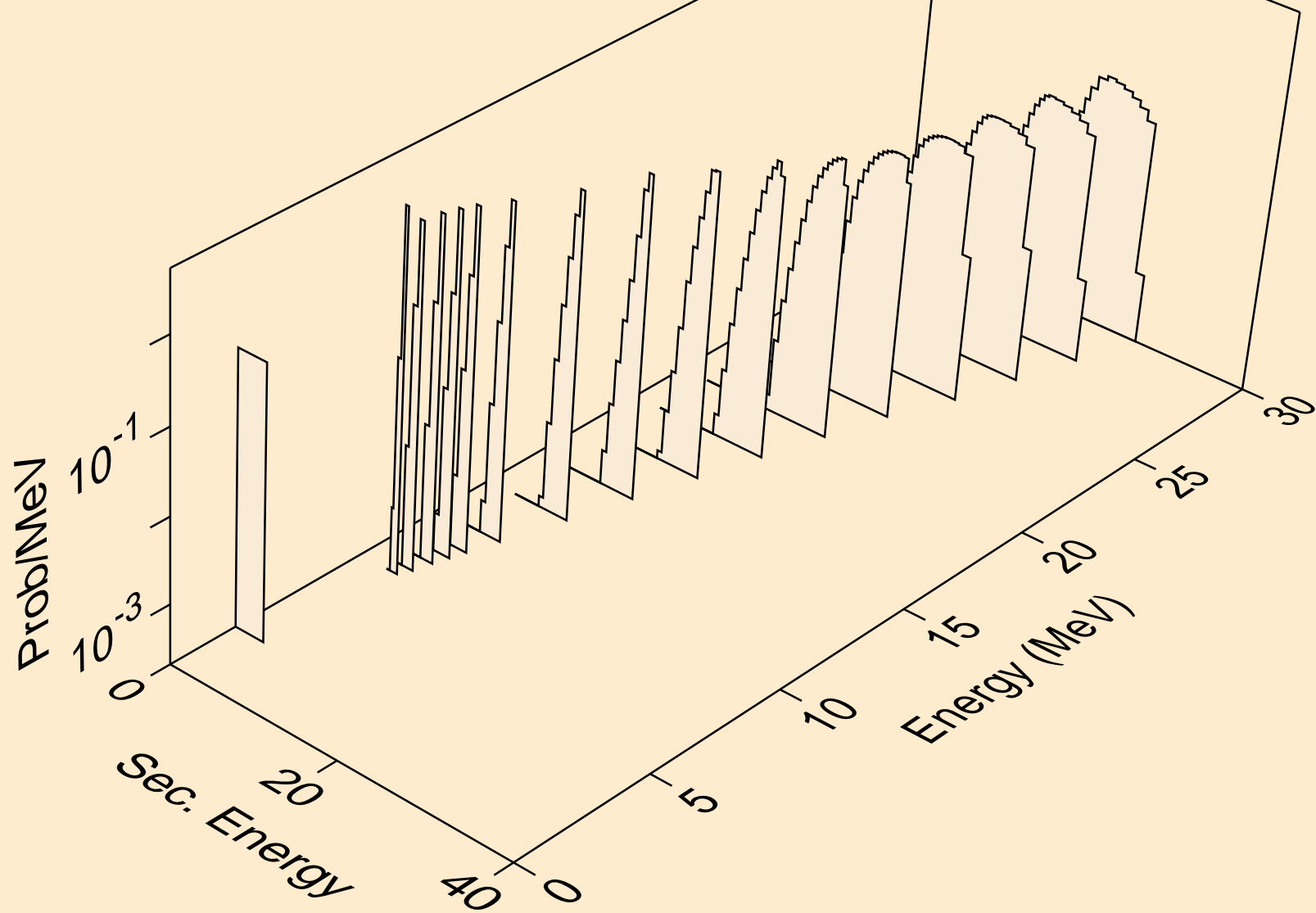

I136 NEUTRON ACER TENDL-2024 LIBRARY; T=0.K
alphas from (n,2n)a

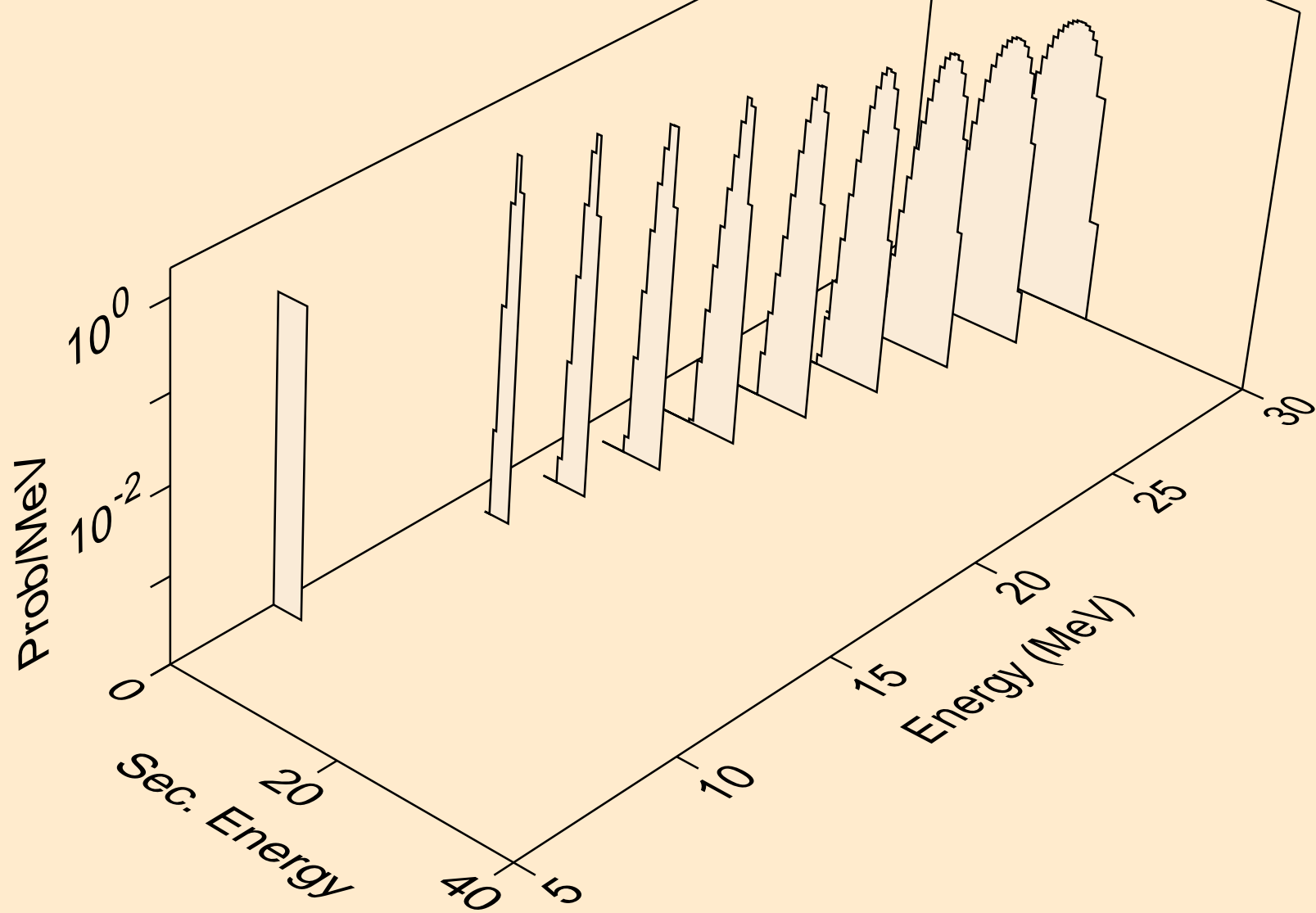

I136 NEUTRON ACER TENDL-2024 LIBRARY; T=0.K
alphas from (n,3n)a

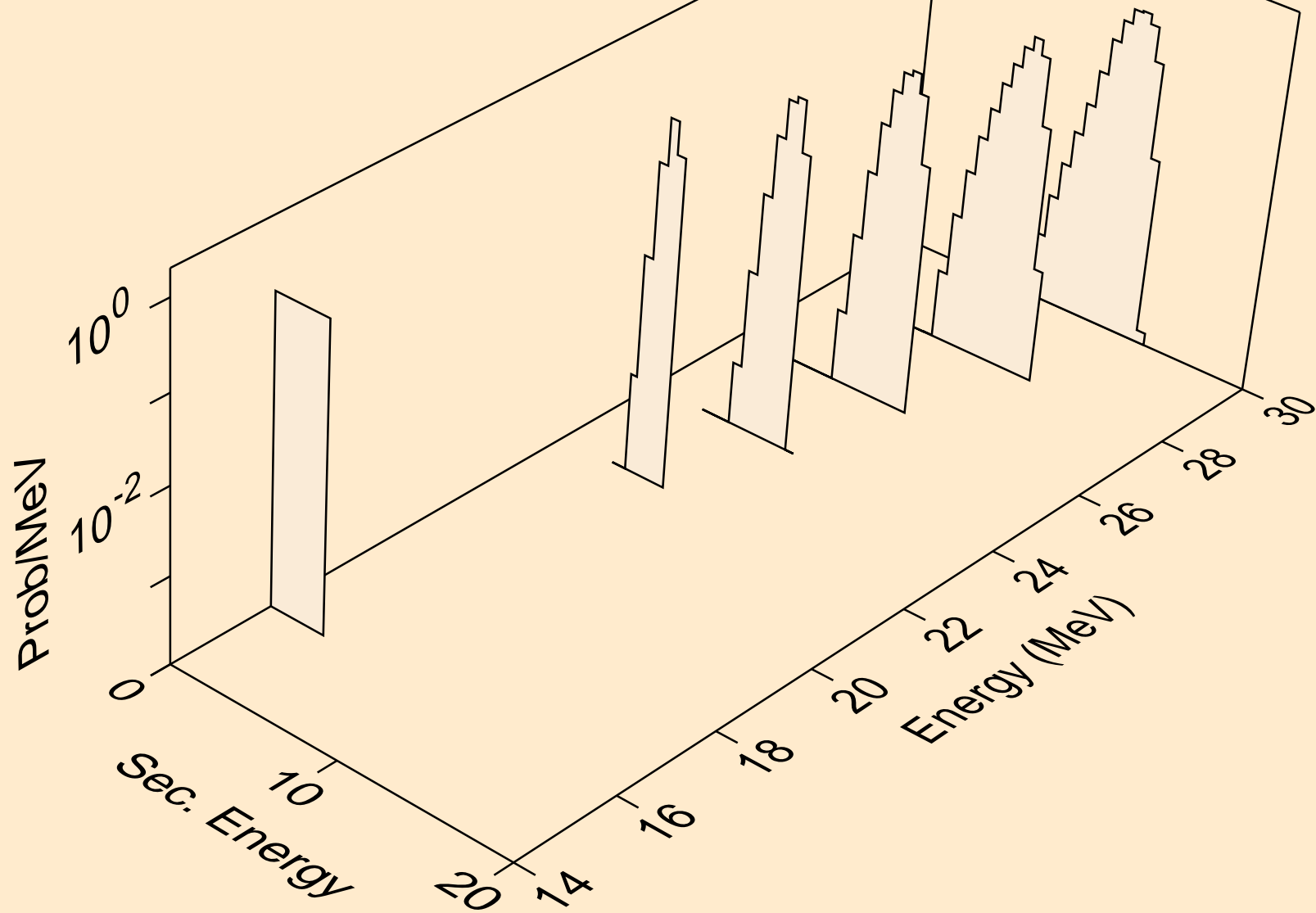

I136 NEUTRON ACER TENDL-2024 LIBRARY; T=0.K
alphas from (n,a)

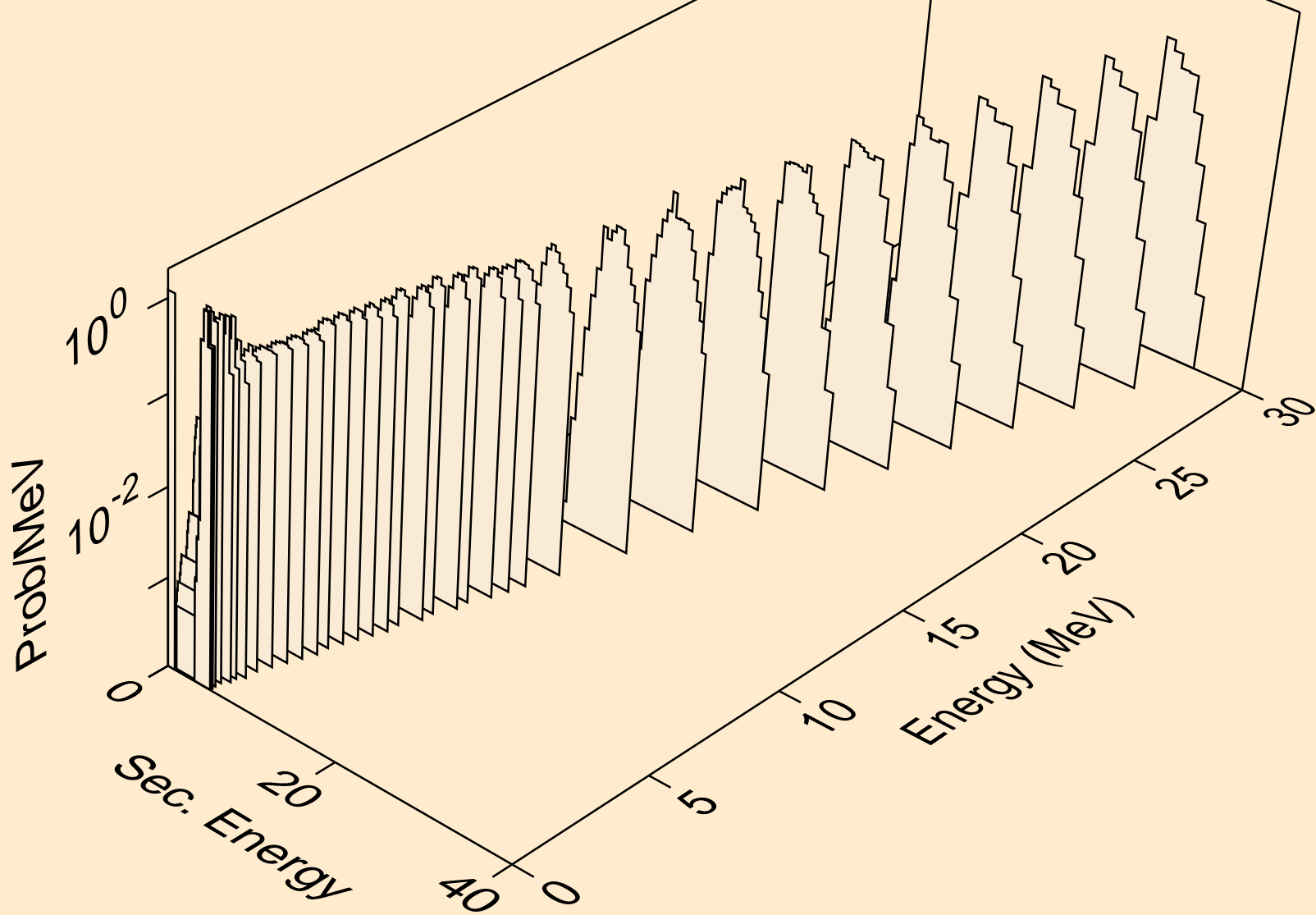

I136 NEUTRON ACER TENDL-2024 LIBRARY; T=0.K
alphas from (n,pa)

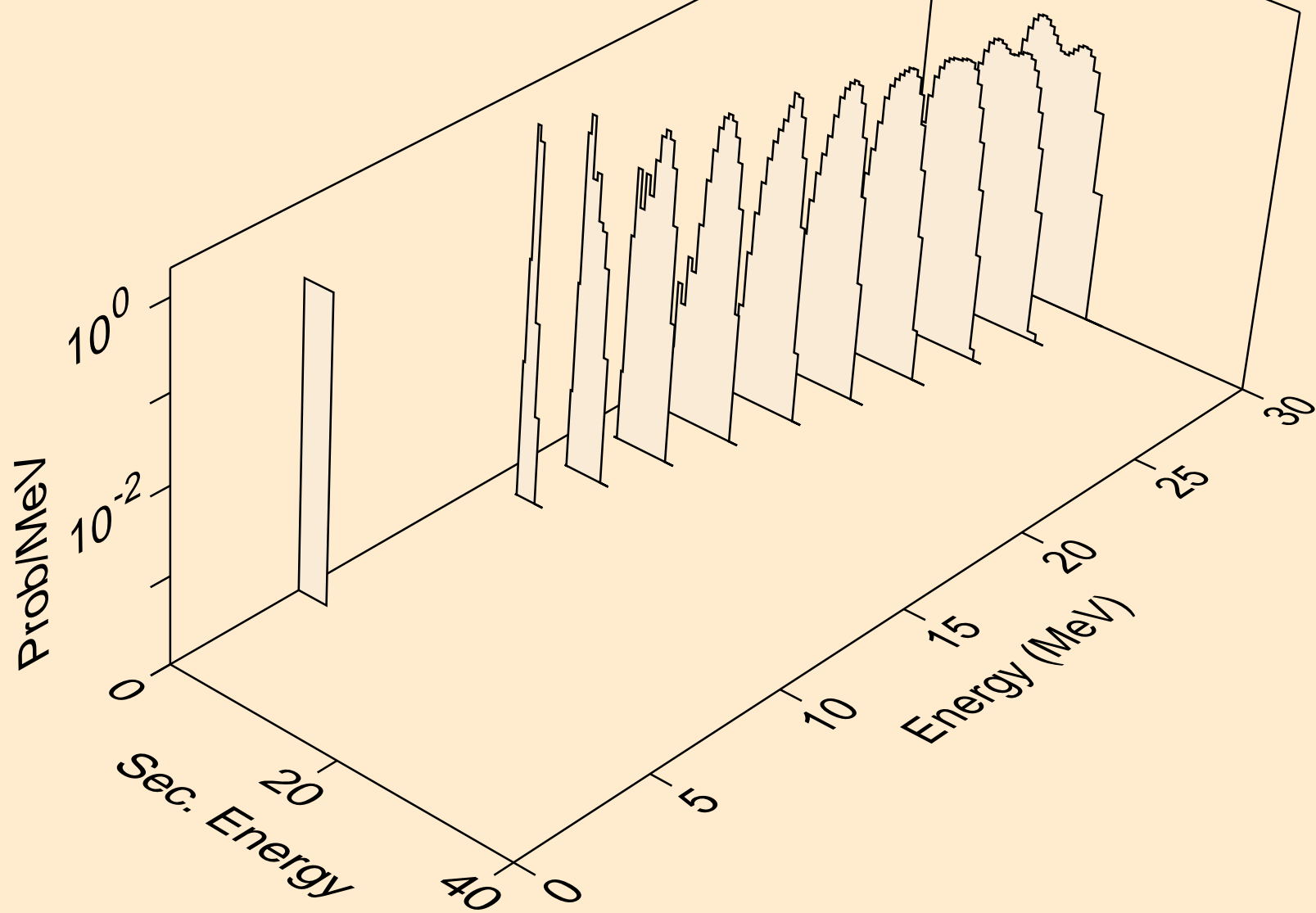

I136 NEUTRON ACER TENDL-2024 LIBRARY; T=0.K
alphas from (n,da)

