

Program EVALPLOT
(Version 2021-1)

by

Dermott E. Cullen
(Present Contact Information)

Dermott E. Cullen
1466 Hudson Way
Livermore, CA 94550
U.S.A.

Tele: 925-443-1911

E.Mail:redcullen1@comcast.net

Web:redcullen1.net/HOMEPAGE.NEW

Press Mouse Button to Start

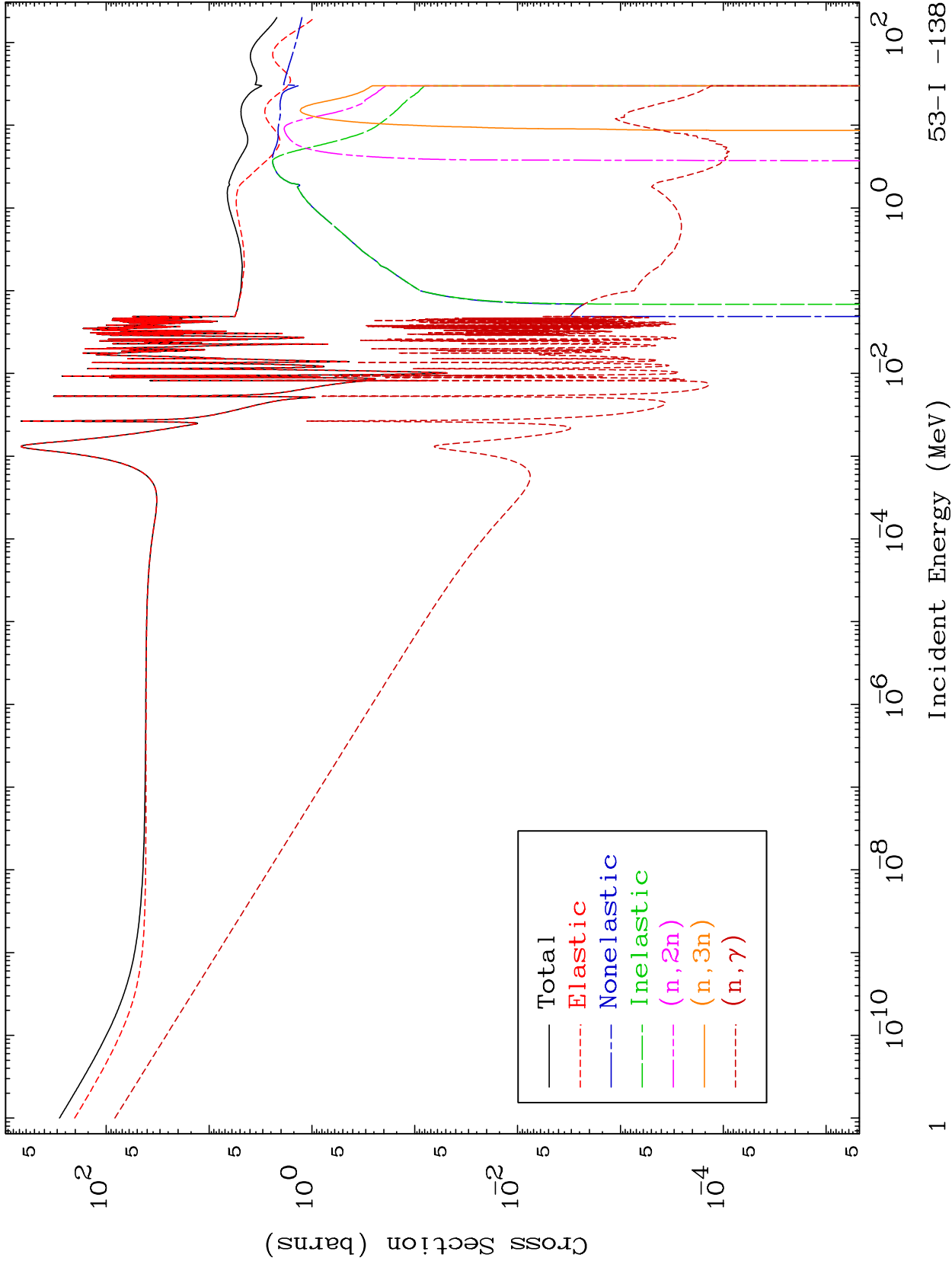

293 Kelvin Cross Sections

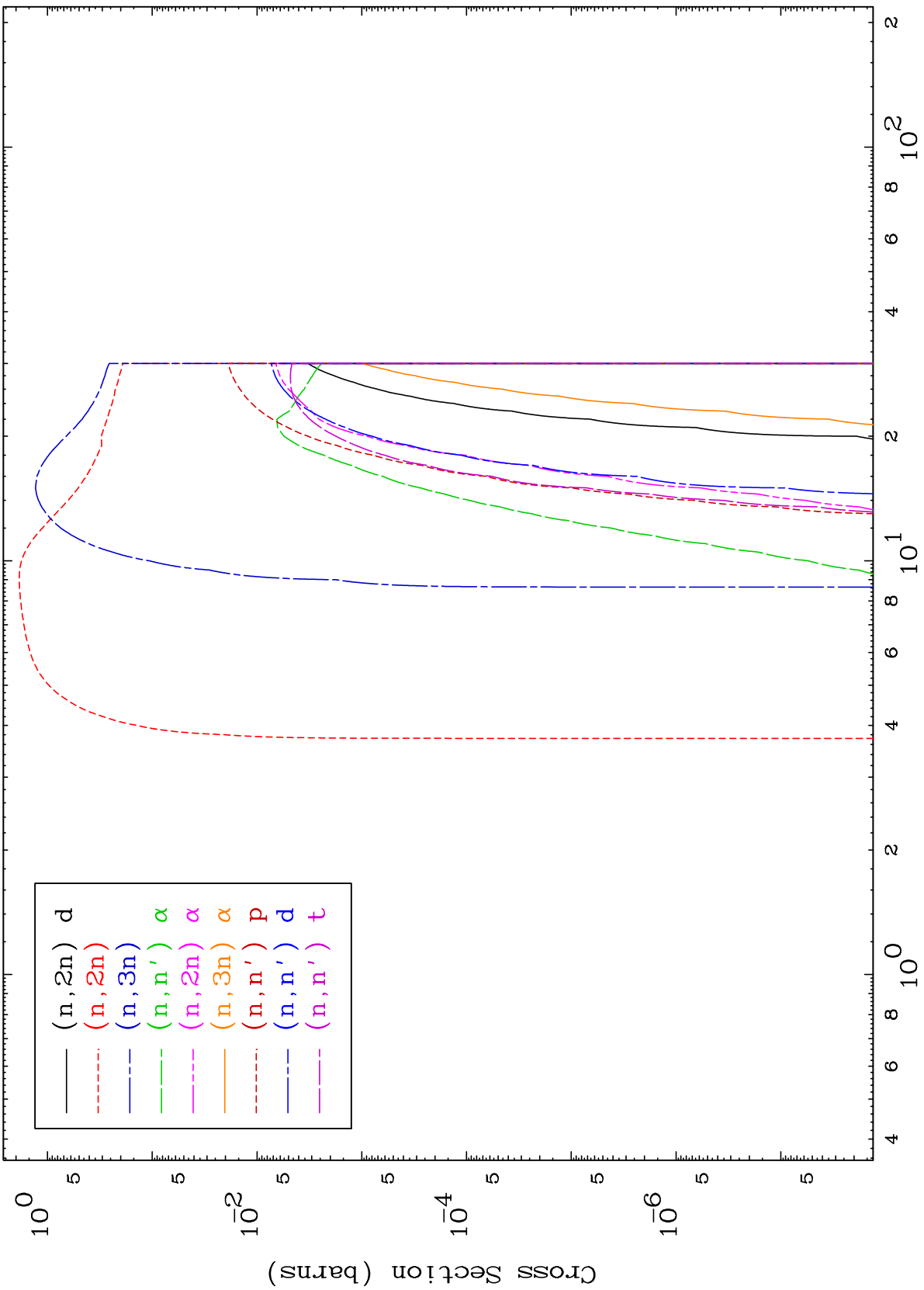

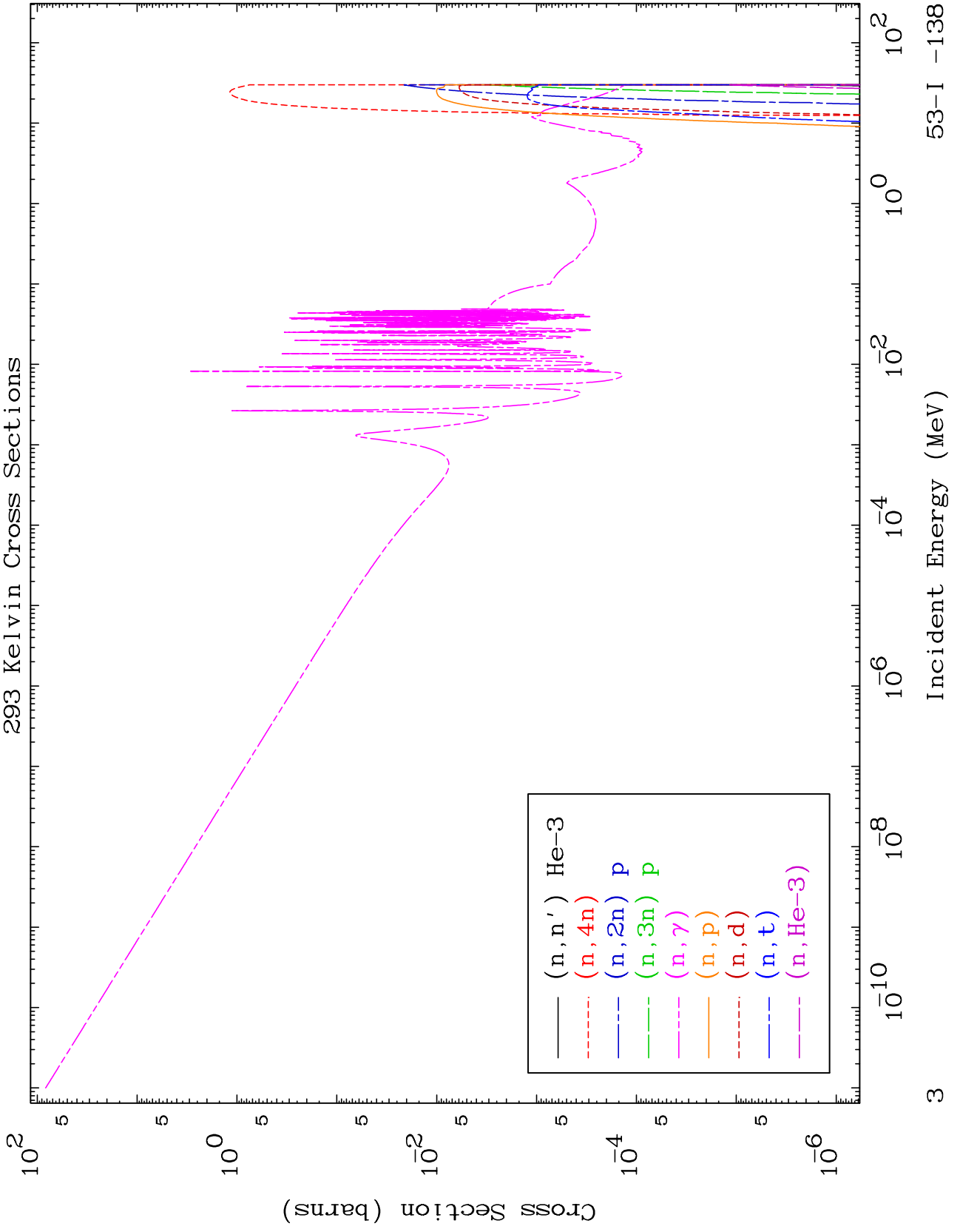

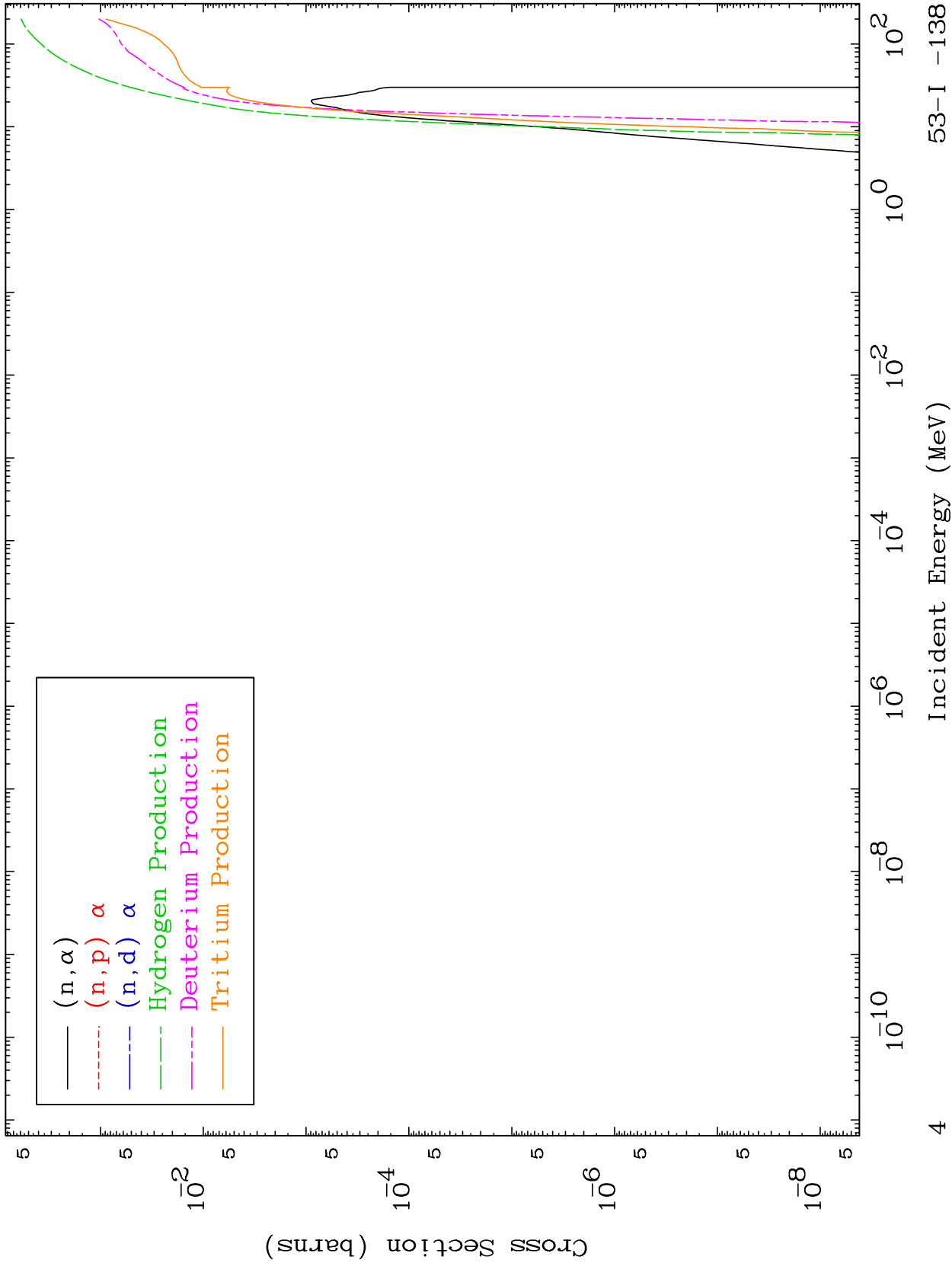

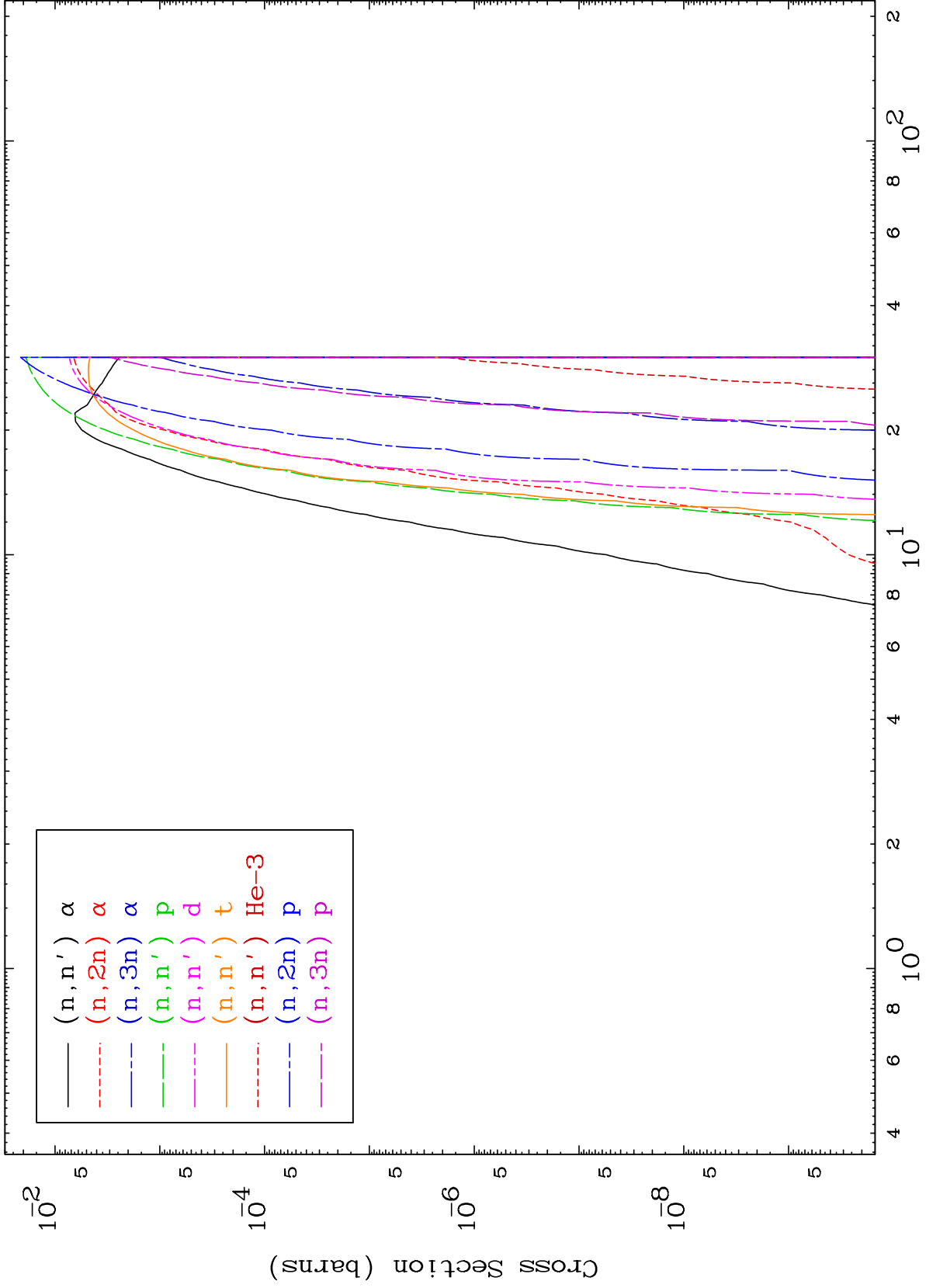

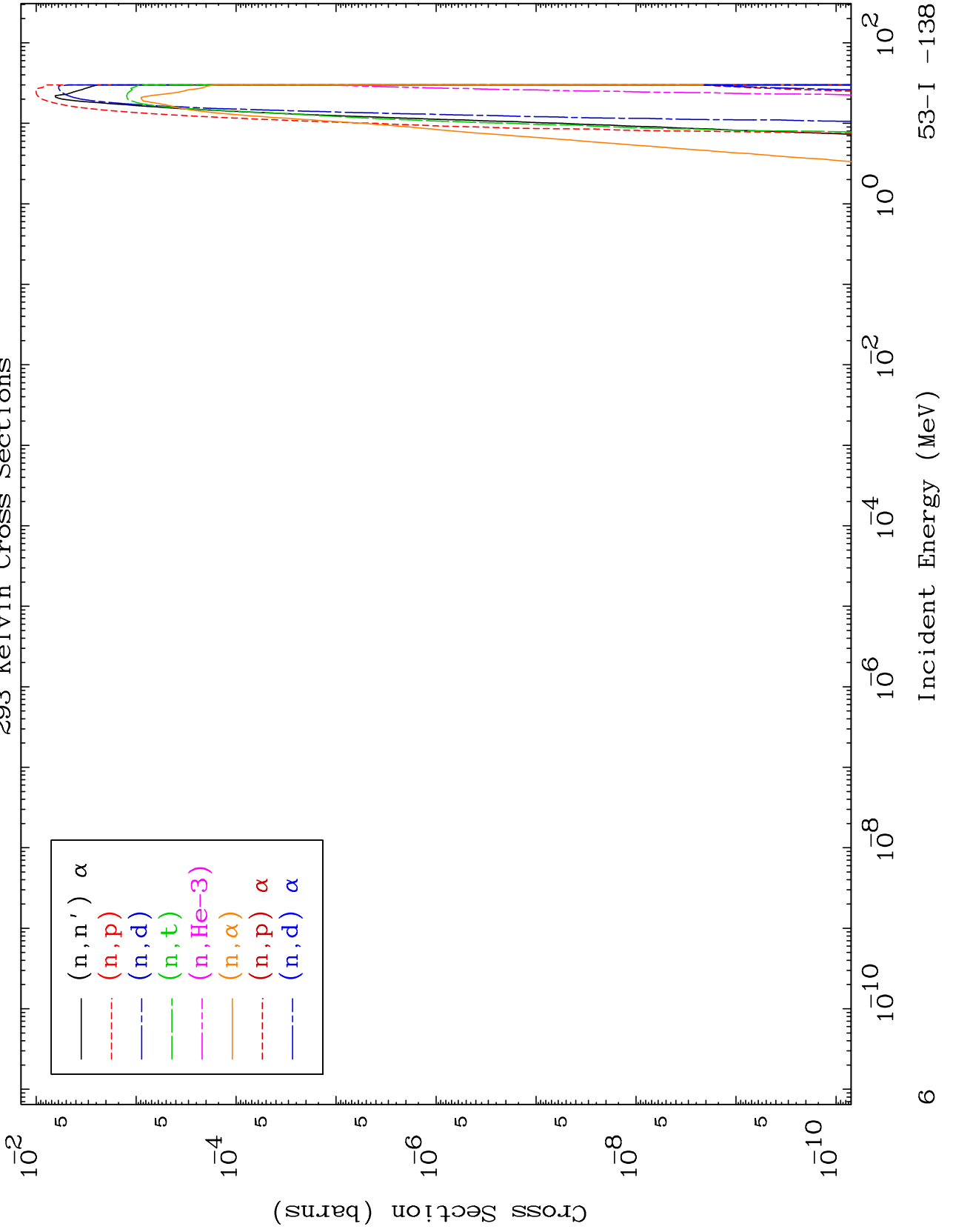

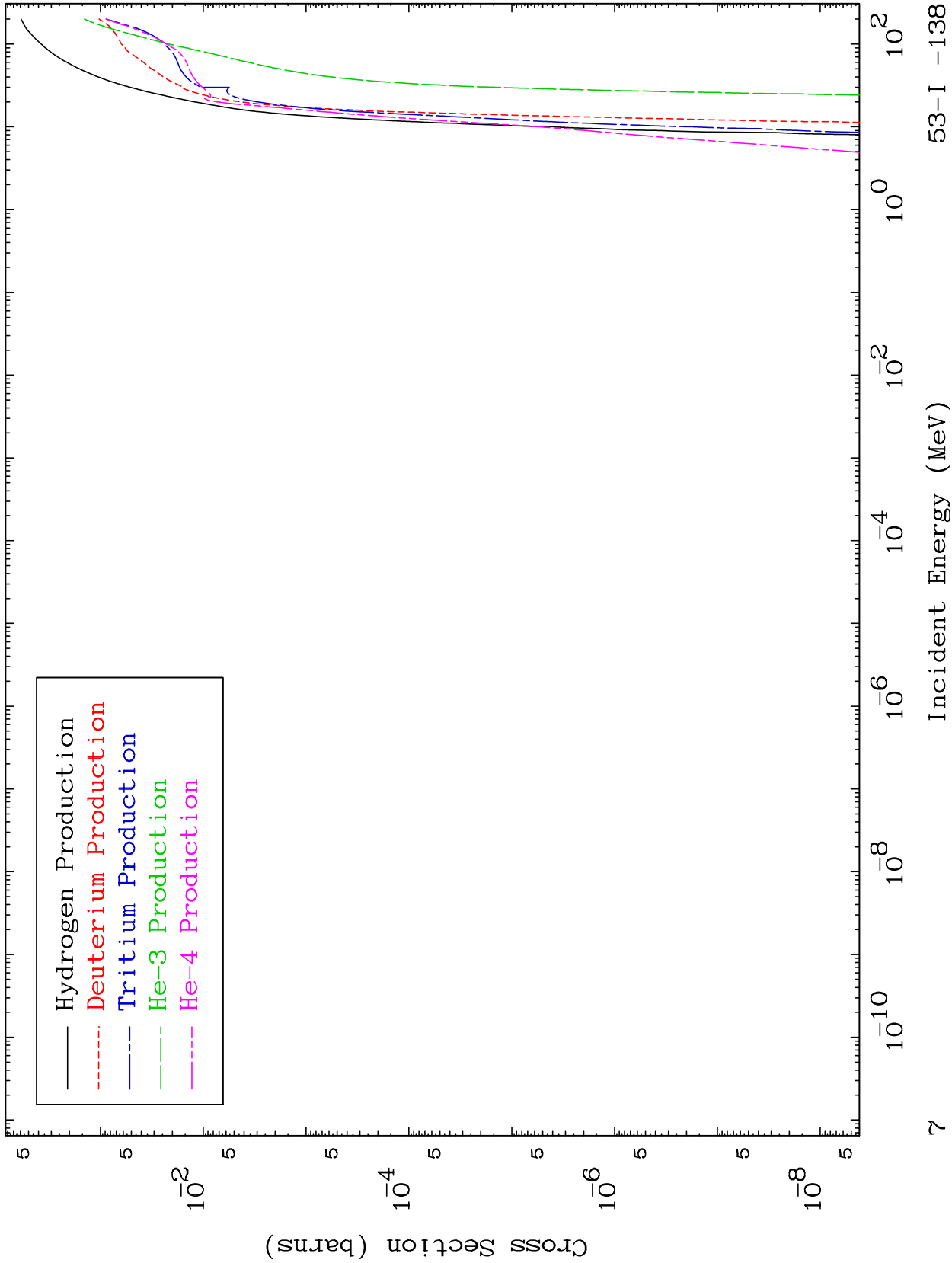

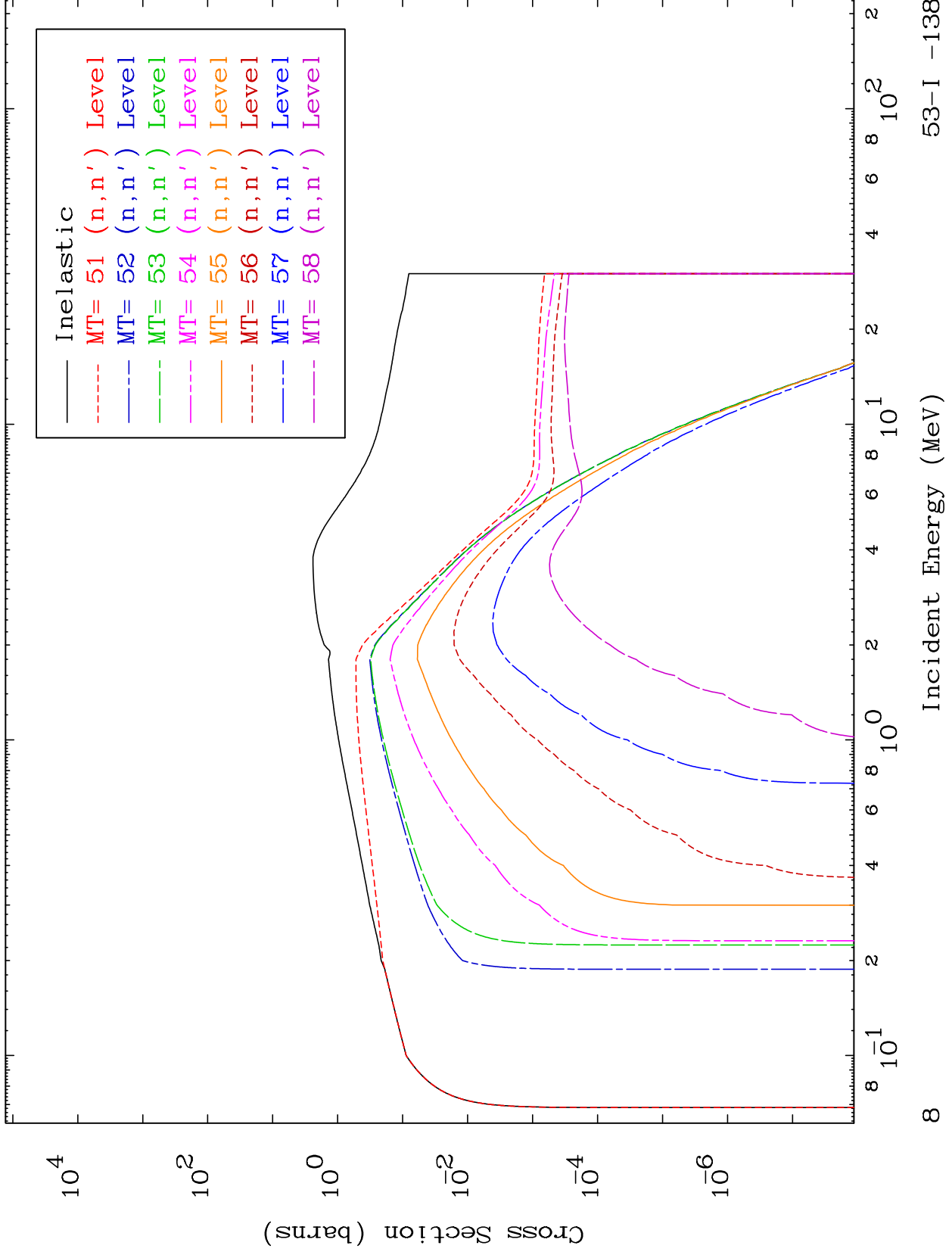

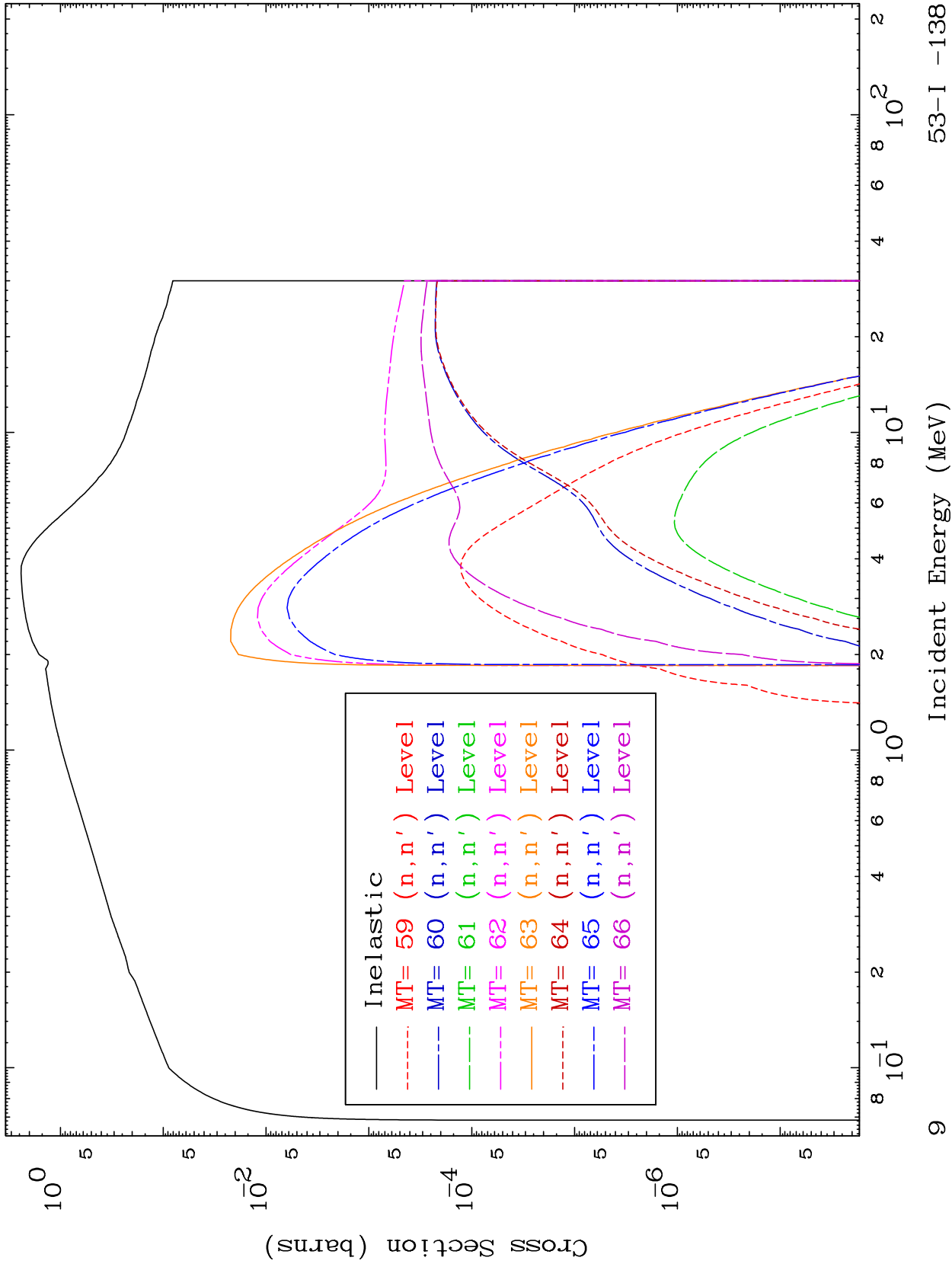

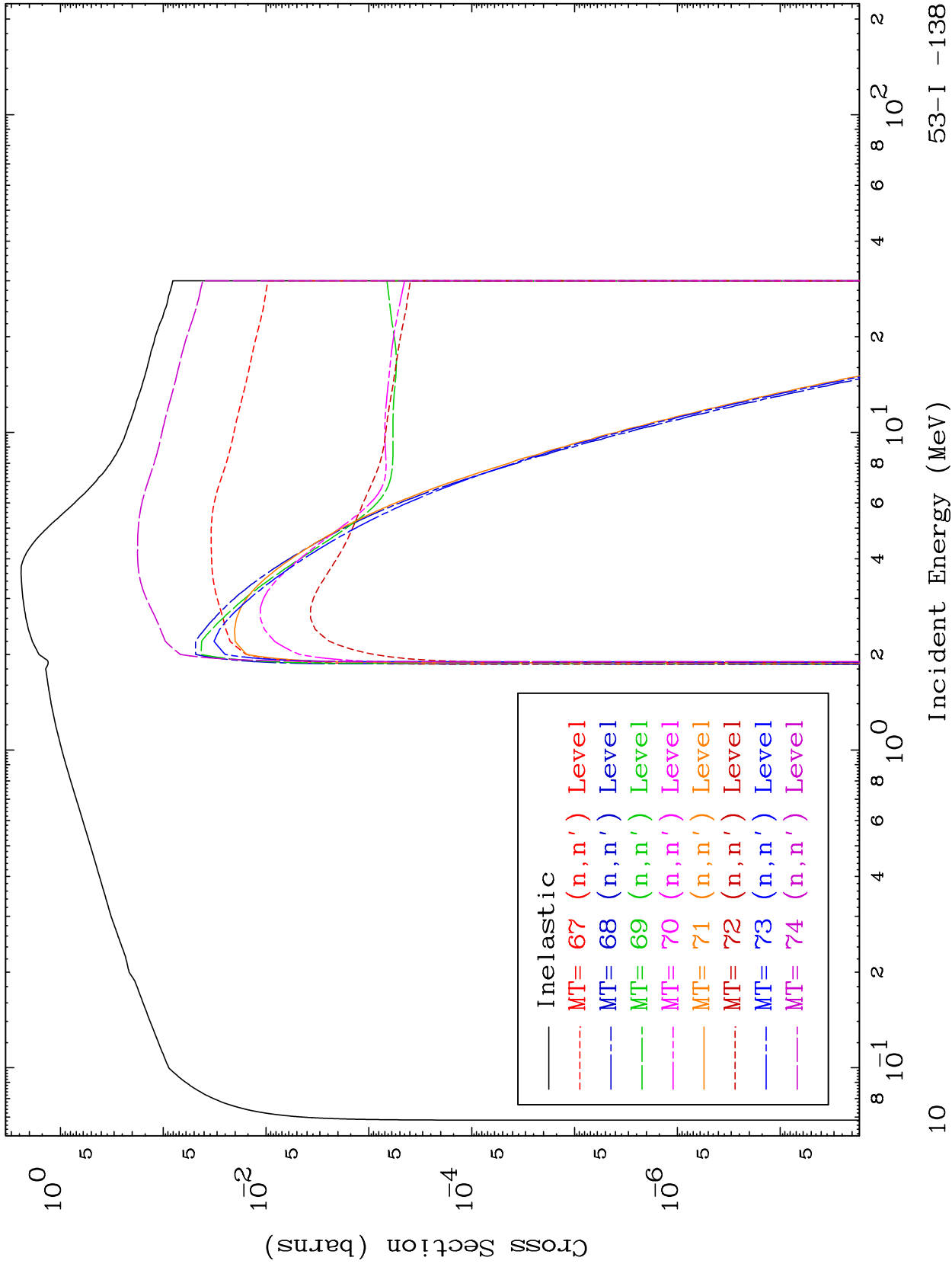

(n,n') Levels
293 Kelvin Cross Sections

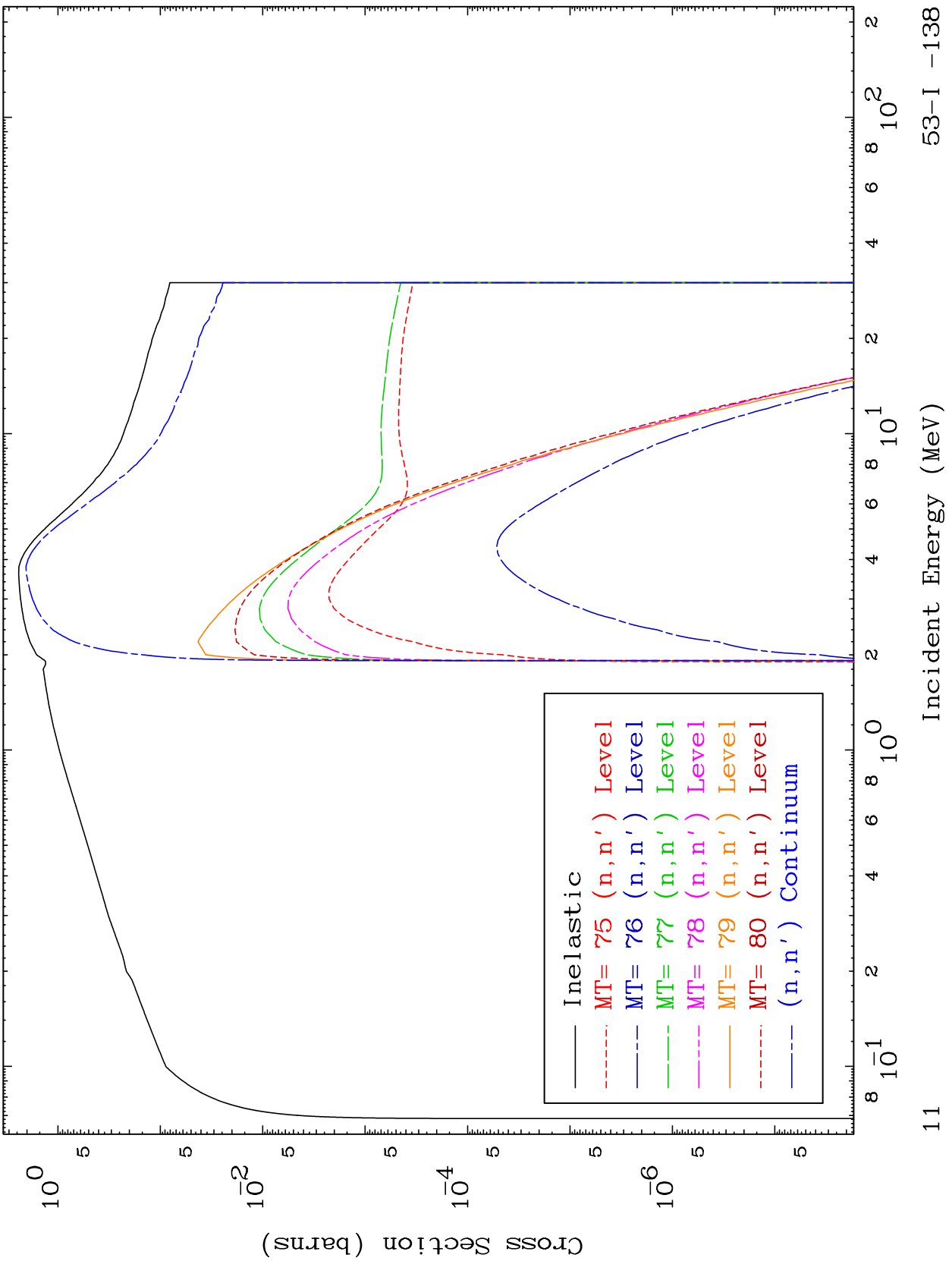

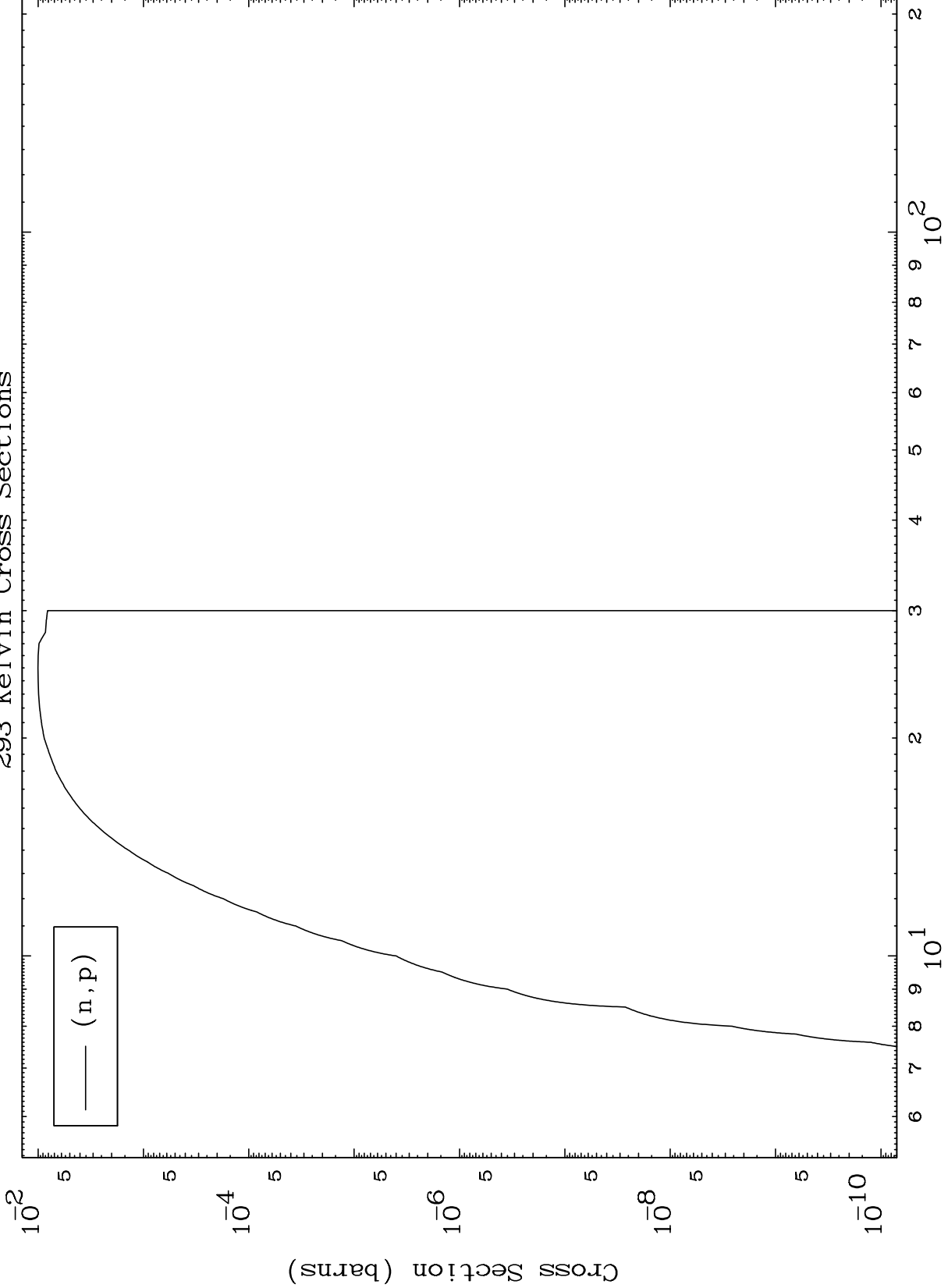

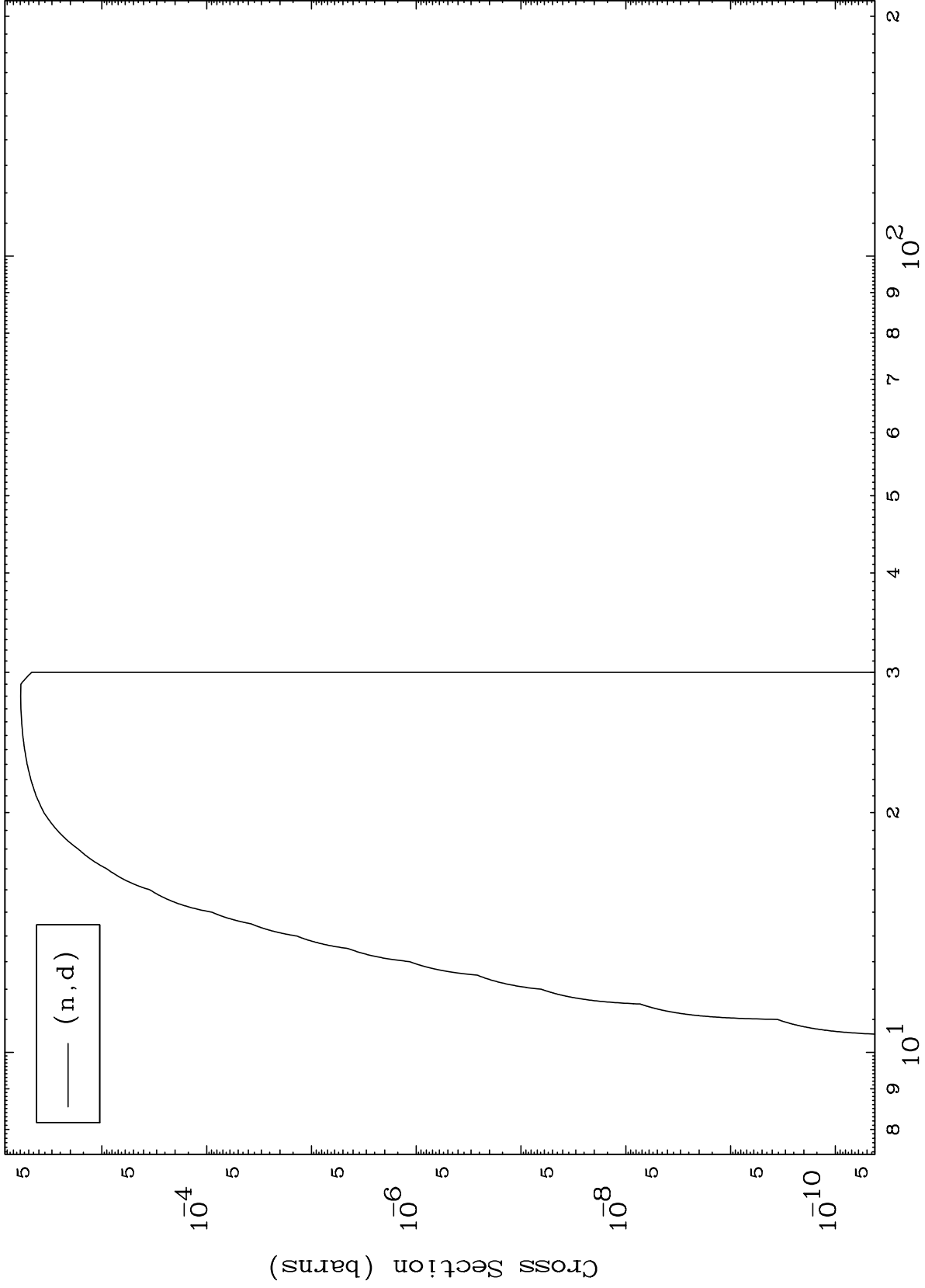

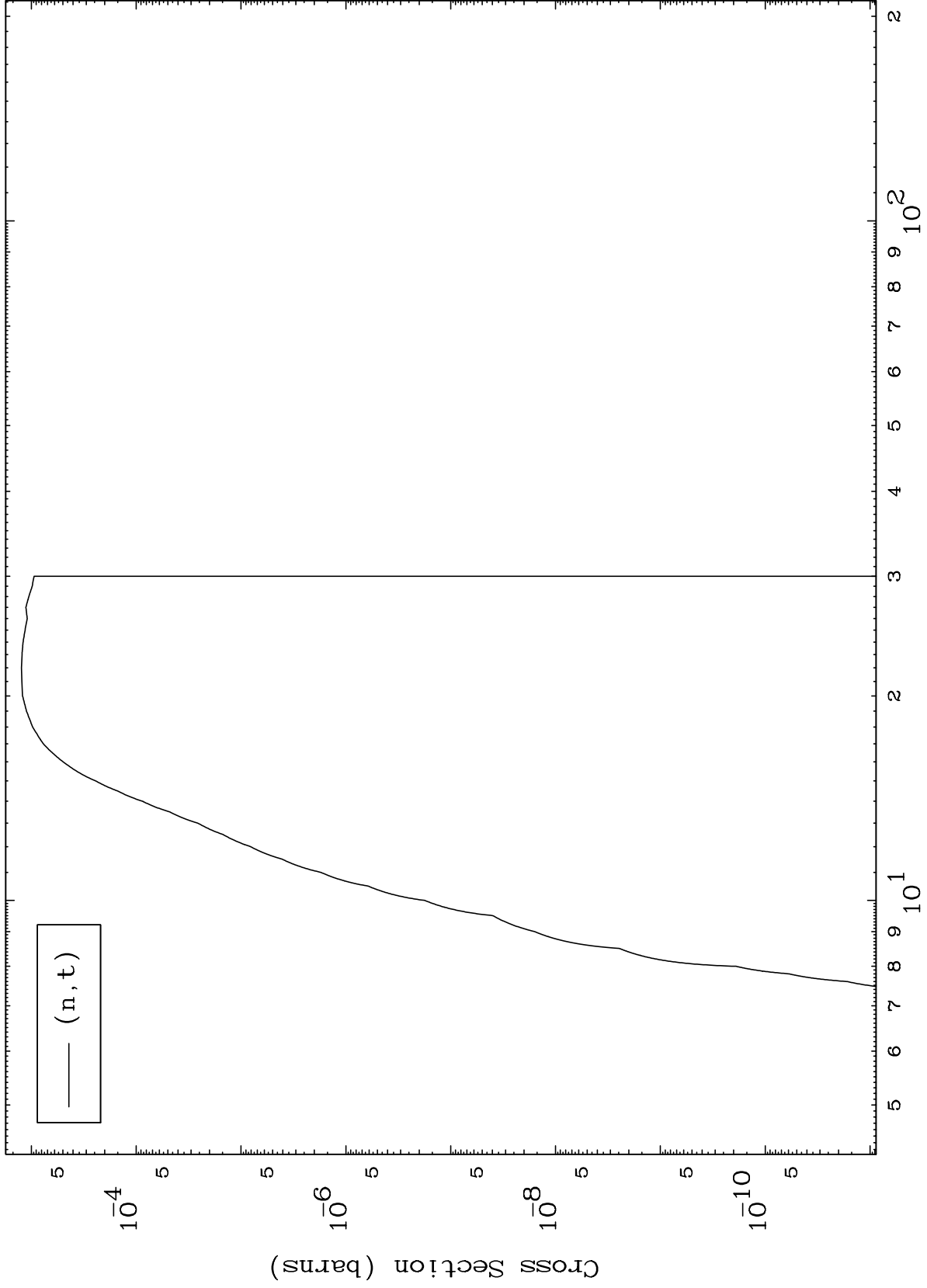

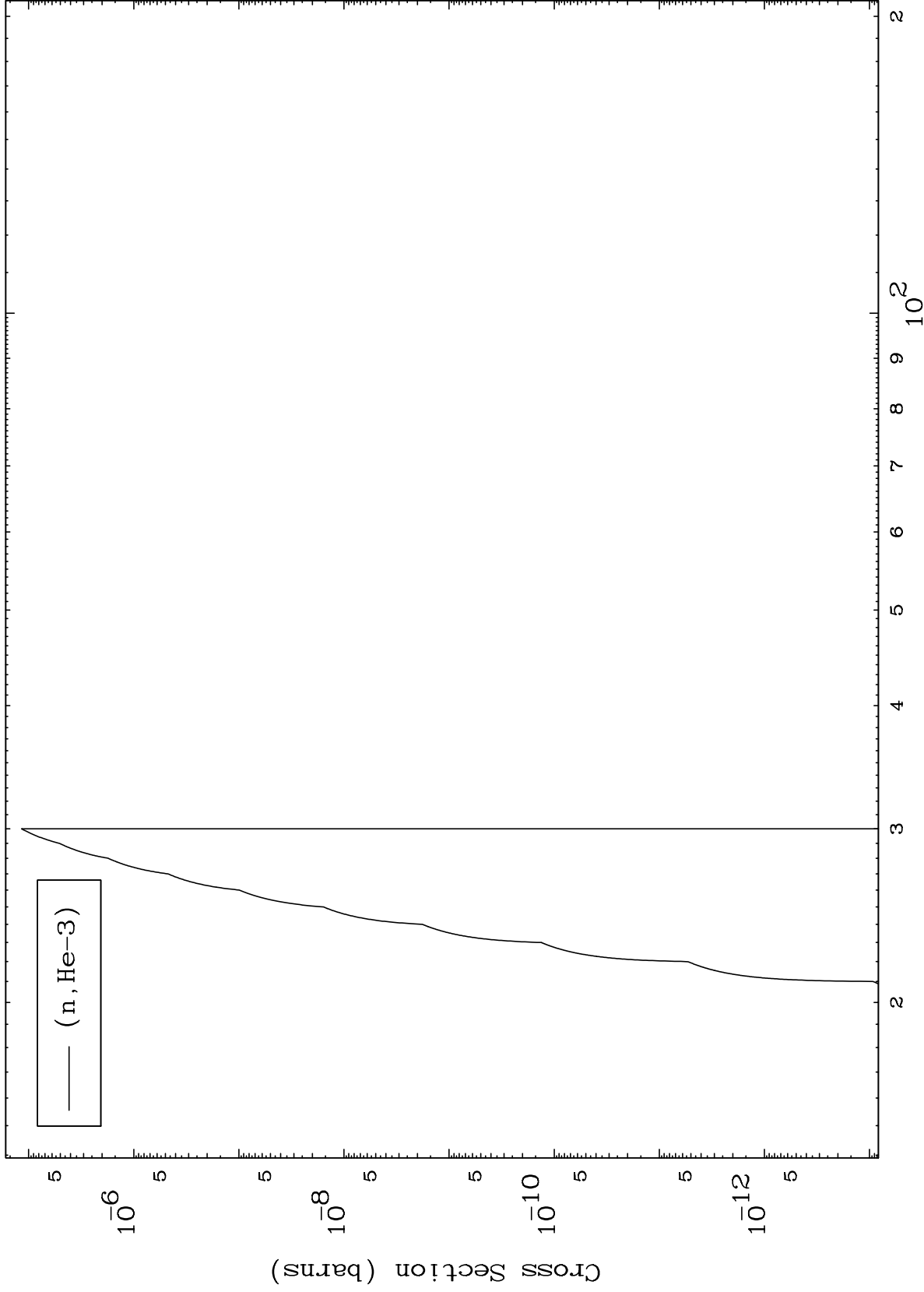

MAT 5358

(n, α) Levels
293 Kelvin Cross Sections

53-I -138

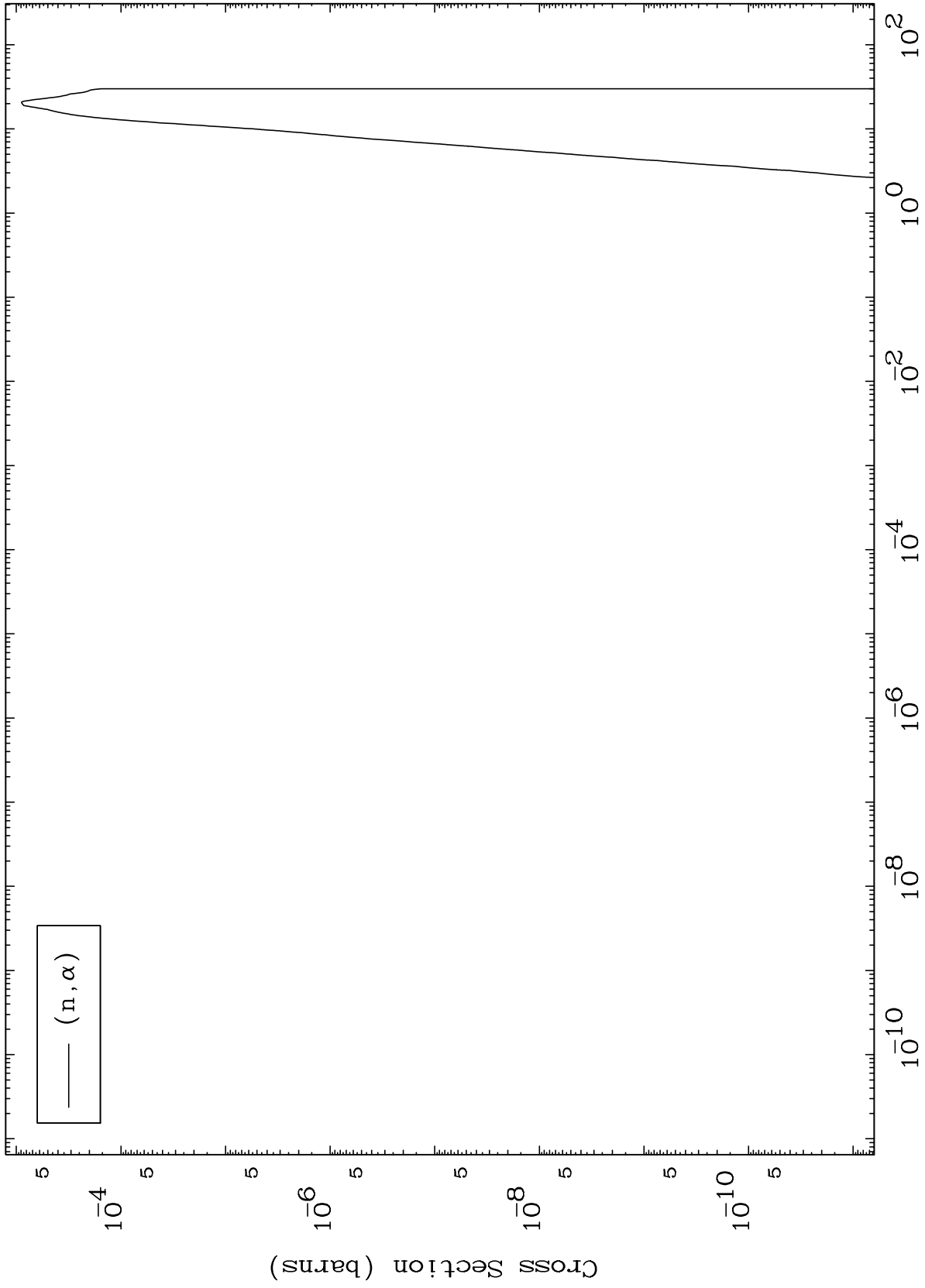

16

53-I -138

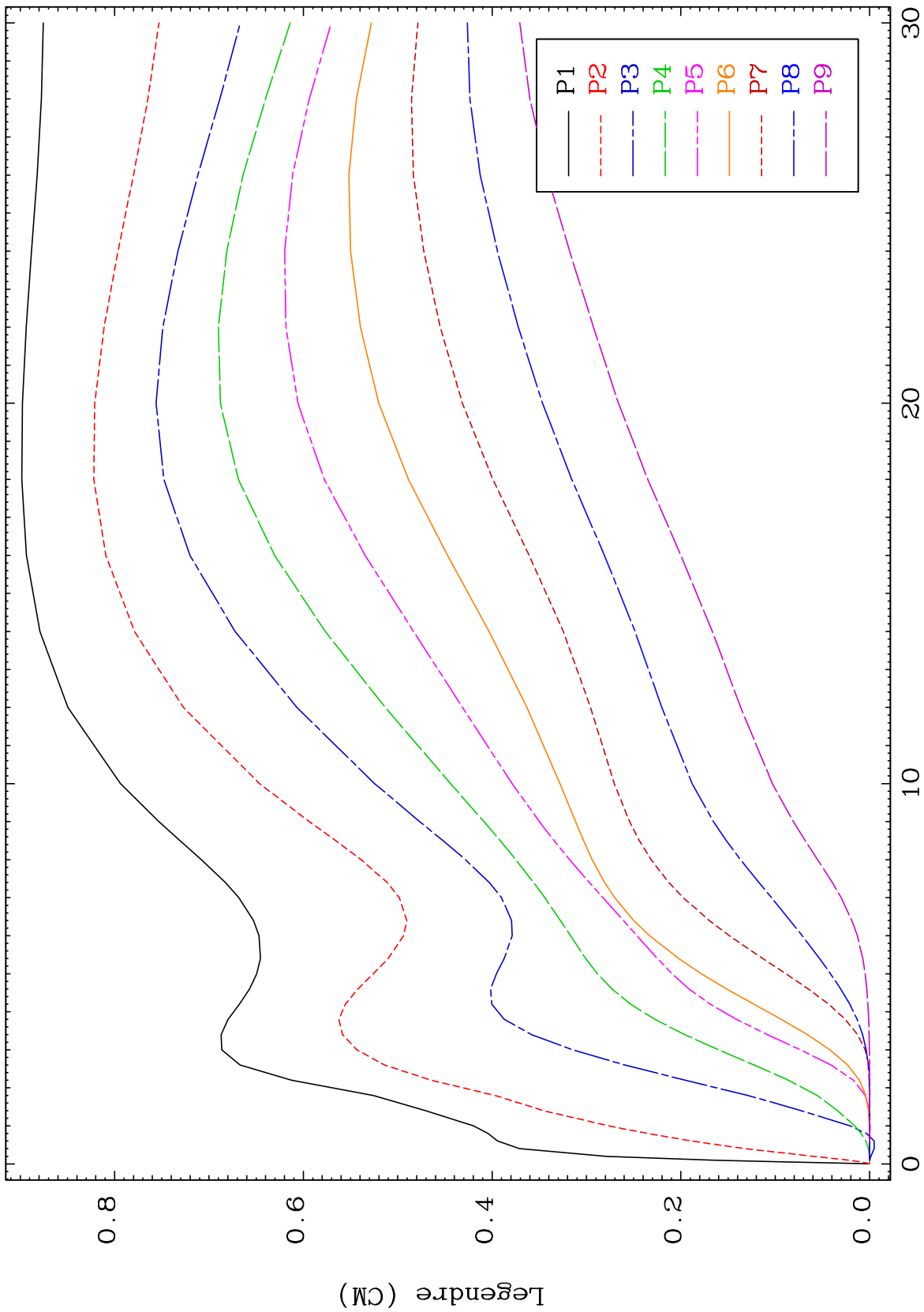

Elastic Legendre Coefficients

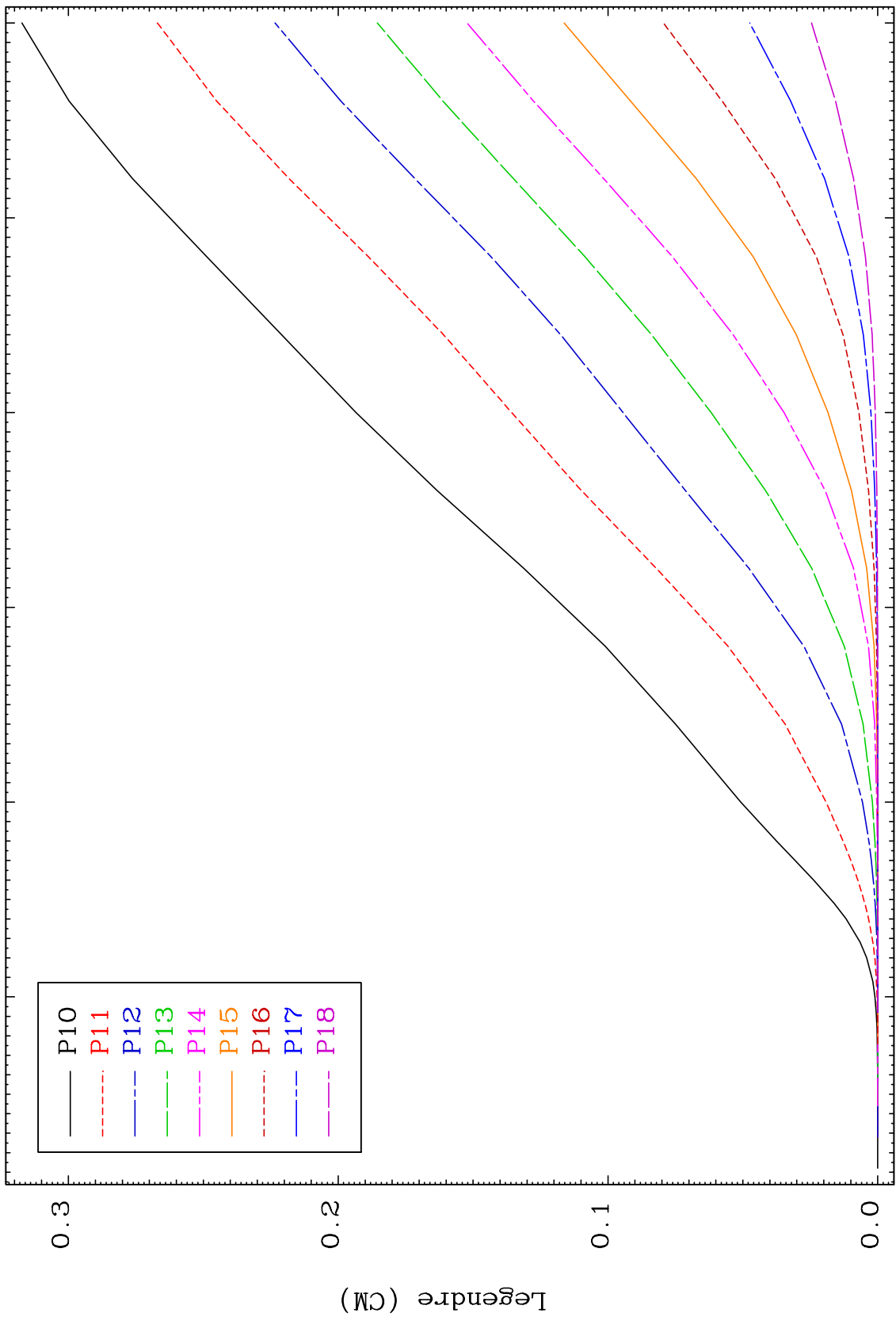

MAT 5358

Elastic Legendre Coefficients

53-I -138

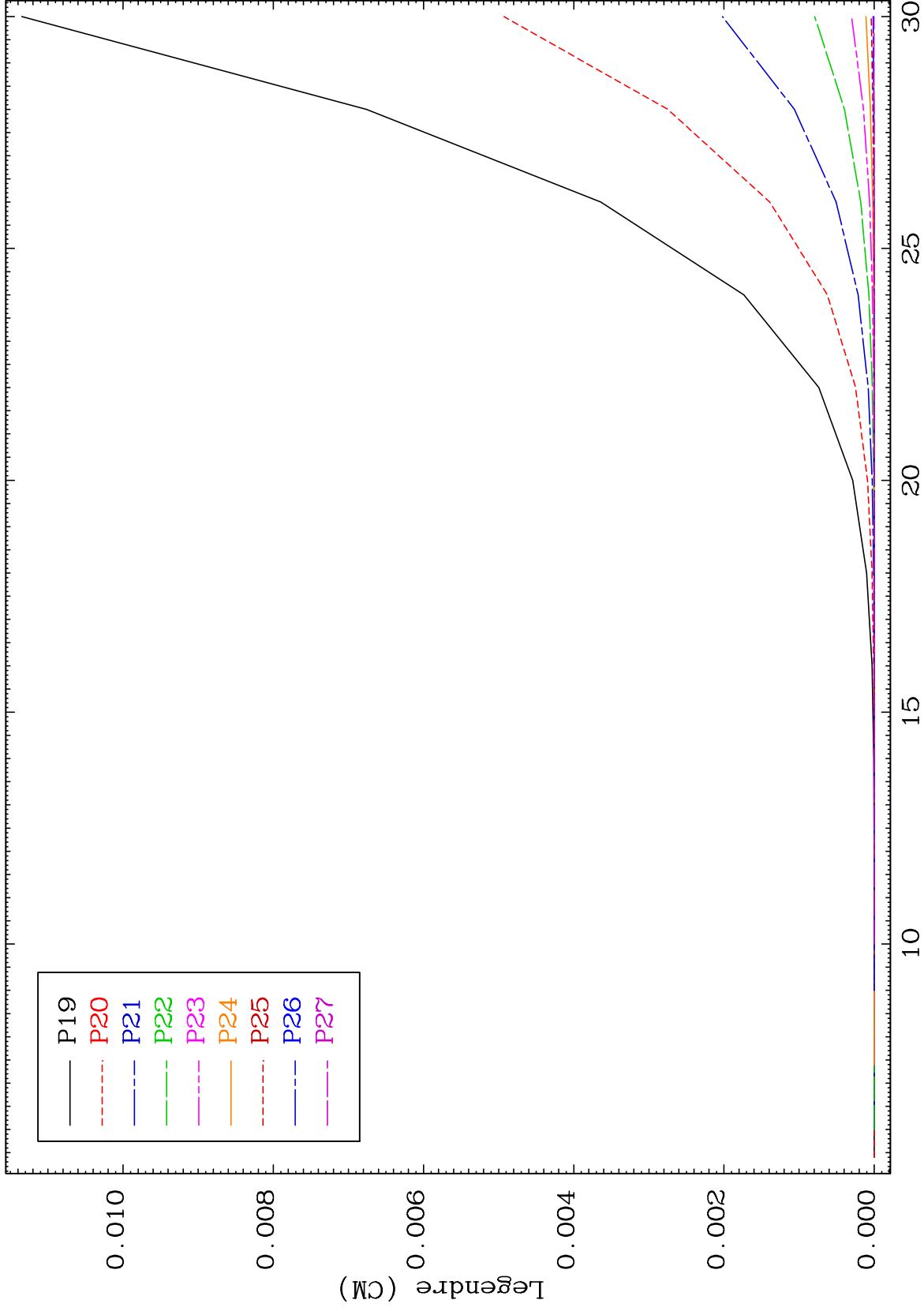

19

Incident Energy (MeV)

53-I -138

MAT 5358

Elastic Legendre Coefficients

53-I -138

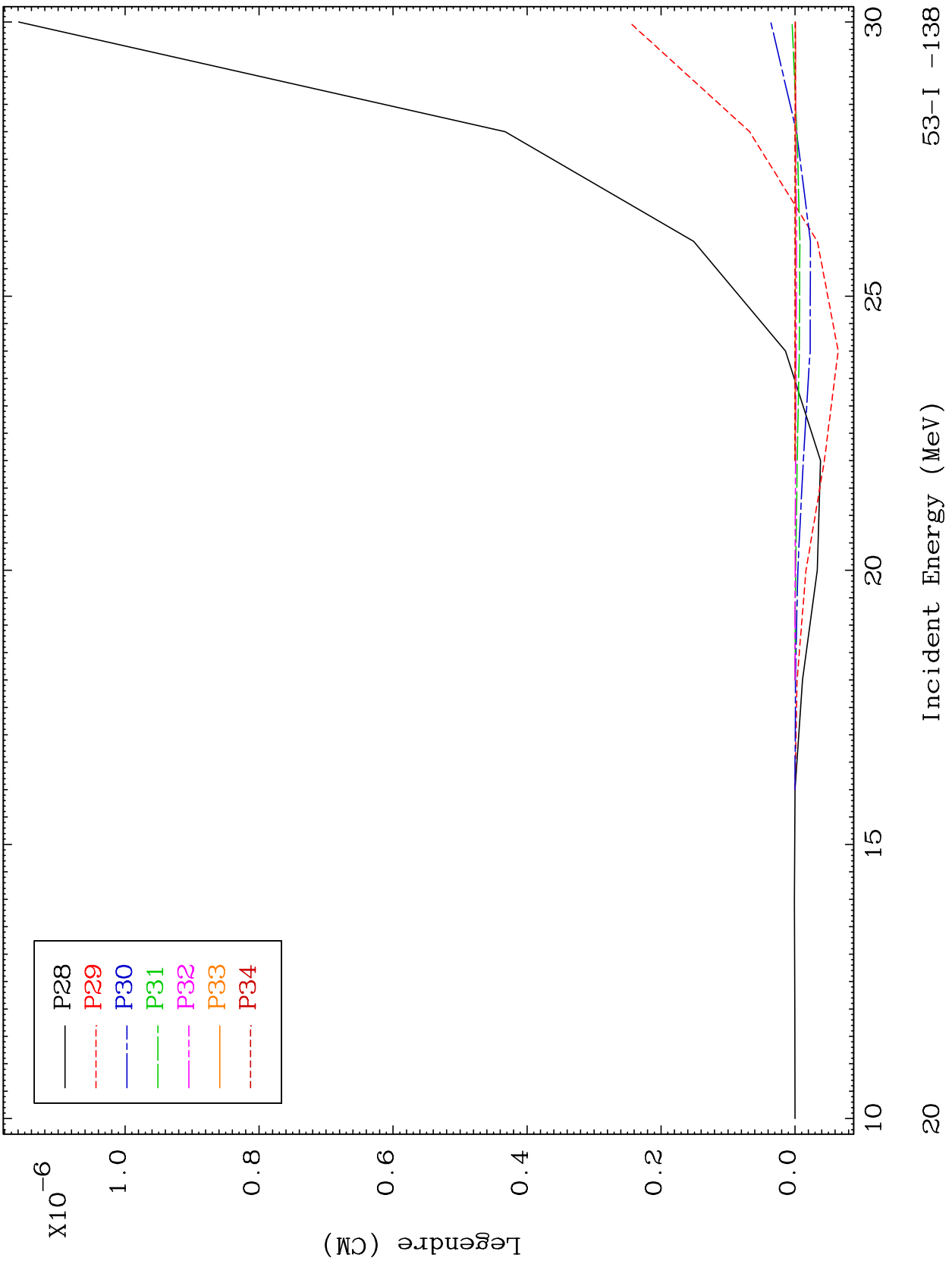

20

Incident Energy (MeV)

53-I -138

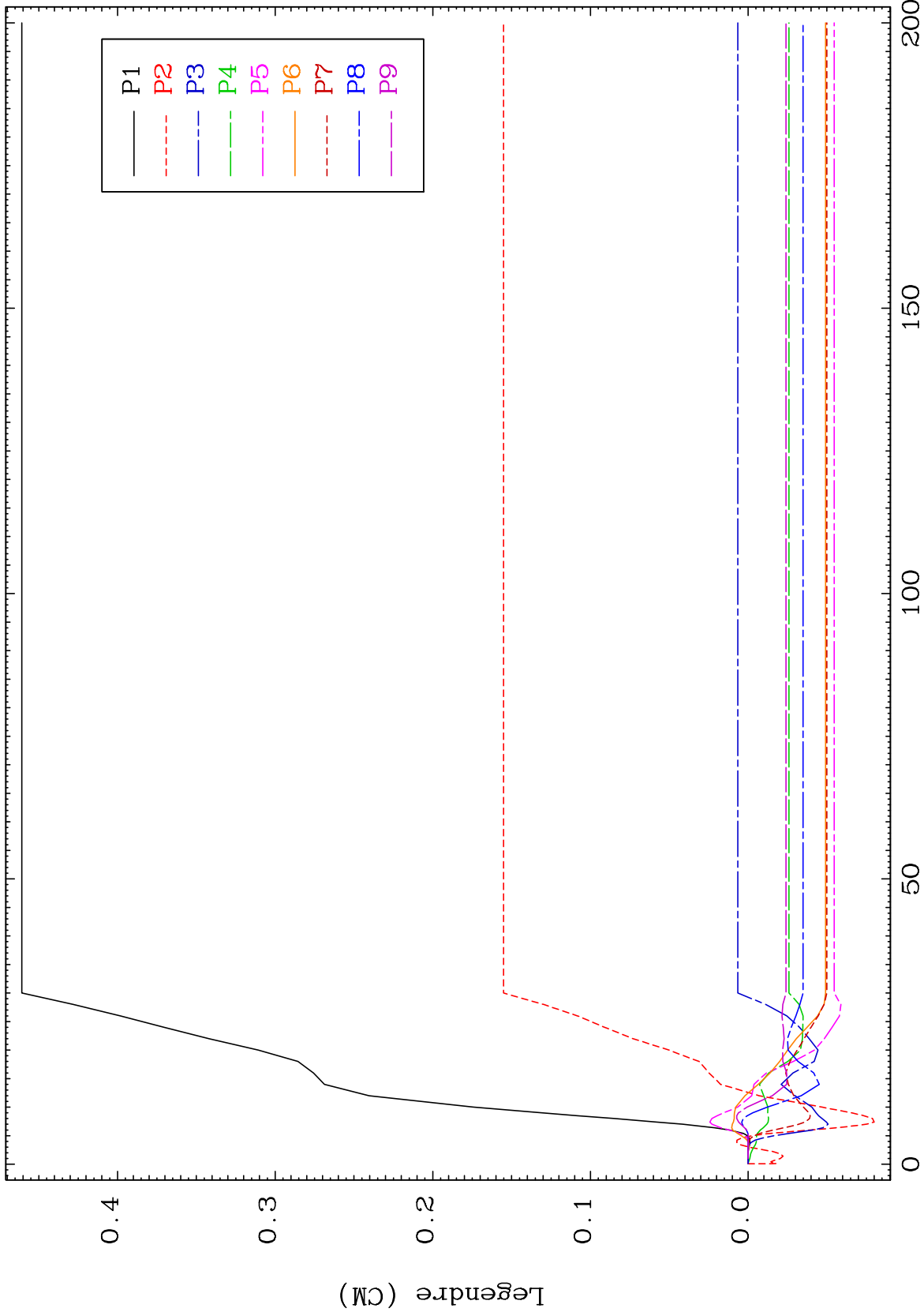

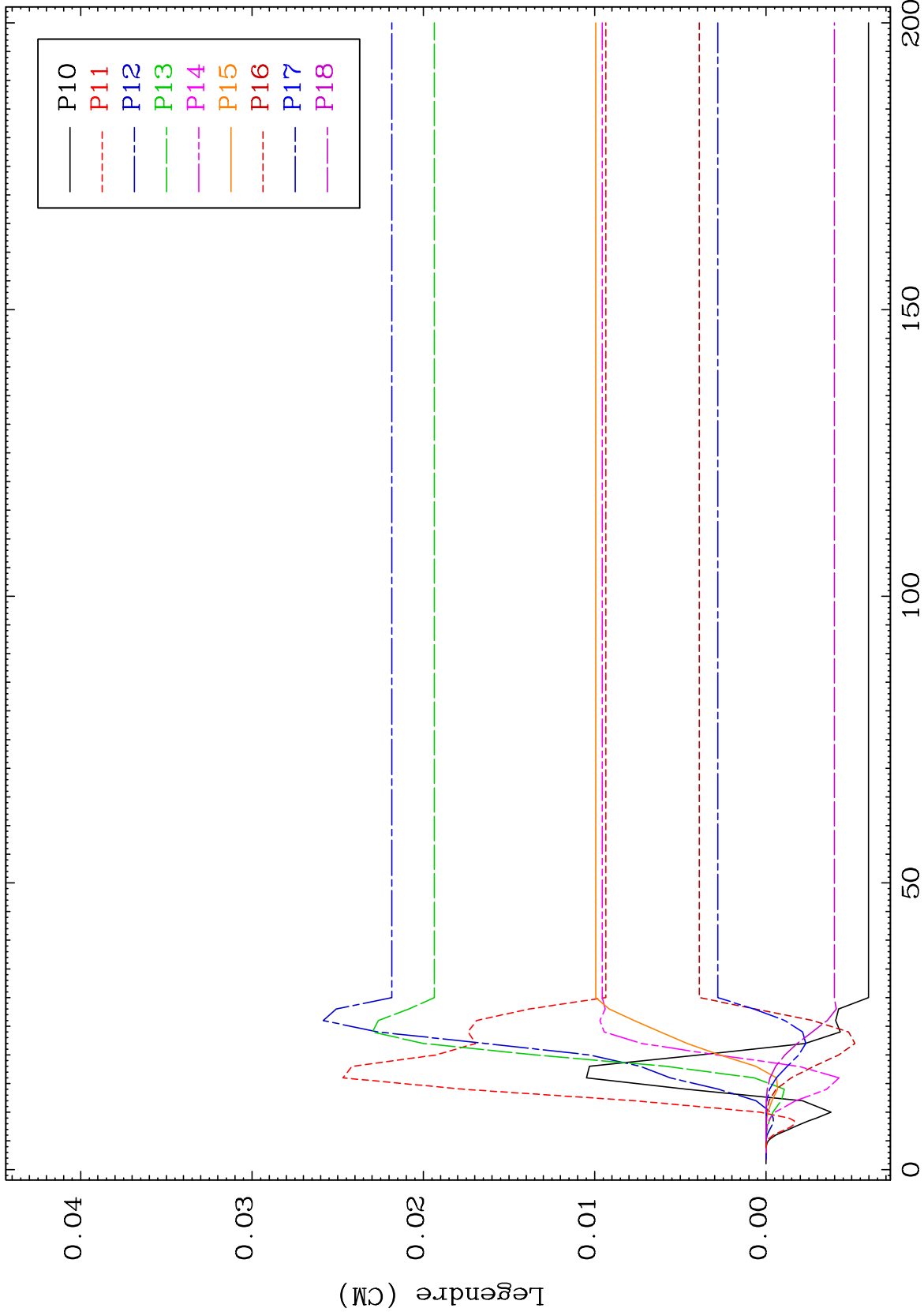

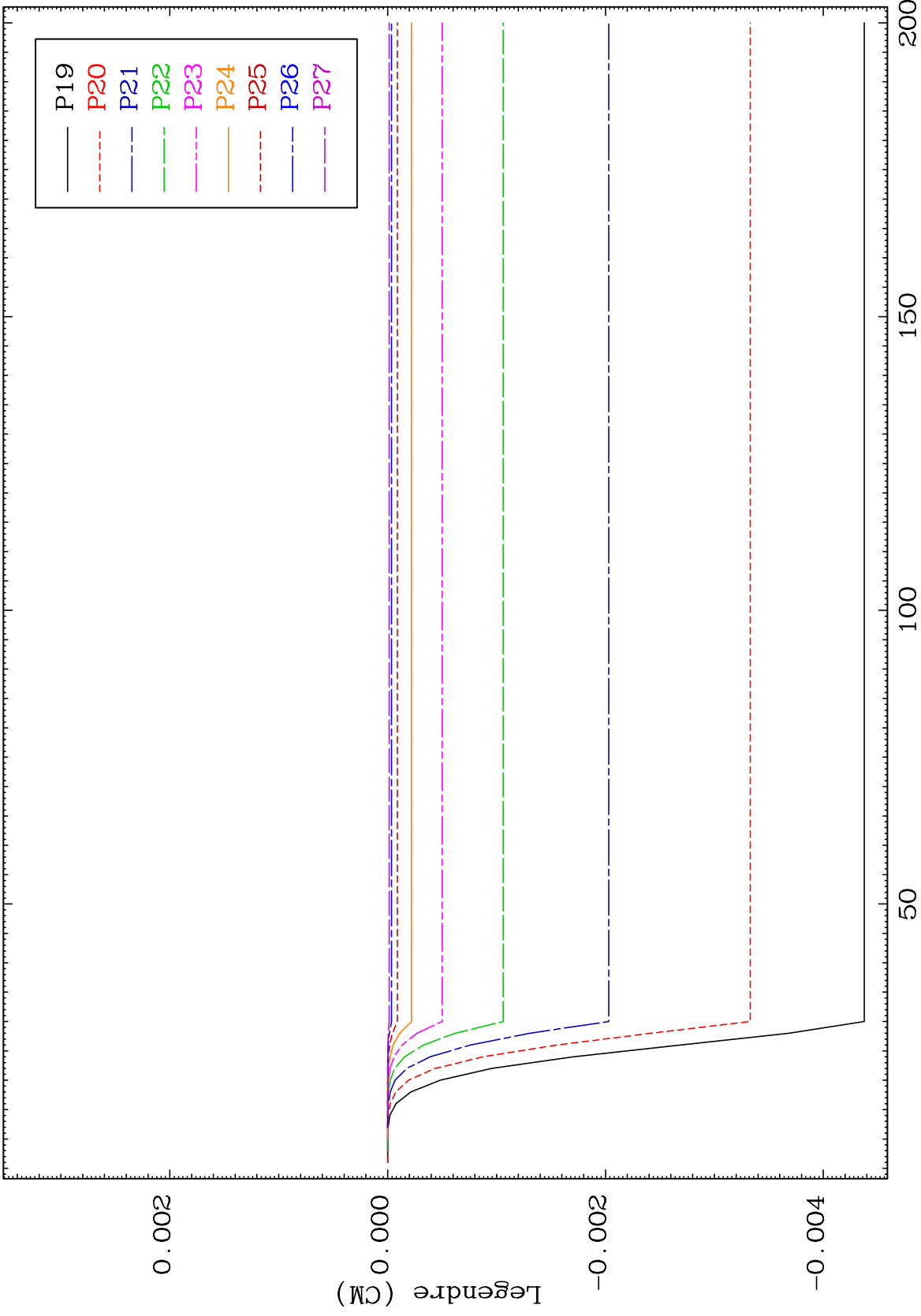

MAT 5358

MT= 51 (n,n') Level
Legendre Coefficients

53-I -138

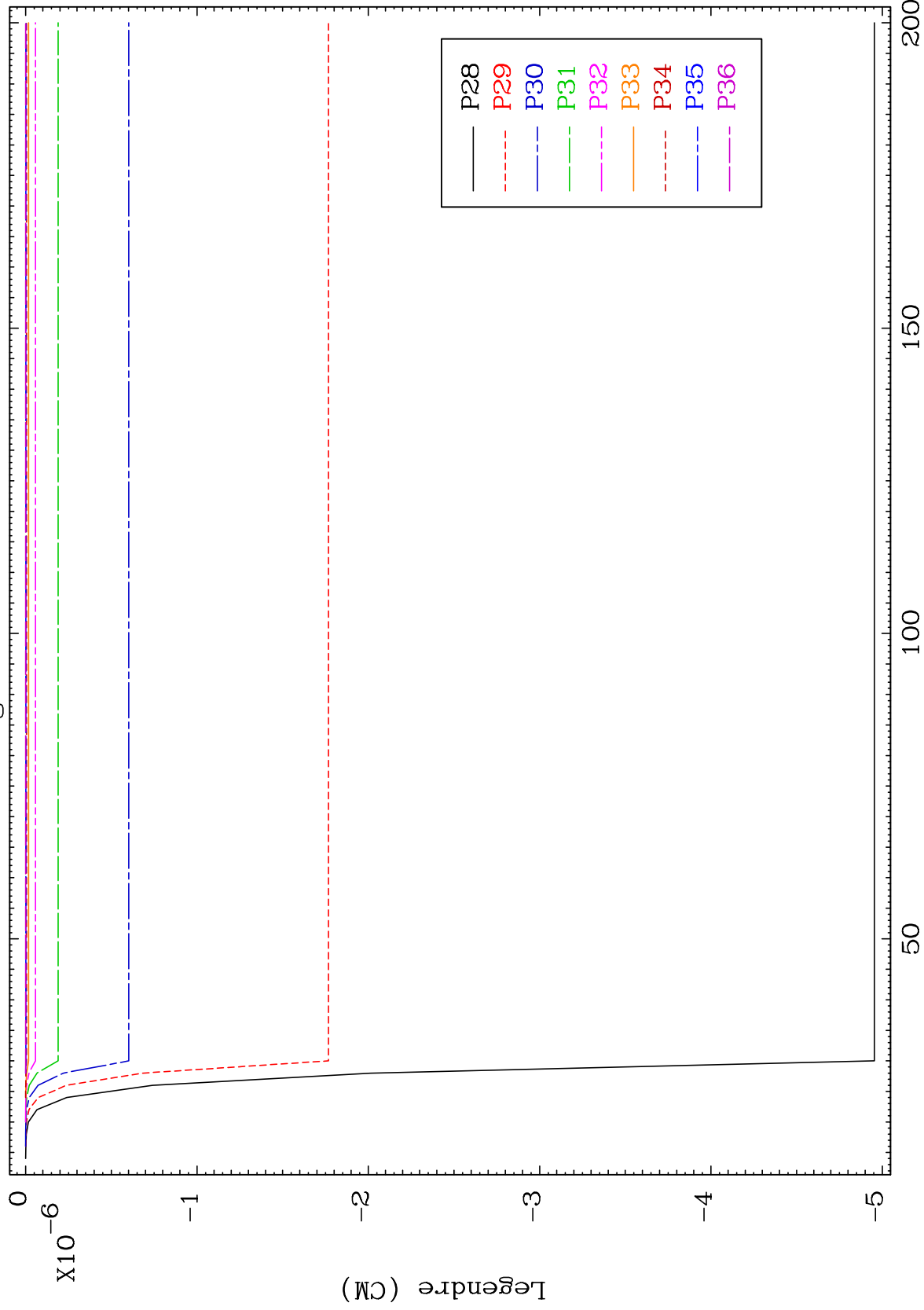

24

Incident Energy (MeV)

53-I -138

MAT 5358

MT= 52 (n,n') Level
Legendre Coefficients

53-I -138

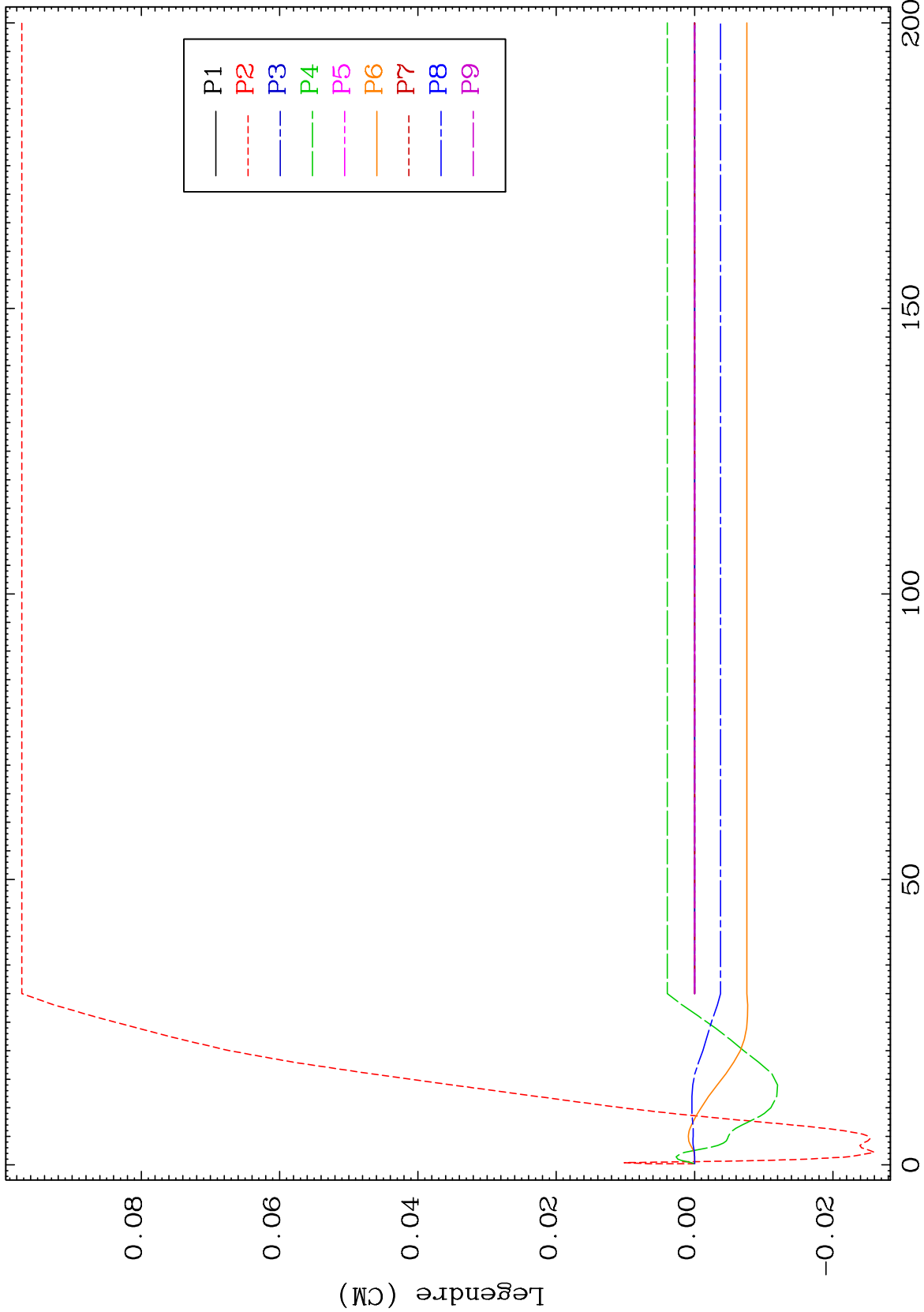

53-I -138

Incident Energy (MeV)

25

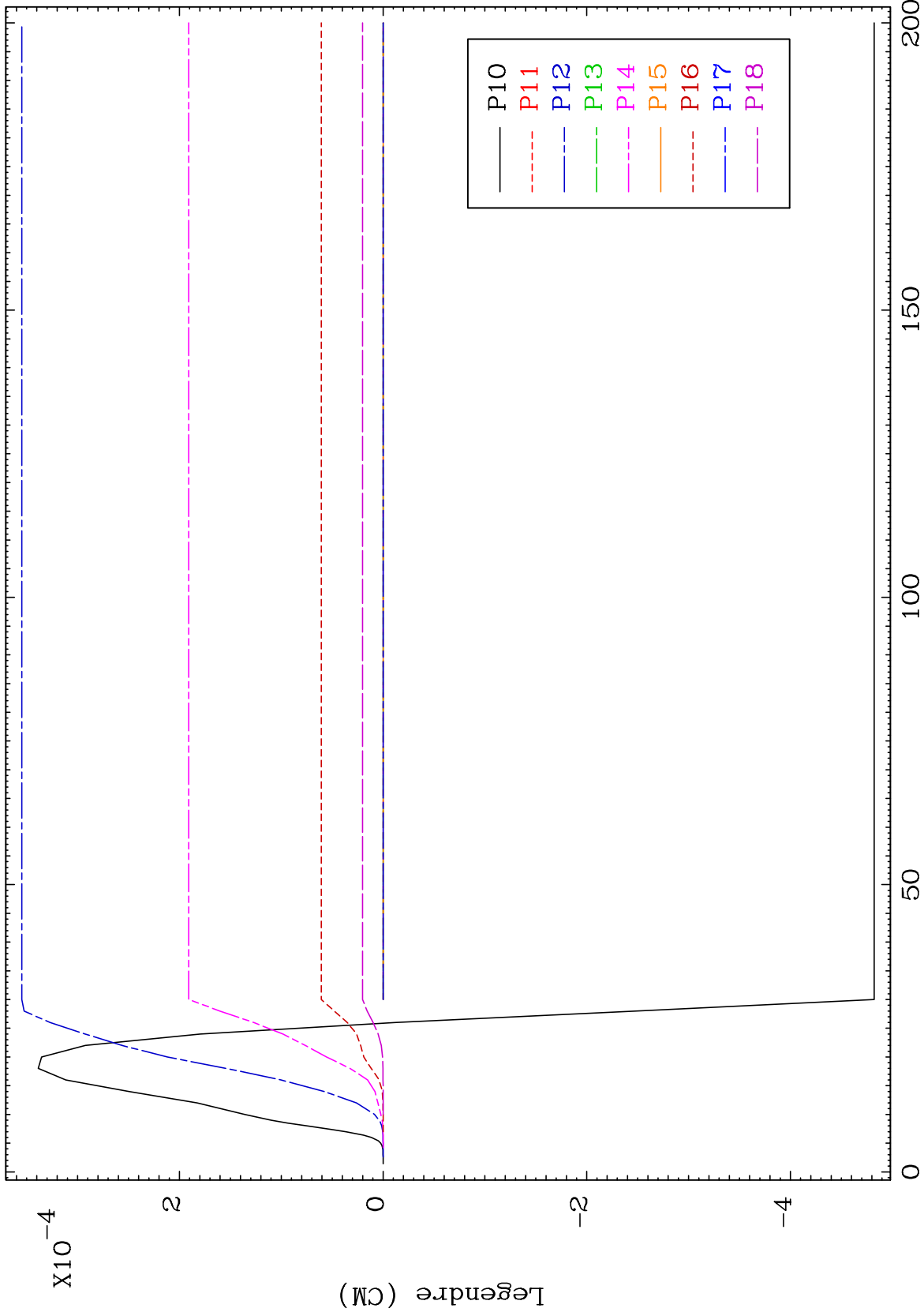

MAT 5358

MT= 52 (n,n') Level
Legendre Coefficients

53-I -138

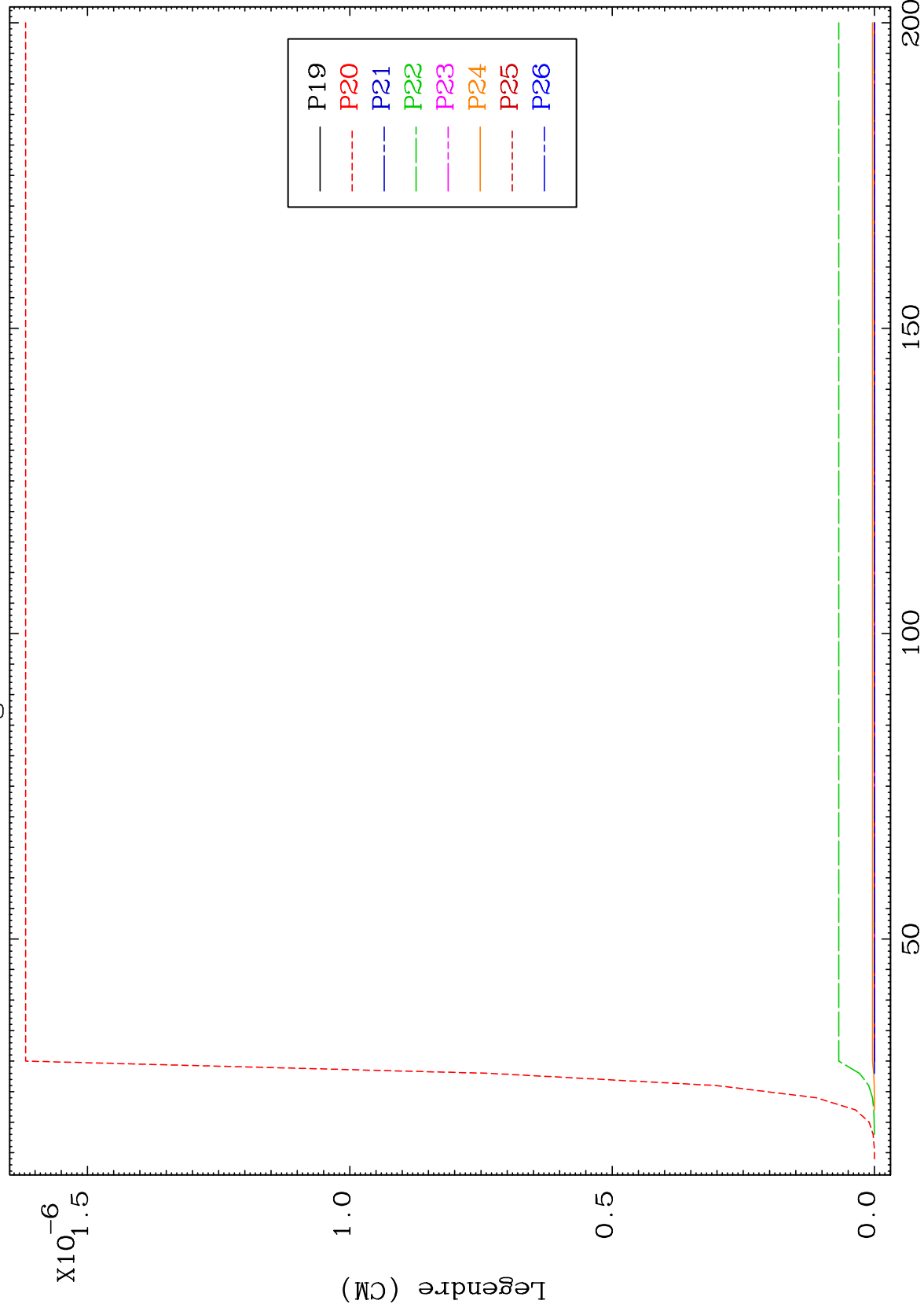

27

Incident Energy (MeV)

53-I -138

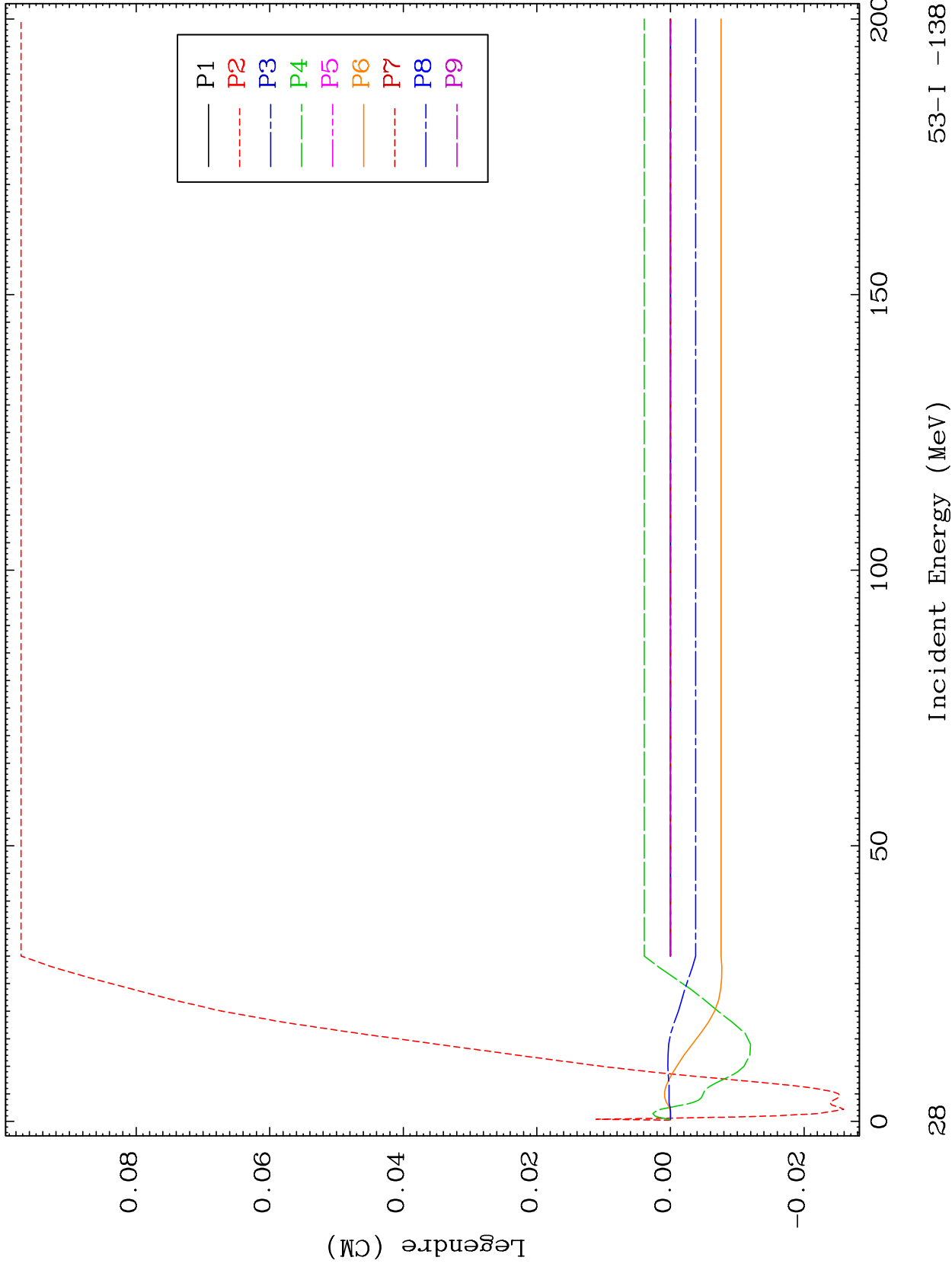

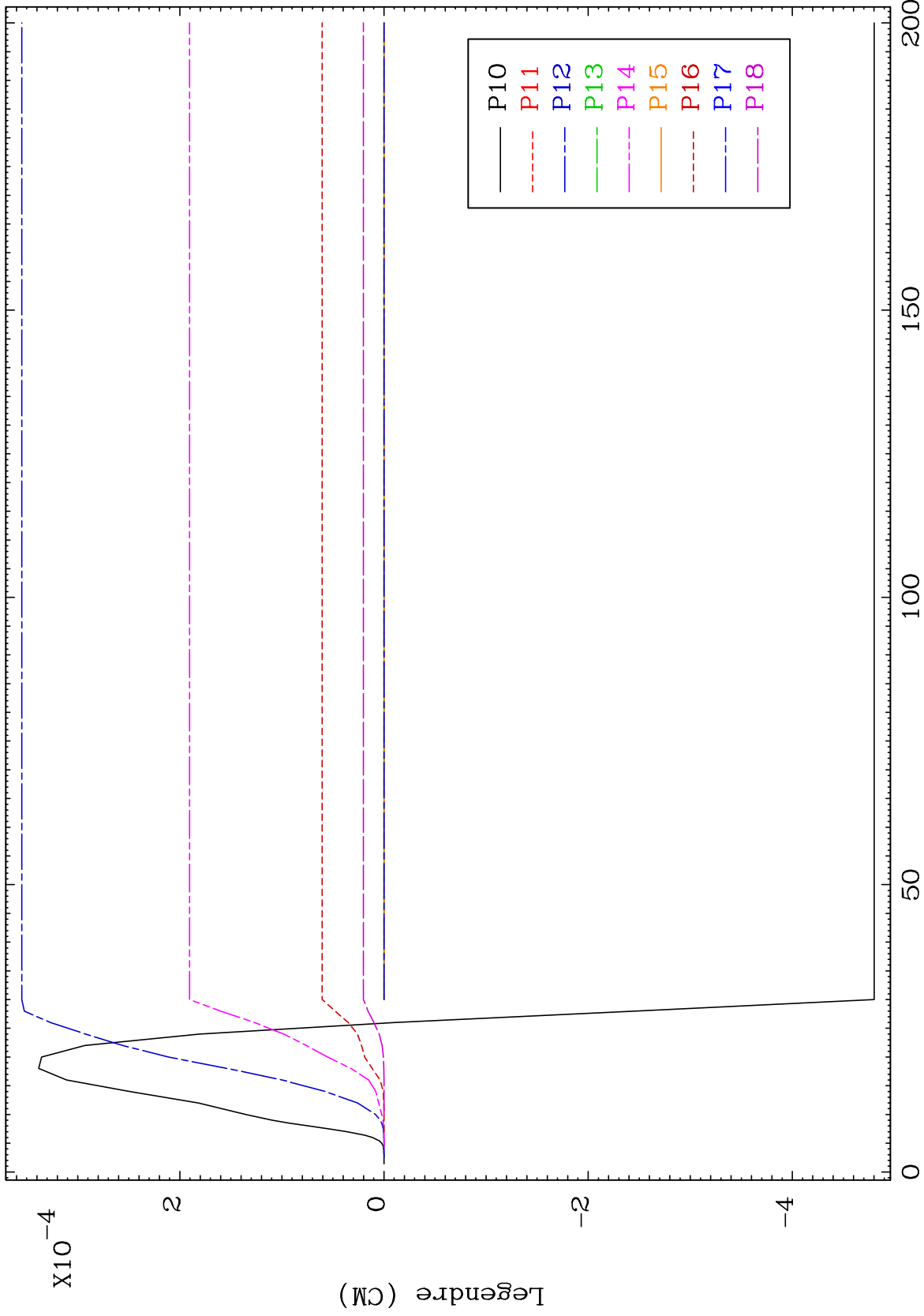

MAT 5358

MT= 53 (n,n') Level
Legendre Coefficients

53-I -138

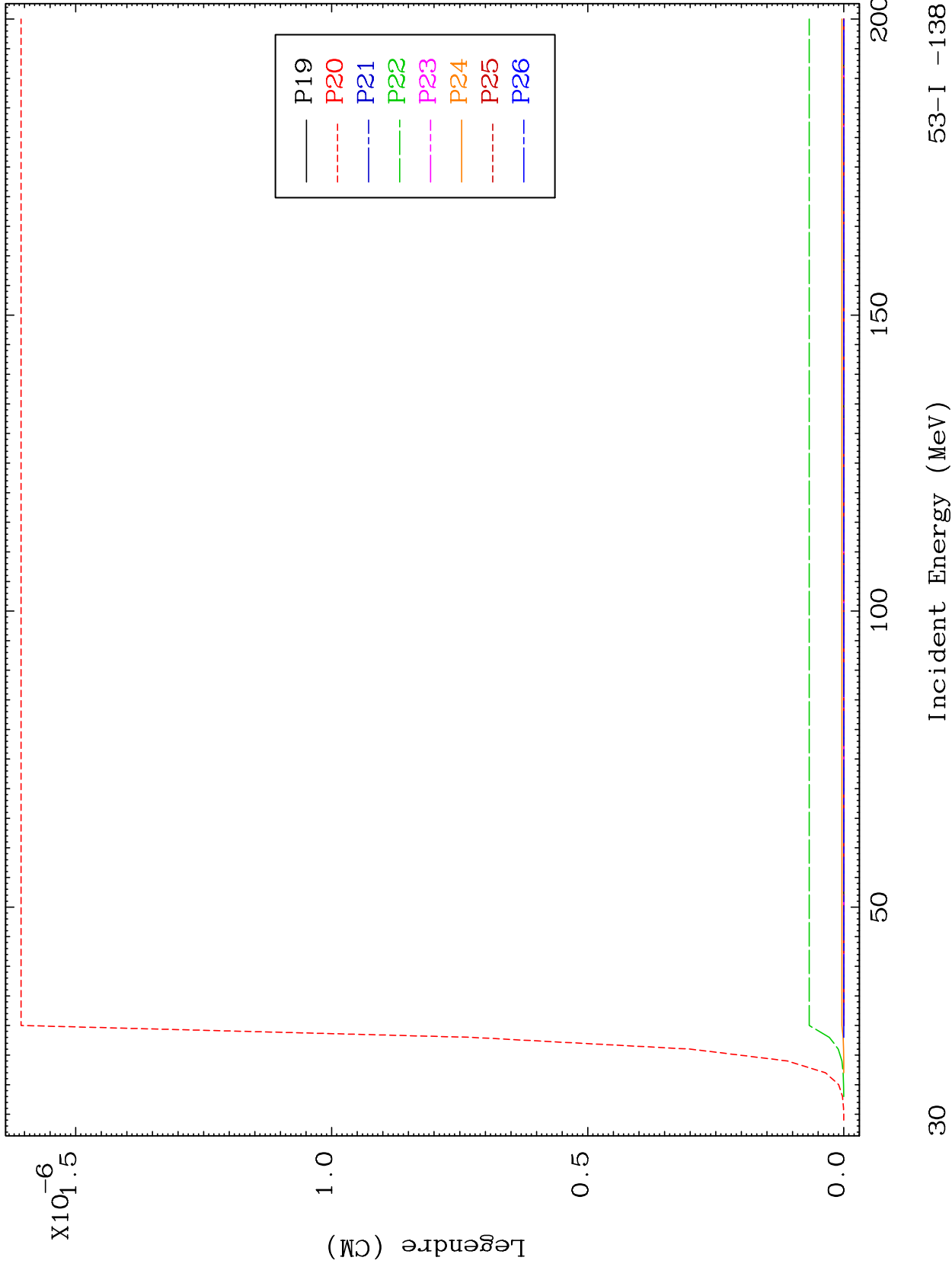

30

Incident Energy (MeV)

53-I -138

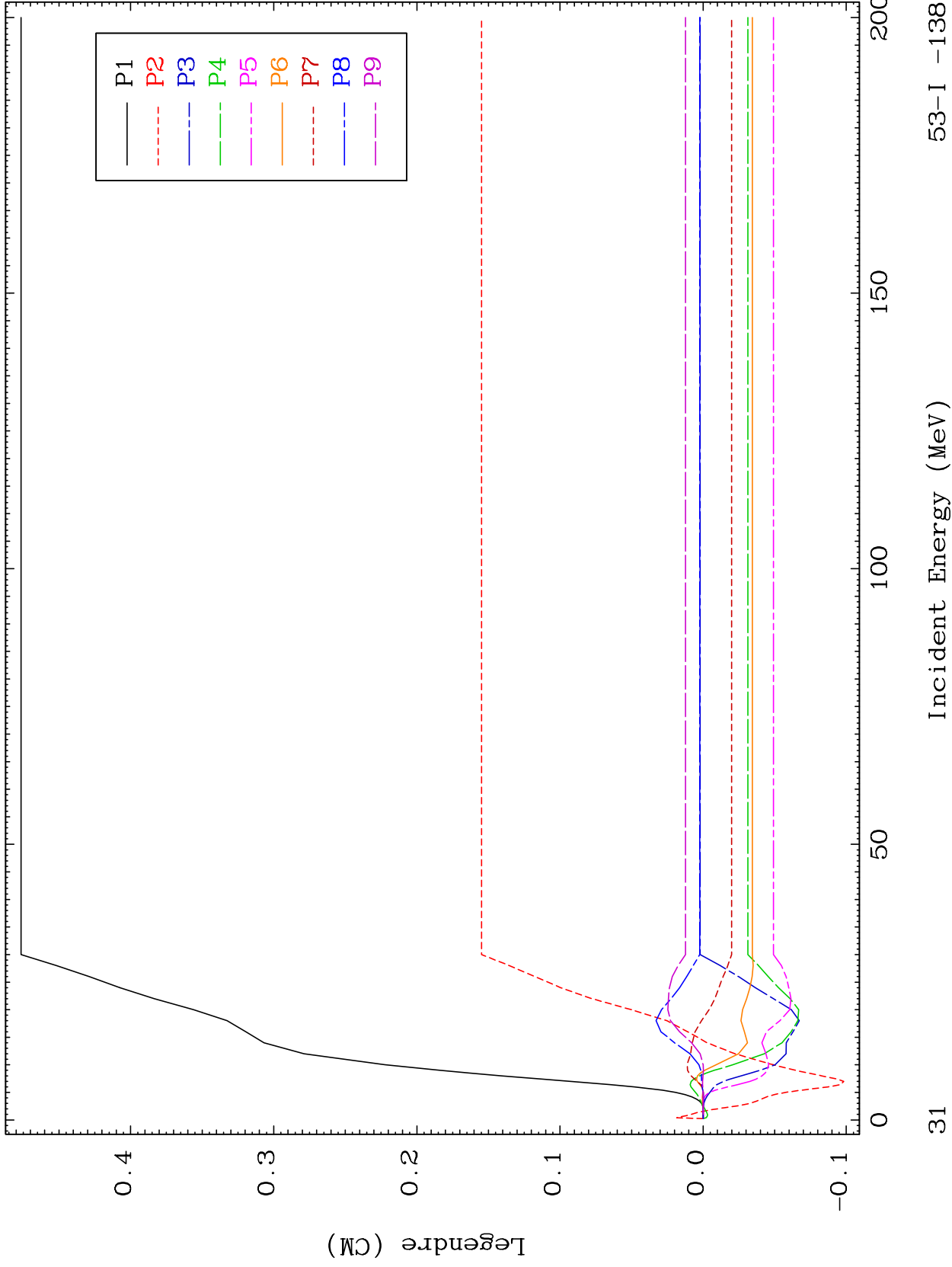

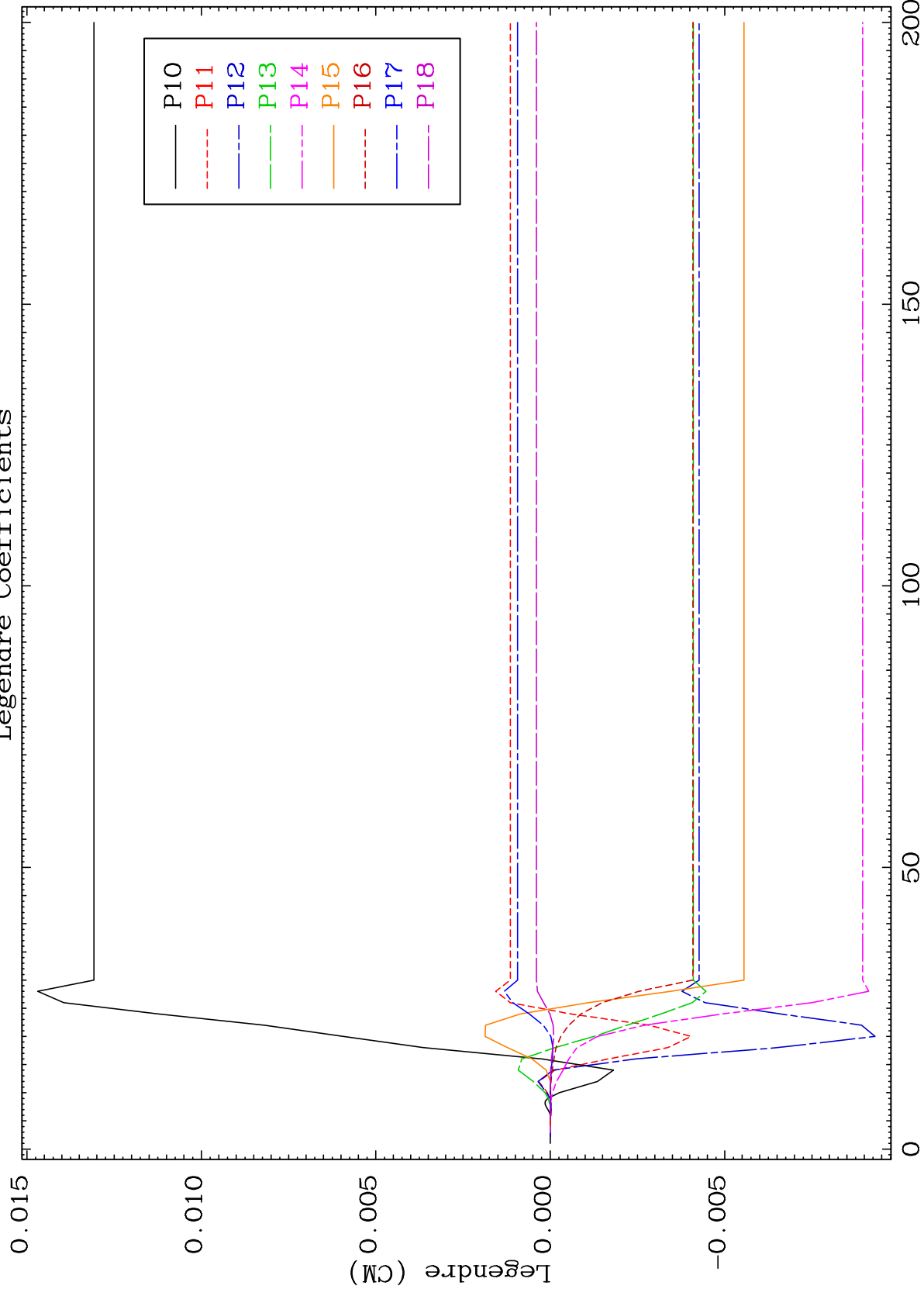

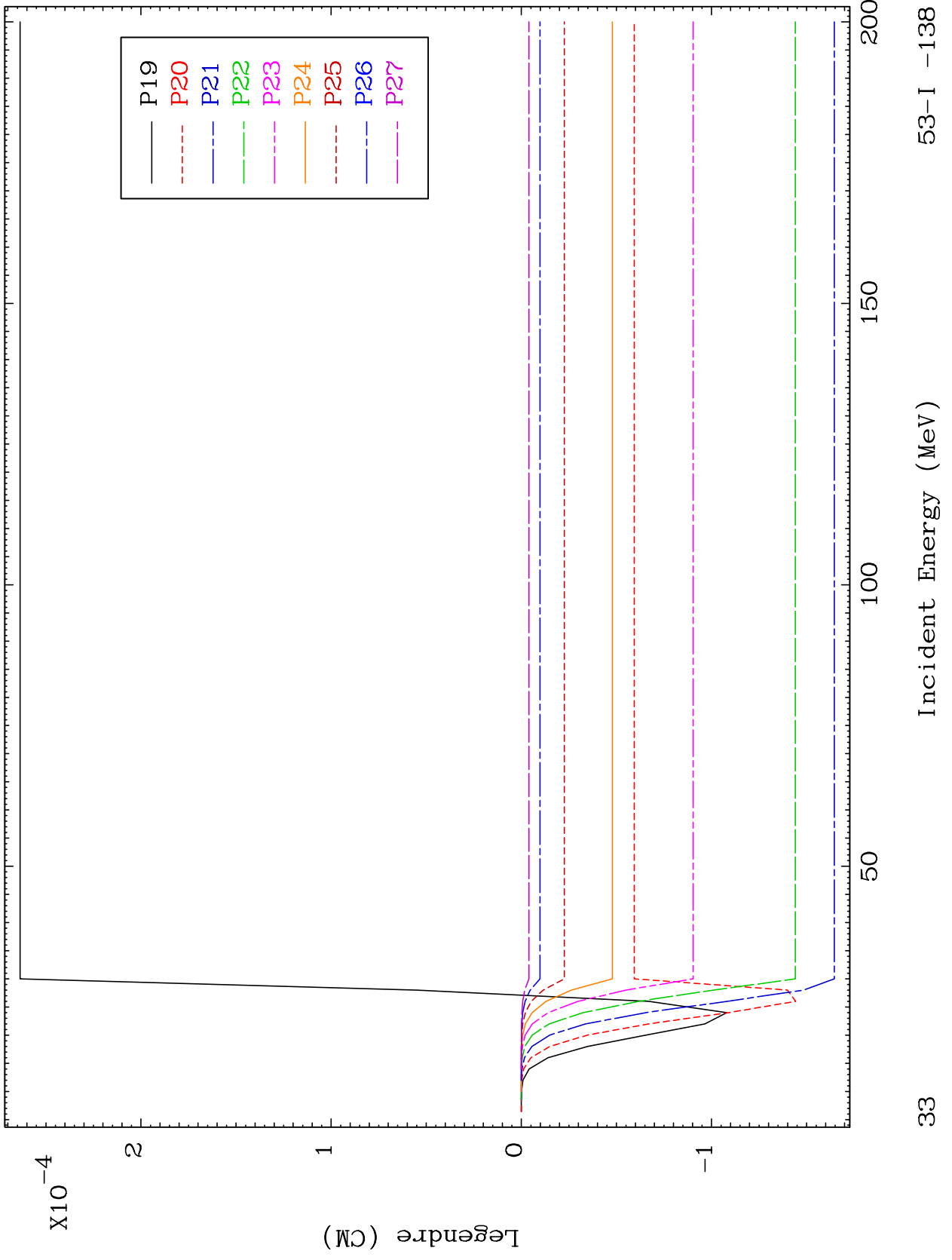

MAT 5358

MT= 54 (n,n') Level
Legendre Coefficients

53-I -138

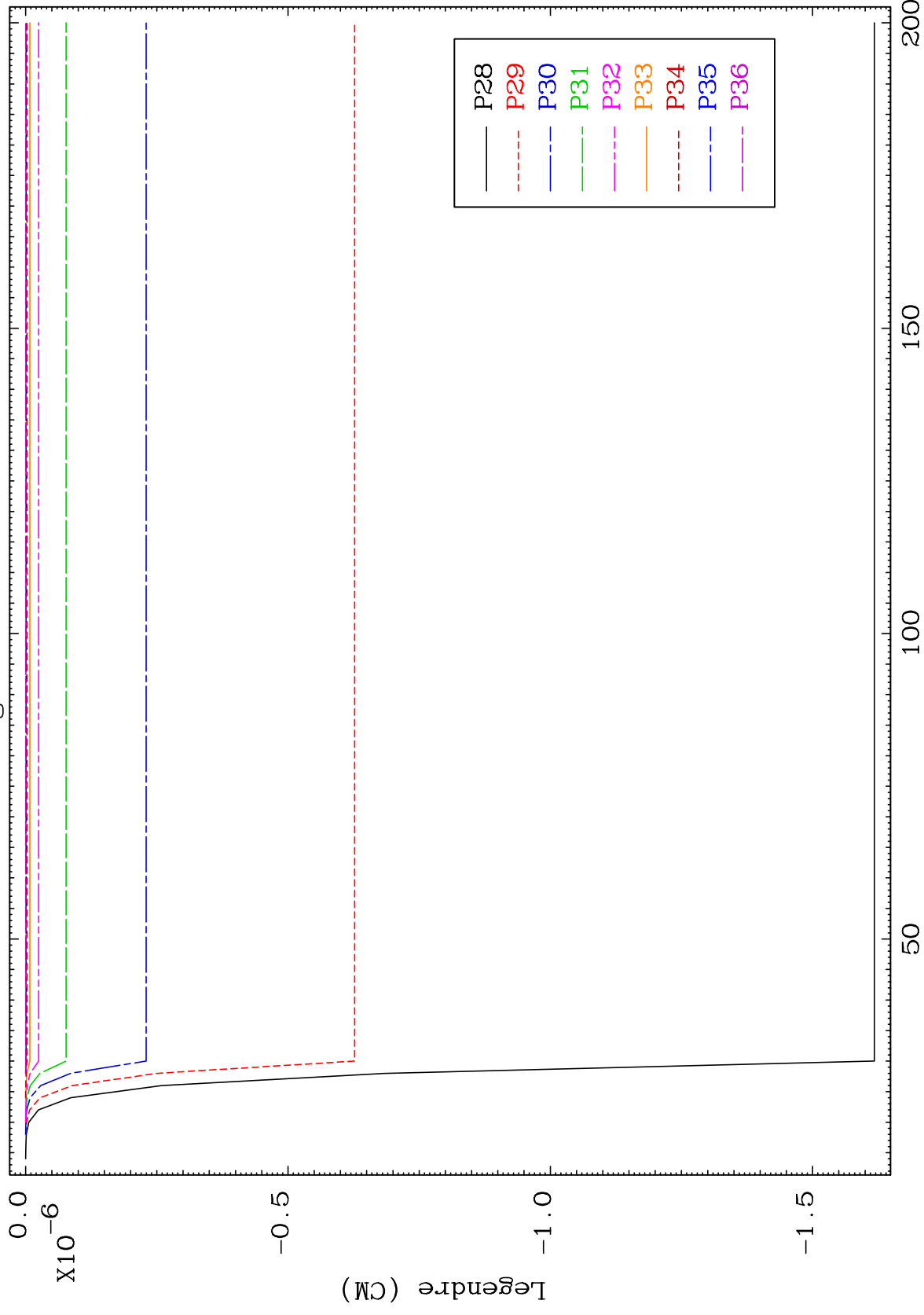

34

Incident Energy (MeV)

53-I -138

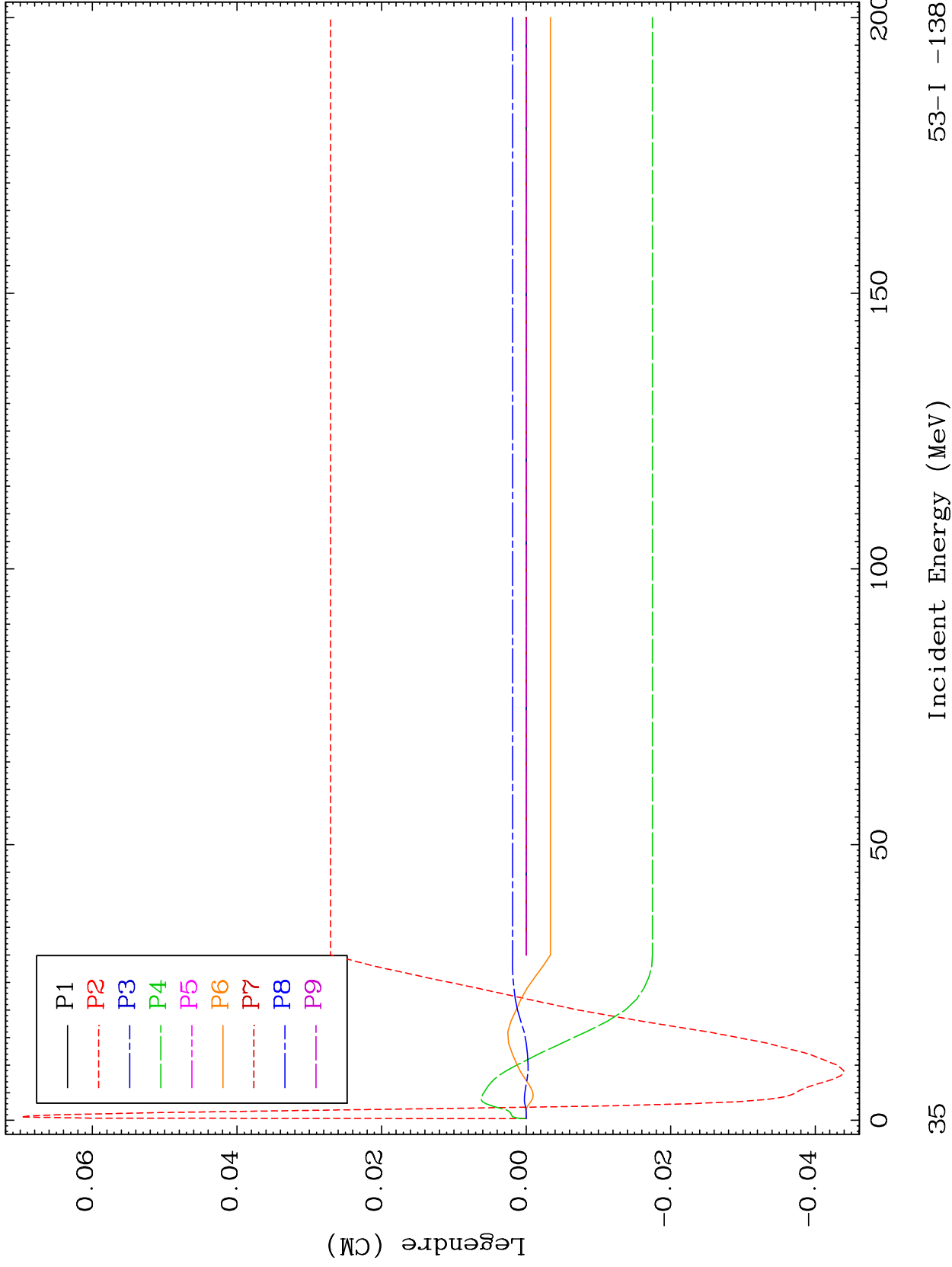

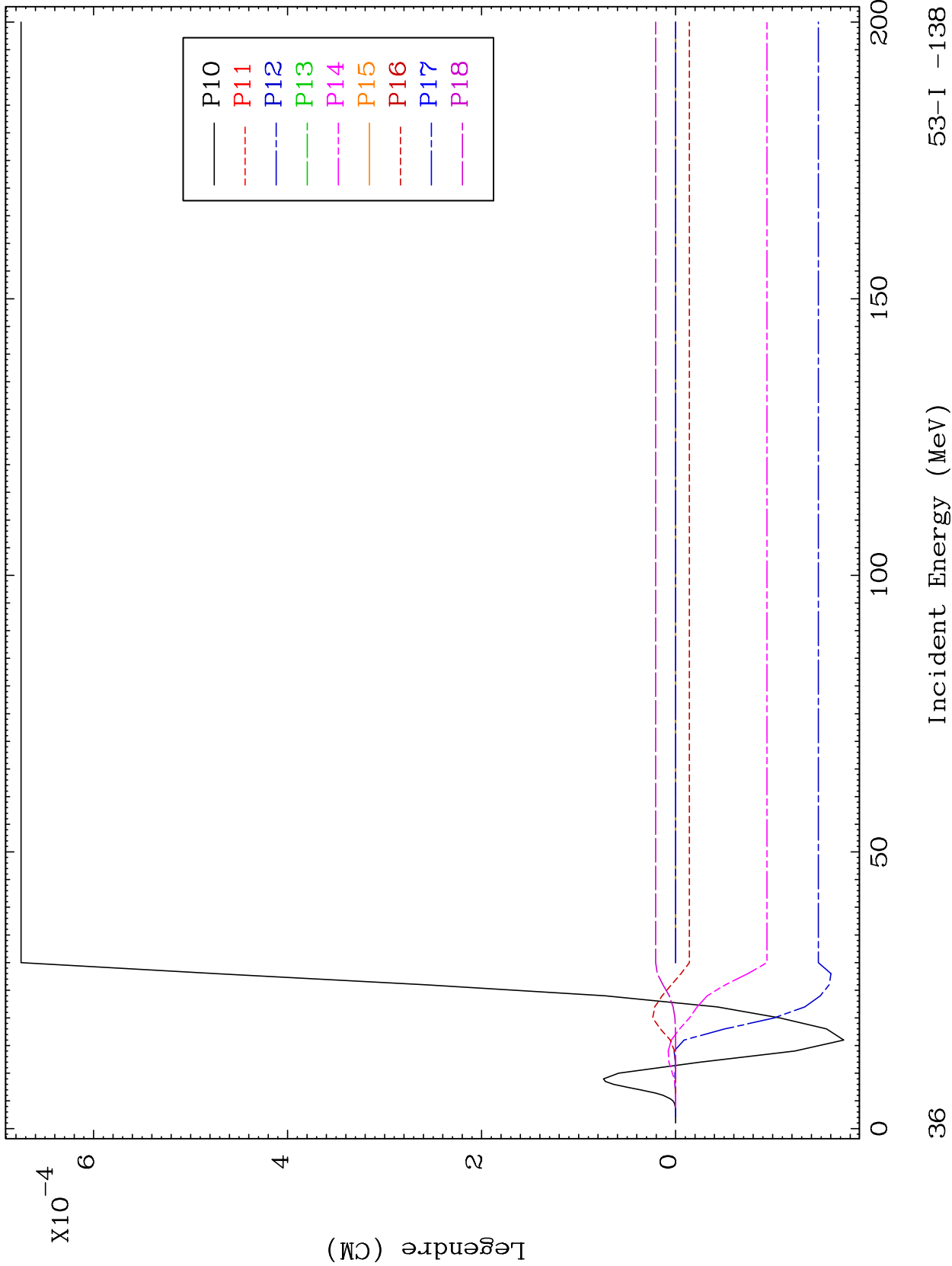

MAT 5358

MT= 55 (n,n') Level
Legendre Coefficients

53-I -138

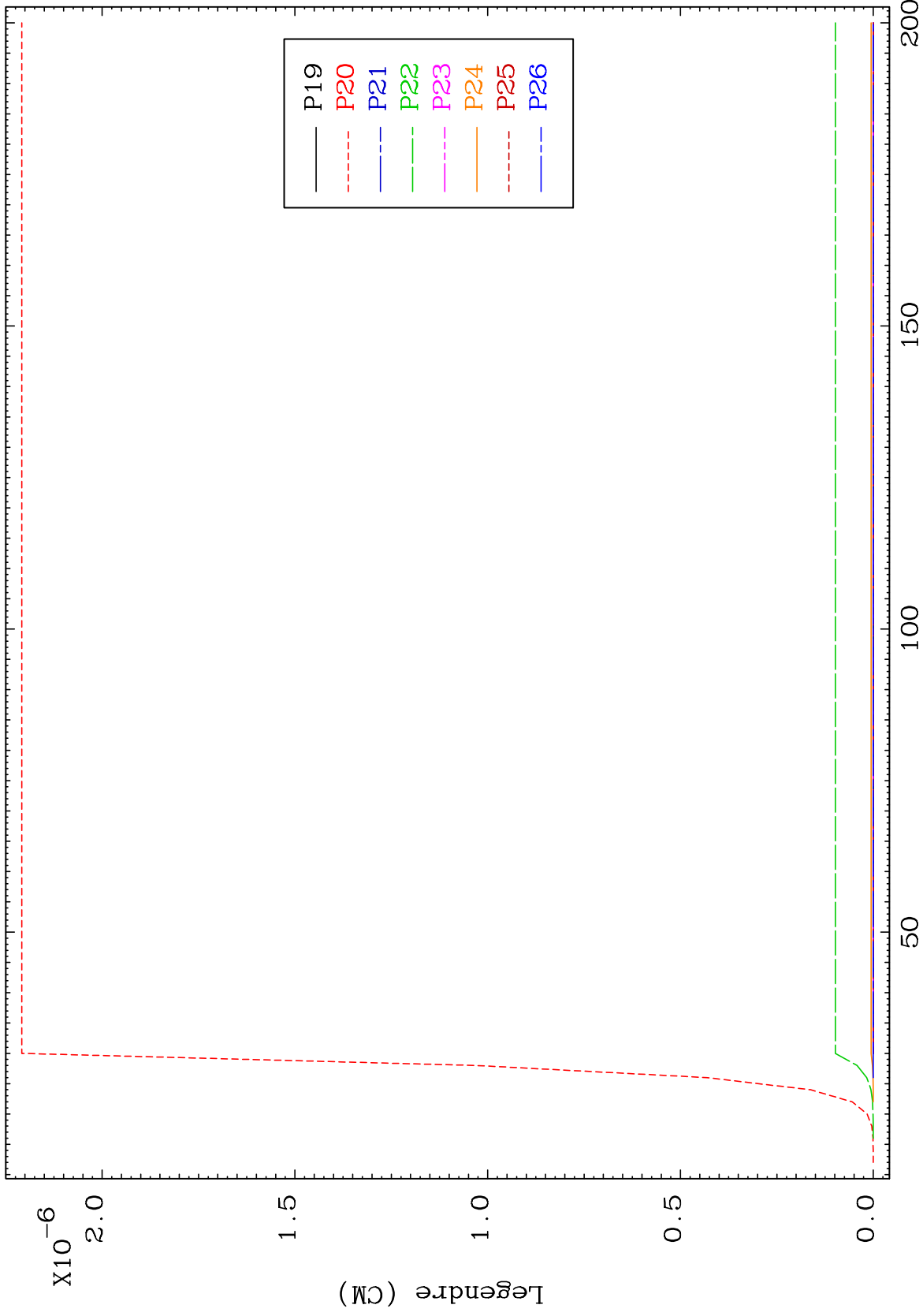

37

Incident Energy (MeV)

53-I -138

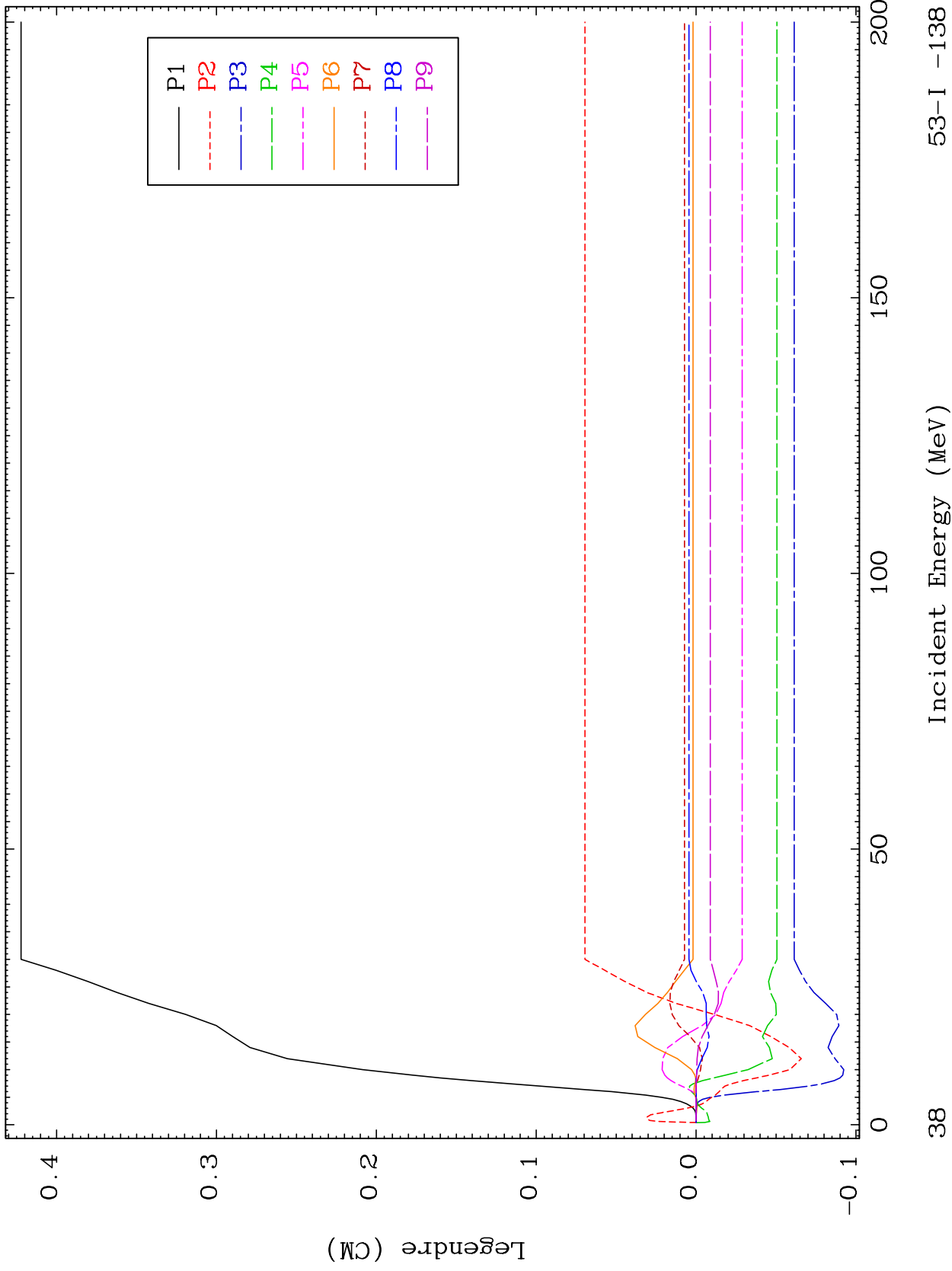

MAT 5358

MT= 56 (n,n') Level
Legendre Coefficients

53-I -138

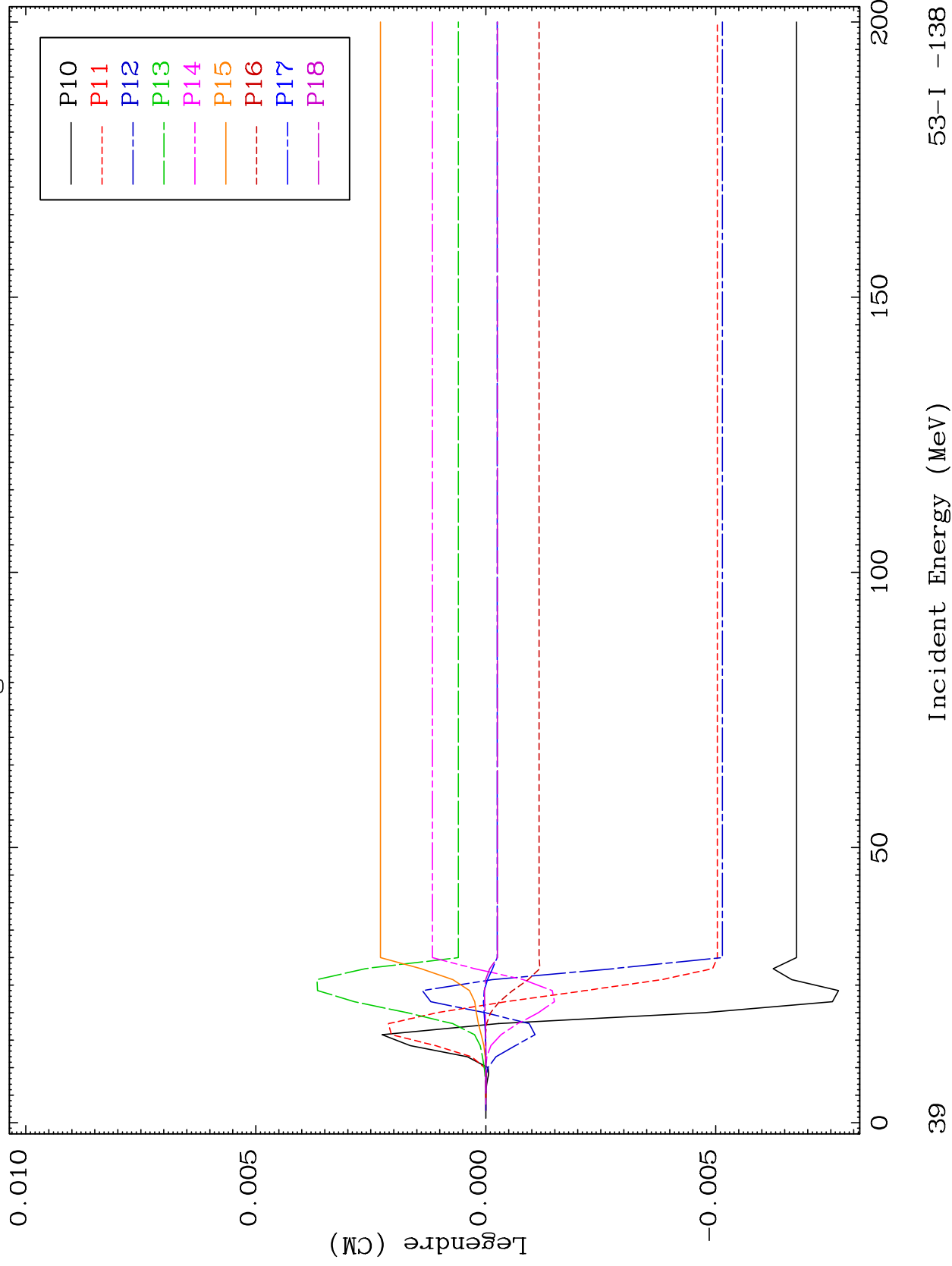

MAT 5358

MT= 56 (n,n') Level
Legendre Coefficients

53-I -138

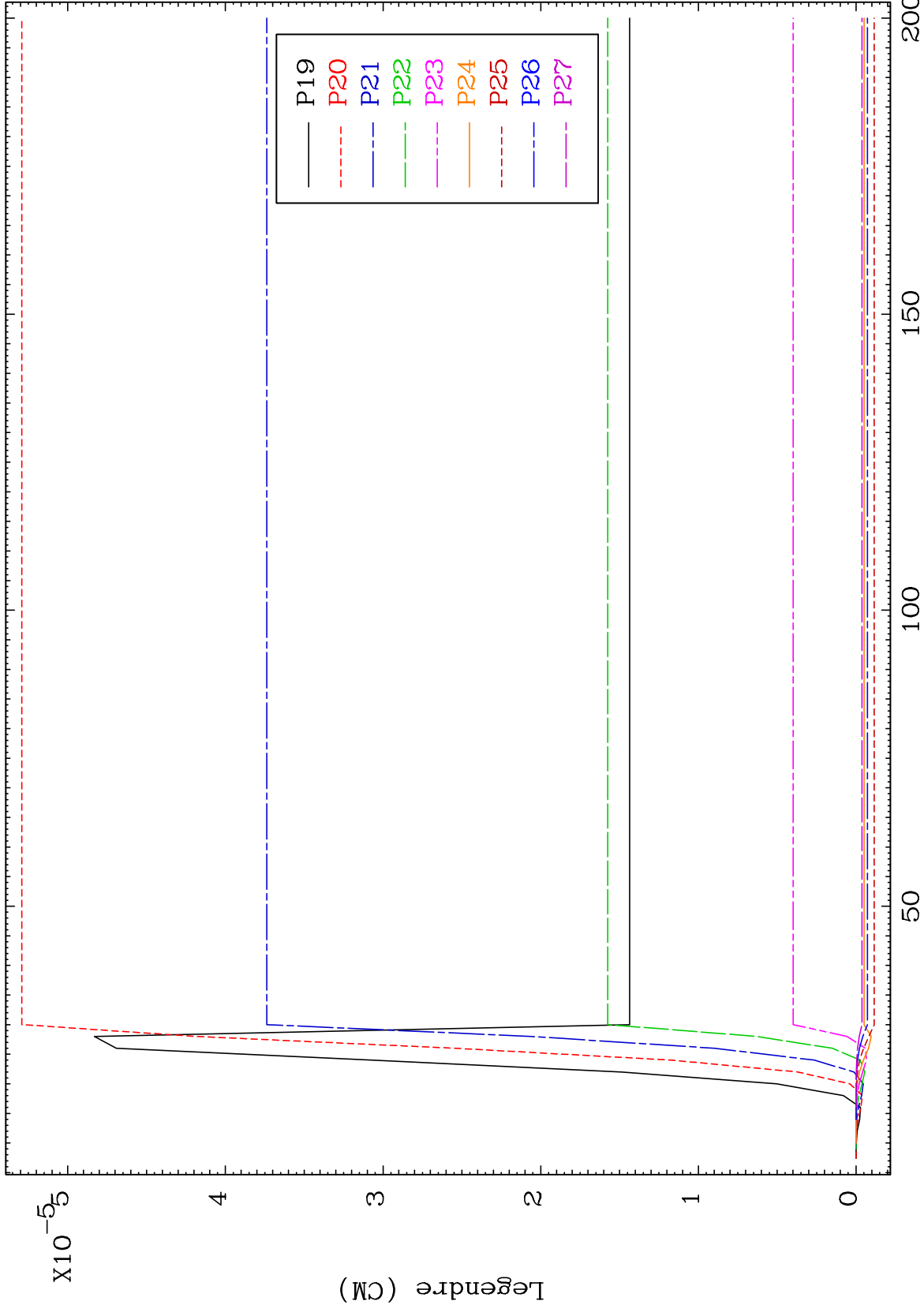

40

Incident Energy (MeV)

53-I -138

Legendre Coefficients

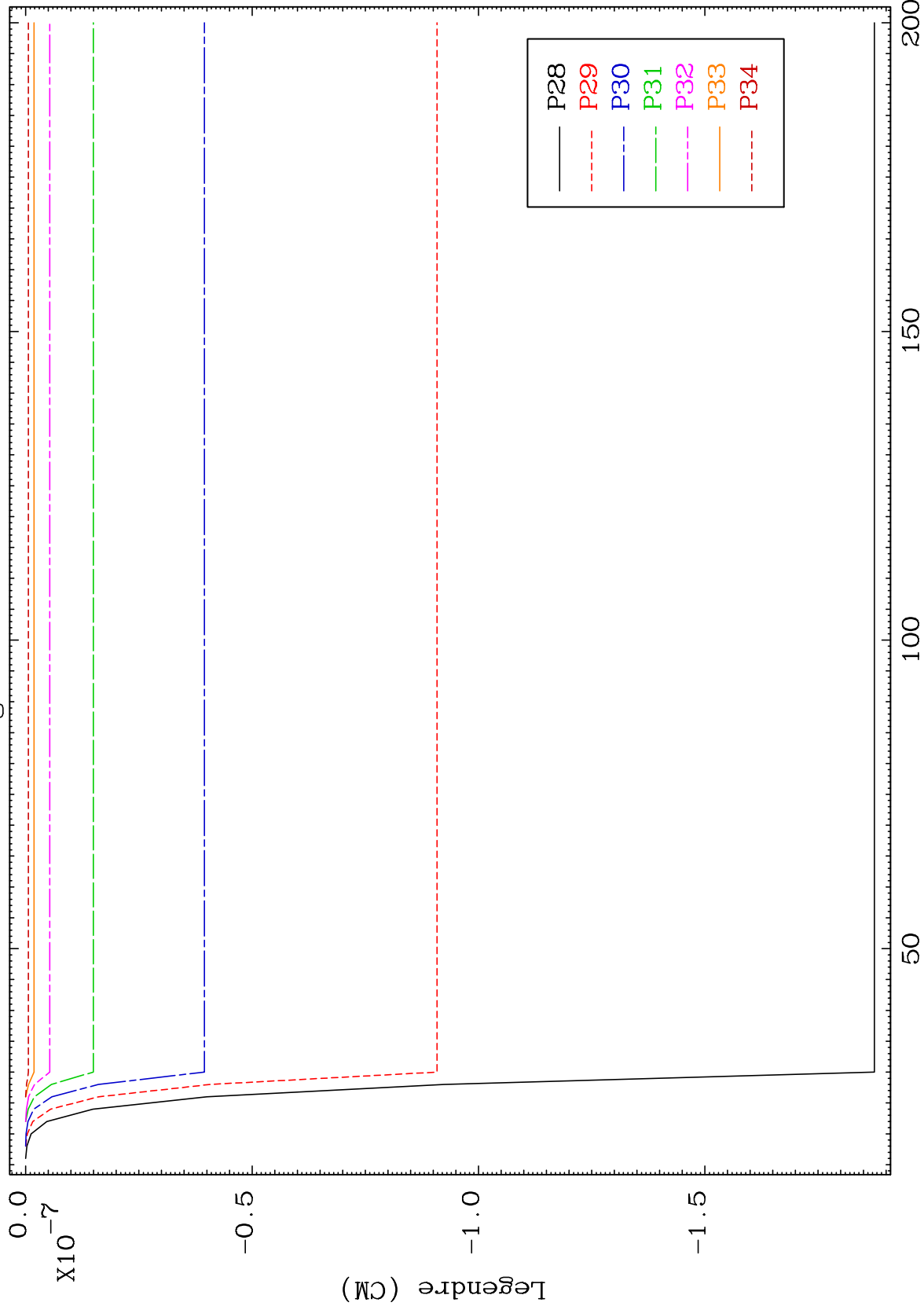

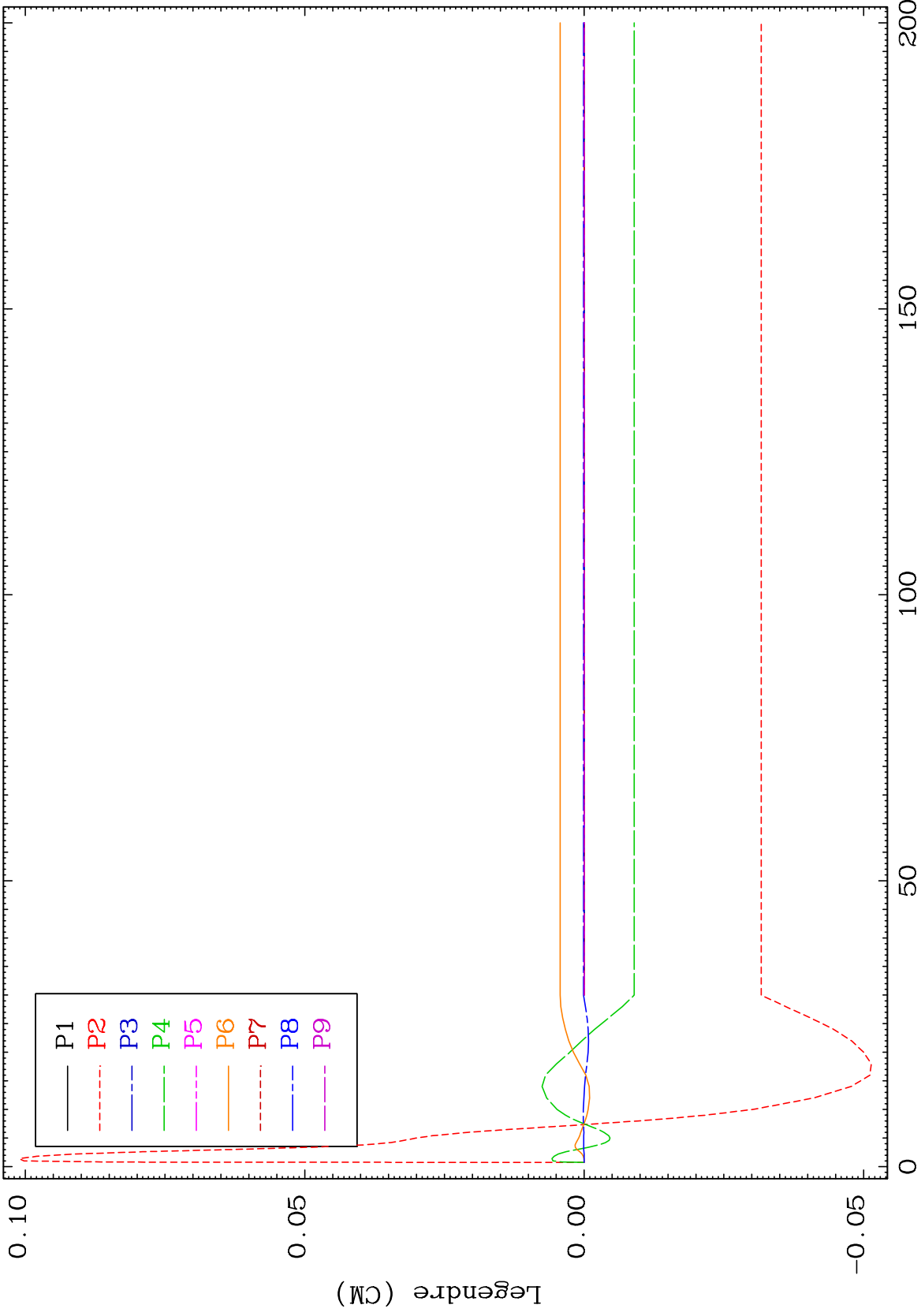

MAT 5358

MT= 57 (n,n') Level
Legendre Coefficients

53-I -138

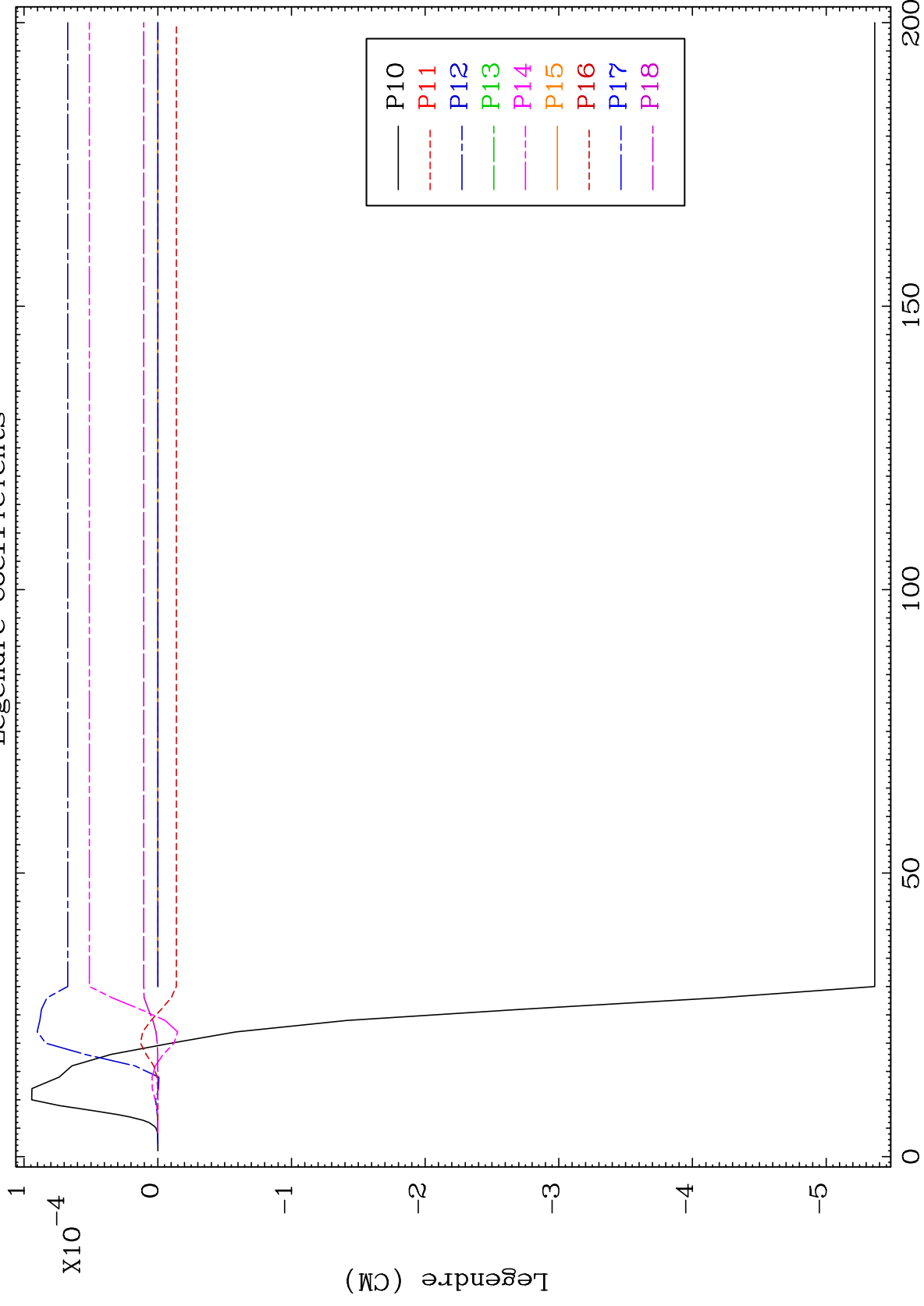

43

Incident Energy (MeV)

53-I -138

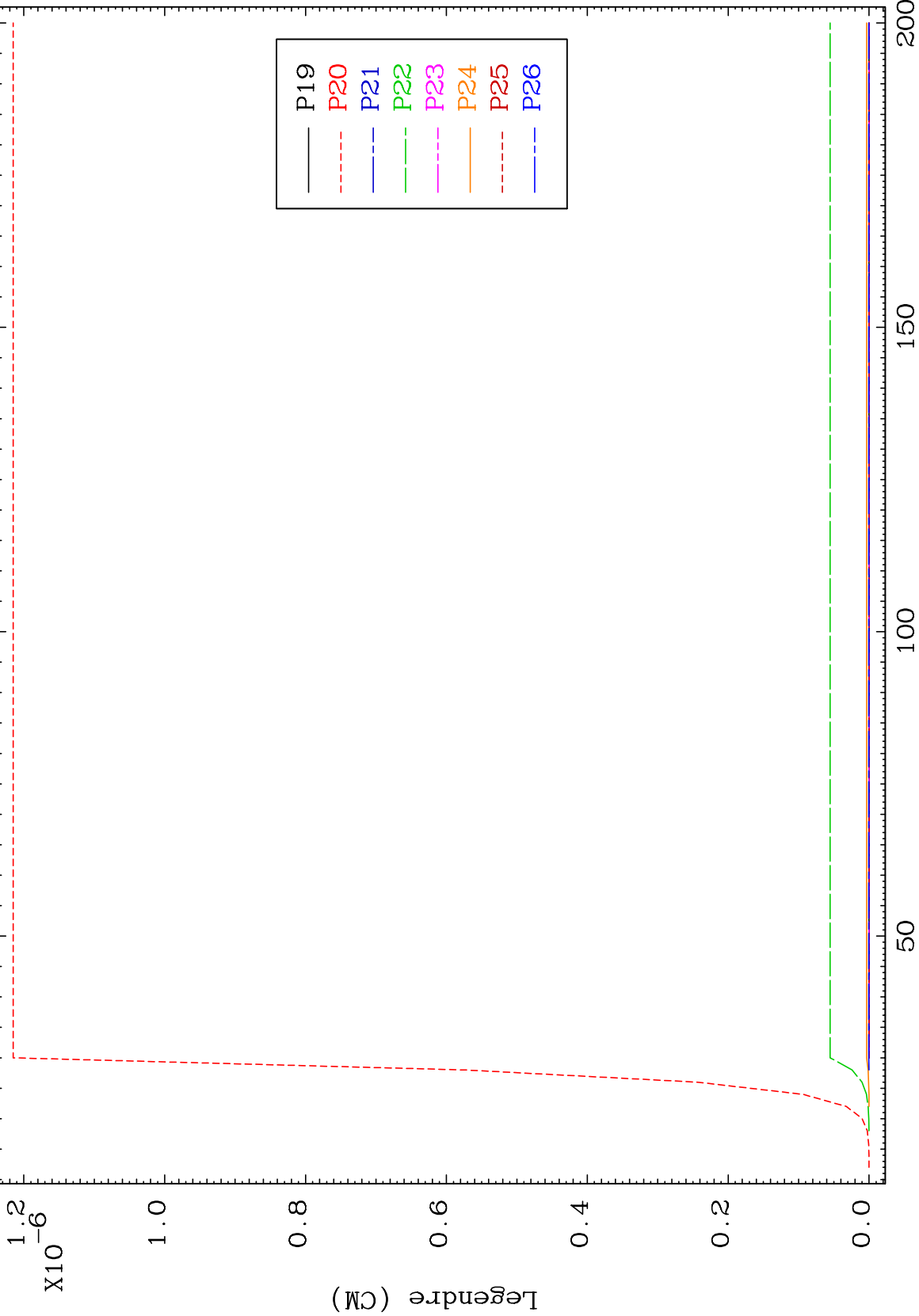

MAT 5358

MT= 58 (n,n') Level
Legendre Coefficients

53-I -138

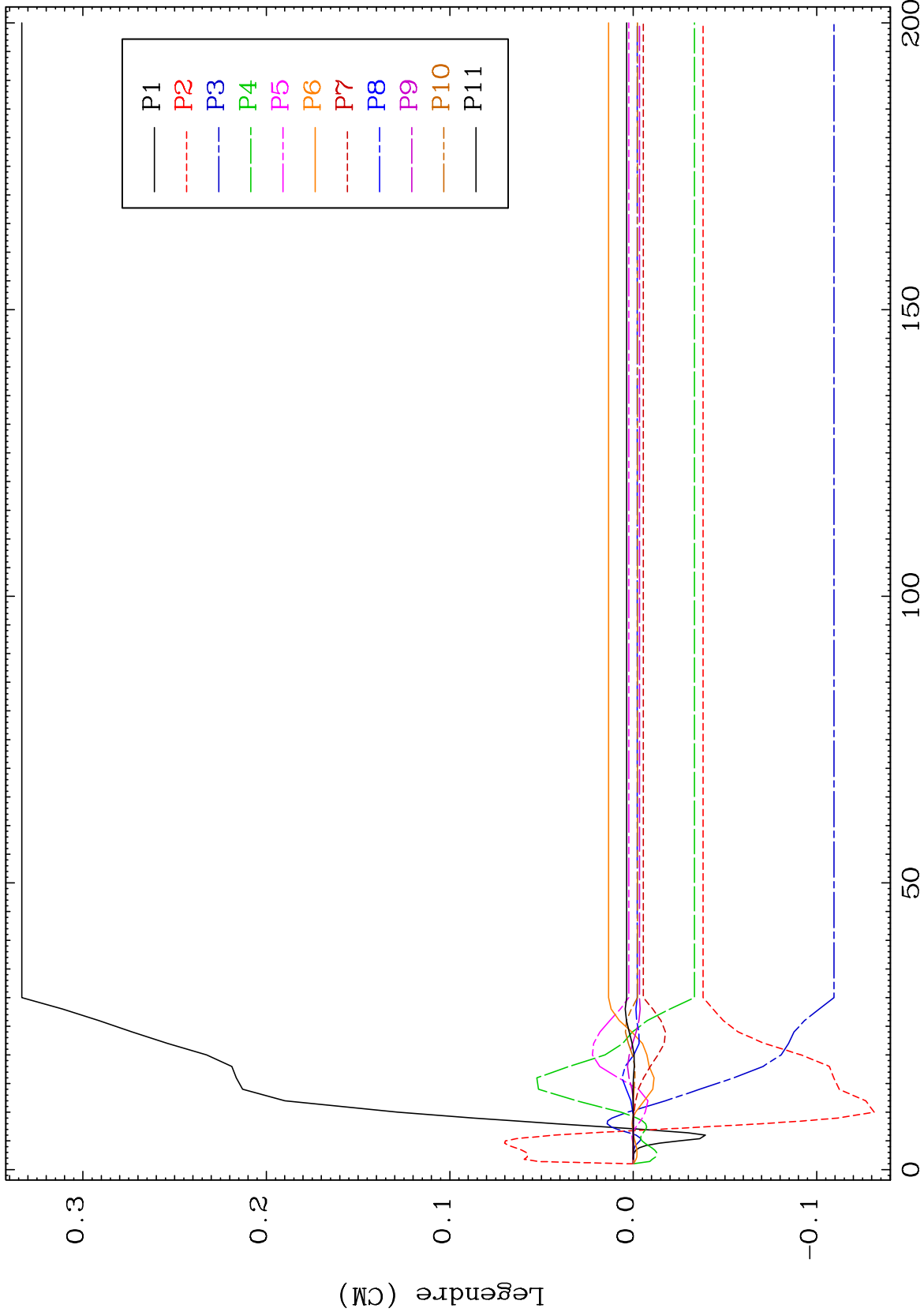

53-I -138

Incident Energy (MeV)

45

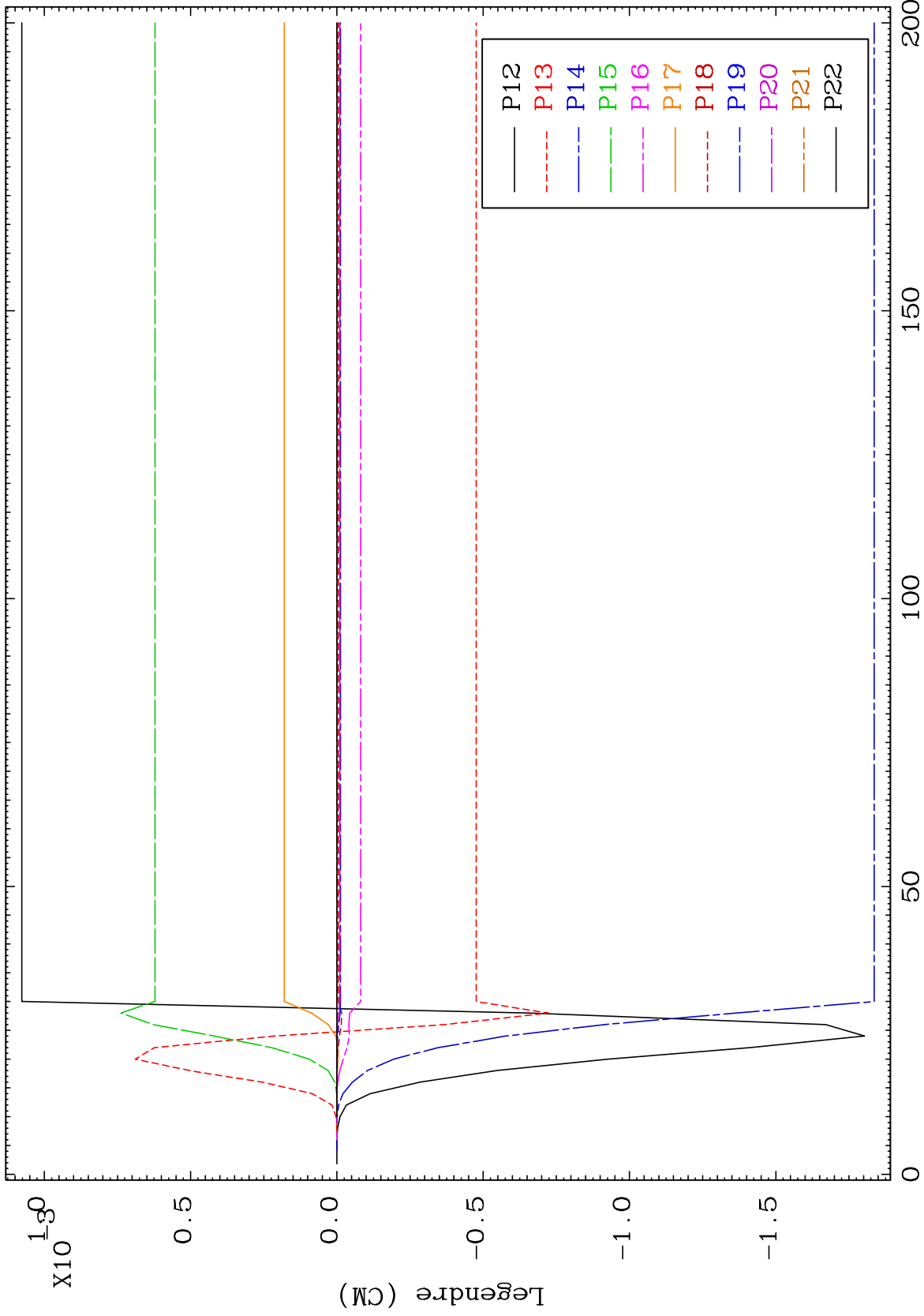

MAT 5358

MT= 58 (n,n') Level
Legendre Coefficients

53-I -138

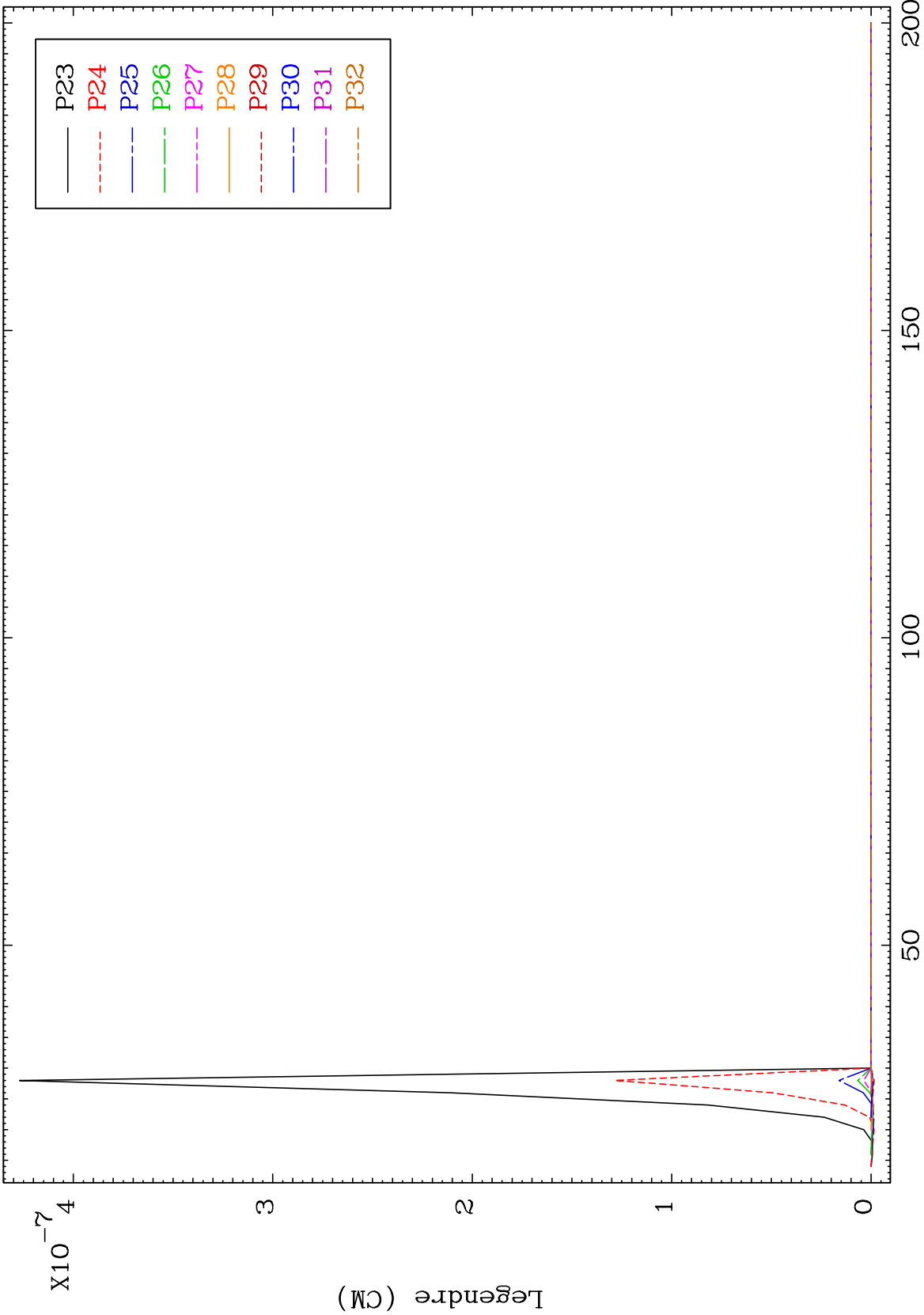

47

Incident Energy (MeV)

53-I -138

MAT 5358

MT= 59 (n,n') Level
Legendre Coefficients

53-I -138

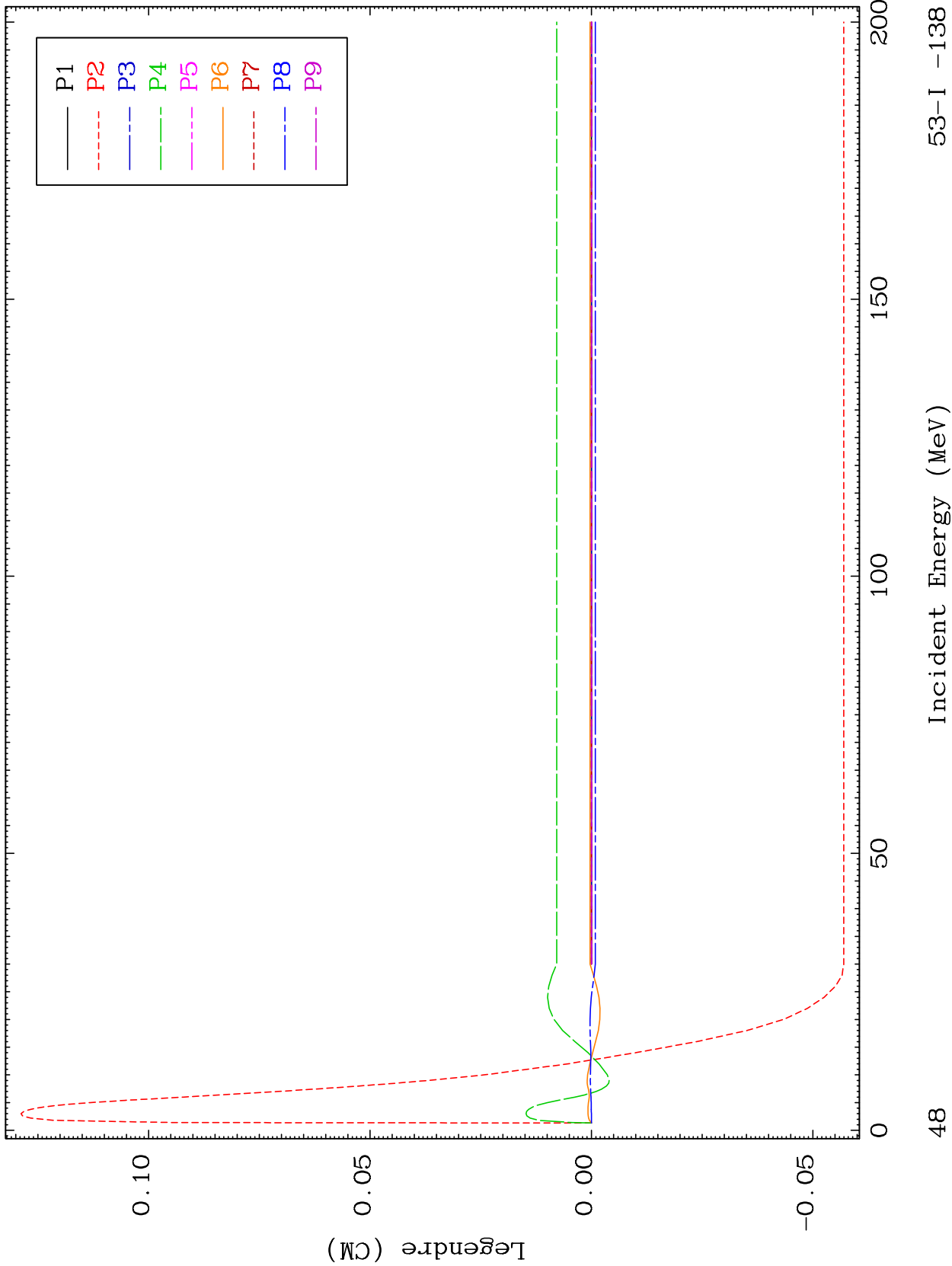

53-I -138

Incident Energy (MeV)

48

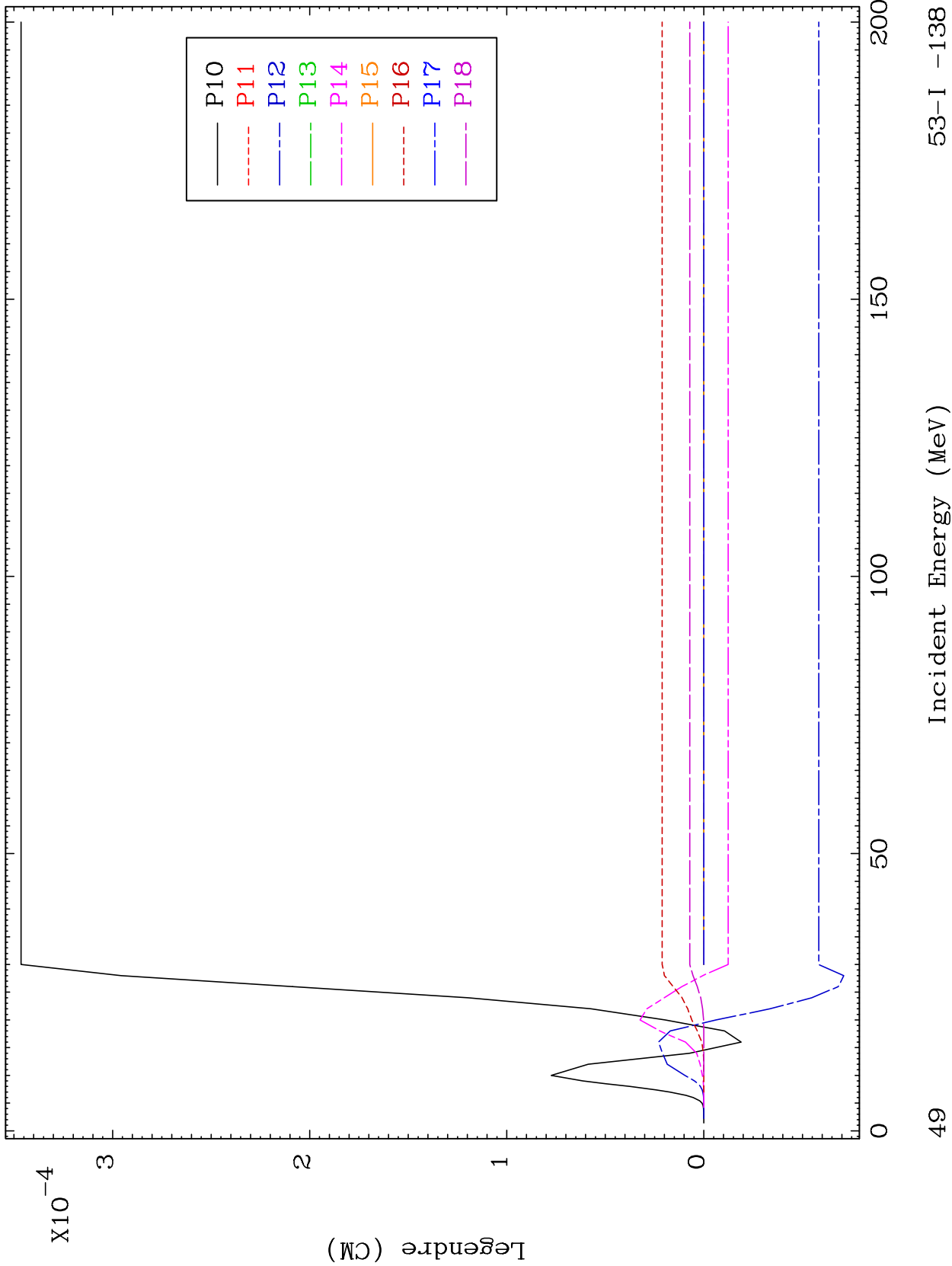

MAT 5358

MT= 59 (n,n') Level
Legendre Coefficients

53-I -138

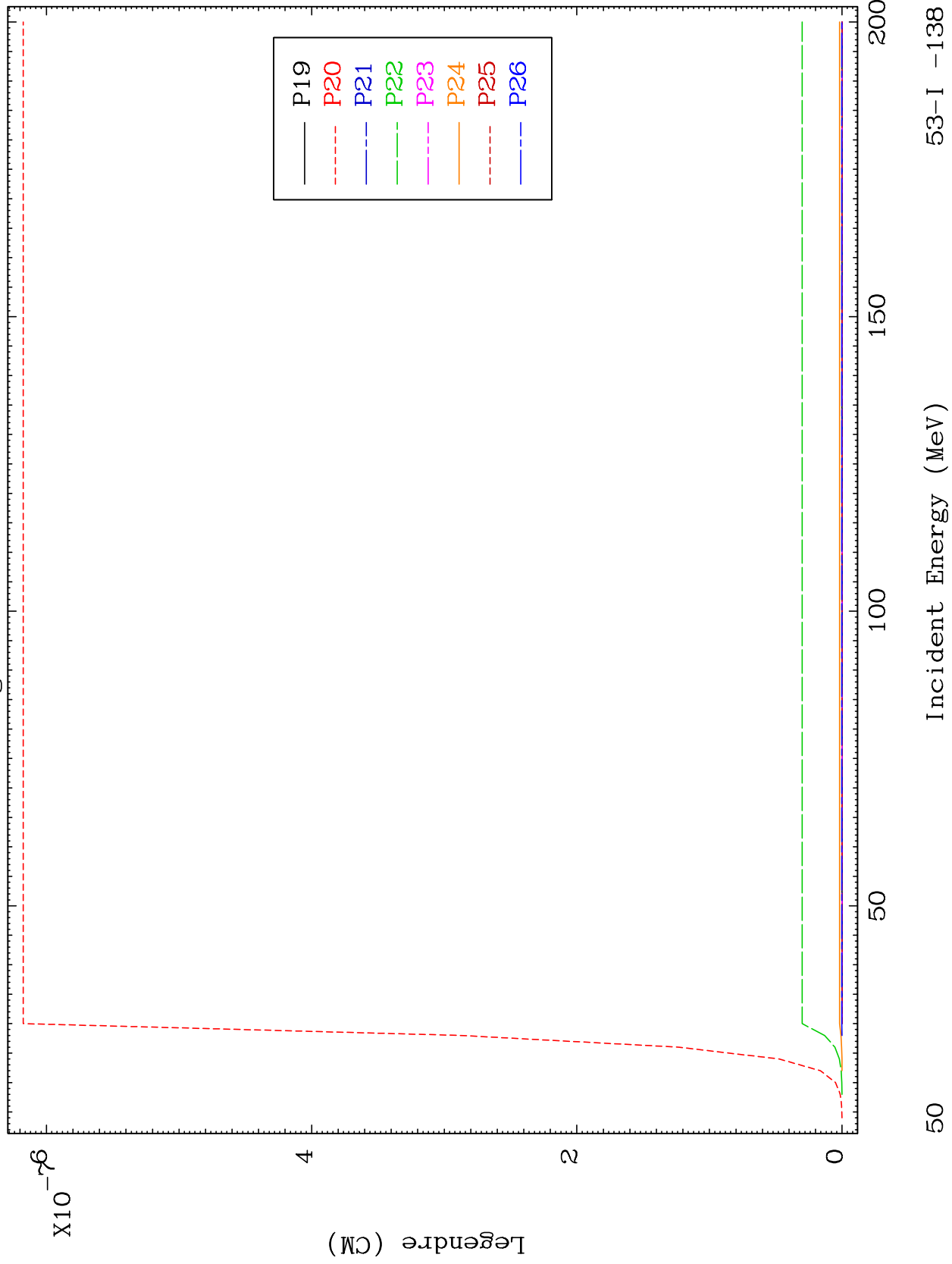

53-I -138

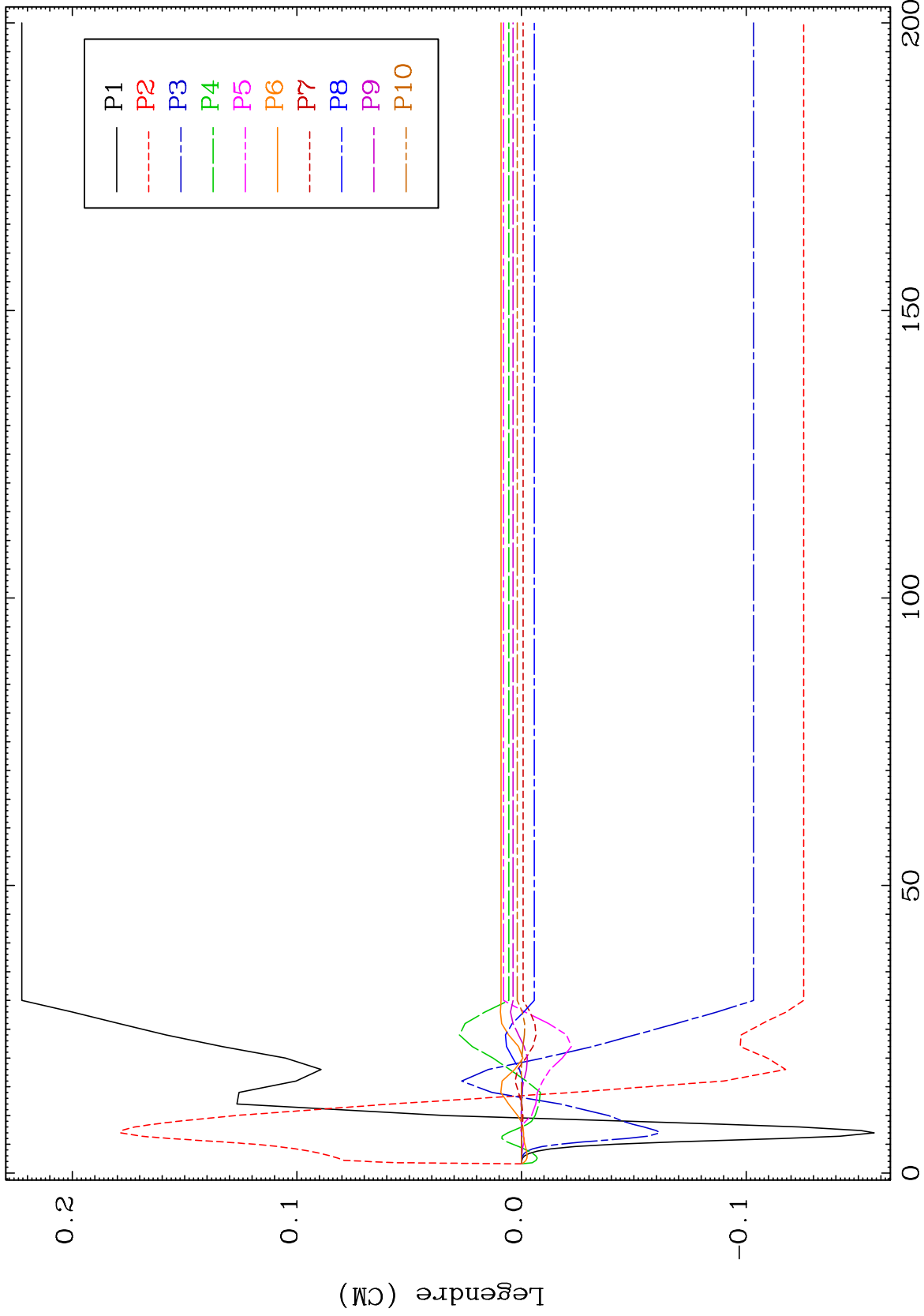

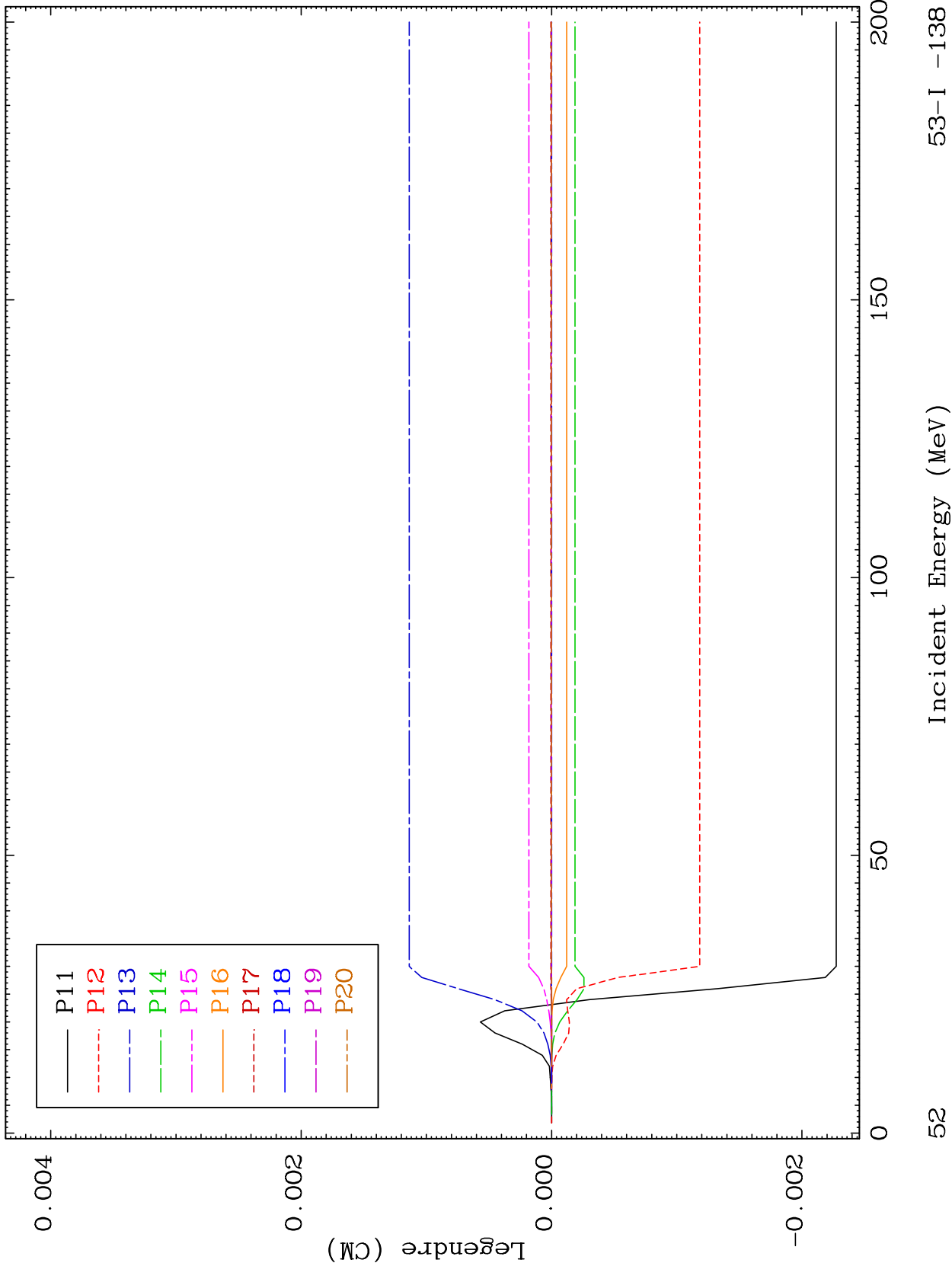

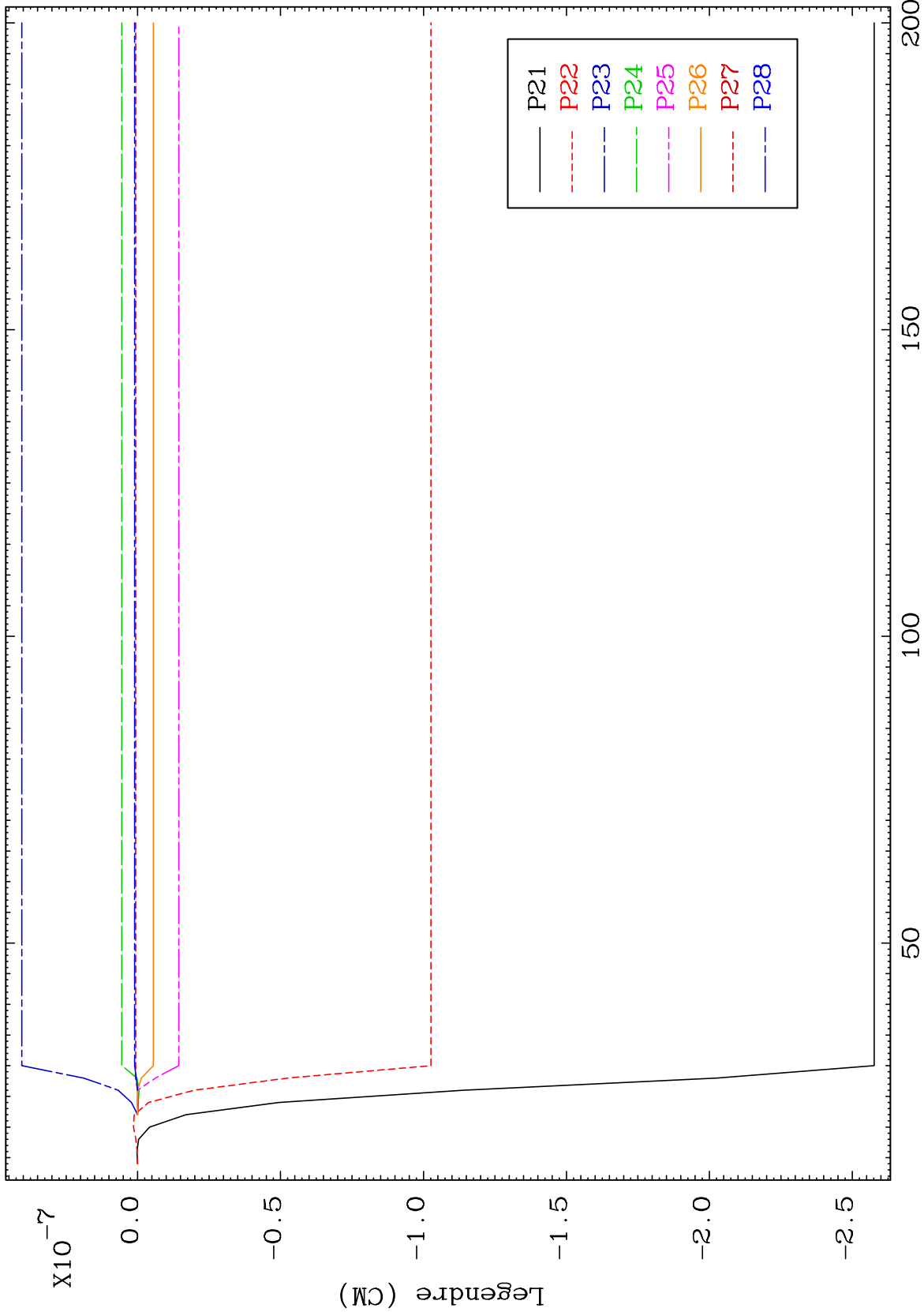

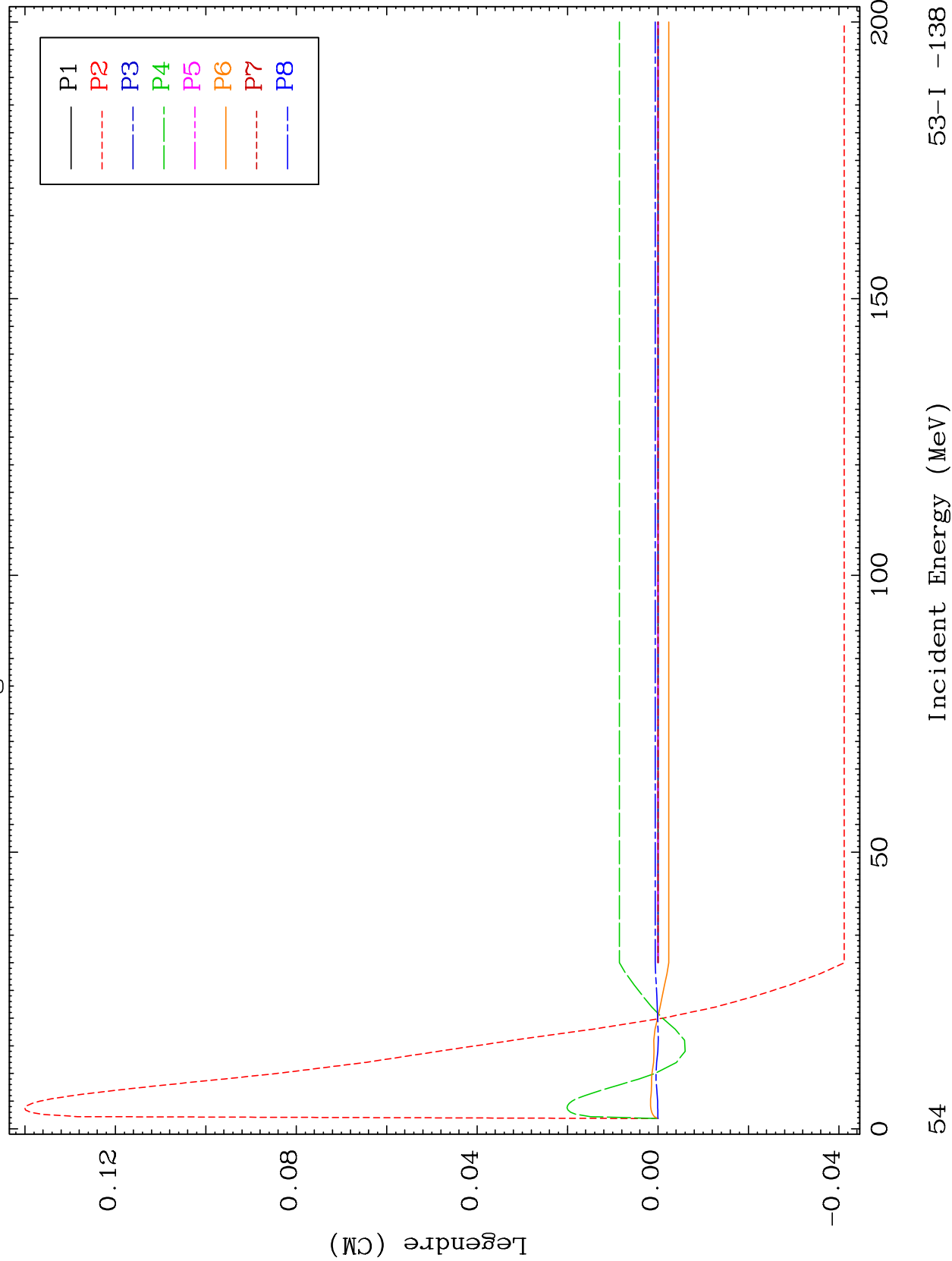

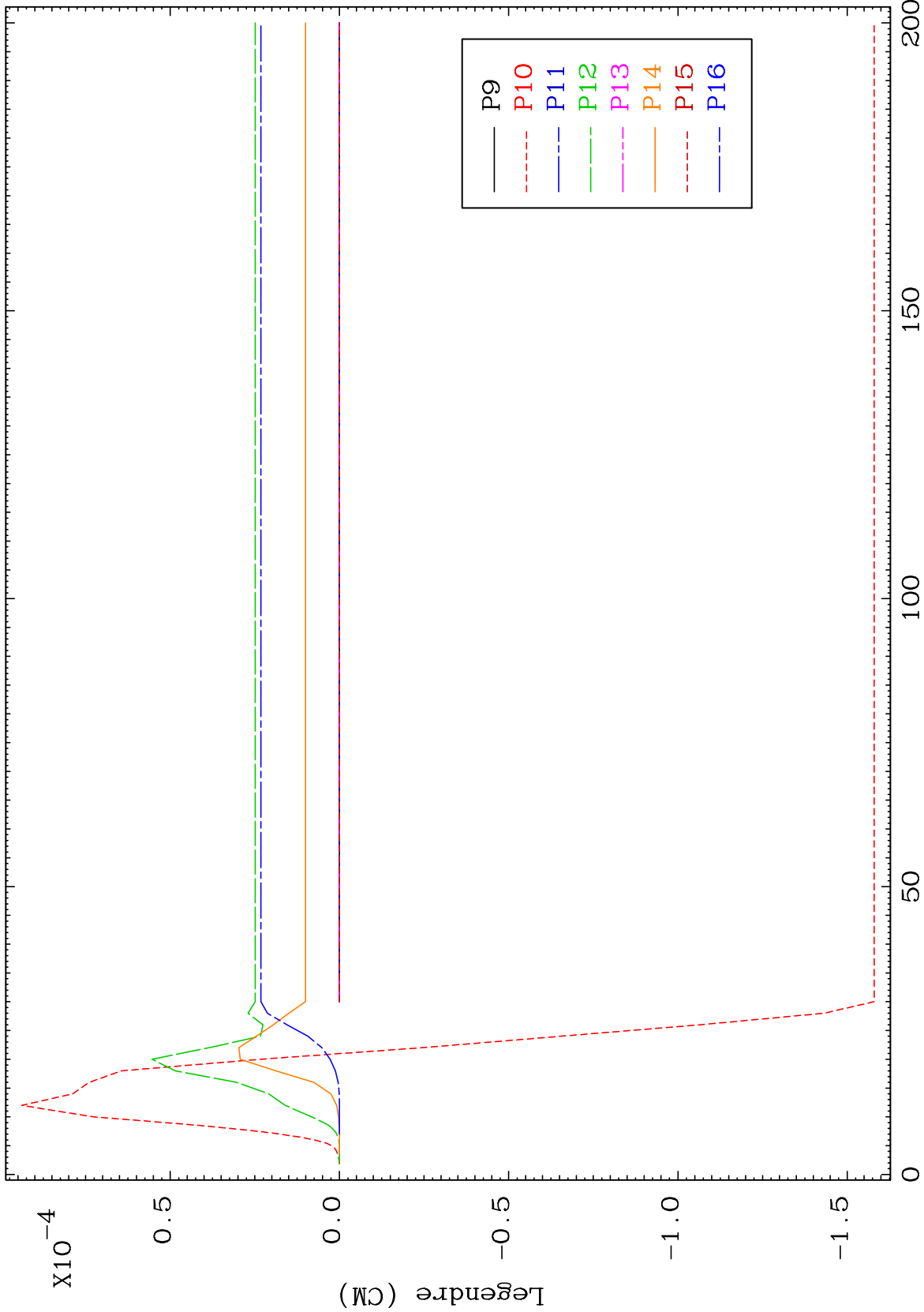

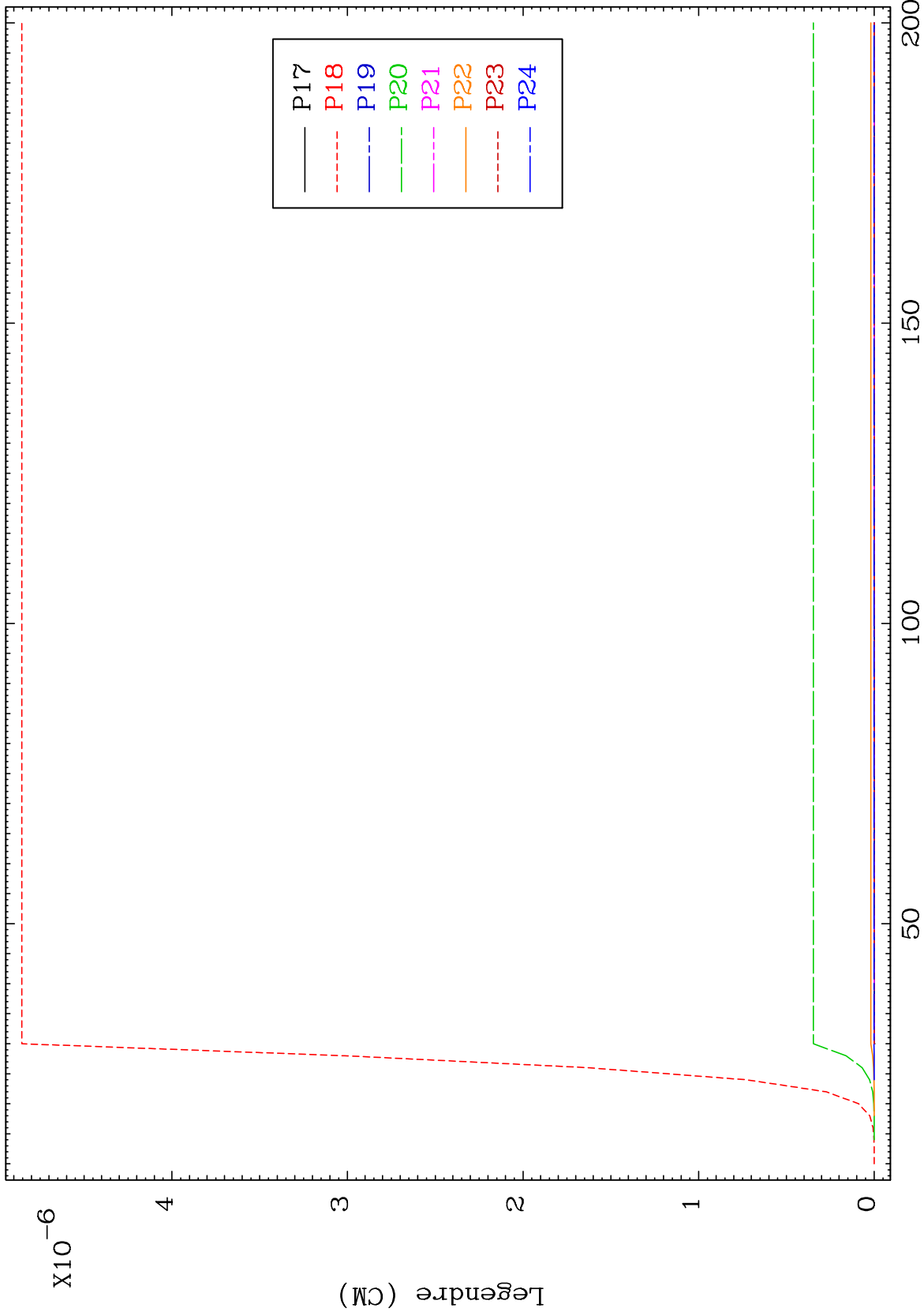

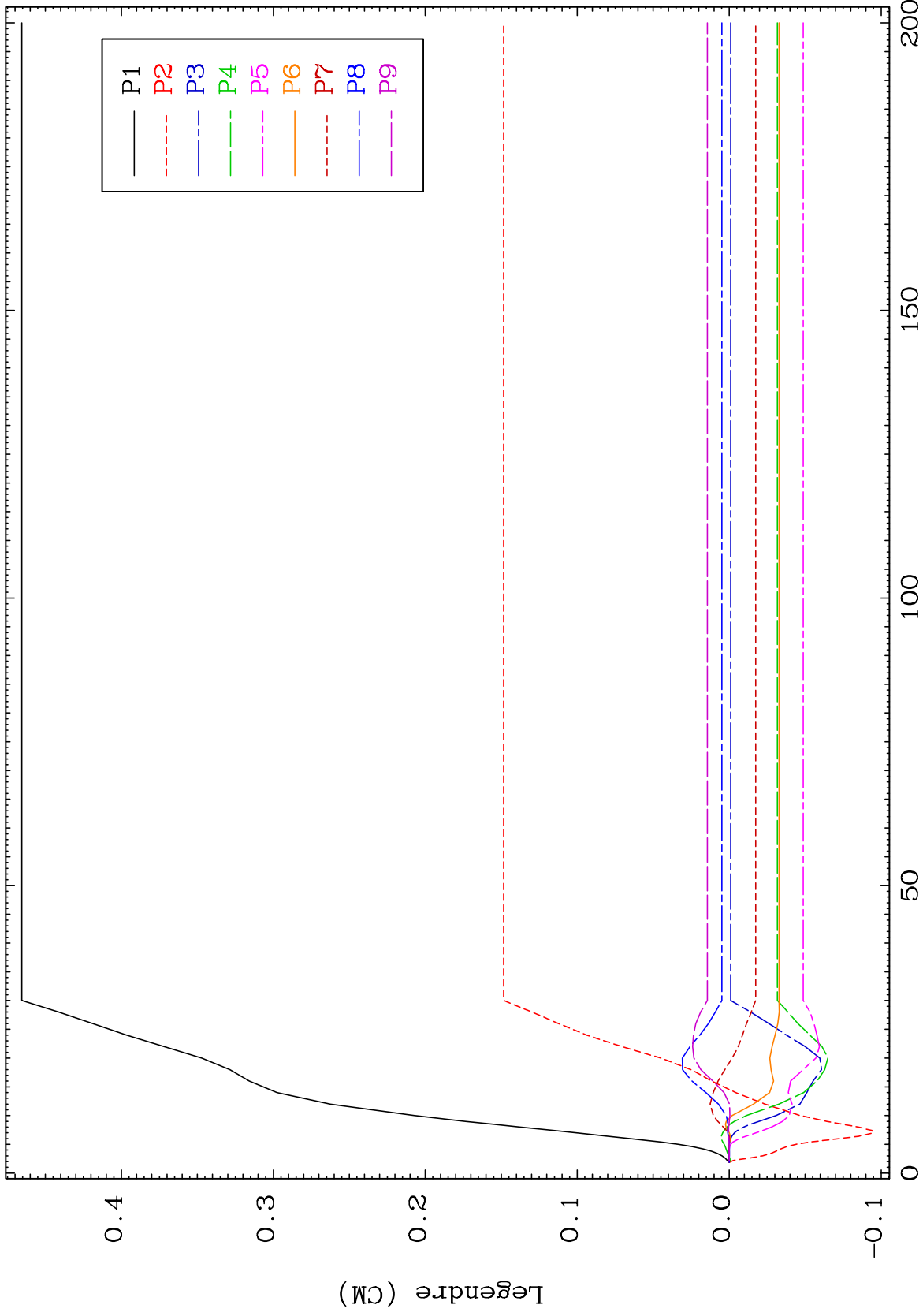

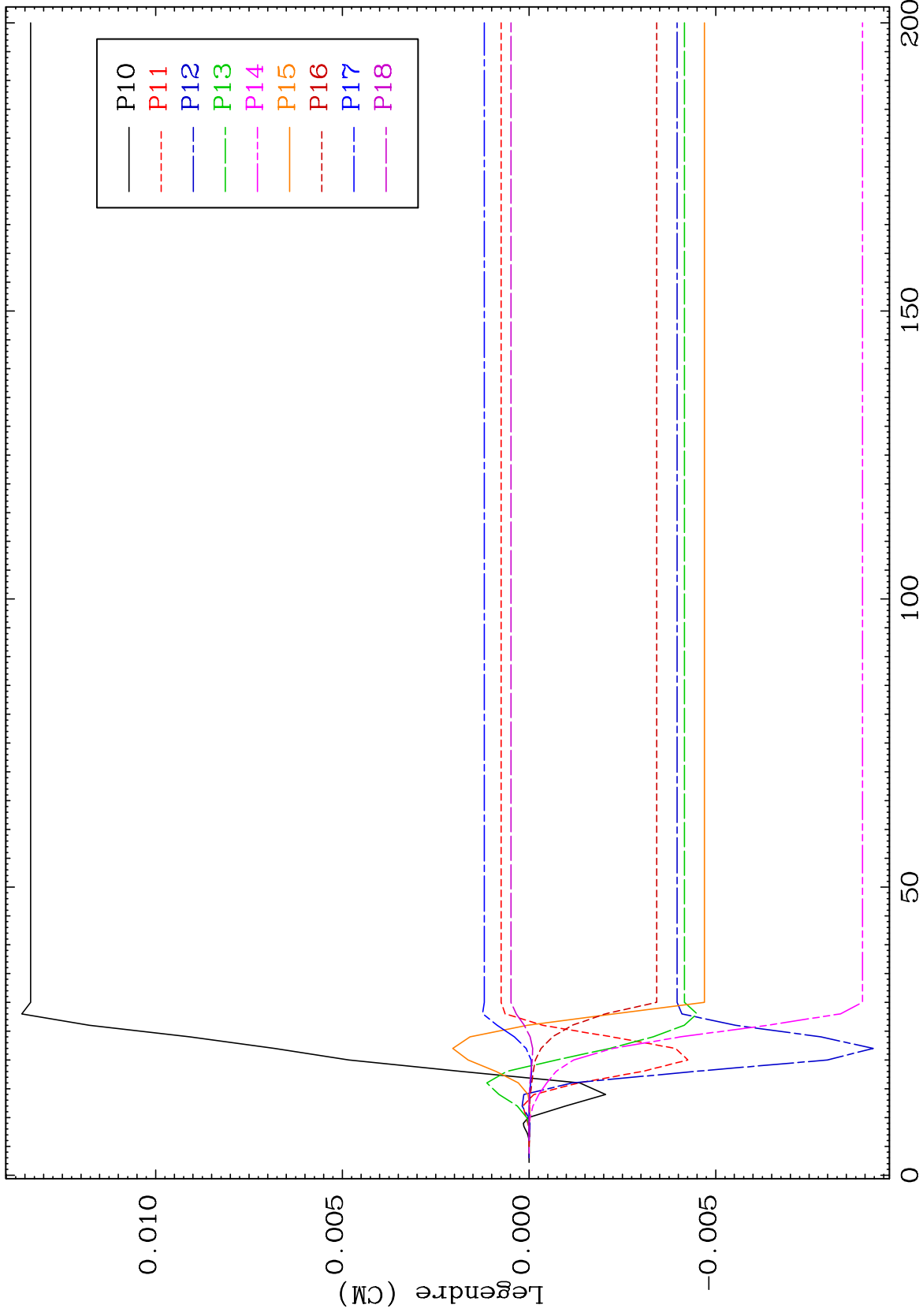

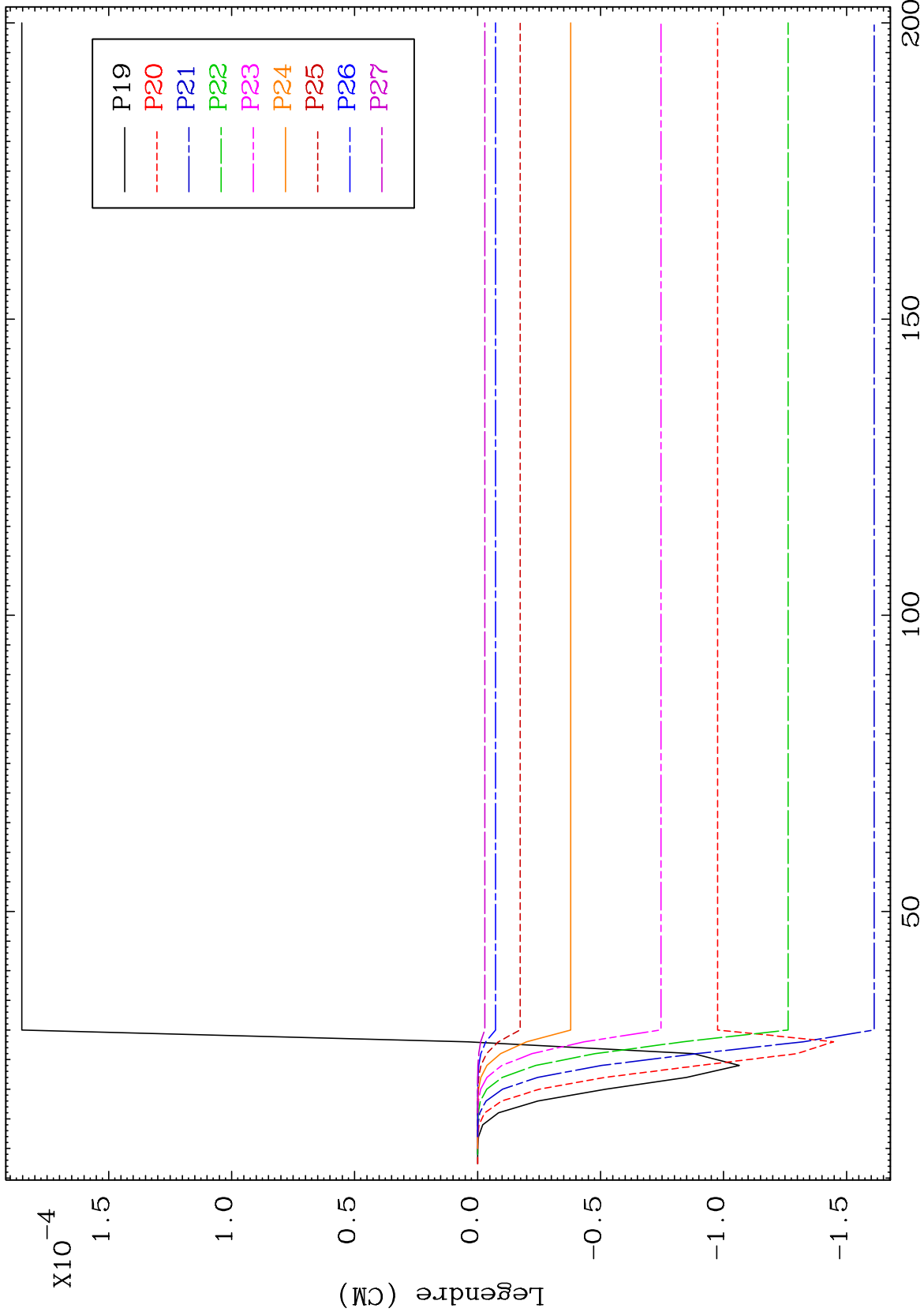

MAT 5358

MT= 62 (n,n') Level
Legendre Coefficients

53-I -138

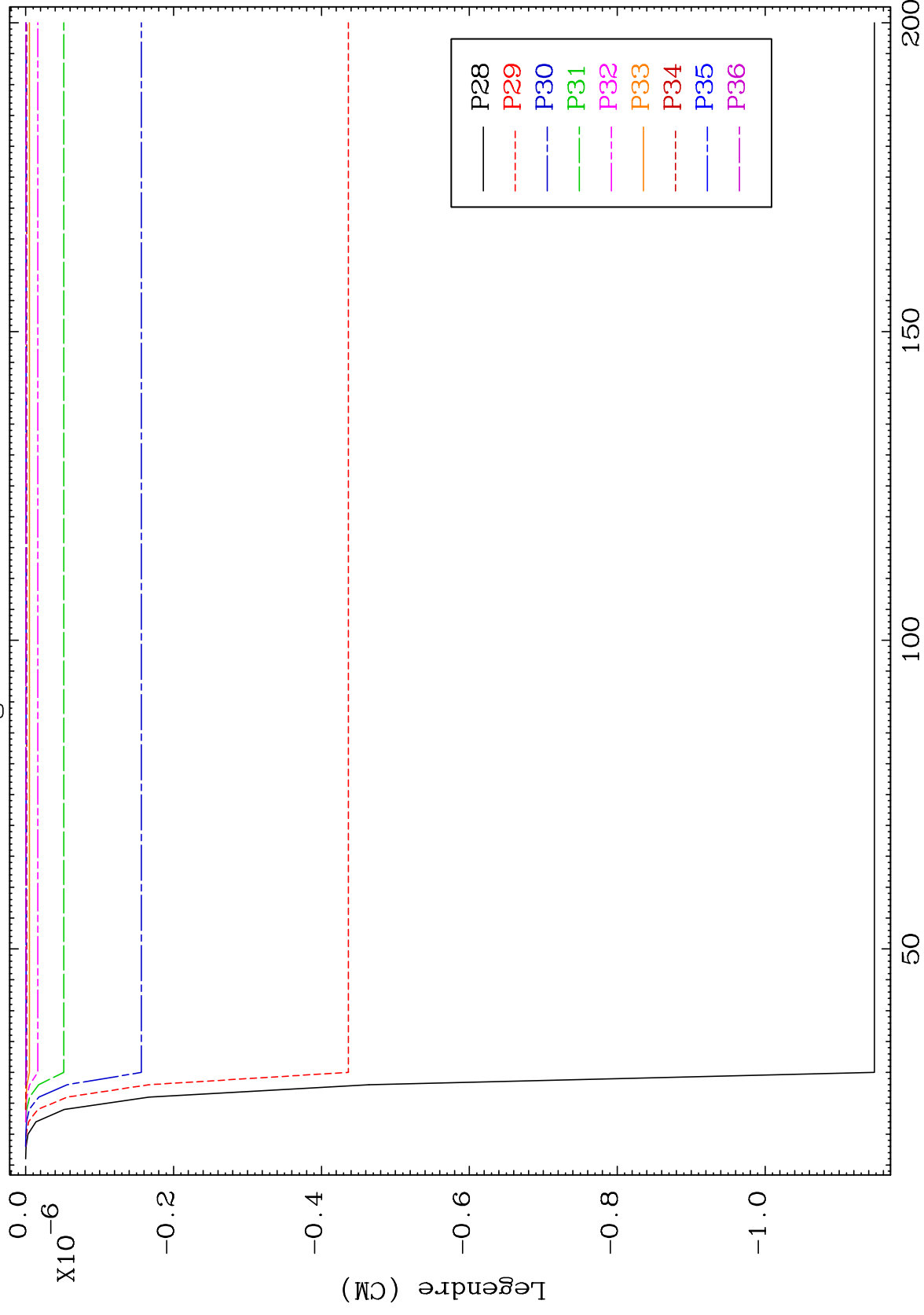

60

Incident Energy (MeV)

53-I -138

MAT 5358

MT= 63 (n,n') Level
Legendre Coefficients

53-I -138

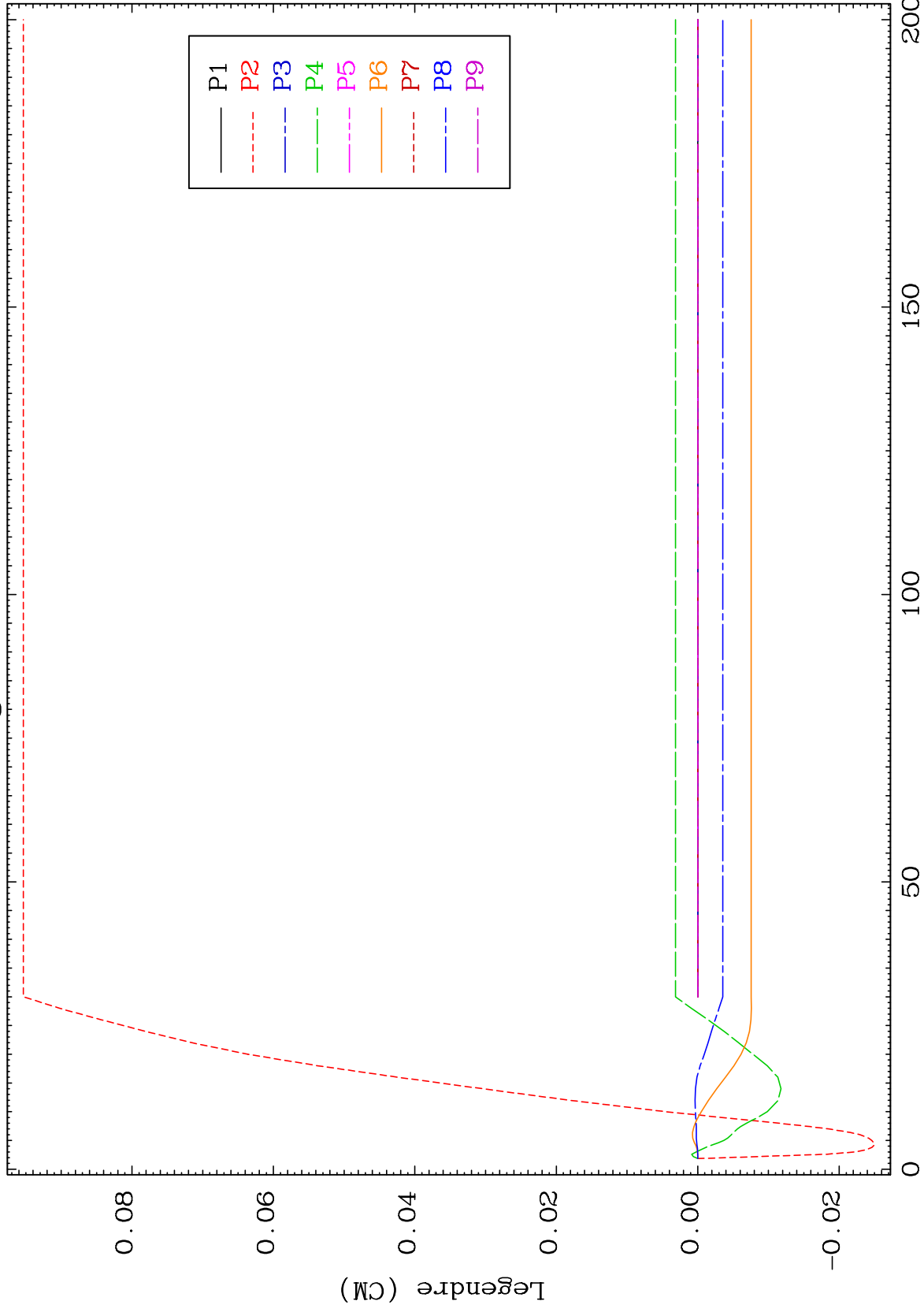

61

Incident Energy (MeV)

53-I -138

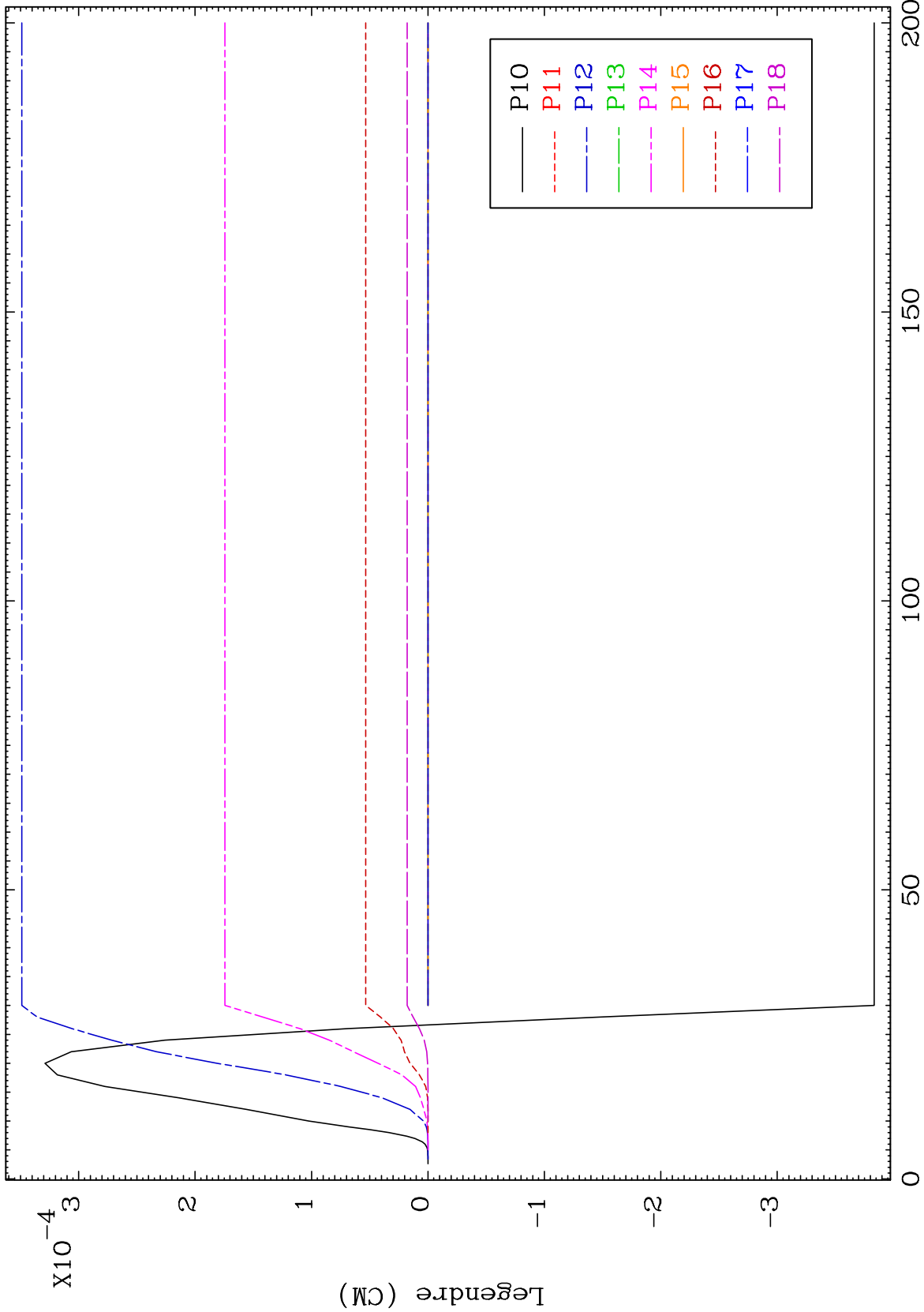

MAT 5358

MT= 63 (n,n') Level
Legendre Coefficients

53-I -138

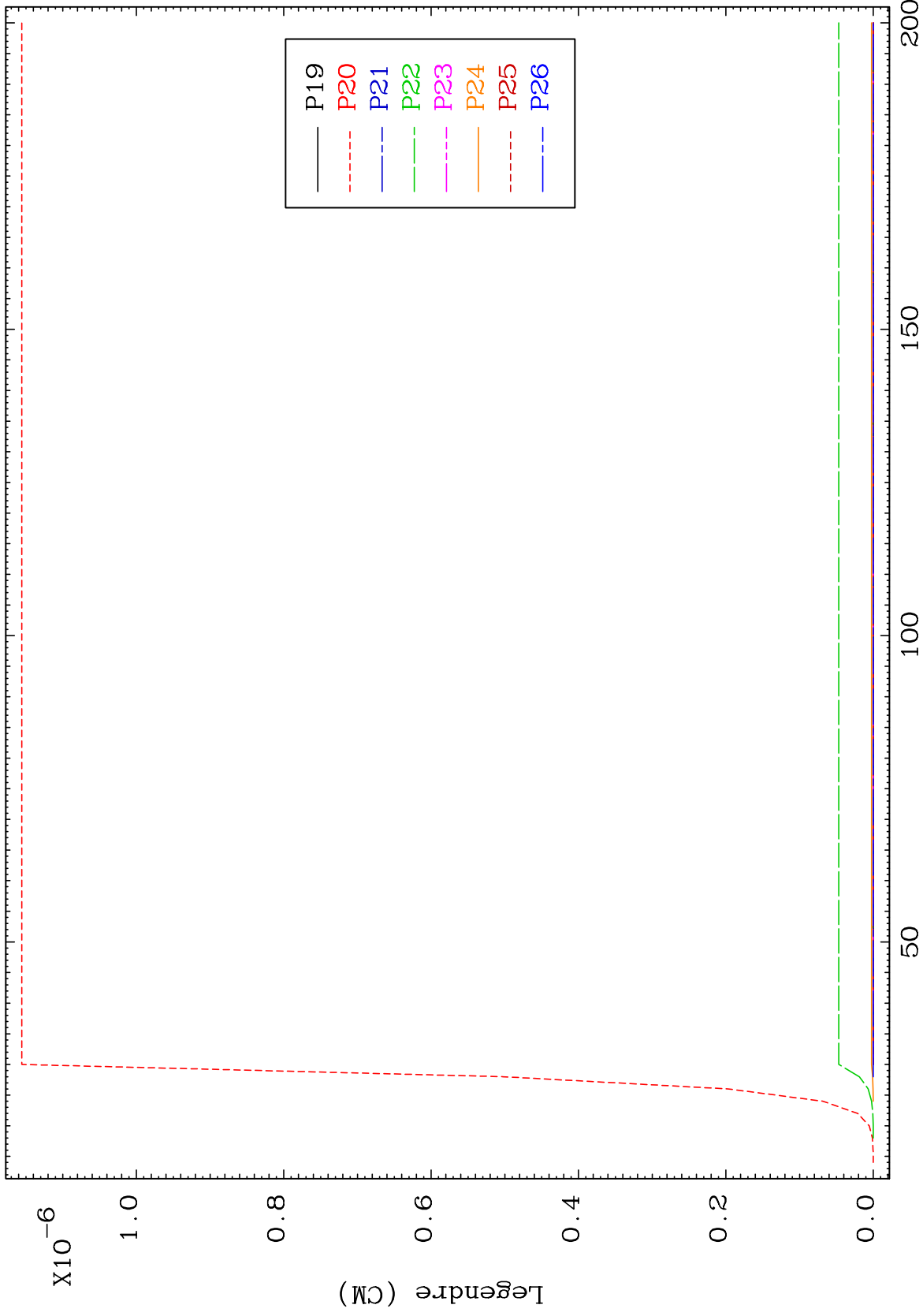

63

Incident Energy (MeV)

53-I -138

MAT 5358

MT= 64 (n,n') Level
Legendre Coefficients

53-I -138

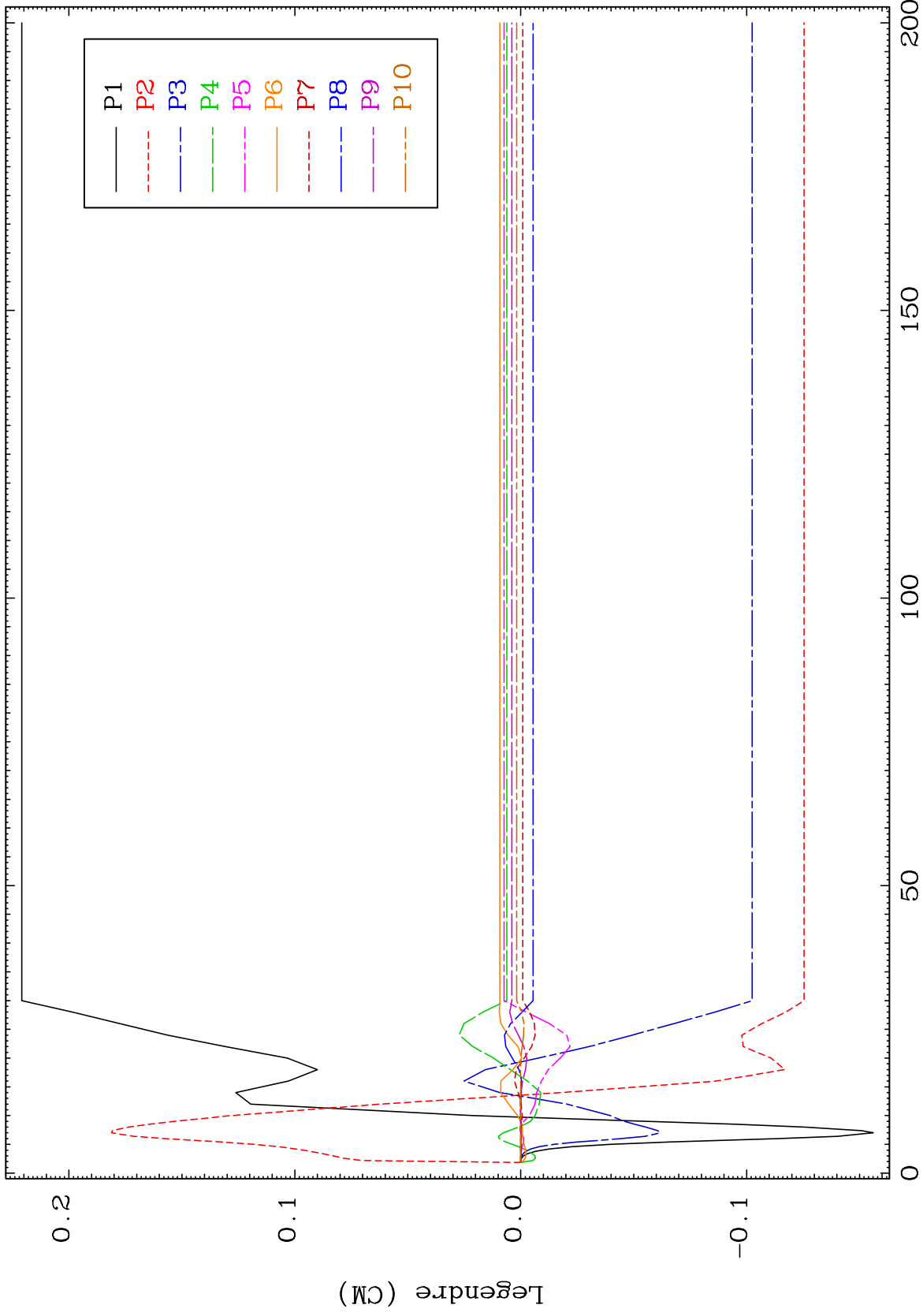

64

Incident Energy (MeV)

53-I -138

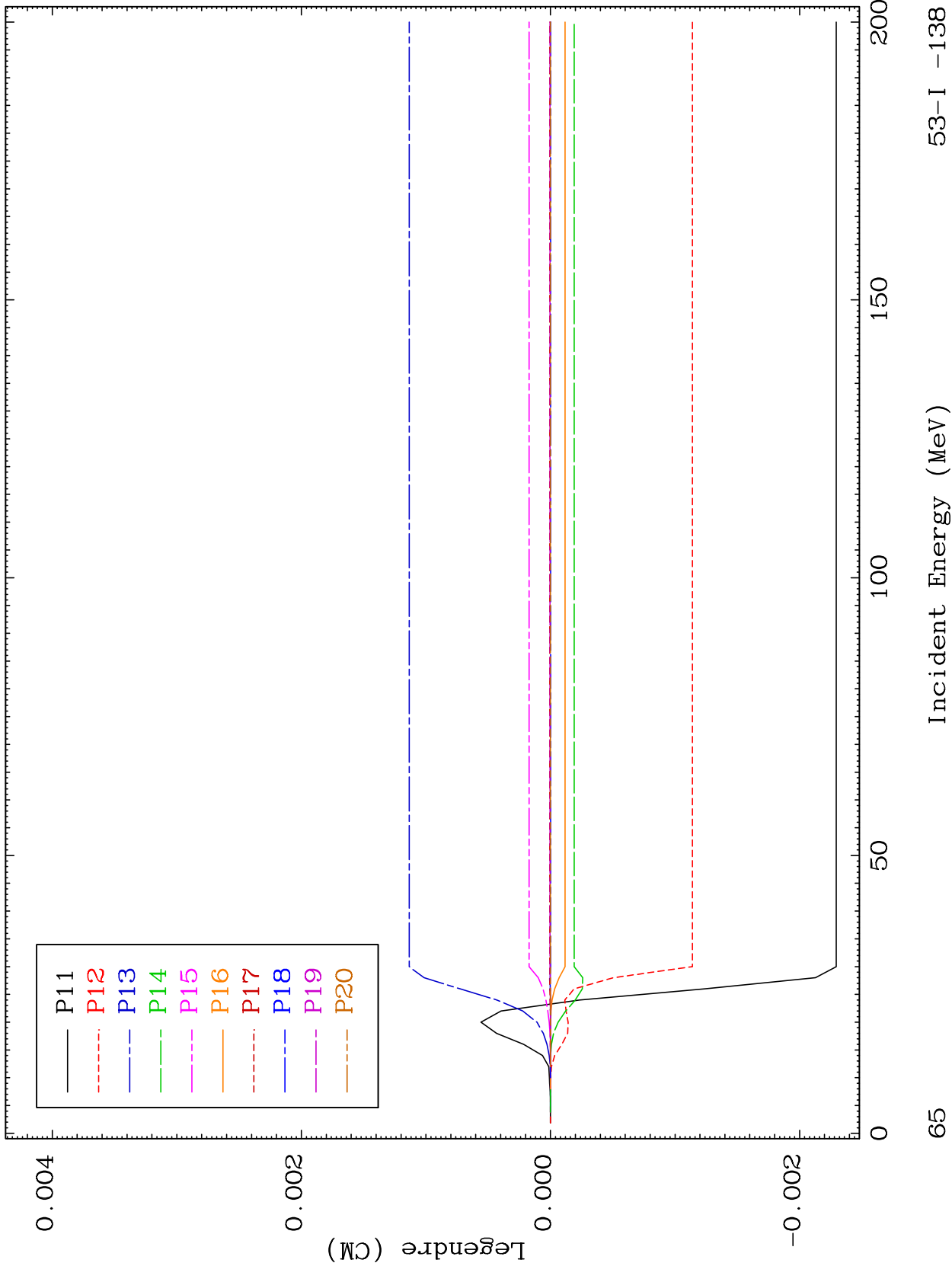

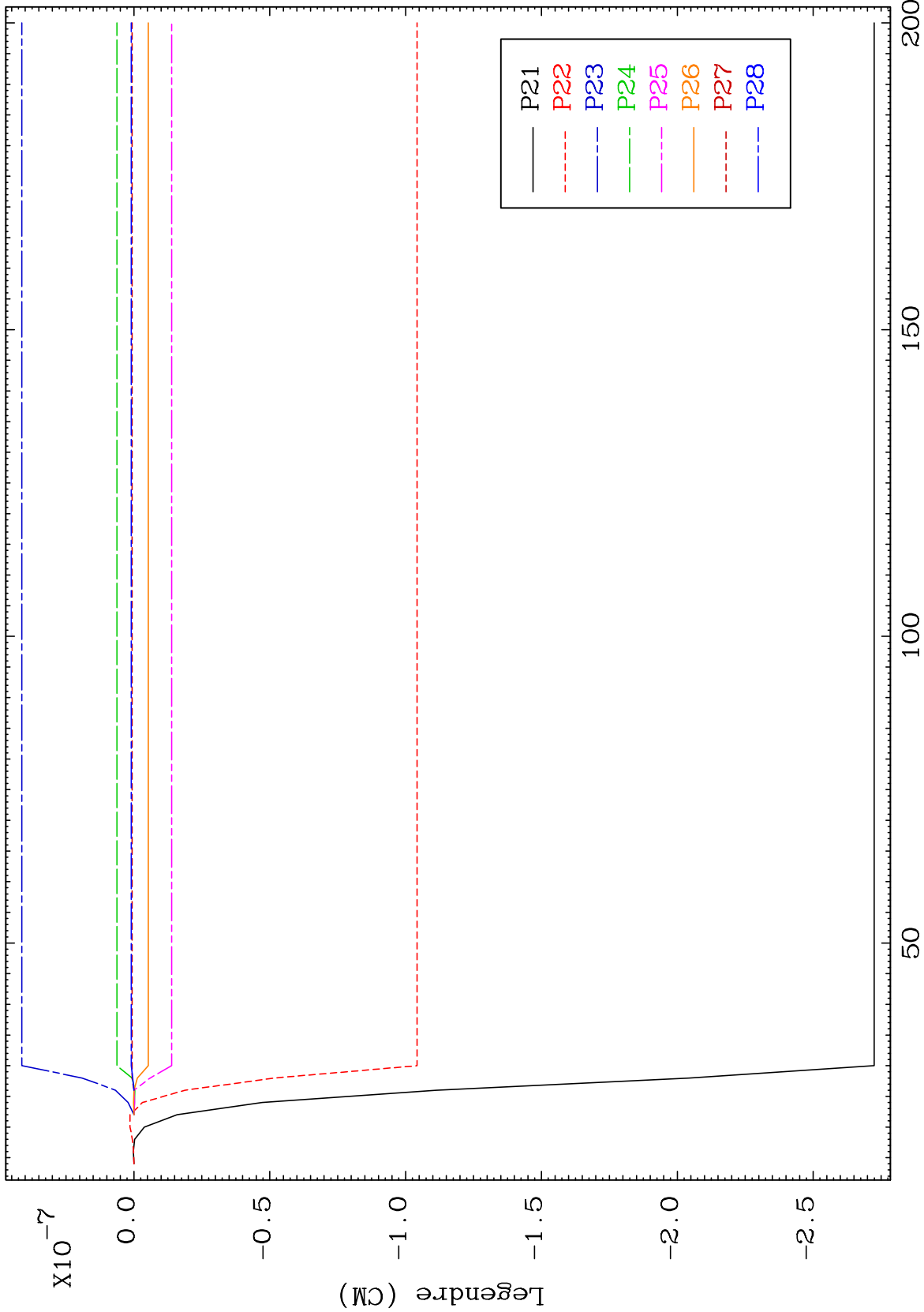

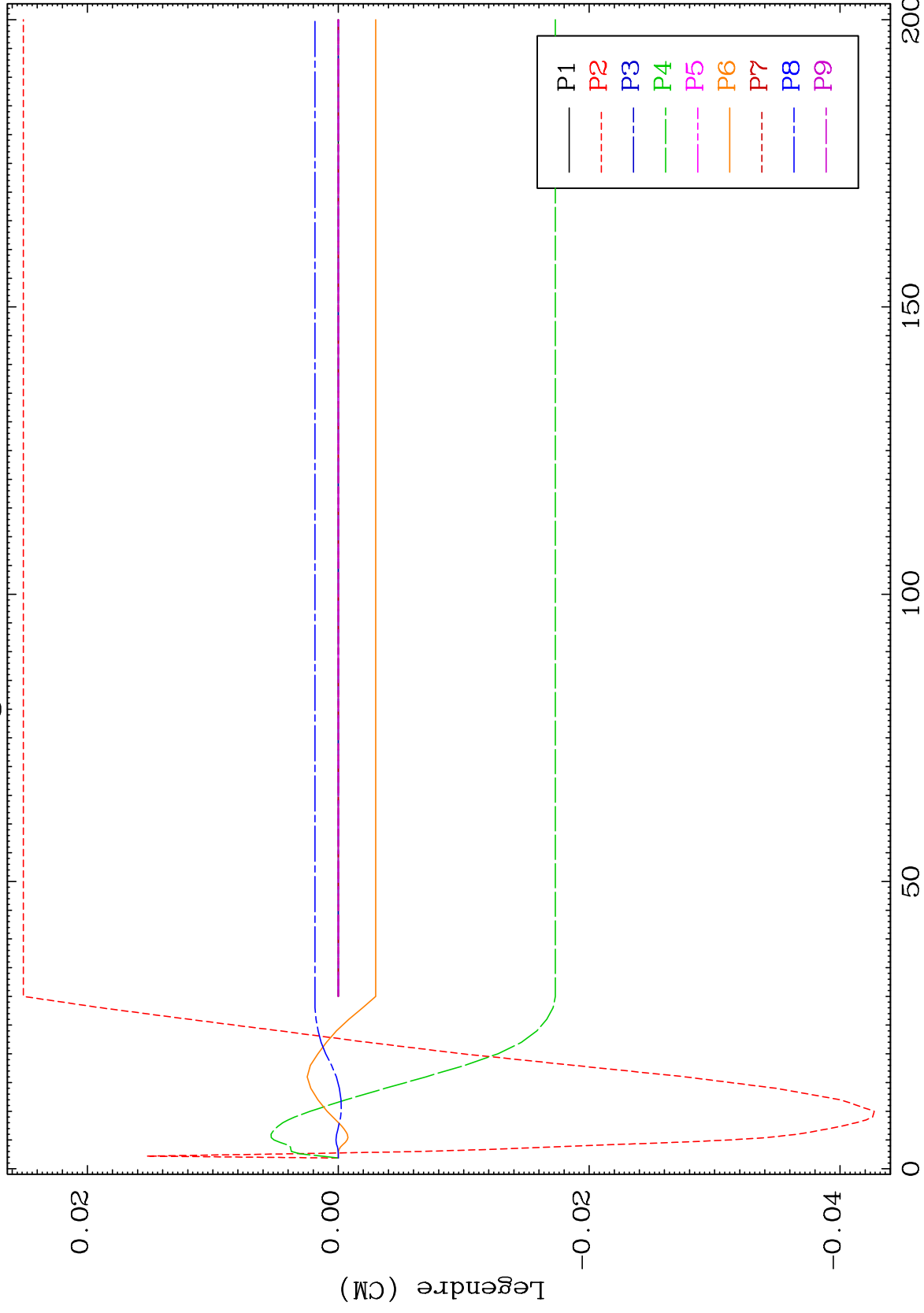

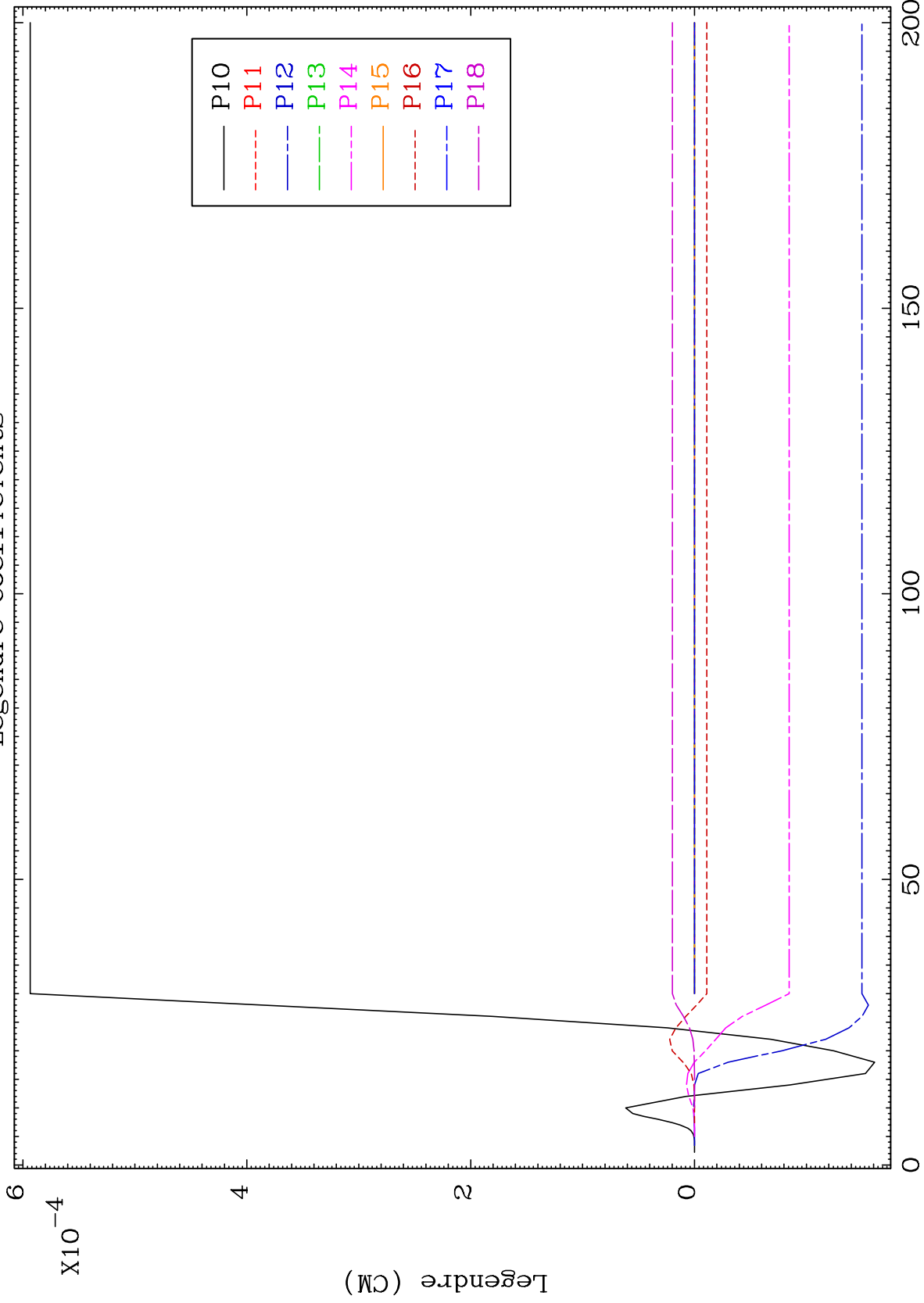

MAT 5358

MT= 65 (n,n') Level
Legendre Coefficients

53-I -138

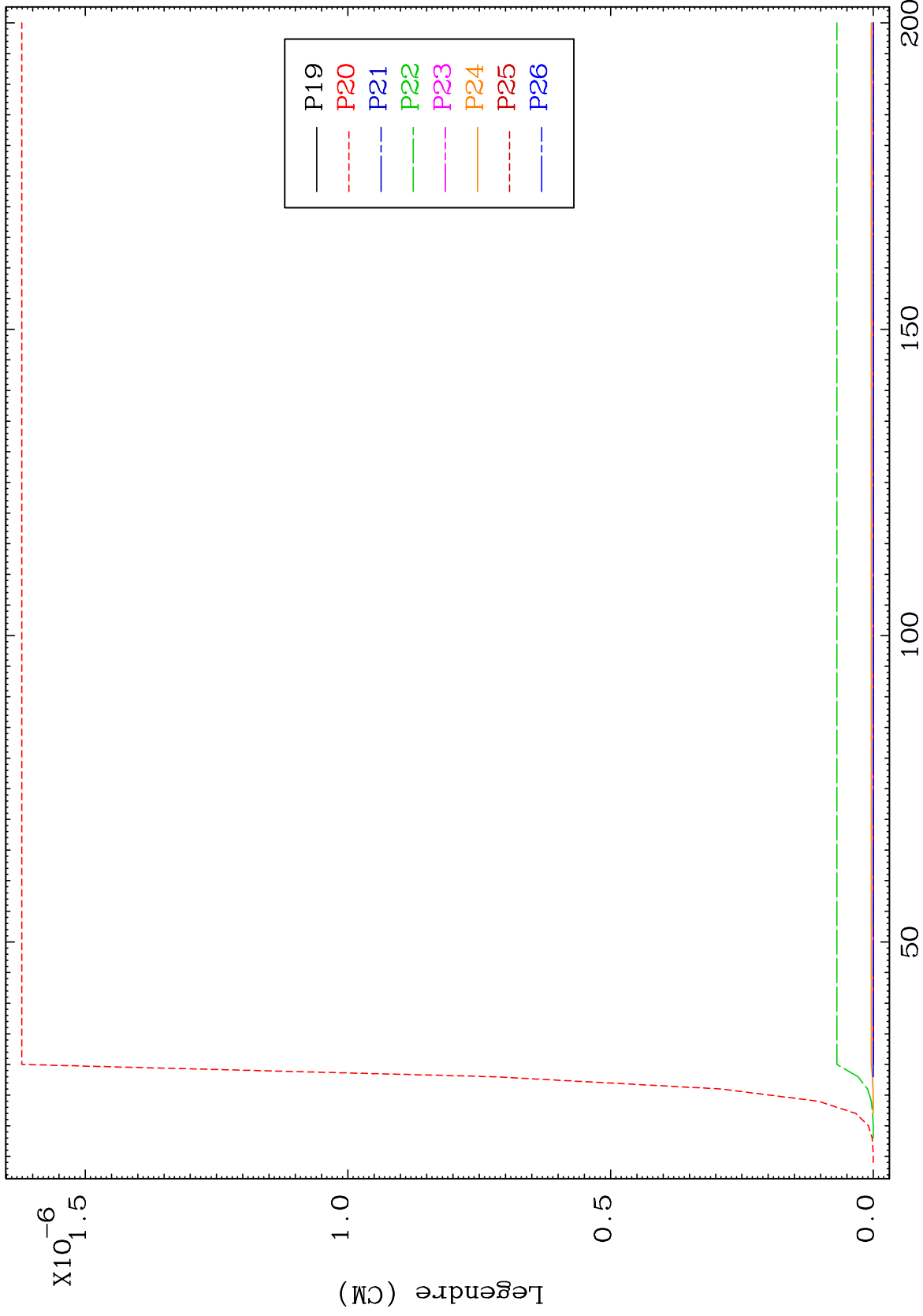

69

Incident Energy (MeV)

53-I -138

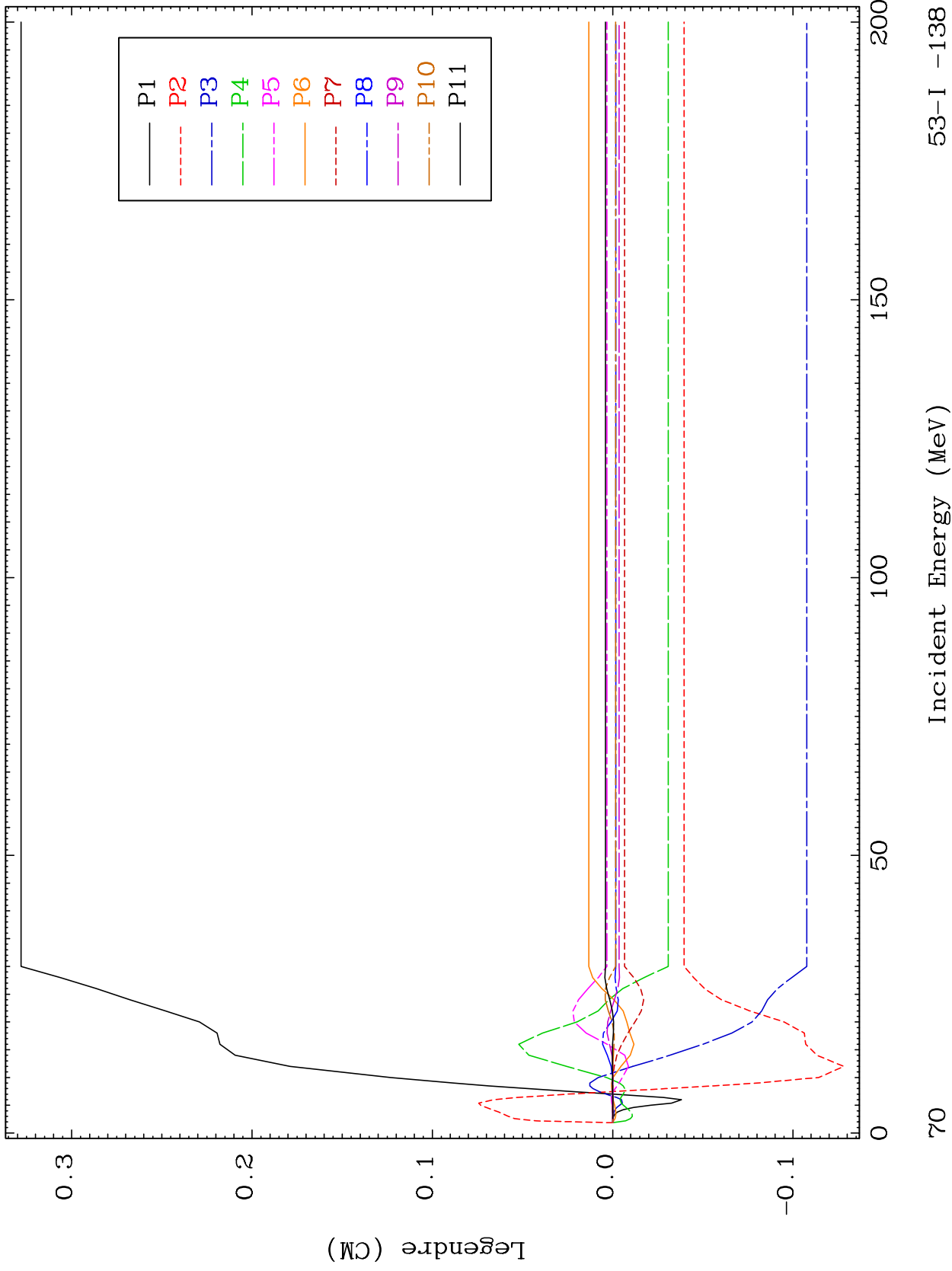

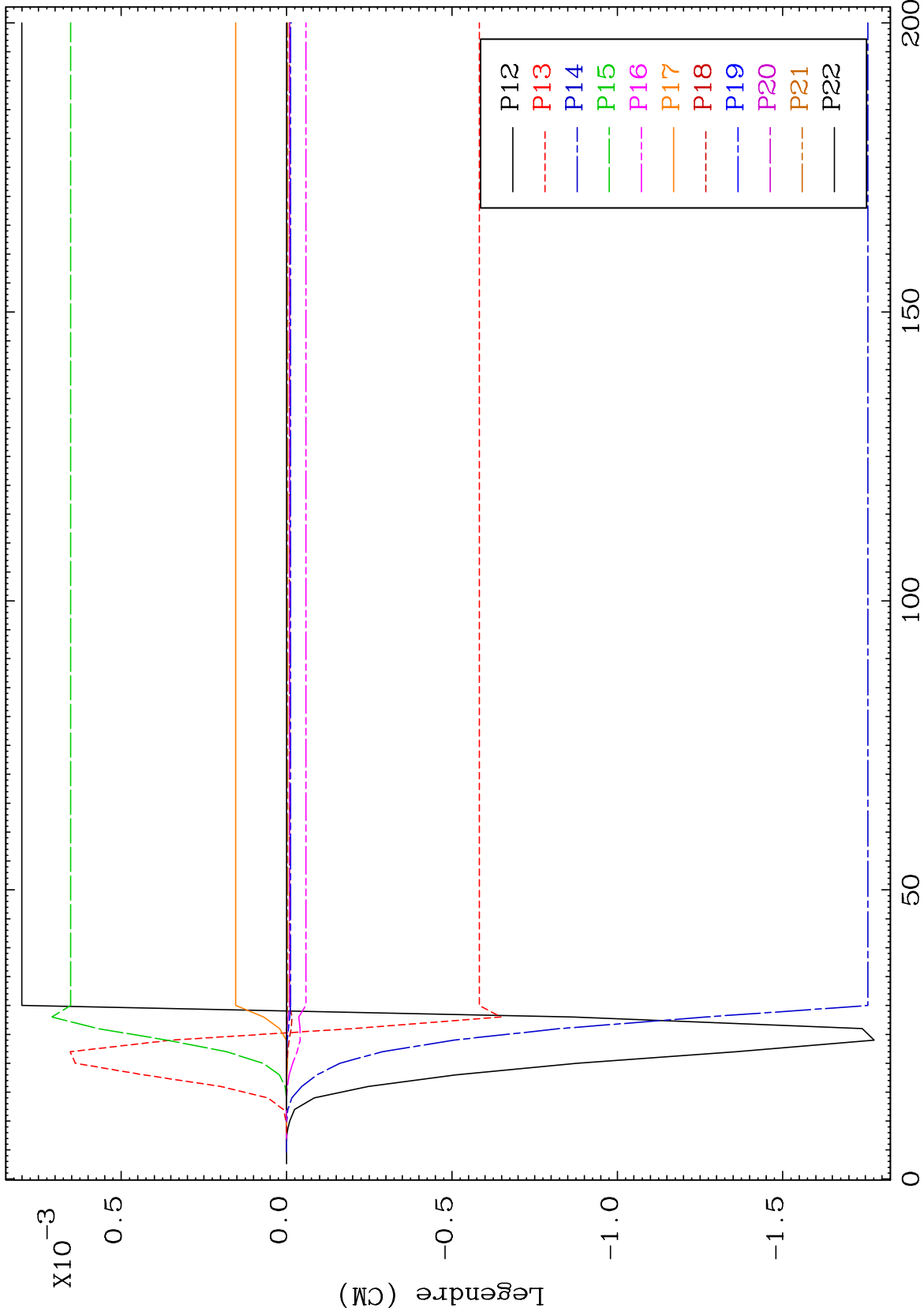

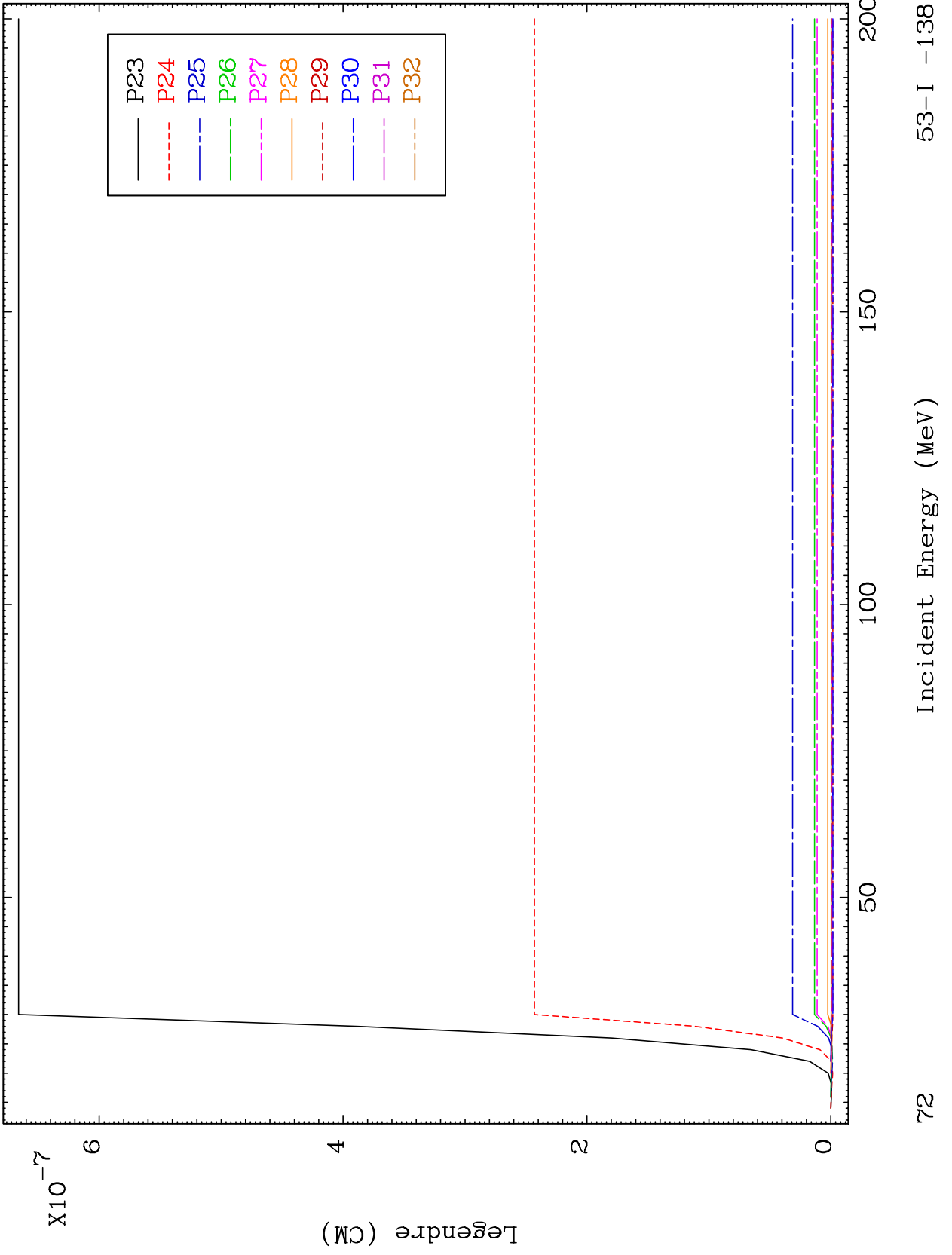

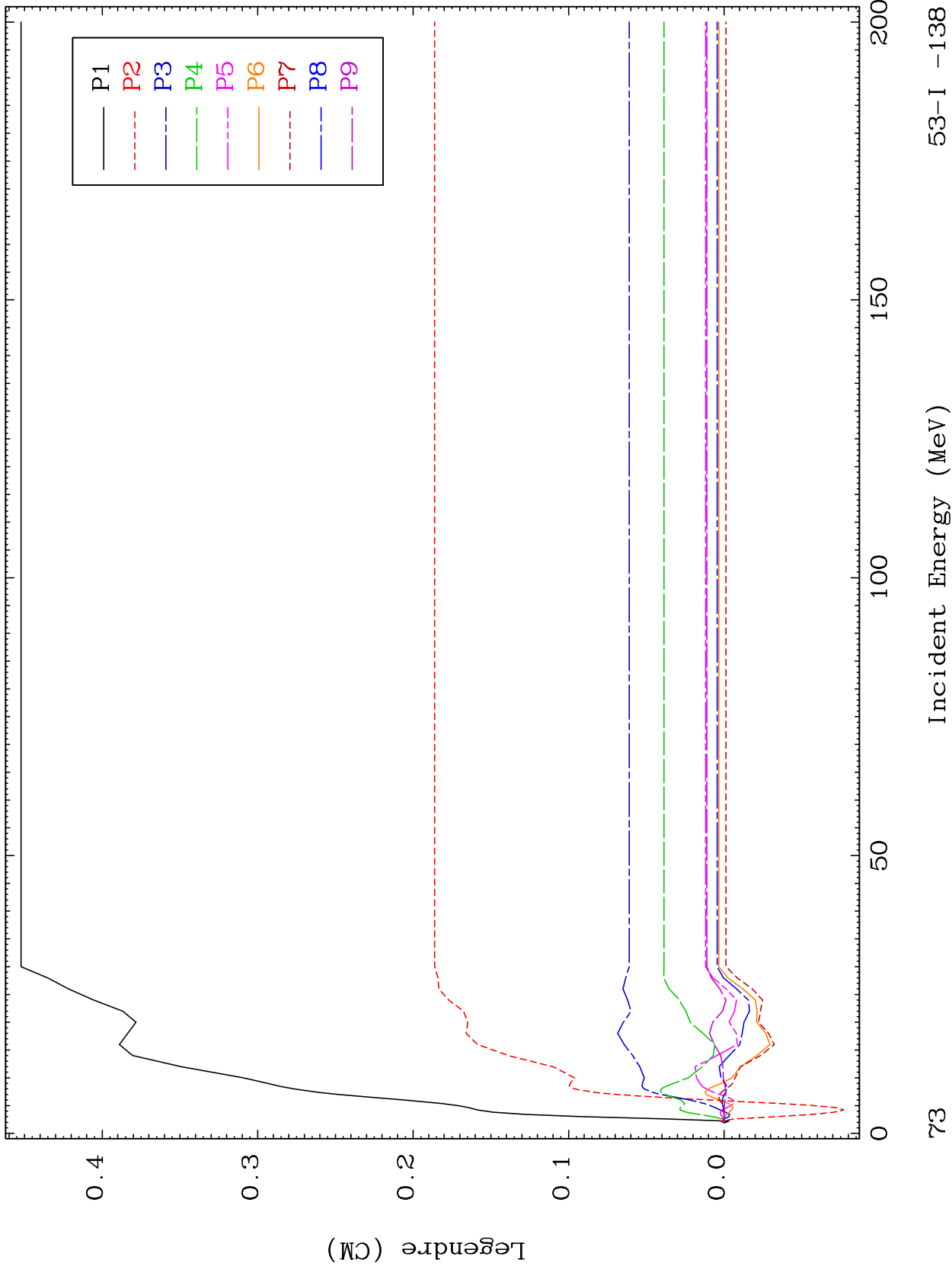

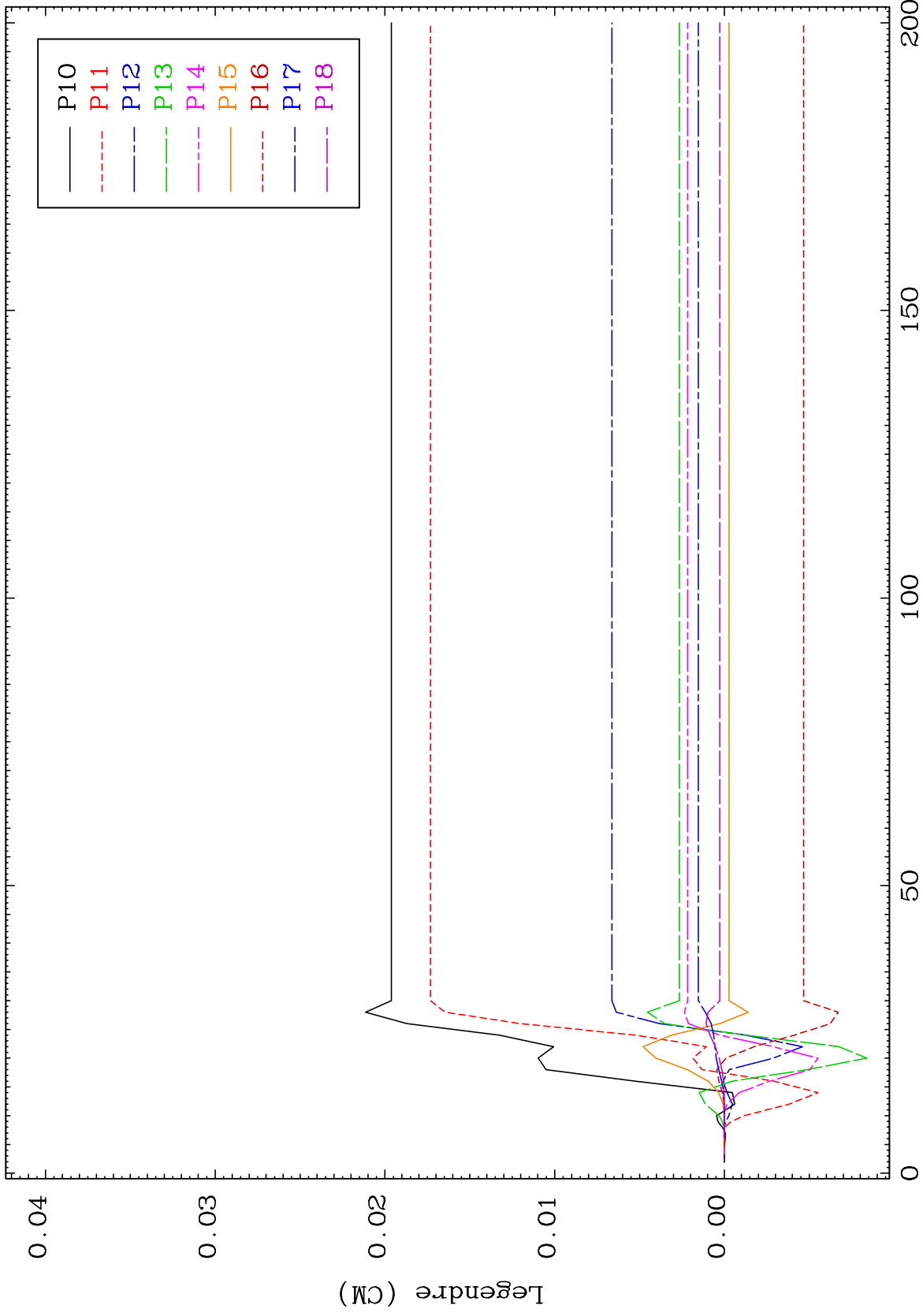

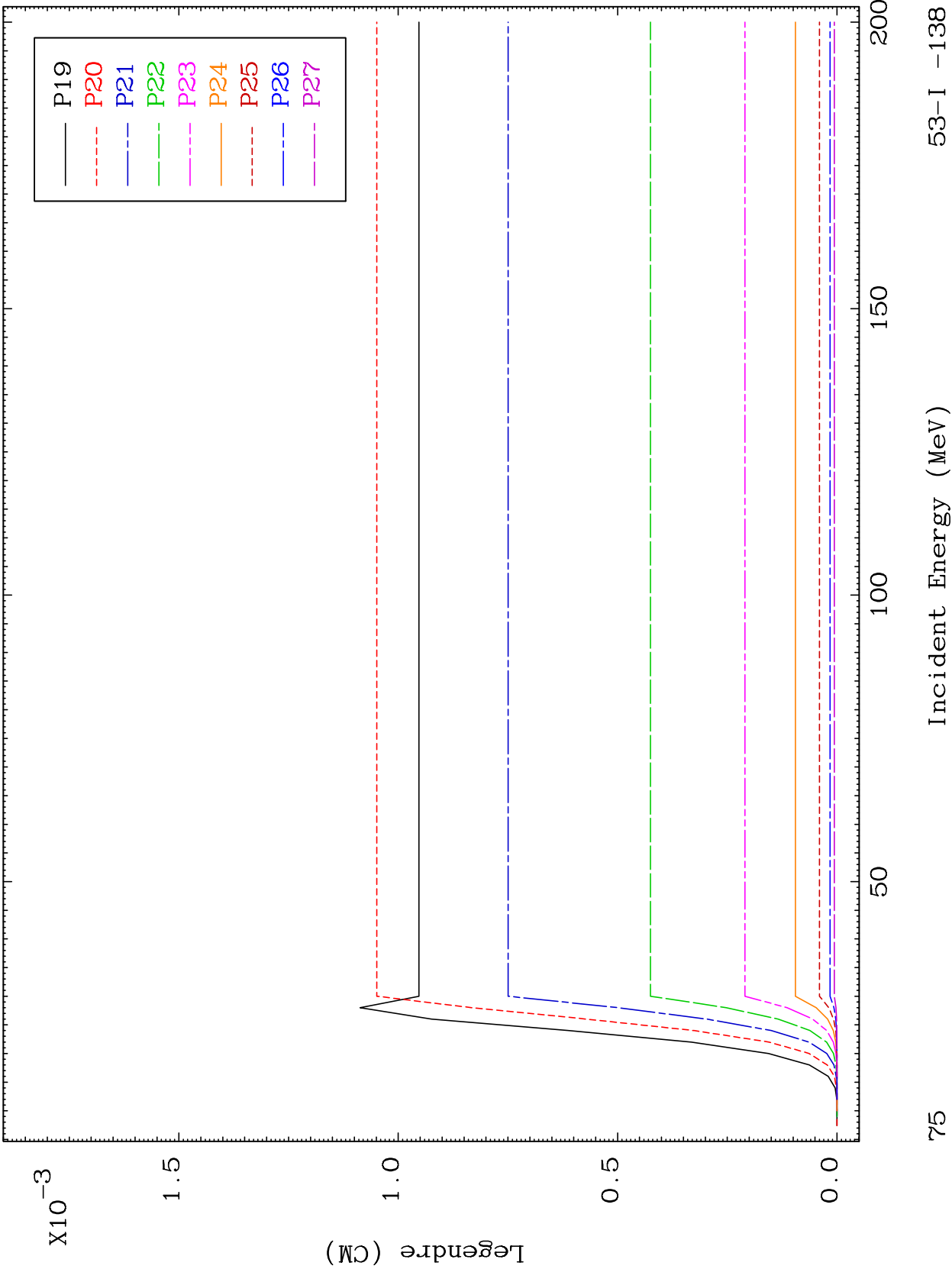

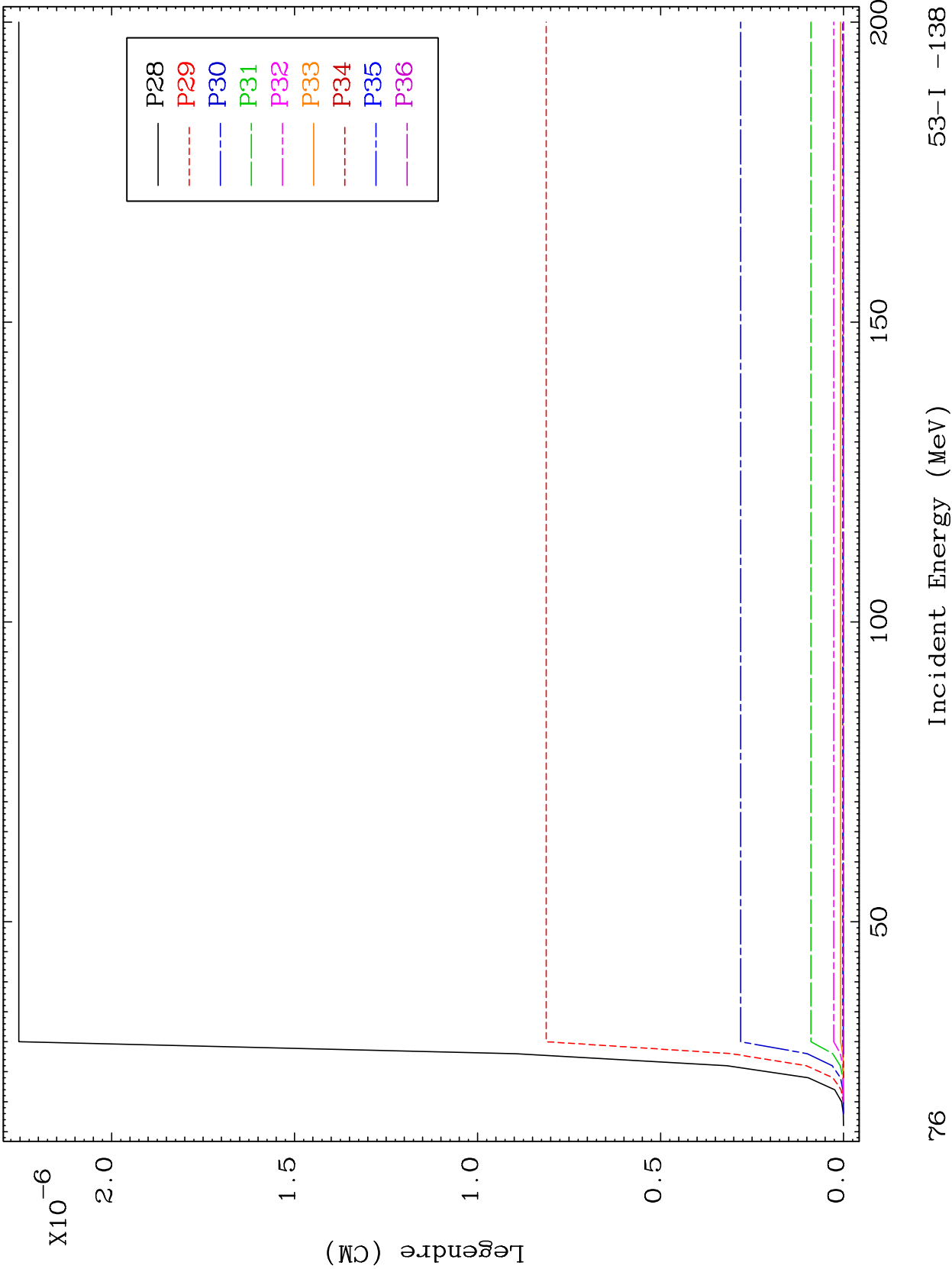

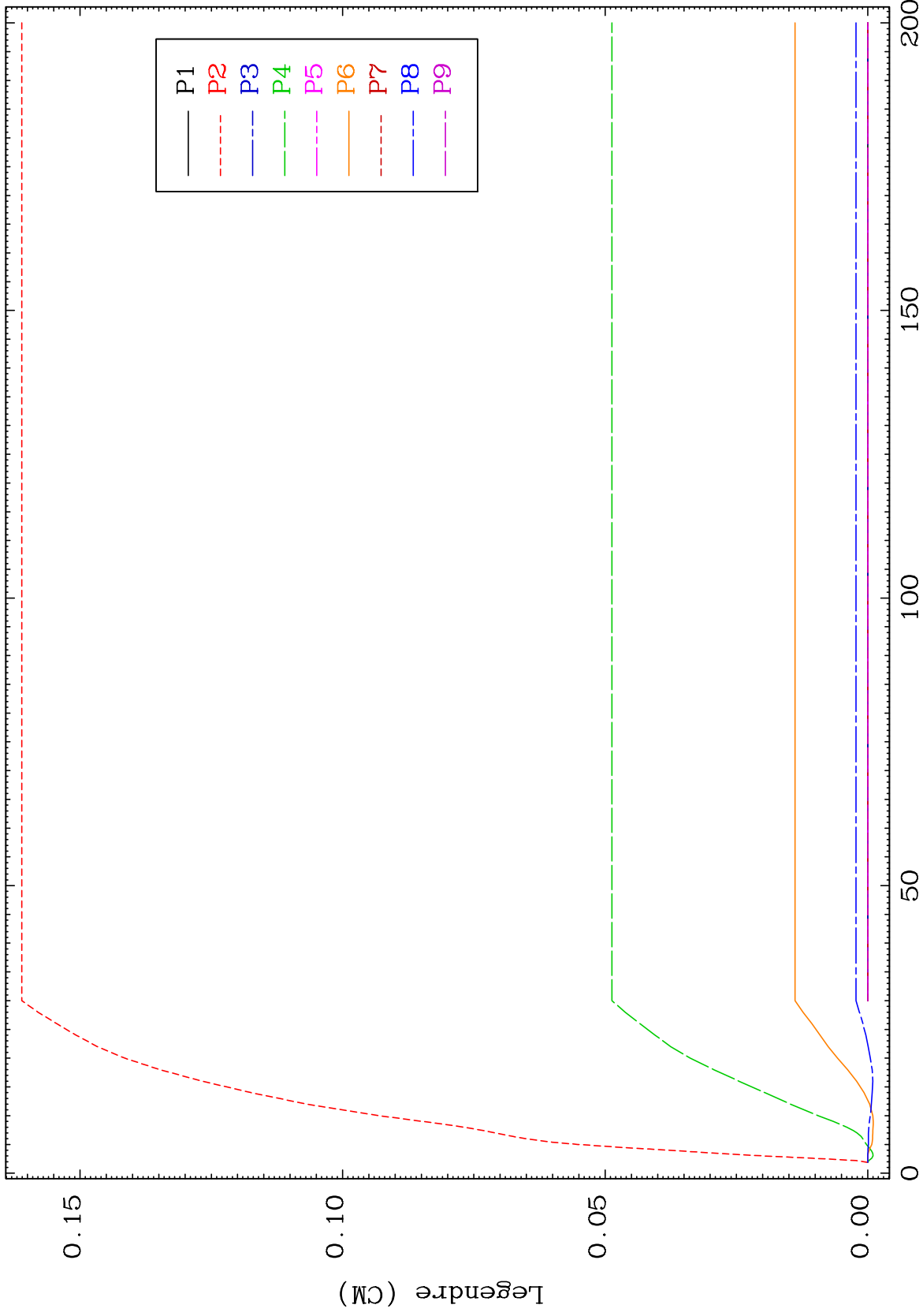

MAT 5358

MT= 68 (n,n') Level
Legendre Coefficients

53-I -138

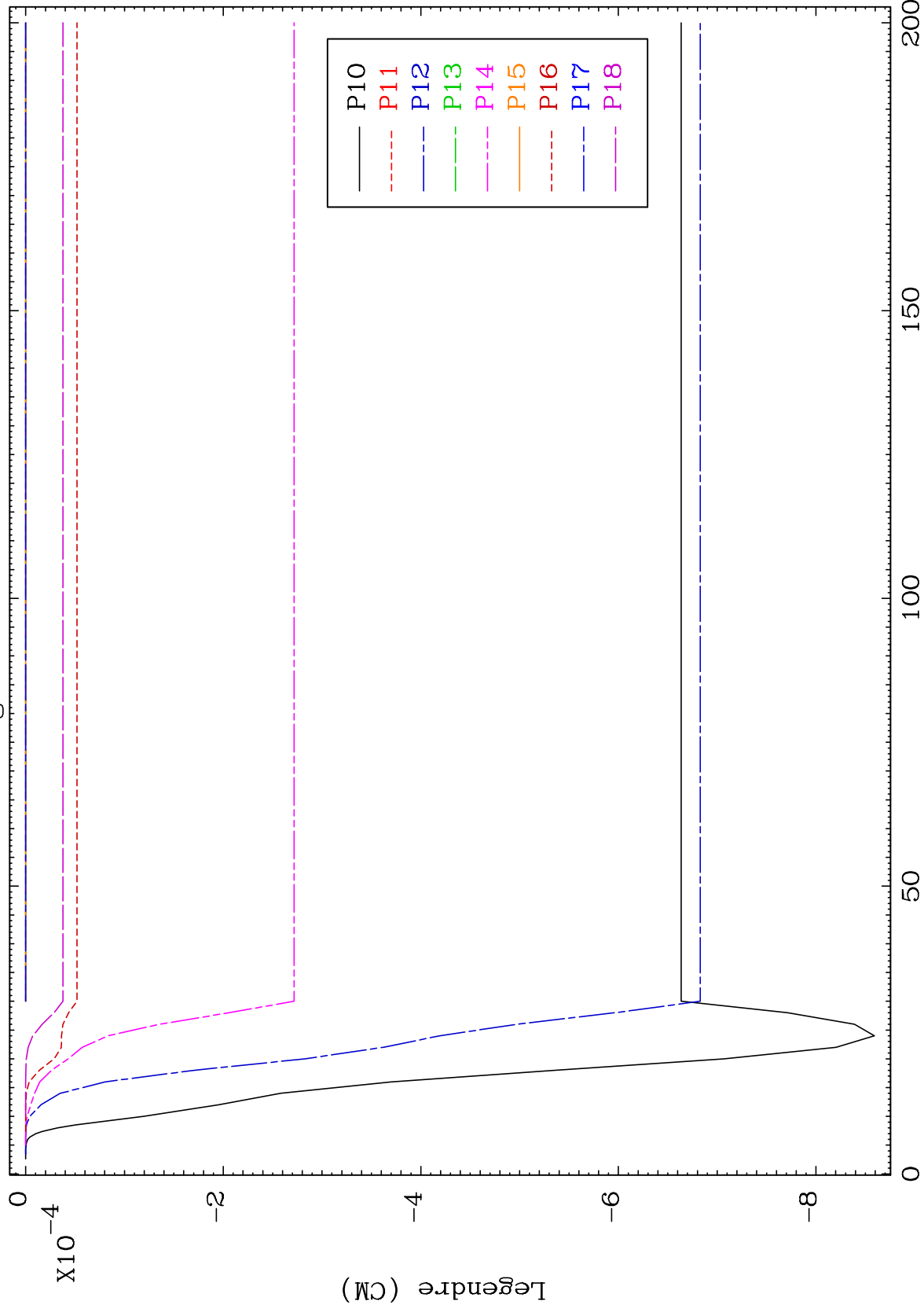

78

Incident Energy (MeV)

53-I -138

MAT 5358

MT= 68 (n,n') Level
Legendre Coefficients

53-I -138

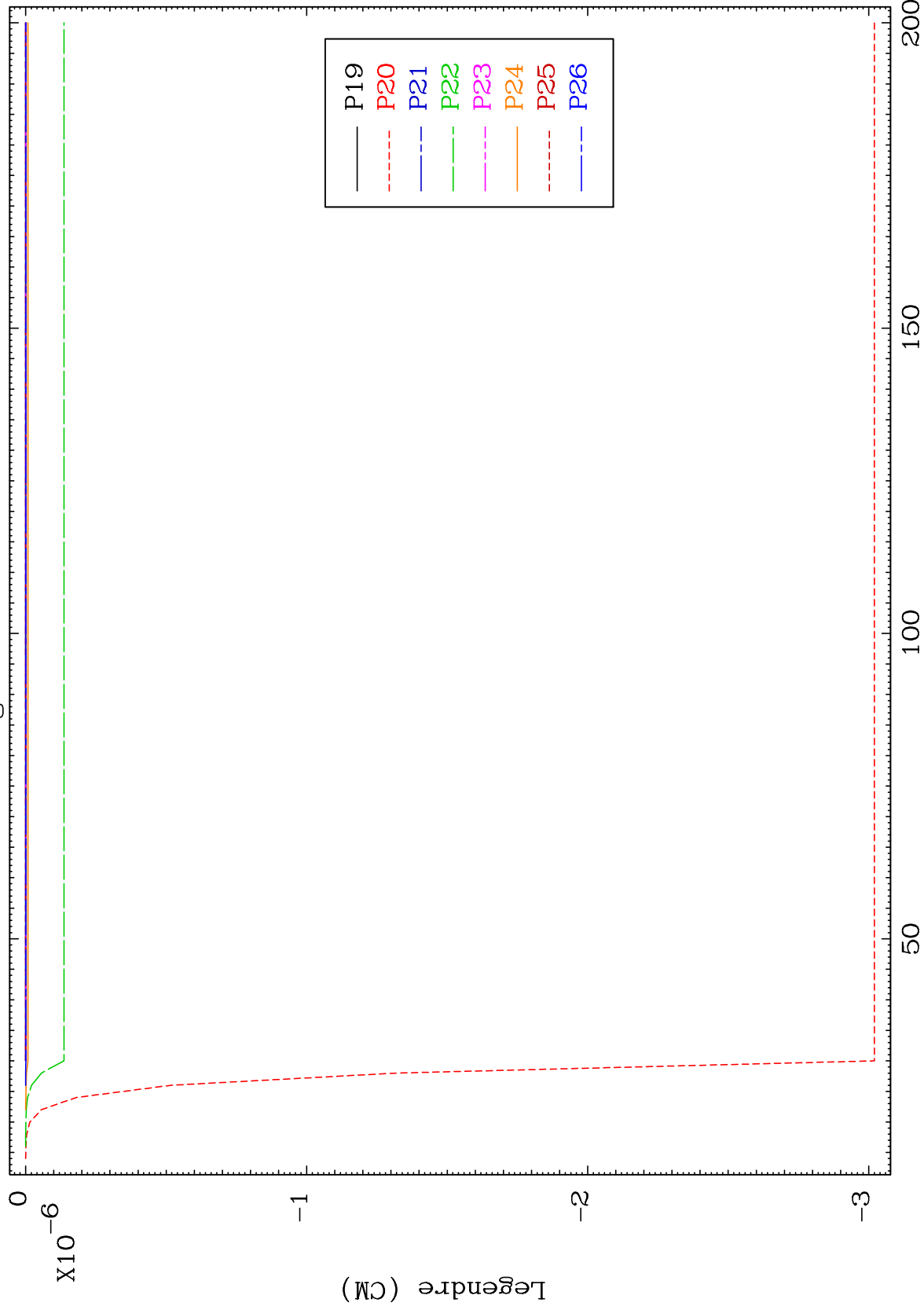

79

Incident Energy (MeV)

53-I -138

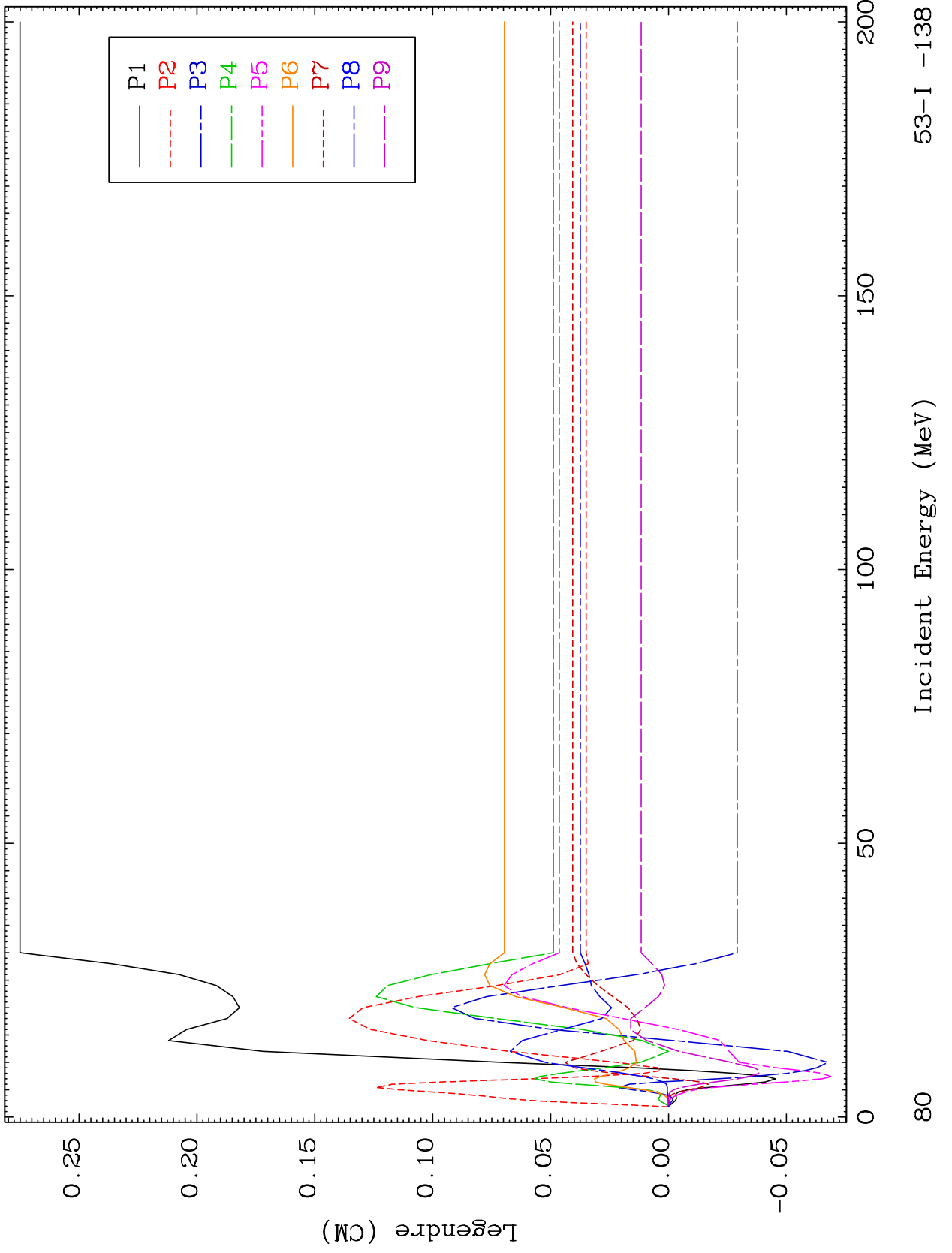

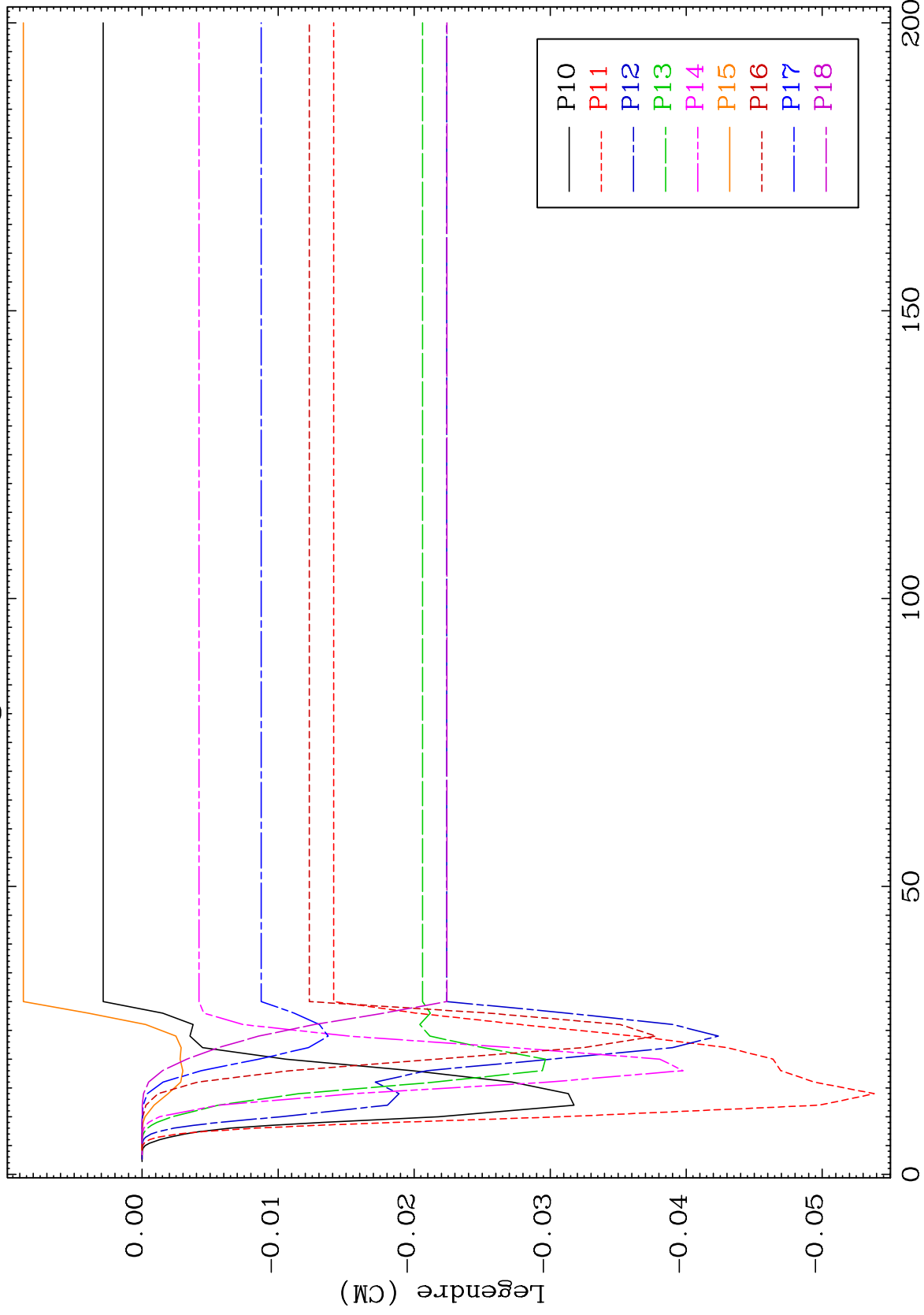

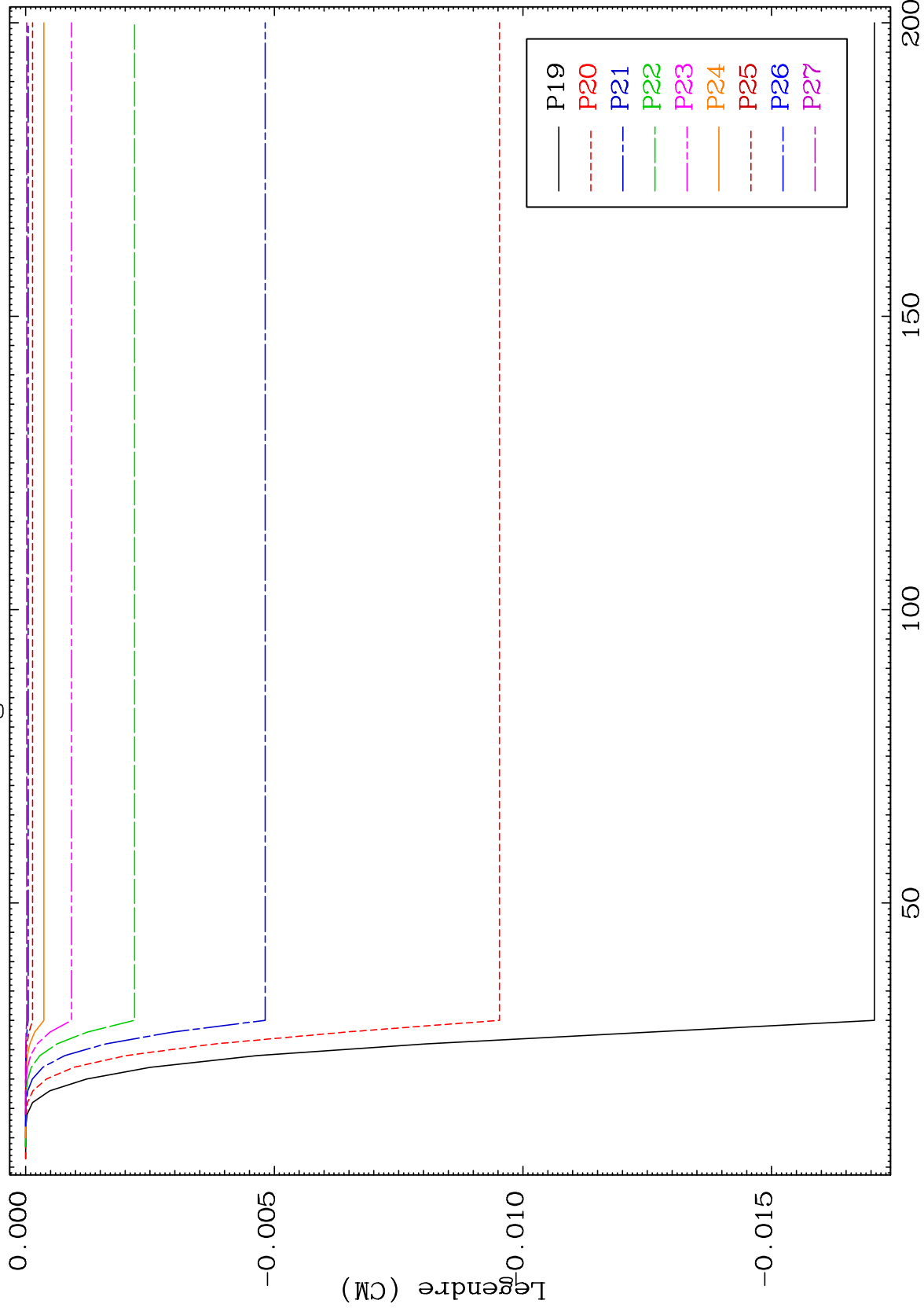

MAT 5358

MT= 69 (n,n') Level
Legendre Coefficients

53-I -138

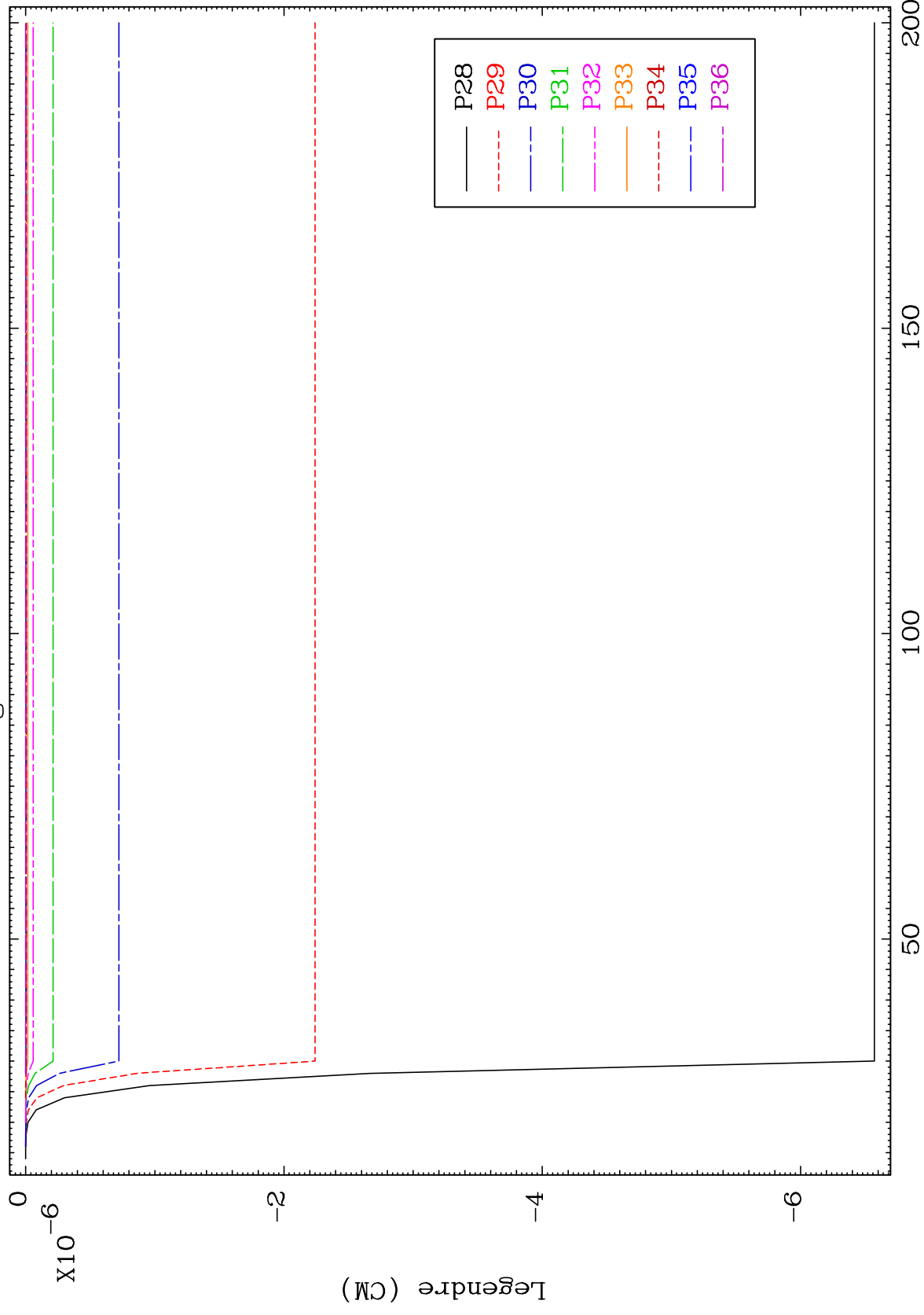

83

Incident Energy (MeV)

53-I -138

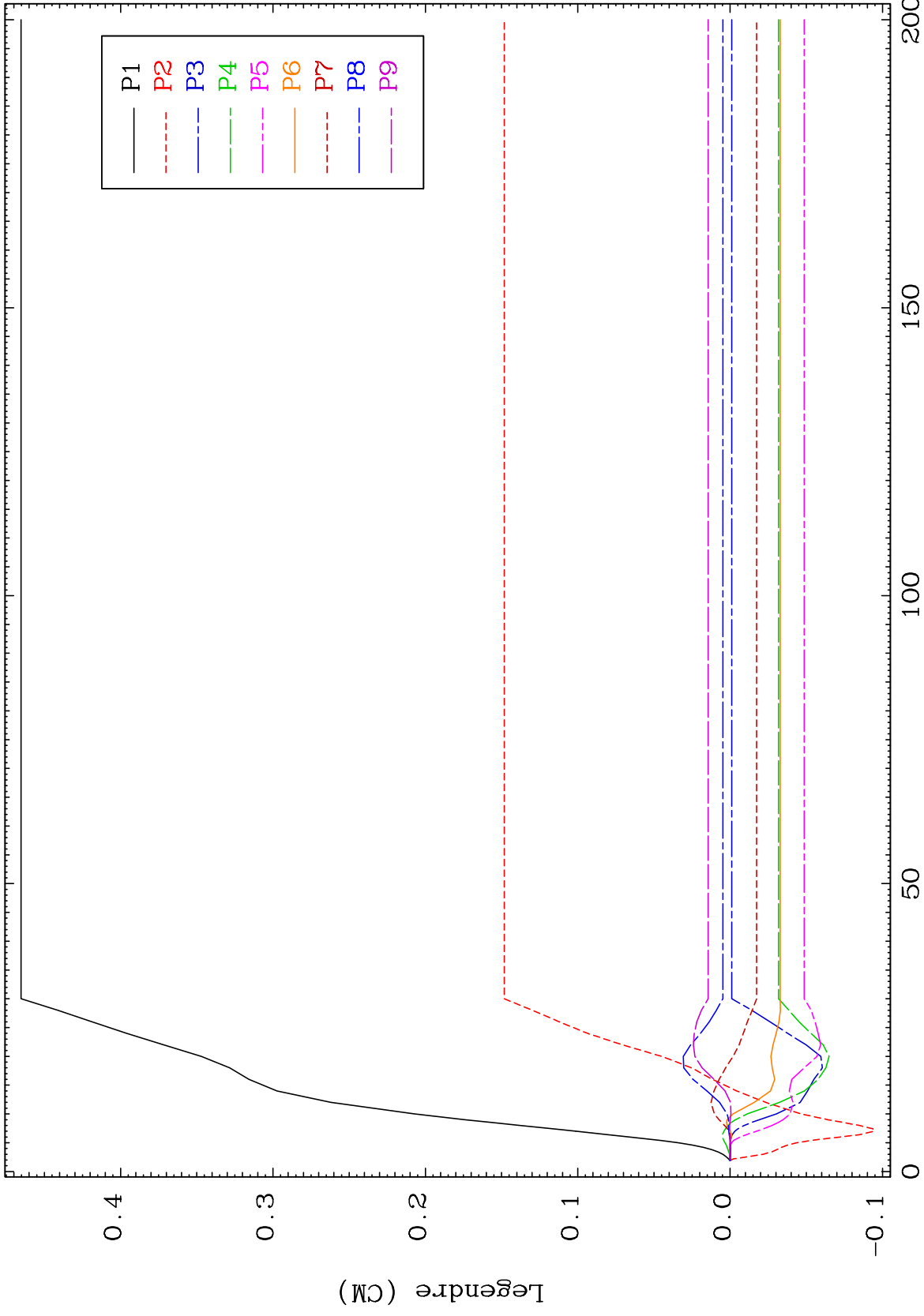

MAT 5358

MT= 70 (n,n') Level
Legendre Coefficients

53-I -138

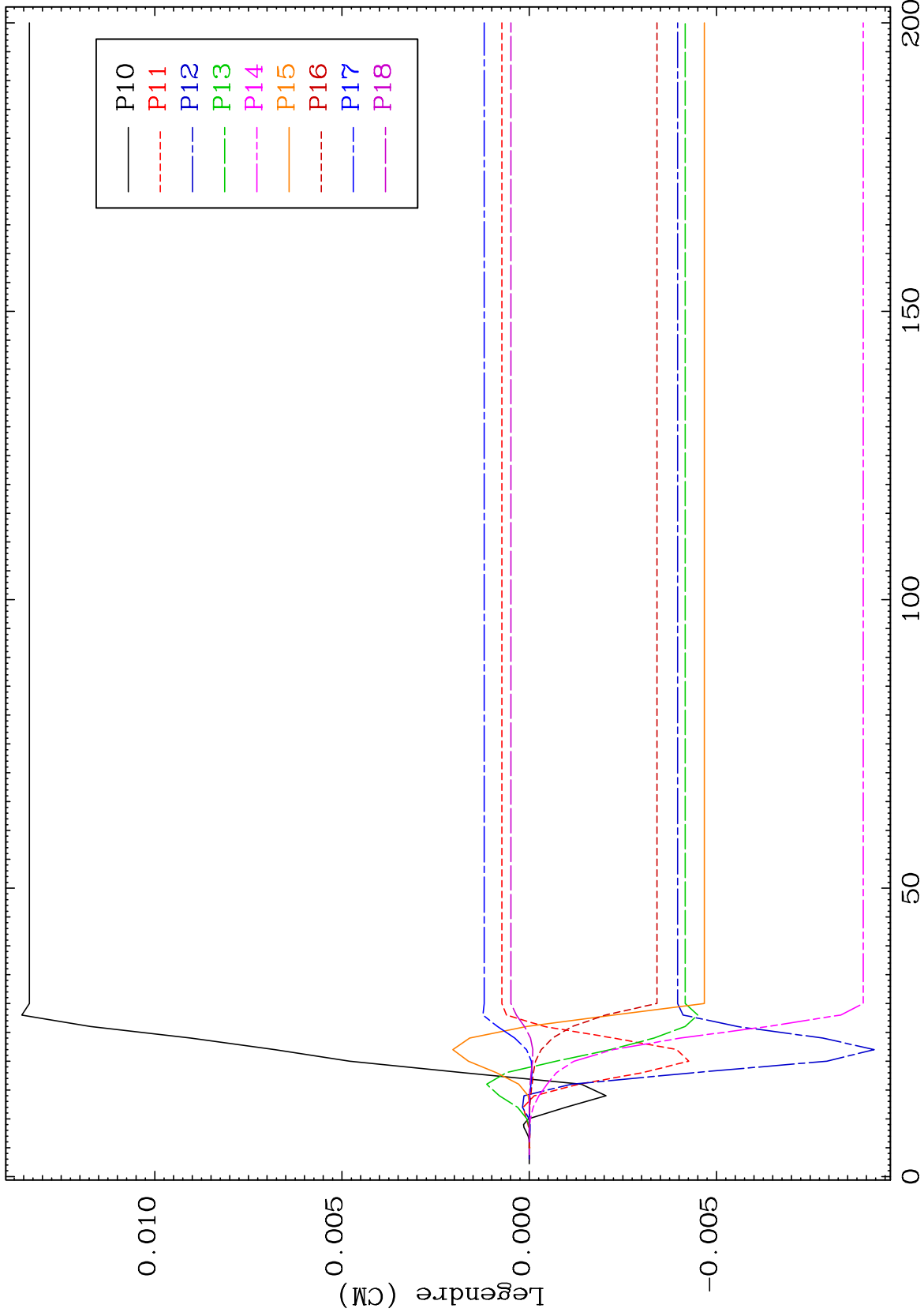

85

Incident Energy (MeV)

53-I -138

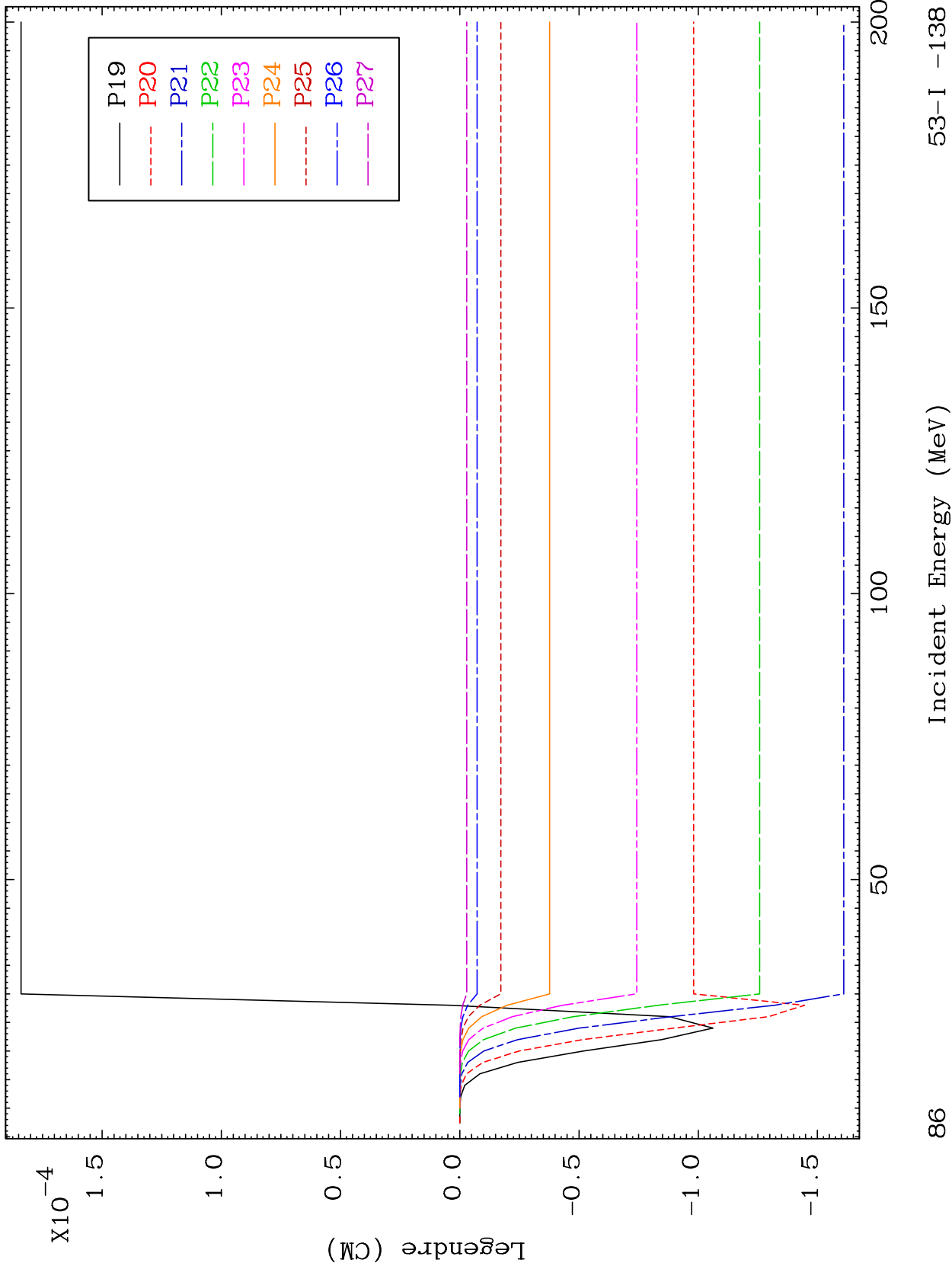

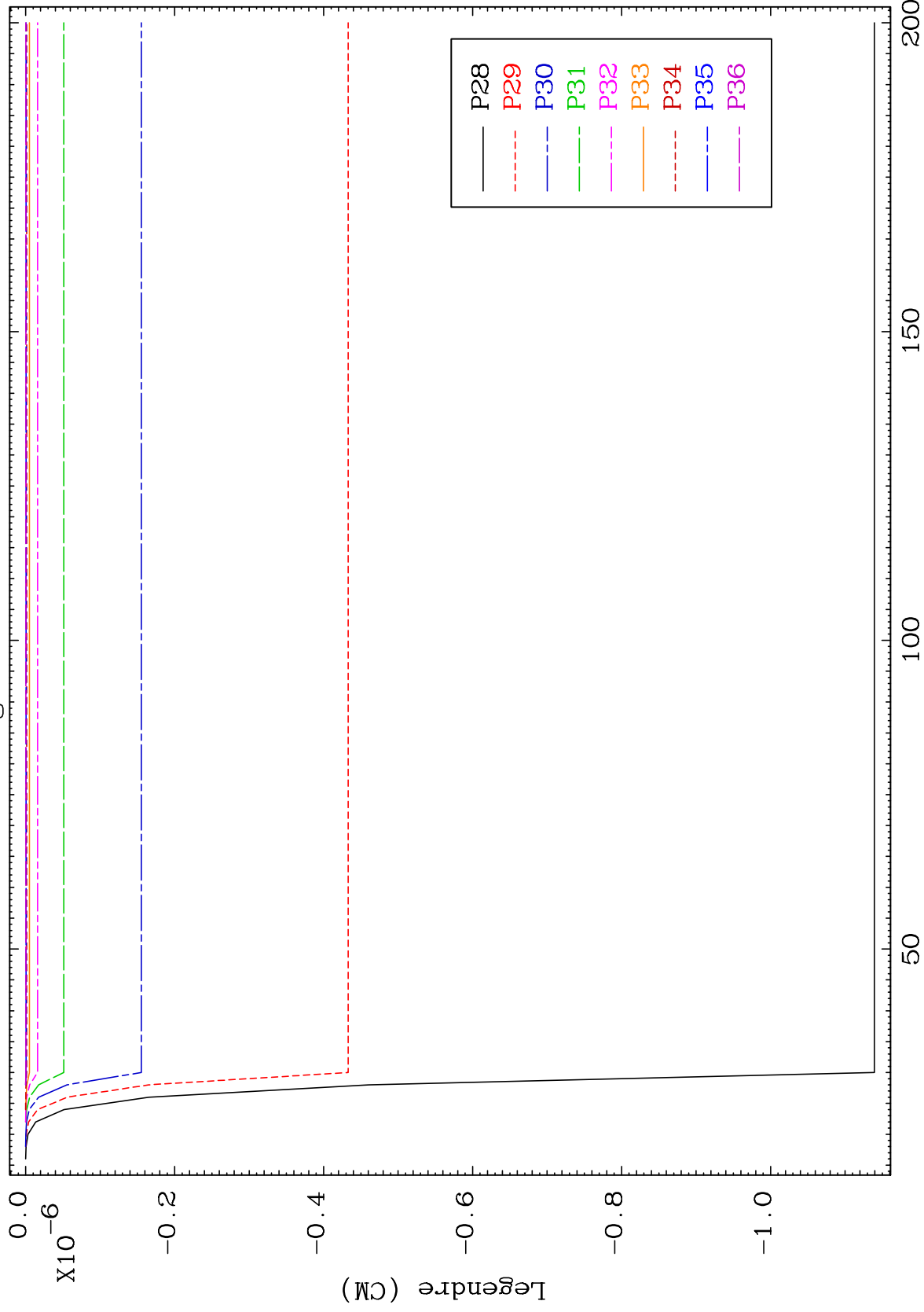

MAT 5358

MT= 71 (n,n') Level
Legendre Coefficients

53-I -138

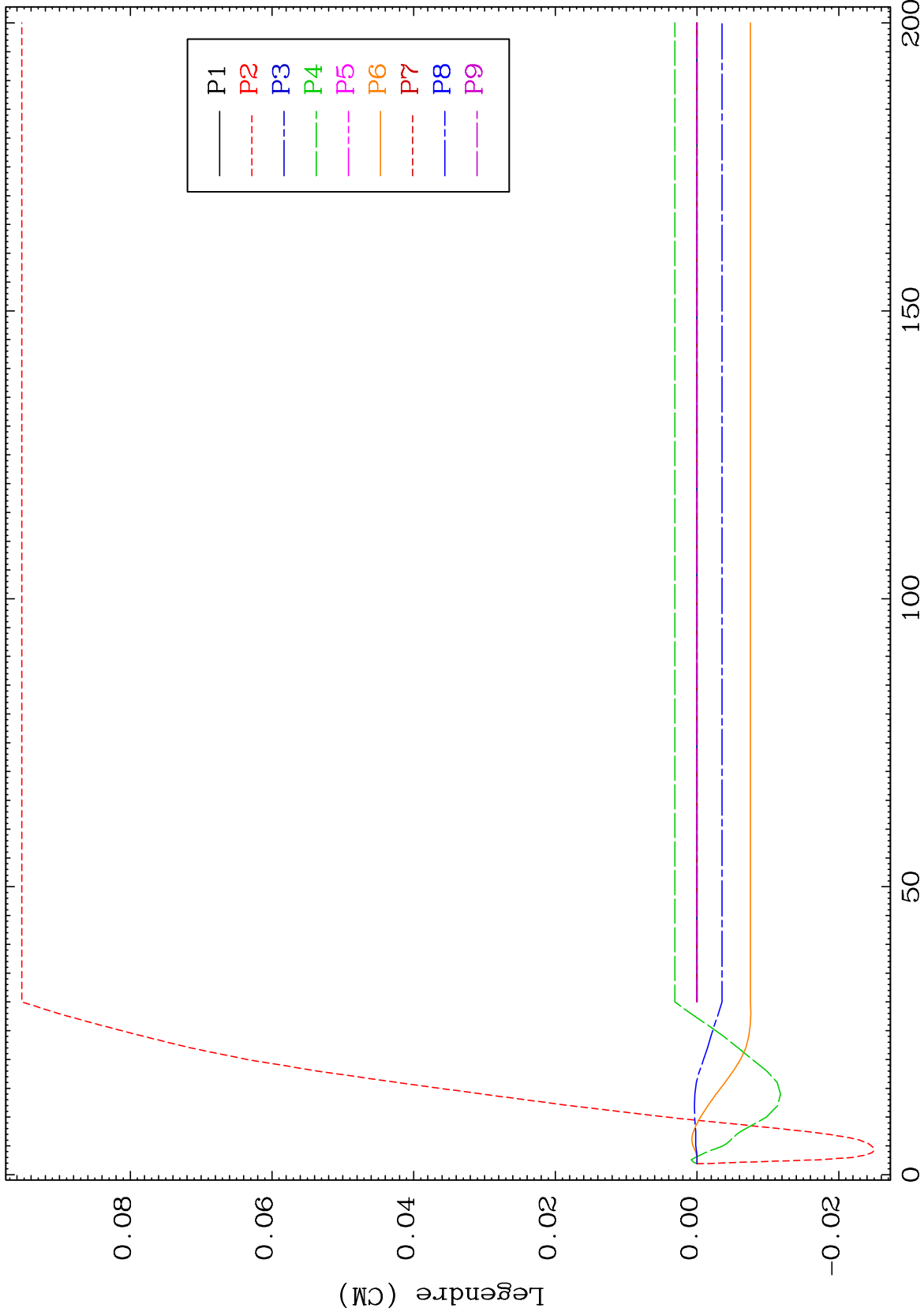

88

Incident Energy (MeV)

53-I -138

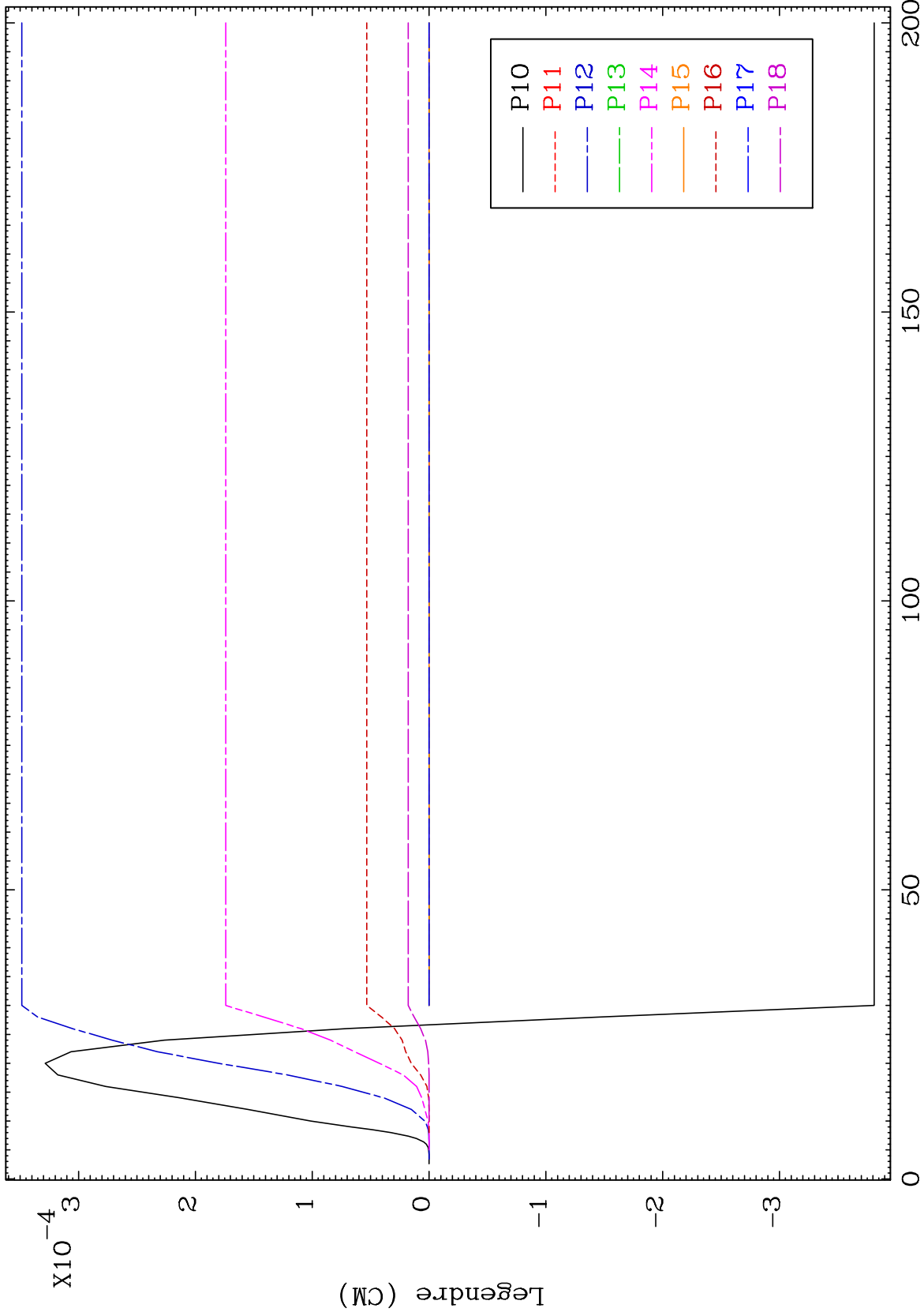

MAT 5358

MT= 71 (n,n') Level
Legendre Coefficients

53-I -138

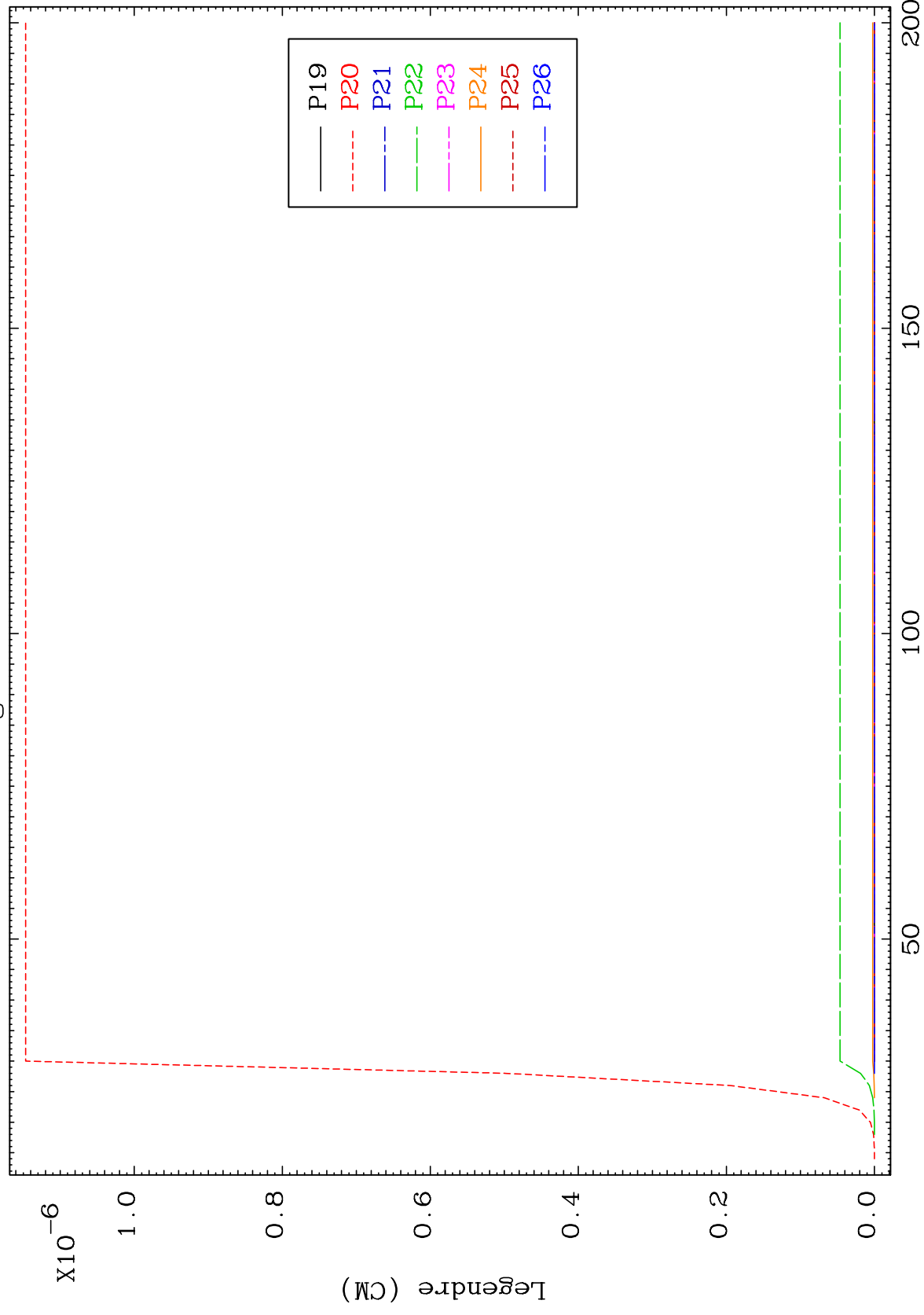

90

Incident Energy (MeV)

53-I -138

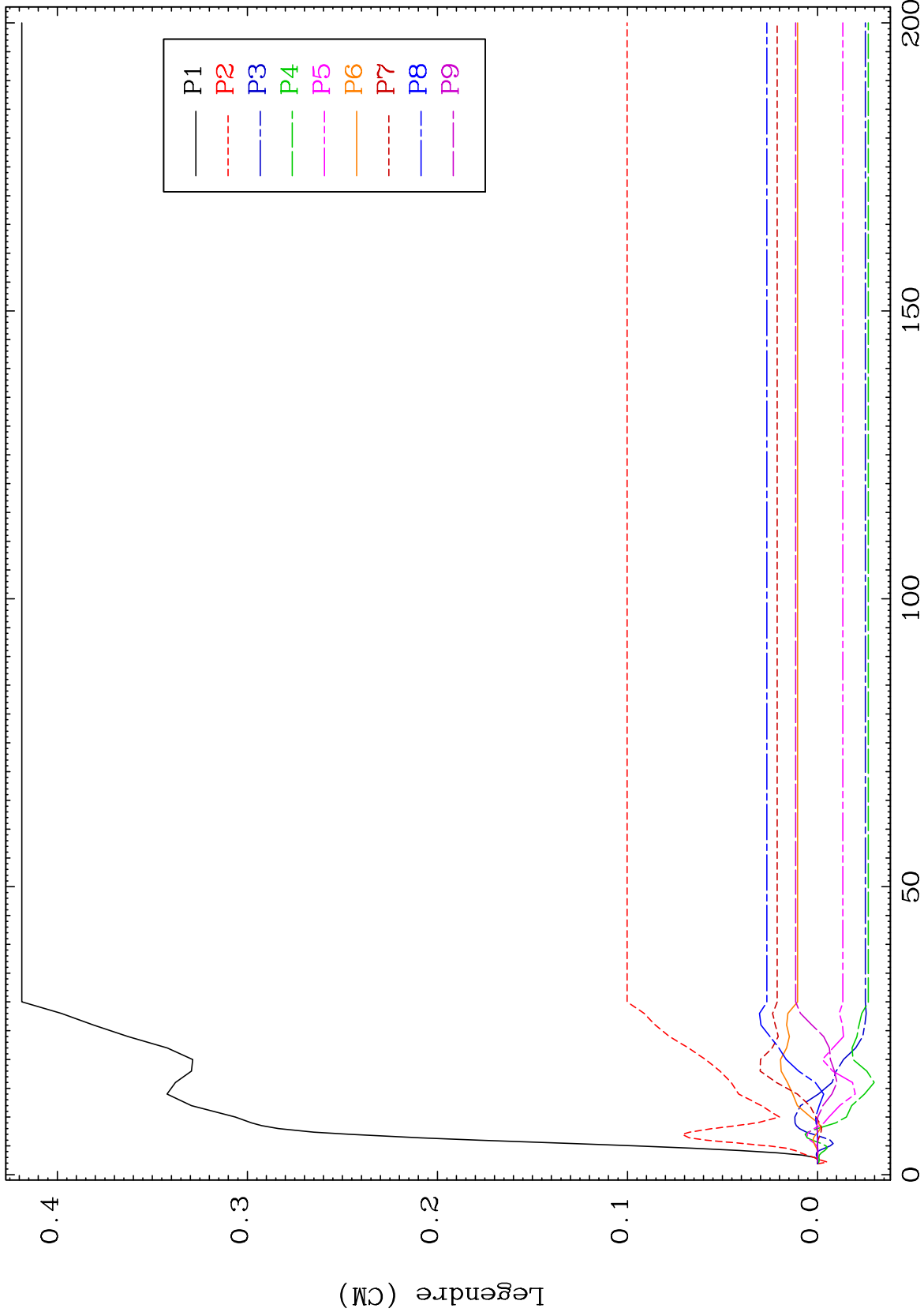

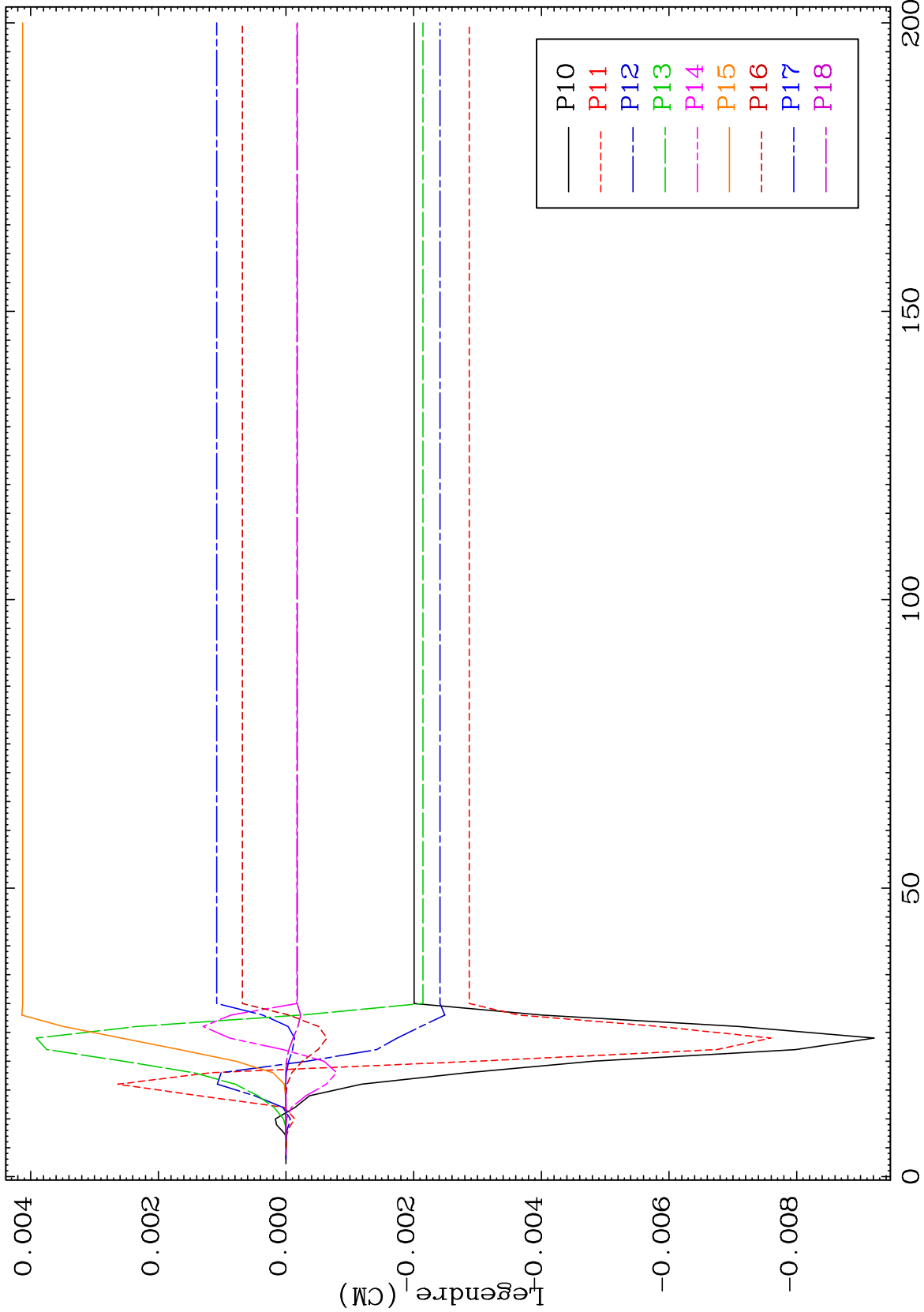

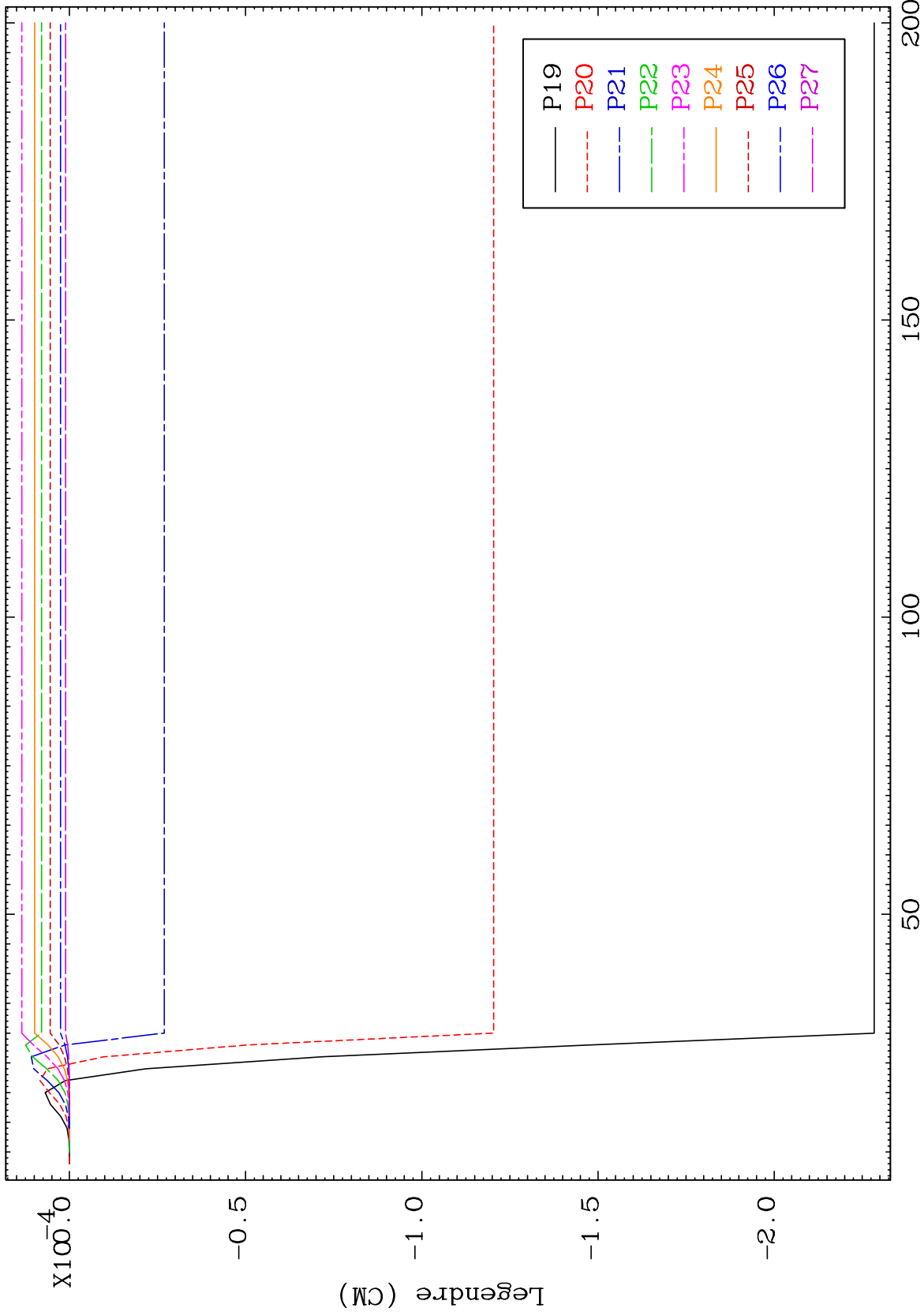

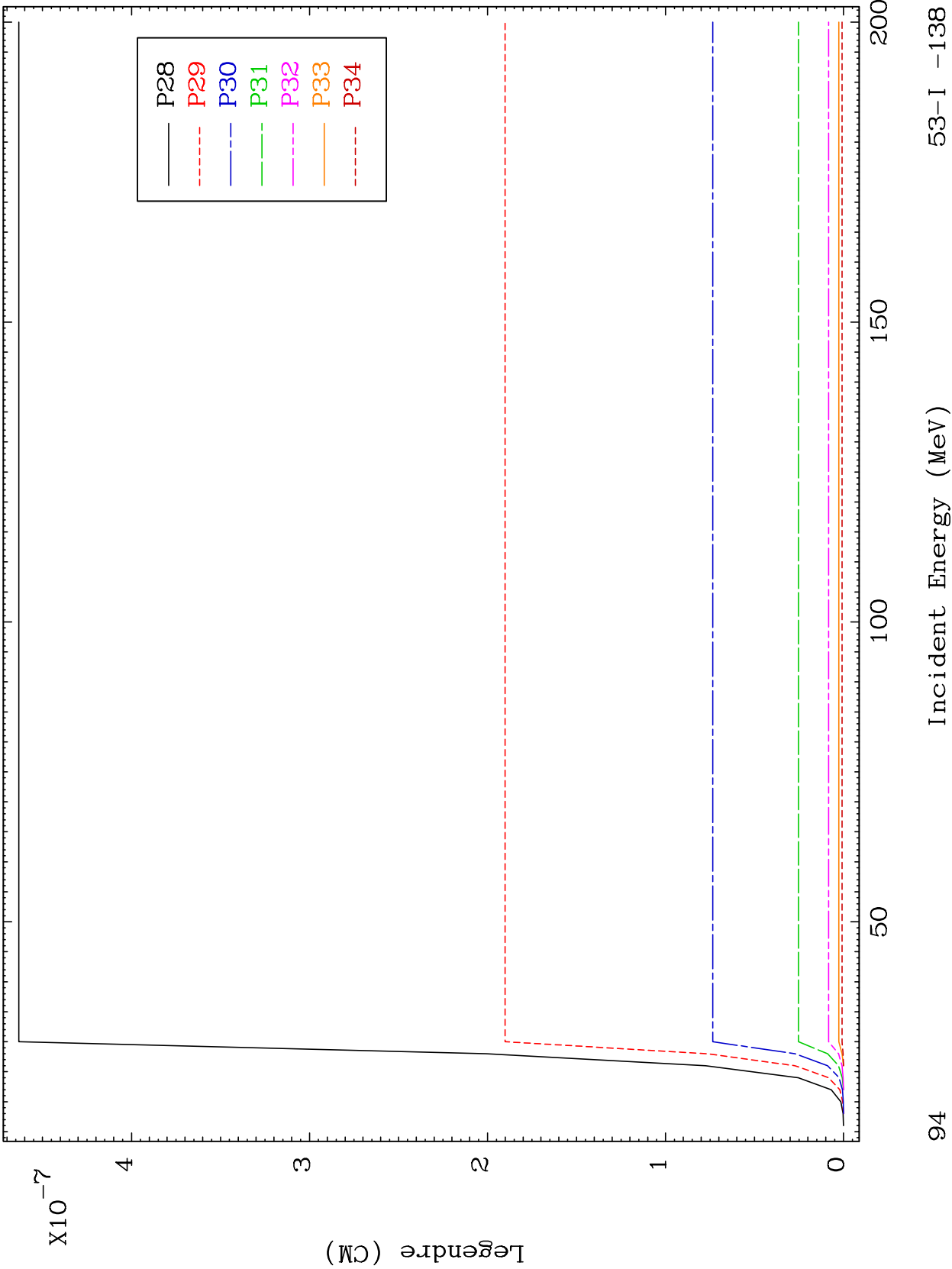

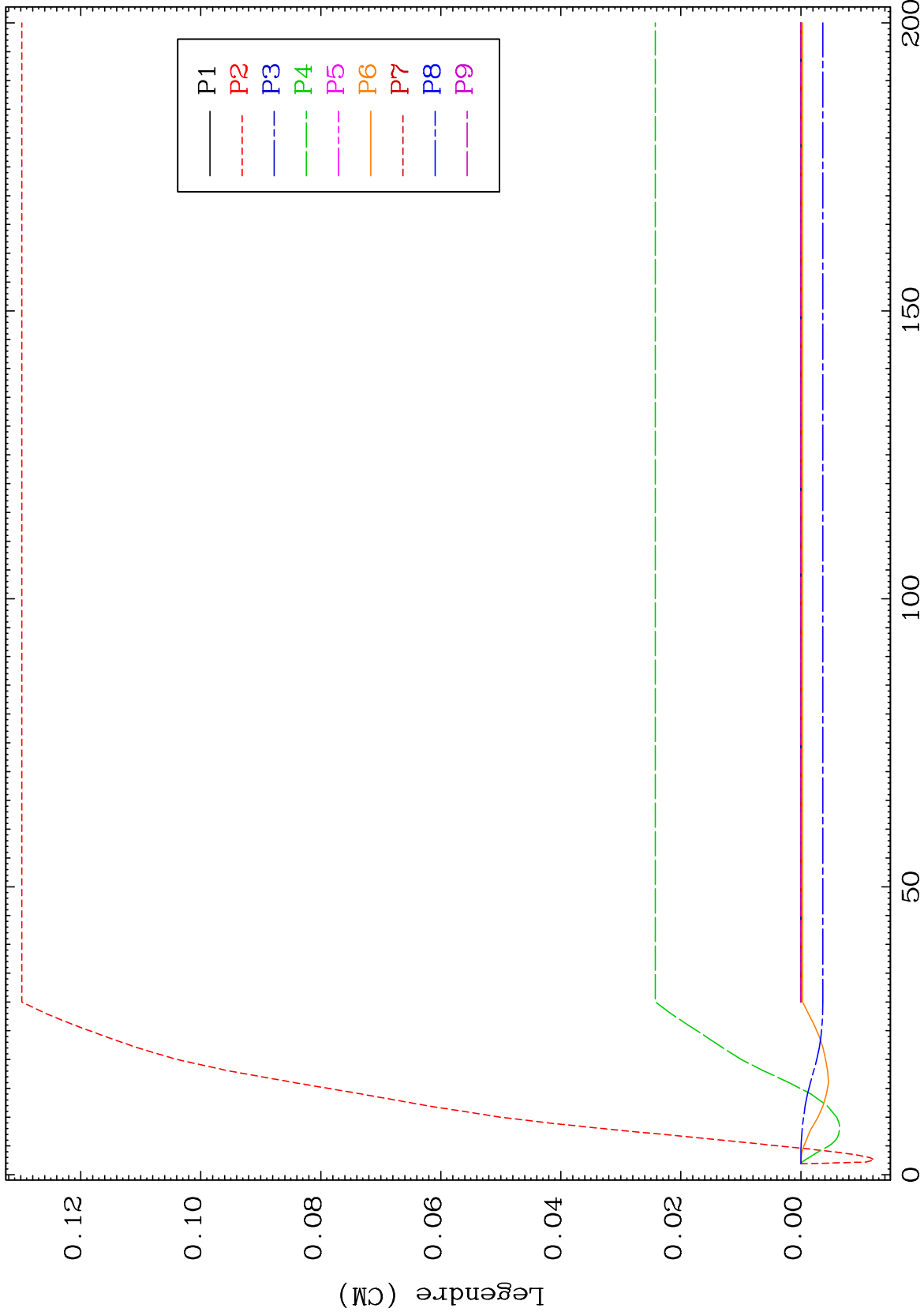

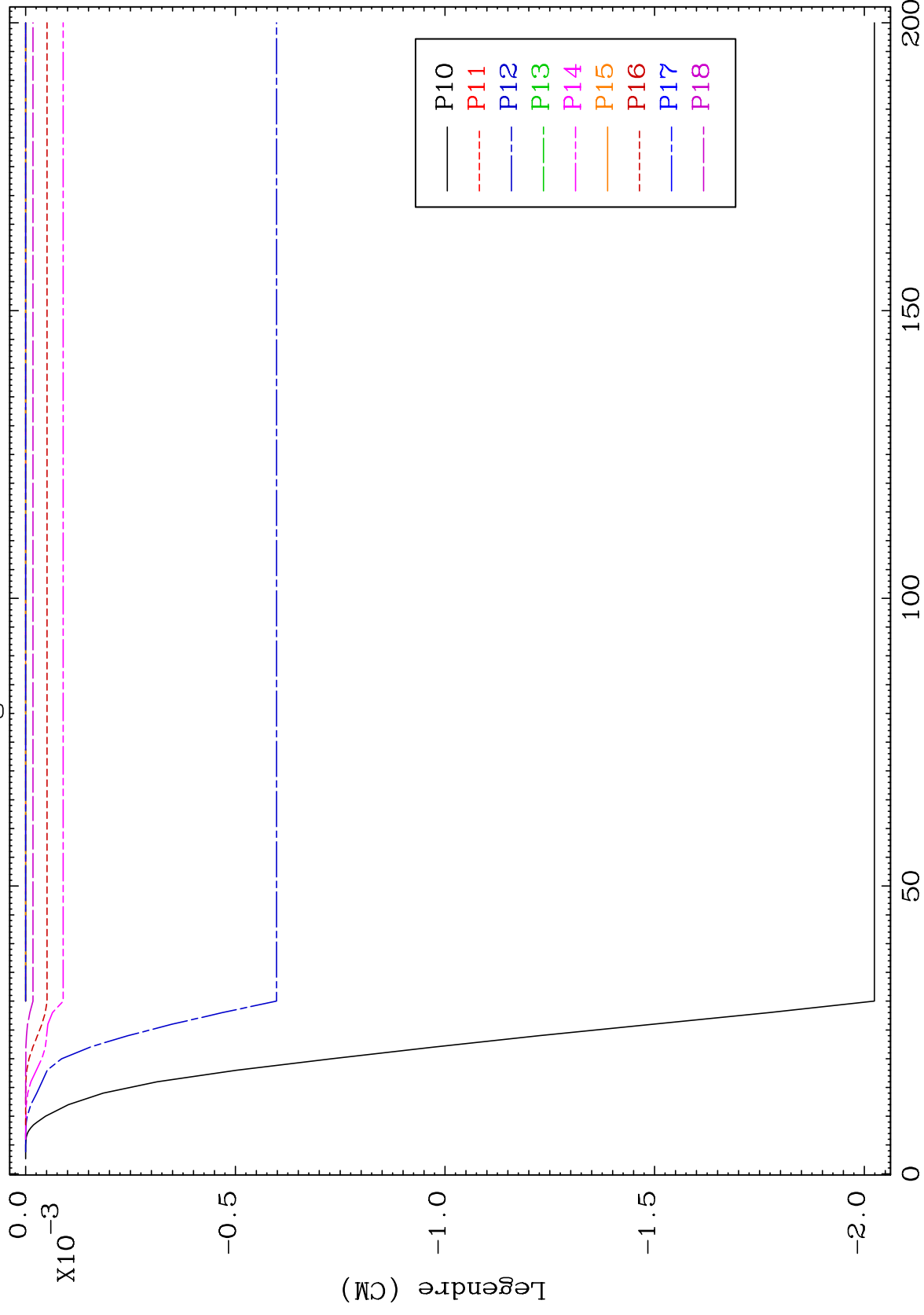

MAT 5358

MT= 73 (n,n') Level
Legendre Coefficients

53-I -138

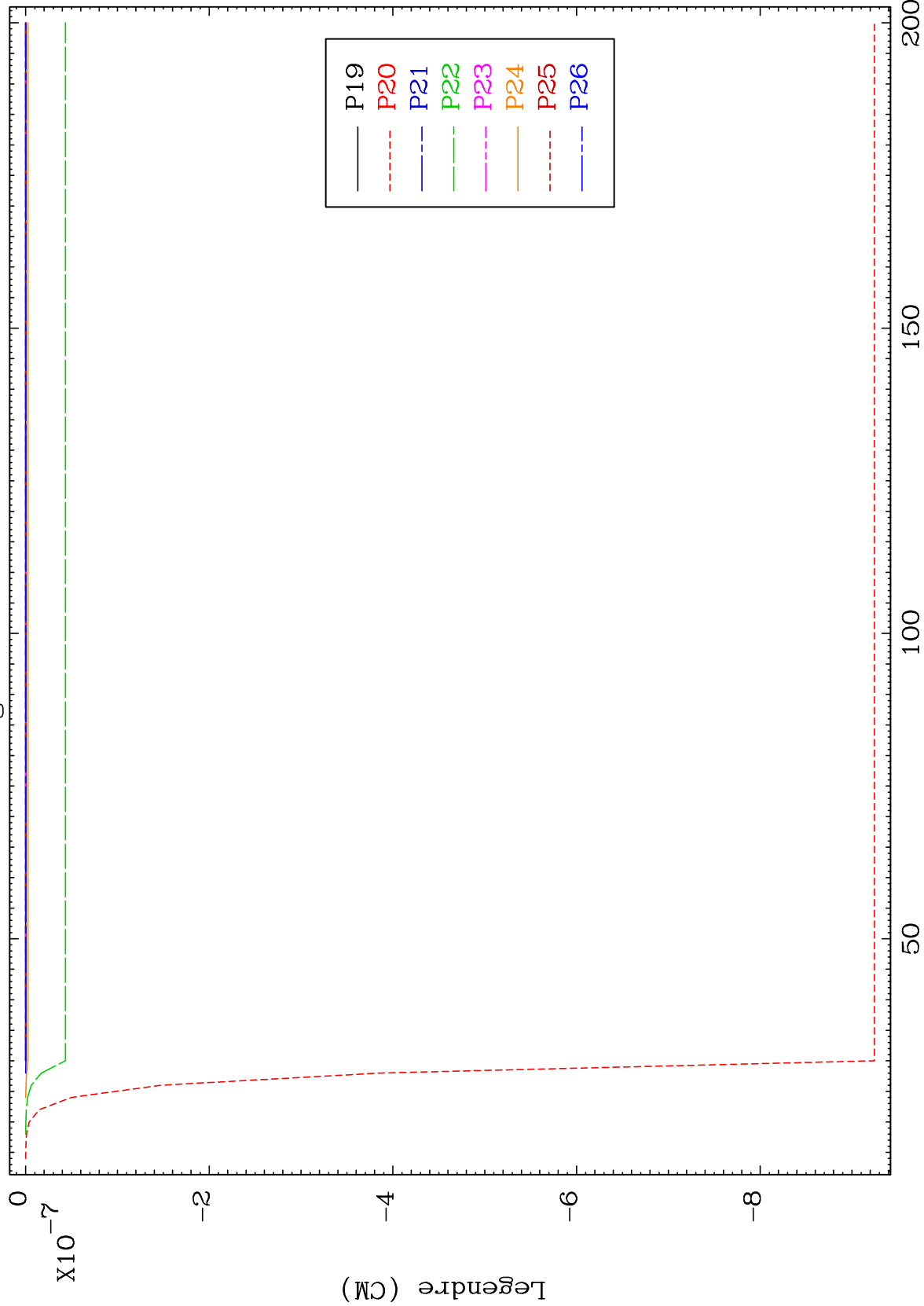

97

Incident Energy (MeV)

53-I -138

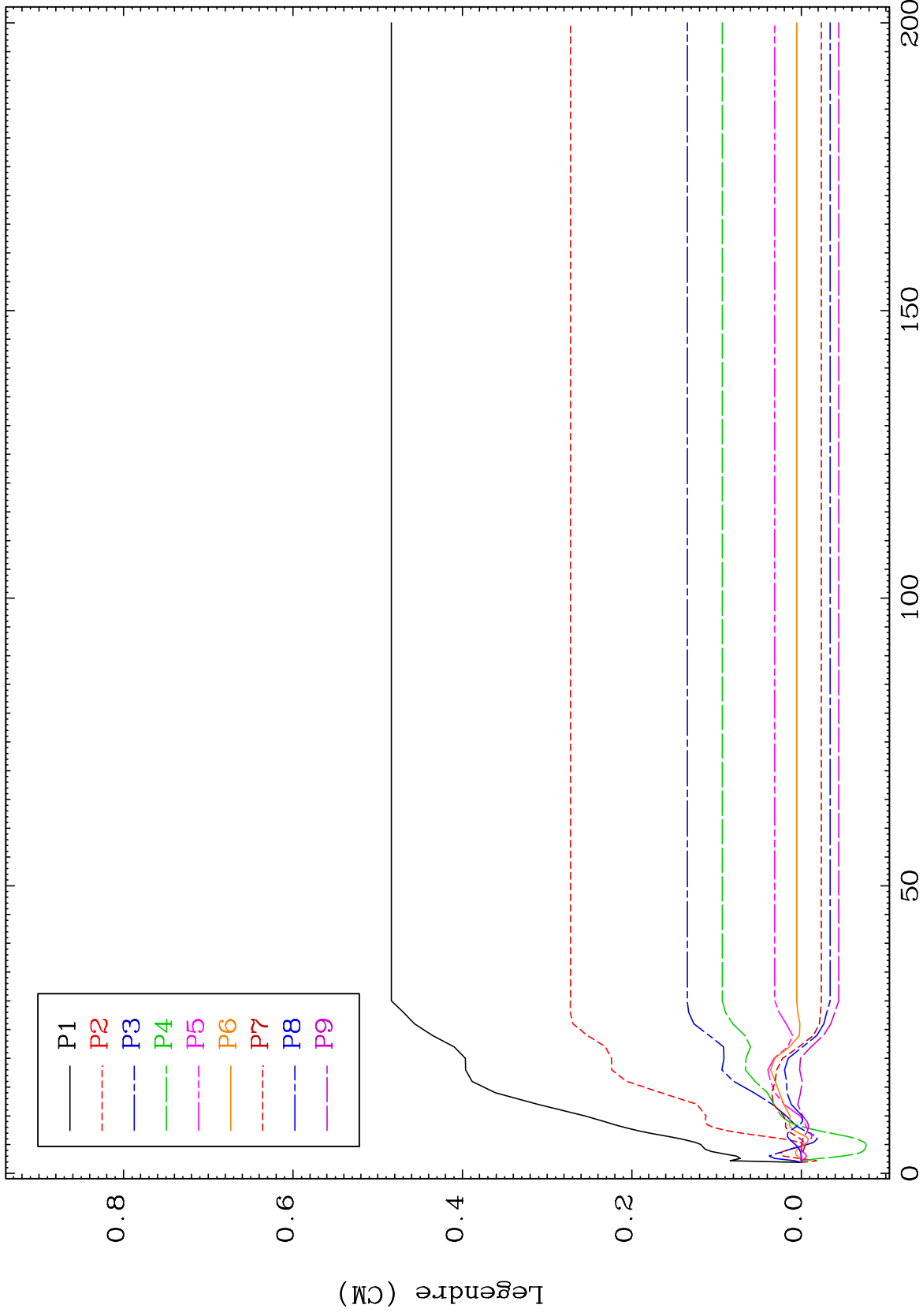

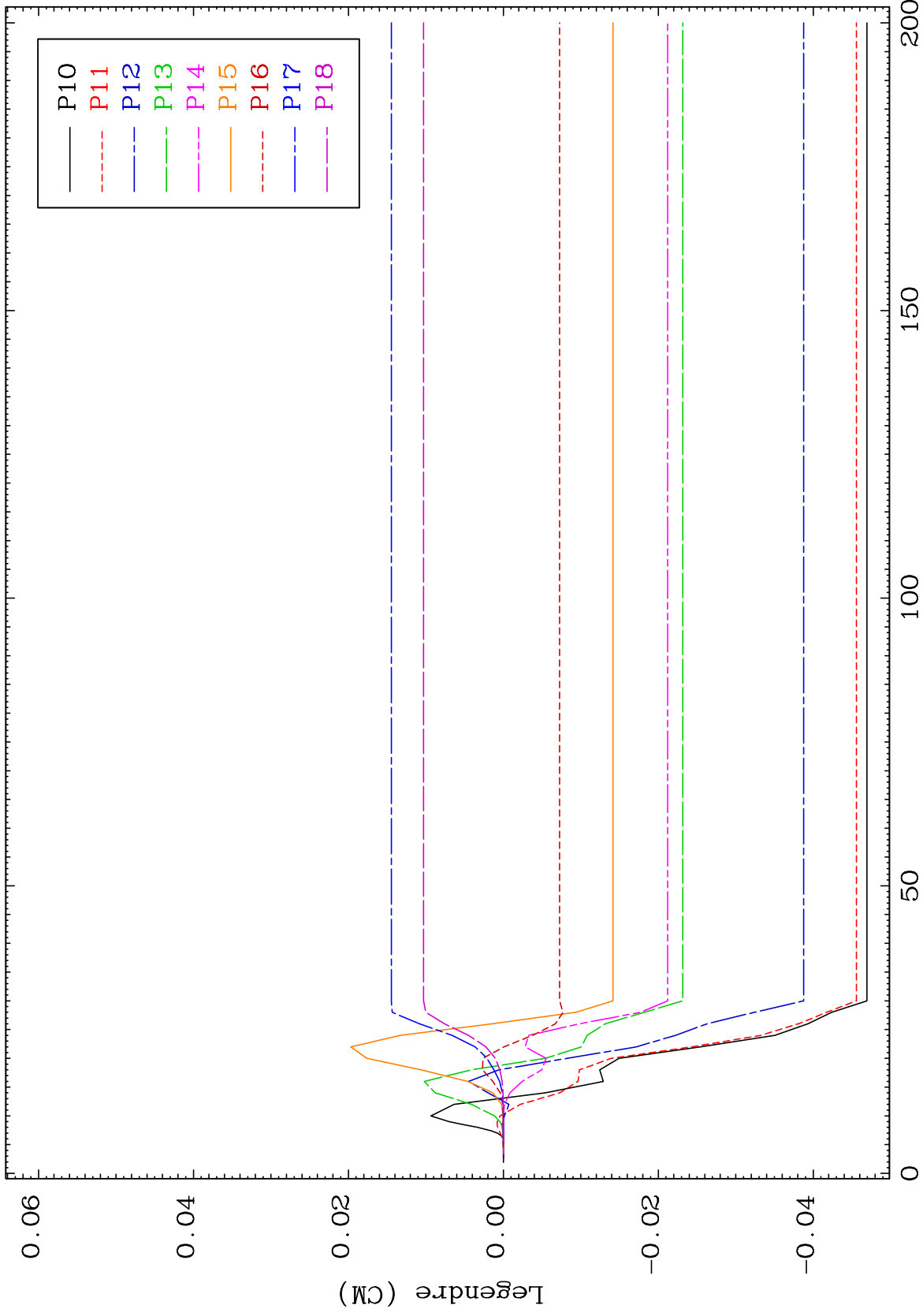

MAT 5358

MT= 74 (n,n') Level
Legendre Coefficients

53-I -138

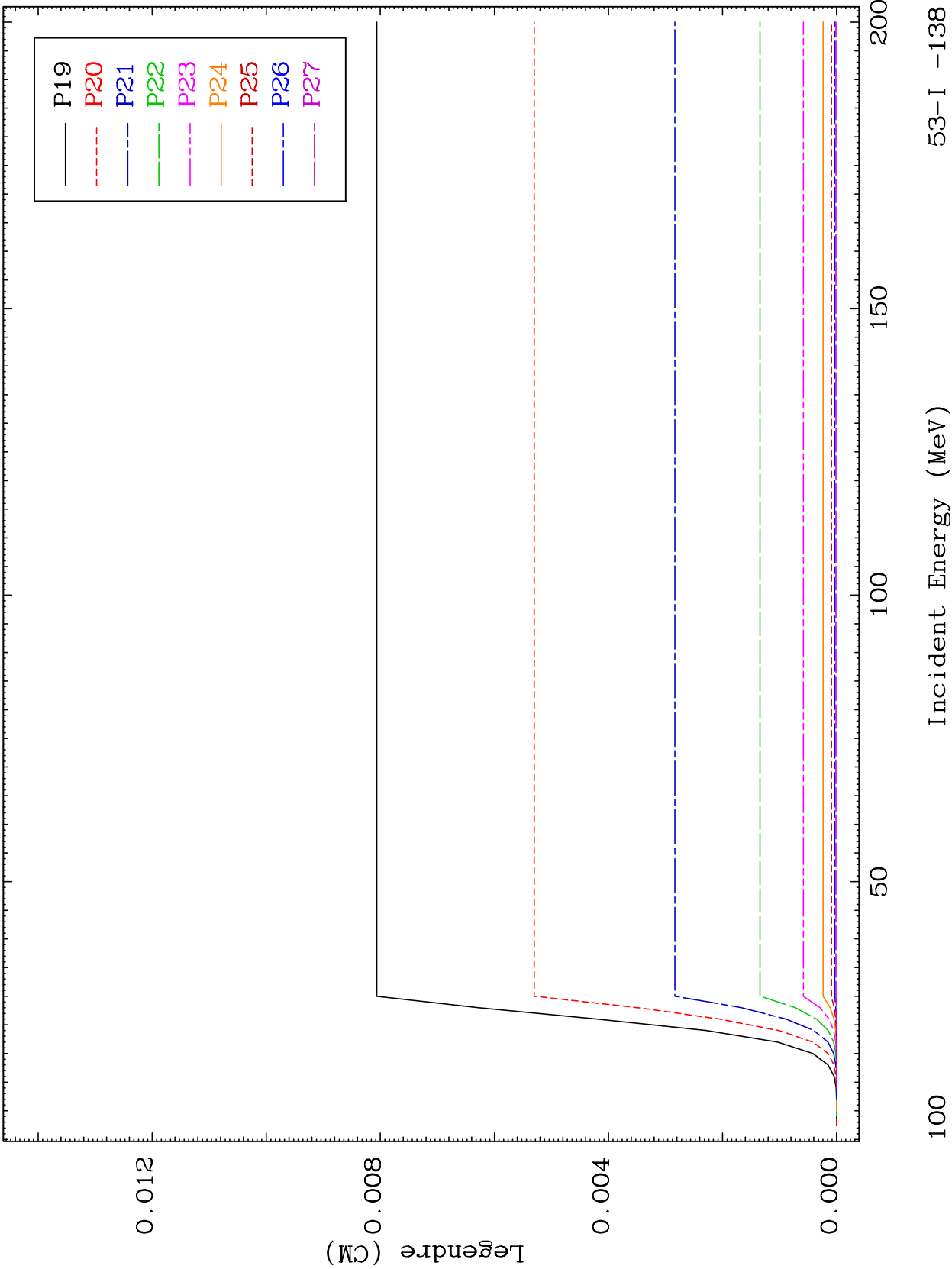

53-I -138

Incident Energy (MeV)

100

50

100

150

200

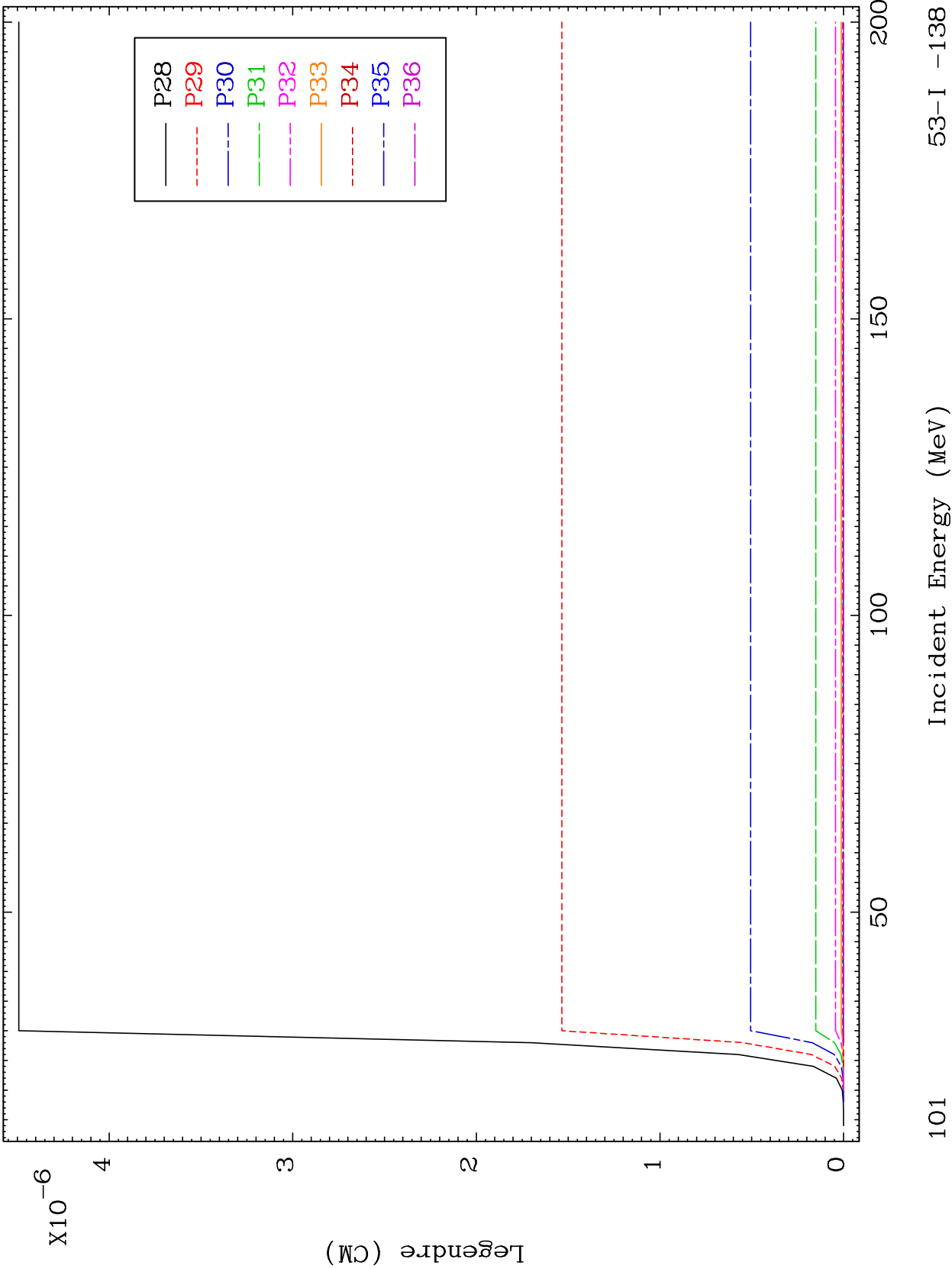

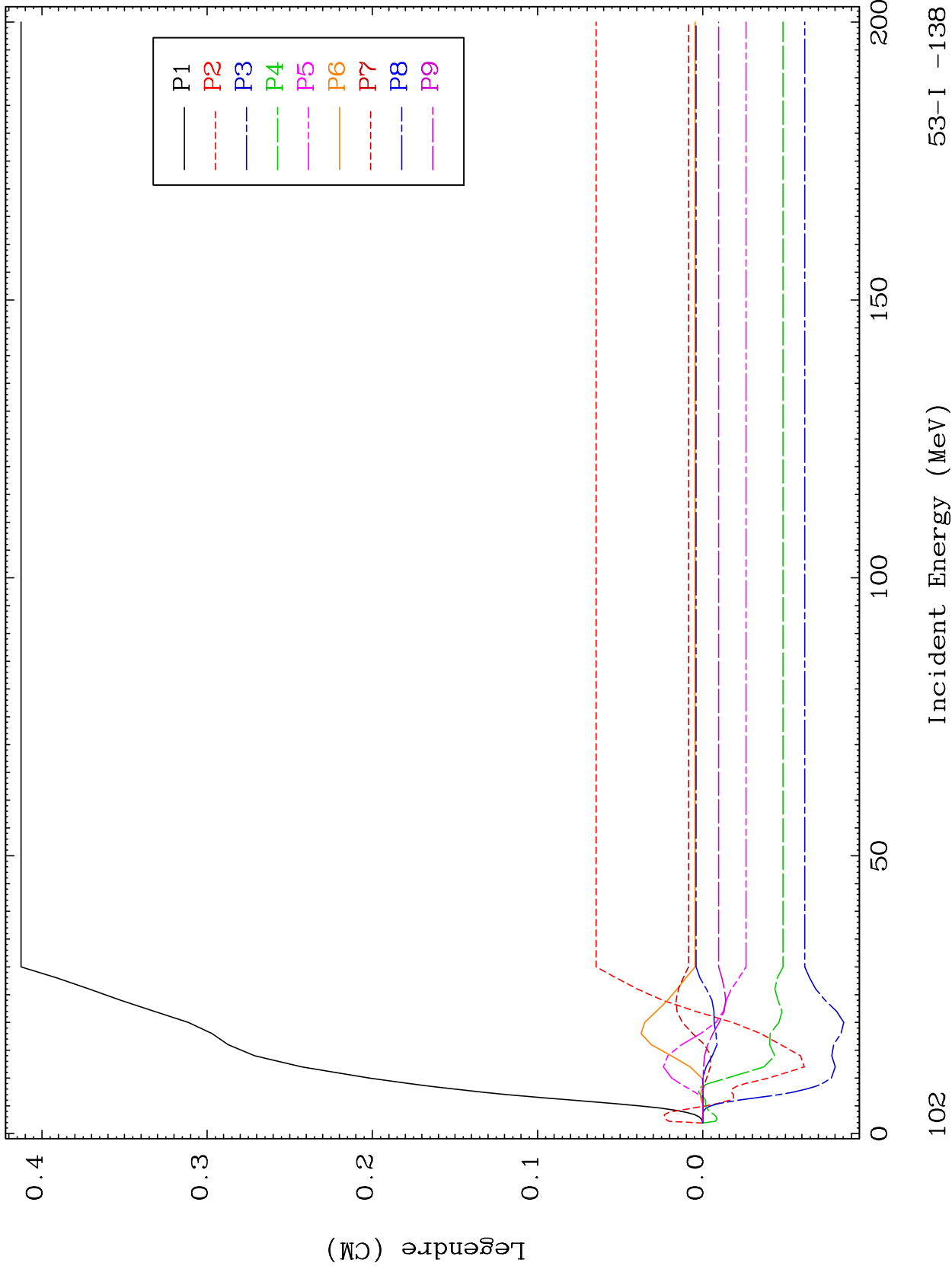

MAT 5358

MT= 75 (n,n') Level
Legendre Coefficients

53-I -138

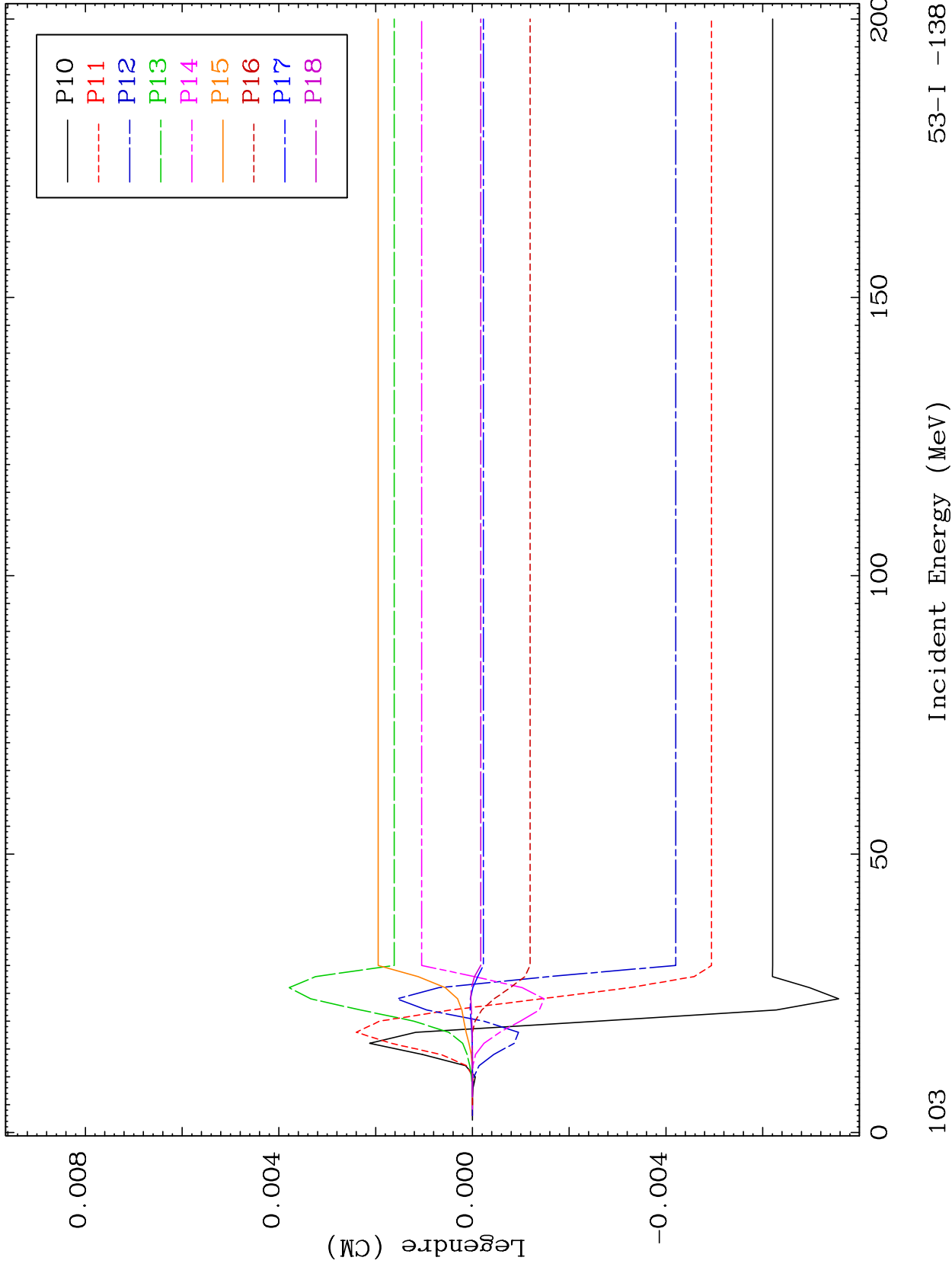

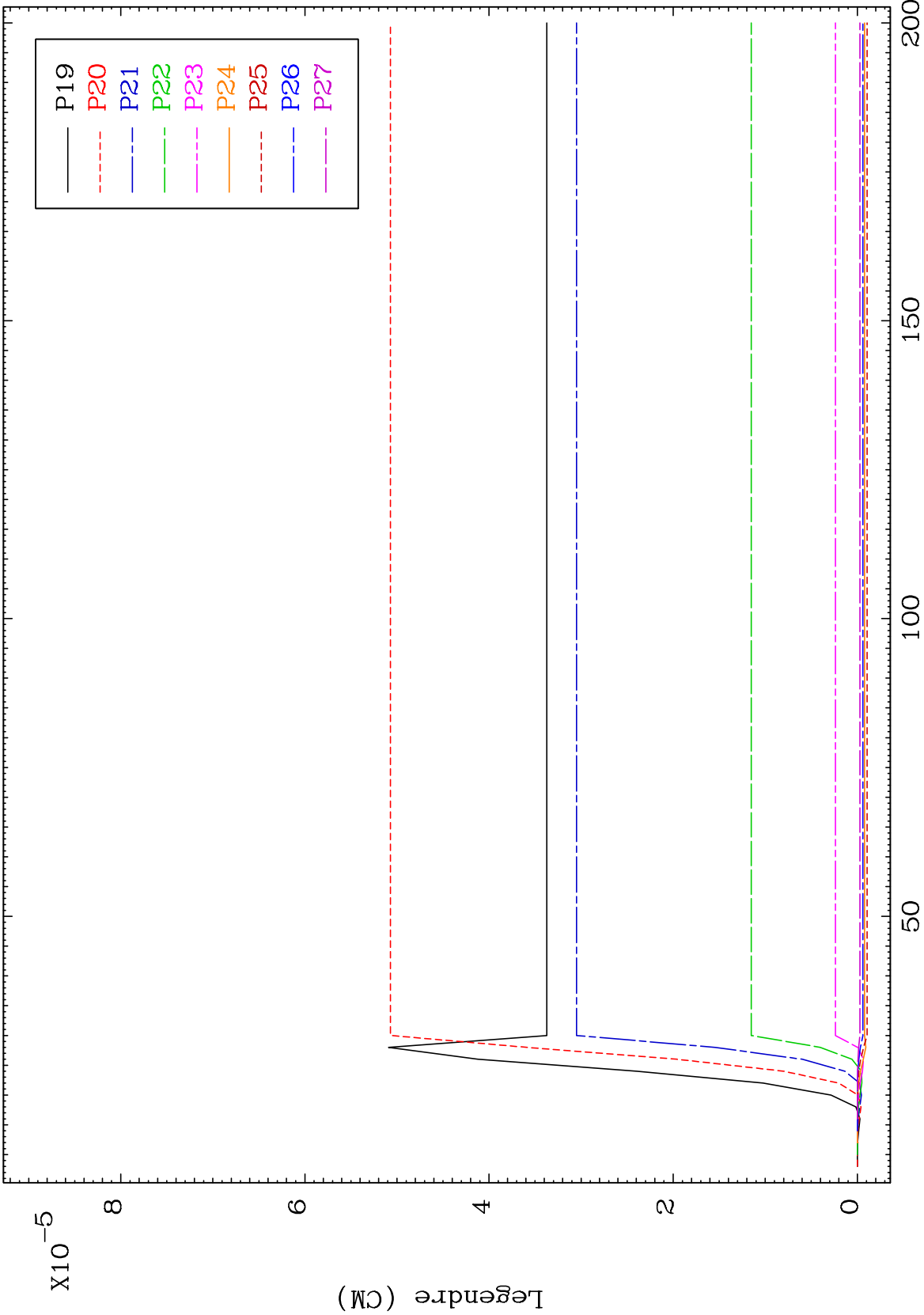

MAT 5358

MT= 75 (n,n') Level

53-I -138

Legendre Coefficients

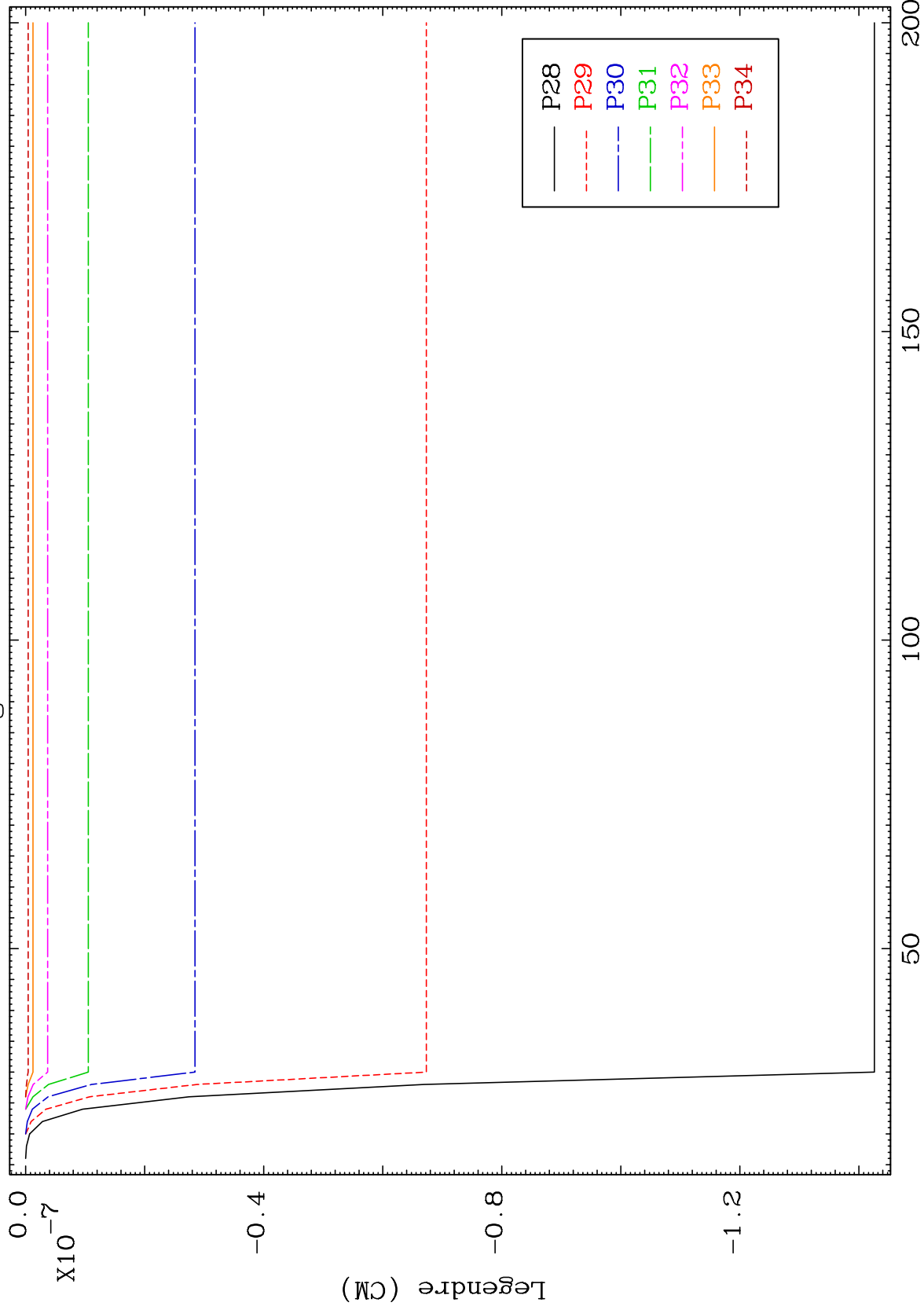

105

Incident Energy (MeV)

53-I -138

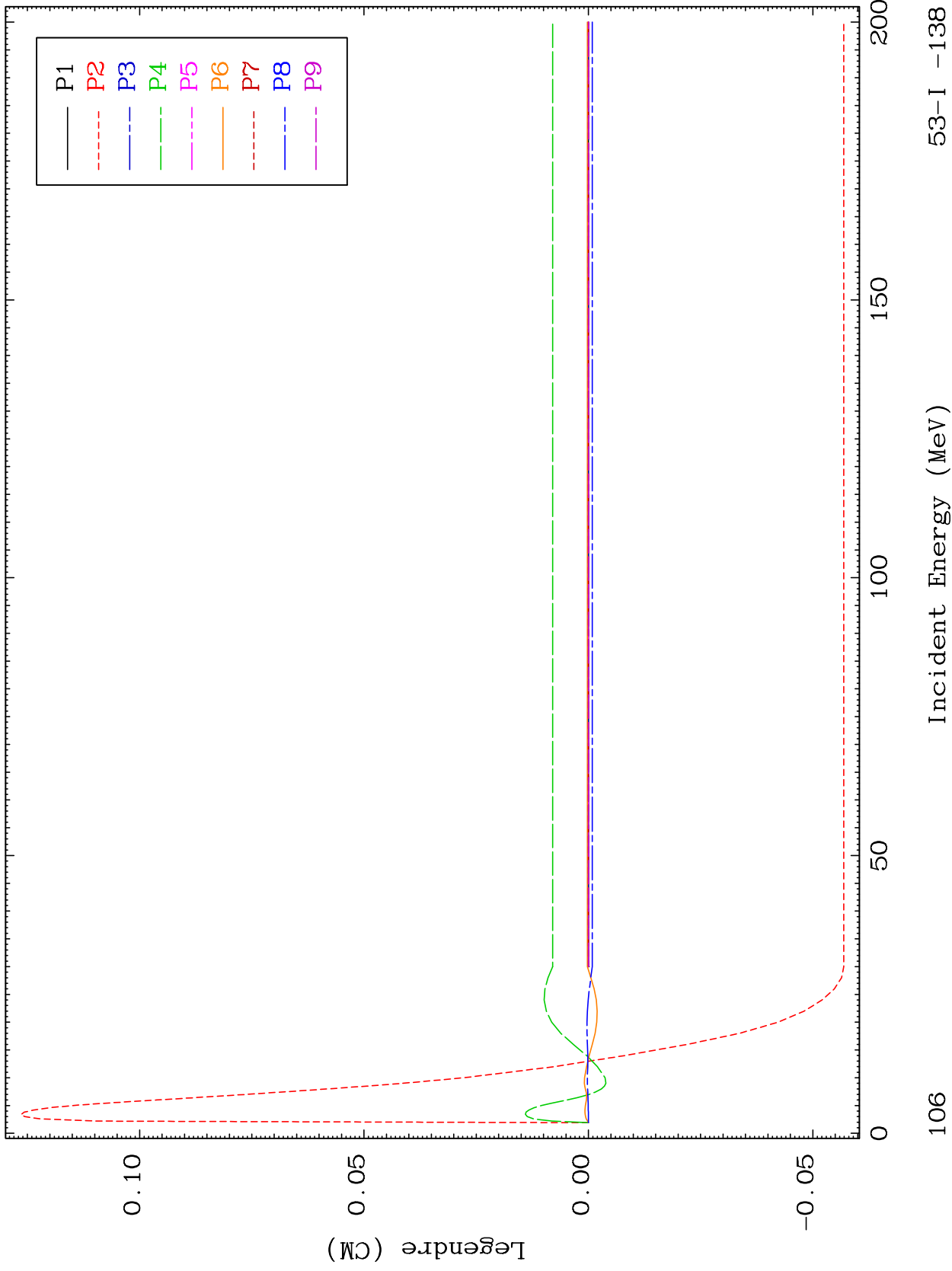

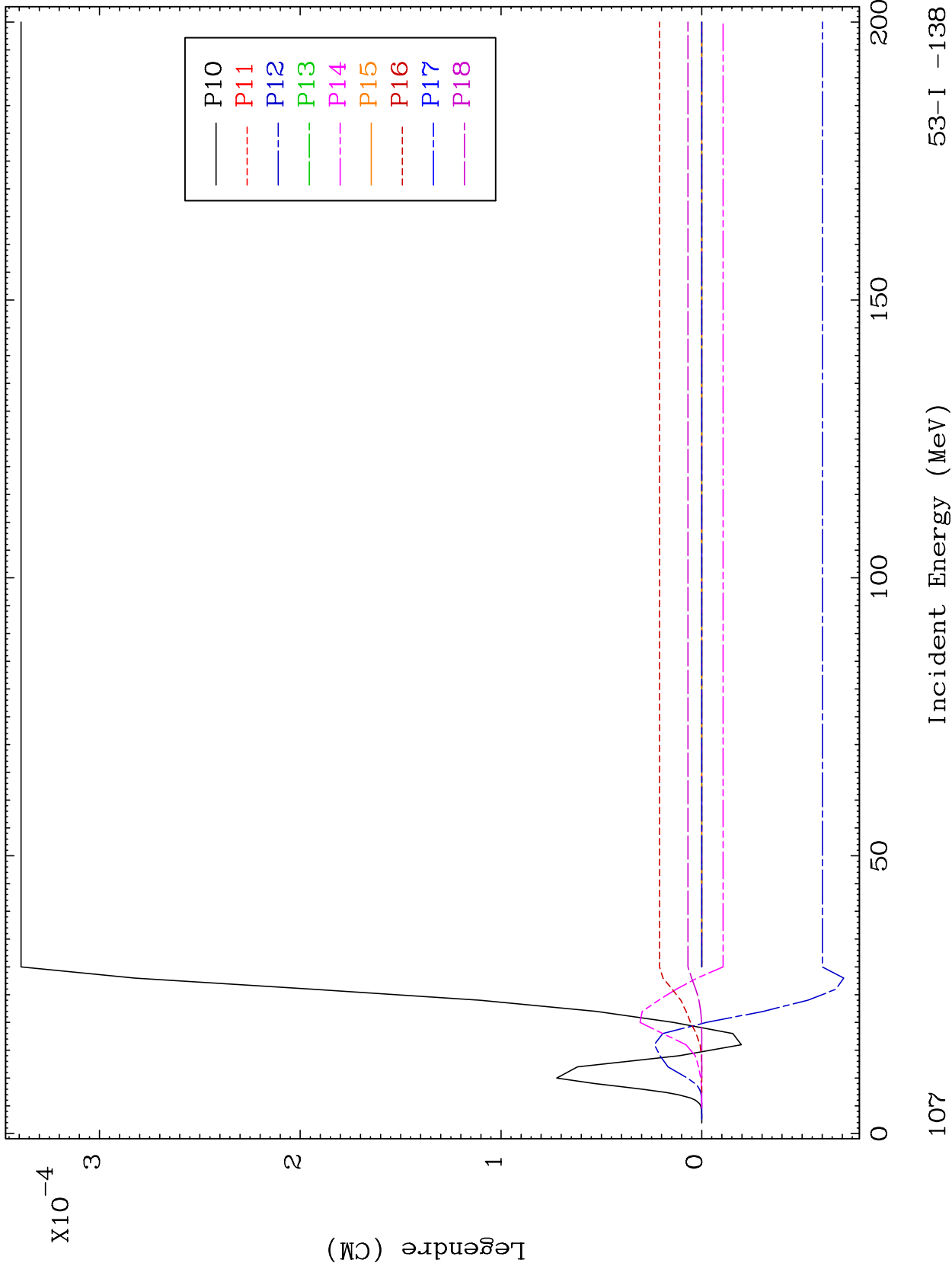

MAT 5358

MT= 76 (n,n') Level
Legendre Coefficients

53-I -138

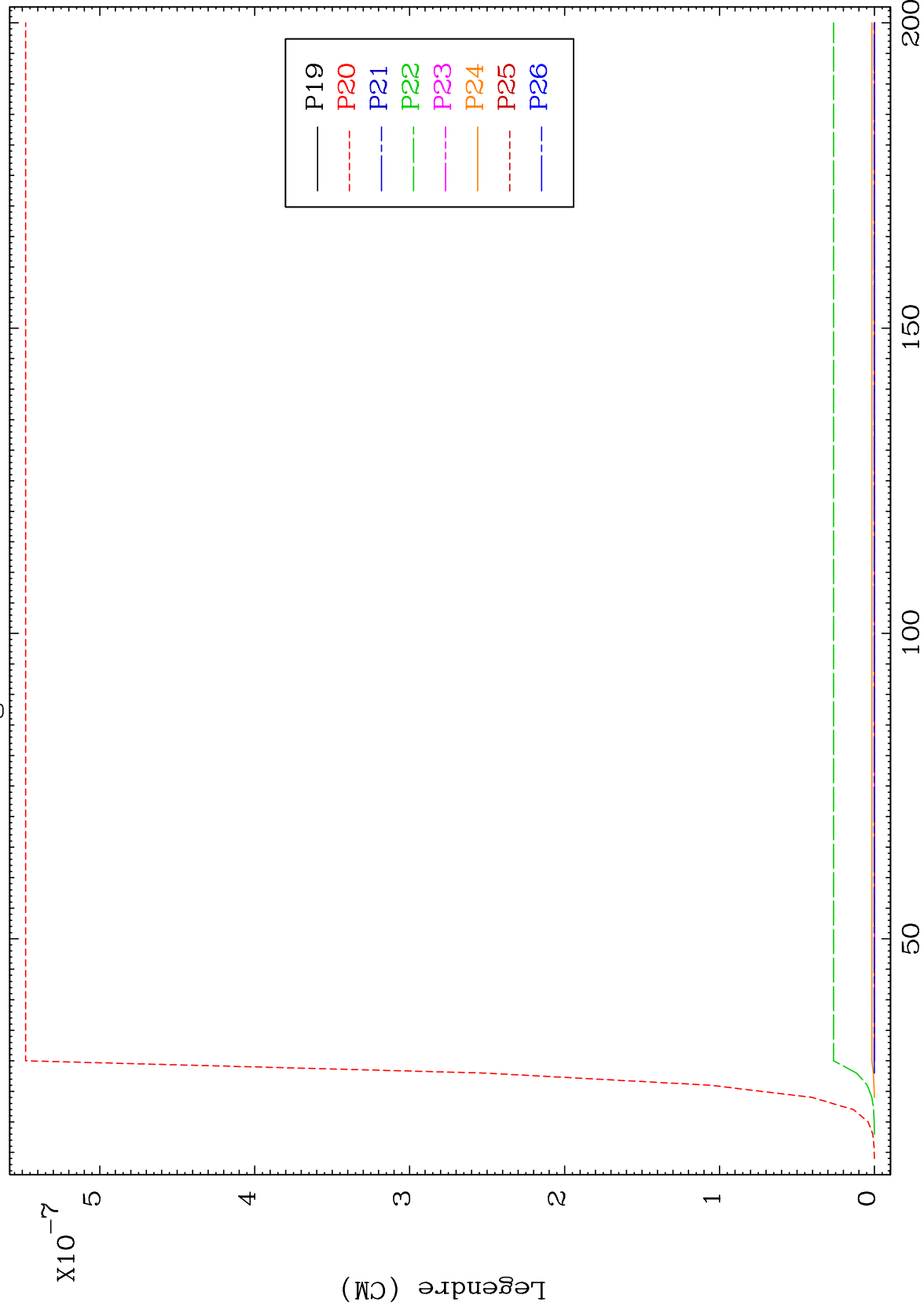

108

Incident Energy (MeV)

53-I -138

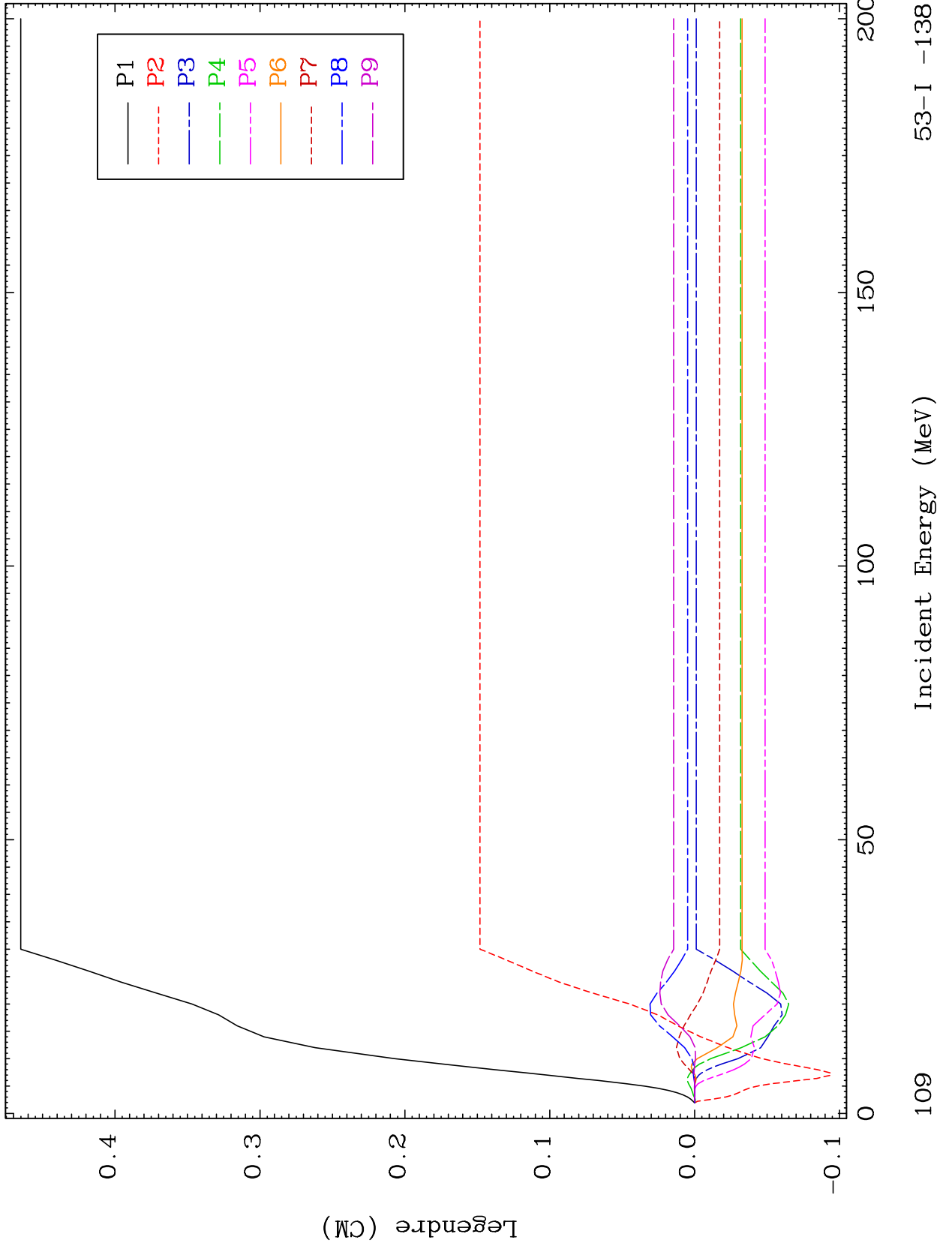

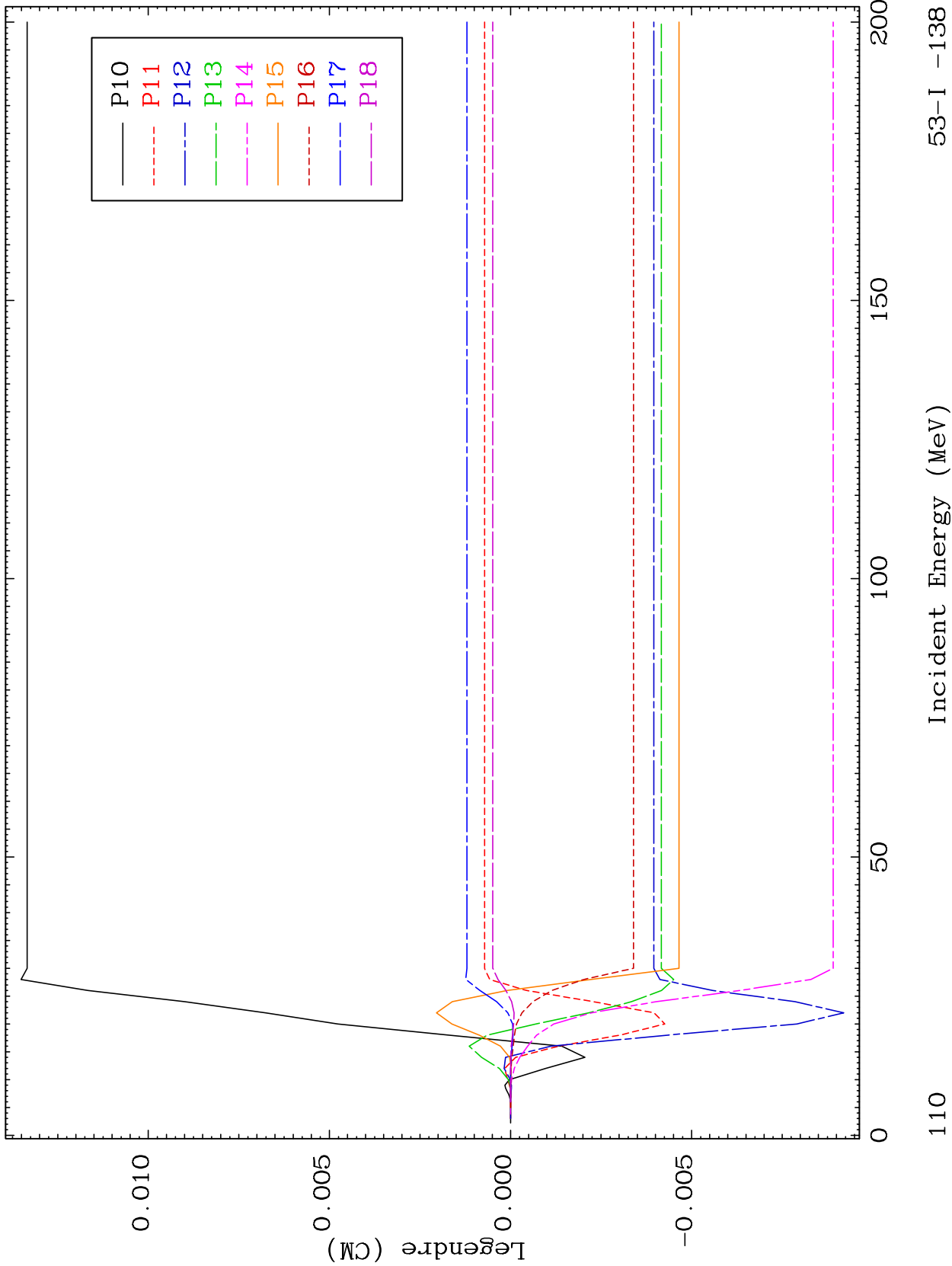

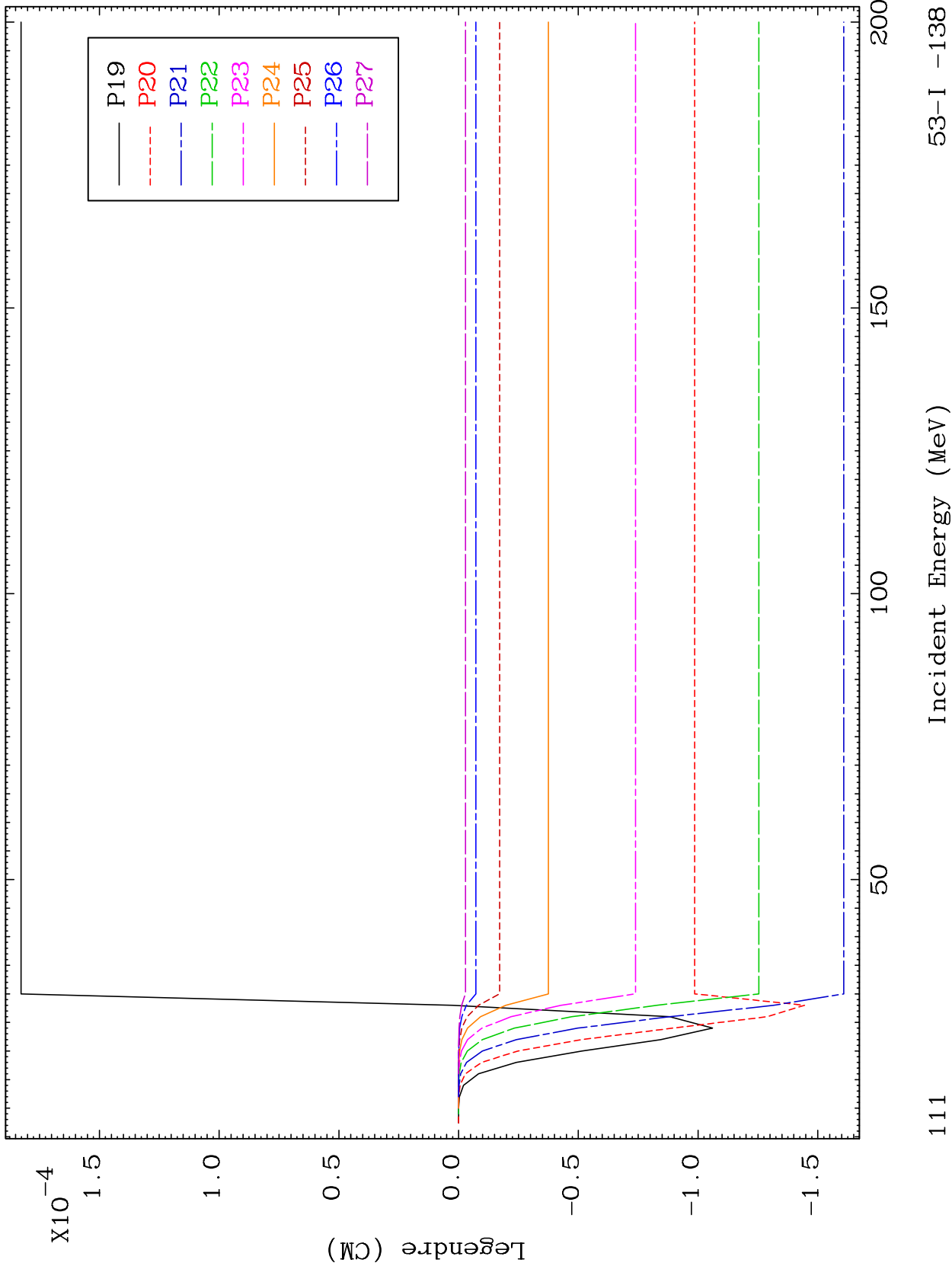

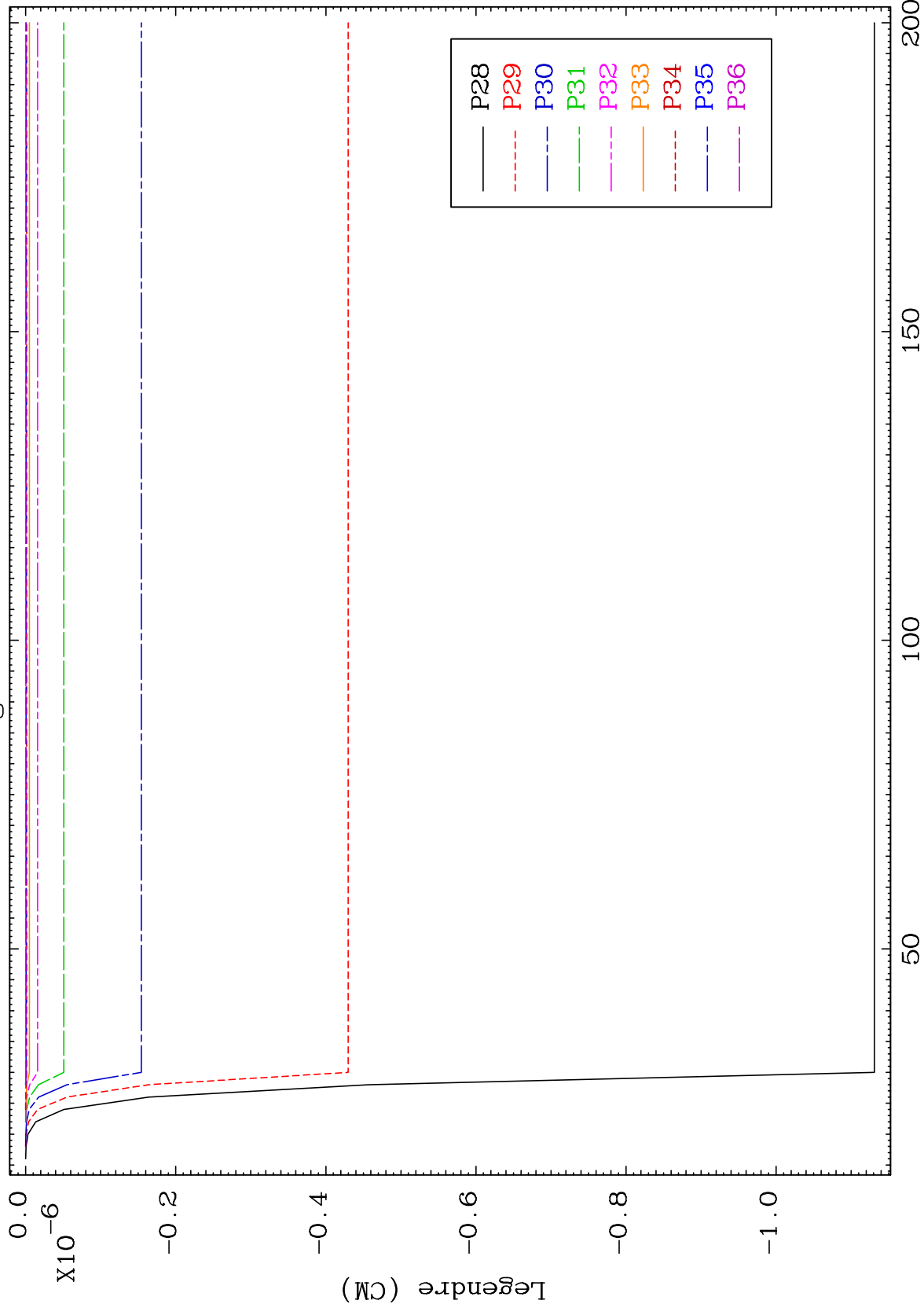

MAT 5358

MT= 78 (n,n') Level
Legendre Coefficients

53-I -138

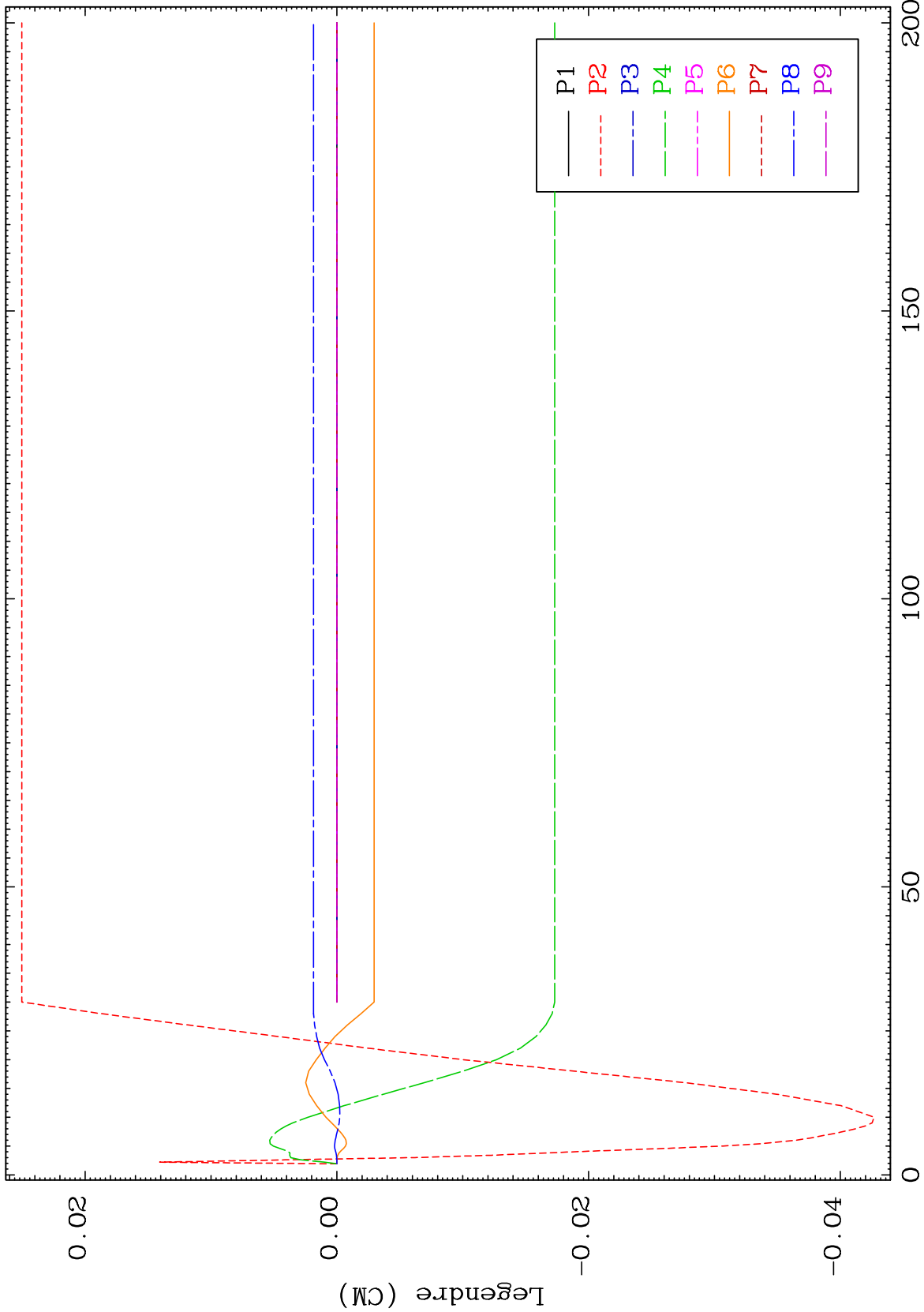

113

Incident Energy (MeV)

53-I -138

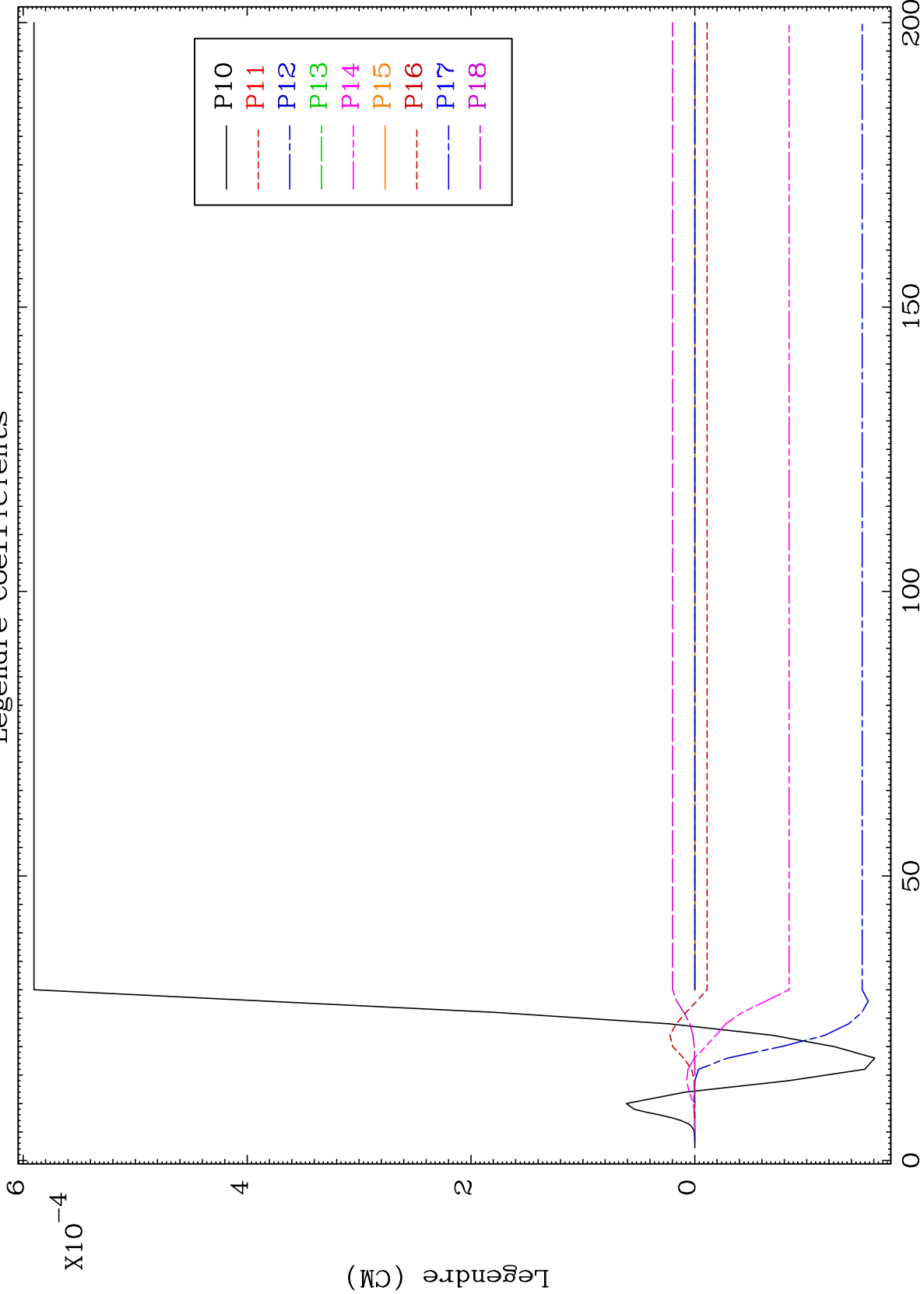

MAT 5358

MT= 78 (n,n') Level
Legendre Coefficients

53-I -138

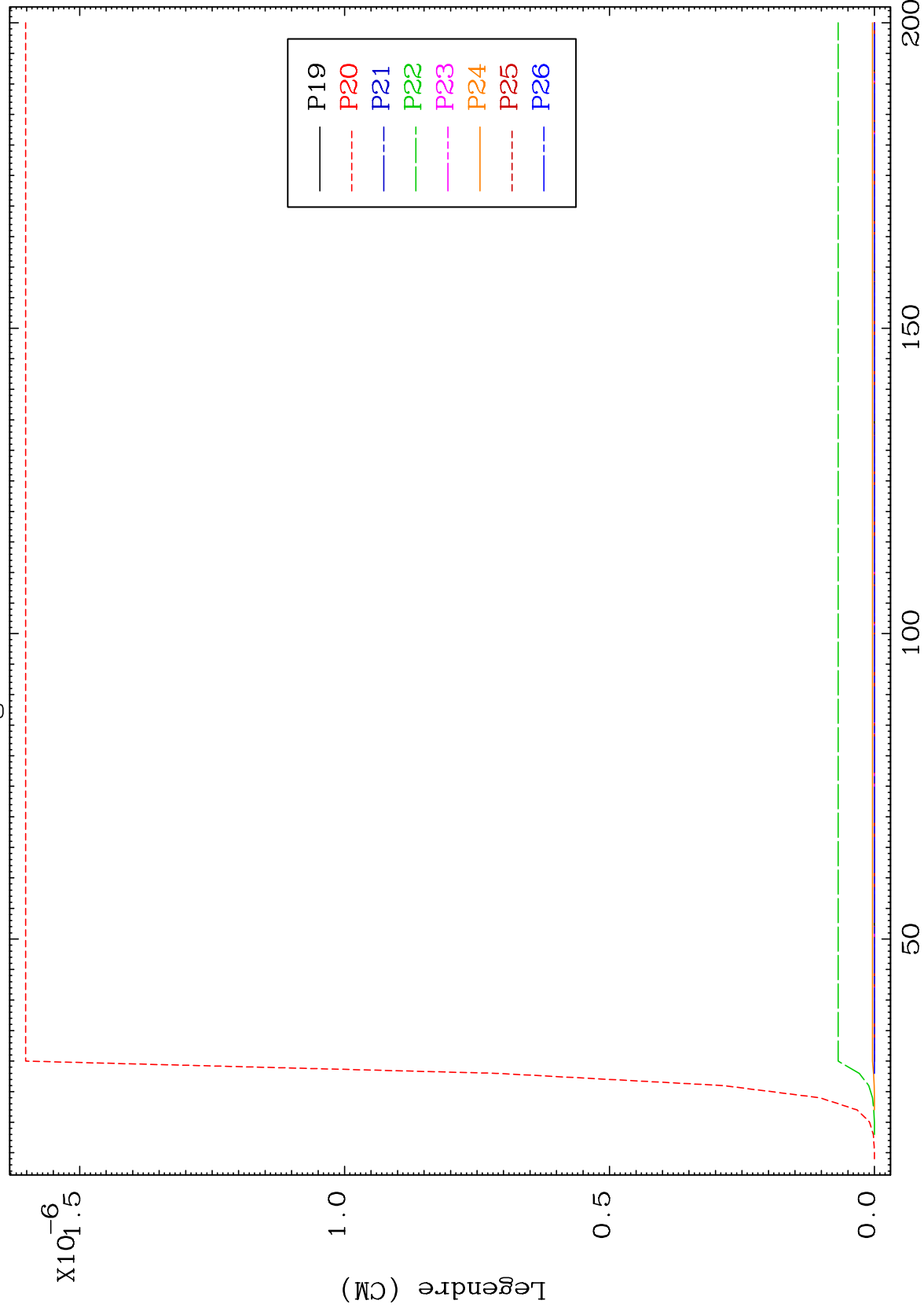

115

Incident Energy (MeV)

53-I -138

MAT 5358

MT= 79 (n,n') Level
Legendre Coefficients

53-I -138

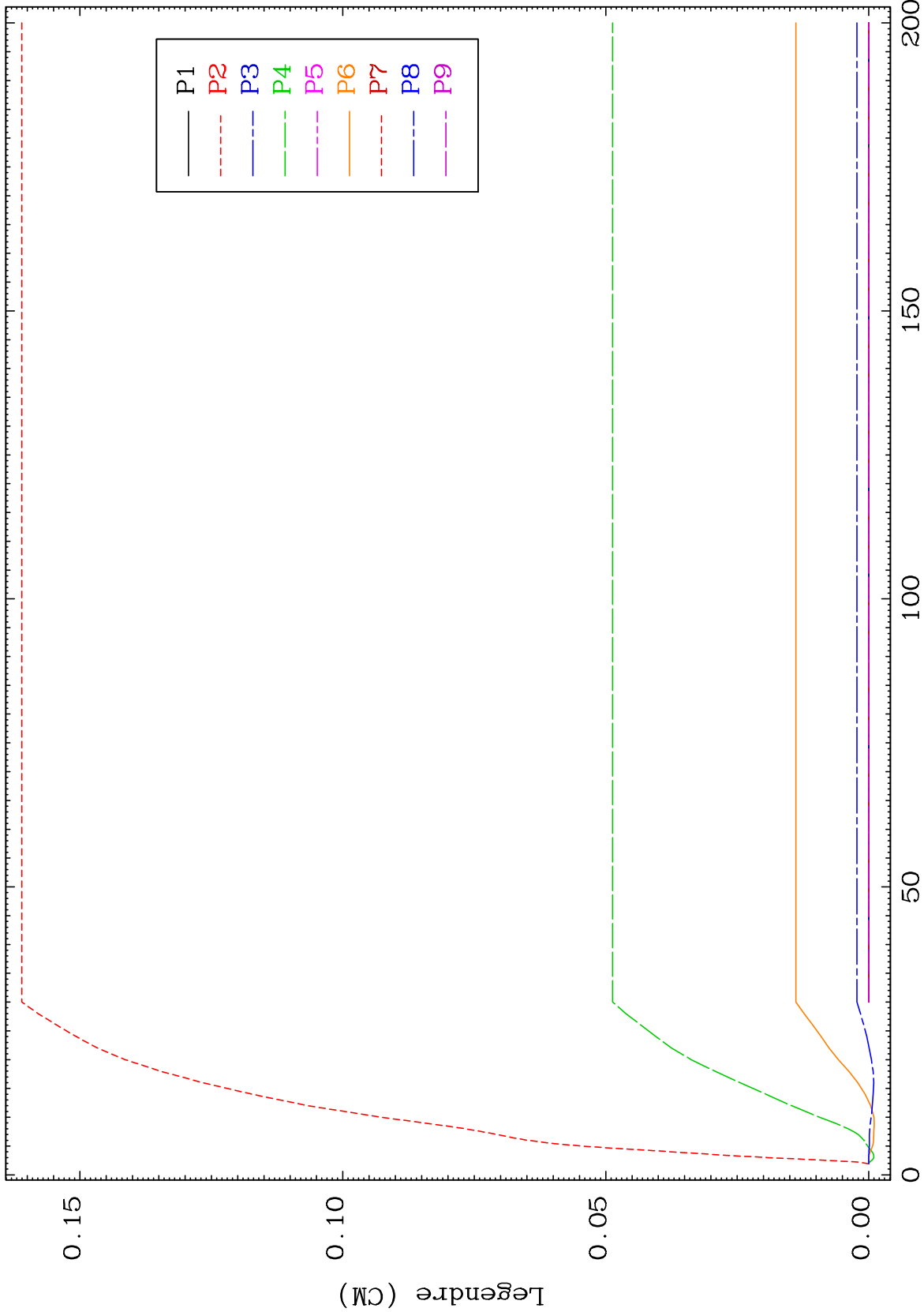

116

Incident Energy (MeV)

53-I -138

MAT 5358

MT= 79 (n,n') Level

53-I -138

Legendre Coefficients

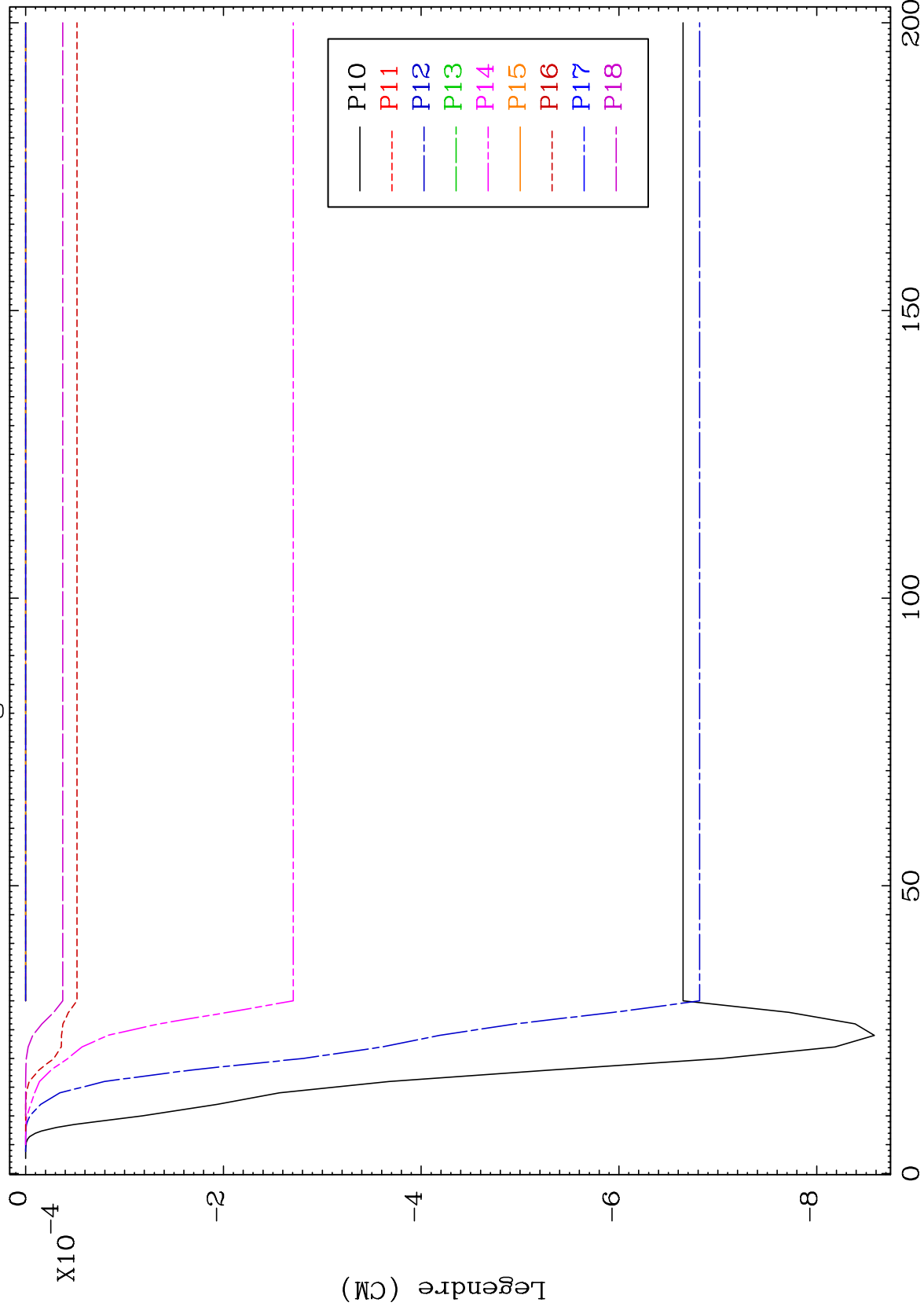

53-I -138

Incident Energy (MeV)

117

MAT 5358

MT= 79 (n,n') Level
Legendre Coefficients

53-I -138

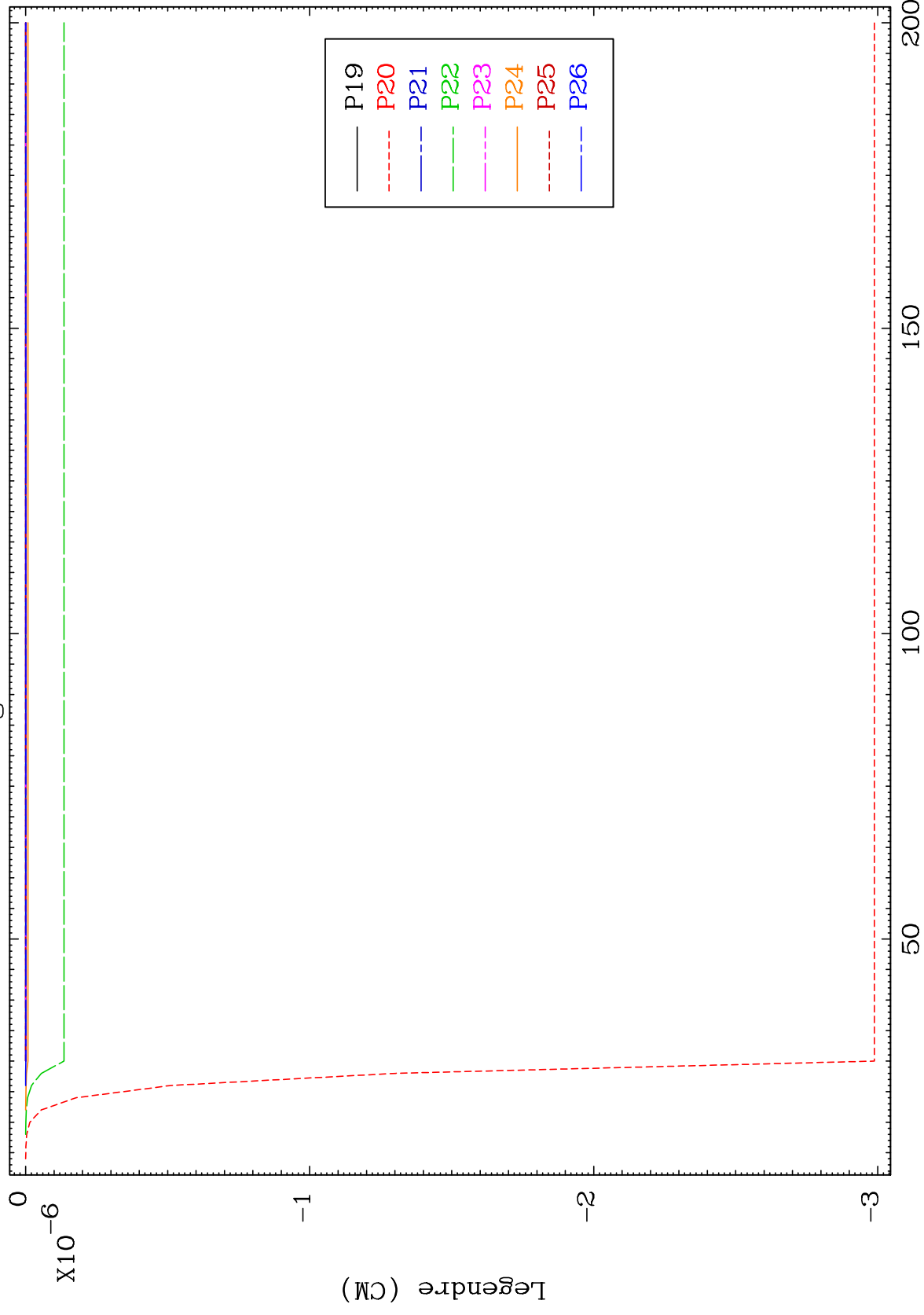

118

Incident Energy (MeV)

53-I -138

MAT 5358

MT= 80 (n,n') Level
Legendre Coefficients

53-I -138

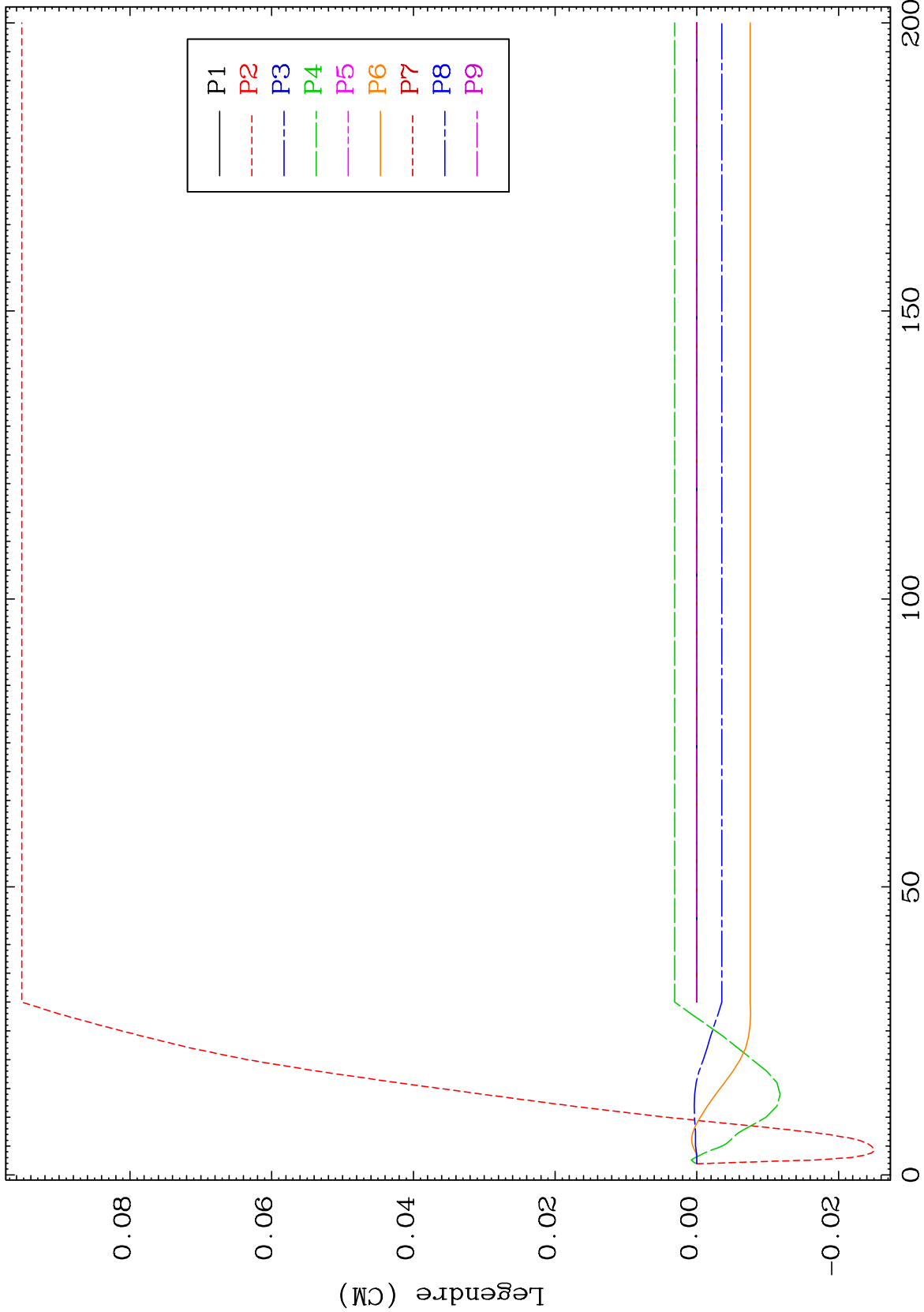

119

Incident Energy (MeV)

53-I -138

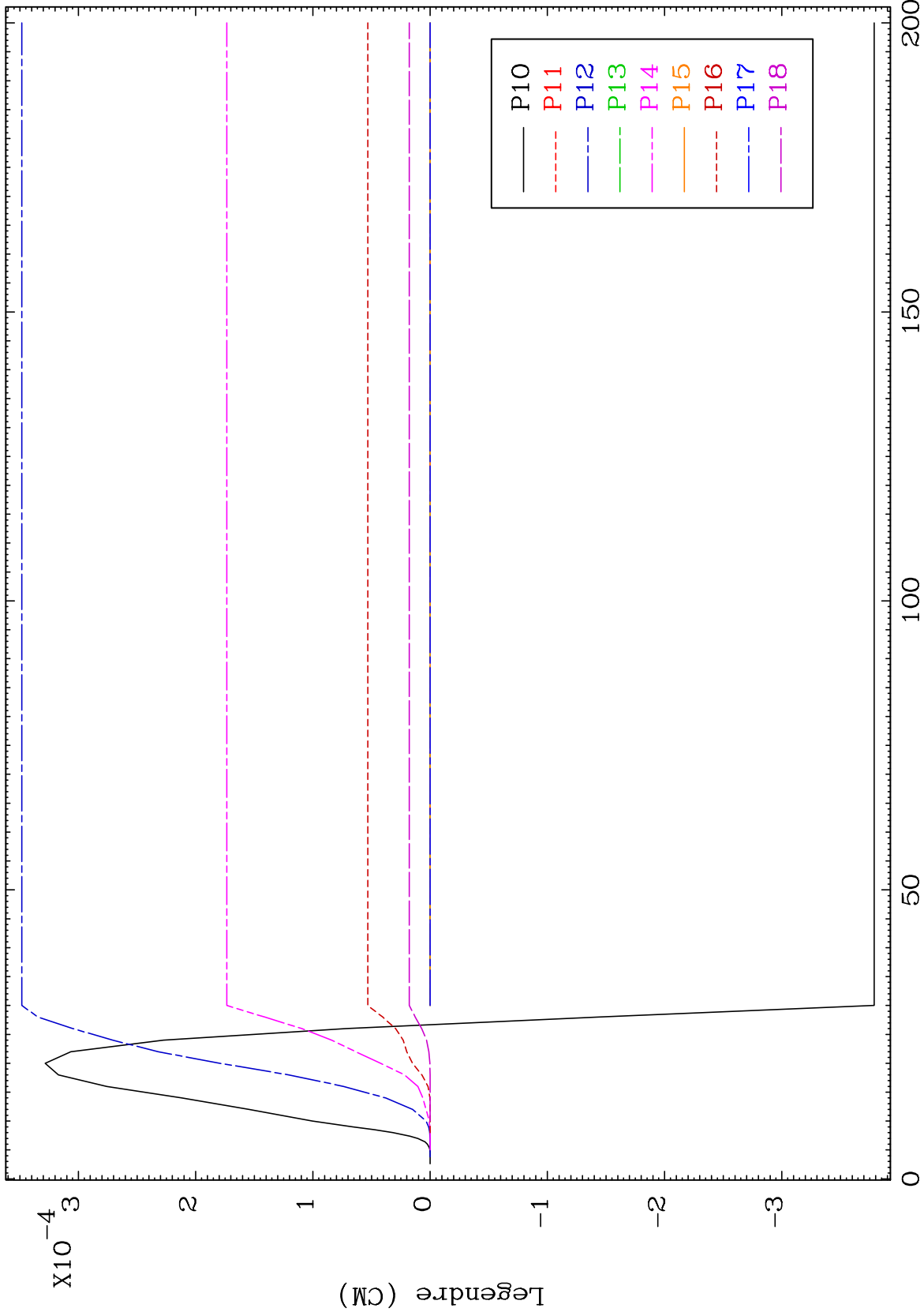

MAT 5358

MT= 80 (n,n') Level
Legendre Coefficients

53-I -138

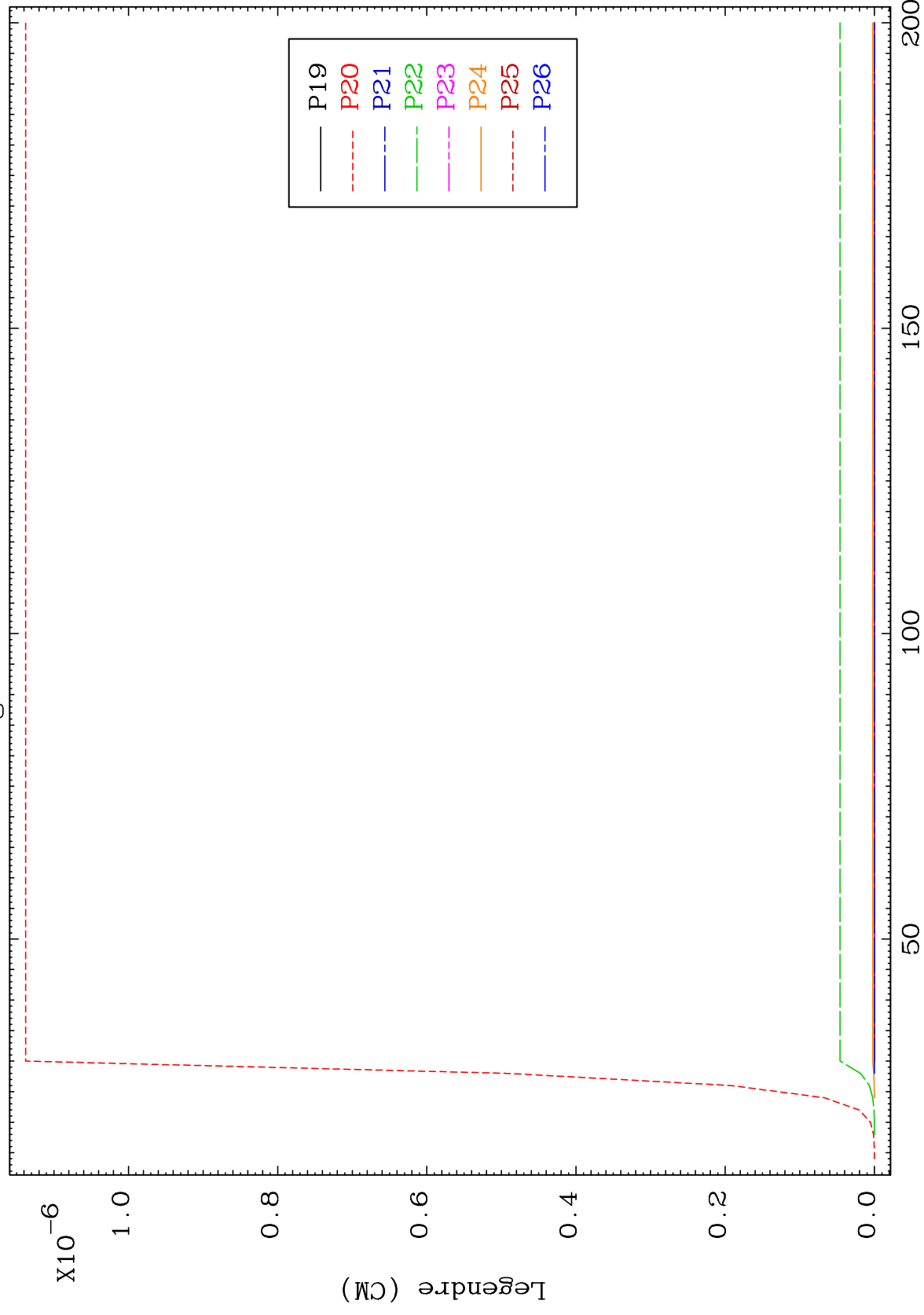

121

Incident Energy (MeV)

53-I -138

MAT 5358

(n,3n)

53-I -138

Radionuclide Production Cross Section

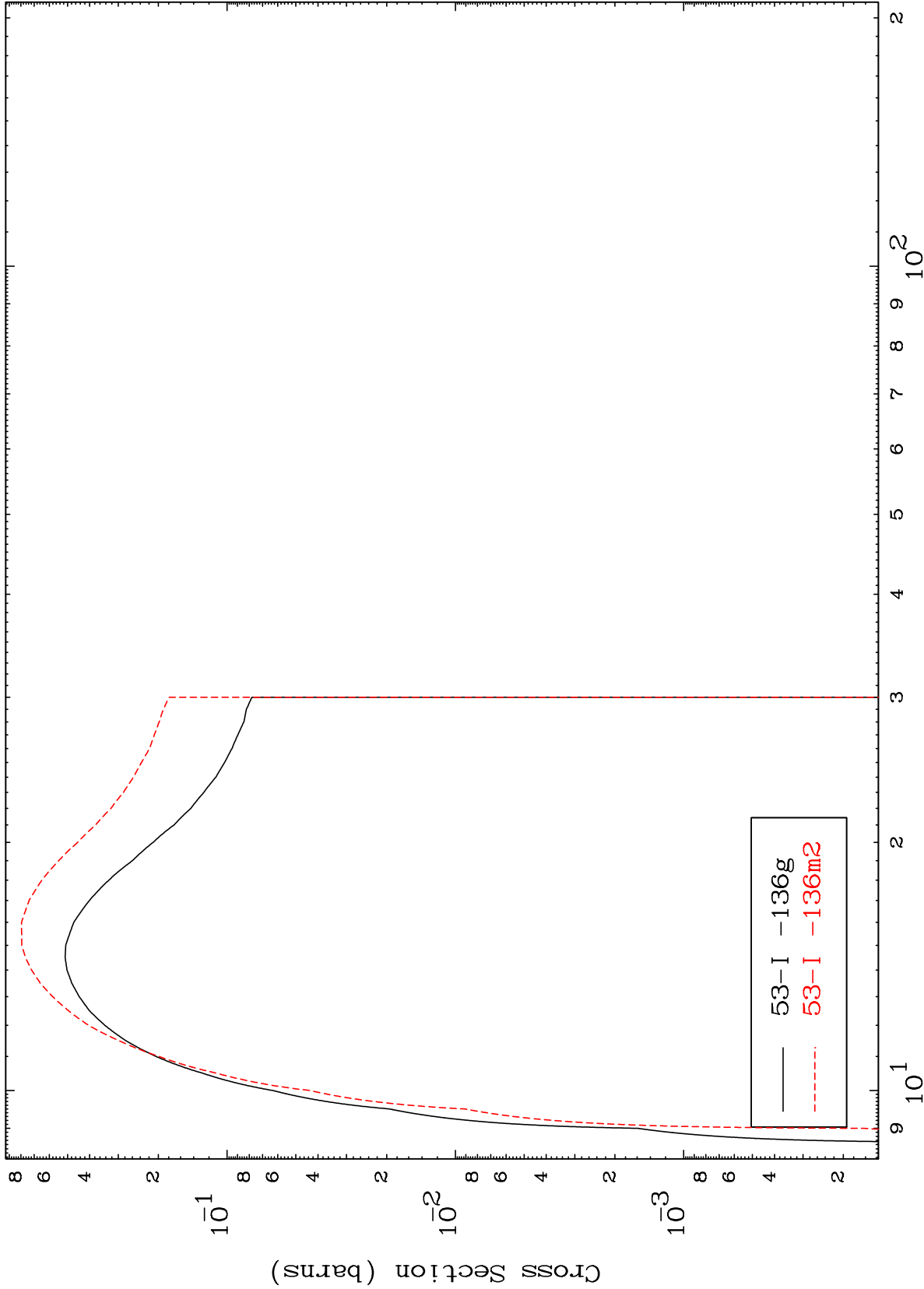

122

Incident Energy (MeV)

53-I -138

MAT 5358

(n,n') α

53-I -138

Radionuclide Production Cross Section

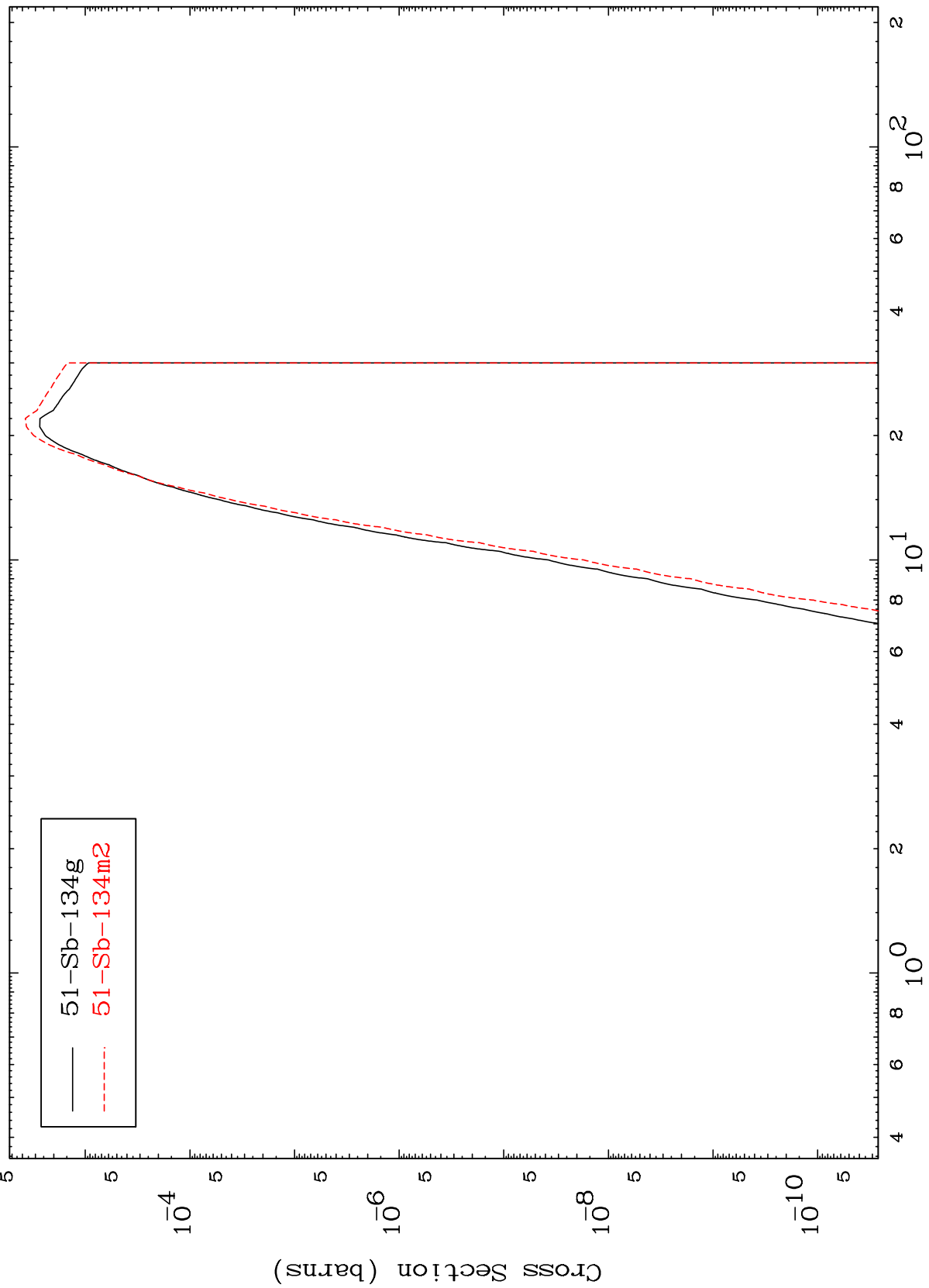

123

Incident Energy (MeV)

53-I -138

Radionuclide Production Cross Section

