

IN104M NEUTRON ACER TENDL-2024 LIBRARY; T=0.K

Principal cross sections

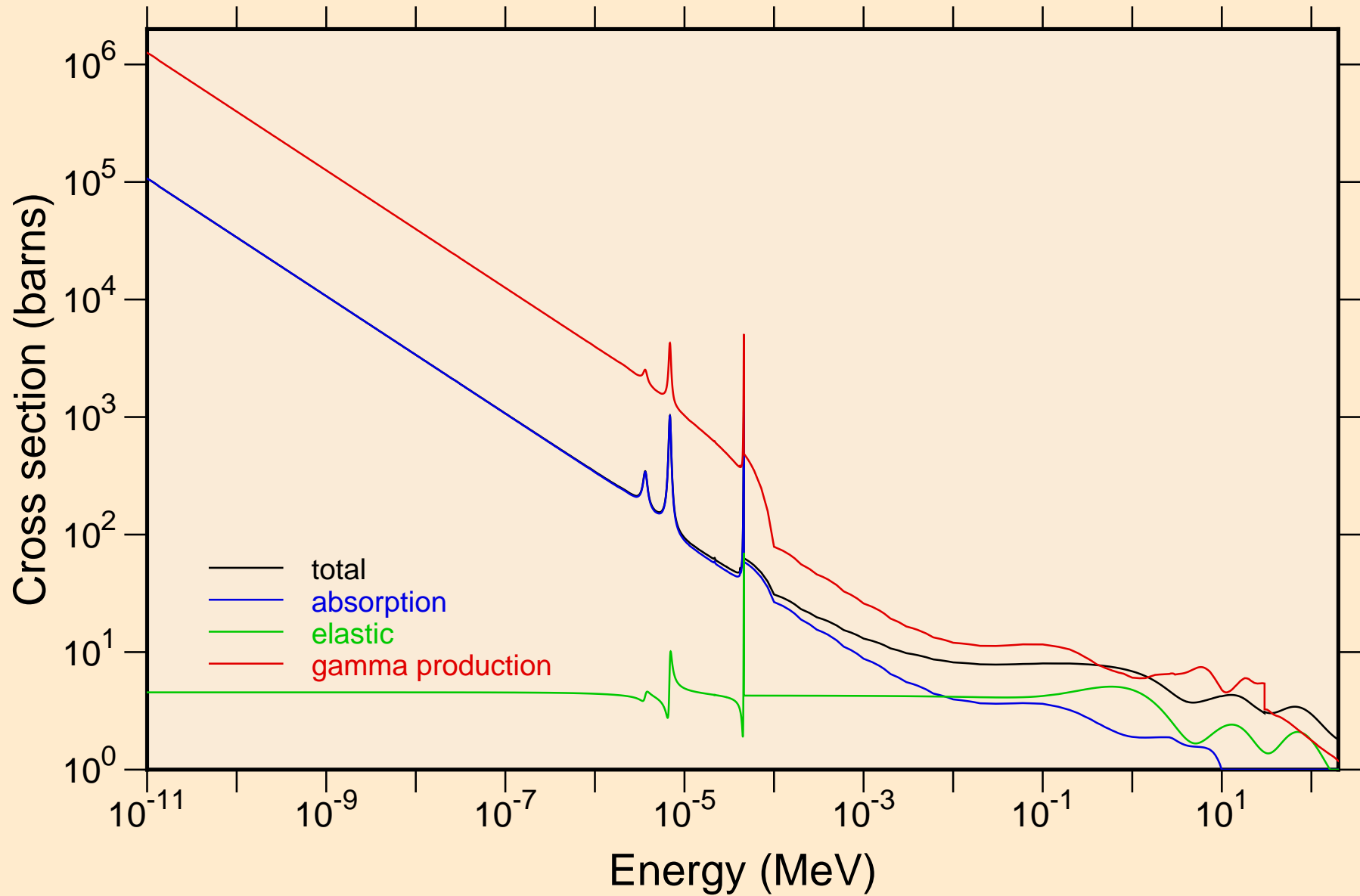

IN104M NEUTRON ACER TENDL-2024 LIBRARY; T=0.K

Heating

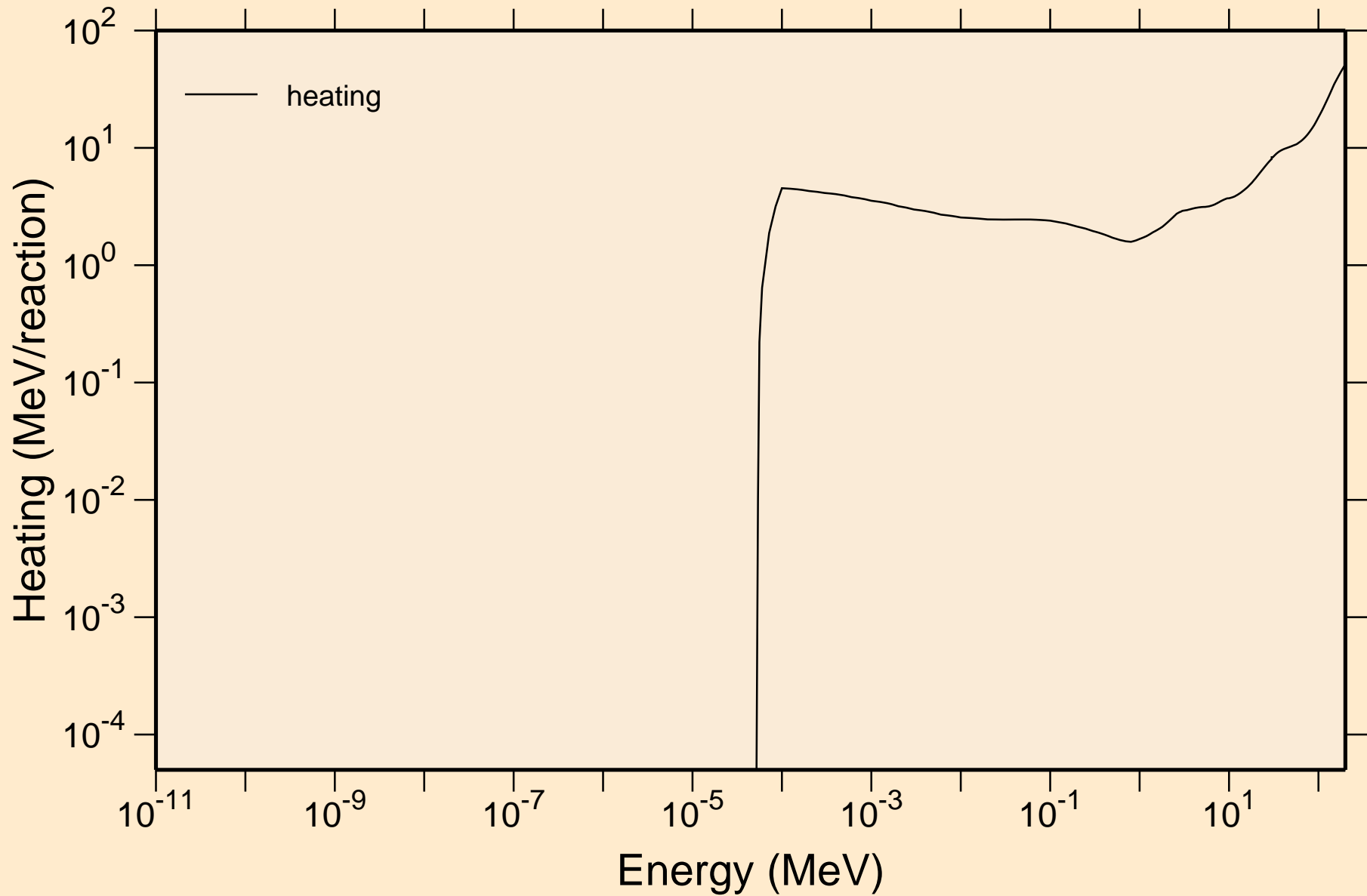

IN104M NEUTRON ACER TENDL-2024 LIBRARY; T=0.K
Damage

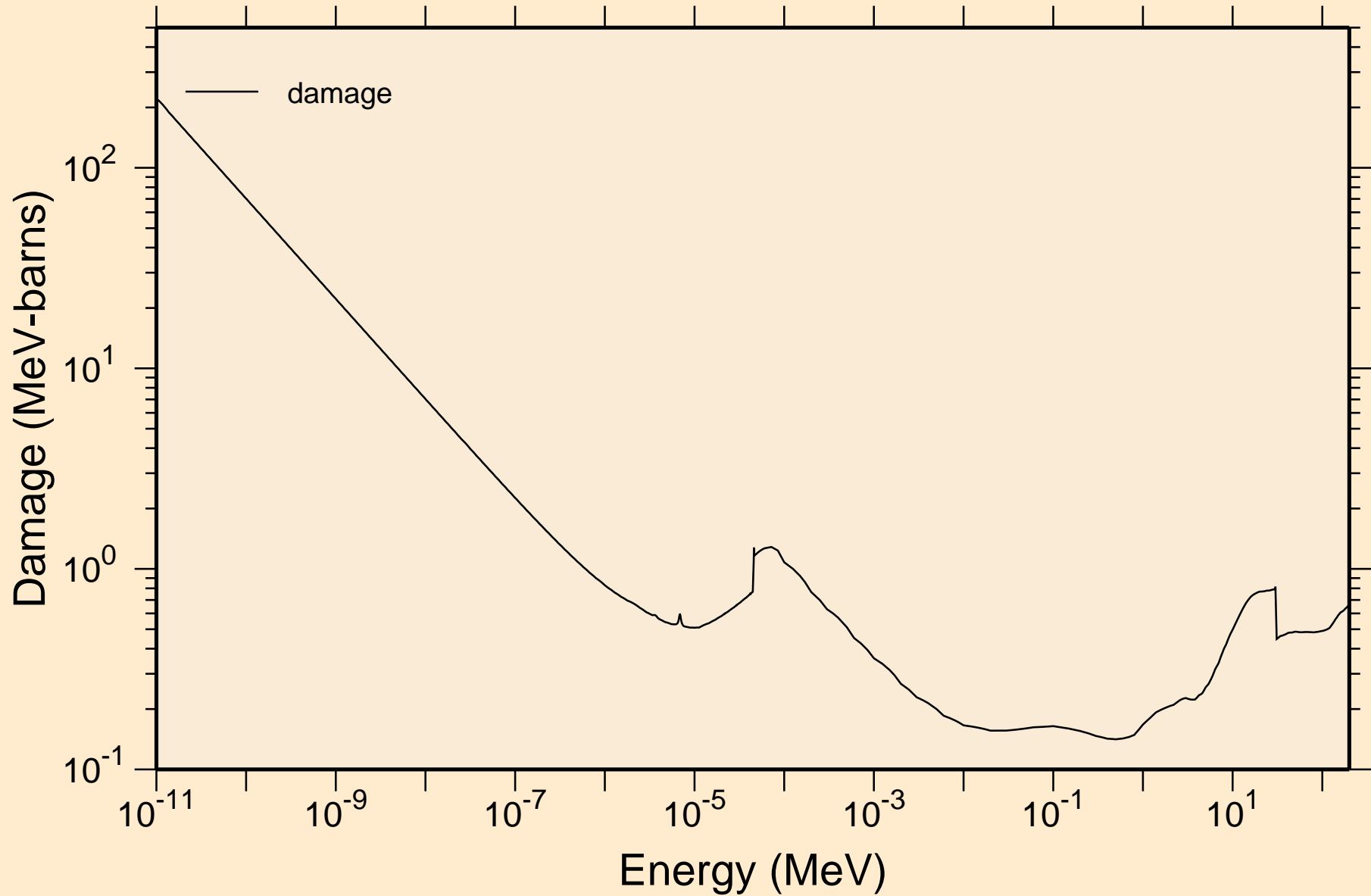

IN104M NEUTRON ACER TENDL-2024 LIBRARY; T=0.K

Non-threshold reactions

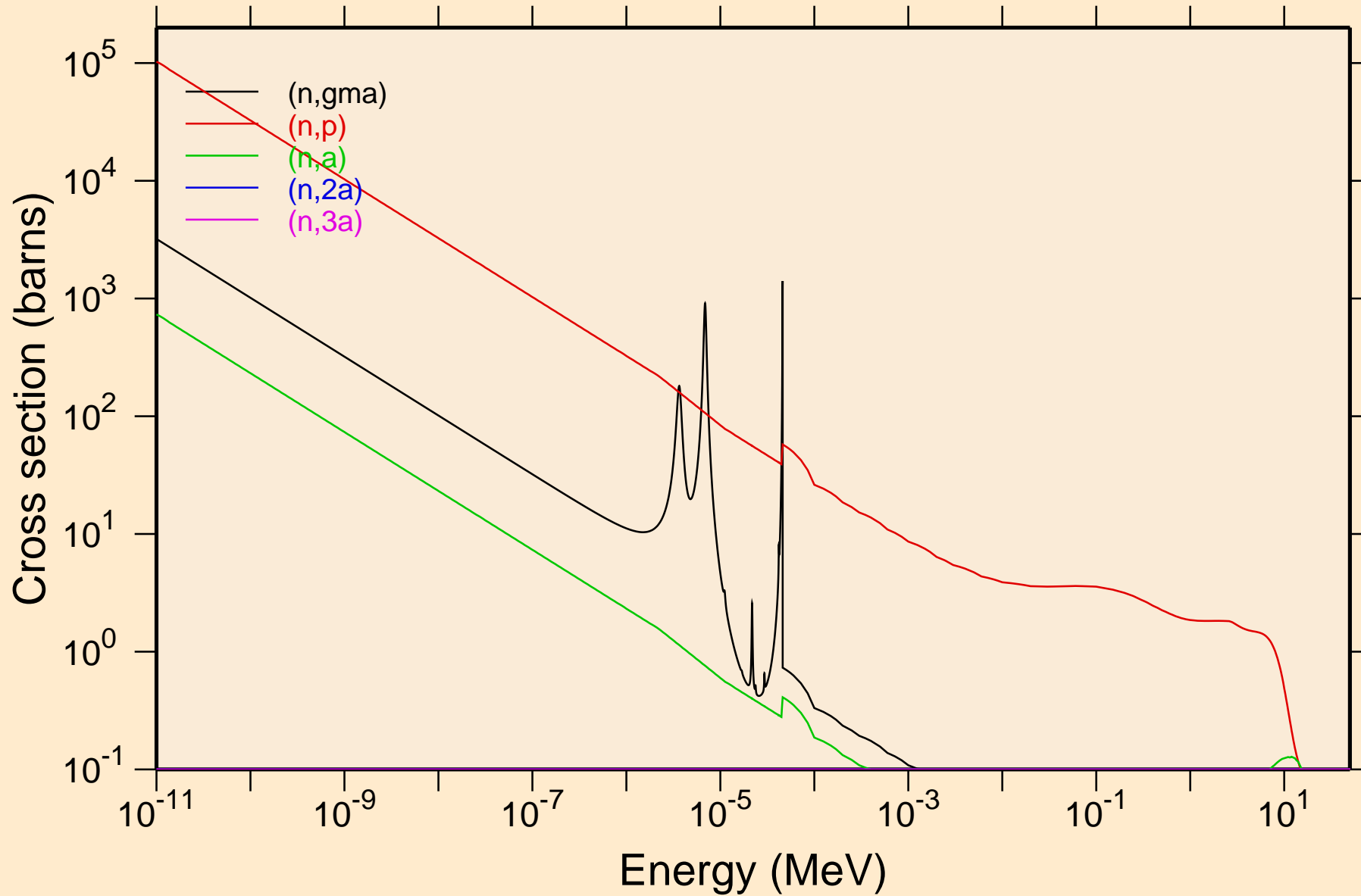

IN104M NEUTRON ACER TENDL-2024 LIBRARY; T=0.K

Non-threshold reactions

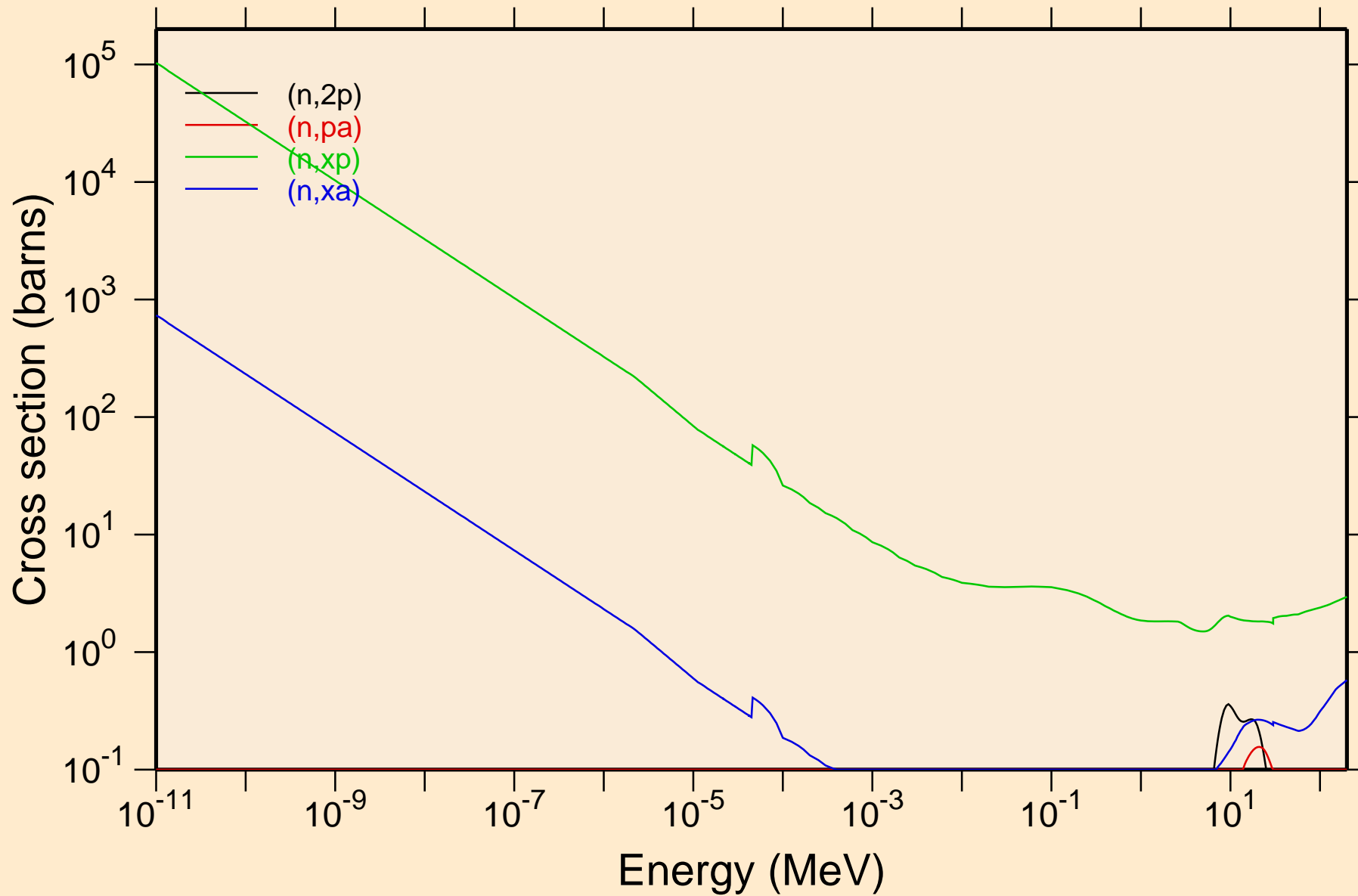

IN104M NEUTRON ACER TENDL-2024 LIBRARY; T=0.K

Principal cross sections

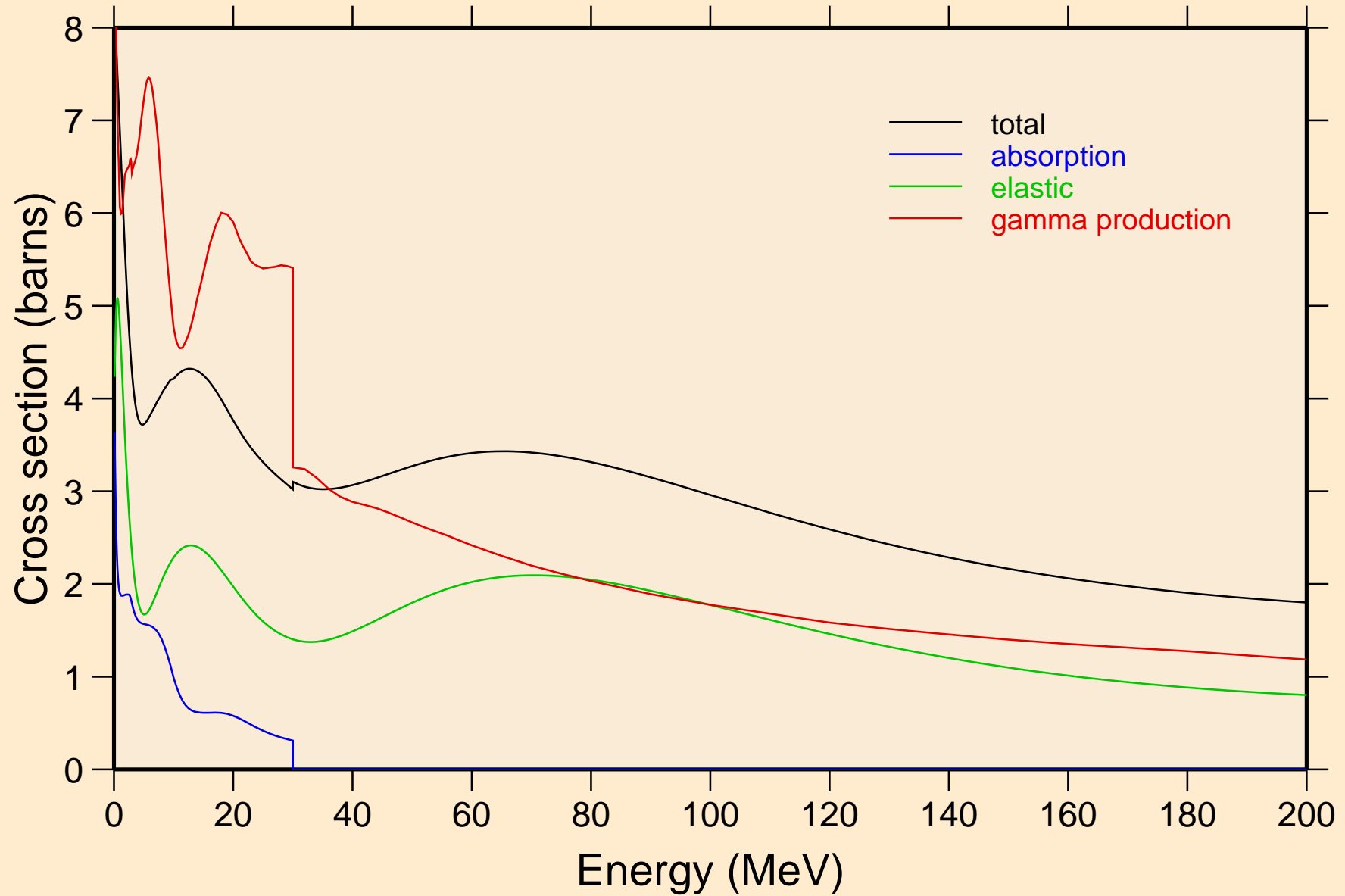

IN104M NEUTRON ACER TENDL-2024 LIBRARY; T=0.K

Heating

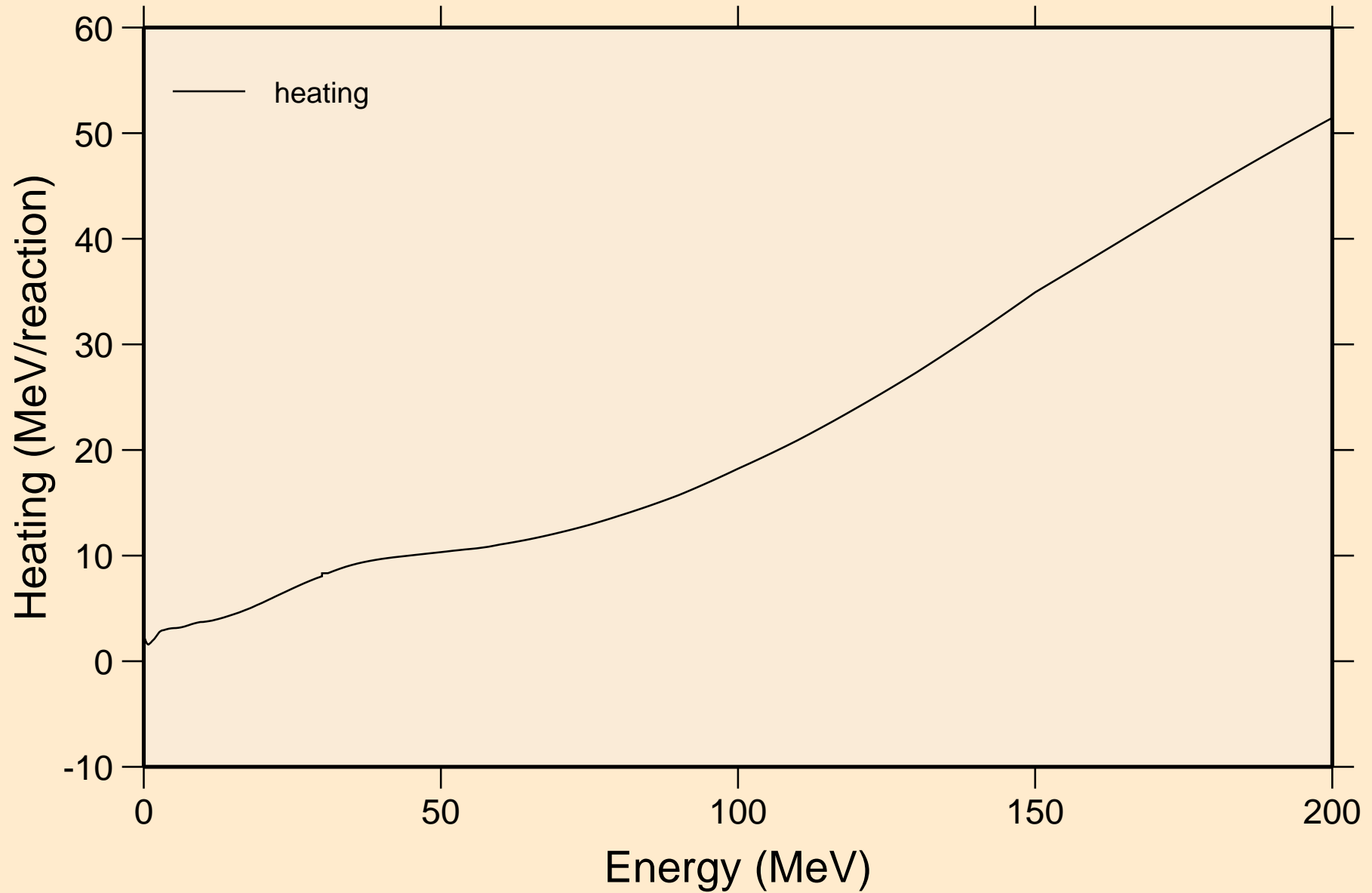

IN104M NEUTRON ACER TENDL-2024 LIBRARY; T=0.K
Damage

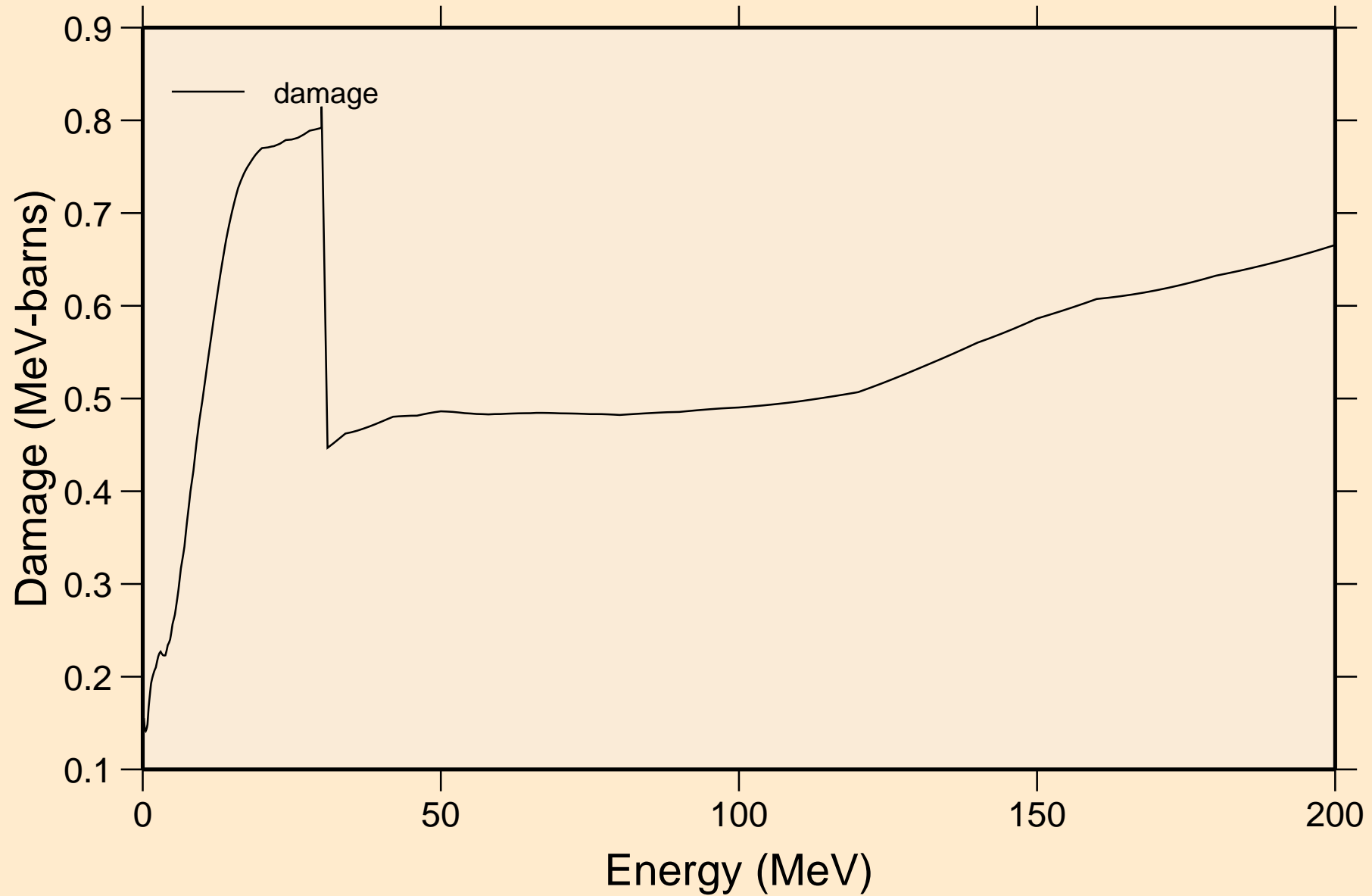

IN104M NEUTRON ACER TENDL-2024 LIBRARY; T=0.K
Non-threshold reactions

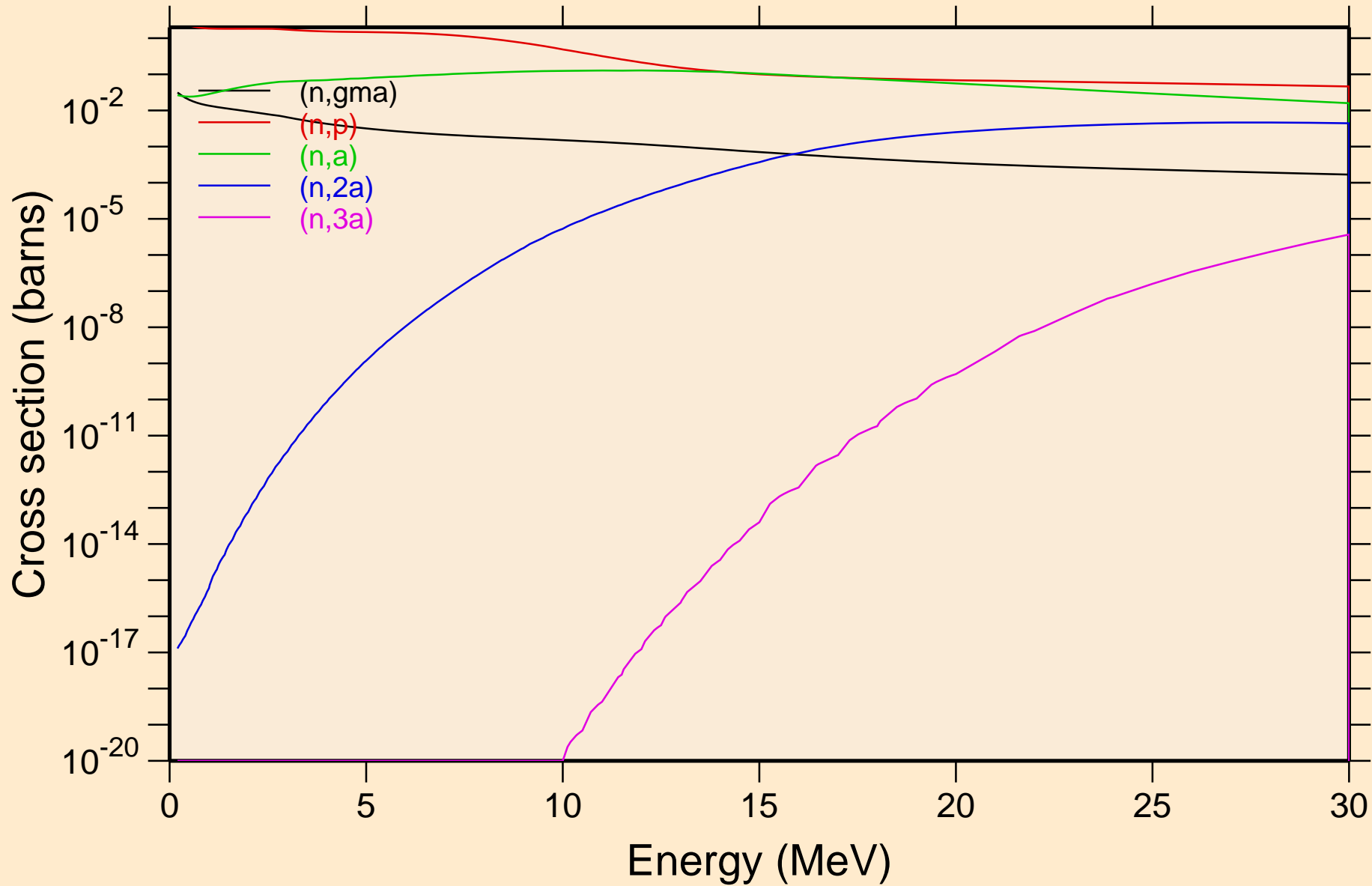

IN104M NEUTRON ACER TENDL-2024 LIBRARY; T=0.K

Non-threshold reactions

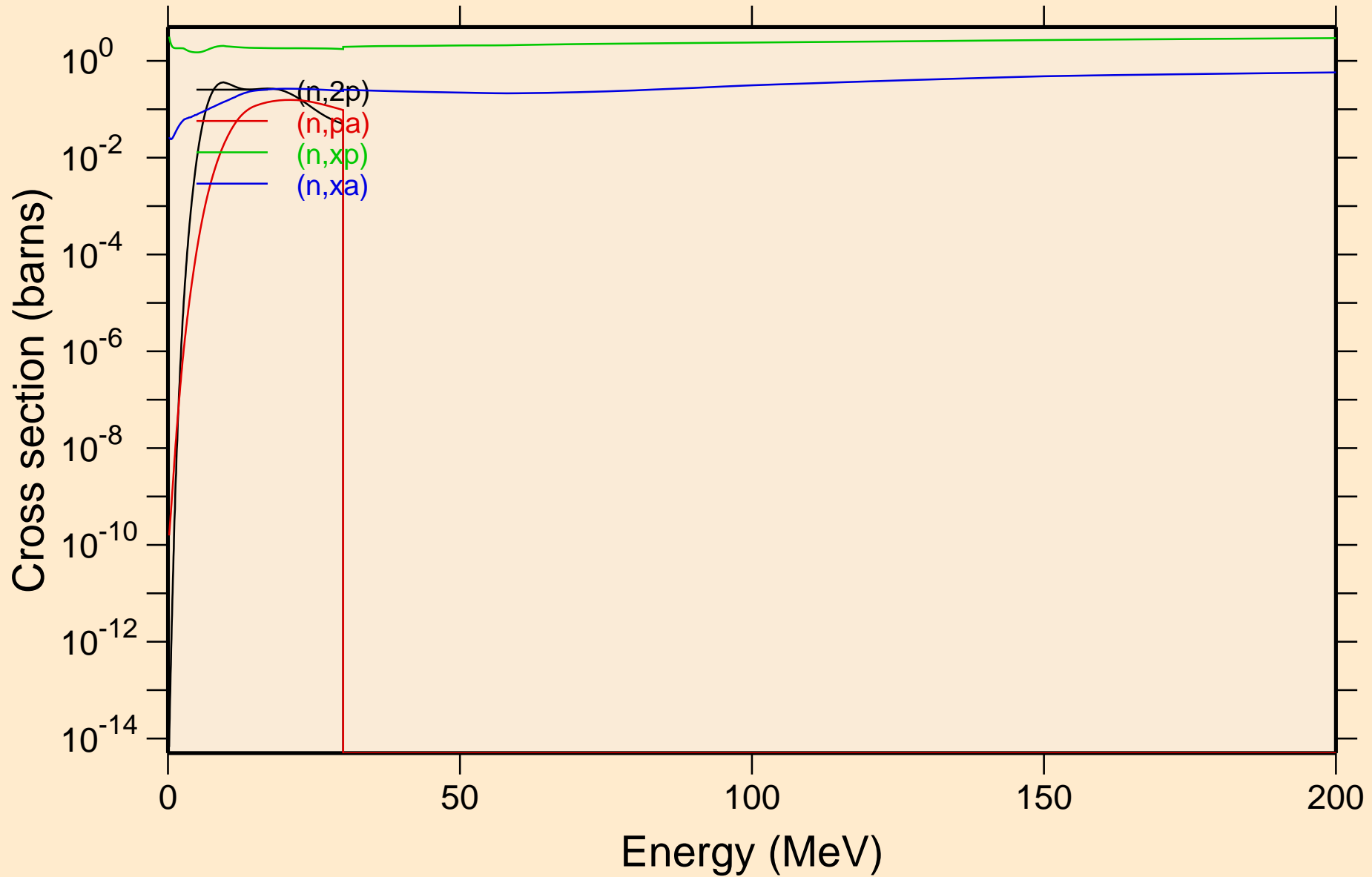

IN104M NEUTRON ACER TENDL-2024 LIBRARY; T=0.K
Inelastic levels

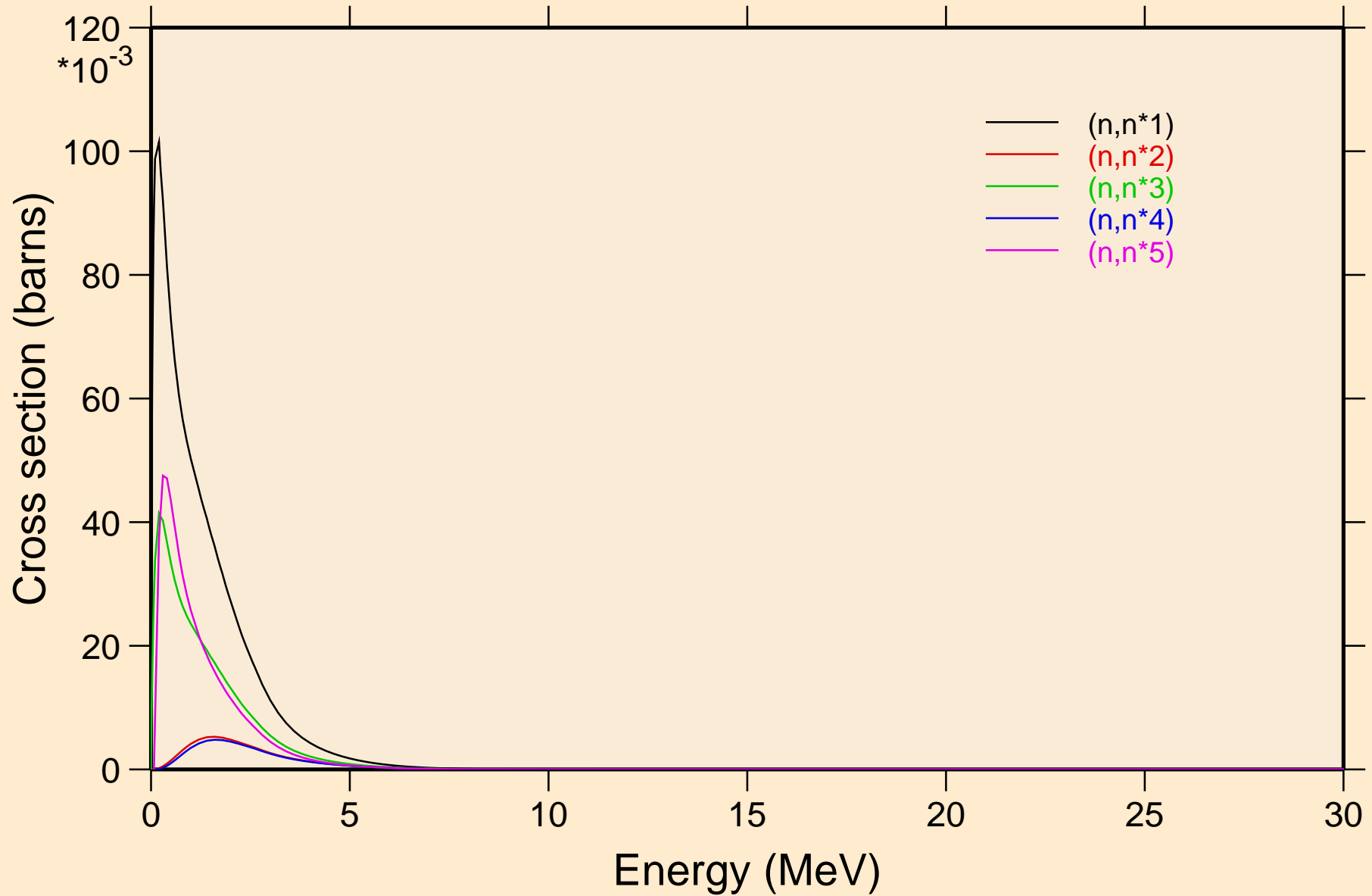

IN104M NEUTRON ACER TENDL-2024 LIBRARY; T=0.K
Inelastic levels

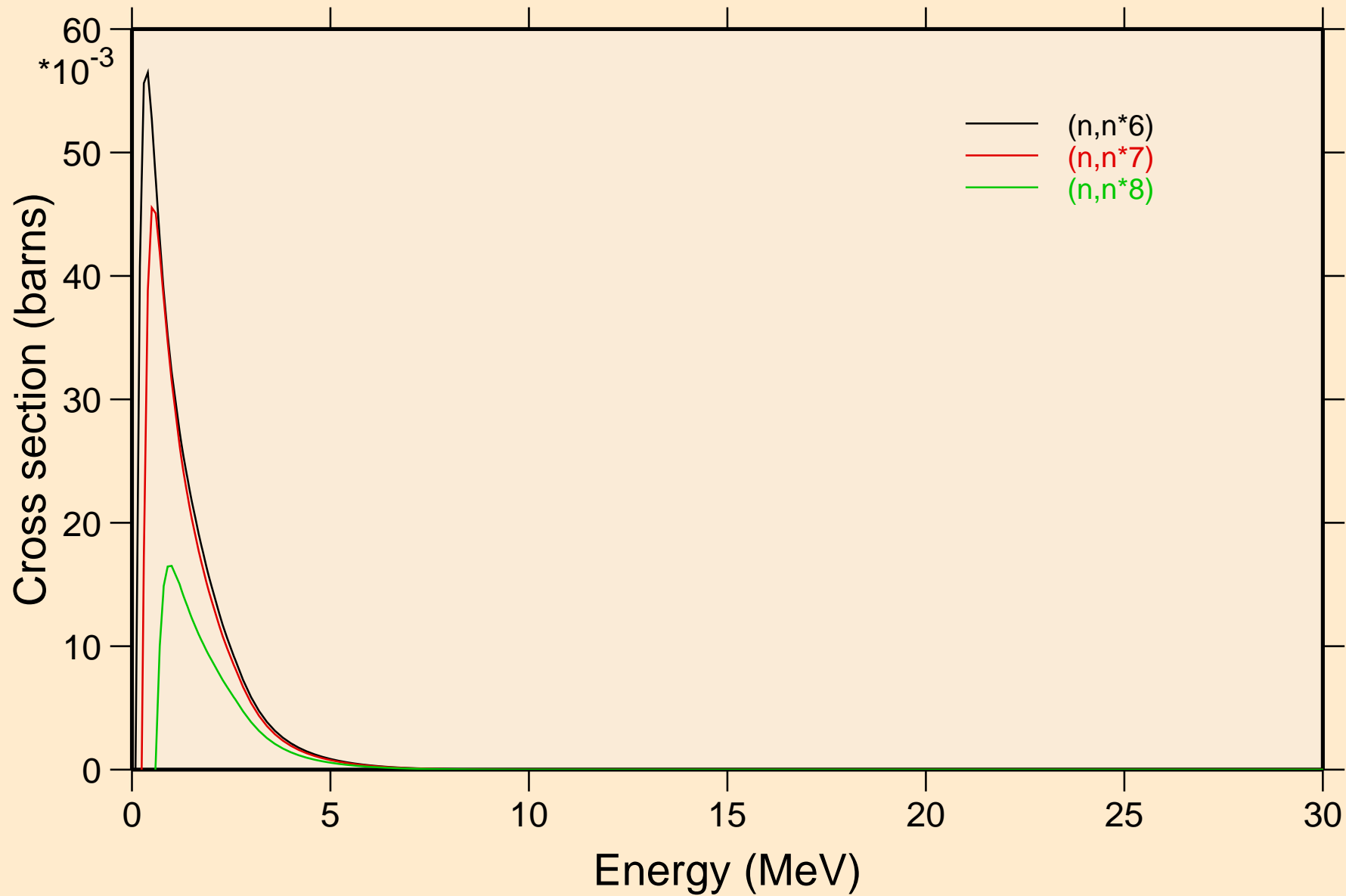

IN104M NEUTRON ACER TENDL-2024 LIBRARY; T=0.K

Threshold reactions

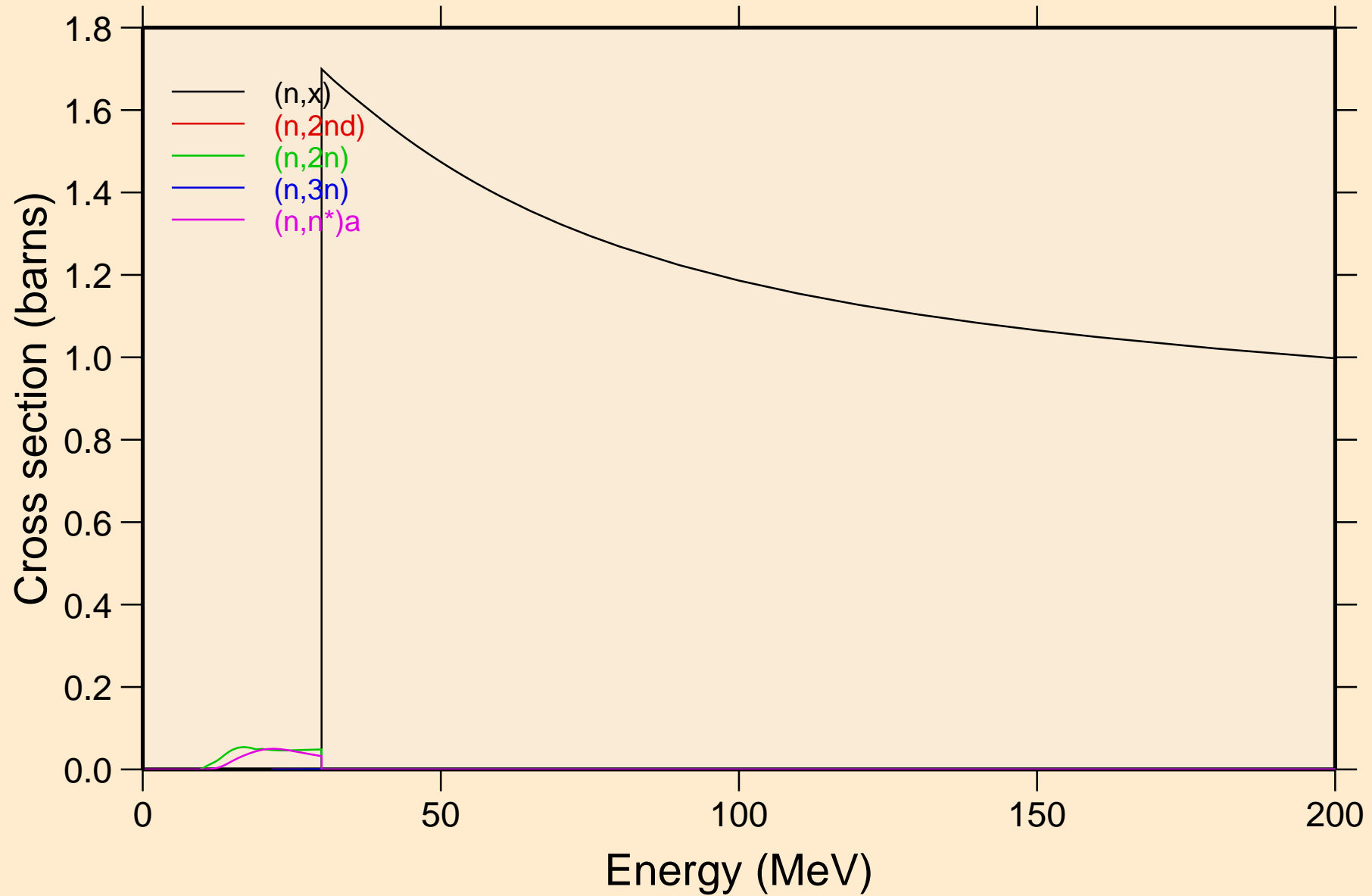

IN104M NEUTRON ACER TENDL-2024 LIBRARY; T=0.K
Threshold reactions

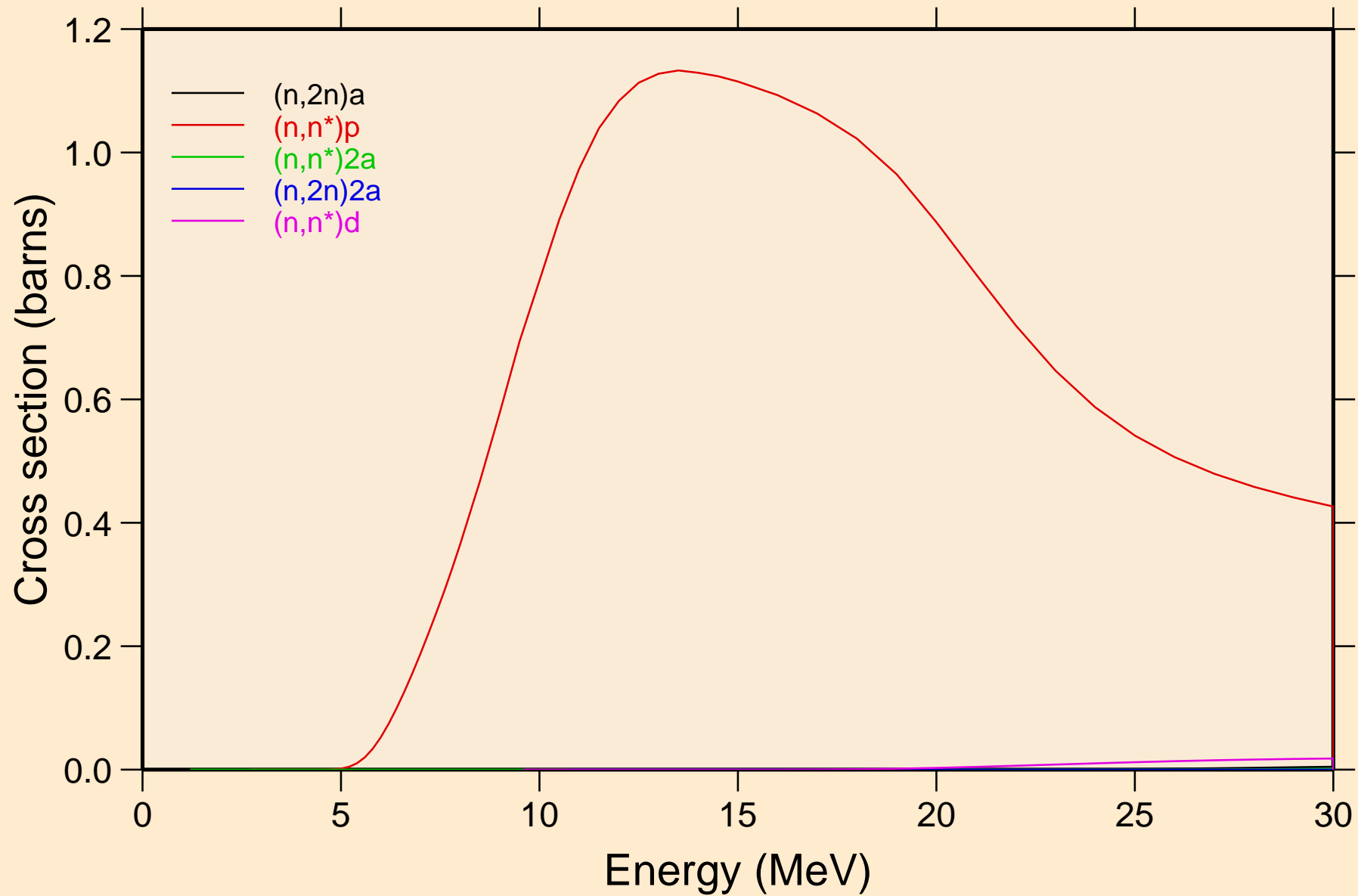

IN104M NEUTRON ACER TENDL-2024 LIBRARY; T=0.K

Threshold reactions

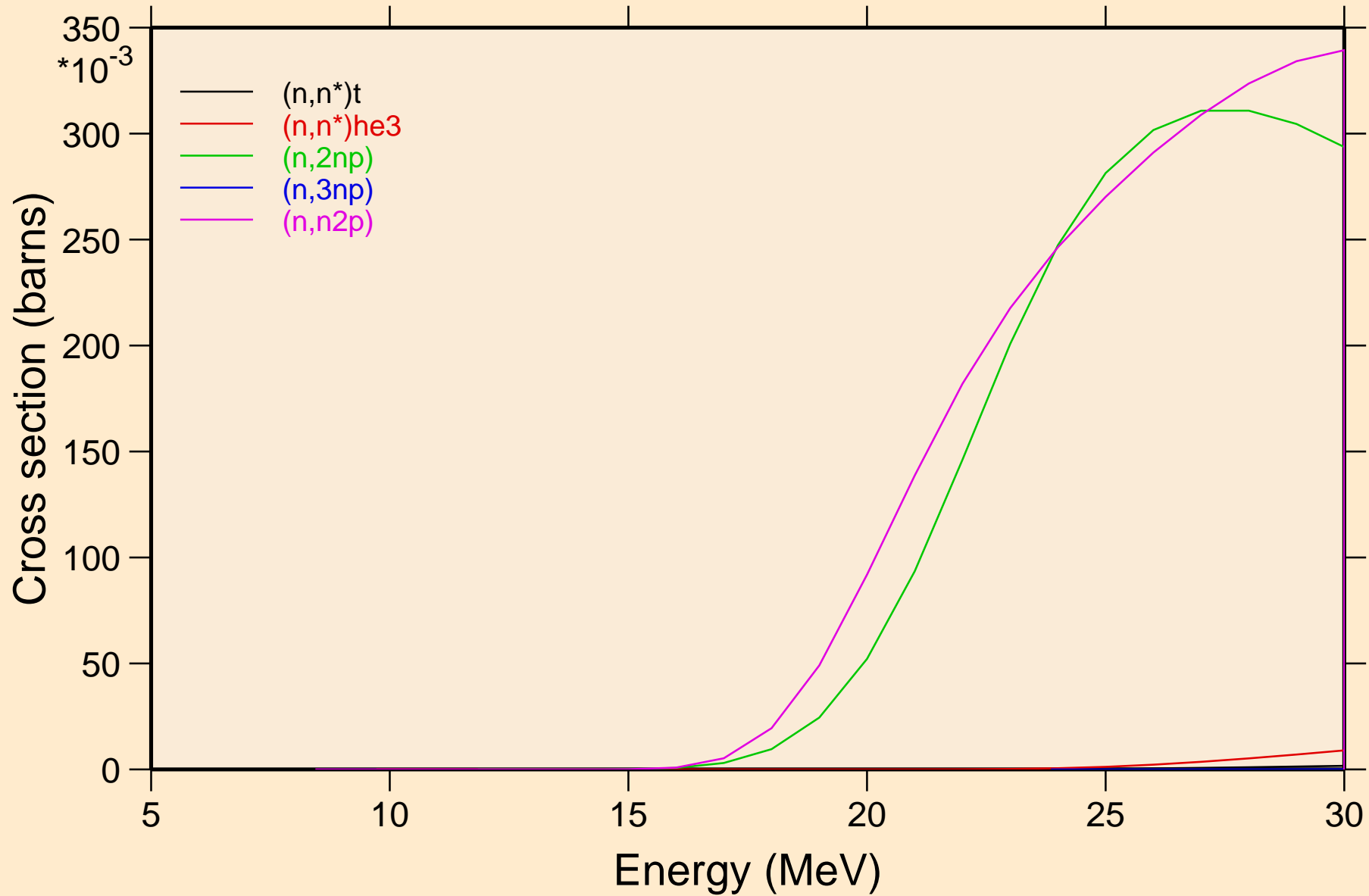

IN104M NEUTRON ACER TENDL-2024 LIBRARY; T=0.K

Threshold reactions

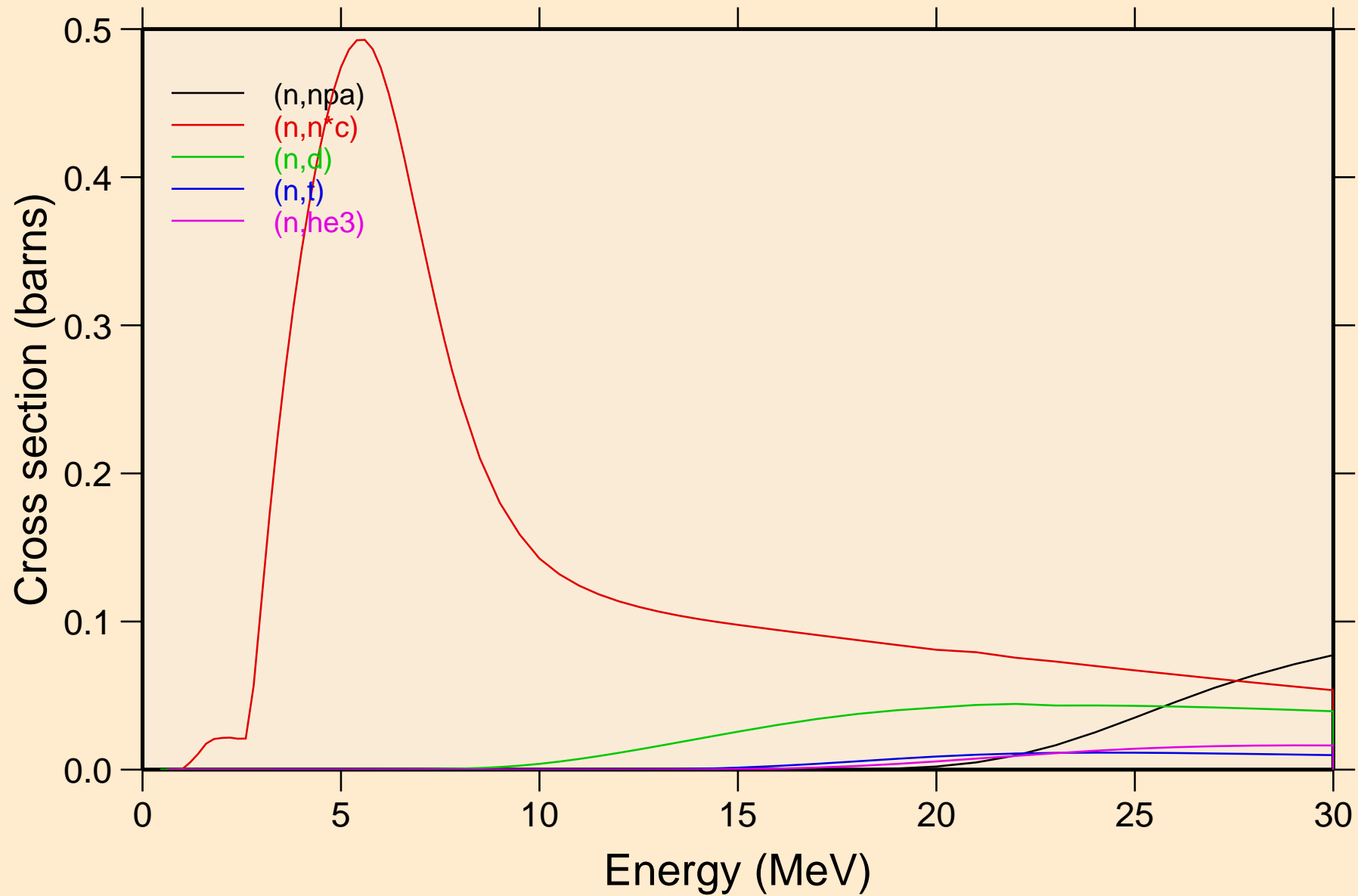

IN104M NEUTRON ACER TENDL-2024 LIBRARY; T=0.K
Threshold reactions

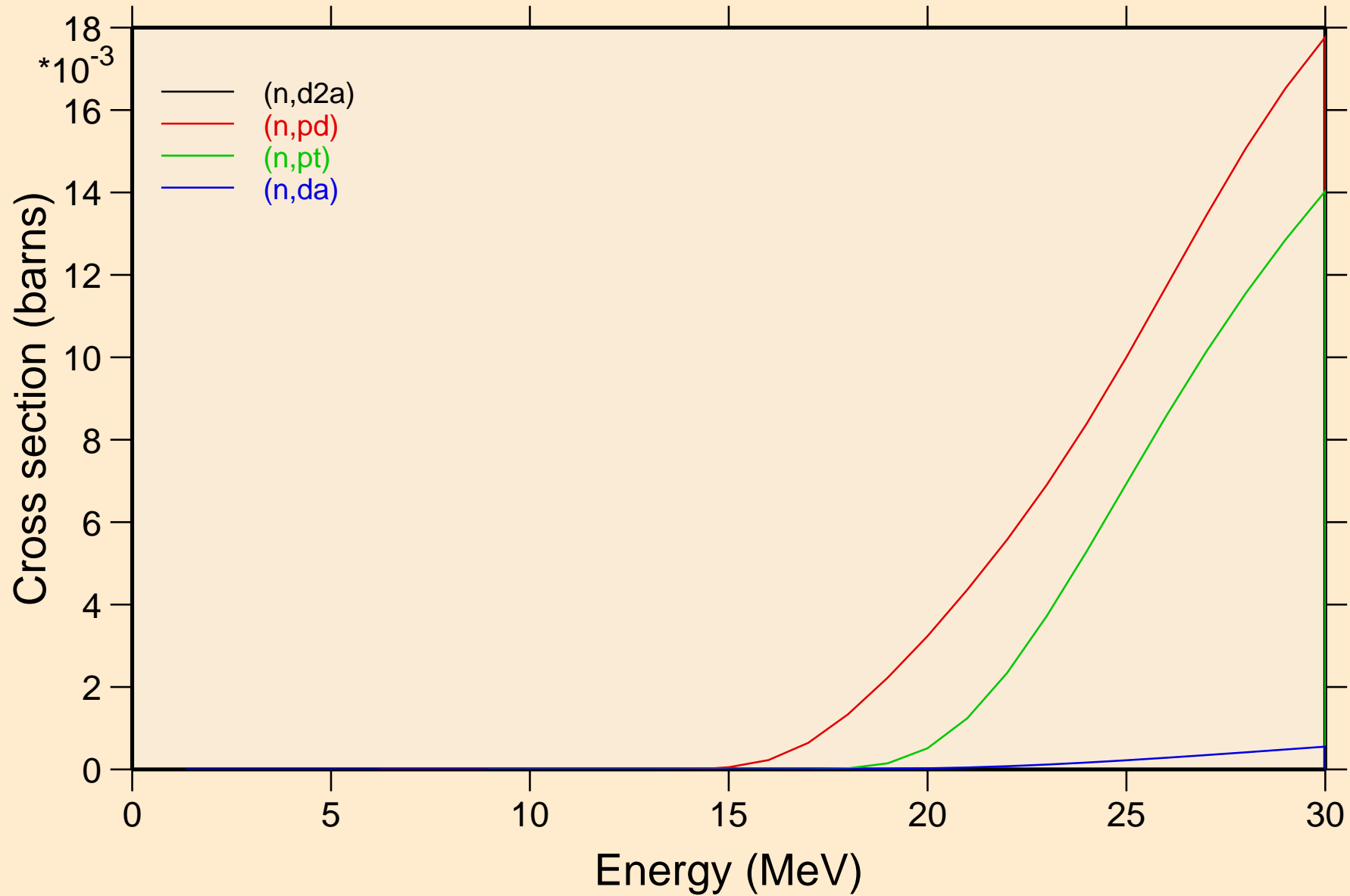

IN104M NEUTRON ACER TENDL-2024 LIBRARY; T=0.K
Threshold reactions

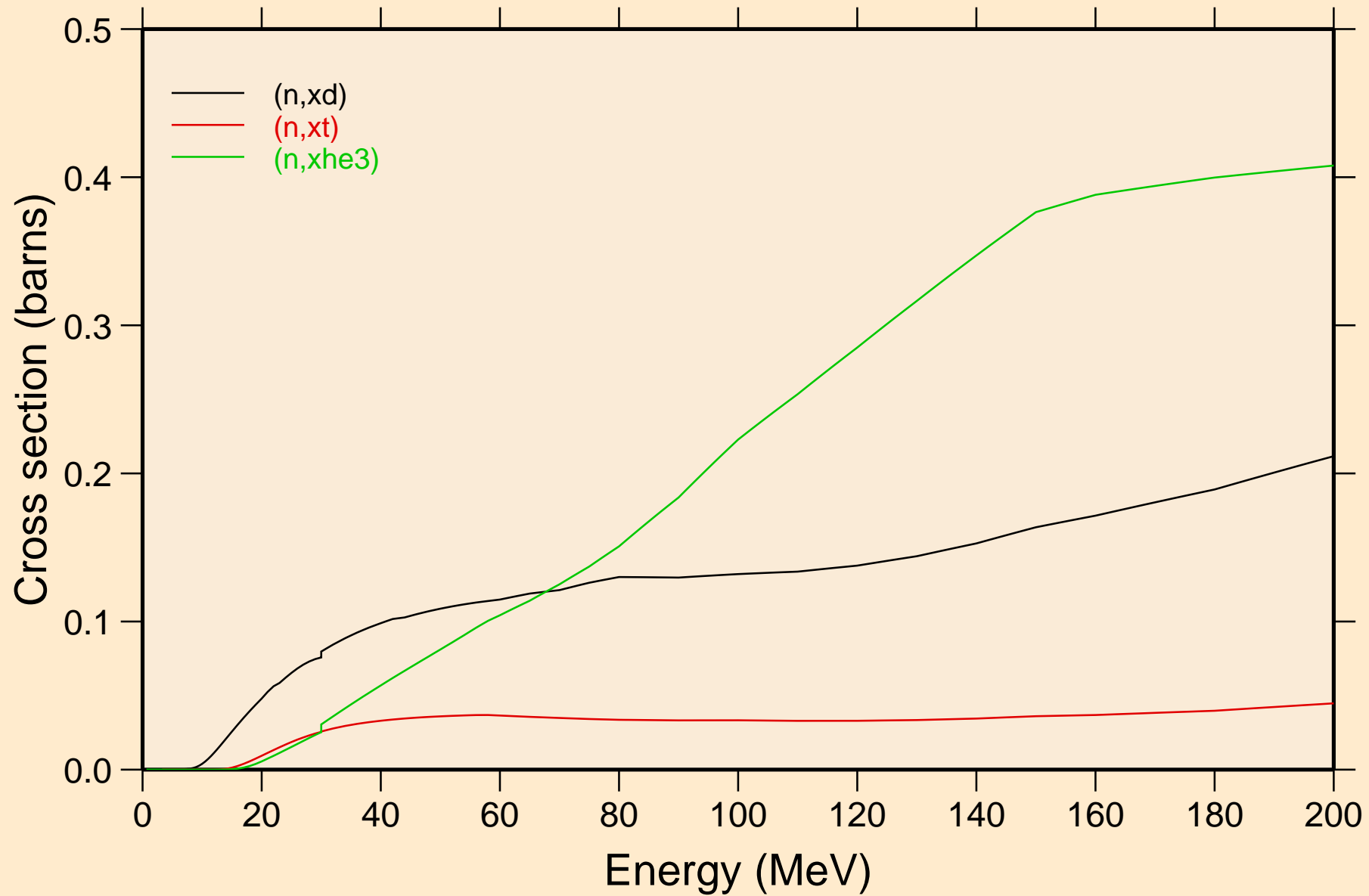

IN104M NEUTRON ACER TENDL-2024 LIBRARY; T=0.K
angular distribution for elastic

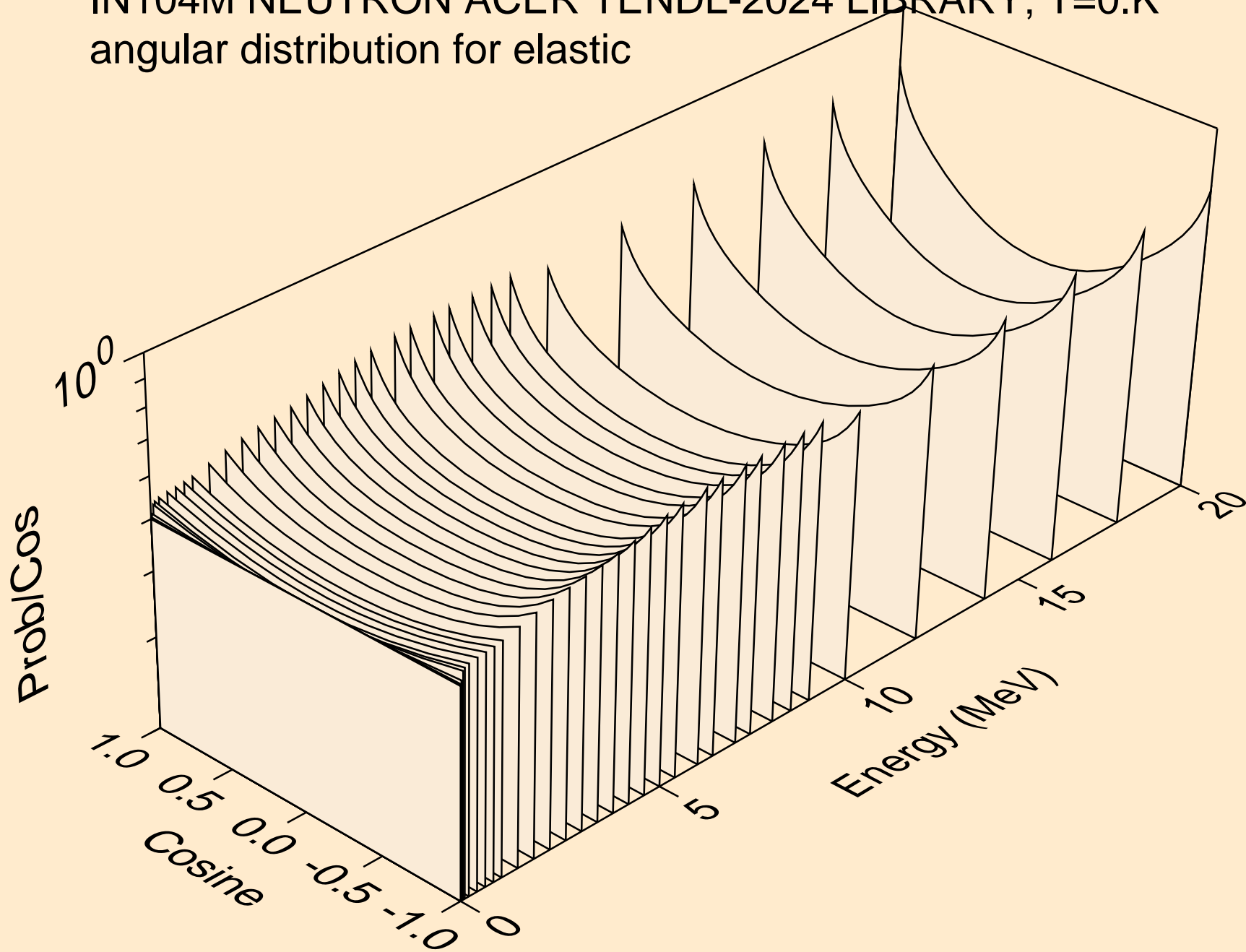

IN104M NEUTRON ACER TENDL-2024 LIBRARY; T=0.K
angular distribution for elastic

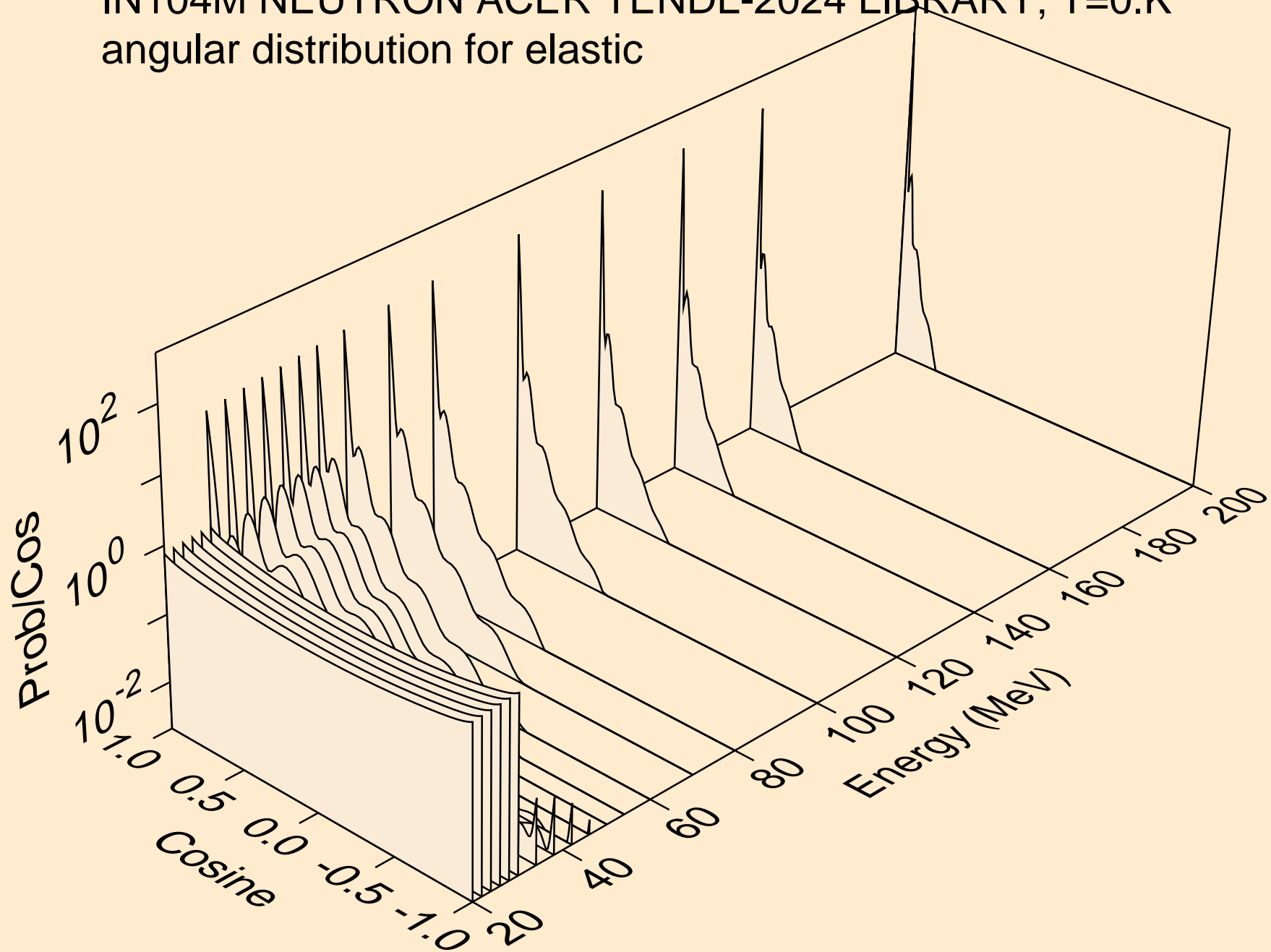

IN104M NEUTRON ACER TENDL-2024 LIBRARY; T=0.K
angular distribution for (n,n*1)

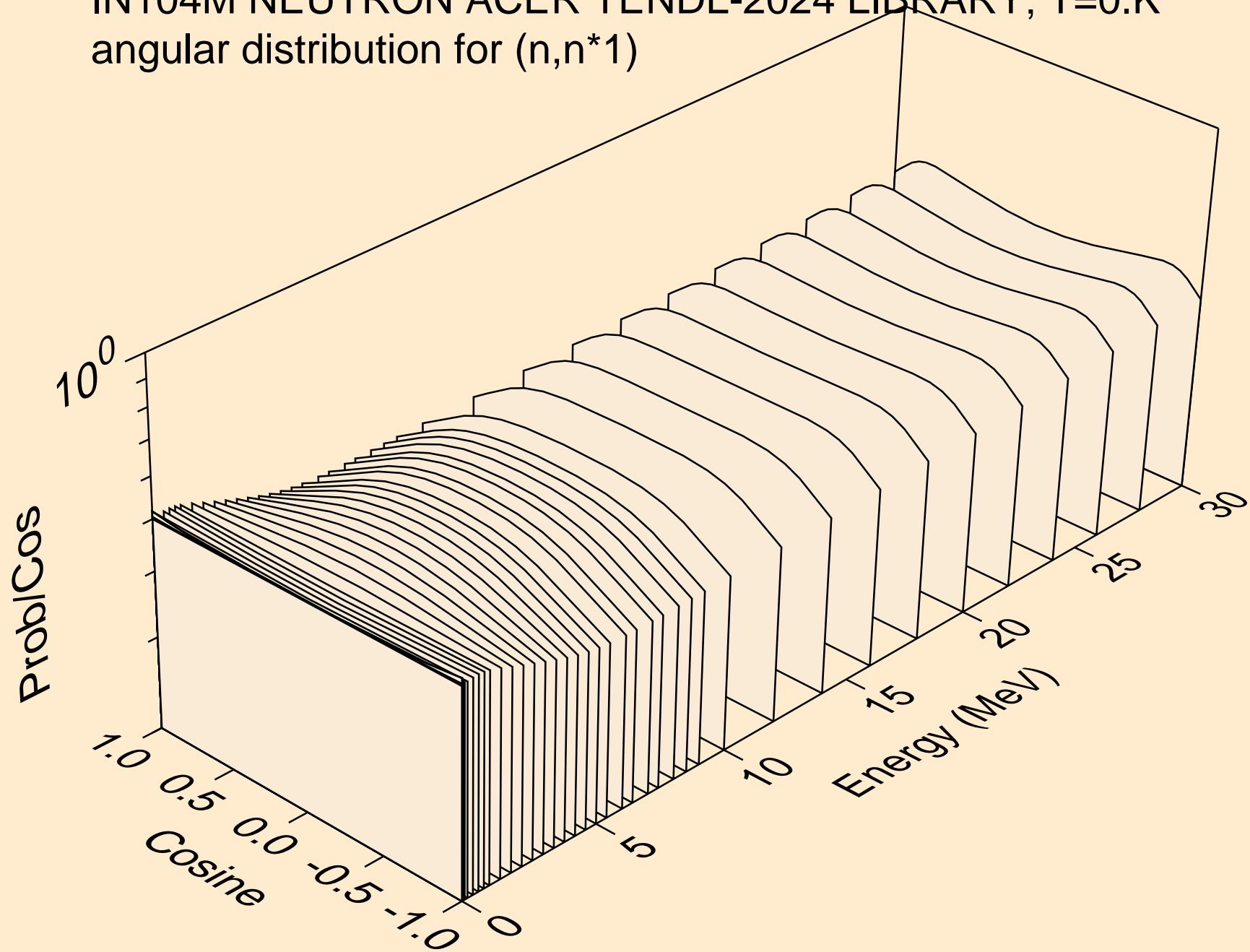

IN104M NEUTRON ACER TENDL-2024 LIBRARY; T=0.K
angular distribution for (n,n*2)

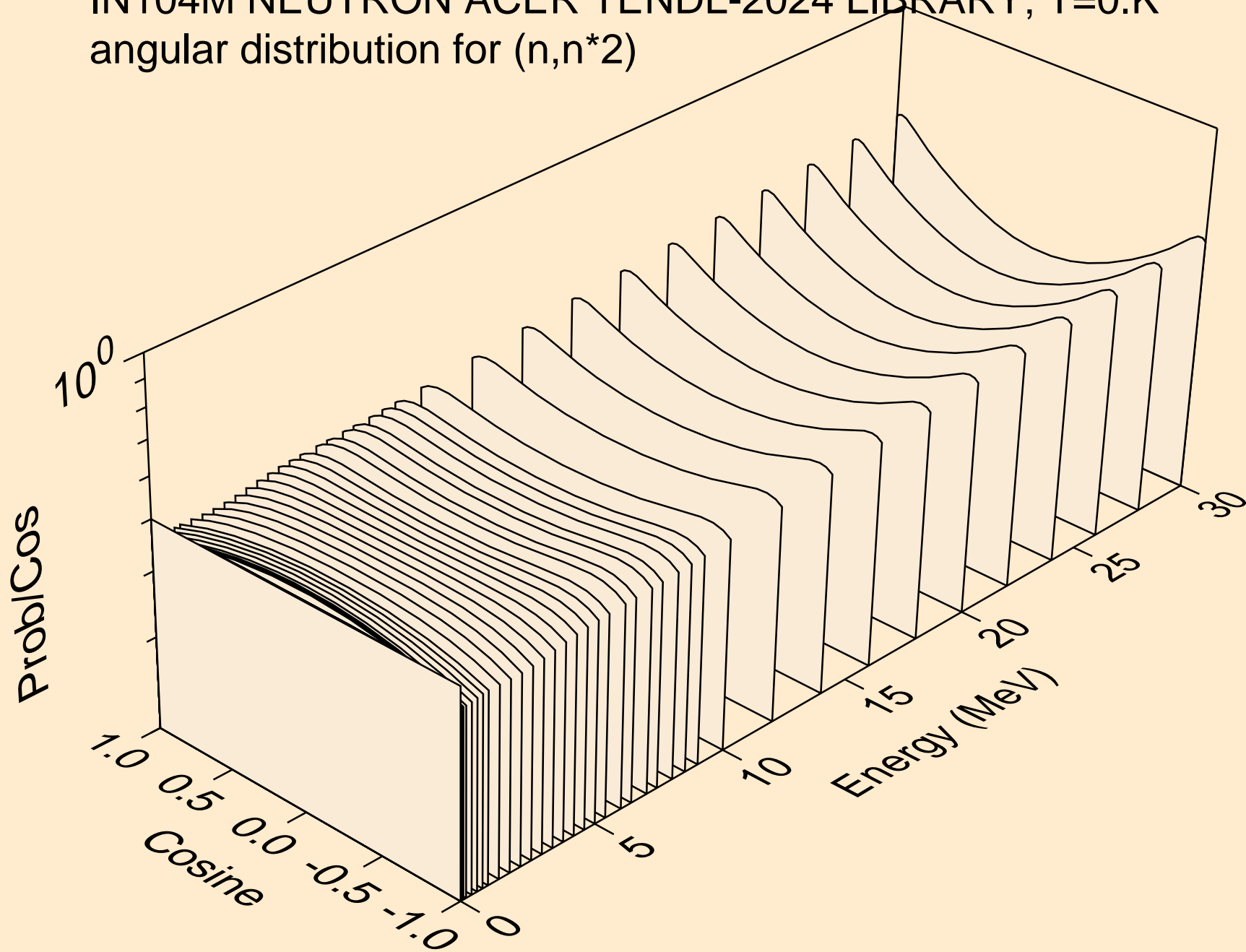

IN104M NEUTRON ACER TENDL-2024 LIBRARY; T=0.K
angular distribution for (n,n*3)

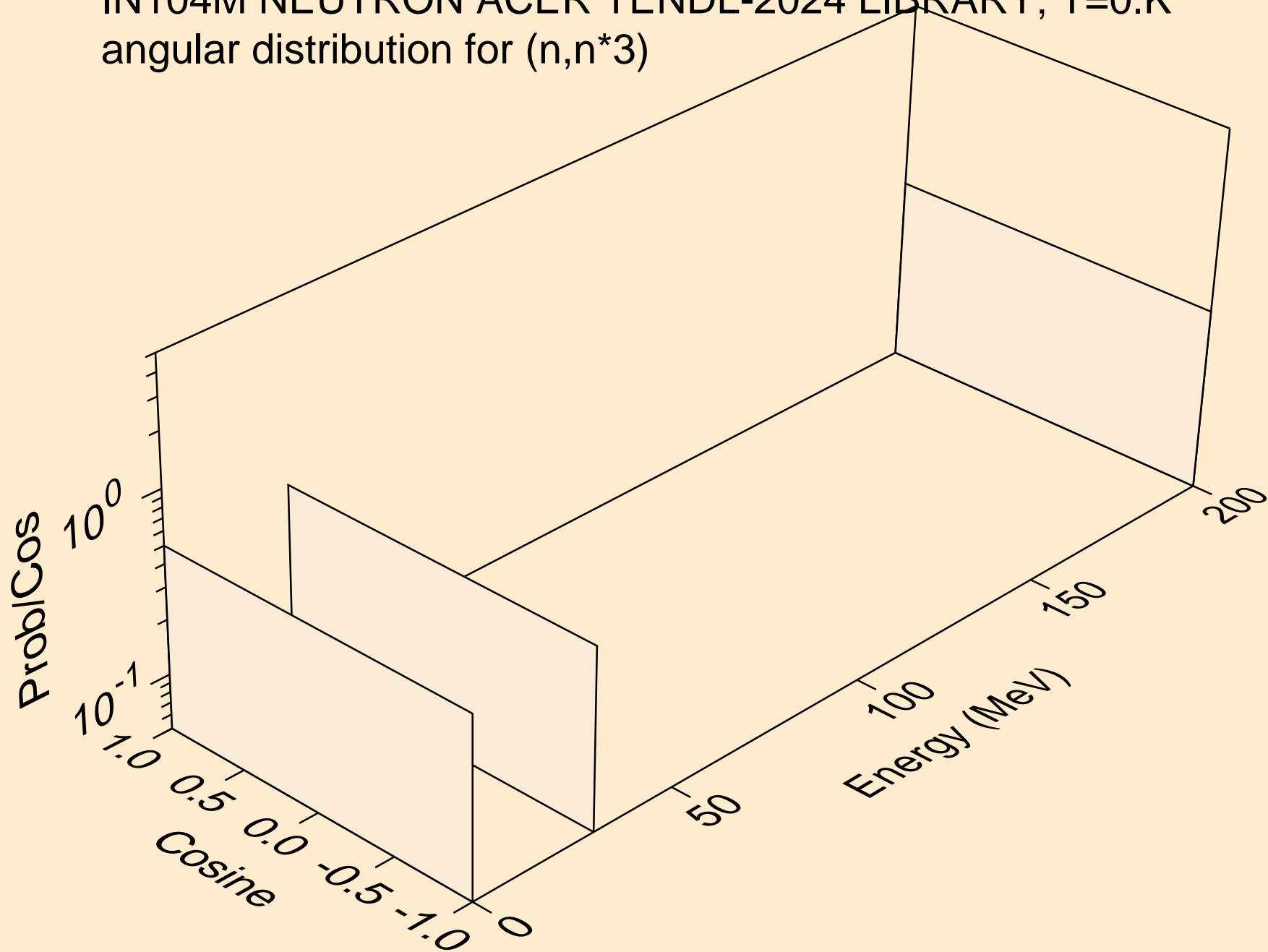

IN104M NEUTRON ACER TENDL-2024 LIBRARY; T=0.K
angular distribution for (n,n*4)

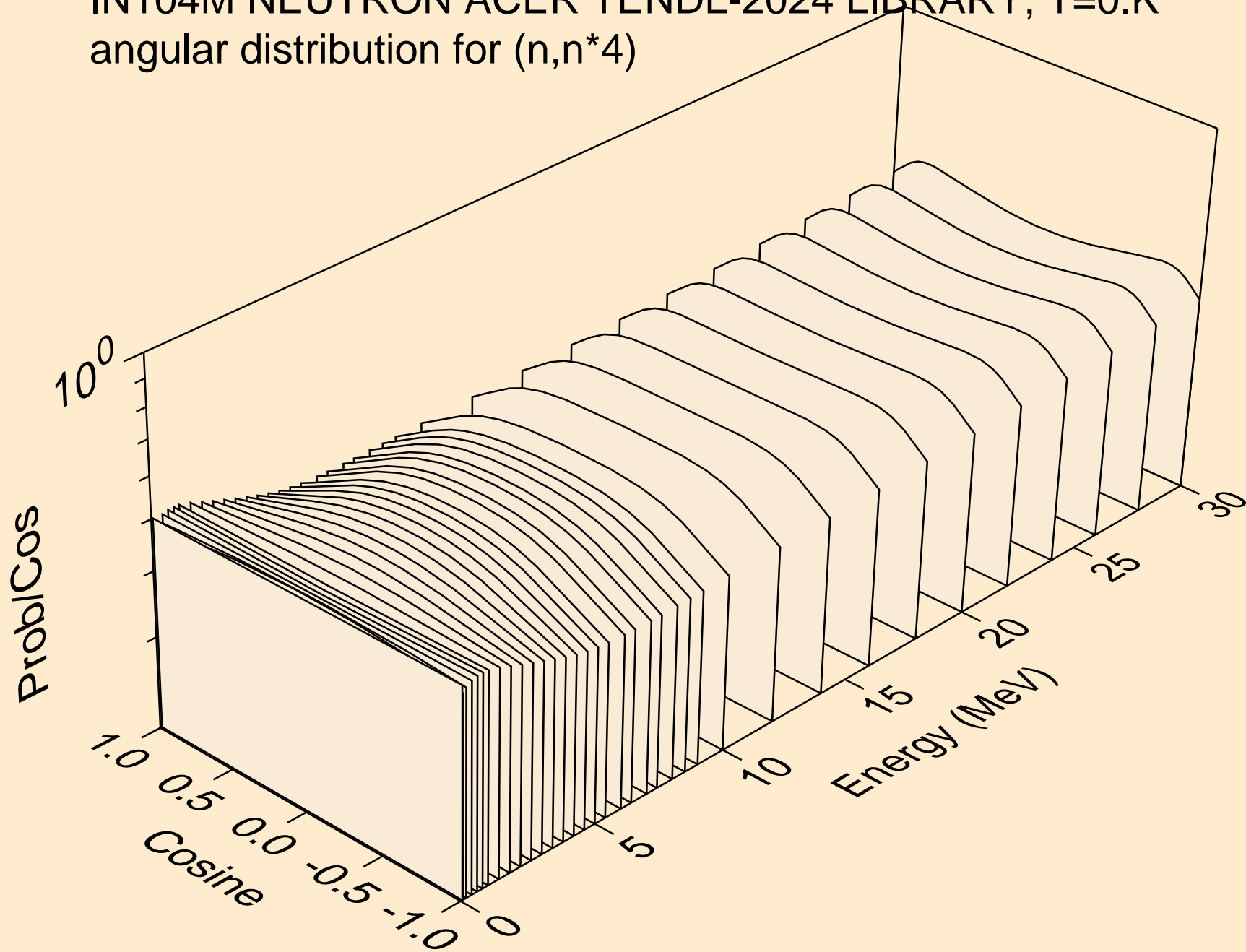

IN104M NEUTRON ACER TENDL-2024 LIBRARY; T=0.K
angular distribution for (n,n*5)

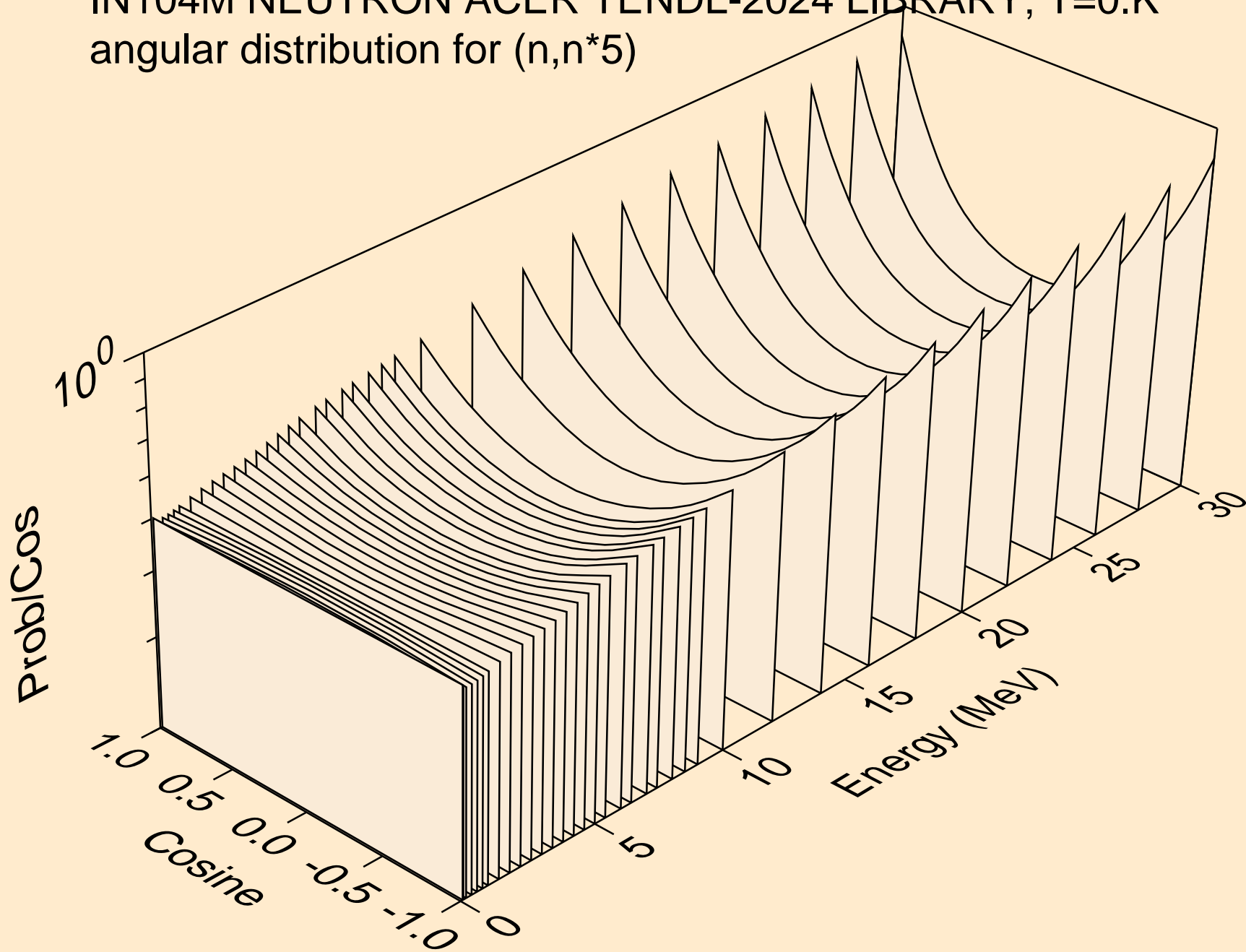

IN104M NEUTRON ACER TENDL-2024 LIBRARY; T=0.K
angular distribution for (n,n*6)

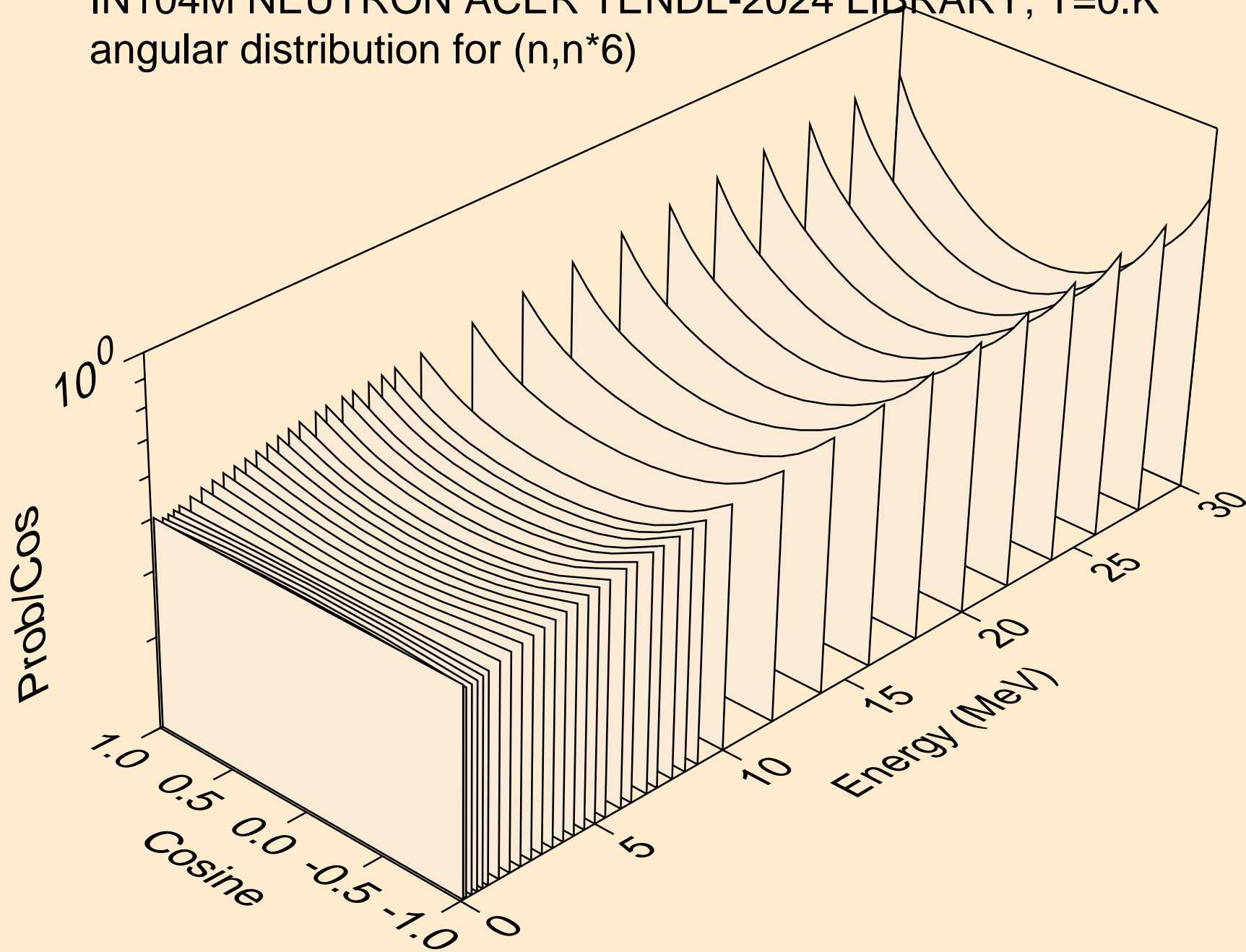

IN104M NEUTRON ACER TENDL-2024 LIBRARY; T=0.K
angular distribution for (n,n*7)

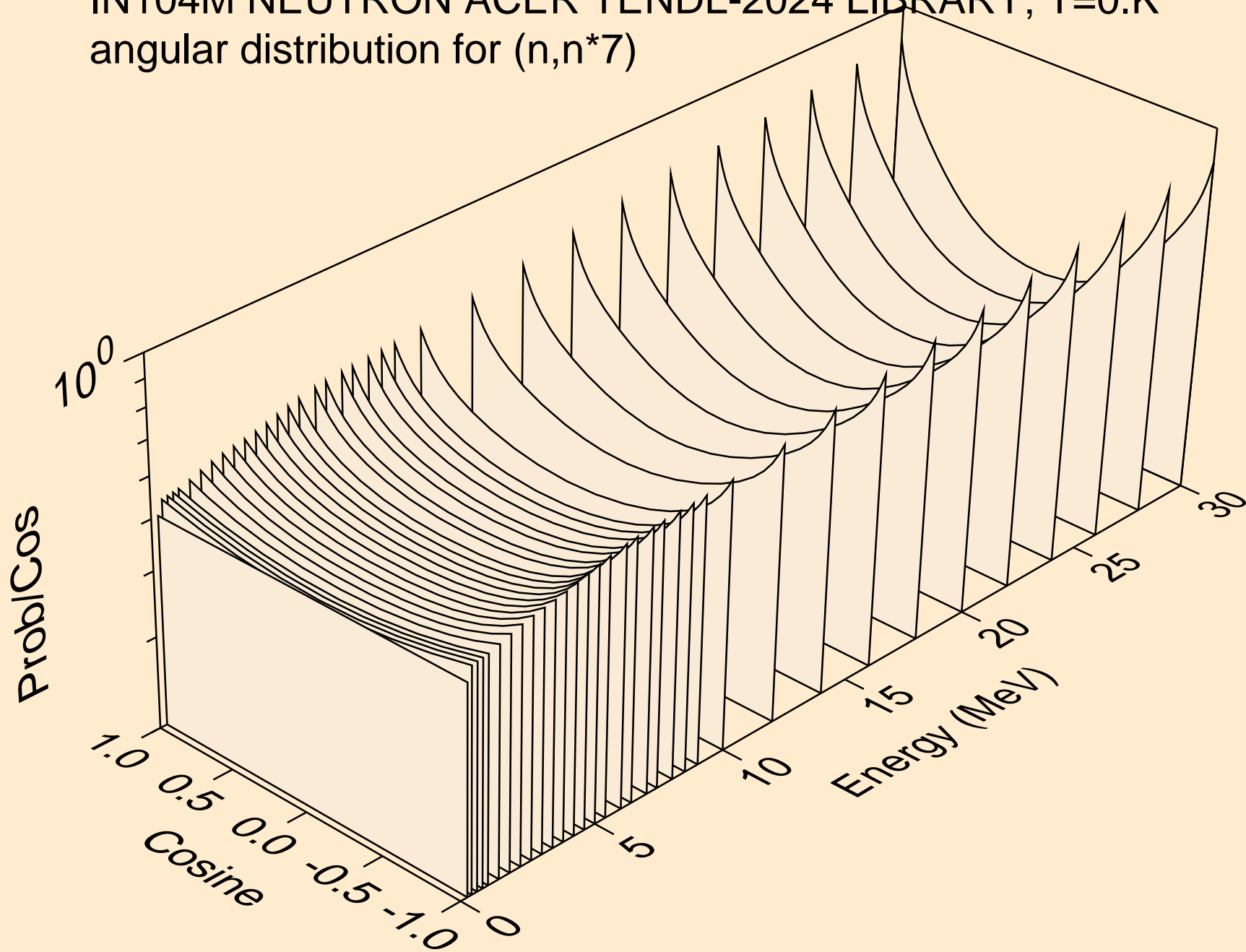

IN104M NEUTRON ACER TENDL-2024 LIBRARY; T=0.K
angular distribution for (n,n*8)

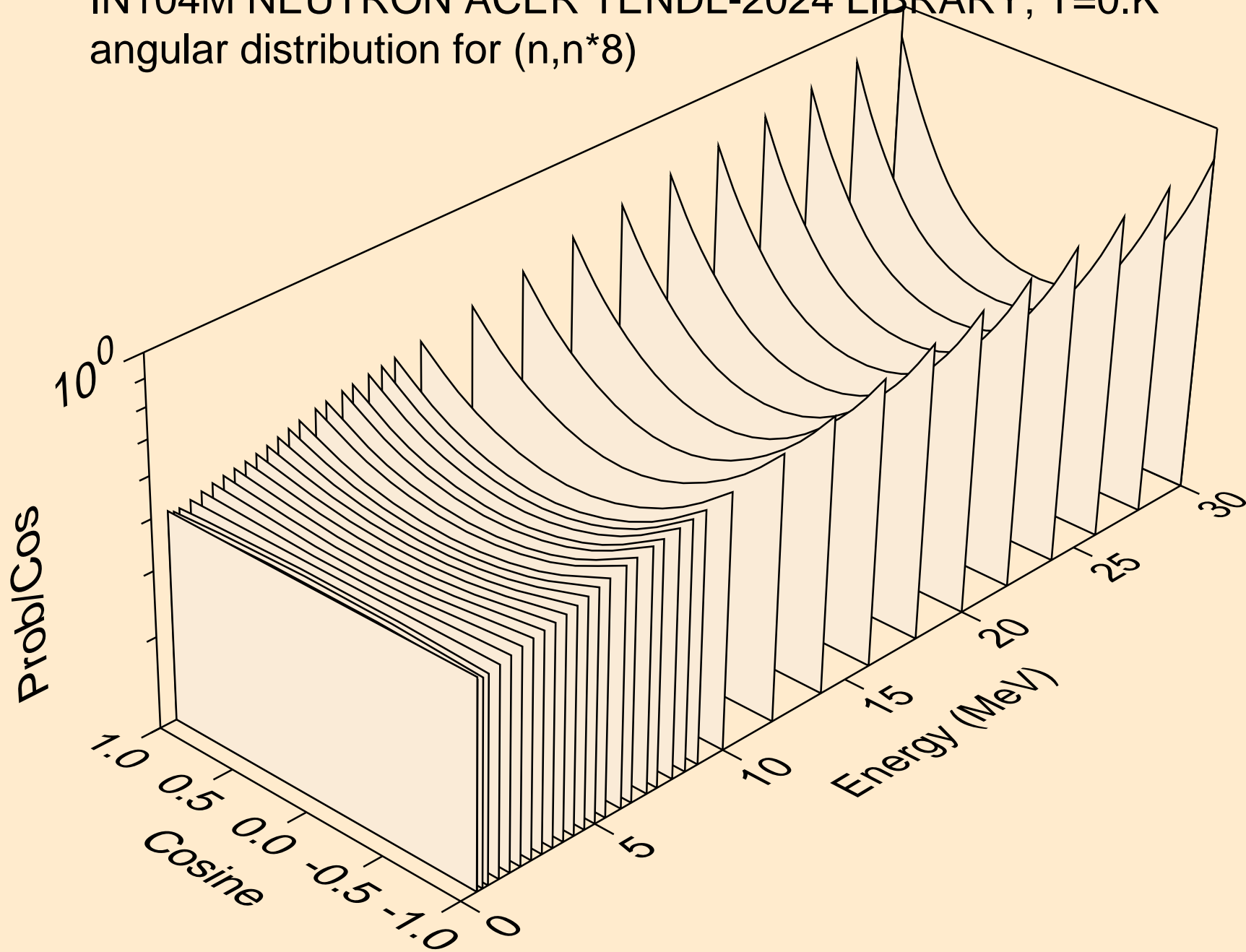

IN104M NEUTRON ACER TENDL-2024 LIBRARY; T=0.K
Neutron emission for (n,x)

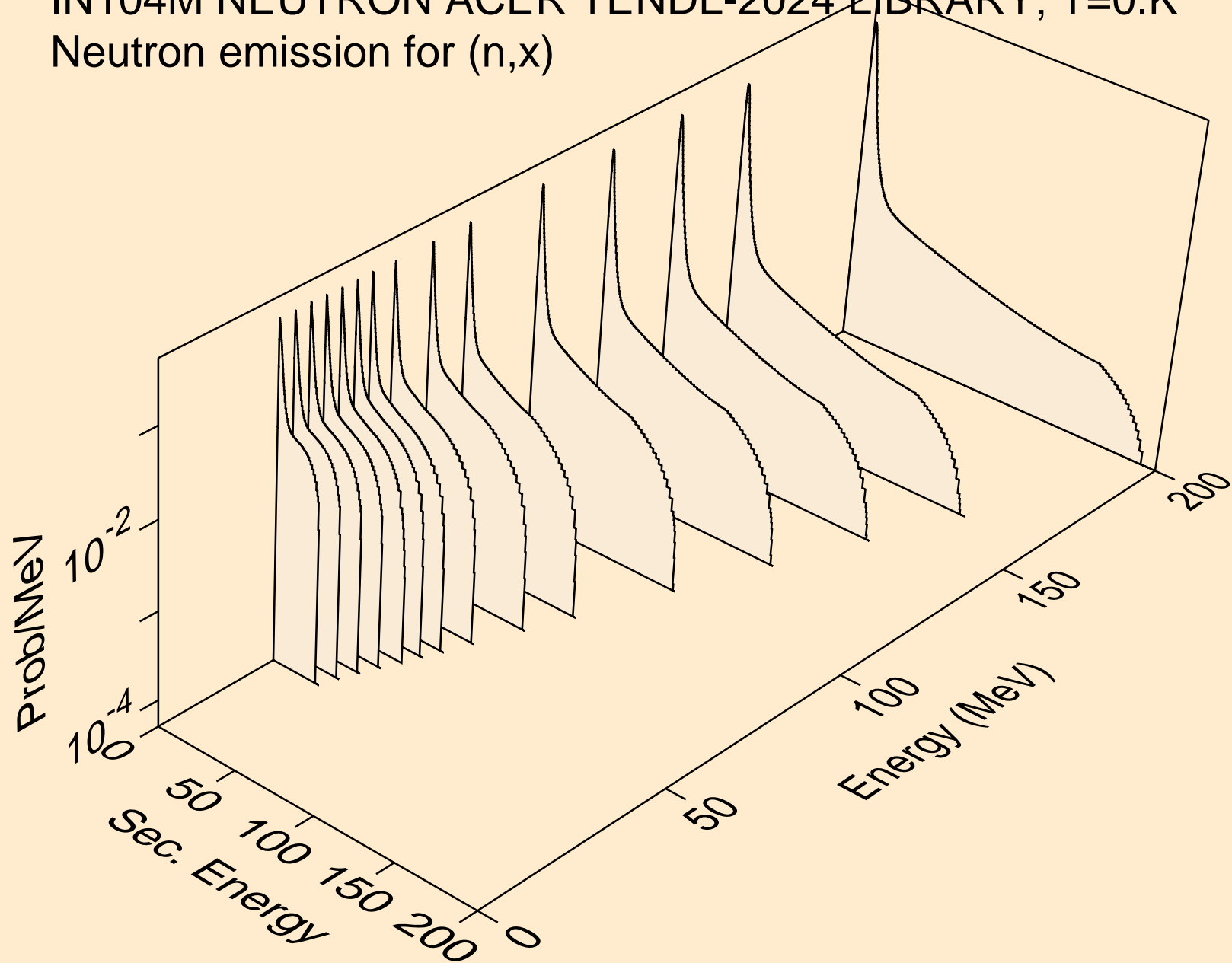

IN104M NEUTRON ACER TENDL-2024 LIBRARY; T=0.K
Neutron emission for (n,2nd)

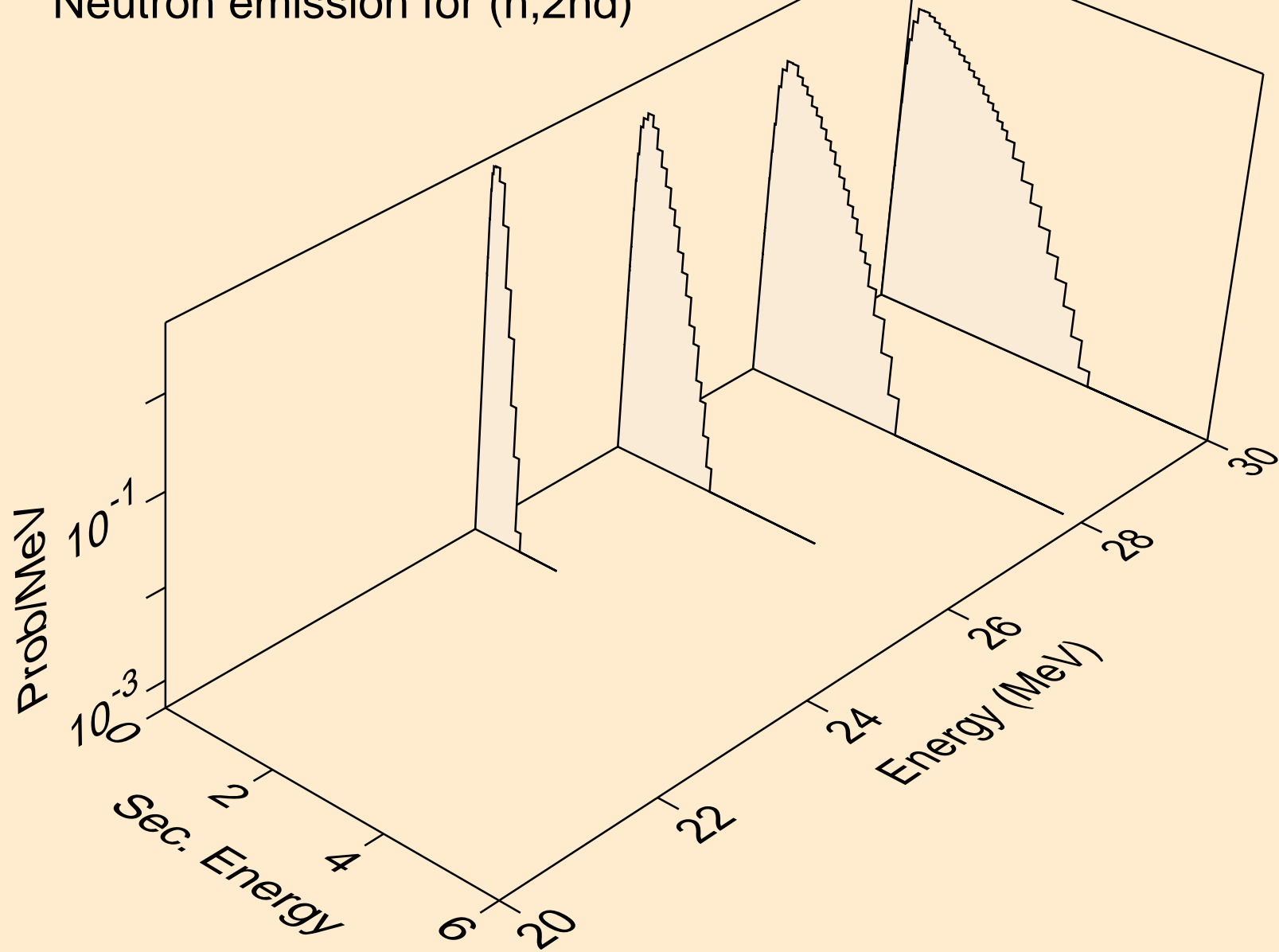

IN104M NEUTRON ACER TENDL-2024 LIBRARY; T=0.K
Neutron emission for (n,2n)

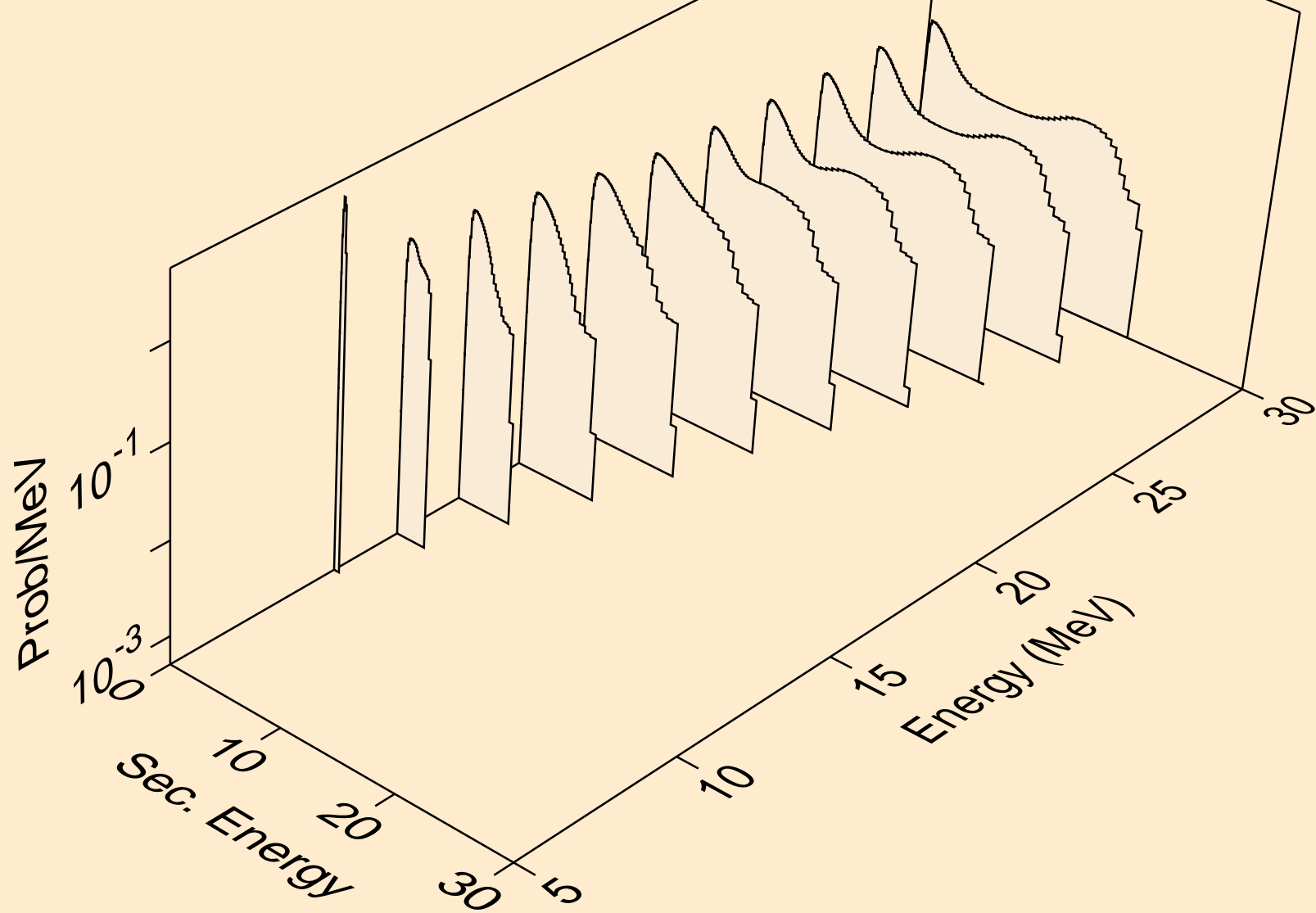

IN104M NEUTRON ACER TENDL-2024 LIBRARY; T=0.K
Neutron emission for (n,3n)

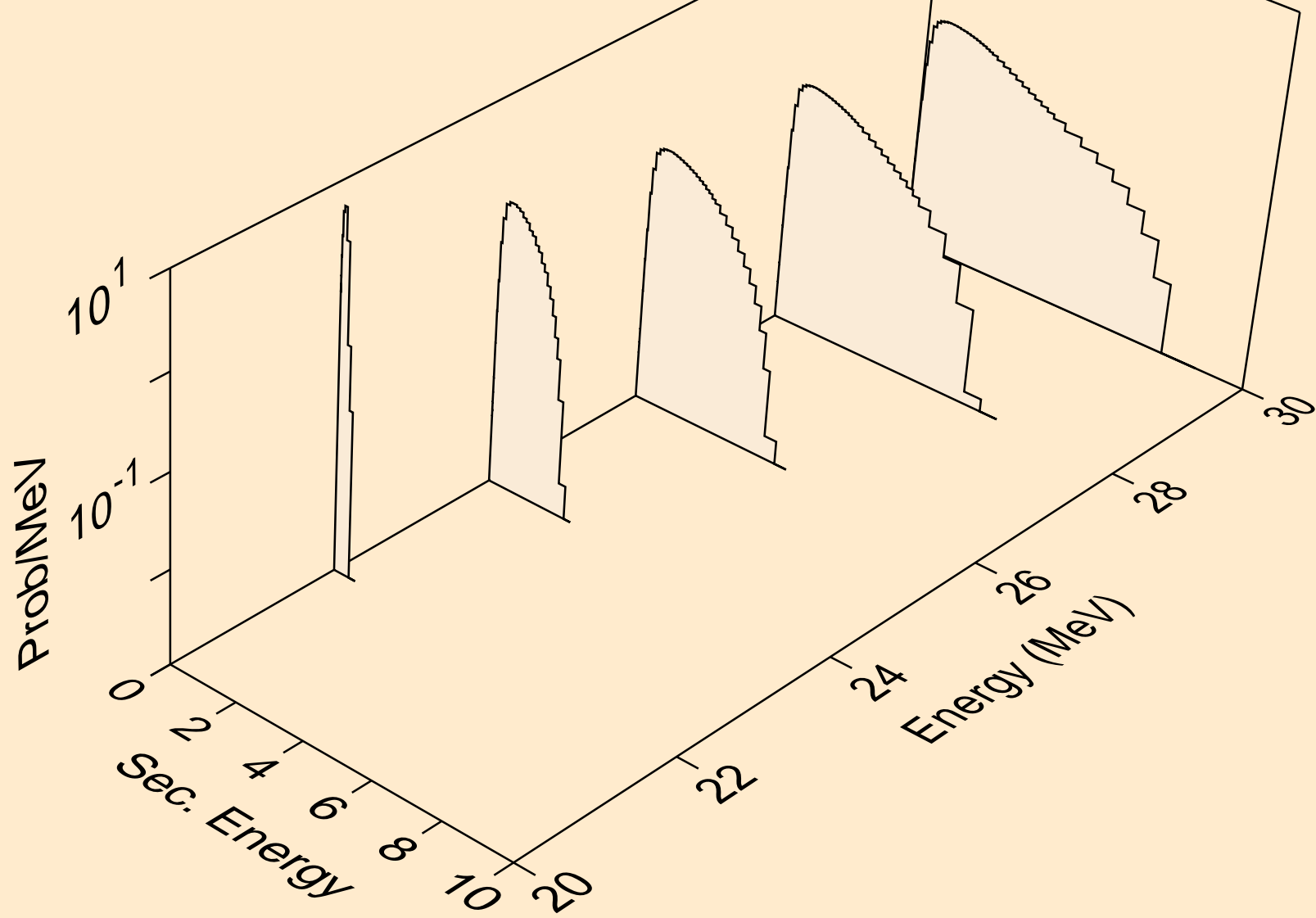

IN104M NEUTRON ACER TENDL-2024 LIBRARY; T=0.K
Neutron emission for (n,n*)a

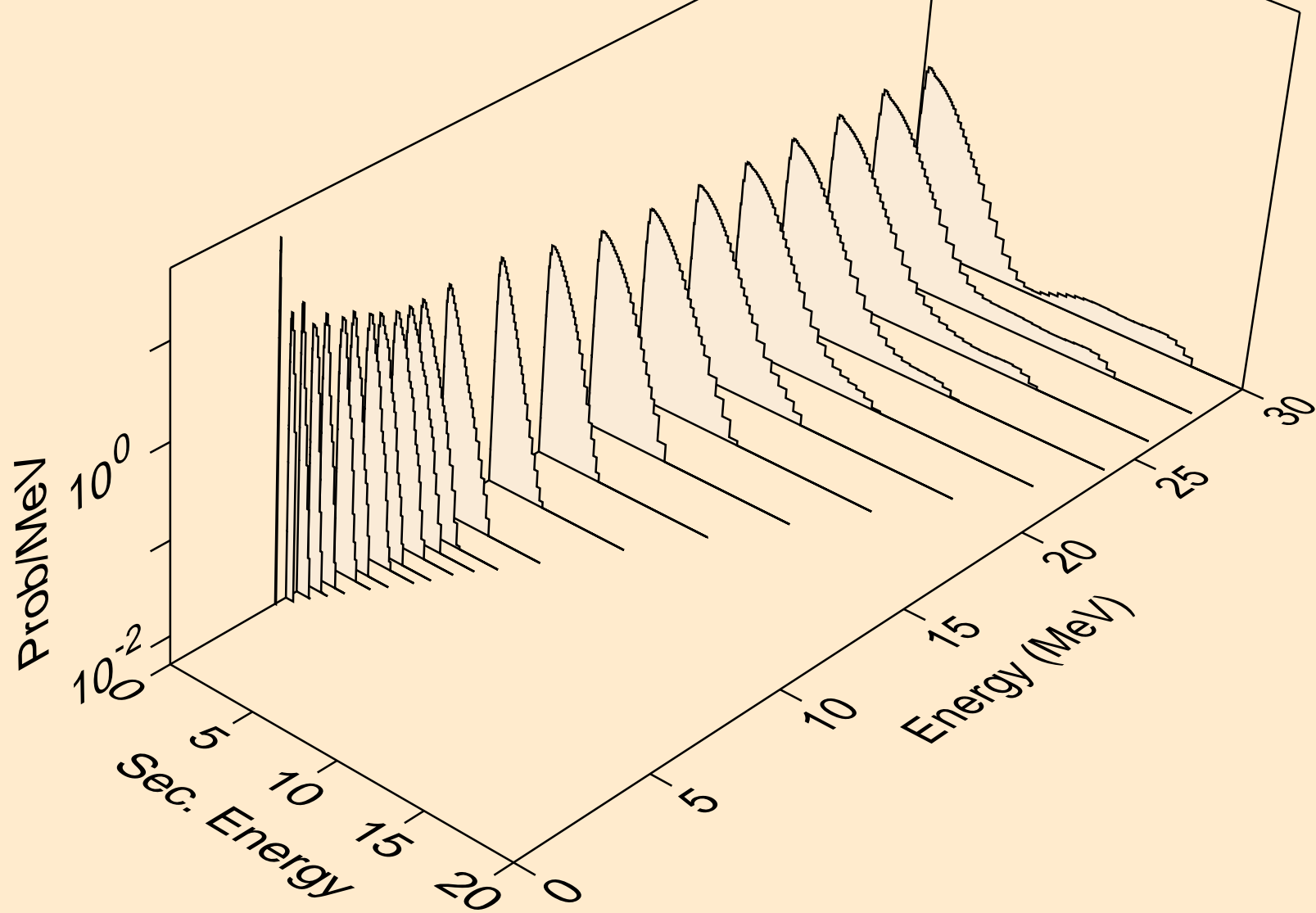

IN104M NEUTRON ACER TENDL-2024 LIBRARY; T=0.K
Neutron emission for (n,2n)a

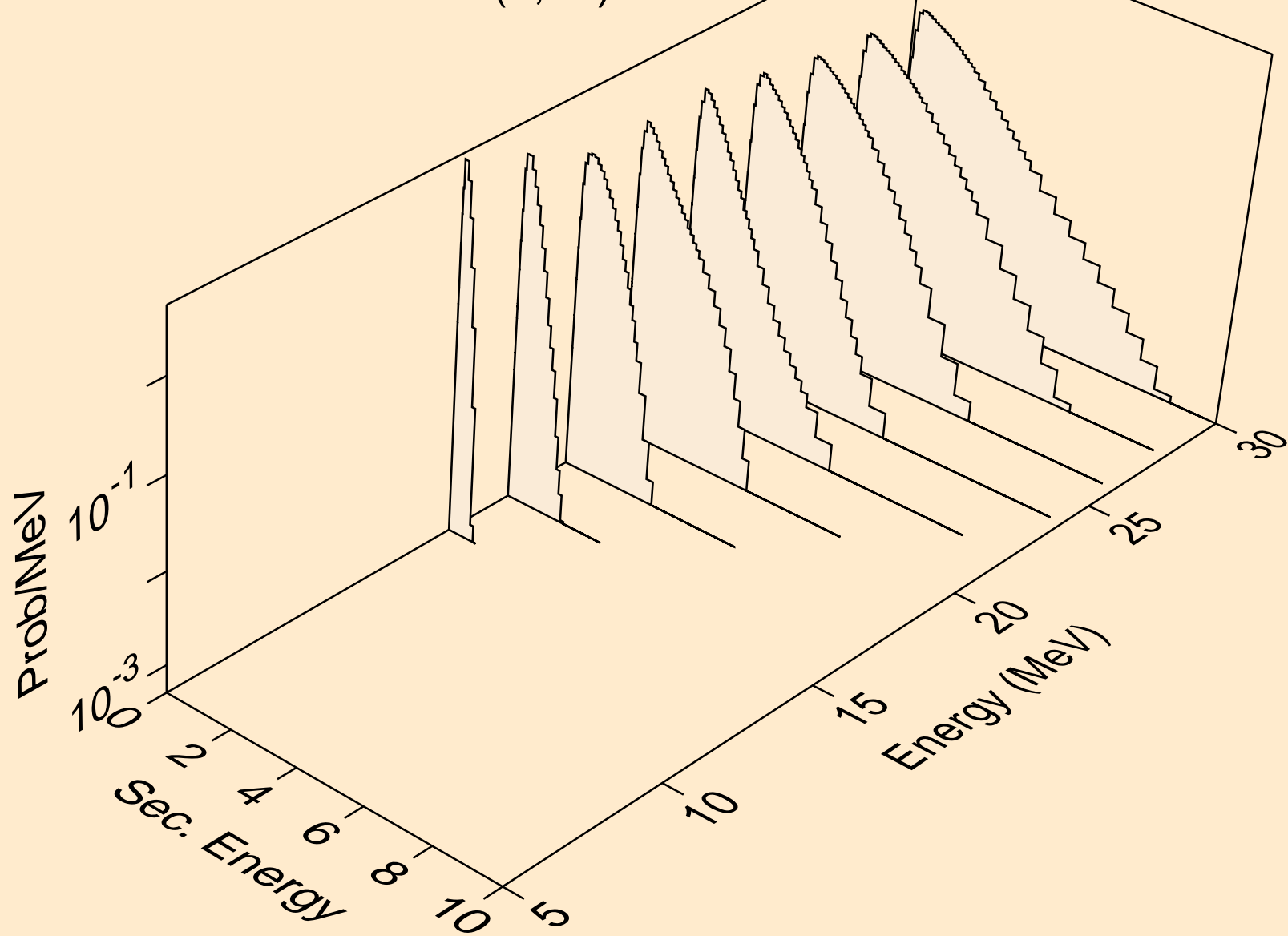

IN104M NEUTRON ACER TENDL-2024 LIBRARY; T=0.K
Neutron emission for (n,n*)p

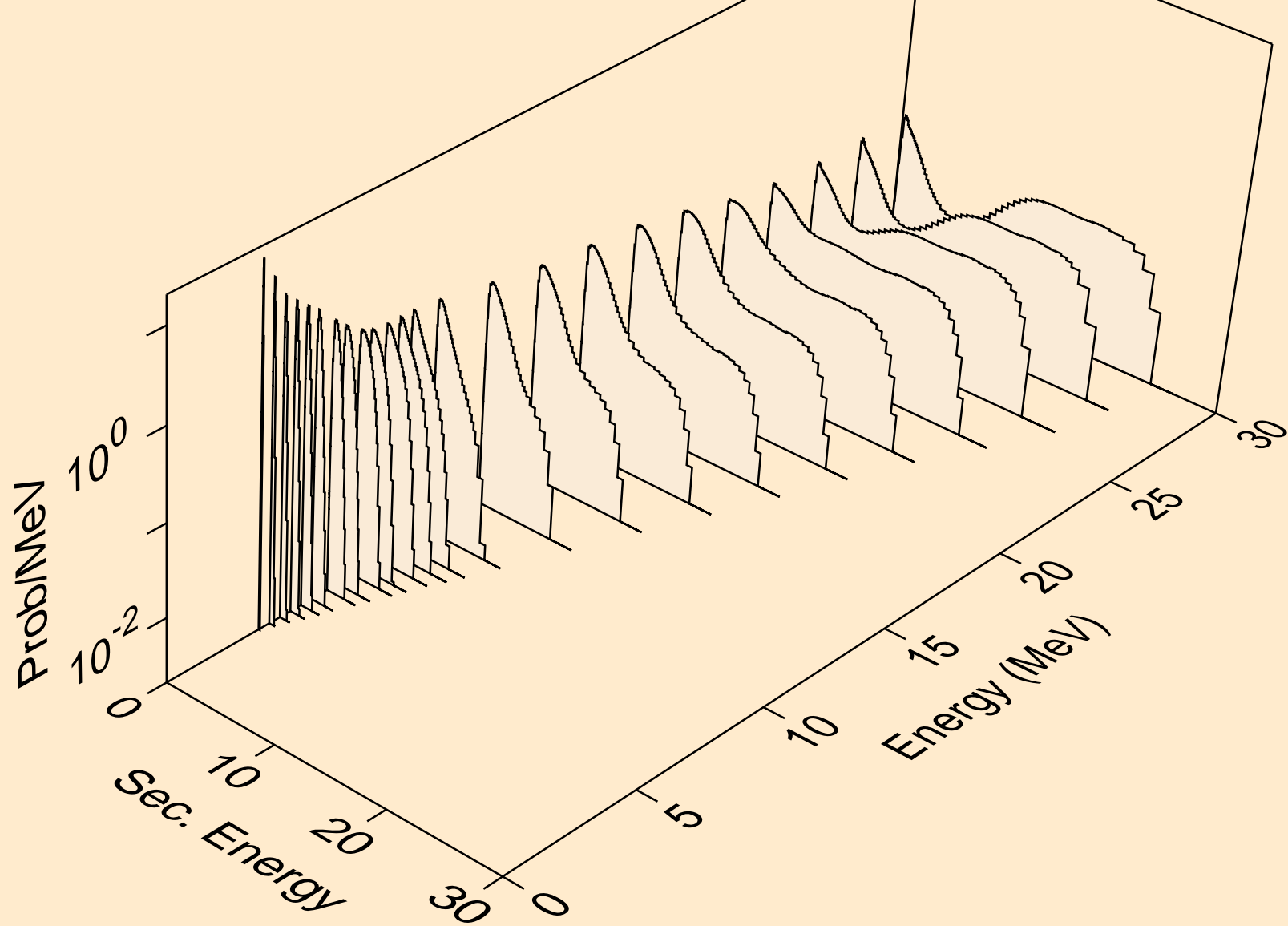

IN104M NEUTRON ACER TENDL-2024 LIBRARY; T=0.K
Neutron emission for (n,n*)2a

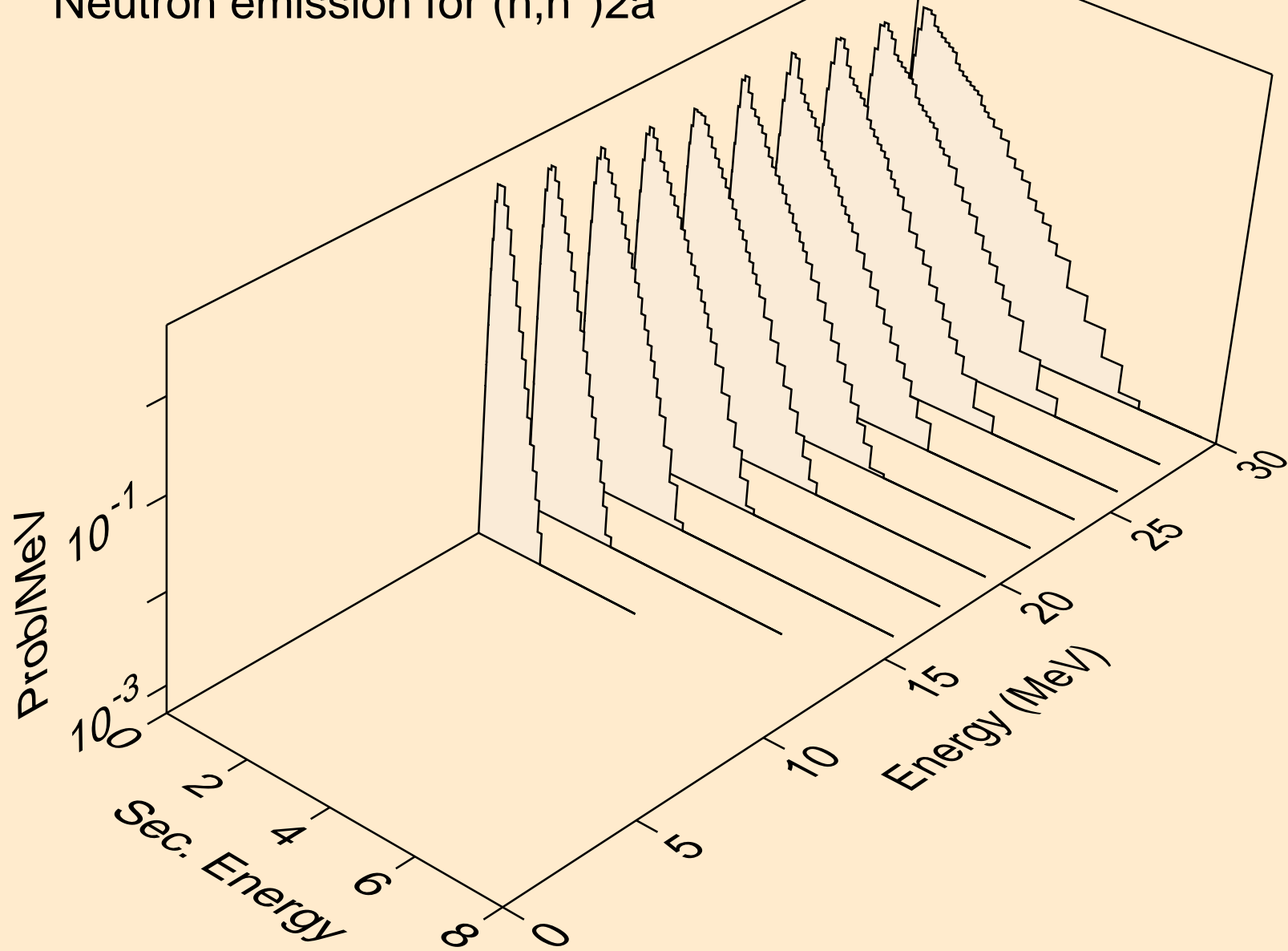

IN104M NEUTRON ACER TENDL-2024 LIBRARY; T=0.K
Neutron emission for (n,2n)2a

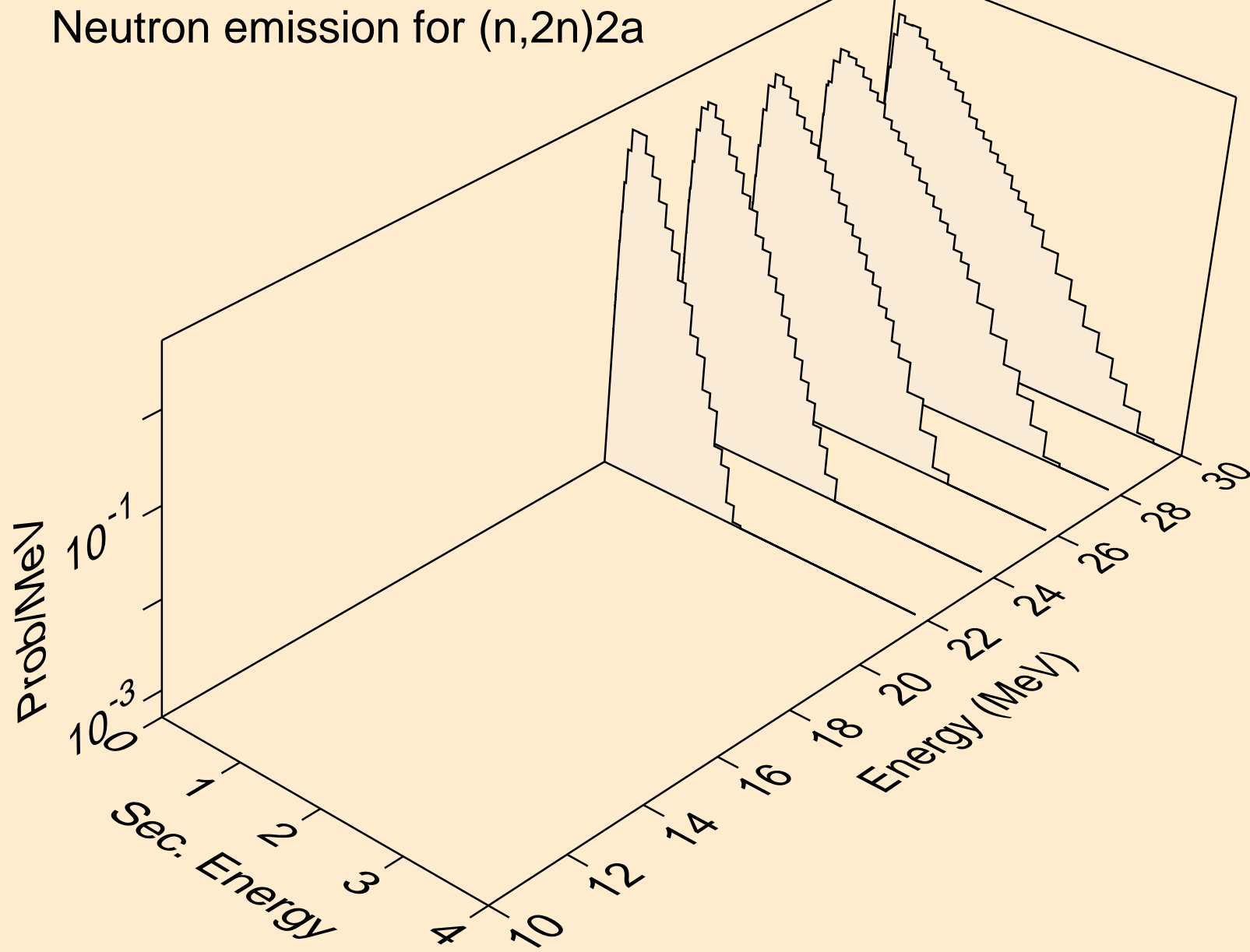

IN104M NEUTRON ACER TENDL-2024 LIBRARY; T=0.K
Neutron emission for (n,n*)d

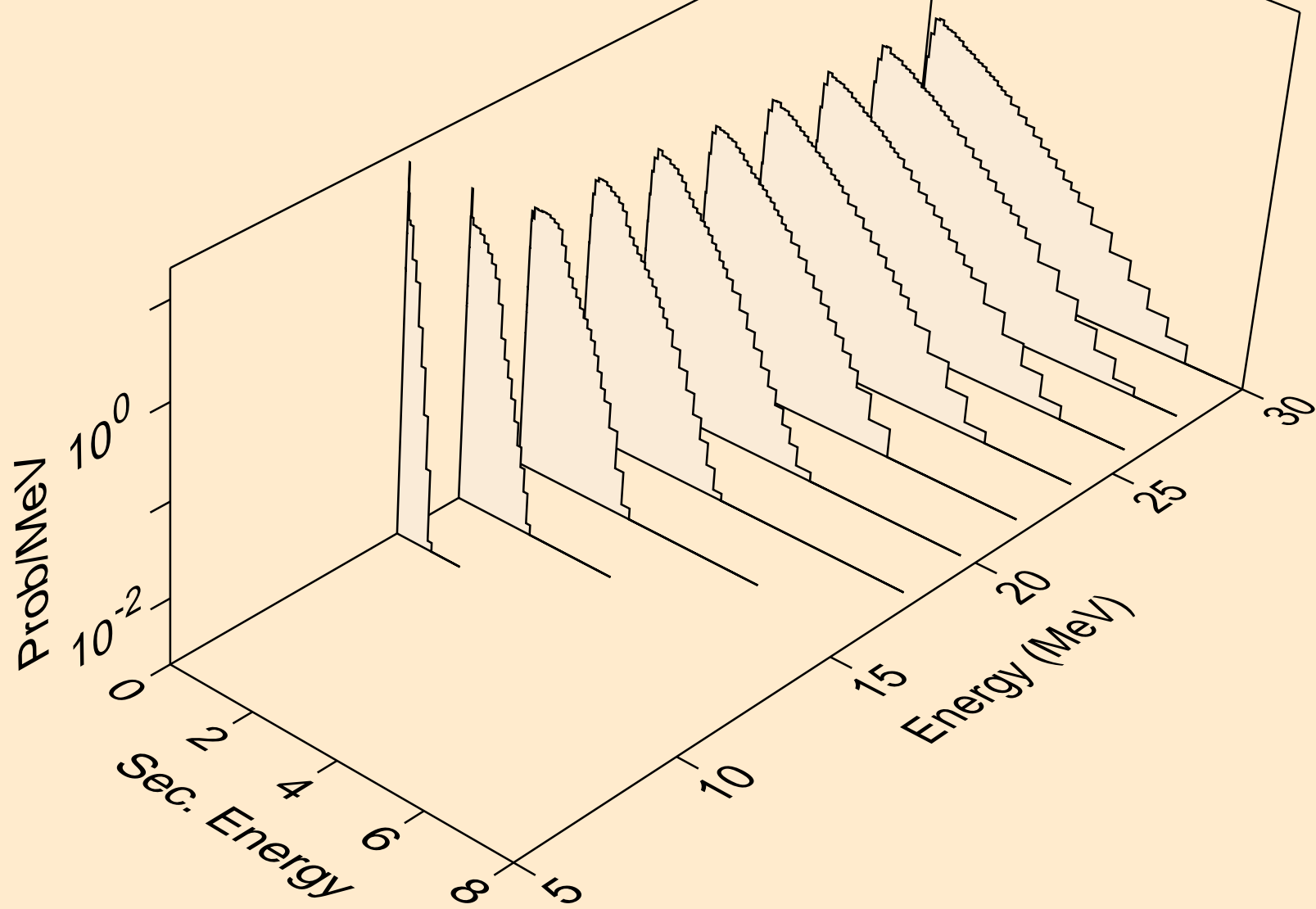

IN104M NEUTRON ACER TENDL-2024 LIBRARY; T=0.K
Neutron emission for (n,n*)t

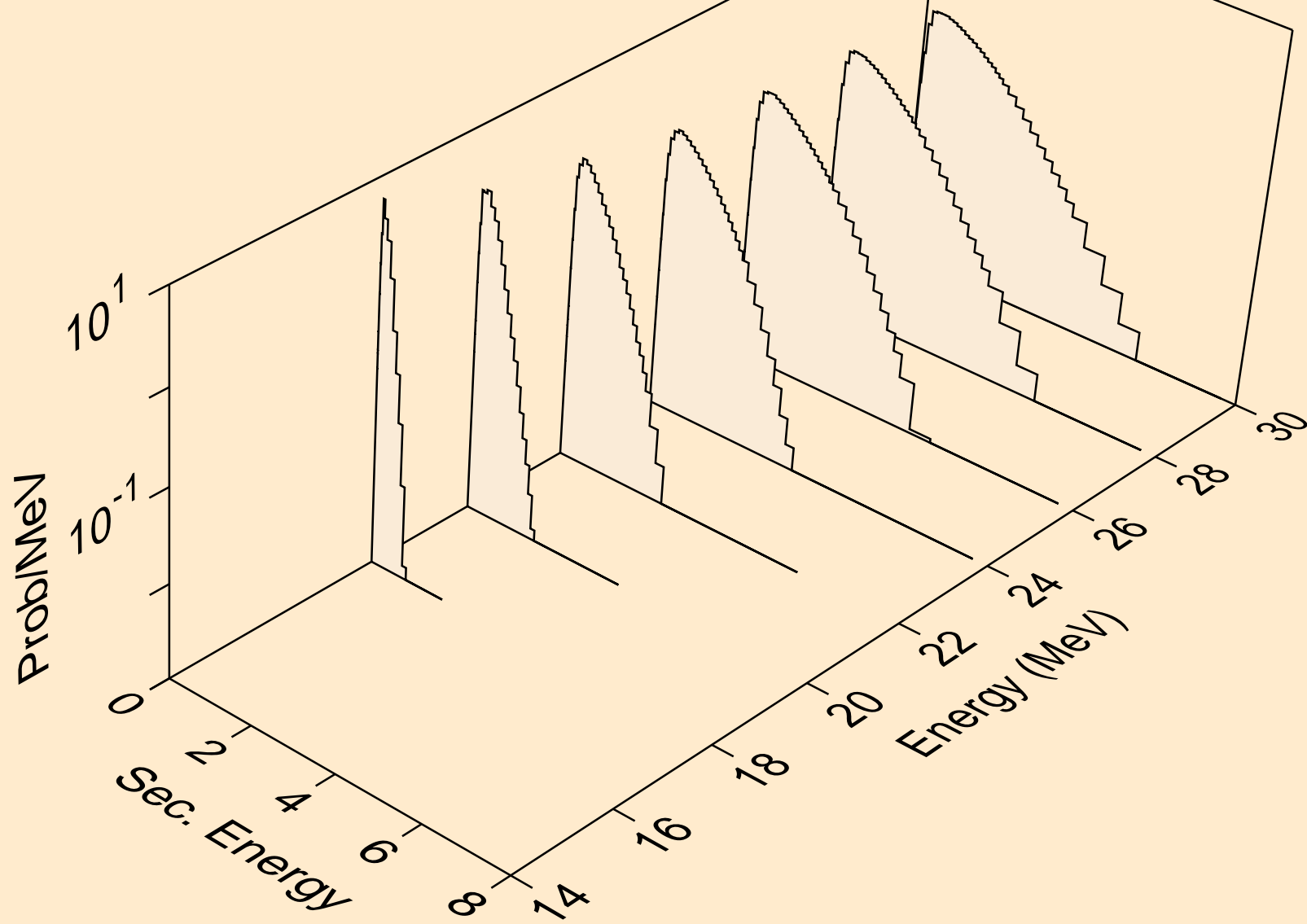

IN104M NEUTRON ACER TENDL-2024 LIBRARY; T=0.K
Neutron emission for (n,n*)he3

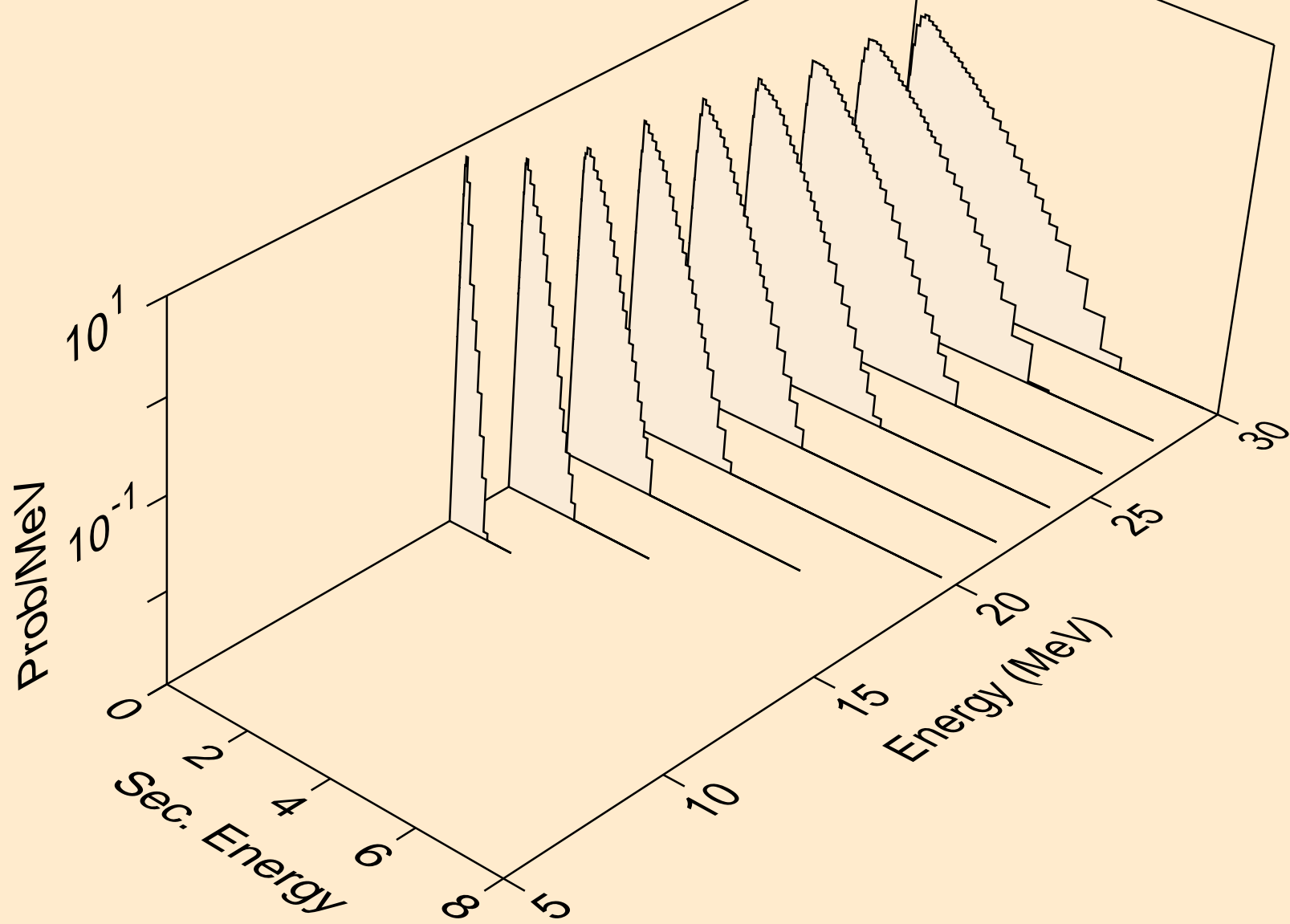

IN104M NEUTRON ACER TENDL-2024 LIBRARY; T=0.K
Neutron emission for (n,2np)

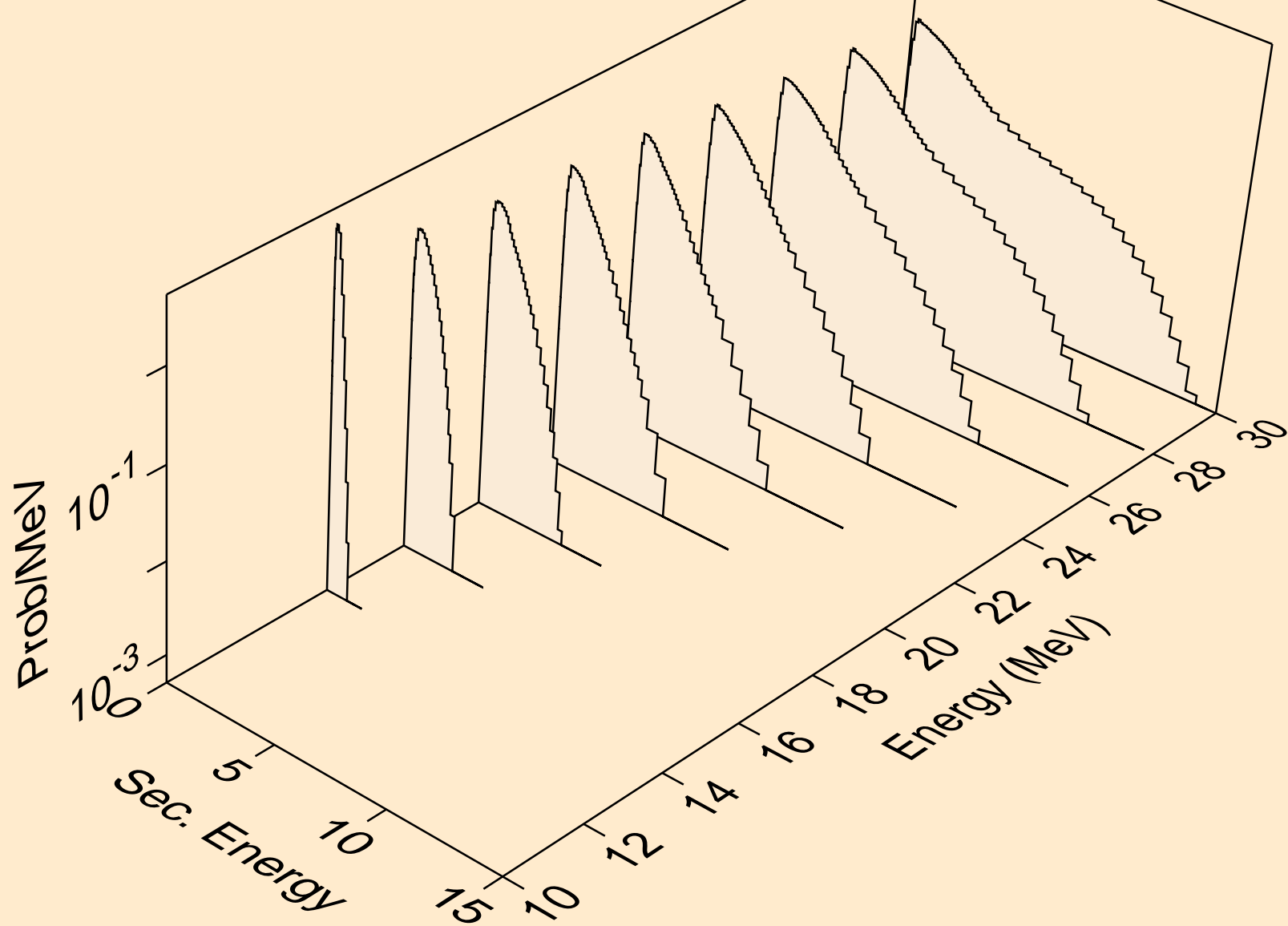

IN104M NEUTRON ACER TENDL-2024 LIBRARY; T=0.K
Neutron emission for (n,3np)

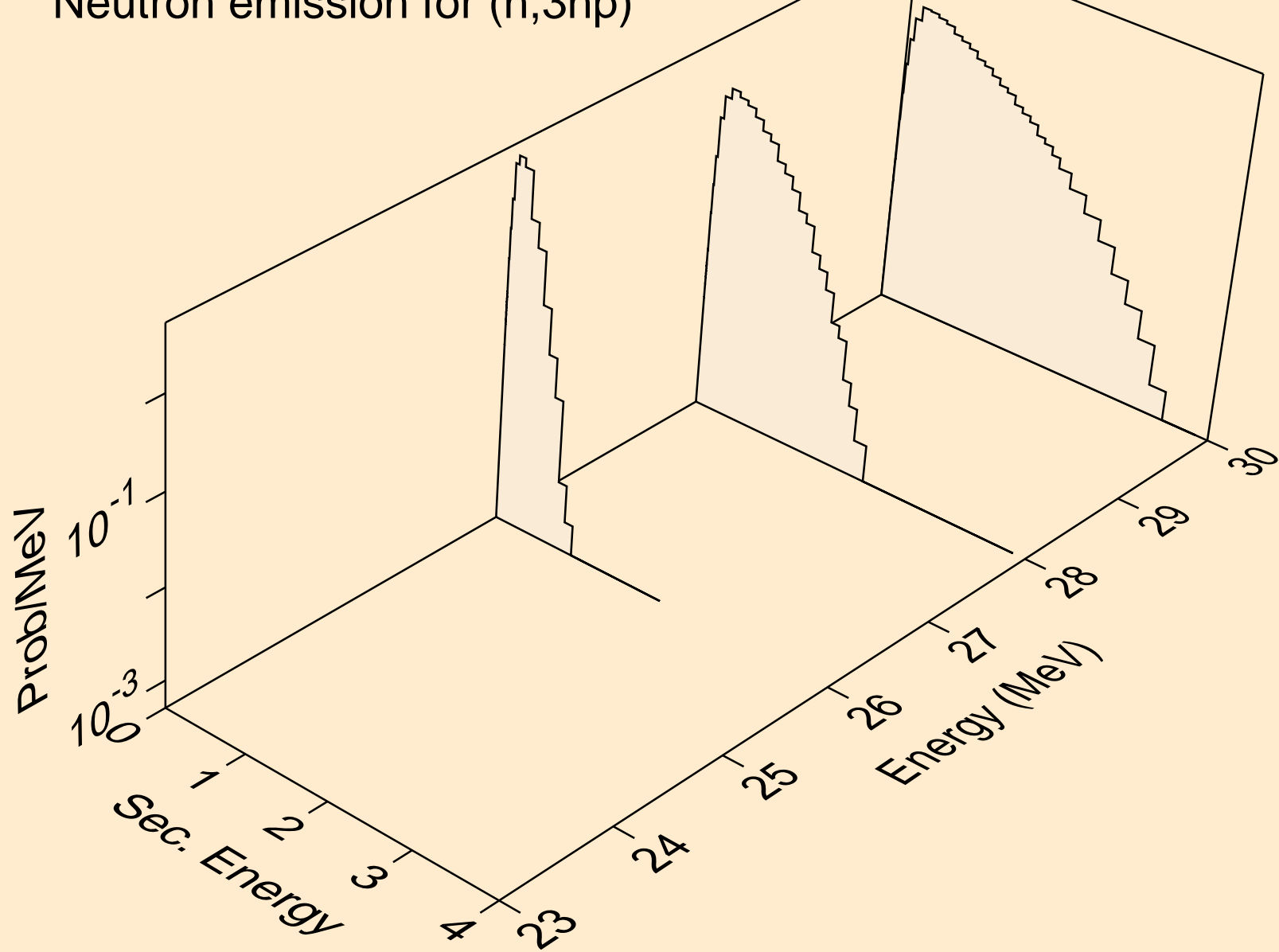

IN104M NEUTRON ACER TENDL-2024 LIBRARY; T=0.K
Neutron emission for (n,n2p)

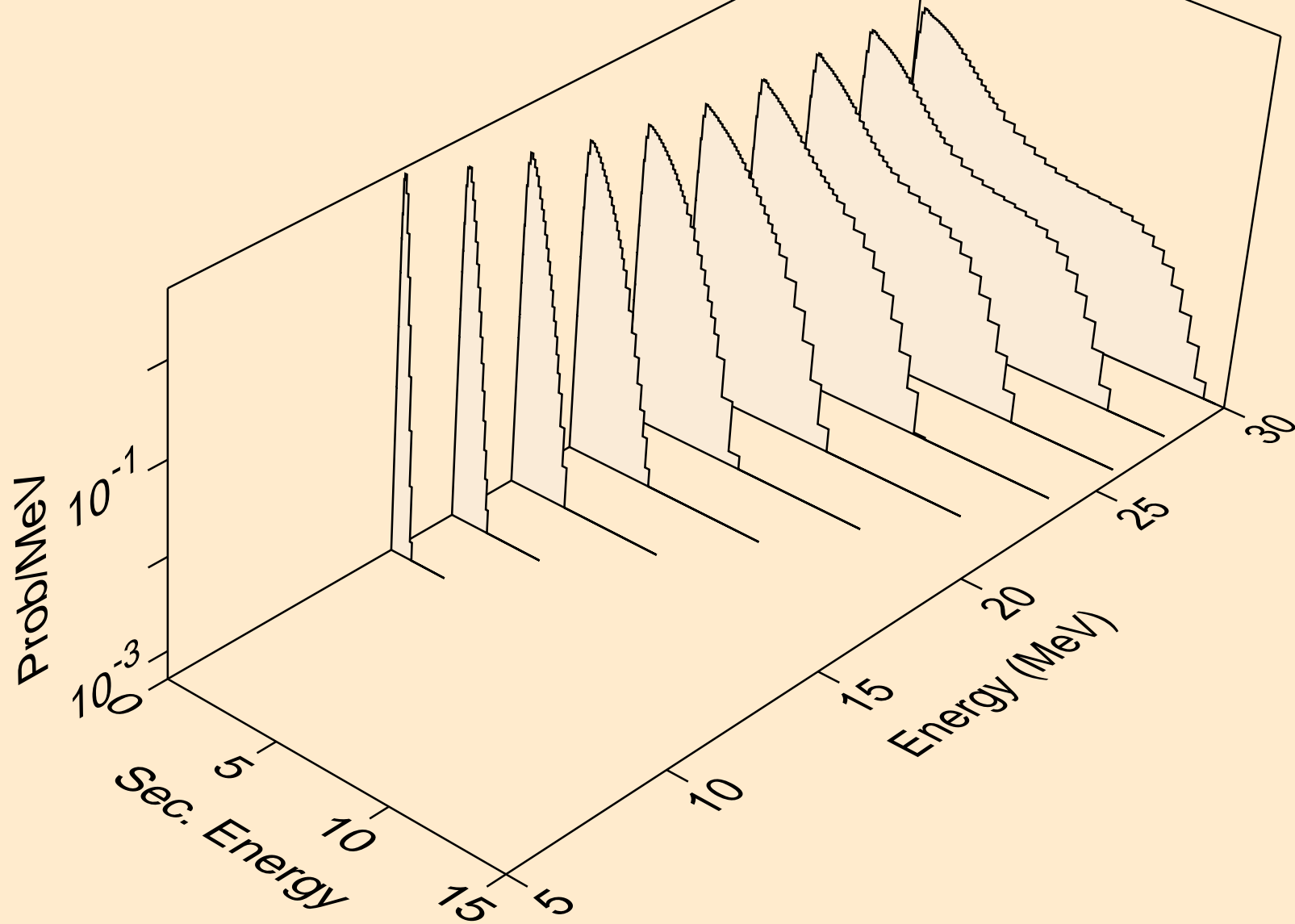

IN104M NEUTRON ACER TENDL-2024 LIBRARY; T=0.K
Neutron emission for (n,npa)

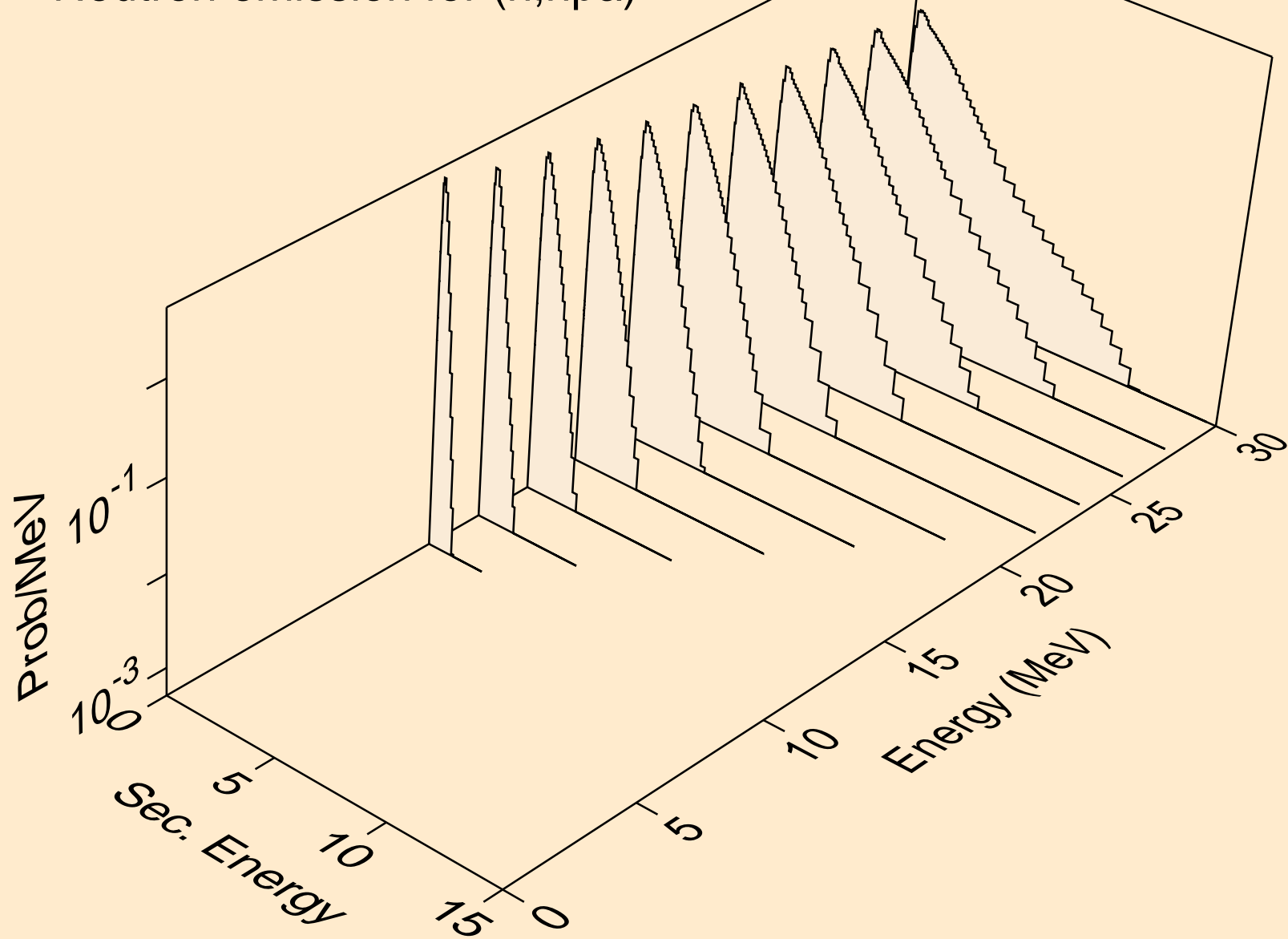

IN104M NEUTRON ACER TENDL-2024 LIBRARY; T=0.K
Neutron emission for (n,n*c)

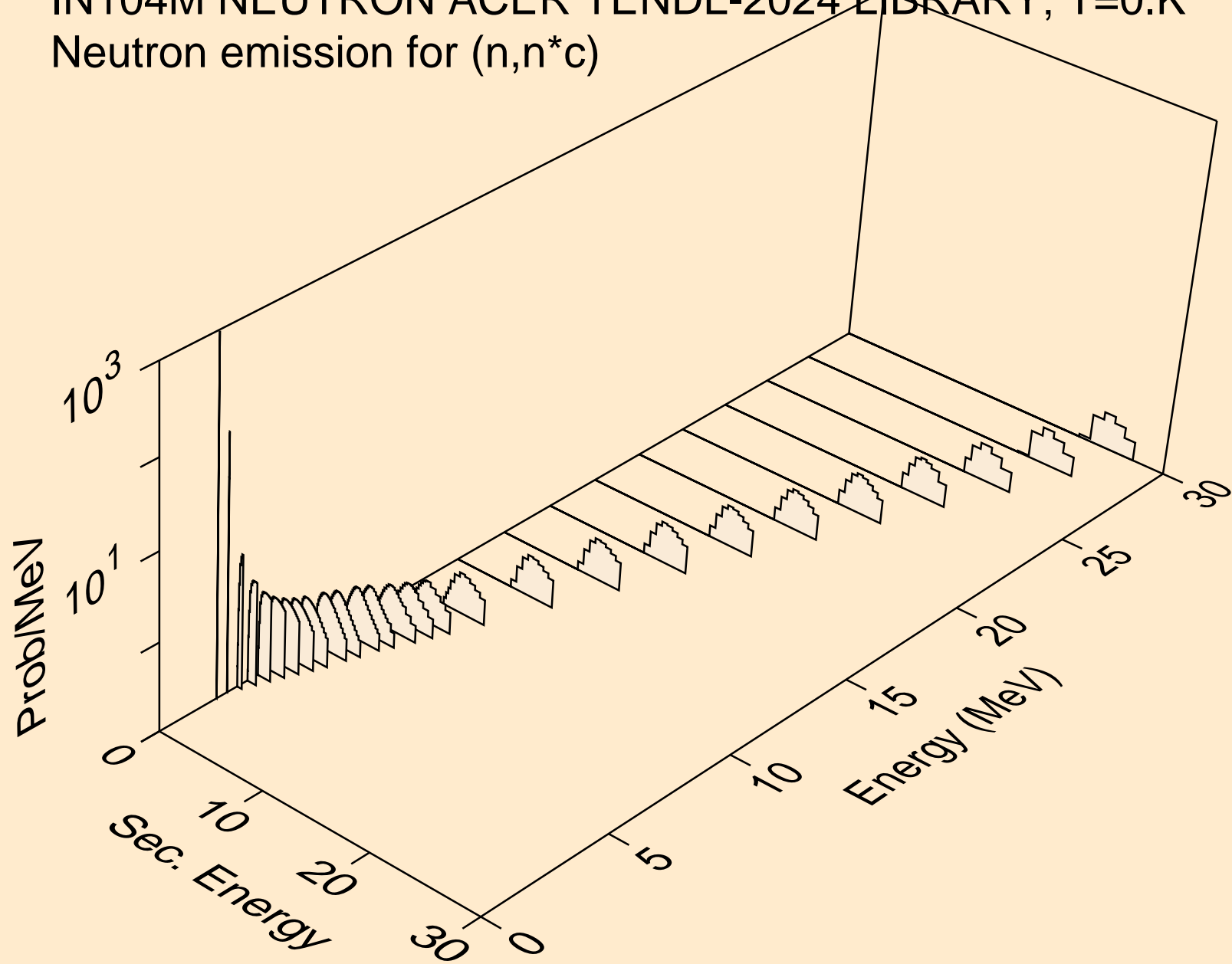

IN104M NEUTRON ACER TENDL-2024 LIBRARY; T=0.K
Photon emission for (n,x)

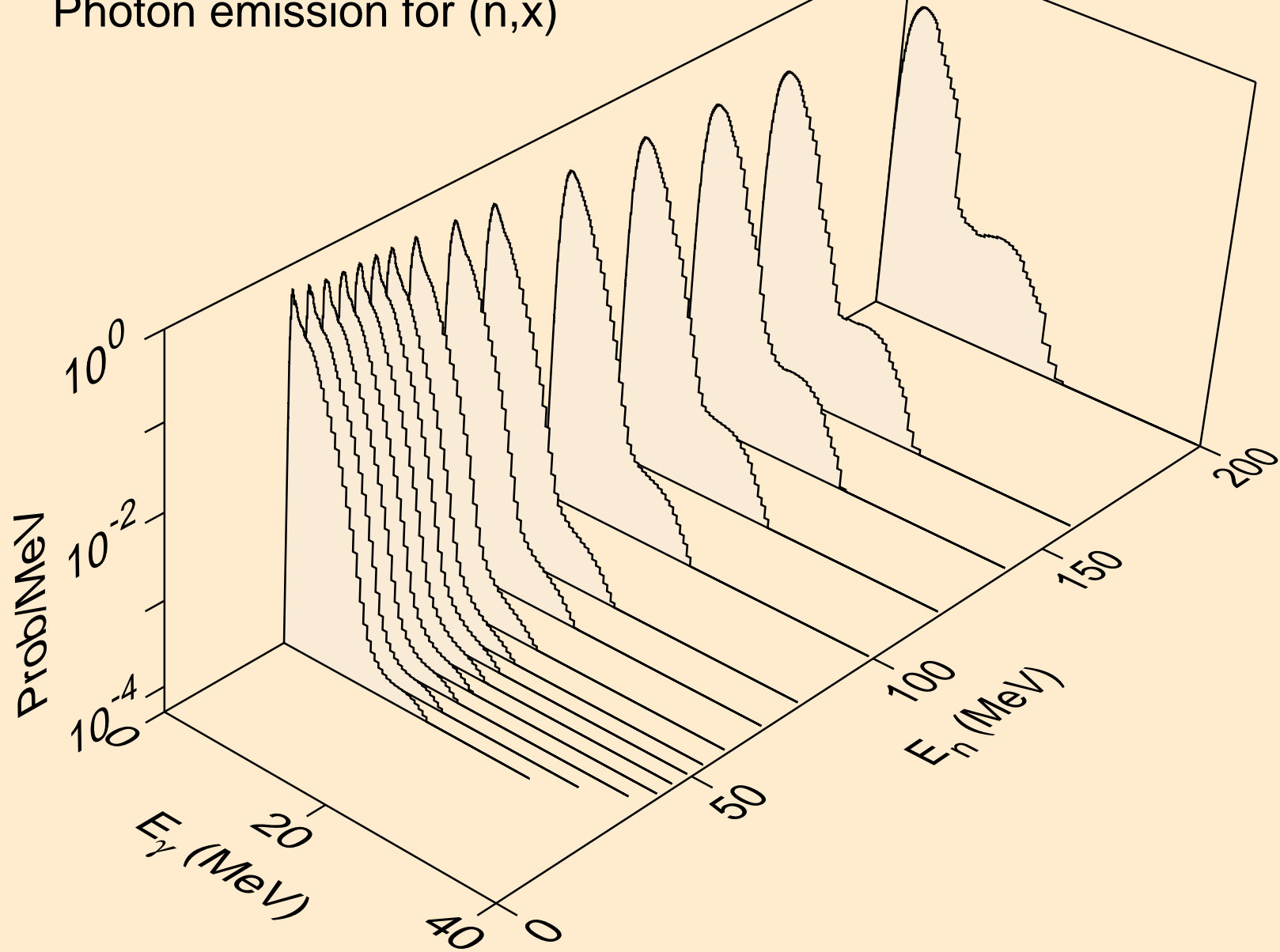

IN104M NEUTRON ACER TENDL-2024 LIBRARY; T=0.K
Photon emission for (n,2nd)

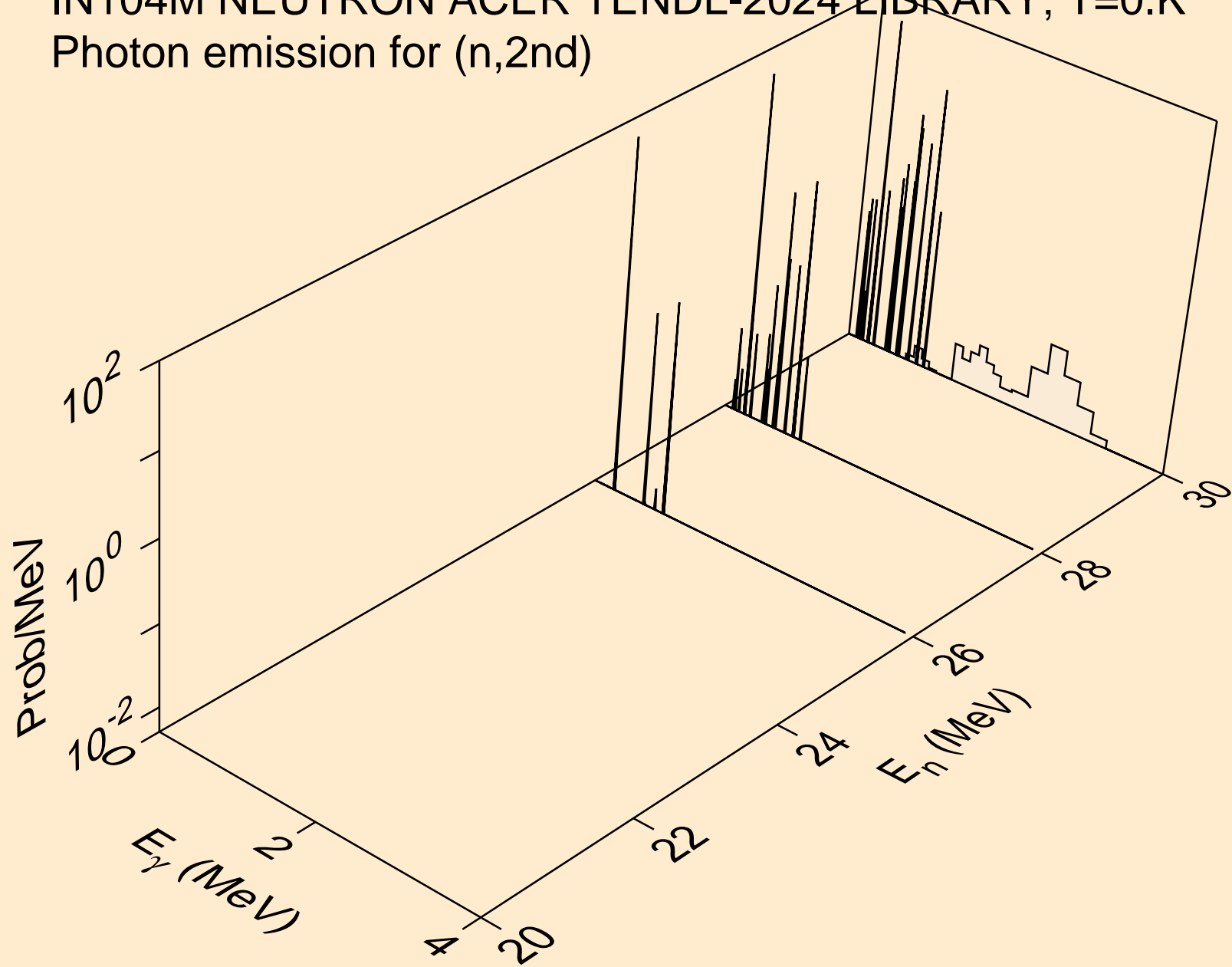

IN104M NEUTRON ACER TENDL-2024 LIBRARY; T=0.K
Photon emission for (n,2n)

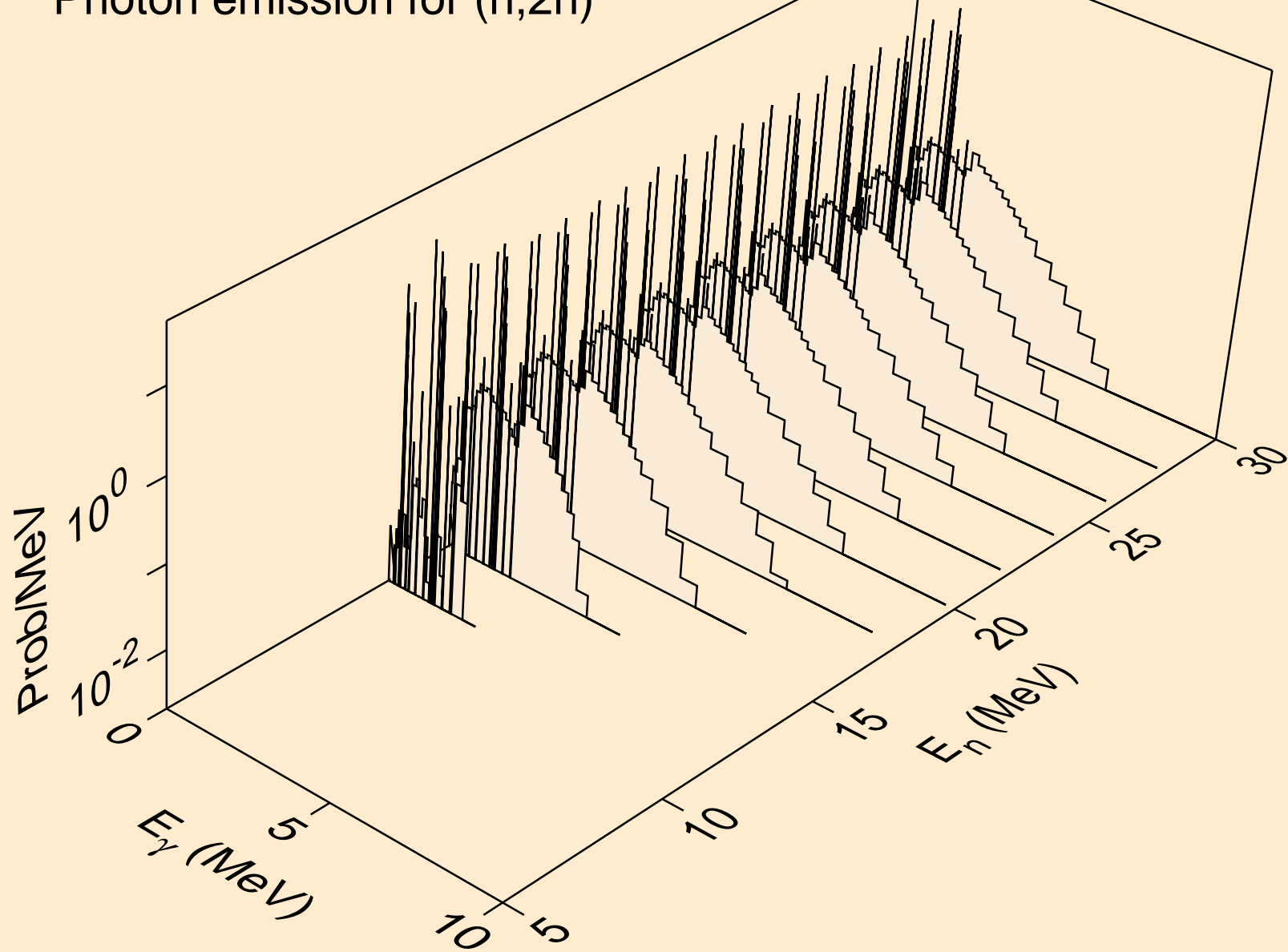

IN104M NEUTRON ACER TENDL-2024 LIBRARY; T=0.K
Photon emission for (n,3n)

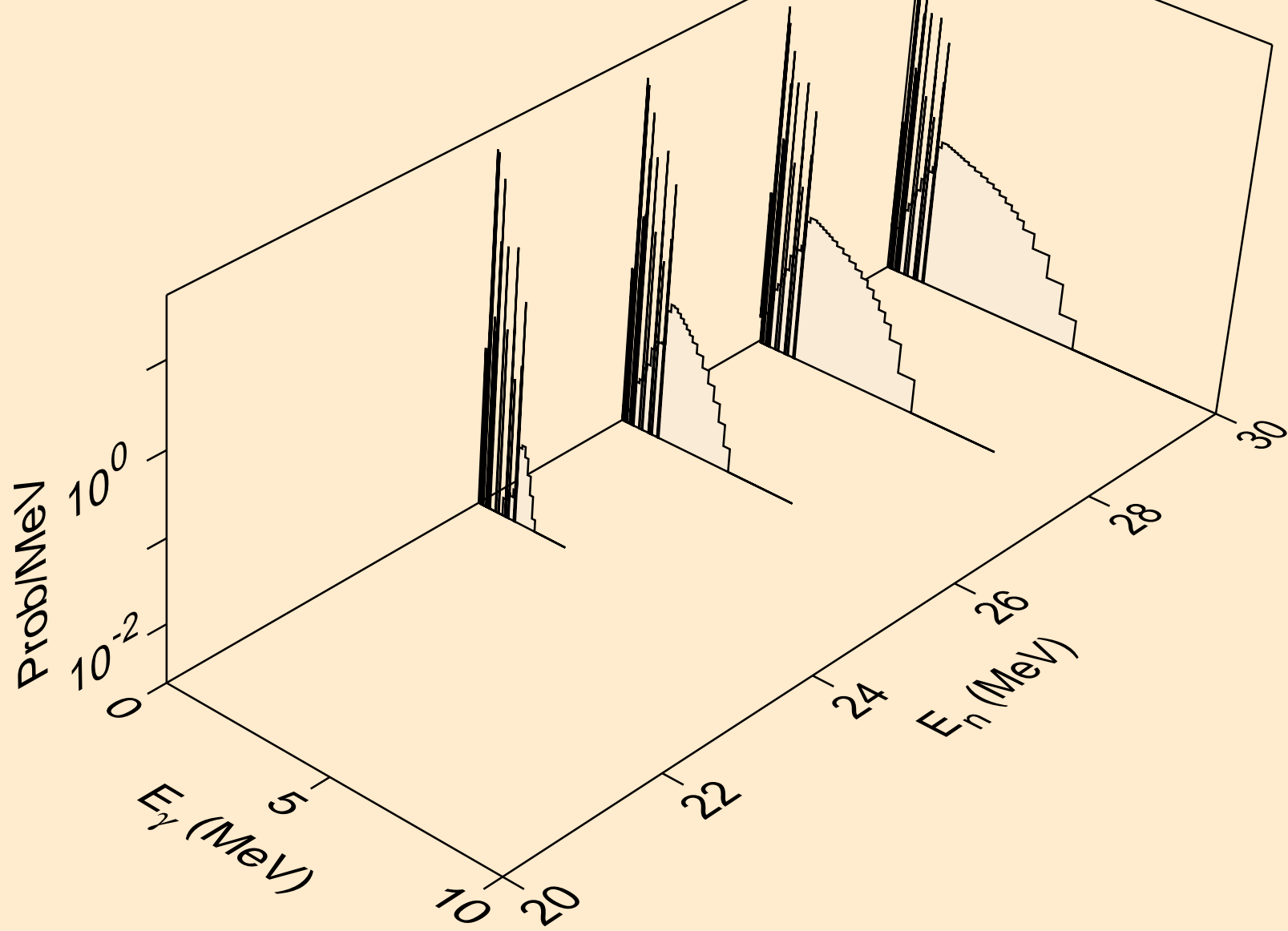

IN104M NEUTRON ACER TENDL-2024 LIBRARY; T=0.K
Photon emission for (n,n*)a

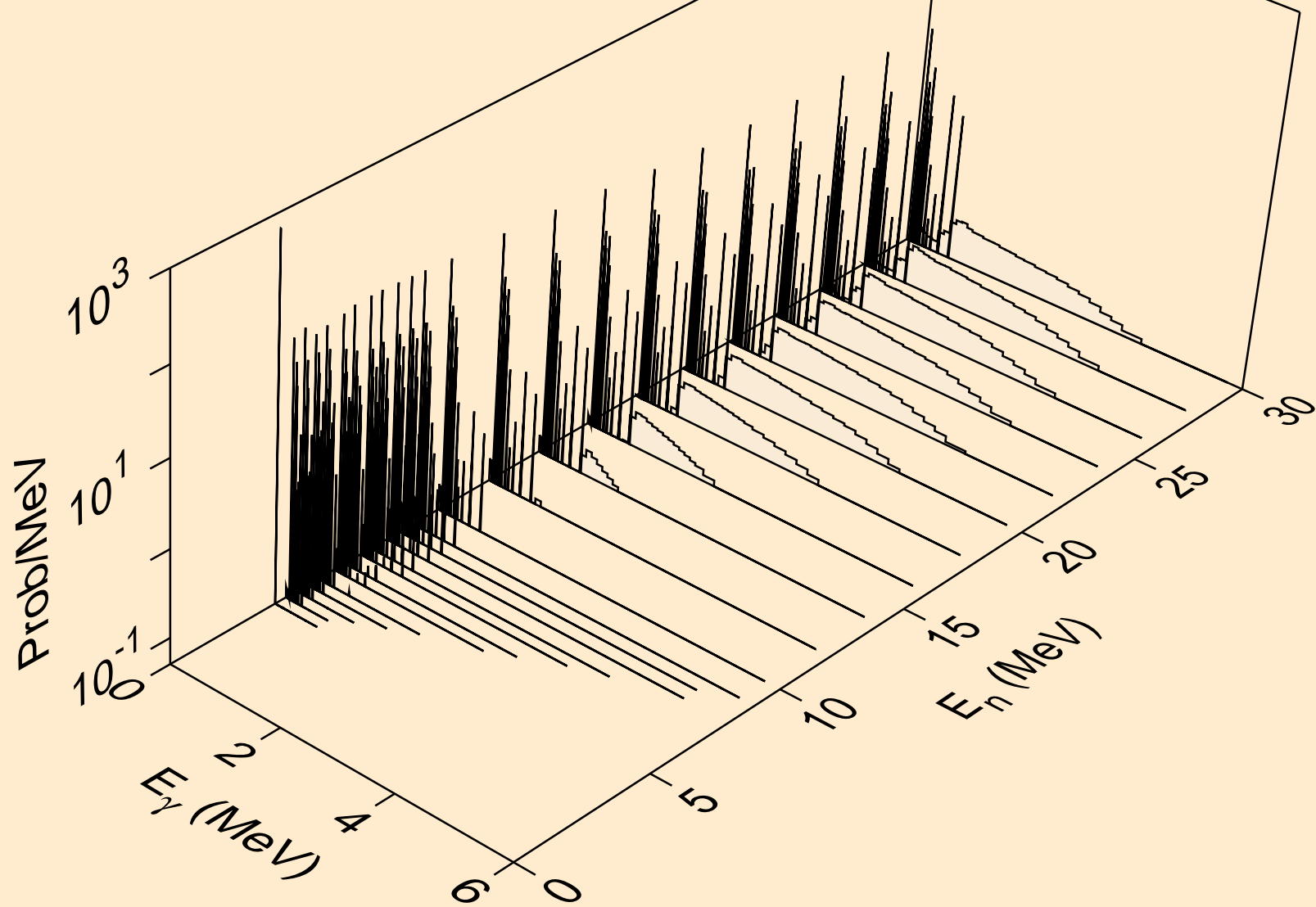

IN104M NEUTRON ACER TENDL-2024 LIBRARY; T=0.K
Photon emission for (n,2n)a

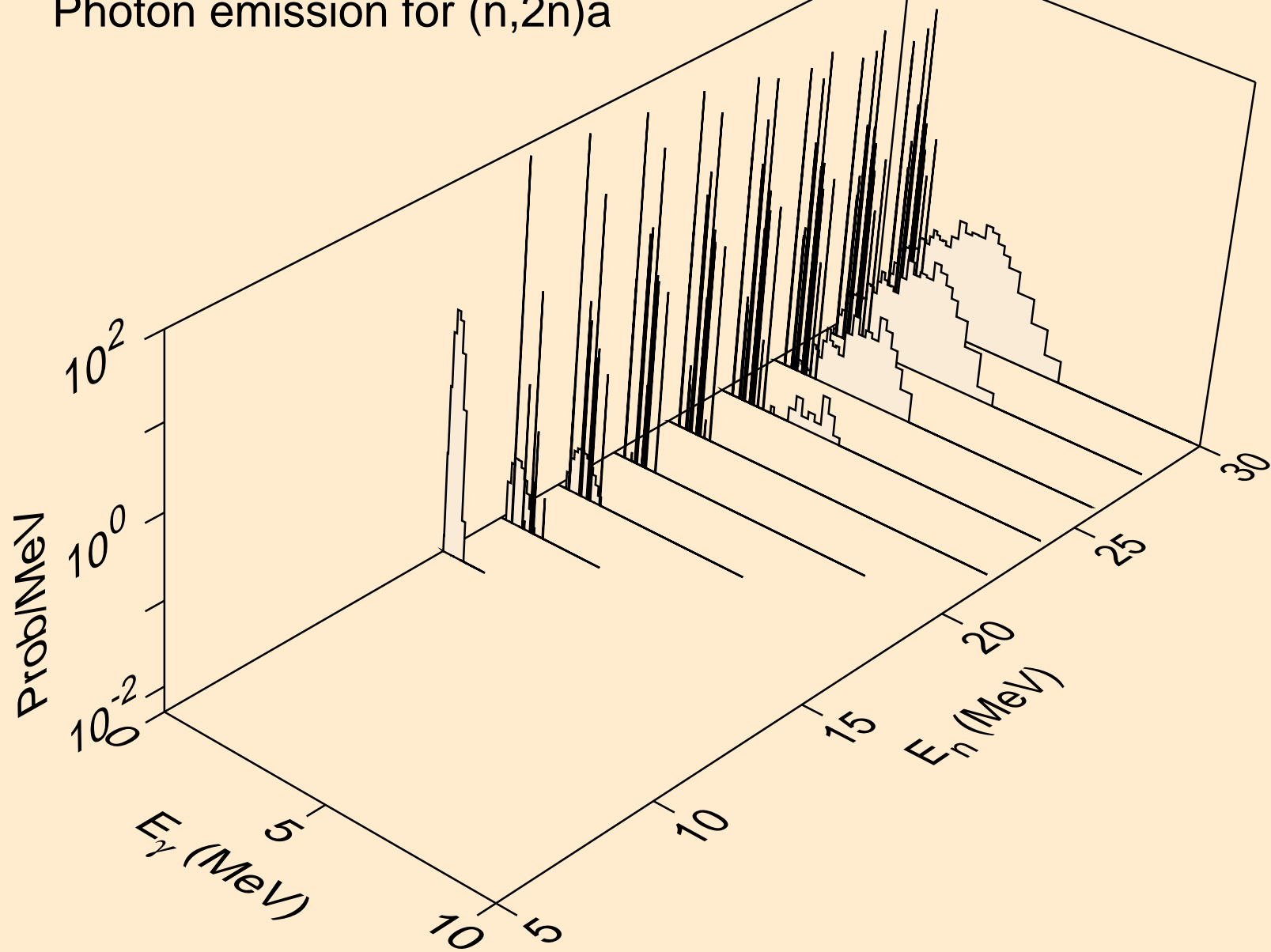

IN104M NEUTRON ACER TENDL-2024 LIBRARY; T=0.K
Photon emission for (n,n*)p

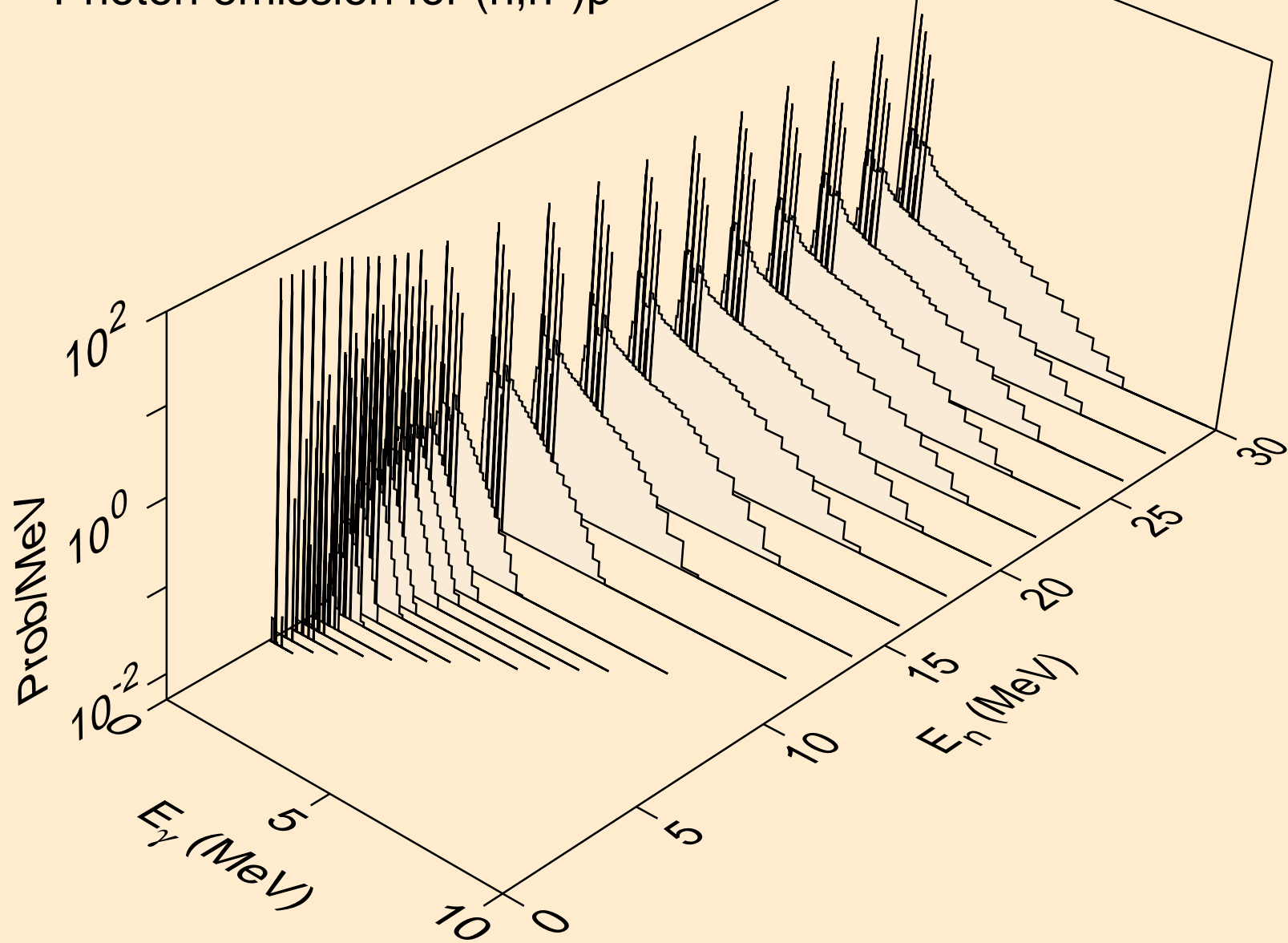

IN104M NEUTRON ACER TENDL-2024 LIBRARY; T=0.K
Photon emission for (n,n*)2a

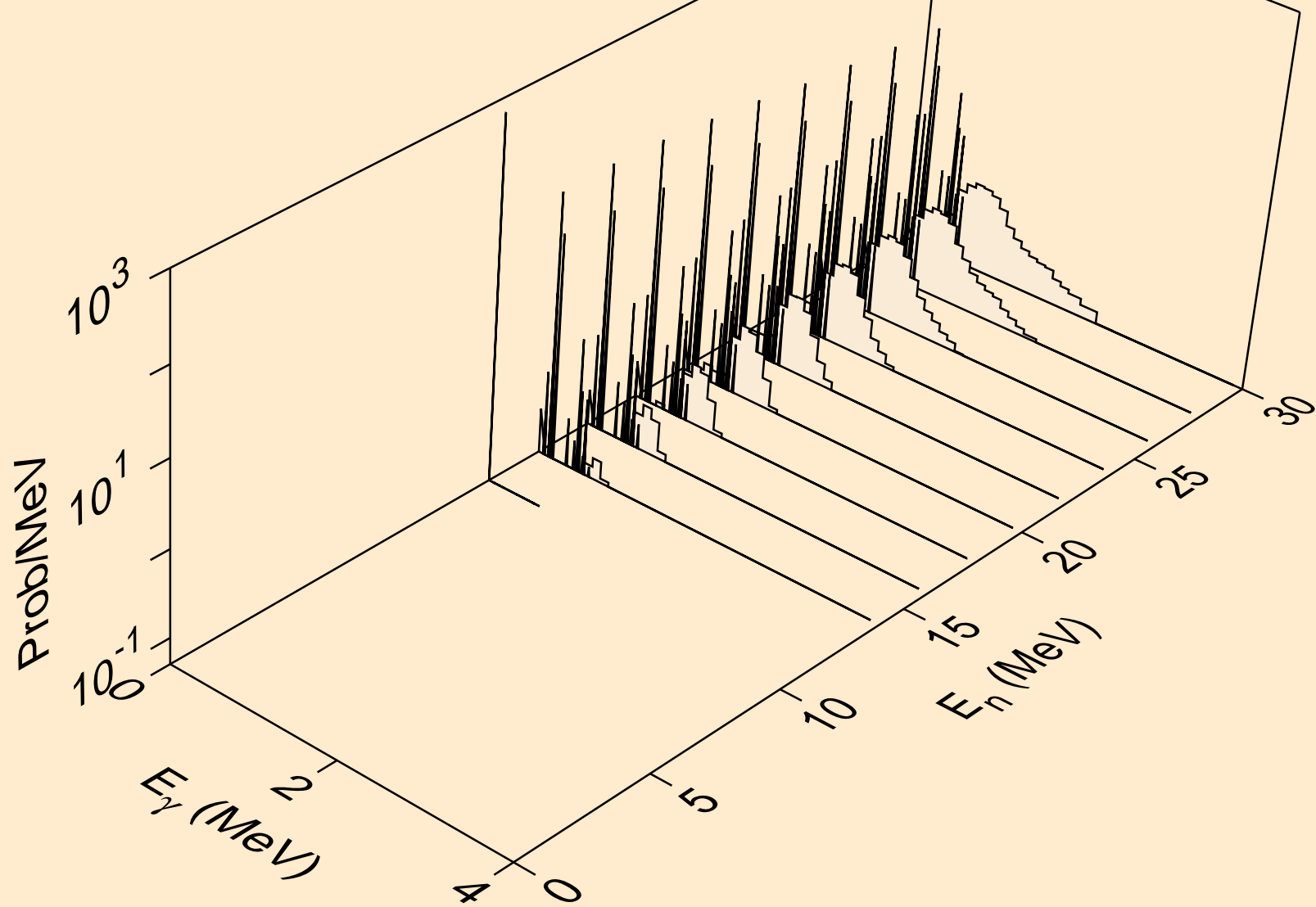

IN104M NEUTRON ACER TENDL-2024 LIBRARY; T=0.K
Photon emission for (n,2n)2a

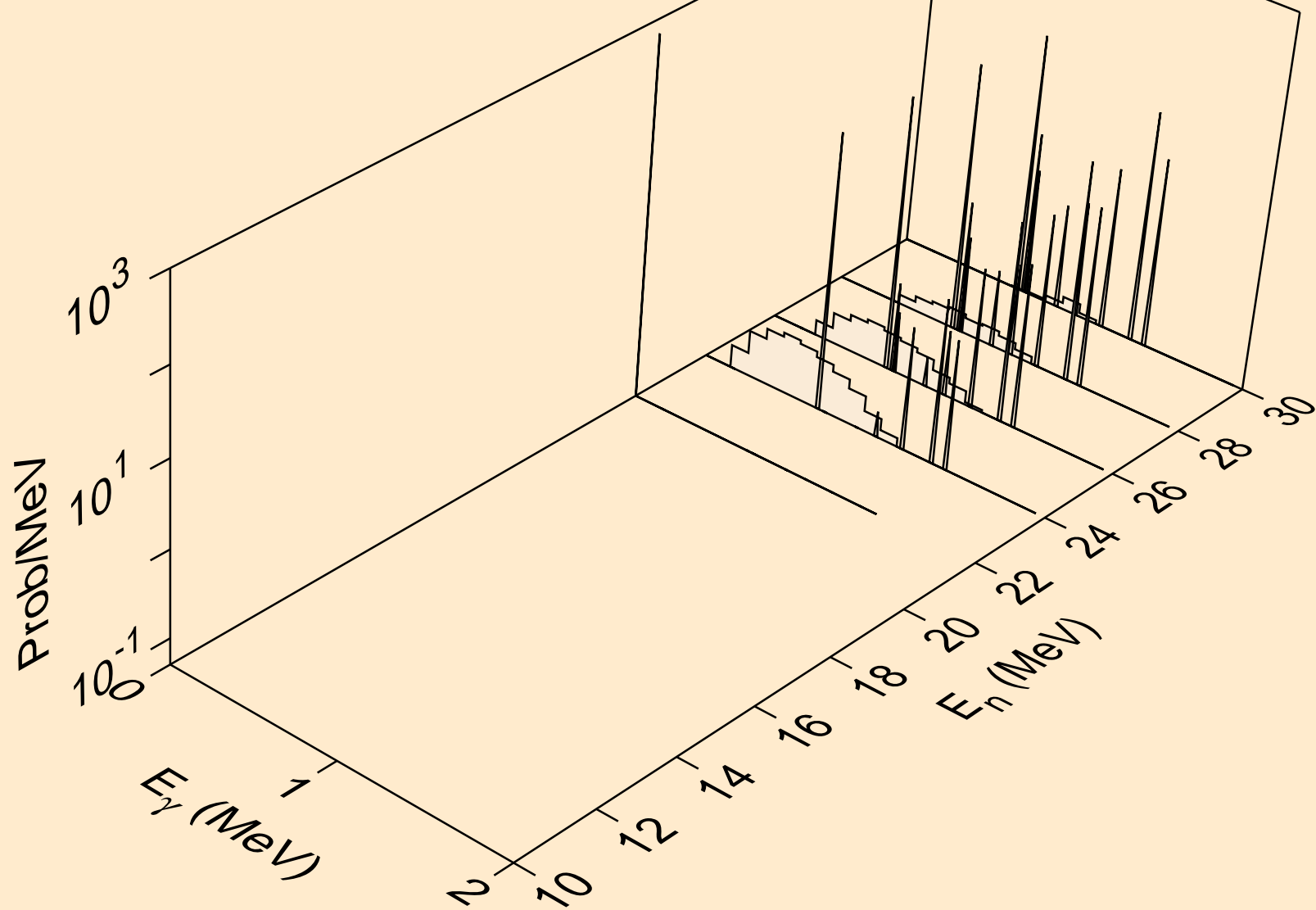

IN104M NEUTRON ACER TENDL-2024 LIBRARY; T=0.K
Photon emission for (n,n*)d

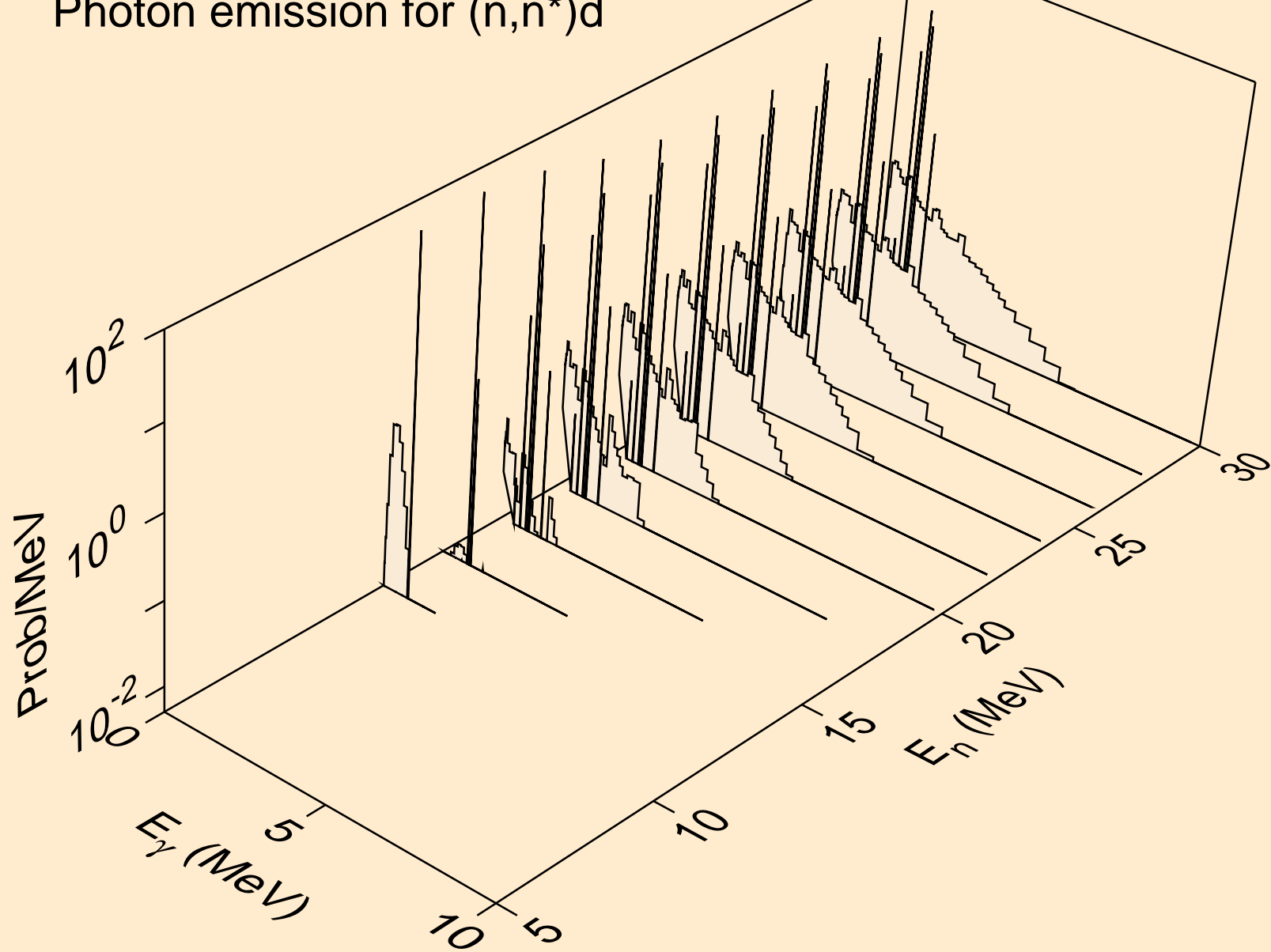

IN104M NEUTRON ACER TENDL-2024 LIBRARY; T=0.K
Photon emission for (n,n*)t

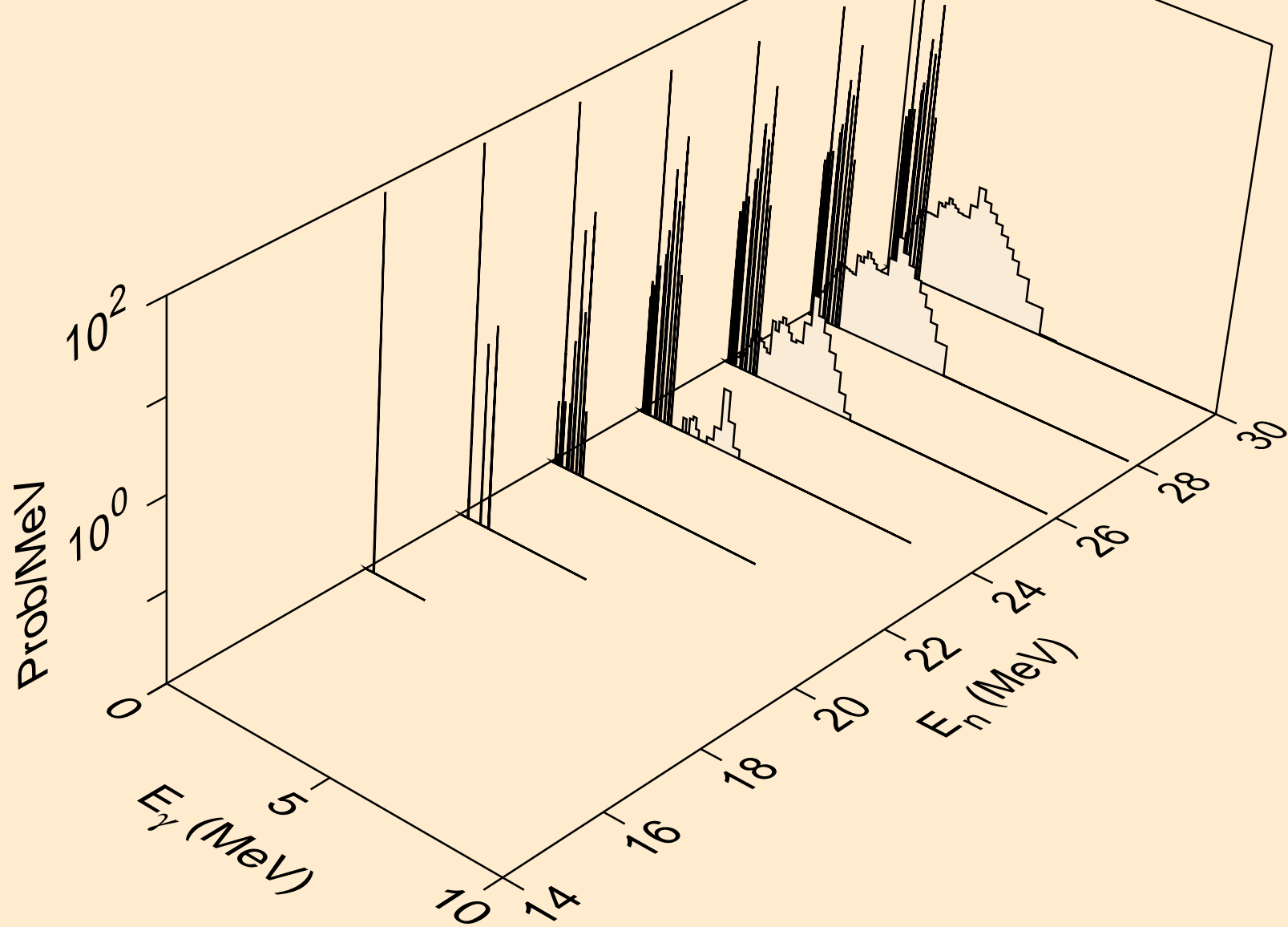

IN104M NEUTRON ACER TENDL-2024 LIBRARY; T=0.K
Photon emission for (n,n*)he3

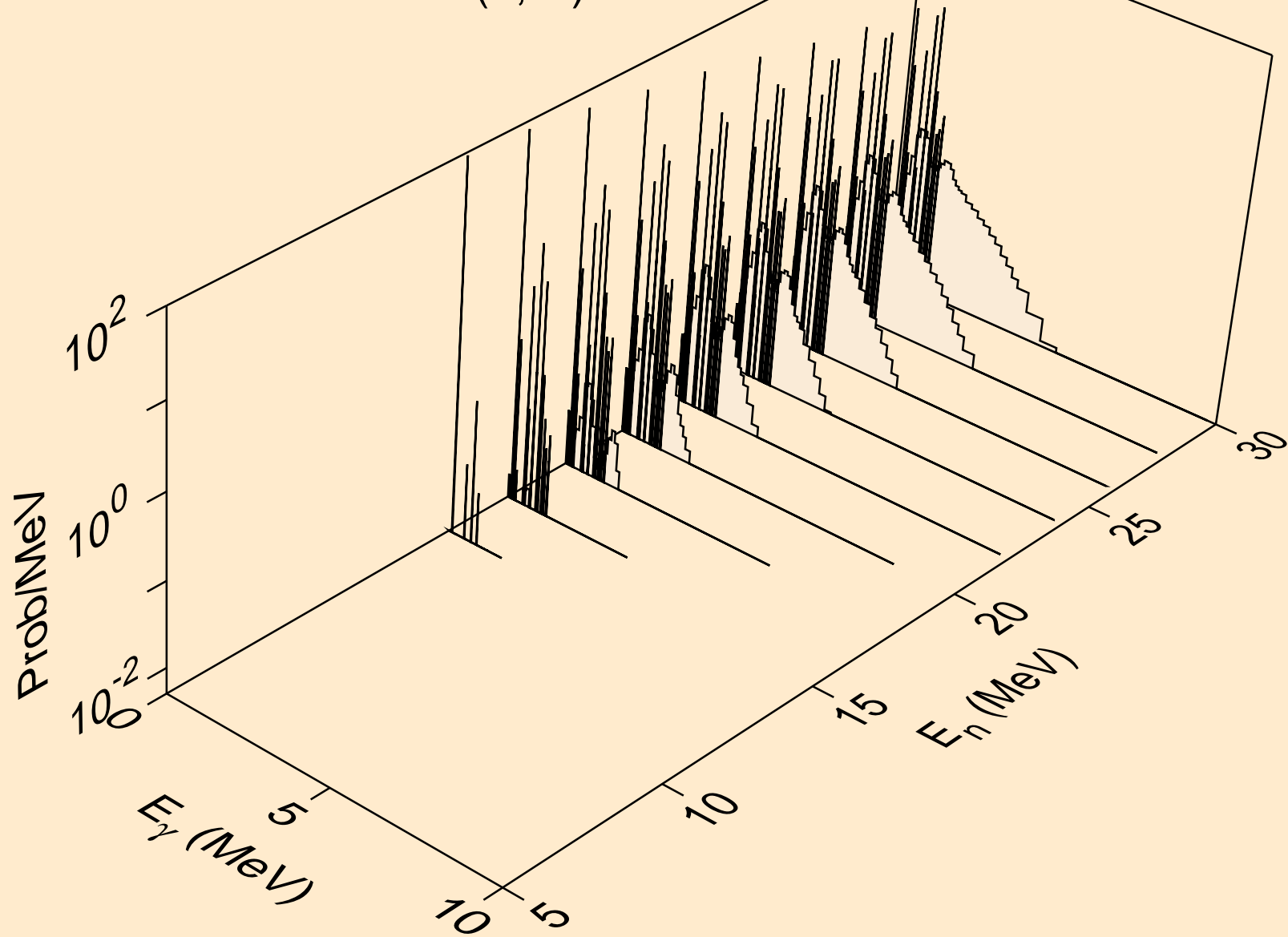

IN104M NEUTRON ACER TENDL-2024 LIBRARY; T=0.K
Photon emission for (n,2np)

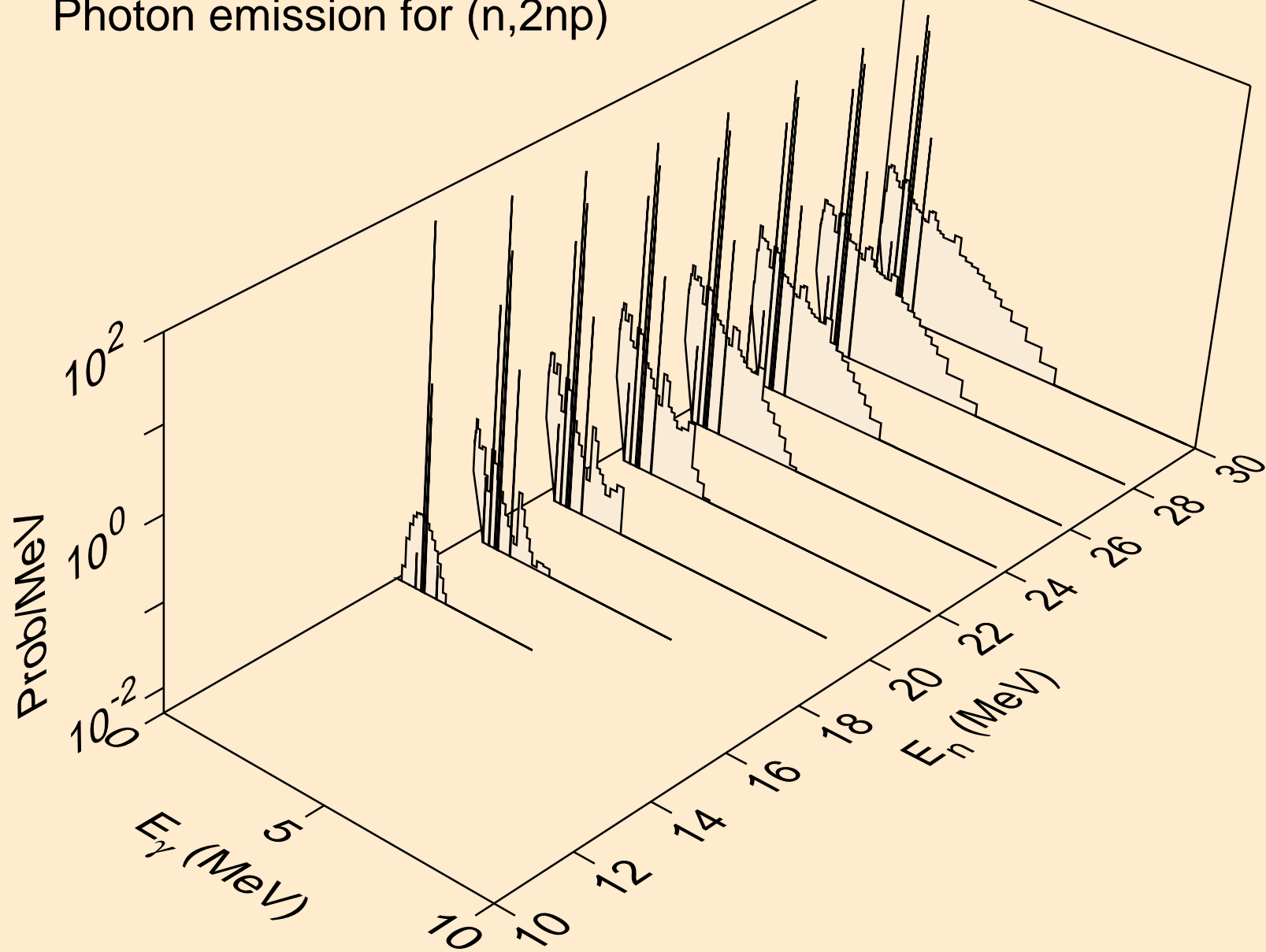

IN104M NEUTRON ACER TENDL-2024 LIBRARY; T=0.K
Photon emission for (n,3np)

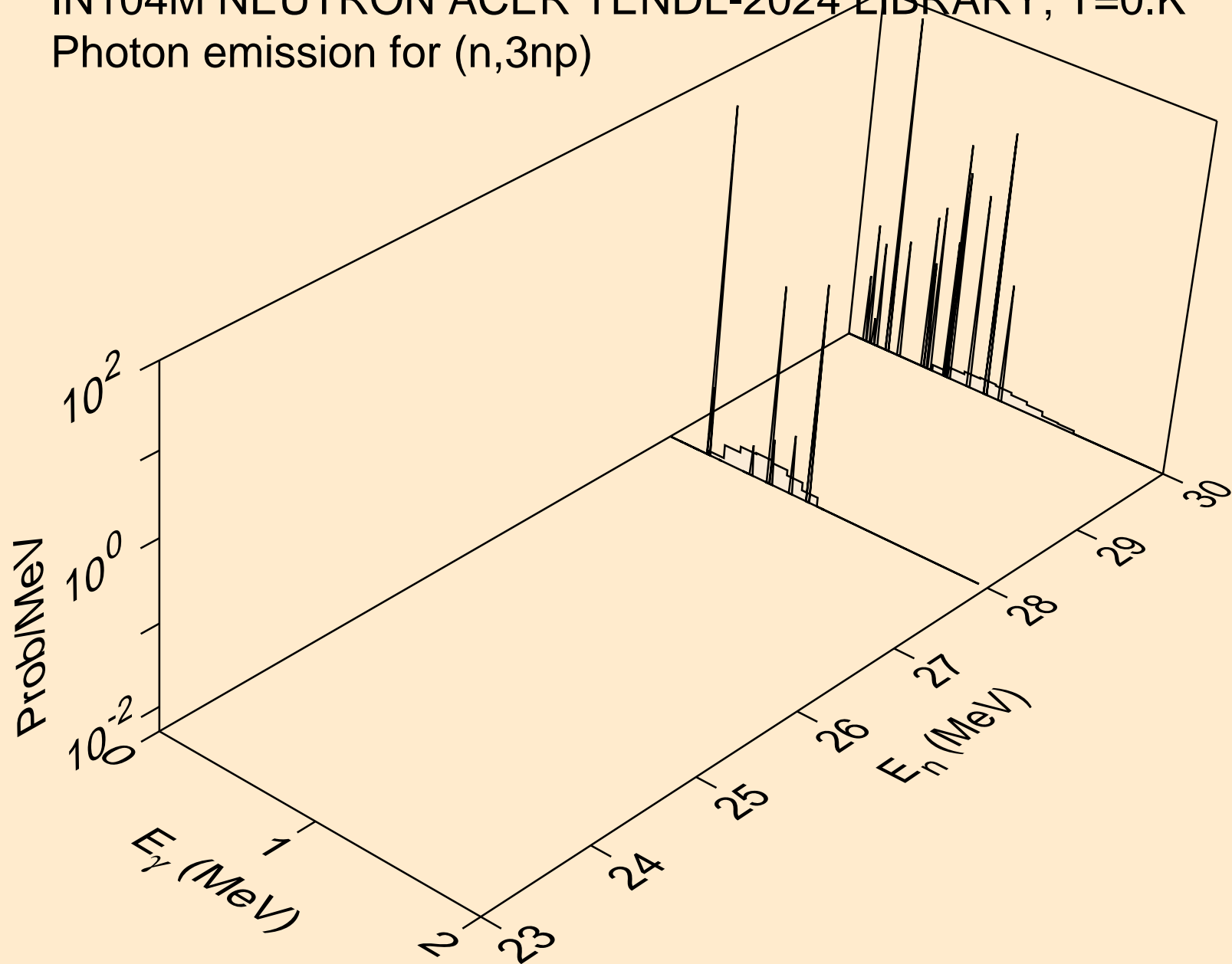

IN104M NEUTRON ACER TENDL-2024 LIBRARY; T=0.K
Photon emission for (n,n2p)

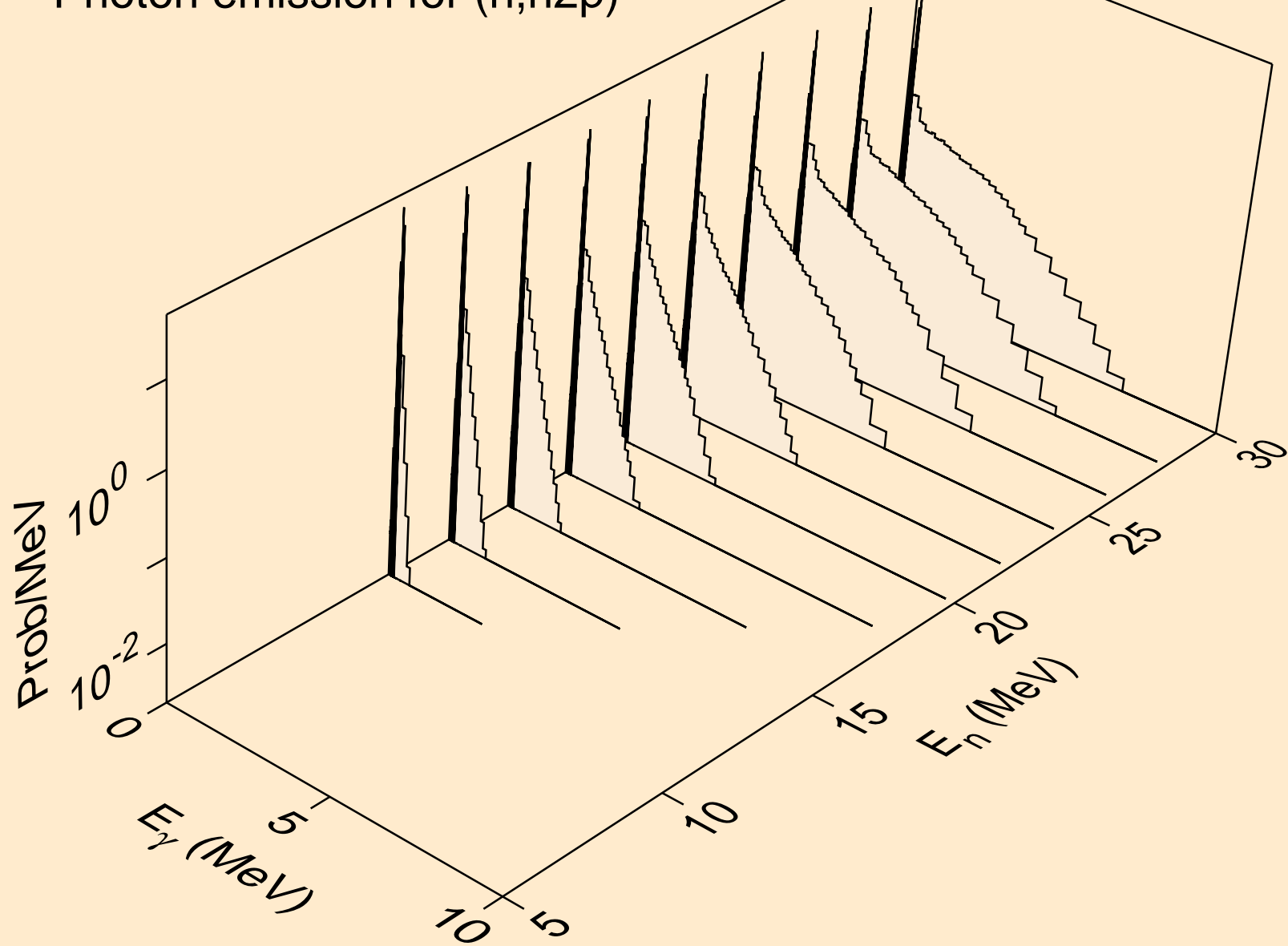

IN104M NEUTRON ACER TENDL-2024 LIBRARY; T=0.K
Photon emission for (n,npa)

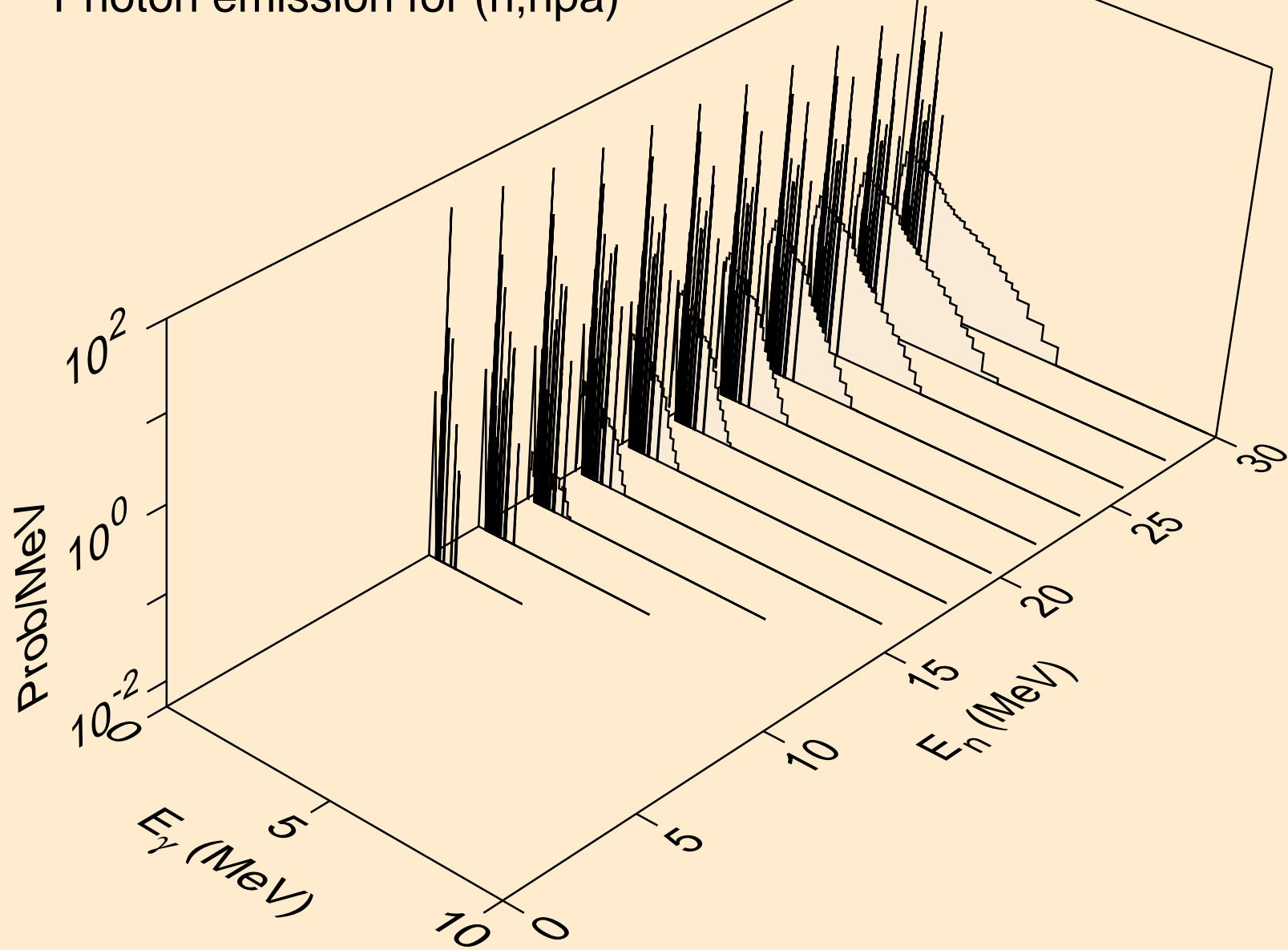

IN104M NEUTRON ACER TENDL-2024 LIBRARY; T=0.K
Photon emission for (n,n*1)

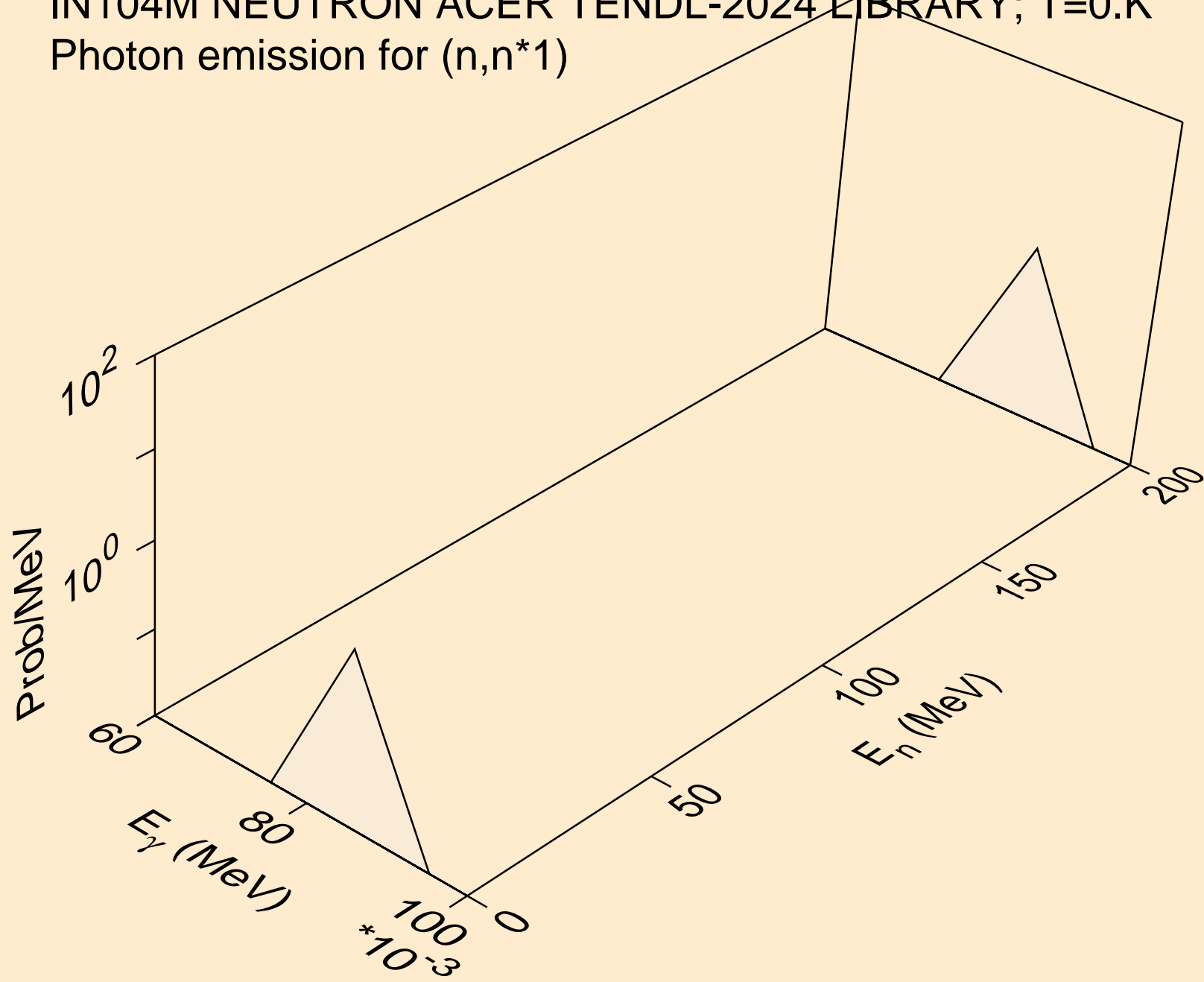

IN104M NEUTRON ACER TENDL-2024 LIBRARY; T=0.K
Photon emission for (n,n*2)

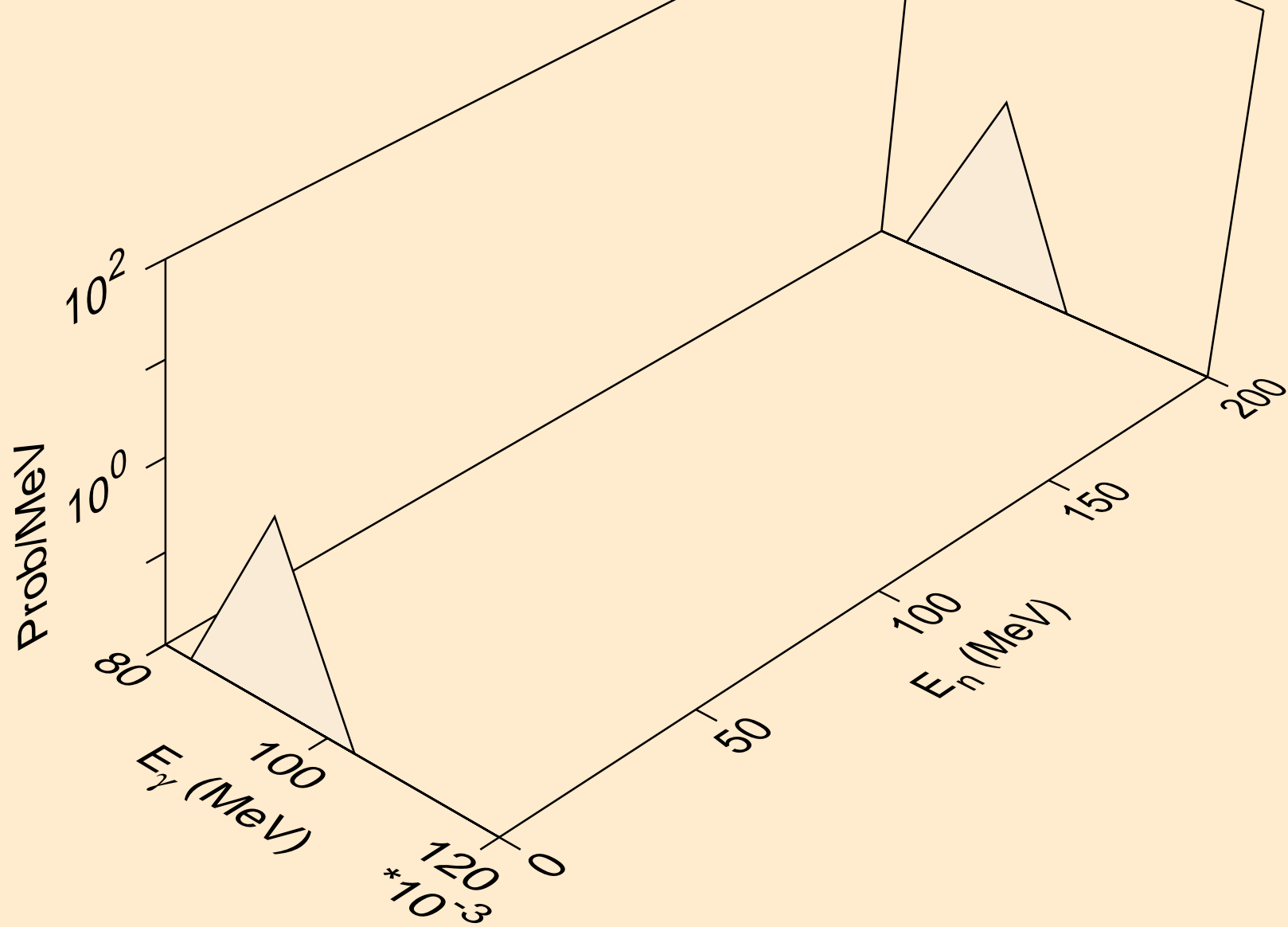

IN104M NEUTRON ACER TENDL-2024 LIBRARY; T=0.K
Photon emission for (n,n*4)

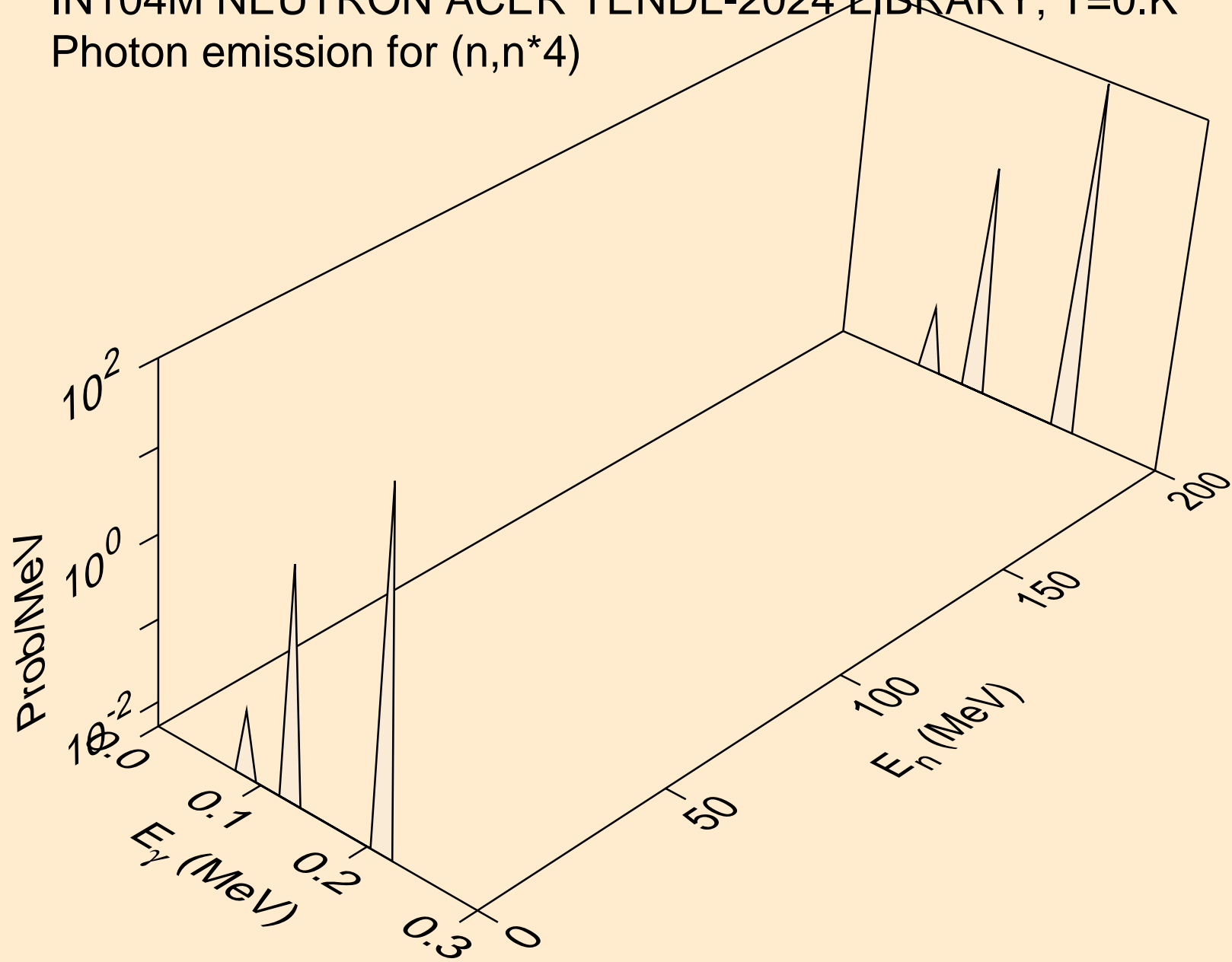

IN104M NEUTRON ACER TENDL-2024 LIBRARY; T=0.K
Photon emission for (n,n*5)

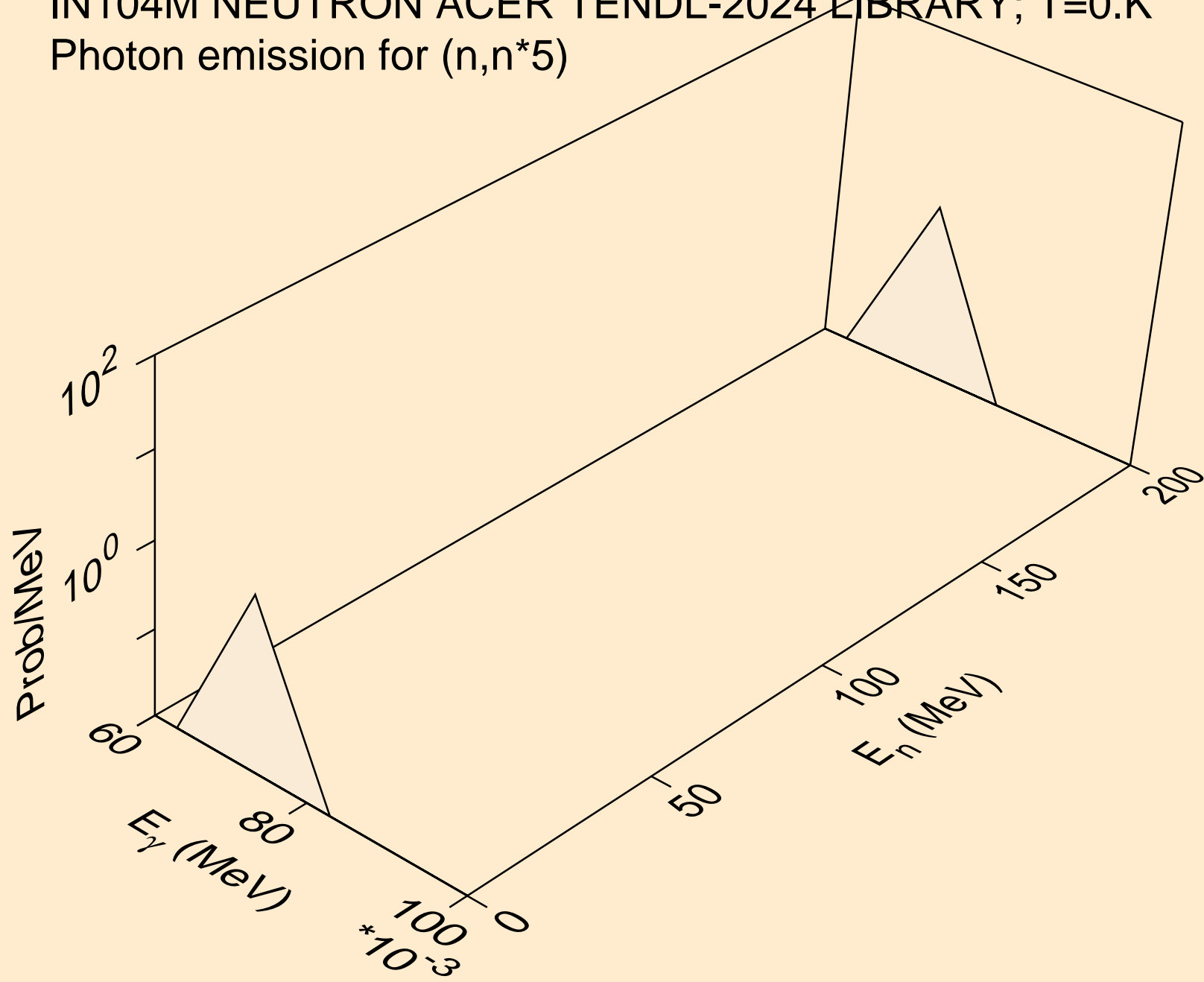

IN104M NEUTRON ACER TENDL-2024 LIBRARY; T=0.K
Photon emission for (n,n*6)

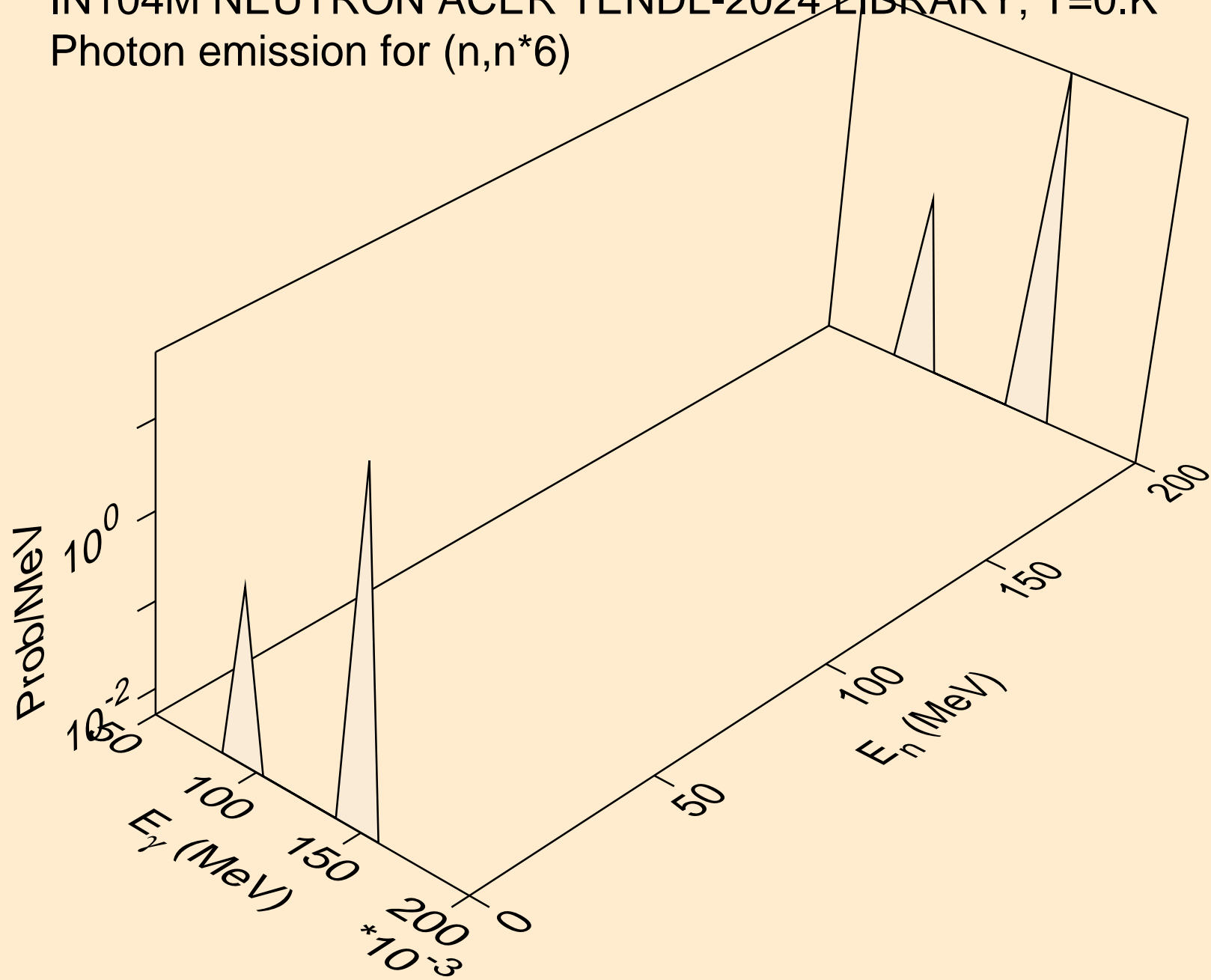

IN104M NEUTRON ACER TENDL-2024 LIBRARY; T=0.K
Photon emission for (n,n*7)

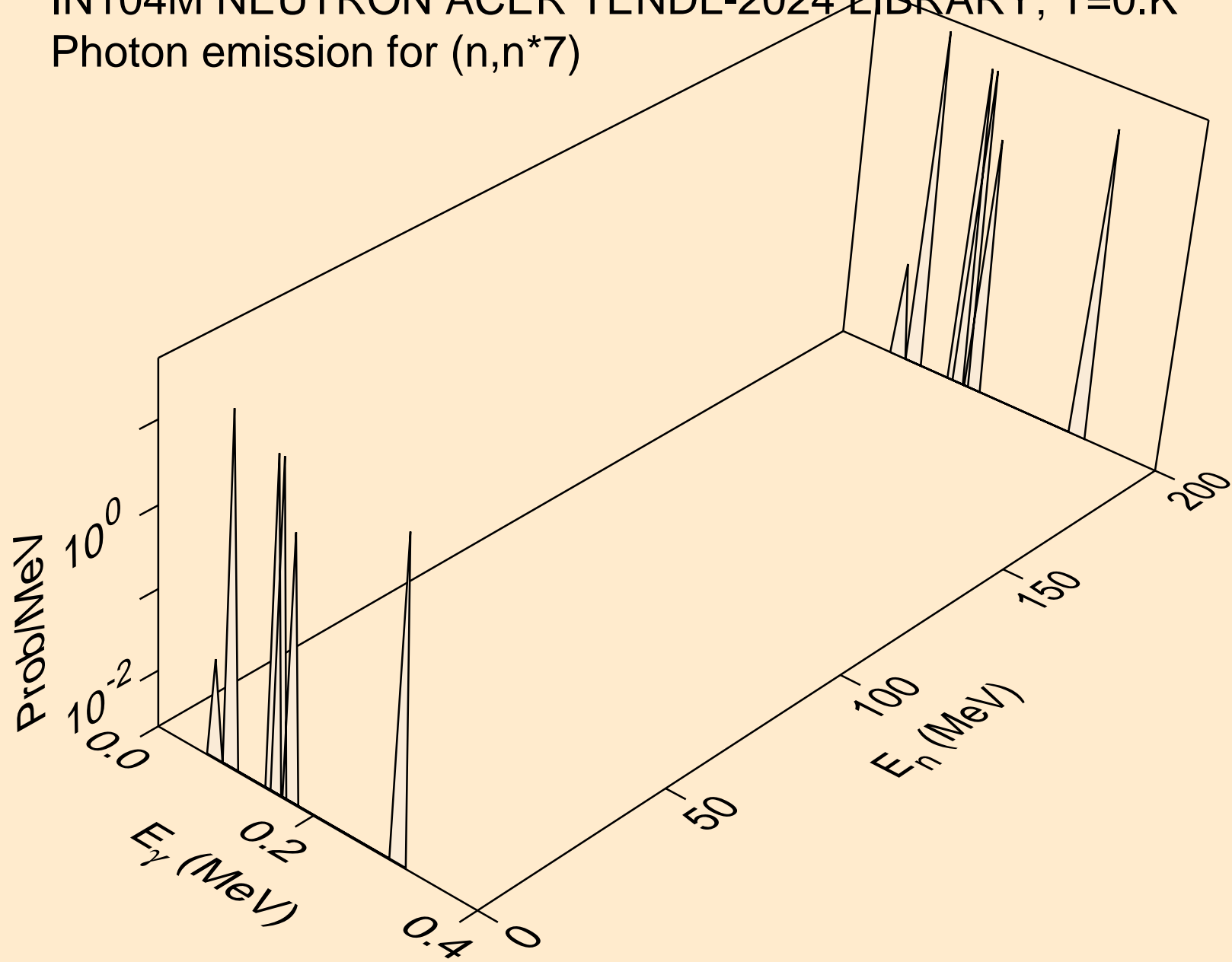

IN104M NEUTRON ACER TENDL-2024 LIBRARY; T=0.K
Photon emission for (n,n*8)

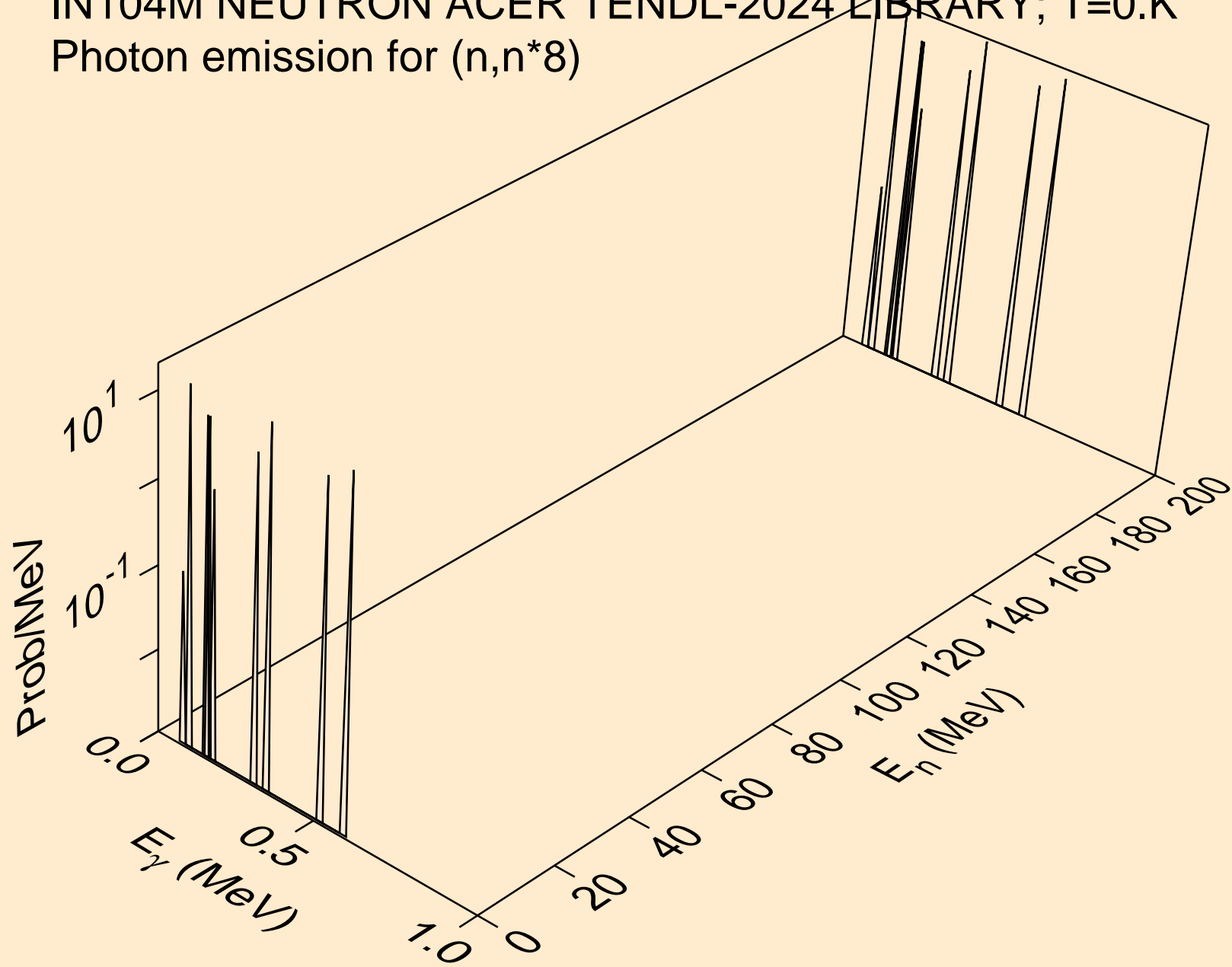

IN104M NEUTRON ACER TENDL-2024 LIBRARY; T=0.K
Photon emission for (n,n*c)

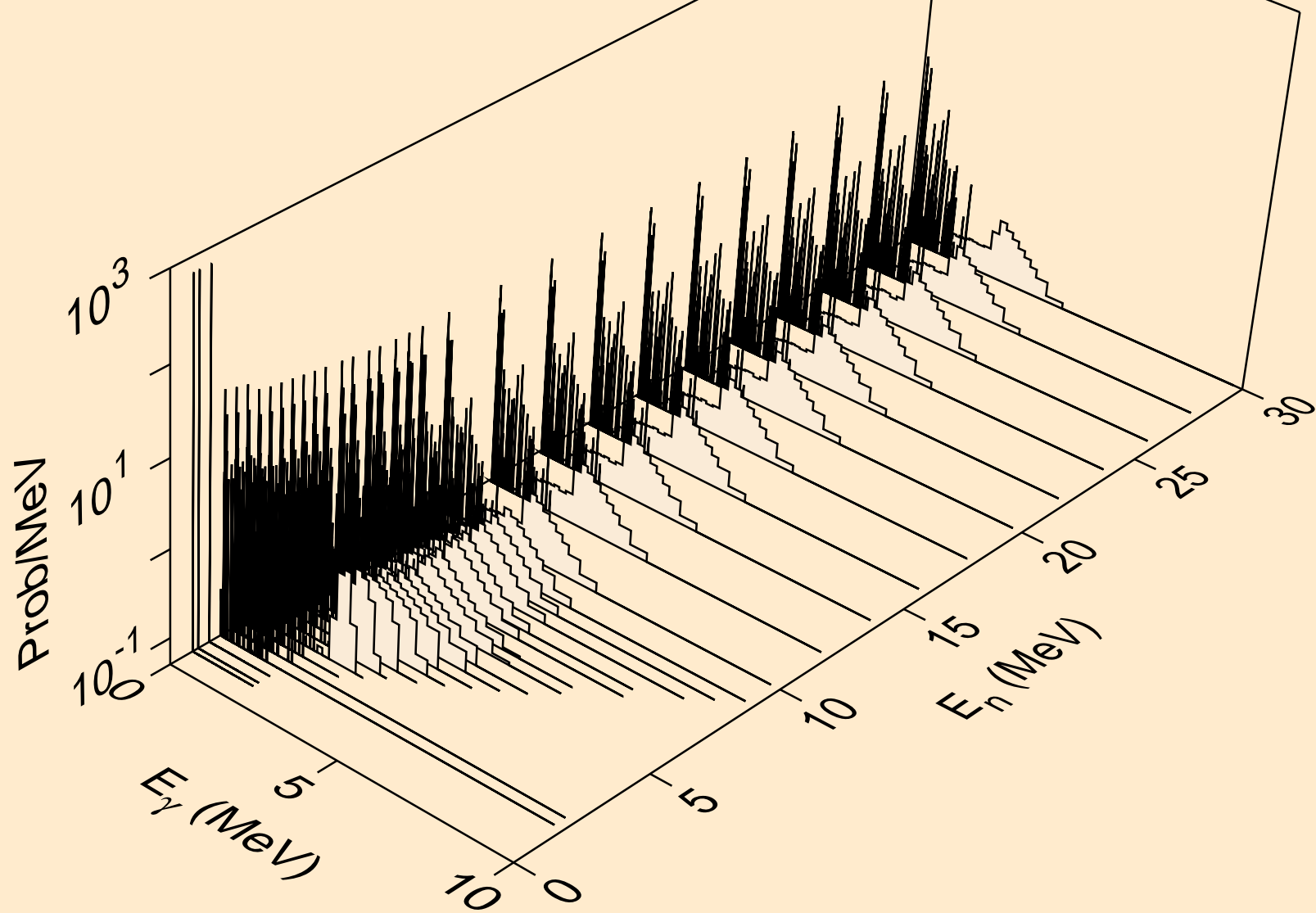

IN104M NEUTRON ACER TENDL-2024 LIBRARY; T=0.K
Photon emission for (n,gma)

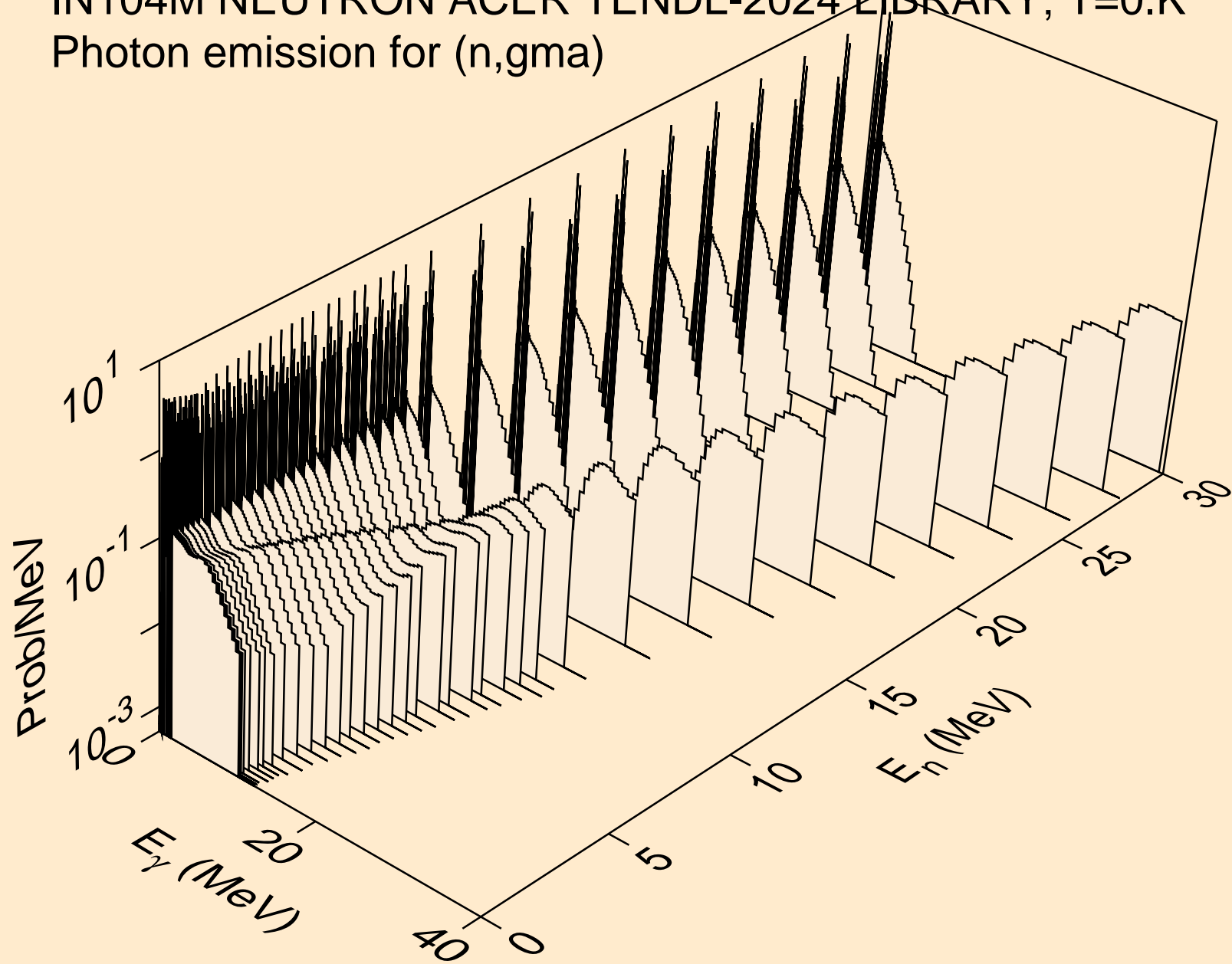

IN104M NEUTRON ACER TENDL-2024 LIBRARY; T=0.K
Photon emission for (n,p)

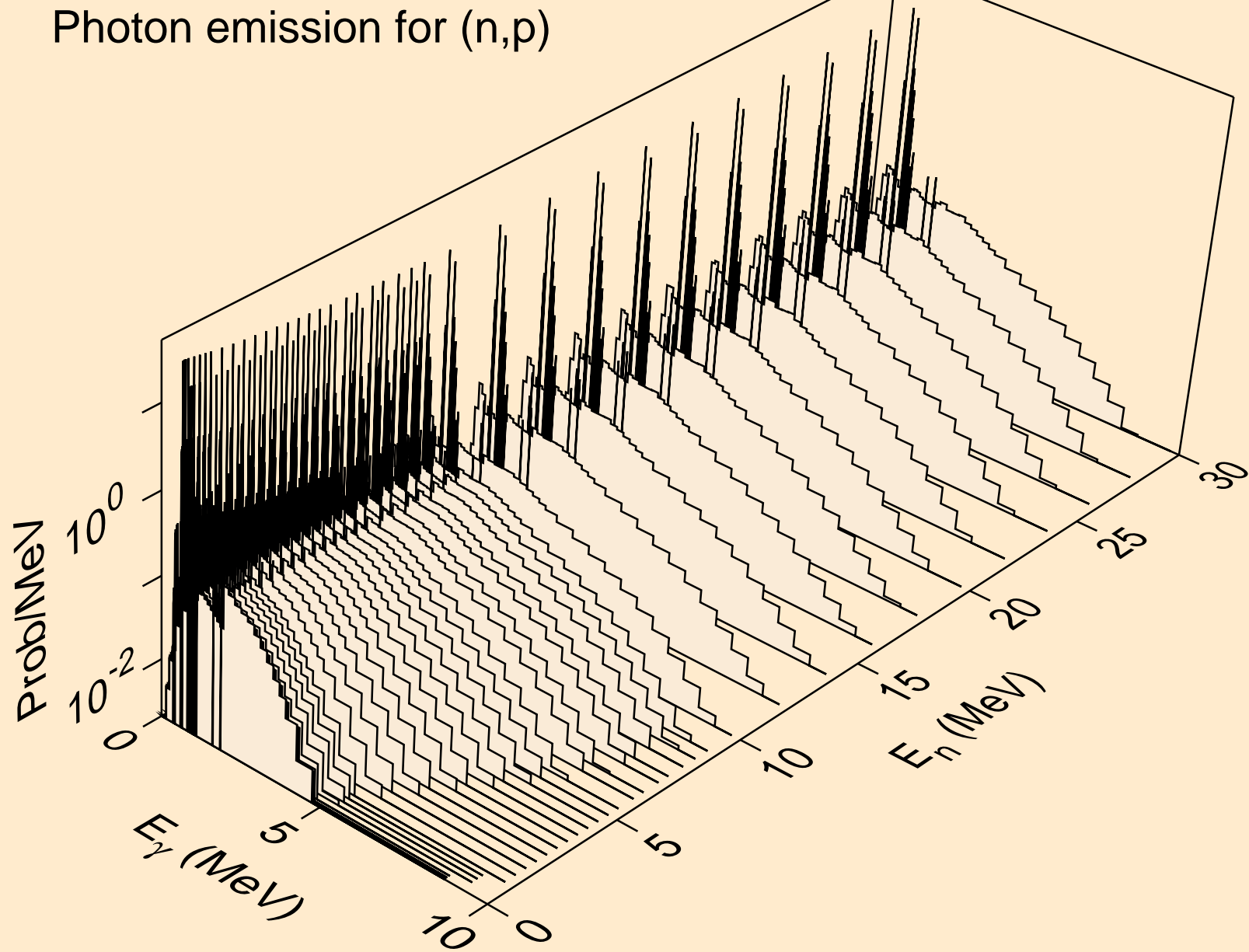

IN104M NEUTRON ACER TENDL-2024 LIBRARY; T=0.K
Photon emission for (n,d)

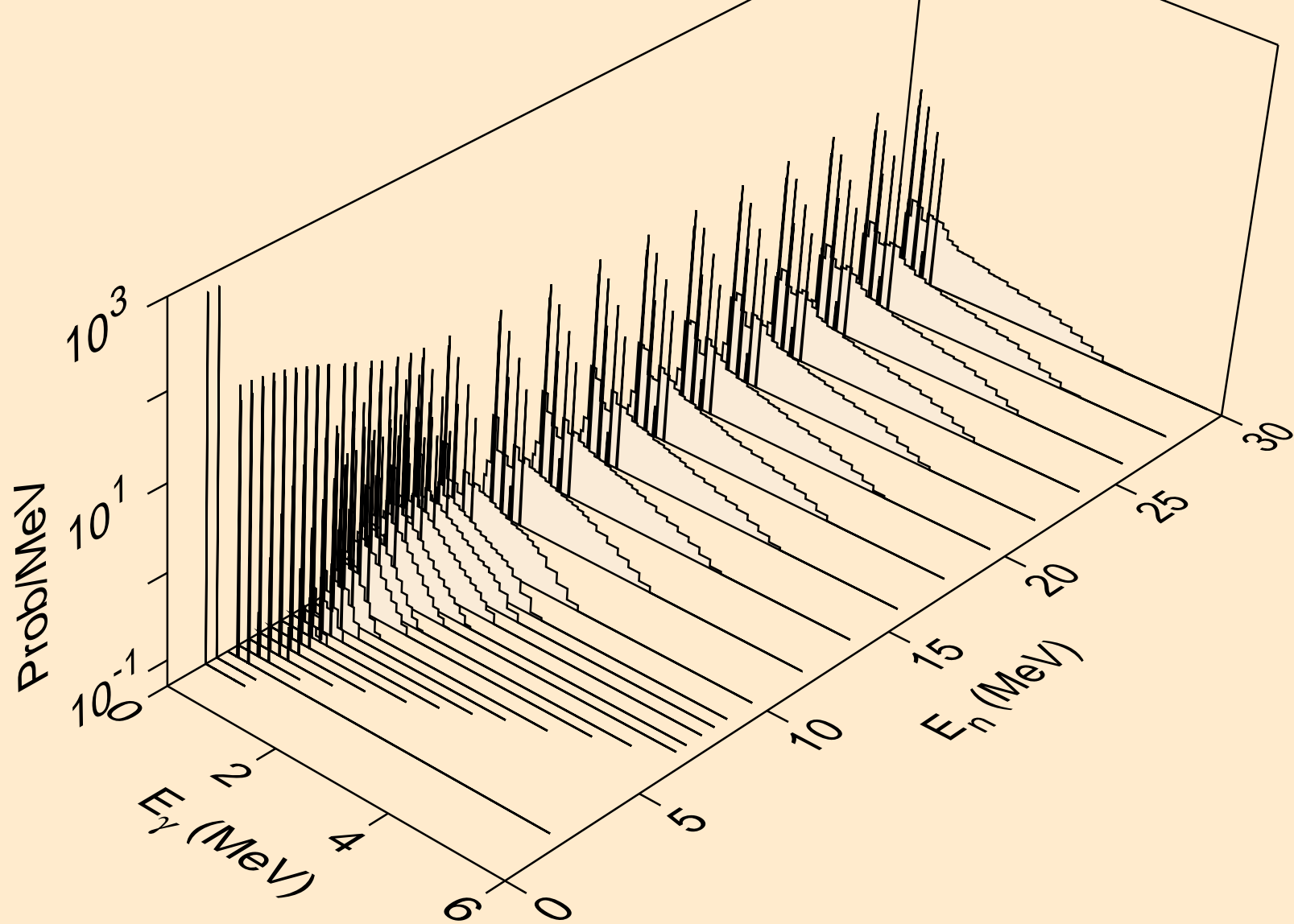

IN104M NEUTRON ACER TENDL-2024 LIBRARY; T=0.K
Photon emission for (n,t)

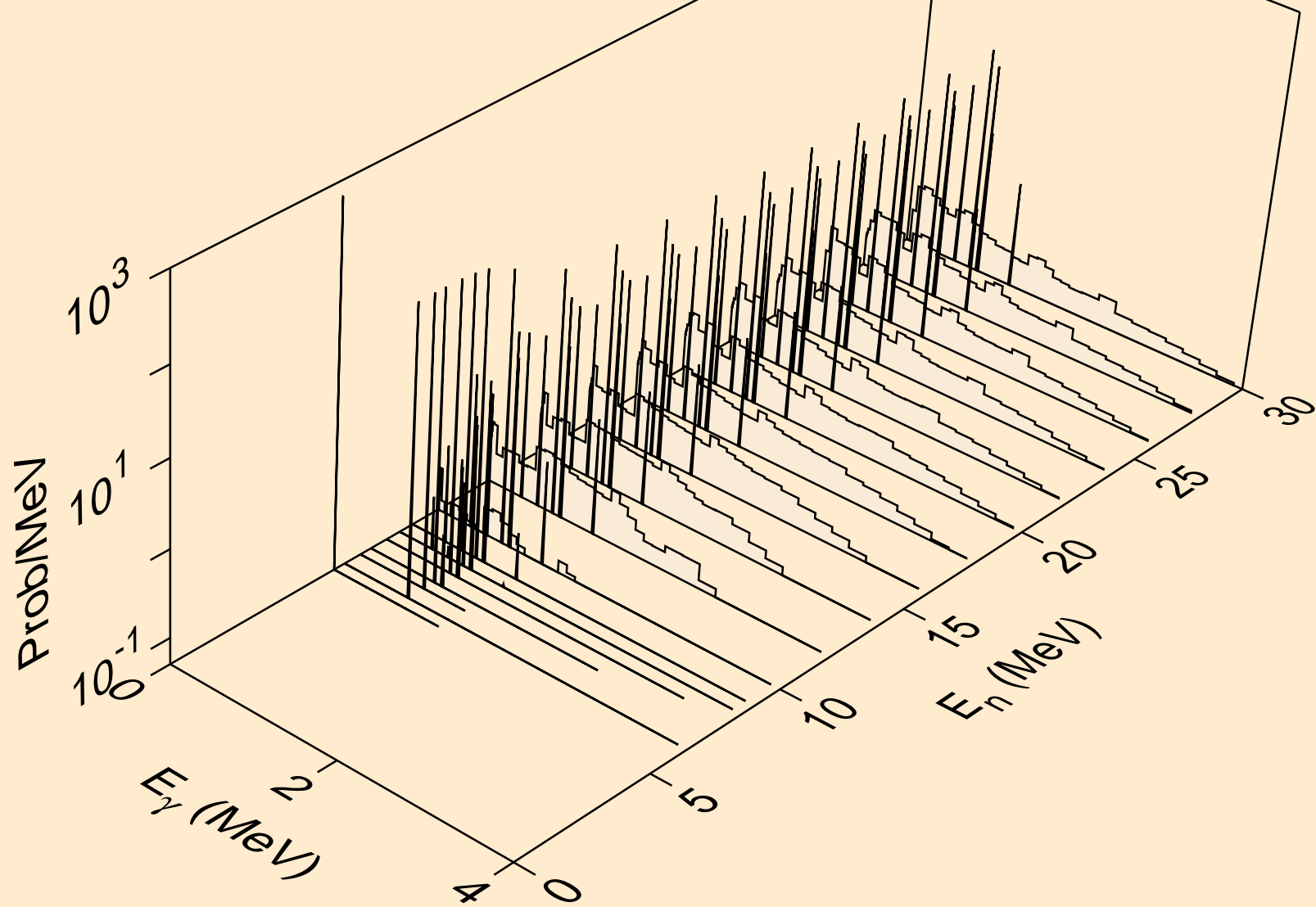

IN104M NEUTRON ACER TENDL-2024 LIBRARY; T=0.K
Photon emission for (n,he3)

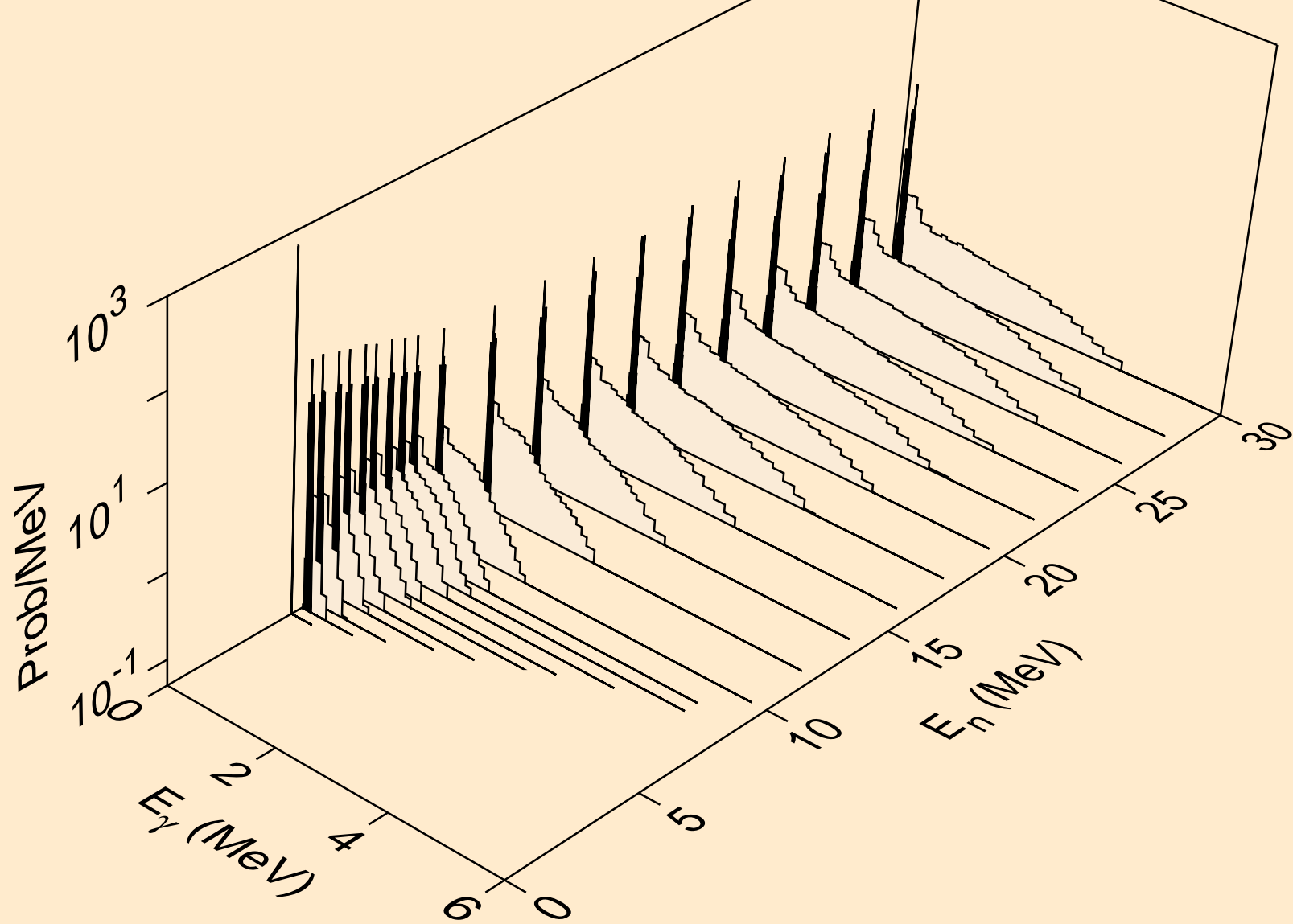

IN104M NEUTRON ACER TENDL-2024 LIBRARY; T=0.K
Photon emission for (n,a)

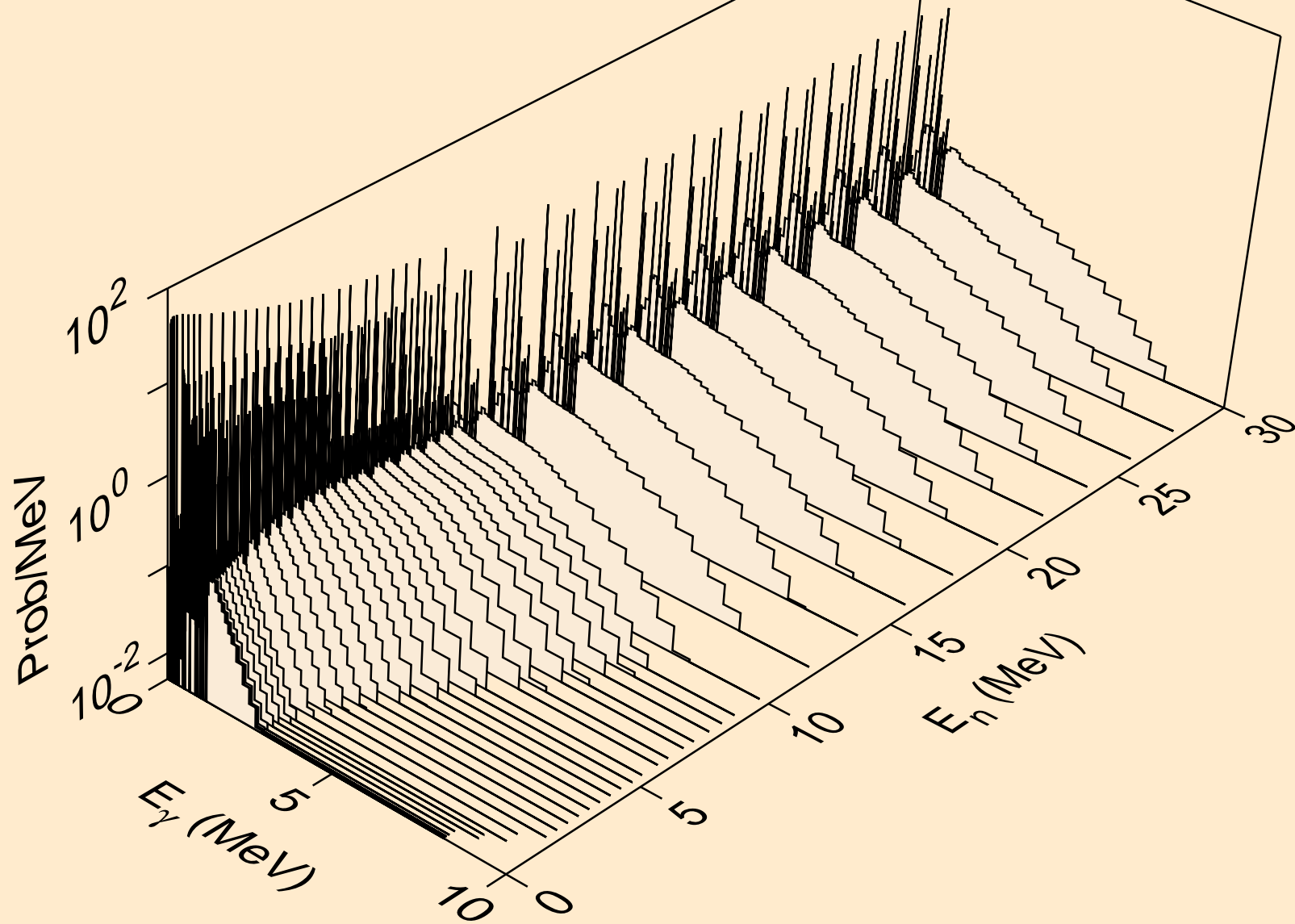

IN104M NEUTRON ACER TENDL-2024 LIBRARY; T=0.K
Photon emission for (n,2a)

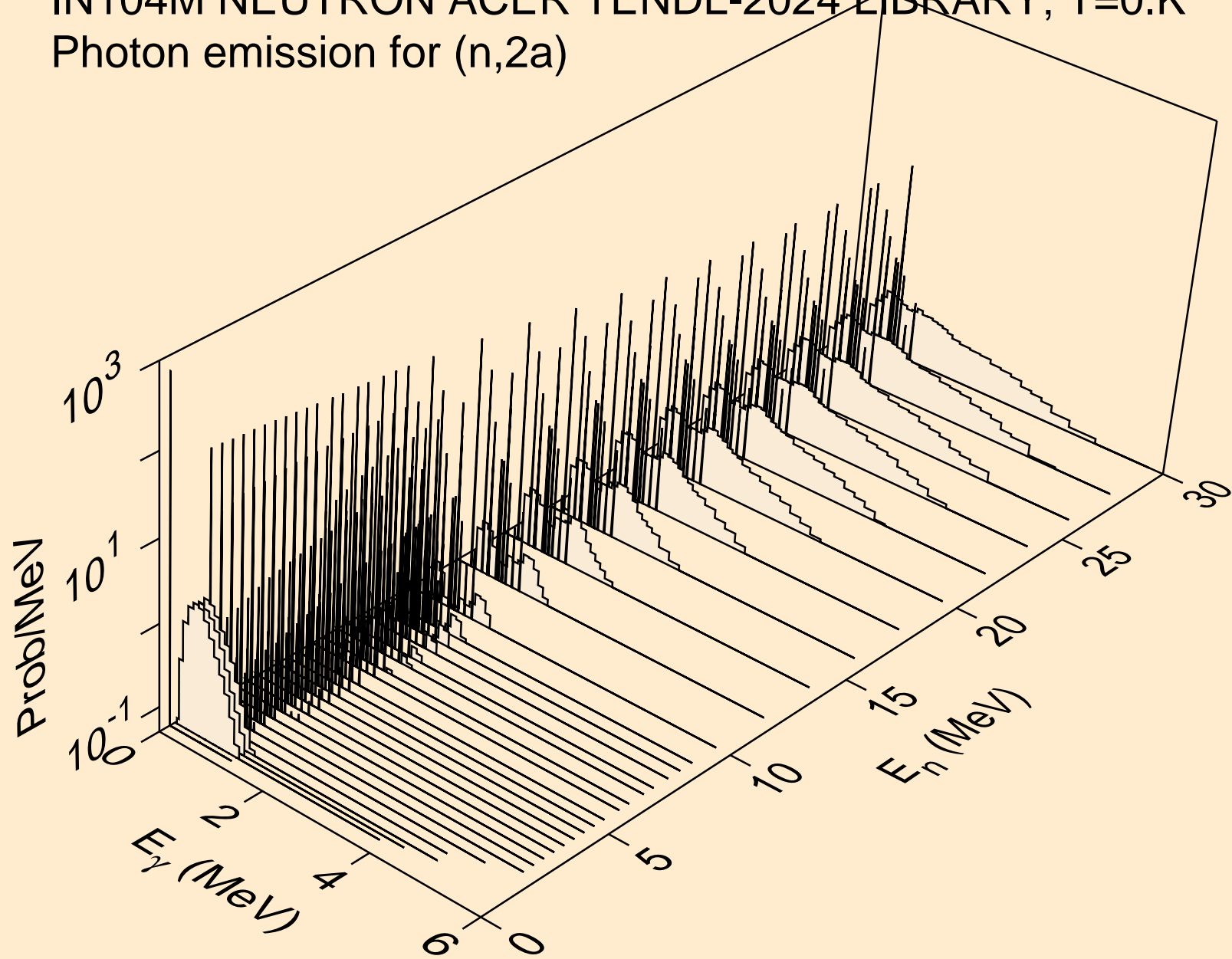

IN104M NEUTRON ACER TENDL-2024 LIBRARY; T=0.K
Photon emission for (n,3a)

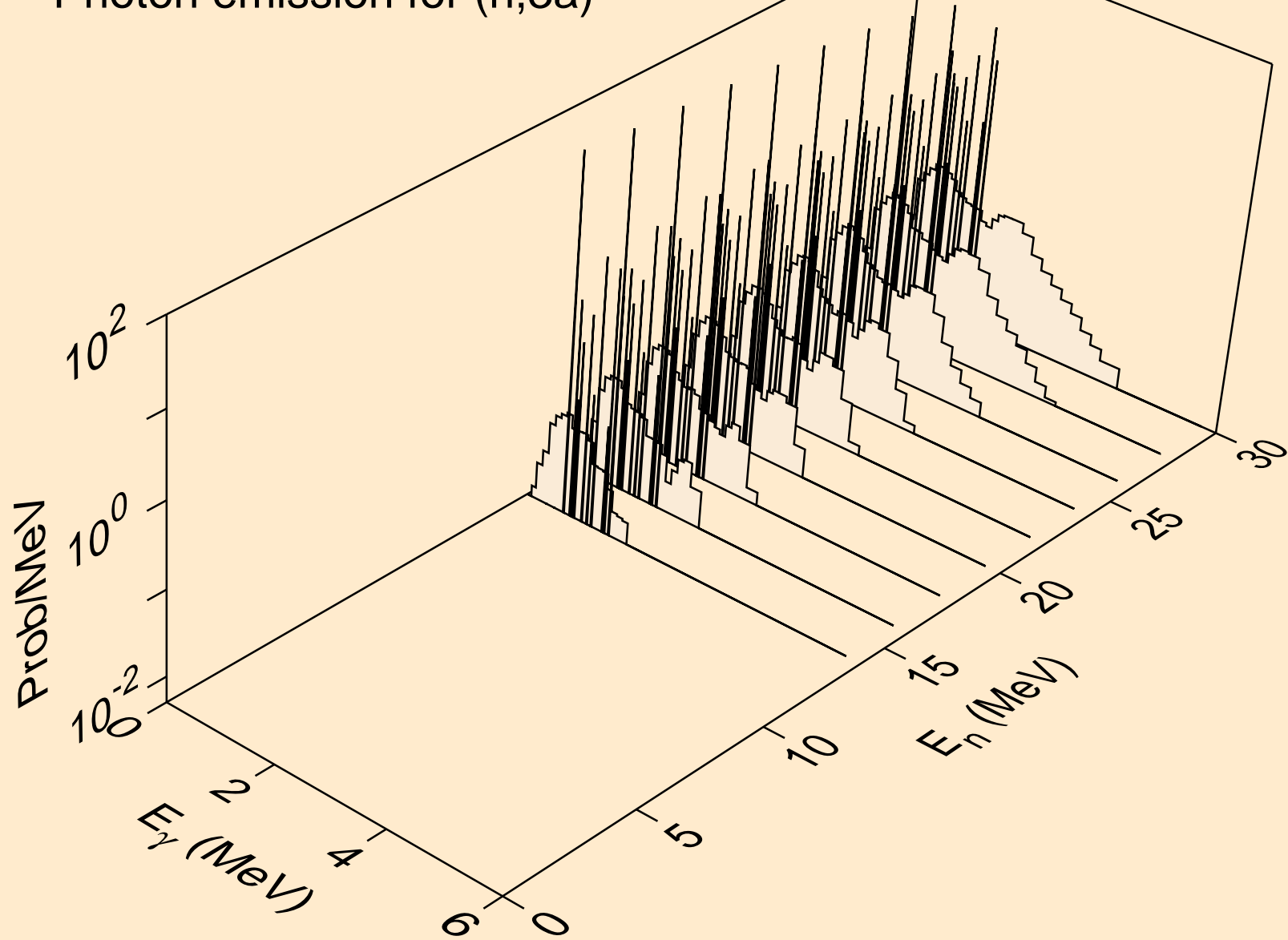

IN104M NEUTRON ACER TENDL-2024 LIBRARY; T=0.K
Photon emission for (n,2p)

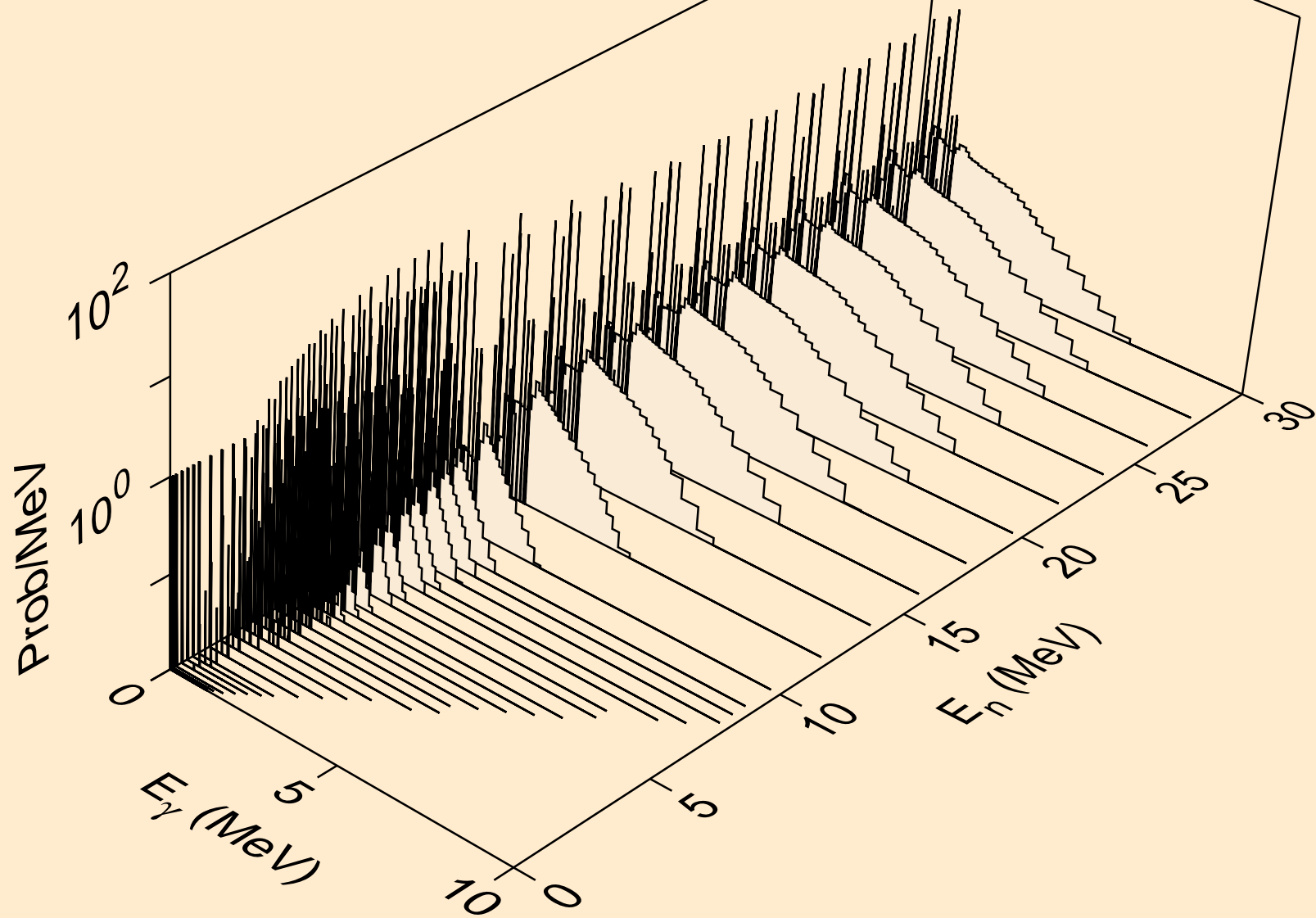

IN104M NEUTRON ACER TENDL-2024 LIBRARY; T=0.K
Photon emission for (n,p α)

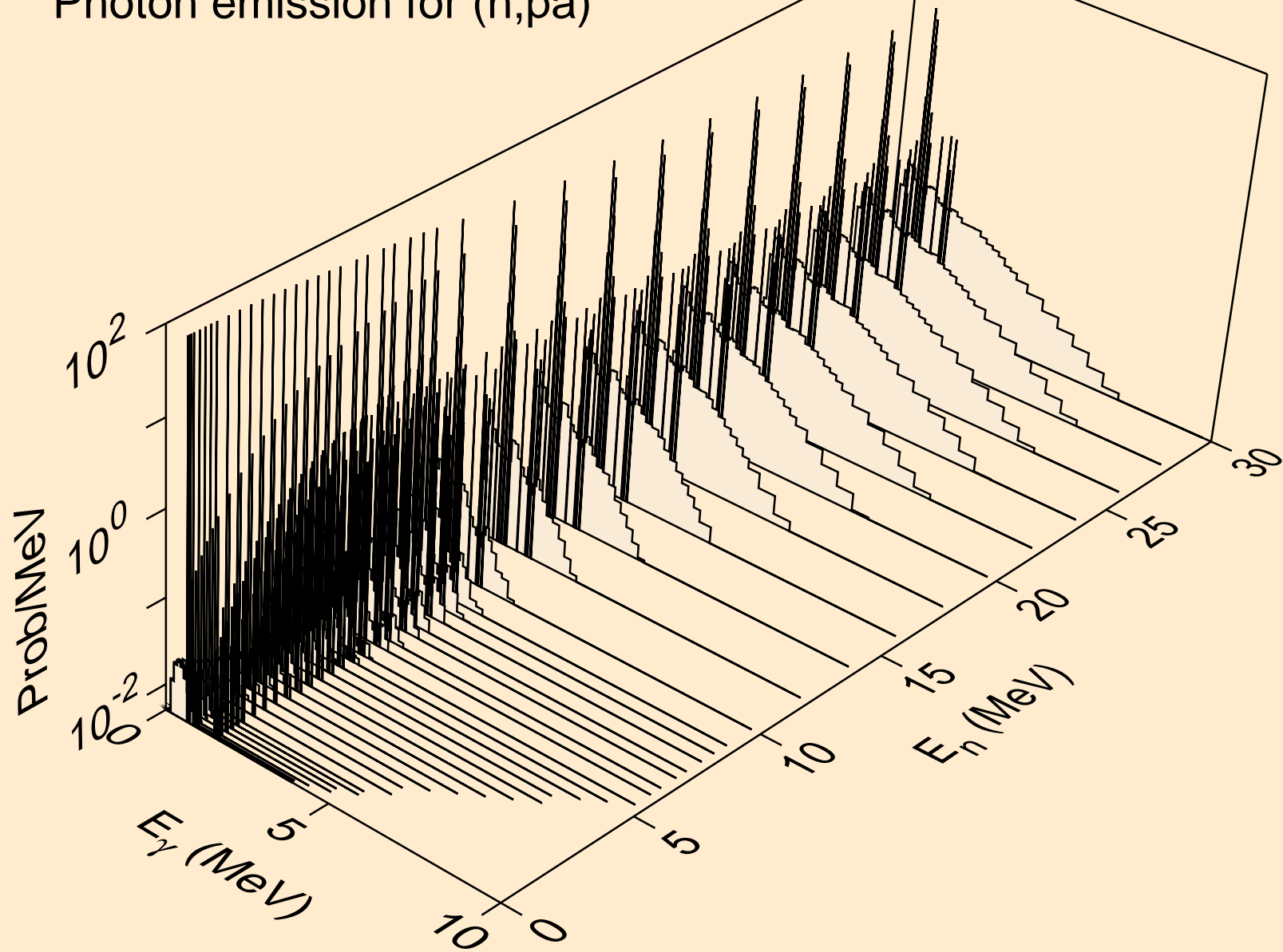

IN104M NEUTRON ACER TENDL-2024 LIBRARY; T=0.K
Photon emission for (n,d2a)

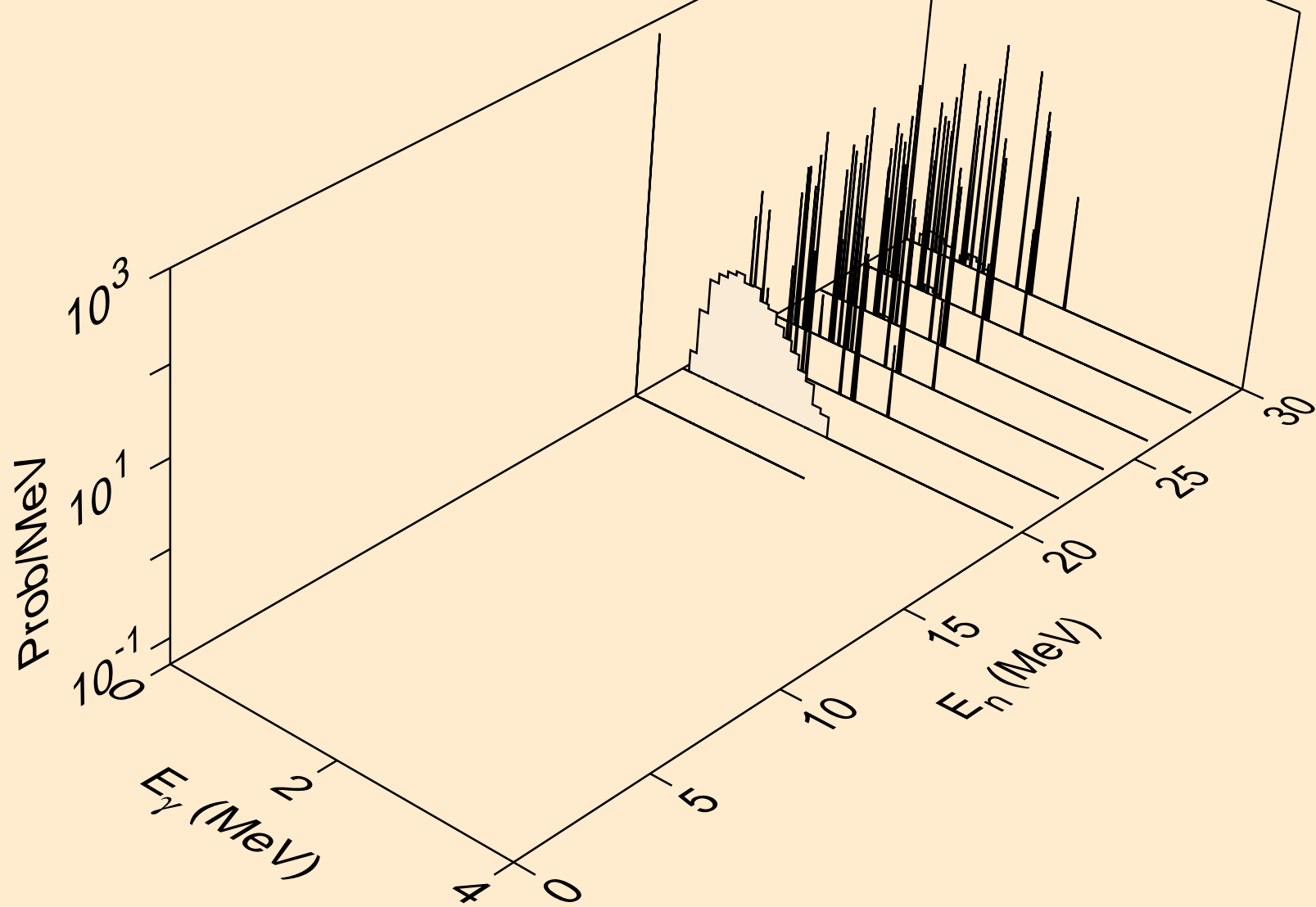

IN104M NEUTRON ACER TENDL-2024 LIBRARY; T=0.K
Photon emission for (n,pd)

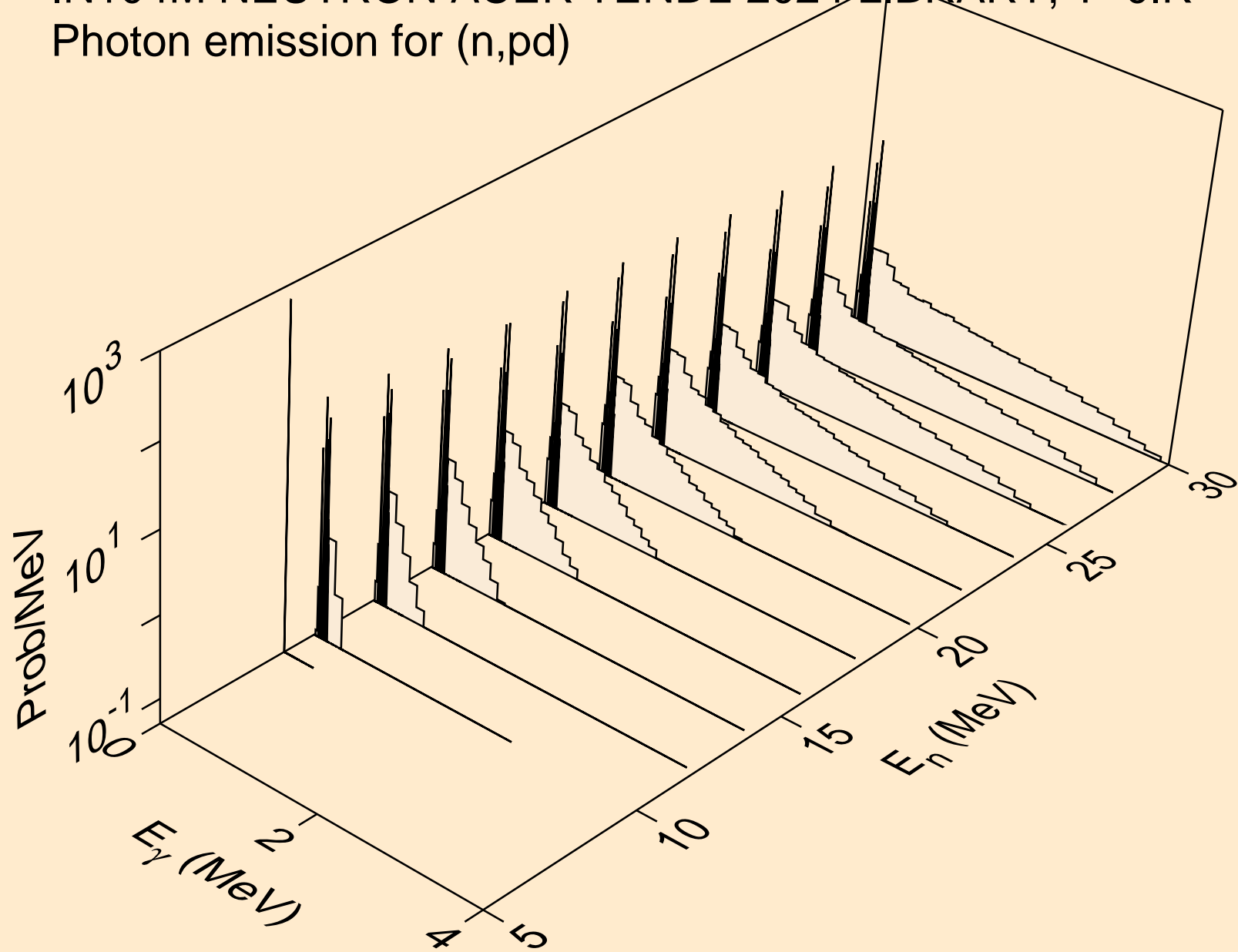

IN104M NEUTRON ACER TENDL-2024 LIBRARY; T=0.K
Photon emission for (n,pt)

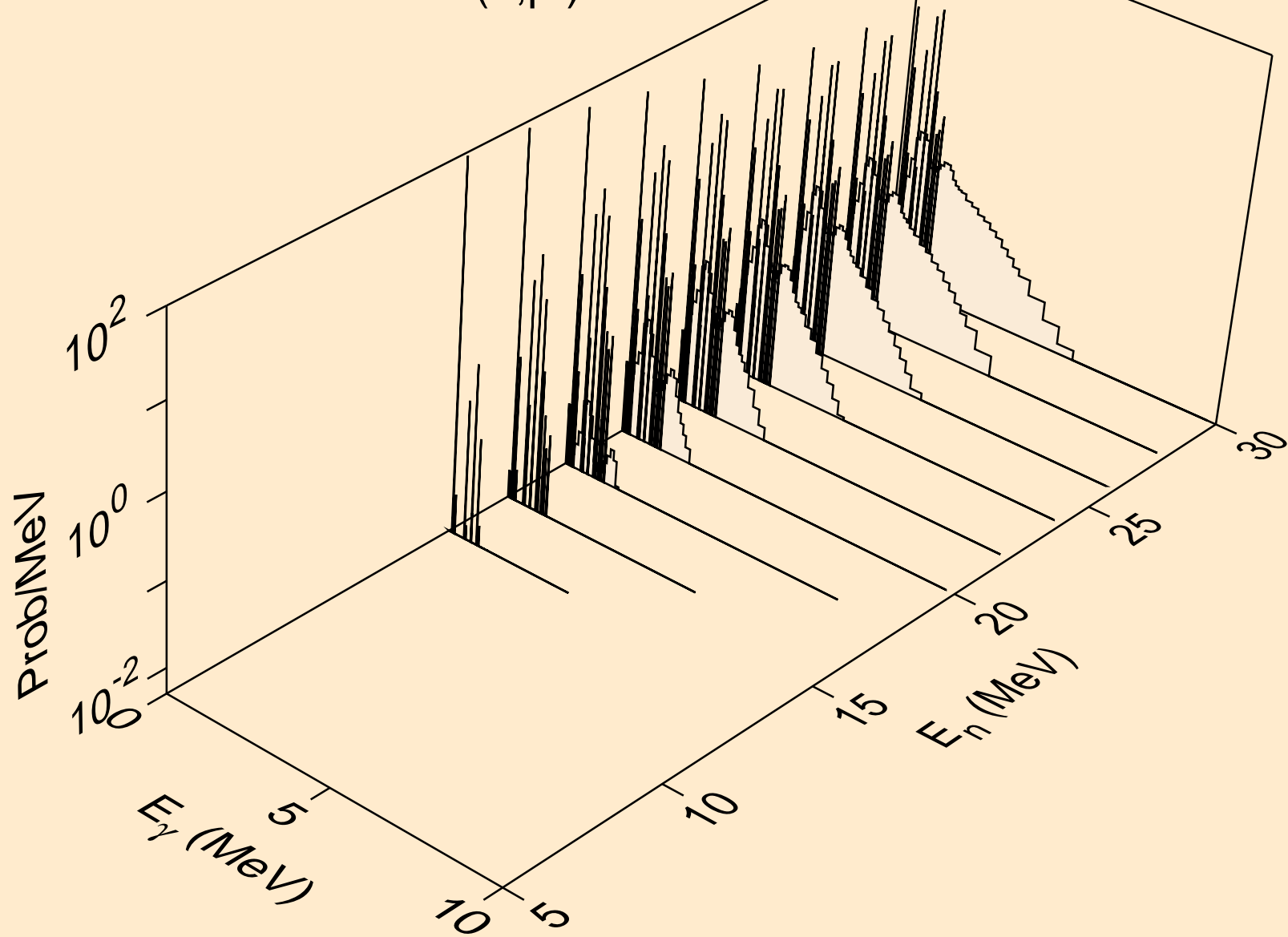

IN104M NEUTRON ACER TENDL-2024 LIBRARY; T=0.K
Photon emission for (n,da)

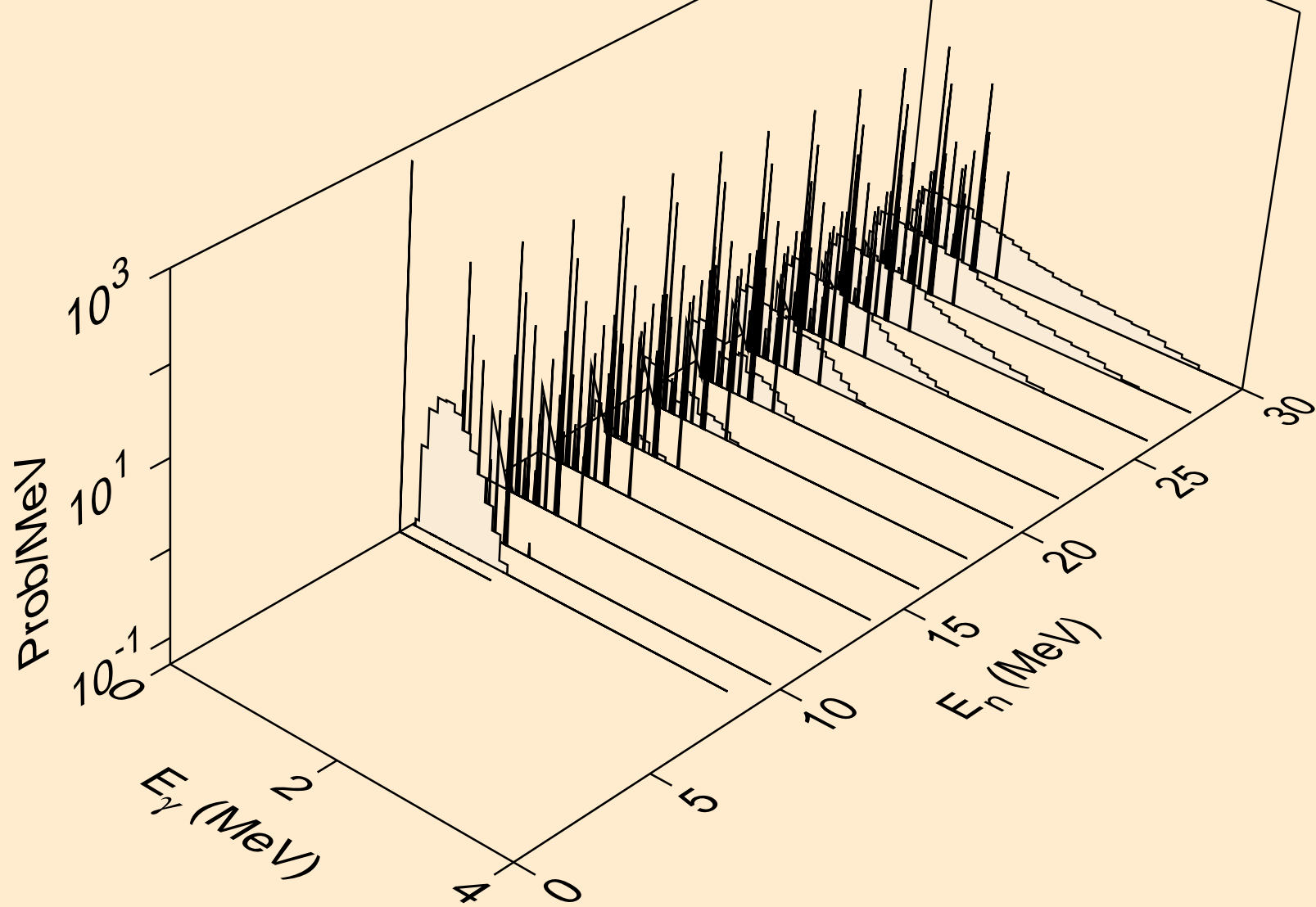

IN104M NEUTRON ACER TENDL-2024 LIBRARY; T=0.K
thermal capture photon spectrum

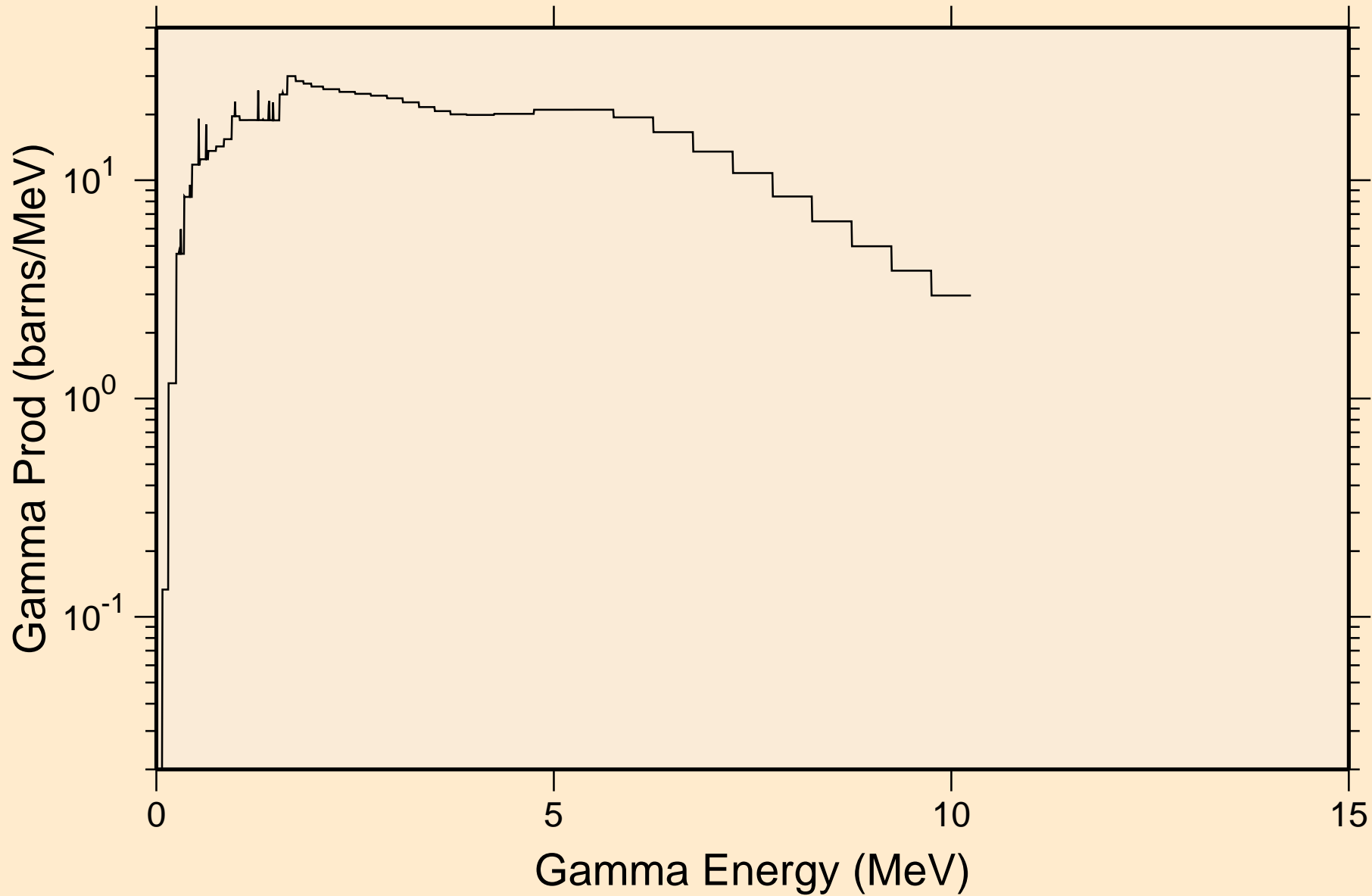

IN104M NEUTRON ACER TENDL-2024 LIBRARY; T=0.K
14 MeV photon spectrum

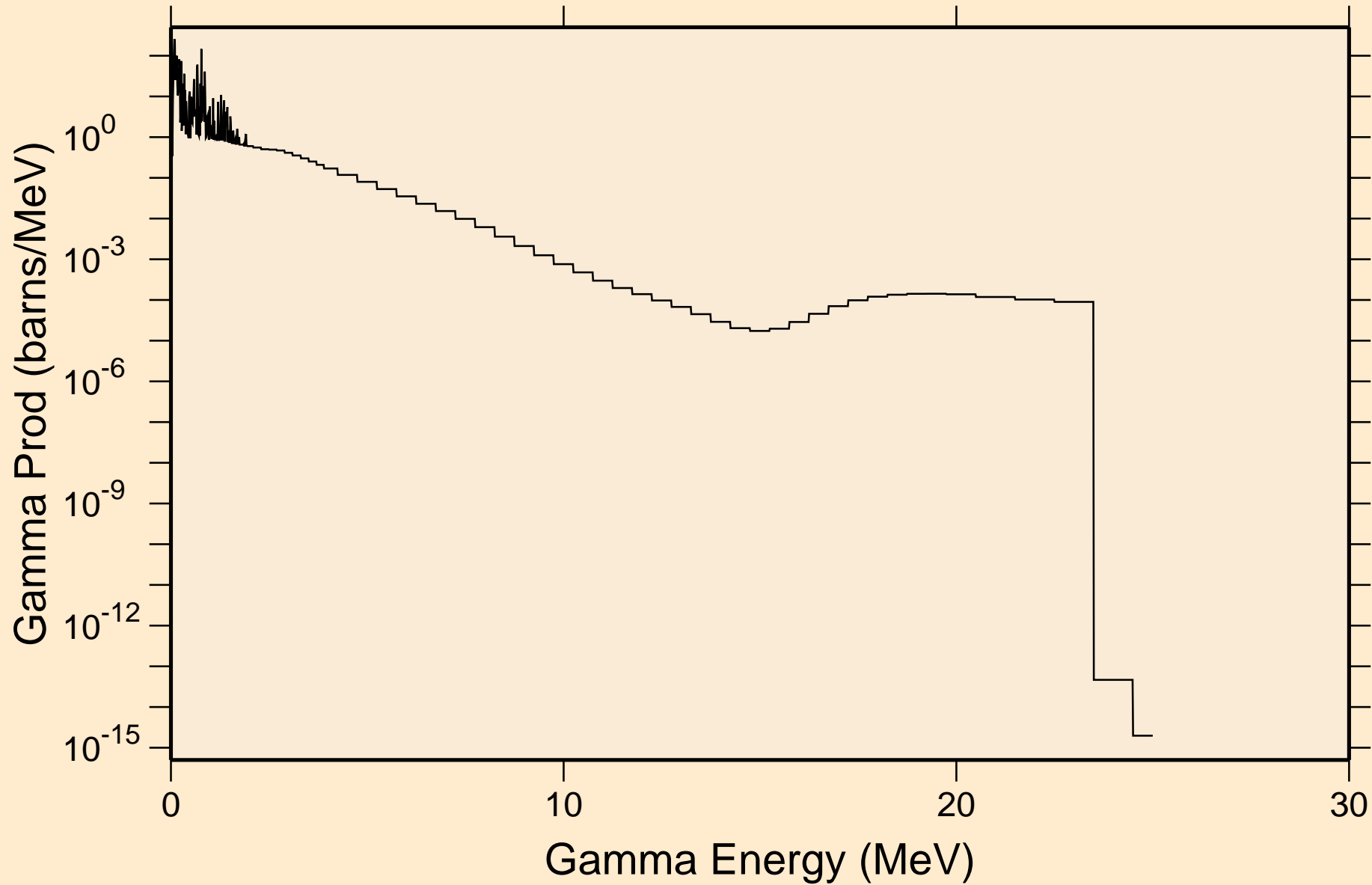

IN104M NEUTRON ACER TENDL-2024 LIBRARY; T=0.K

Particle heating contributions

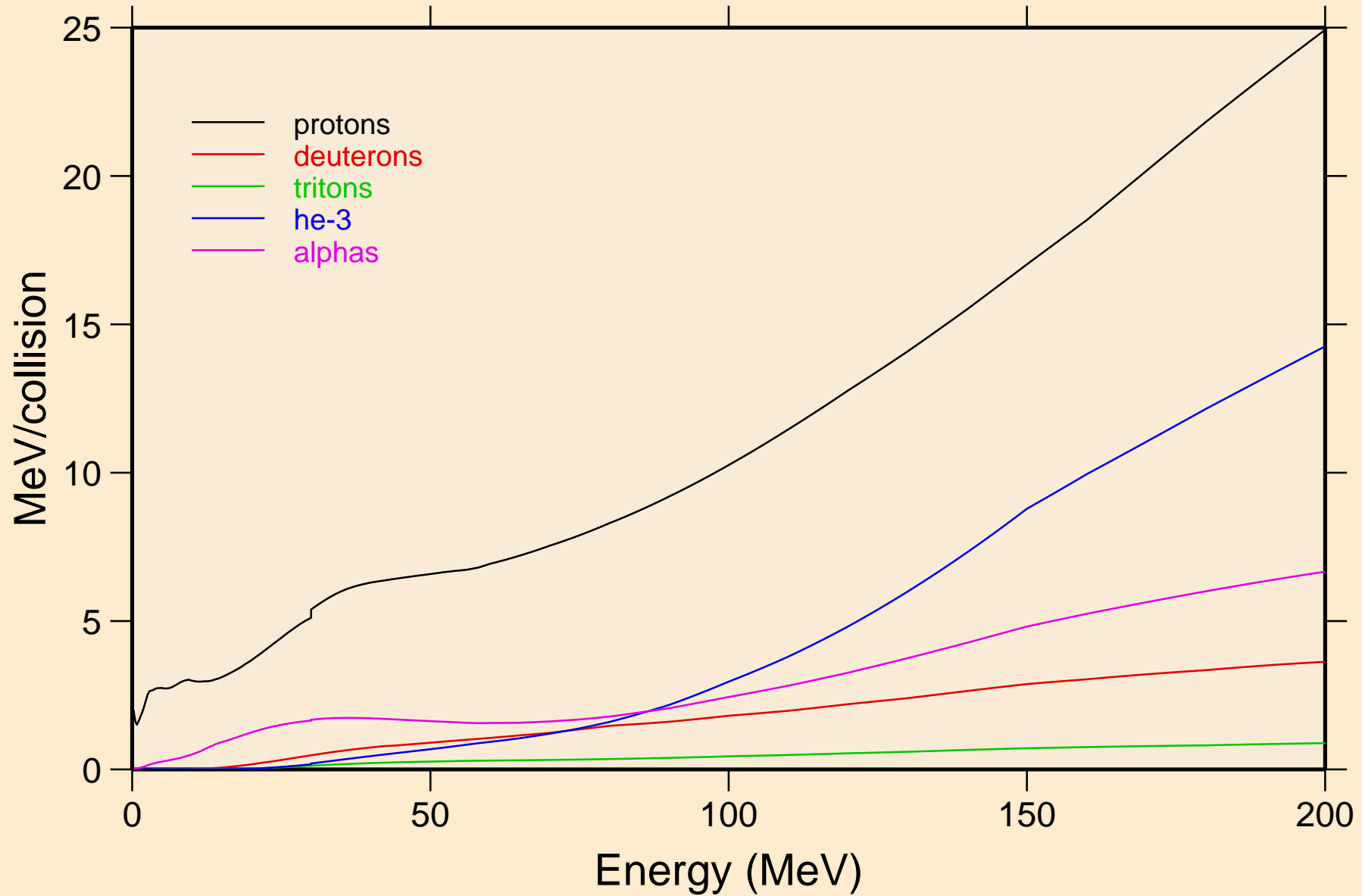

IN104M NEUTRON ACER TENDL-2024 LIBRARY; T=0.K
Recoil Heating

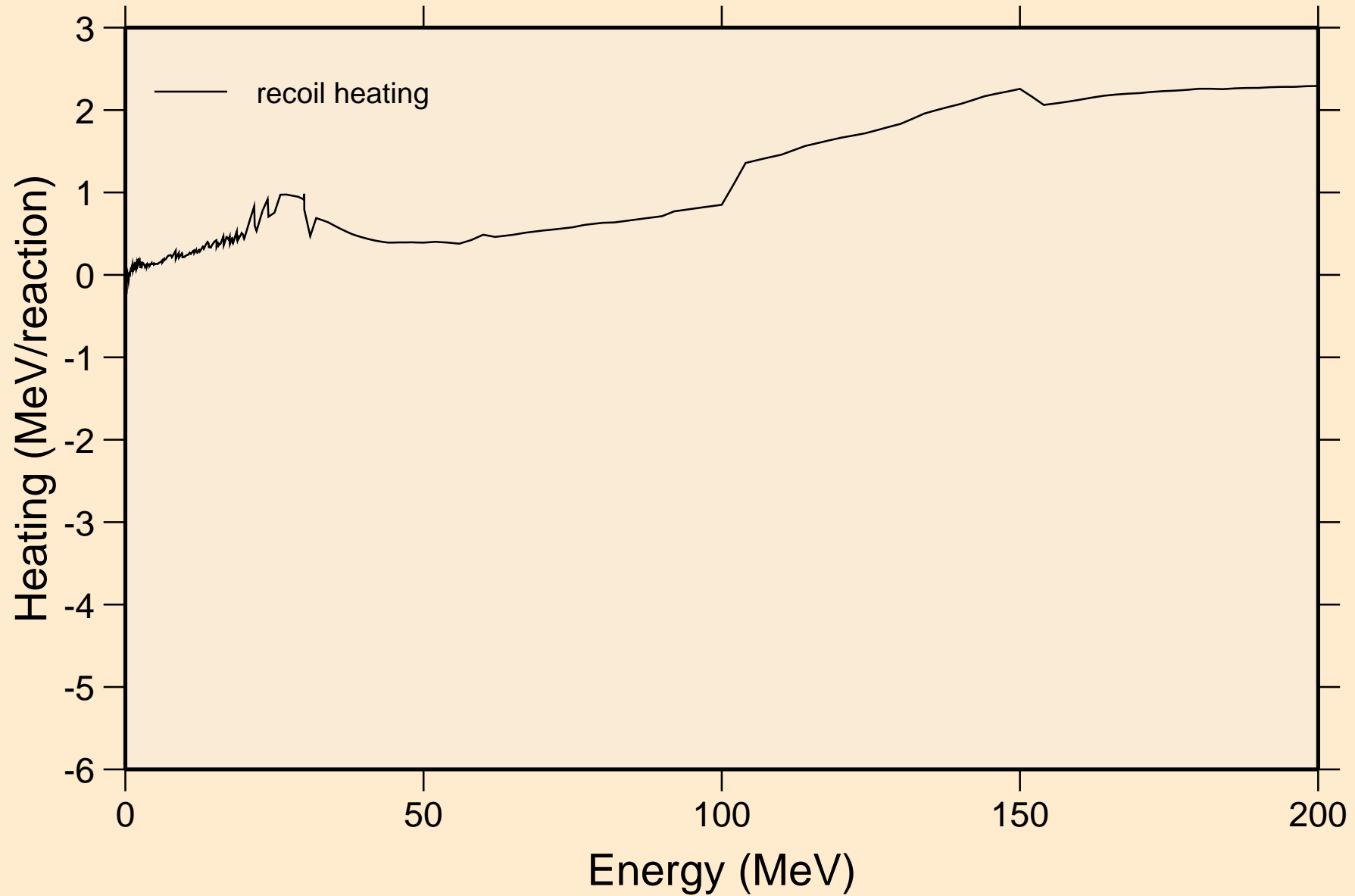

IN104M NEUTRON ACER TENDL-2024 LIBRARY; T=0.K

Particle production cross sections

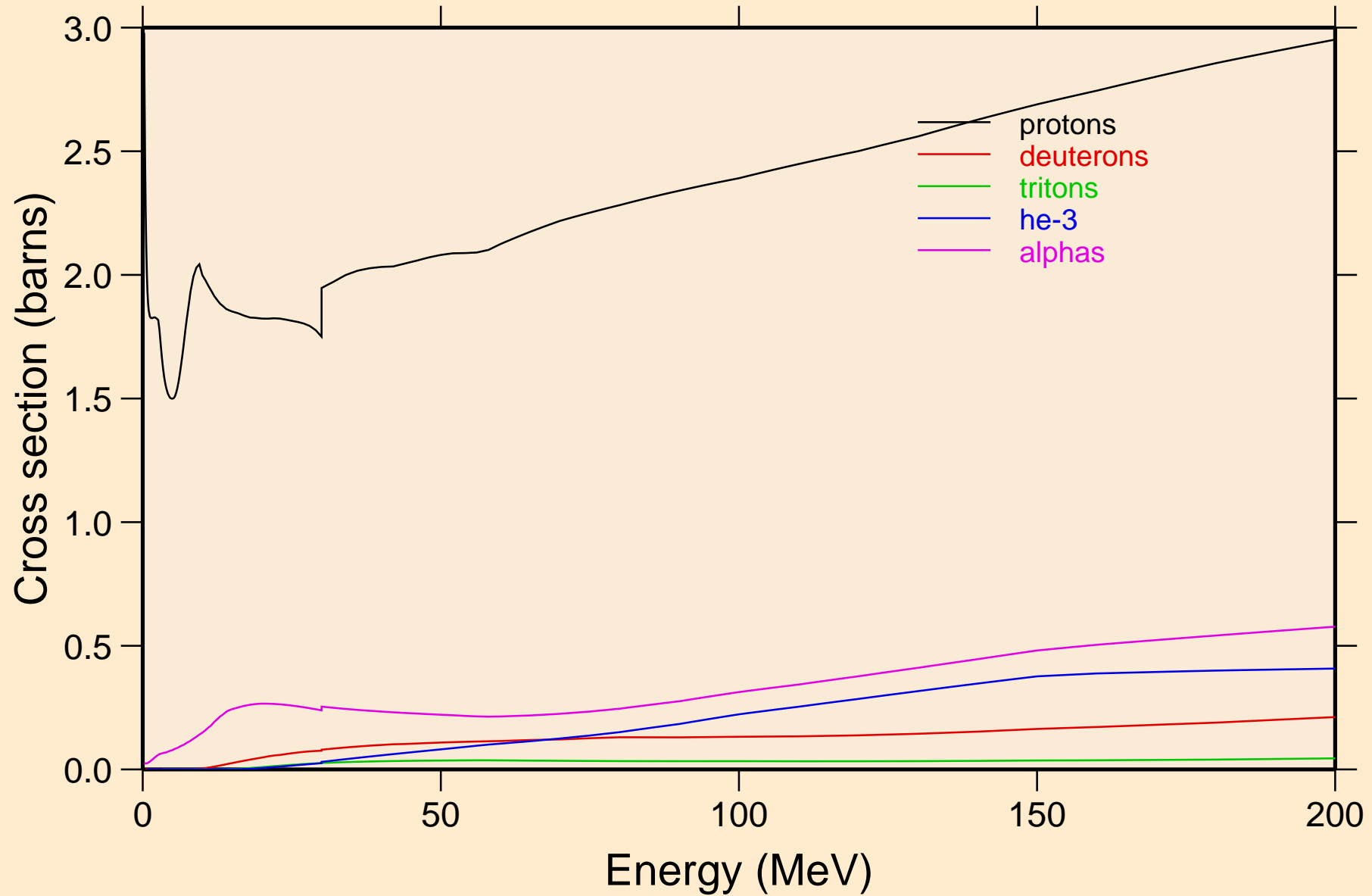

IN104M NEUTRON ACER TENDL-2024 LIBRARY; T=0.K
protons from (n,x)

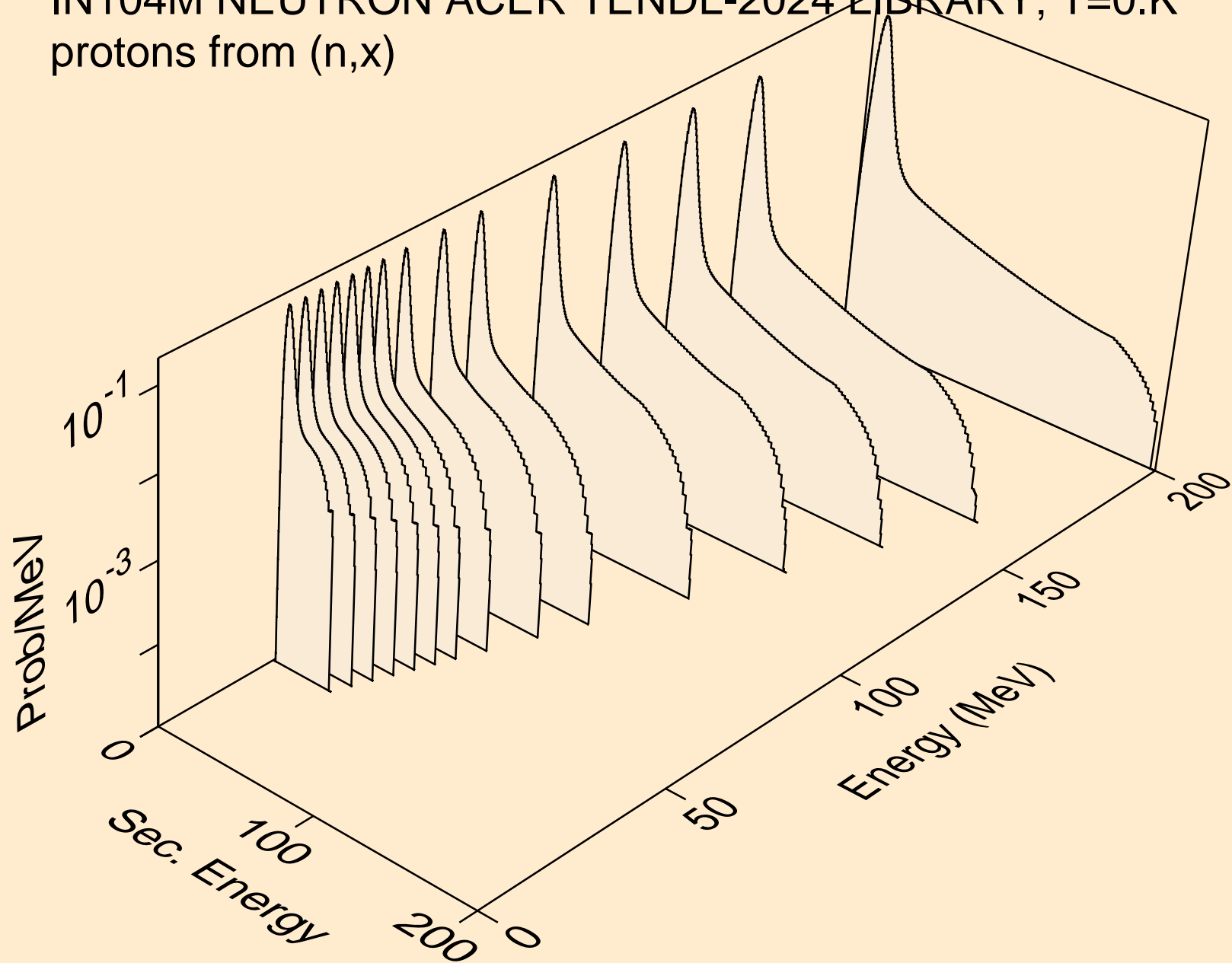

IN104M NEUTRON ACER TENDL-2024 LIBRARY; T=0.K
protons from (n,n*)p

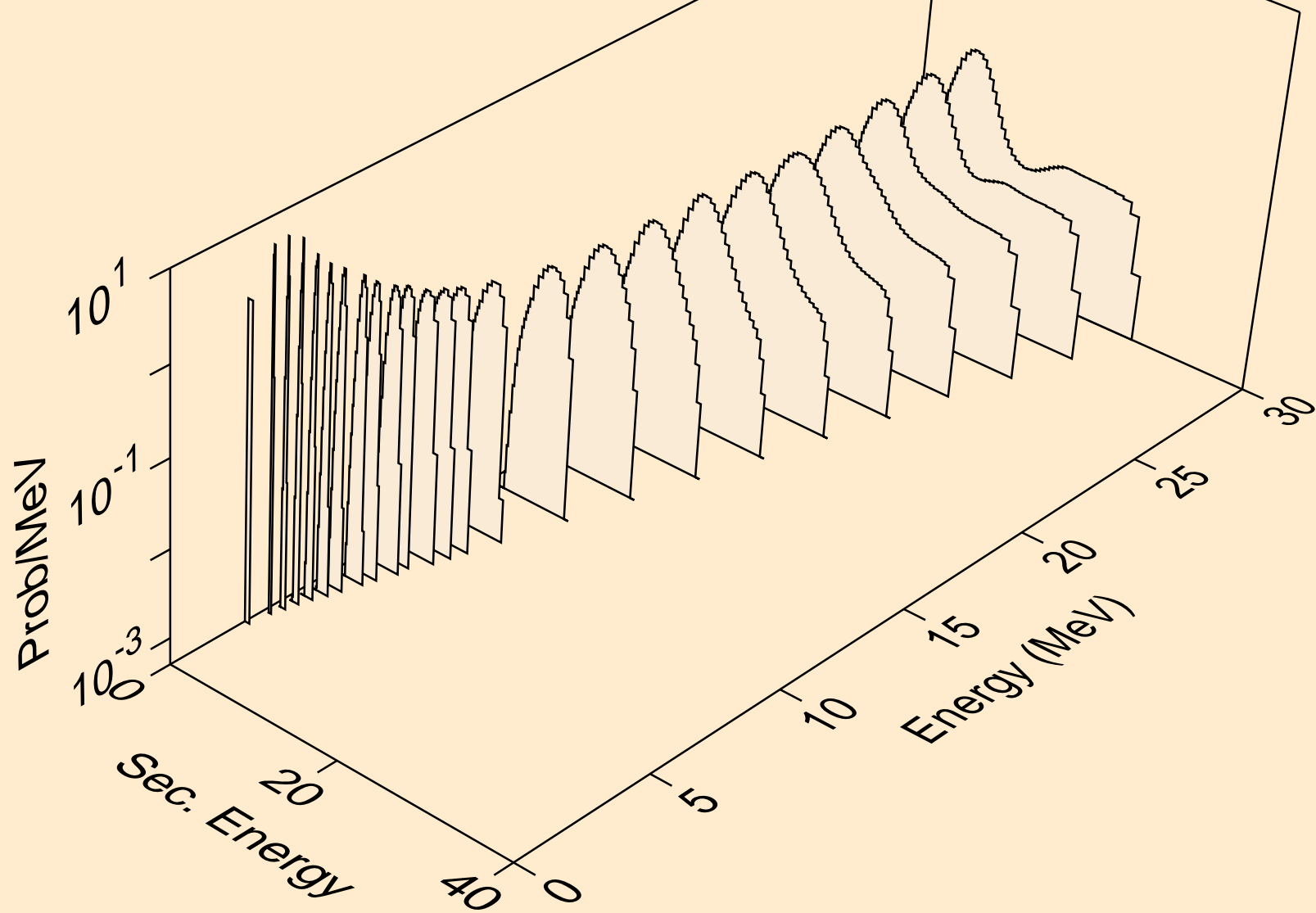

IN104M NEUTRON ACER TENDL-2024 LIBRARY; T=0.K
protons from (n,2np)

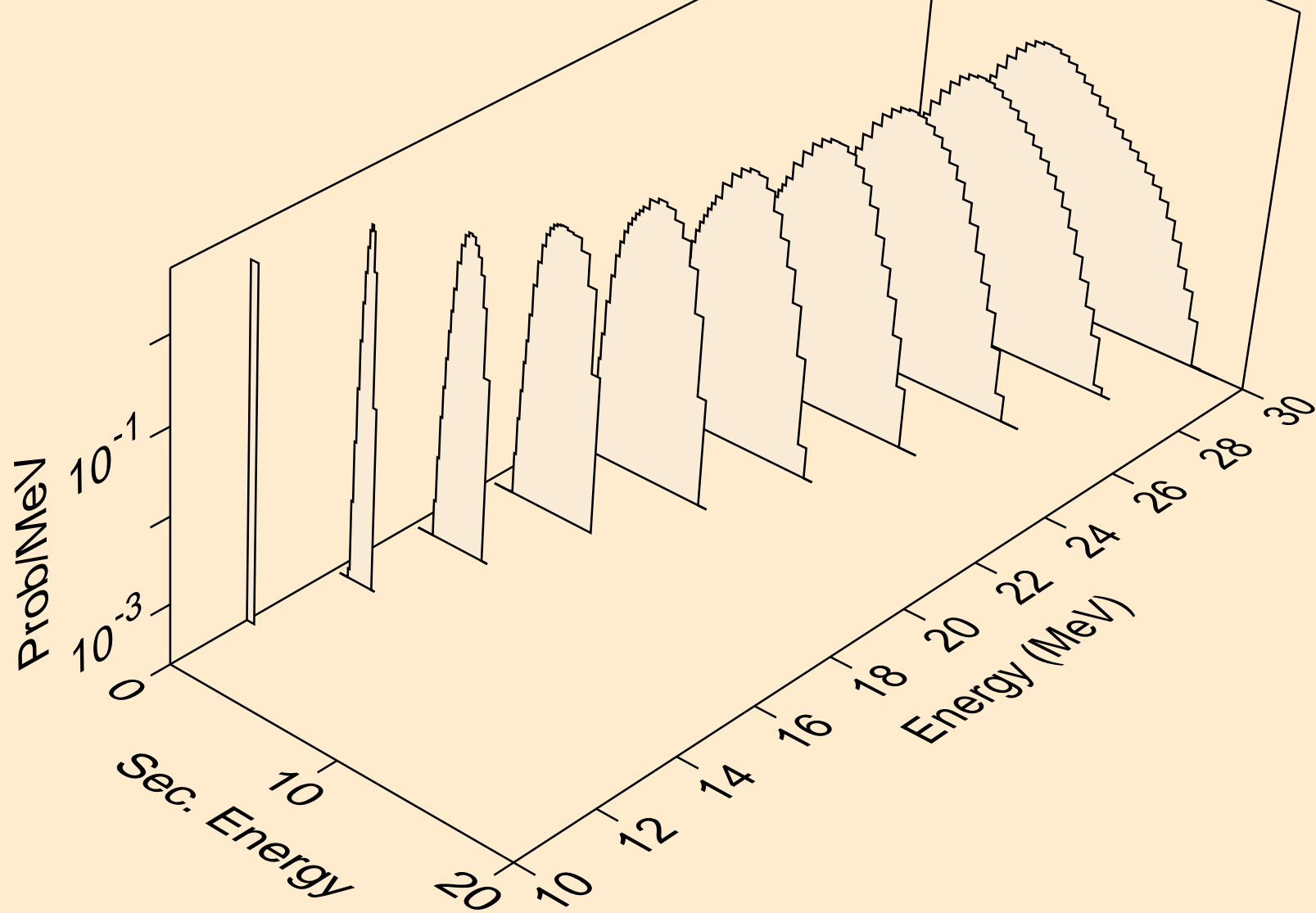

IN104M NEUTRON ACER TENDL-2024 LIBRARY; T=0.K
protons from (n,3np)

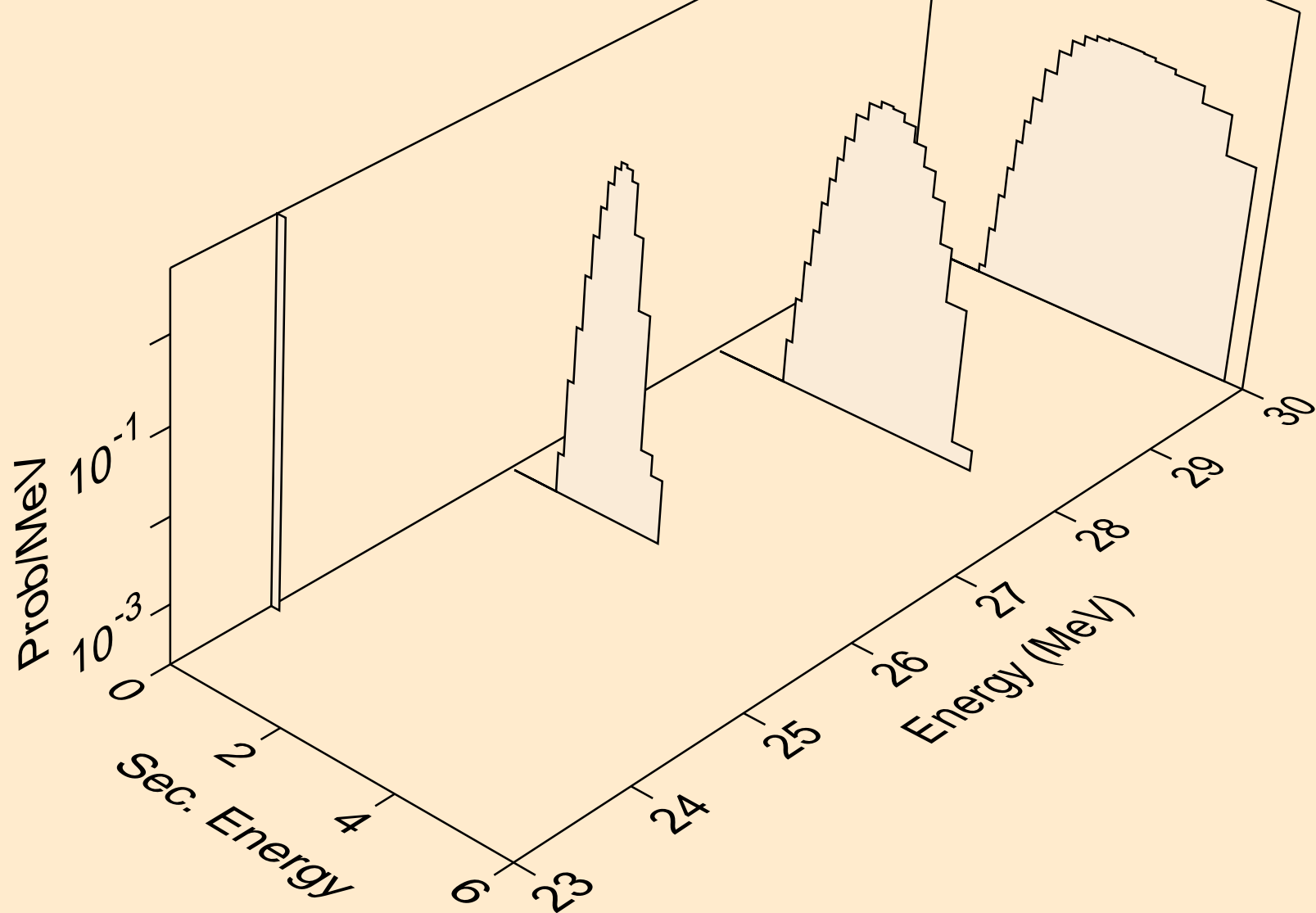

IN104M NEUTRON ACER TENDL-2024 LIBRARY; T=0.K
protons from (n,n2p)

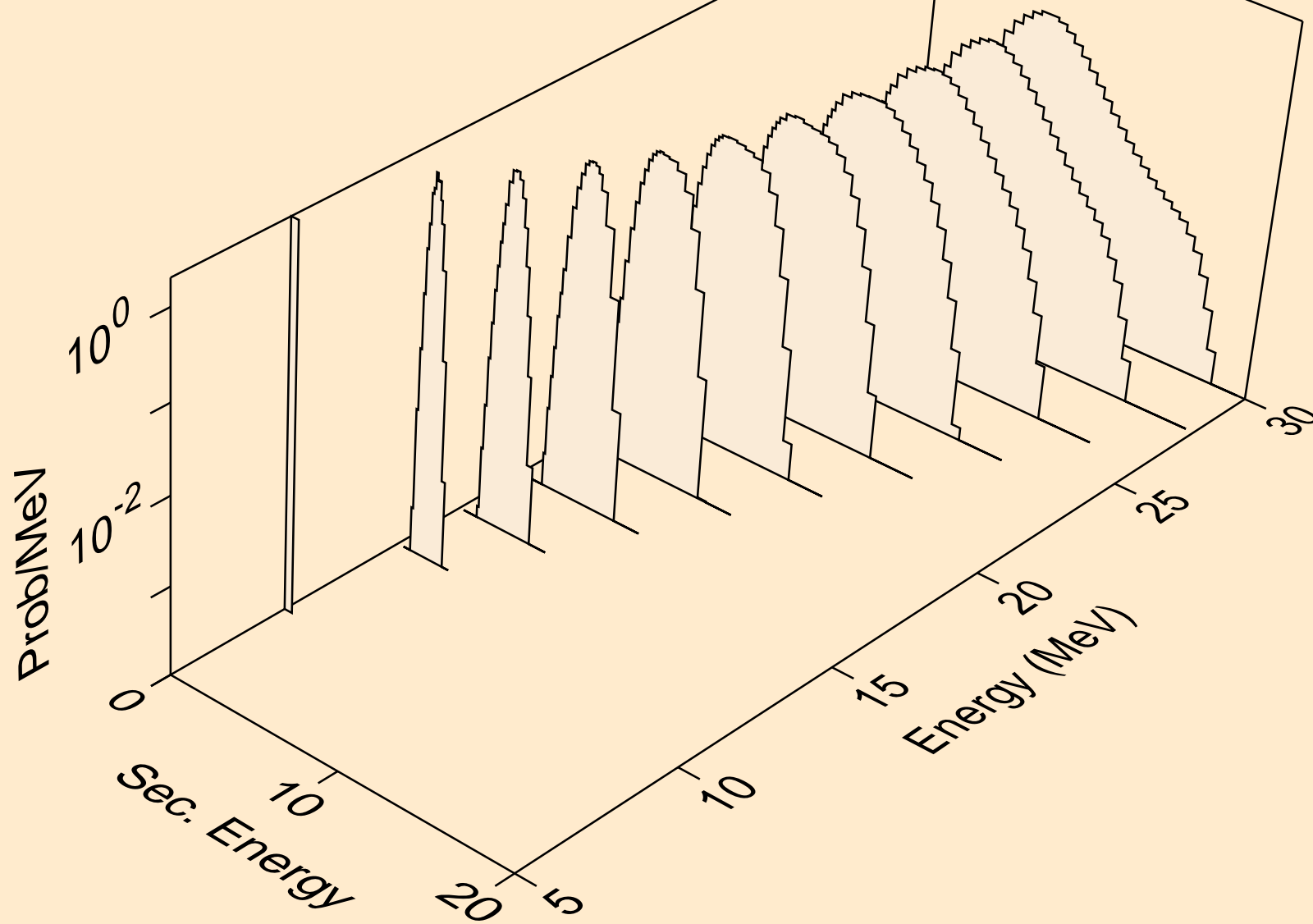

IN104M NEUTRON ACER TENDL-2024 LIBRARY; T=0.K
protons from (n,npa)

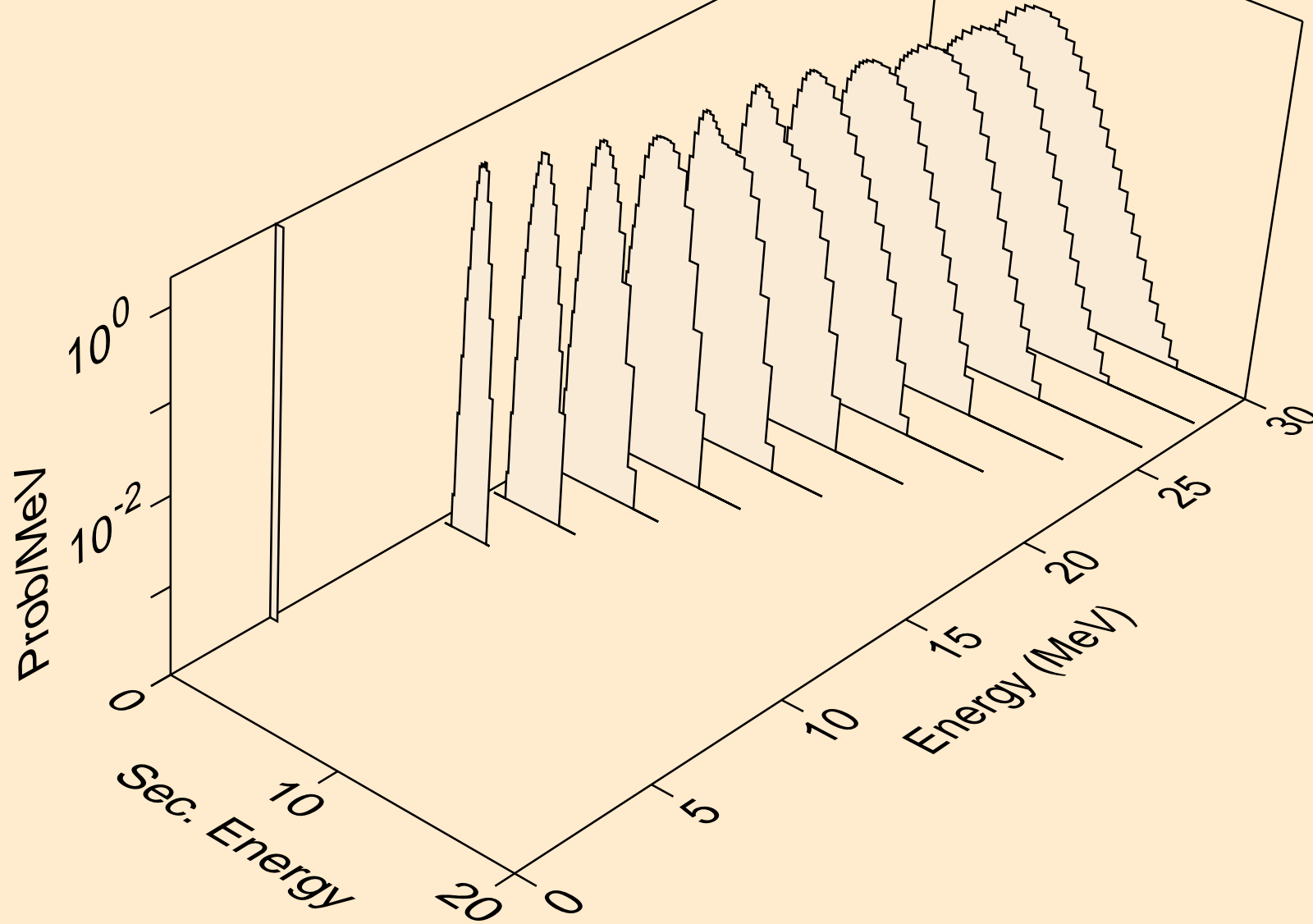

IN104M NEUTRON ACER TENDL-2024 LIBRARY; T=0.K
protons from (n,p)

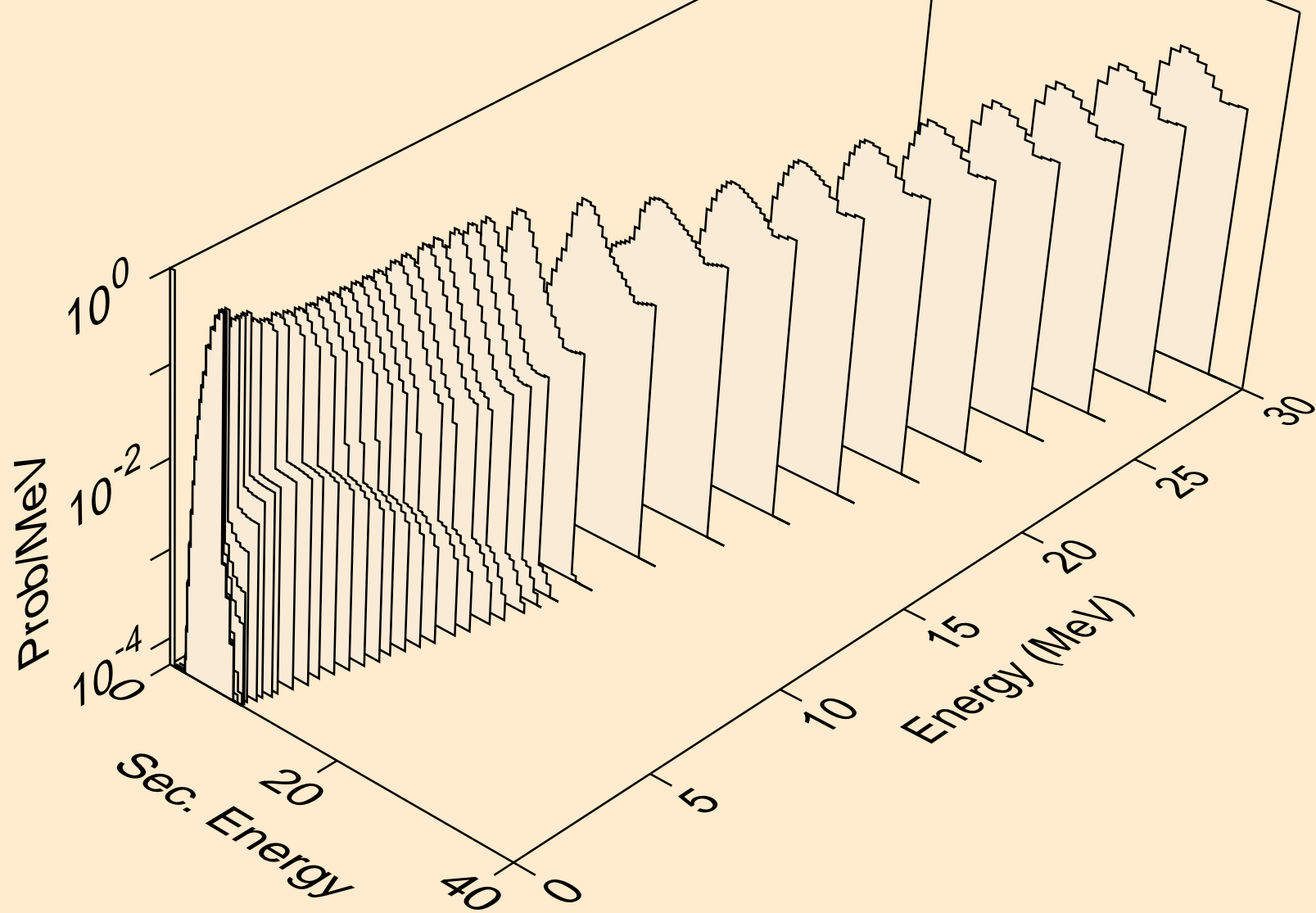

IN104M NEUTRON ACER TENDL-2024 LIBRARY; T=0.K
protons from (n,2p)

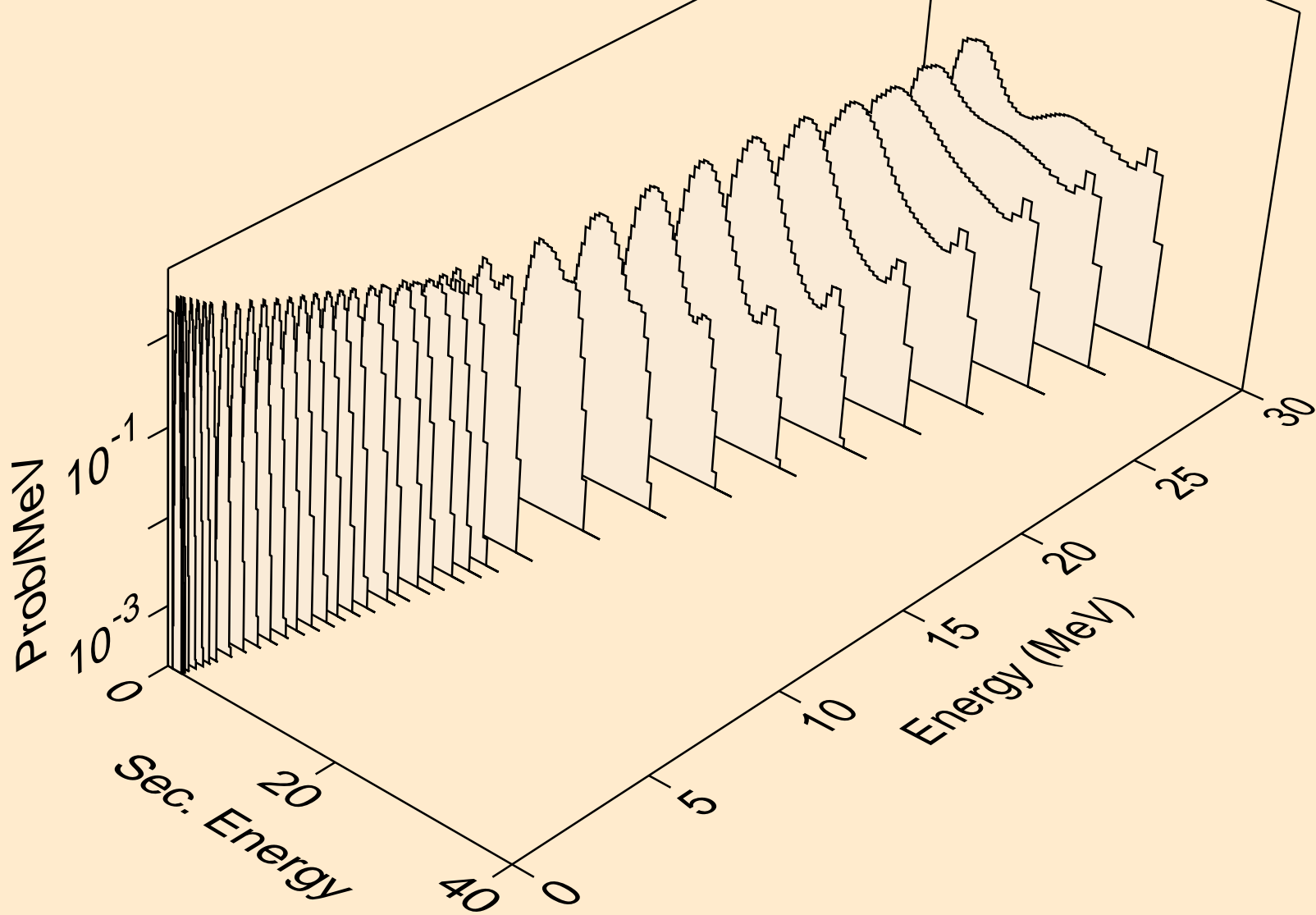

IN104M NEUTRON ACER TENDL-2024 LIBRARY; T=0.K
protons from (n,p)

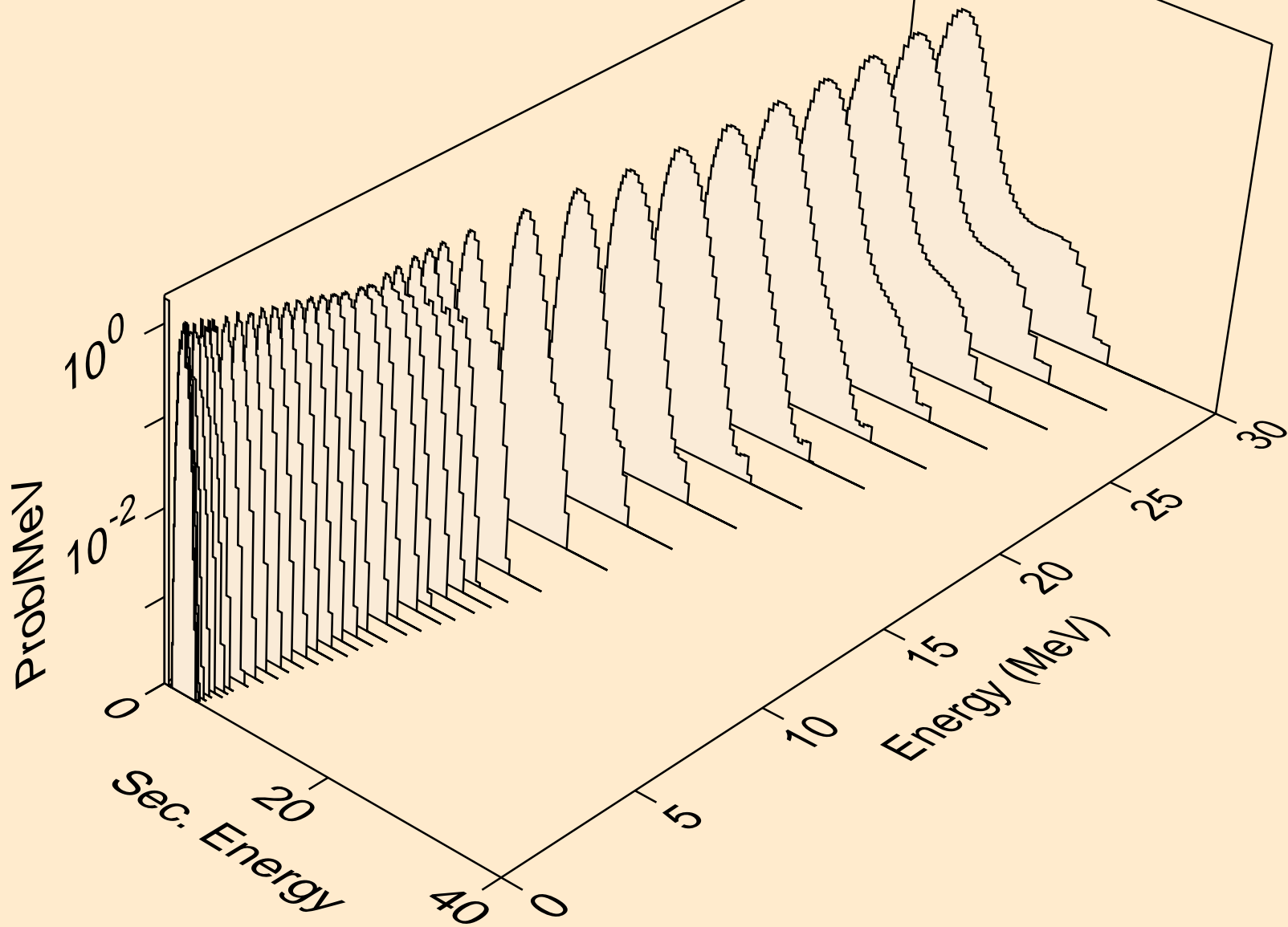

IN104M NEUTRON ACER TENDL-2024 LIBRARY; T=0.K
protons from (n,pd)

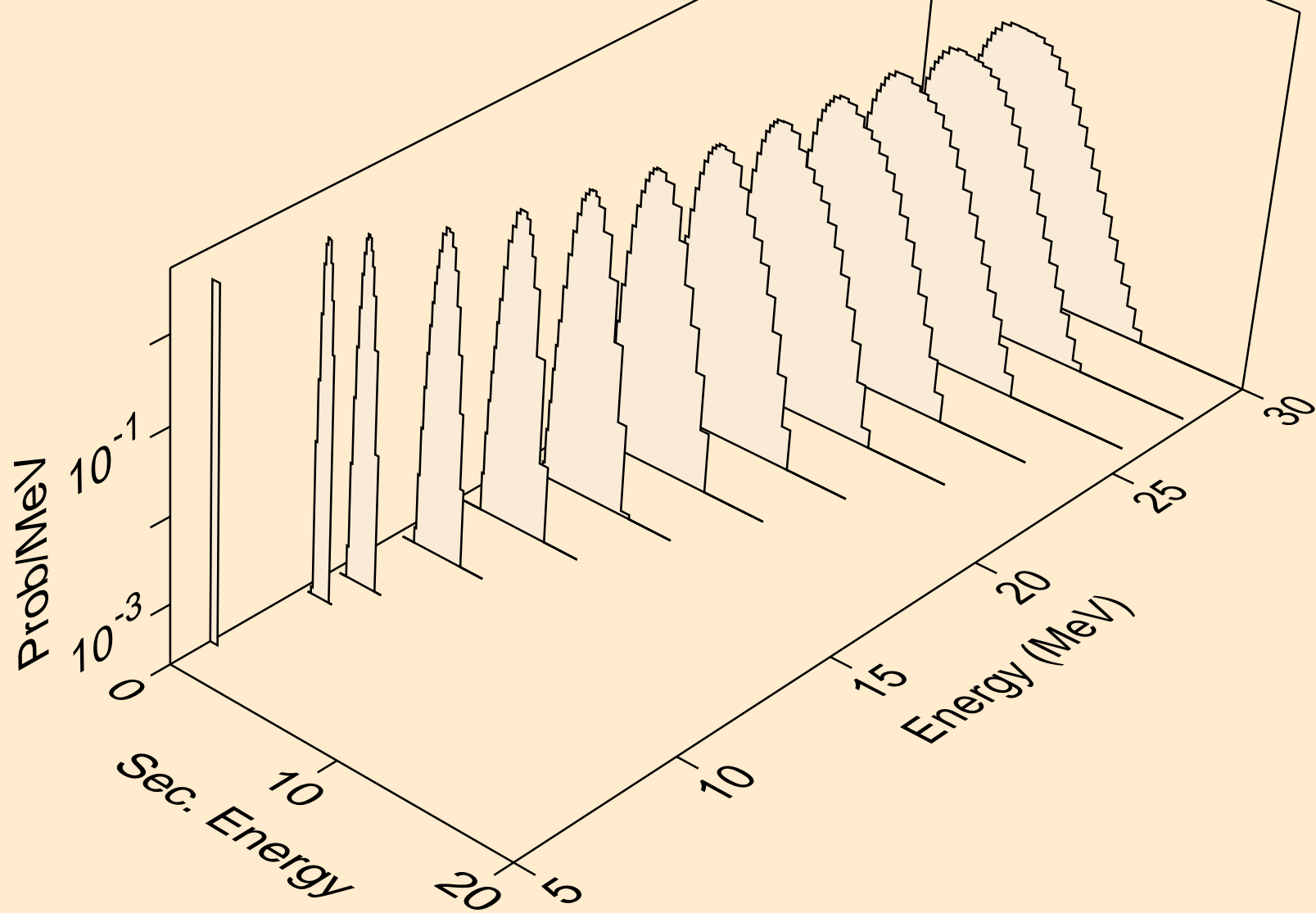

IN104M NEUTRON ACER TENDL-2024 LIBRARY; T=0.K
protons from (n,pt)

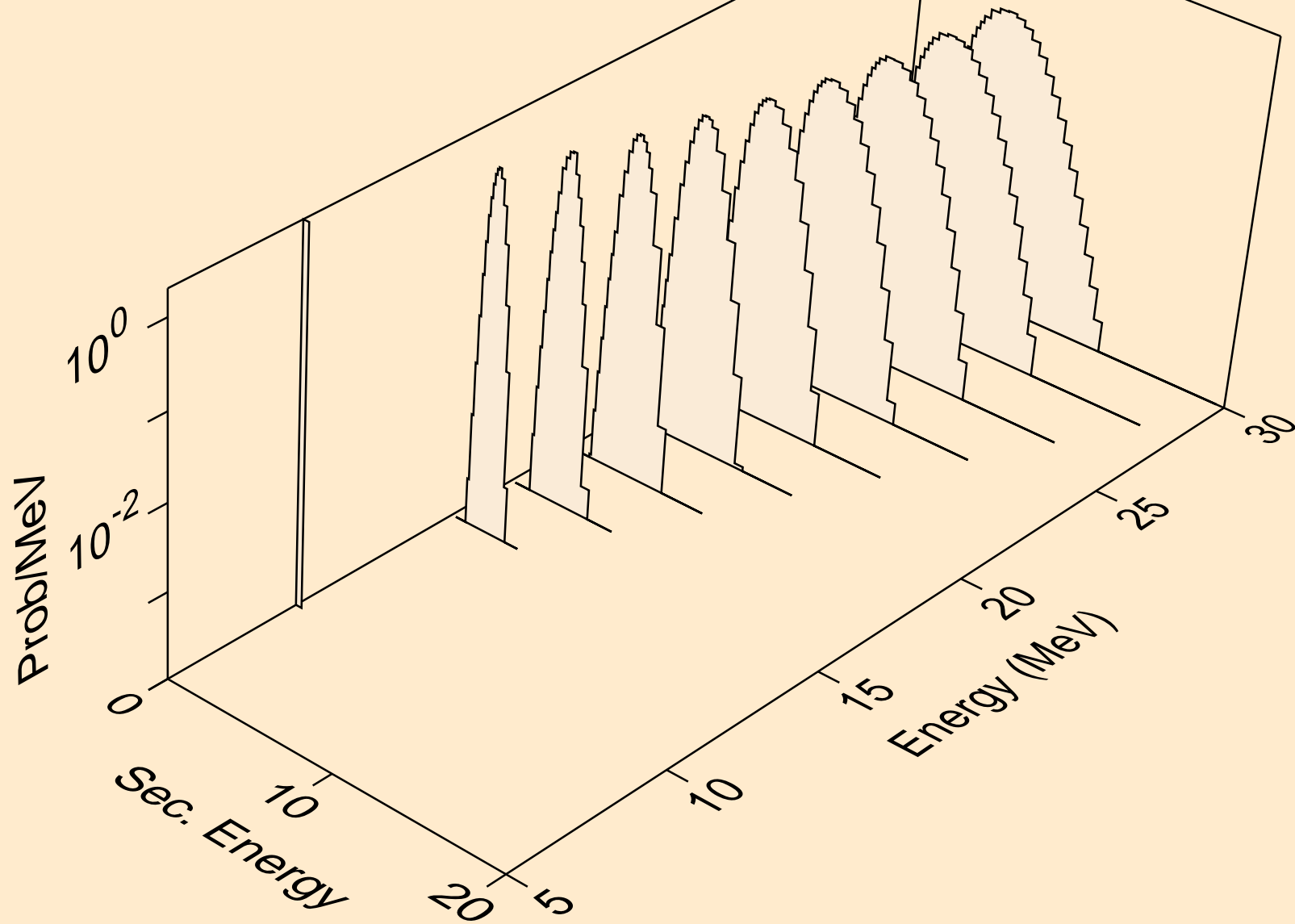

IN104M NEUTRON ACER TENDL-2024 LIBRARY; T=0.K
deuterons from (n,x)

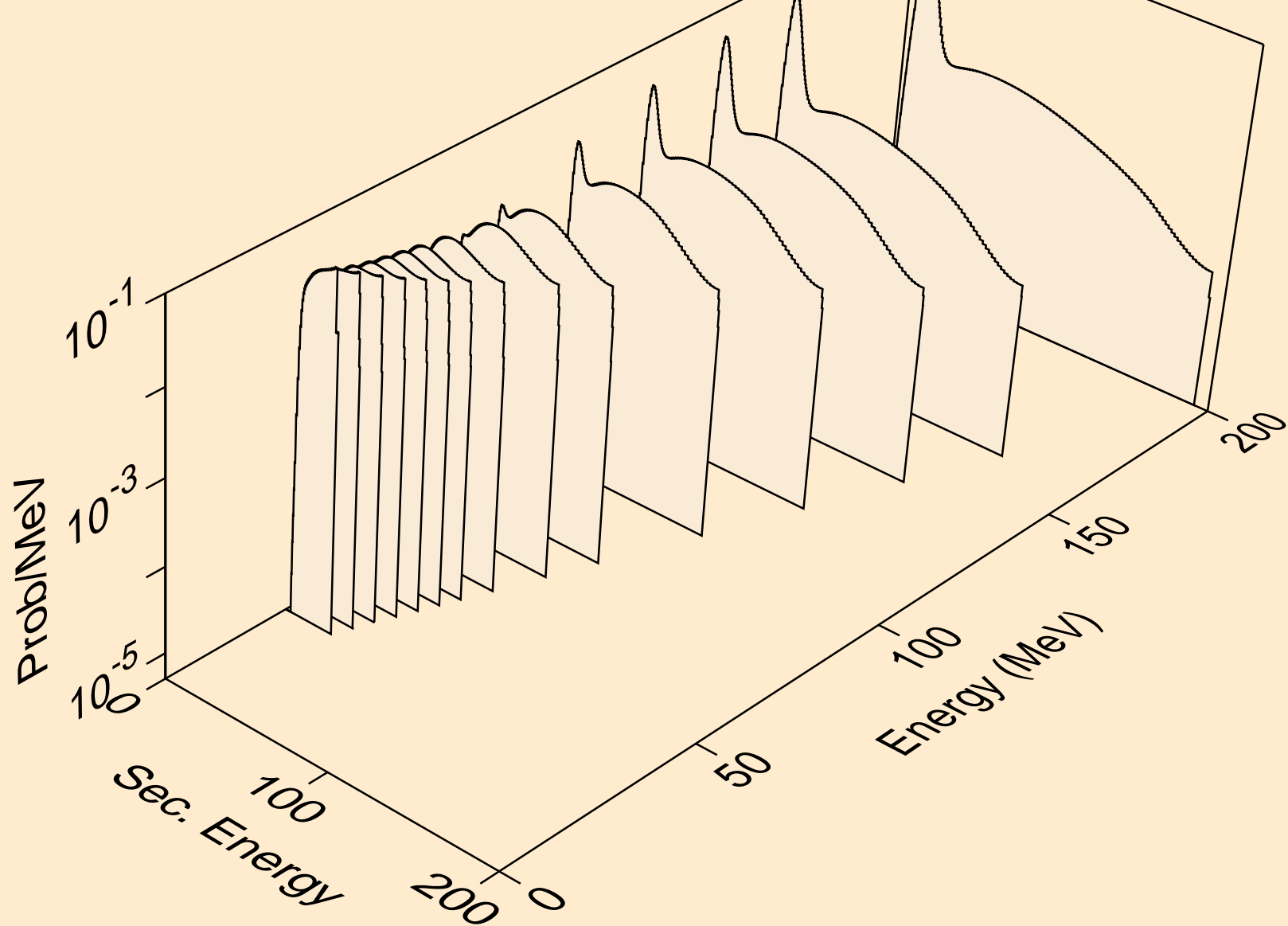

IN104M NEUTRON ACER TENDL-2024 LIBRARY; T=0.K
deuterons from (n,2nd)

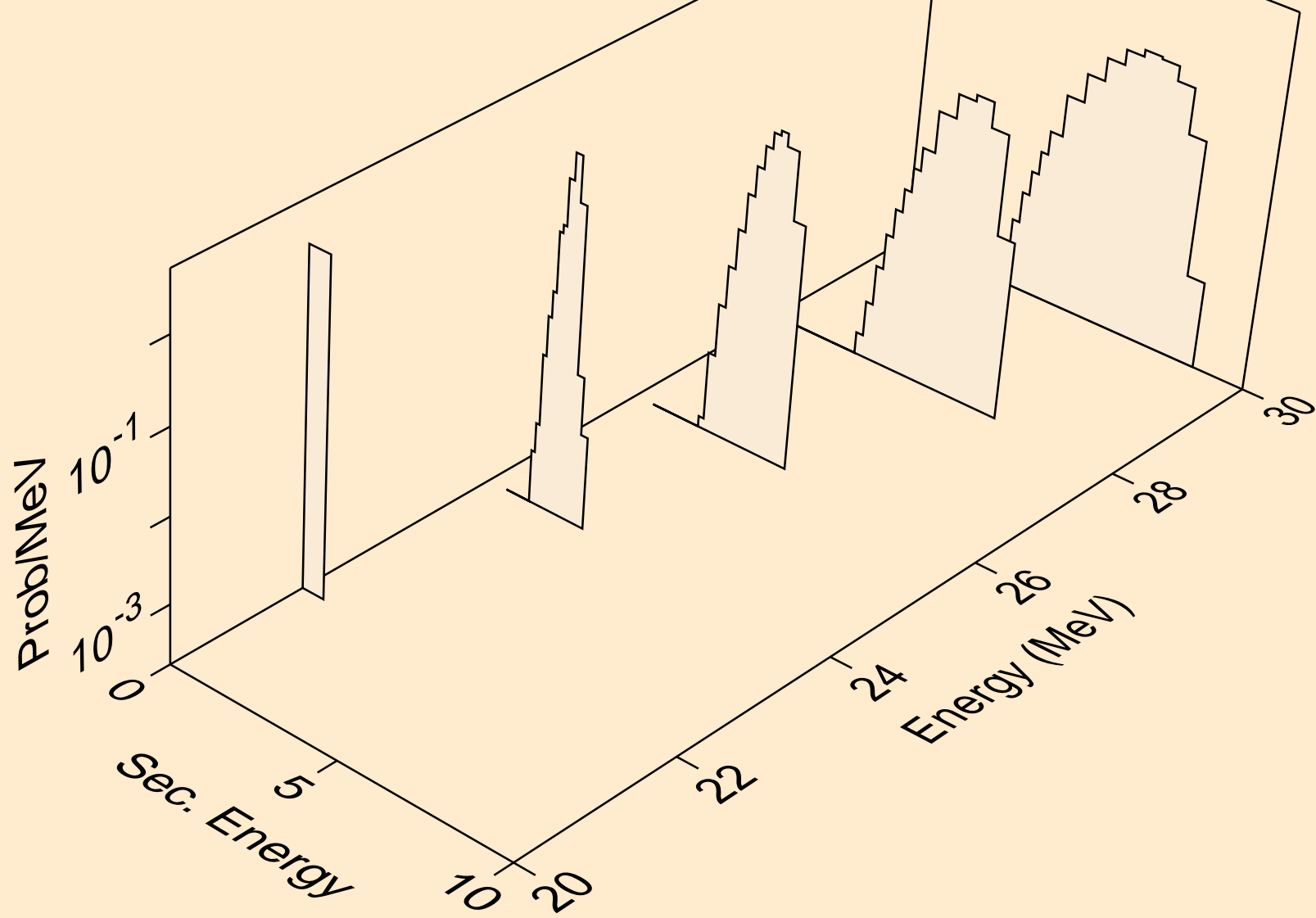

IN104M NEUTRON ACER TENDL-2024 LIBRARY; T=0.K
deuterons from (n,n*)d

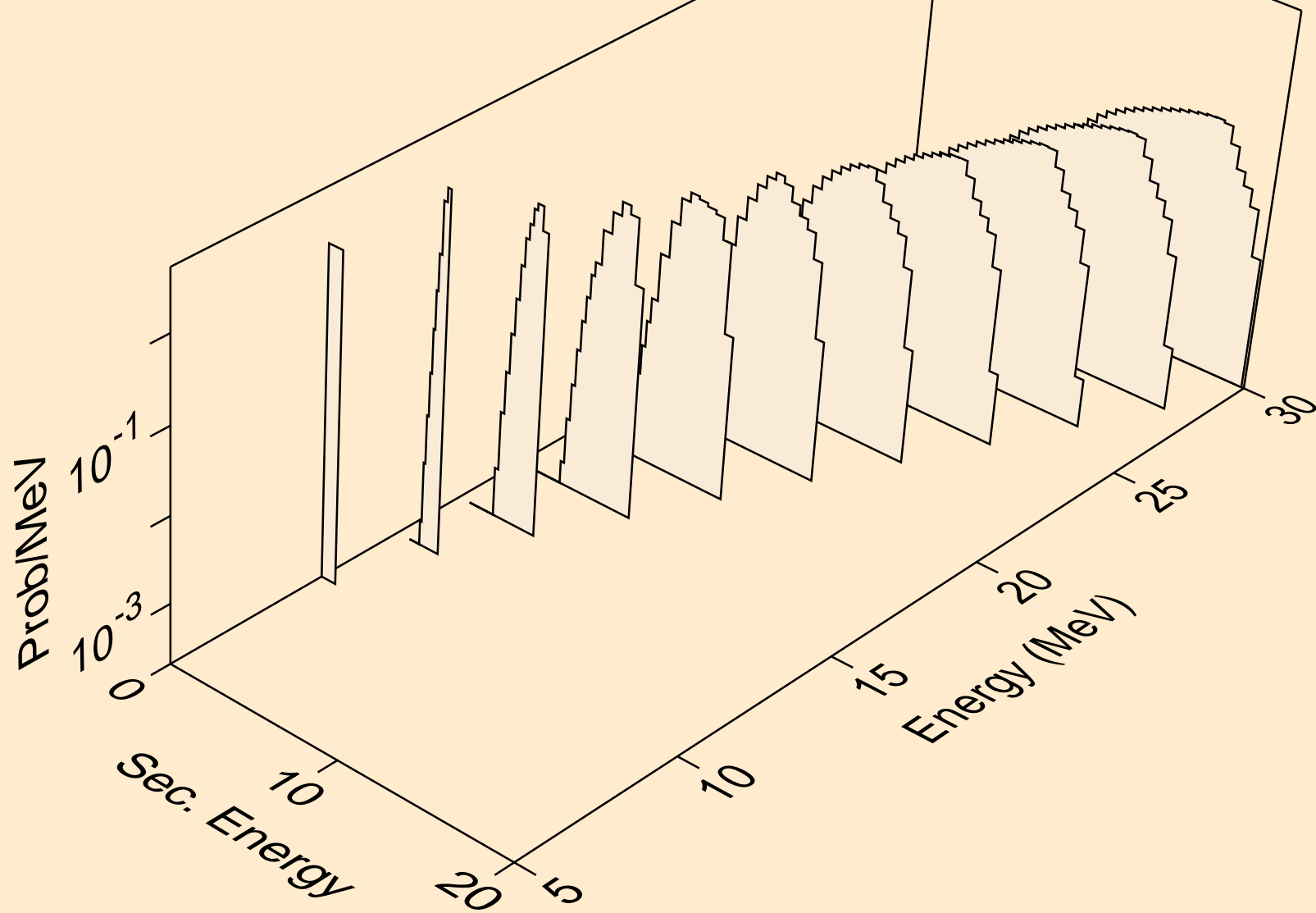

IN104M NEUTRON ACER TENDL-2024 LIBRARY; T=0.K
deuterons from (n,d)

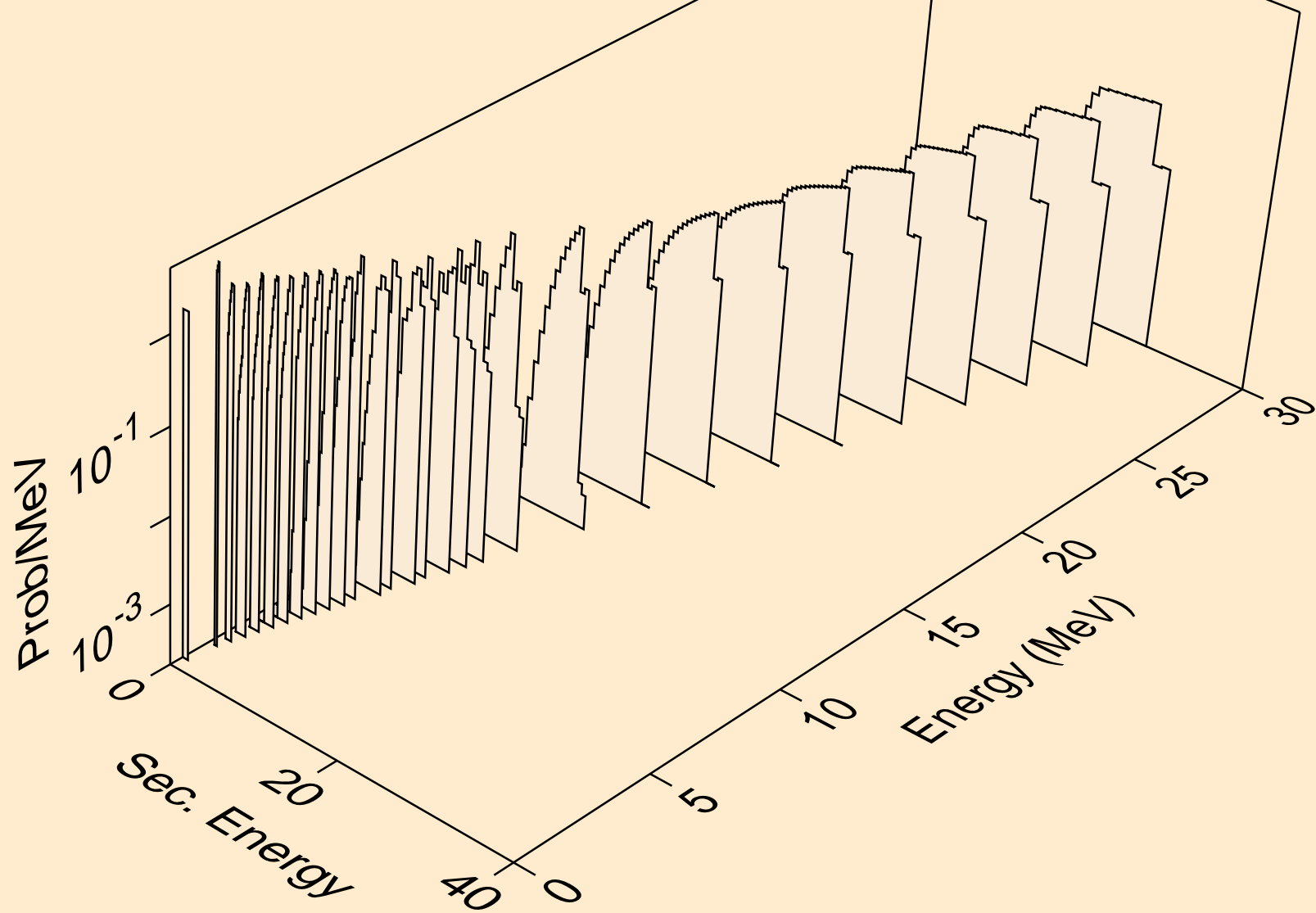

IN104M NEUTRON ACER TENDL-2024 LIBRARY; T=0.K
deuterons from (n,d2a)

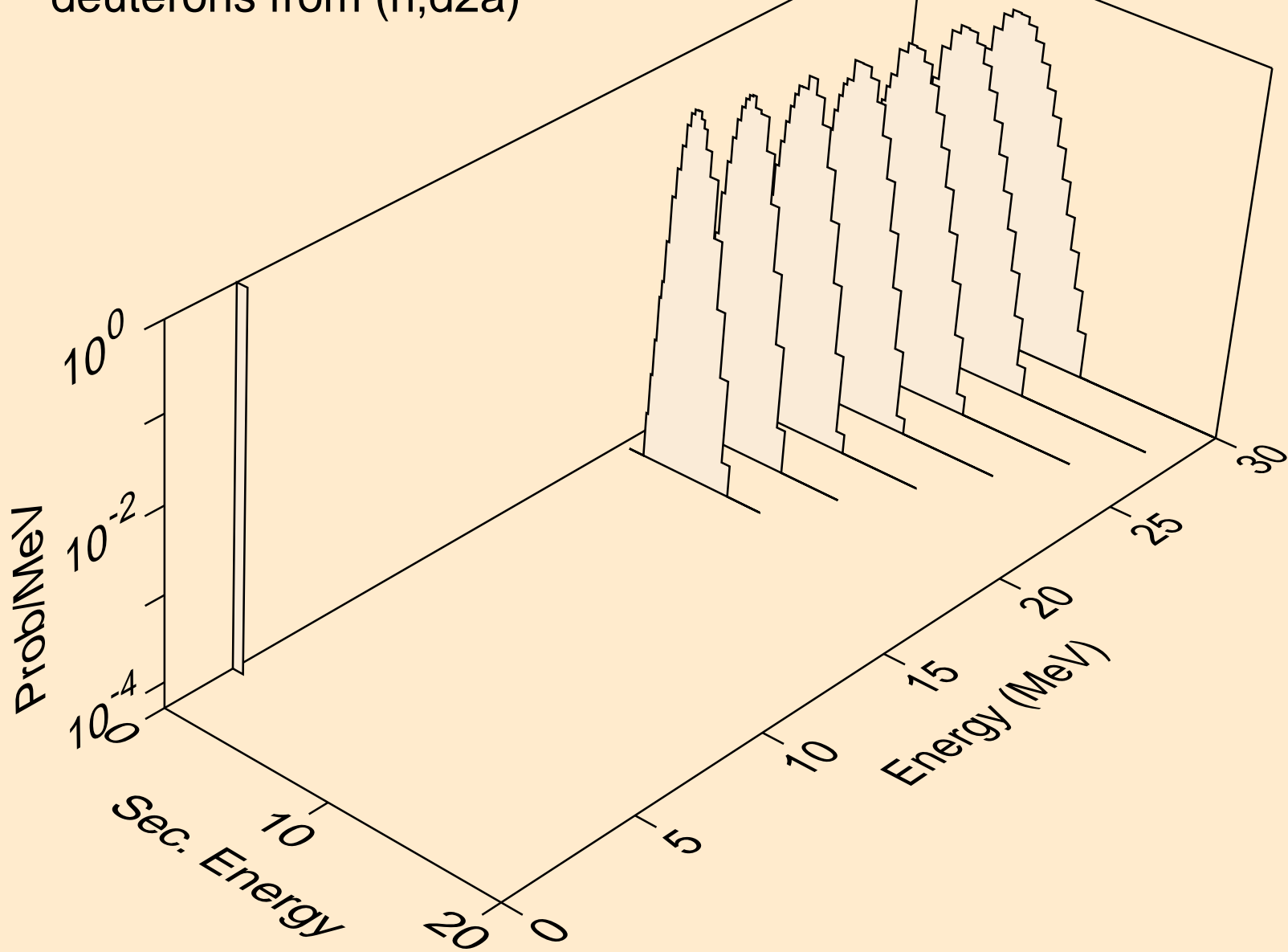

IN104M NEUTRON ACER TENDL-2024 LIBRARY; T=0.K
deuterons from (n,pd)

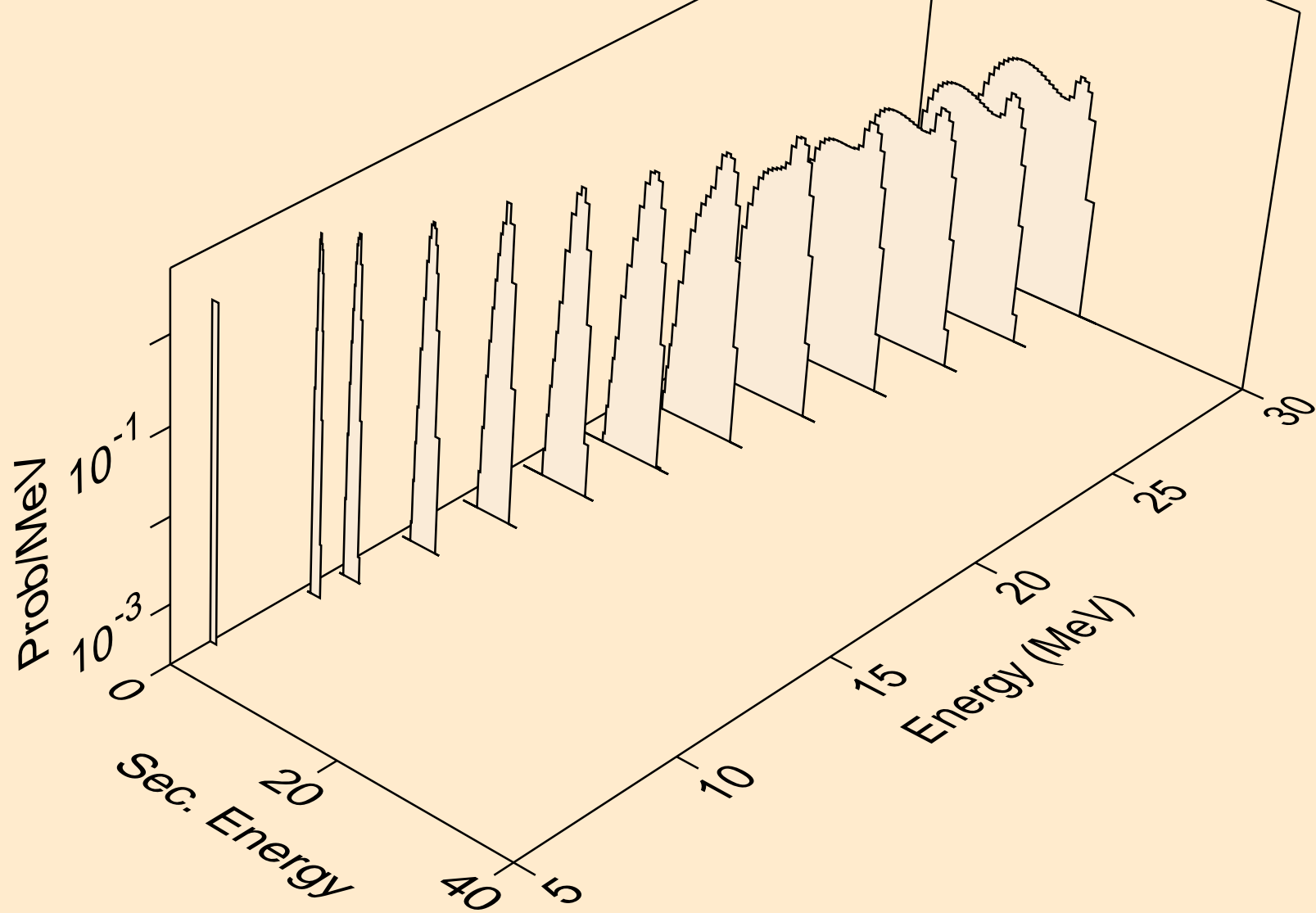

IN104M NEUTRON ACER TENDL-2024 LIBRARY; T=0.K
deuterons from (n,da)

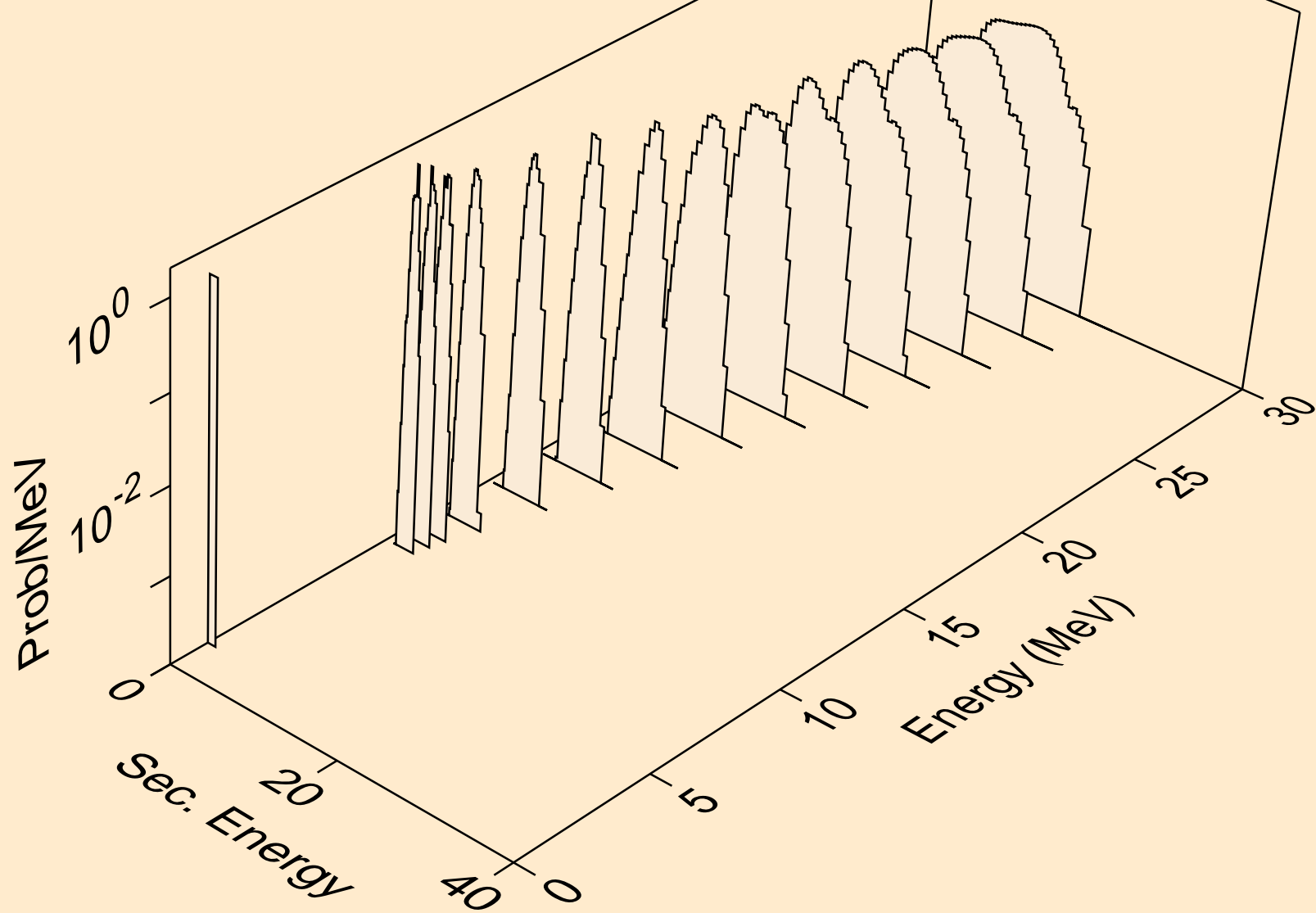

IN104M NEUTRON ACER TENDL-2024 LIBRARY; T=0.K
tritons from (n,x)

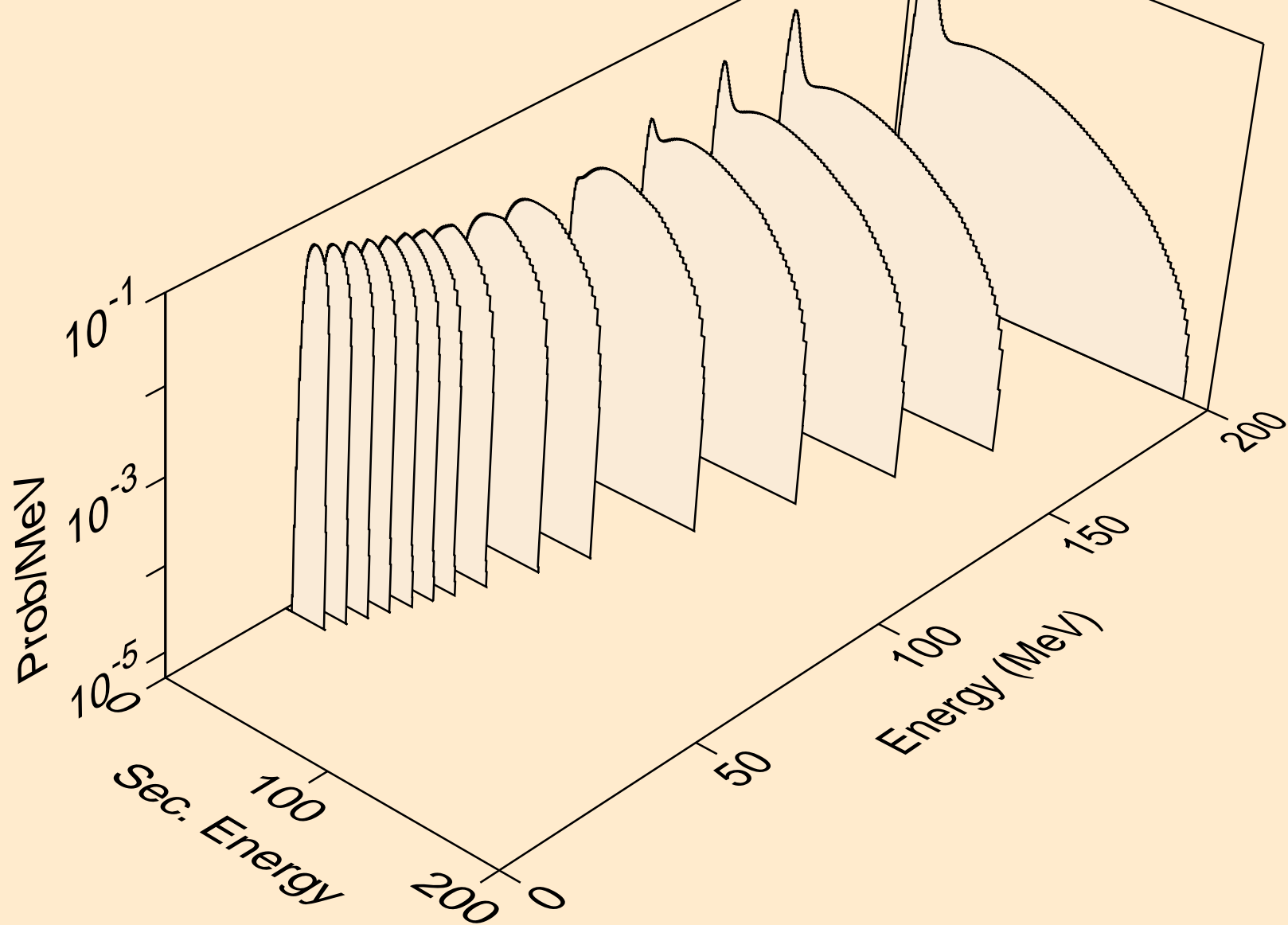

IN104M NEUTRON ACER TENDL-2024 LIBRARY; T=0.K
tritons from (n,n*)t

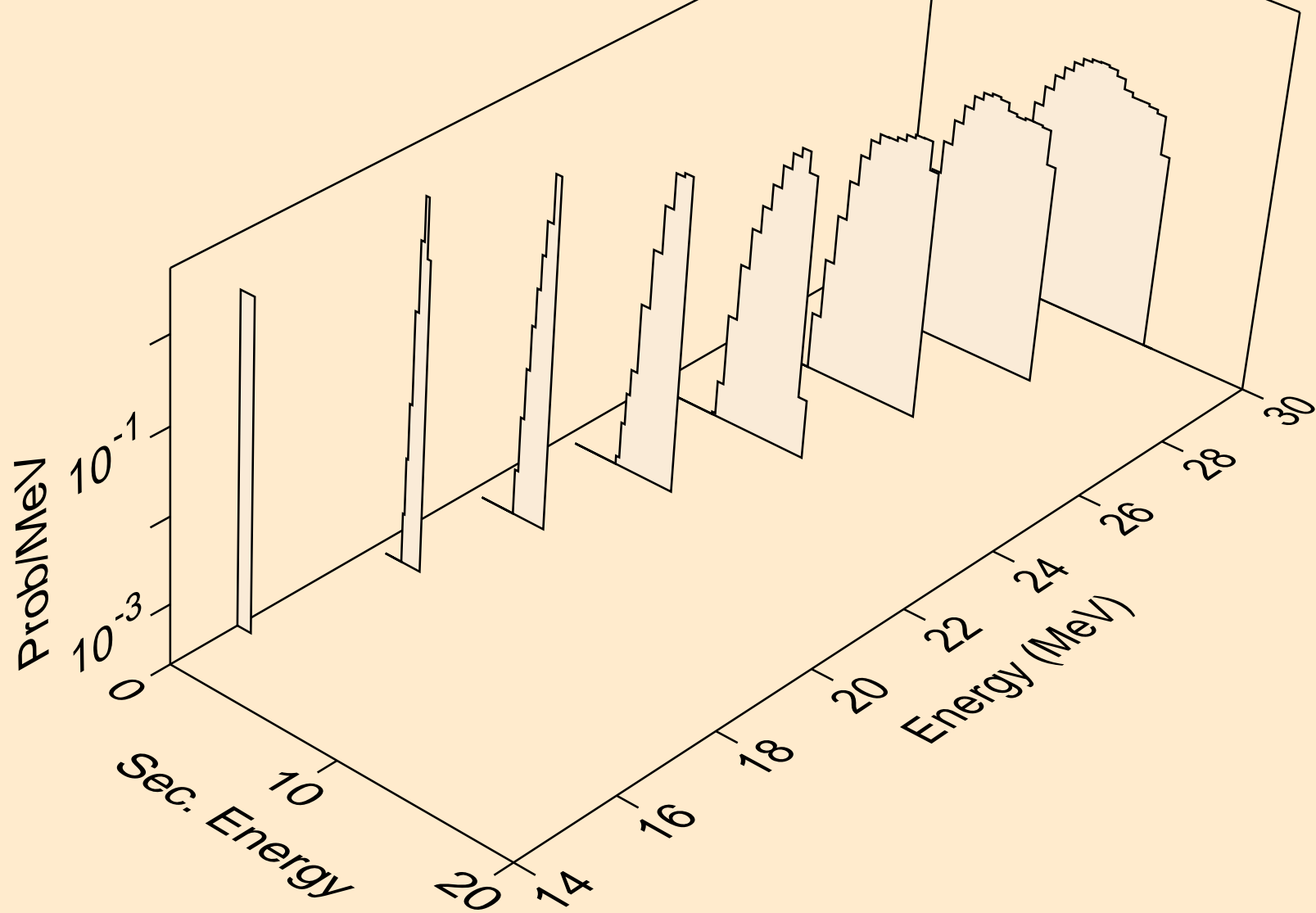

IN104M NEUTRON ACER TENDL-2024 LIBRARY; T=0.K
tritons from (n,t)

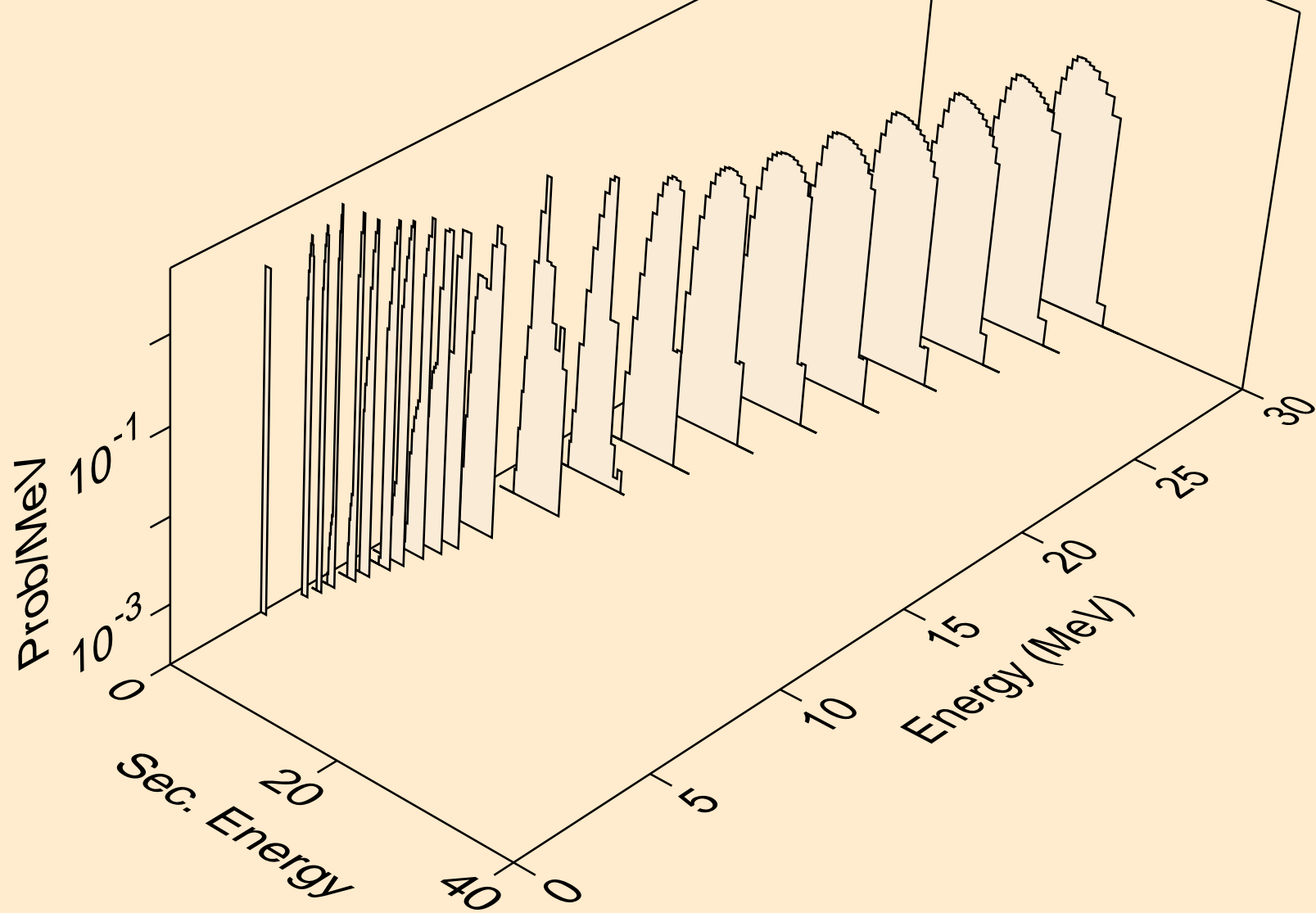

IN104M NEUTRON ACER TENDL-2024 LIBRARY; T=0.K
tritons from (n,pt)

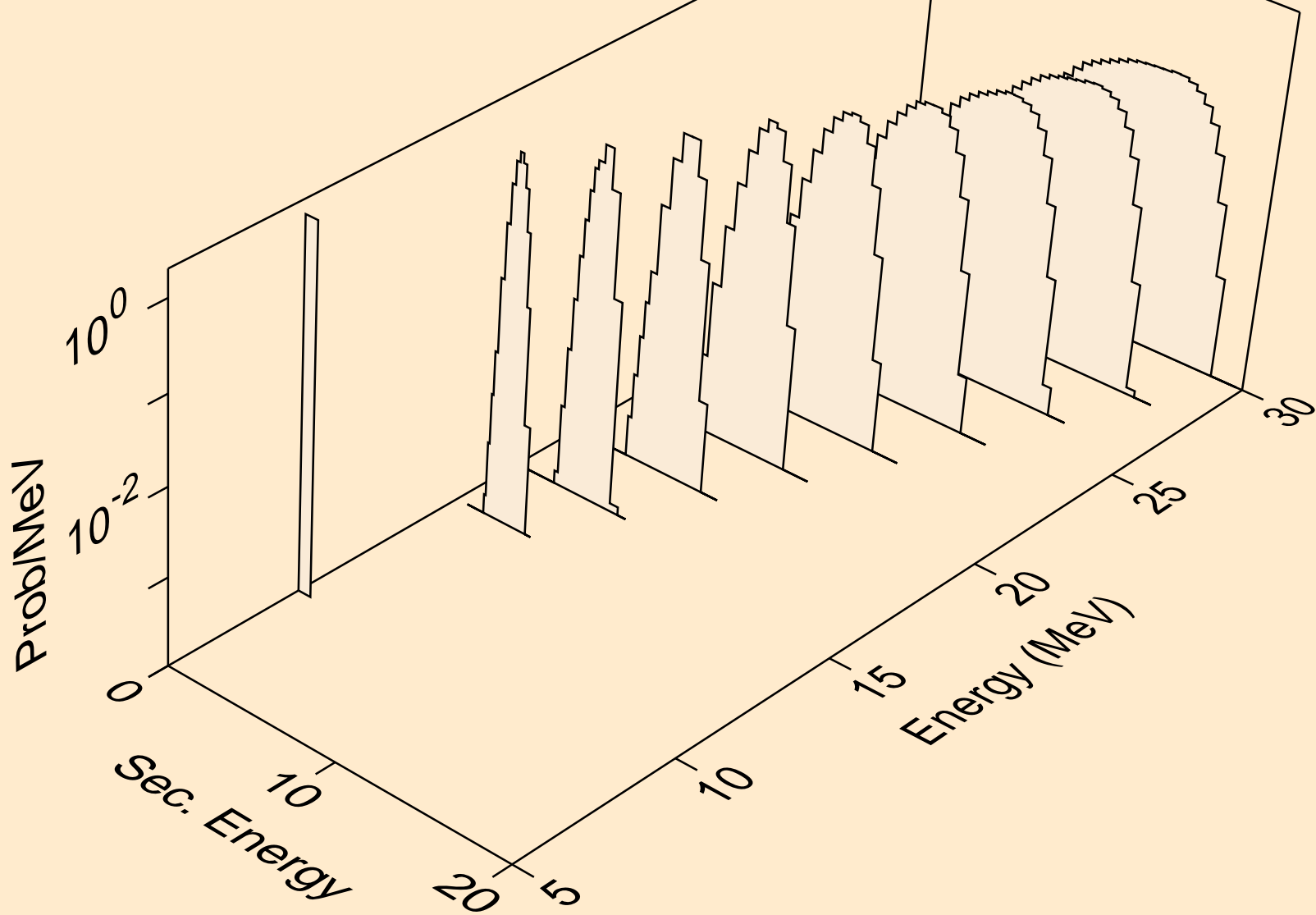

IN104M NEUTRON ACER TENDL-2024 LIBRARY; T=0.K
he3s from (n,x)

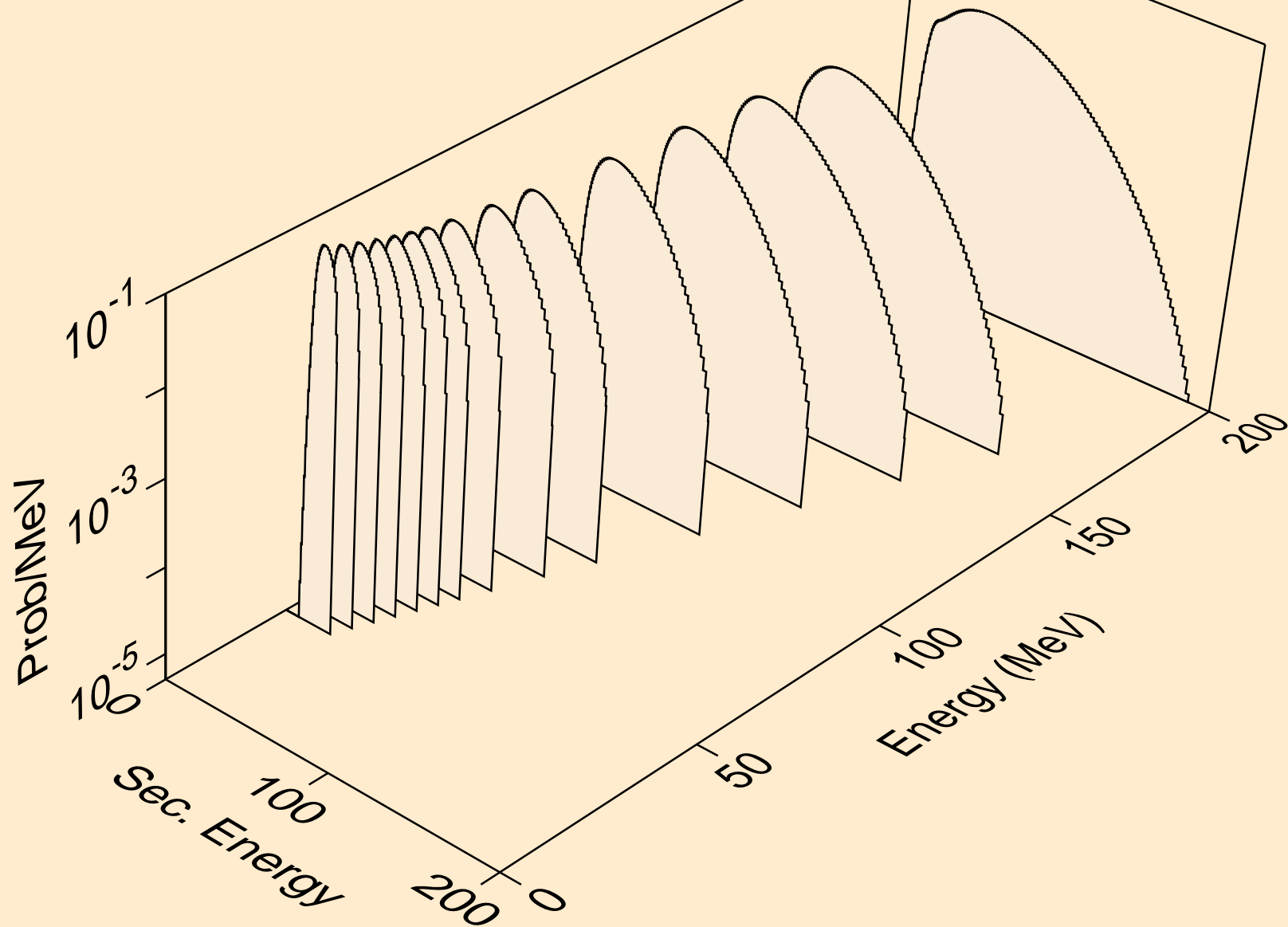

IN104M NEUTRON ACER TENDL-2024 LIBRARY; T=0.K
he3s from (n,n*)he3

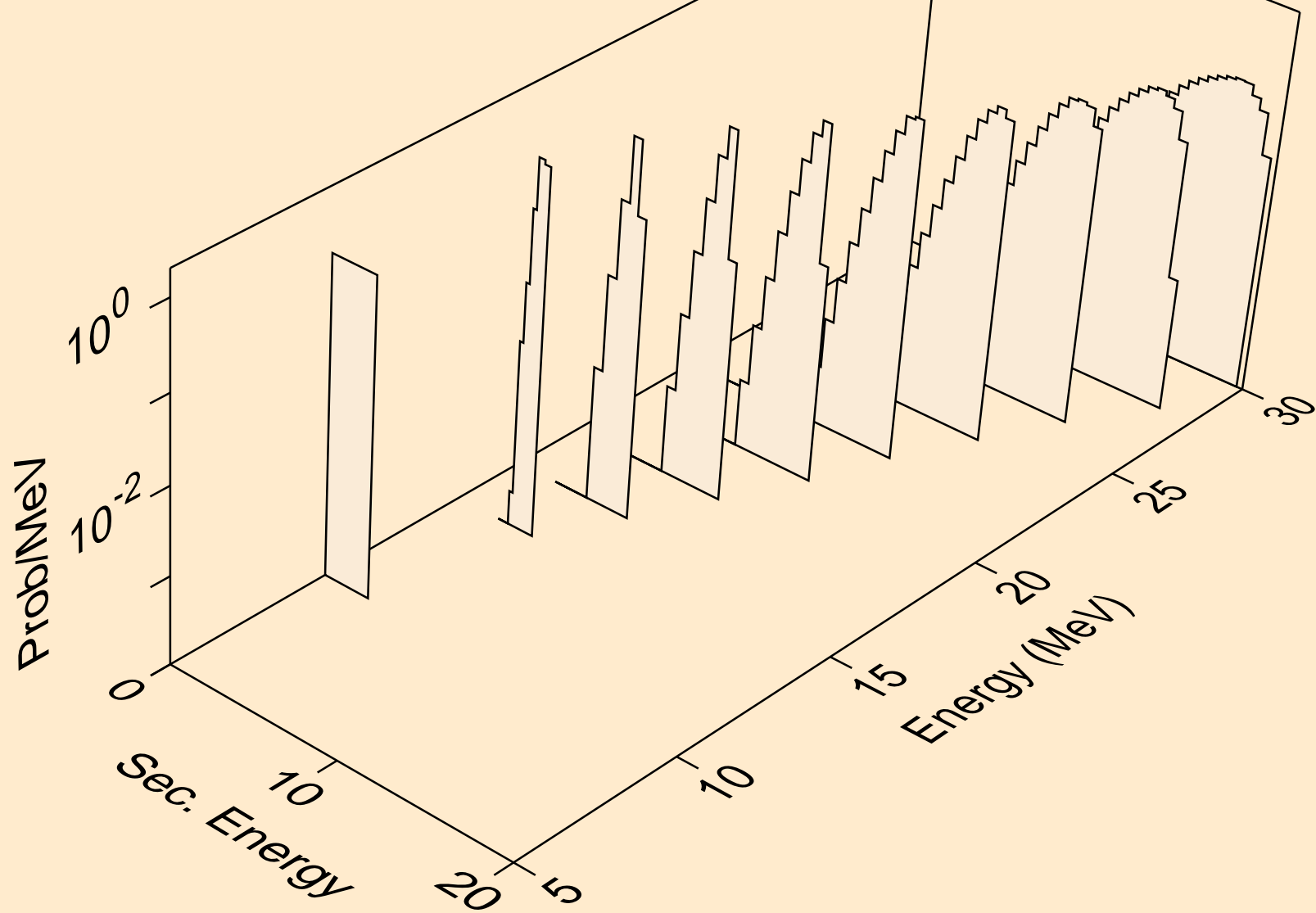

IN104M NEUTRON ACER TENDL-2024 LIBRARY; T=0.K
he3s from (n,he3)

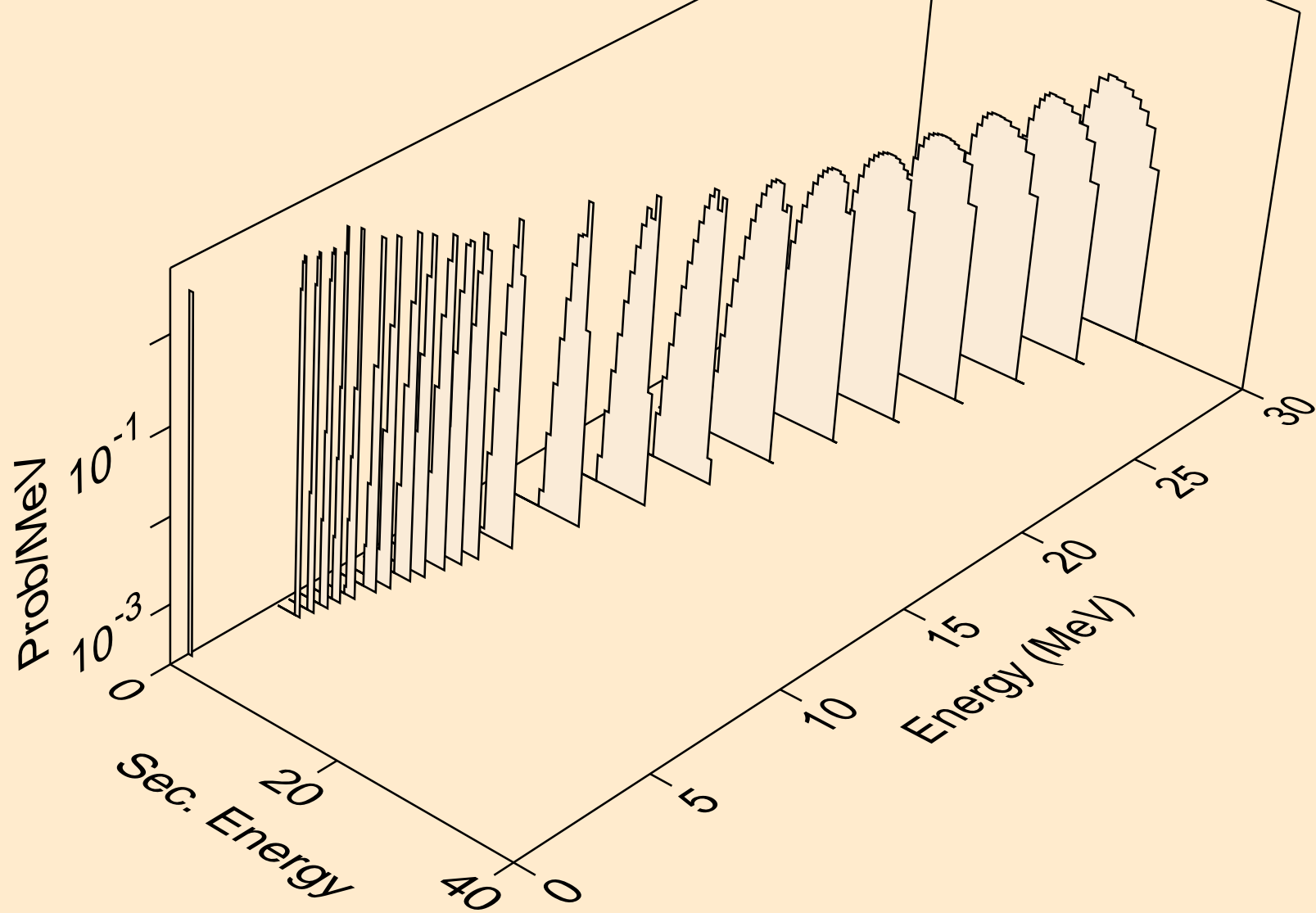

IN104M NEUTRON ACER TENDL-2024 LIBRARY; T=0.K
alphas from (n,x)

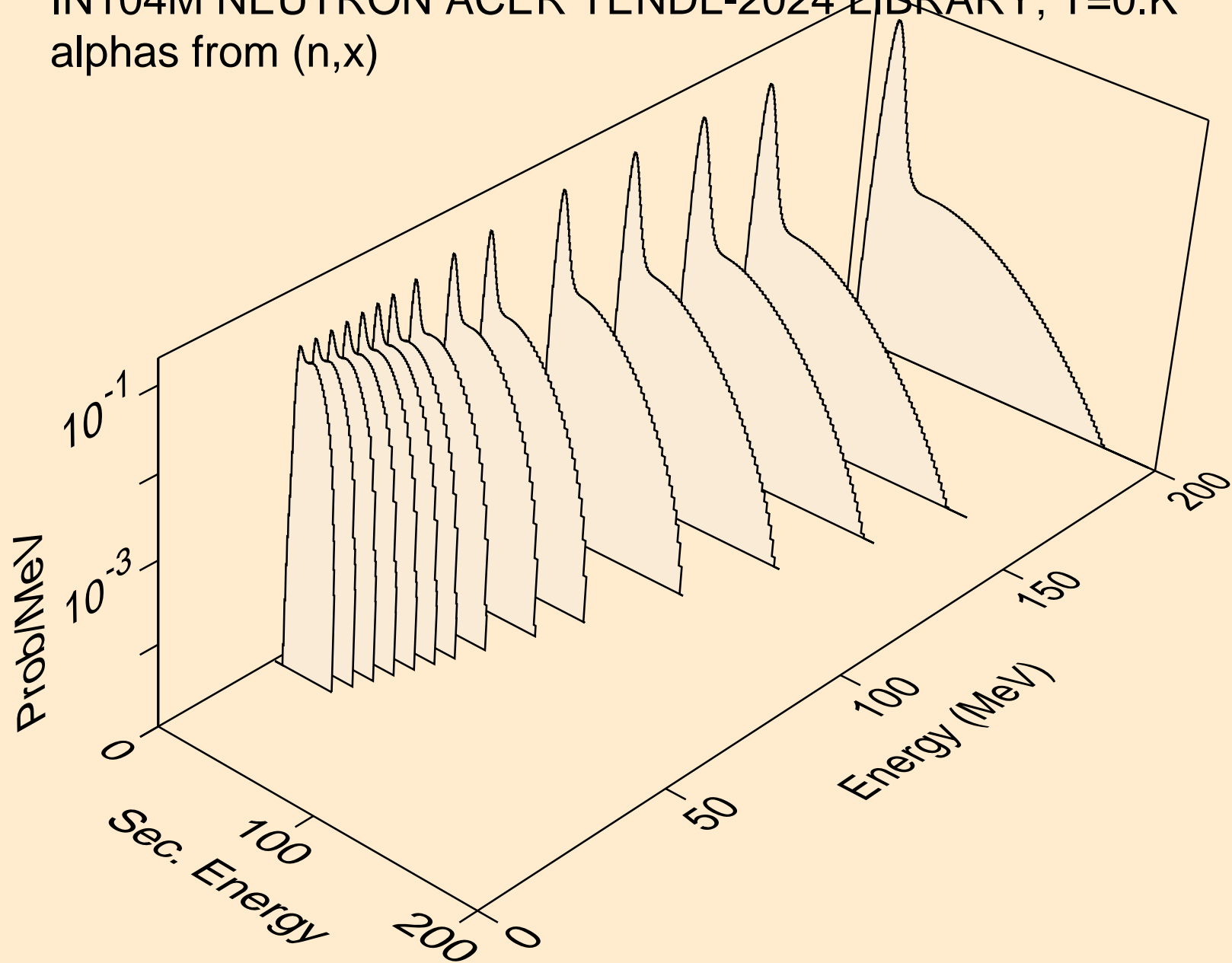

IN104M NEUTRON ACER TENDL-2024 LIBRARY; T=0.K
alphas from (n,n*)a

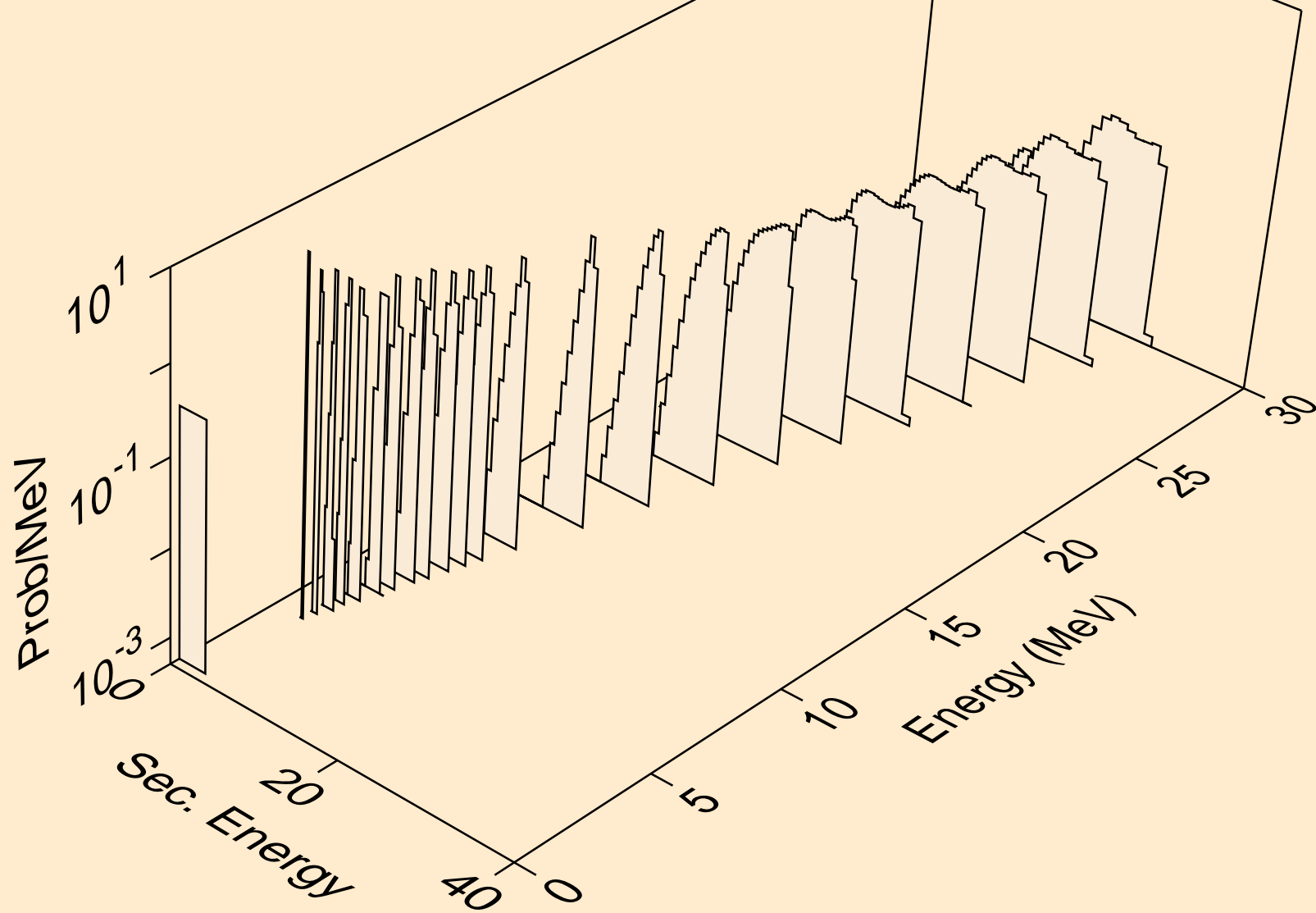

IN104M NEUTRON ACER TENDL-2024 LIBRARY; T=0.K
alphas from (n,2n)a

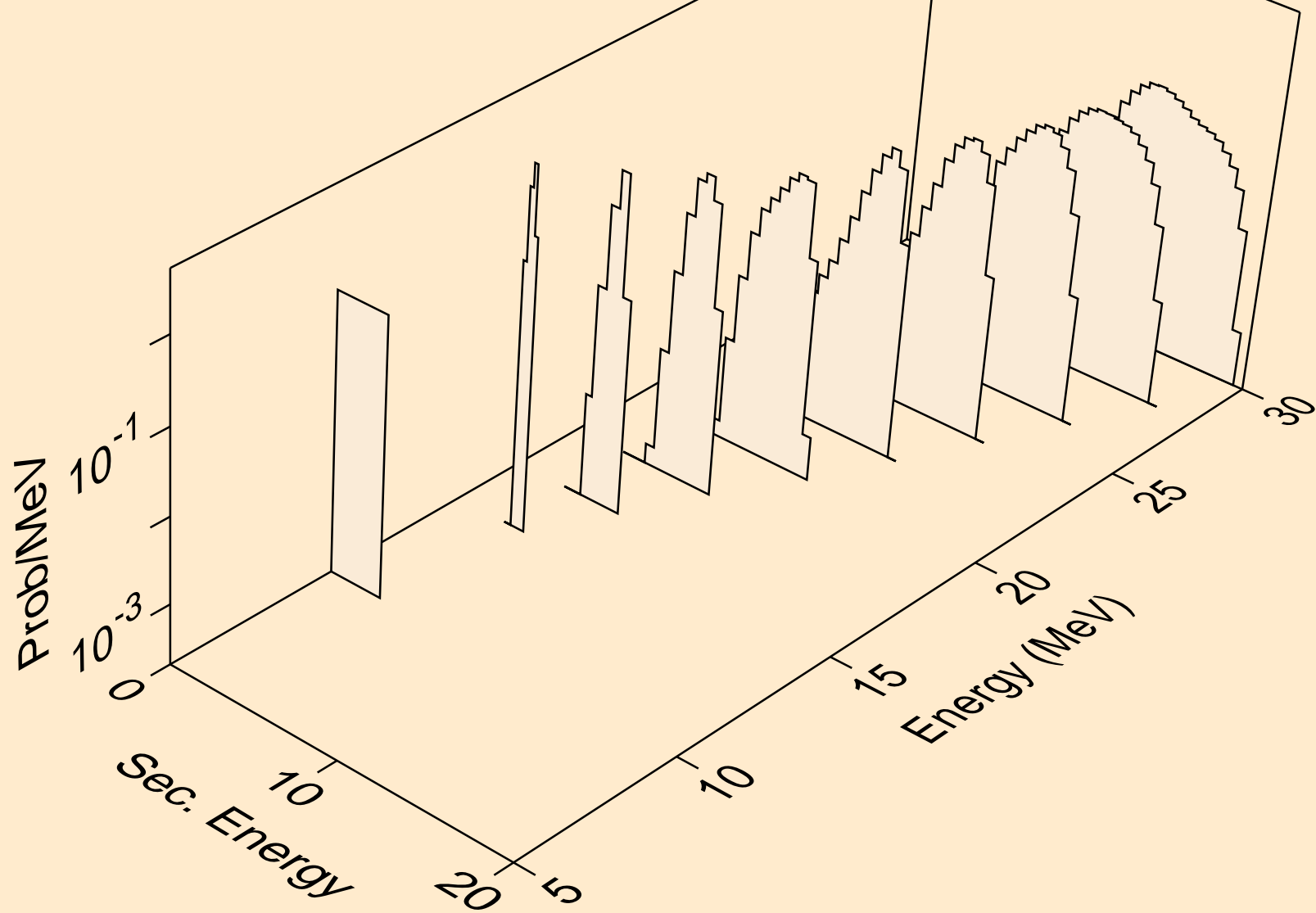

IN104M NEUTRON ACER TENDL-2024 LIBRARY; T=0.K
alphas from (n,n*)2a

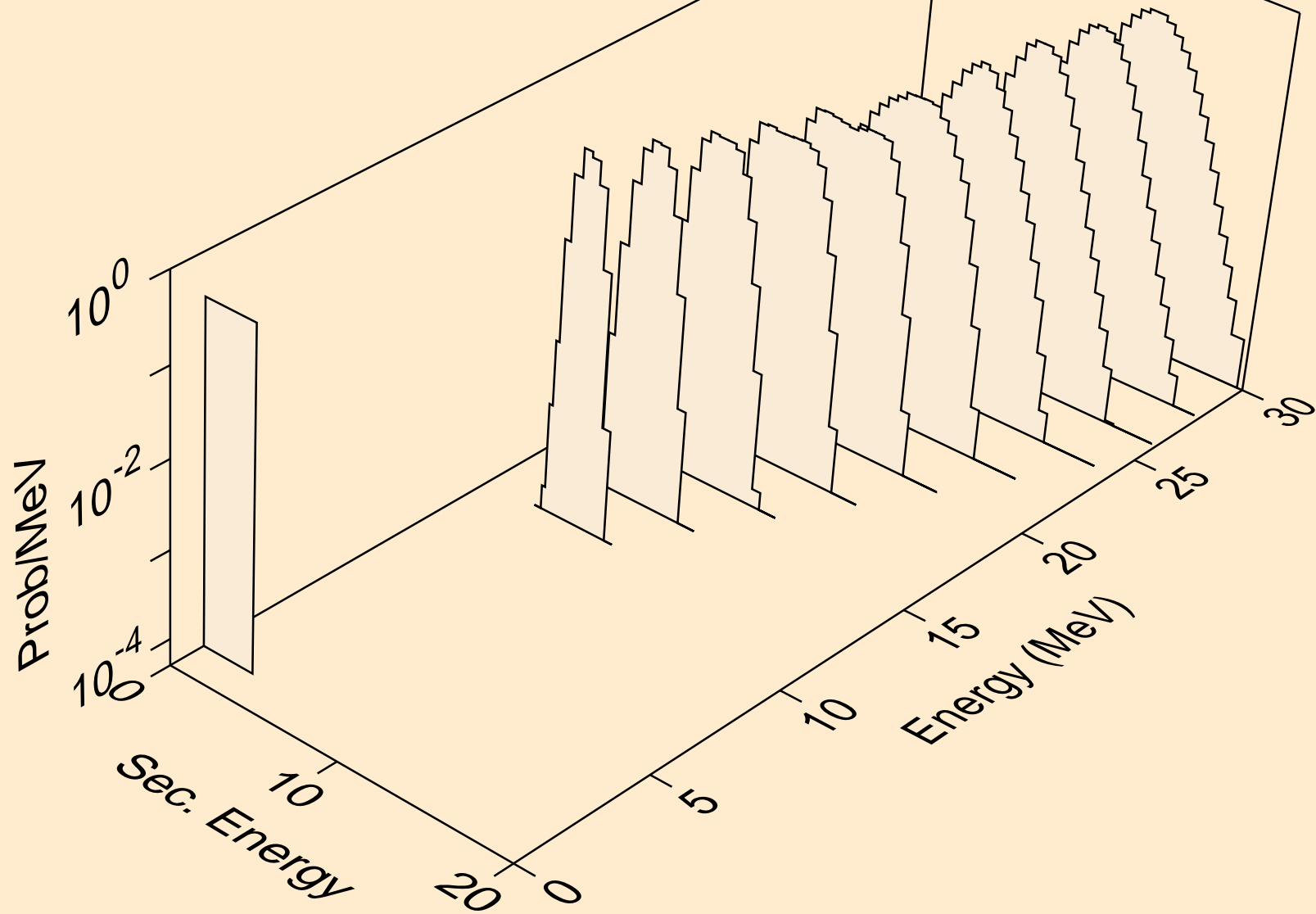

IN104M NEUTRON ACER TENDL-2024 LIBRARY; T=0.K
alphas from (n,2n)2a

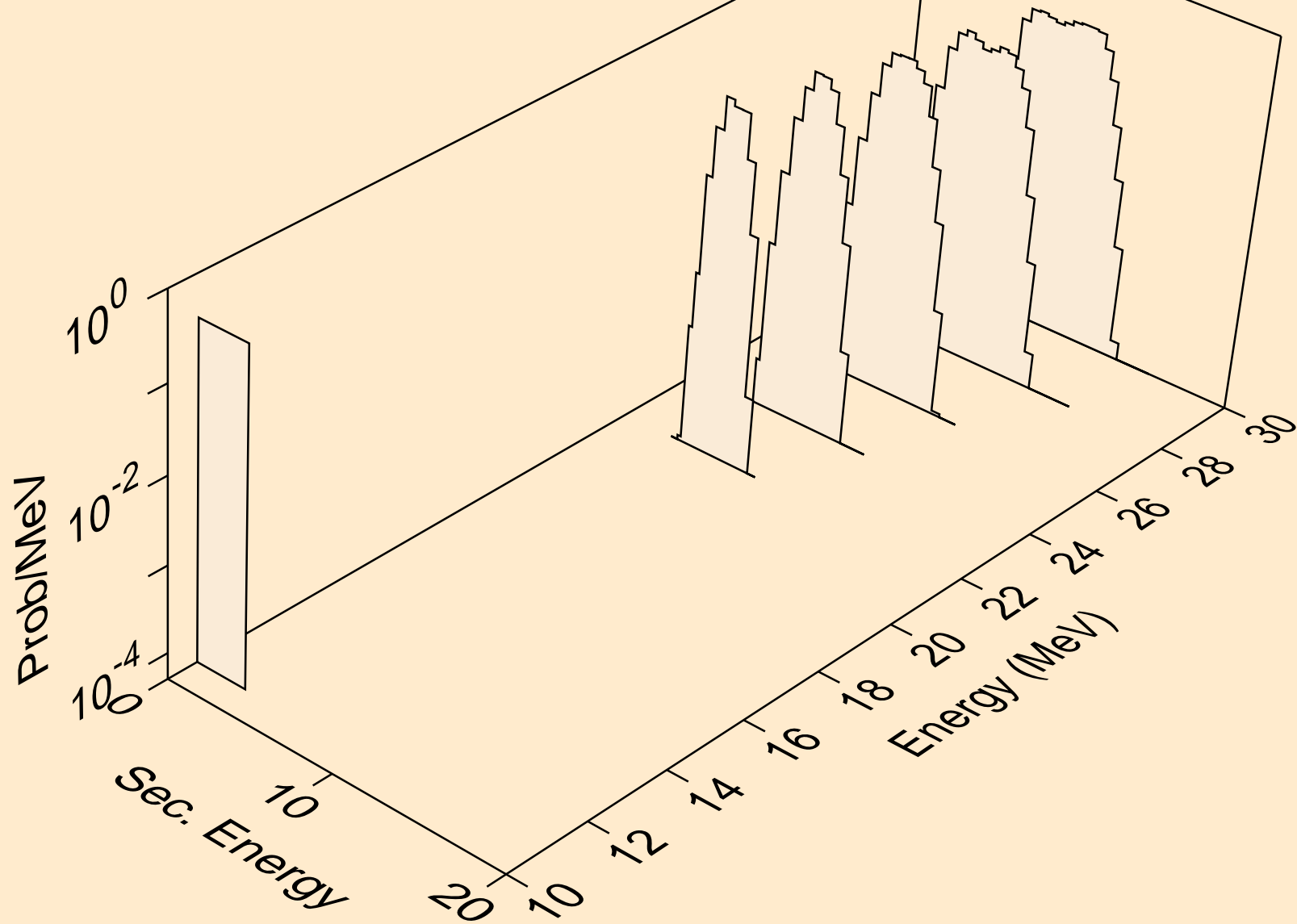

IN104M NEUTRON ACER TENDL-2024 LIBRARY; T=0.K
alphas from (n,npa)

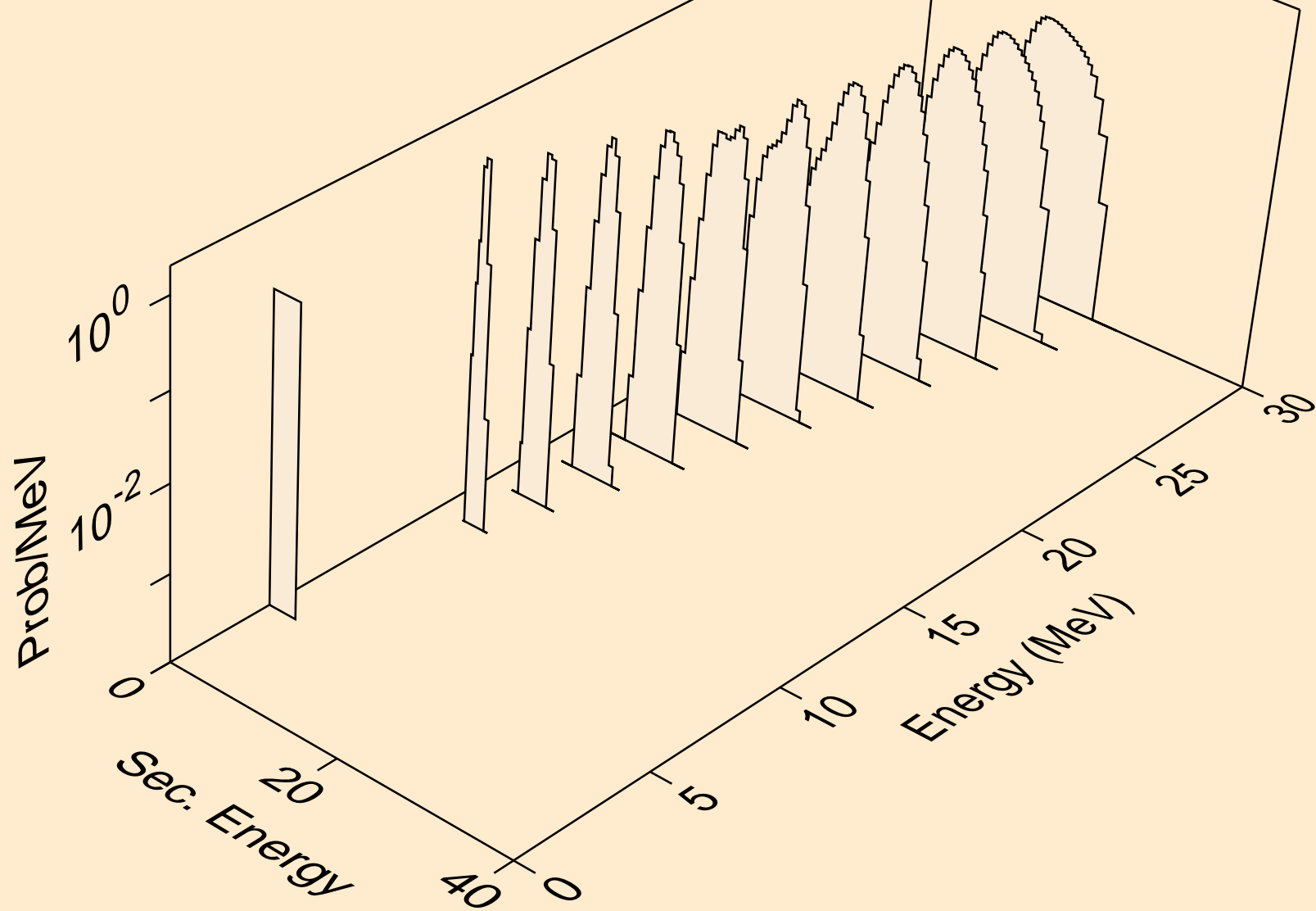

IN104M NEUTRON ACER TENDL-2024 LIBRARY; T=0.K
alphas from (n,a)

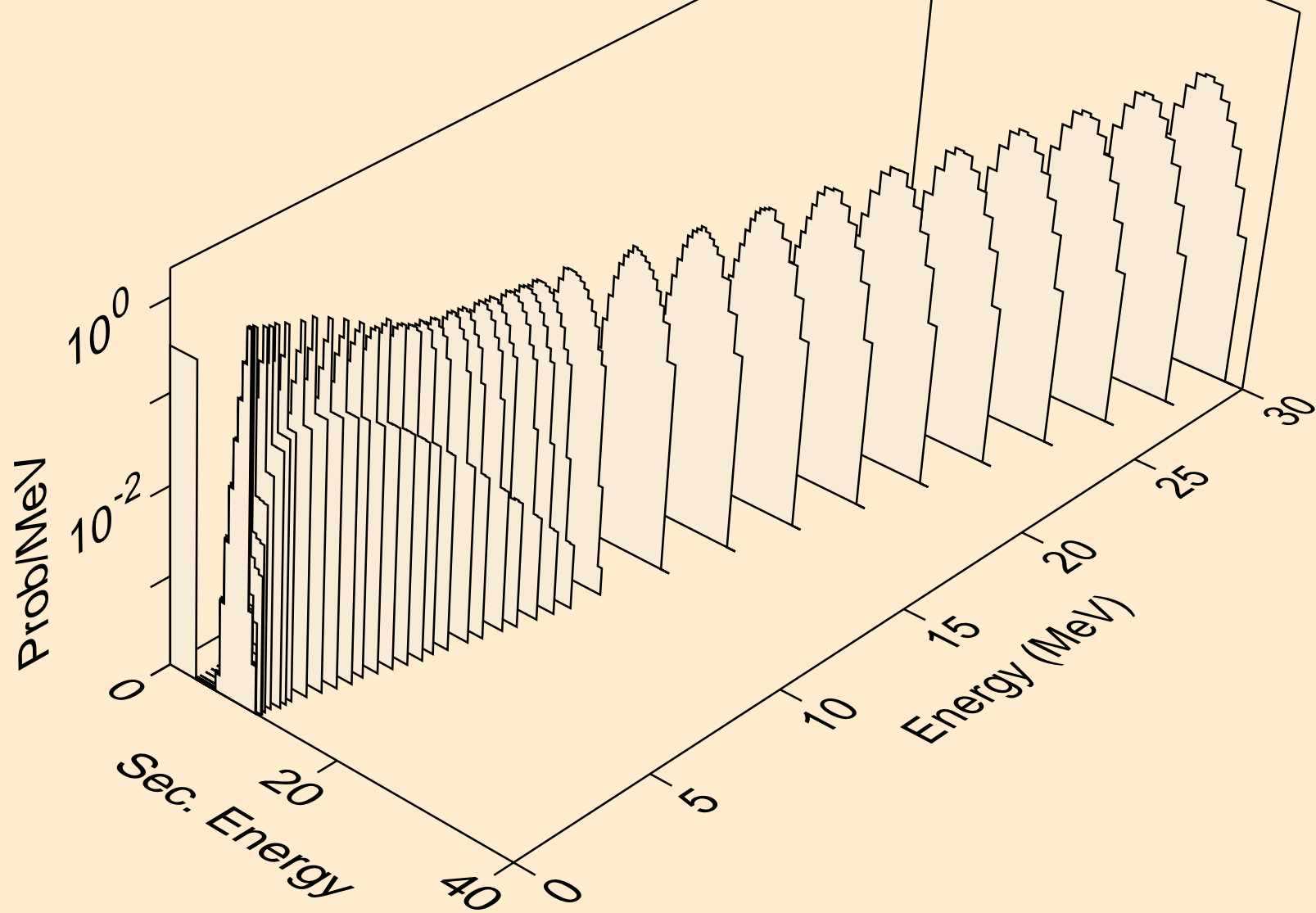

IN104M NEUTRON ACER TENDL-2024 LIBRARY; T=0.K
alphas from (n,2a)

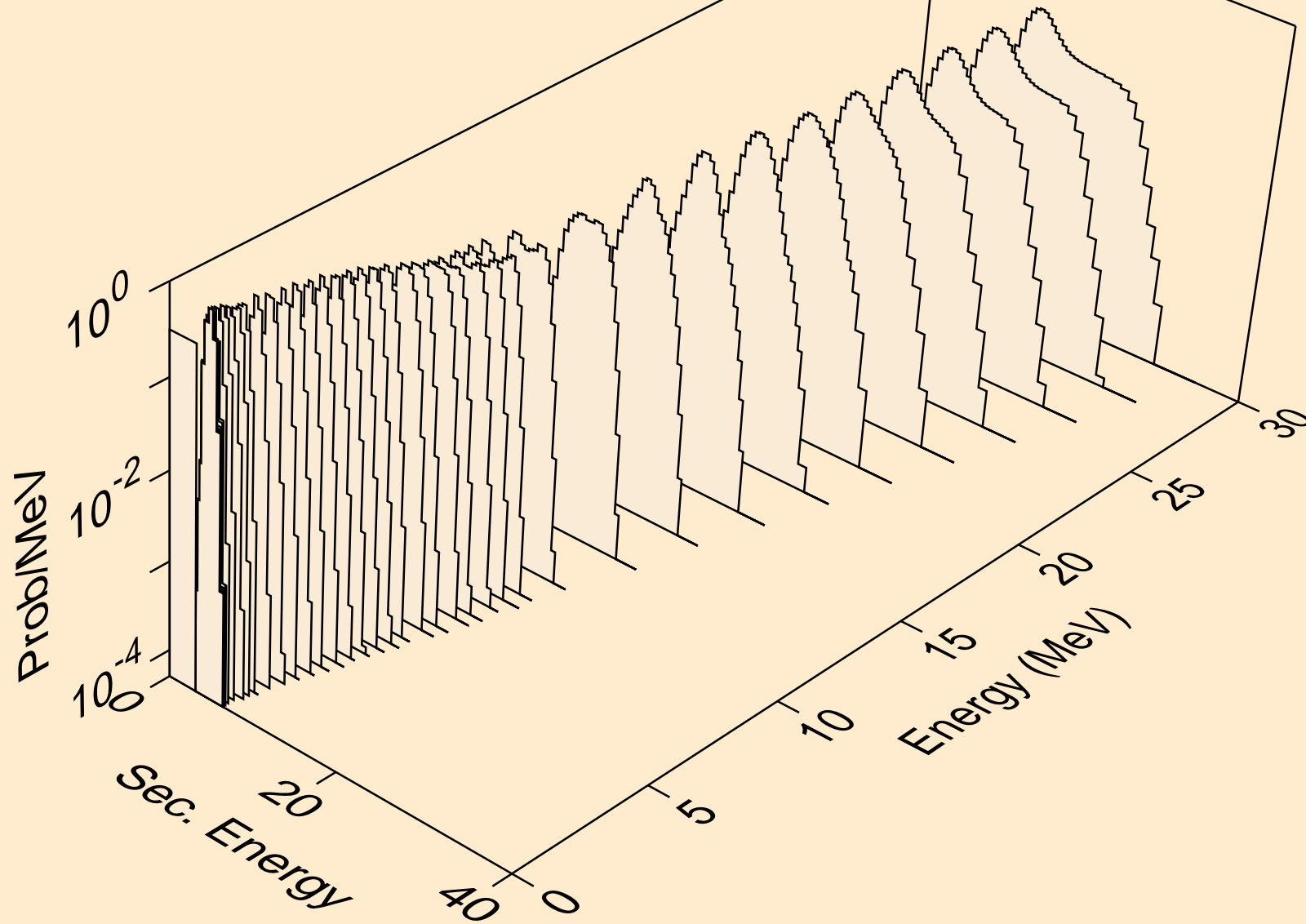

IN104M NEUTRON ACER TENDL-2024 LIBRARY; T=0.K
alphas from (n,3a)

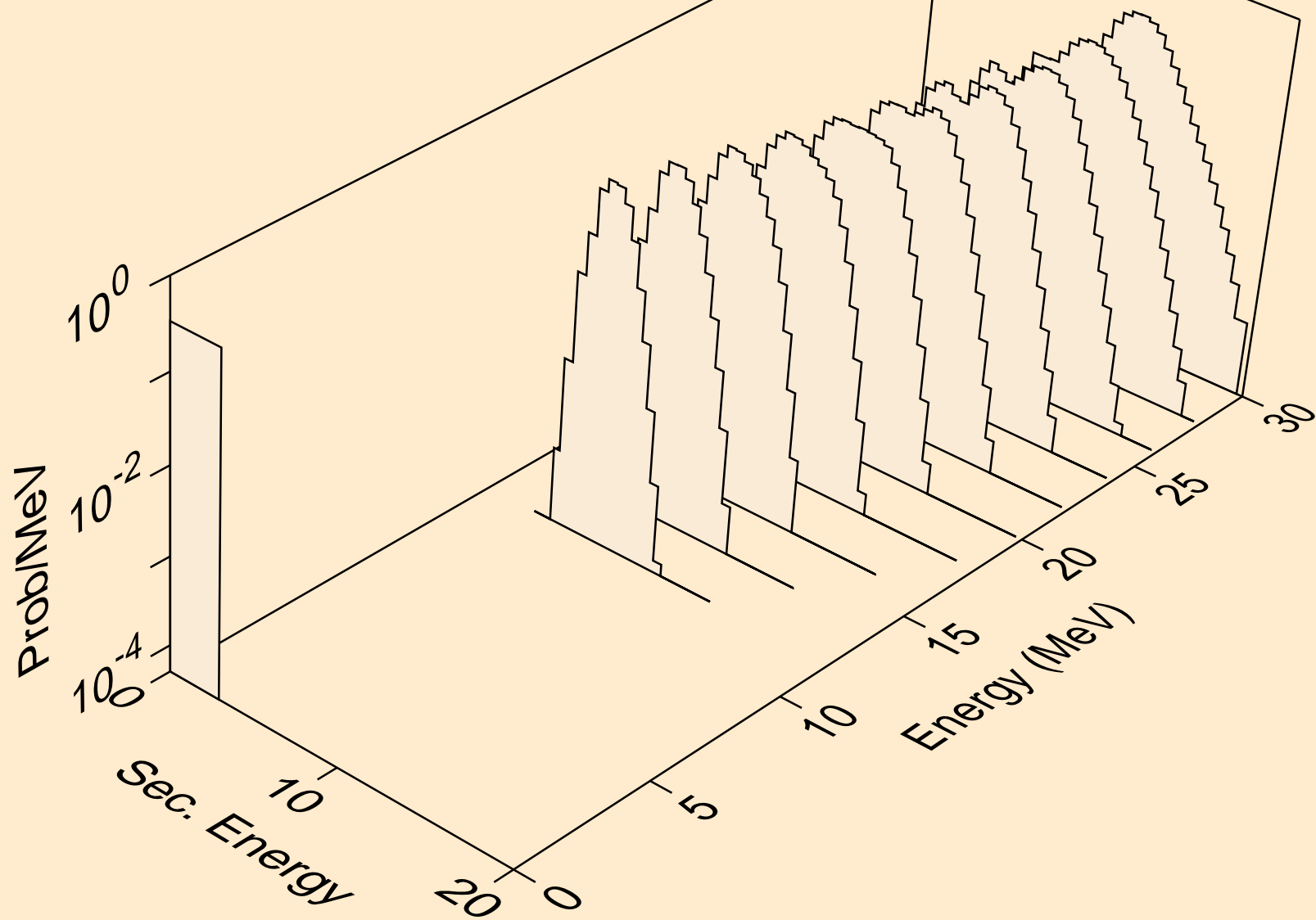

IN104M NEUTRON ACER TENDL-2024 LIBRARY; T=0.K
alphas from (n,pa)

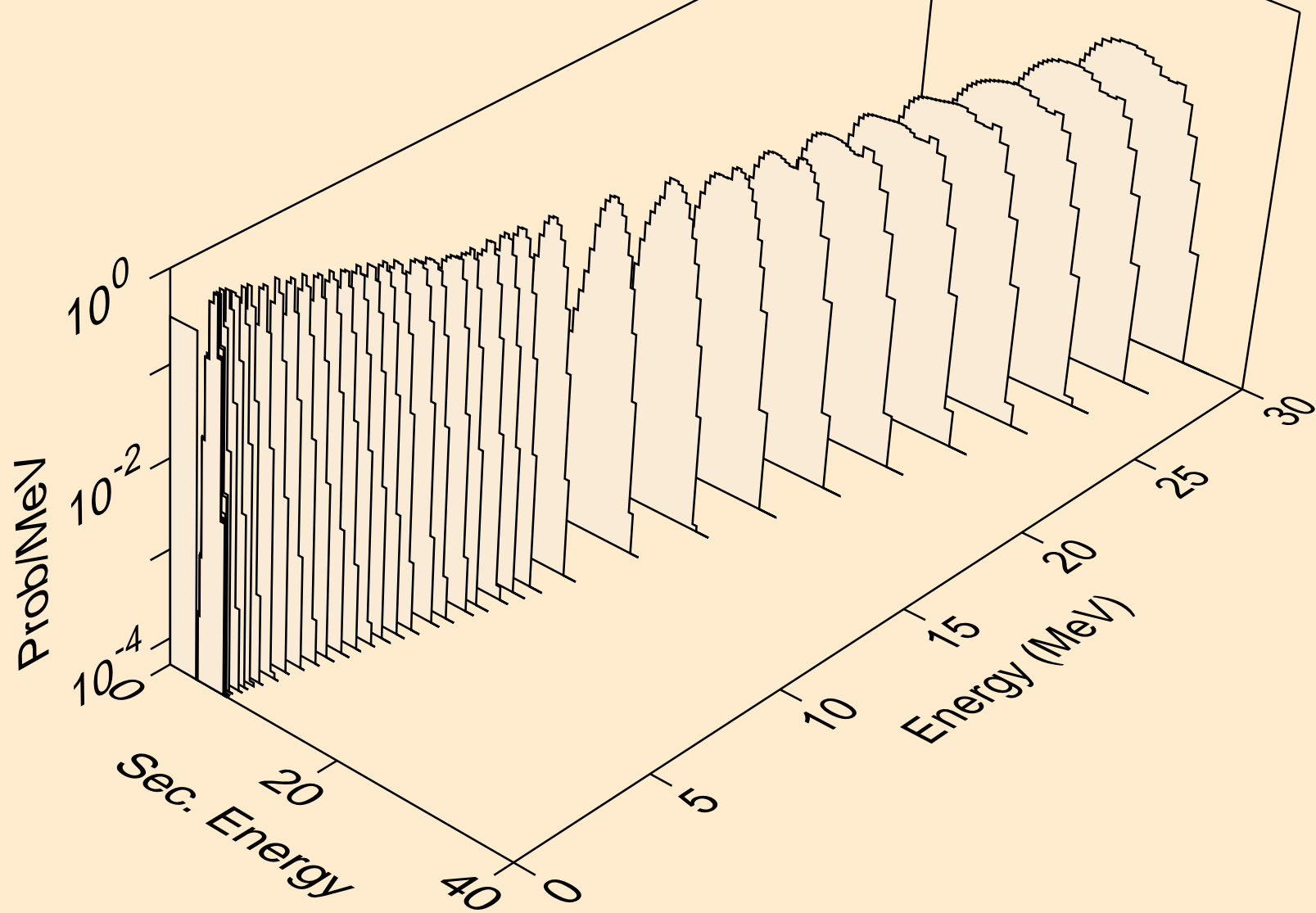

IN104M NEUTRON ACER TENDL-2024 LIBRARY; T=0.K
alphas from (n,d2a)

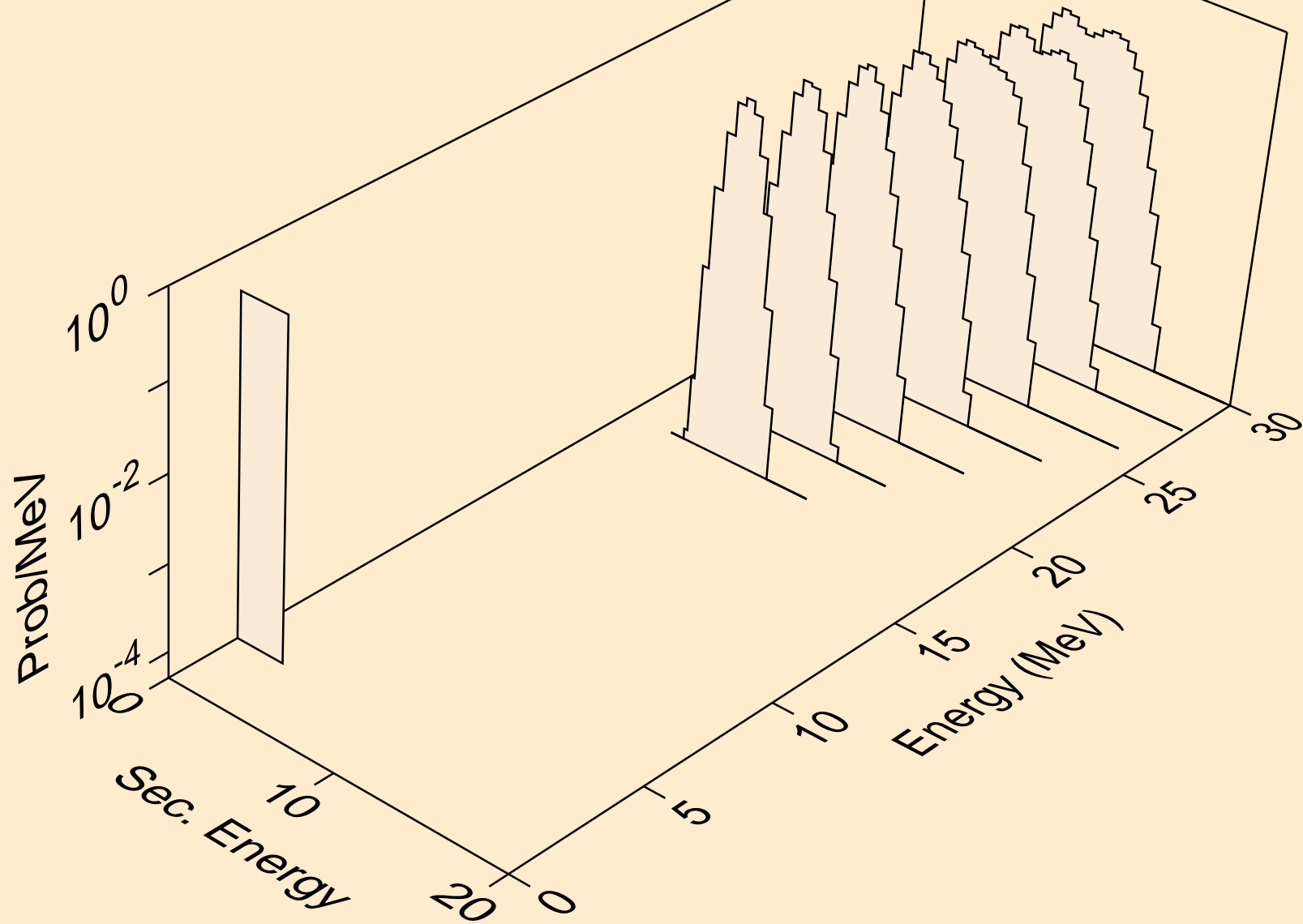

IN104M NEUTRON ACER TENDL-2024 LIBRARY; T=0.K
alphas from (n,da)

