

IN107M NEUTRON ACER TENDL-2024 LIBRARY; T=0.K

Principal cross sections

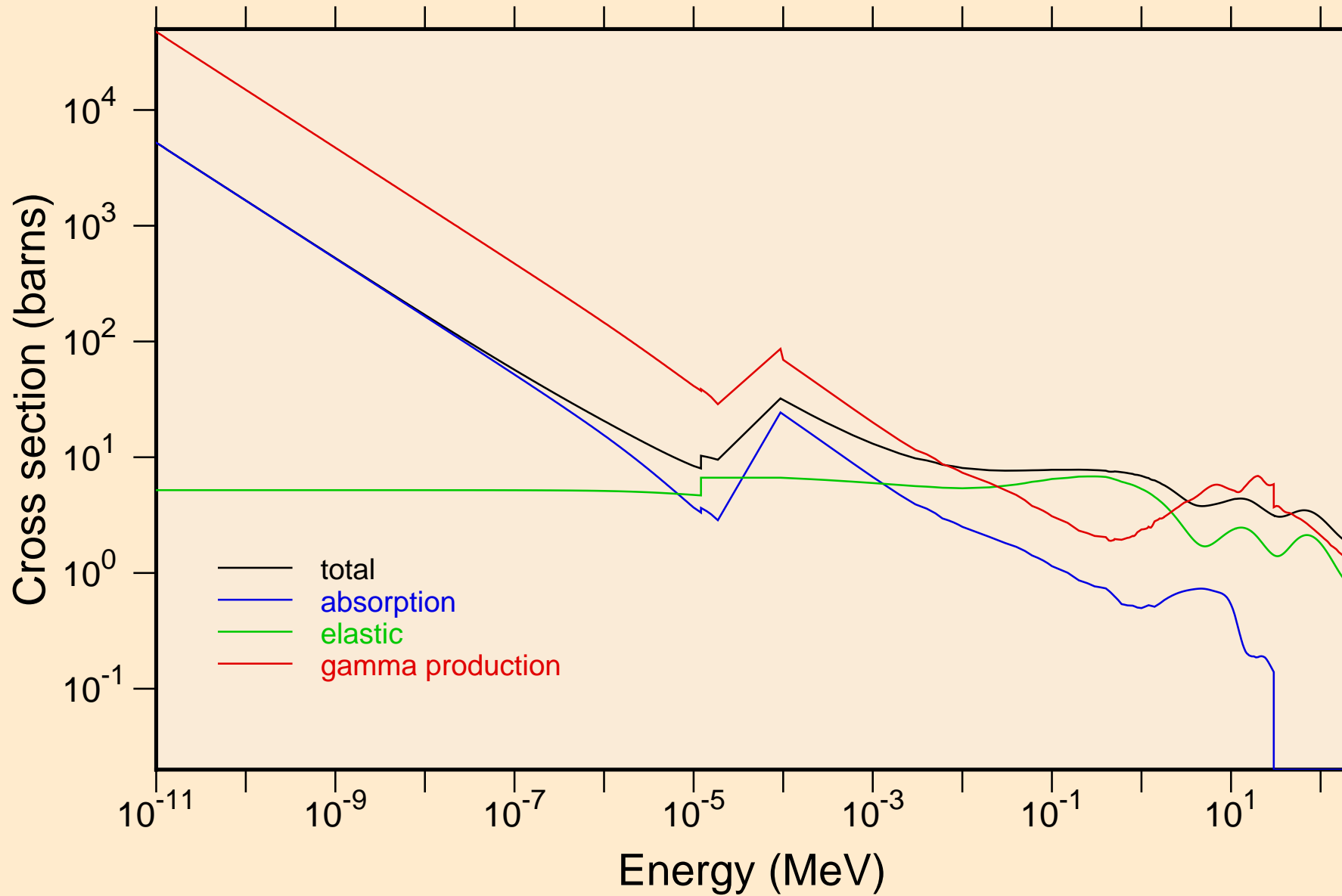

IN107M NEUTRON ACER TENDL-2024 LIBRARY; T=0.K
Heating

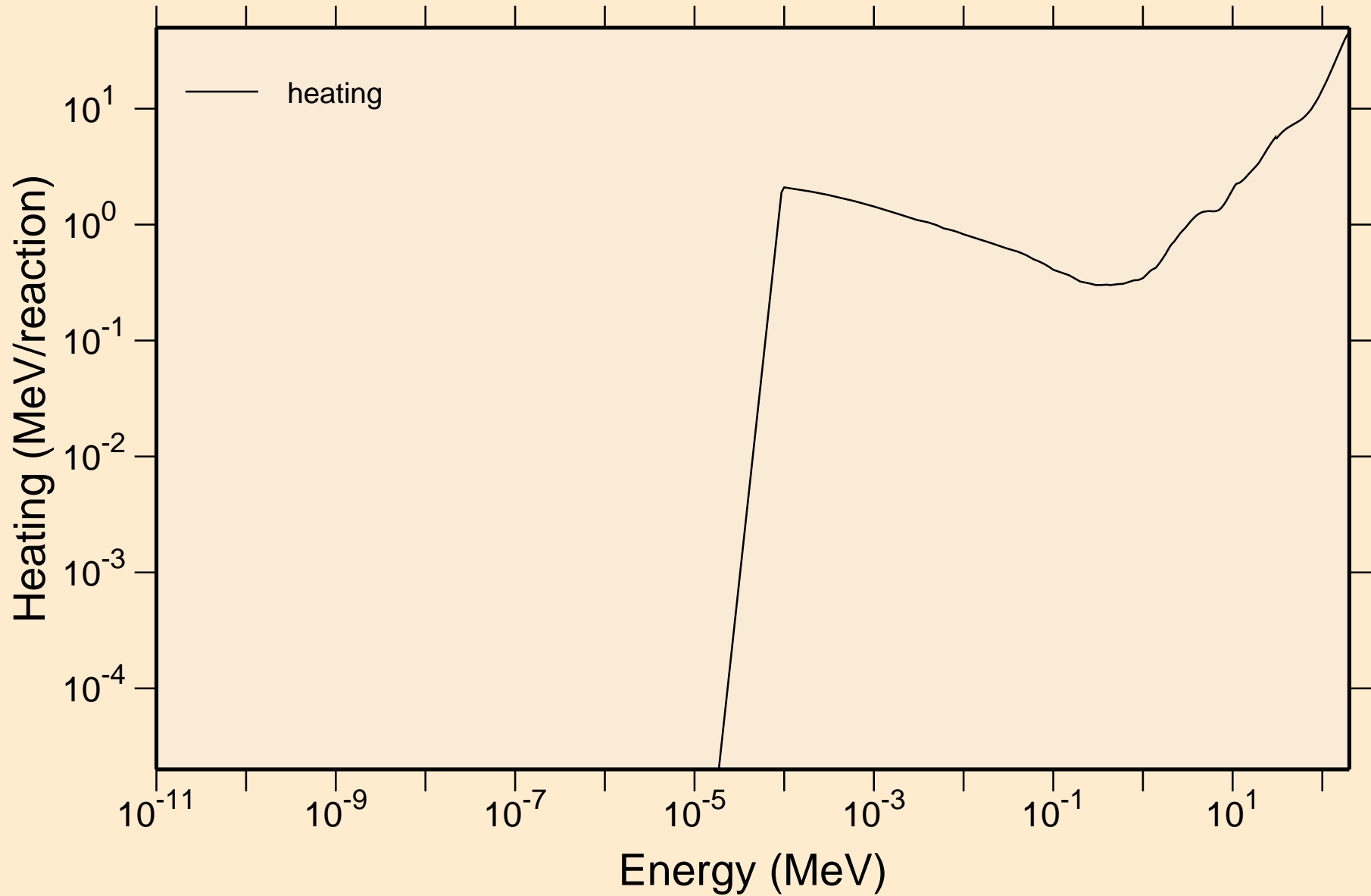

IN107M NEUTRON ACER TENDL-2024 LIBRARY; T=0.K
Damage

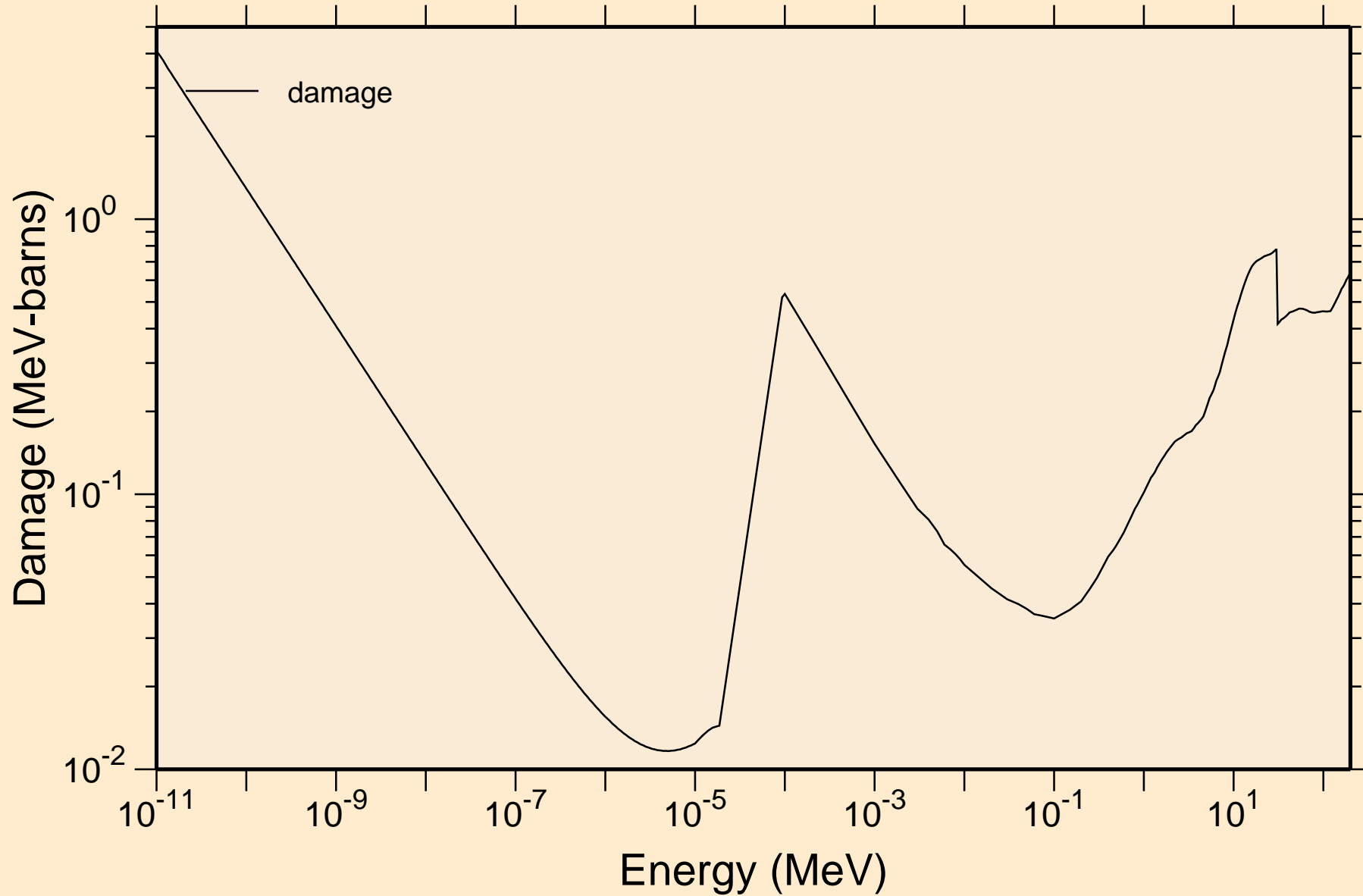

IN107M NEUTRON ACER TENDL-2024 LIBRARY; T=0.K

Non-threshold reactions

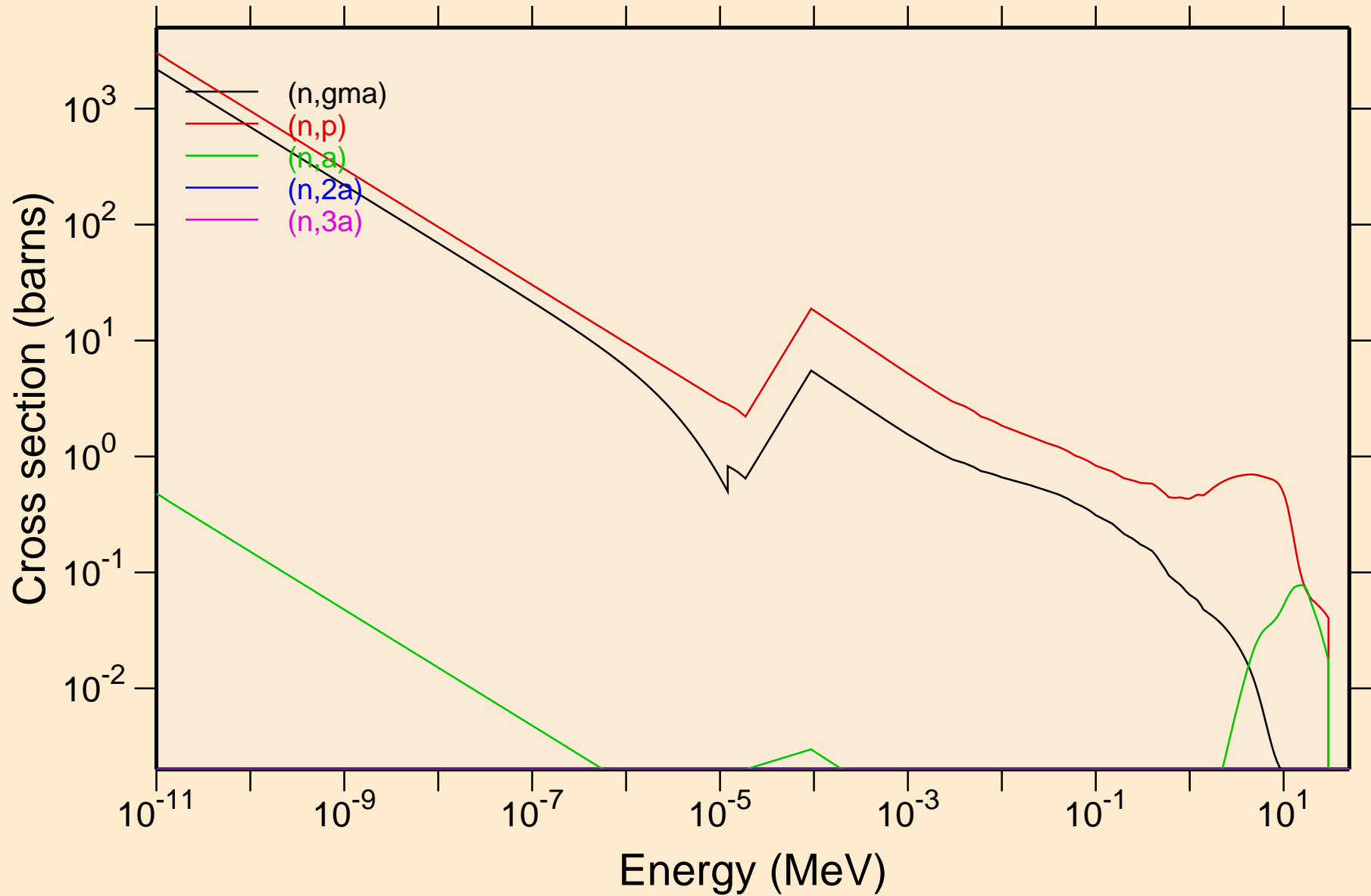

IN107M NEUTRON ACER TENDL-2024 LIBRARY; T=0.K
Non-threshold reactions

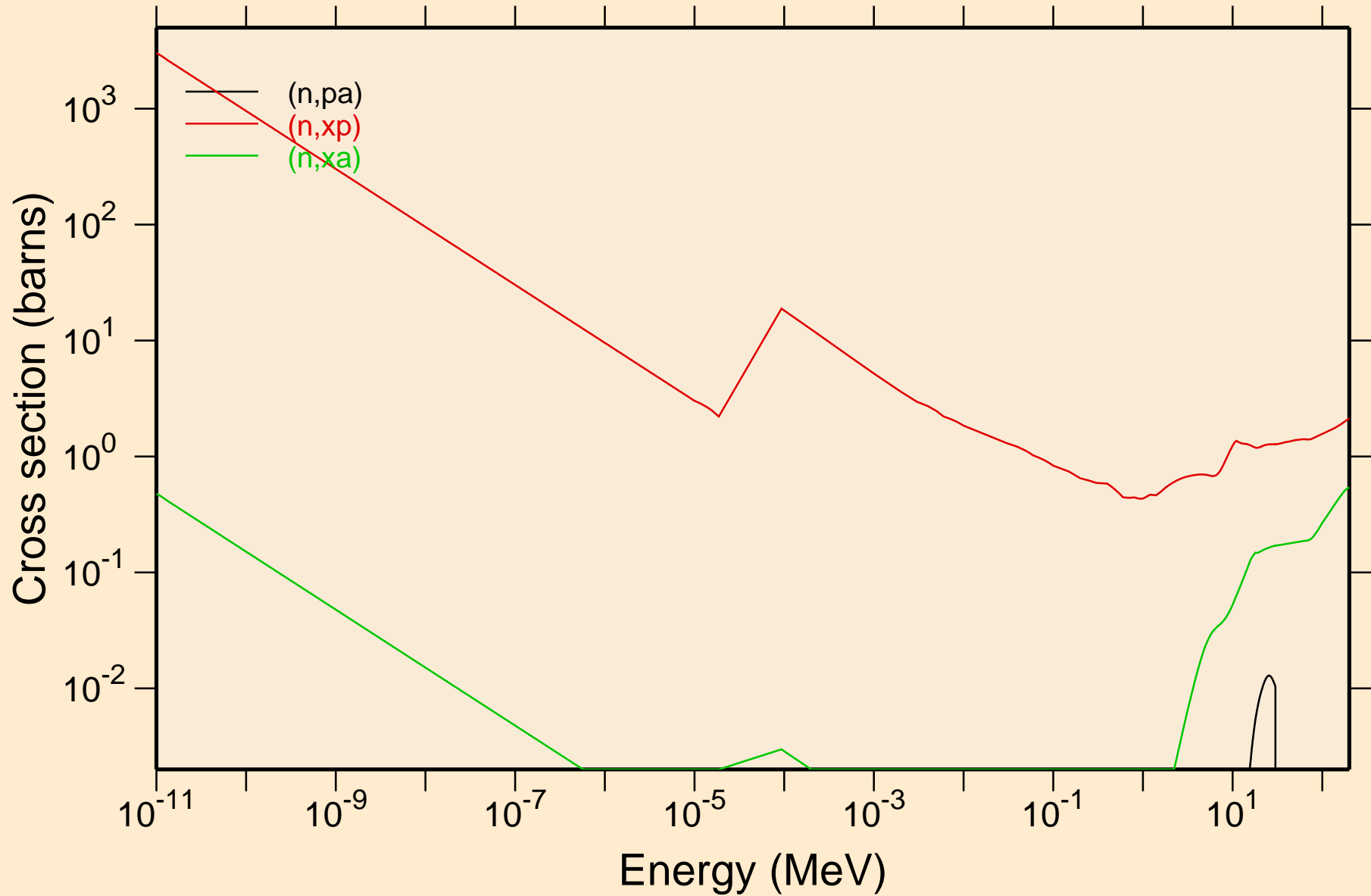

IN107M NEUTRON ACER TENDL-2024 LIBRARY; T=0.K

Principal cross sections

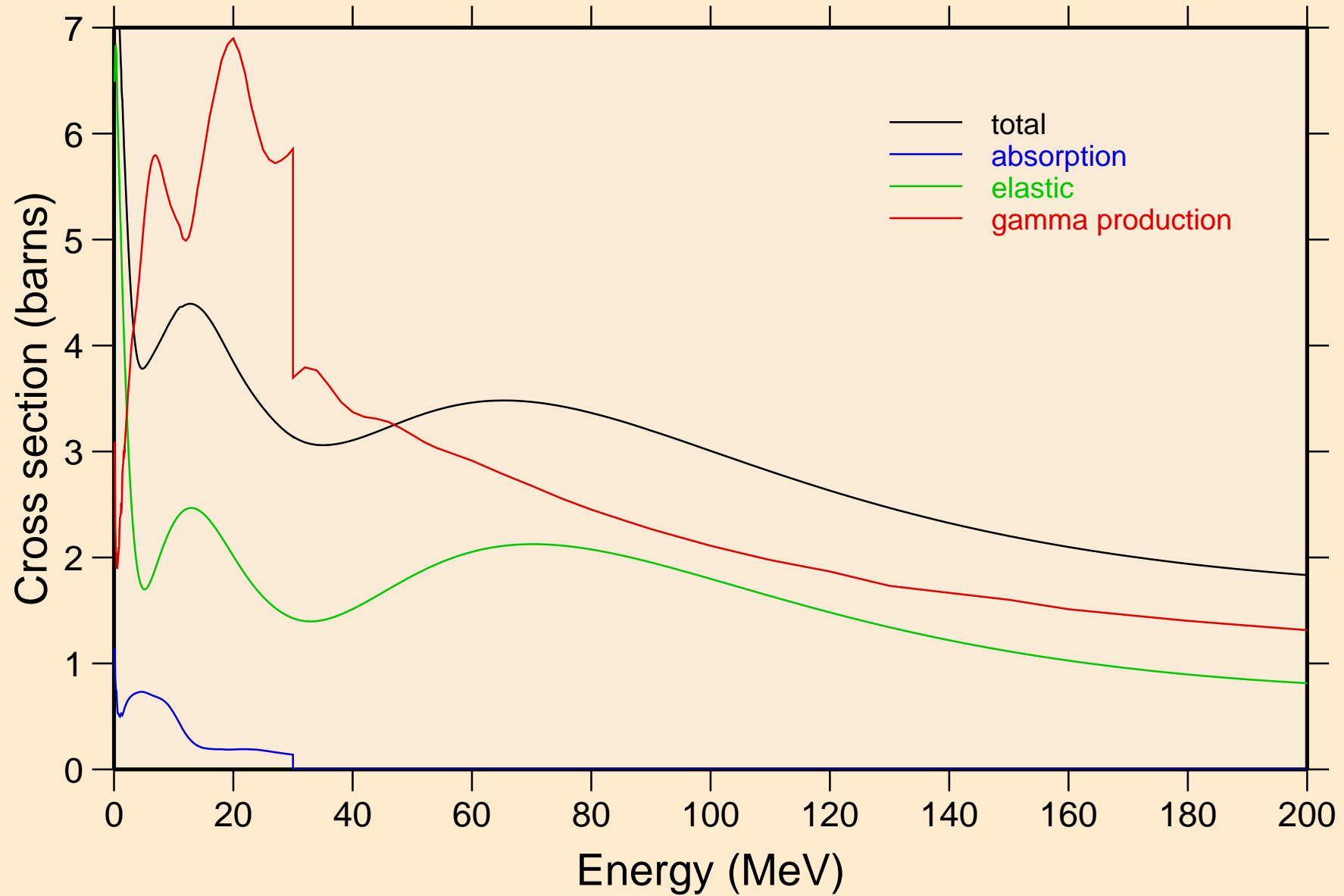

IN107M NEUTRON ACER TENDL-2024 LIBRARY; T=0.K

Heating

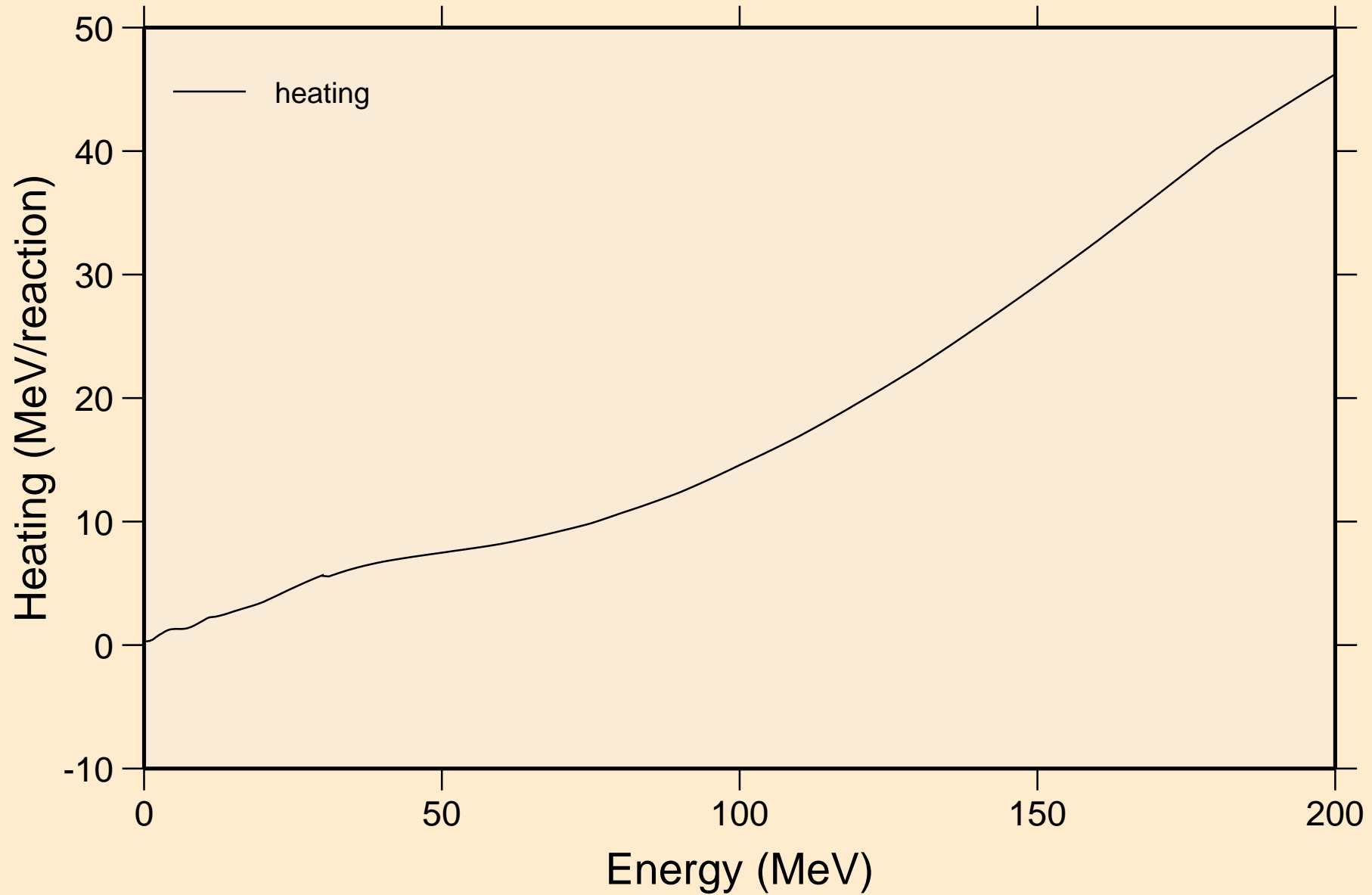

IN107M NEUTRON ACER TENDL-2024 LIBRARY; T=0.K

Damage

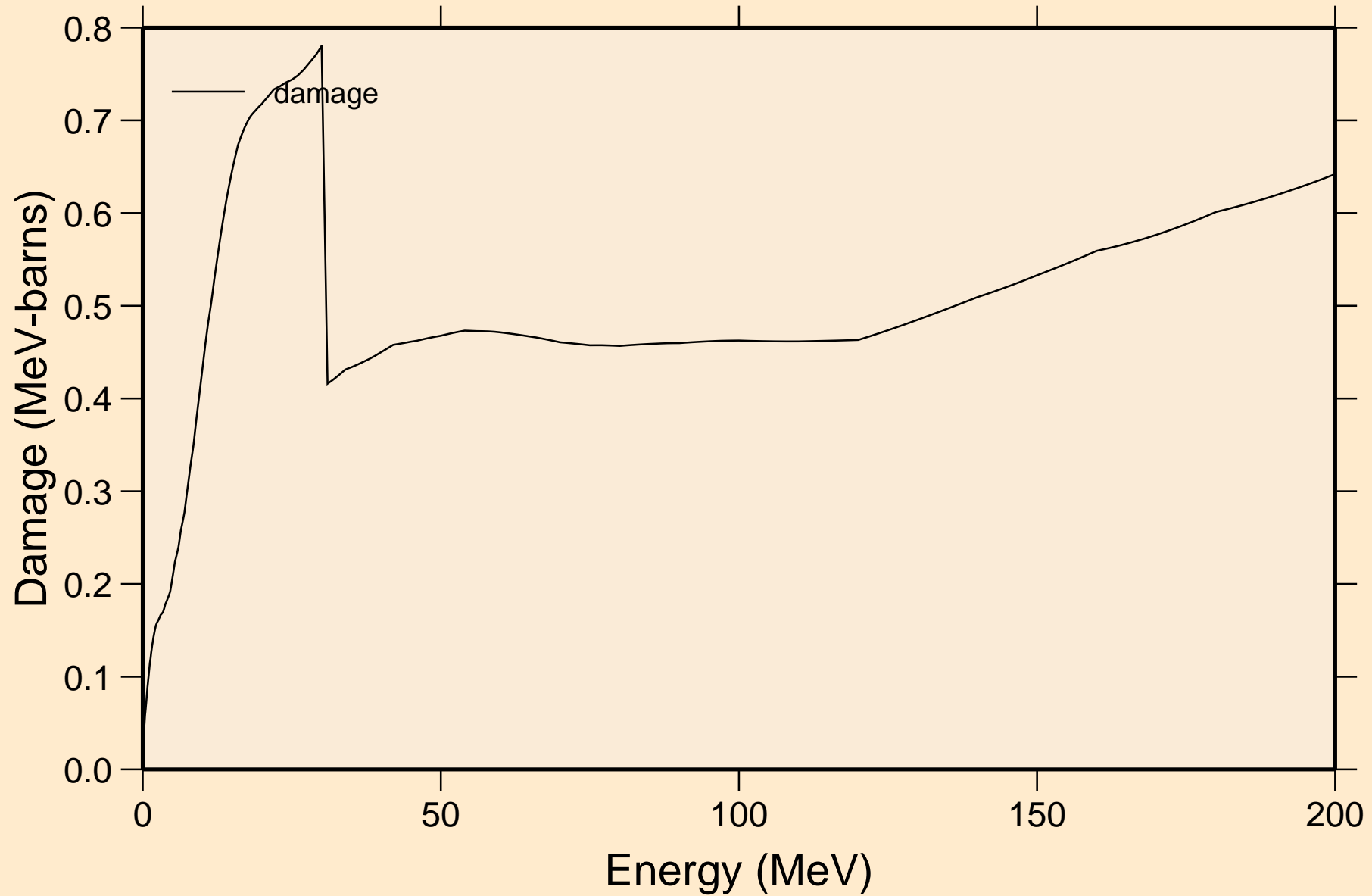

IN107M NEUTRON ACER TENDL-2024 LIBRARY; T=0.K

Non-threshold reactions

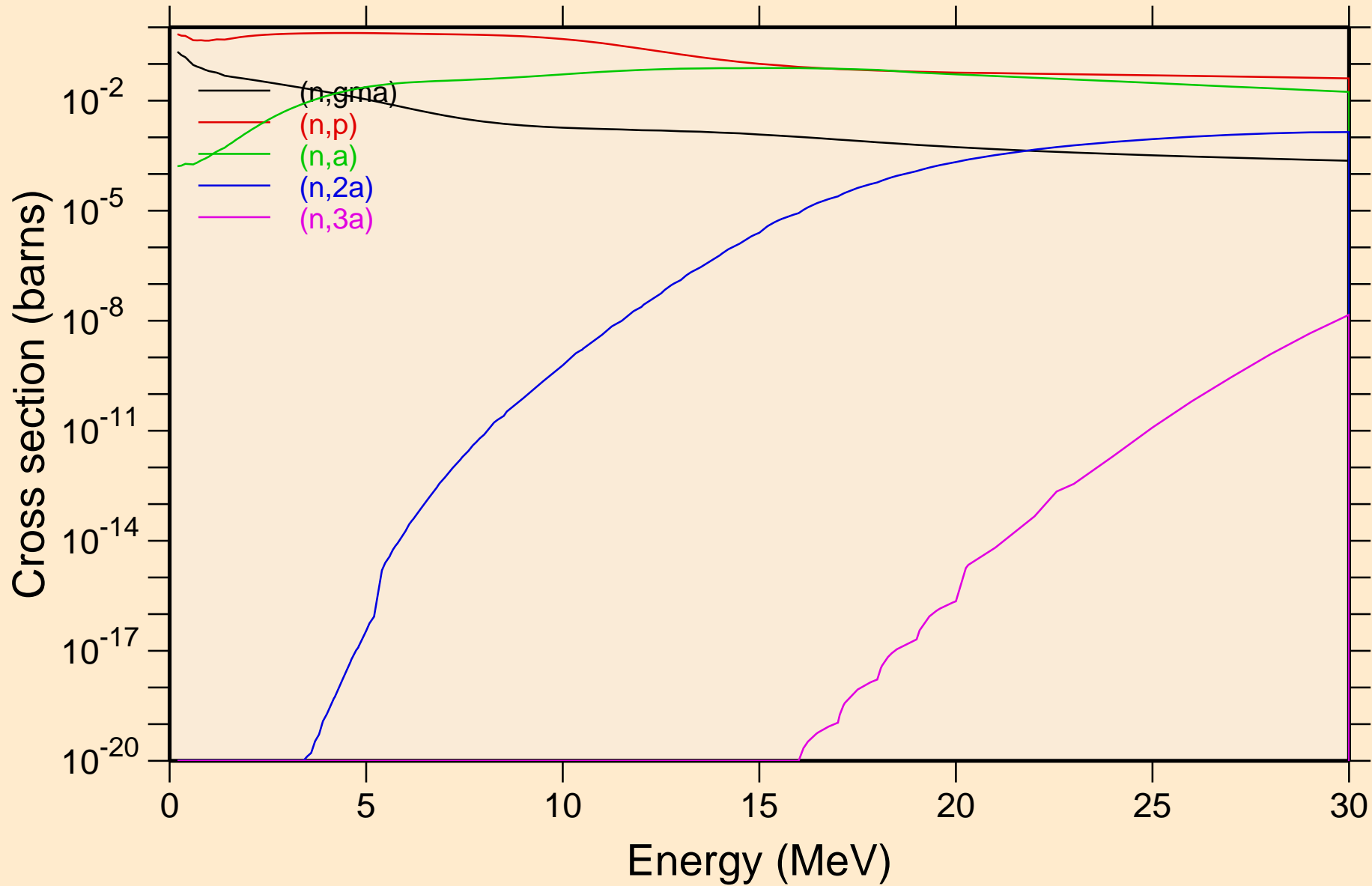

IN107M NEUTRON ACER TENDL-2024 LIBRARY; T=0.K

Non-threshold reactions

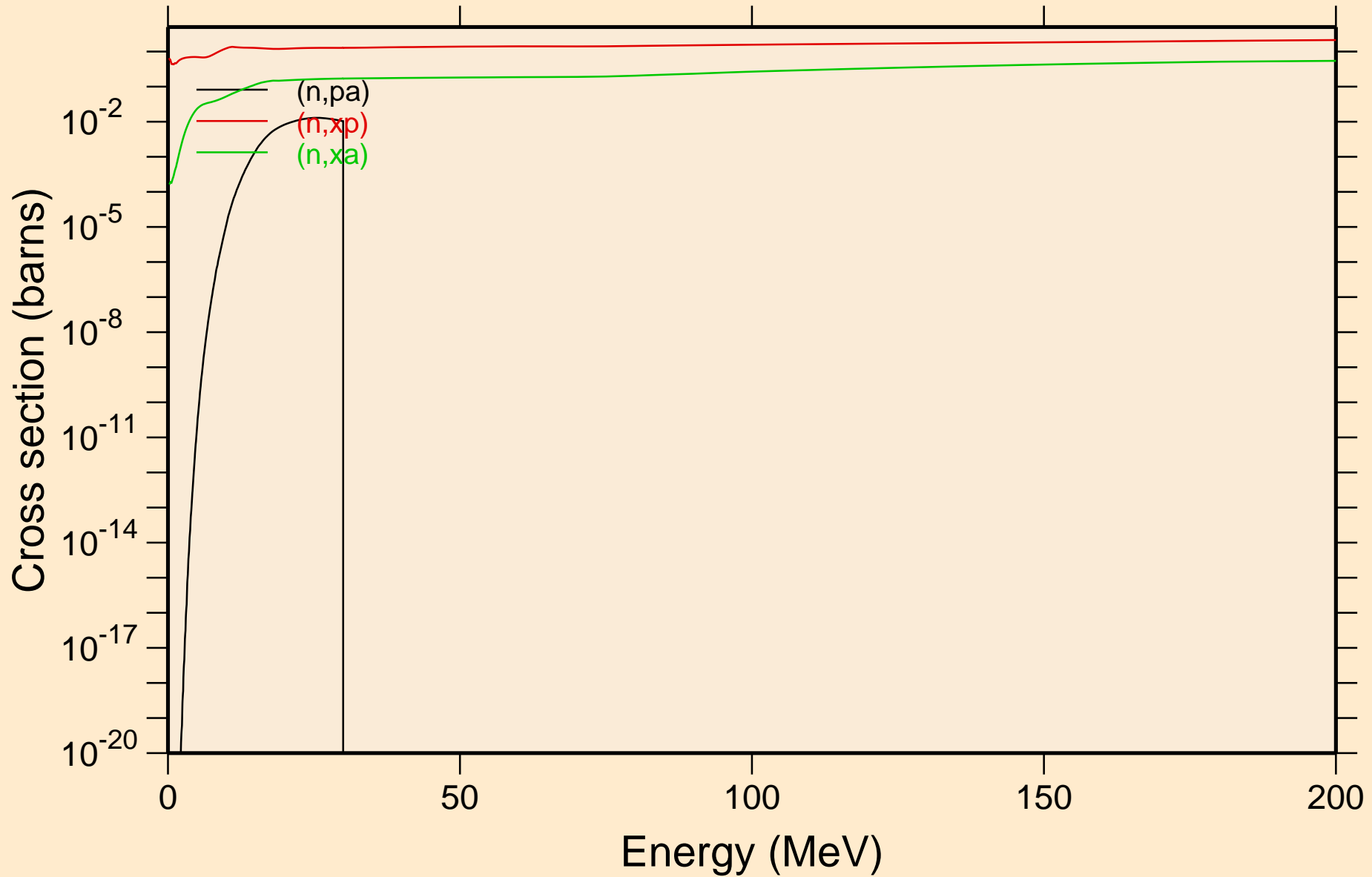

IN107M NEUTRON ACER TENDL-2024 LIBRARY; T=0.K
Inelastic levels

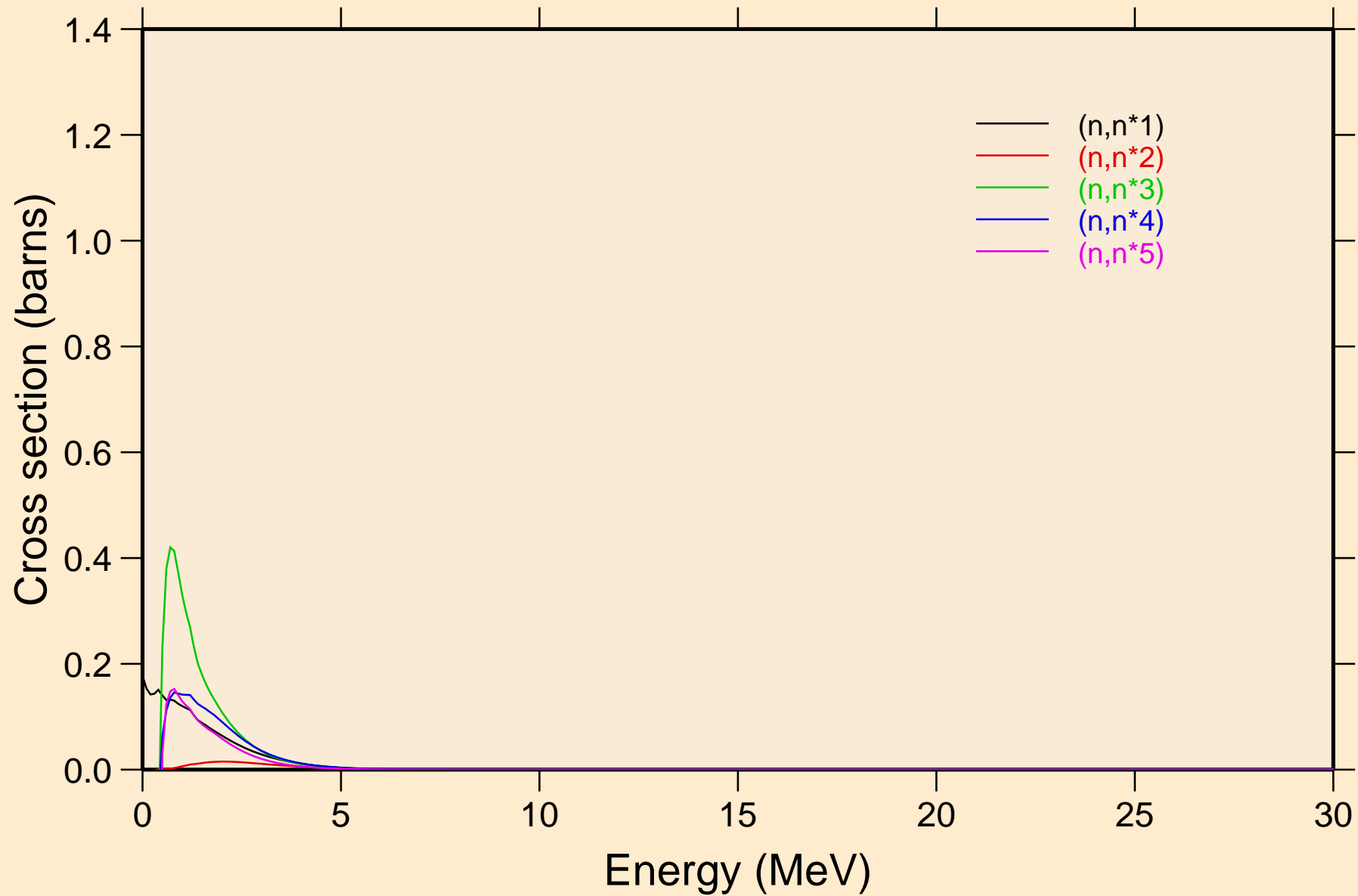

IN107M NEUTRON ACER TENDL-2024 LIBRARY; T=0.K
Inelastic levels

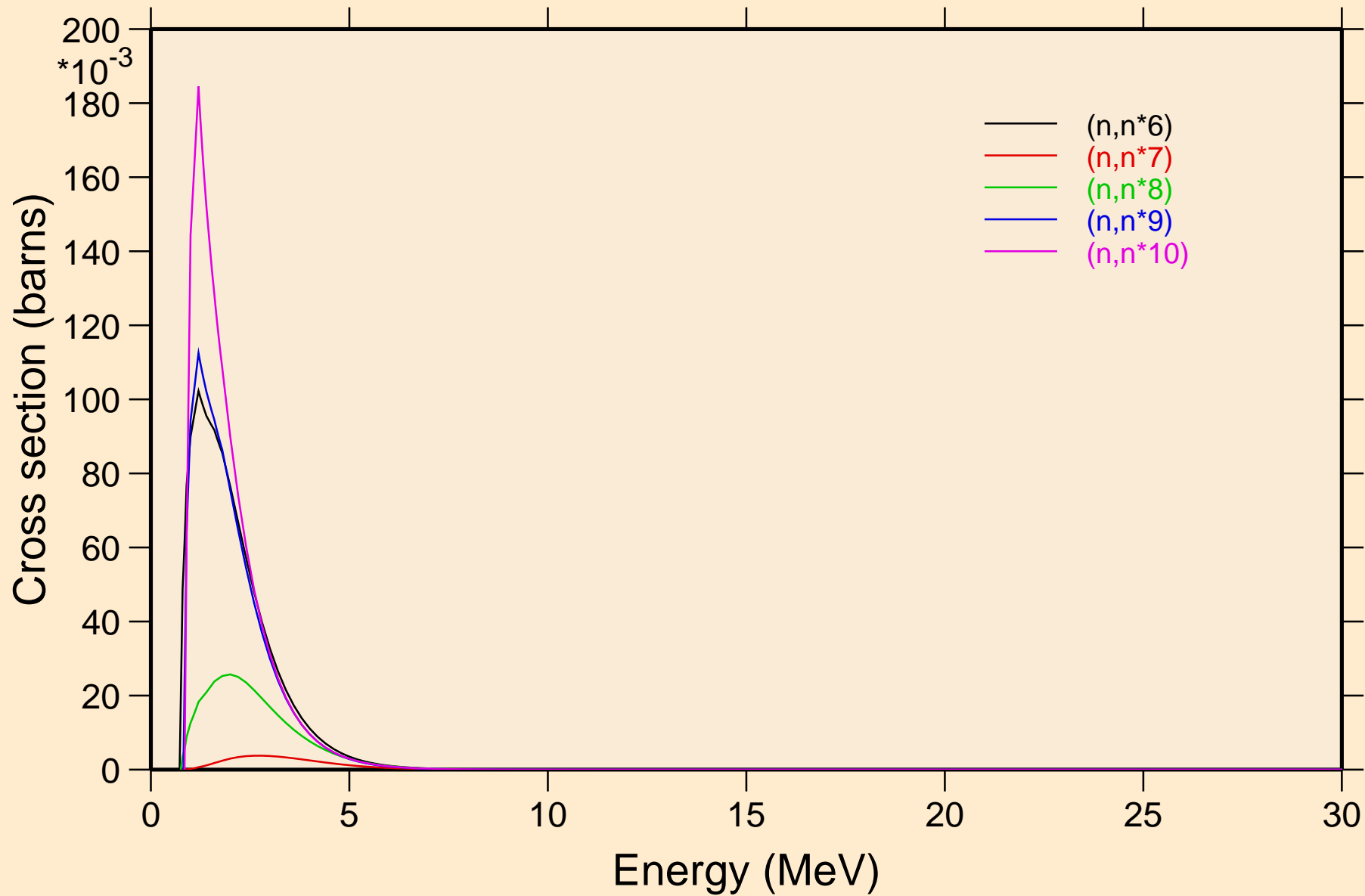

IN107M NEUTRON ACER TENDL-2024 LIBRARY; T=0.K
Inelastic levels

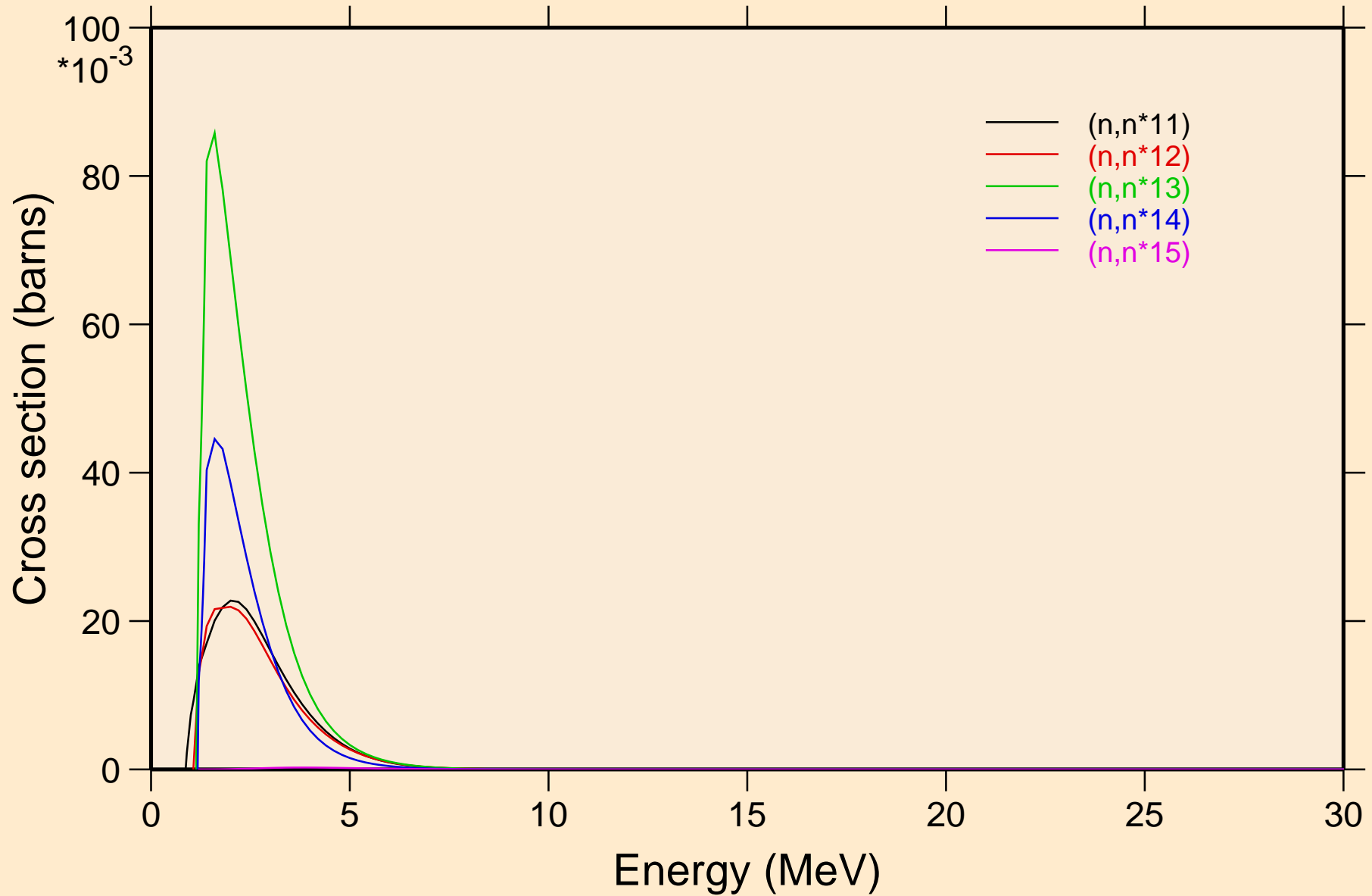

IN107M NEUTRON ACER TENDL-2024 LIBRARY; T=0.K
Inelastic levels

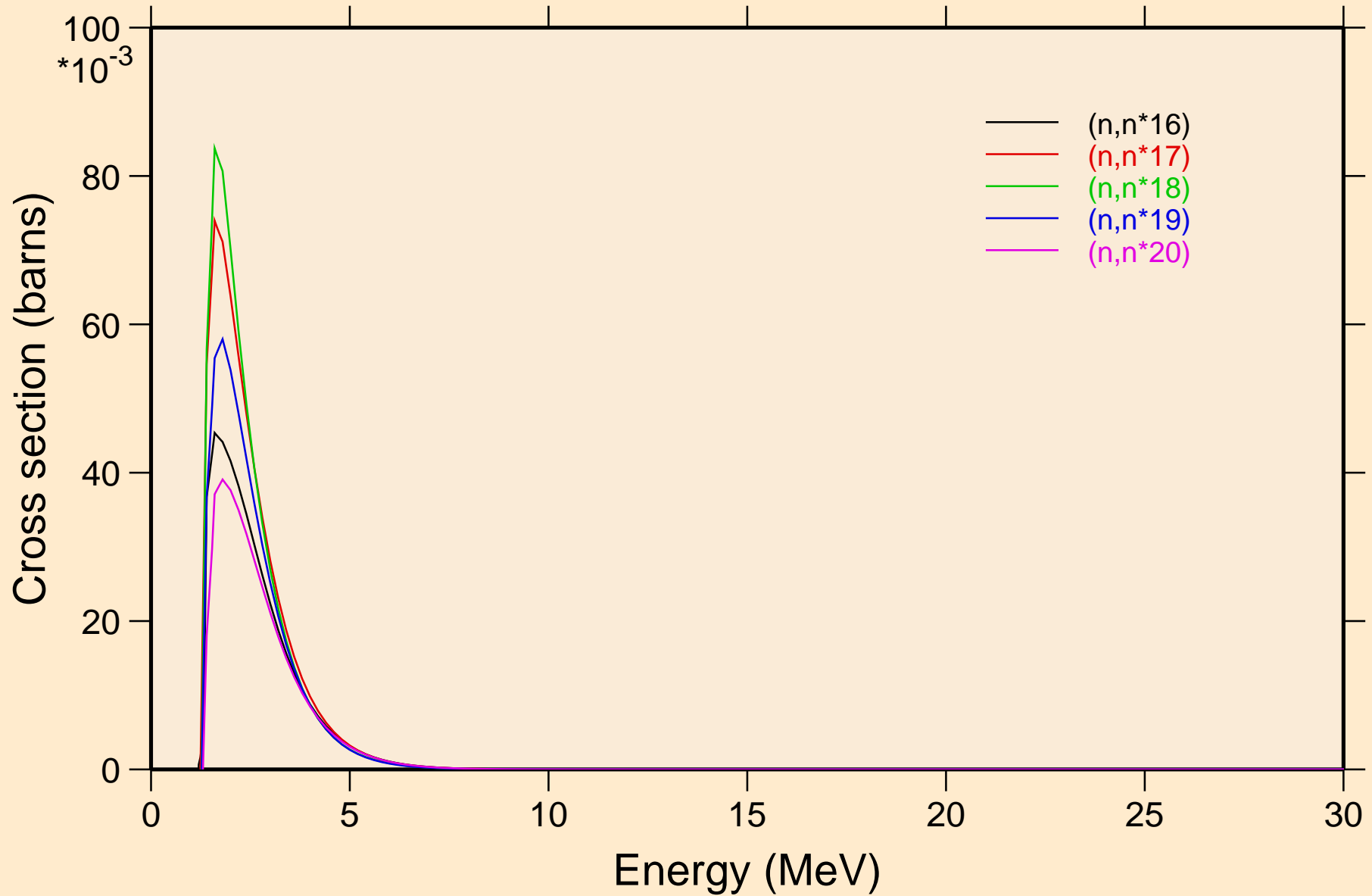

IN107M NEUTRON ACER TENDL-2024 LIBRARY; T=0.K
Inelastic levels

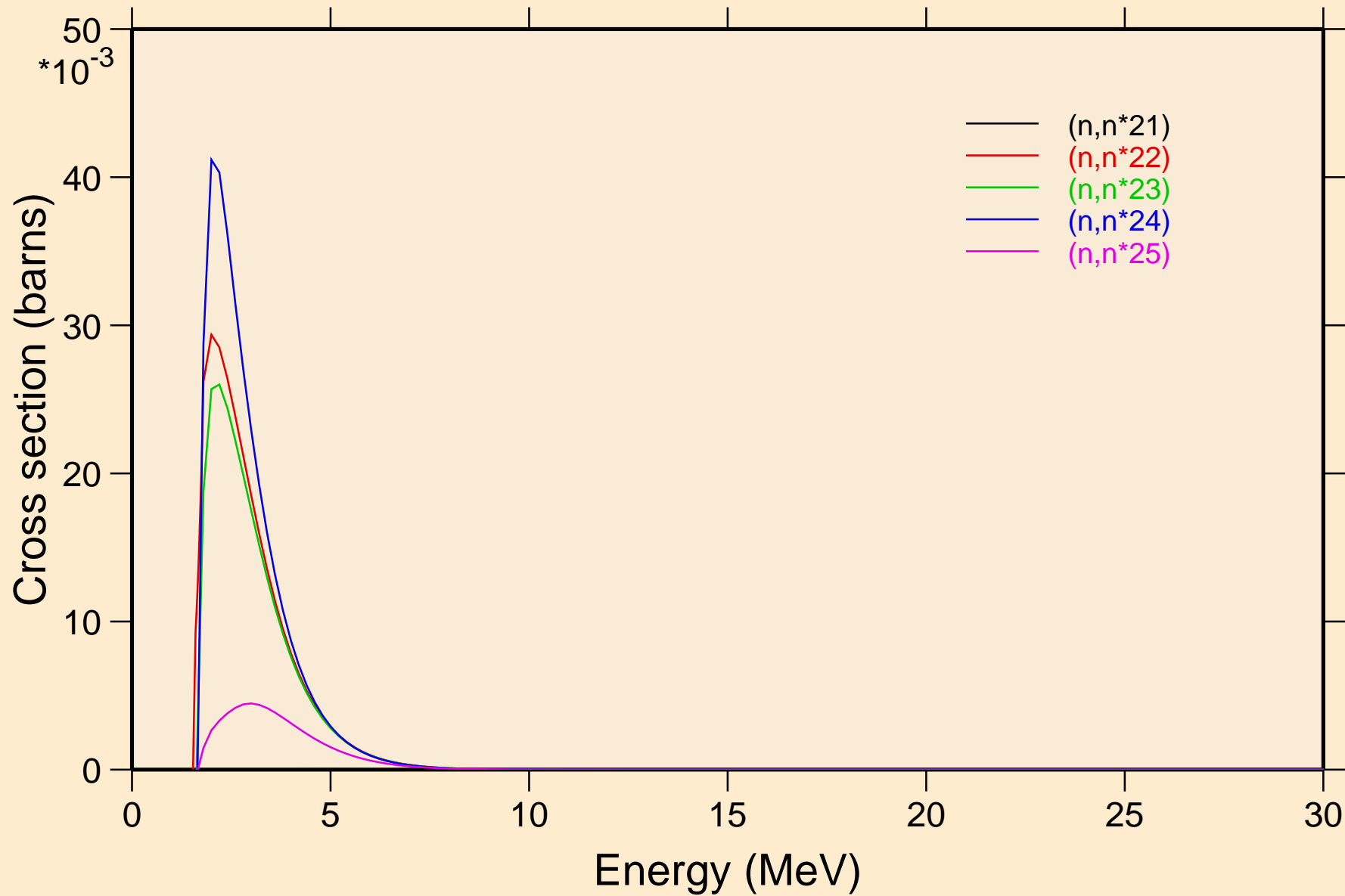

IN107M NEUTRON ACER TENDL-2024 LIBRARY; T=0.K
Inelastic levels

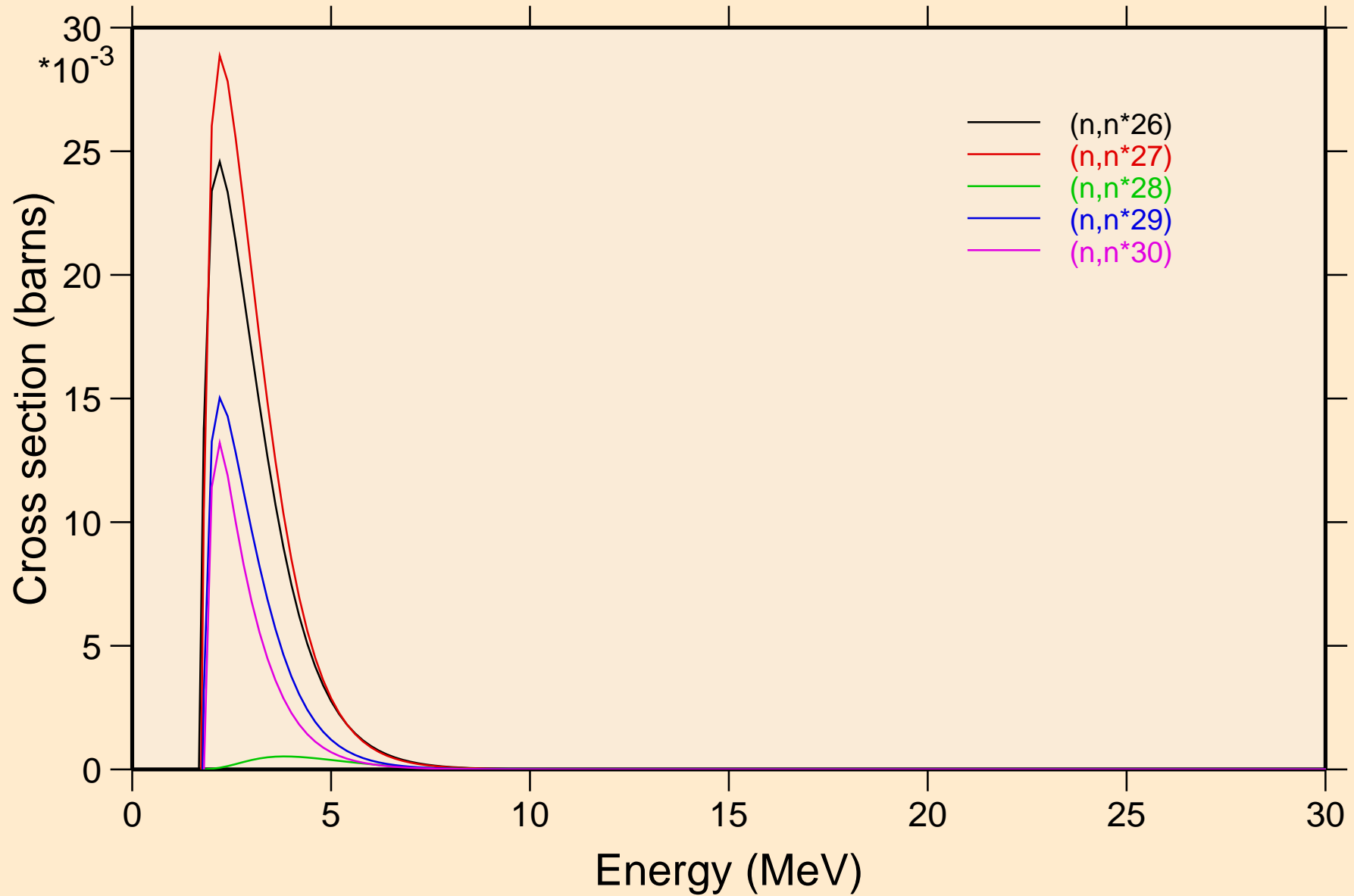

IN107M NEUTRON ACER TENDL-2024 LIBRARY; T=0.K
Threshold reactions

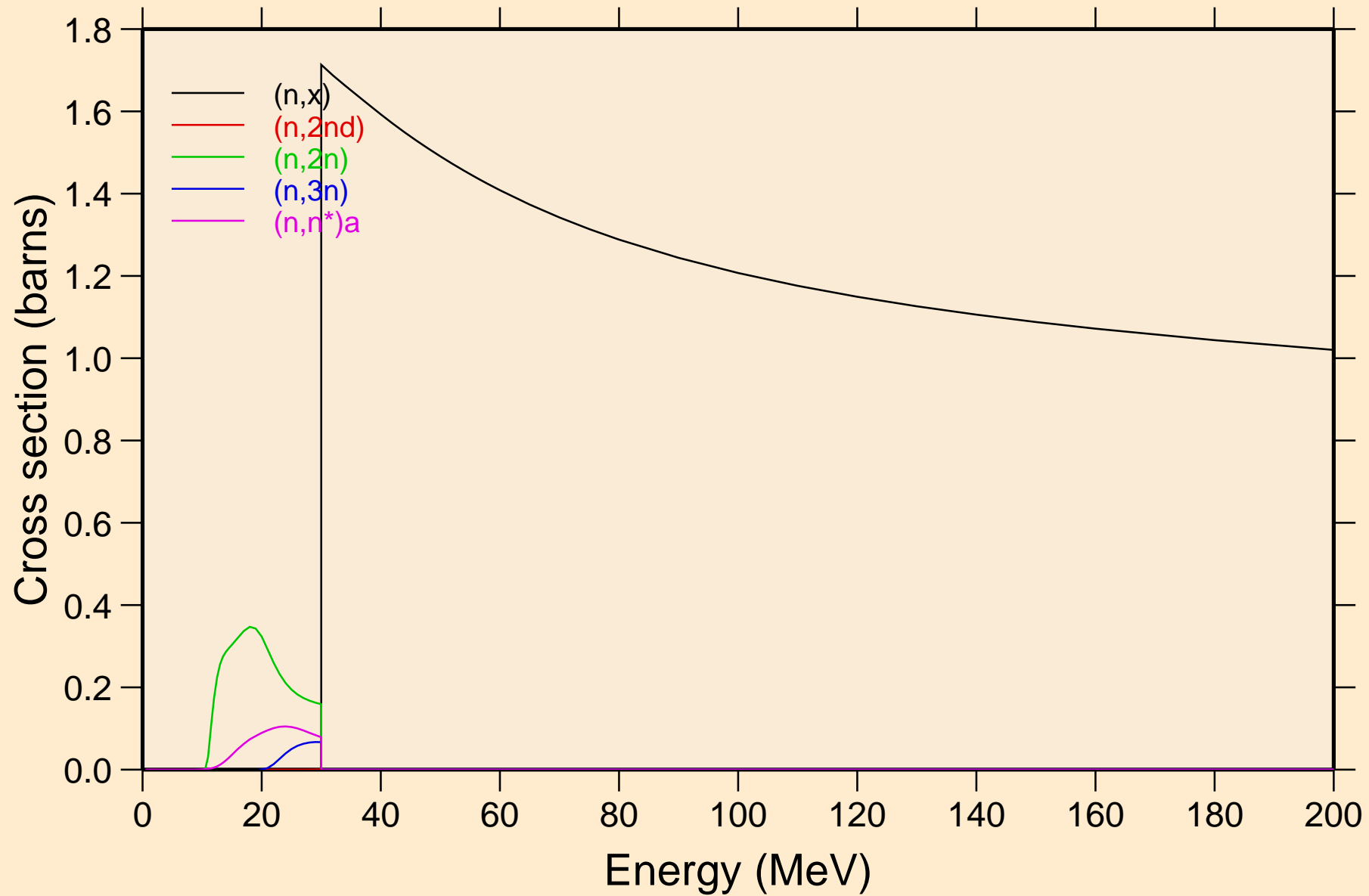

IN107M NEUTRON ACER TENDL-2024 LIBRARY; T=0.K

Threshold reactions

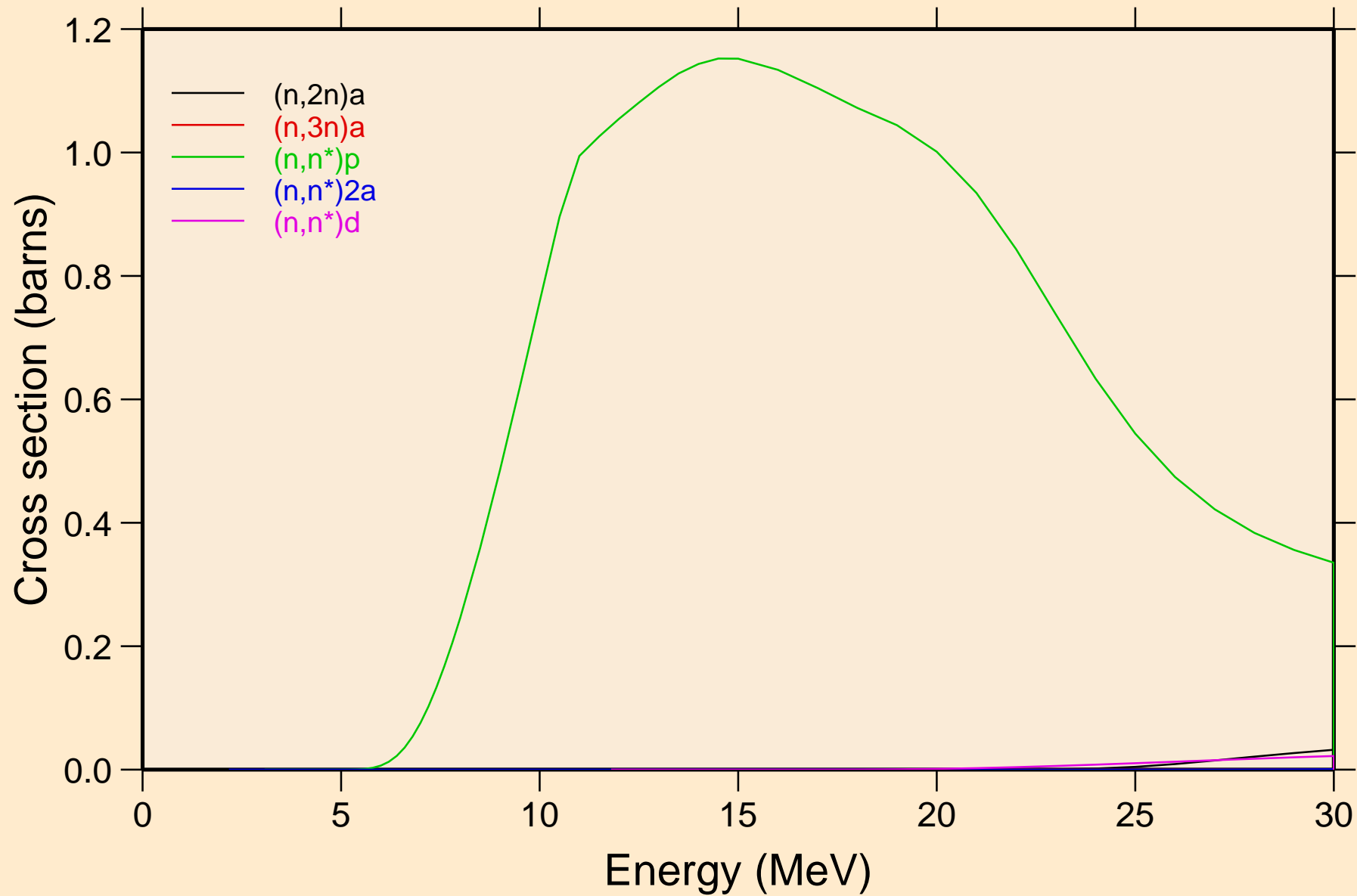

IN107M NEUTRON ACER TENDL-2024 LIBRARY; T=0.K
Threshold reactions

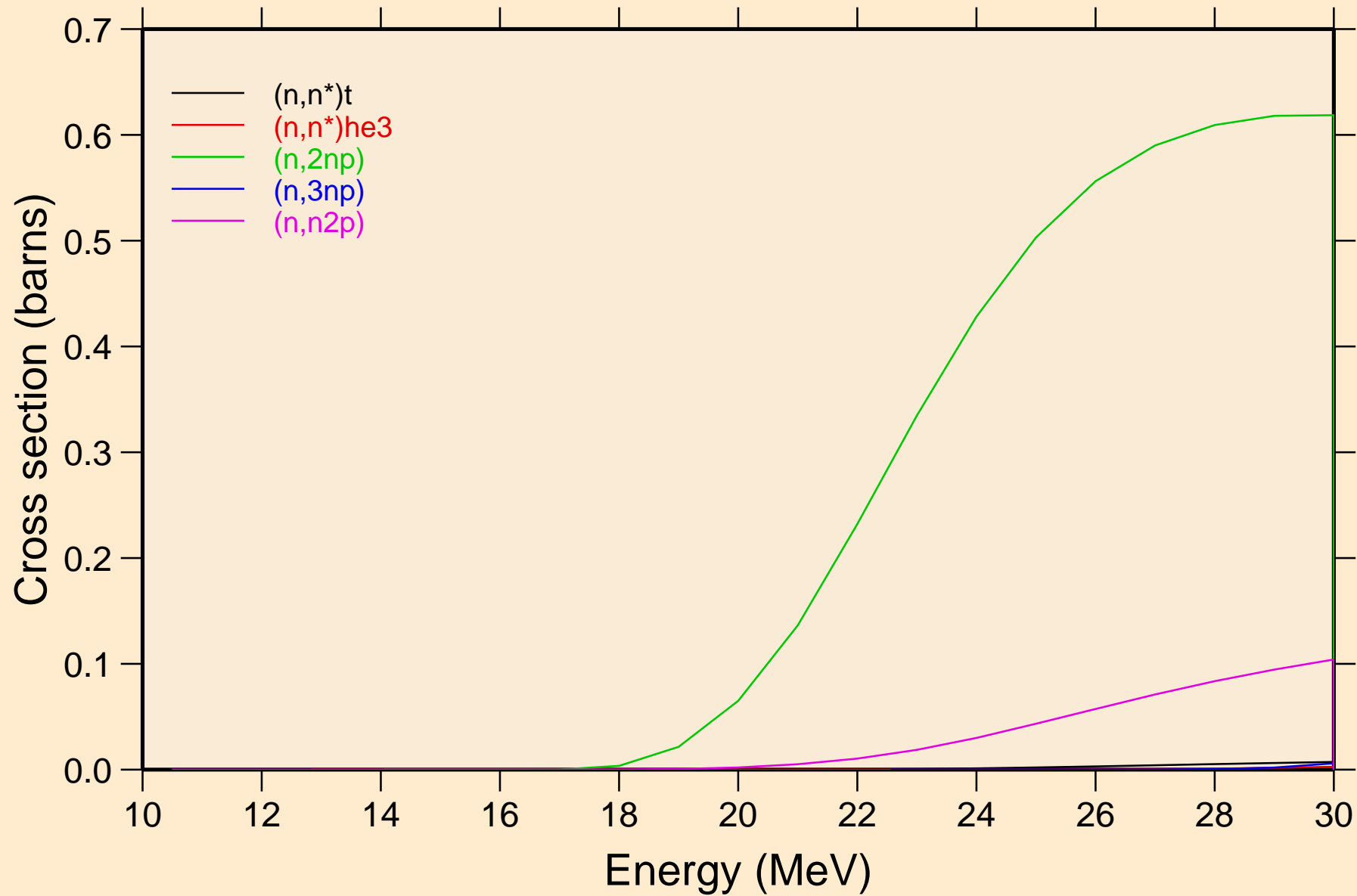

IN107M NEUTRON ACER TENDL-2024 LIBRARY; T=0.K
Threshold reactions

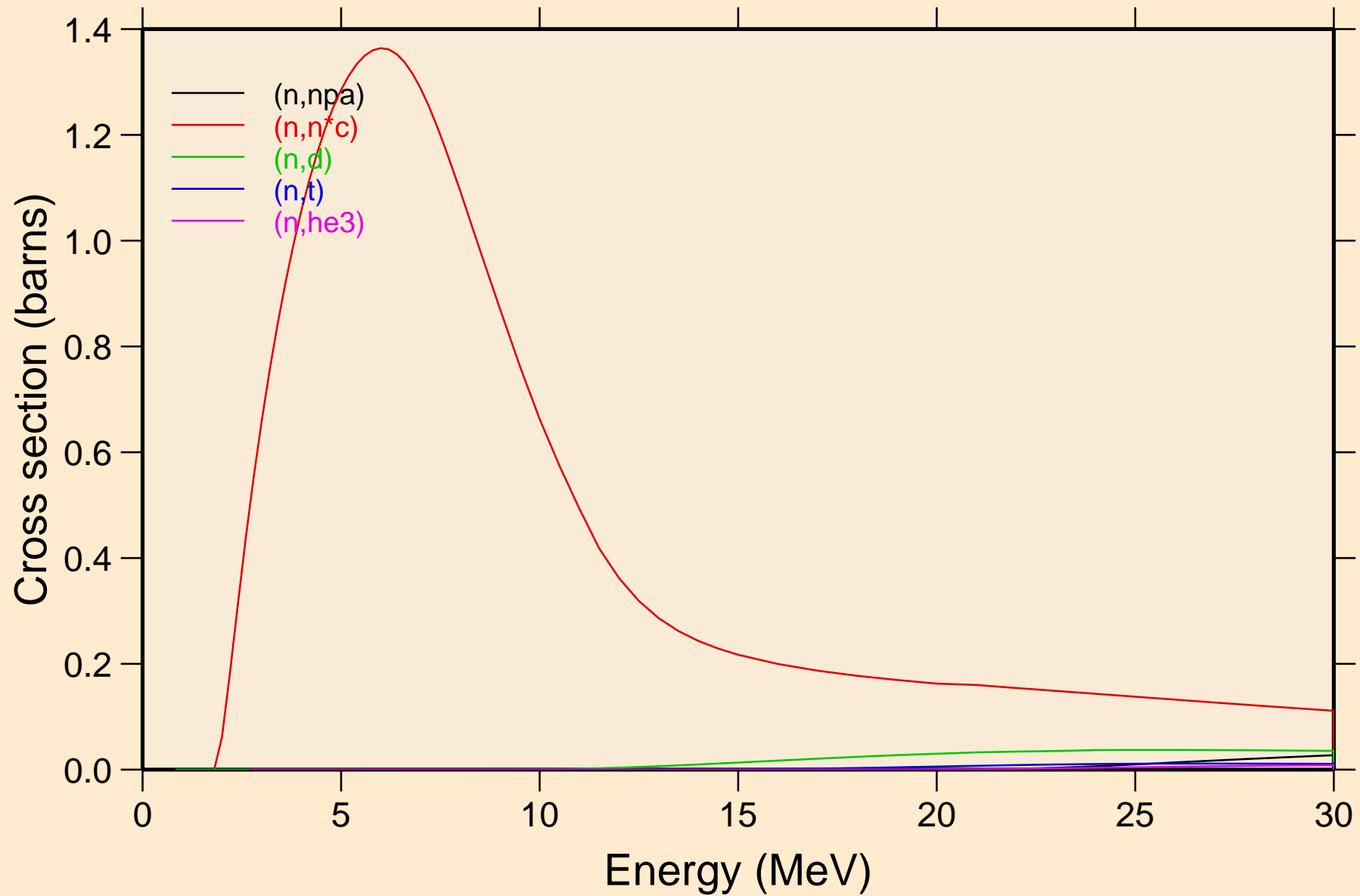

IN107M NEUTRON ACER TENDL-2024 LIBRARY; T=0.K

Threshold reactions

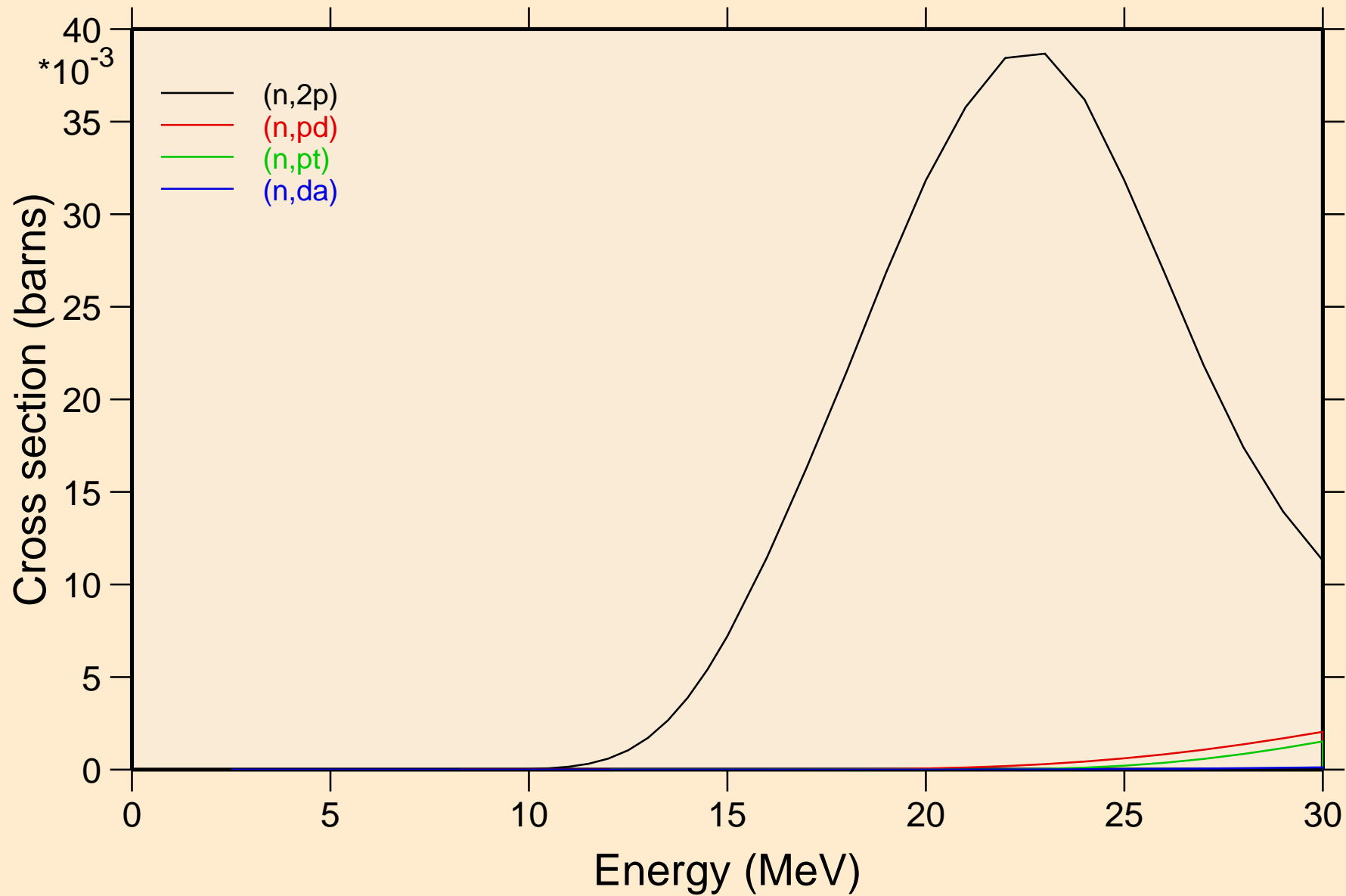

IN107M NEUTRON ACER TENDL-2024 LIBRARY; T=0.K

Threshold reactions

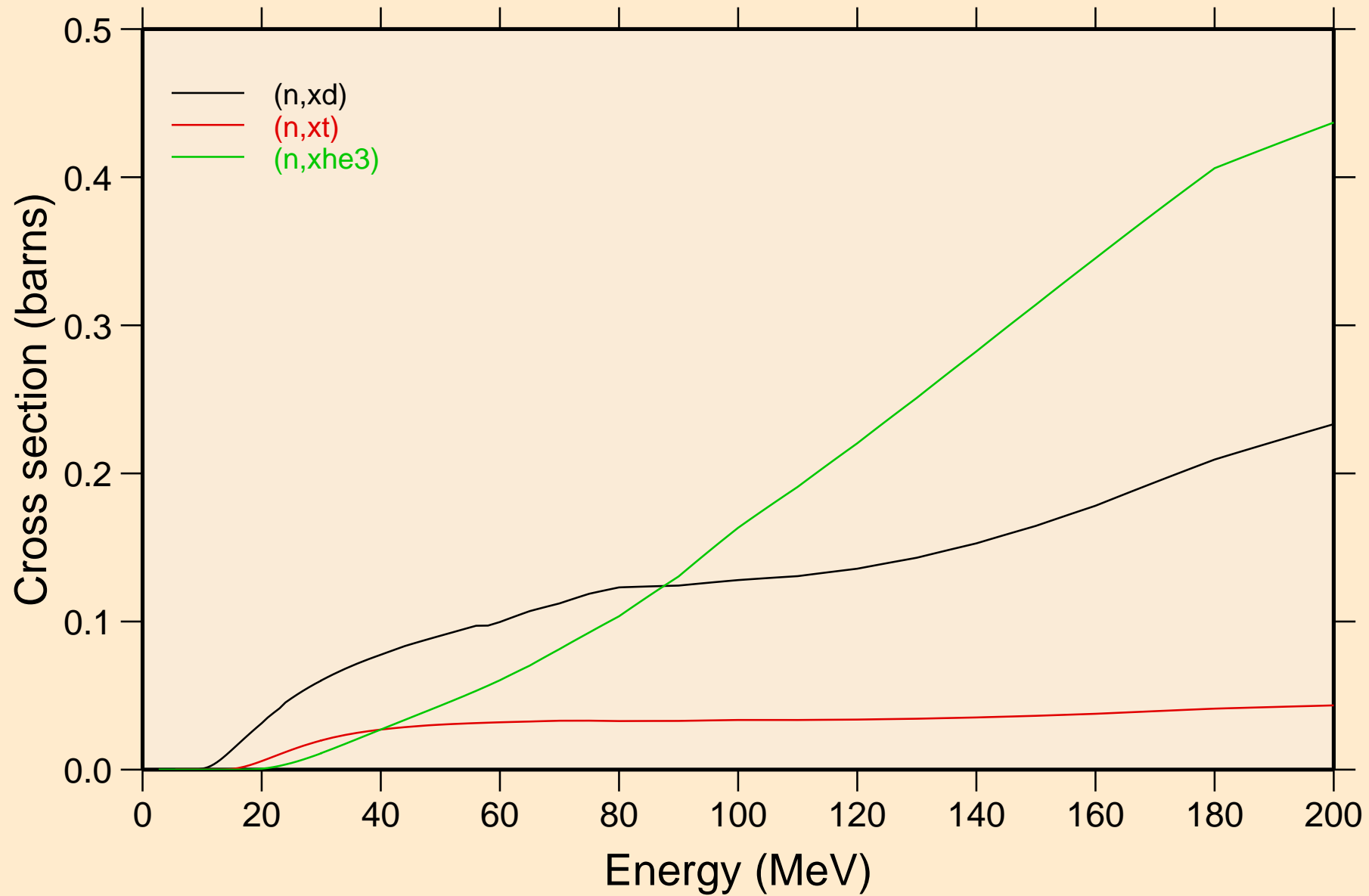

IN107M NEUTRON ACER TENDL-2024 LIBRARY; T=0.K
angular distribution for elastic

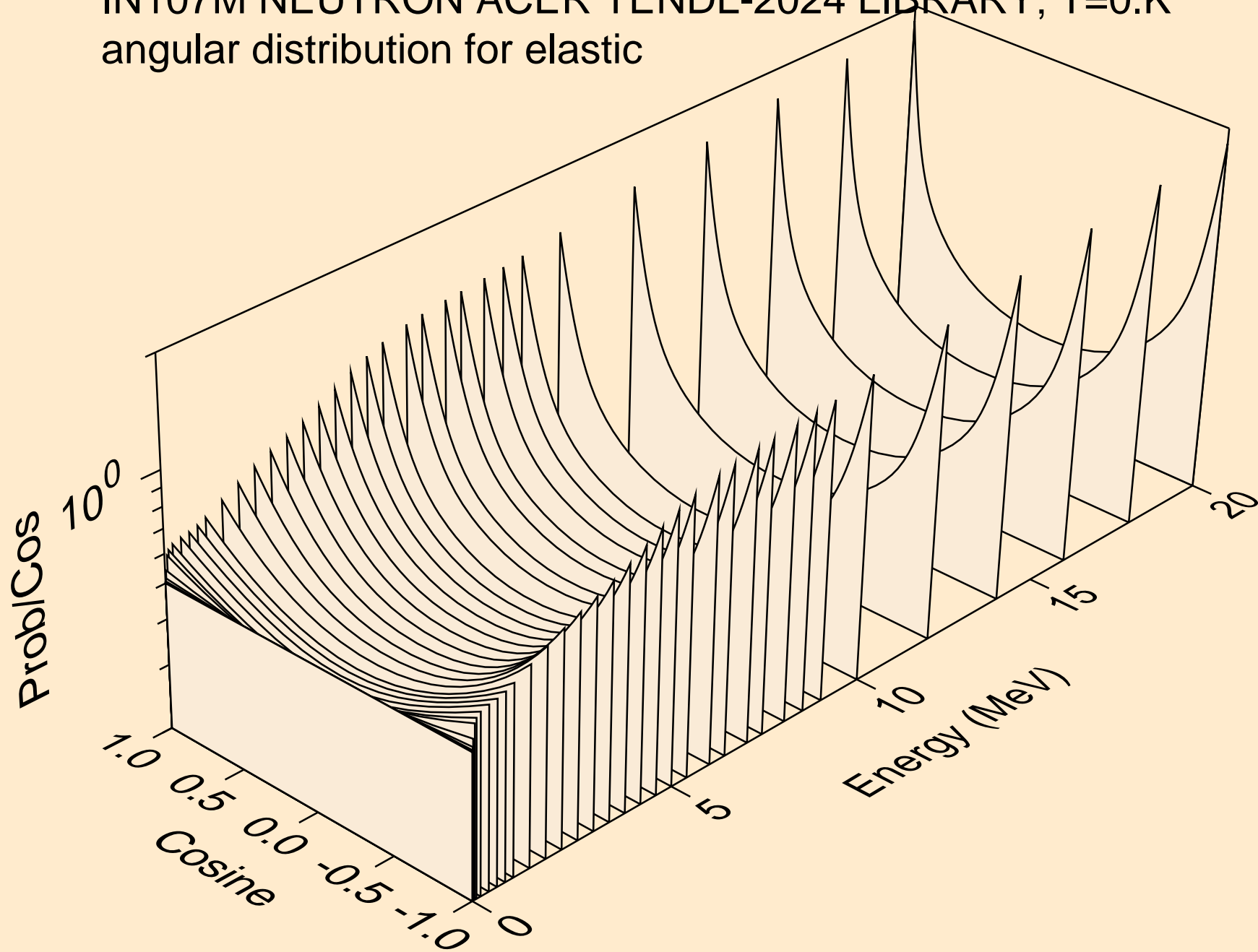

IN107M NEUTRON ACER TENDL-2024 LIBRARY; T=0.K
angular distribution for elastic

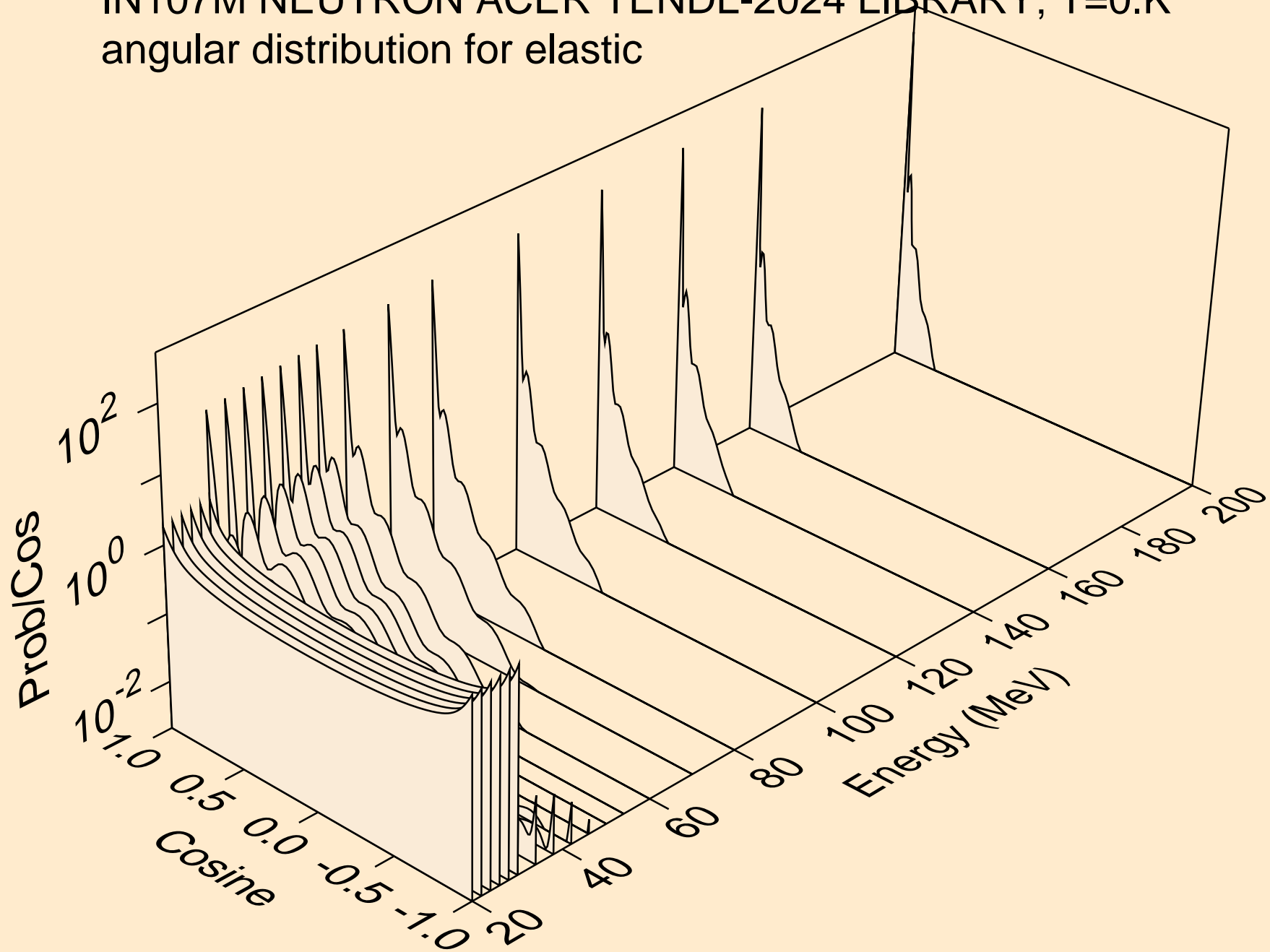

IN107M NEUTRON ACER TENDL-2024 LIBRARY; T=0.K
angular distribution for (n,n*1)

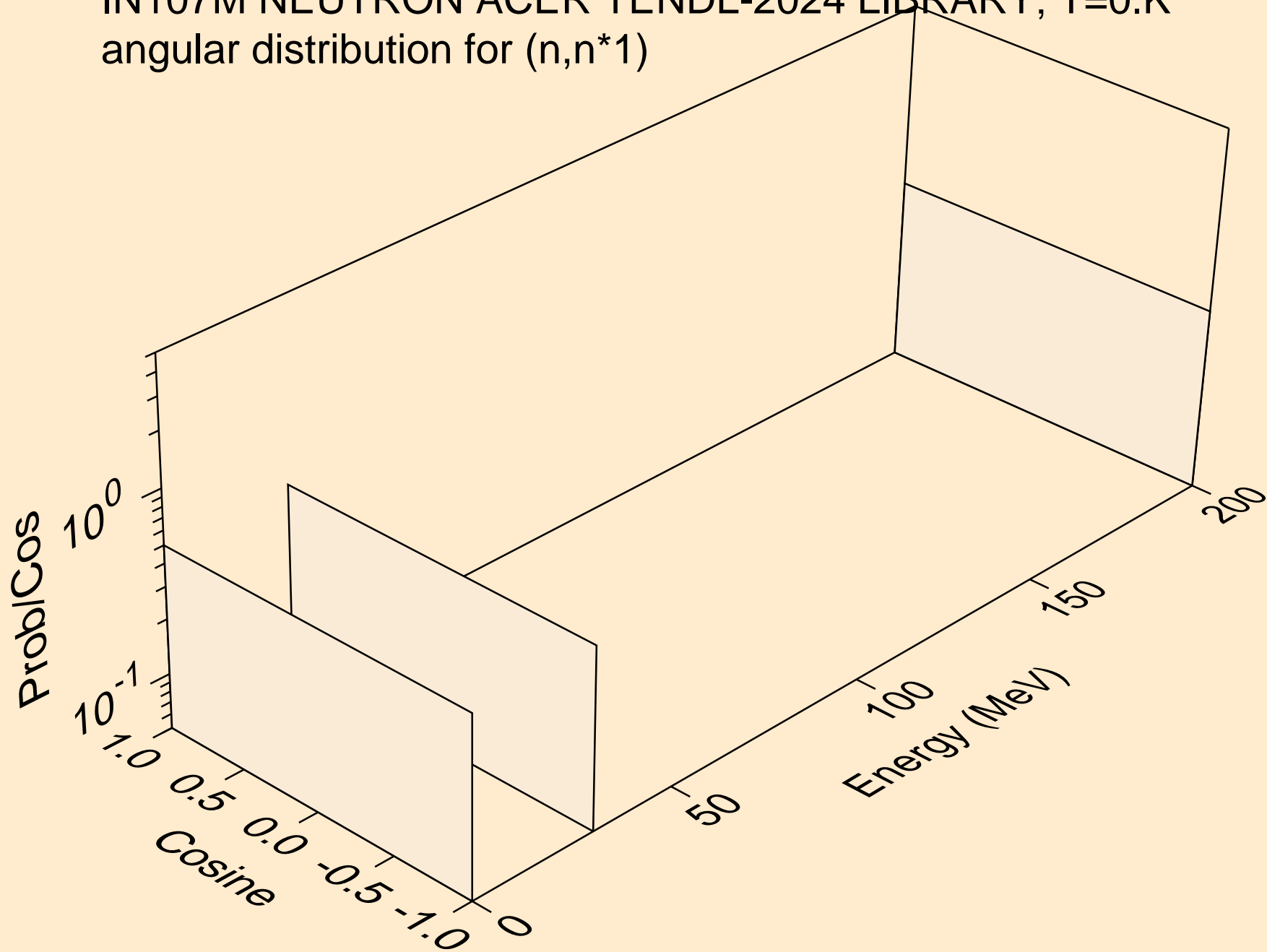

IN107M NEUTRON ACER TENDL-2024 LIBRARY; T=0.K
angular distribution for (n,n*2)

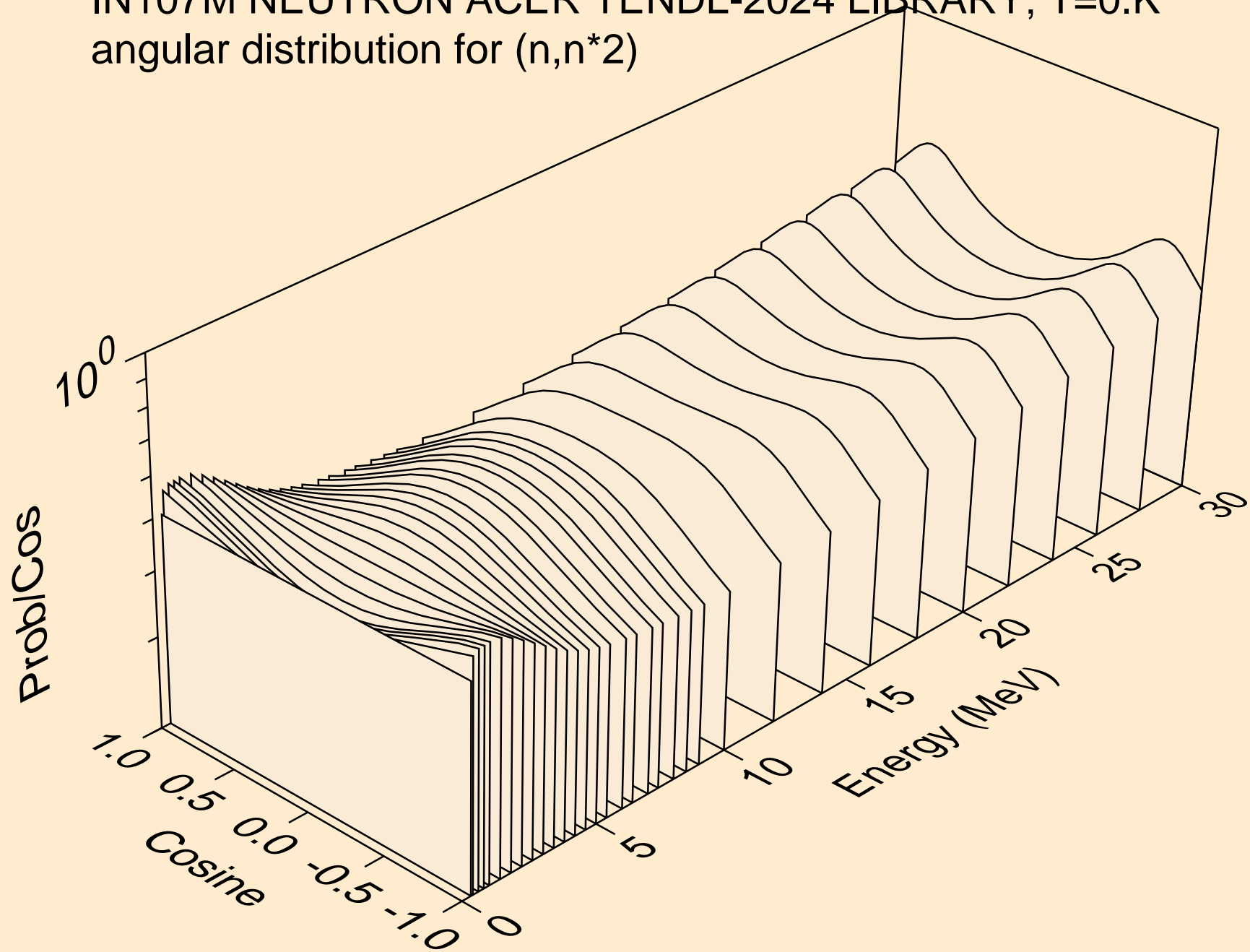

IN107M NEUTRON ACER TENDL-2024 LIBRARY; T=0.K
angular distribution for (n,n*3)

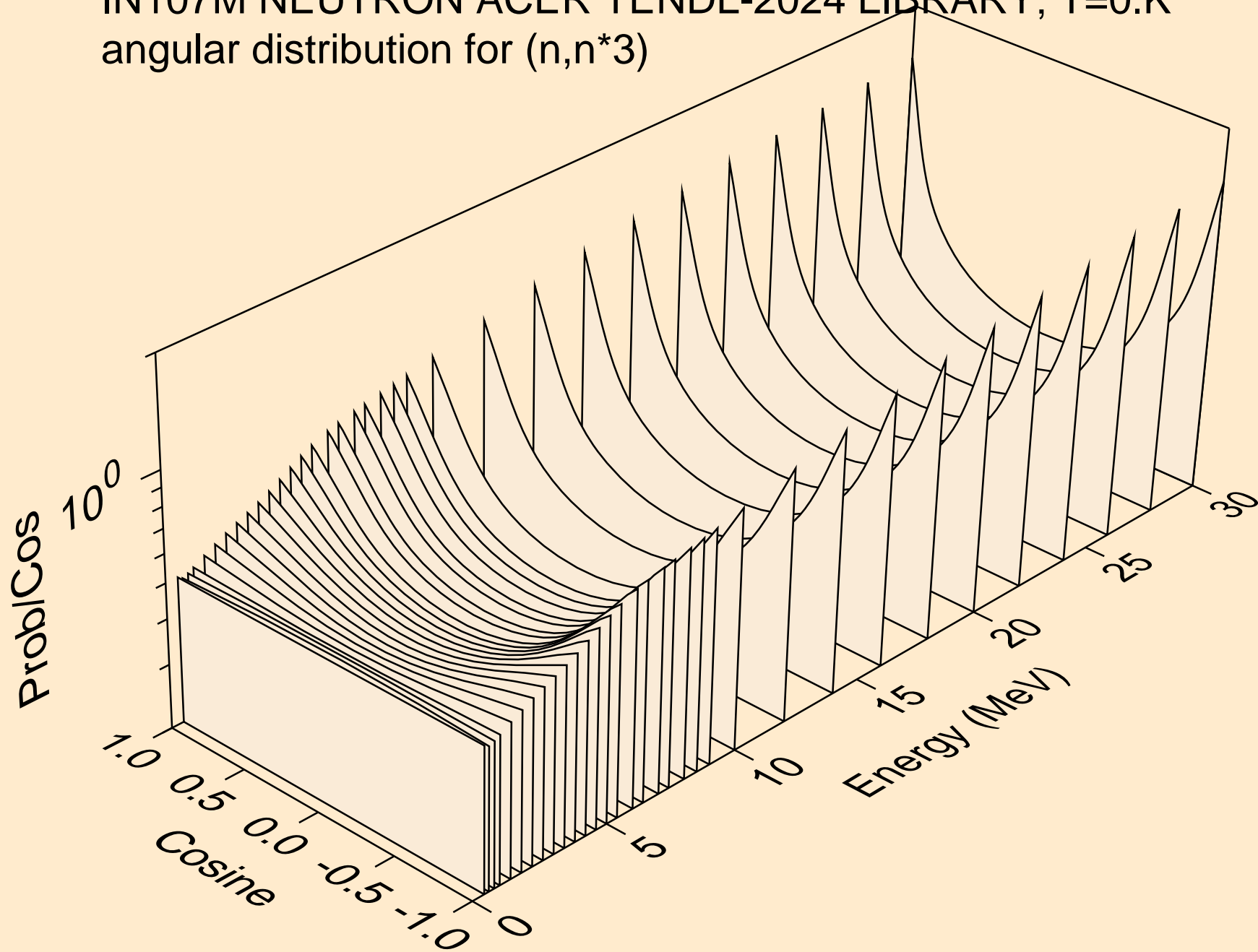

IN107M NEUTRON ACER TENDL-2024 LIBRARY; T=0.K
angular distribution for (n,n*4)

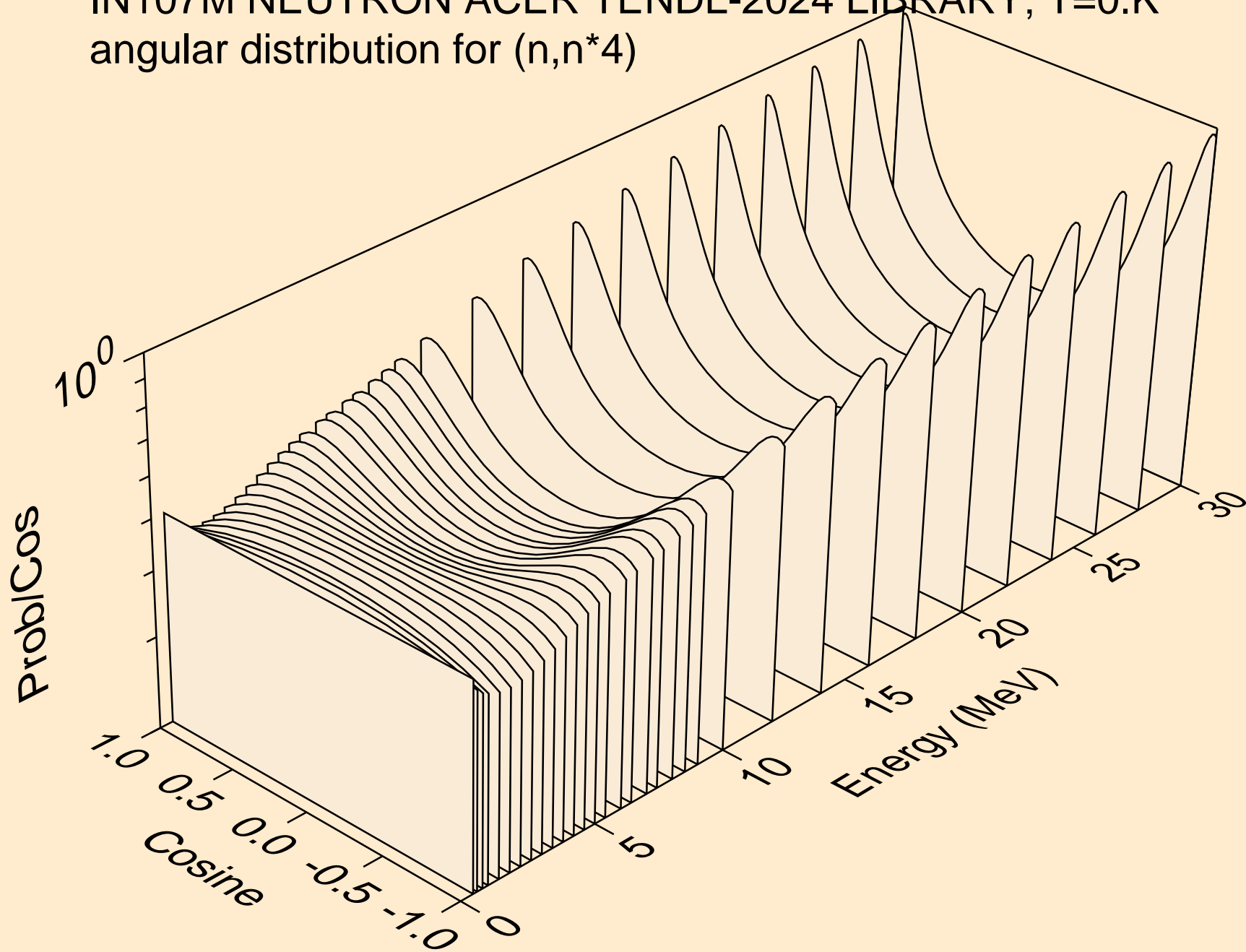

IN107M NEUTRON ACER TENDL-2024 LIBRARY; T=0.K
angular distribution for (n,n*5)

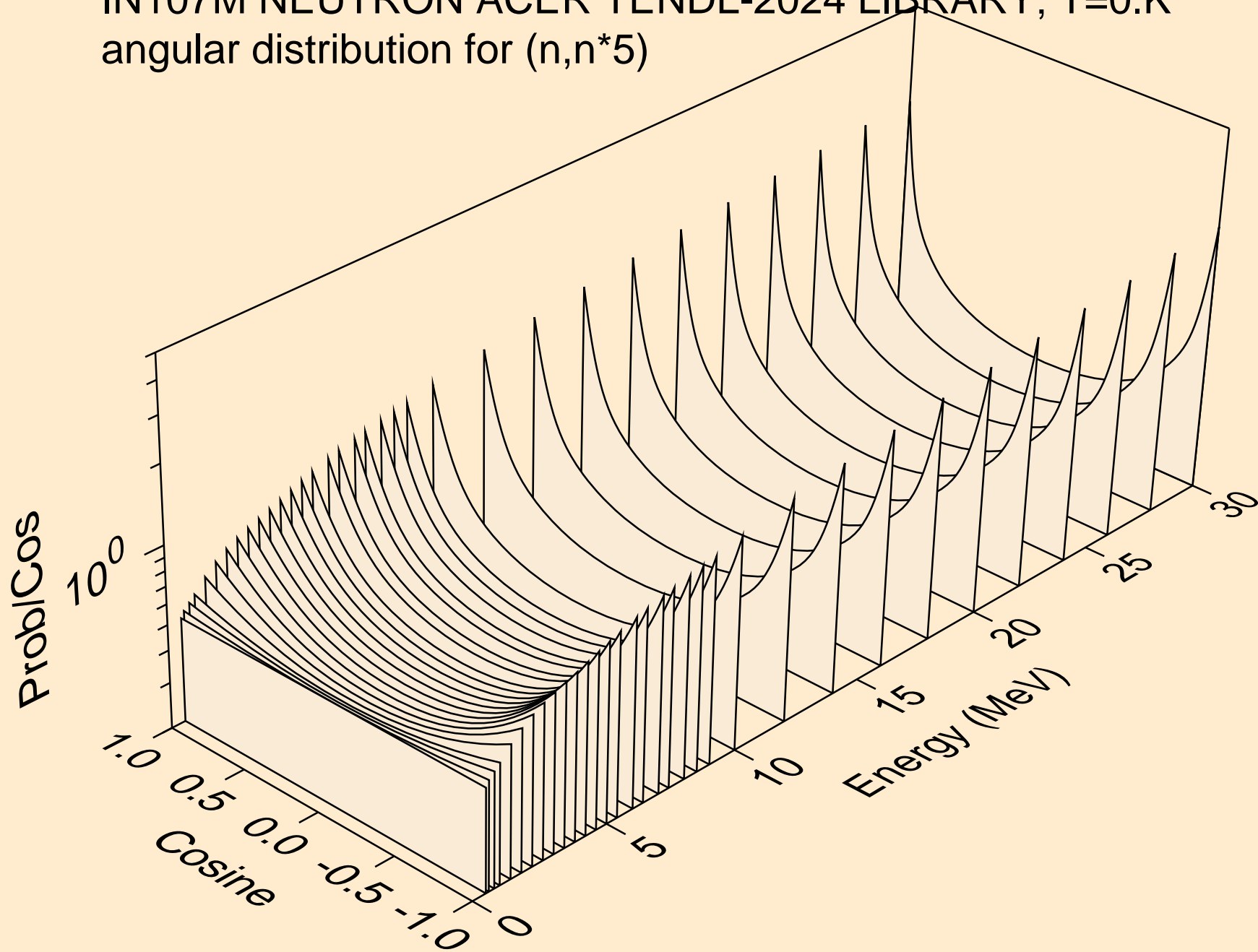

IN107M NEUTRON ACER TENDL-2024 LIBRARY; T=0.K
angular distribution for (n,n*6)

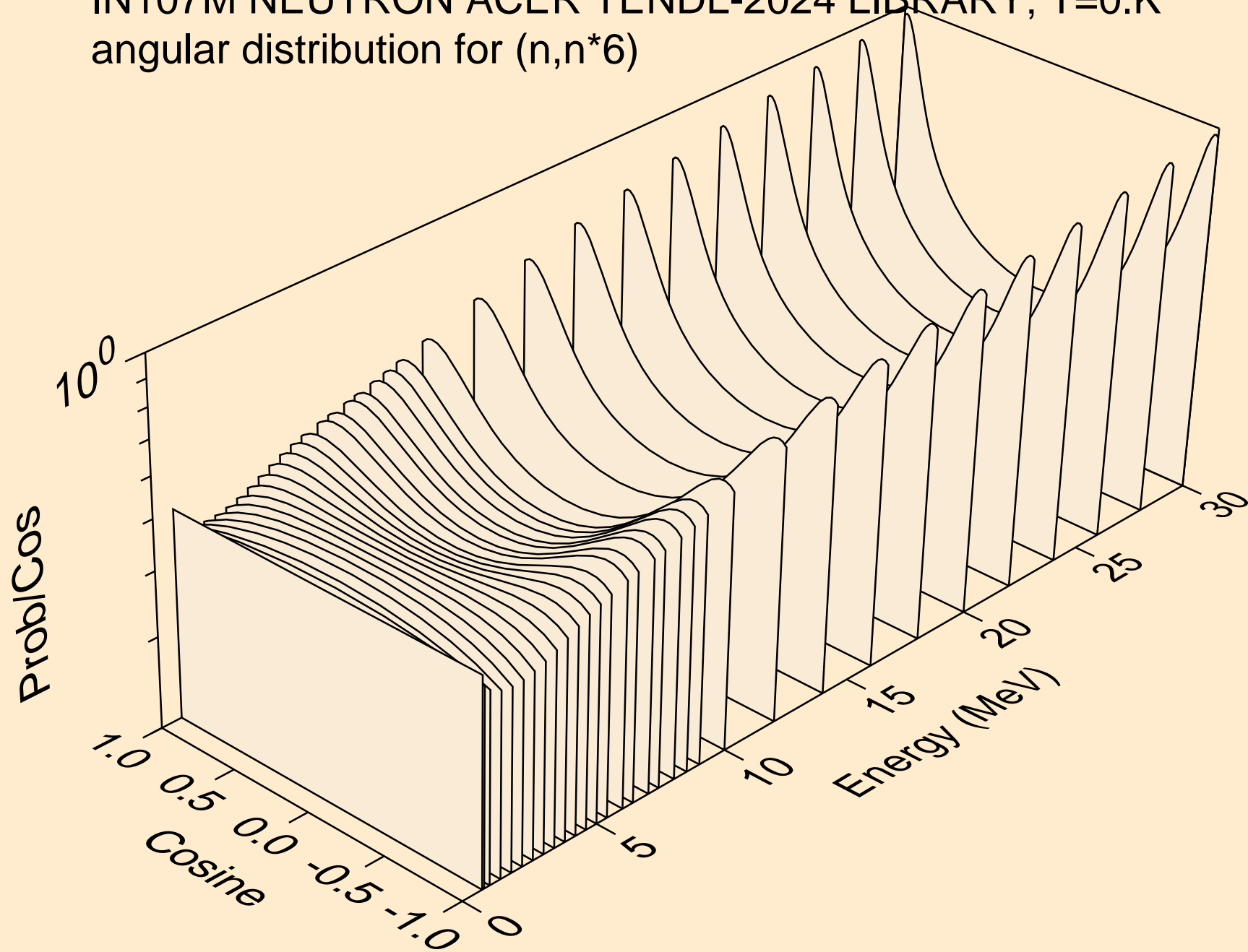

IN107M NEUTRON ACER TENDL-2024 LIBRARY; T=0.K
angular distribution for (n,n*7)

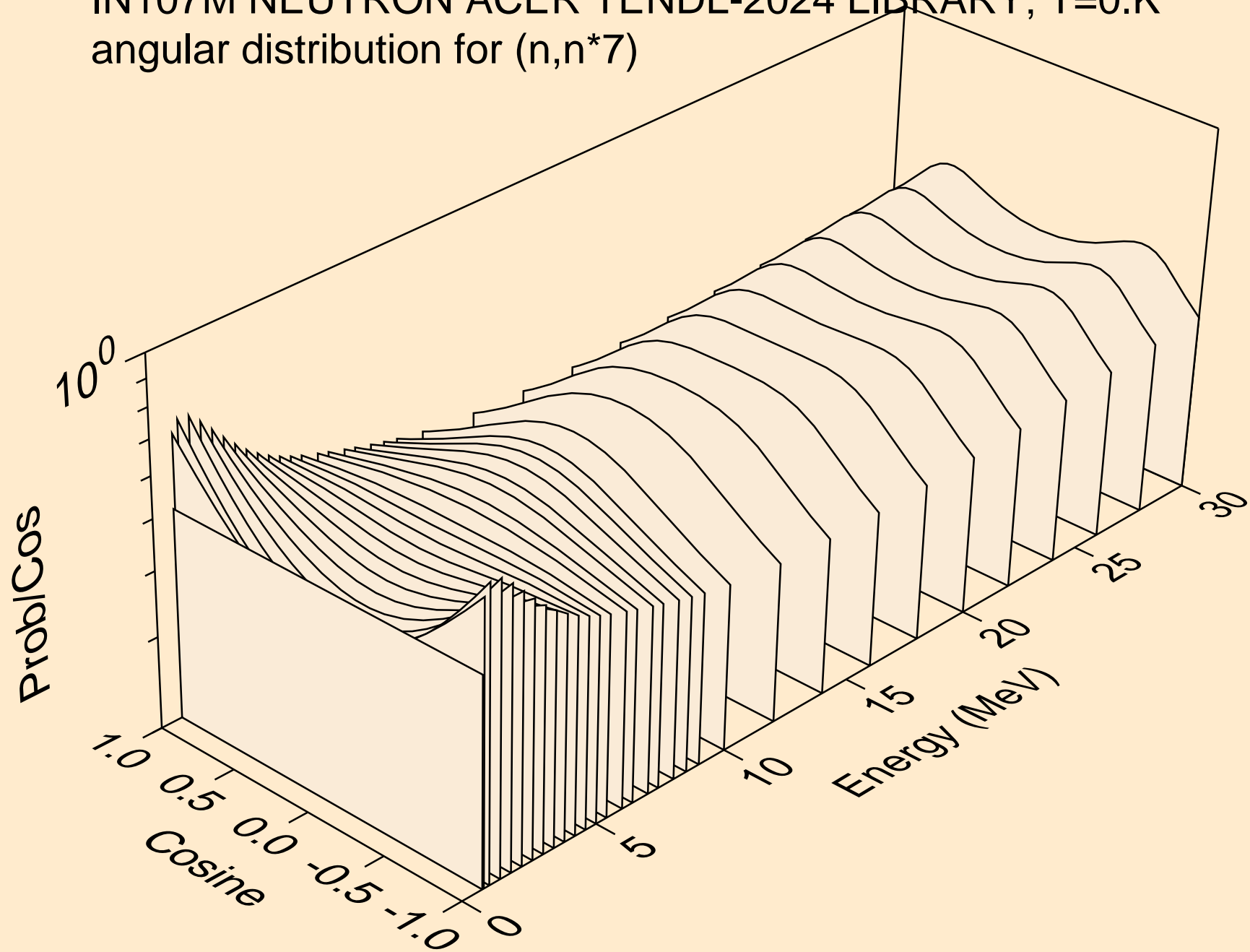

IN107M NEUTRON ACER TENDL-2024 LIBRARY; T=0.K
angular distribution for (n,n*8)

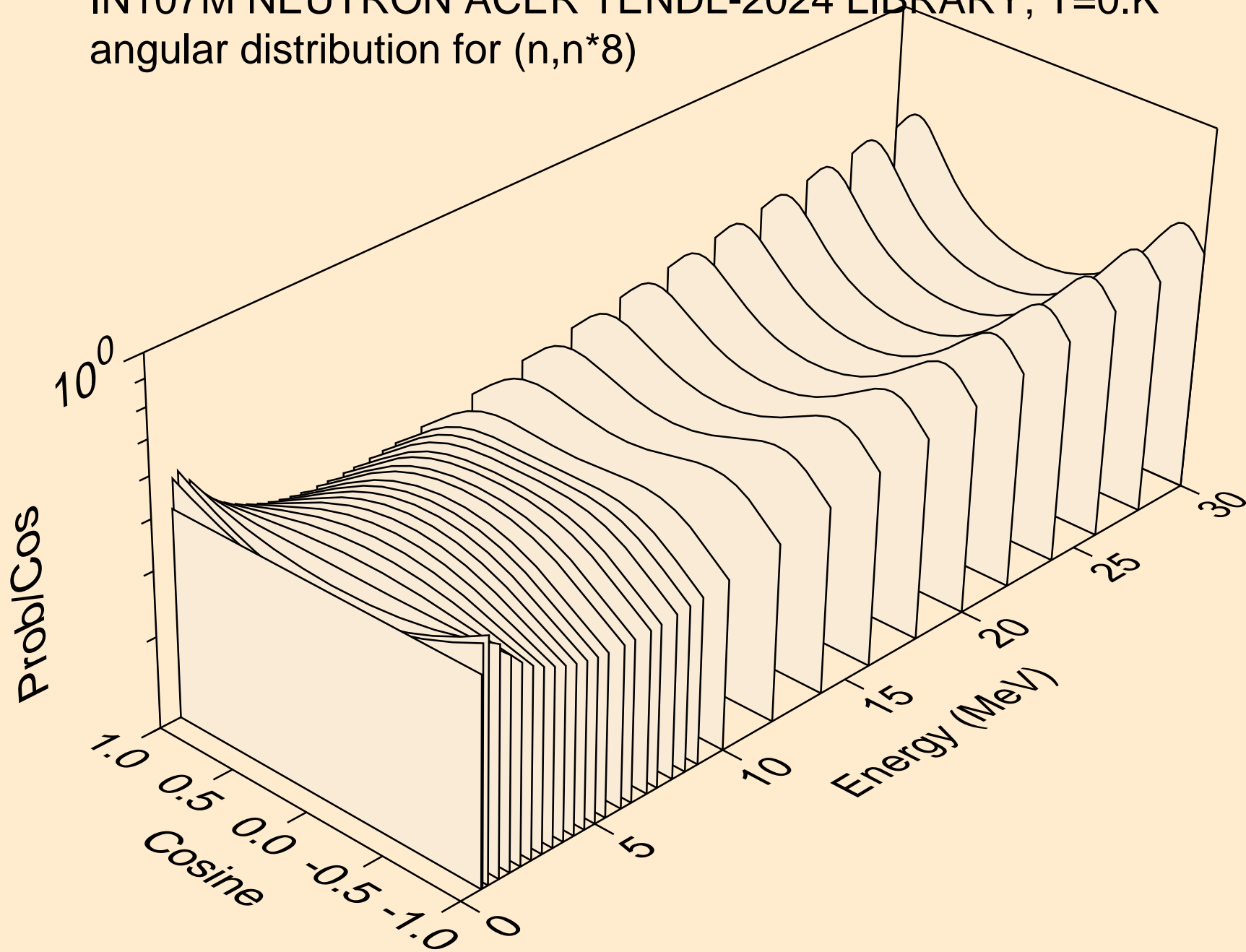

IN107M NEUTRON ACER TENDL-2024 LIBRARY; T=0.K
angular distribution for (n,n*9)

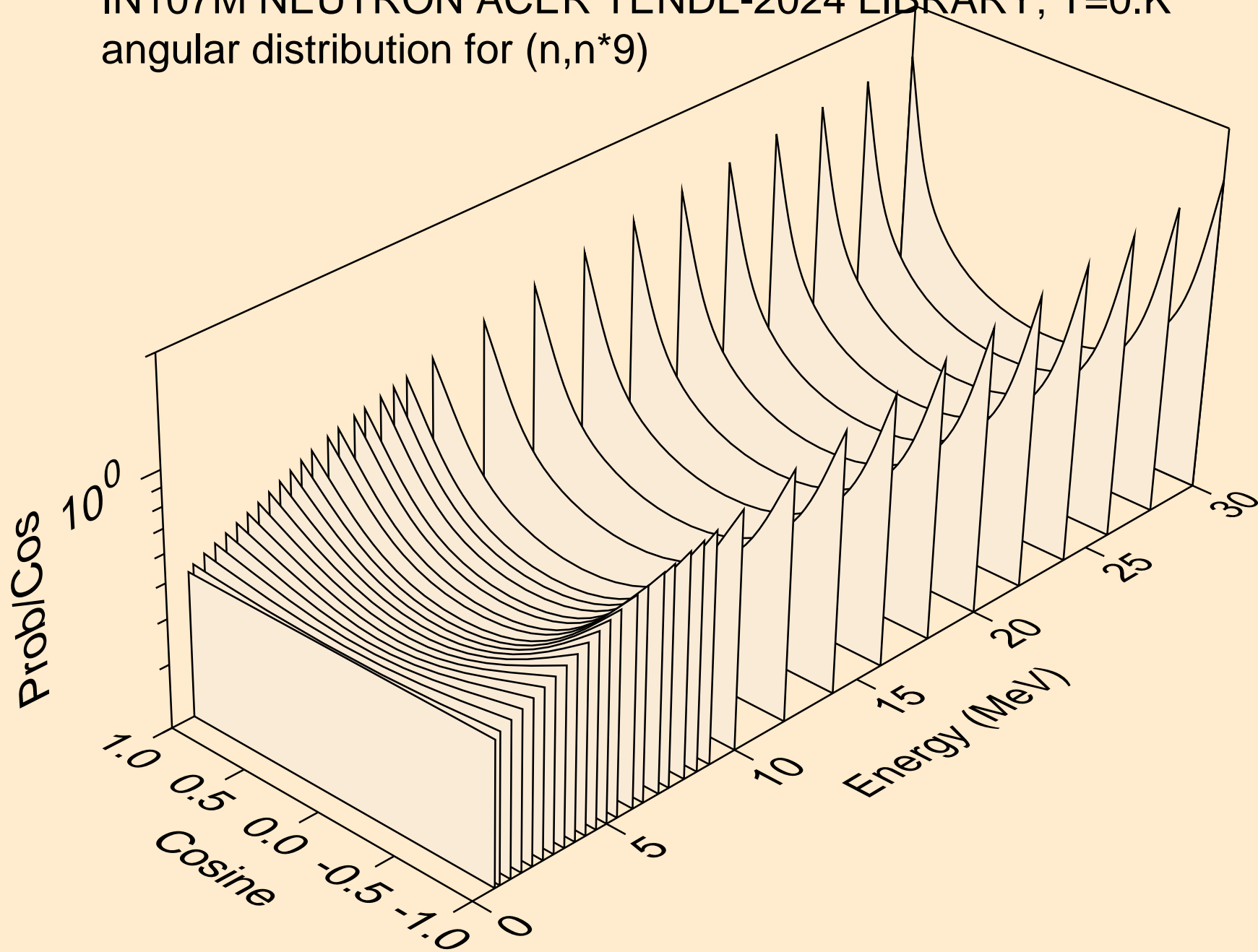

IN107M NEUTRON ACER TENDL-2024 LIBRARY; T=0.K
angular distribution for (n,n*10)

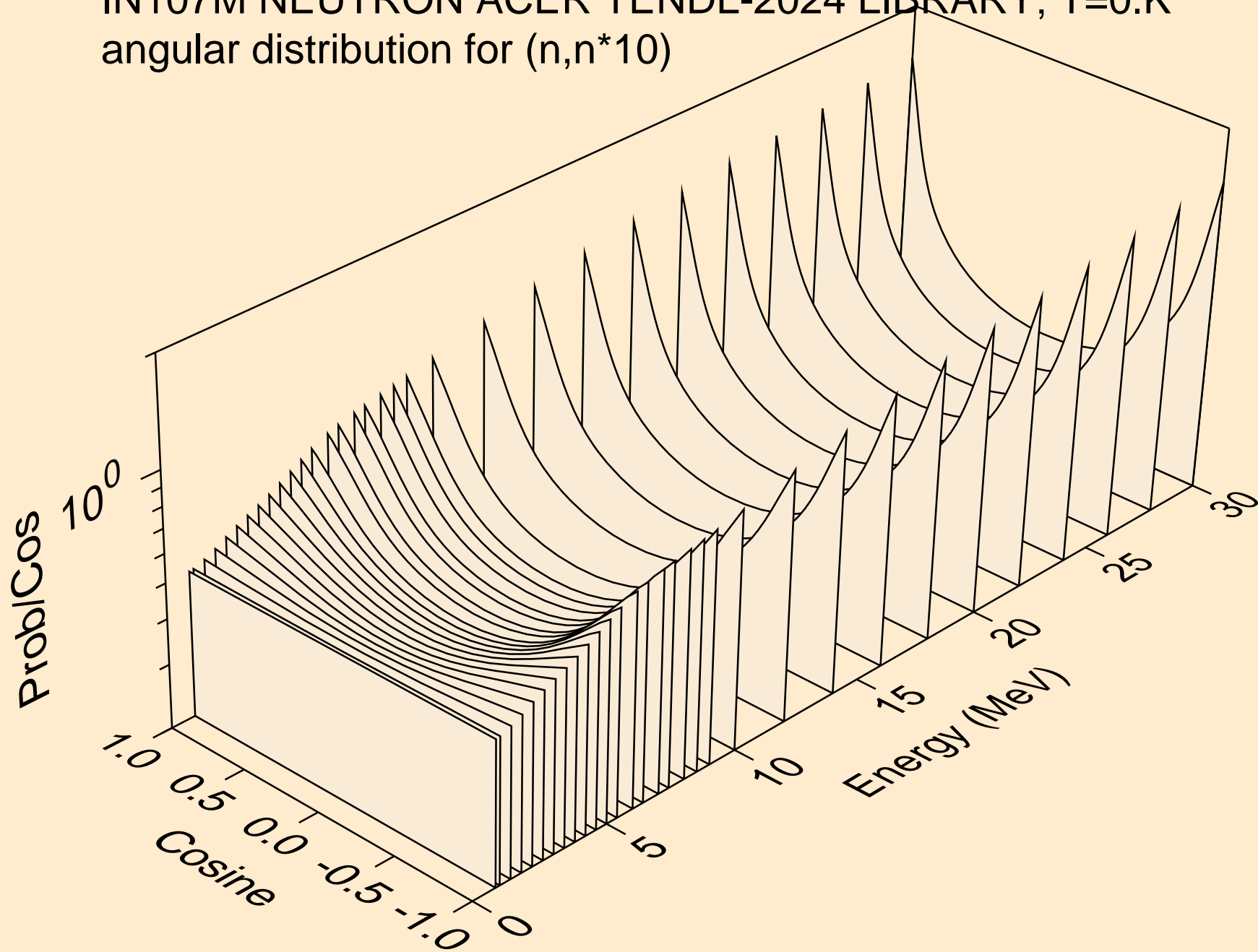

IN107M NEUTRON ACER TENDL-2024 LIBRARY; T=0.K
angular distribution for (n,n*11)

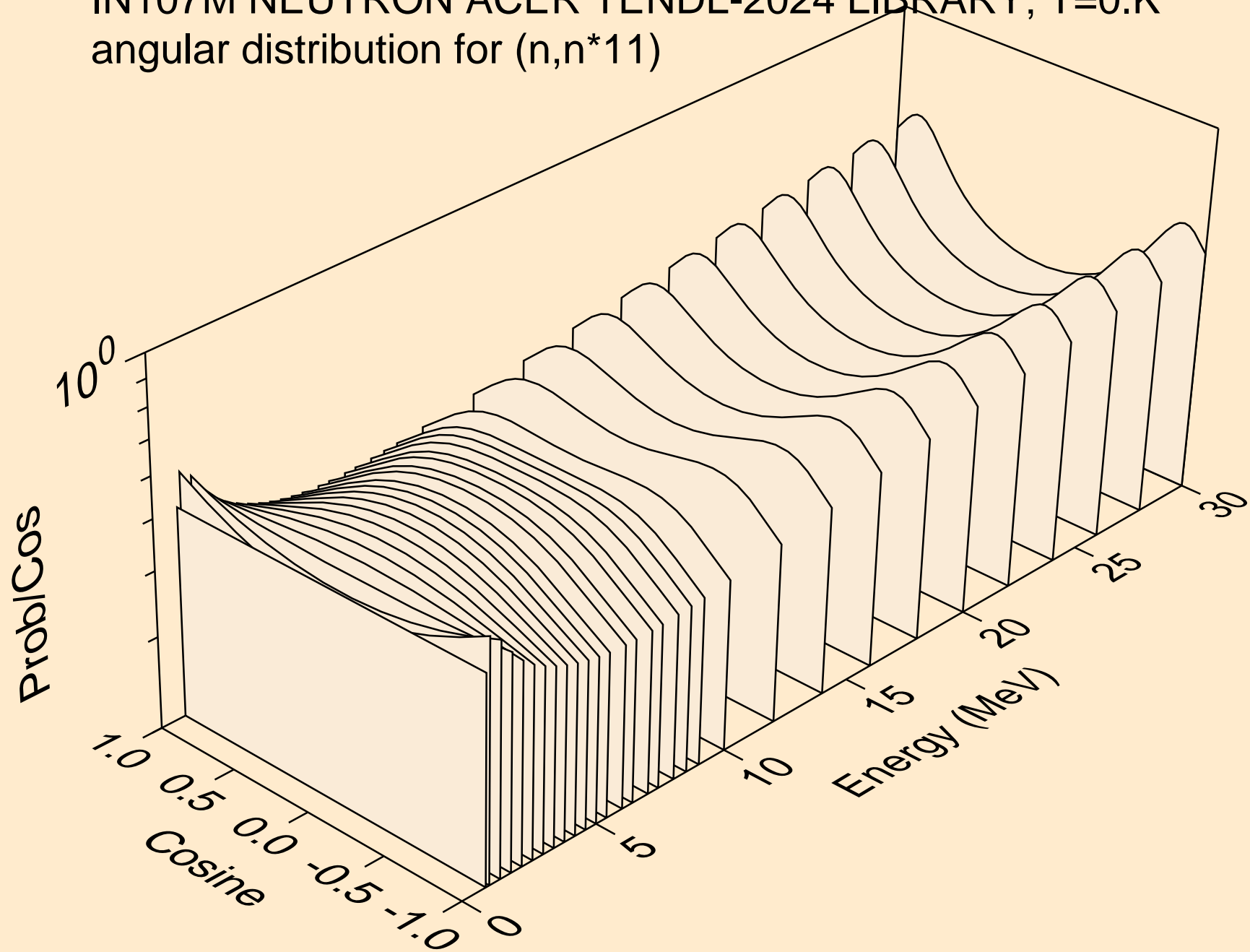

IN107M NEUTRON ACER TENDL-2024 LIBRARY; T=0.K
angular distribution for (n,n*12)

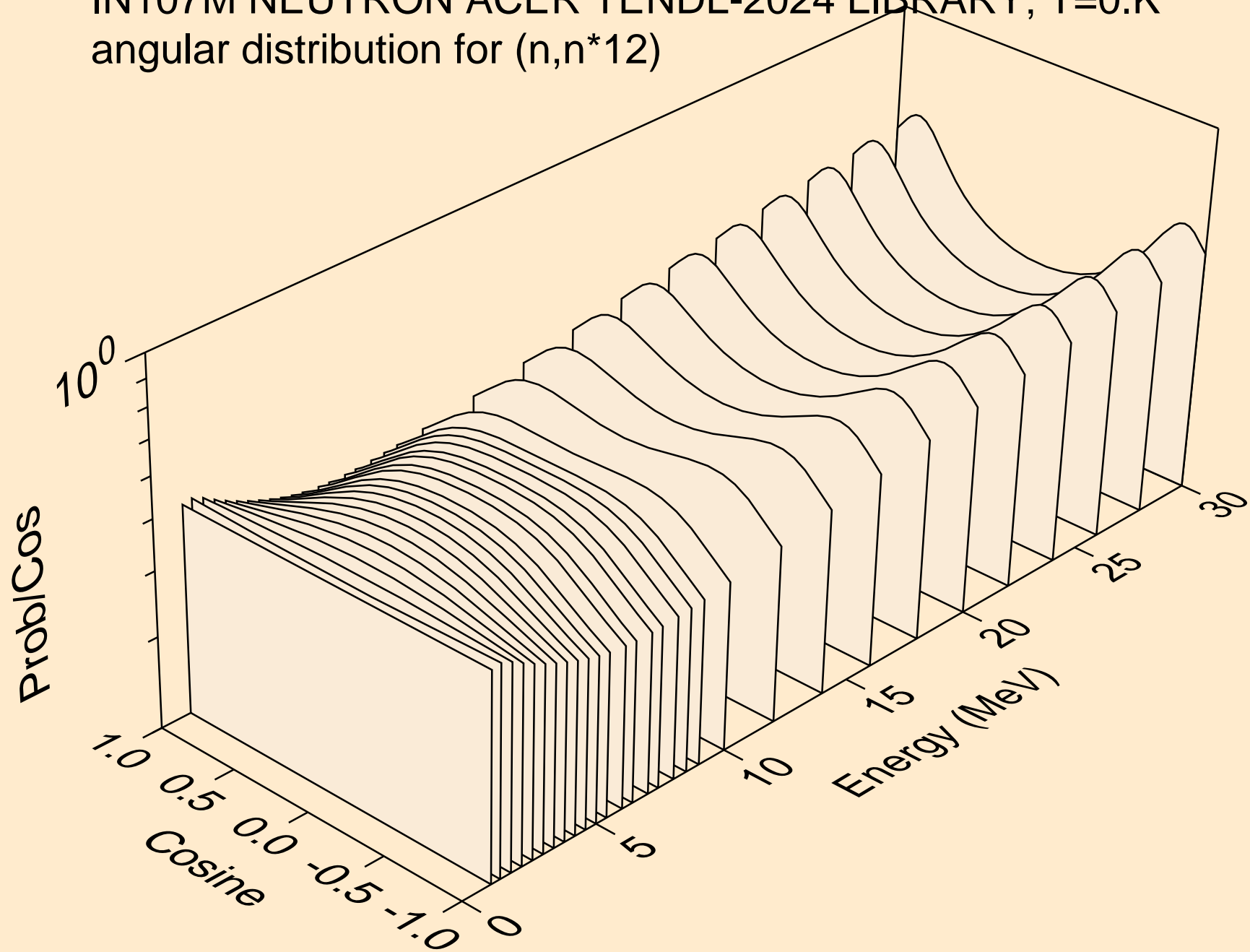

IN107M NEUTRON ACER TENDL-2024 LIBRARY; T=0.K
angular distribution for (n,n*13)

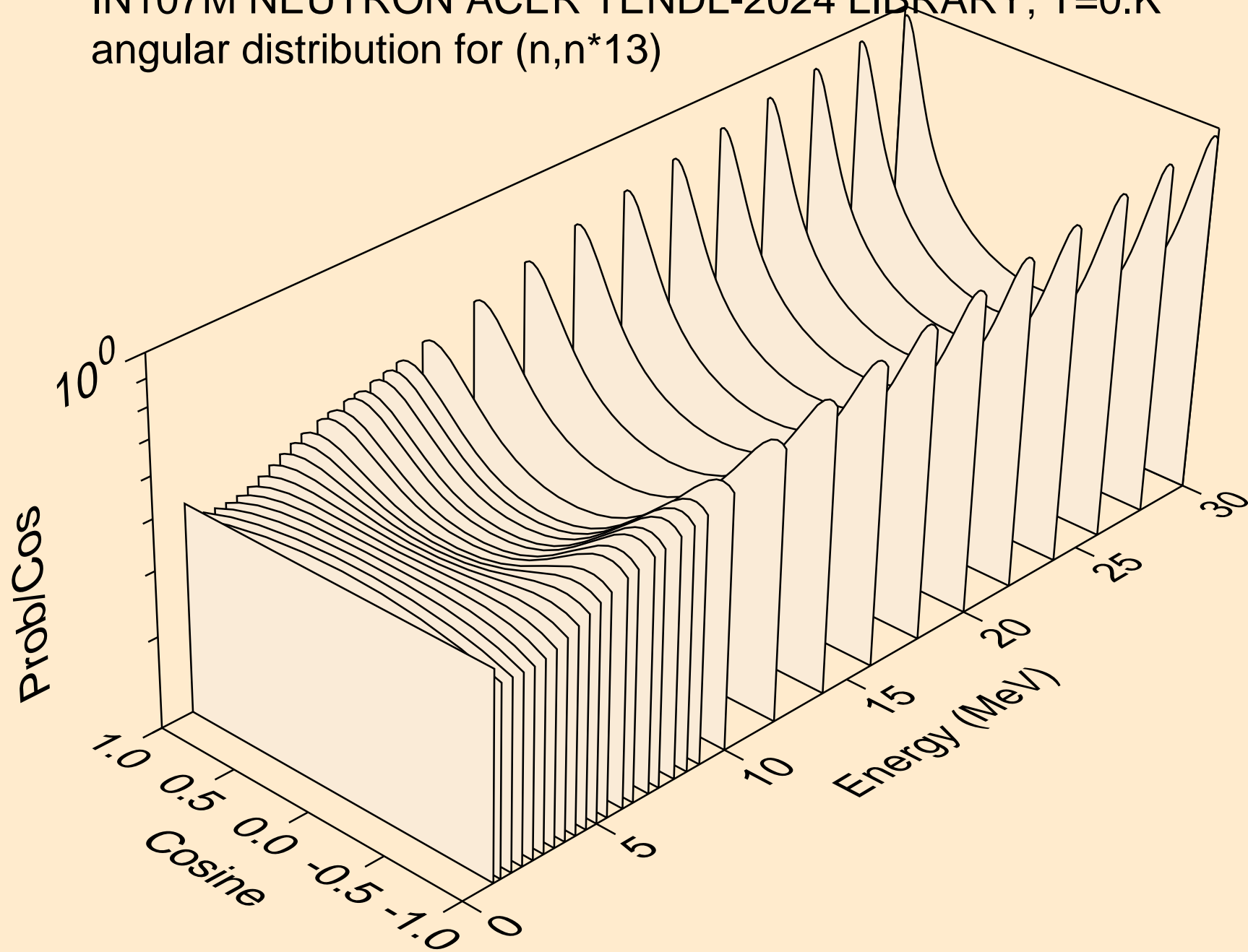

IN107M NEUTRON ACER TENDL-2024 LIBRARY; T=0.K
angular distribution for (n,n*14)

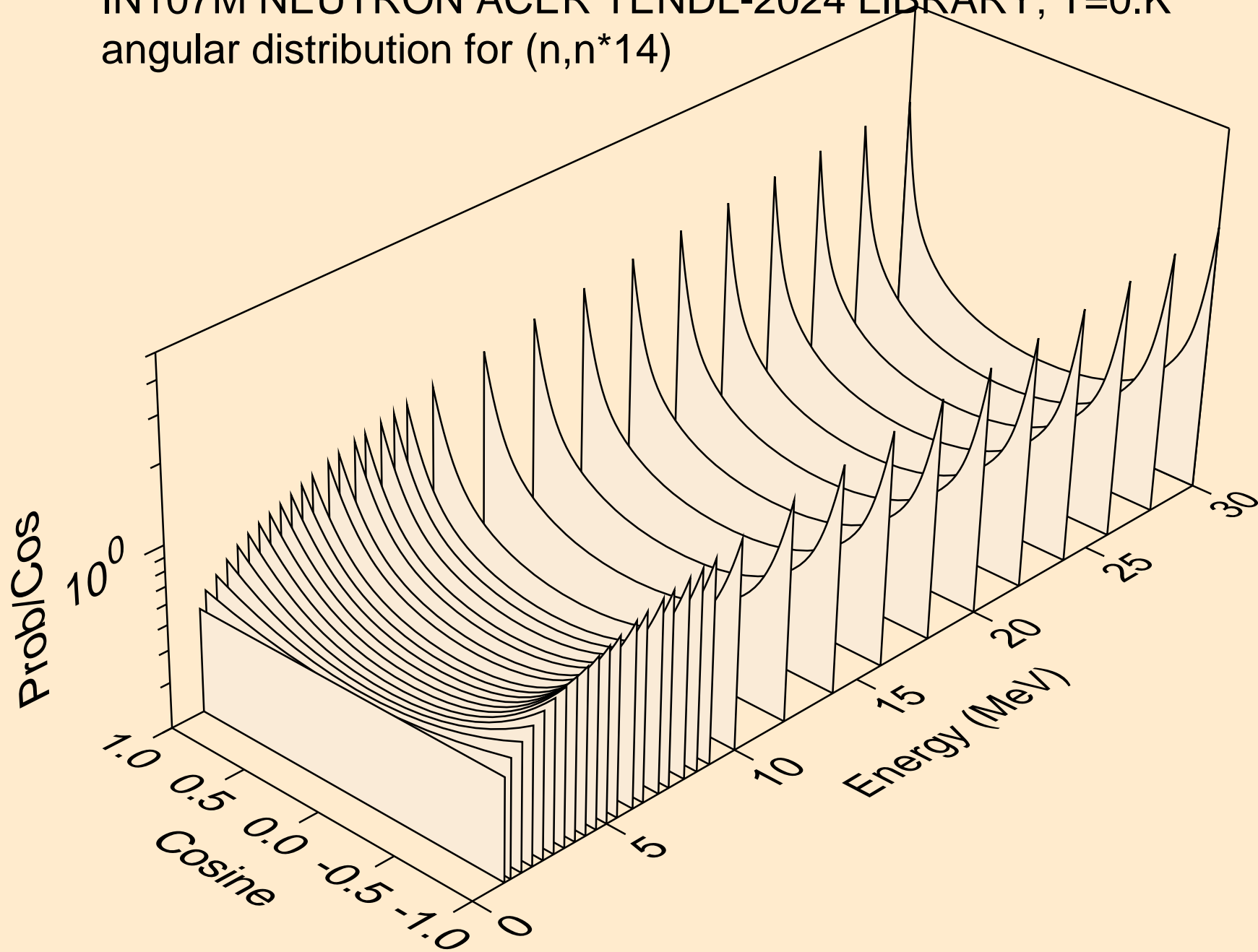

IN107M NEUTRON ACER TENDL-2024 LIBRARY; T=0.K
angular distribution for (n,n*15)

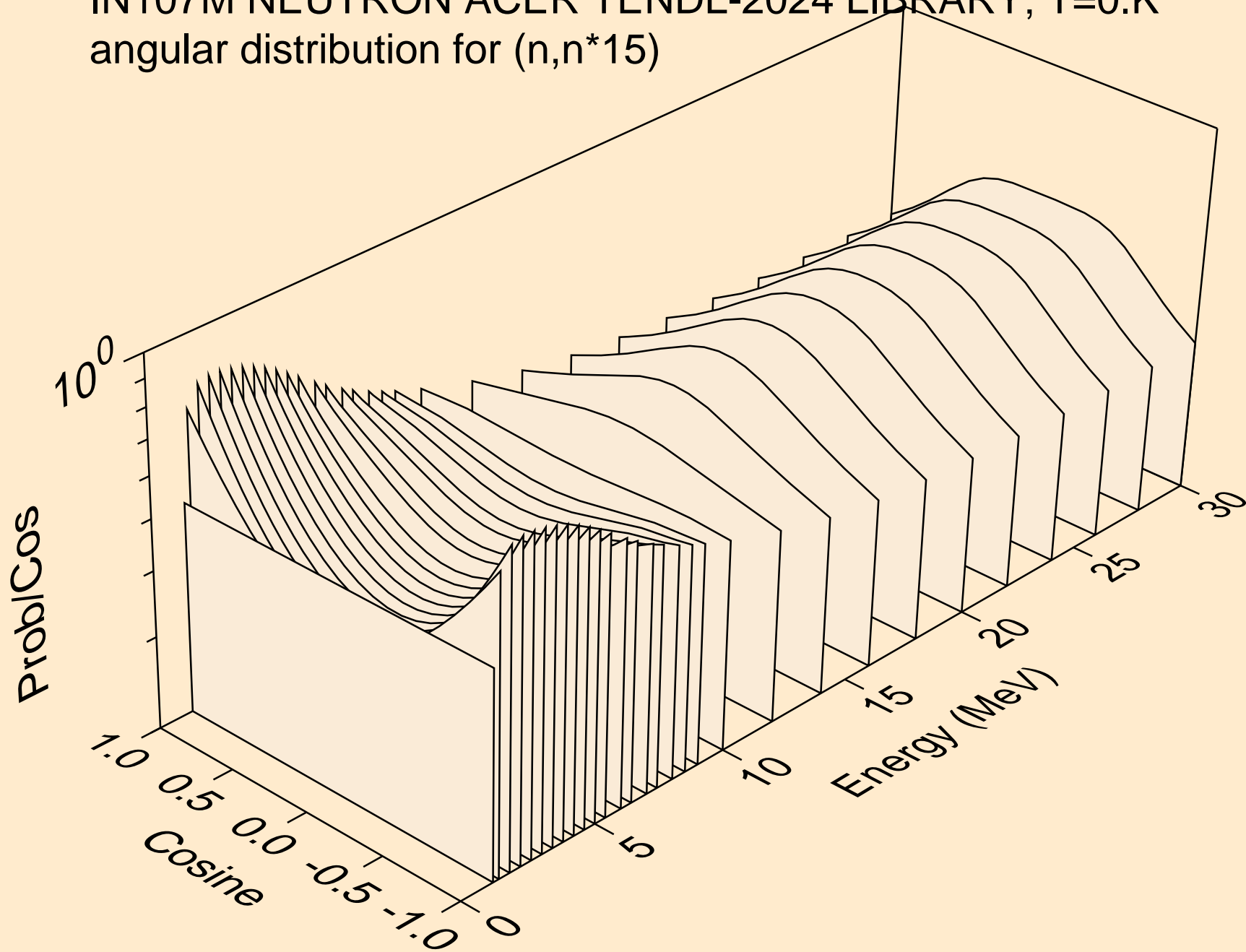

IN107M NEUTRON ACER TENDL-2024 LIBRARY; T=0.K
angular distribution for (n,n*16)

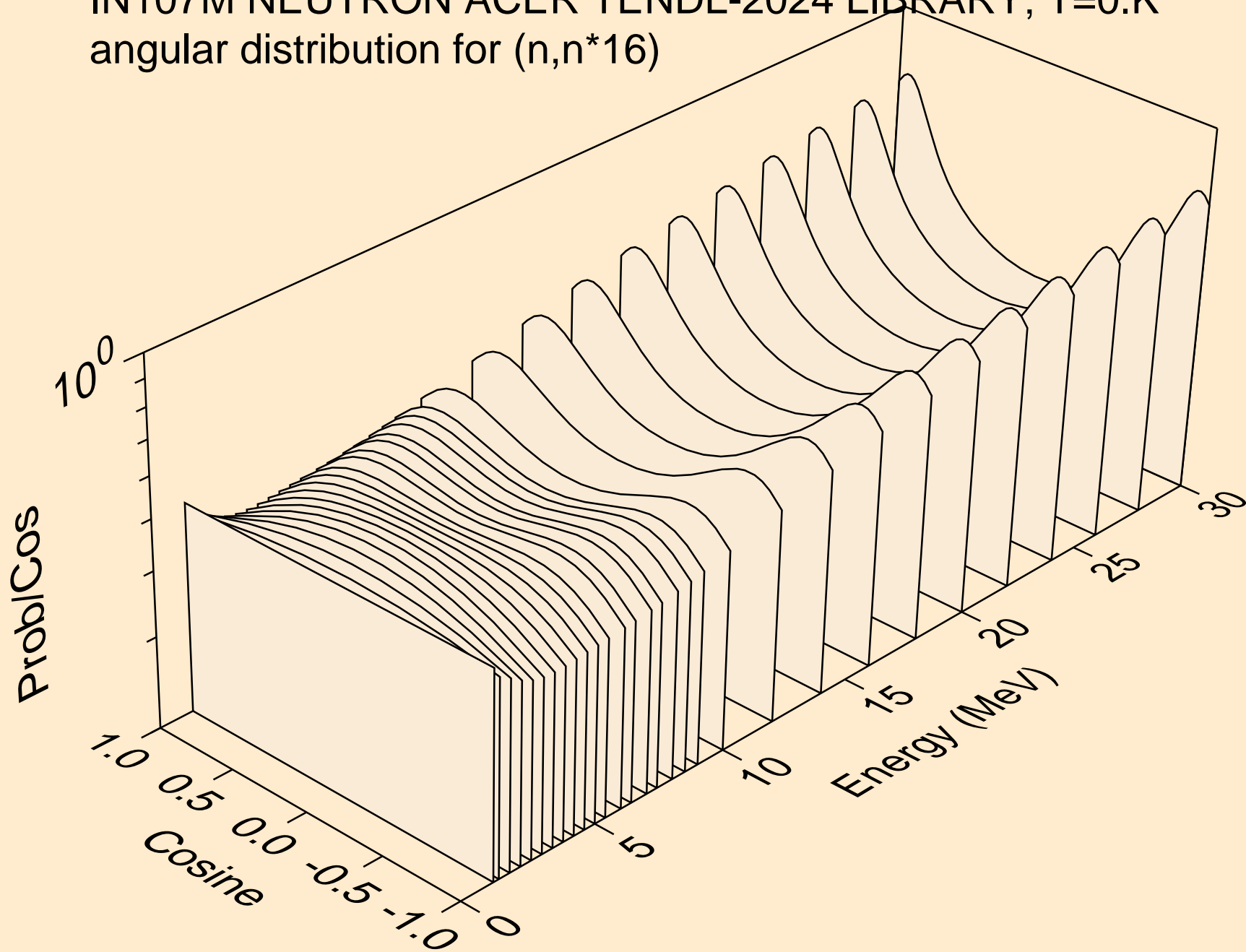

IN107M NEUTRON ACER TENDL-2024 LIBRARY; T=0.K
angular distribution for (n,n*17)

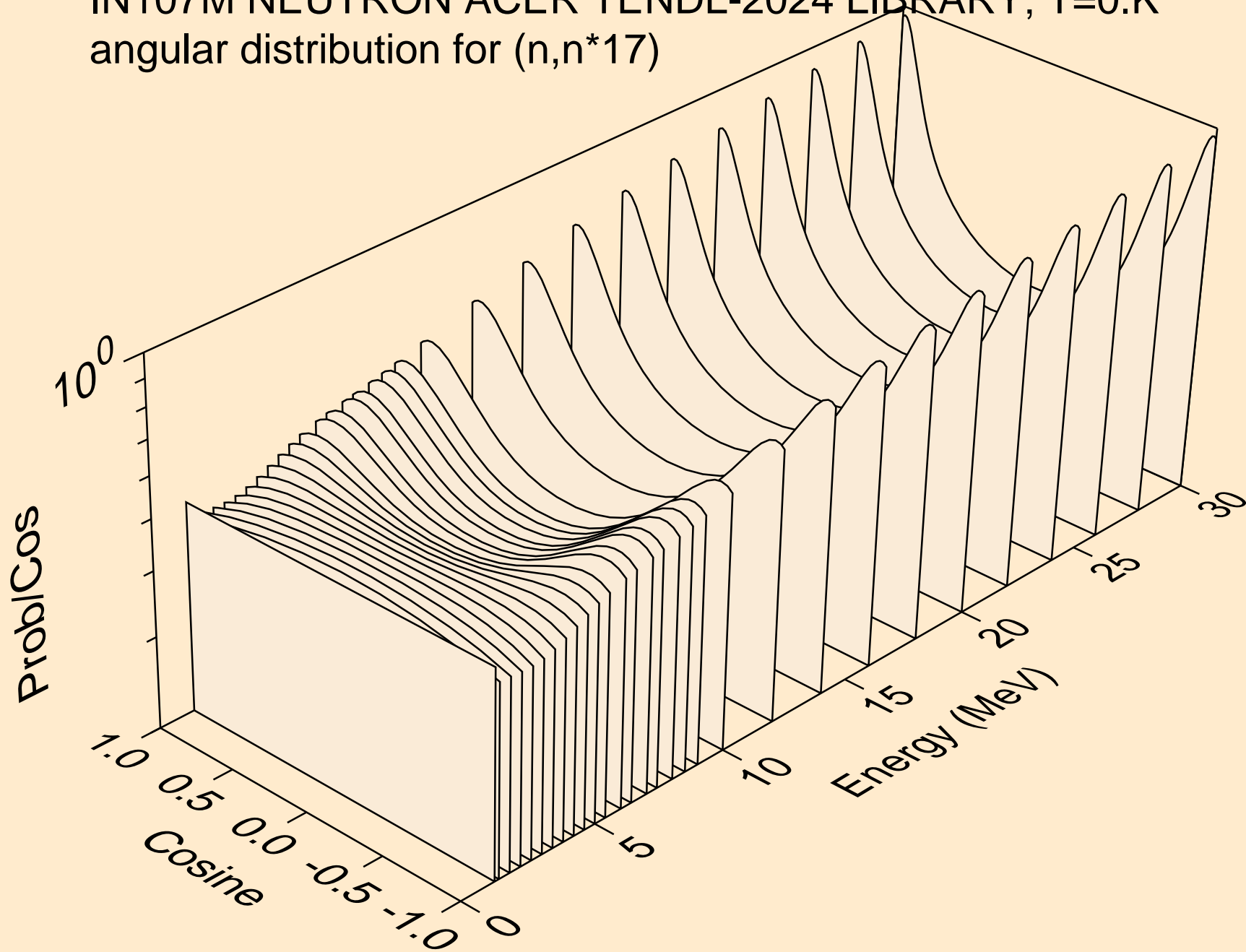

IN107M NEUTRON ACER TENDL-2024 LIBRARY; T=0.K
angular distribution for (n,n*18)

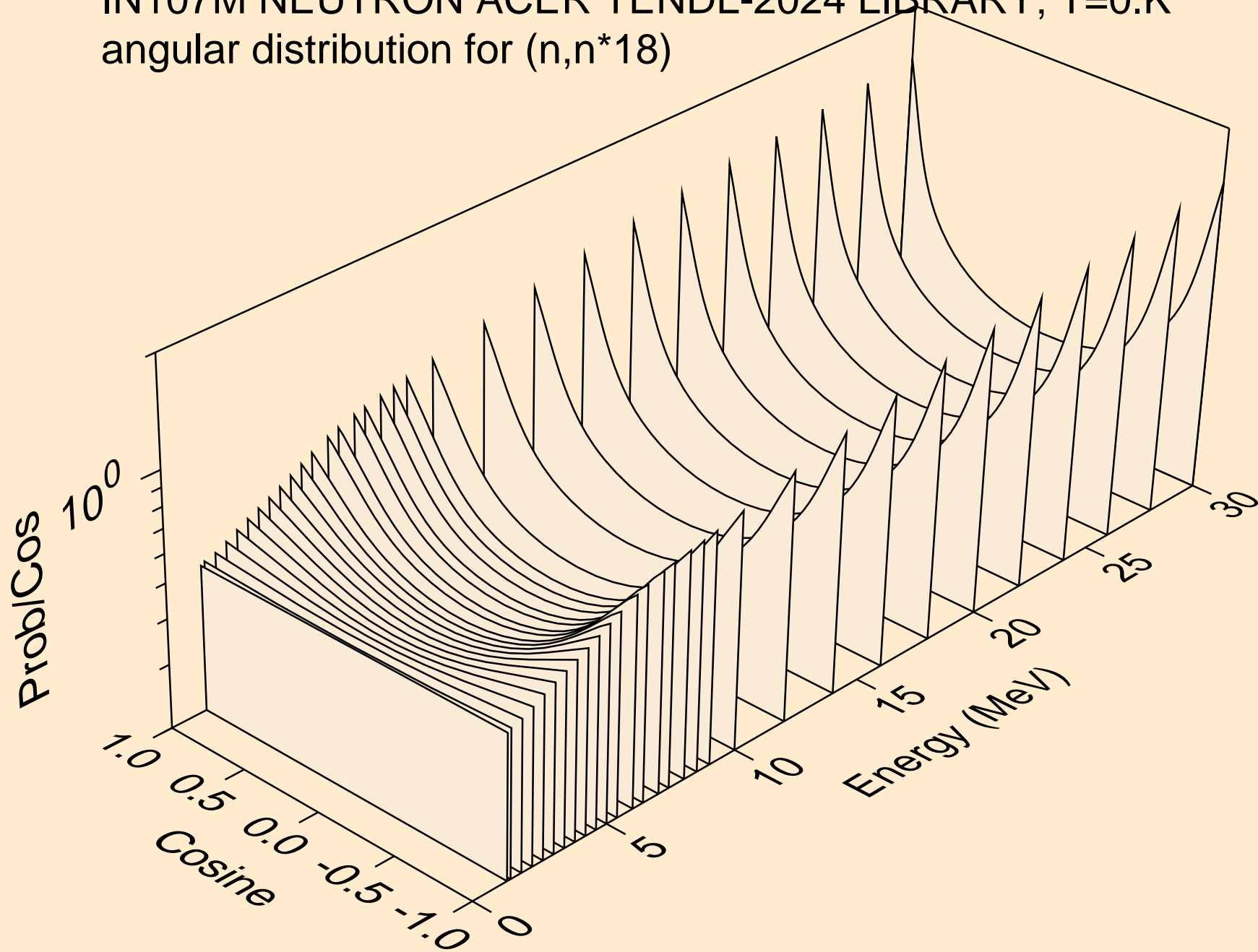

IN107M NEUTRON ACER TENDL-2024 LIBRARY; T=0.K
angular distribution for (n,n*19)

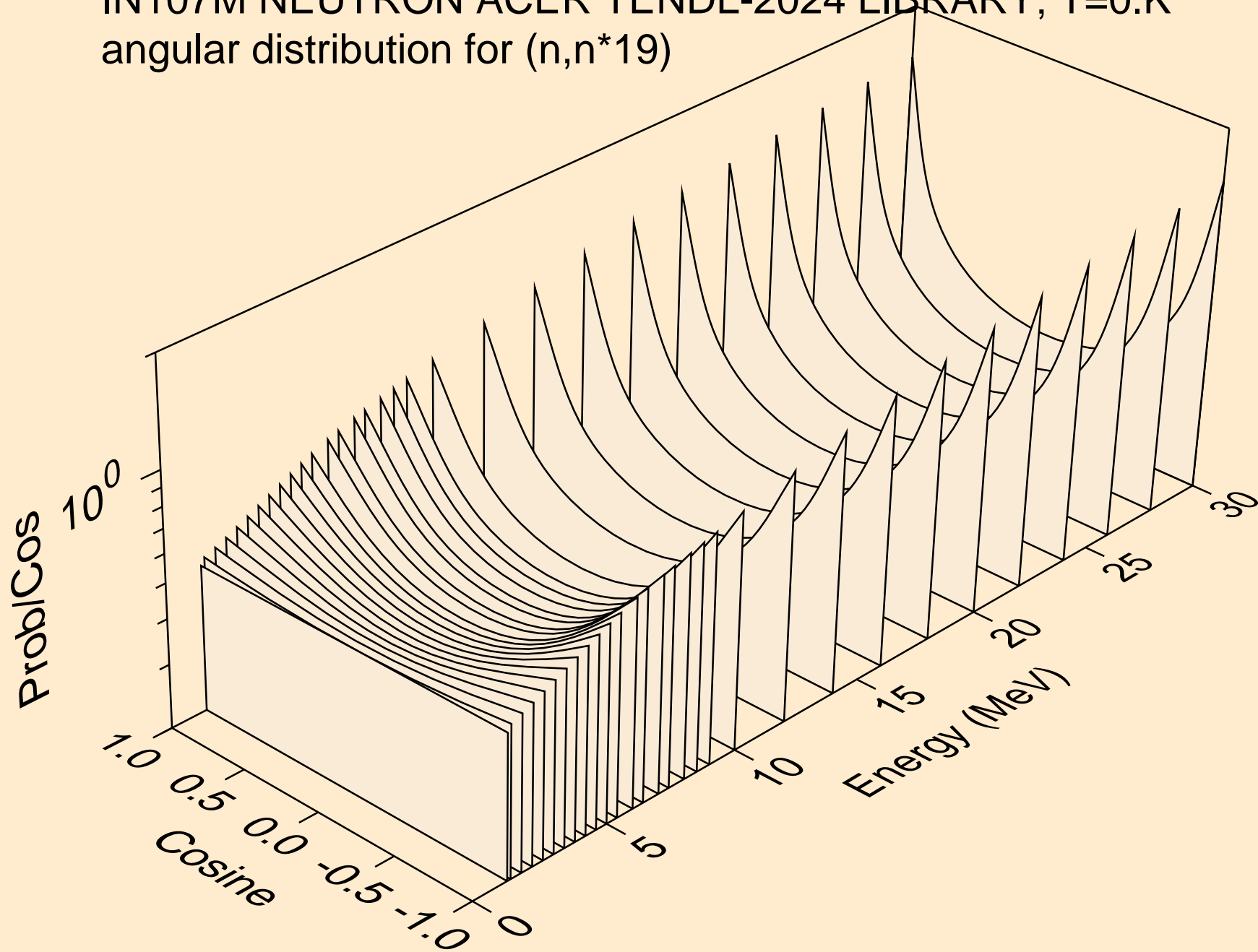

IN107M NEUTRON ACER TENDL-2024 LIBRARY; T=0.K
angular distribution for (n,n*20)

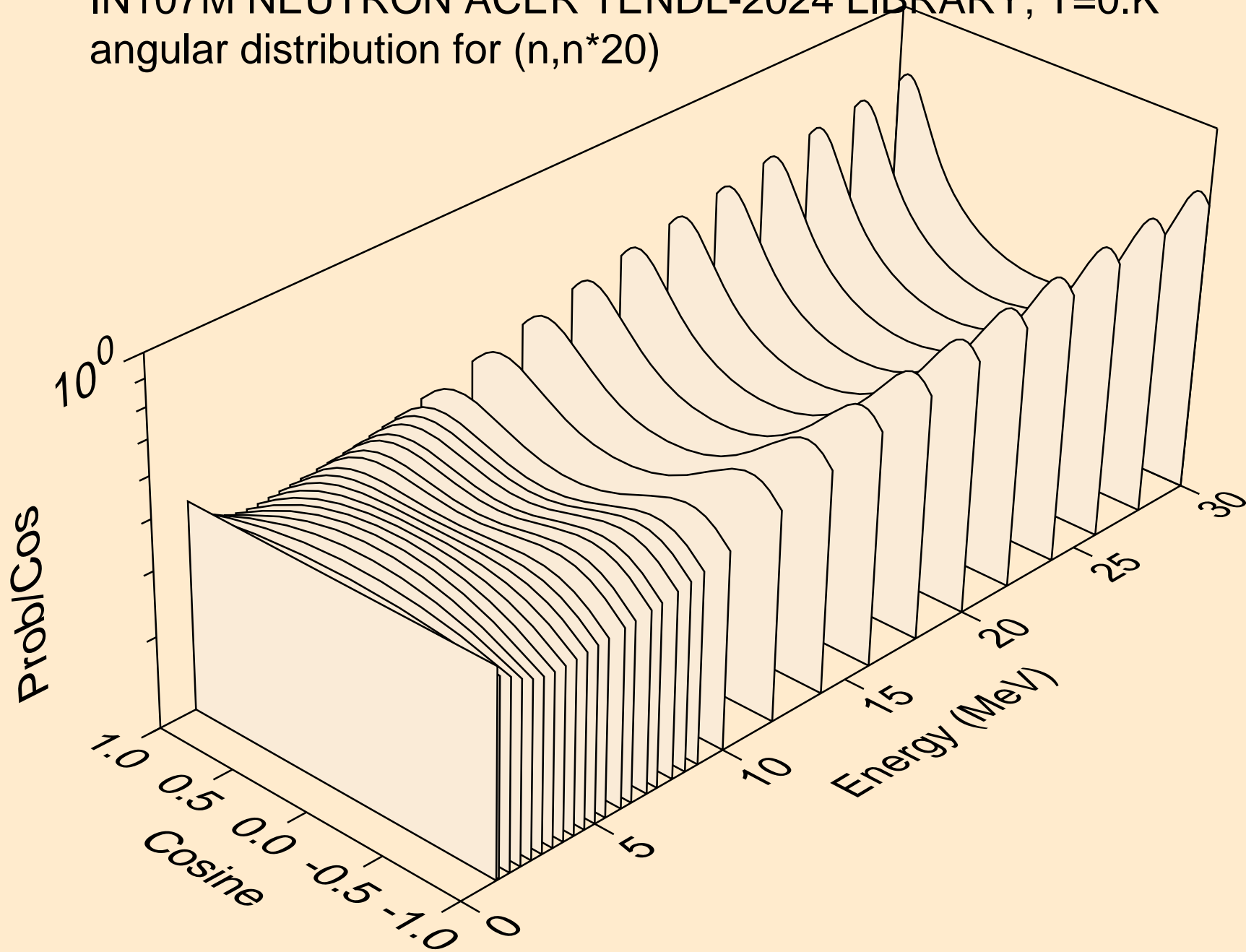

IN107M NEUTRON ACER TENDL-2024 LIBRARY; T=0.K
angular distribution for (n,n*21)

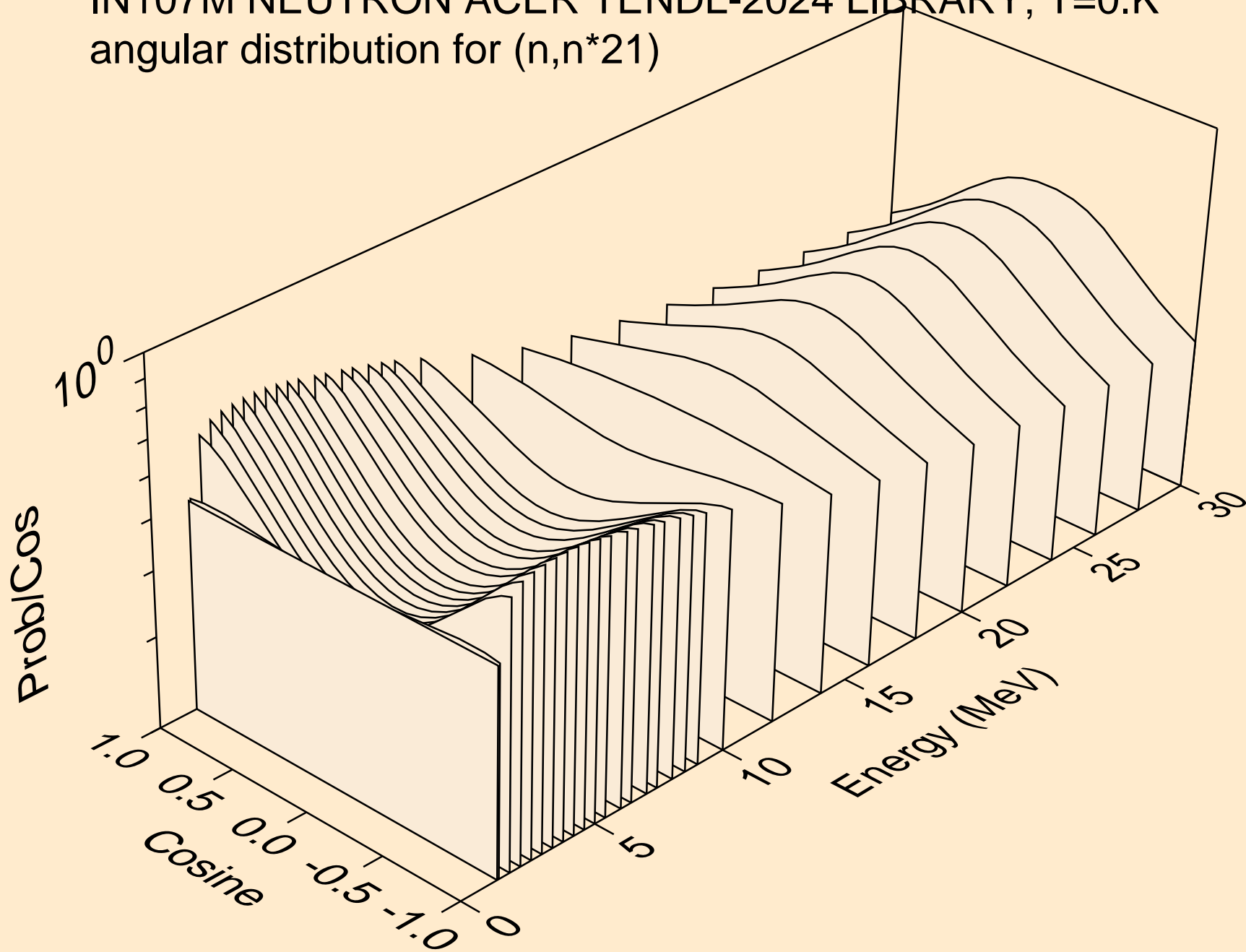

IN107M NEUTRON ACER TENDL-2024 LIBRARY; T=0.K
angular distribution for (n,n*22)

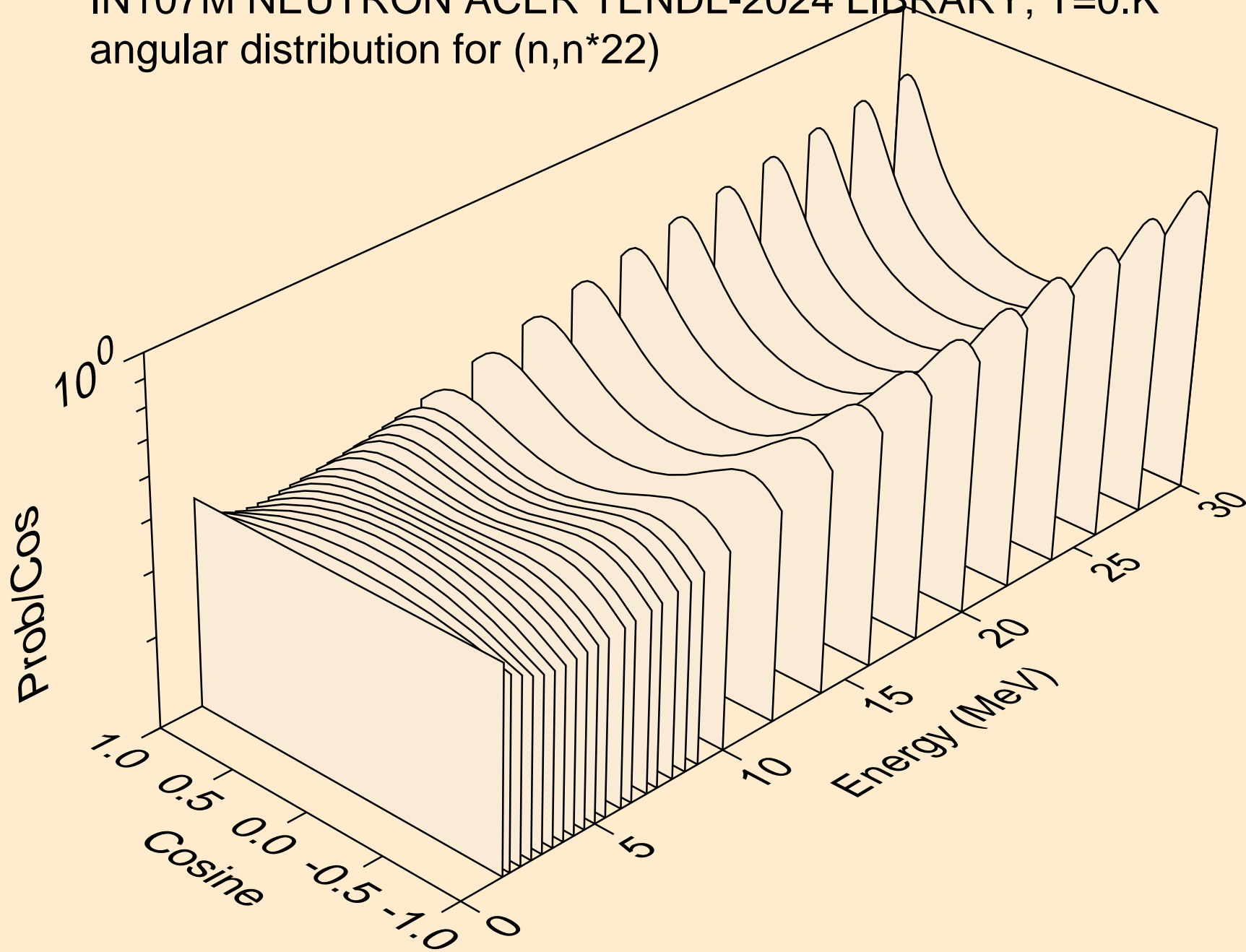

IN107M NEUTRON ACER TENDL-2024 LIBRARY; T=0.K
angular distribution for (n,n*23)

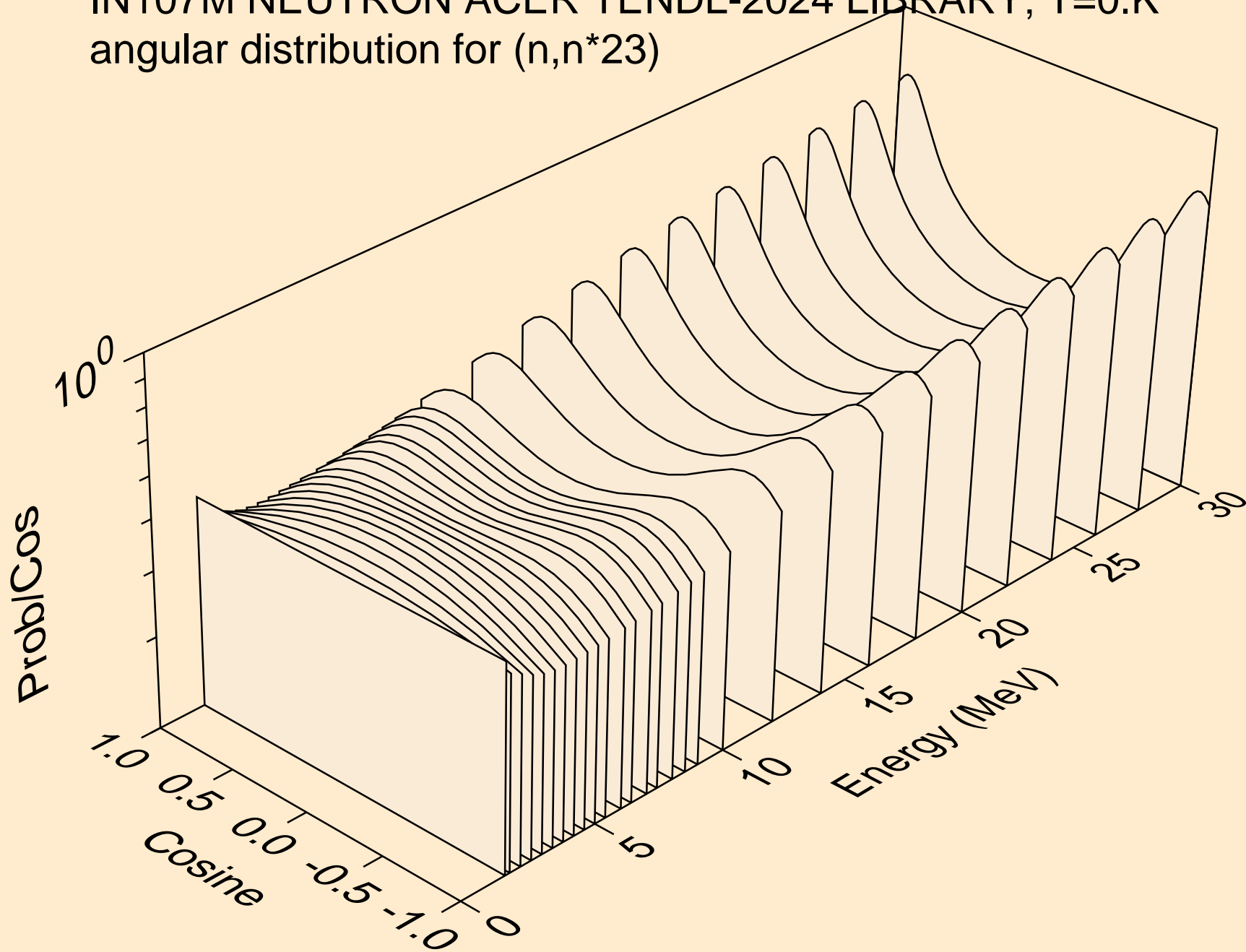

IN107M NEUTRON ACER TENDL-2024 LIBRARY; T=0.K
angular distribution for (n,n*24)

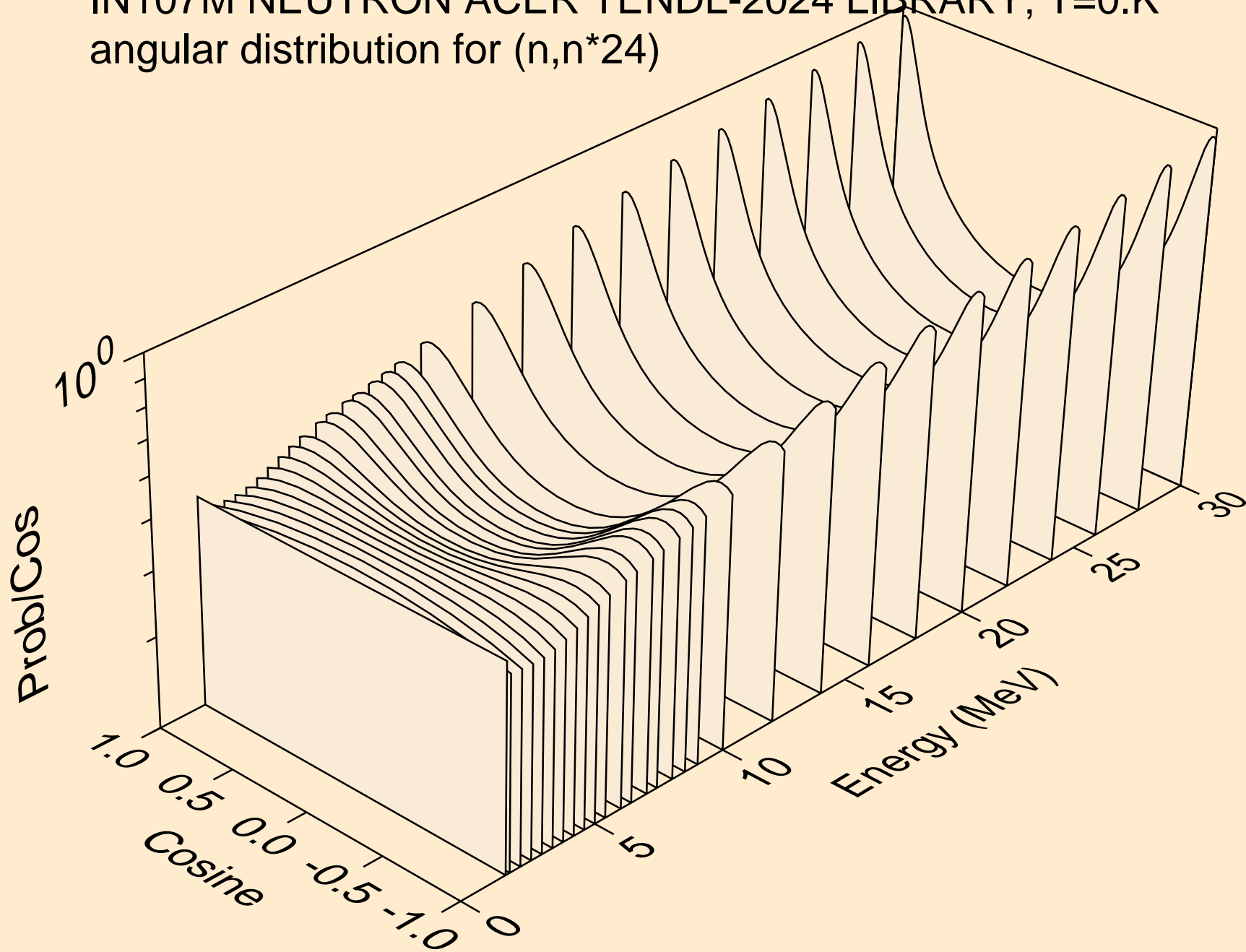

IN107M NEUTRON ACER TENDL-2024 LIBRARY; T=0.K
angular distribution for (n,n*25)

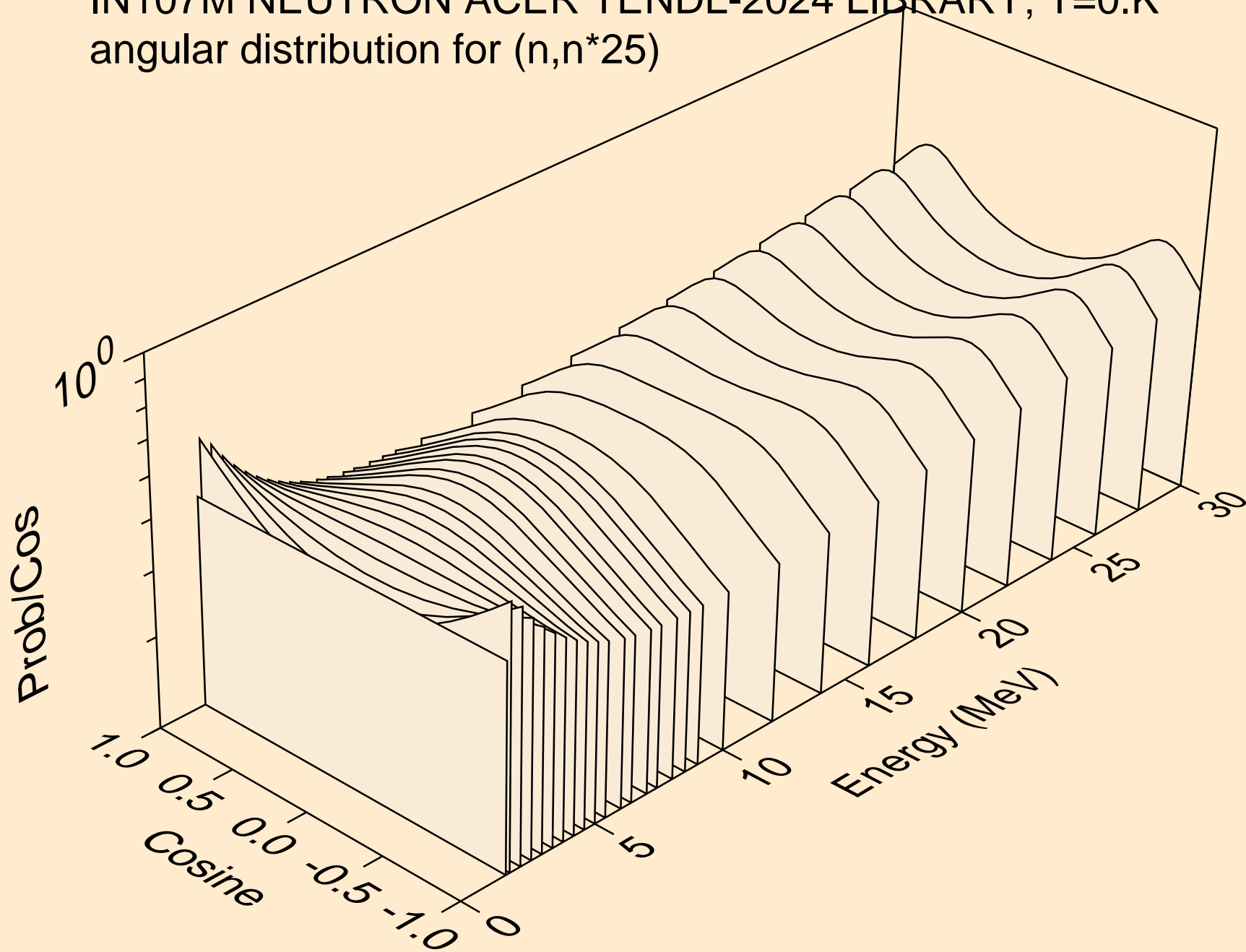

IN107M NEUTRON ACER TENDL-2024 LIBRARY; T=0.K
angular distribution for (n,n*26)

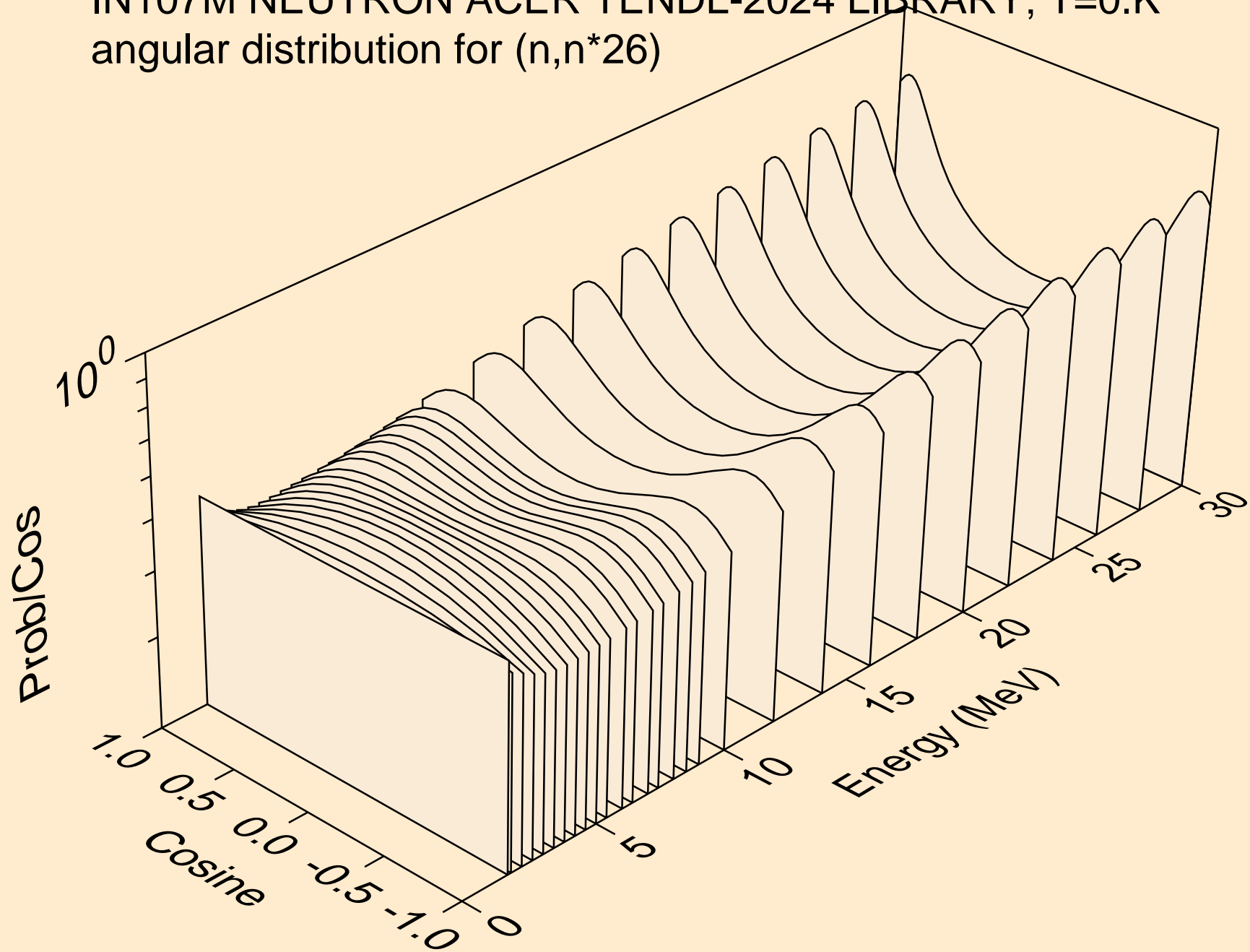

IN107M NEUTRON ACER TENDL-2024 LIBRARY; T=0.K
angular distribution for (n,n*27)

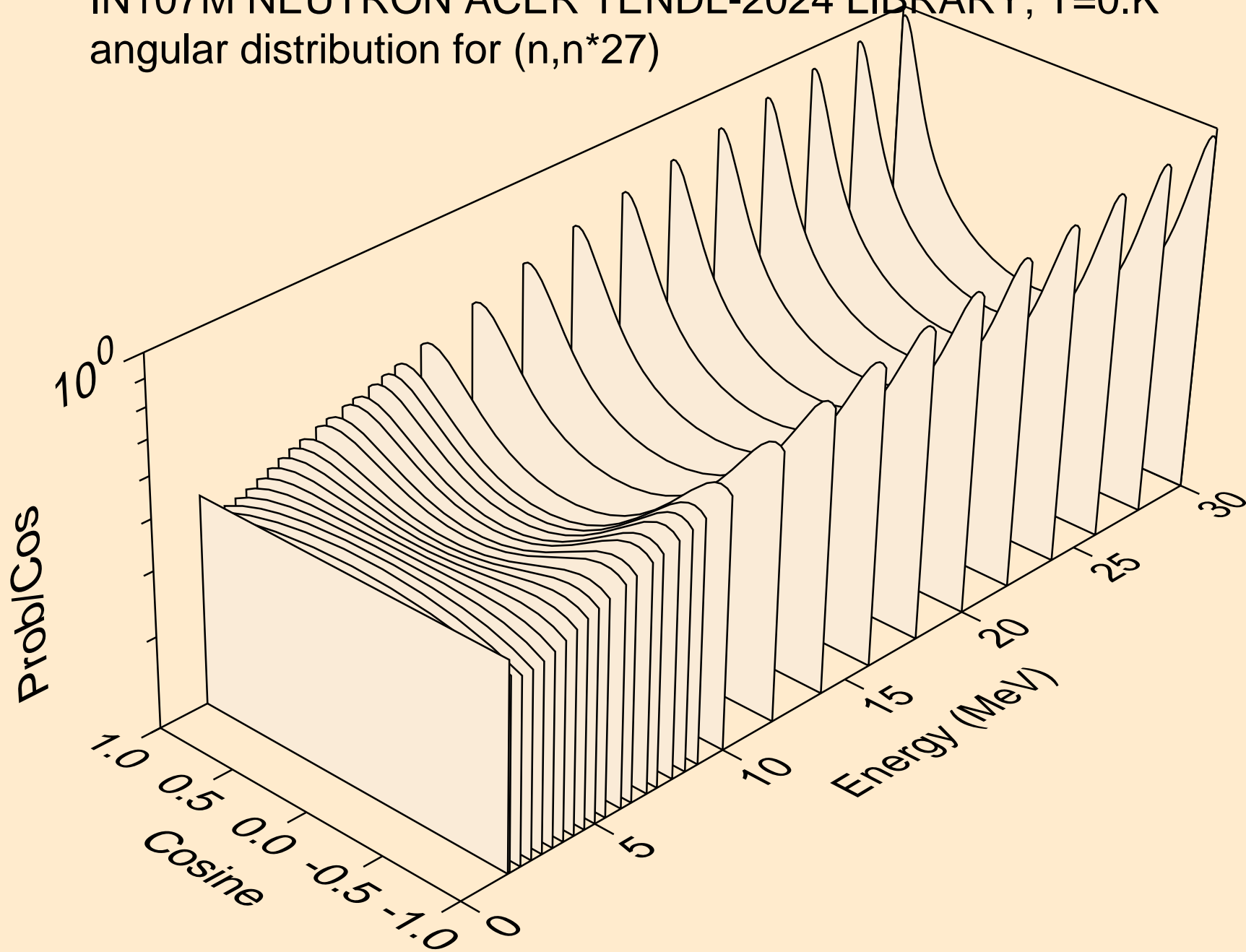

IN107M NEUTRON ACER TENDL-2024 LIBRARY; T=0.K
angular distribution for (n,n*28)

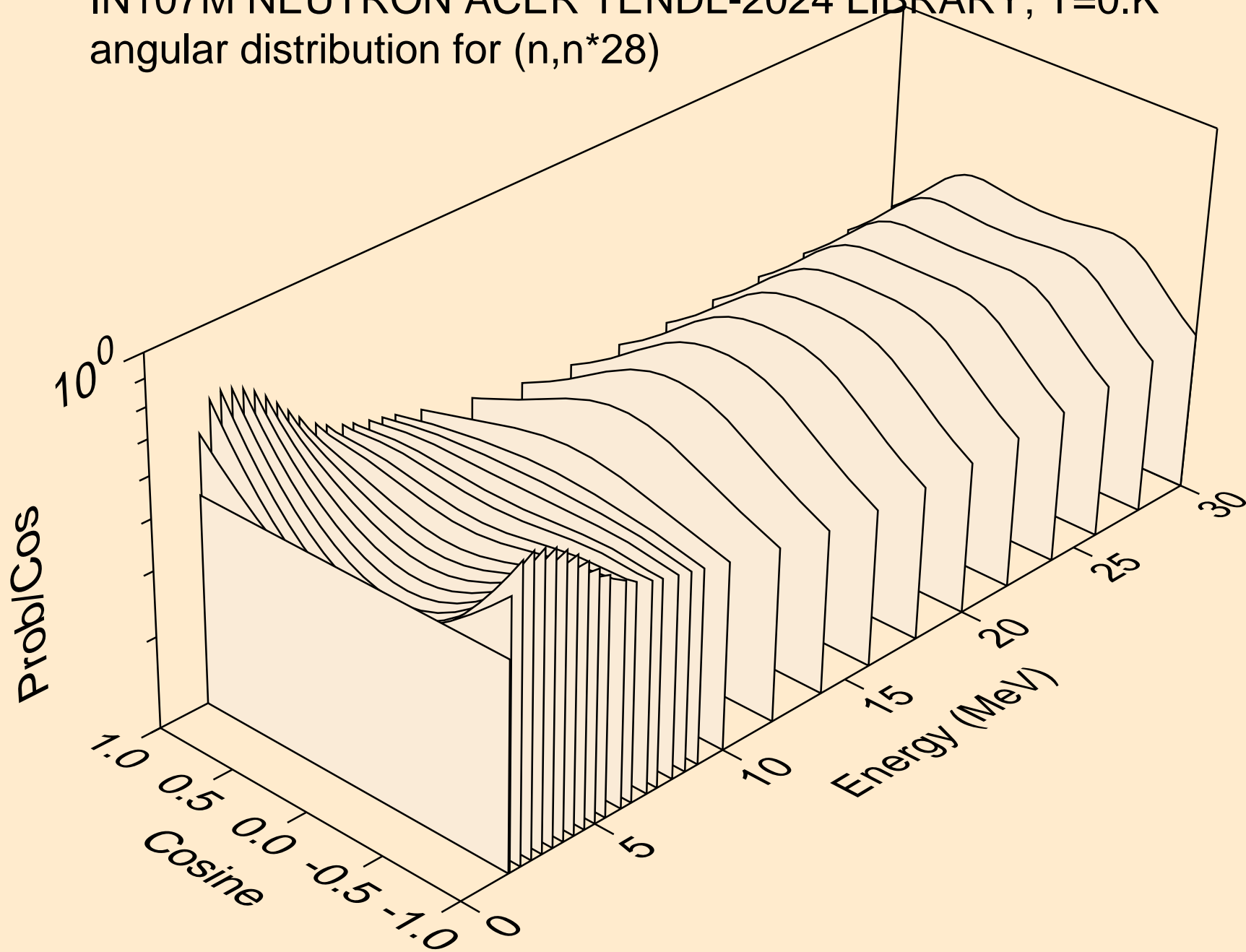

IN107M NEUTRON ACER TENDL-2024 LIBRARY; T=0.K
angular distribution for (n,n*29)

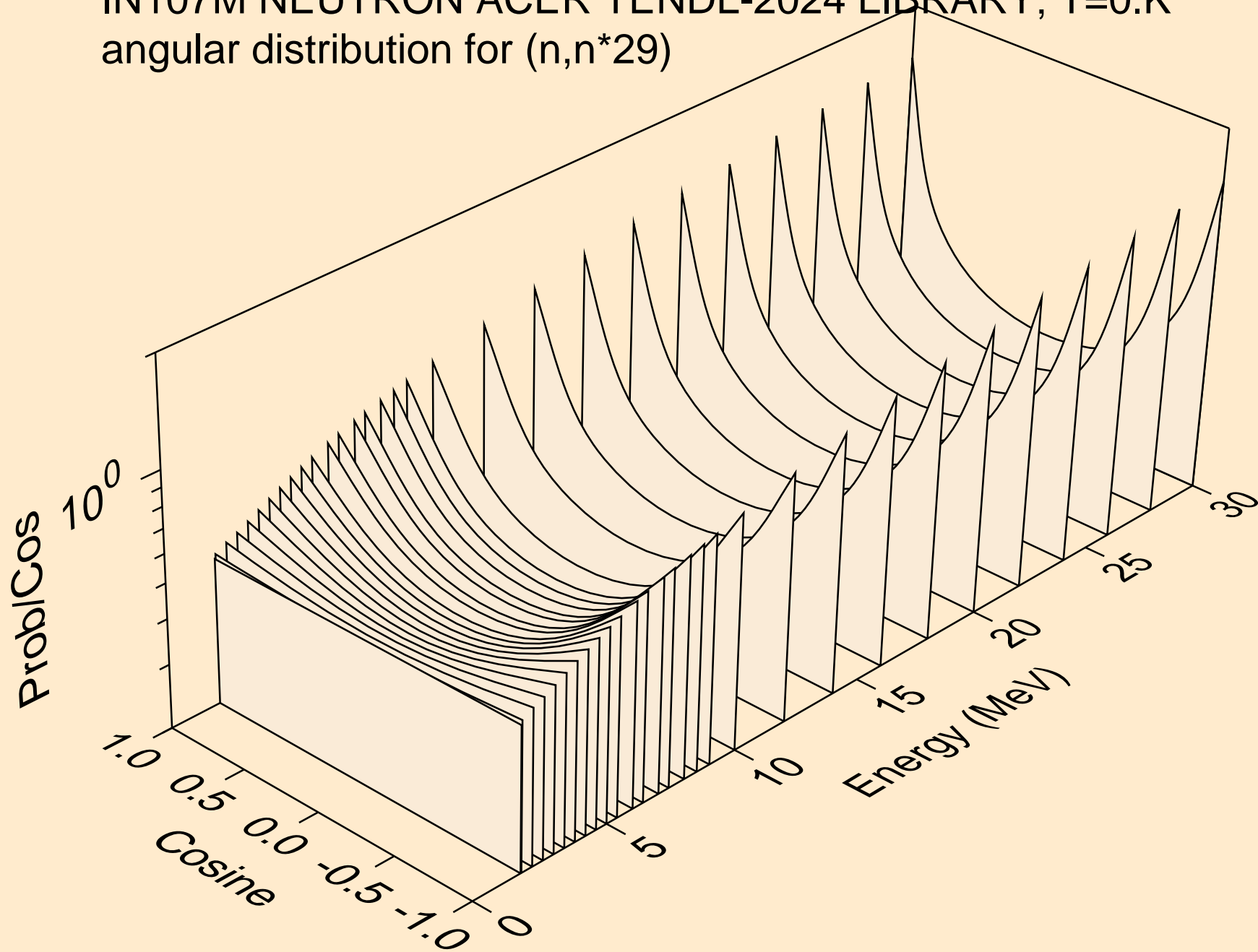

IN107M NEUTRON ACER TENDL-2024 LIBRARY; T=0.K
angular distribution for (n,n*30)

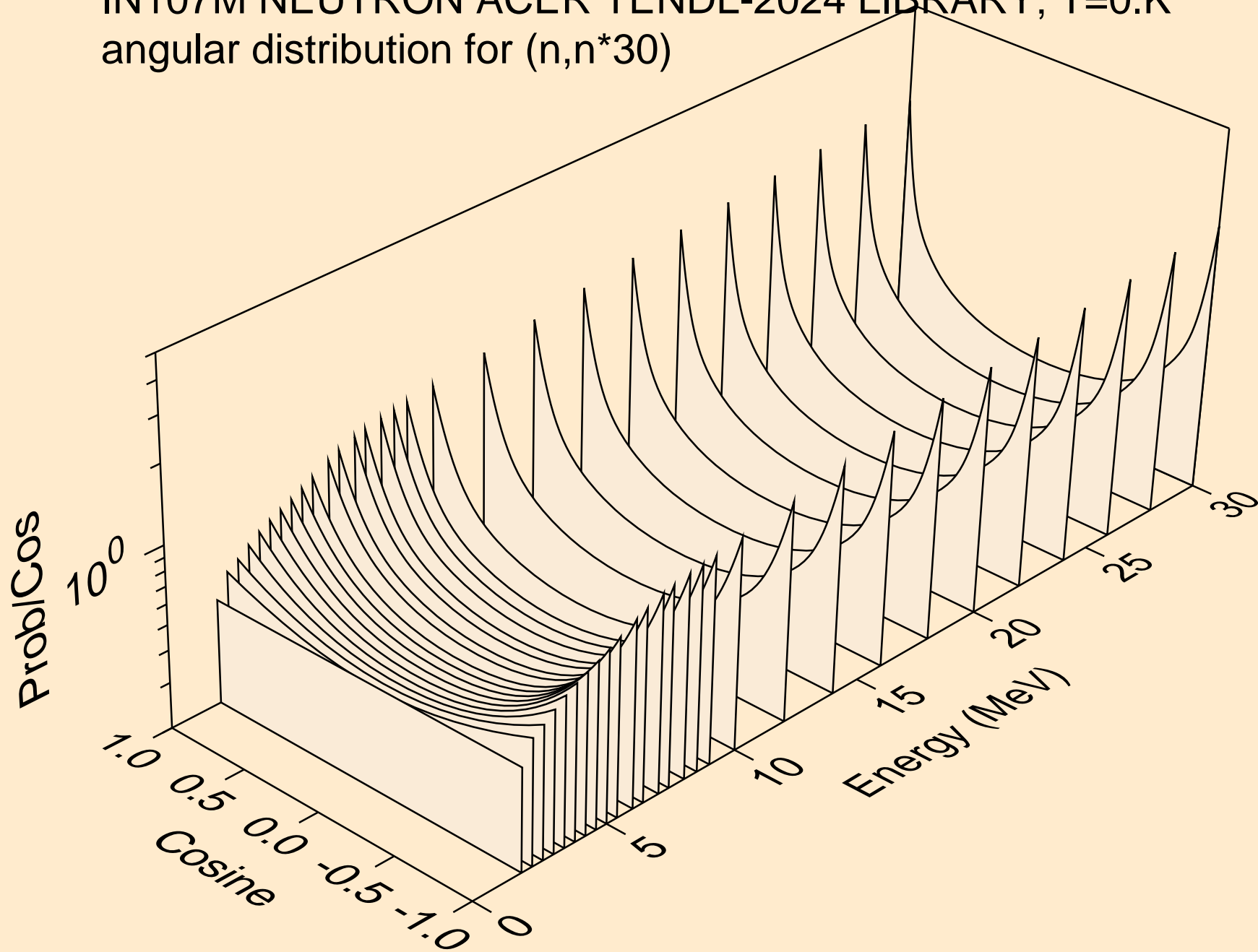

IN107M NEUTRON ACER TENDL-2024 LIBRARY; T=0.K
Neutron emission for (n,x)

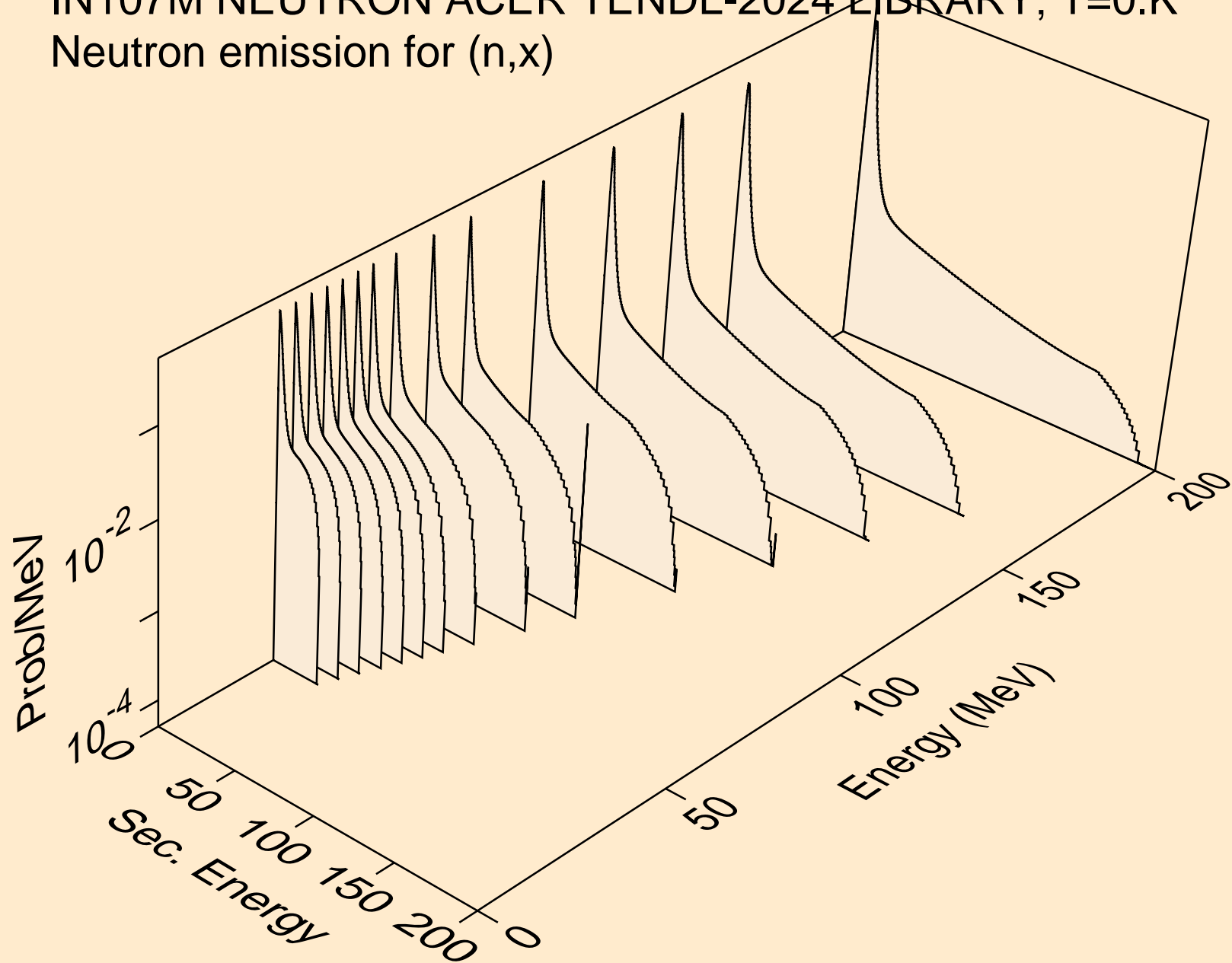

IN107M NEUTRON ACER TENDL-2024 LIBRARY; T=0.K
Neutron emission for (n,2nd)

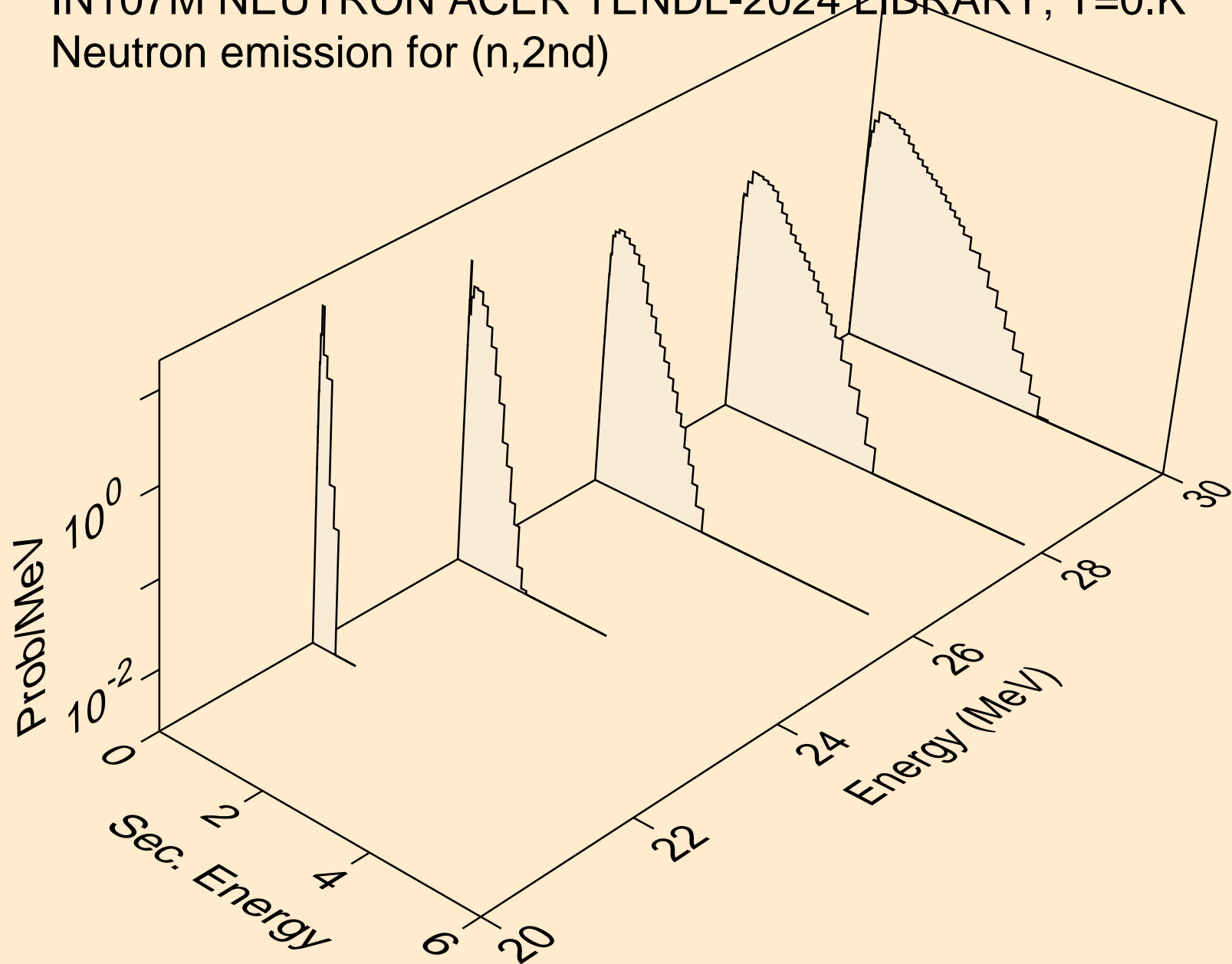

IN107M NEUTRON ACER TENDL-2024 LIBRARY; T=0.K
Neutron emission for (n,2n)

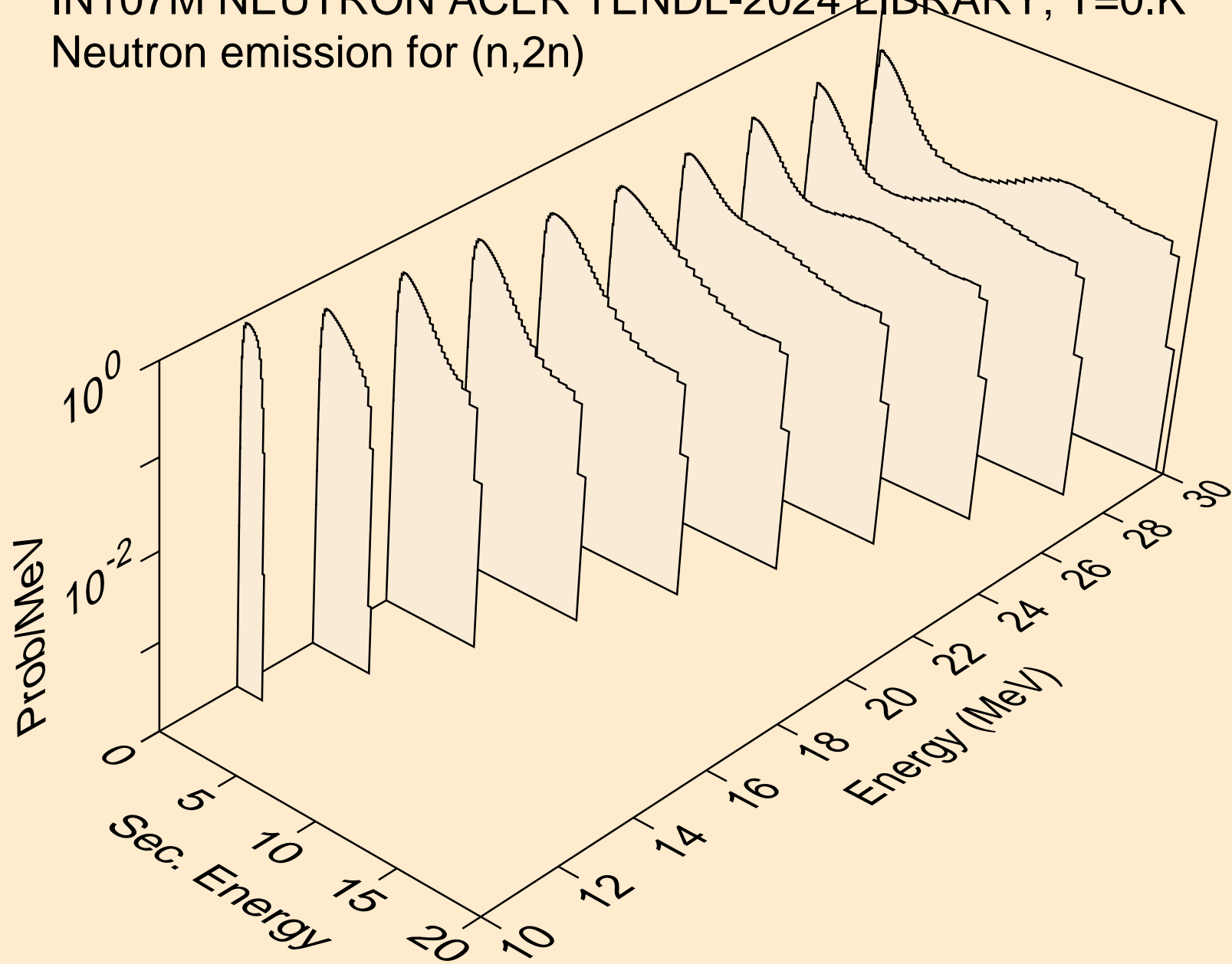

IN107M NEUTRON ACER TENDL-2024 LIBRARY; T=0.K
Neutron emission for (n,3n)

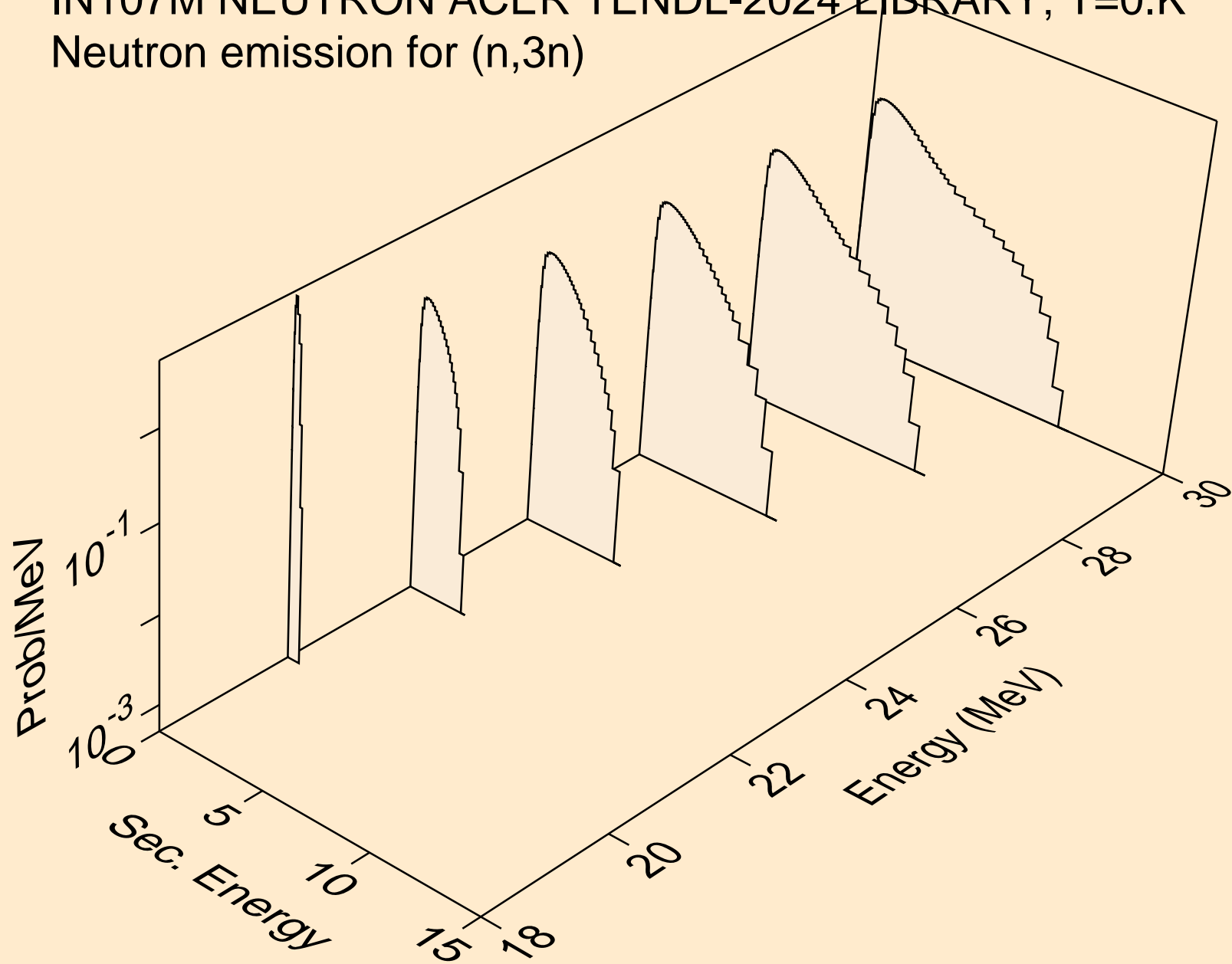

IN107M NEUTRON ACER TENDL-2024 LIBRARY; T=0.K
Neutron emission for (n,n*)a

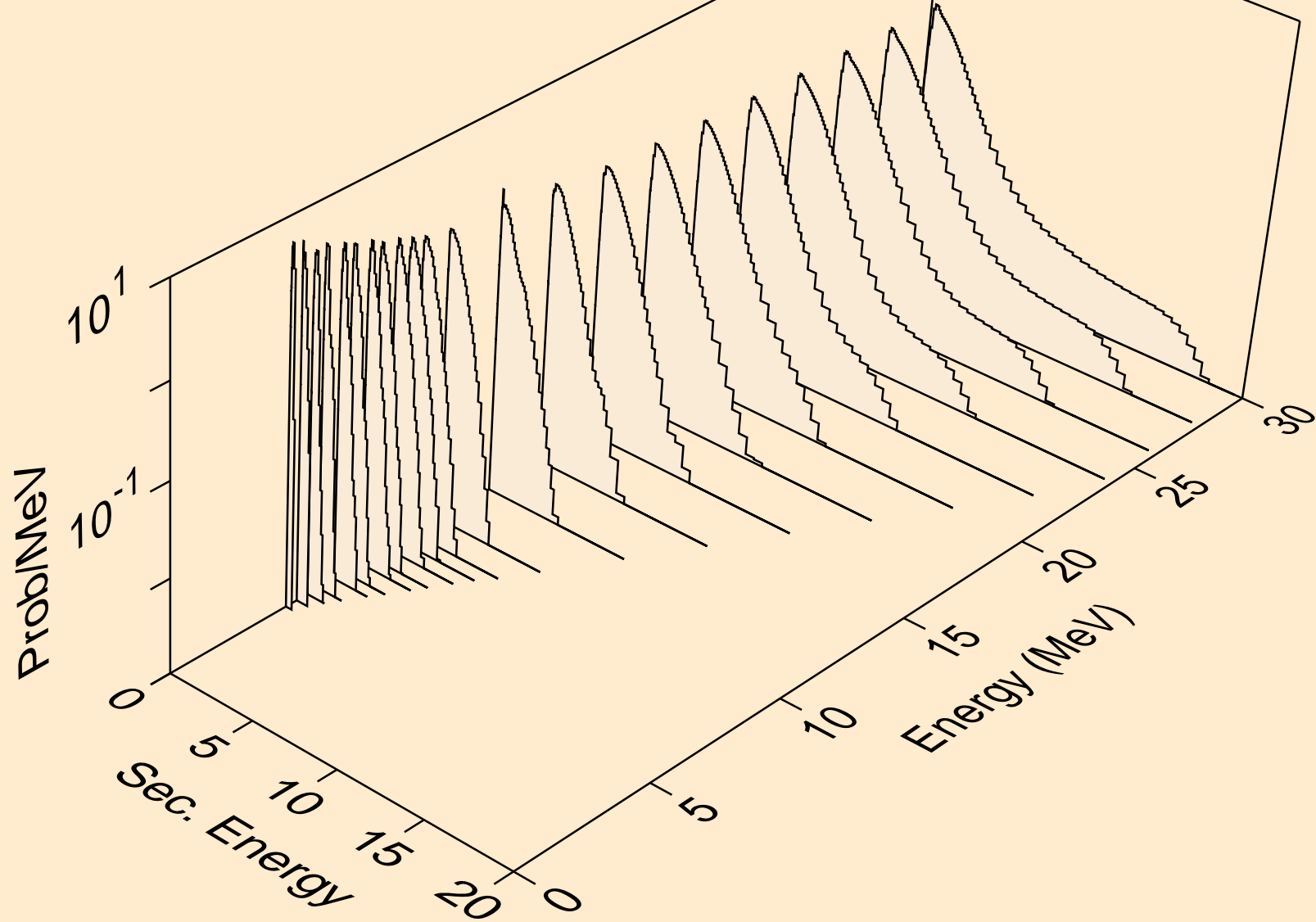

IN107M NEUTRON ACER TENDL-2024 LIBRARY; T=0.K
Neutron emission for (n,2n)_a

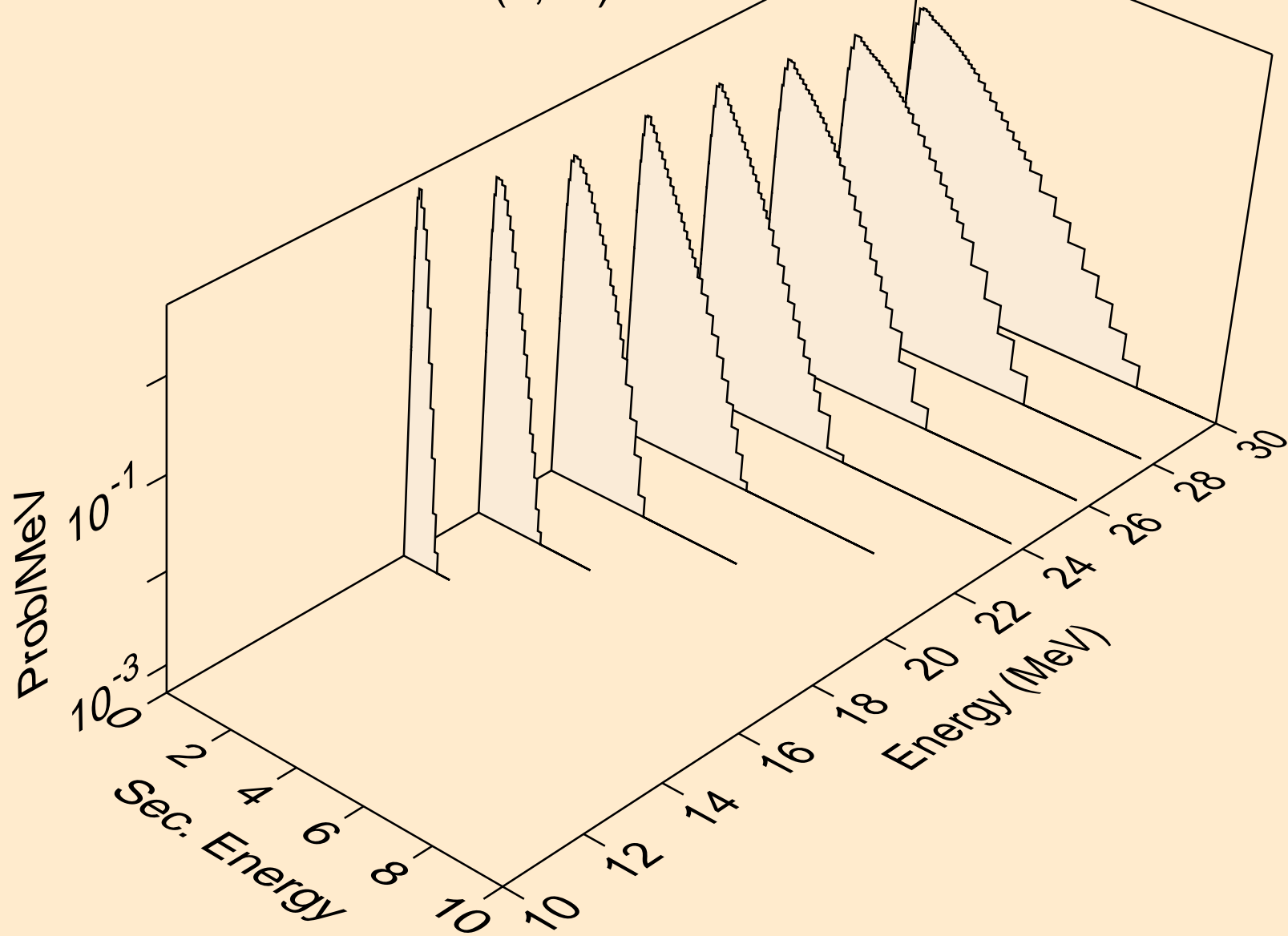

IN107M NEUTRON ACER TENDL-2024 LIBRARY; T=0.K
Neutron emission for (n,3n)a

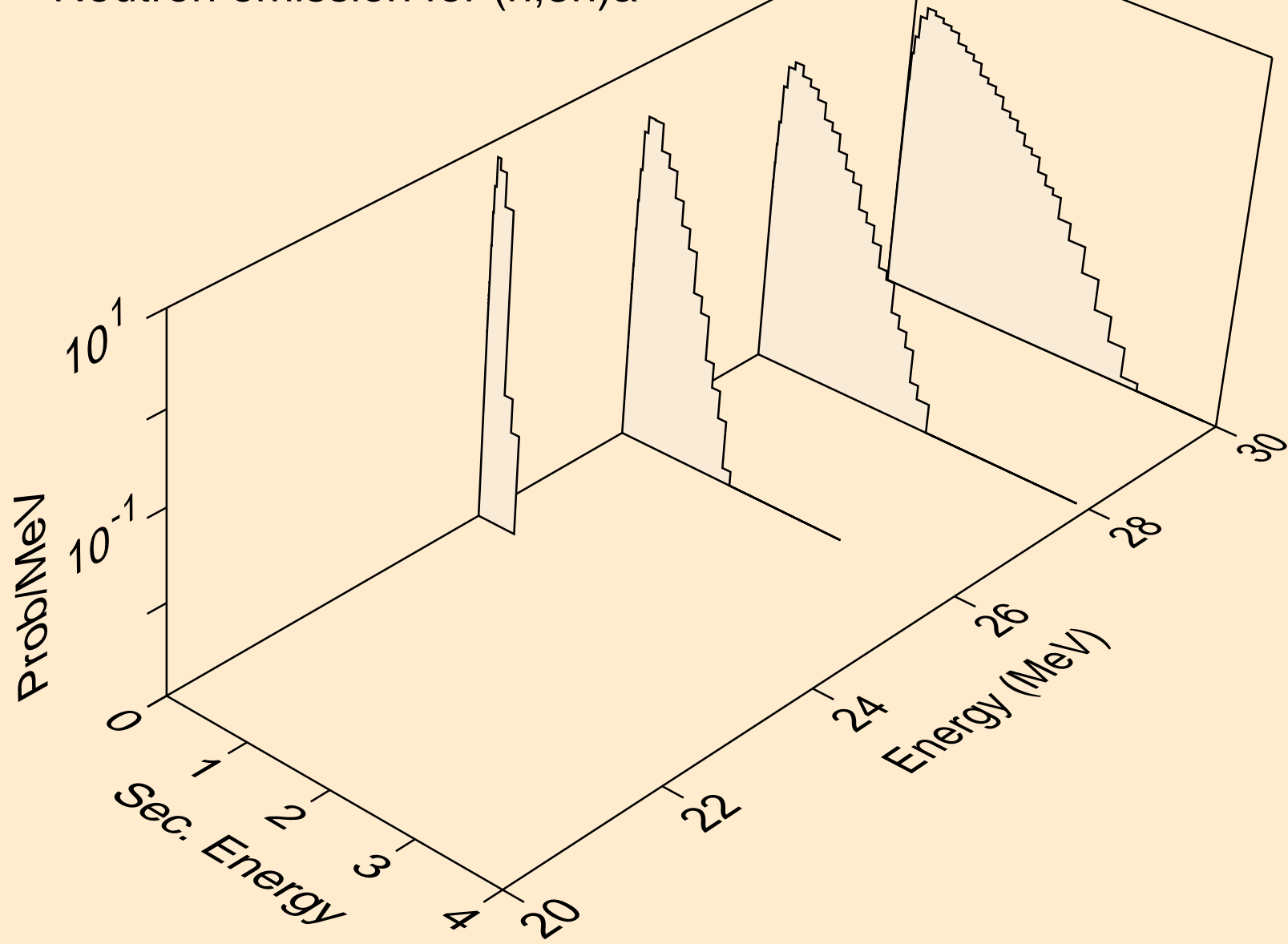

IN107M NEUTRON ACER TENDL-2024 LIBRARY; T=0.K
Neutron emission for (n,n*)p

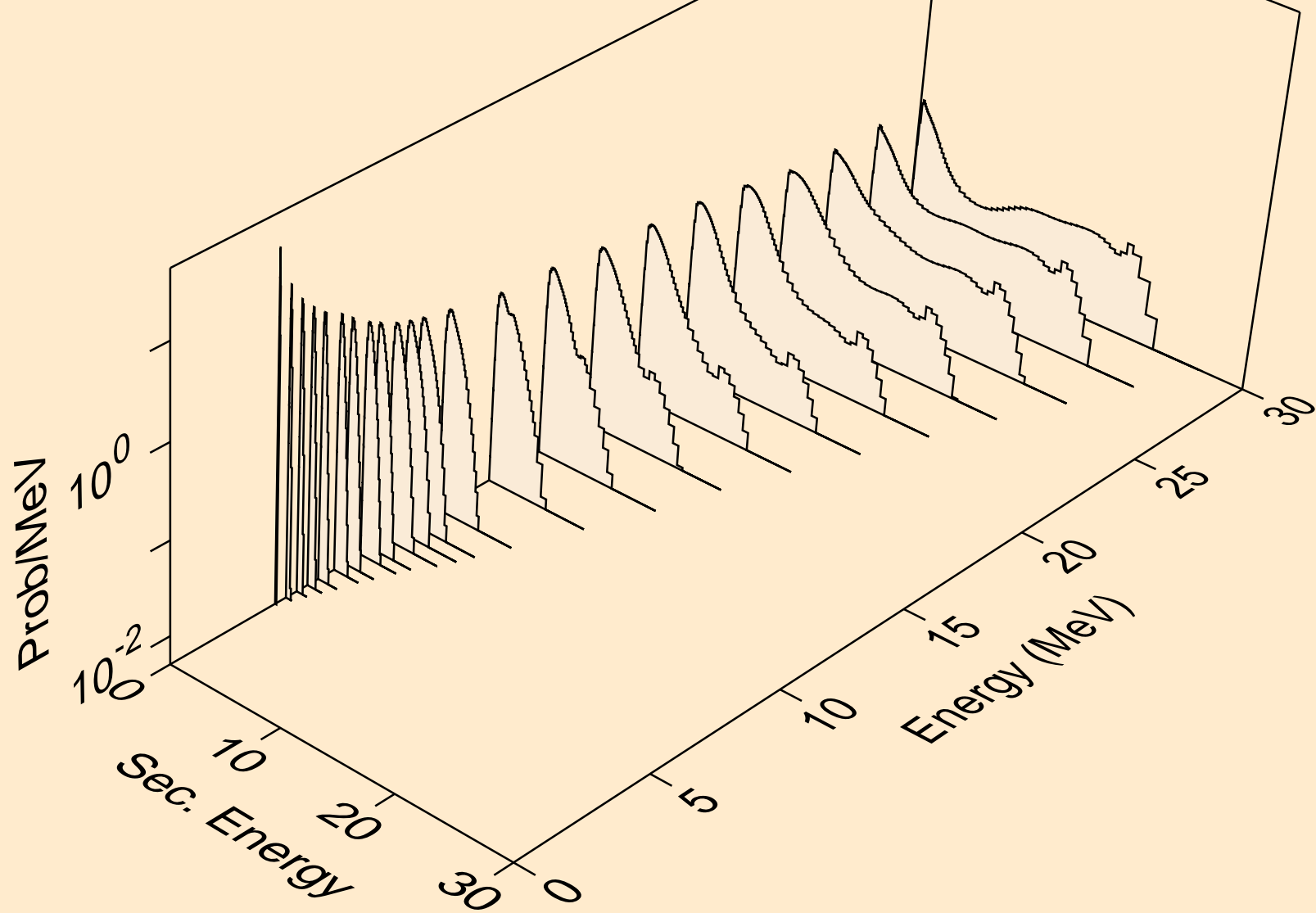

IN107M NEUTRON ACER TENDL-2024 LIBRARY; T=0.K
Neutron emission for (n,n*)2a

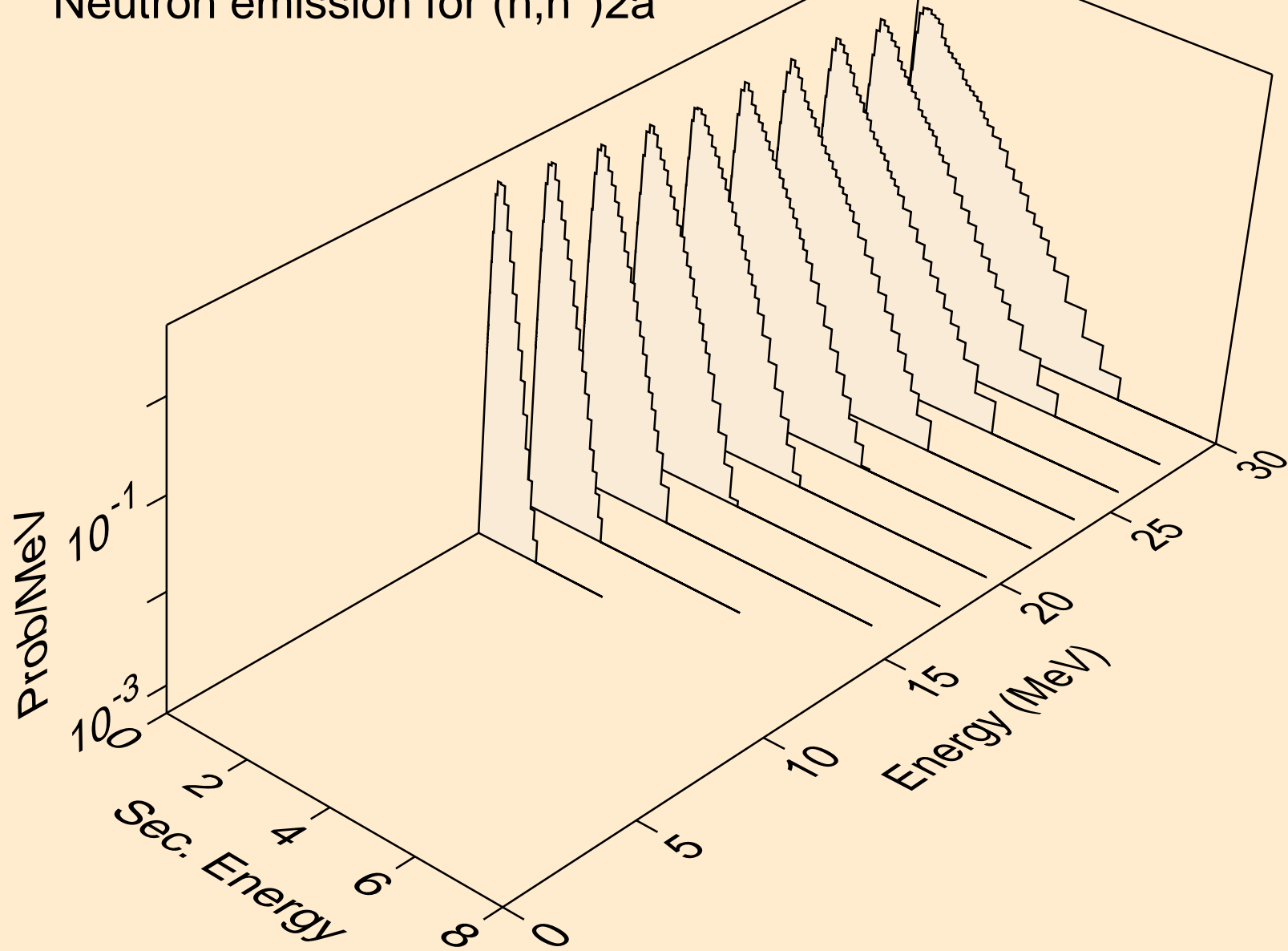

IN107M NEUTRON ACER TENDL-2024 LIBRARY; T=0.K
Neutron emission for (n,n*)d

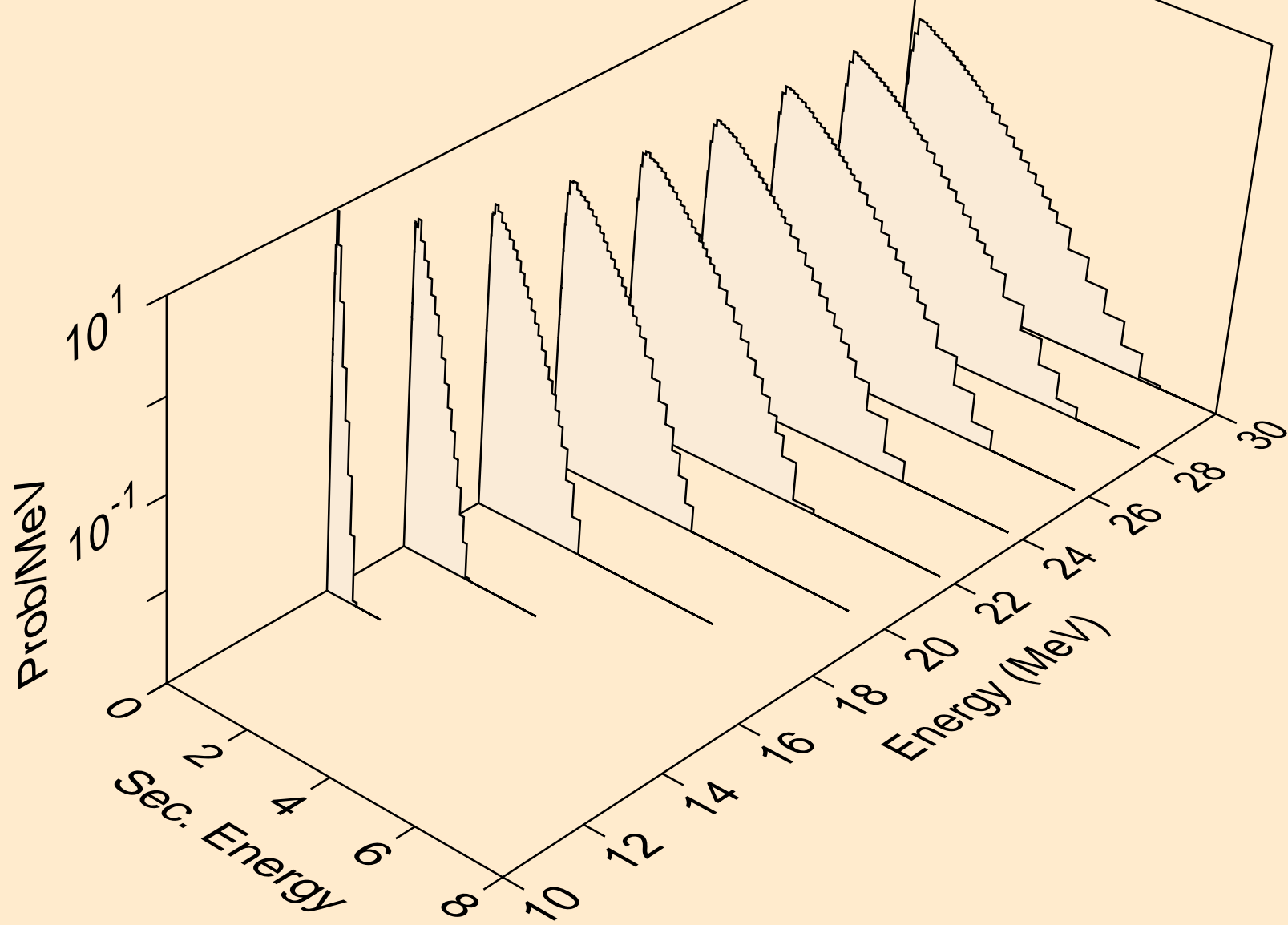

IN107M NEUTRON ACER TENDL-2024 LIBRARY; T=0.K
Neutron emission for (n,n*)t

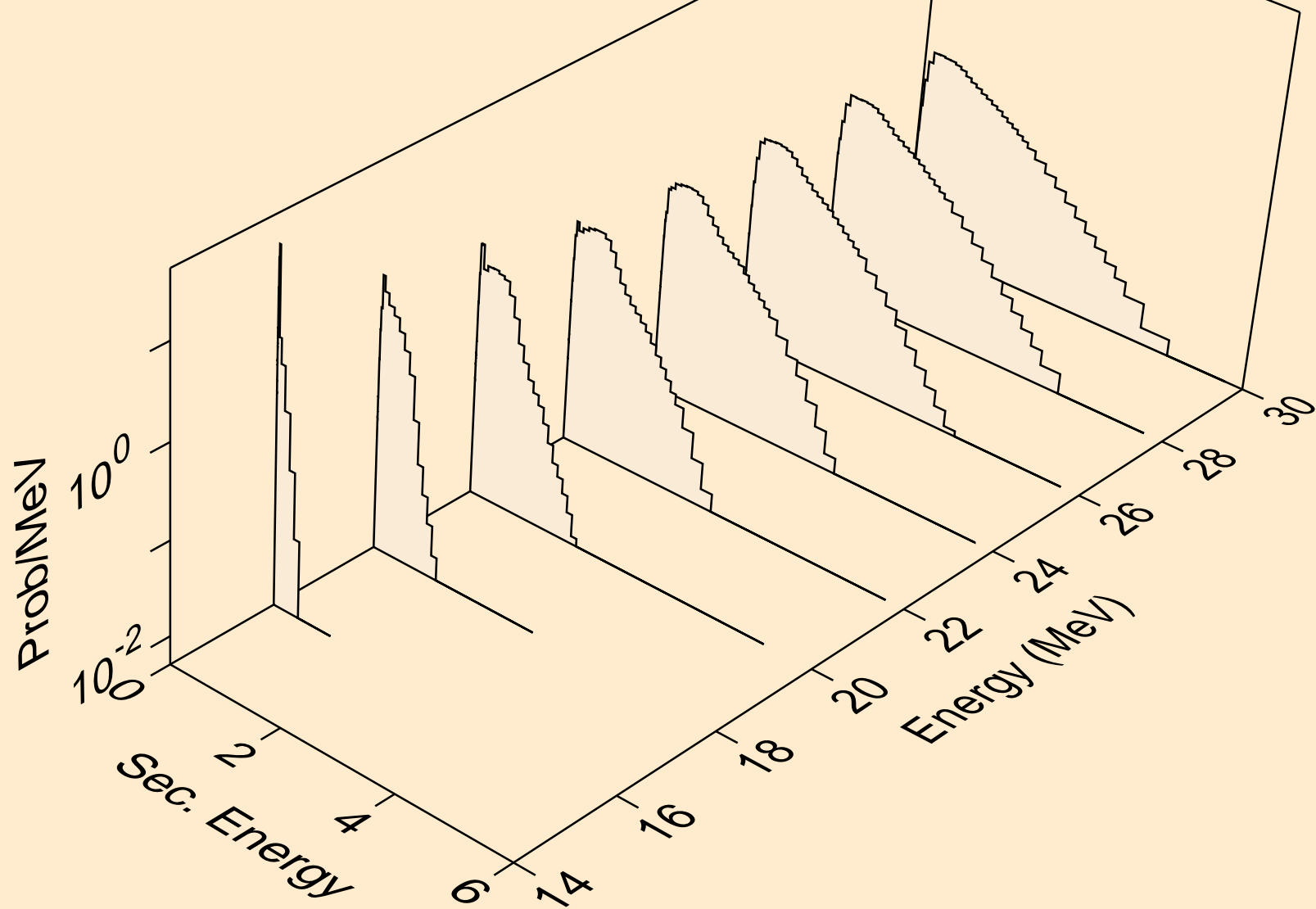

IN107M NEUTRON ACER TENDL-2024 LIBRARY; T=0.K
Neutron emission for (n,n*)he3

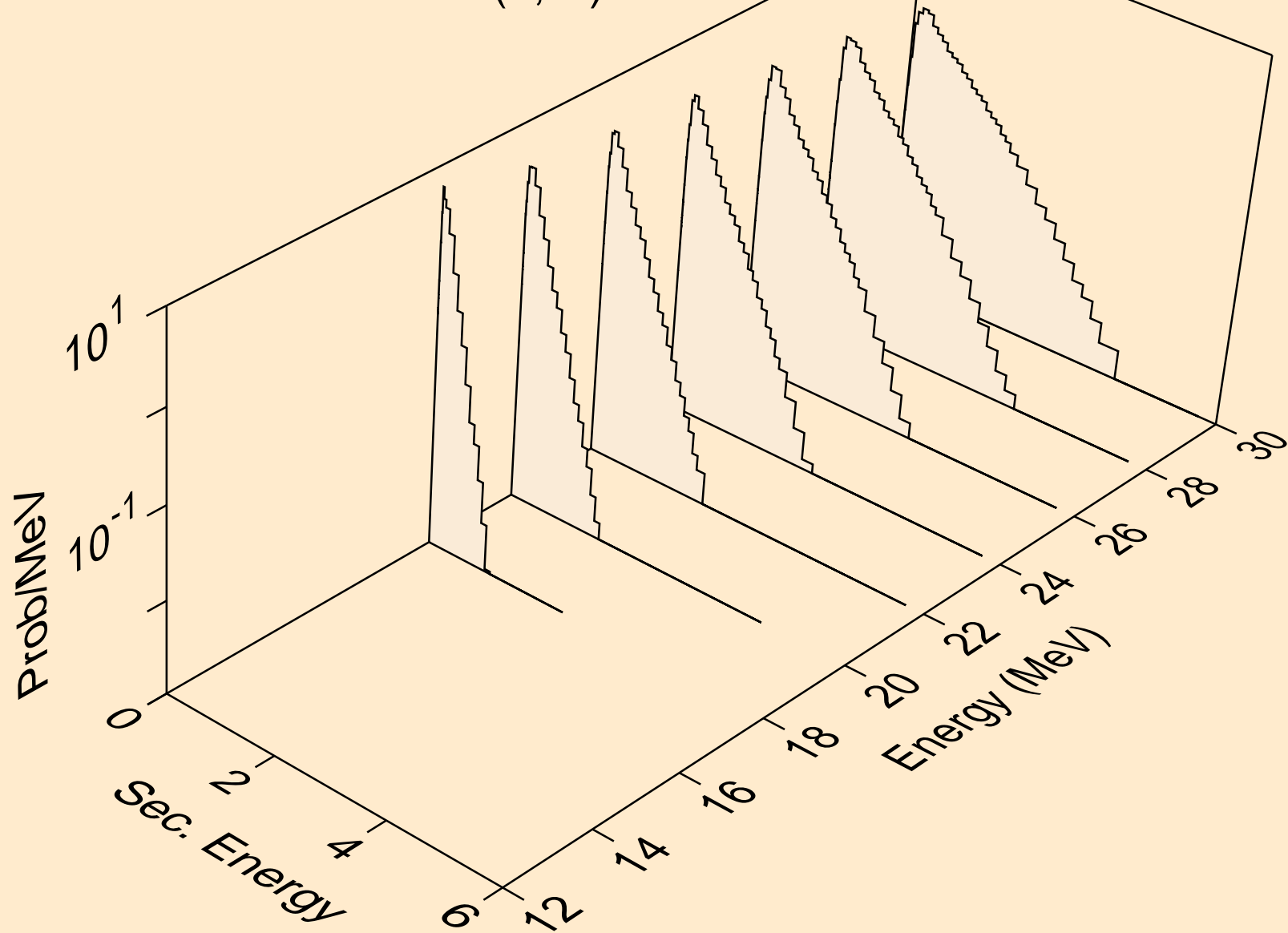

IN107M NEUTRON ACER TENDL-2024 LIBRARY; T=0.K
Neutron emission for (n,2np)

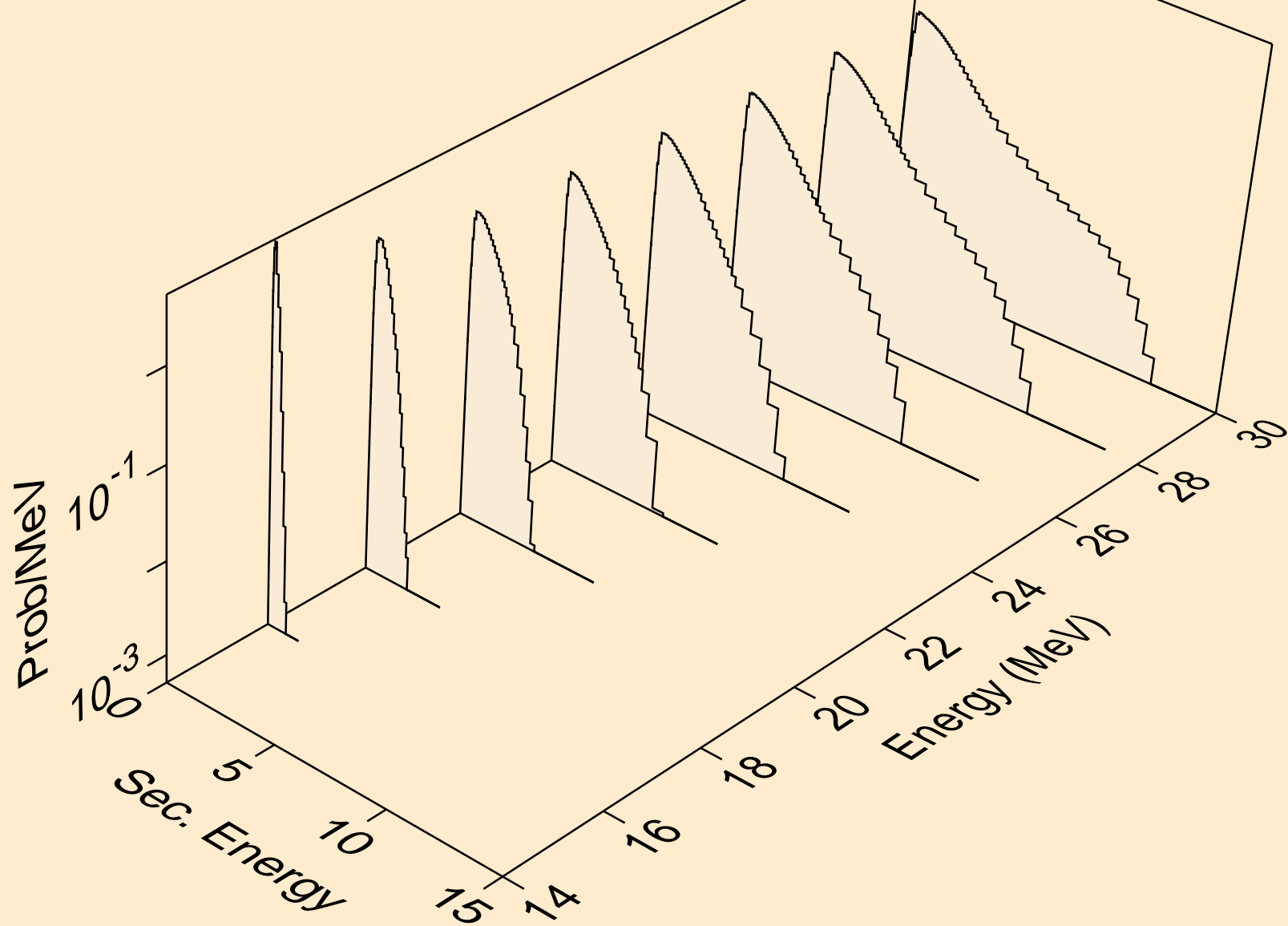

IN107M NEUTRON ACER TENDL-2024 LIBRARY; T=0.K
Neutron emission for (n,3np)

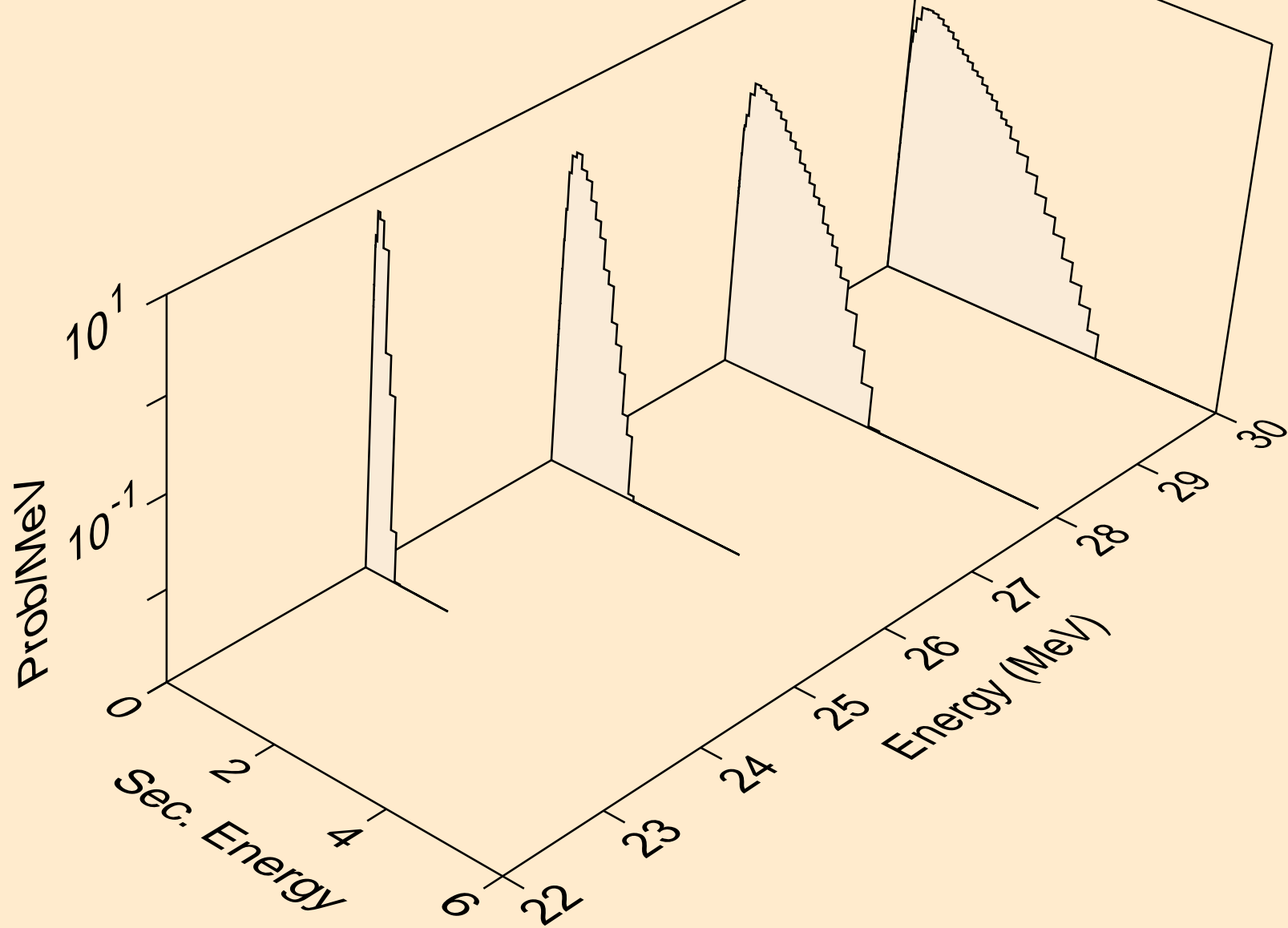

IN107M NEUTRON ACER TENDL-2024 LIBRARY; T=0.K
Neutron emission for (n,n2p)

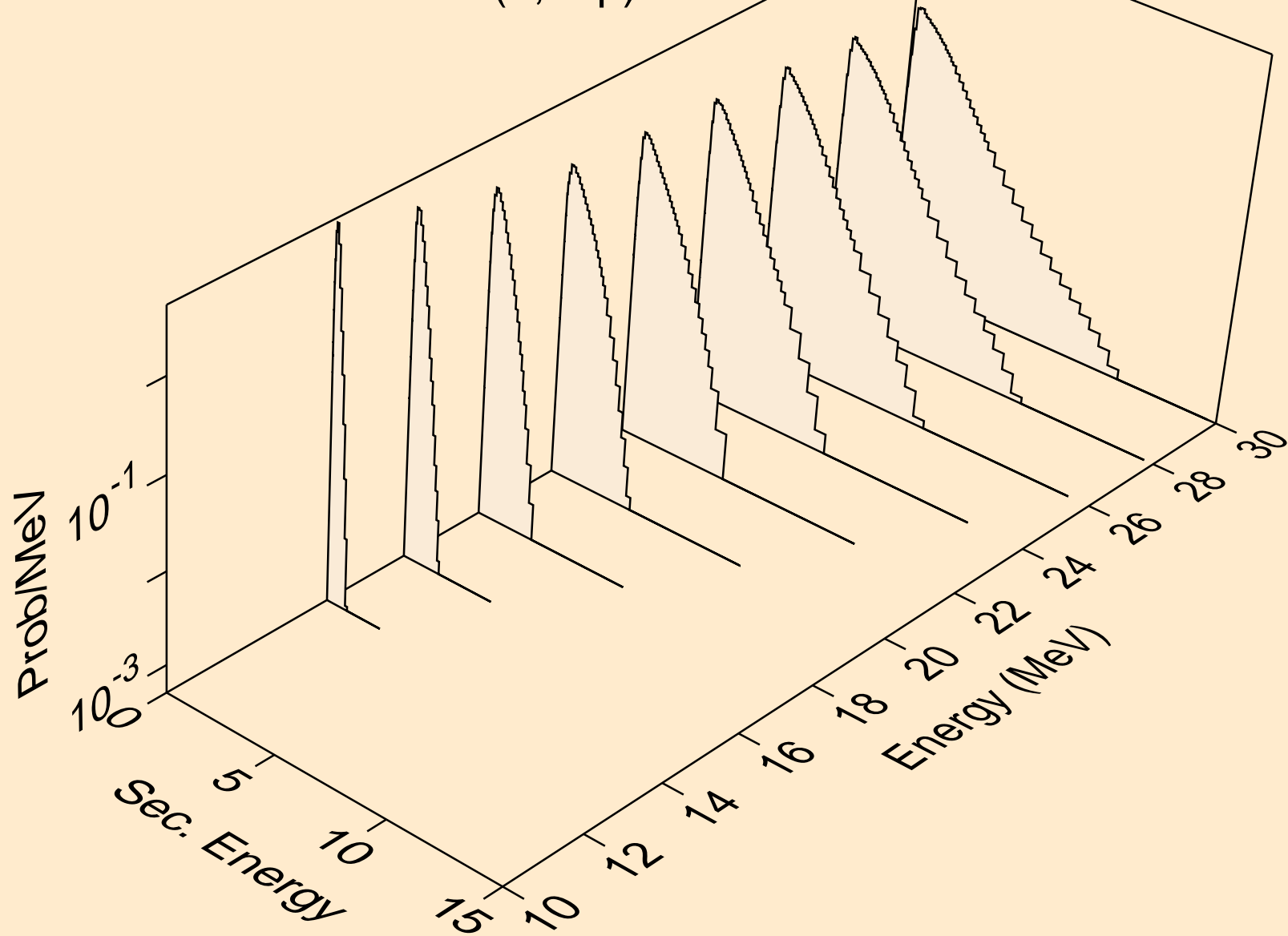

IN107M NEUTRON ACER TENDL-2024 LIBRARY; T=0.K
Neutron emission for (n,npa)

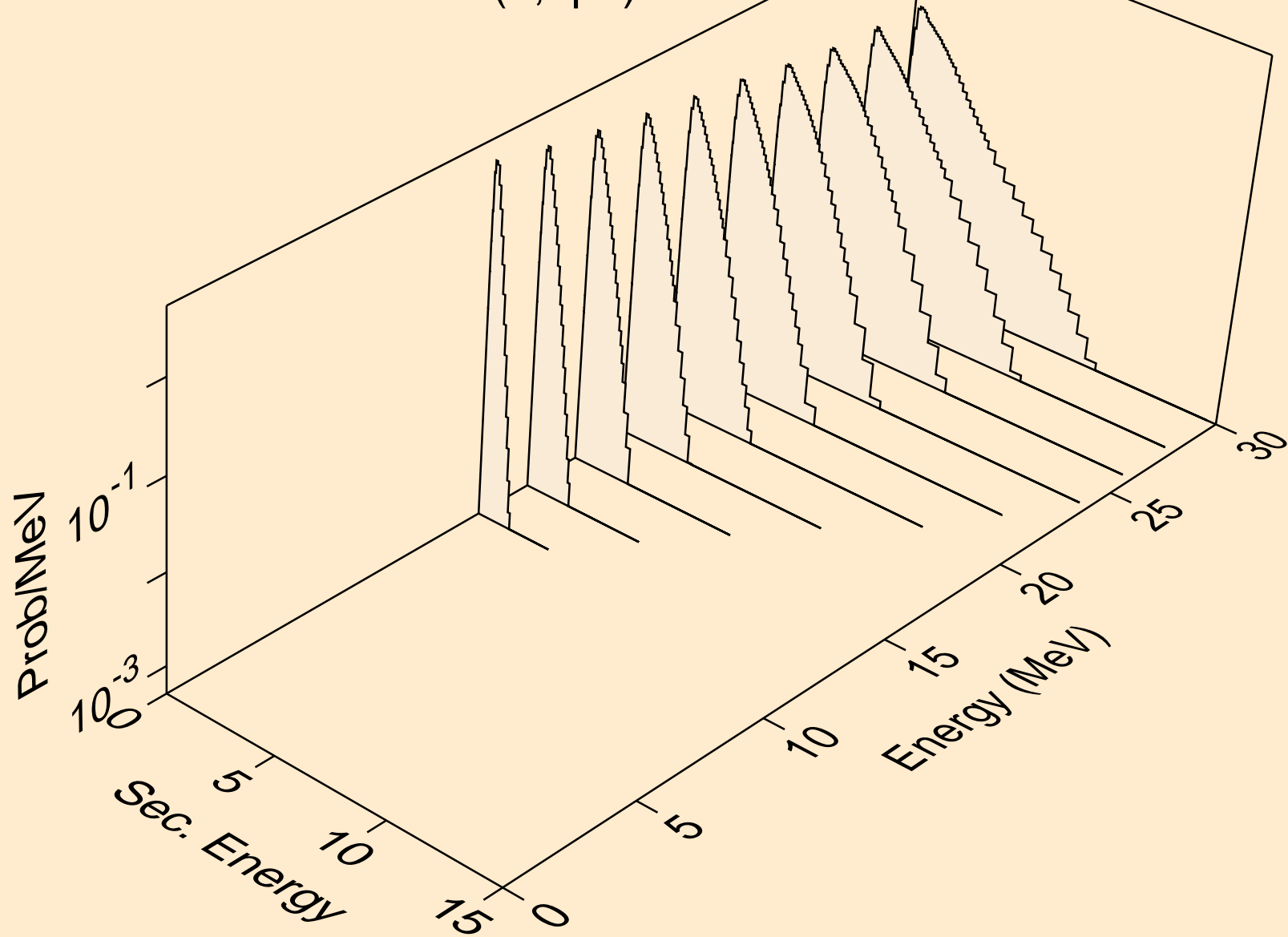

IN107M NEUTRON ACER TENDL-2024 LIBRARY; T=0.K
Neutron emission for (n,n*c)

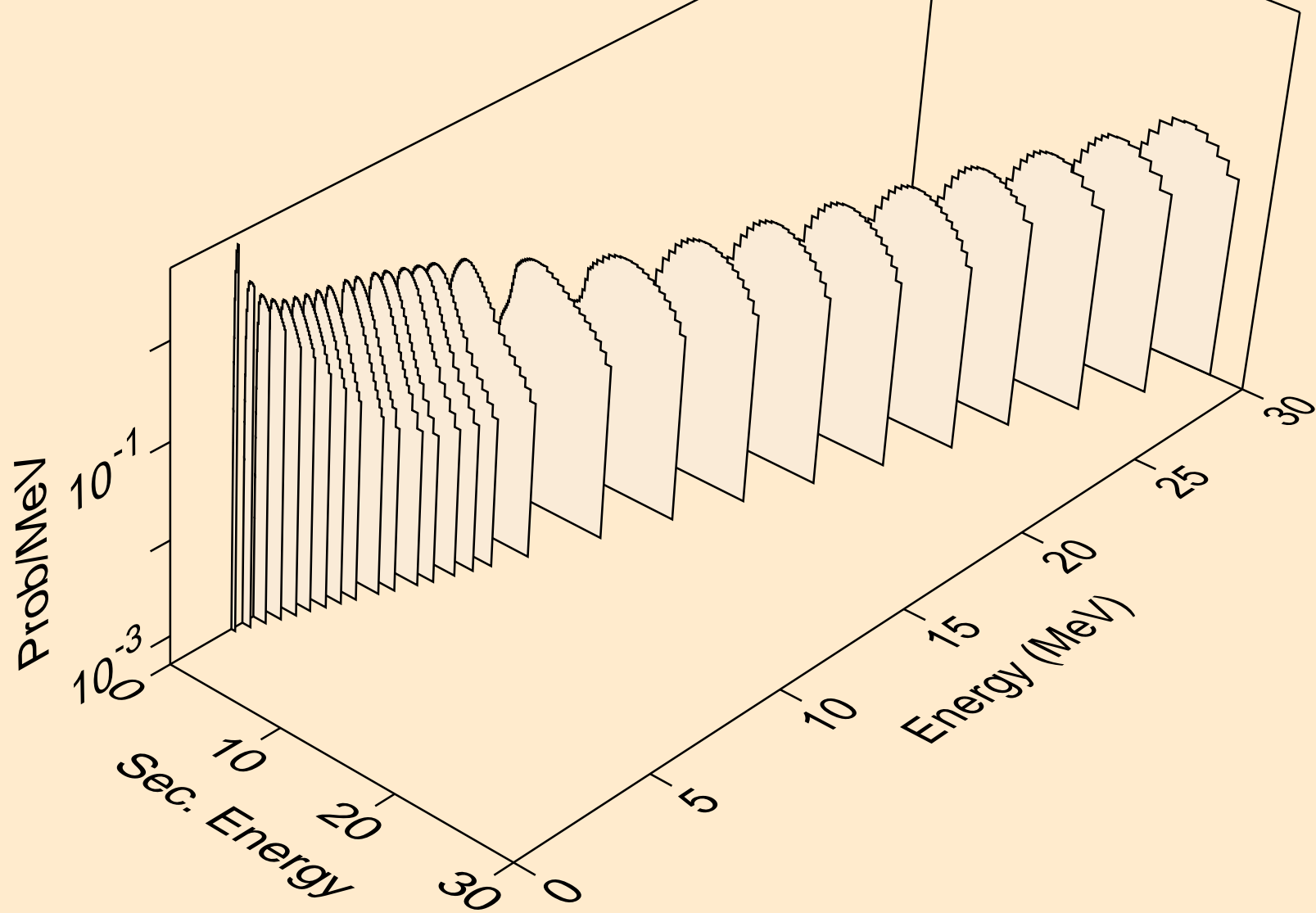

IN107M NEUTRON ACER TENDL-2024 LIBRARY; T=0.K
Photon emission for (n,x)

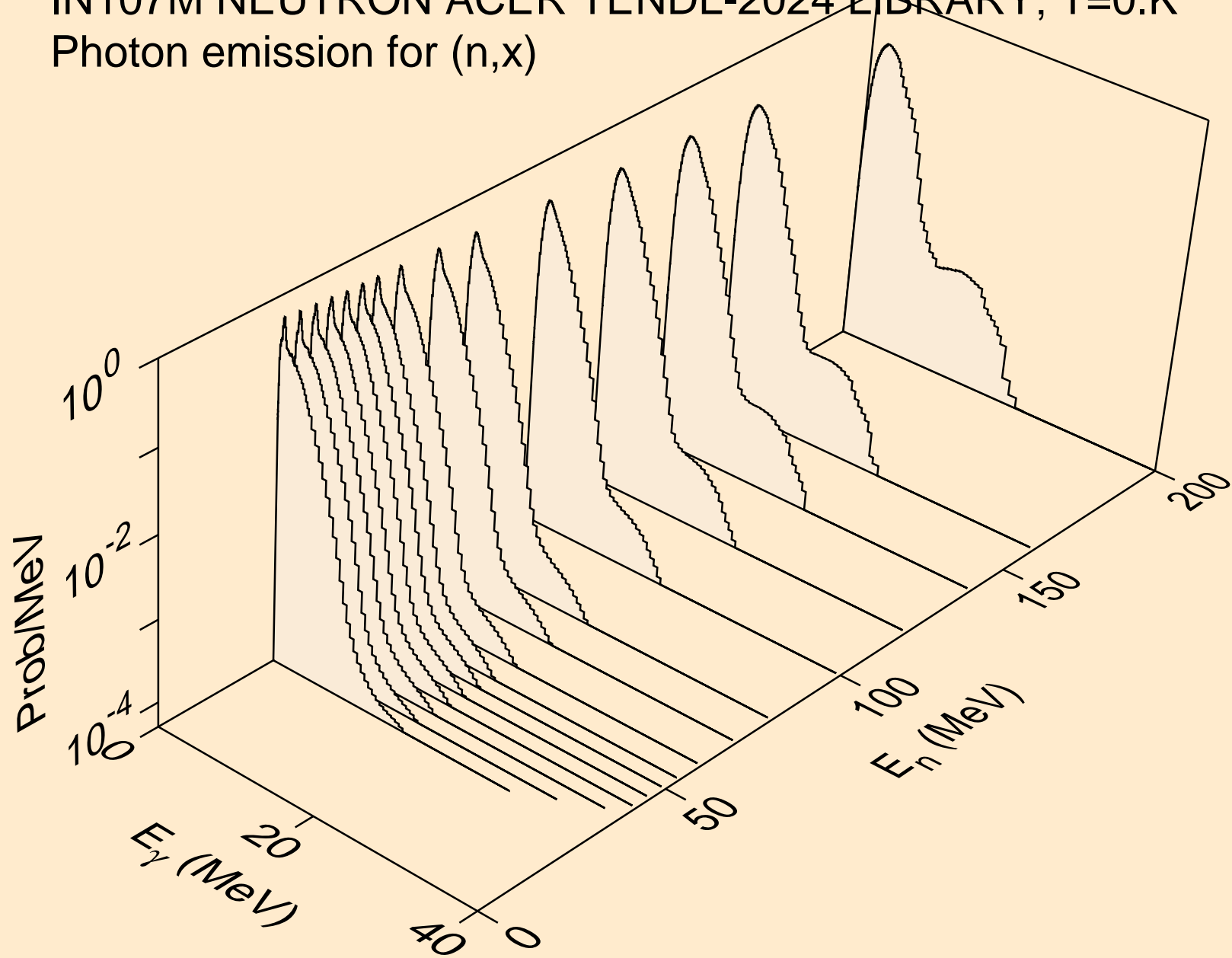

IN107M NEUTRON ACER TENDL-2024 LIBRARY; T=0.K
Photon emission for (n,2nd)

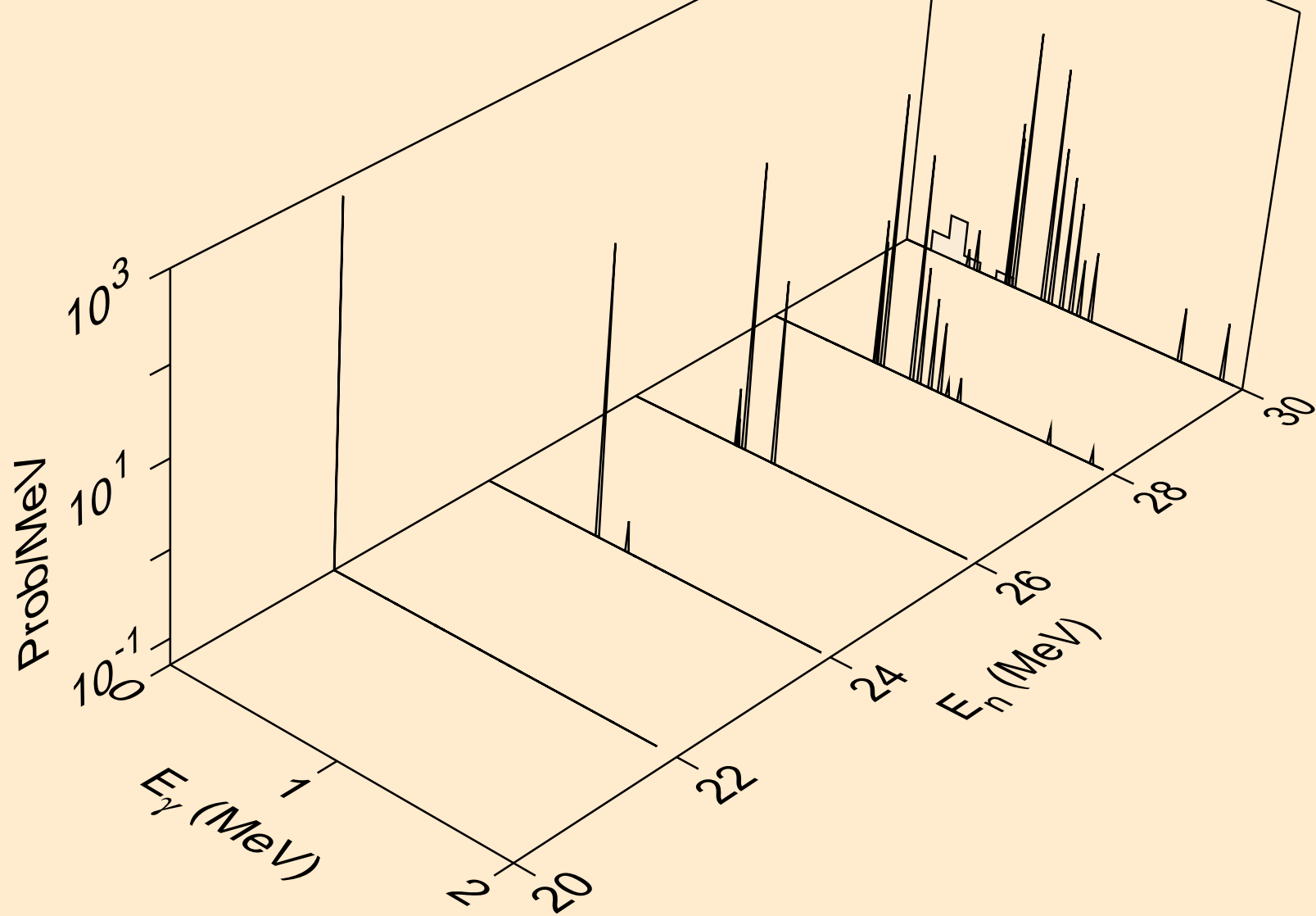

IN107M NEUTRON ACER TENDL-2024 LIBRARY; T=0.K
Photon emission for (n,2n)

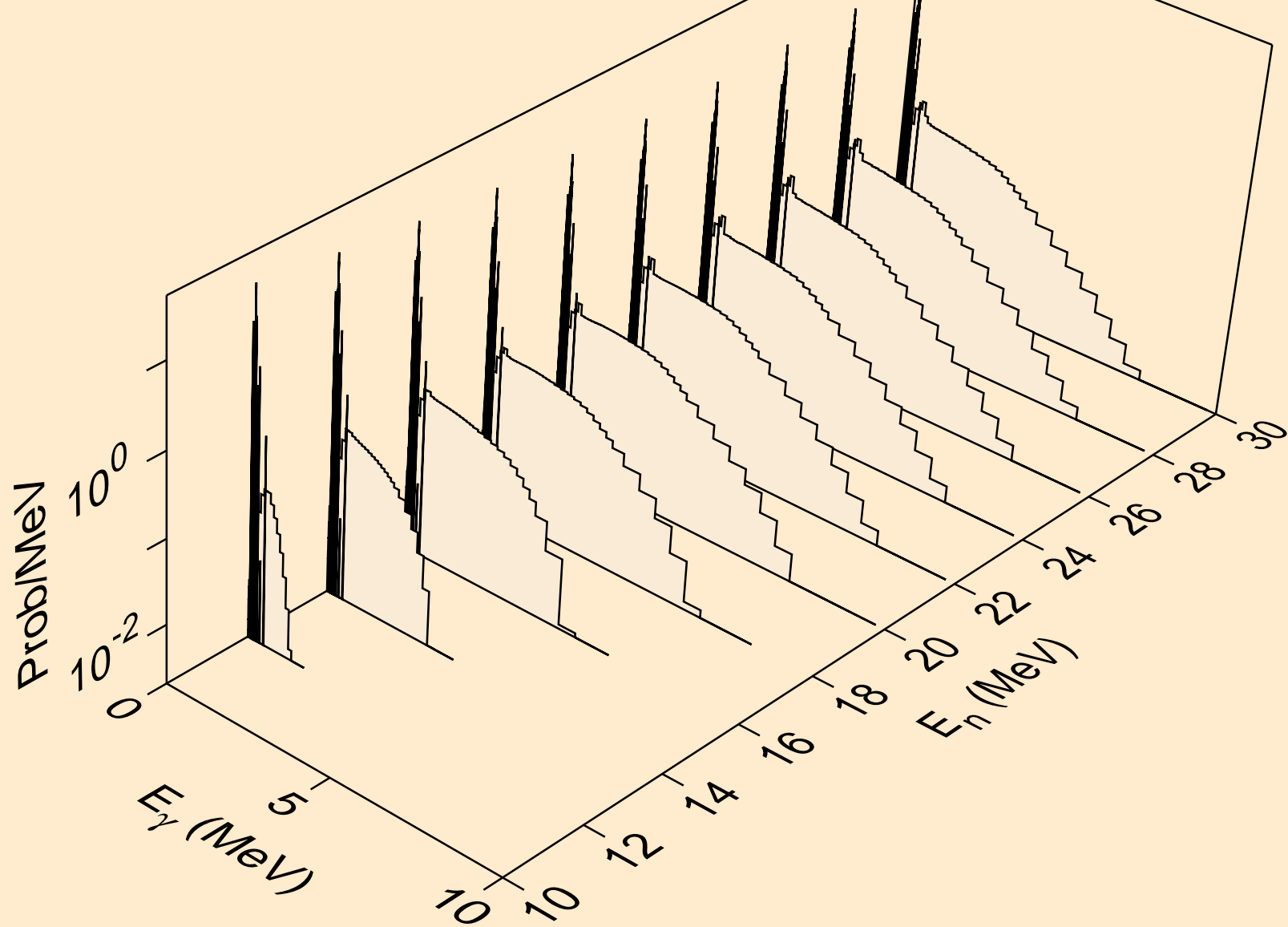

IN107M NEUTRON ACER TENDL-2024 LIBRARY; T=0.K
Photon emission for (n,3n)

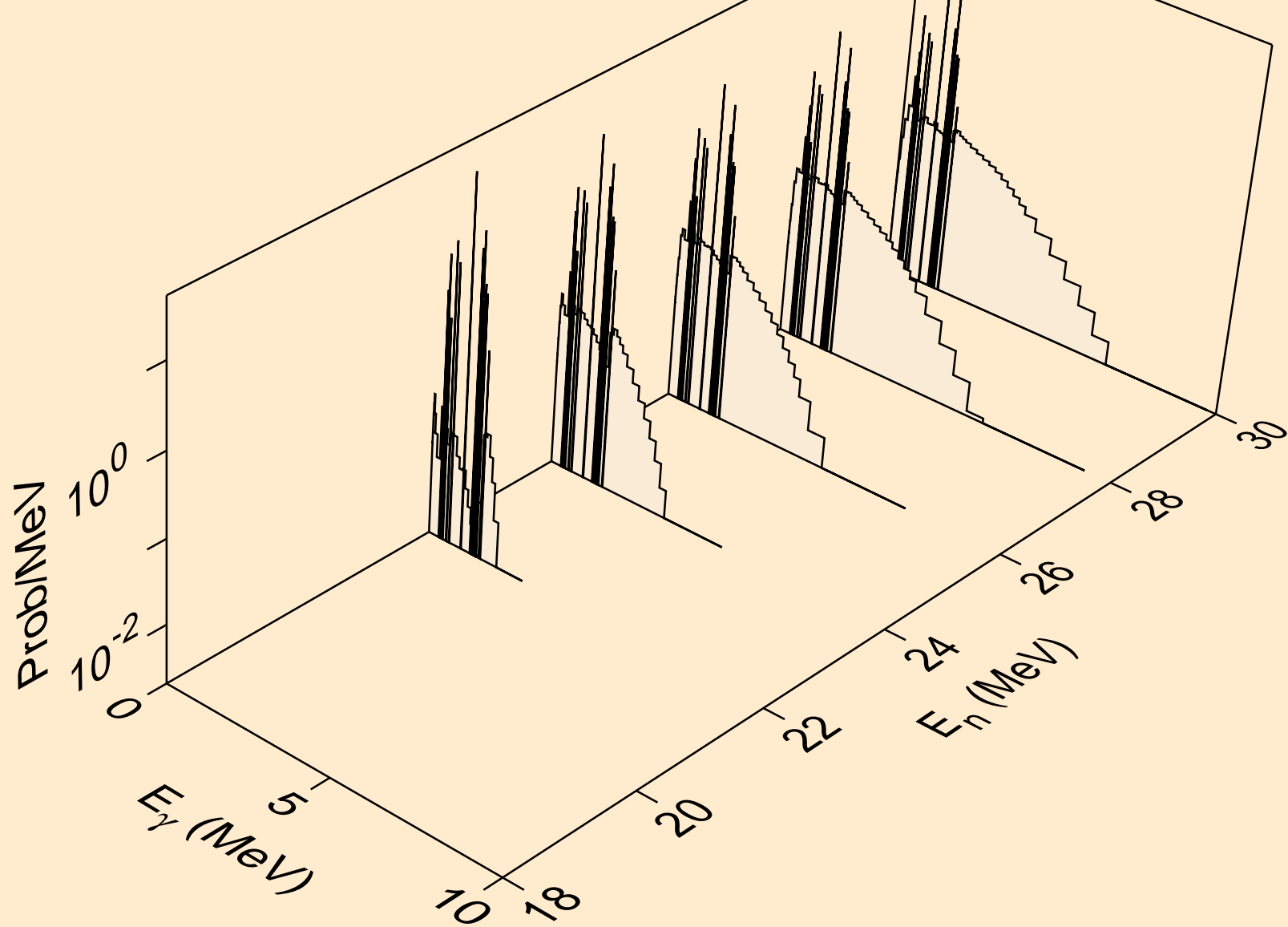

IN107M NEUTRON ACER TENDL-2024 LIBRARY; T=0.K
Photon emission for (n,n*)a

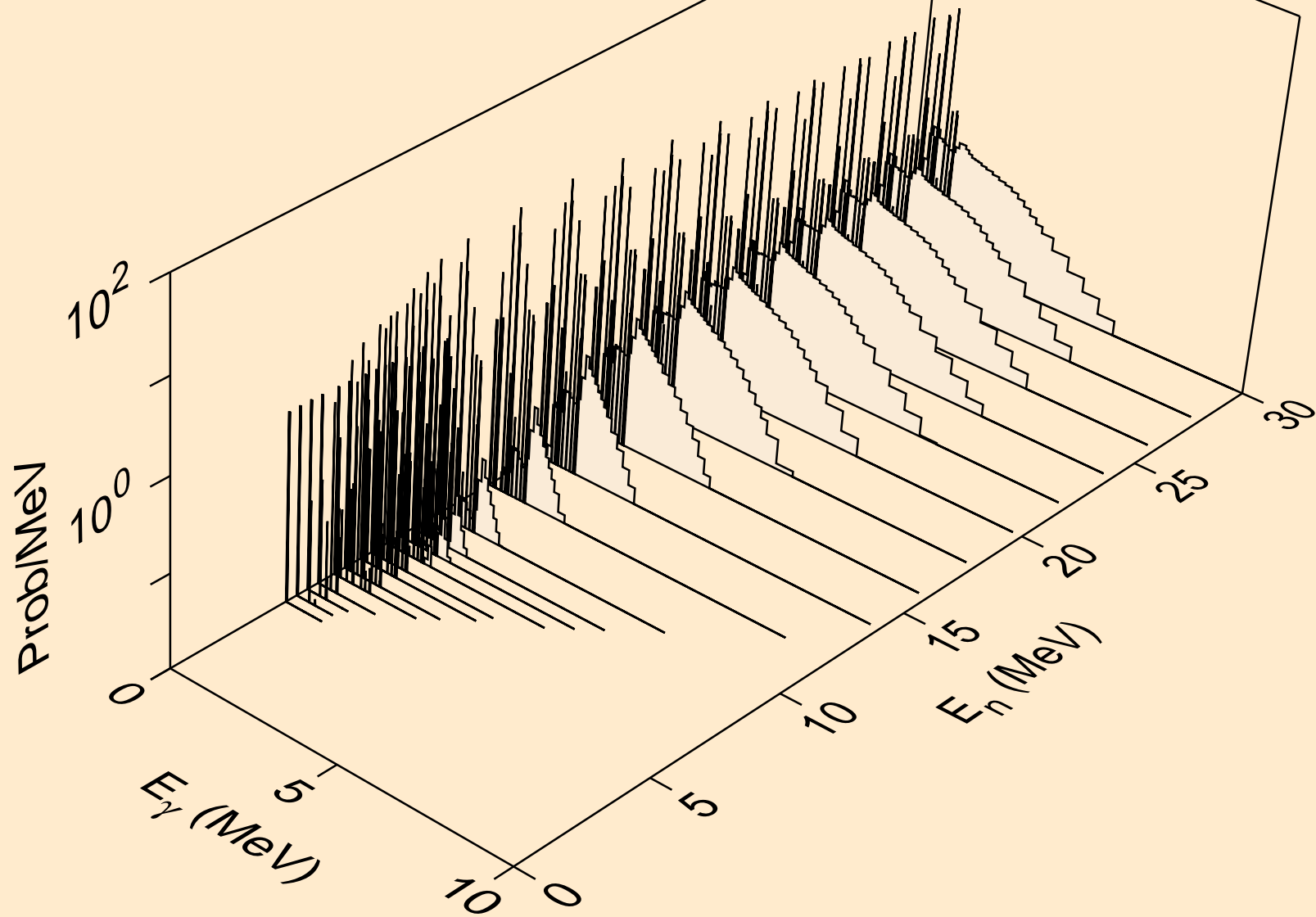

IN107M NEUTRON ACER TENDL-2024 LIBRARY; T=0.K
Photon emission for (n,2n)a

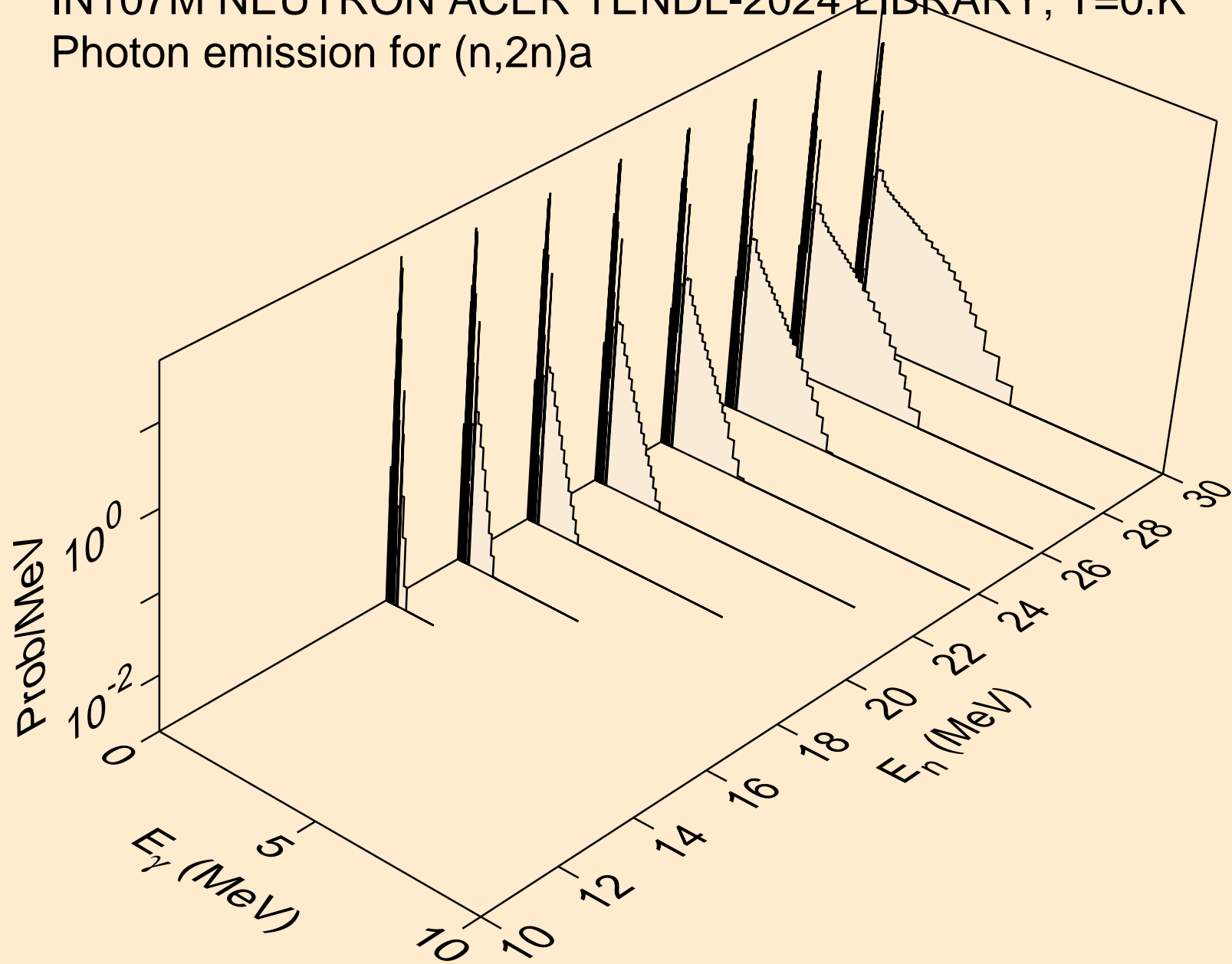

IN107M NEUTRON ACER TENDL-2024 LIBRARY; T=0.K
Photon emission for (n,3n)a

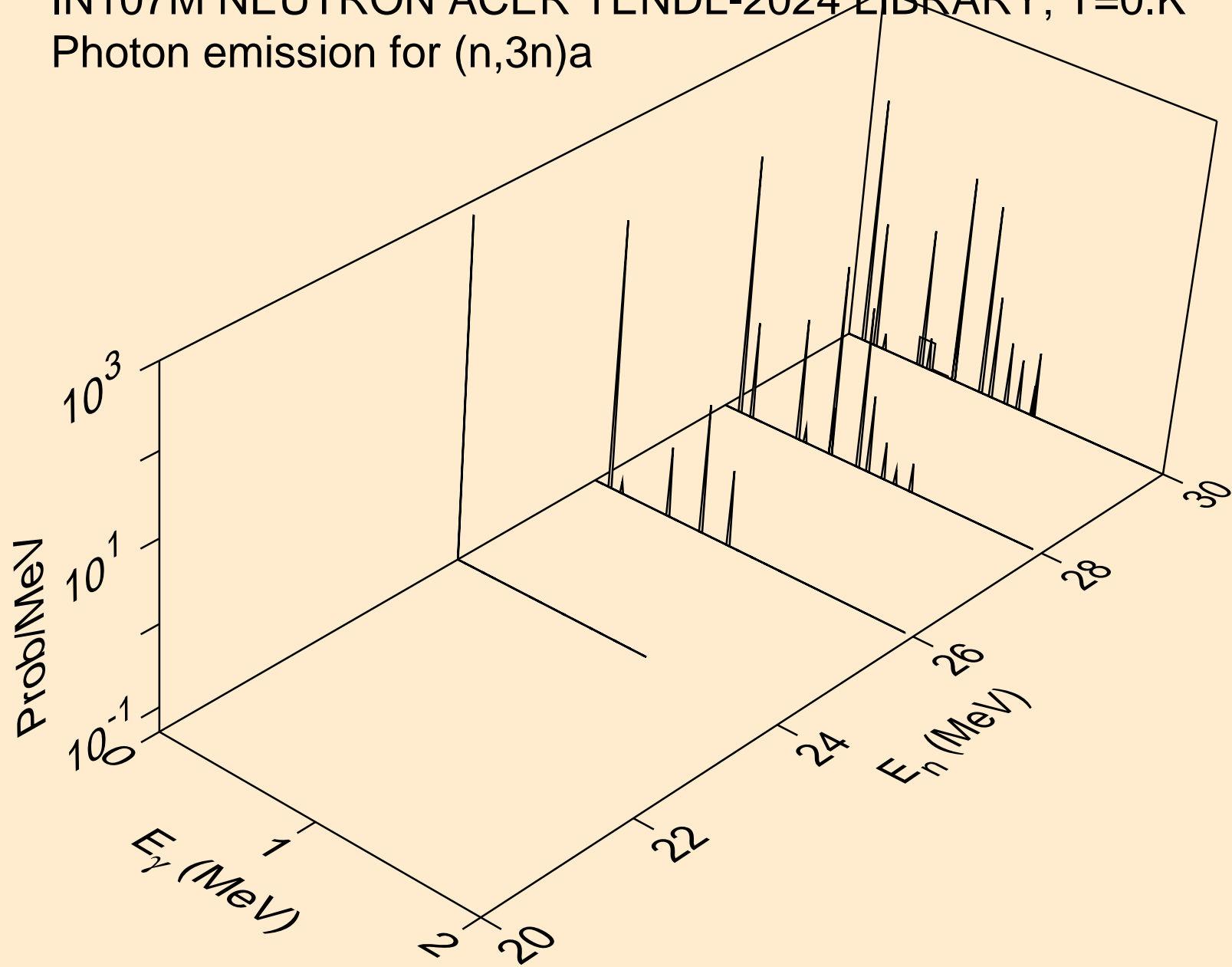

IN107M NEUTRON ACER TENDL-2024 LIBRARY; T=0.K
Photon emission for (n,n*)p

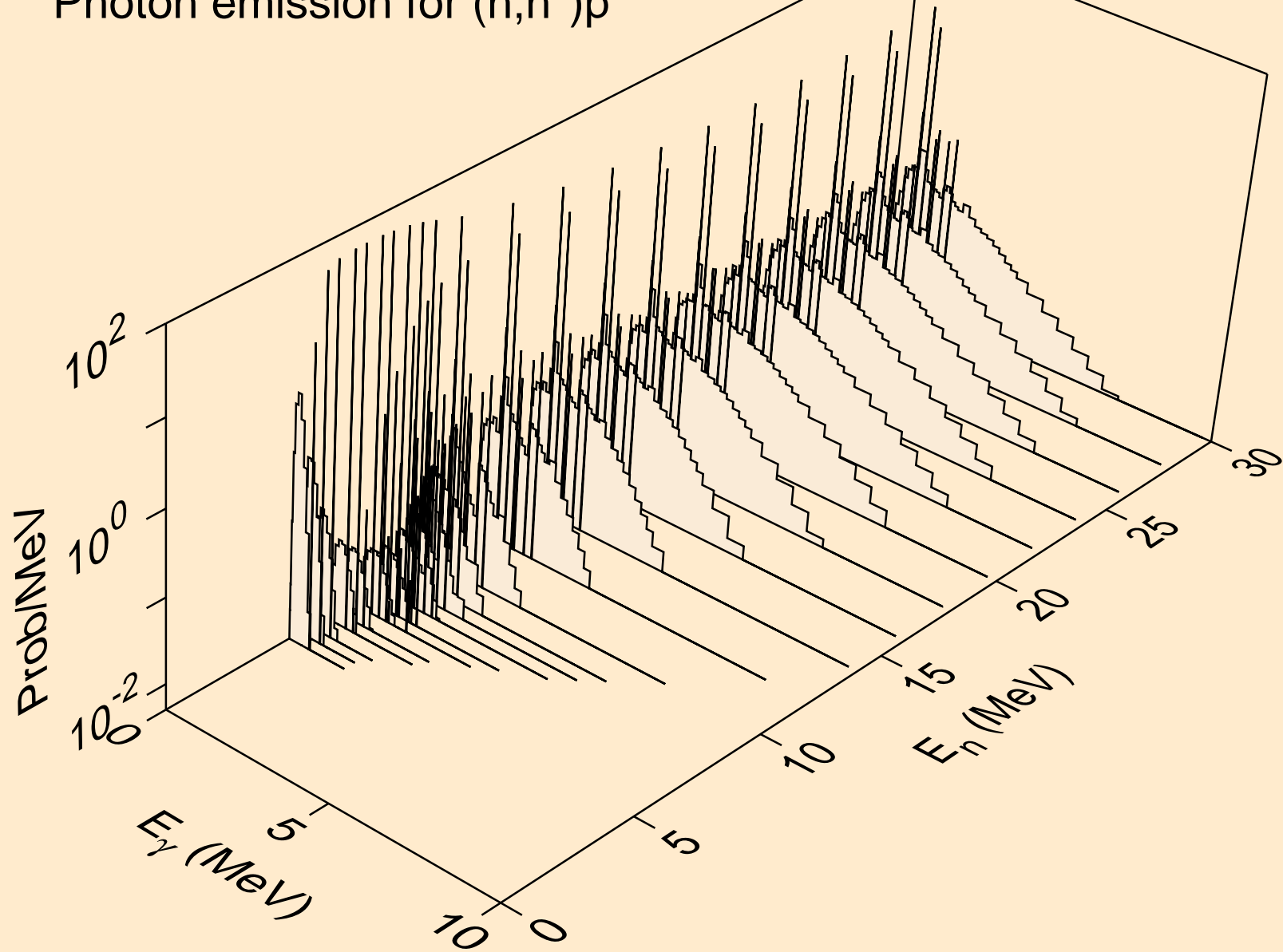

IN107M NEUTRON ACER TENDL-2024 LIBRARY; T=0.K
Photon emission for (n,n*)2a

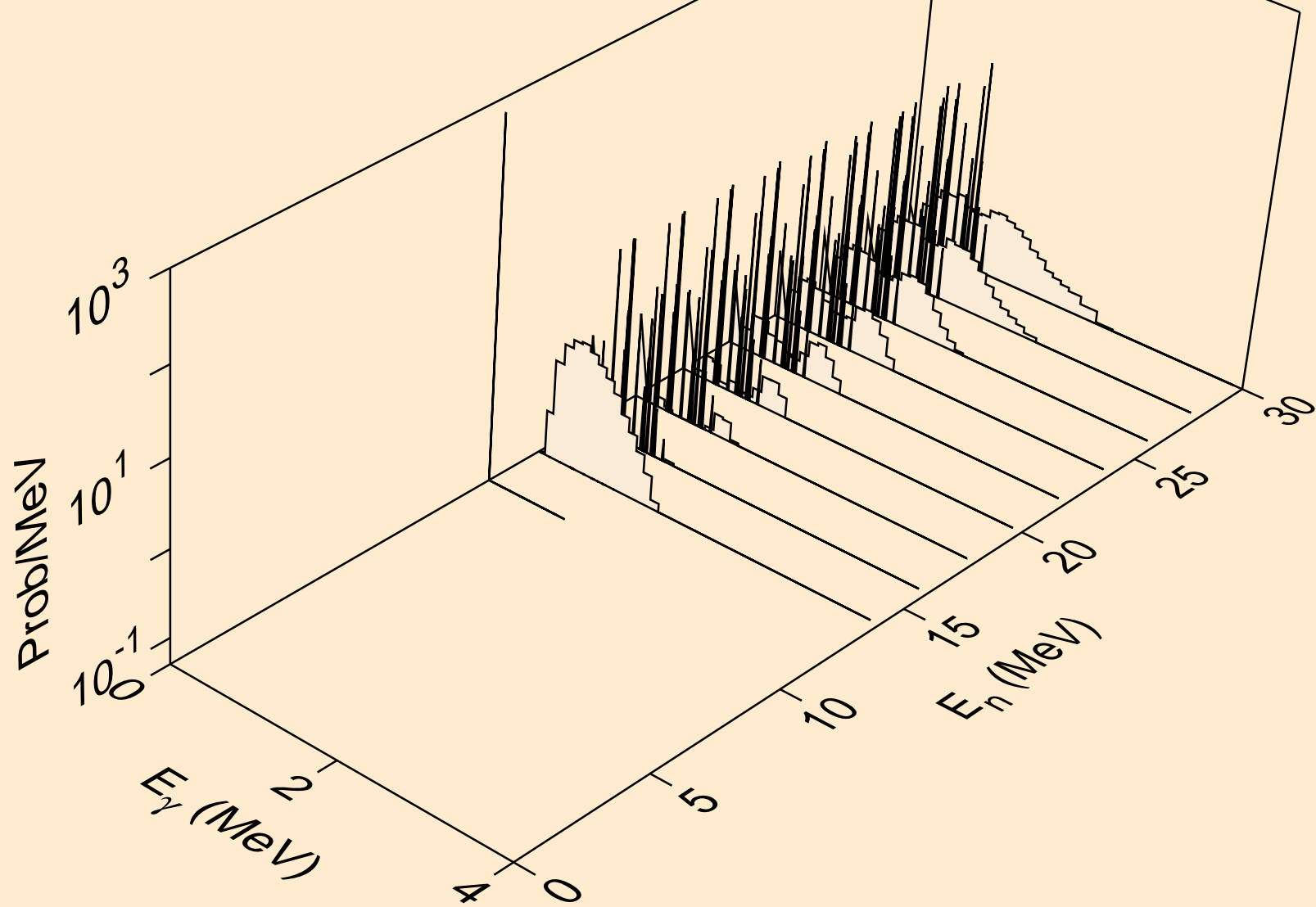

IN107M NEUTRON ACER TENDL-2024 LIBRARY; T=0.K
Photon emission for (n,n*)d

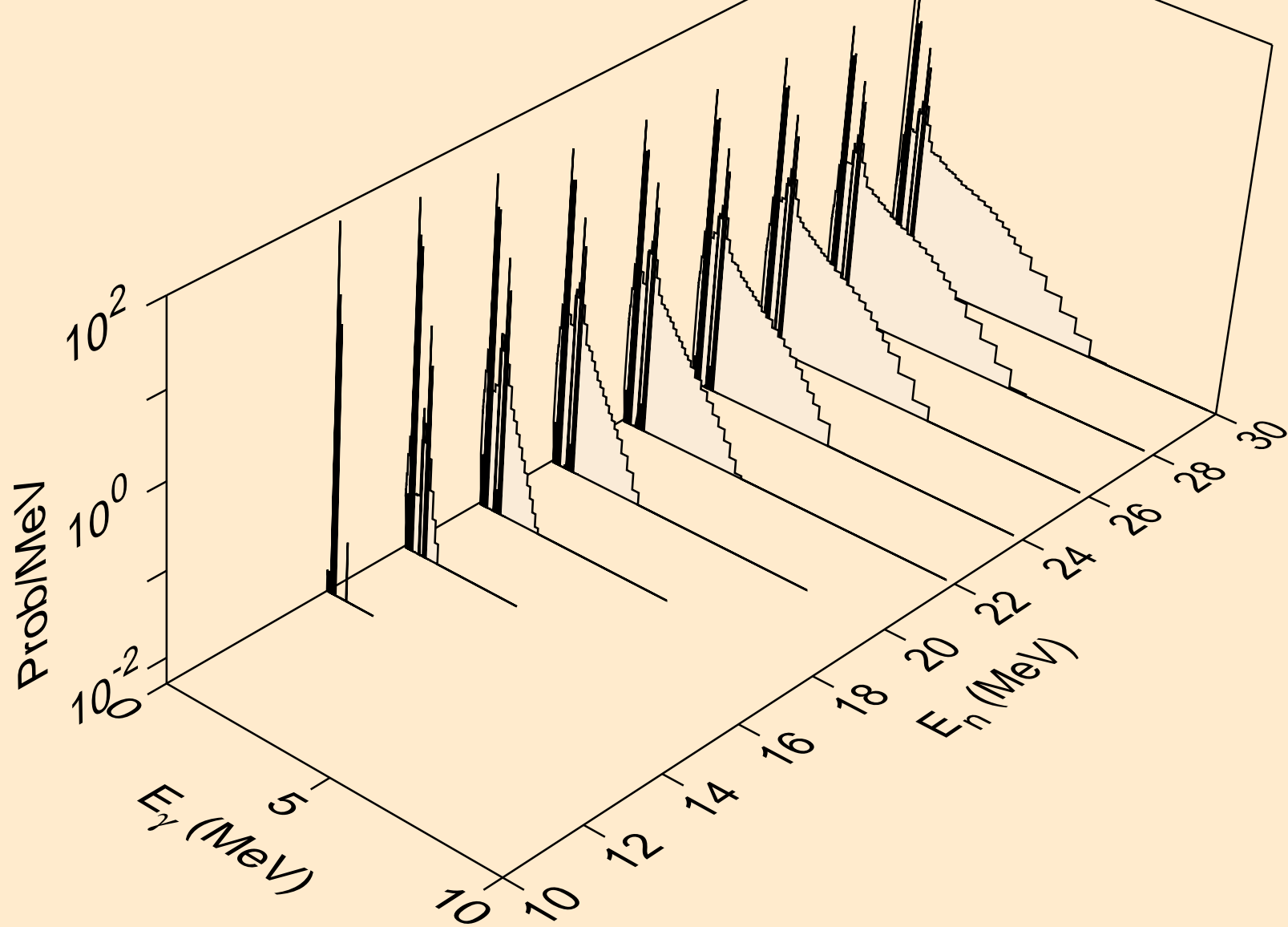

IN107M NEUTRON ACER TENDL-2024 LIBRARY; T=0.K
Photon emission for (n,n*)t

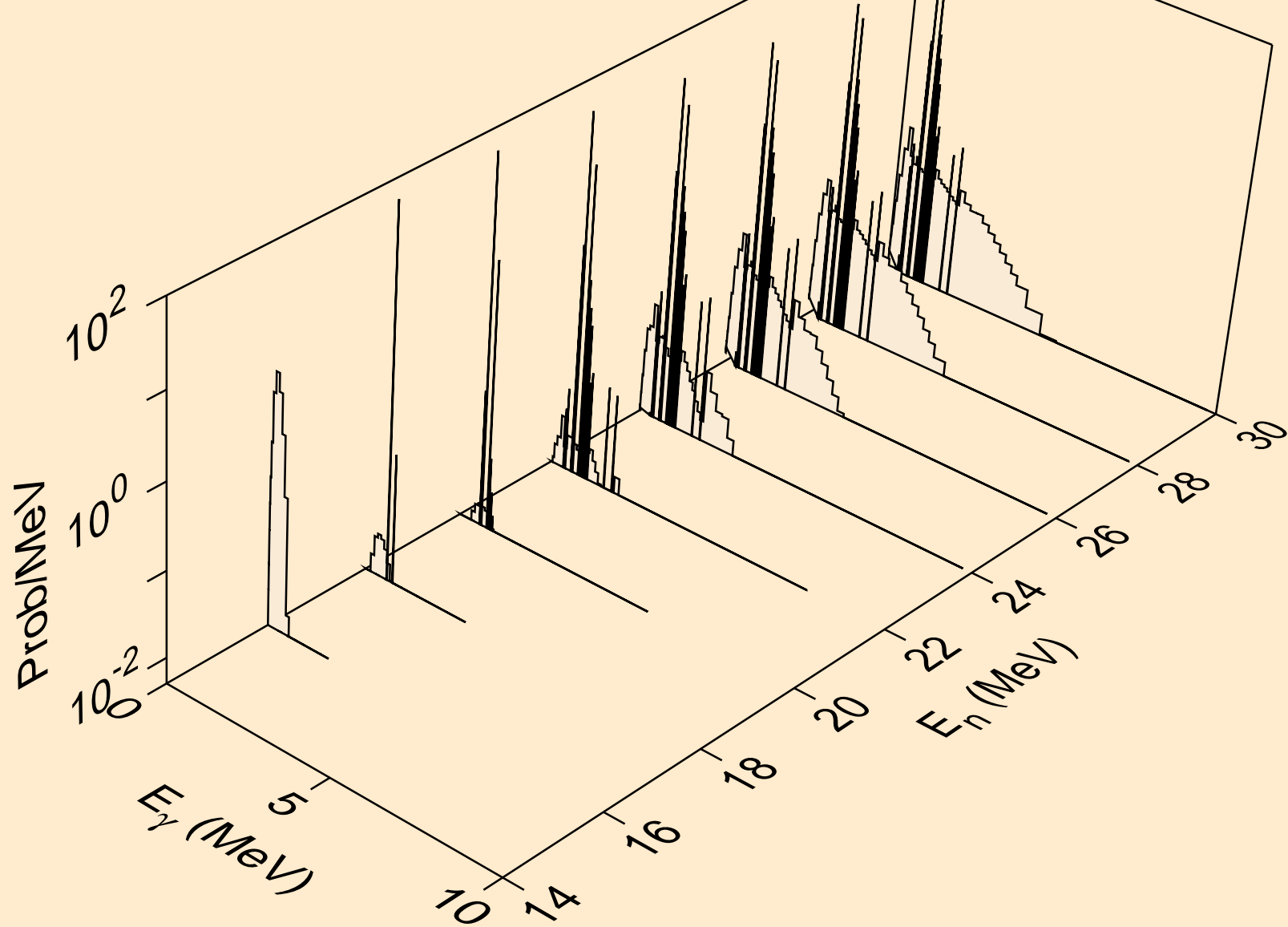

IN107M NEUTRON ACER TENDL-2024 LIBRARY; T=0.K
Photon emission for (n,n*)he3

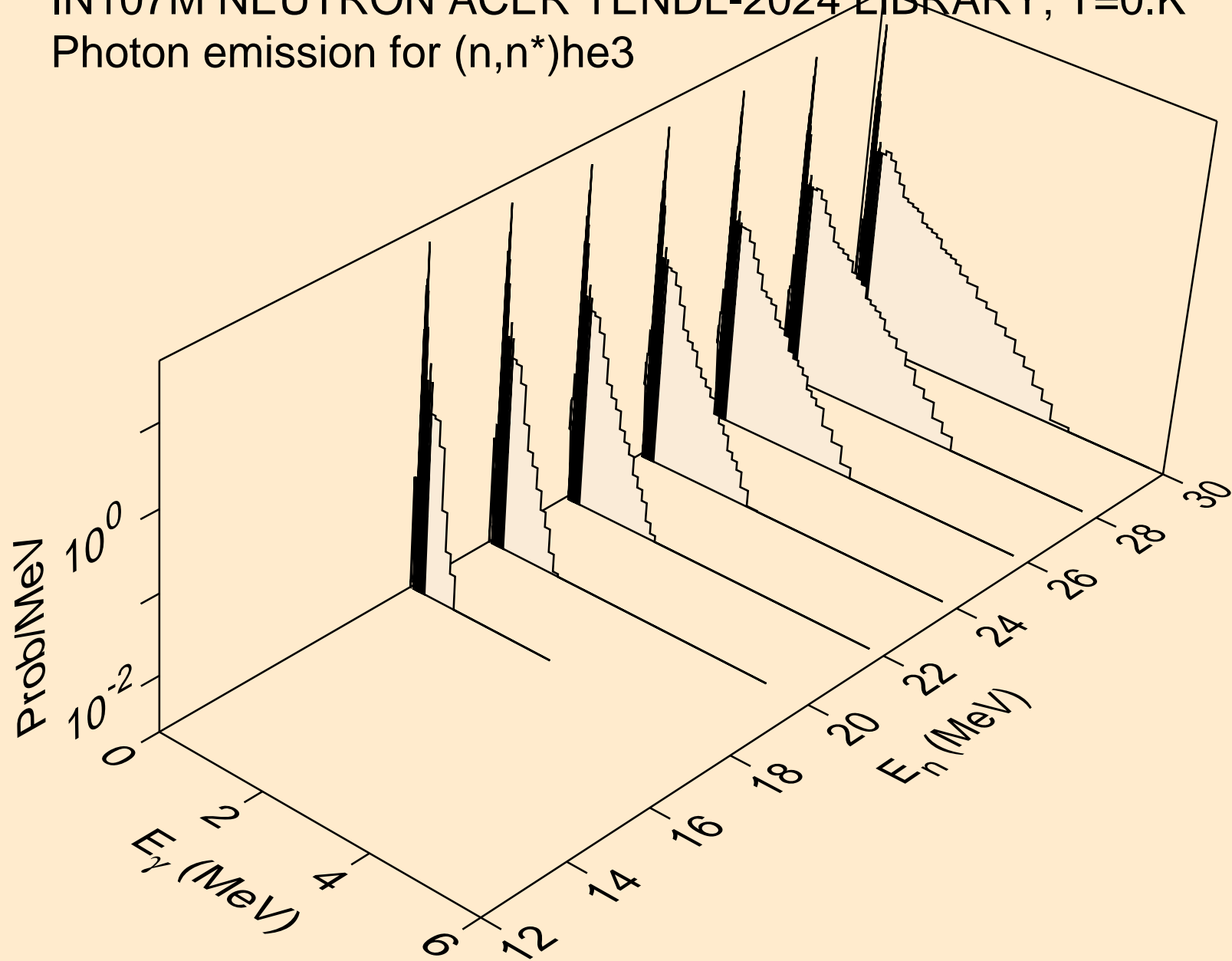

IN107M NEUTRON ACER TENDL-2024 LIBRARY; T=0.K
Photon emission for (n,2np)

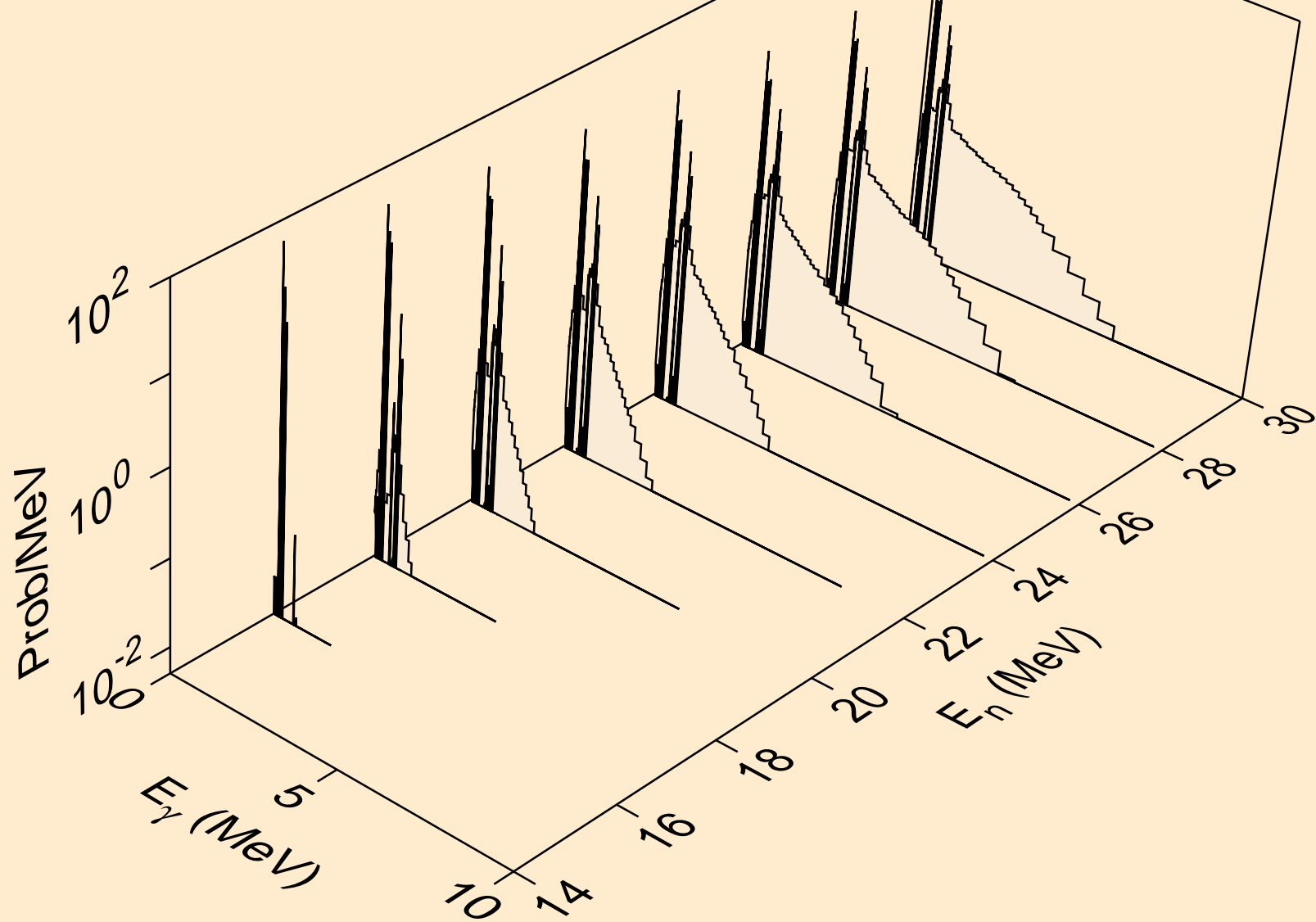

IN107M NEUTRON ACER TENDL-2024 LIBRARY; T=0.K
Photon emission for (n,3np)

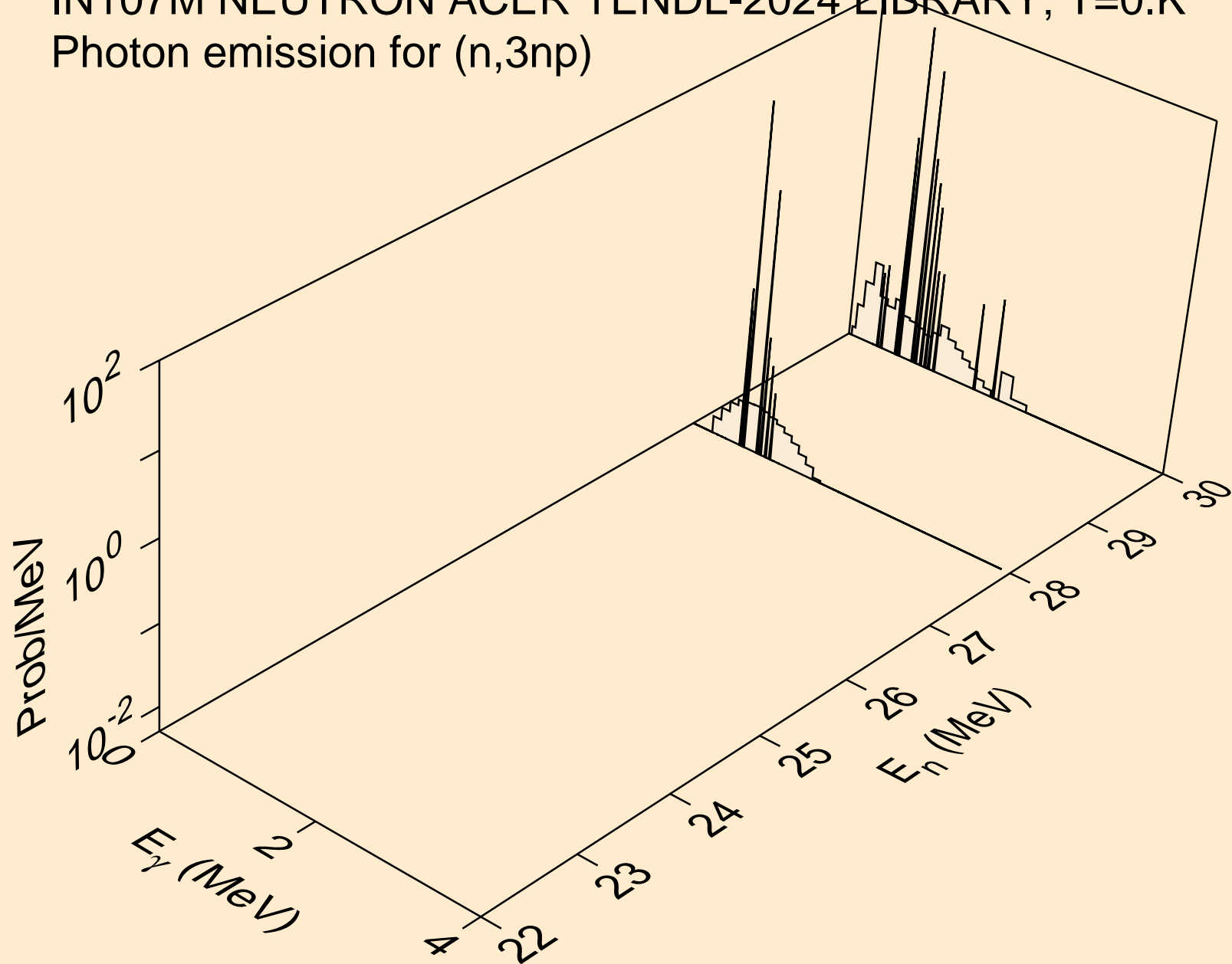

IN107M NEUTRON ACER TENDL-2024 LIBRARY; T=0.K
Photon emission for (n,n2p)

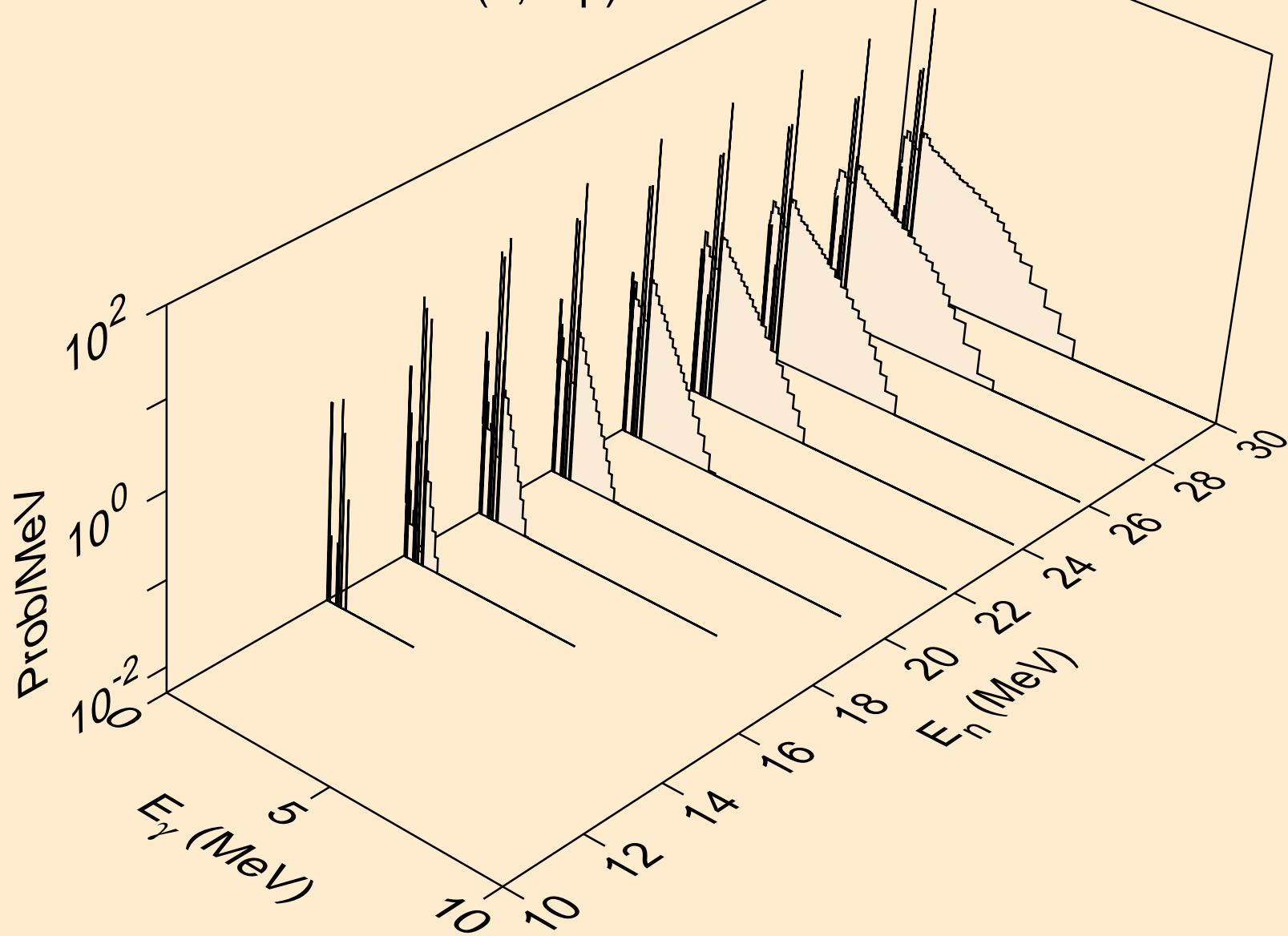

IN107M NEUTRON ACER TENDL-2024 LIBRARY; T=0.K
Photon emission for (n,npa)

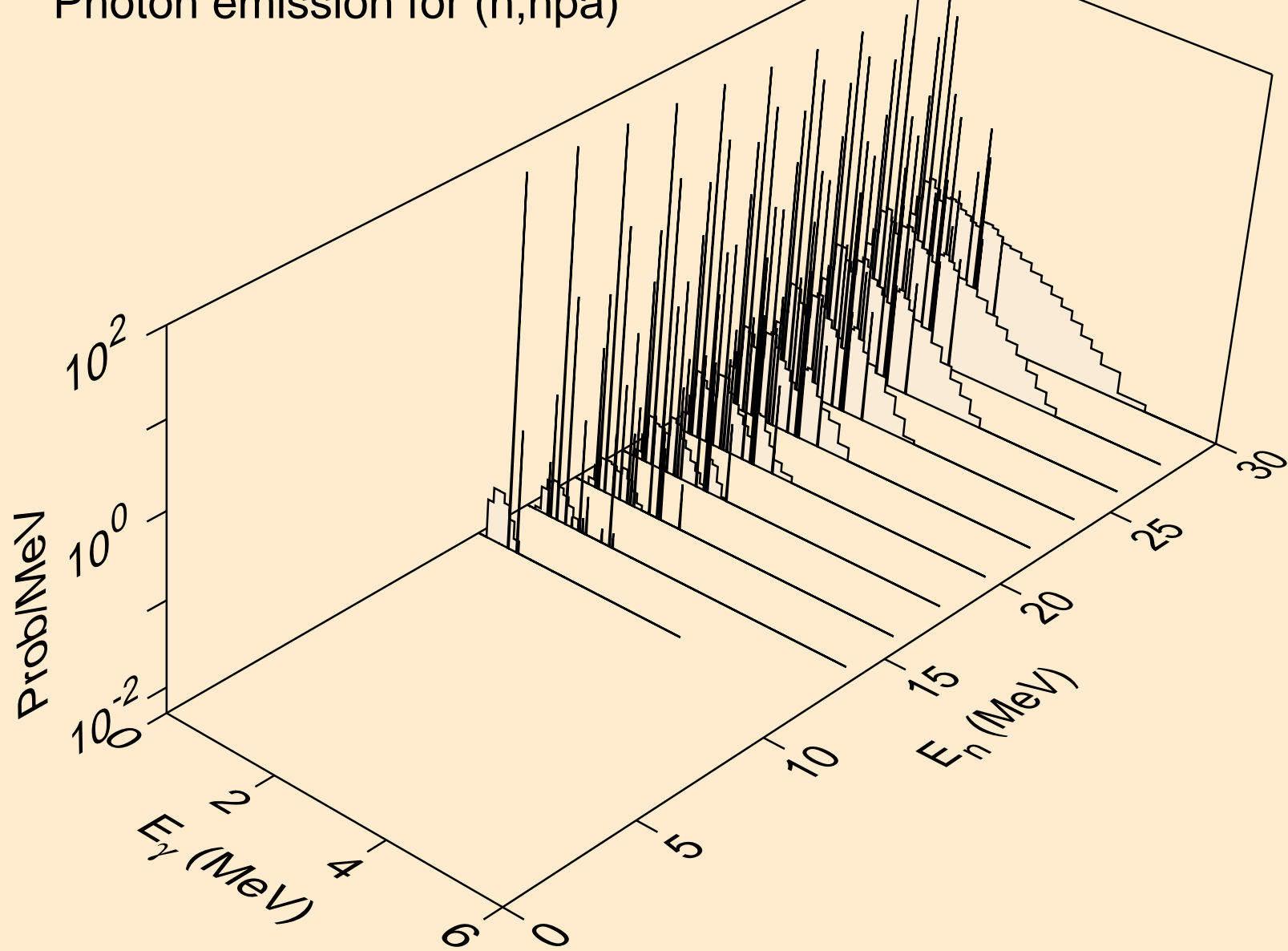

IN107M NEUTRON ACER TENDL-2024 LIBRARY; T=0.K
Photon emission for (n,n*2)

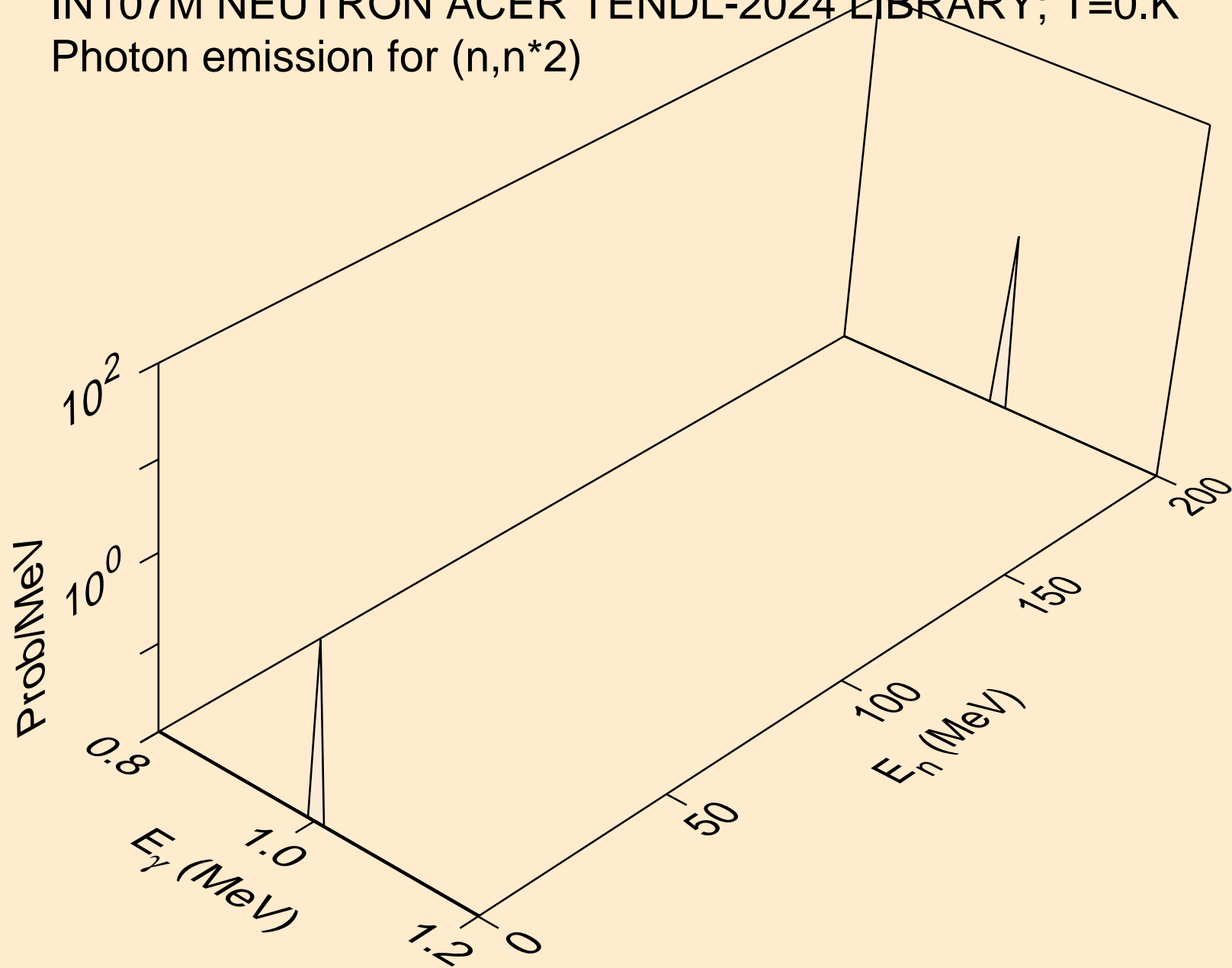

IN107M NEUTRON ACER TENDL-2024 LIBRARY; T=0.K
Photon emission for (n,n*3)

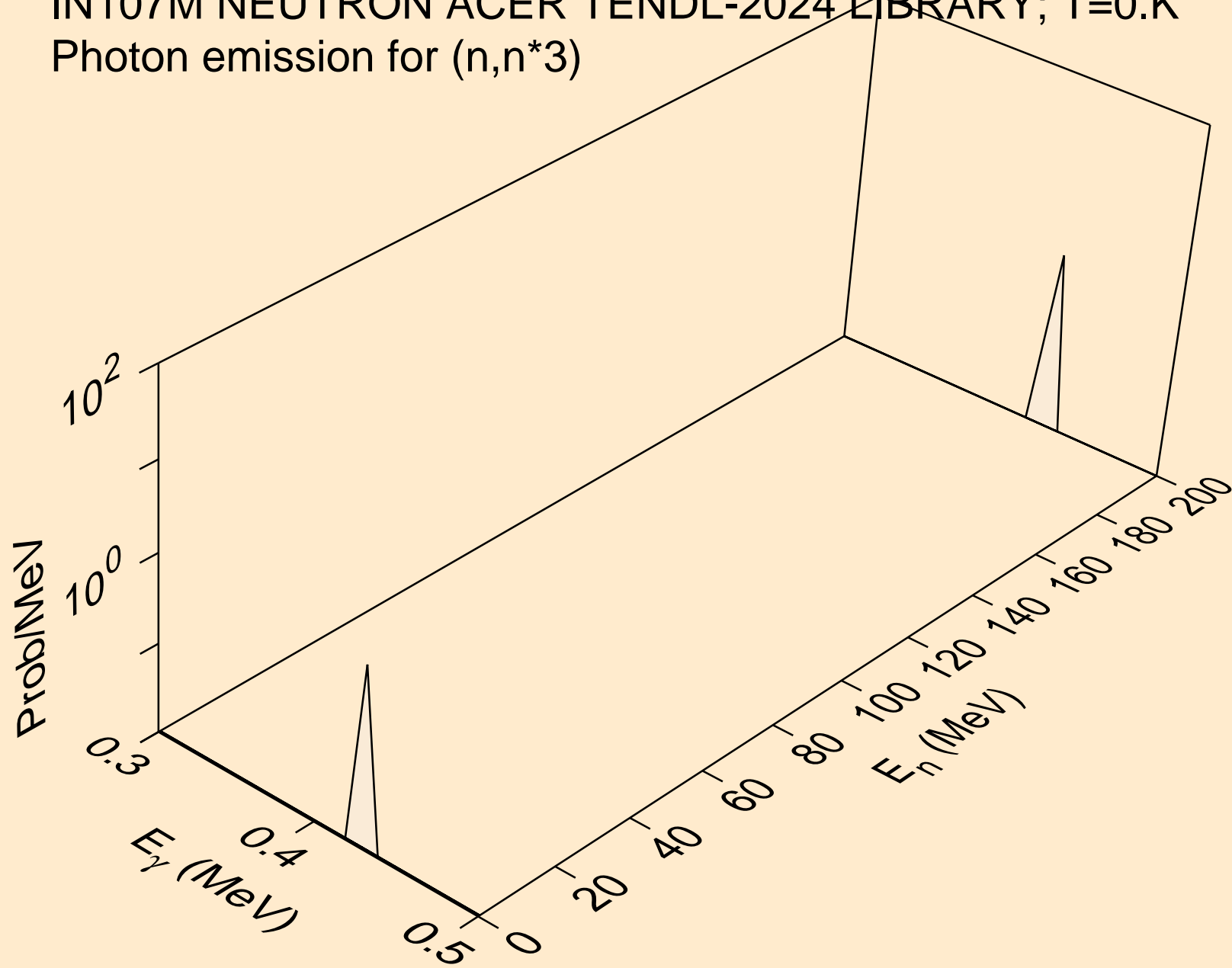

IN107M NEUTRON ACER TENDL-2024 LIBRARY; T=0.K
Photon emission for (n,n*4)

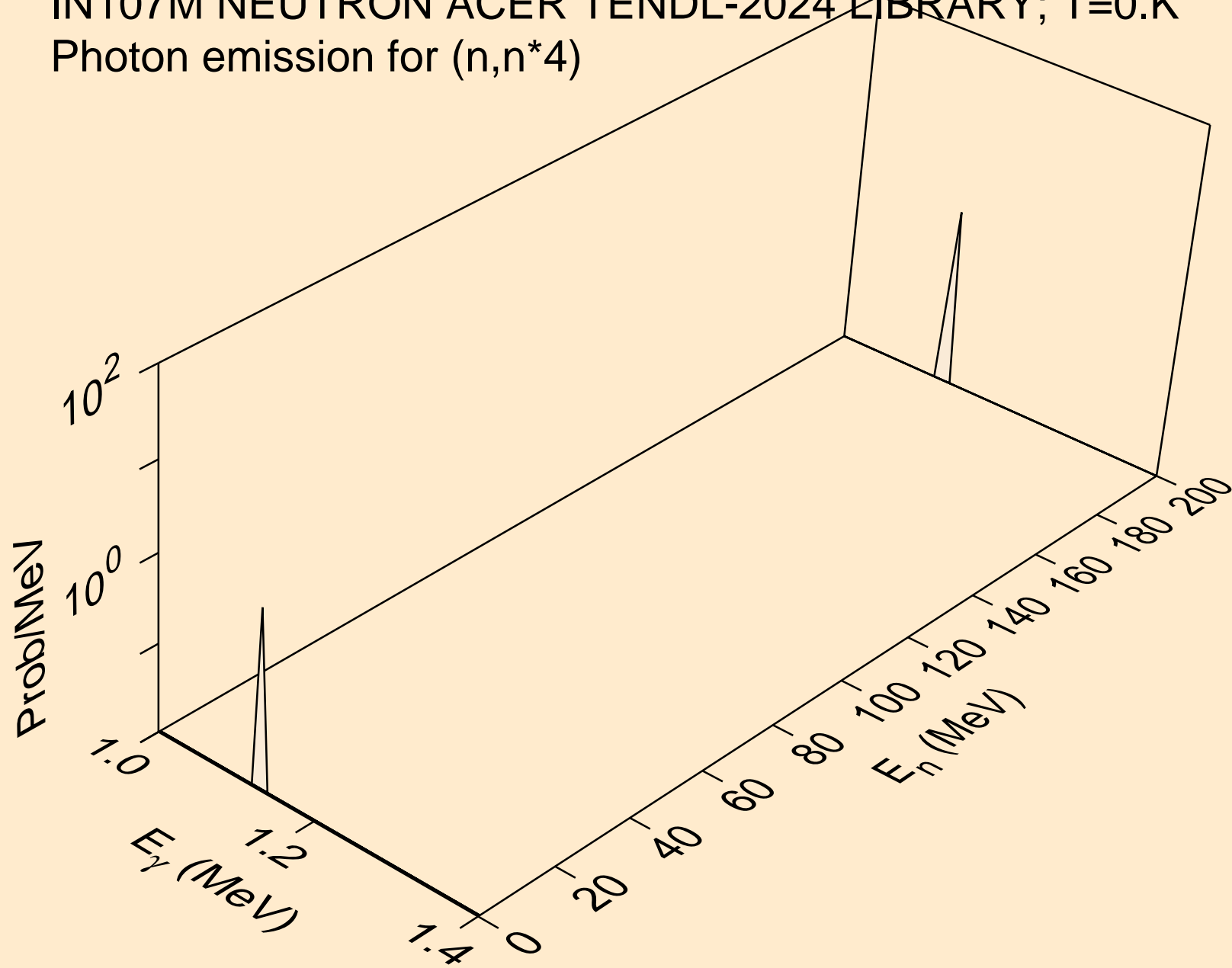

IN107M NEUTRON ACER TENDL-2024 LIBRARY; T=0.K
Photon emission for (n,n*5)

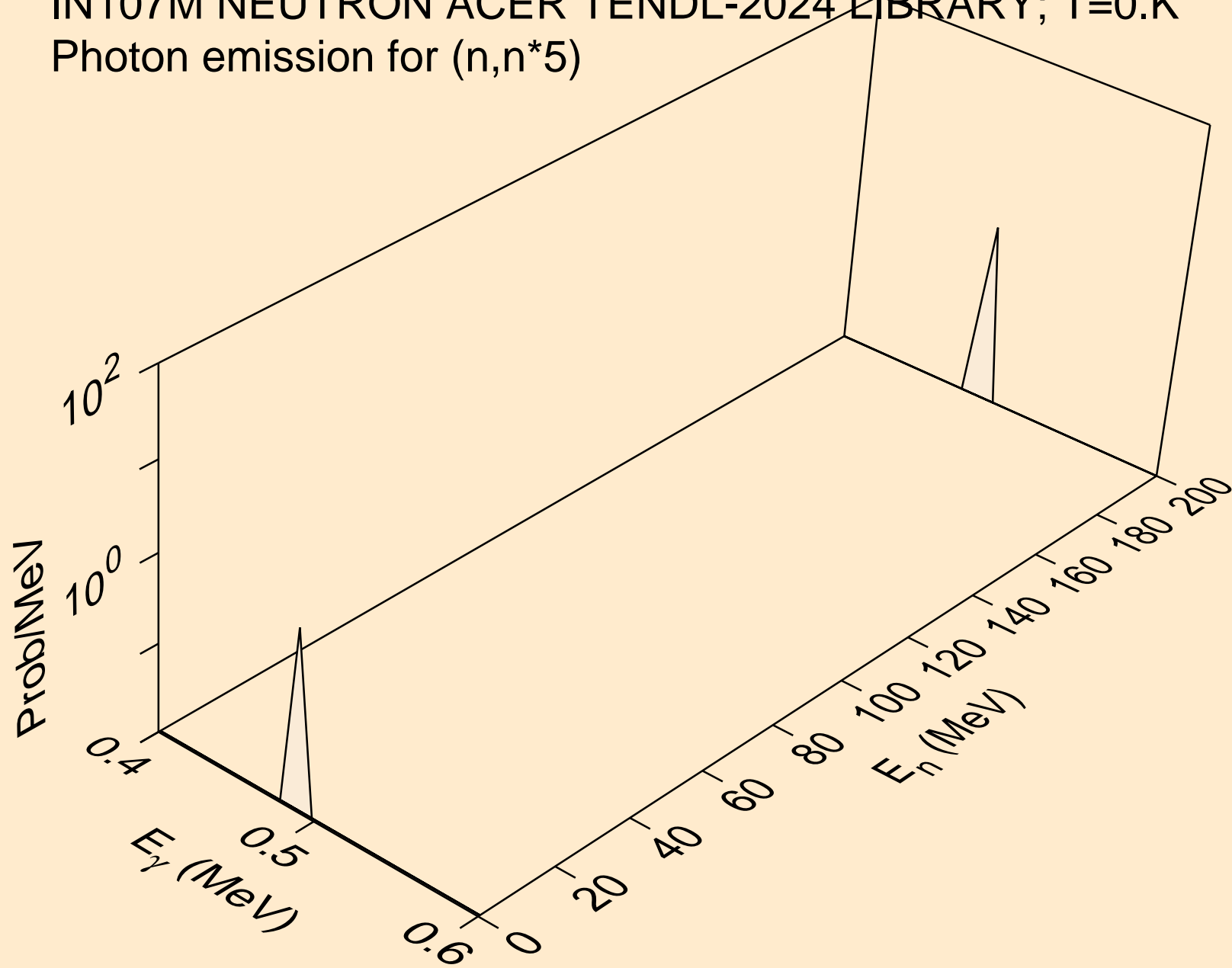

IN107M NEUTRON ACER TENDL-2024 LIBRARY; T=0.K
Photon emission for (n,n*6)

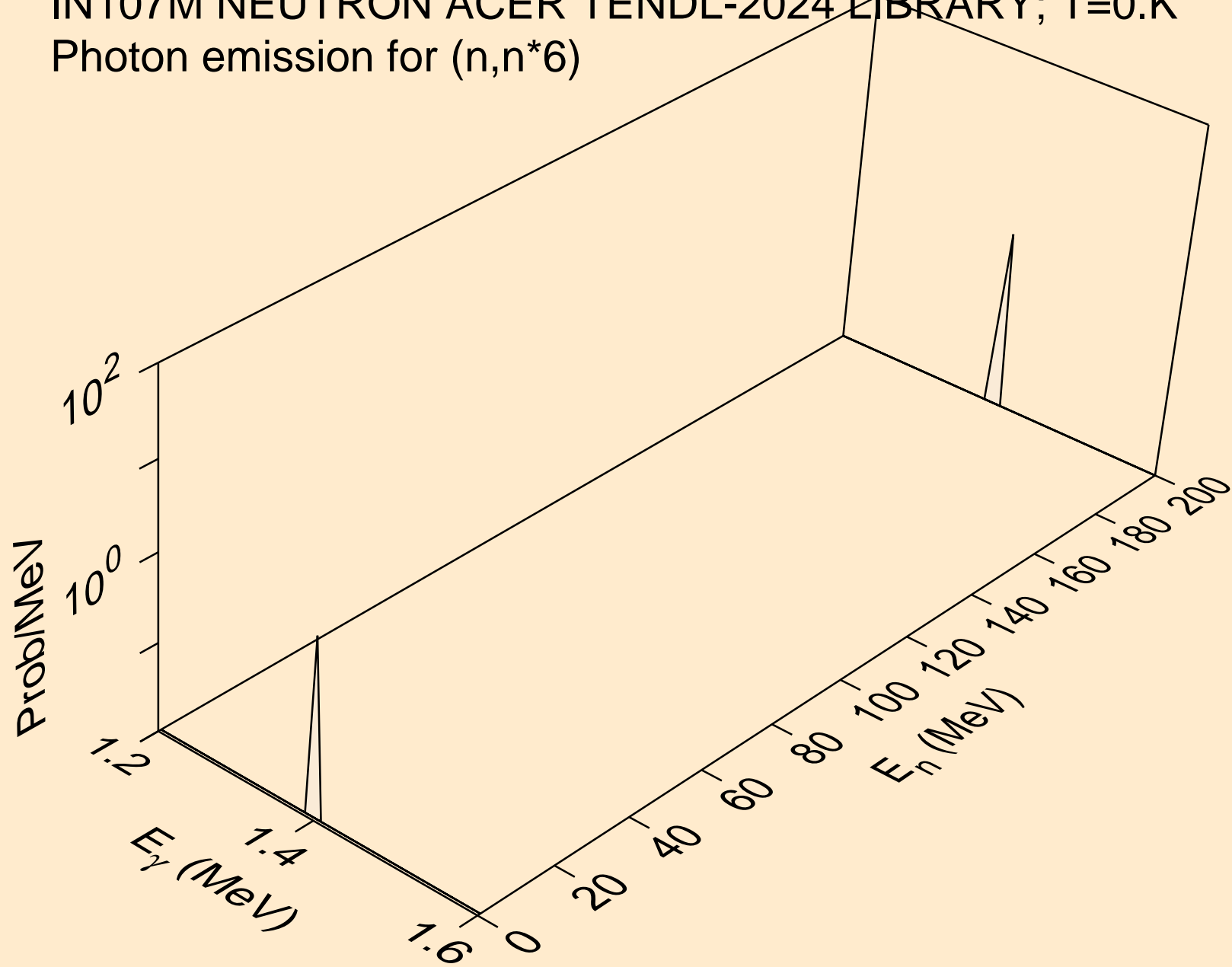

IN107M NEUTRON ACER TENDL-2024 LIBRARY; T=0.K
Photon emission for (n,n*7)

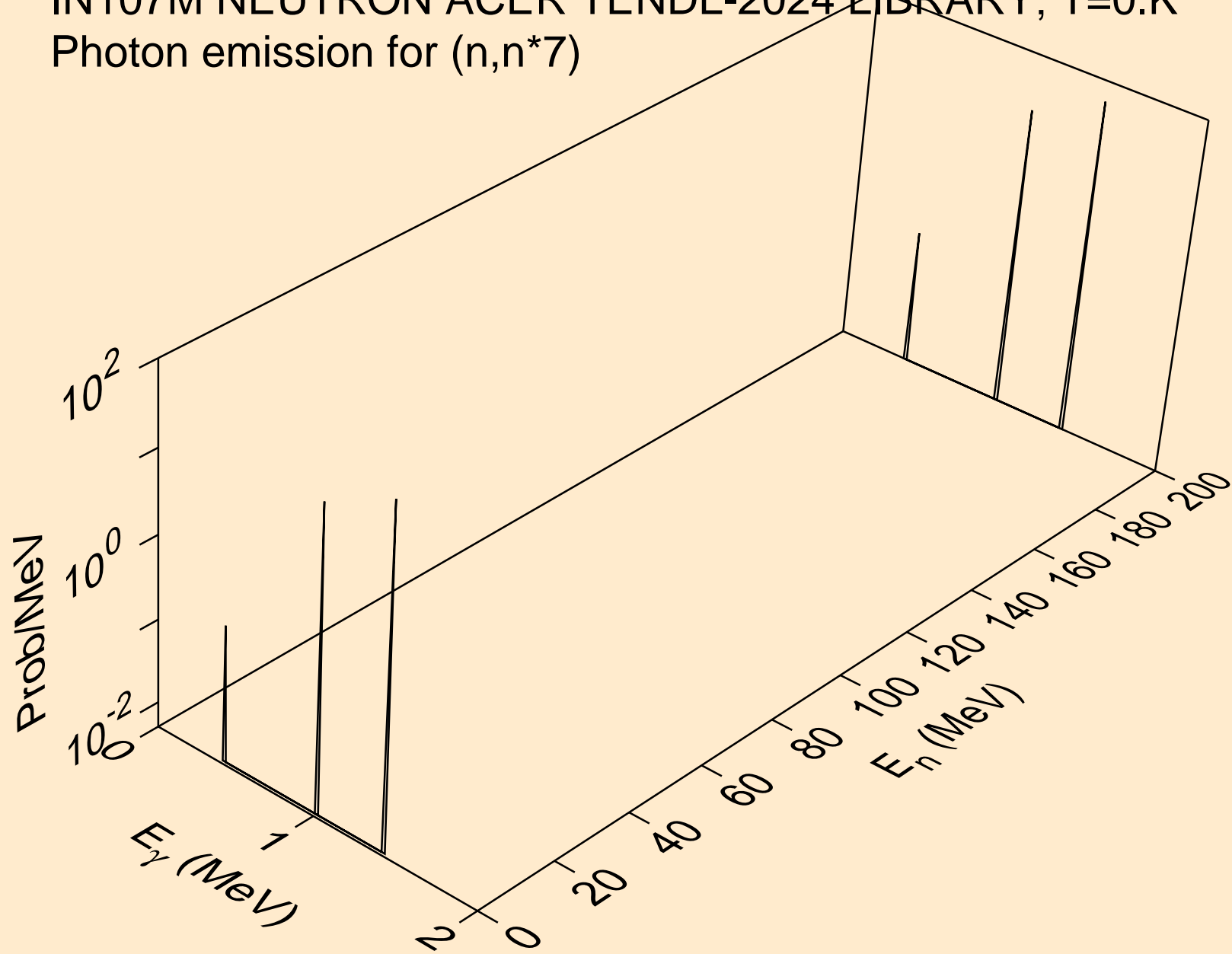

IN107M NEUTRON ACER TENDL-2024 LIBRARY; T=0.K
Photon emission for (n,n*8)

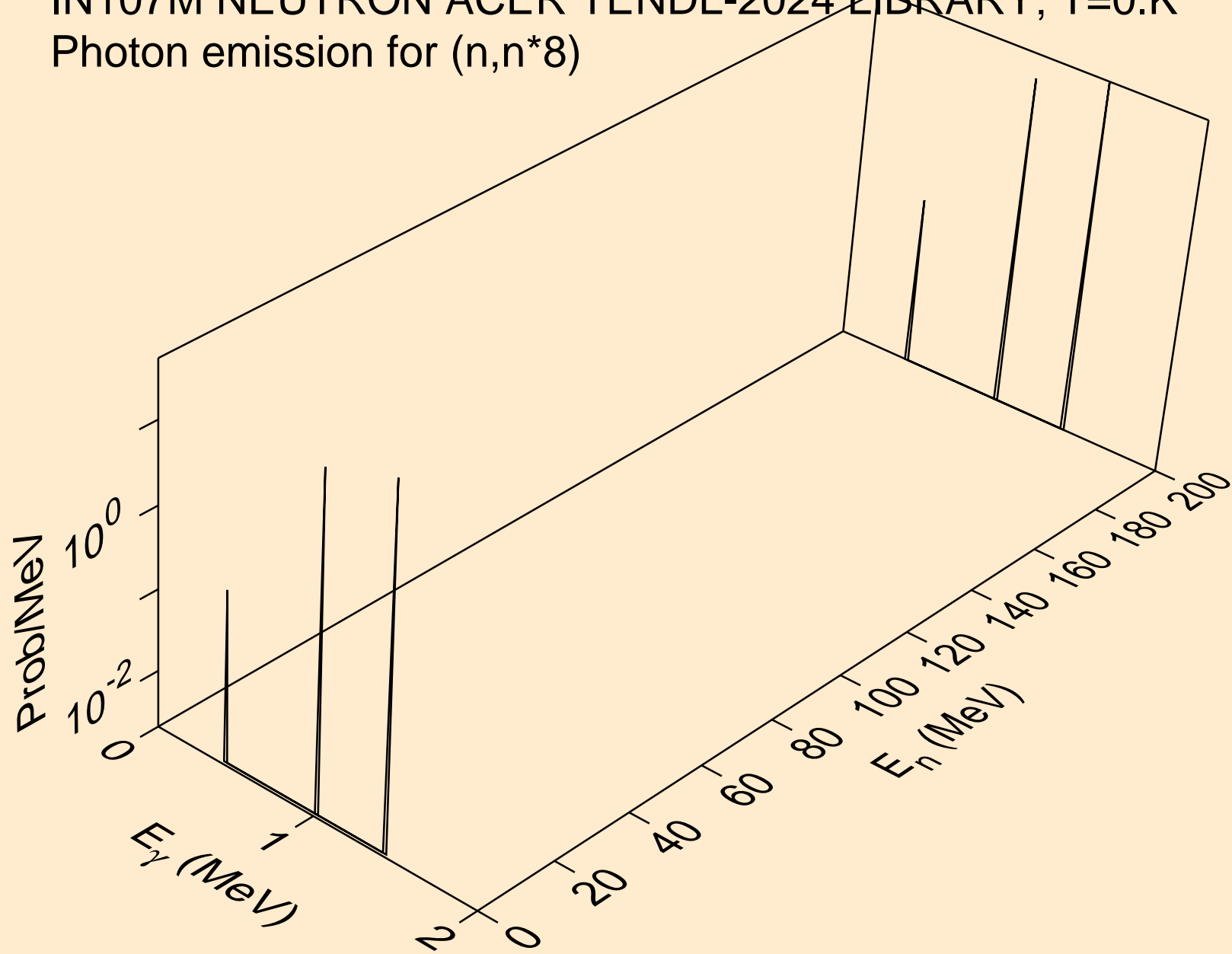

IN107M NEUTRON ACER TENDL-2024 LIBRARY; T=0.K
Photon emission for (n,n*9)

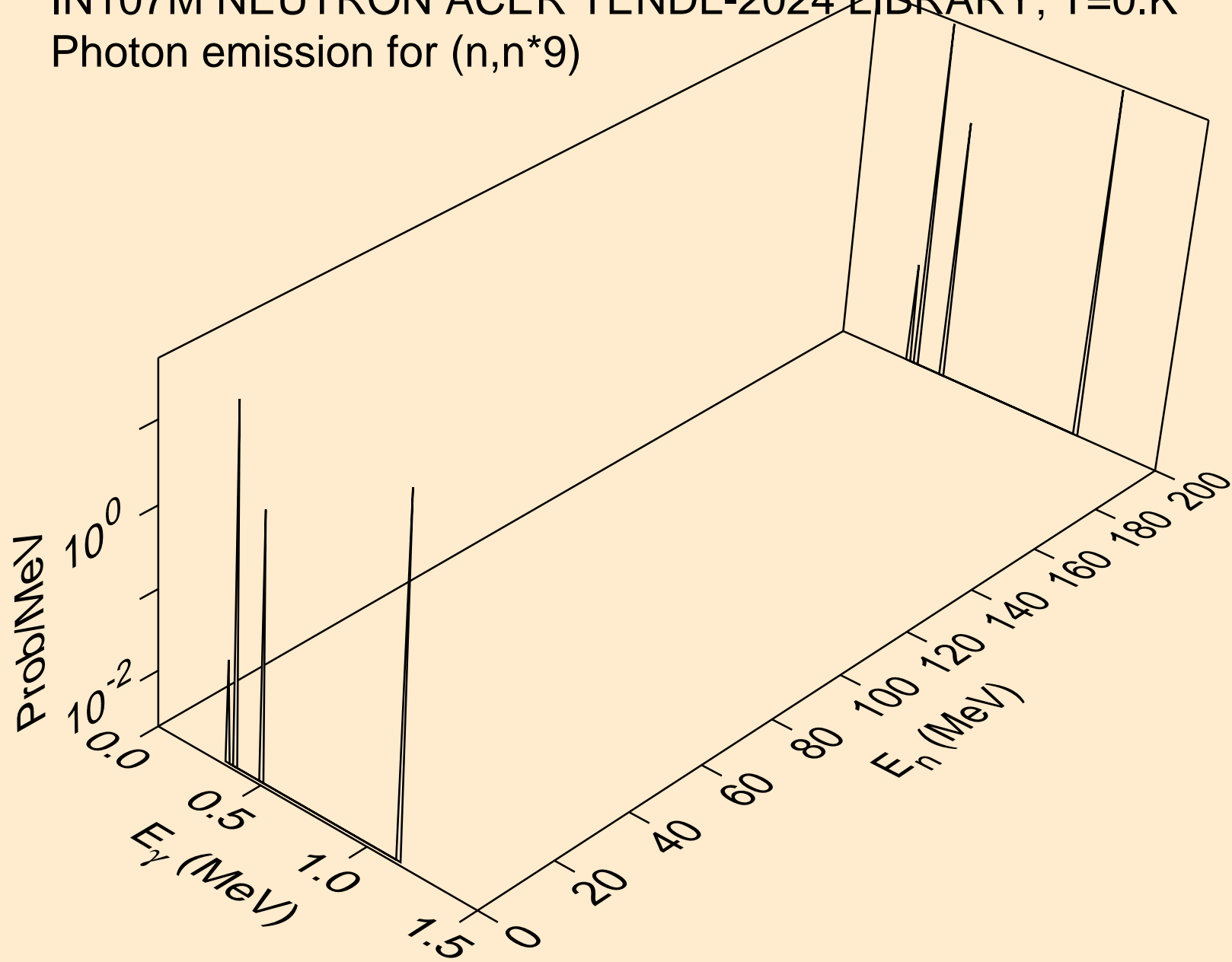

IN107M NEUTRON ACER TENDL-2024 LIBRARY; T=0.K
Photon emission for (n,n*10)

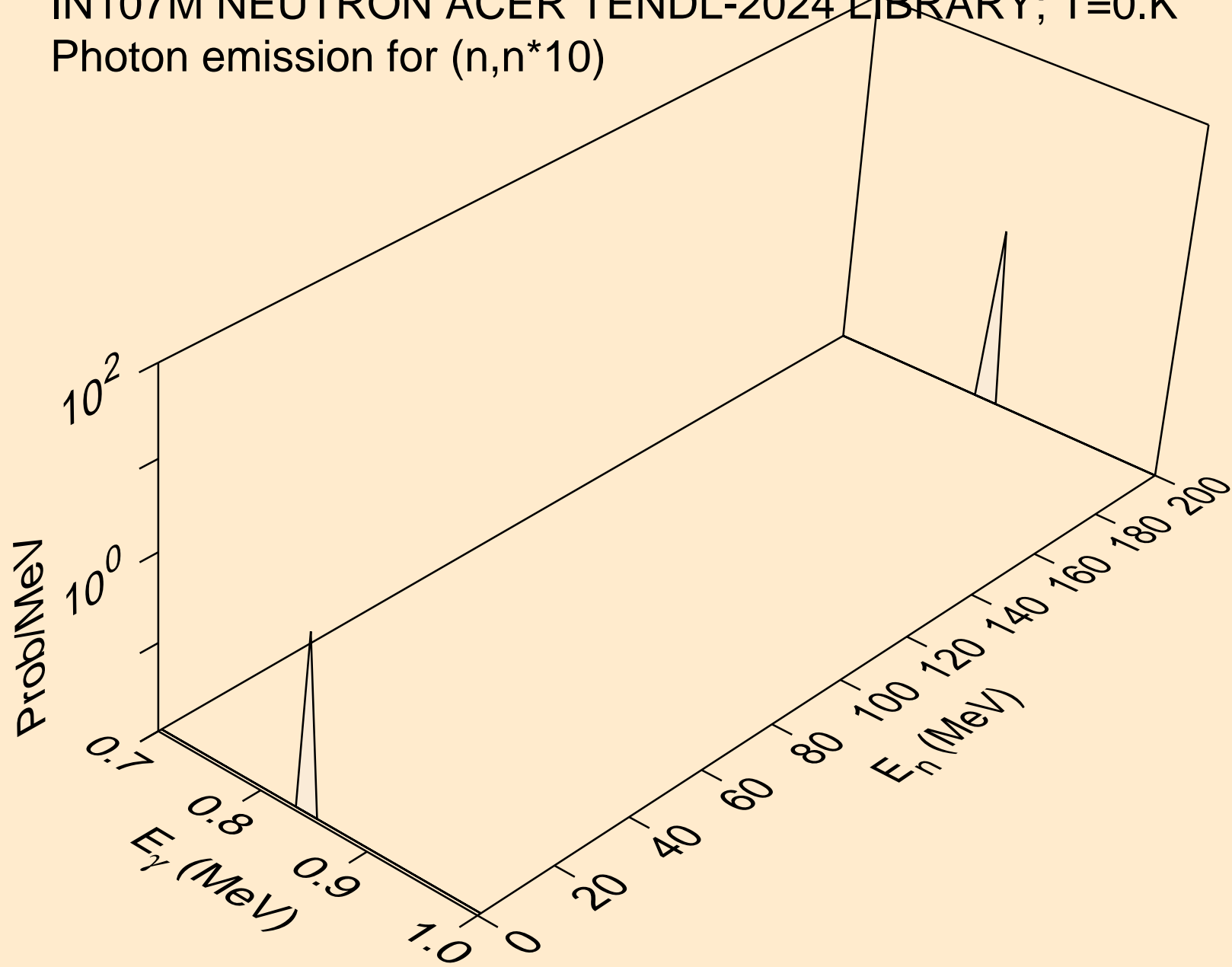

IN107M NEUTRON ACER TENDL-2024 LIBRARY; T=0.K
Photon emission for (n,n*11)

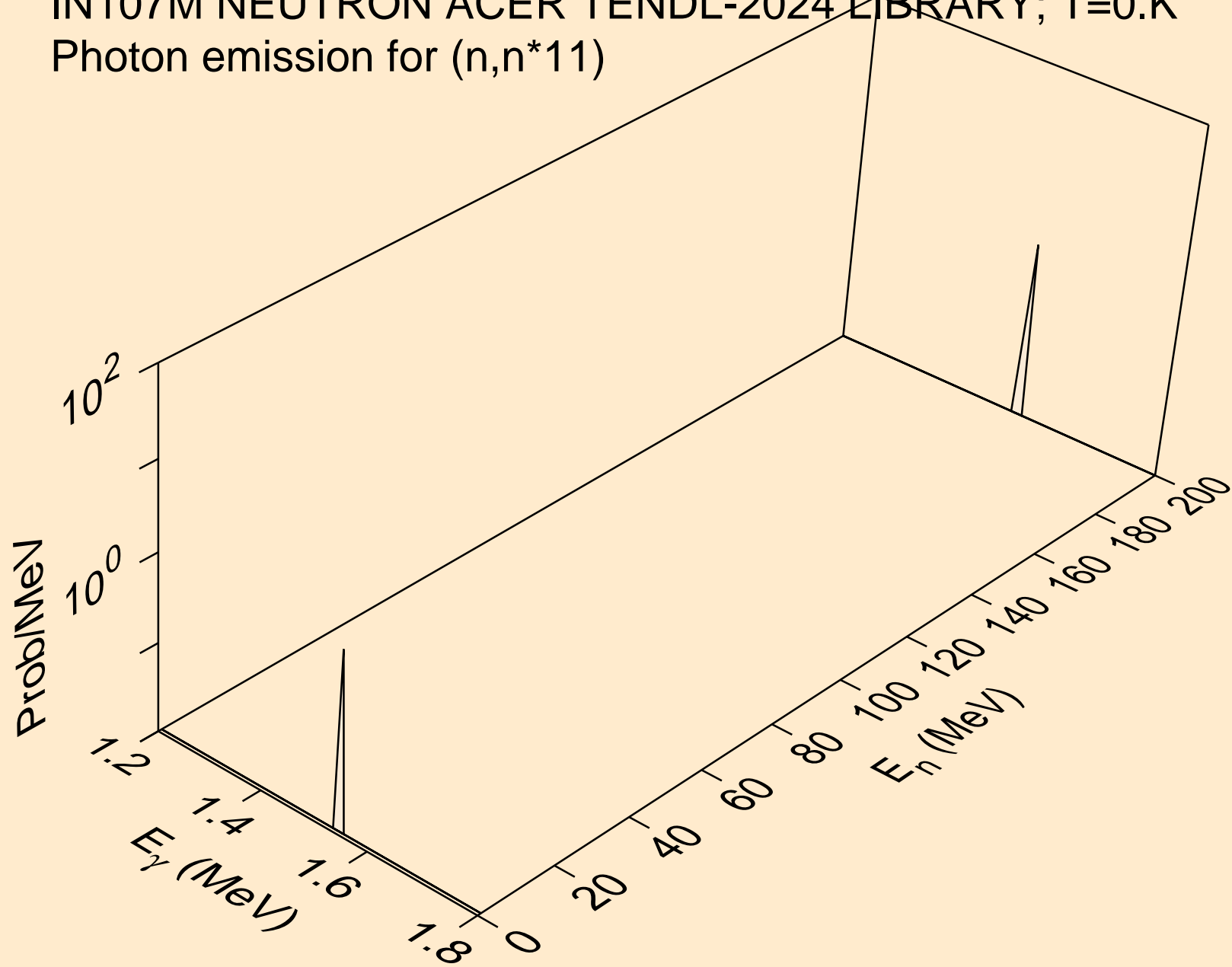

IN107M NEUTRON ACER TENDL-2024 LIBRARY; T=0.K
Photon emission for (n,n*12)

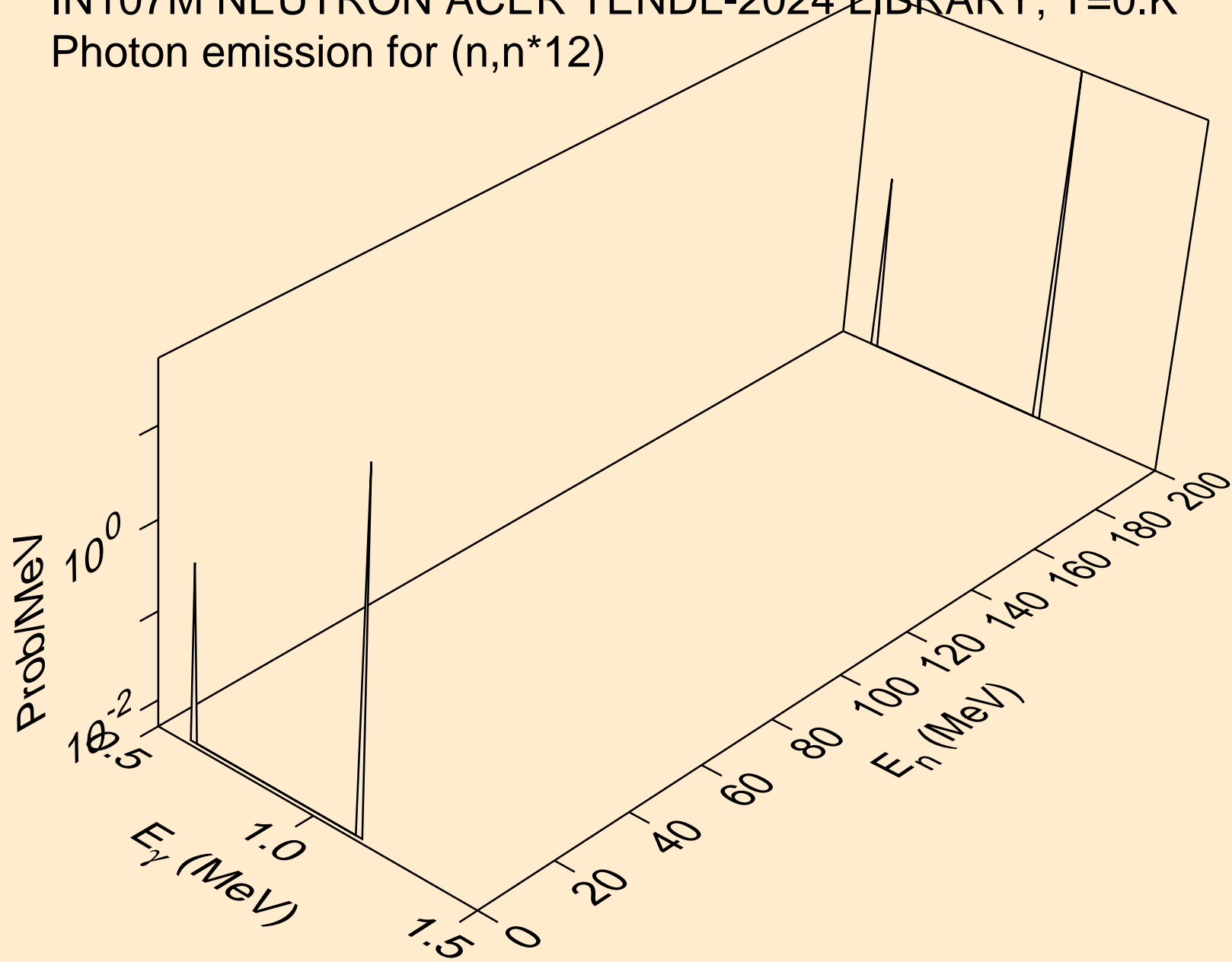

IN107M NEUTRON ACER TENDL-2024 LIBRARY; T=0.K
Photon emission for (n,n*13)

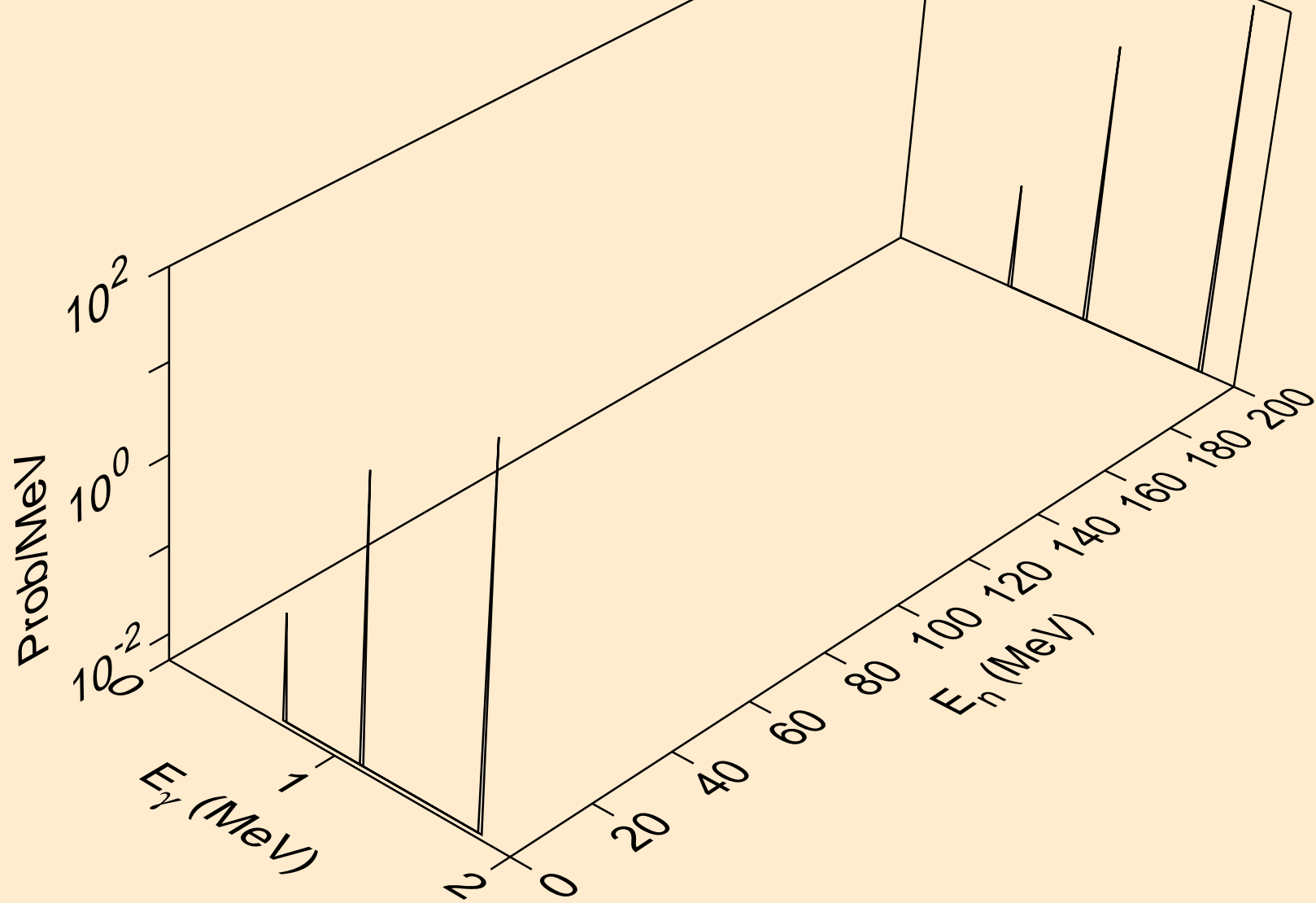

IN107M NEUTRON ACER TENDL-2024 LIBRARY; T=0.K
Photon emission for (n,n*14)

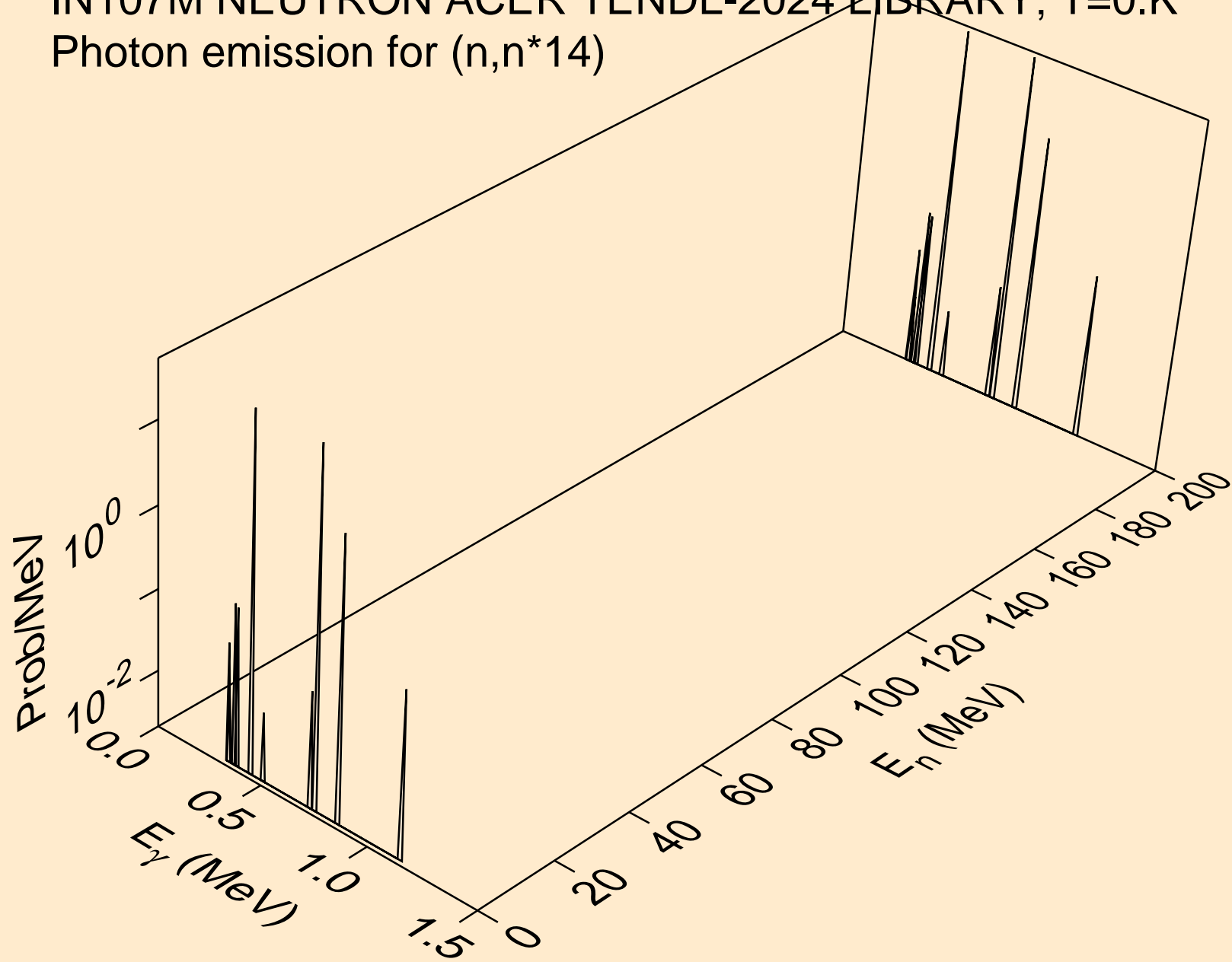

IN107M NEUTRON ACER TENDL-2024 LIBRARY; T=0.K
Photon emission for (n,n*15)

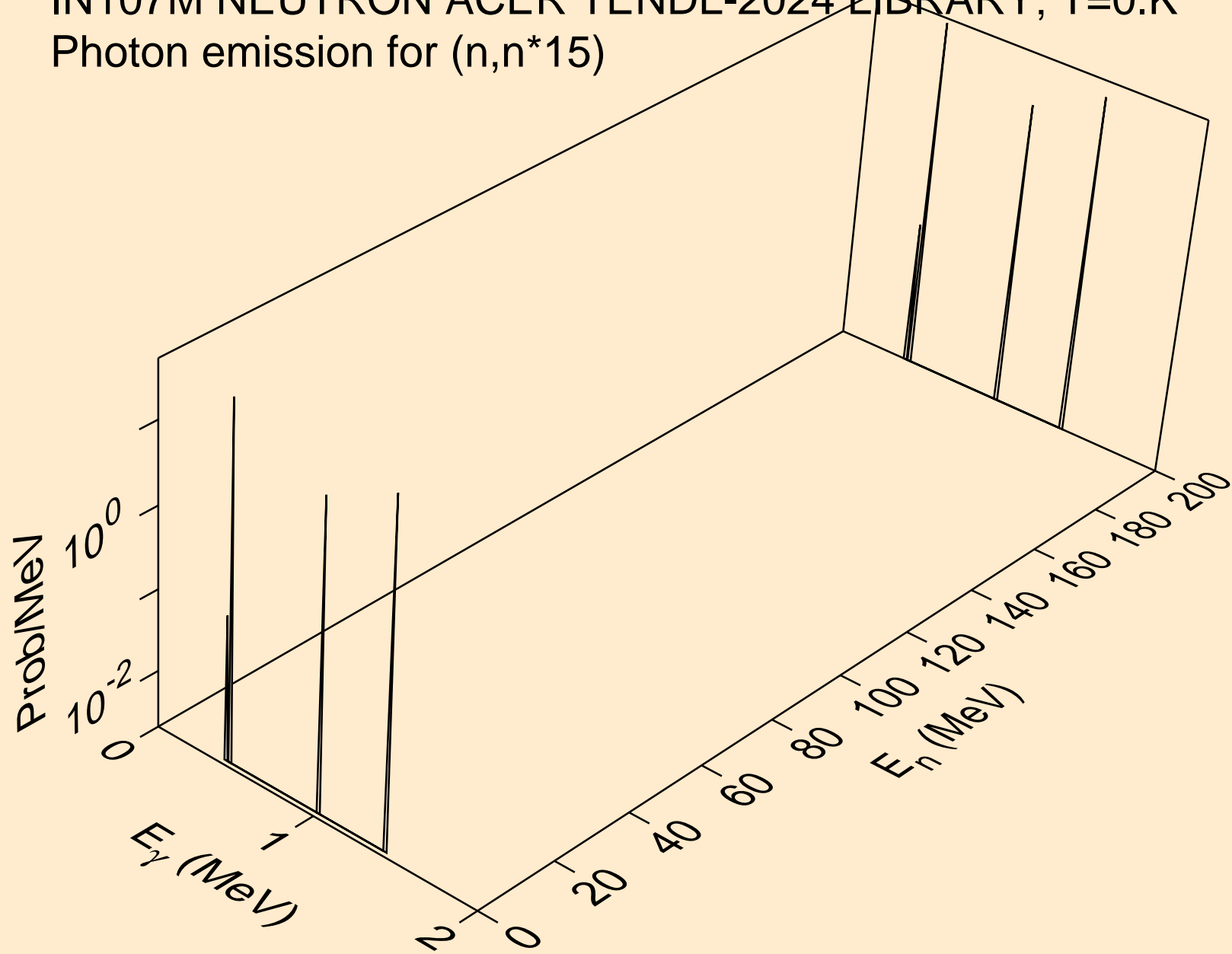

IN107M NEUTRON ACER TENDL-2024 LIBRARY; T=0.K
Photon emission for (n,n*16)

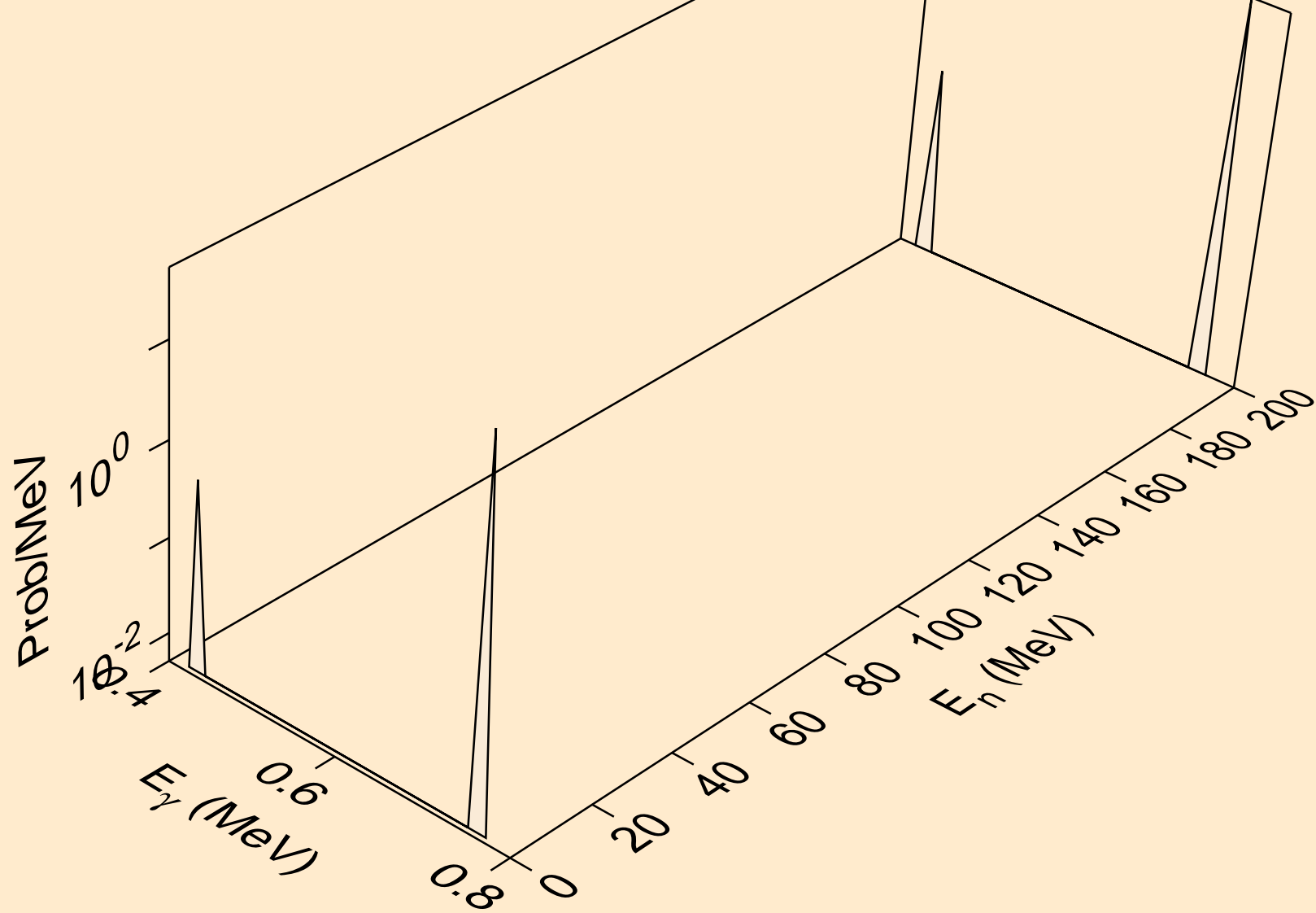

IN107M NEUTRON ACER TENDL-2024 LIBRARY; T=0.K
Photon emission for (n,n*17)

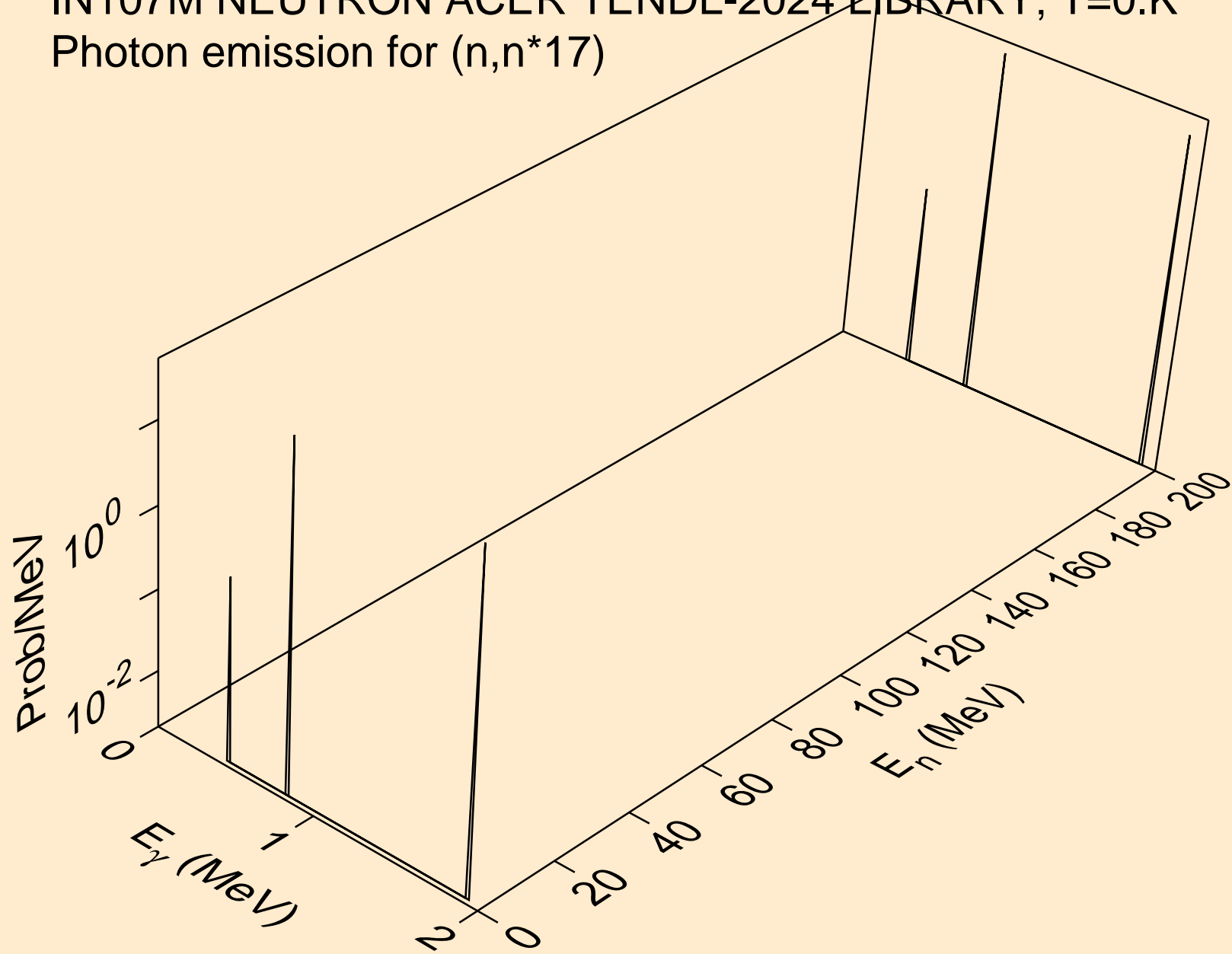

IN107M NEUTRON ACER TENDL-2024 LIBRARY; T=0.K
Photon emission for (n,n*18)

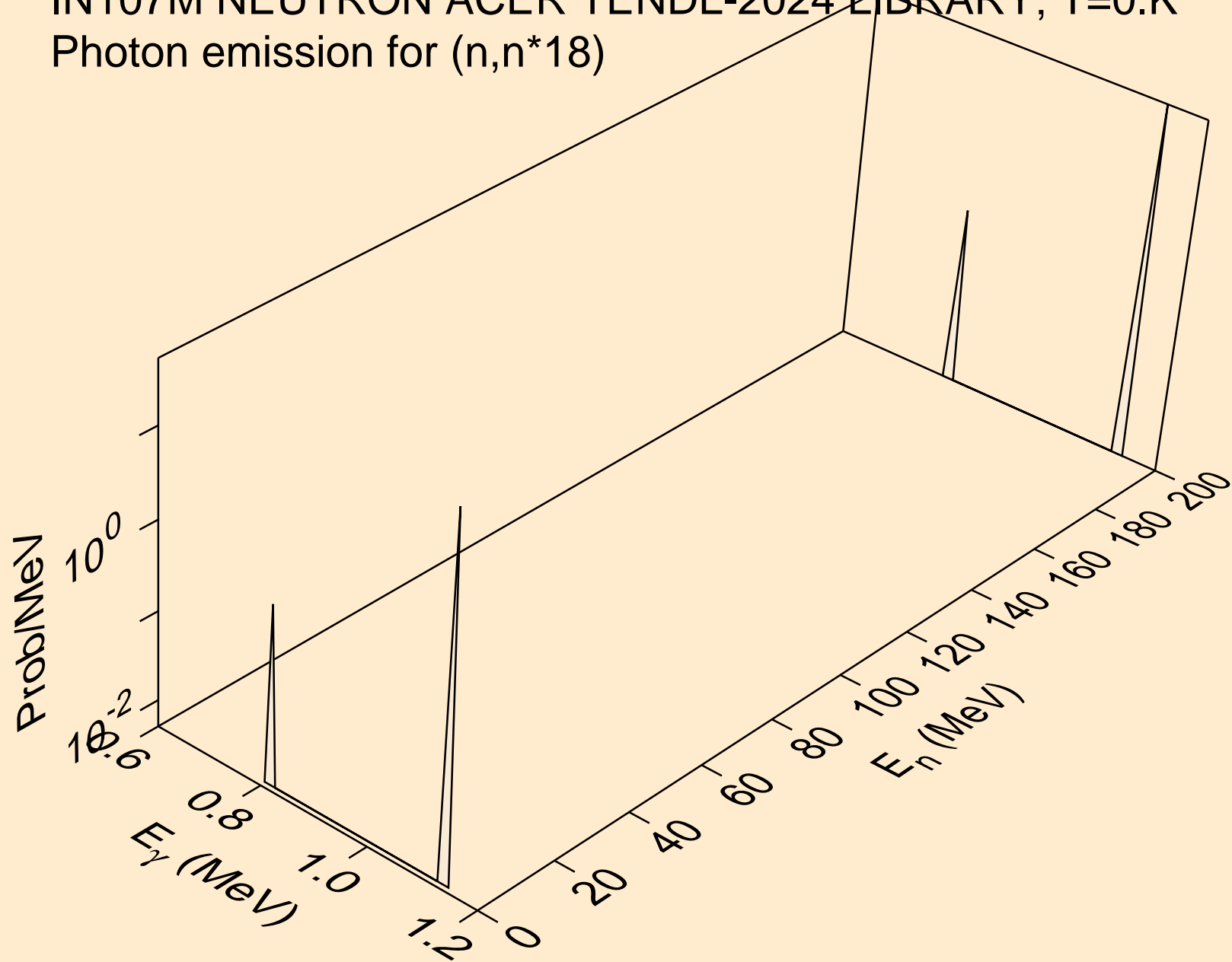

IN107M NEUTRON ACER TENDL-2024 LIBRARY; T=0.K
Photon emission for (n,n*19)

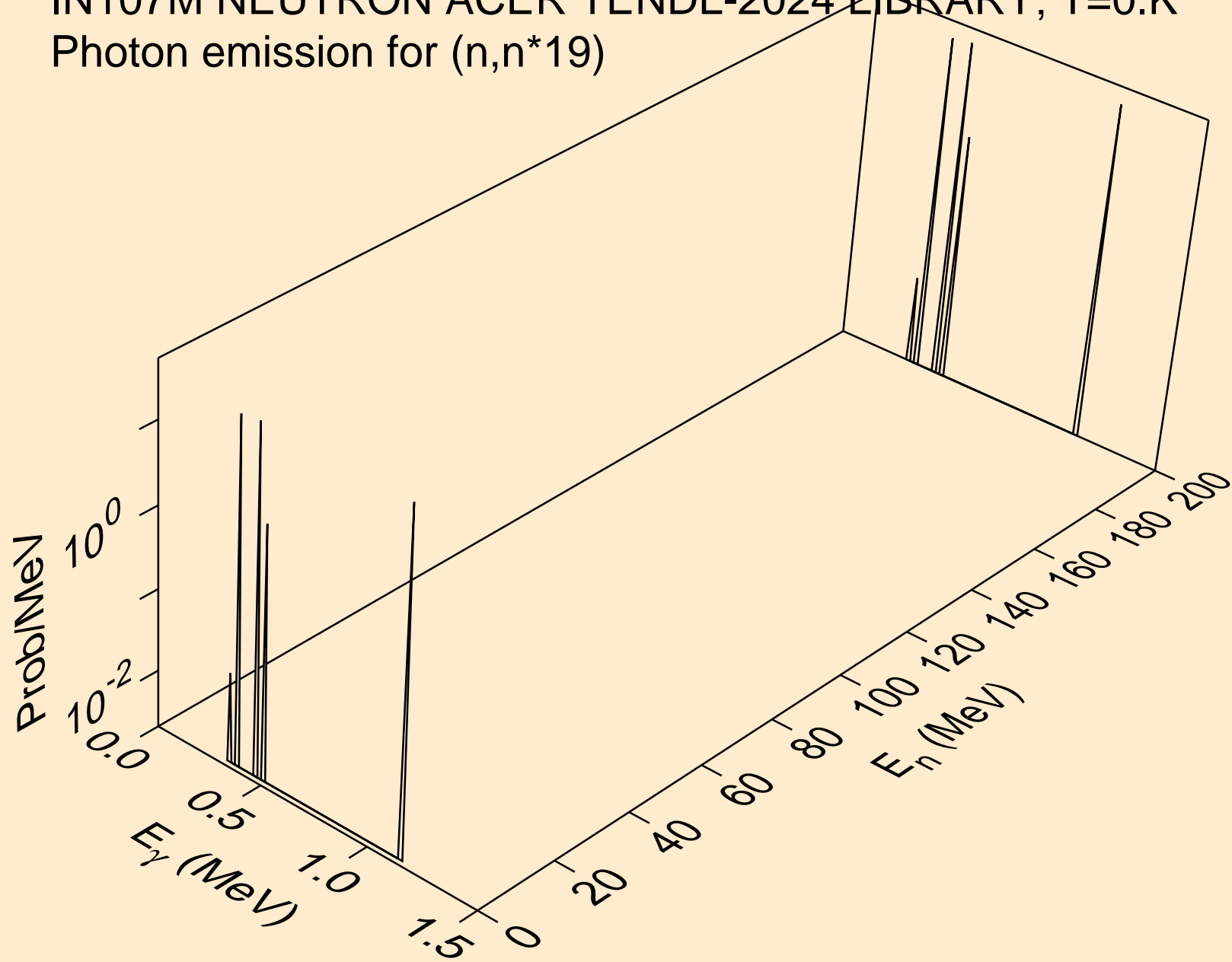

IN107M NEUTRON ACER TENDL-2024 LIBRARY; T=0.K
Photon emission for (n,n*20)

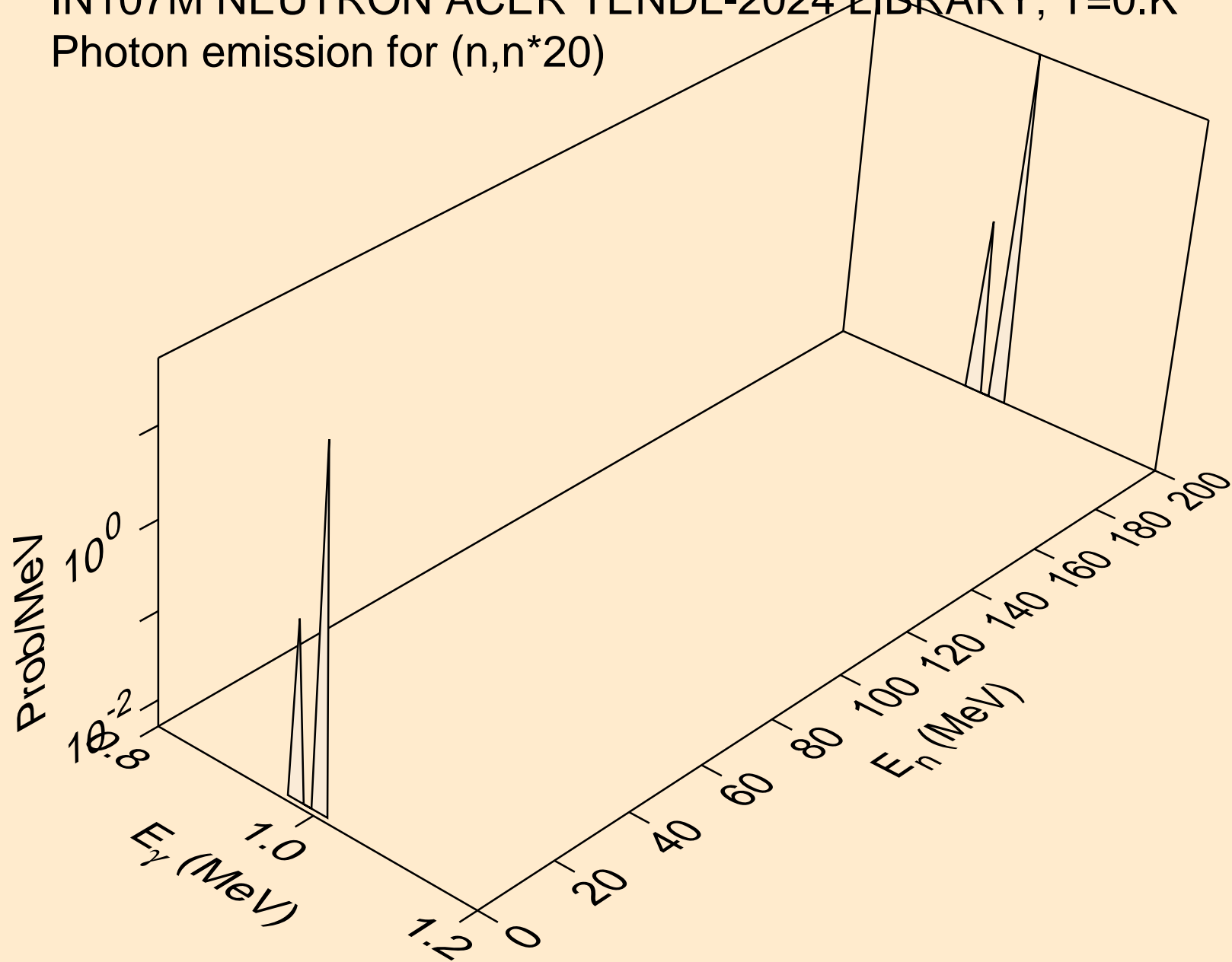

IN107M NEUTRON ACER TENDL-2024 LIBRARY; T=0.K
Photon emission for (n,n*21)

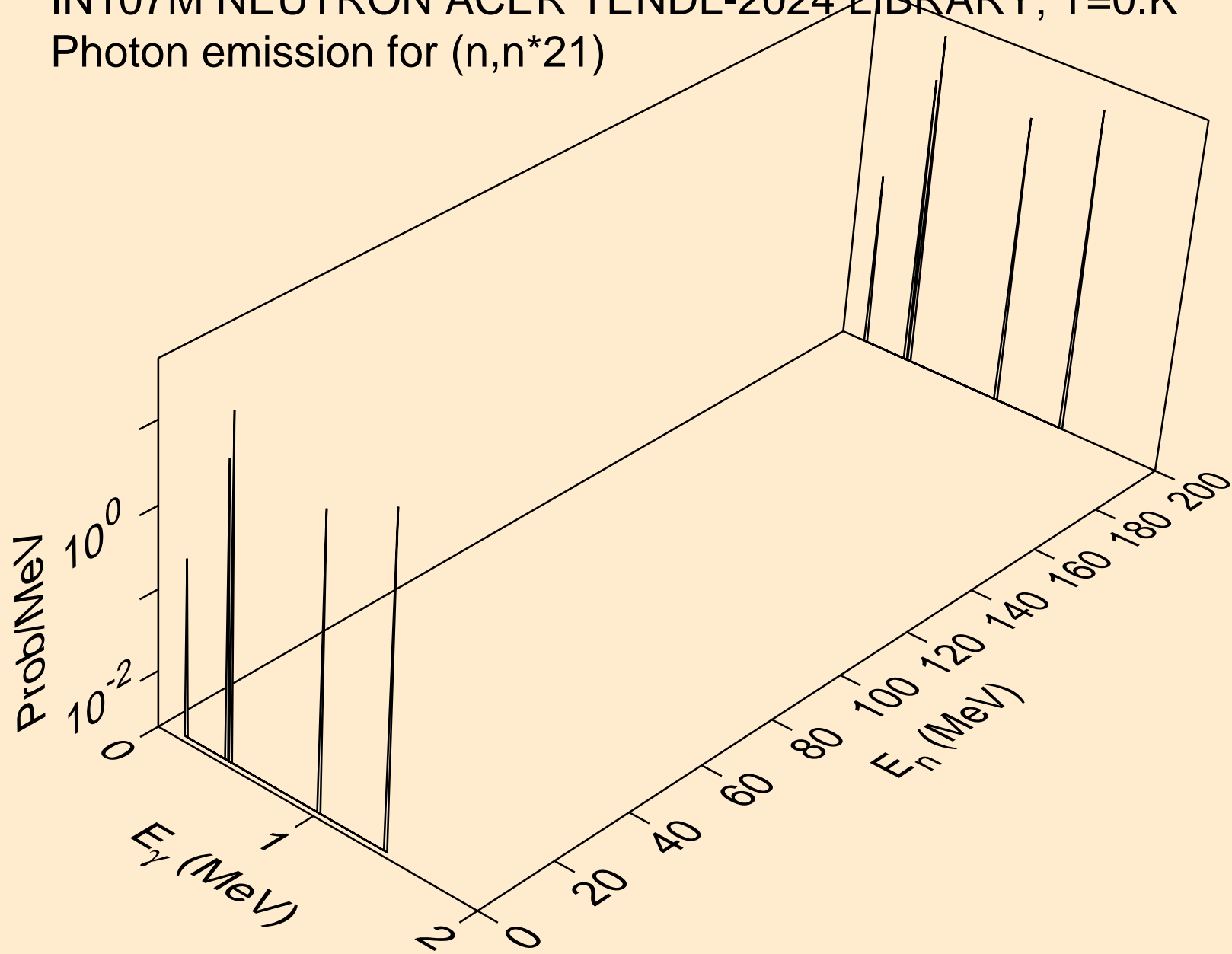

IN107M NEUTRON ACER TENDL-2024 LIBRARY; T=0.K
Photon emission for (n,n*22)

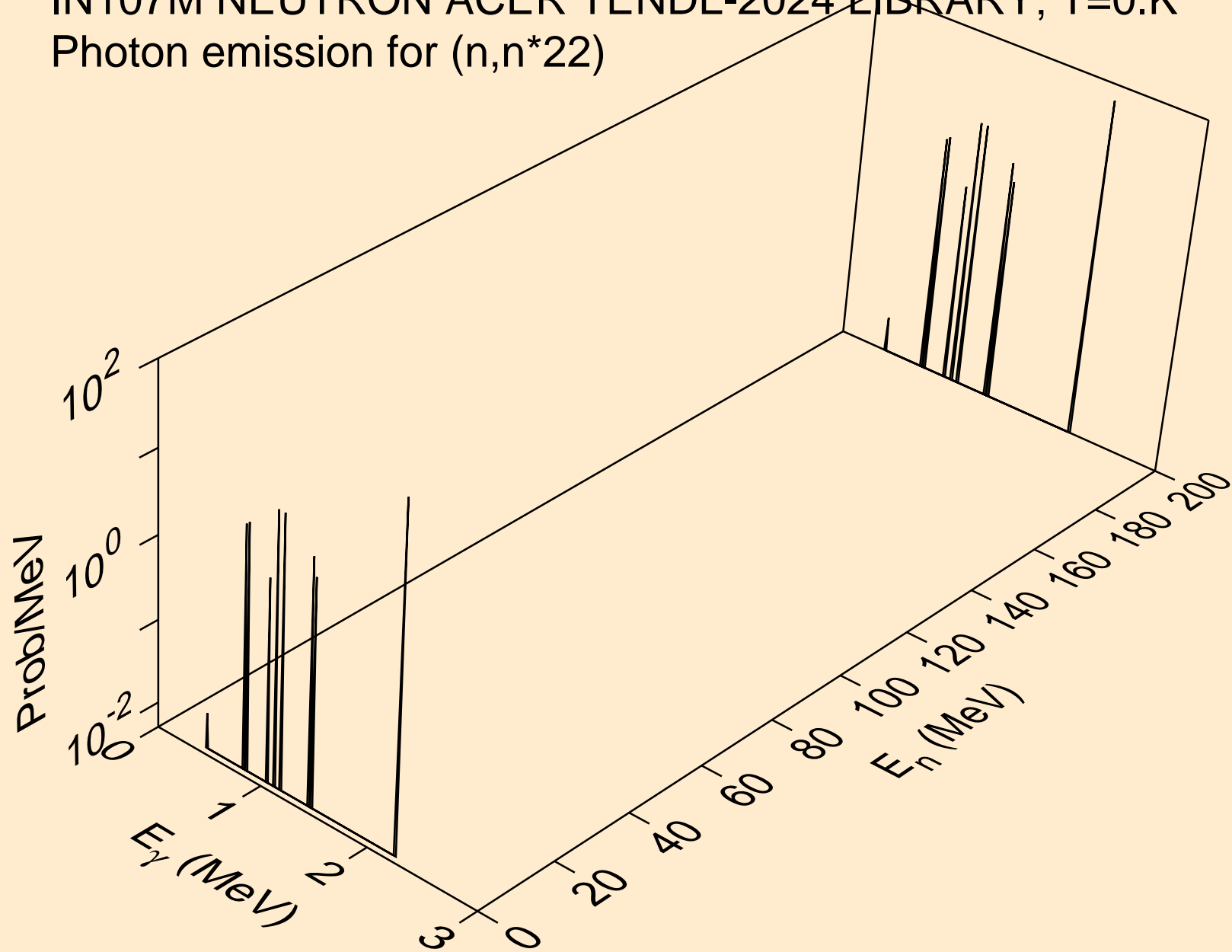

IN107M NEUTRON ACER TENDL-2024 LIBRARY; T=0.K
Photon emission for (n,n*23)

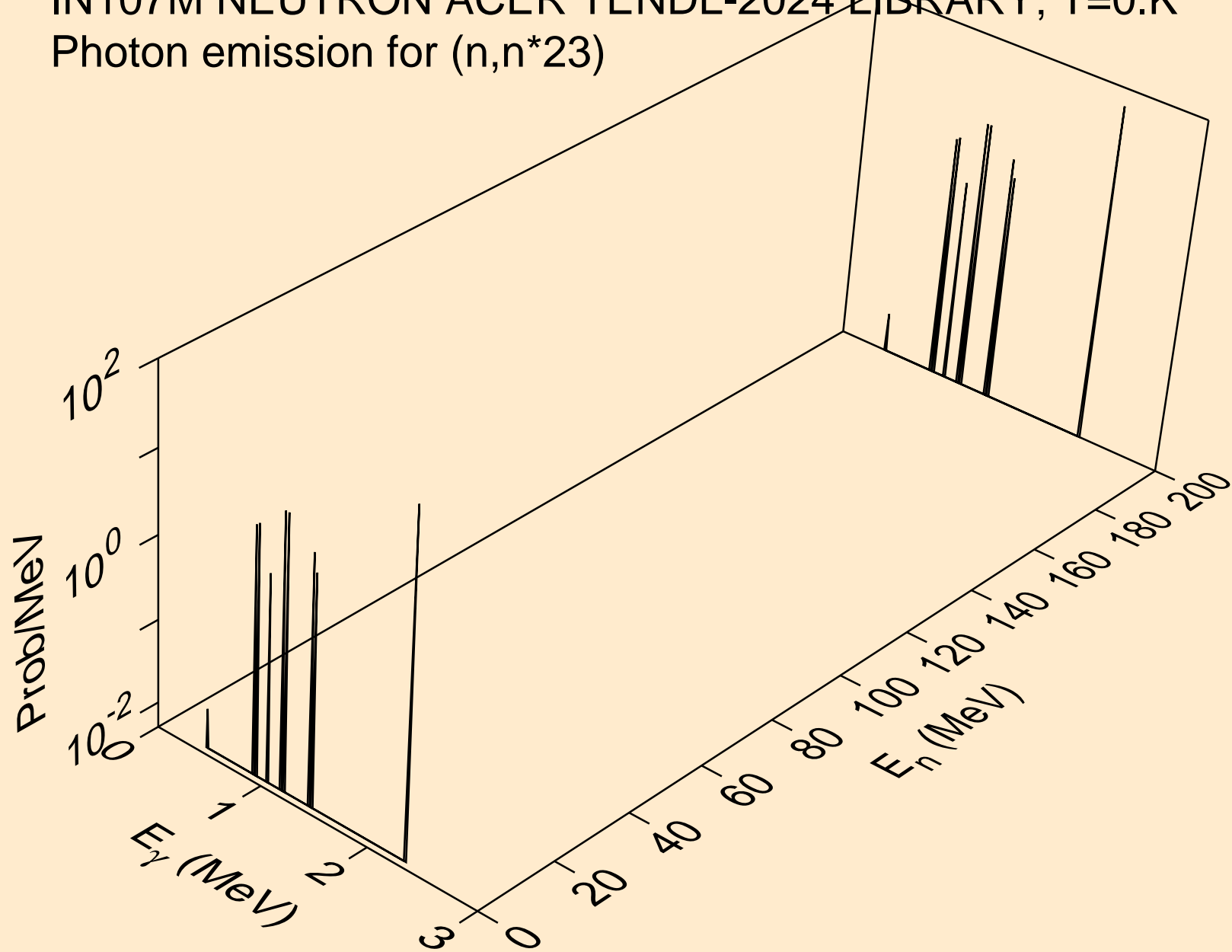

IN107M NEUTRON ACER TENDL-2024 LIBRARY; T=0.K
Photon emission for (n,n*24)

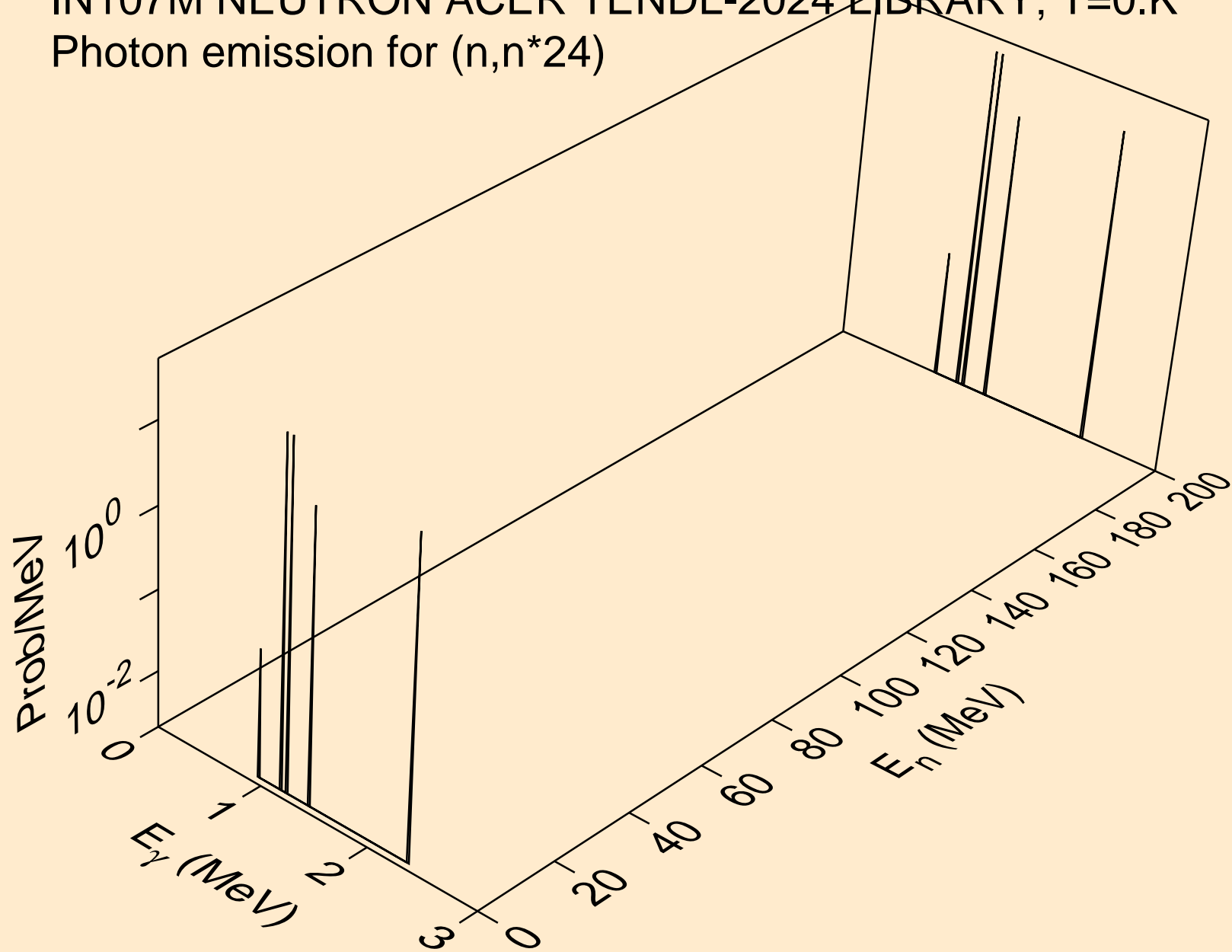

IN107M NEUTRON ACER TENDL-2024 LIBRARY; T=0.K
Photon emission for (n,n*25)

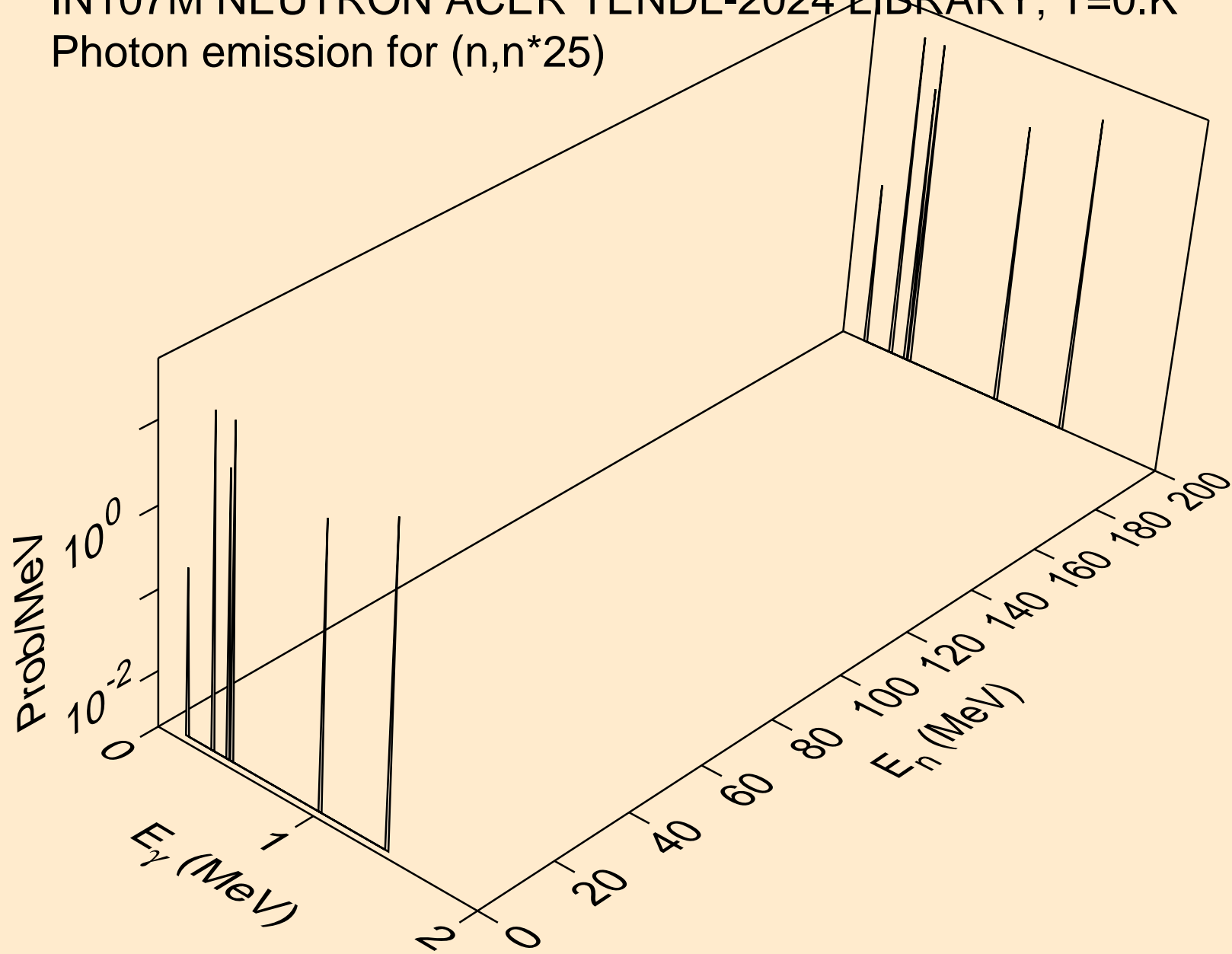

IN107M NEUTRON ACER TENDL-2024 LIBRARY; T=0.K
Photon emission for (n,n*26)

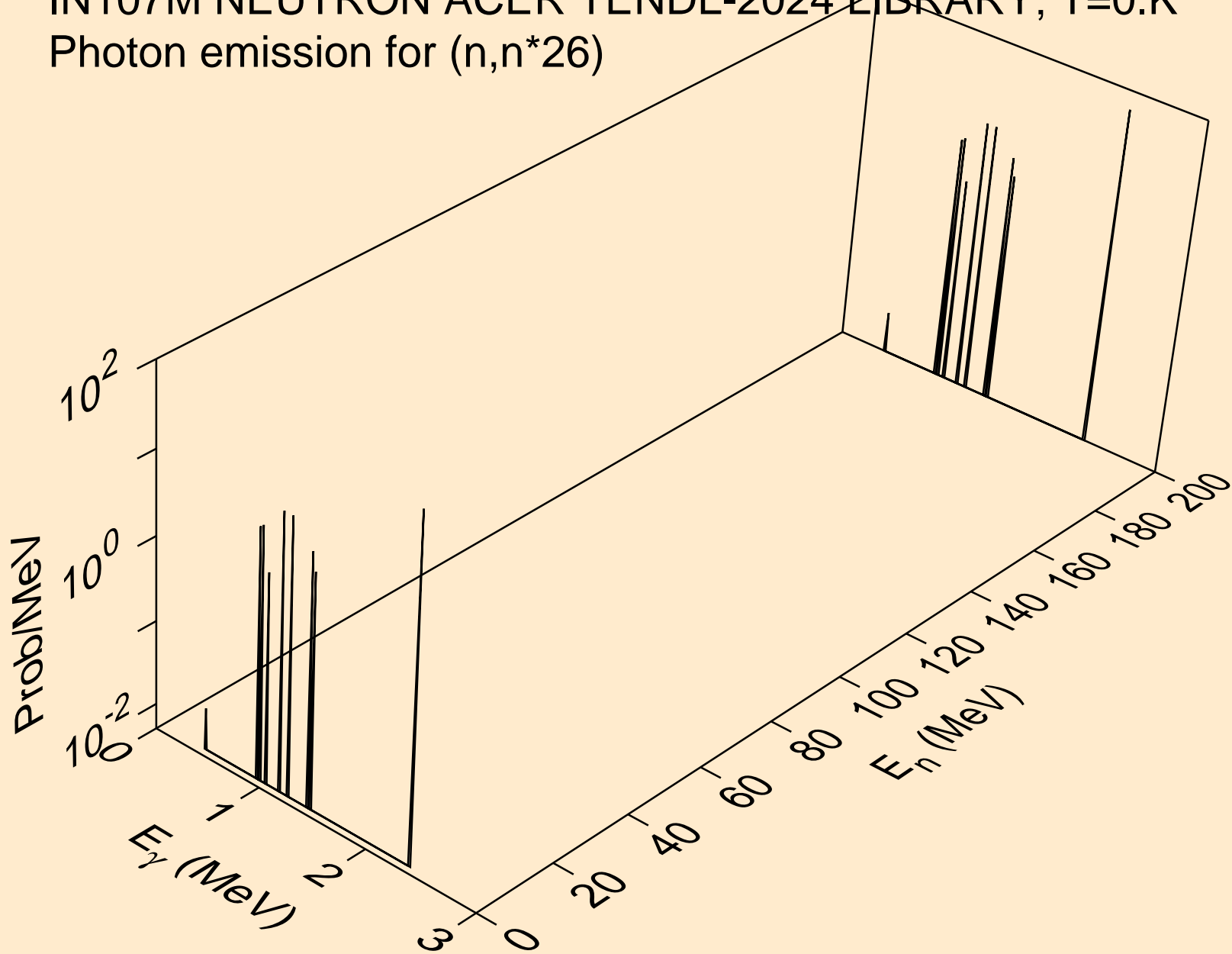

IN107M NEUTRON ACER TENDL-2024 LIBRARY; T=0.K
Photon emission for (n,n*27)

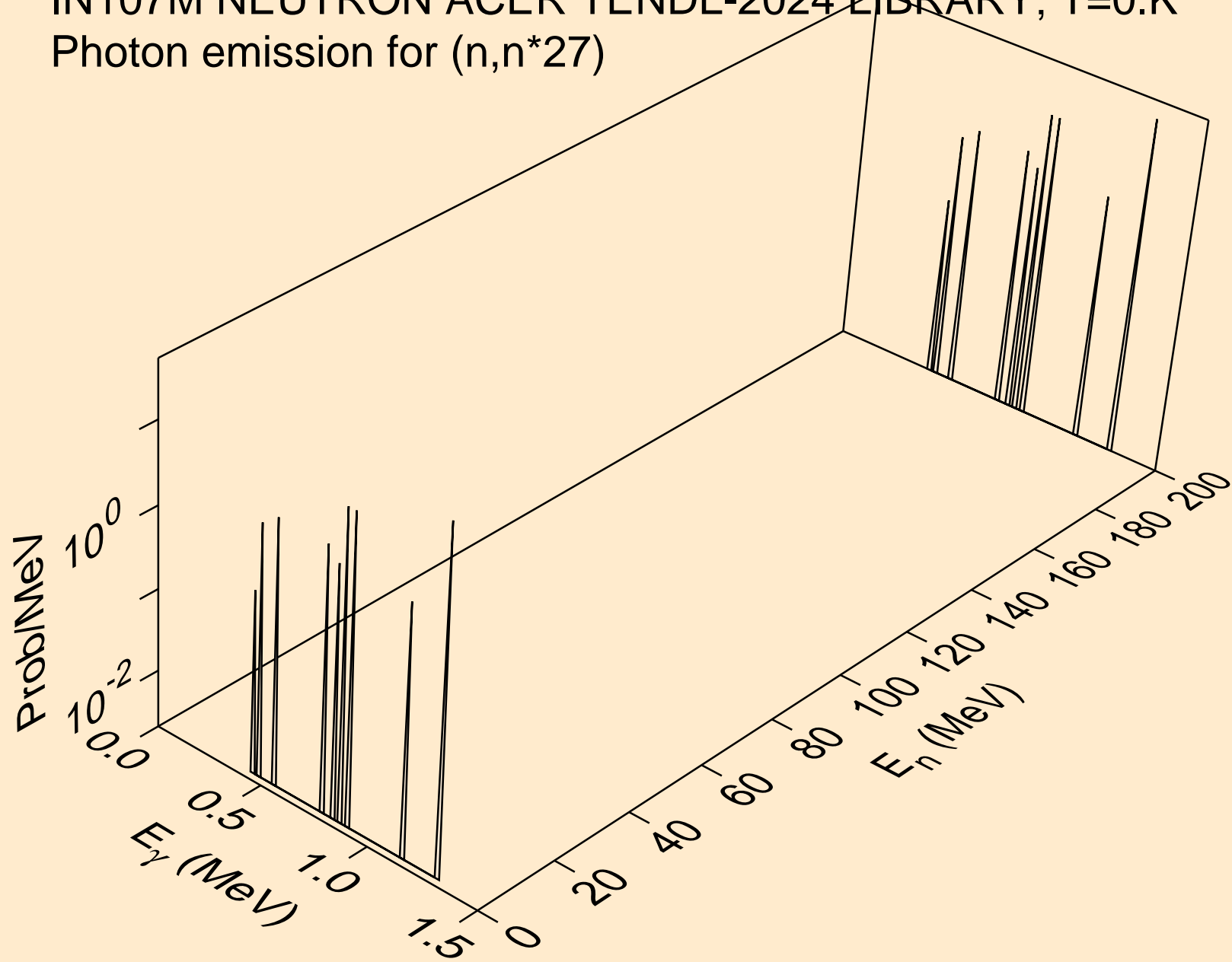

IN107M NEUTRON ACER TENDL-2024 LIBRARY; T=0.K
Photon emission for (n,n*28)

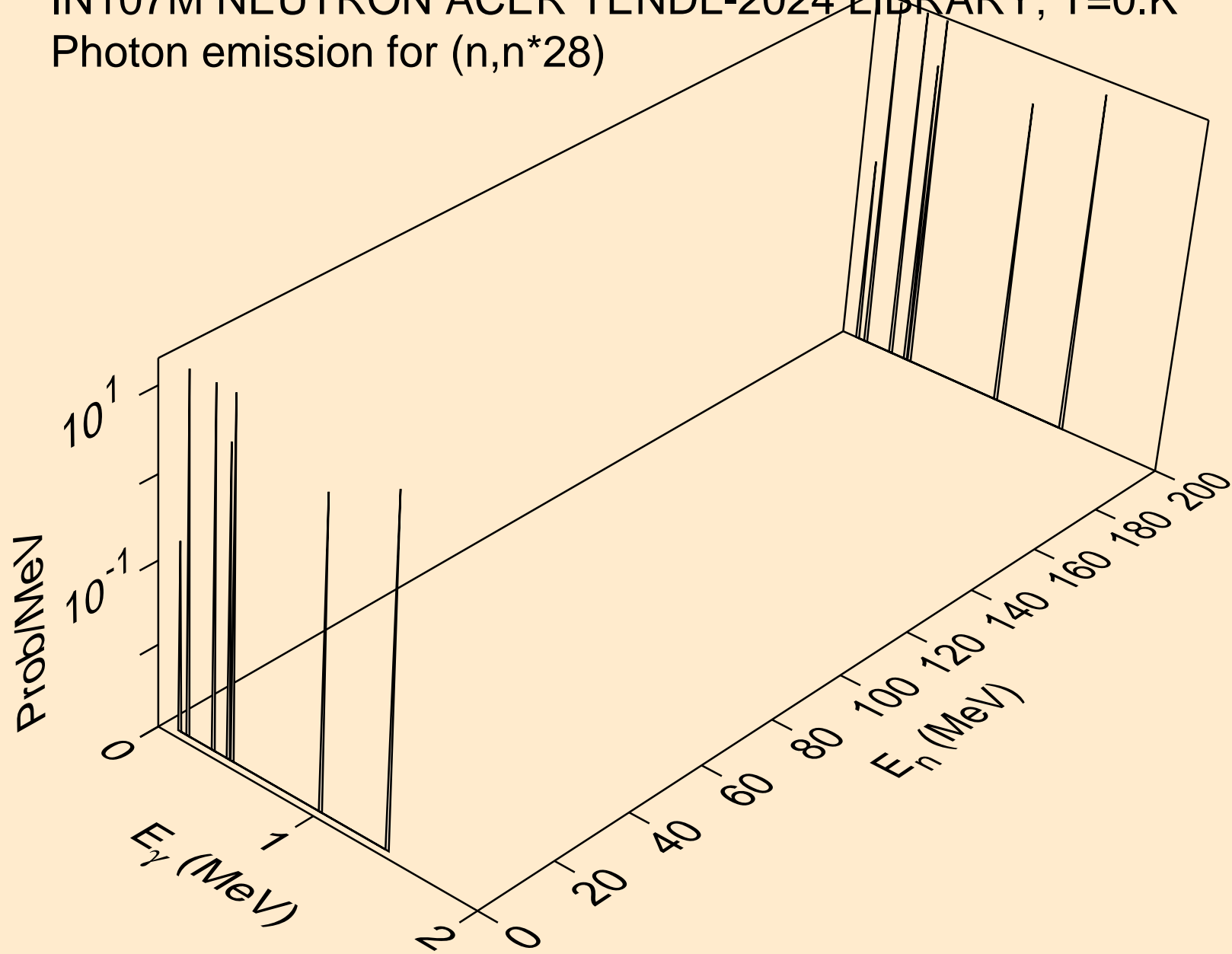

IN107M NEUTRON ACER TENDL-2024 LIBRARY; T=0.K
Photon emission for (n,n*29)

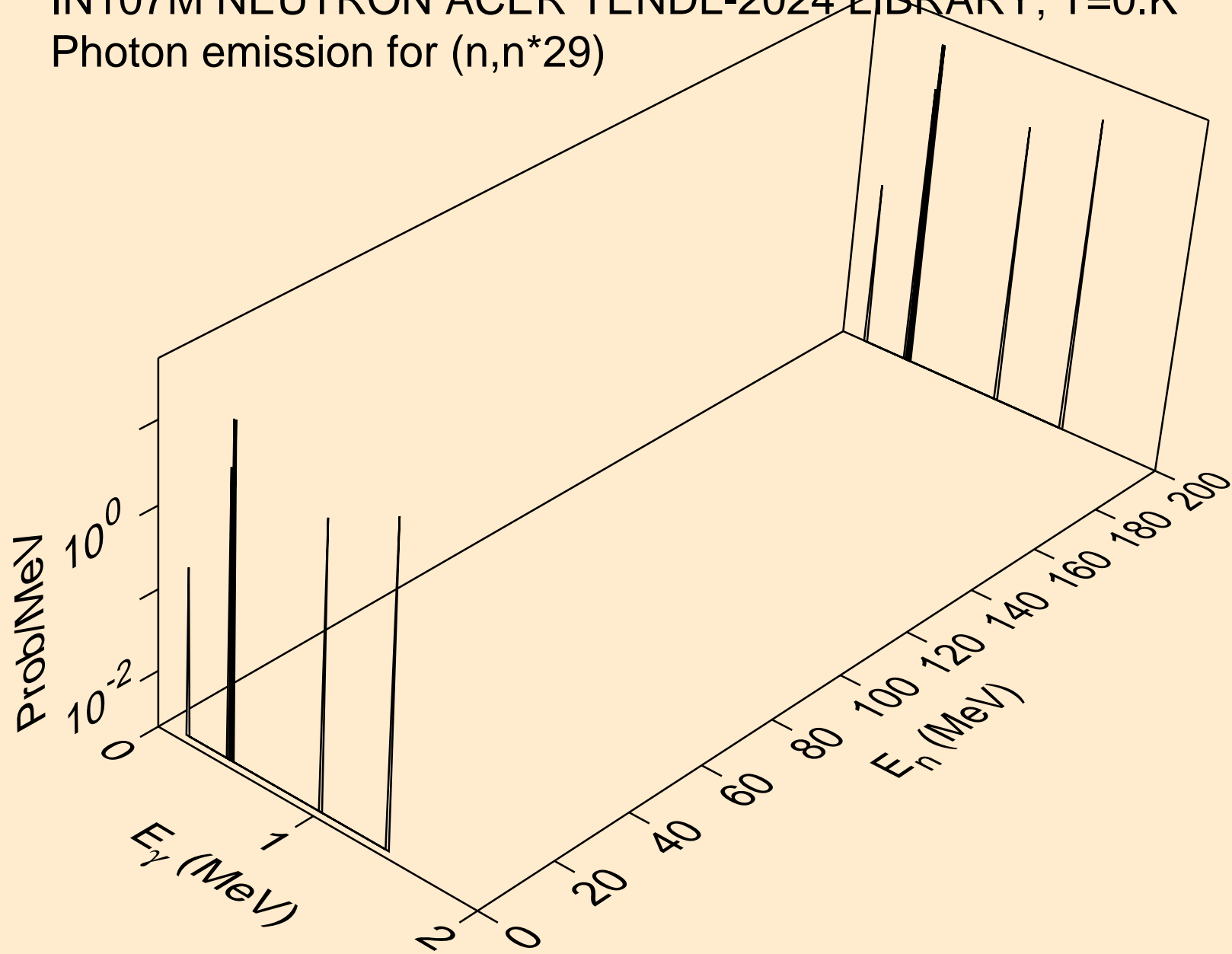

IN107M NEUTRON ACER TENDL-2024 LIBRARY; T=0.K
Photon emission for (n,n*30)

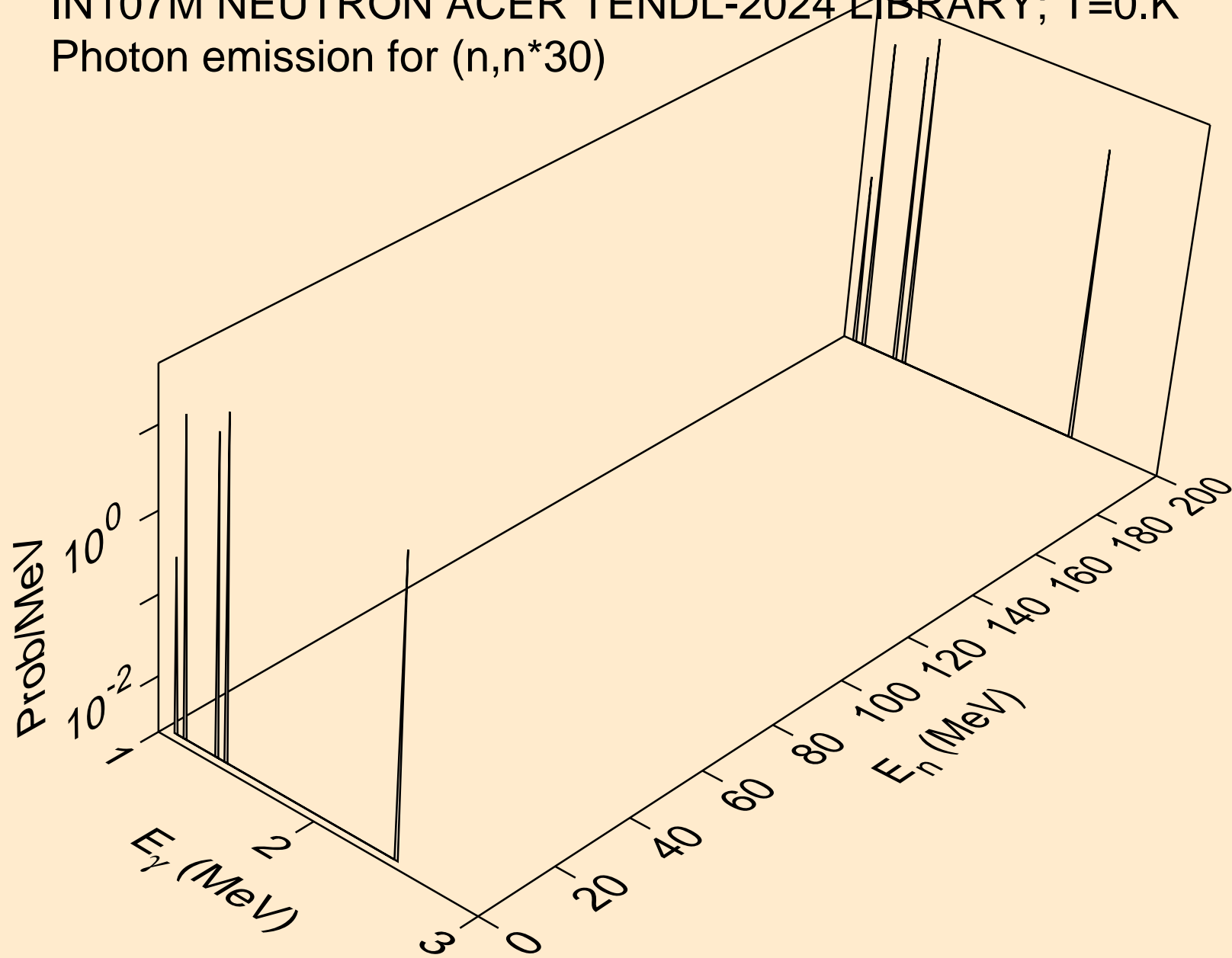

IN107M NEUTRON ACER TENDL-2024 LIBRARY; T=0.K
Photon emission for (n,n*c)

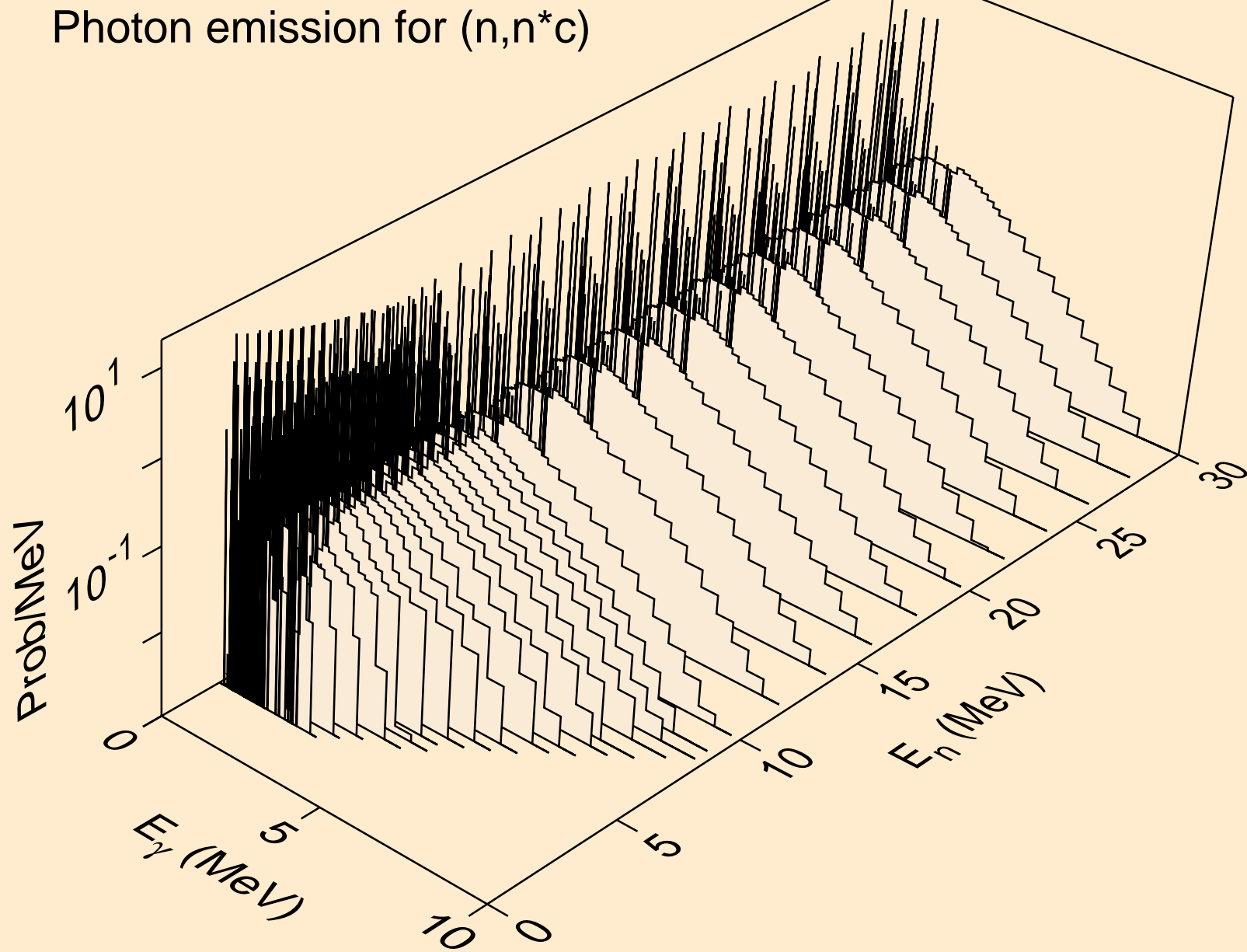

IN107M NEUTRON ACER TENDL-2024 LIBRARY; T=0.K
Photon emission for (n,gma)

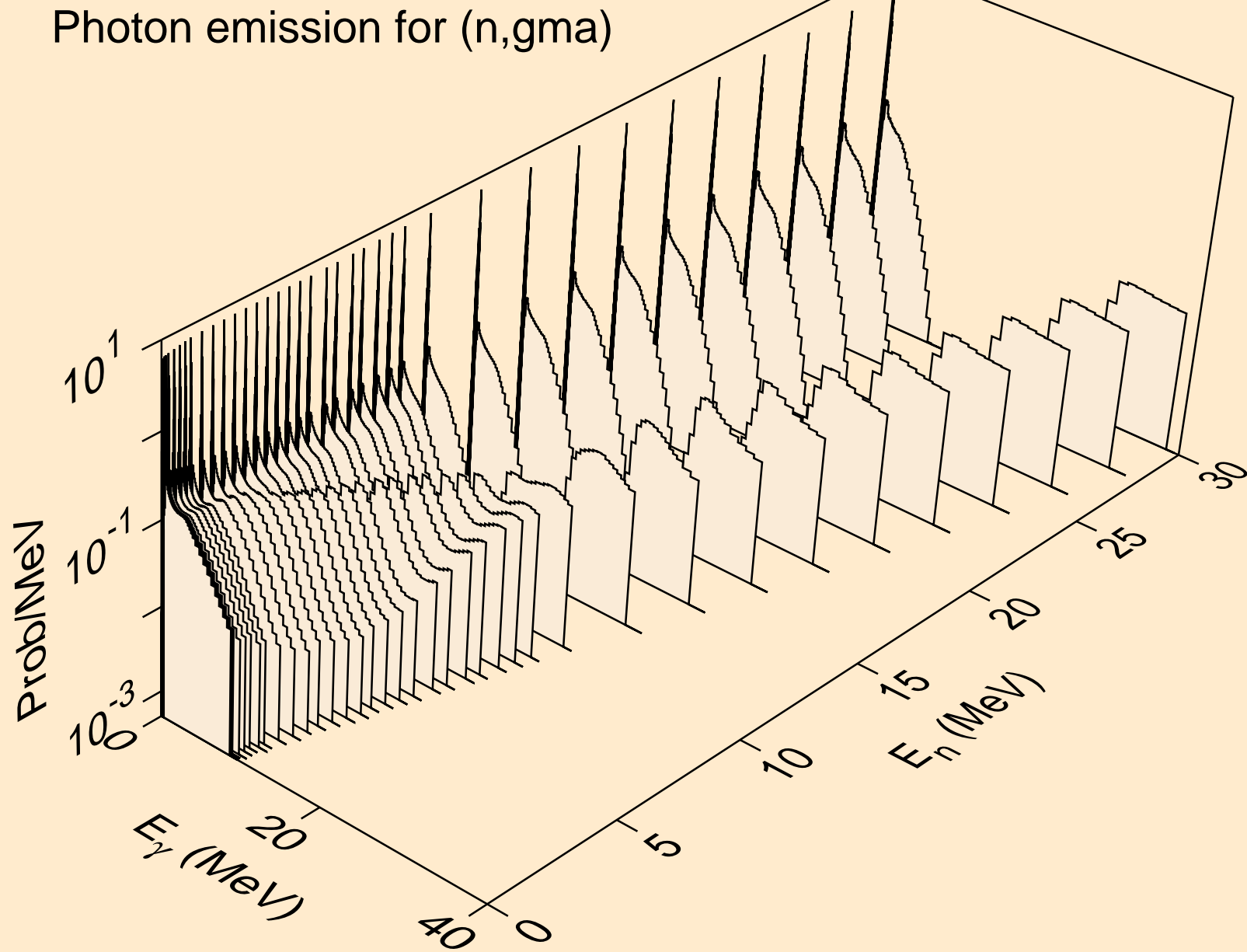

IN107M NEUTRON ACER TENDL-2024 LIBRARY; T=0.K
Photon emission for (n,p)

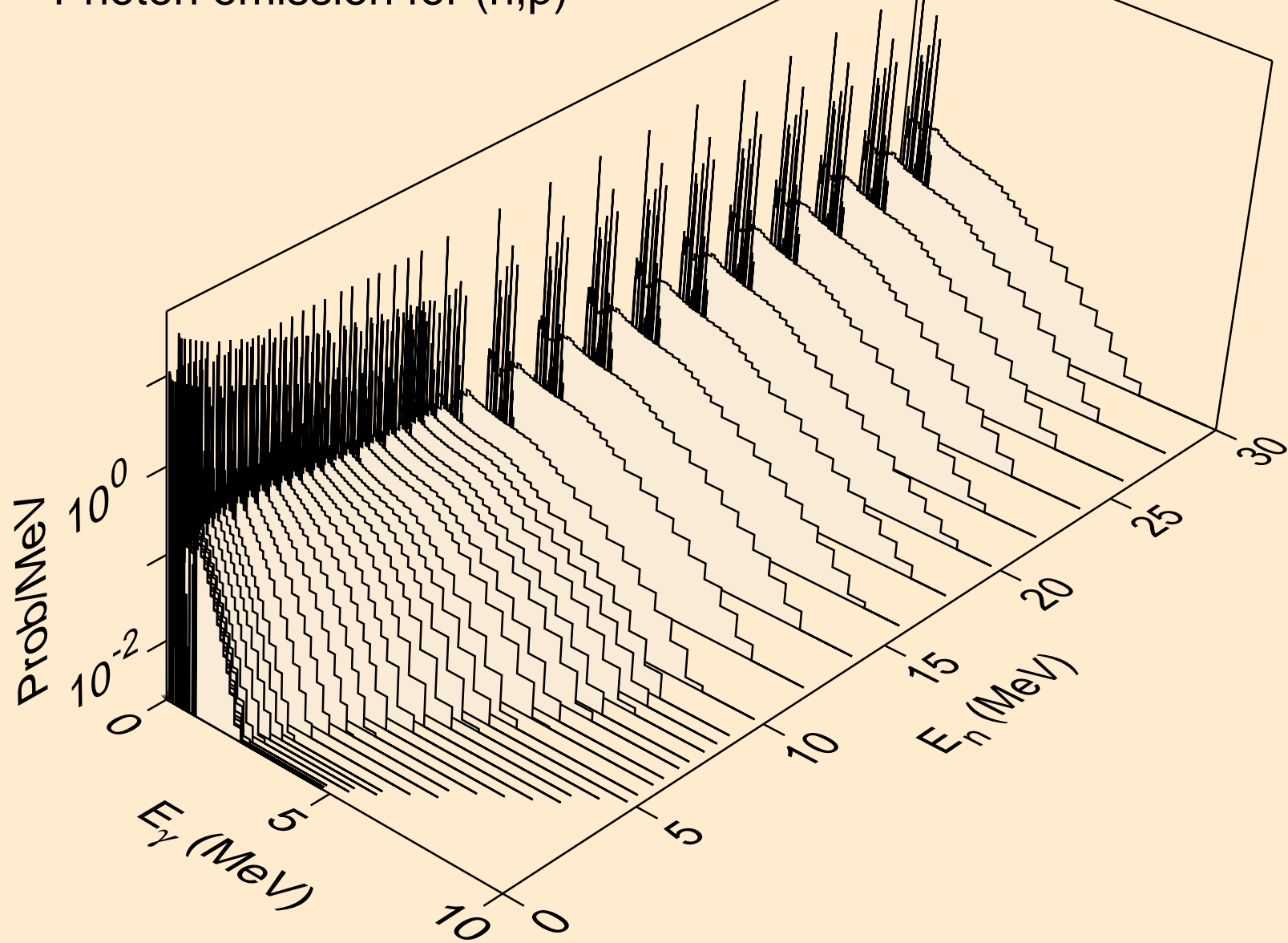

IN107M NEUTRON ACER TENDL-2024 LIBRARY; T=0.K
Photon emission for (n,d)

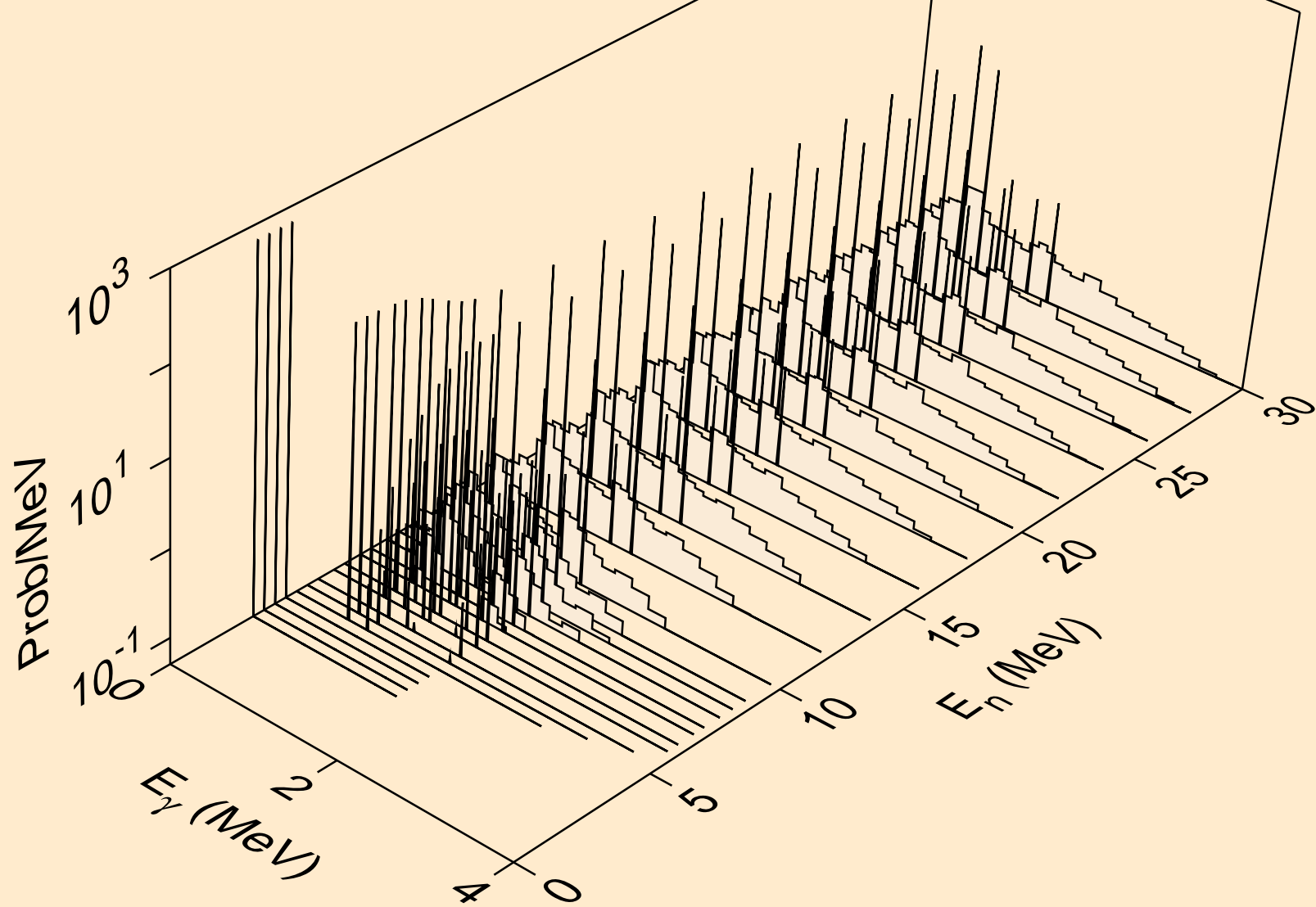

IN107M NEUTRON ACER TENDL-2024 LIBRARY; T=0.K
Photon emission for (n,t)

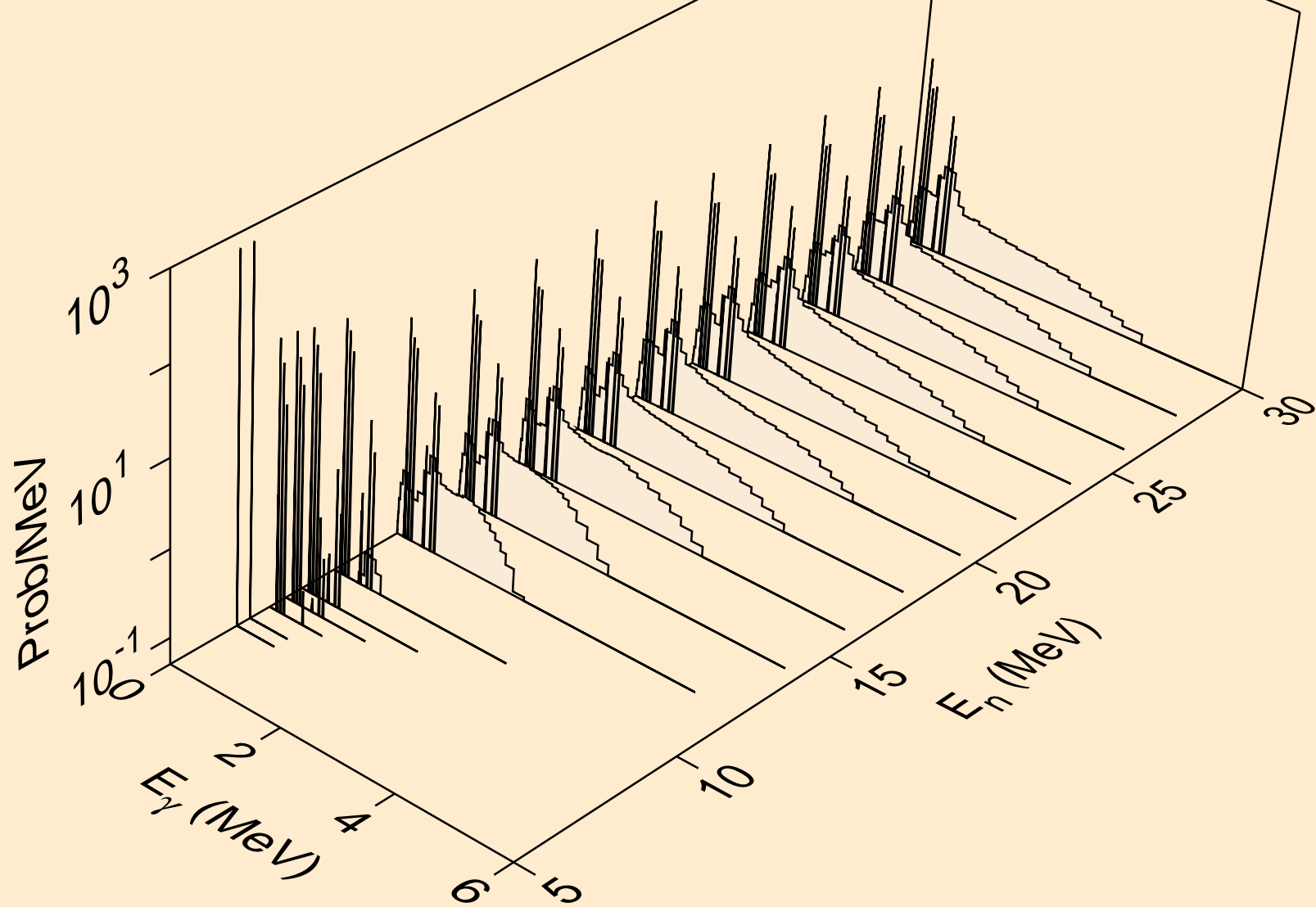

IN107M NEUTRON ACER TENDL-2024 LIBRARY; T=0.K
Photon emission for (n,he3)

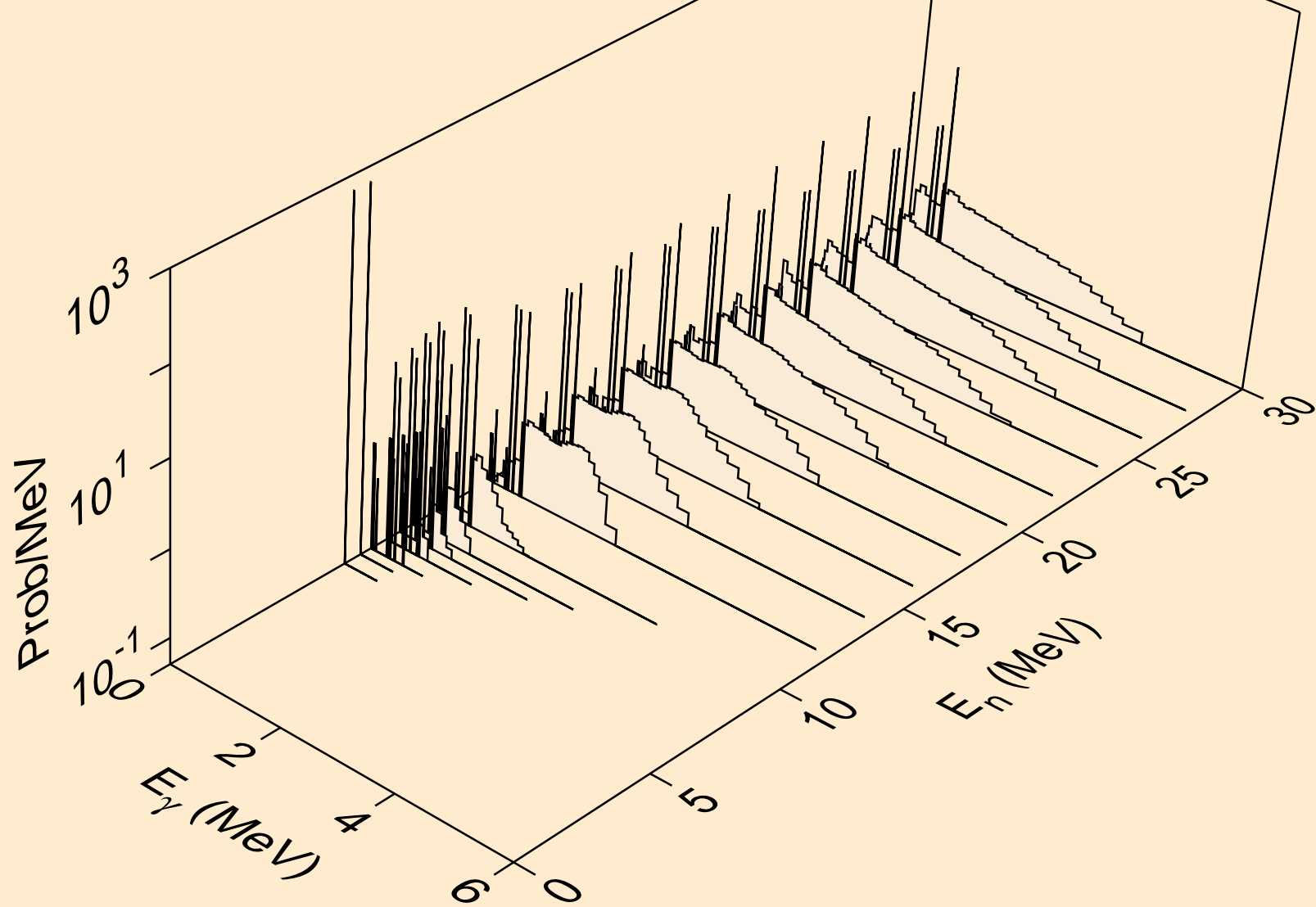

IN107M NEUTRON ACER TENDL-2024 LIBRARY; T=0.K
Photon emission for (n,a)

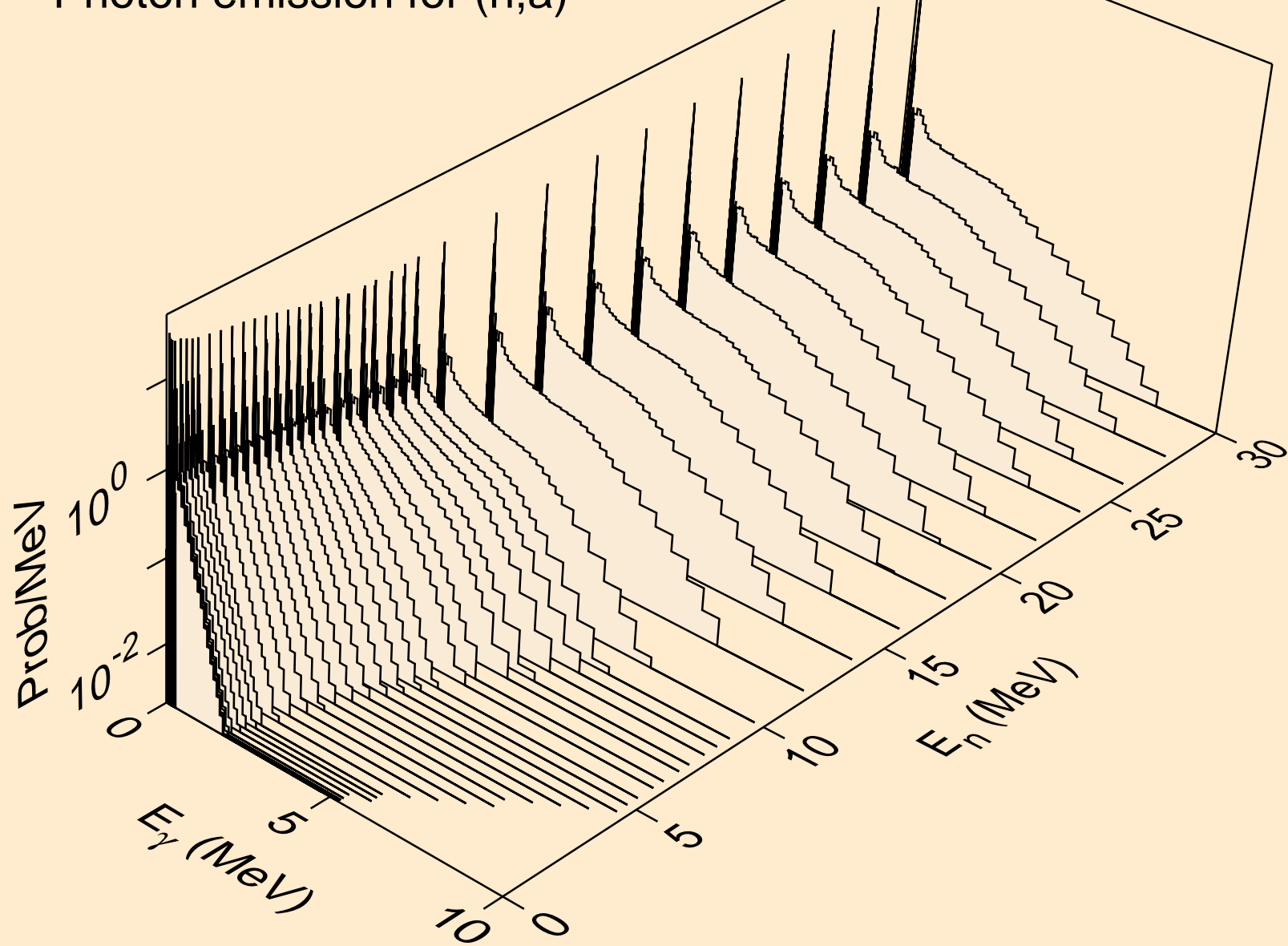

IN107M NEUTRON ACER TENDL-2024 LIBRARY; T=0.K
Photon emission for (n,2a)

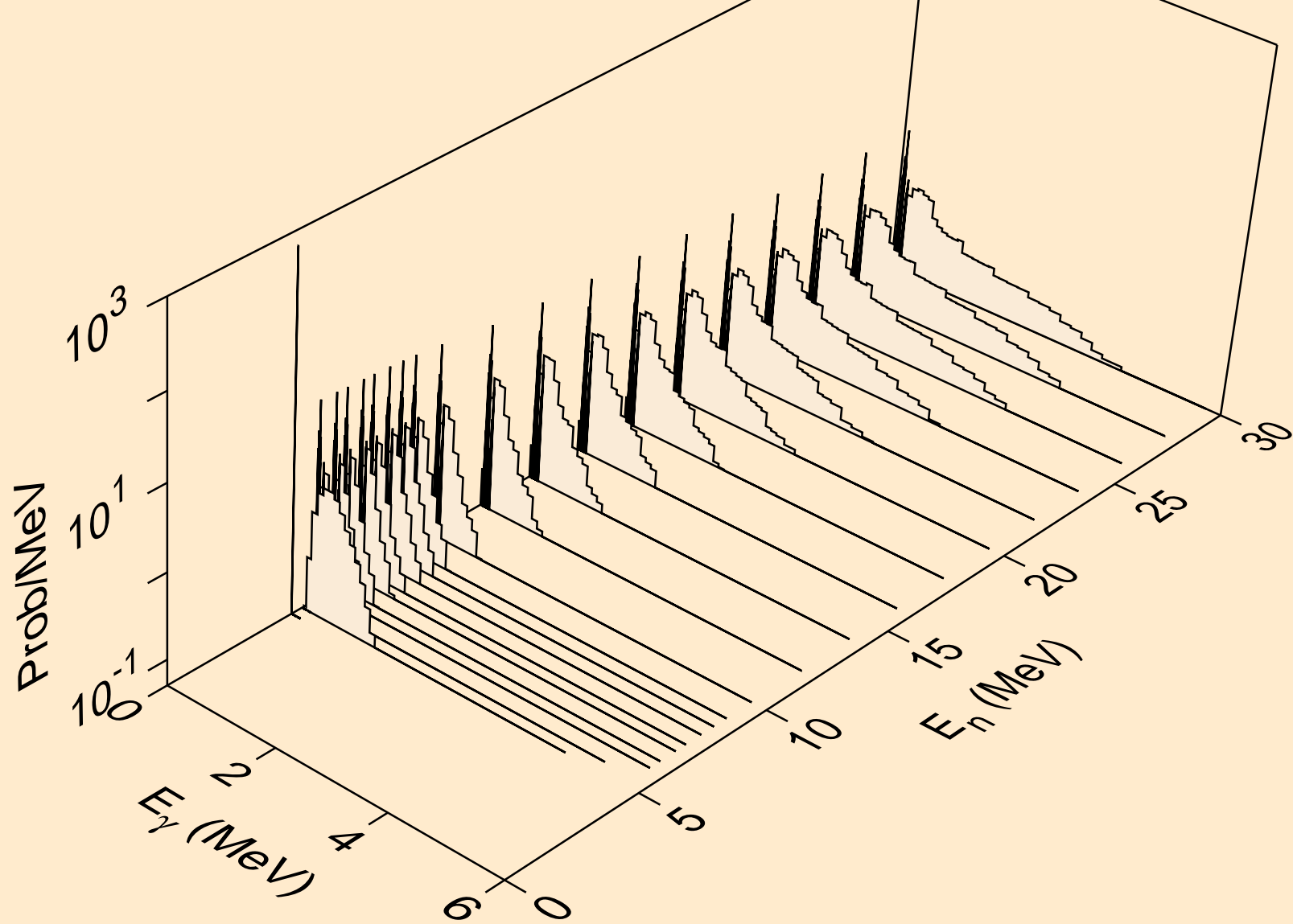

IN107M NEUTRON ACER TENDL-2024 LIBRARY; T=0.K
Photon emission for (n,3a)

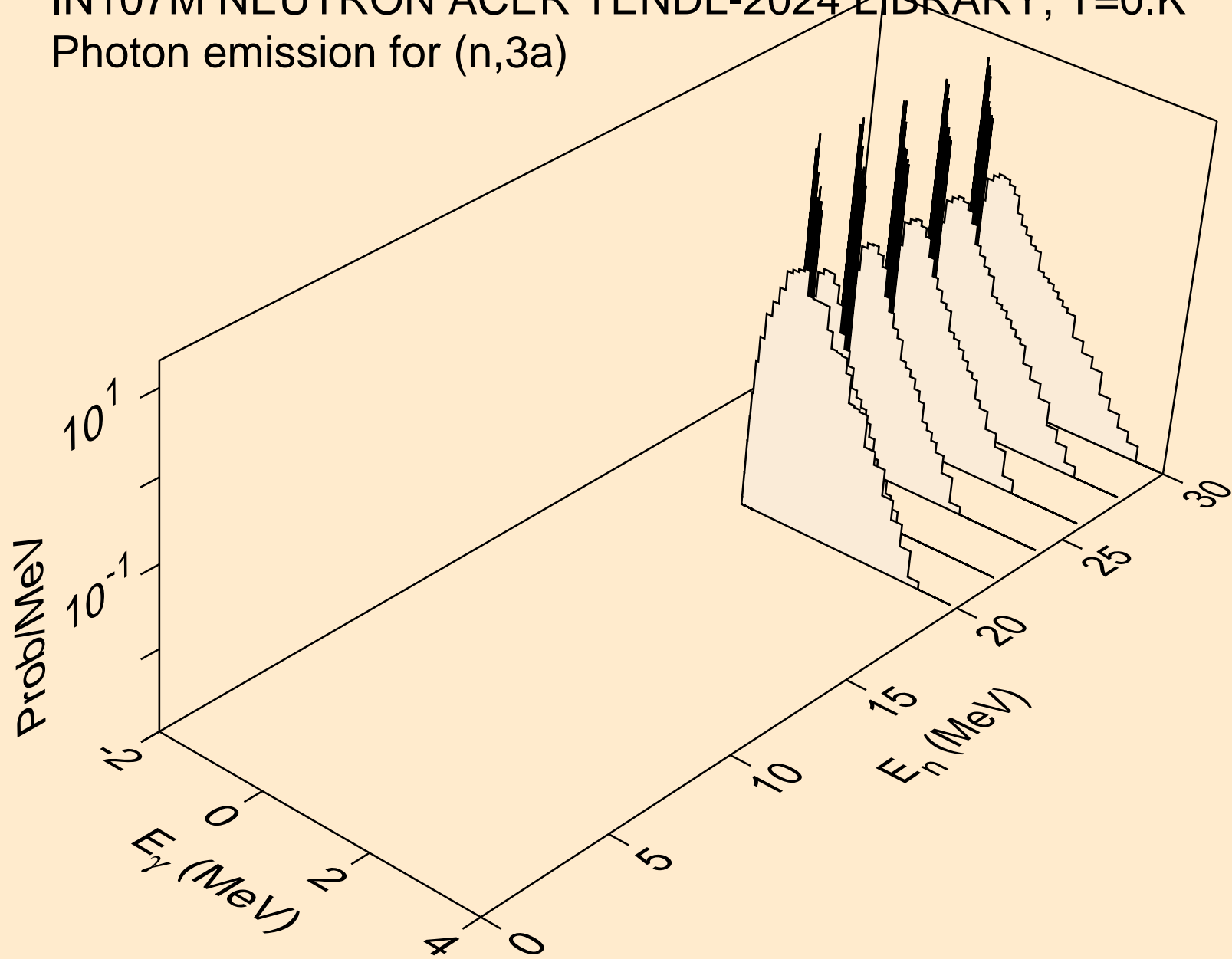

IN107M NEUTRON ACER TENDL-2024 LIBRARY; T=0.K
Photon emission for (n,2p)

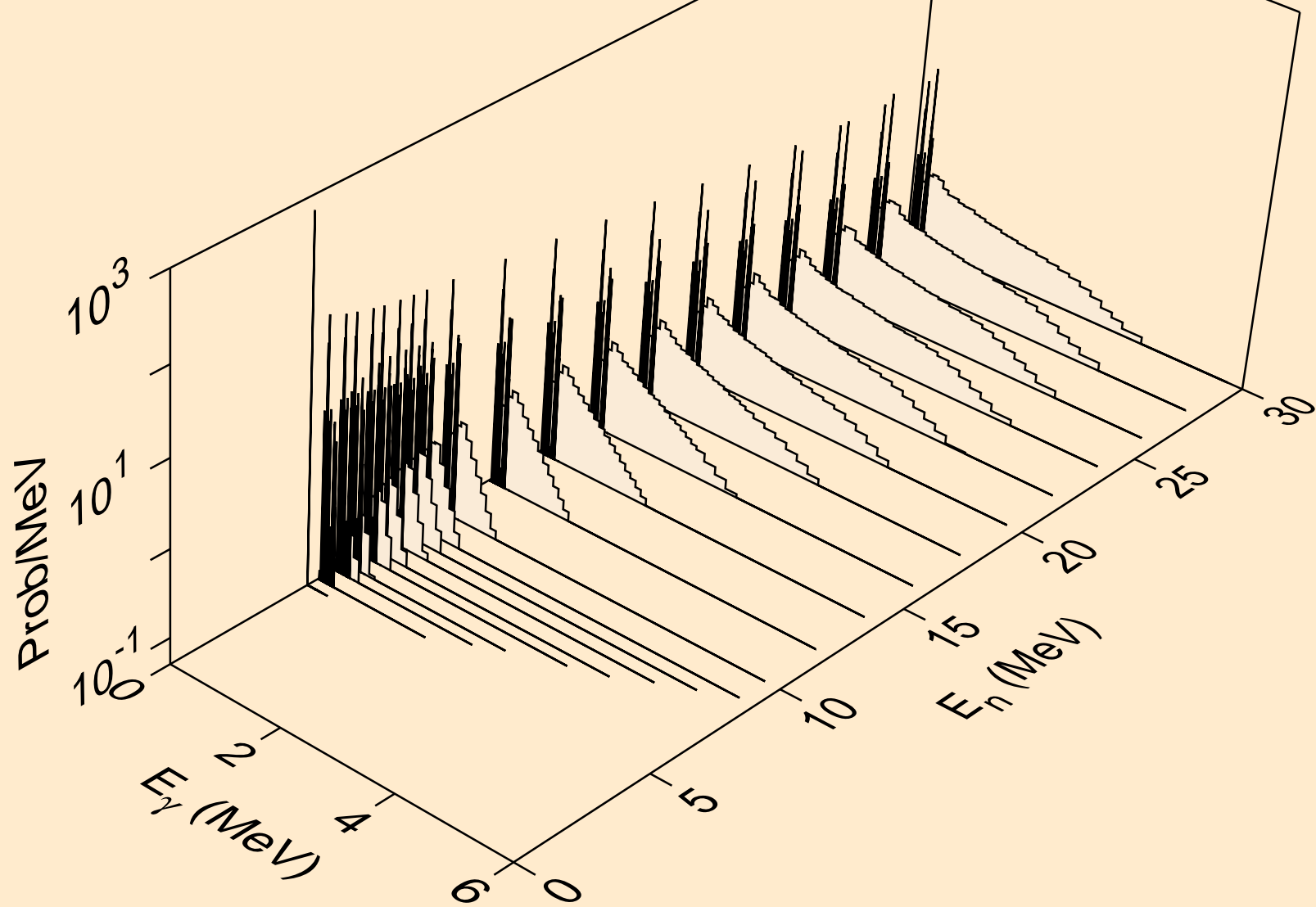

IN107M NEUTRON ACER TENDL-2024 LIBRARY; T=0.K
Photon emission for (n,p α)

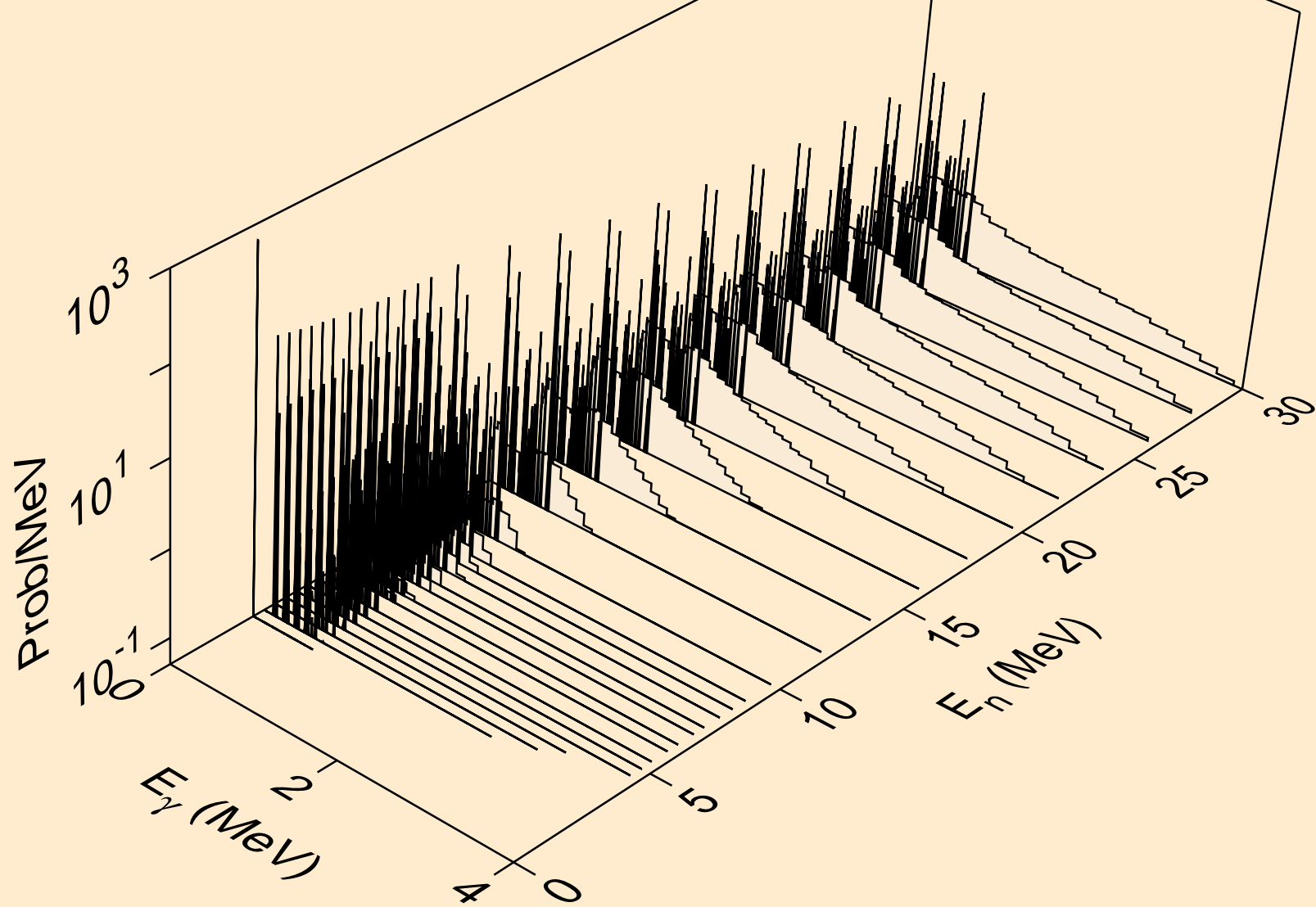

IN107M NEUTRON ACER TENDL-2024 LIBRARY; T=0.K
Photon emission for (n,pd)

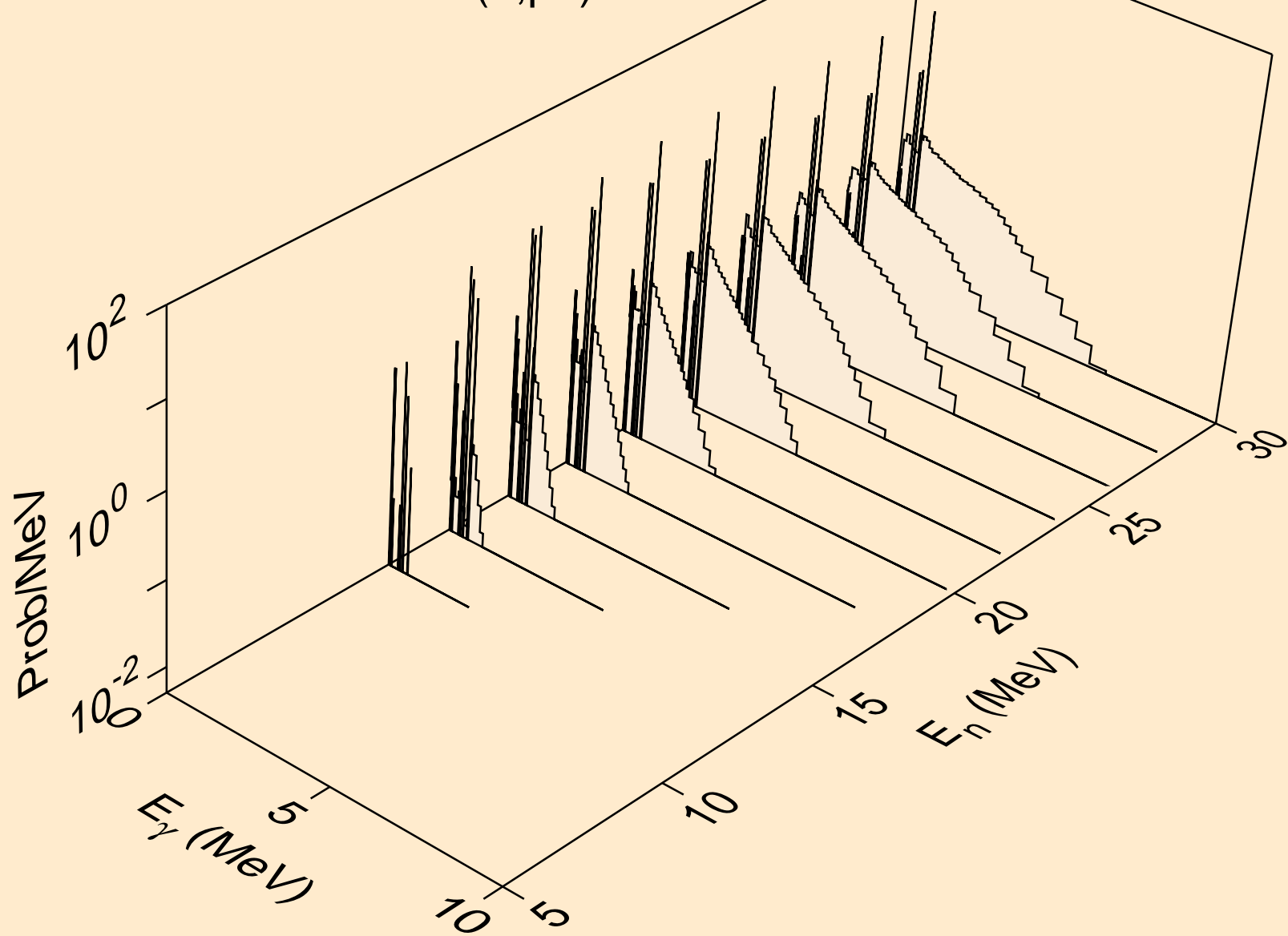

IN107M NEUTRON ACER TENDL-2024 LIBRARY; T=0.K
Photon emission for (n,pt)

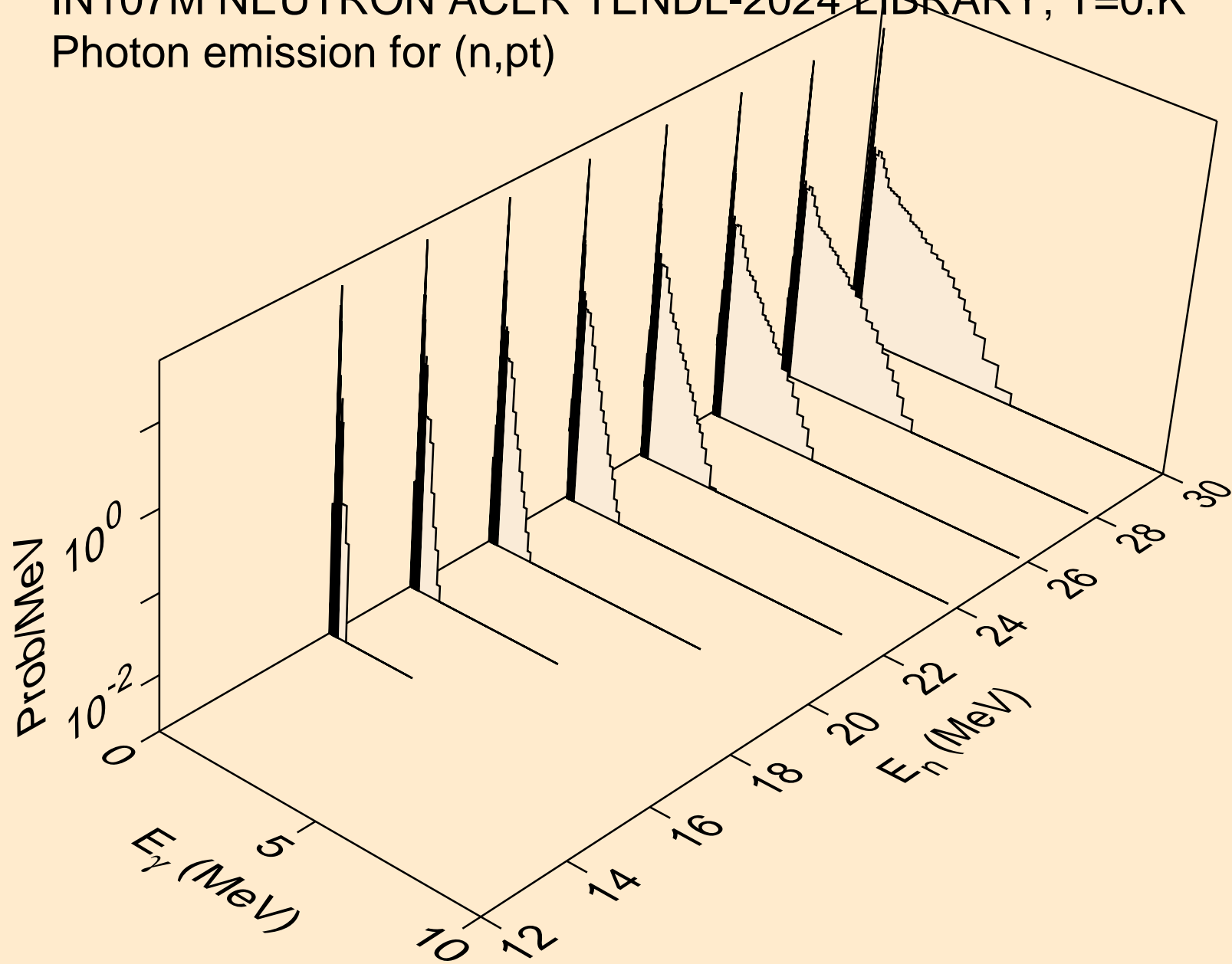

IN107M NEUTRON ACER TENDL-2024 LIBRARY; T=0.K
Photon emission for (n,da)

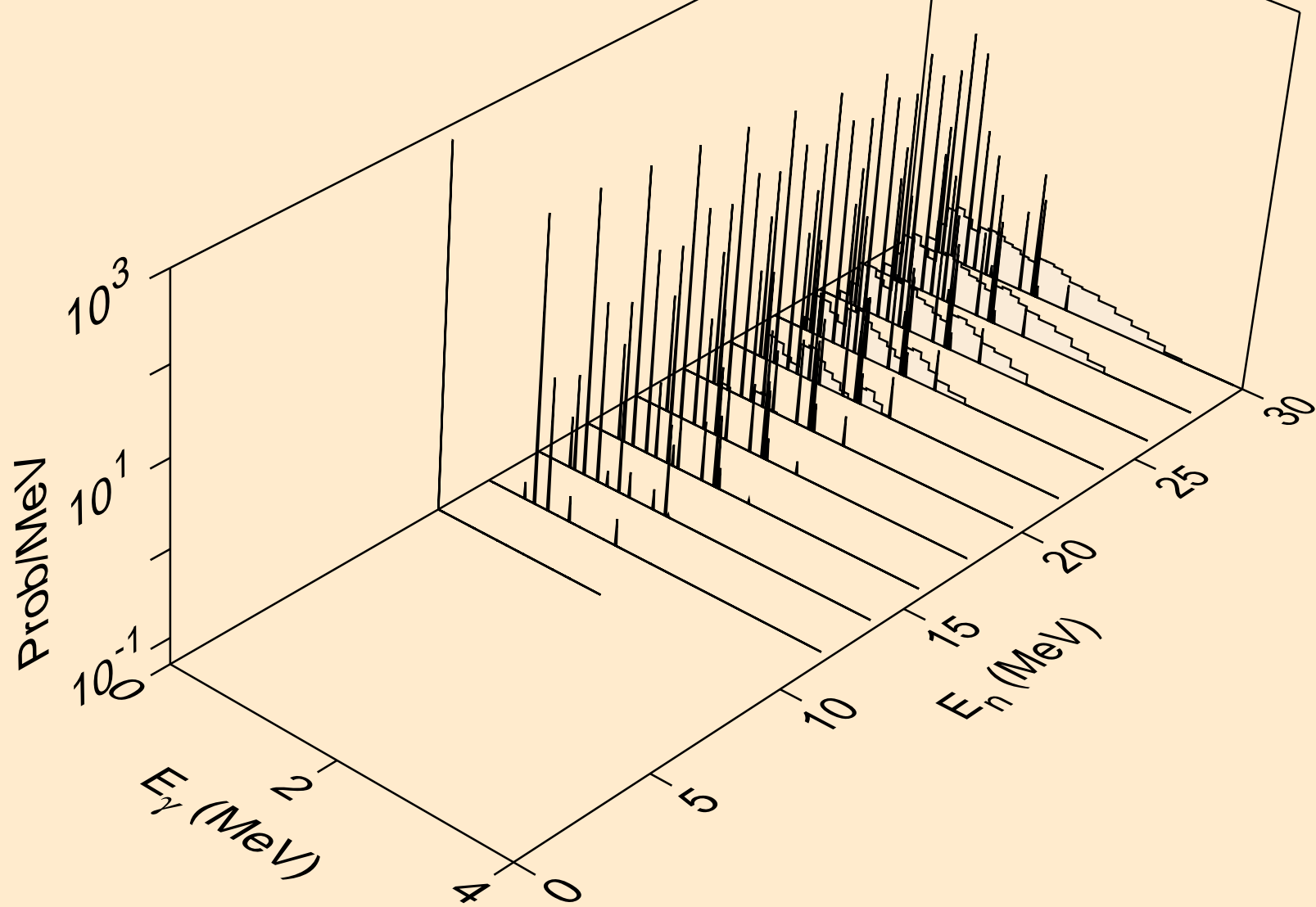

IN107M NEUTRON ACER TENDL-2024 LIBRARY; T=0.K
thermal capture photon spectrum

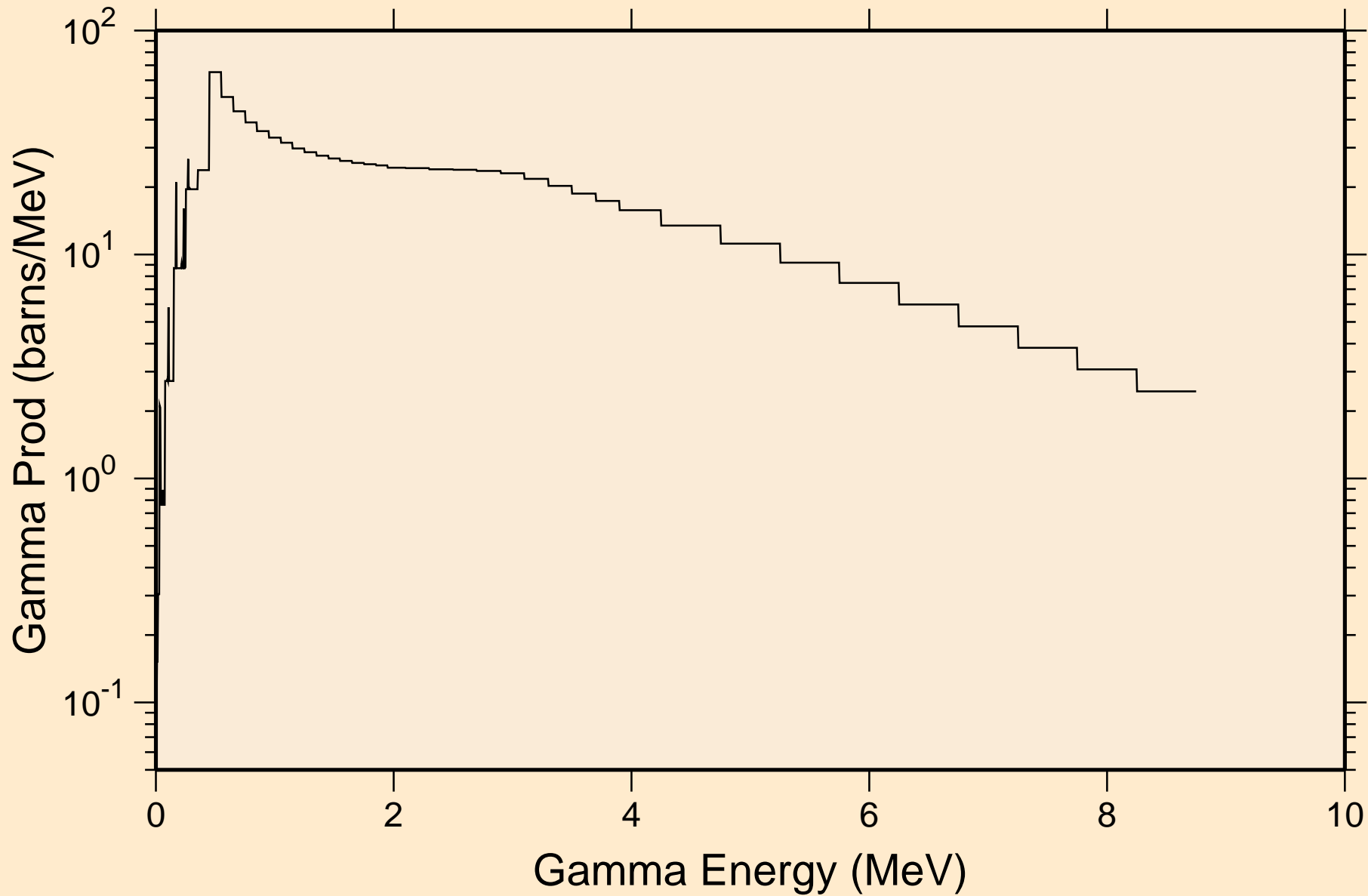

IN107M NEUTRON ACER TENDL-2024 LIBRARY; T=0.K
14 MeV photon spectrum

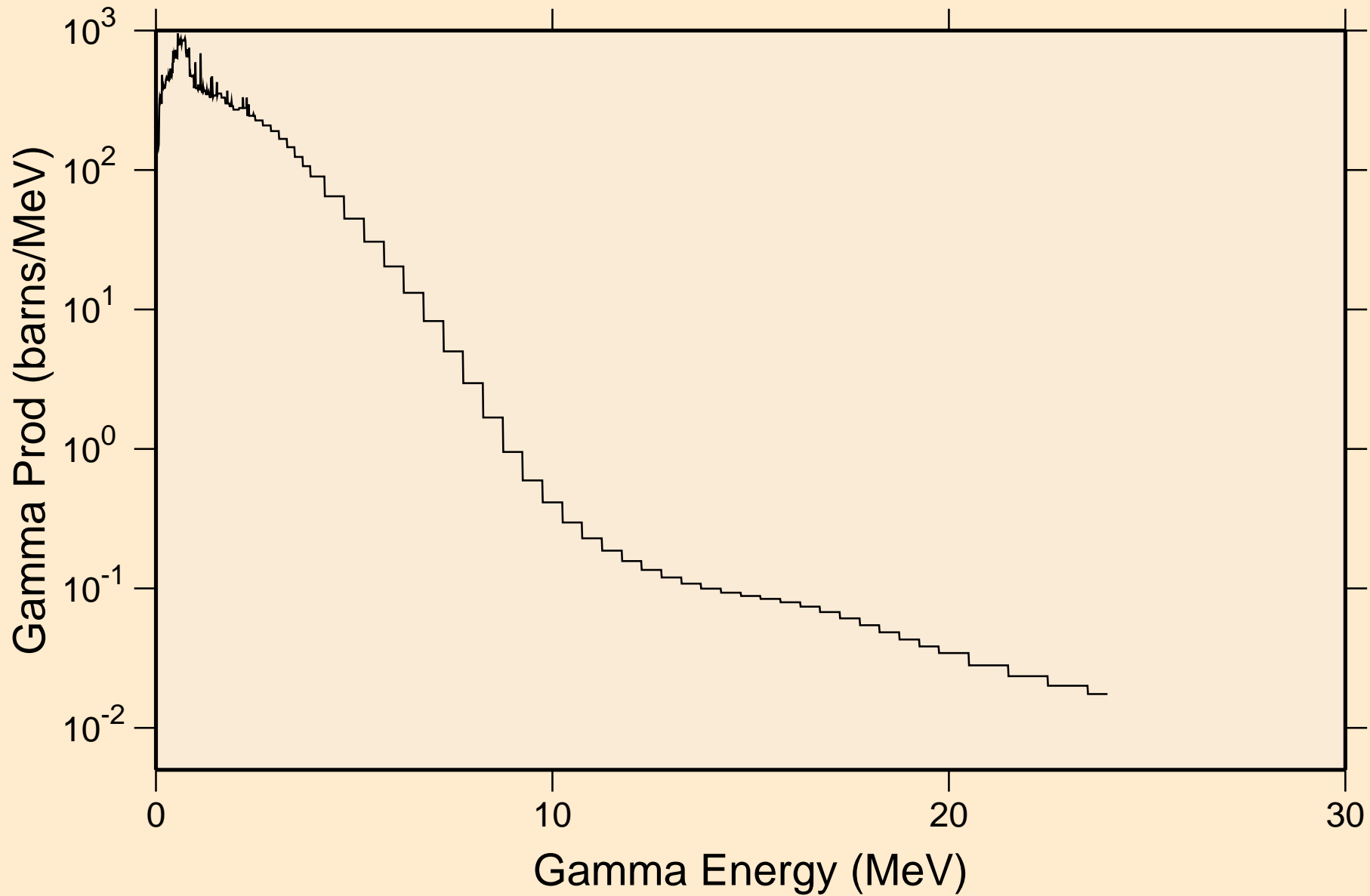

IN107M NEUTRON ACER TENDL-2024 LIBRARY; T=0.K

Particle heating contributions

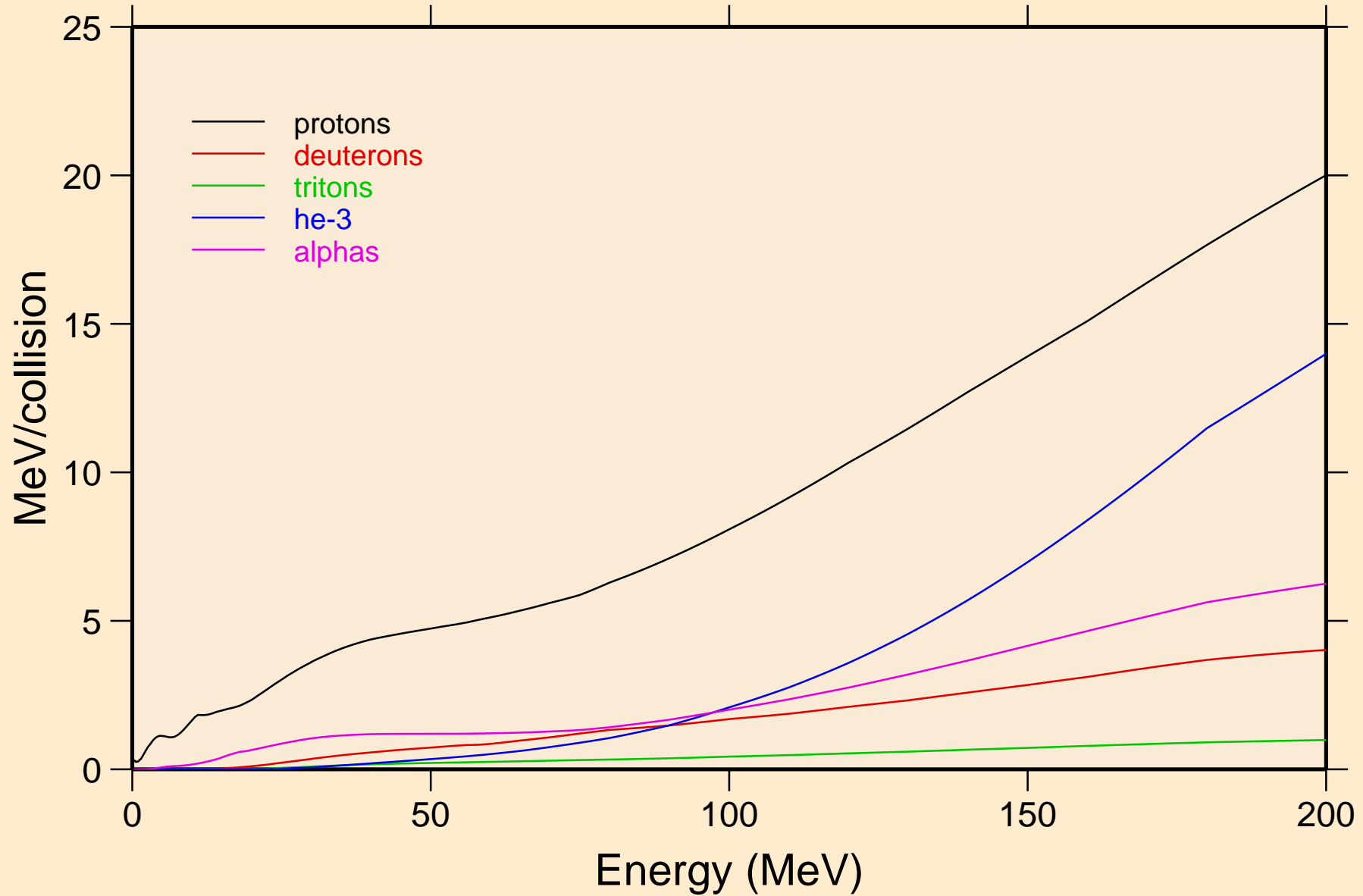

IN107M NEUTRON ACER TENDL-2024 LIBRARY; T=0.K
Recoil Heating

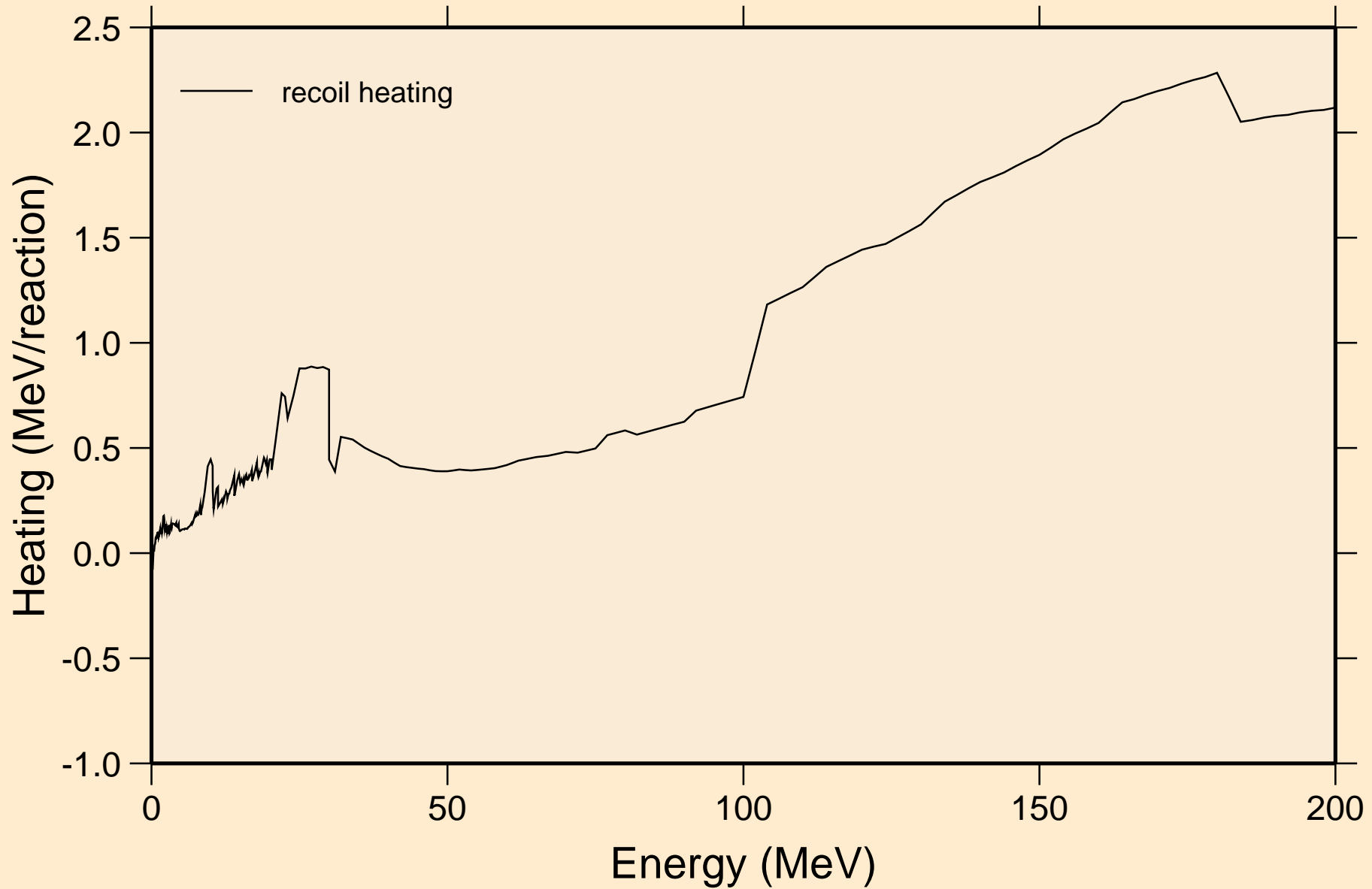

IN107M NEUTRON ACER TENDL-2024 LIBRARY; T=0.K

Particle production cross sections

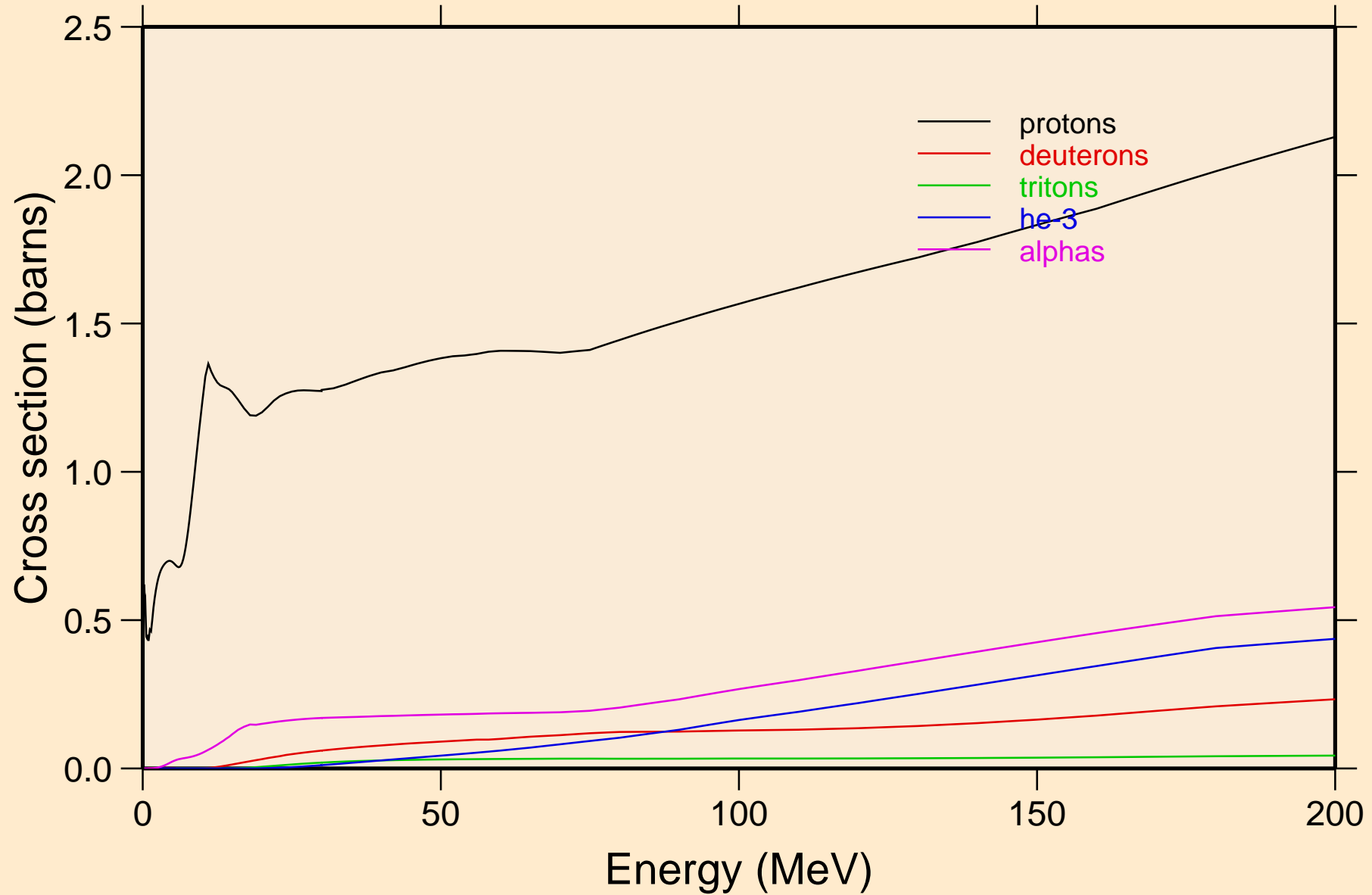

IN107M NEUTRON ACER TENDL-2024 LIBRARY; T=0.K
protons from (n,x)

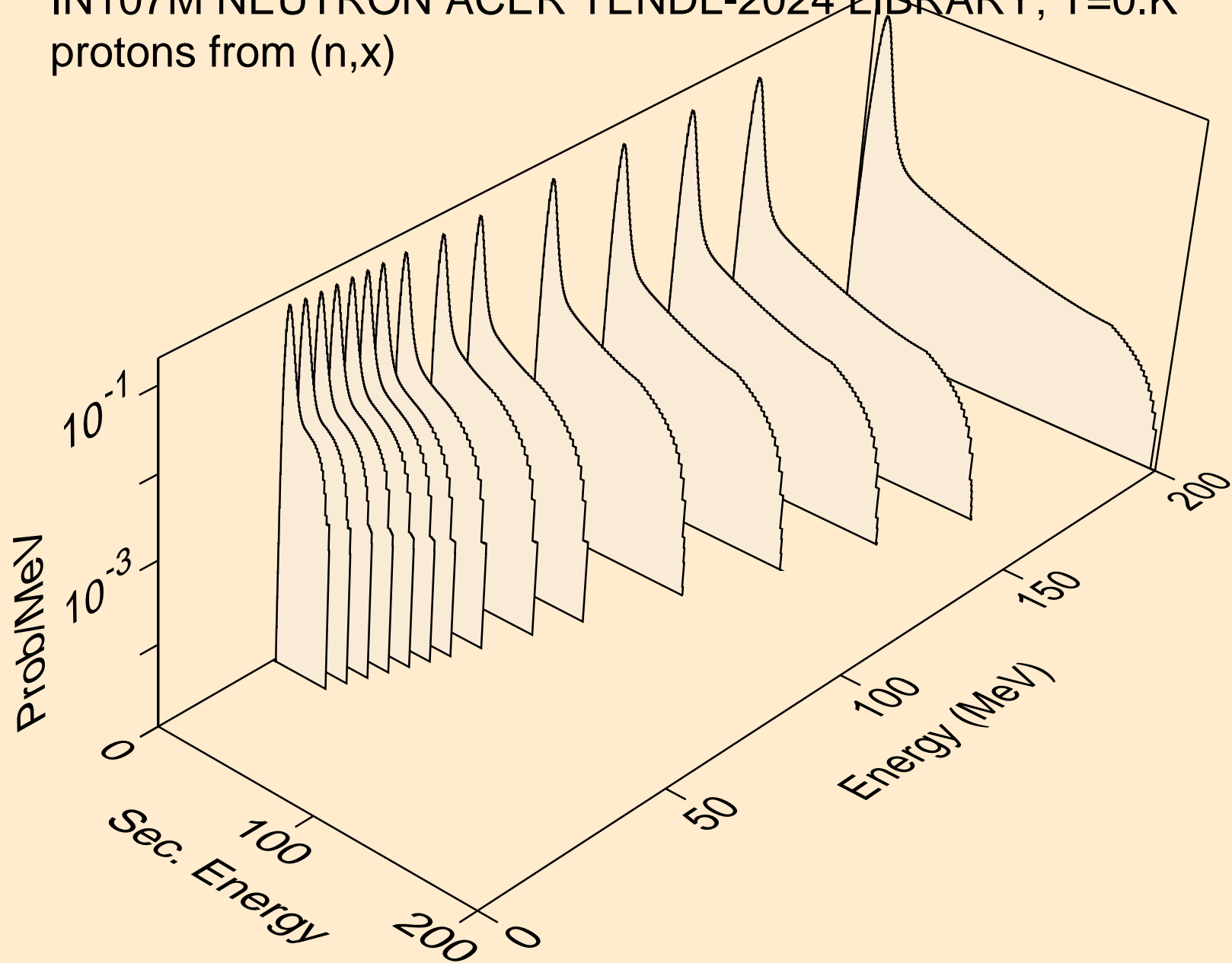

IN107M NEUTRON ACER TENDL-2024 LIBRARY; T=0.K
protons from (n,n*)p

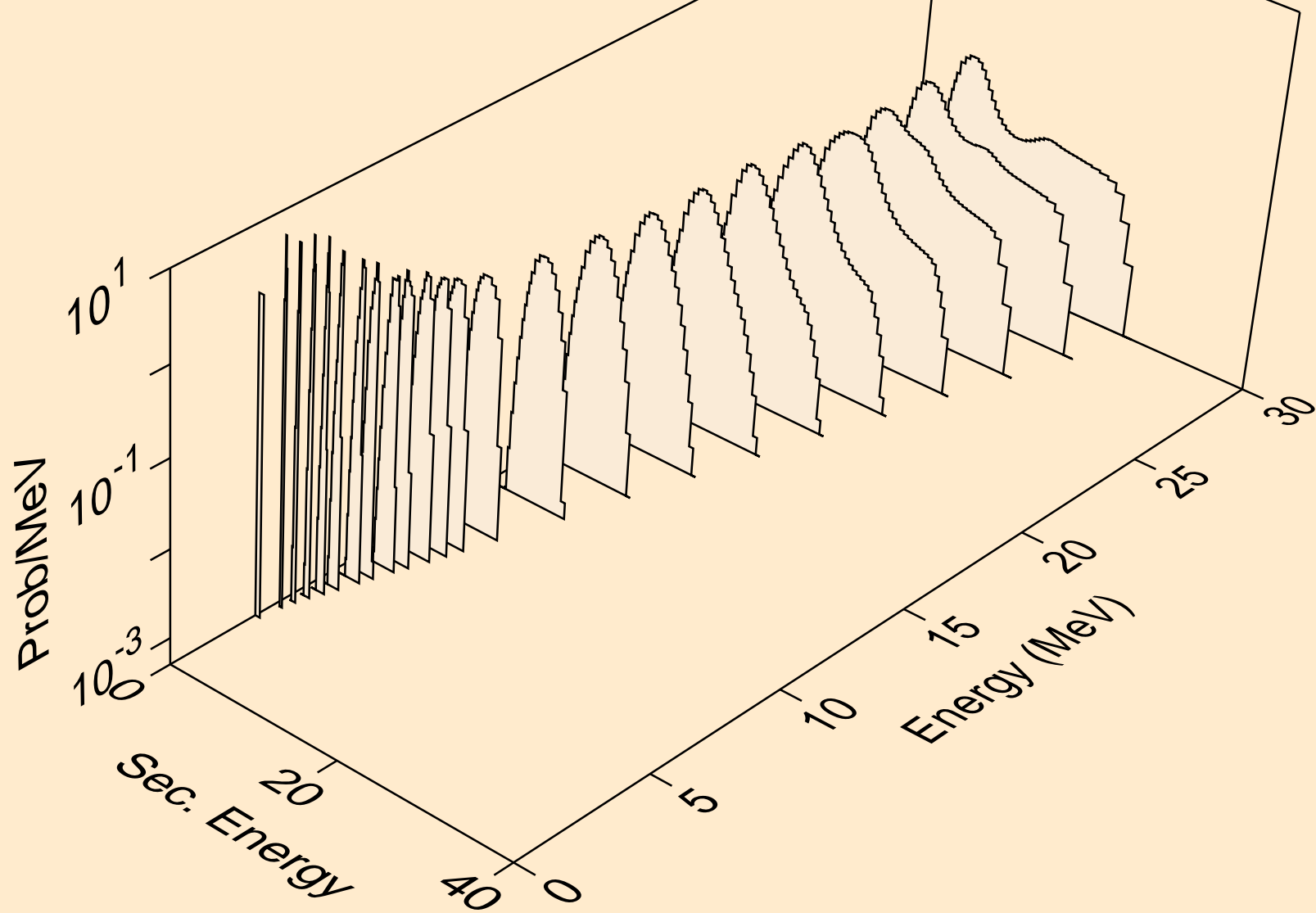

IN107M NEUTRON ACER TENDL-2024 LIBRARY; T=0.K
protons from (n,2np)

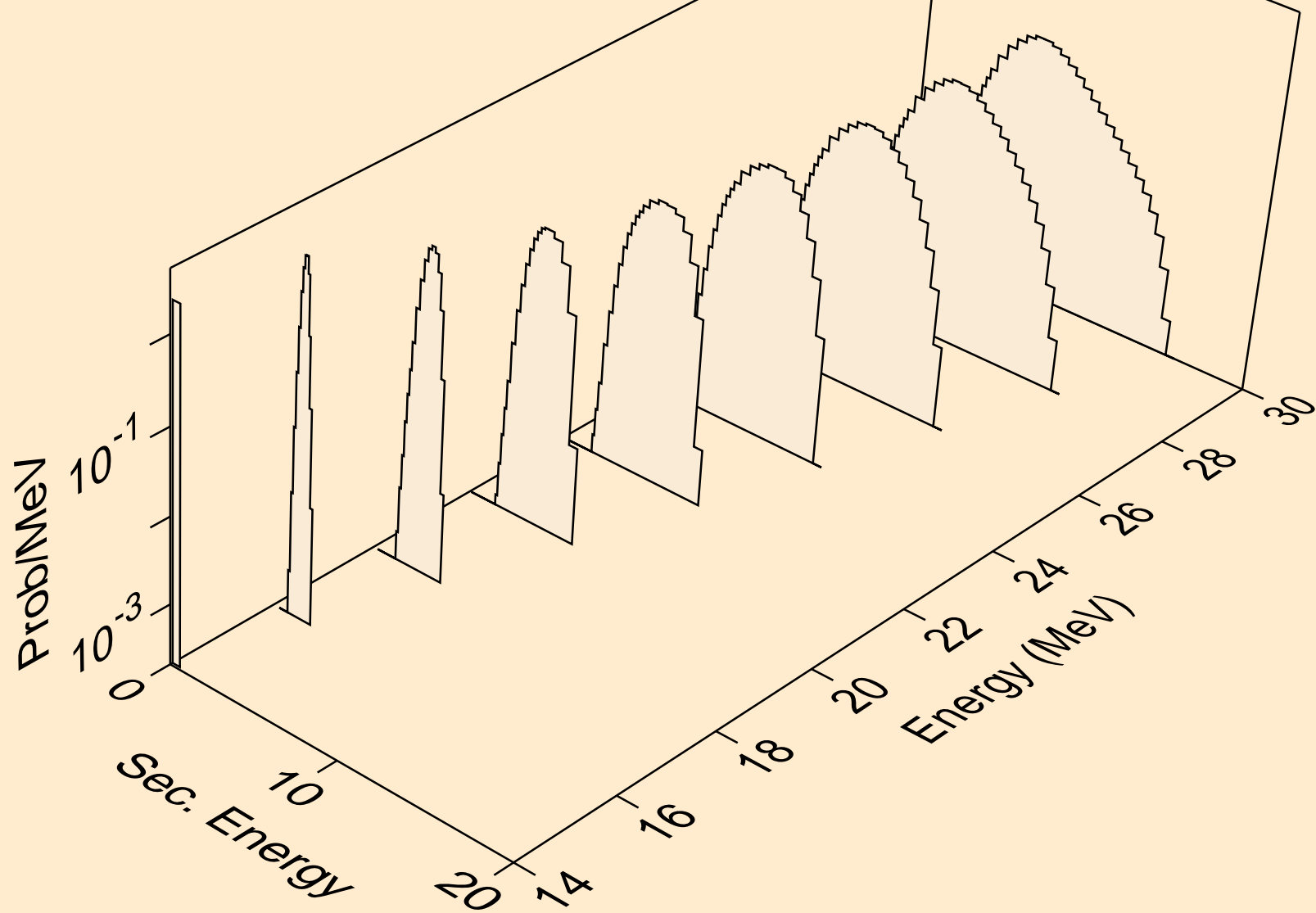

IN107M NEUTRON ACER TENDL-2024 LIBRARY; T=0.K
protons from (n,3np)

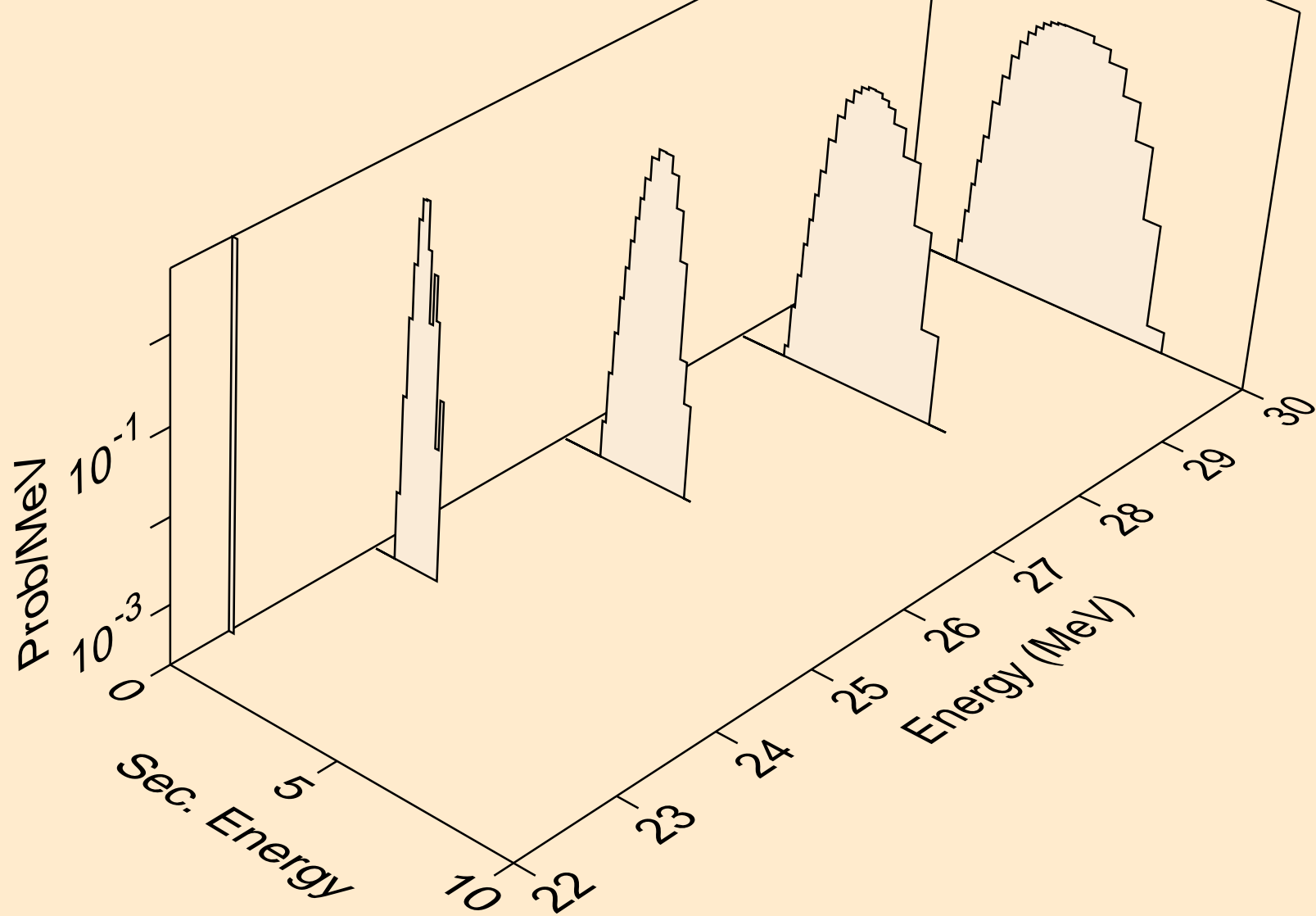

IN107M NEUTRON ACER TENDL-2024 LIBRARY; T=0.K
protons from (n,n2p)

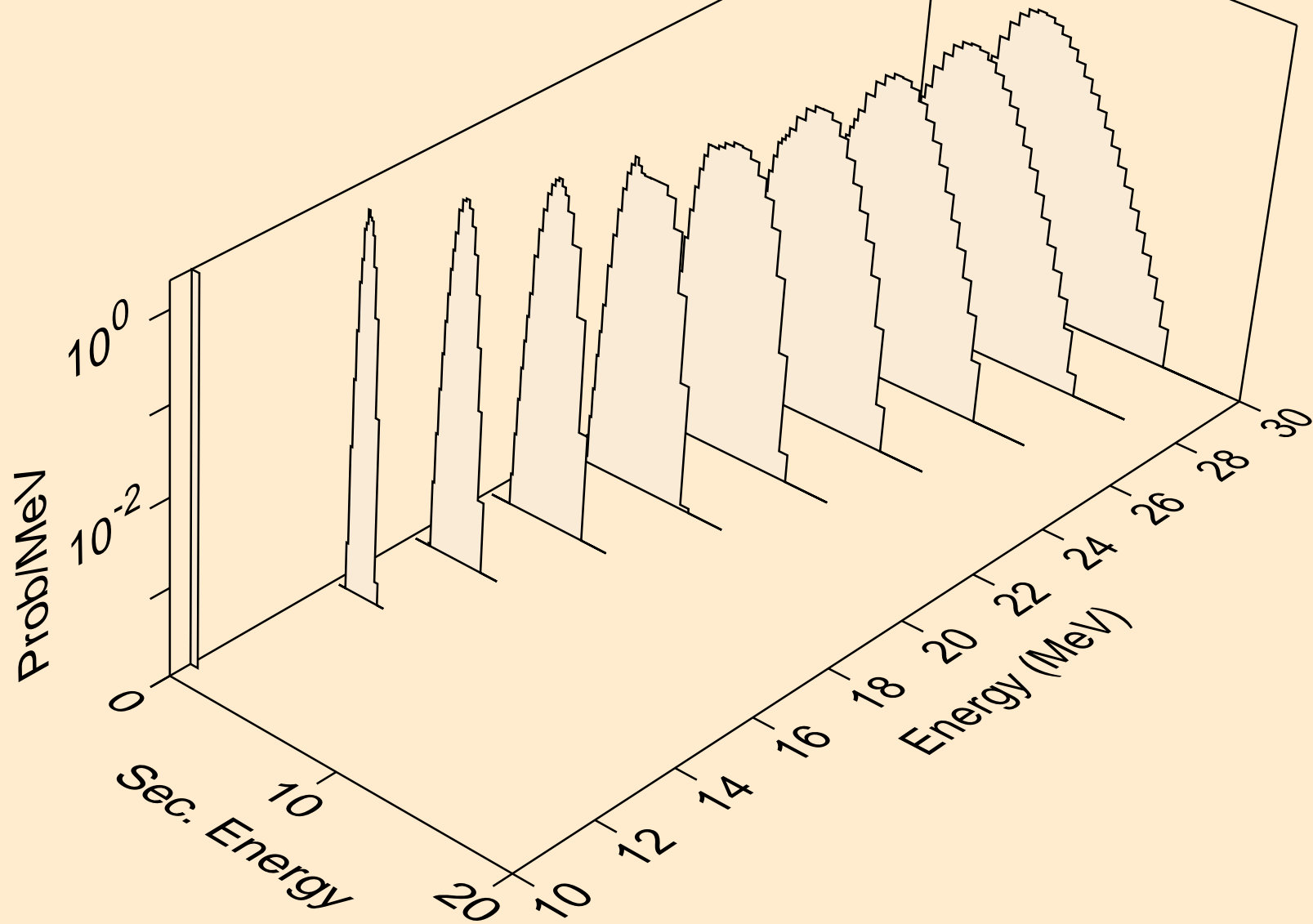

IN107M NEUTRON ACER TENDL-2024 LIBRARY; T=0.K
protons from (n,npa)

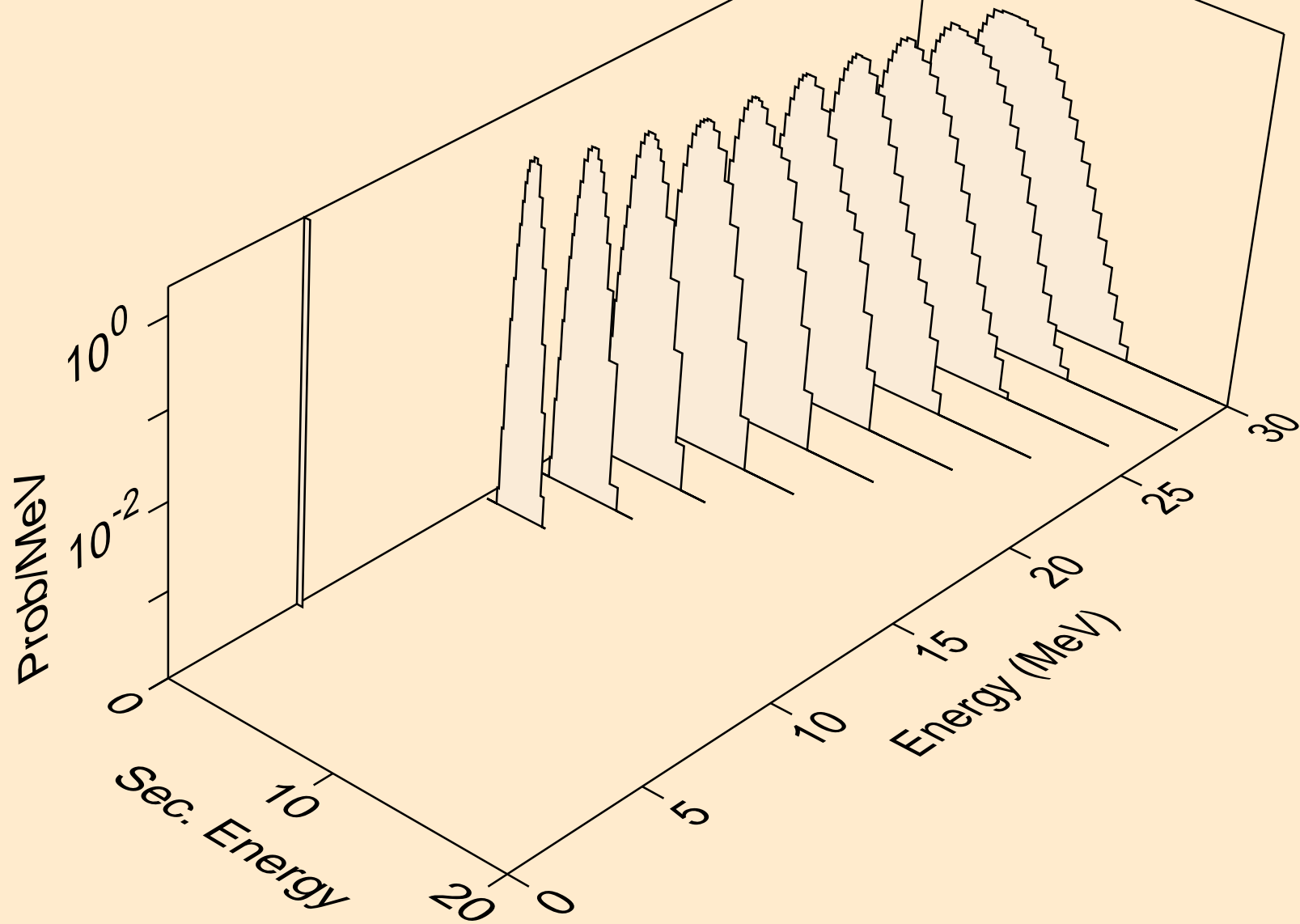

IN107M NEUTRON ACER TENDL-2024 LIBRARY; T=0.K
protons from (n,p)

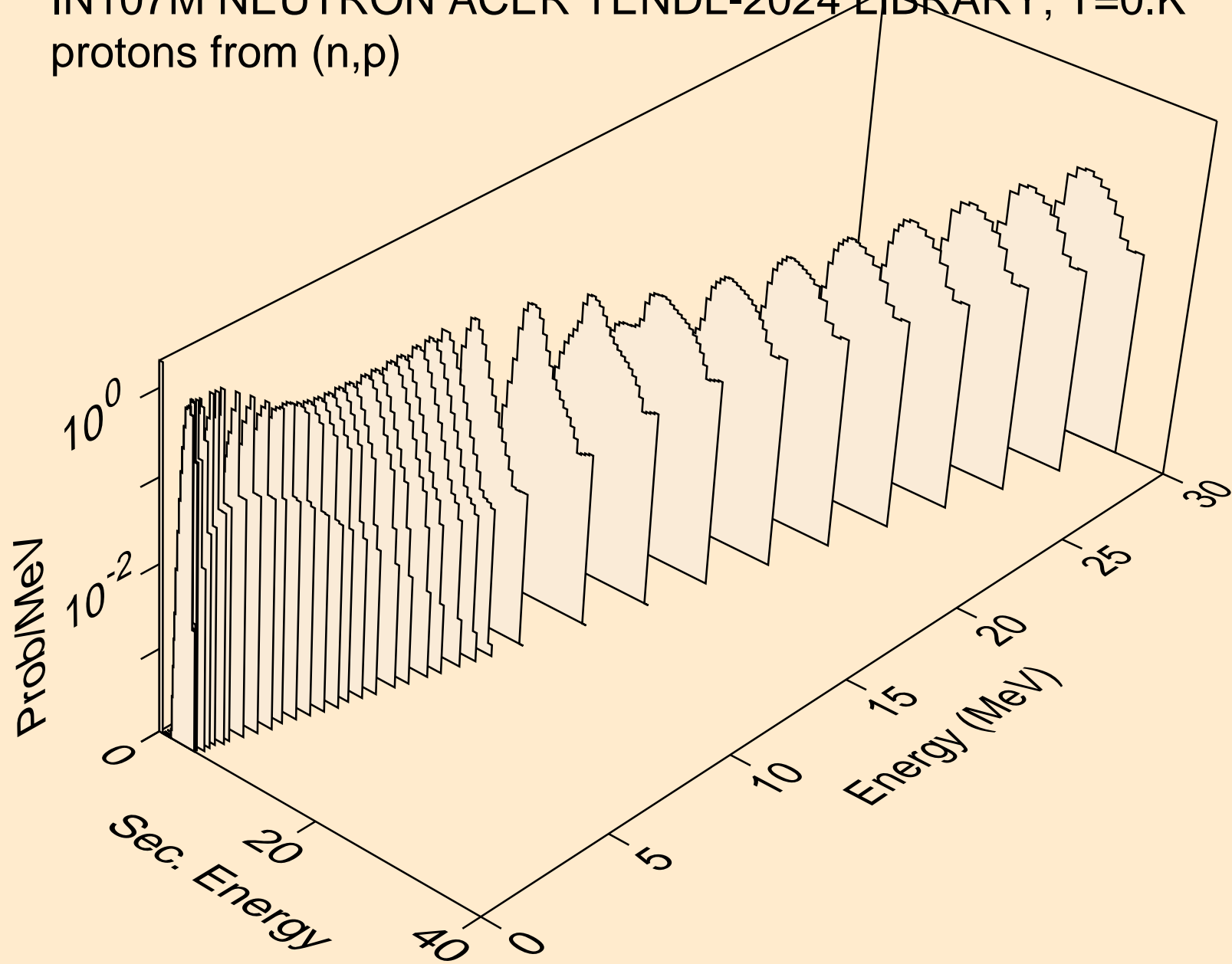

IN107M NEUTRON ACER TENDL-2024 LIBRARY; T=0.K
protons from (n,2p)

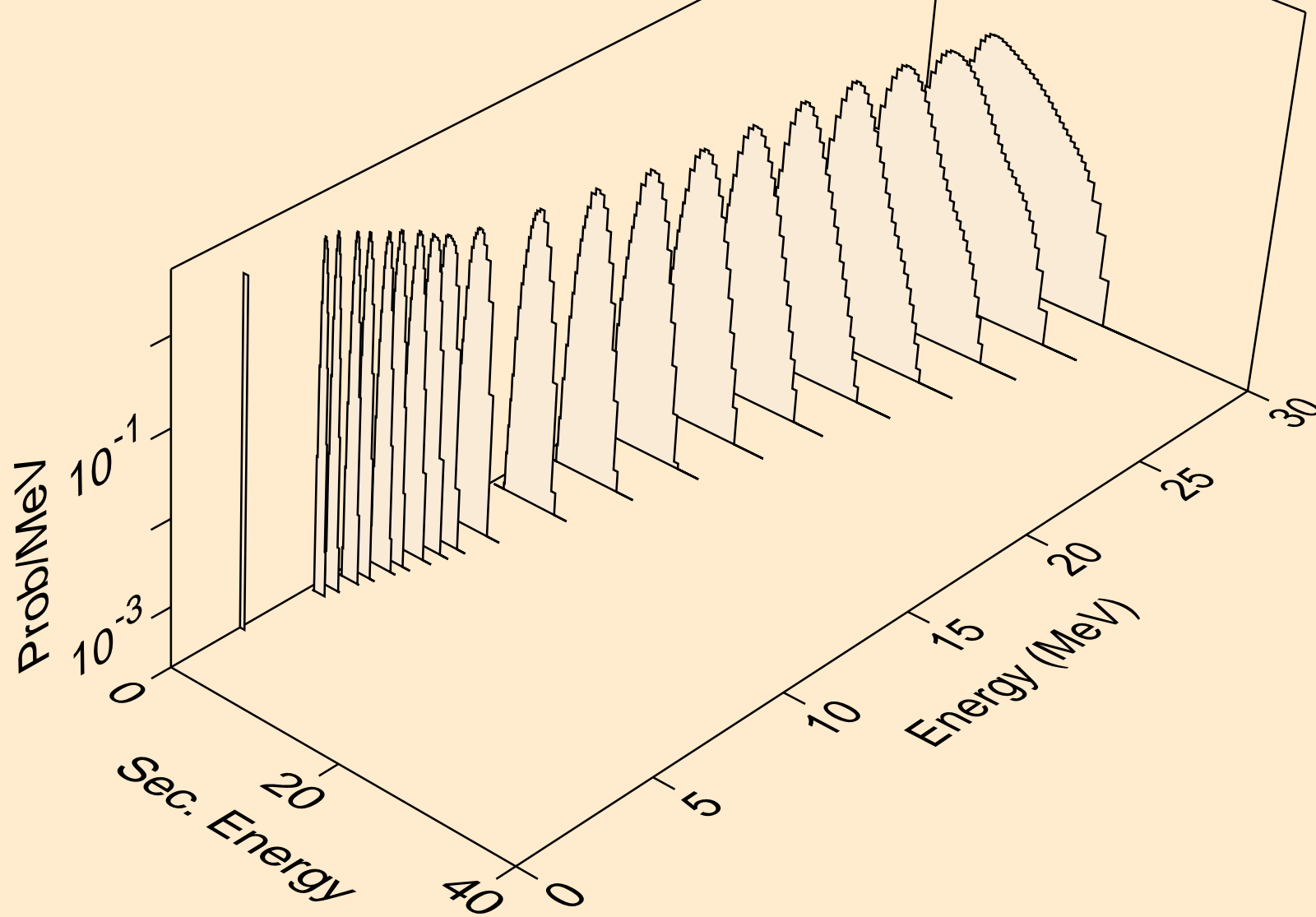

IN107M NEUTRON ACER TENDL-2024 LIBRARY; T=0.K
protons from (n,p)

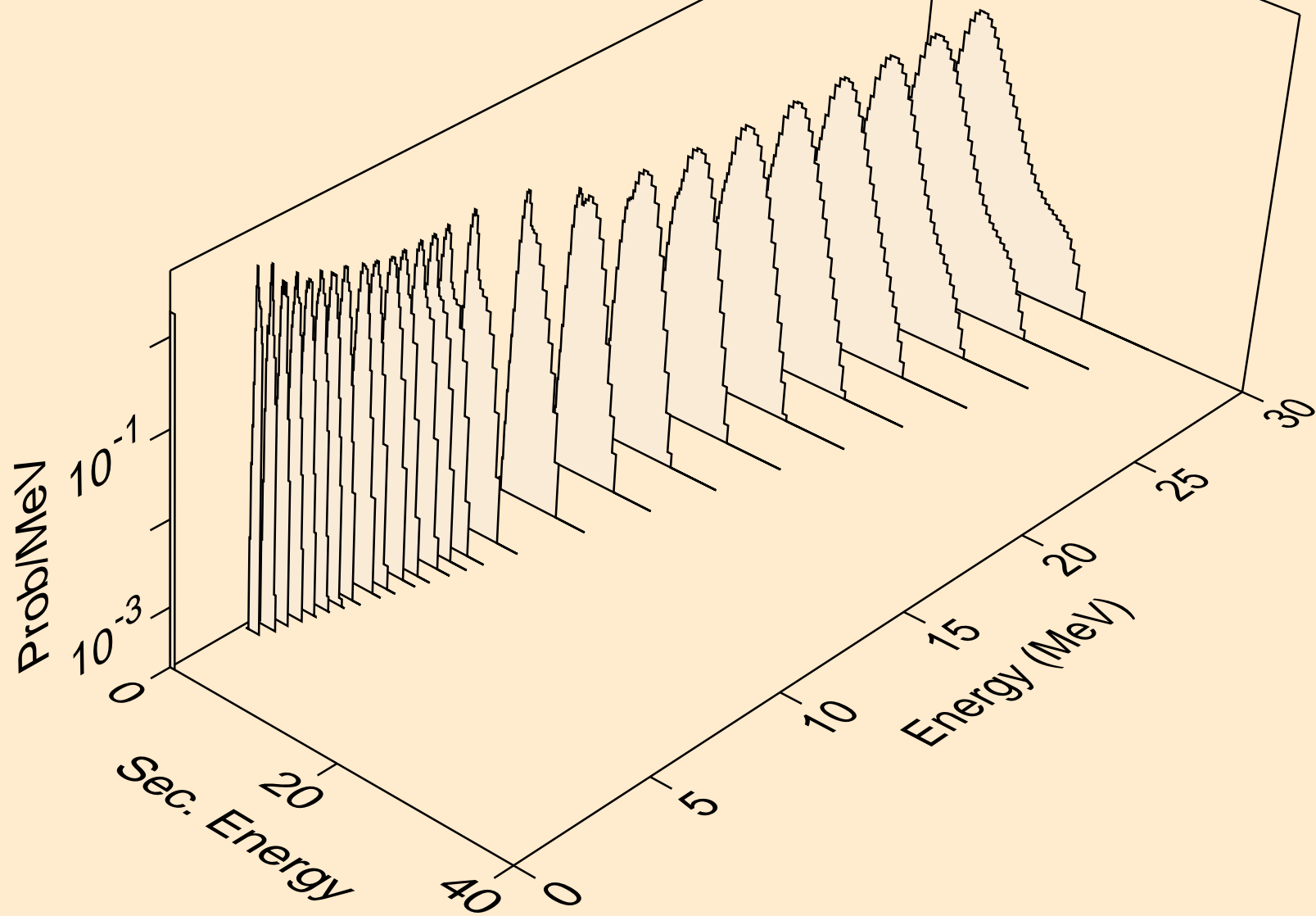

IN107M NEUTRON ACER TENDL-2024 LIBRARY; T=0.K
protons from (n,pd)

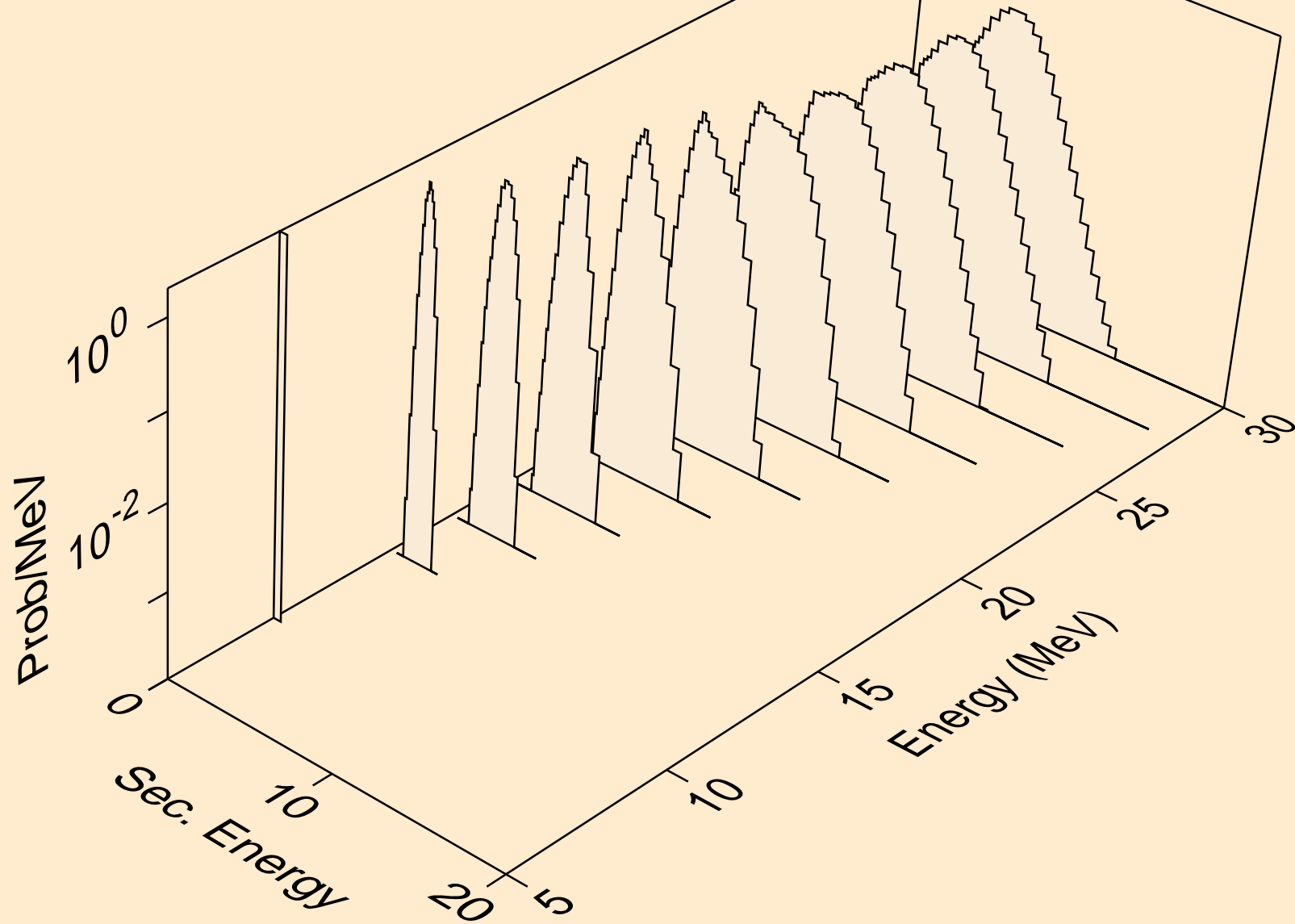

IN107M NEUTRON ACER TENDL-2024 LIBRARY; T=0.K
protons from (n,pt)

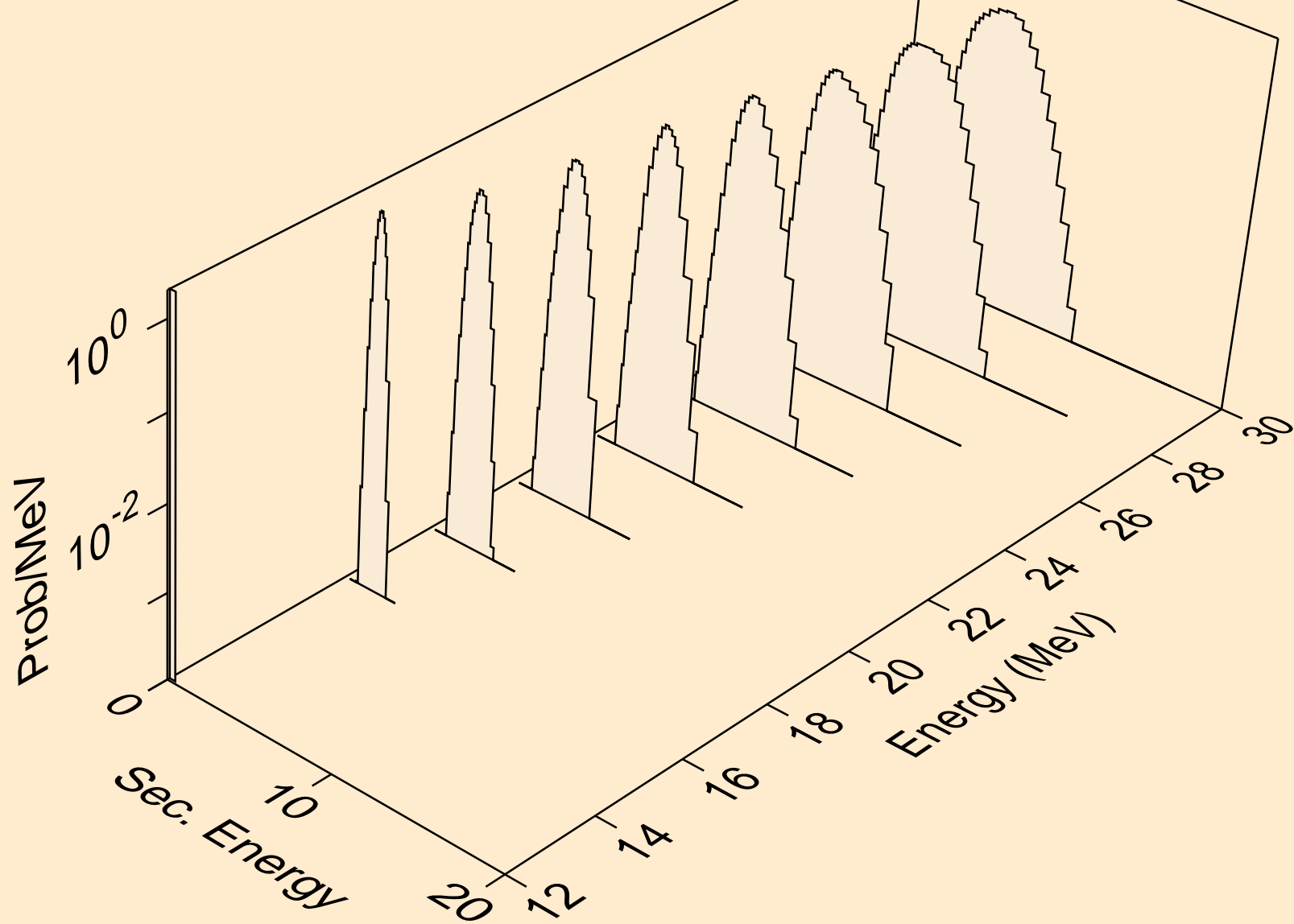

IN107M NEUTRON ACER TENDL-2024 LIBRARY; T=0.K
deuterons from (n,x)

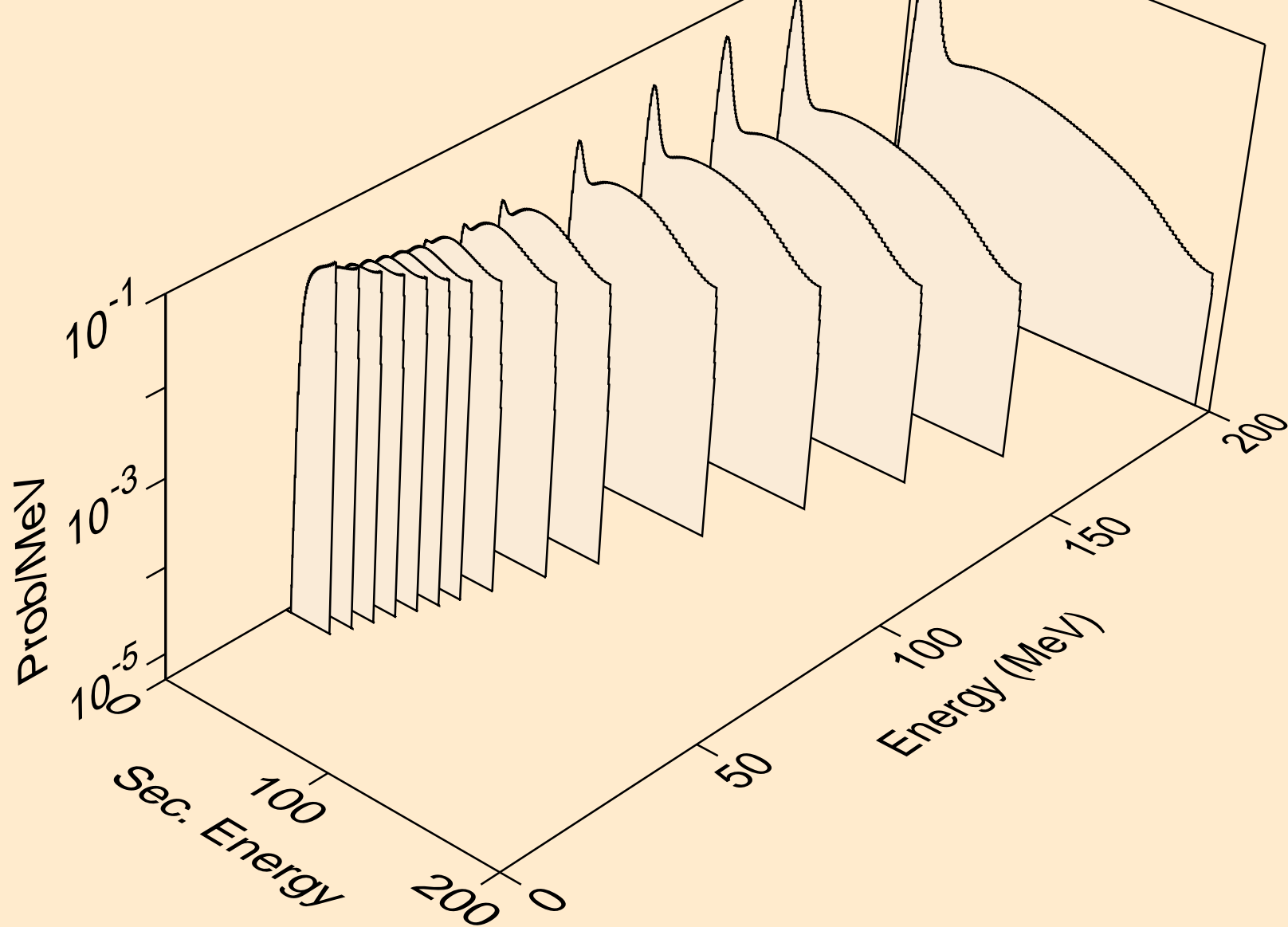

IN107M NEUTRON ACER TENDL-2024 LIBRARY; T=0.K
deuterons from (n,2nd)

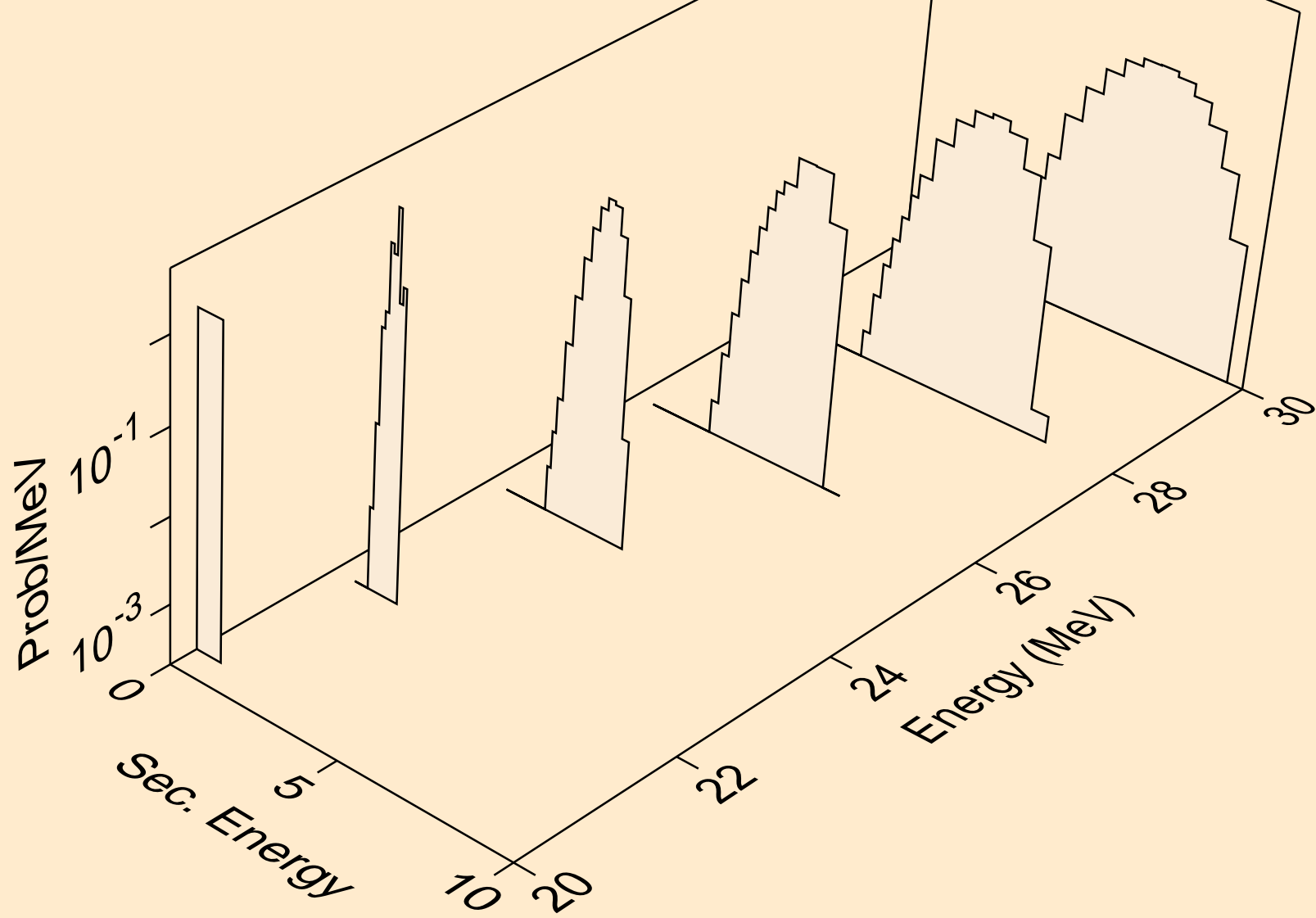

IN107M NEUTRON ACER TENDL-2024 LIBRARY; T=0.K
deuterons from (n,n*)d

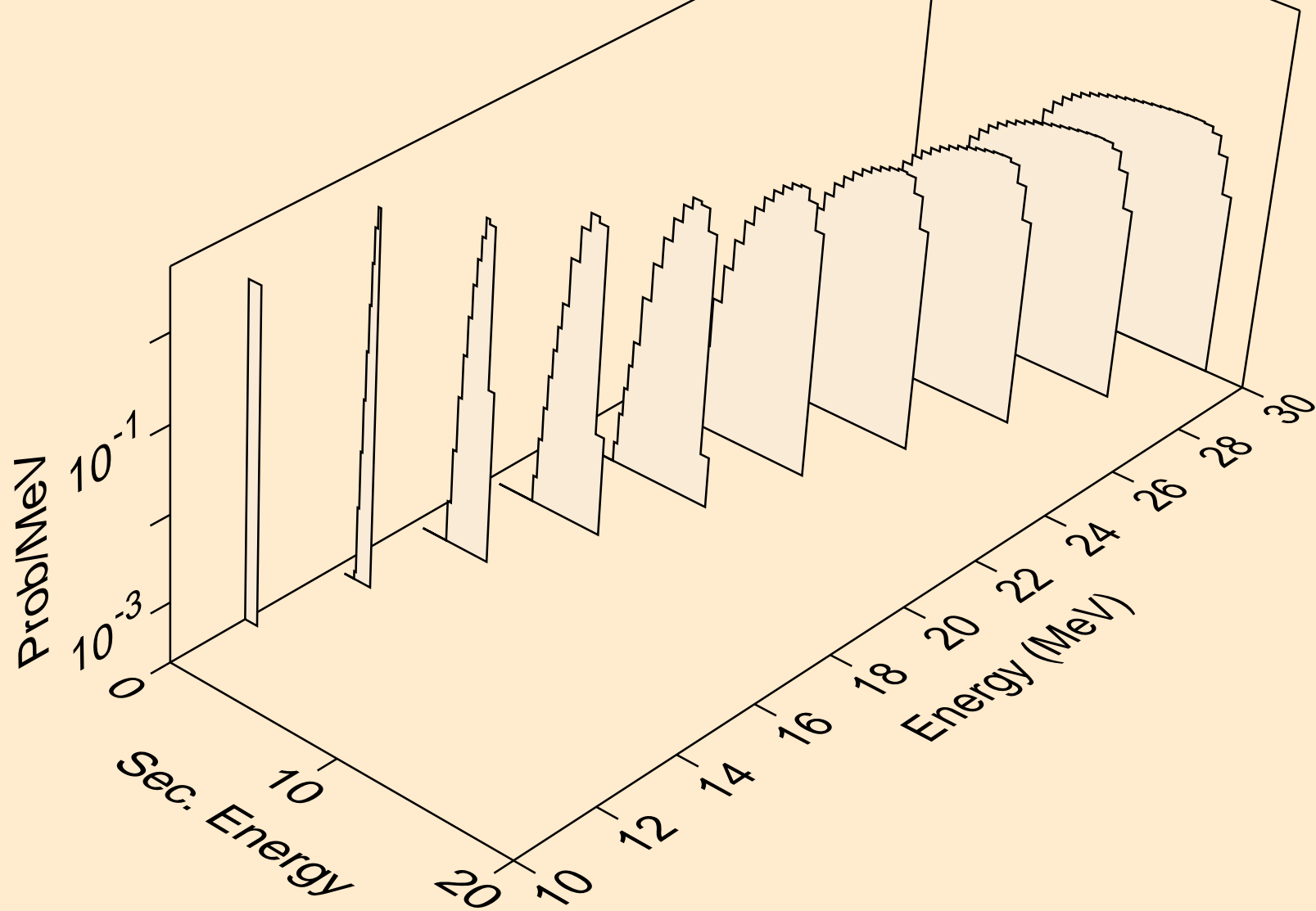

IN107M NEUTRON ACER TENDL-2024 LIBRARY; T=0.K
deuterons from (n,d)

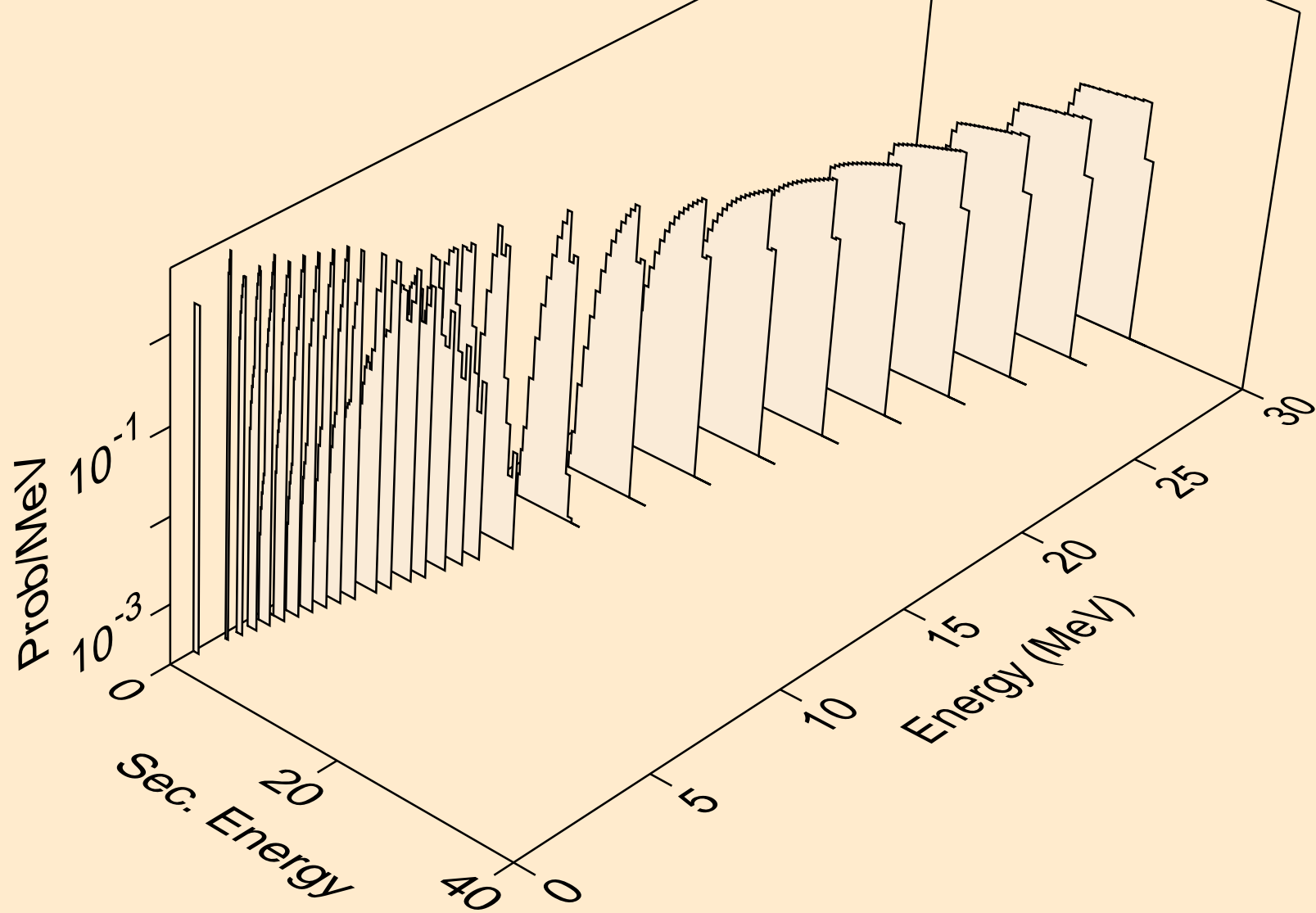

IN107M NEUTRON ACER TENDL-2024 LIBRARY; T=0.K
deuterons from (n,pd)

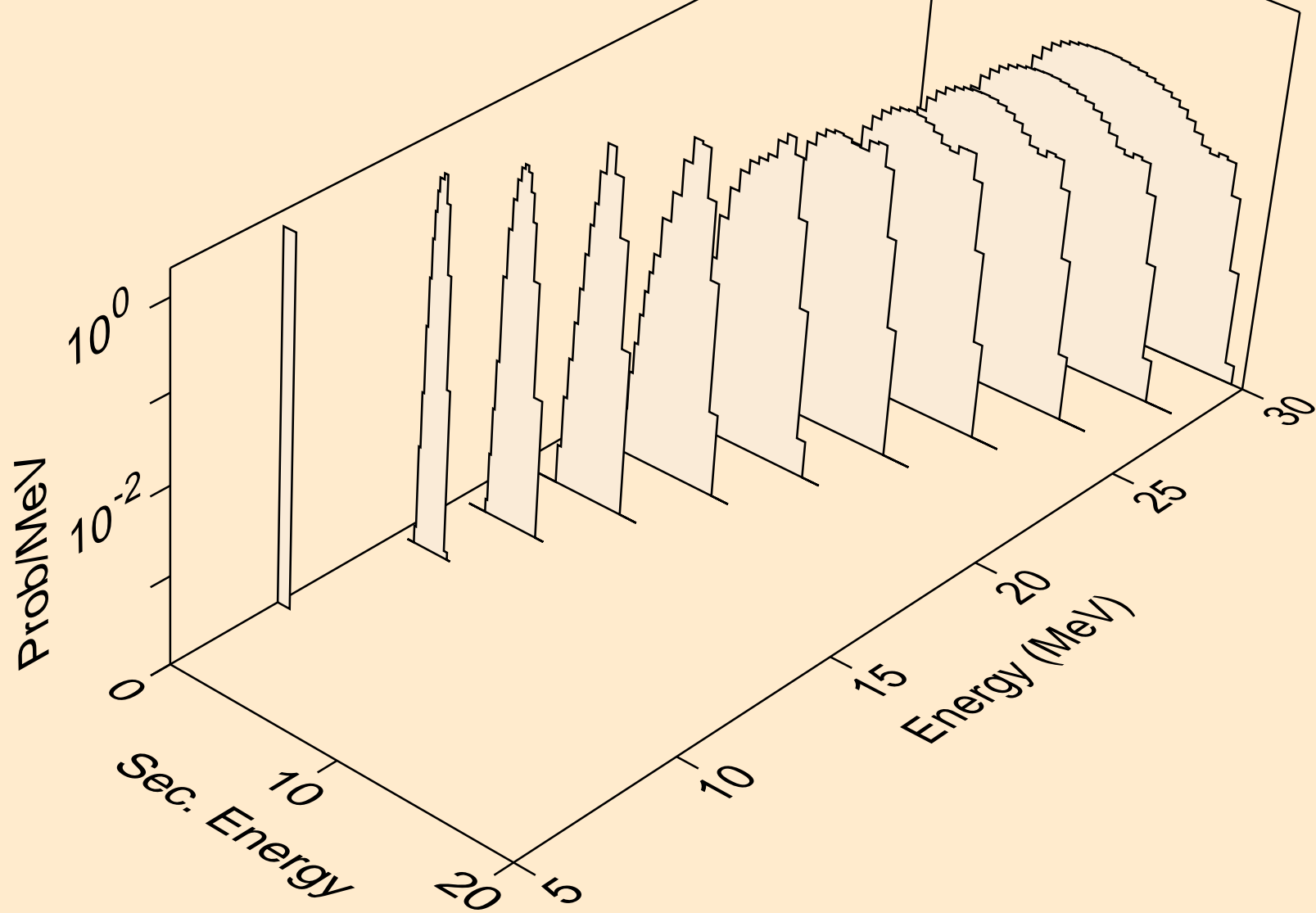

IN107M NEUTRON ACER TENDL-2024 LIBRARY; T=0.K
deuterons from (n,da)

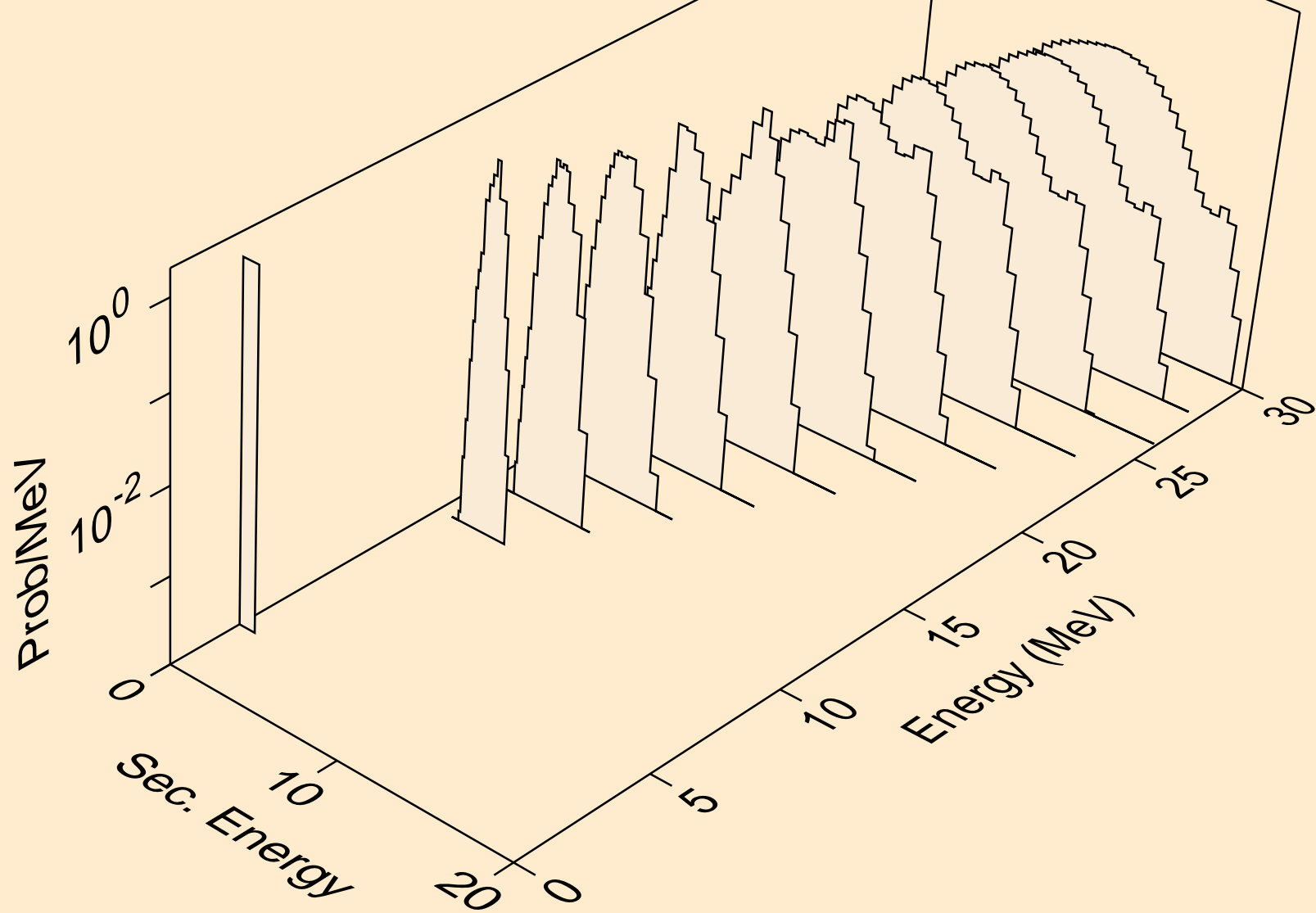

IN107M NEUTRON ACER TENDL-2024 LIBRARY; T=0.K
tritons from (n,x)

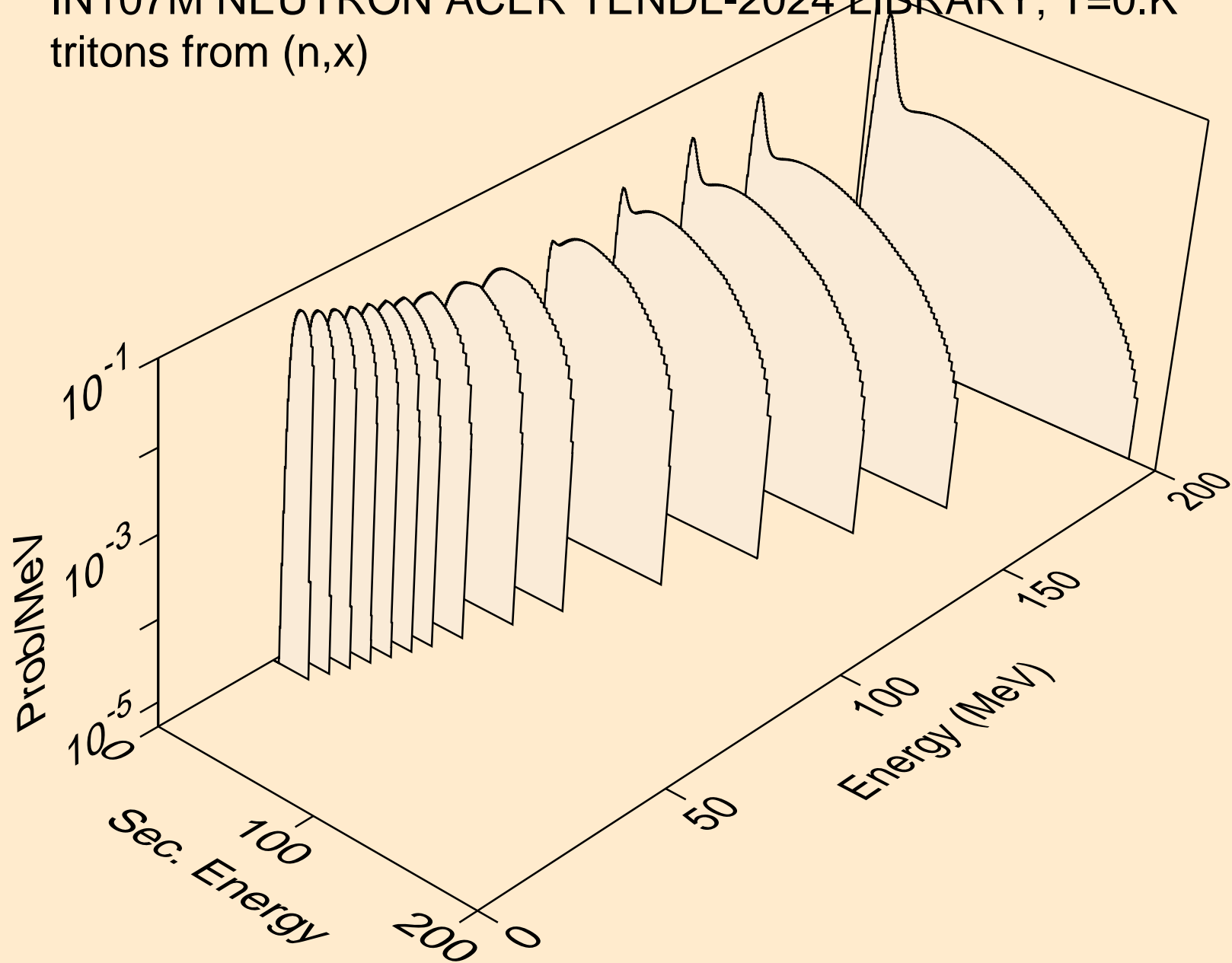

IN107M NEUTRON ACER TENDL-2024 LIBRARY; T=0.K
tritons from (n,n*)t

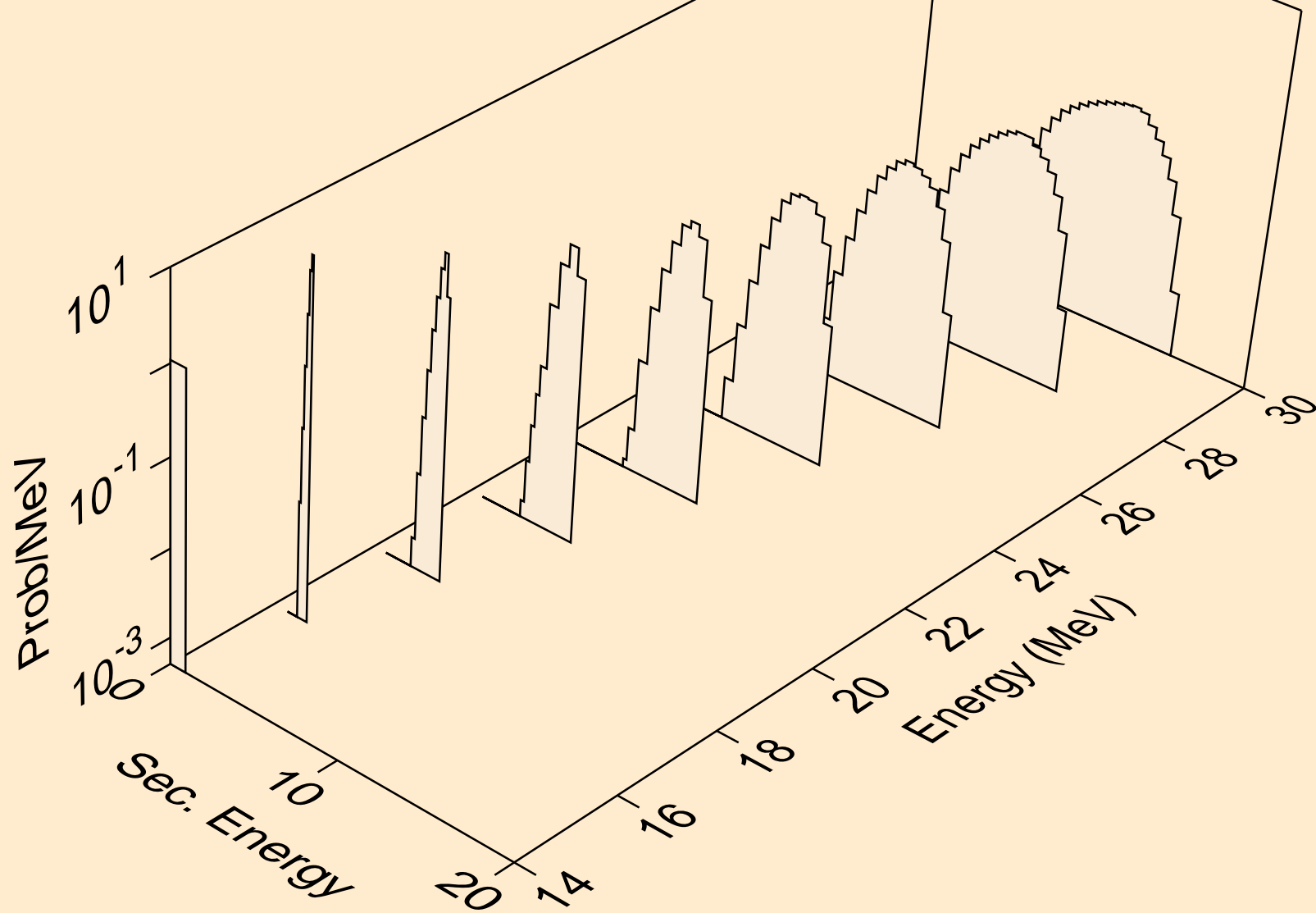

IN107M NEUTRON ACER TENDL-2024 LIBRARY; T=0.K
tritons from (n,t)

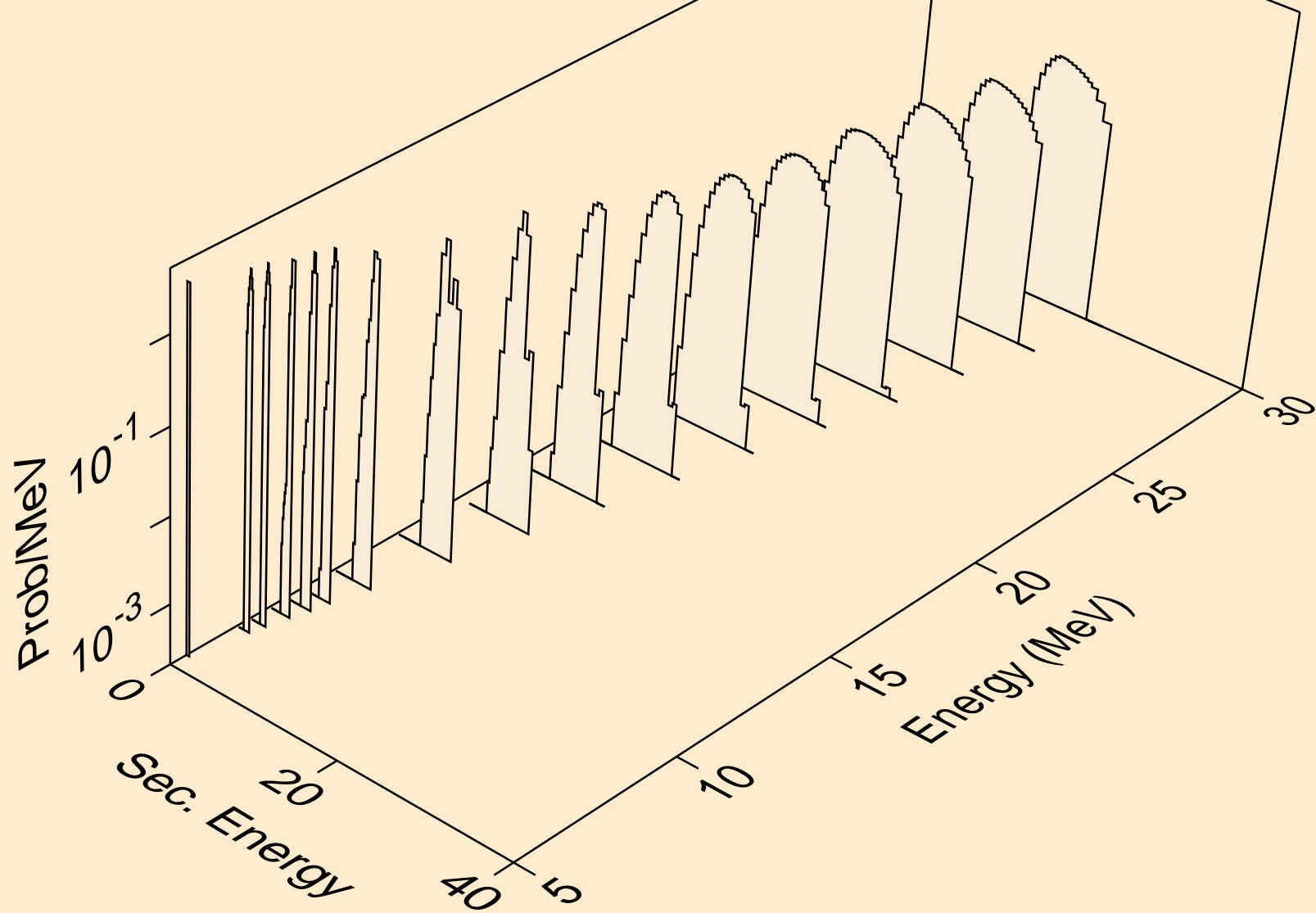

IN107M NEUTRON ACER TENDL-2024 LIBRARY; T=0.K
tritons from (n,pt)

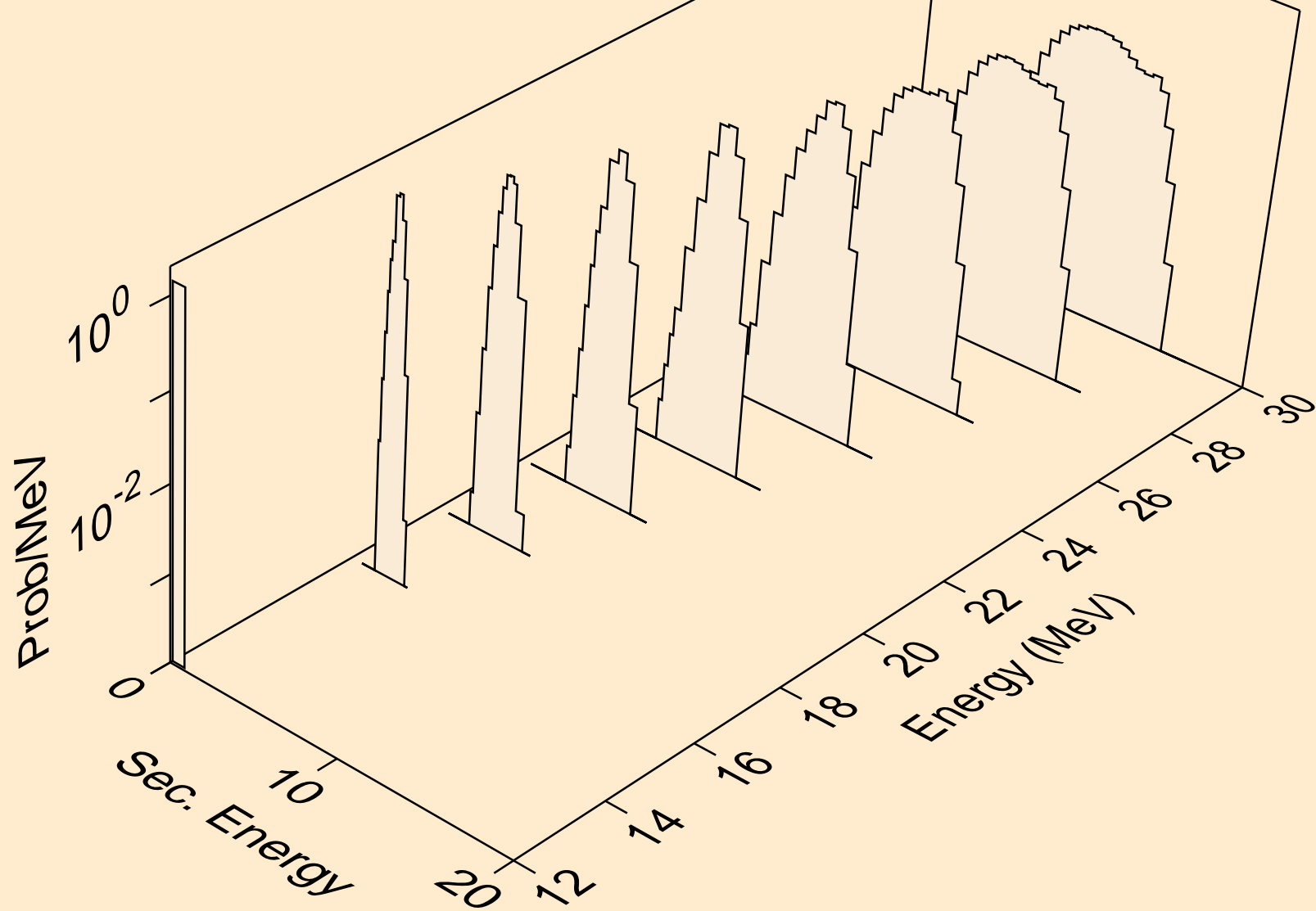

IN107M NEUTRON ACER TENDL-2024 LIBRARY; T=0.K
he3s from (n,x)

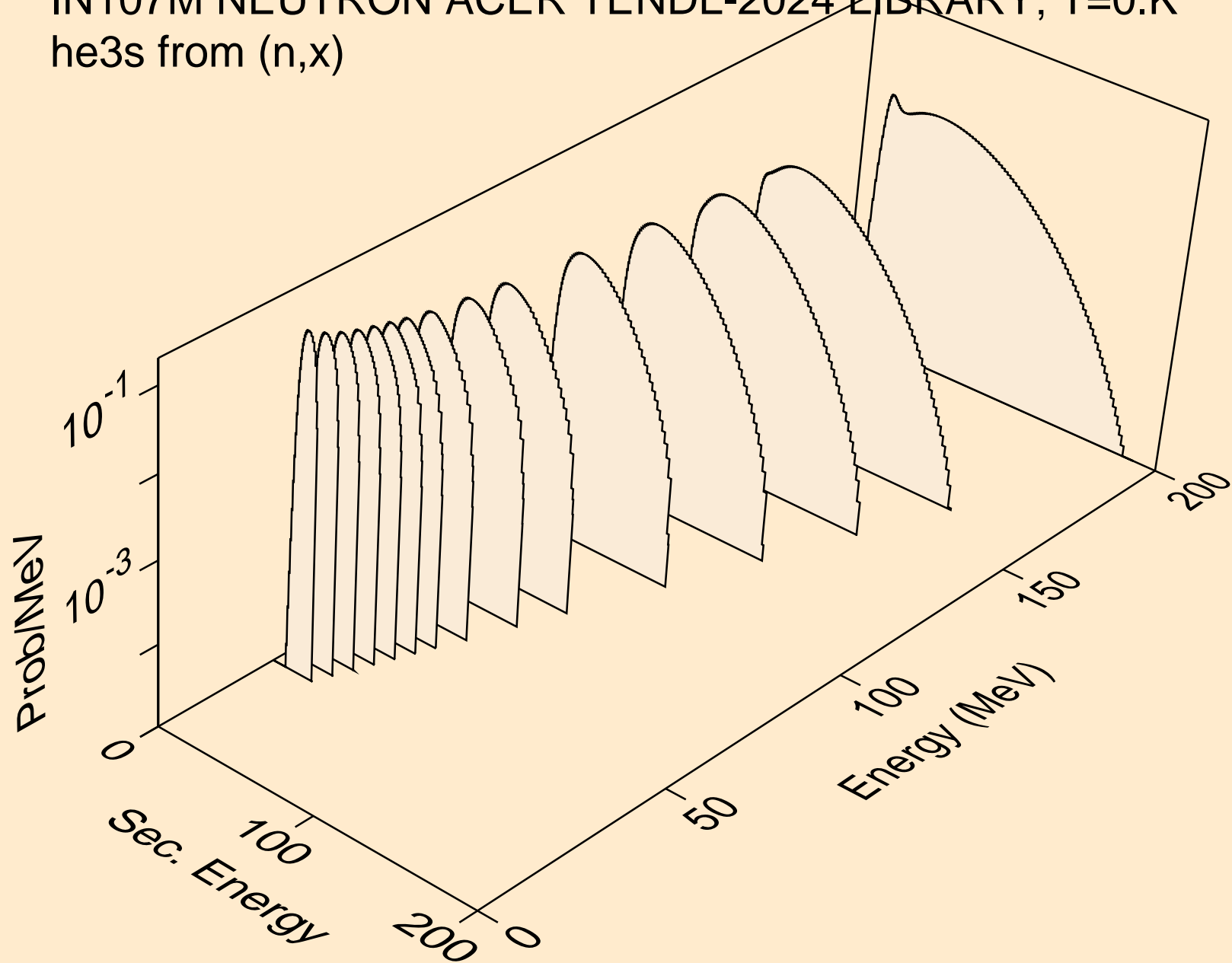

IN107M NEUTRON ACER TENDL-2024 LIBRARY; T=0.K
he3s from (n,n*)he3

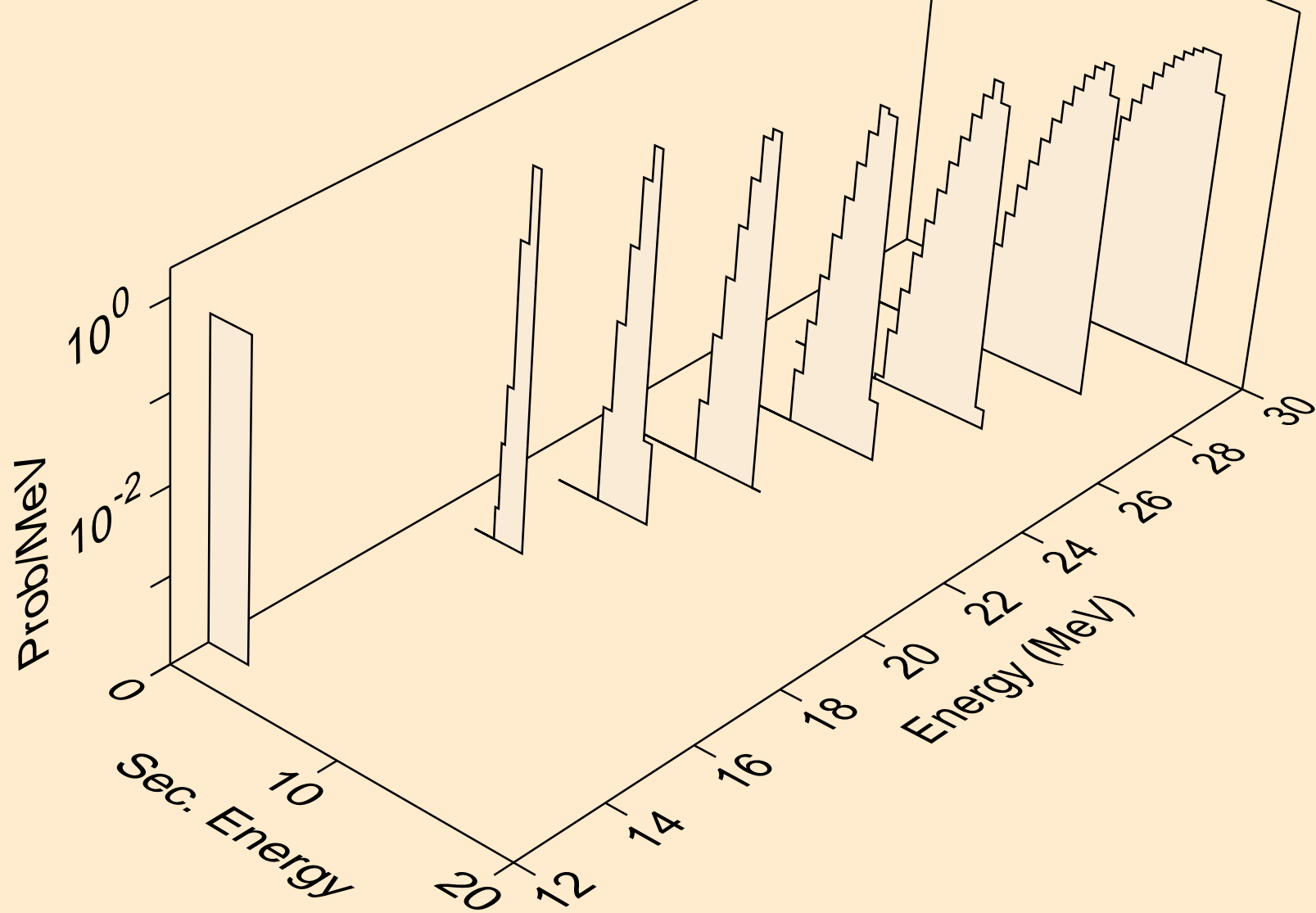

IN107M NEUTRON ACER TENDL-2024 LIBRARY; T=0.K
he3s from (n,he3)

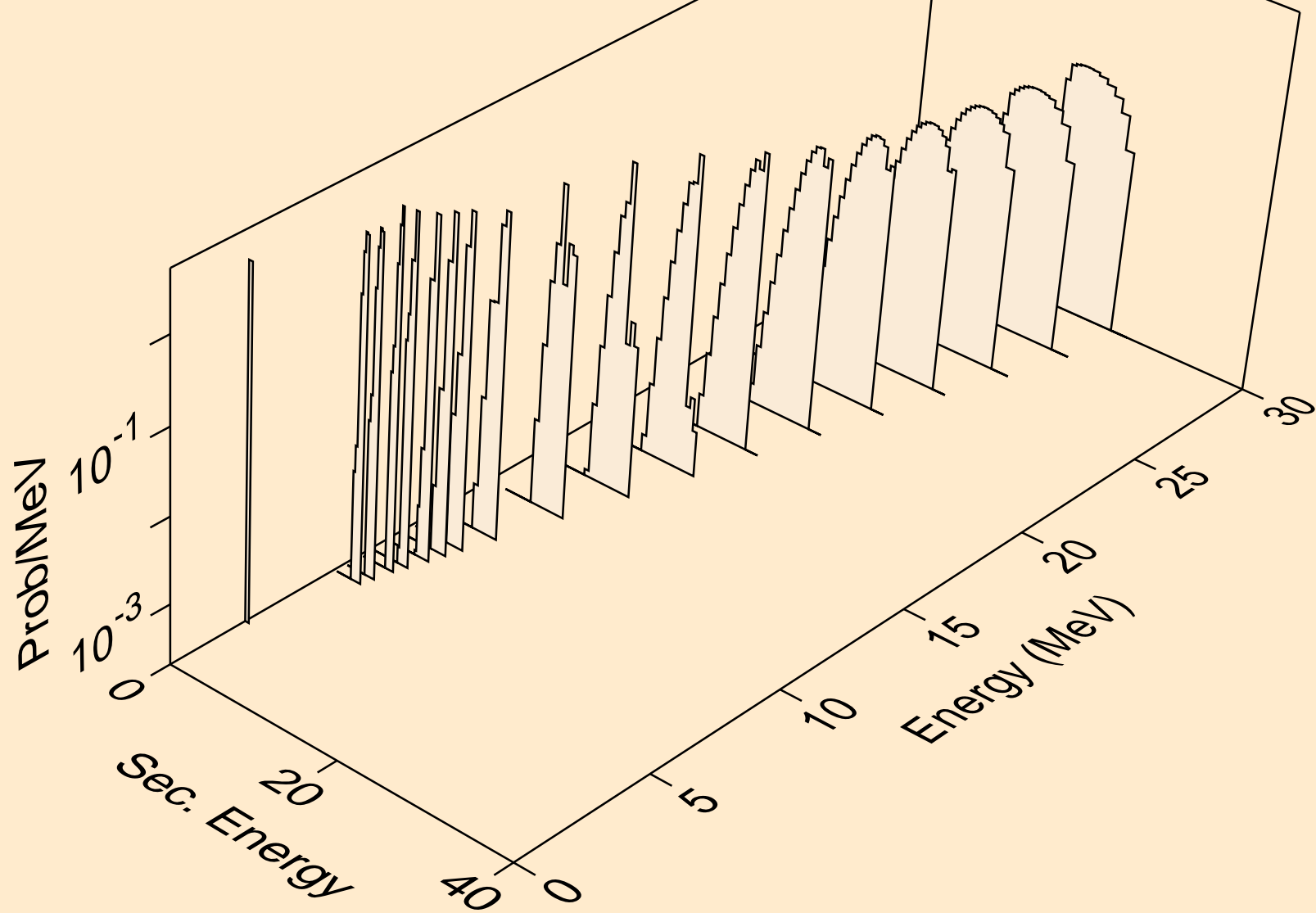

IN107M NEUTRON ACER TENDL-2024 LIBRARY; T=0.K
alphas from (n,x)

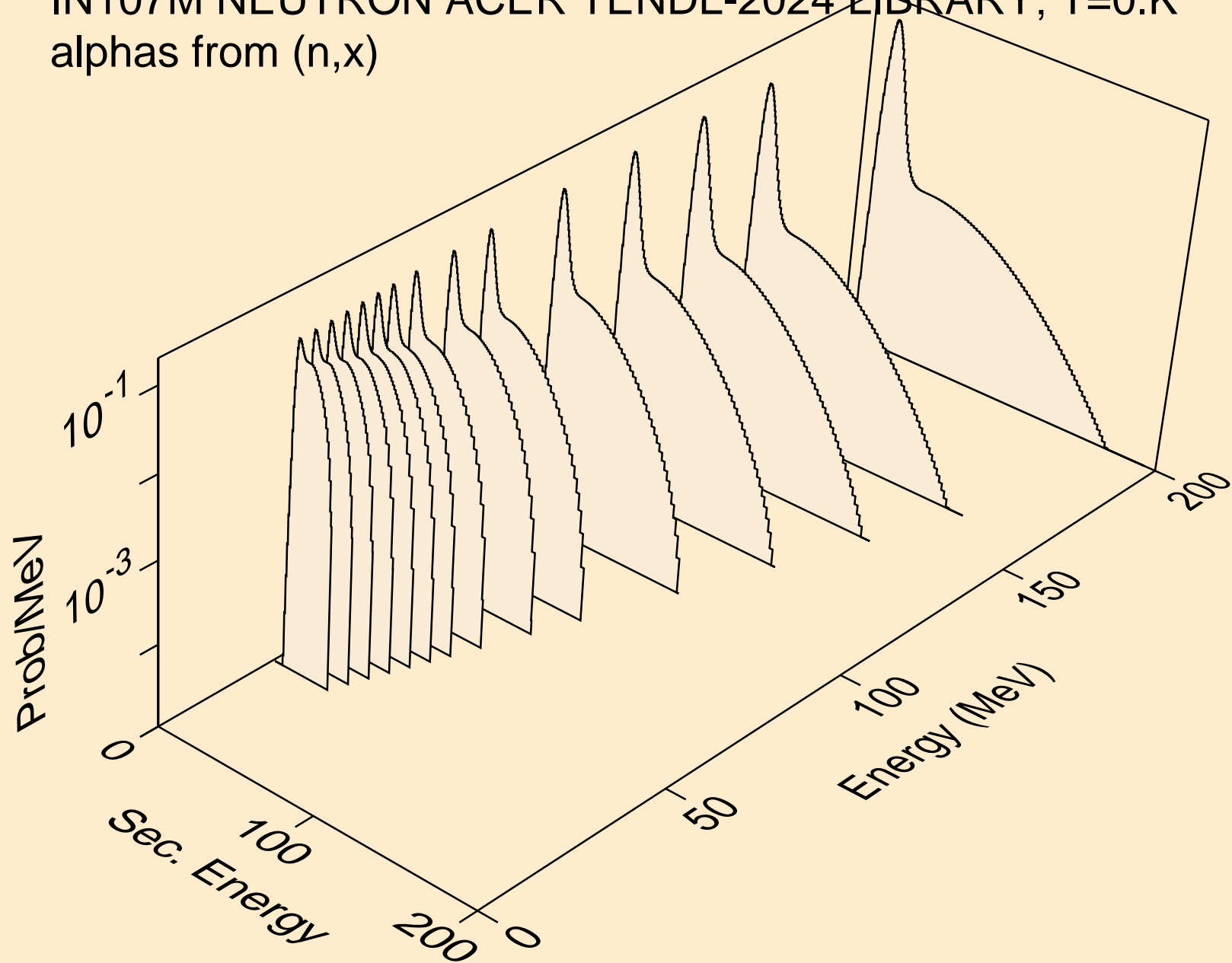

IN107M NEUTRON ACER TENDL-2024 LIBRARY; T=0.K
alphas from (n,n*)a

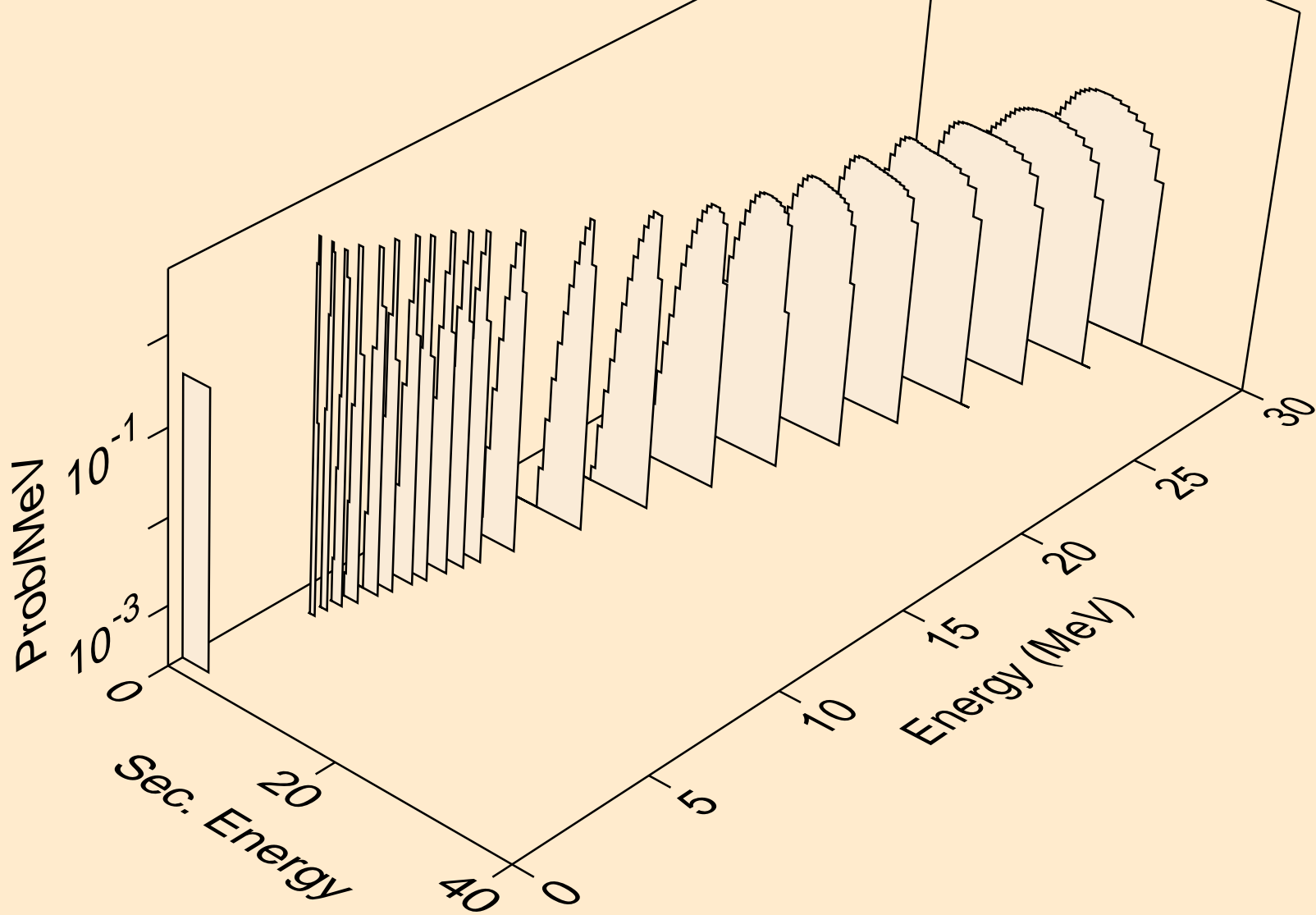

IN107M NEUTRON ACER TENDL-2024 LIBRARY; T=0.K
alphas from (n,2n)a

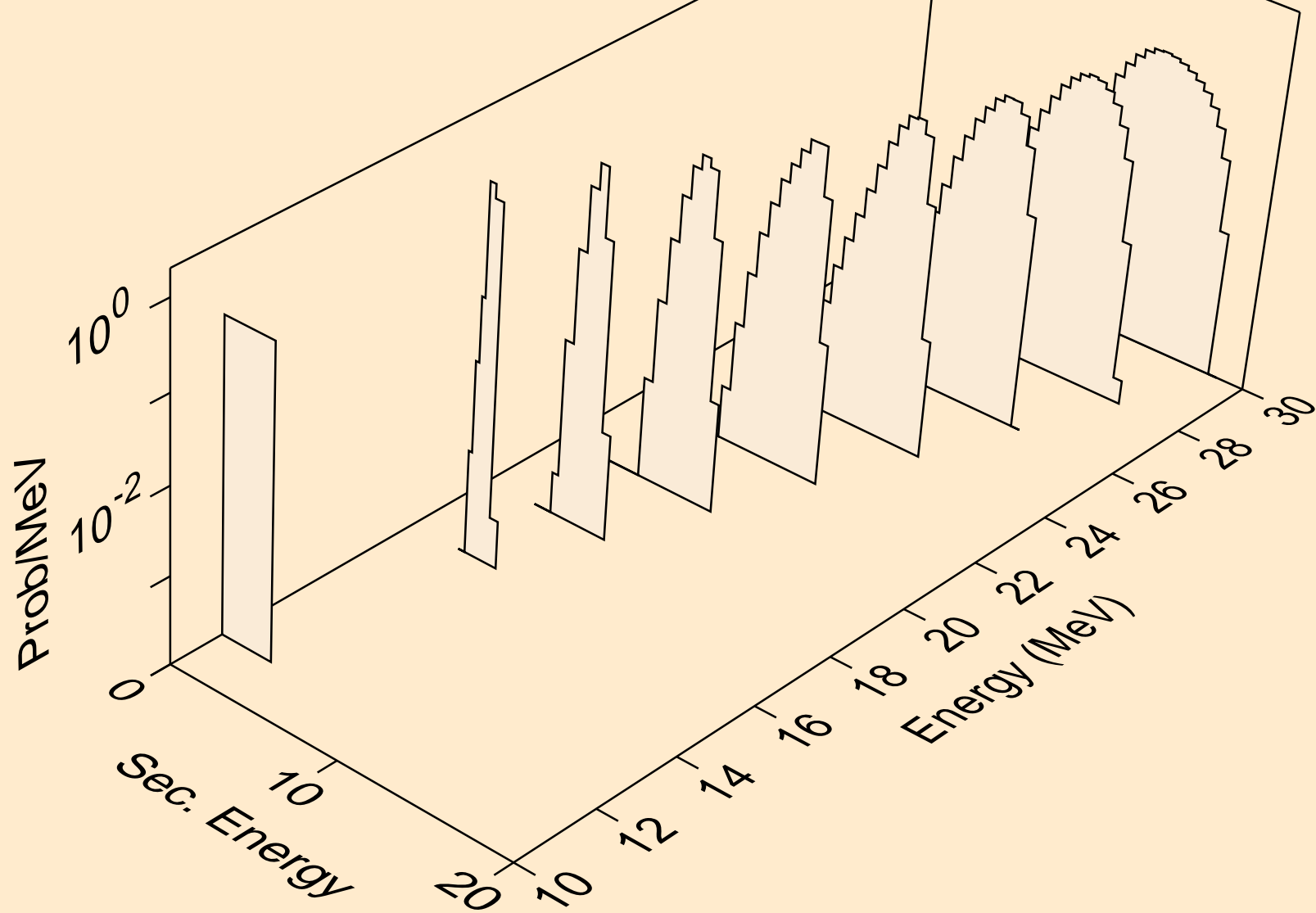

IN107M NEUTRON ACER TENDL-2024 LIBRARY; T=0.K
alphas from (n,3n)a

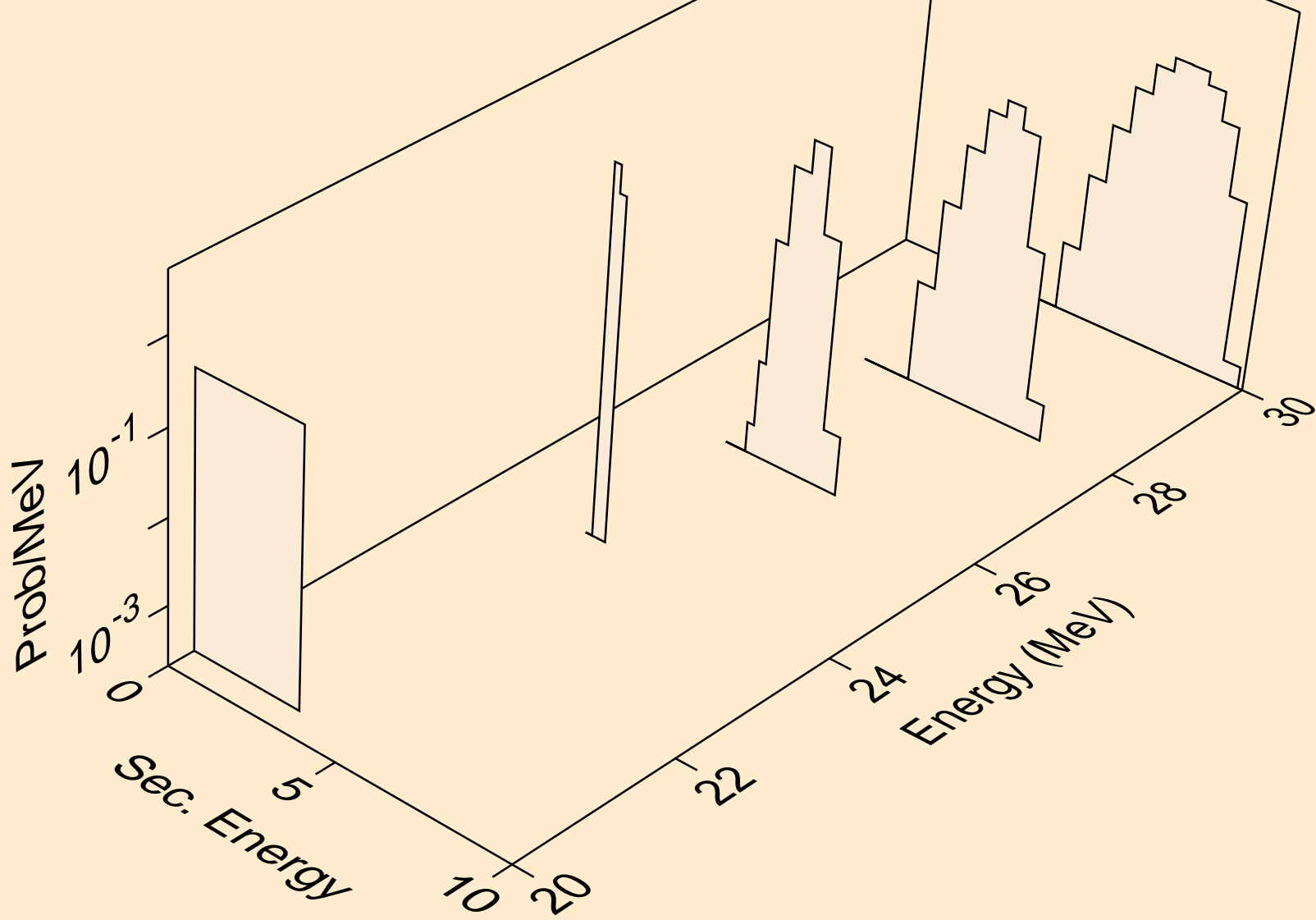

IN107M NEUTRON ACER TENDL-2024 LIBRARY; T=0.K
alphas from (n,n*)2a

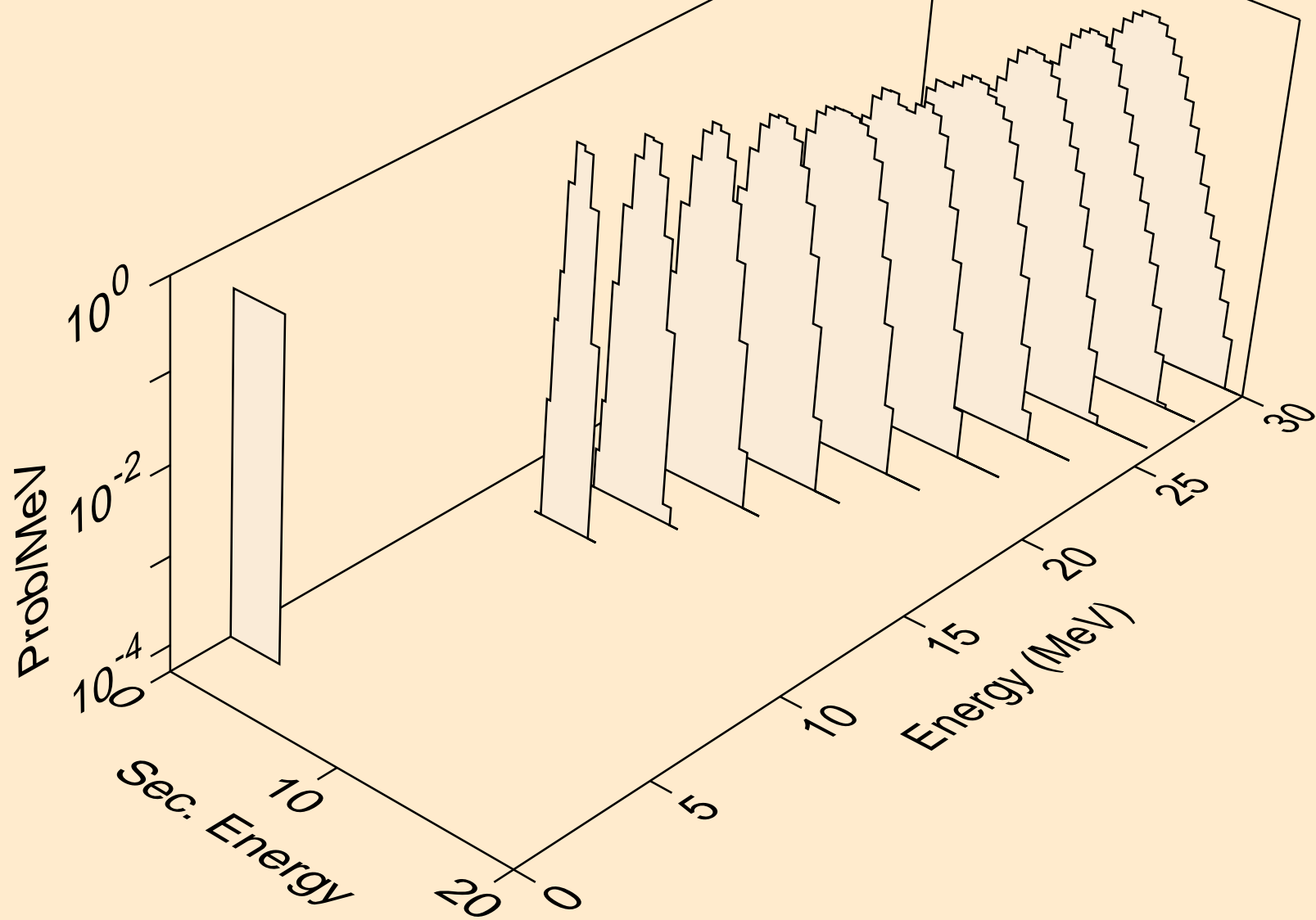

IN107M NEUTRON ACER TENDL-2024 LIBRARY; T=0.K
alphas from (n,npa)

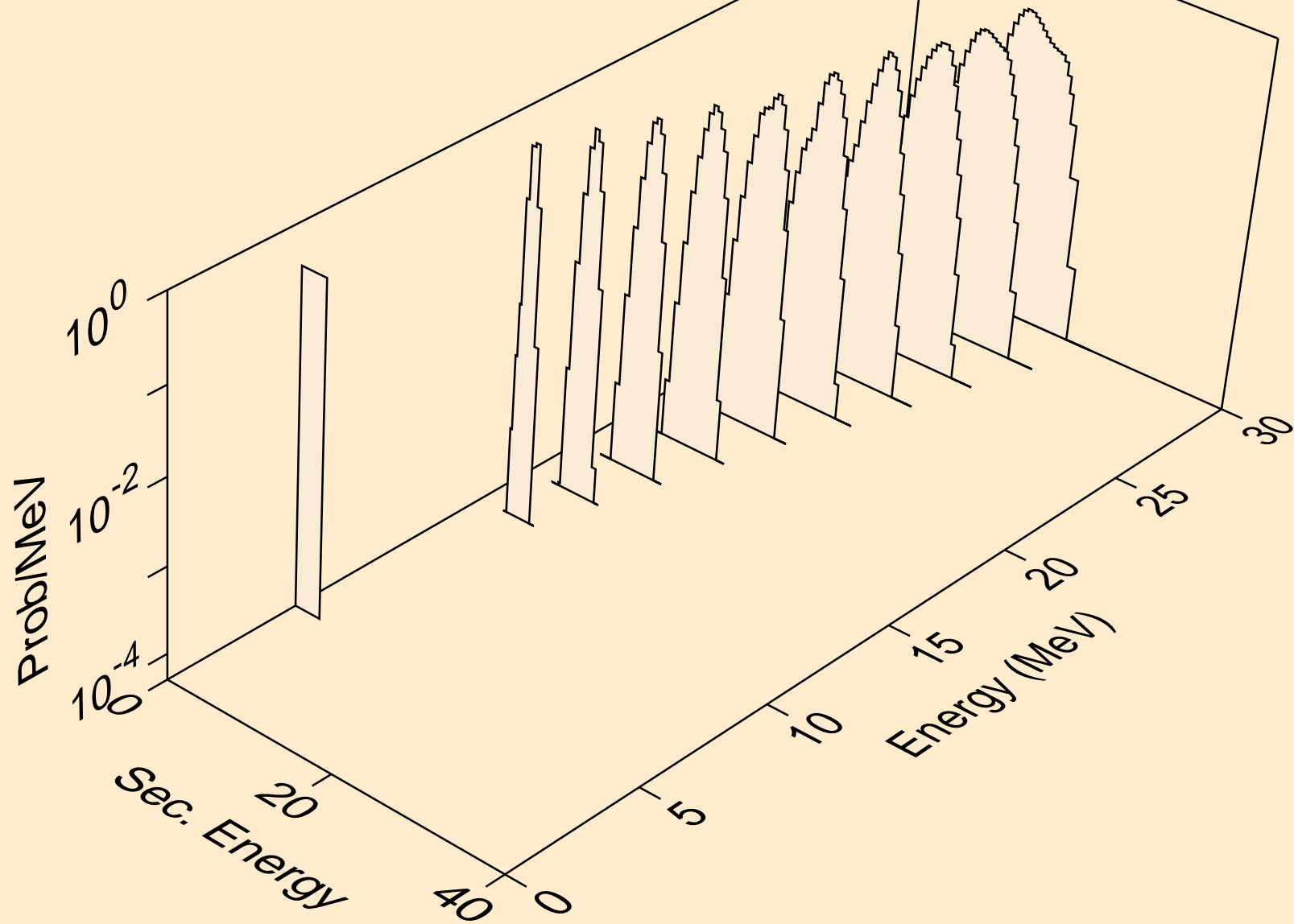

IN107M NEUTRON ACER TENDL-2024 LIBRARY; T=0.K
alphas from (n,a)

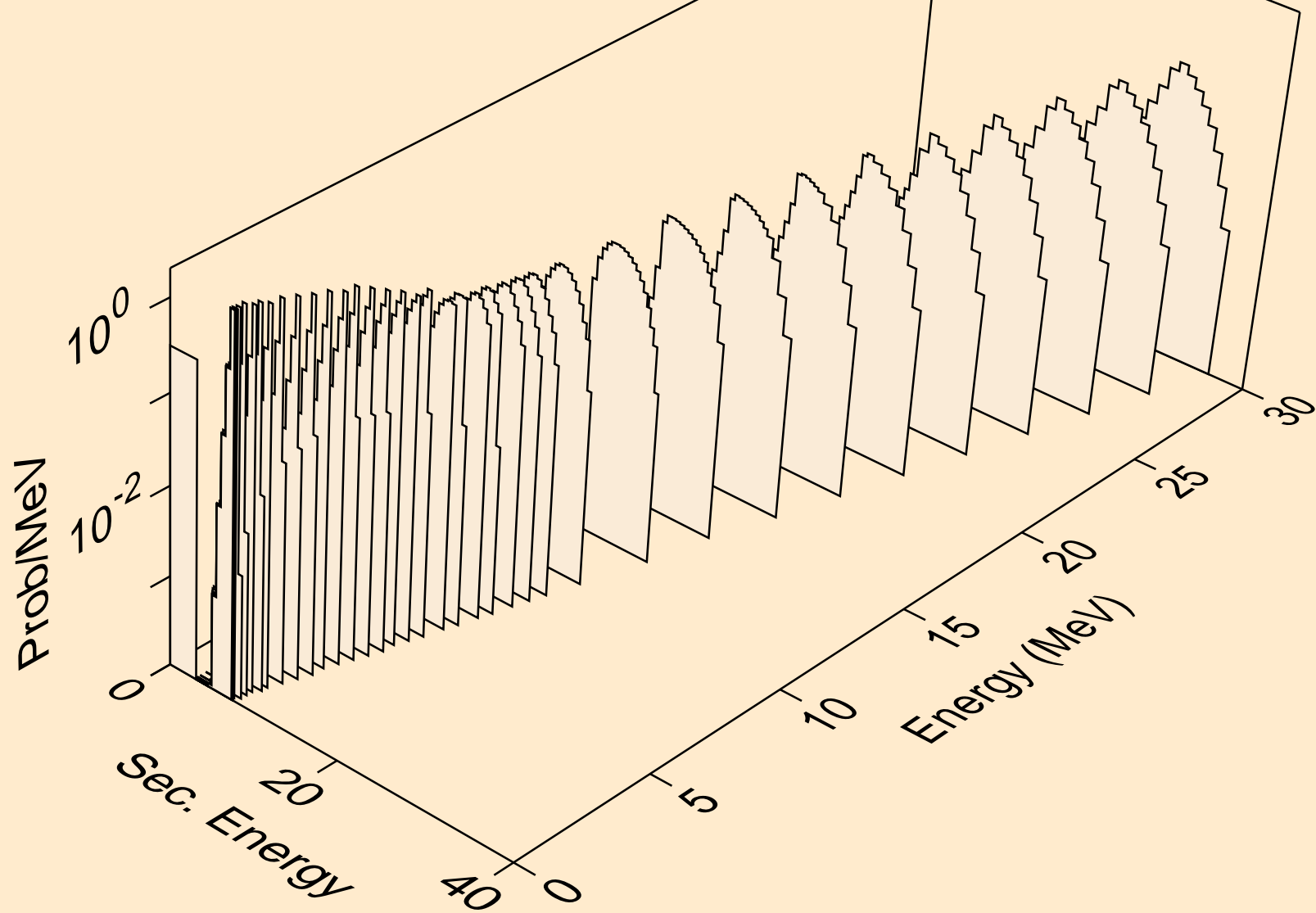

IN107M NEUTRON ACER TENDL-2024 LIBRARY; T=0.K
alphas from (n,2a)

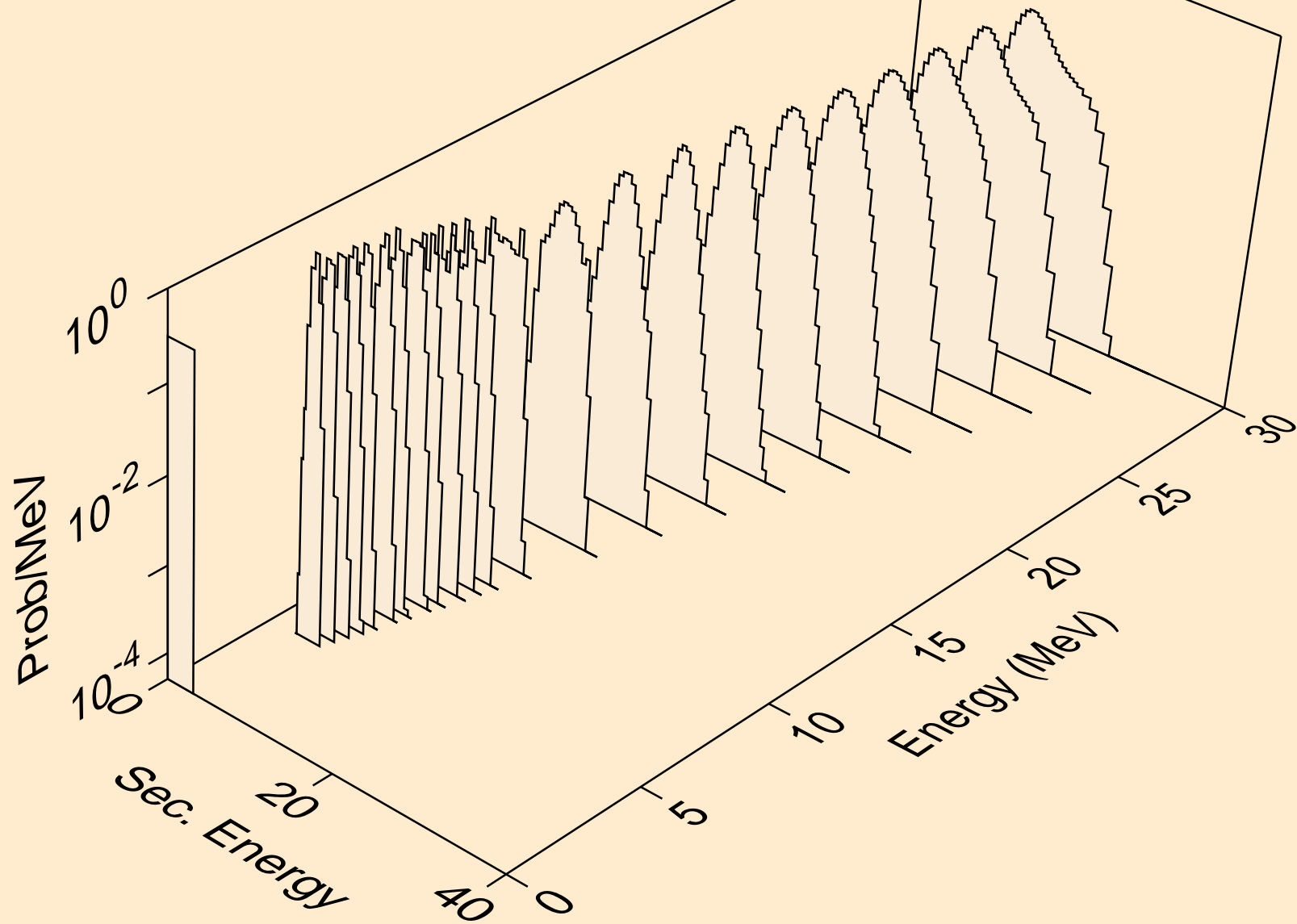

IN107M NEUTRON ACER TENDL-2024 LIBRARY; T=0.K
alphas from (n,3a)

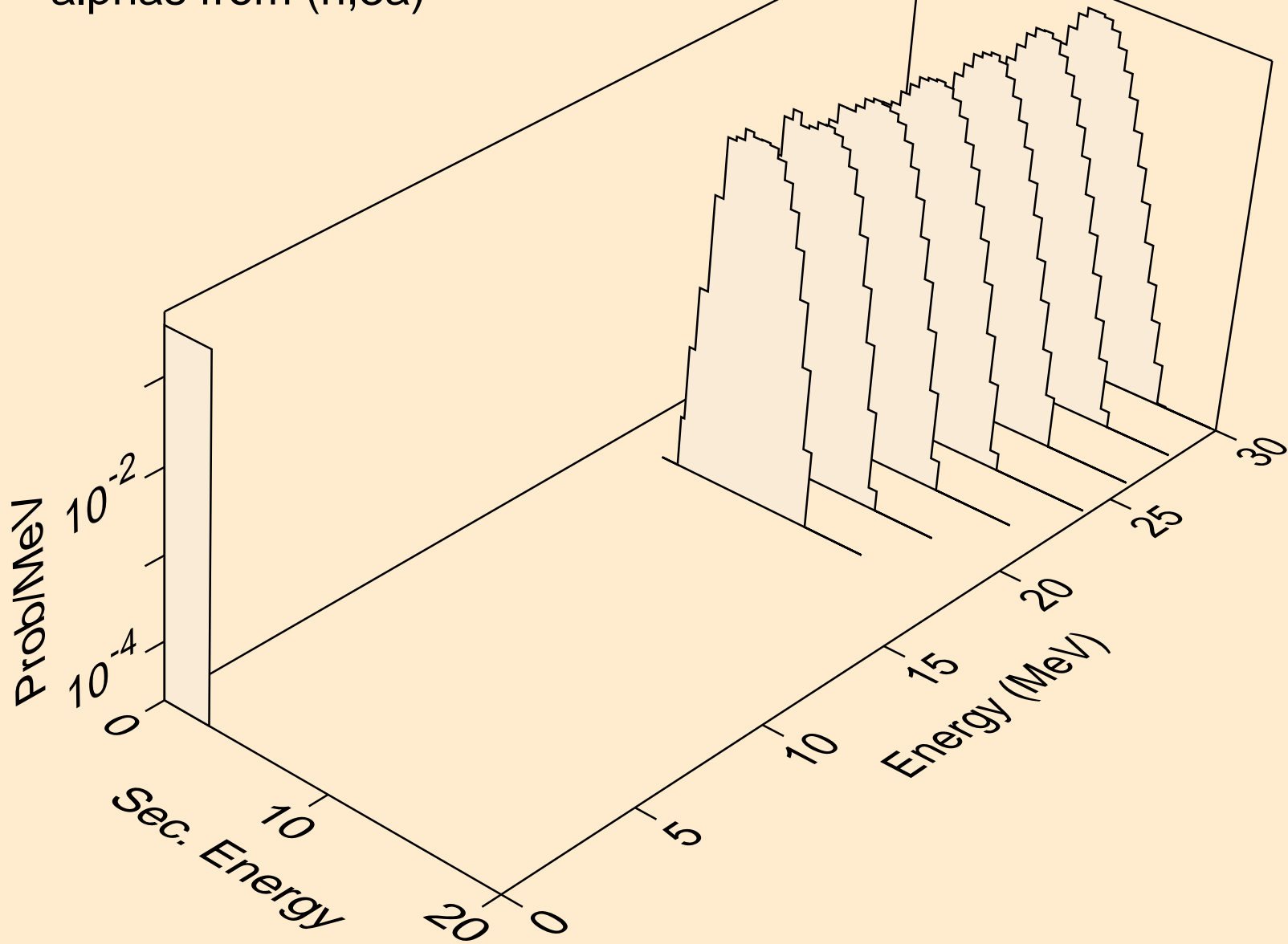

IN107M NEUTRON ACER TENDL-2024 LIBRARY; T=0.K
alphas from (n,pa)

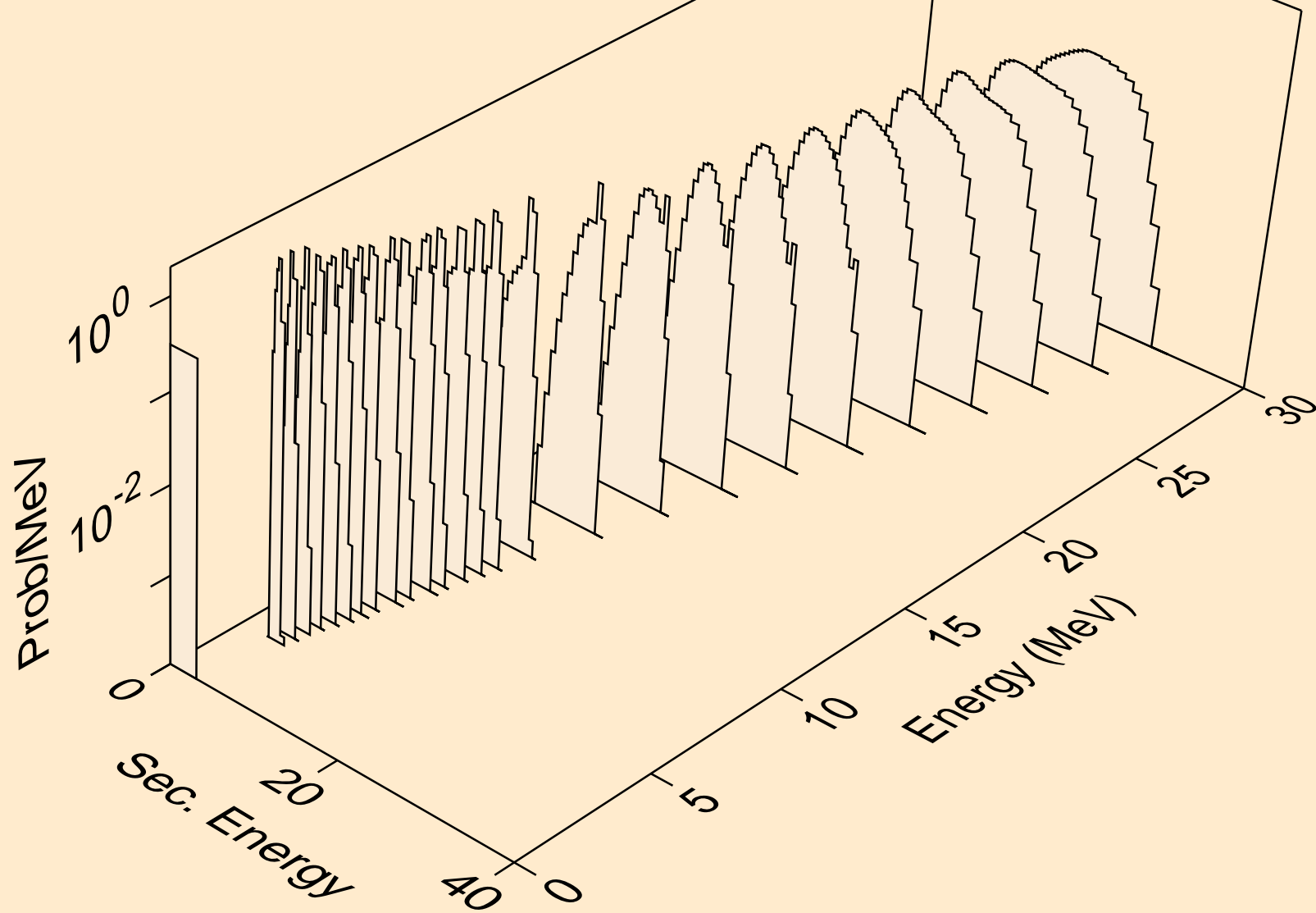

IN107M NEUTRON ACER TENDL-2024 LIBRARY; T=0.K
alphas from (n,da)

