

IN112 NEUTRON ACER TENDL-2024 LIBRARY; T=0.K

Principal cross sections

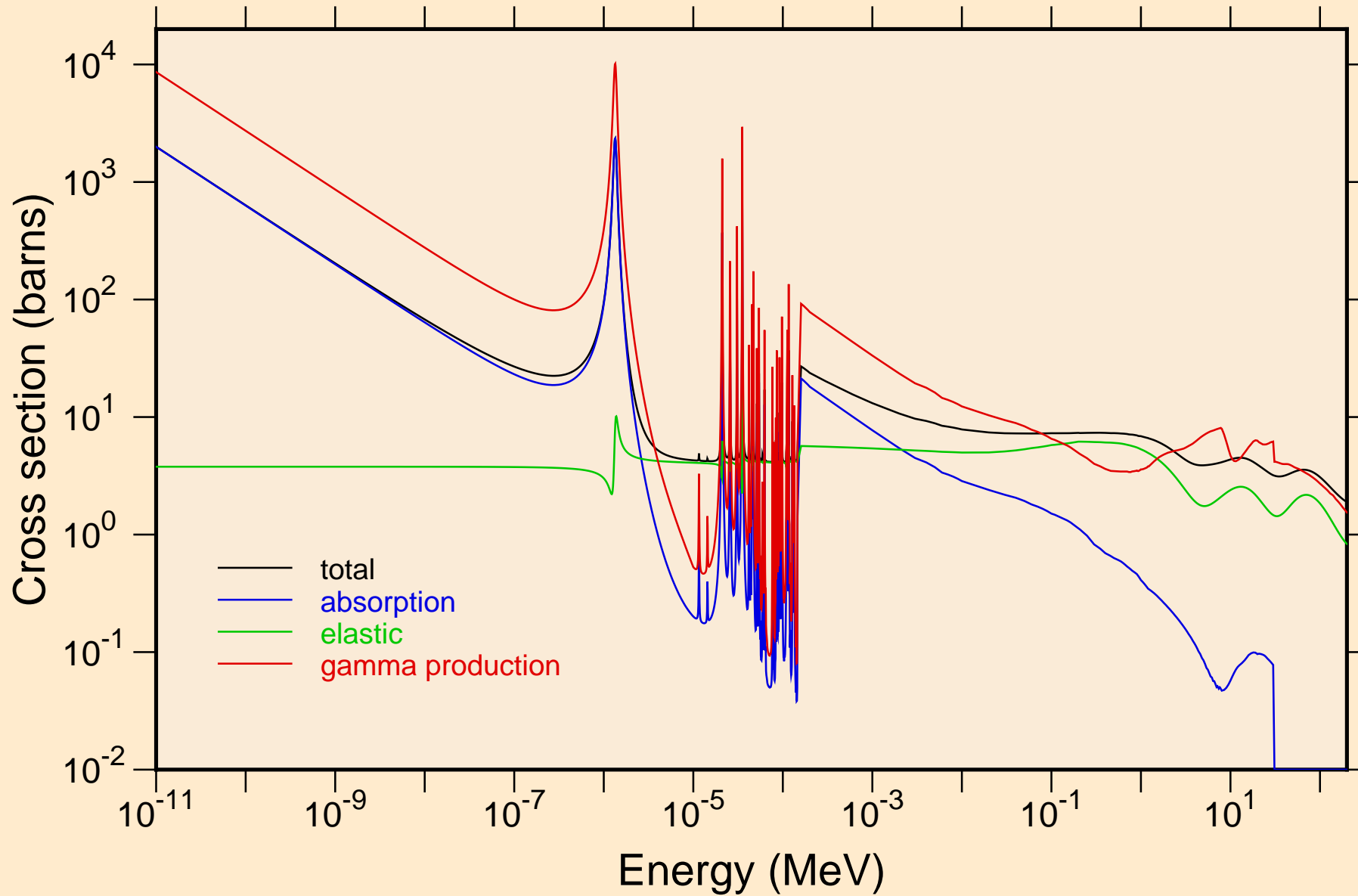

IN112 NEUTRON ACER TENDL-2024 LIBRARY; T=0.K
resonance total cross section

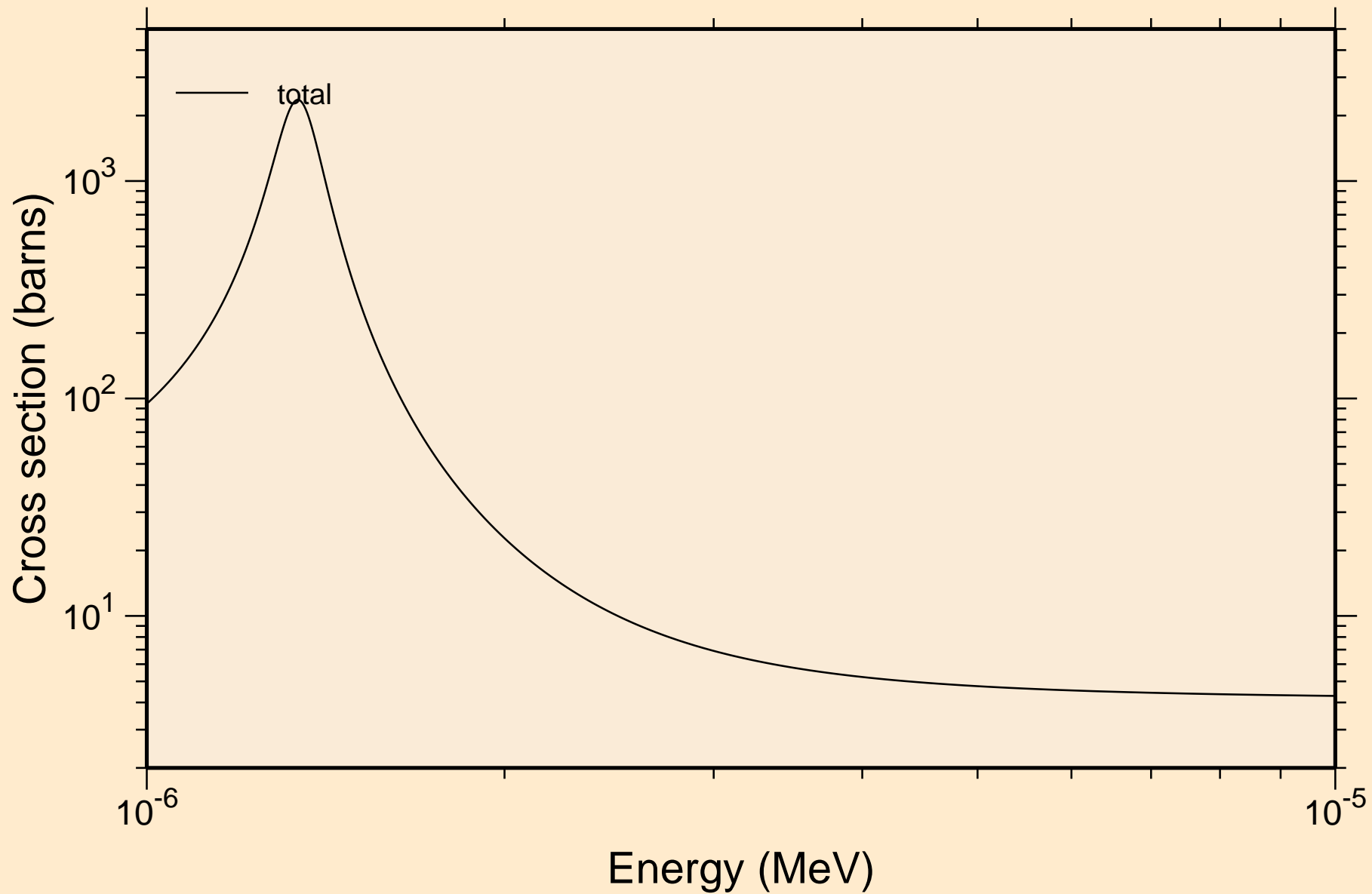

IN112 NEUTRON ACER TENDL-2024 LIBRARY; T=0.K
resonance total cross section

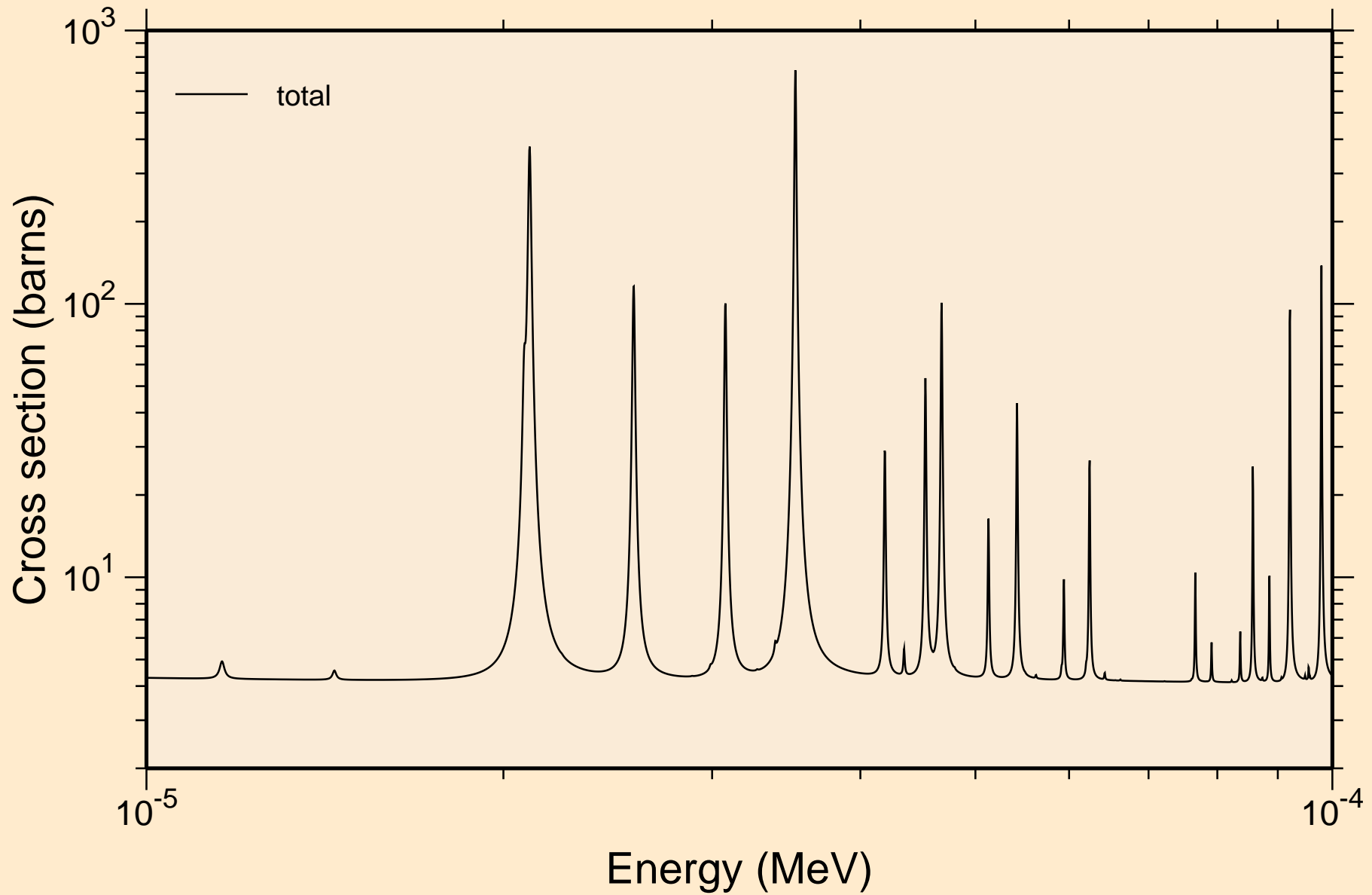

IN112 NEUTRON ACER TENDL-2024 LIBRARY; T=0.K
resonance total cross section

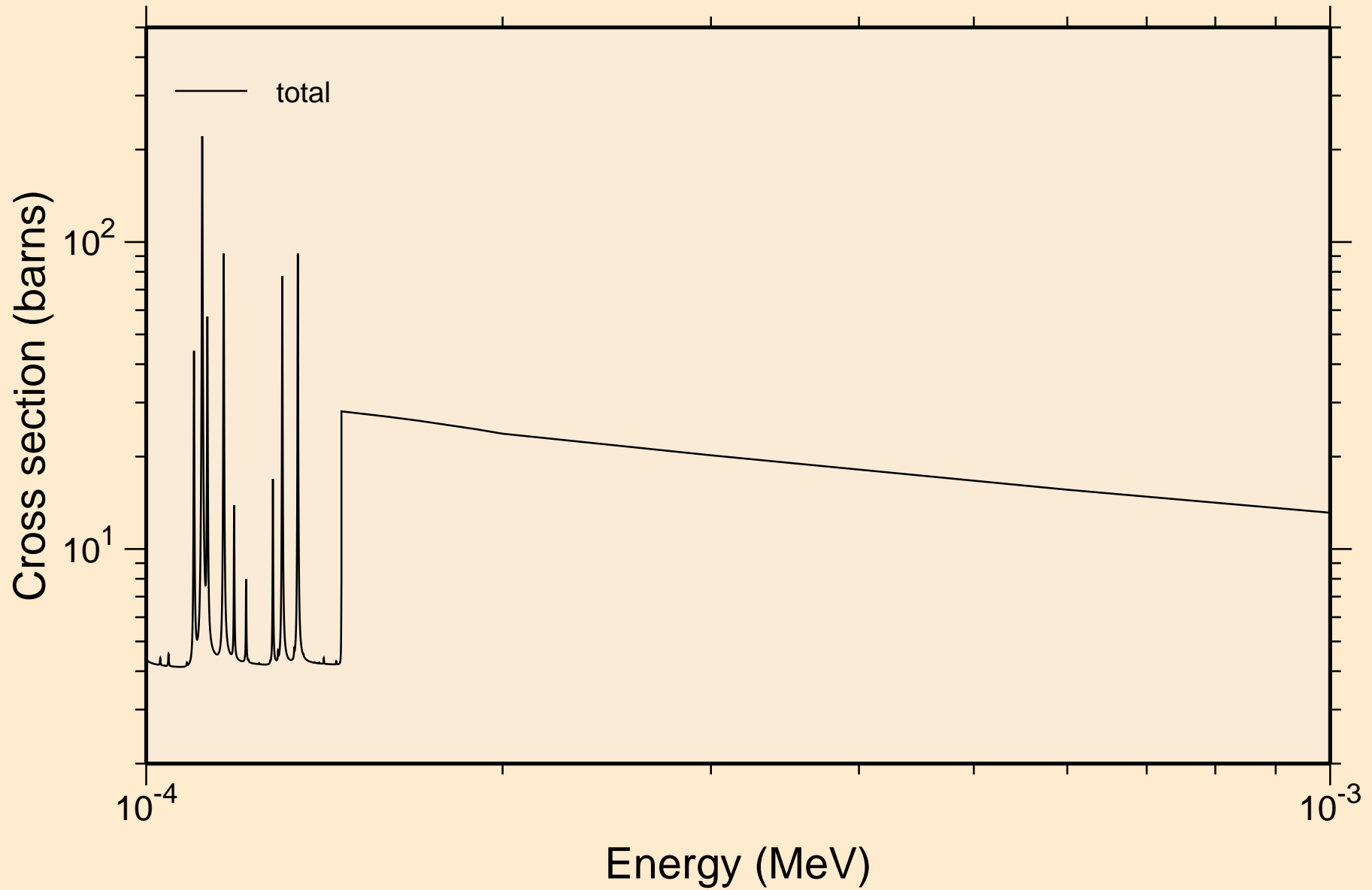

IN112 NEUTRON ACER TENDL-2024 LIBRARY; T=0.K
resonance total cross section

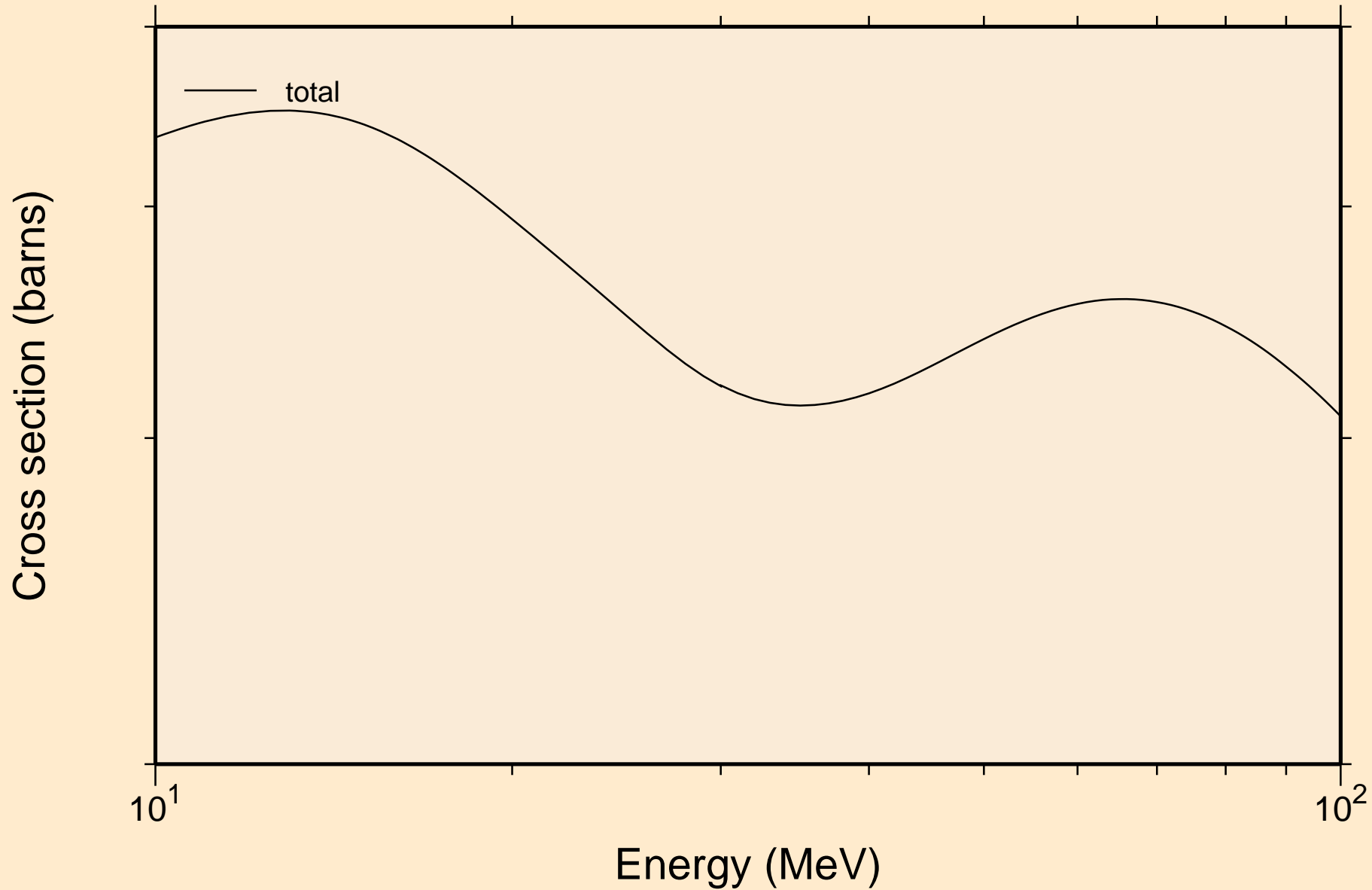

IN112 NEUTRON ACER TENDL-2024 LIBRARY; T=0.K
resonance absorption cross sections

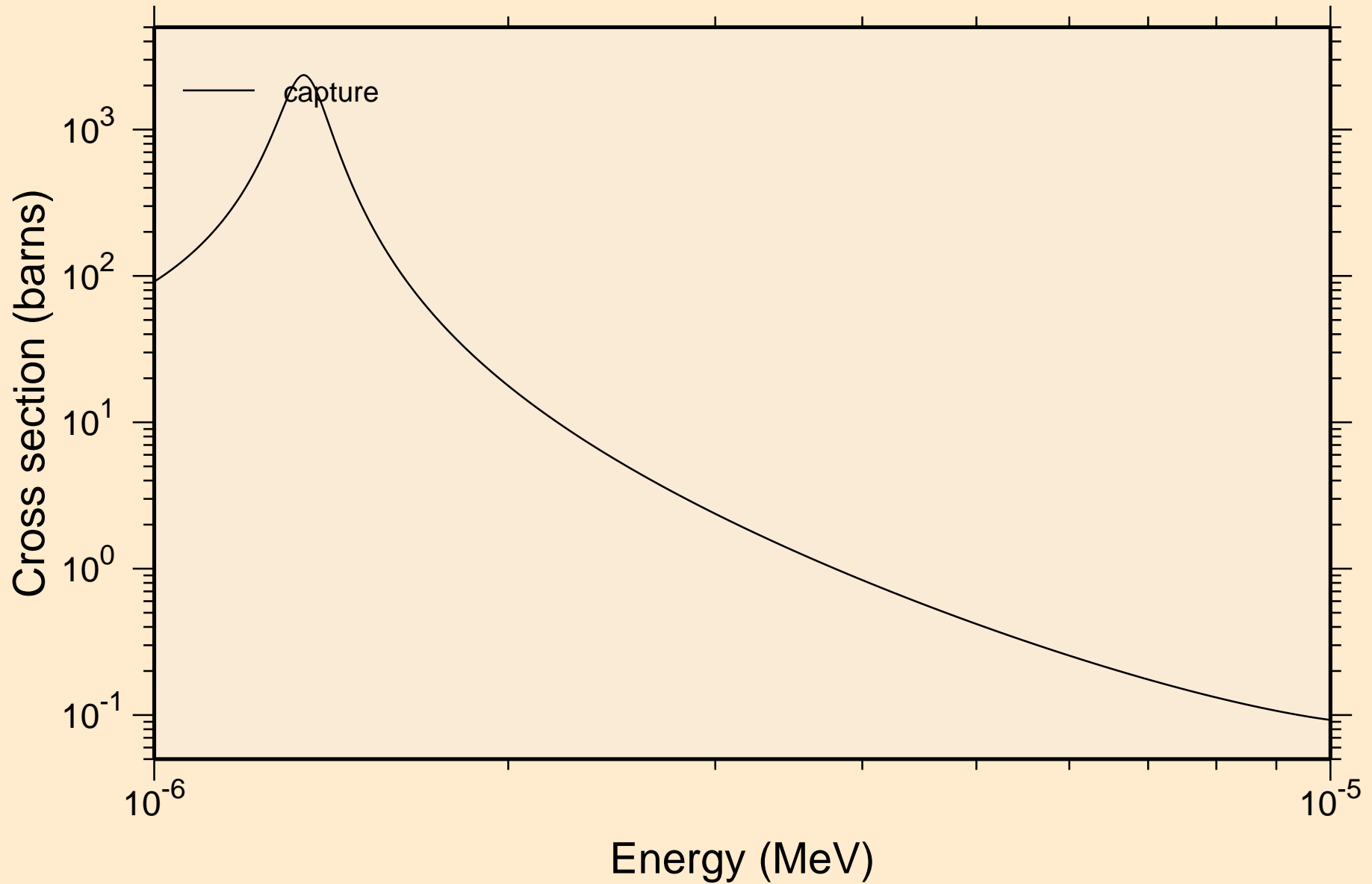

IN112 NEUTRON ACER TENDL-2024 LIBRARY; T=0.K
resonance absorption cross sections

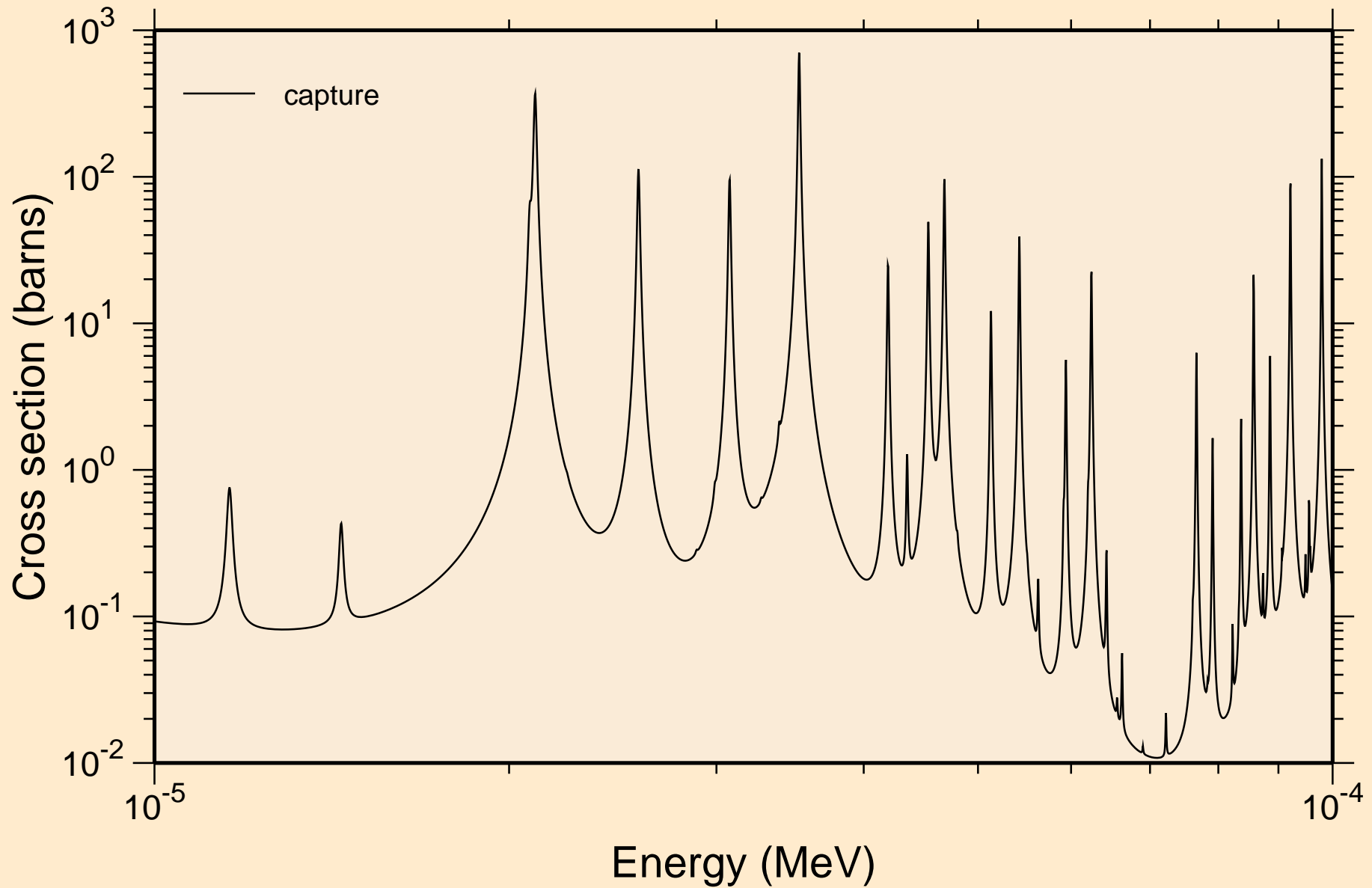

IN112 NEUTRON ACER TENDL-2024 LIBRARY; T=0.K
resonance absorption cross sections

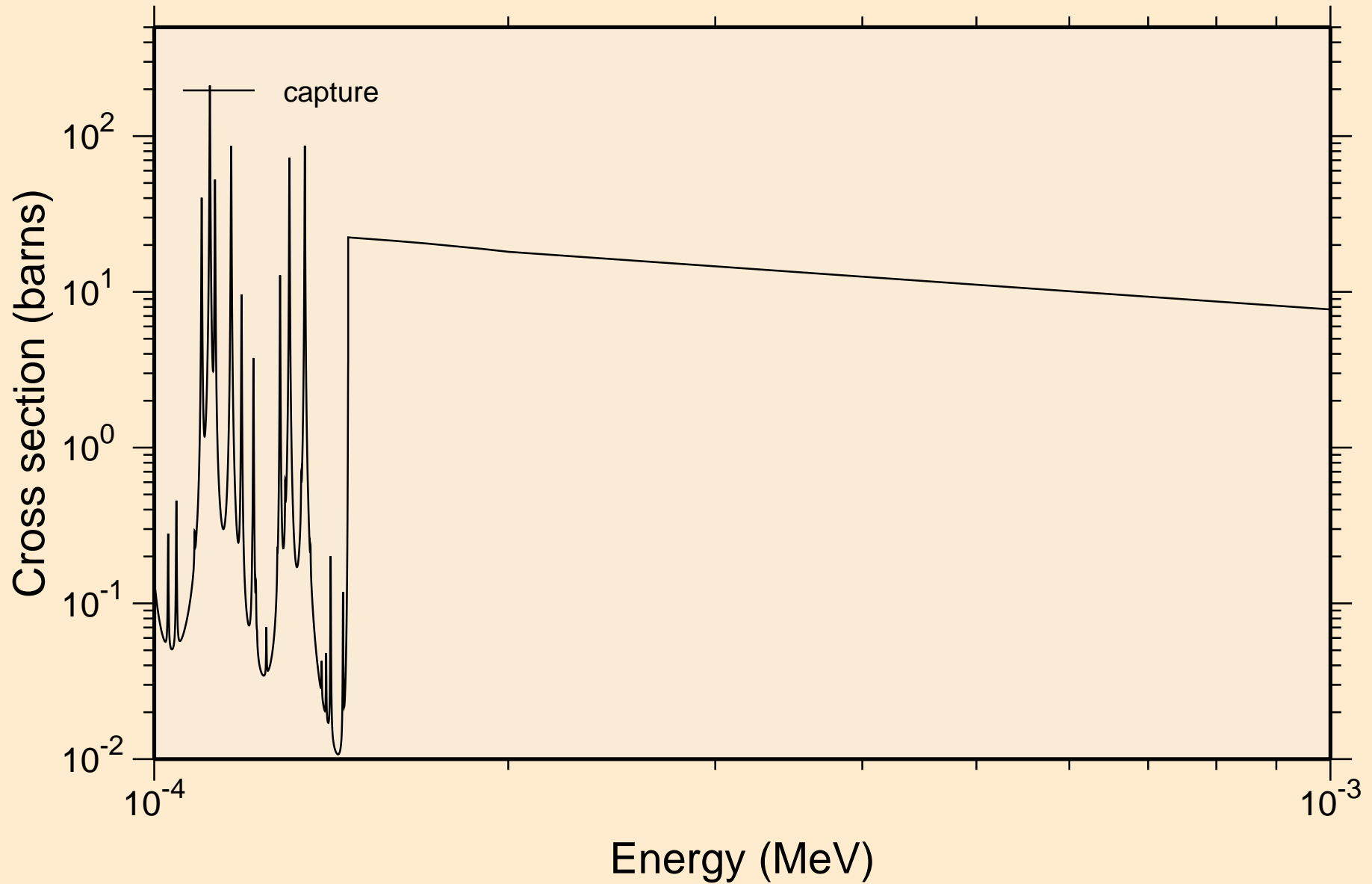

IN112 NEUTRON ACER TENDL-2024 LIBRARY; T=0.K
resonance absorption cross sections

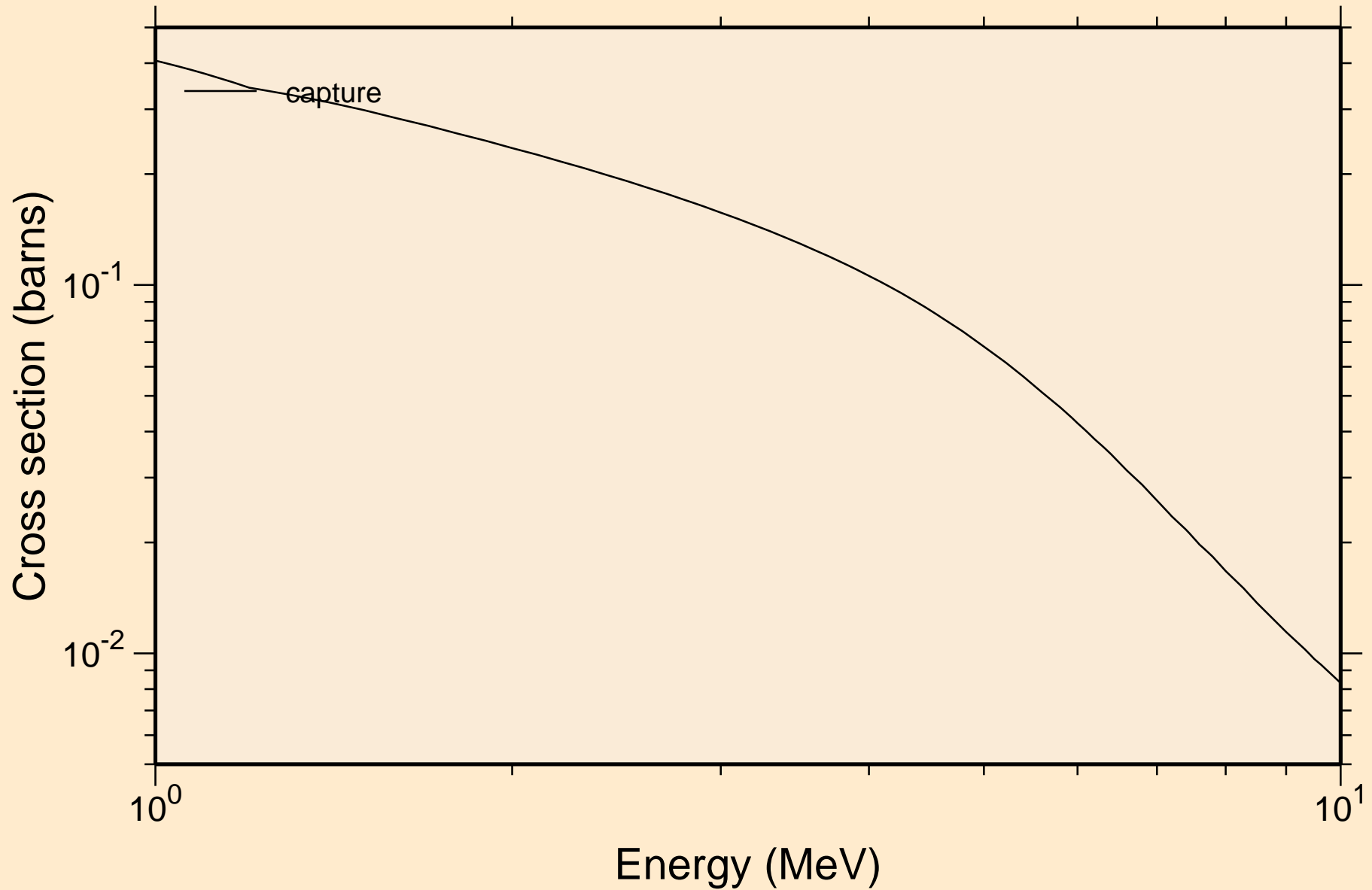

IN112 NEUTRON ACER TENDL-2024 LIBRARY; T=0.K

Heating

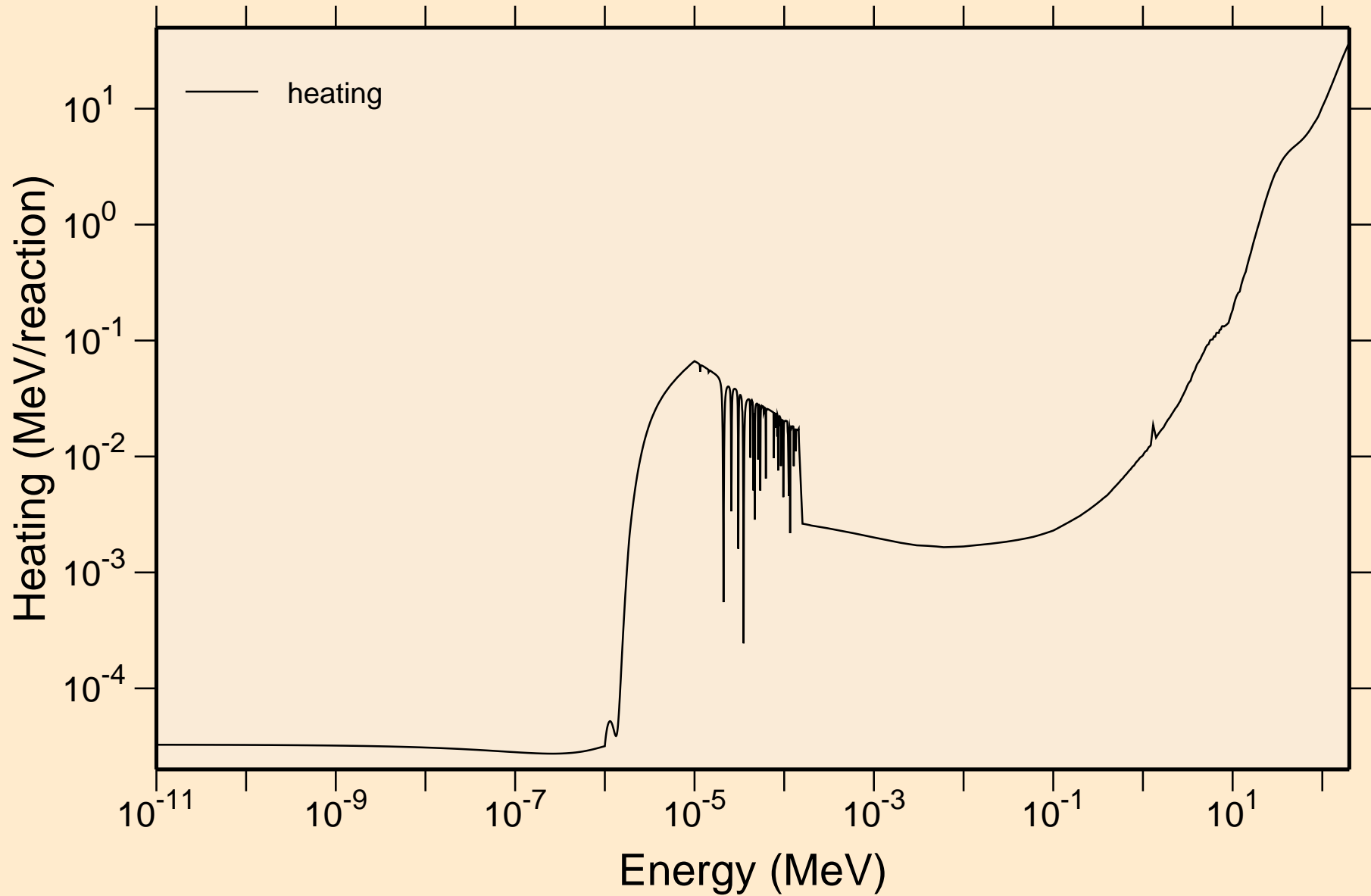

IN112 NEUTRON ACER TENDL-2024 LIBRARY; T=0.K

Damage

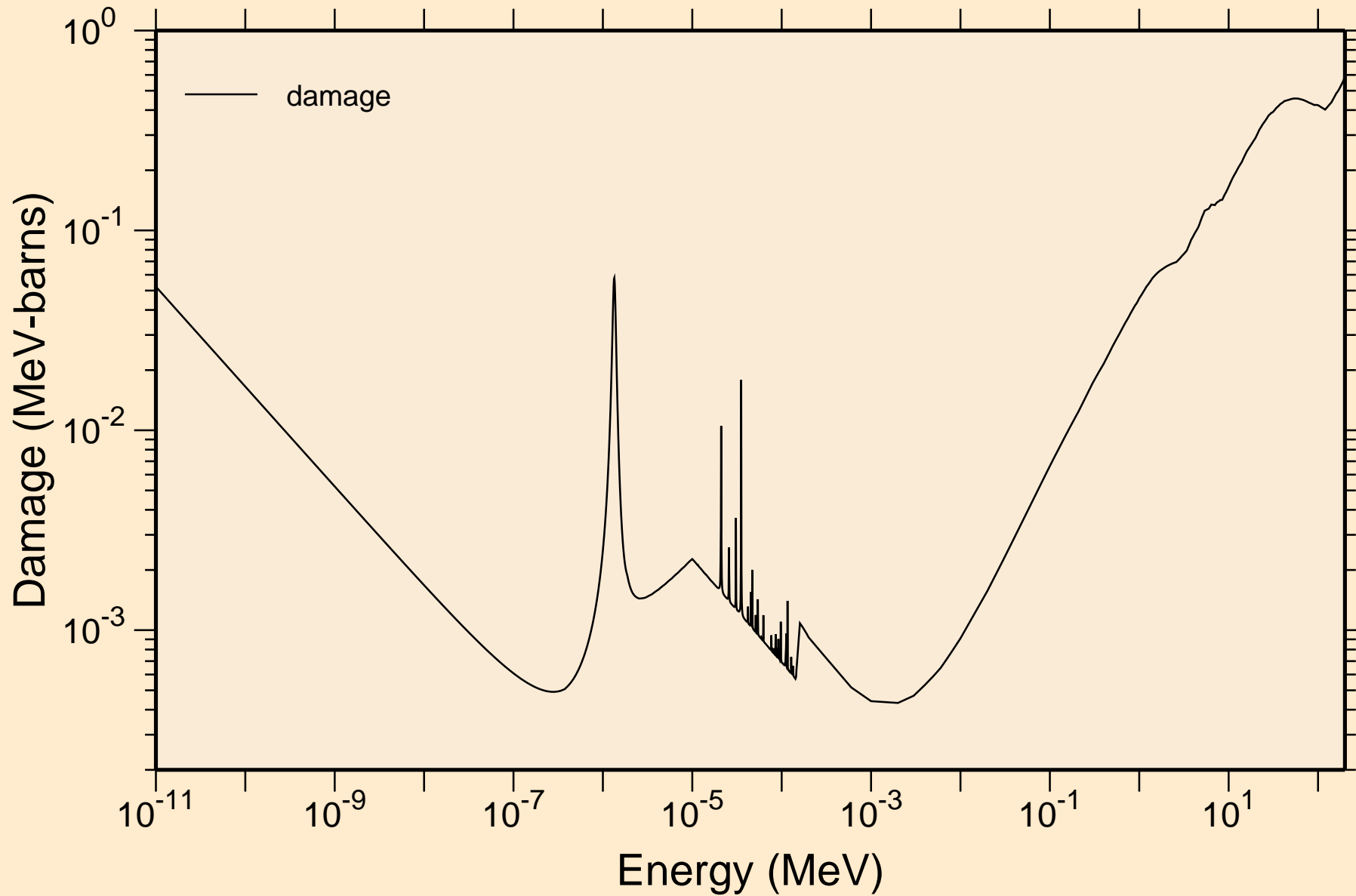

IN112 NEUTRON ACER TENDL-2024 LIBRARY; T=0.K

Non-threshold reactions

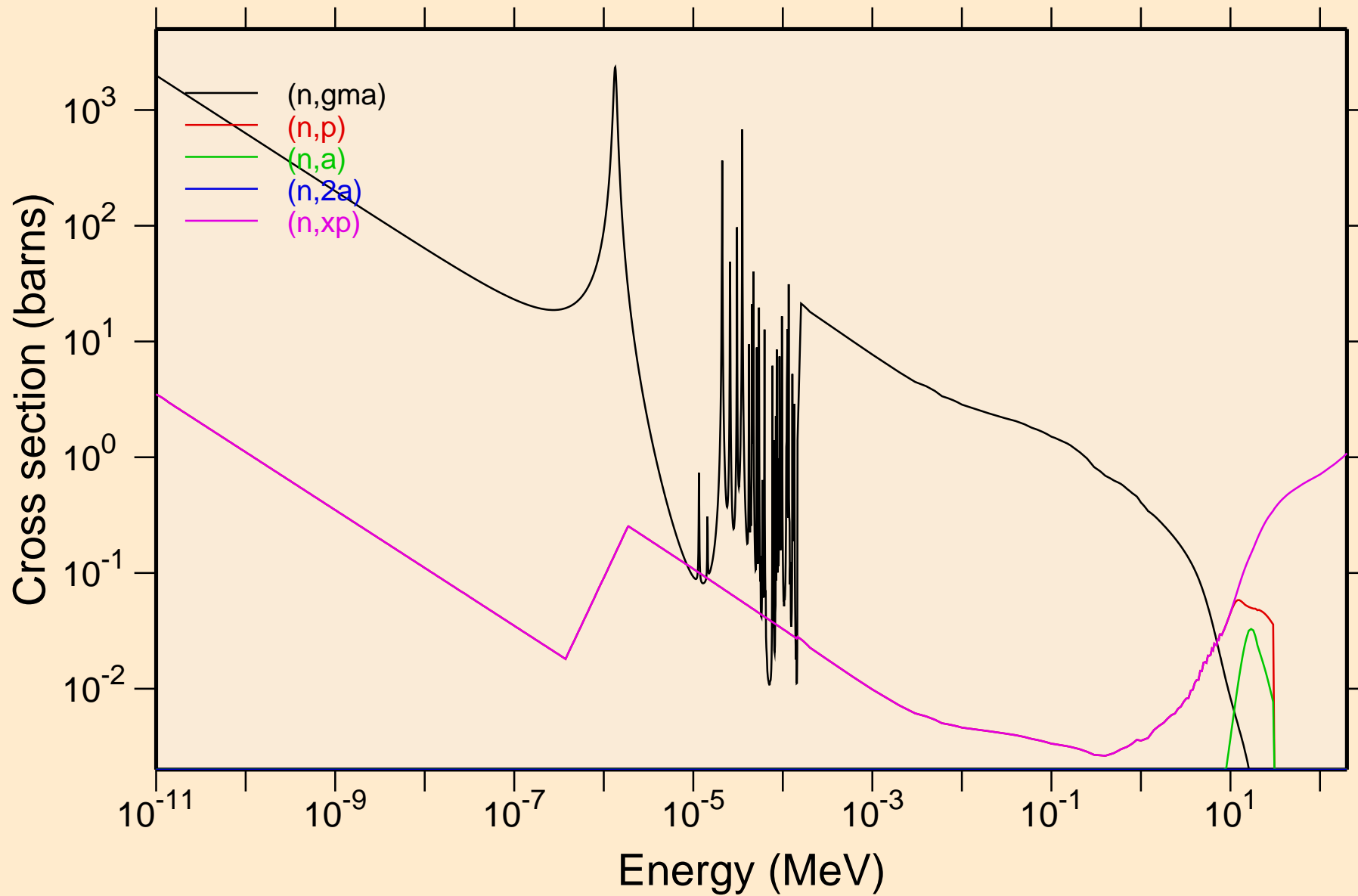

IN112 NEUTRON ACER TENDL-2024 LIBRARY; T=0.K
Non-threshold reactions

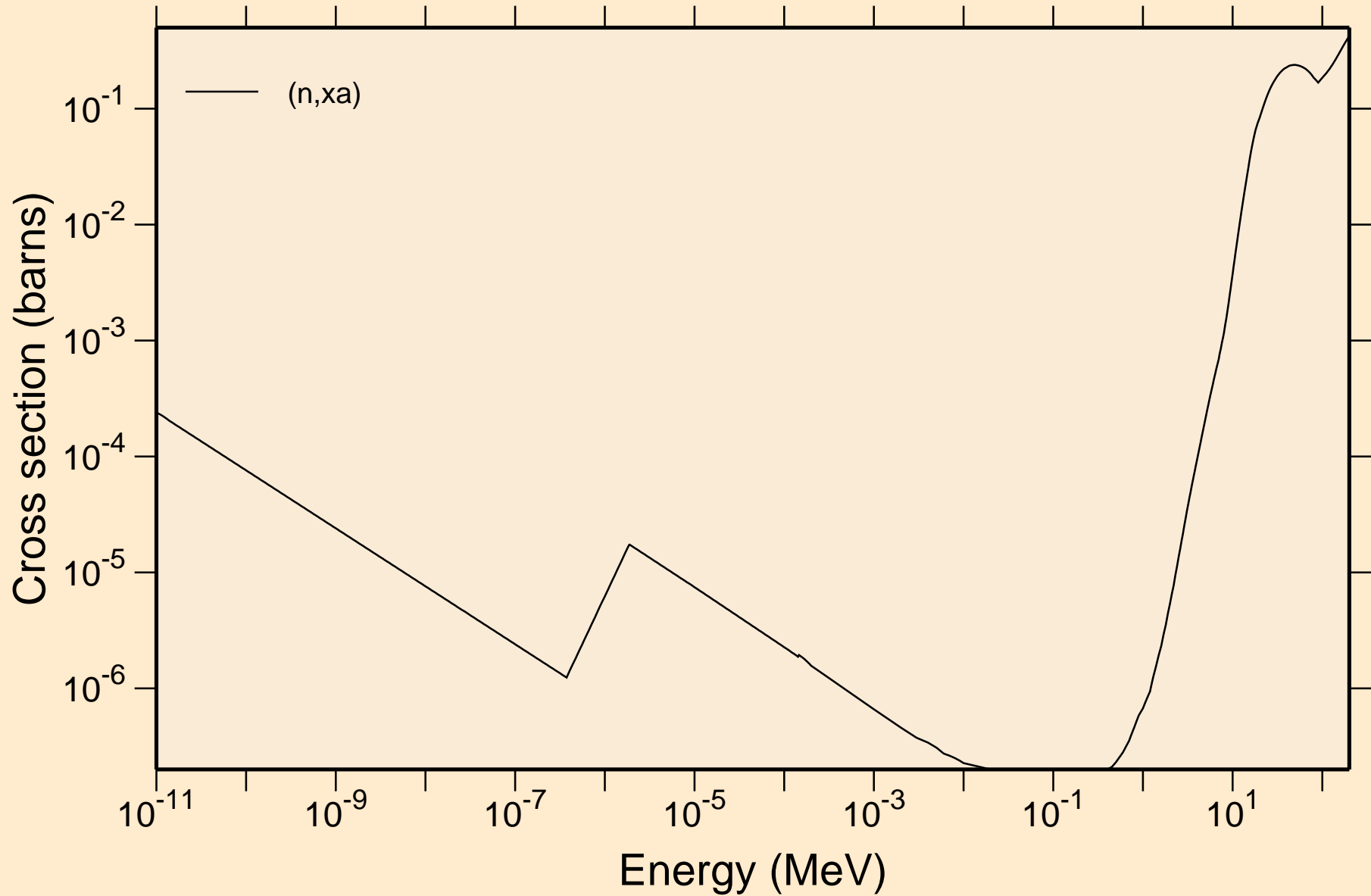

IN112 NEUTRON ACER TENDL-2024 LIBRARY; T=0.K

Principal cross sections

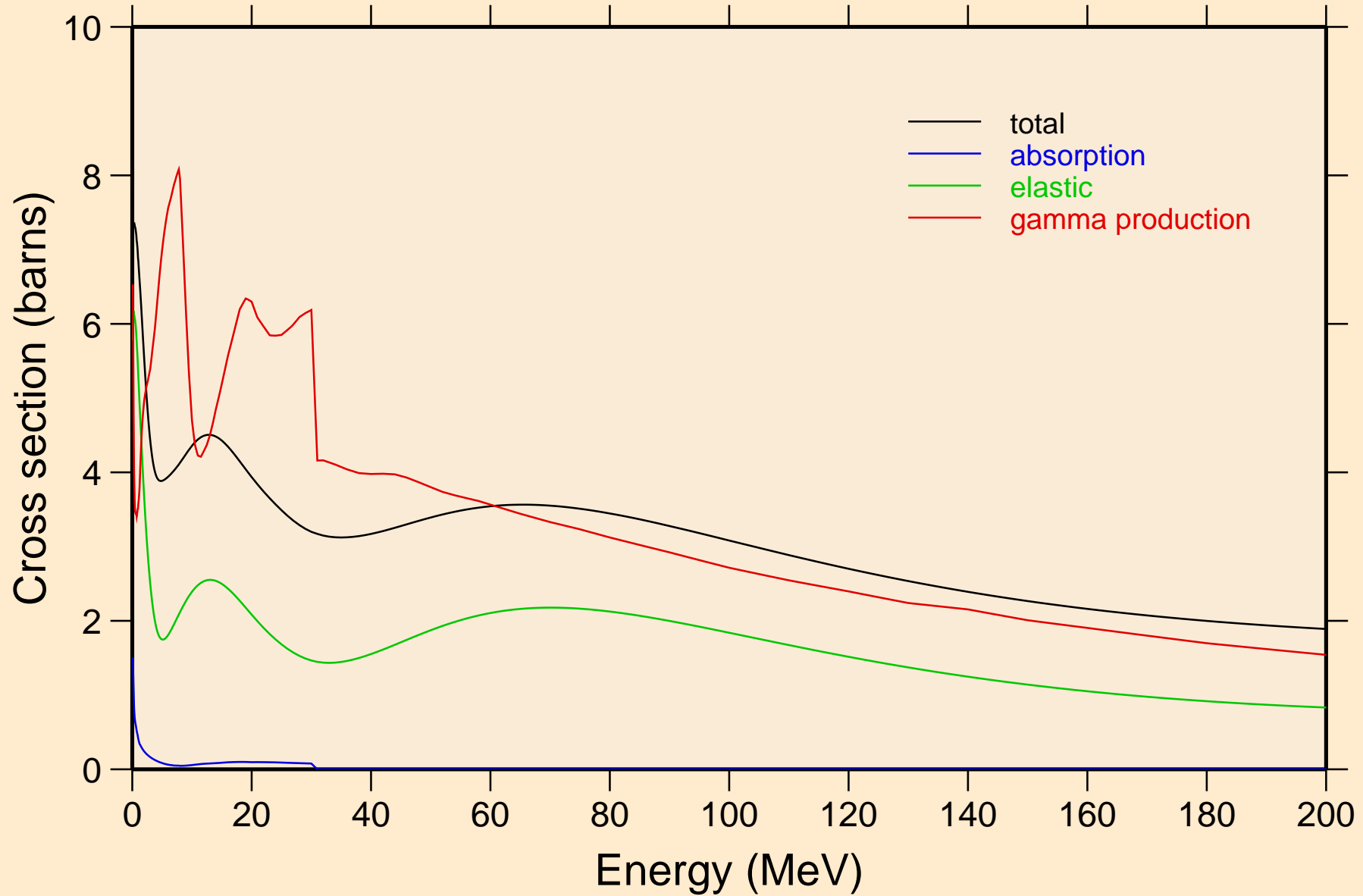

IN112 NEUTRON ACER TENDL-2024 LIBRARY; T=0.K

Heating

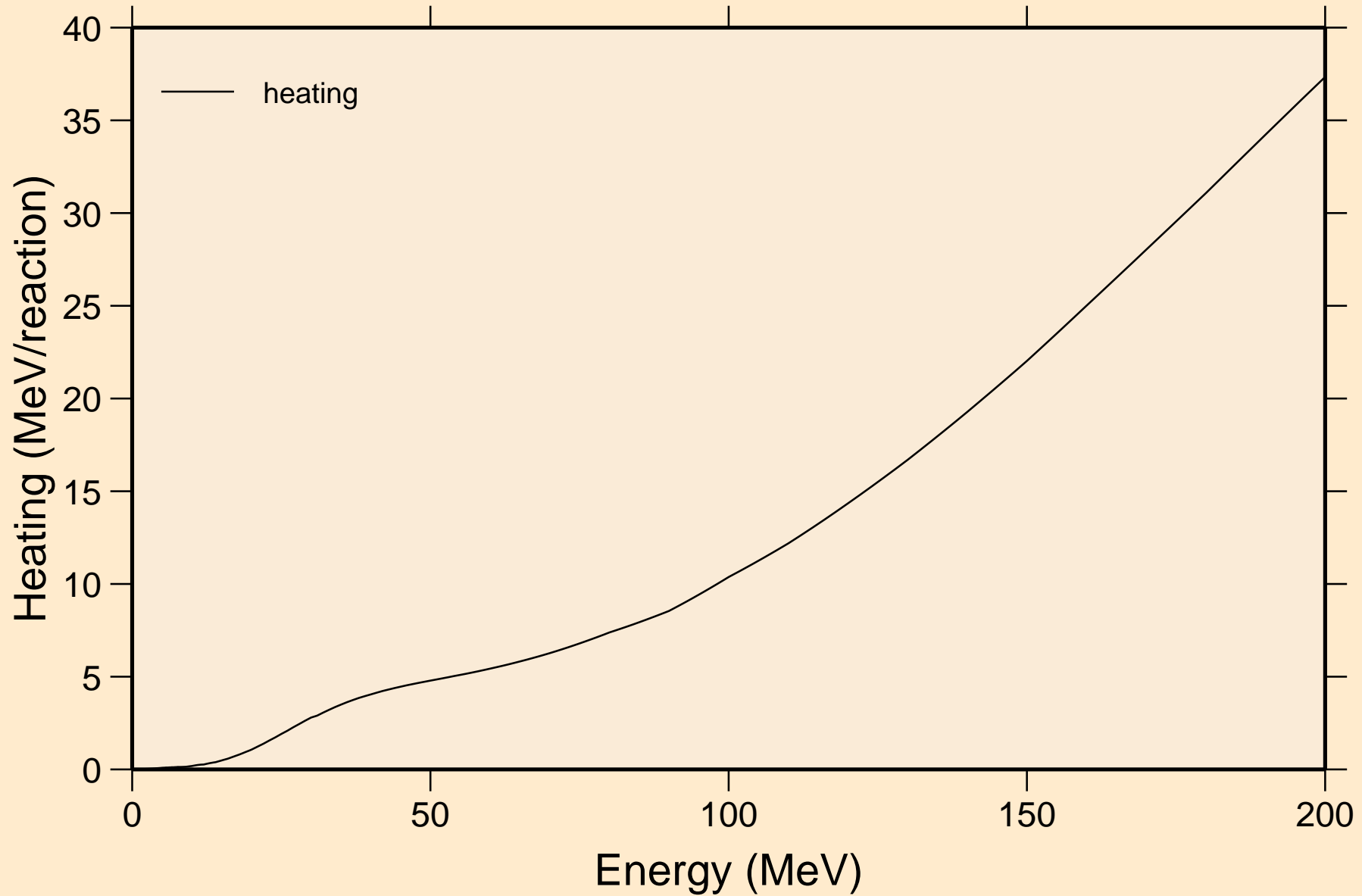

IN112 NEUTRON ACER TENDL-2024 LIBRARY; T=0.K

Damage

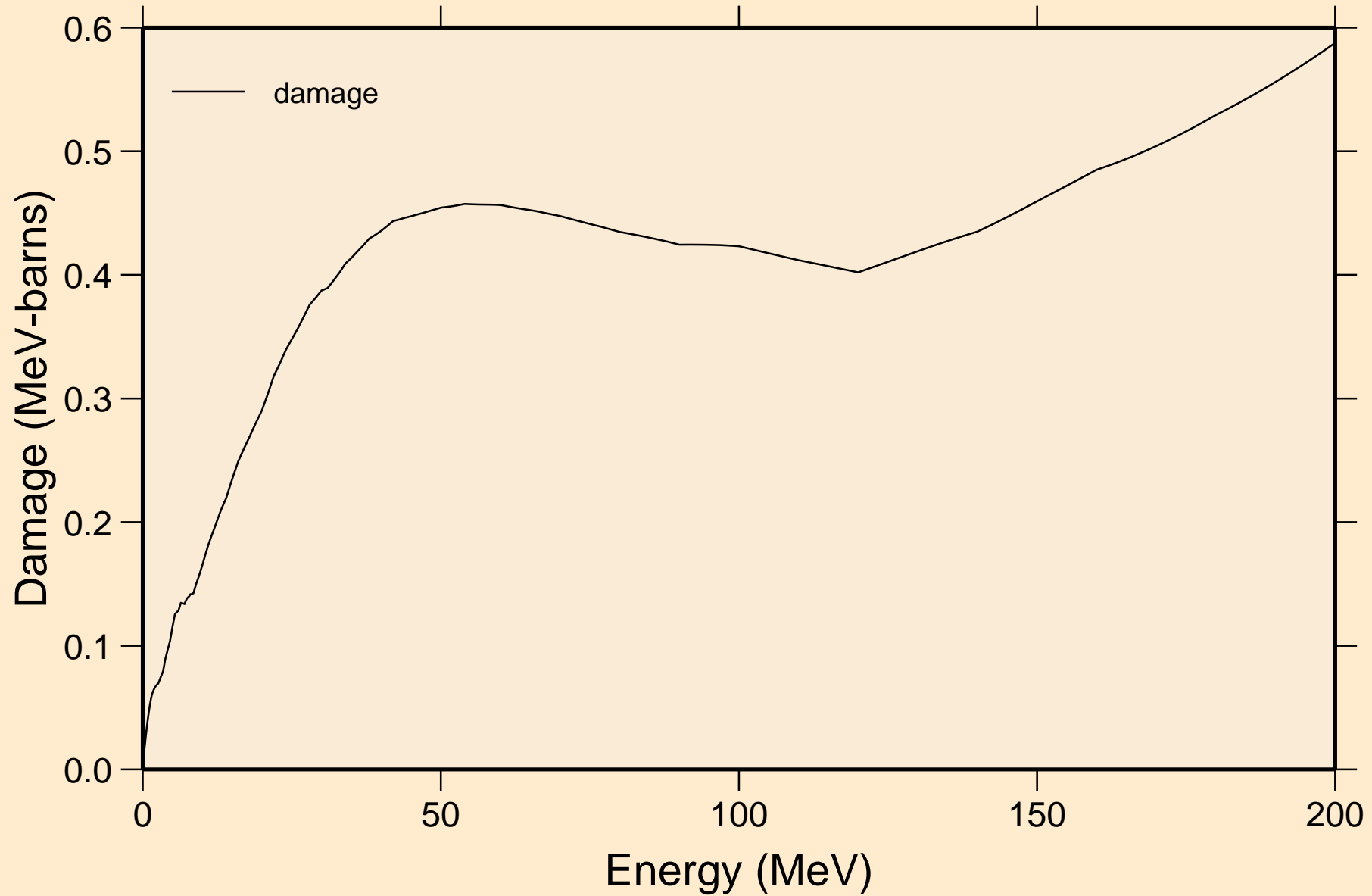

IN112 NEUTRON ACER TENDL-2024 LIBRARY; T=0.K

Non-threshold reactions

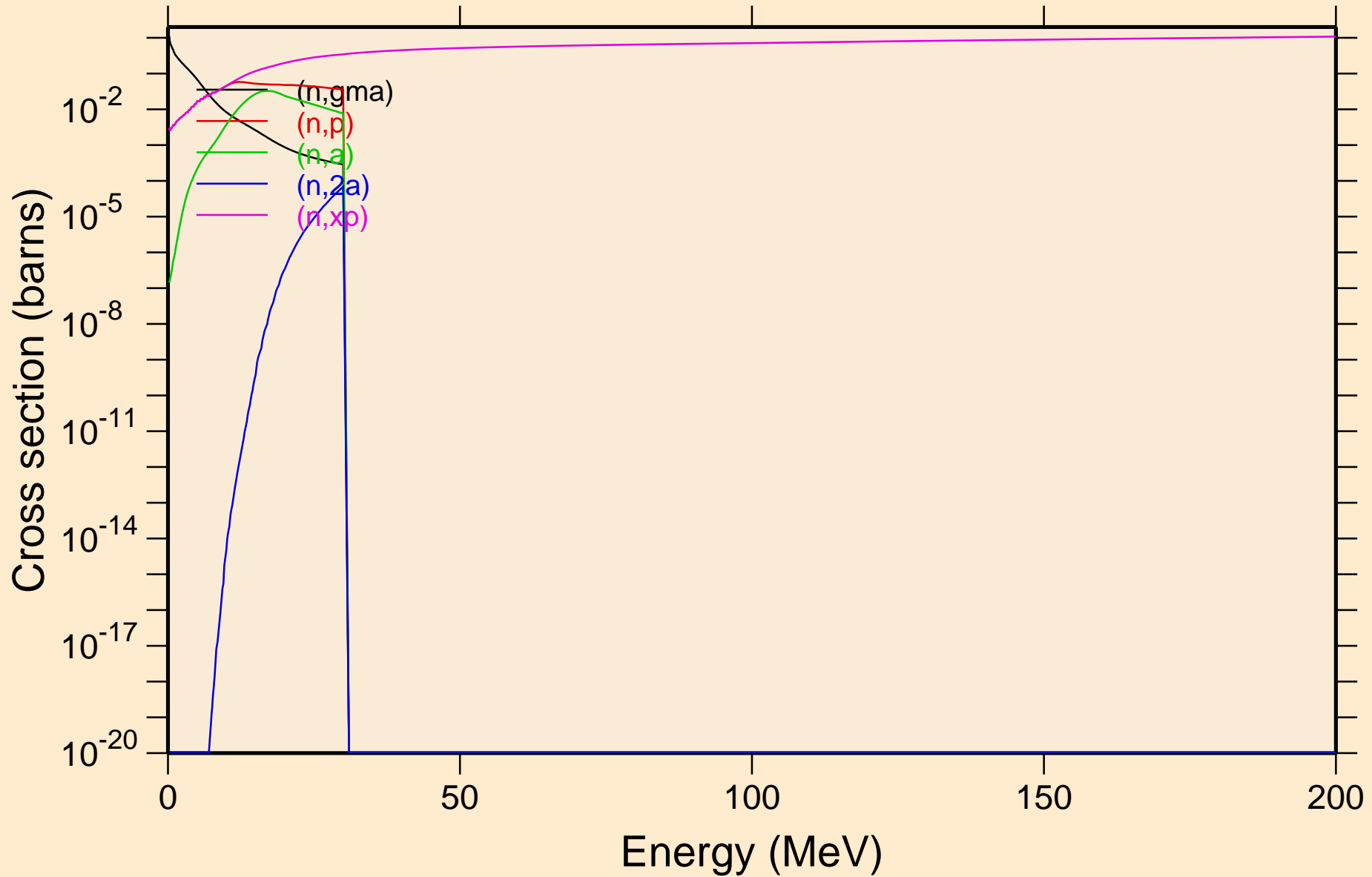

IN112 NEUTRON ACER TENDL-2024 LIBRARY; T=0.K
Non-threshold reactions

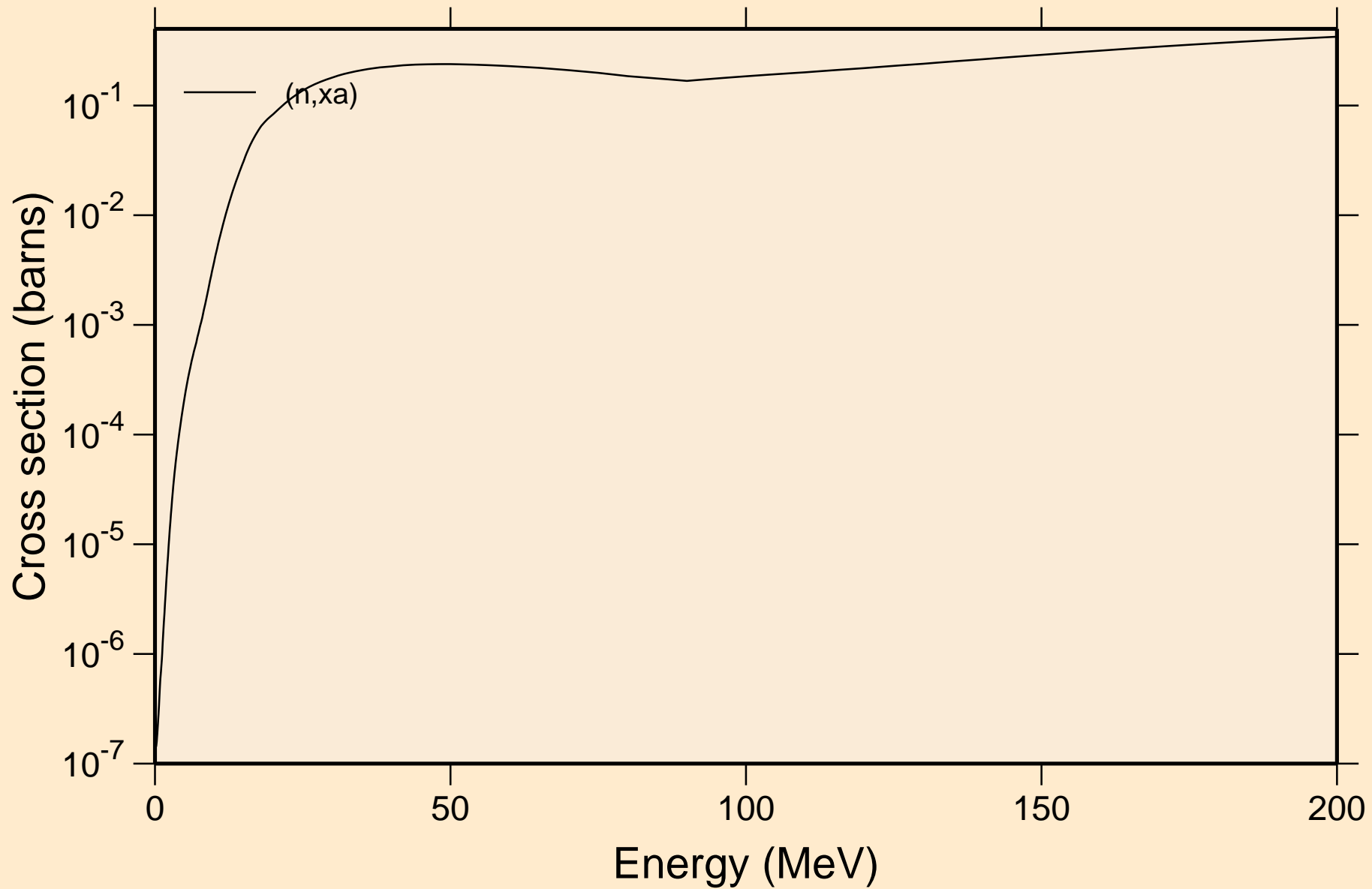

IN112 NEUTRON ACER TENDL-2024 LIBRARY; T=0.K
Inelastic levels

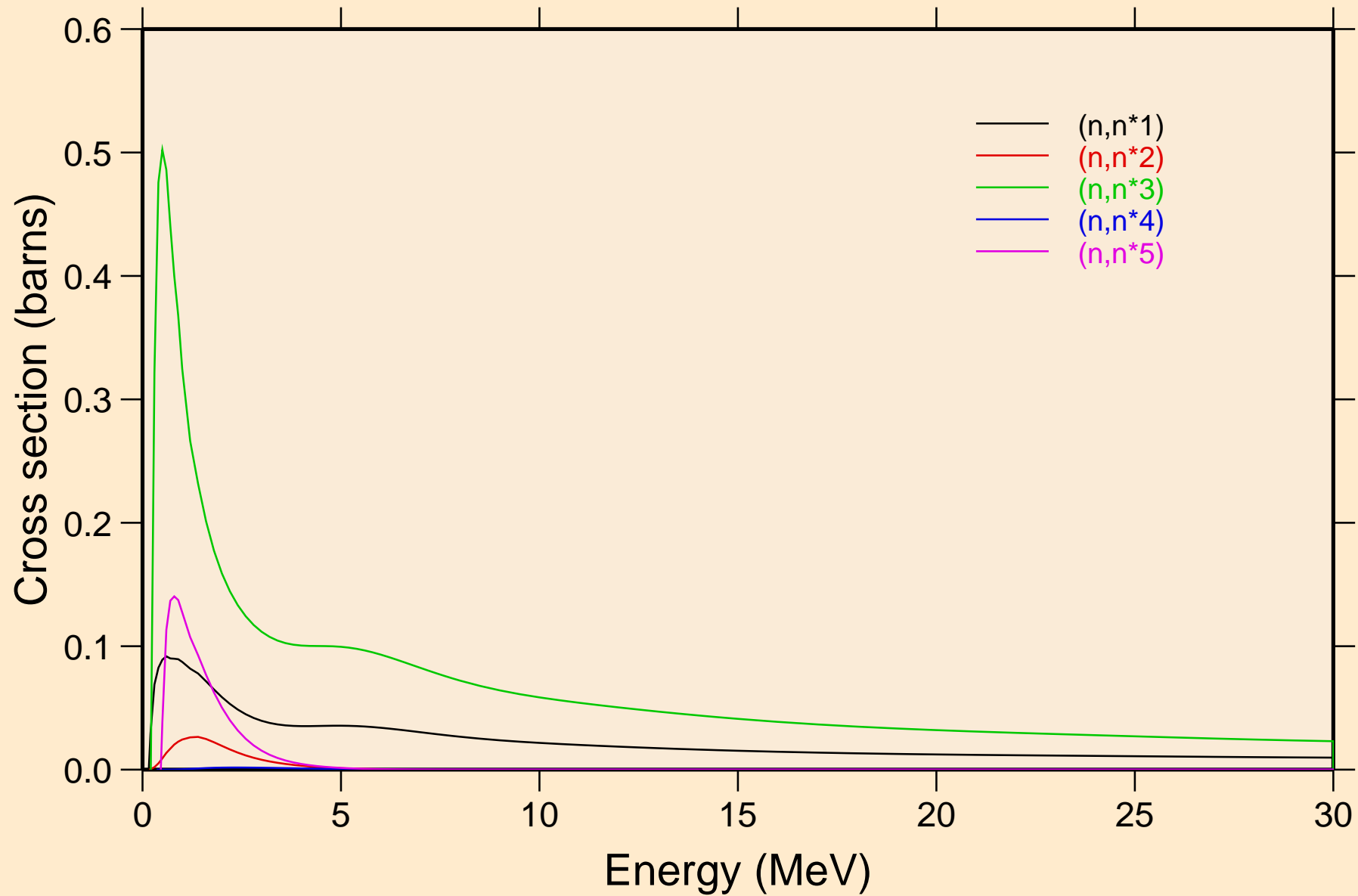

IN112 NEUTRON ACER TENDL-2024 LIBRARY; T=0.K
Inelastic levels

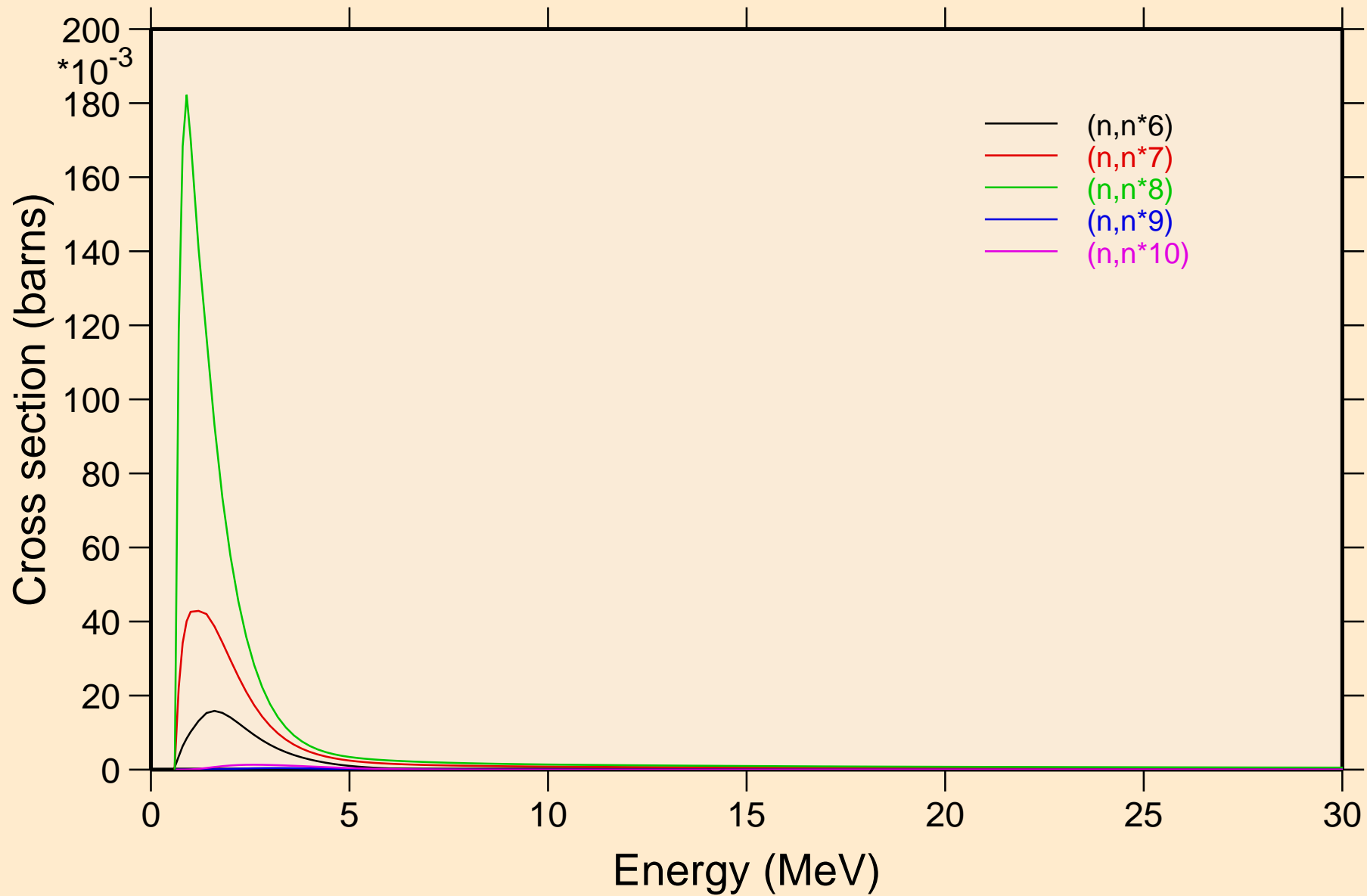

IN112 NEUTRON ACER TENDL-2024 LIBRARY; T=0.K

Inelastic levels

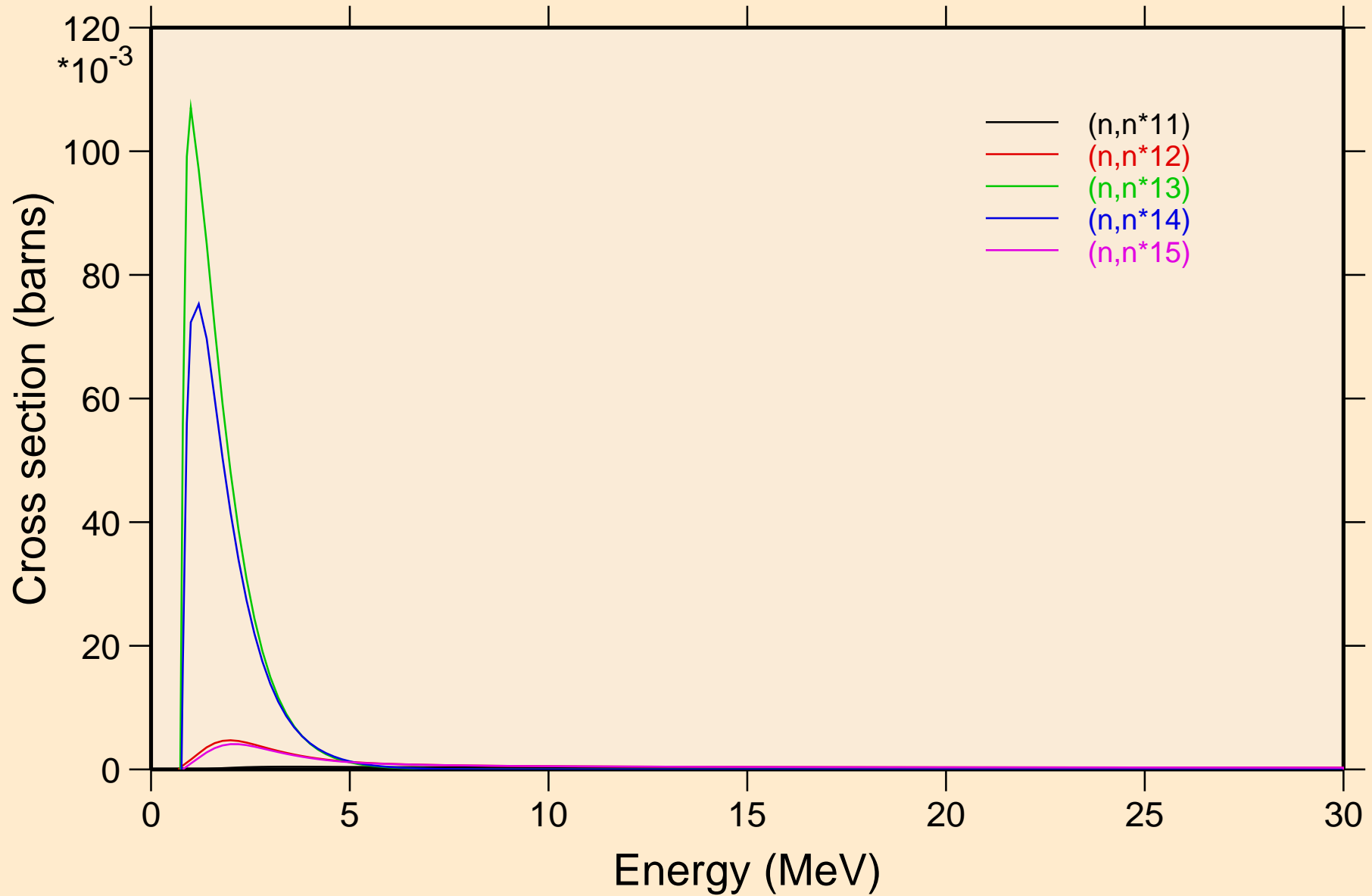

IN112 NEUTRON ACER TENDL-2024 LIBRARY; T=0.K
Inelastic levels

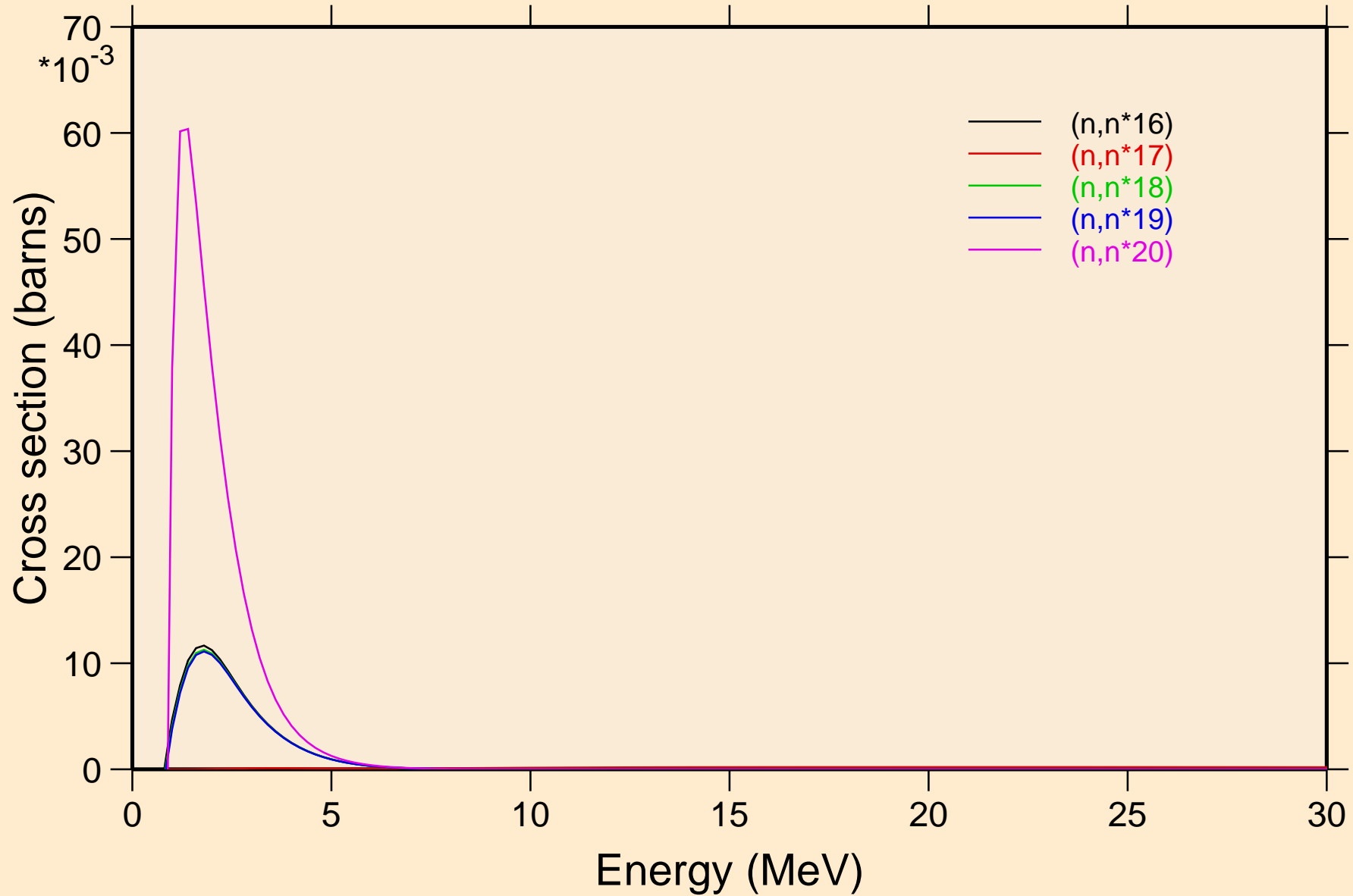

IN112 NEUTRON ACER TENDL-2024 LIBRARY; T=0.K
Inelastic levels

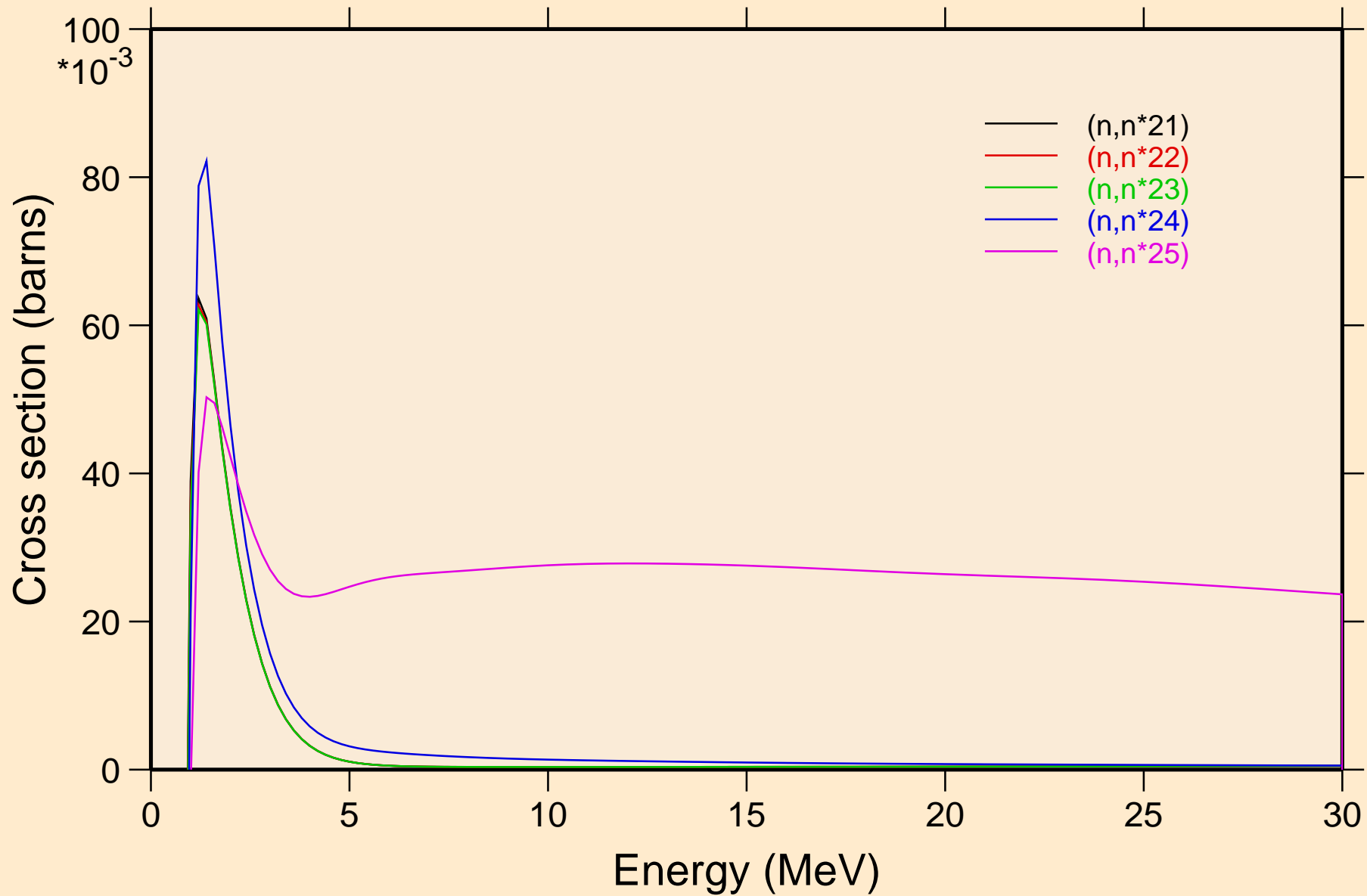

IN112 NEUTRON ACER TENDL-2024 LIBRARY; T=0.K

Inelastic levels

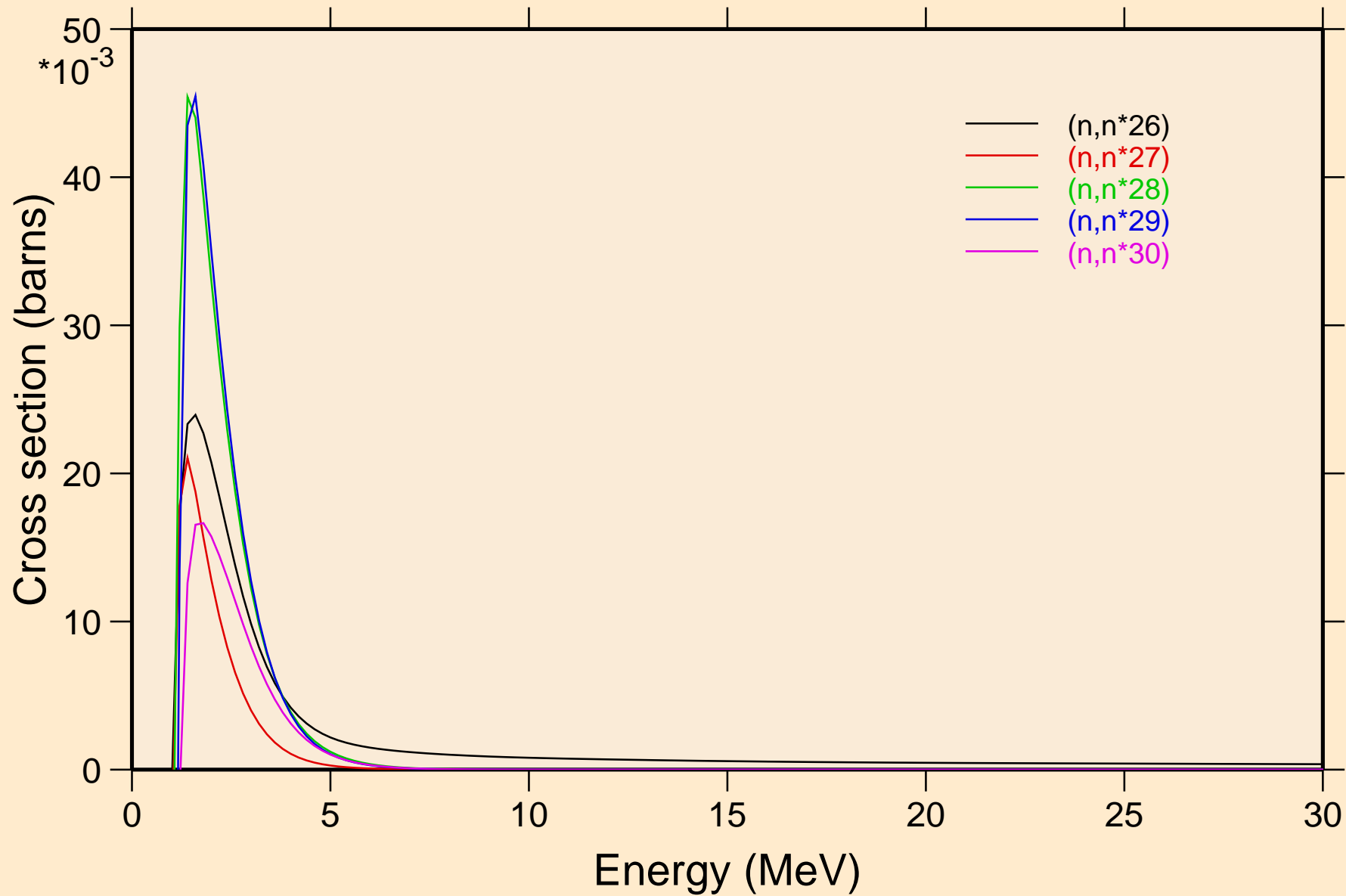

IN112 NEUTRON ACER TENDL-2024 LIBRARY; T=0.K

Threshold reactions

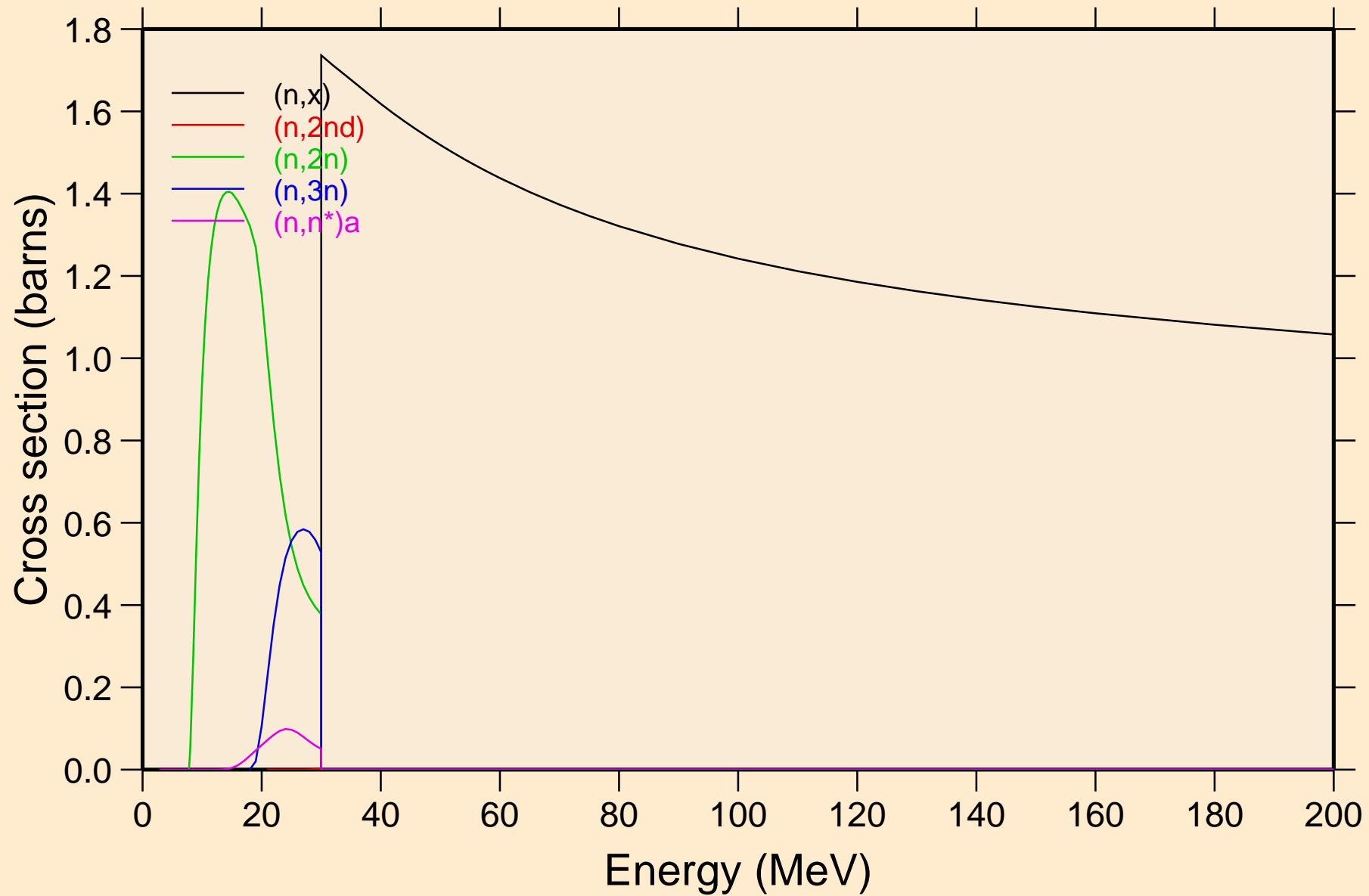

IN112 NEUTRON ACER TENDL-2024 LIBRARY; T=0.K

Threshold reactions

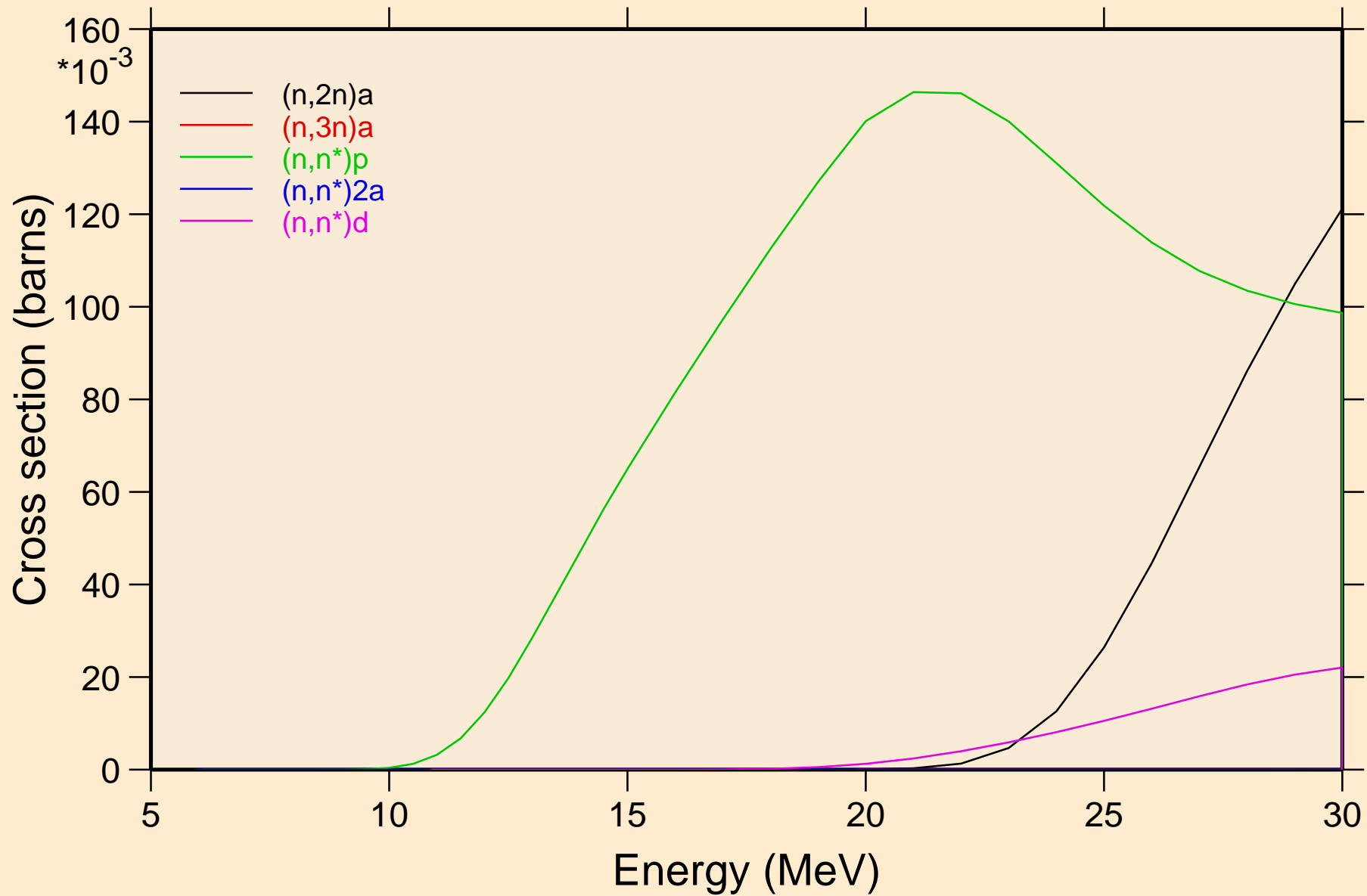

IN112 NEUTRON ACER TENDL-2024 LIBRARY; T=0.K

Threshold reactions

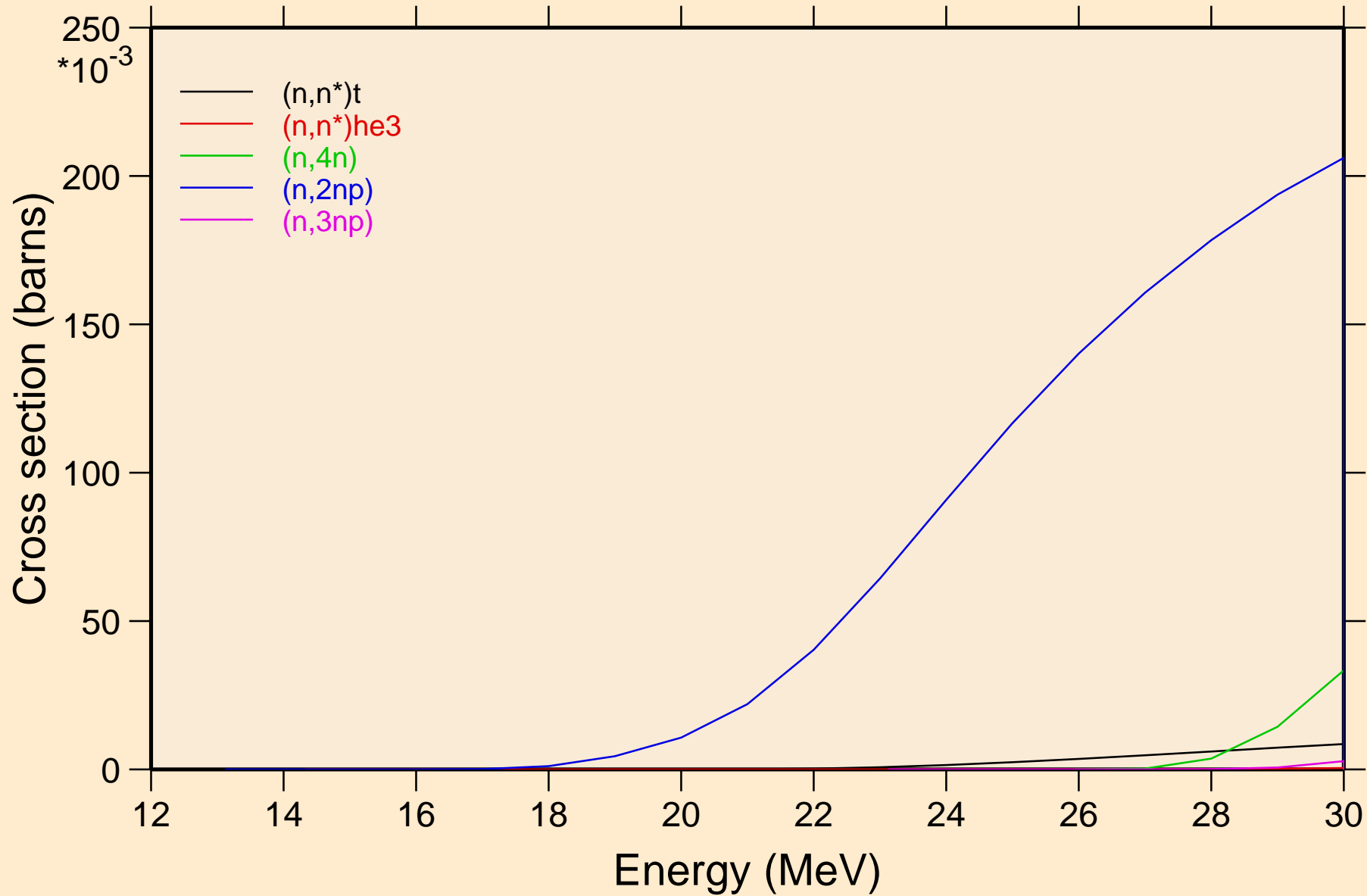

IN112 NEUTRON ACER TENDL-2024 LIBRARY; T=0.K

Threshold reactions

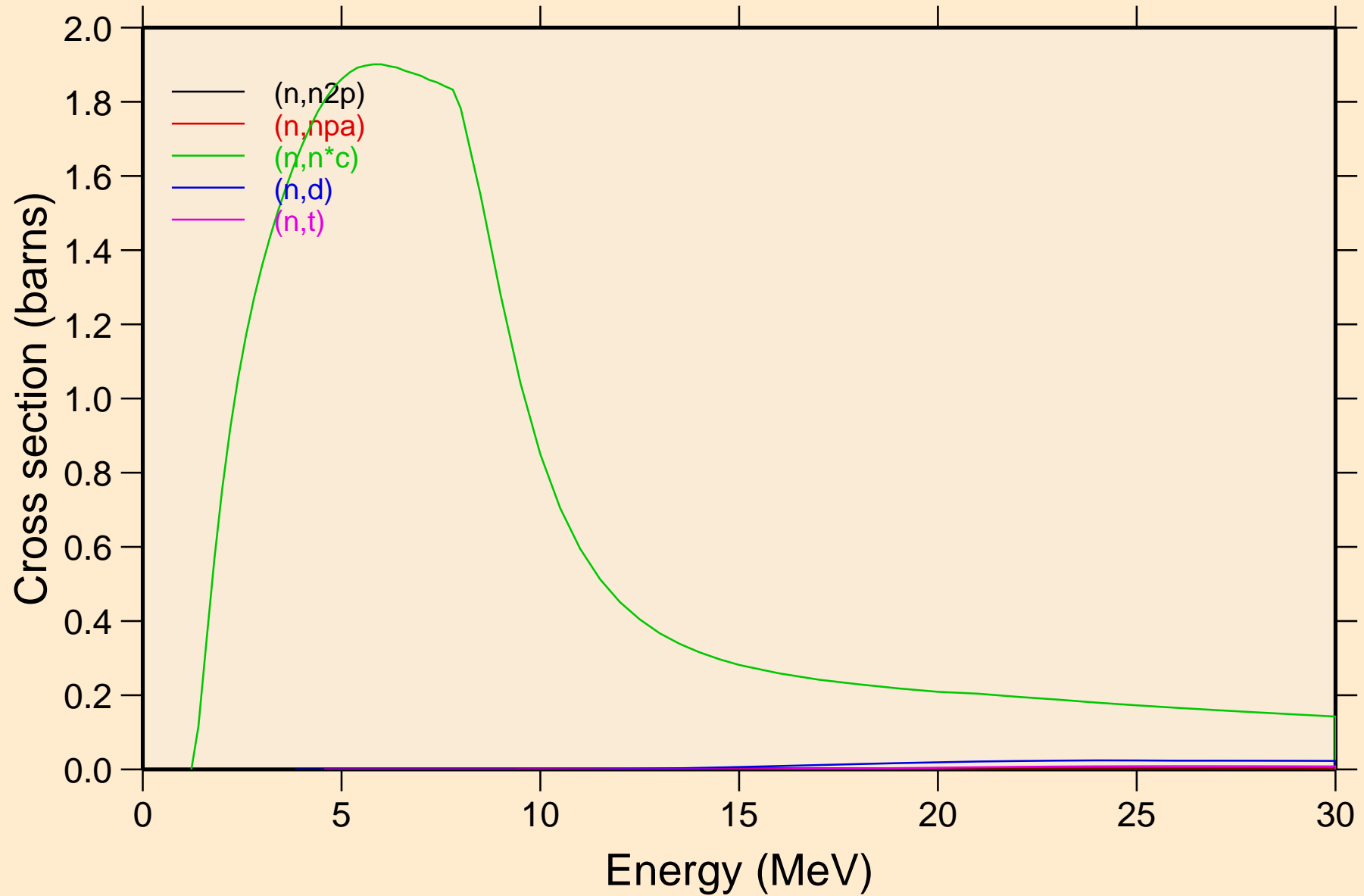

IN112 NEUTRON ACER TENDL-2024 LIBRARY; T=0.K

Threshold reactions

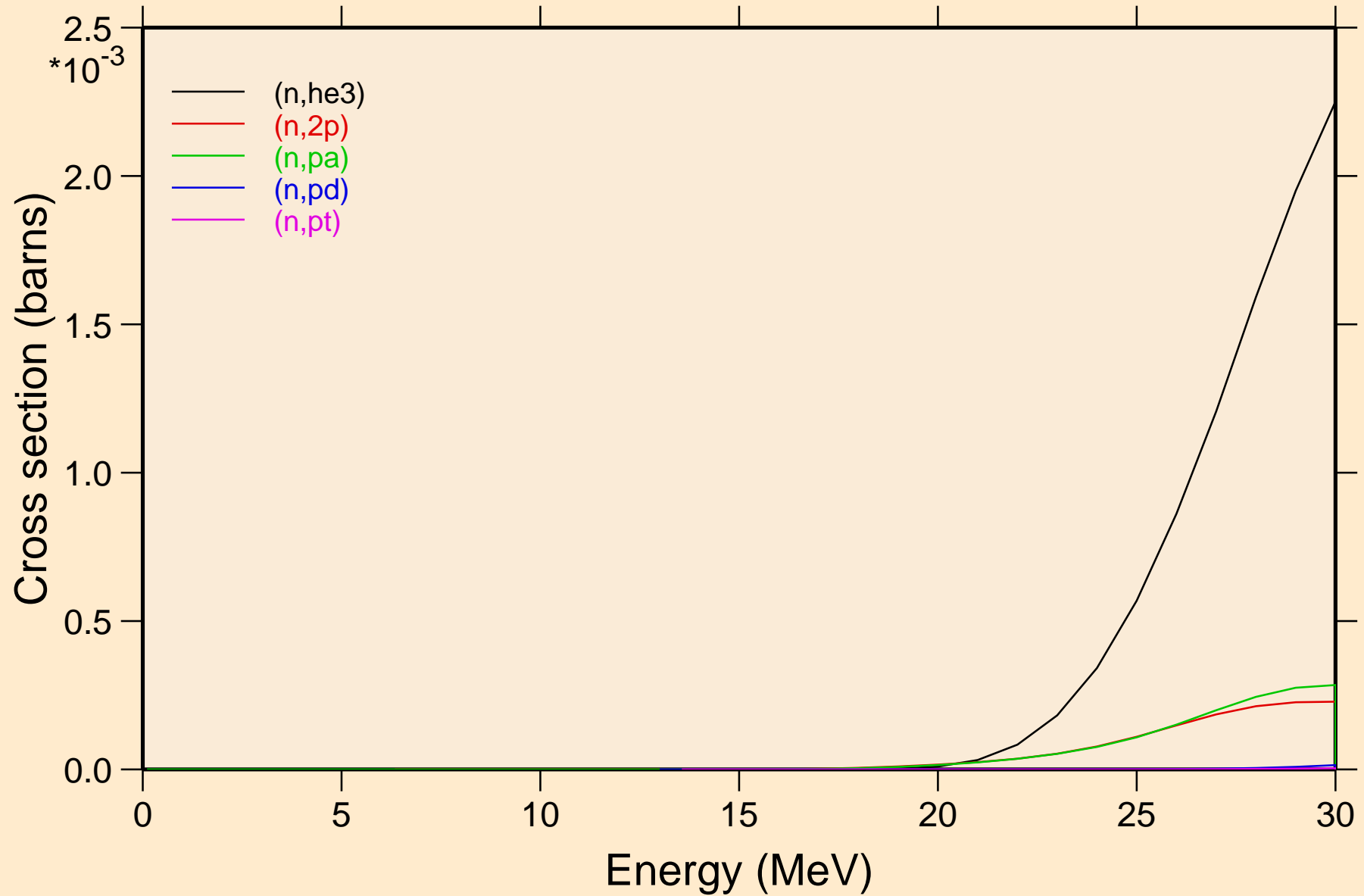

IN112 NEUTRON ACER TENDL-2024 LIBRARY; T=0.K
Threshold reactions

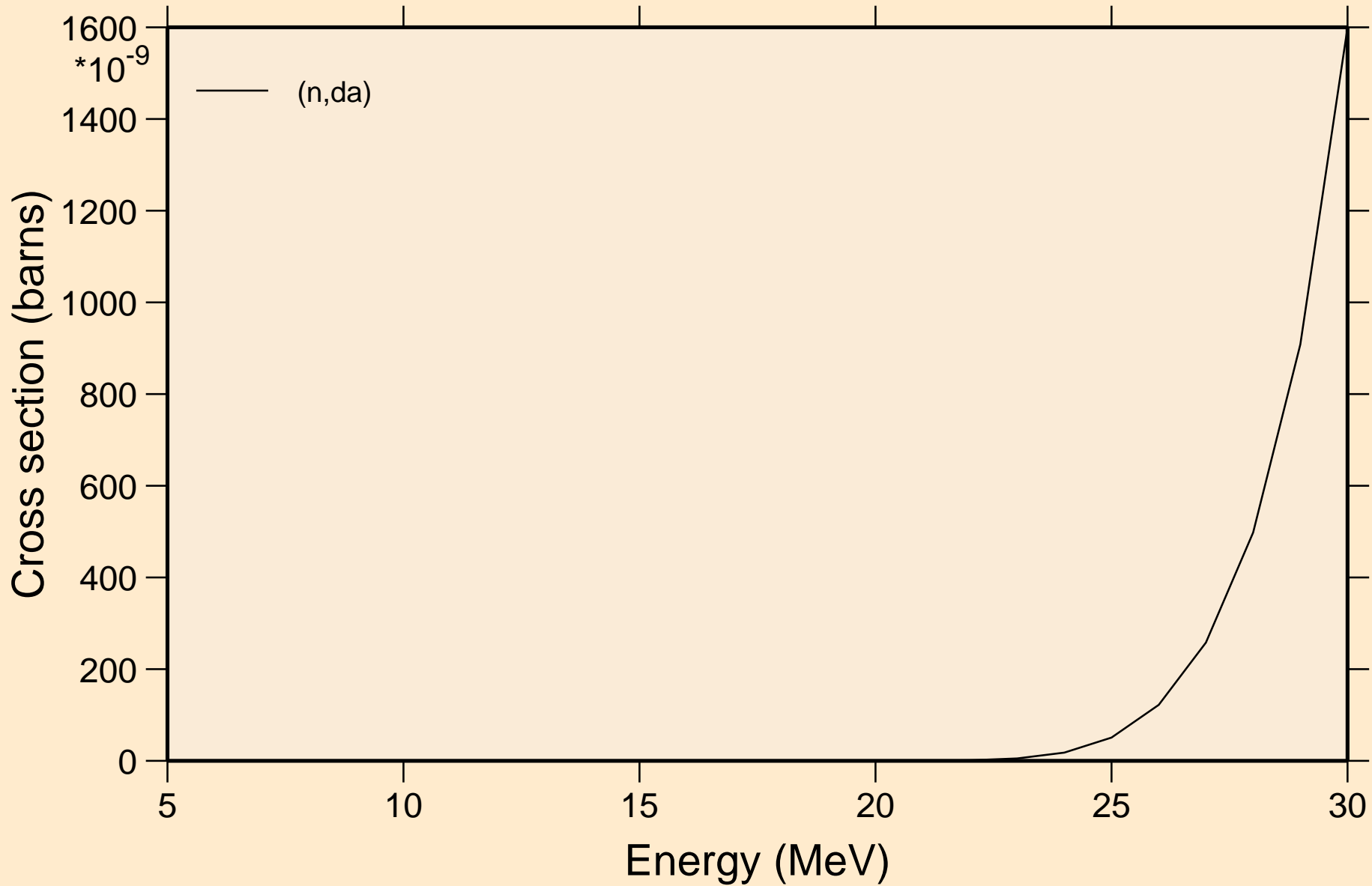

IN112 NEUTRON ACER TENDL-2024 LIBRARY; T=0.K

Threshold reactions

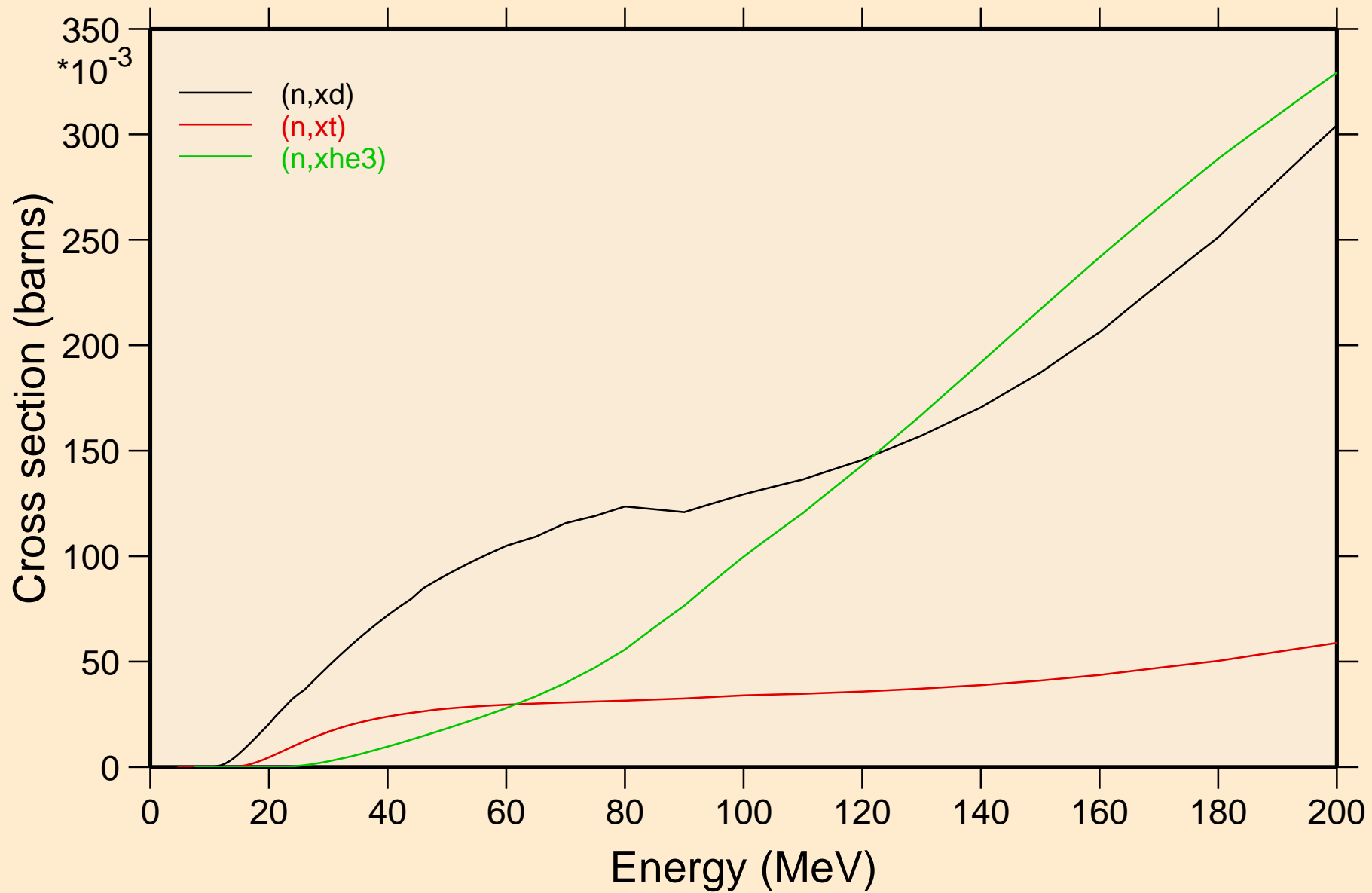

IN112 NEUTRON ACER TENDL-2024 LIBRARY; T=0.K
angular distribution for elastic

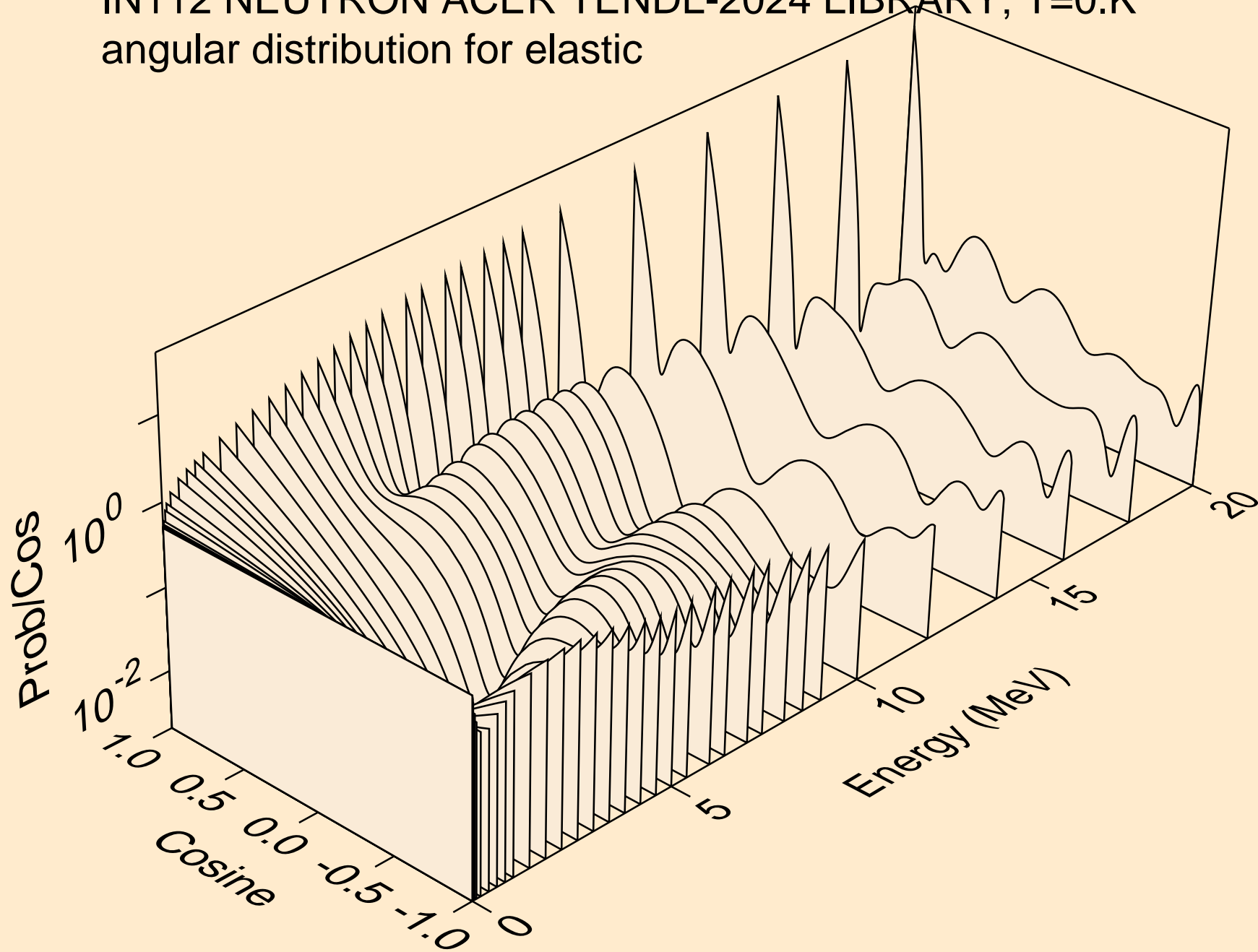

IN112 NEUTRON ACER TENDL-2024 LIBRARY; T=0.K
angular distribution for elastic

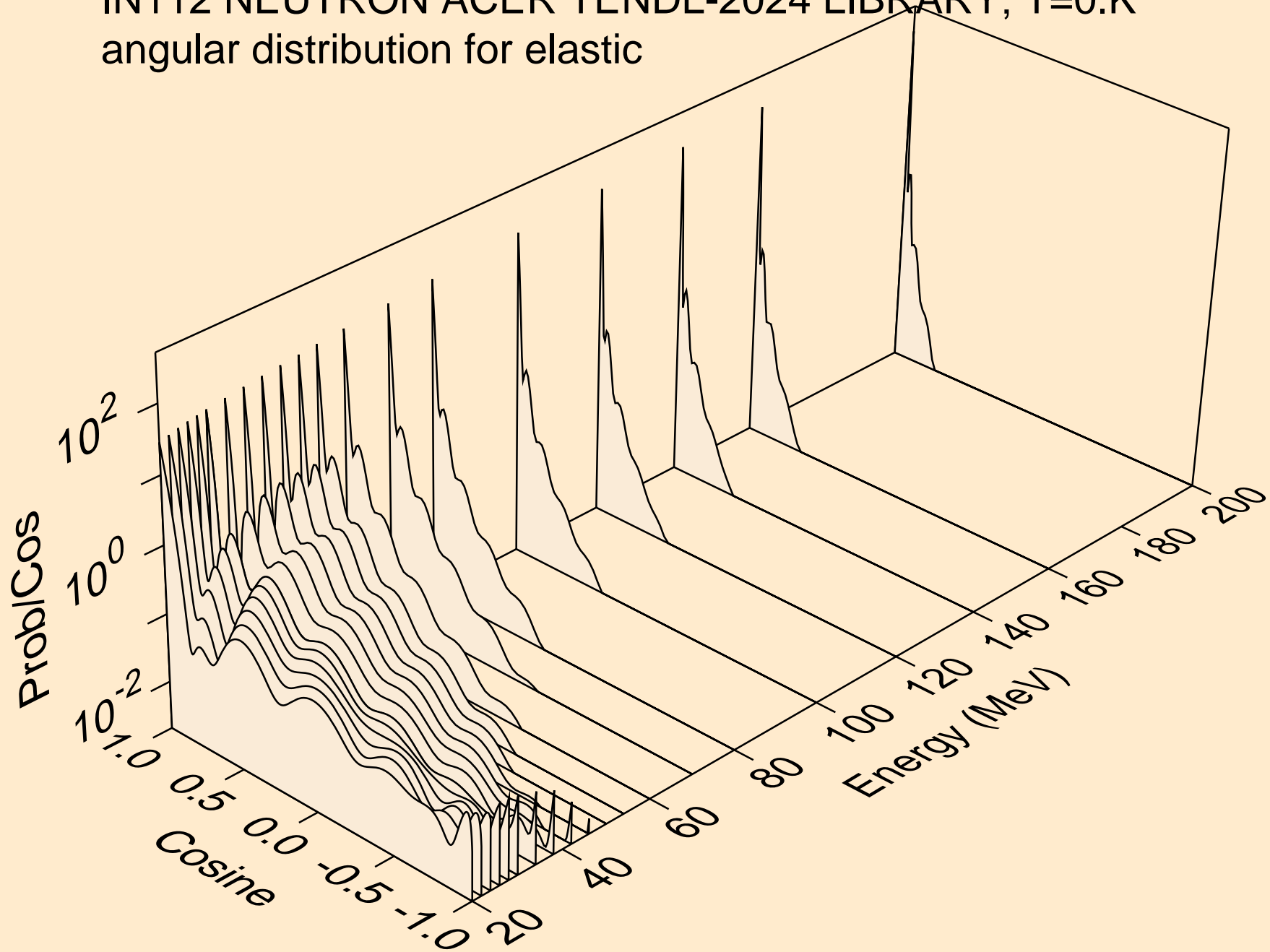

IN112 NEUTRON ACER TENDL-2024 LIBRARY; T=0.K
angular distribution for (n,n*1)

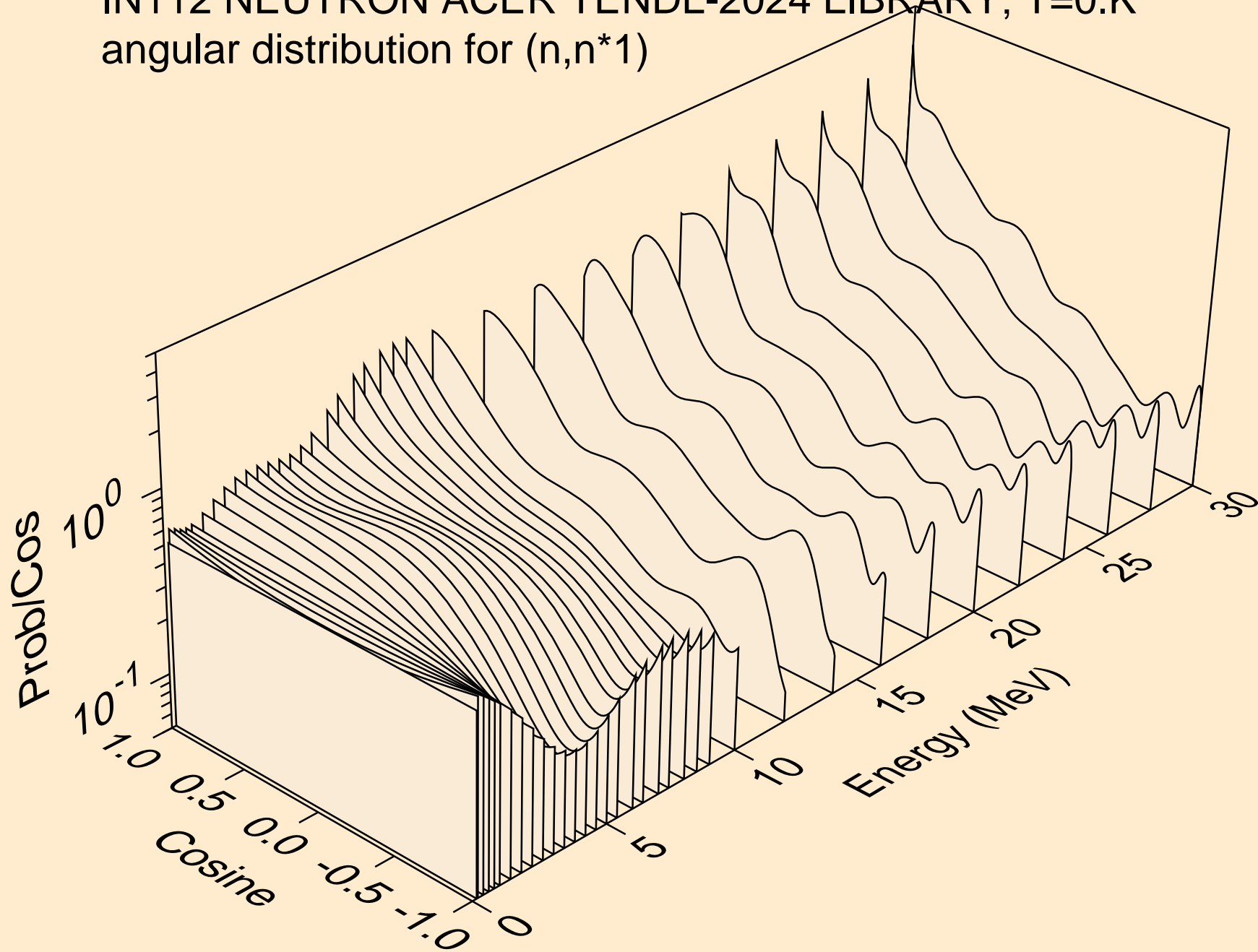

IN112 NEUTRON ACER TENDL-2024 LIBRARY; T=0.K
angular distribution for (n,n*2)

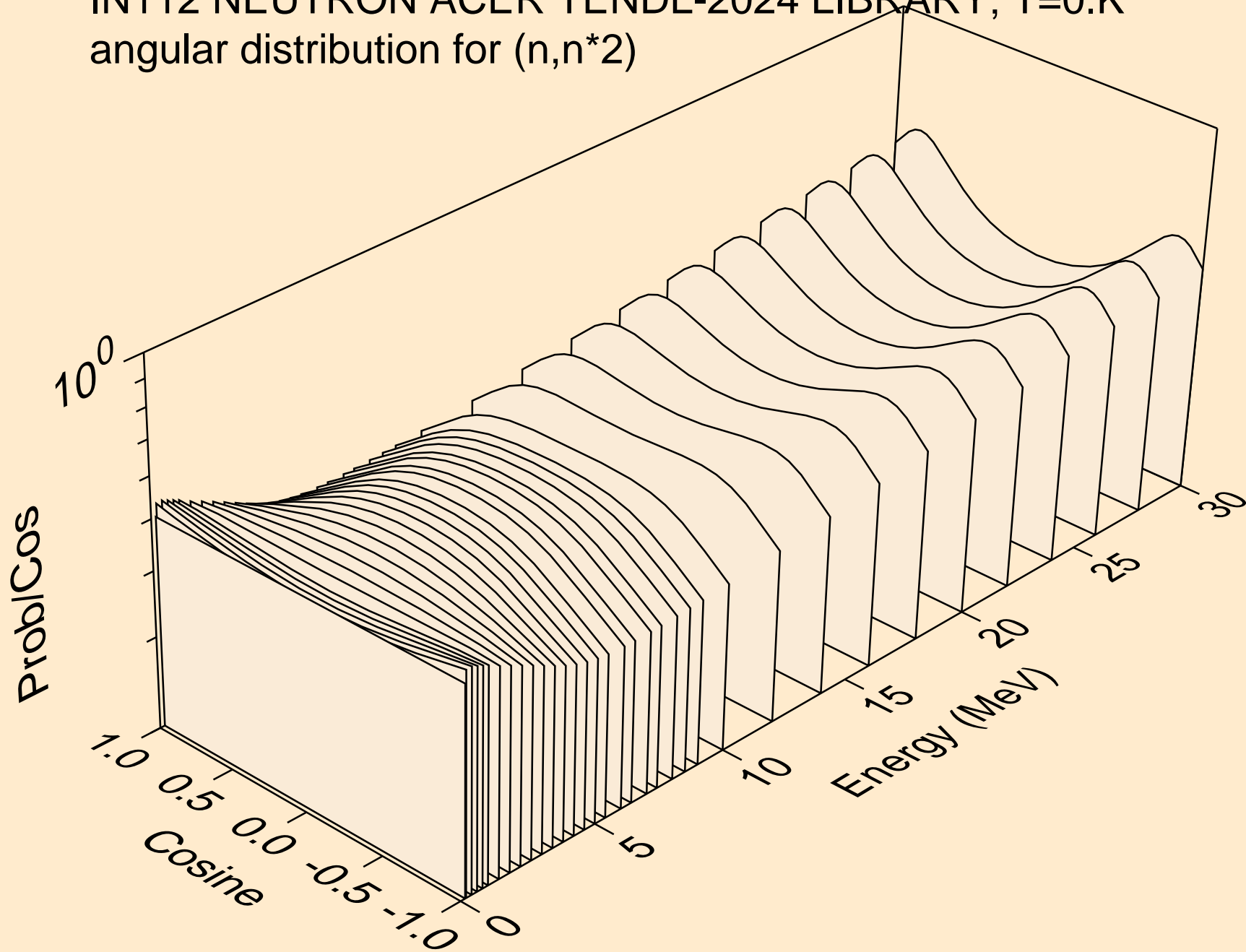

IN112 NEUTRON ACER TENDL-2024 LIBRARY; T=0.K
angular distribution for (n,n*3)

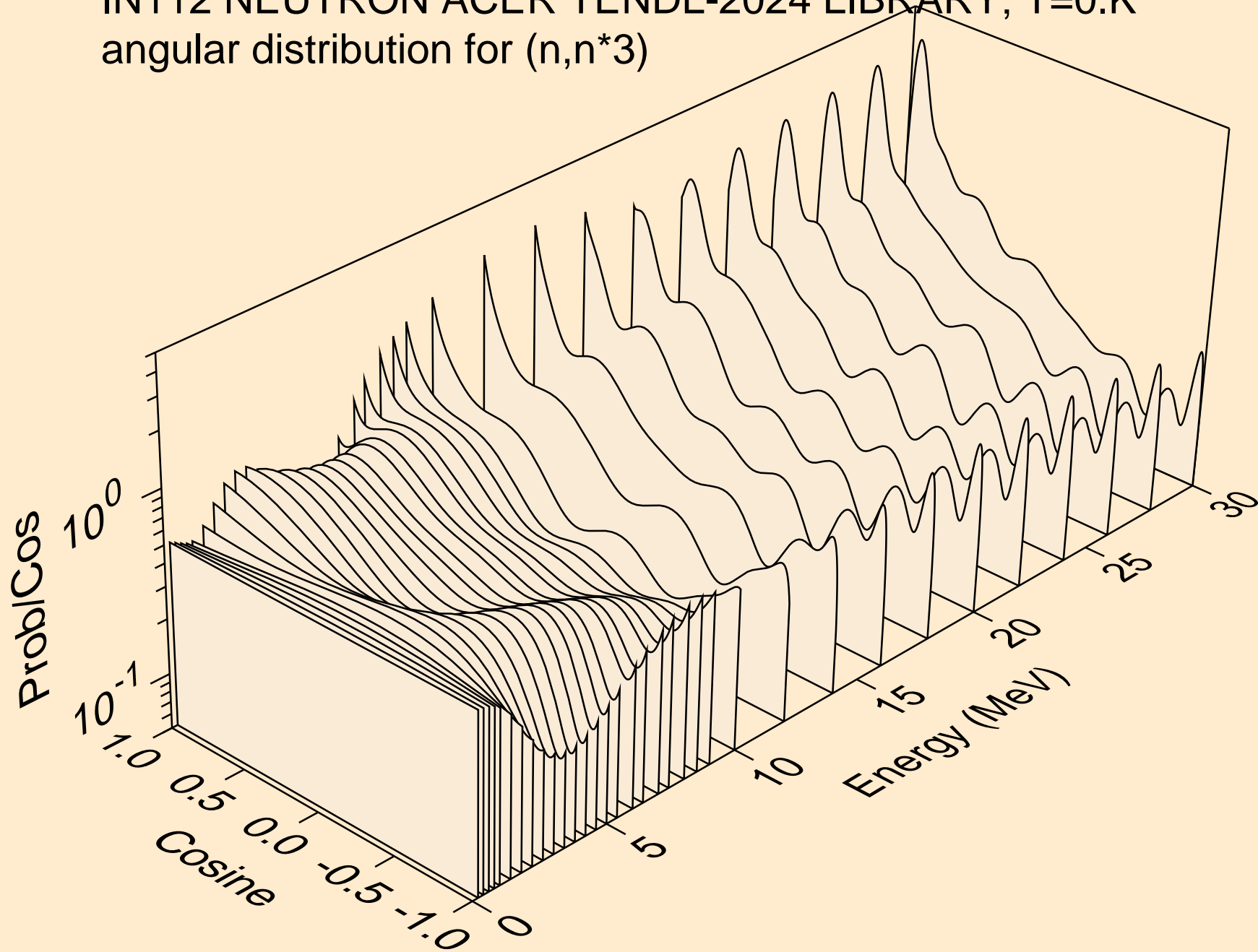

IN112 NEUTRON ACER TENDL-2024 LIBRARY; T=0.K
angular distribution for (n,n*4)

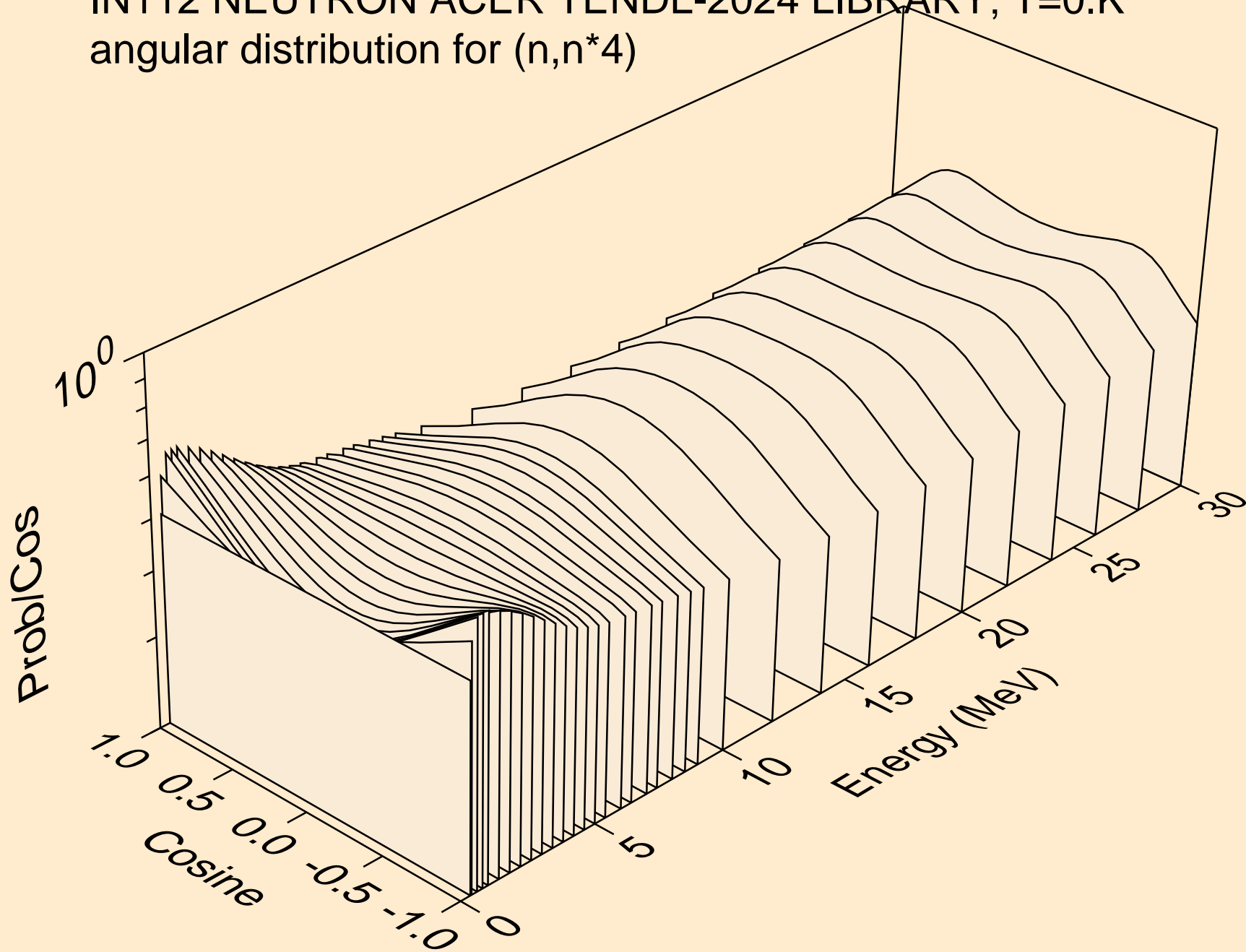

IN112 NEUTRON ACER TENDL-2024 LIBRARY; T=0.K
angular distribution for (n,n*5)

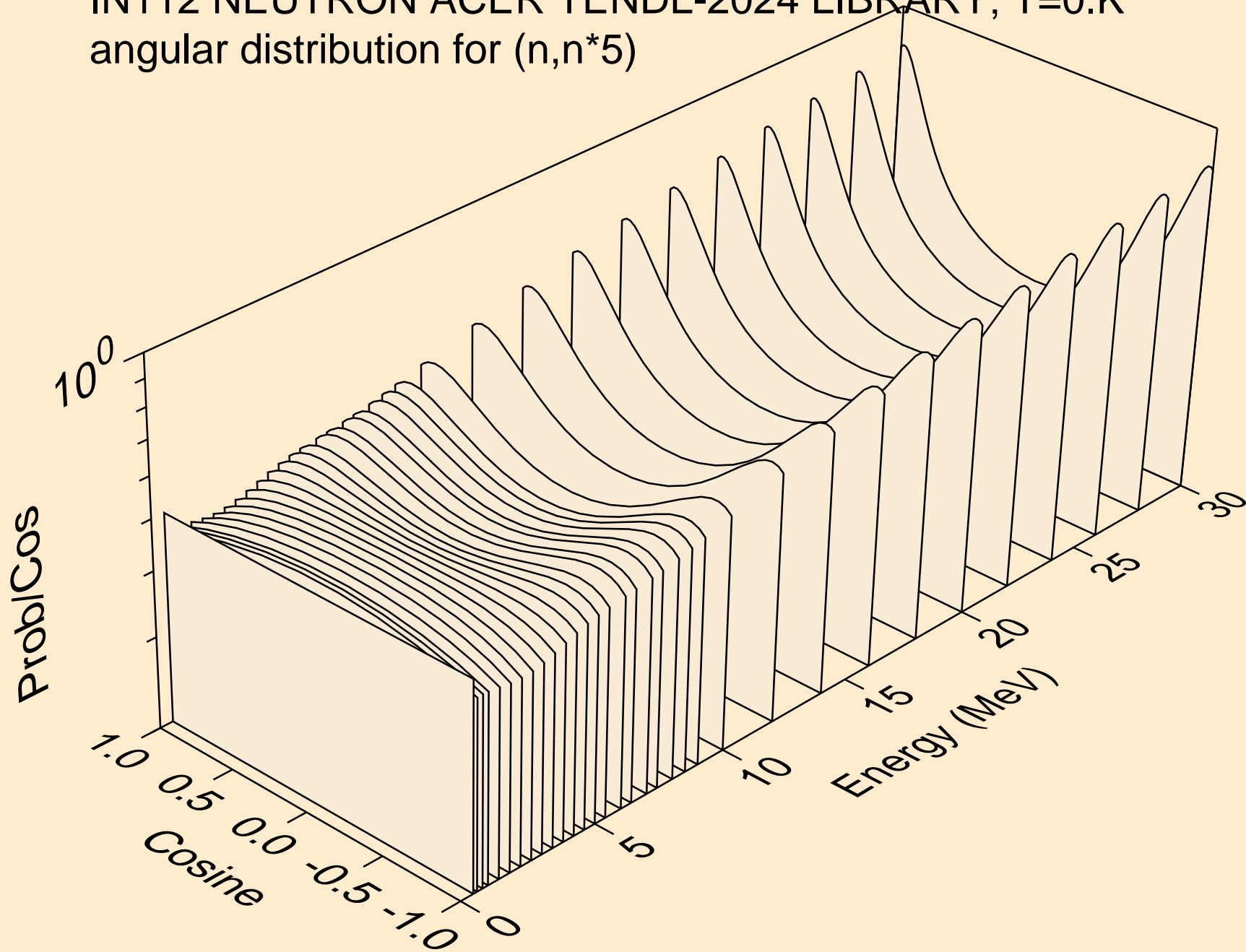

IN112 NEUTRON ACER TENDL-2024 LIBRARY; T=0.K
angular distribution for (n,n*6)

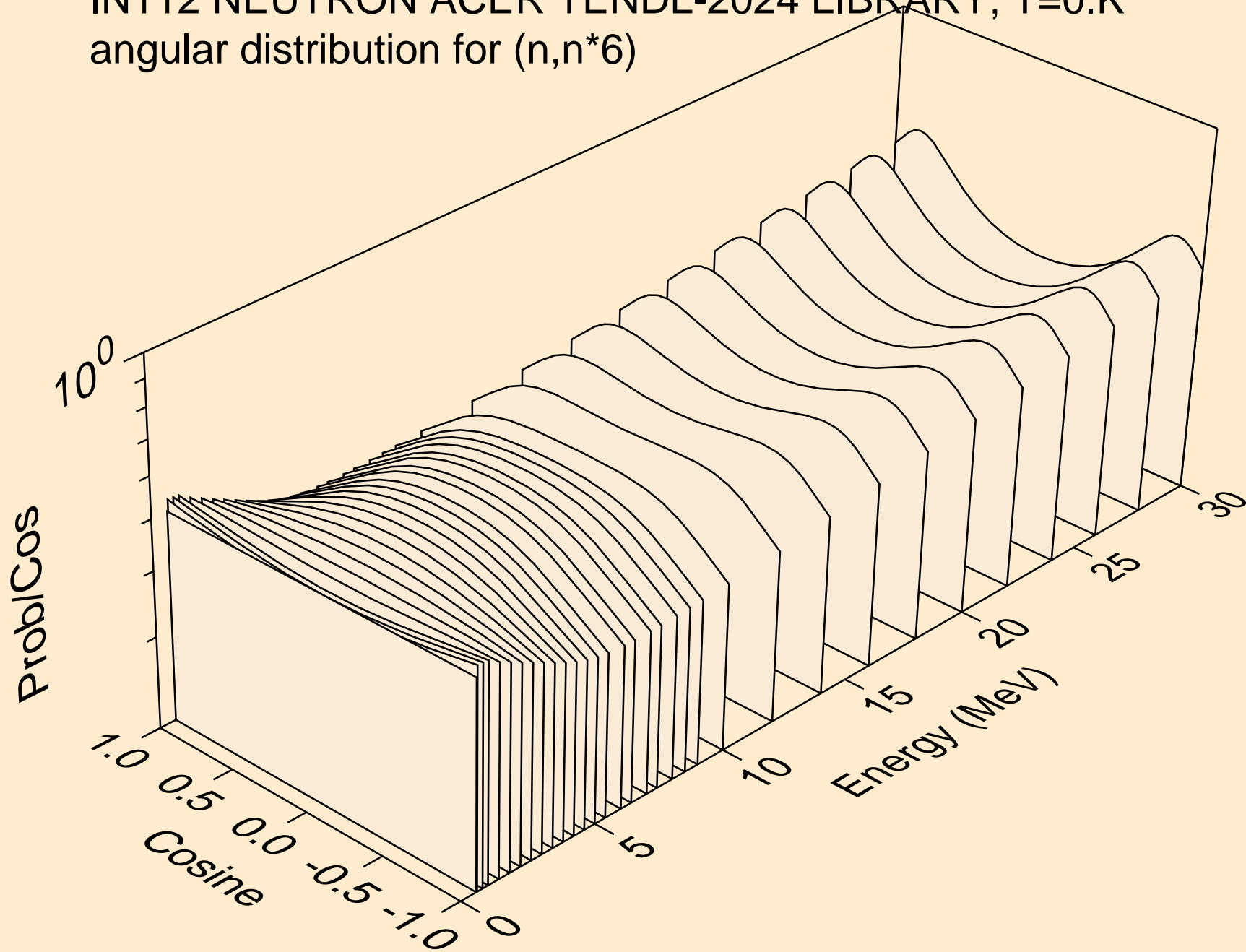

IN112 NEUTRON ACER TENDL-2024 LIBRARY; T=0.K
angular distribution for (n,n*7)

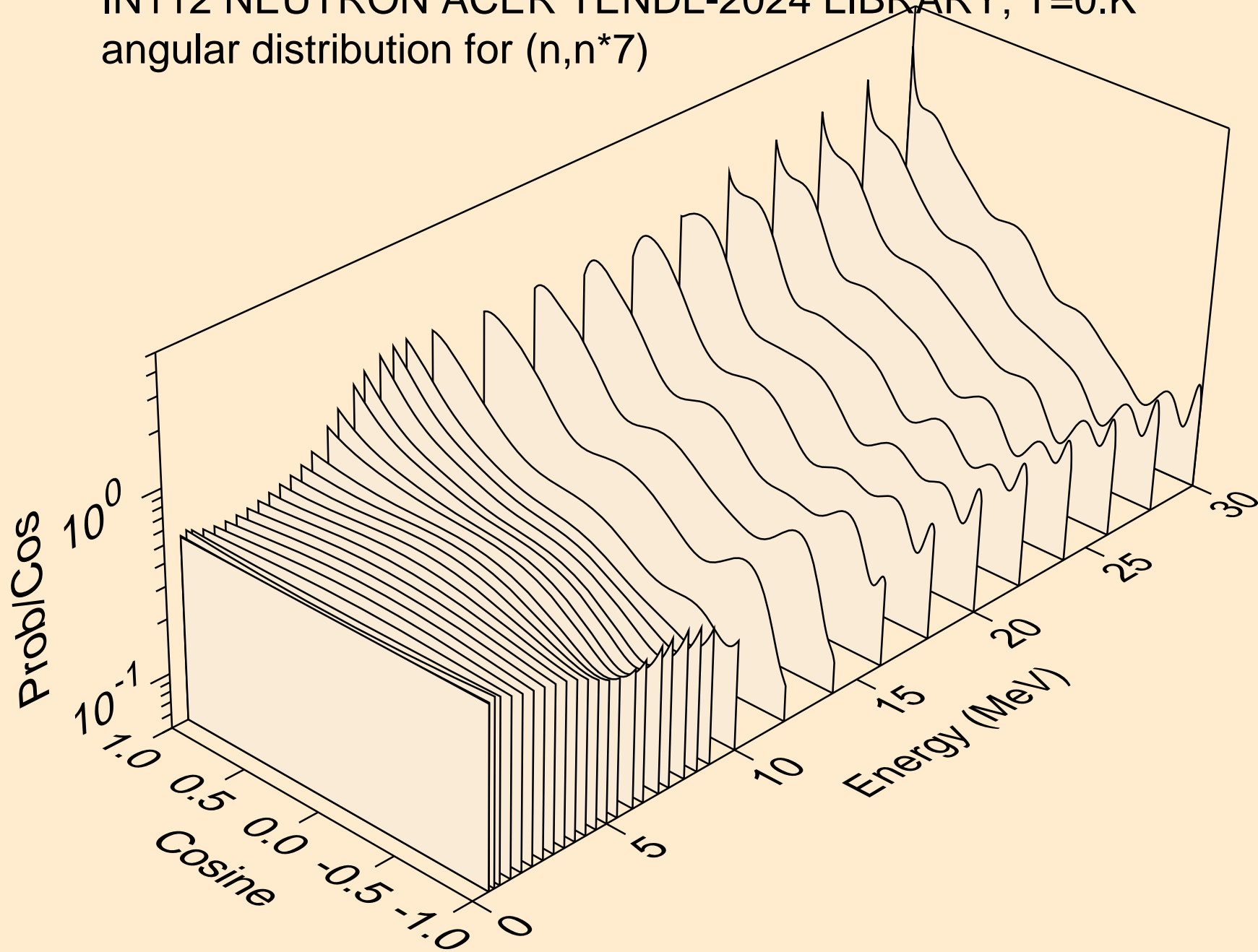

IN112 NEUTRON ACER TENDL-2024 LIBRARY; T=0.K
angular distribution for (n,n*8)

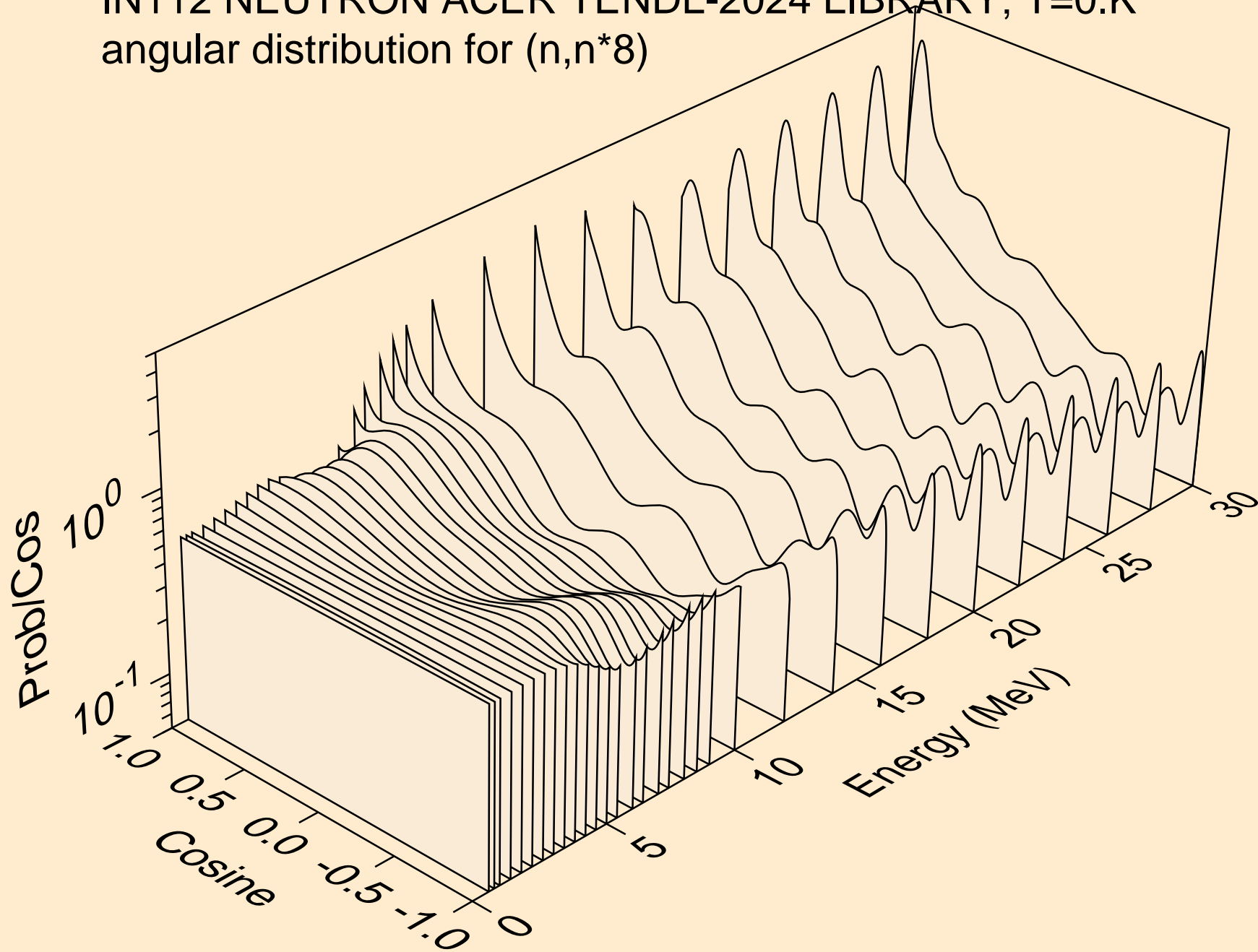

IN112 NEUTRON ACER TENDL-2024 LIBRARY; T=0.K
angular distribution for (n,n*9)

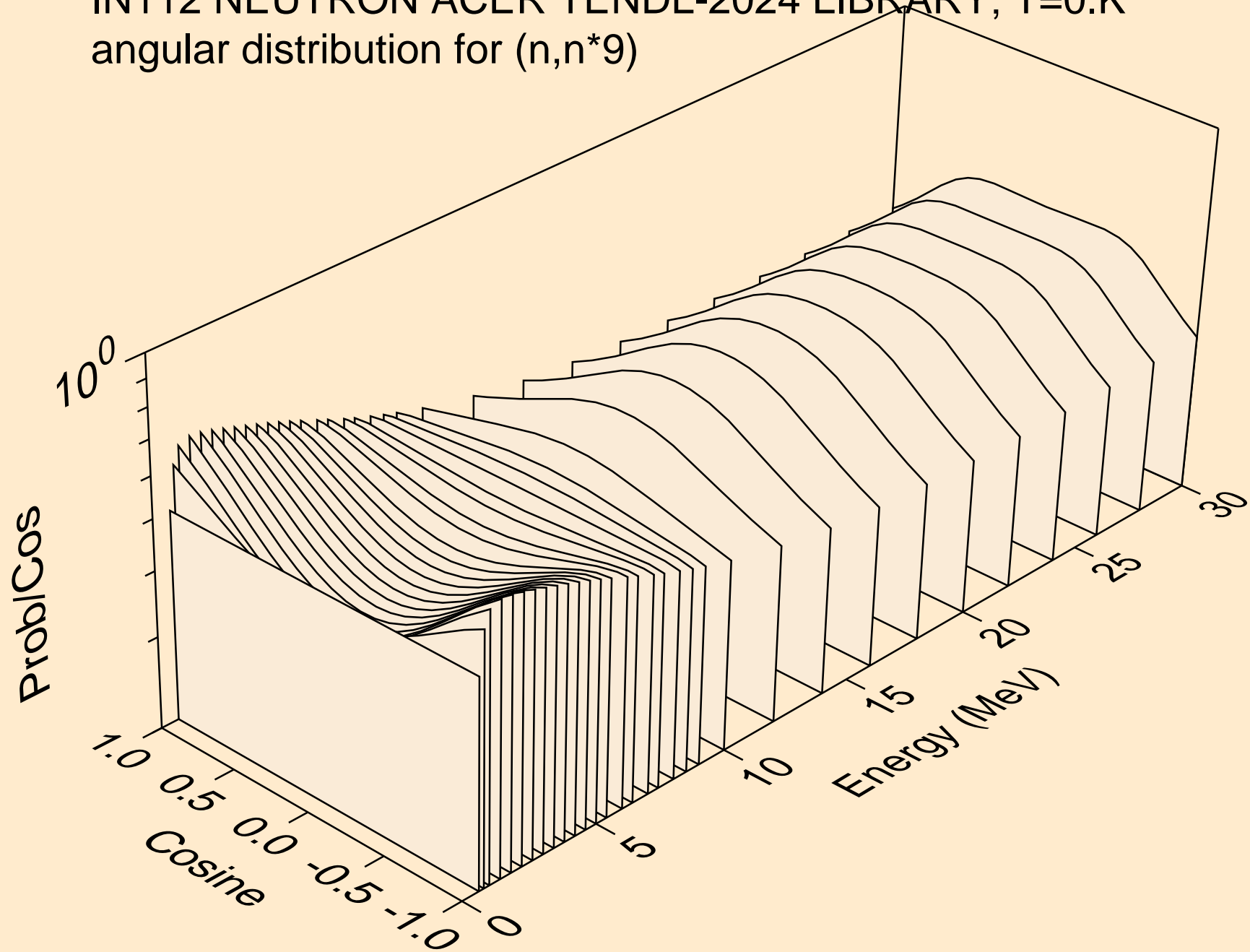

IN112 NEUTRON ACER TENDL-2024 LIBRARY; T=0.K
angular distribution for (n,n*10)

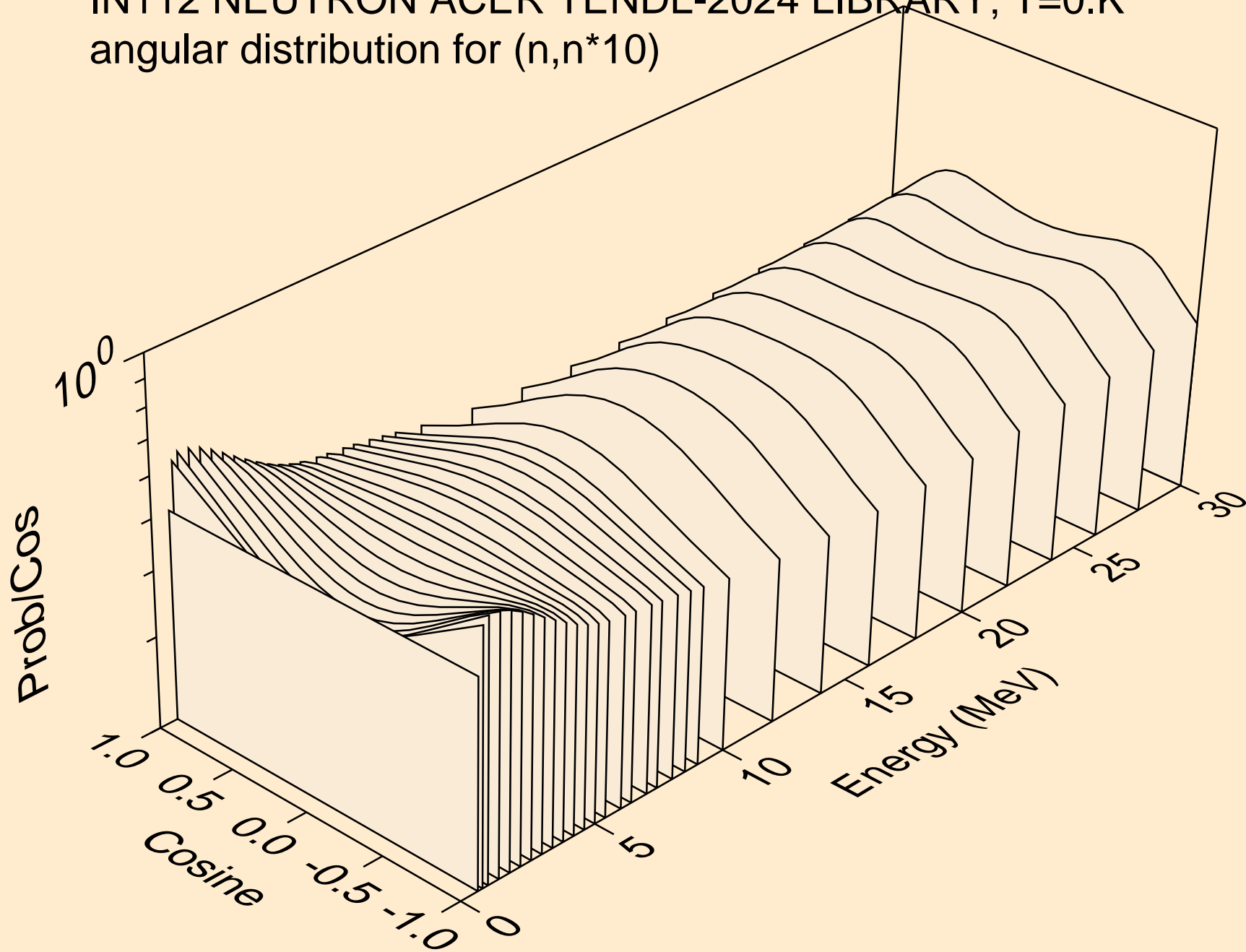

IN112 NEUTRON ACER TENDL-2024 LIBRARY; T=0.K
angular distribution for (n,n*11)

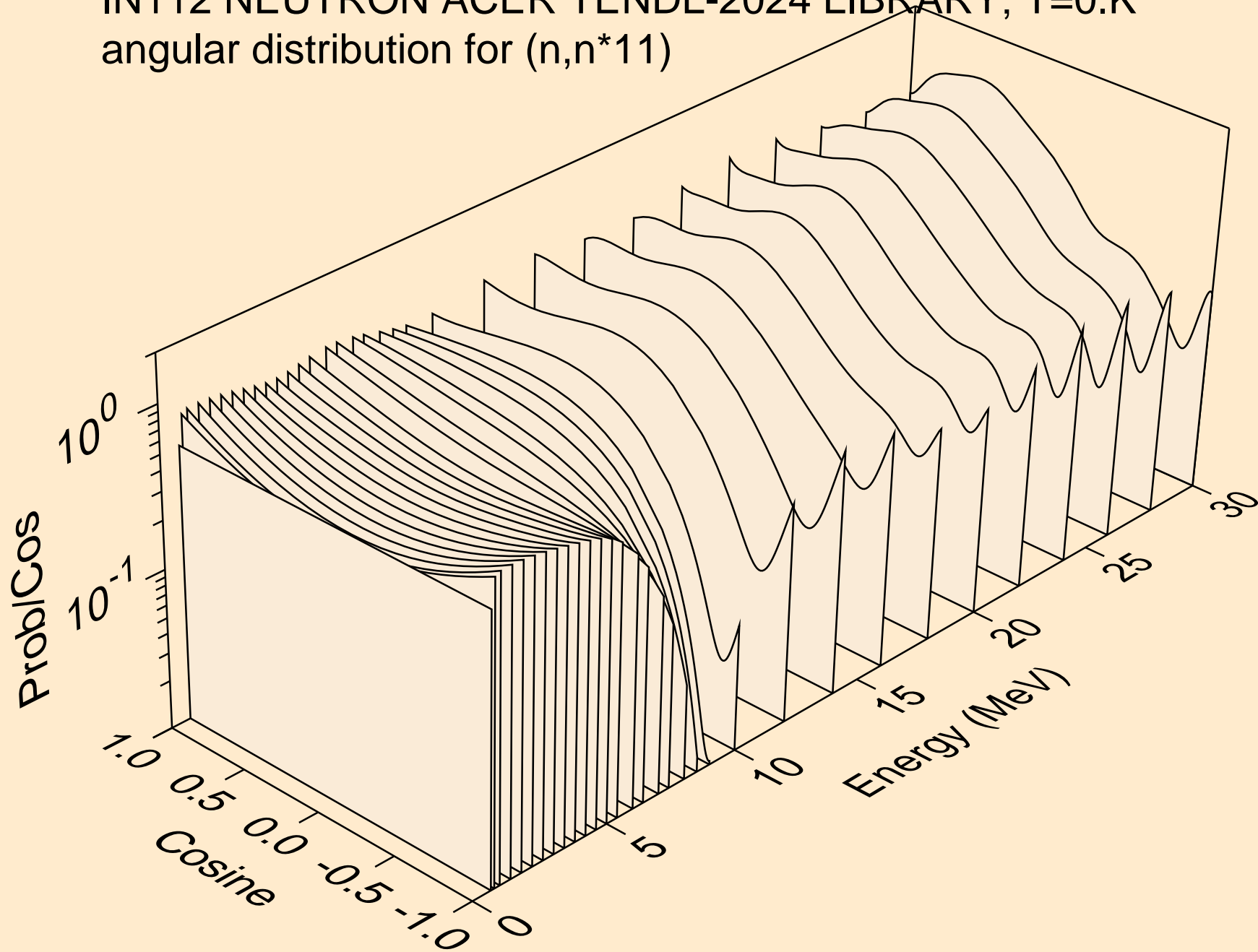

IN112 NEUTRON ACER TENDL-2024 LIBRARY; T=0.K
angular distribution for (n,n*12)

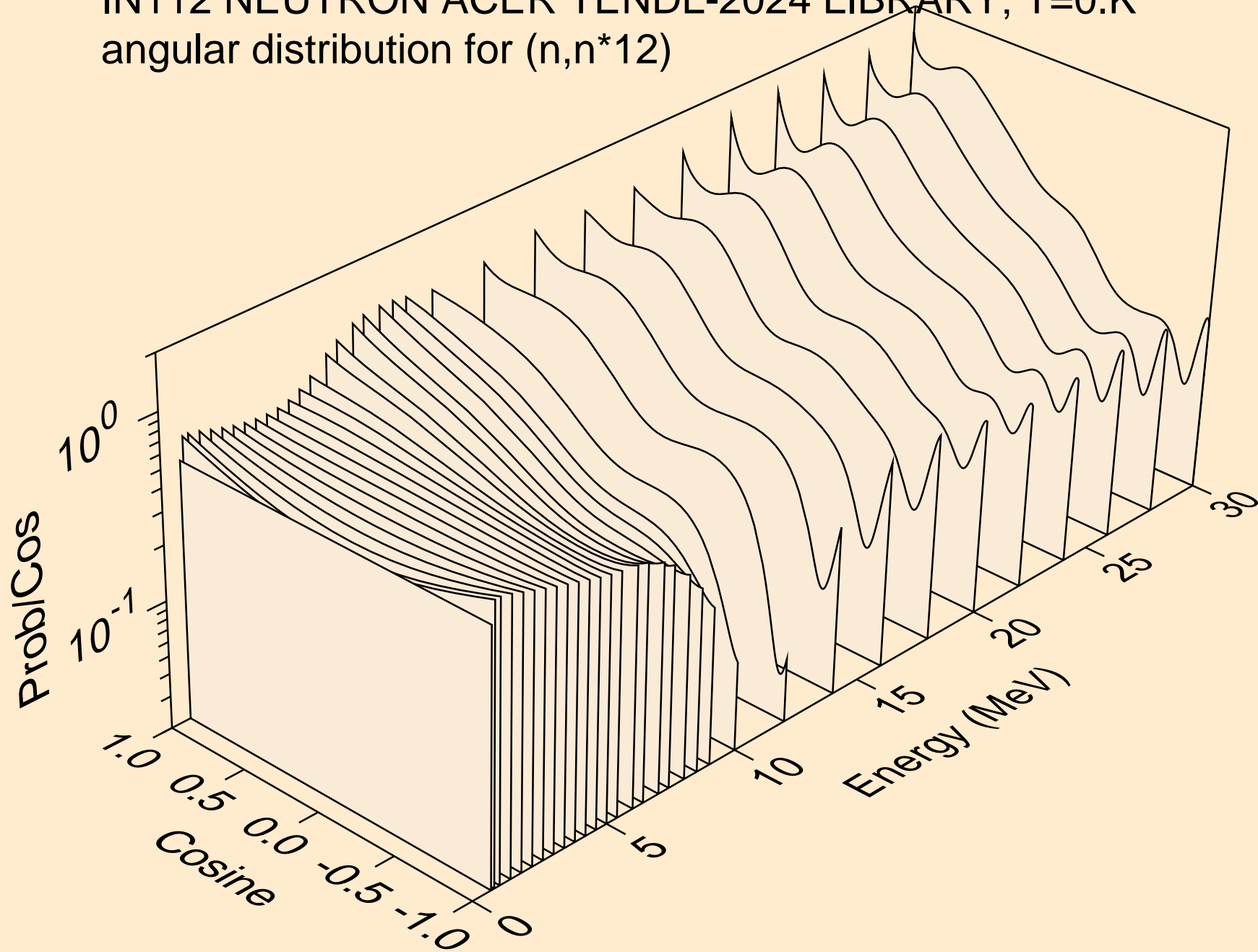

IN112 NEUTRON ACER TENDL-2024 LIBRARY; T=0.K
angular distribution for (n,n*13)

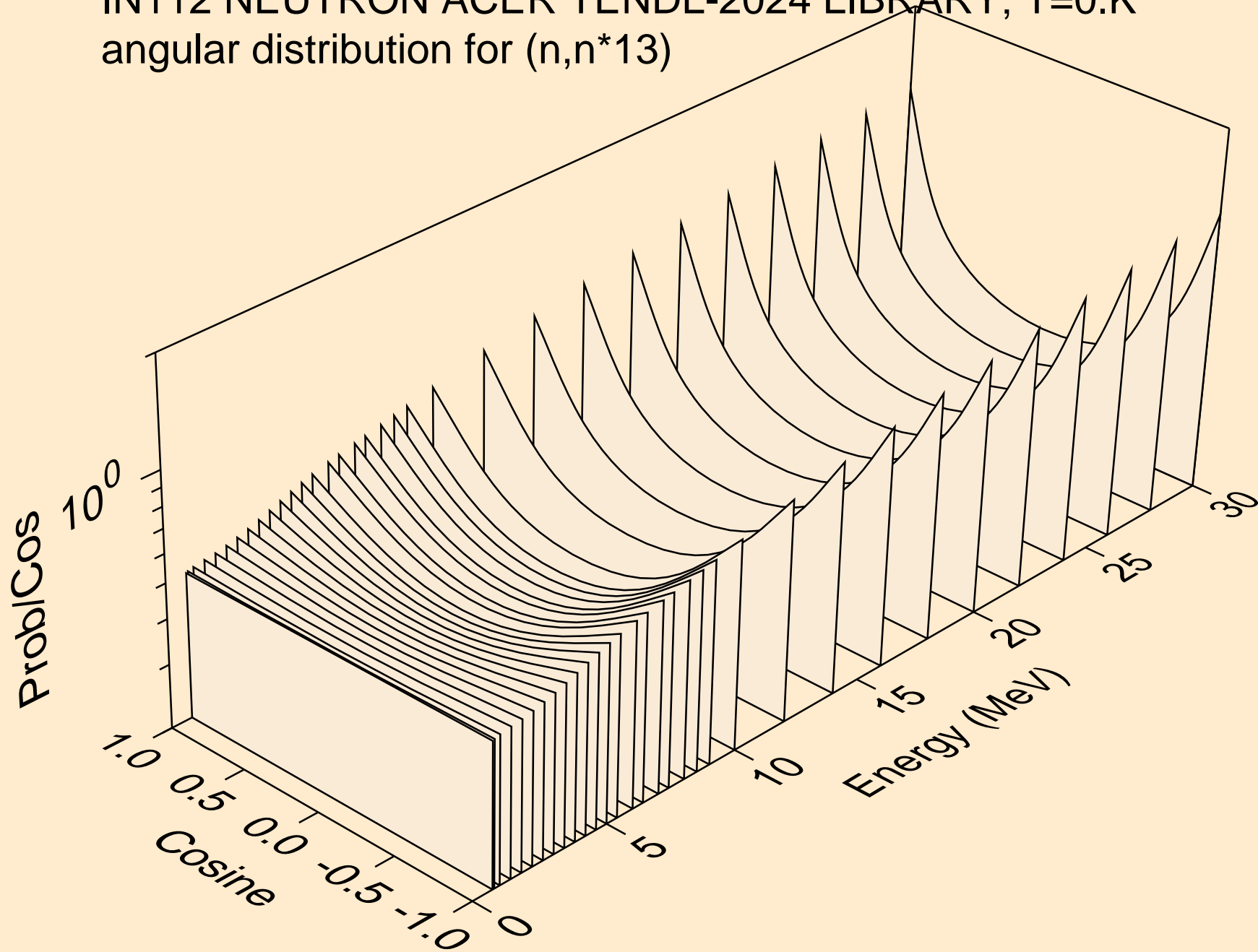

IN112 NEUTRON ACER TENDL-2024 LIBRARY; T=0.K
angular distribution for (n,n*14)

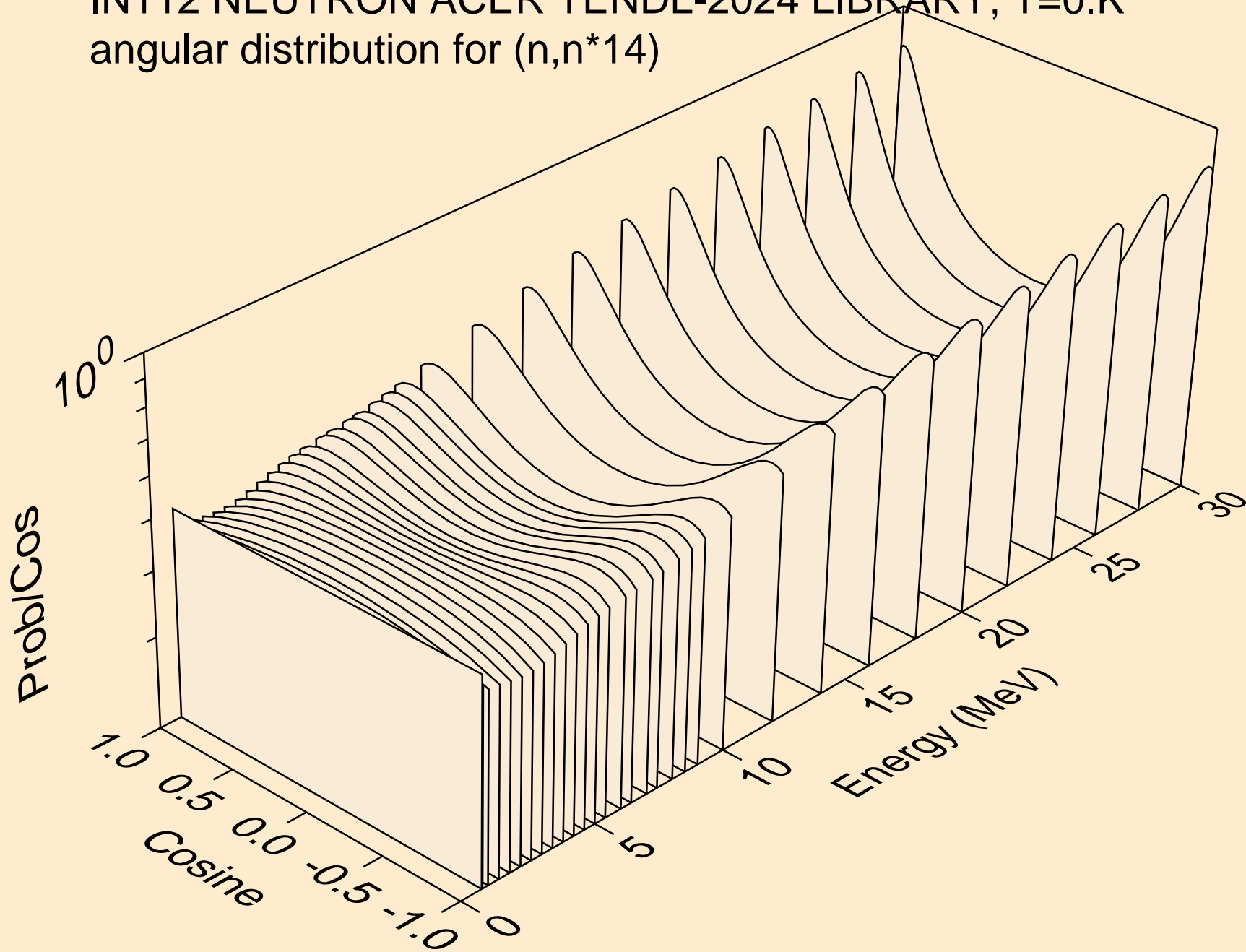

IN112 NEUTRON ACER TENDL-2024 LIBRARY; T=0.K
angular distribution for (n,n*15)

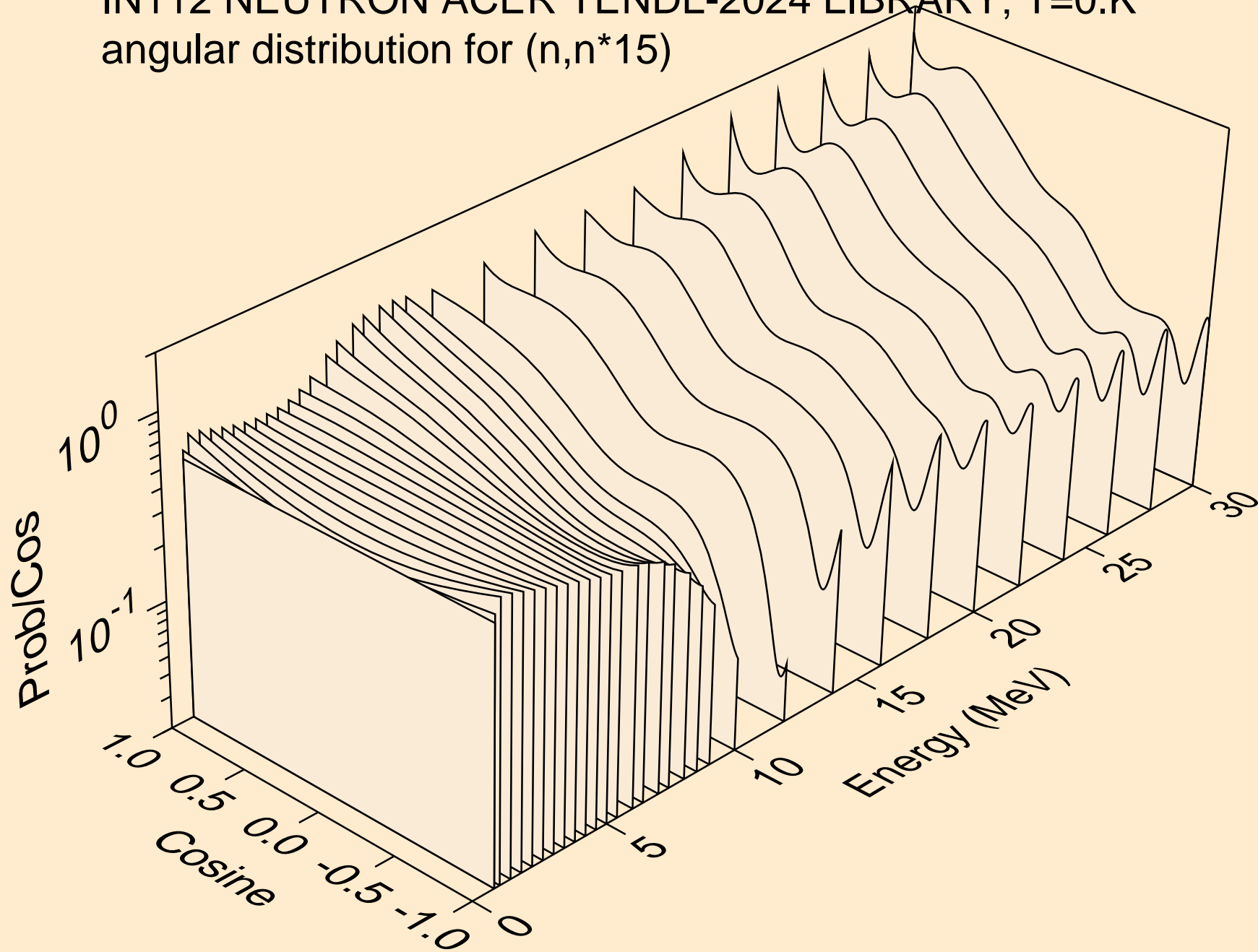

IN112 NEUTRON ACER TENDL-2024 LIBRARY; T=0.K
angular distribution for (n,n*16)

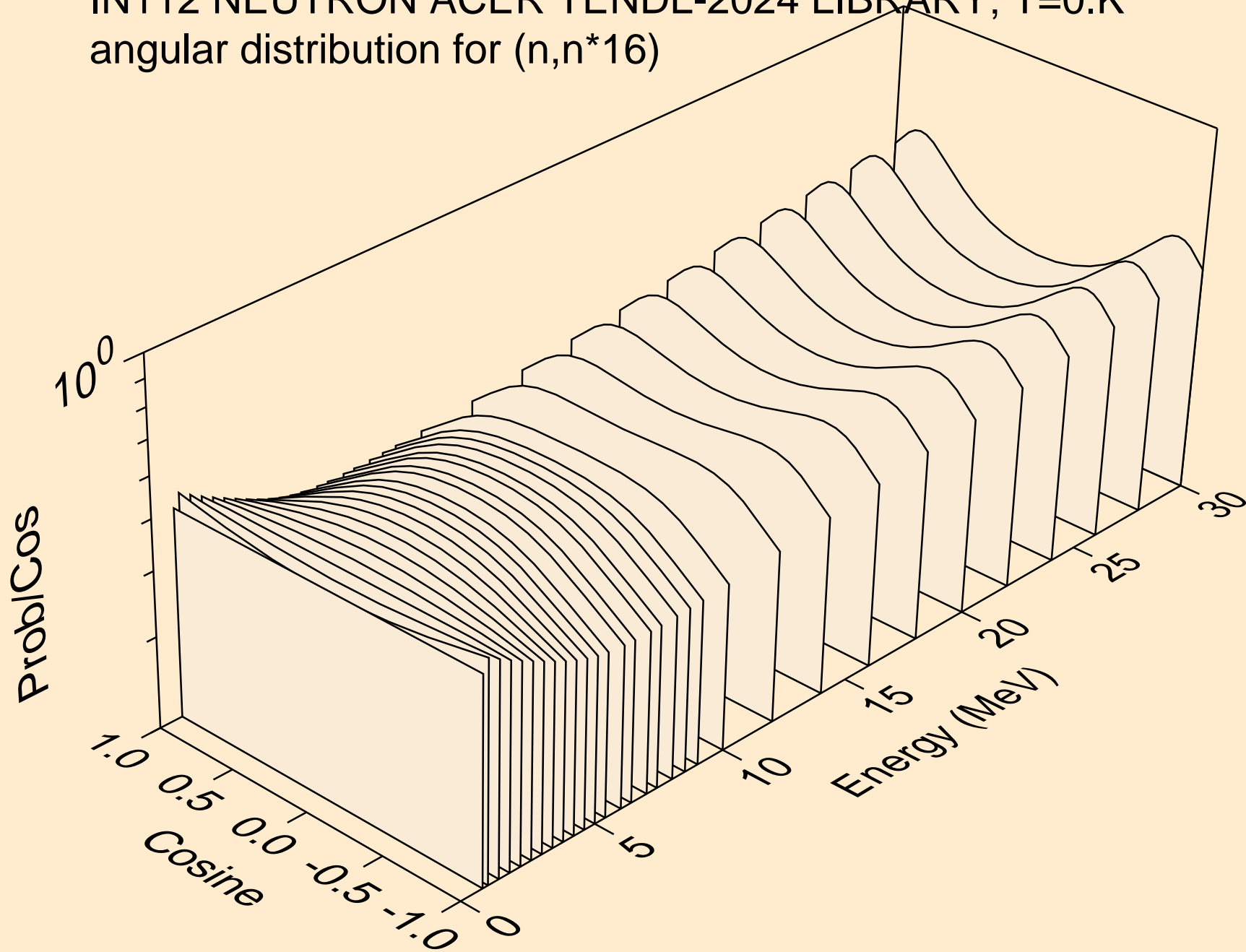

IN112 NEUTRON ACER TENDL-2024 LIBRARY; T=0.K
angular distribution for (n,n*17)

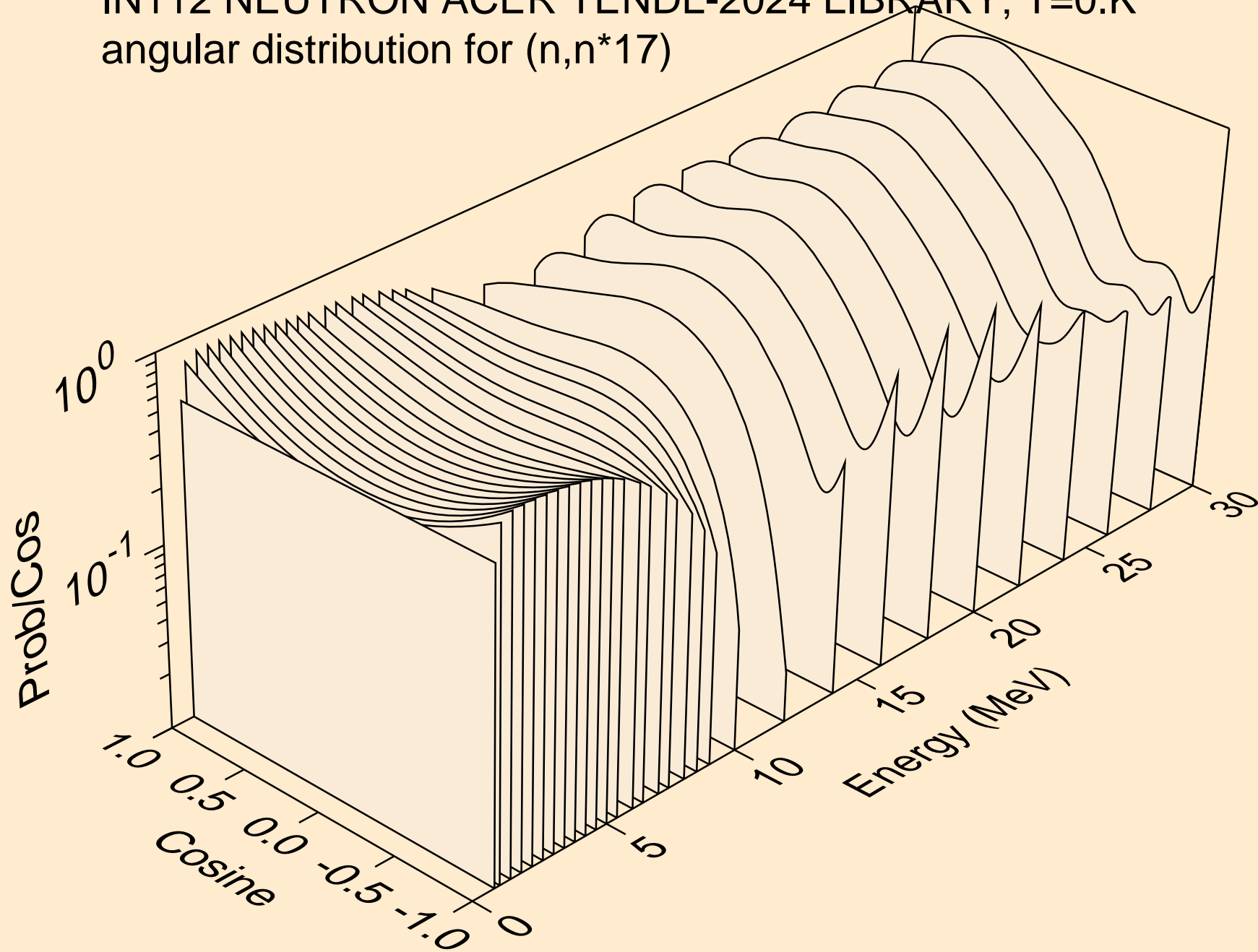

IN112 NEUTRON ACER TENDL-2024 LIBRARY; T=0.K
angular distribution for (n,n*18)

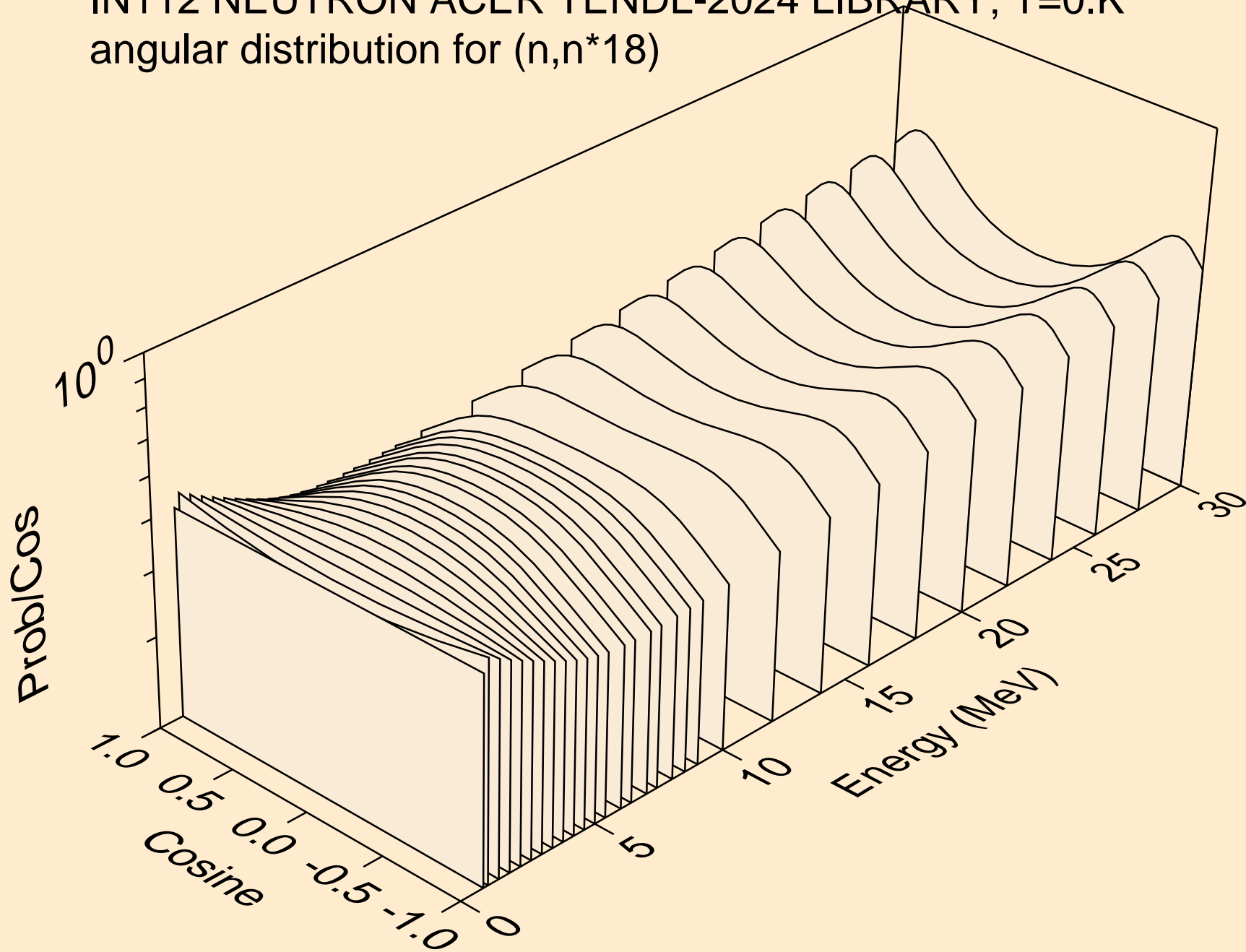

IN112 NEUTRON ACER TENDL-2024 LIBRARY; T=0.K
angular distribution for (n,n*19)

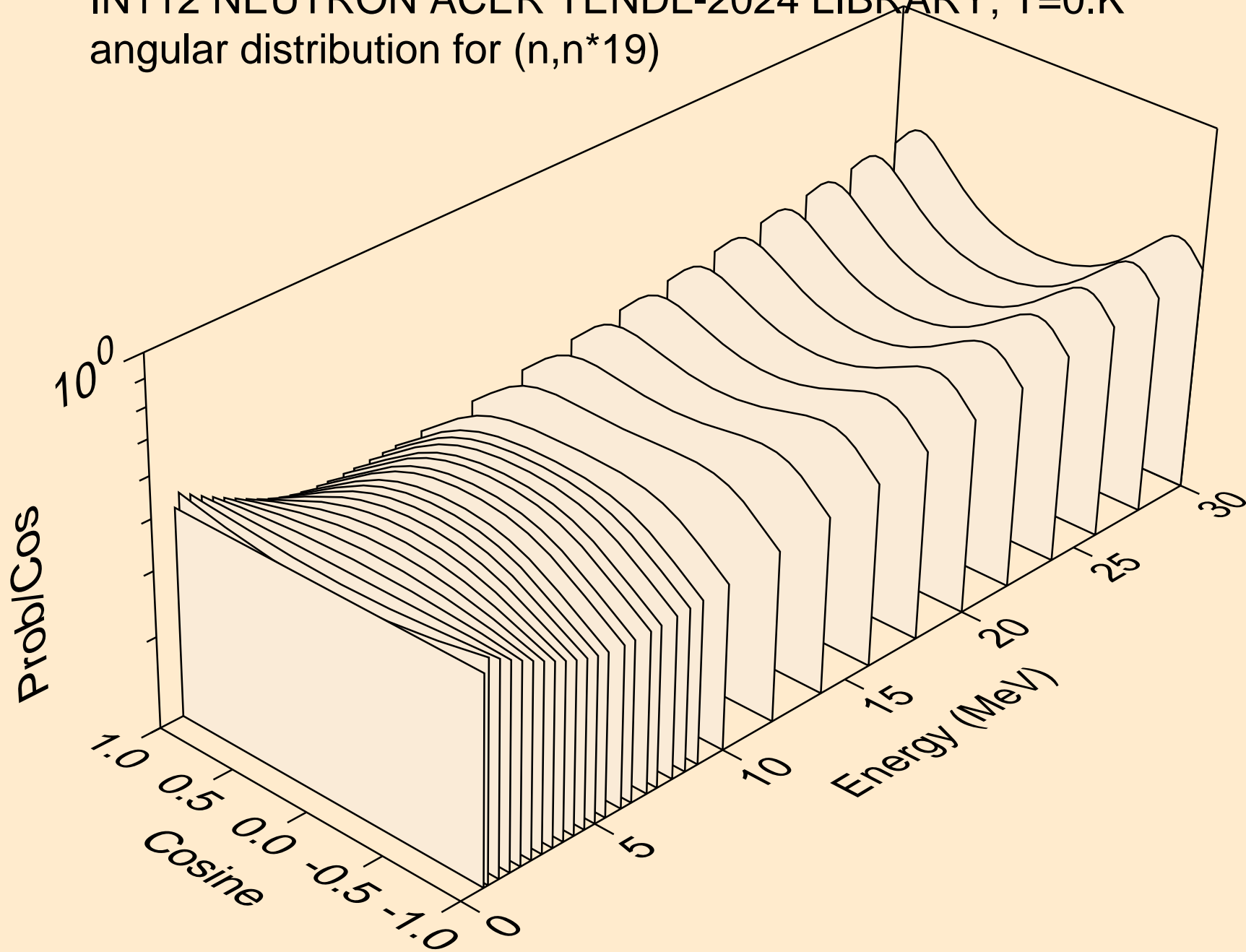

IN112 NEUTRON ACER TENDL-2024 LIBRARY; T=0.K
angular distribution for (n,n*20)

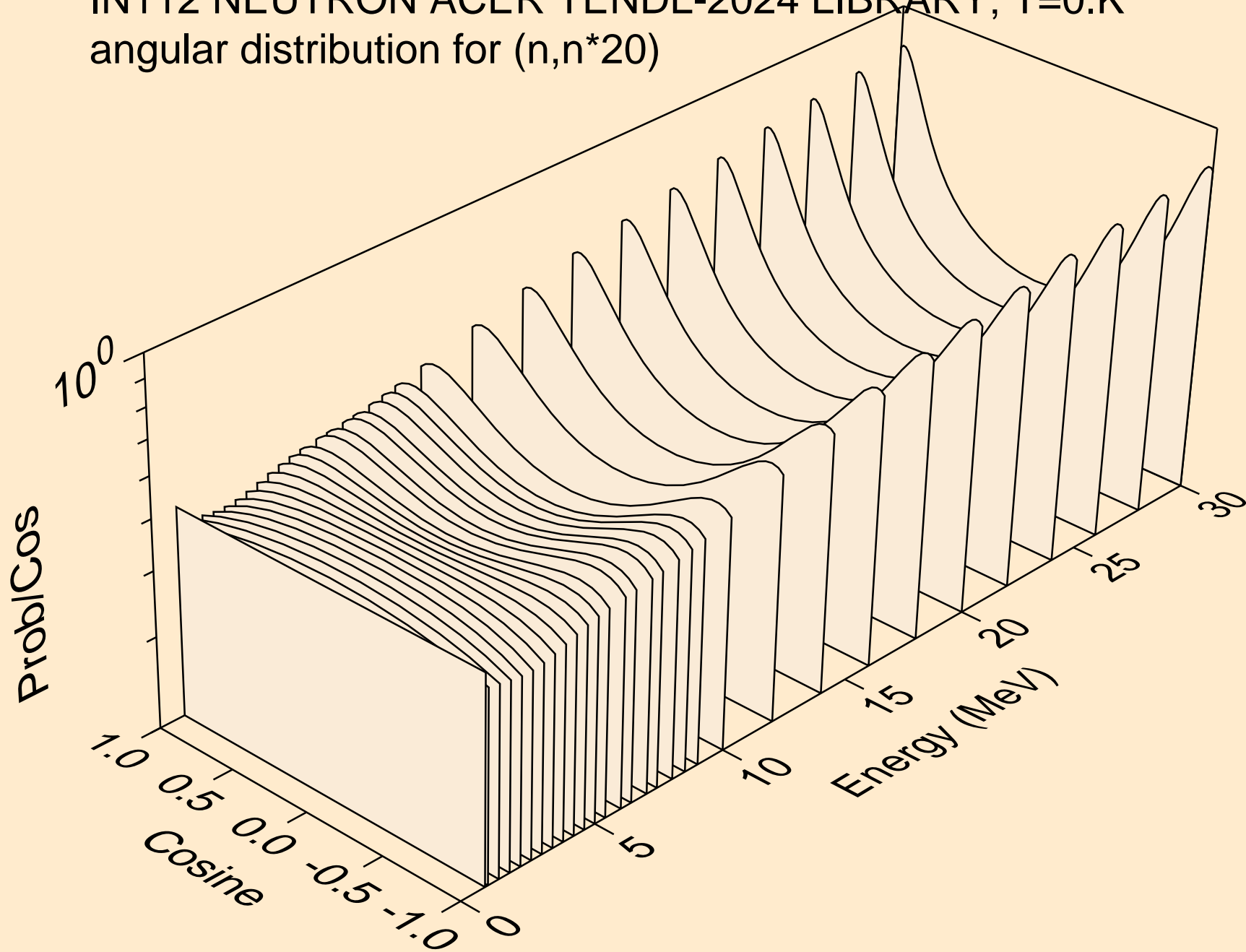

IN112 NEUTRON ACER TENDL-2024 LIBRARY; T=0.K
angular distribution for (n,n*21)

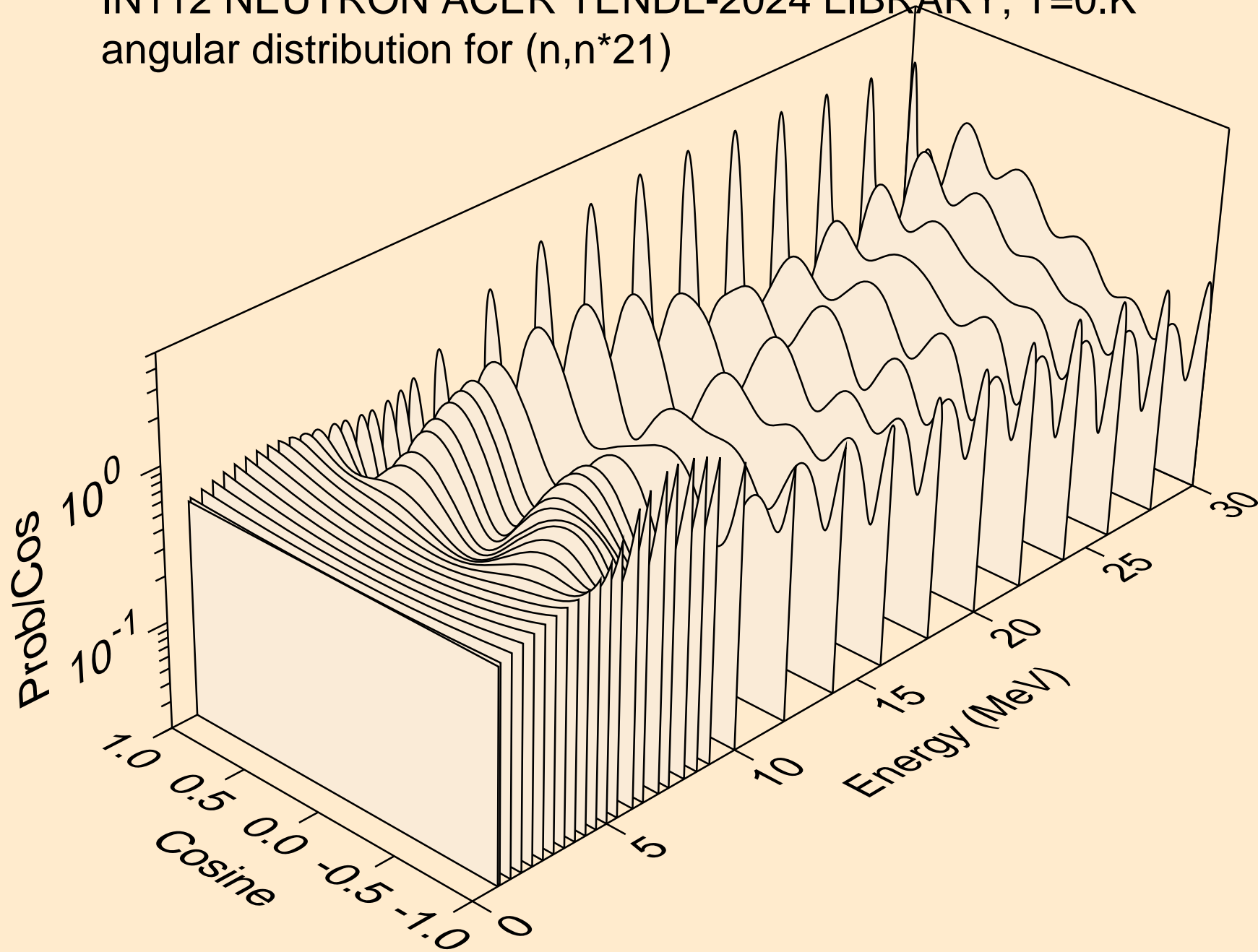

IN112 NEUTRON ACER TENDL-2024 LIBRARY; T=0.K
angular distribution for (n,n*22)

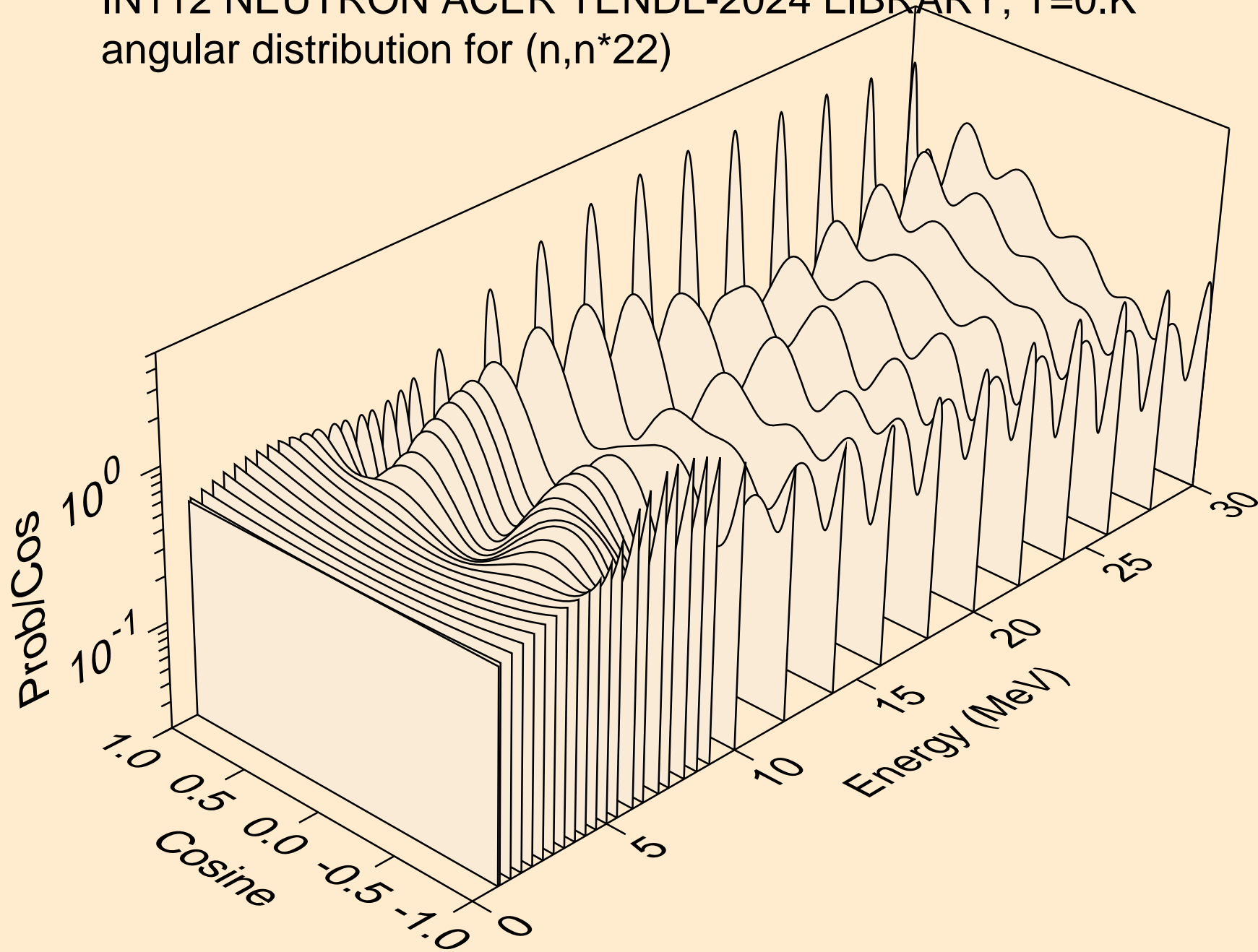

IN112 NEUTRON ACER TENDL-2024 LIBRARY; T=0.K
angular distribution for (n,n*23)

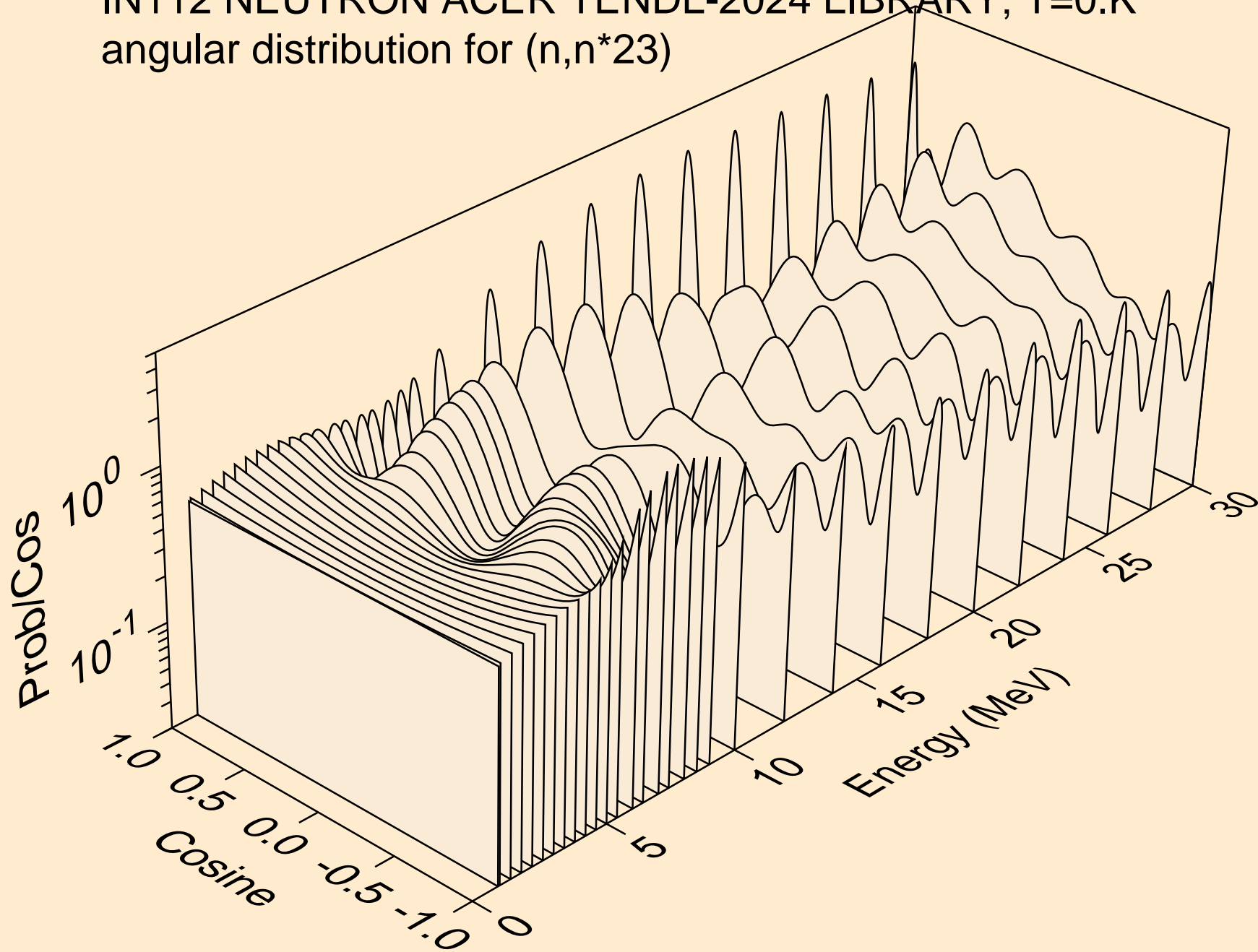

IN112 NEUTRON ACER TENDL-2024 LIBRARY; T=0.K
angular distribution for (n,n*24)

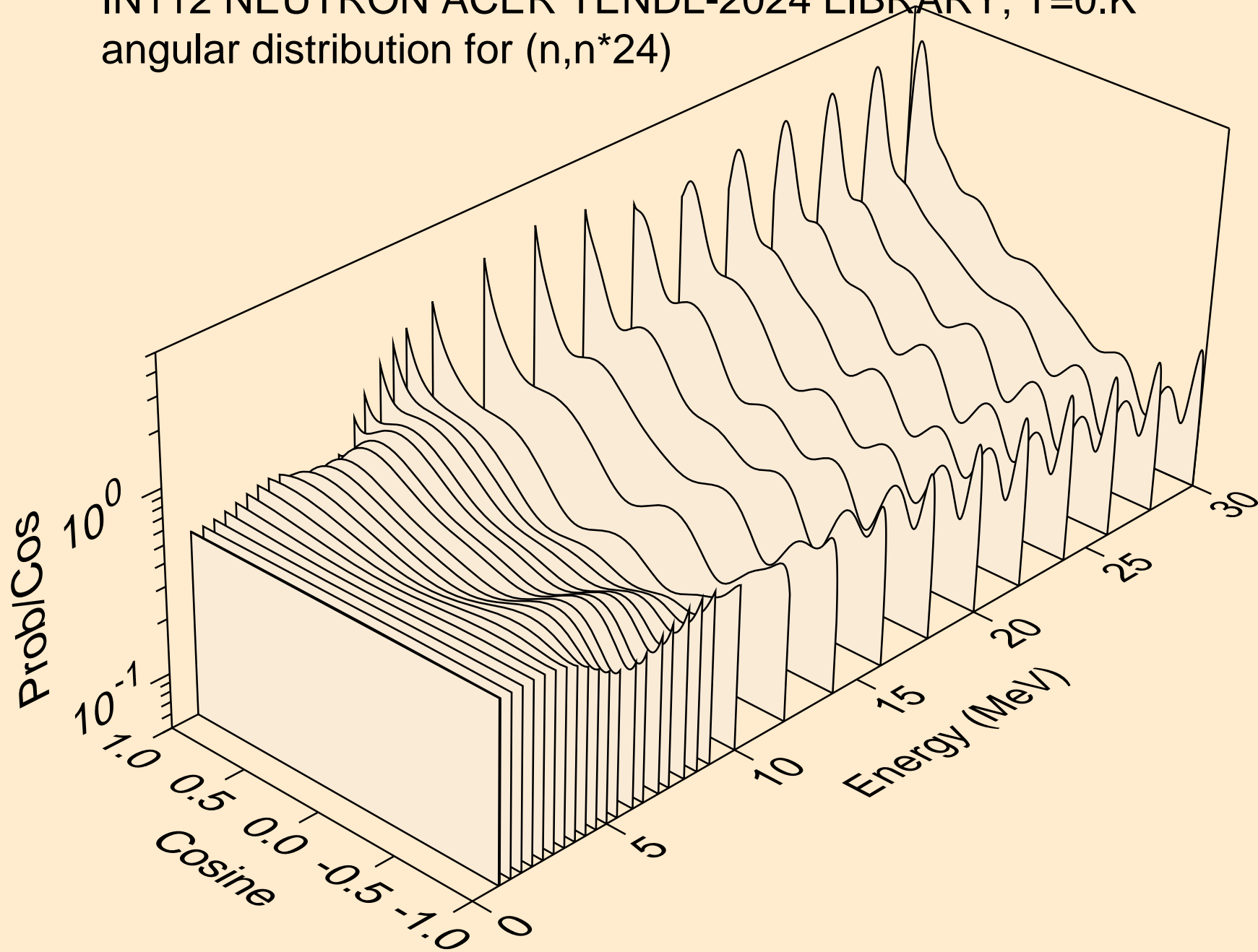

IN112 NEUTRON ACER TENDL-2024 LIBRARY; T=0.K
angular distribution for (n,n*25)

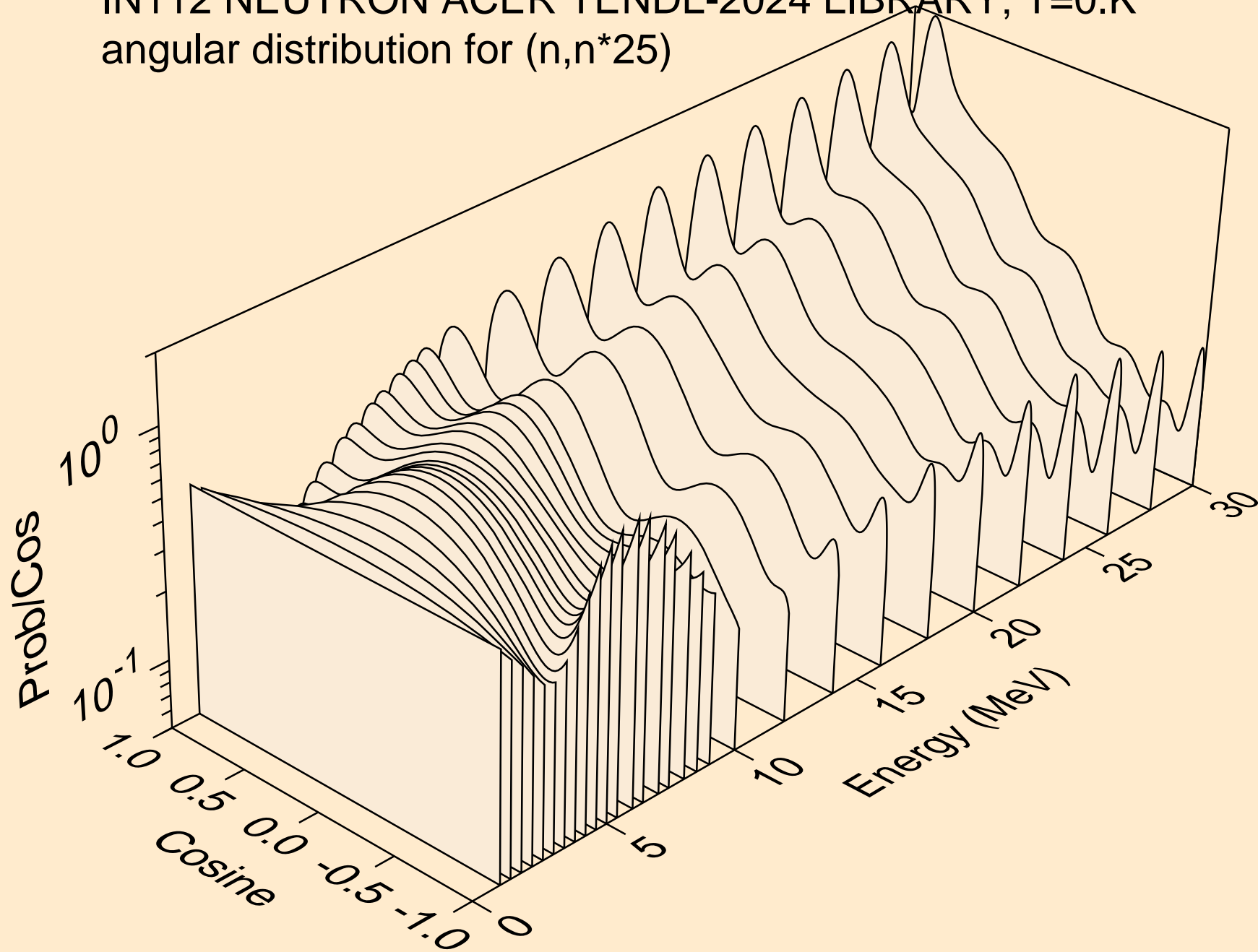

IN112 NEUTRON ACER TENDL-2024 LIBRARY; T=0.K
angular distribution for (n,n*26)

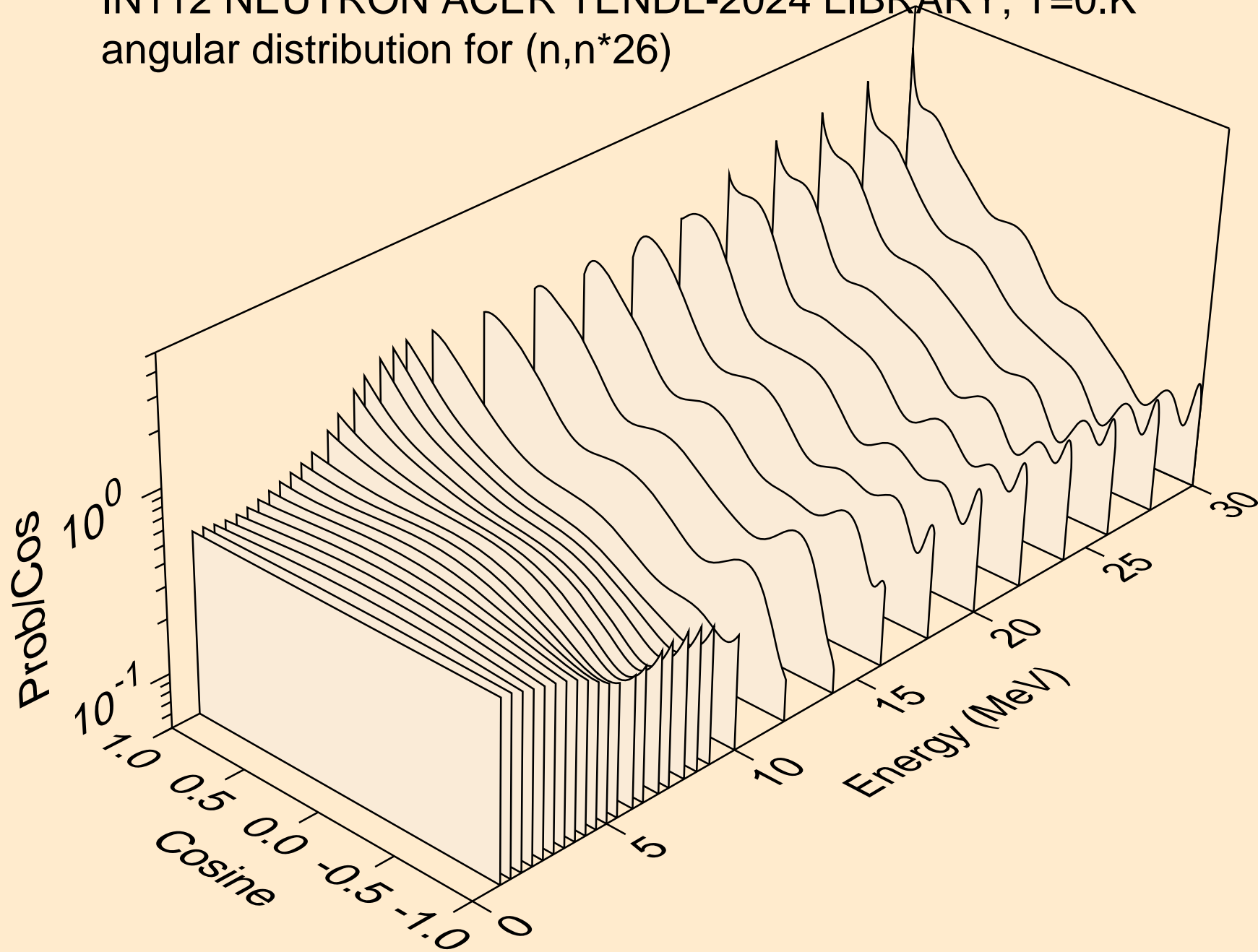

IN112 NEUTRON ACER TENDL-2024 LIBRARY; T=0.K
angular distribution for (n,n*27)

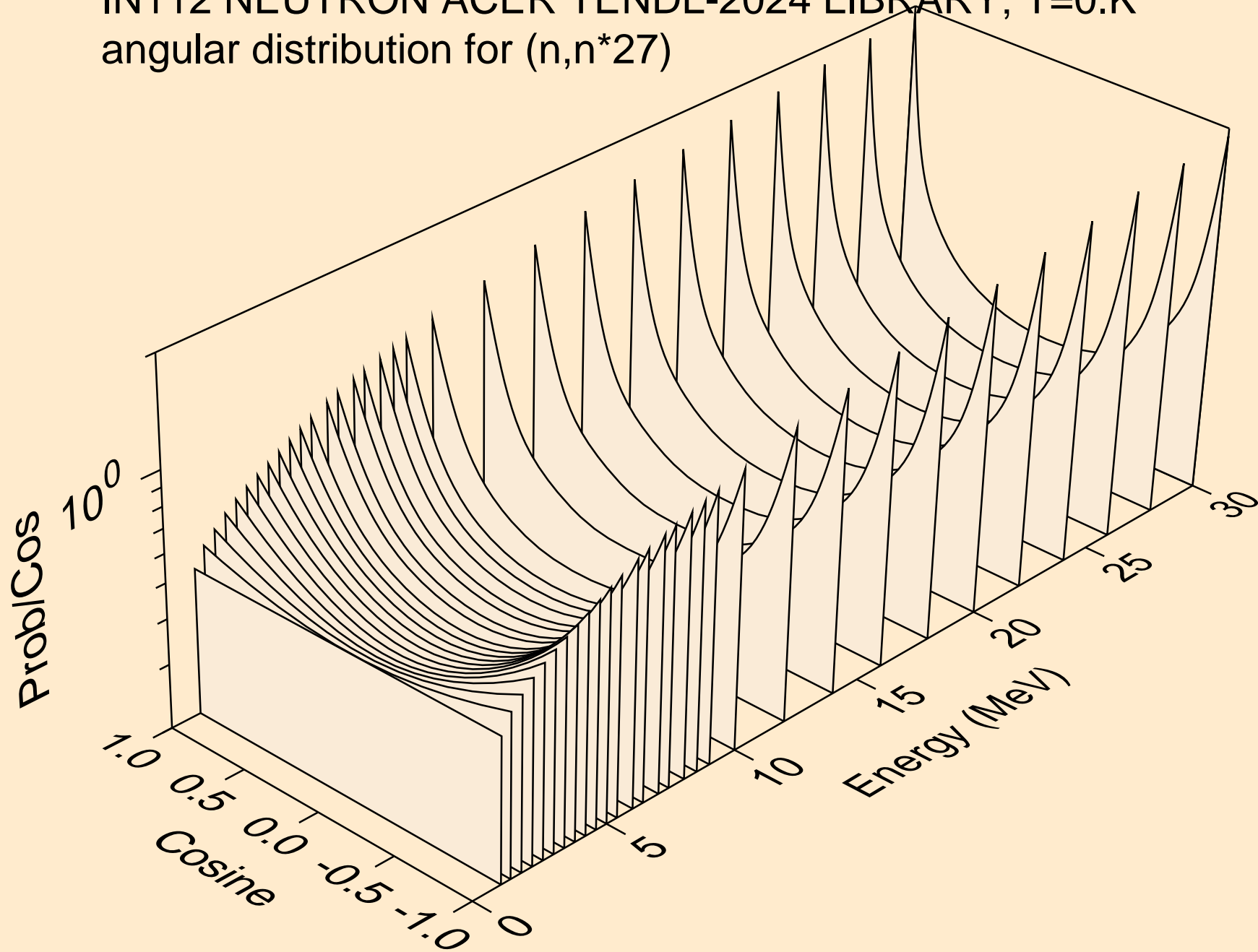

IN112 NEUTRON ACER TENDL-2024 LIBRARY; T=0.K
angular distribution for (n,n*28)

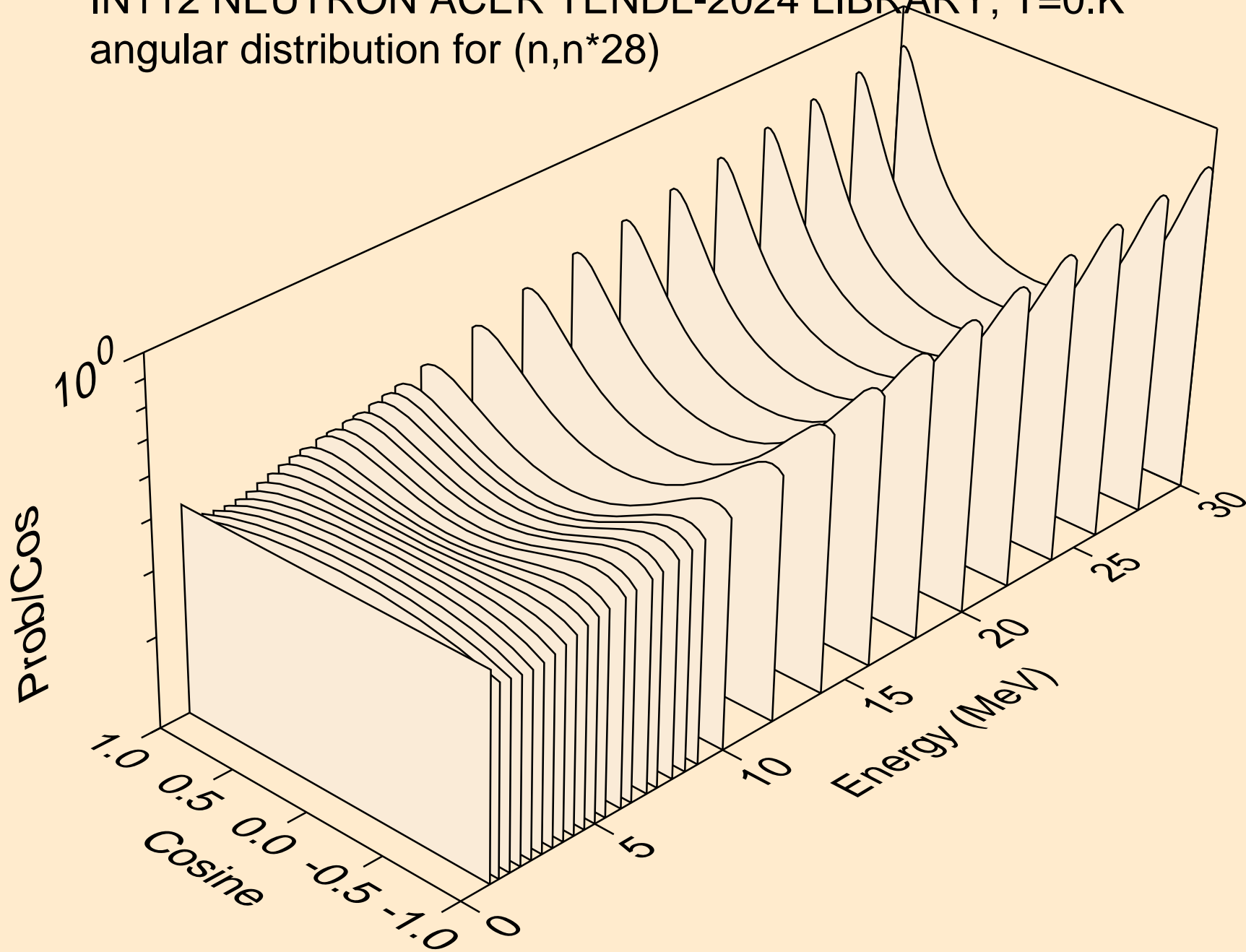

IN112 NEUTRON ACER TENDL-2024 LIBRARY; T=0.K
angular distribution for (n,n*29)

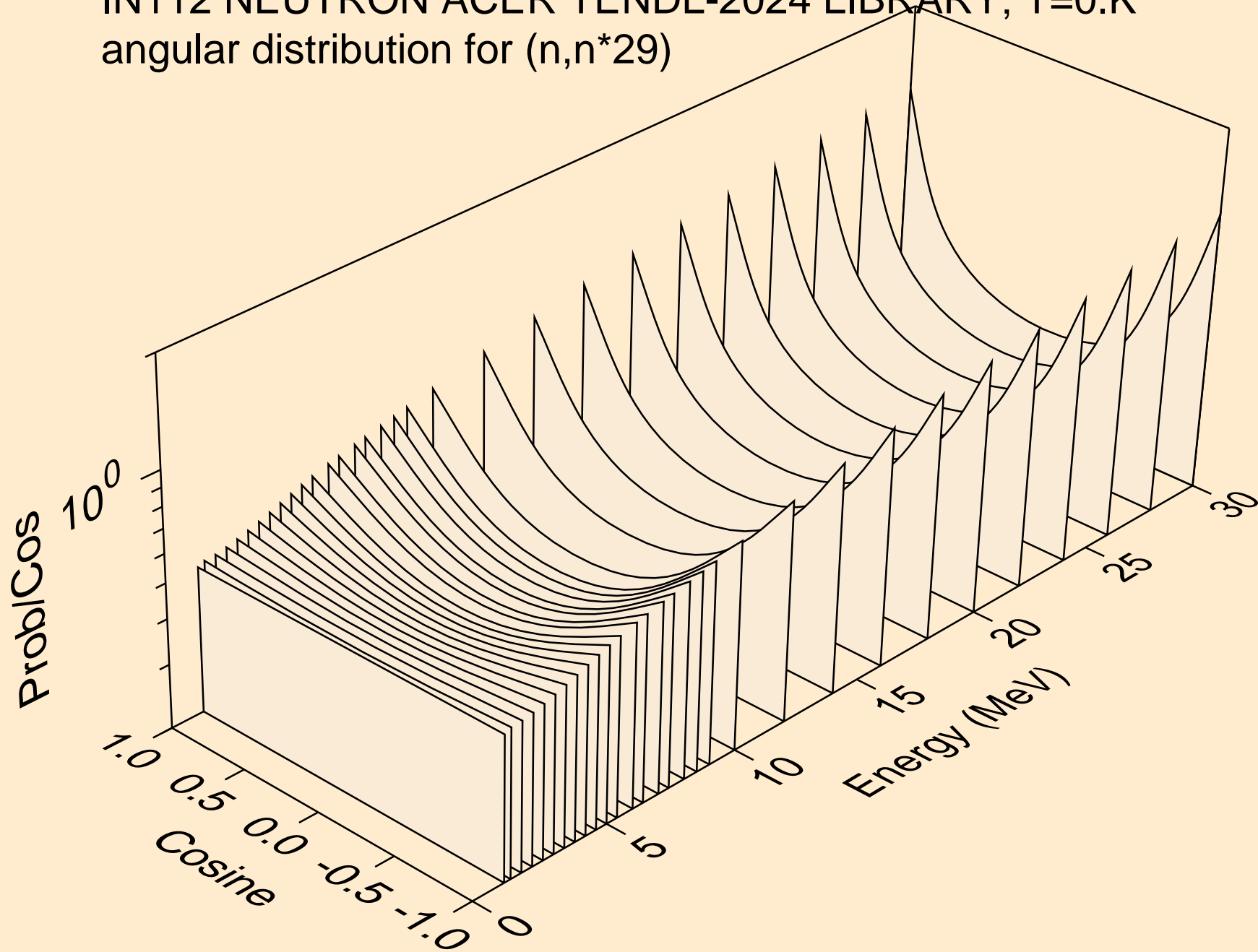

IN112 NEUTRON ACER TENDL-2024 LIBRARY; T=0.K
angular distribution for (n,n*30)

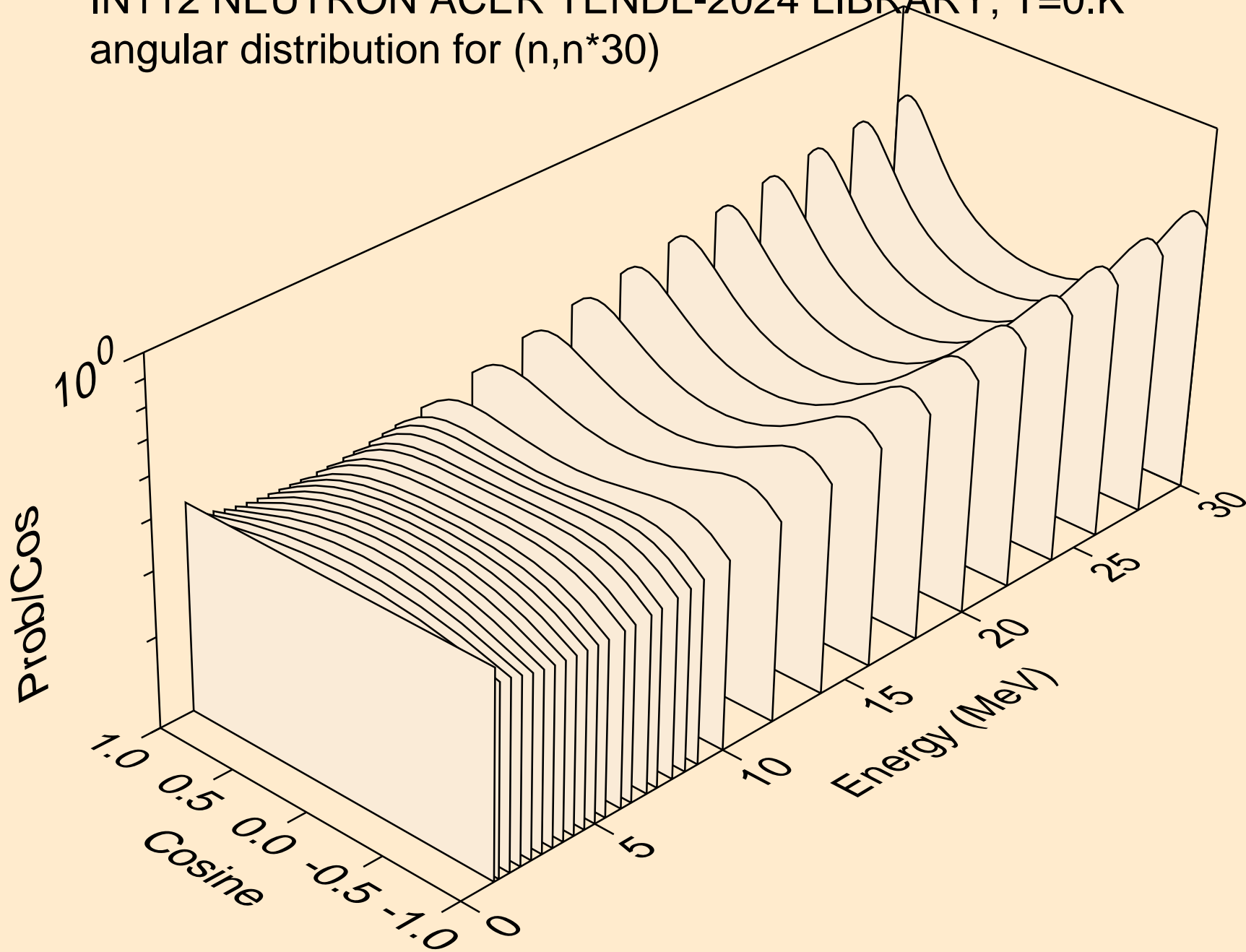

IN112 NEUTRON ACER TENDL-2024 LIBRARY; T=0.K
Neutron emission for (n,x)

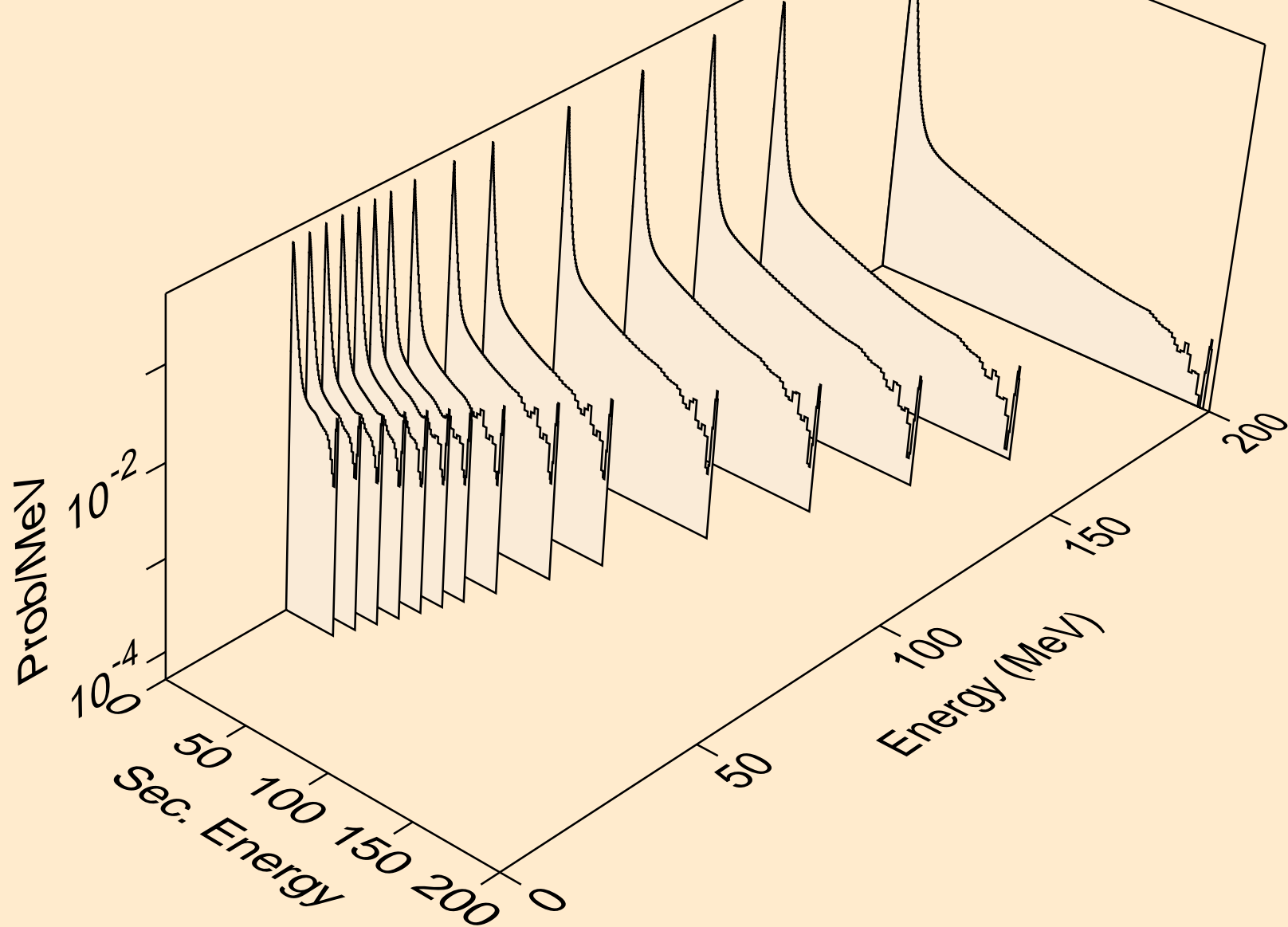

IN112 NEUTRON ACER TENDL-2024 LIBRARY; T=0.K
Neutron emission for (n,2nd)

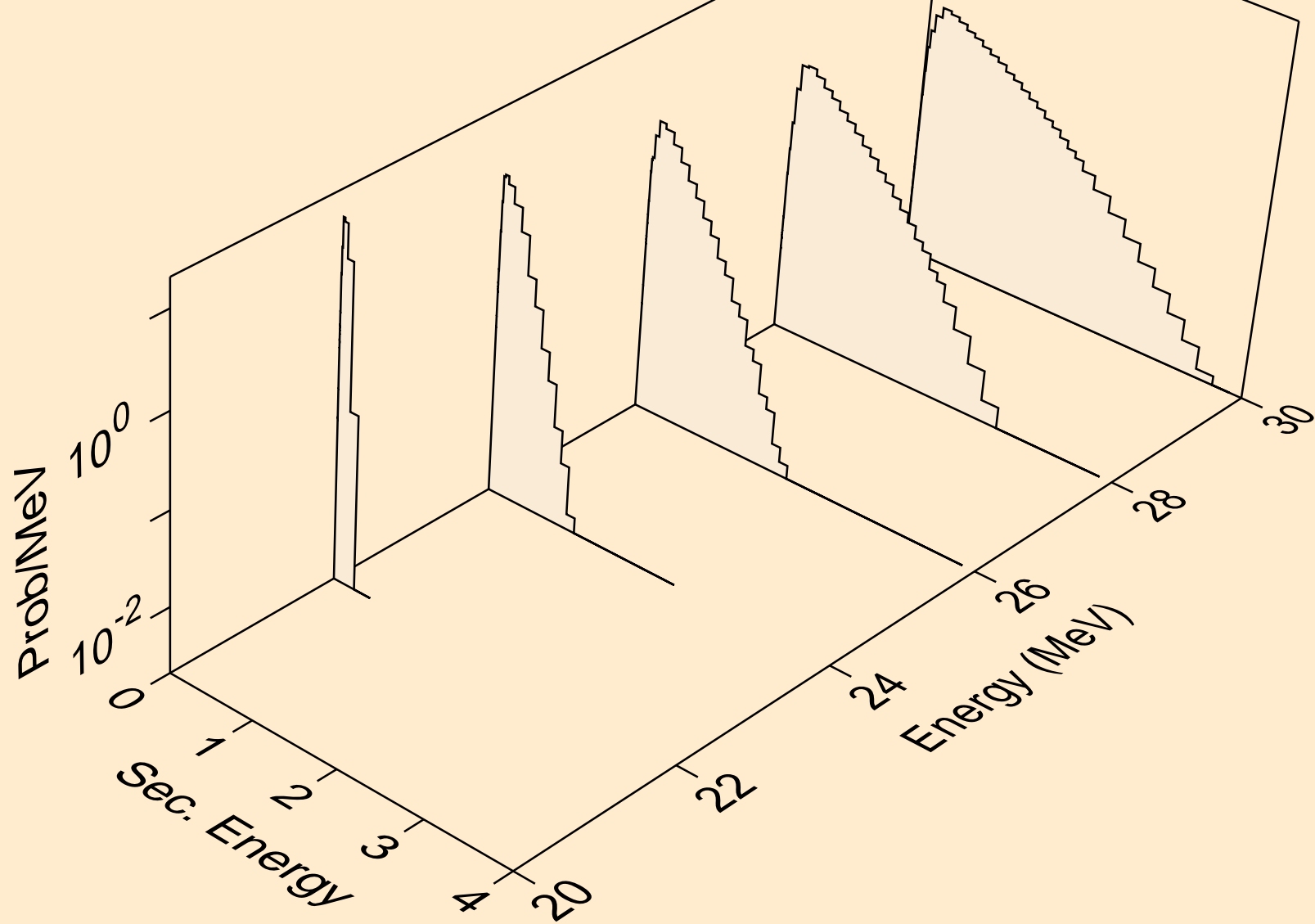

IN112 NEUTRON ACER TENDL-2024 LIBRARY; T=0.K
Neutron emission for (n,2n)

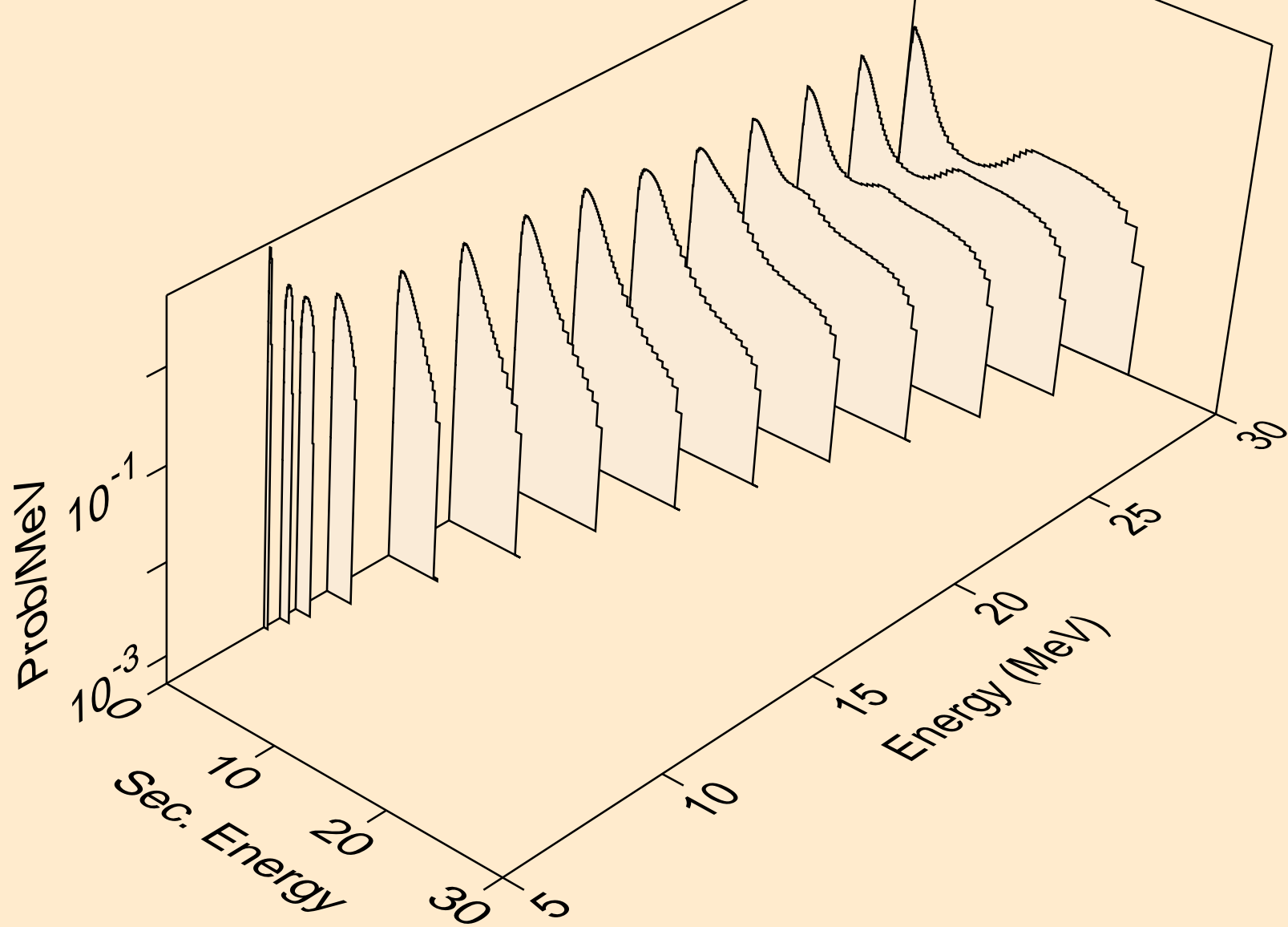

IN112 NEUTRON ACER TENDL-2024 LIBRARY; T=0.K
Neutron emission for (n,3n)

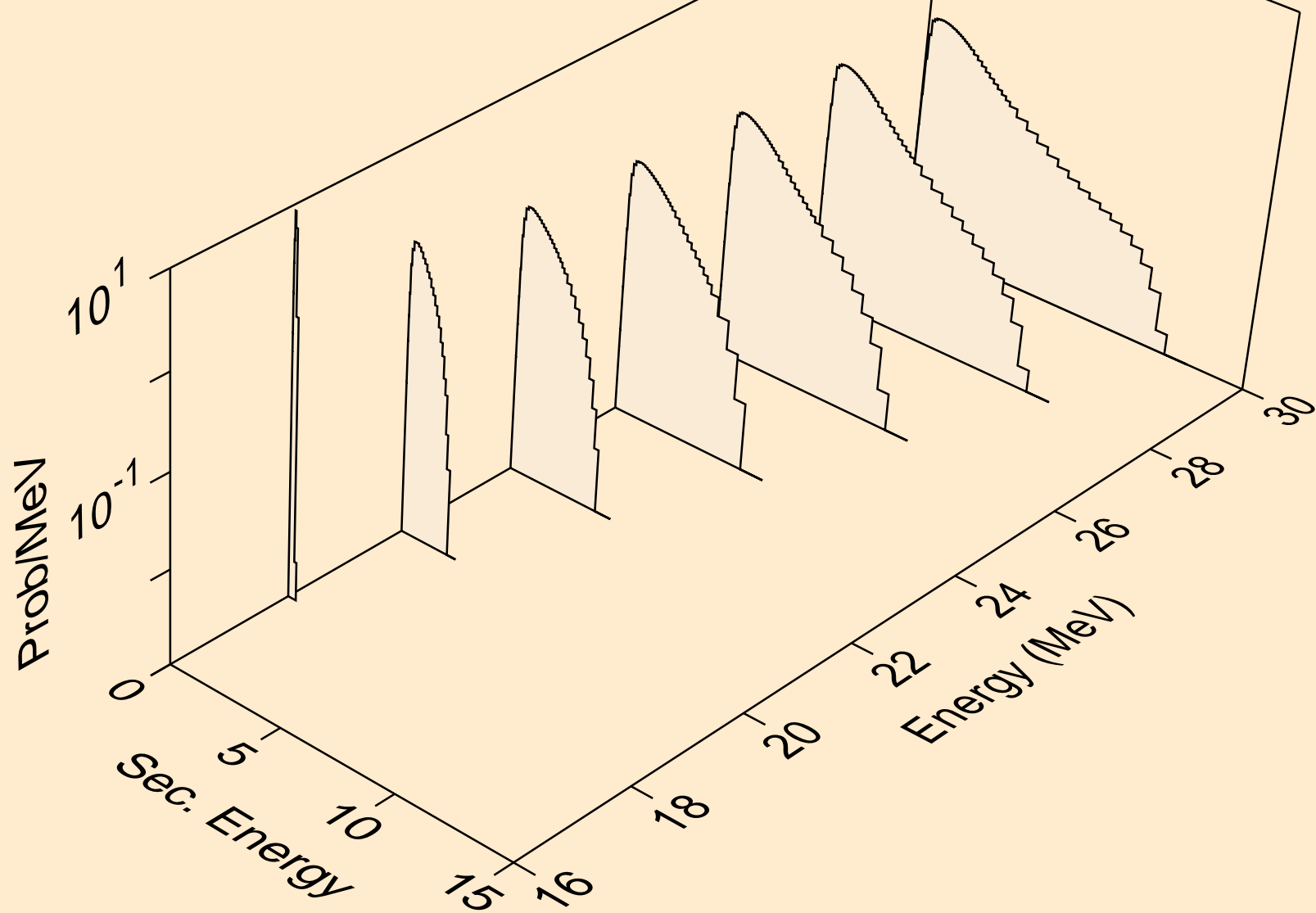

IN112 NEUTRON ACER TENDL-2024 LIBRARY; T=0.K
Neutron emission for (n,n*)a

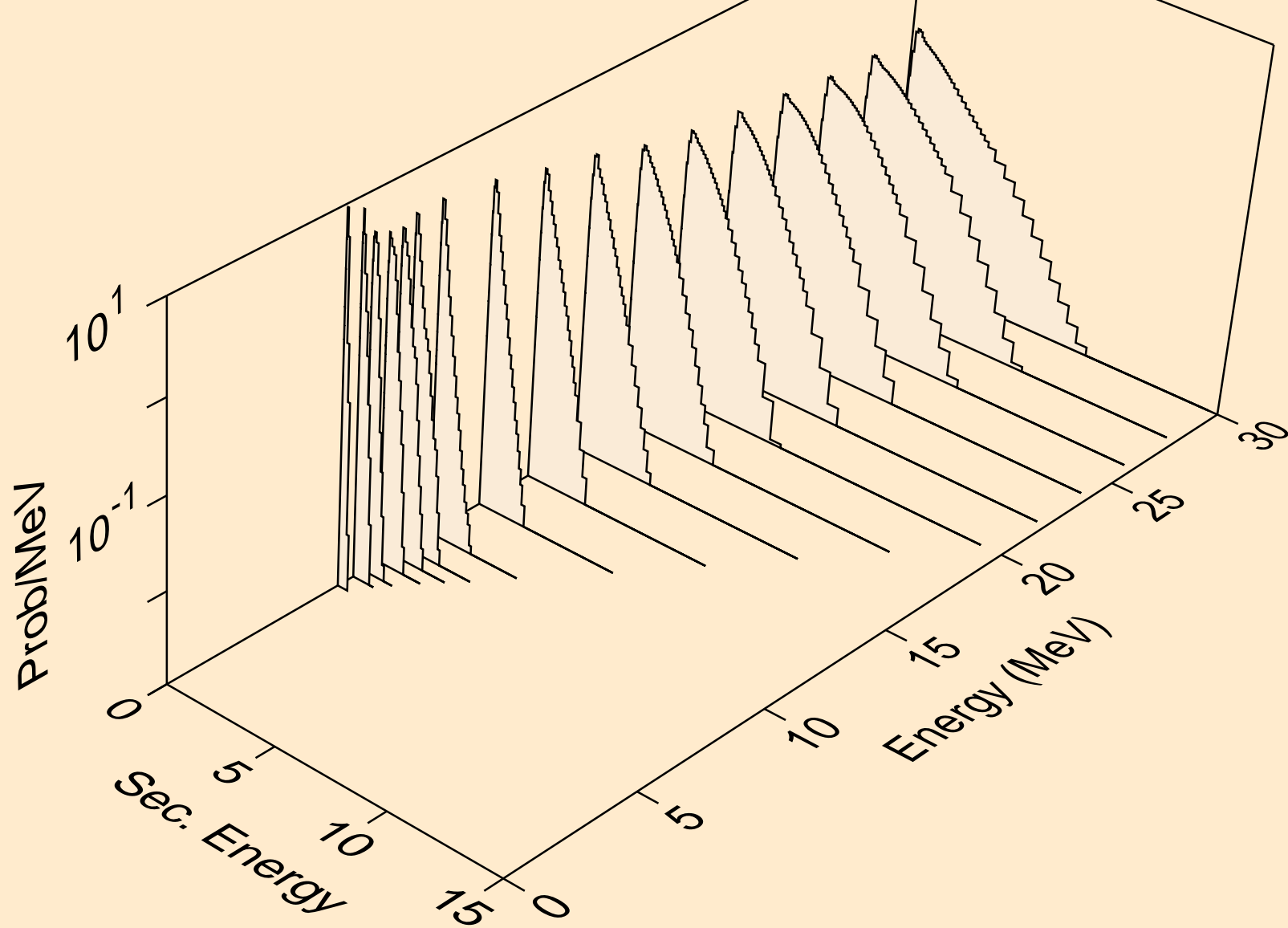

IN112 NEUTRON ACER TENDL-2024 LIBRARY; T=0.K
Neutron emission for (n,2n)a

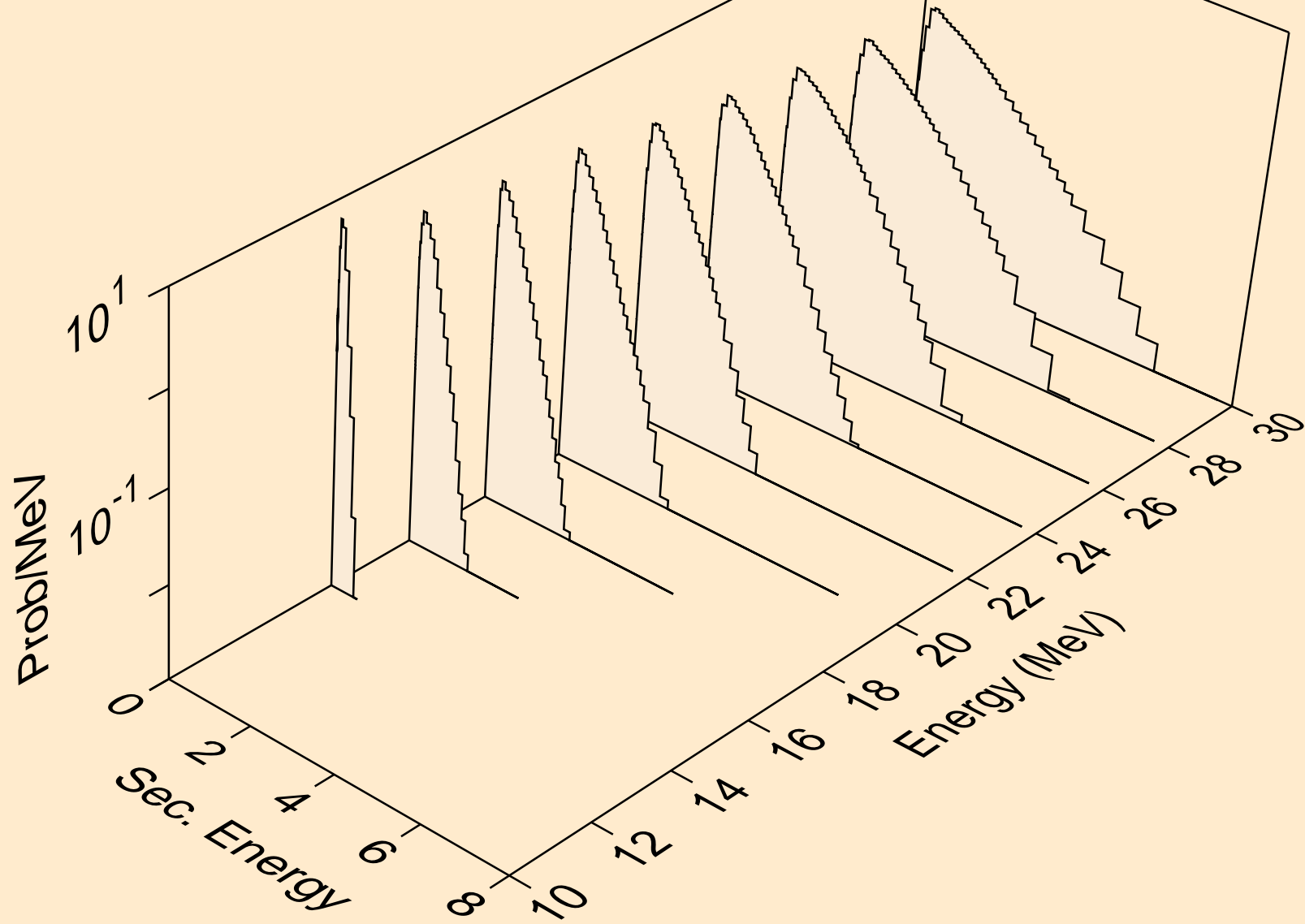

IN112 NEUTRON ACER TENDL-2024 LIBRARY; T=0.K
Neutron emission for (n,3n)a

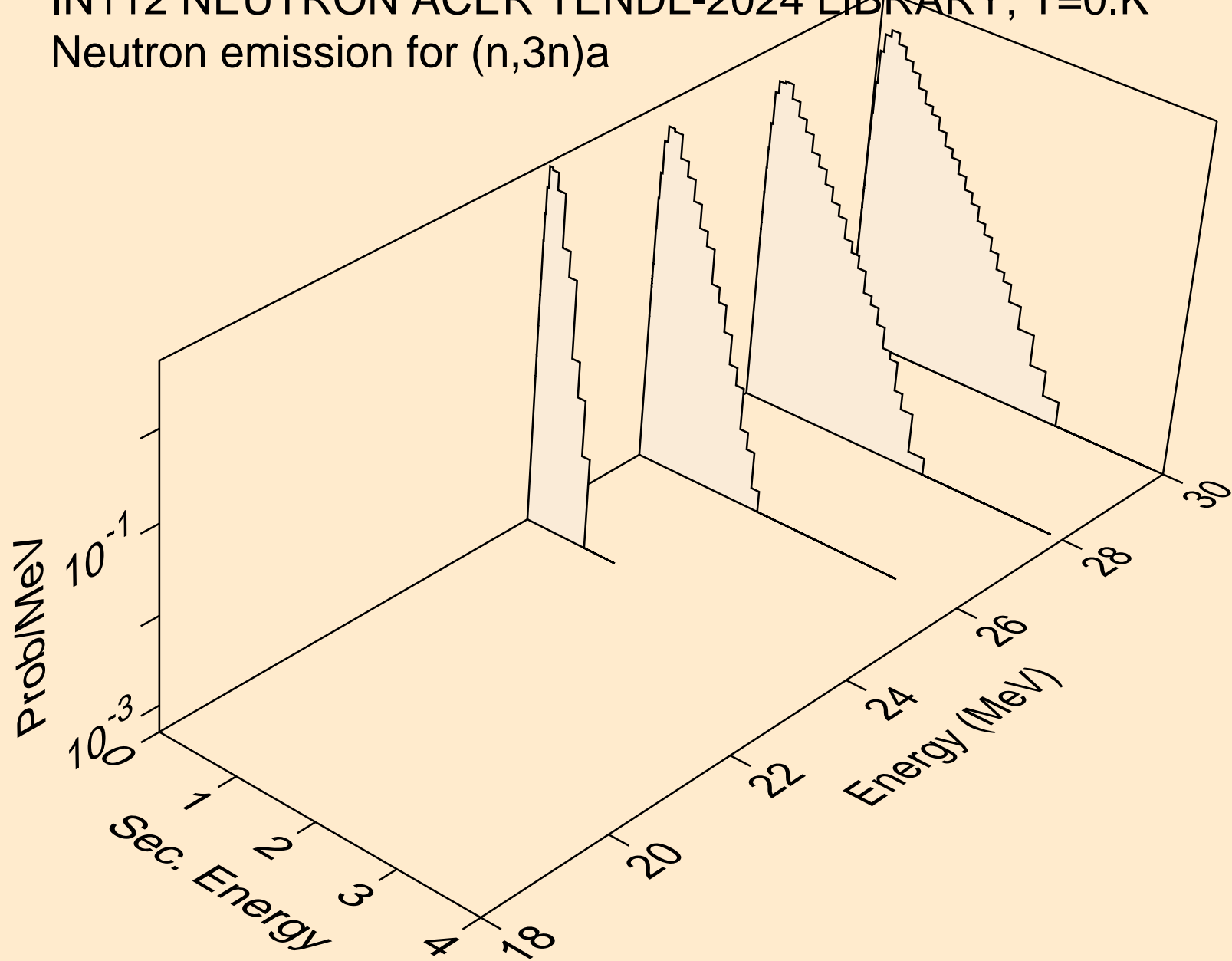

IN112 NEUTRON ACER TENDL-2024 LIBRARY; T=0.K
Neutron emission for (n,n*)p

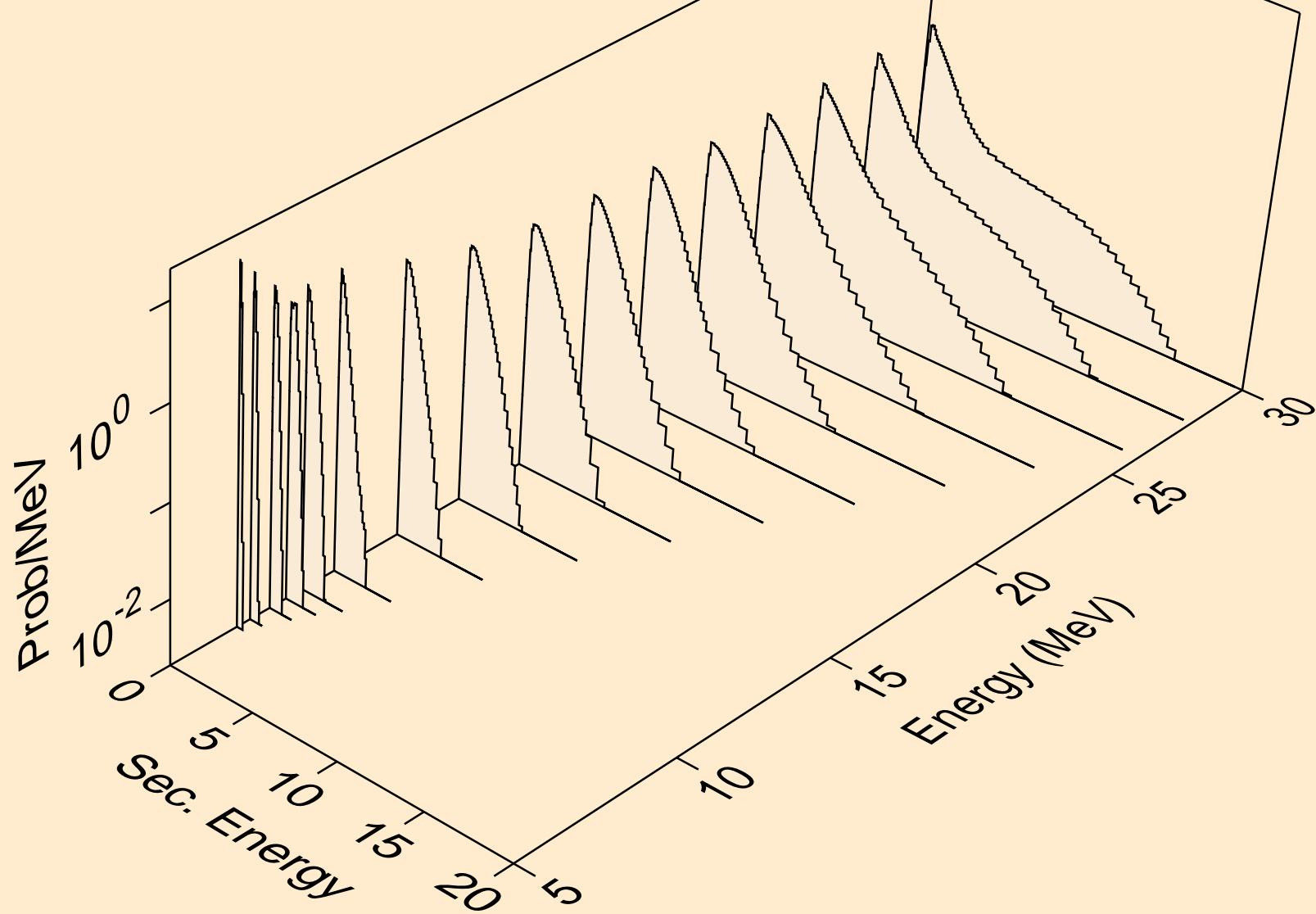

IN112 NEUTRON ACER TENDL-2024 LIBRARY; T=0.K
Neutron emission for (n,n*)2a

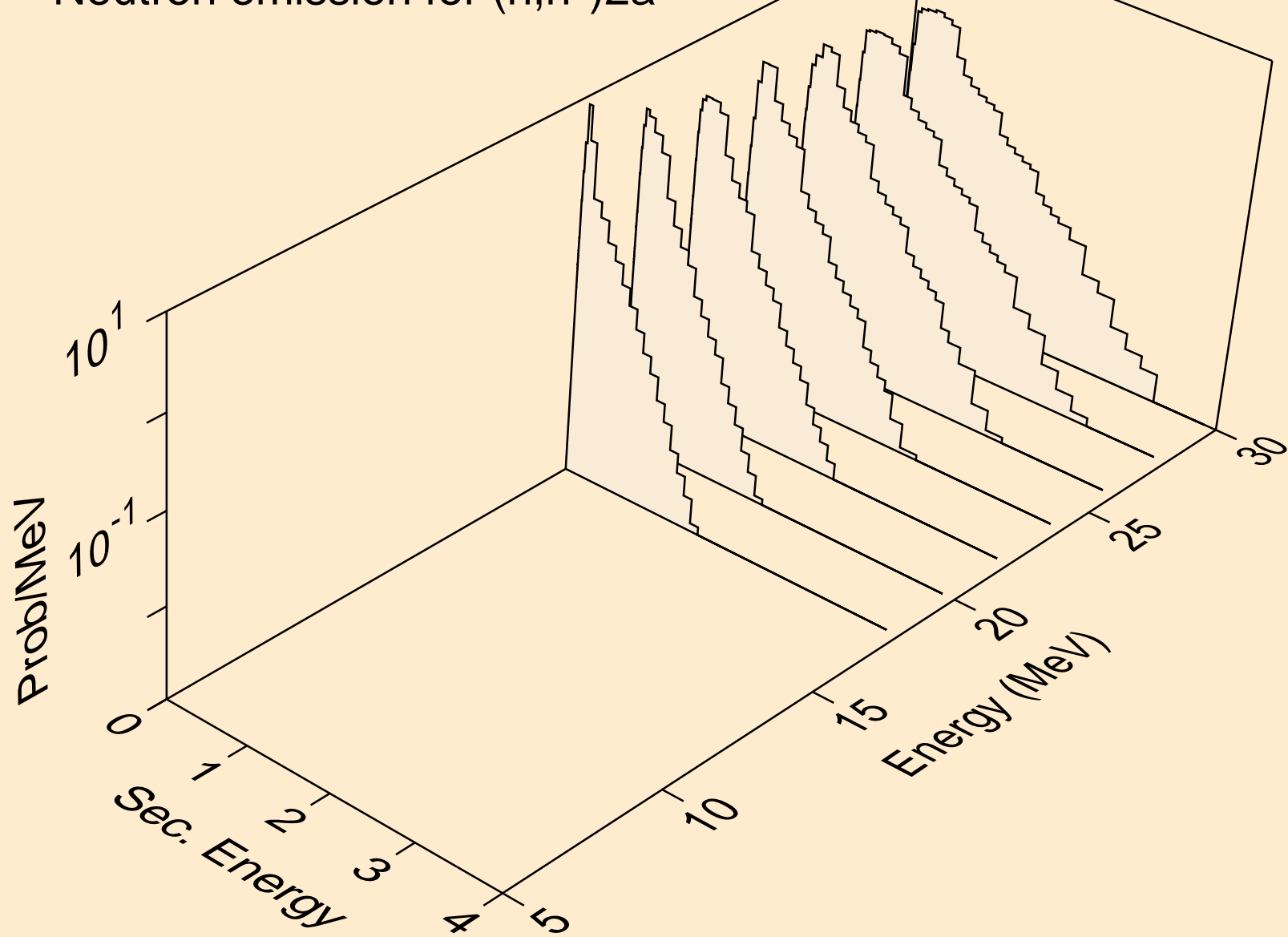

IN112 NEUTRON ACER TENDL-2024 LIBRARY; T=0.K
Neutron emission for (n,n*)d

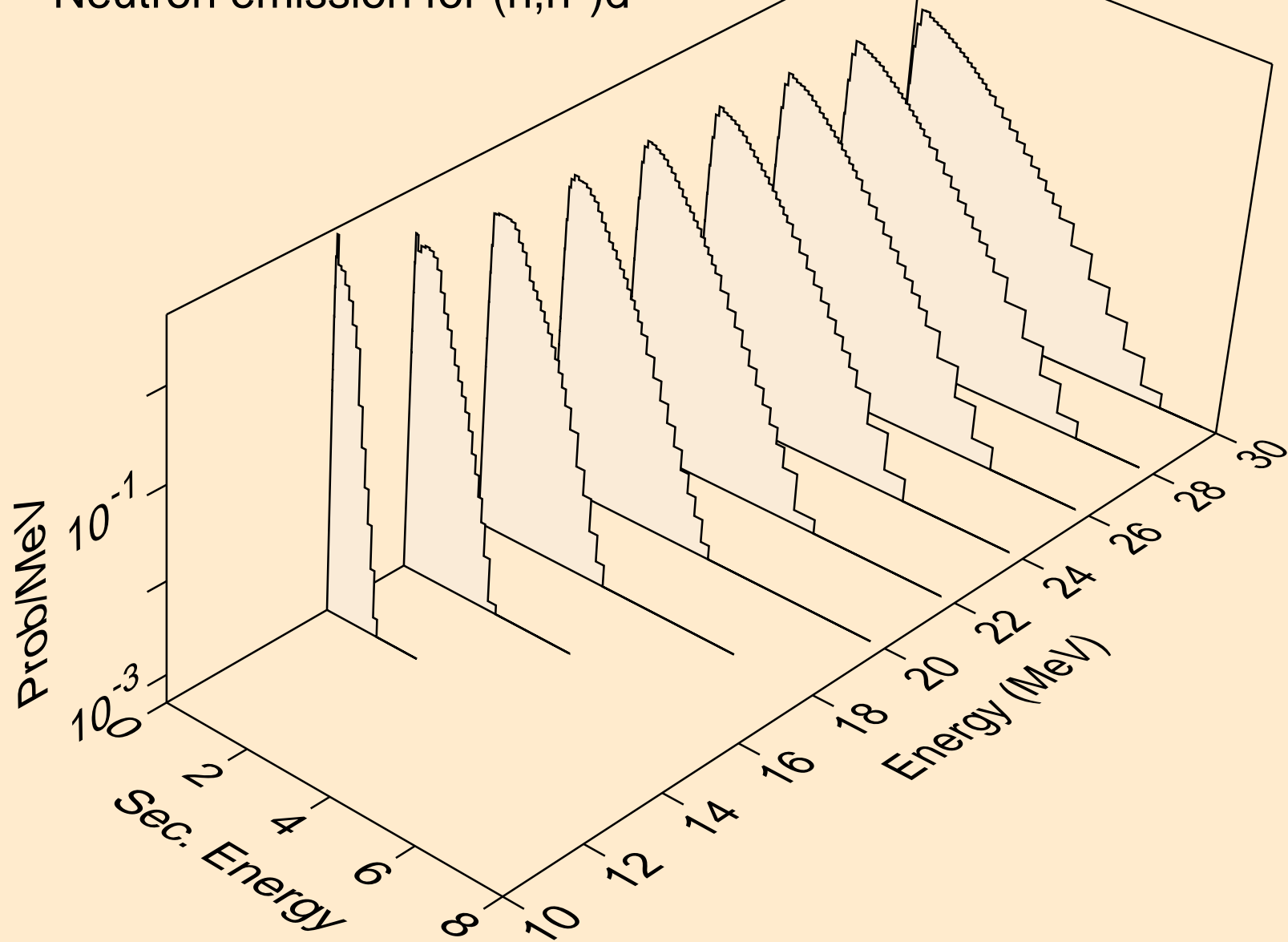

IN112 NEUTRON ACER TENDL-2024 LIBRARY; T=0.K
Neutron emission for (n,n*)t

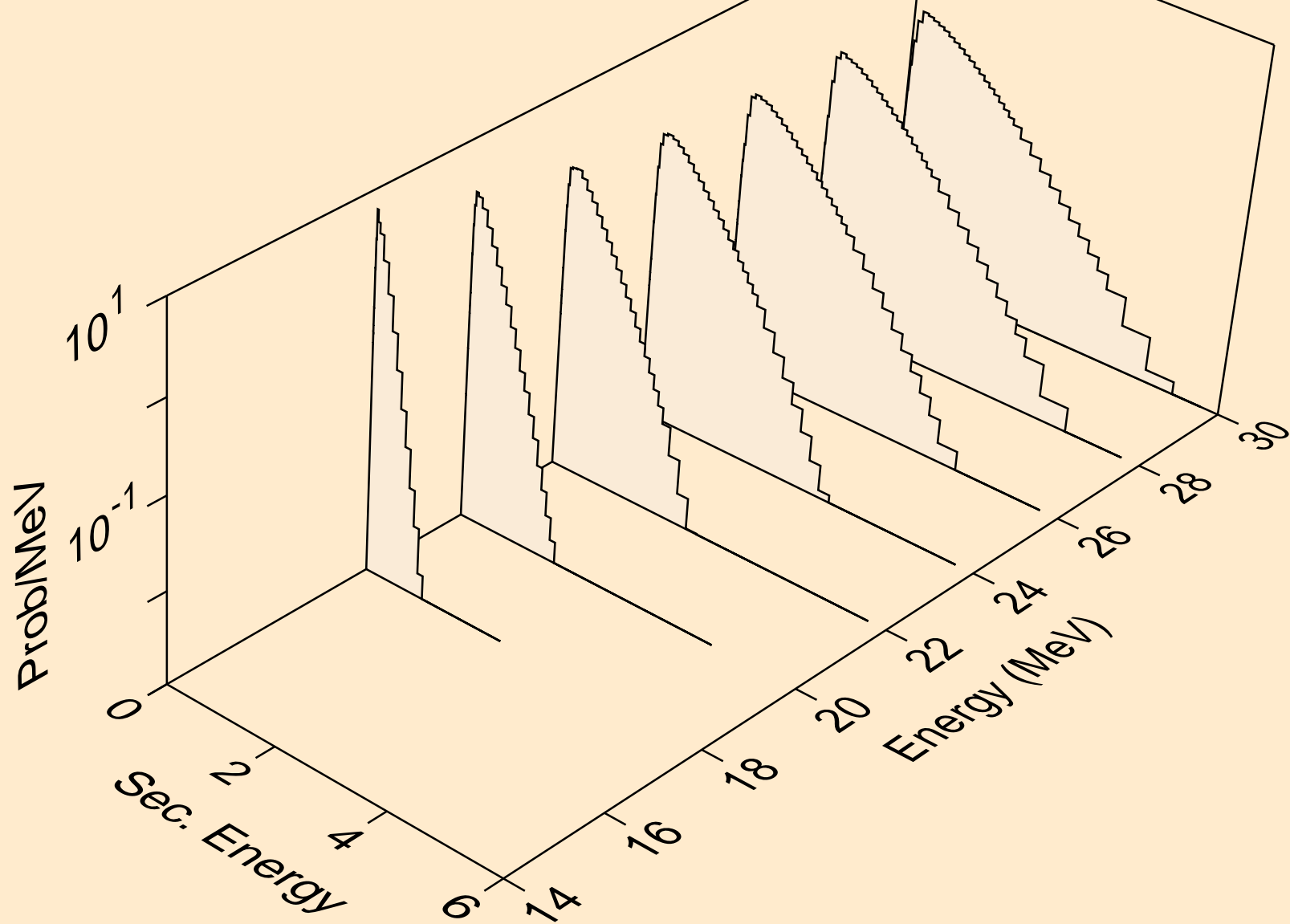

IN112 NEUTRON ACER TENDL-2024 LIBRARY; T=0.K
Neutron emission for (n,n*)he3

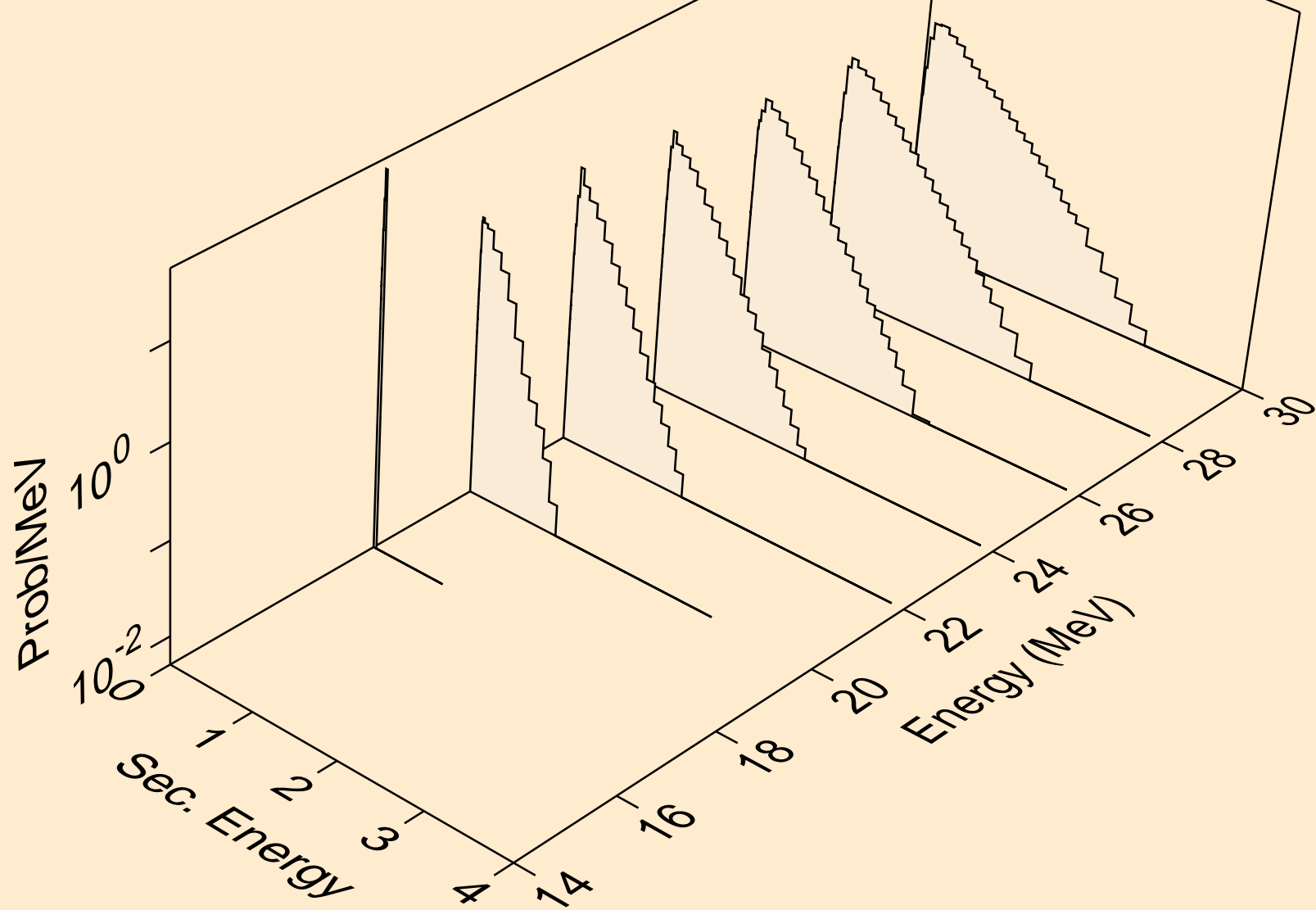

IN112 NEUTRON ACER TENDL-2024 LIBRARY; T=0.K
Neutron emission for (n,4n)

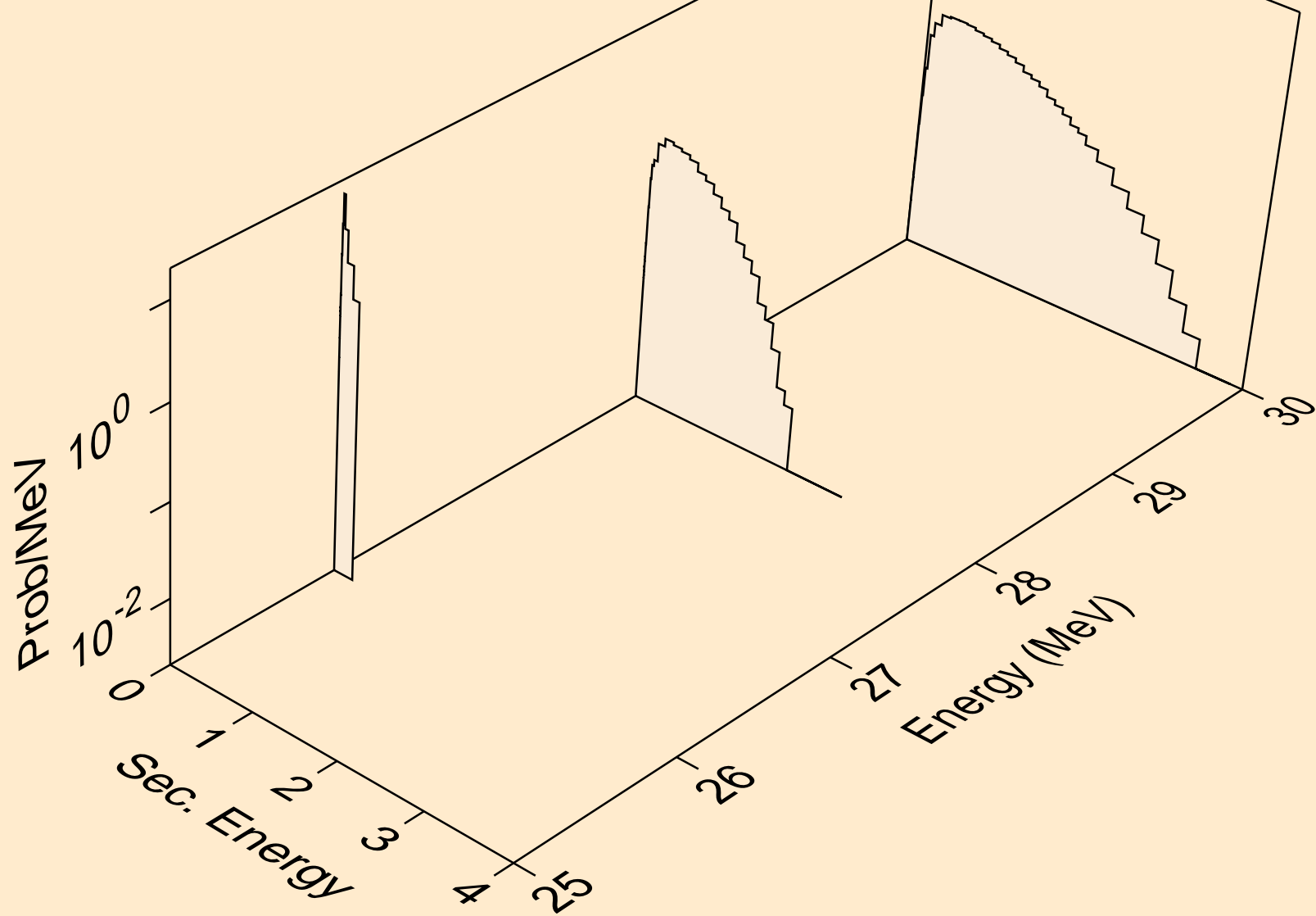

IN112 NEUTRON ACER TENDL-2024 LIBRARY; T=0.K
Neutron emission for (n,2np)

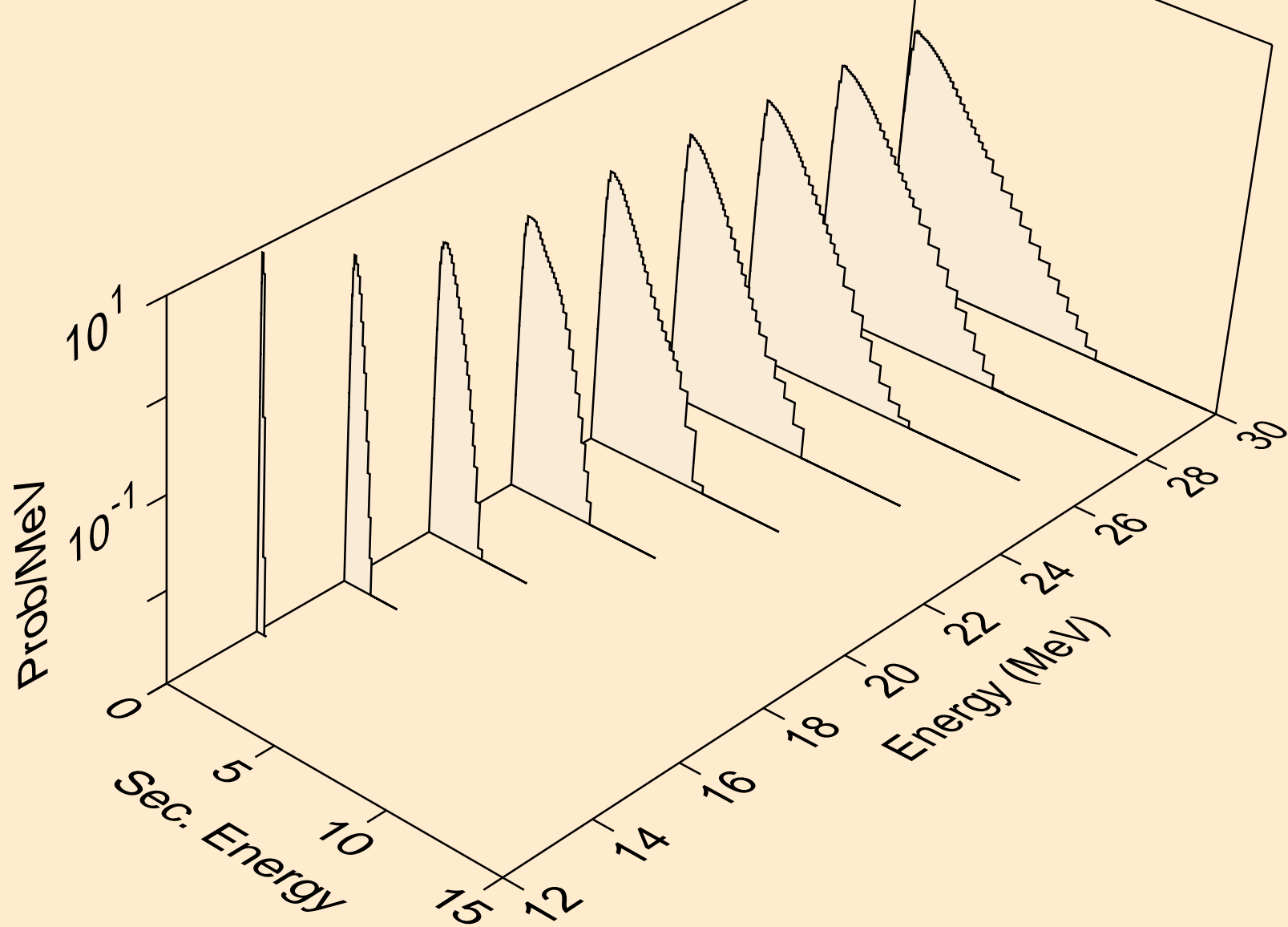

IN112 NEUTRON ACER TENDL-2024 LIBRARY; T=0.K
Neutron emission for (n,3np)

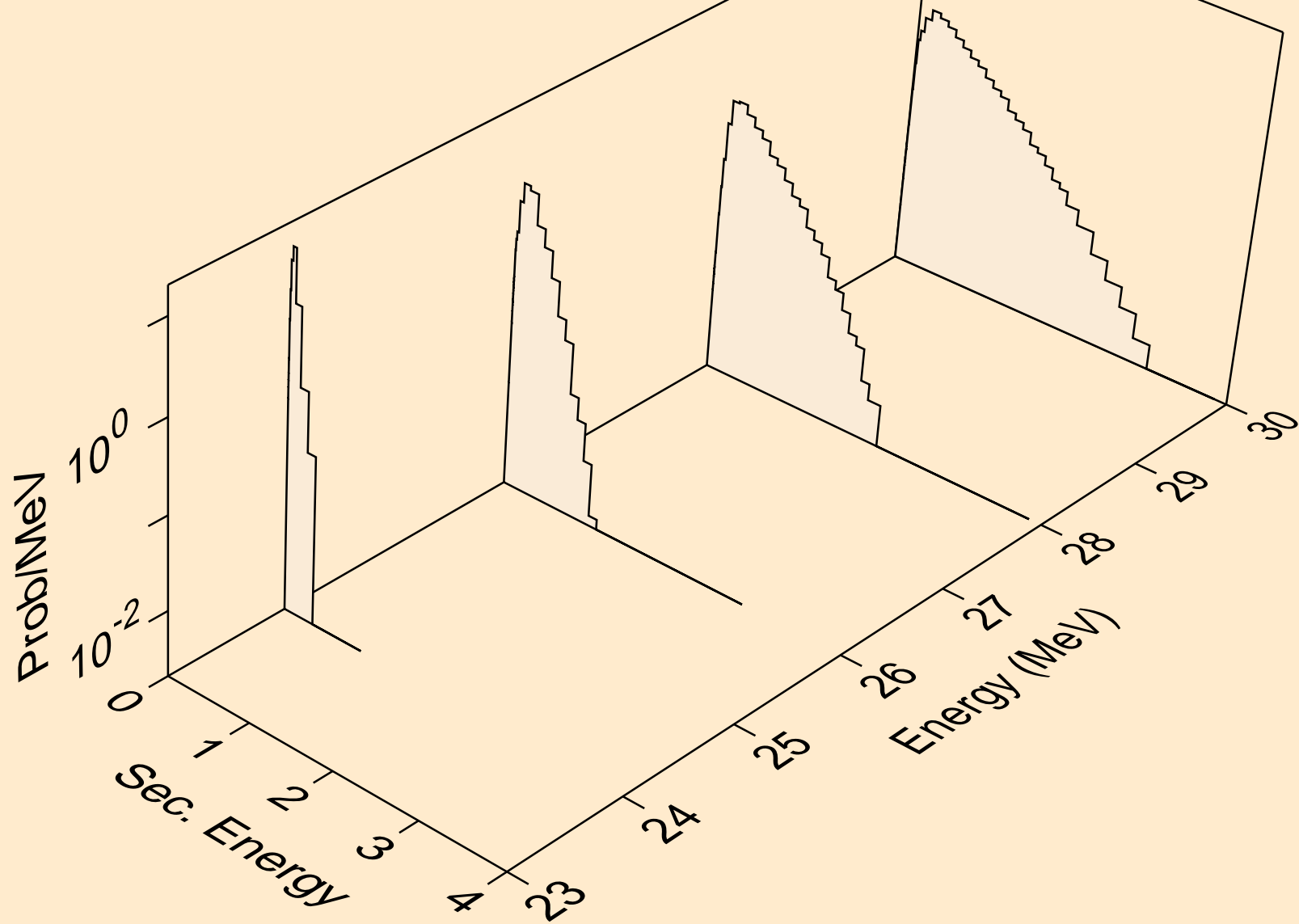

IN112 NEUTRON ACER TENDL-2024 LIBRARY; T=0.K
Neutron emission for (n,n2p)

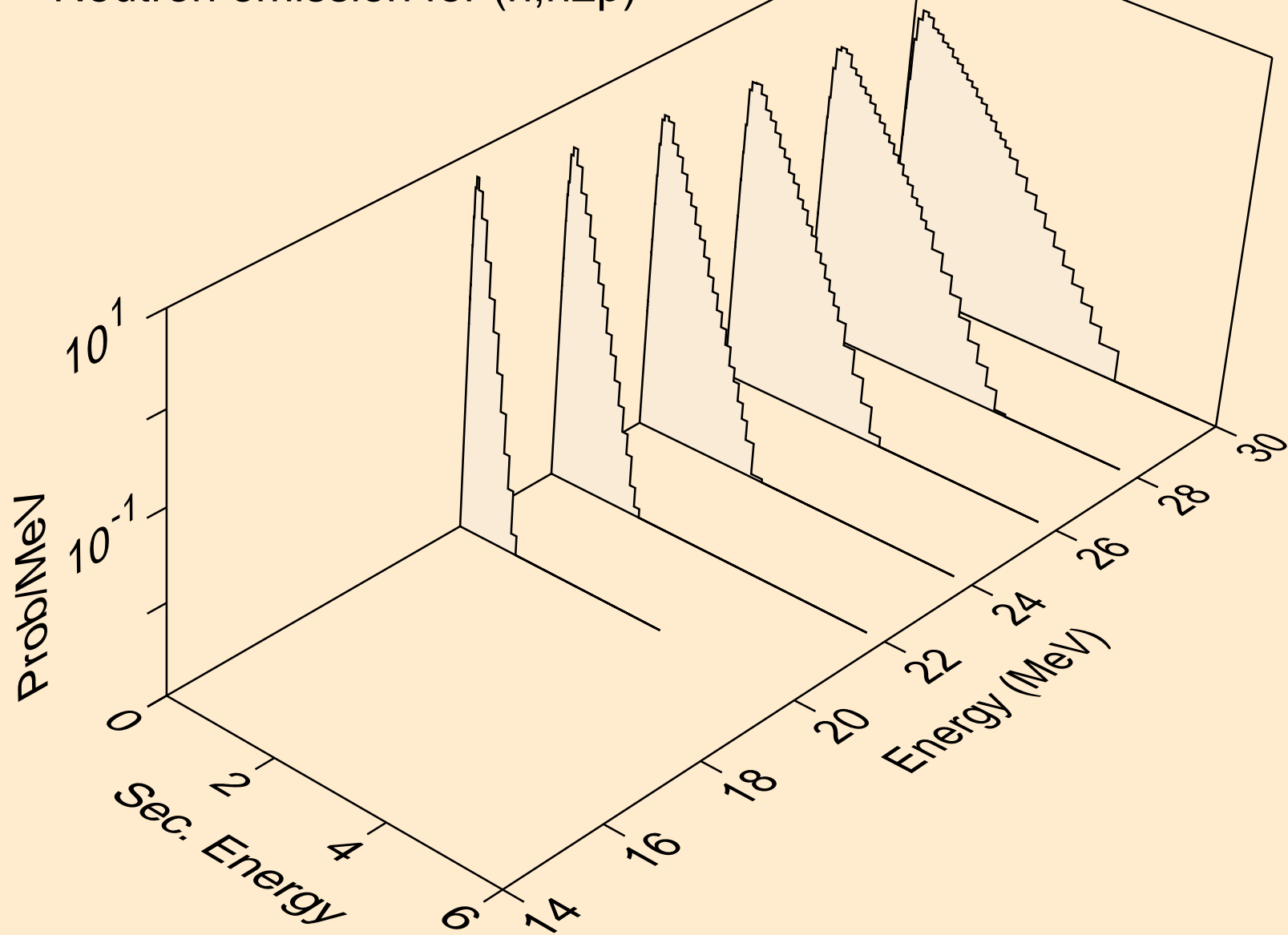

IN112 NEUTRON ACER TENDL-2024 LIBRARY; T=0.K
Neutron emission for (n,npa)

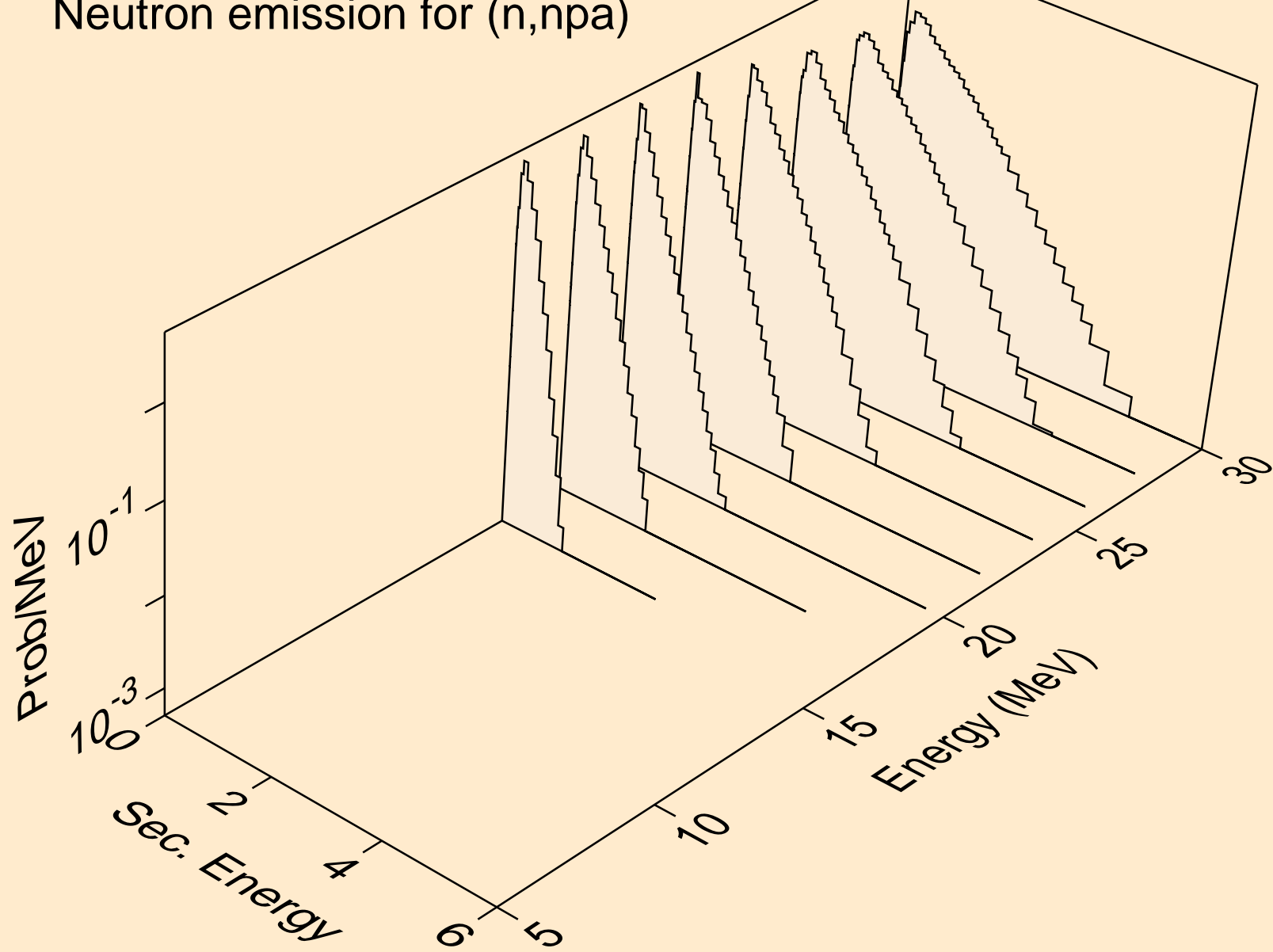

IN112 NEUTRON ACER TENDL-2024 LIBRARY; T=0.K
Neutron emission for (n,n*c)

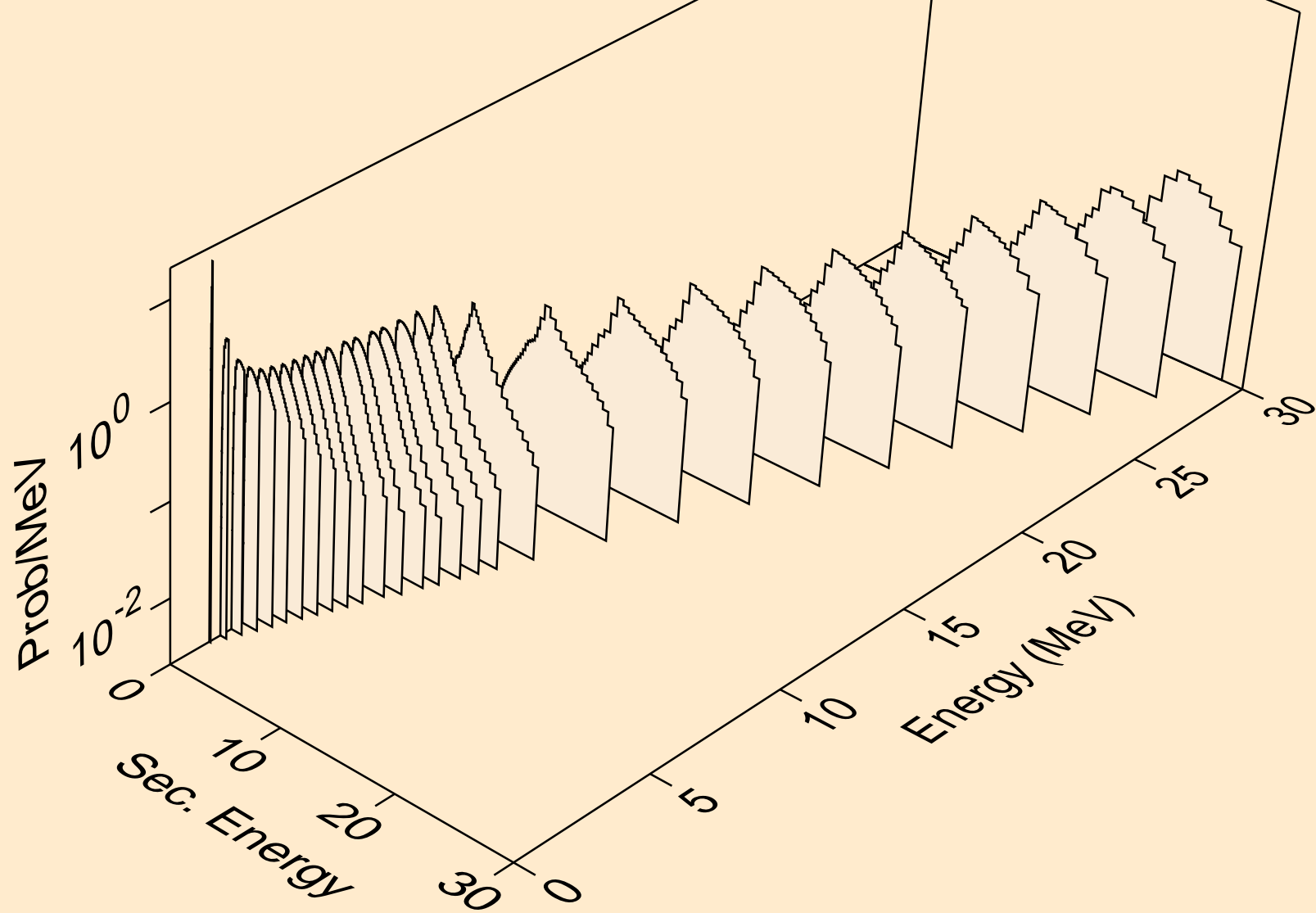

IN112 NEUTRON ACER TENDL-2024 LIBRARY; T=0.K
Photon emission for (n,x)

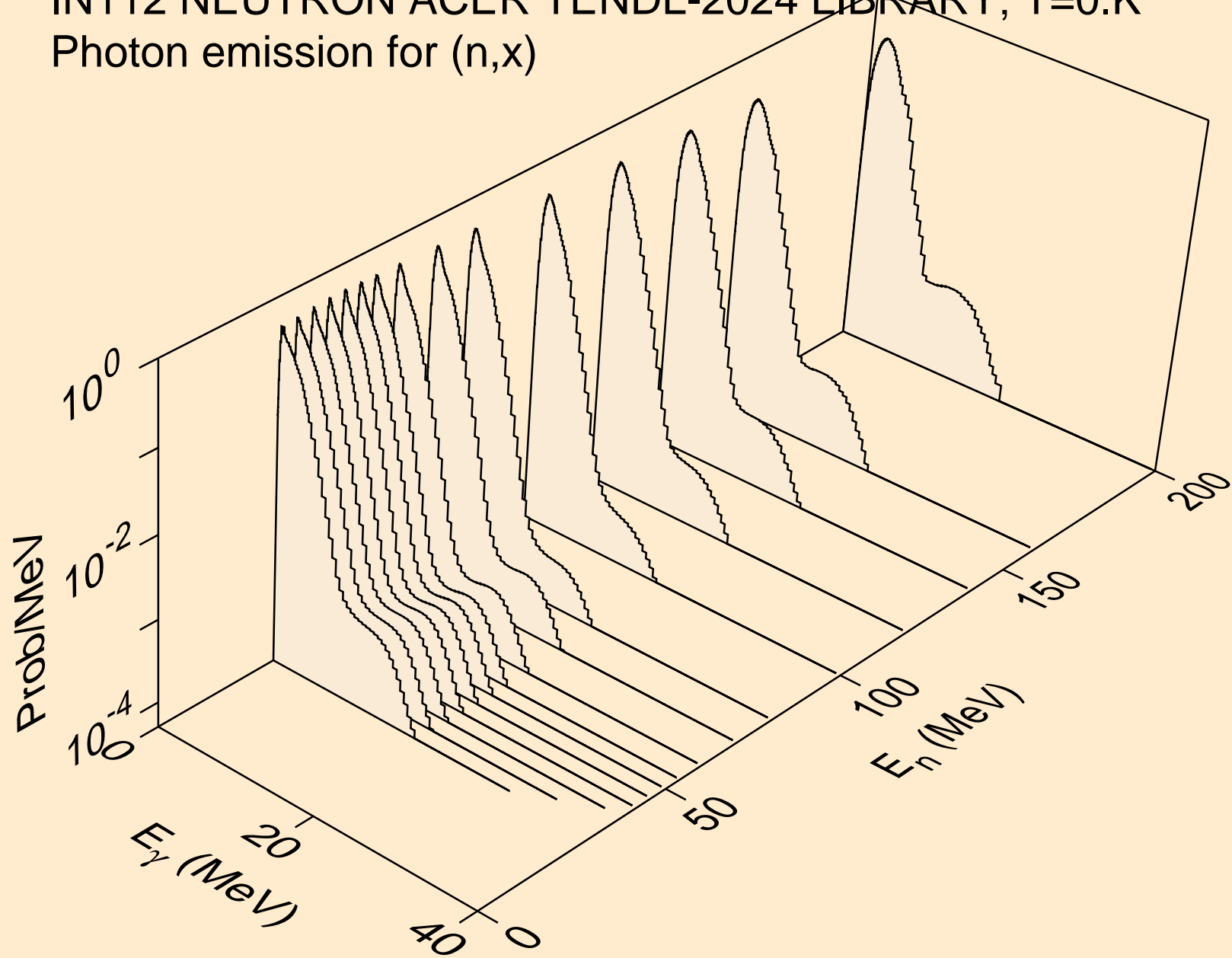

IN112 NEUTRON ACER TENDL-2024 LIBRARY; T=0.K
Photon emission for (n,2nd)

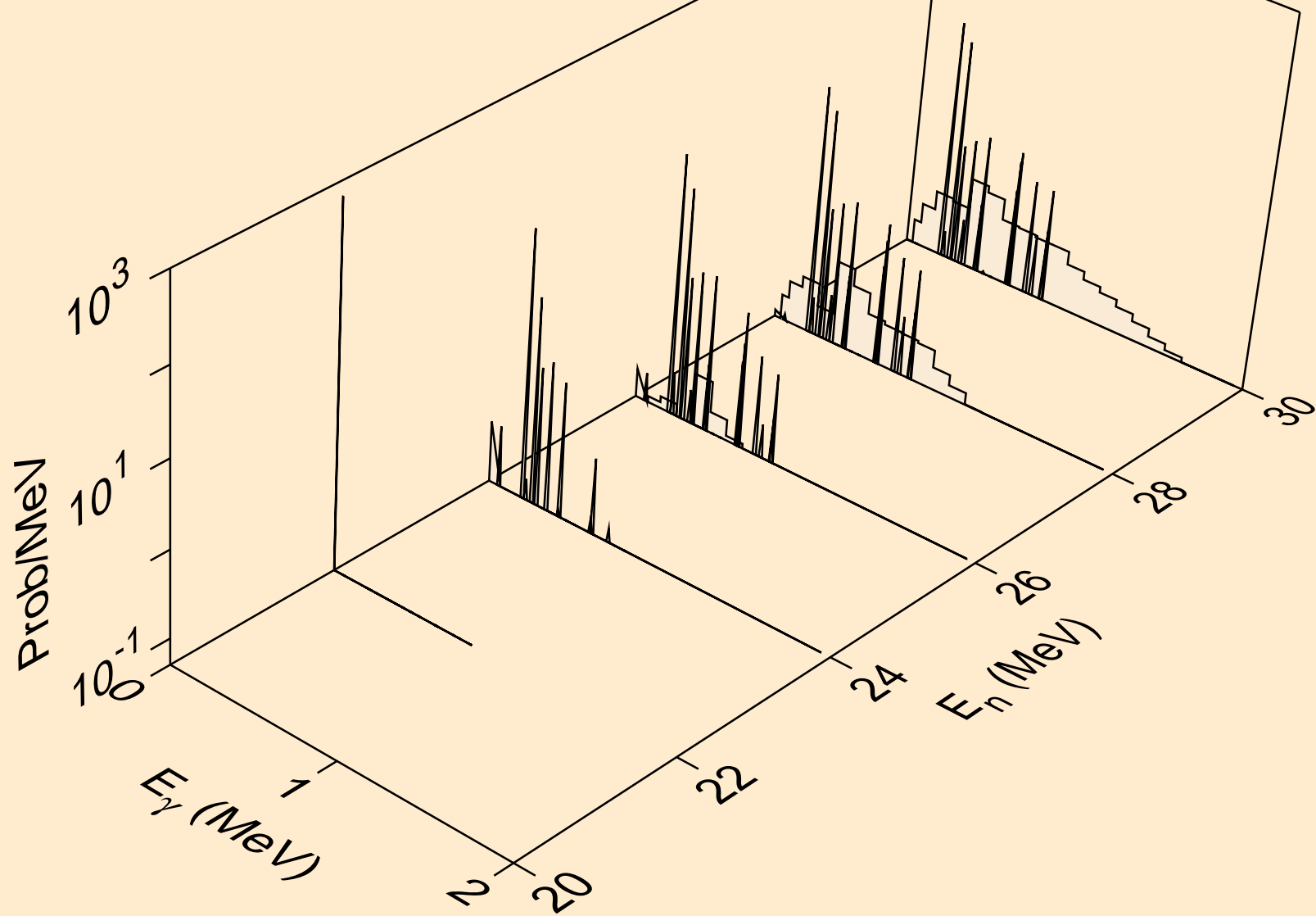

IN112 NEUTRON ACER TENDL-2024 LIBRARY; T=0.K
Photon emission for (n,2n)

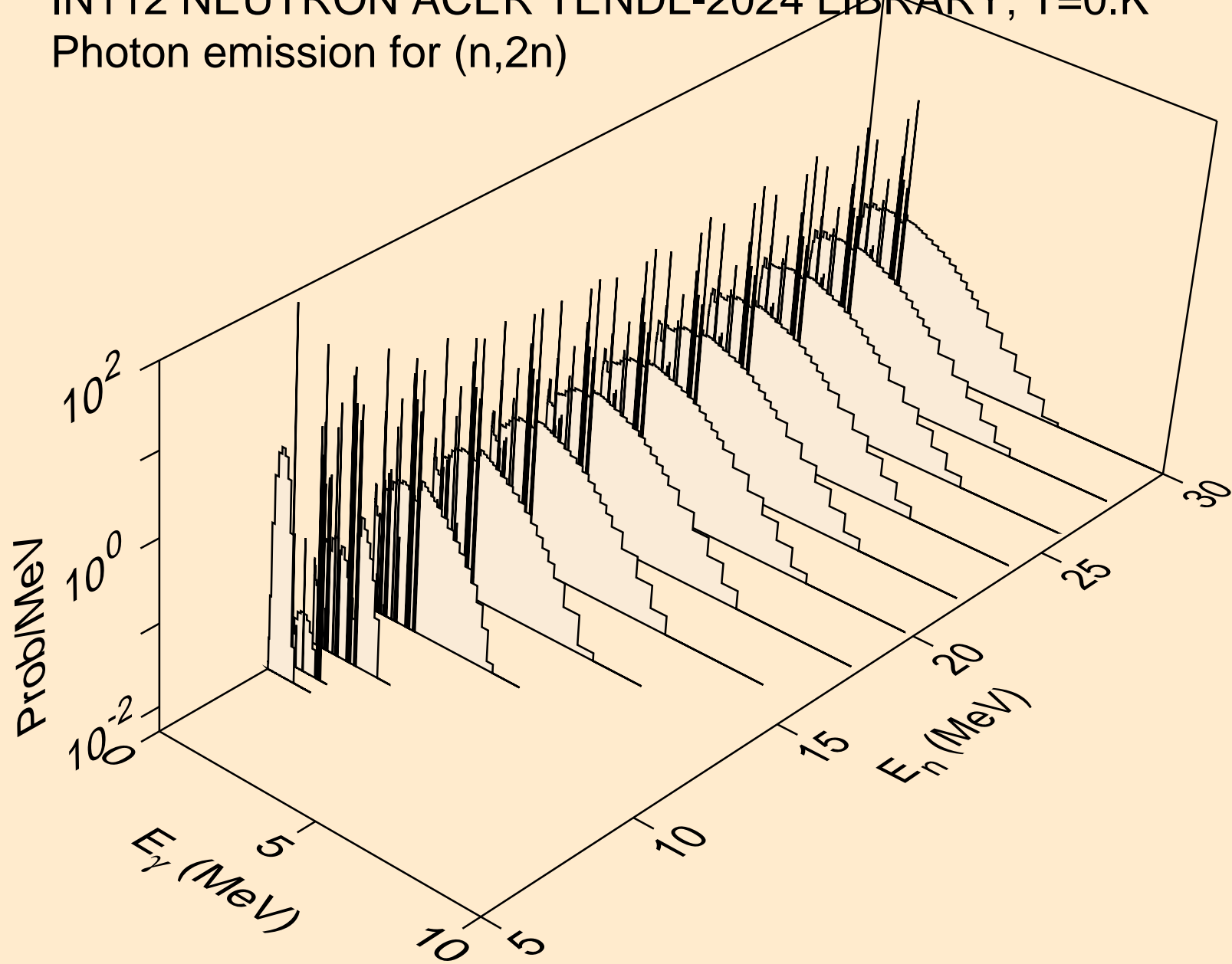

IN112 NEUTRON ACER TENDL-2024 LIBRARY; T=0.K
Photon emission for (n,3n)

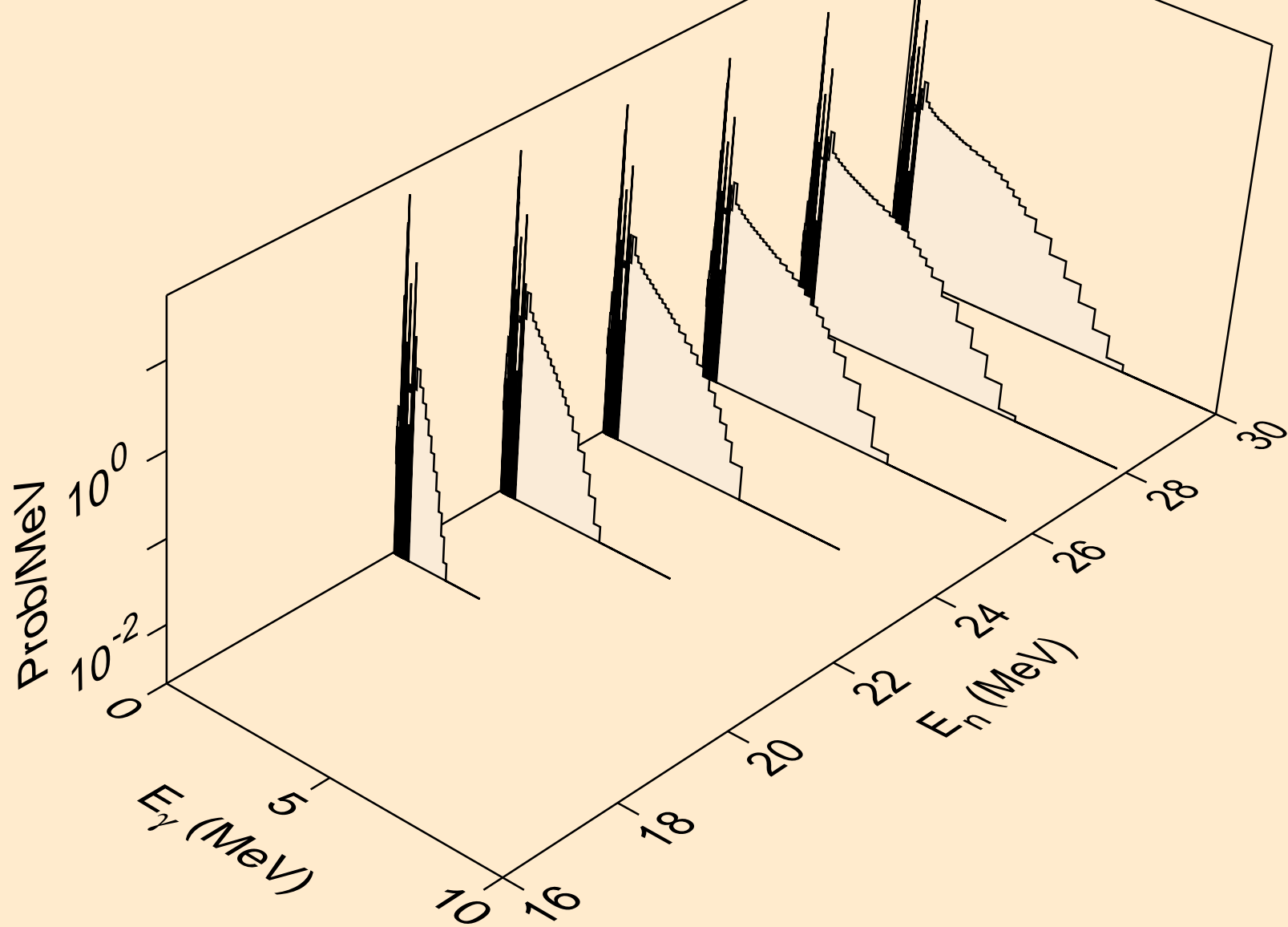

IN112 NEUTRON ACER TENDL-2024 LIBRARY; T=0.K
Photon emission for (n,n*)a

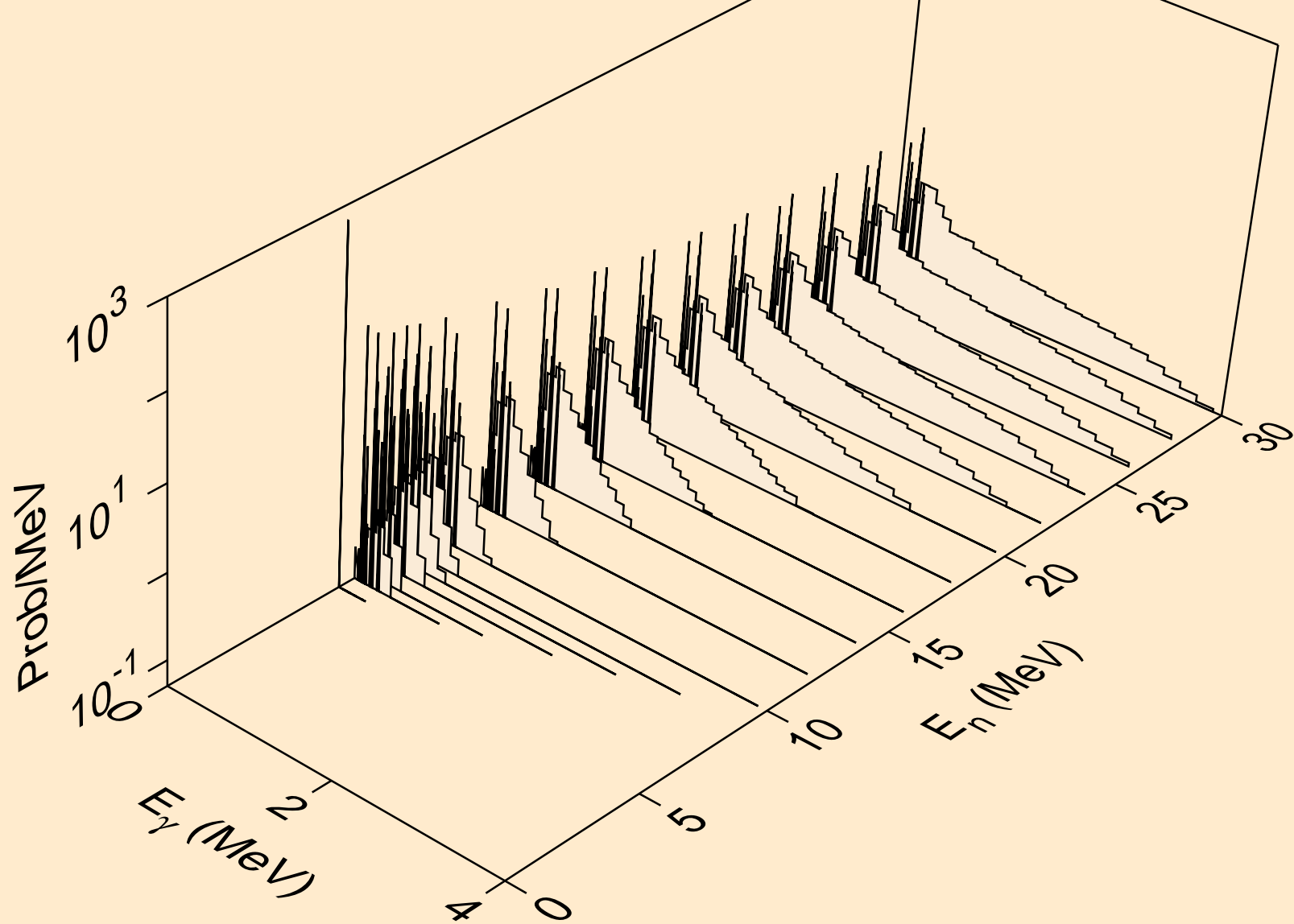

IN112 NEUTRON ACER TENDL-2024 LIBRARY; T=0.K
Photon emission for (n,2n)a

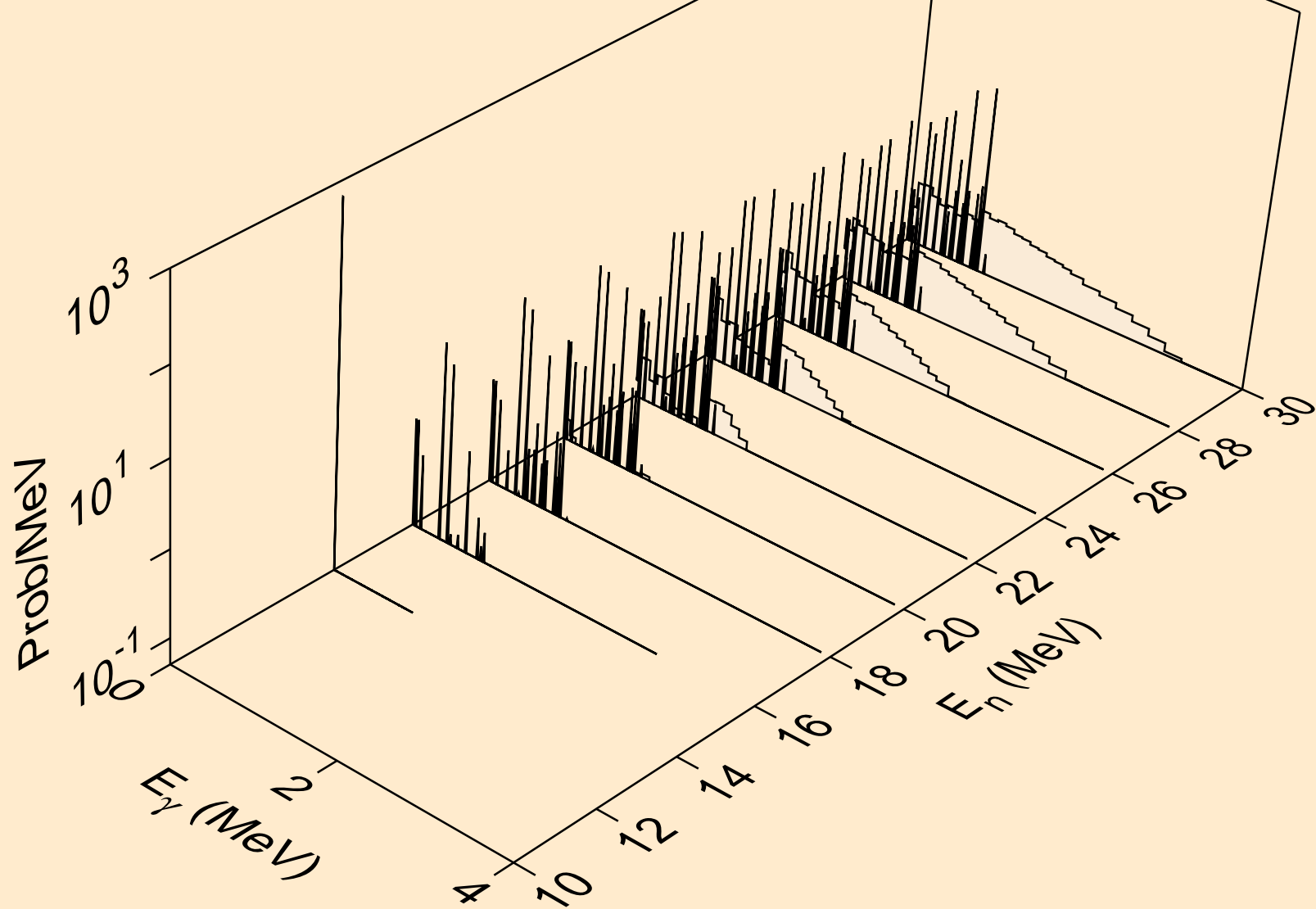

IN112 NEUTRON ACER TENDL-2024 LIBRARY; T=0.K
Photon emission for (n,3n)a

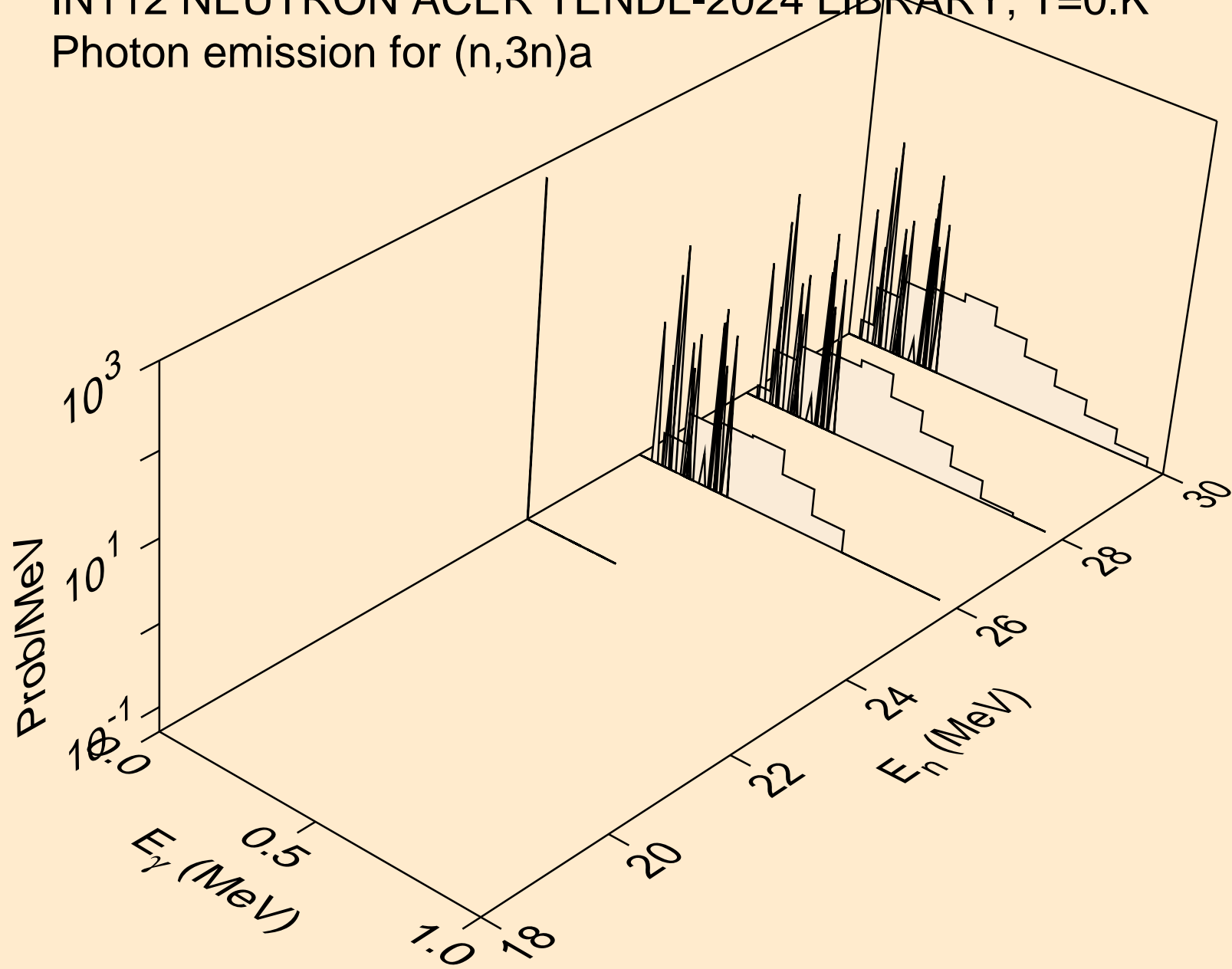

IN112 NEUTRON ACER TENDL-2024 LIBRARY; T=0.K
Photon emission for (n,n*)p

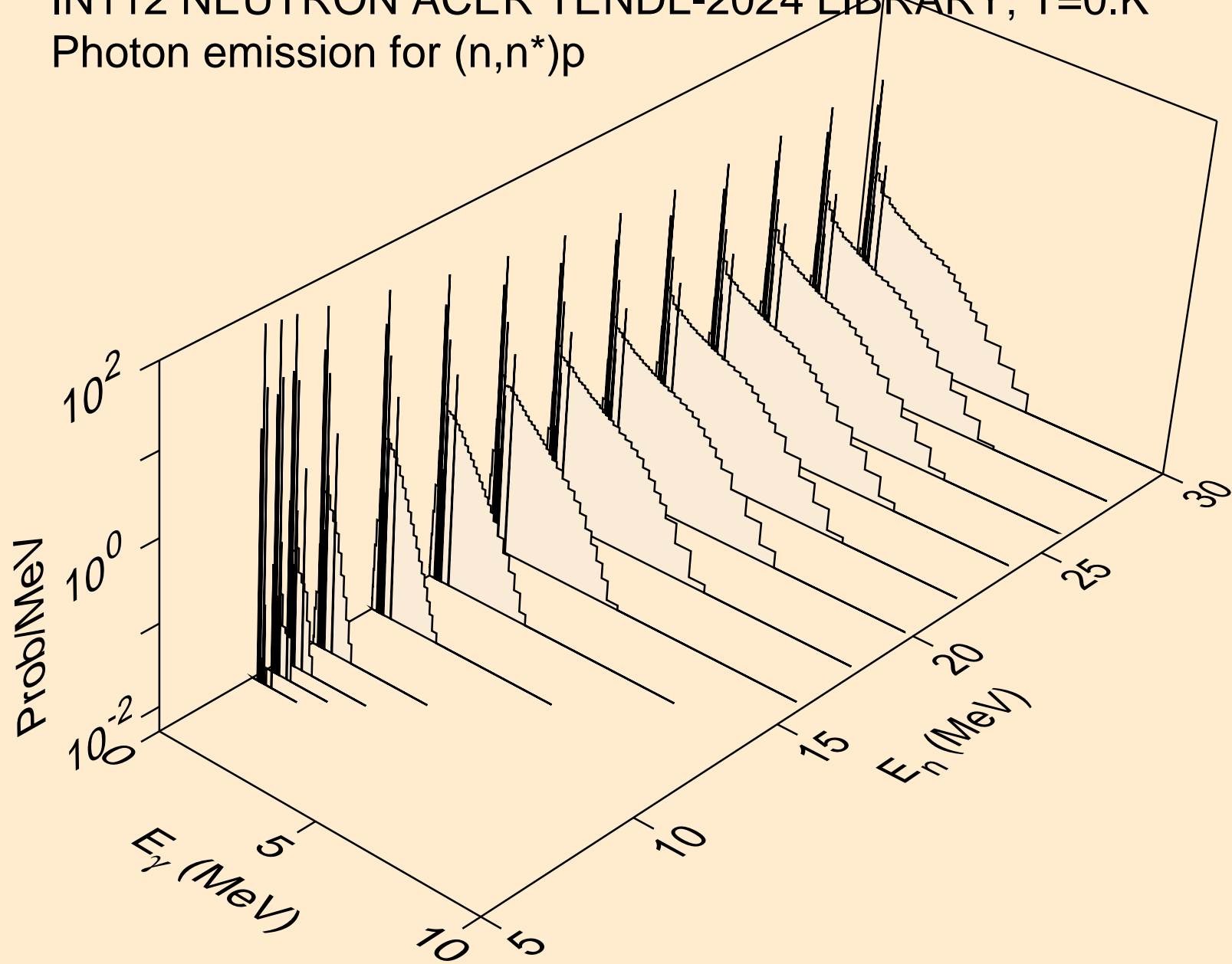

IN112 NEUTRON ACER TENDL-2024 LIBRARY; T=0.K
Photon emission for (n,n*)2a

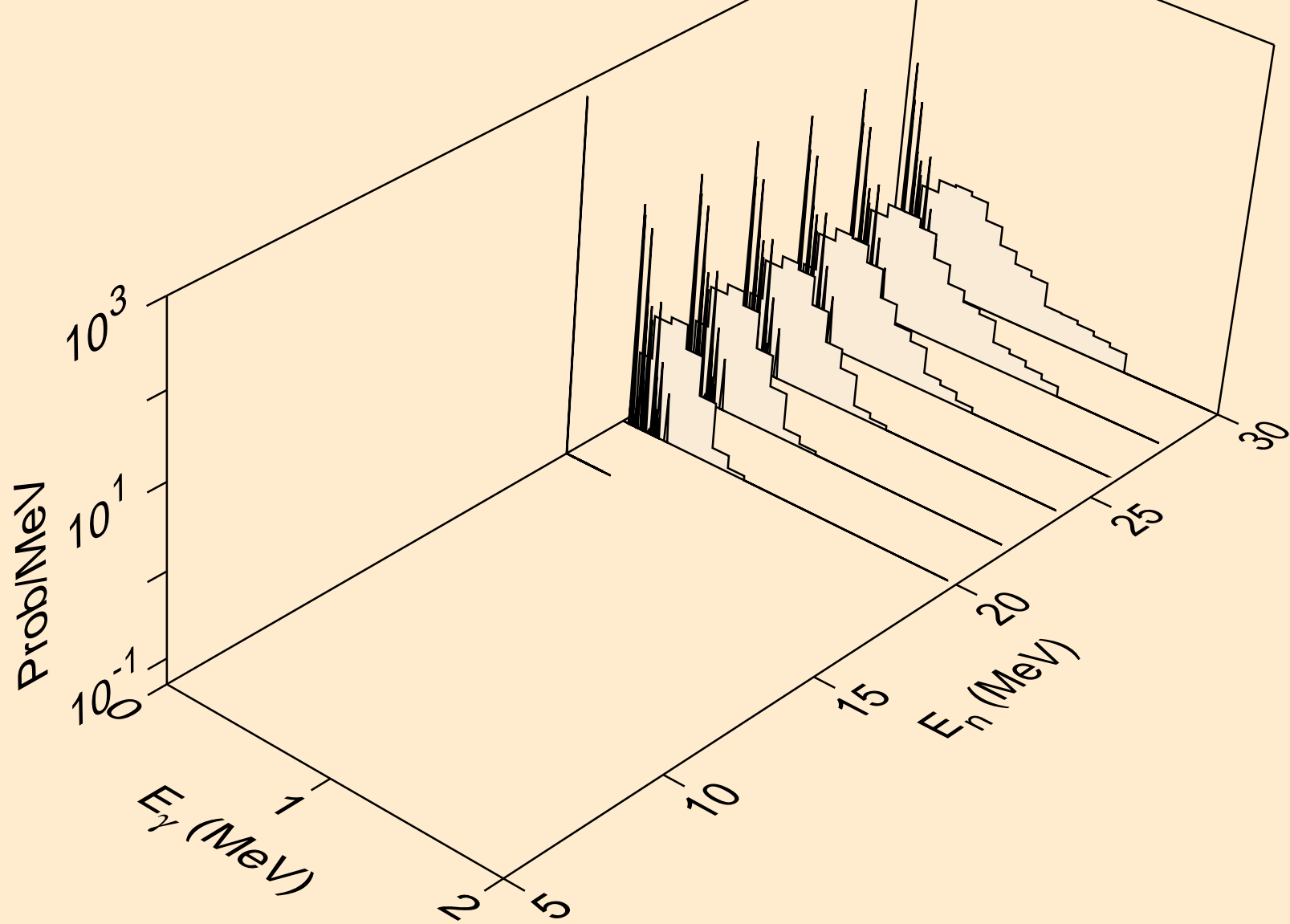

IN112 NEUTRON ACER TENDL-2024 LIBRARY; T=0.K
Photon emission for (n,n*)d

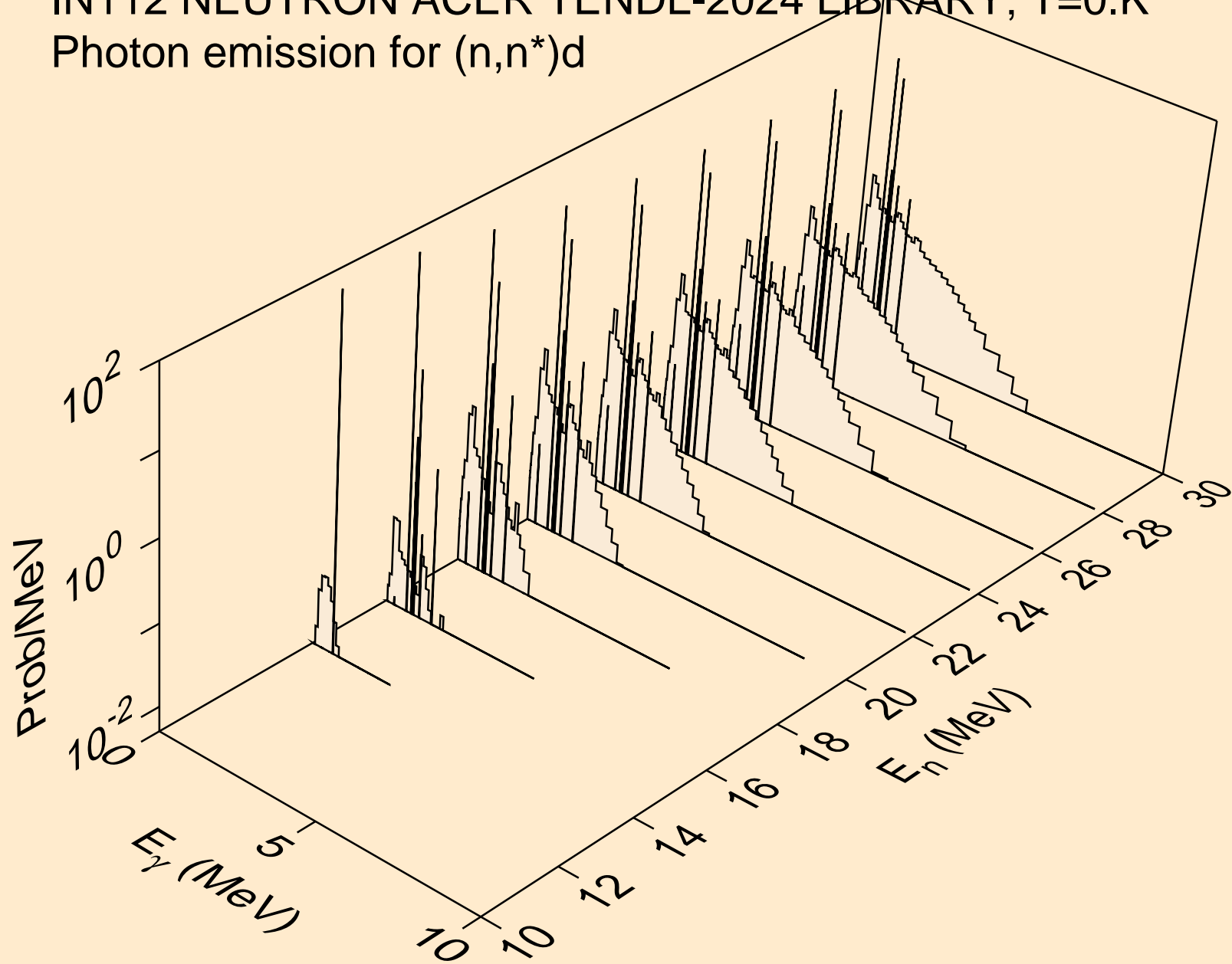

IN112 NEUTRON ACER TENDL-2024 LIBRARY; T=0.K
Photon emission for (n,n*)t

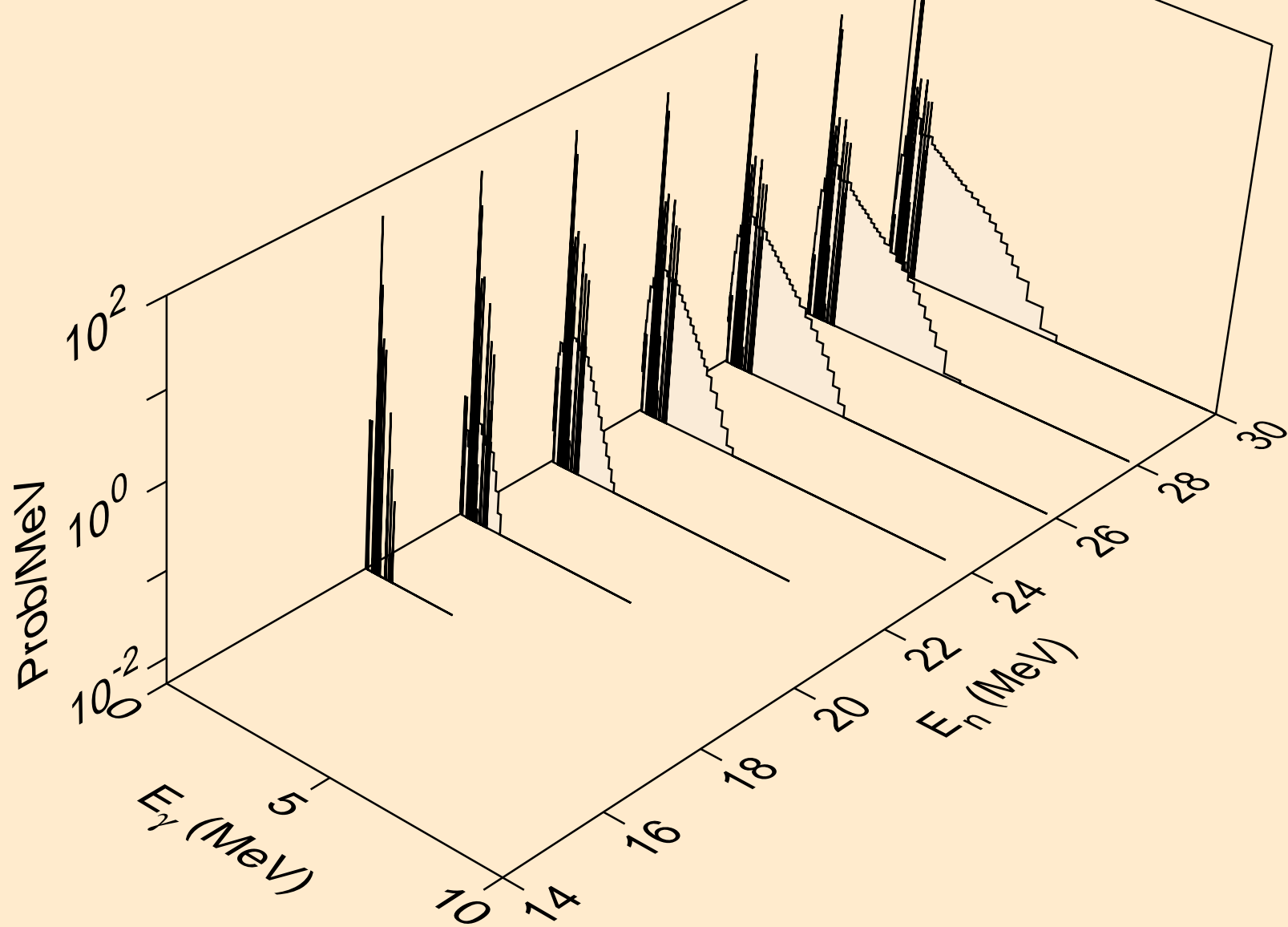

IN112 NEUTRON ACER TENDL-2024 LIBRARY; T=0.K
Photon emission for (n,n*)he3

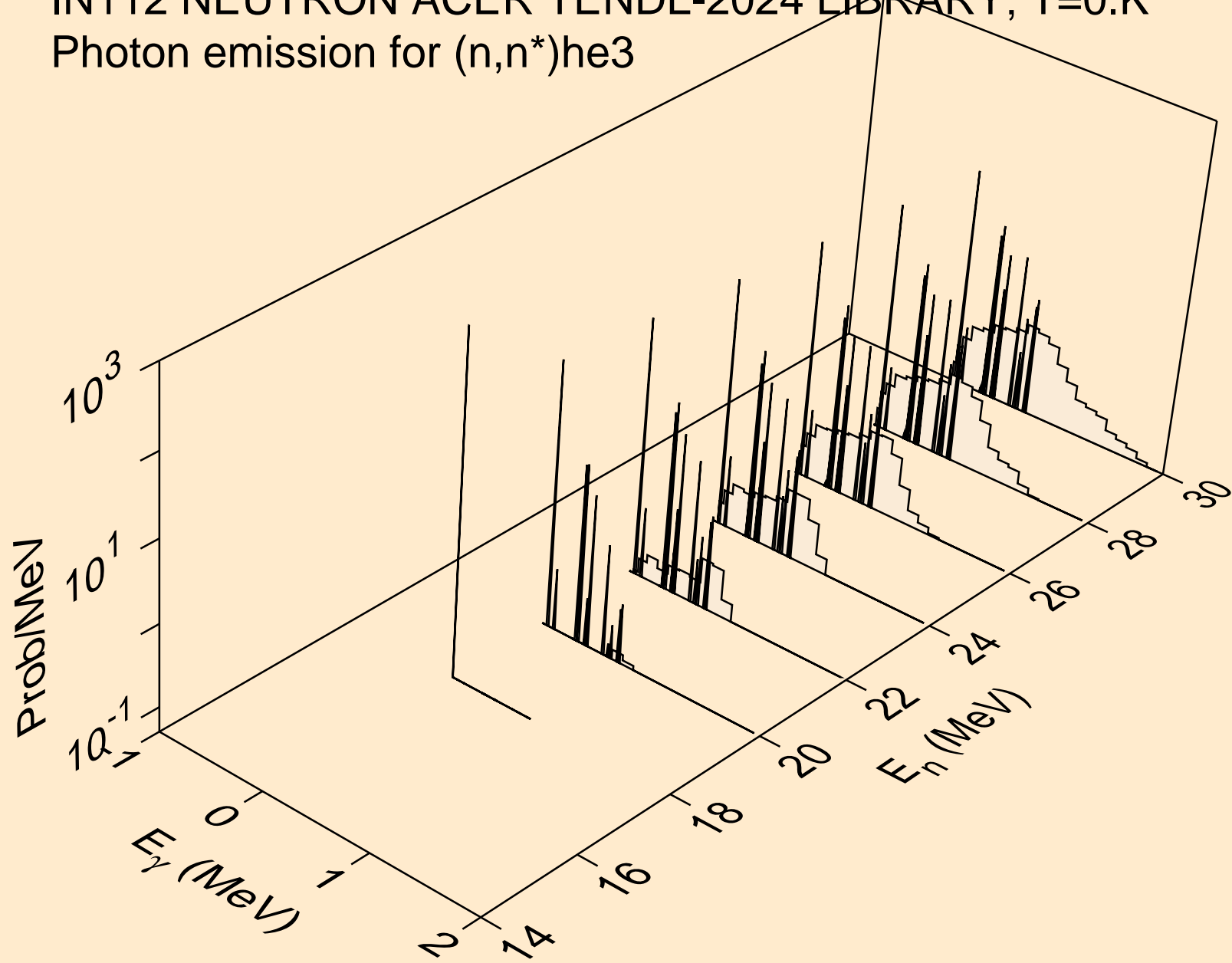

IN112 NEUTRON ACER TENDL-2024 LIBRARY; T=0.K
Photon emission for (n,4n)

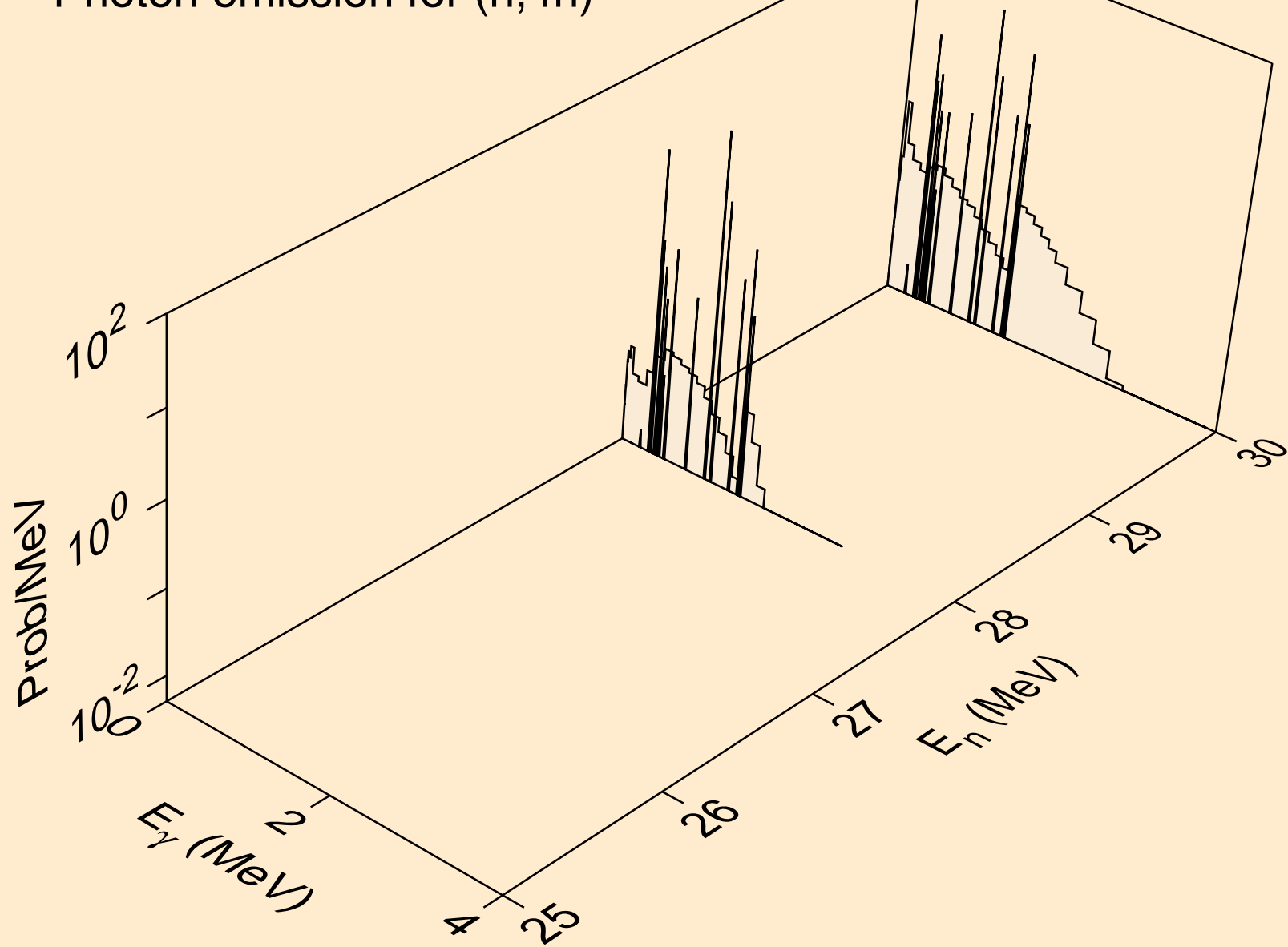

IN112 NEUTRON ACER TENDL-2024 LIBRARY; T=0.K
Photon emission for (n,2np)

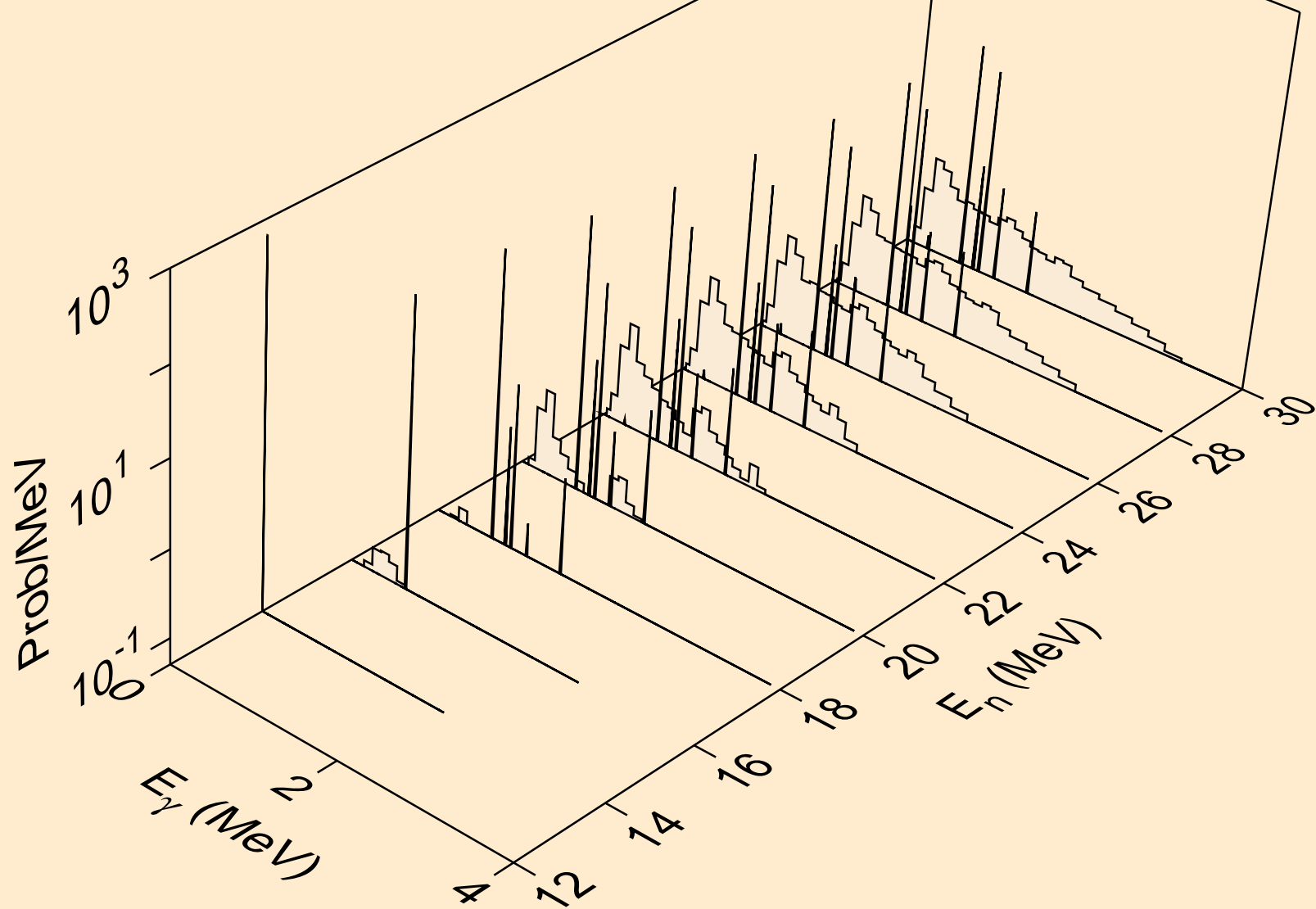

IN112 NEUTRON ACER TENDL-2024 LIBRARY; T=0.K
Photon emission for (n,3np)

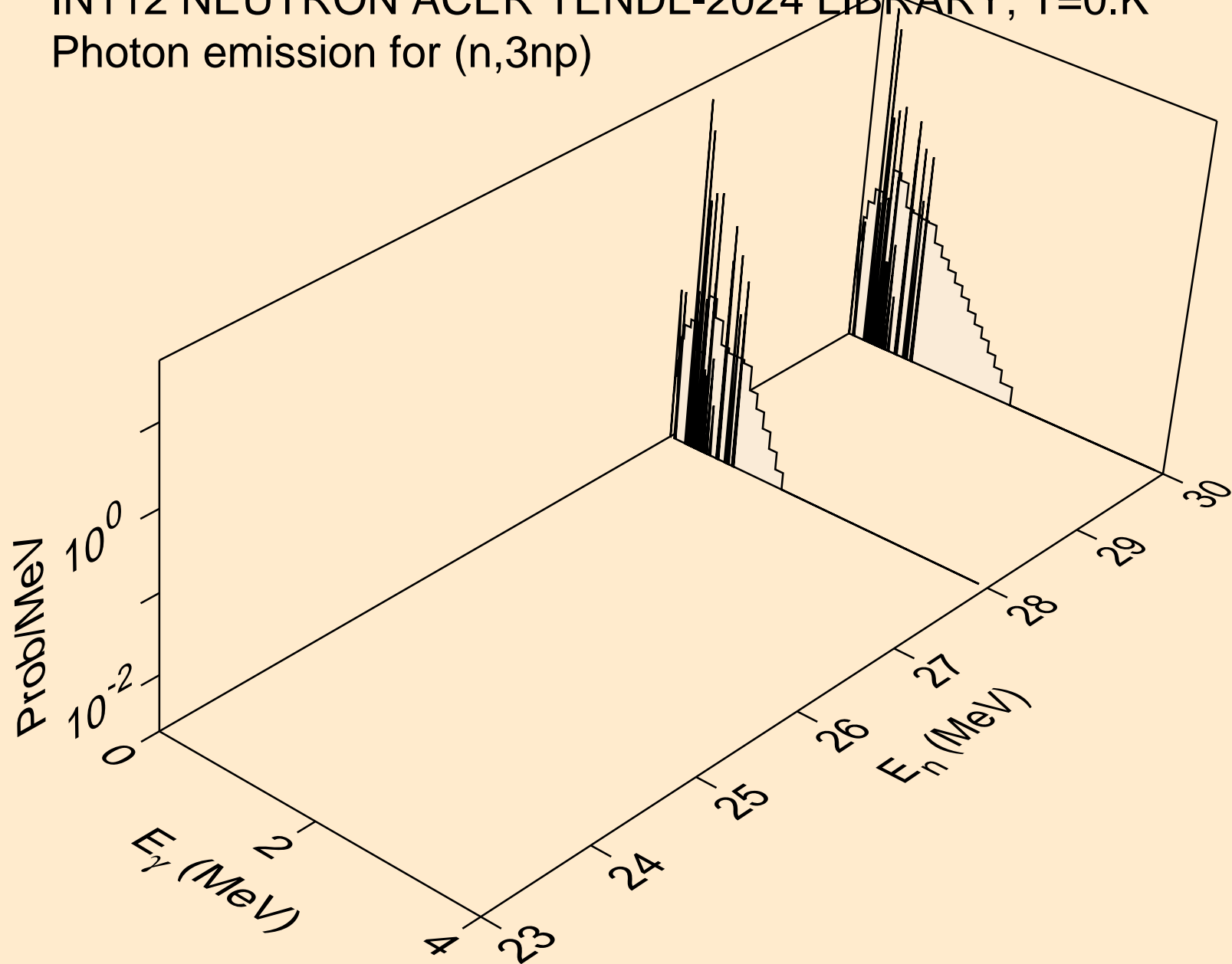

IN112 NEUTRON ACER TENDL-2024 LIBRARY; T=0.K
Photon emission for (n,n2p)

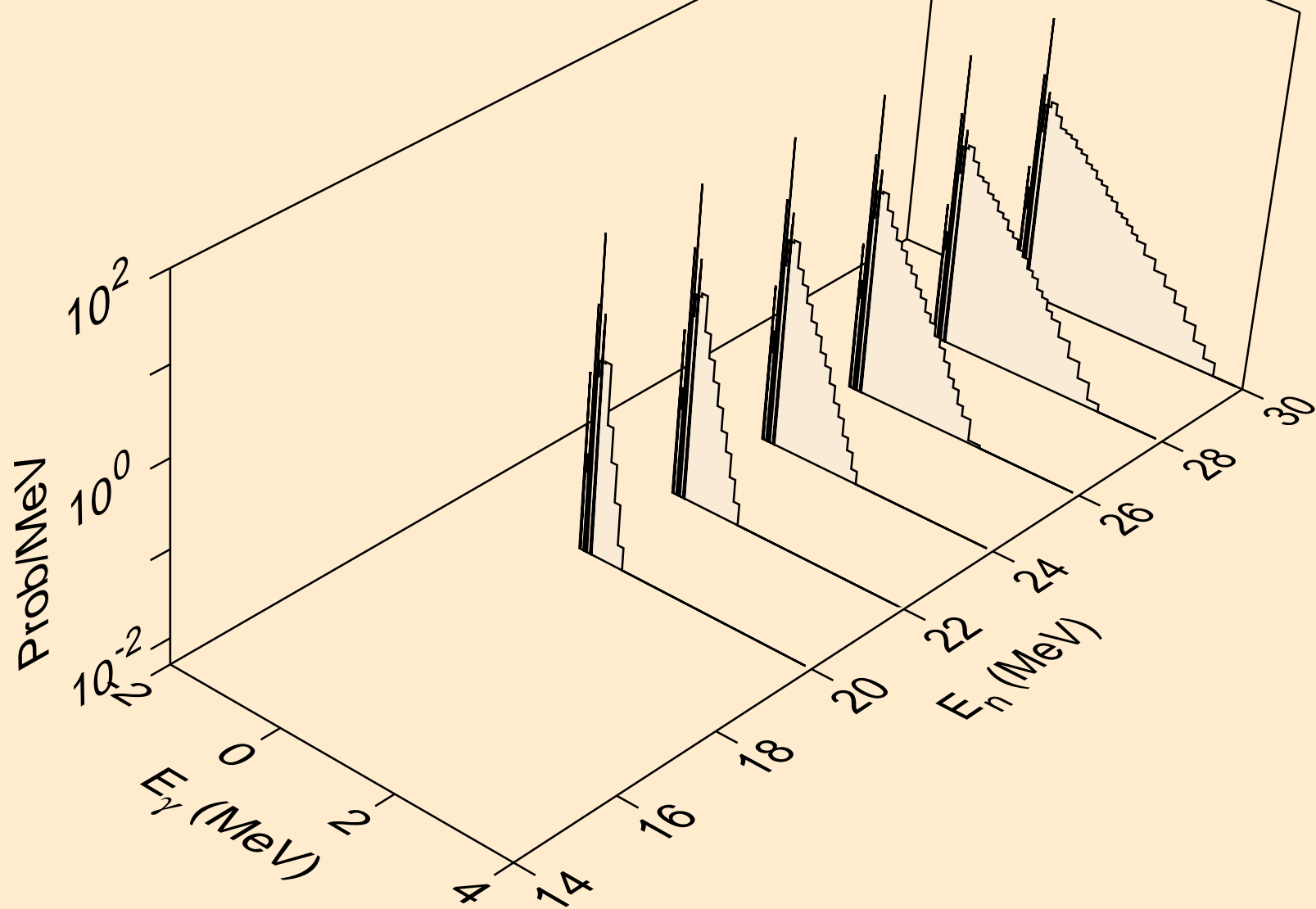

IN112 NEUTRON ACER TENDL-2024 LIBRARY; T=0.K
Photon emission for (n,npa)

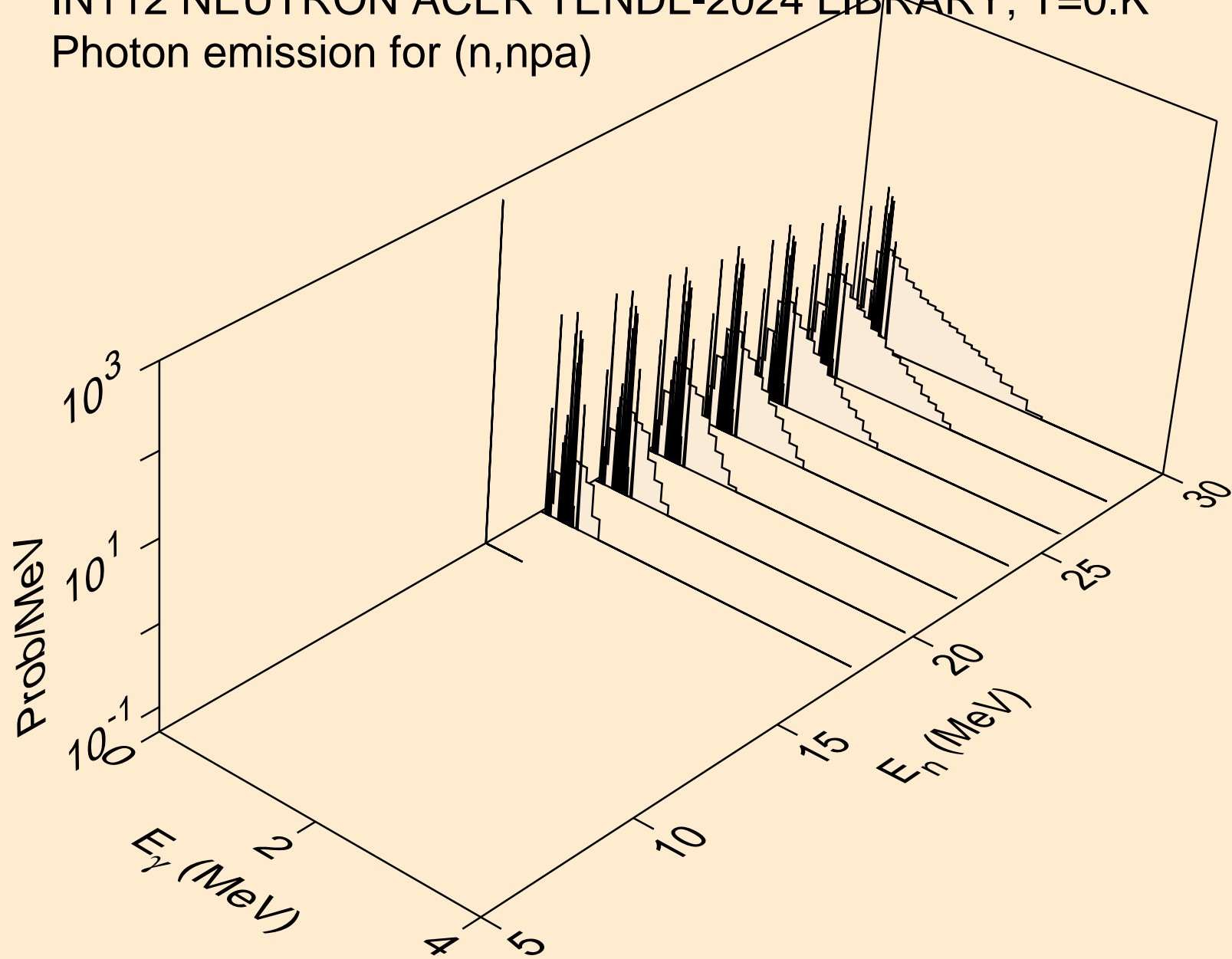

IN112 NEUTRON ACER TENDL-2024 LIBRARY; T=0.K
Photon emission for (n,n*c)

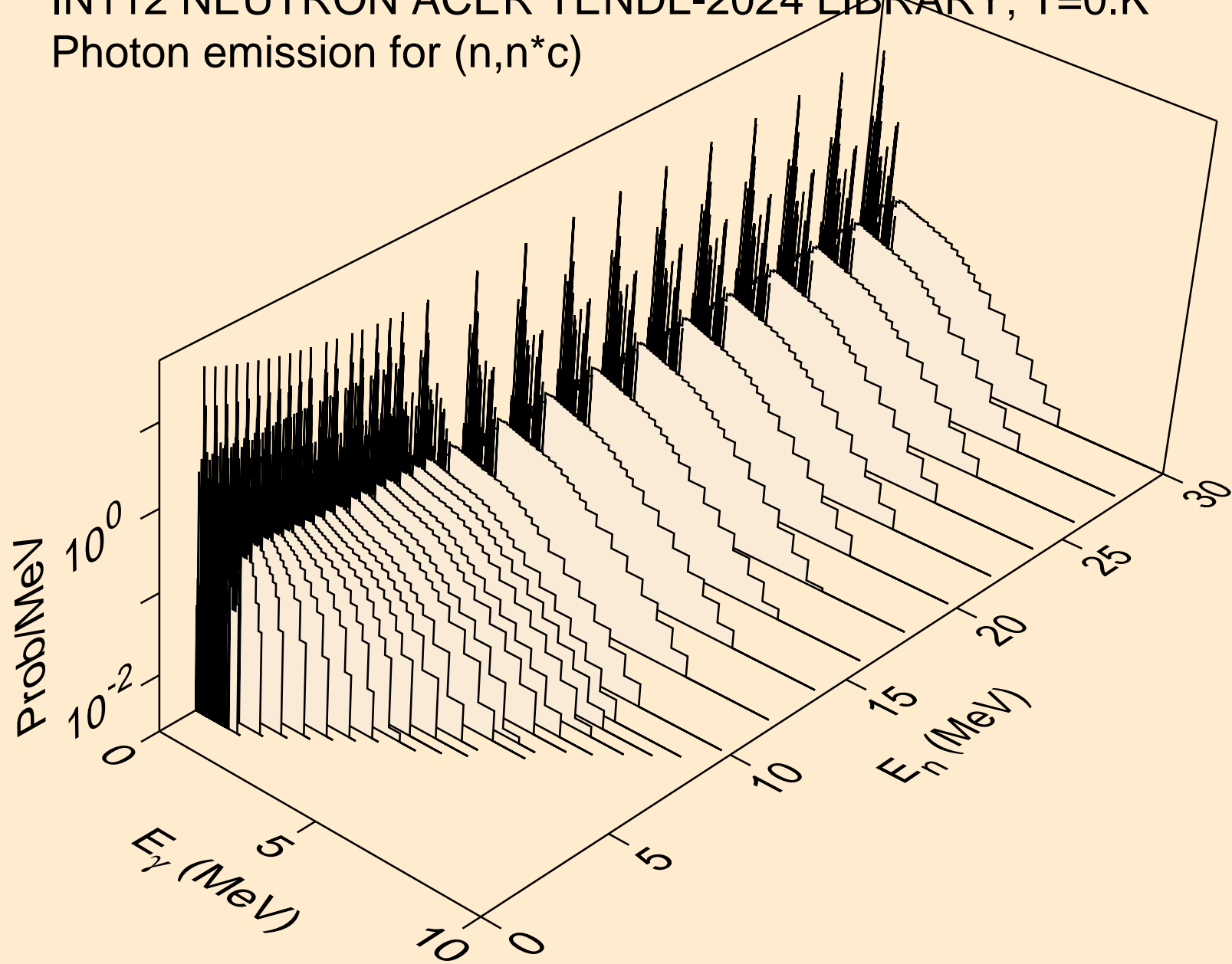

IN112 NEUTRON ACER TENDL-2024 LIBRARY; T=0.K
Photon emission for (n,gma)

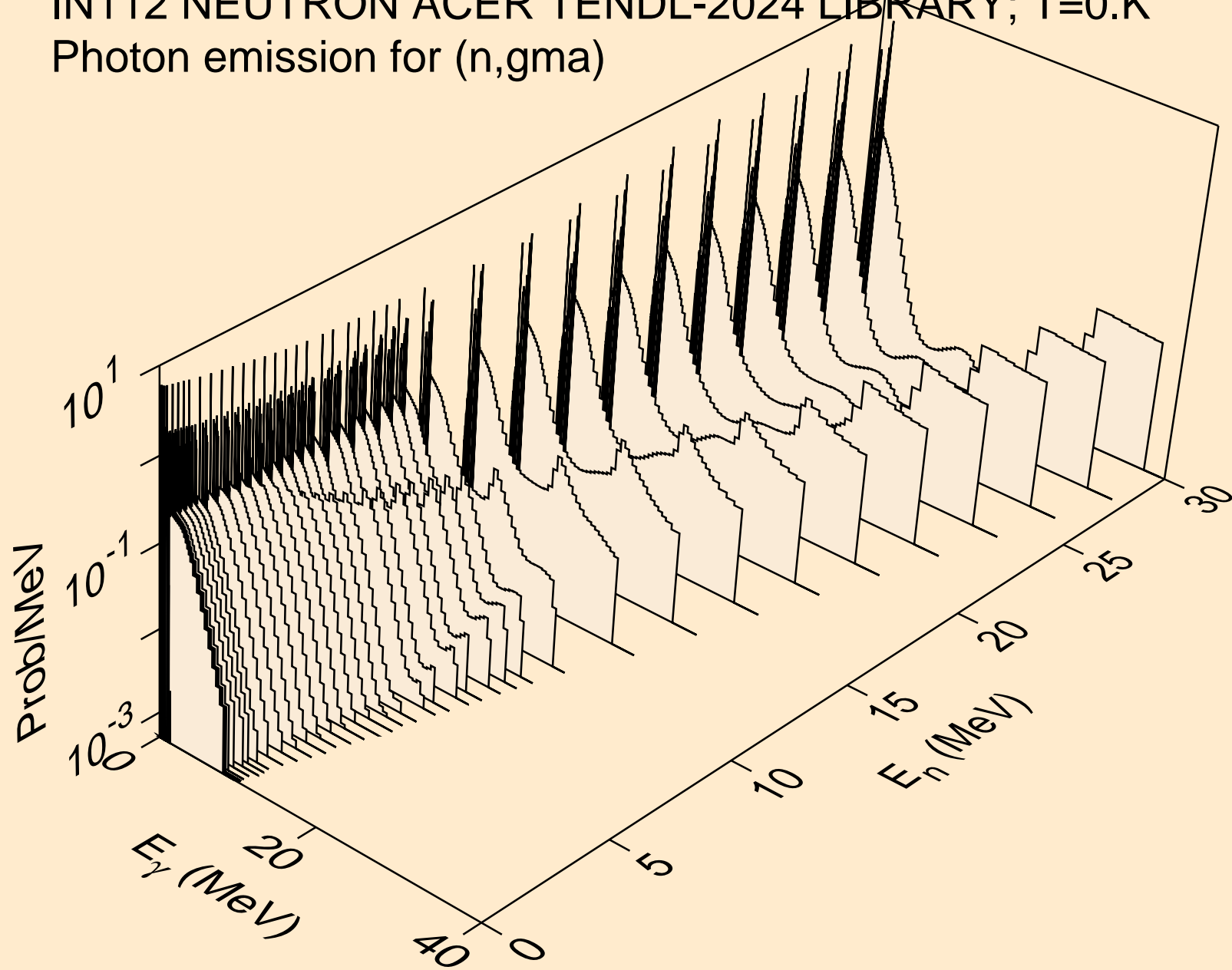

IN112 NEUTRON ACER TENDL-2024 LIBRARY; T=0.K
Photon emission for (n,p)

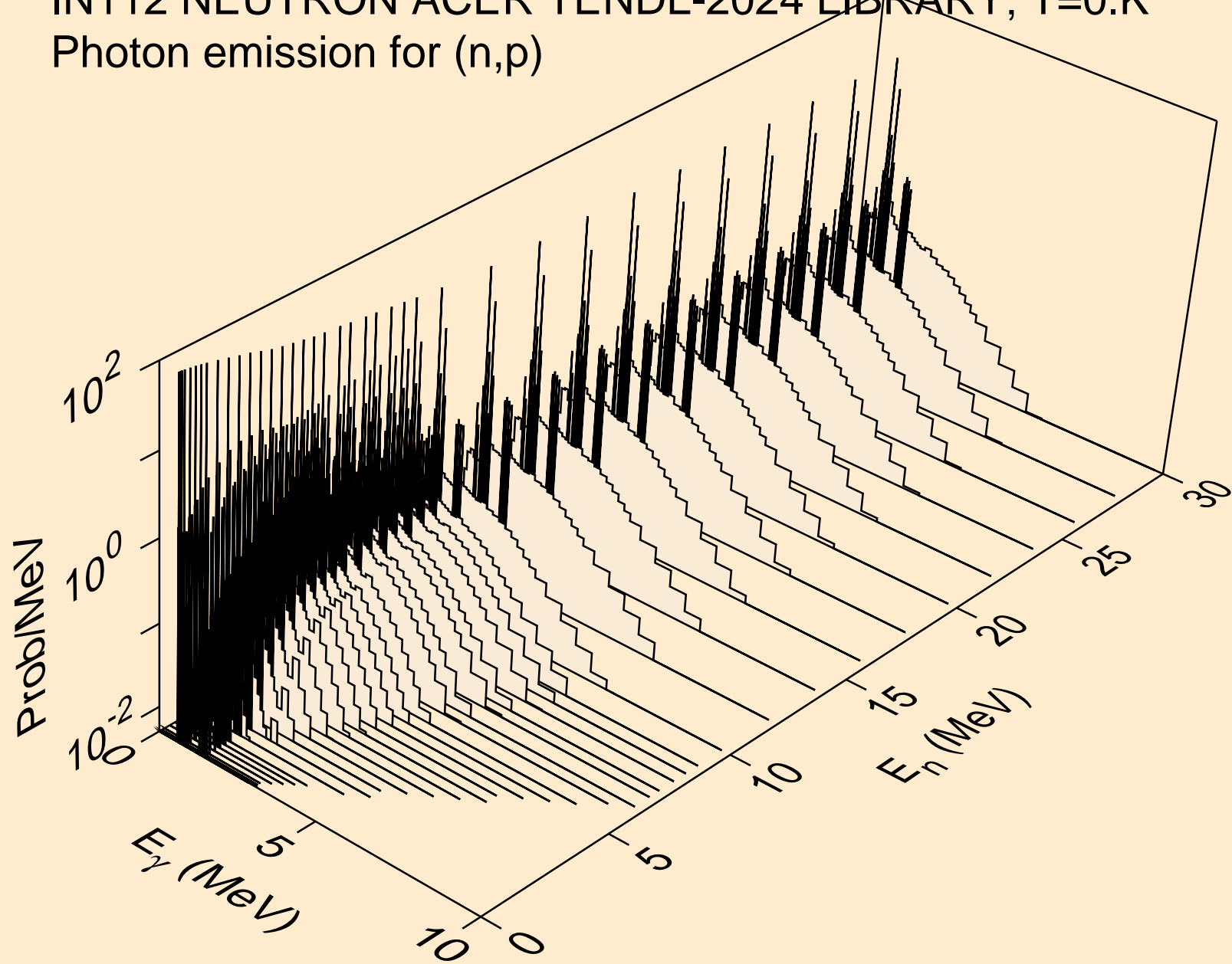

IN112 NEUTRON ACER TENDL-2024 LIBRARY; T=0.K
Photon emission for (n,d)

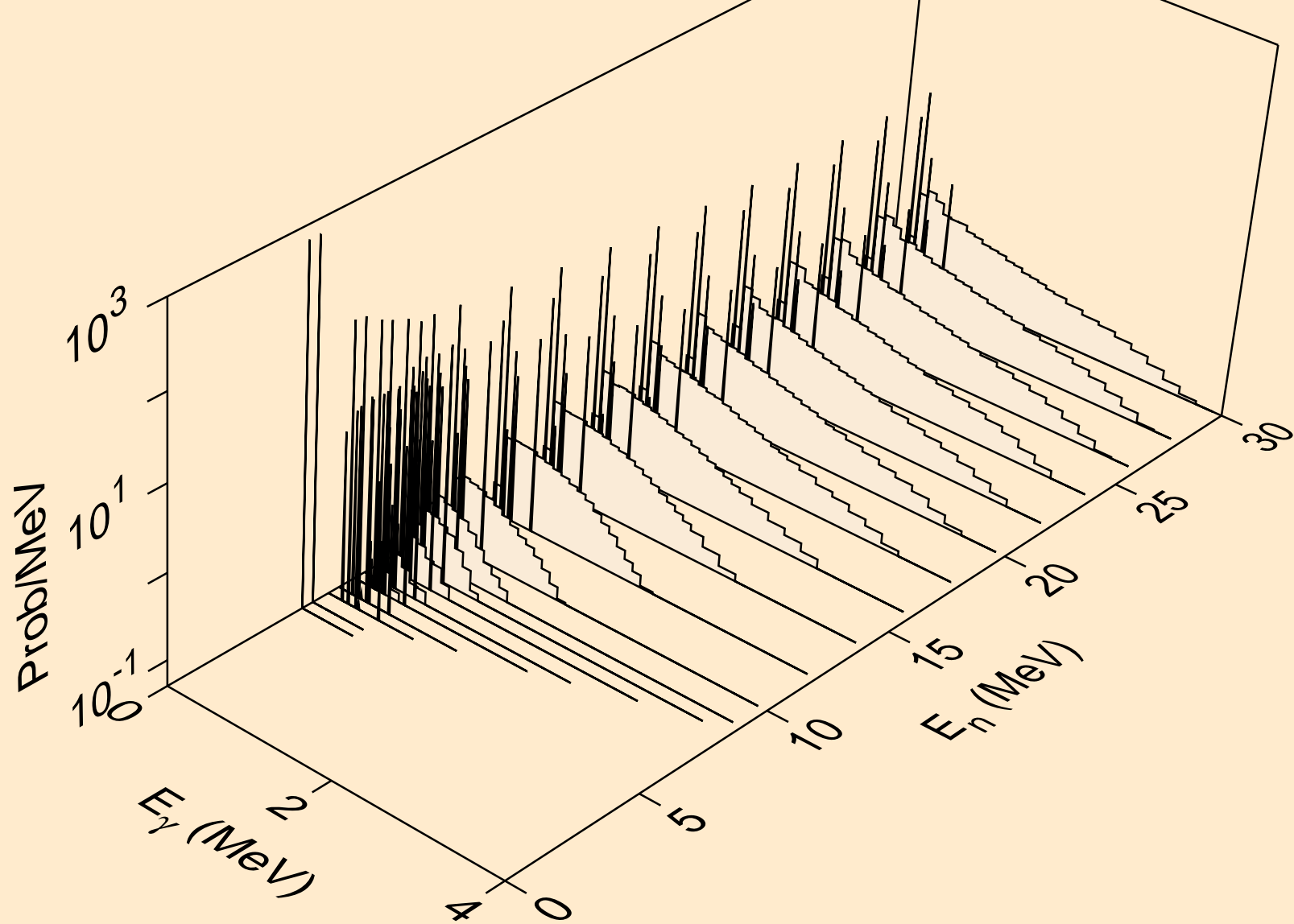

IN112 NEUTRON ACER TENDL-2024 LIBRARY; T=0.K
Photon emission for (n,t)

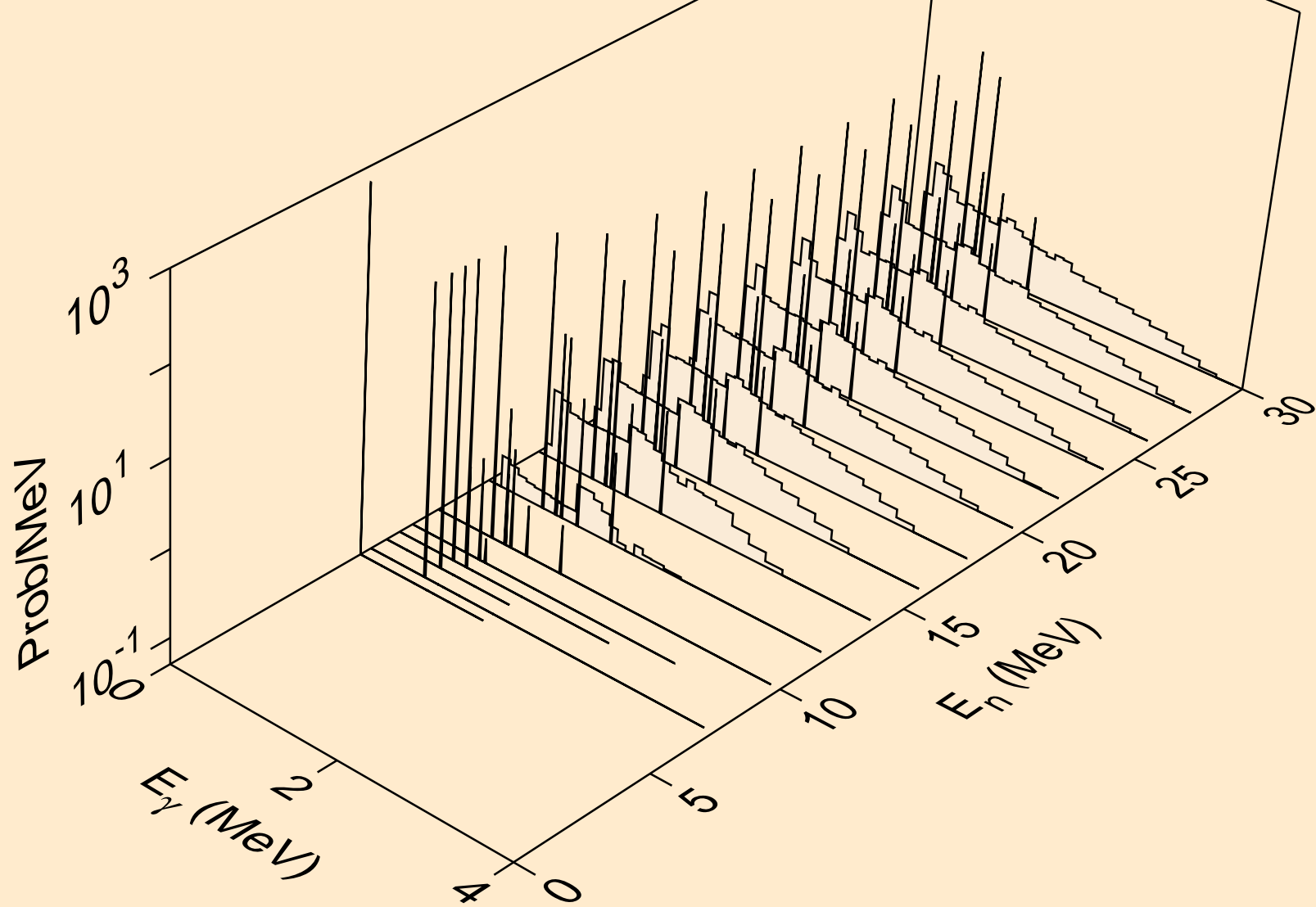

IN112 NEUTRON ACER TENDL-2024 LIBRARY; T=0.K
Photon emission for (n,he3)

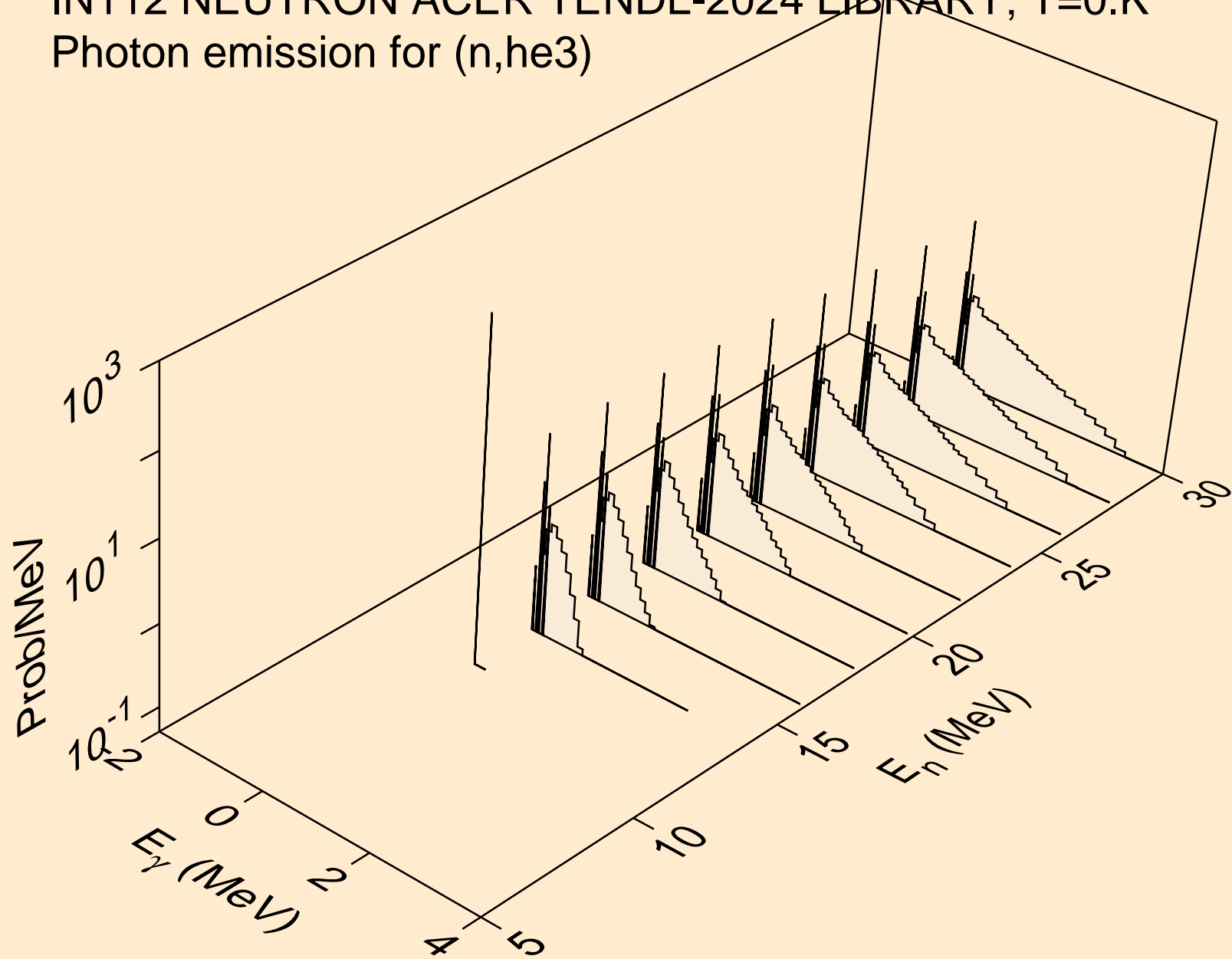

IN112 NEUTRON ACER TENDL-2024 LIBRARY; T=0.K
Photon emission for (n,a)

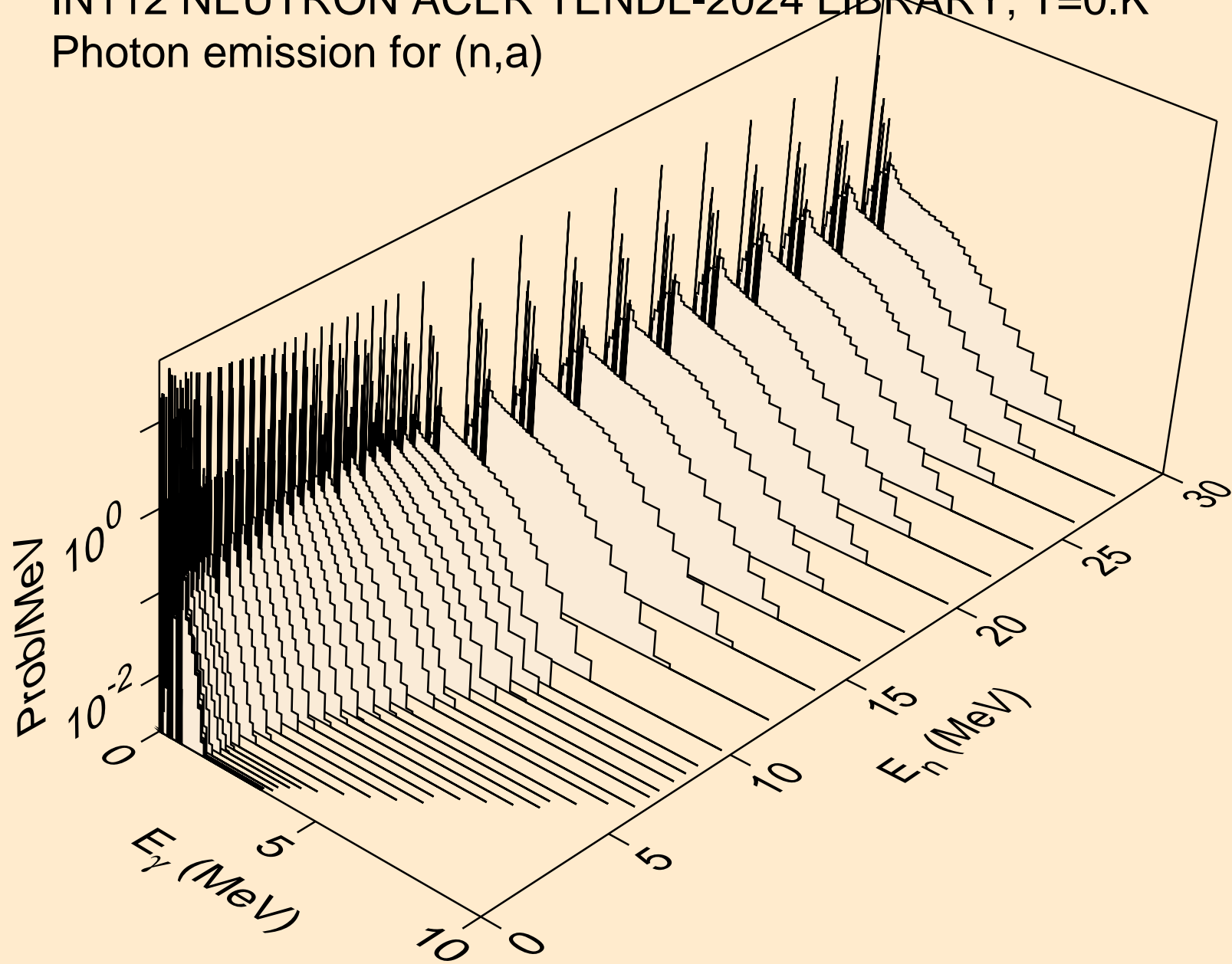

IN112 NEUTRON ACER TENDL-2024 LIBRARY; T=0.K
Photon emission for (n,2a)

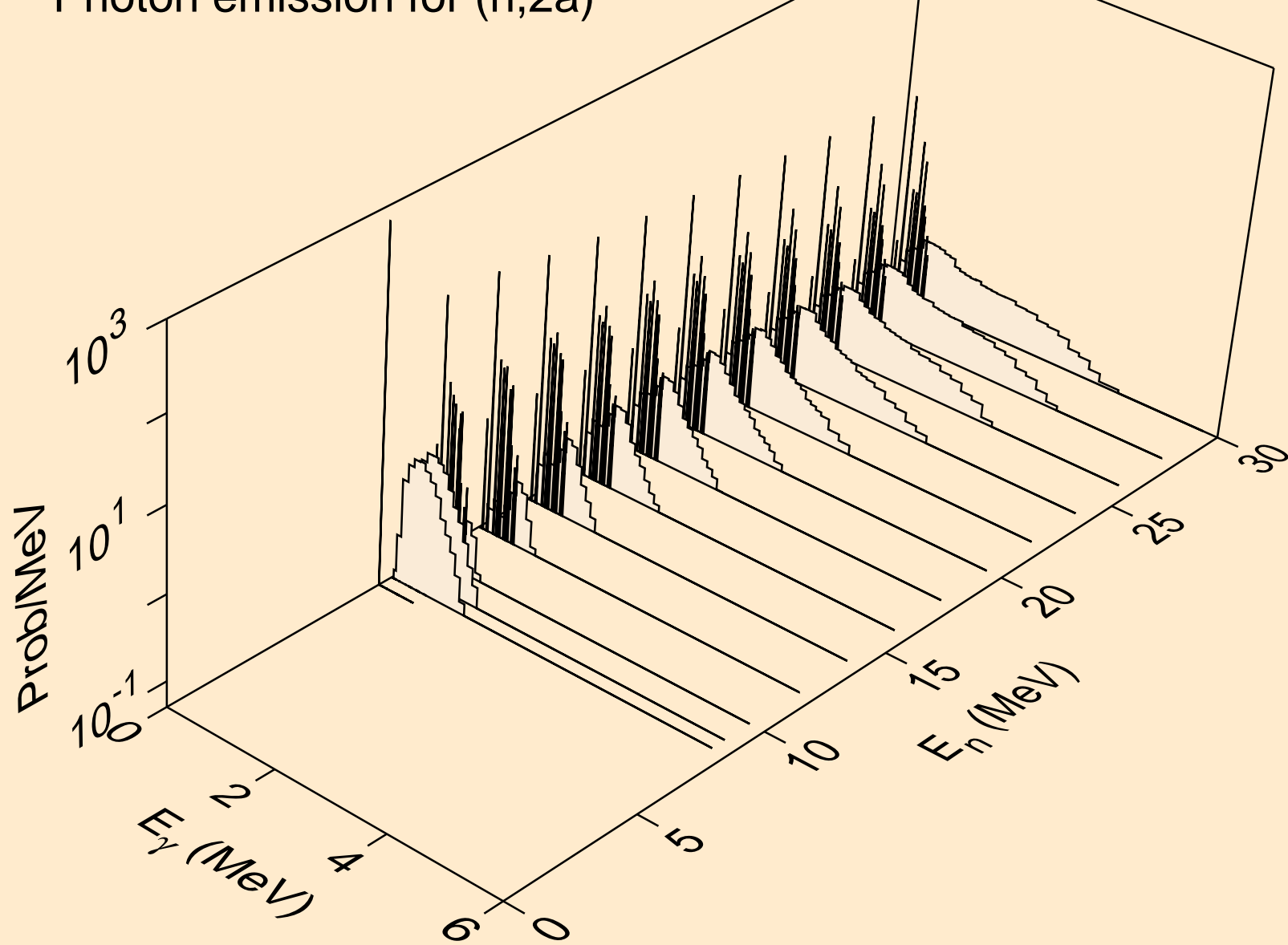

IN112 NEUTRON ACER TENDL-2024 LIBRARY; T=0.K
Photon emission for (n,2p)

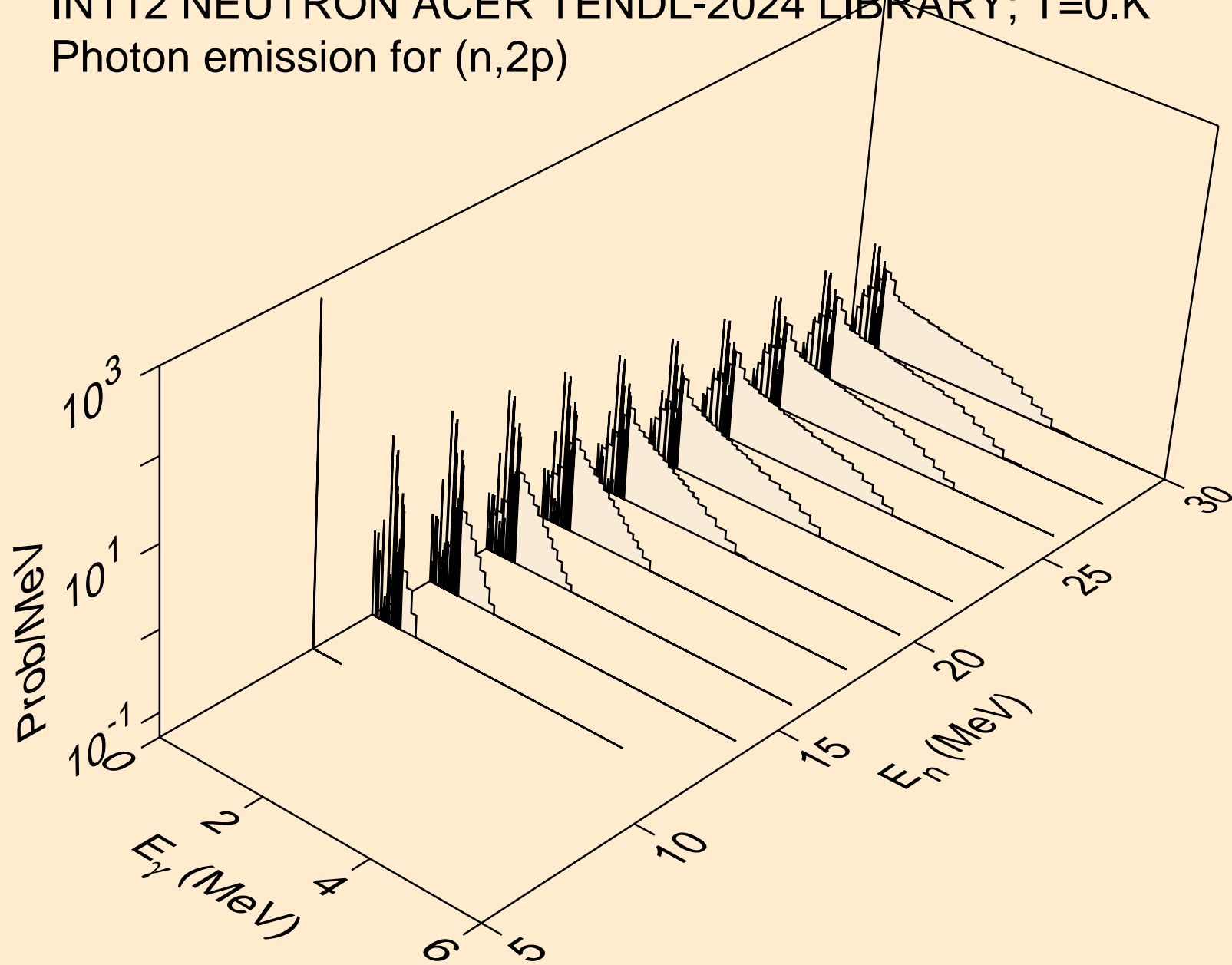

IN112 NEUTRON ACER TENDL-2024 LIBRARY; T=0.K
Photon emission for (n,p α)

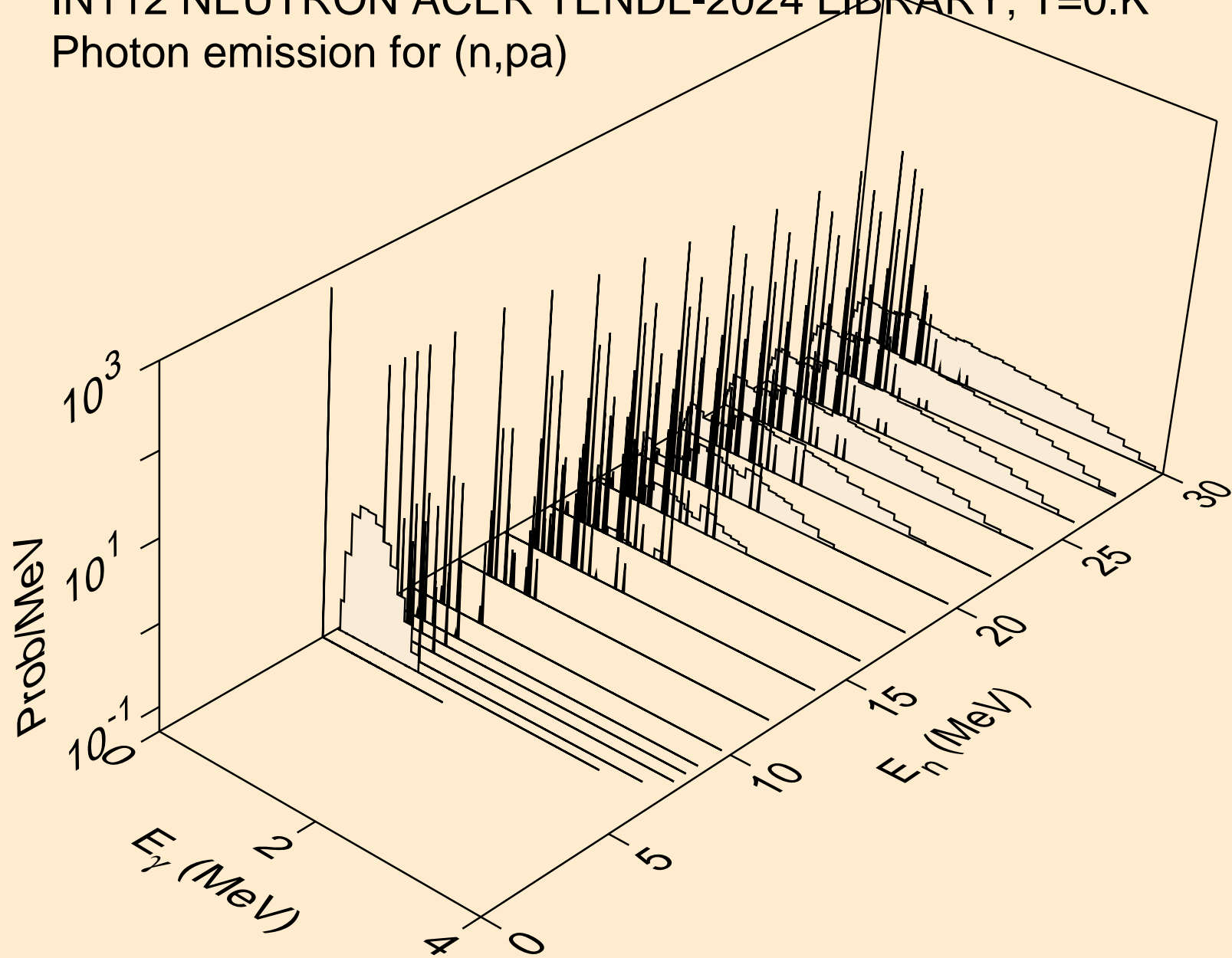

IN112 NEUTRON ACER TENDL-2024 LIBRARY; T=0.K
Photon emission for (n,pd)

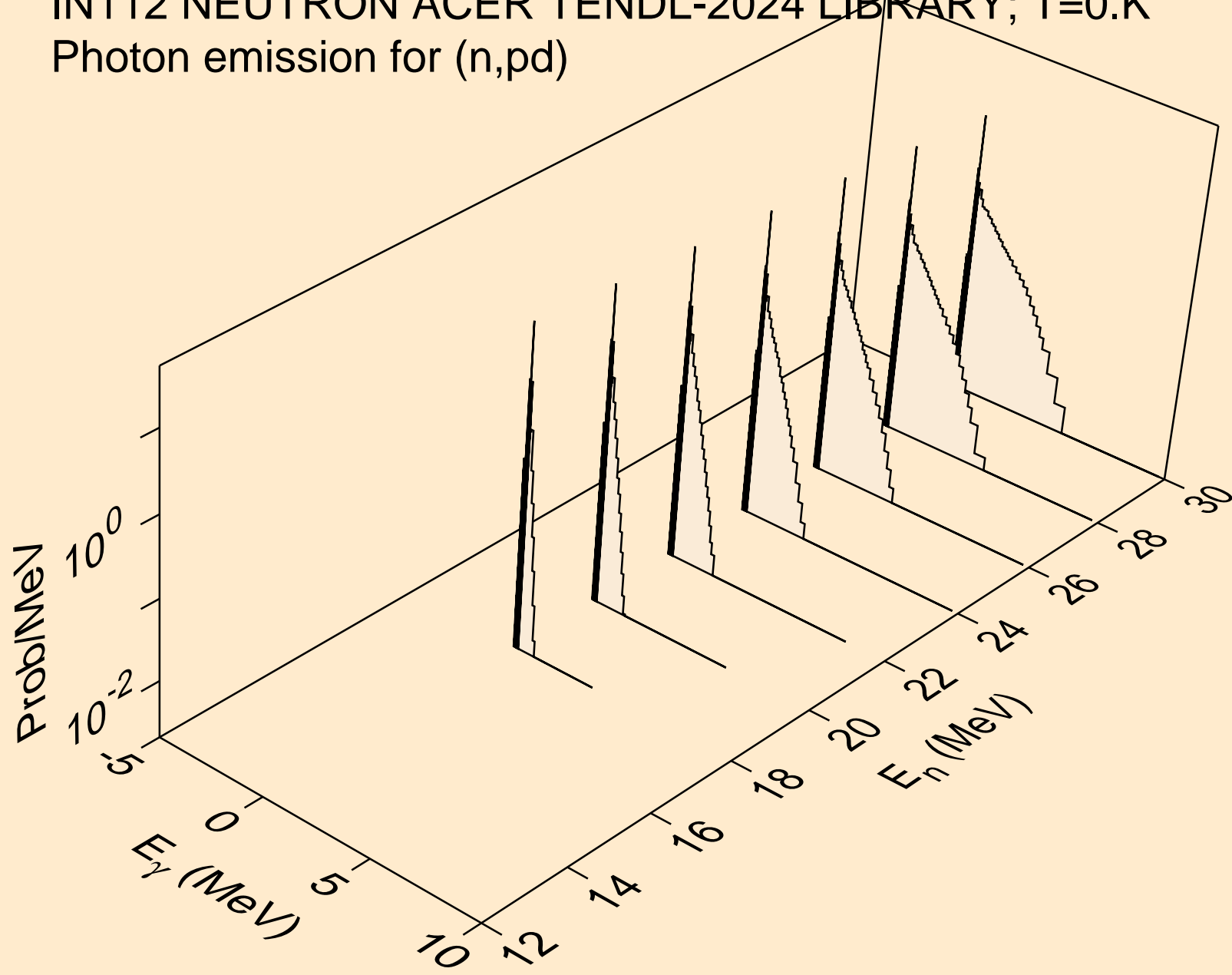

IN112 NEUTRON ACER TENDL-2024 LIBRARY; T=0.K
Photon emission for (n,pt)

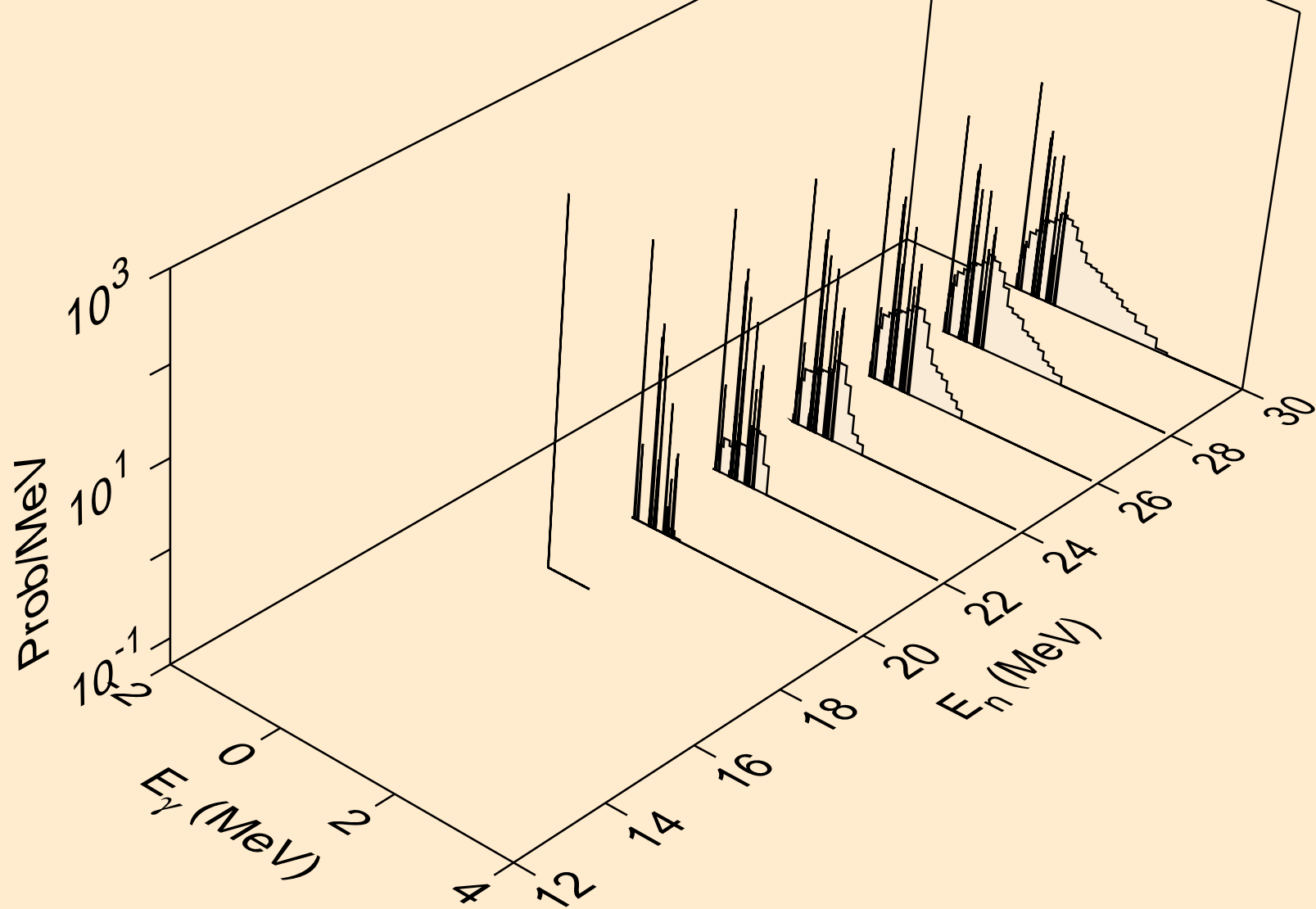

IN112 NEUTRON ACER TENDL-2024 LIBRARY; T=0.K
Photon emission for (n,da)

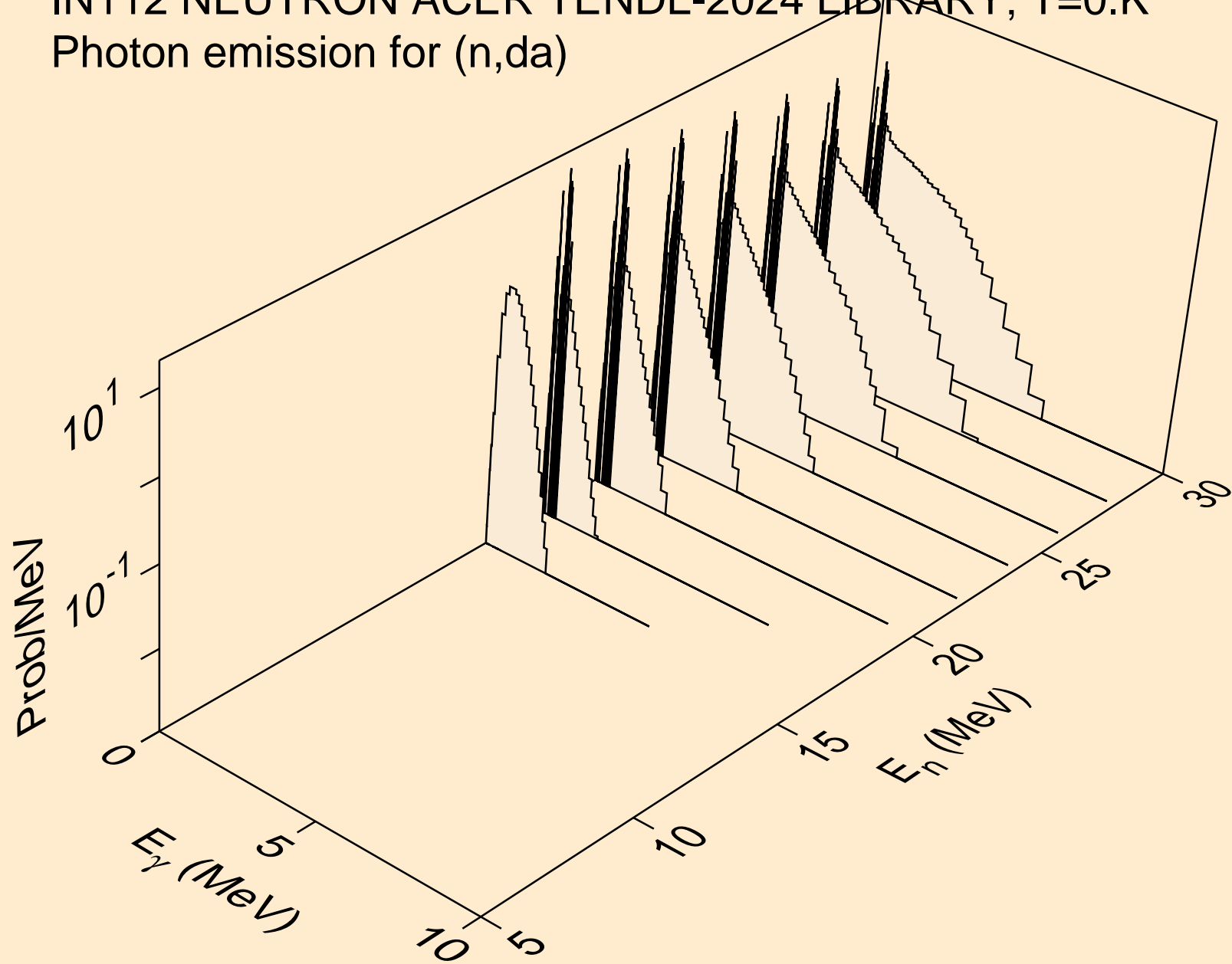

IN112 NEUTRON ACER TENDL-2024 LIBRARY; T=0.K
thermal capture photon spectrum

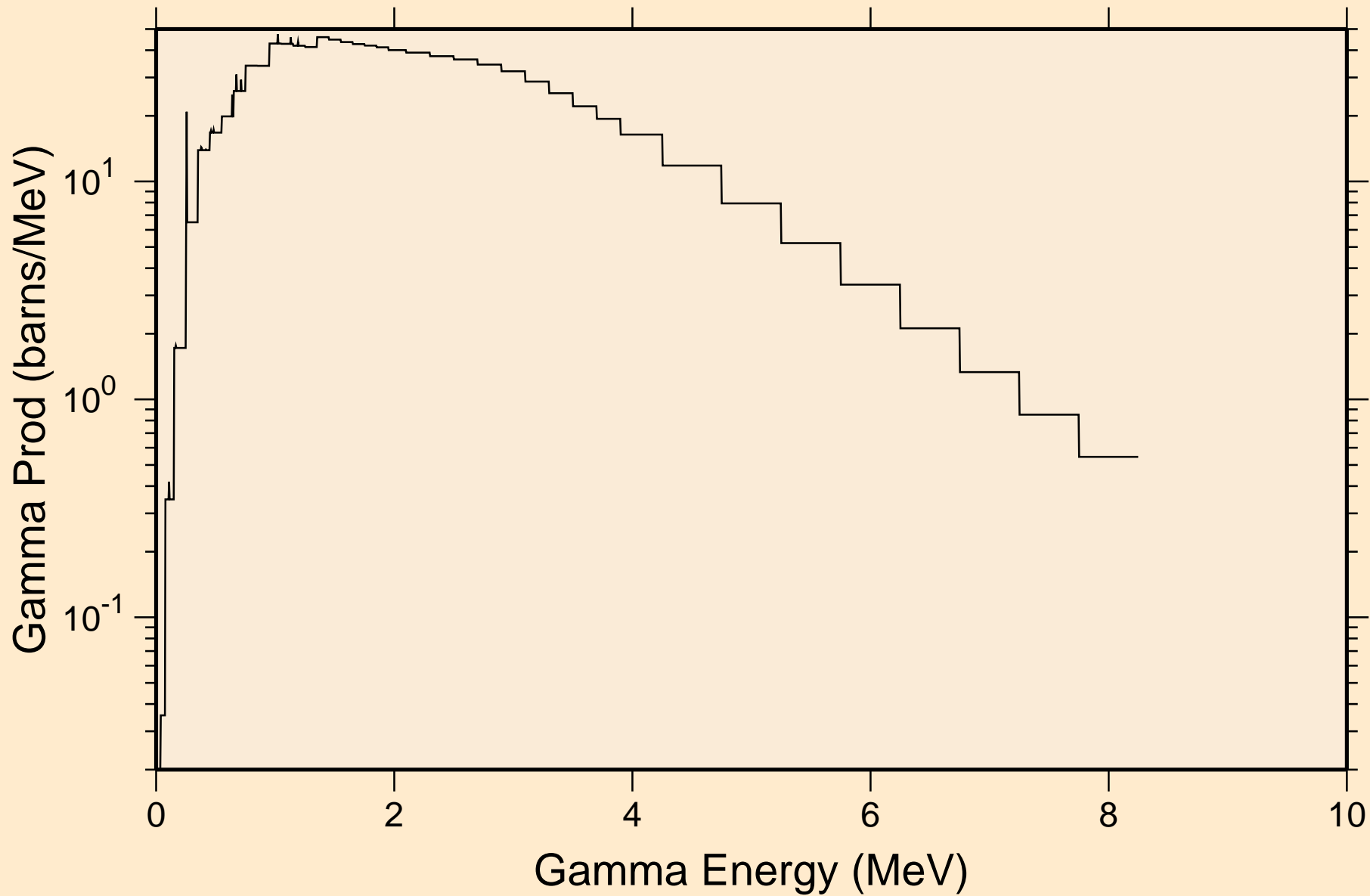

IN112 NEUTRON ACER TENDL-2024 LIBRARY; T=0.K
14 MeV photon spectrum

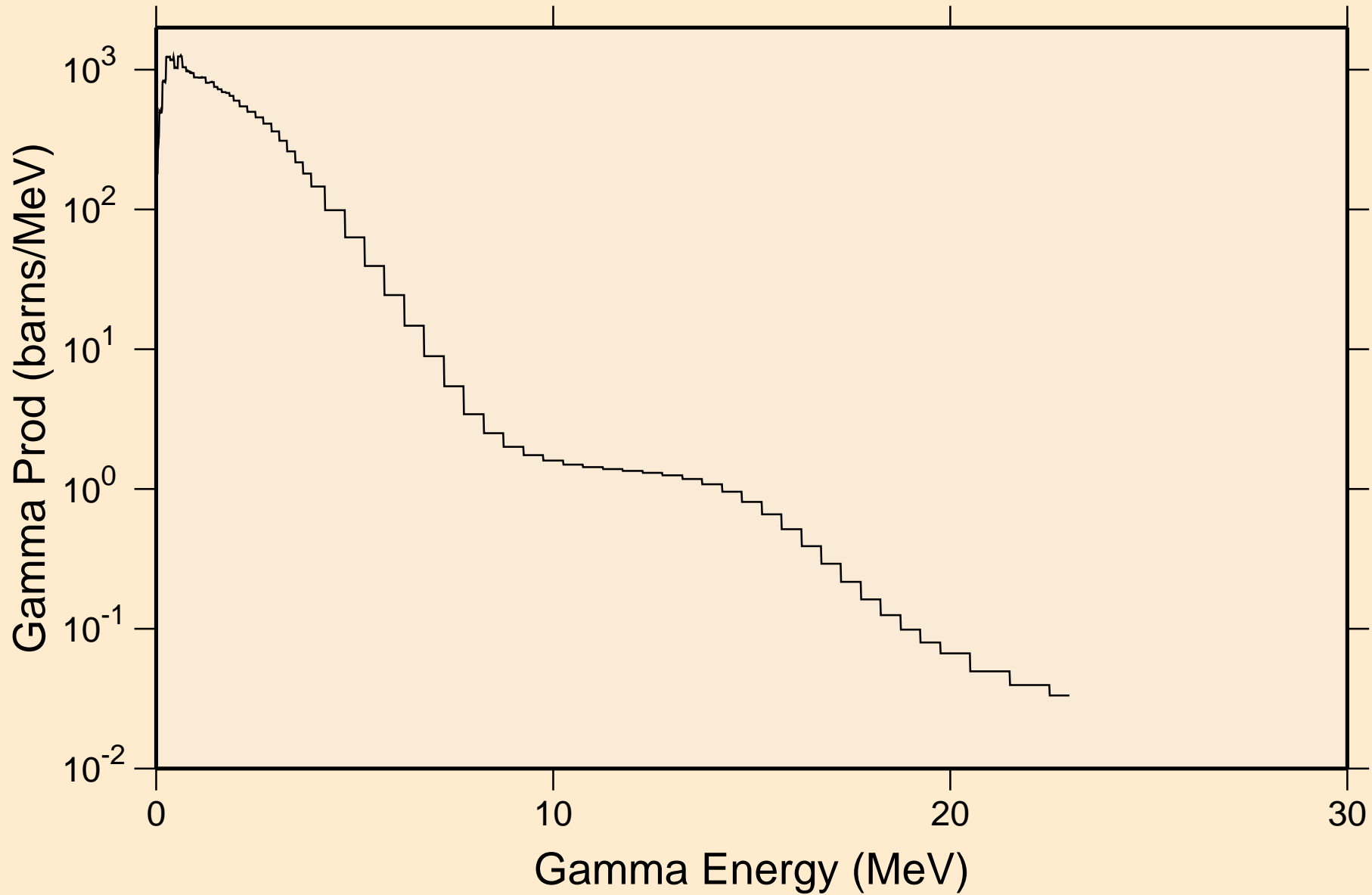

IN112 NEUTRON ACER TENDL-2024 LIBRARY; T=0.K

Particle heating contributions

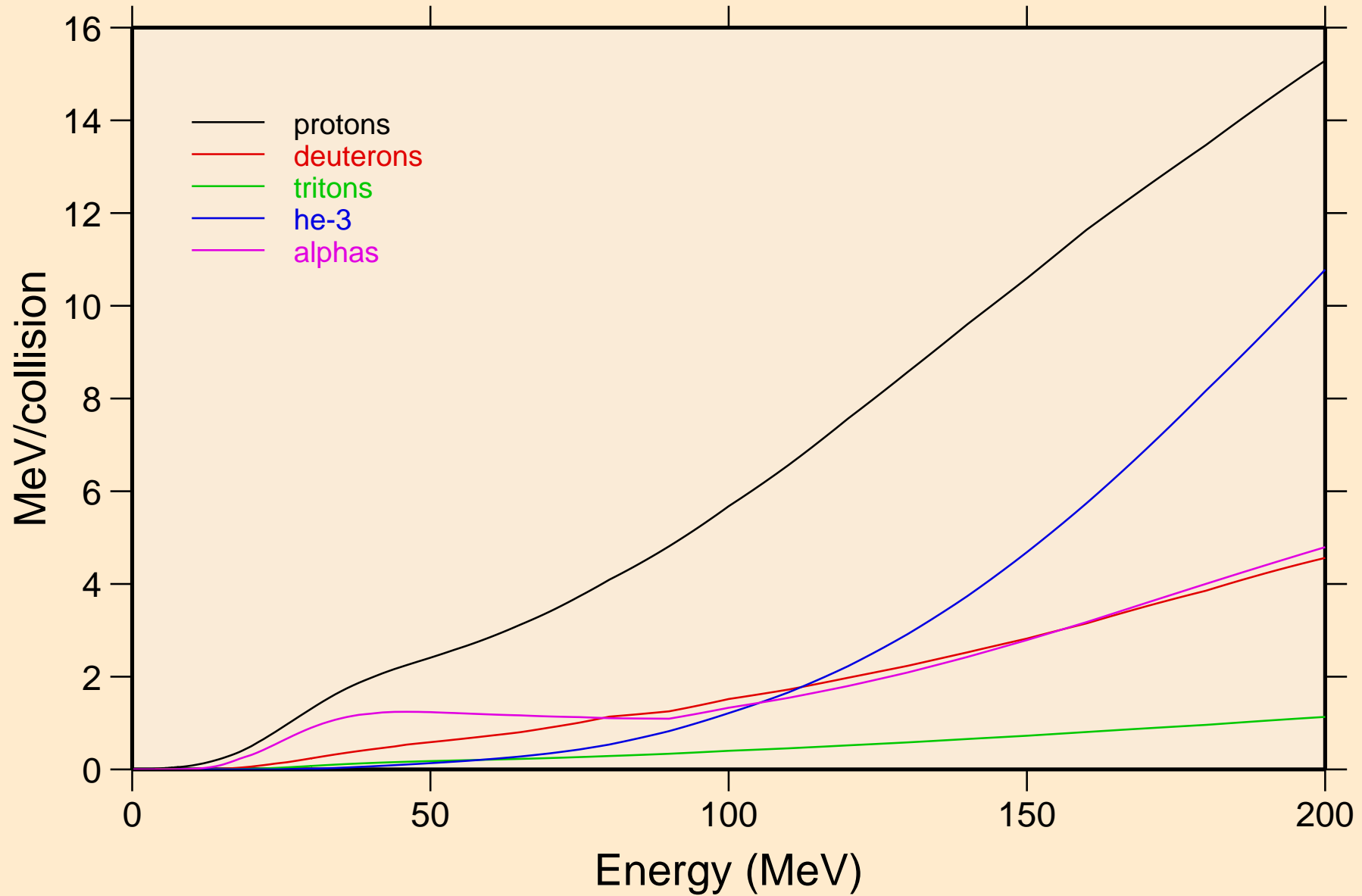

IN112 NEUTRON ACER TENDL-2024 LIBRARY; T=0.K
Recoil Heating

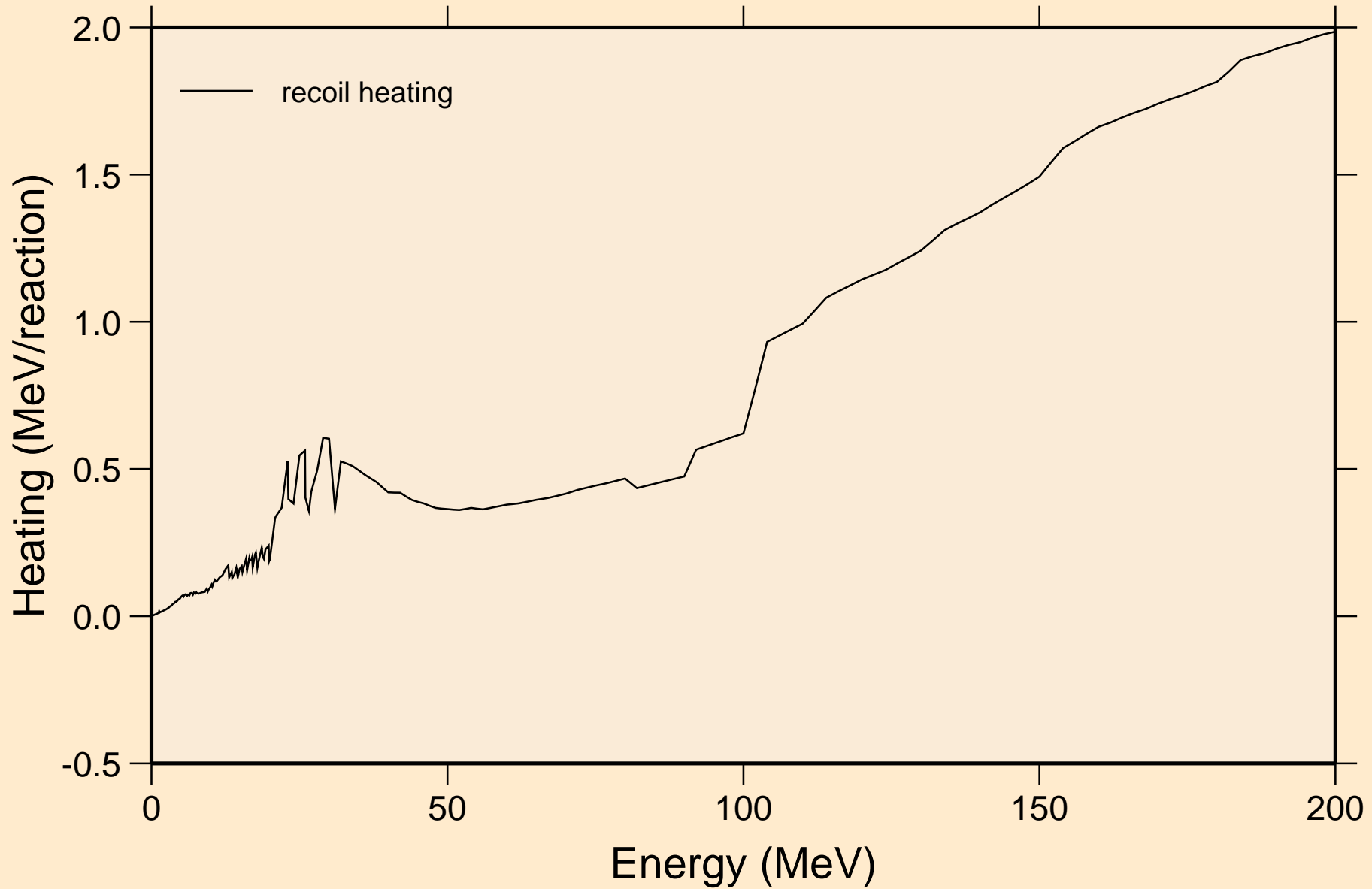

IN112 NEUTRON ACER TENDL-2024 LIBRARY; T=0.K
Particle production cross sections

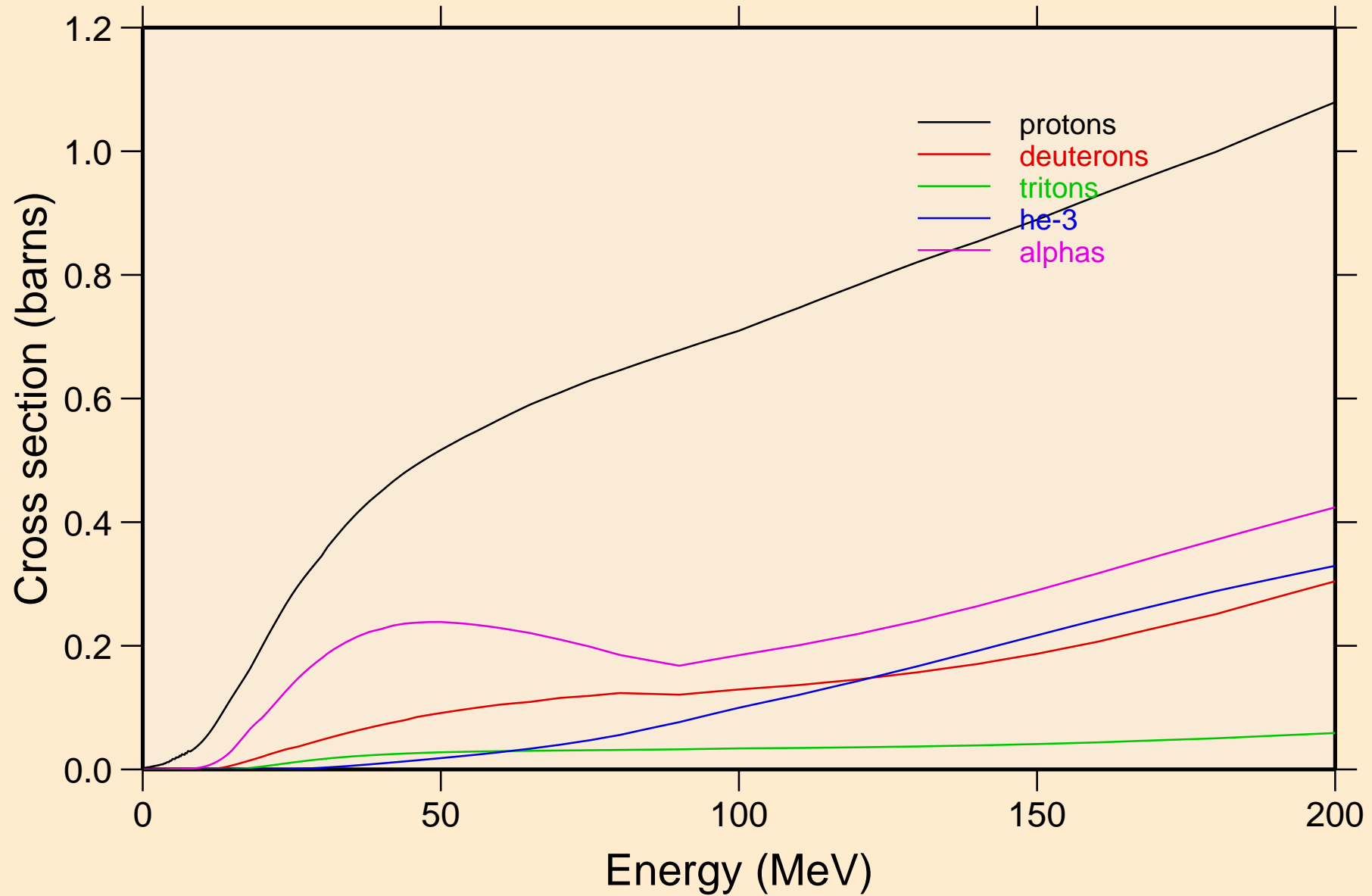

IN112 NEUTRON ACER TENDL-2024 LIBRARY; T=0.K
protons from (n,x)

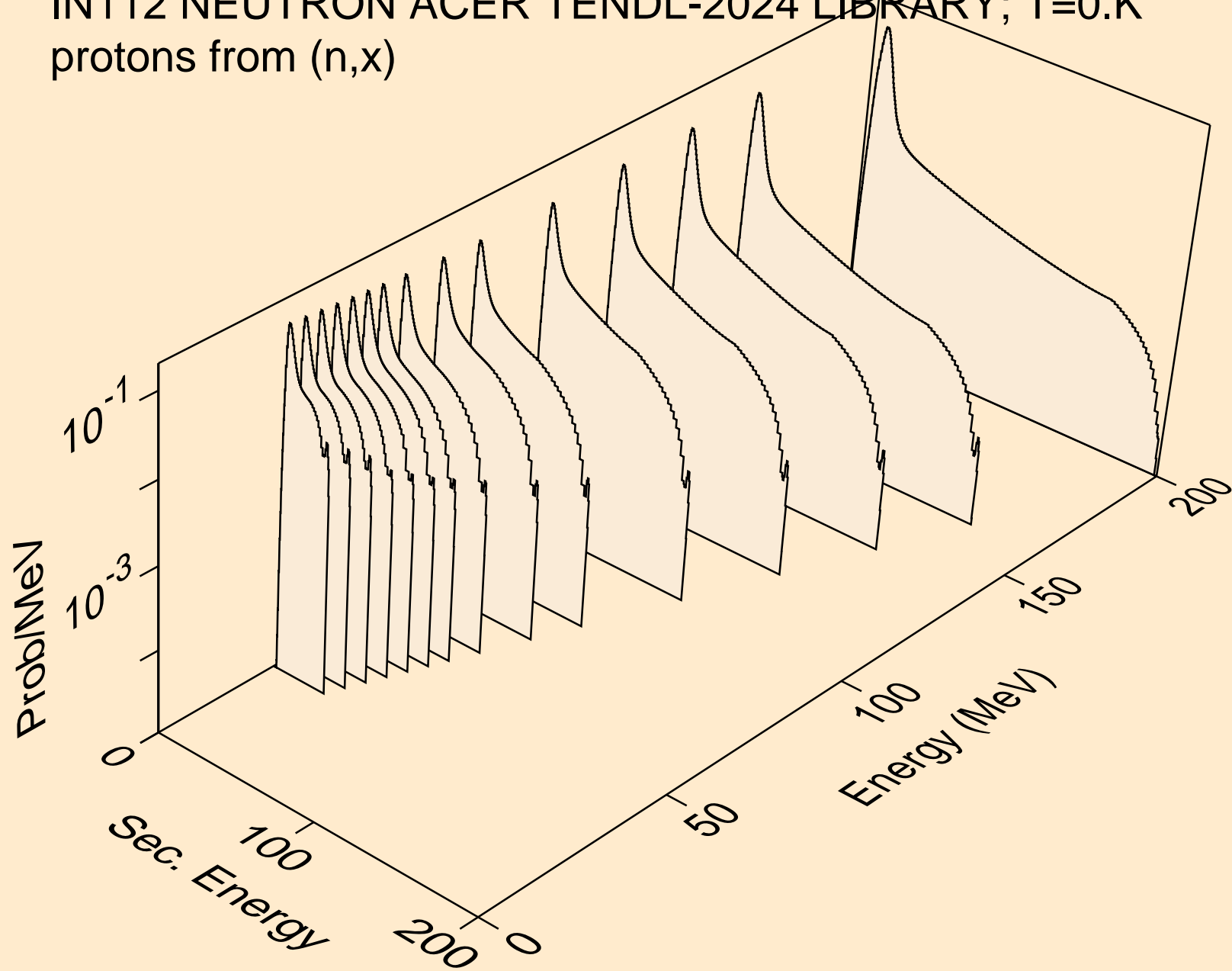

IN112 NEUTRON ACER TENDL-2024 LIBRARY; T=0.K
protons from (n,n*)p

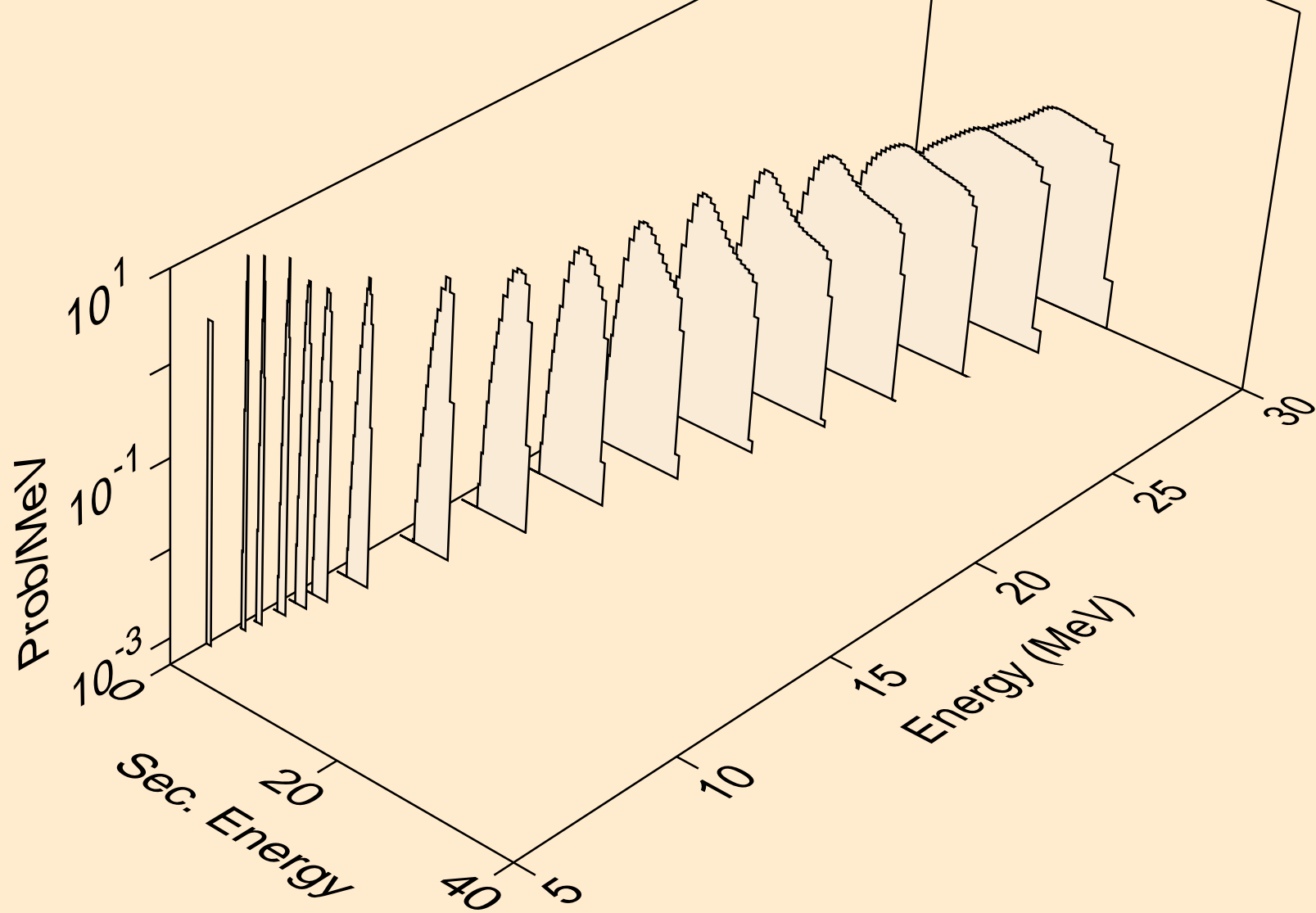

IN112 NEUTRON ACER TENDL-2024 LIBRARY; T=0.K
protons from (n,2np)

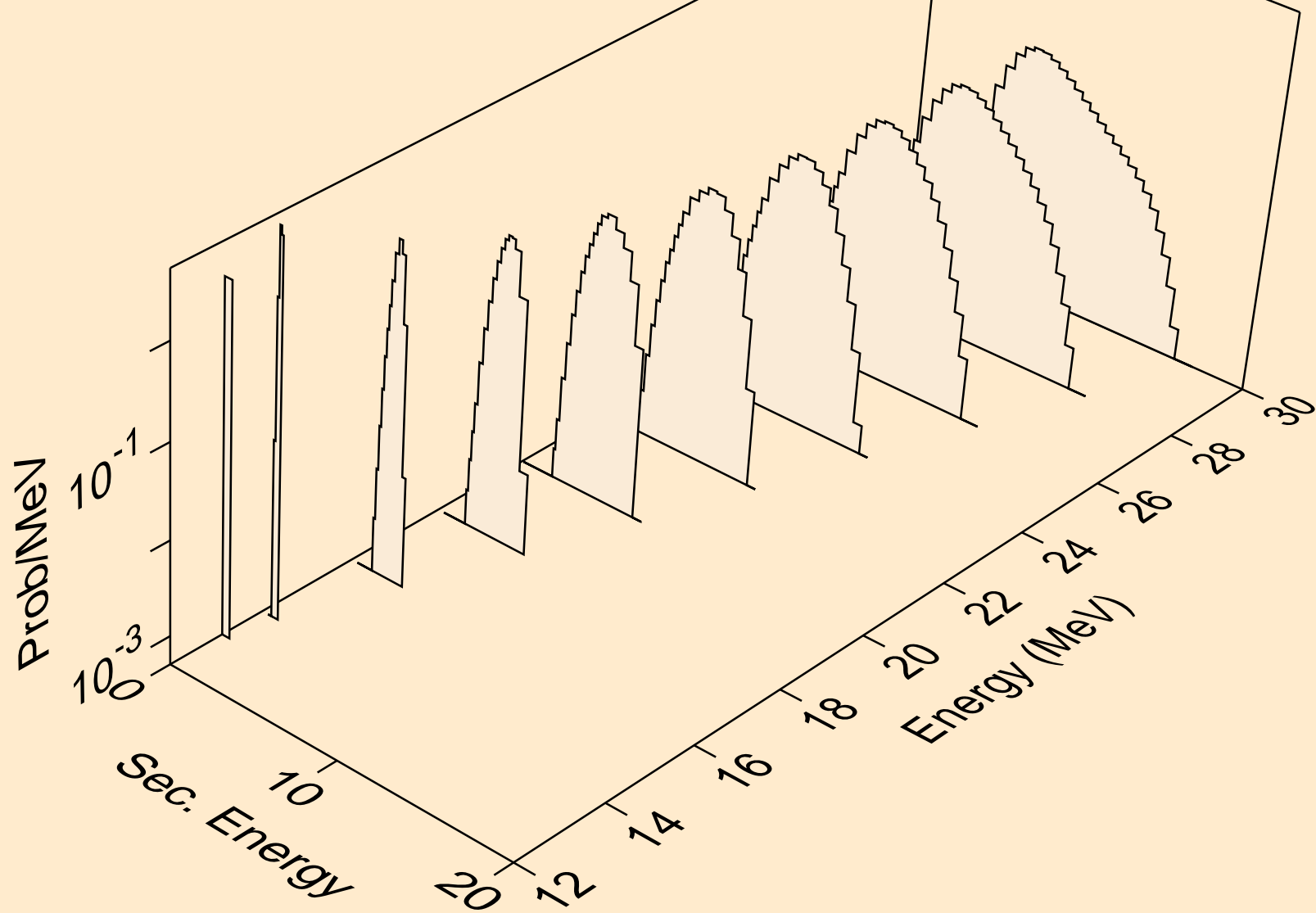

IN112 NEUTRON ACER TENDL-2024 LIBRARY; T=0.K
protons from (n,3np)

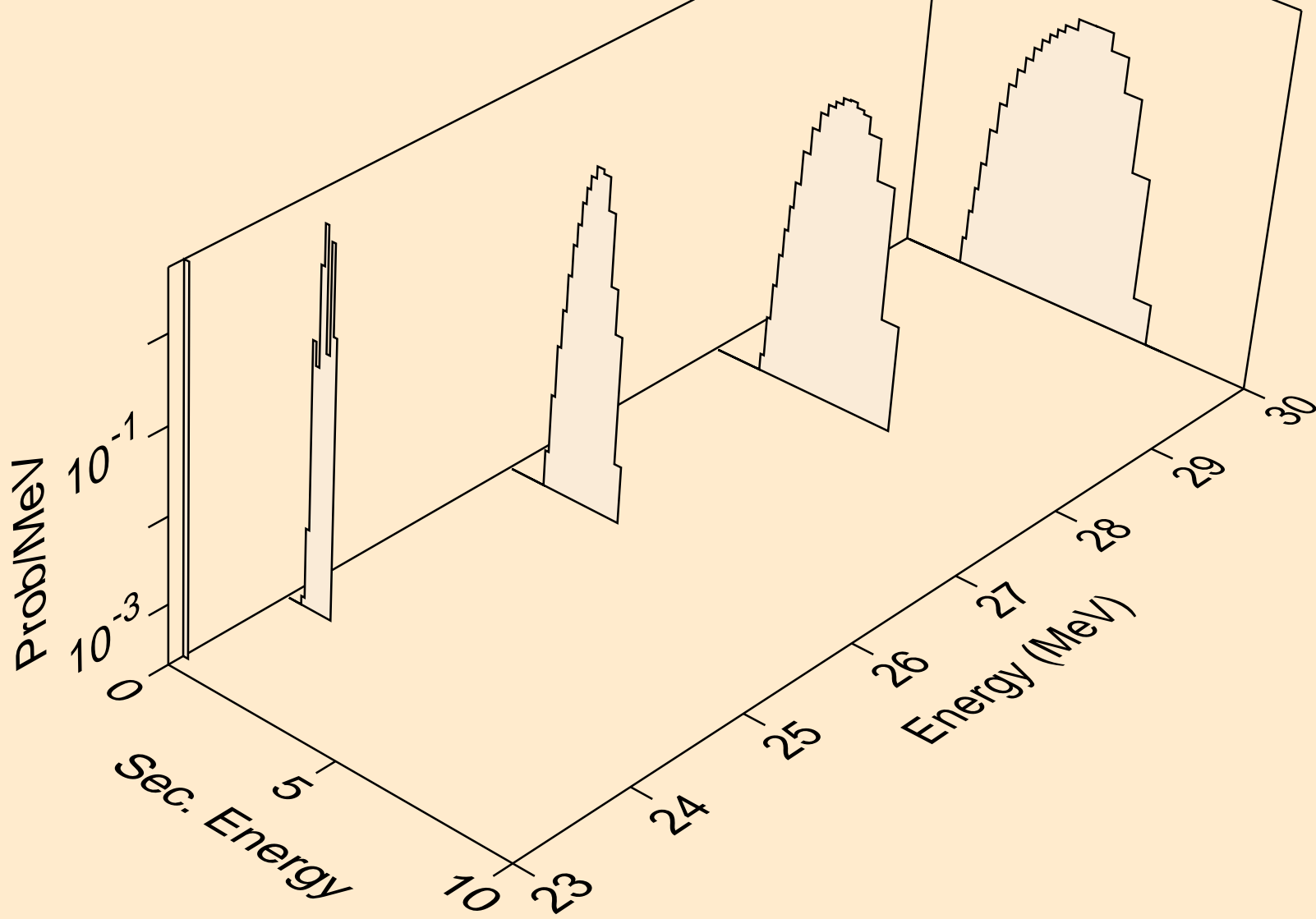

IN112 NEUTRON ACER TENDL-2024 LIBRARY; T=0.K
protons from (n,n2p)

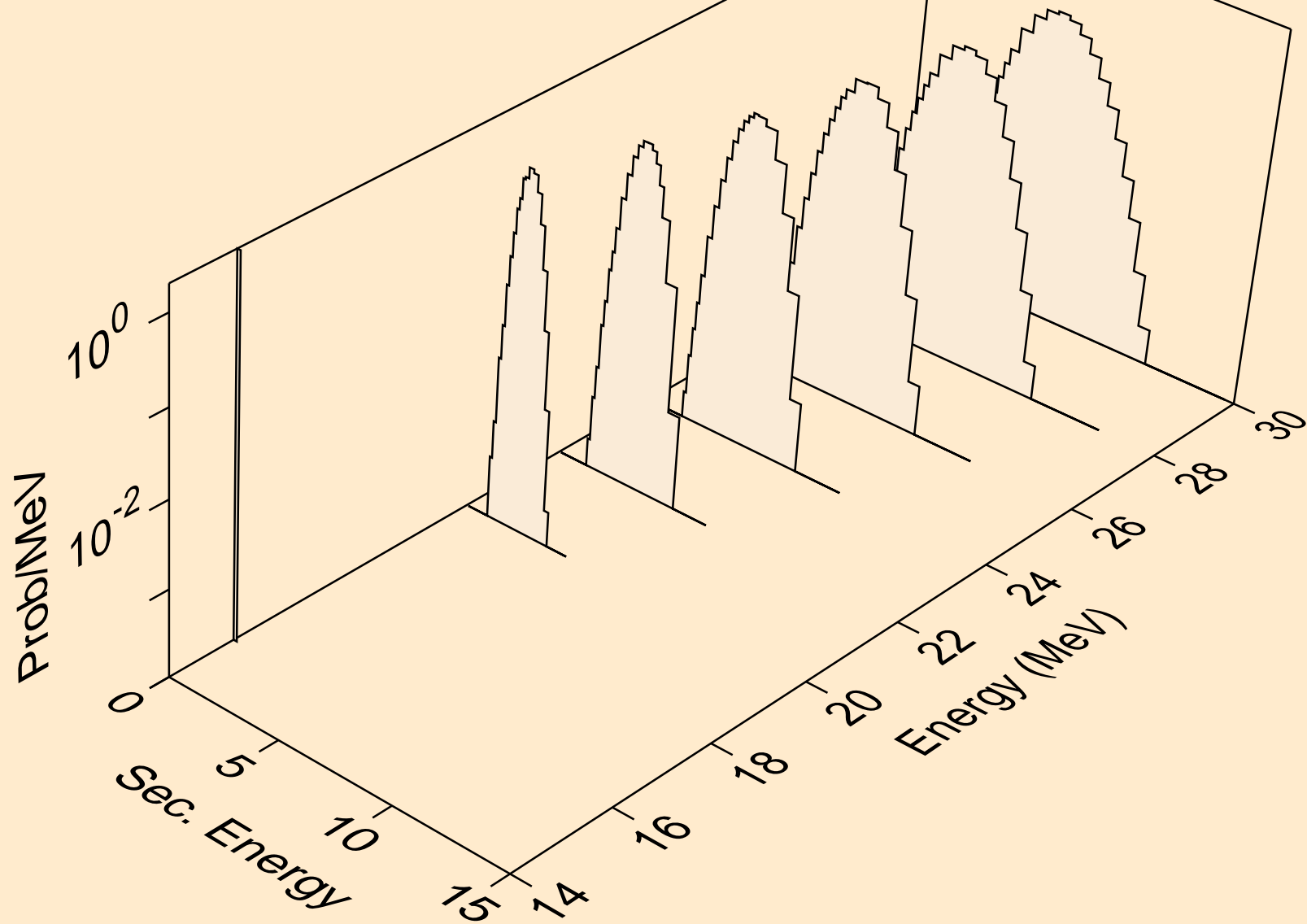

IN112 NEUTRON ACER TENDL-2024 LIBRARY; T=0.K
protons from (n,npa)

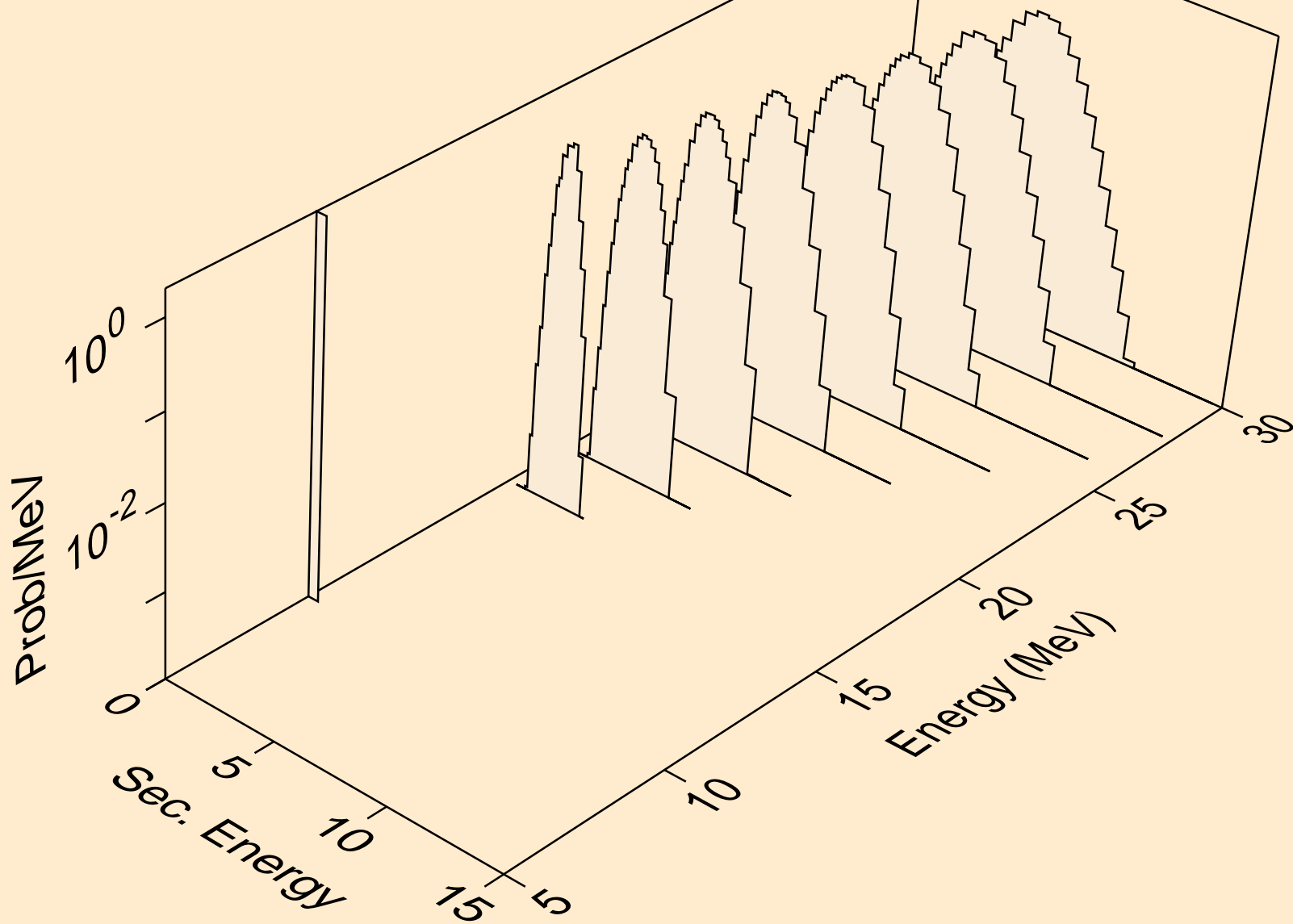

IN112 NEUTRON ACER TENDL-2024 LIBRARY; T=0.K
protons from (n,p)

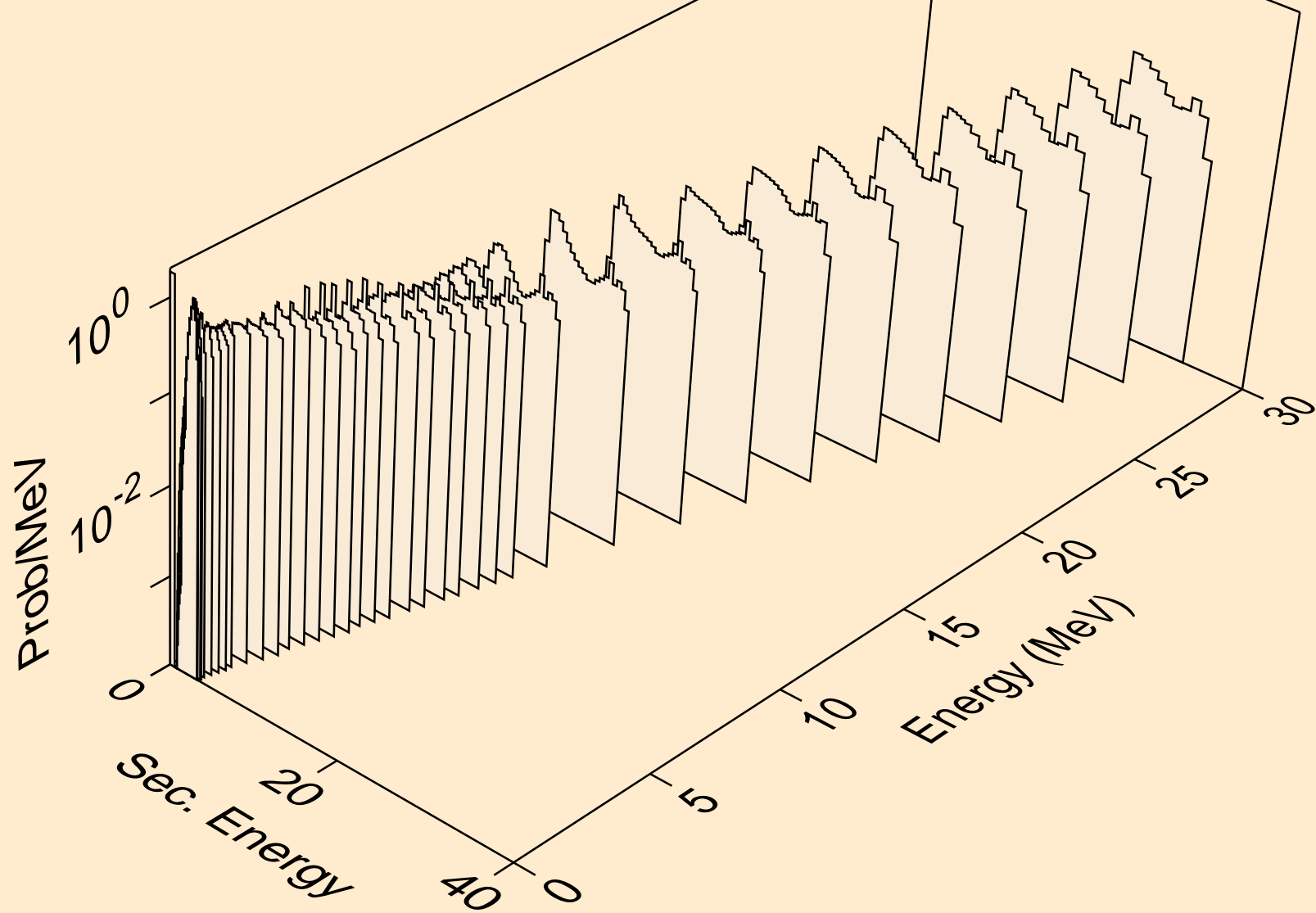

IN112 NEUTRON ACER TENDL-2024 LIBRARY; T=0.K
protons from (n,2p)

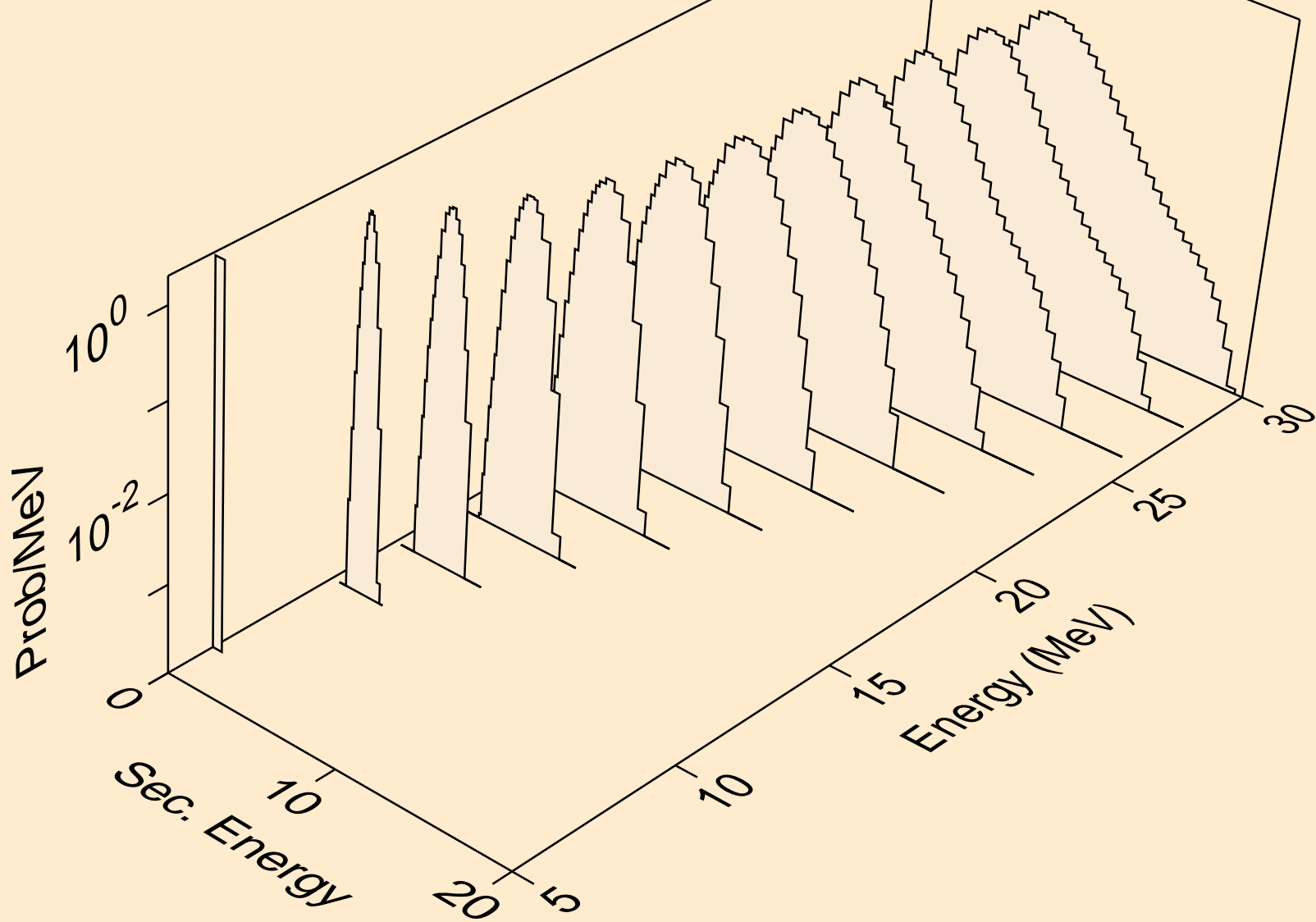

IN112 NEUTRON ACER TENDL-2024 LIBRARY; T=0.K
protons from (n,p)

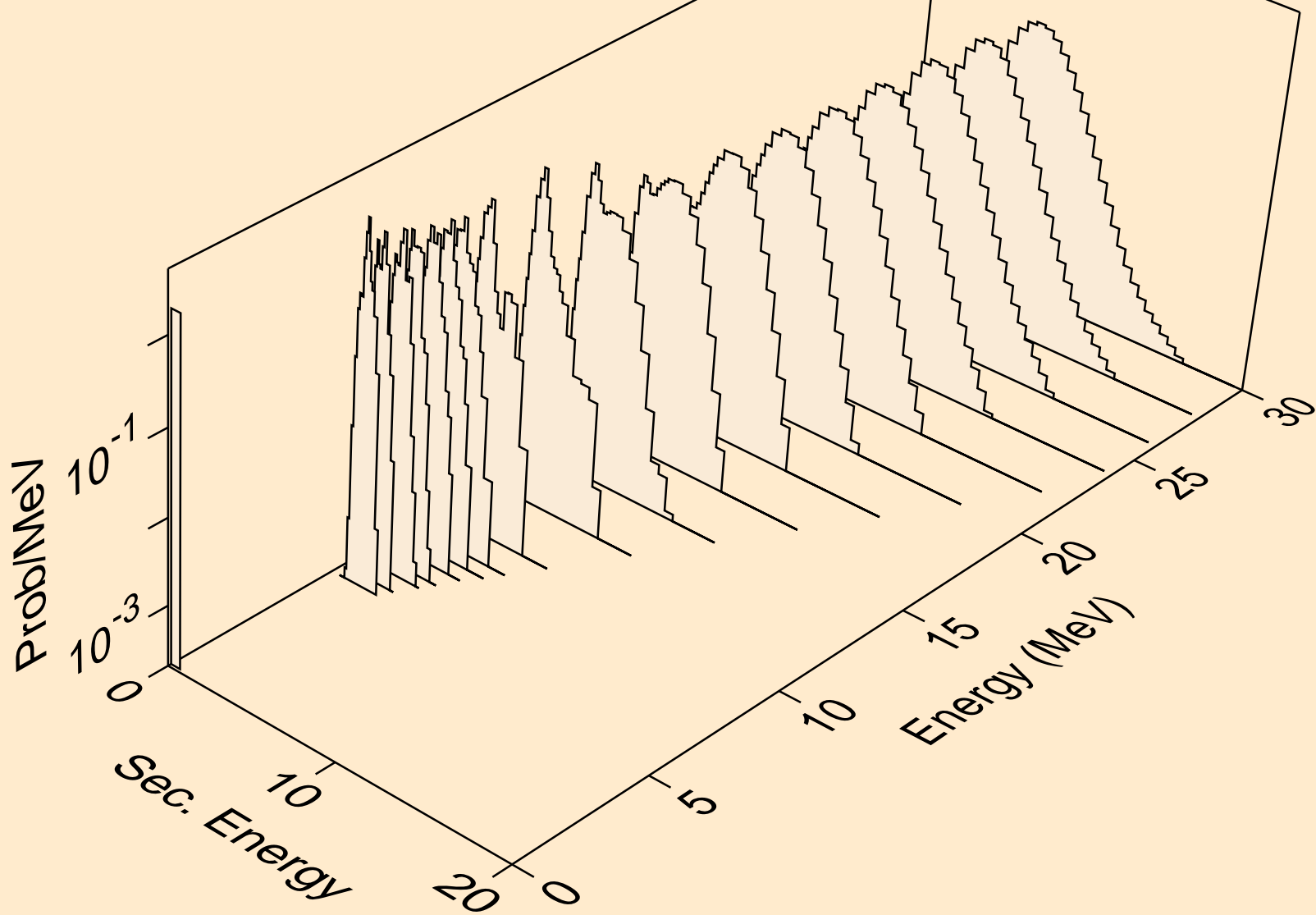

IN112 NEUTRON ACER TENDL-2024 LIBRARY; T=0.K
protons from (n,pd)

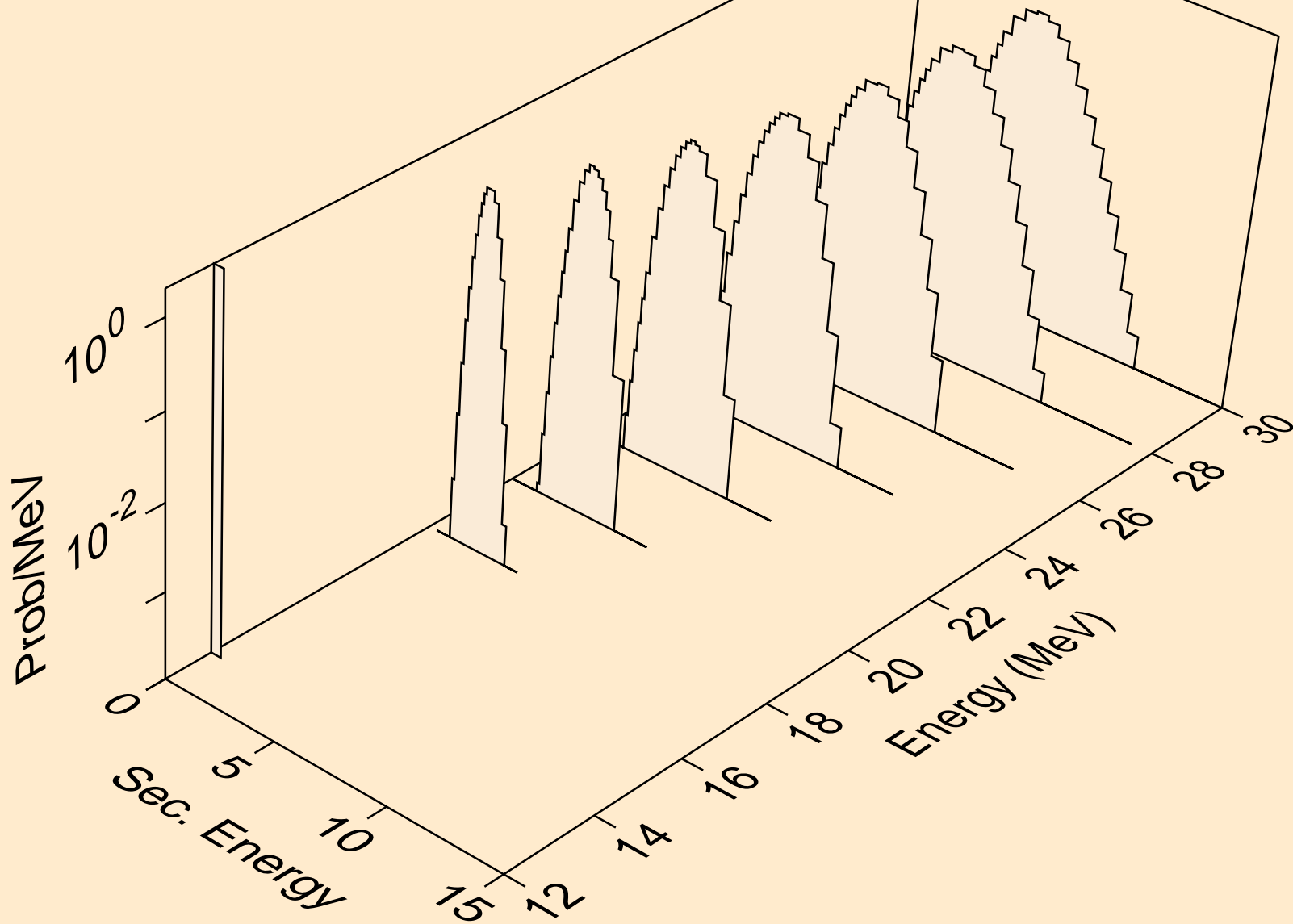

IN112 NEUTRON ACER TENDL-2024 LIBRARY; T=0.K
protons from (n,pt)

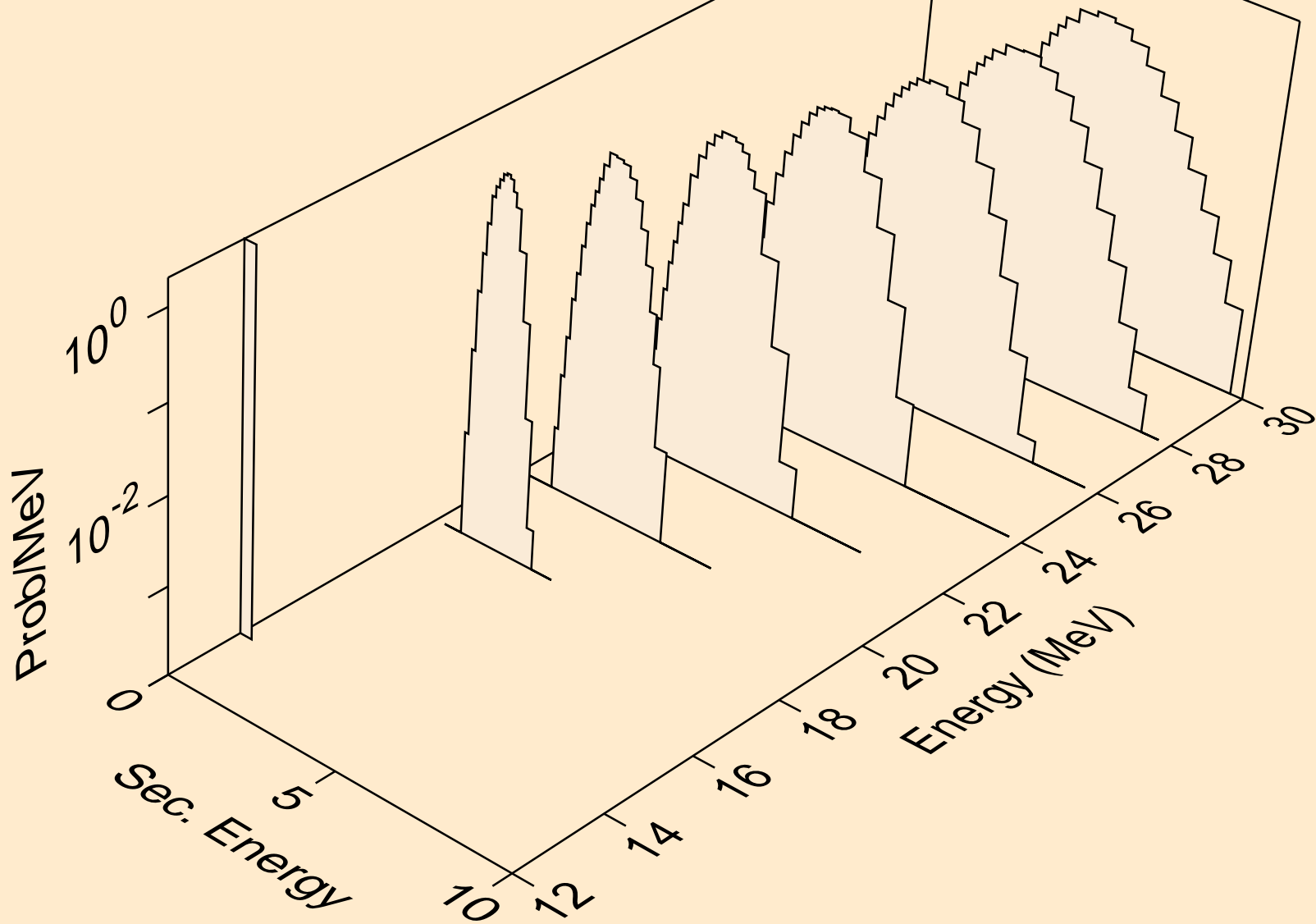

IN112 NEUTRON ACER TENDL-2024 LIBRARY; T=0.K
deuterons from (n,x)

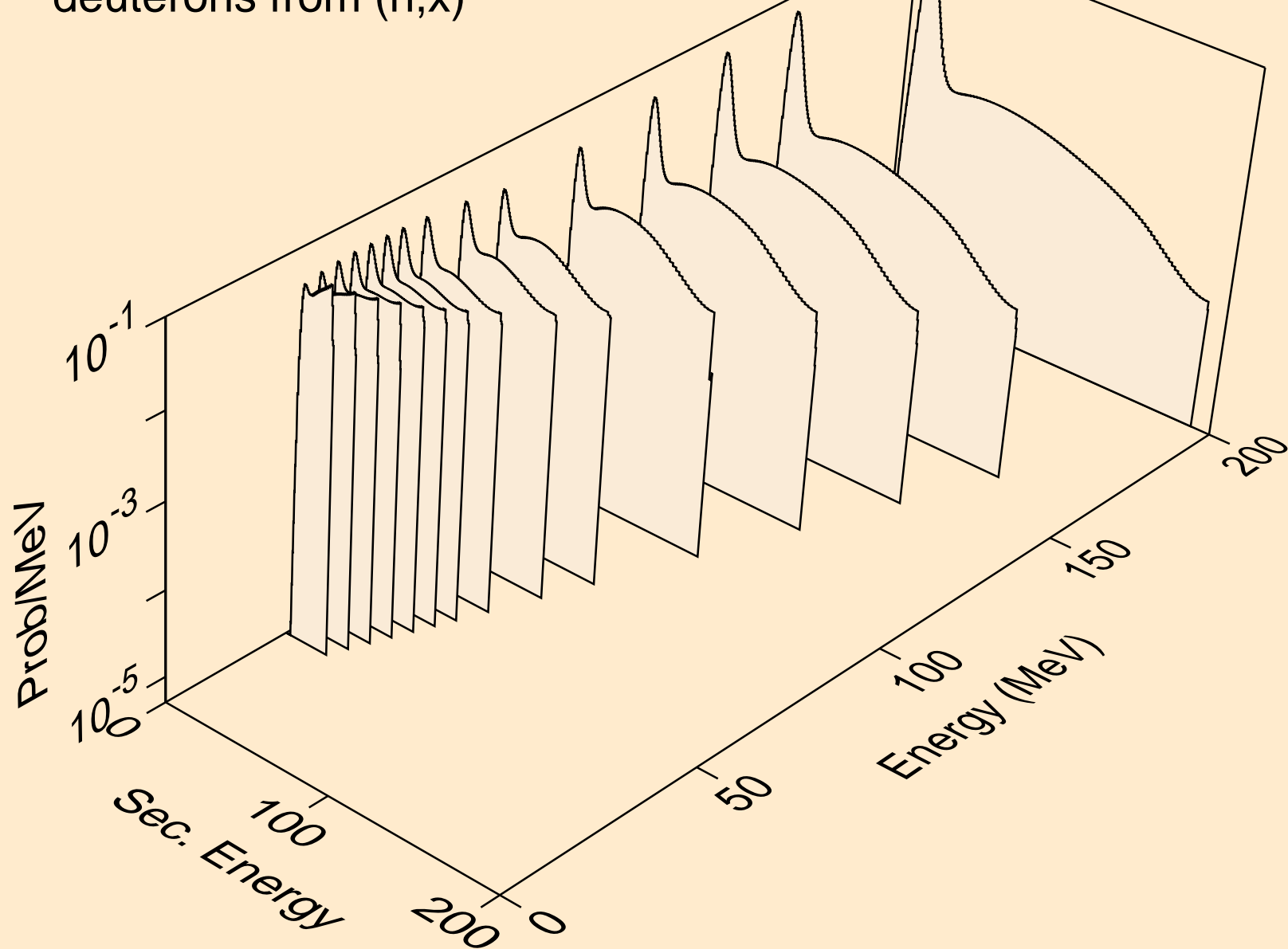

IN112 NEUTRON ACER TENDL-2024 LIBRARY; T=0.K
deuterons from (n,2nd)

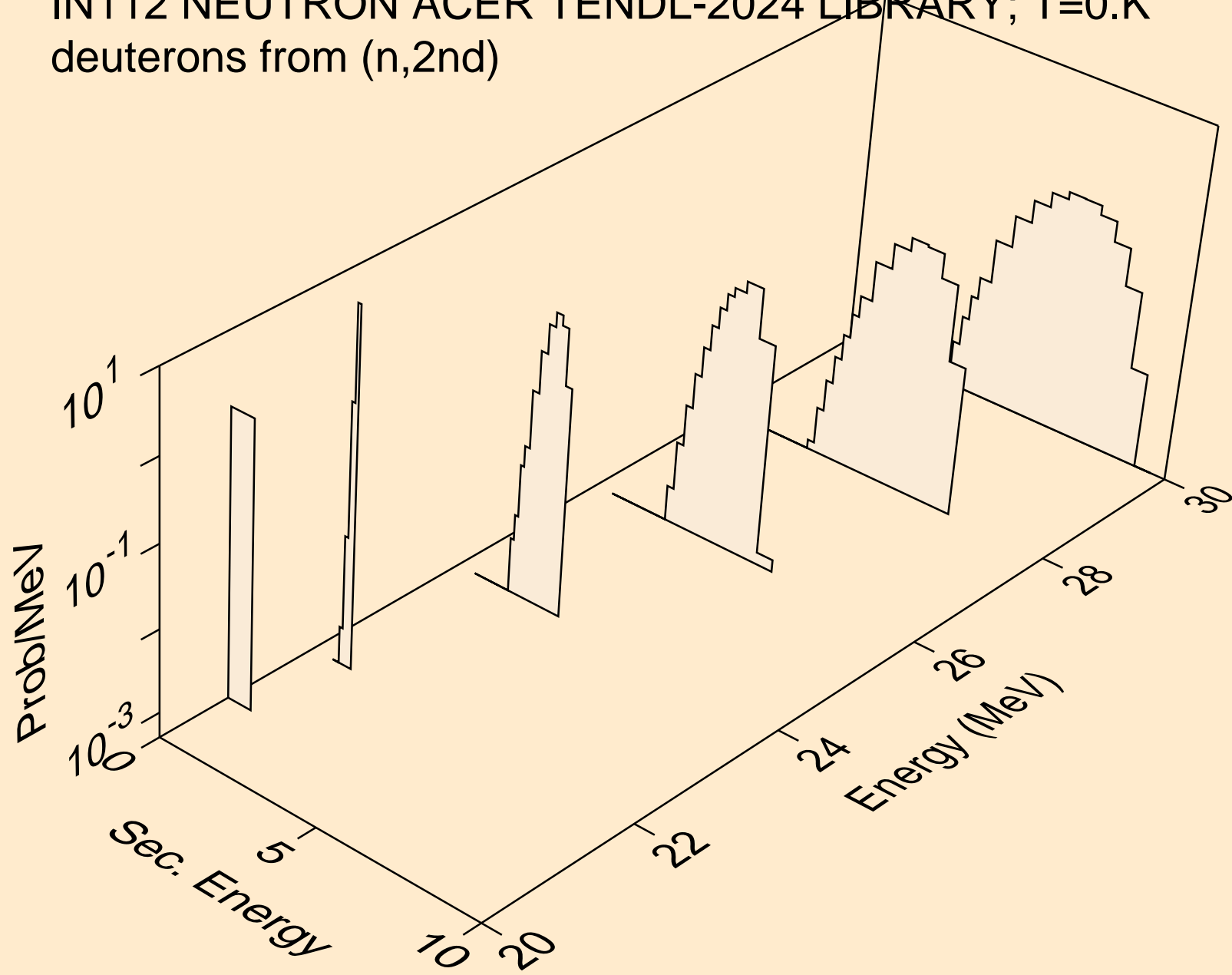

IN112 NEUTRON ACER TENDL-2024 LIBRARY; T=0.K
deuterons from (n,n*)d

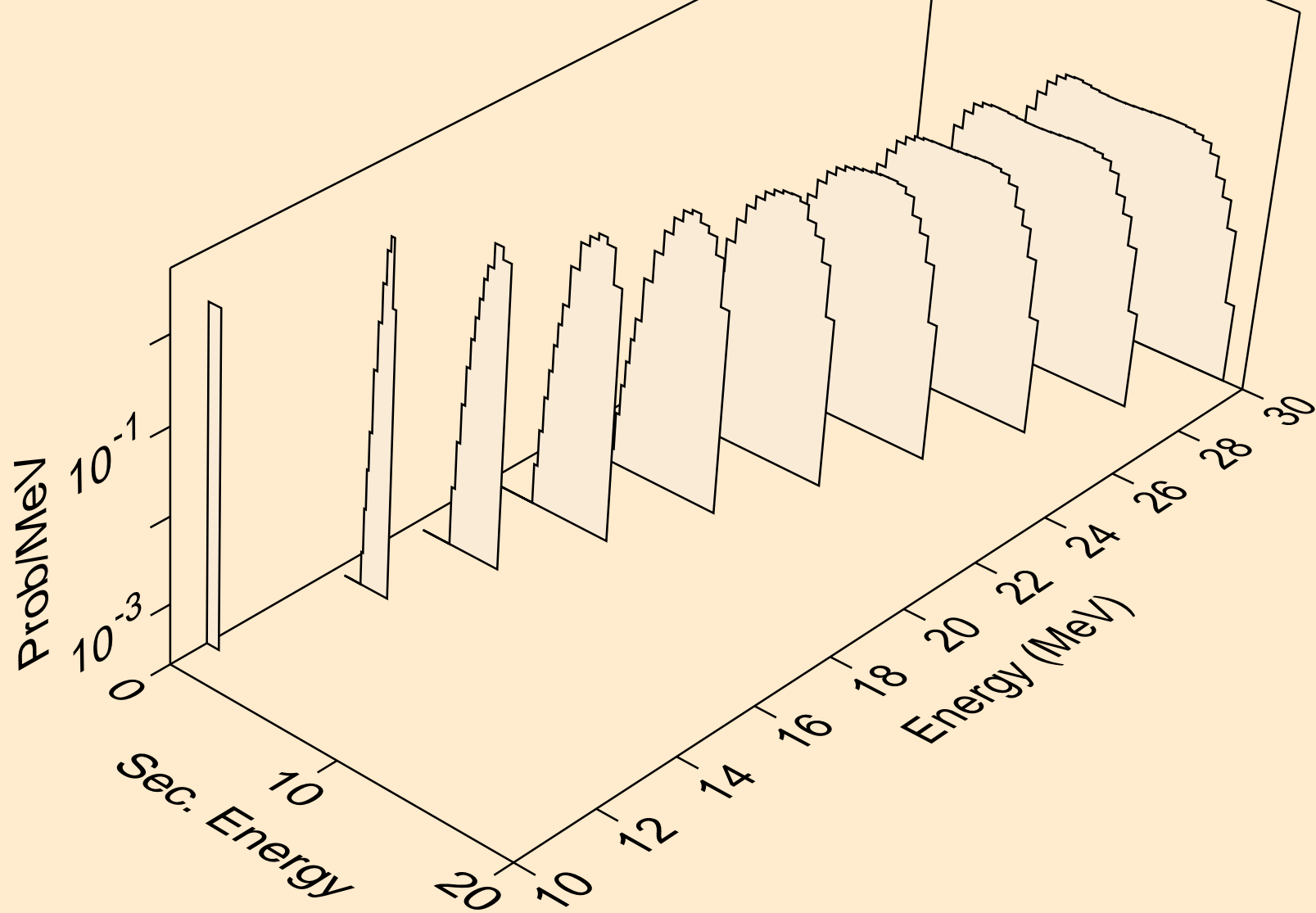

IN112 NEUTRON ACER TENDL-2024 LIBRARY; T=0.K
deuterons from (n,d)

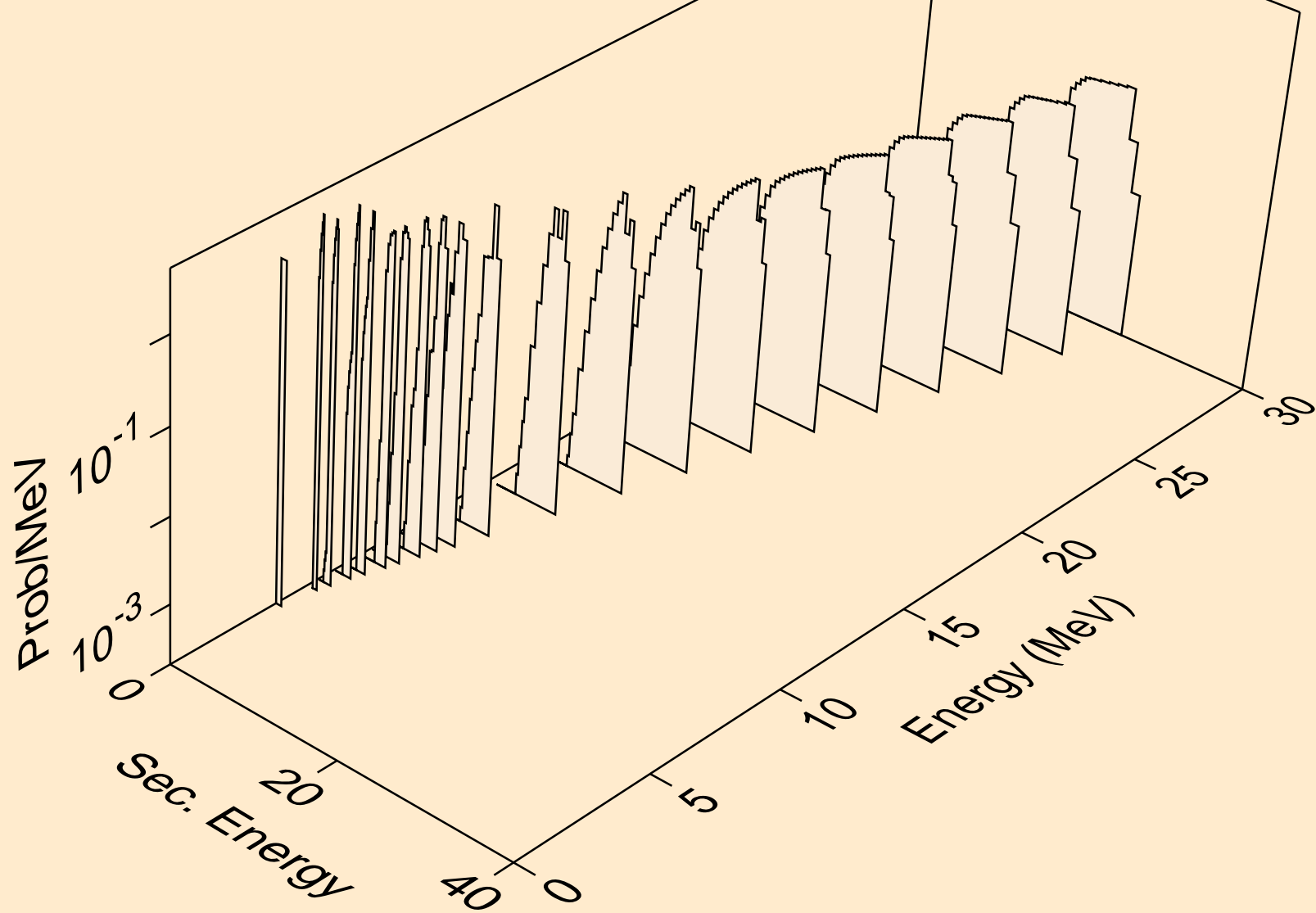

IN112 NEUTRON ACER TENDL-2024 LIBRARY; T=0.K
deuterons from (n,pd)

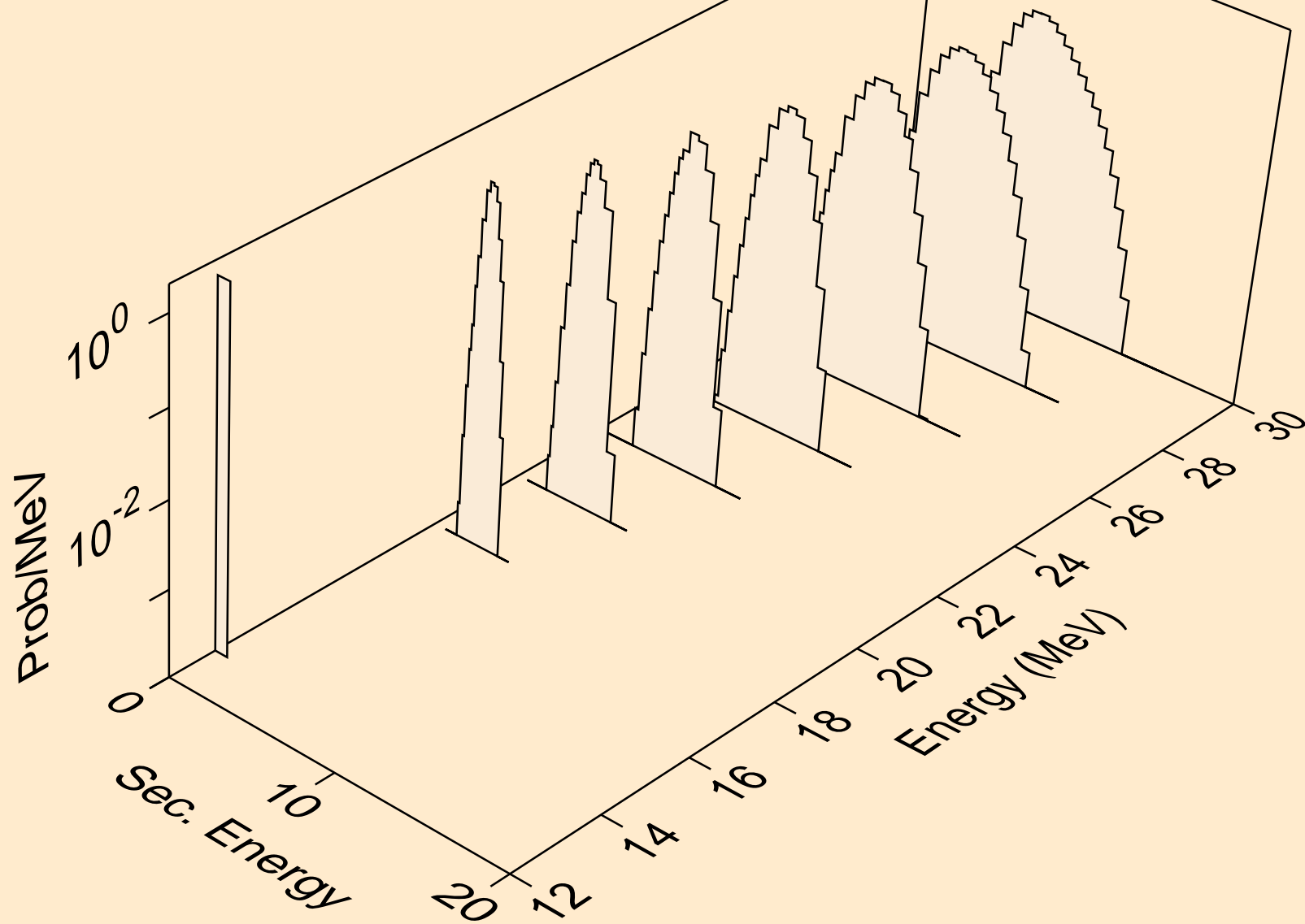

IN112 NEUTRON ACER TENDL-2024 LIBRARY; T=0.K
deuterons from (n,da)

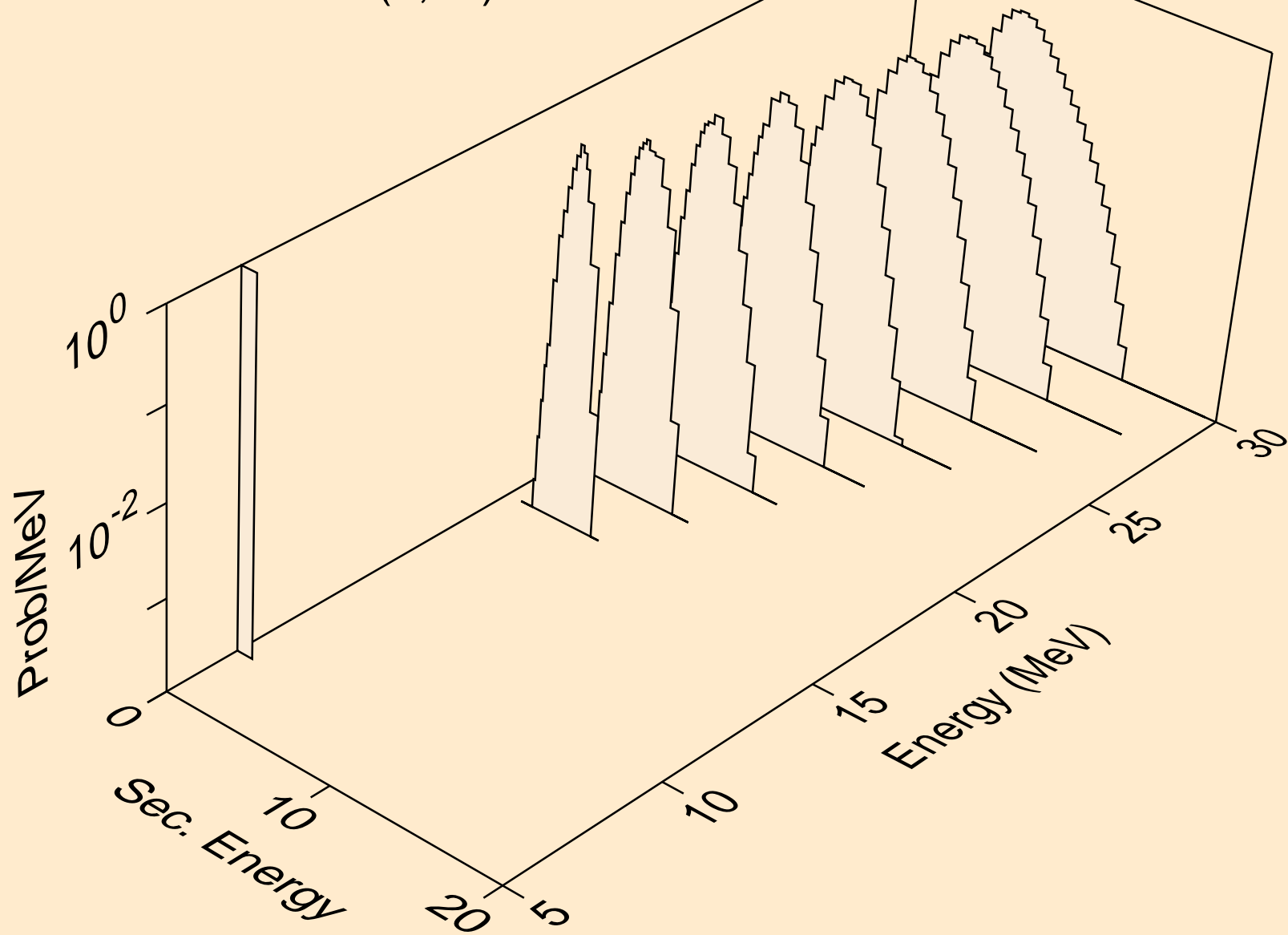

IN112 NEUTRON ACER TENDL-2024 LIBRARY; T=0.K
tritons from (n,x)

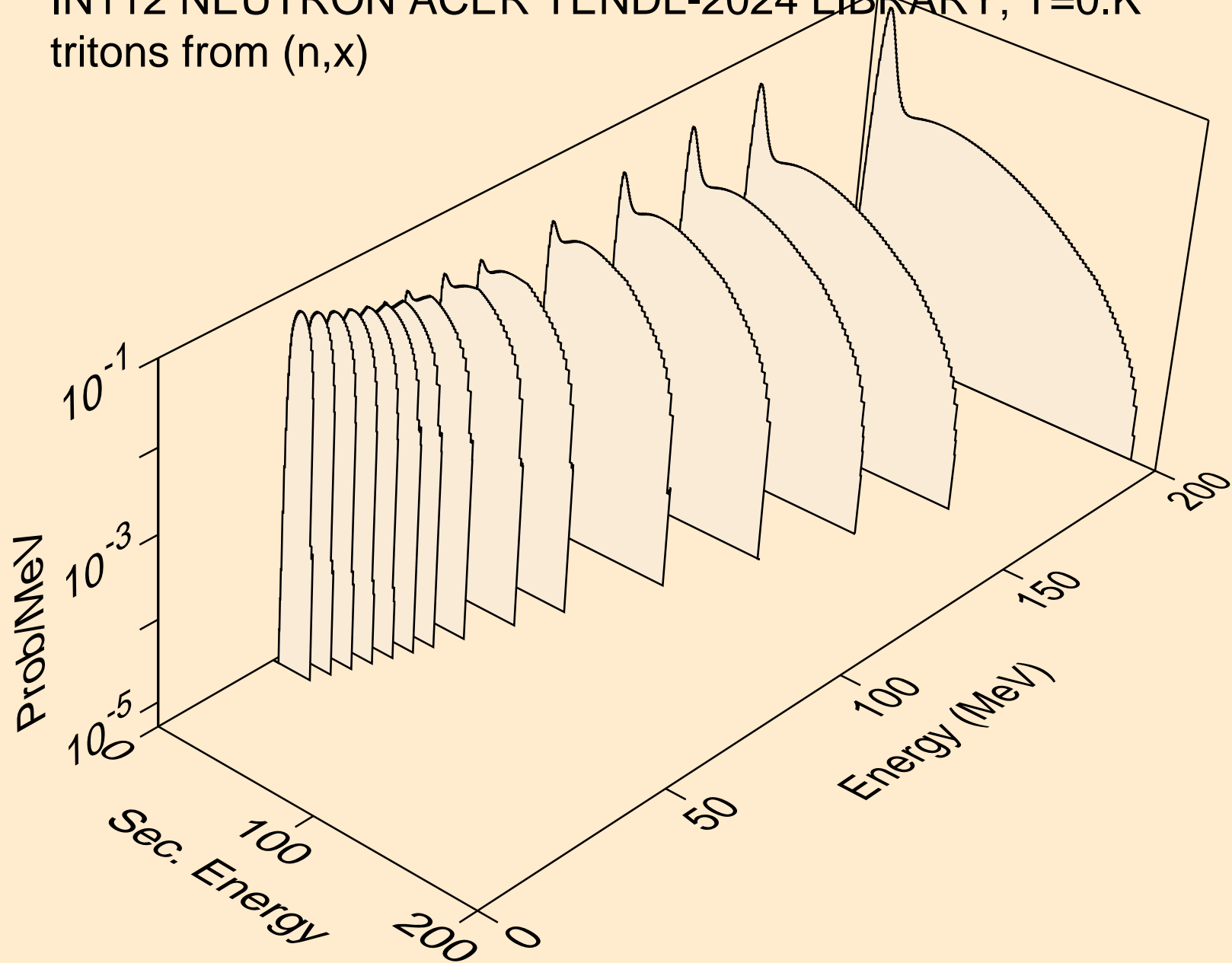

IN112 NEUTRON ACER TENDL-2024 LIBRARY; T=0.K
tritons from (n,n*)t

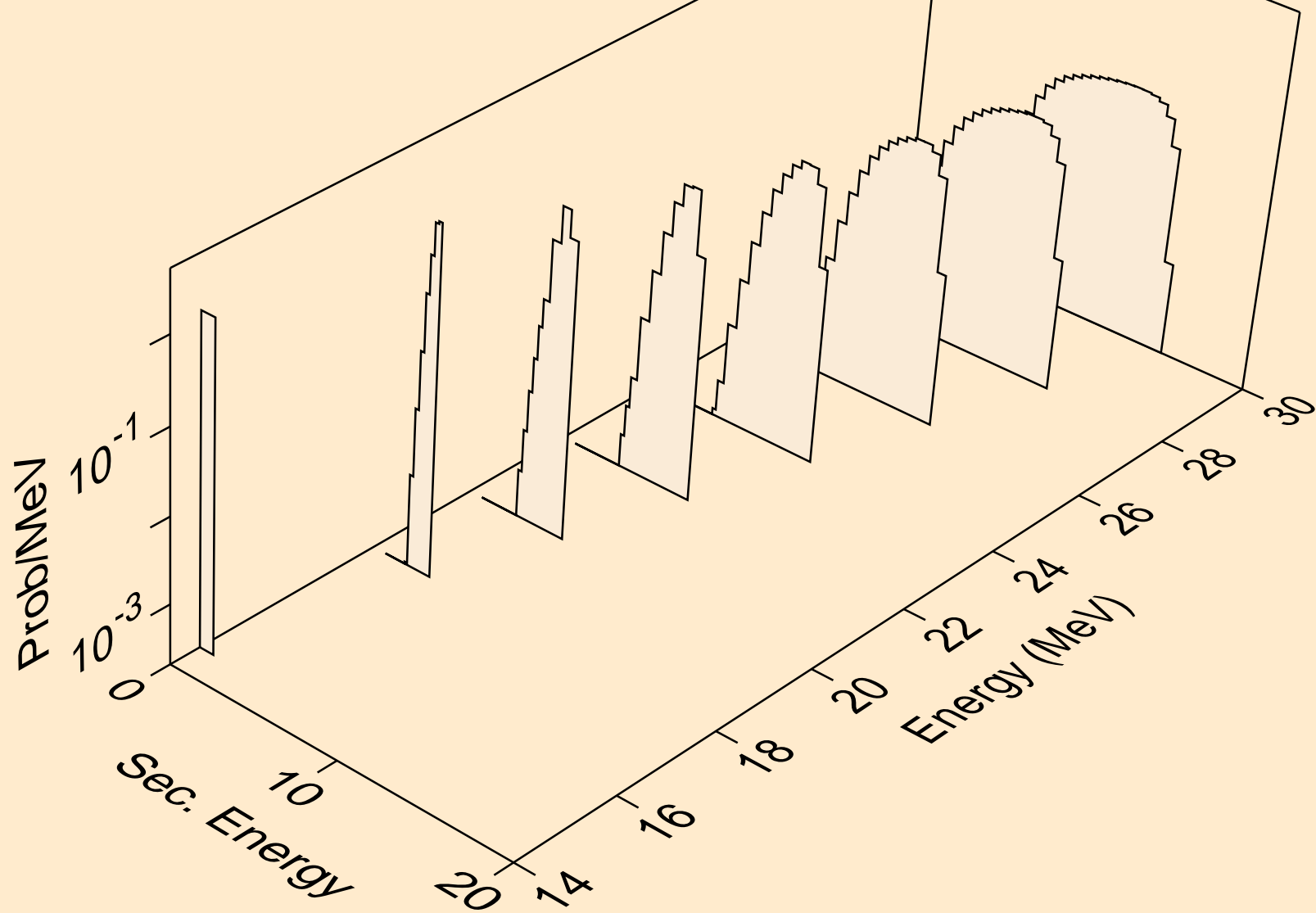

IN112 NEUTRON ACER TENDL-2024 LIBRARY; T=0.K
tritons from (n,t)

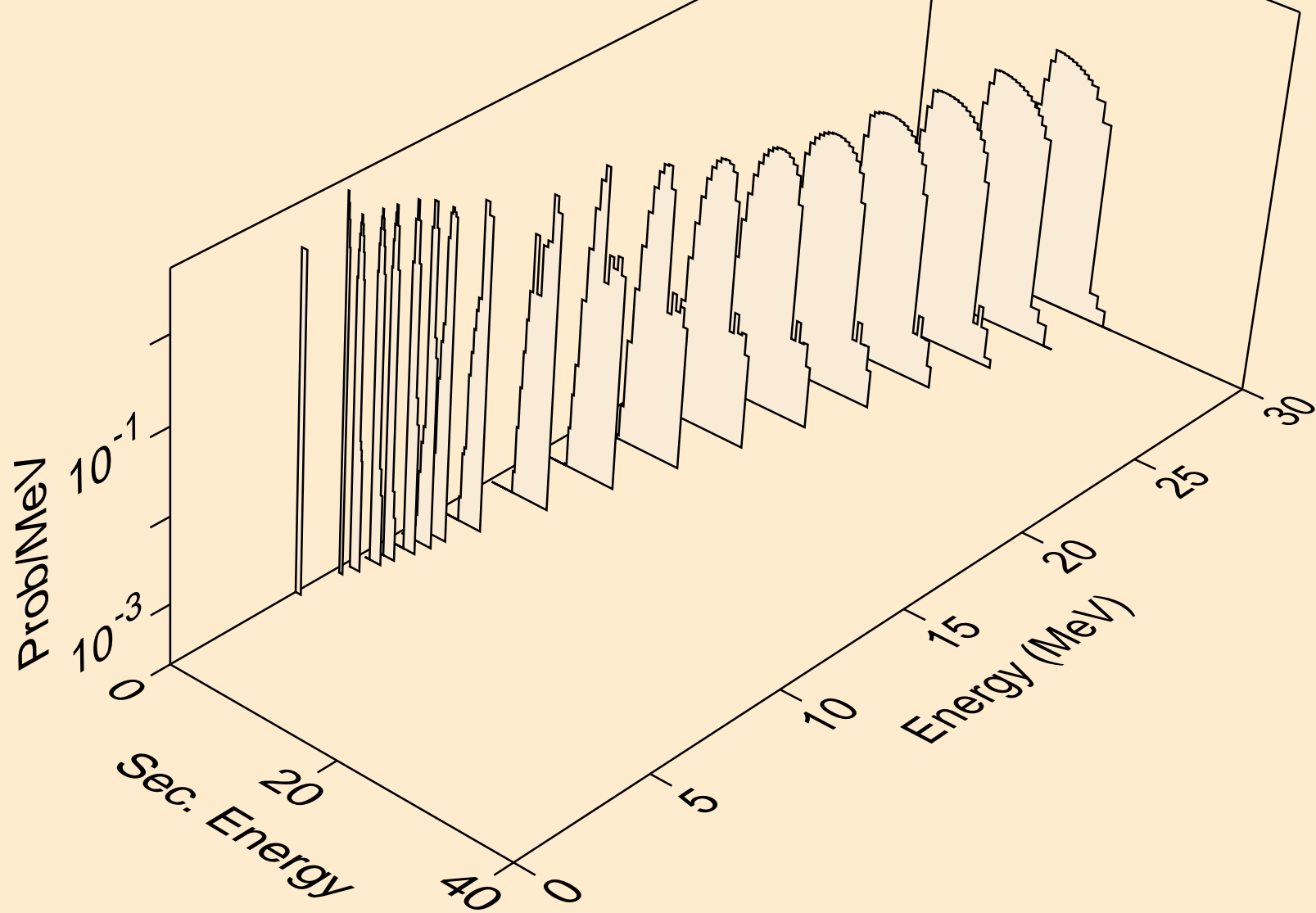

IN112 NEUTRON ACER TENDL-2024 LIBRARY; T=0.K
tritons from (n,pt)

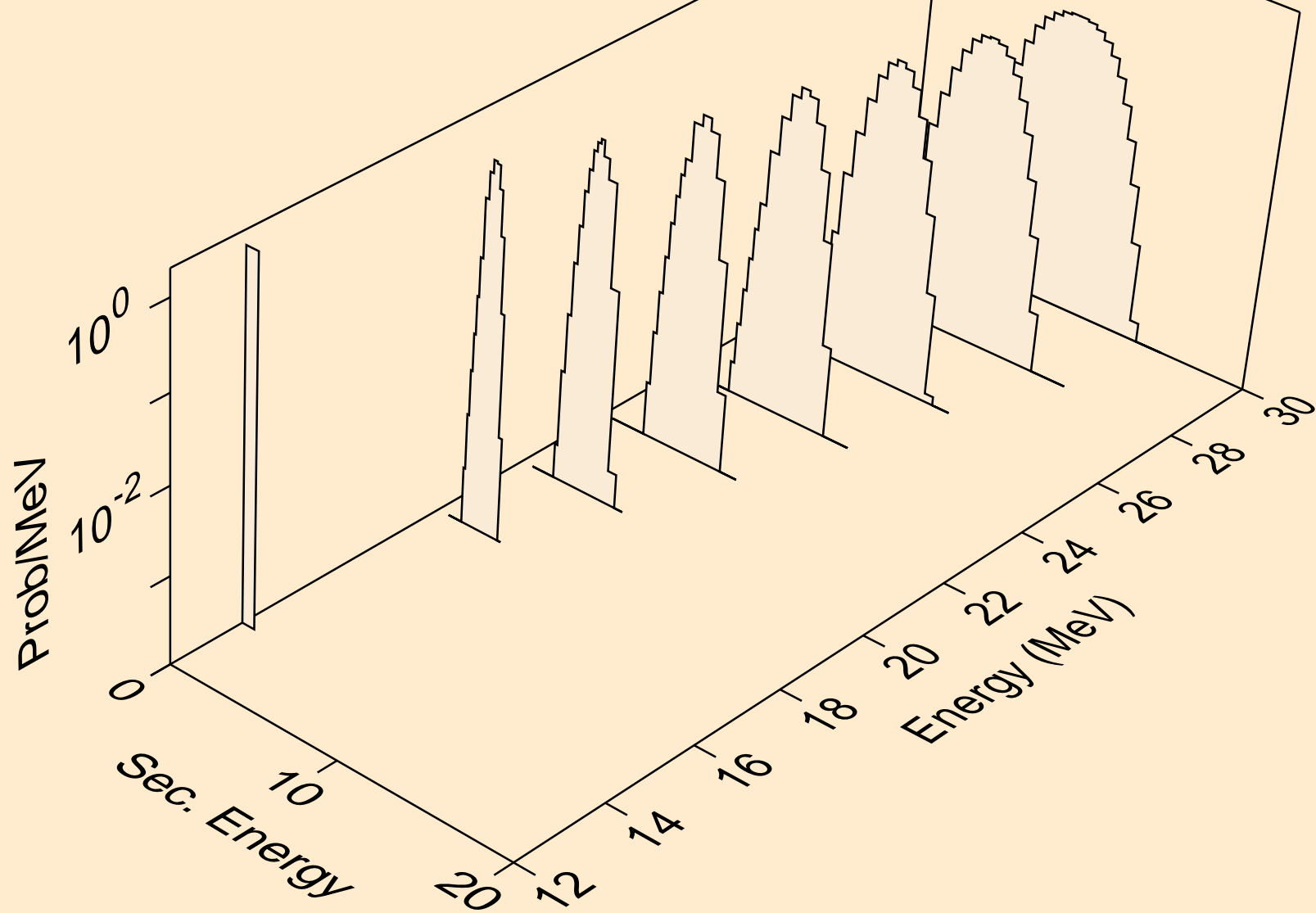

IN112 NEUTRON ACER TENDL-2024 LIBRARY; T=0.K
he3s from (n,x)

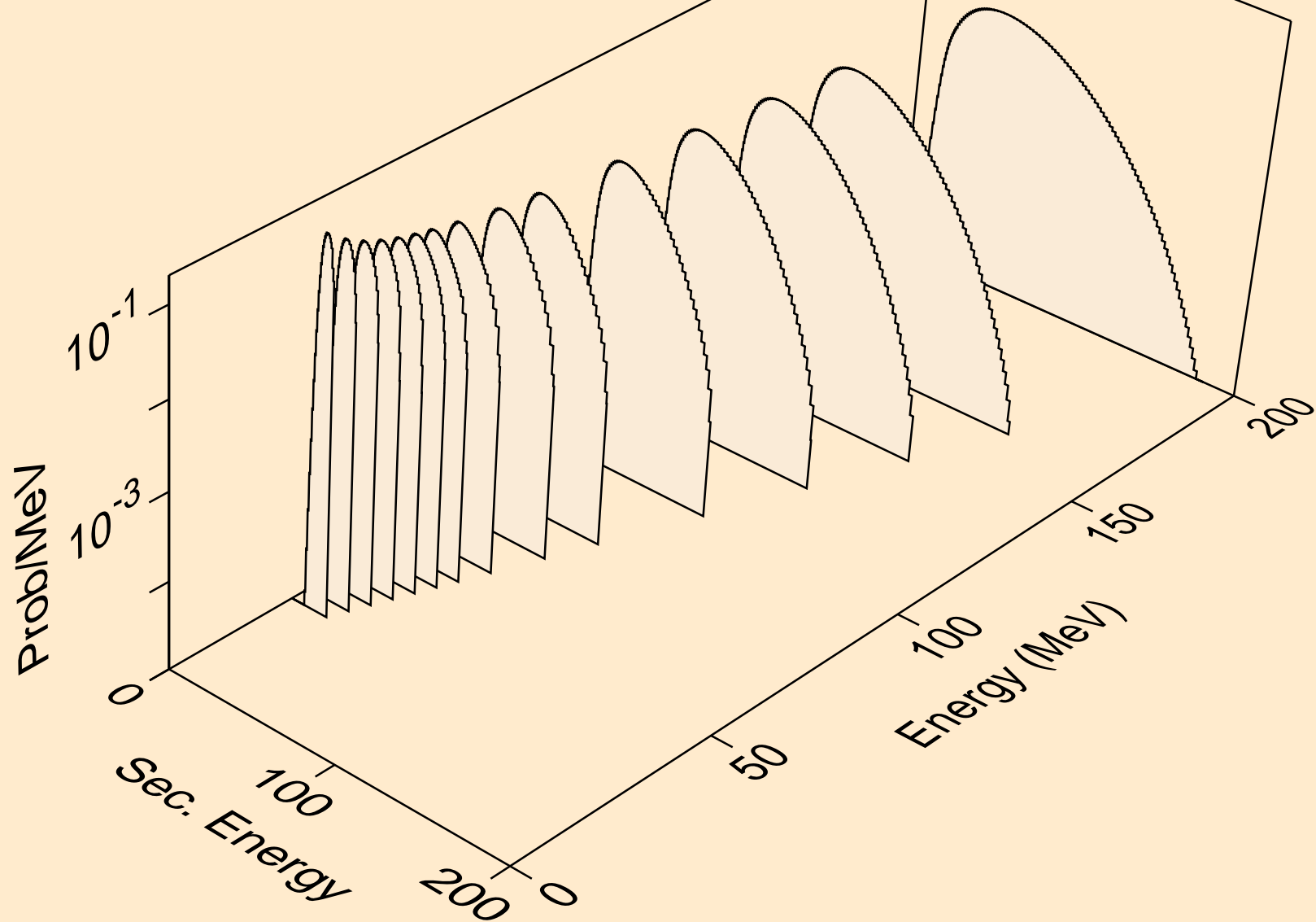

IN112 NEUTRON ACER TENDL-2024 LIBRARY; T=0.K
he3s from (n,n*)he3

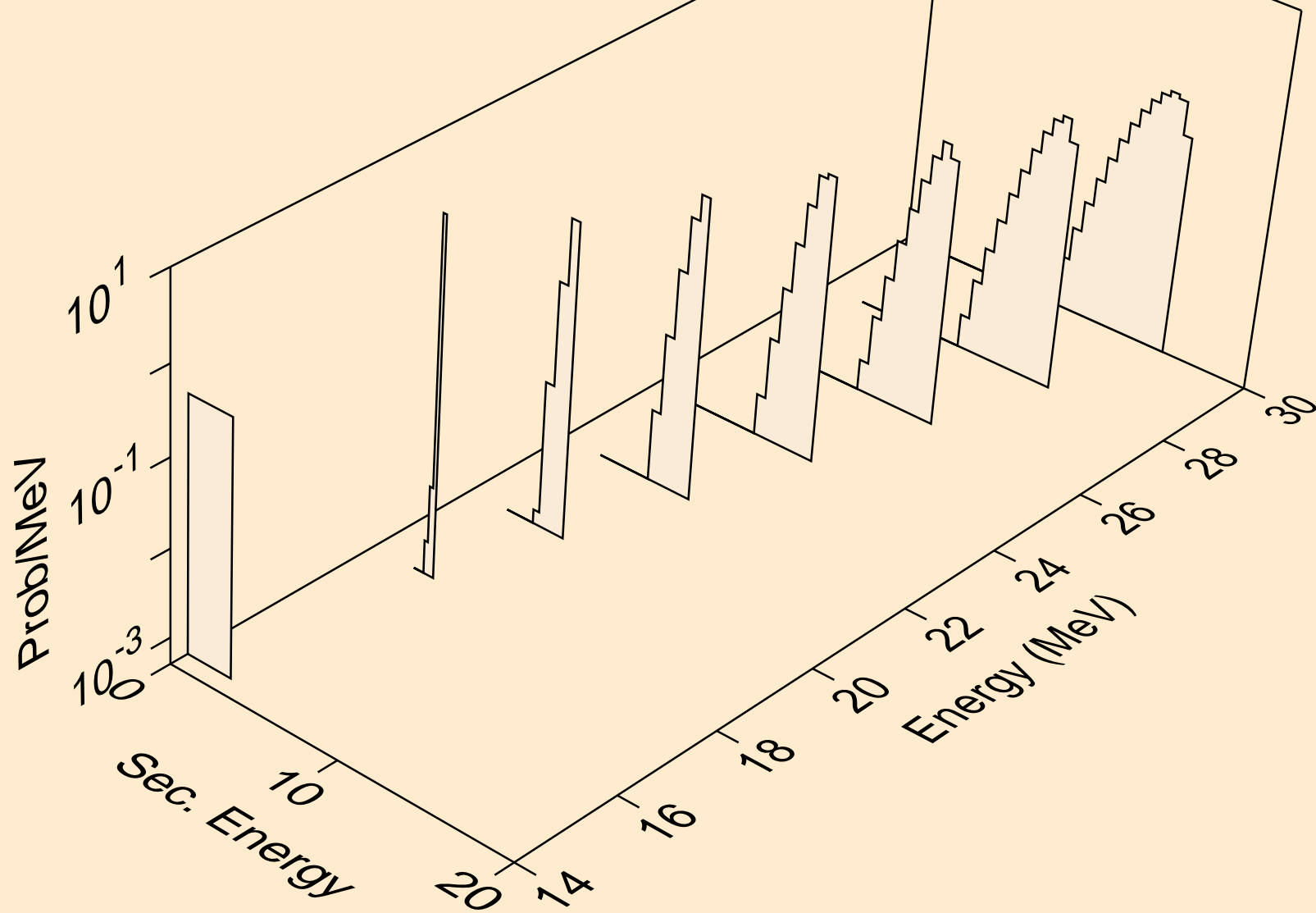

IN112 NEUTRON ACER TENDL-2024 LIBRARY; T=0.K
he3s from (n,he3)

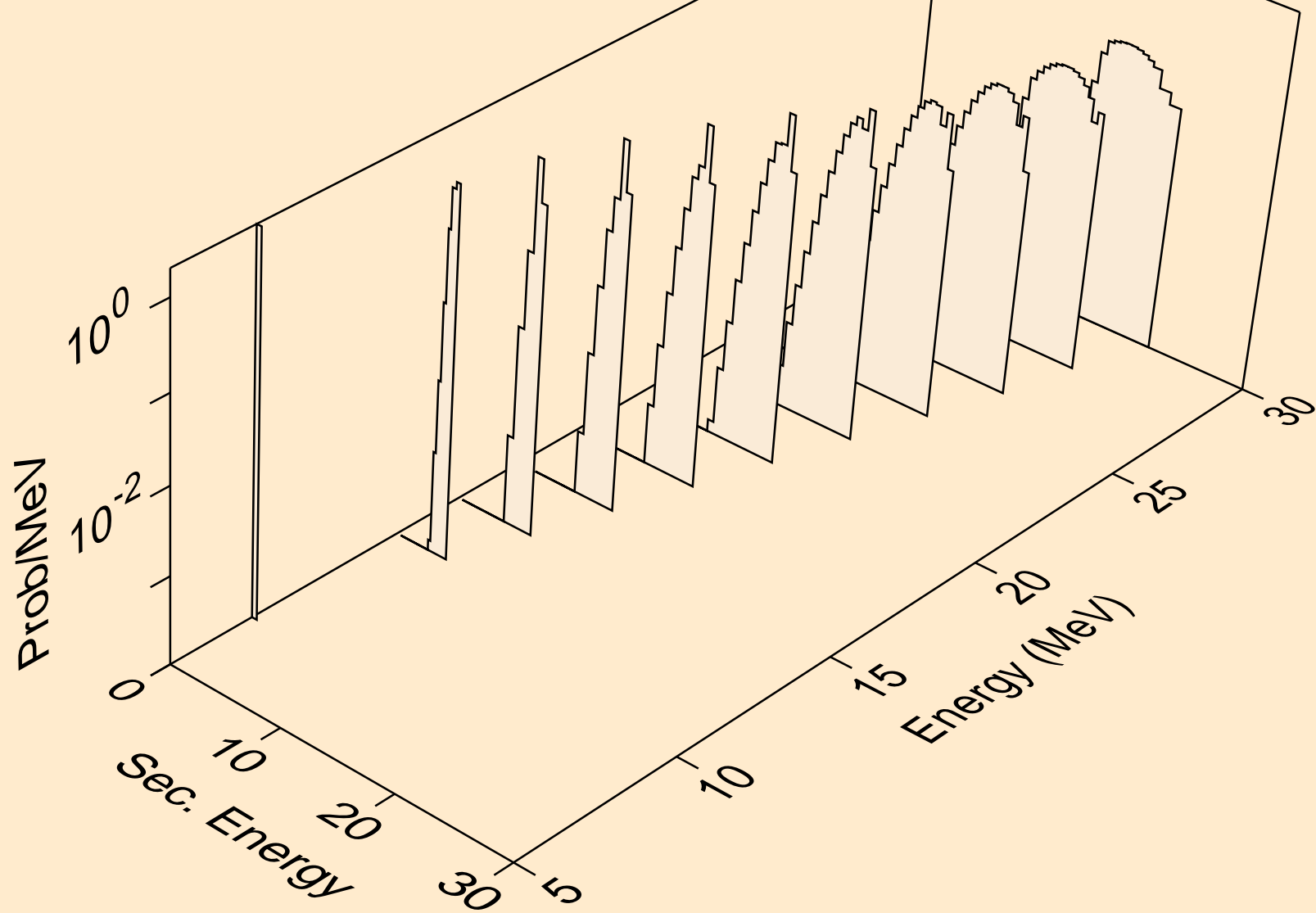

IN112 NEUTRON ACER TENDL-2024 LIBRARY; T=0.K
alphas from (n,x)

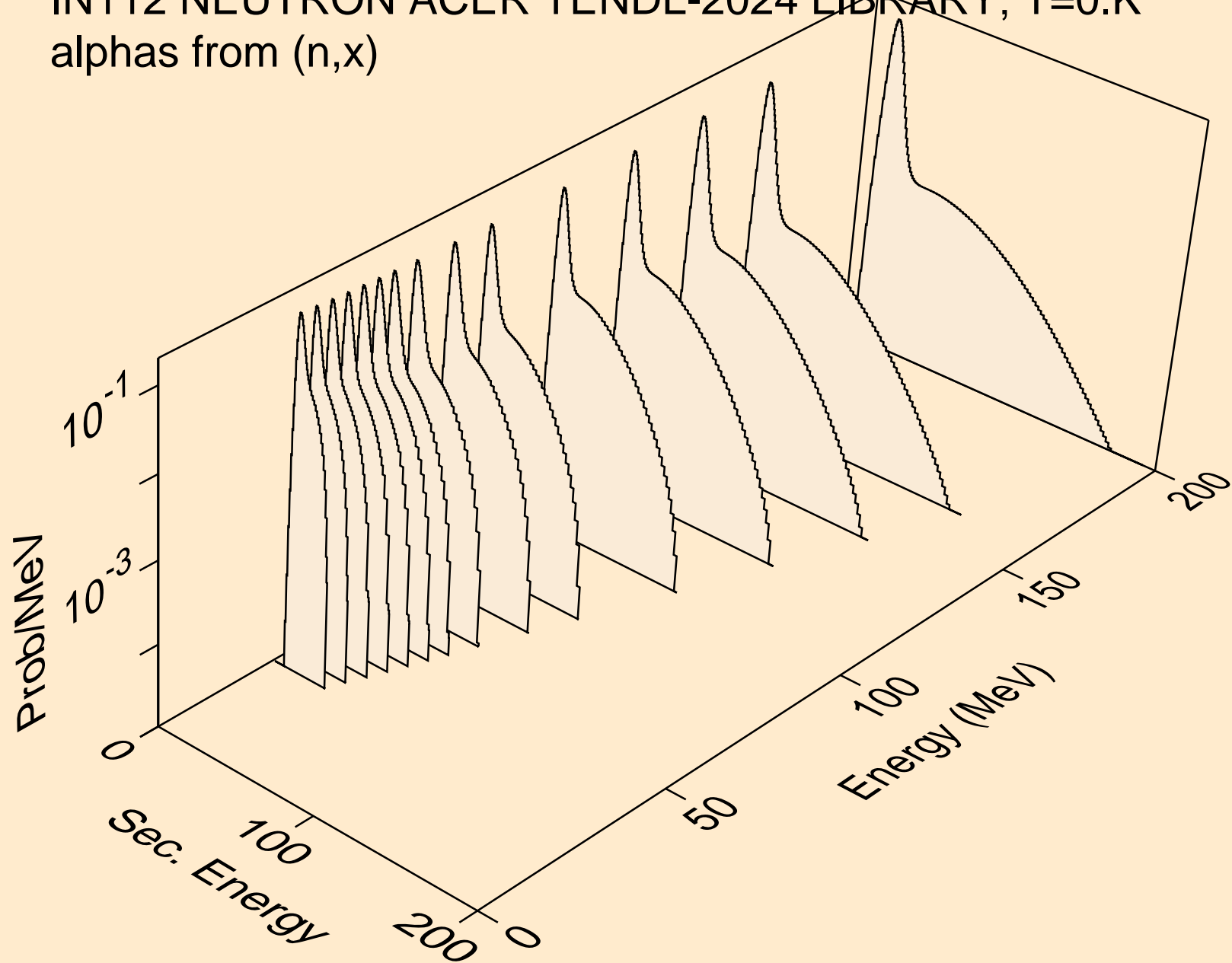

IN112 NEUTRON ACER TENDL-2024 LIBRARY; T=0.K
alphas from (n,n*)a

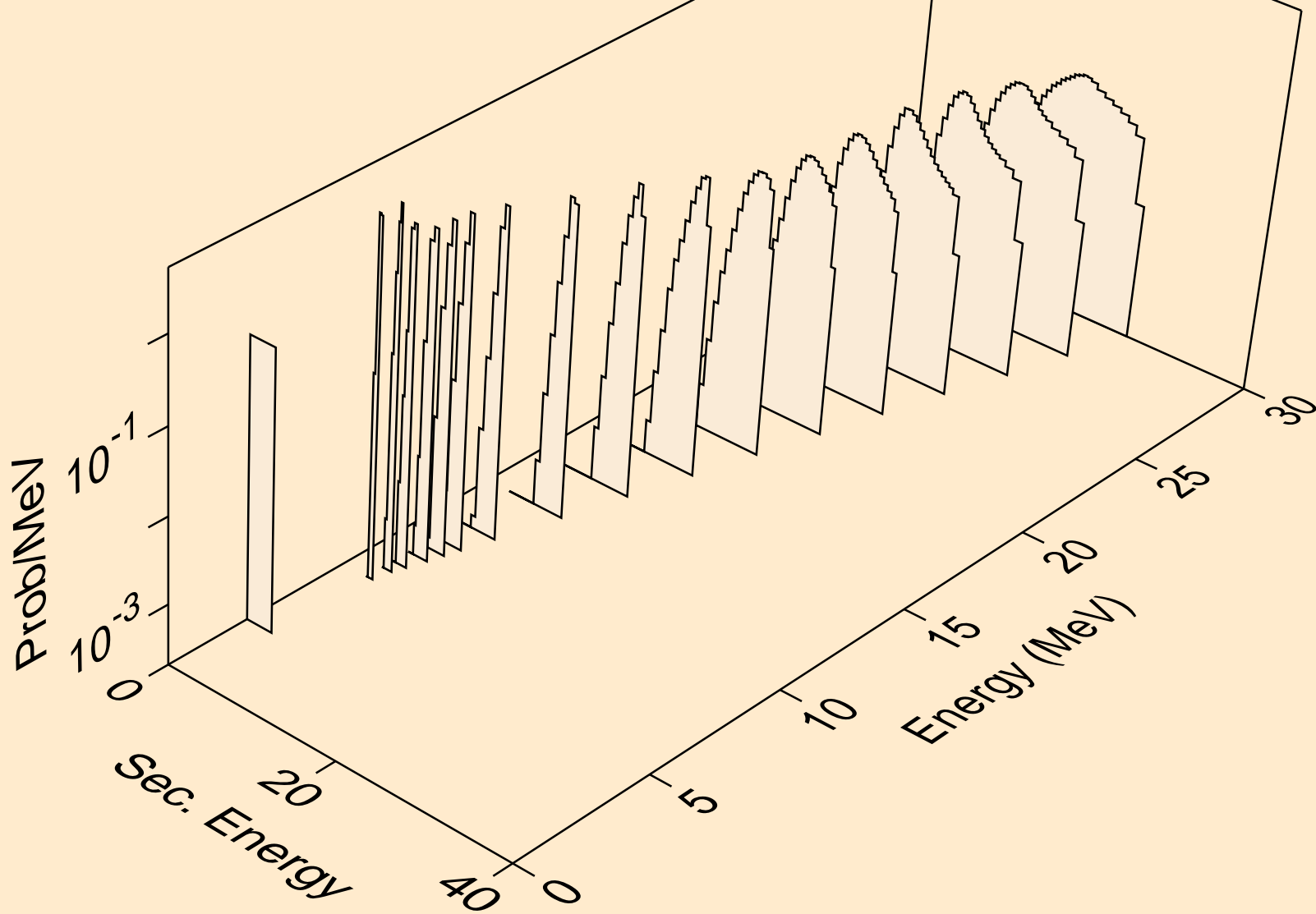

IN112 NEUTRON ACER TENDL-2024 LIBRARY; T=0.K
alphas from (n,2n)a

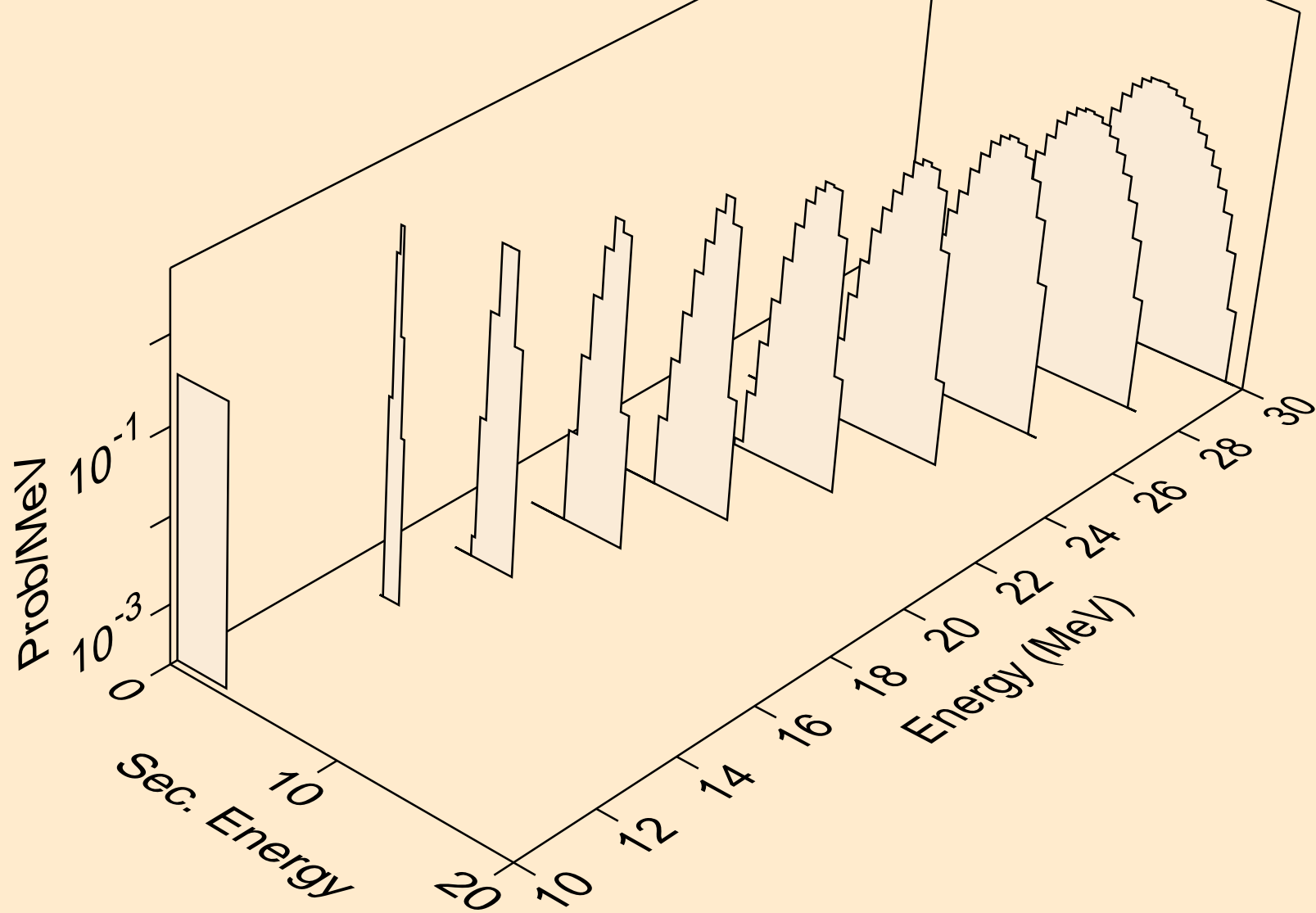

IN112 NEUTRON ACER TENDL-2024 LIBRARY; T=0.K
alphas from (n,3n)a

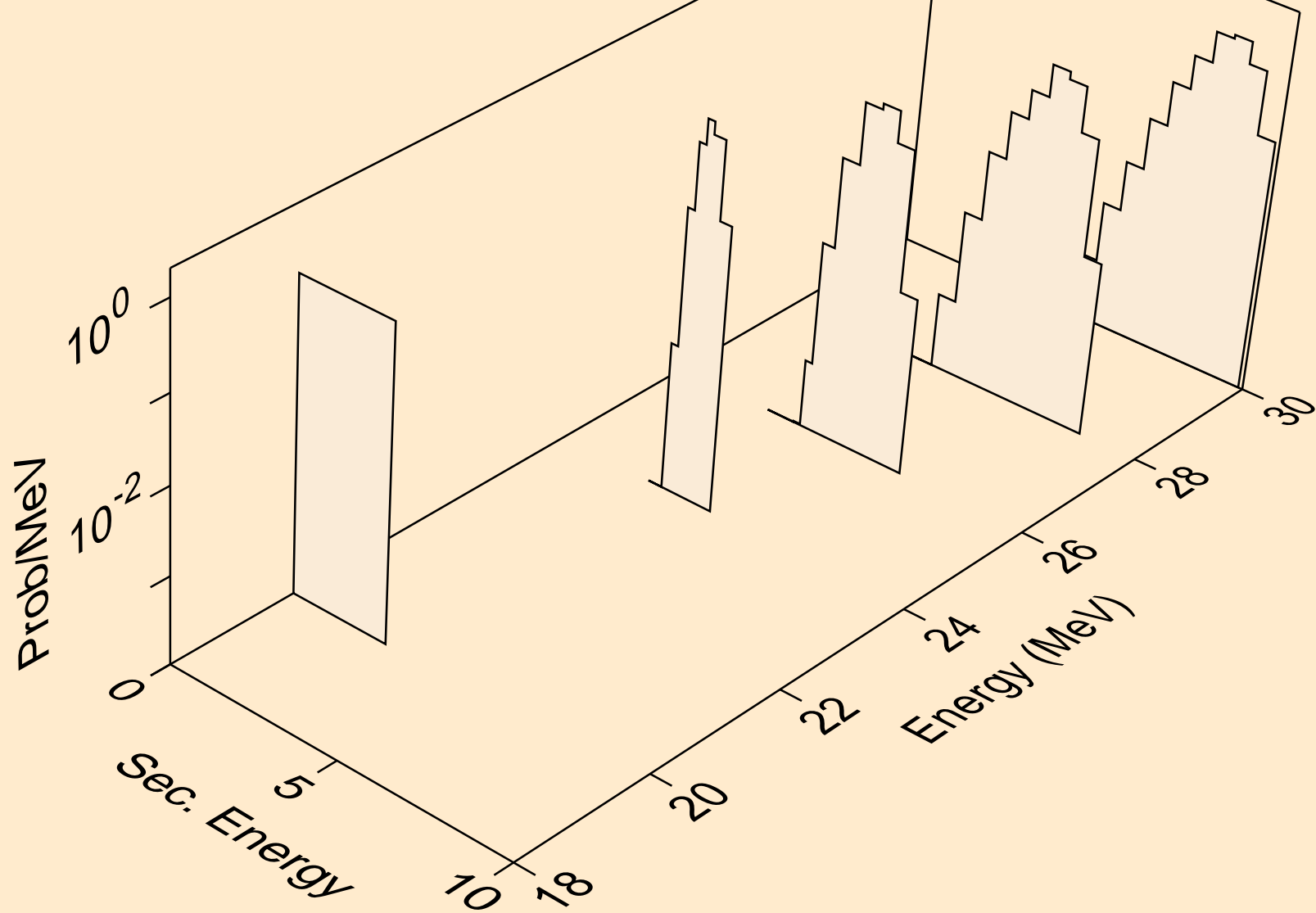

IN112 NEUTRON ACER TENDL-2024 LIBRARY; T=0.K
alphas from (n,n*)2a

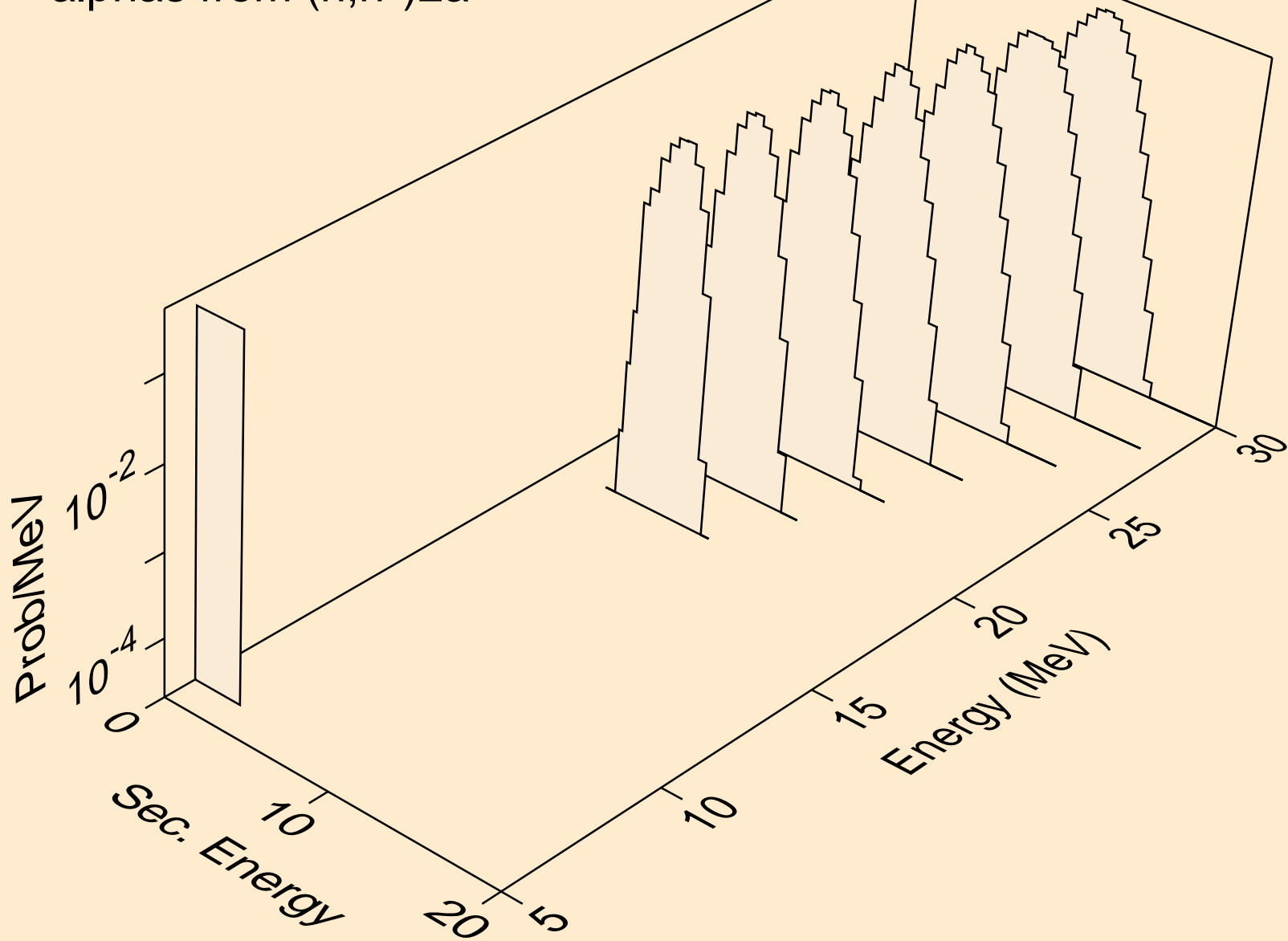

IN112 NEUTRON ACER TENDL-2024 LIBRARY; T=0.K
alphas from (n,npa)

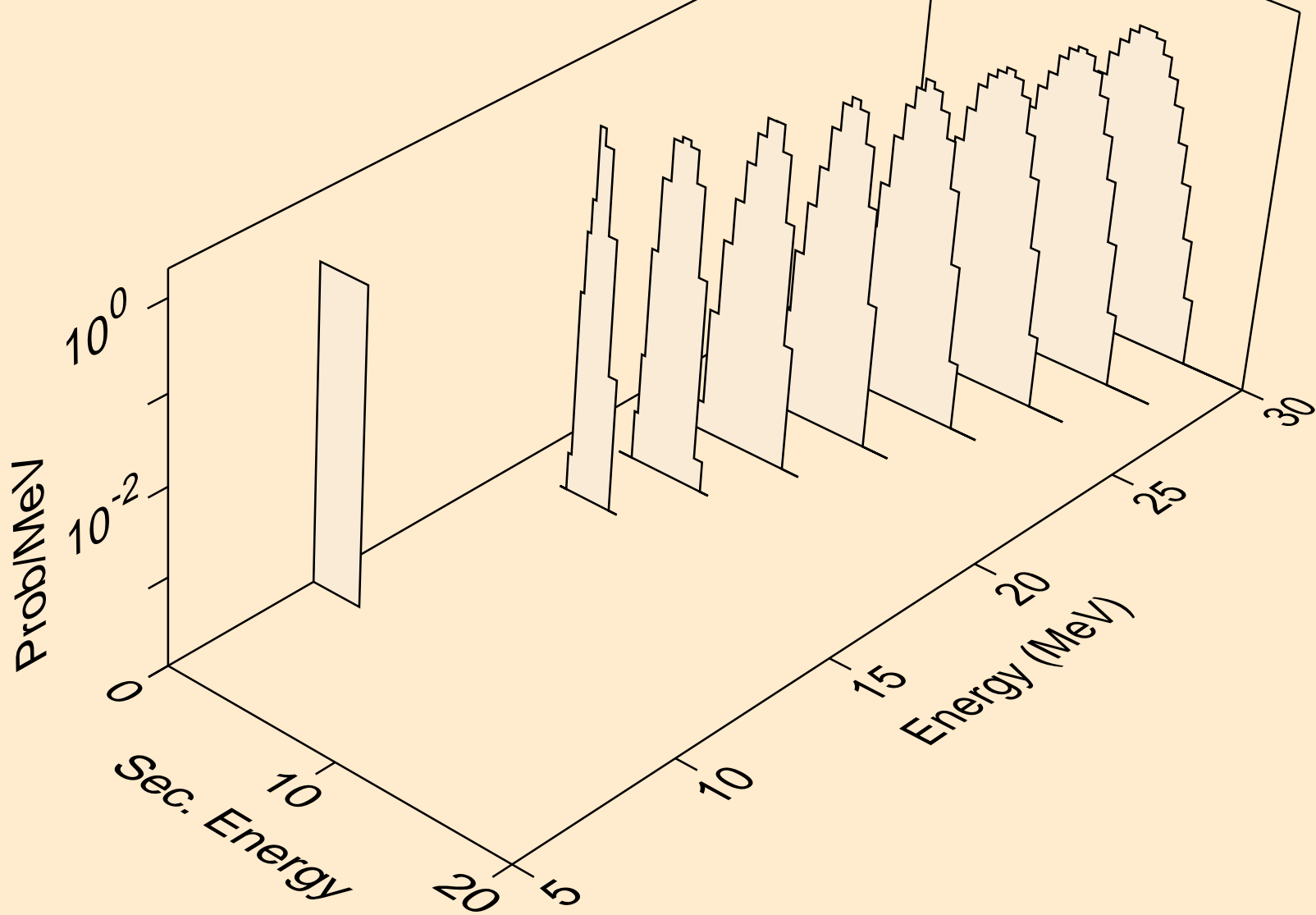

IN112 NEUTRON ACER TENDL-2024 LIBRARY; T=0.K
alphas from (n,a)

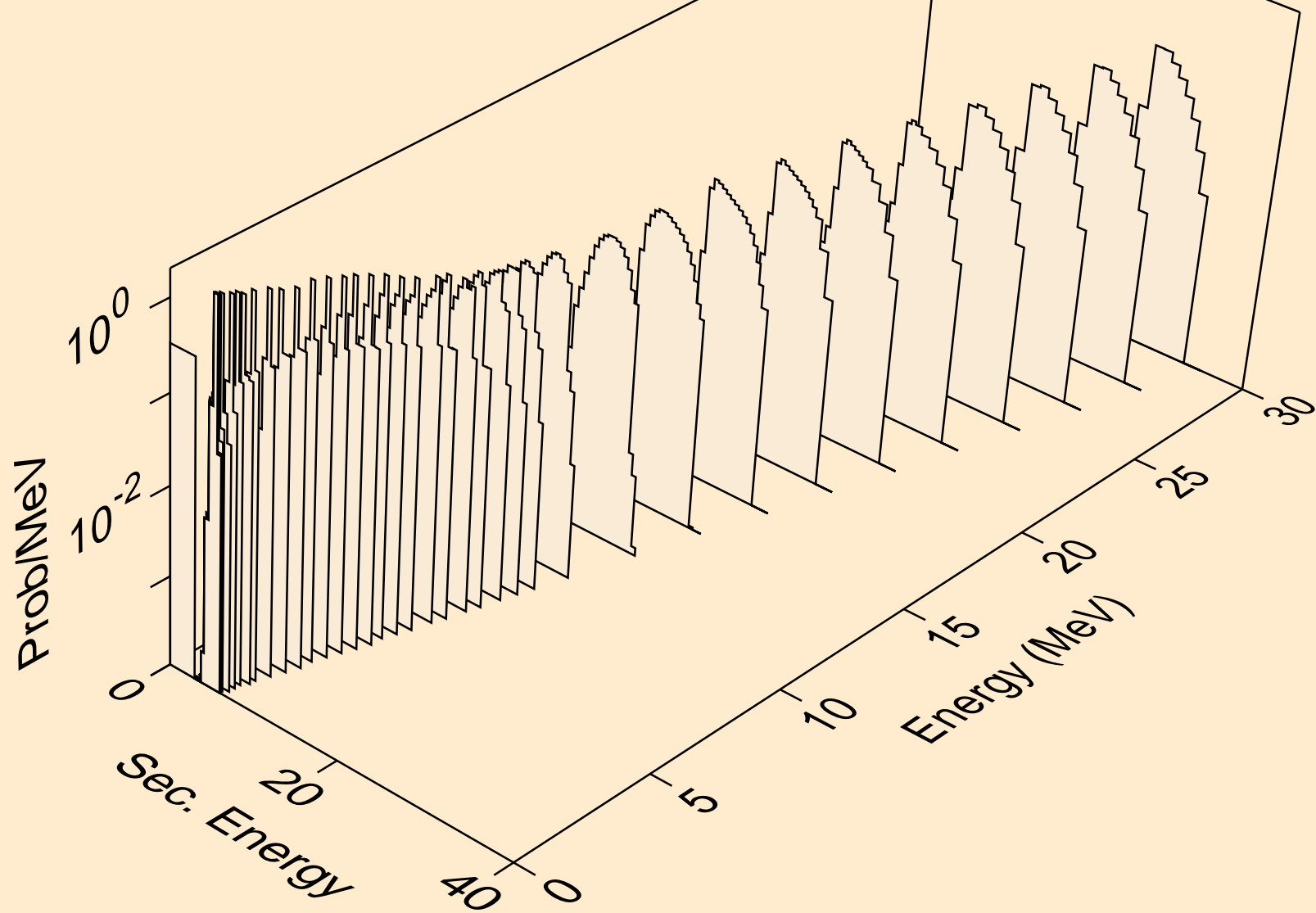

IN112 NEUTRON ACER TENDL-2024 LIBRARY; T=0.K
alphas from (n,2a)

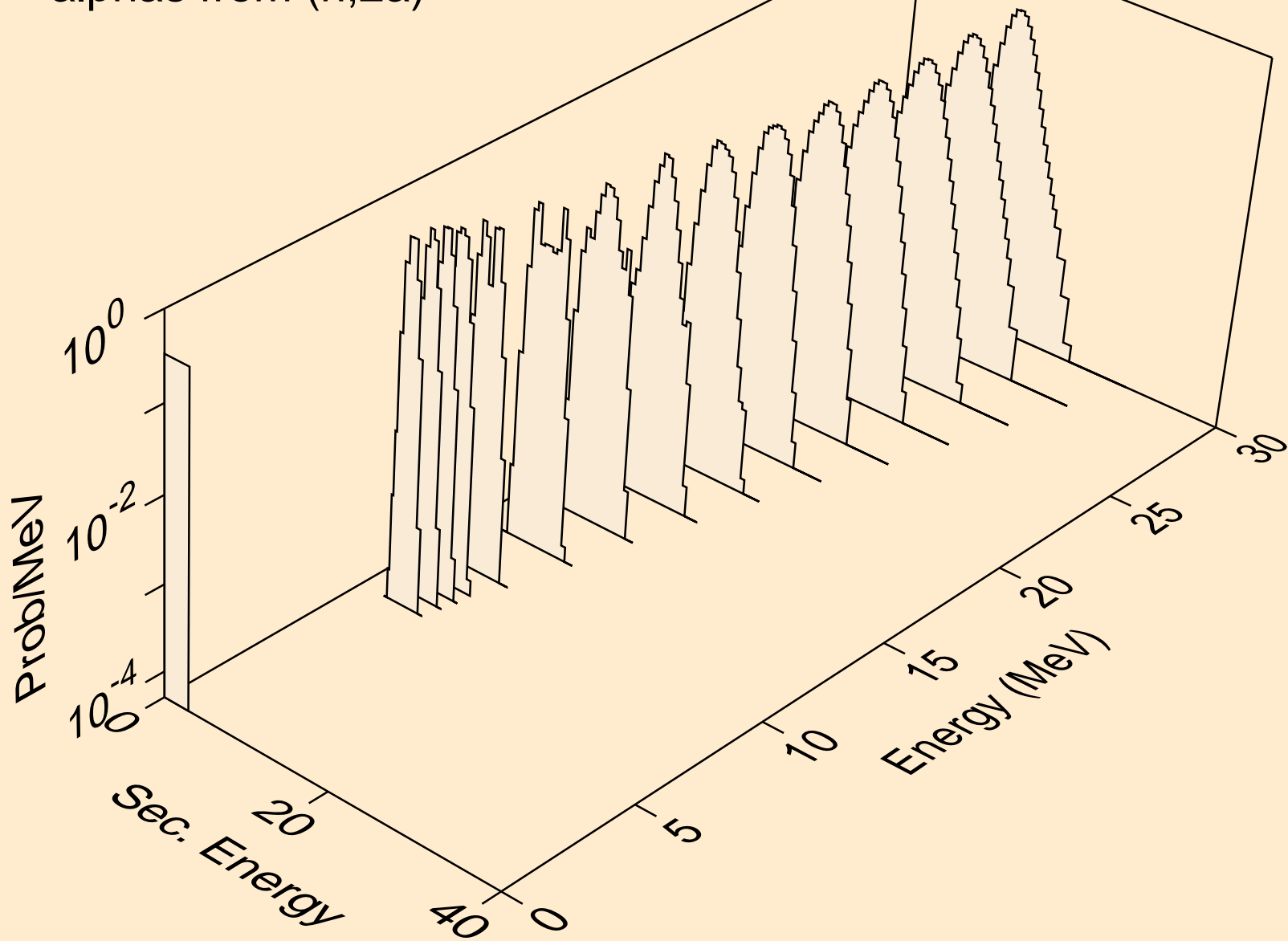

IN112 NEUTRON ACER TENDL-2024 LIBRARY; T=0.K
alphas from (n,pa)

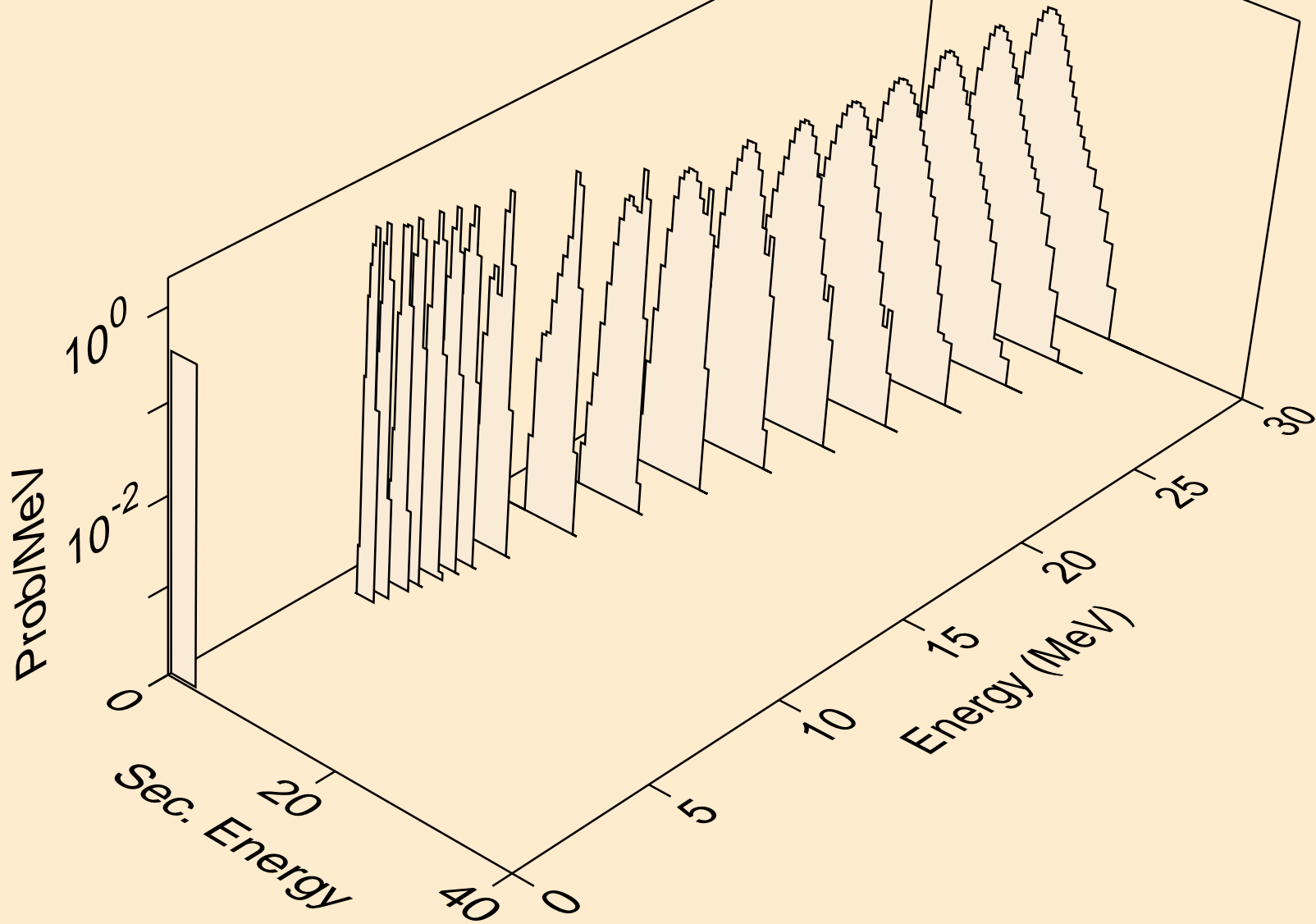

IN112 NEUTRON ACER TENDL-2024 LIBRARY; T=0.K
alphas from (n,da)

