

IN127N NEUTRON ACER TENDL-2024 LIBRARY; T=0.K

Principal cross sections

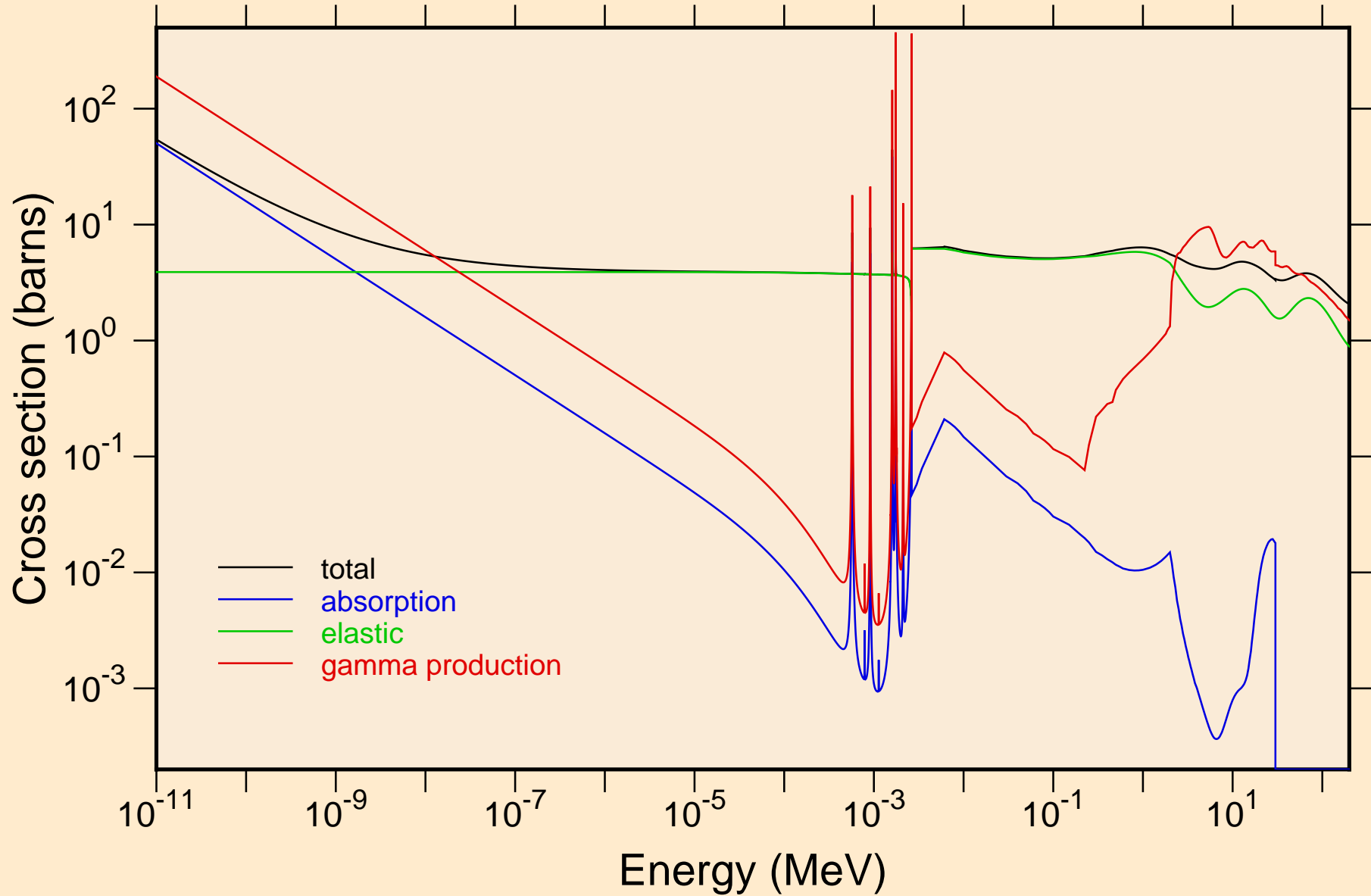

IN127N NEUTRON ACER TENDL-2024 LIBRARY; T=0.K
resonance total cross section

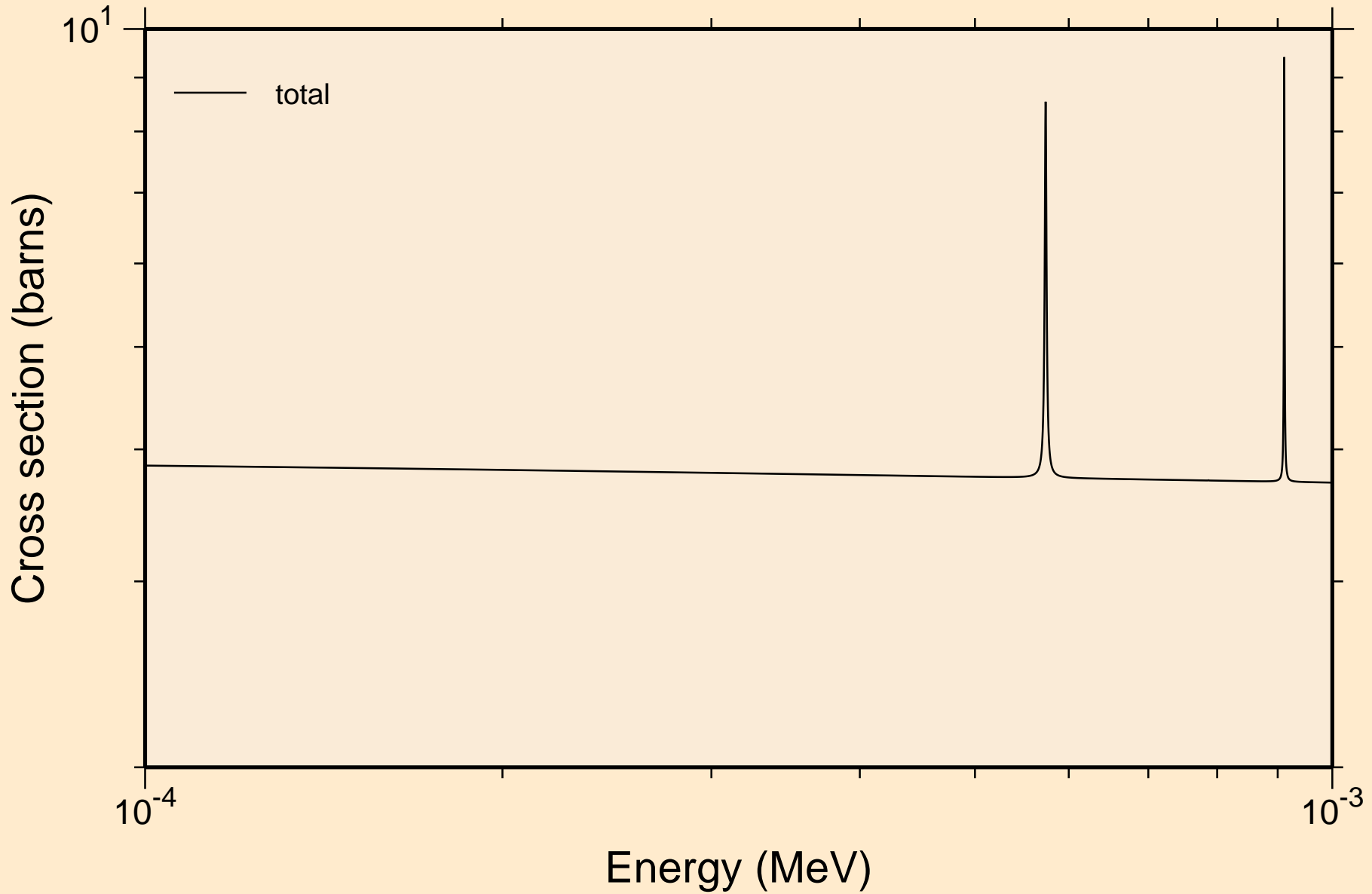

IN127N NEUTRON ACER TENDL-2024 LIBRARY; T=0.K
resonance total cross section

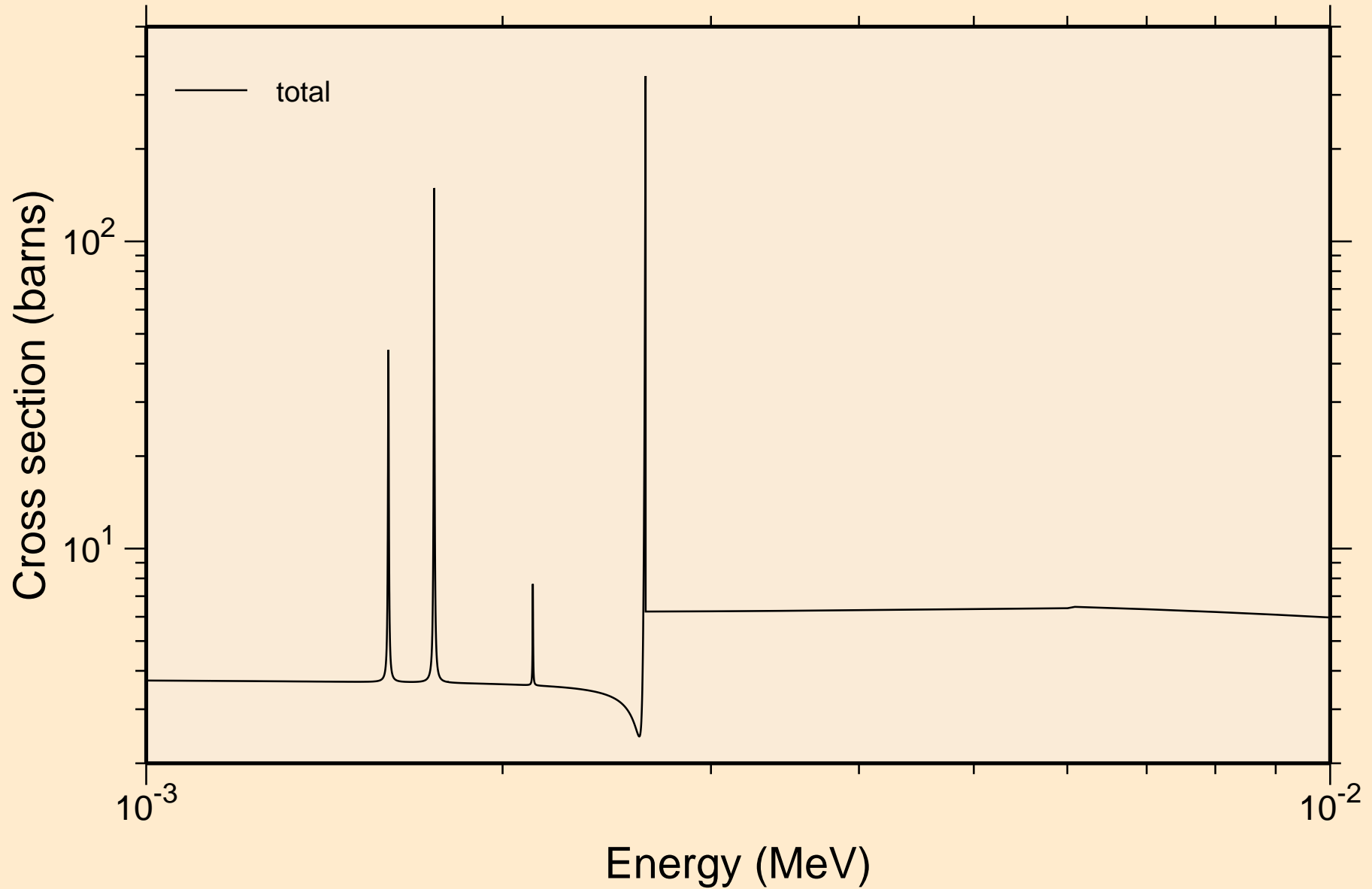

IN127N NEUTRON ACER TENDL-2024 LIBRARY; T=0.K
resonance total cross section

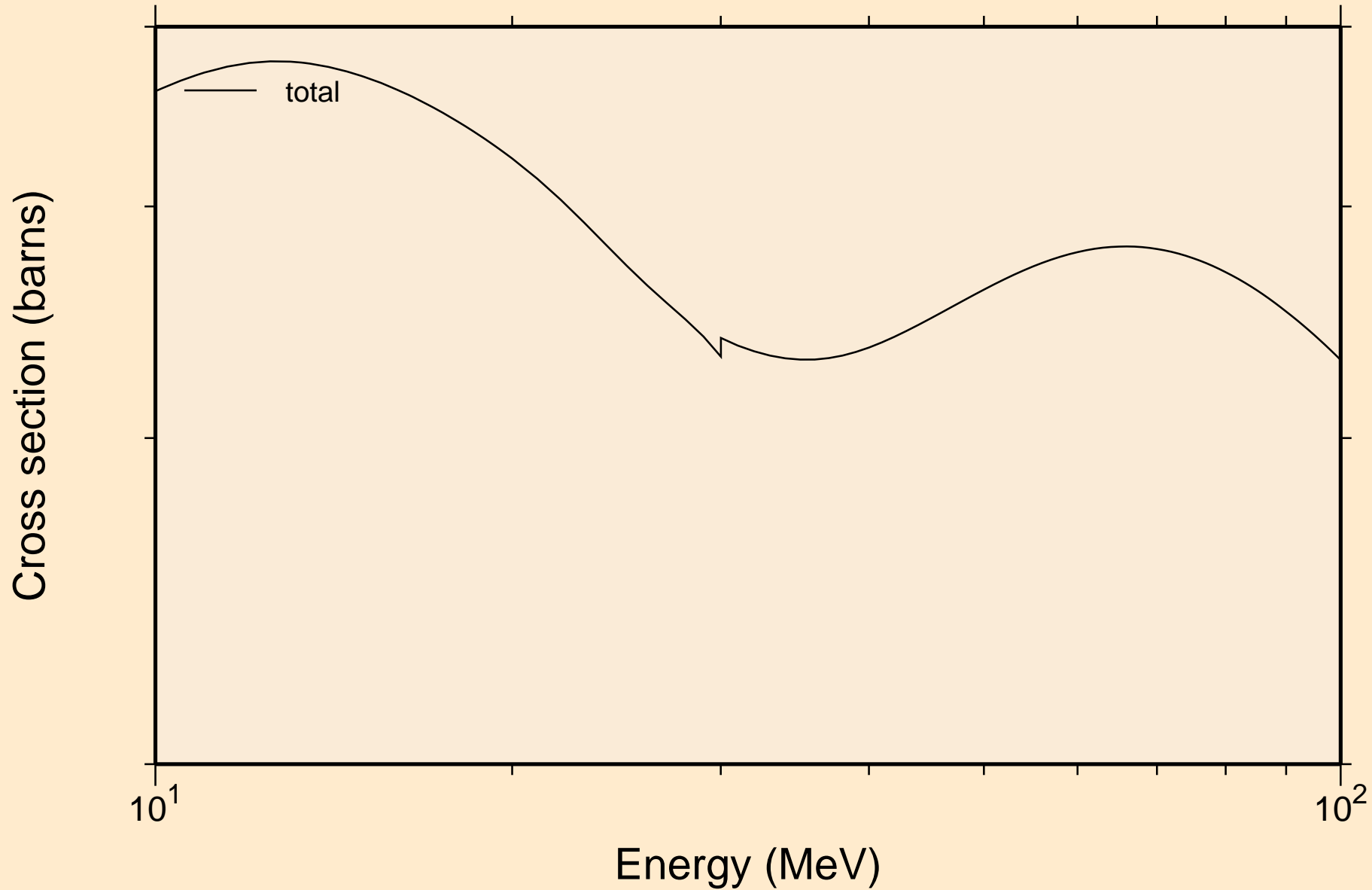

IN127N NEUTRON ACER TENDL-2024 LIBRARY; T=0.K
resonance absorption cross sections

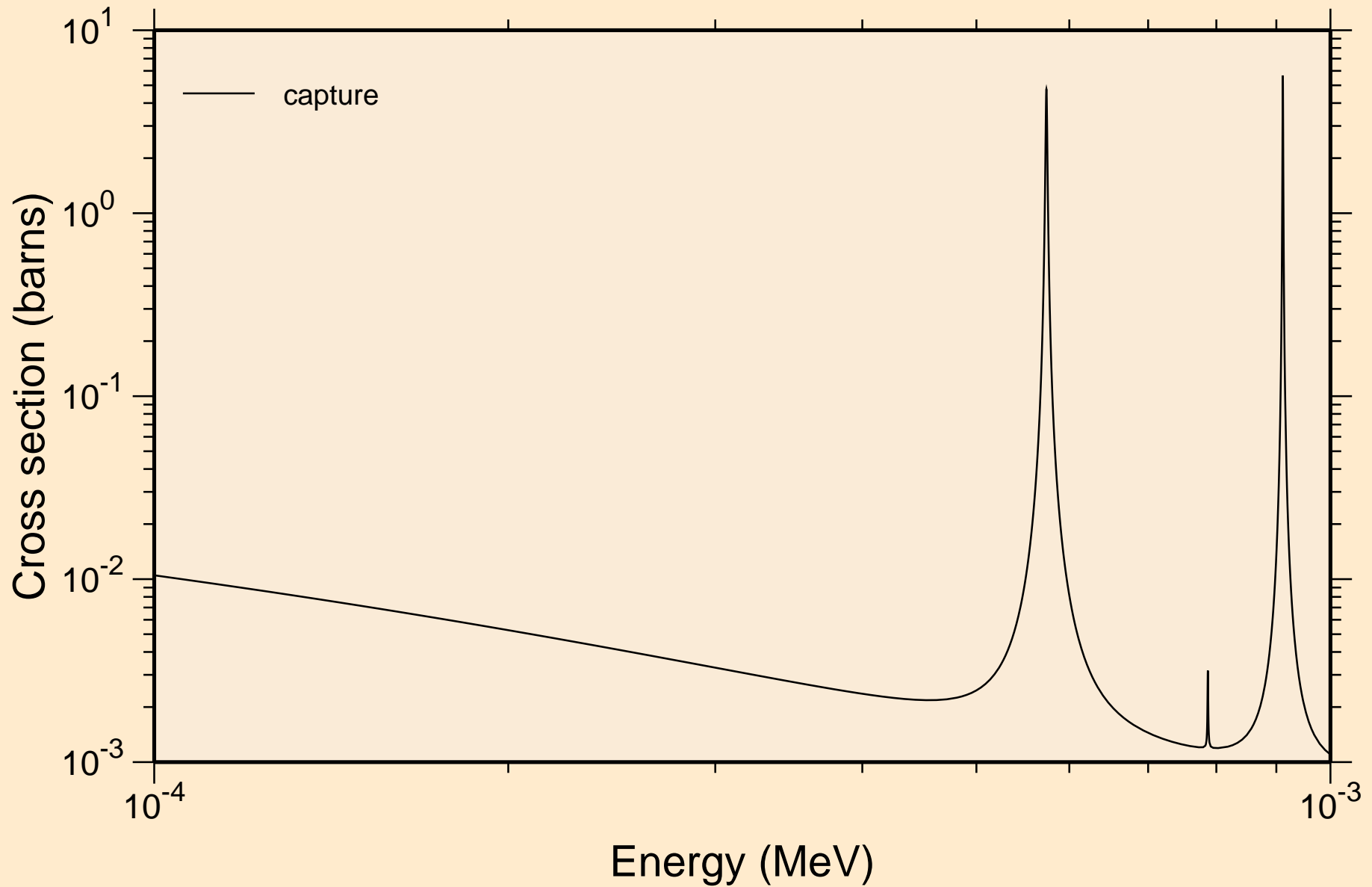

IN127N NEUTRON ACER TENDL-2024 LIBRARY; T=0.K
resonance absorption cross sections

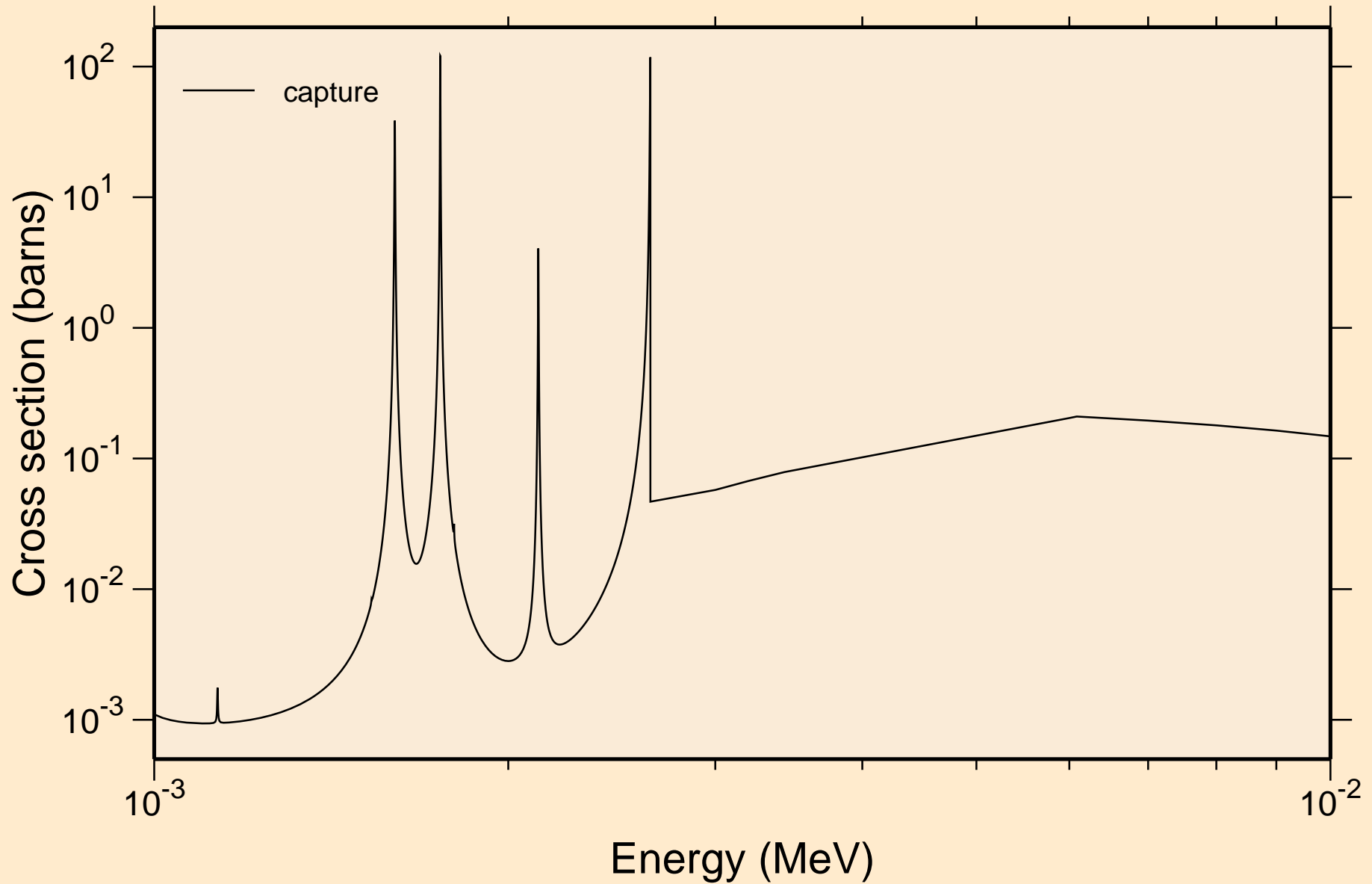

IN127N NEUTRON ACER TENDL-2024 LIBRARY; T=0.K
resonance absorption cross sections

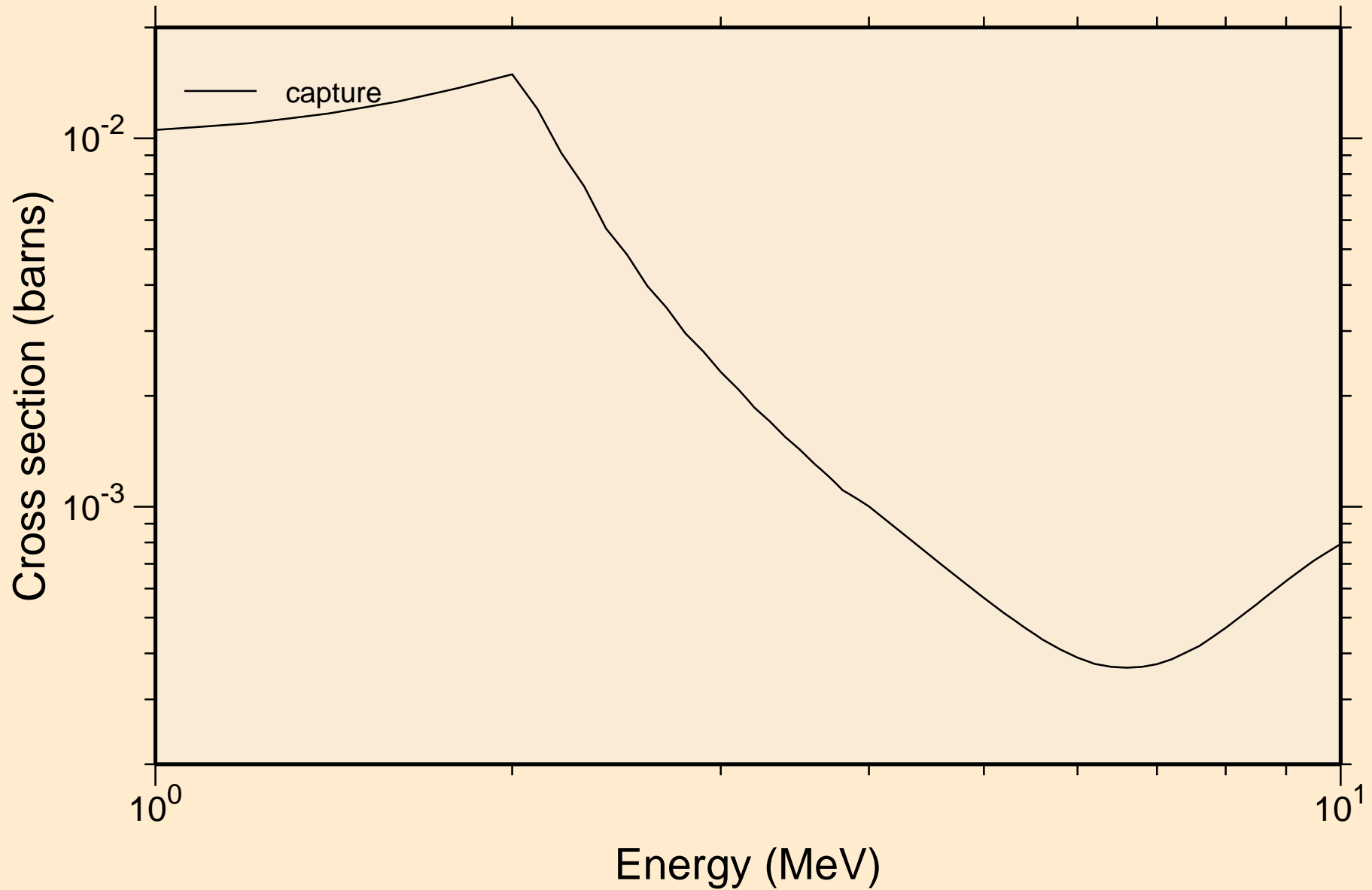

IN127N NEUTRON ACER TENDL-2024 LIBRARY; T=0.K
Heating

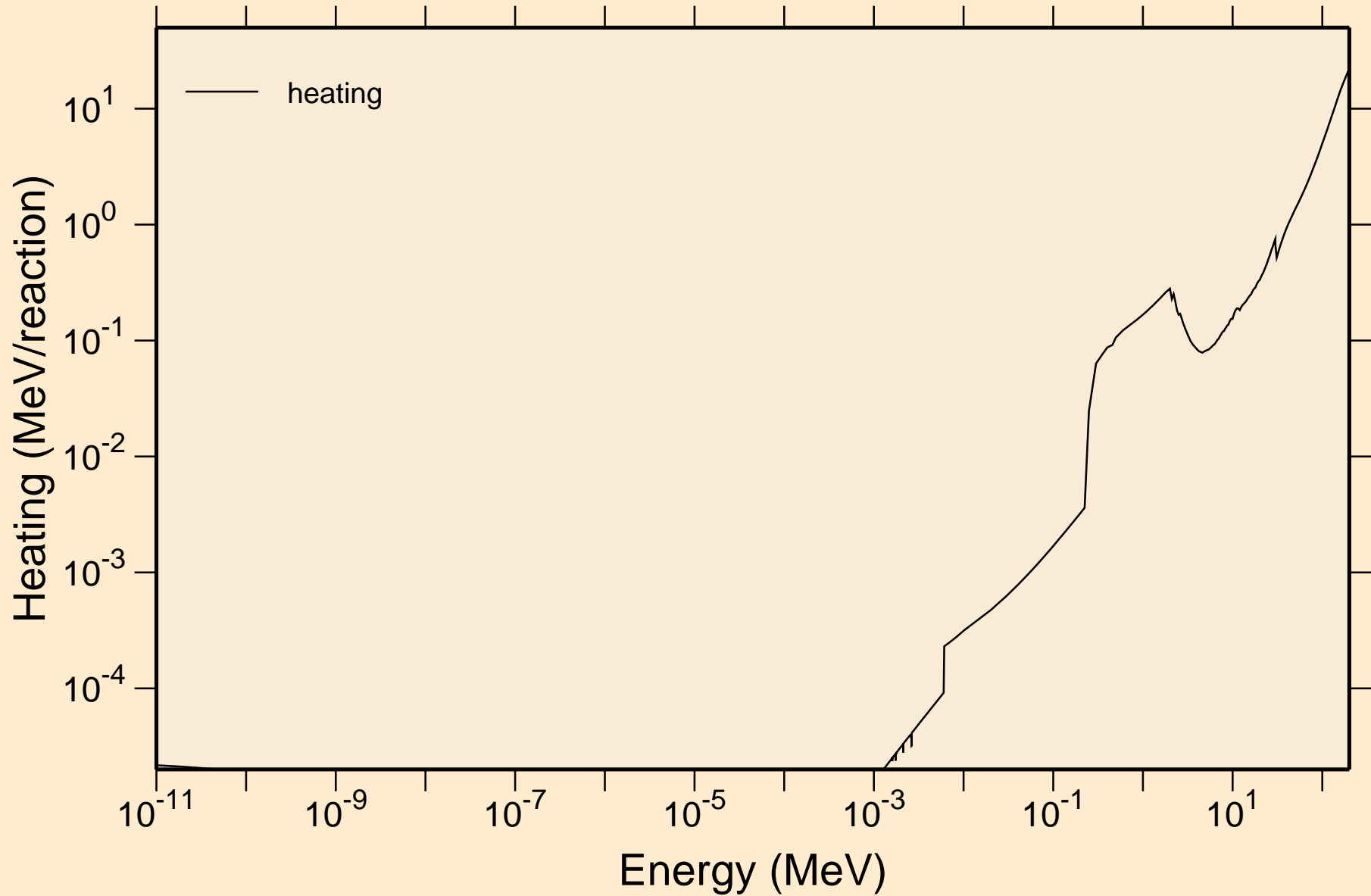

IN127N NEUTRON ACER TENDL-2024 LIBRARY; T=0.K

Damage

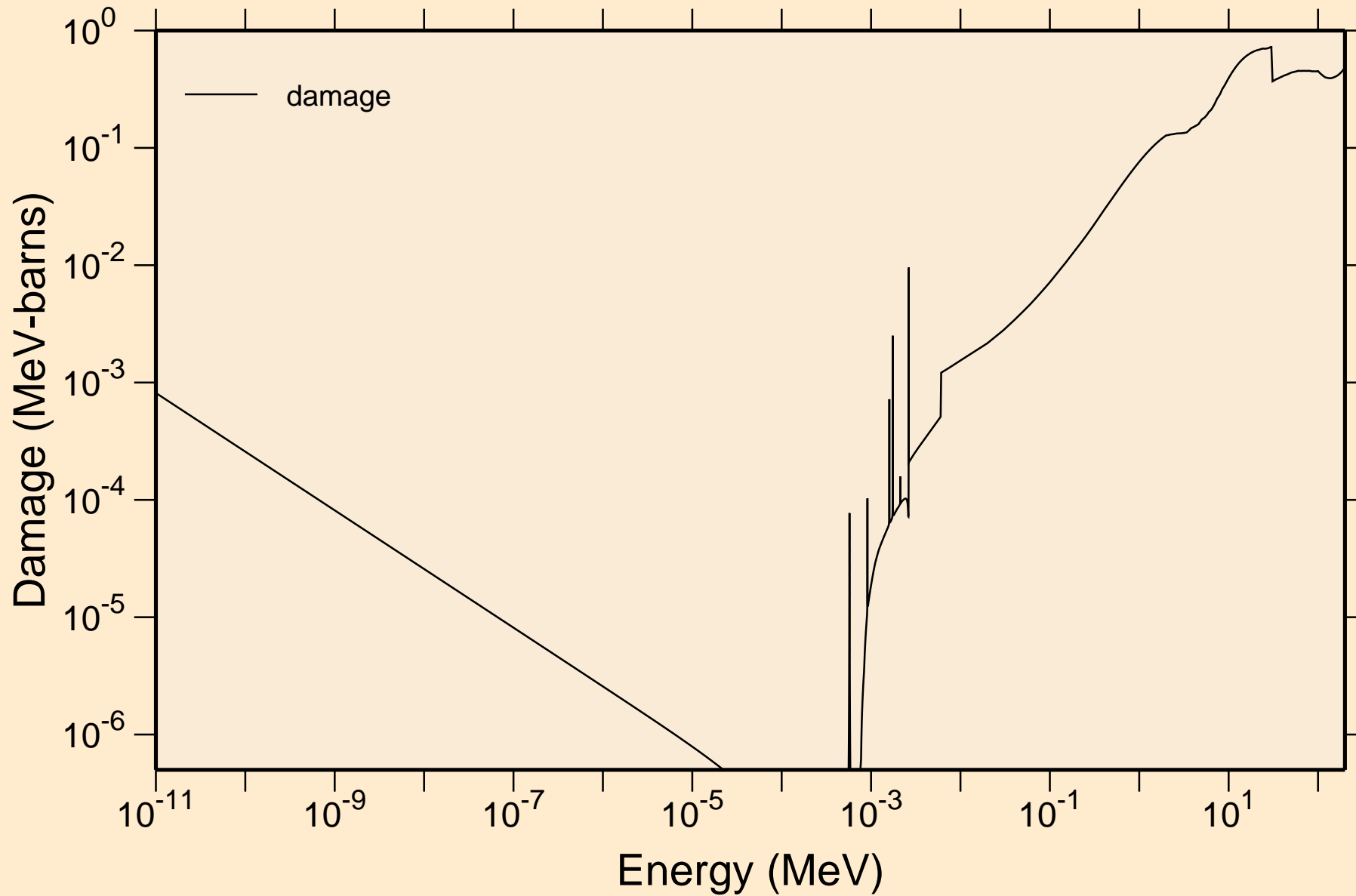

IN127N NEUTRON ACER TENDL-2024 LIBRARY; T=0.K
Non-threshold reactions

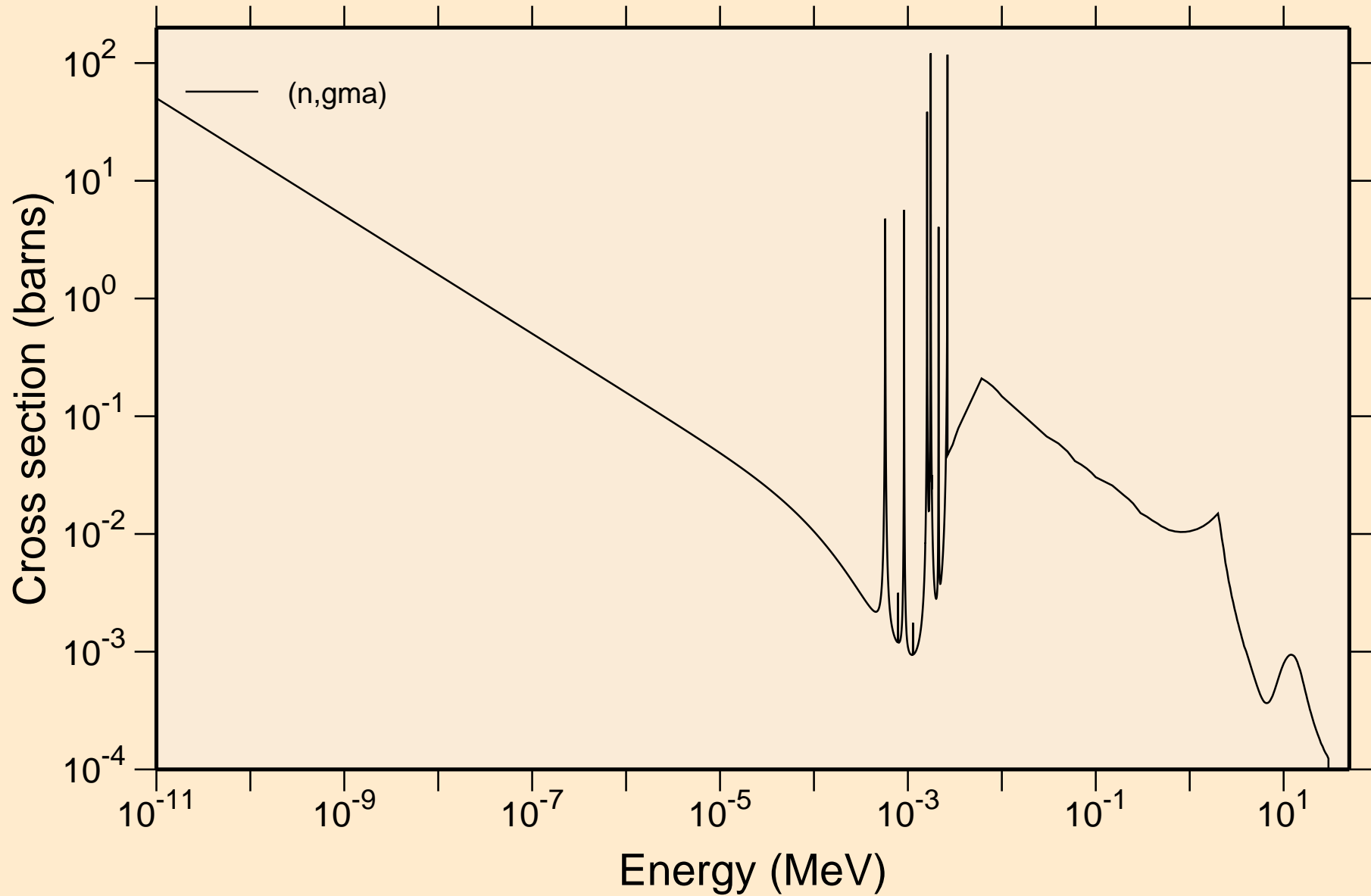

IN127N NEUTRON ACER TENDL-2024 LIBRARY; T=0.K
Principal cross sections

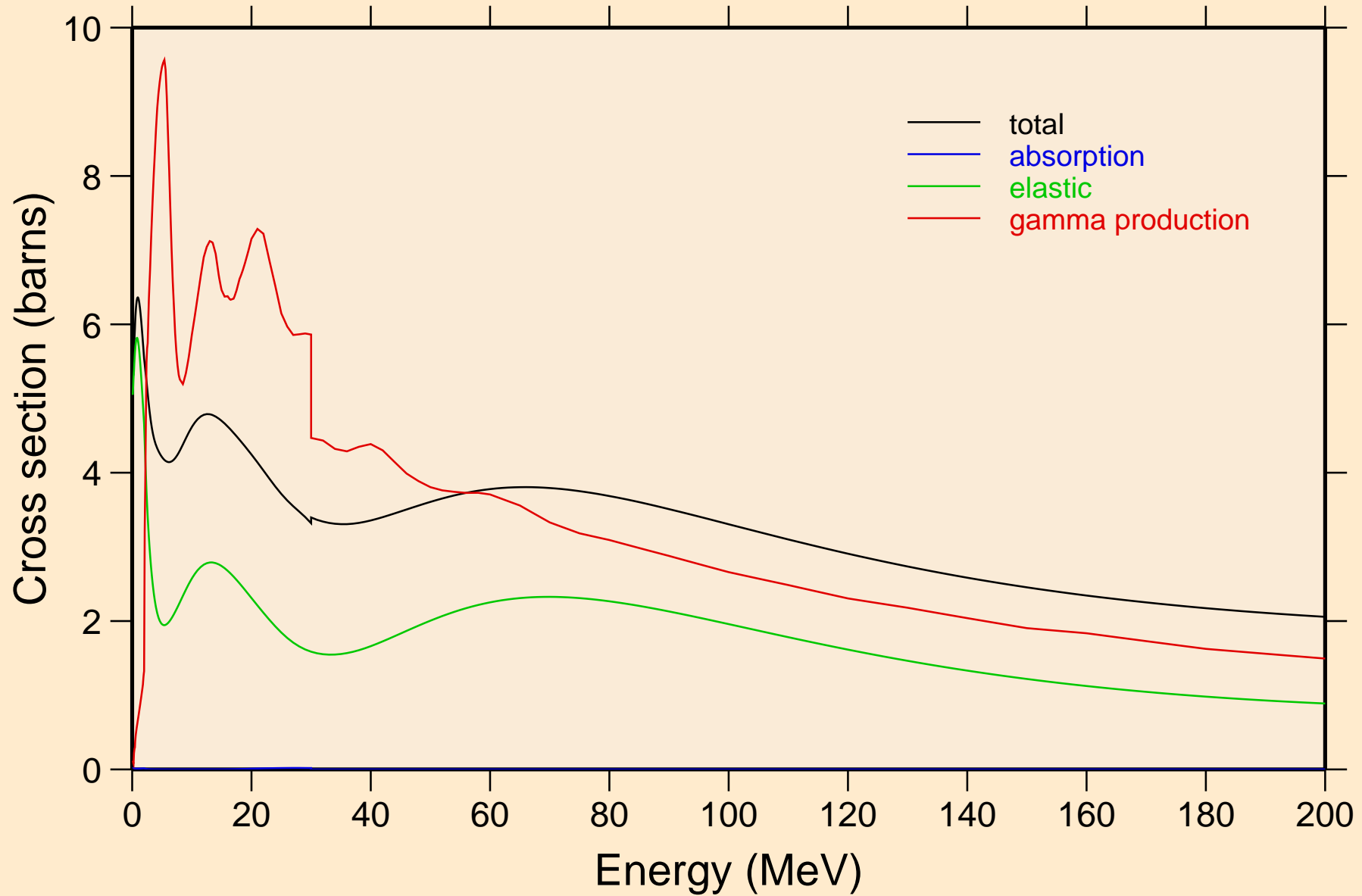

IN127N NEUTRON ACER TENDL-2024 LIBRARY; T=0.K

Heating

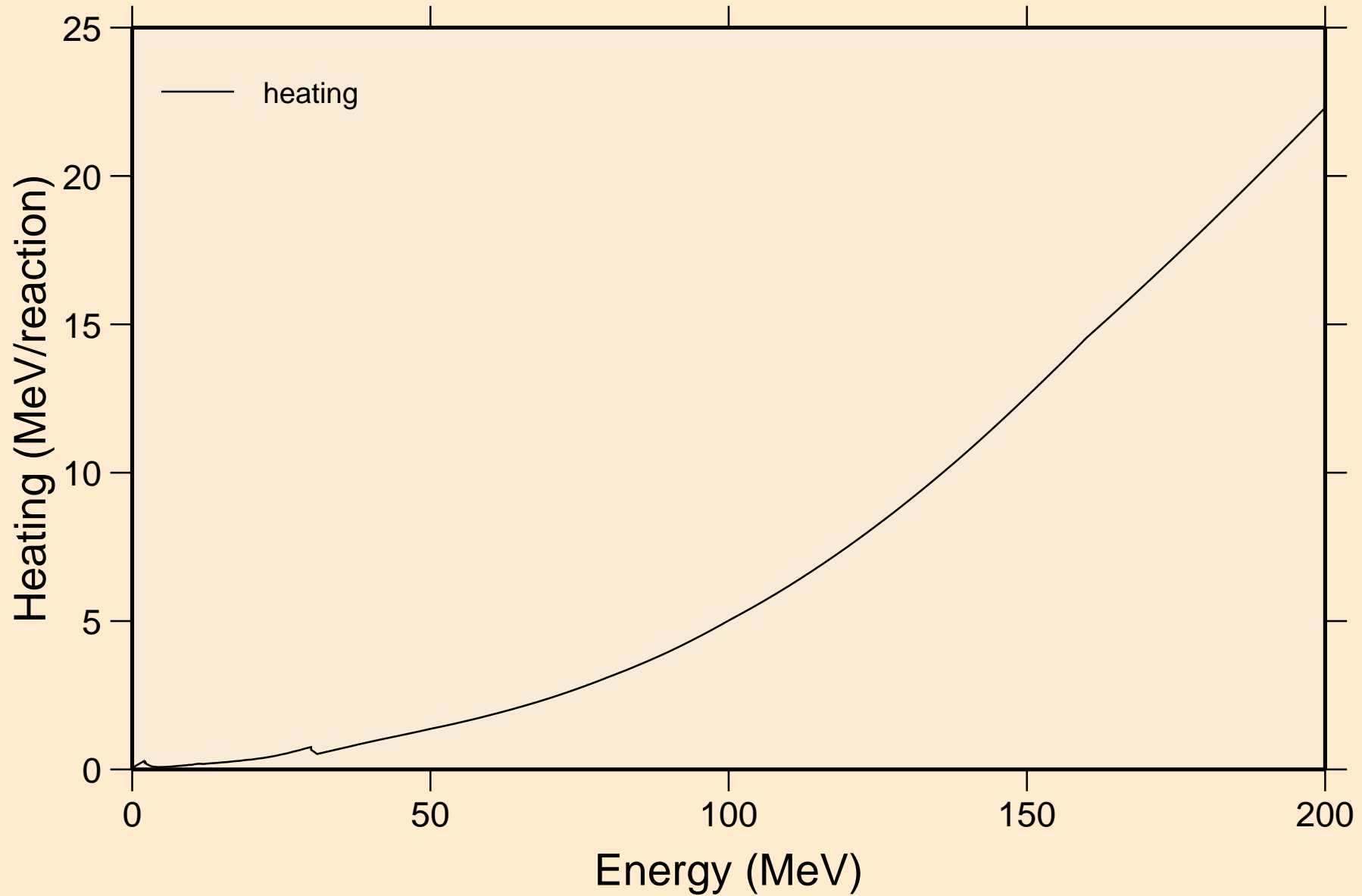

IN127N NEUTRON ACER TENDL-2024 LIBRARY; T=0.K

Damage

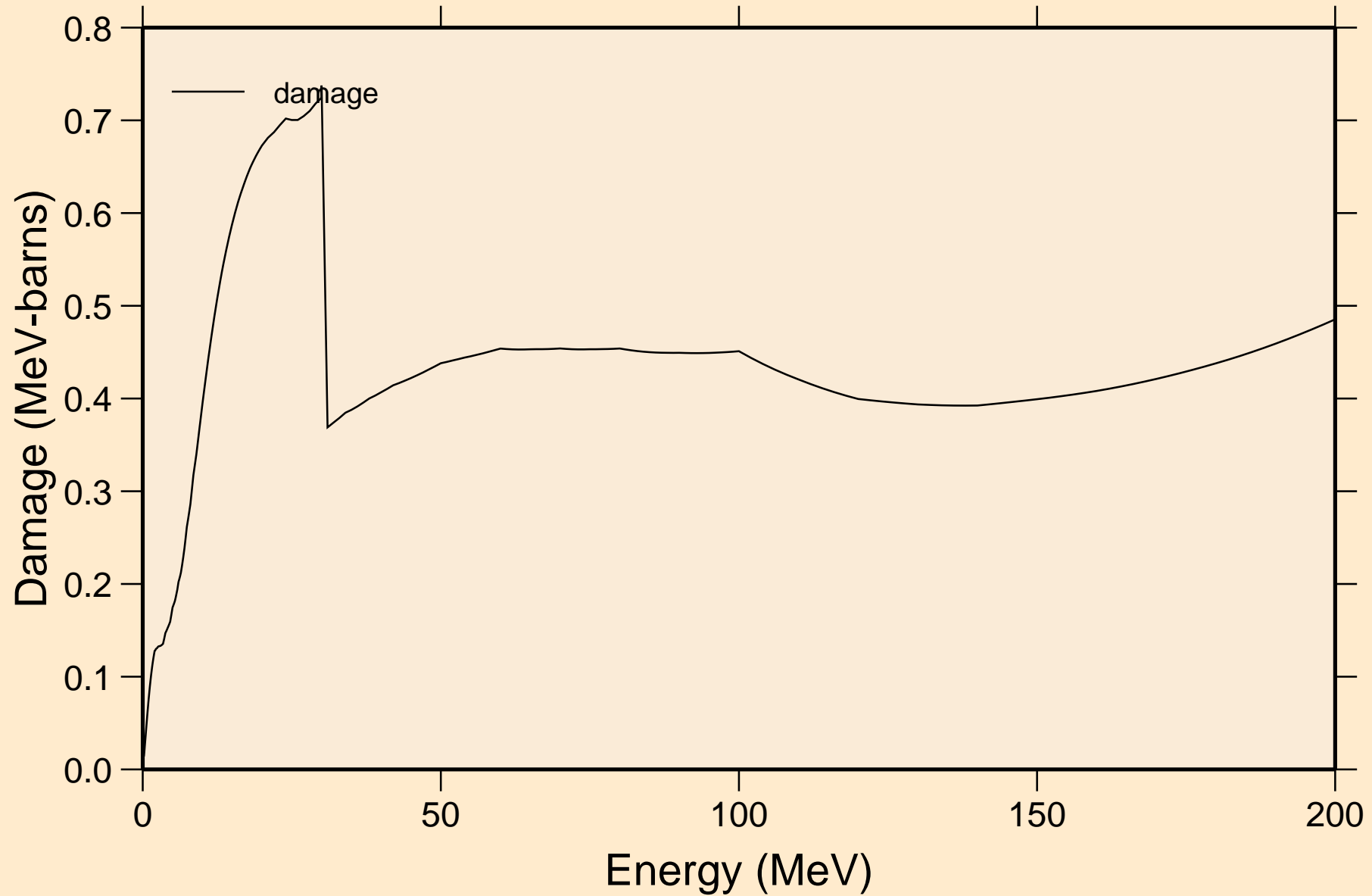

IN127N NEUTRON ACER TENDL-2024 LIBRARY; T=0.K
Non-threshold reactions

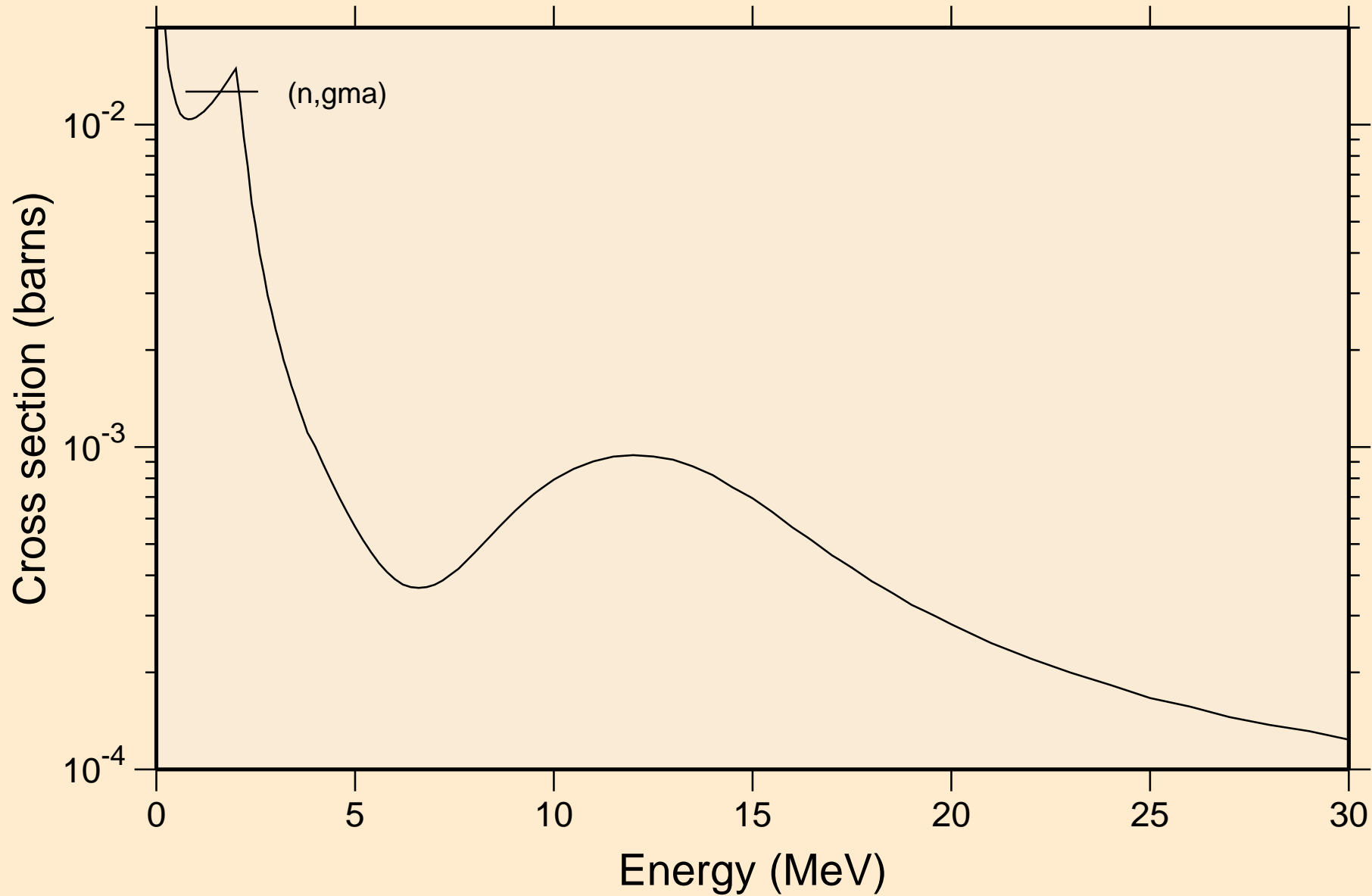

IN127N NEUTRON ACER TENDL-2024 LIBRARY; T=0.K
Inelastic levels

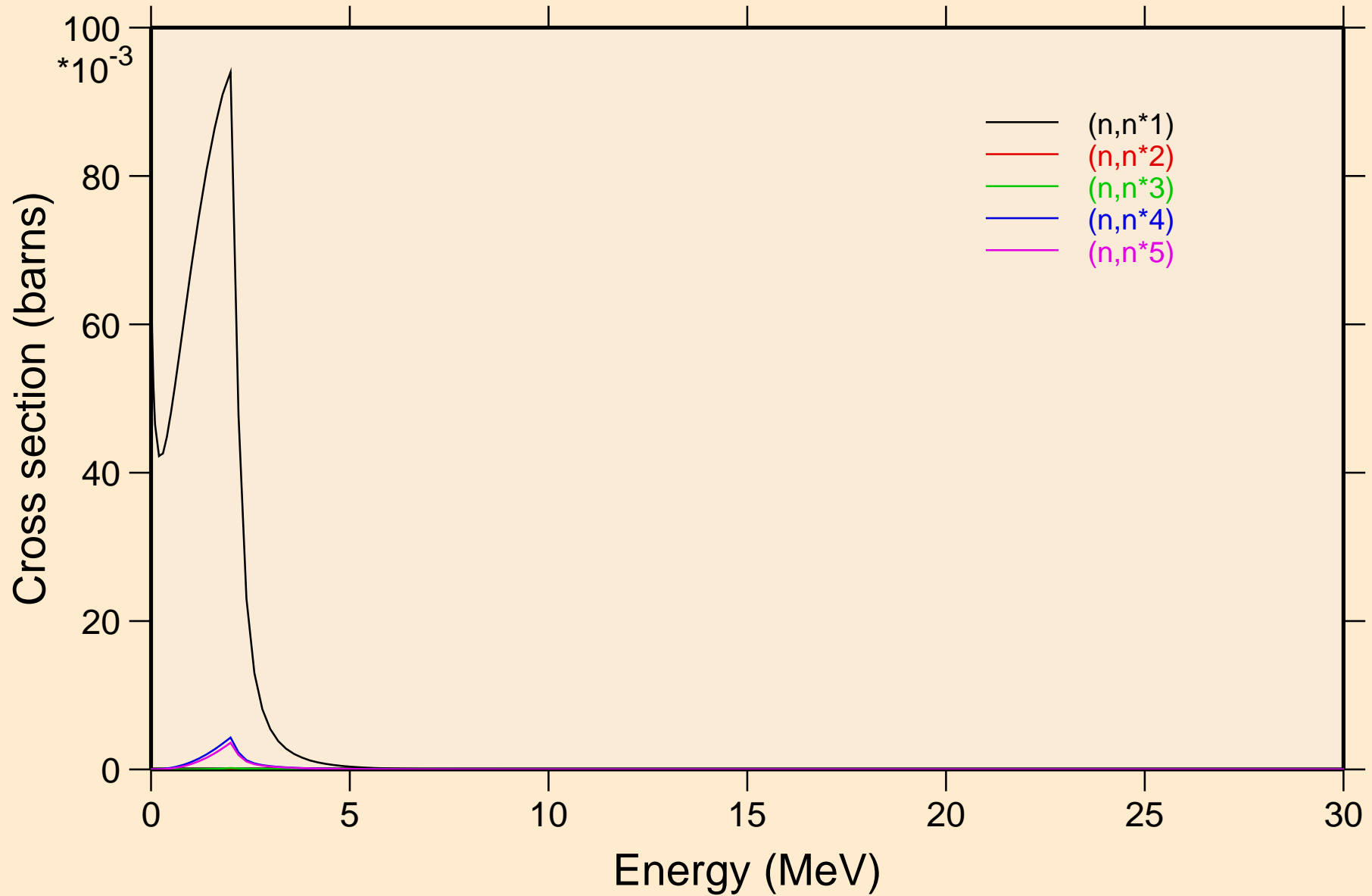

IN127N NEUTRON ACER TENDL-2024 LIBRARY; T=0.K
Inelastic levels

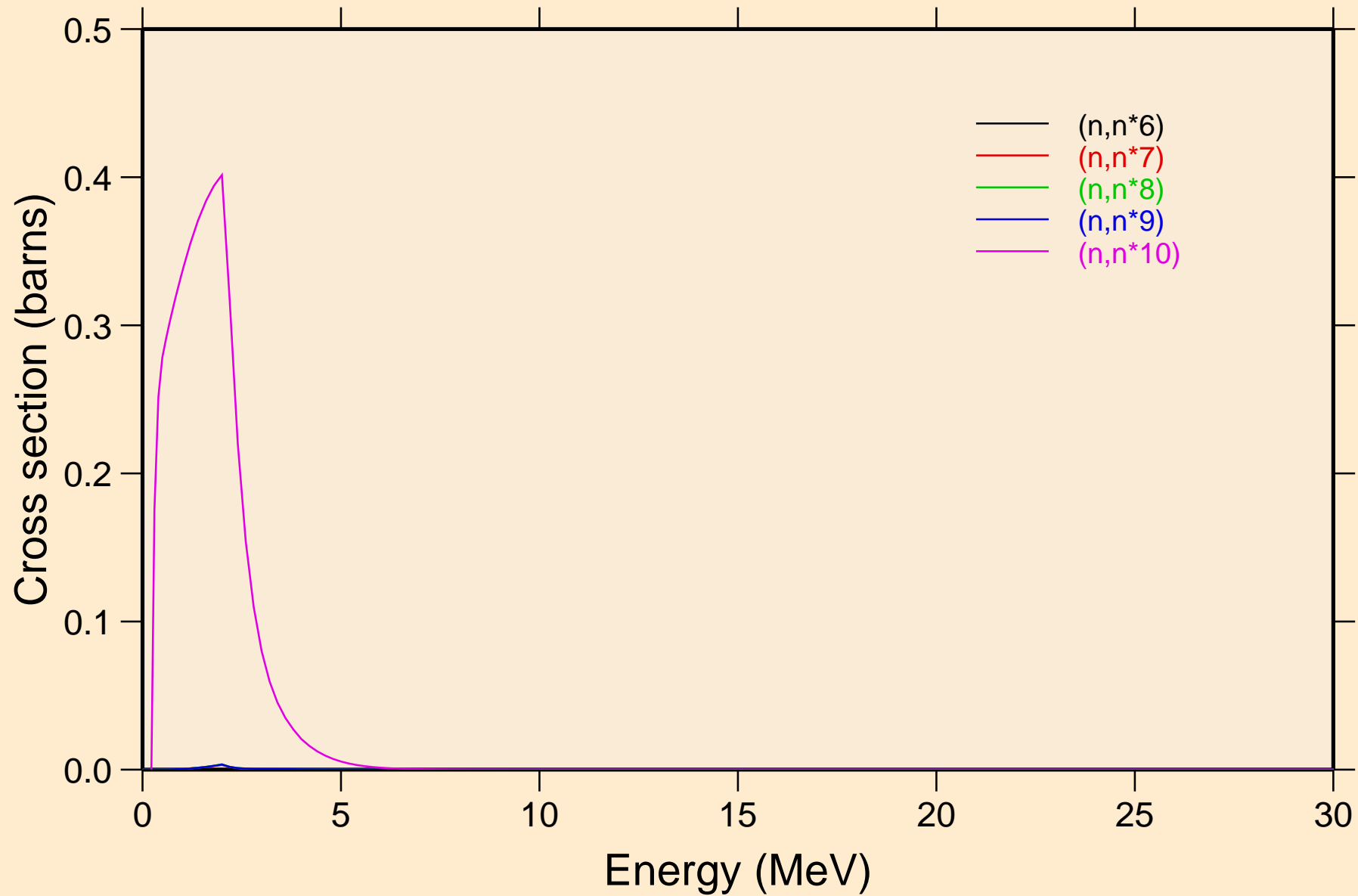

IN127N NEUTRON ACER TENDL-2024 LIBRARY; T=0.K
Inelastic levels

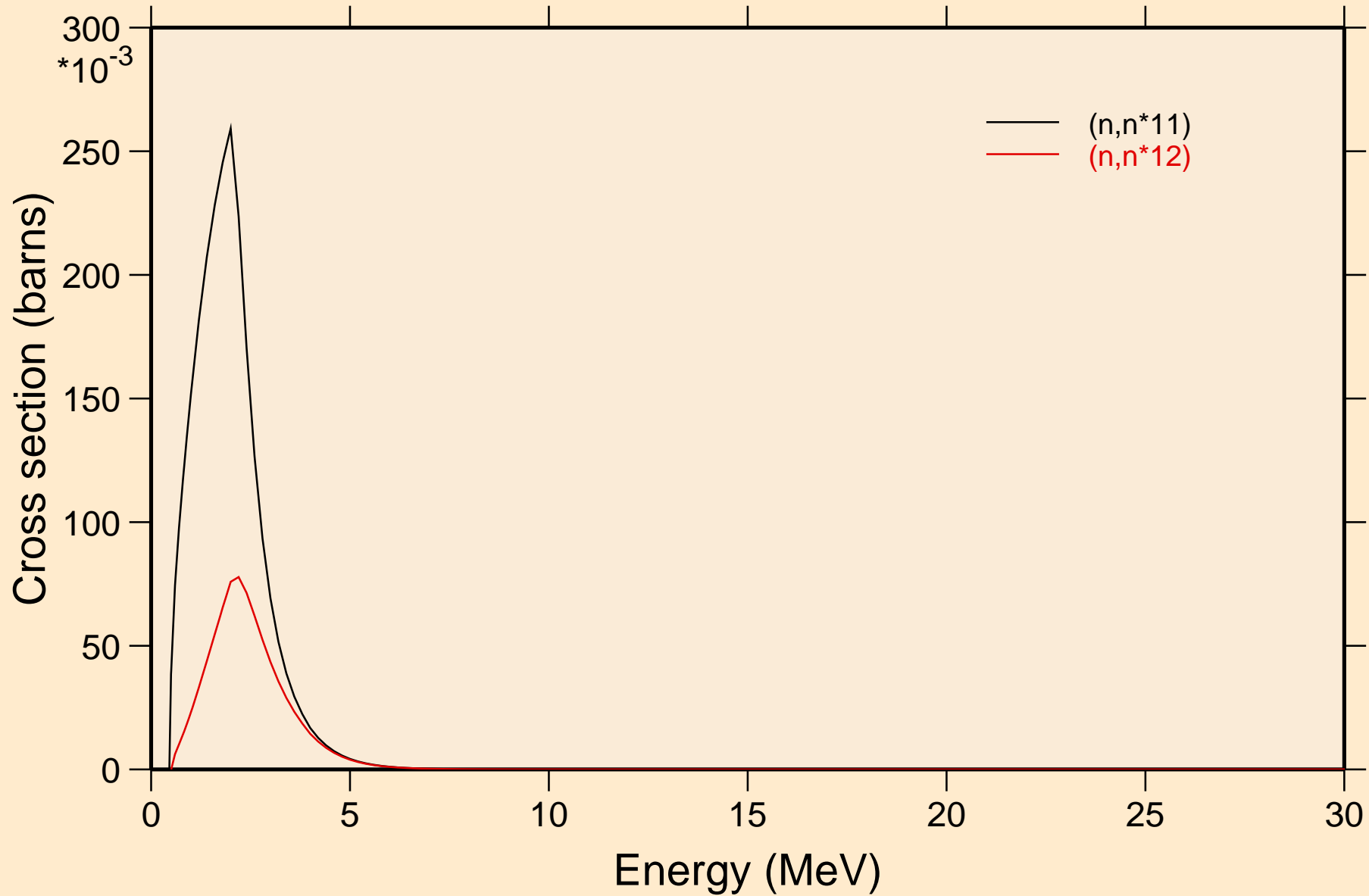

IN127N NEUTRON ACER TENDL-2024 LIBRARY; T=0.K

Threshold reactions

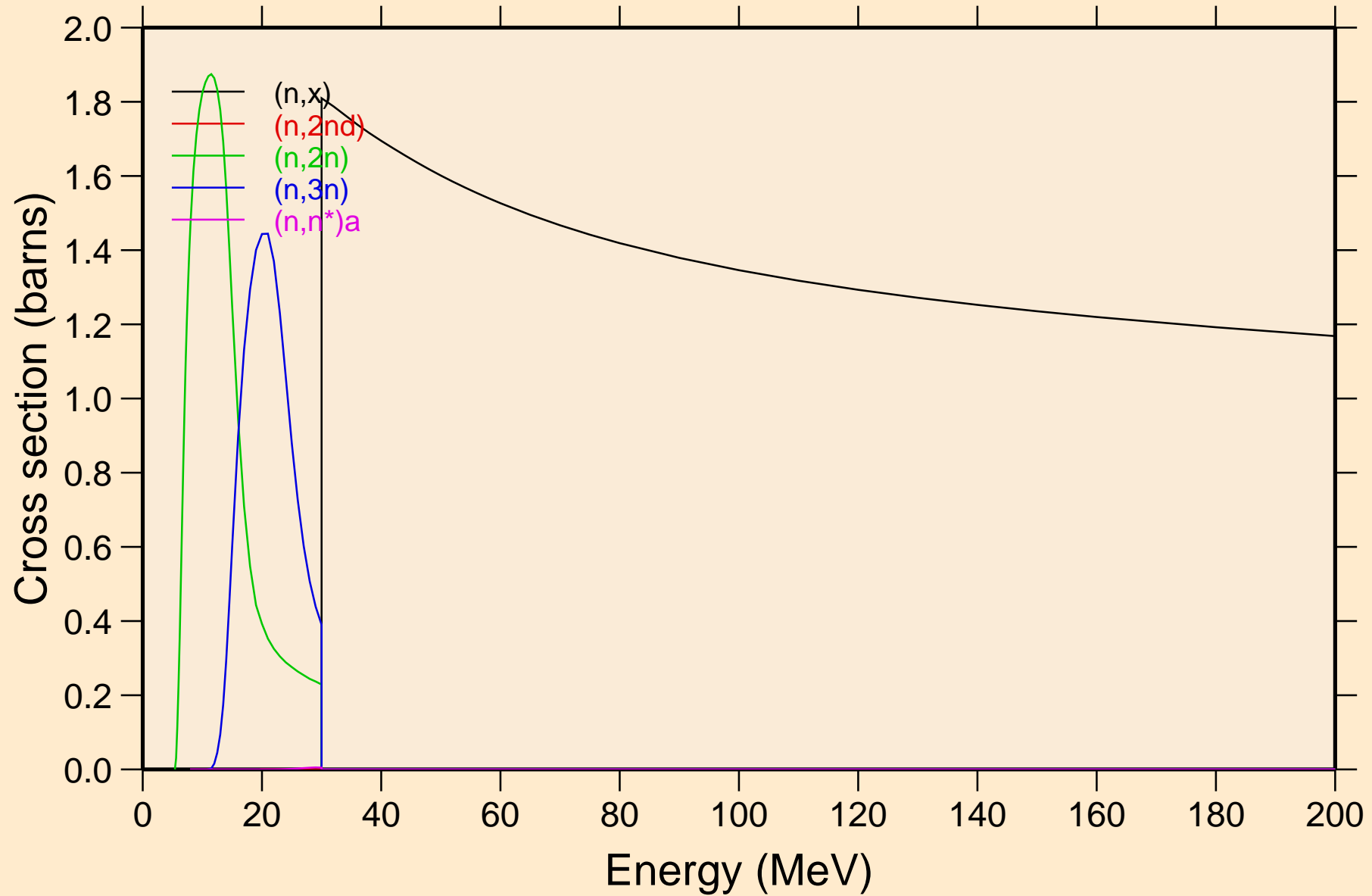

IN127N NEUTRON ACER TENDL-2024 LIBRARY; T=0.K
Threshold reactions

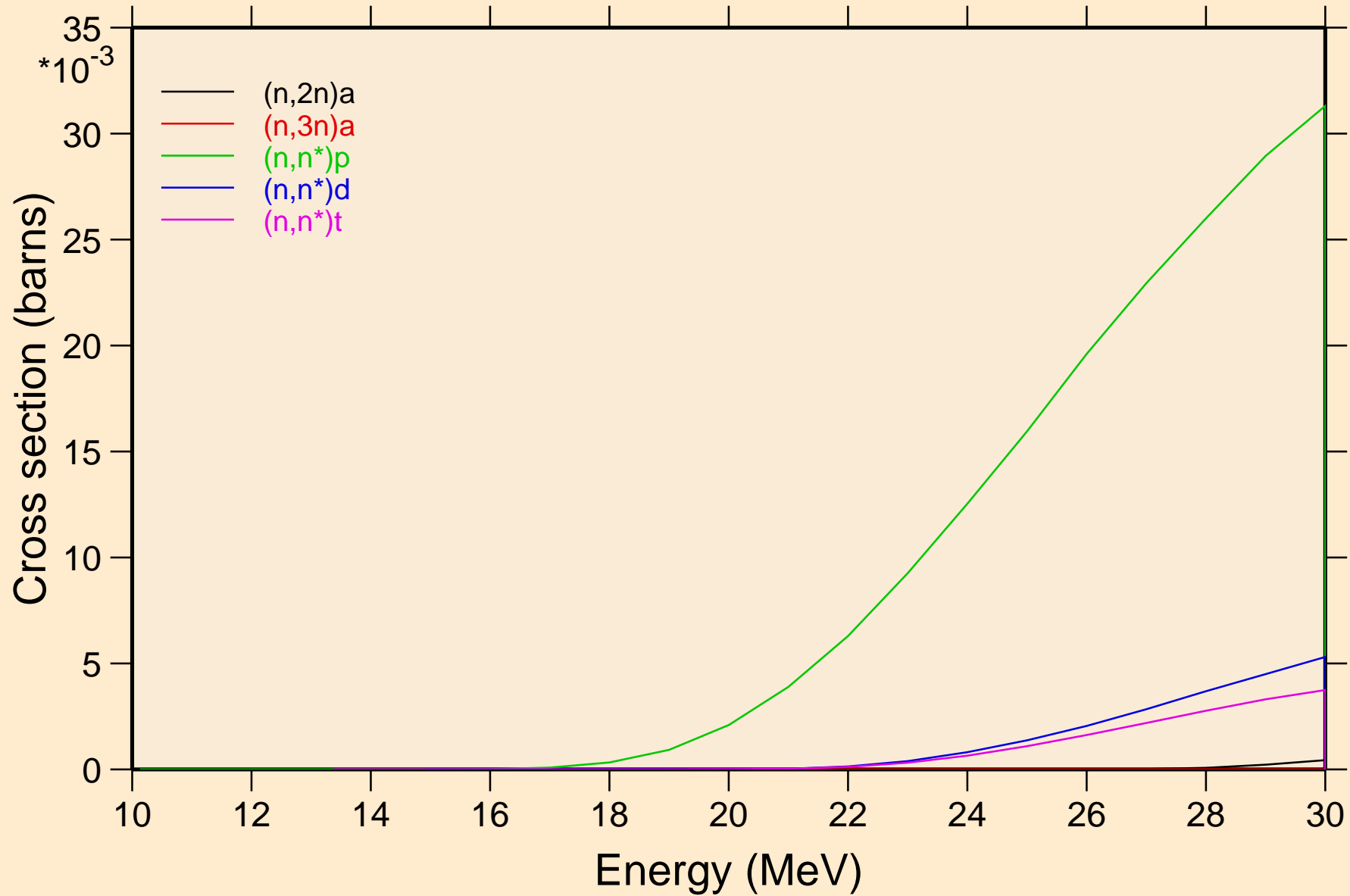

IN127N NEUTRON ACER TENDL-2024 LIBRARY; T=0.K

Threshold reactions

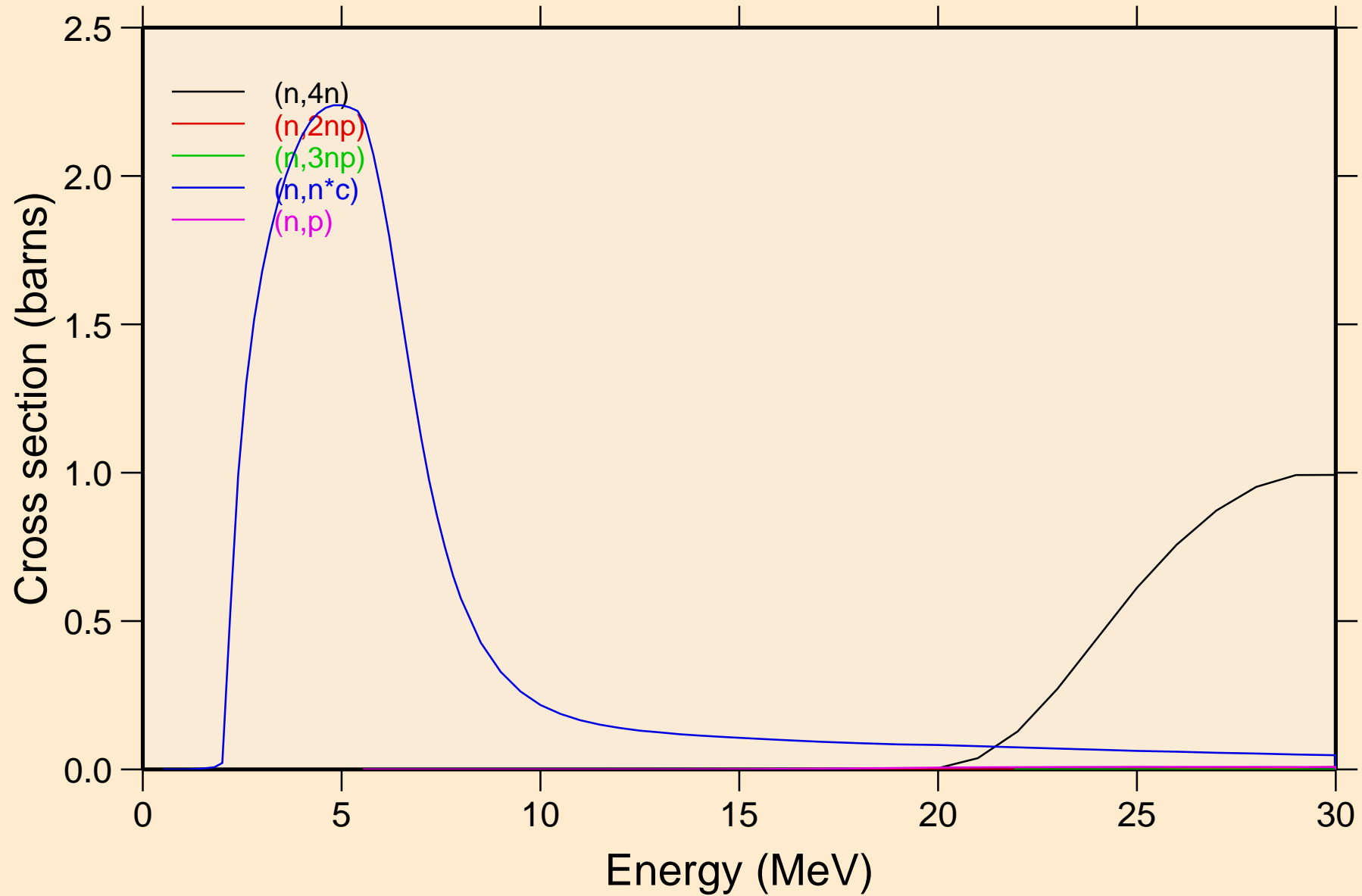

IN127N NEUTRON ACER TENDL-2024 LIBRARY; T=0.K
Threshold reactions

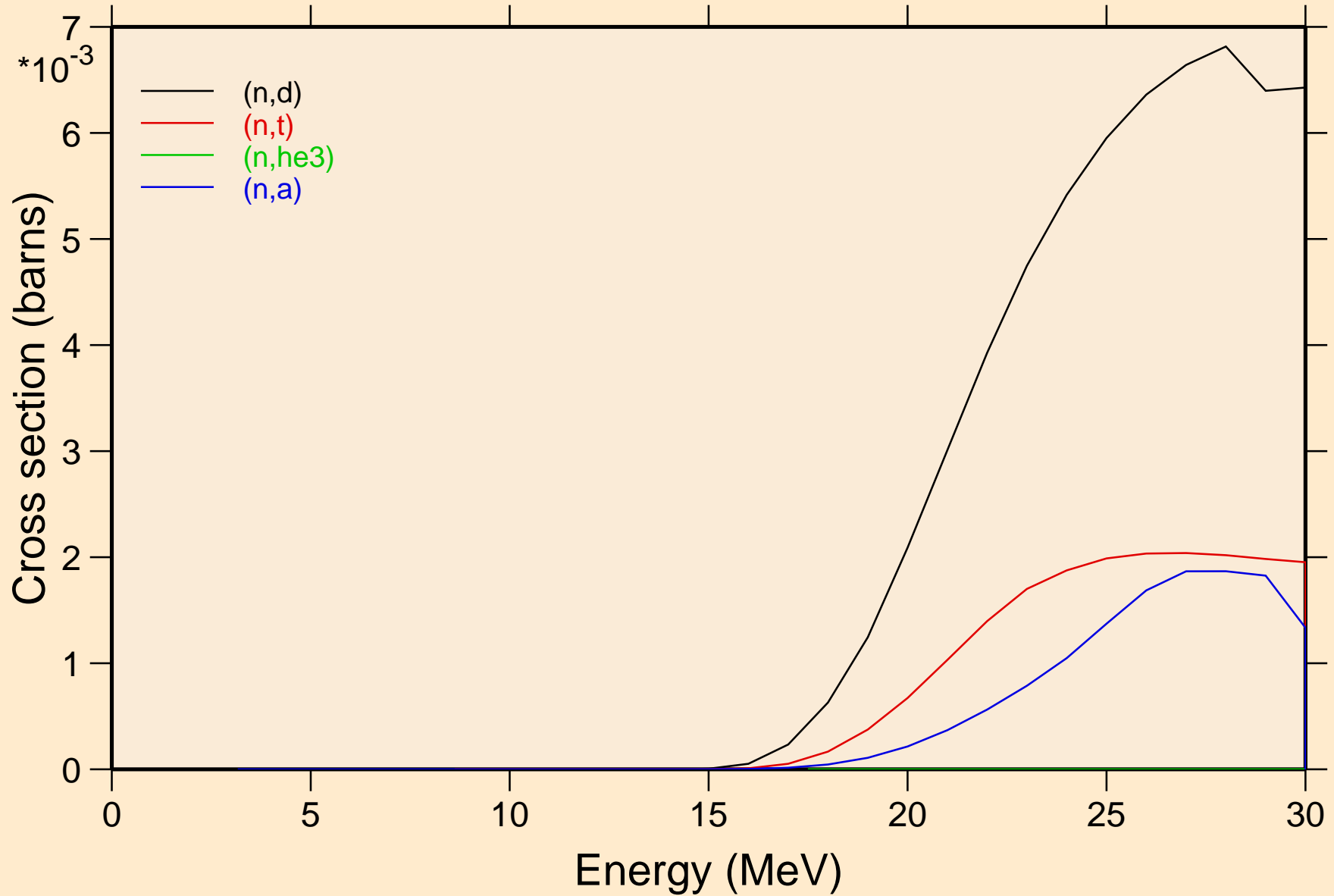

IN127N NEUTRON ACER TENDL-2024 LIBRARY; T=0.K
Threshold reactions

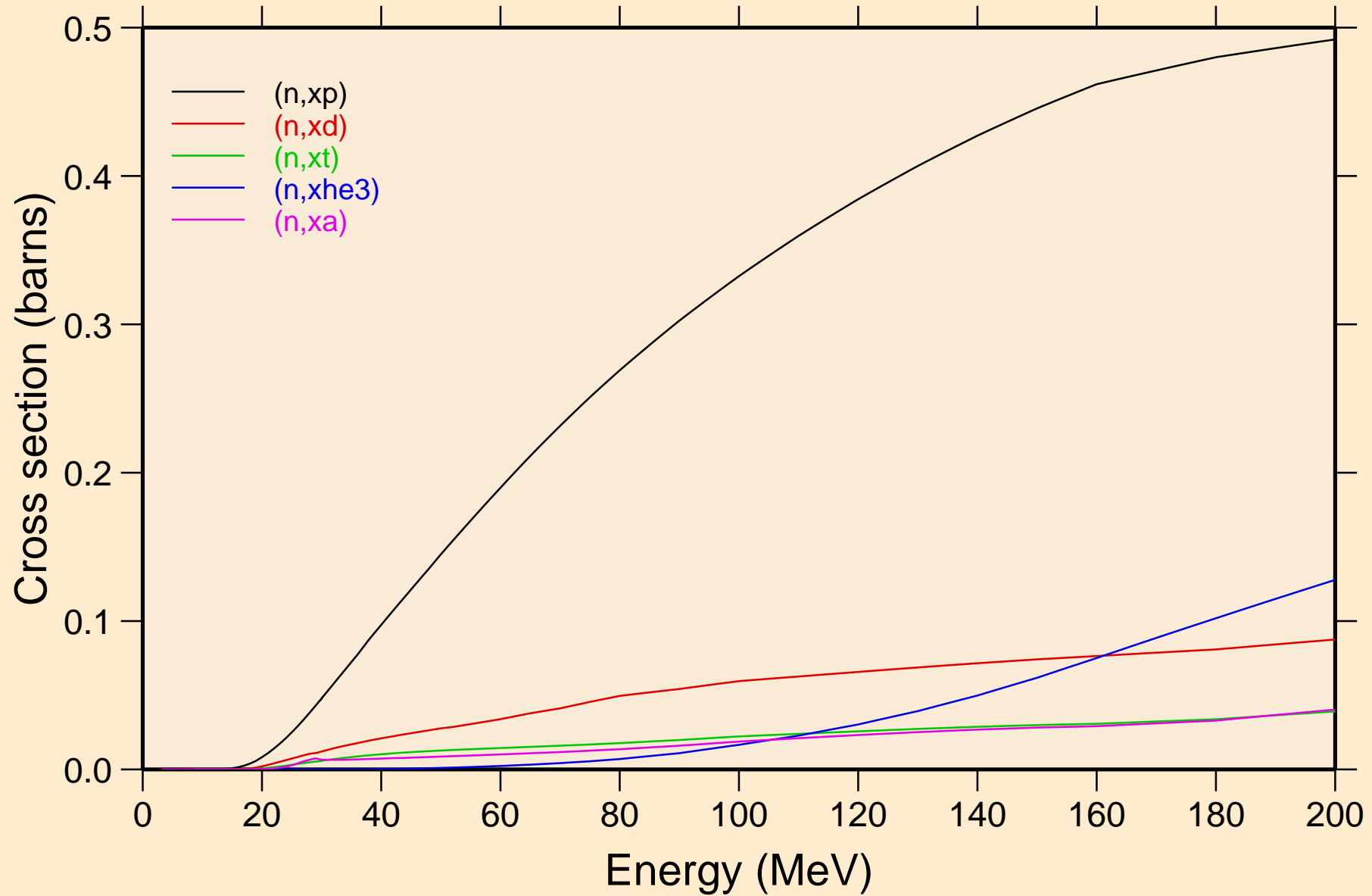

IN127N NEUTRON ACER TENDL-2024 LIBRARY; T=0.K
angular distribution for elastic

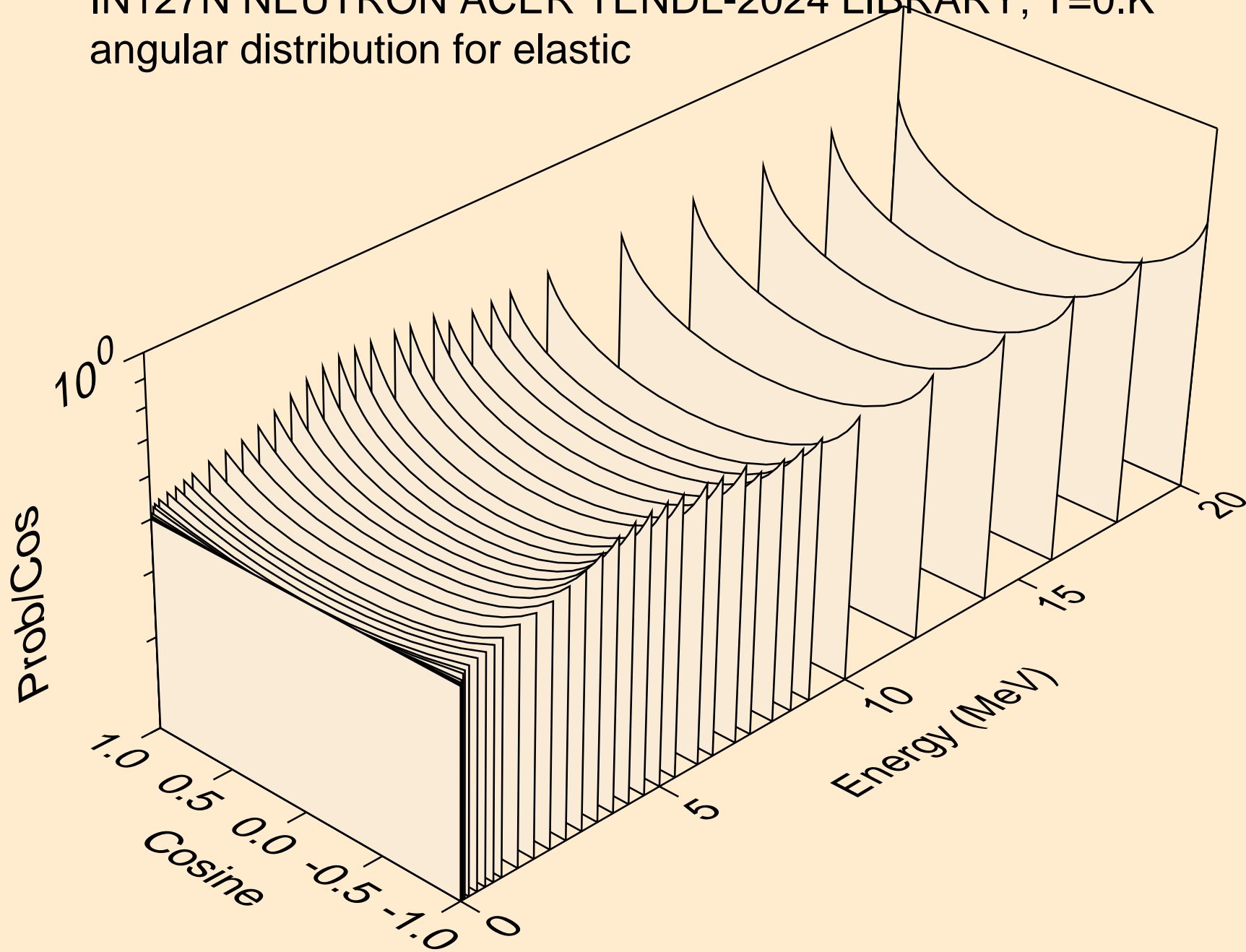

IN127N NEUTRON ACER TENDL-2024 LIBRARY; T=0.K
angular distribution for elastic

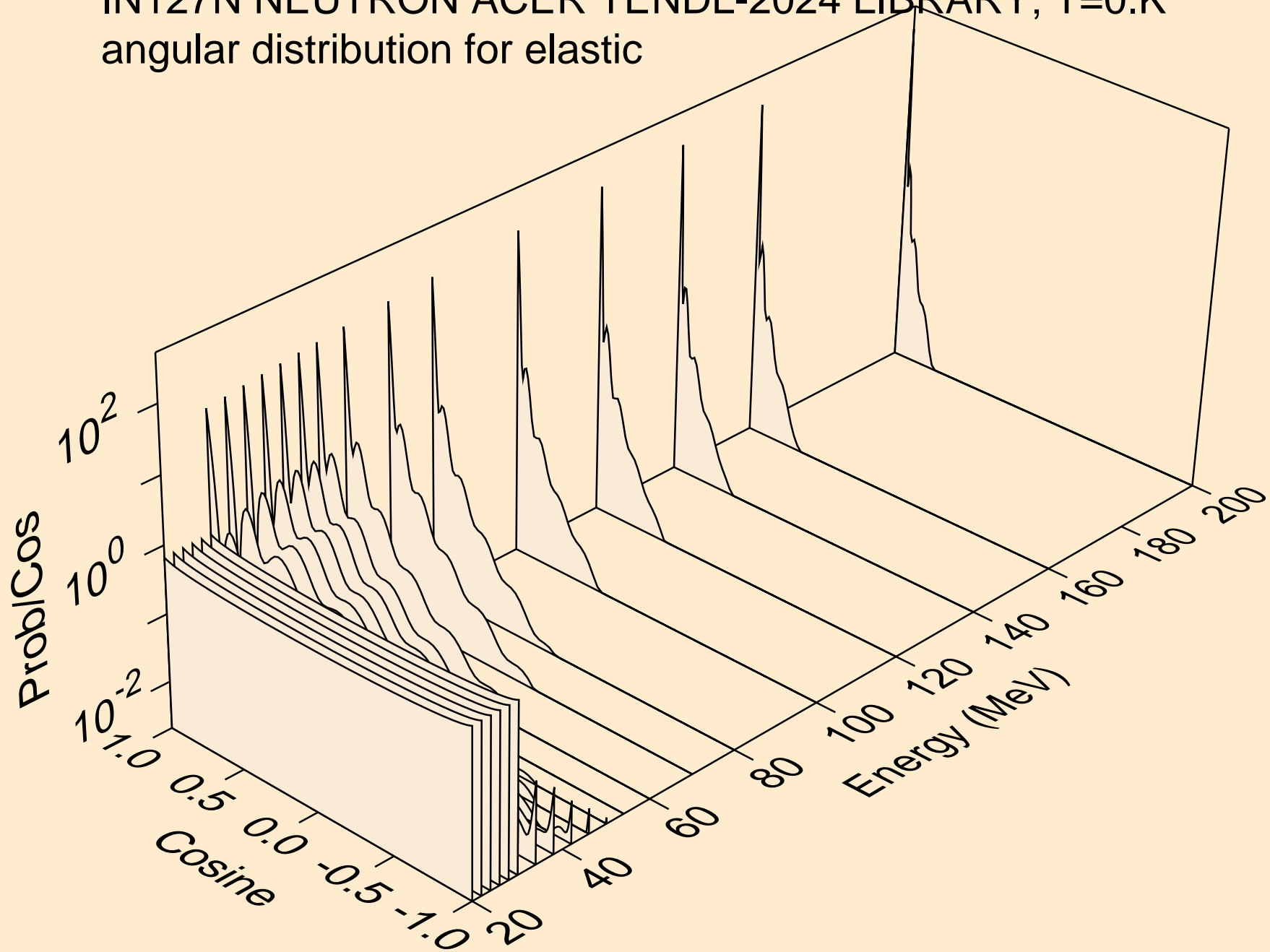

IN127N NEUTRON ACER TENDL-2024 LIBRARY; T=0.K
angular distribution for (n,n*1)

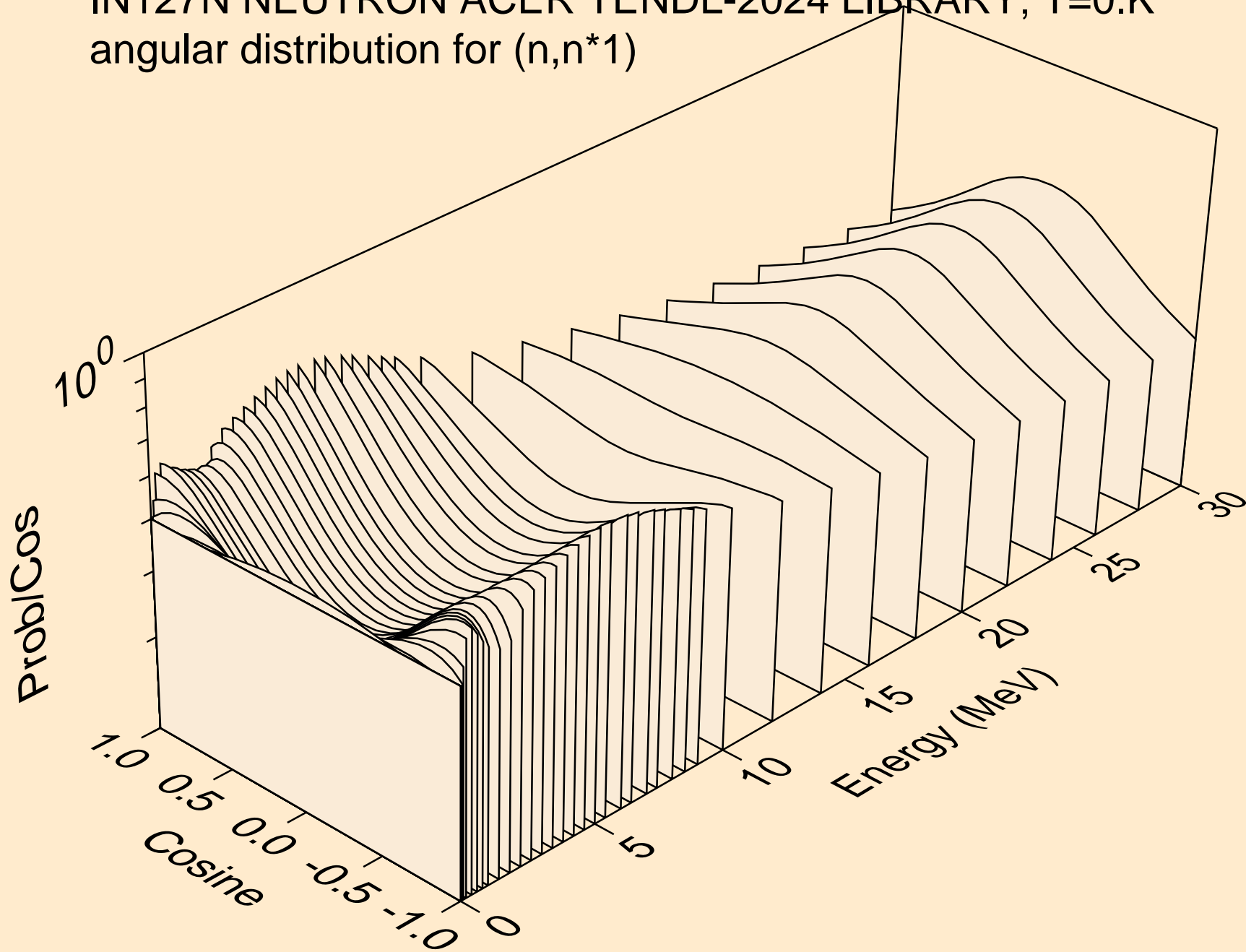

IN127N NEUTRON ACER TENDL-2024 LIBRARY; T=0.K
angular distribution for (n,n*2)

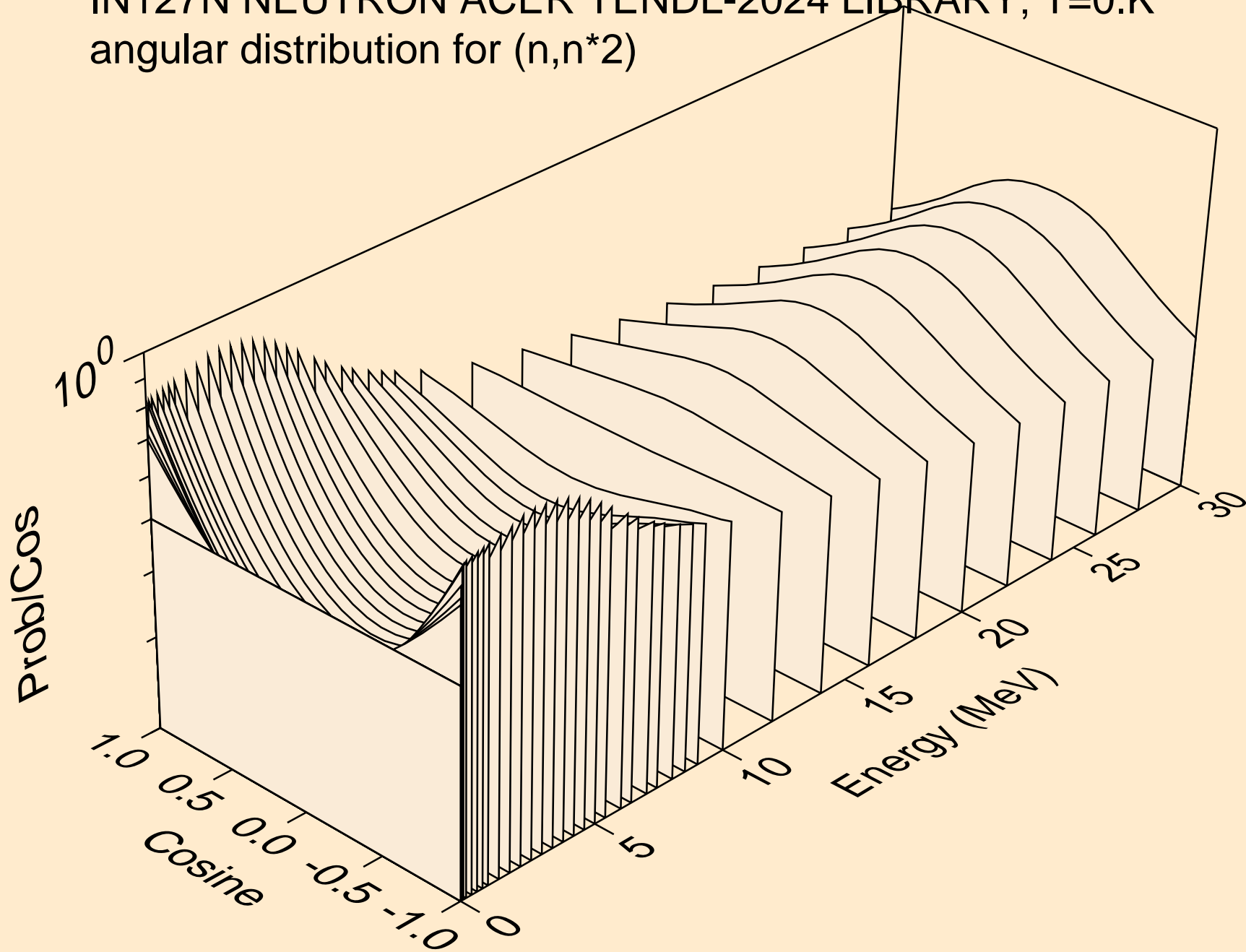

IN127N NEUTRON ACER TENDL-2024 LIBRARY; T=0.K
angular distribution for (n,n*3)

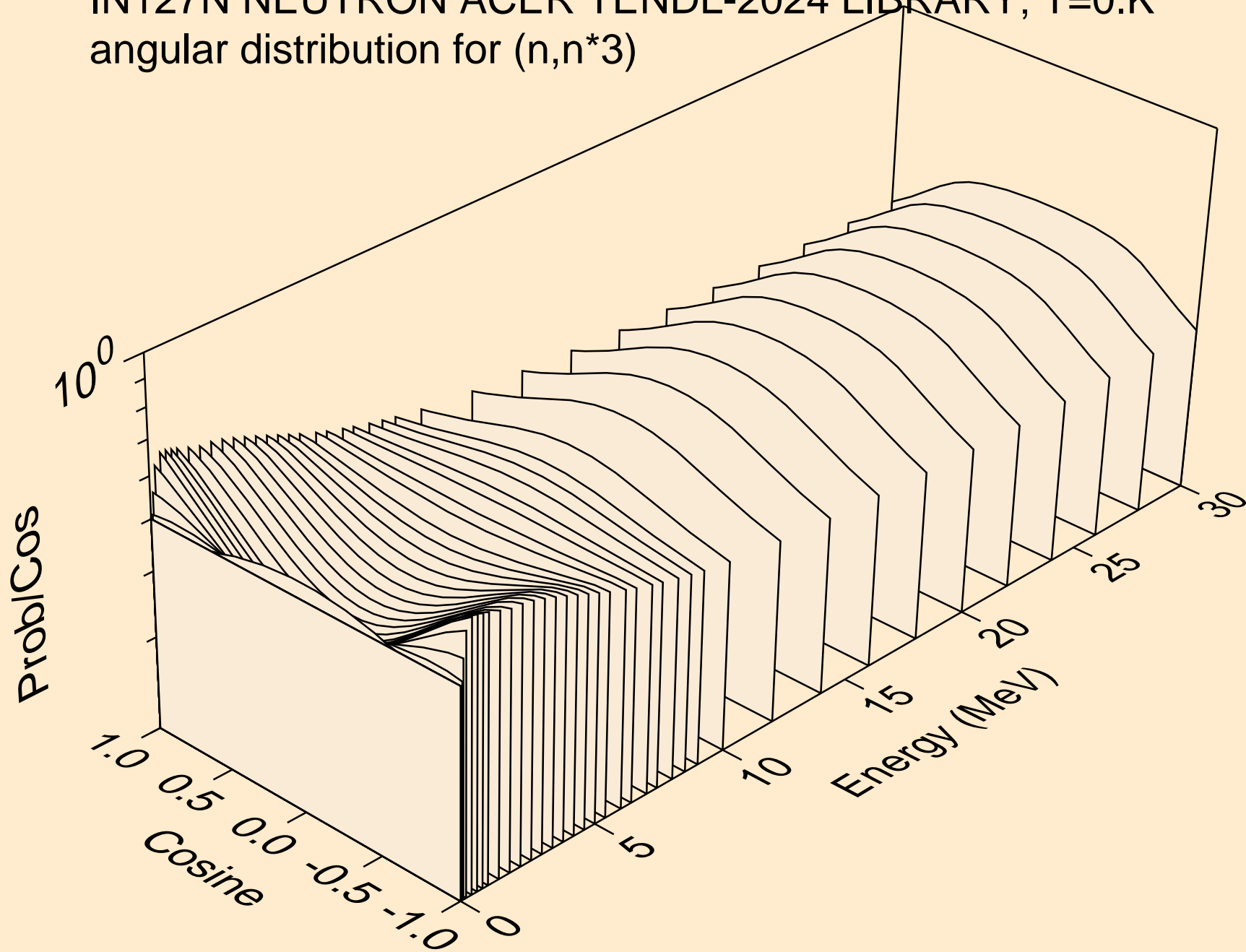

IN127N NEUTRON ACER TENDL-2024 LIBRARY; T=0.K
angular distribution for (n,n*4)

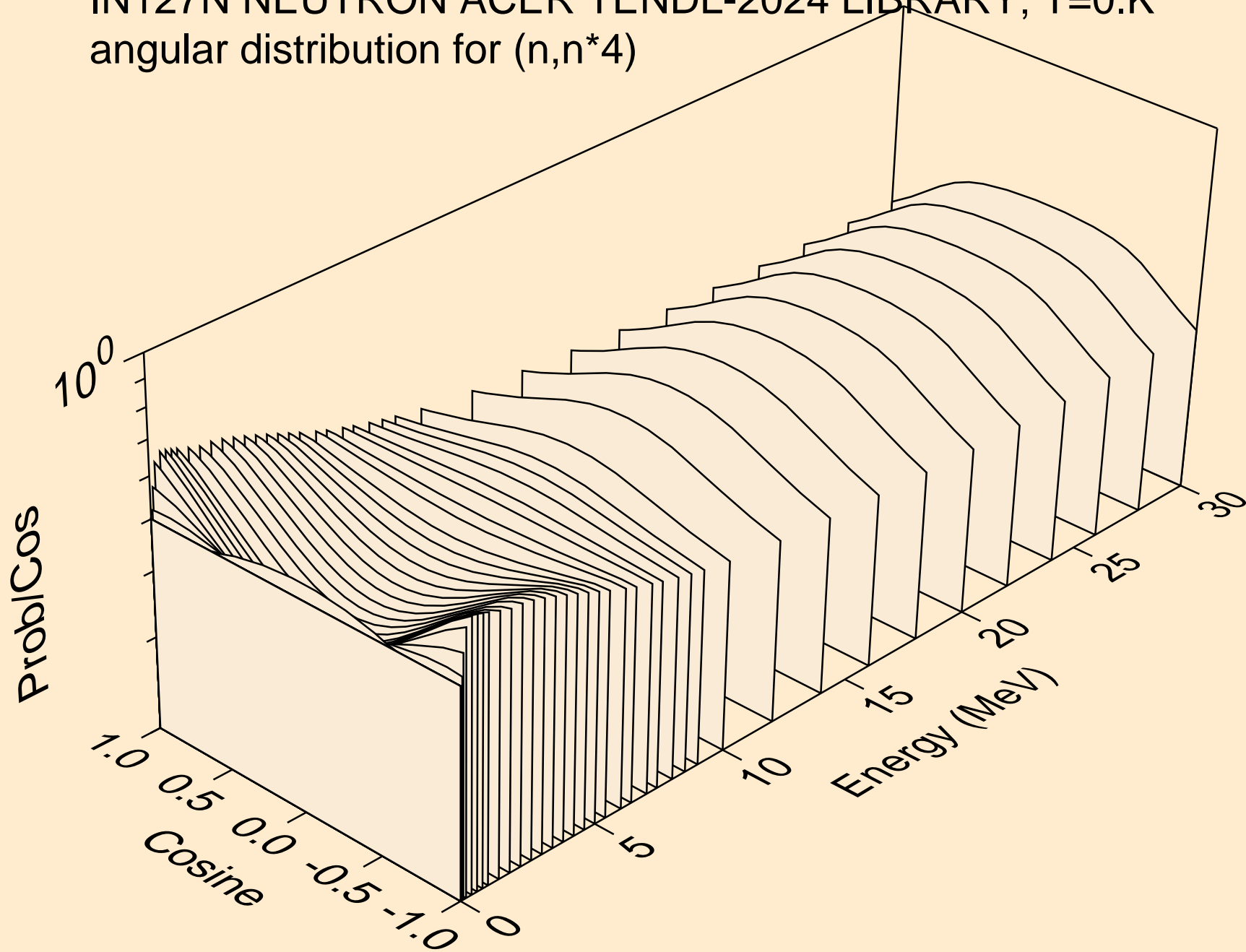

IN127N NEUTRON ACER TENDL-2024 LIBRARY; T=0.K
angular distribution for (n,n*5)

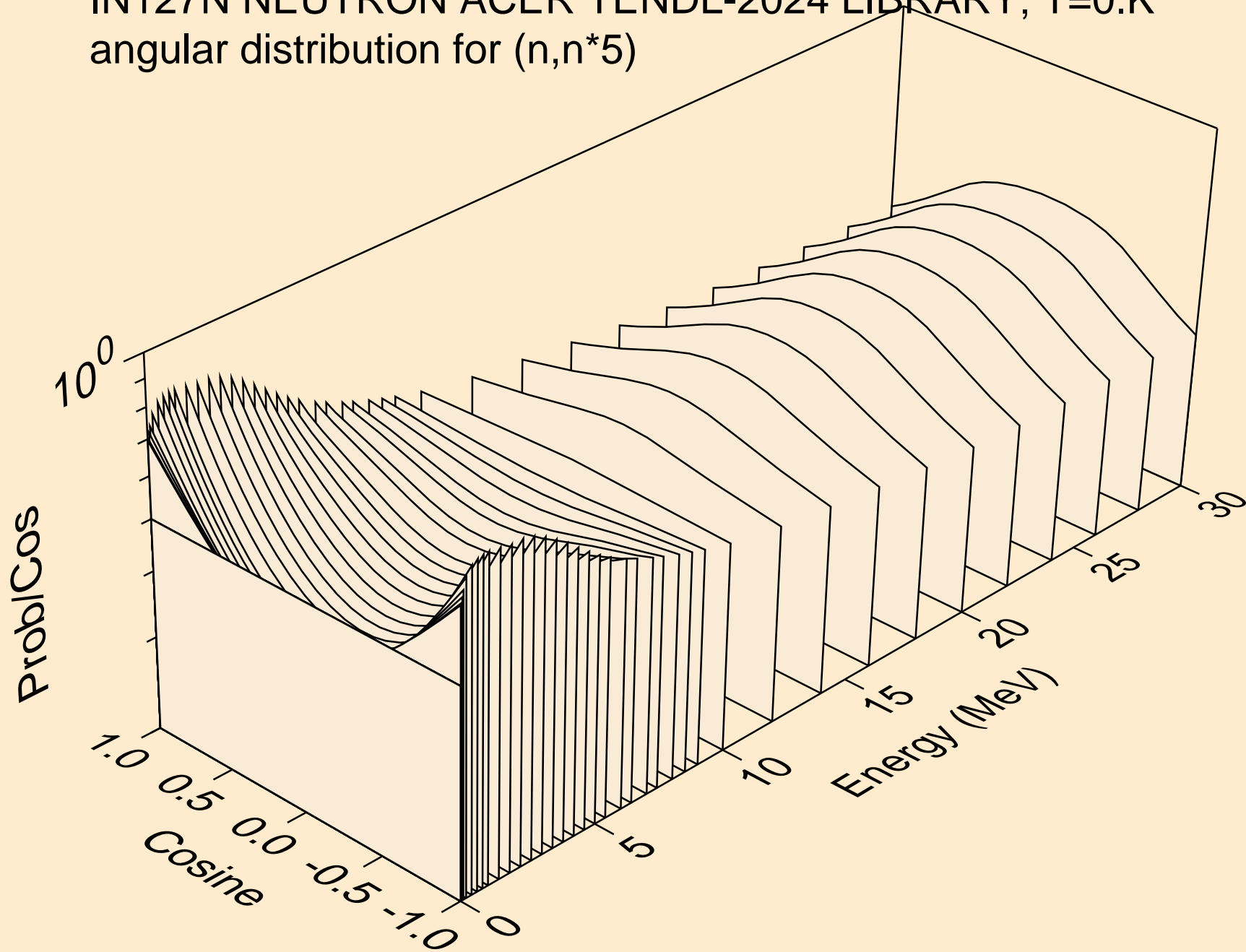

IN127N NEUTRON ACER TENDL-2024 LIBRARY; T=0.K
angular distribution for (n,n*6)

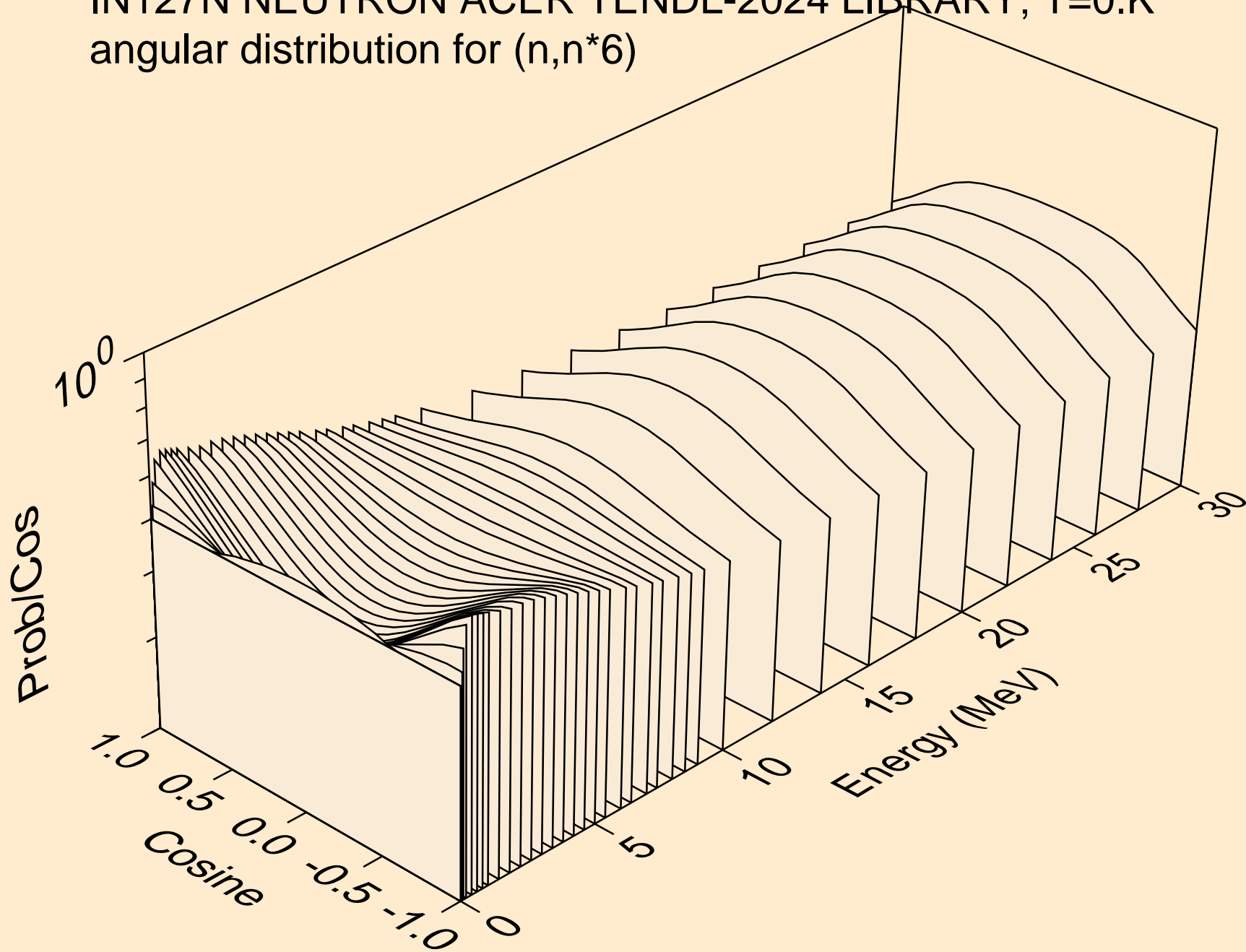

IN127N NEUTRON ACER TENDL-2024 LIBRARY; T=0.K
angular distribution for (n,n*7)

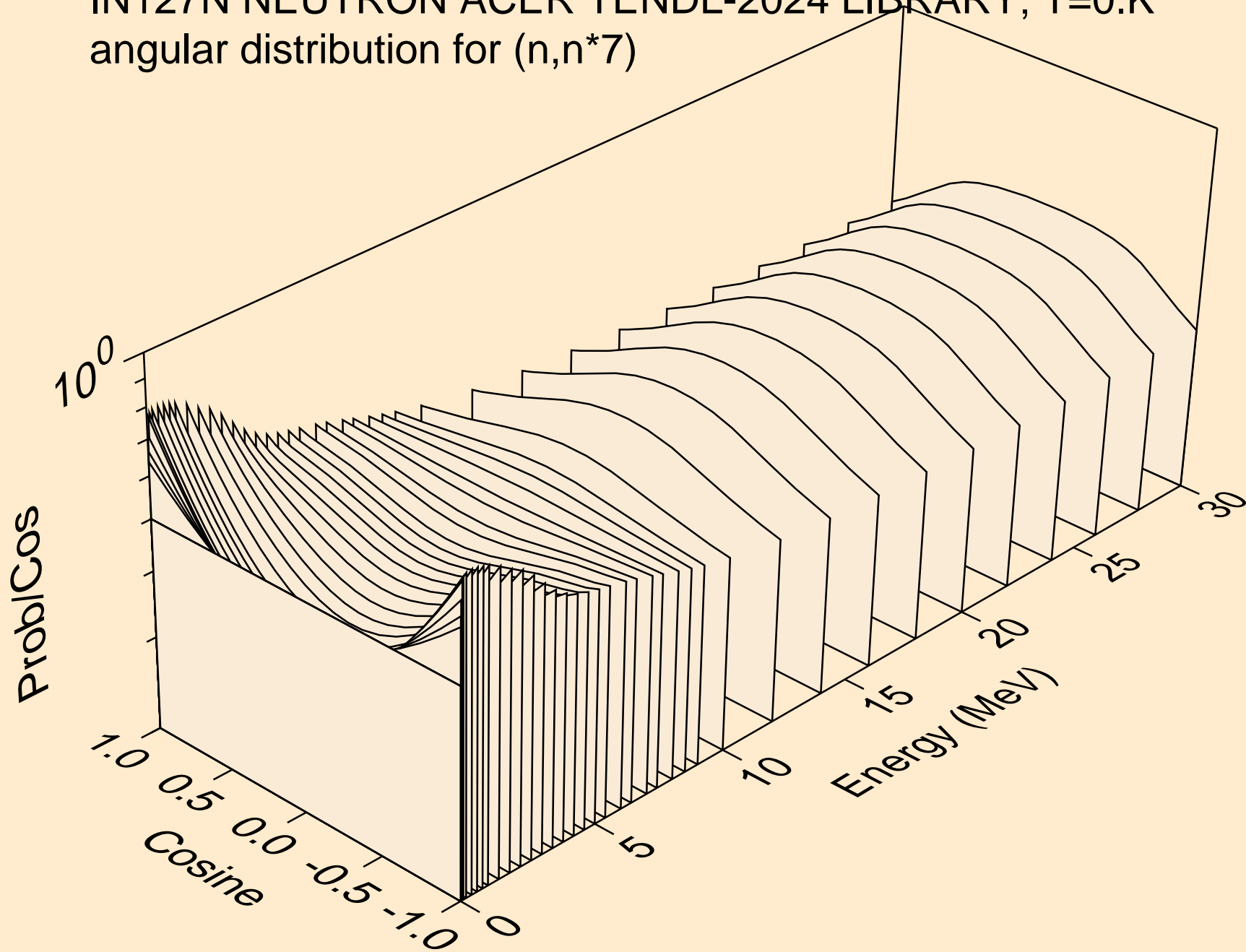

IN127N NEUTRON ACER TENDL-2024 LIBRARY; T=0.K
angular distribution for (n,n*8)

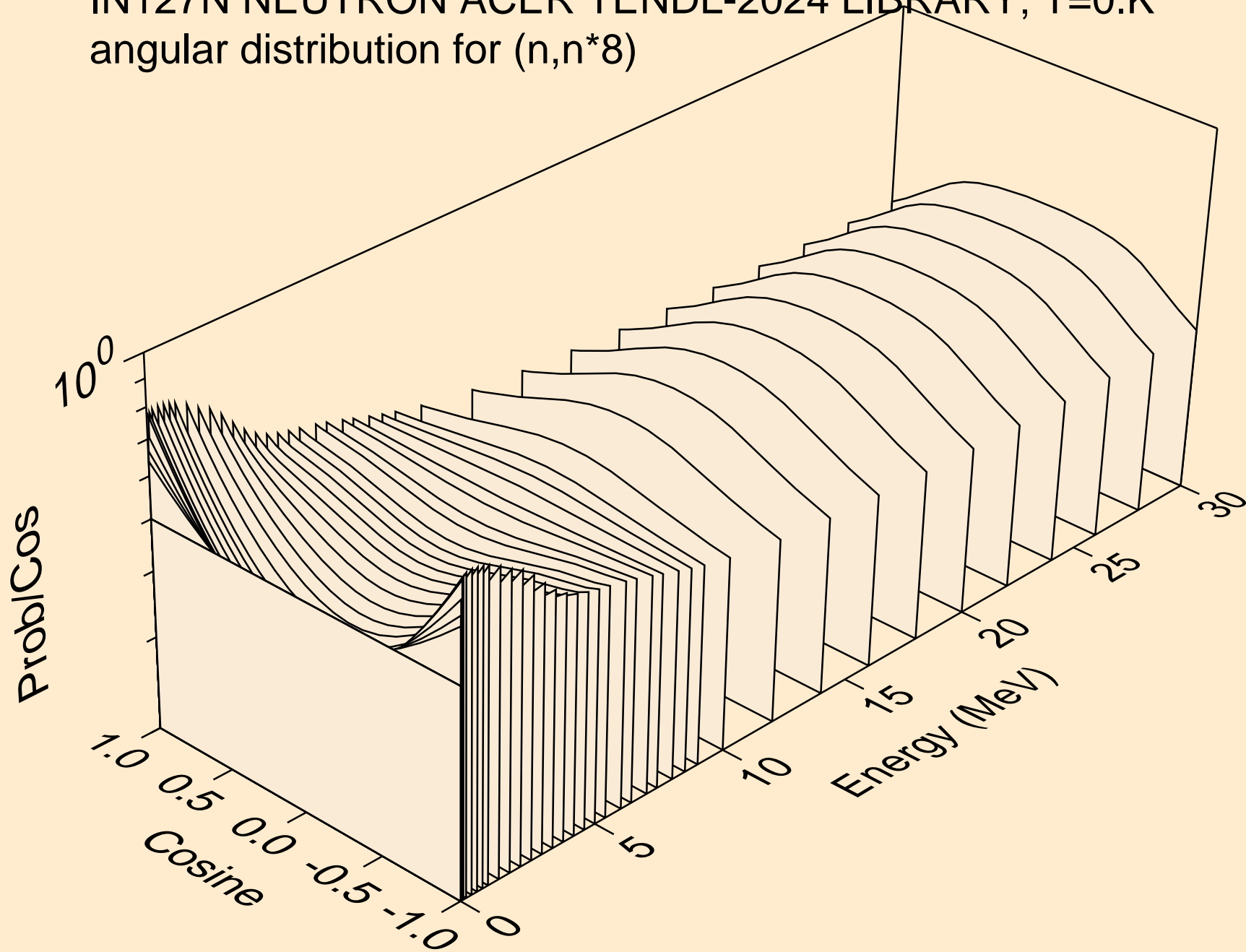

IN127N NEUTRON ACER TENDL-2024 LIBRARY; T=0.K
angular distribution for (n,n*9)

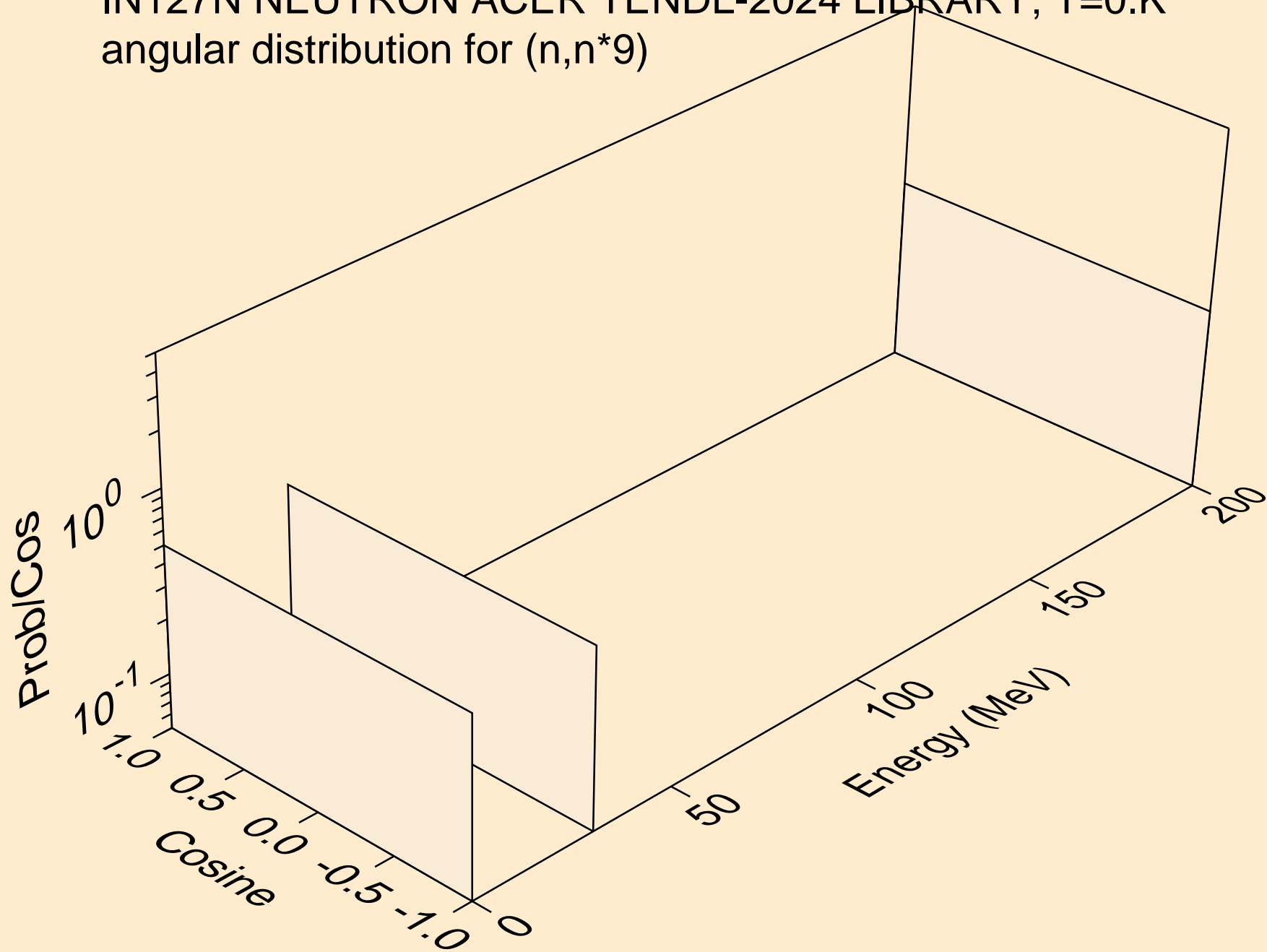

IN127N NEUTRON ACER TENDL-2024 LIBRARY; T=0.K
angular distribution for (n,n*10)

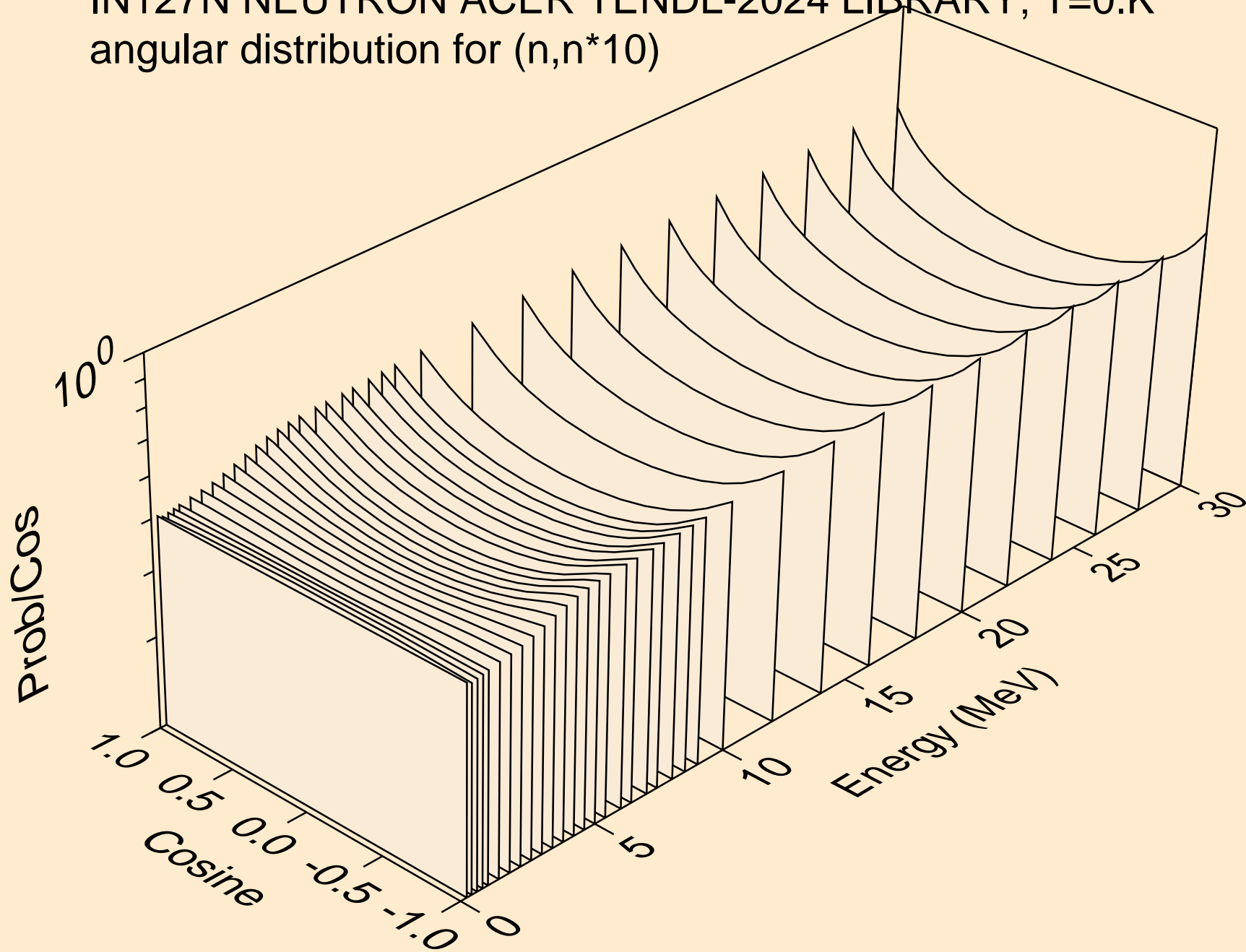

IN127N NEUTRON ACER TENDL-2024 LIBRARY; T=0.K
angular distribution for (n,n*11)

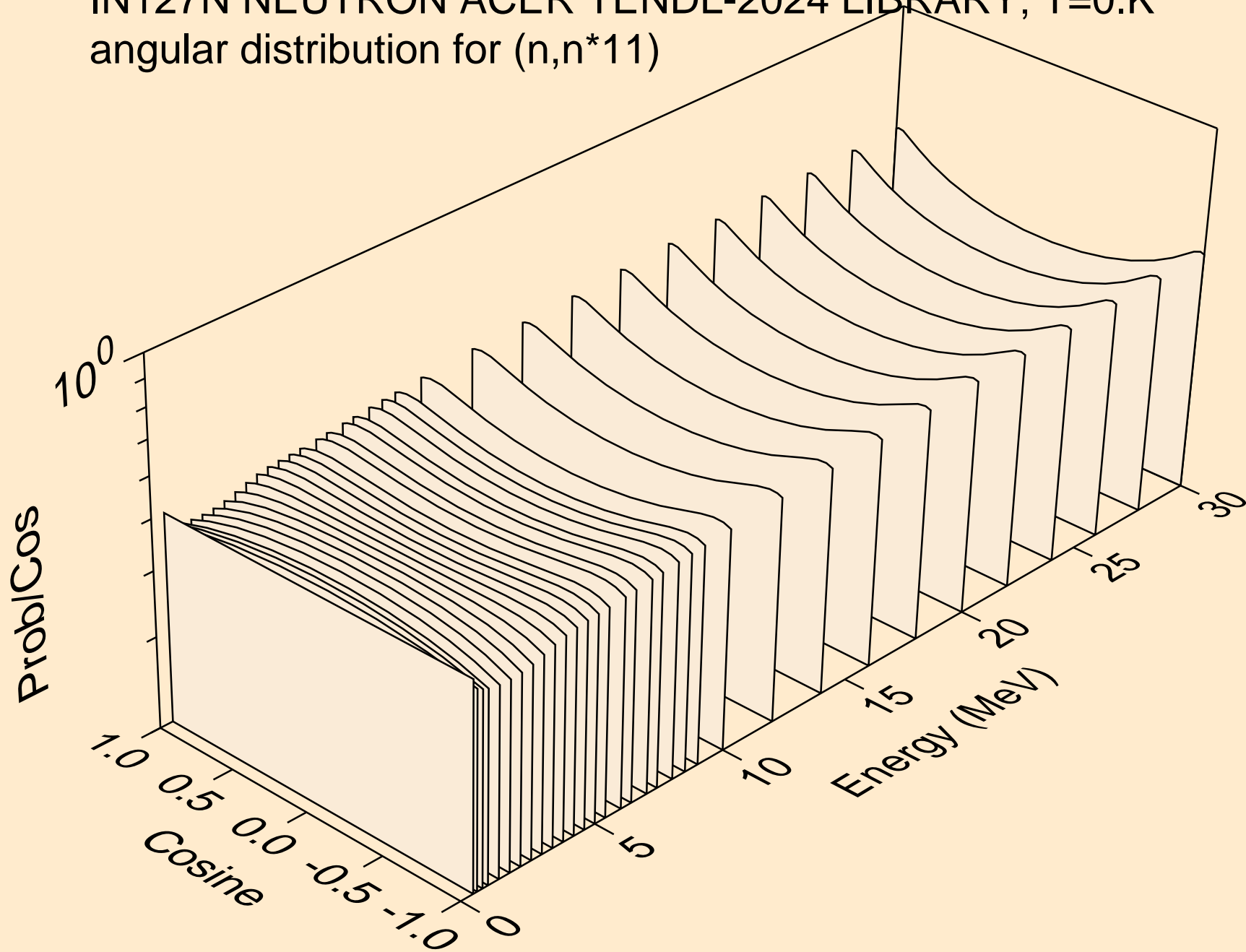

IN127N NEUTRON ACER TENDL-2024 LIBRARY; T=0.K
angular distribution for (n,n*12)

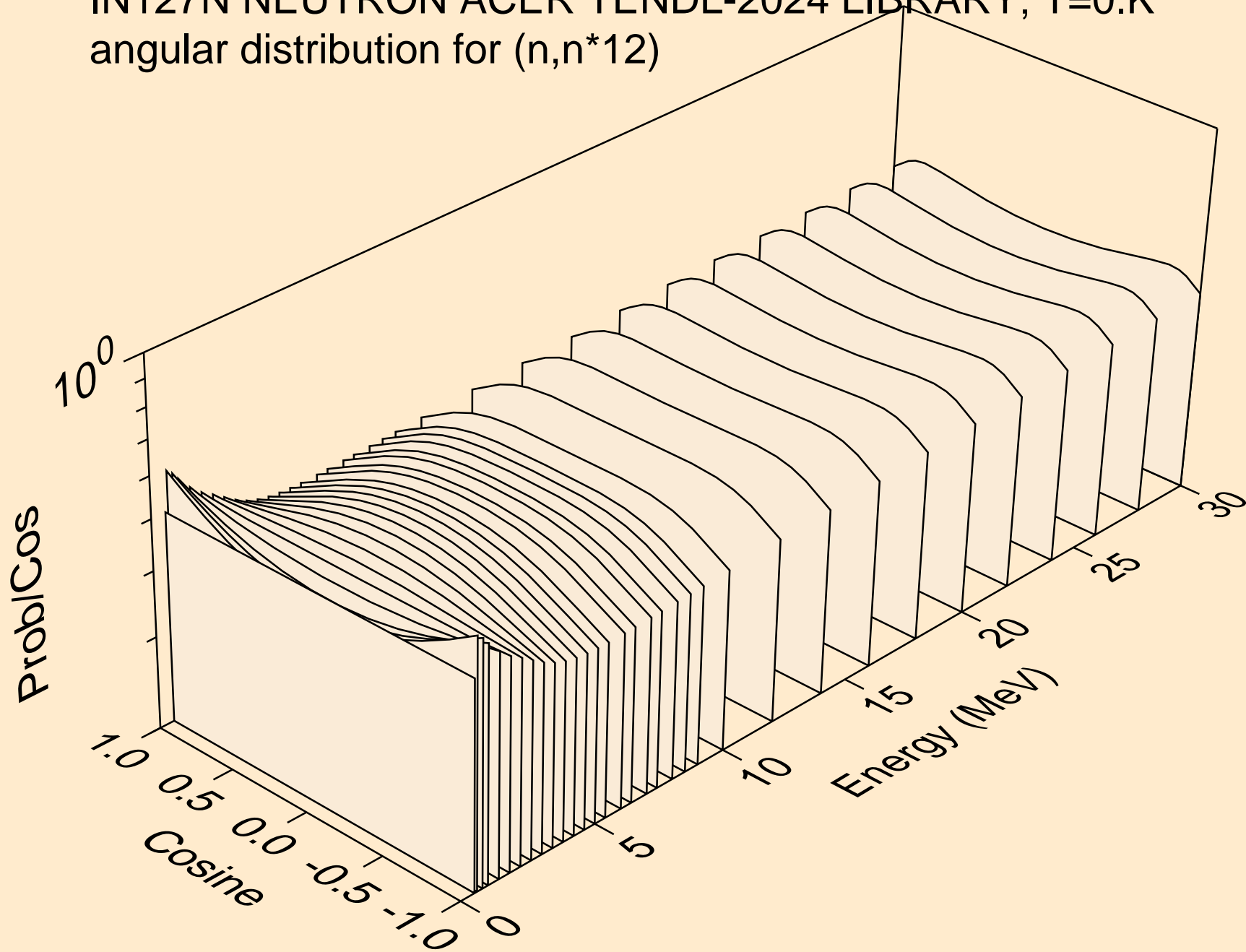

IN127N NEUTRON ACER TENDL-2024 LIBRARY; T=0.K
Neutron emission for (n,x)

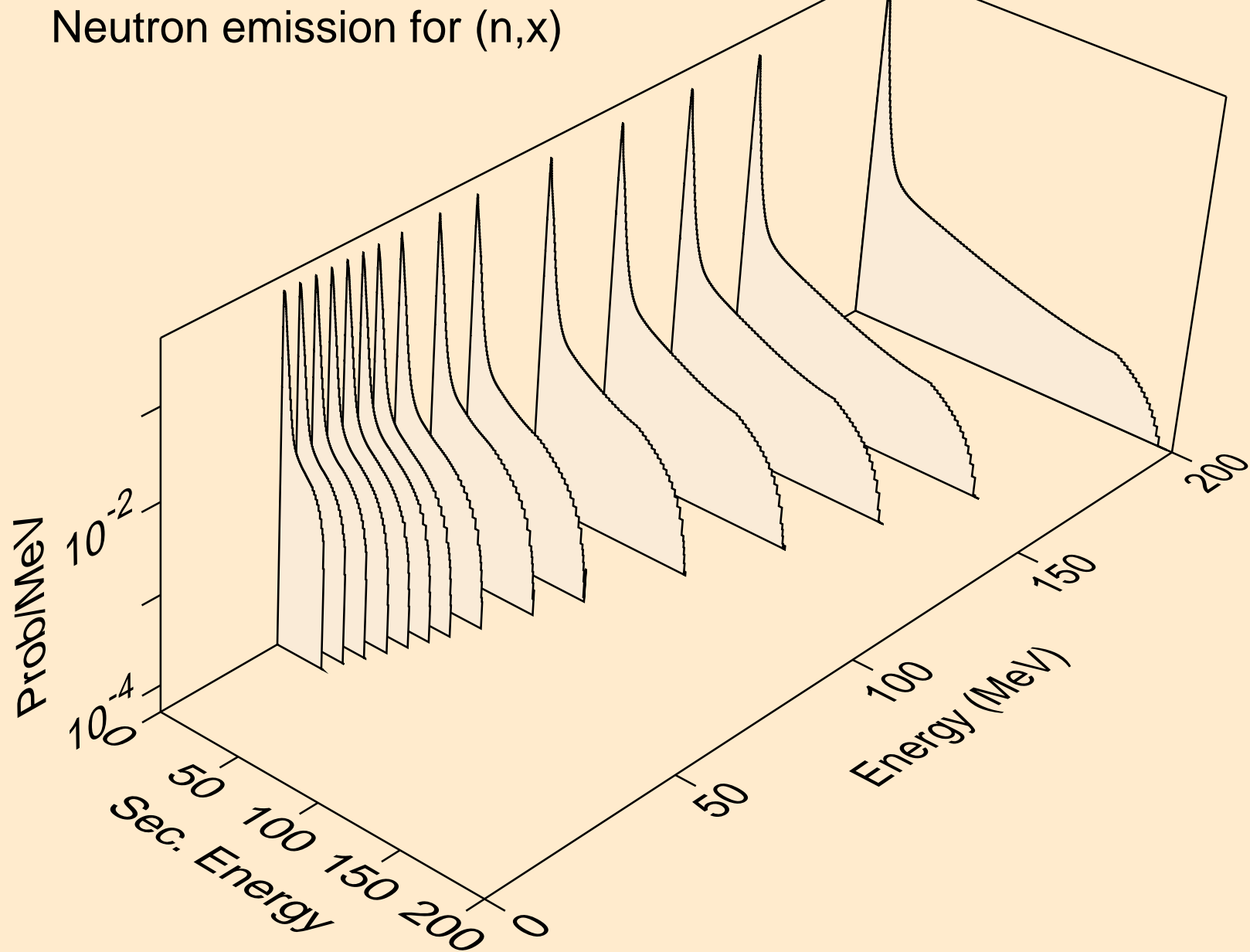

IN127N NEUTRON ACER TENDL-2024 LIBRARY; T=0.K
Neutron emission for (n,2nd)

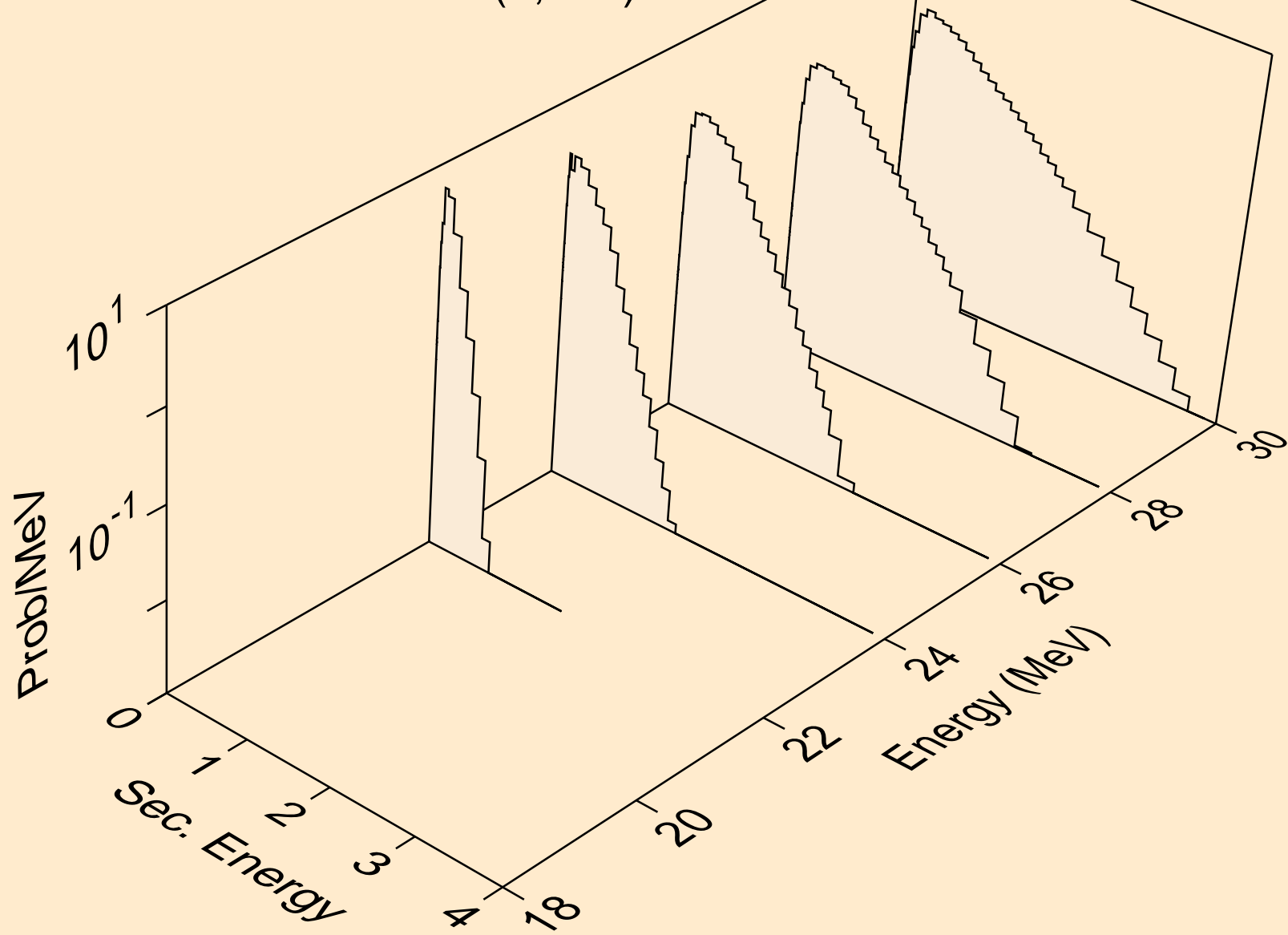

IN127N NEUTRON ACER TENDL-2024 LIBRARY; T=0.K
Neutron emission for (n,2n)

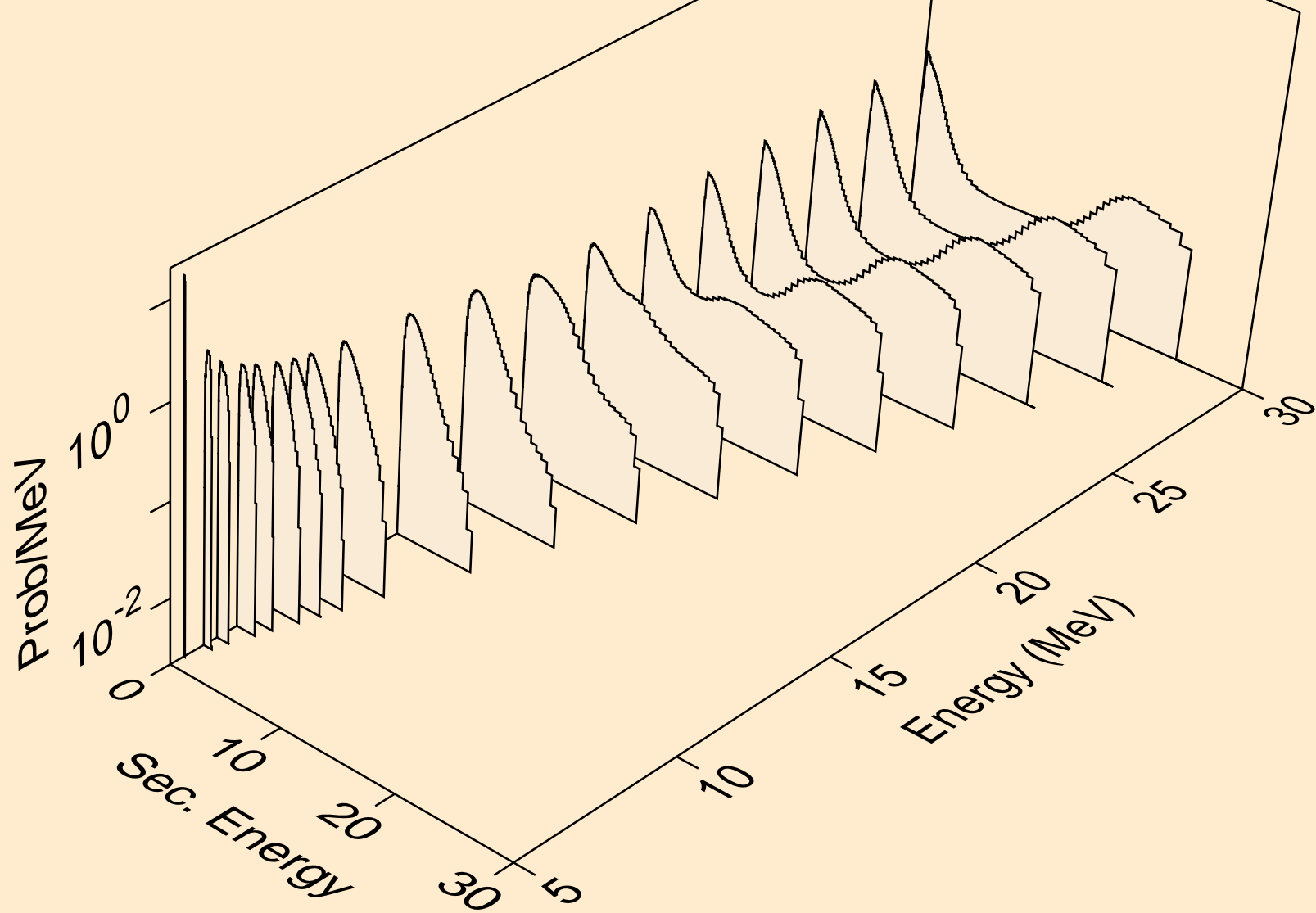

IN127N NEUTRON ACER TENDL-2024 LIBRARY; T=0.K
Neutron emission for (n,3n)

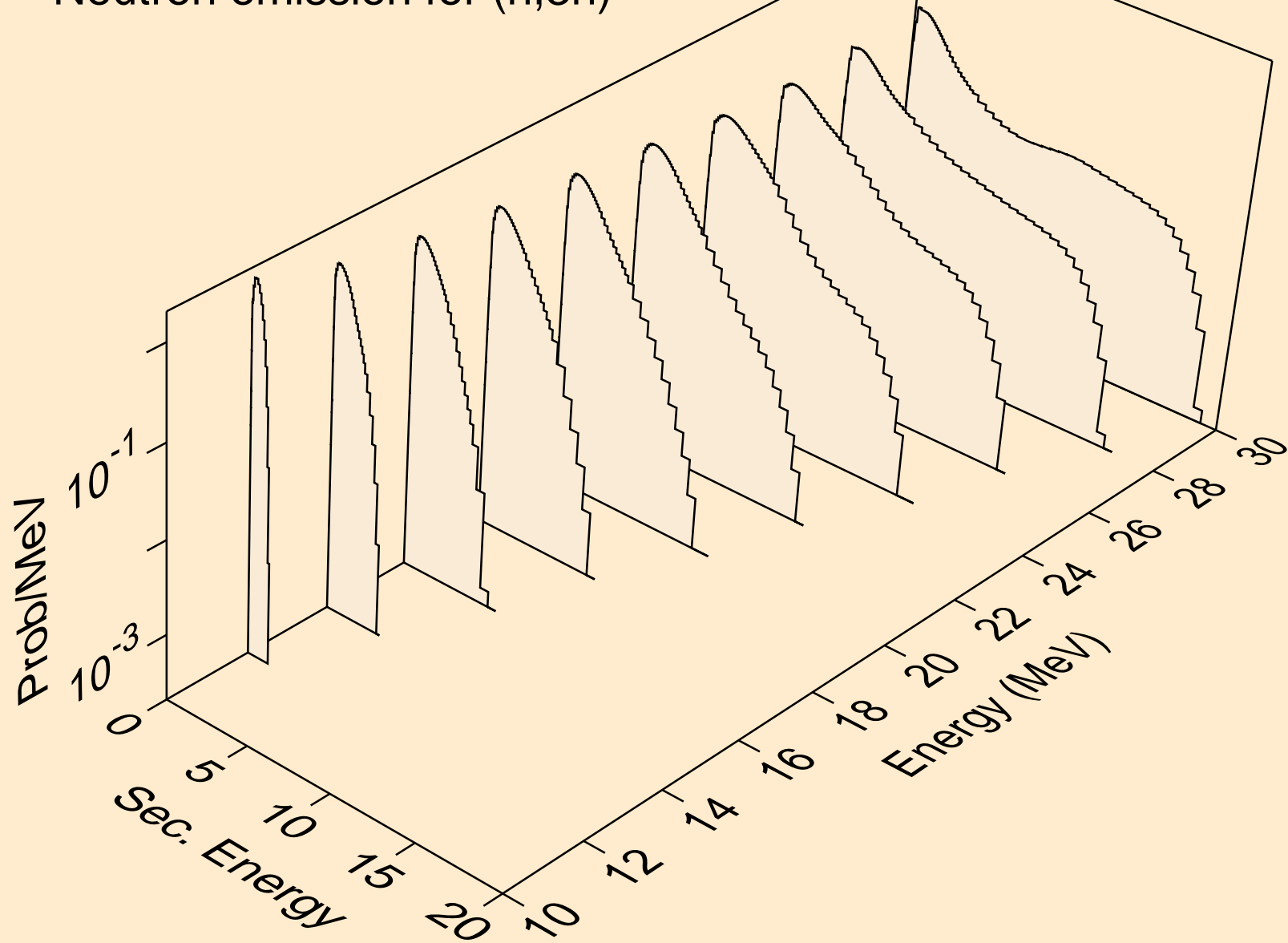

IN127N NEUTRON ACER TENDL-2024 LIBRARY; T=0.K
Neutron emission for (n,n*)a

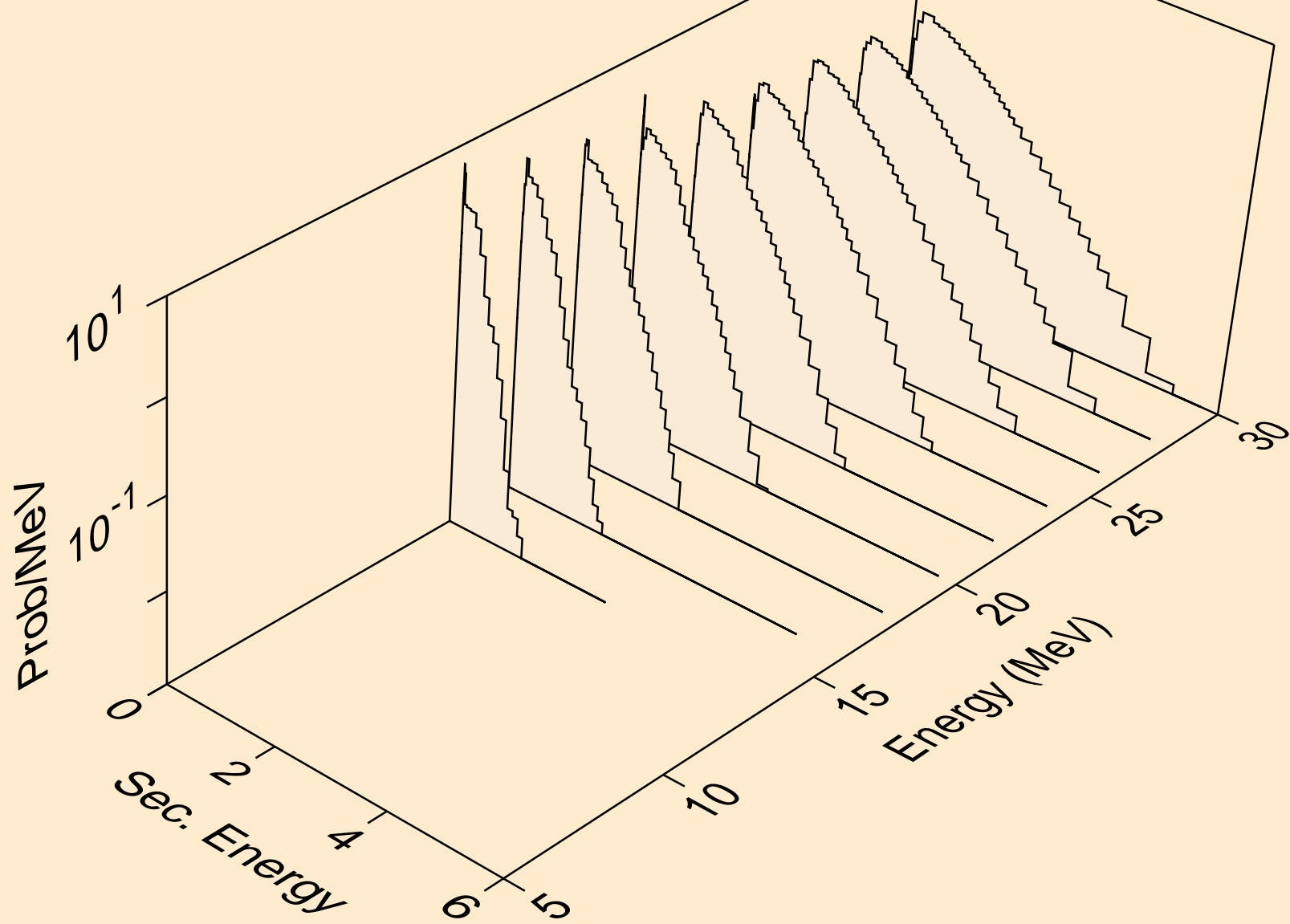

IN127N NEUTRON ACER TENDL-2024 LIBRARY; T=0.K
Neutron emission for (n,2n)a

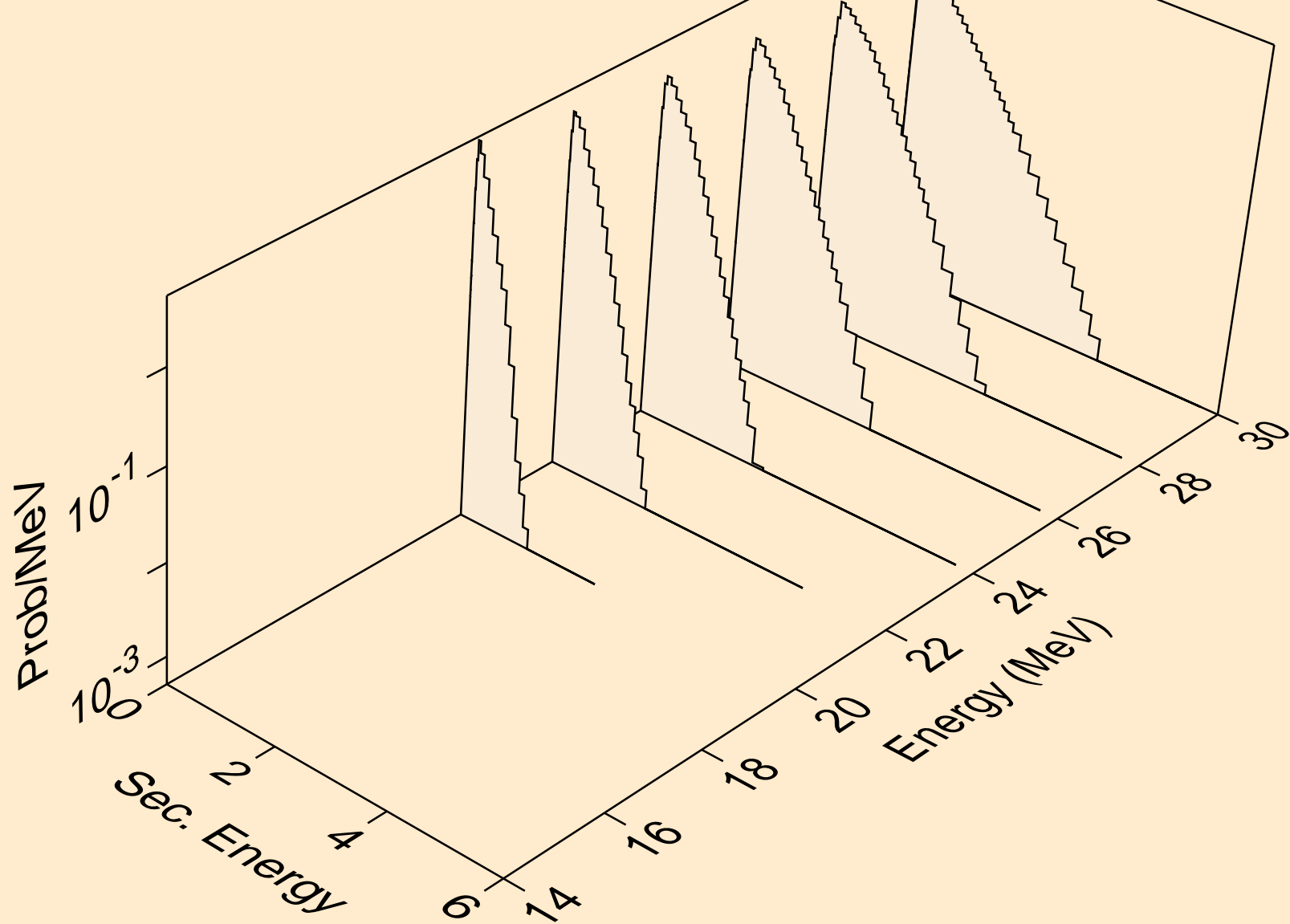

IN127N NEUTRON ACER TENDL-2024 LIBRARY; T=0.K
Neutron emission for (n,3n)a

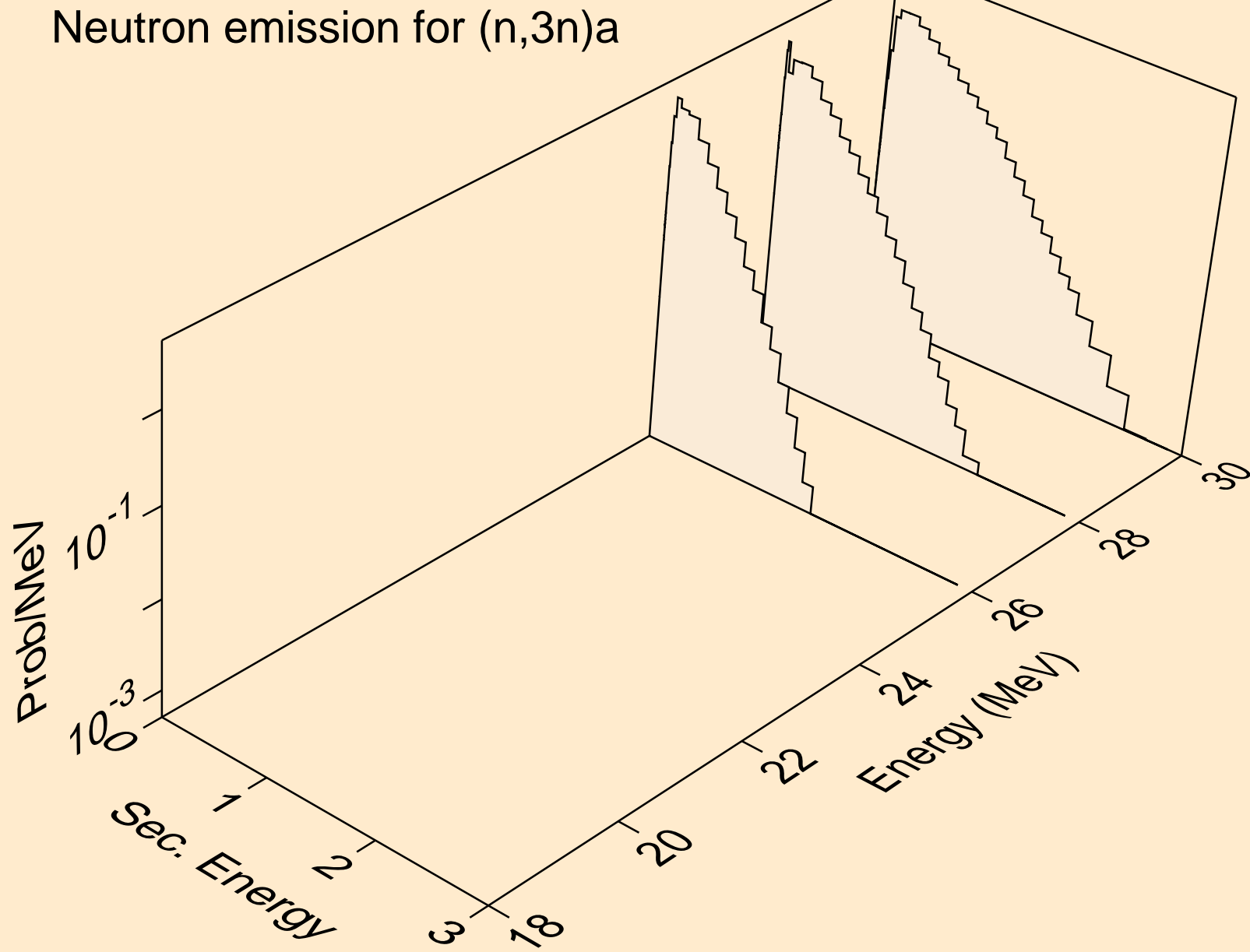

IN127N NEUTRON ACER TENDL-2024 LIBRARY; T=0.K
Neutron emission for (n,n*)p

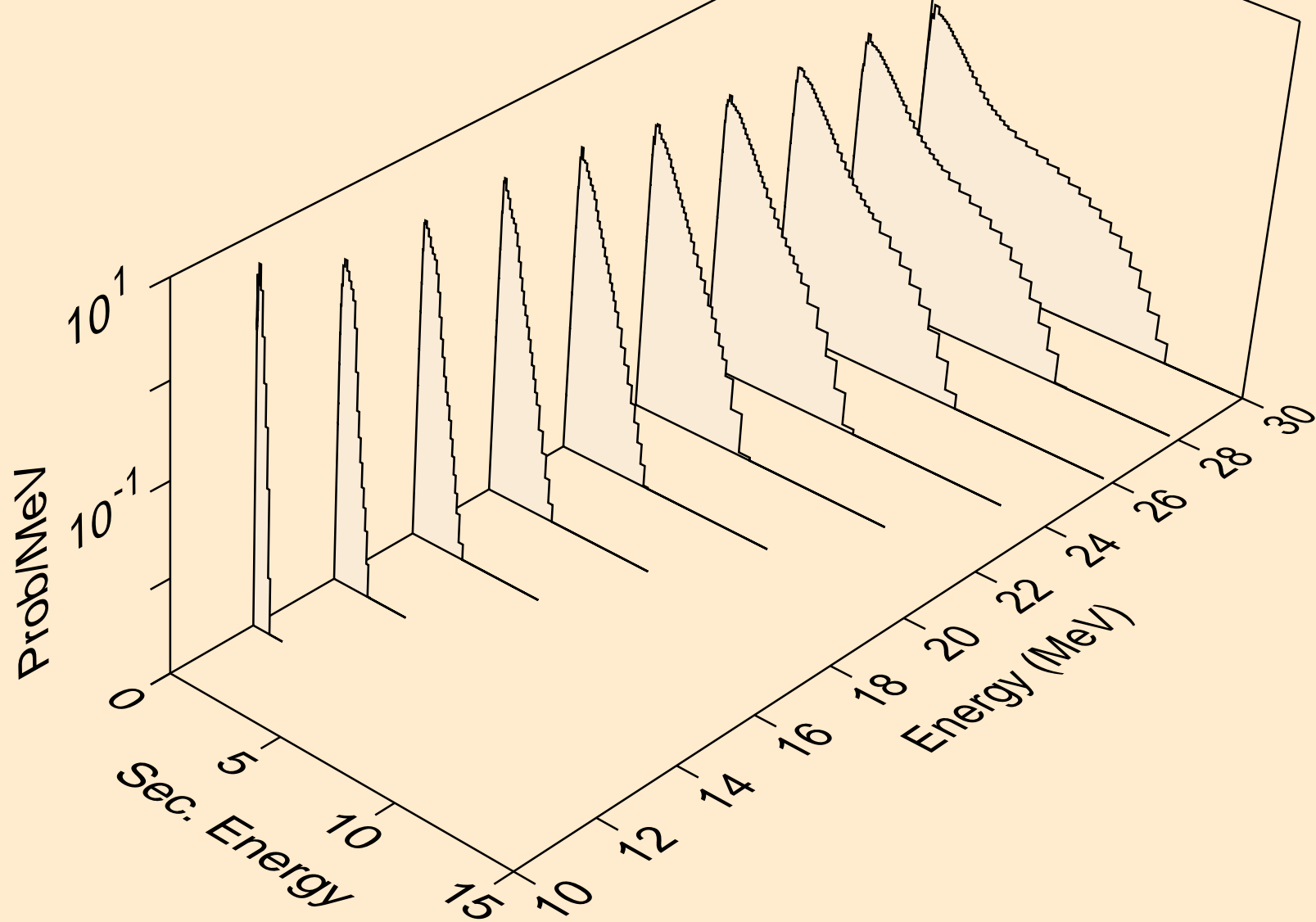

IN127N NEUTRON ACER TENDL-2024 LIBRARY; T=0.K
Neutron emission for (n,n*)d

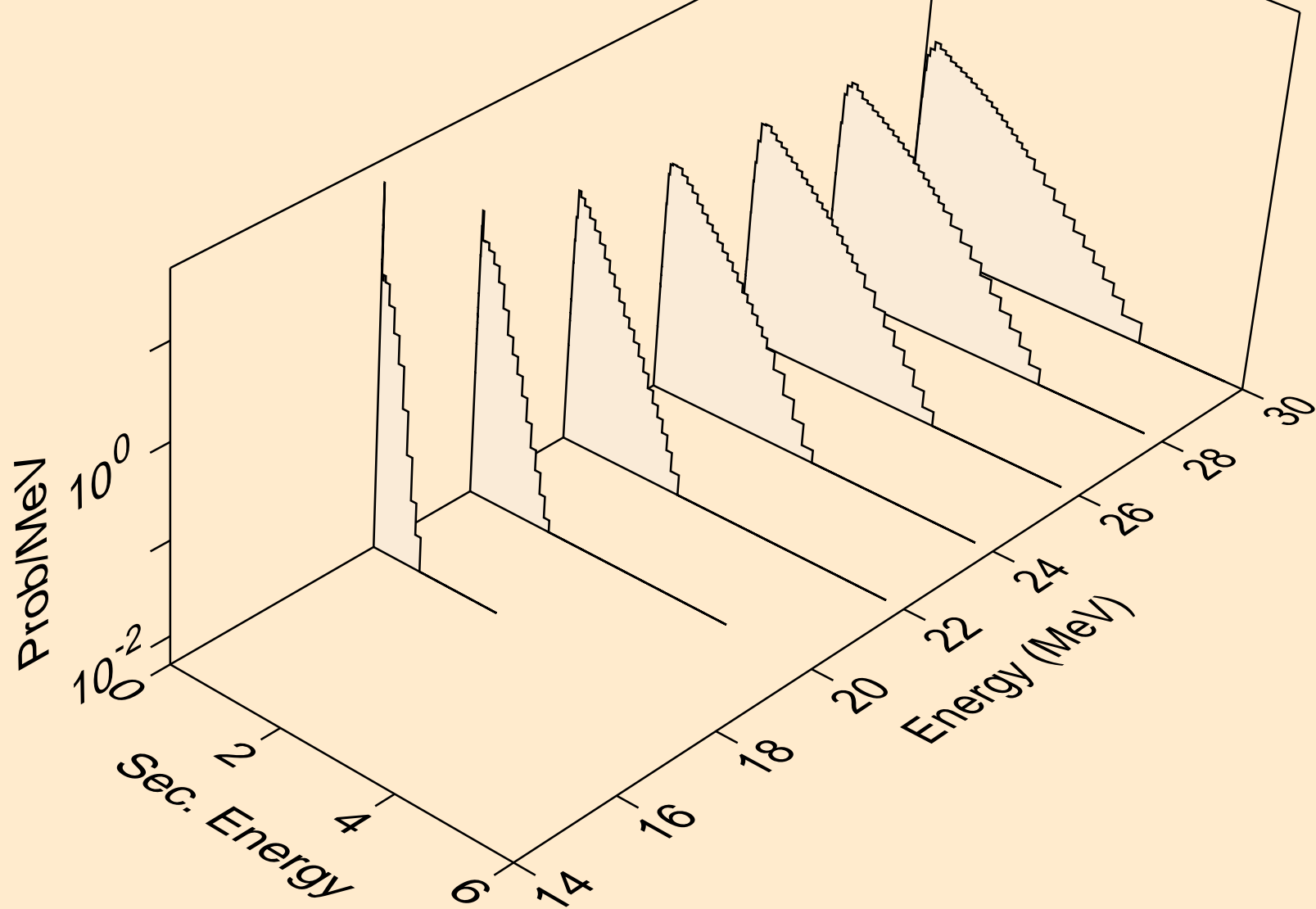

IN127N NEUTRON ACER TENDL-2024 LIBRARY; T=0.K
Neutron emission for (n,n*)t

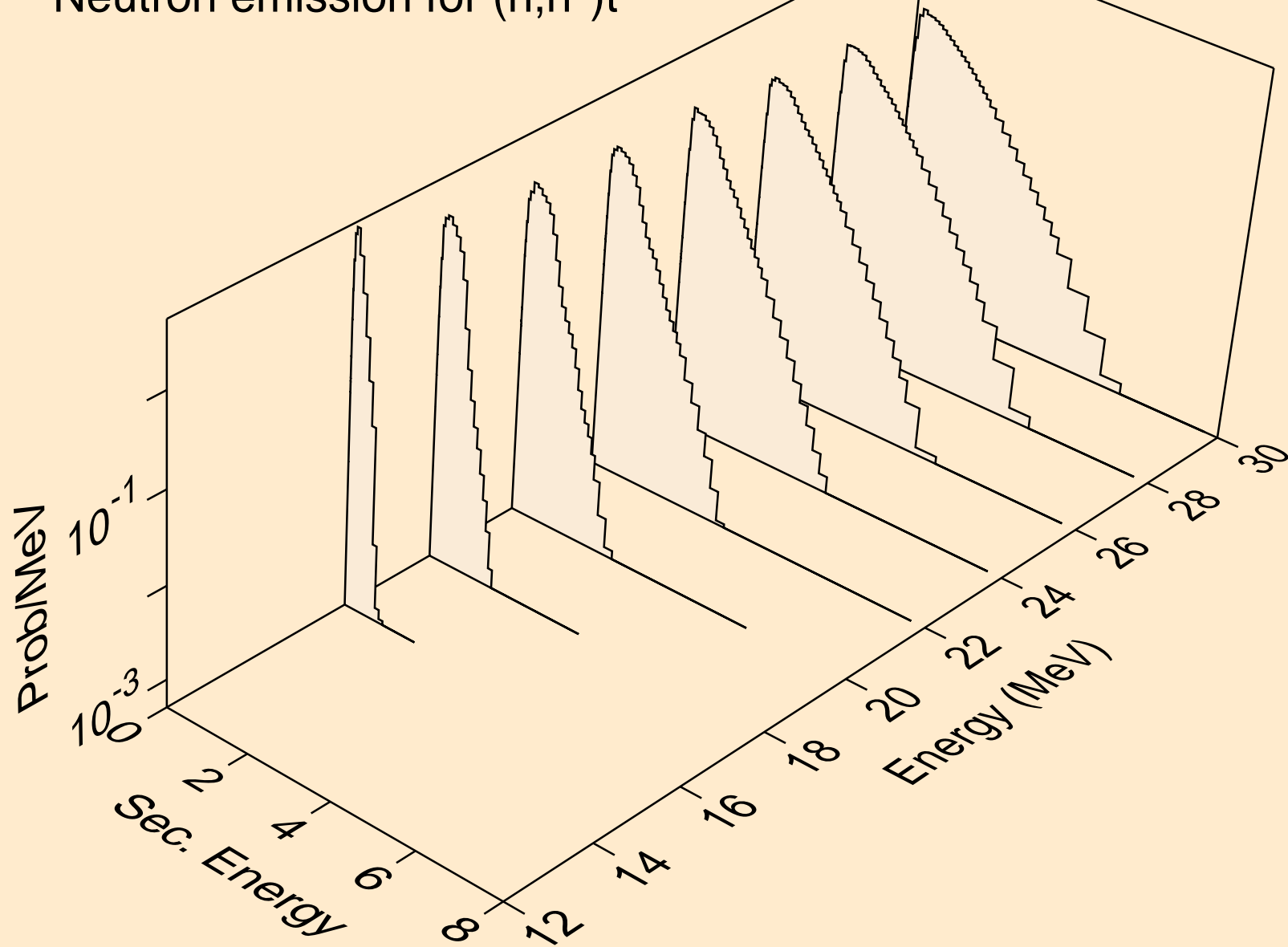

IN127N NEUTRON ACER TENDL-2024 LIBRARY; T=0.K
Neutron emission for (n,4n)

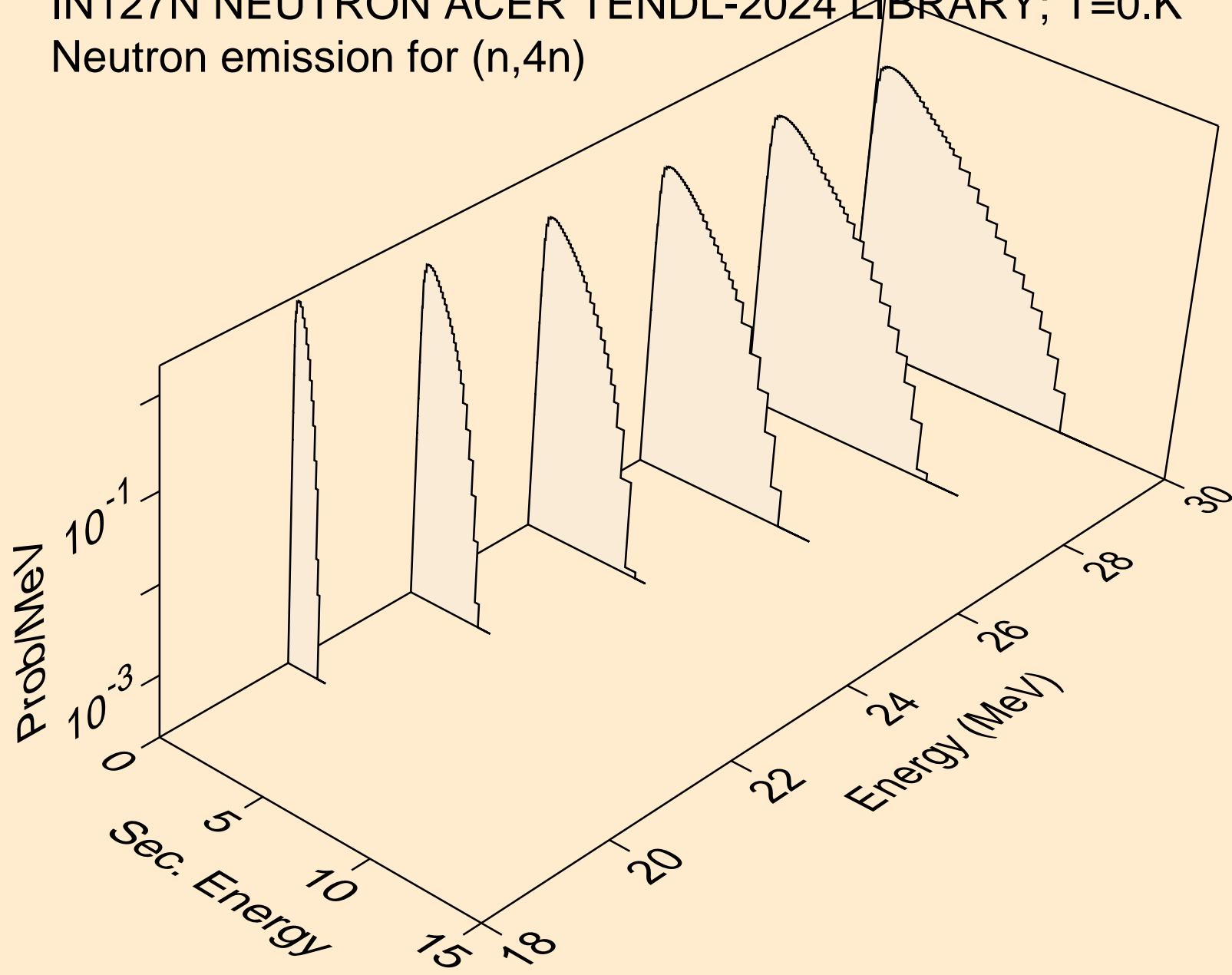

IN127N NEUTRON ACER TENDL-2024 LIBRARY; T=0.K
Neutron emission for (n,2np)

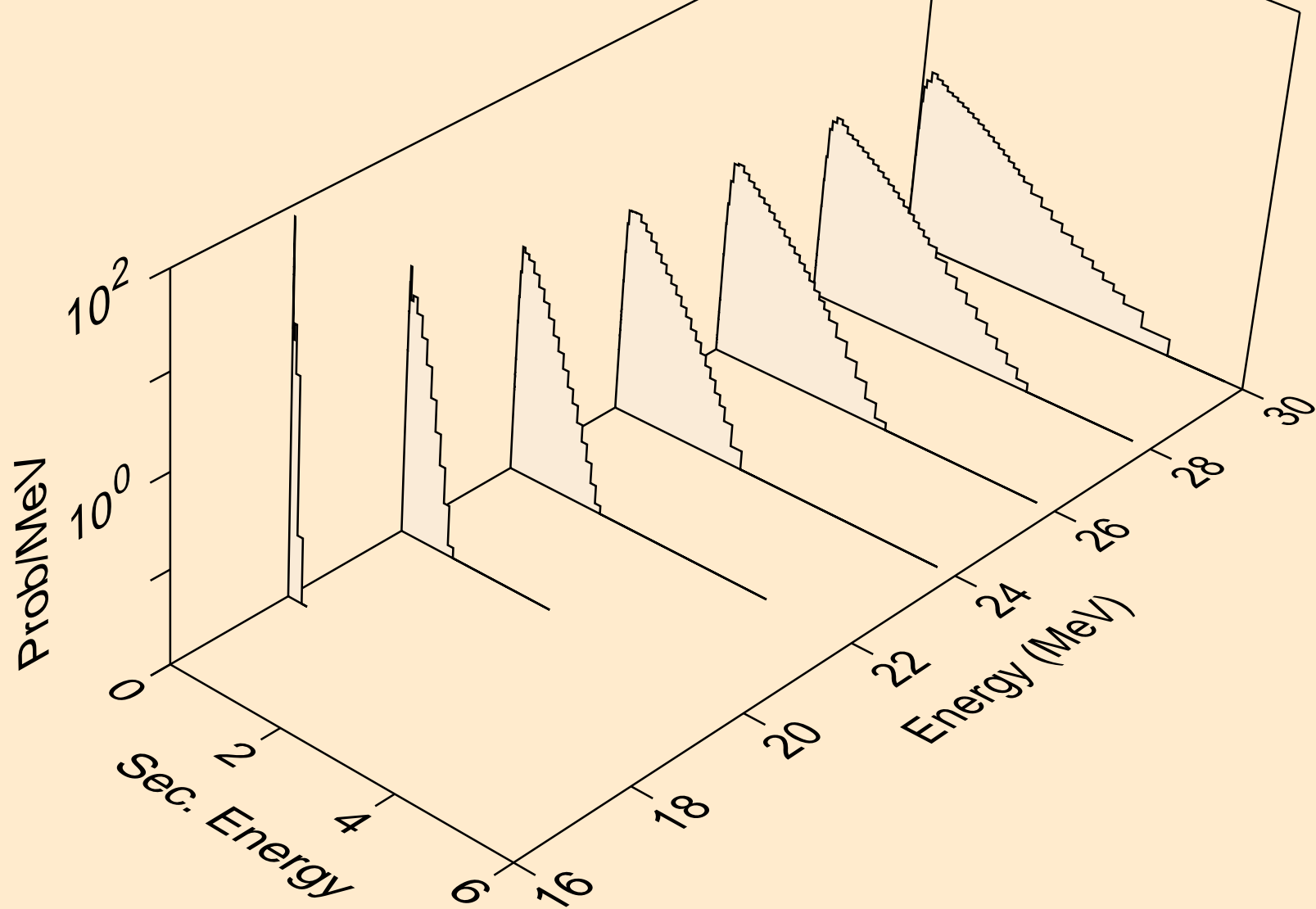

IN127N NEUTRON ACER TENDL-2024 LIBRARY; T=0.K
Neutron emission for (n,3np)

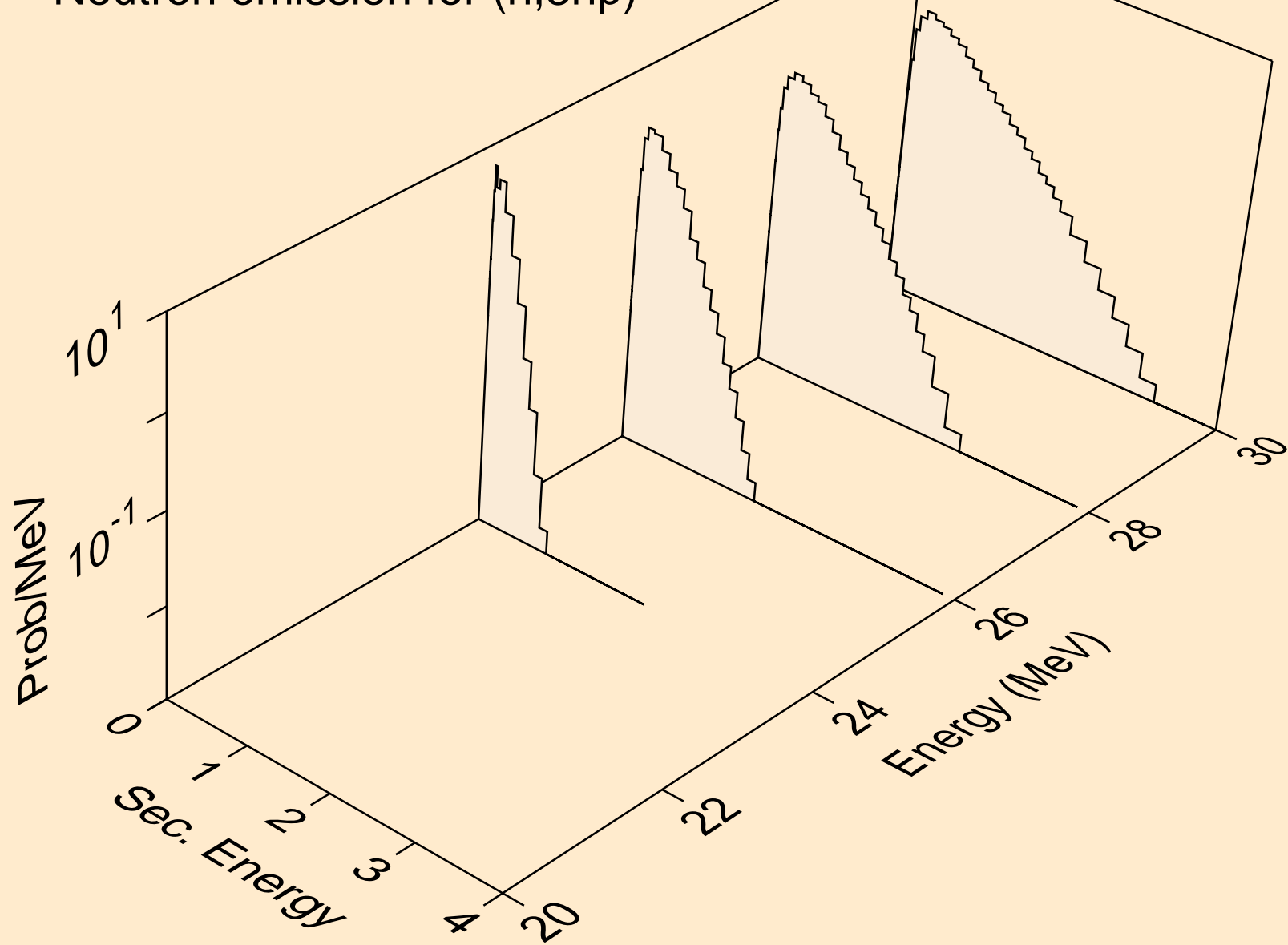

IN127N NEUTRON ACER TENDL-2024 LIBRARY; T=0.K
Neutron emission for (n,n*c)

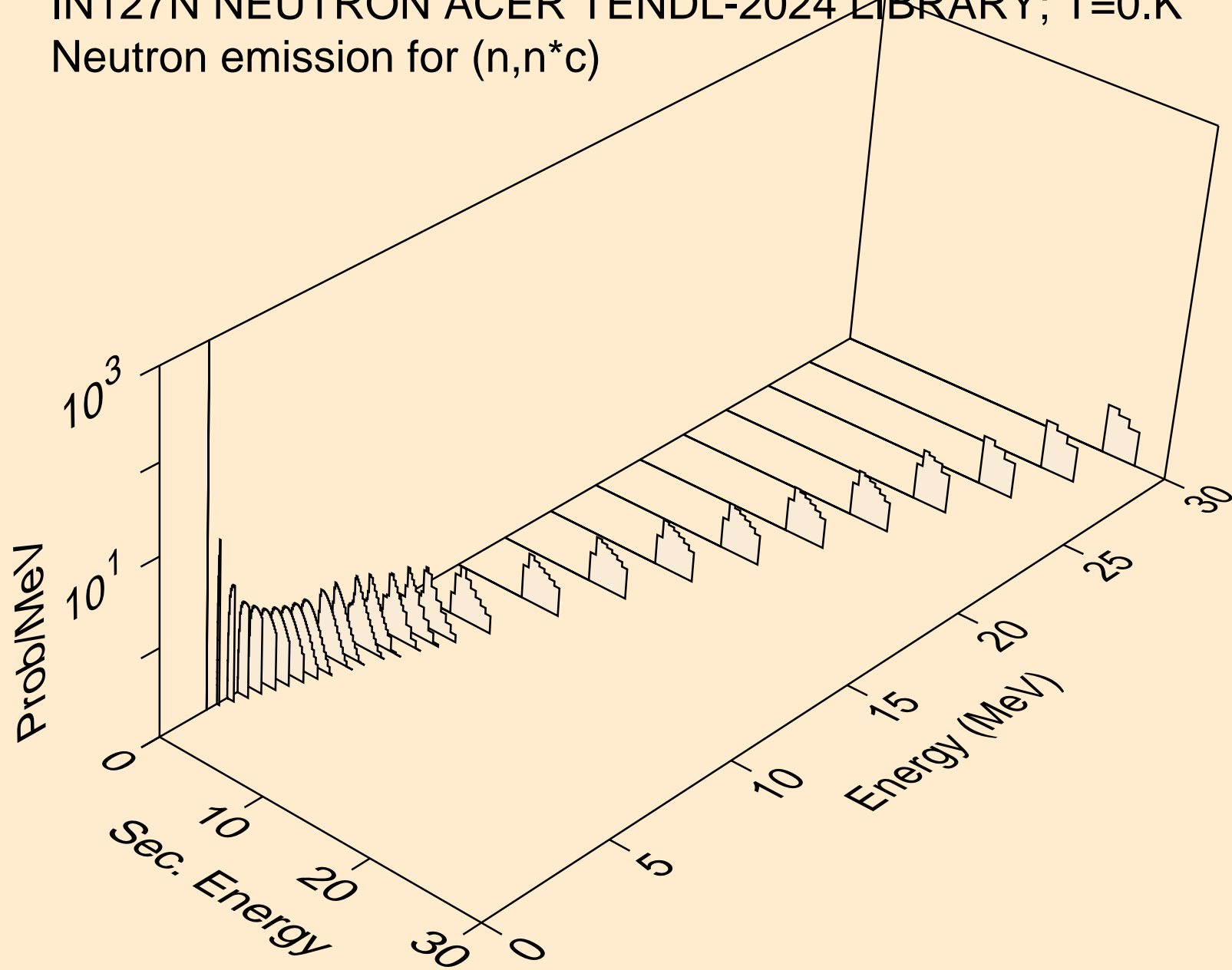

IN127N NEUTRON ACER TENDL-2024 LIBRARY; T=0.K
Photon emission for (n,x)

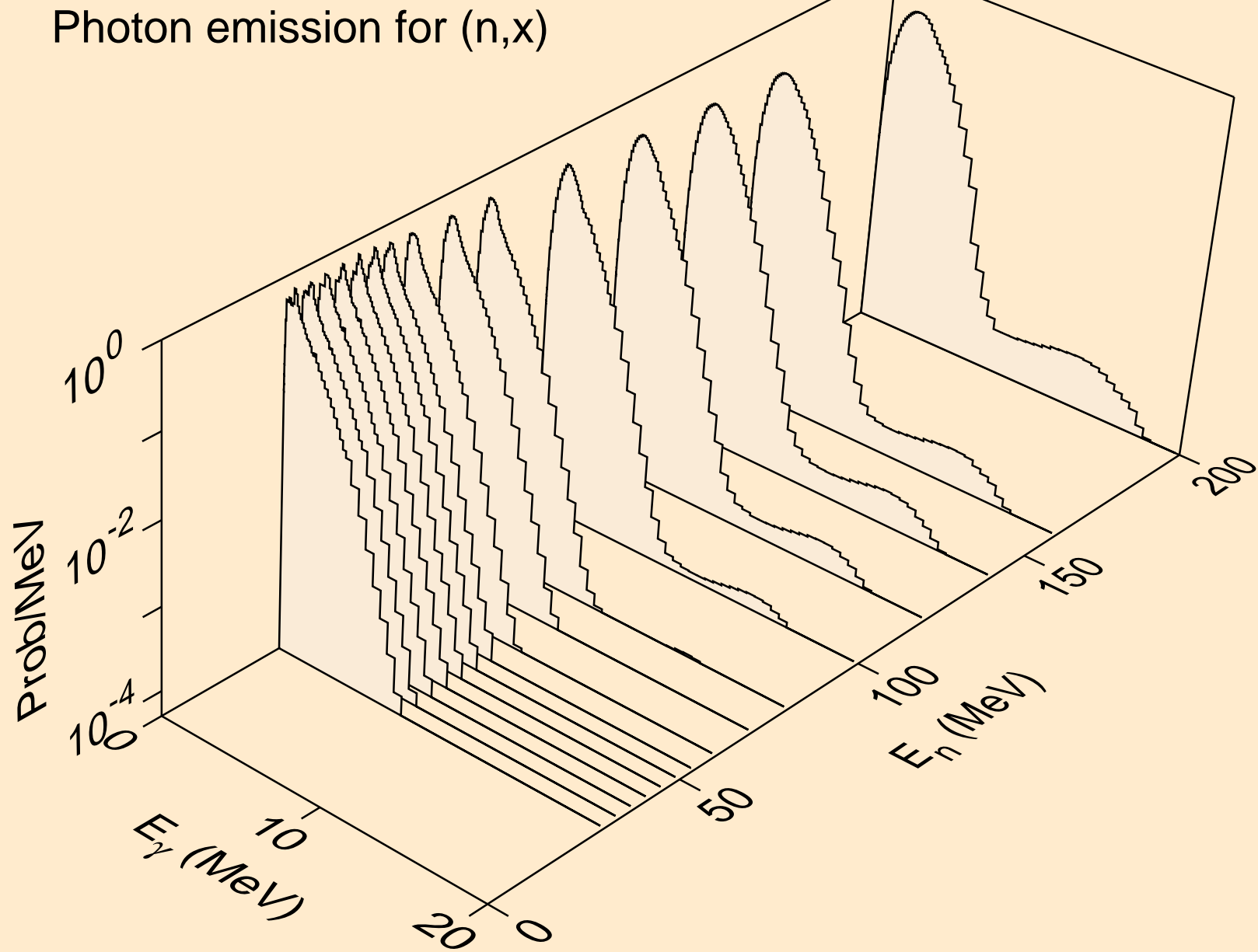

IN127N NEUTRON ACER TENDL-2024 LIBRARY; T=0.K
Photon emission for (n,2nd)

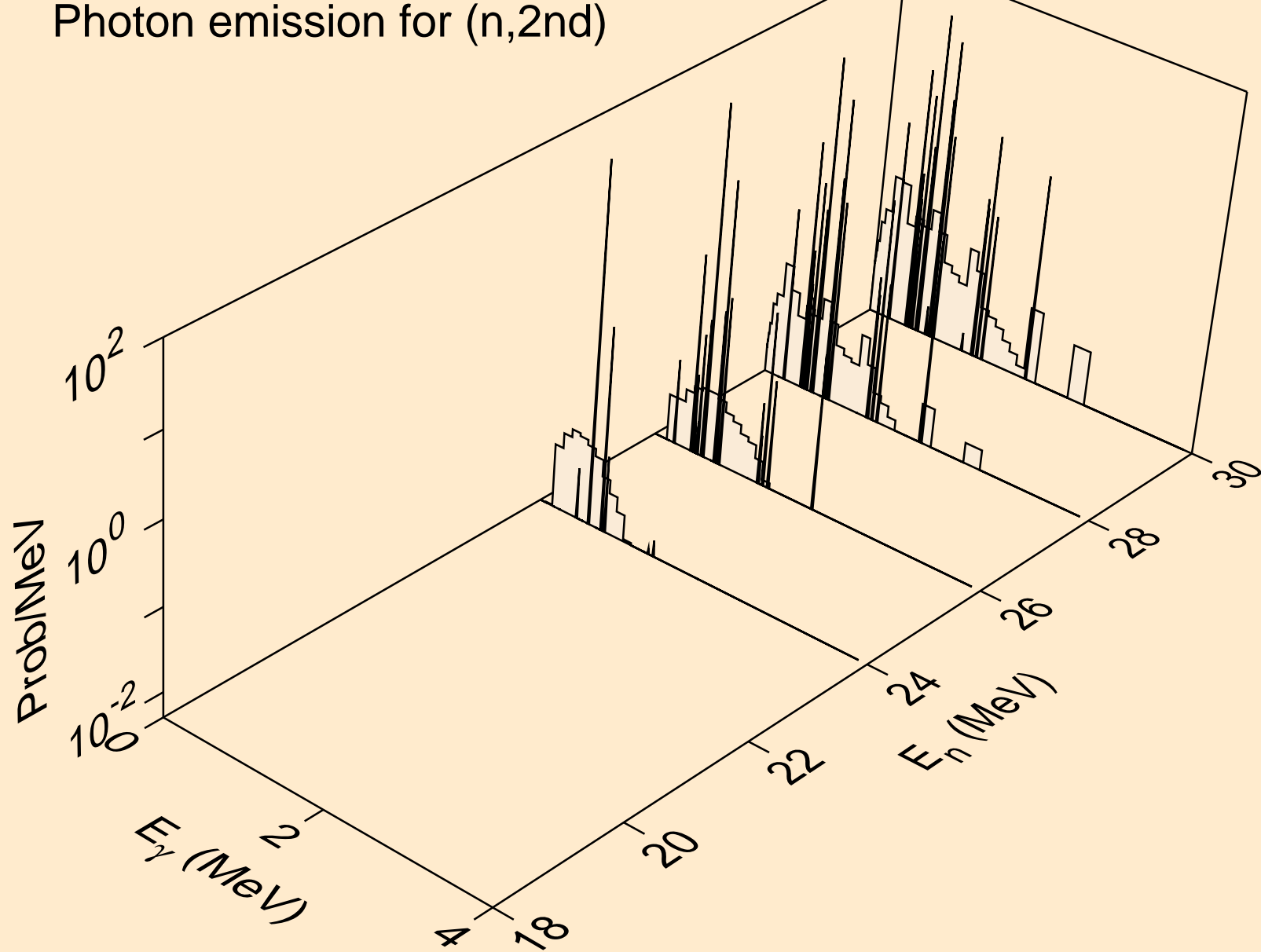

IN127N NEUTRON ACER TENDL-2024 LIBRARY; T=0.K
Photon emission for (n,2n)

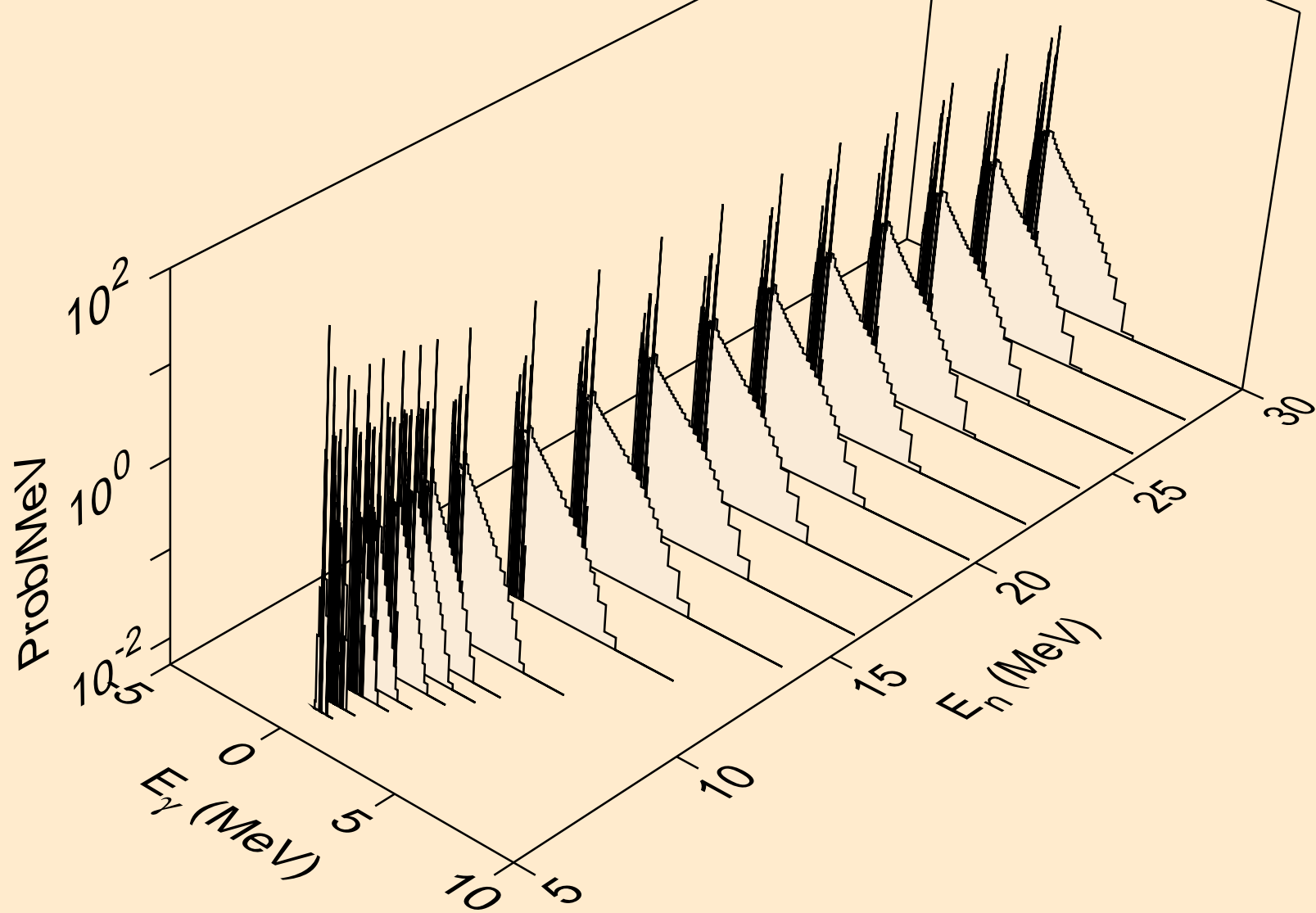

IN127N NEUTRON ACER TENDL-2024 LIBRARY; T=0.K
Photon emission for (n,3n)

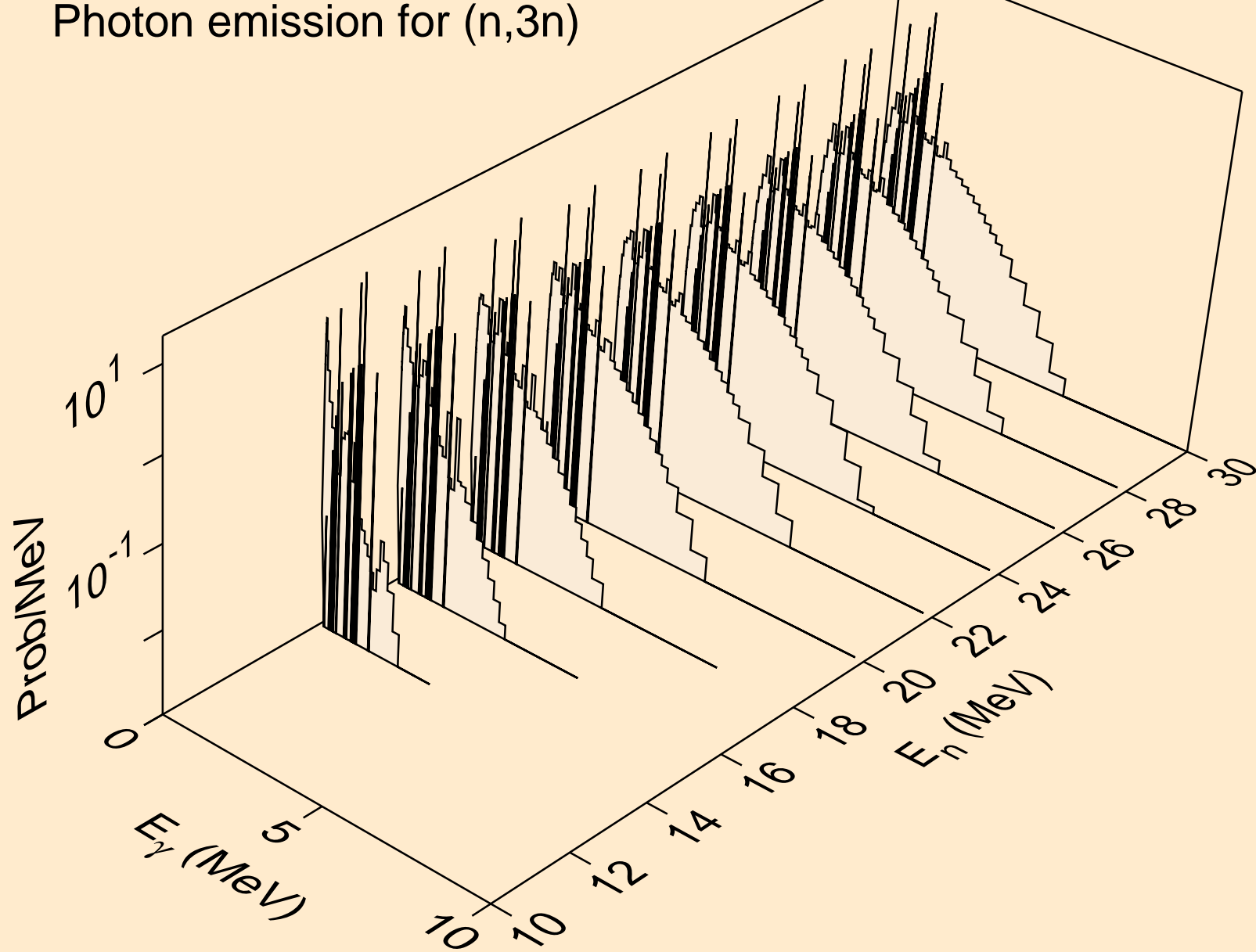

IN127N NEUTRON ACER TENDL-2024 LIBRARY; T=0.K
Photon emission for (n,n*)a

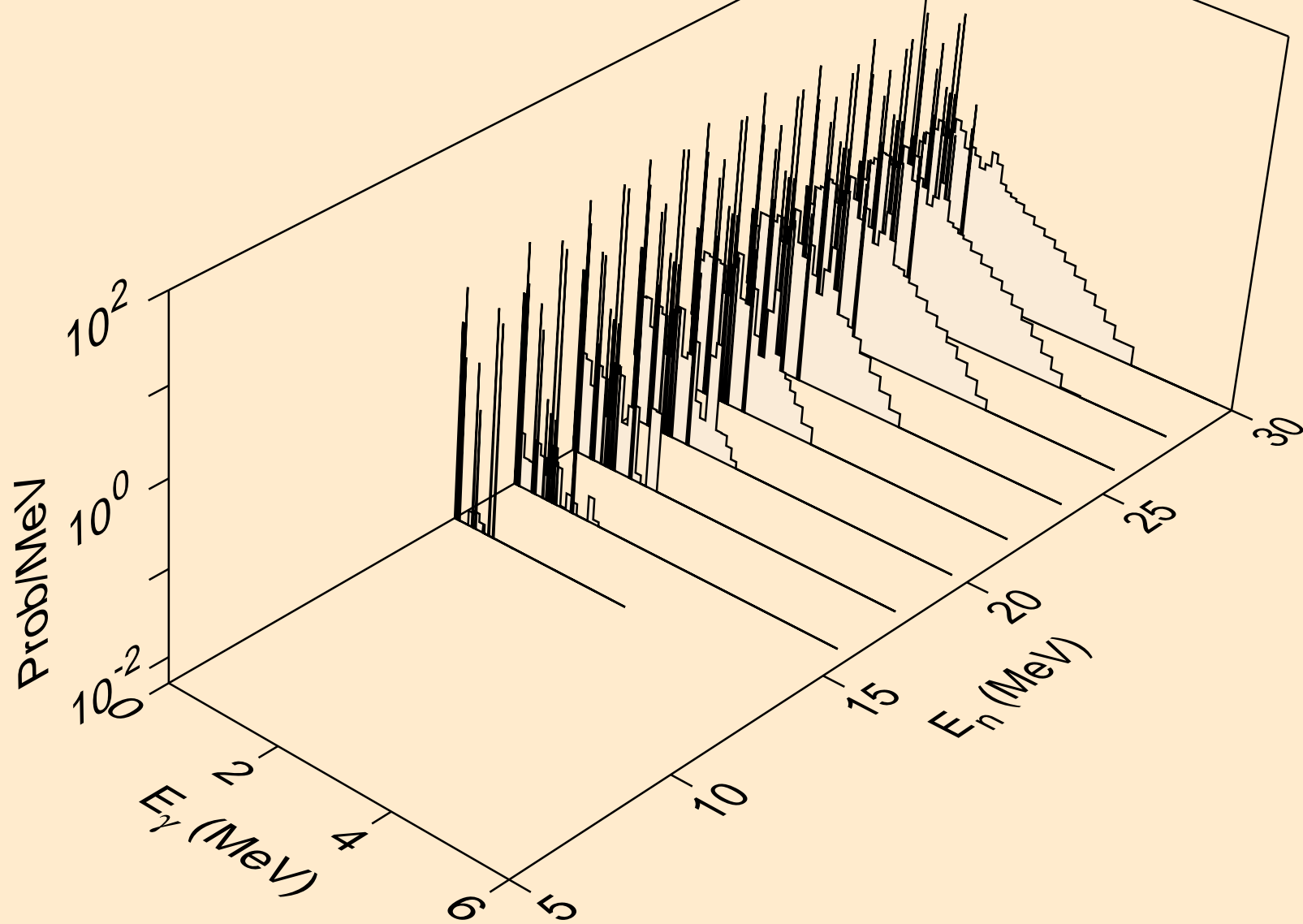

IN127N NEUTRON ACER TENDL-2024 LIBRARY; T=0.K
Photon emission for (n,2n)a

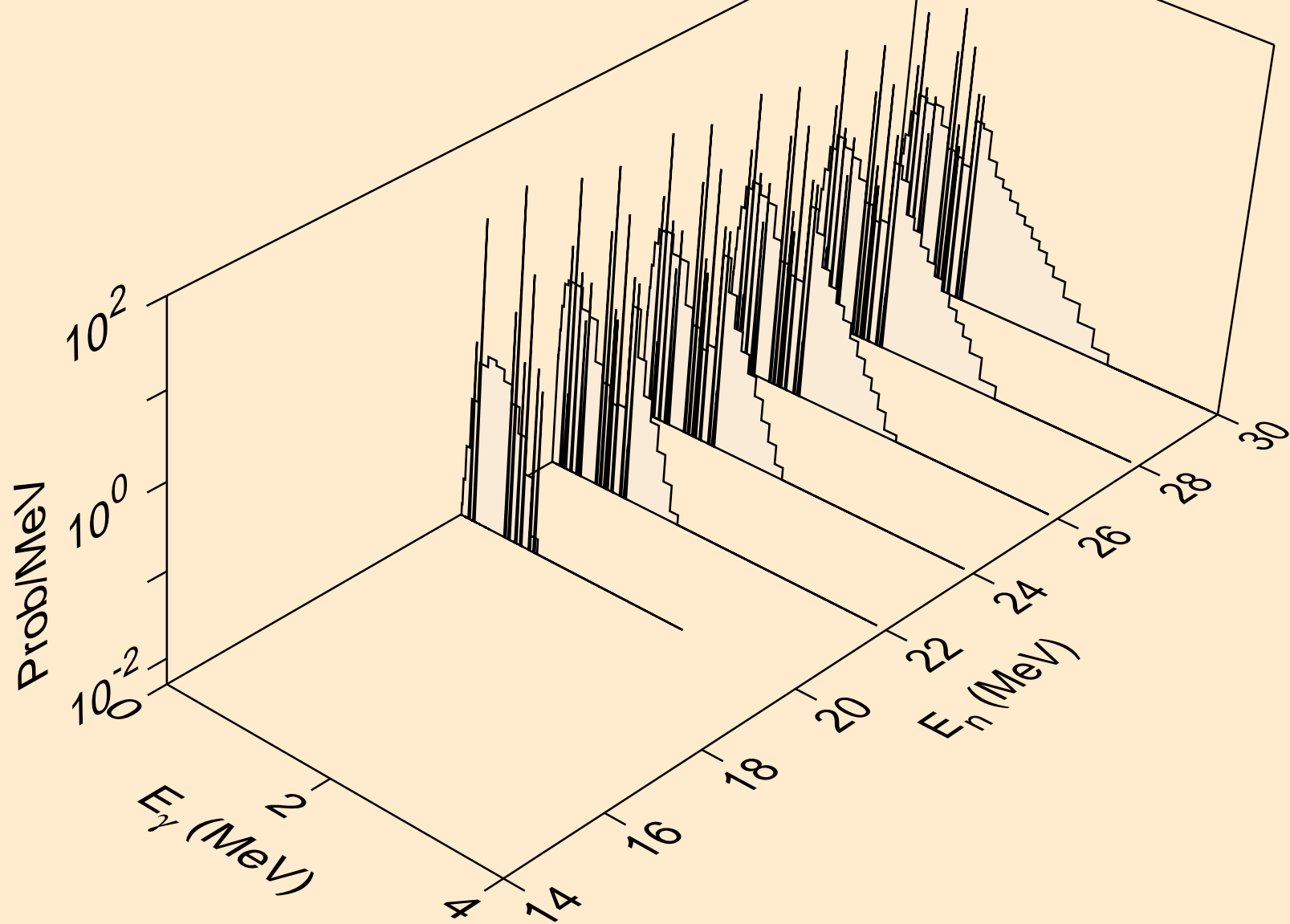

IN127N NEUTRON ACER TENDL-2024 LIBRARY; T=0.K
Photon emission for (n,3n)a

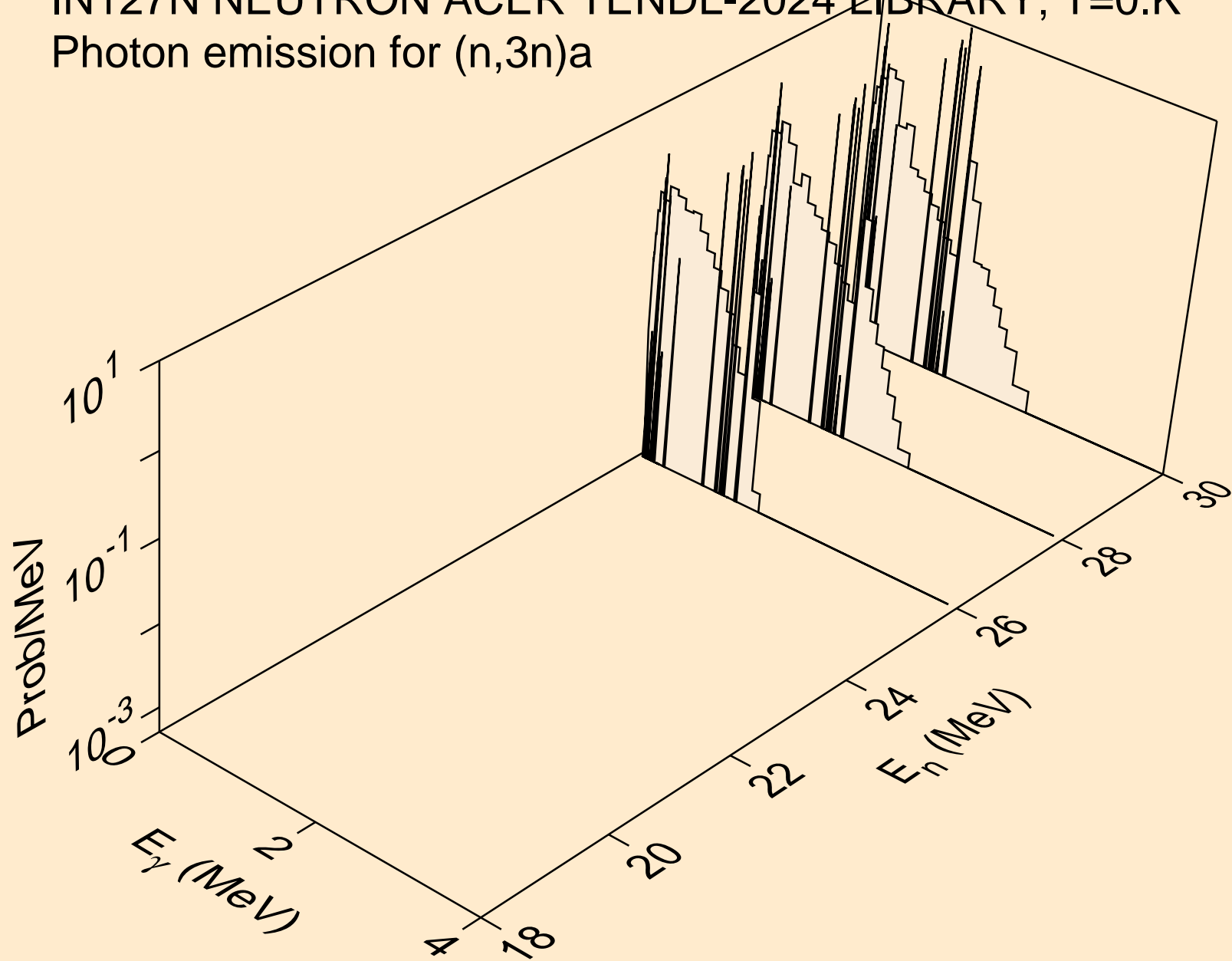

IN127N NEUTRON ACER TENDL-2024 LIBRARY; T=0.K
Photon emission for (n,n*)p

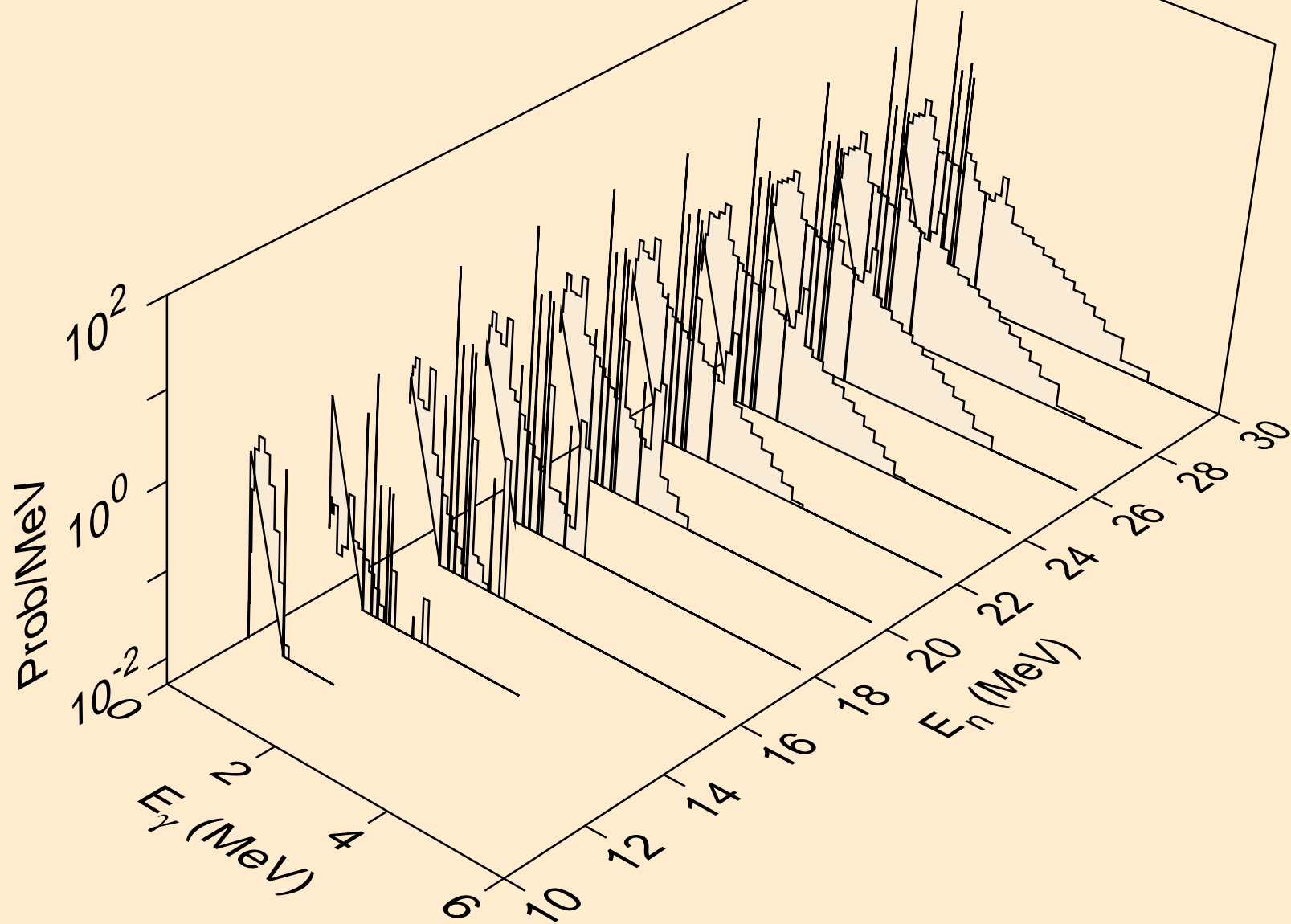

IN127N NEUTRON ACER TENDL-2024 LIBRARY; T=0.K
Photon emission for (n,n*)d

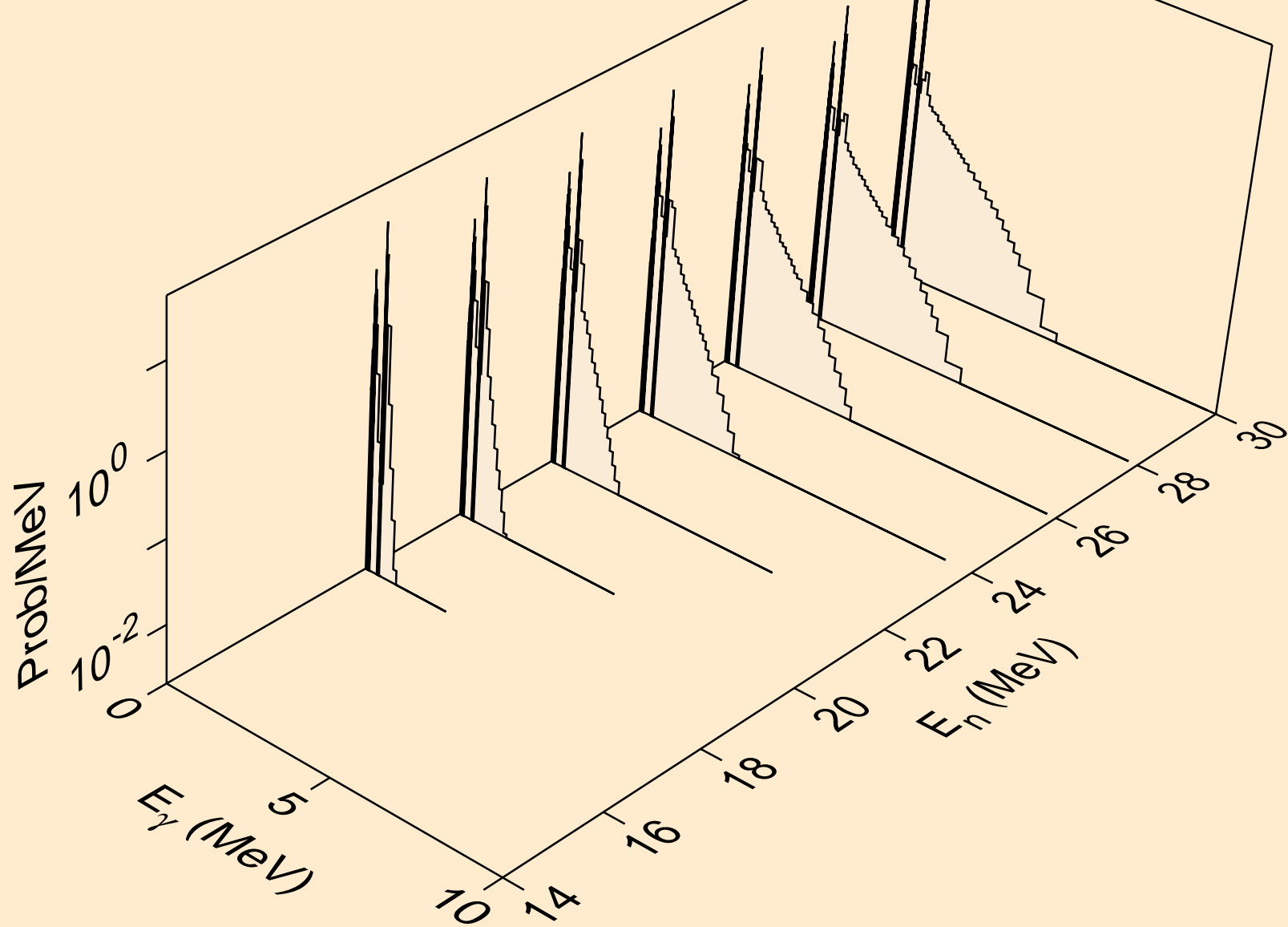

IN127N NEUTRON ACER TENDL-2024 LIBRARY; T=0.K
Photon emission for (n,n*)t

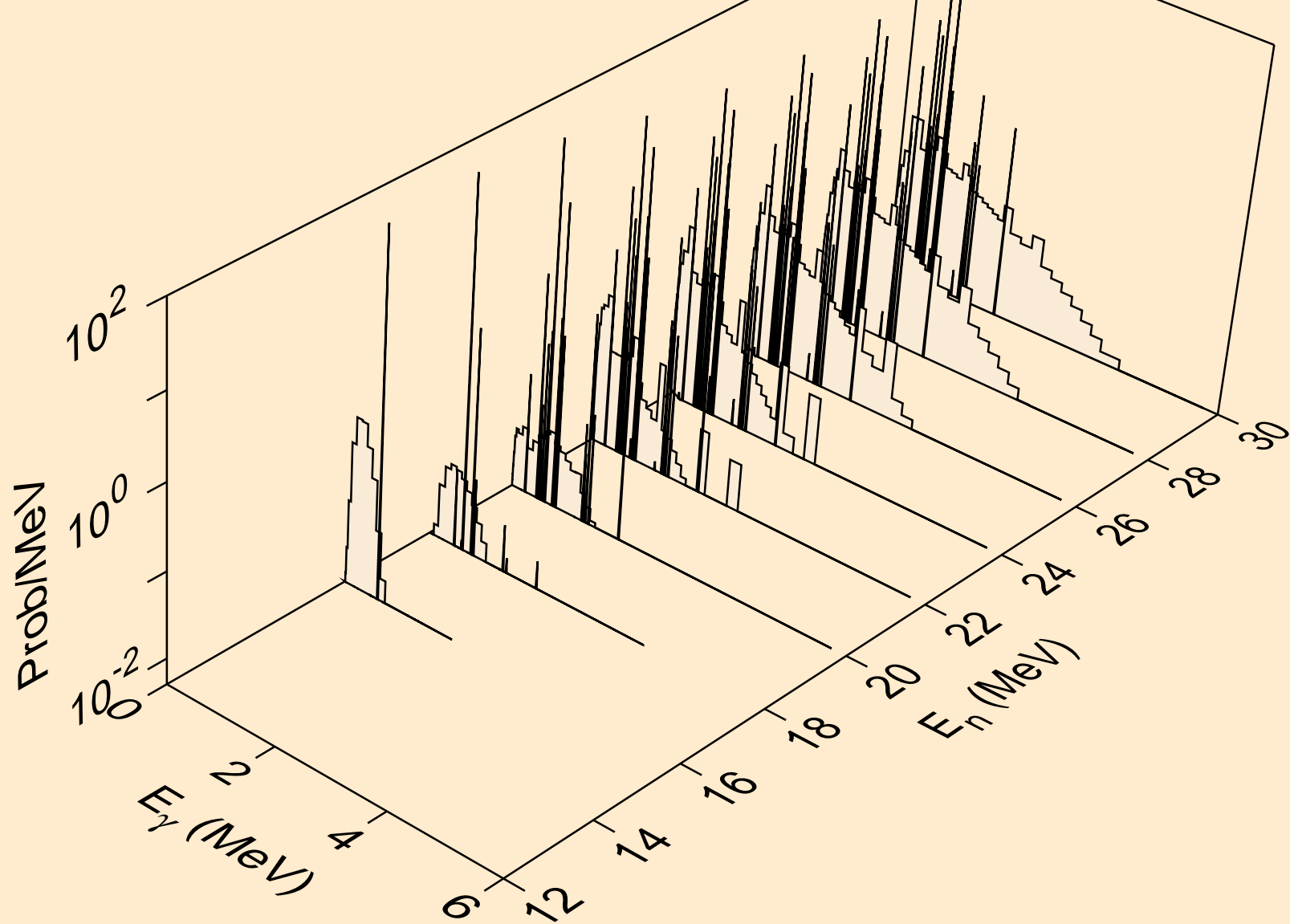

IN127N NEUTRON ACER TENDL-2024 LIBRARY; T=0.K
Photon emission for (n,4n)

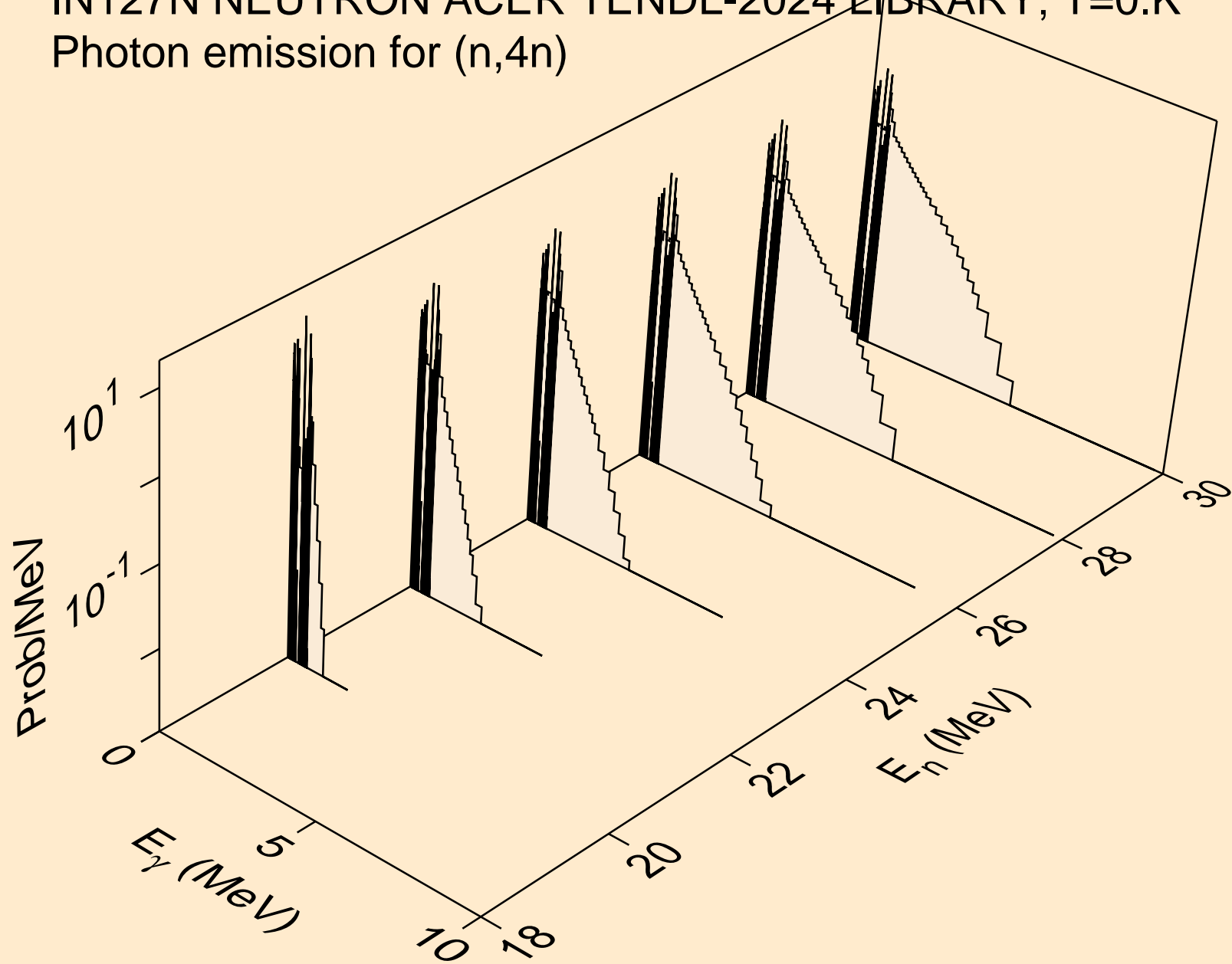

IN127N NEUTRON ACER TENDL-2024 LIBRARY; T=0.K
Photon emission for (n,2np)

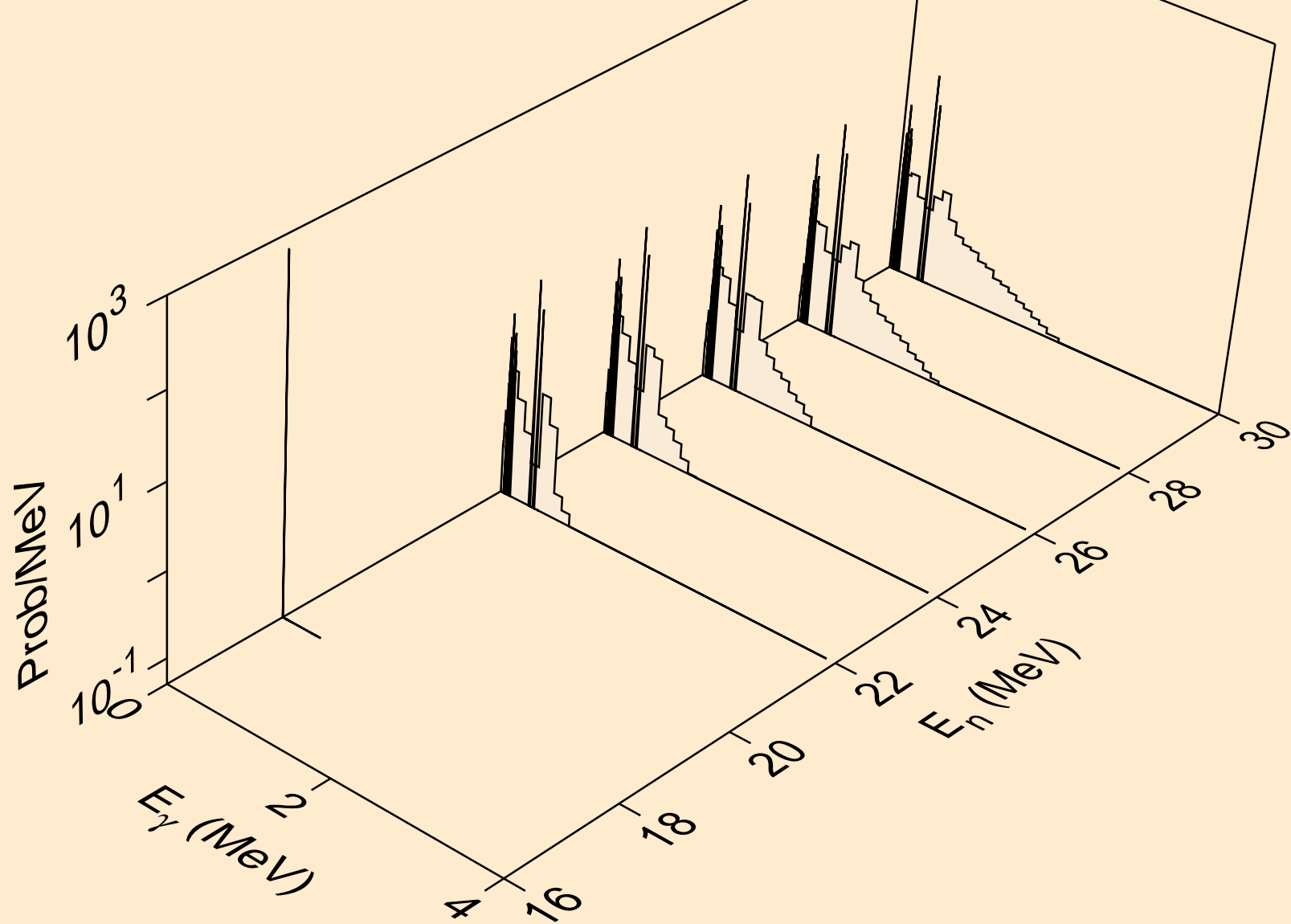

IN127N NEUTRON ACER TENDL-2024 LIBRARY; T=0.K
Photon emission for (n,3np)

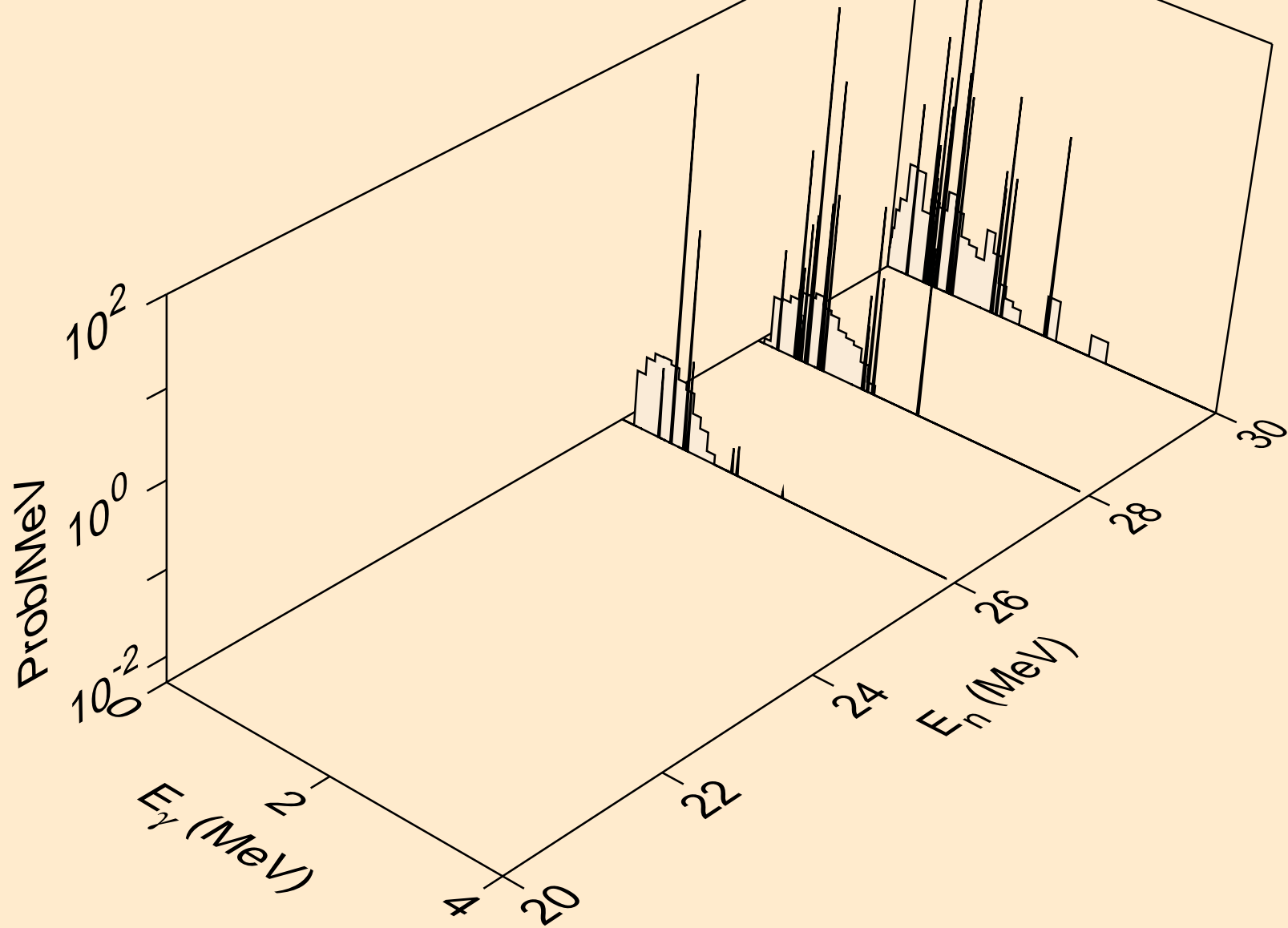

IN127N NEUTRON ACER TENDL-2024 LIBRARY; T=0.K
Photon emission for (n,n*2)

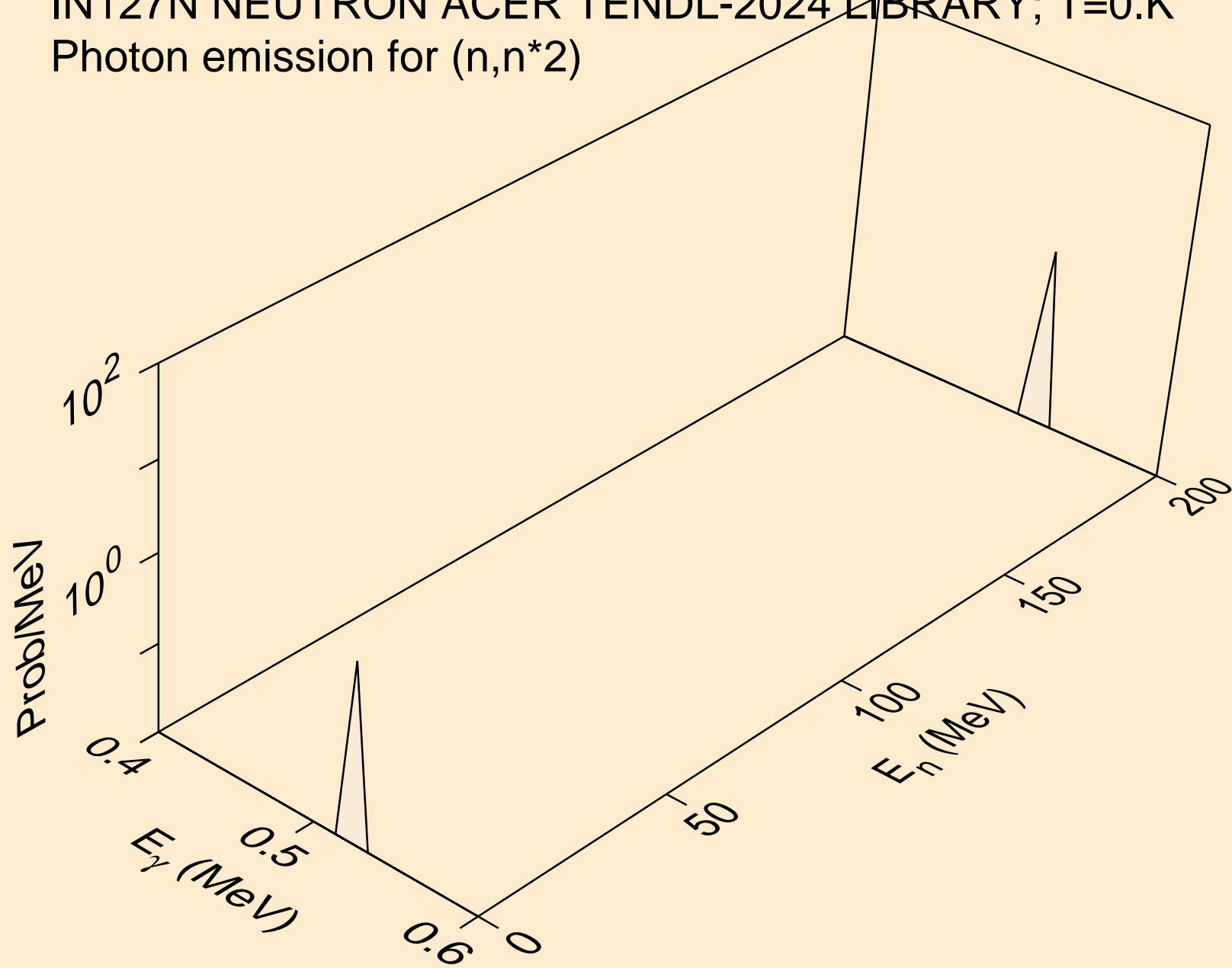

IN127N NEUTRON ACER TENDL-2024 LIBRARY; T=0.K
Photon emission for (n,n*3)

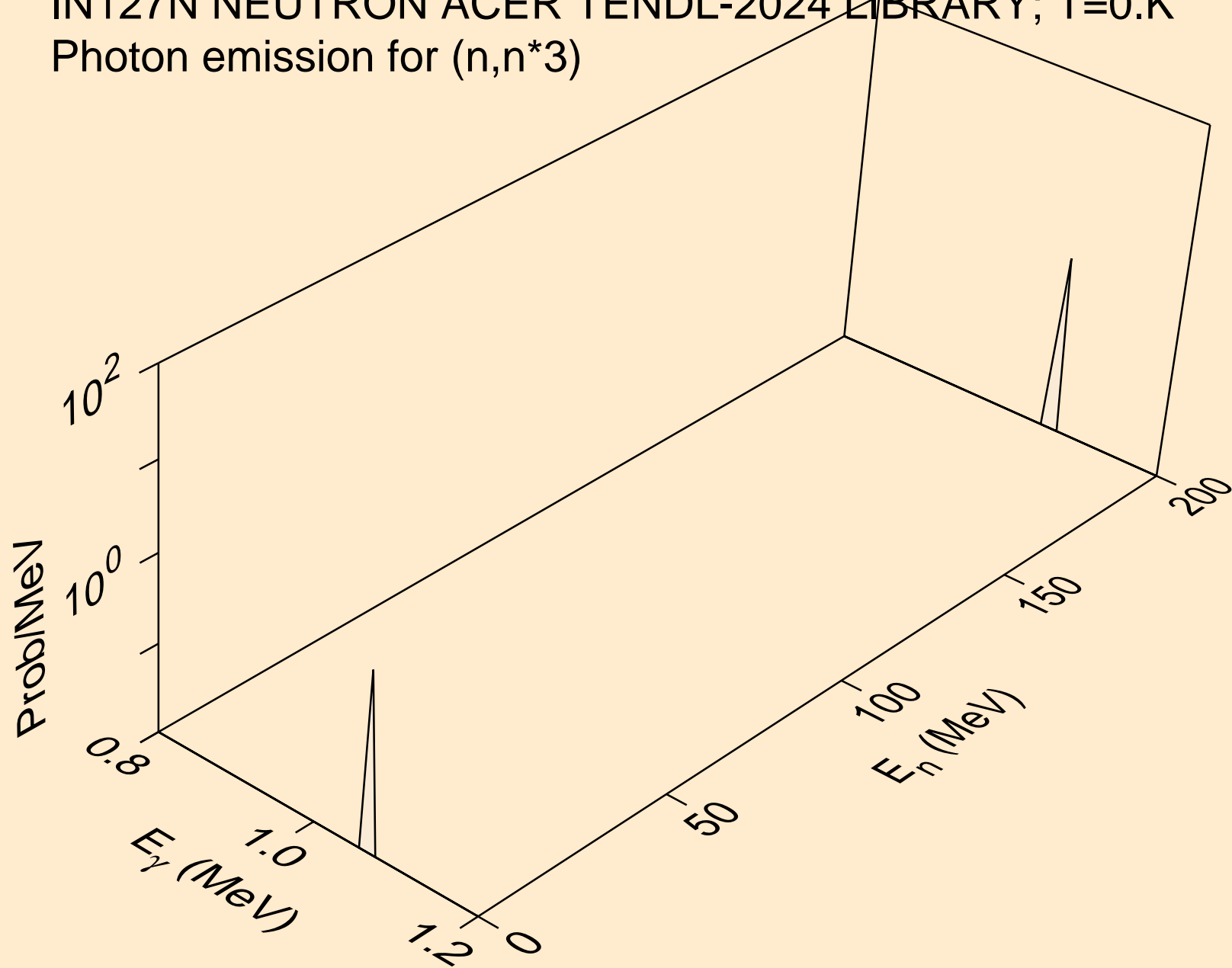

IN127N NEUTRON ACER TENDL-2024 LIBRARY; T=0.K
Photon emission for (n,n*4)

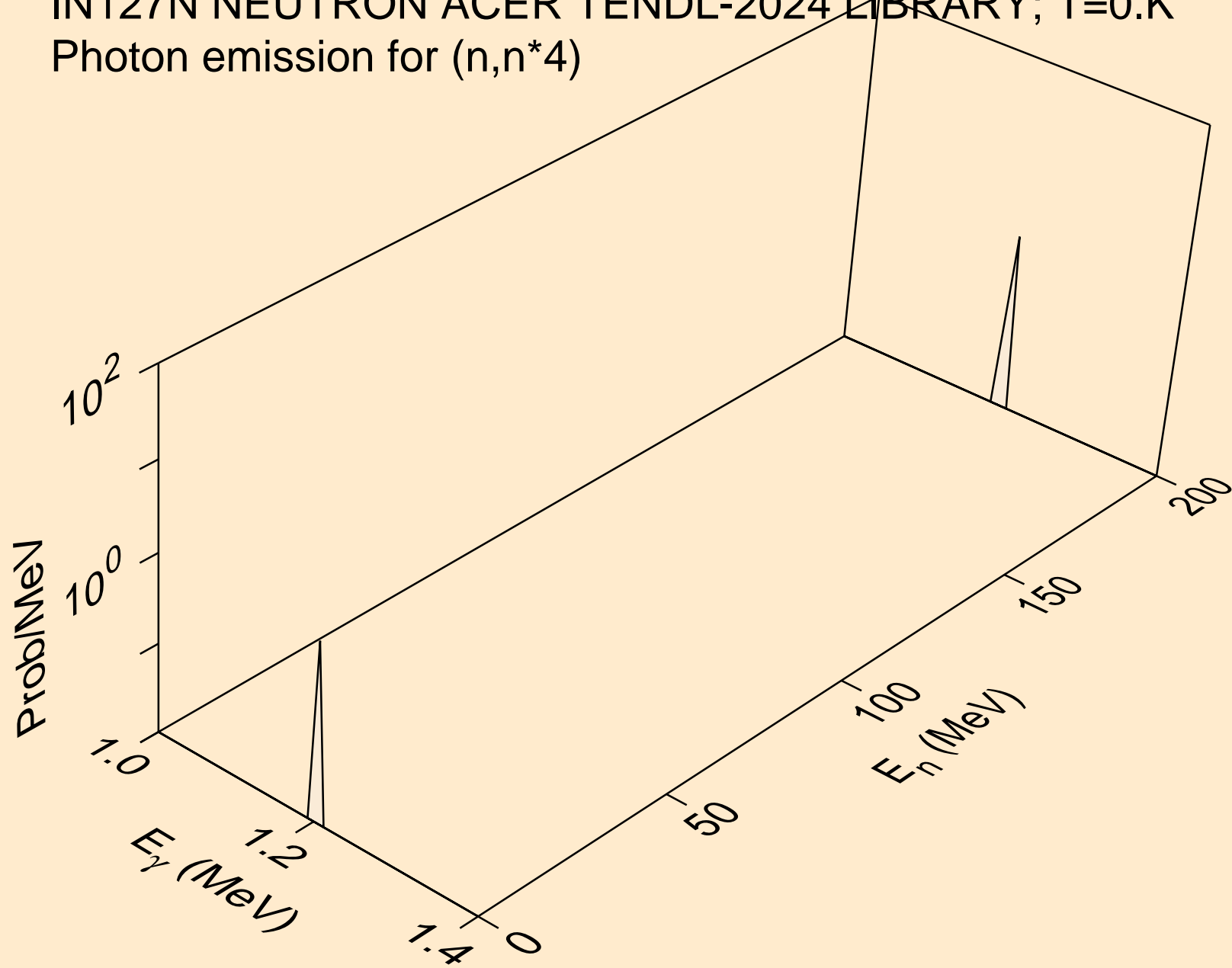

IN127N NEUTRON ACER TENDL-2024 LIBRARY; T=0.K
Photon emission for (n,n*5)

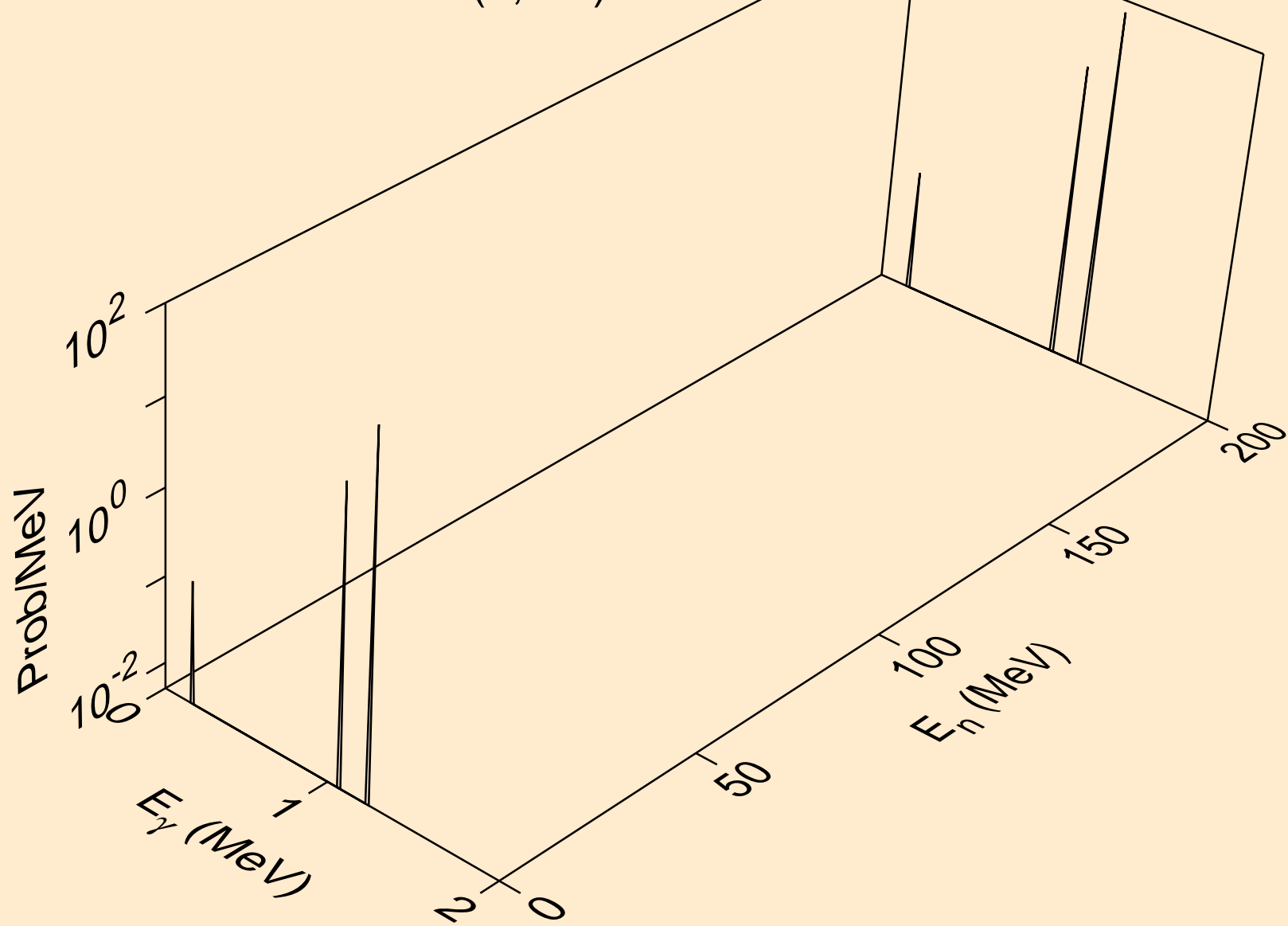

IN127N NEUTRON ACER TENDL-2024 LIBRARY; T=0.K
Photon emission for (n,n*6)

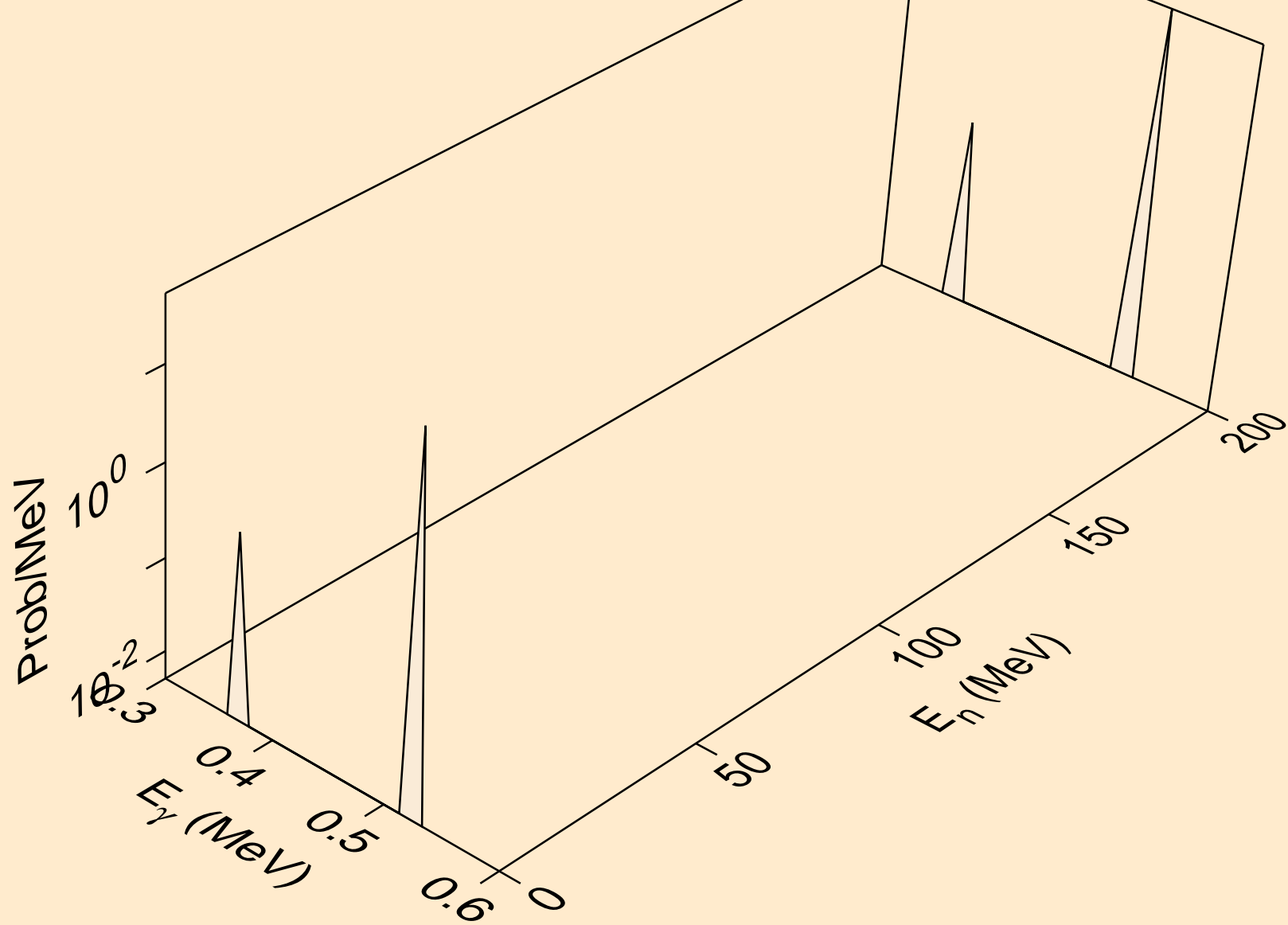

IN127N NEUTRON ACER TENDL-2024 LIBRARY; T=0.K
Photon emission for (n,n*7)

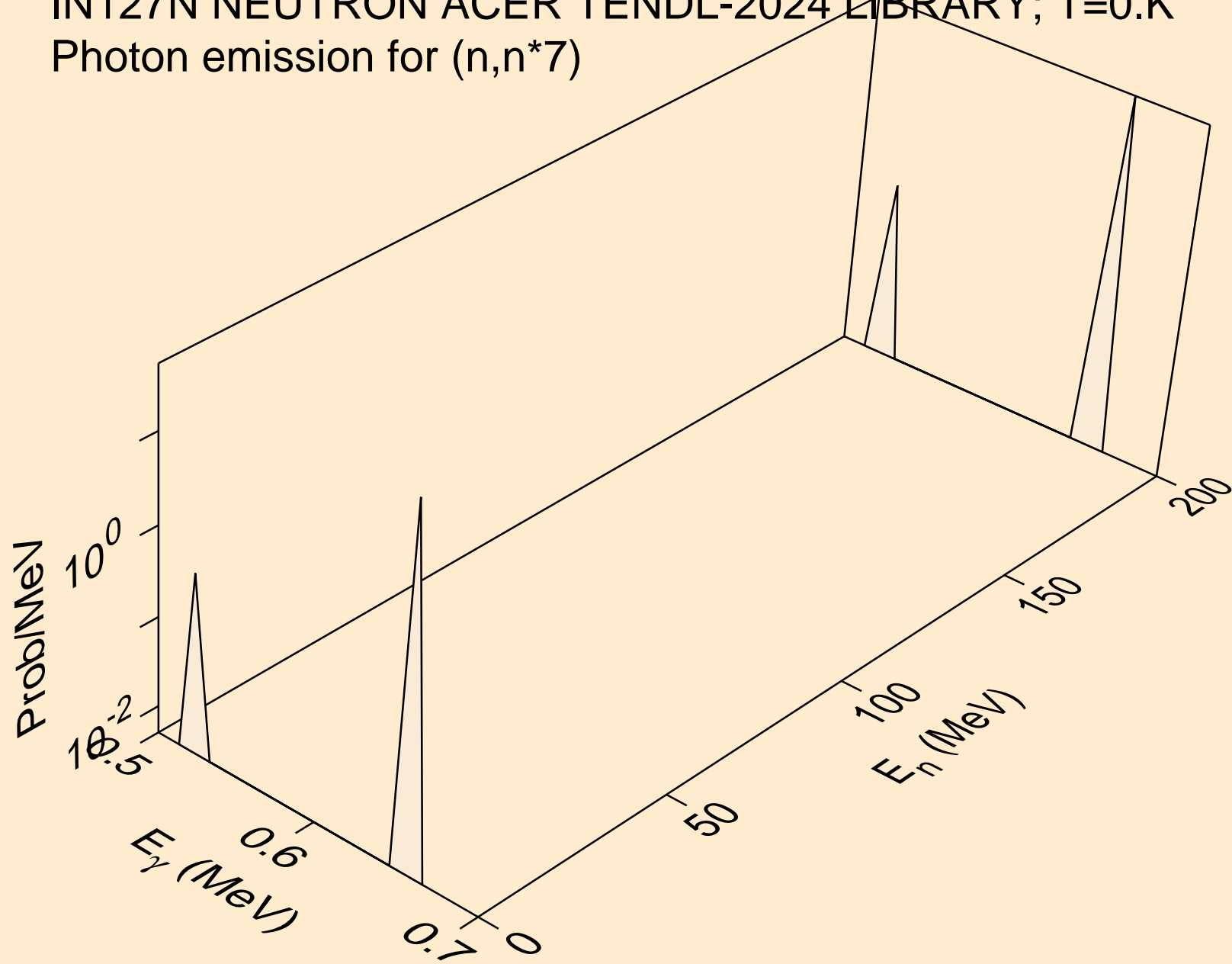

IN127N NEUTRON ACER TENDL-2024 LIBRARY; T=0.K
Photon emission for (n,n*8)

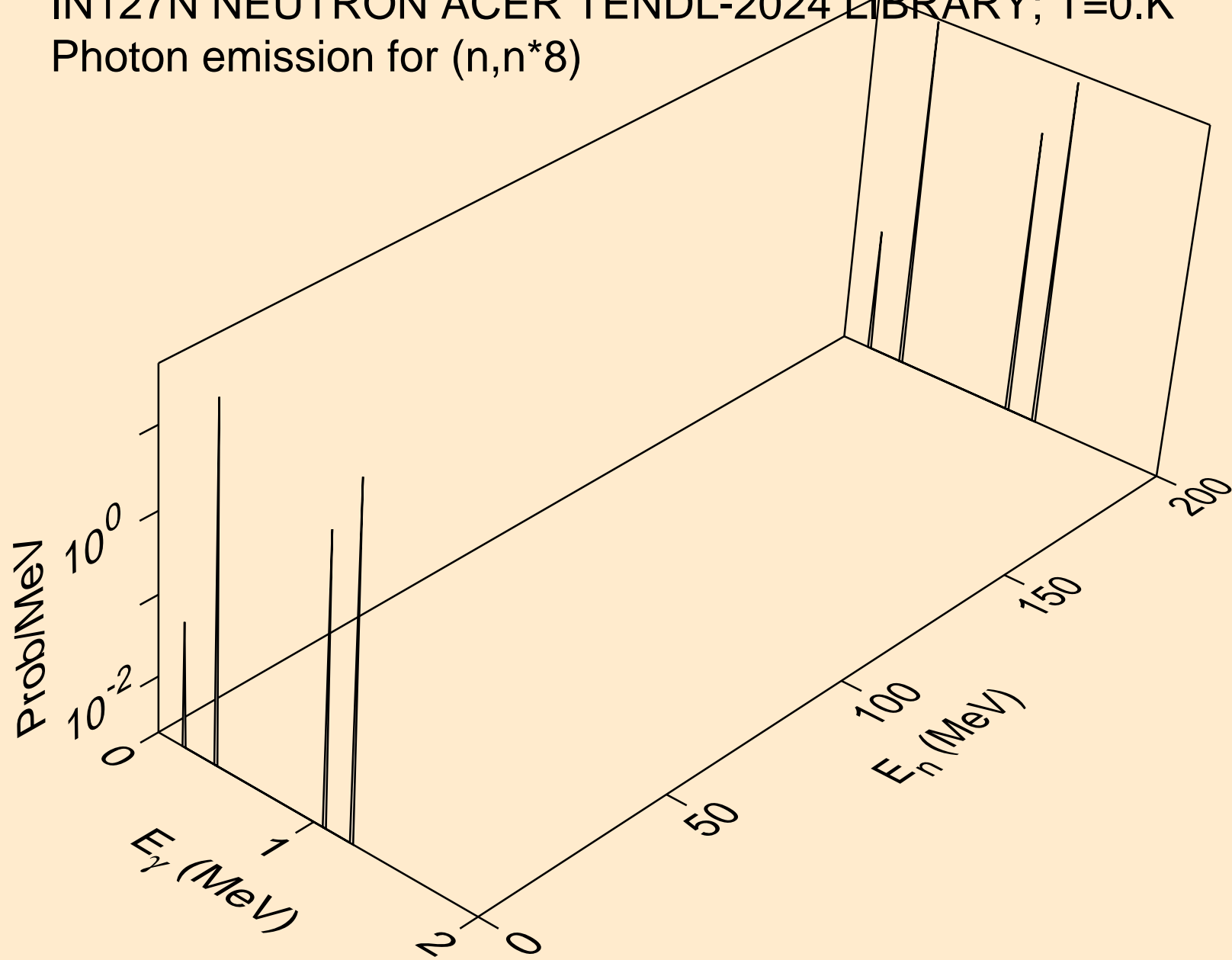

IN127N NEUTRON ACER TENDL-2024 LIBRARY; T=0.K
Photon emission for (n,n*10)

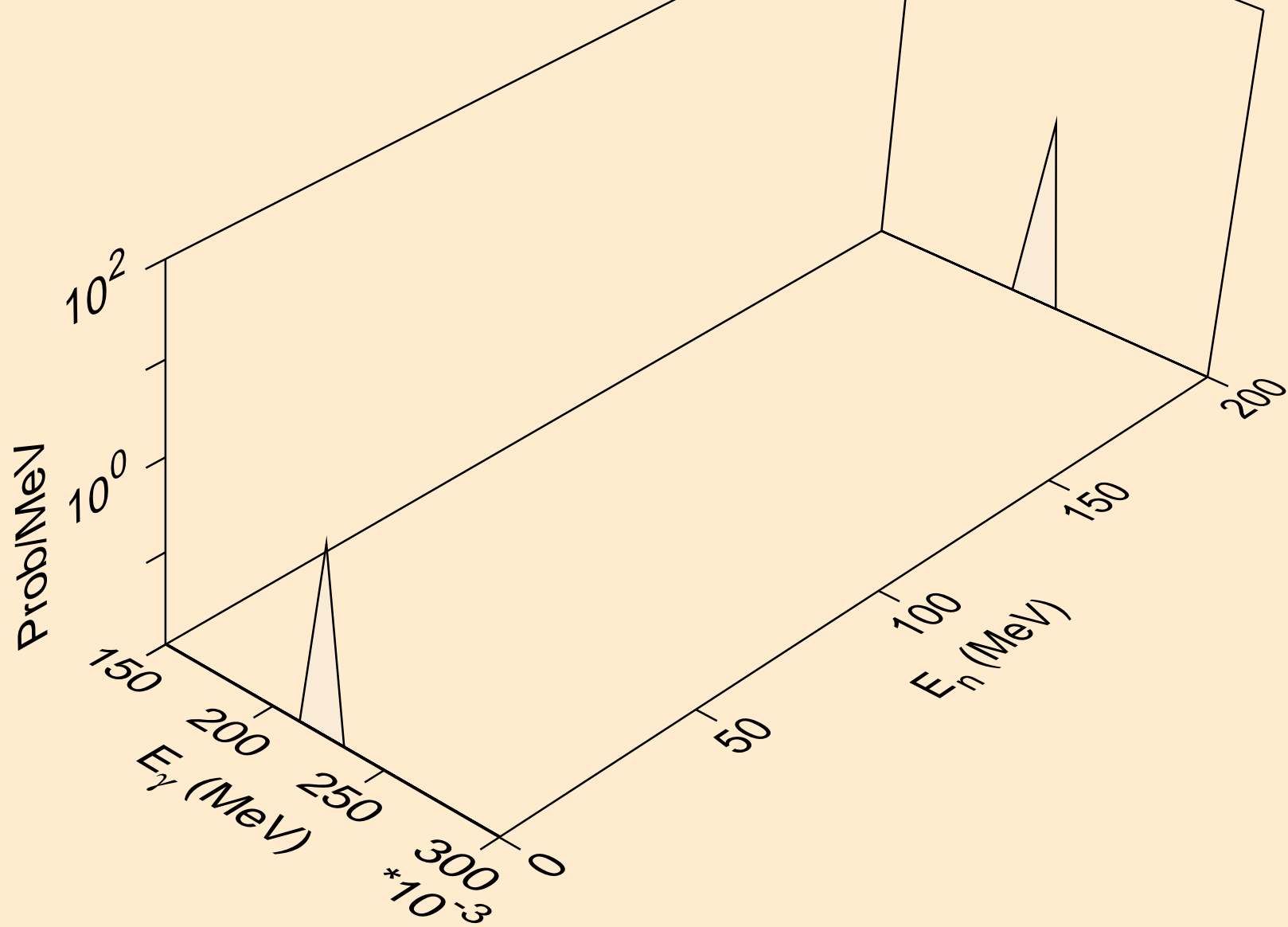

IN127N NEUTRON ACER TENDL-2024 LIBRARY; T=0.K
Photon emission for (n,n*11)

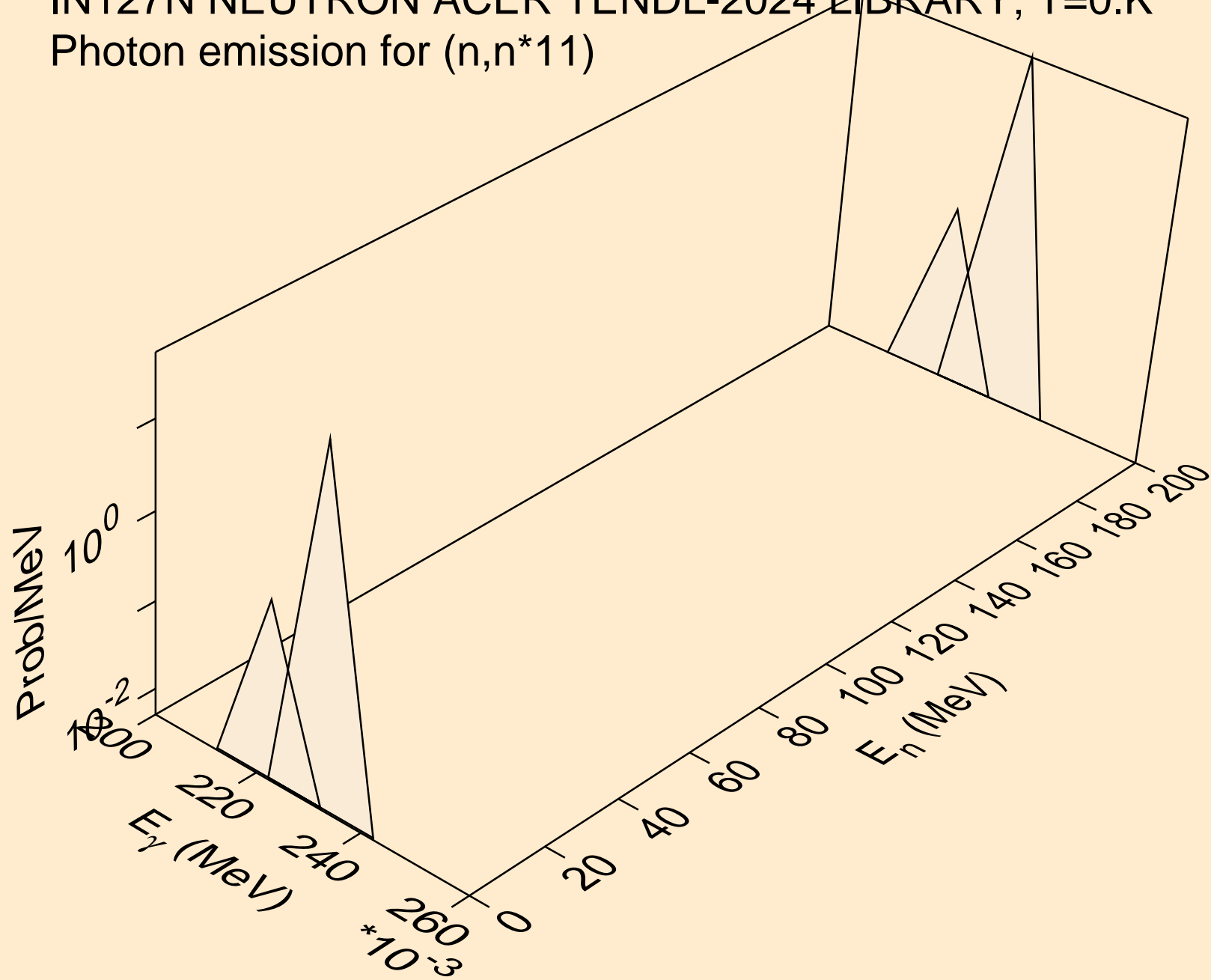

IN127N NEUTRON ACER TENDL-2024 LIBRARY; T=0.K
Photon emission for (n,n*12)

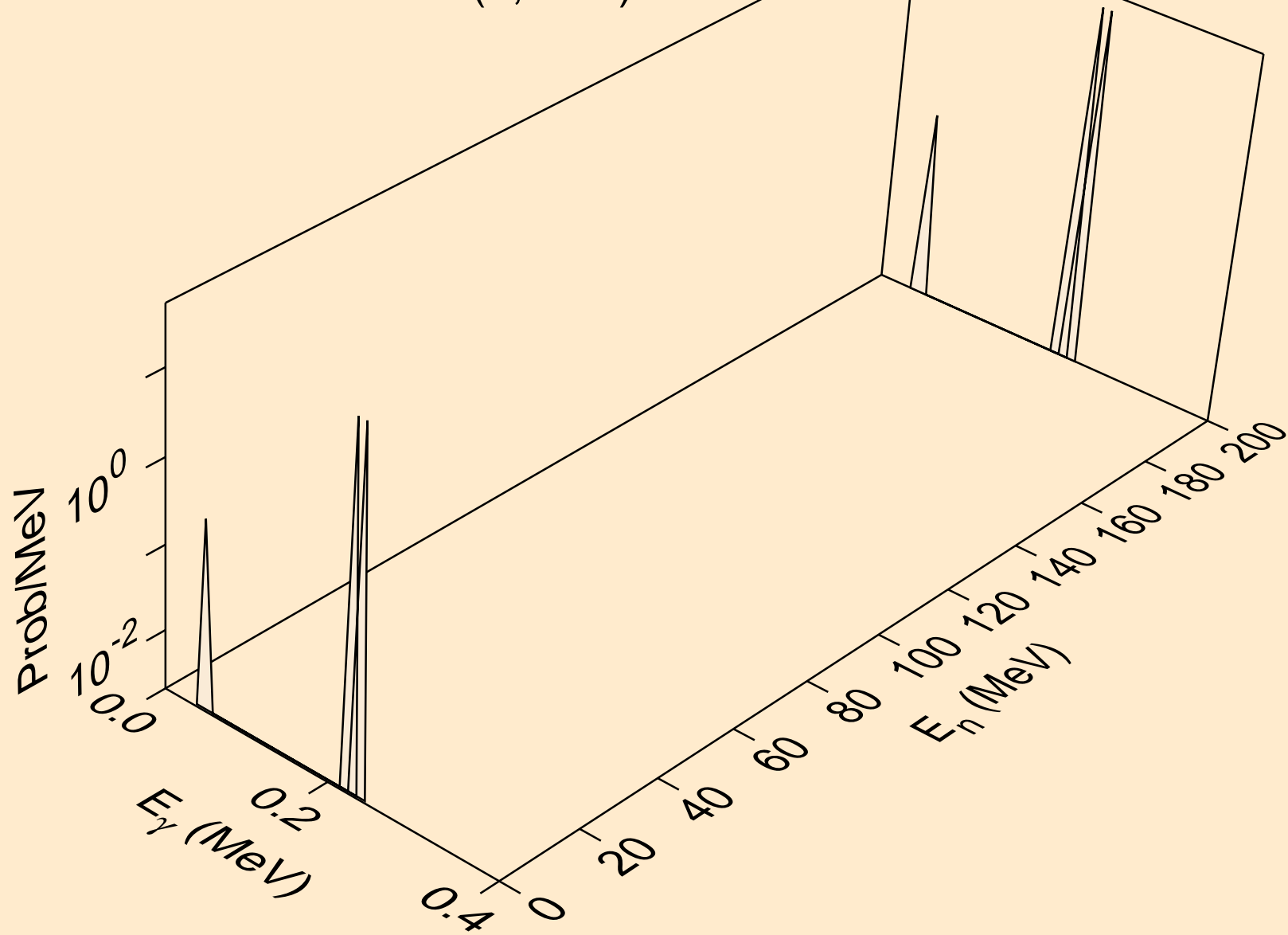

IN127N NEUTRON ACER TENDL-2024 LIBRARY; T=0.K
Photon emission for (n,n*c)

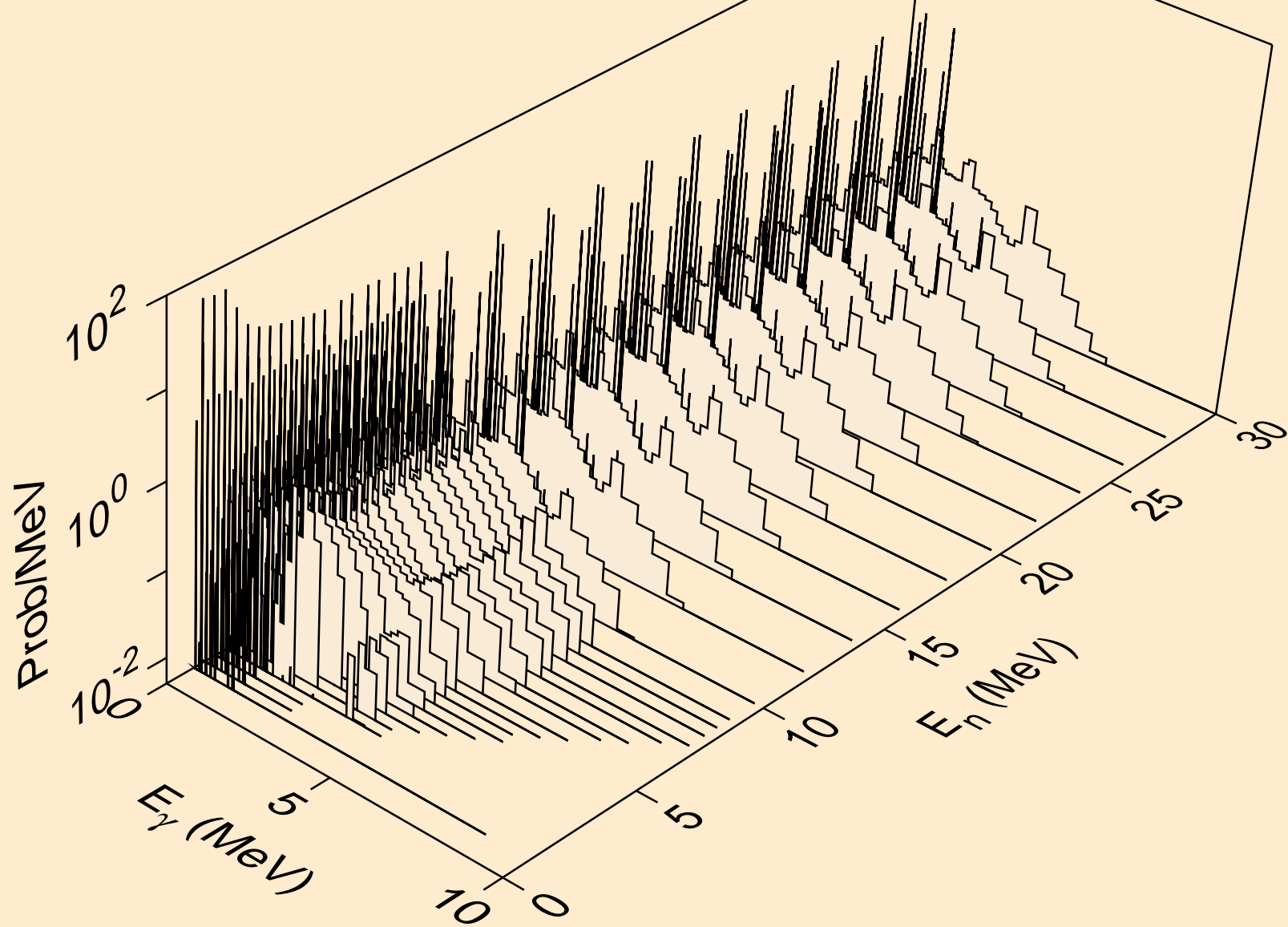

IN127N NEUTRON ACER TENDL-2024 LIBRARY; T=0.K
Photon emission for (n,gma)

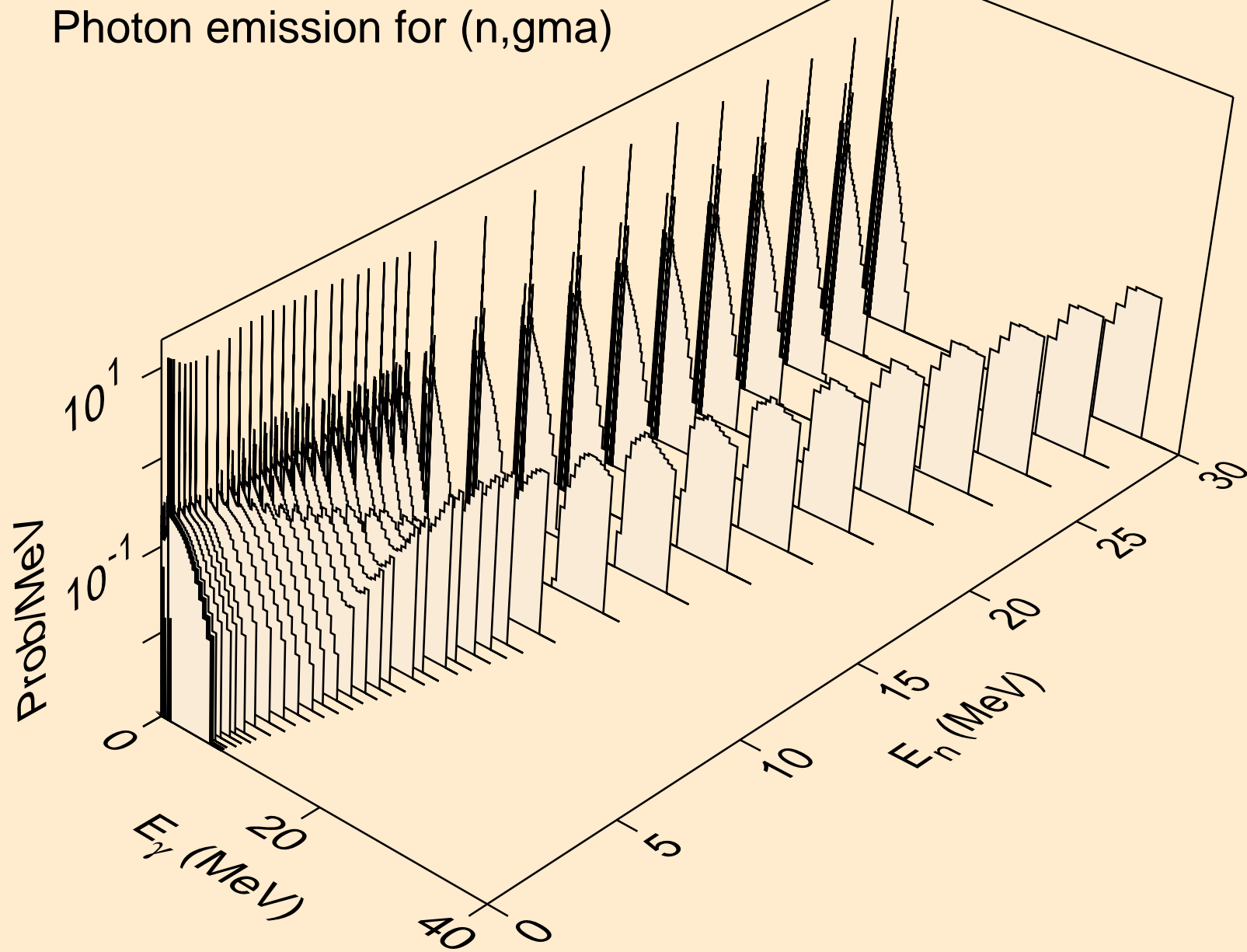

IN127N NEUTRON ACER TENDL-2024 LIBRARY; T=0.K
Photon emission for (n,p)

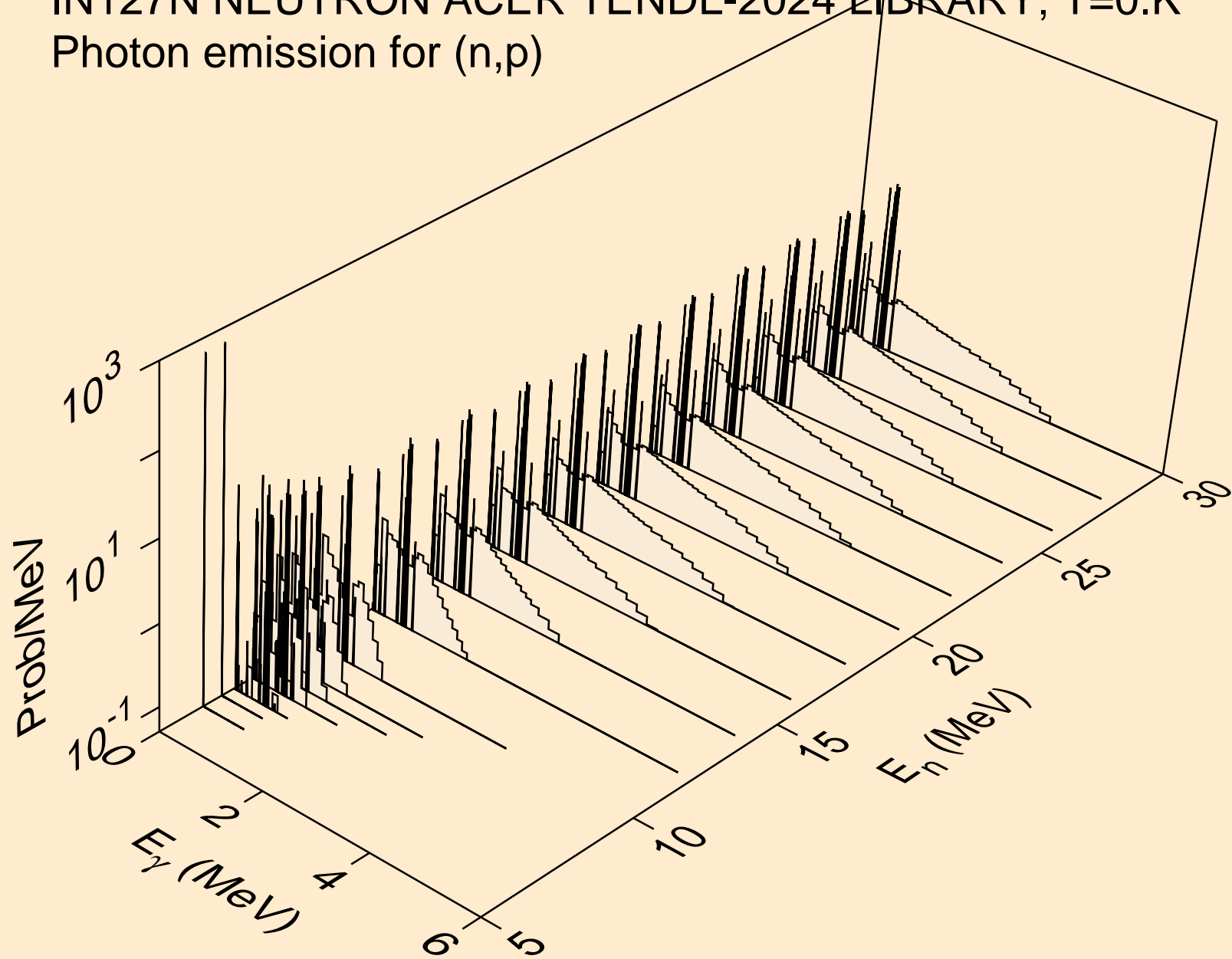

IN127N NEUTRON ACER TENDL-2024 LIBRARY; T=0.K
Photon emission for (n,d)

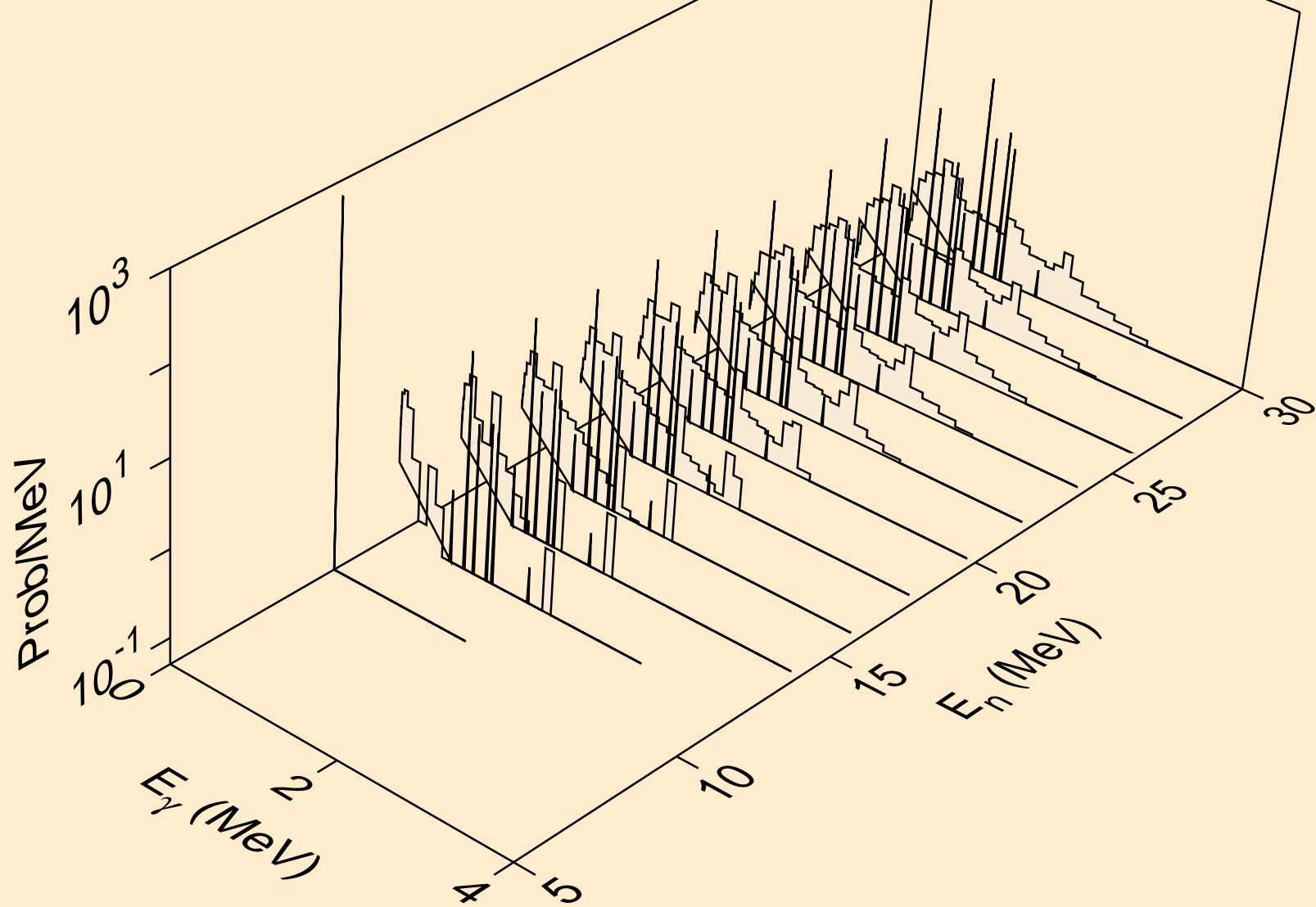

IN127N NEUTRON ACER TENDL-2024 LIBRARY; T=0.K
Photon emission for (n,t)

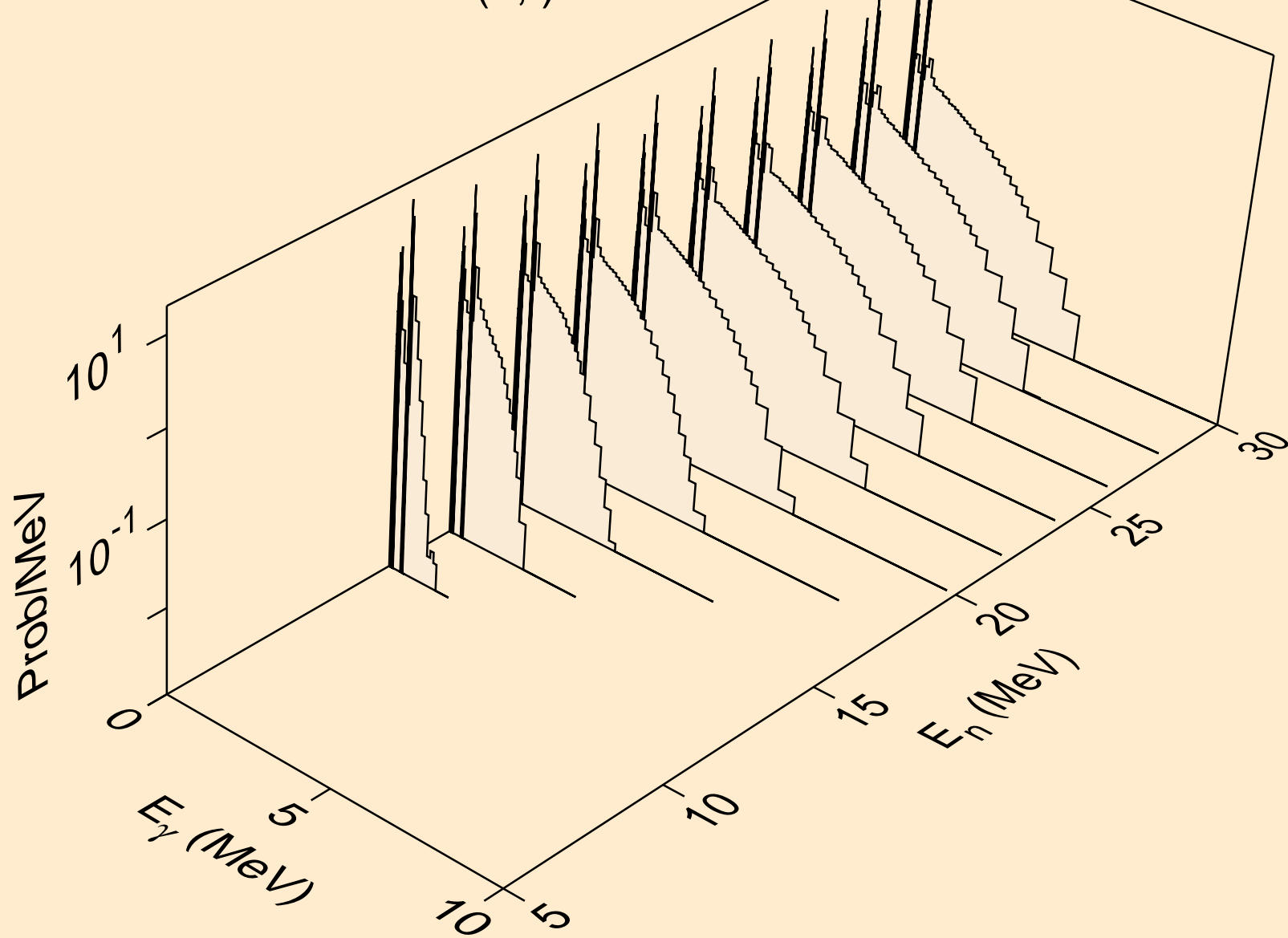

IN127N NEUTRON ACER TENDL-2024 LIBRARY; T=0.K
Photon emission for (n,he3)

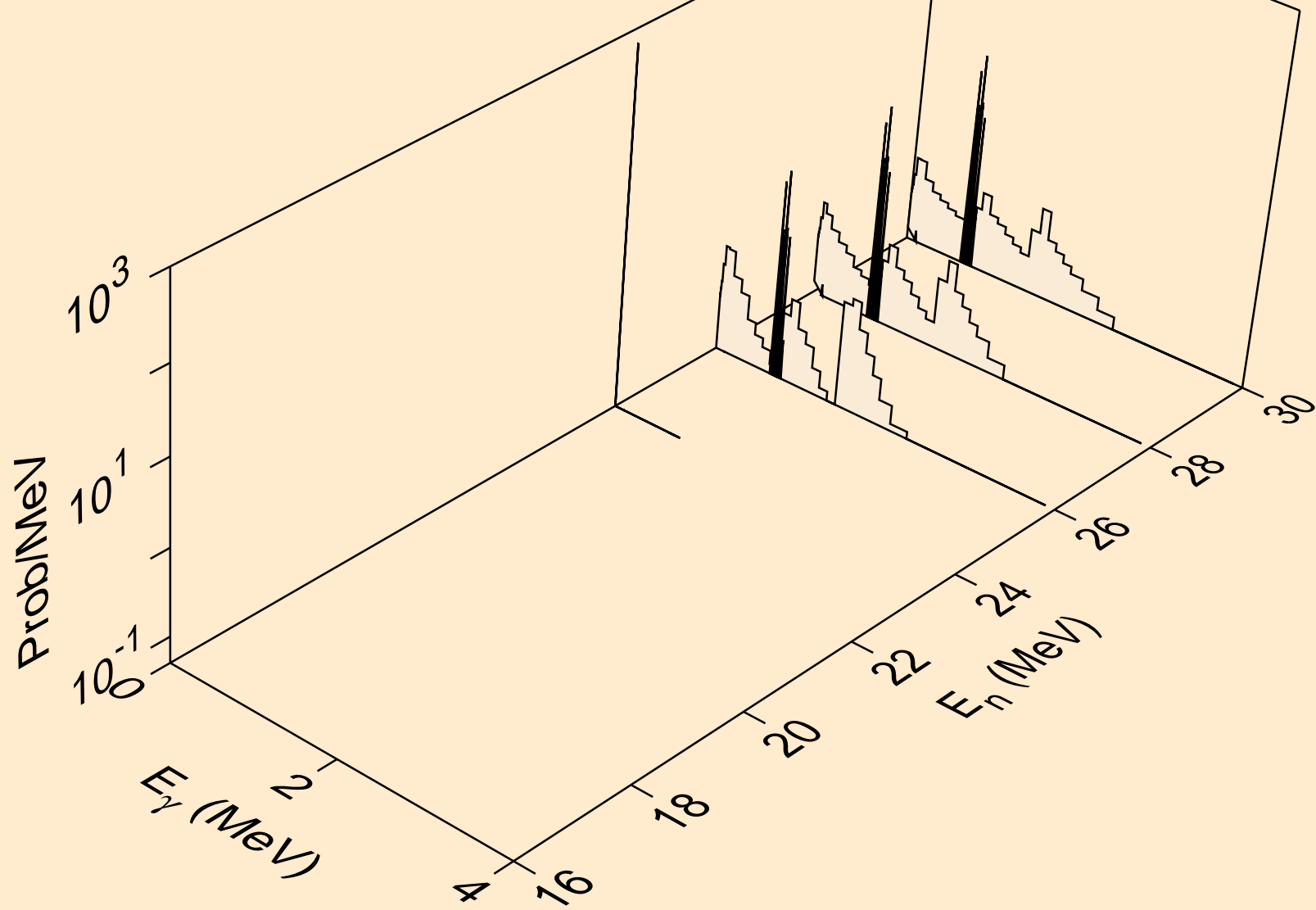

IN127N NEUTRON ACER TENDL-2024 LIBRARY; T=0.K
Photon emission for (n,a)

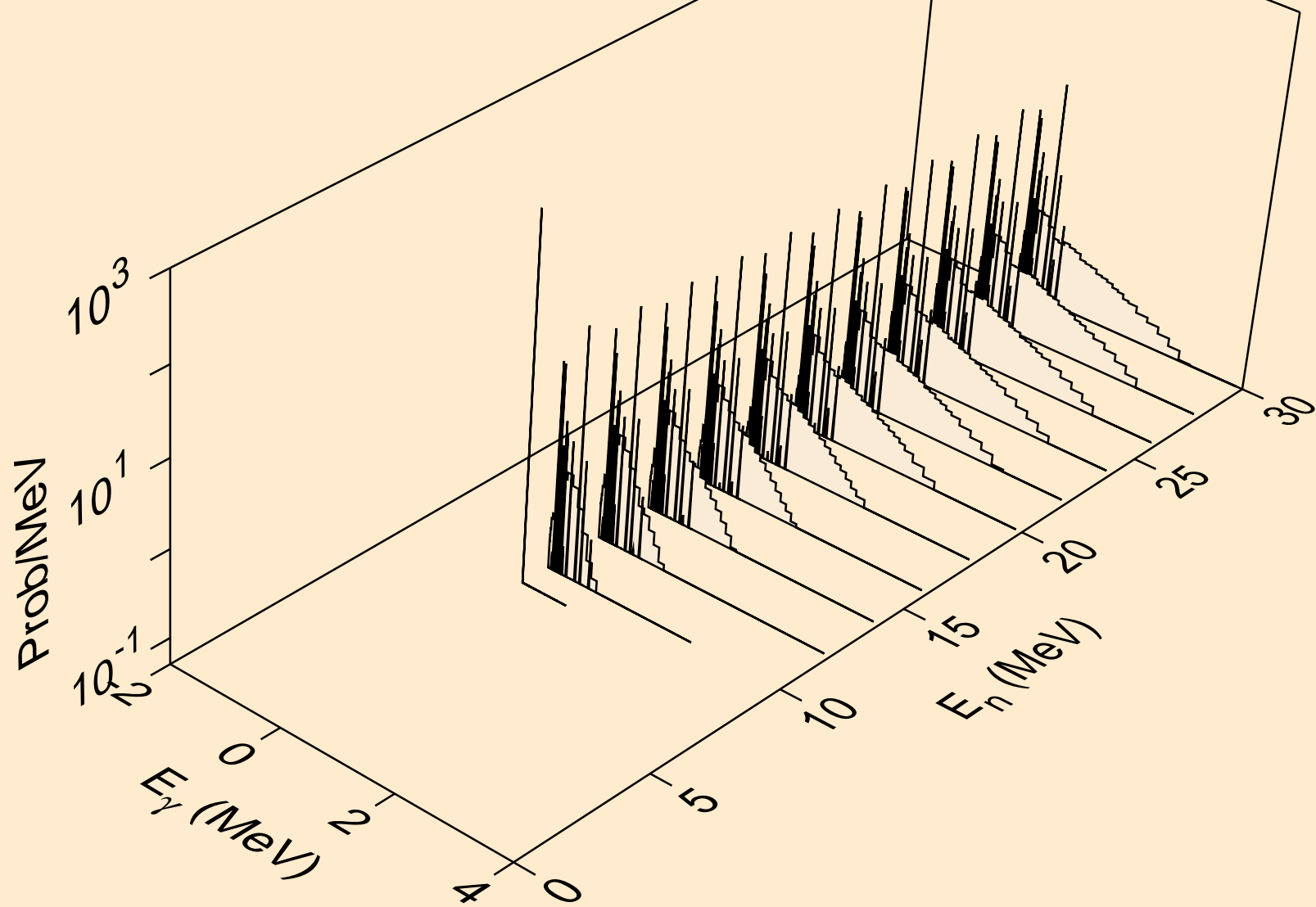

IN127N NEUTRON ACER TENDL-2024 LIBRARY; T=0.K
thermal capture photon spectrum

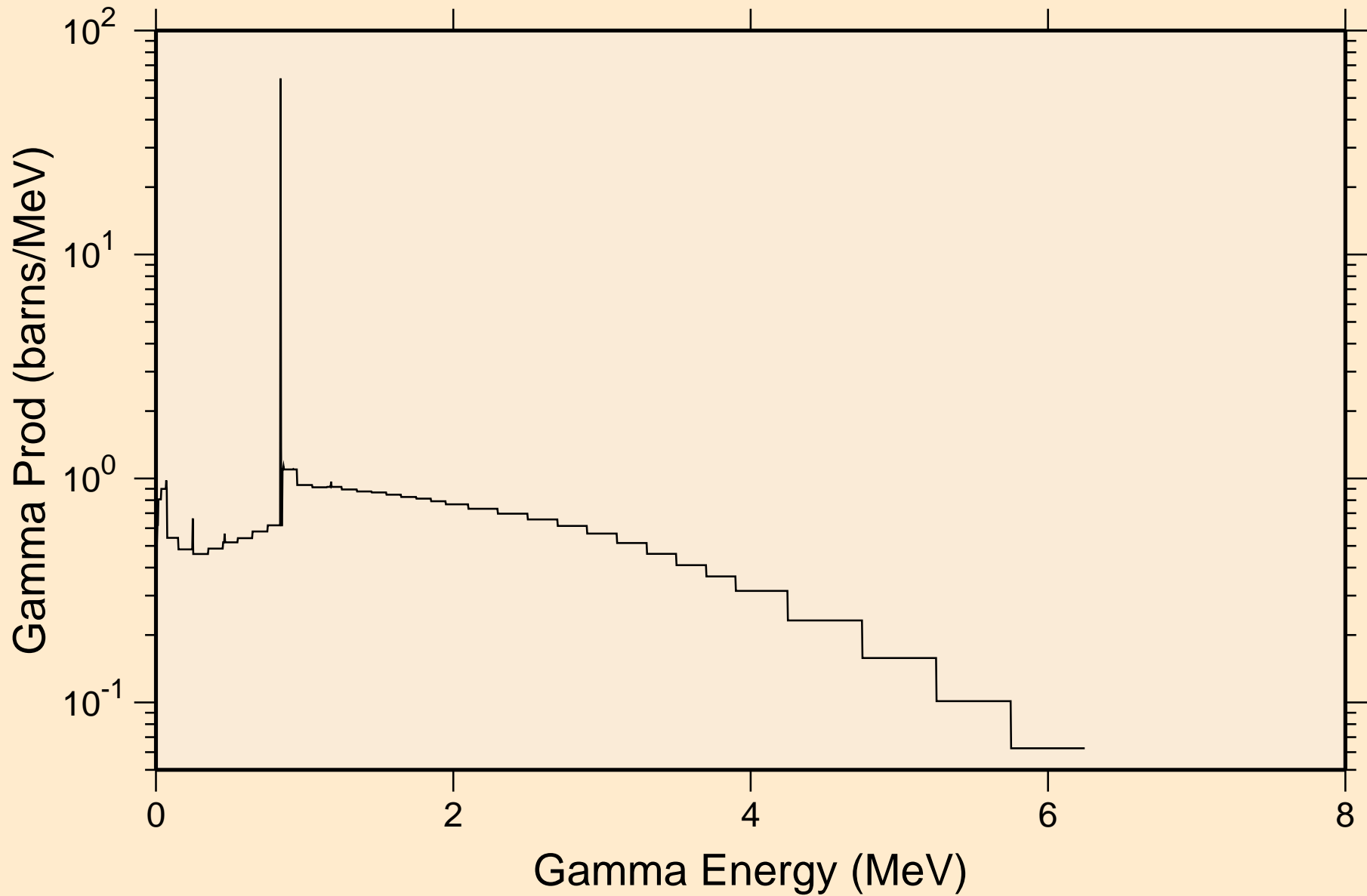

IN127N NEUTRON ACER TENDL-2024 LIBRARY; T=0.K
14 MeV photon spectrum

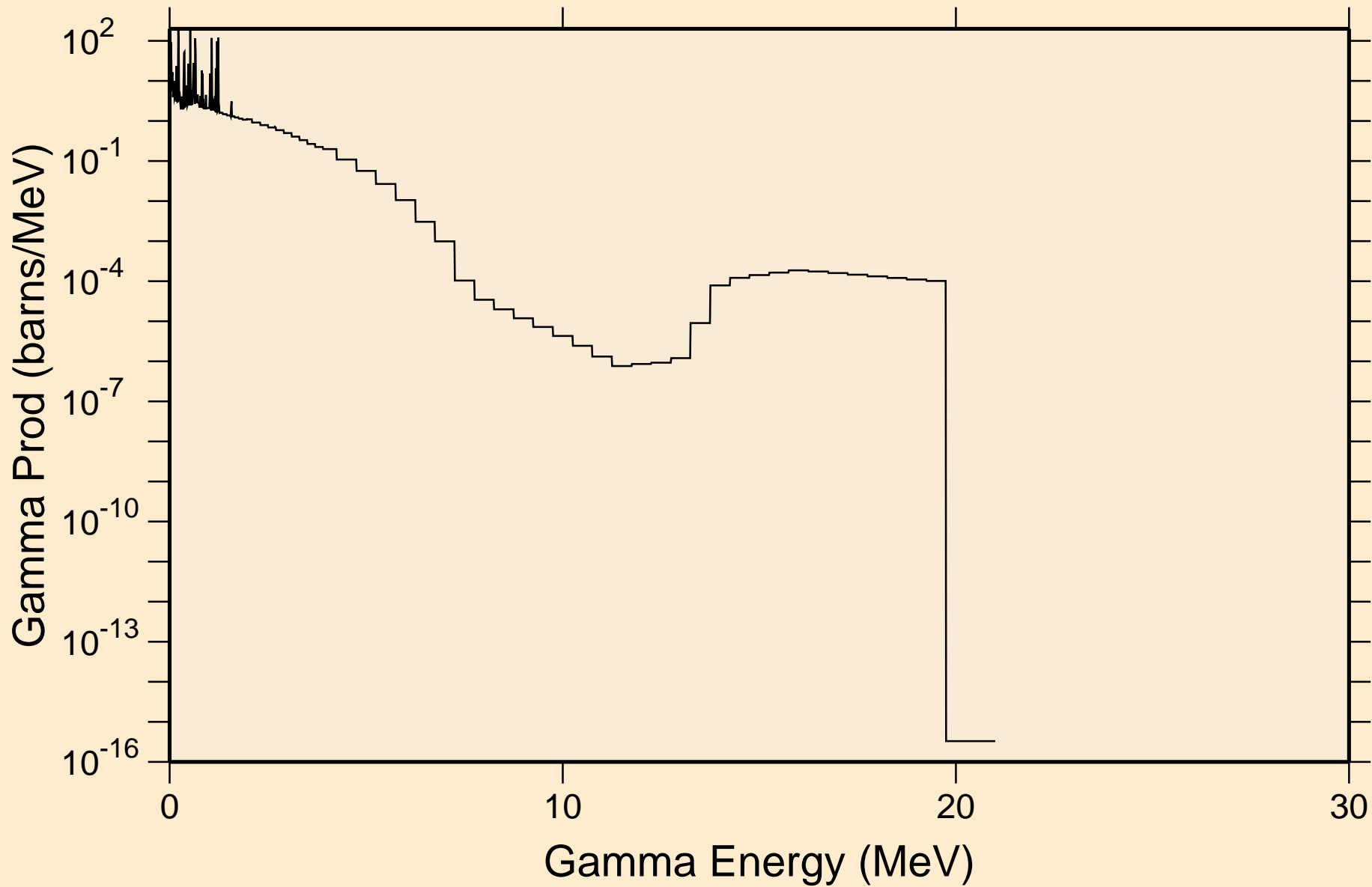

IN127N NEUTRON ACER TENDL-2024 LIBRARY; T=0.K

Particle heating contributions

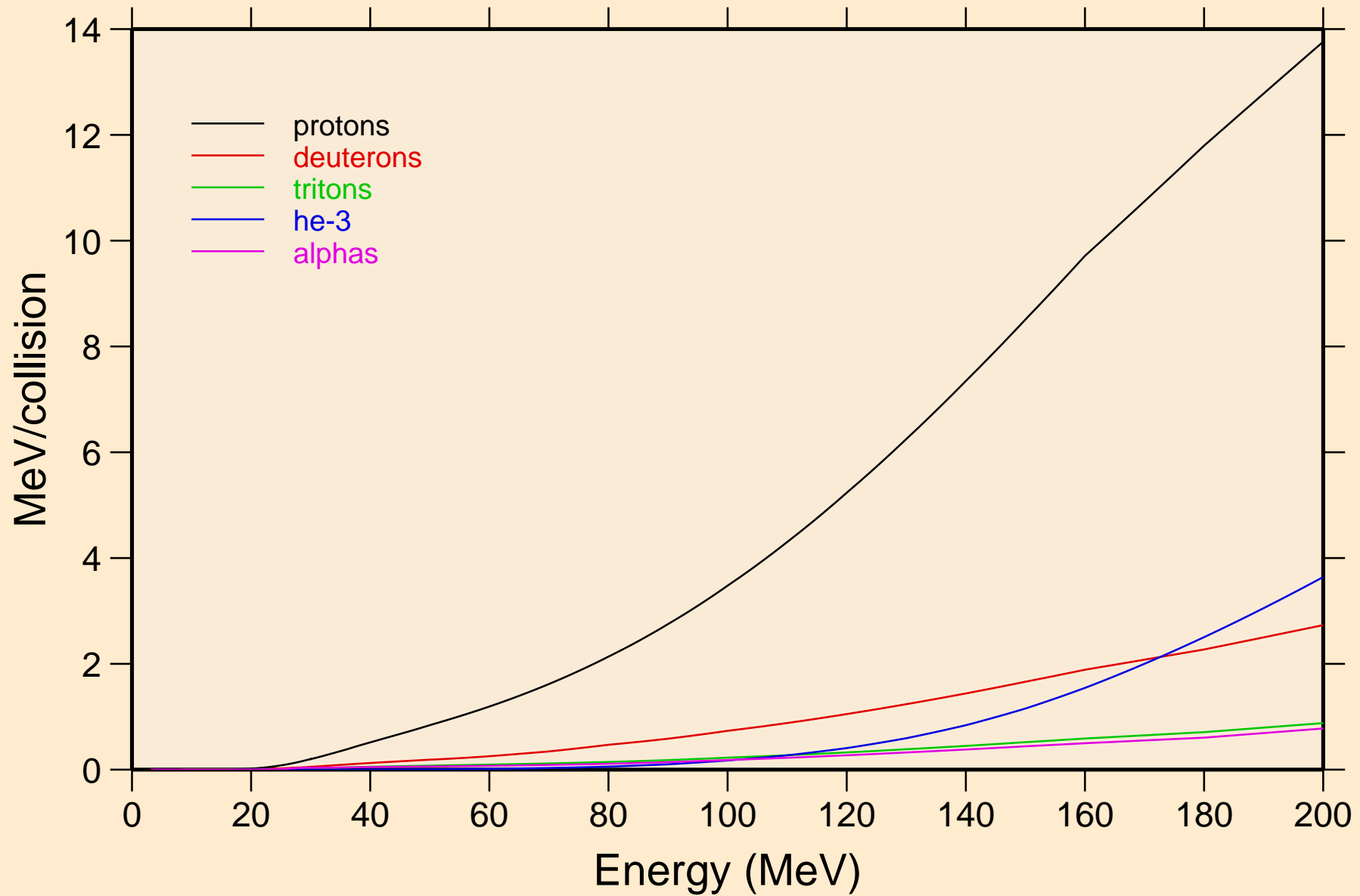

IN127N NEUTRON ACER TENDL-2024 LIBRARY; T=0.K
Recoil Heating

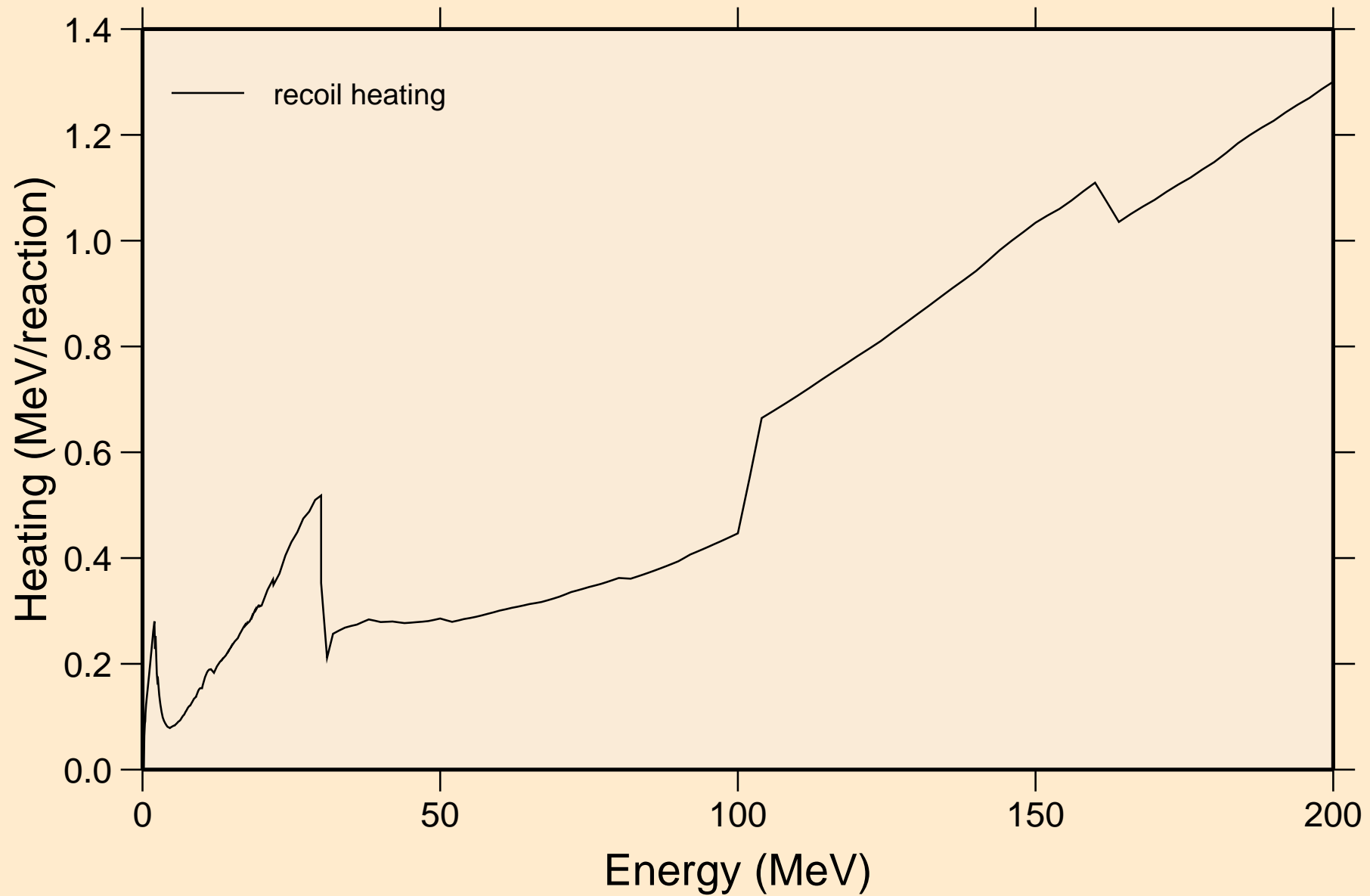

IN127N NEUTRON ACER TENDL-2024 LIBRARY; T=0.K
Particle production cross sections

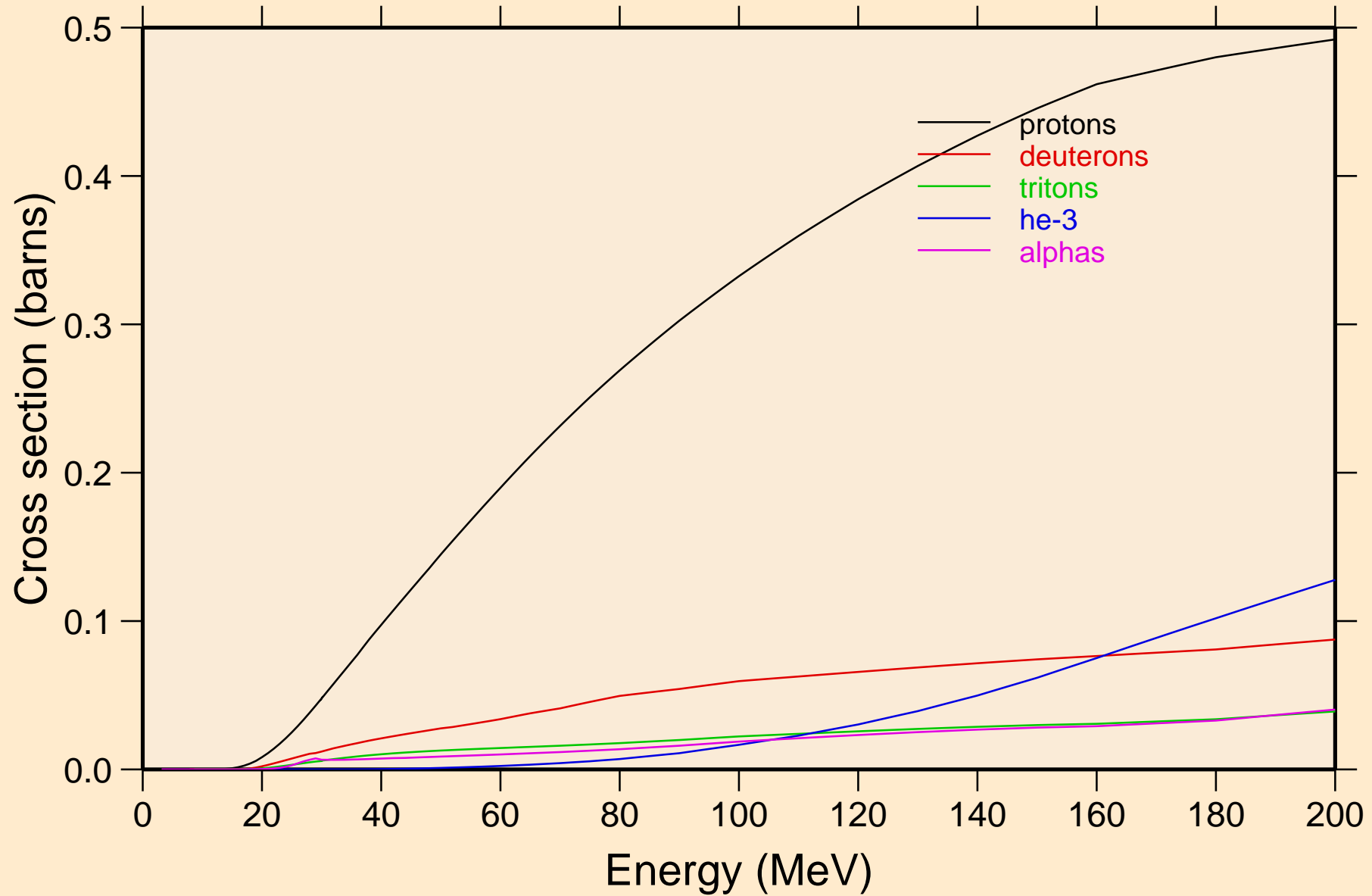

IN127N NEUTRON ACER TENDL-2024 LIBRARY; T=0.K
protons from (n,x)

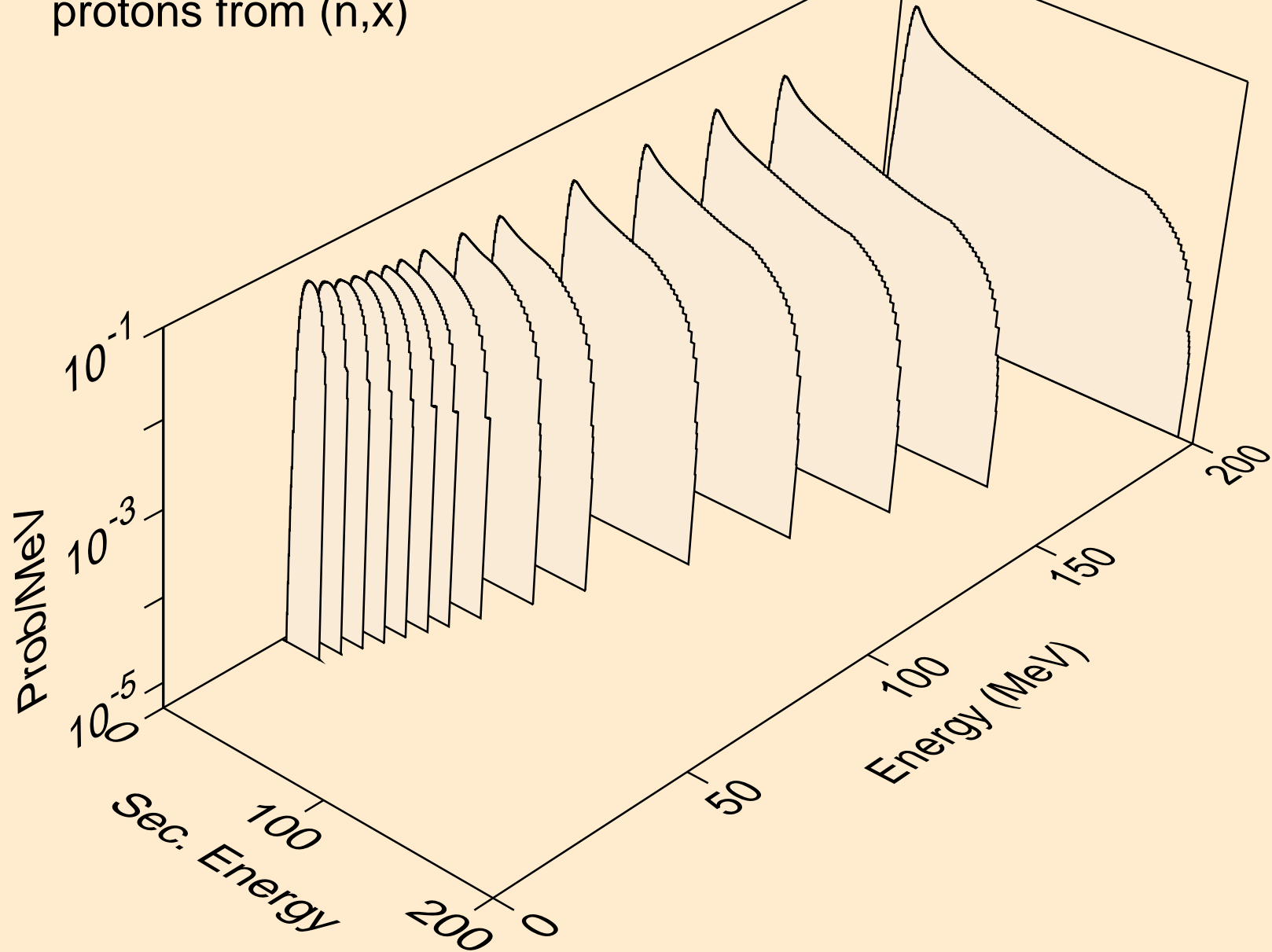

IN127N NEUTRON ACER TENDL-2024 LIBRARY; T=0.K
protons from (n,n*)p

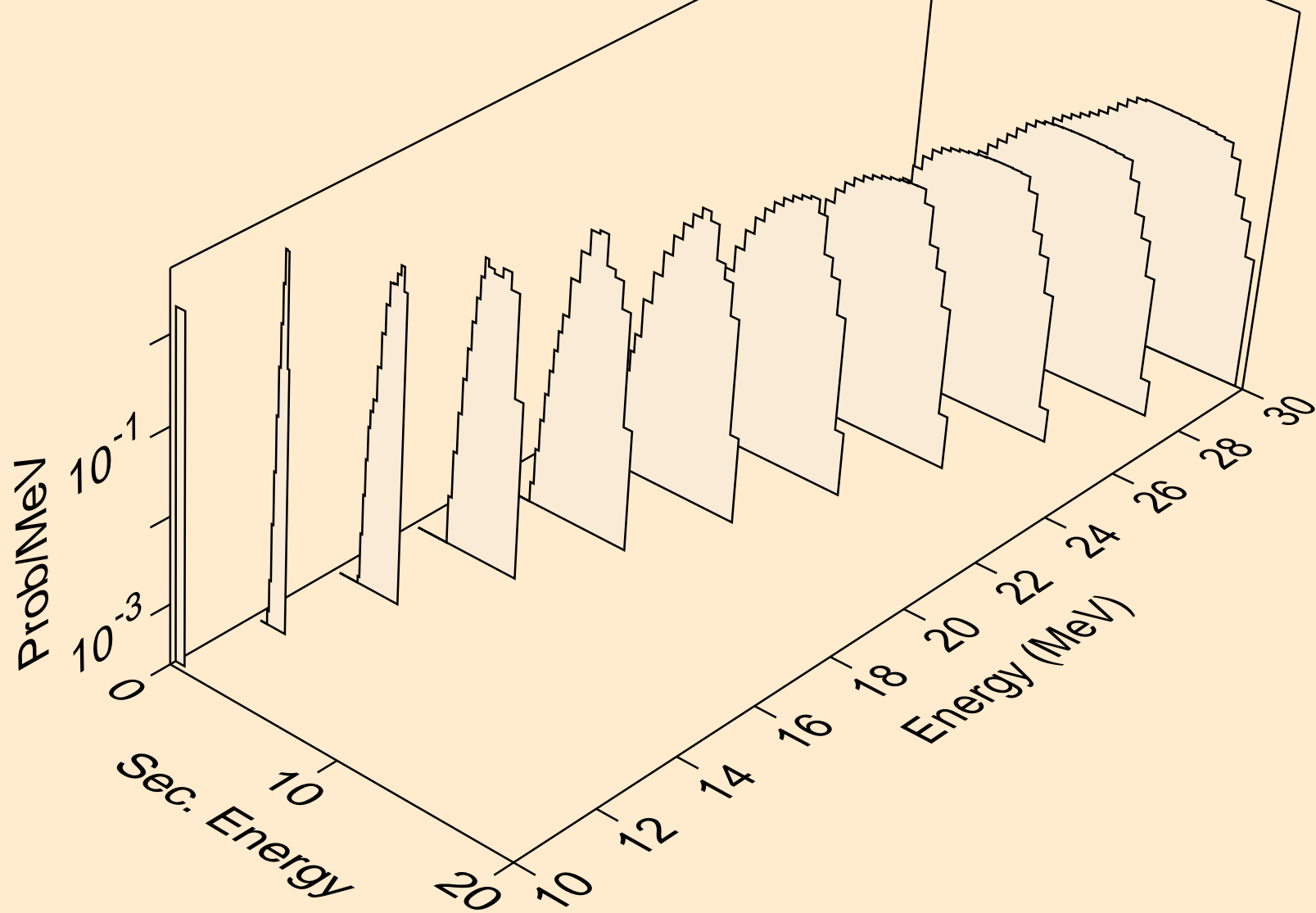

IN127N NEUTRON ACER TENDL-2024 LIBRARY; T=0.K
protons from (n,2np)

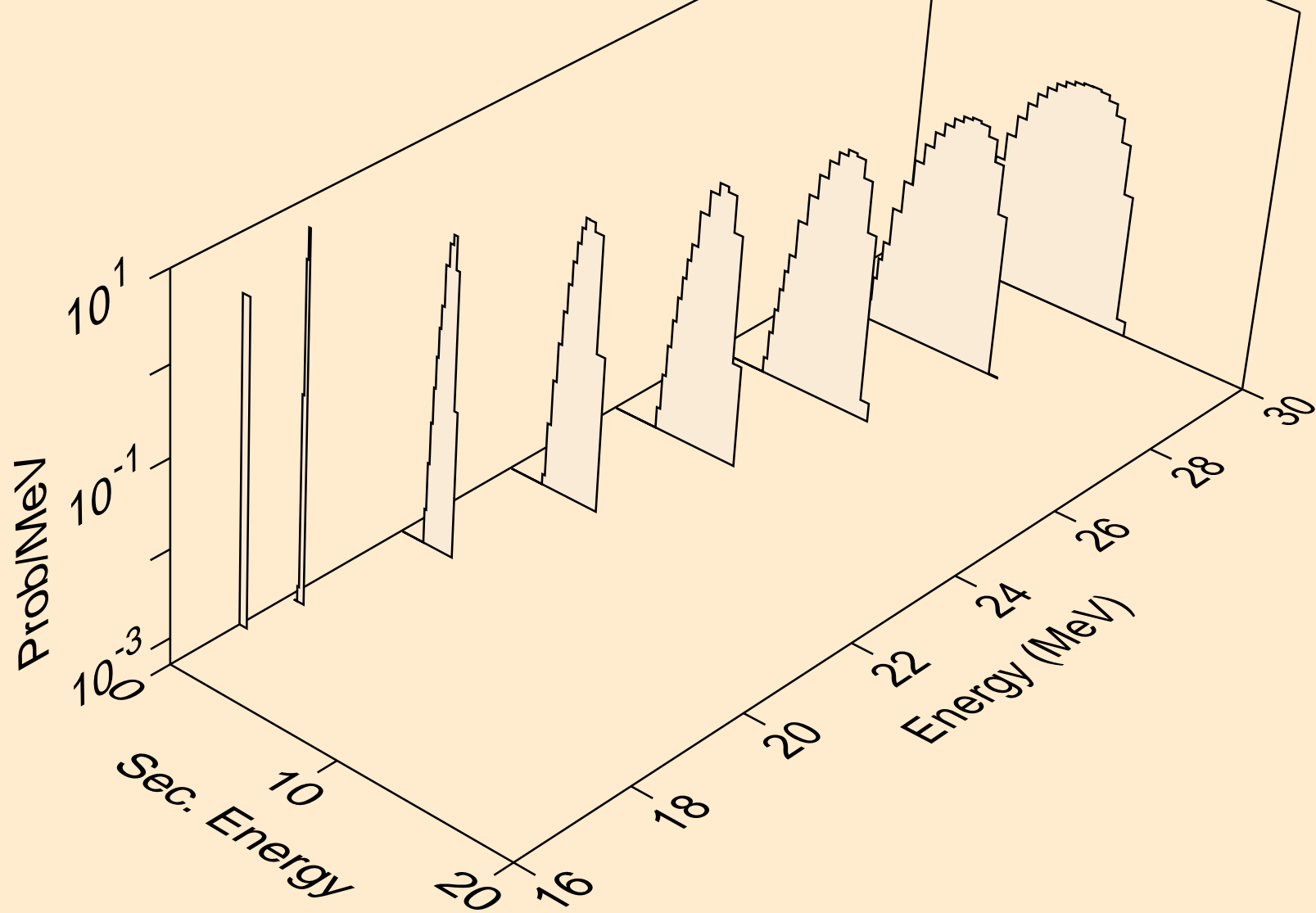

IN127N NEUTRON ACER TENDL-2024 LIBRARY; T=0.K
protons from (n,3np)

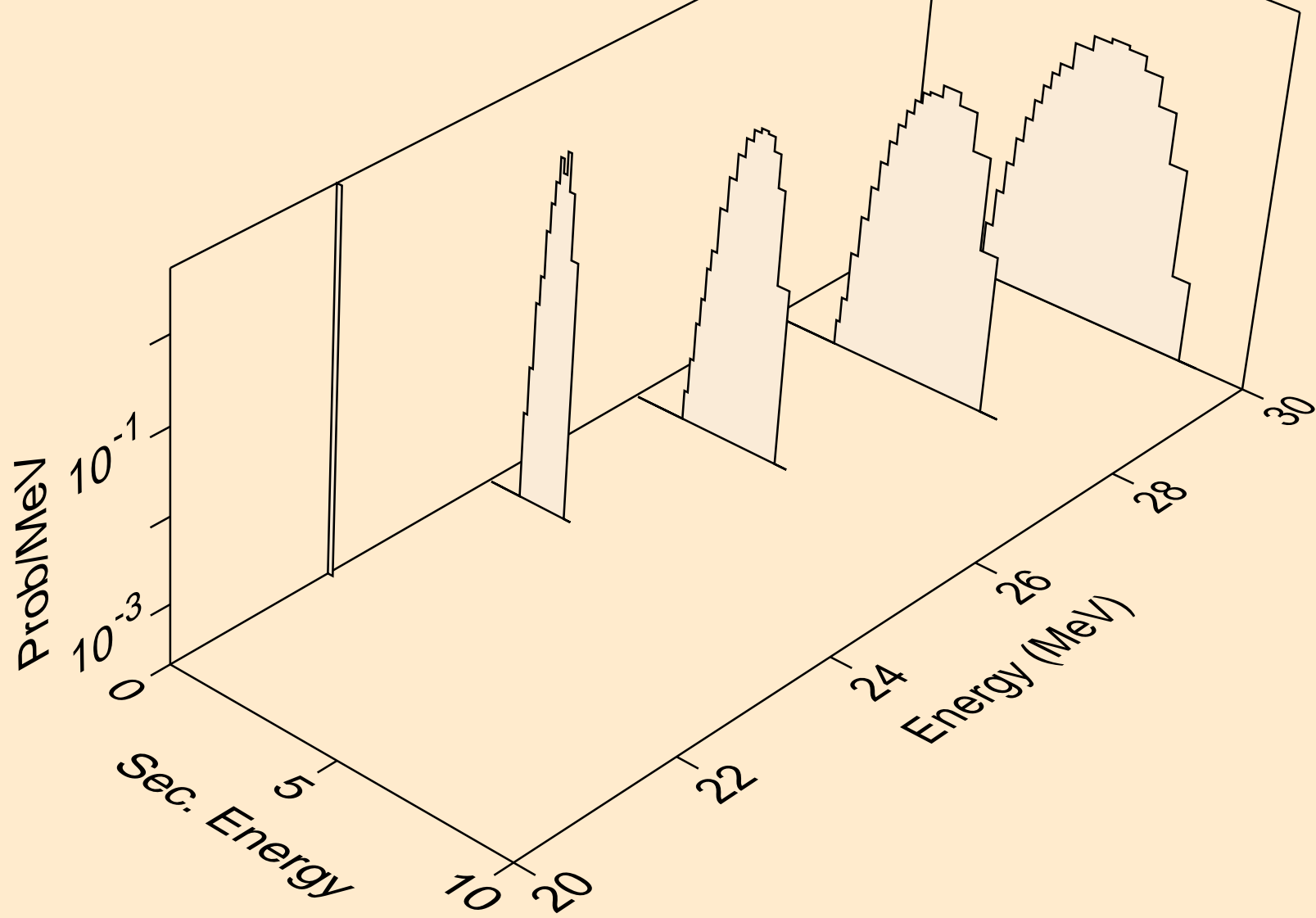

IN127N NEUTRON ACER TENDL-2024 LIBRARY; T=0.K
protons from (n,p)

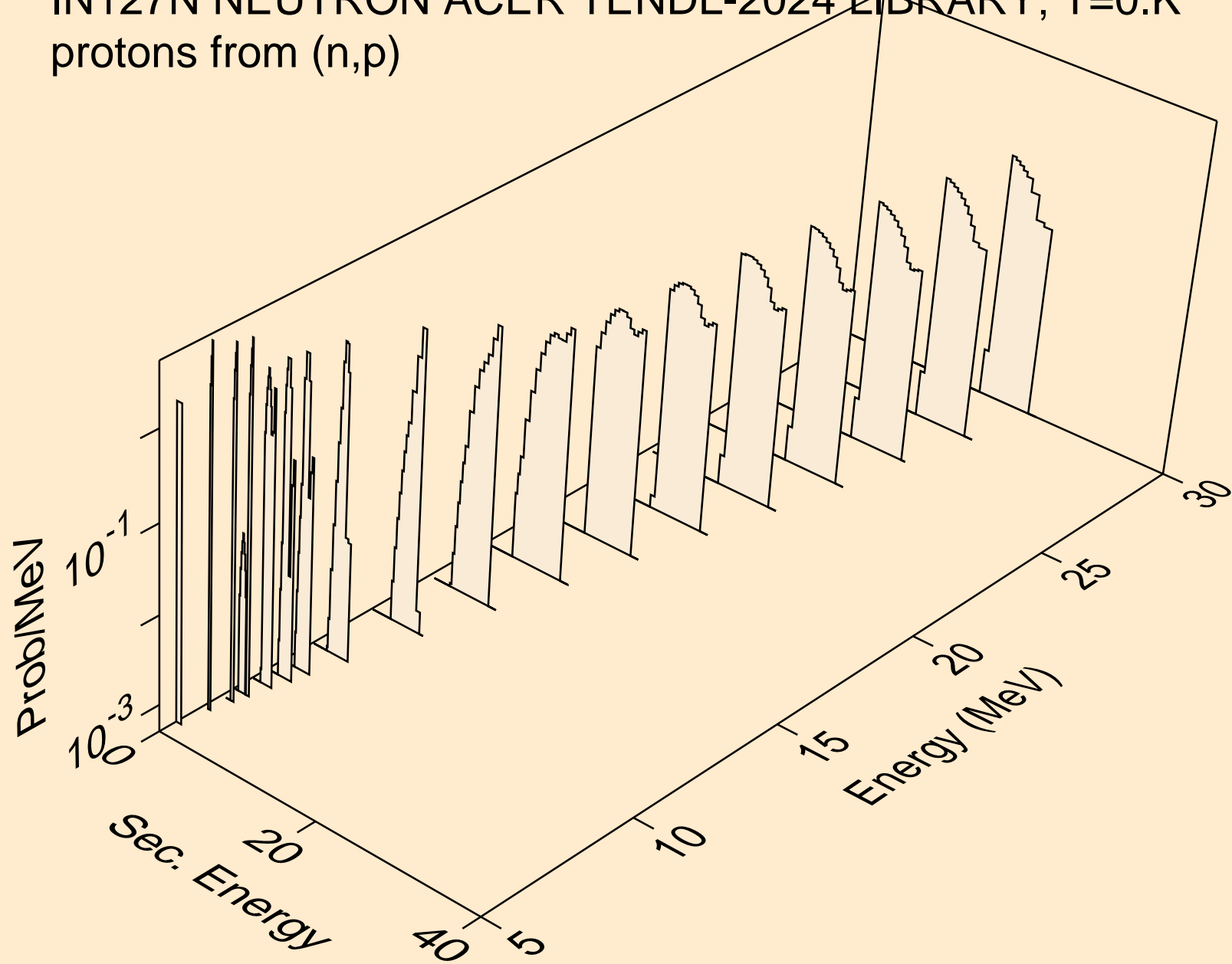

IN127N NEUTRON ACER TENDL-2024 LIBRARY; T=0.K
deuterons from (n,x)

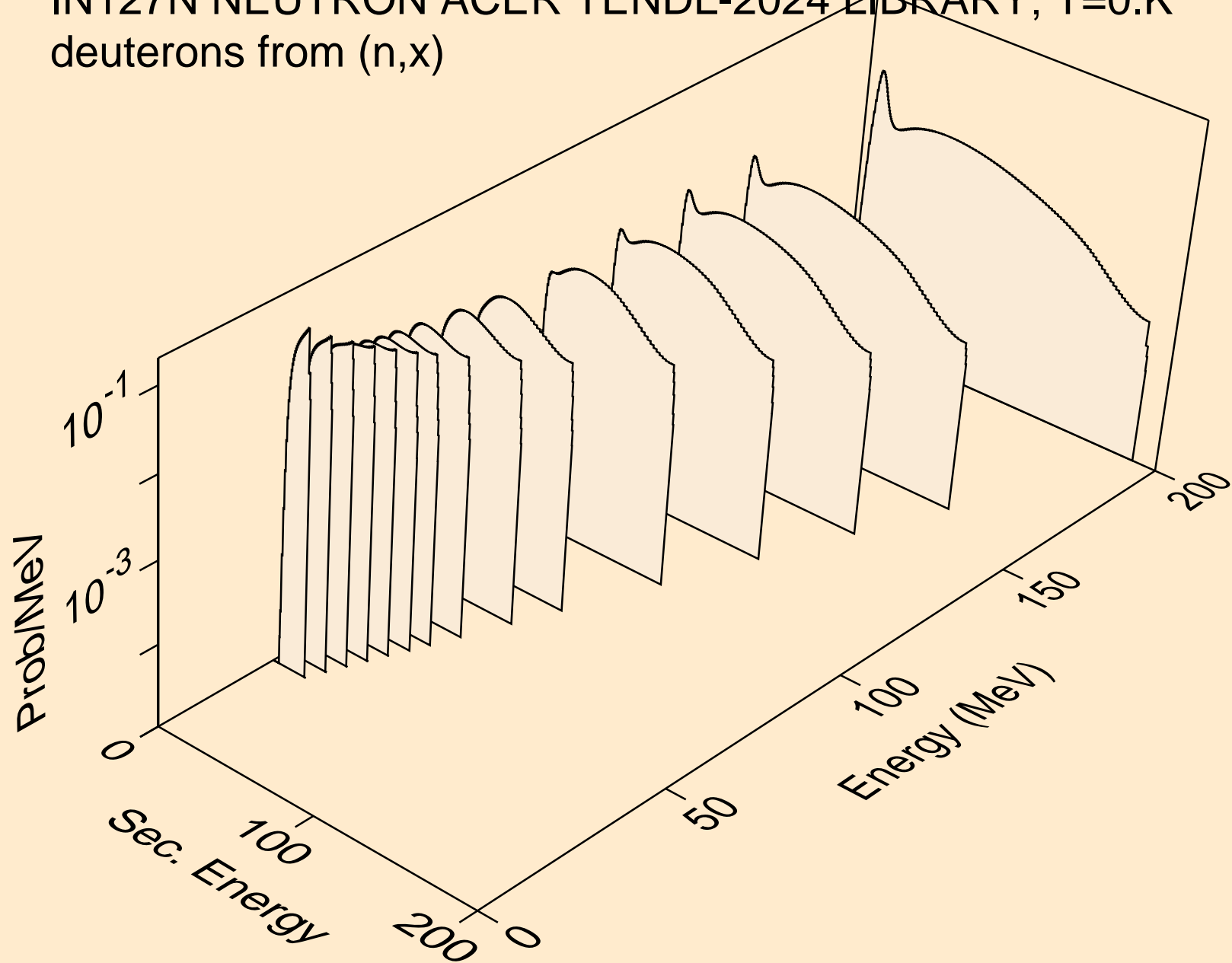

IN127N NEUTRON ACER TENDL-2024 LIBRARY; T=0.K
deuterons from (n,2nd)

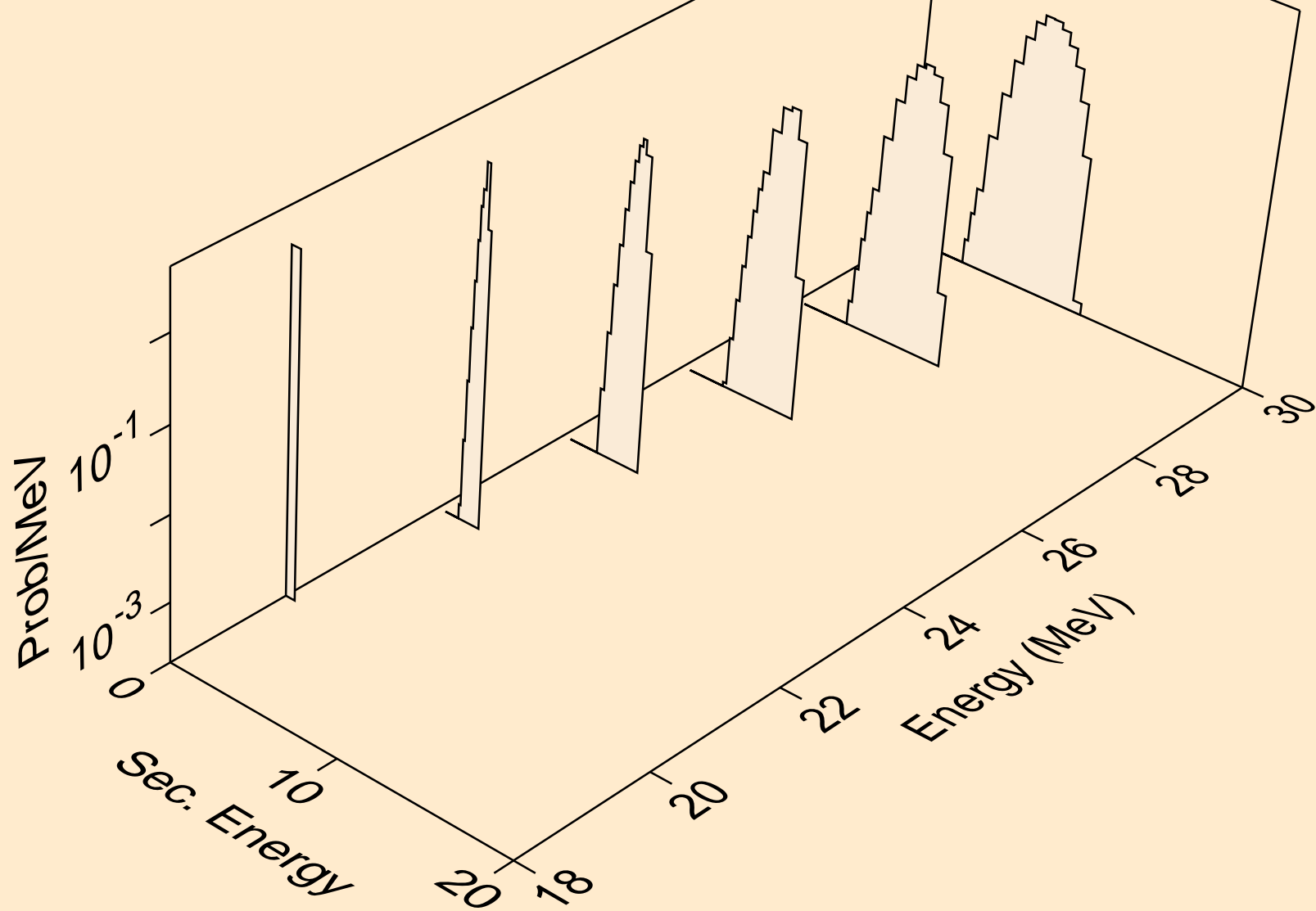

IN127N NEUTRON ACER TENDL-2024 LIBRARY; T=0.K
deuterons from (n,n*)d

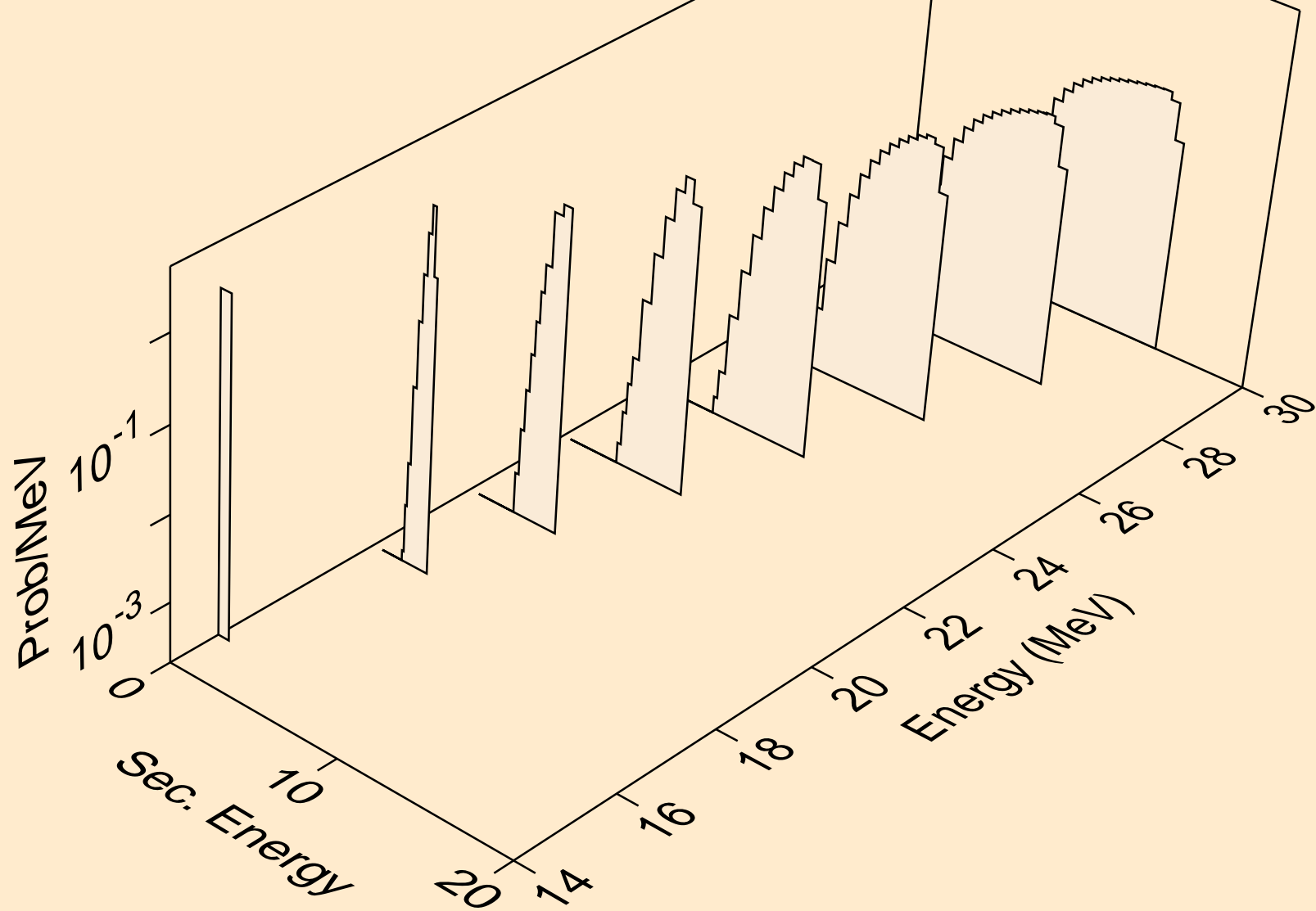

IN127N NEUTRON ACER TENDL-2024 LIBRARY; T=0.K
deuterons from (n,d)

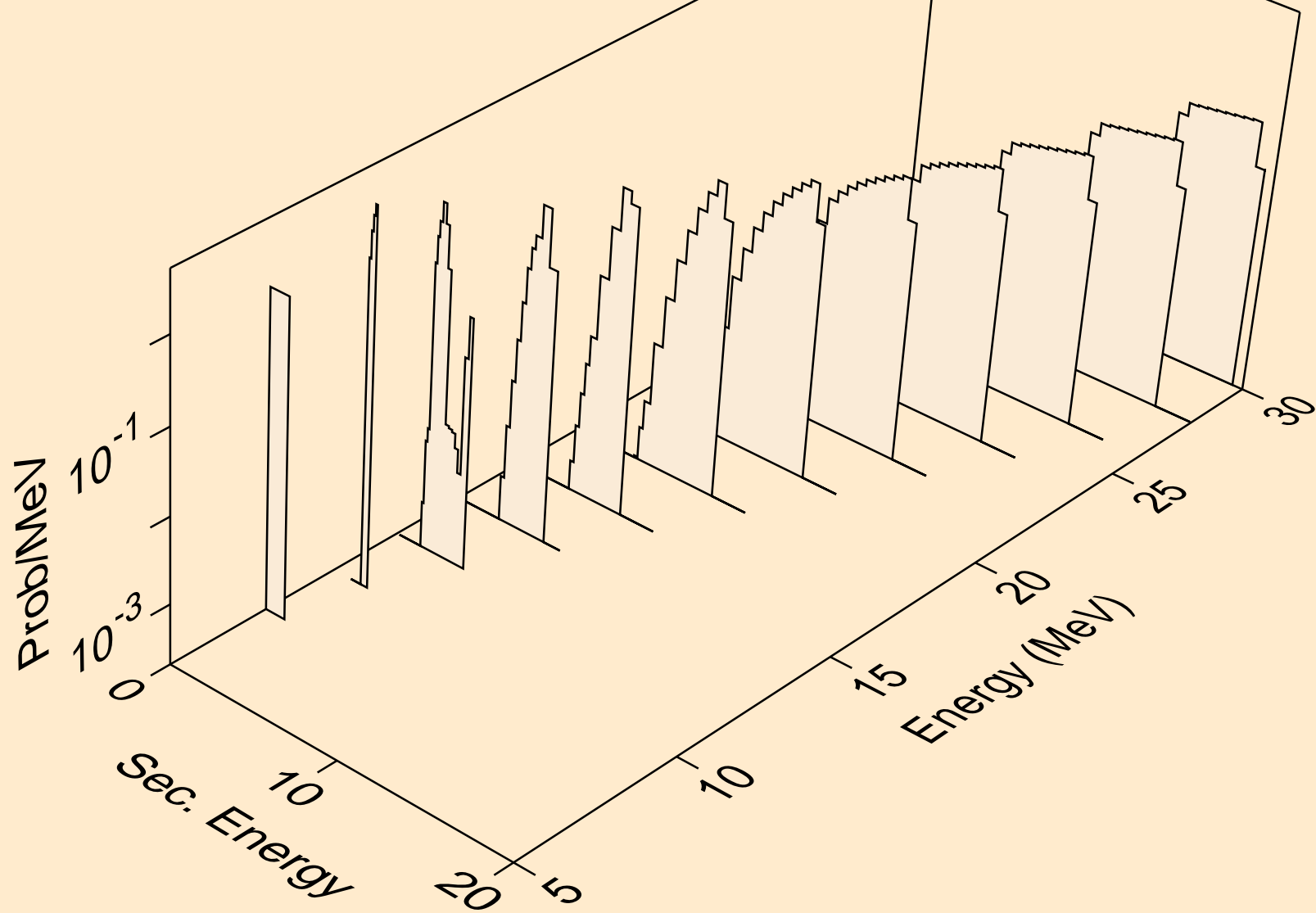

IN127N NEUTRON ACER TENDL-2024 LIBRARY; T=0.K
tritons from (n,x)

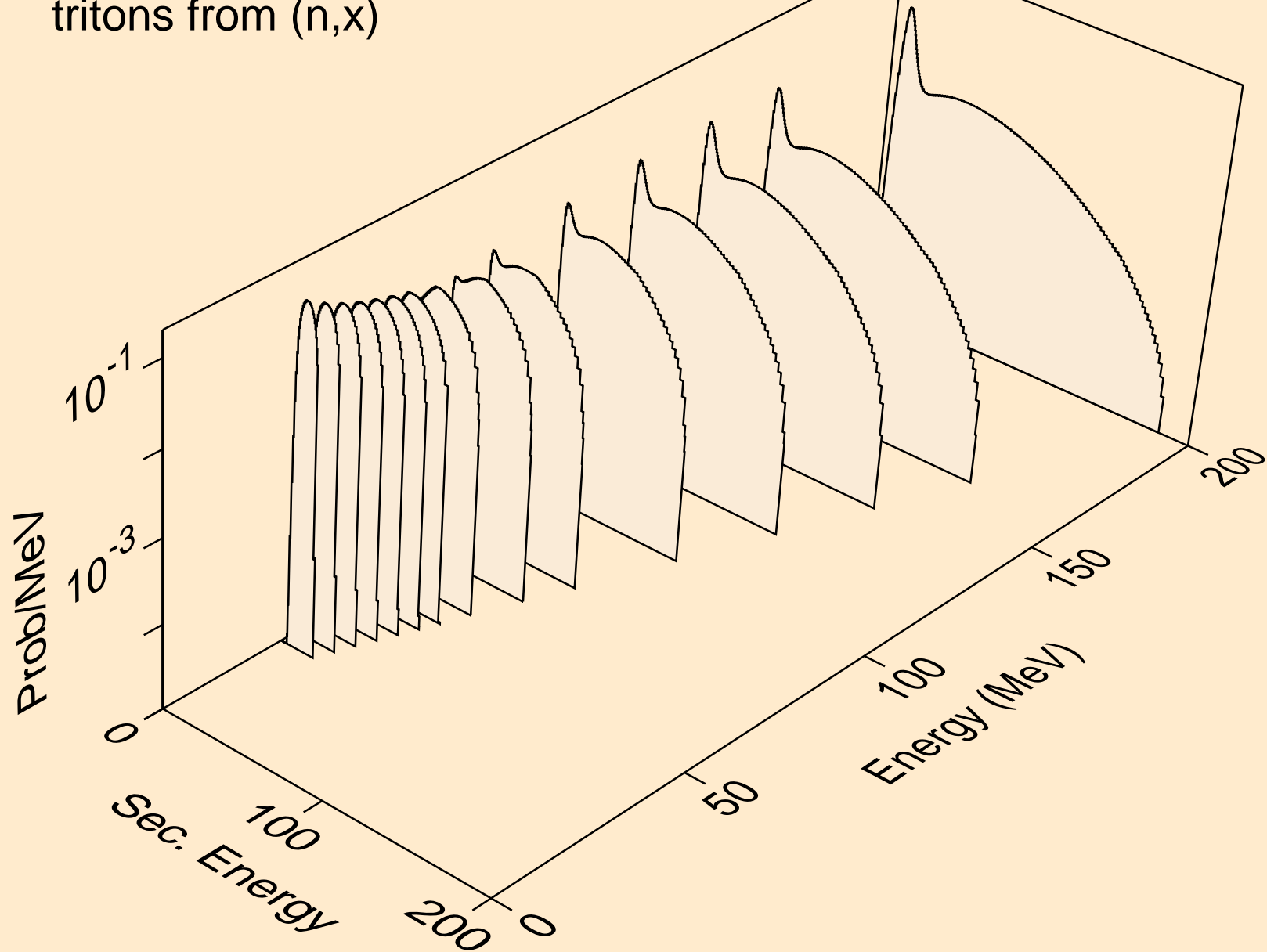

IN127N NEUTRON ACER TENDL-2024 LIBRARY; T=0.K
tritons from (n,n*)t

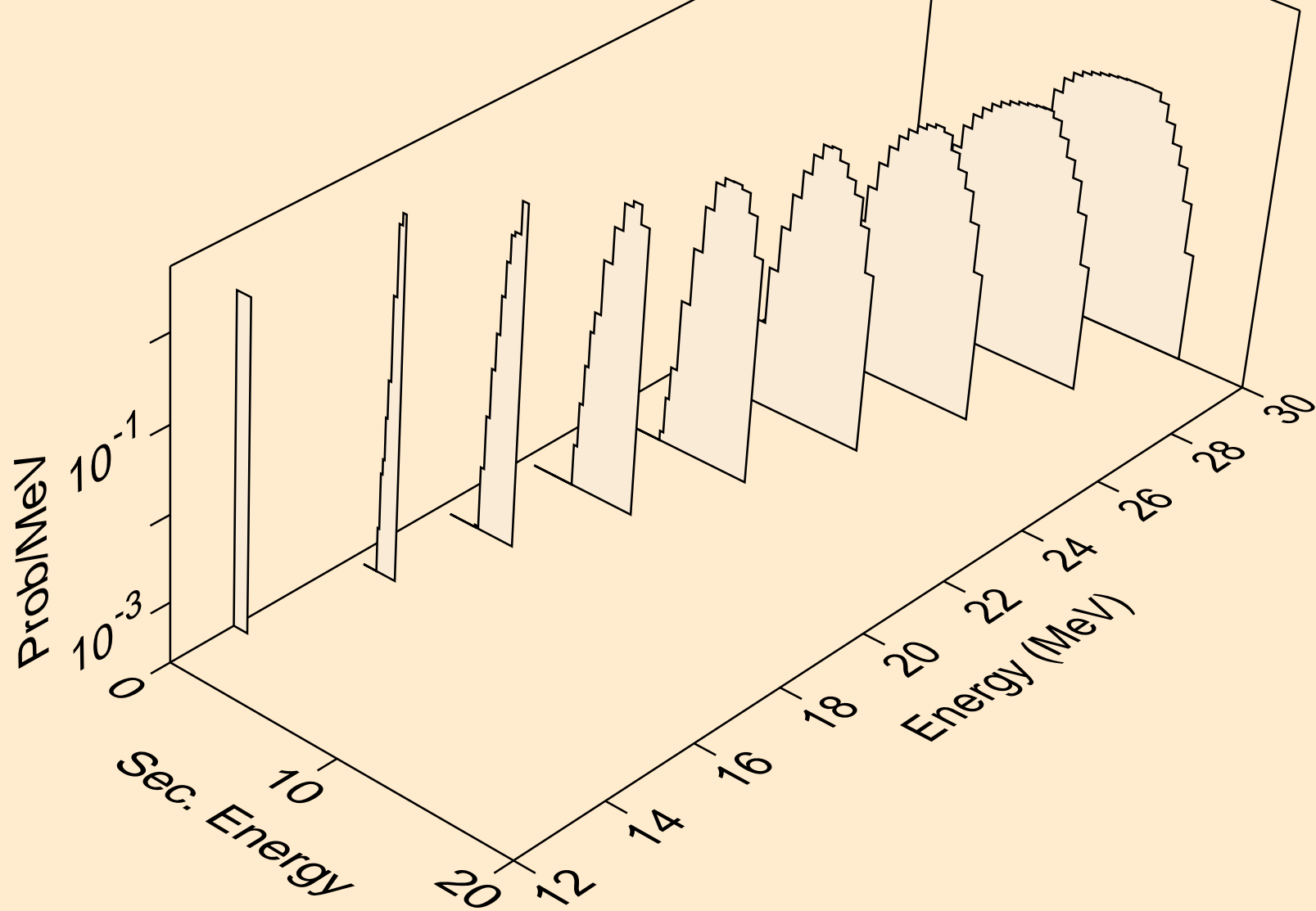

IN127N NEUTRON ACER TENDL-2024 LIBRARY; T=0.K
tritons from (n,t)

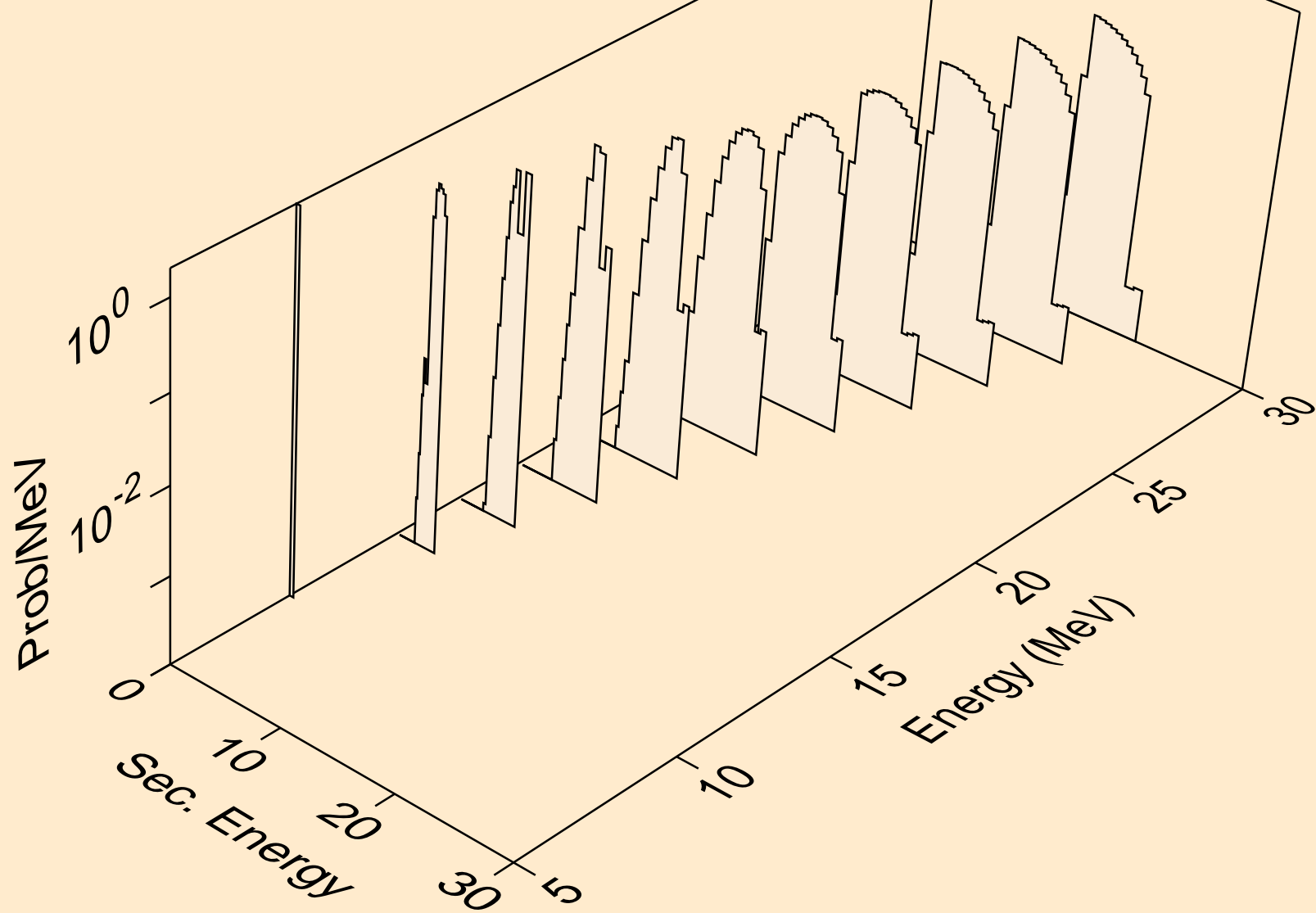

IN127N NEUTRON ACER TENDL-2024 LIBRARY; T=0.K
he3s from (n,x)

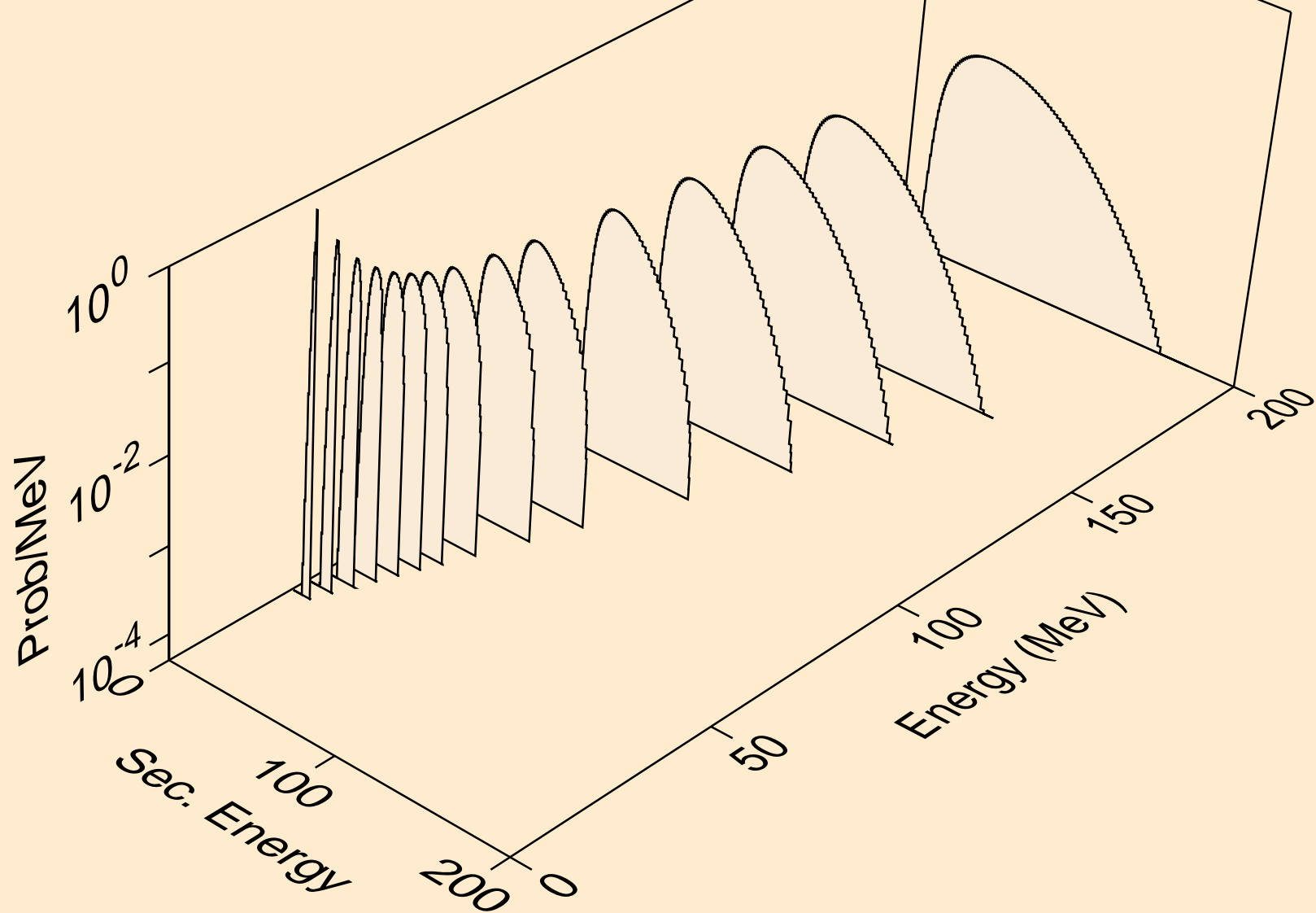

IN127N NEUTRON ACER TENDL-2024 LIBRARY; T=0.K
he3s from (n,he3)

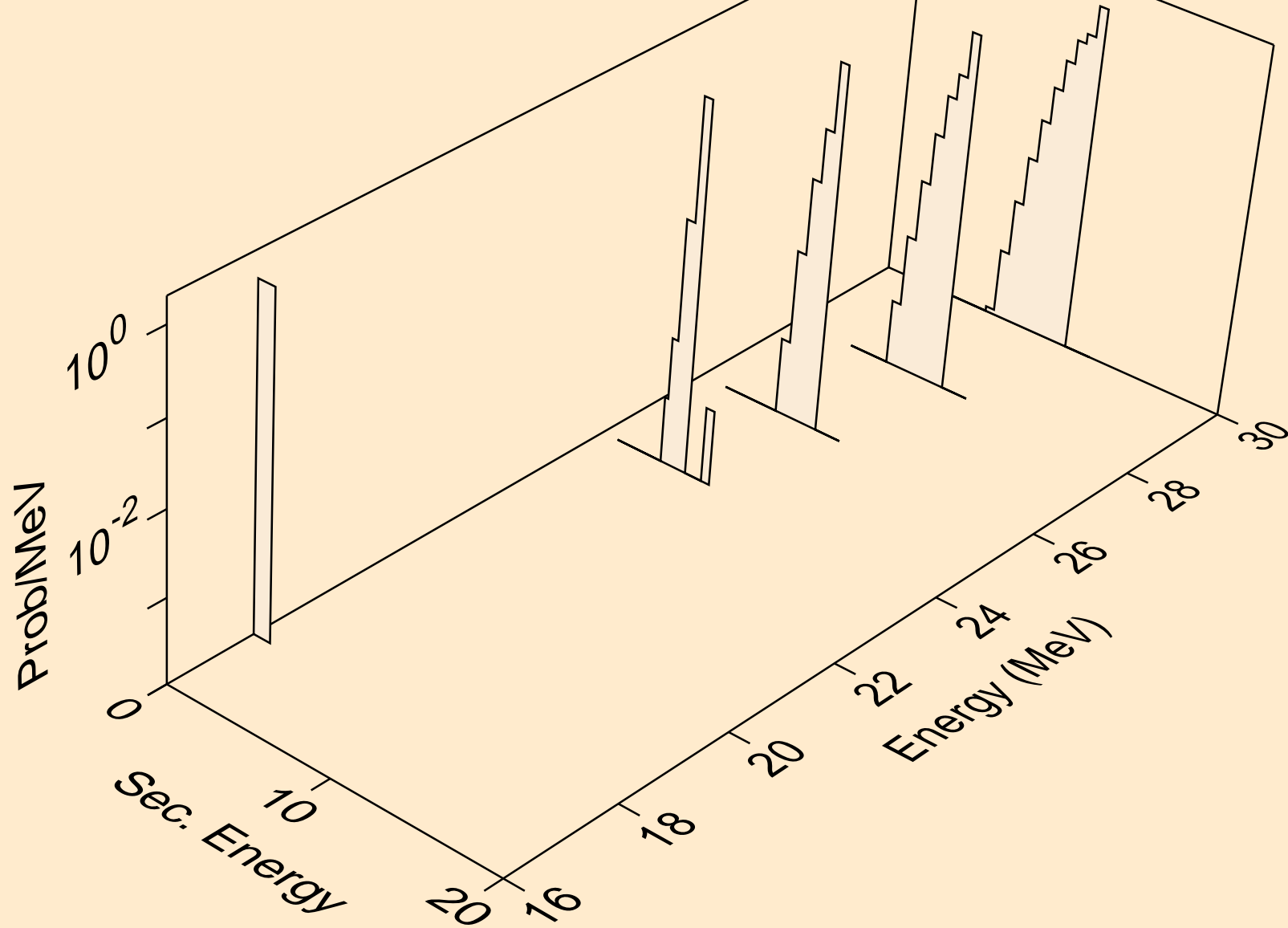

IN127N NEUTRON ACER TENDL-2024 LIBRARY; T=0.K
alphas from (n,x)

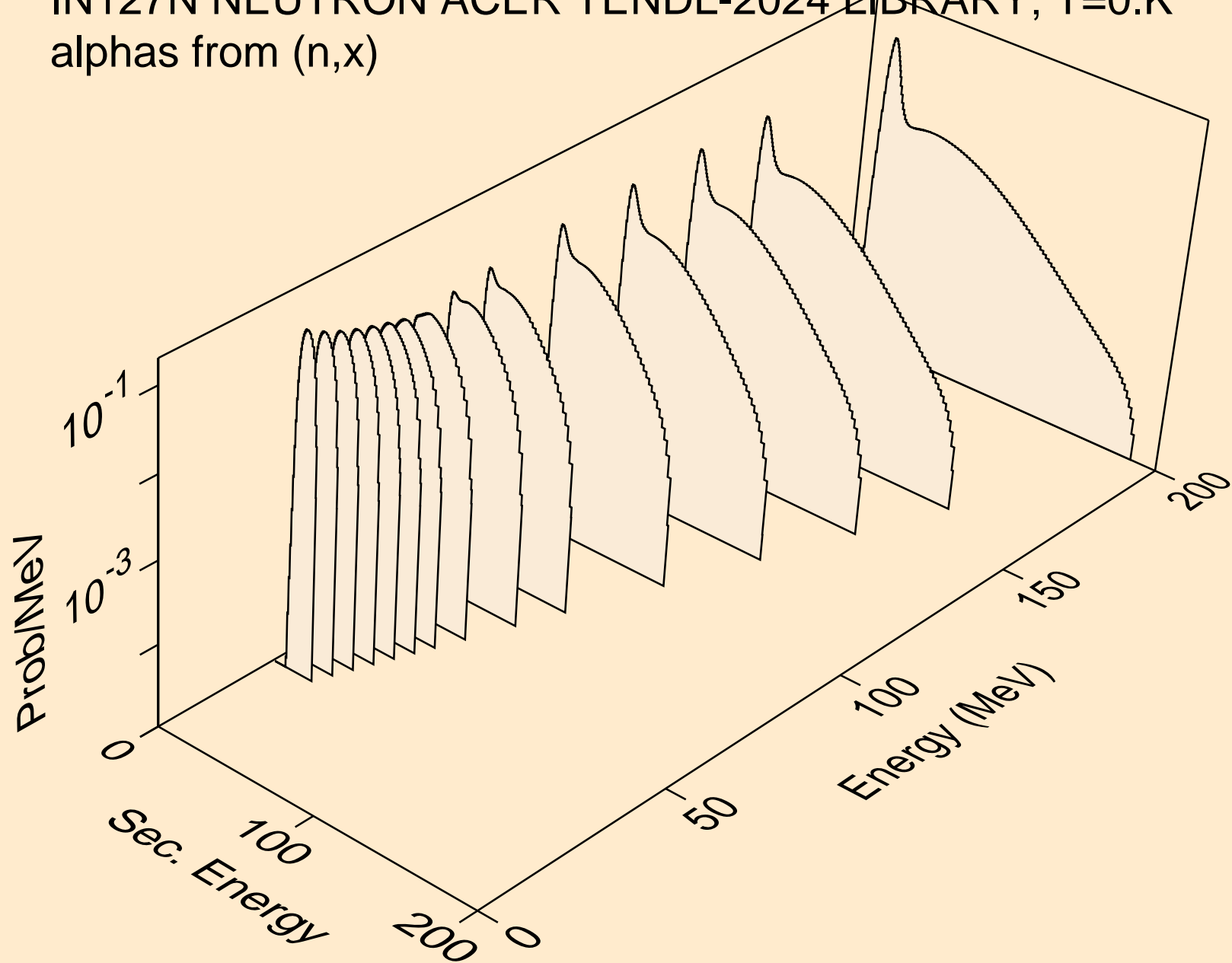

IN127N NEUTRON ACER TENDL-2024 LIBRARY; T=0.K
alphas from (n,n*)a

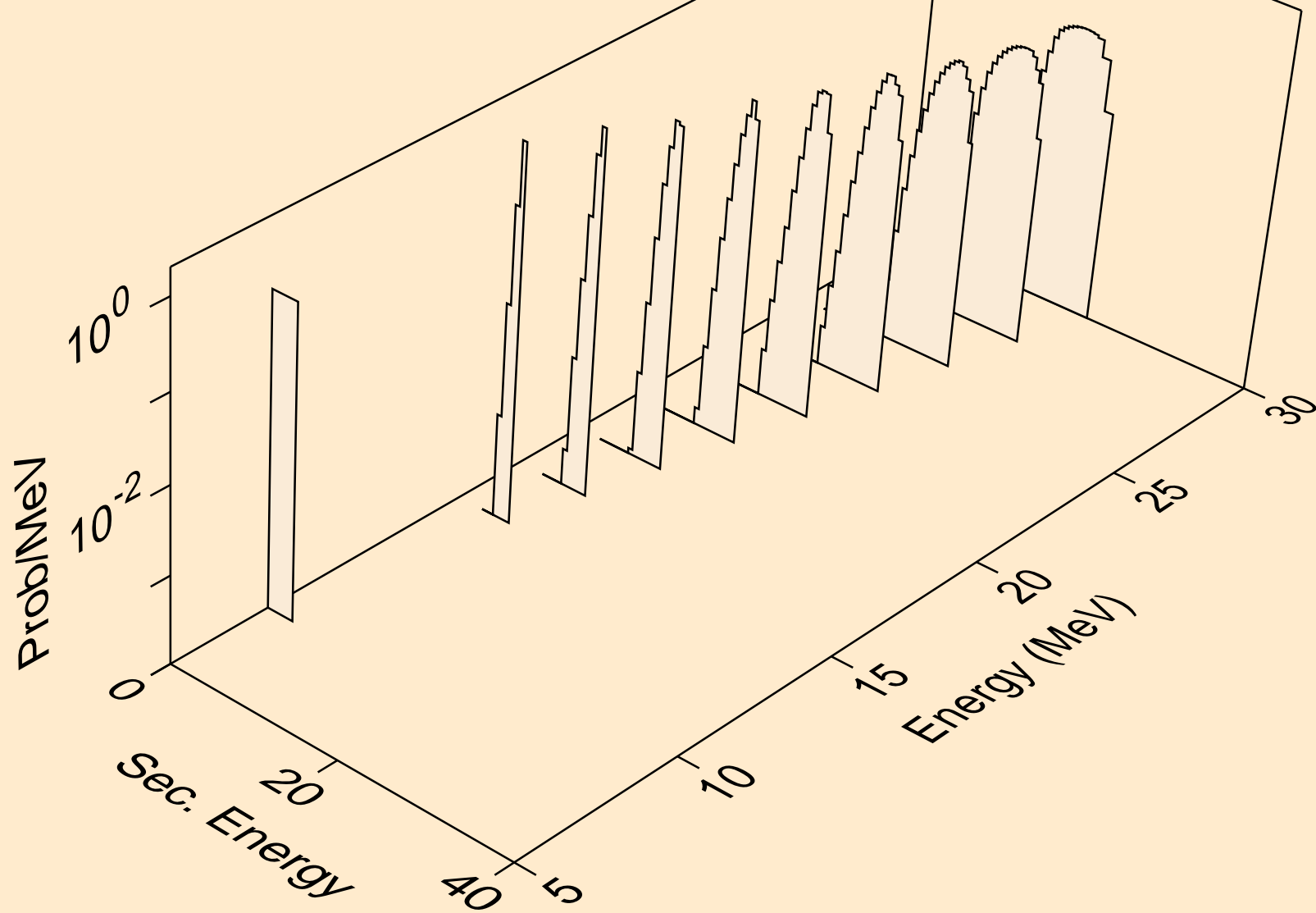

IN127N NEUTRON ACER TENDL-2024 LIBRARY; T=0.K
alphas from (n,2n)a

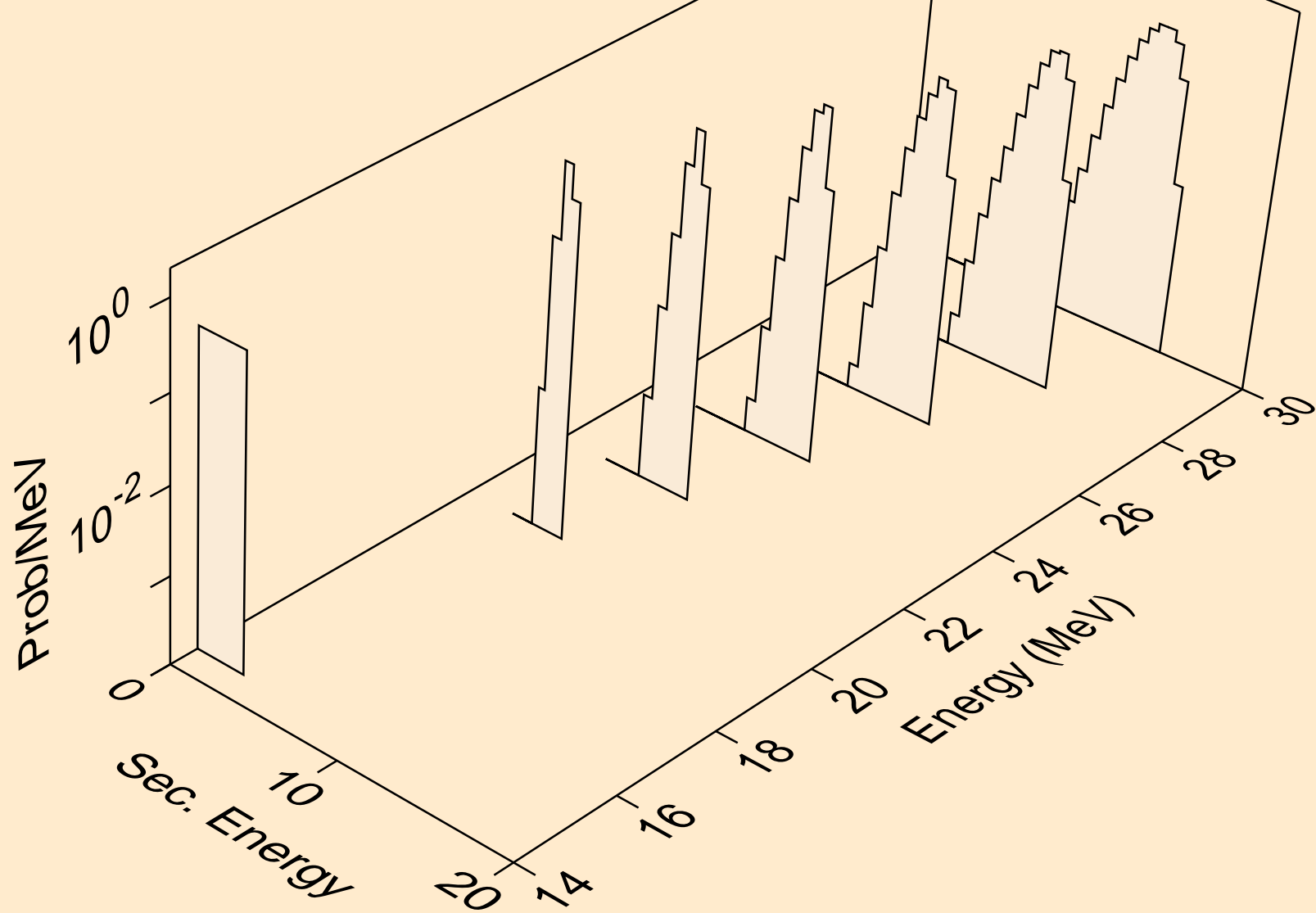

IN127N NEUTRON ACER TENDL-2024 LIBRARY; T=0.K
alphas from (n,3n)a

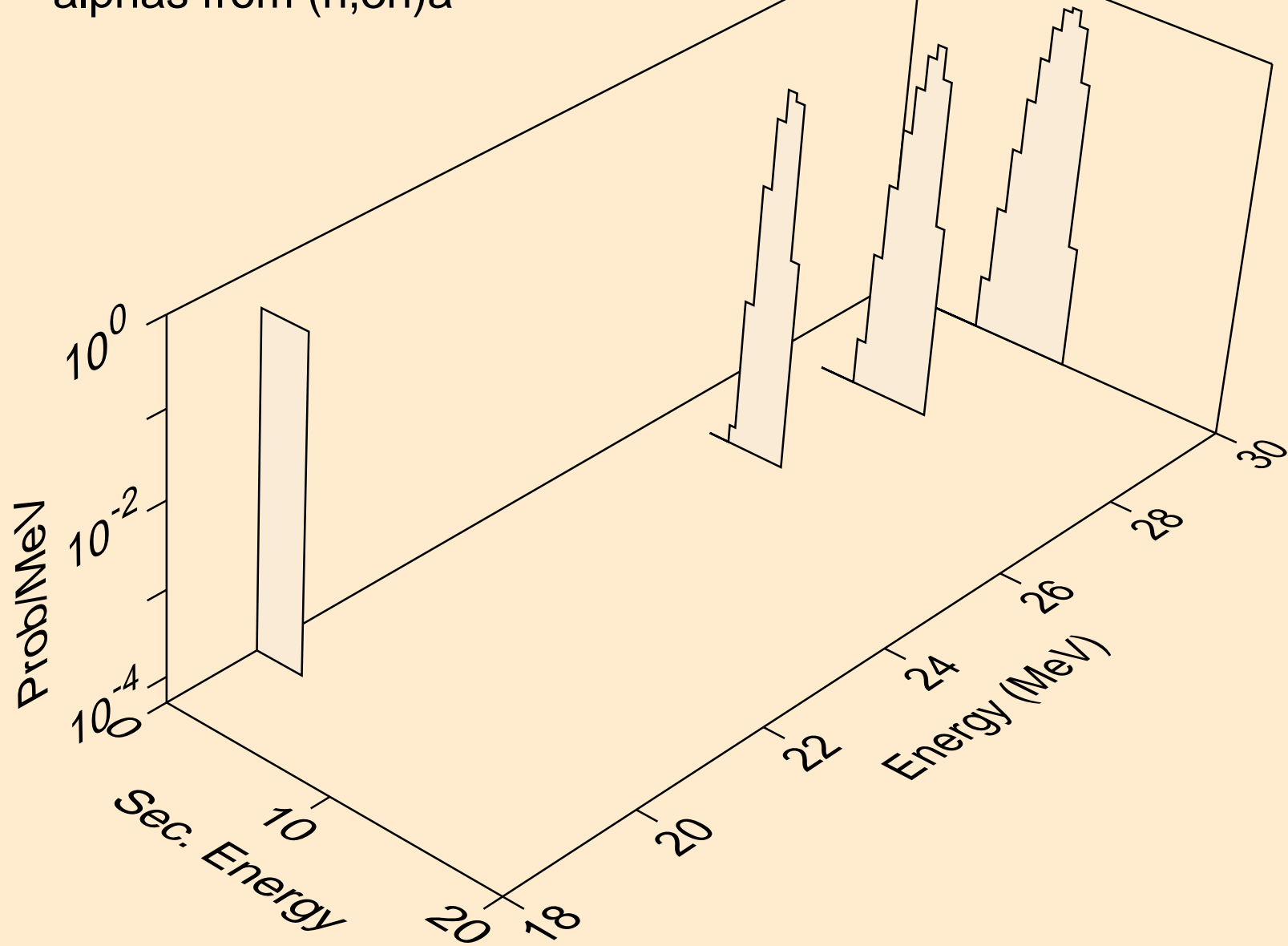

IN127N NEUTRON ACER TENDL-2024 LIBRARY; T=0.K
alphas from (n,a)

