

IR171M NEUTRON ACER TENDL-2024 LIBRARY; T=0.K

Principal cross sections

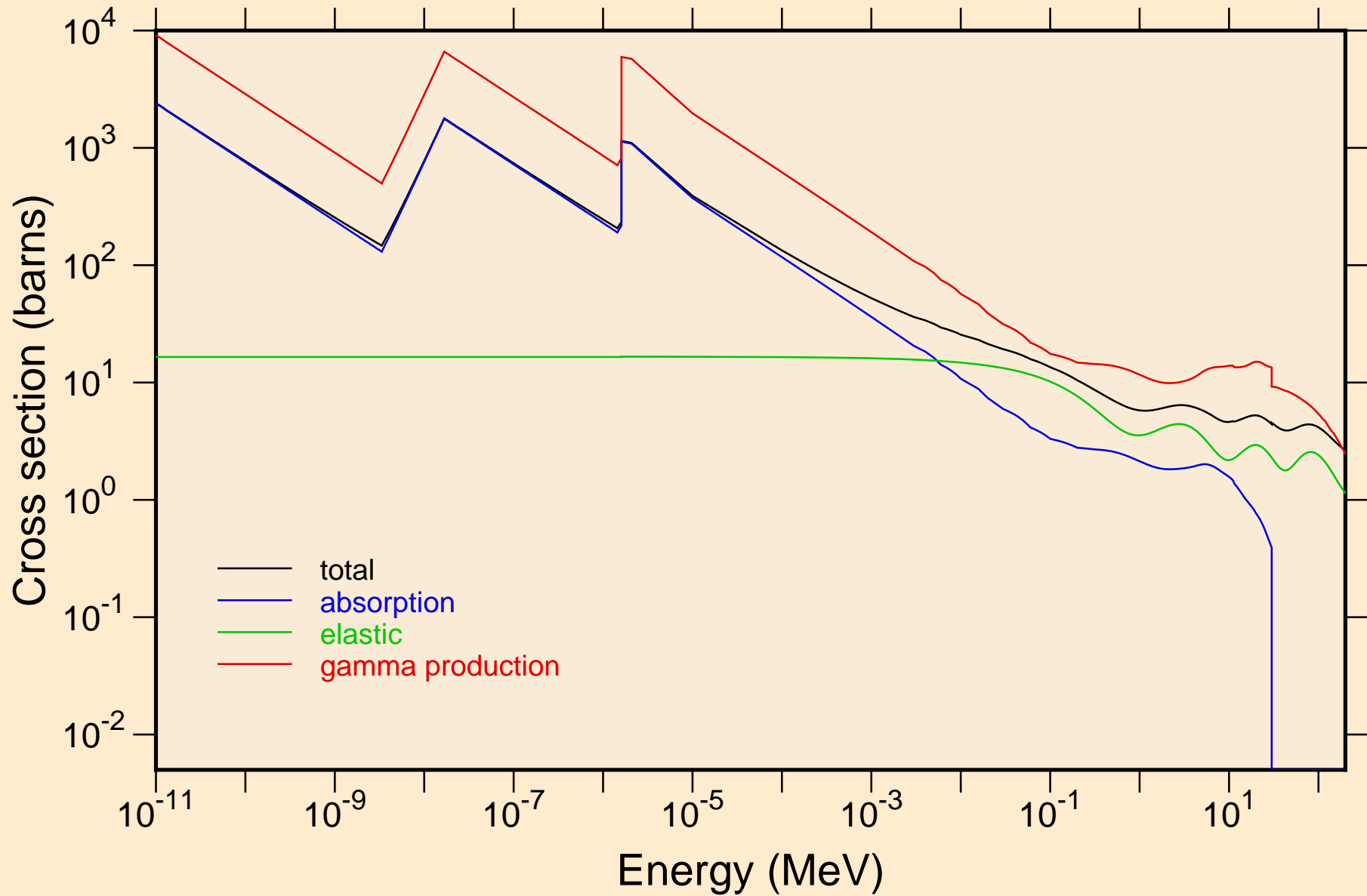

IR171M NEUTRON ACER TENDL-2024 LIBRARY; T=0.K

Heating

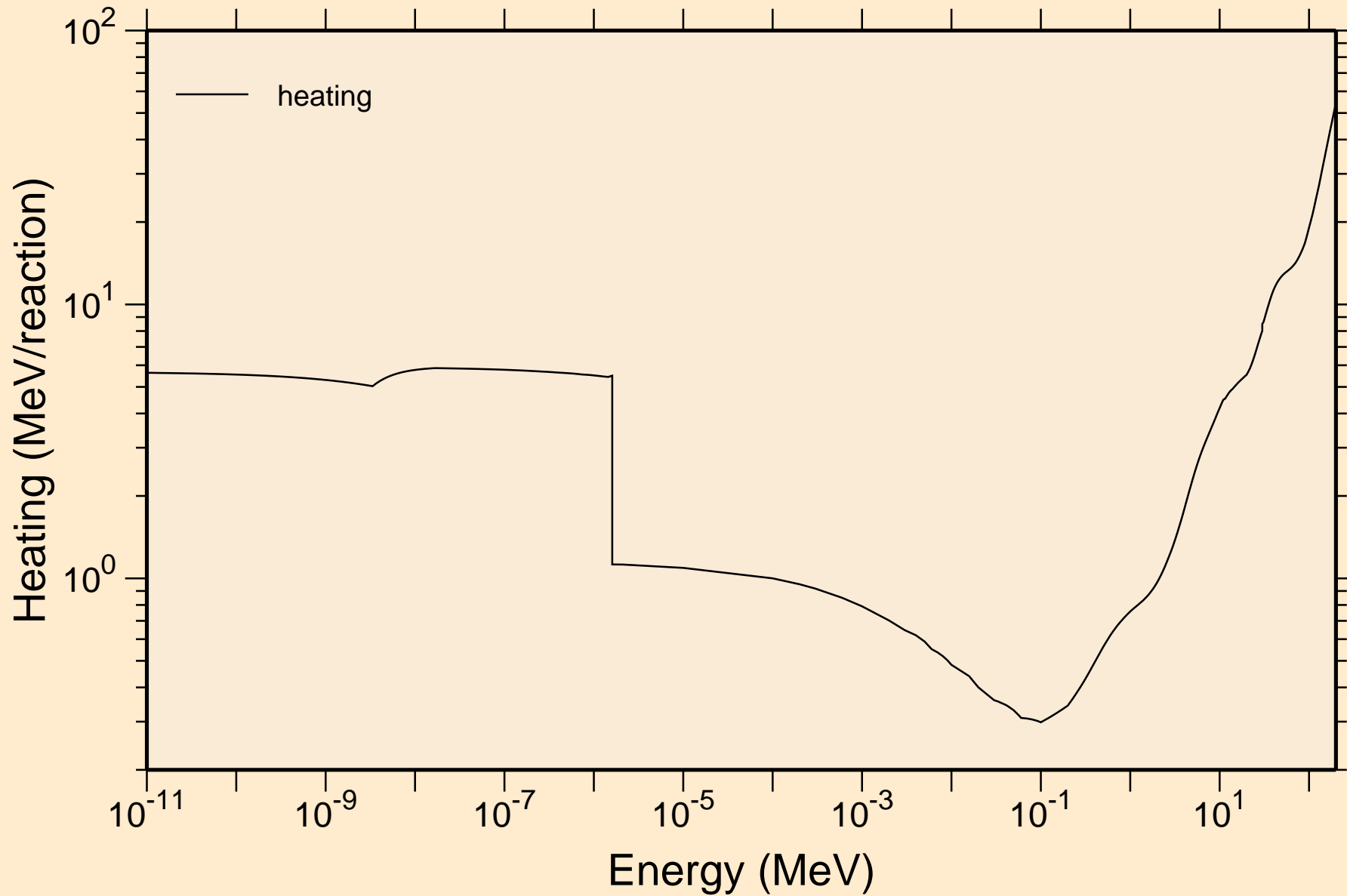

IR171M NEUTRON ACER TENDL-2024 LIBRARY; T=0.K

Damage

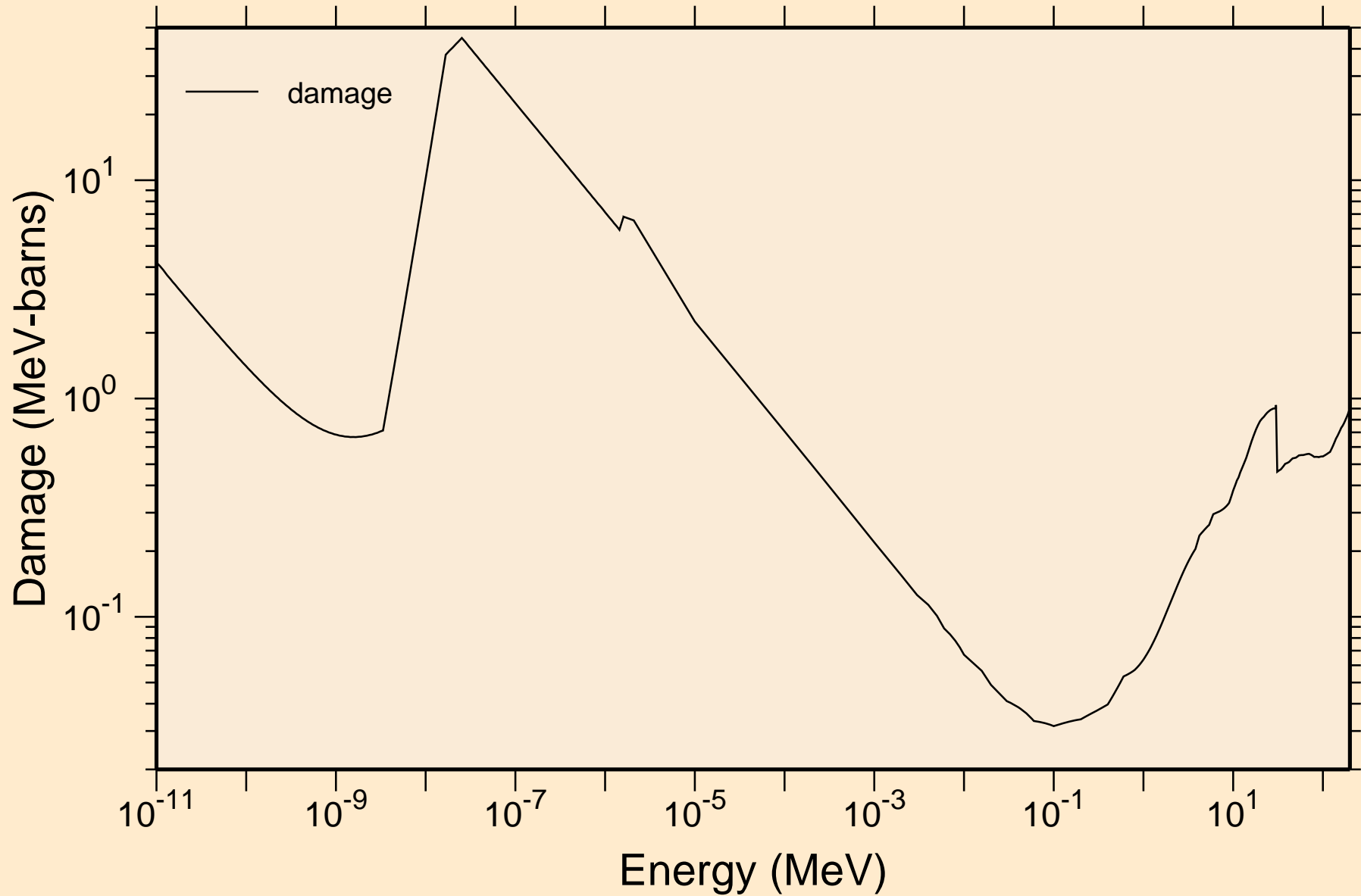

IR171M NEUTRON ACER TENDL-2024 LIBRARY; T=0.K
Non-threshold reactions

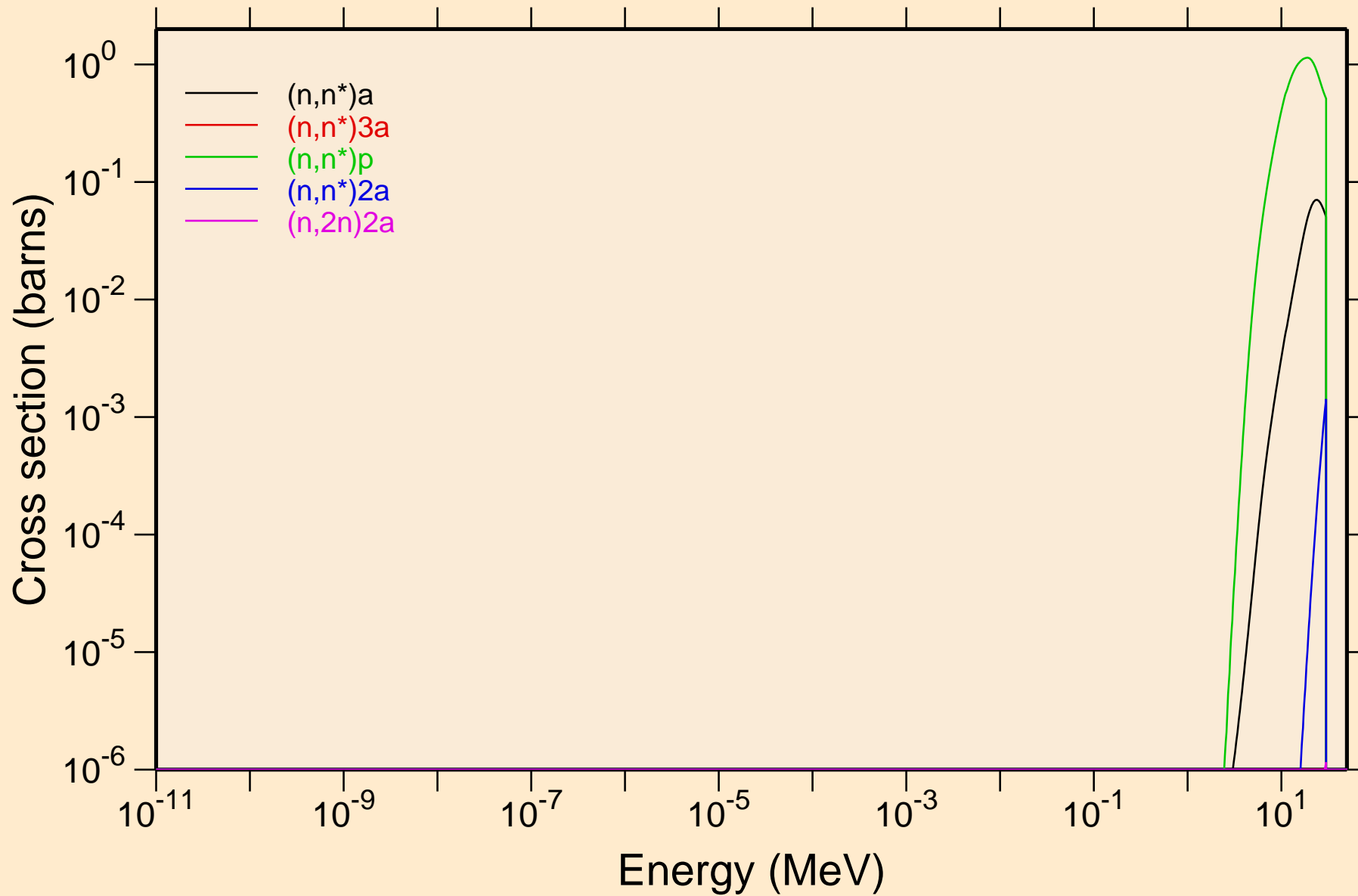

IR171M NEUTRON ACER TENDL-2024 LIBRARY; T=0.K

Non-threshold reactions

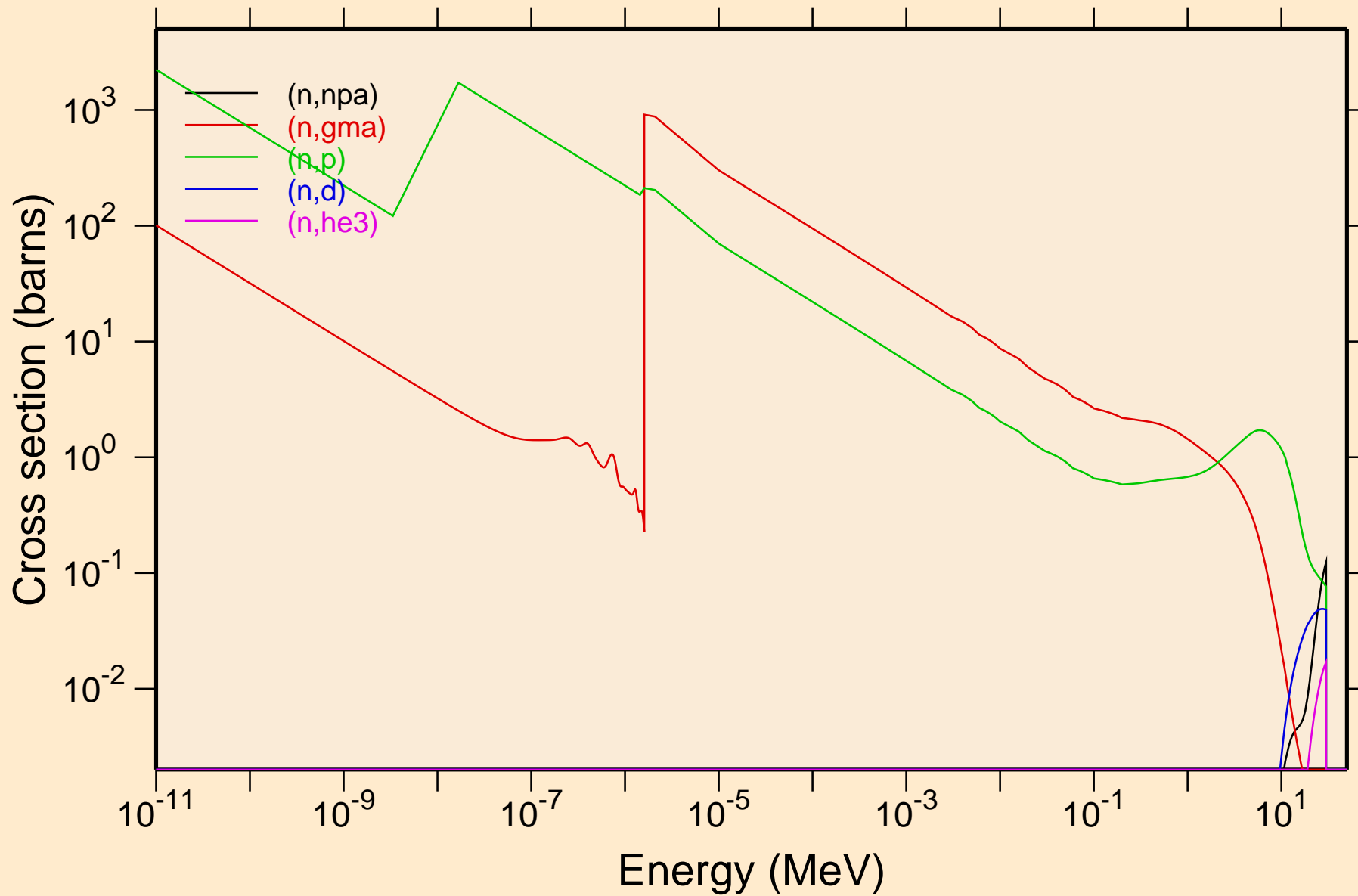

IR171M NEUTRON ACER TENDL-2024 LIBRARY; T=0.K
Non-threshold reactions

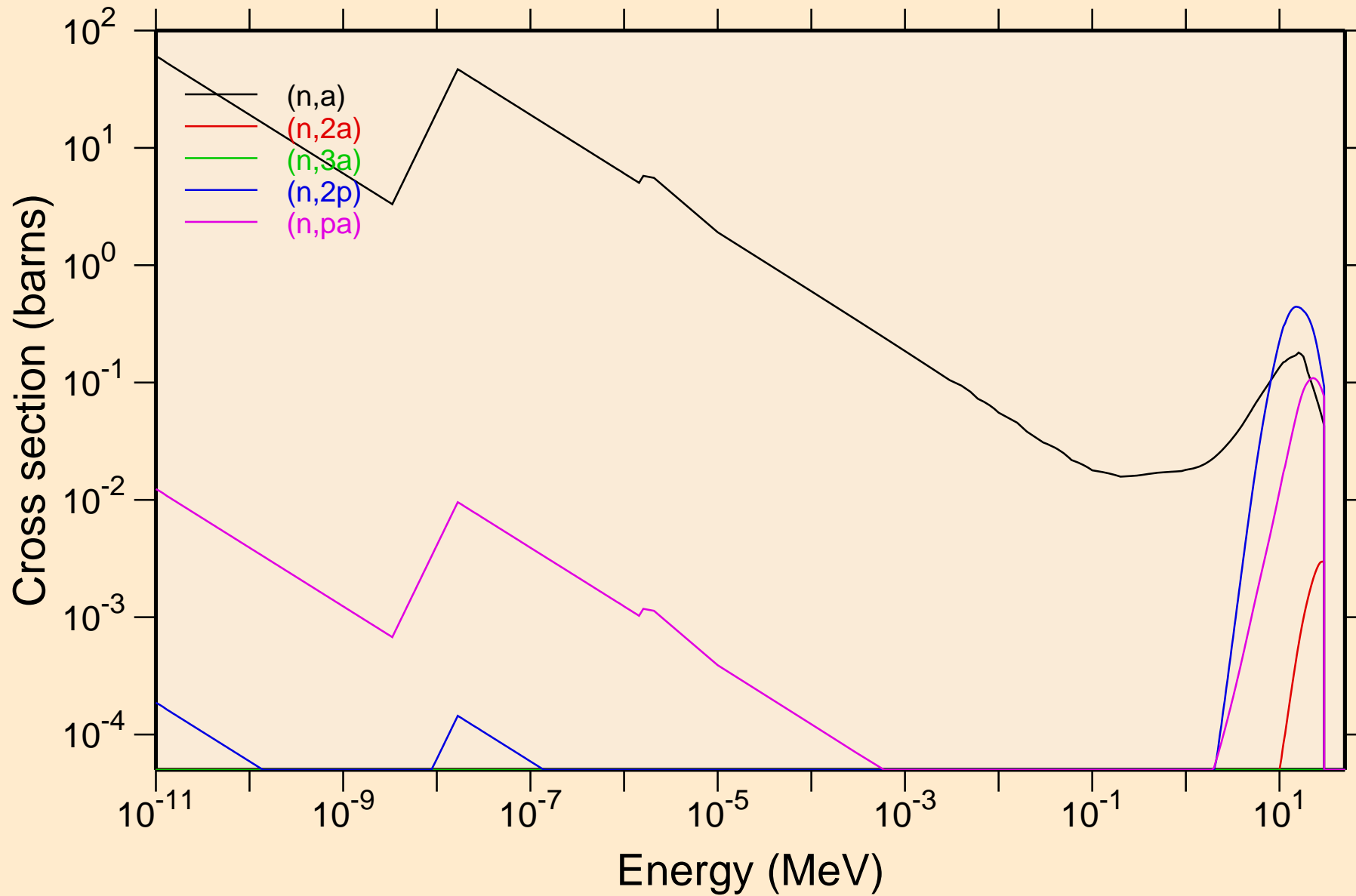

IR171M NEUTRON ACER TENDL-2024 LIBRARY; T=0.K
Non-threshold reactions

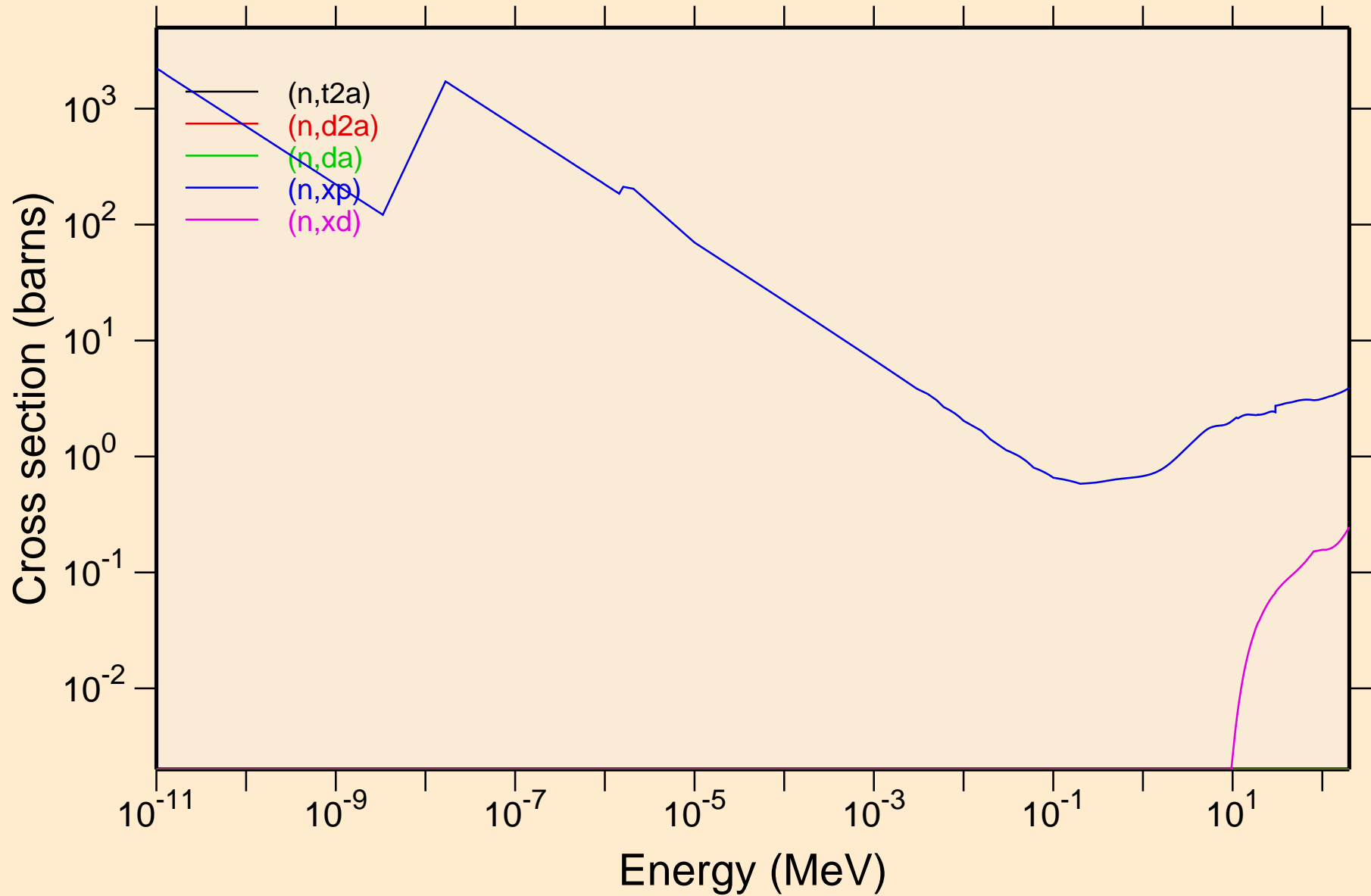

IR171M NEUTRON ACER TENDL-2024 LIBRARY; T=0.K
Non-threshold reactions

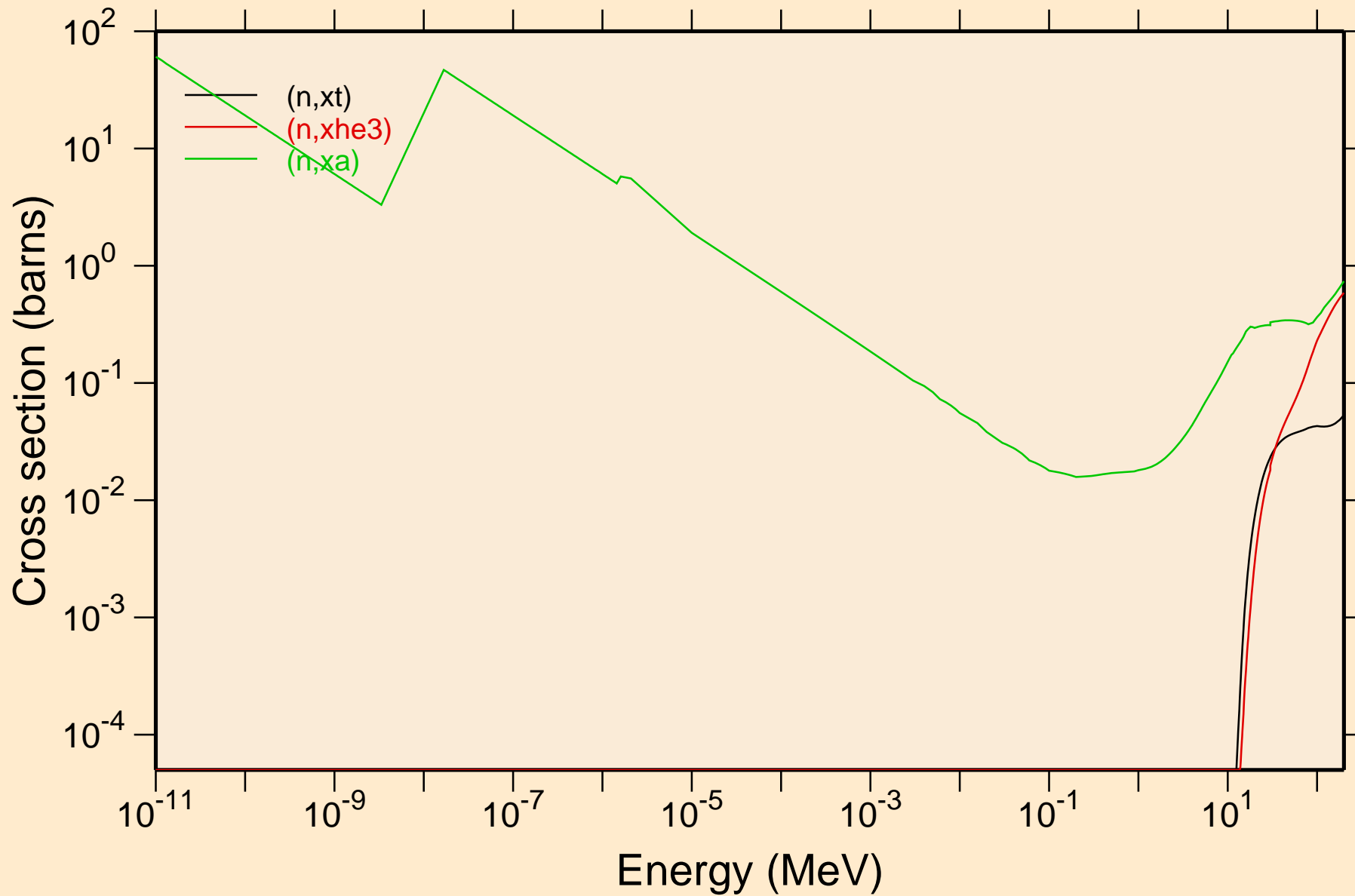

IR171M NEUTRON ACER TENDL-2024 LIBRARY; T=0.K

Principal cross sections

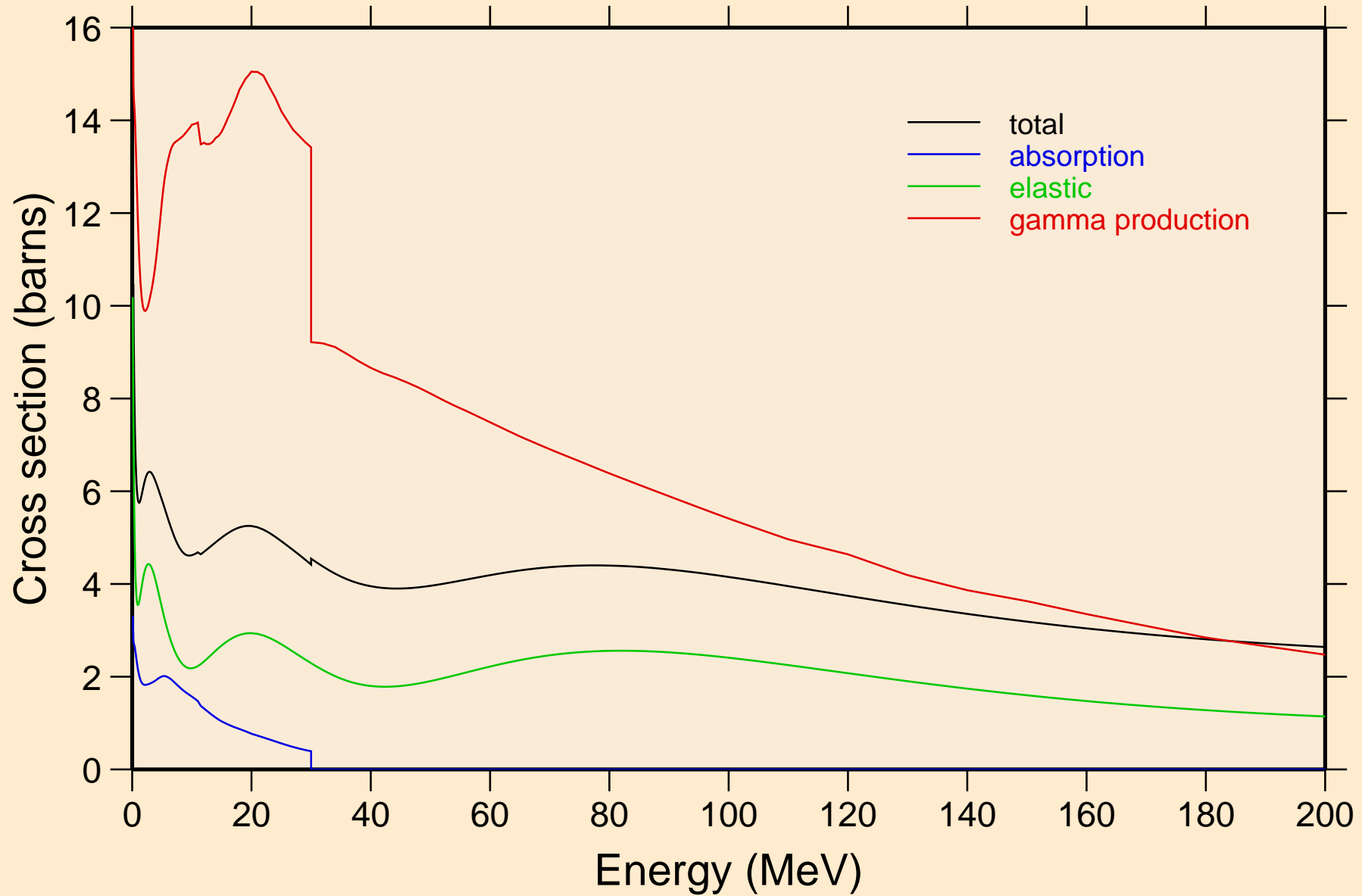

IR171M NEUTRON ACER TENDL-2024 LIBRARY; T=0.K

Heating

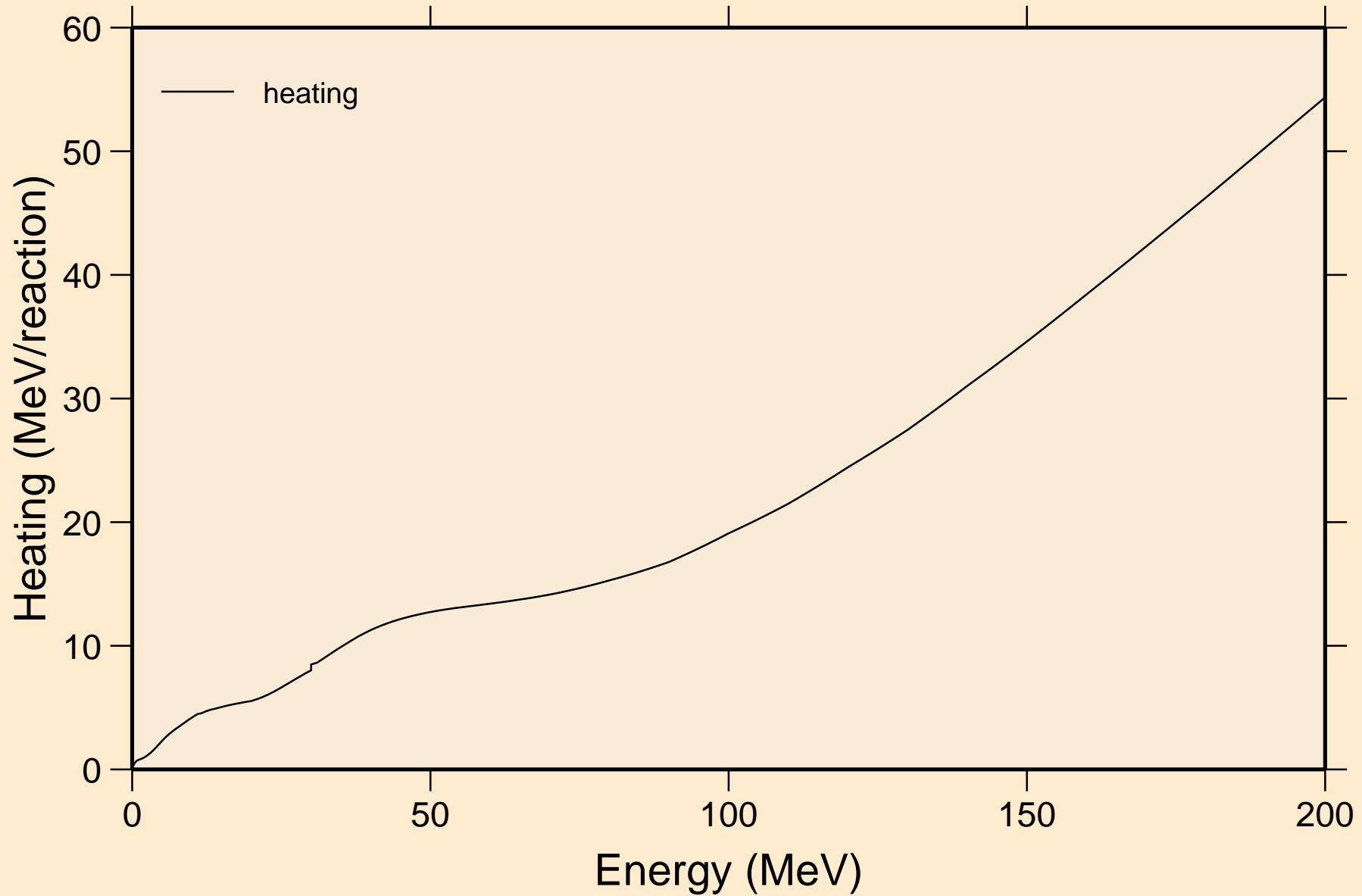

IR171M NEUTRON ACER TENDL-2024 LIBRARY; T=0.K

Damage

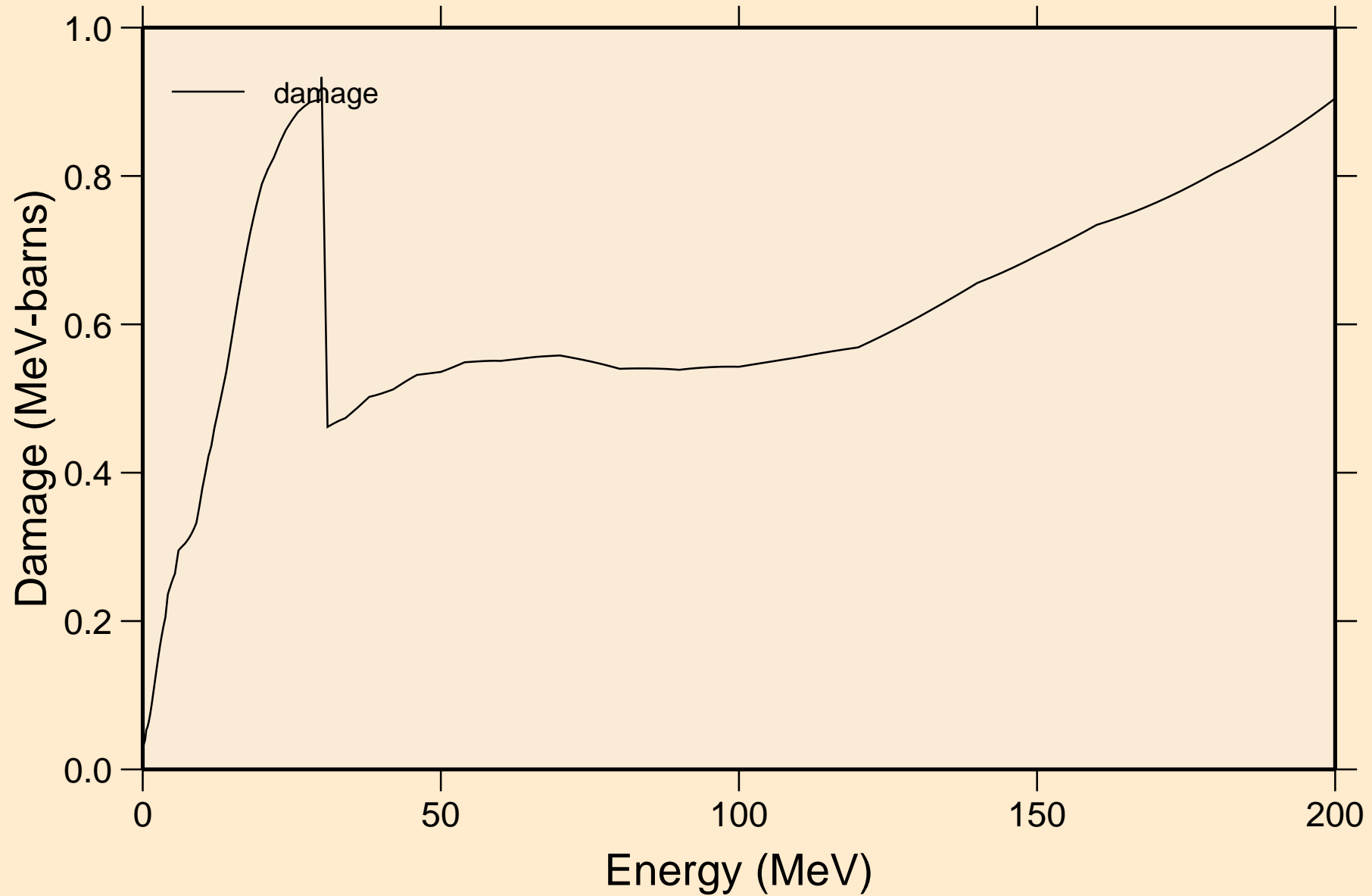

IR171M NEUTRON ACER TENDL-2024 LIBRARY; T=0.K
Non-threshold reactions

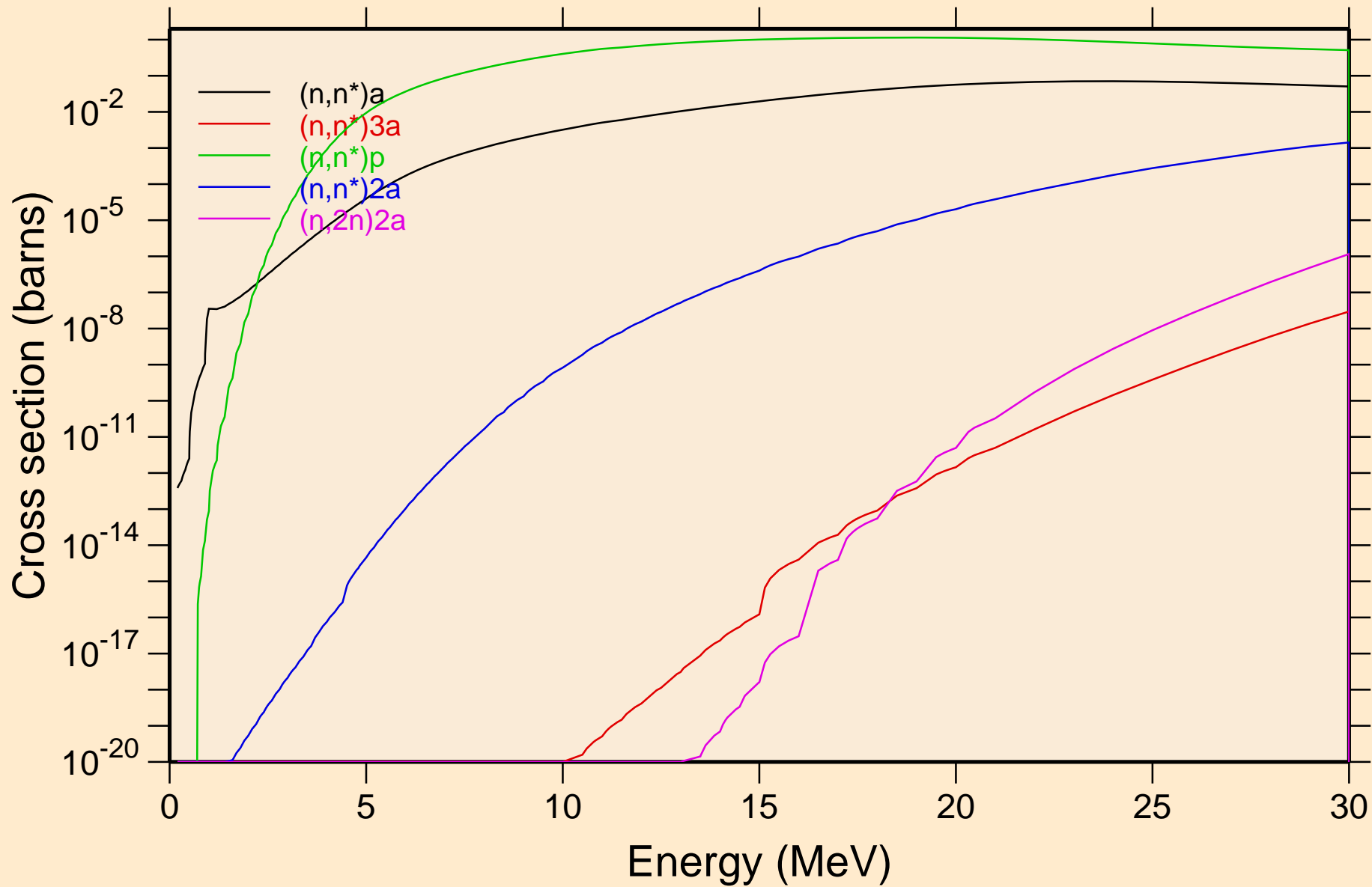

IR171M NEUTRON ACER TENDL-2024 LIBRARY; T=0.K
Non-threshold reactions

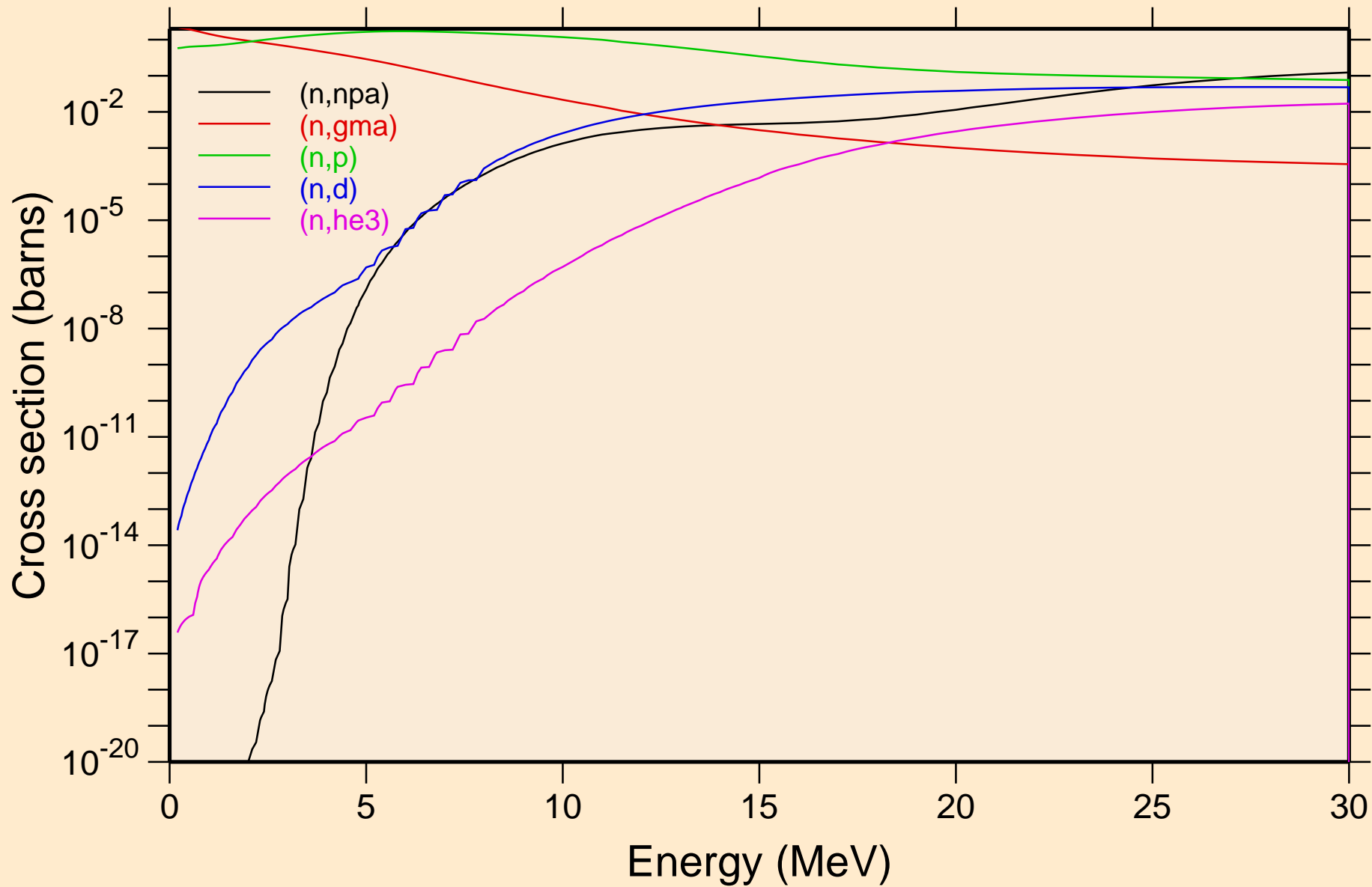

IR171M NEUTRON ACER TENDL-2024 LIBRARY; T=0.K
Non-threshold reactions

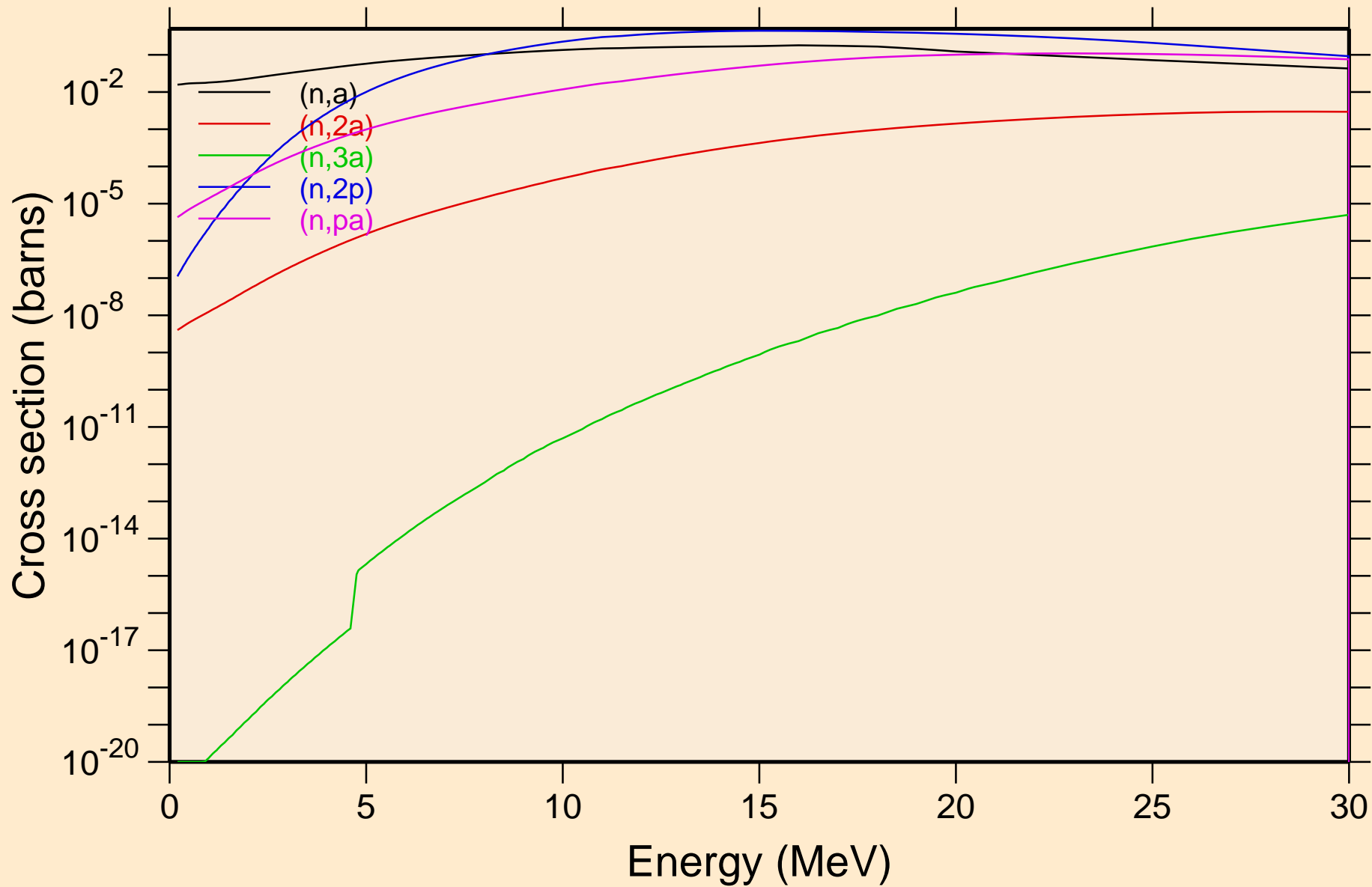

IR171M NEUTRON ACER TENDL-2024 LIBRARY; T=0.K

Non-threshold reactions

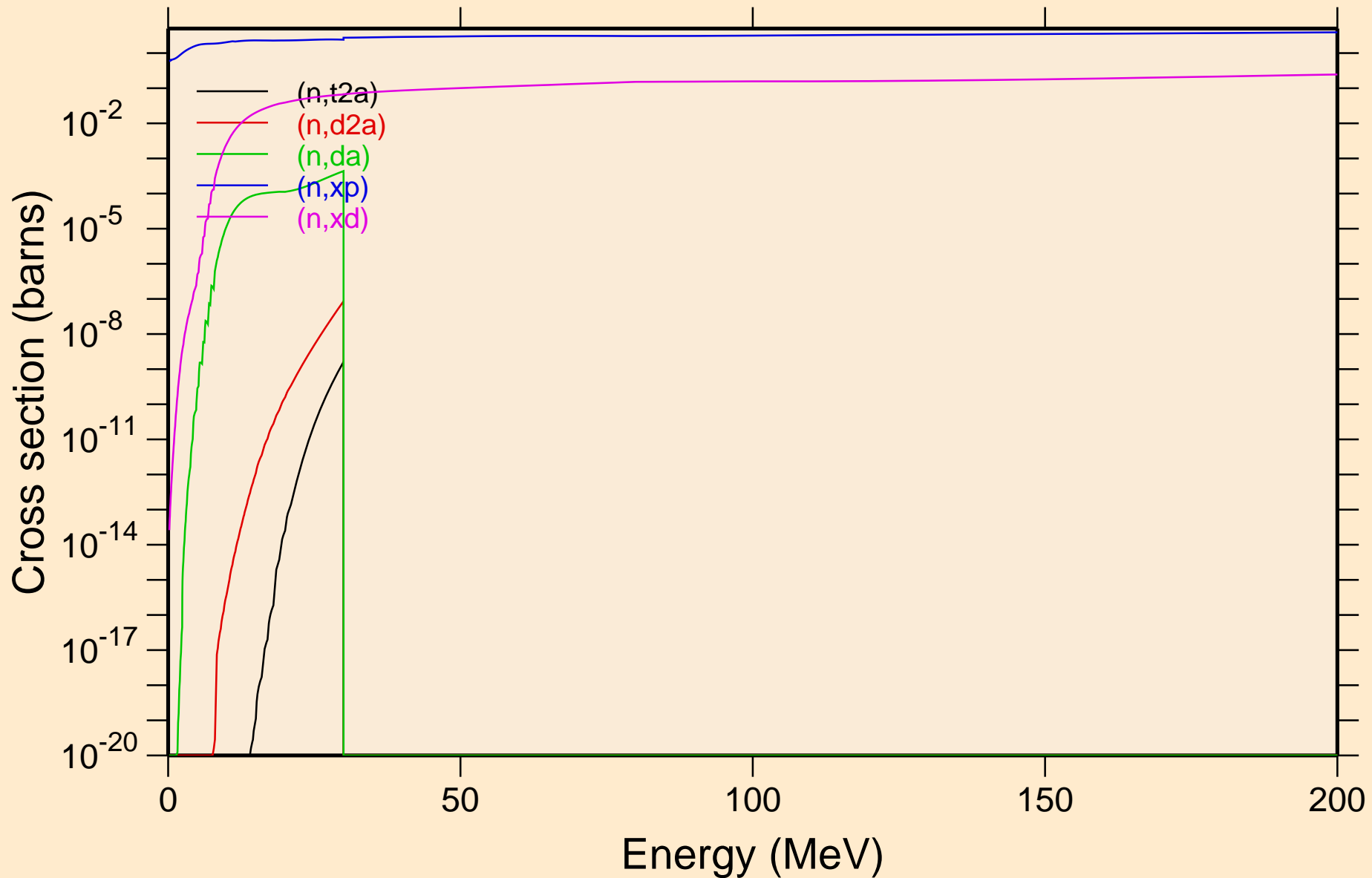

IR171M NEUTRON ACER TENDL-2024 LIBRARY; T=0.K
Non-threshold reactions

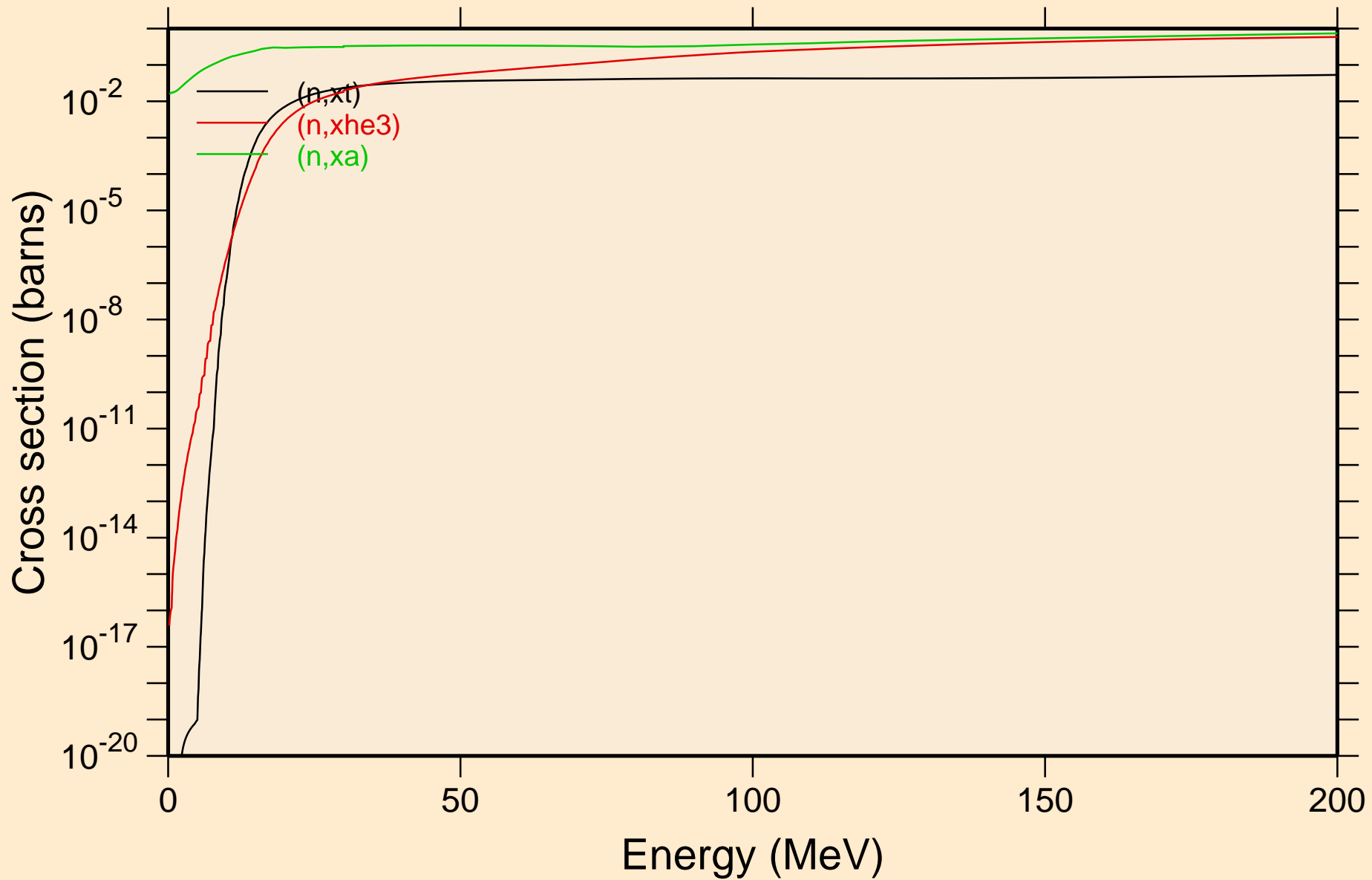

IR171M NEUTRON ACER TENDL-2024 LIBRARY; T=0.K
Inelastic levels

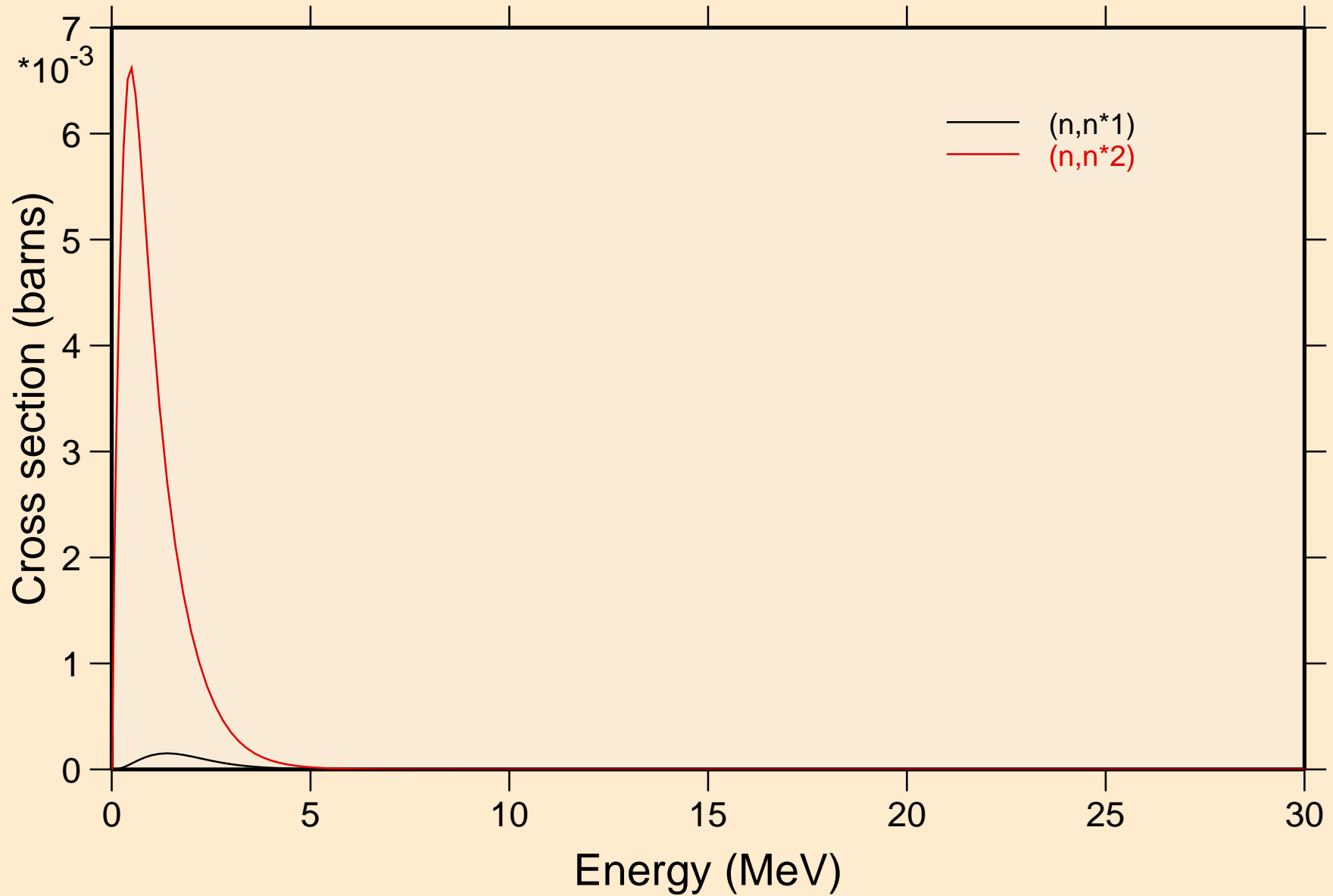

IR171M NEUTRON ACER TENDL-2024 LIBRARY; T=0.K

Threshold reactions

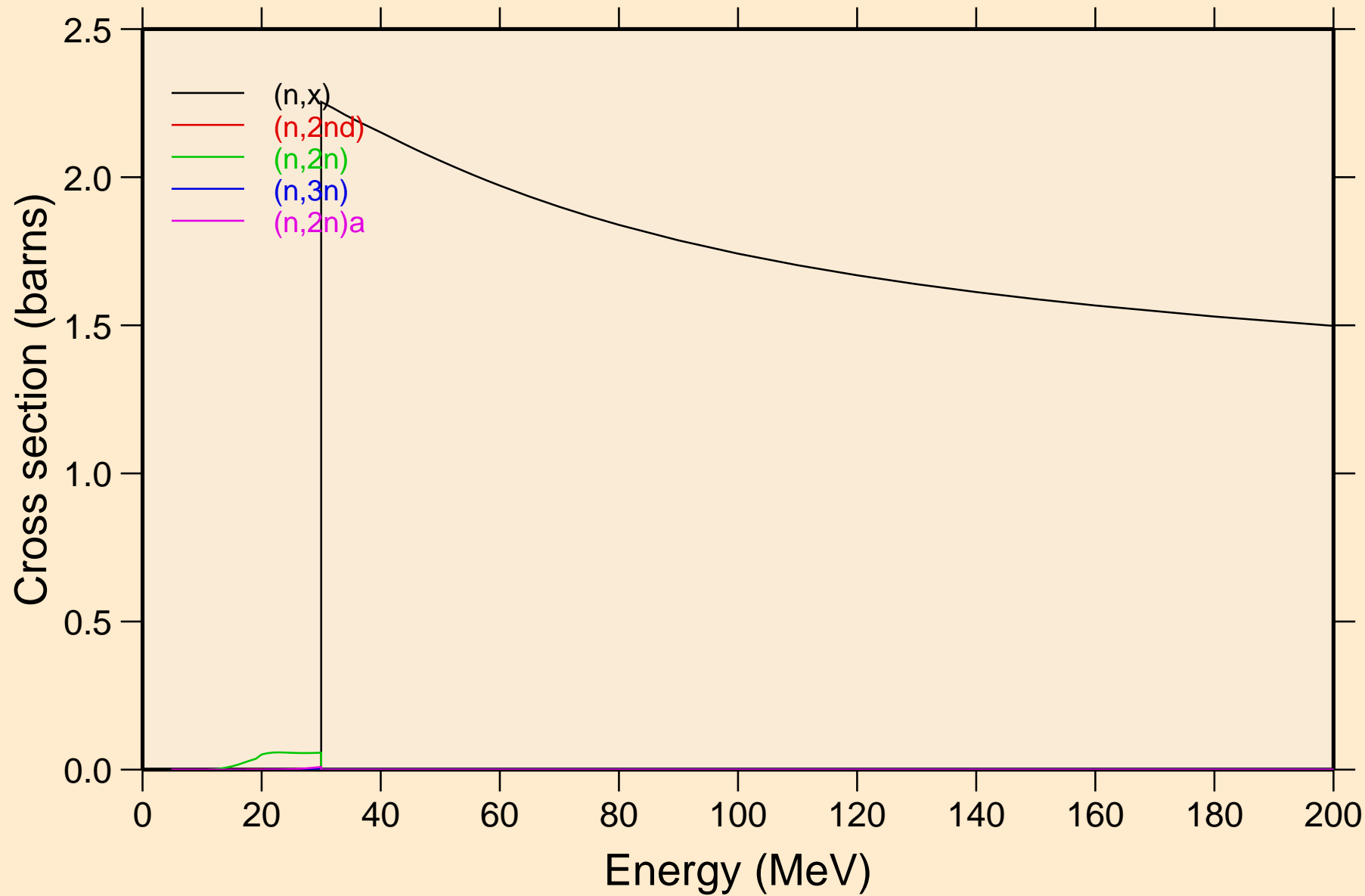

IR171M NEUTRON ACER TENDL-2024 LIBRARY; T=0.K

Threshold reactions

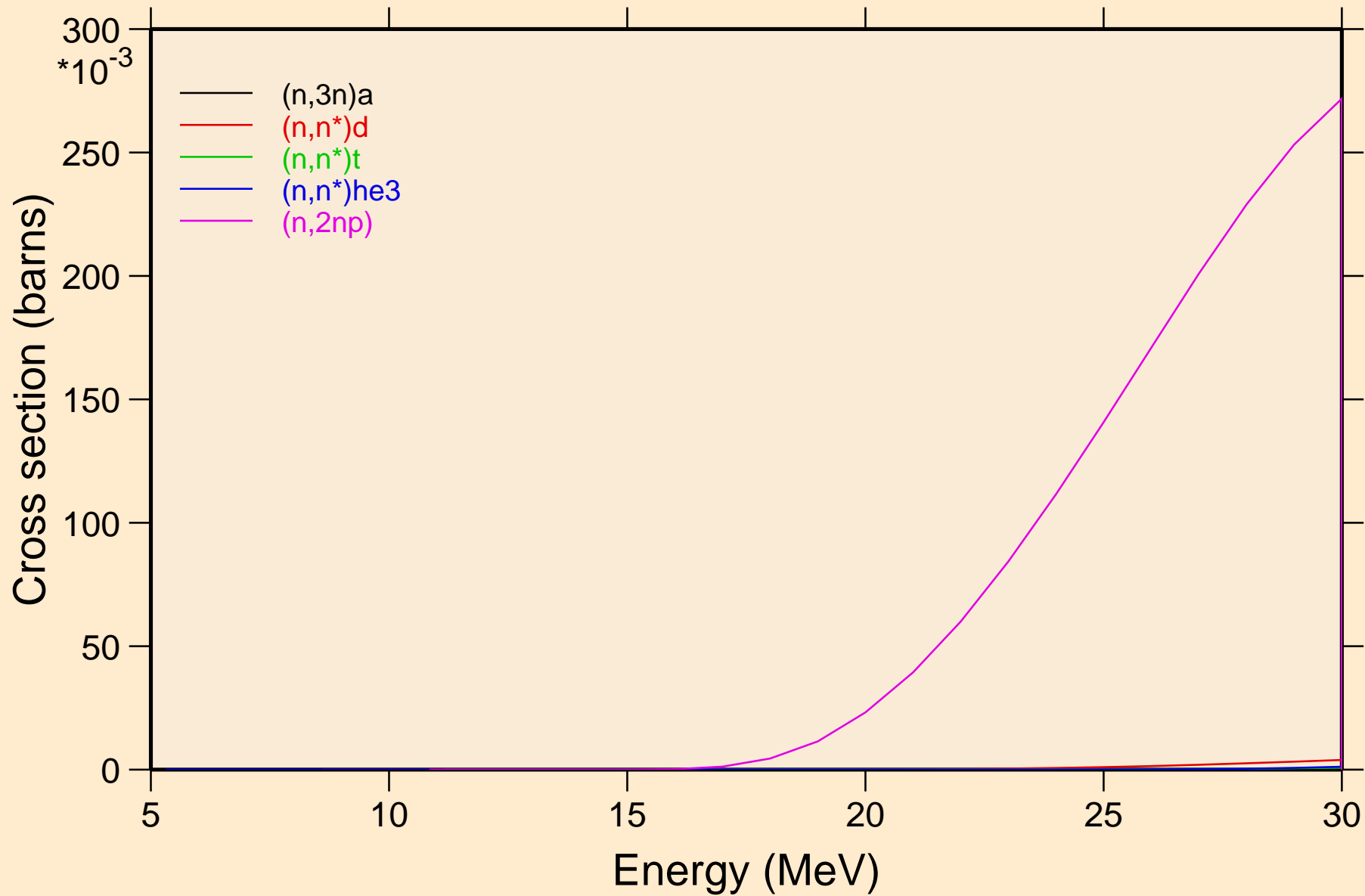

IR171M NEUTRON ACER TENDL-2024 LIBRARY; T=0.K
Threshold reactions

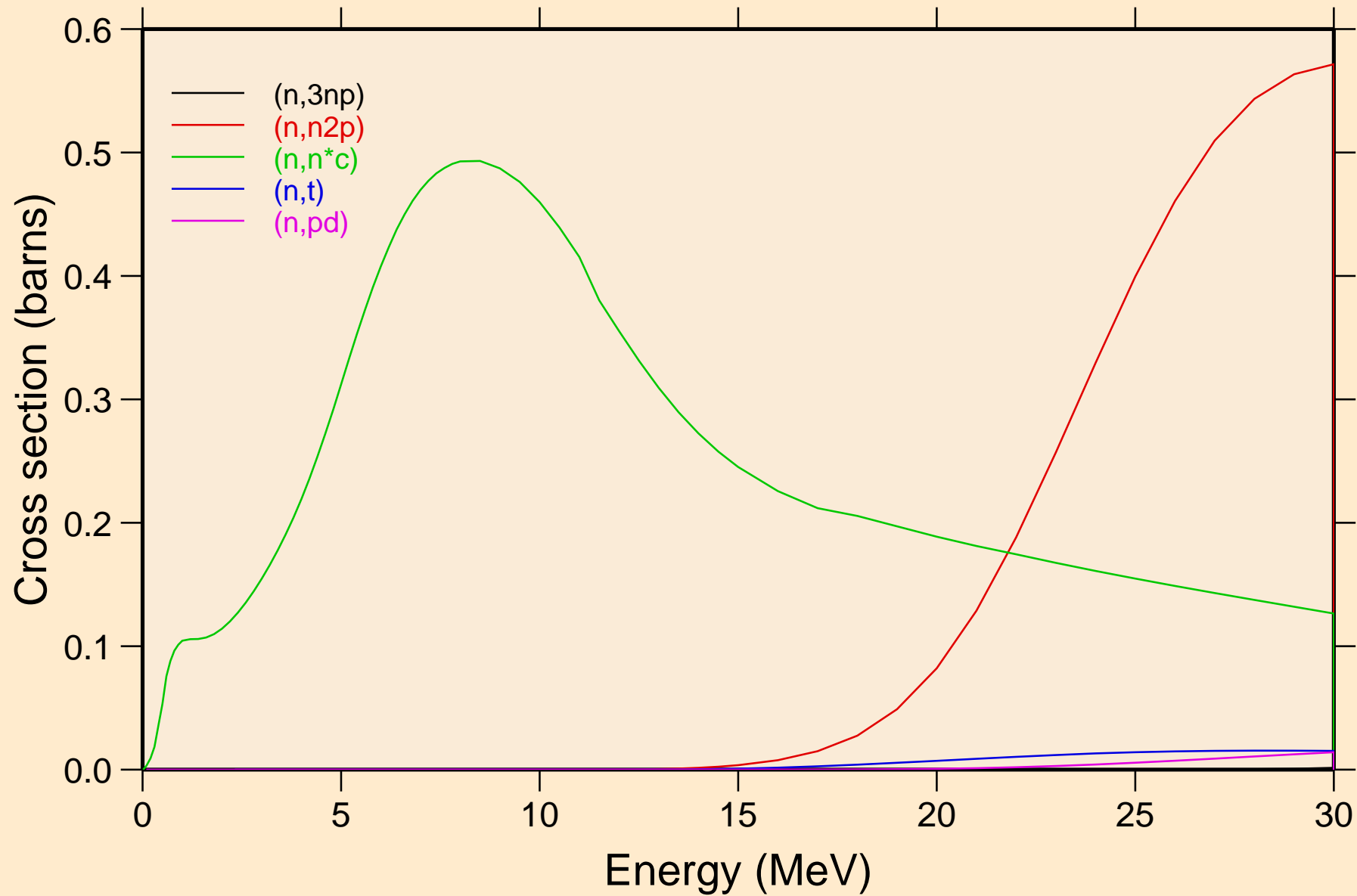

IR171M NEUTRON ACER TENDL-2024 LIBRARY; T=0.K
Threshold reactions

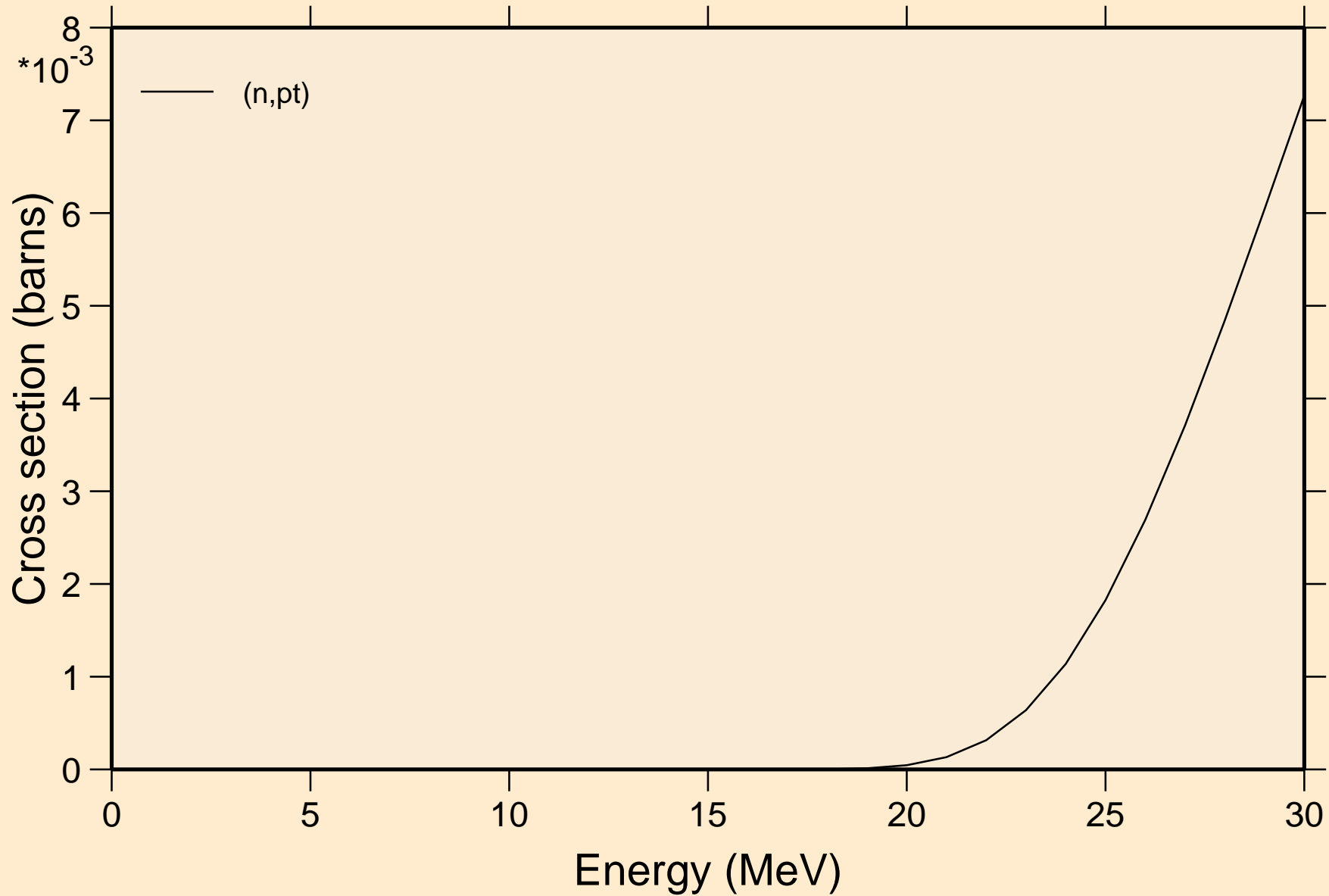

IR171M NEUTRON ACER TENDL-2024 LIBRARY; T=0.K
angular distribution for elastic

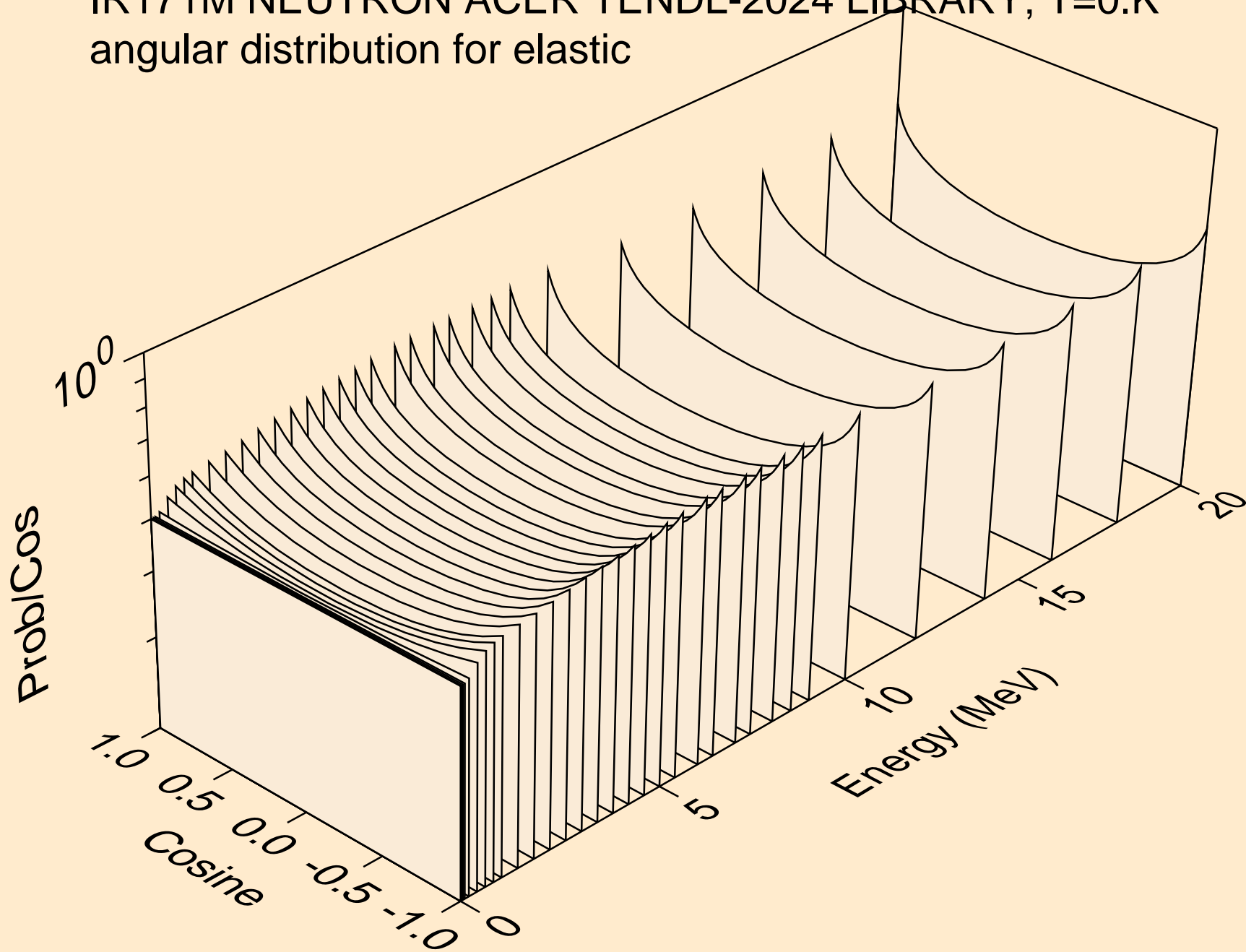

IR171M NEUTRON ACER TENDL-2024 LIBRARY; T=0.K
angular distribution for elastic

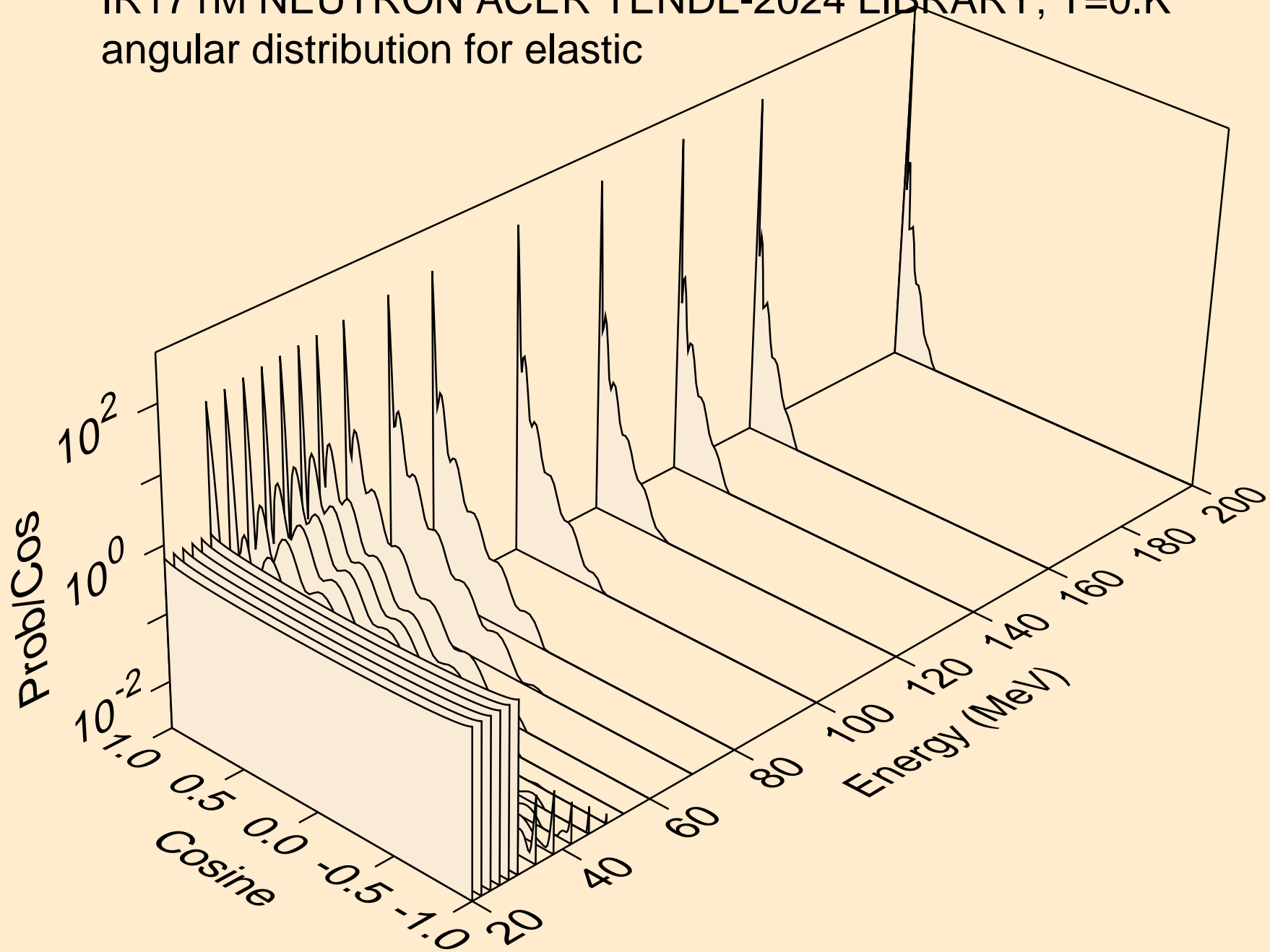

IR171M NEUTRON ACER TENDL-2024 LIBRARY; T=0.K
angular distribution for (n,n*1)

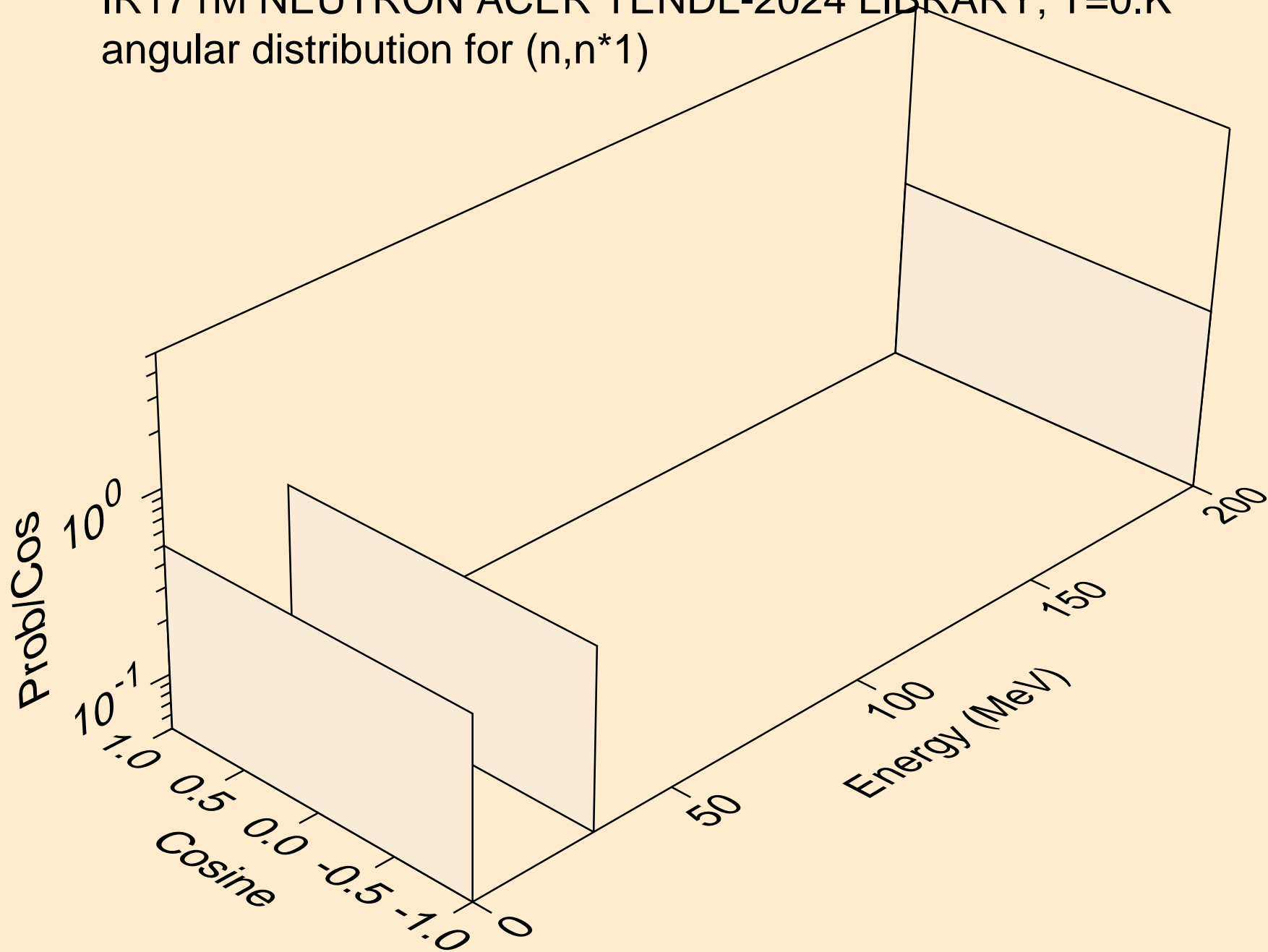

IR171M NEUTRON ACER TENDL-2024 LIBRARY; T=0.K
angular distribution for (n,n*2)

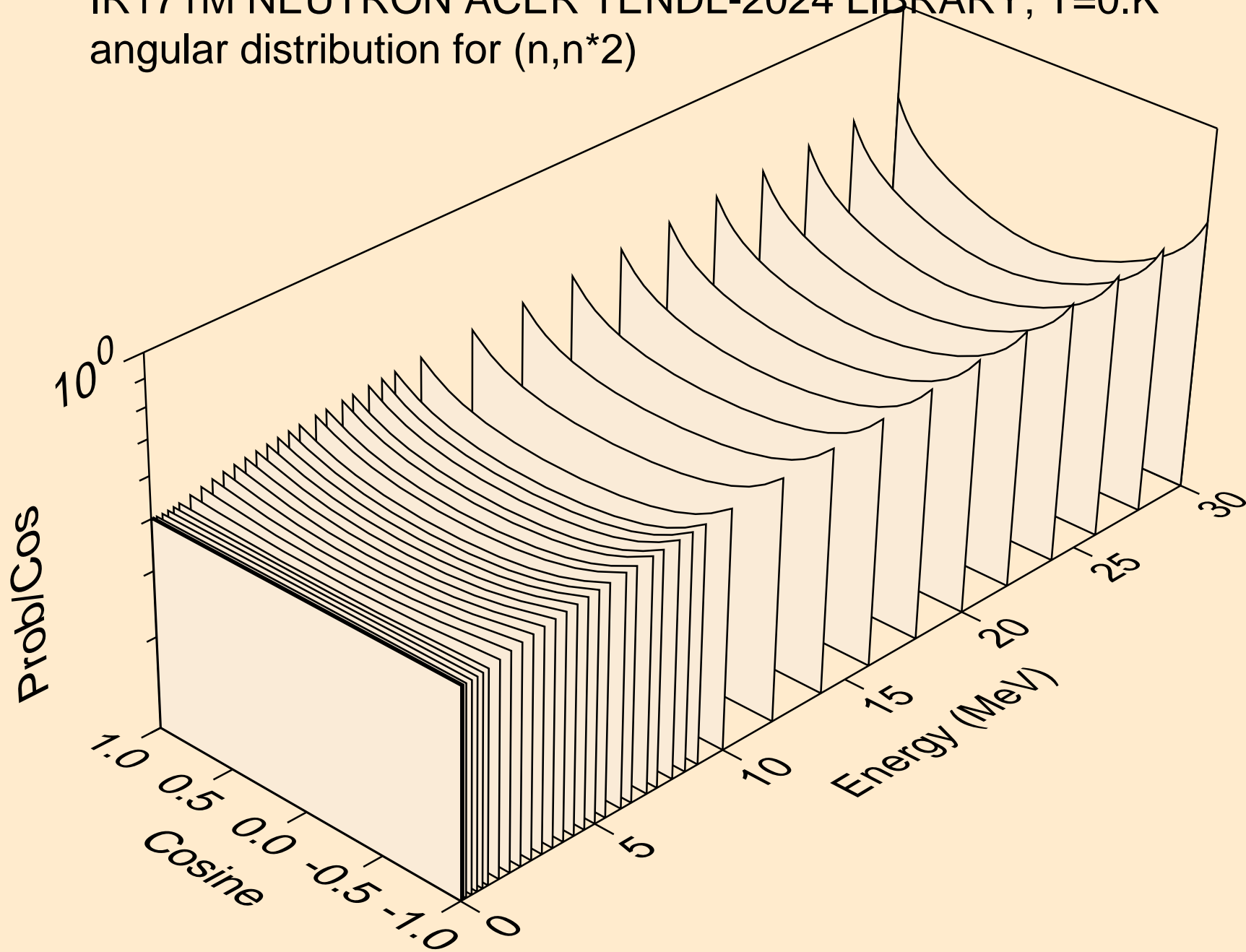

IR171M NEUTRON ACER TENDL-2024 LIBRARY; T=0.K
Neutron emission for (n,x)

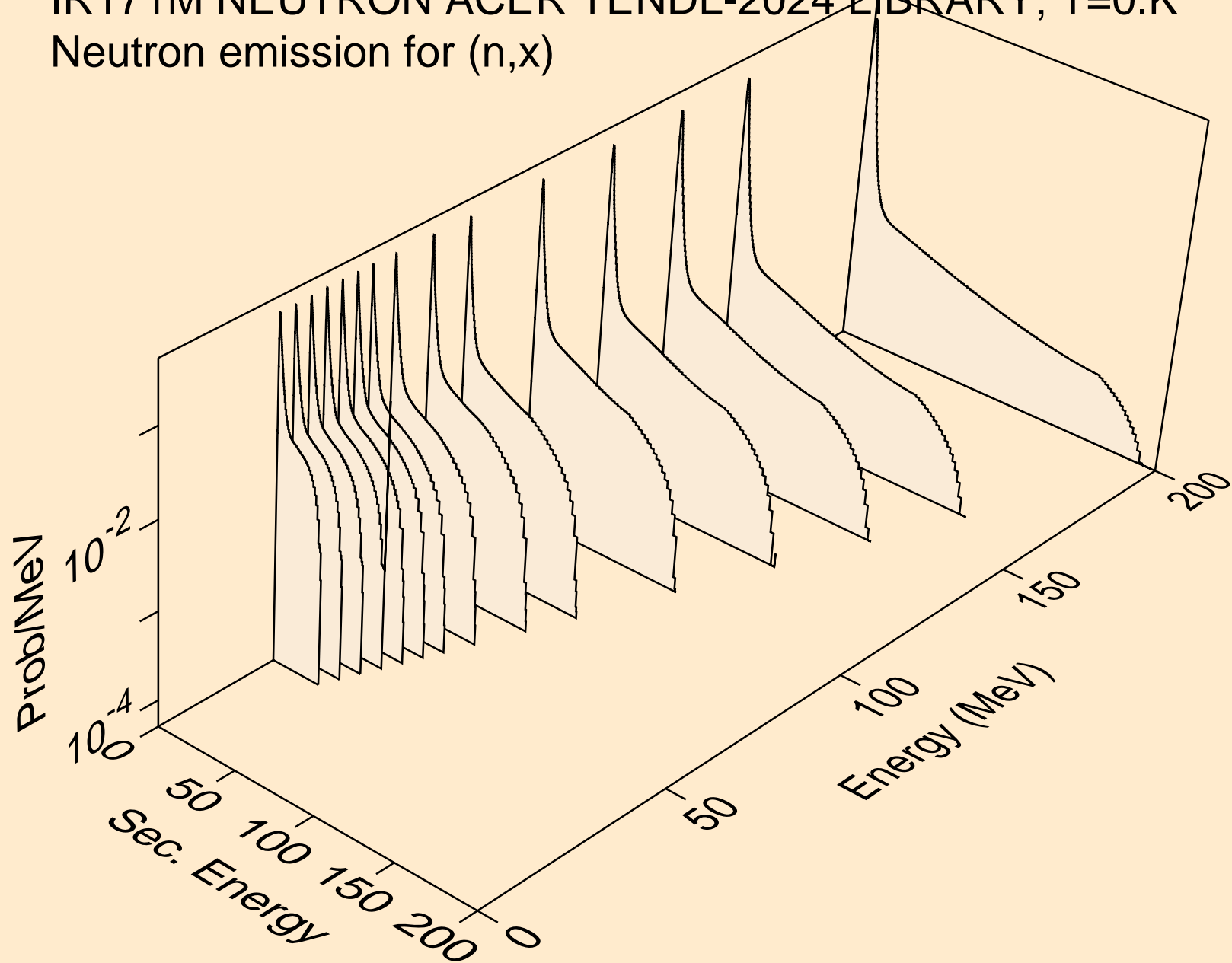

IR171M NEUTRON ACER TENDL-2024 LIBRARY; T=0.K
Neutron emission for (n,2nd)

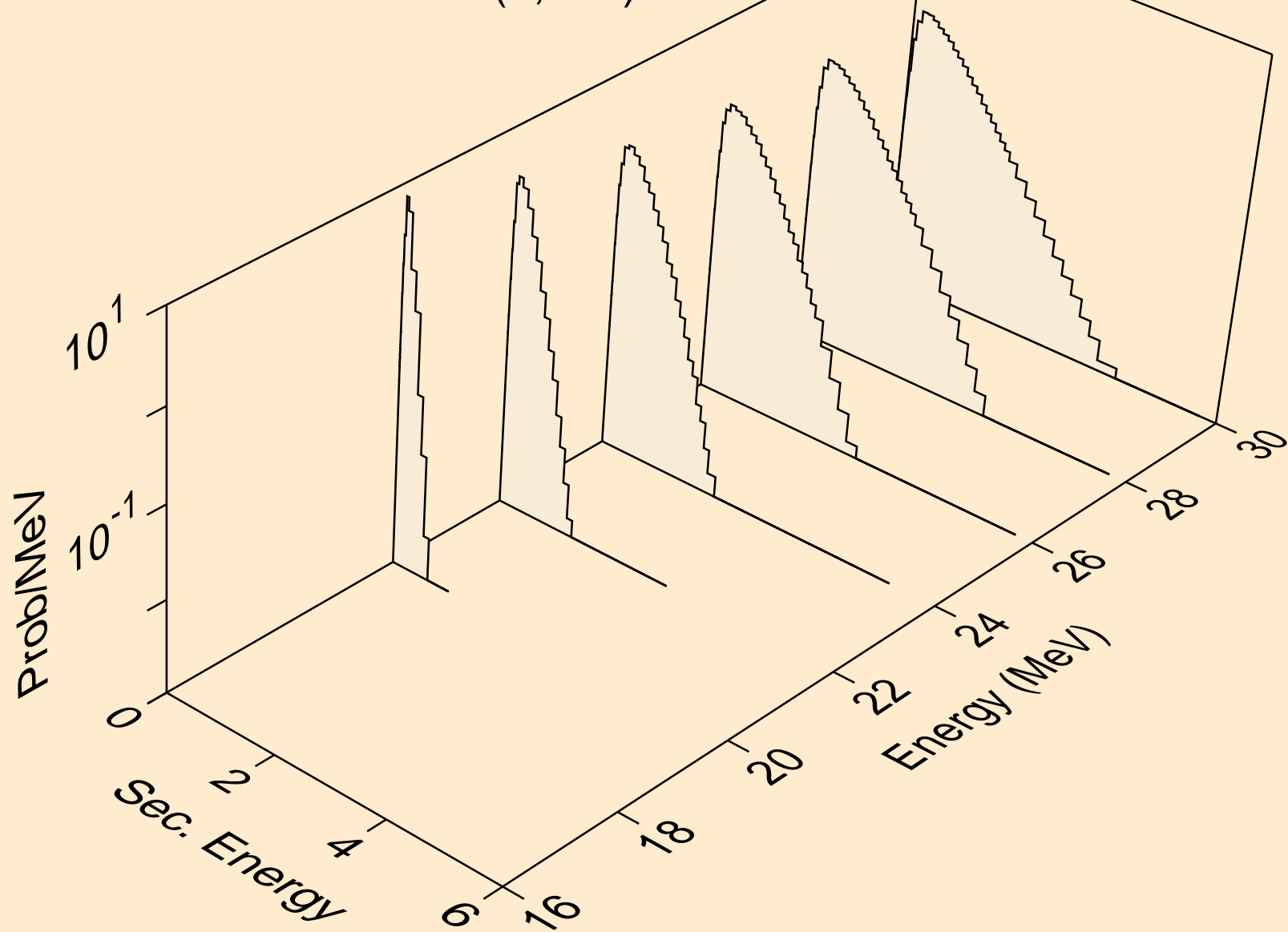

IR171M NEUTRON ACER TENDL-2024 LIBRARY; T=0.K
Neutron emission for (n,2n)

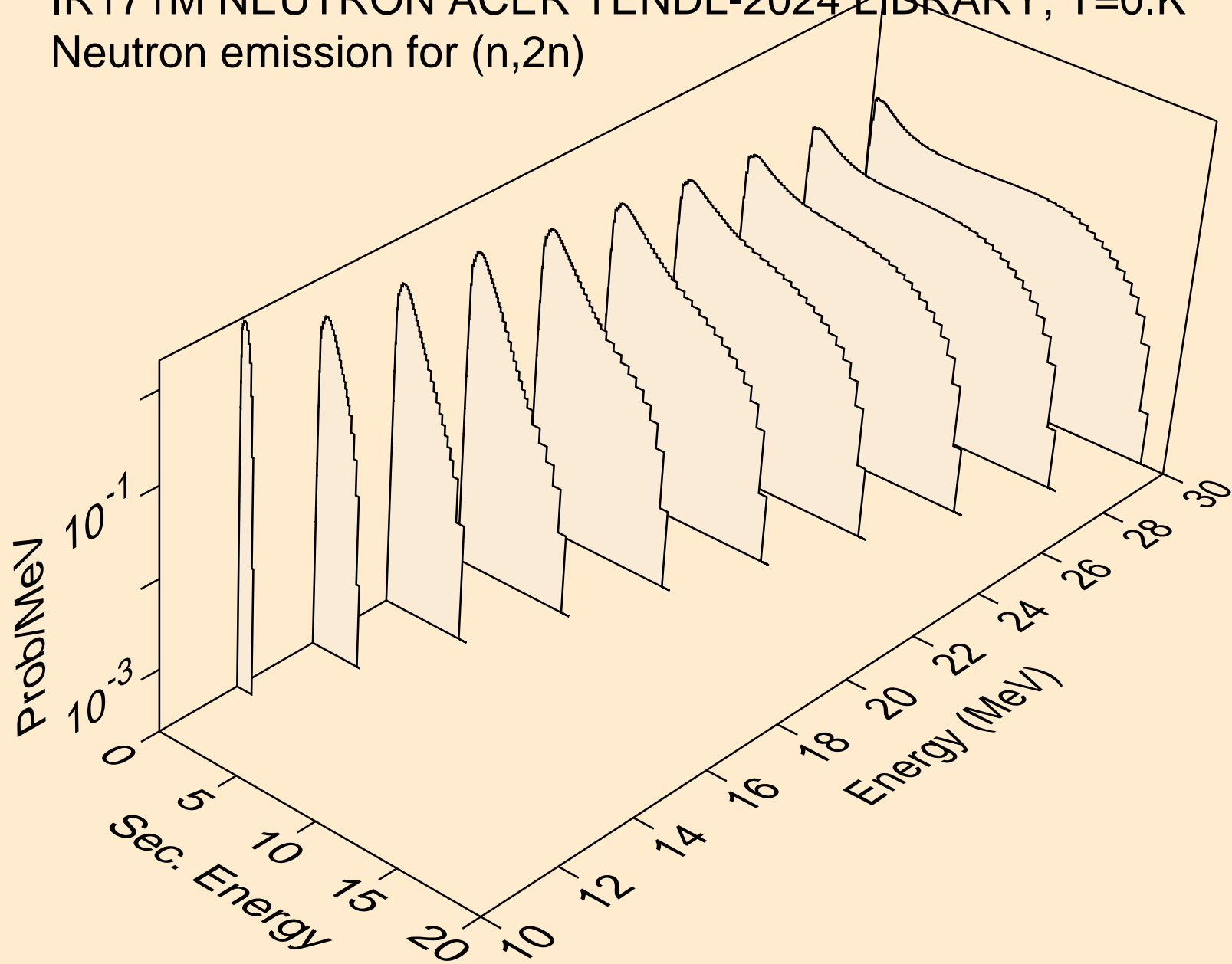

IR171M NEUTRON ACER TENDL-2024 LIBRARY; T=0.K
Neutron emission for (n,3n)

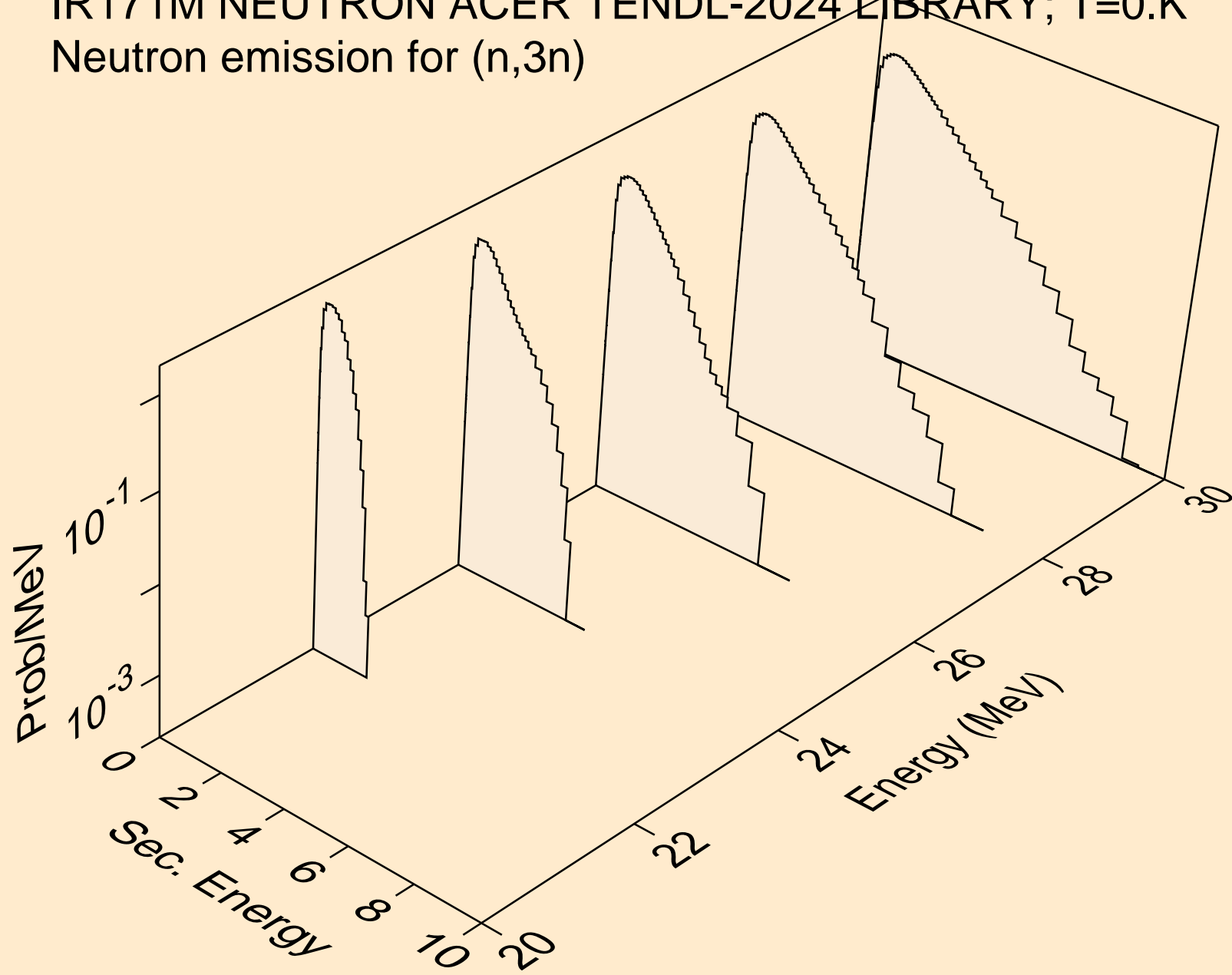

IR171M NEUTRON ACER TENDL-2024 LIBRARY; T=0.K
Neutron emission for (n,n*)a

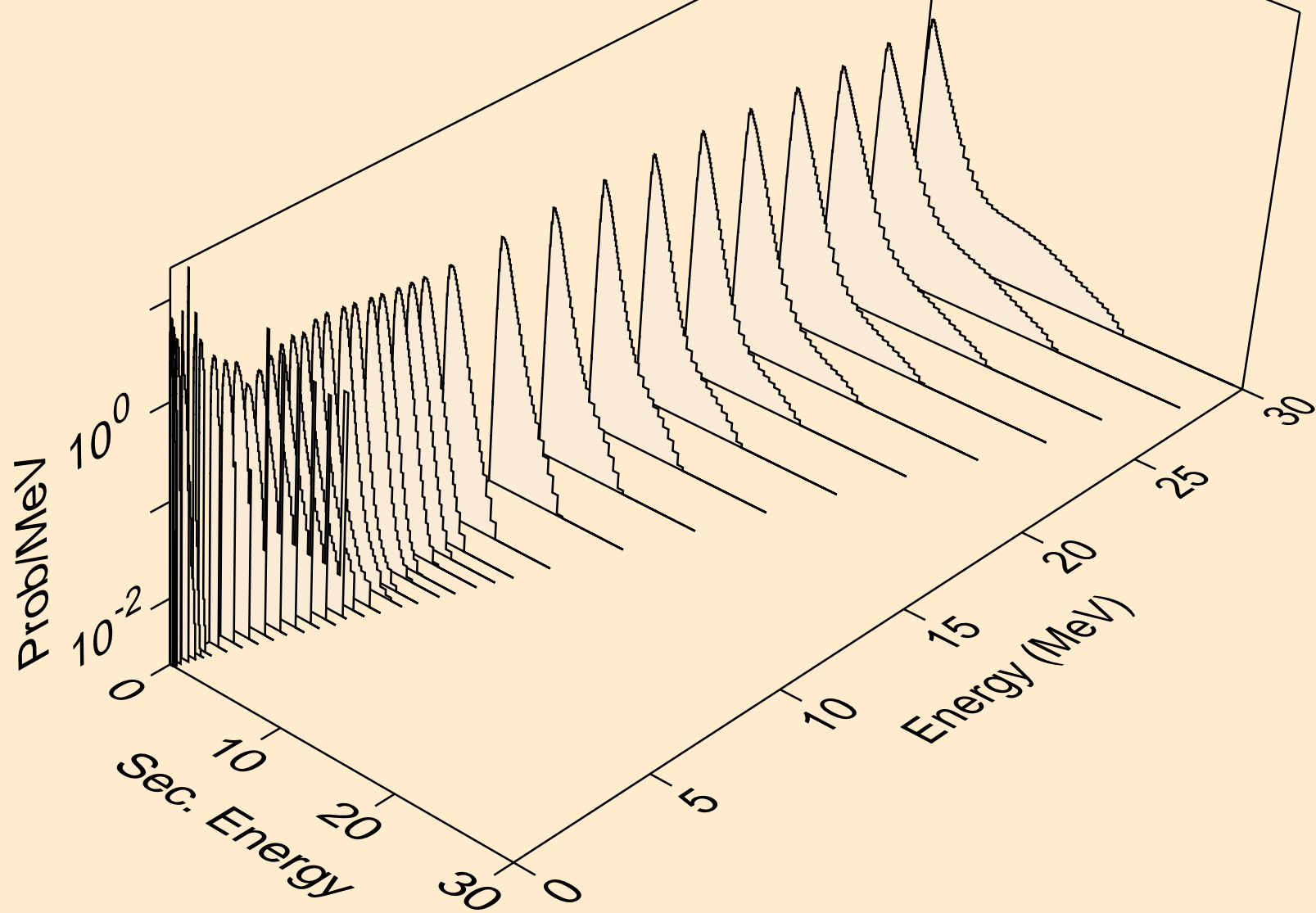

IR171M NEUTRON ACER TENDL-2024 LIBRARY; T=0.K
Neutron emission for (n,n*)3a

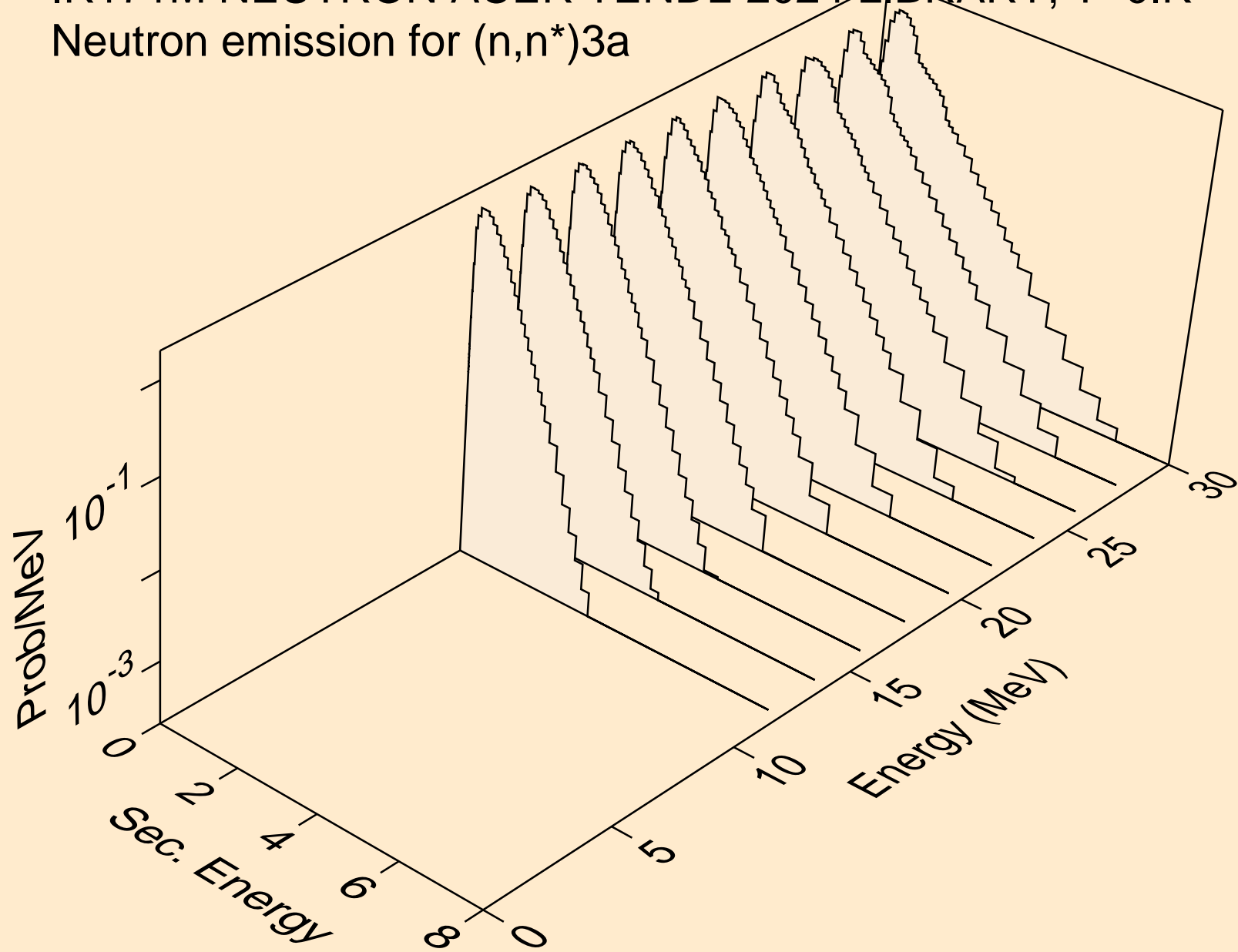

IR171M NEUTRON ACER TENDL-2024 LIBRARY; T=0.K
Neutron emission for (n,2n)a

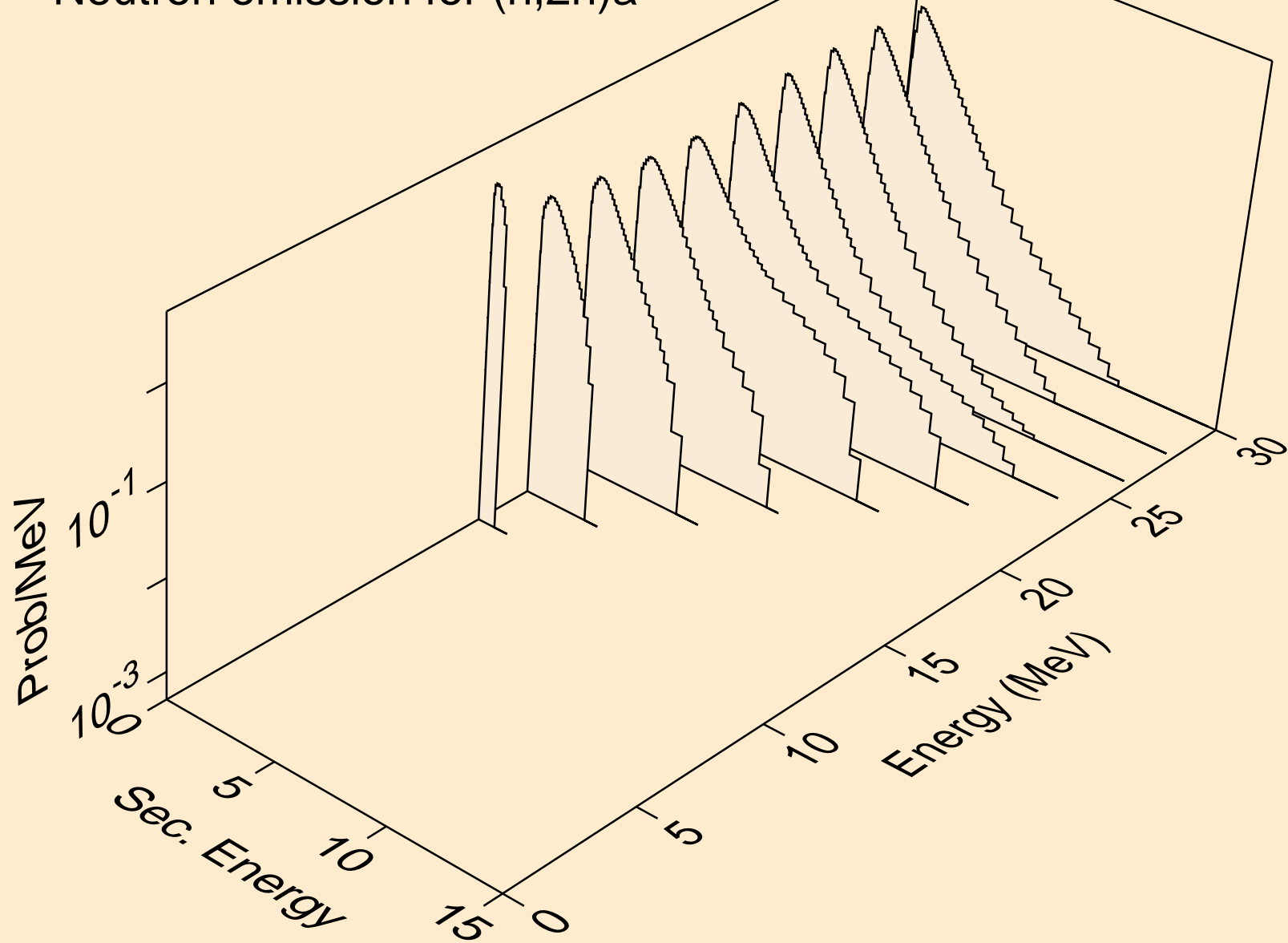

IR171M NEUTRON ACER TENDL-2024 LIBRARY; T=0.K
Neutron emission for (n,3n)a

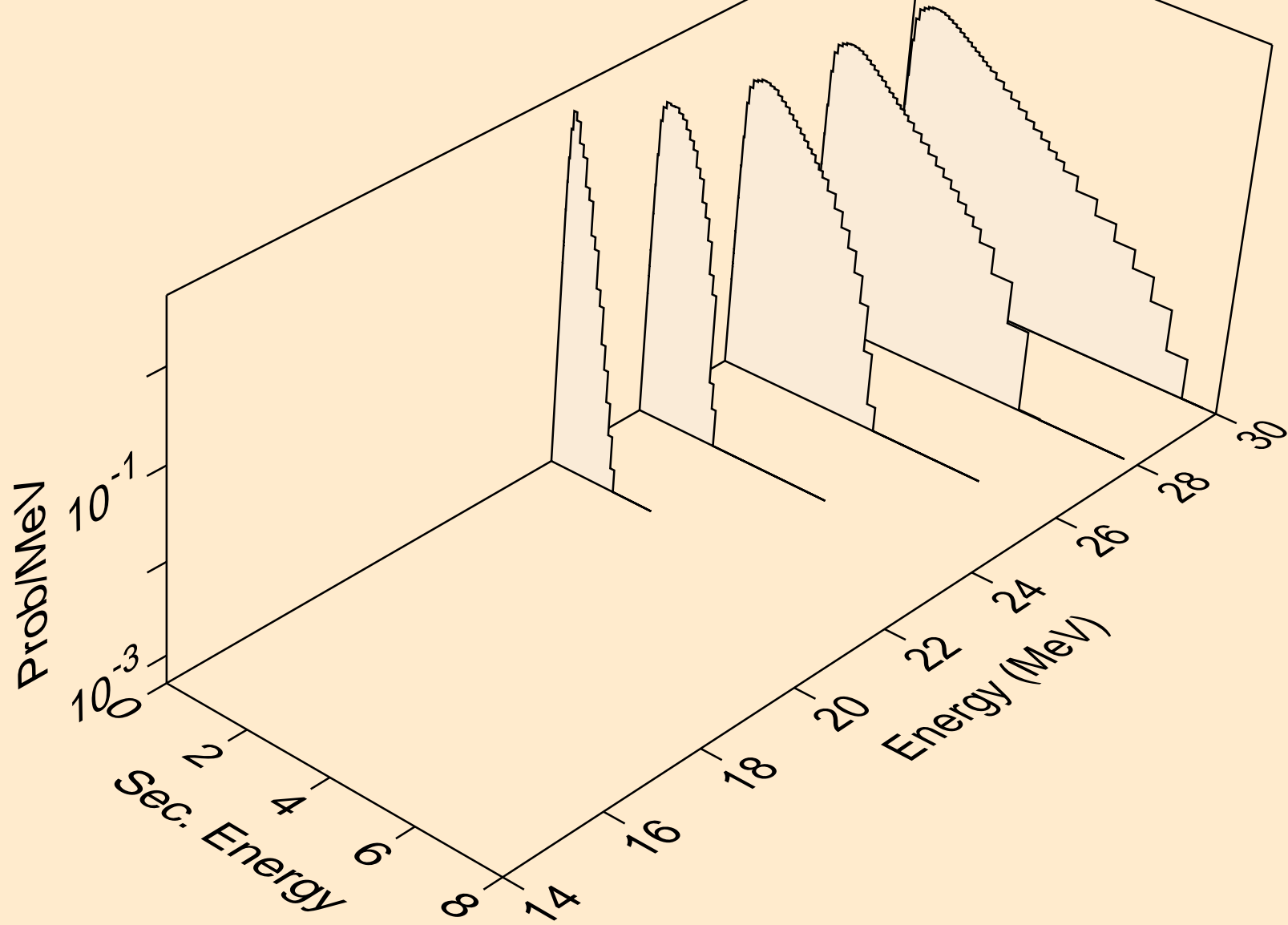

IR171M NEUTRON ACER TENDL-2024 LIBRARY; T=0.K
Neutron emission for (n,n*)p

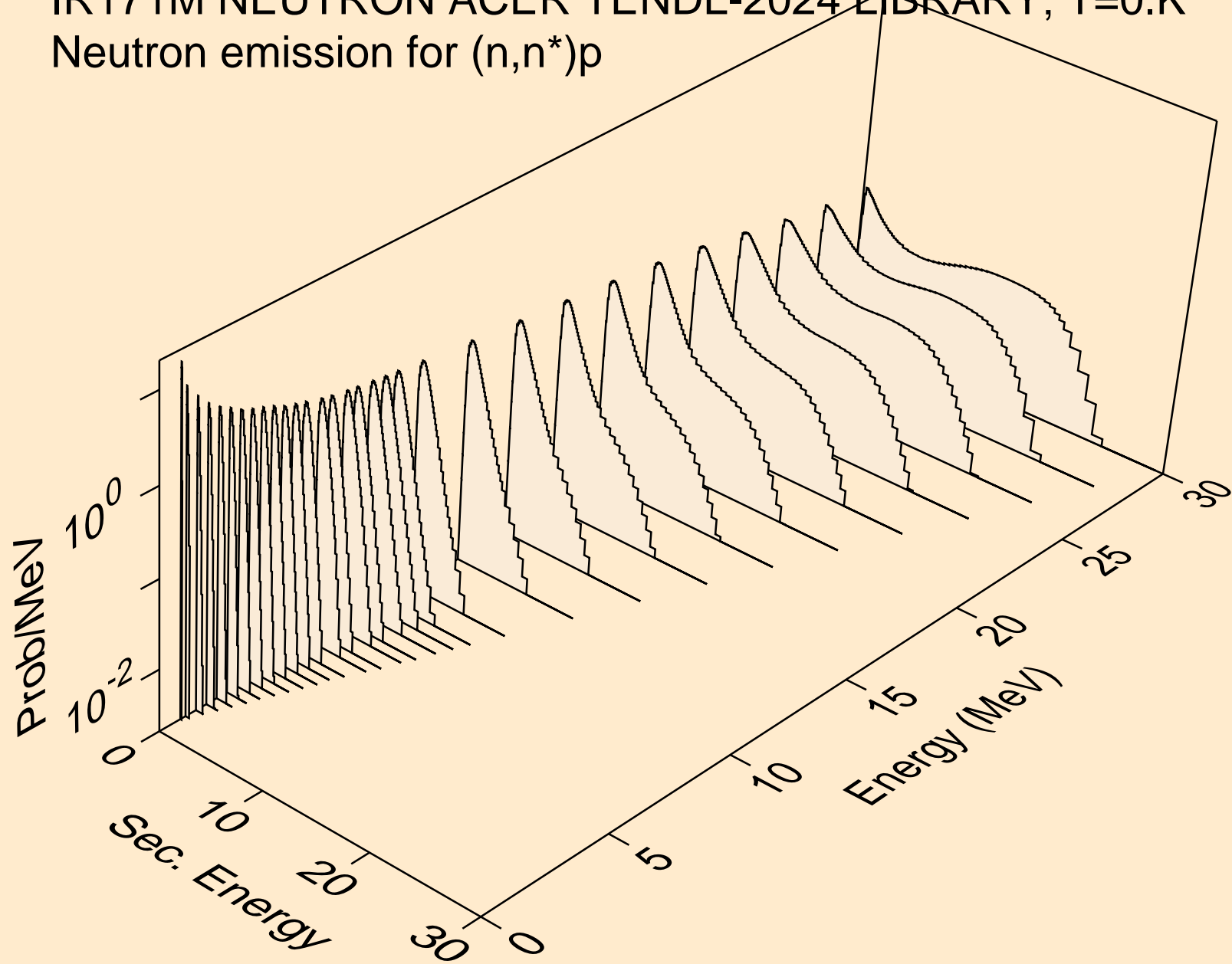

IR171M NEUTRON ACER TENDL-2024 LIBRARY; T=0.K
Neutron emission for (n,n*)2a

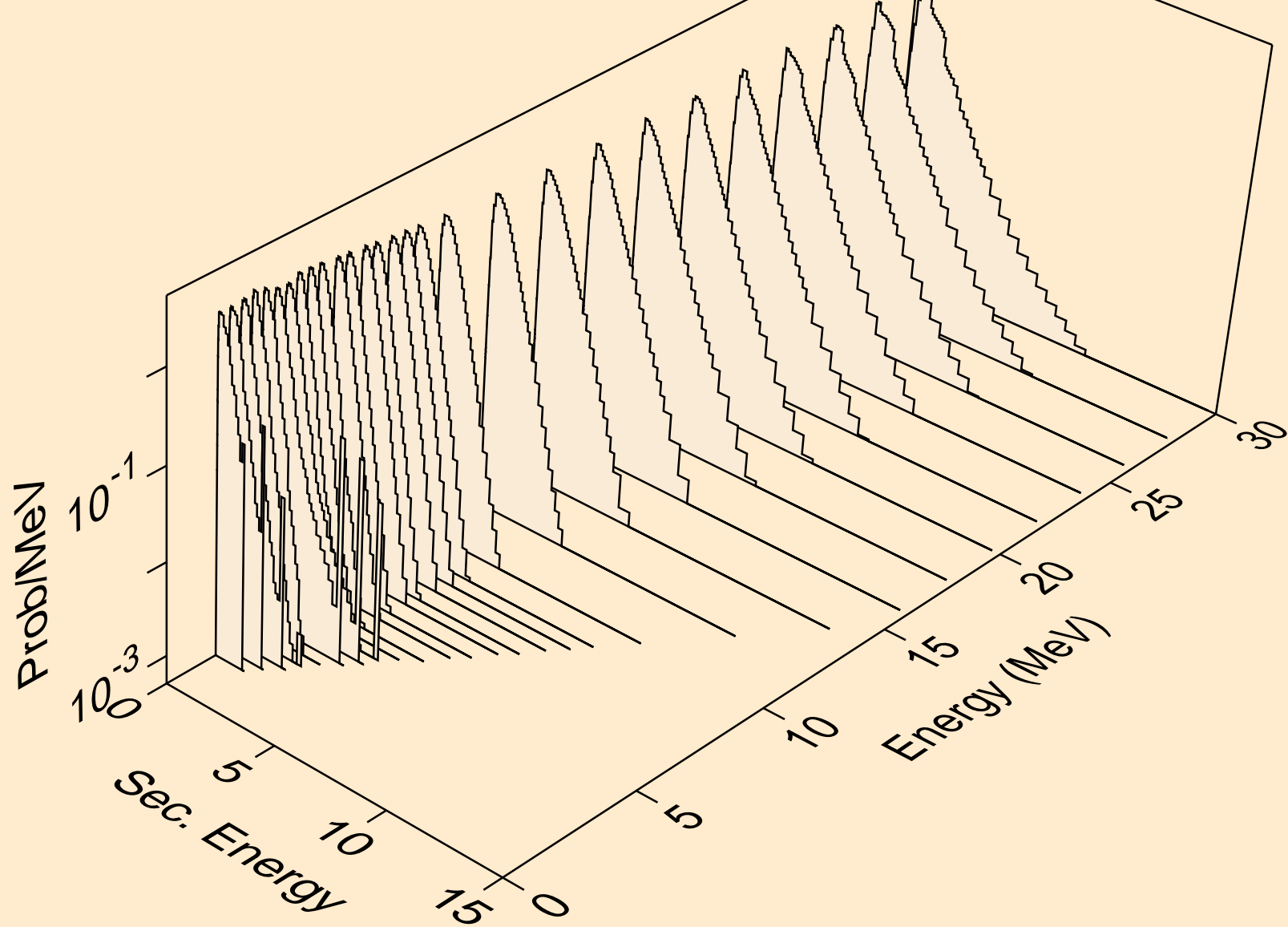

IR171M NEUTRON ACER TENDL-2024 LIBRARY; T=0.K
Neutron emission for (n,2n)2a

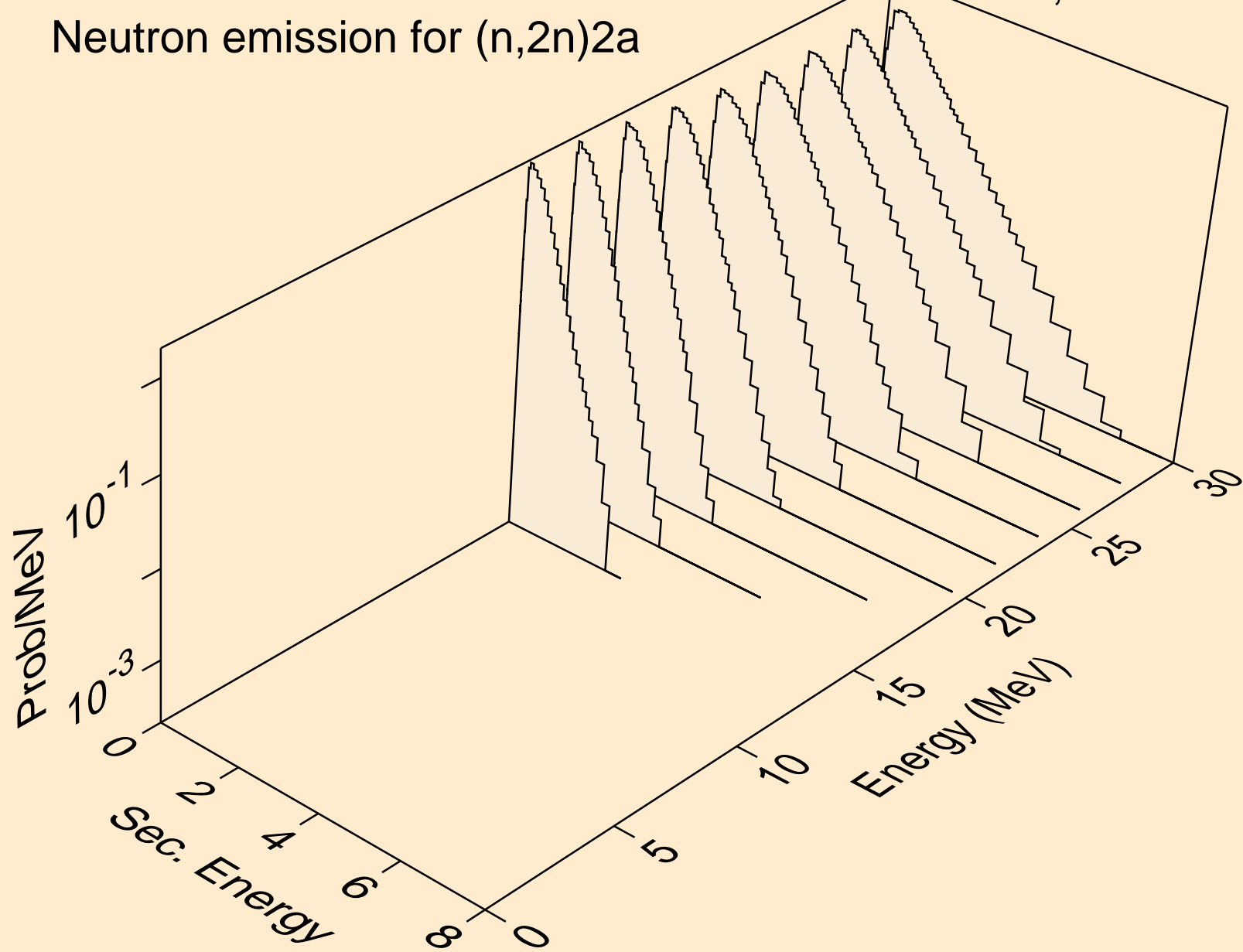

IR171M NEUTRON ACER TENDL-2024 LIBRARY; T=0.K
Neutron emission for (n,n*)d

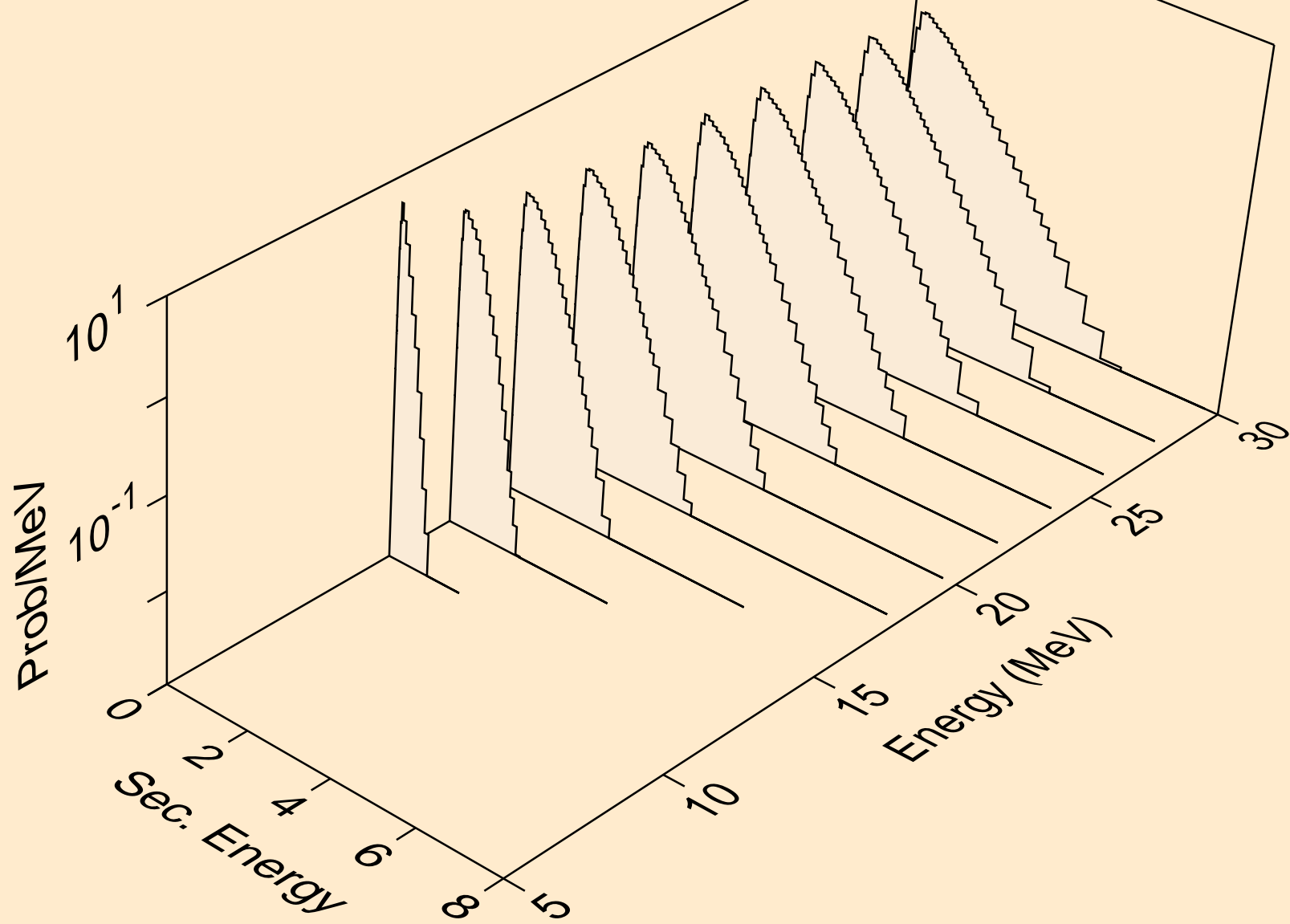

IR171M NEUTRON ACER TENDL-2024 LIBRARY; T=0.K
Neutron emission for (n,n*)t

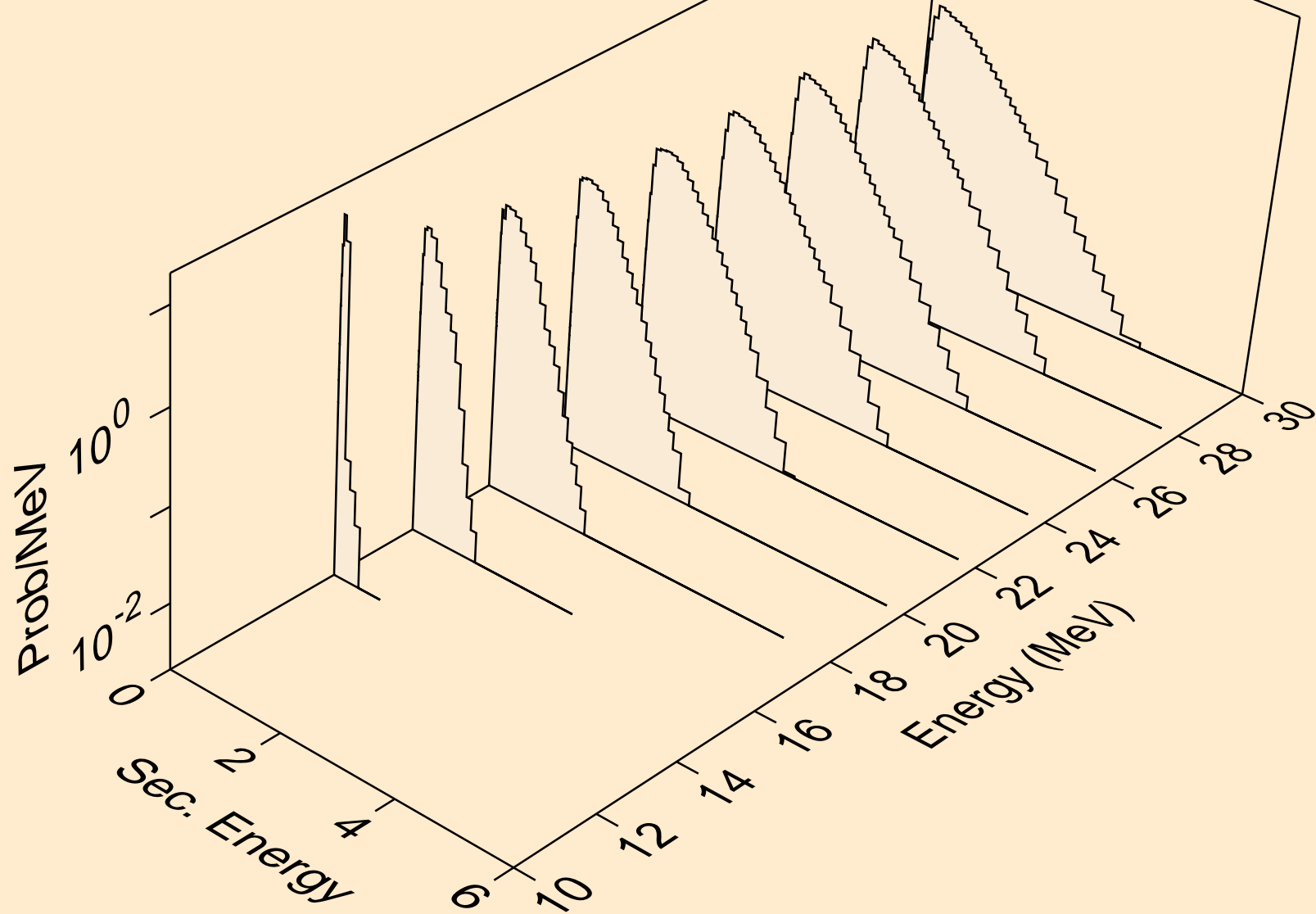

IR171M NEUTRON ACER TENDL-2024 LIBRARY; T=0.K
Neutron emission for (n,n*)he3

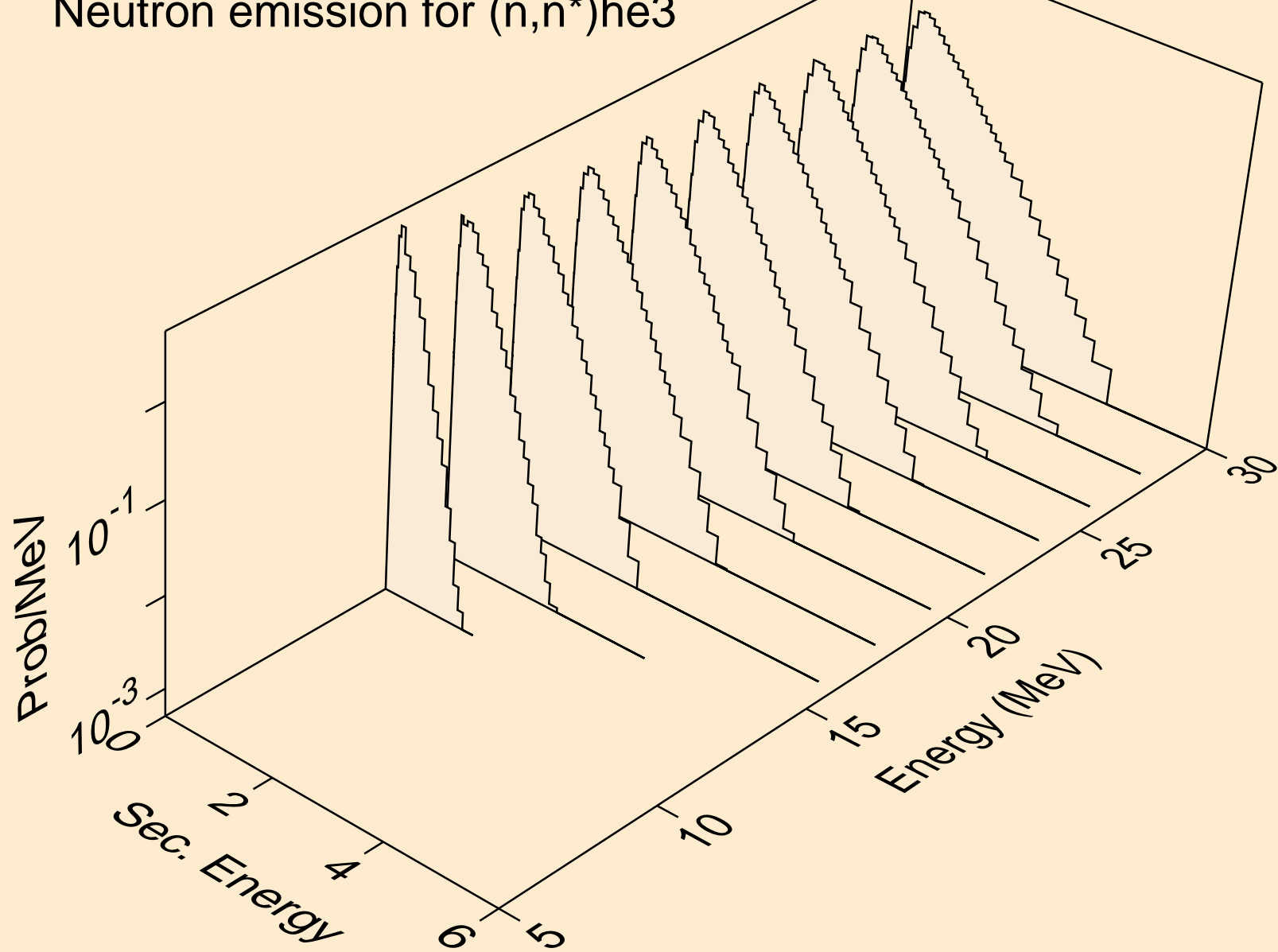

IR171M NEUTRON ACER TENDL-2024 LIBRARY; T=0.K
Neutron emission for (n,2np)

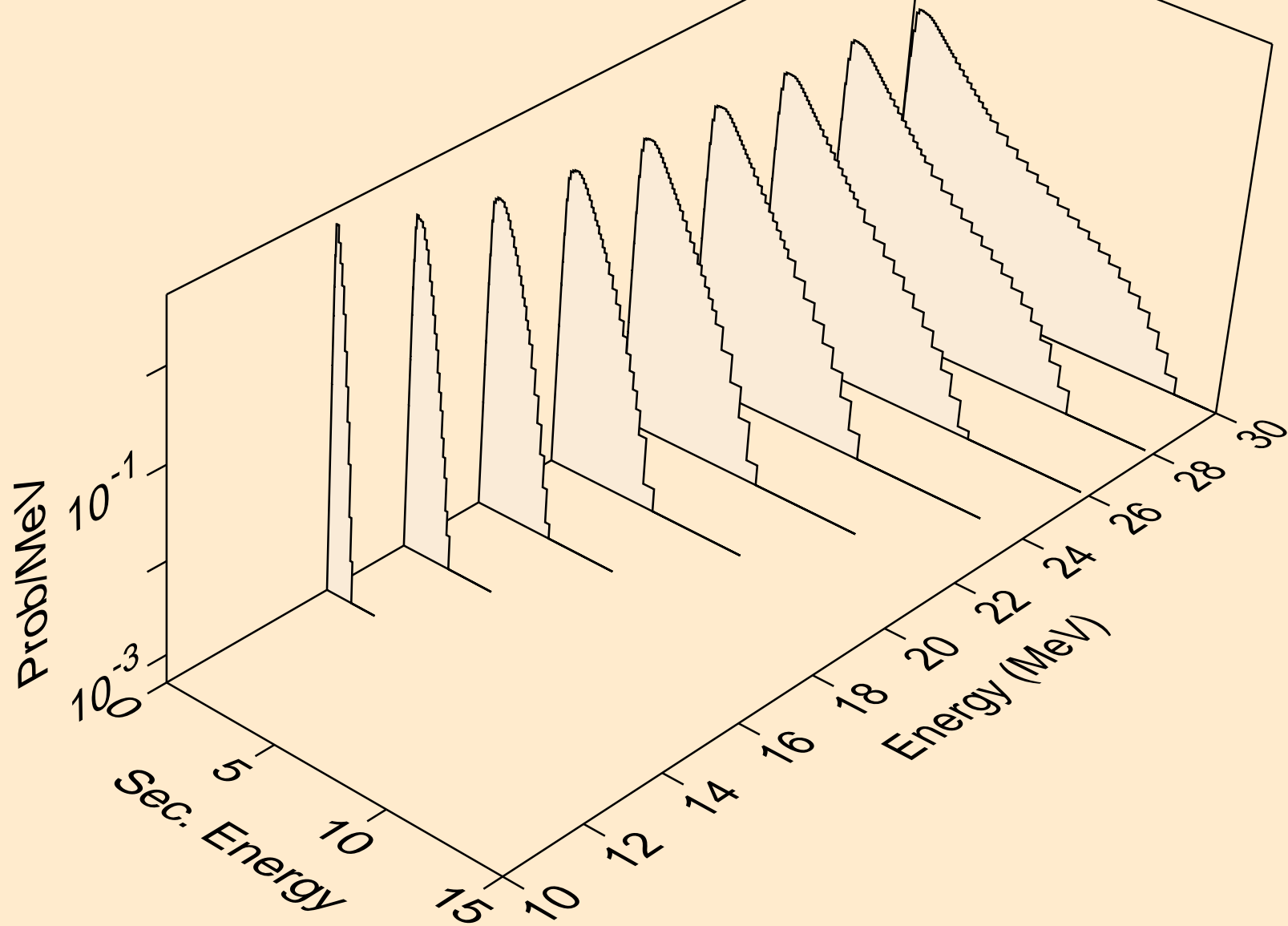

IR171M NEUTRON ACER TENDL-2024 LIBRARY; T=0.K
Neutron emission for (n,3np)

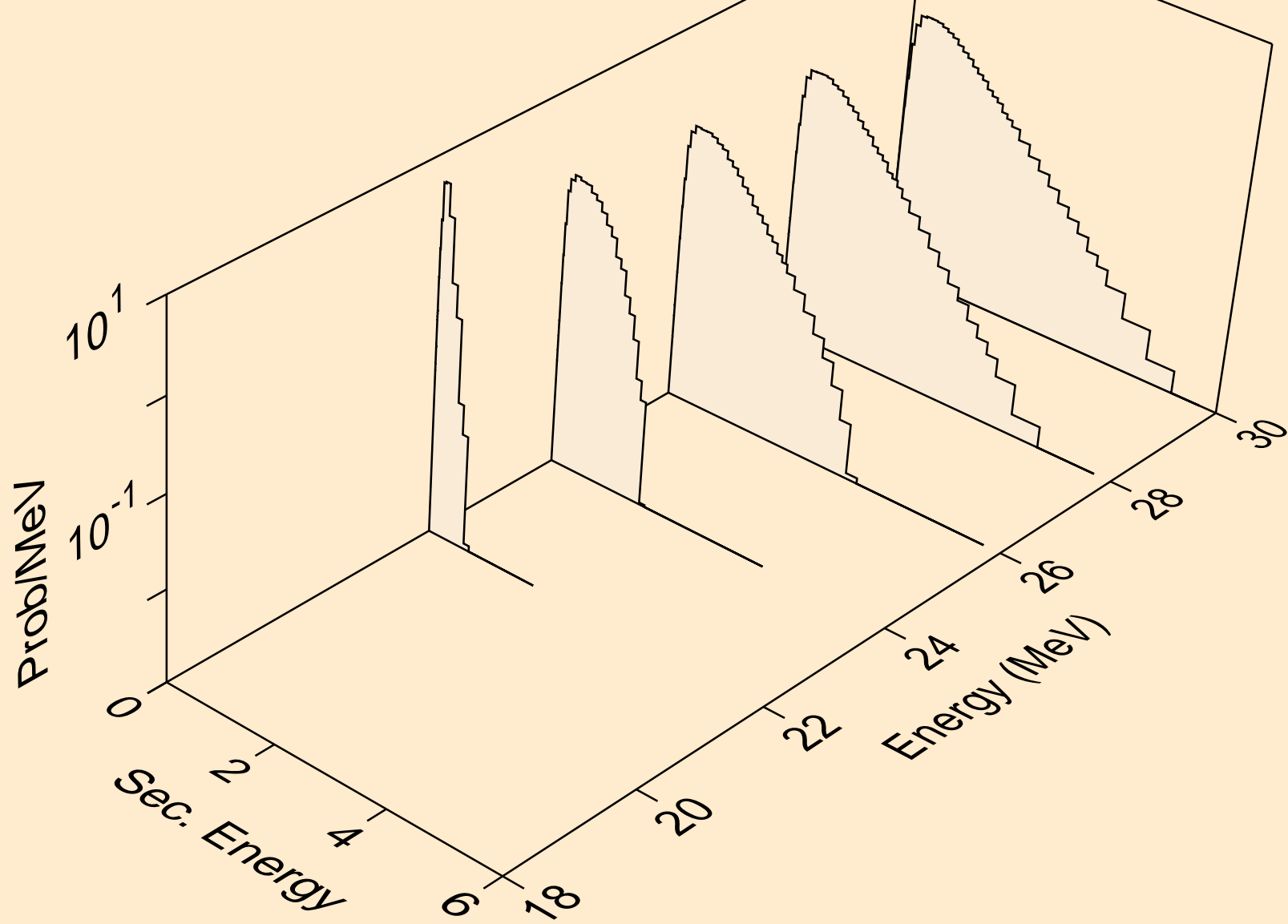

IR171M NEUTRON ACER TENDL-2024 LIBRARY; T=0.K
Neutron emission for (n,n2p)

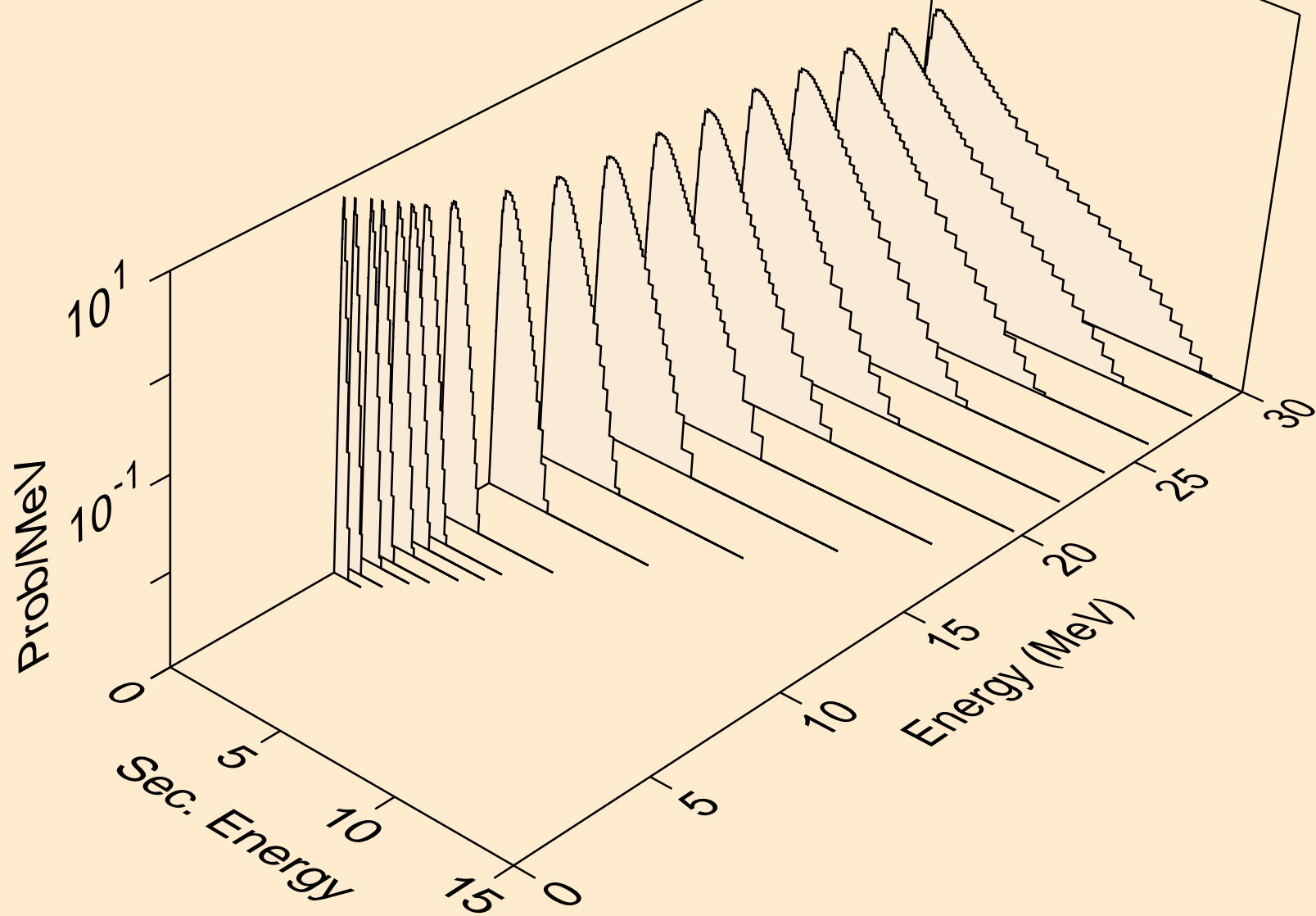

IR171M NEUTRON ACER TENDL-2024 LIBRARY; T=0.K
Neutron emission for (n,npa)

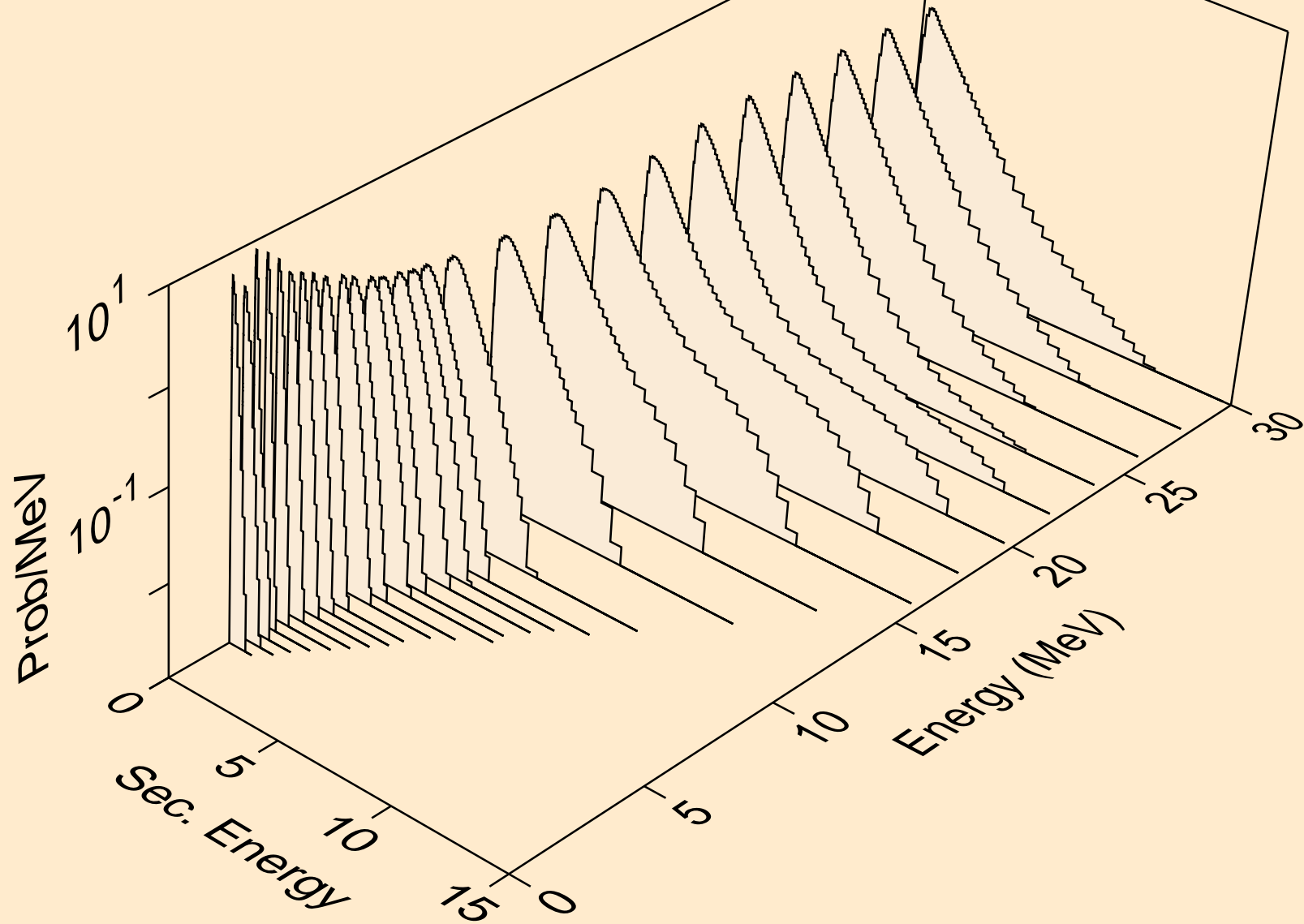

IR171M NEUTRON ACER TENDL-2024 LIBRARY; T=0.K
Neutron emission for (n,n*c)

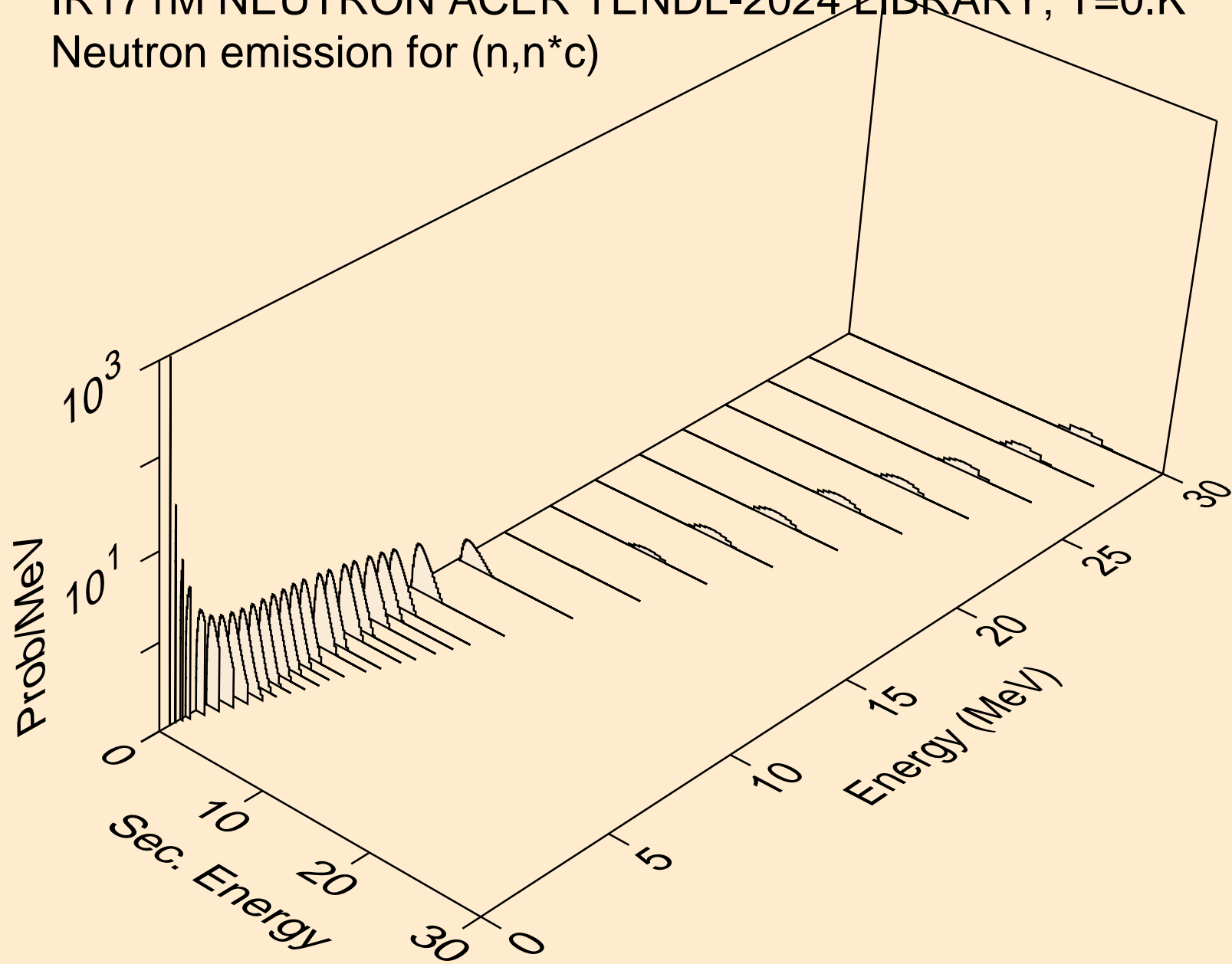

IR171M NEUTRON ACER TENDL-2024 LIBRARY; T=0.K
Photon emission for (n,x)

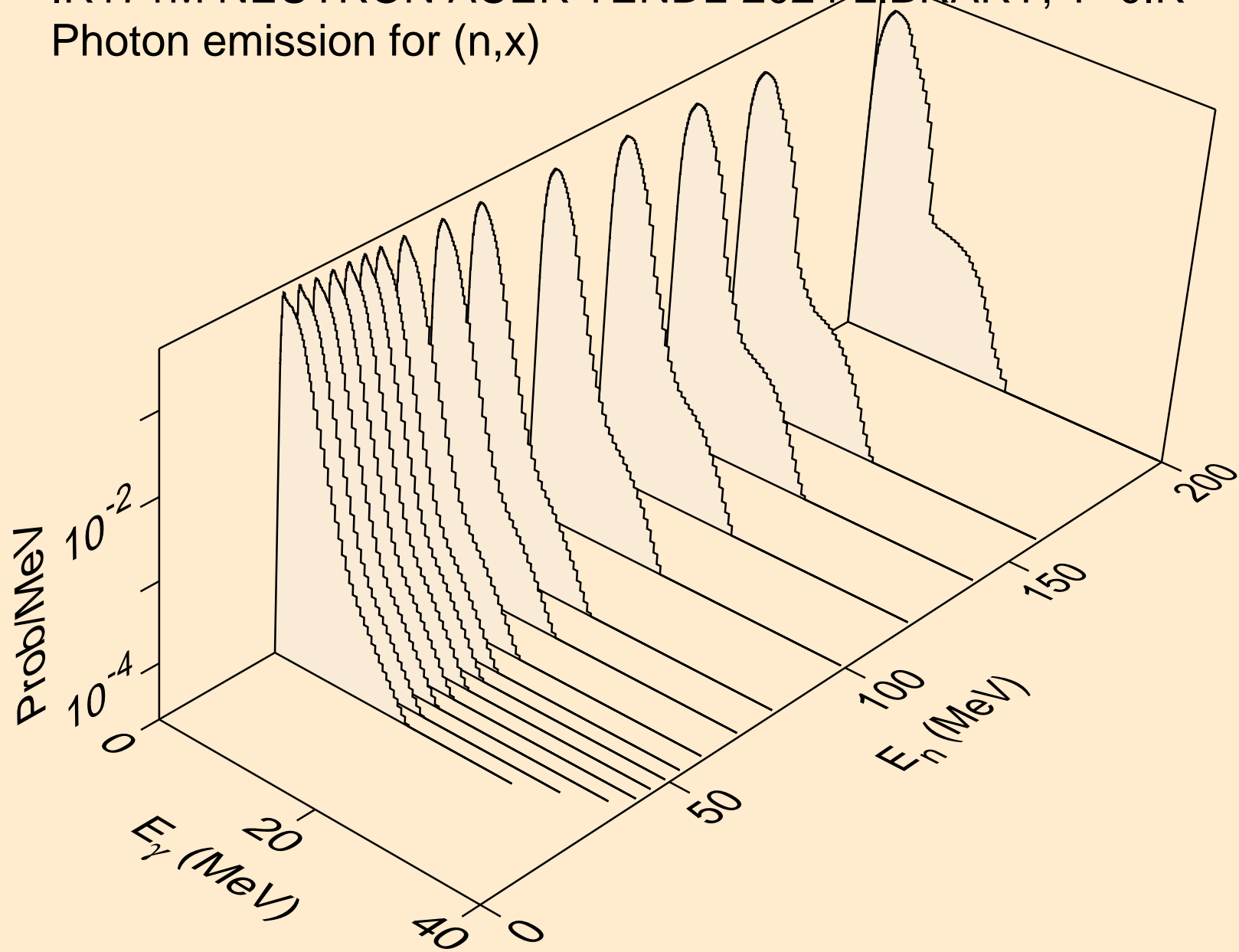

IR171M NEUTRON ACER TENDL-2024 LIBRARY; T=0.K
Photon emission for (n,2nd)

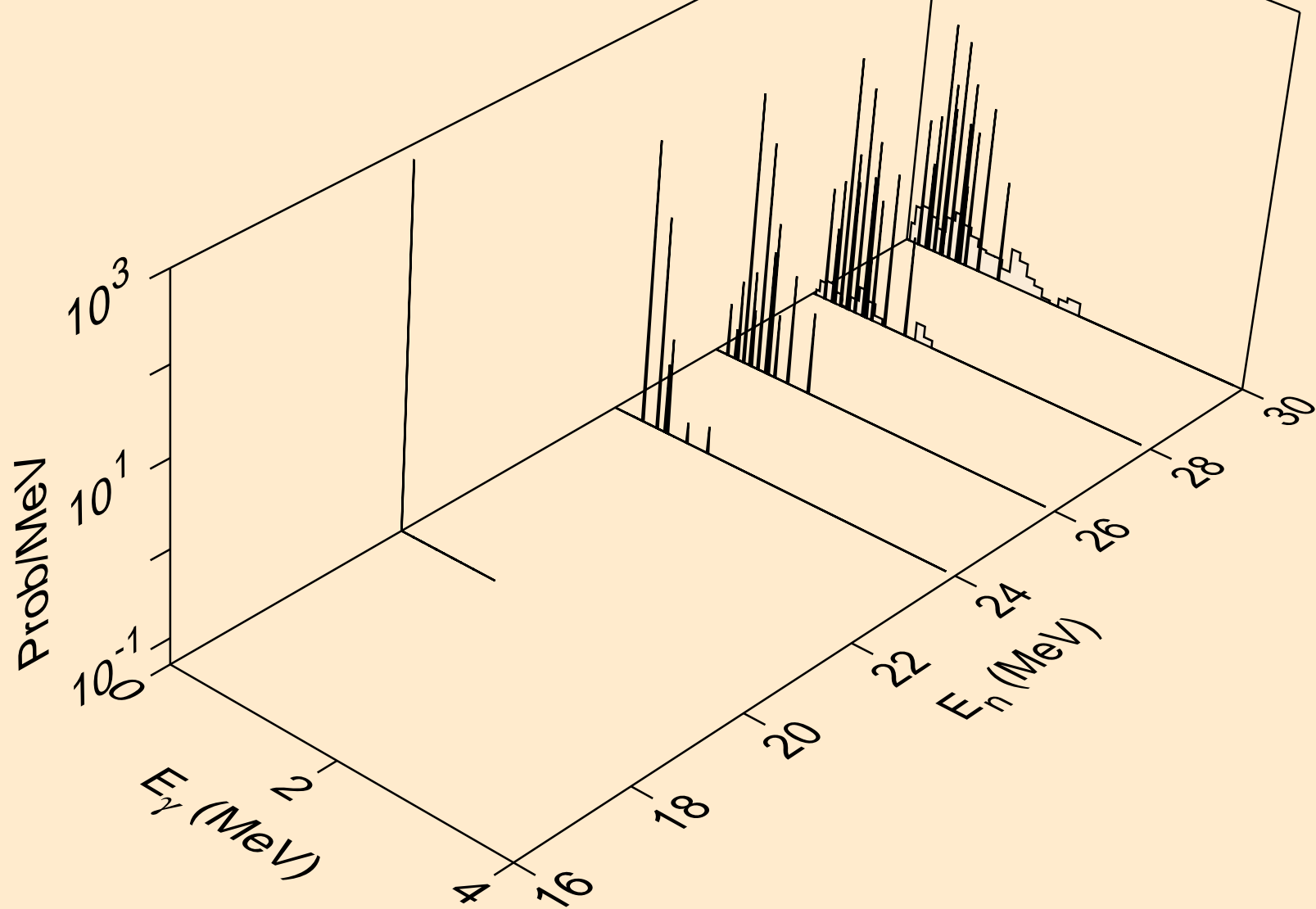

IR171M NEUTRON ACER TENDL-2024 LIBRARY; T=0.K
Photon emission for (n,2n)

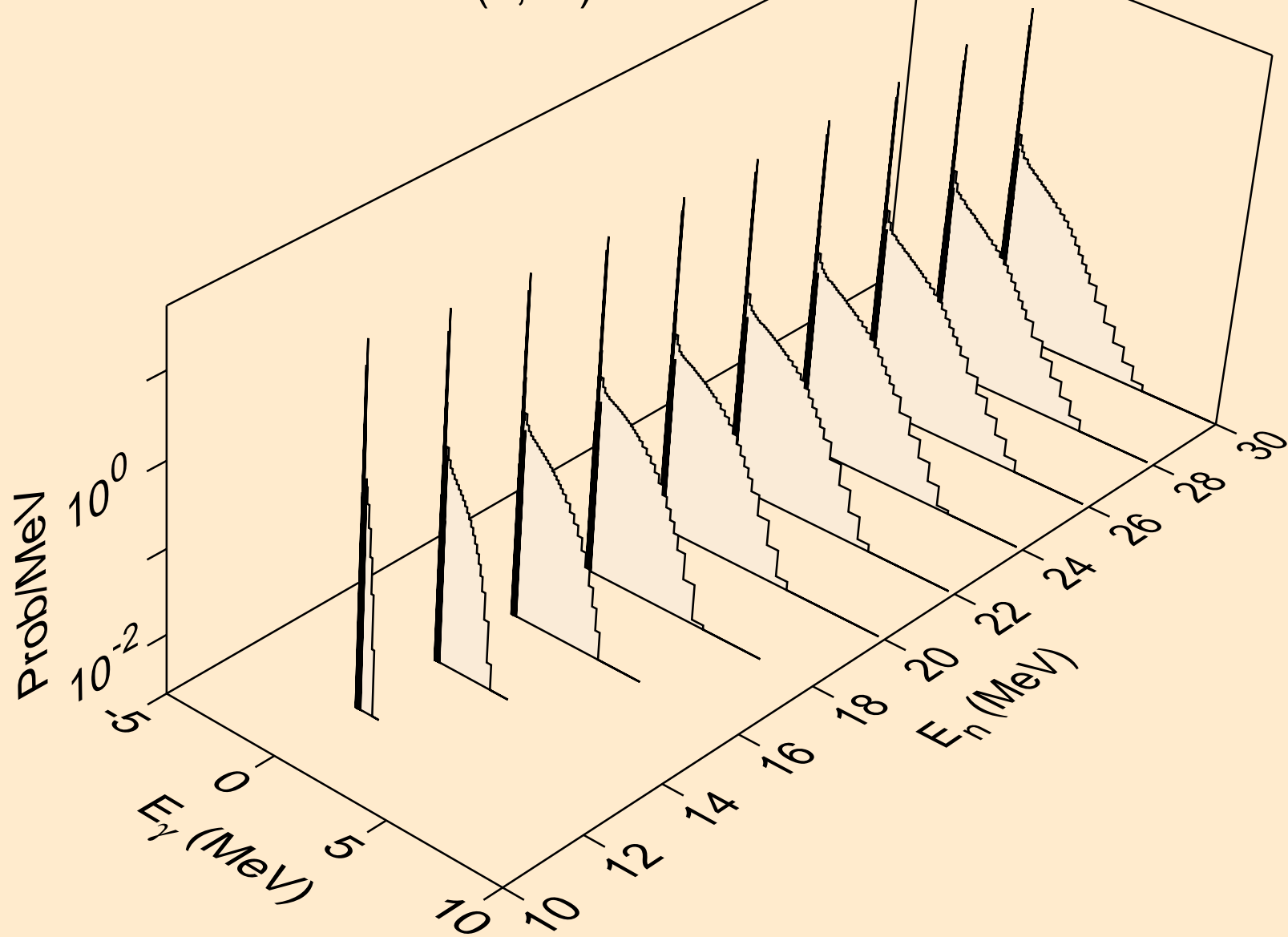

IR171M NEUTRON ACER TENDL-2024 LIBRARY; T=0.K
Photon emission for (n,3n)

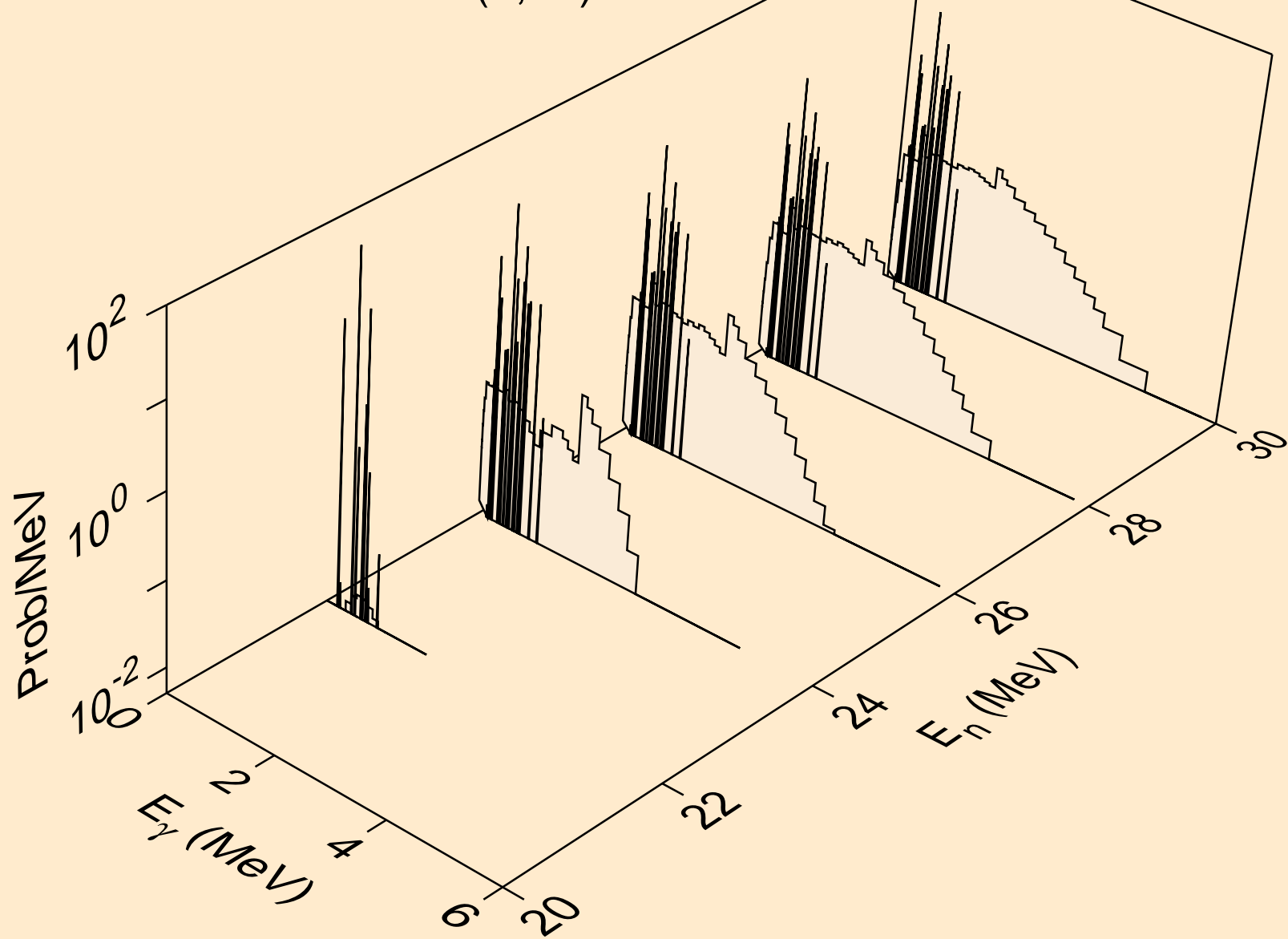

IR171M NEUTRON ACER TENDL-2024 LIBRARY; T=0.K
Photon emission for (n,n*)a

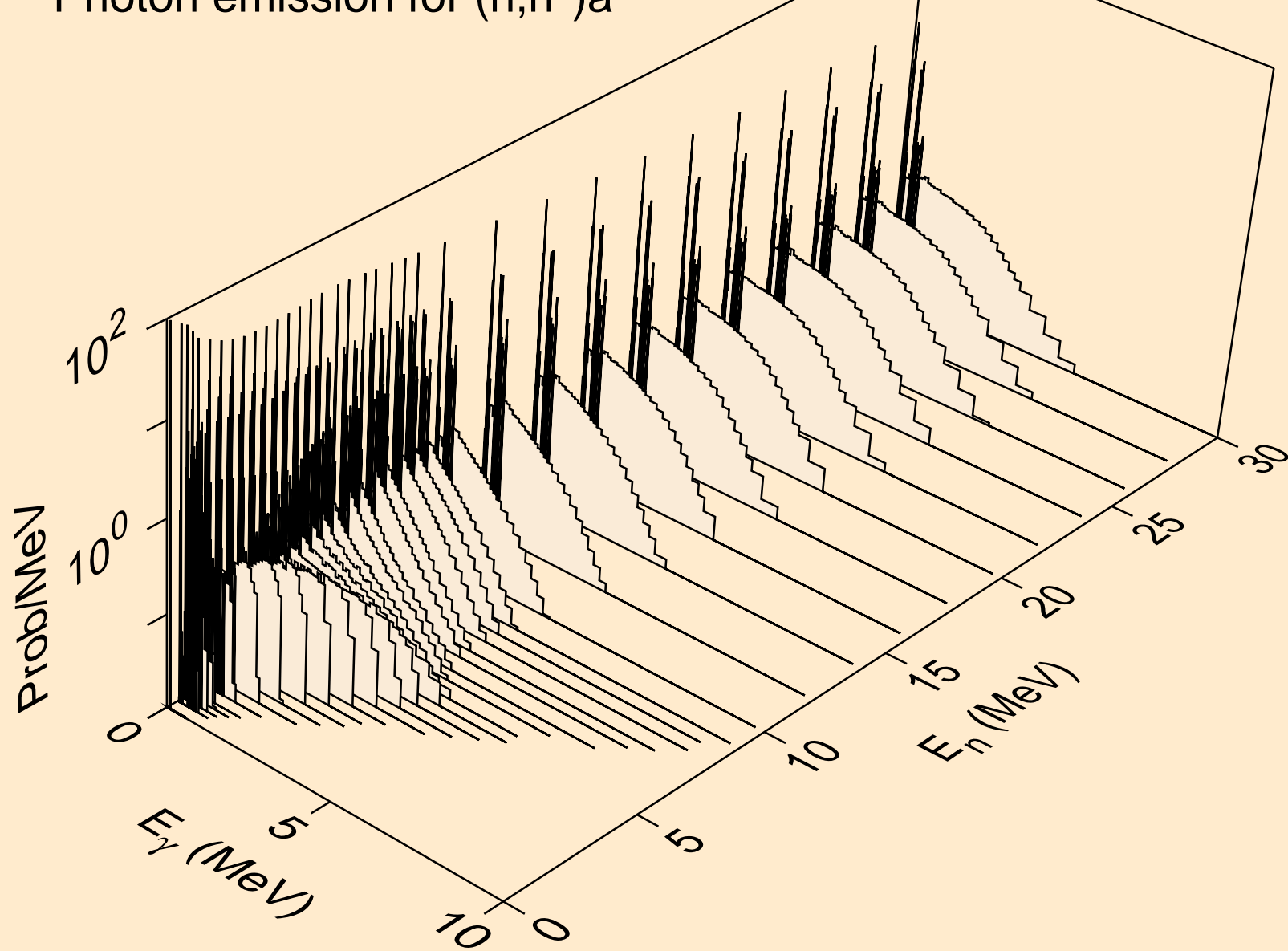

IR171M NEUTRON ACER TENDL-2024 LIBRARY; T=0.K
Photon emission for (n,n*)3a

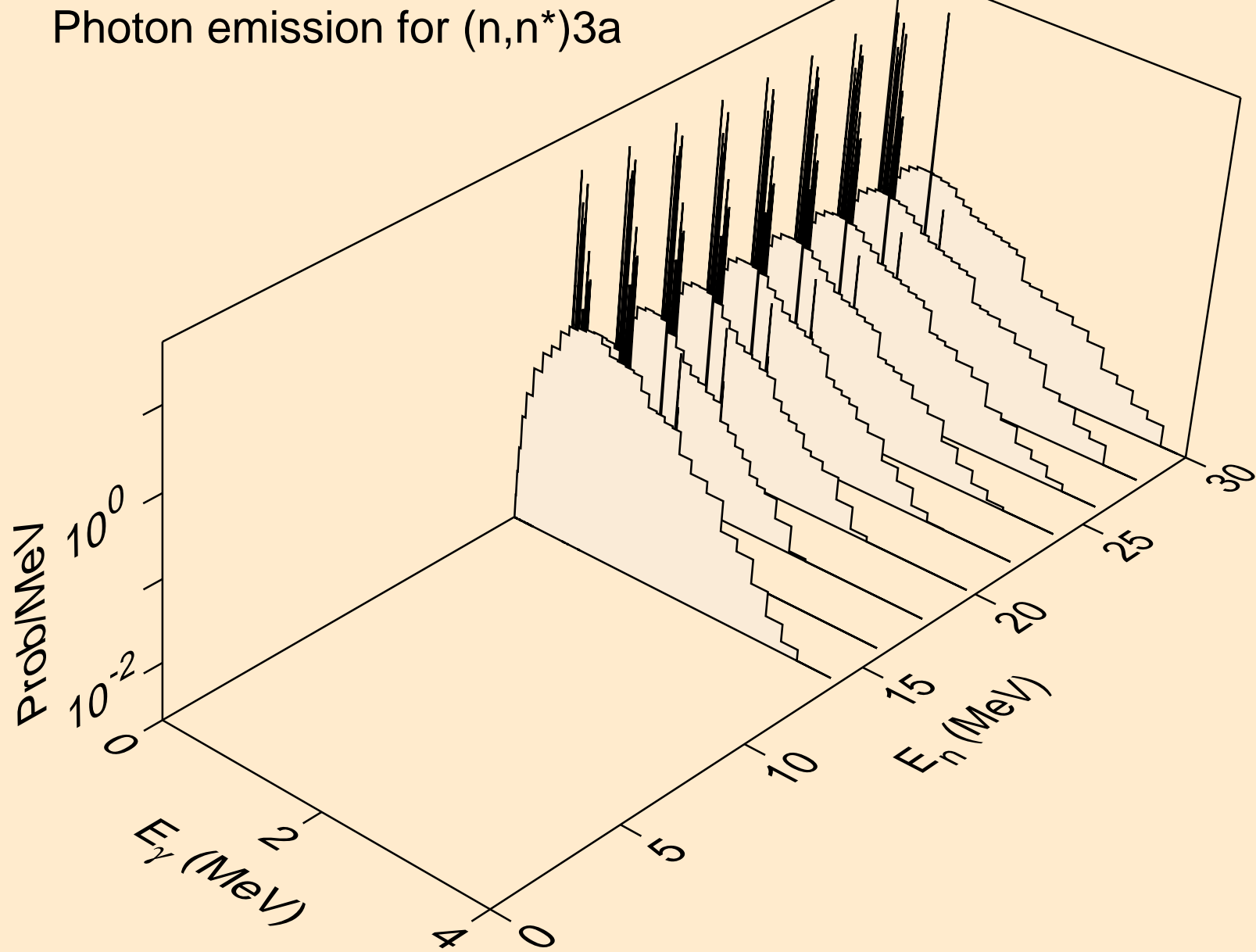

IR171M NEUTRON ACER TENDL-2024 LIBRARY; T=0.K
Photon emission for (n,2n)a

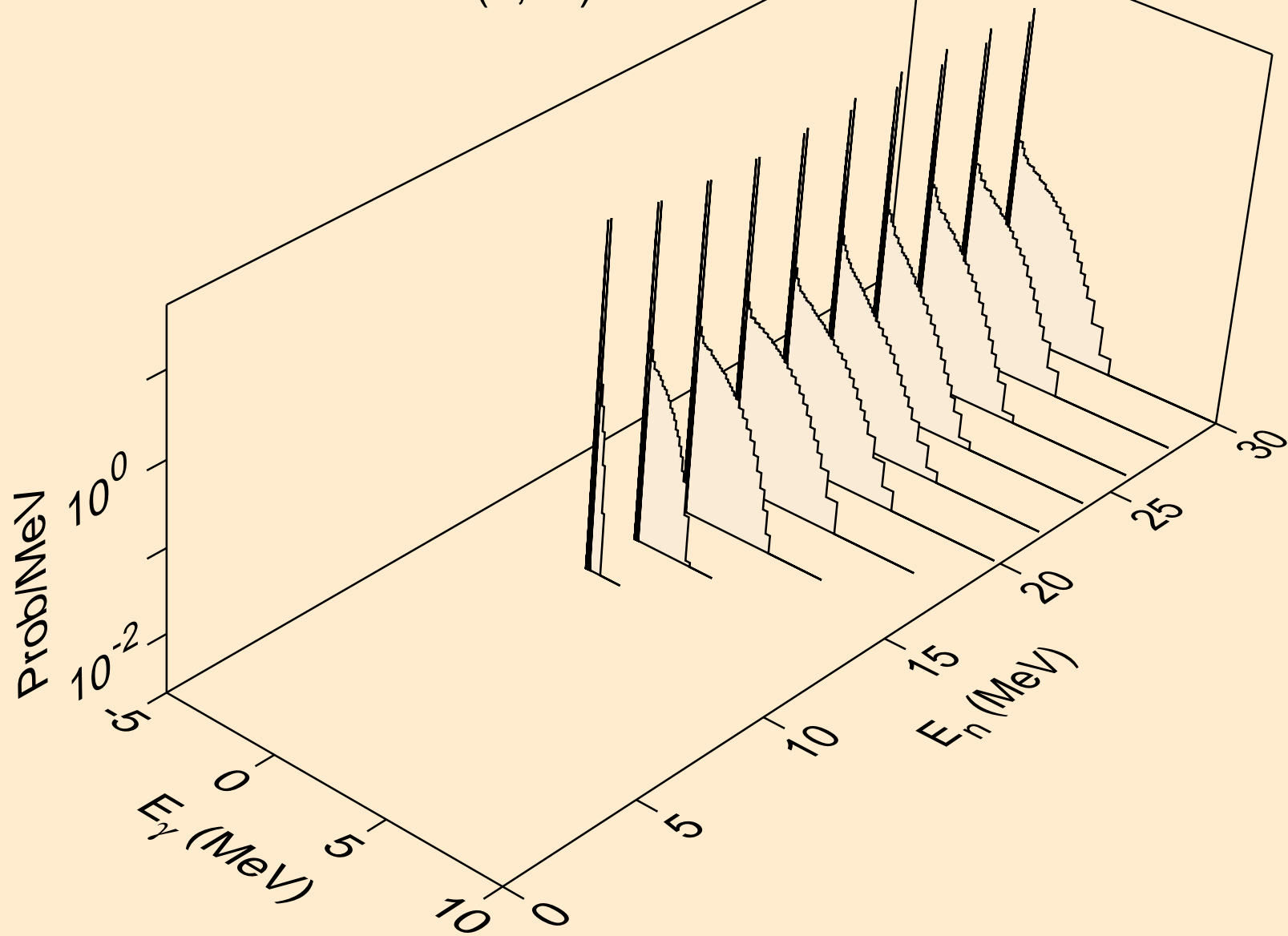

IR171M NEUTRON ACER TENDL-2024 LIBRARY; T=0.K
Photon emission for (n,3n)a

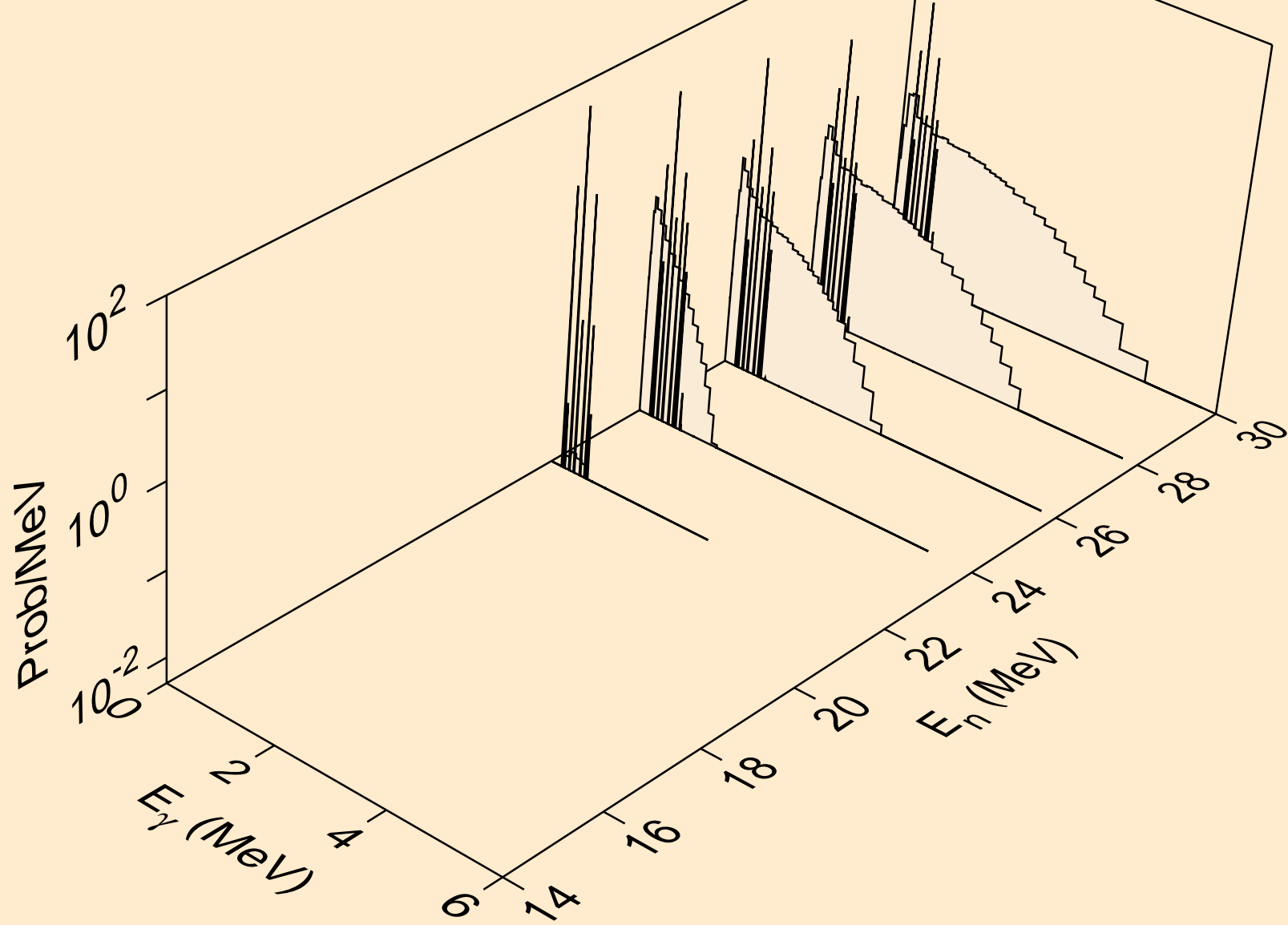

IR171M NEUTRON ACER TENDL-2024 LIBRARY; T=0.K
Photon emission for (n,n*)p

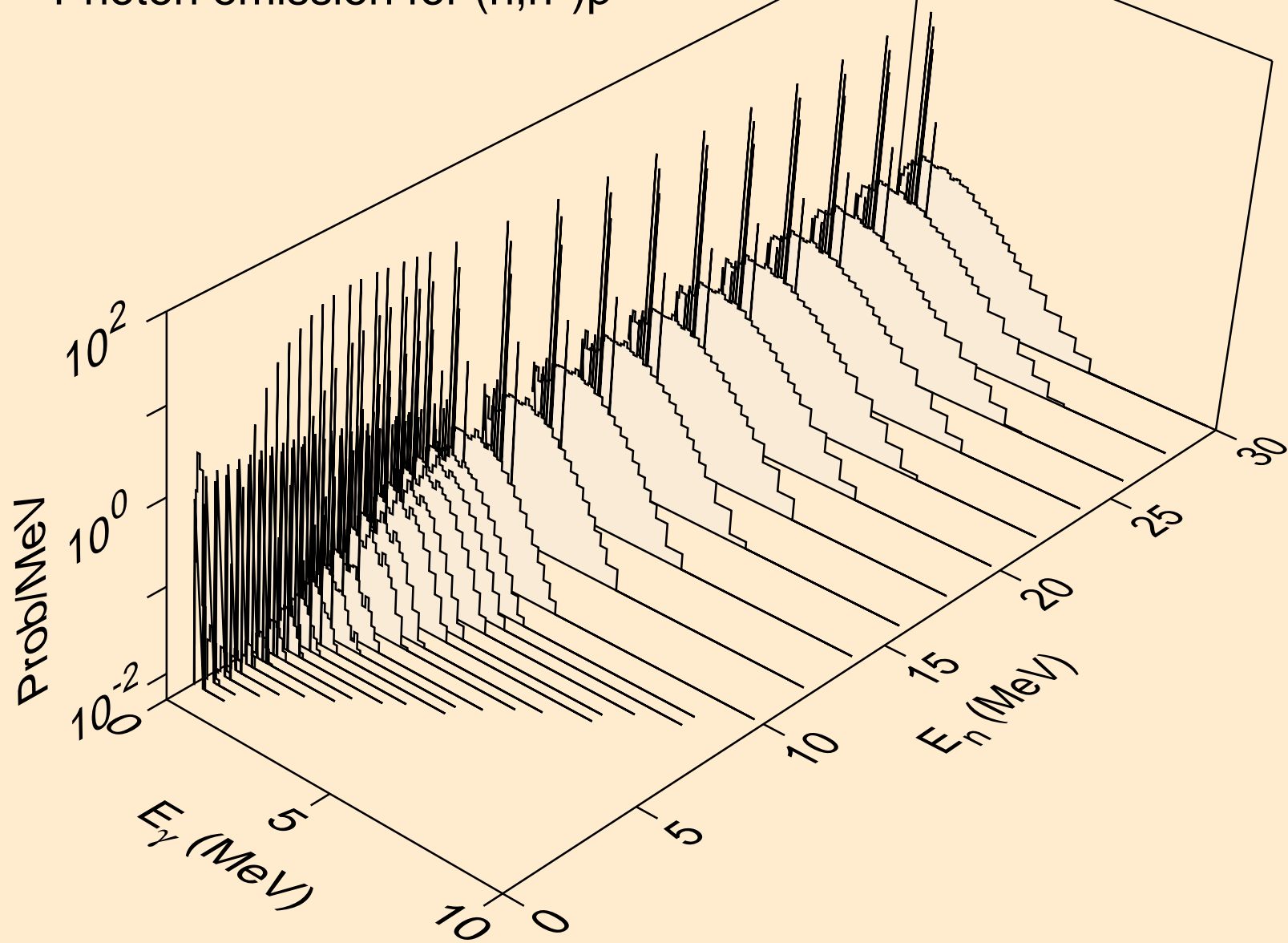

IR171M NEUTRON ACER TENDL-2024 LIBRARY; T=0.K
Photon emission for (n,n*)2a

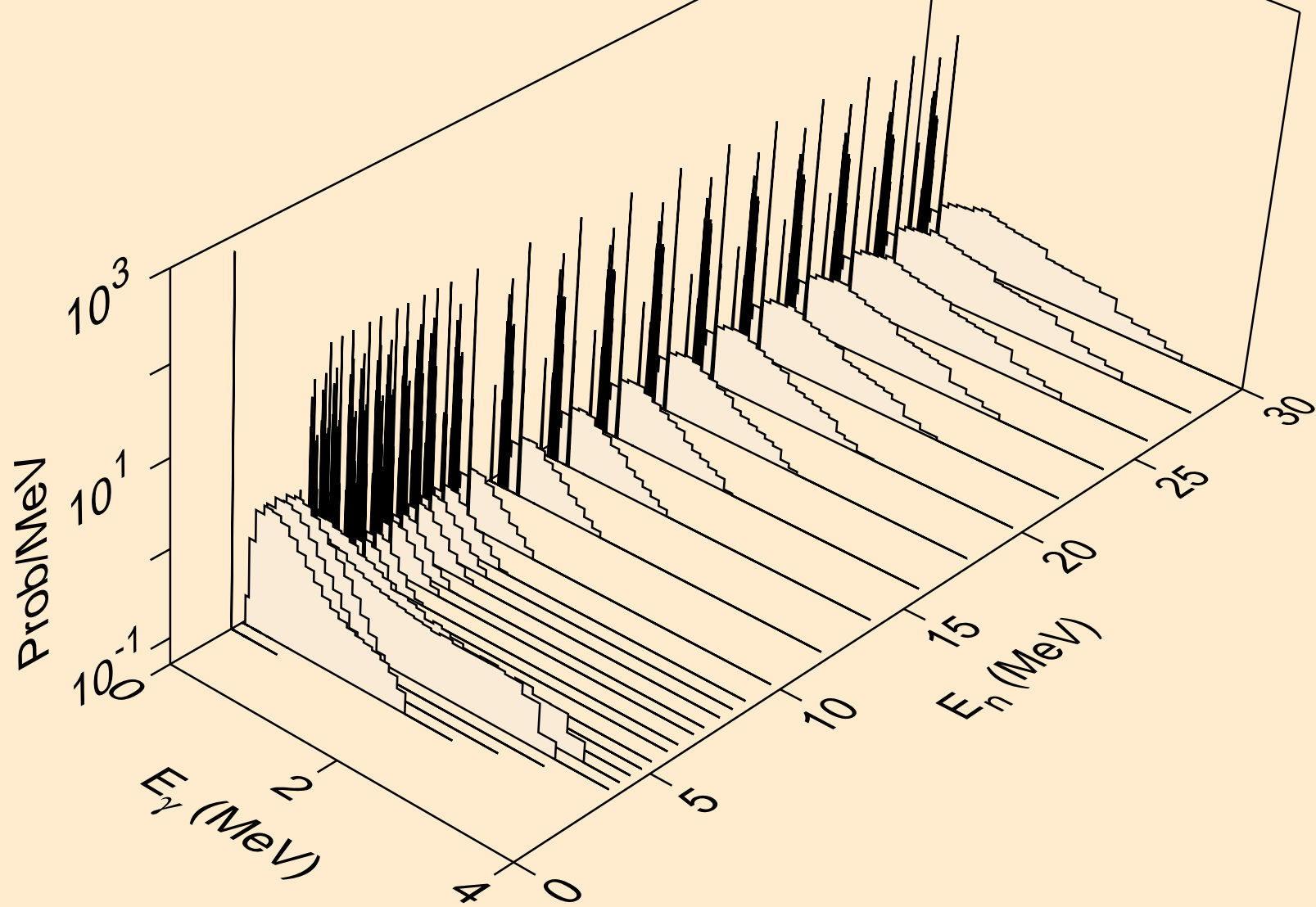

IR171M NEUTRON ACER TENDL-2024 LIBRARY; T=0.K
Photon emission for (n,2n)2a

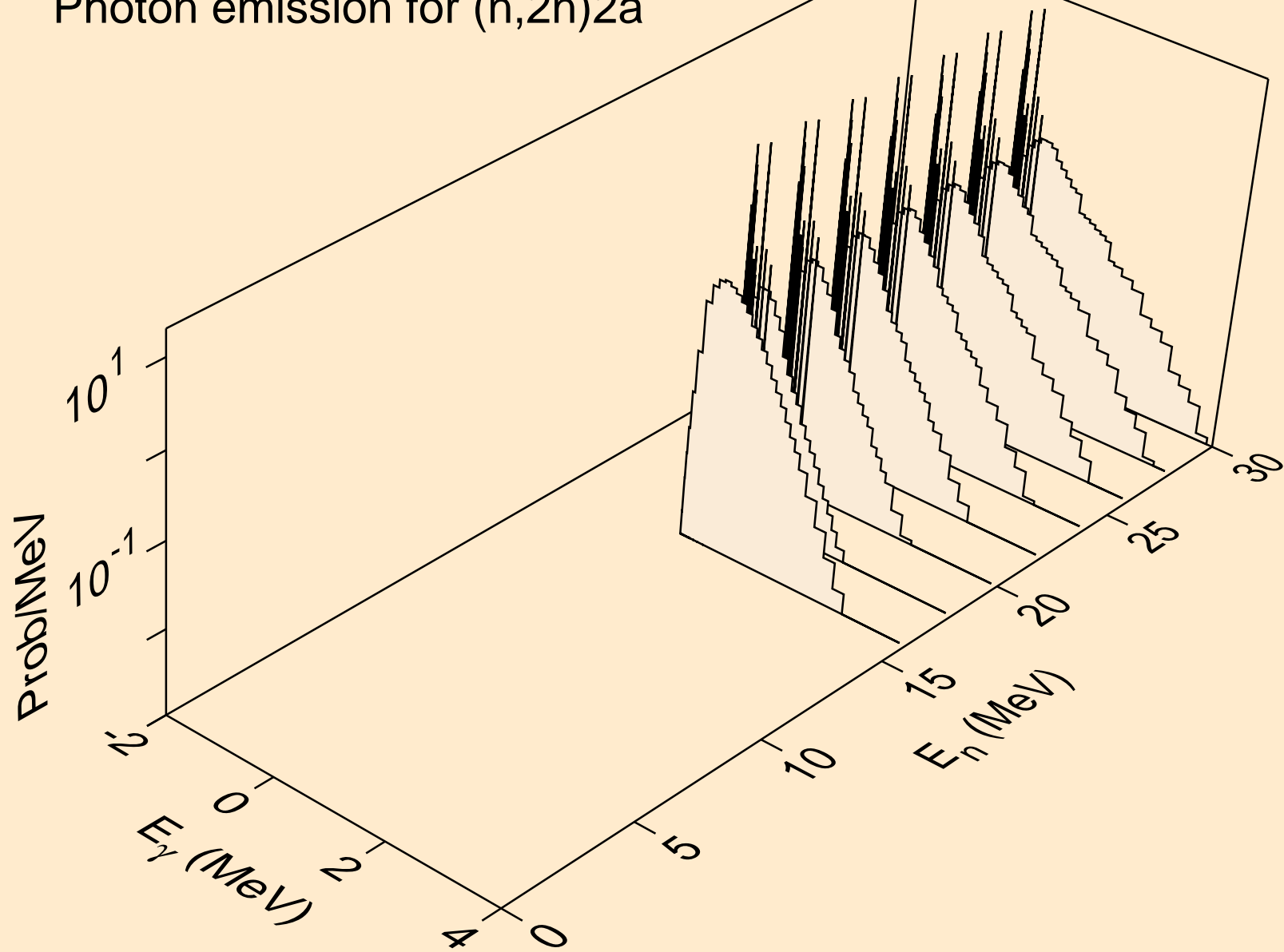

IR171M NEUTRON ACER TENDL-2024 LIBRARY; T=0.K
Photon emission for (n,n*)d

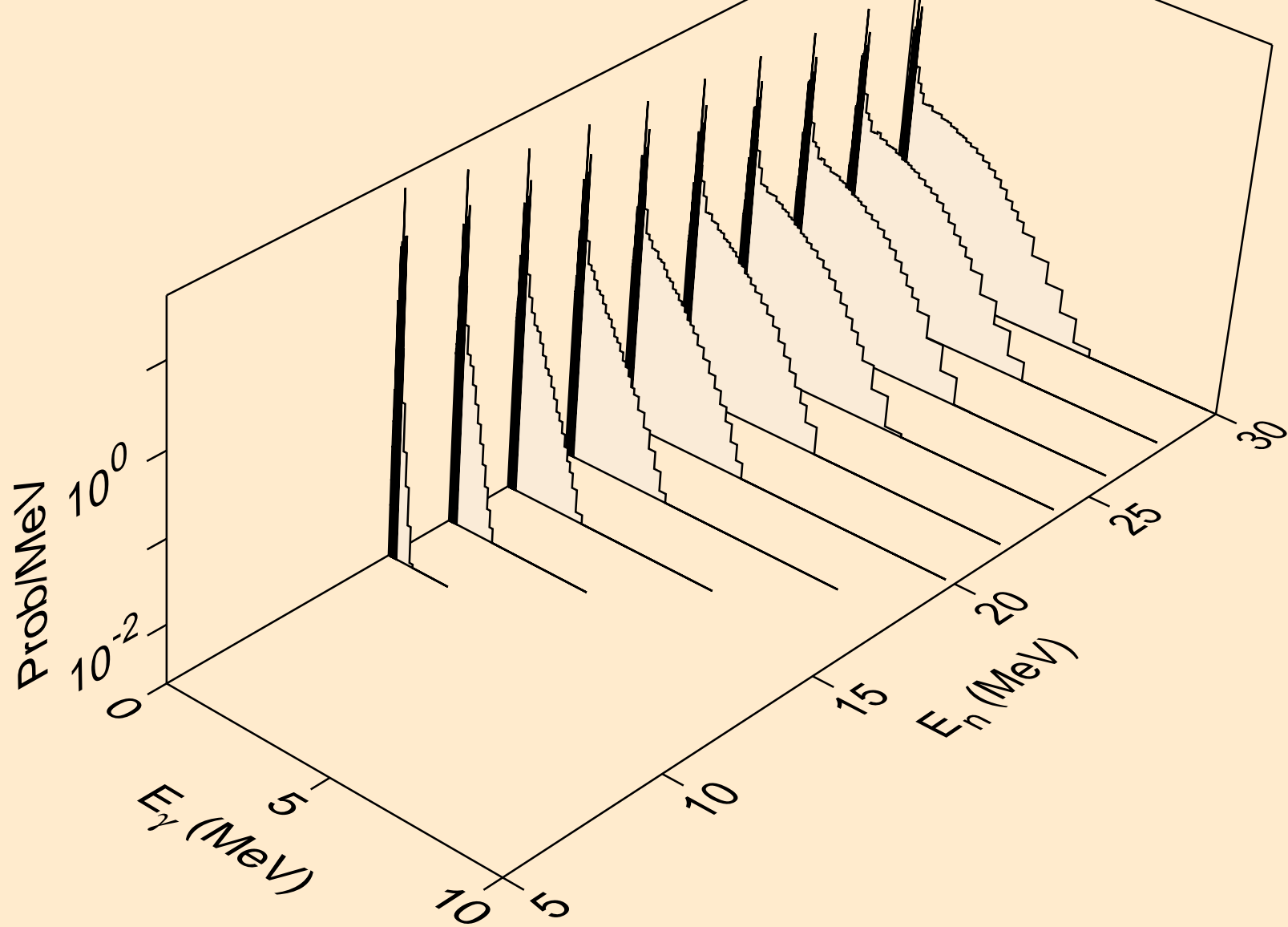

IR171M NEUTRON ACER TENDL-2024 LIBRARY; T=0.K
Photon emission for (n,n*)t

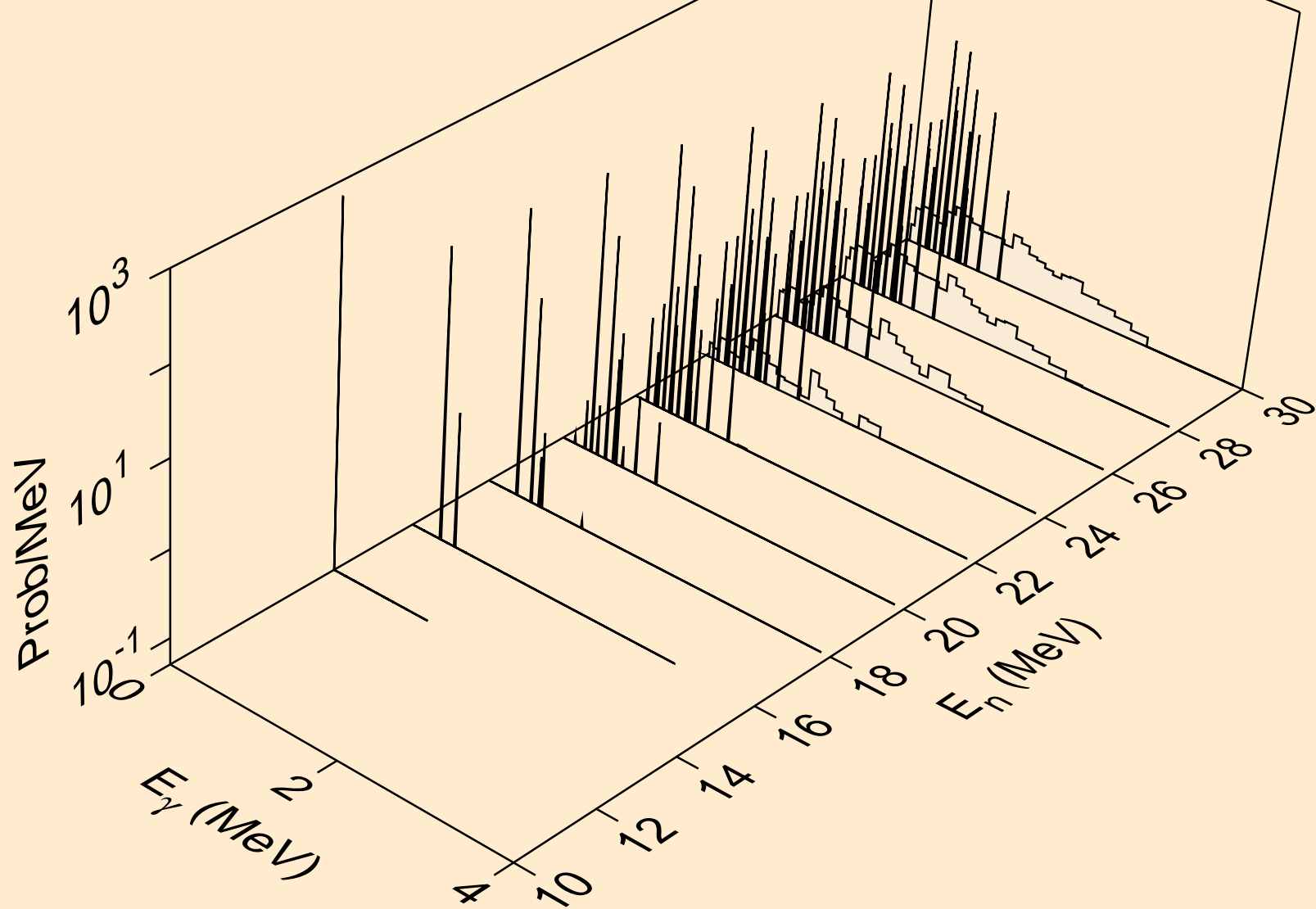

IR171M NEUTRON ACER TENDL-2024 LIBRARY; T=0.K
Photon emission for (n,n*)he3

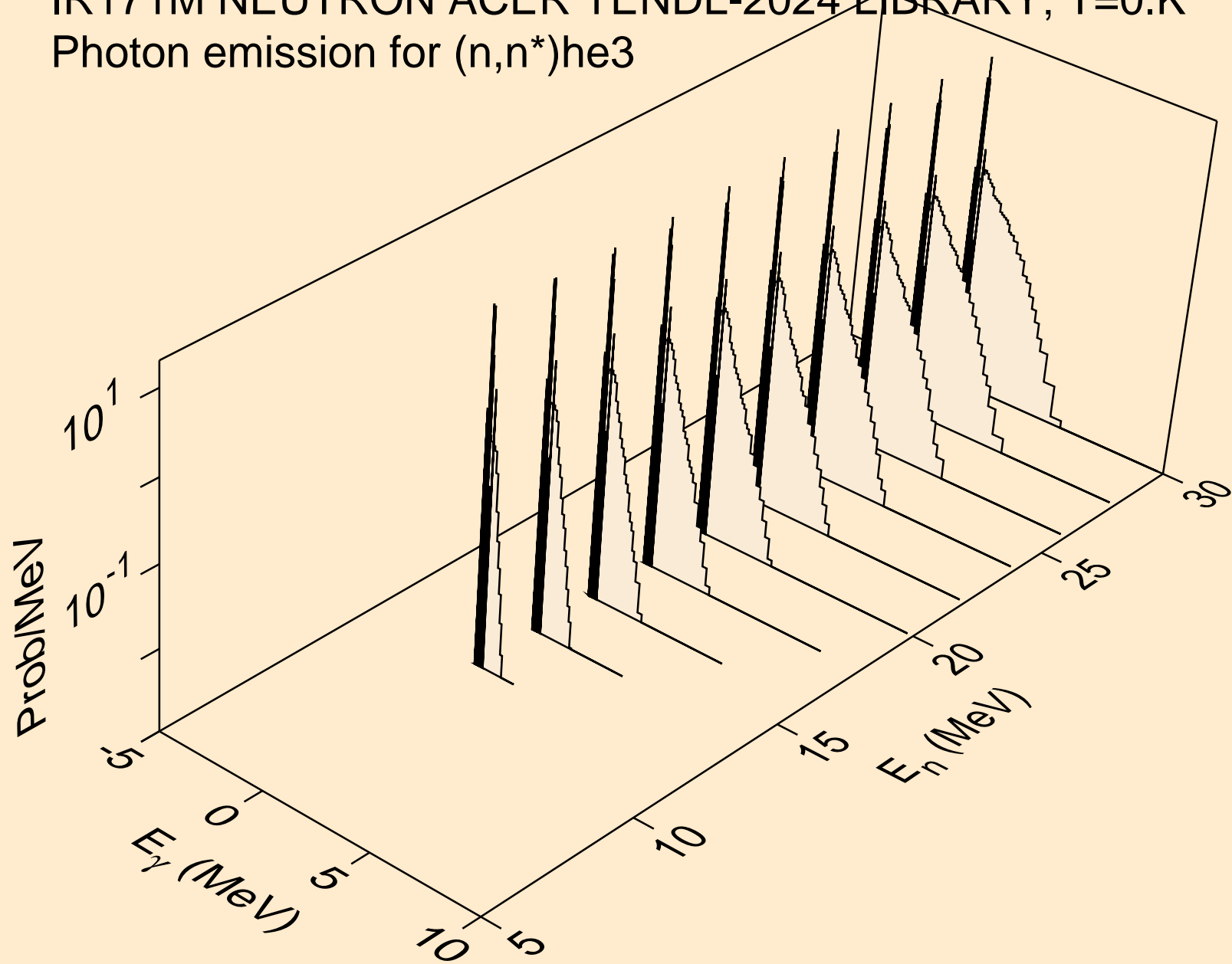

IR171M NEUTRON ACER TENDL-2024 LIBRARY; T=0.K
Photon emission for (n,2np)

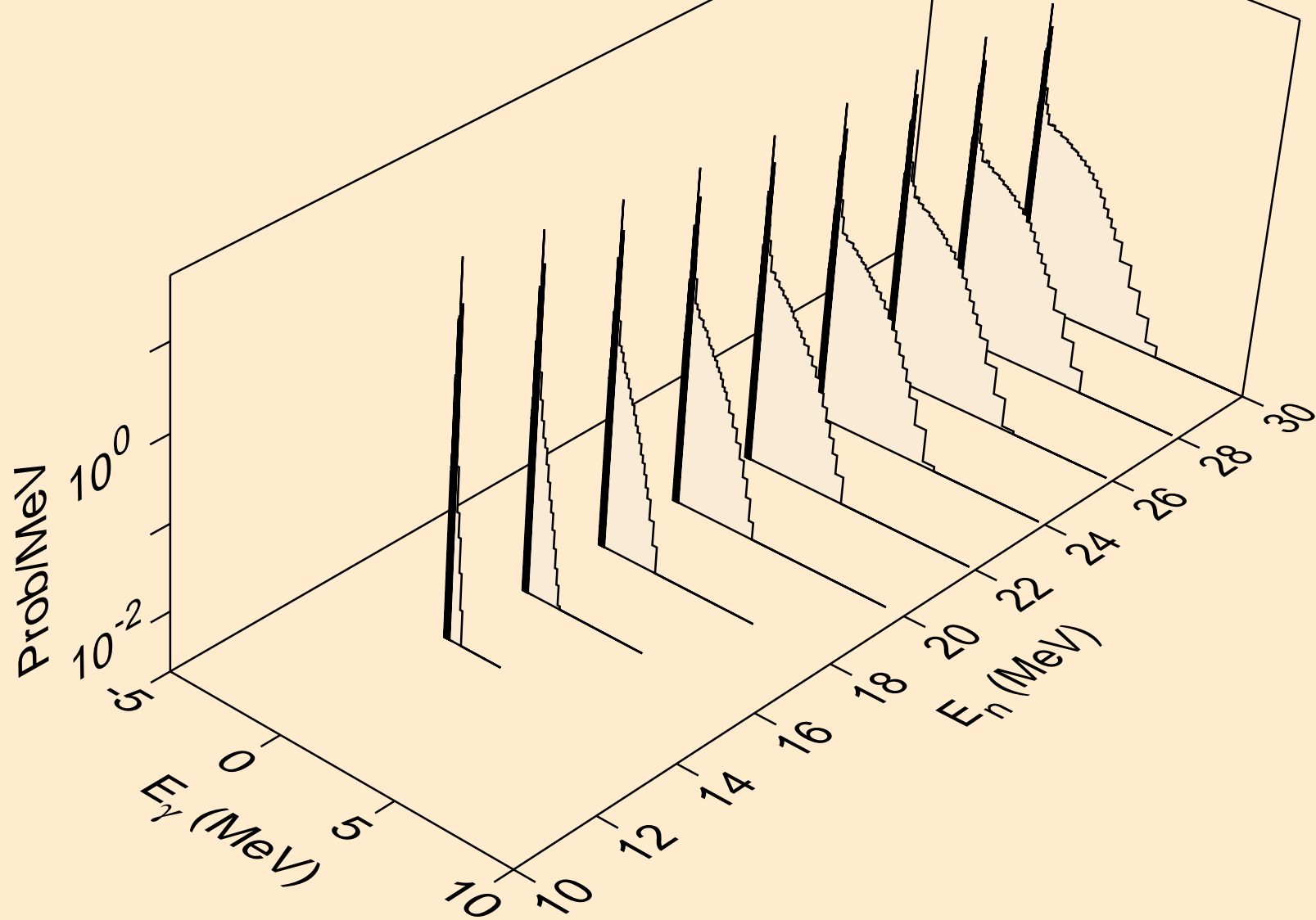

IR171M NEUTRON ACER TENDL-2024 LIBRARY; T=0.K
Photon emission for (n,3np)

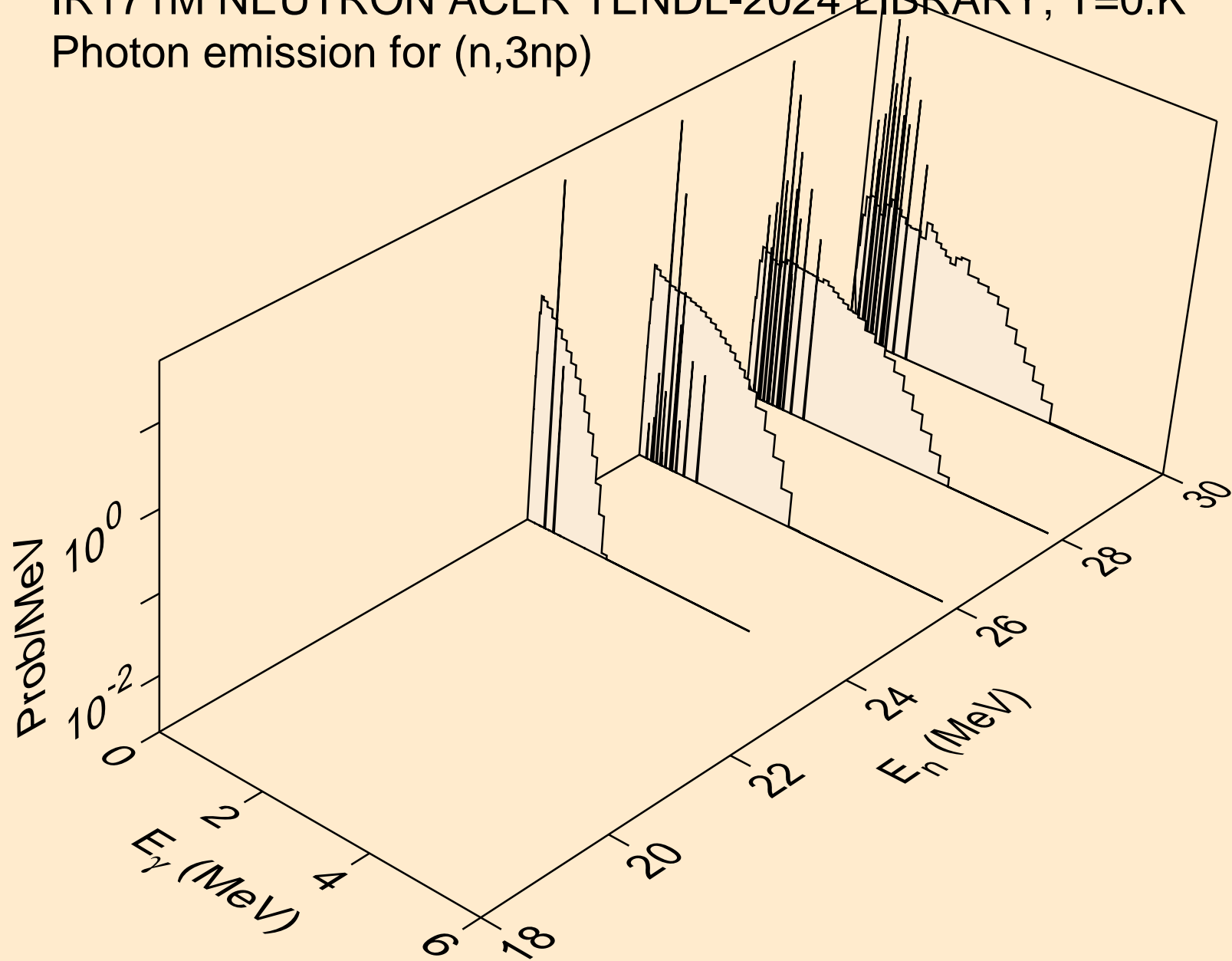

IR171M NEUTRON ACER TENDL-2024 LIBRARY; T=0.K
Photon emission for (n,n2p)

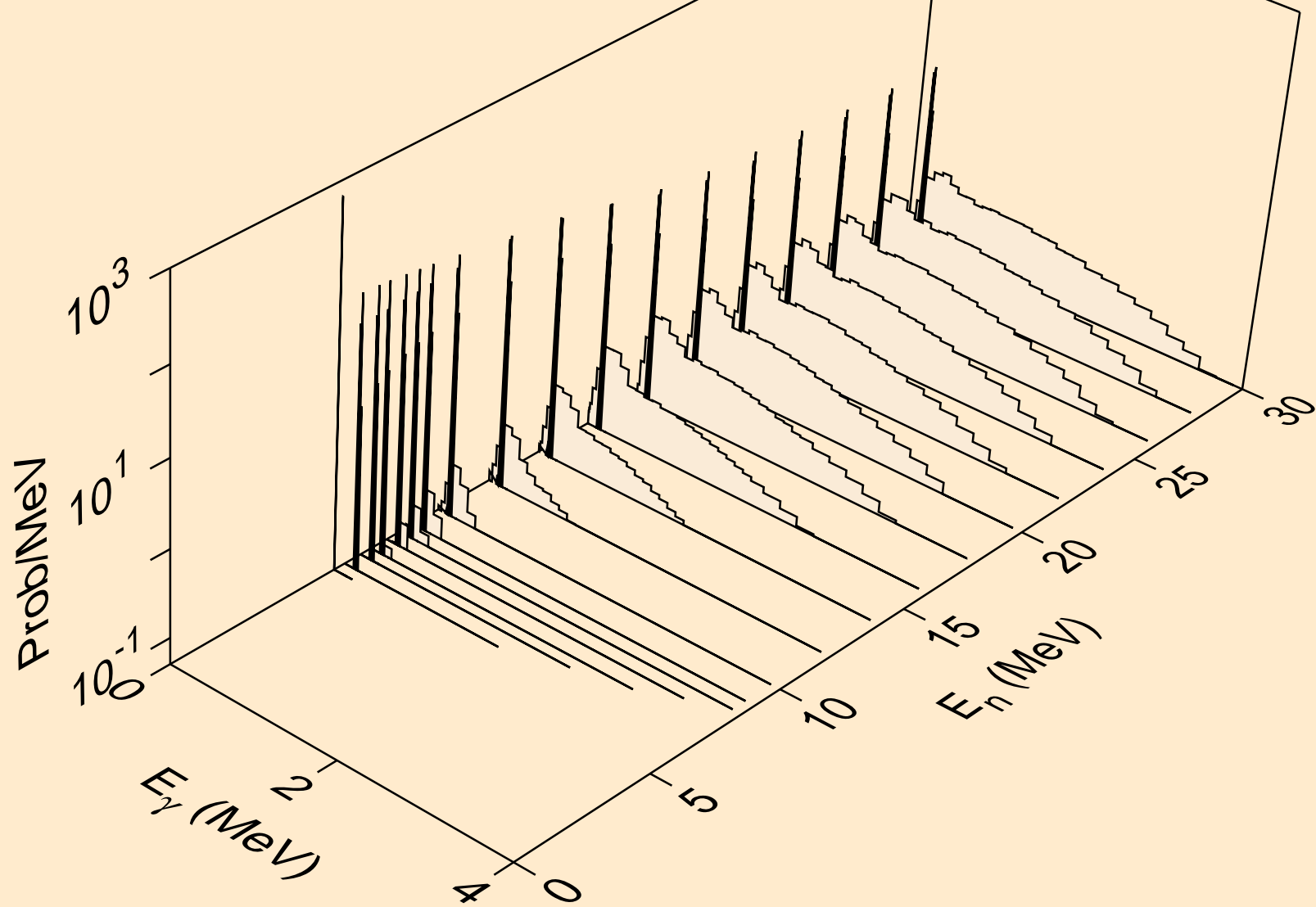

IR171M NEUTRON ACER TENDL-2024 LIBRARY; T=0.K
Photon emission for (n,npa)

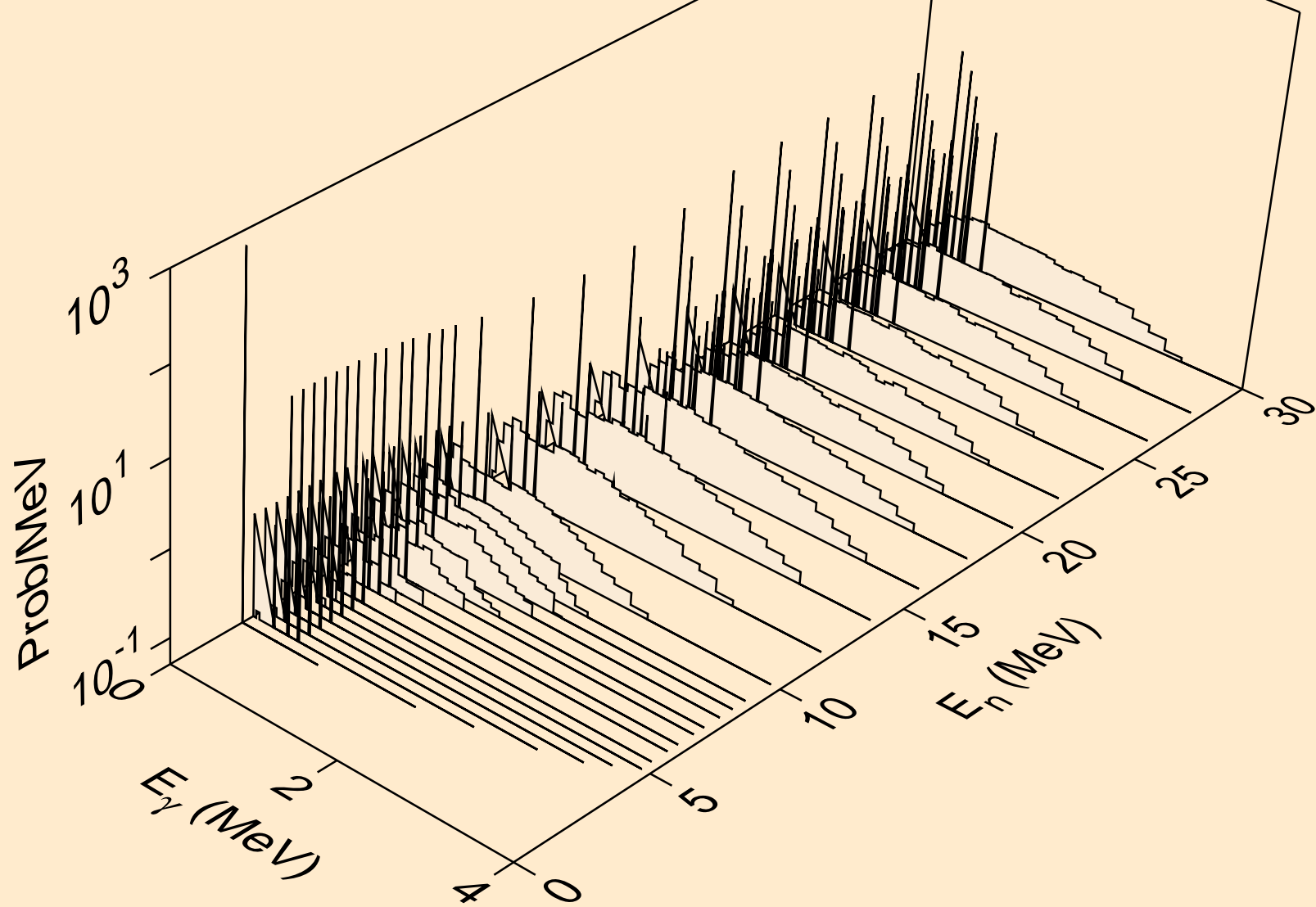

IR171M NEUTRON ACER TENDL-2024 LIBRARY; T=0.K
Photon emission for (n,n*2)

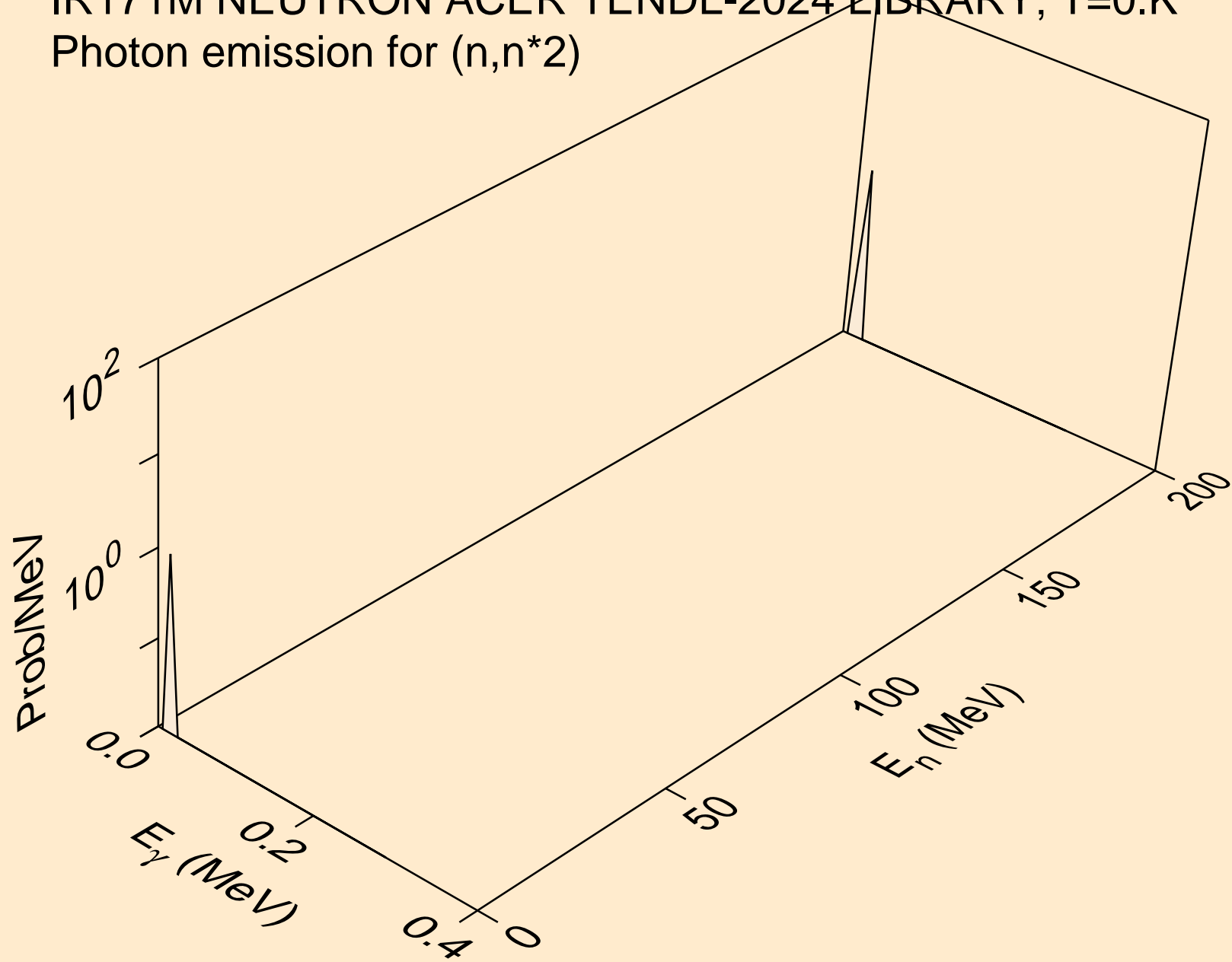

IR171M NEUTRON ACER TENDL-2024 LIBRARY; T=0.K
Photon emission for (n,n*c)

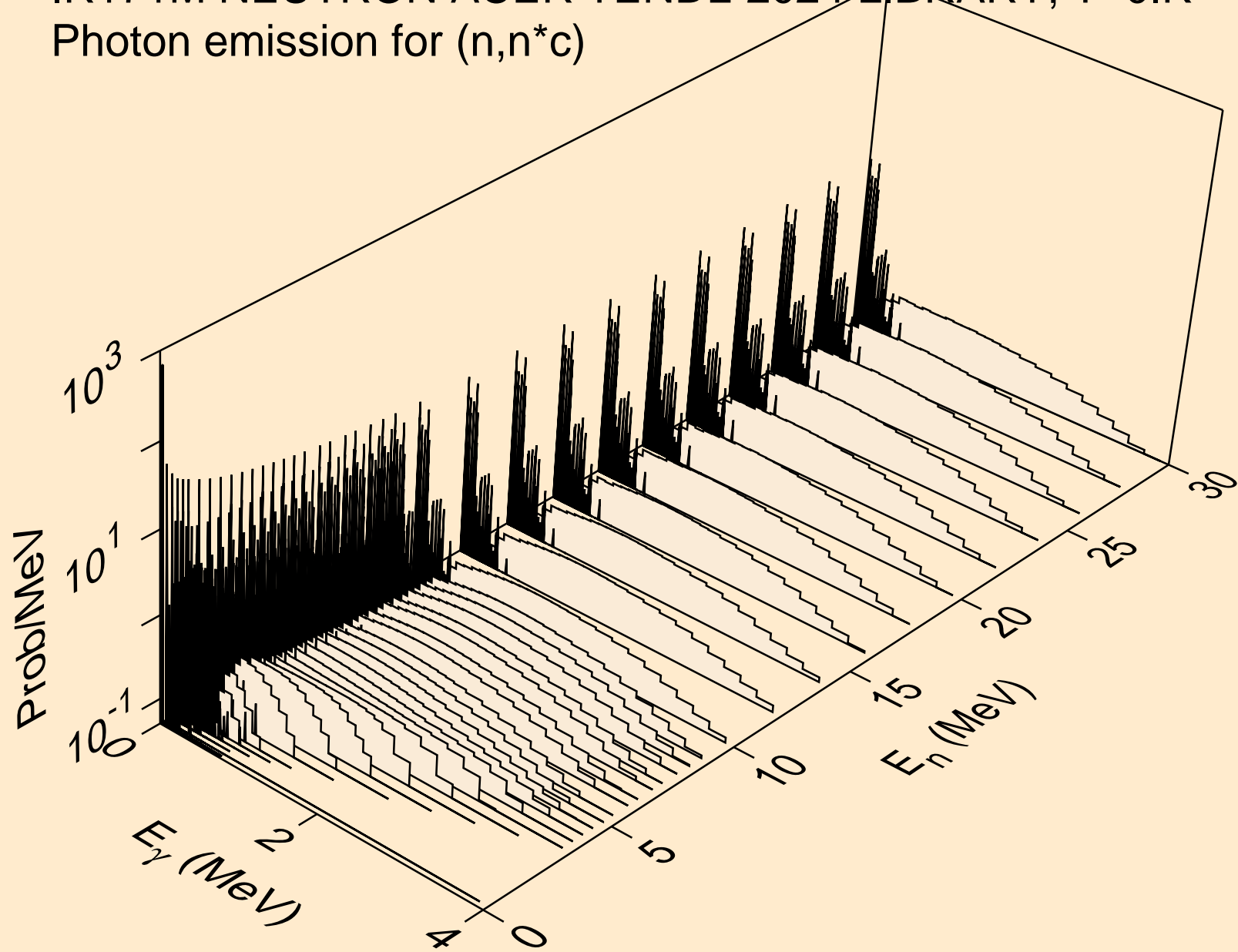

IR171M NEUTRON ACER TENDL-2024 LIBRARY; T=0.K
Photon emission for (n,gma)

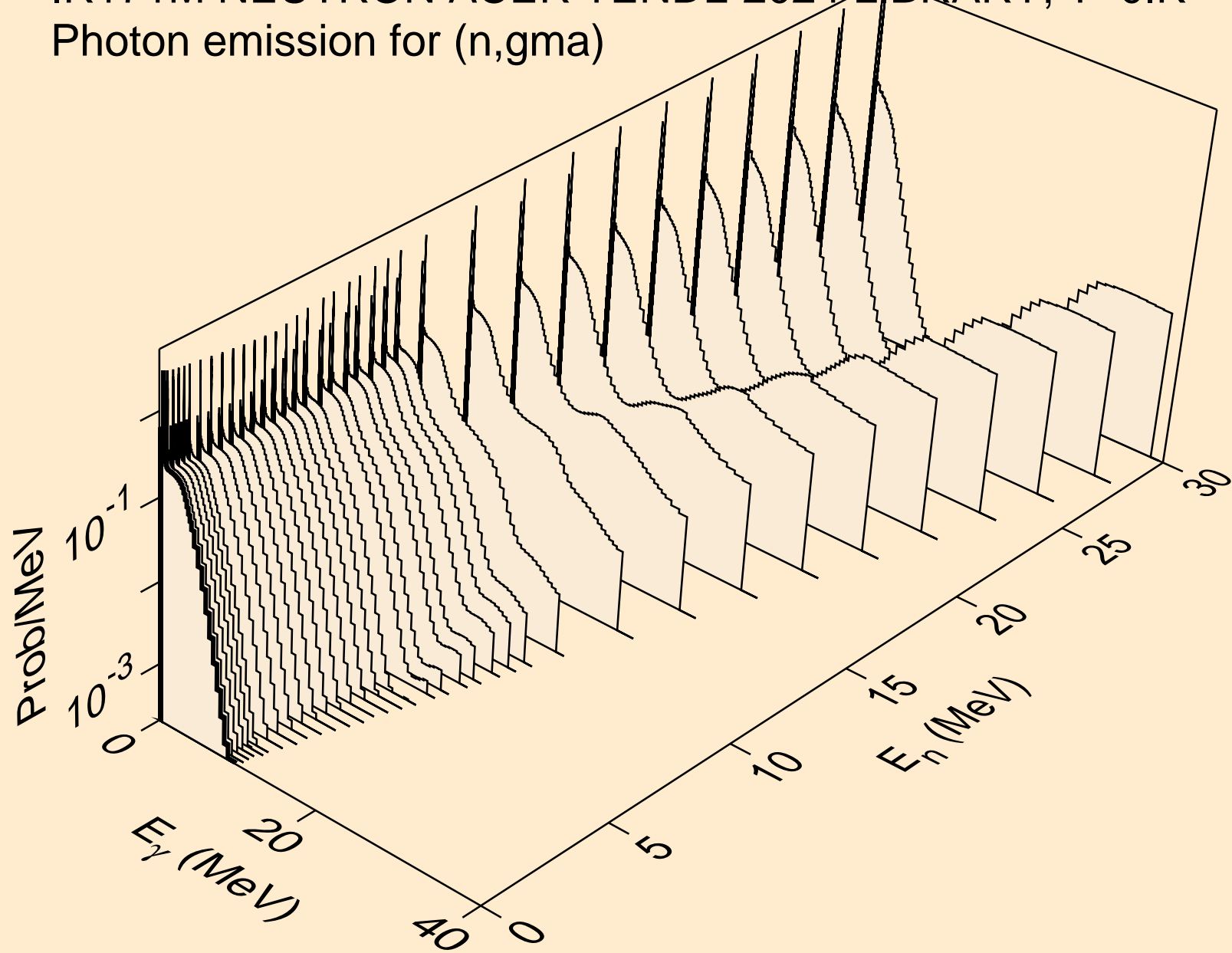

IR171M NEUTRON ACER TENDL-2024 LIBRARY; T=0.K
Photon emission for (n,p)

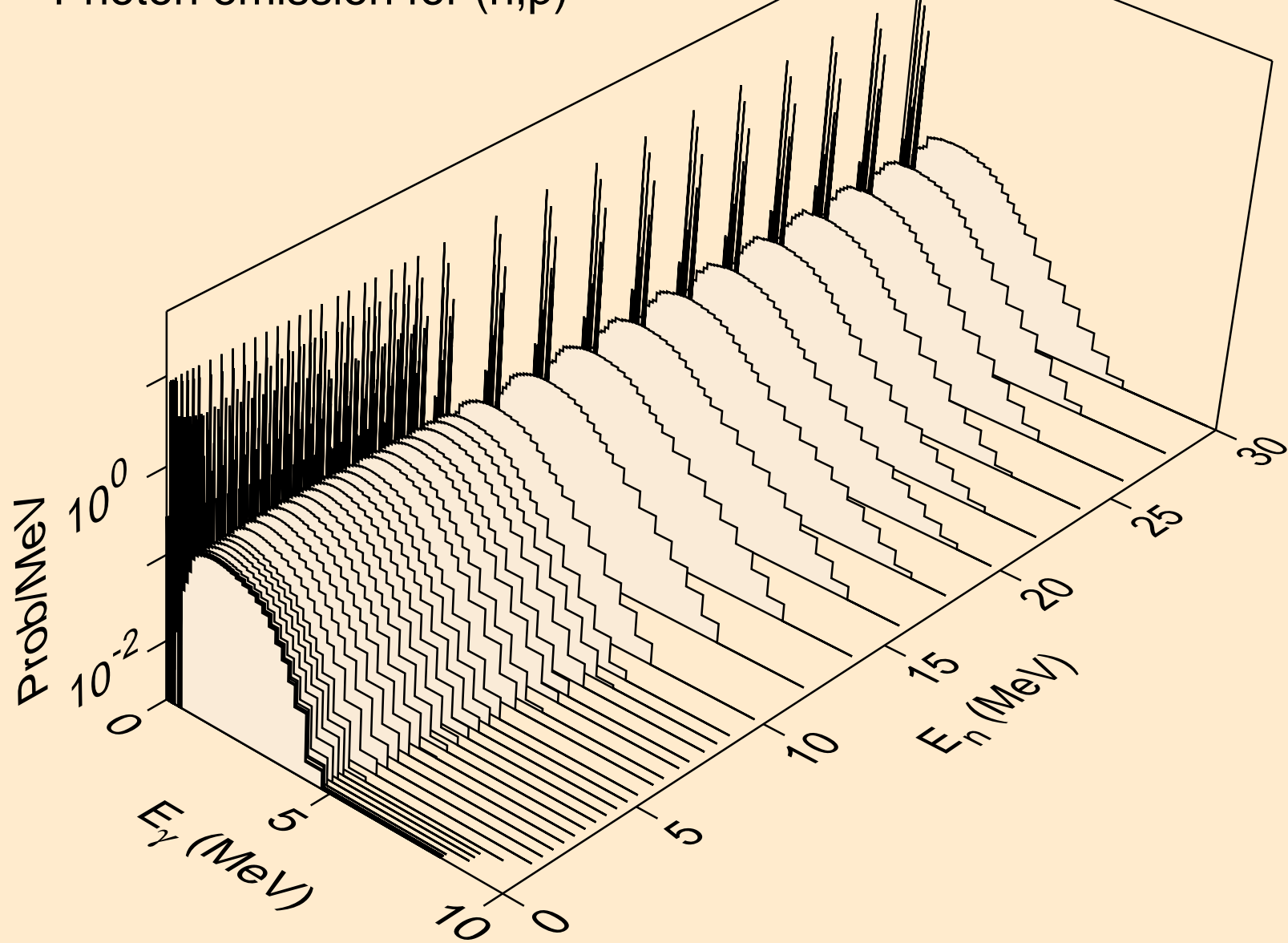

IR171M NEUTRON ACER TENDL-2024 LIBRARY; T=0.K
Photon emission for (n,d)

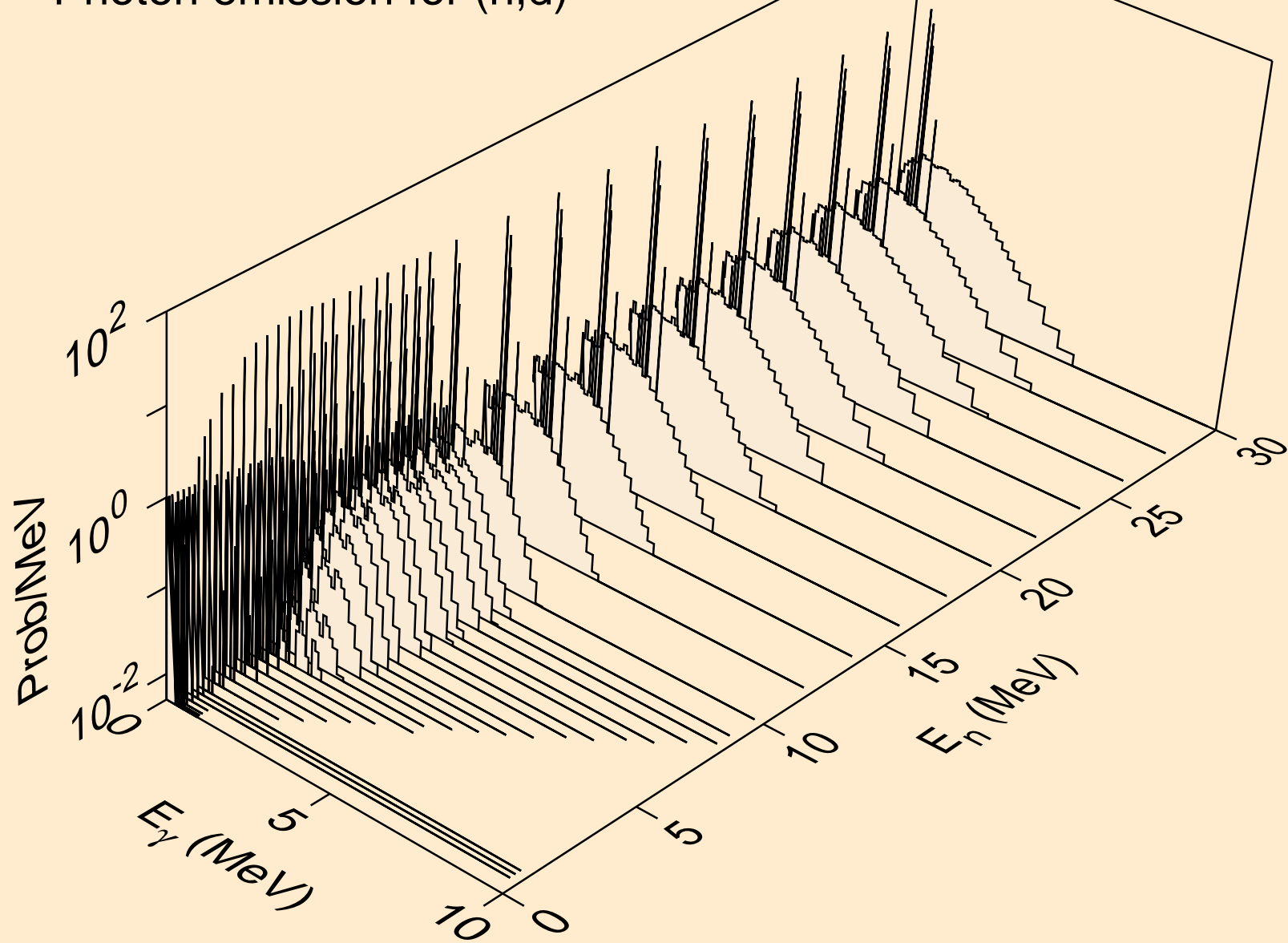

IR171M NEUTRON ACER TENDL-2024 LIBRARY; T=0.K
Photon emission for (n,t)

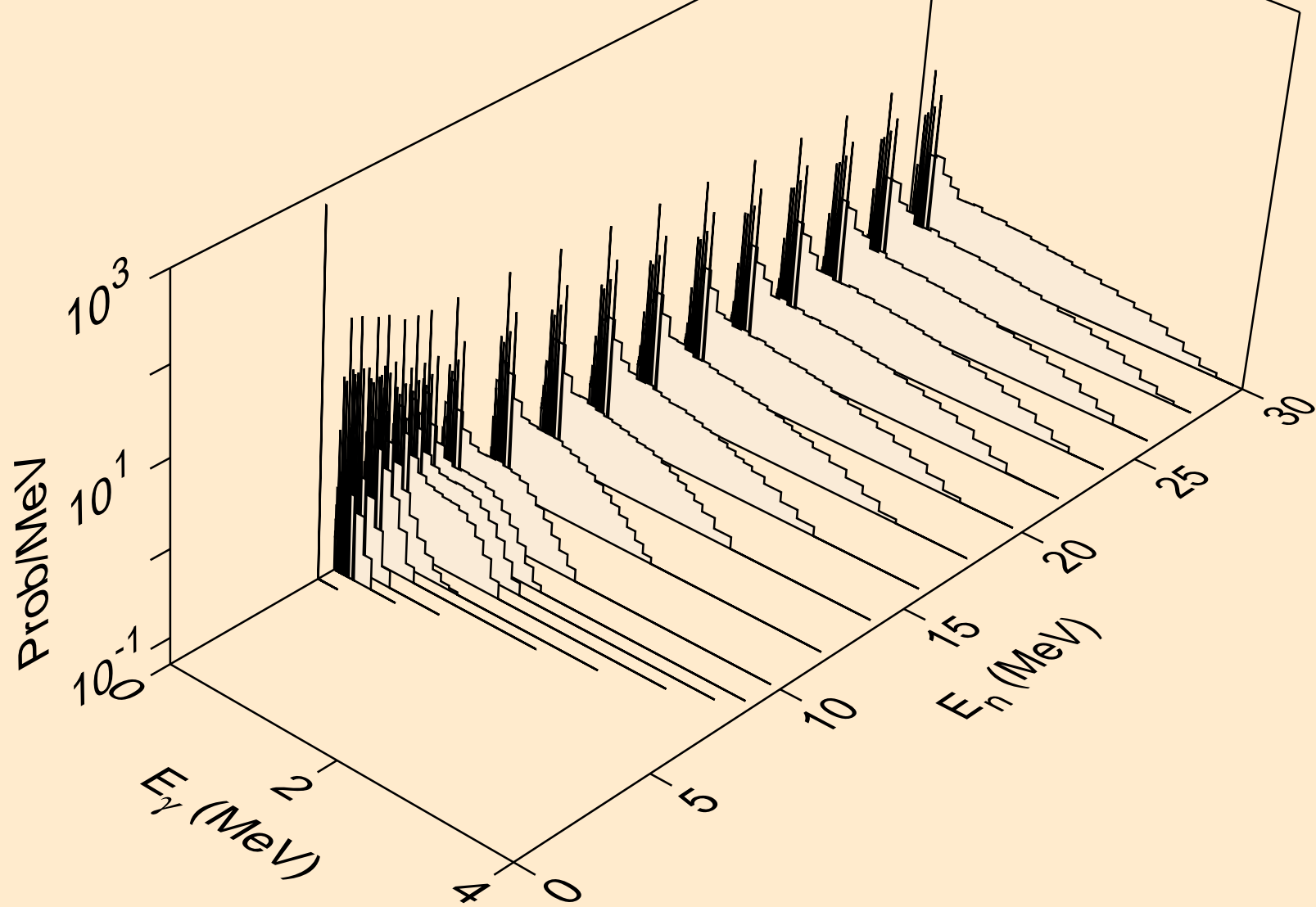

IR171M NEUTRON ACER TENDL-2024 LIBRARY; T=0.K
Photon emission for (n,he3)

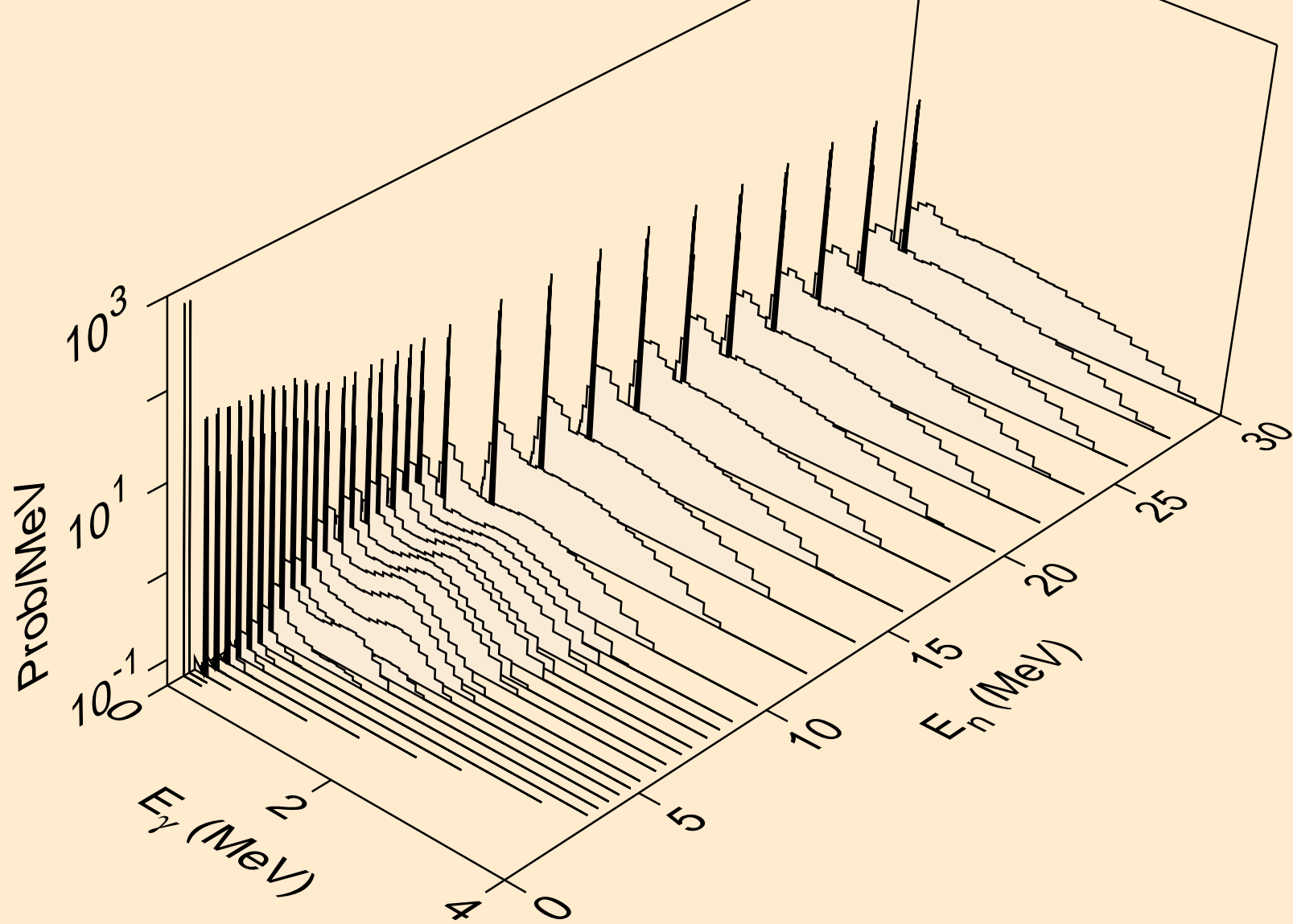

IR171M NEUTRON ACER TENDL-2024 LIBRARY; T=0.K
Photon emission for (n,a)

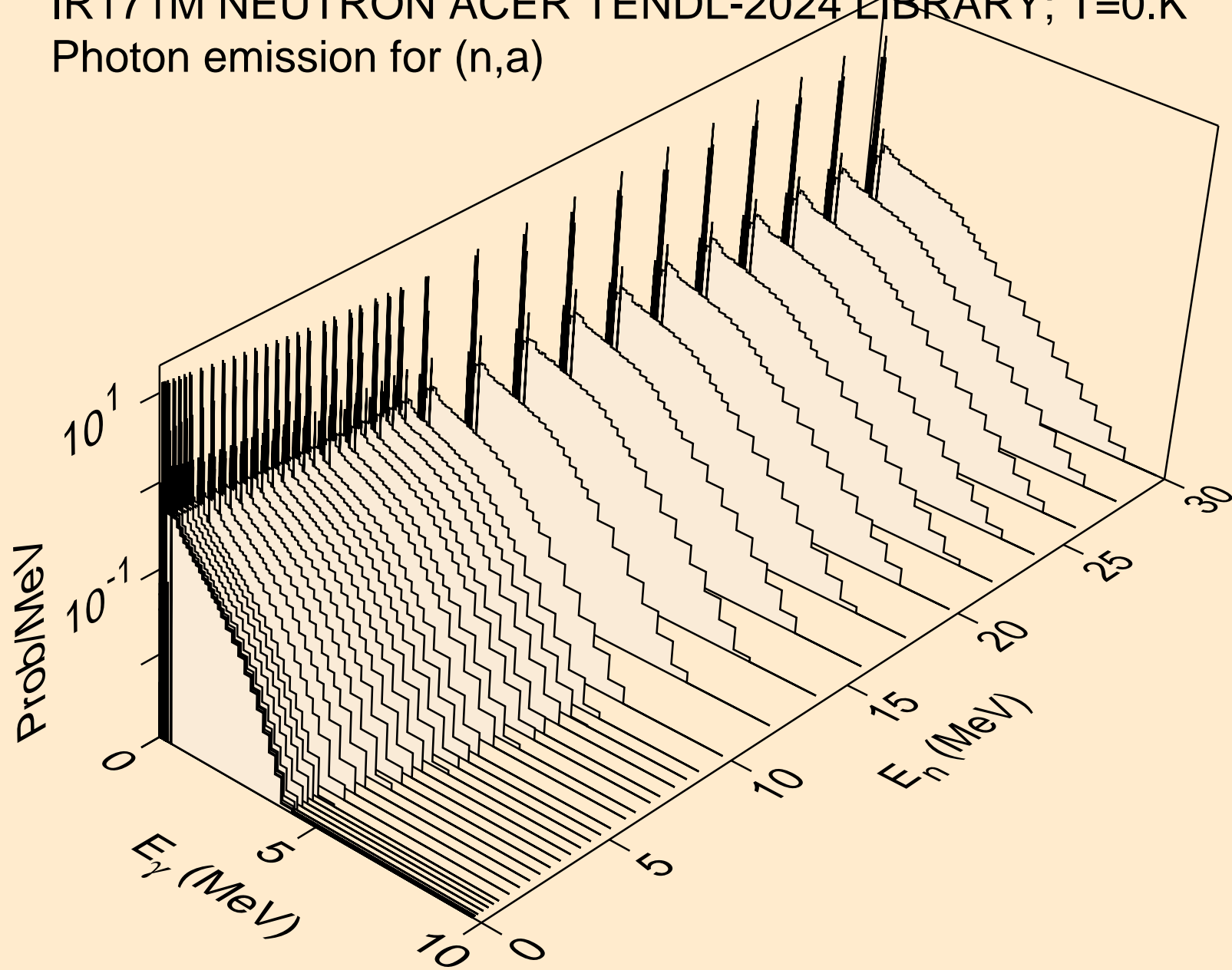

IR171M NEUTRON ACER TENDL-2024 LIBRARY; T=0.K
Photon emission for (n,2a)

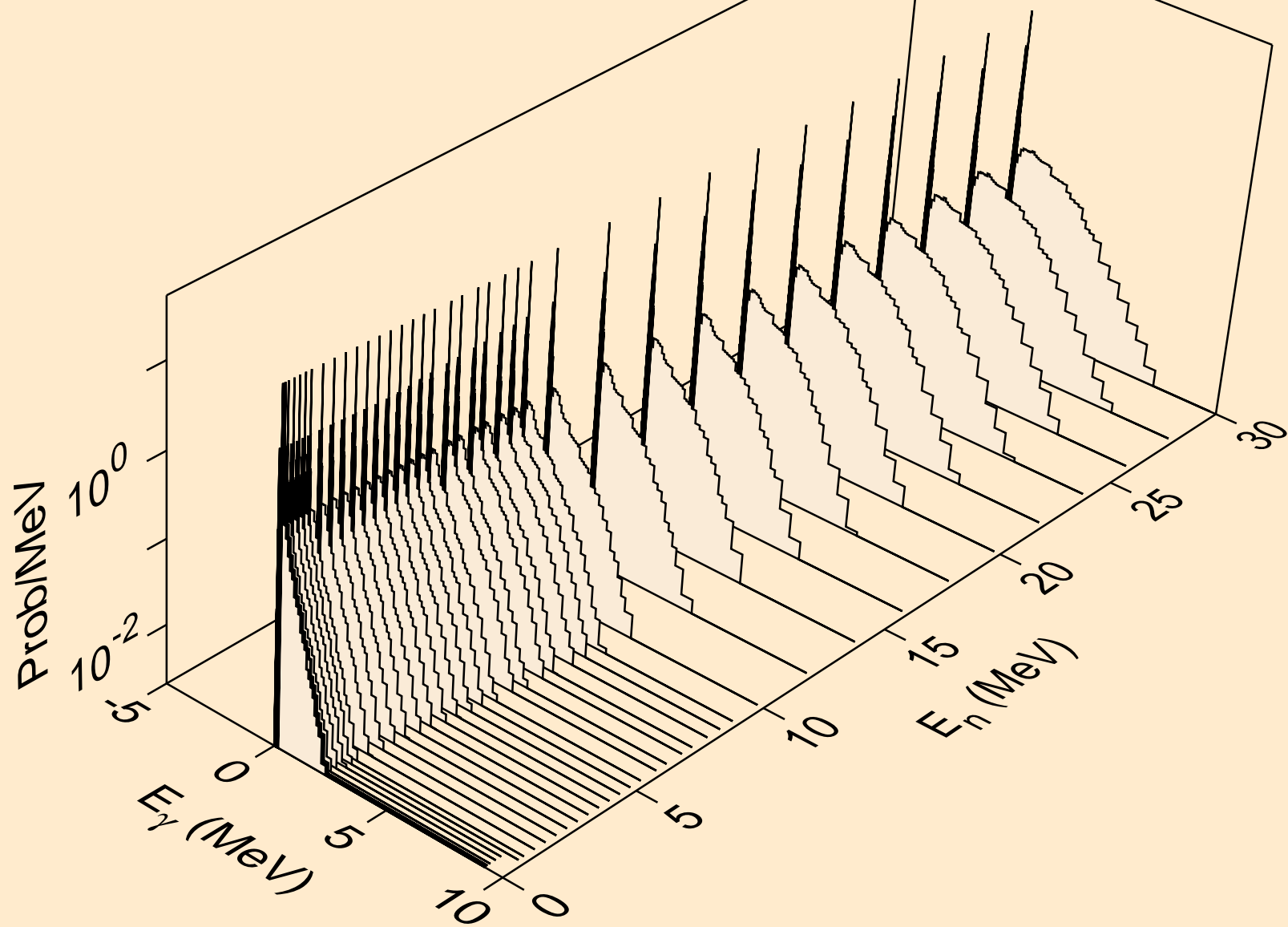

IR171M NEUTRON ACER TENDL-2024 LIBRARY; T=0.K
Photon emission for (n,3a)

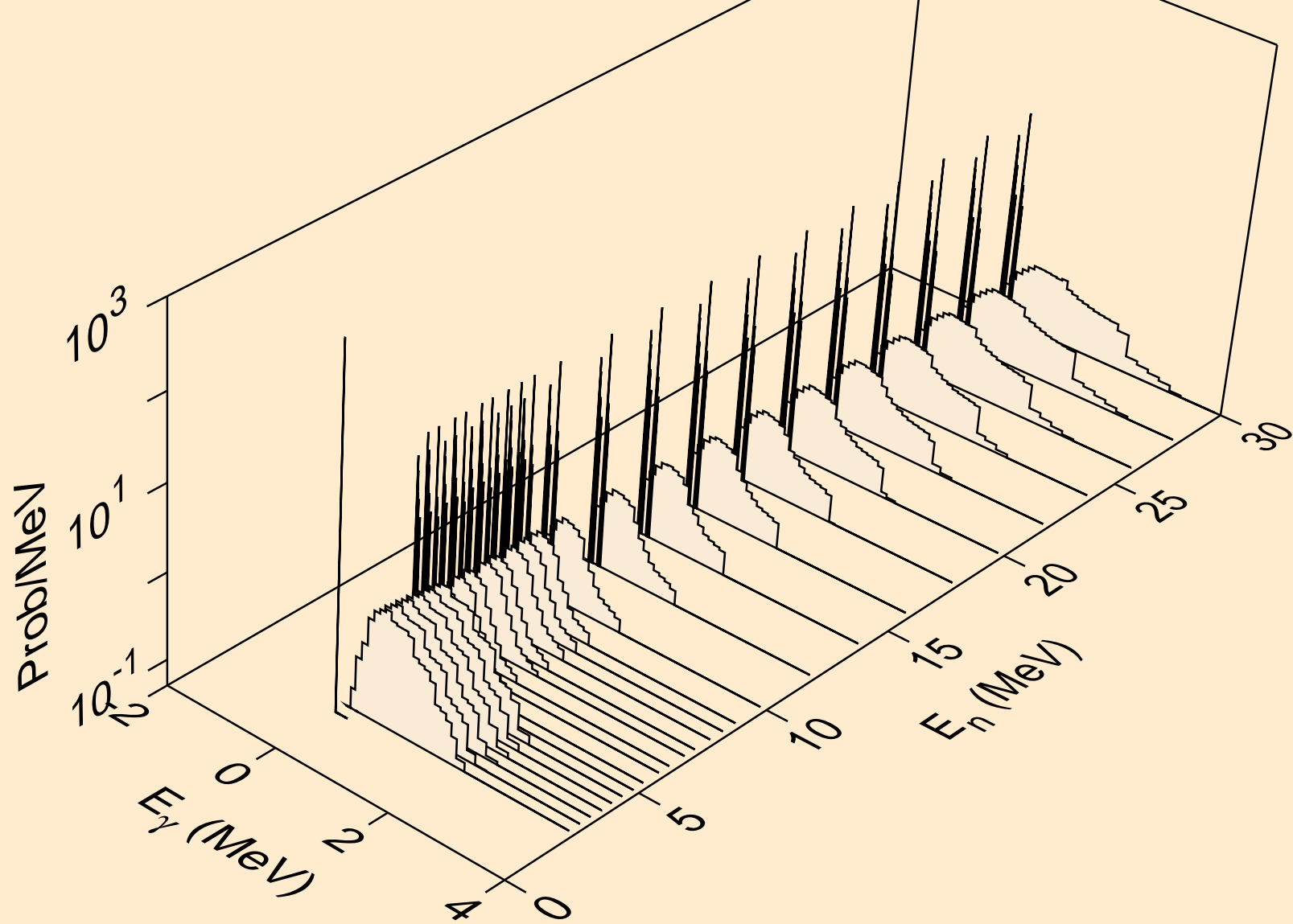

IR171M NEUTRON ACER TENDL-2024 LIBRARY; T=0.K
Photon emission for (n,2p)

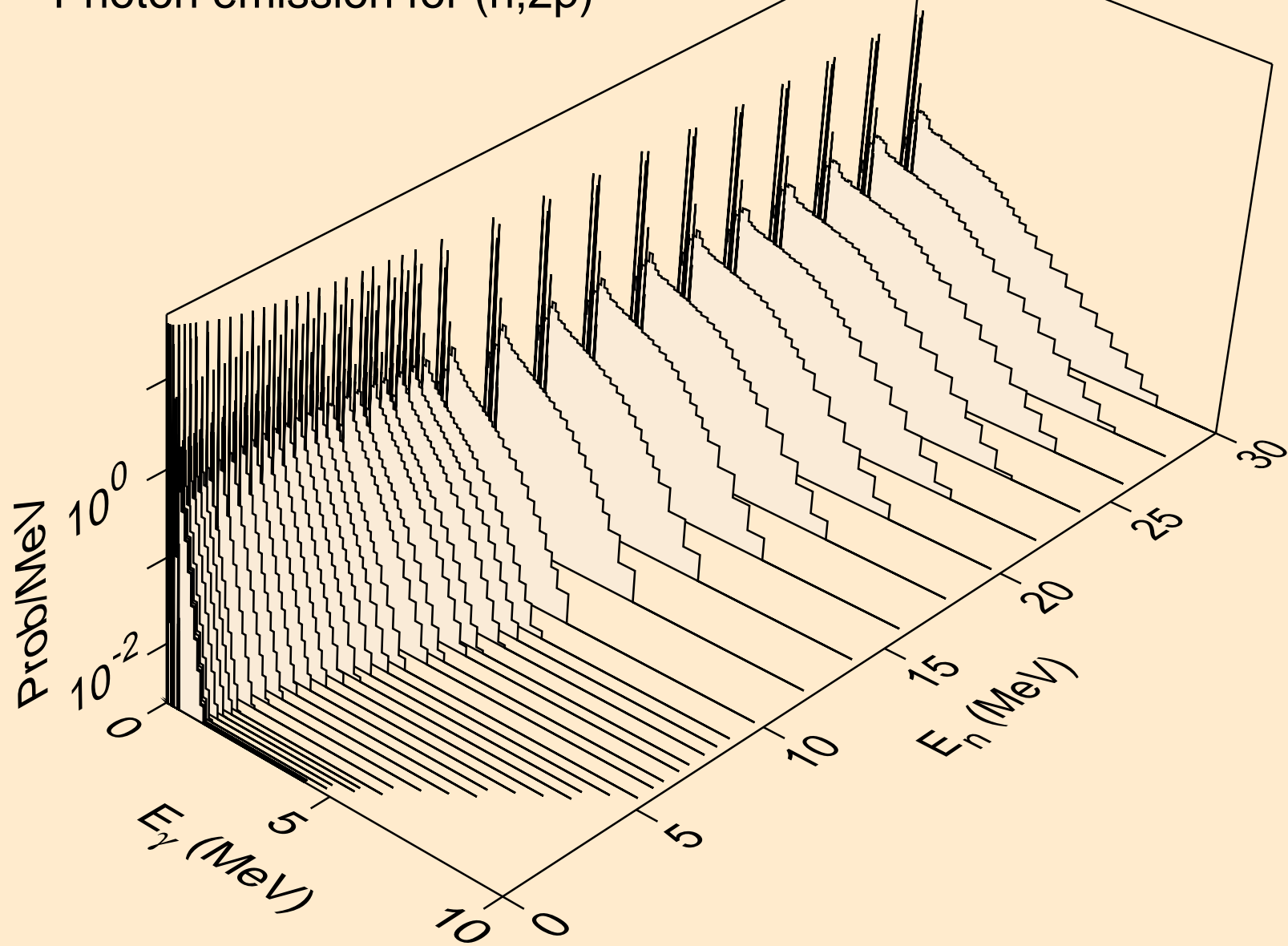

IR171M NEUTRON ACER TENDL-2024 LIBRARY; T=0.K
Photon emission for (n,p α)

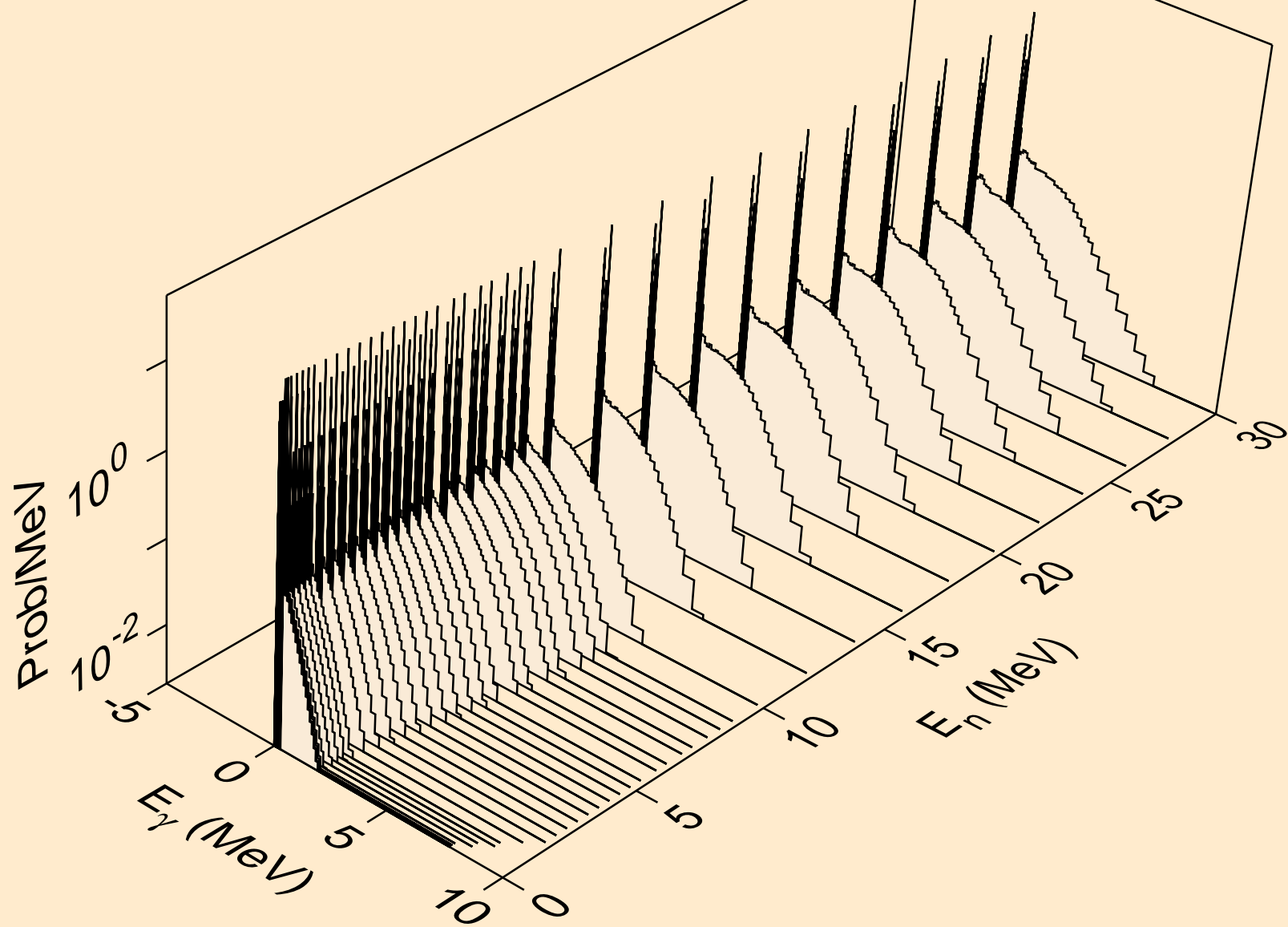

IR171M NEUTRON ACER TENDL-2024 LIBRARY; T=0.K
Photon emission for (n,t2a)

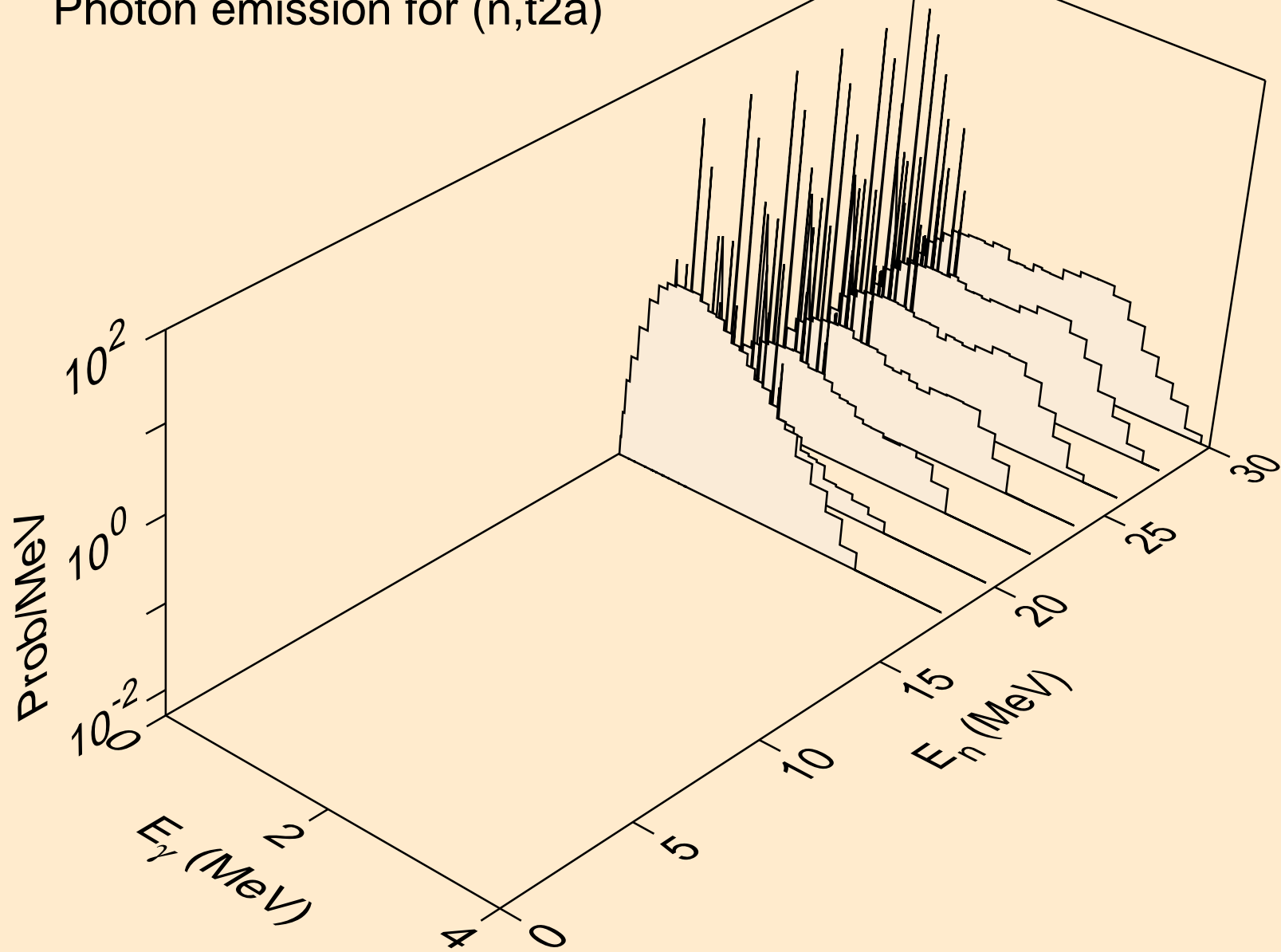

IR171M NEUTRON ACER TENDL-2024 LIBRARY; T=0.K
Photon emission for (n,d2a)

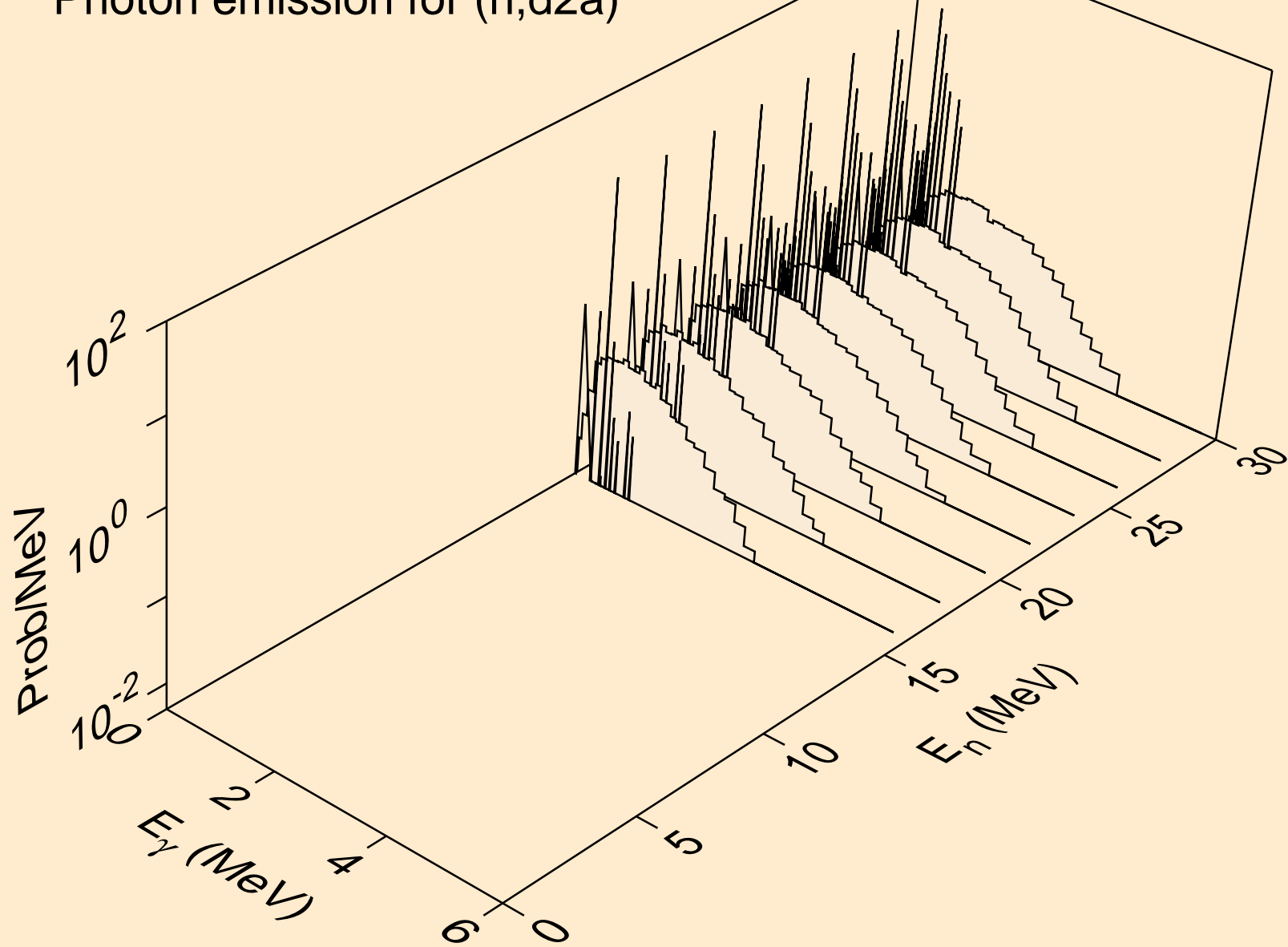

IR171M NEUTRON ACER TENDL-2024 LIBRARY; T=0.K
Photon emission for (n,pd)

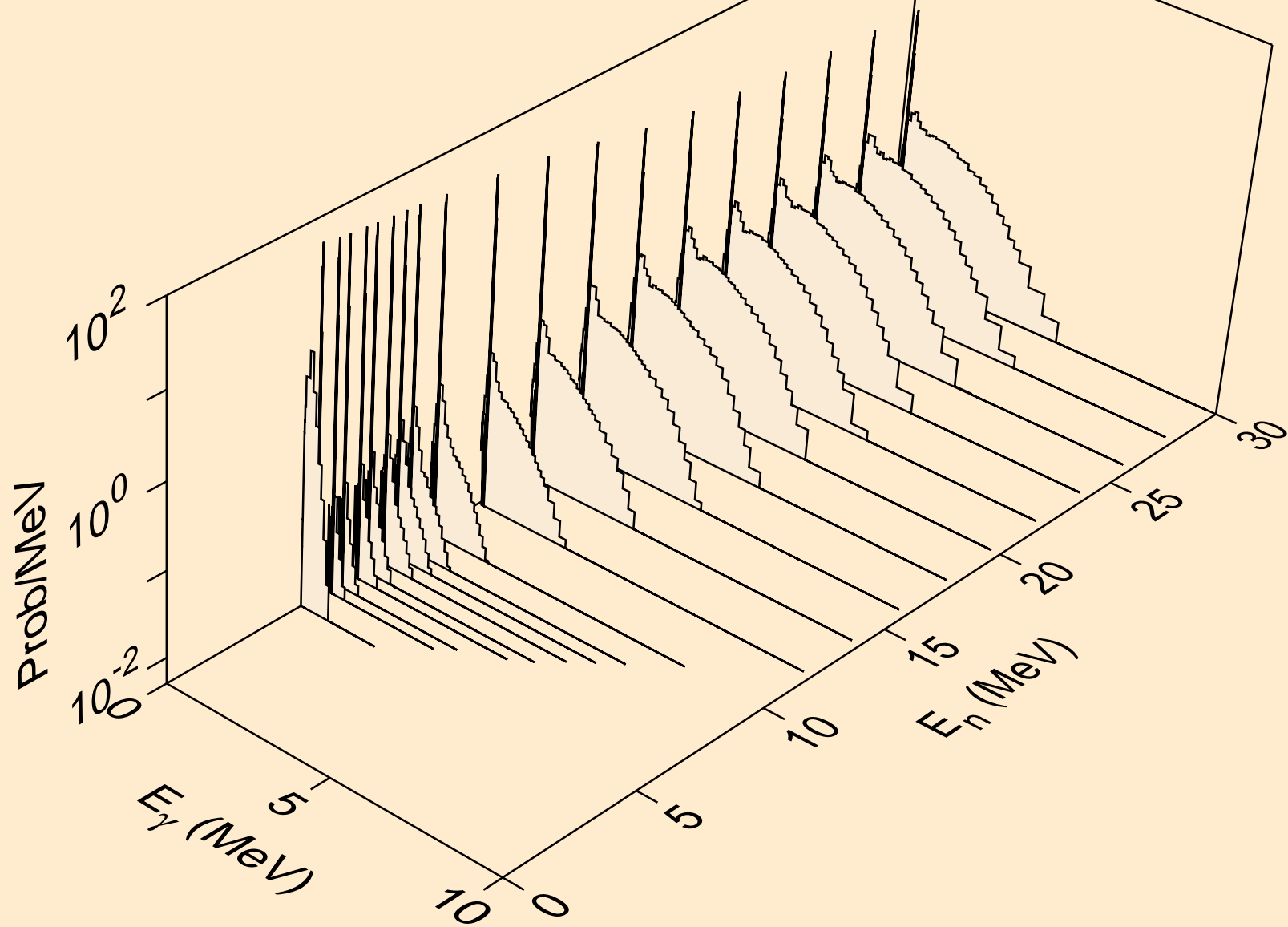

IR171M NEUTRON ACER TENDL-2024 LIBRARY; T=0.K
Photon emission for (n,pt)

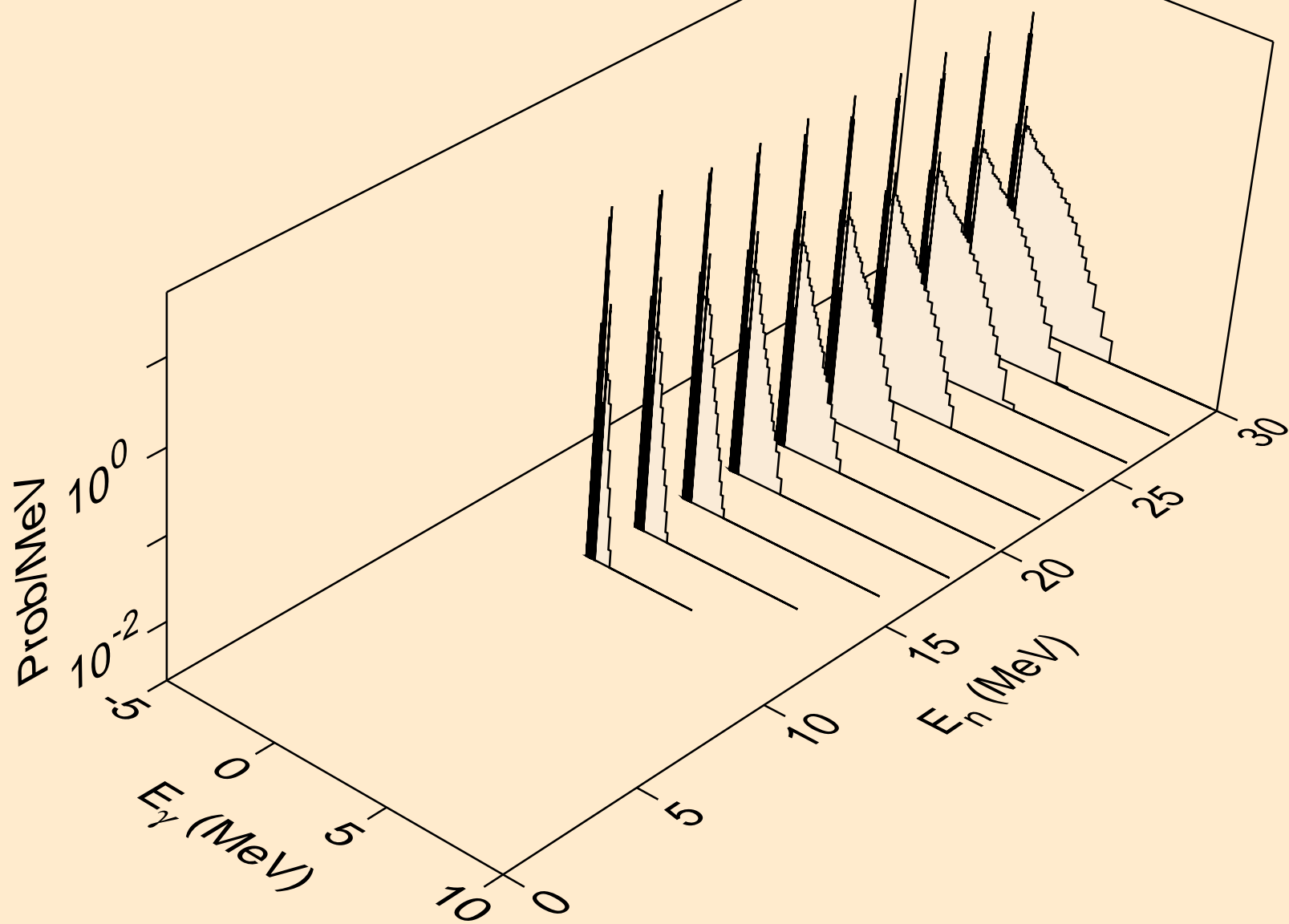

IR171M NEUTRON ACER TENDL-2024 LIBRARY; T=0.K
Photon emission for (n,da)

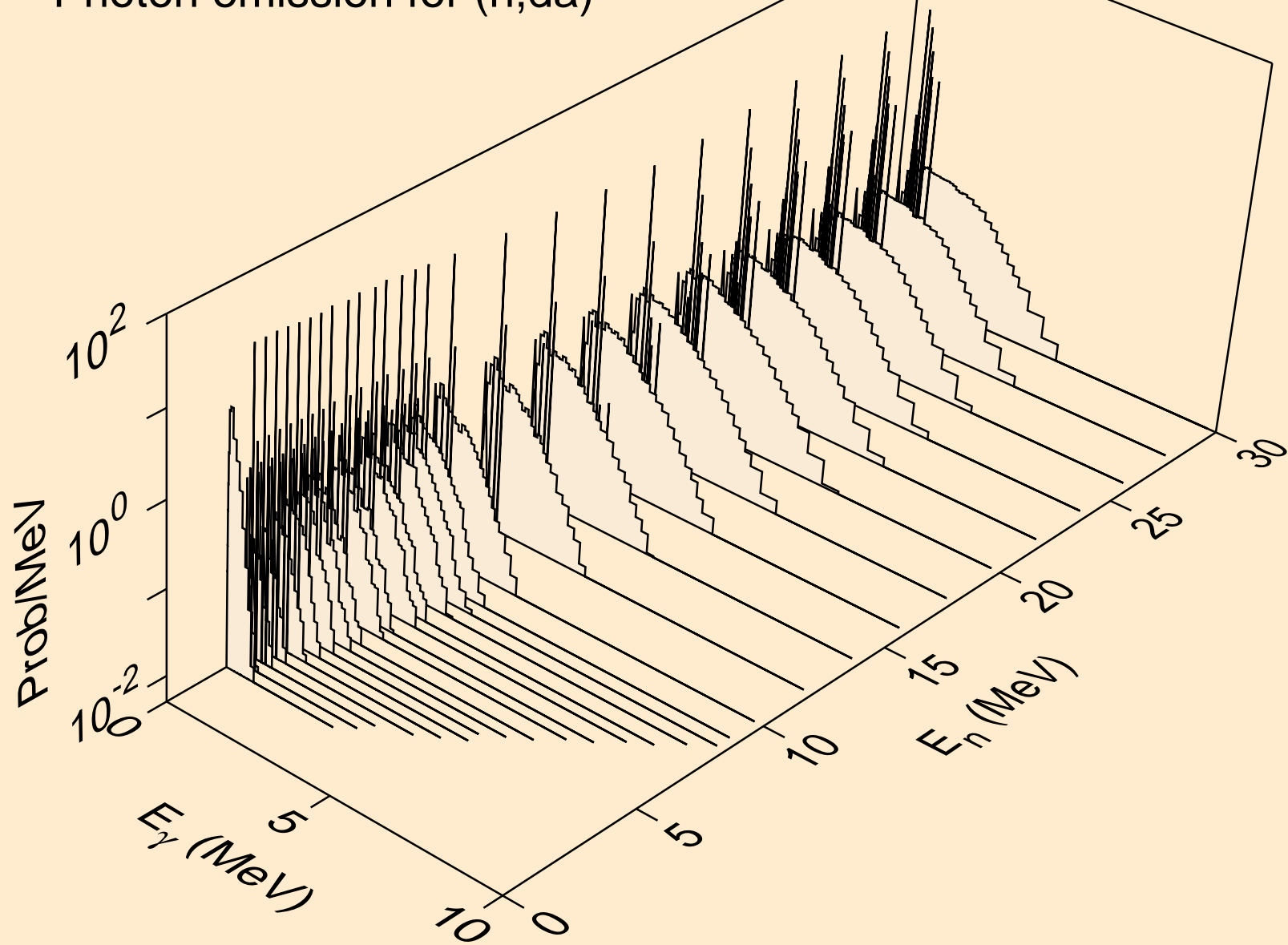

IR171M NEUTRON ACER TENDL-2024 LIBRARY; T=0.K
thermal capture photon spectrum

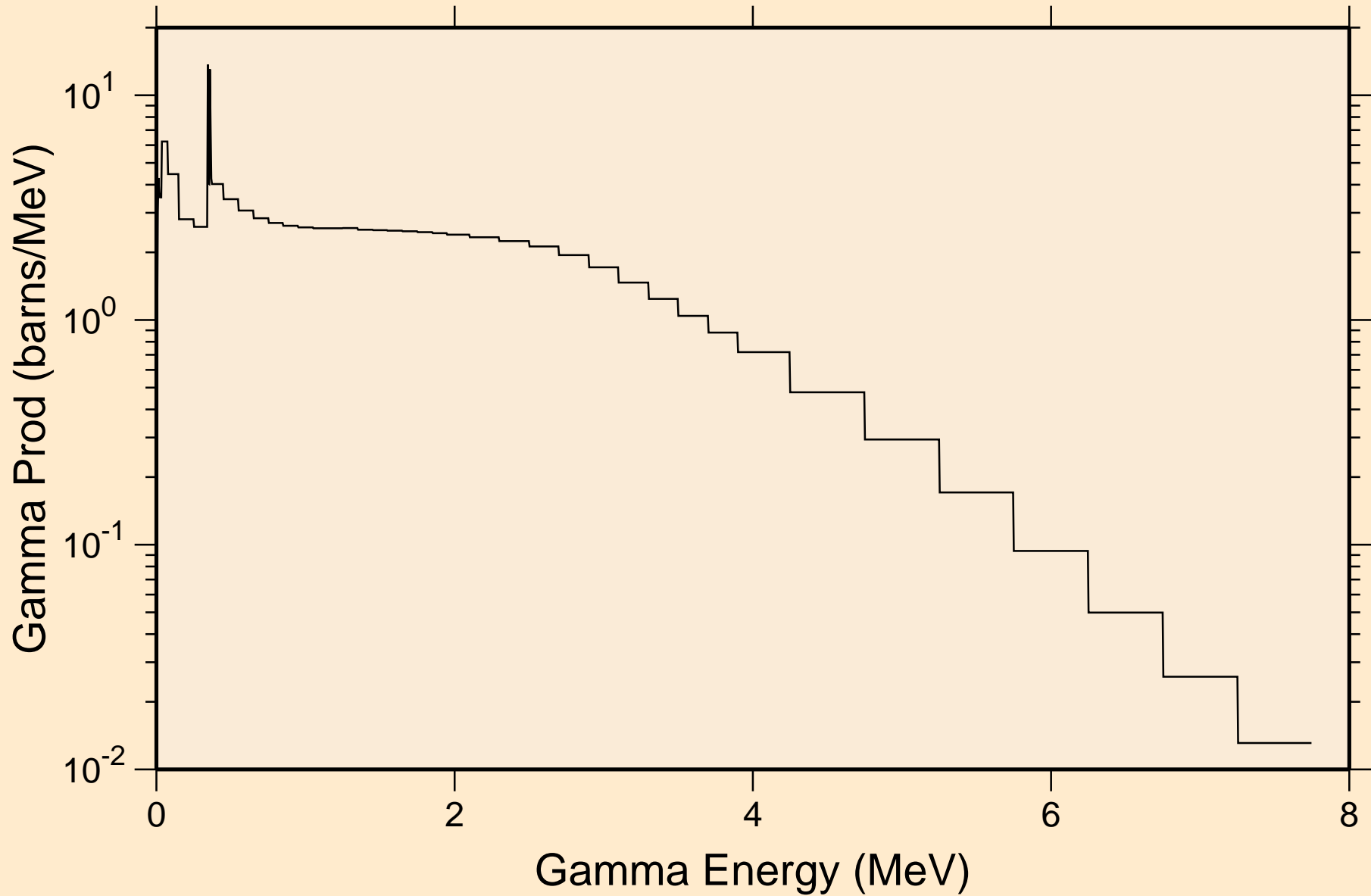

IR171M NEUTRON ACER TENDL-2024 LIBRARY; T=0.K
14 MeV photon spectrum

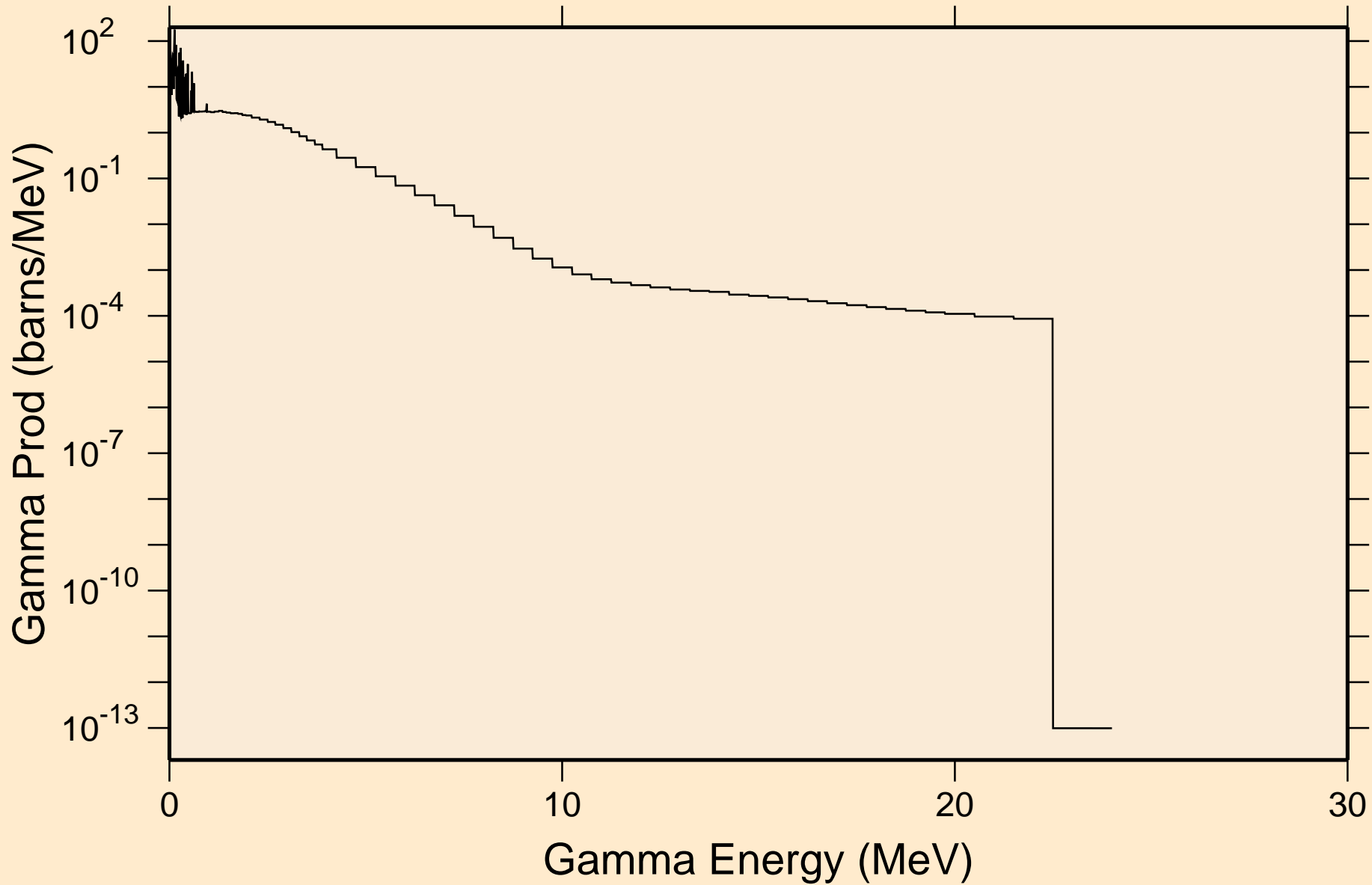

IR171M NEUTRON ACER TENDL-2024 LIBRARY; T=0.K

Particle heating contributions

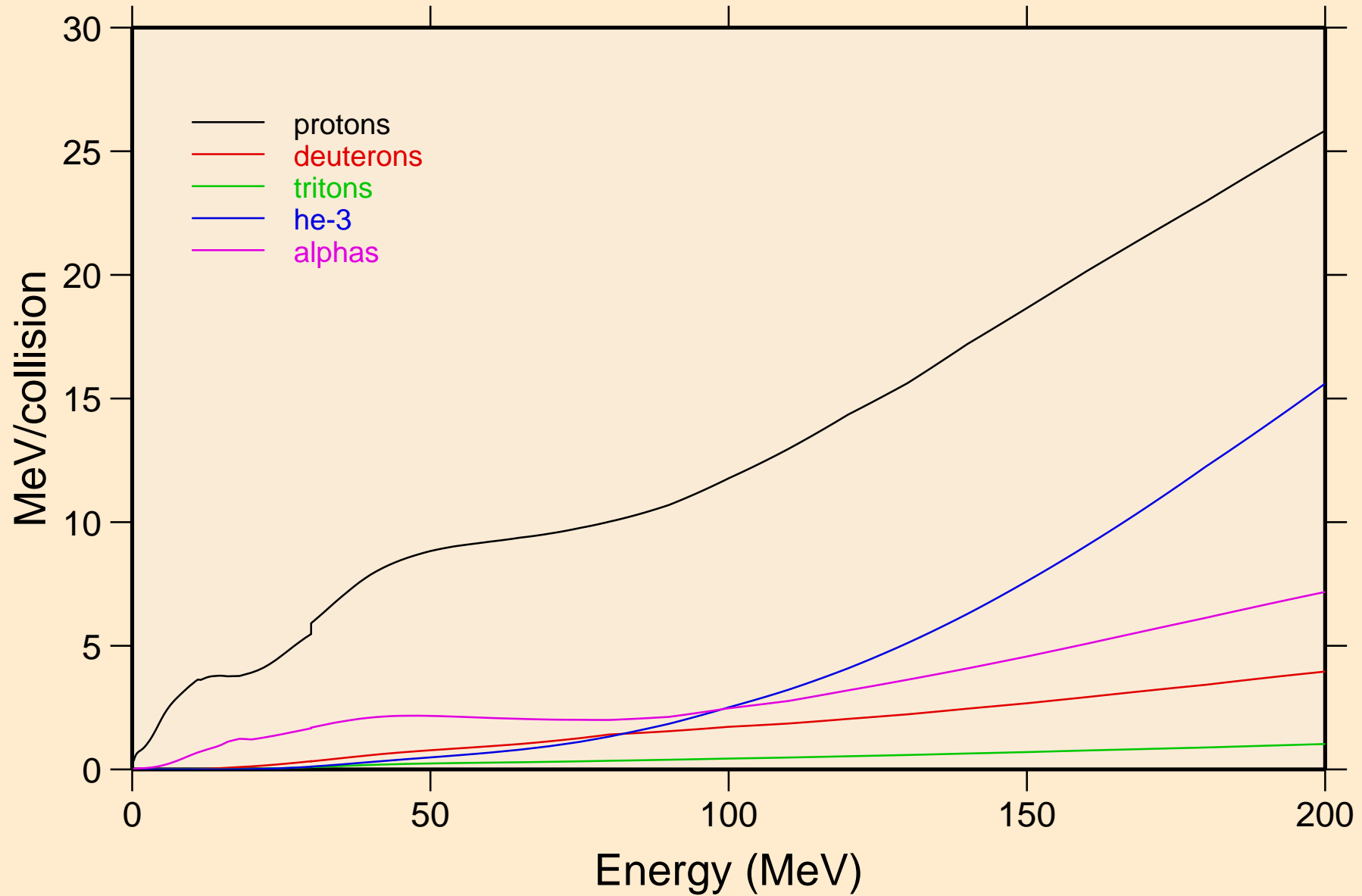

IR171M NEUTRON ACER TENDL-2024 LIBRARY; T=0.K
Recoil Heating

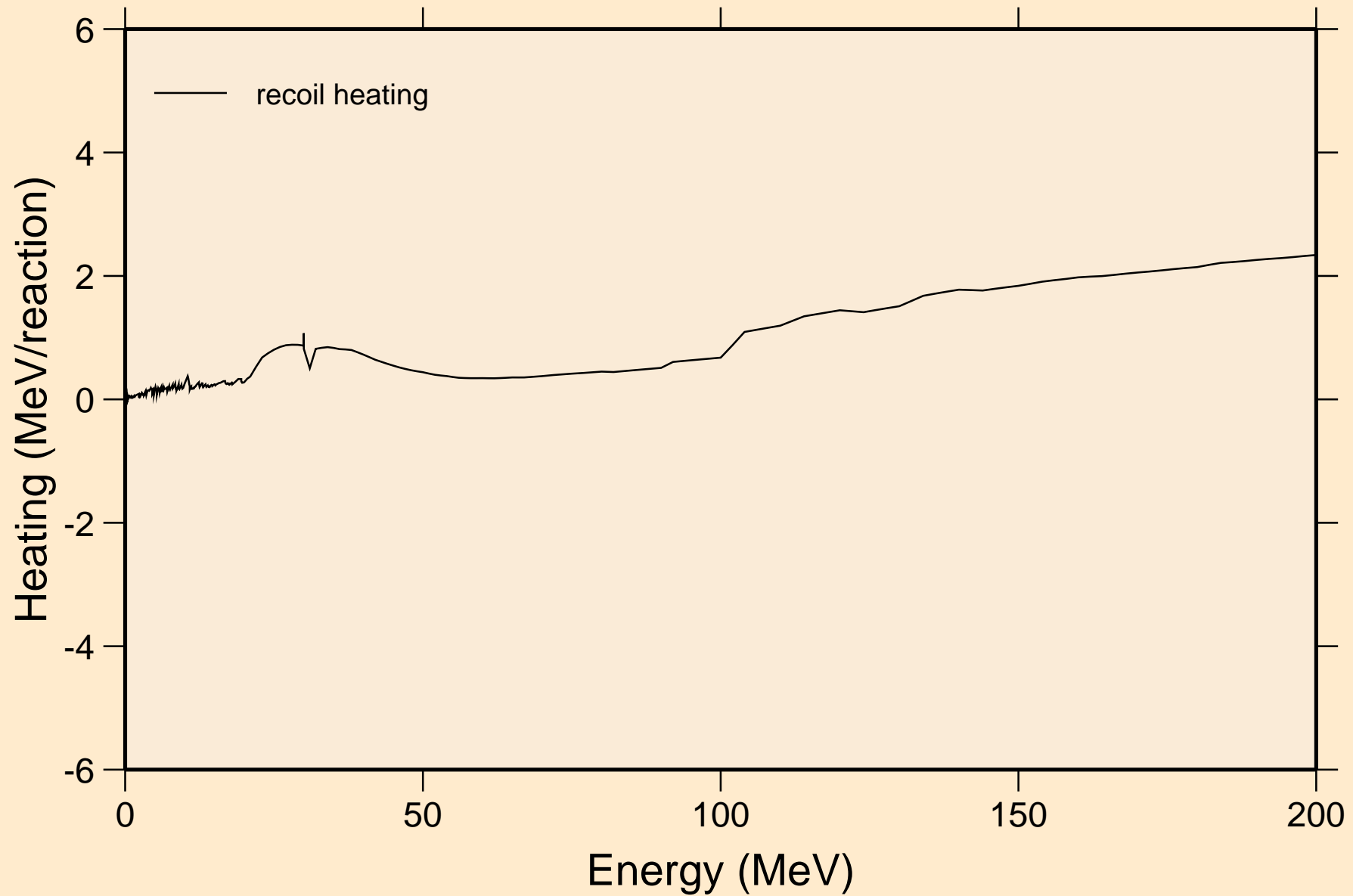

IR171M NEUTRON ACER TENDL-2024 LIBRARY; T=0.K

Particle production cross sections

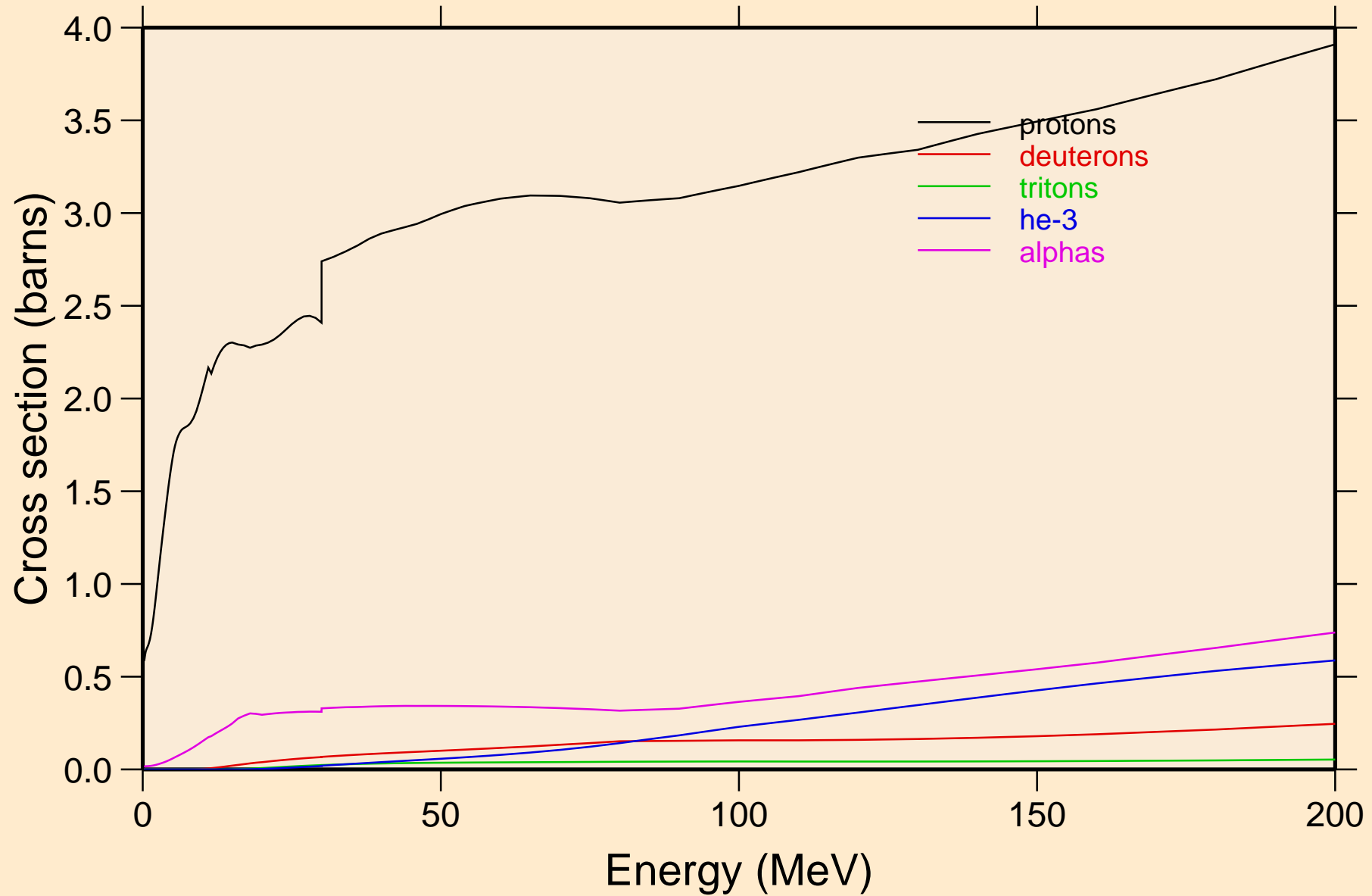

IR171M NEUTRON ACER TENDL-2024 LIBRARY; T=0.K
protons from (n,x)

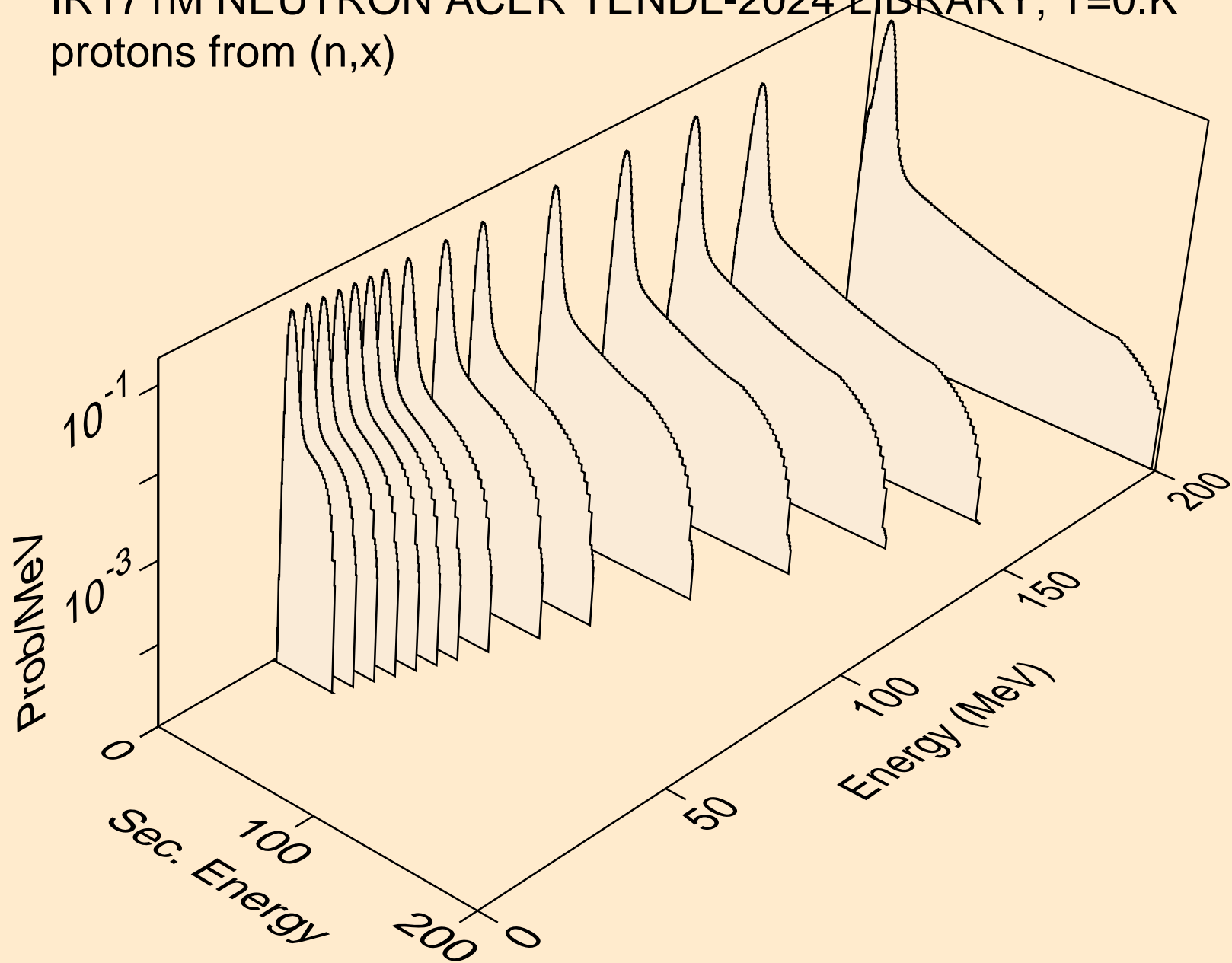

IR171M NEUTRON ACER TENDL-2024 LIBRARY; T=0.K
protons from (n,n*)p

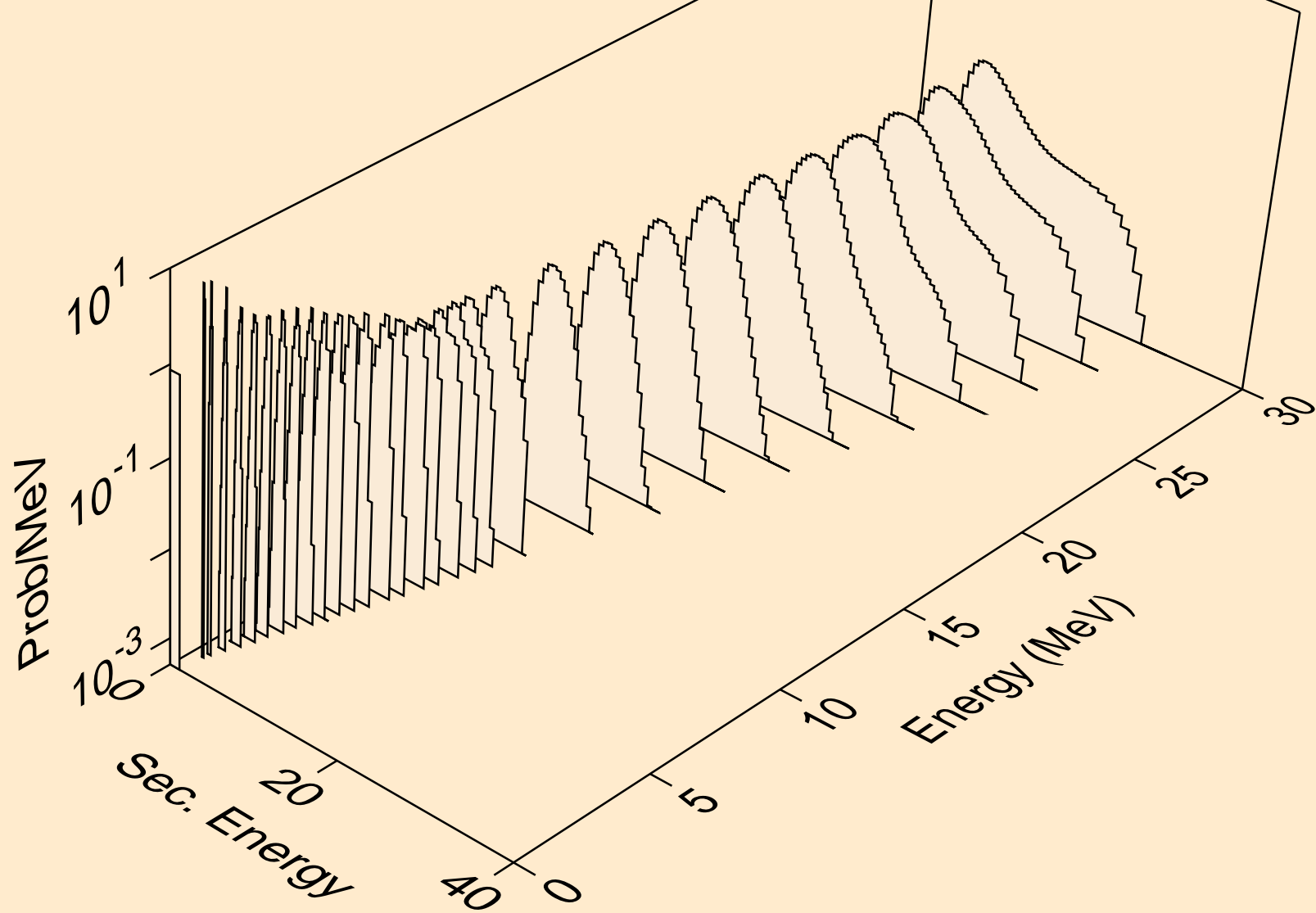

IR171M NEUTRON ACER TENDL-2024 LIBRARY; T=0.K
protons from (n,2np)

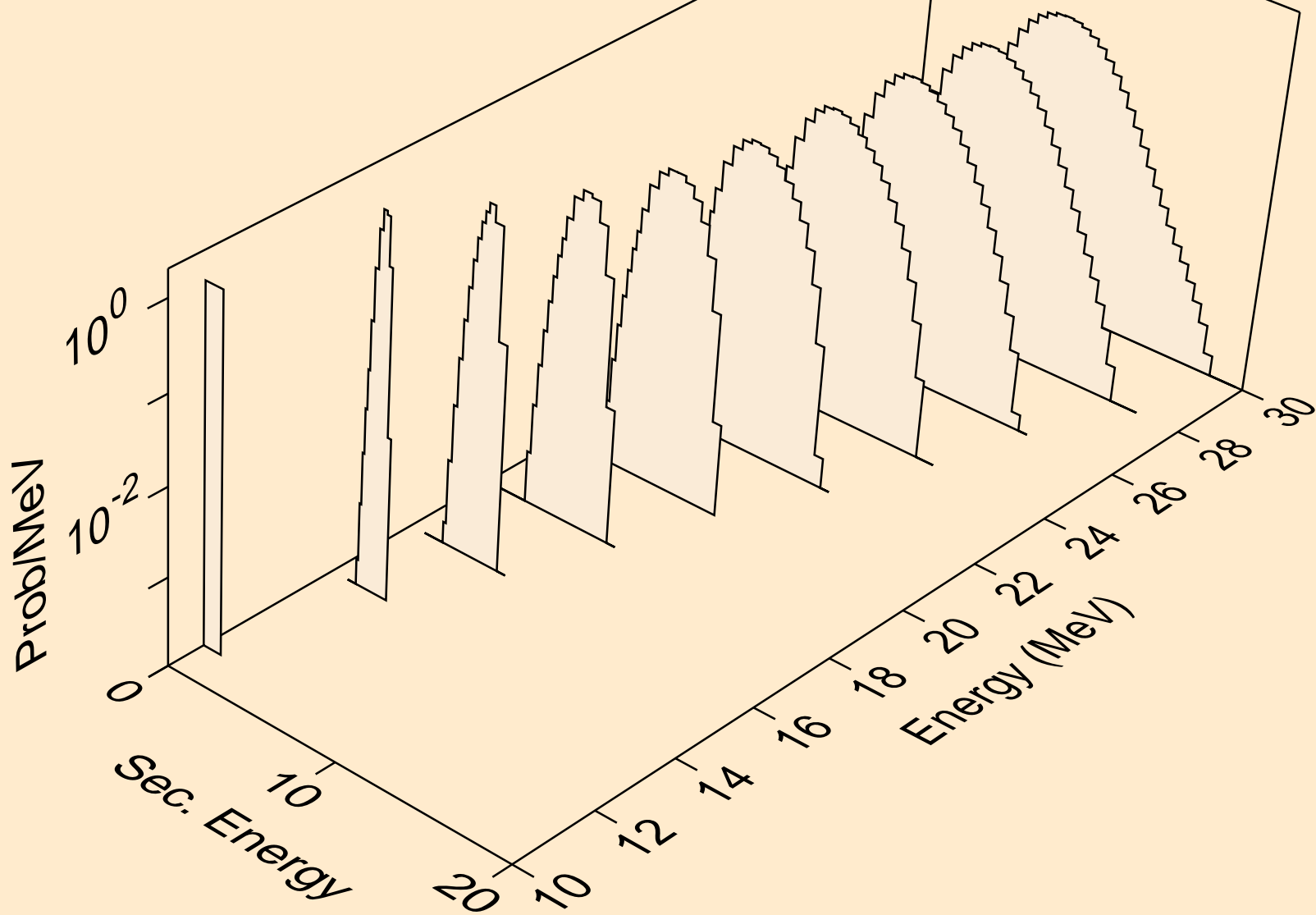

IR171M NEUTRON ACER TENDL-2024 LIBRARY; T=0.K
protons from (n,3np)

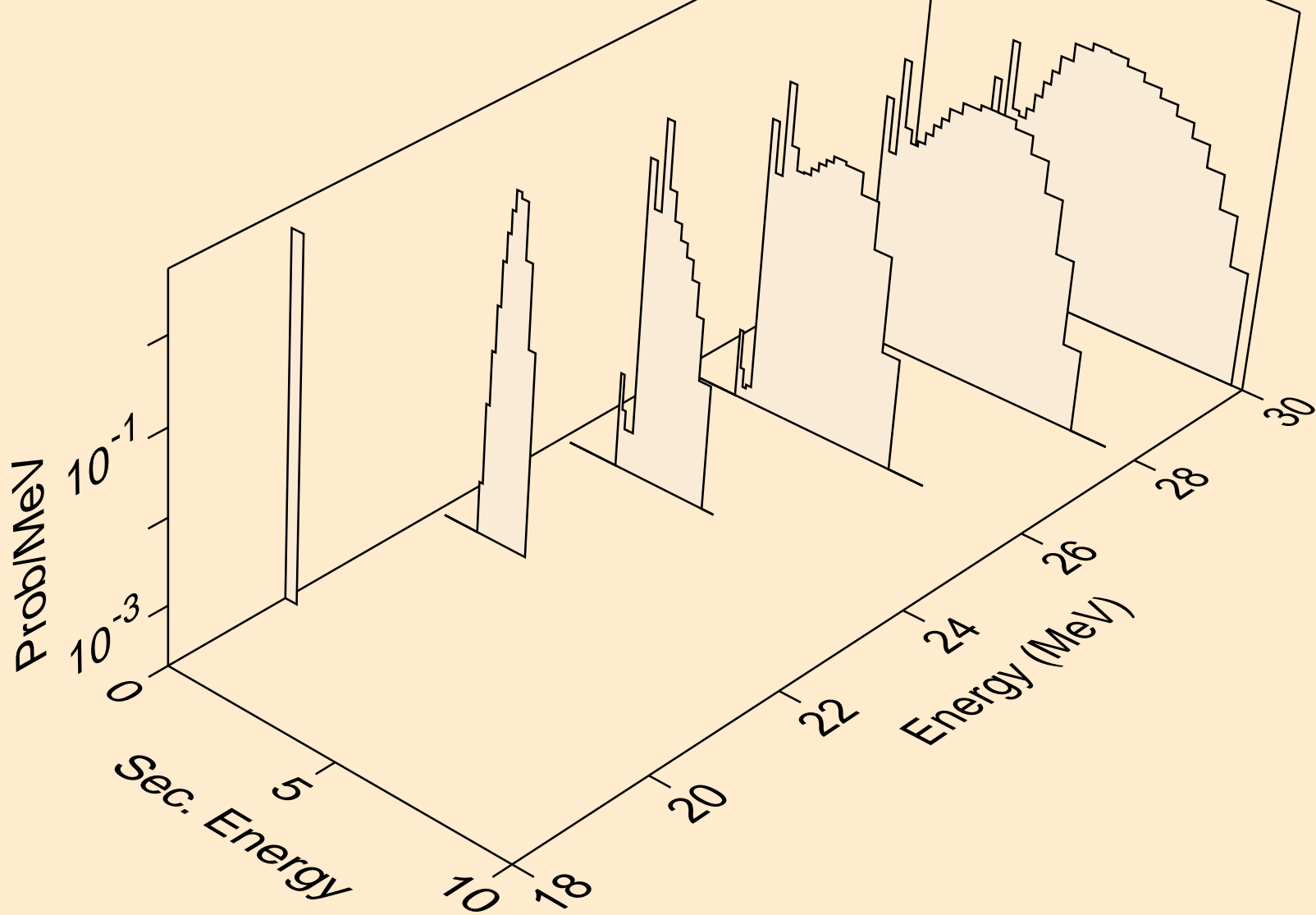

IR171M NEUTRON ACER TENDL-2024 LIBRARY; T=0.K
protons from (n,n2p)

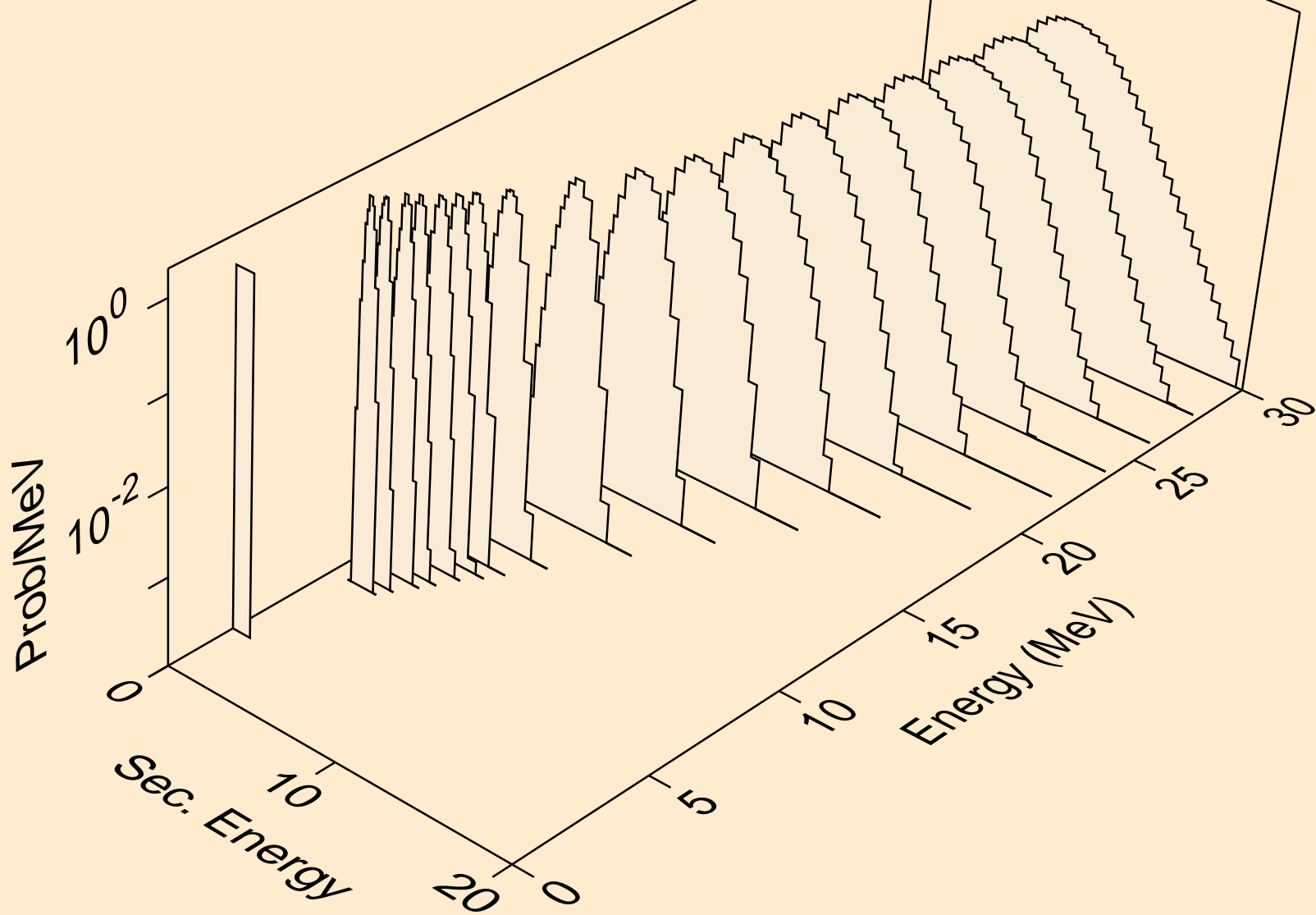

IR171M NEUTRON ACER TENDL-2024 LIBRARY; T=0.K
protons from (n,npa)

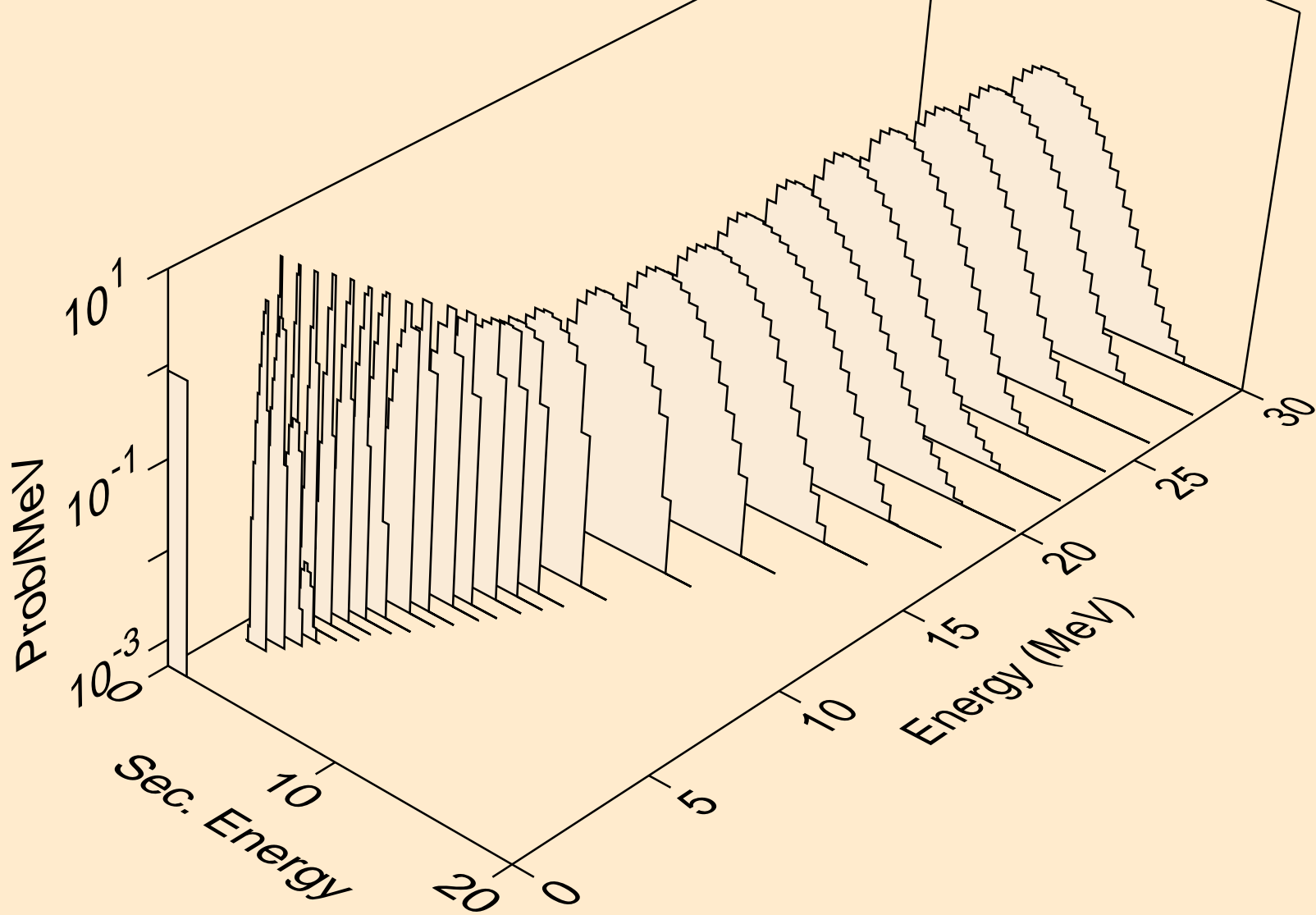

IR171M NEUTRON ACER TENDL-2024 LIBRARY; T=0.K
protons from (n,p)

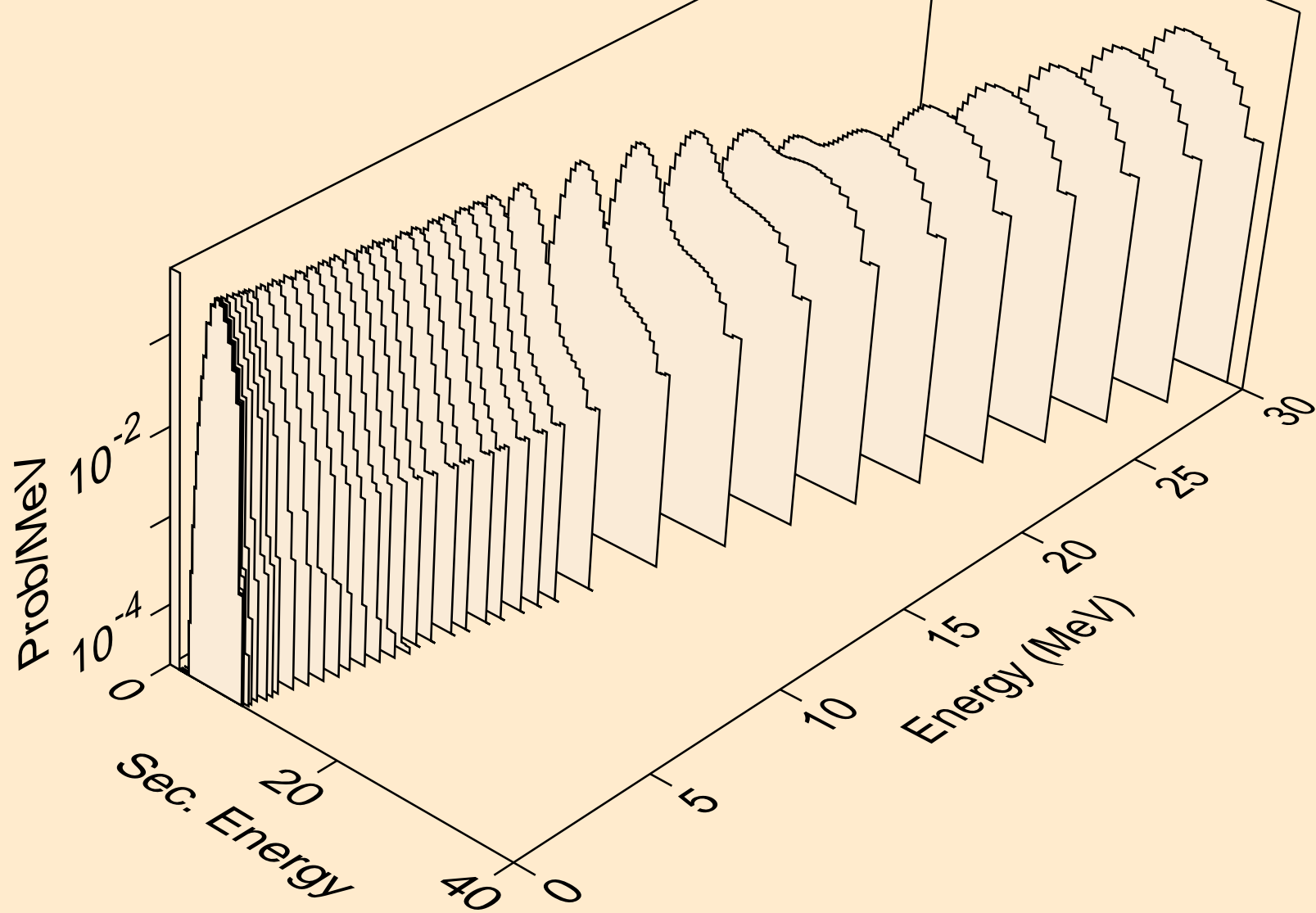

IR171M NEUTRON ACER TENDL-2024 LIBRARY; T=0.K
protons from (n,2p)

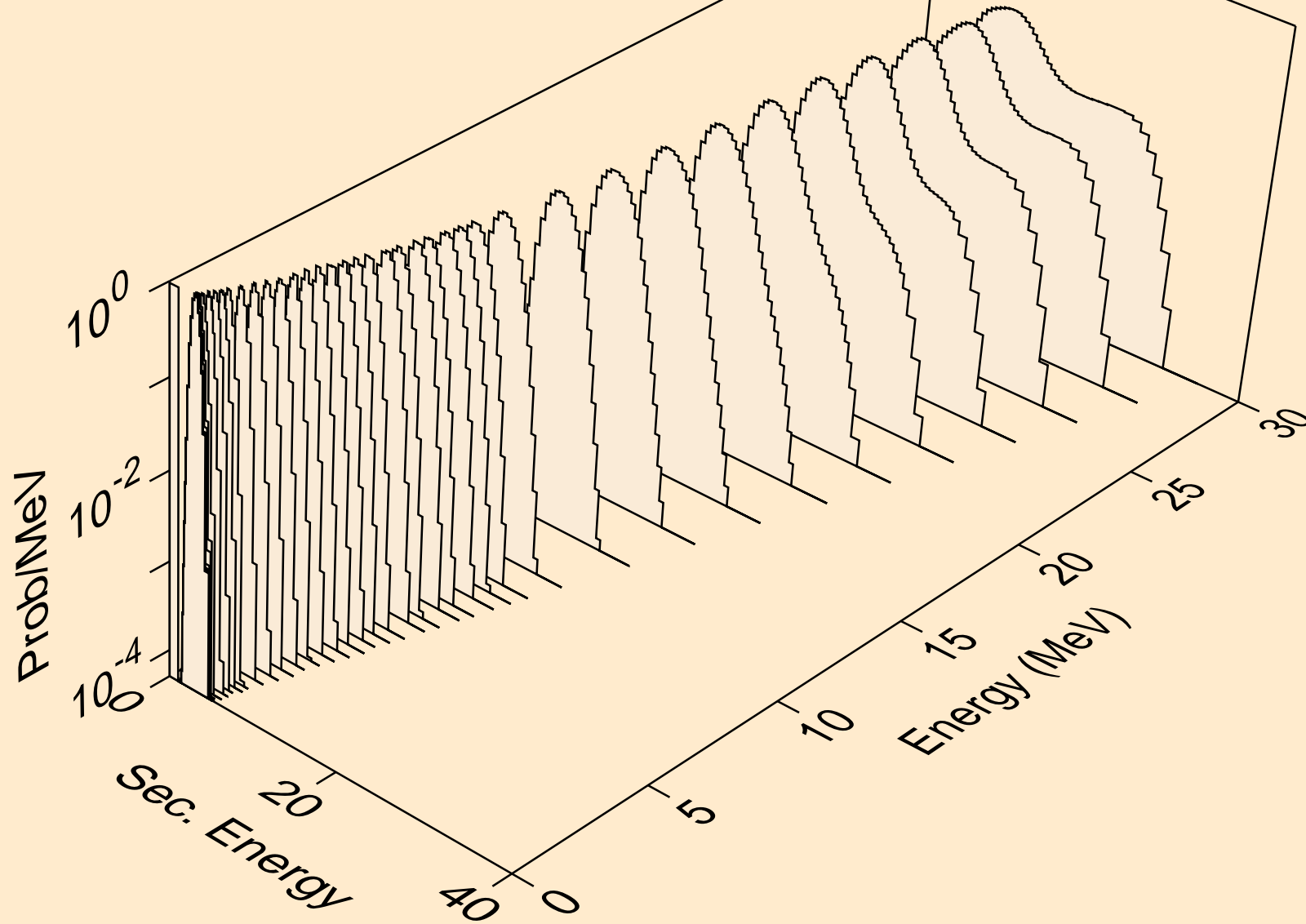

IR171M NEUTRON ACER TENDL-2024 LIBRARY; T=0.K
protons from (n,p)

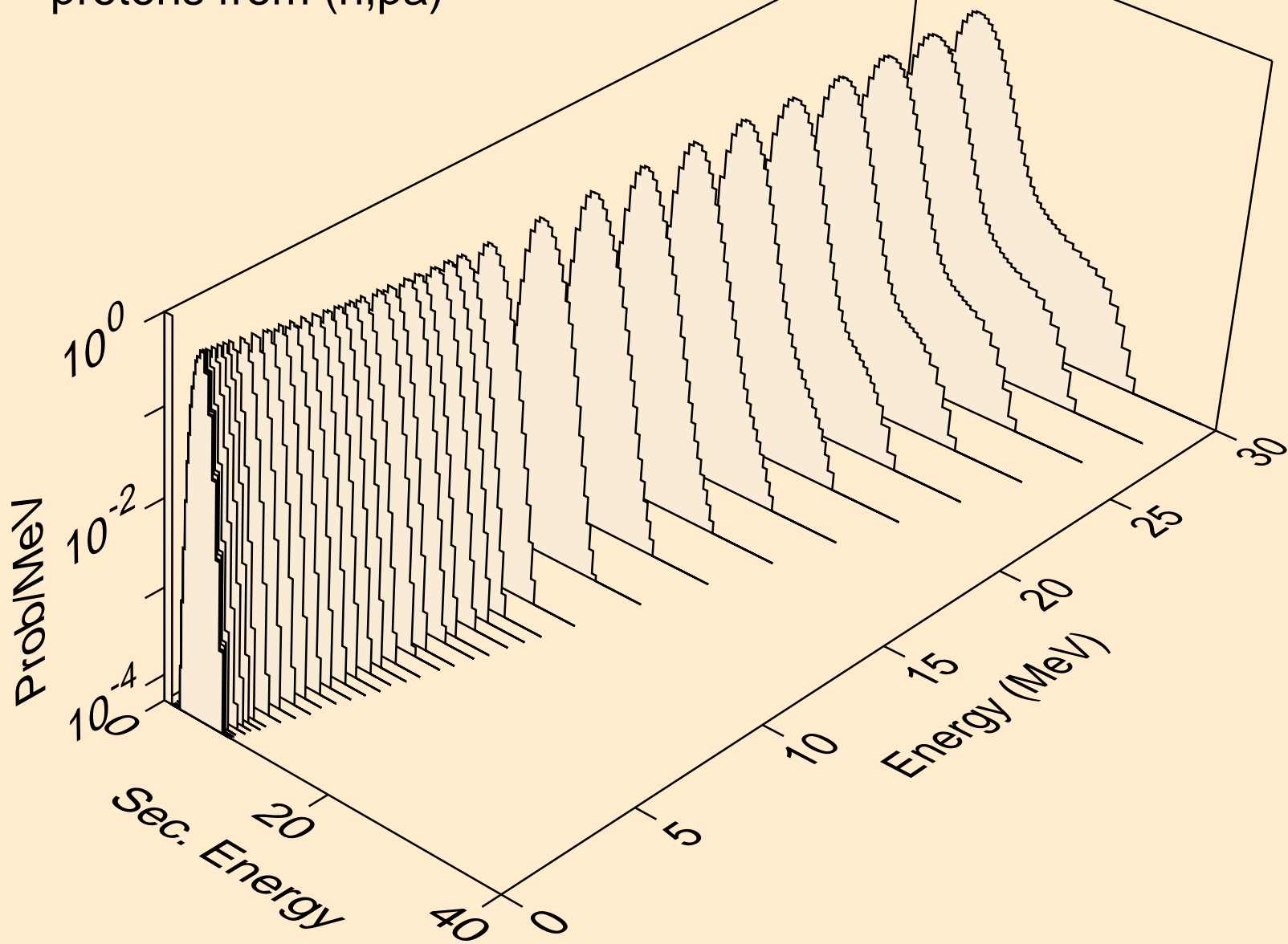

IR171M NEUTRON ACER TENDL-2024 LIBRARY; T=0.K
protons from (n,pd)

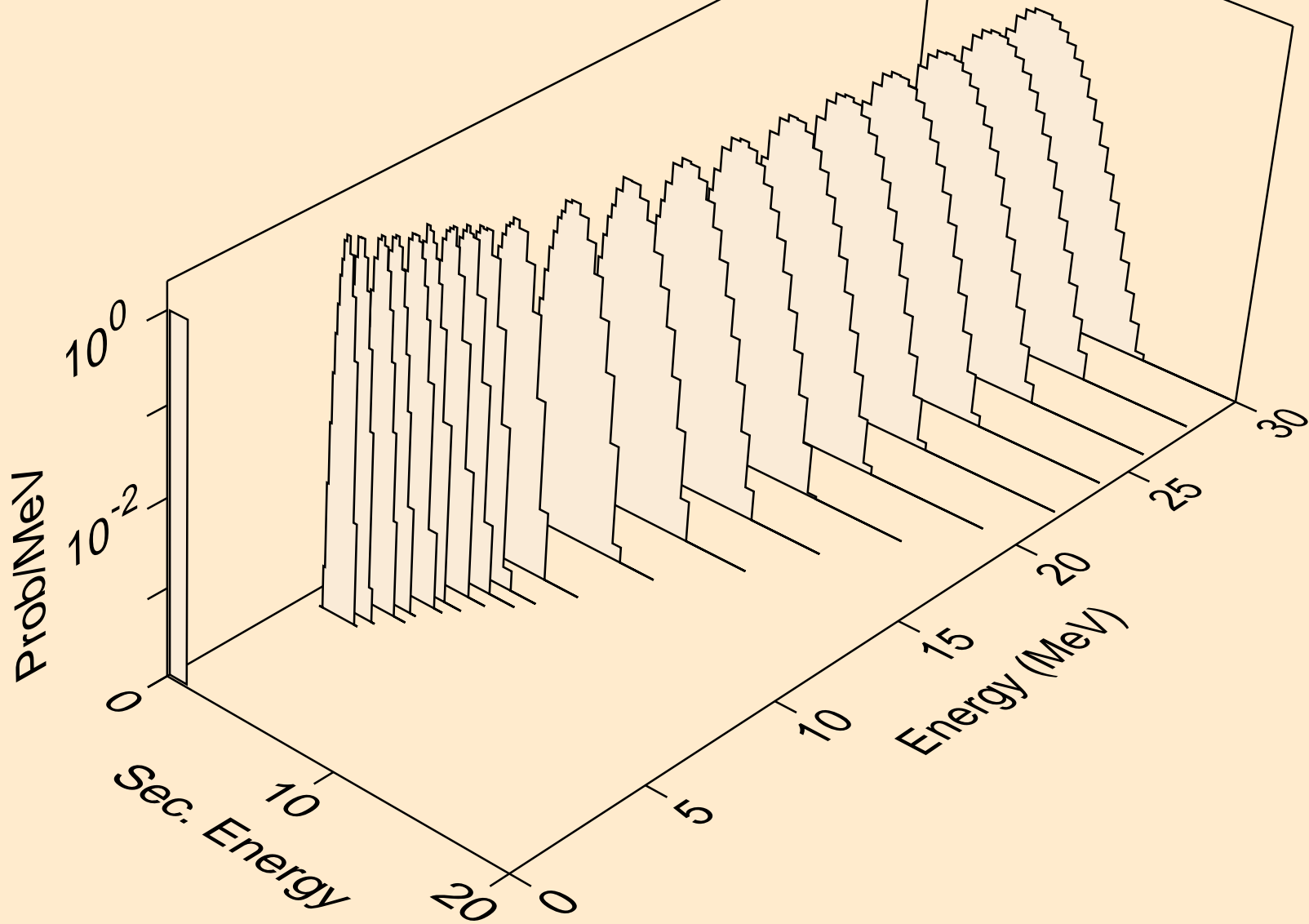

IR171M NEUTRON ACER TENDL-2024 LIBRARY; T=0.K
protons from (n,pt)

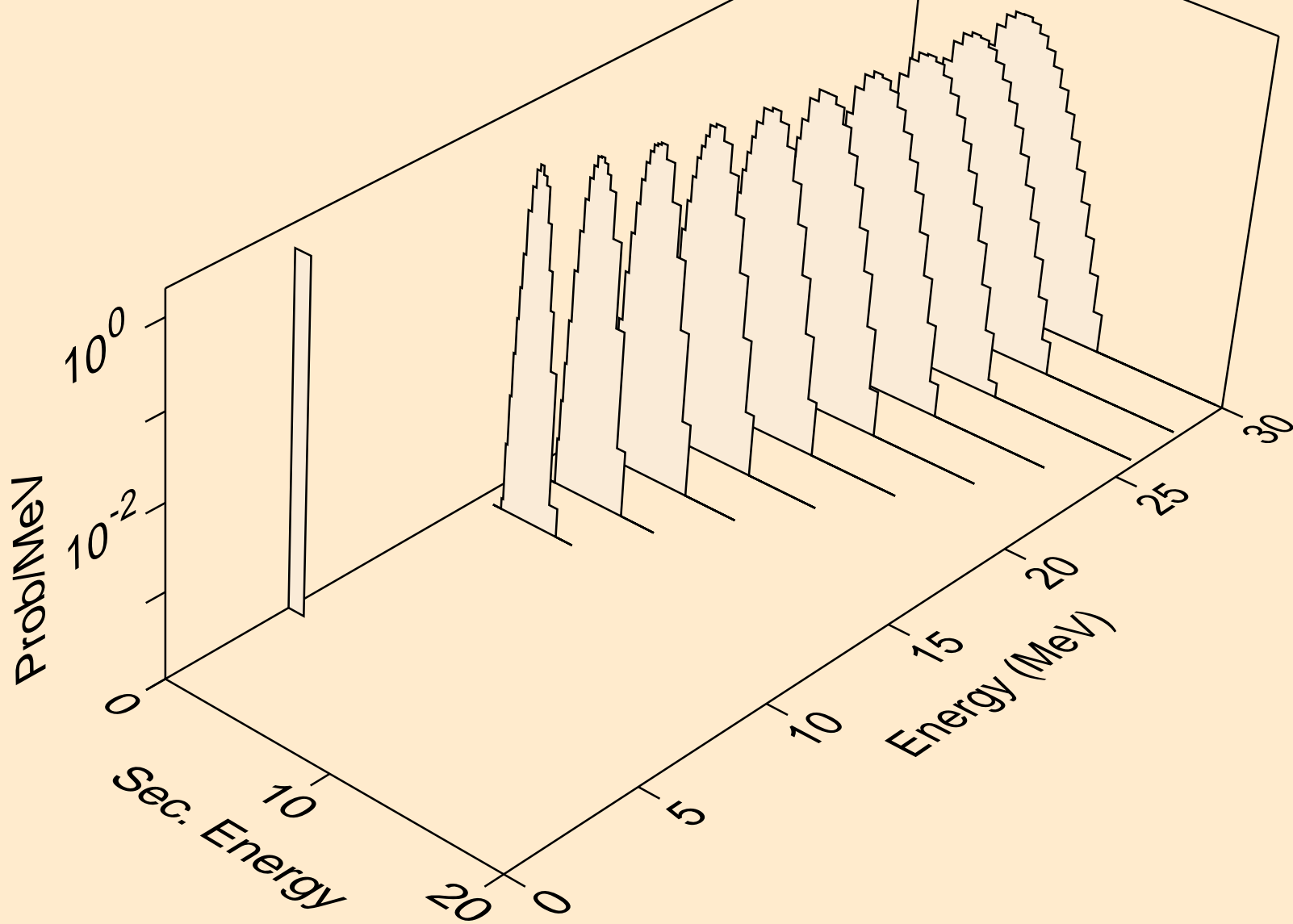

IR171M NEUTRON ACER TENDL-2024 LIBRARY; T=0.K
deuterons from (n,x)

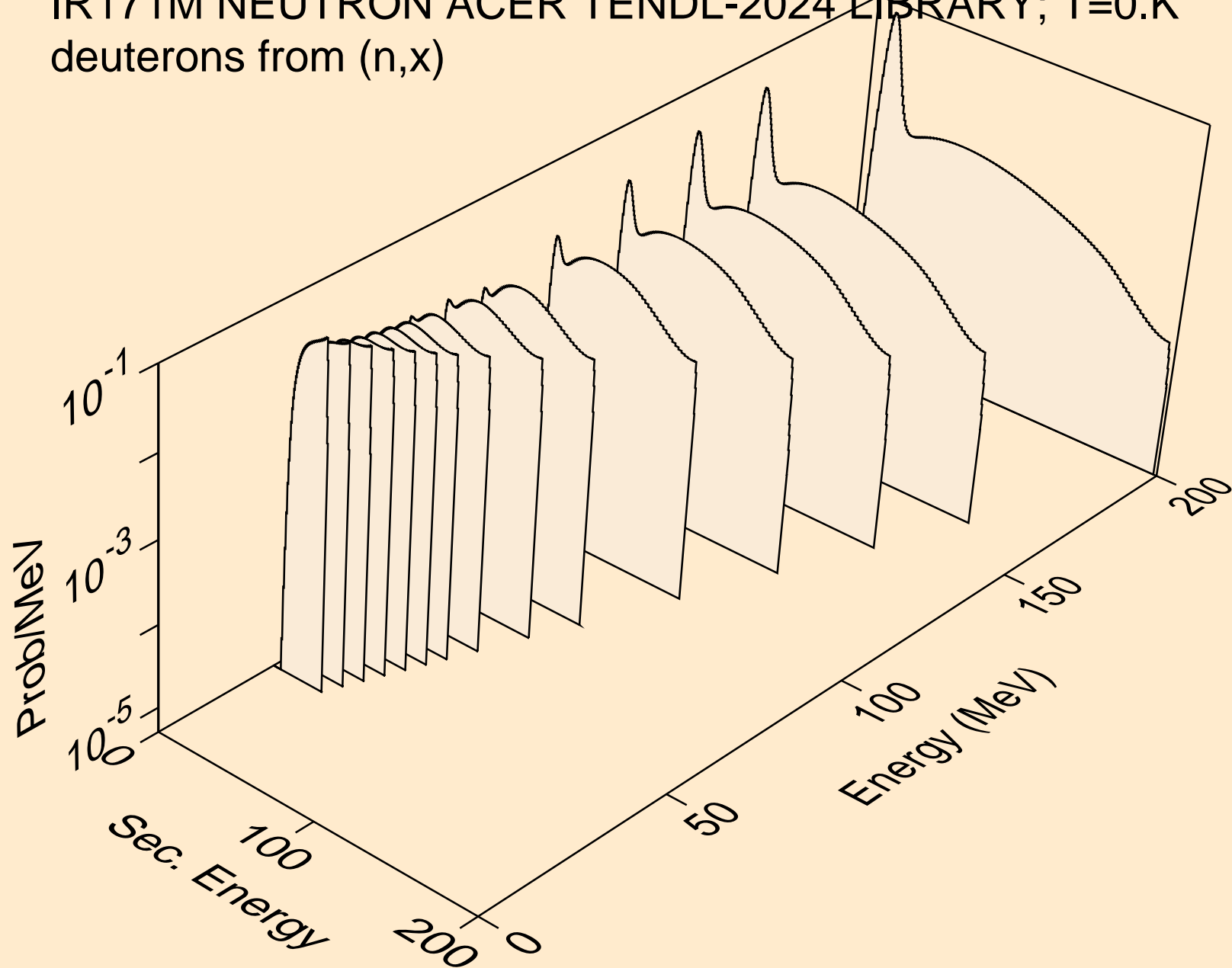

IR171M NEUTRON ACER TENDL-2024 LIBRARY; T=0.K
deuterons from (n,2nd)

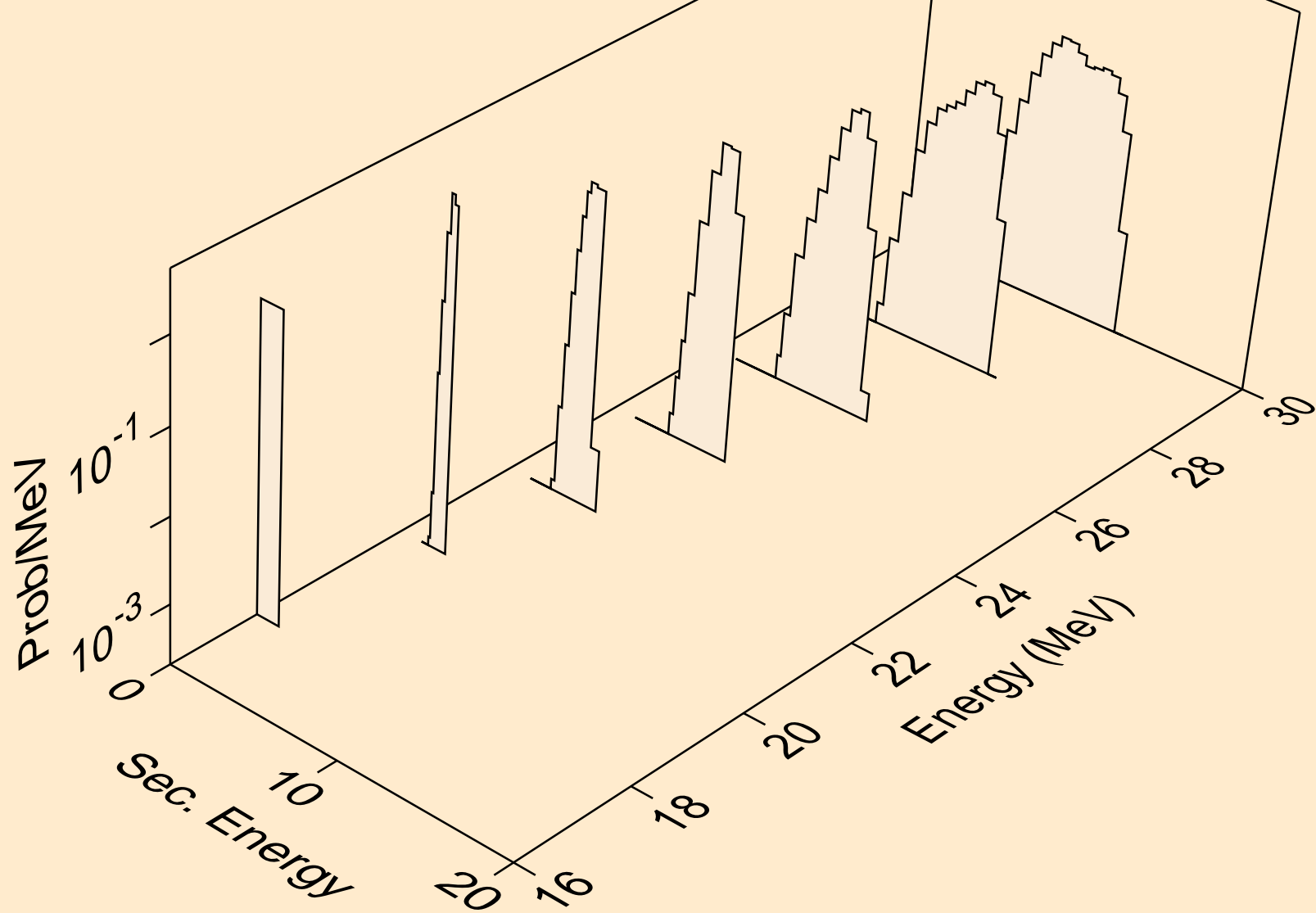

IR171M NEUTRON ACER TENDL-2024 LIBRARY; T=0.K
deuterons from (n,n*)d

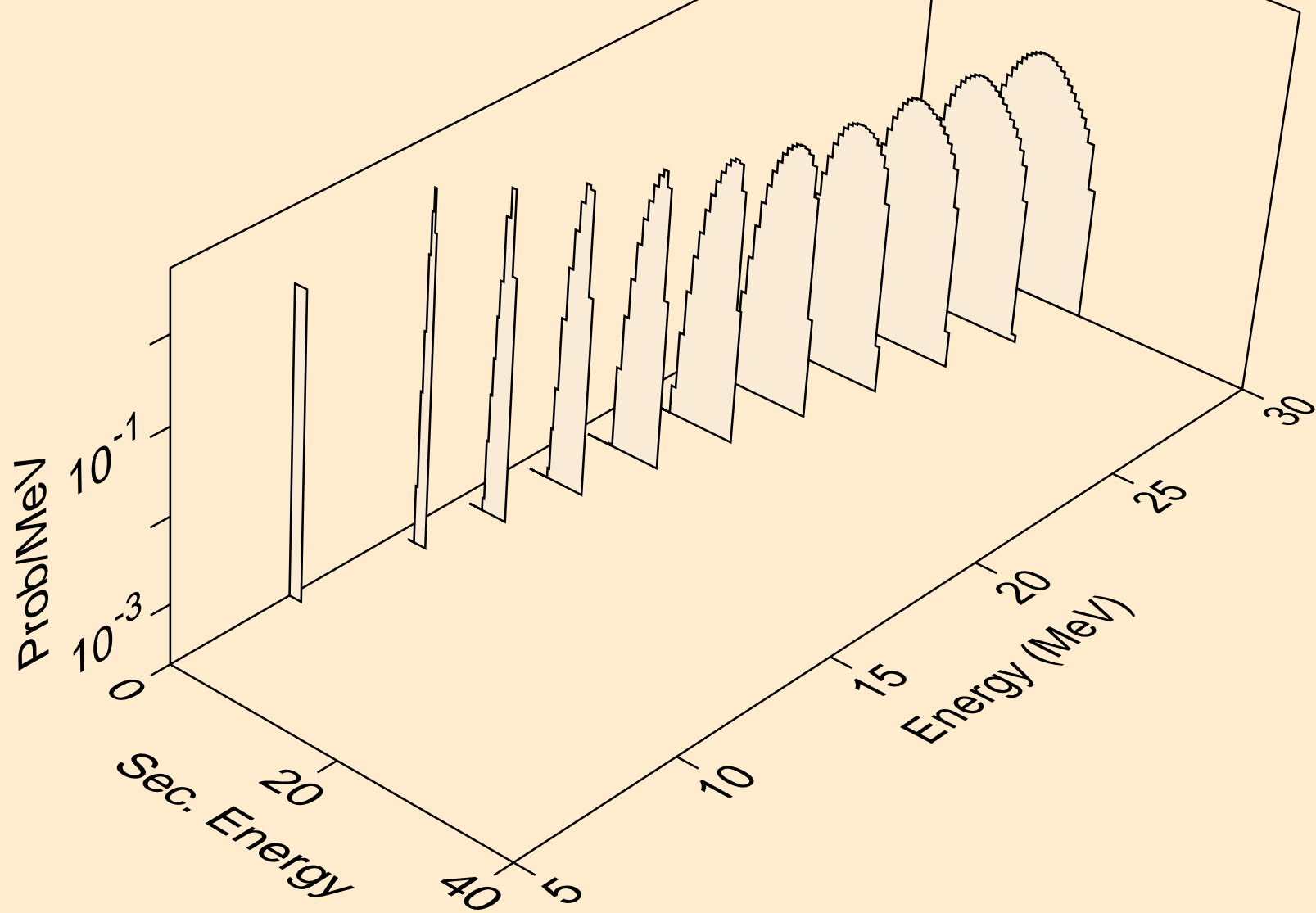

IR171M NEUTRON ACER TENDL-2024 LIBRARY; T=0.K
deuterons from (n,d)

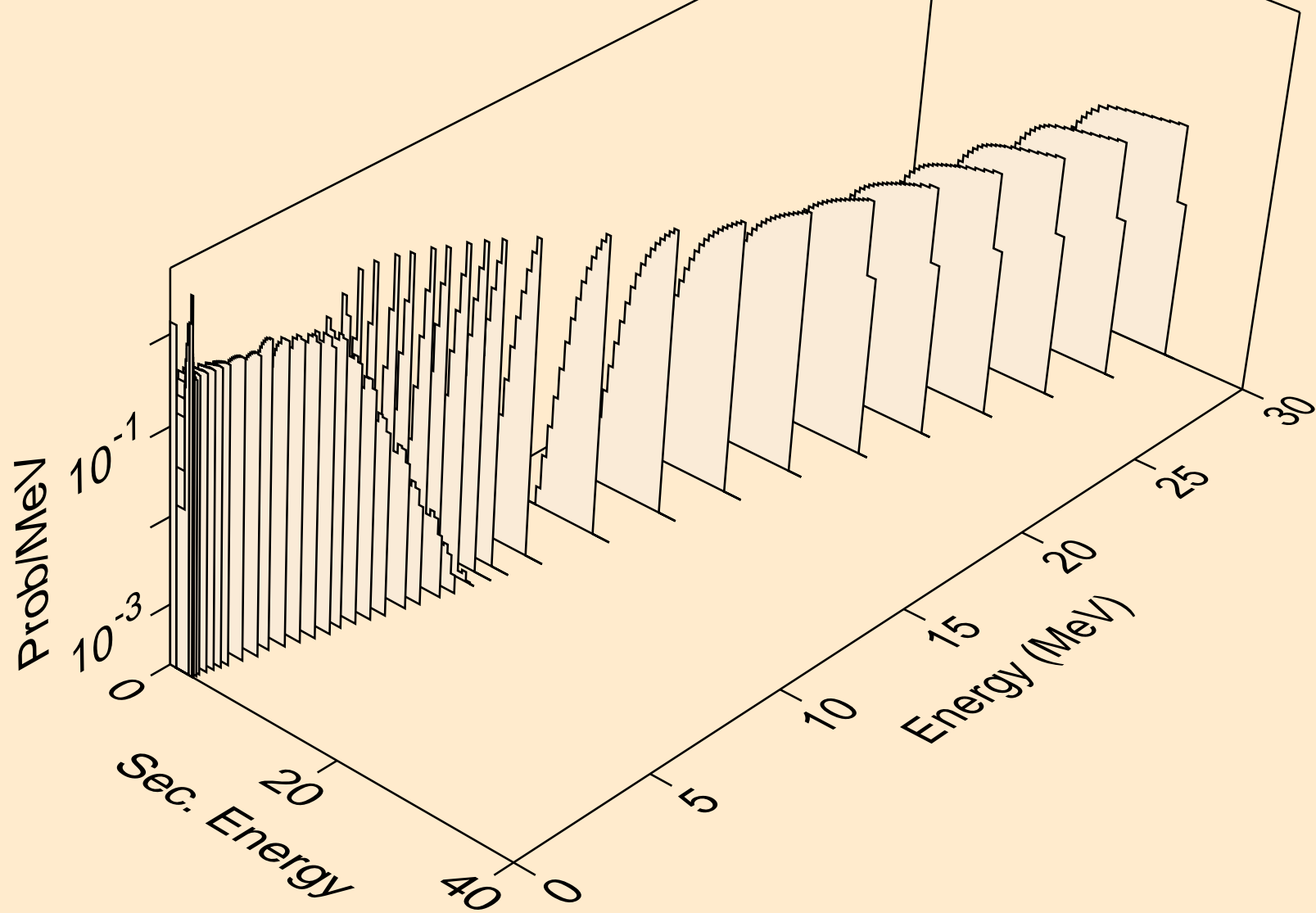

IR171M NEUTRON ACER TENDL-2024 LIBRARY; T=0.K
deuterons from (n,d2a)

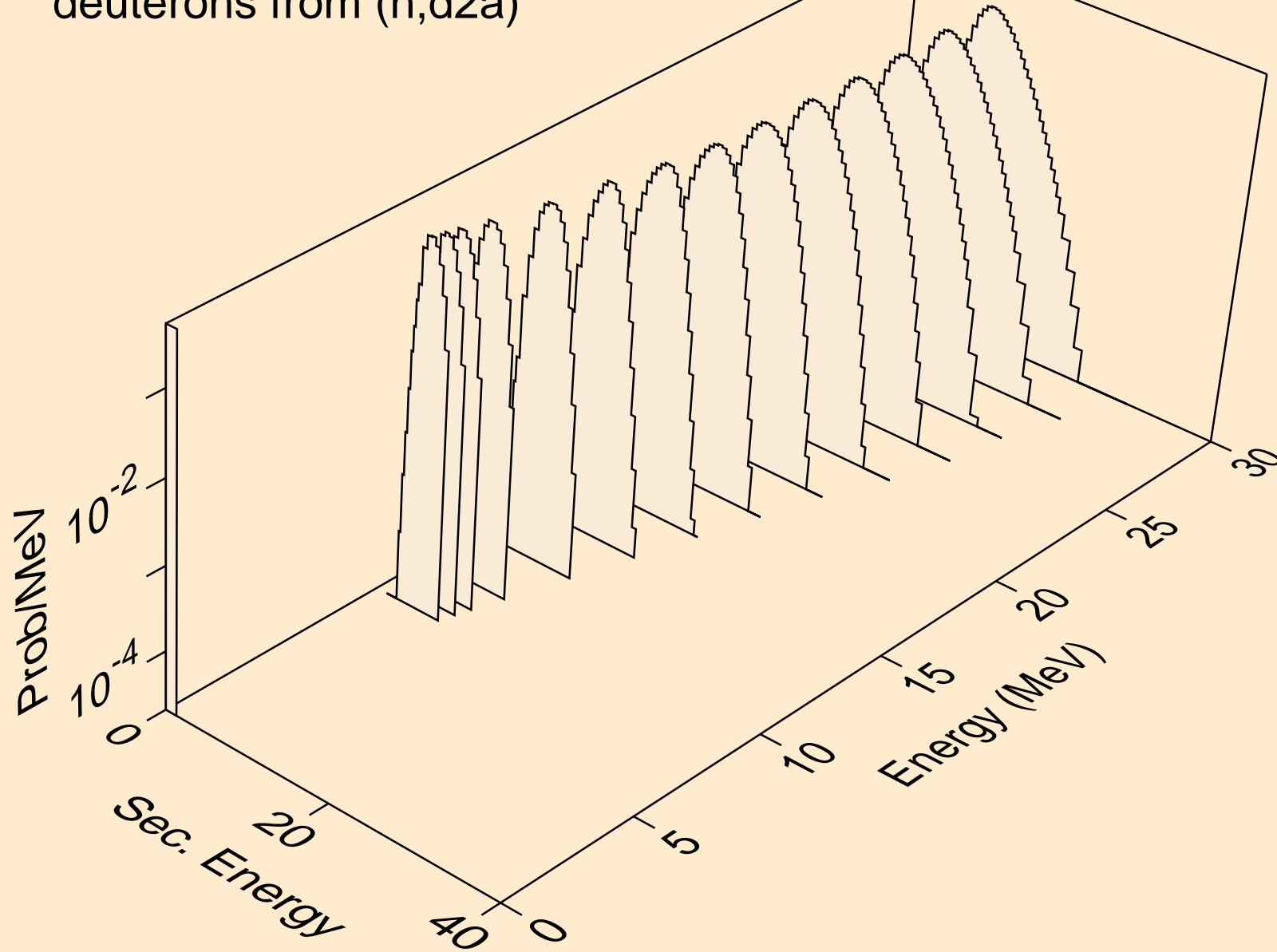

IR171M NEUTRON ACER TENDL-2024 LIBRARY; T=0.K
deuterons from (n,pd)

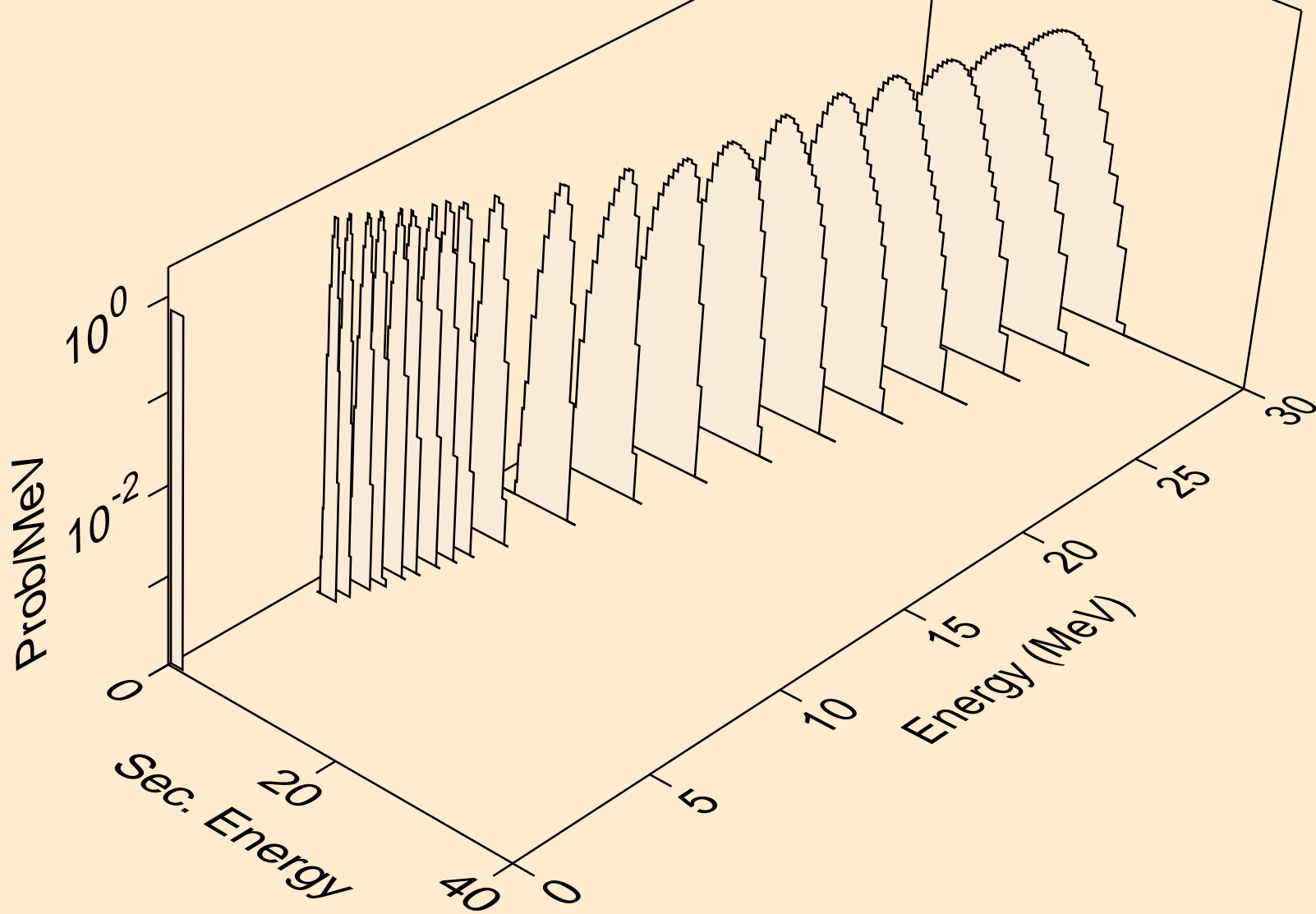

IR171M NEUTRON ACER TENDL-2024 LIBRARY; T=0.K
deuterons from (n,da)

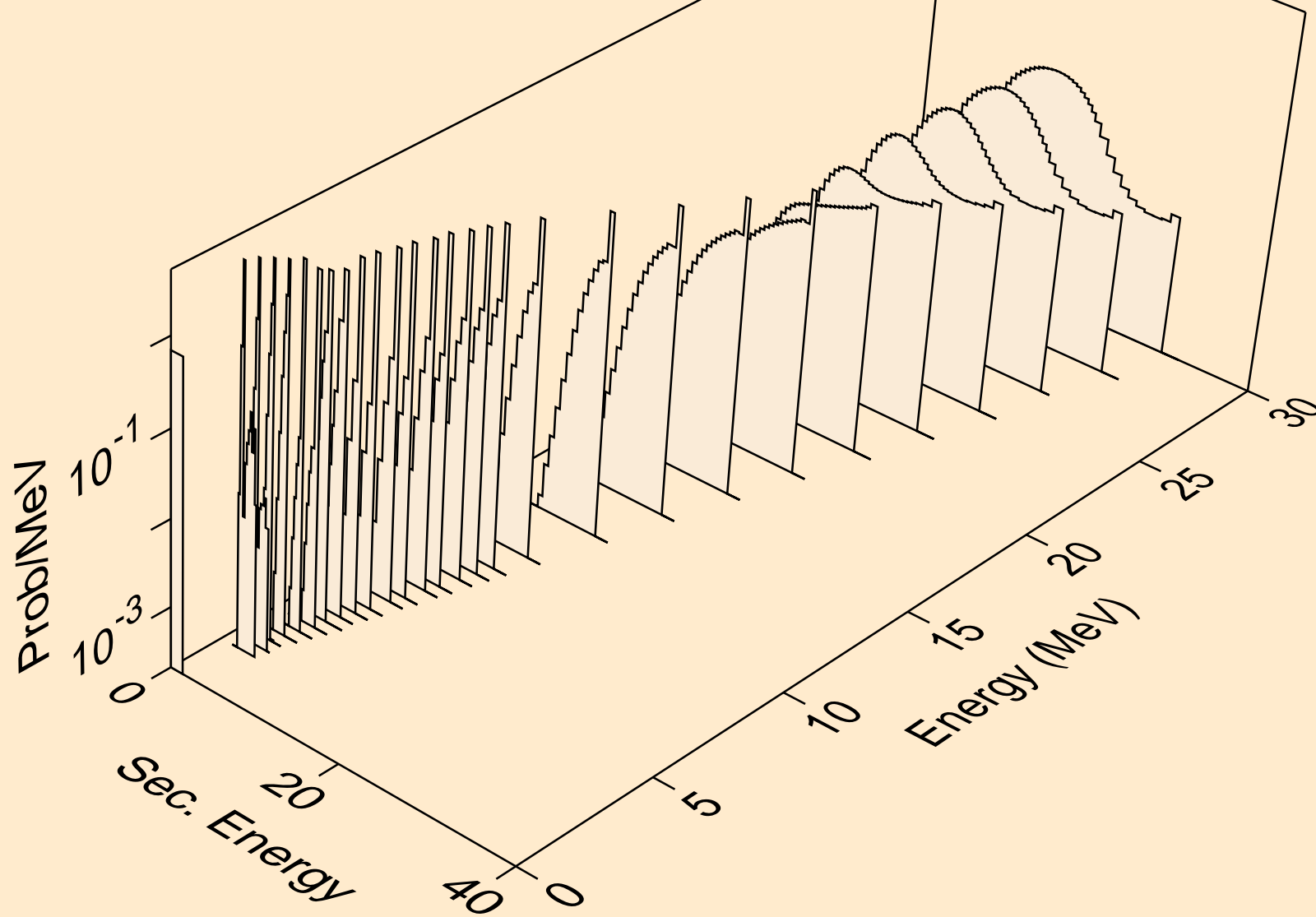

IR171M NEUTRON ACER TENDL-2024 LIBRARY; T=0.K
tritons from (n,x)

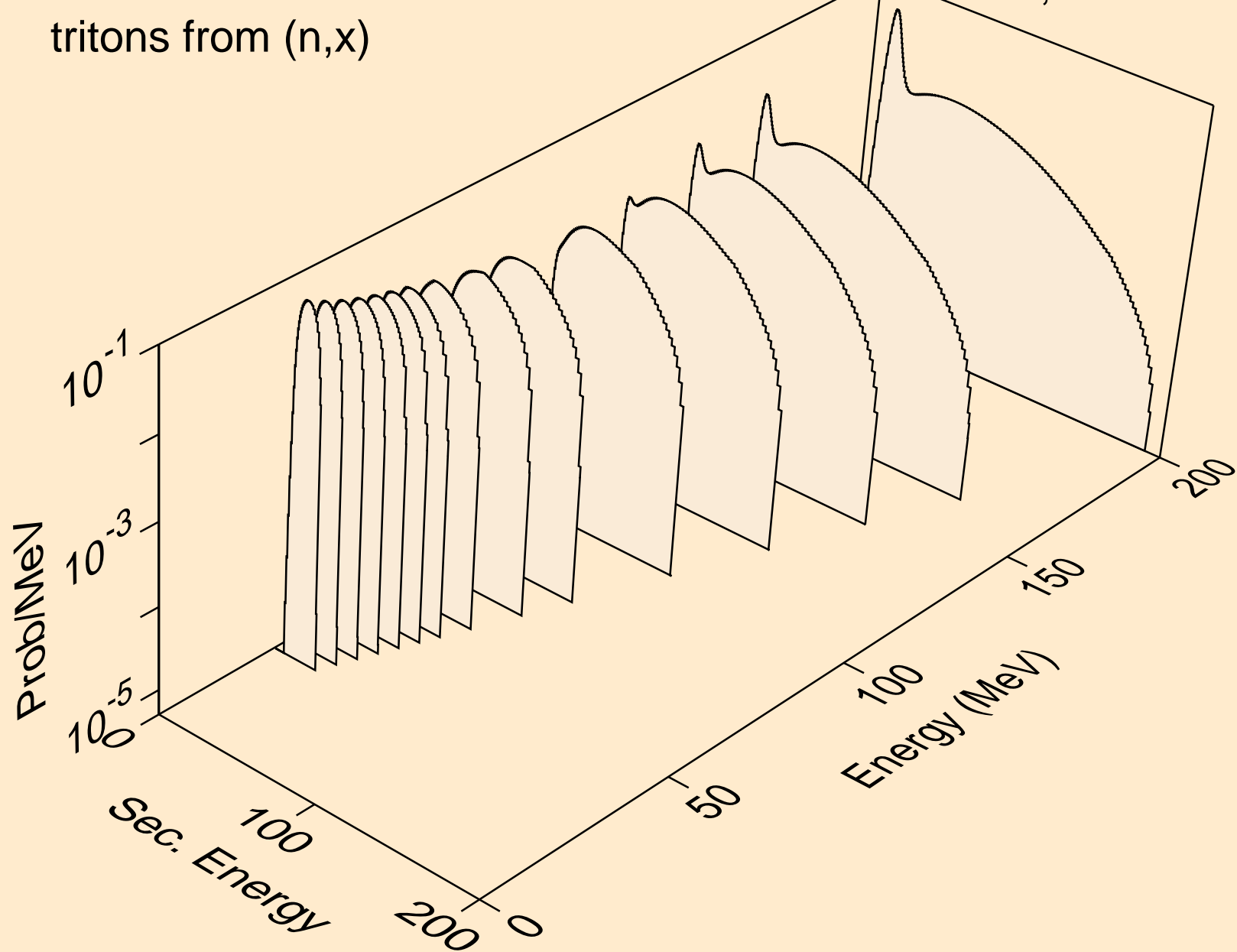

IR171M NEUTRON ACER TENDL-2024 LIBRARY; T=0.K
tritons from (n,n*)t

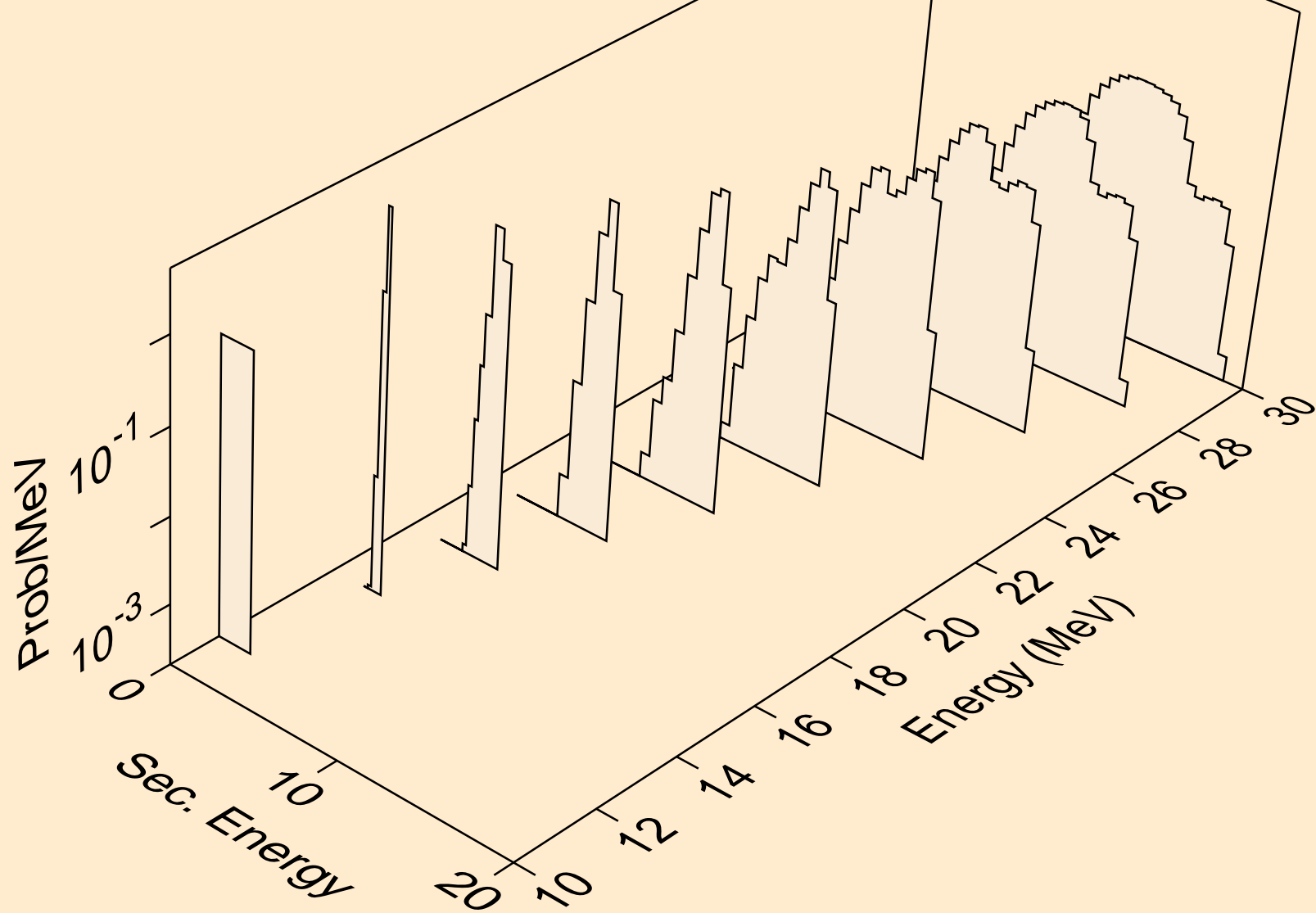

IR171M NEUTRON ACER TENDL-2024 LIBRARY; T=0.K
tritons from (n,t)

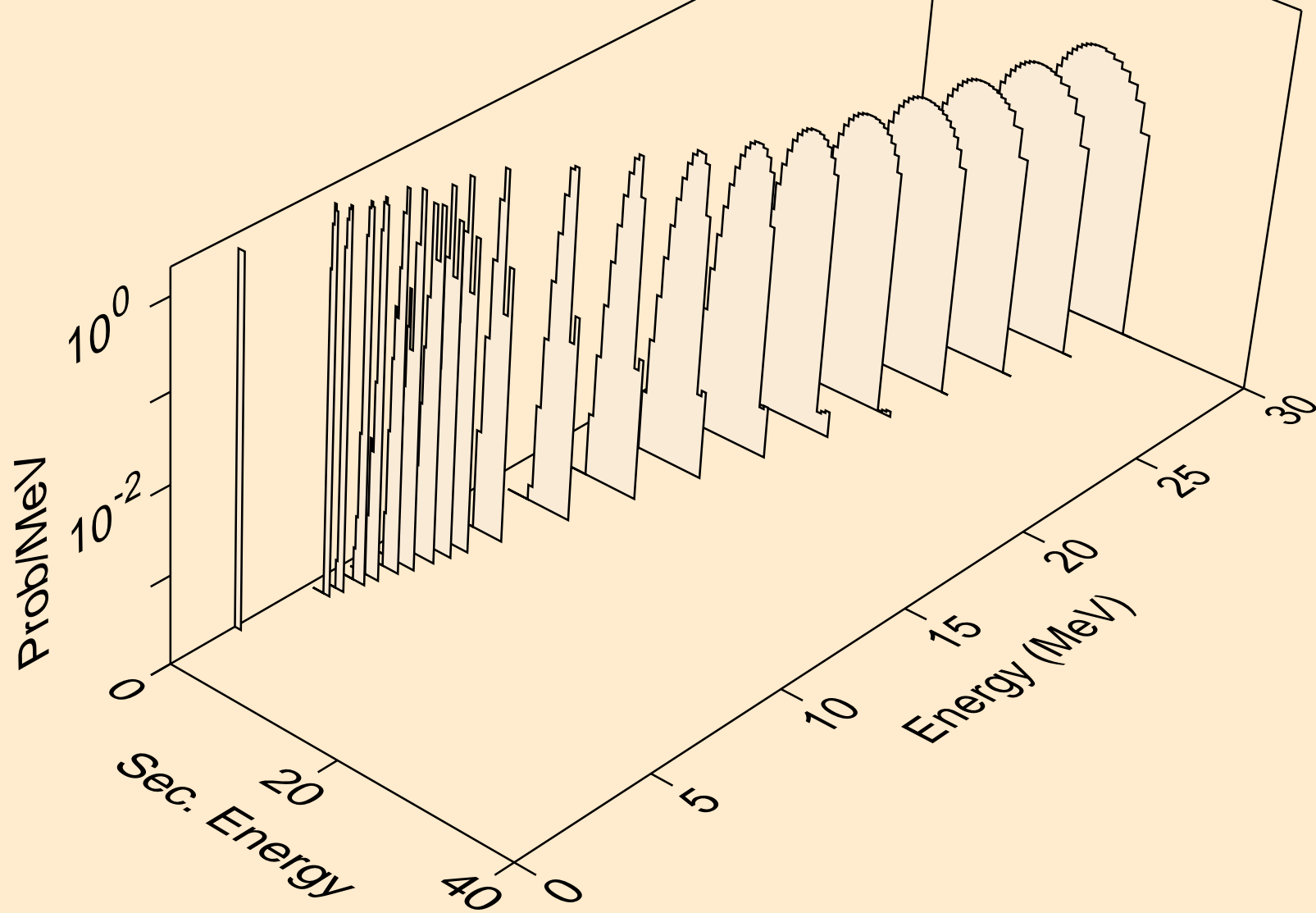

IR171M NEUTRON ACER TENDL-2024 LIBRARY; T=0.K
tritons from (n,t2a)

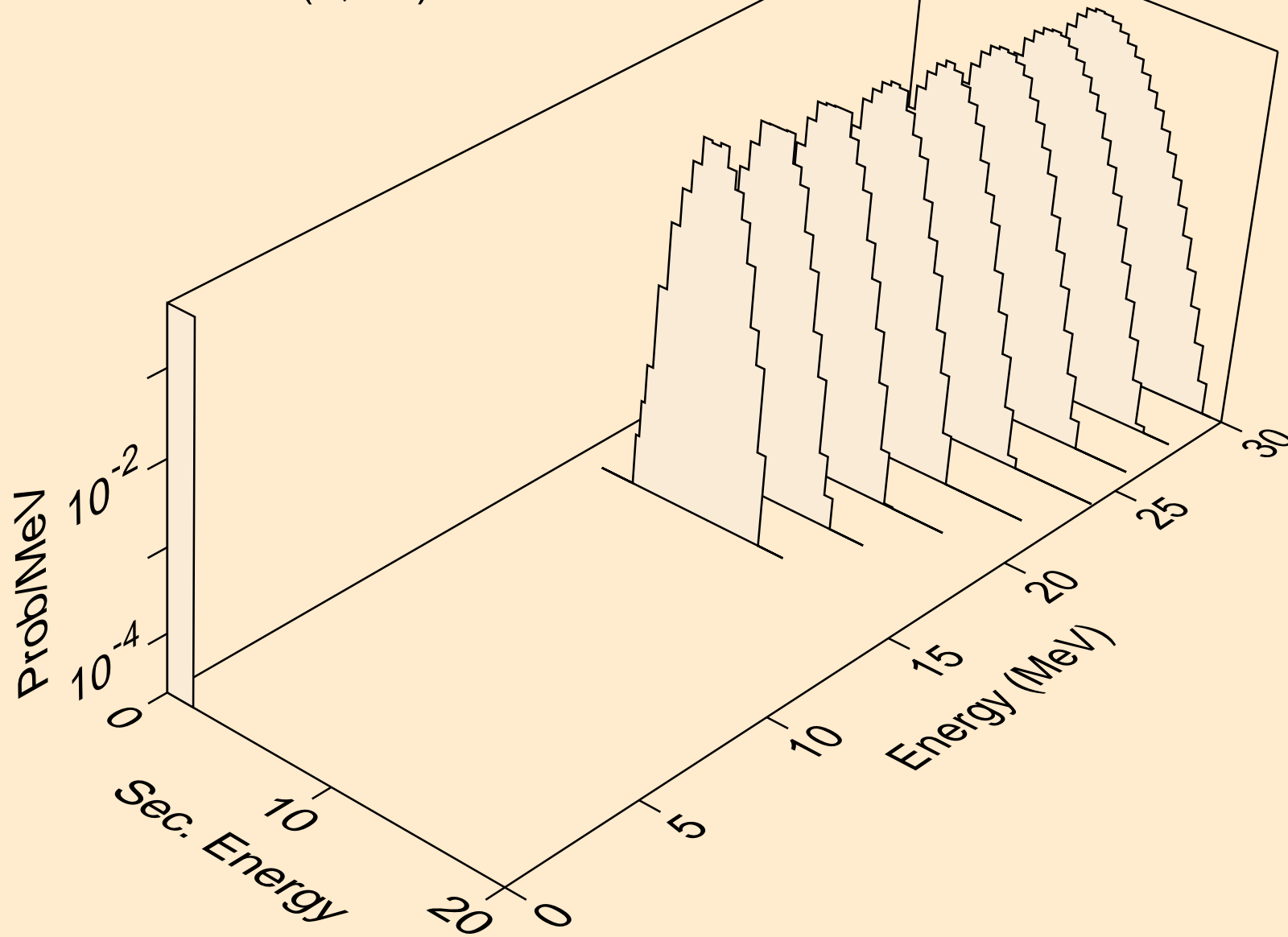

IR171M NEUTRON ACER TENDL-2024 LIBRARY; T=0.K
tritons from (n,pt)

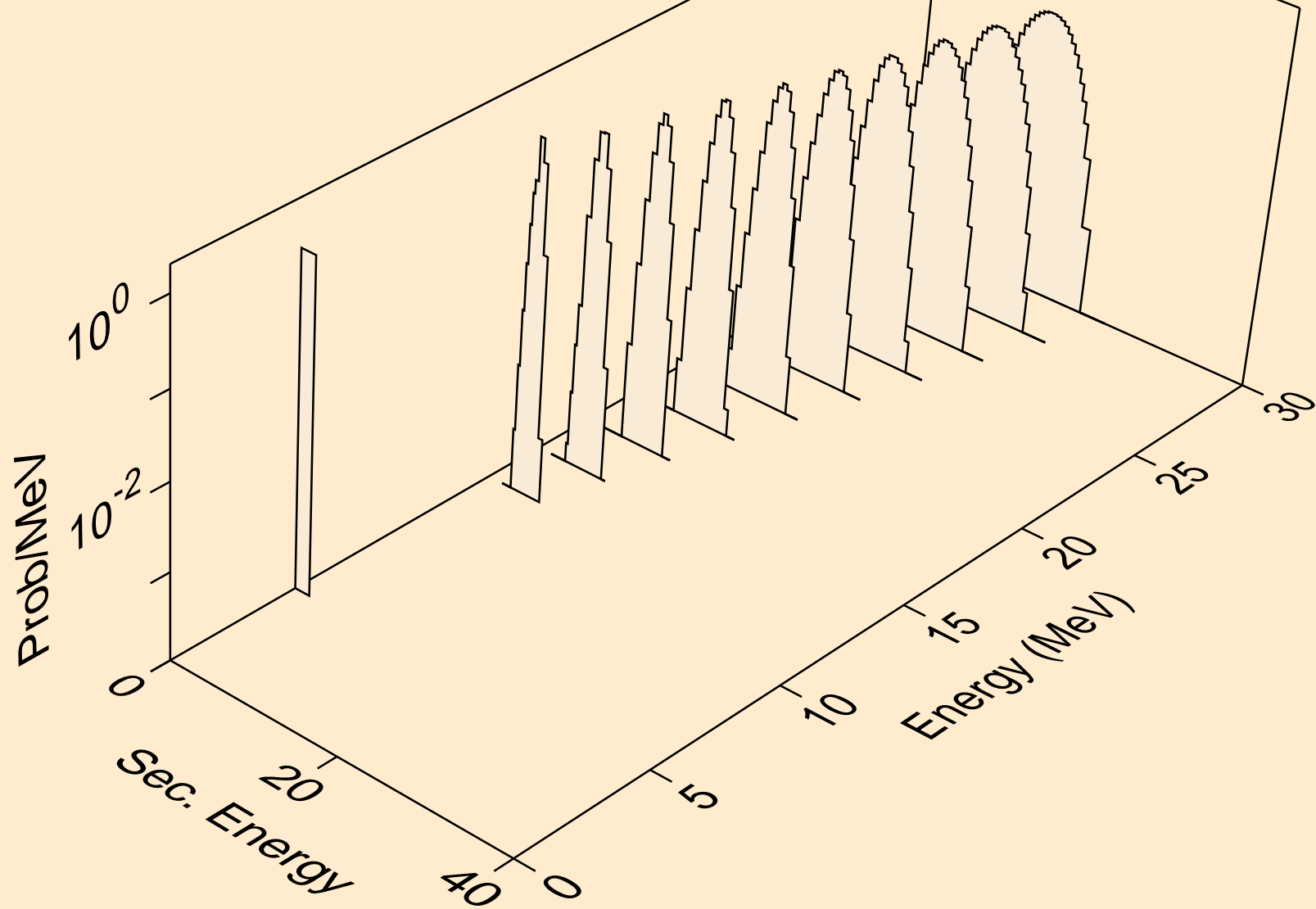

IR171M NEUTRON ACER TENDL-2024 LIBRARY; T=0.K
he3s from (n,x)

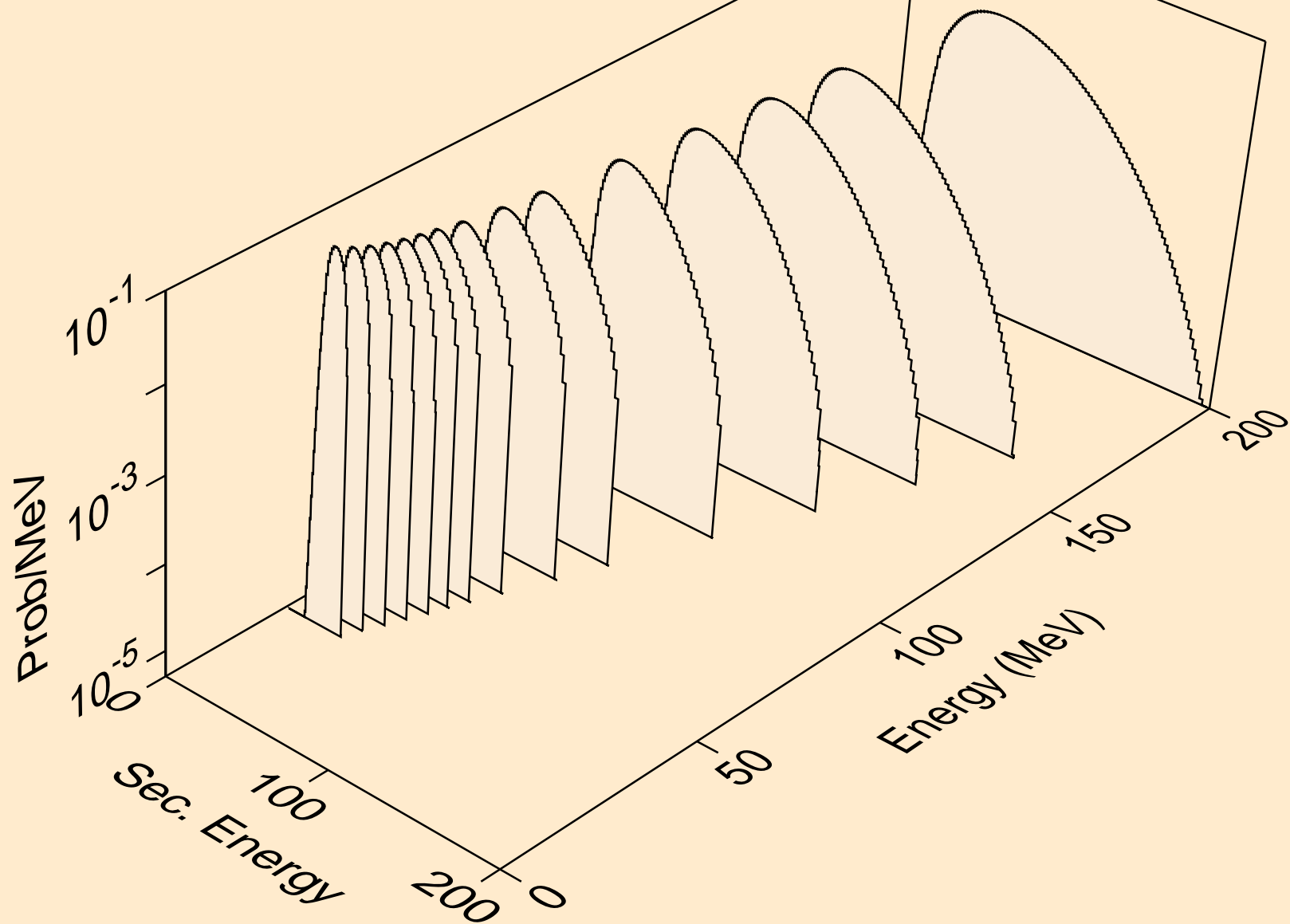

IR171M NEUTRON ACER TENDL-2024 LIBRARY; T=0.K
he3s from (n,n*)he3

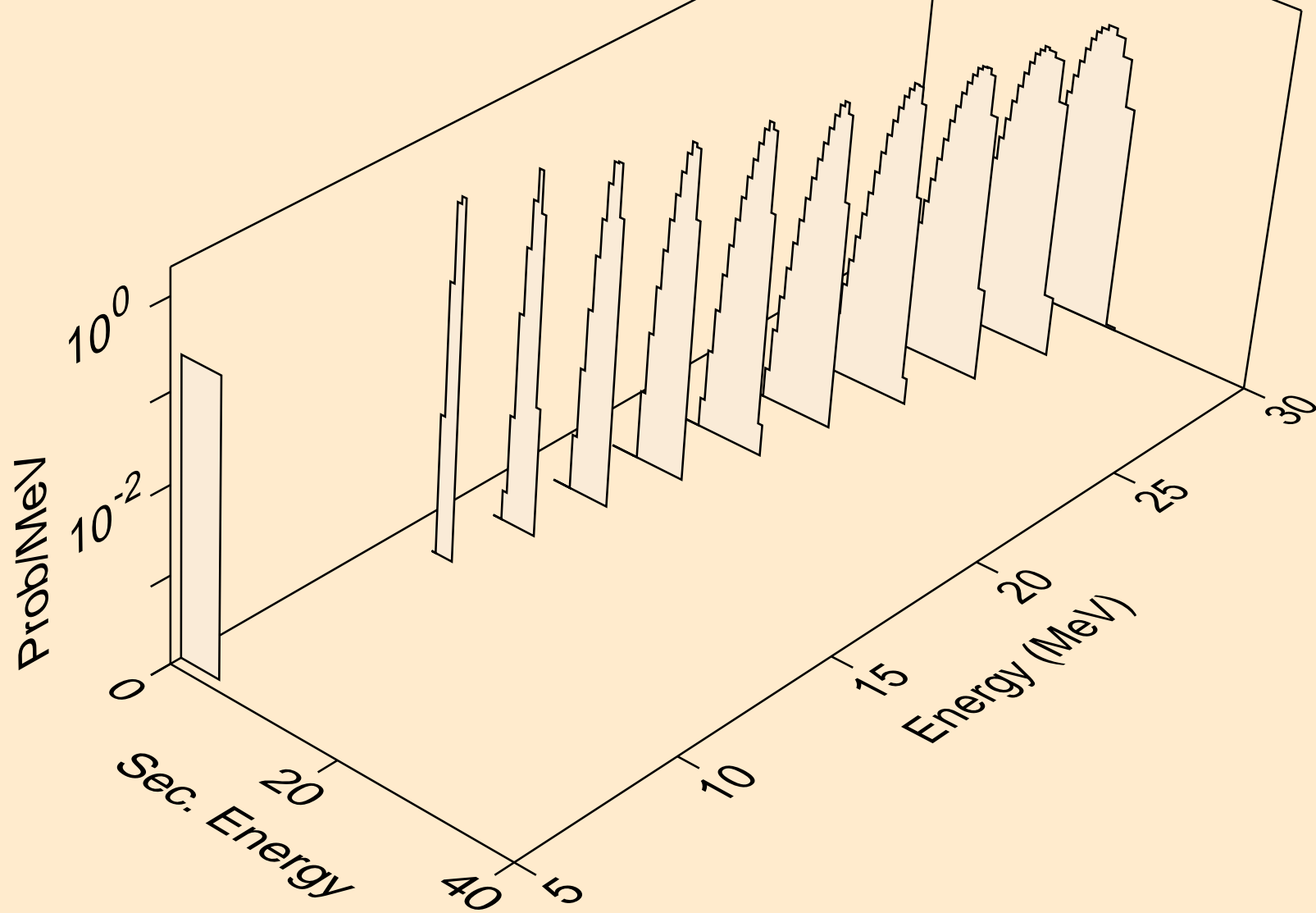

IR171M NEUTRON ACER TENDL-2024 LIBRARY; T=0.K
he3s from (n,he3)

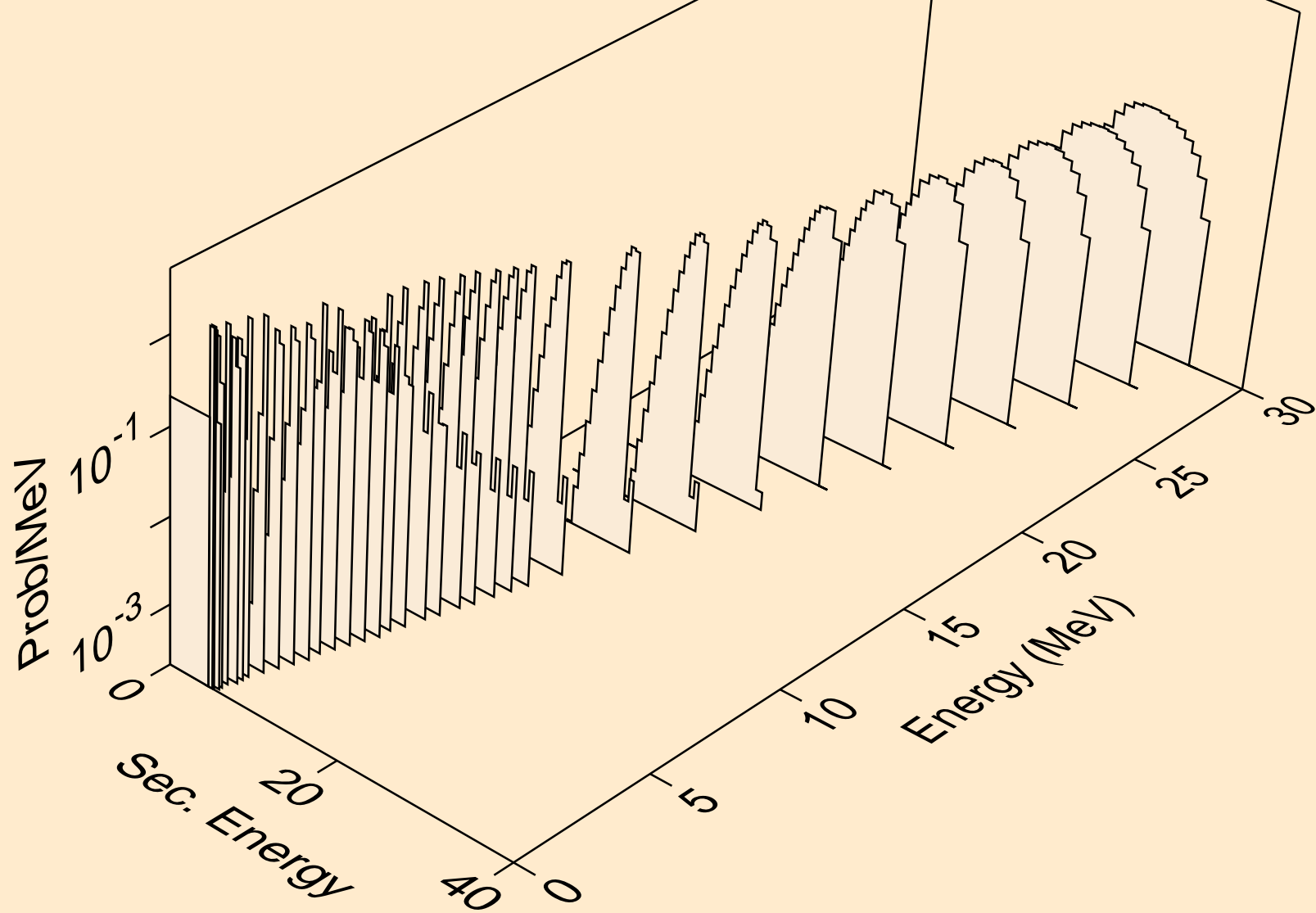

IR171M NEUTRON ACER TENDL-2024 LIBRARY; T=0.K
alphas from (n,x)

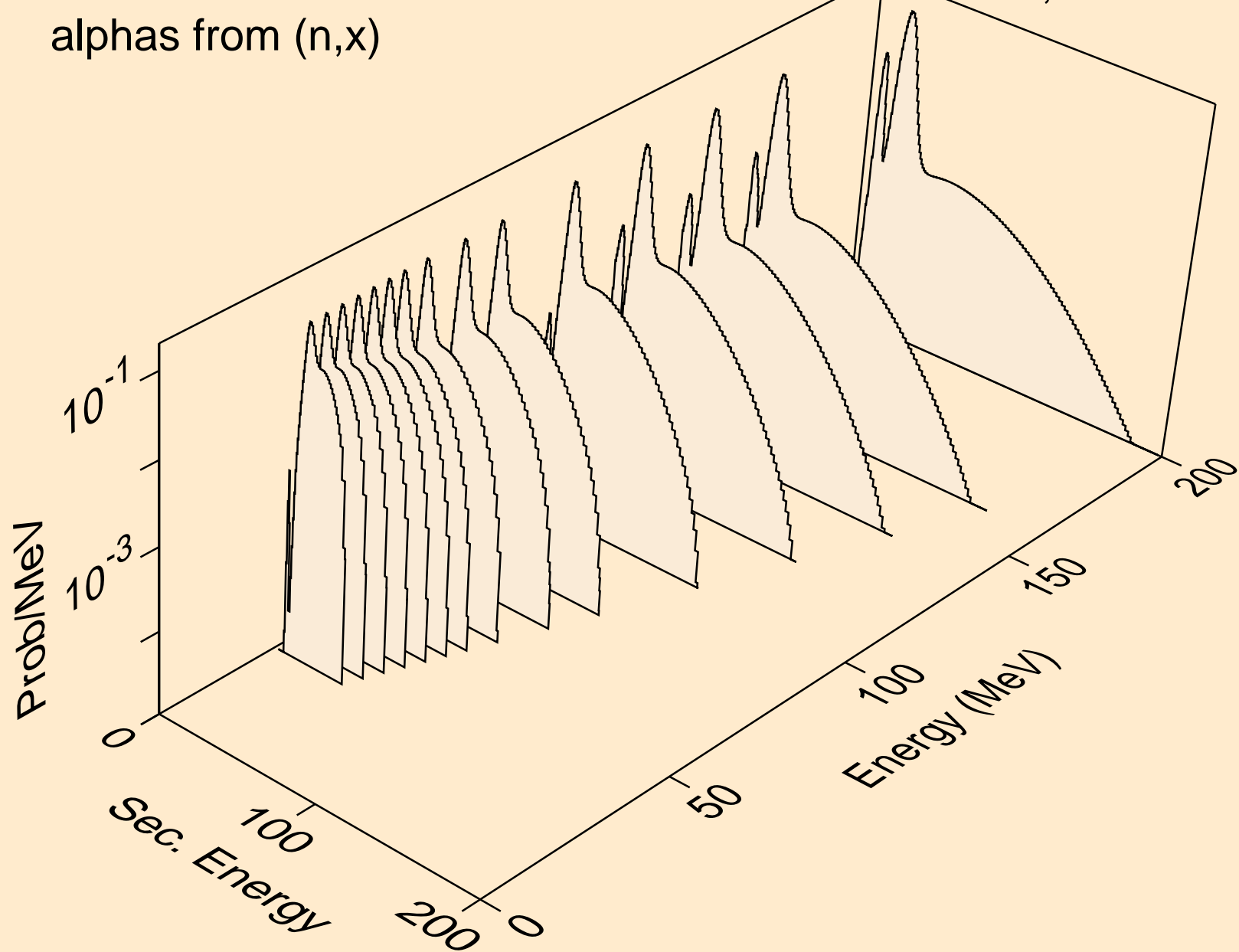

IR171M NEUTRON ACER TENDL-2024 LIBRARY; T=0.K
alphas from (n,n*)a

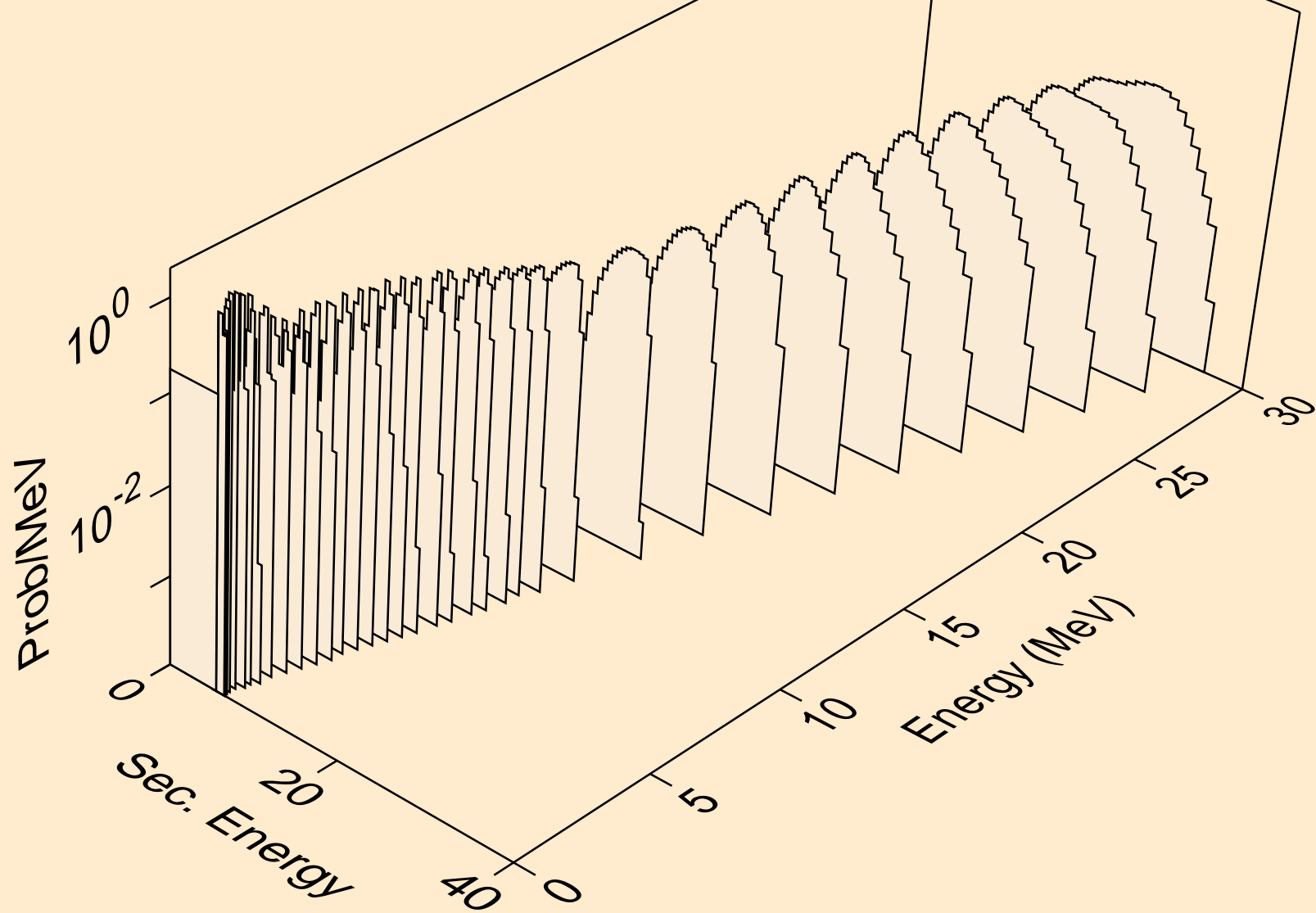

IR171M NEUTRON ACER TENDL-2024 LIBRARY; T=0.K
alphas from (n,n*)3a

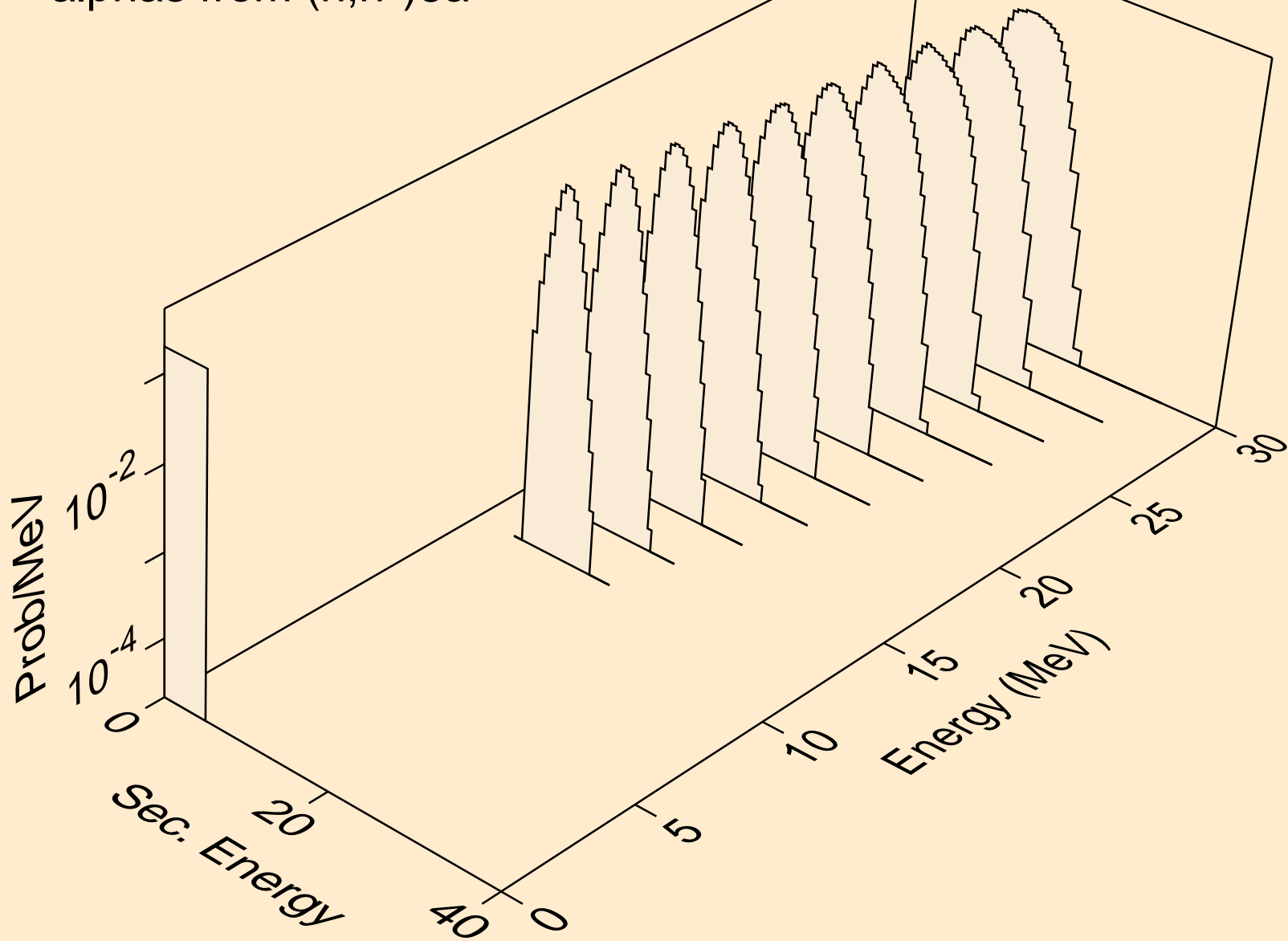

IR171M NEUTRON ACER TENDL-2024 LIBRARY; T=0.K
alphas from (n,2n)a

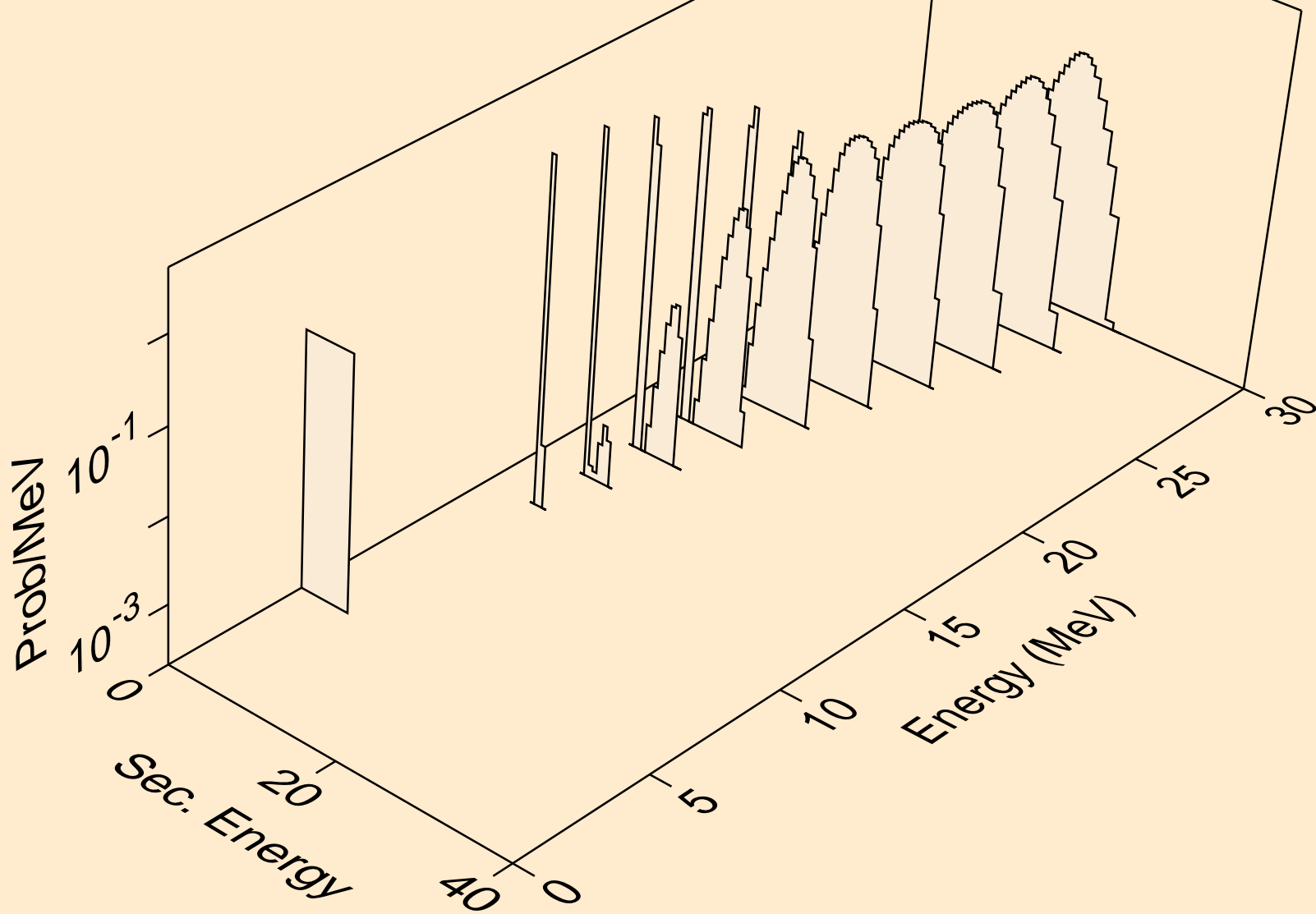

IR171M NEUTRON ACER TENDL-2024 LIBRARY; T=0.K
alphas from (n,3n)a

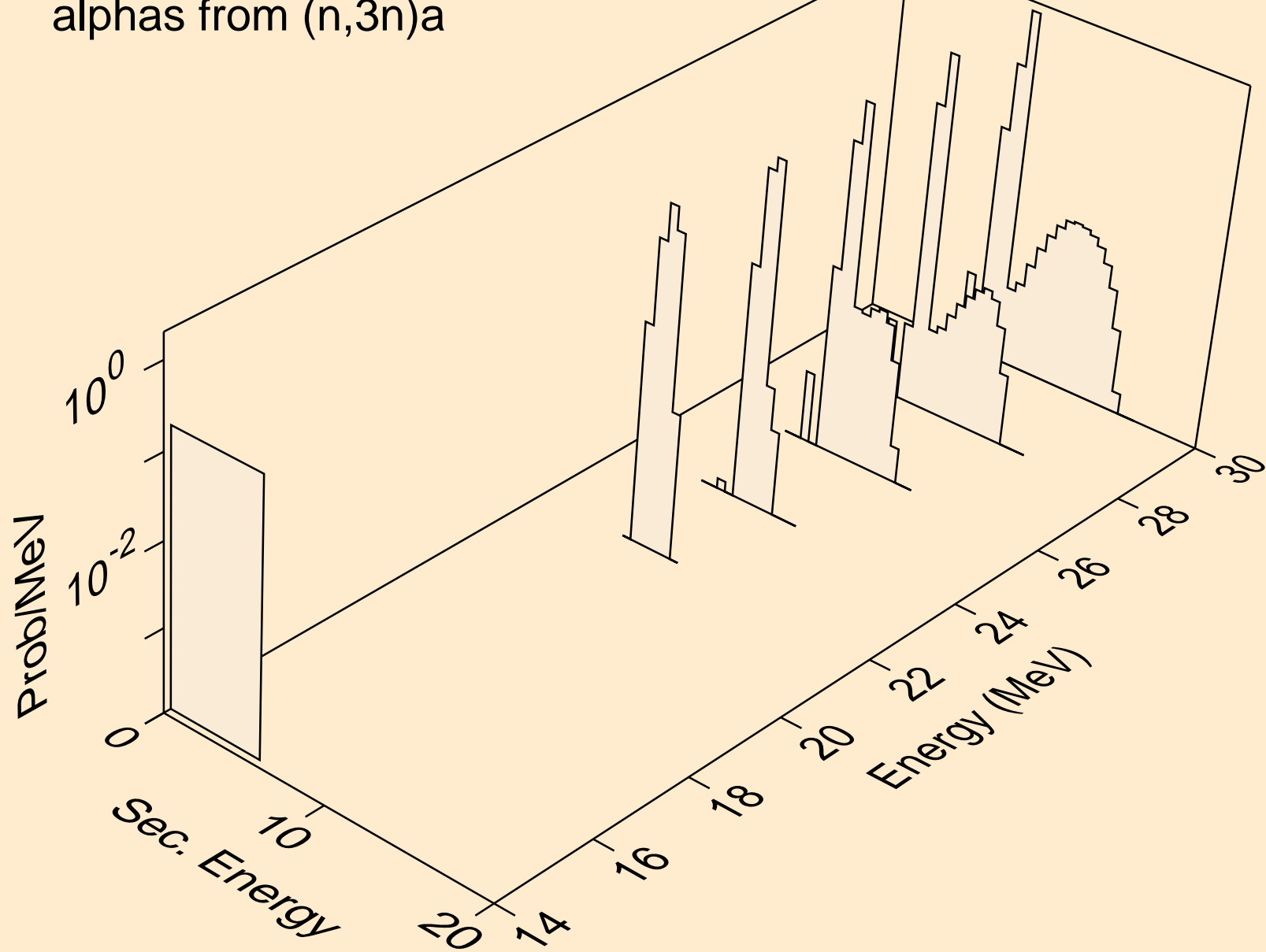

IR171M NEUTRON ACER TENDL-2024 LIBRARY; T=0.K
alphas from (n,n*)2a

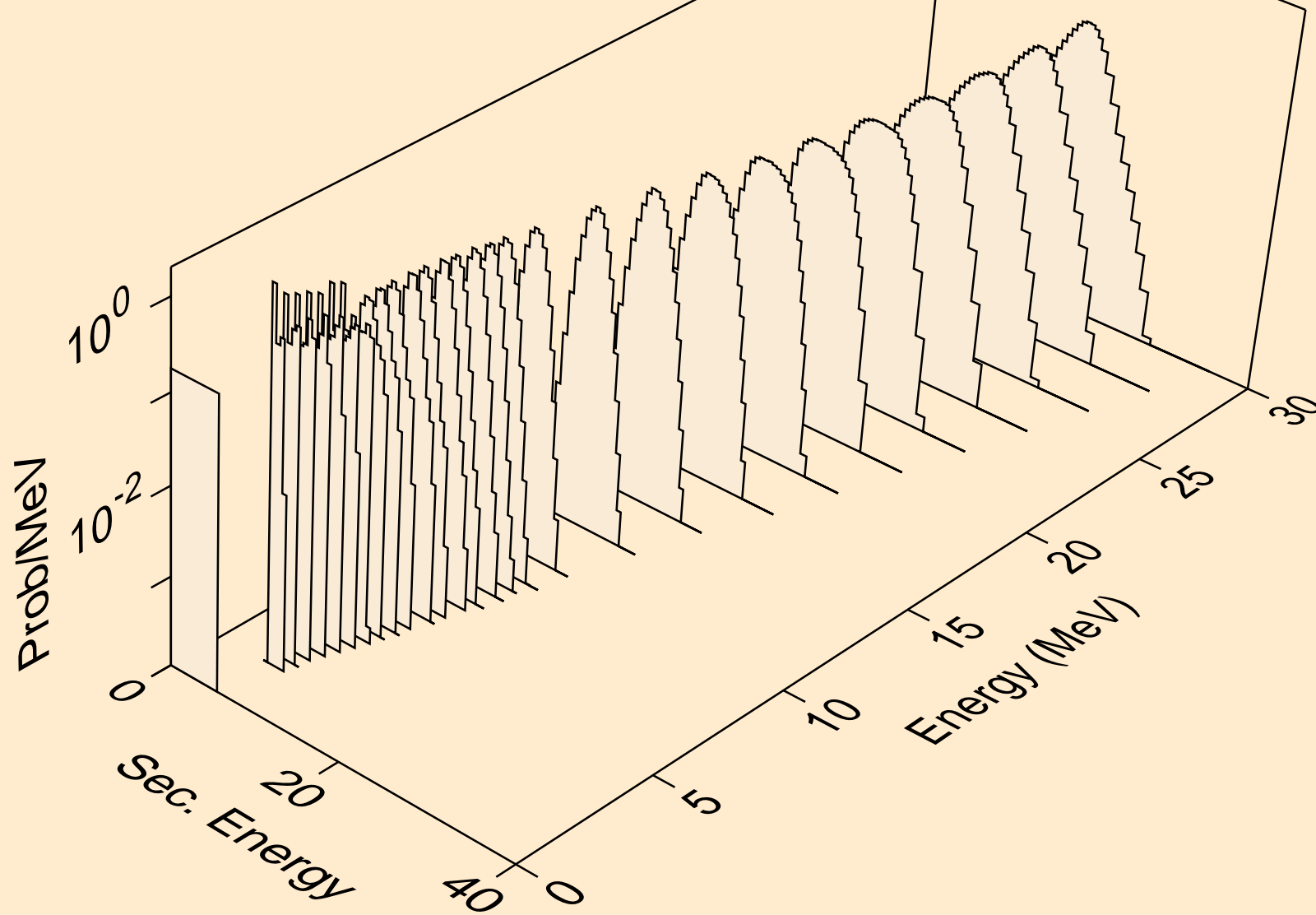

IR171M NEUTRON ACER TENDL-2024 LIBRARY; T=0.K
alphas from (n,2n)2a

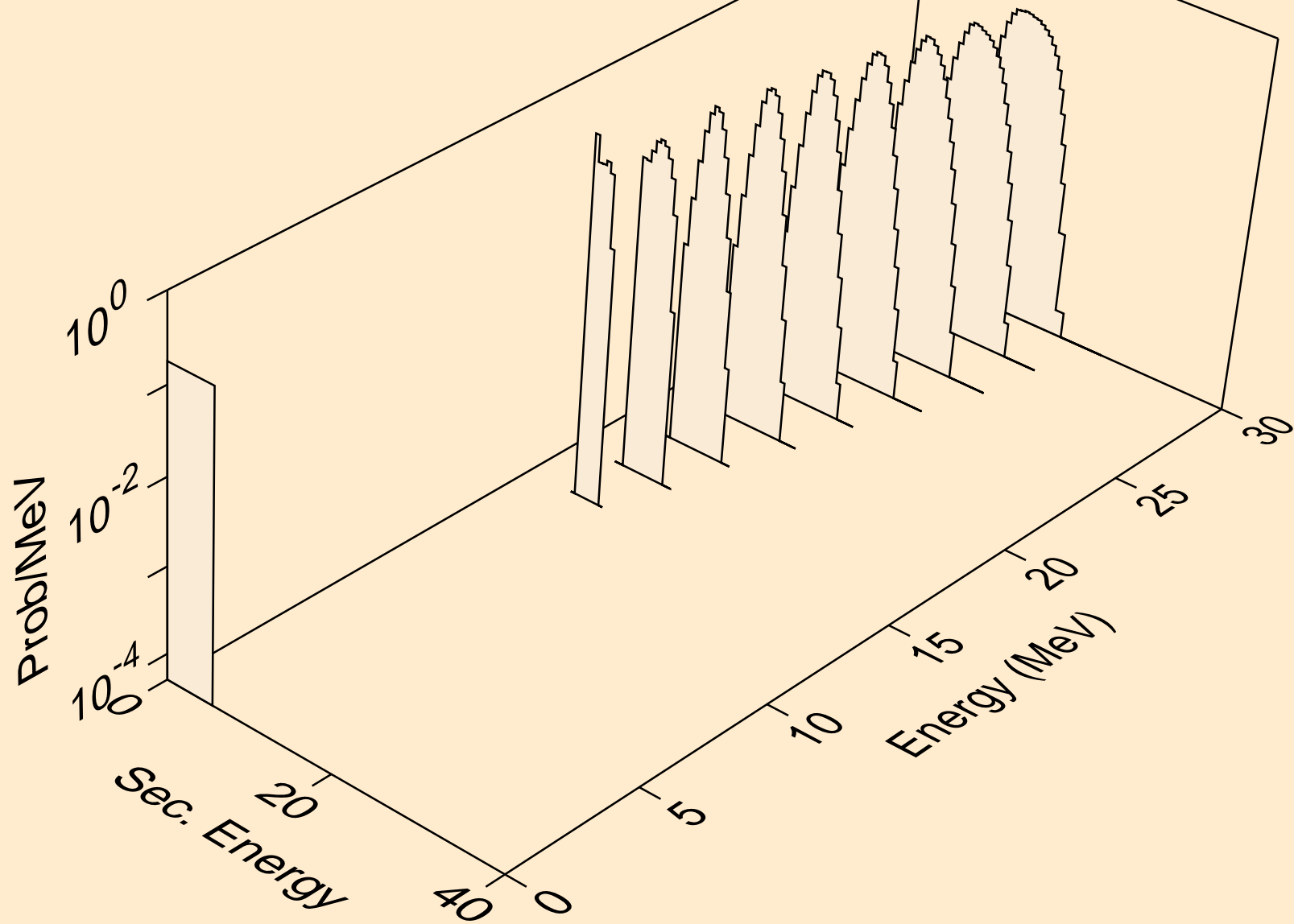

IR171M NEUTRON ACER TENDL-2024 LIBRARY; T=0.K
alphas from (n,npa)

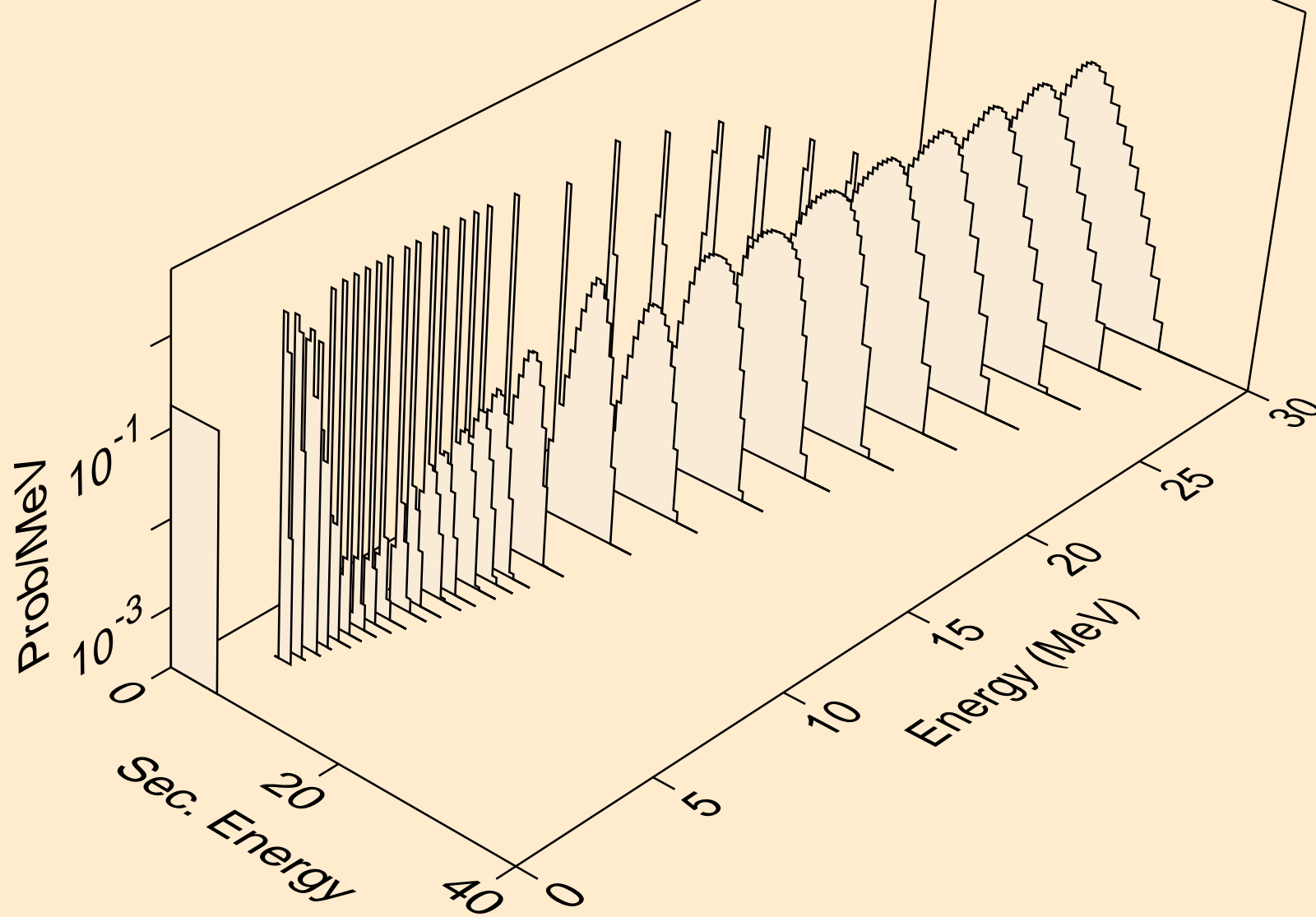

IR171M NEUTRON ACER TENDL-2024 LIBRARY; T=0.K
alphas from (n,a)

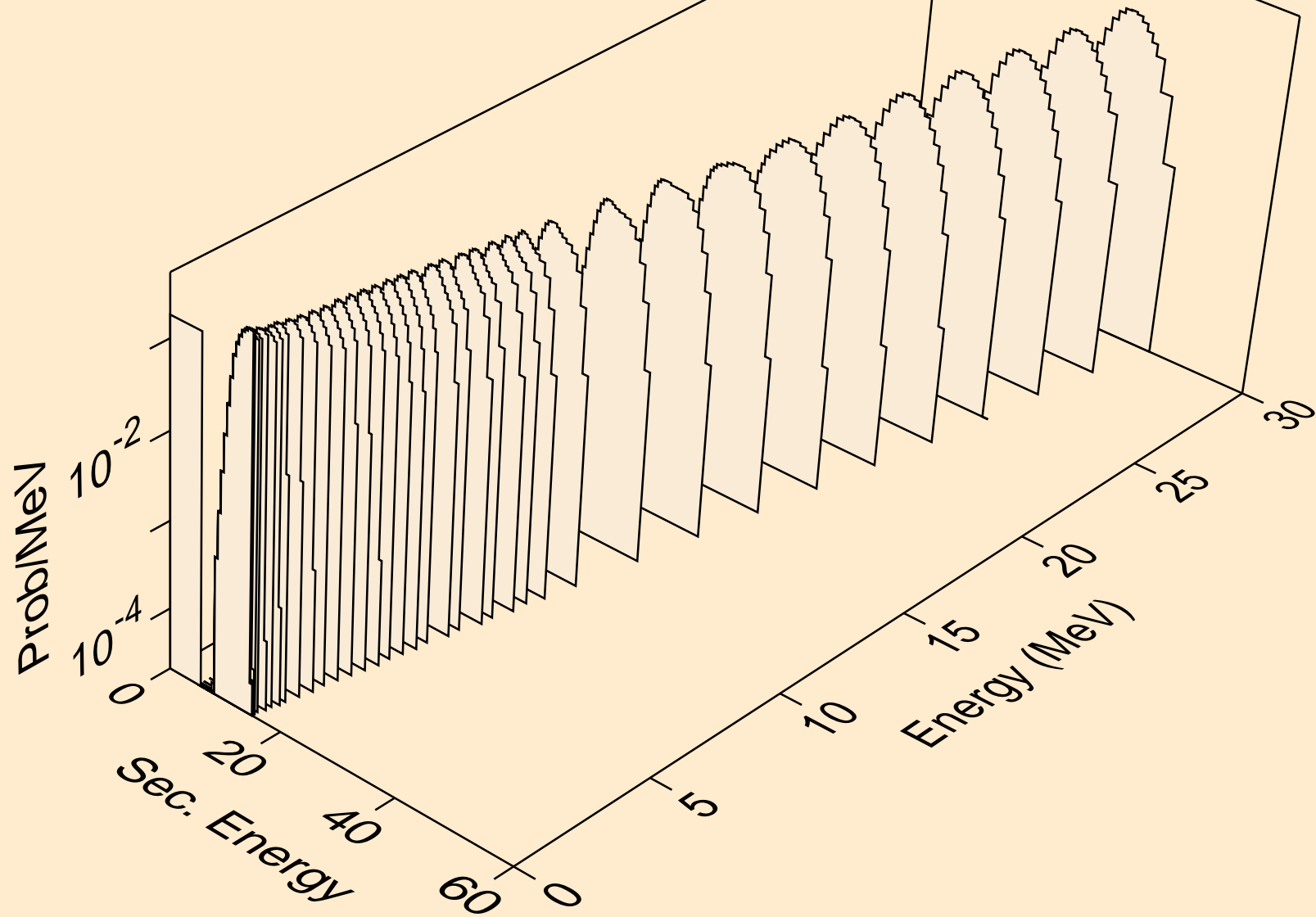

IR171M NEUTRON ACER TENDL-2024 LIBRARY; T=0.K
alphas from (n,2a)

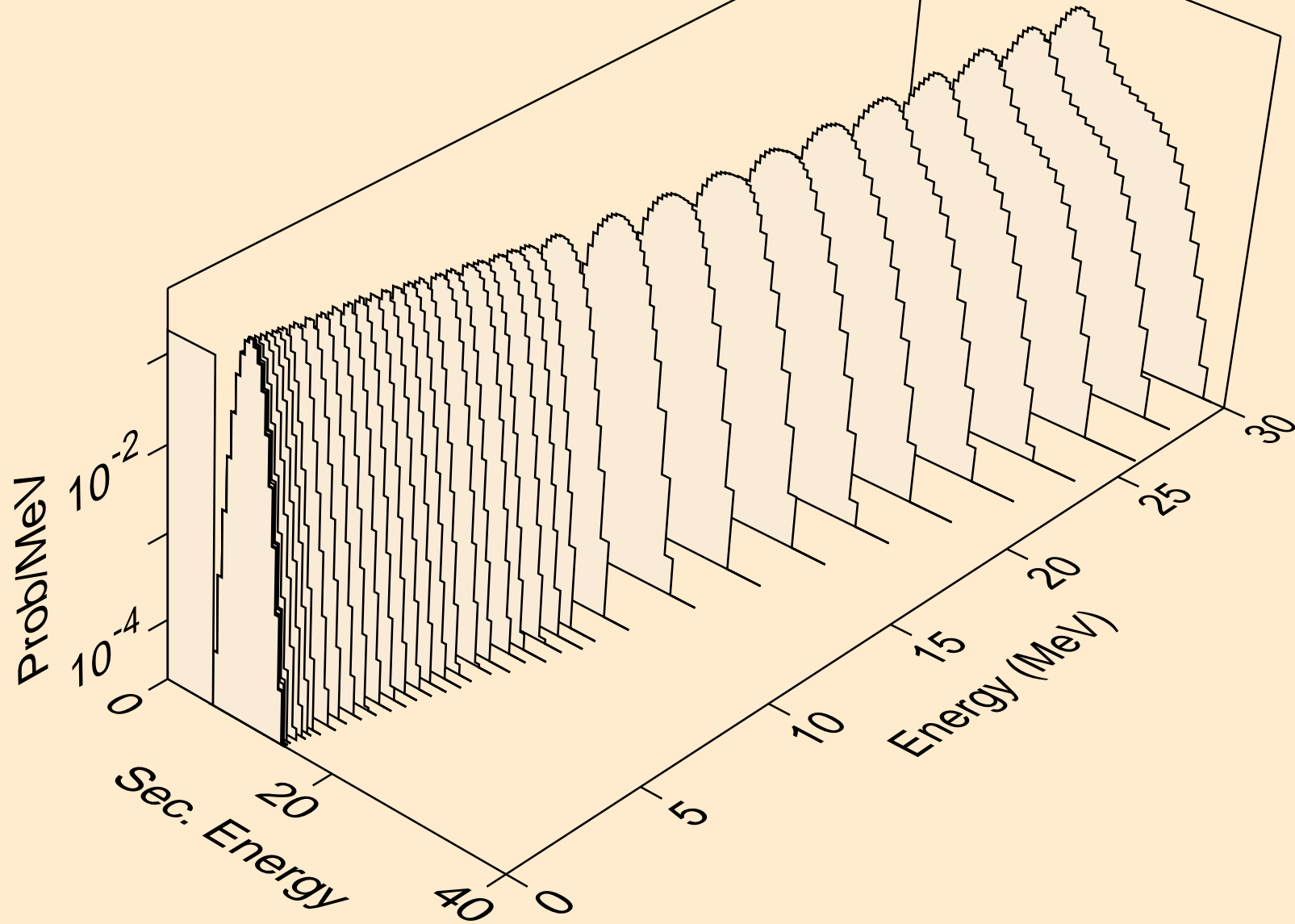

IR171M NEUTRON ACER TENDL-2024 LIBRARY; T=0.K
alphas from (n,3a)

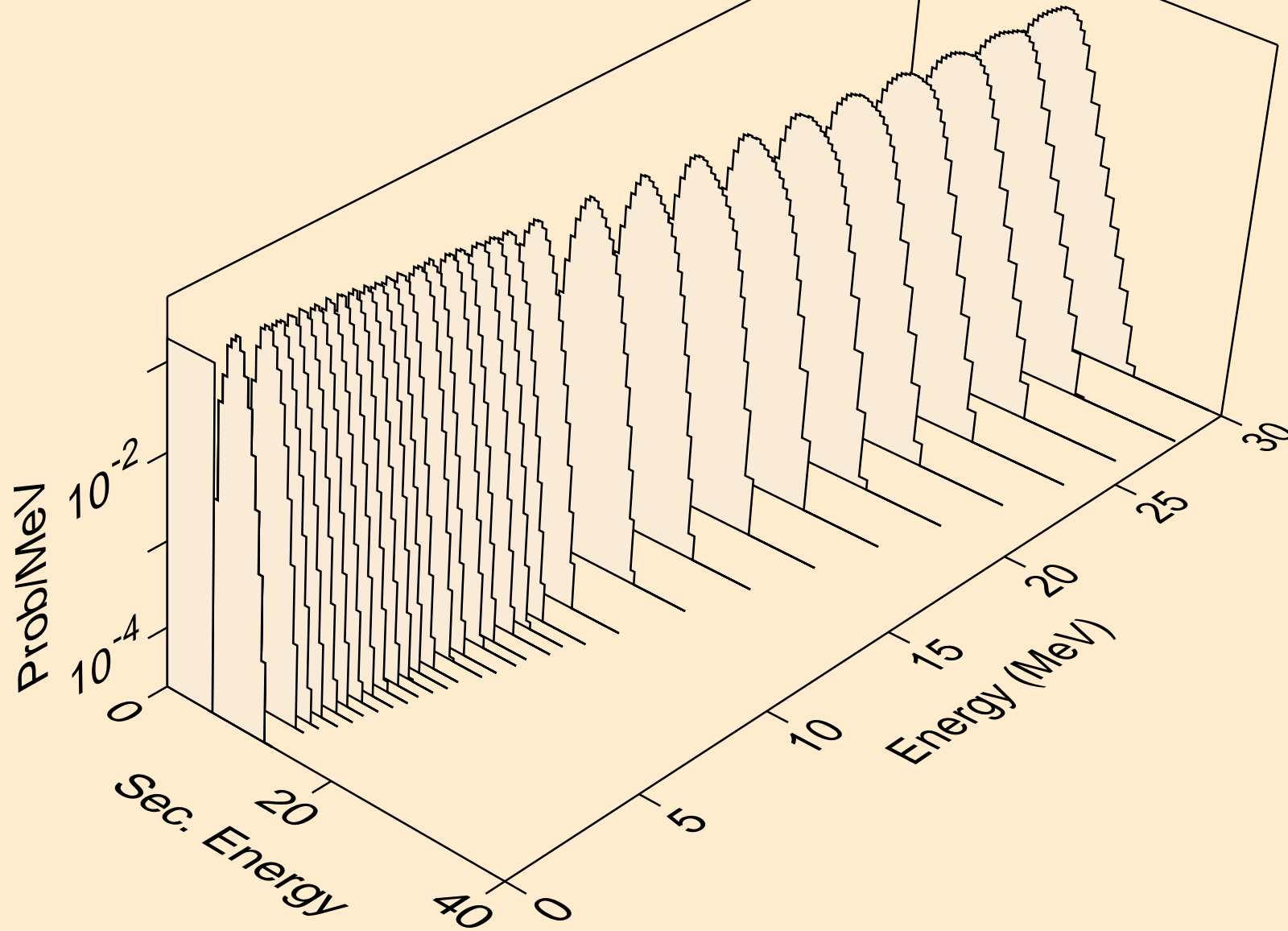

IR171M NEUTRON ACER TENDL-2024 LIBRARY; T=0.K
alphas from (n,pa)

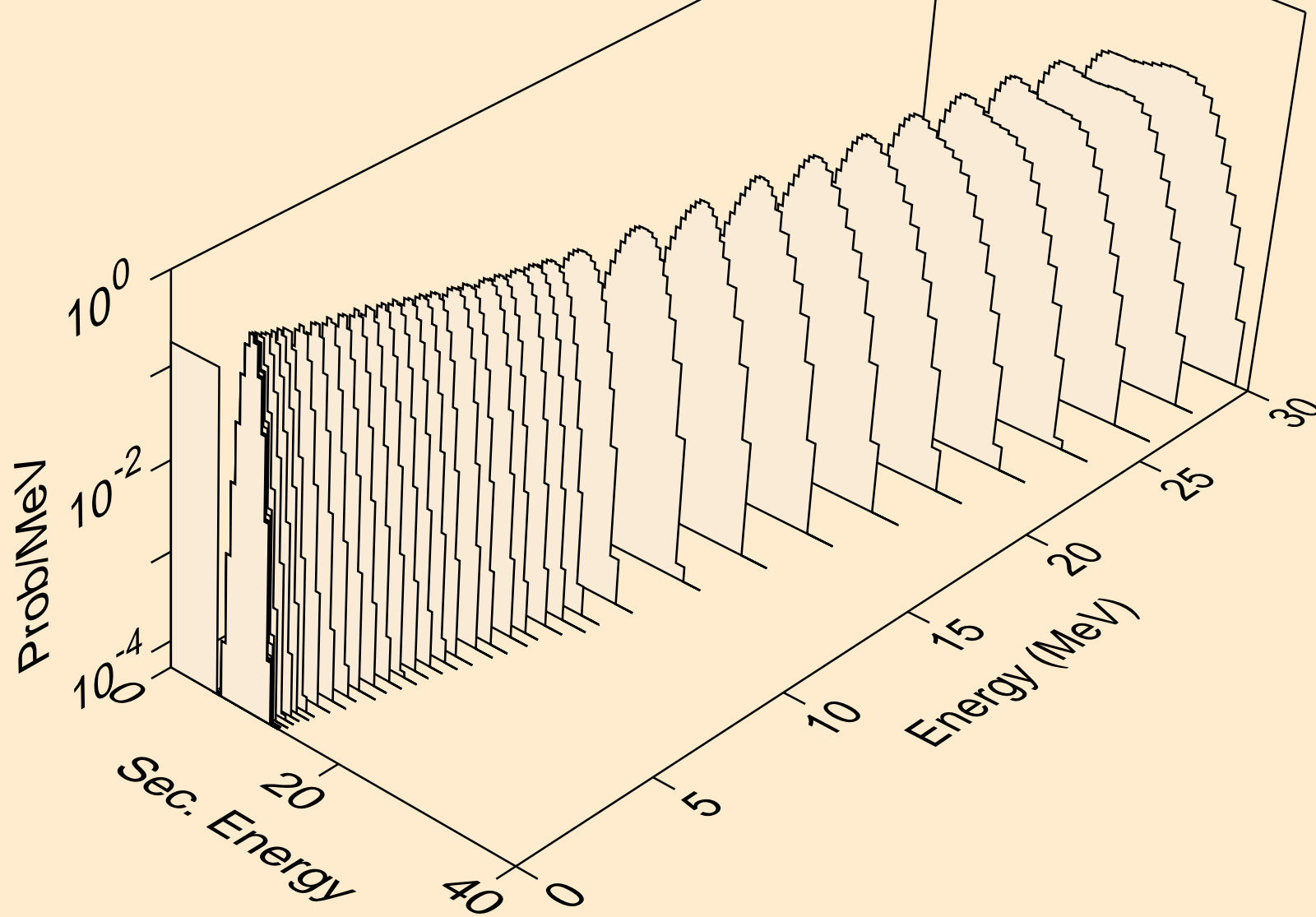

IR171M NEUTRON ACER TENDL-2024 LIBRARY; T=0.K
alphas from (n,t2a)

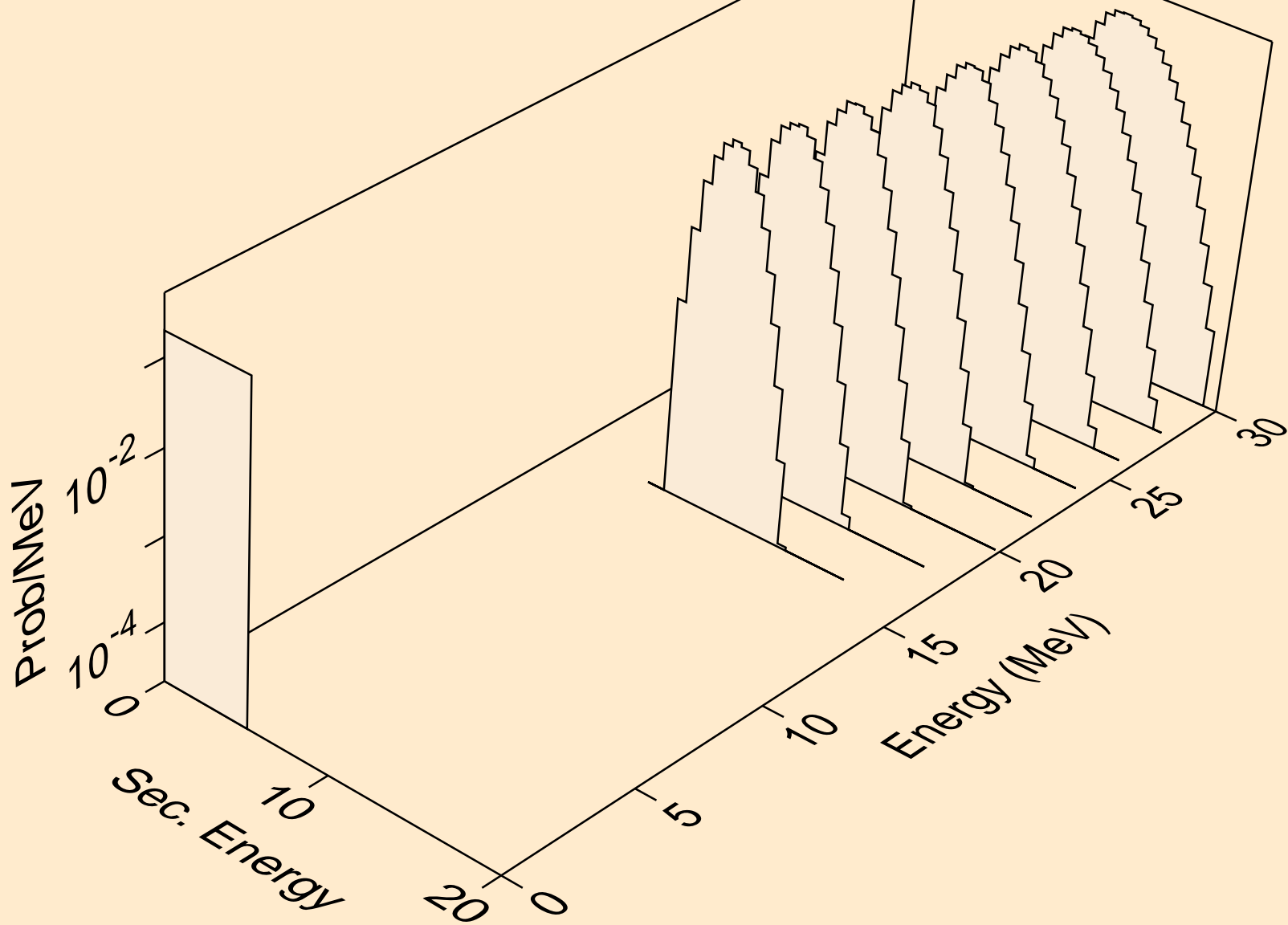

IR171M NEUTRON ACER TENDL-2024 LIBRARY; T=0.K
alphas from (n,d2a)

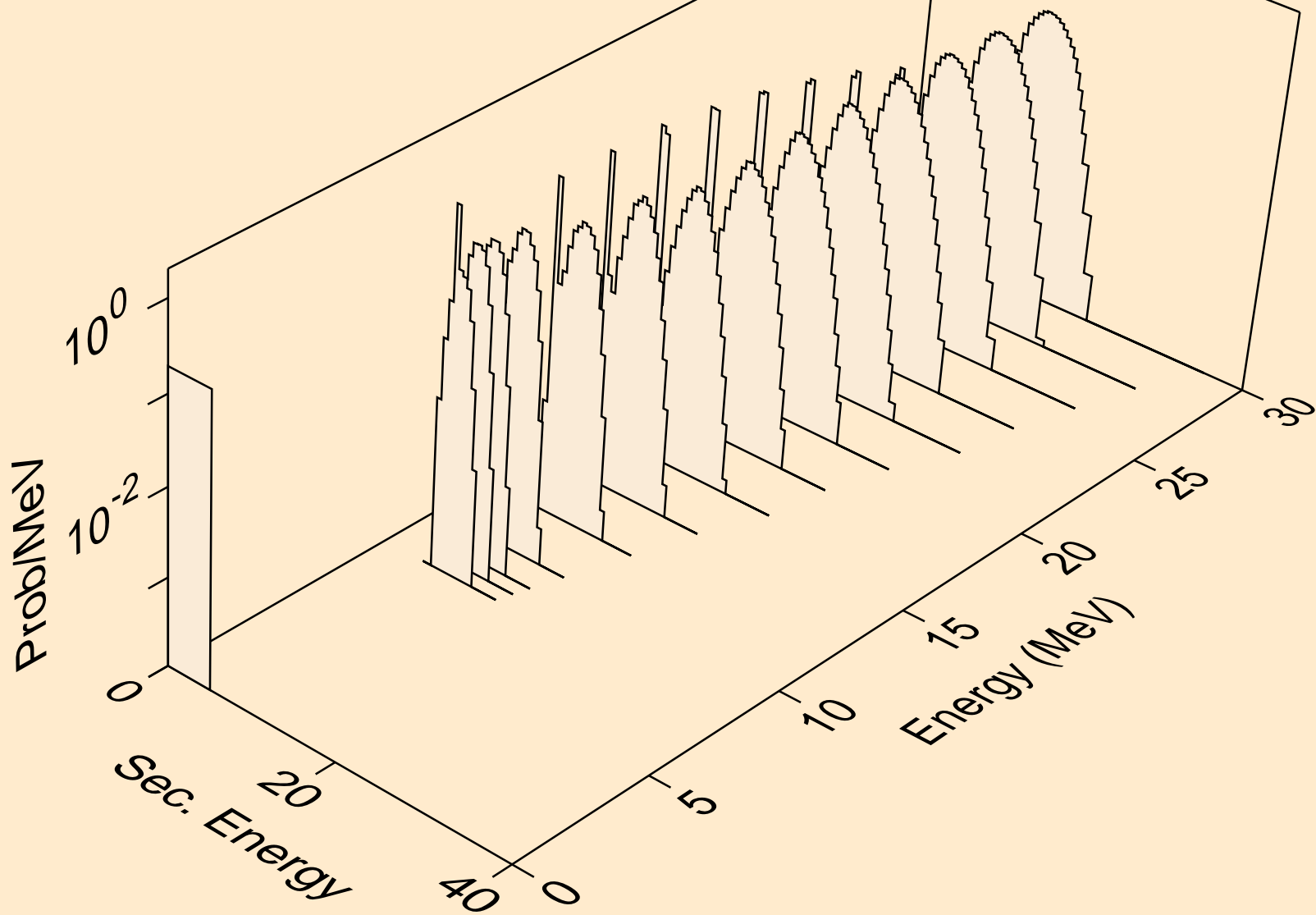

IR171M NEUTRON ACER TENDL-2024 LIBRARY; T=0.K
alphas from (n,da)

