

IR174 NEUTRON ACER TENDL-2024 LIBRARY; T=0.K

Principal cross sections

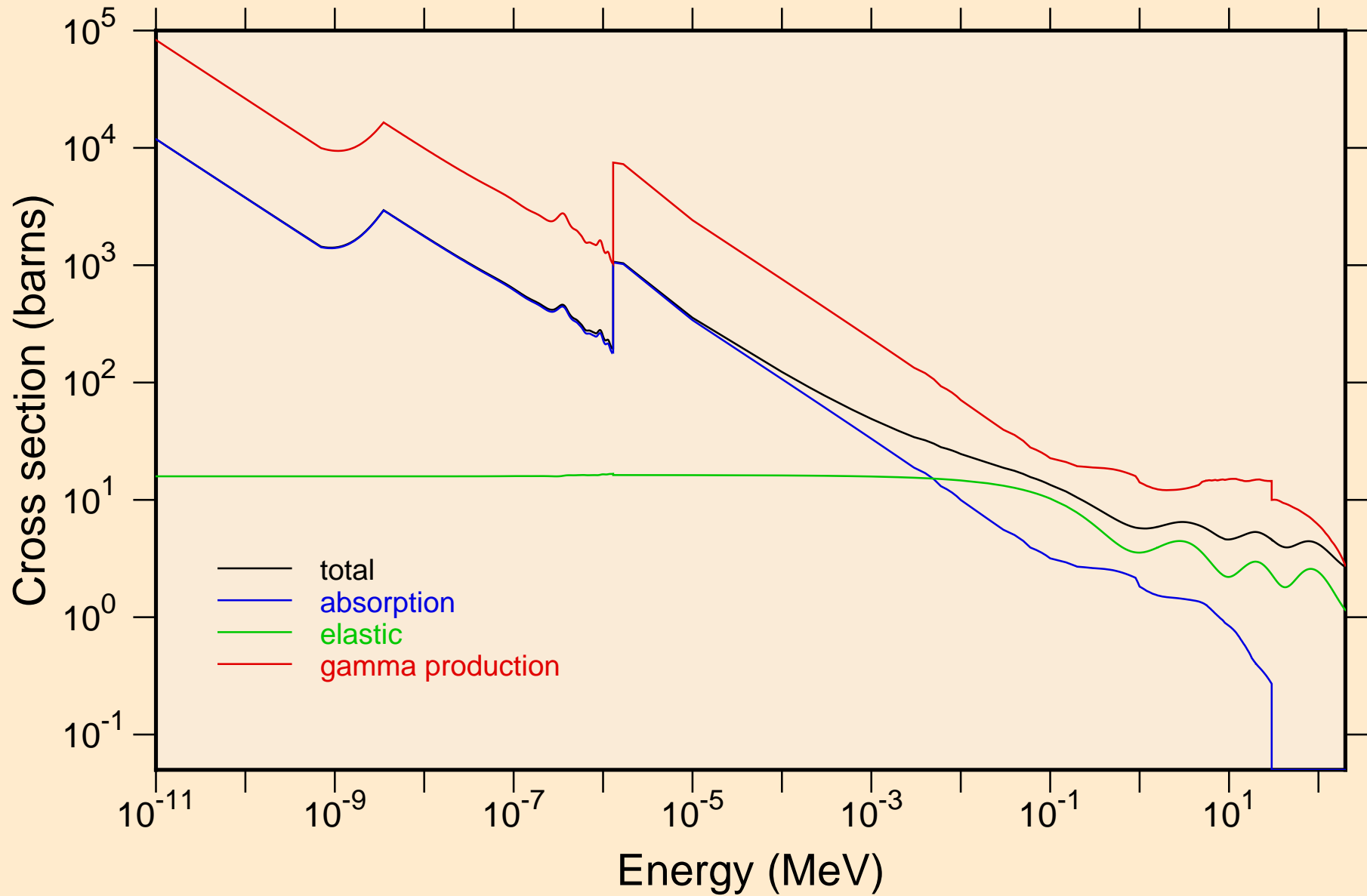

IR174 NEUTRON ACER TENDL-2024 LIBRARY; T=0.K

Heating

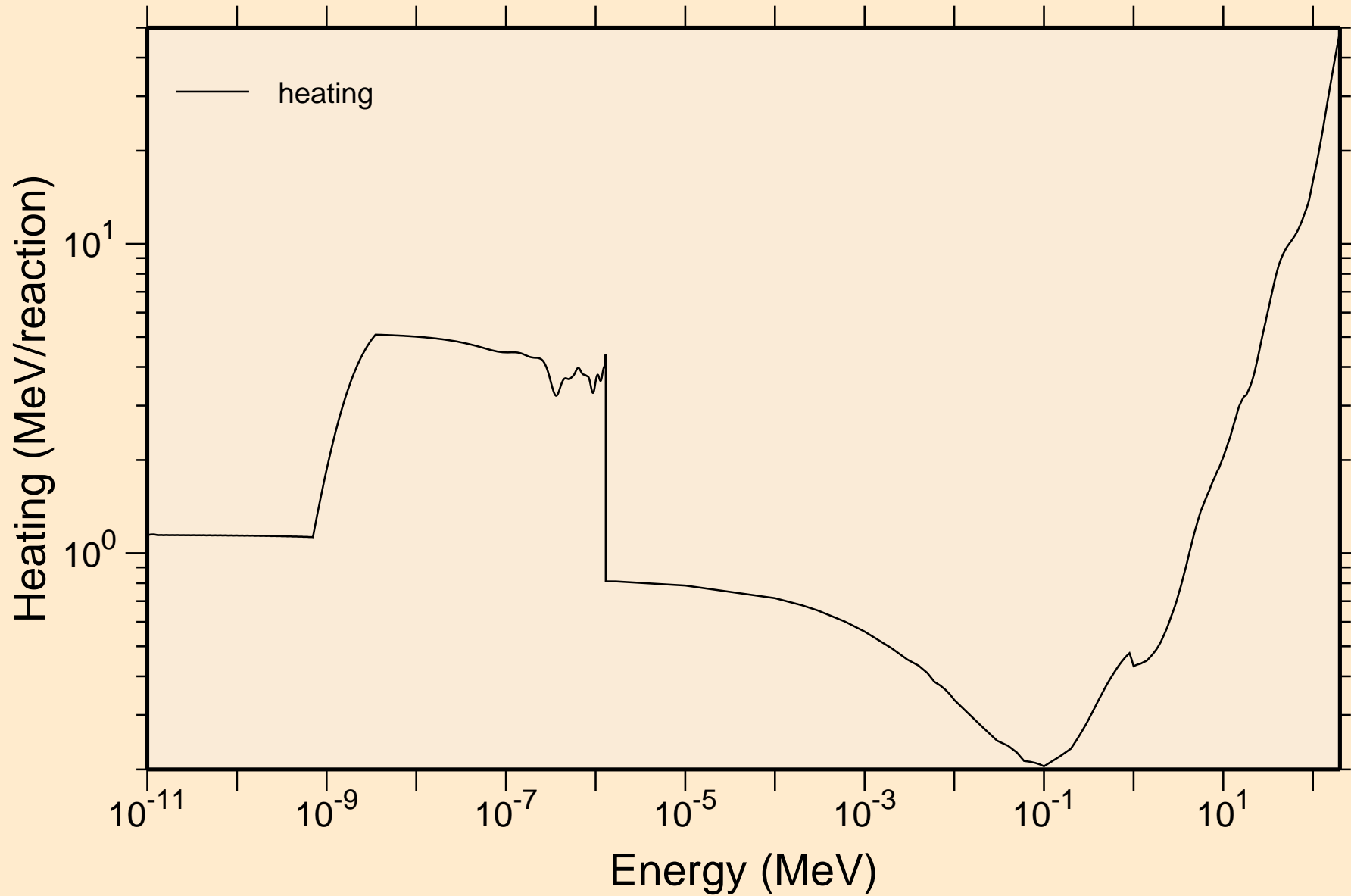

IR174 NEUTRON ACER TENDL-2024 LIBRARY; T=0.K
Damage

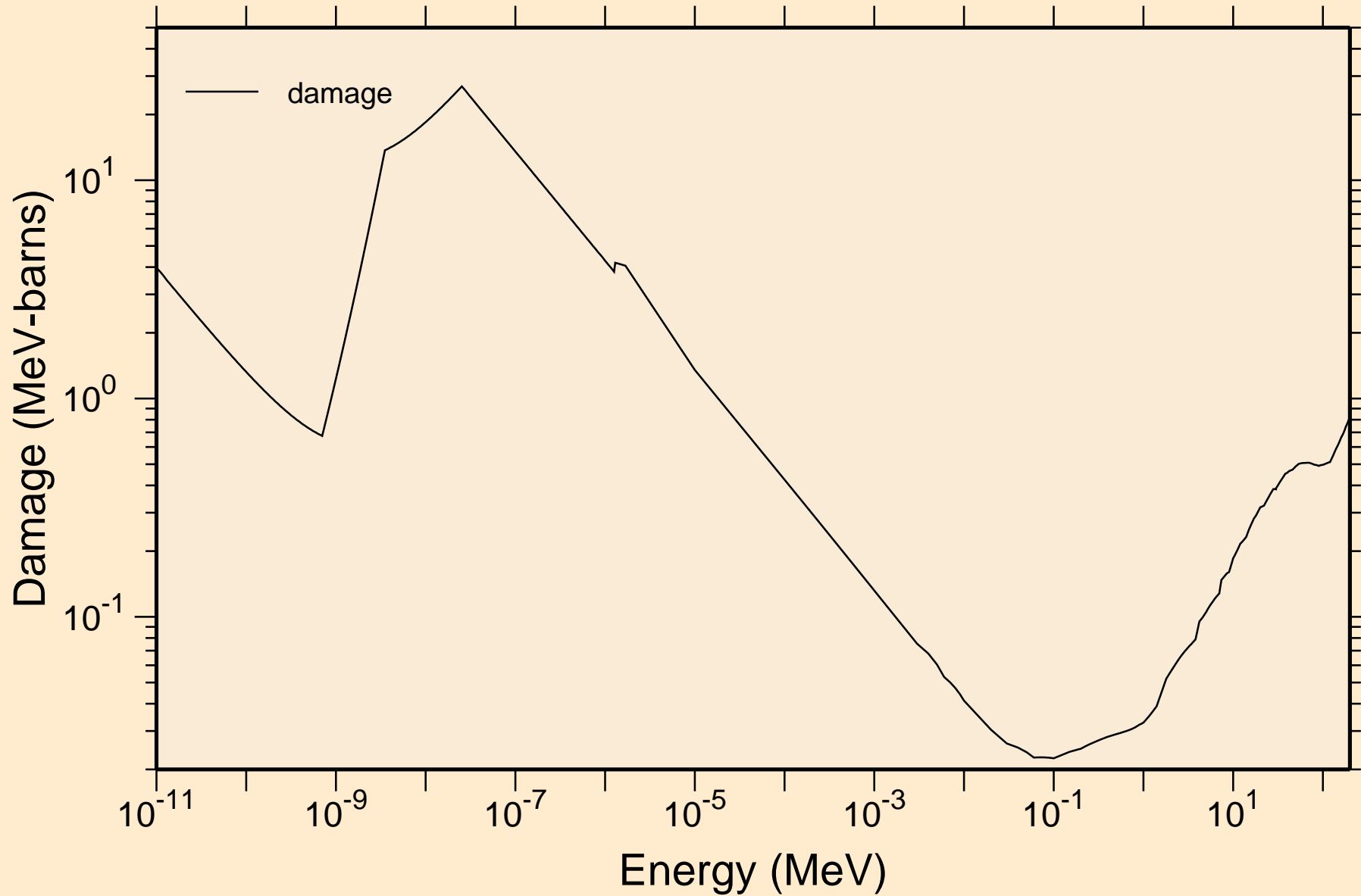

IR174 NEUTRON ACER TENDL-2024 LIBRARY; T=0.K

Non-threshold reactions

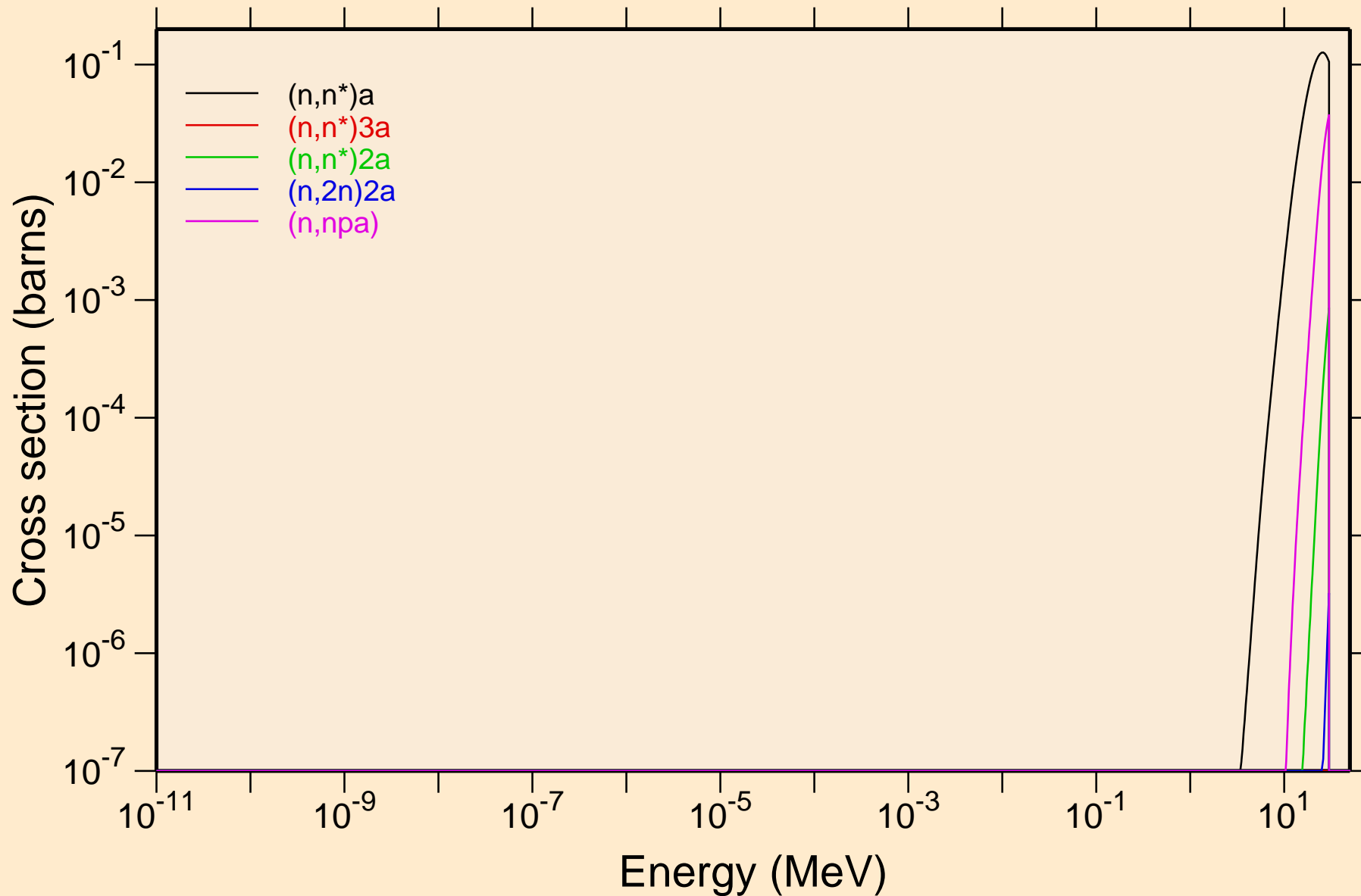

IR174 NEUTRON ACER TENDL-2024 LIBRARY; T=0.K

Non-threshold reactions

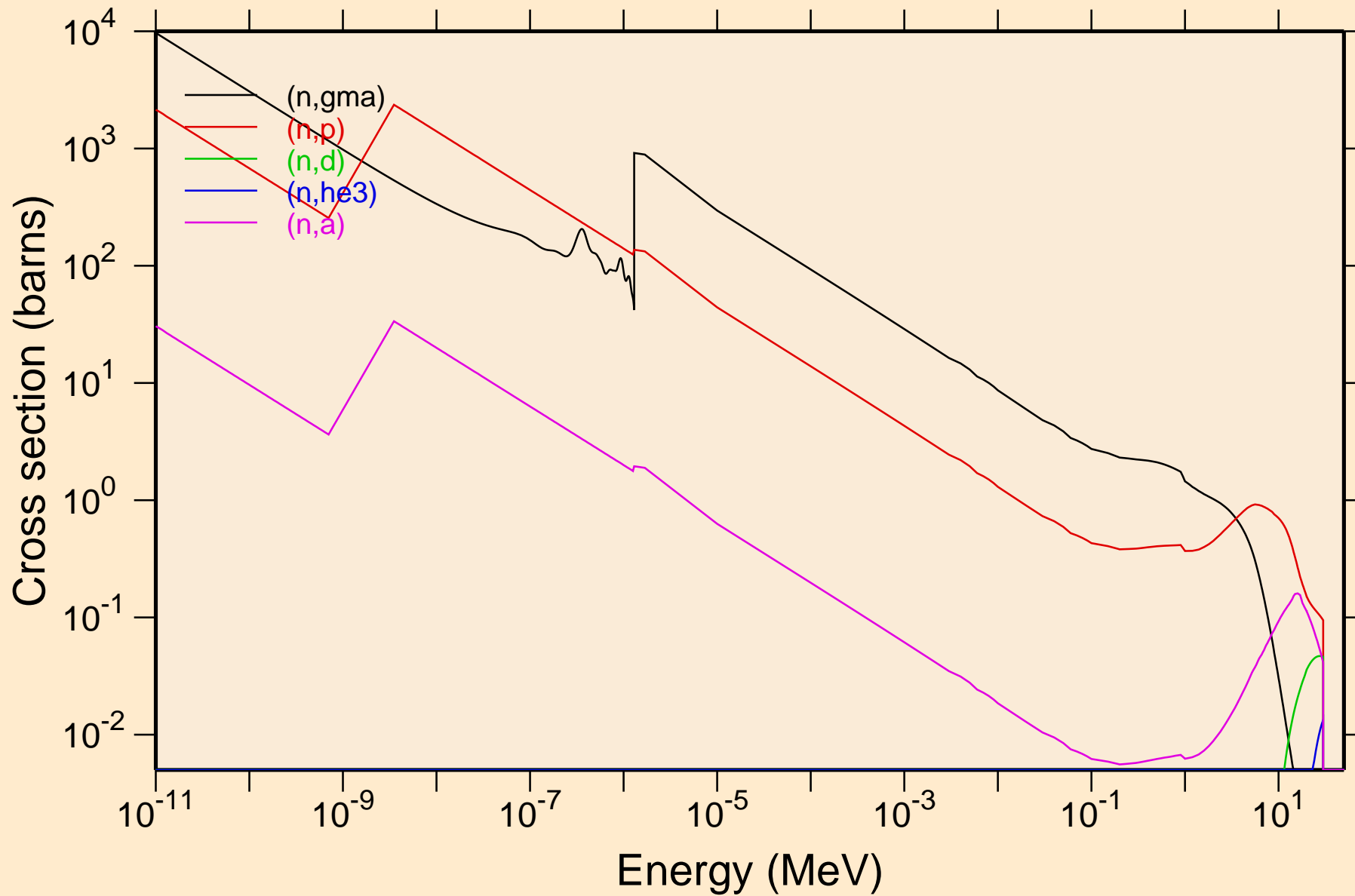

IR174 NEUTRON ACER TENDL-2024 LIBRARY; T=0.K
Non-threshold reactions

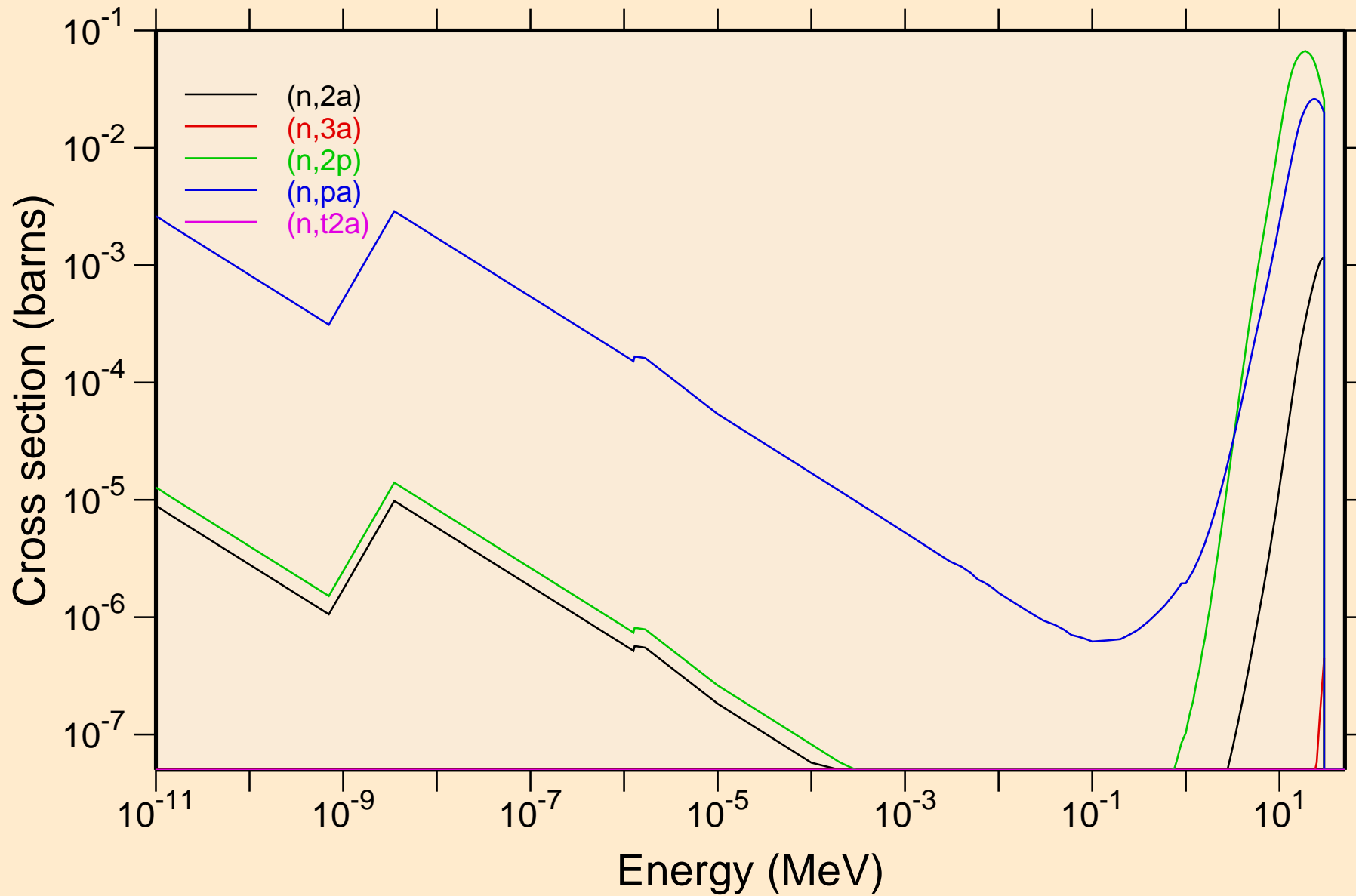

IR174 NEUTRON ACER TENDL-2024 LIBRARY; T=0.K
Non-threshold reactions

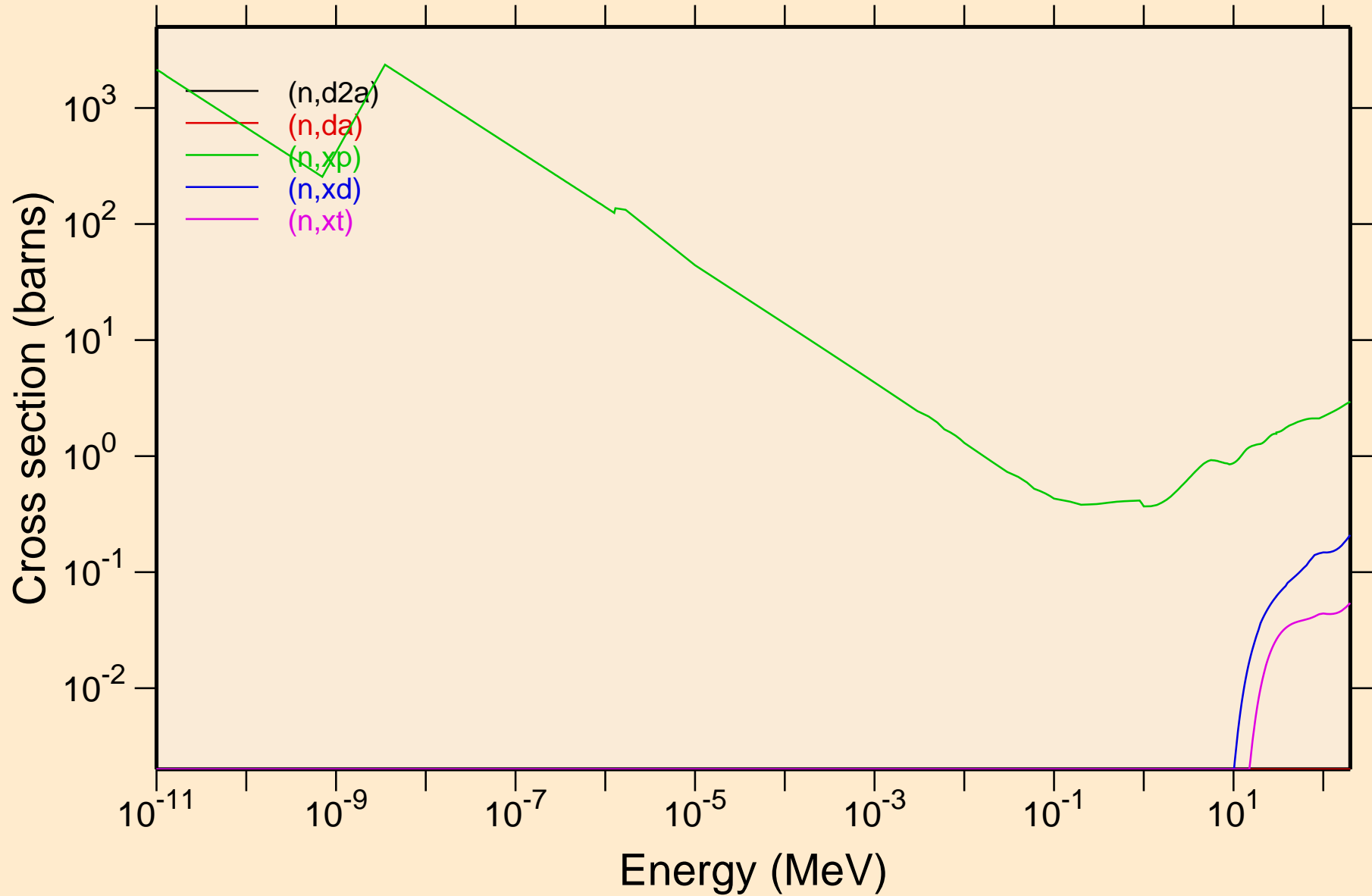

IR174 NEUTRON ACER TENDL-2024 LIBRARY; T=0.K
Non-threshold reactions

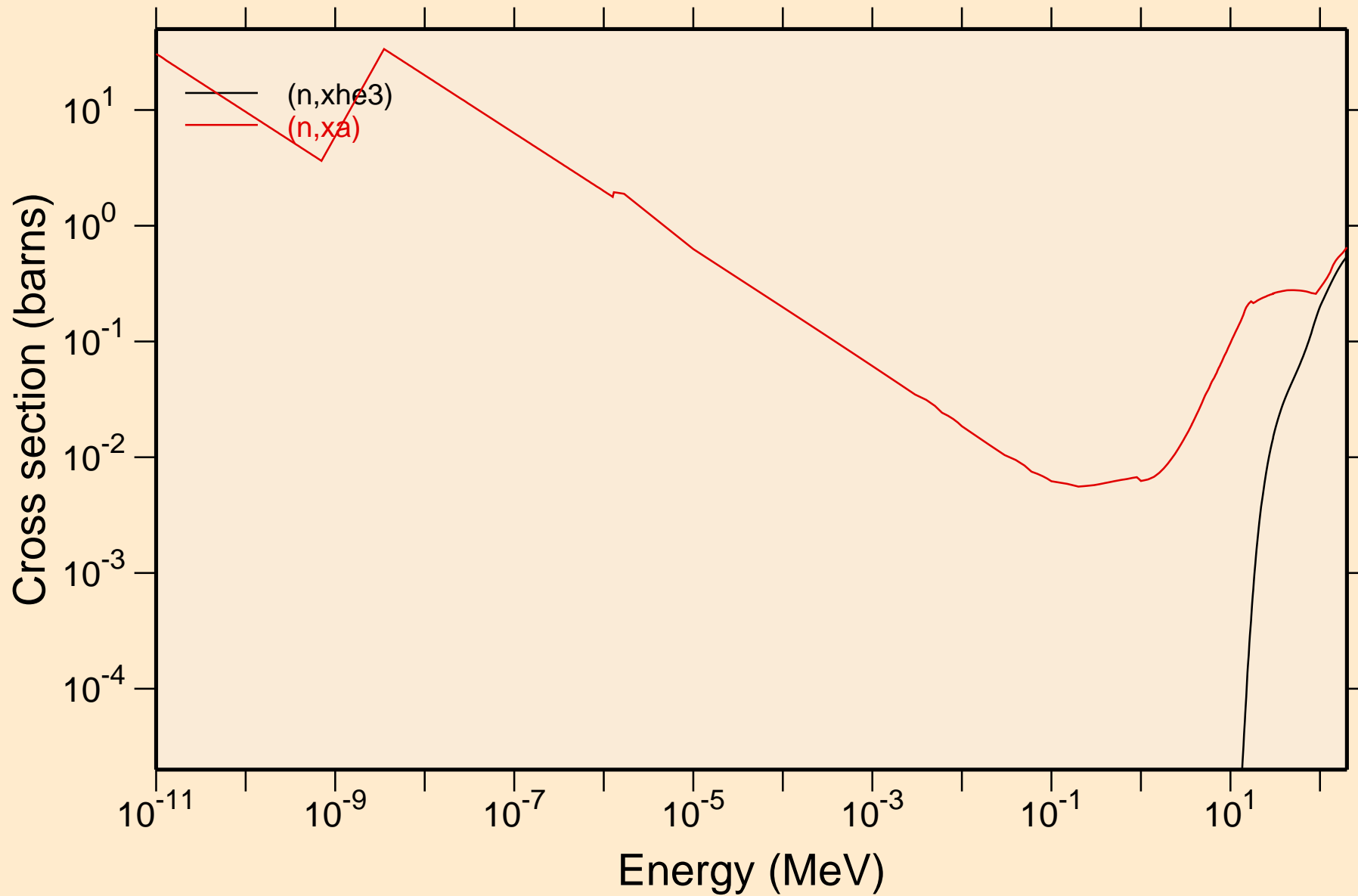

IR174 NEUTRON ACER TENDL-2024 LIBRARY; T=0.K

Principal cross sections

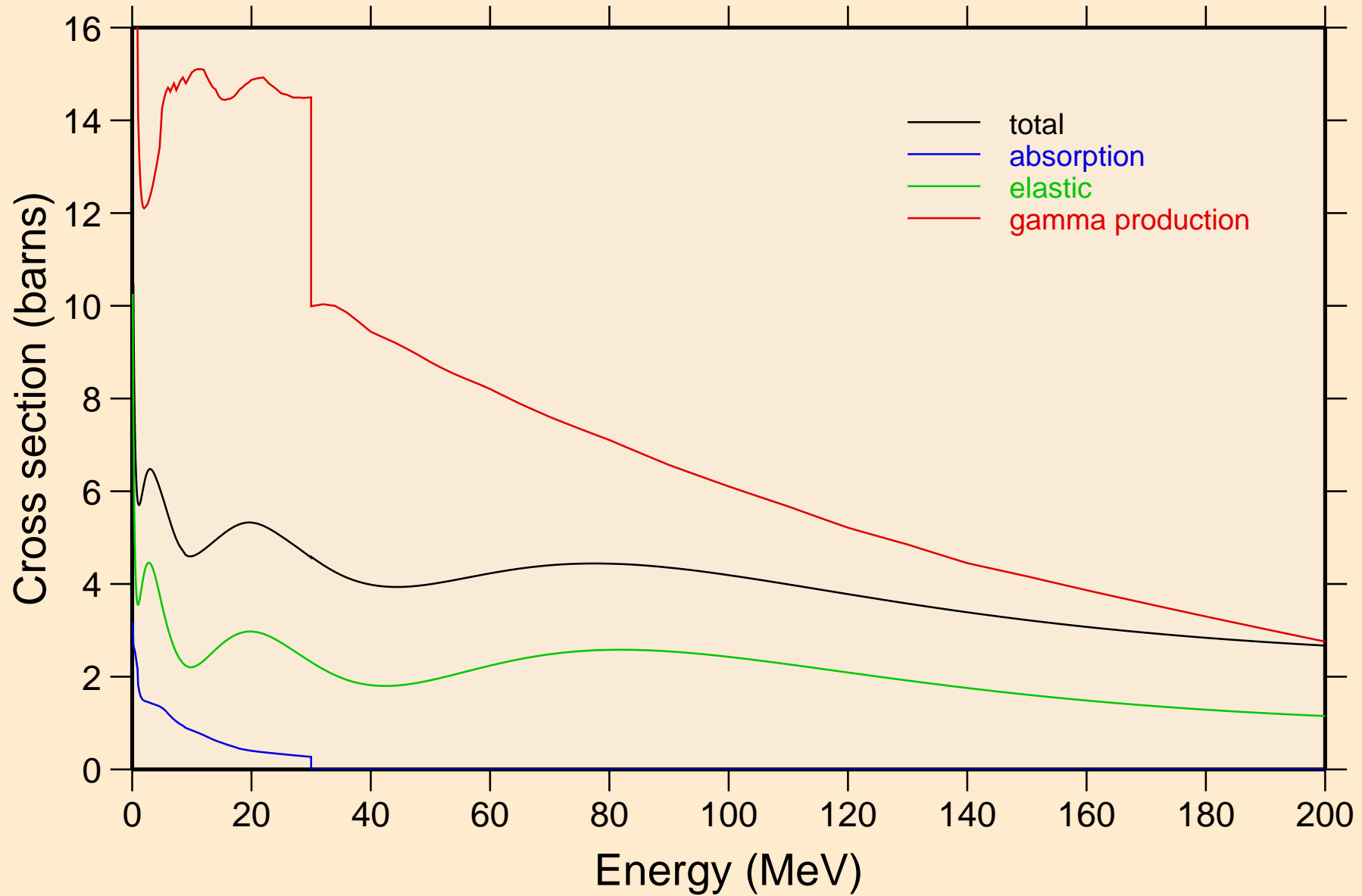

IR174 NEUTRON ACER TENDL-2024 LIBRARY; T=0.K

Heating

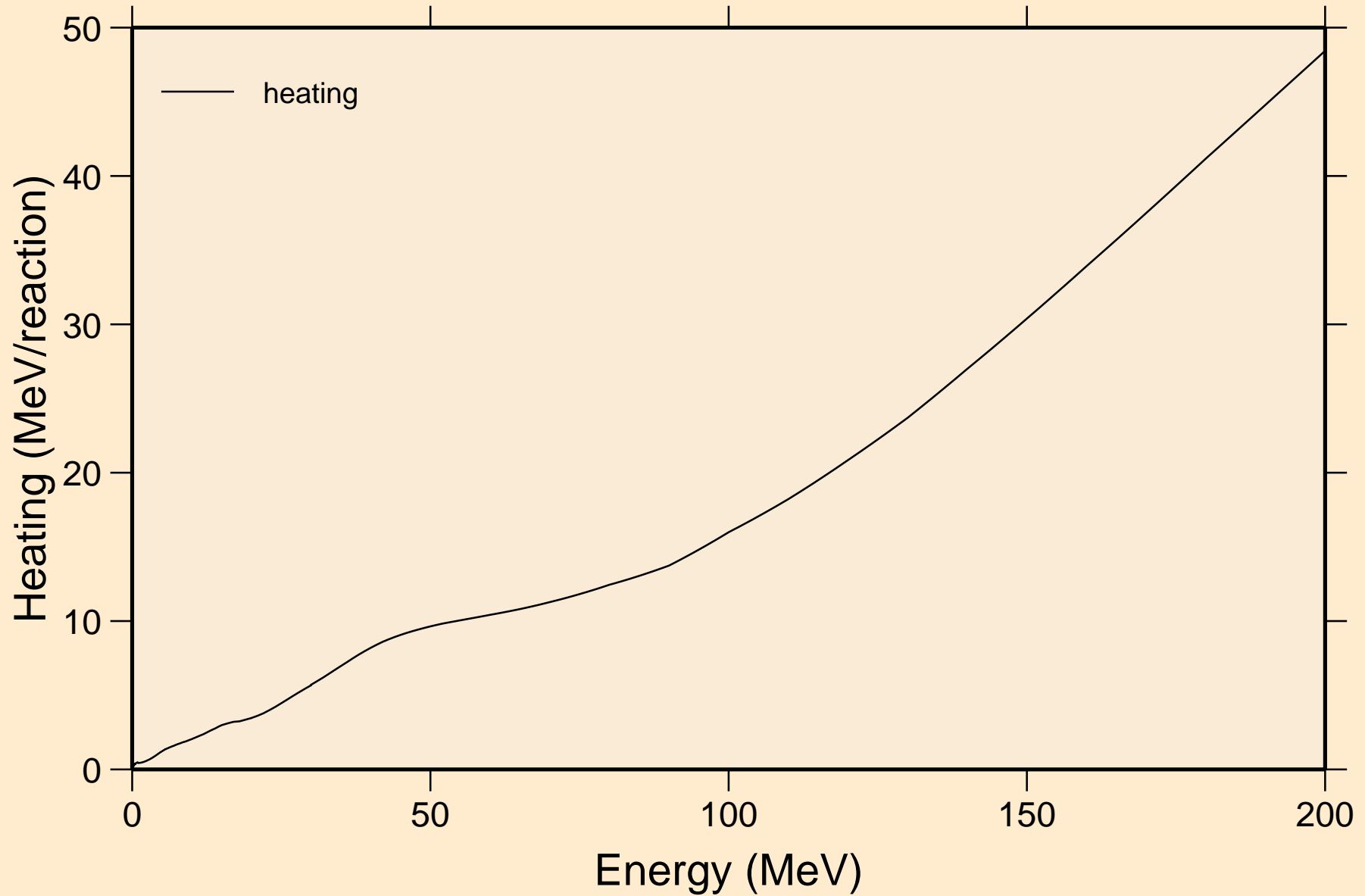

IR174 NEUTRON ACER TENDL-2024 LIBRARY; T=0.K
Damage

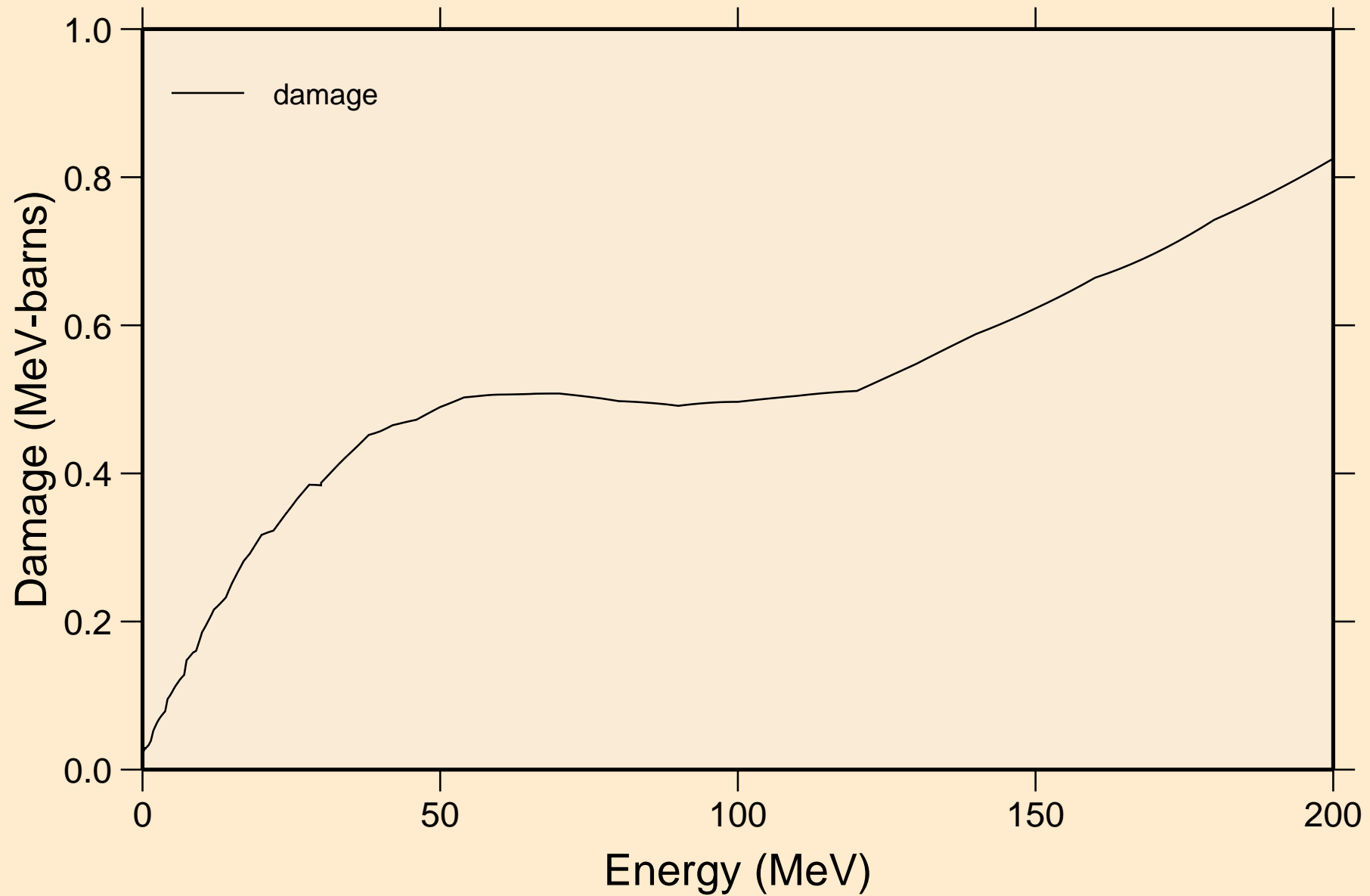

IR174 NEUTRON ACER TENDL-2024 LIBRARY; T=0.K
Non-threshold reactions

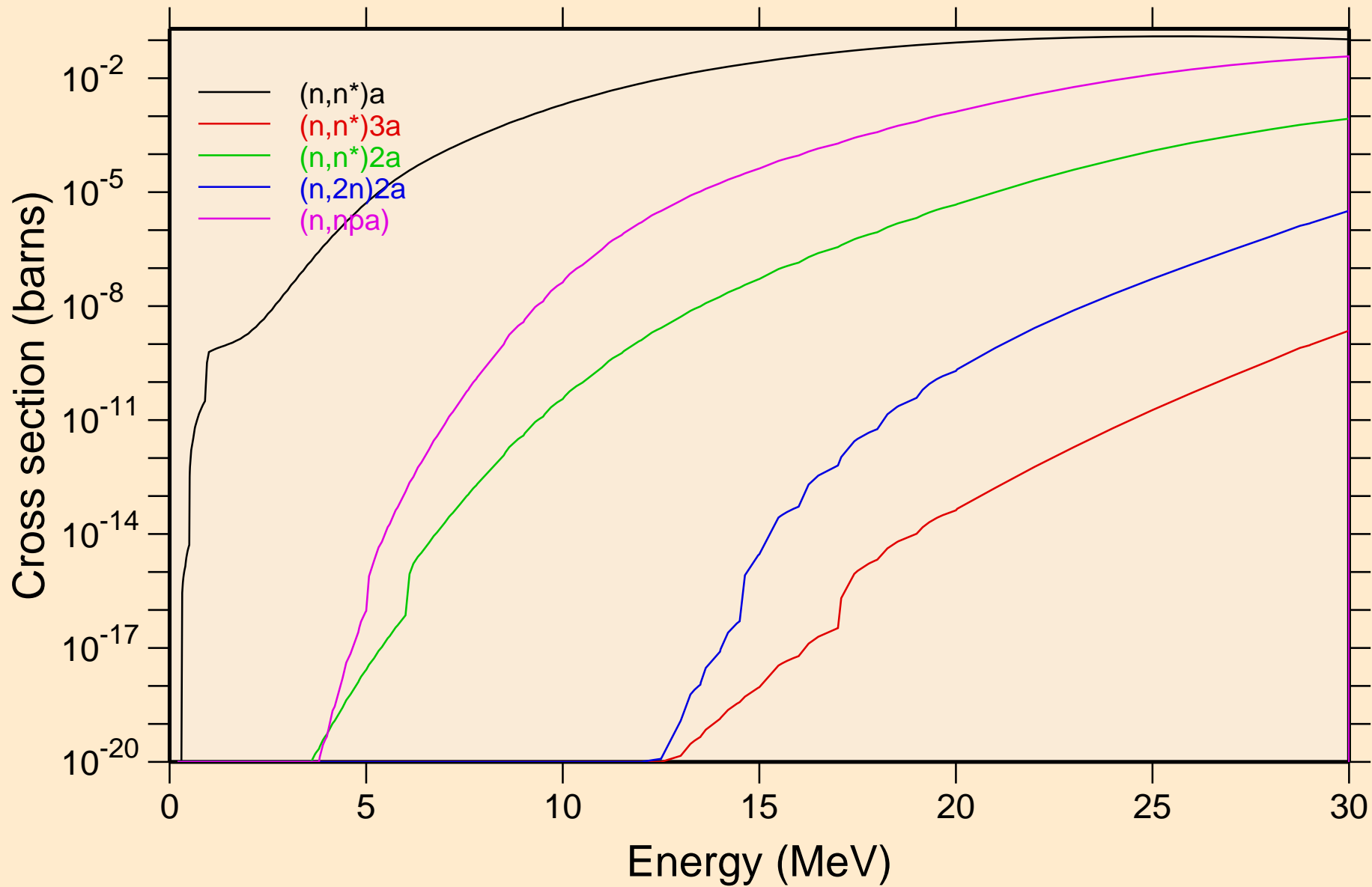

IR174 NEUTRON ACER TENDL-2024 LIBRARY; T=0.K

Non-threshold reactions

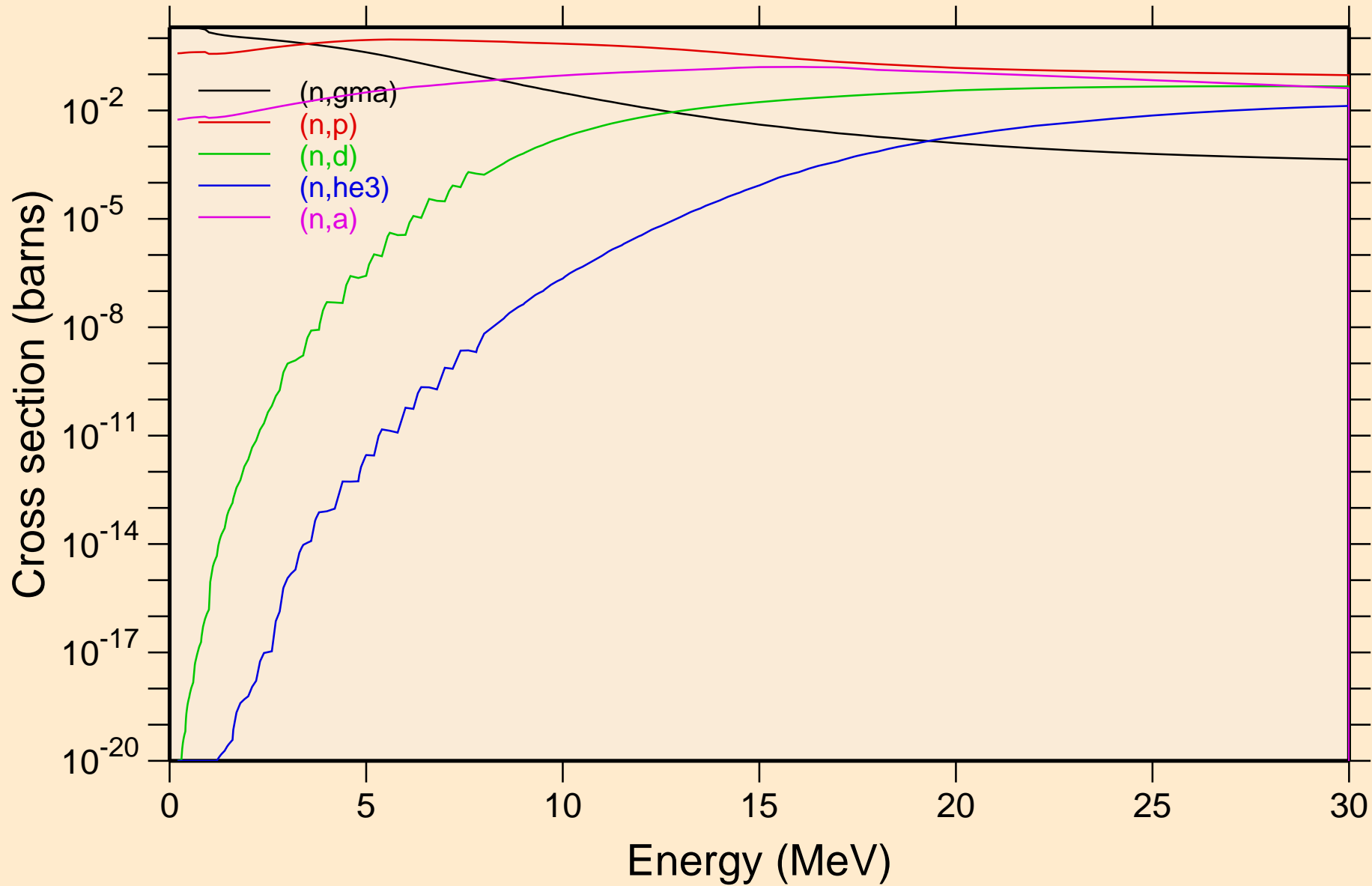

IR174 NEUTRON ACER TENDL-2024 LIBRARY; T=0.K
Non-threshold reactions

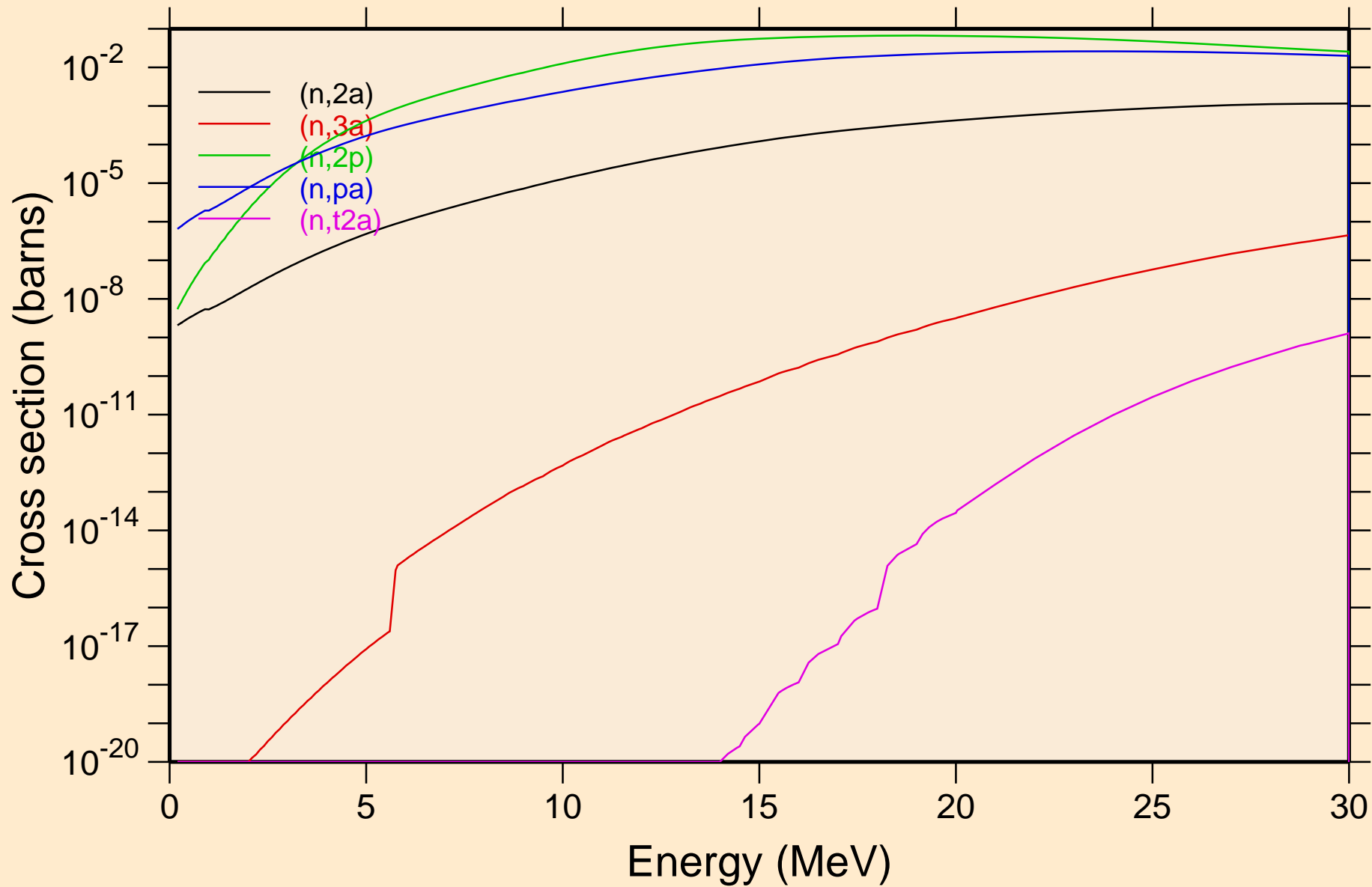

IR174 NEUTRON ACER TENDL-2024 LIBRARY; T=0.K

Non-threshold reactions

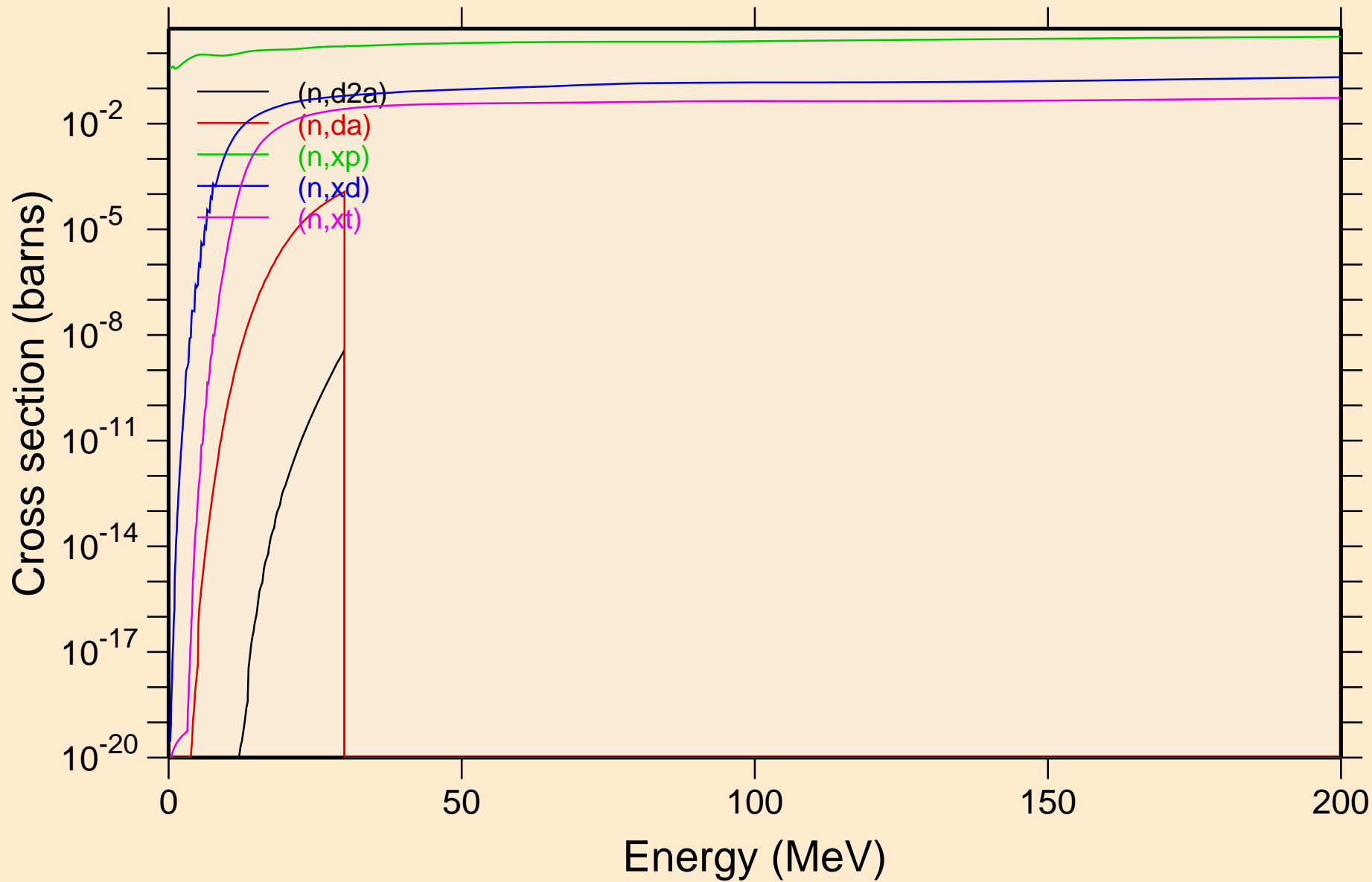

IR174 NEUTRON ACER TENDL-2024 LIBRARY; T=0.K
Non-threshold reactions

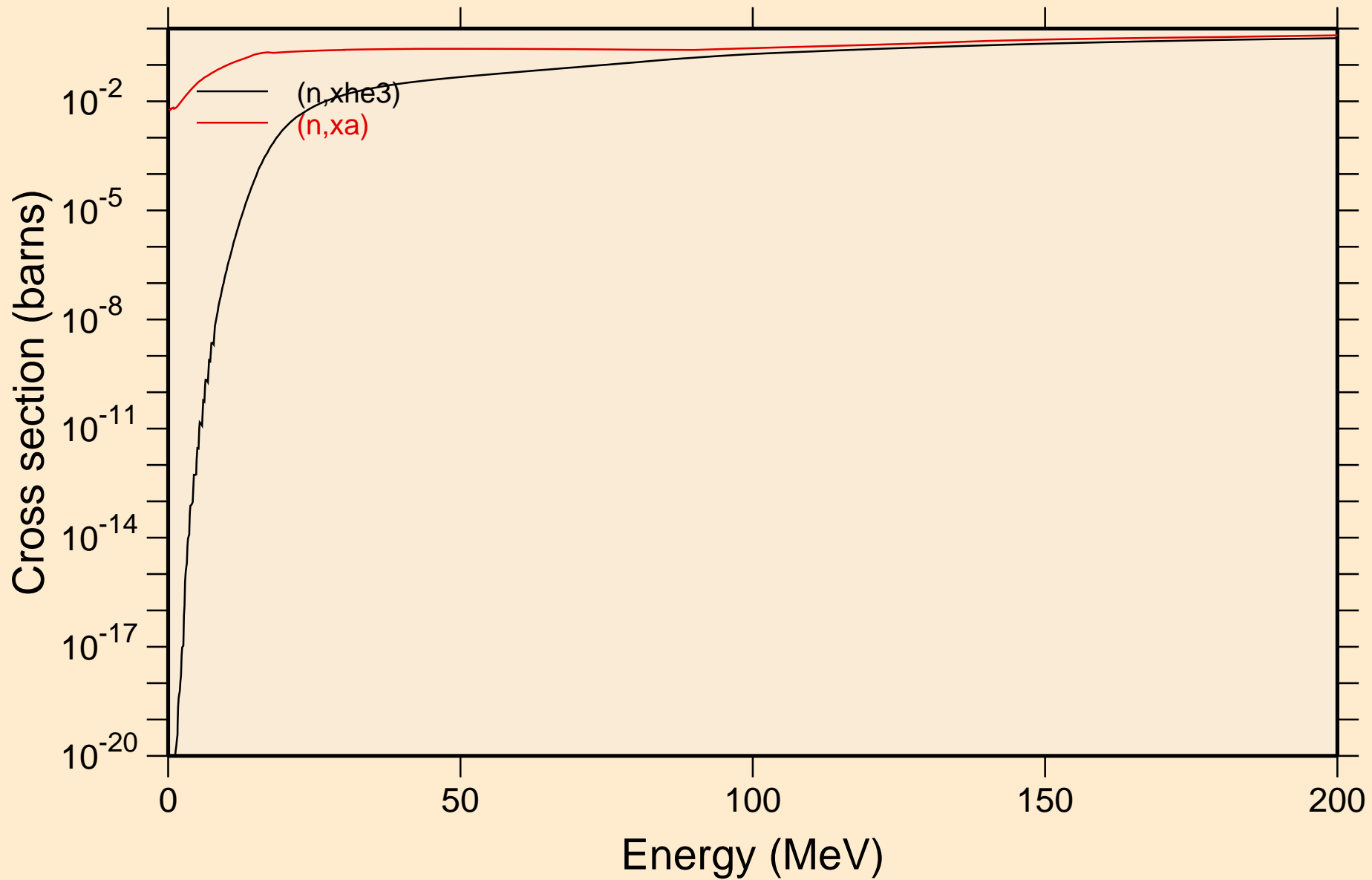

IR174 NEUTRON ACER TENDL-2024 LIBRARY; T=0.K
Inelastic levels

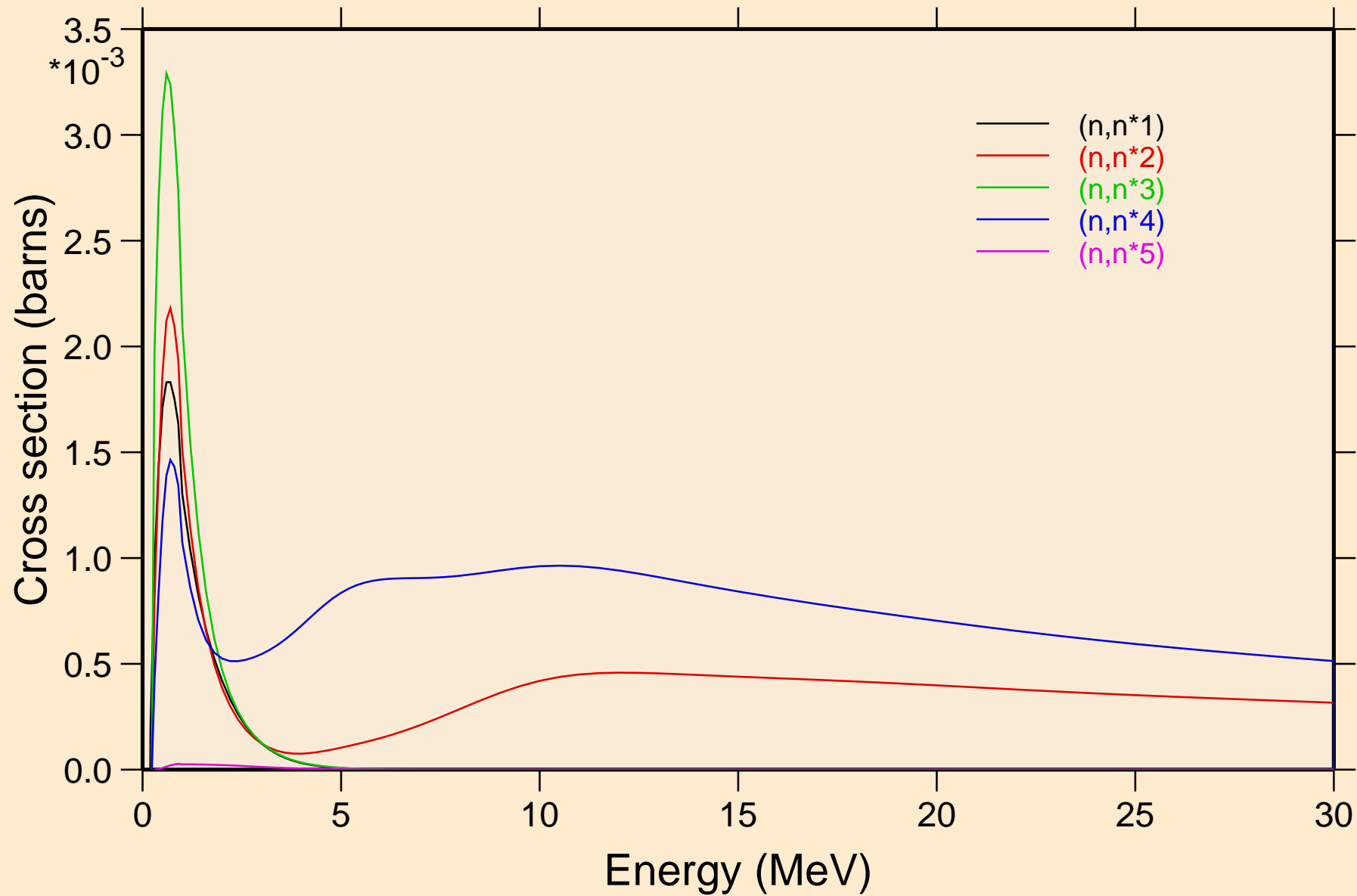

IR174 NEUTRON ACER TENDL-2024 LIBRARY; T=0.K
Inelastic levels

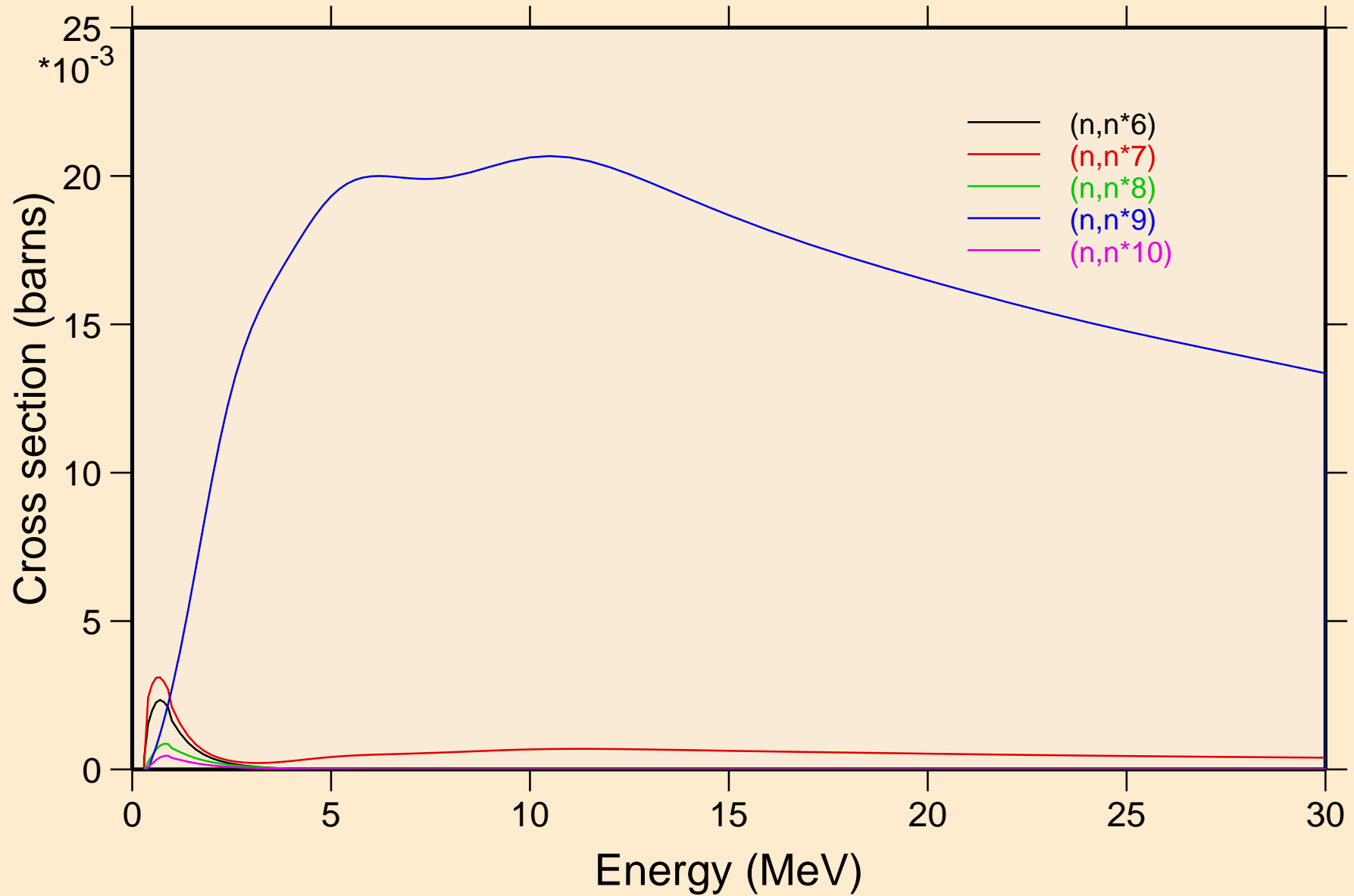

IR174 NEUTRON ACER TENDL-2024 LIBRARY; T=0.K

Inelastic levels

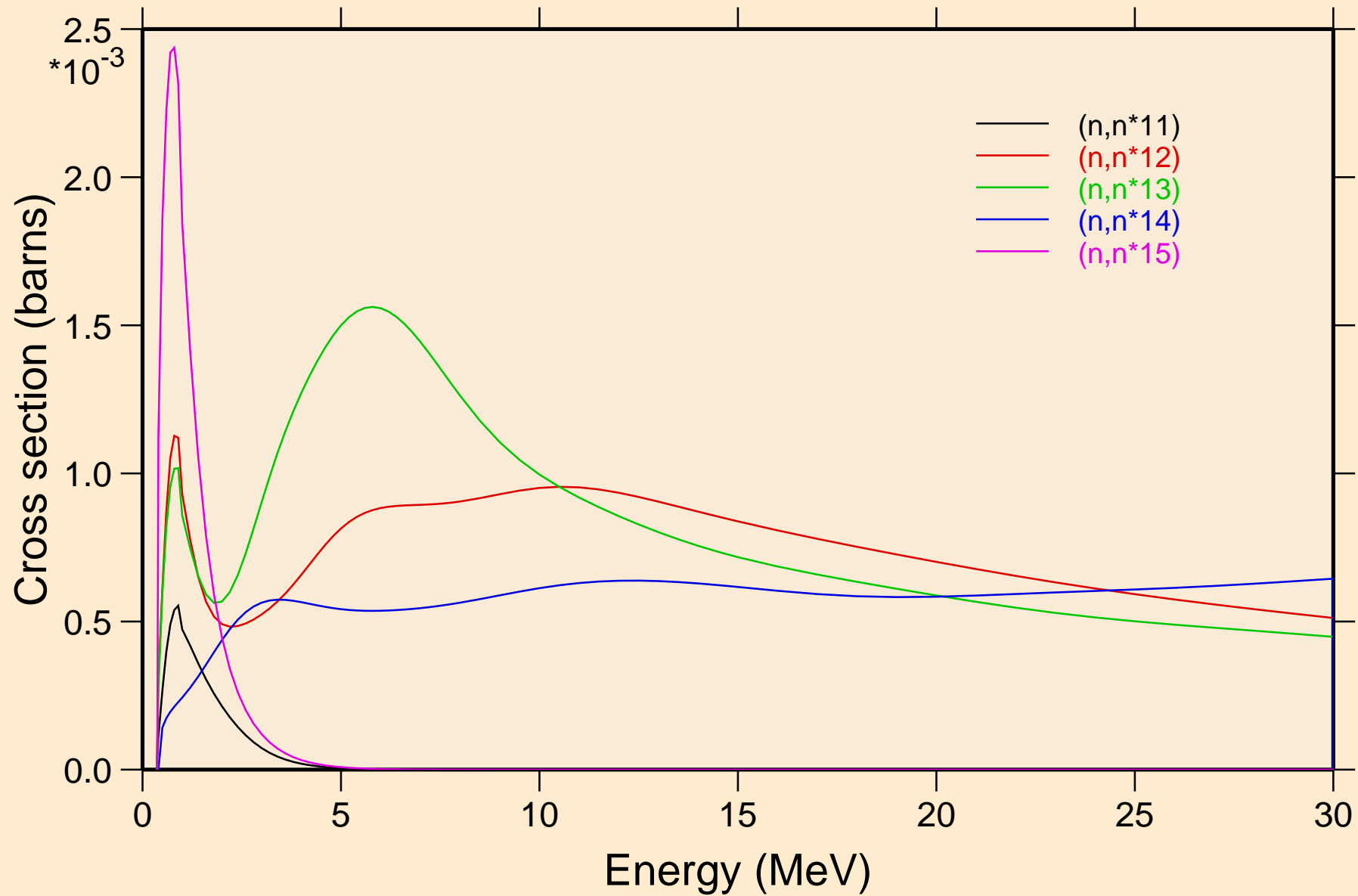

IR174 NEUTRON ACER TENDL-2024 LIBRARY; T=0.K
Inelastic levels

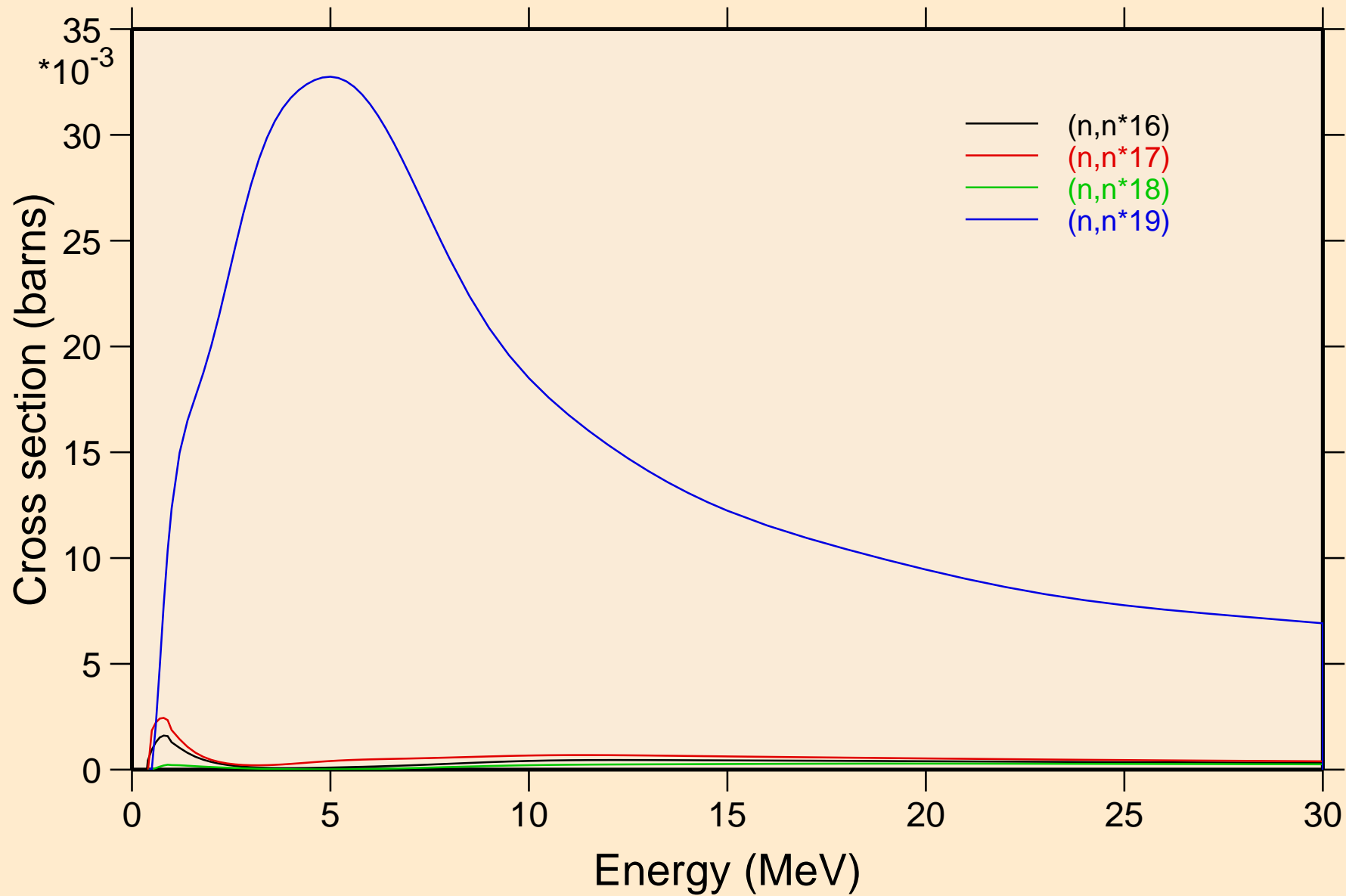

IR174 NEUTRON ACER TENDL-2024 LIBRARY; T=0.K

Threshold reactions

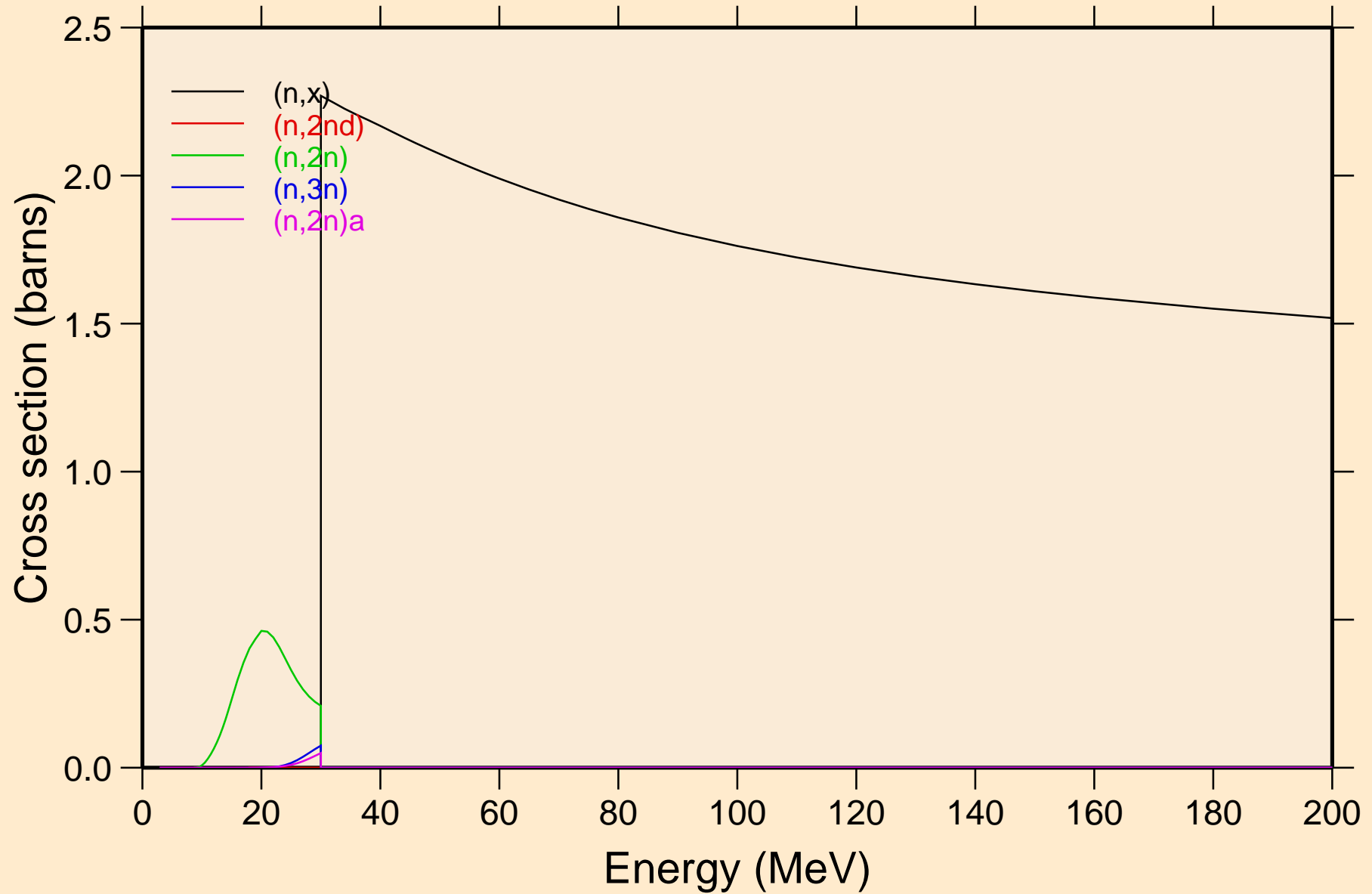

IR174 NEUTRON ACER TENDL-2024 LIBRARY; T=0.K
Threshold reactions

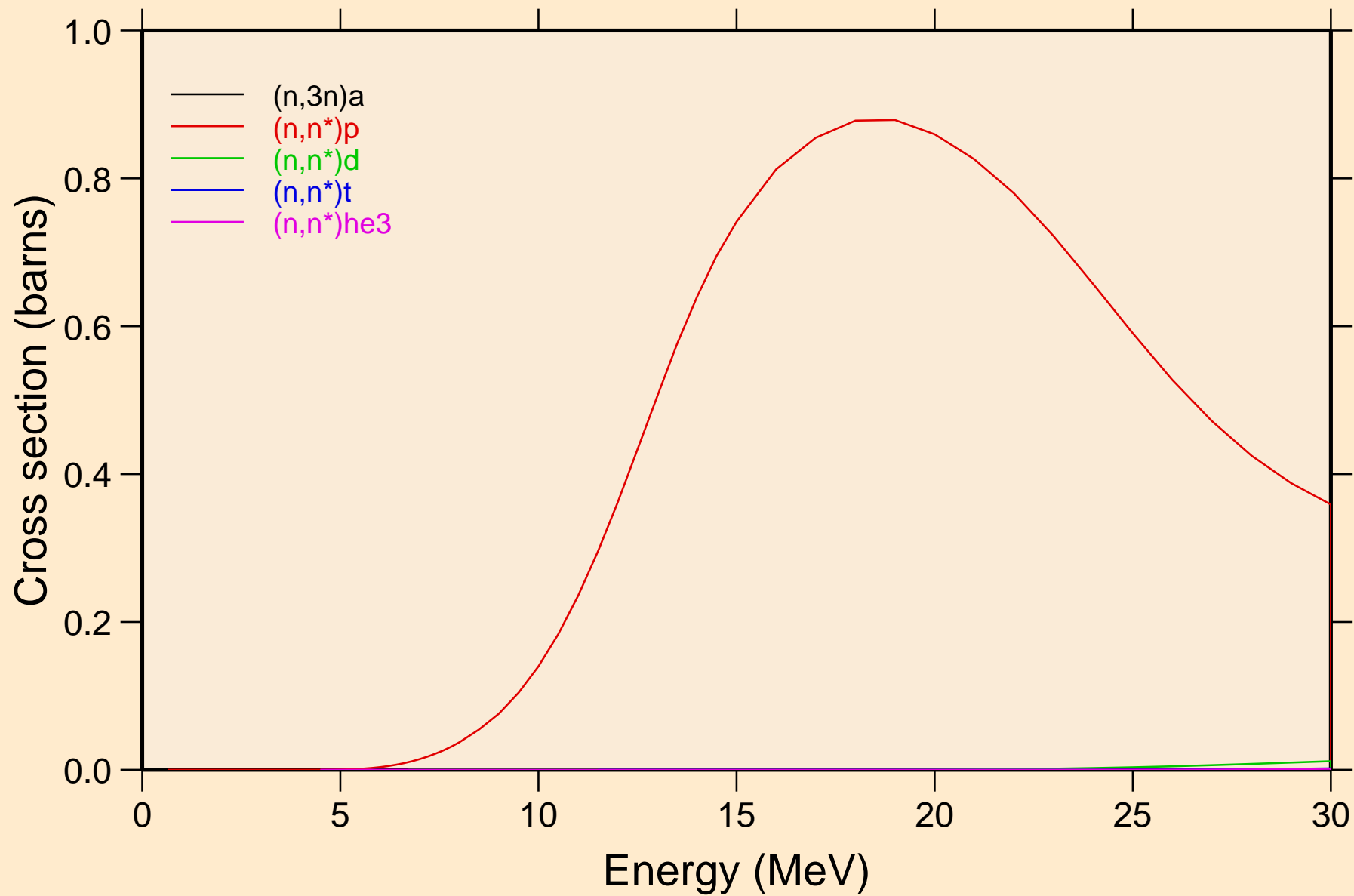

IR174 NEUTRON ACER TENDL-2024 LIBRARY; T=0.K
Threshold reactions

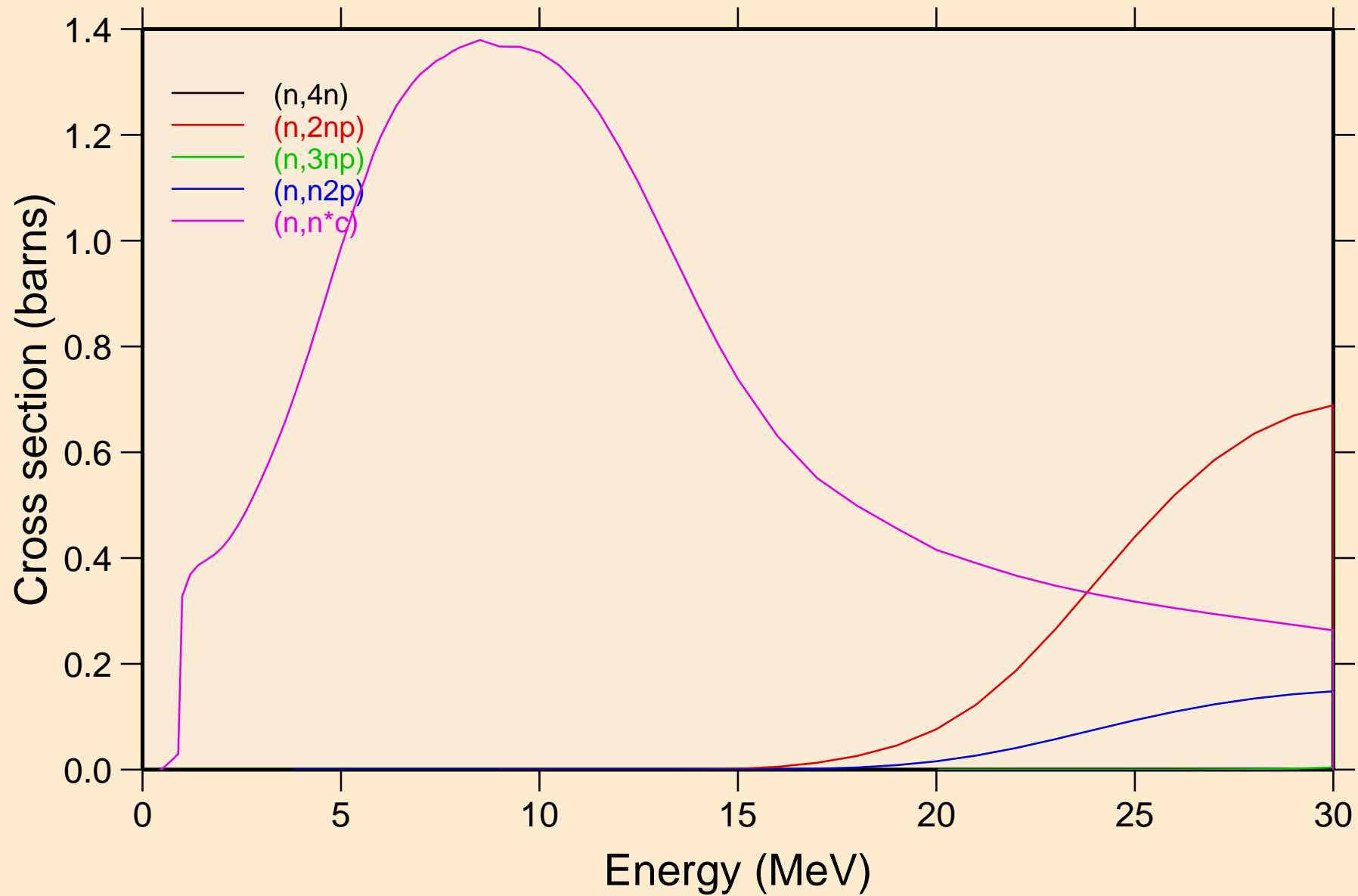

IR174 NEUTRON ACER TENDL-2024 LIBRARY; T=0.K

Threshold reactions

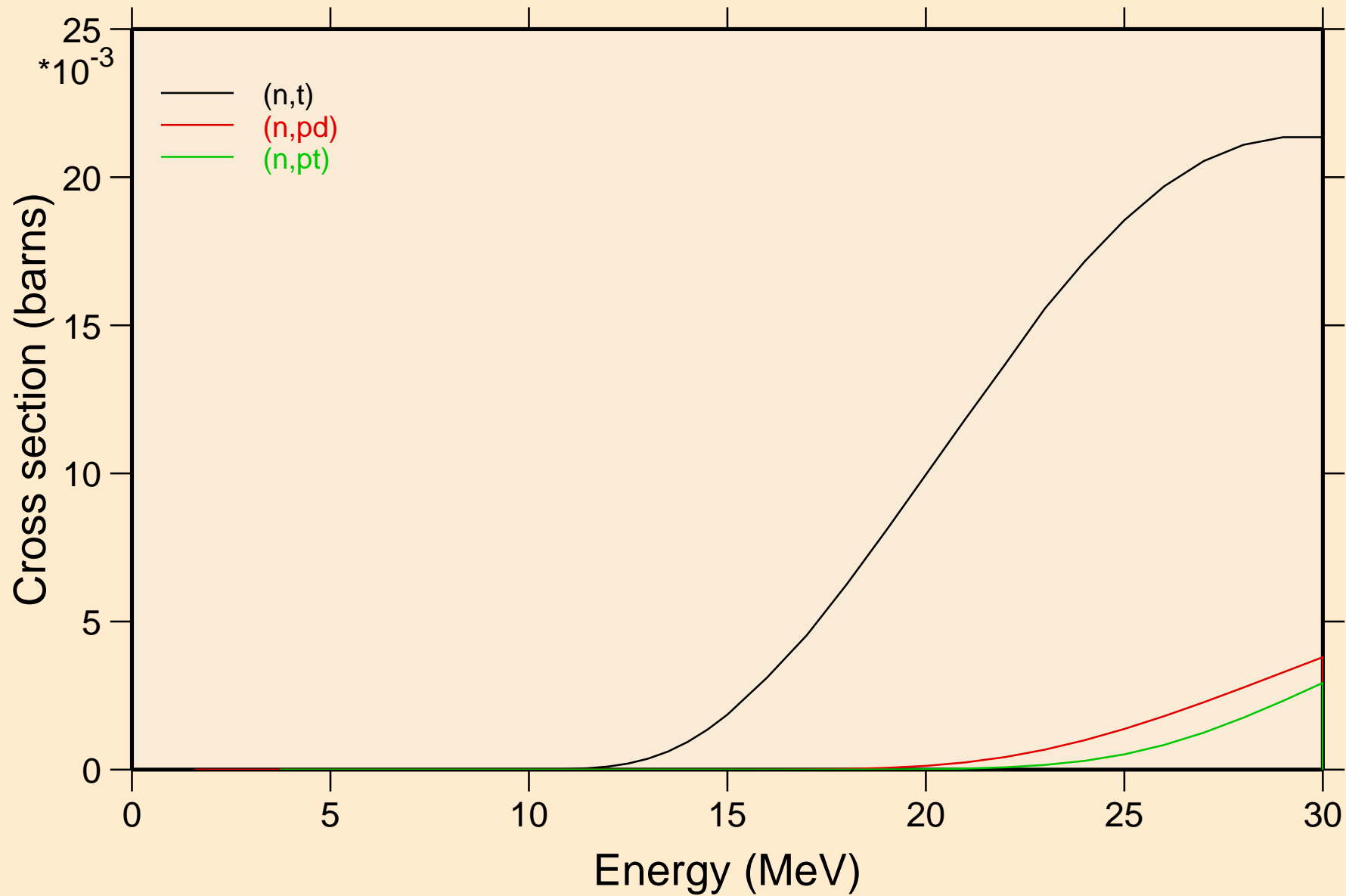

IR174 NEUTRON ACER TENDL-2024 LIBRARY; T=0.K
angular distribution for elastic

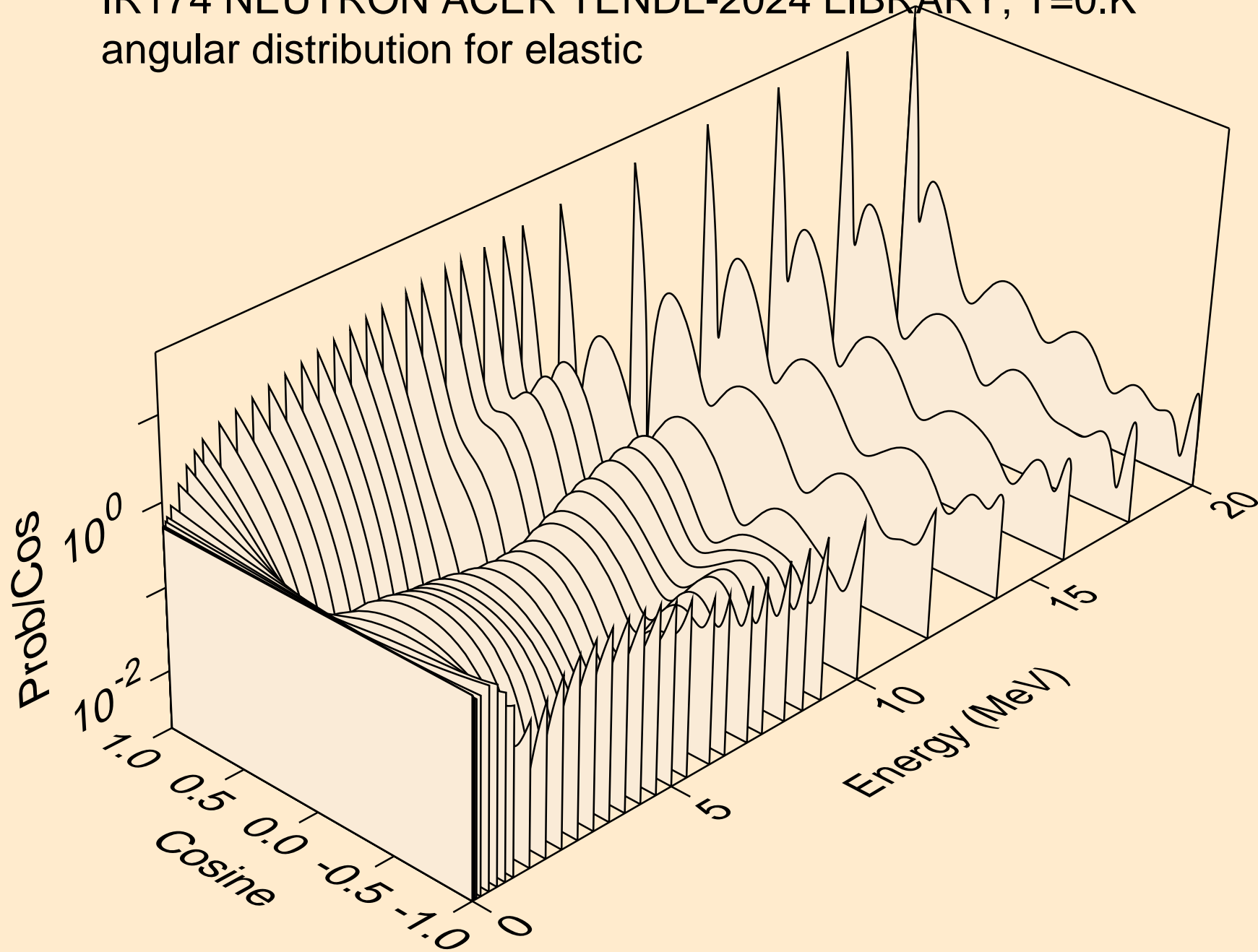

IR174 NEUTRON ACER TENDL-2024 LIBRARY; T=0.K
angular distribution for elastic

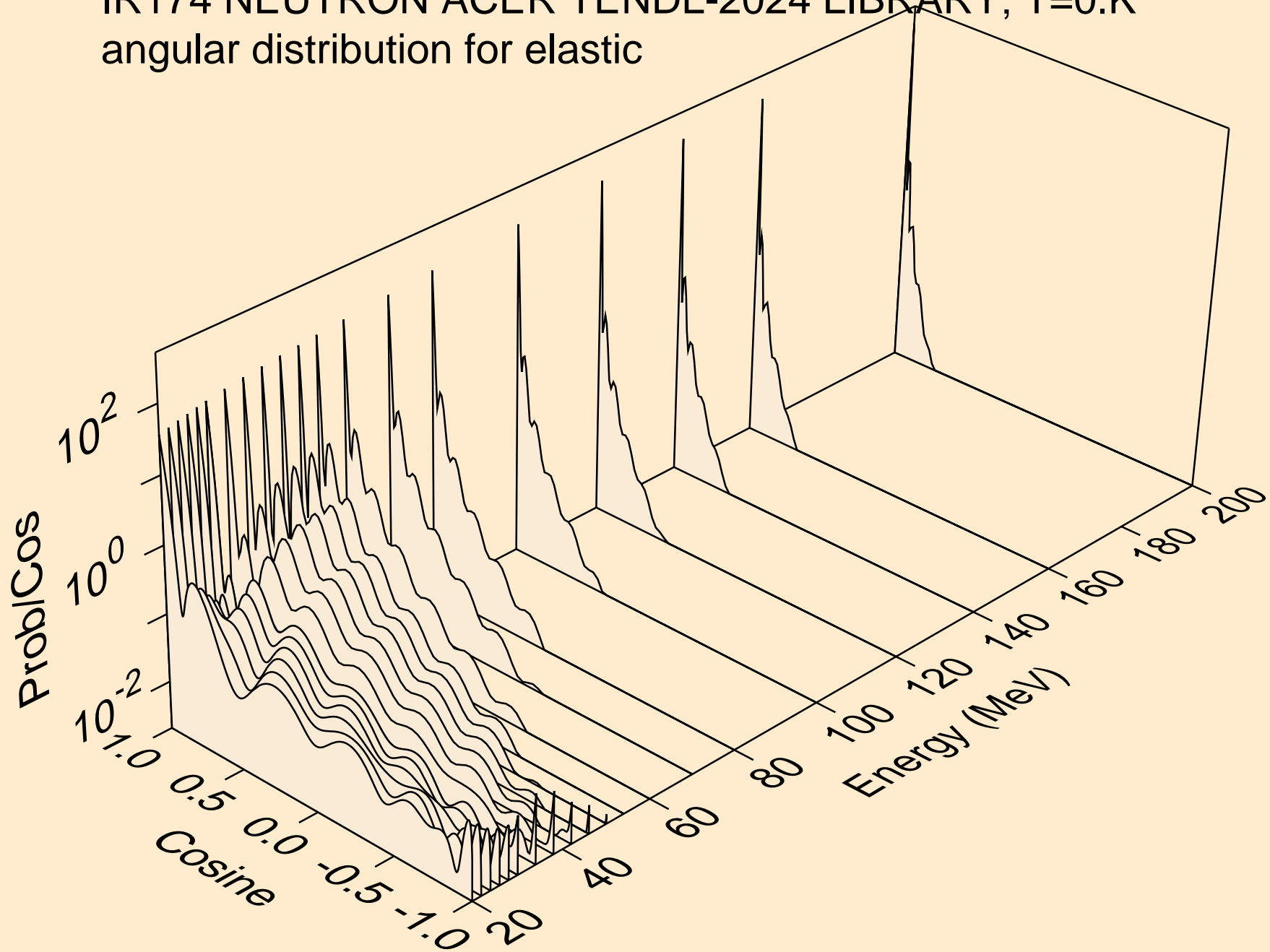

IR174 NEUTRON ACER TENDL-2024 LIBRARY; T=0.K
angular distribution for (n,n*1)

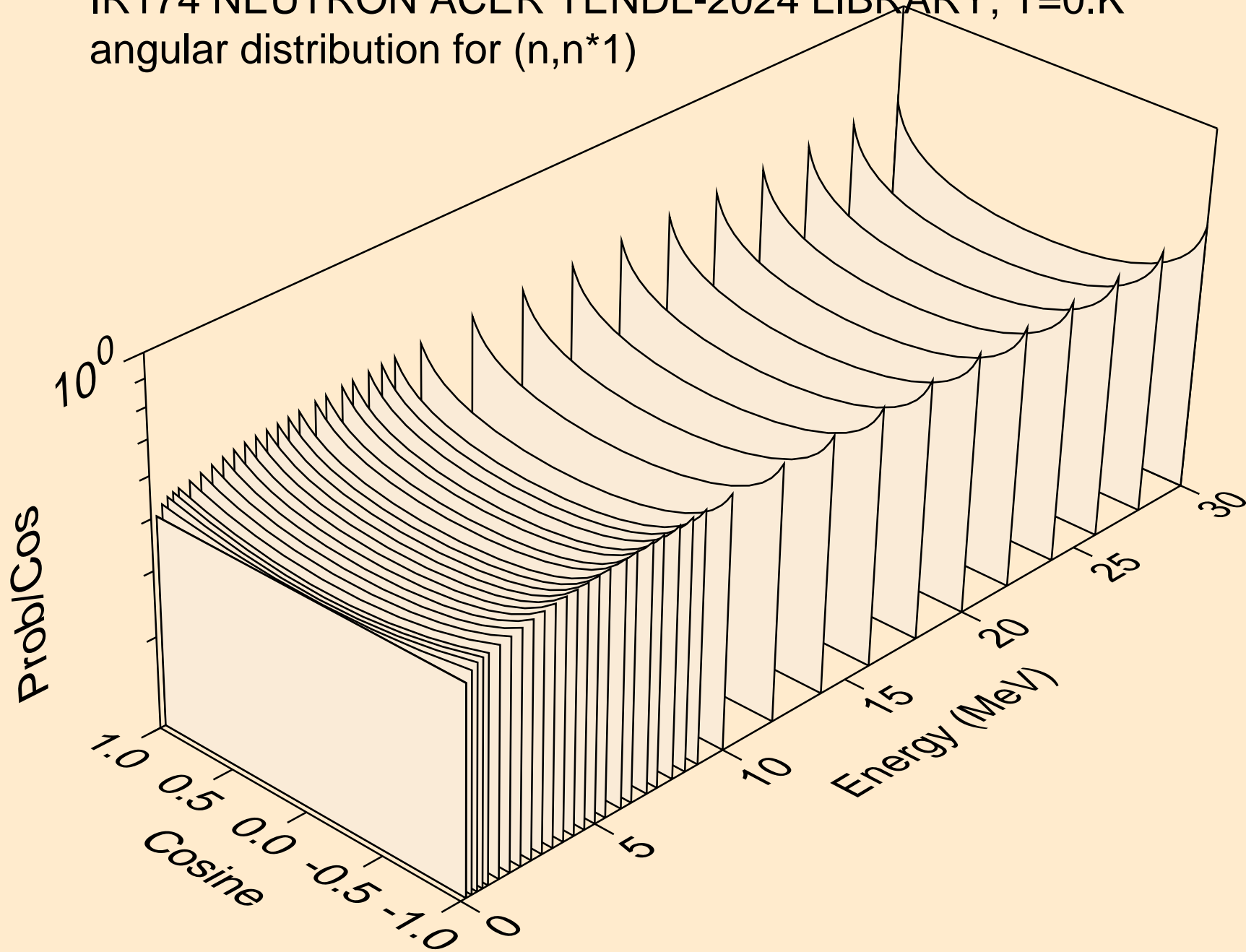

IR174 NEUTRON ACER TENDL-2024 LIBRARY; T=0.K
angular distribution for (n,n*2)

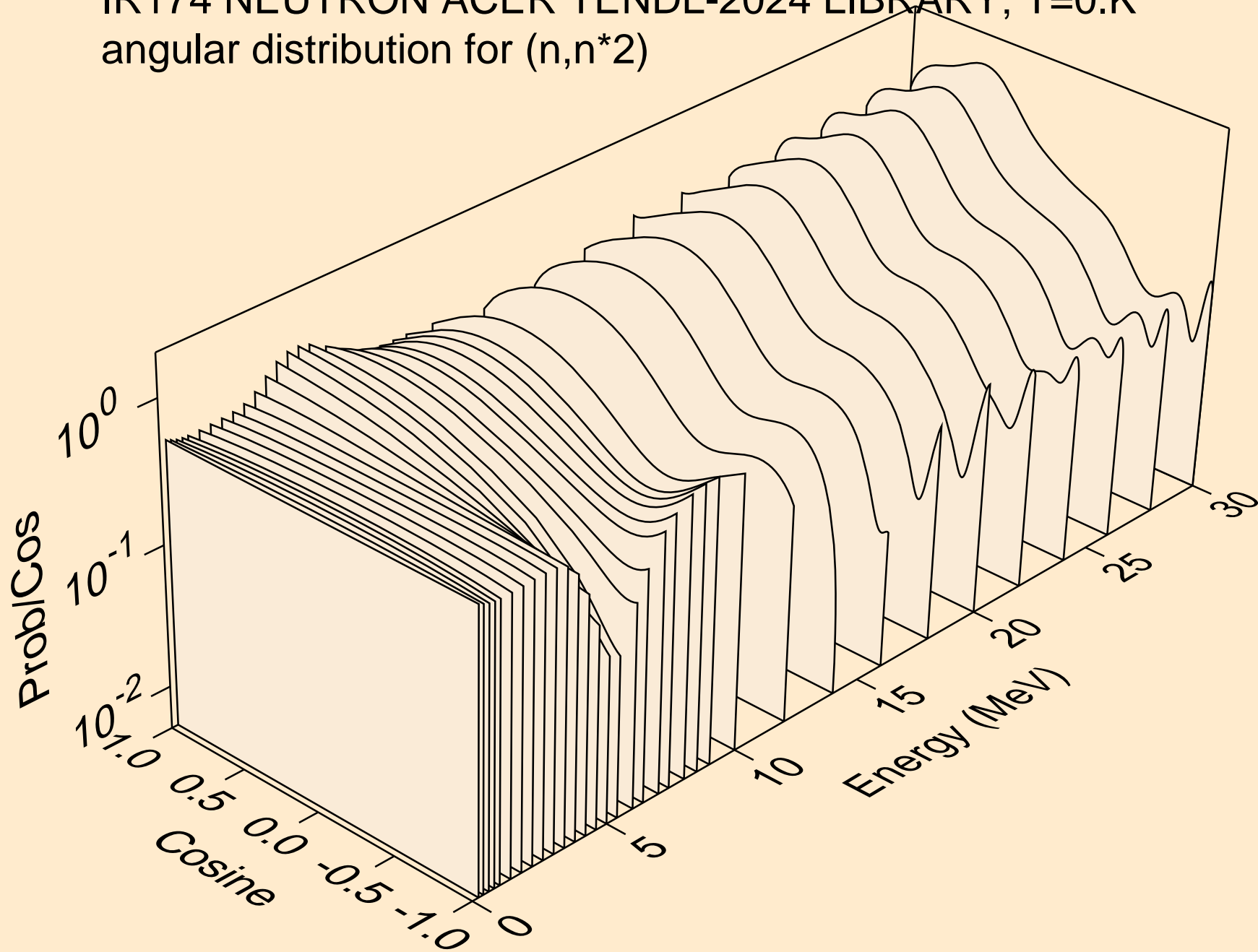

IR174 NEUTRON ACER TENDL-2024 LIBRARY; T=0.K
angular distribution for (n,n*3)

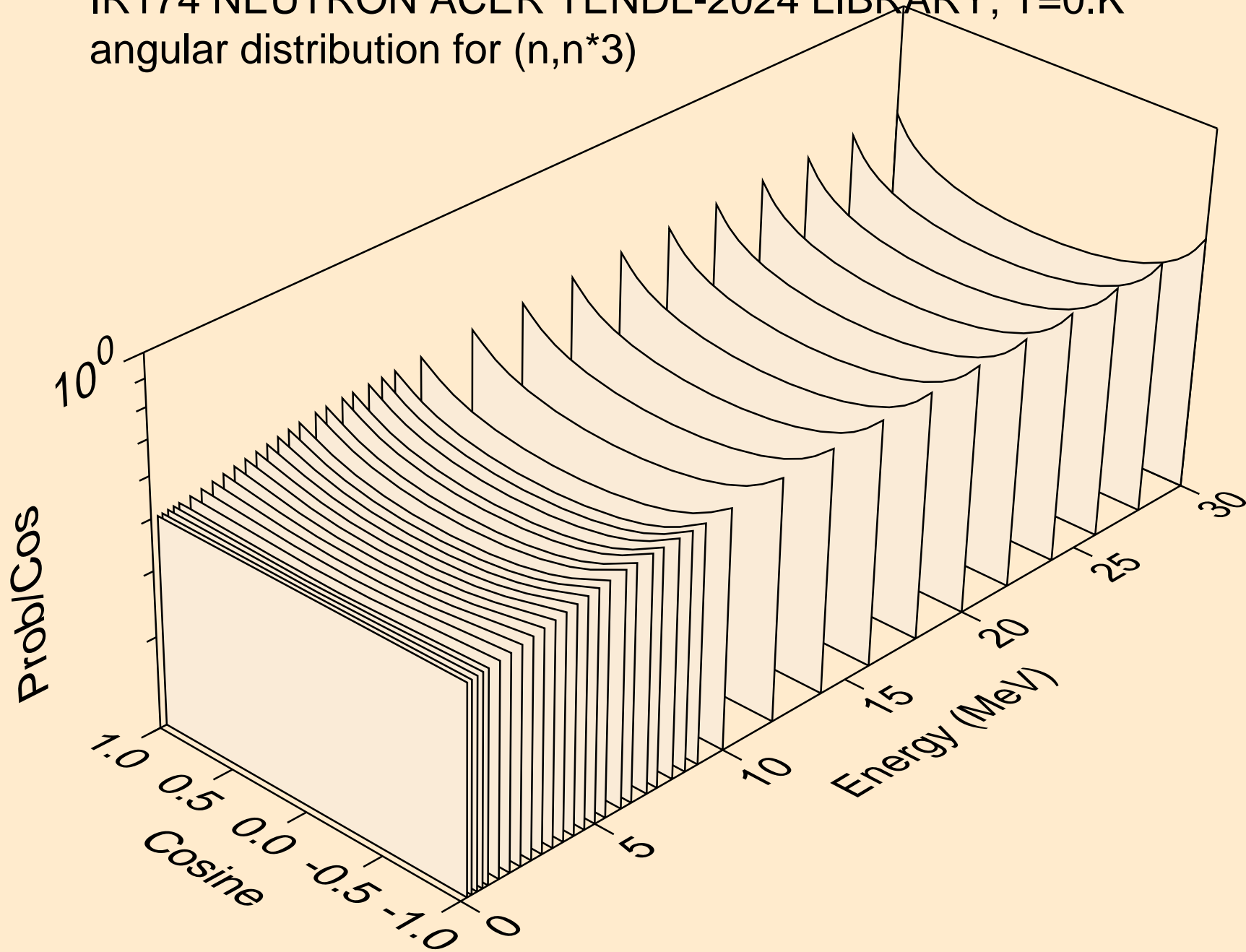

IR174 NEUTRON ACER TENDL-2024 LIBRARY; T=0.K
angular distribution for (n,n*4)

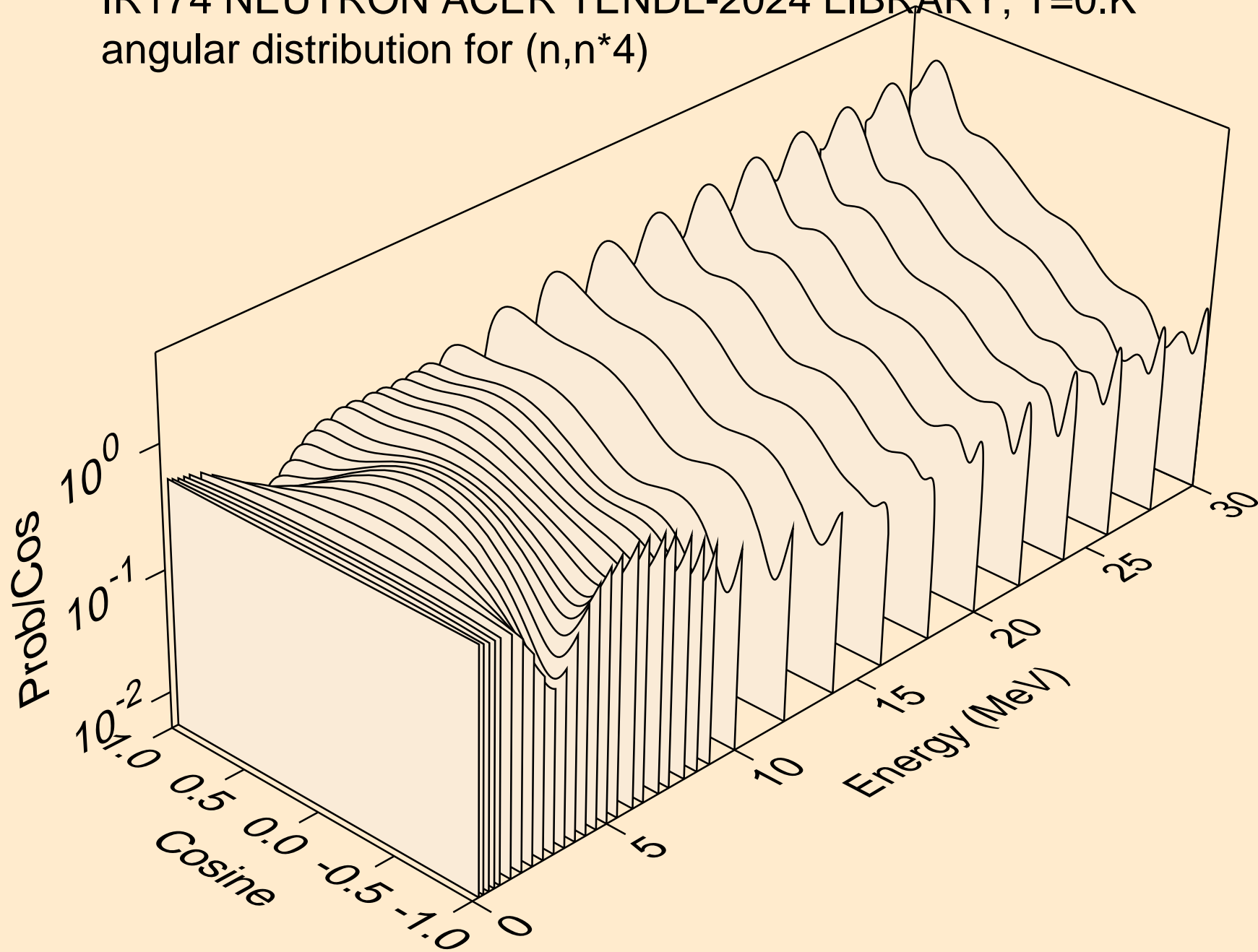

IR174 NEUTRON ACER TENDL-2024 LIBRARY; T=0.K
angular distribution for (n,n*5)

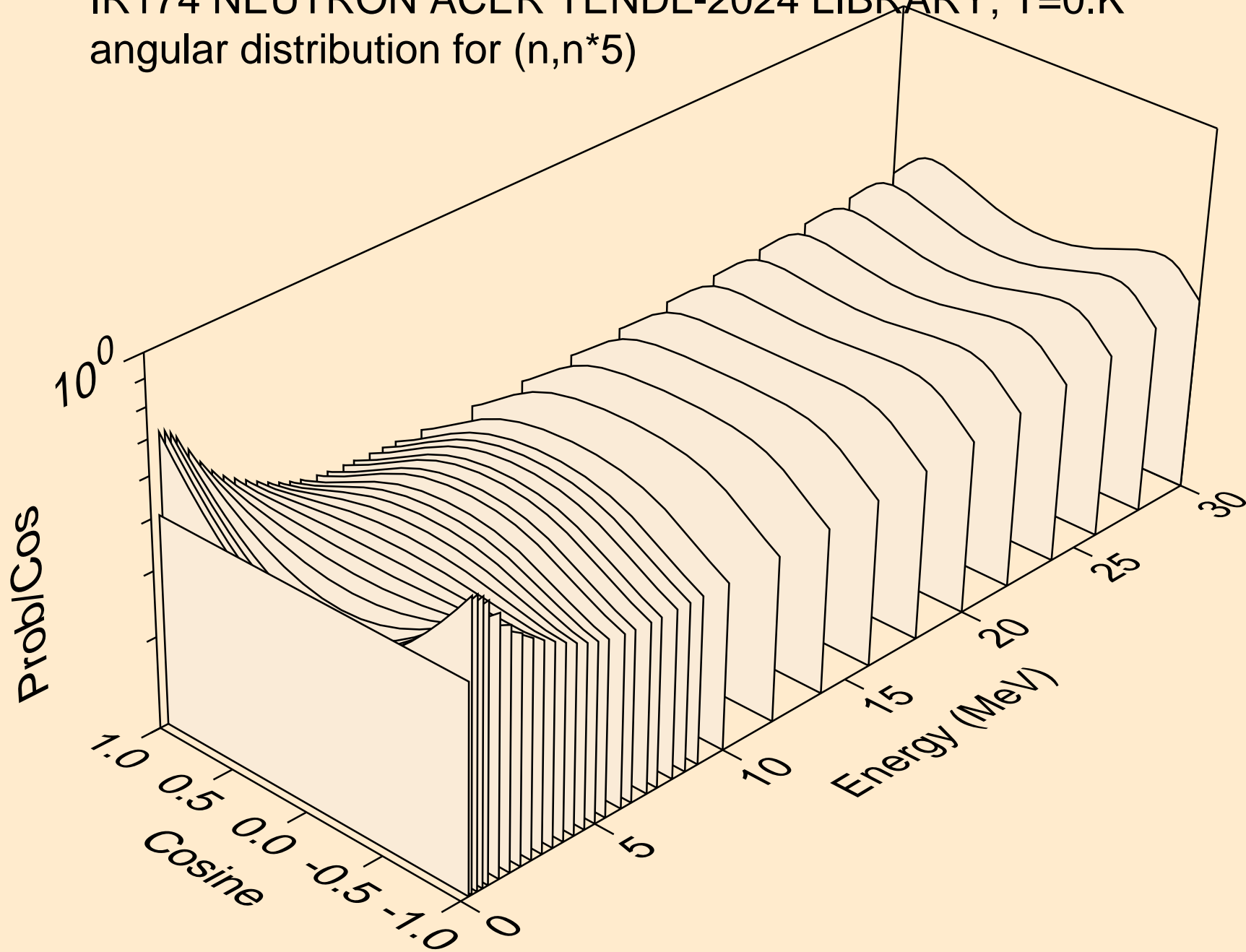

IR174 NEUTRON ACER TENDL-2024 LIBRARY; T=0.K
angular distribution for (n,n*6)

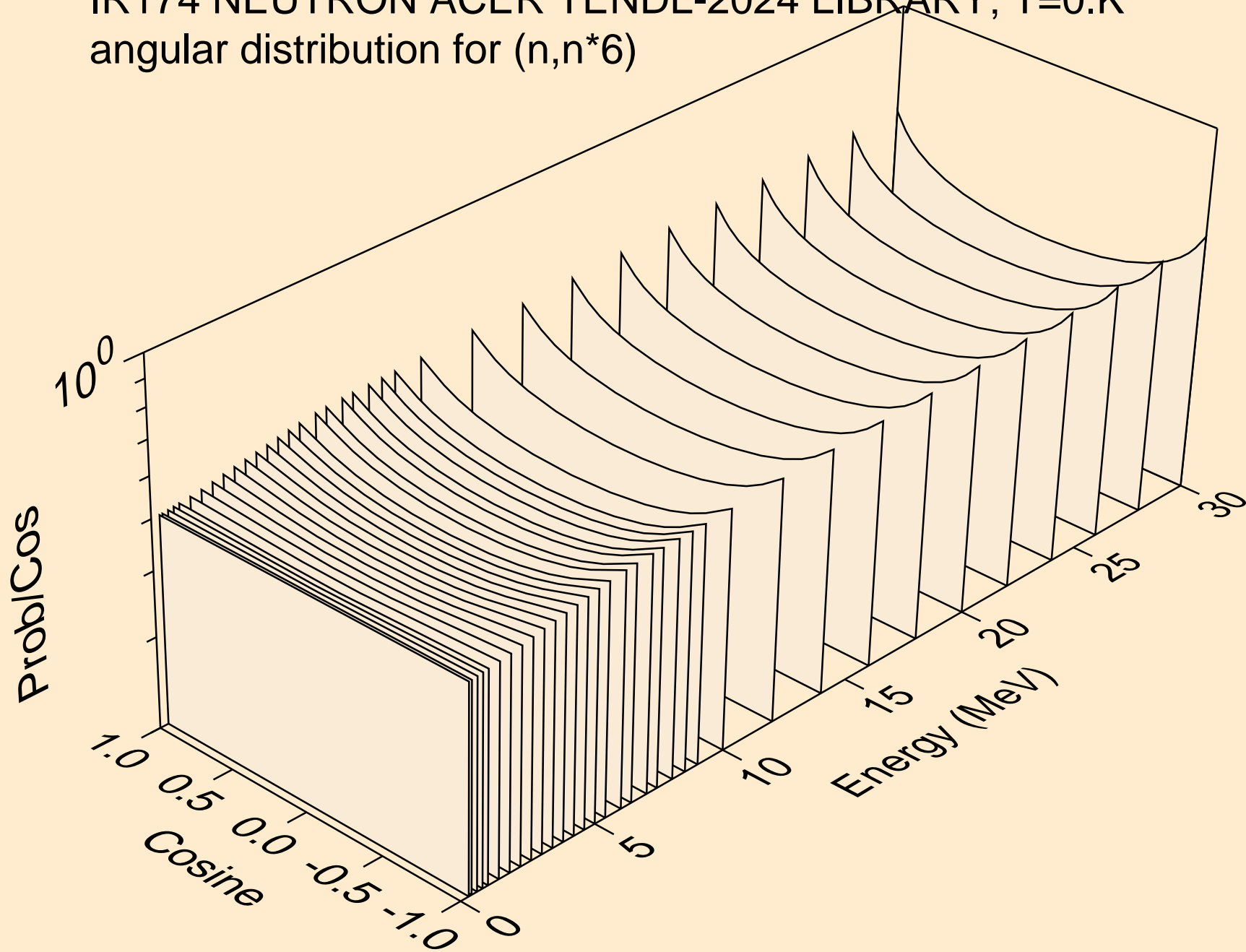

IR174 NEUTRON ACER TENDL-2024 LIBRARY; T=0.K
angular distribution for (n,n*7)

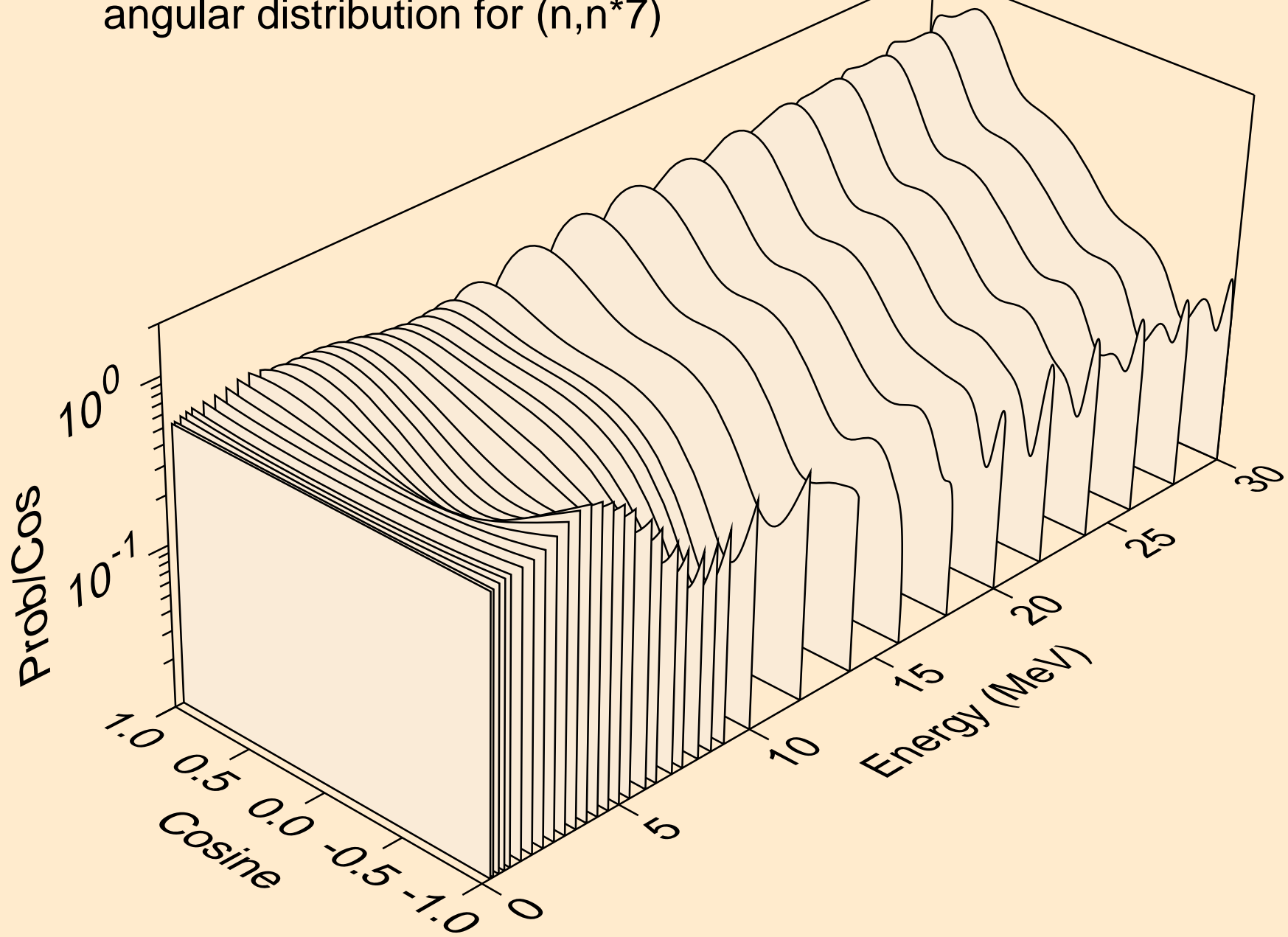

IR174 NEUTRON ACER TENDL-2024 LIBRARY; T=0.K
angular distribution for (n,n*8)

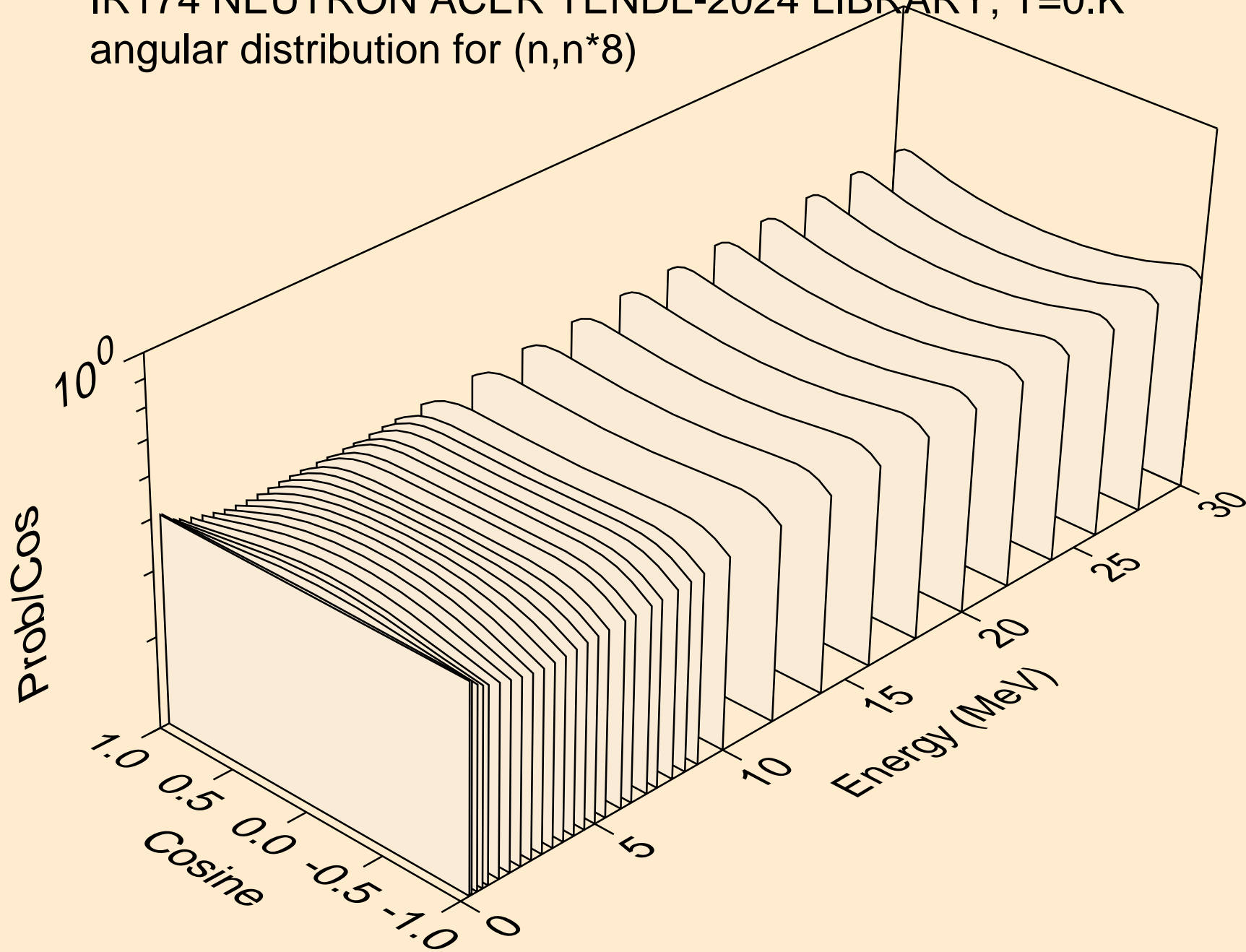

IR174 NEUTRON ACER TENDL-2024 LIBRARY; T=0.K
angular distribution for (n,n*9)

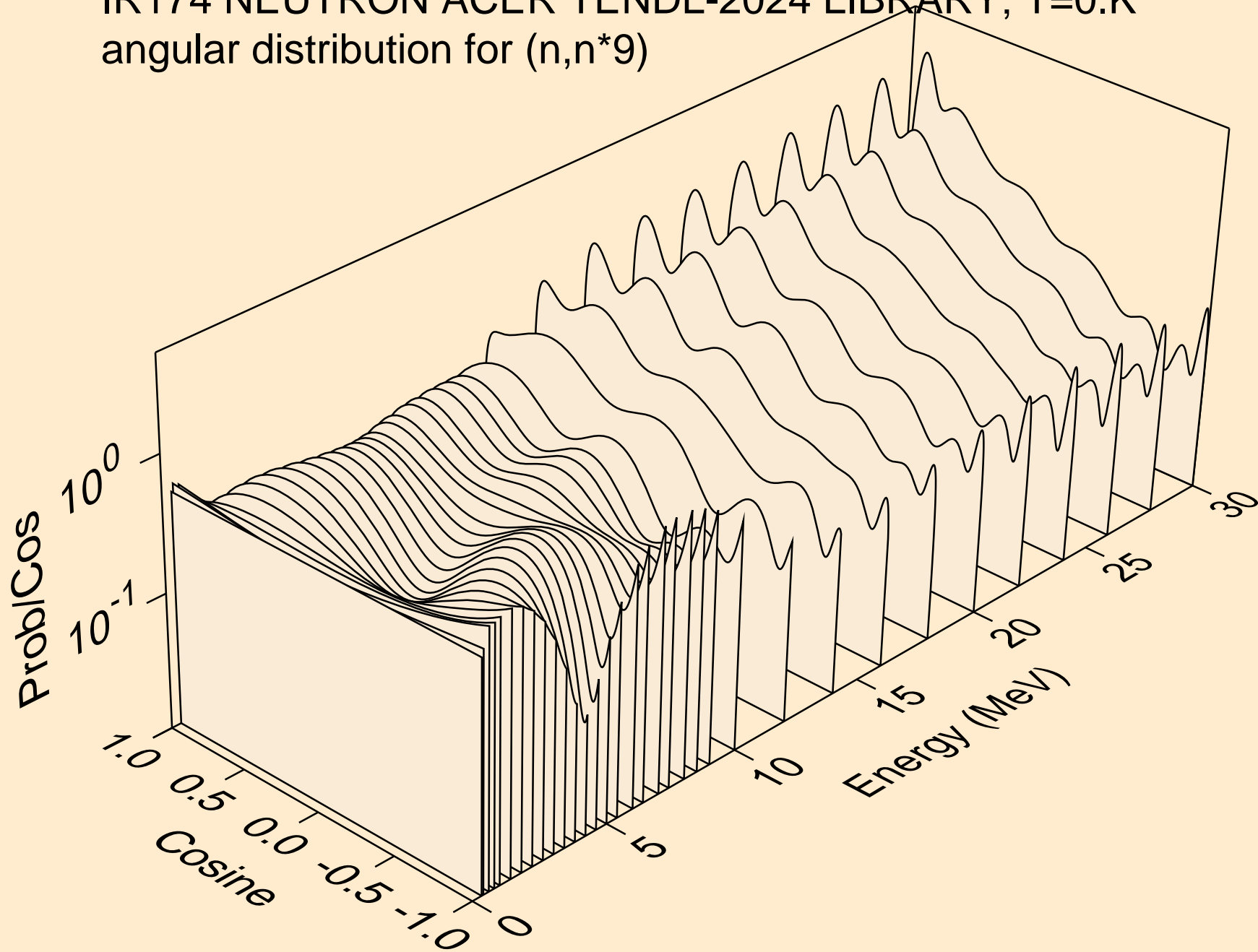

IR174 NEUTRON ACER TENDL-2024 LIBRARY; T=0.K
angular distribution for (n,n*10)

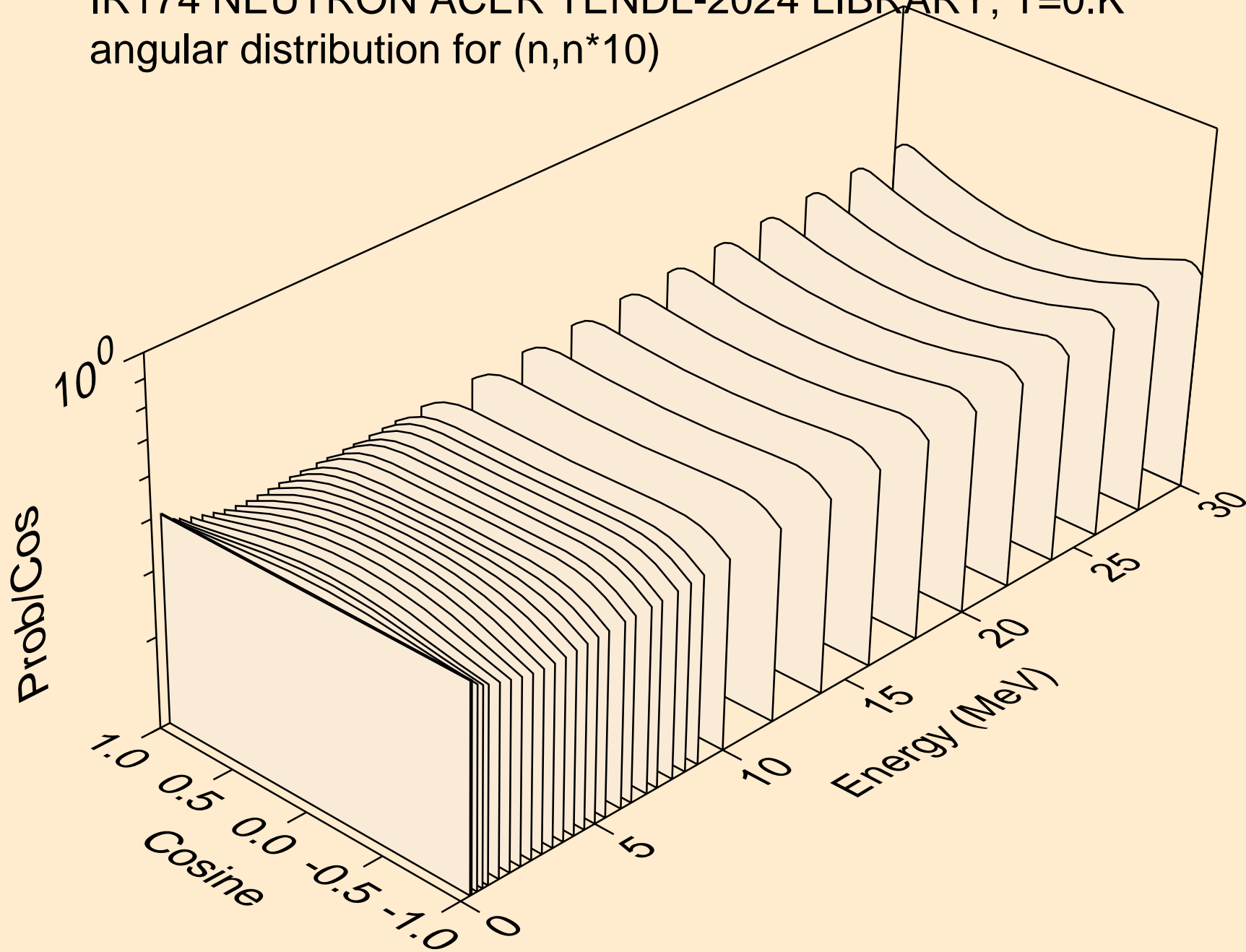

IR174 NEUTRON ACER TENDL-2024 LIBRARY; T=0.K
angular distribution for (n,n*11)

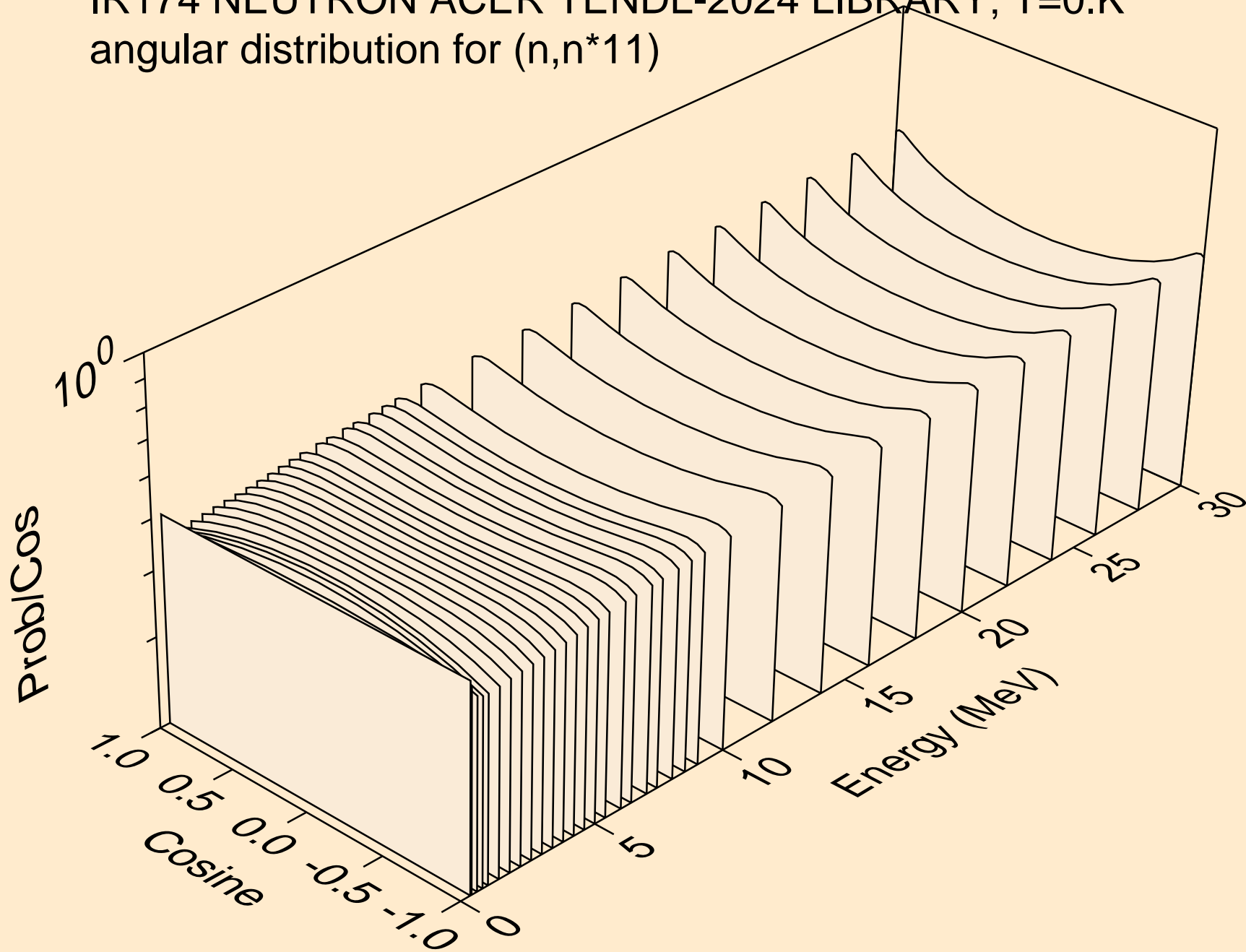

IR174 NEUTRON ACER TENDL-2024 LIBRARY; T=0.K
angular distribution for (n,n*12)

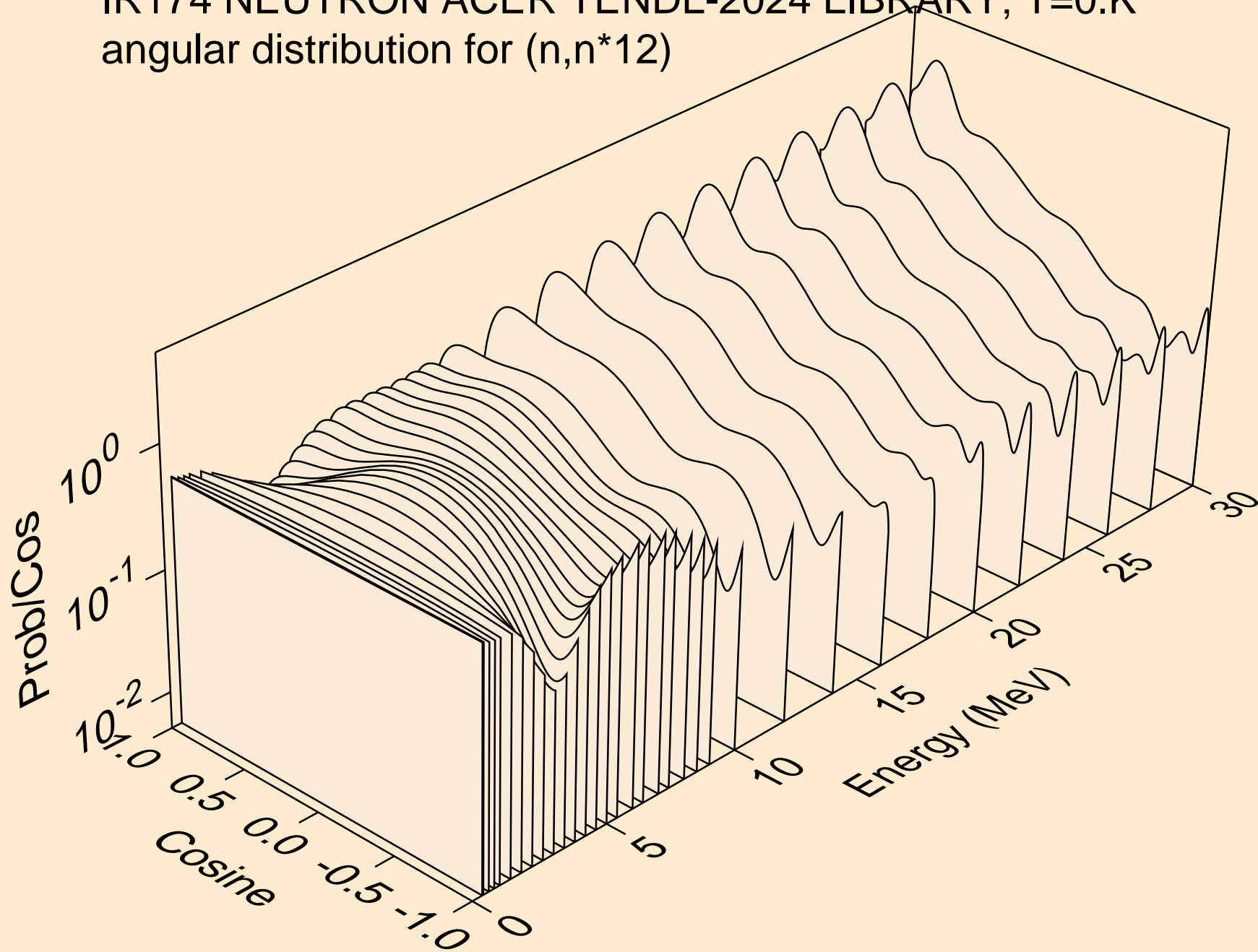

IR174 NEUTRON ACER TENDL-2024 LIBRARY; T=0.K
angular distribution for (n,n*13)

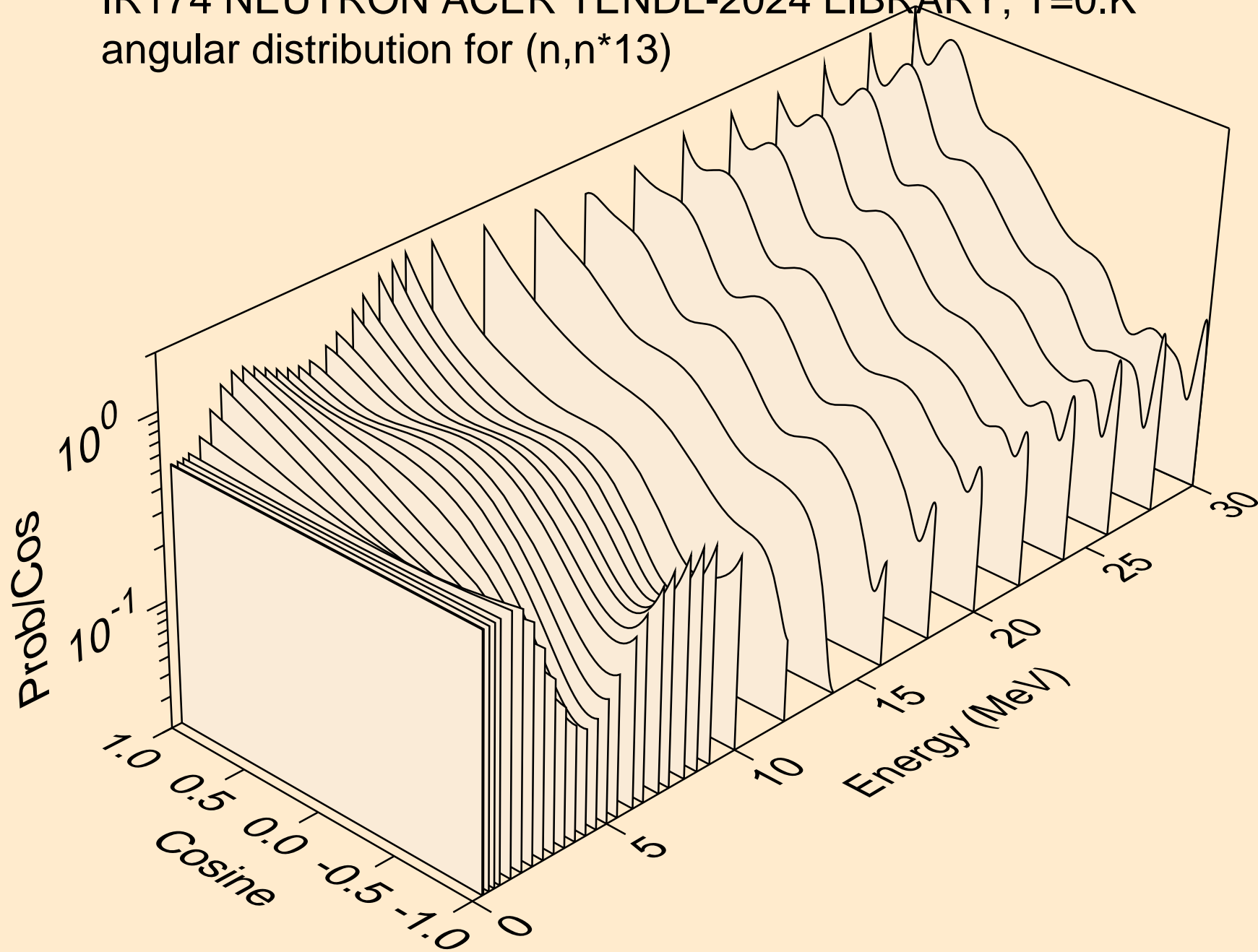

IR174 NEUTRON ACER TENDL-2024 LIBRARY; T=0.K
angular distribution for (n,n*14)

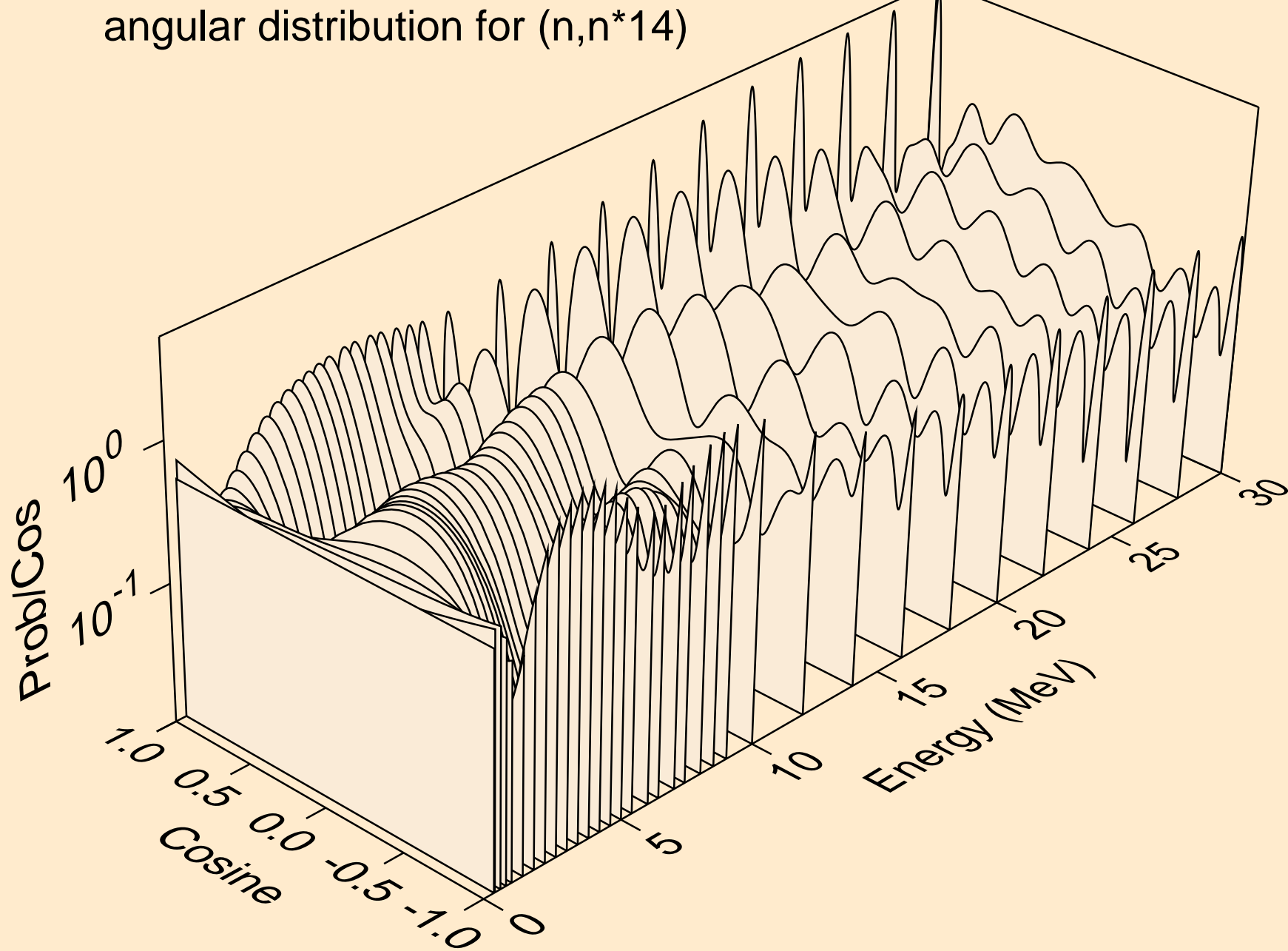

IR174 NEUTRON ACER TENDL-2024 LIBRARY; T=0.K
angular distribution for (n,n*15)

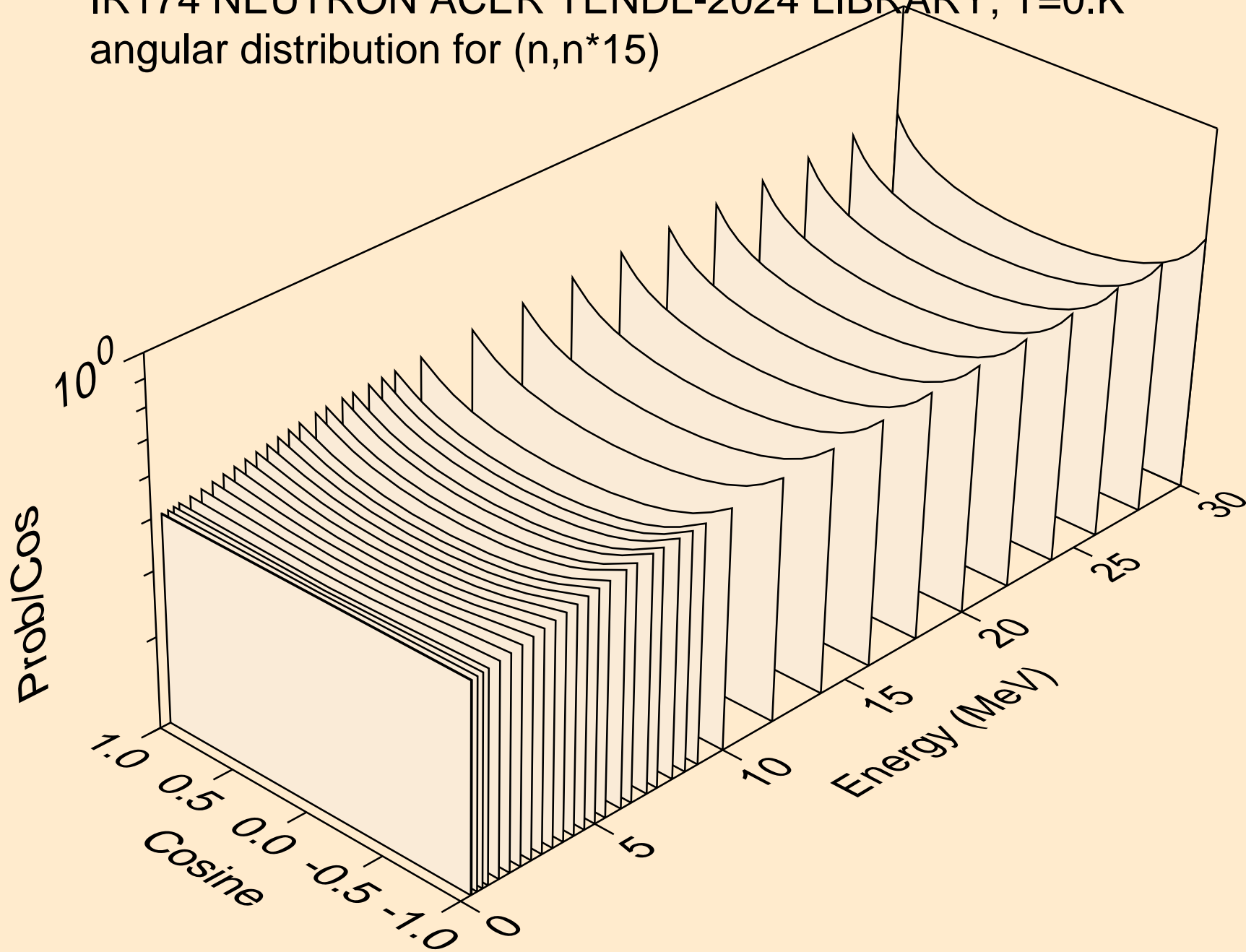

IR174 NEUTRON ACER TENDL-2024 LIBRARY; T=0.K
angular distribution for (n,n*16)

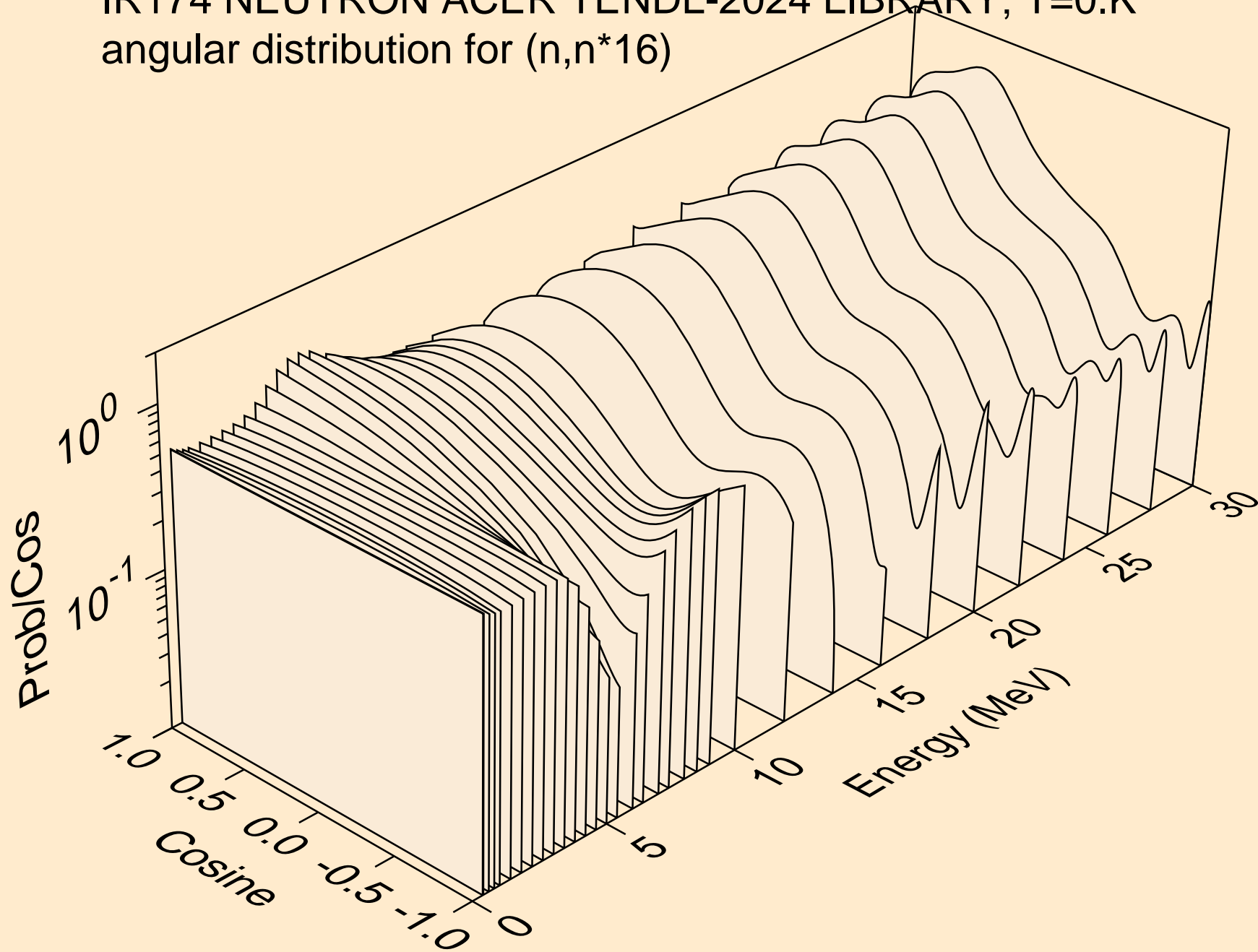

IR174 NEUTRON ACER TENDL-2024 LIBRARY; T=0.K
angular distribution for (n,n*17)

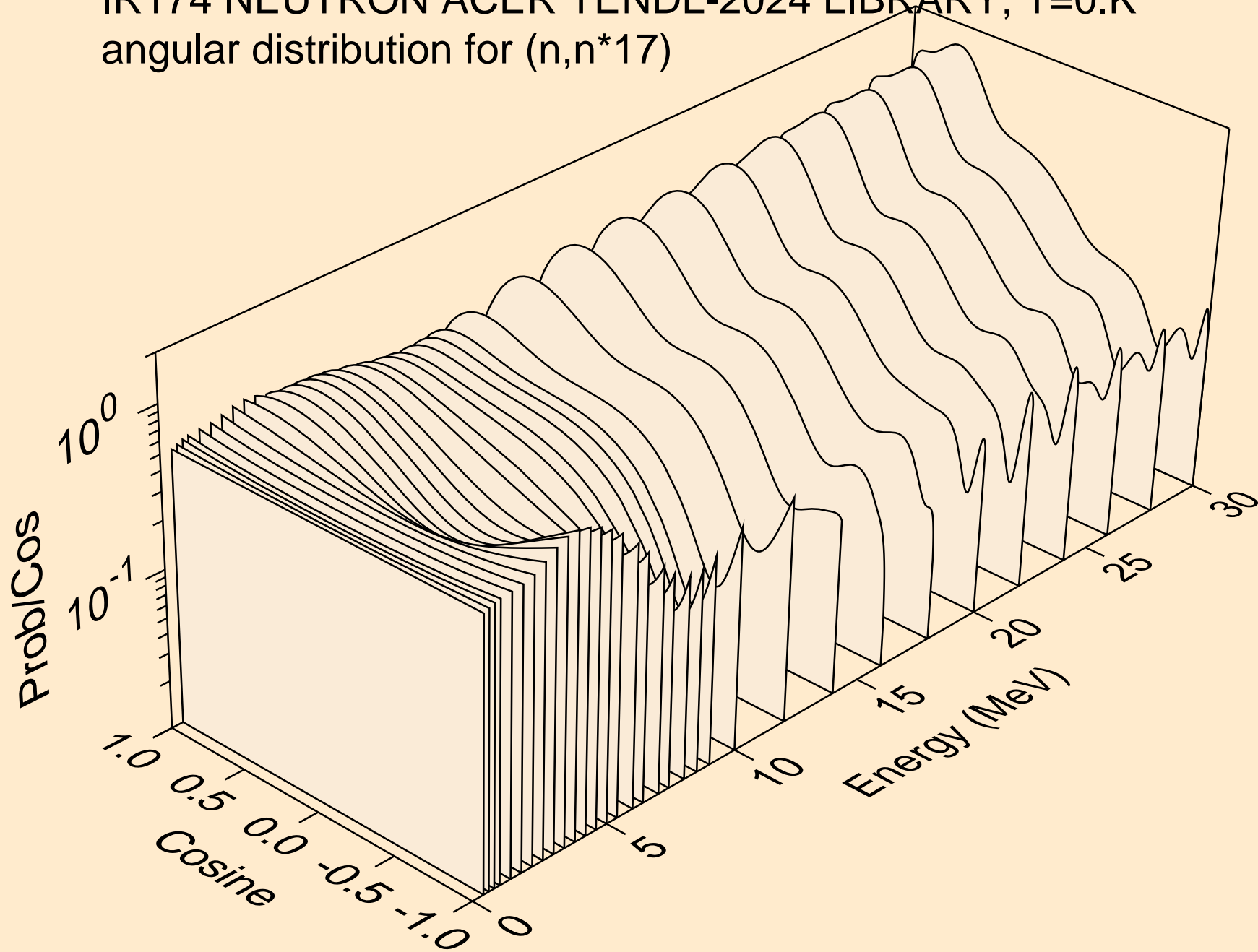

IR174 NEUTRON ACER TENDL-2024 LIBRARY; T=0.K
angular distribution for (n,n*18)

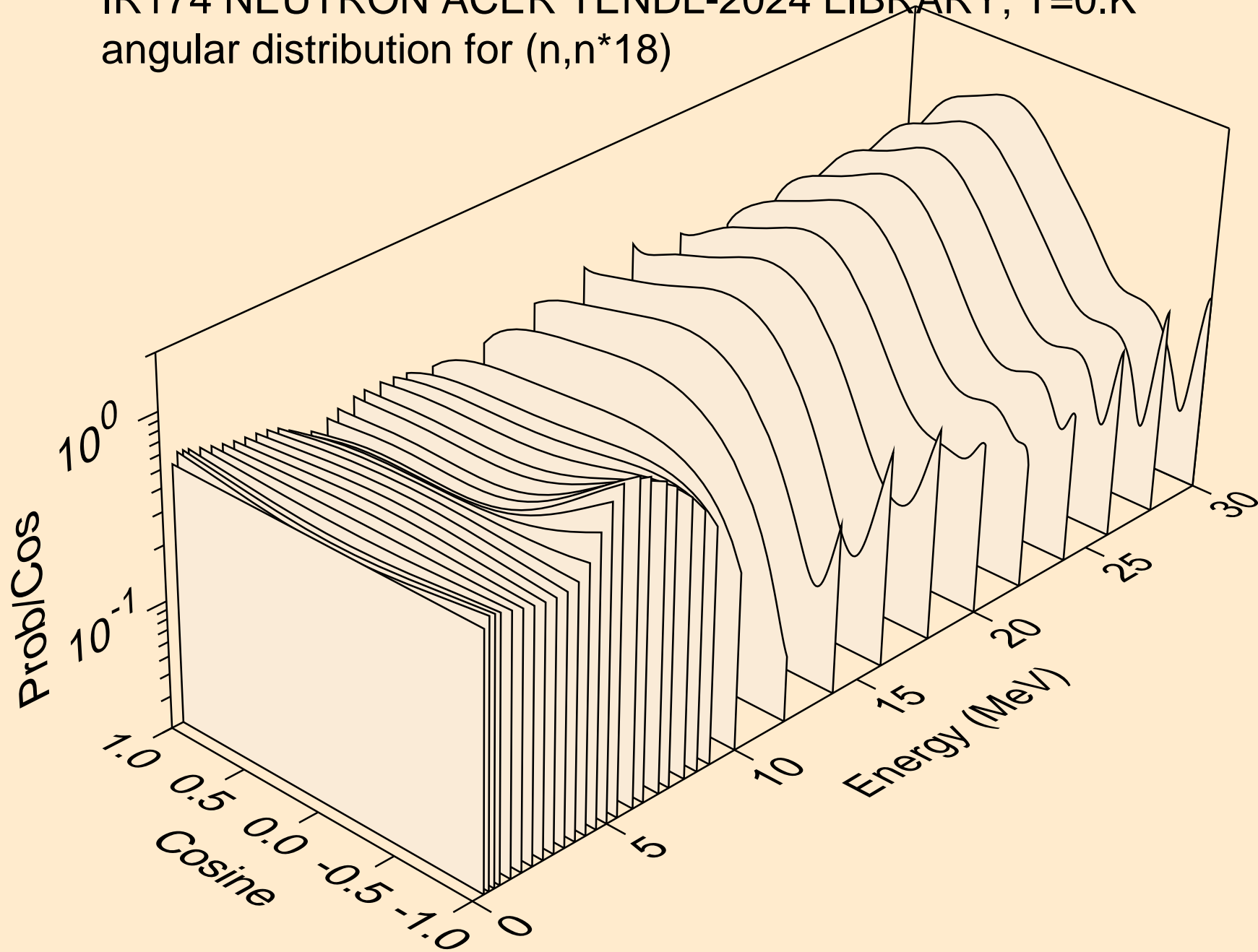

IR174 NEUTRON ACER TENDL-2024 LIBRARY; T=0.K
angular distribution for (n,n*19)

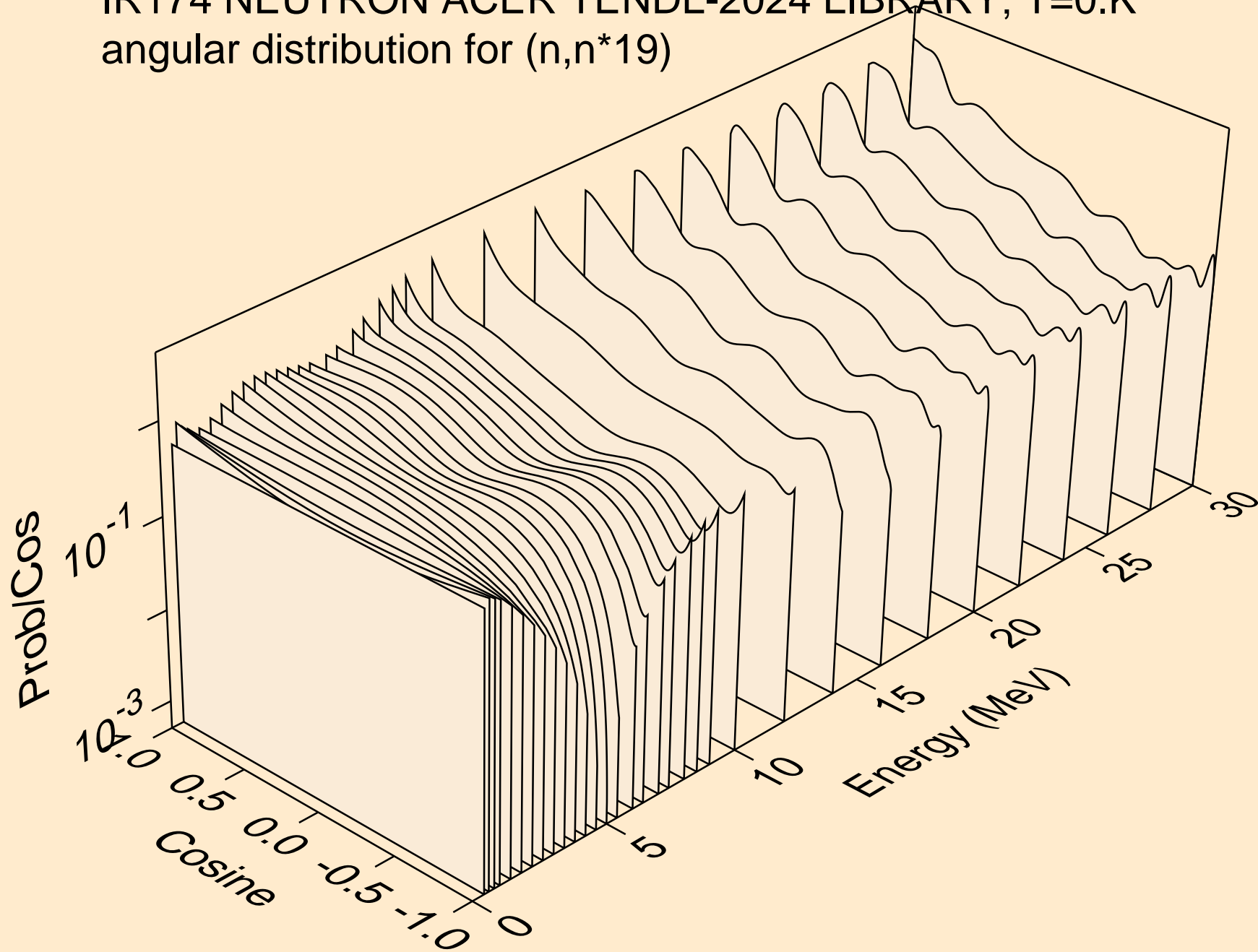

IR174 NEUTRON ACER TENDL-2024 LIBRARY; T=0.K
Neutron emission for (n,x)

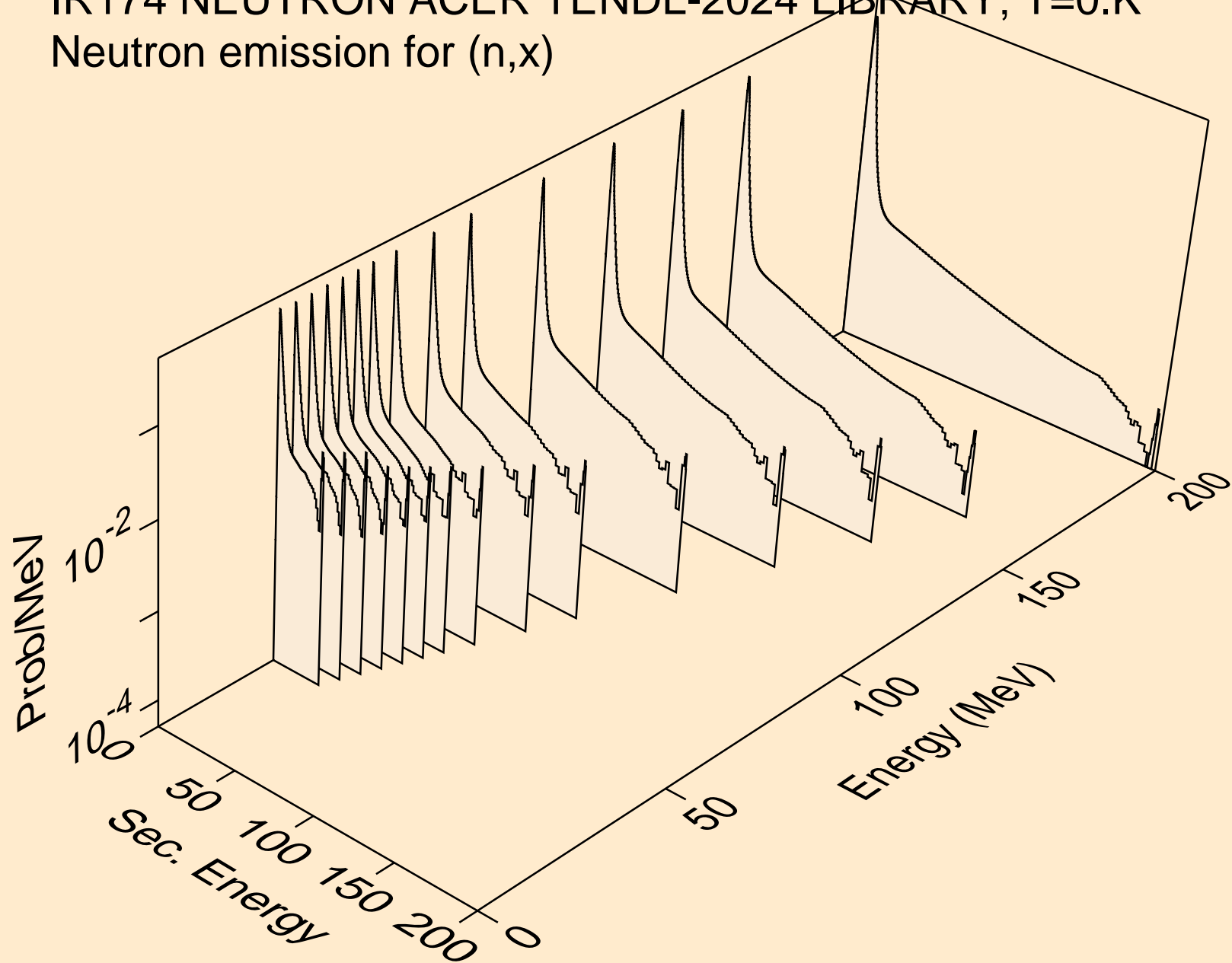

IR174 NEUTRON ACER TENDL-2024 LIBRARY; T=0.K
Neutron emission for (n,2nd)

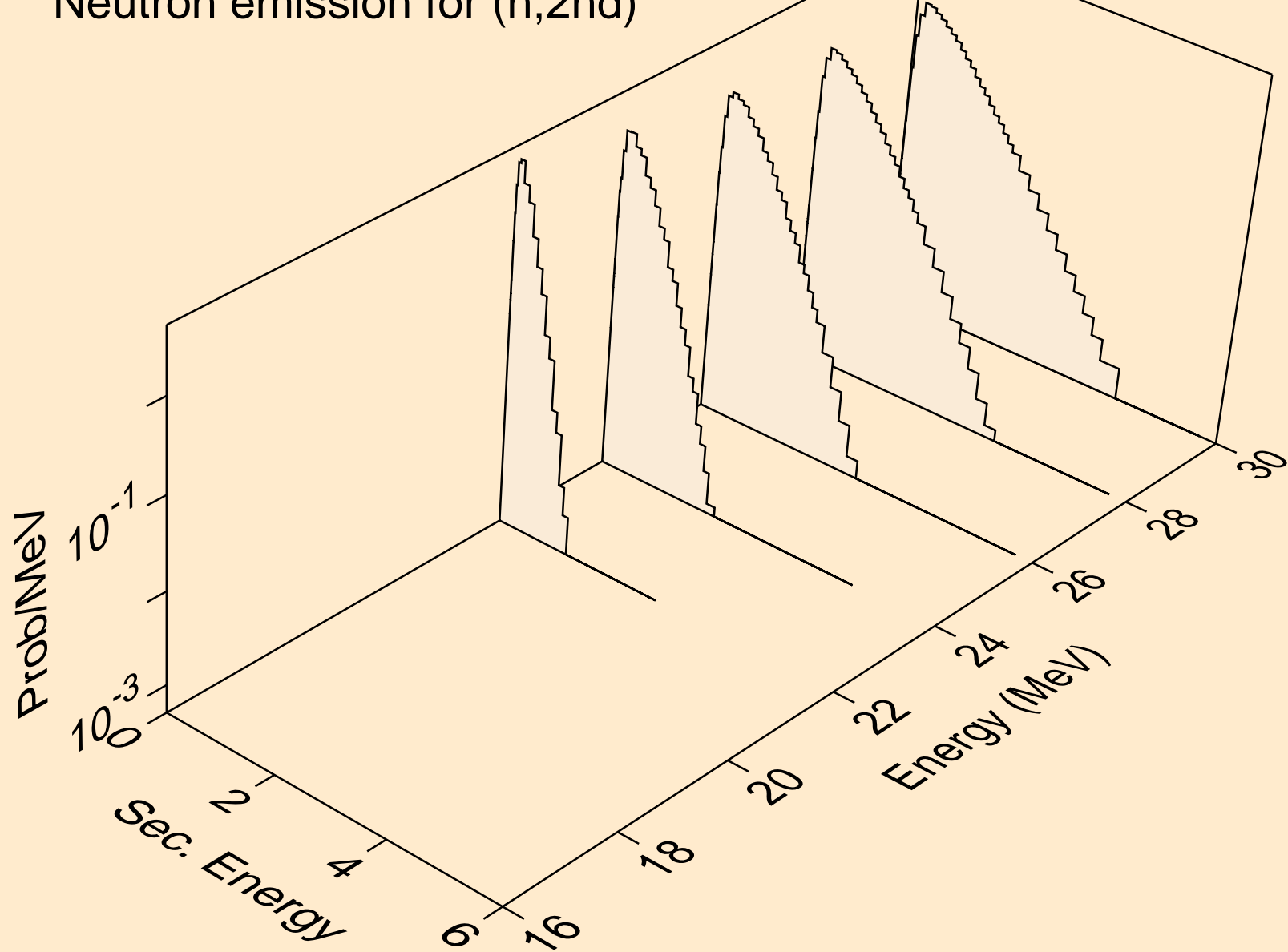

IR174 NEUTRON ACER TENDL-2024 LIBRARY; T=0.K
Neutron emission for (n,2n)

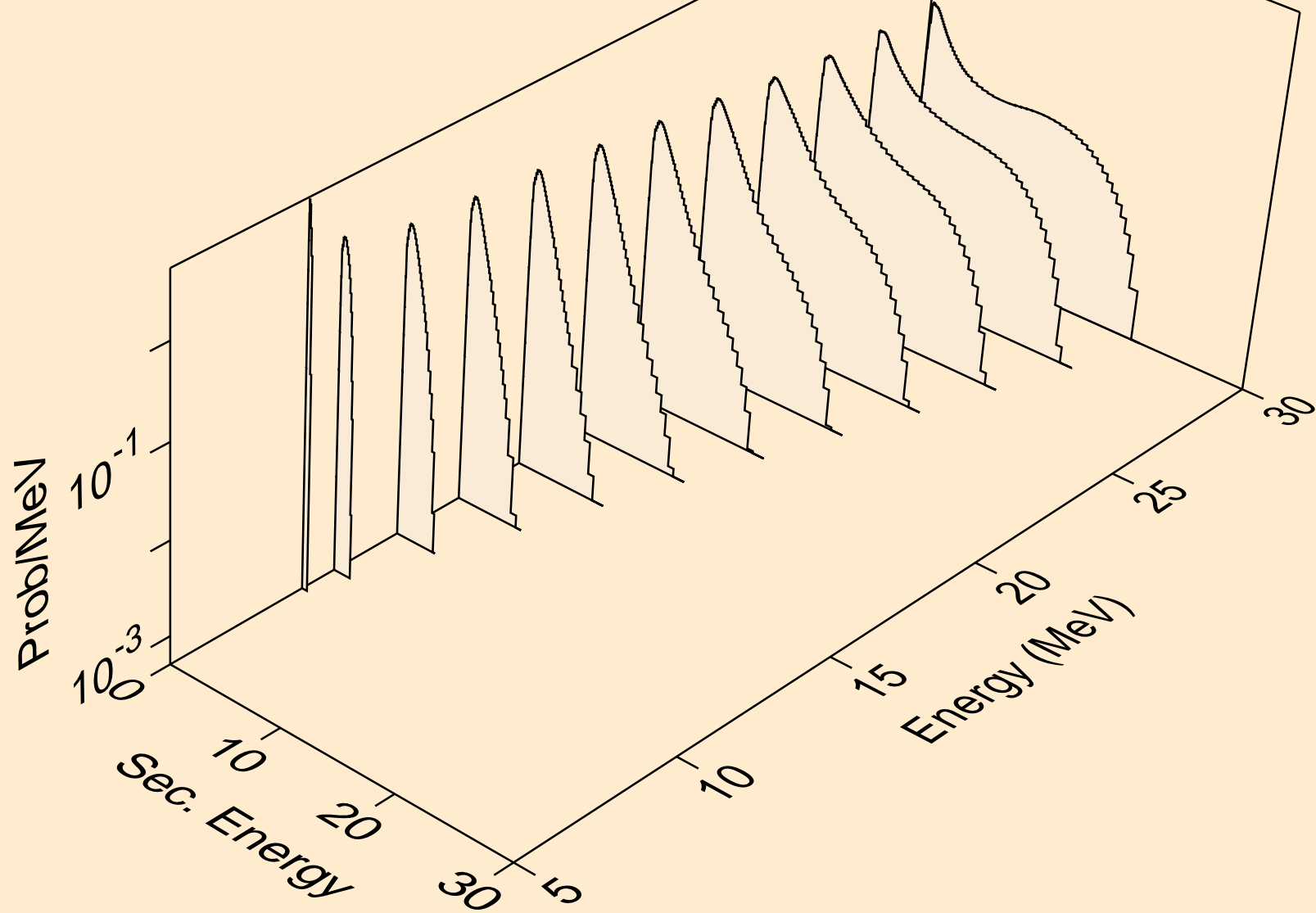

IR174 NEUTRON ACER TENDL-2024 LIBRARY; T=0.K
Neutron emission for (n,3n)

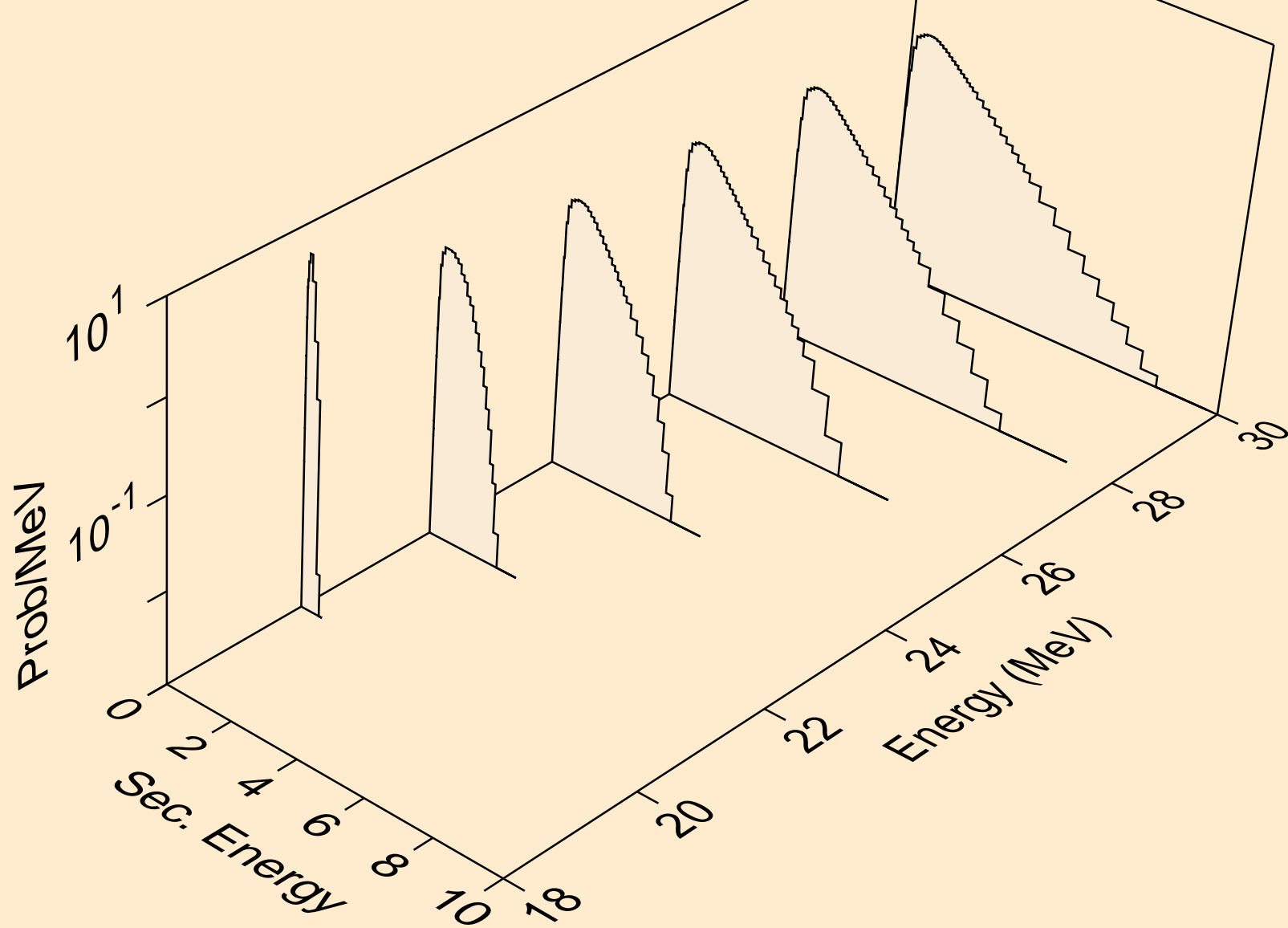

IR174 NEUTRON ACER TENDL-2024 LIBRARY; T=0.K
Neutron emission for (n,n*)a

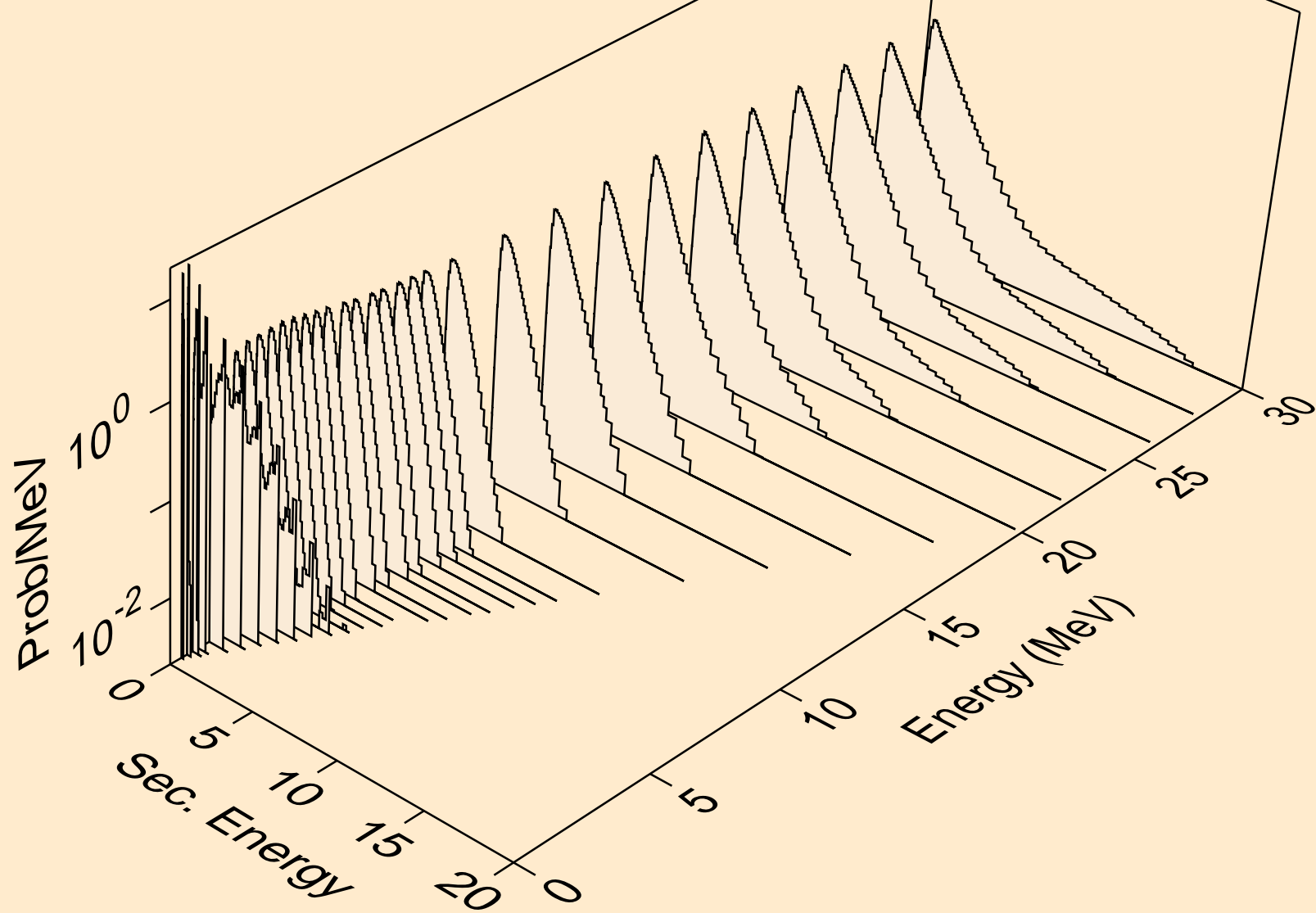

IR174 NEUTRON ACER TENDL-2024 LIBRARY; T=0.K
Neutron emission for (n,n*)3a

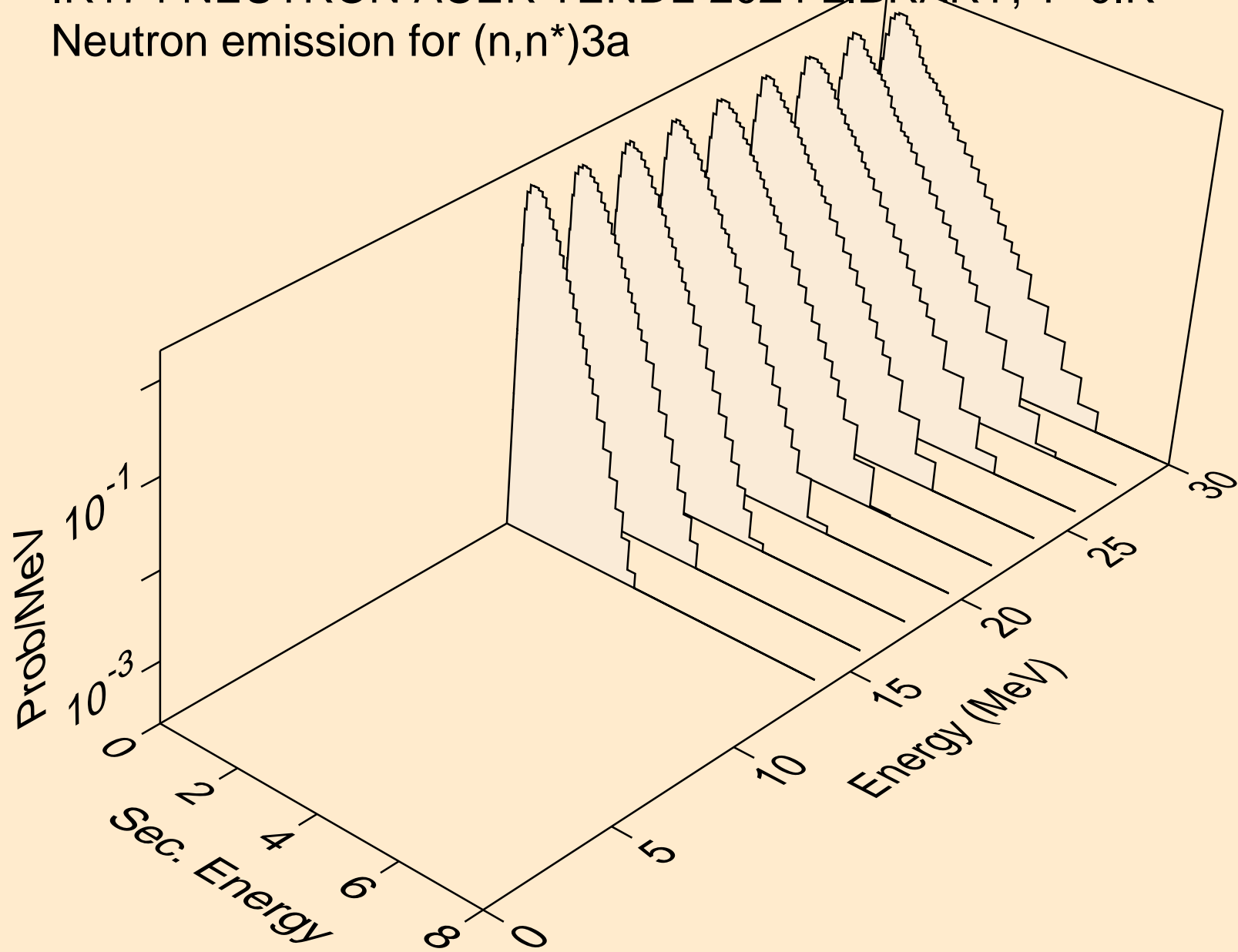

IR174 NEUTRON ACER TENDL-2024 LIBRARY; T=0.K
Neutron emission for (n,2n)a

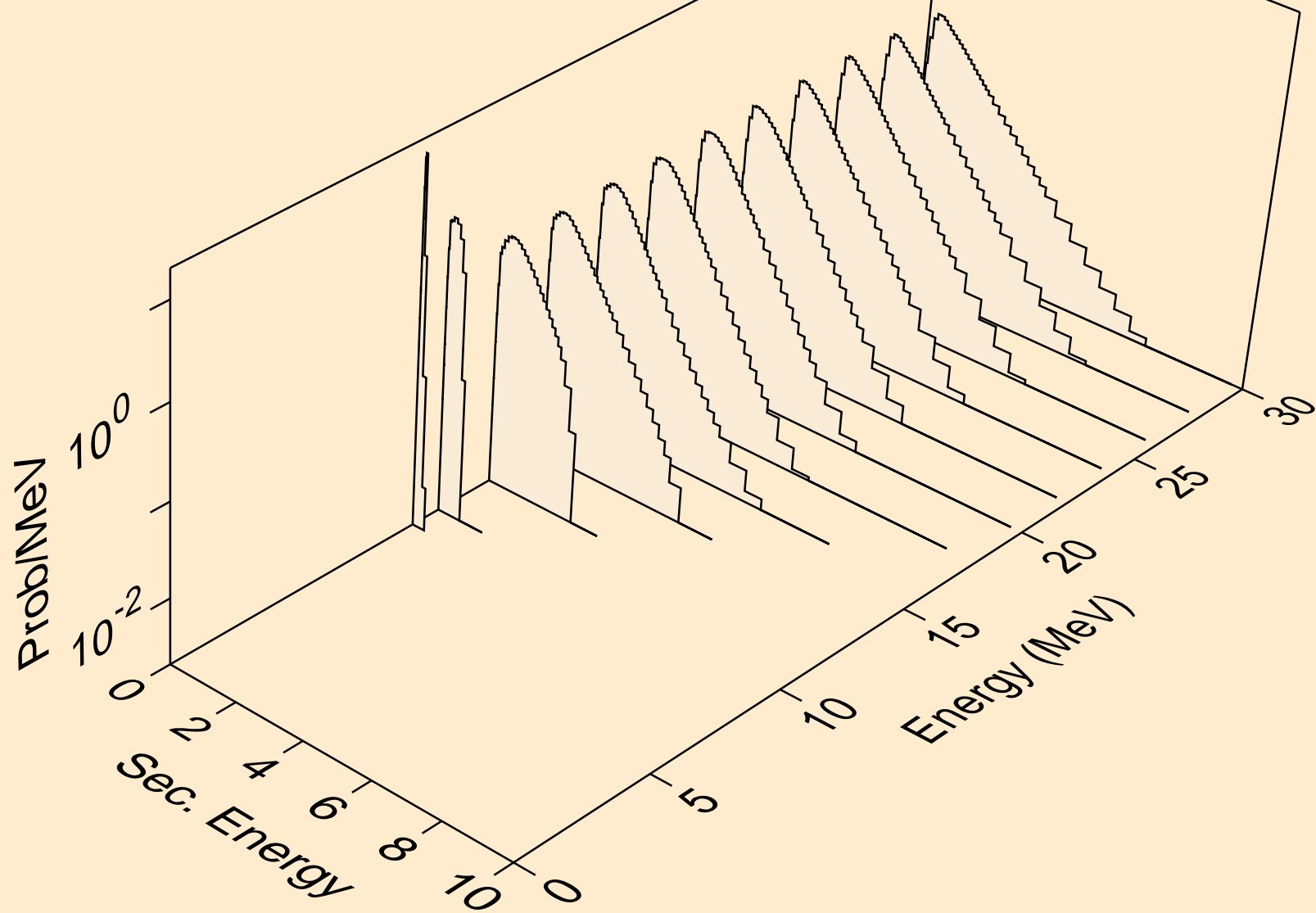

IR174 NEUTRON ACER TENDL-2024 LIBRARY; T=0.K
Neutron emission for (n,3n)a

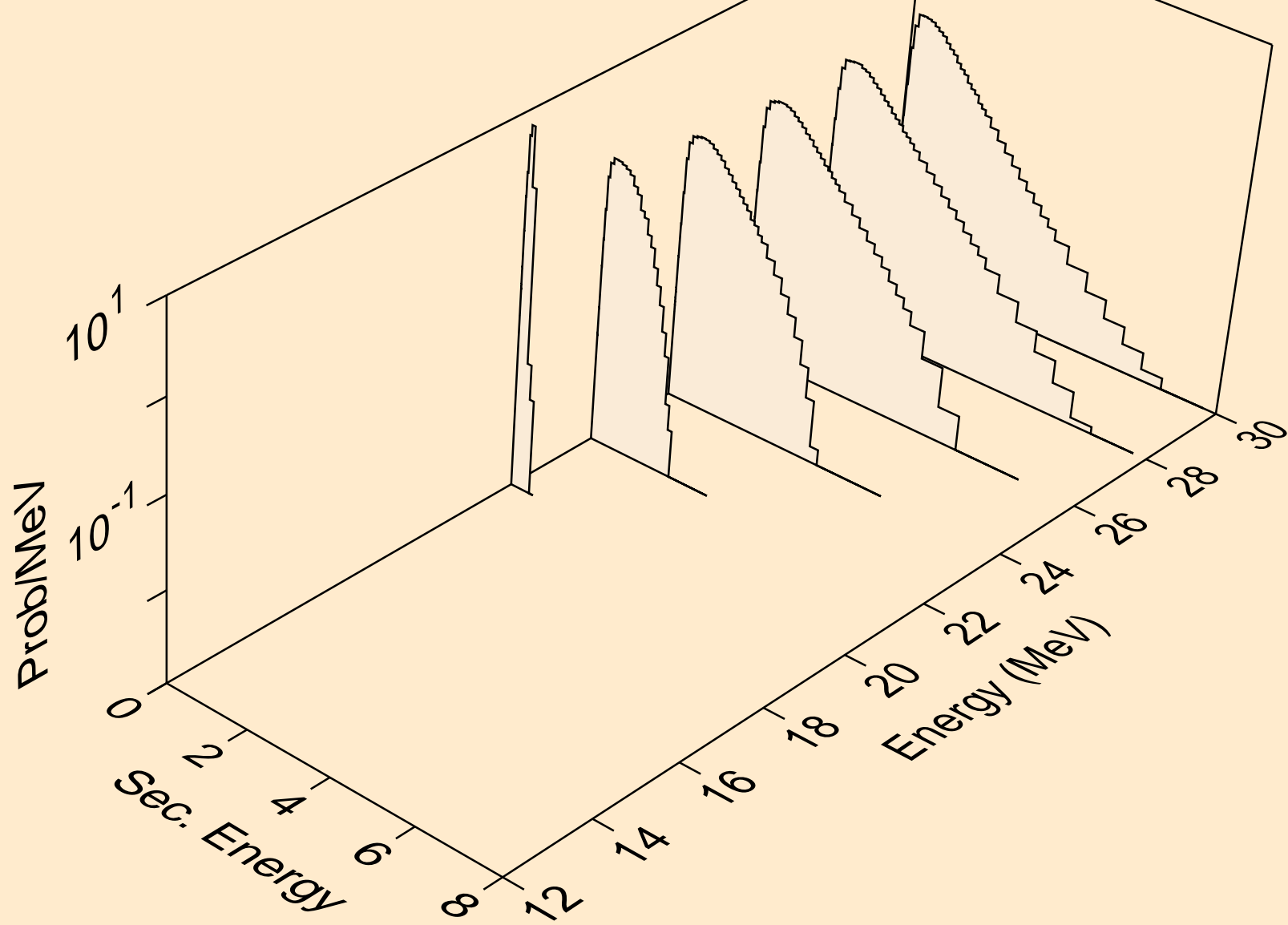

IR174 NEUTRON ACER TENDL-2024 LIBRARY; T=0.K
Neutron emission for (n,n*)p

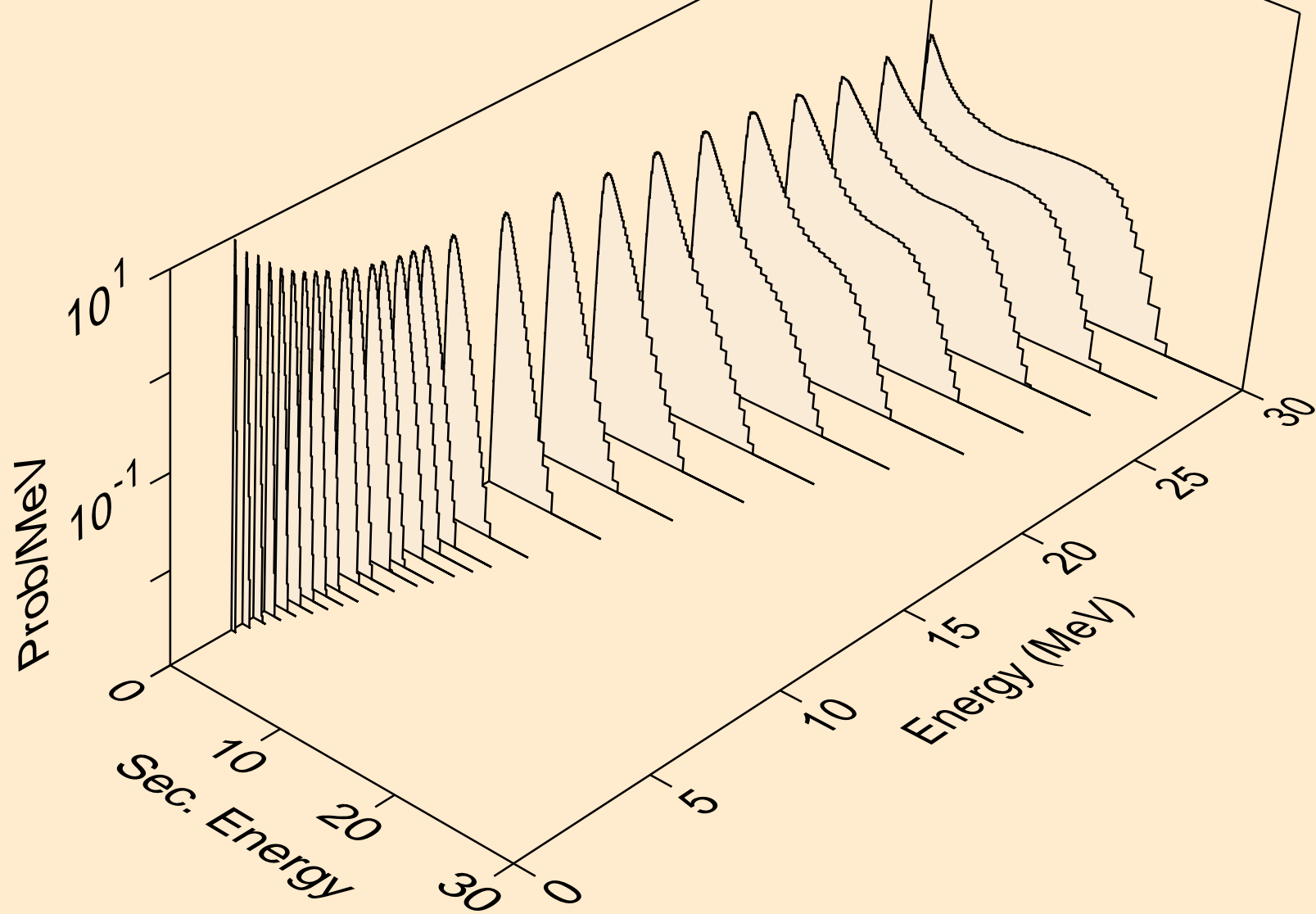

IR174 NEUTRON ACER TENDL-2024 LIBRARY; T=0.K
Neutron emission for (n,n*)2a

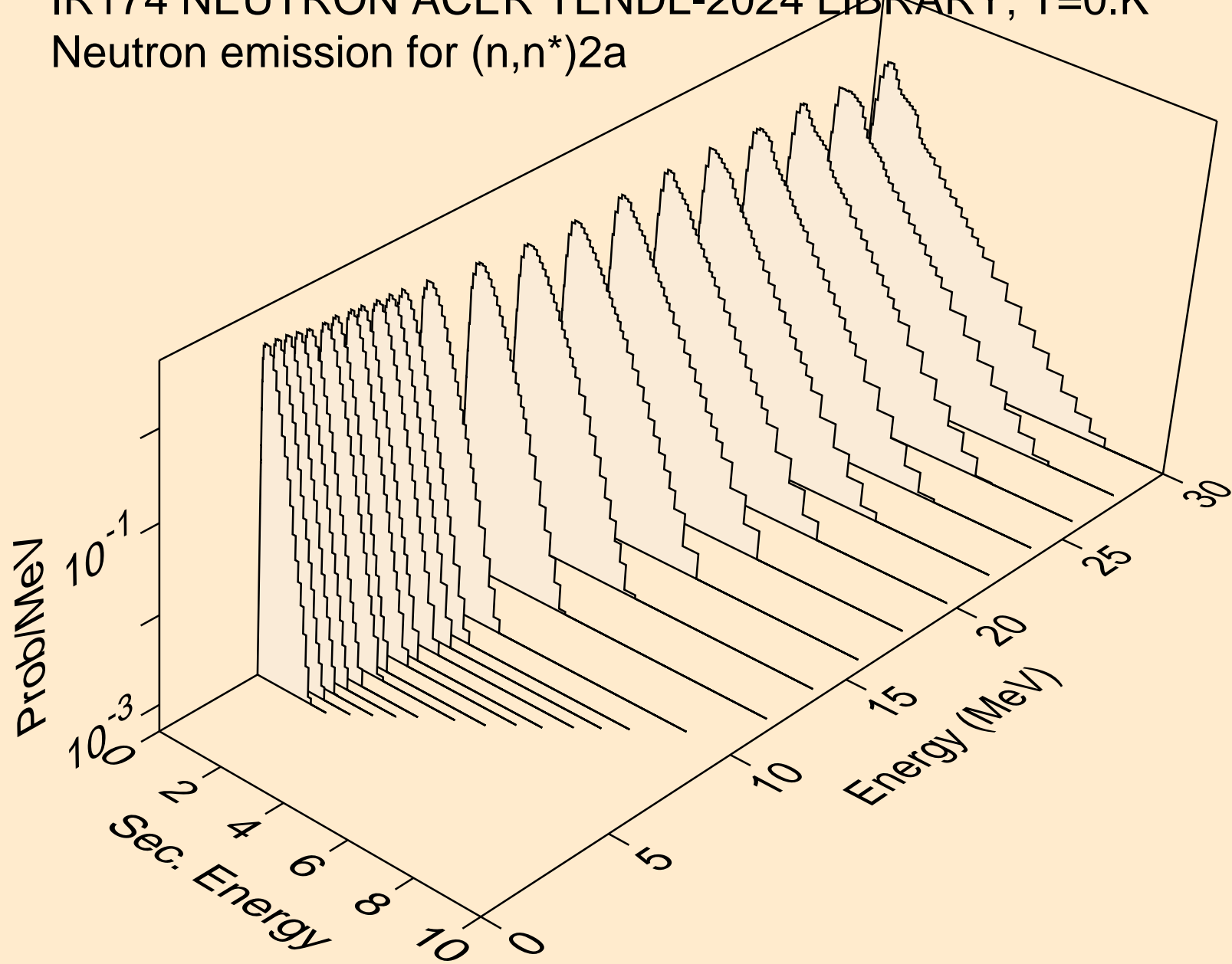

IR174 NEUTRON ACER TENDL-2024 LIBRARY; T=0.K
Neutron emission for (n,2n)2a

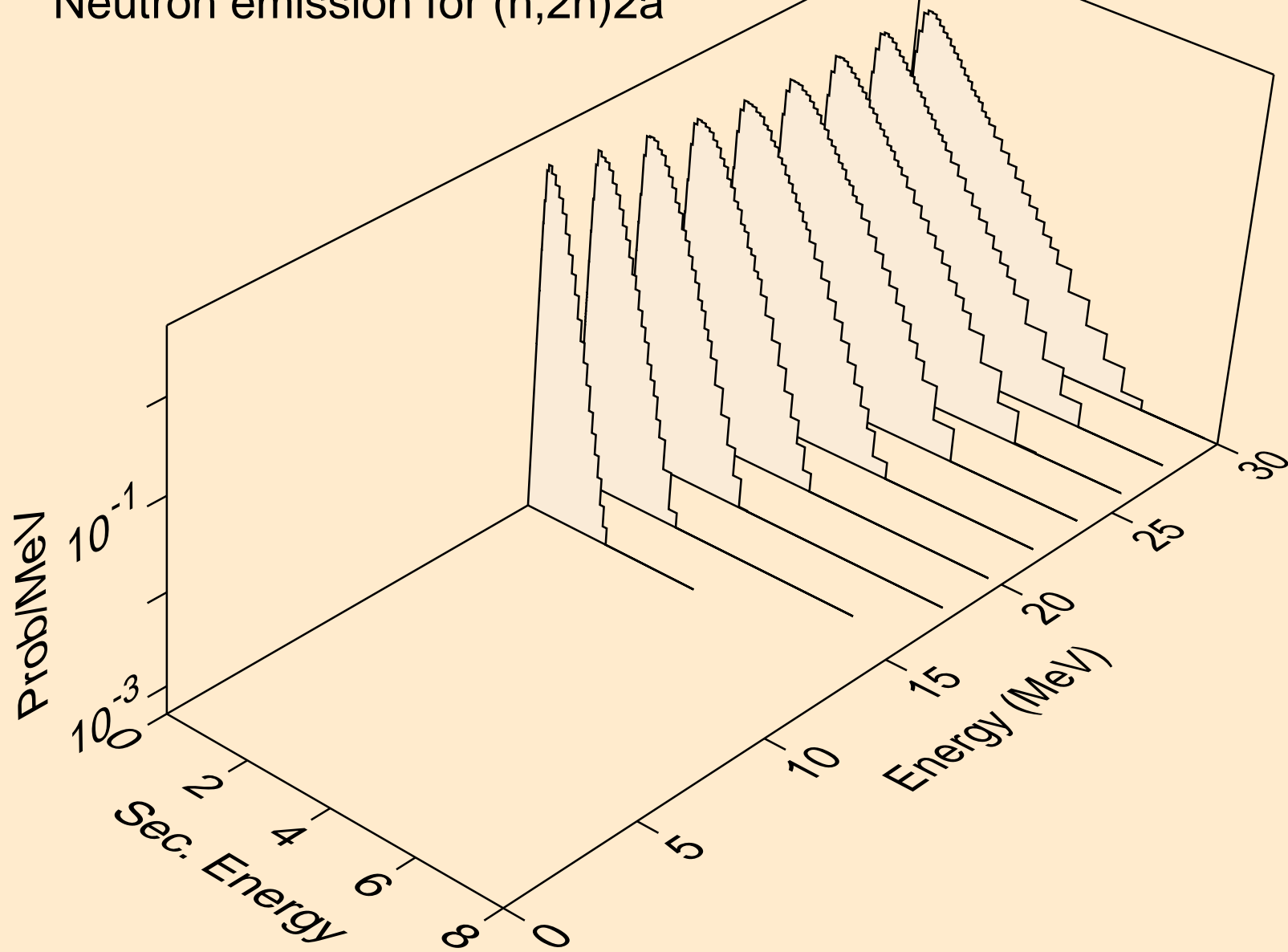

IR174 NEUTRON ACER TENDL-2024 LIBRARY; T=0.K
Neutron emission for (n,n*)d

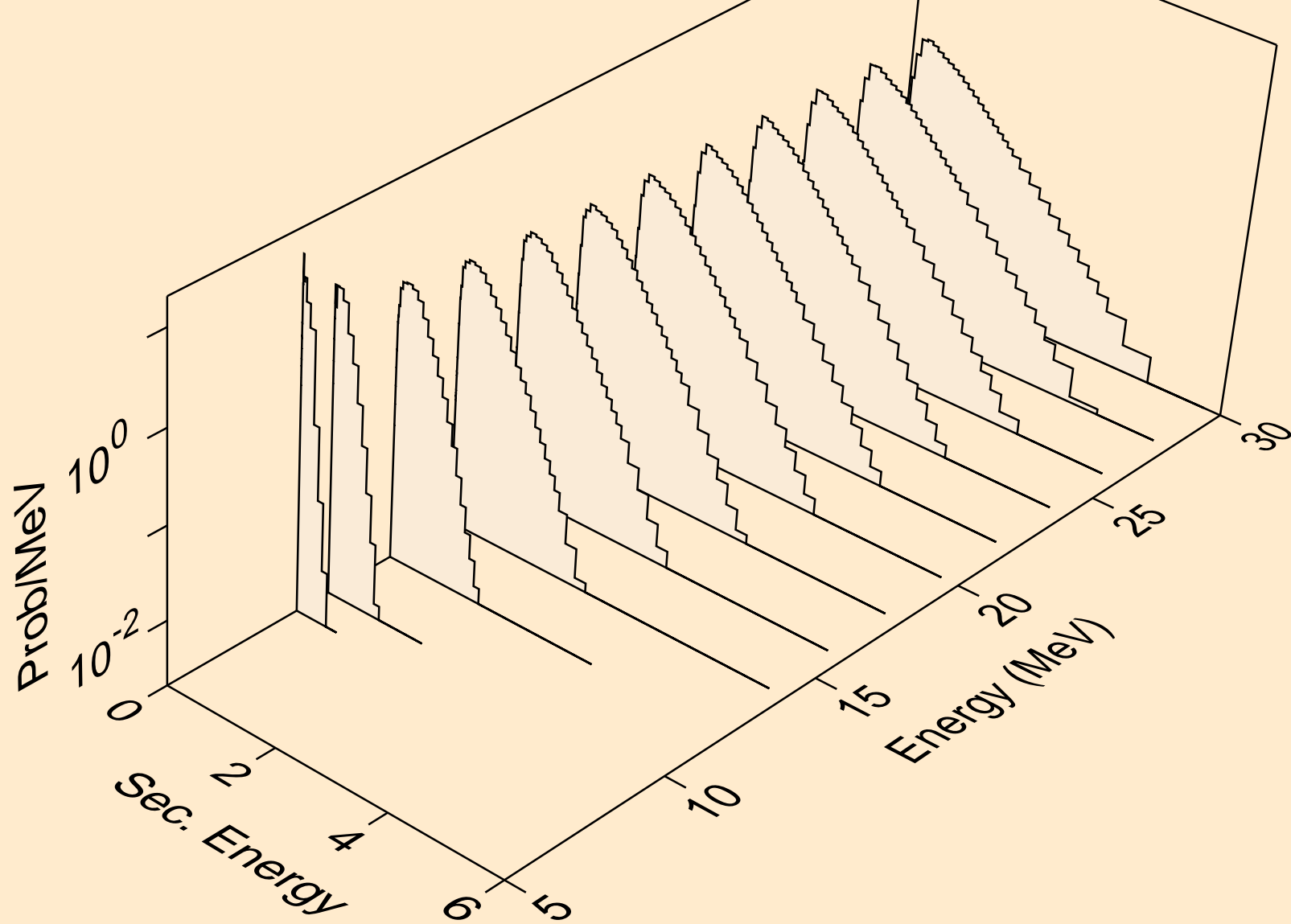

IR174 NEUTRON ACER TENDL-2024 LIBRARY; T=0.K
Neutron emission for (n,n*)t

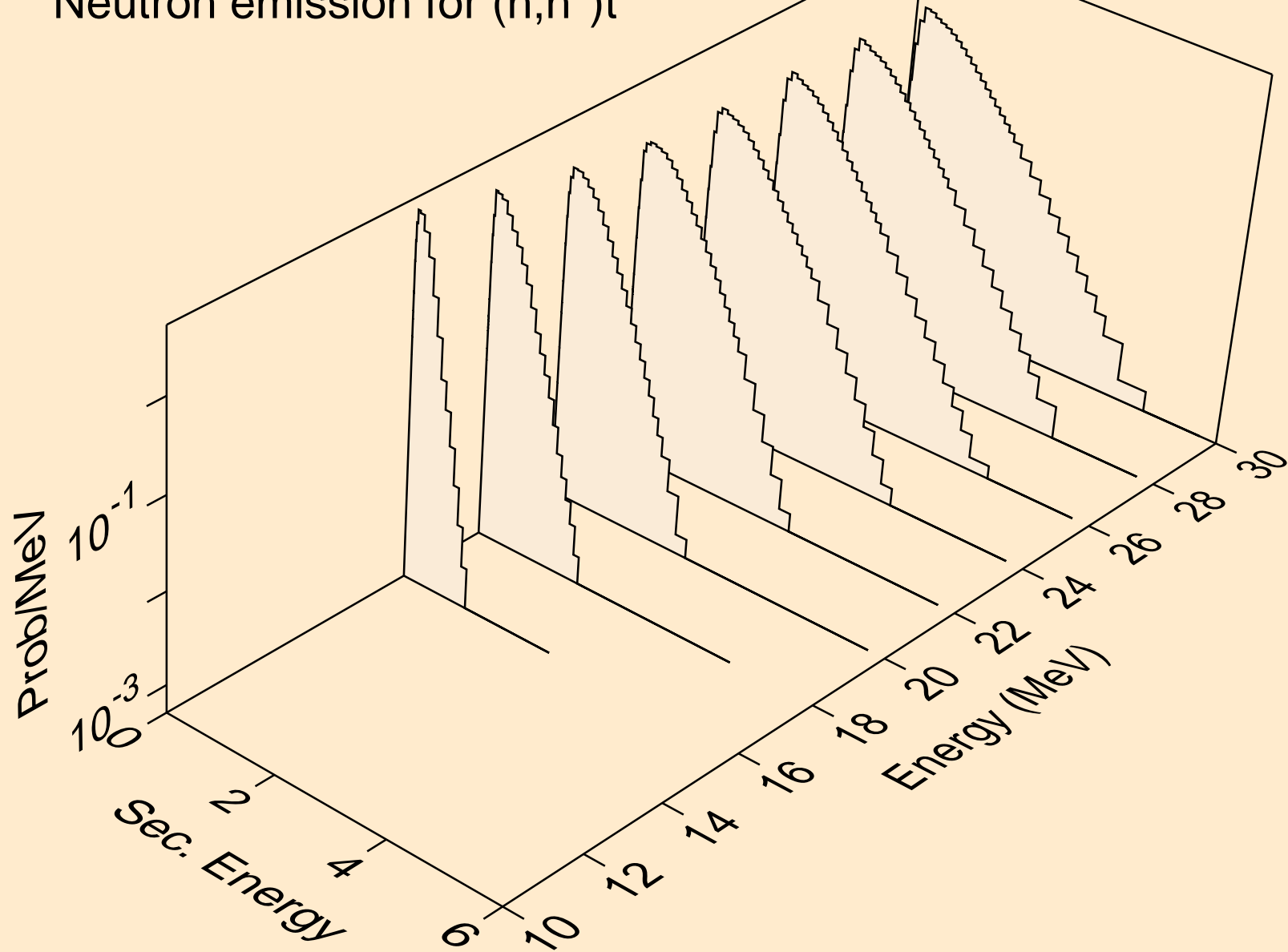

IR174 NEUTRON ACER TENDL-2024 LIBRARY; T=0.K
Neutron emission for (n,n*)he3

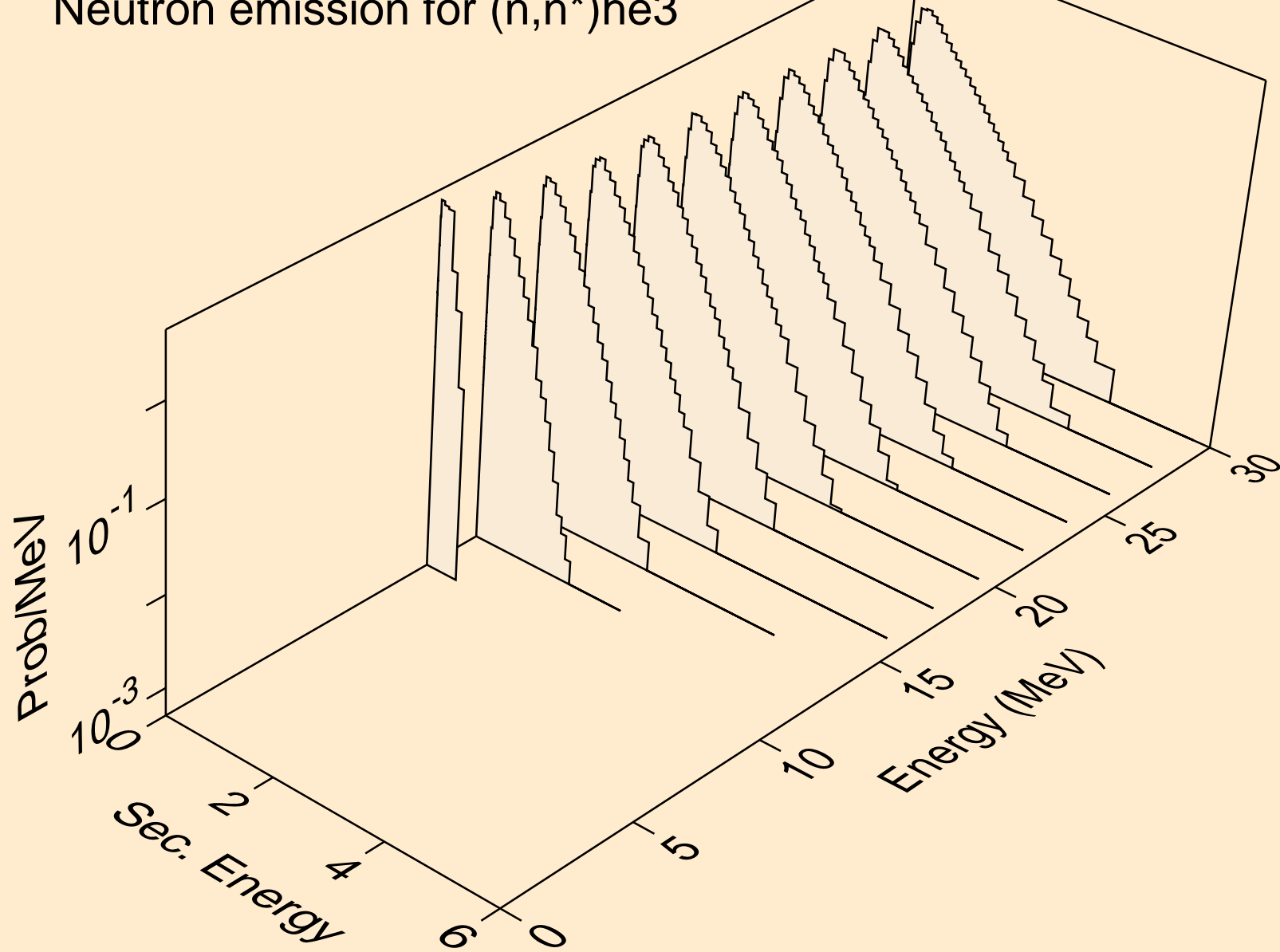

IR174 NEUTRON ACER TENDL-2024 LIBRARY; T=0.K
Neutron emission for (n,4n)

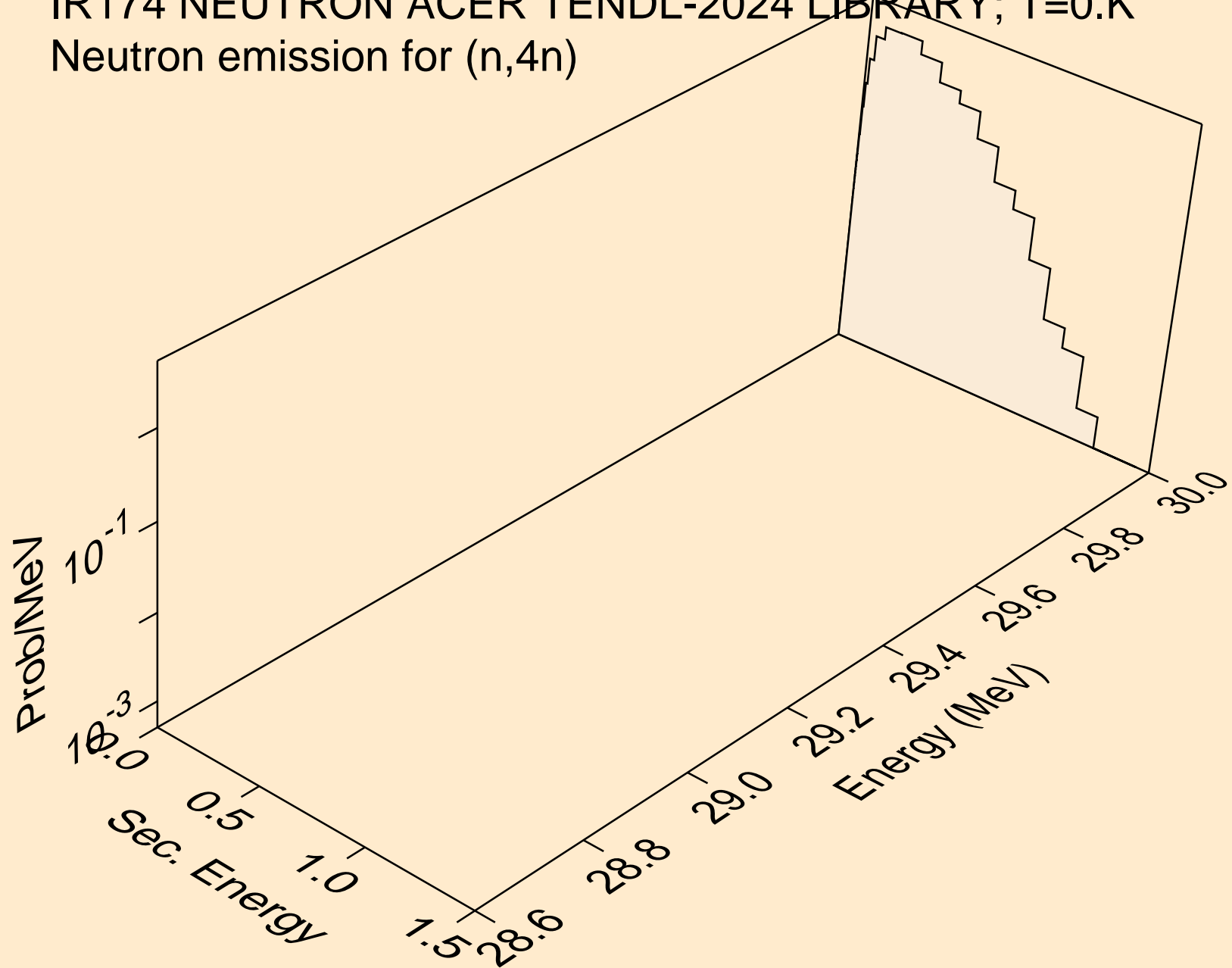

IR174 NEUTRON ACER TENDL-2024 LIBRARY; T=0.K
Neutron emission for (n,2np)

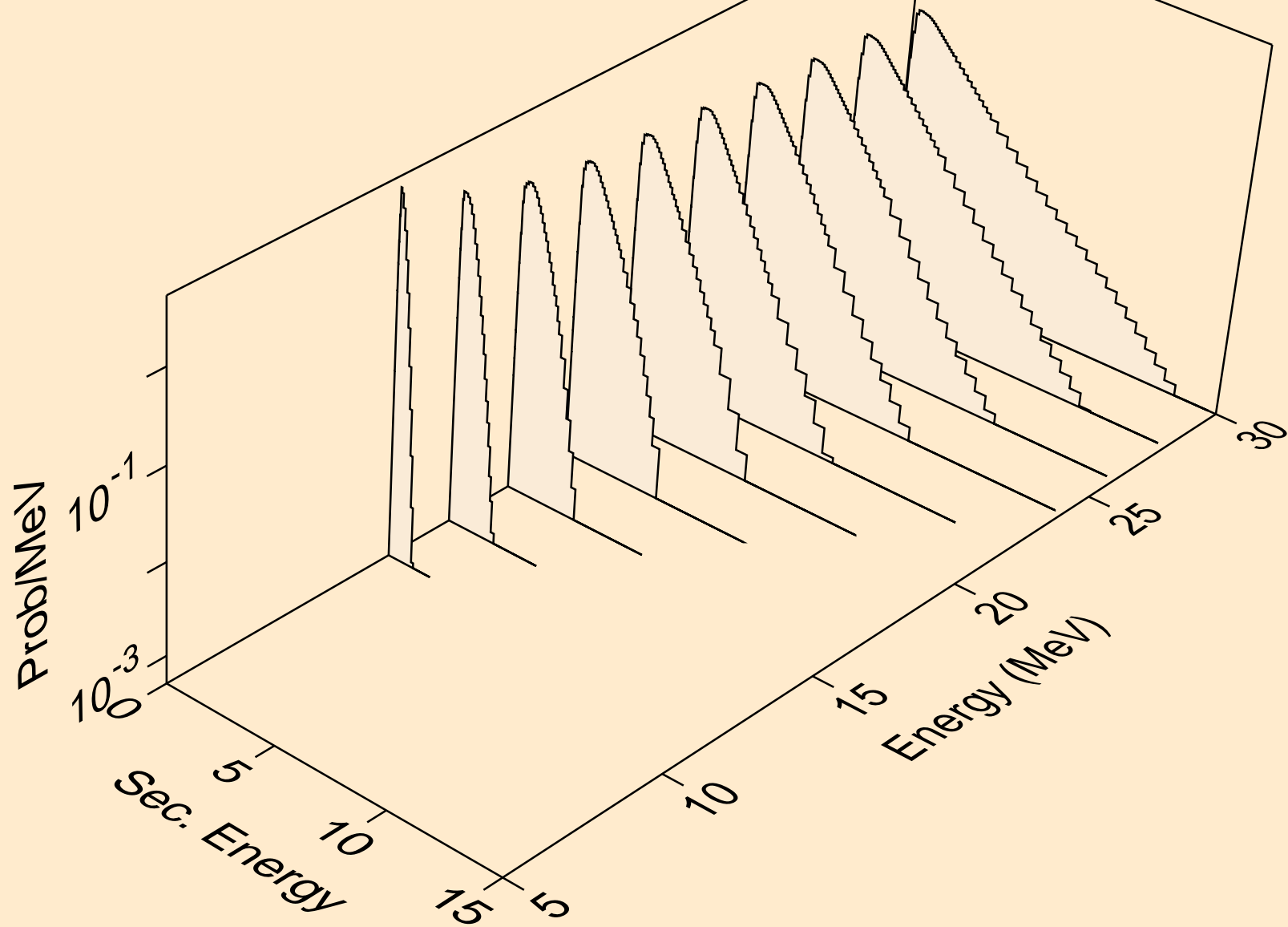

IR174 NEUTRON ACER TENDL-2024 LIBRARY; T=0.K
Neutron emission for (n,3np)

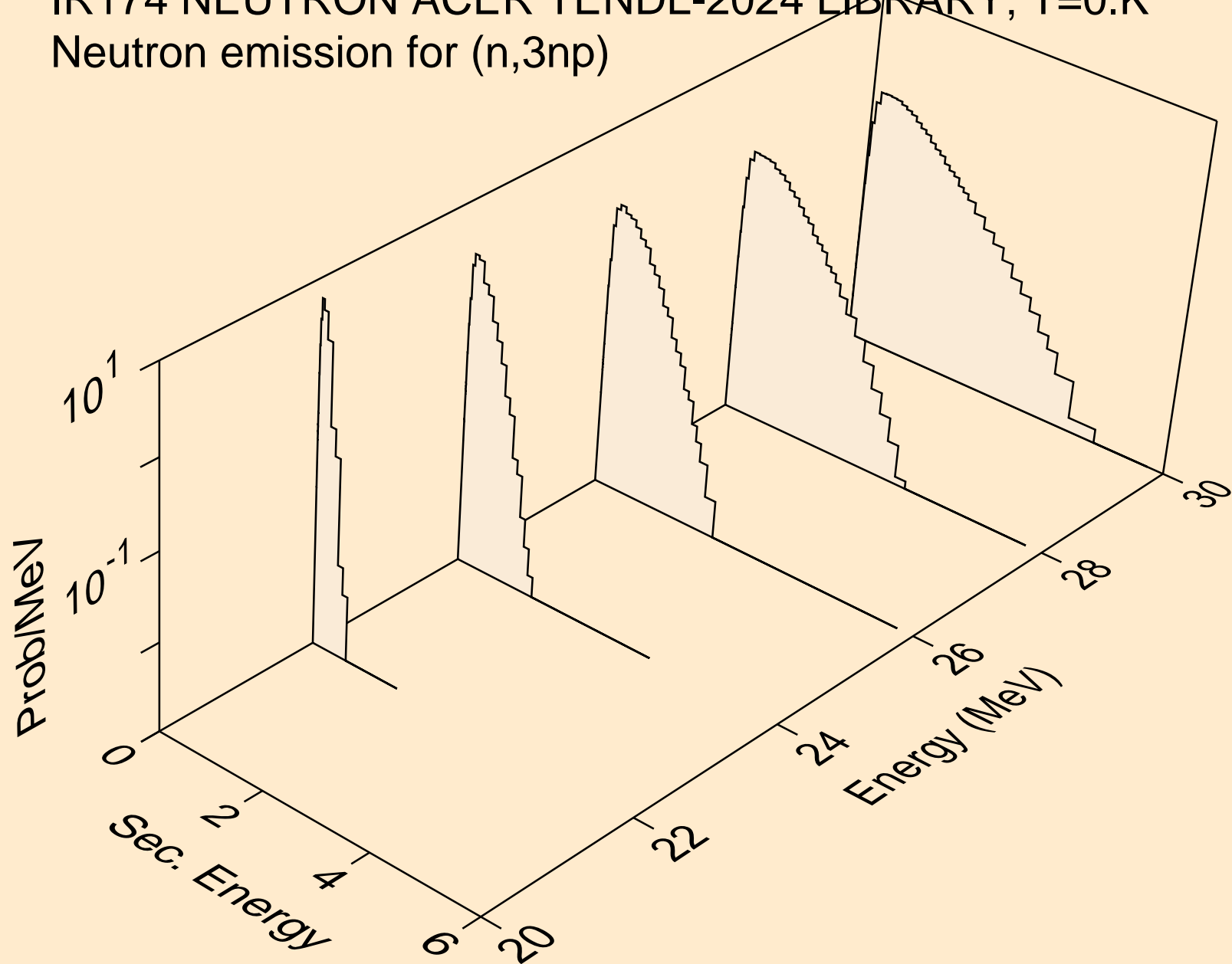

IR174 NEUTRON ACER TENDL-2024 LIBRARY; T=0.K
Neutron emission for (n,n2p)

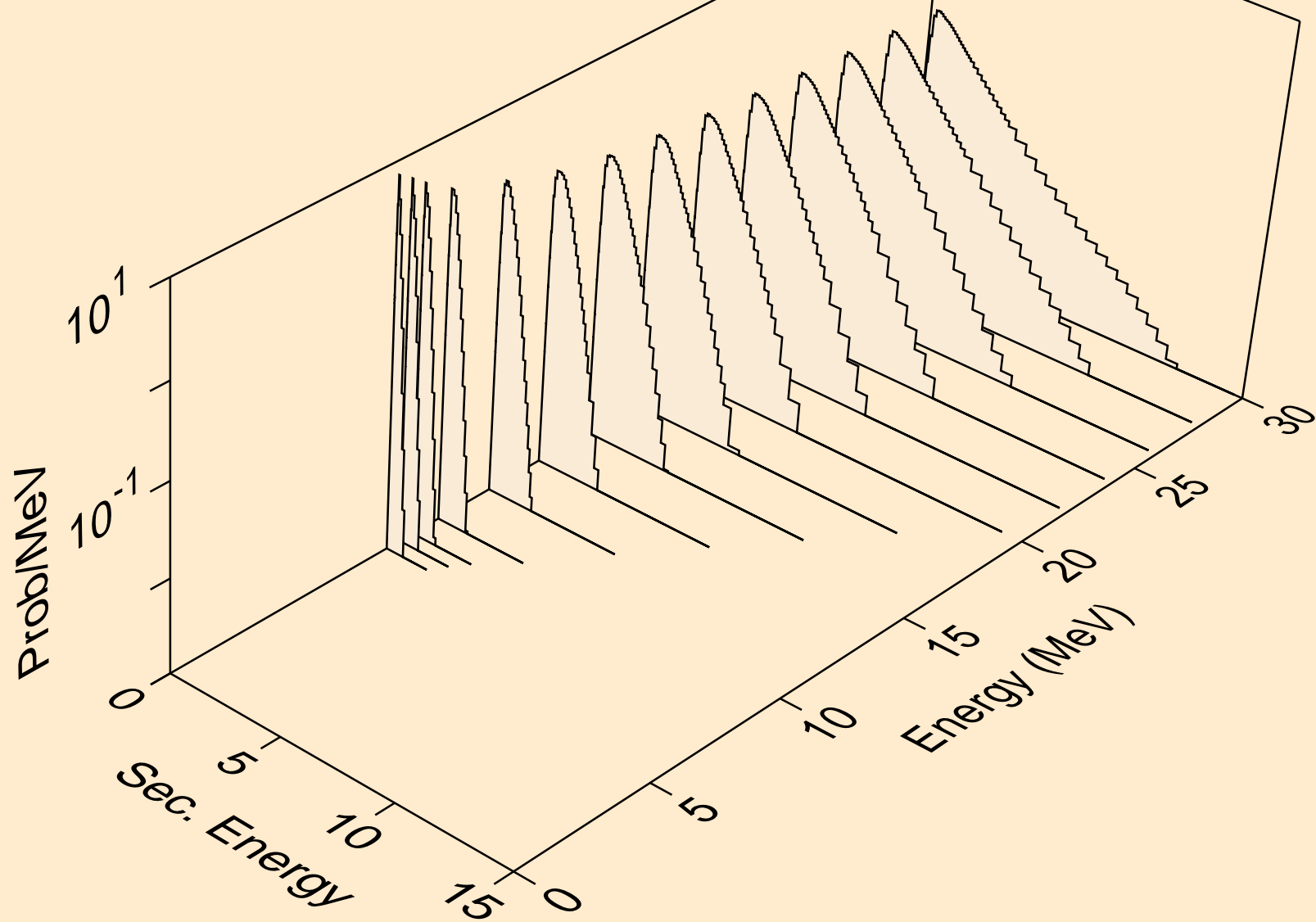

IR174 NEUTRON ACER TENDL-2024 LIBRARY; T=0.K
Neutron emission for (n,npa)

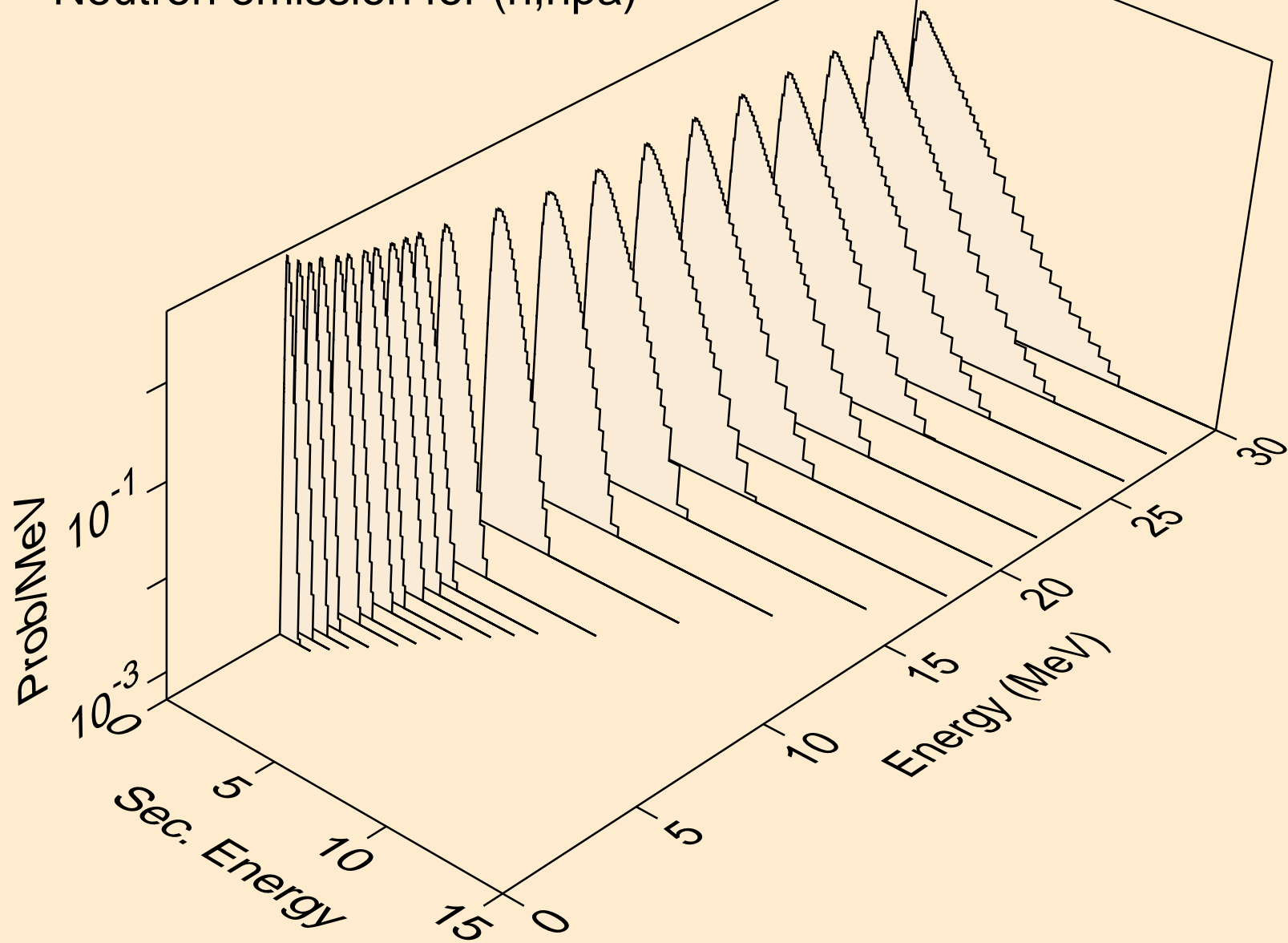

IR174 NEUTRON ACER TENDL-2024 LIBRARY; T=0.K
Neutron emission for (n,n*c)

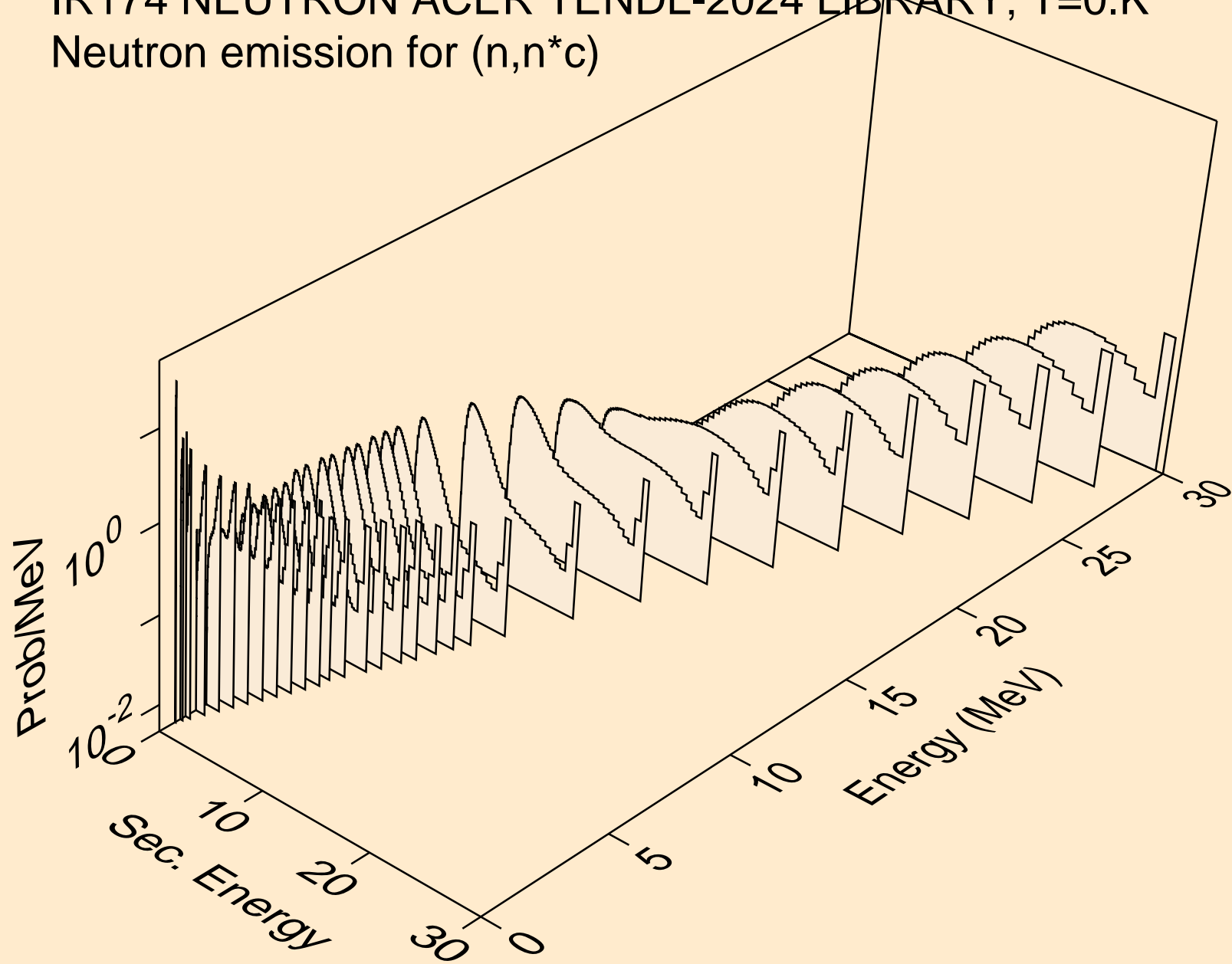

IR174 NEUTRON ACER TENDL-2024 LIBRARY; T=0.K
Photon emission for (n,x)

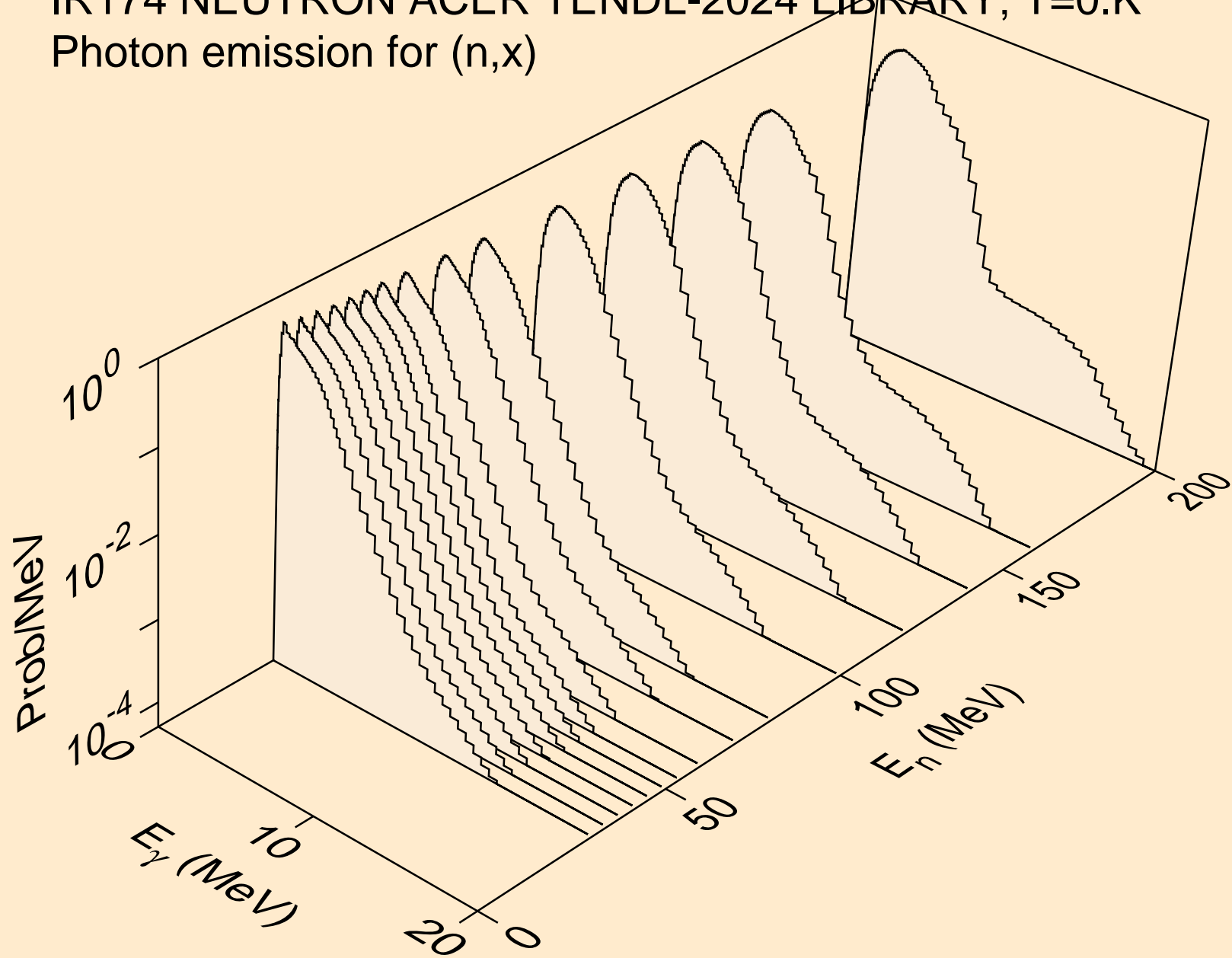

IR174 NEUTRON ACER TENDL-2024 LIBRARY; T=0.K
Photon emission for (n,2nd)

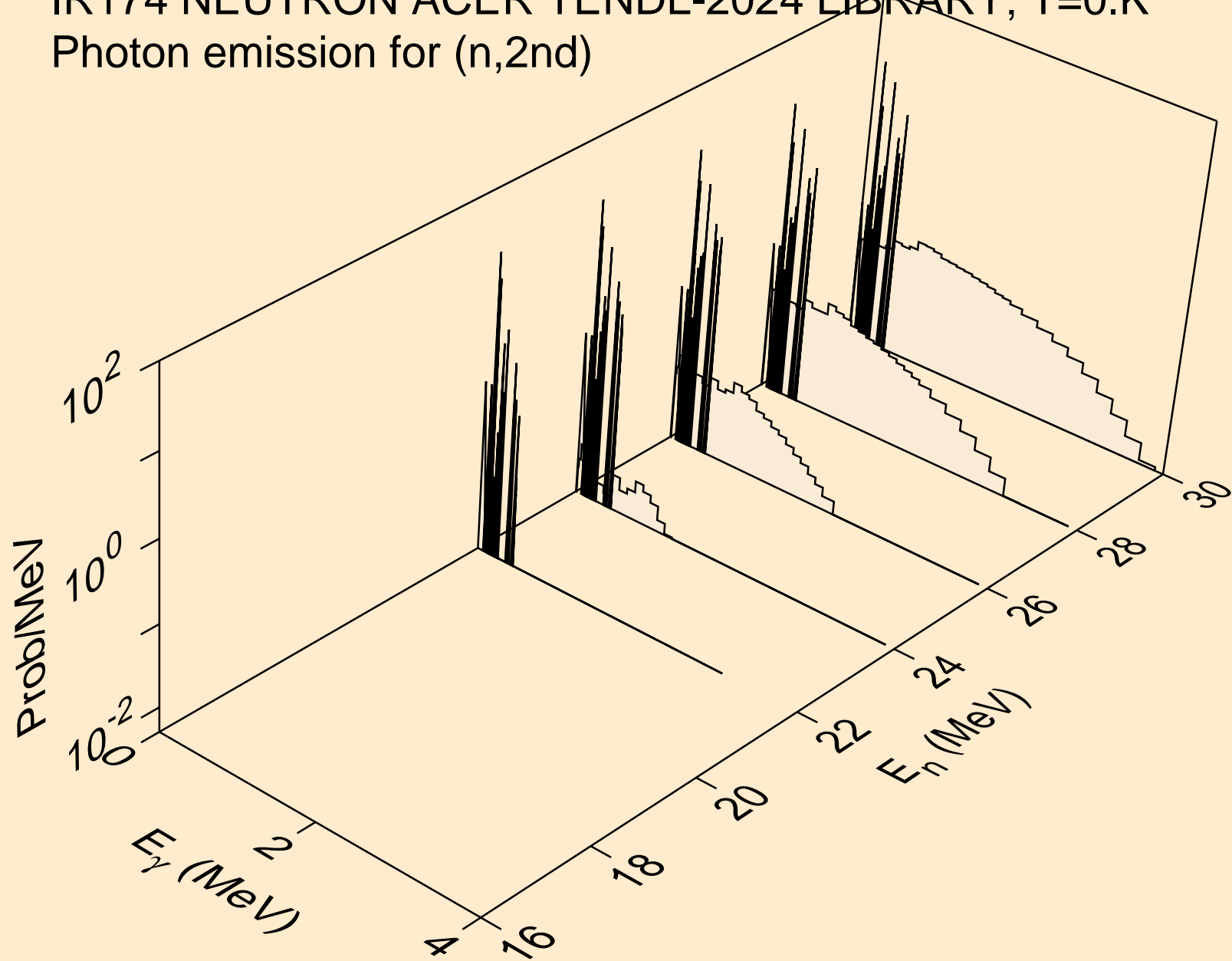

IR174 NEUTRON ACER TENDL-2024 LIBRARY; T=0.K
Photon emission for (n,2n)

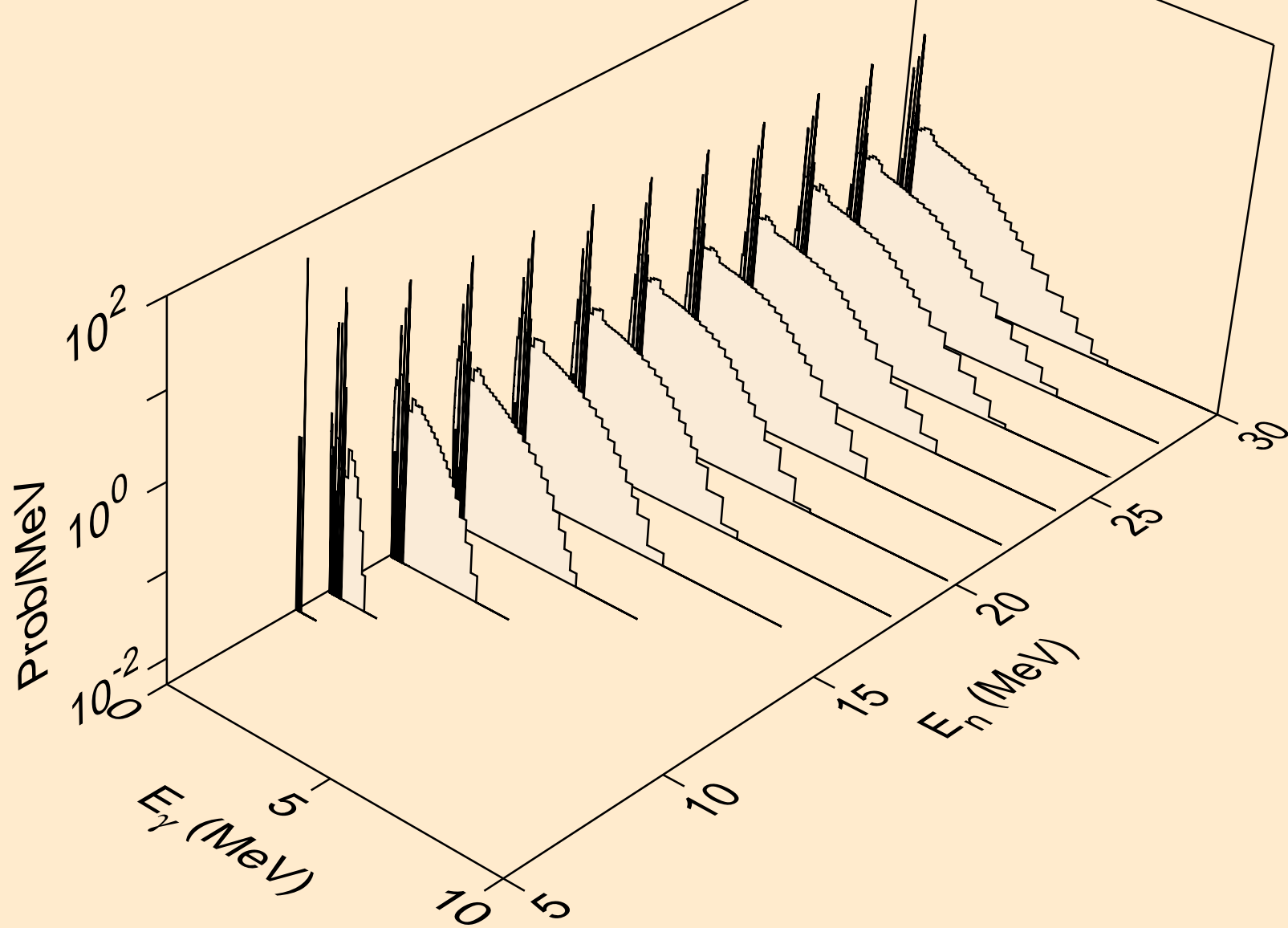

IR174 NEUTRON ACER TENDL-2024 LIBRARY; T=0.K
Photon emission for (n,3n)

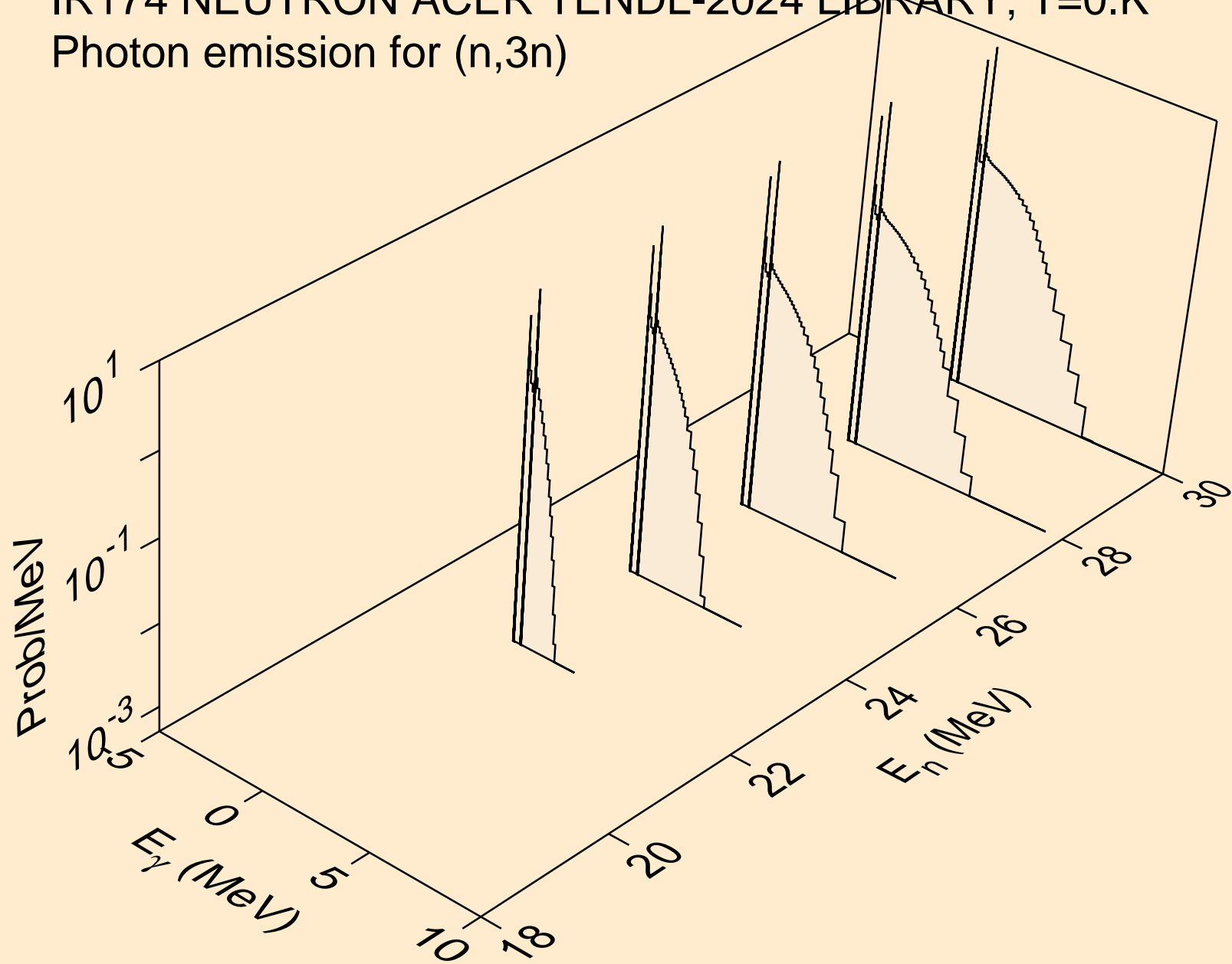

IR174 NEUTRON ACER TENDL-2024 LIBRARY; T=0.K
Photon emission for (n,n*)a

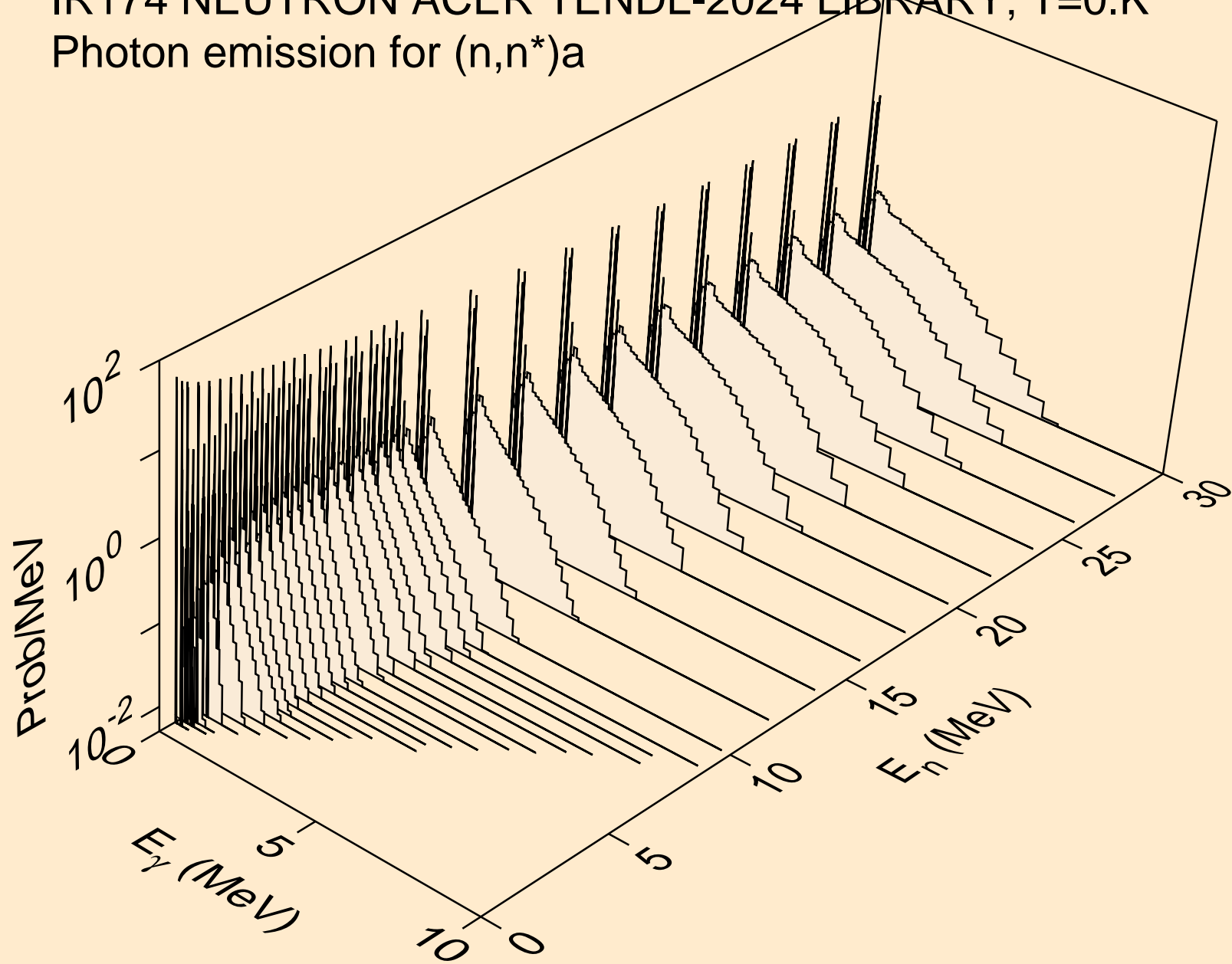

IR174 NEUTRON ACER TENDL-2024 LIBRARY; T=0.K
Photon emission for (n,n*)3a

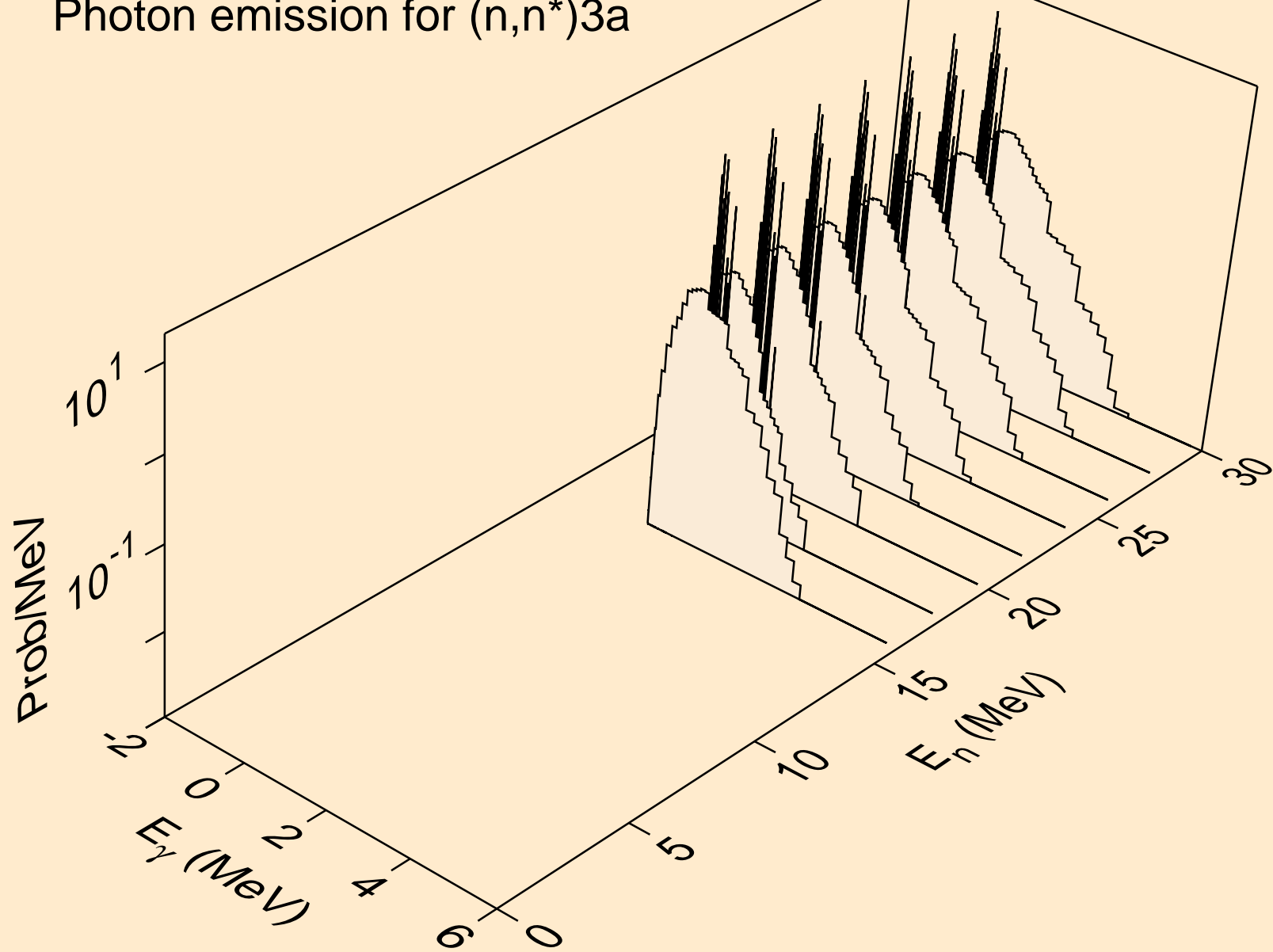

IR174 NEUTRON ACER TENDL-2024 LIBRARY; T=0.K
Photon emission for (n,2n)a

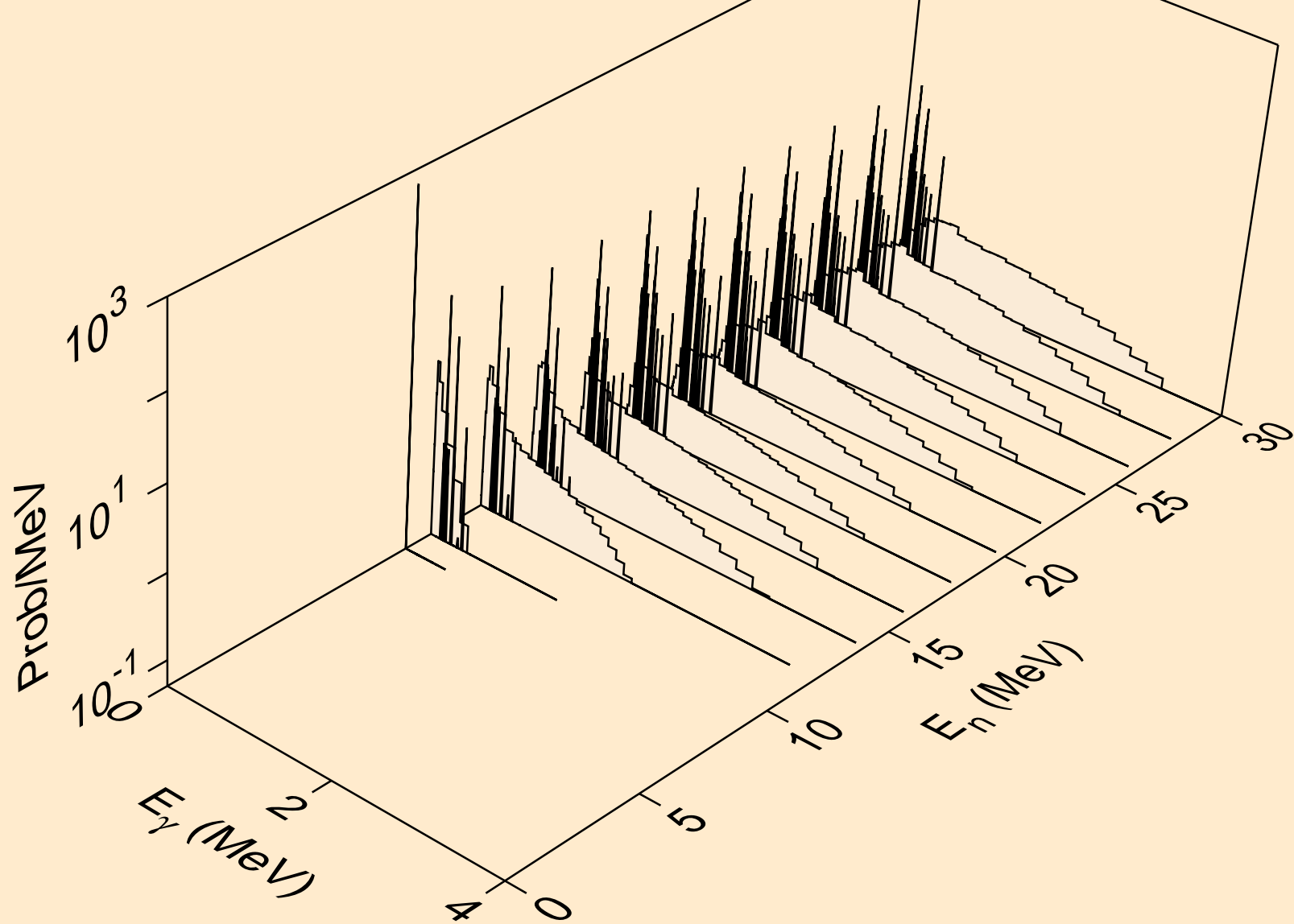

IR174 NEUTRON ACER TENDL-2024 LIBRARY; T=0.K
Photon emission for (n,3n)a

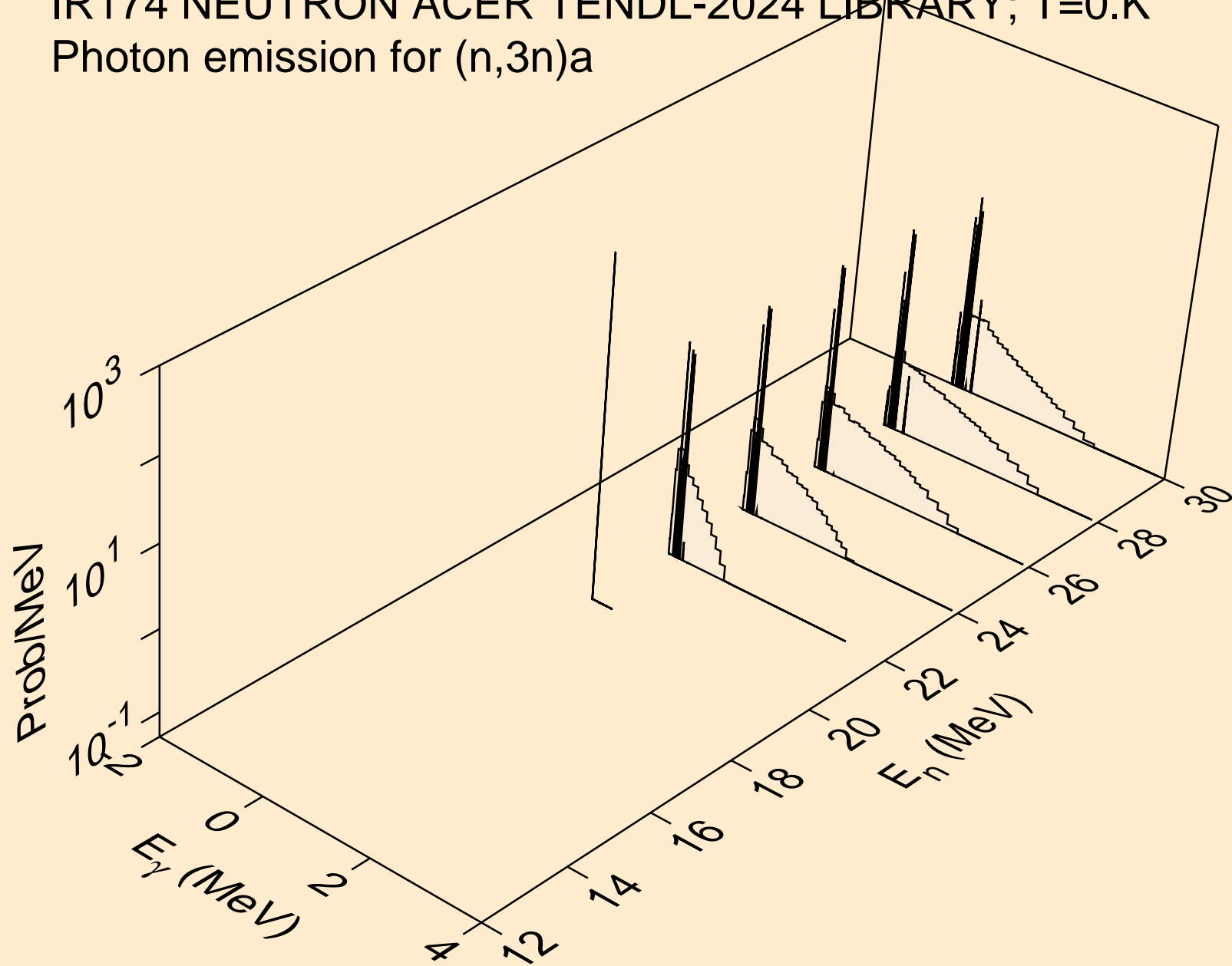

IR174 NEUTRON ACER TENDL-2024 LIBRARY; T=0.K
Photon emission for (n,n*)p

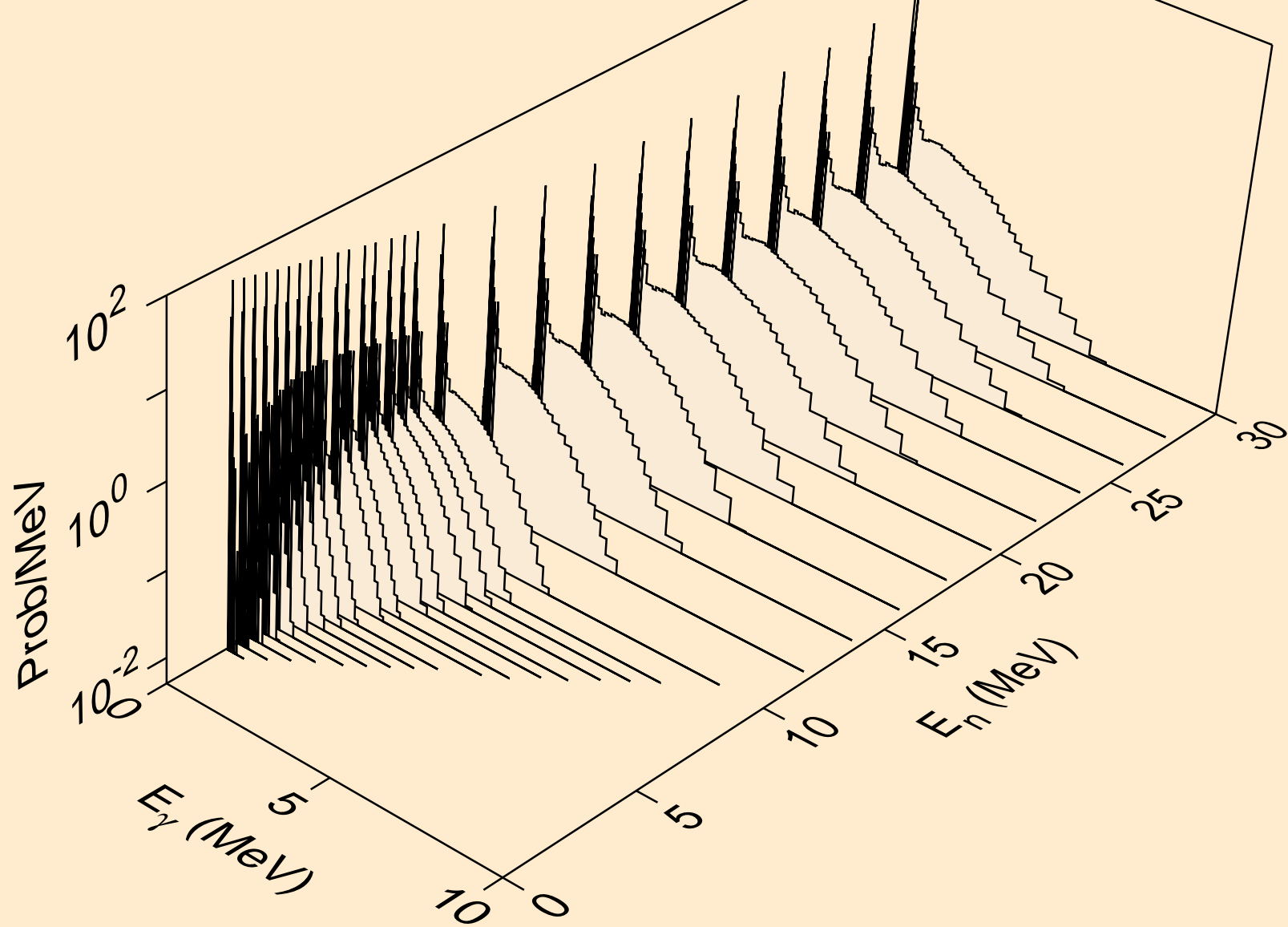

IR174 NEUTRON ACER TENDL-2024 LIBRARY; T=0.K
Photon emission for (n,n*)2a

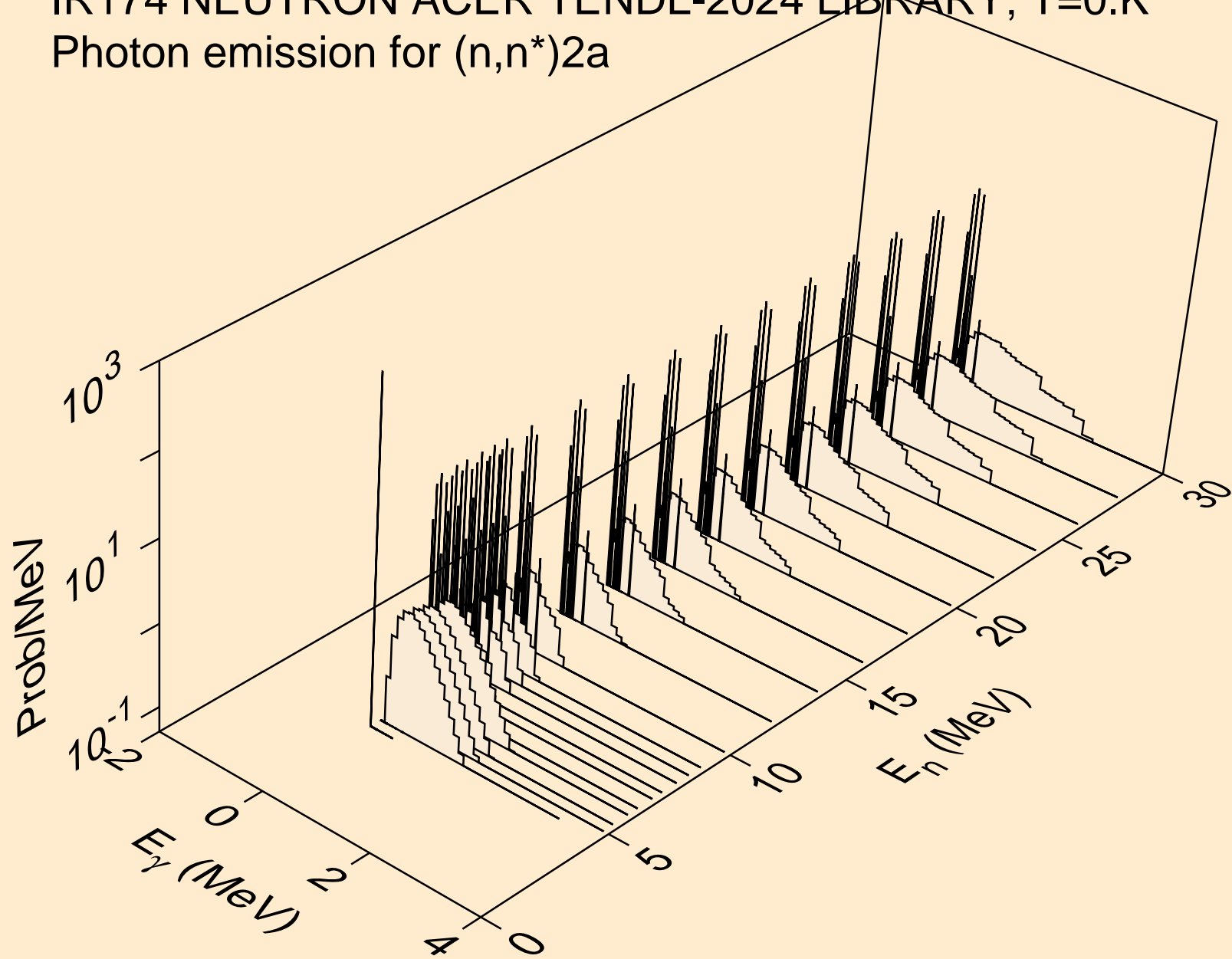

IR174 NEUTRON ACER TENDL-2024 LIBRARY; T=0.K
Photon emission for (n,2n)2a

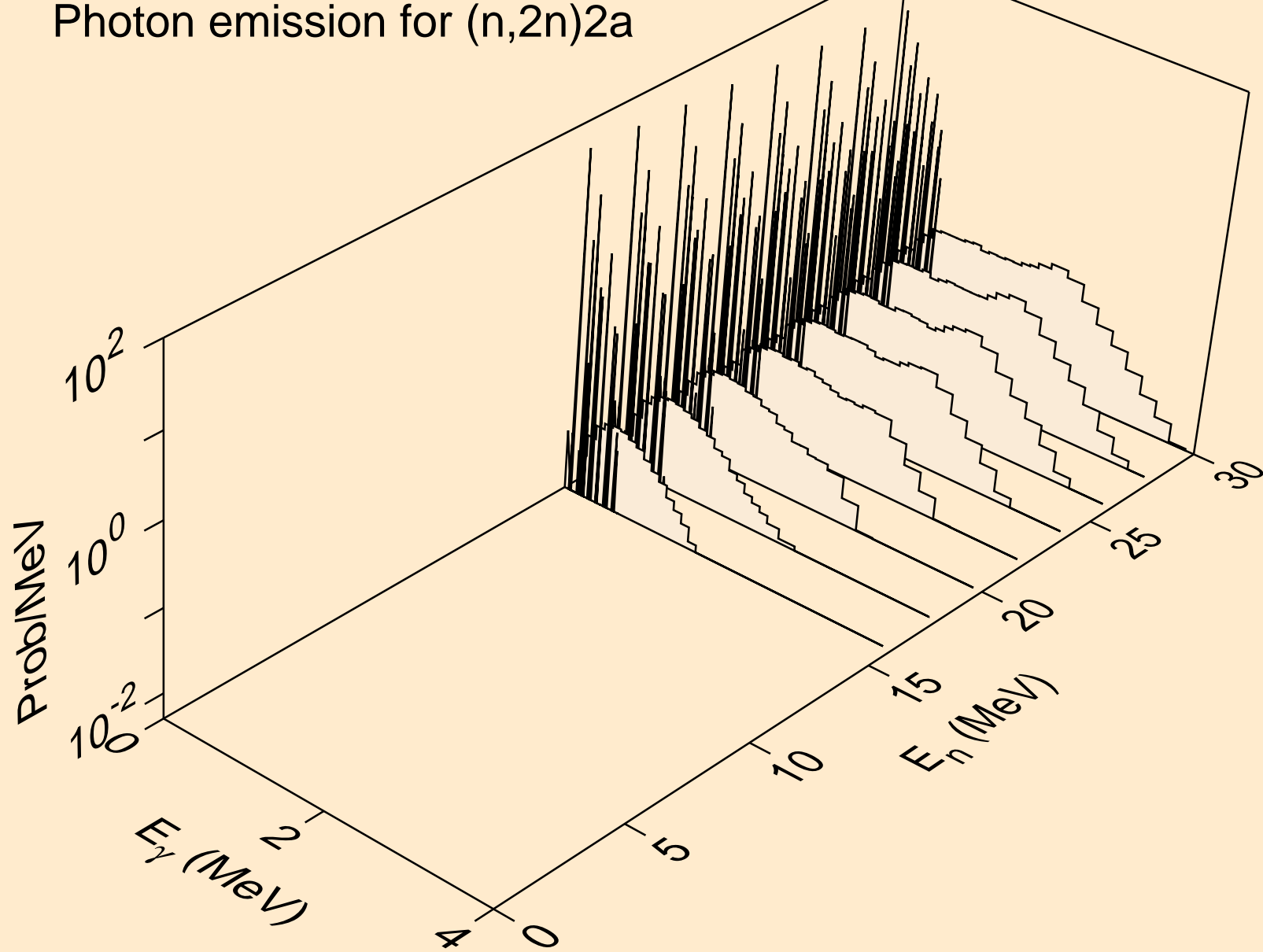

IR174 NEUTRON ACER TENDL-2024 LIBRARY; T=0.K
Photon emission for (n,n*)d

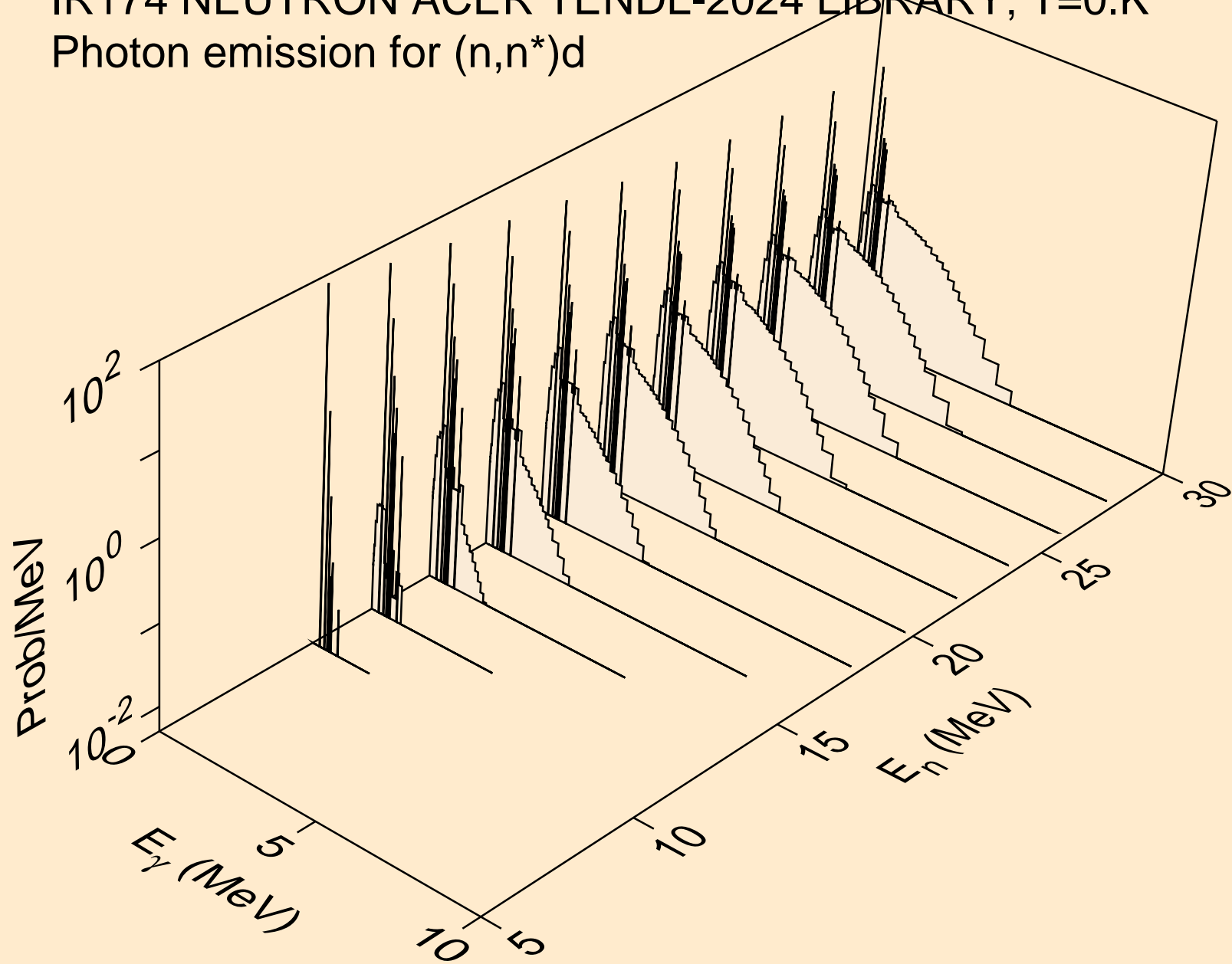

IR174 NEUTRON ACER TENDL-2024 LIBRARY; T=0.K
Photon emission for (n,n*)t

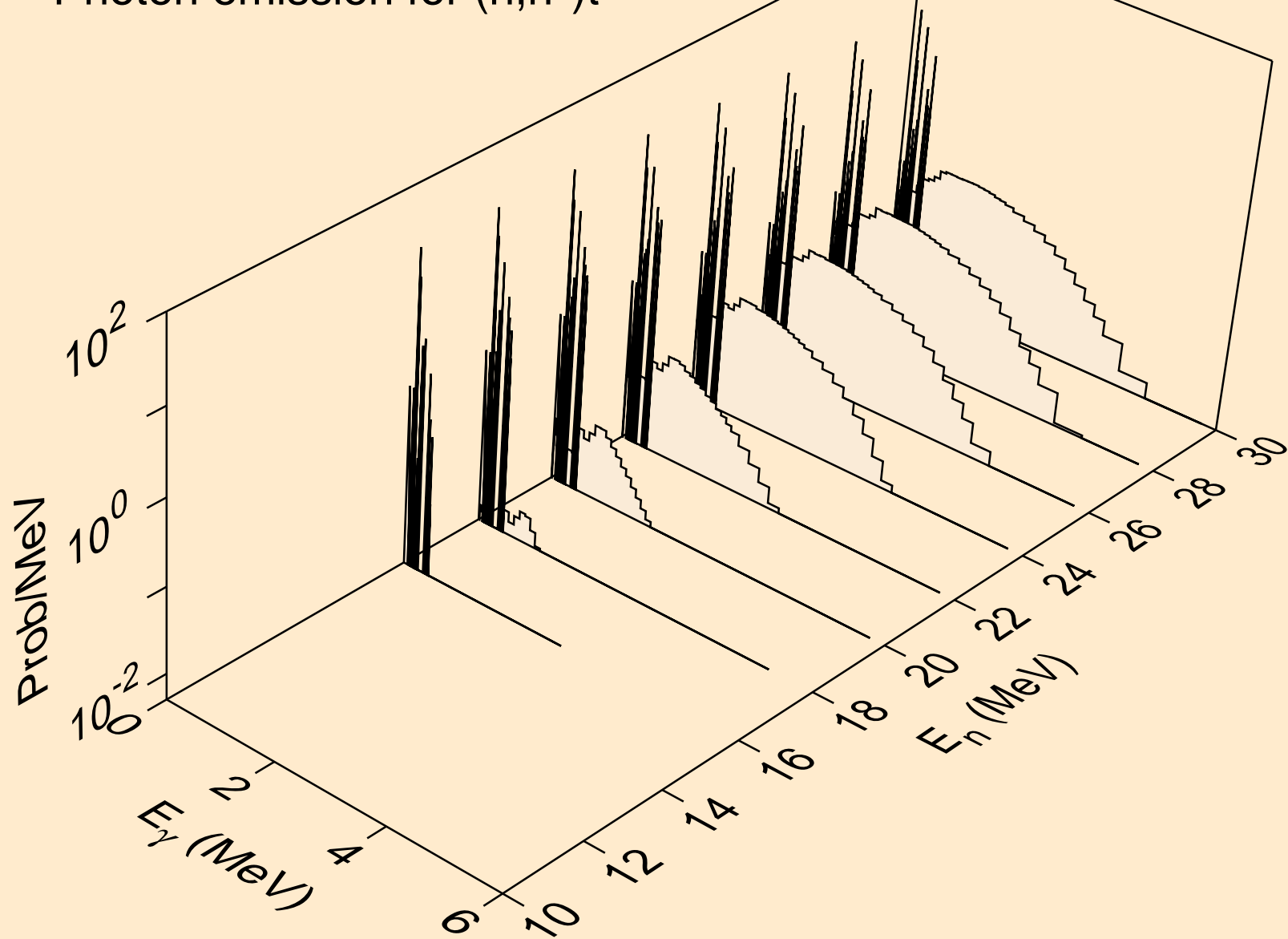

IR174 NEUTRON ACER TENDL-2024 LIBRARY; T=0.K
Photon emission for (n,n*)he3

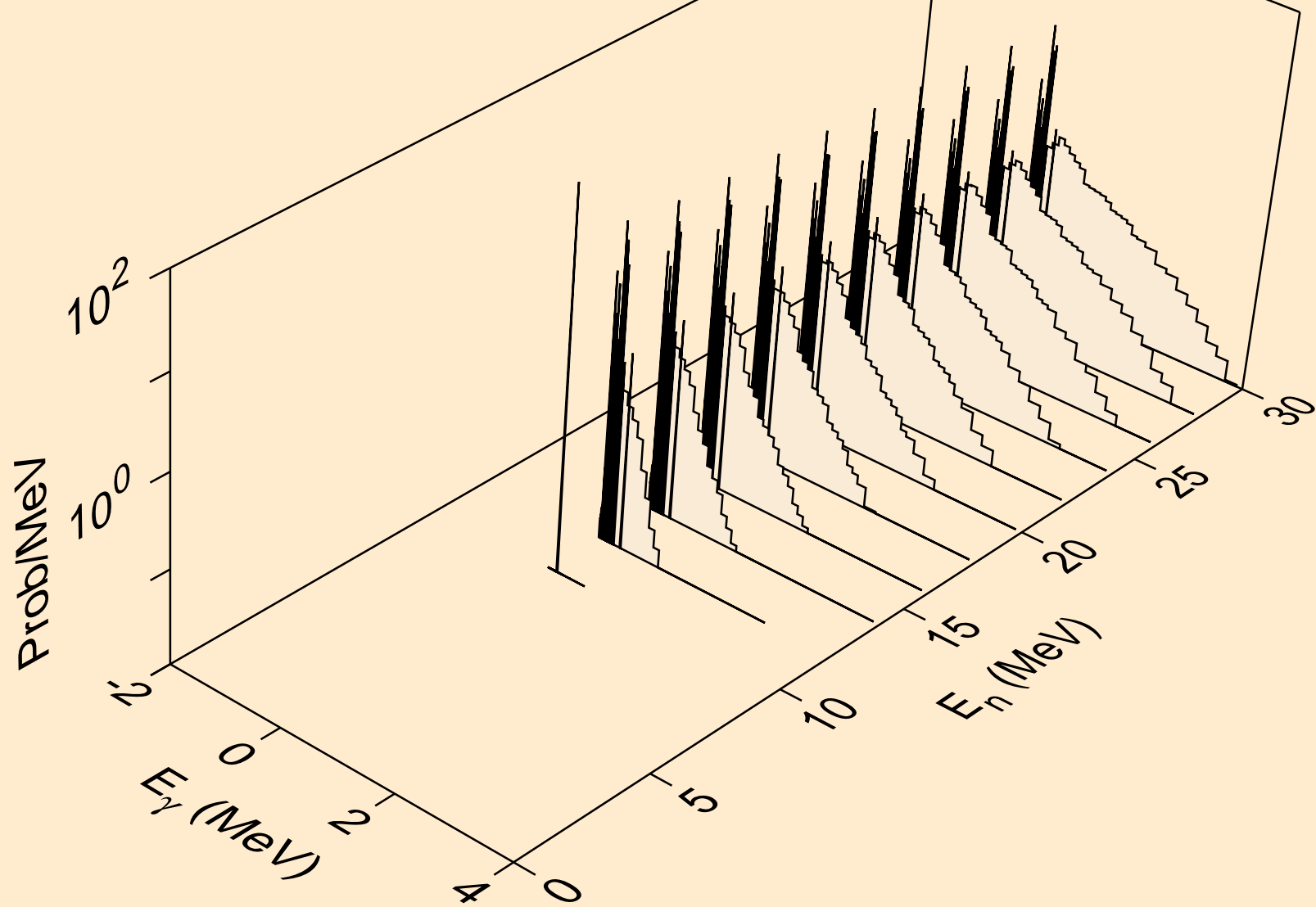

IR174 NEUTRON ACER TENDL-2024 LIBRARY; T=0.K
Photon emission for (n,4n)

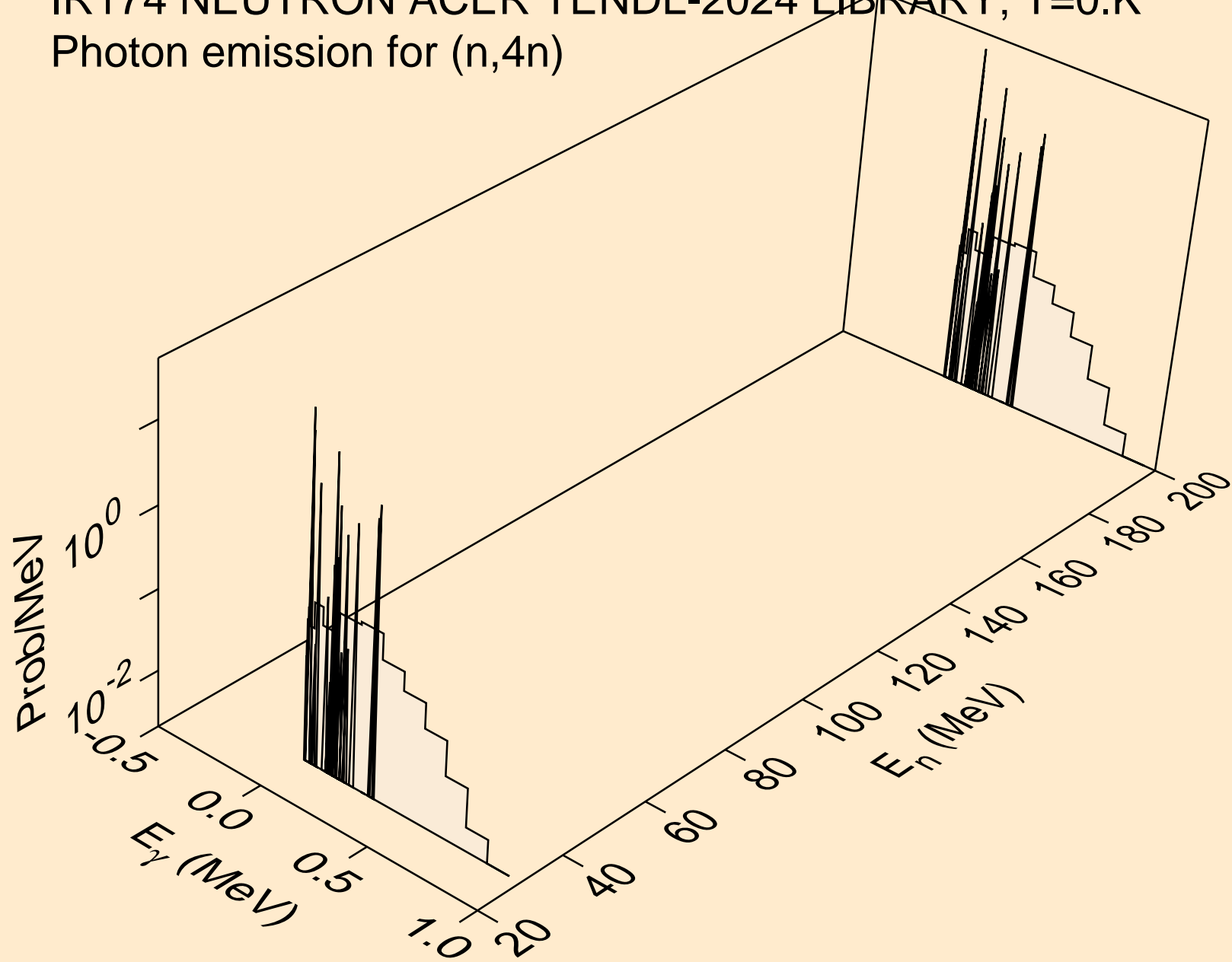

IR174 NEUTRON ACER TENDL-2024 LIBRARY; T=0.K
Photon emission for (n,2np)

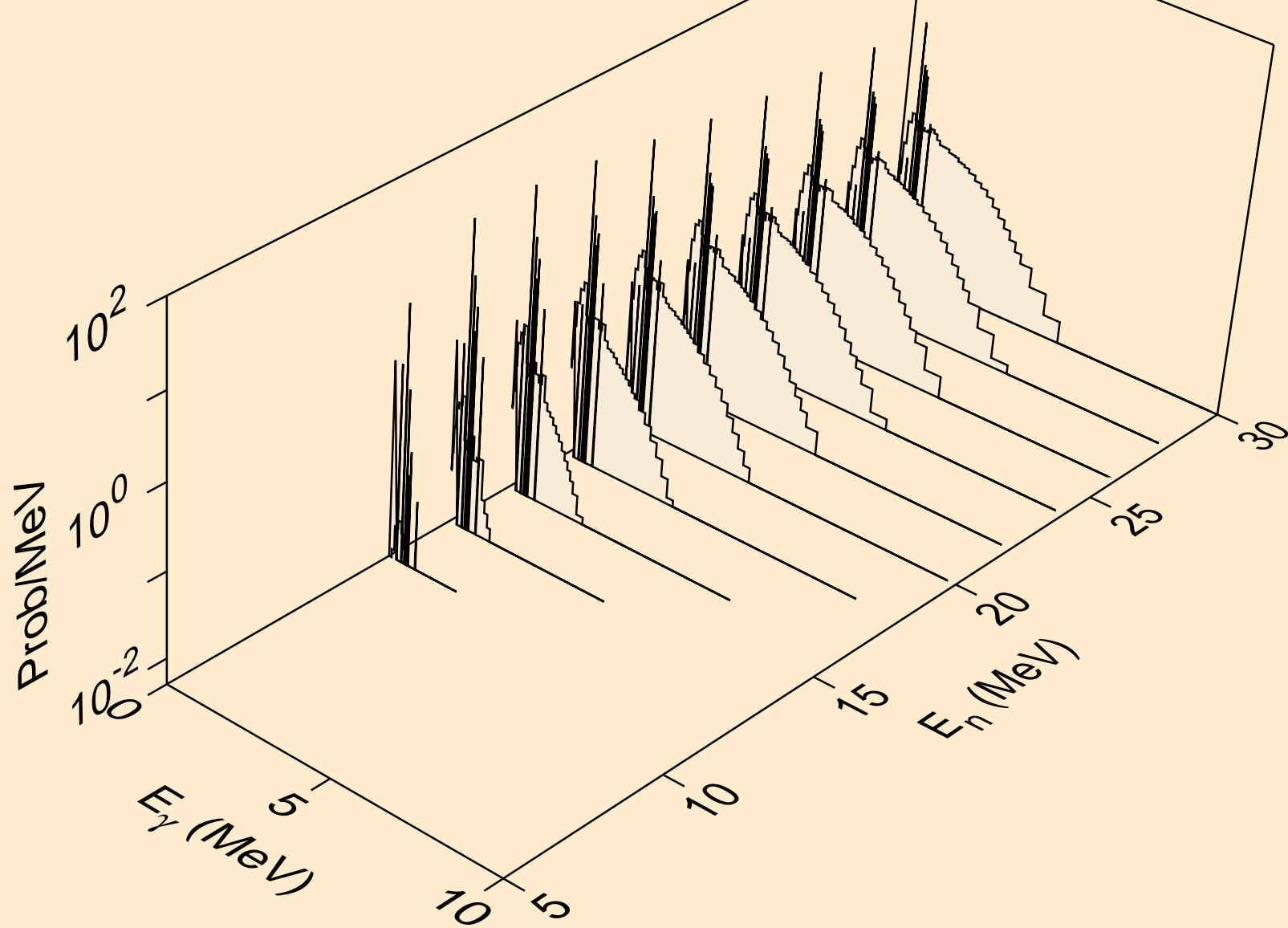

IR174 NEUTRON ACER TENDL-2024 LIBRARY; T=0.K
Photon emission for (n,3np)

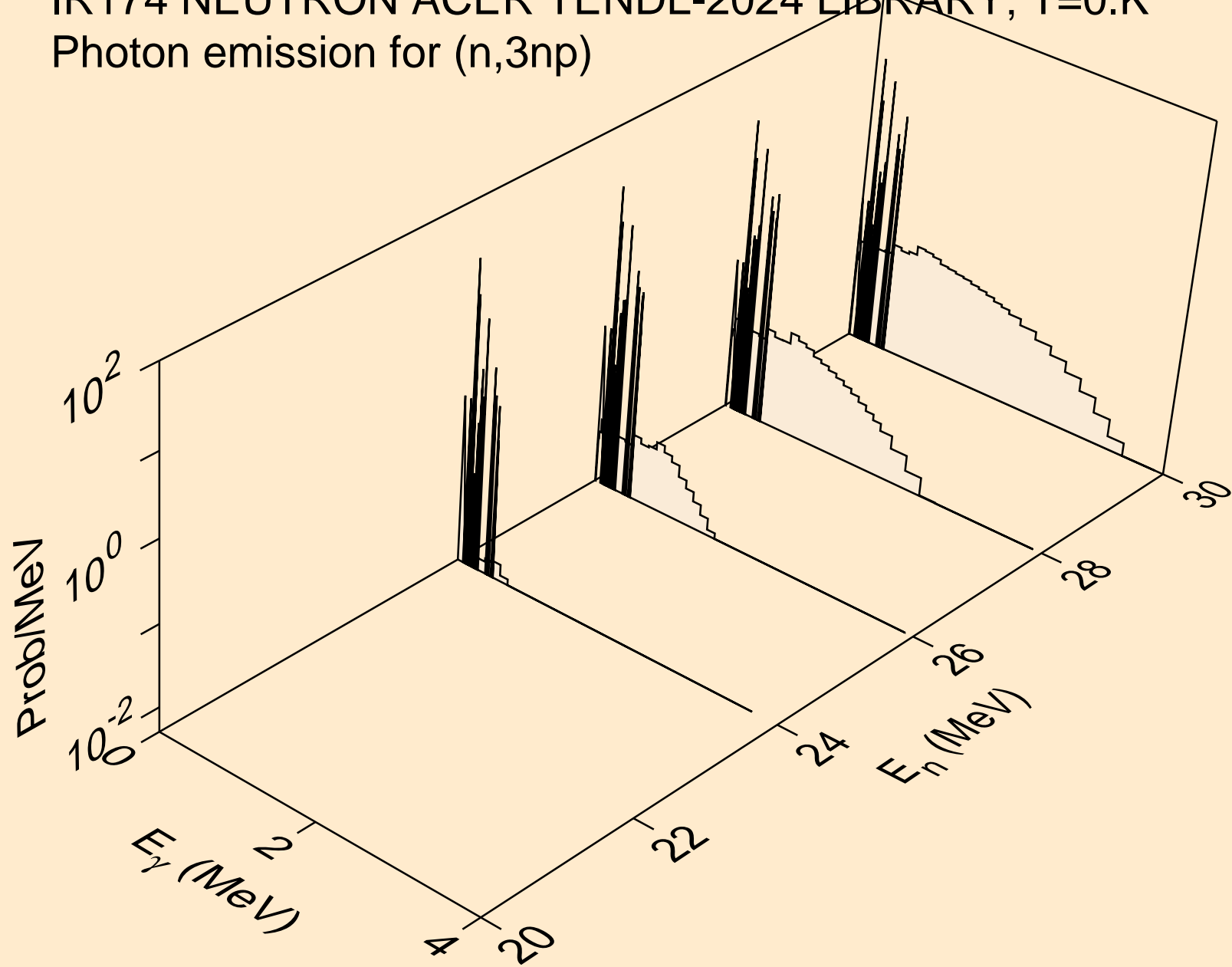

IR174 NEUTRON ACER TENDL-2024 LIBRARY; T=0.K
Photon emission for (n,n2p)

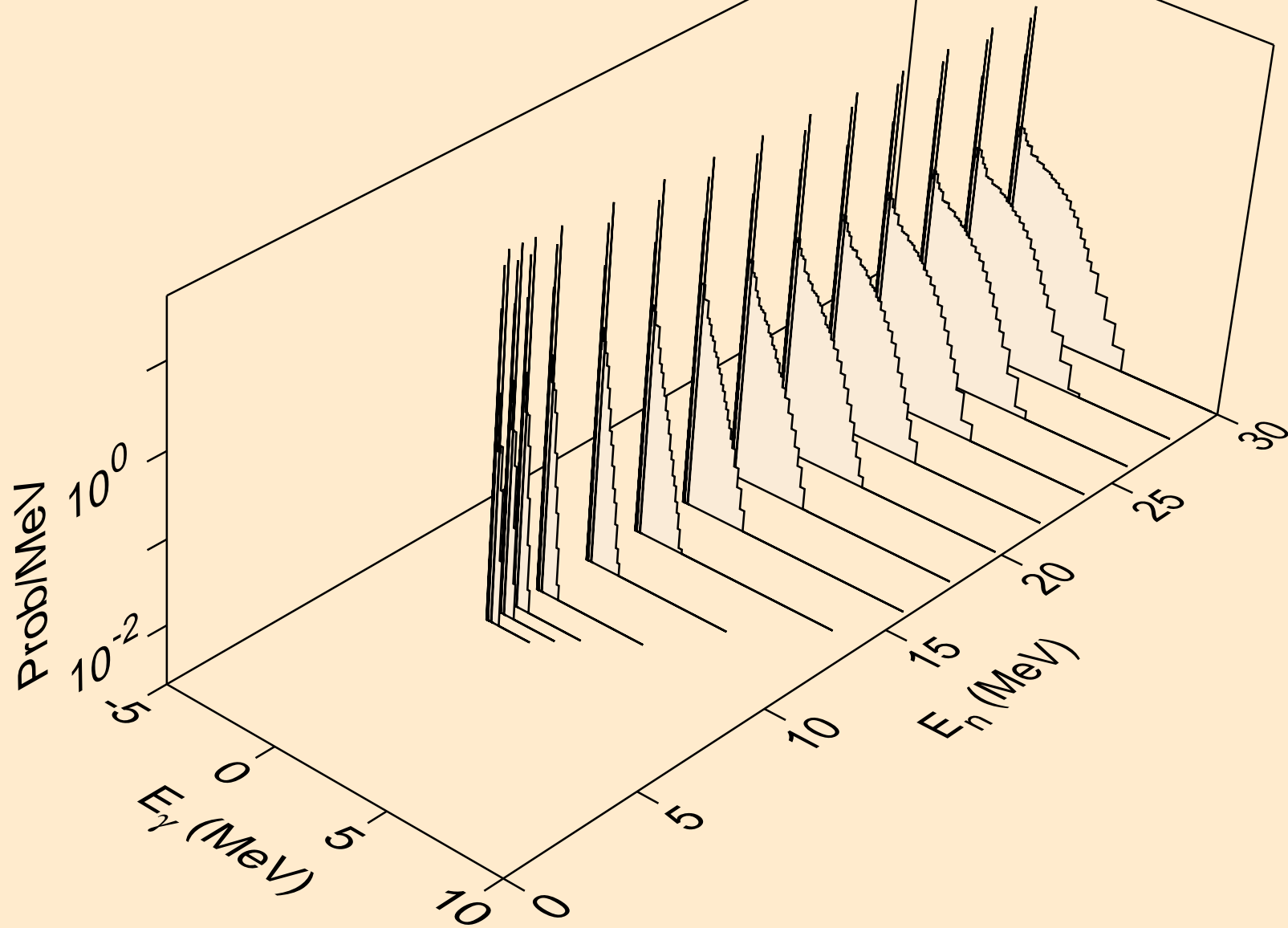

IR174 NEUTRON ACER TENDL-2024 LIBRARY; T=0.K
Photon emission for (n,npa)

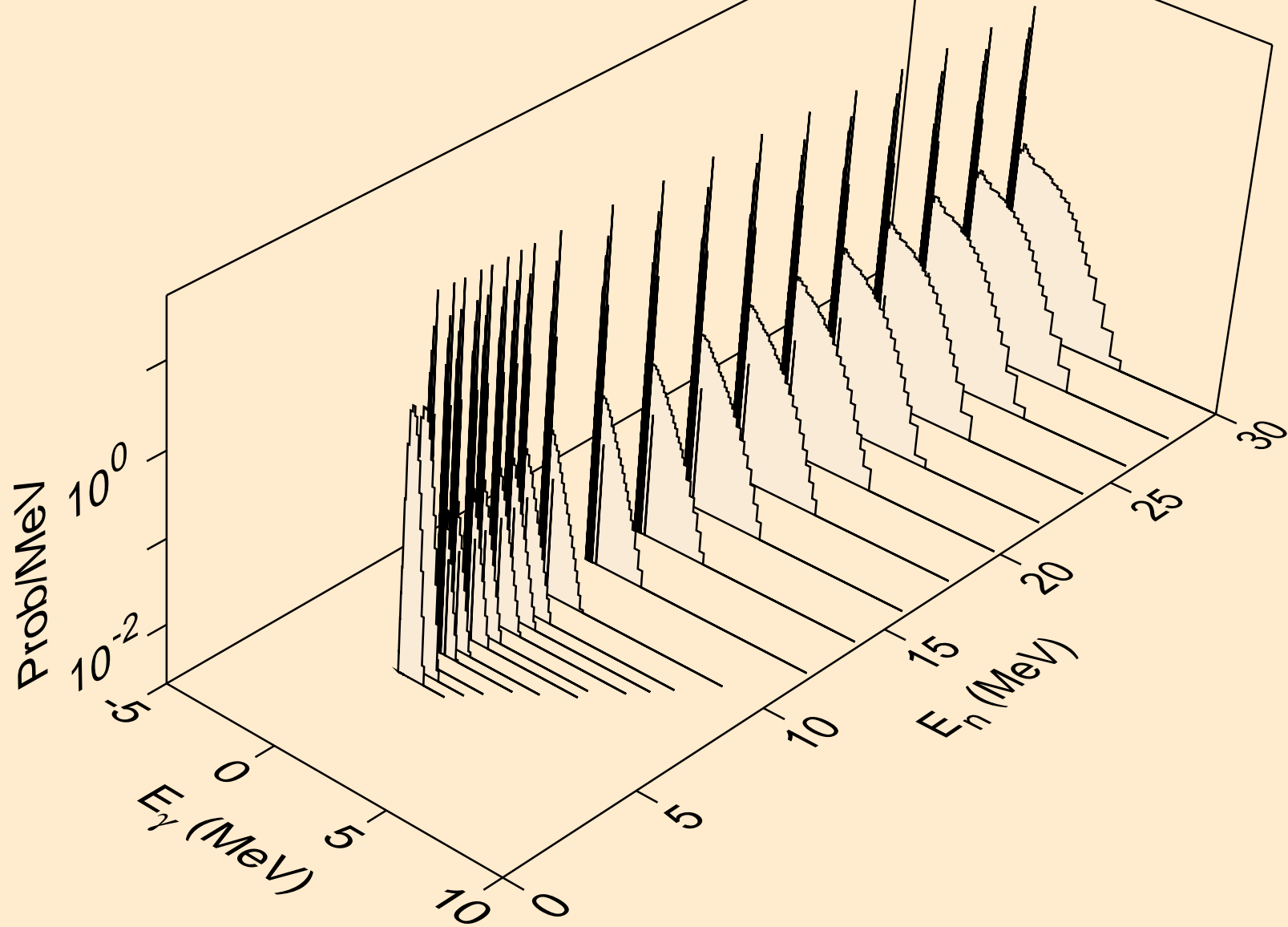

IR174 NEUTRON ACER TENDL-2024 LIBRARY; T=0.K
Photon emission for (n,n*c)

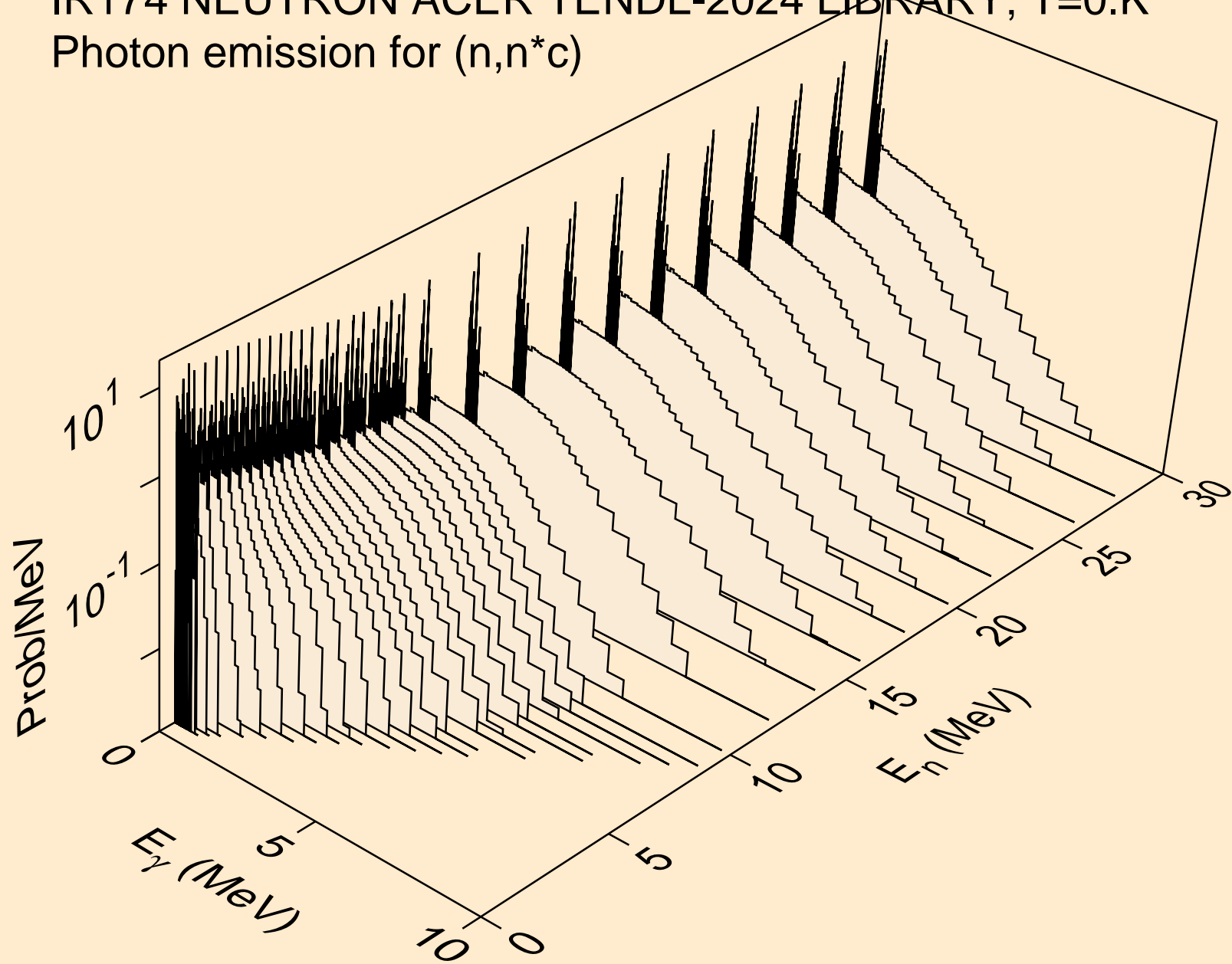

IR174 NEUTRON ACER TENDL-2024 LIBRARY; T=0.K
Photon emission for (n,gma)

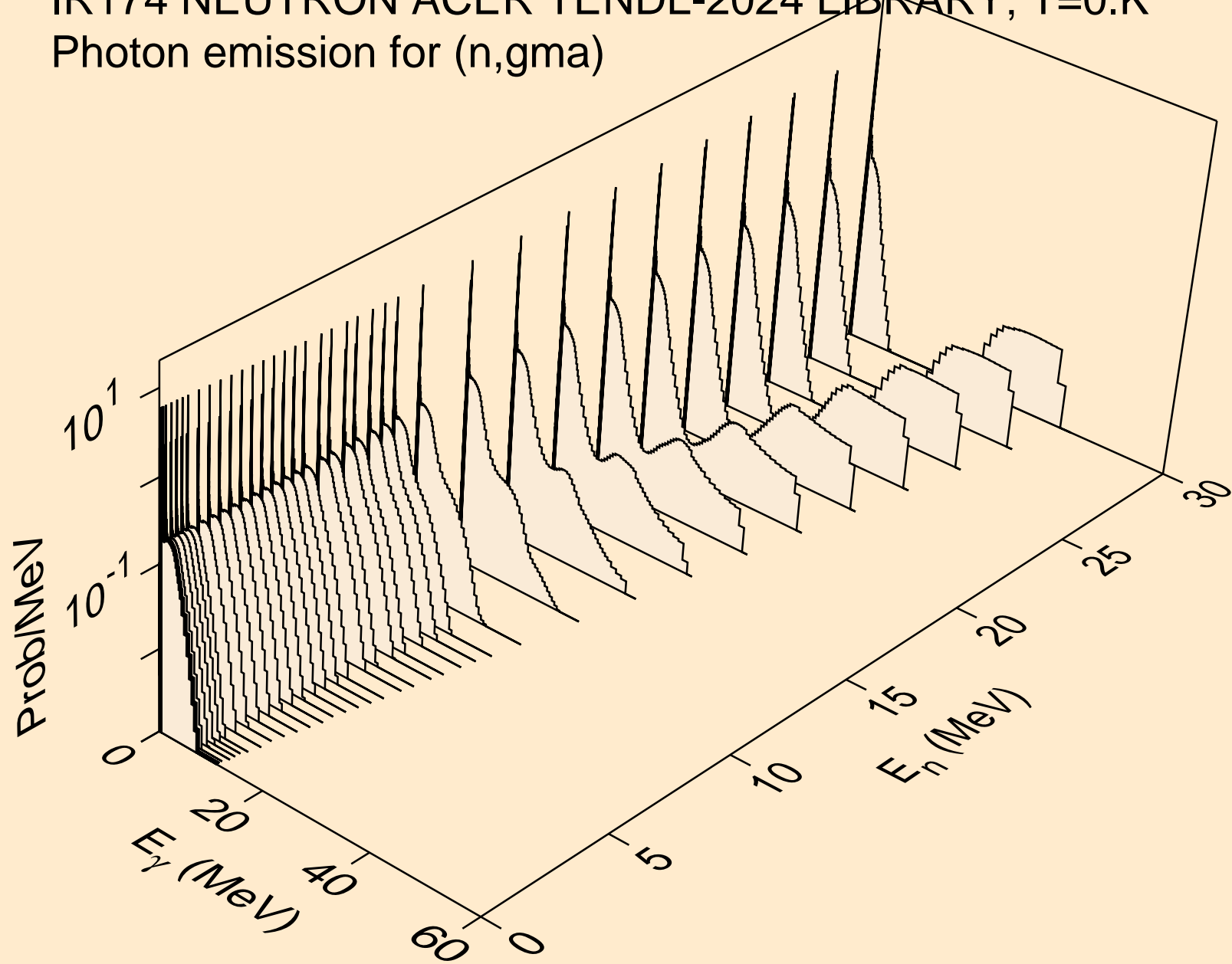

IR174 NEUTRON ACER TENDL-2024 LIBRARY; T=0.K
Photon emission for (n,p)

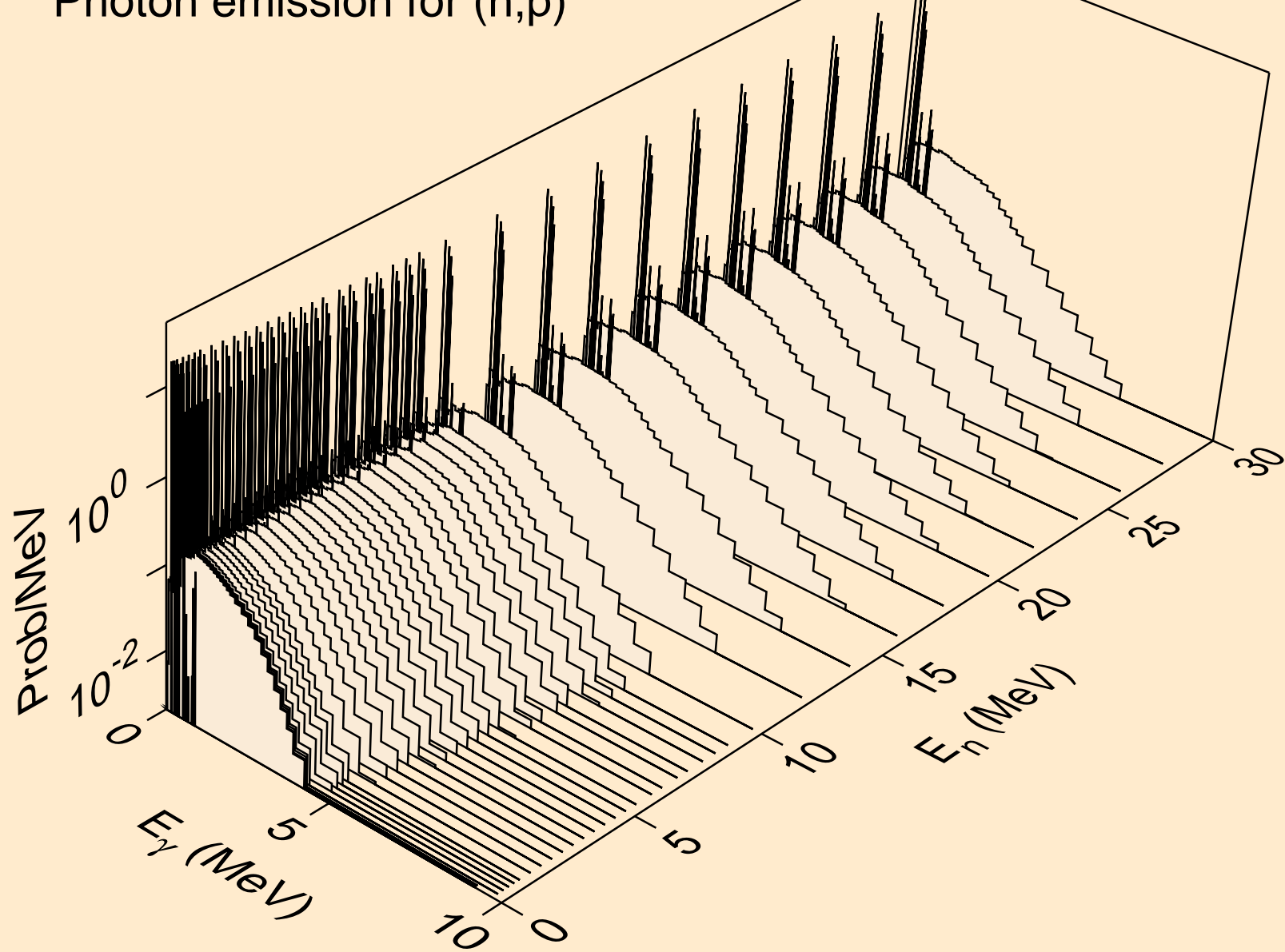

IR174 NEUTRON ACER TENDL-2024 LIBRARY; T=0.K
Photon emission for (n,d)

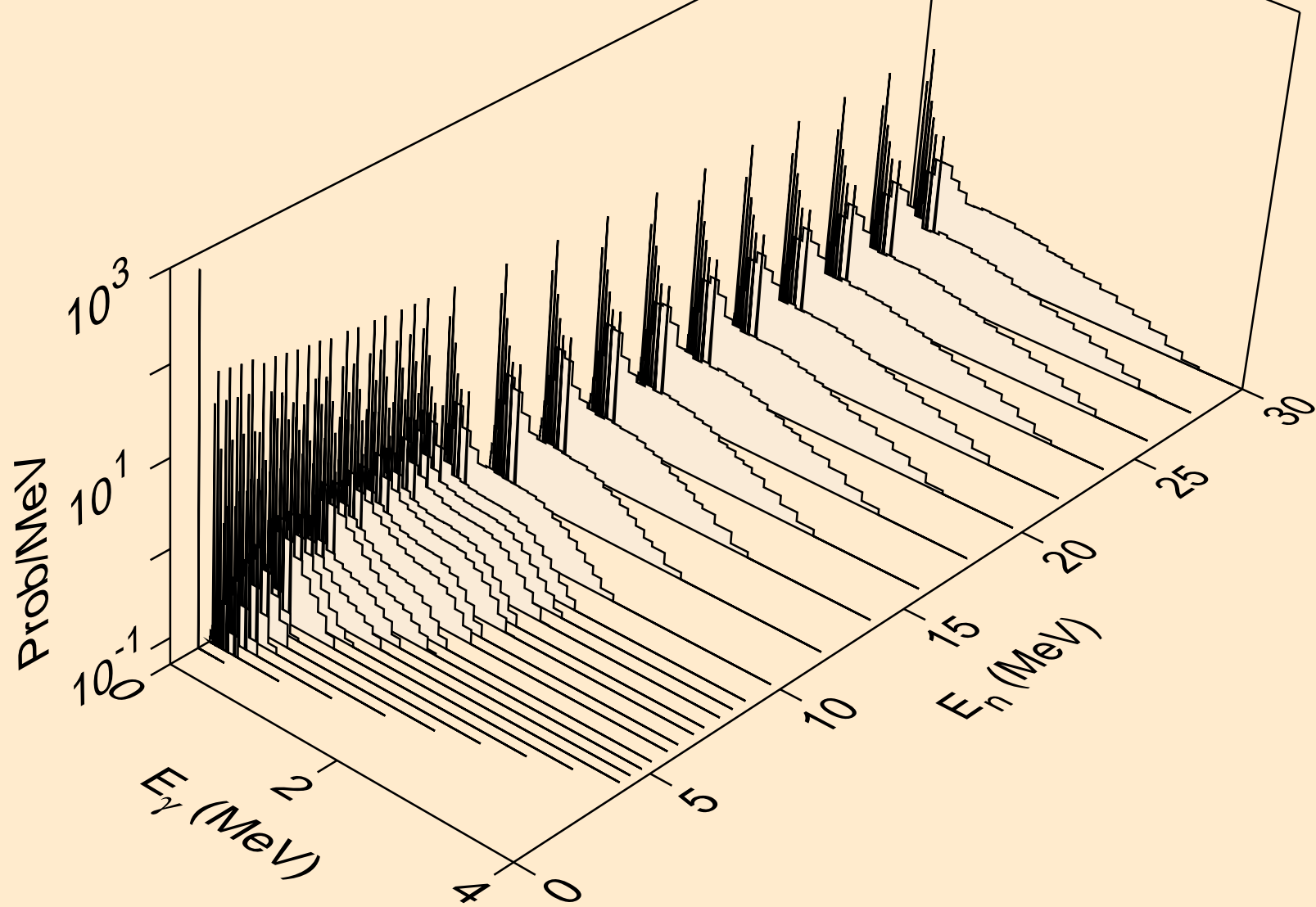

IR174 NEUTRON ACER TENDL-2024 LIBRARY; T=0.K
Photon emission for (n,t)

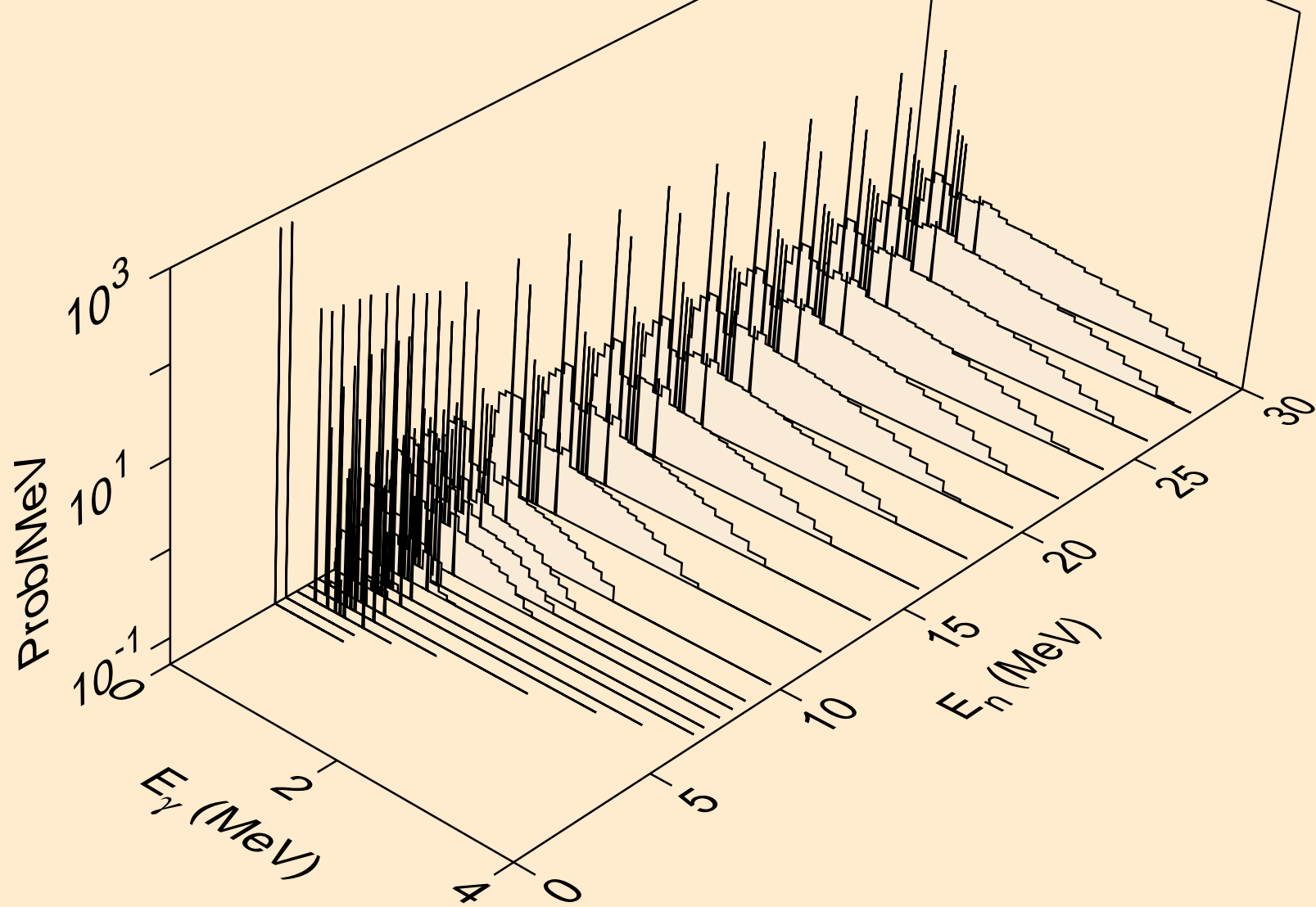

IR174 NEUTRON ACER TENDL-2024 LIBRARY; T=0.K
Photon emission for (n,he3)

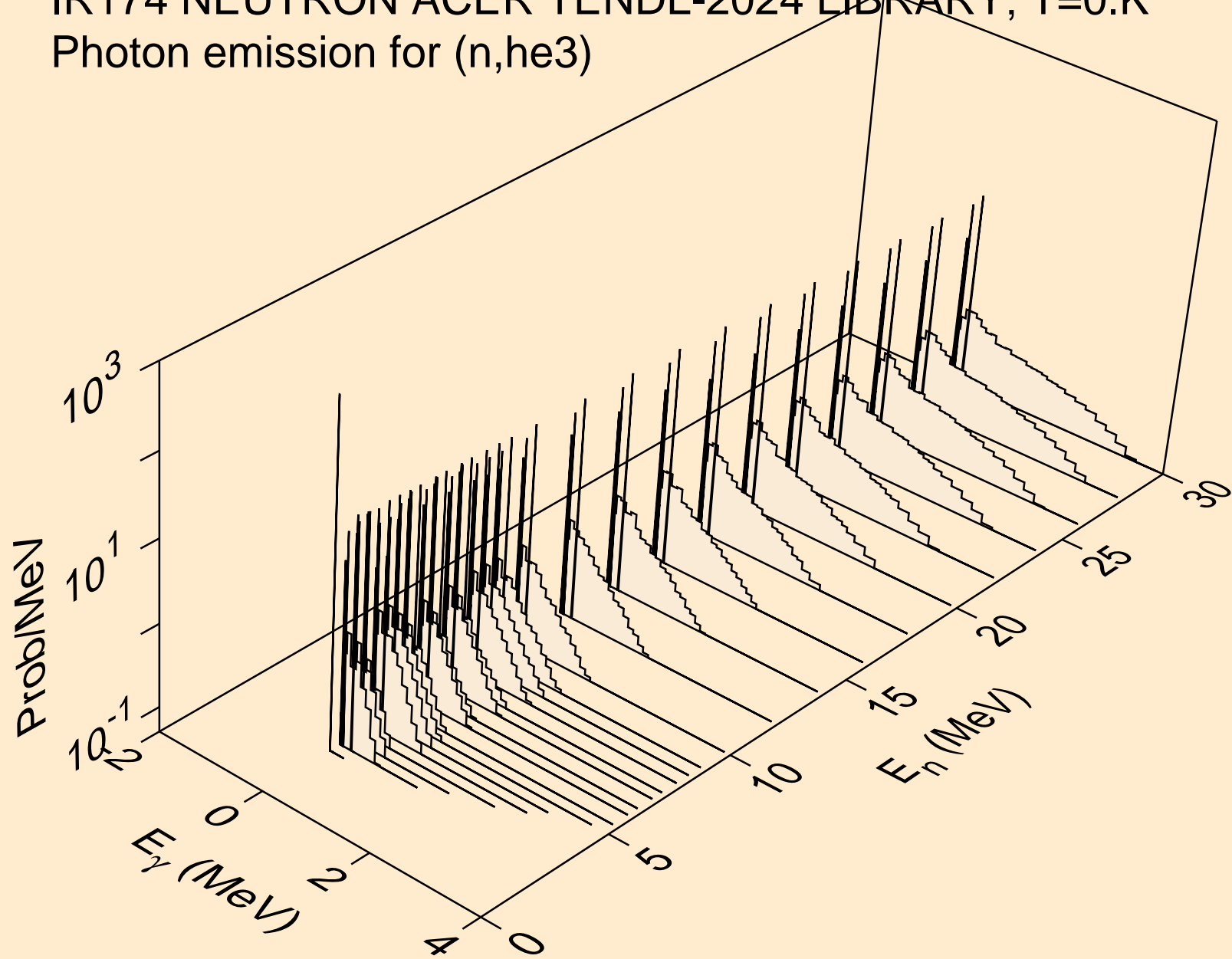

IR174 NEUTRON ACER TENDL-2024 LIBRARY; T=0.K
Photon emission for (n,a)

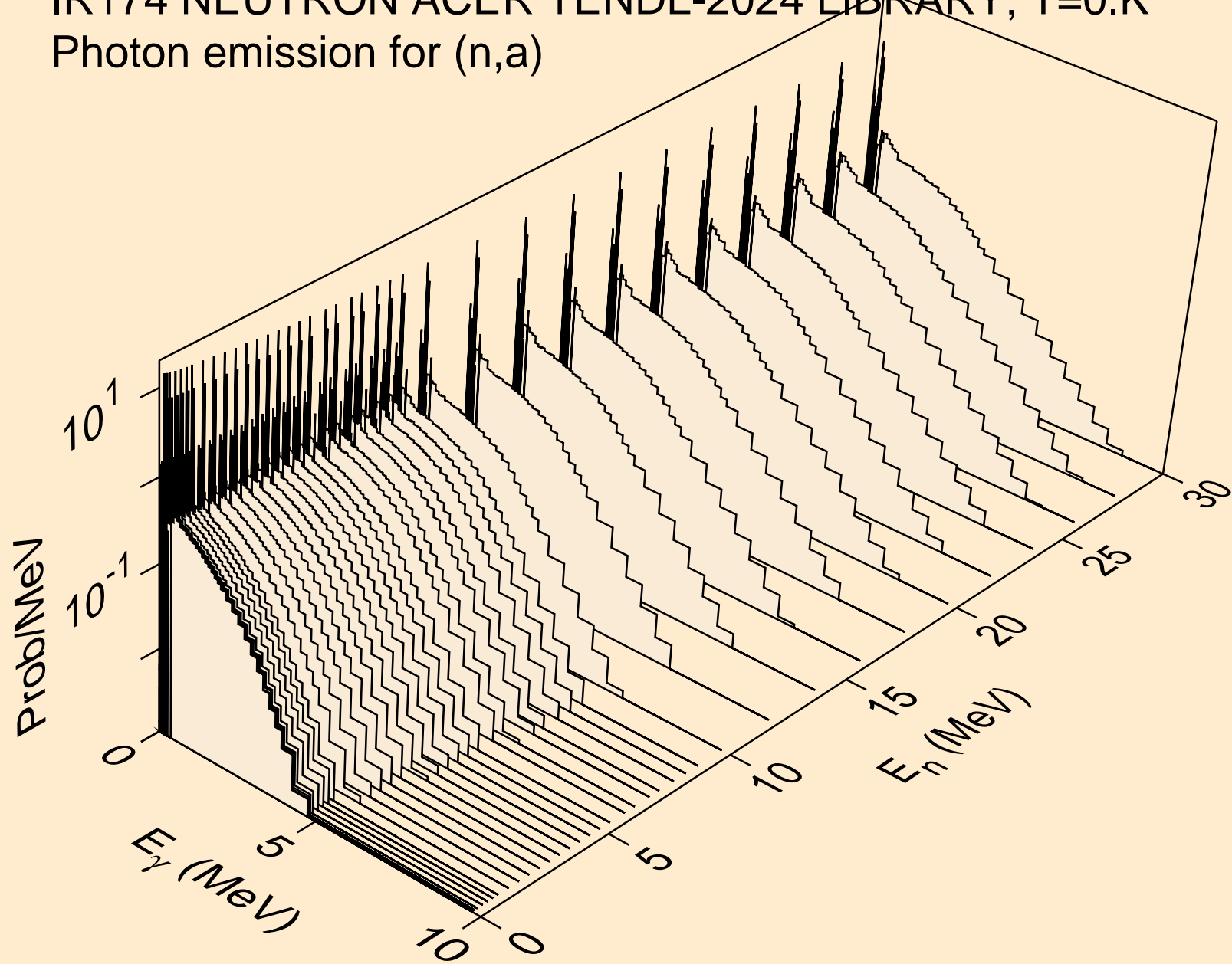

IR174 NEUTRON ACER TENDL-2024 LIBRARY; T=0.K
Photon emission for (n,2a)

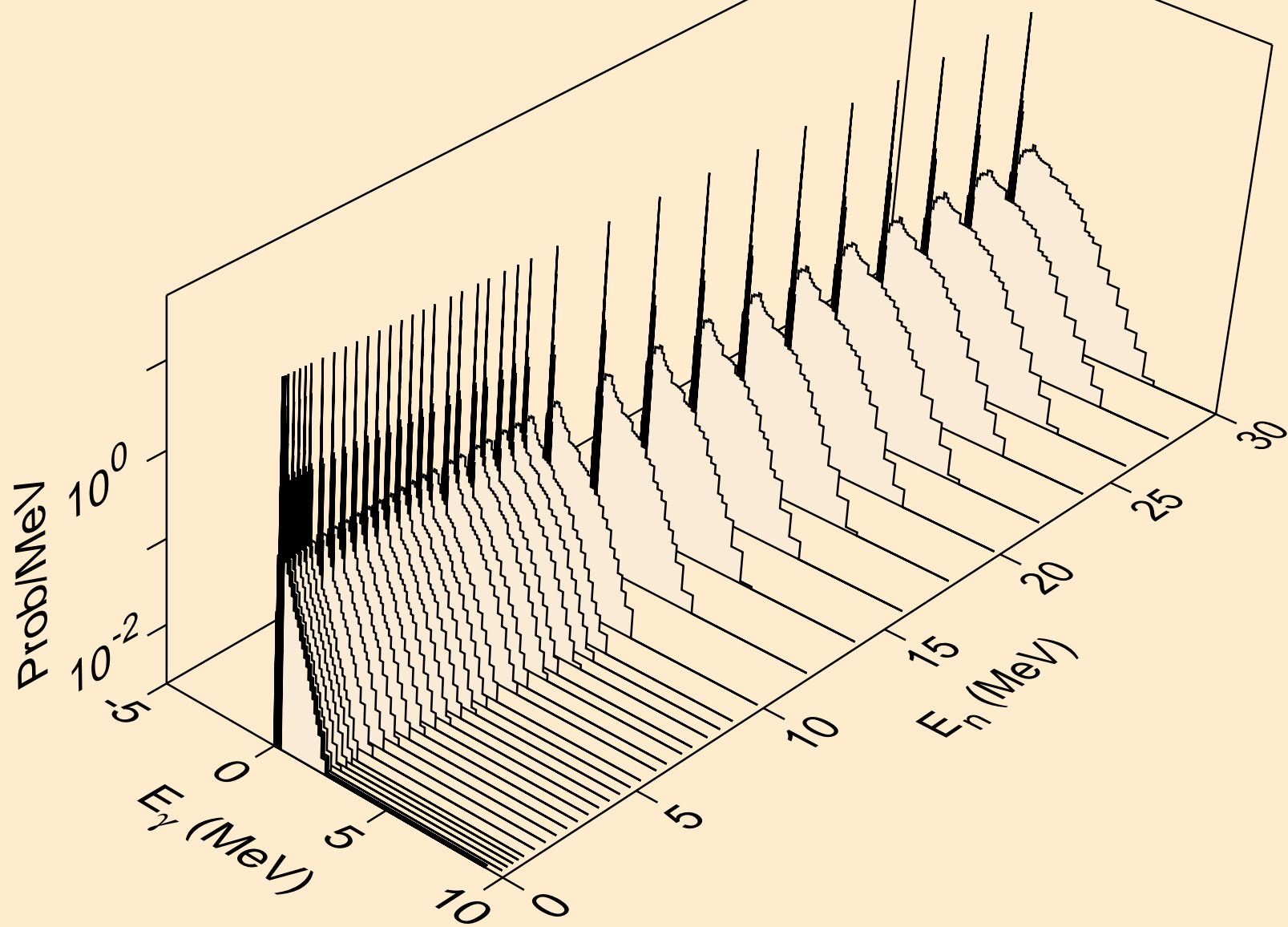

IR174 NEUTRON ACER TENDL-2024 LIBRARY; T=0.K
Photon emission for (n,3a)

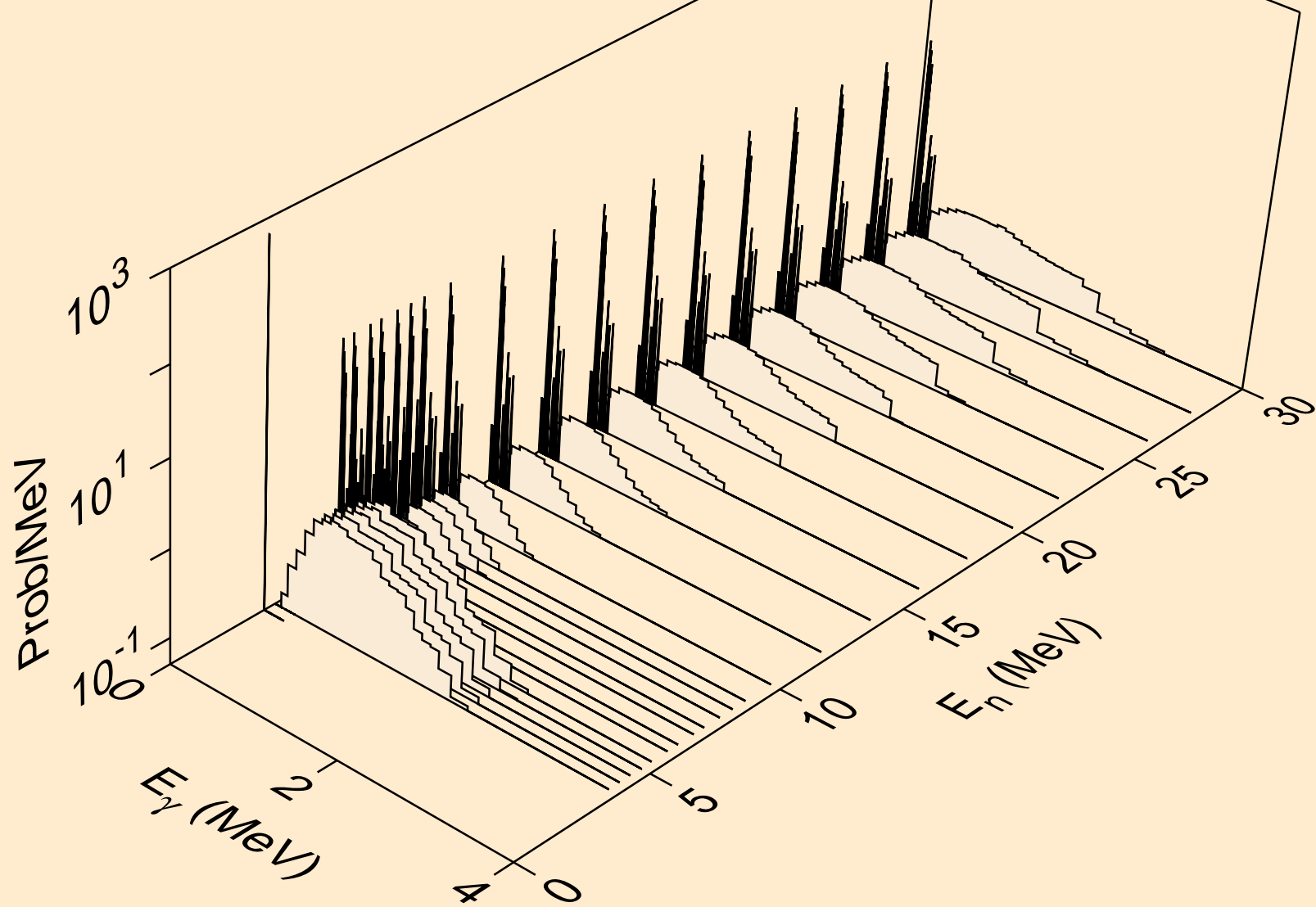

IR174 NEUTRON ACER TENDL-2024 LIBRARY; T=0.K
Photon emission for (n,2p)

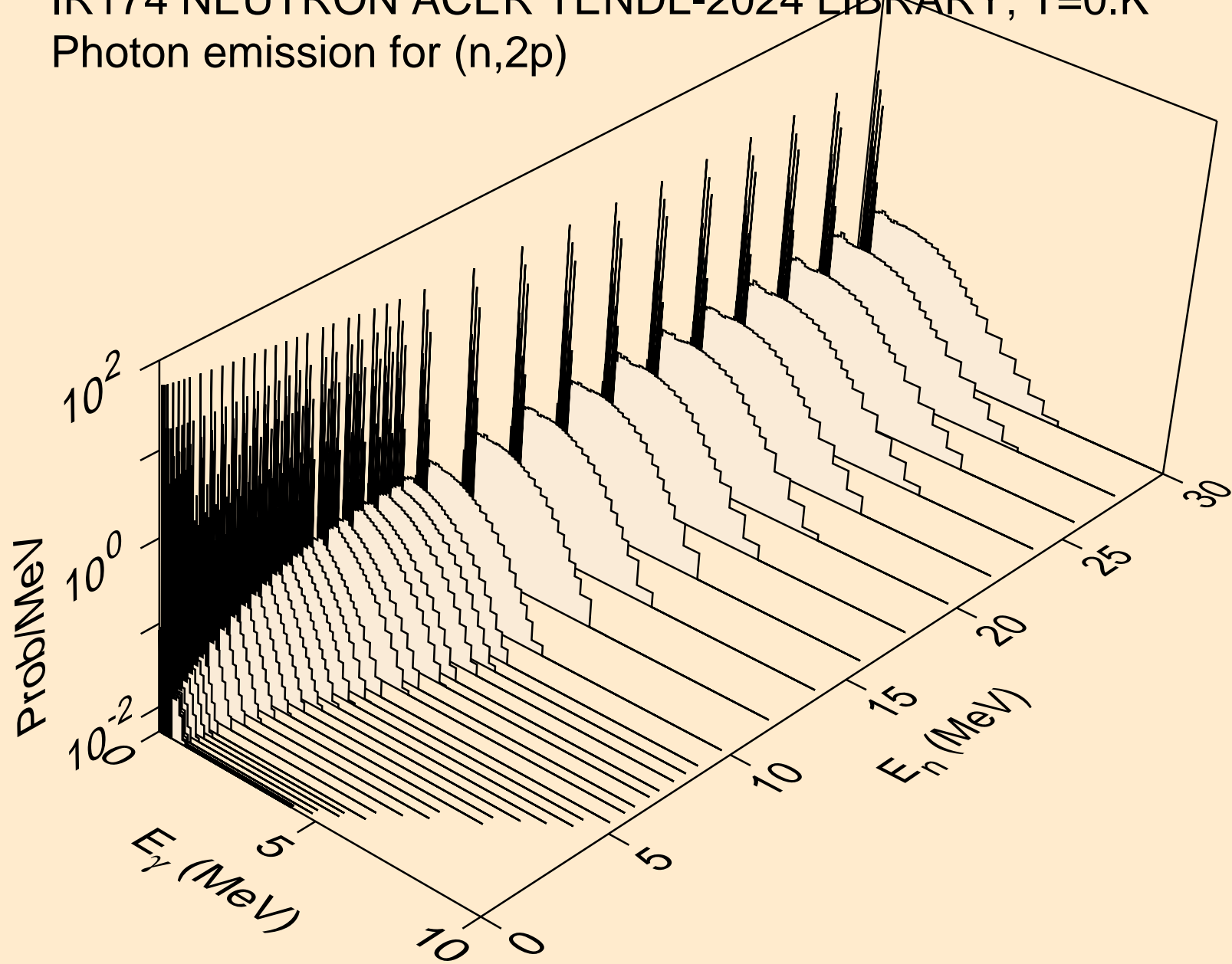

IR174 NEUTRON ACER TENDL-2024 LIBRARY; T=0.K
Photon emission for (n,p α)

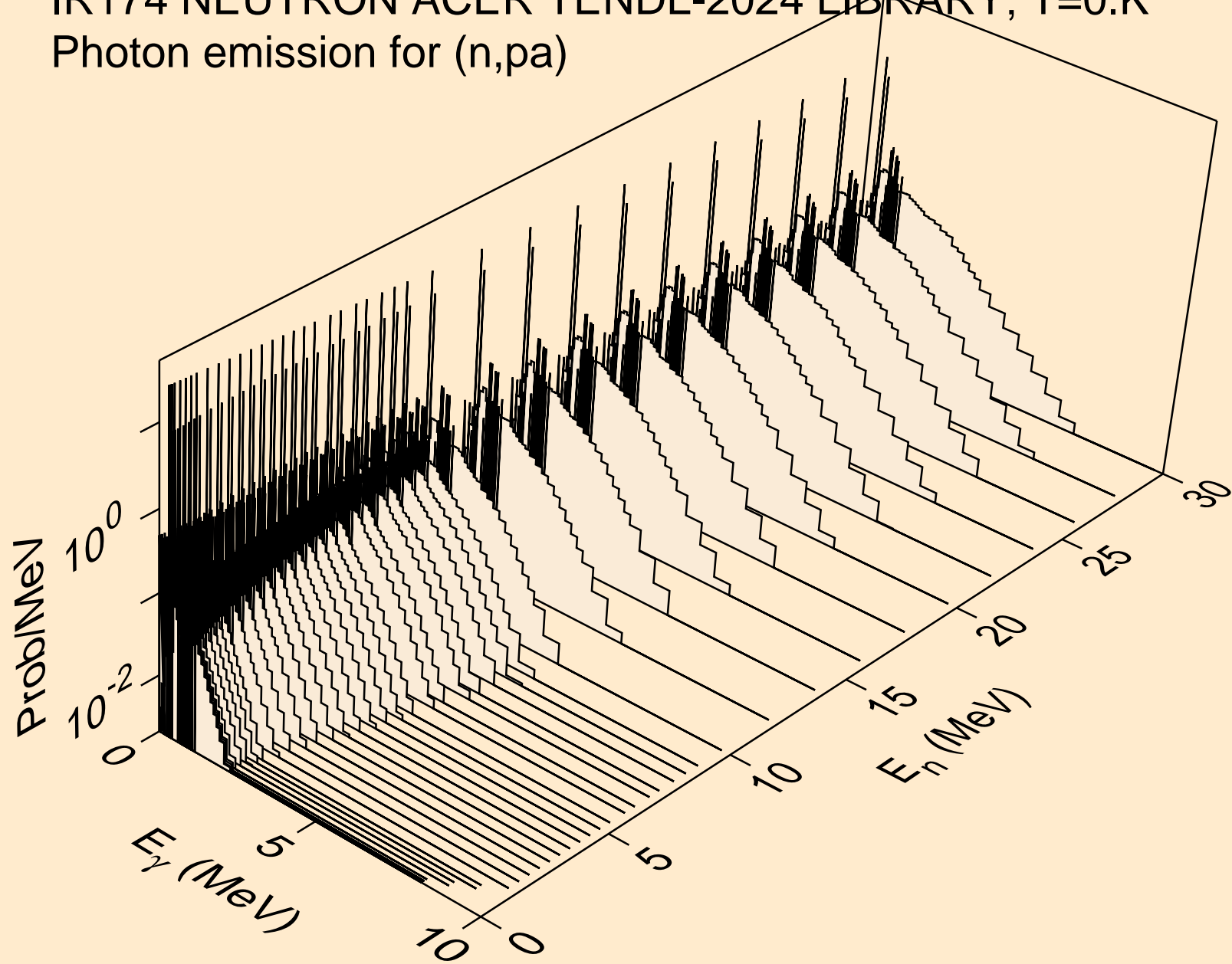

IR174 NEUTRON ACER TENDL-2024 LIBRARY; T=0.K
Photon emission for (n,t2a)

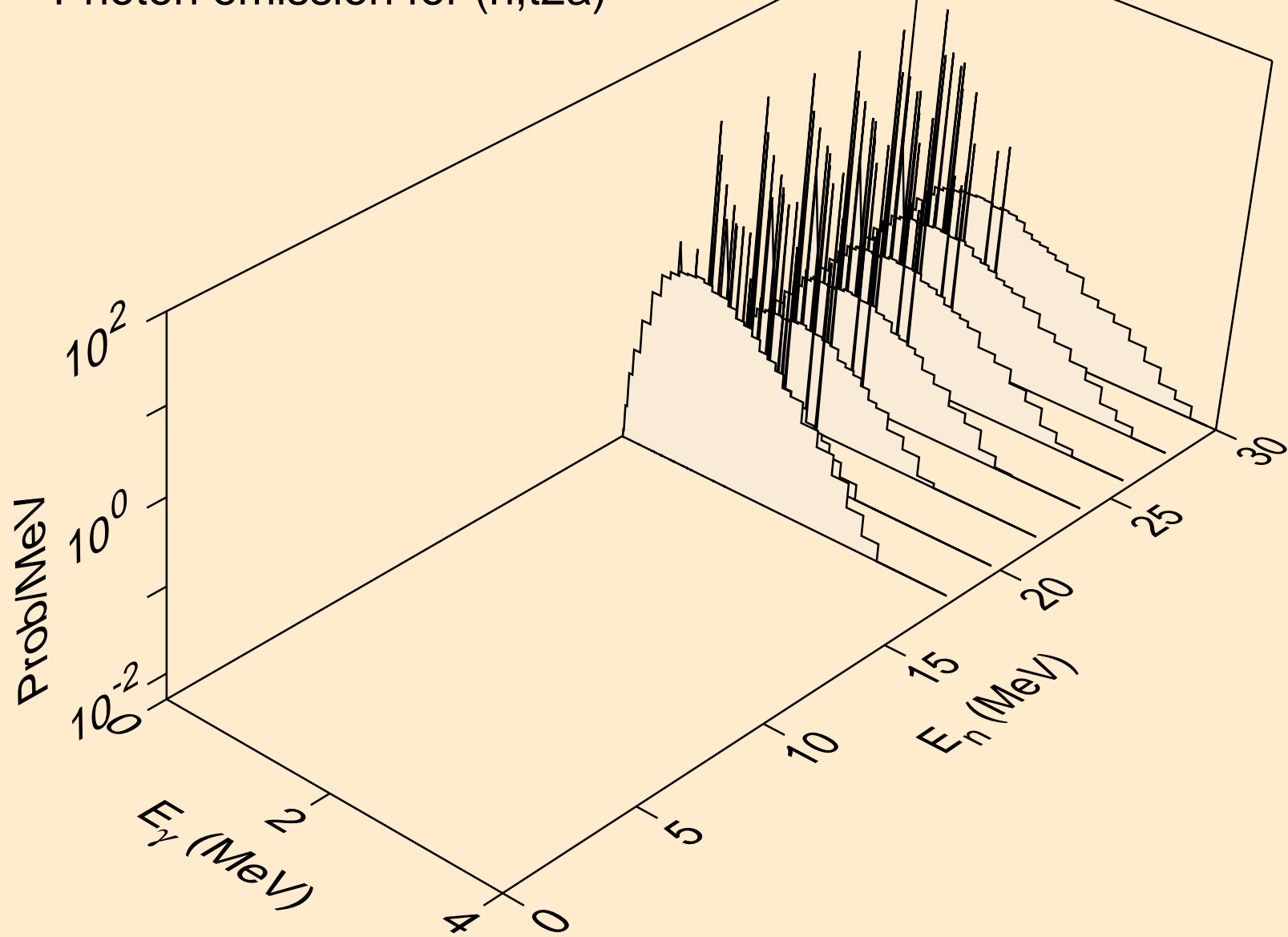

IR174 NEUTRON ACER TENDL-2024 LIBRARY; T=0.K
Photon emission for (n,d2a)

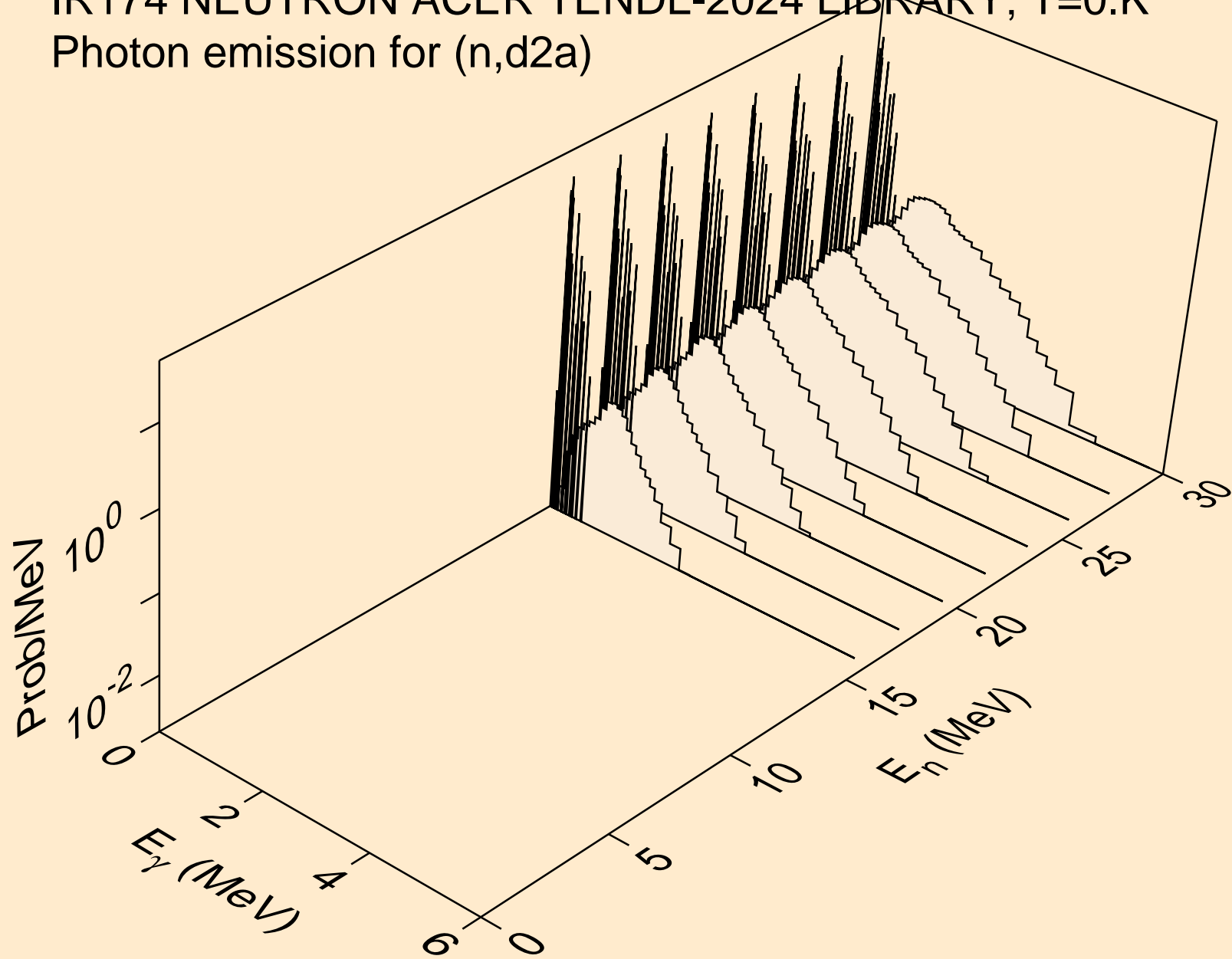

IR174 NEUTRON ACER TENDL-2024 LIBRARY; T=0.K
Photon emission for (n,pd)

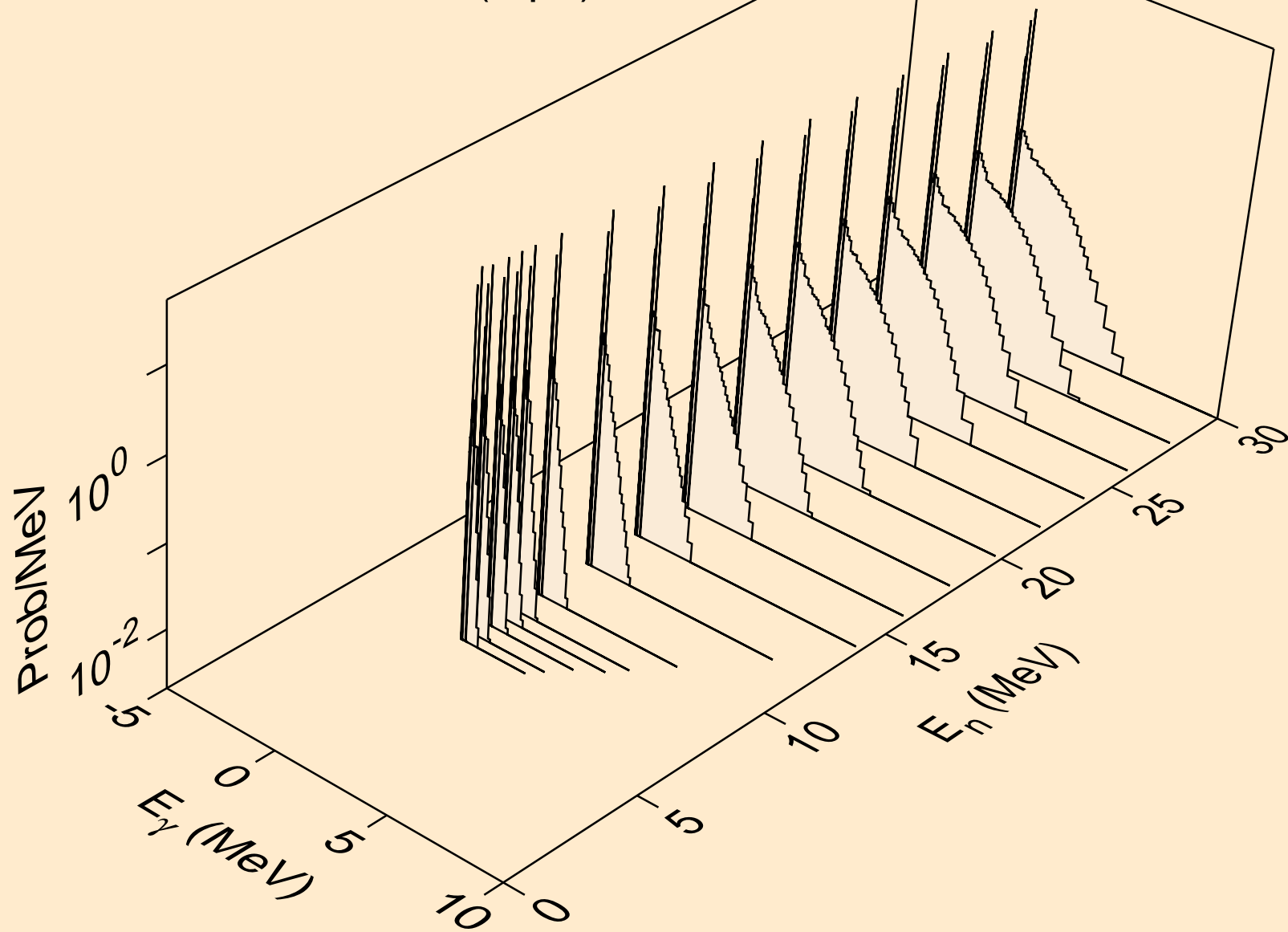

IR174 NEUTRON ACER TENDL-2024 LIBRARY; T=0.K
Photon emission for (n,pt)

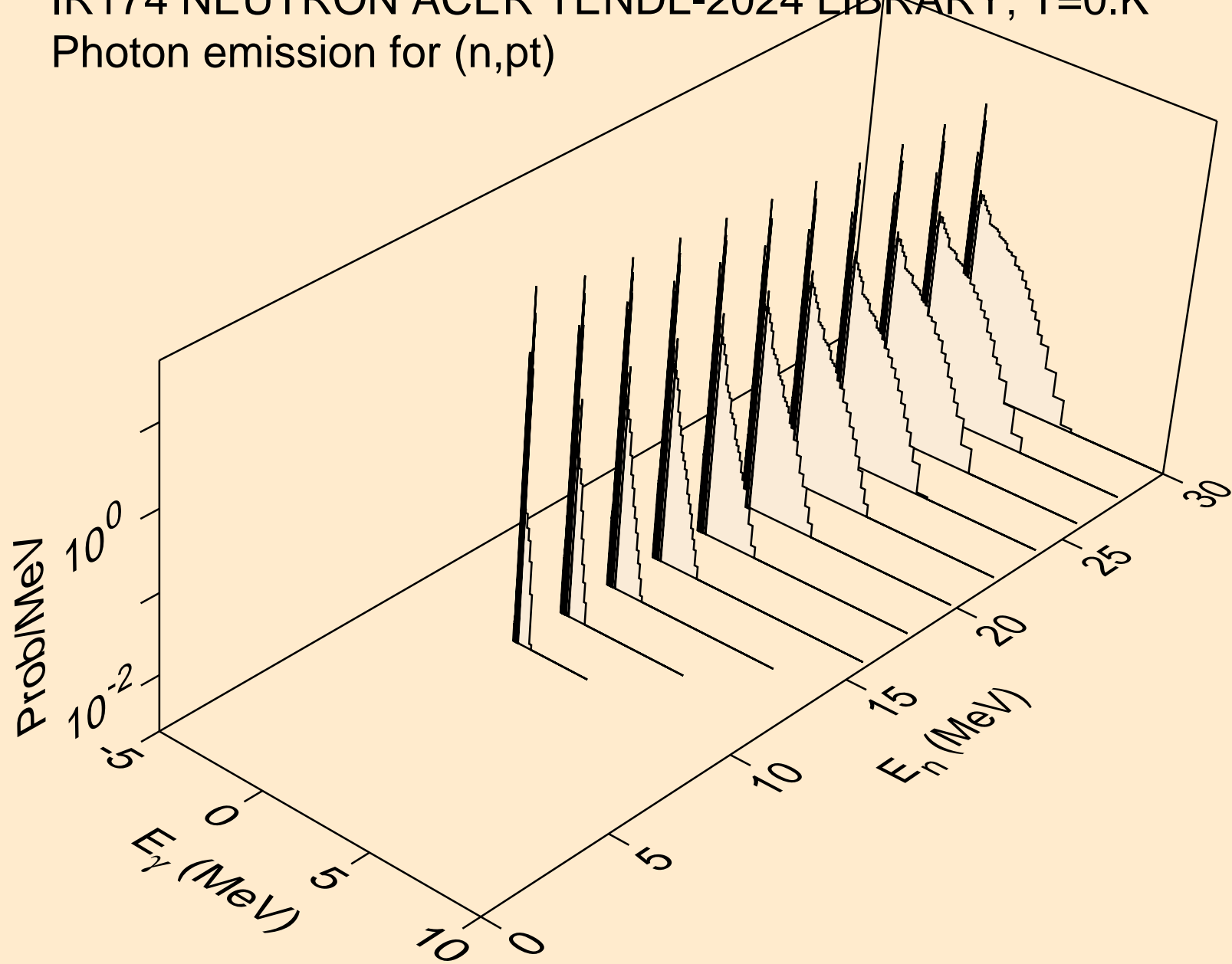

IR174 NEUTRON ACER TENDL-2024 LIBRARY; T=0.K
Photon emission for (n,da)

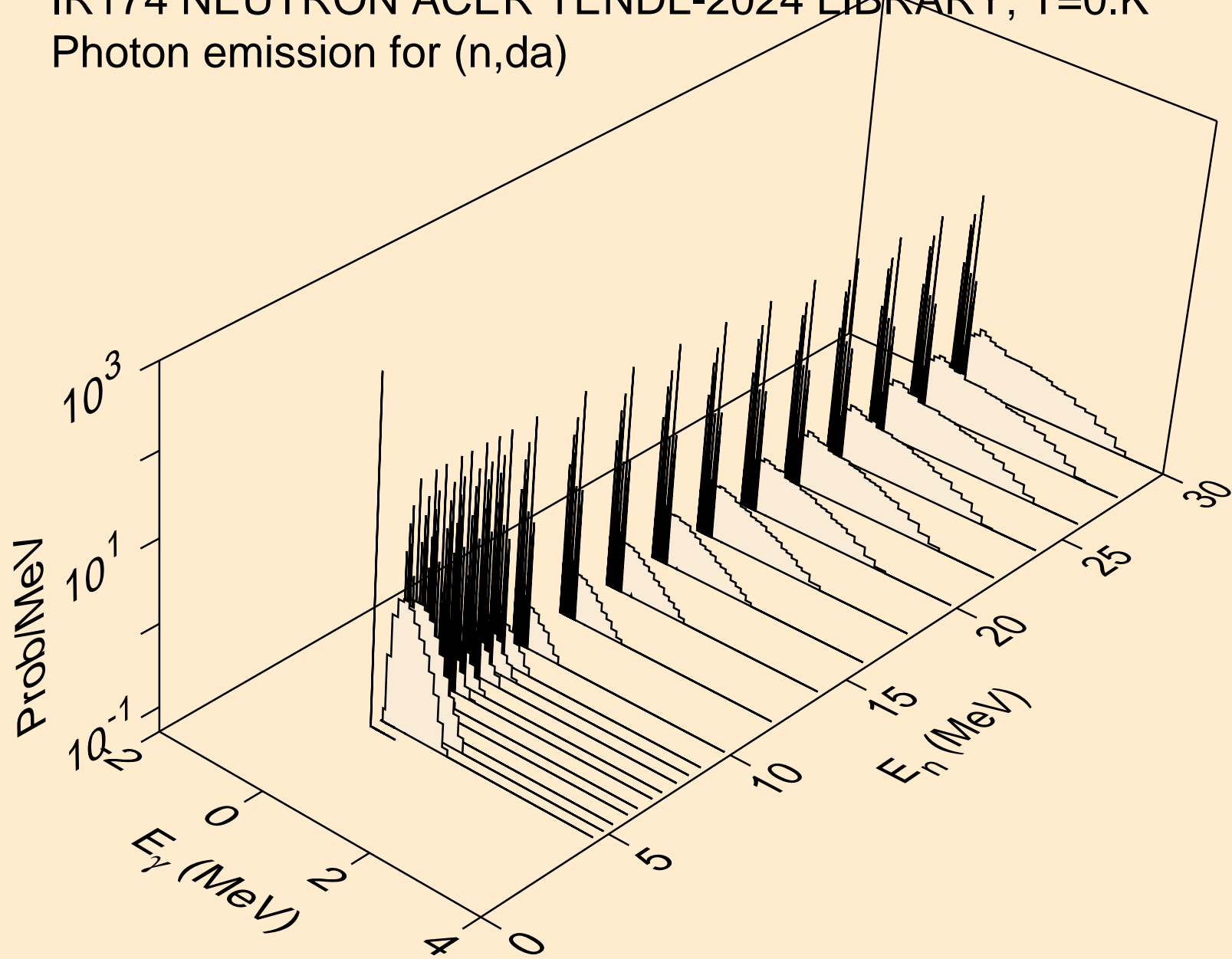

IR174 NEUTRON ACER TENDL-2024 LIBRARY; T=0.K
thermal capture photon spectrum

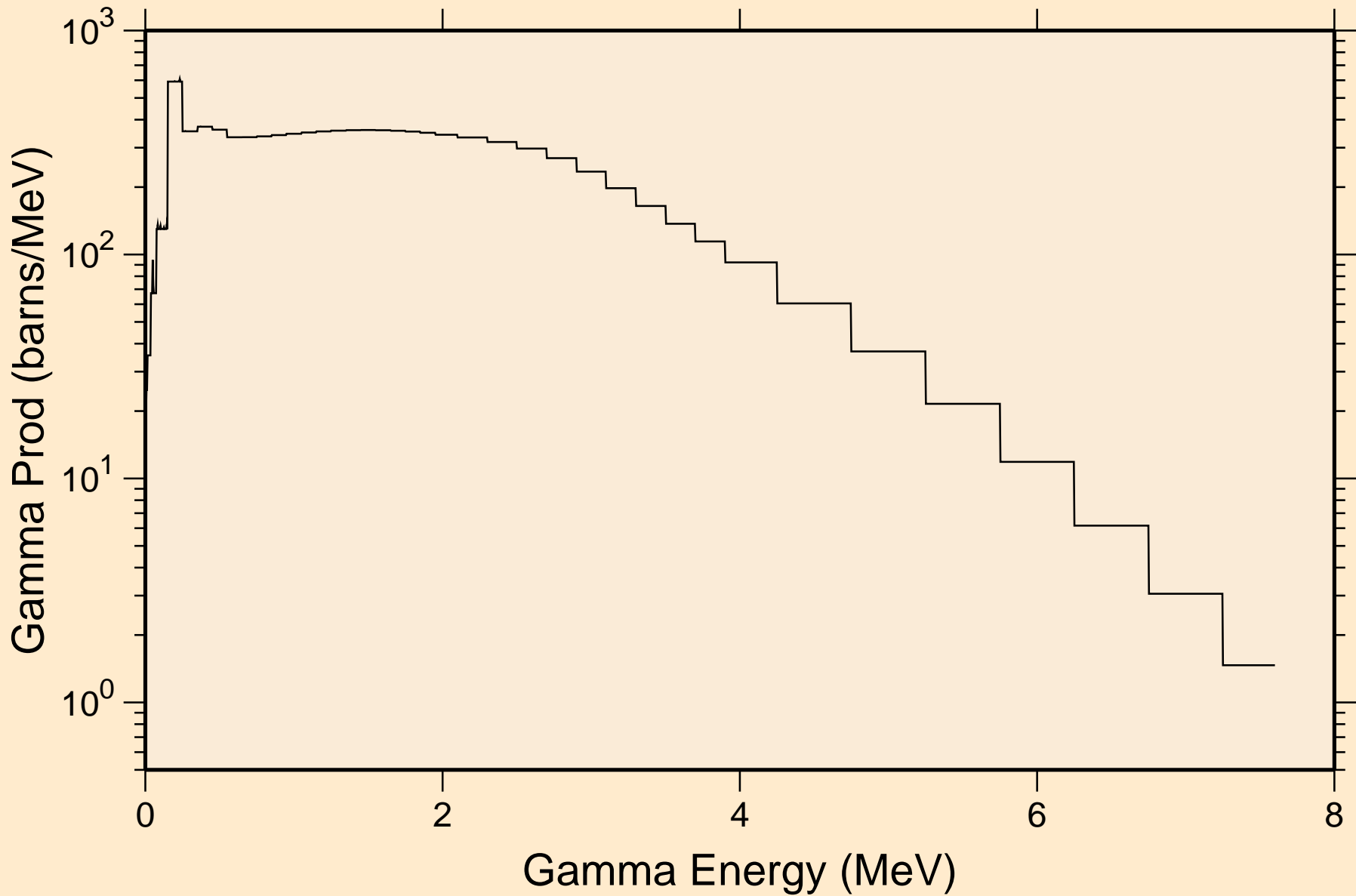

IR174 NEUTRON ACER TENDL-2024 LIBRARY; T=0.K
14 MeV photon spectrum

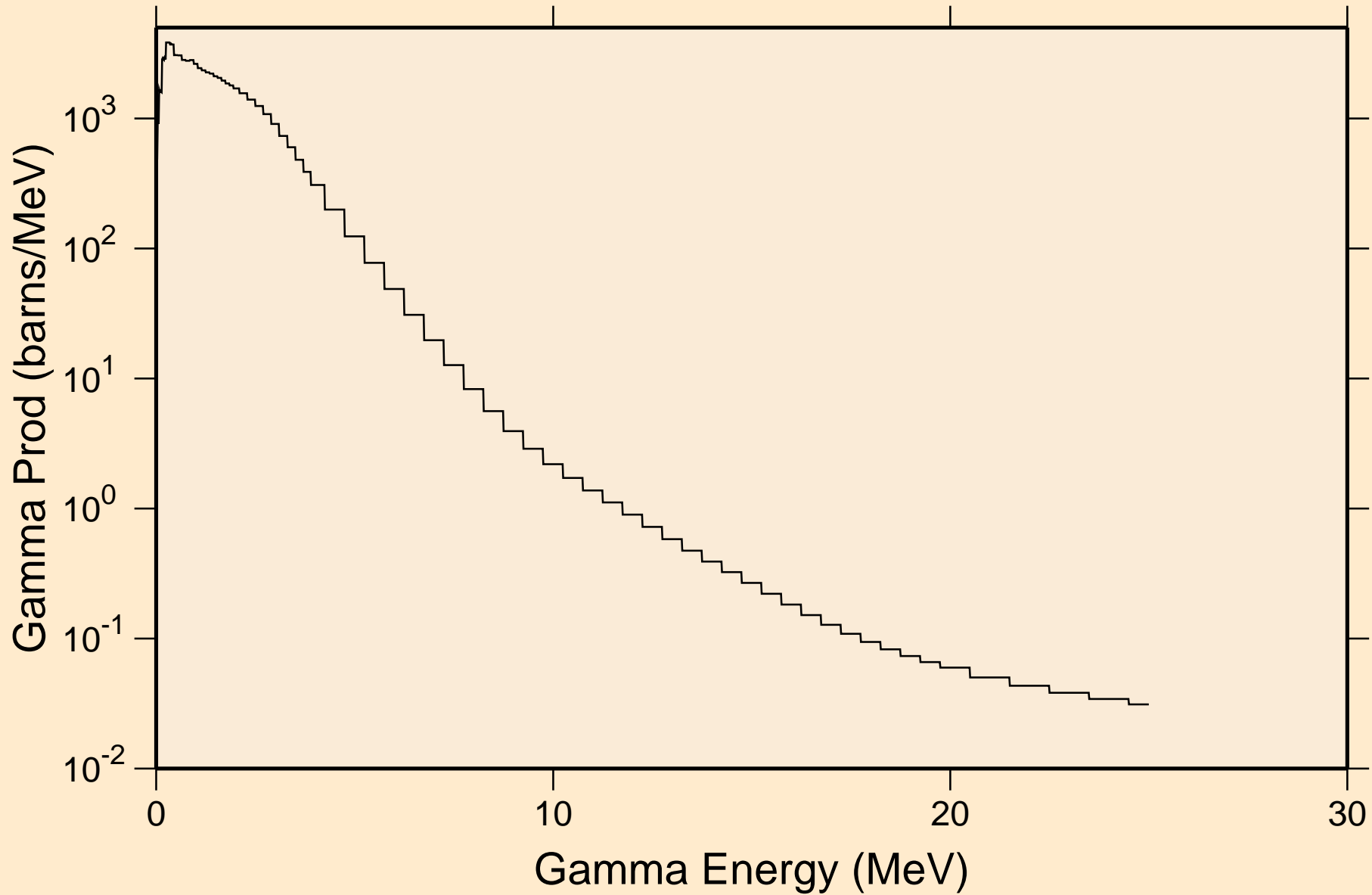

IR174 NEUTRON ACER TENDL-2024 LIBRARY; T=0.K

Particle heating contributions

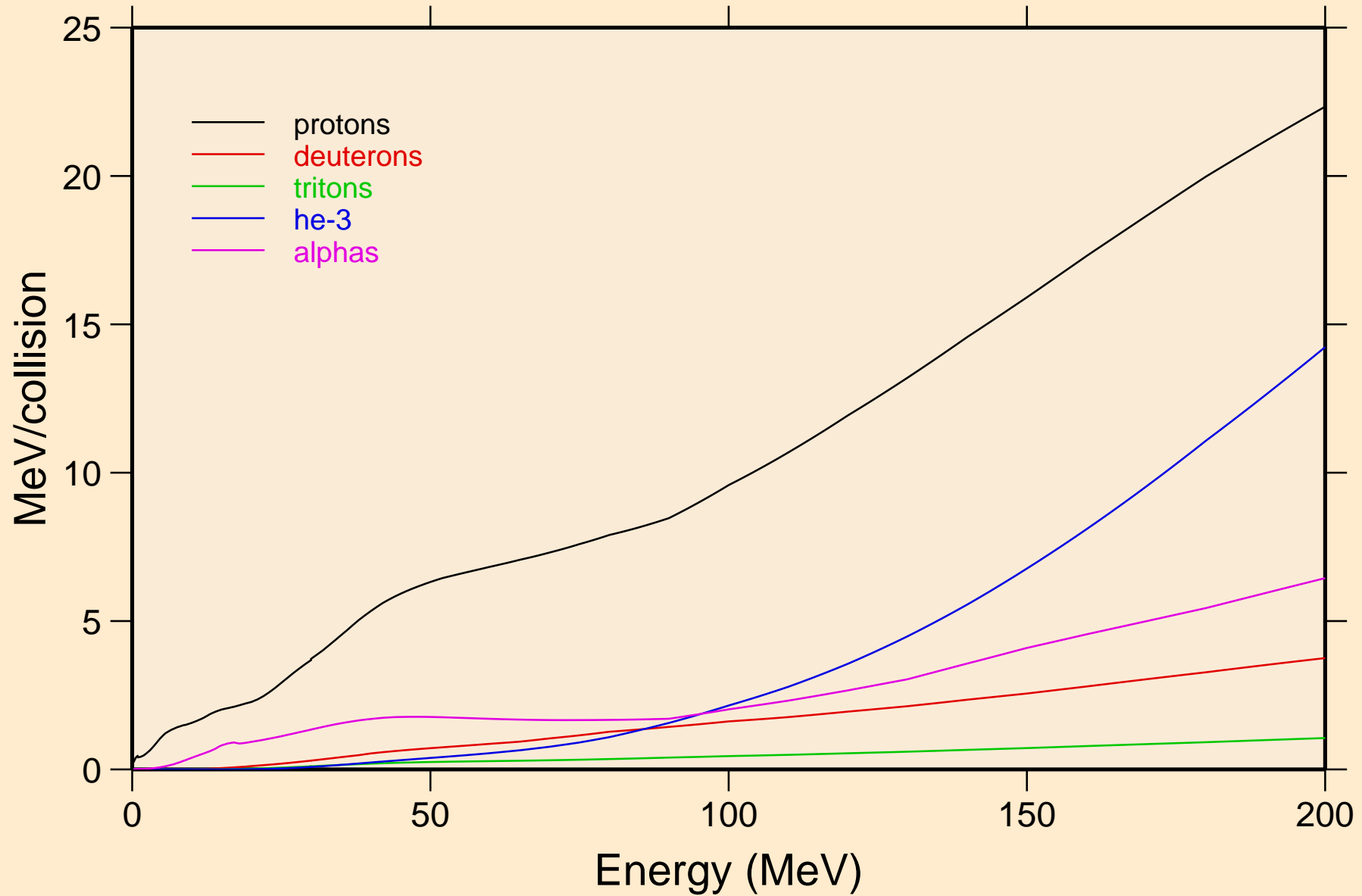

IR174 NEUTRON ACER TENDL-2024 LIBRARY; T=0.K
Recoil Heating

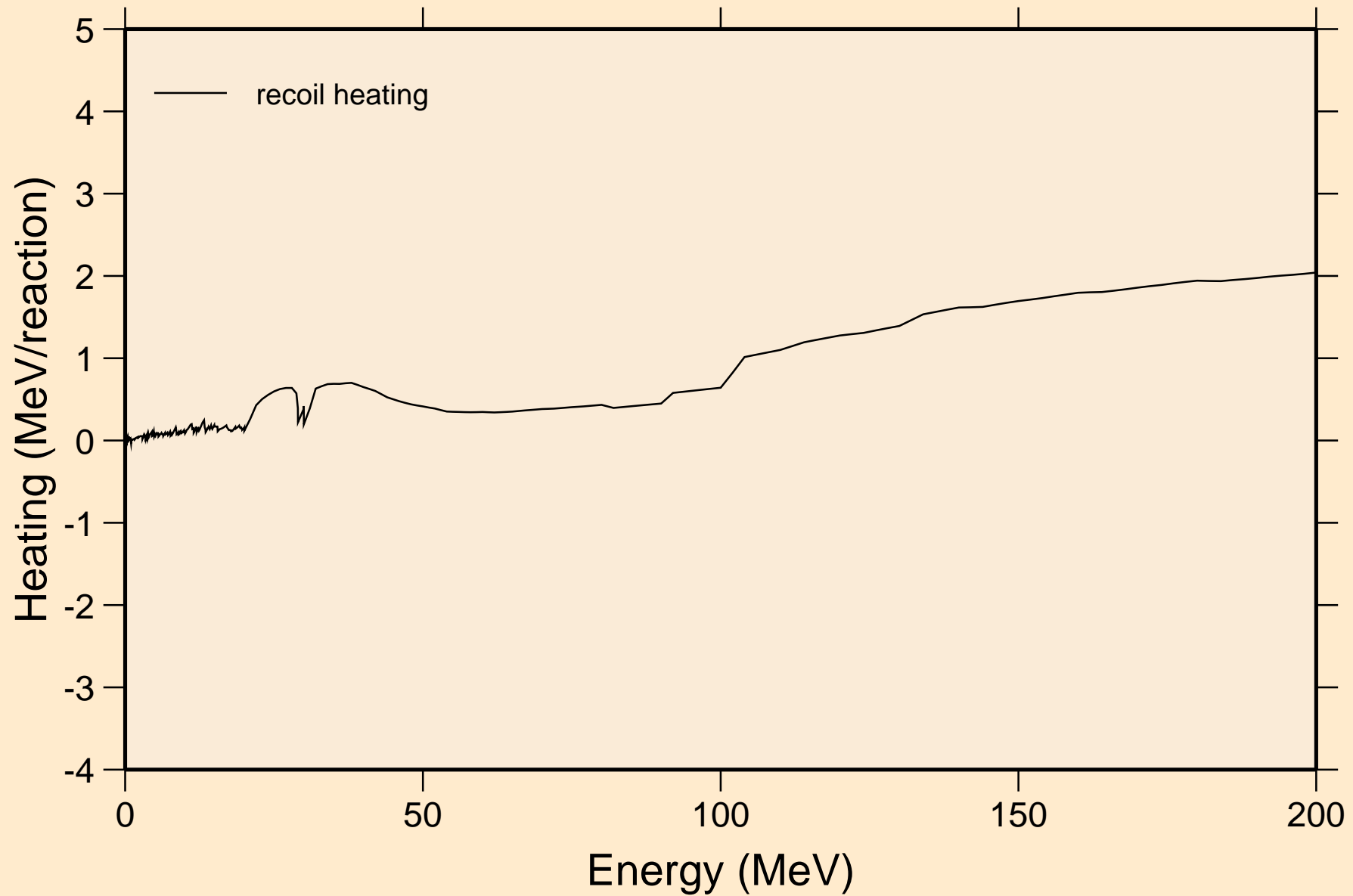

IR174 NEUTRON ACER TENDL-2024 LIBRARY; T=0.K

Particle production cross sections

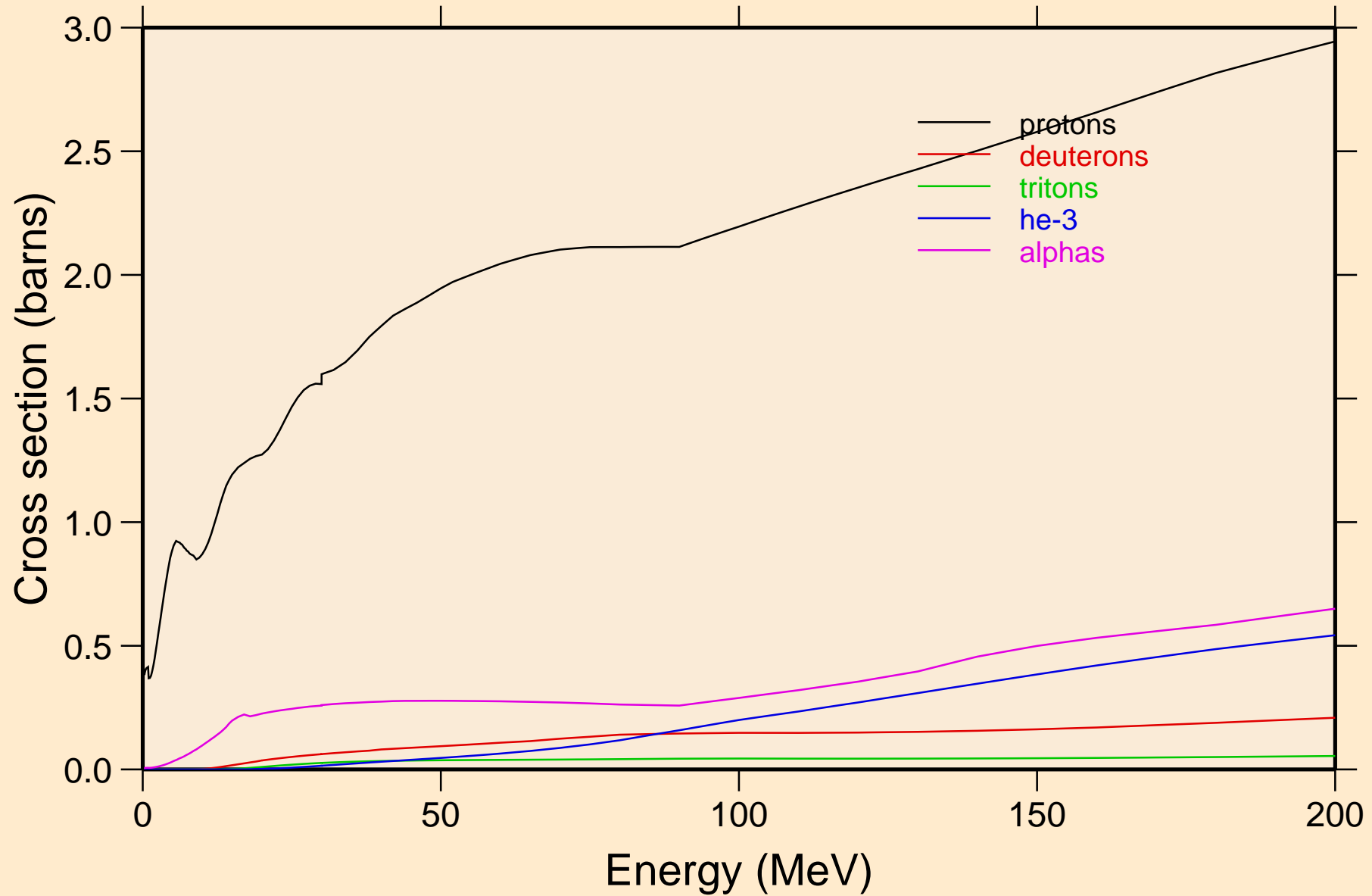

IR174 NEUTRON ACER TENDL-2024 LIBRARY; T=0.K
protons from (n,x)

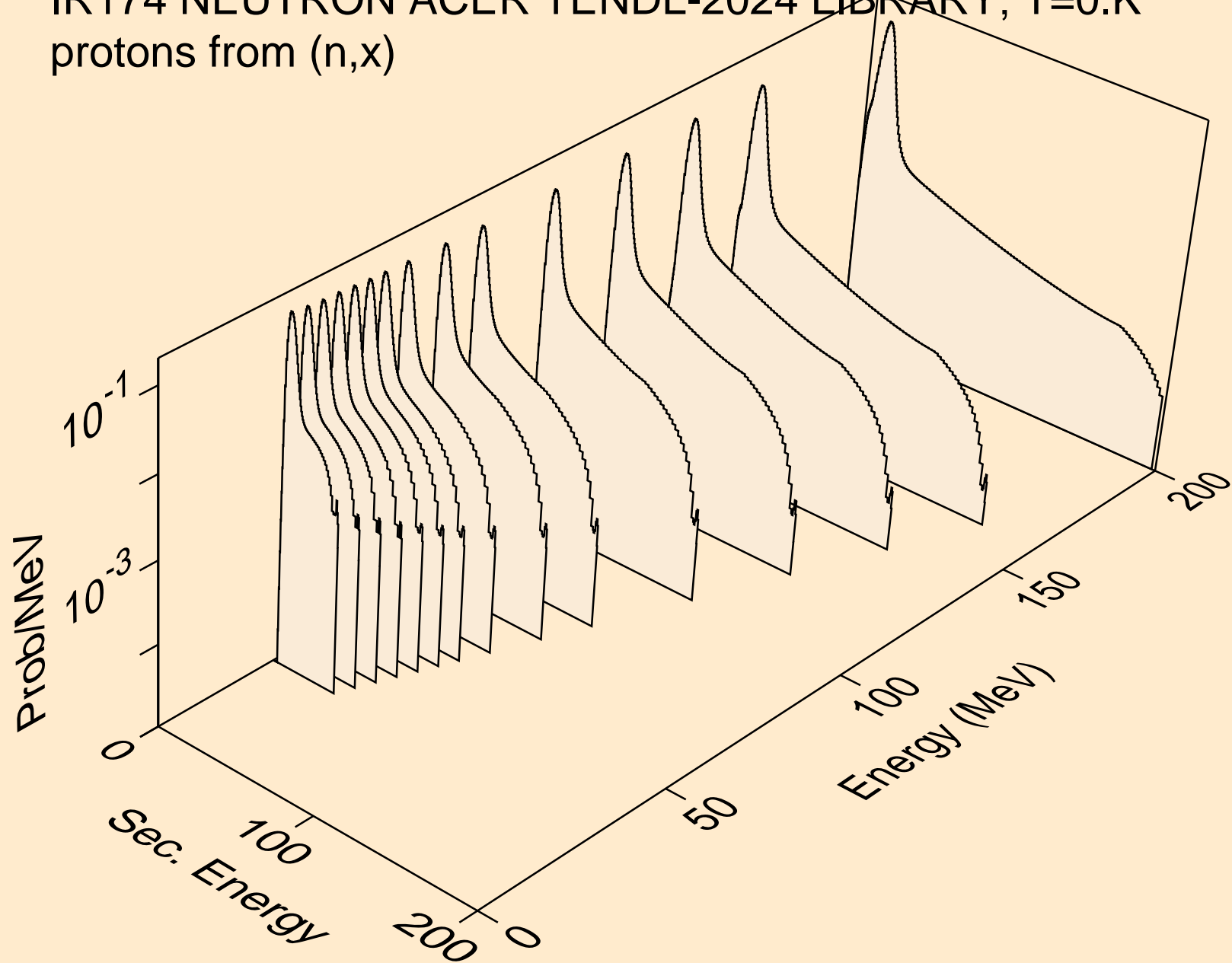

IR174 NEUTRON ACER TENDL-2024 LIBRARY; T=0.K
protons from (n,n*)p

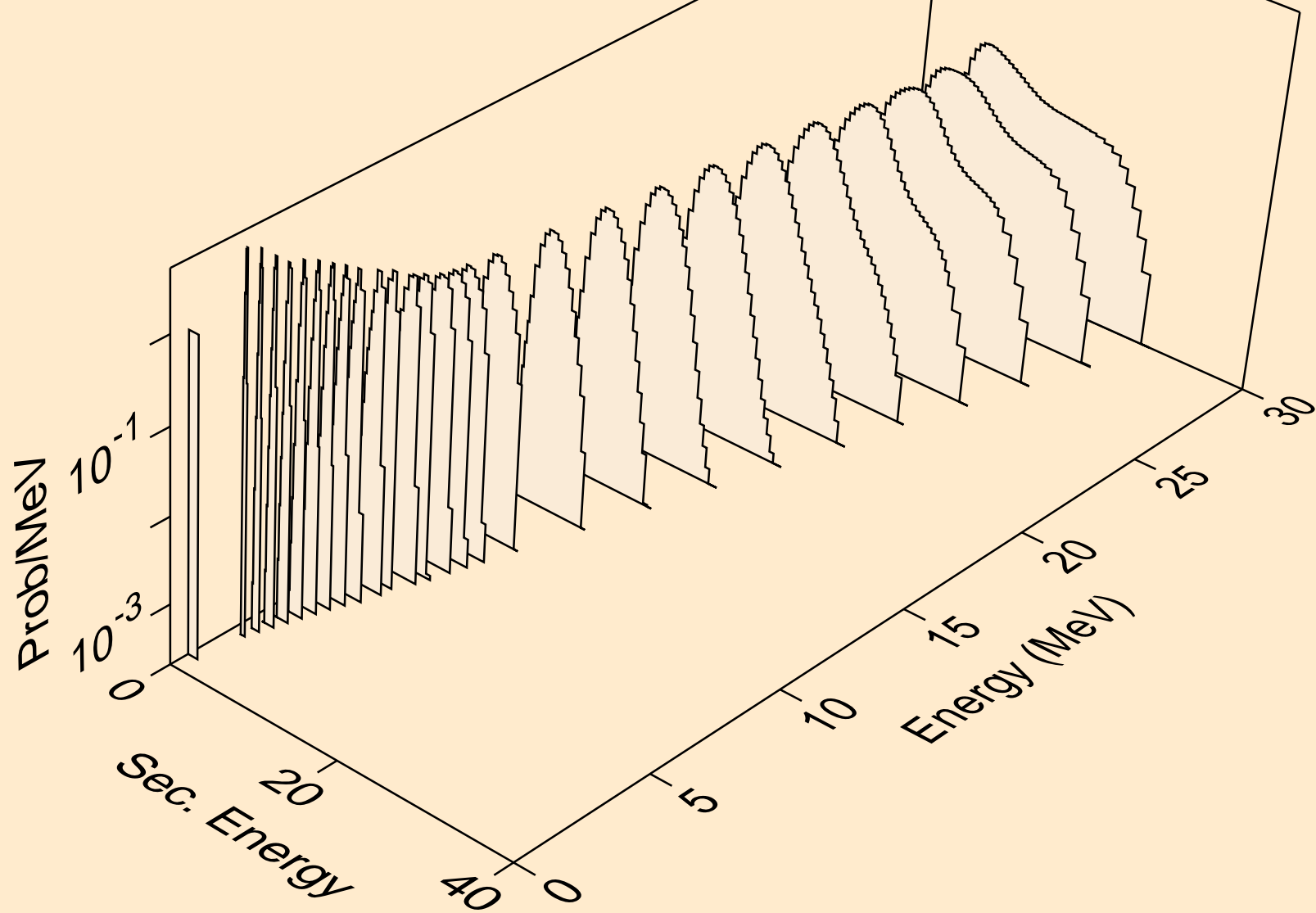

IR174 NEUTRON ACER TENDL-2024 LIBRARY; T=0.K
protons from (n,2np)

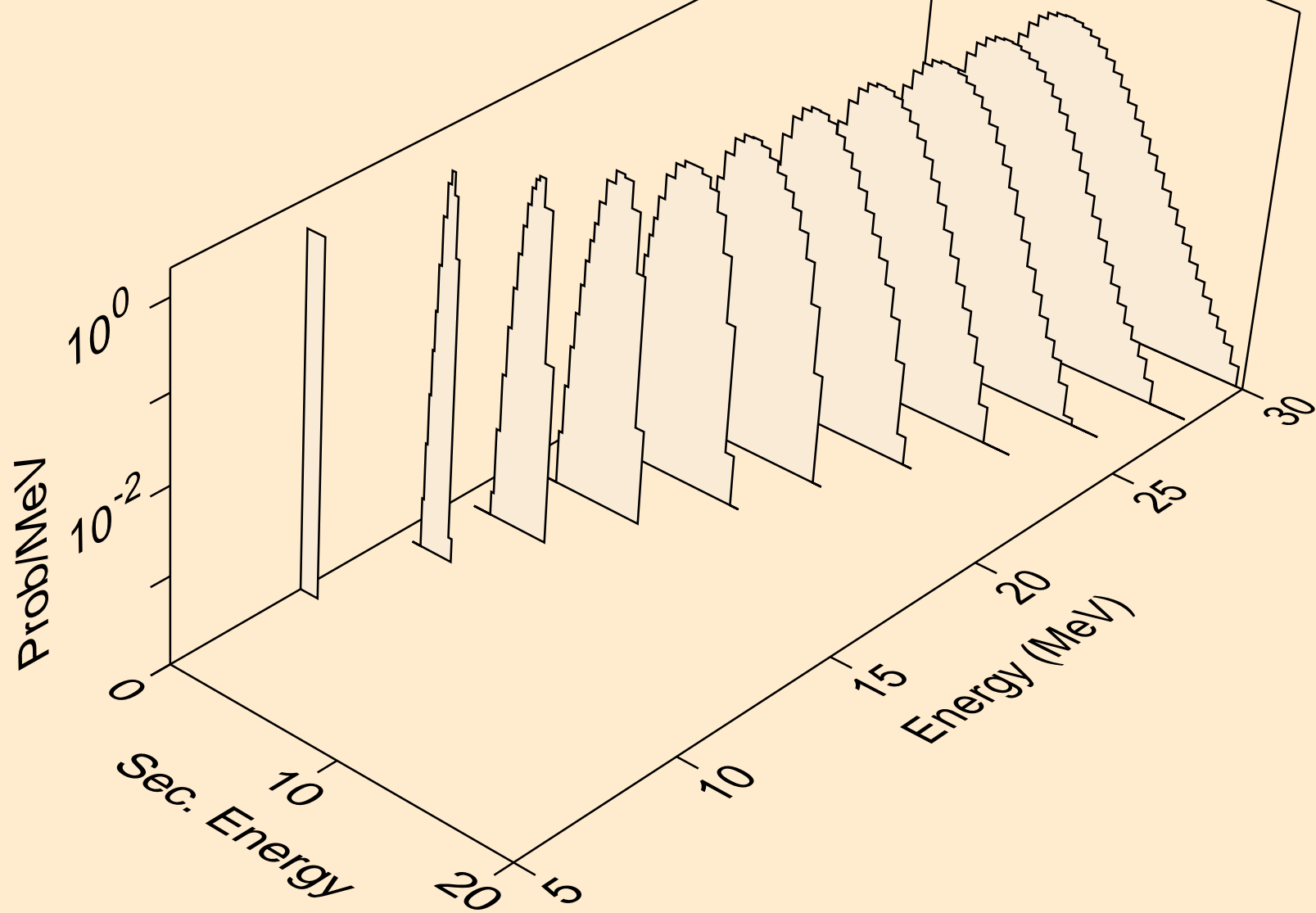

IR174 NEUTRON ACER TENDL-2024 LIBRARY; T=0.K
protons from (n,3np)

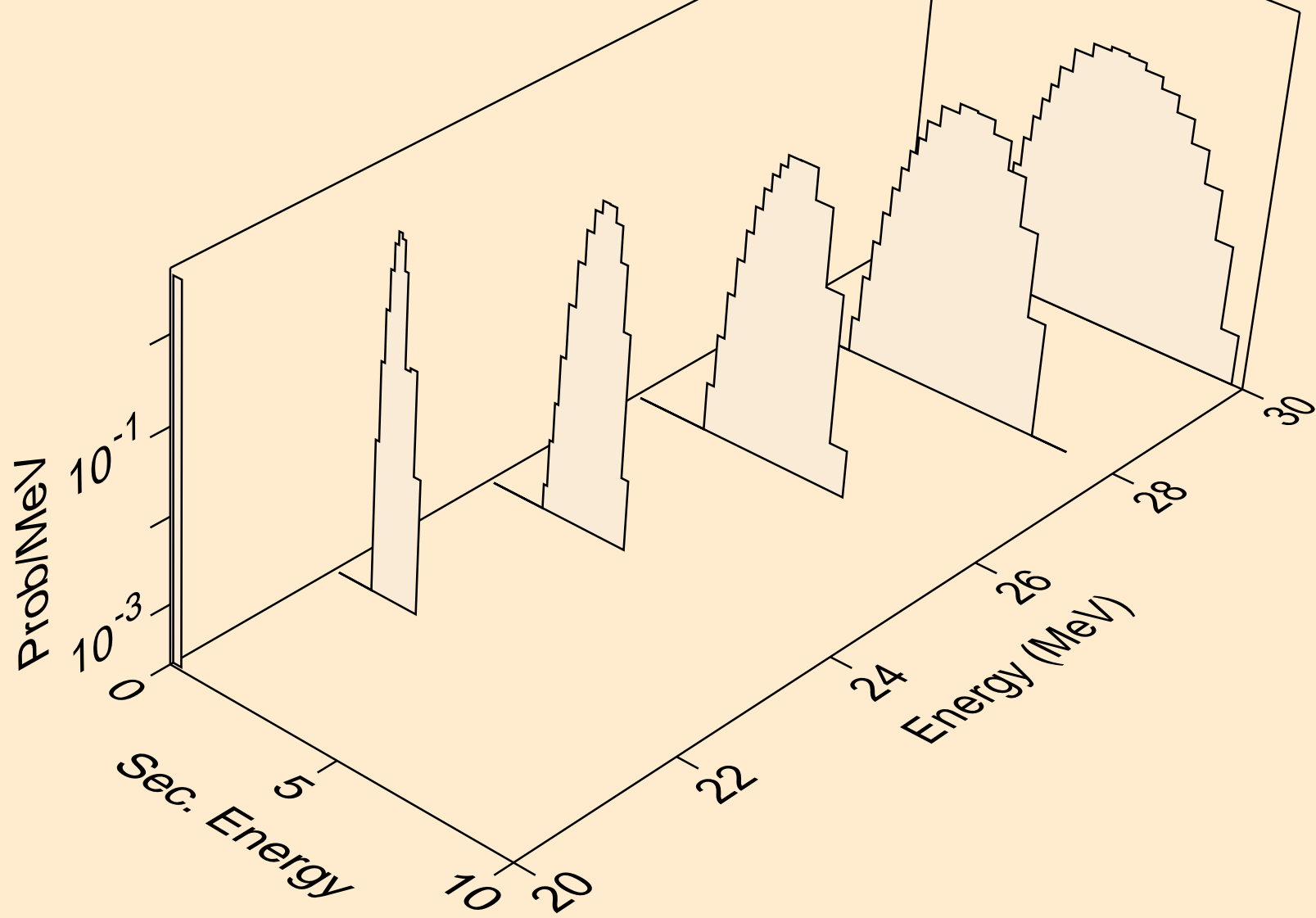

IR174 NEUTRON ACER TENDL-2024 LIBRARY; T=0.K
protons from (n,n2p)

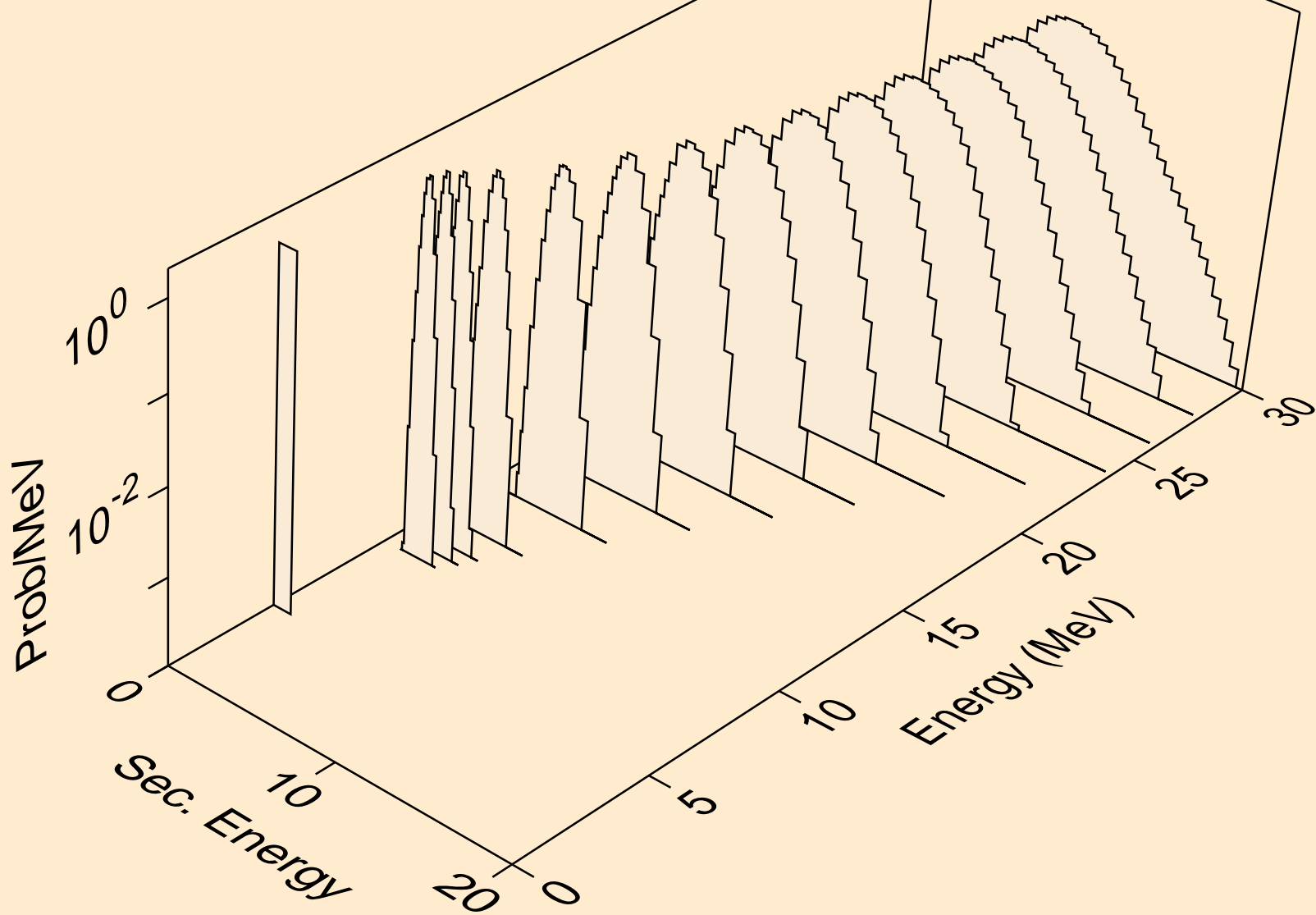

IR174 NEUTRON ACER TENDL-2024 LIBRARY; T=0.K
protons from (n,npa)

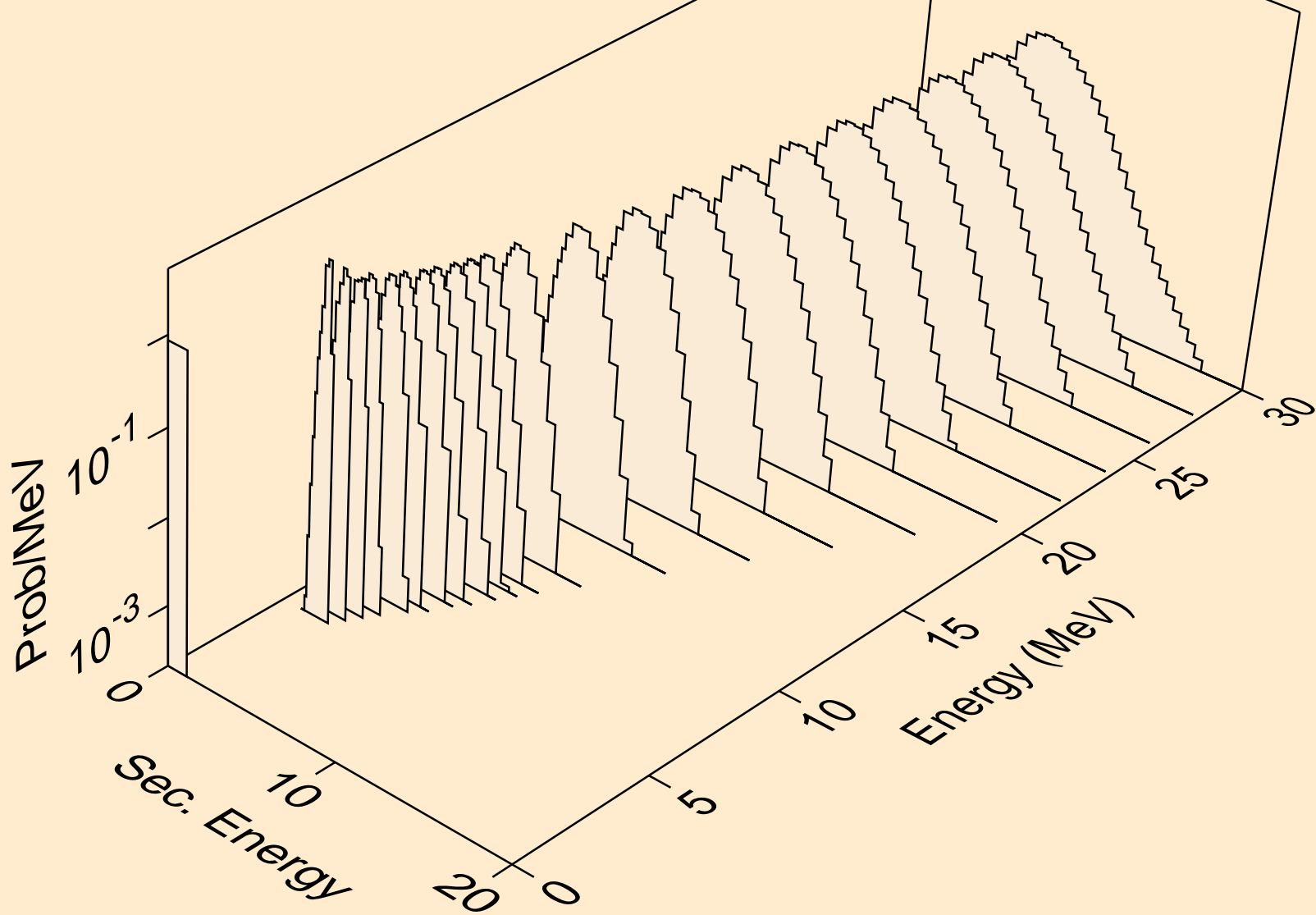

IR174 NEUTRON ACER TENDL-2024 LIBRARY; T=0.K
protons from (n,p)

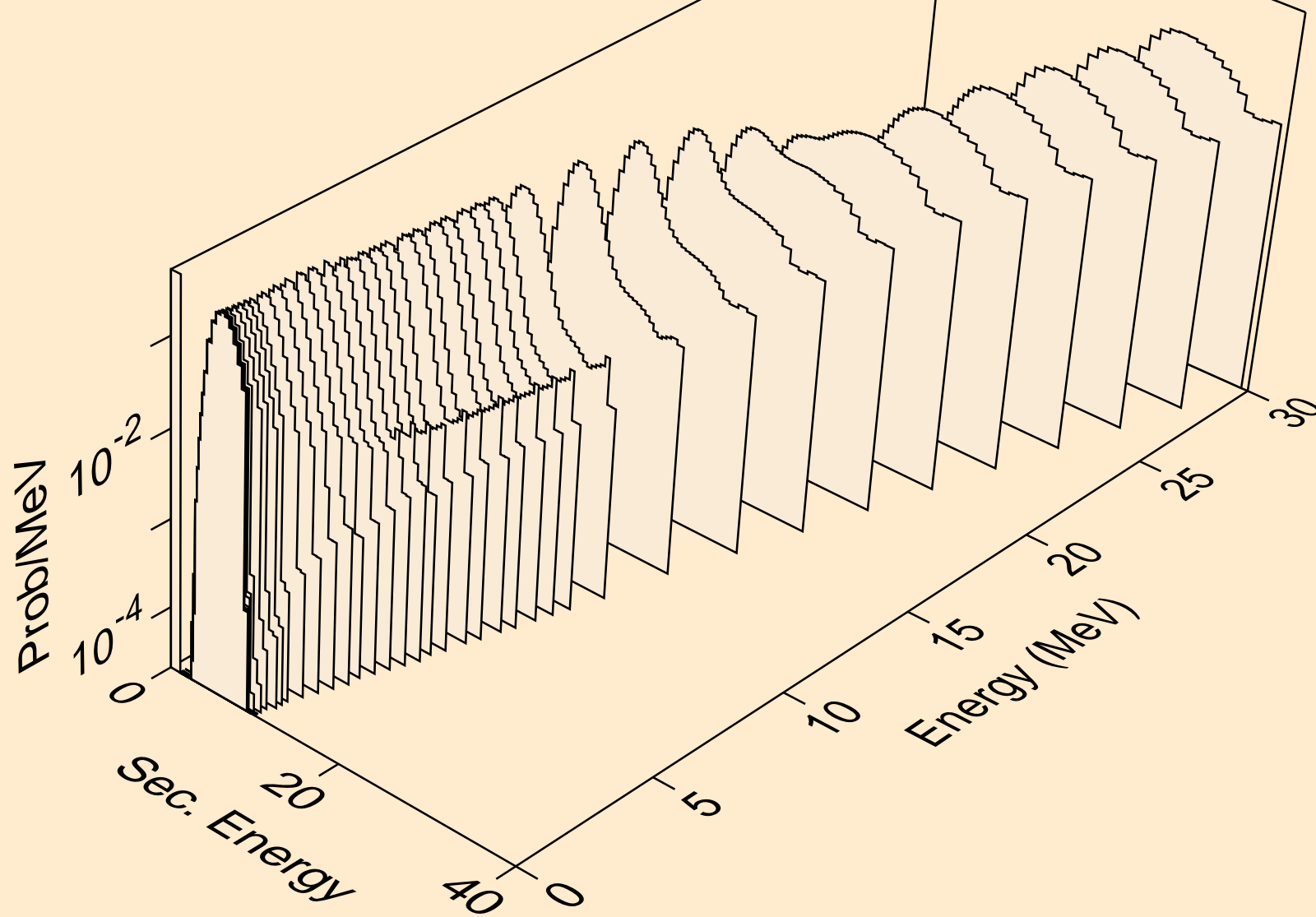

IR174 NEUTRON ACER TENDL-2024 LIBRARY; T=0.K
protons from (n,2p)

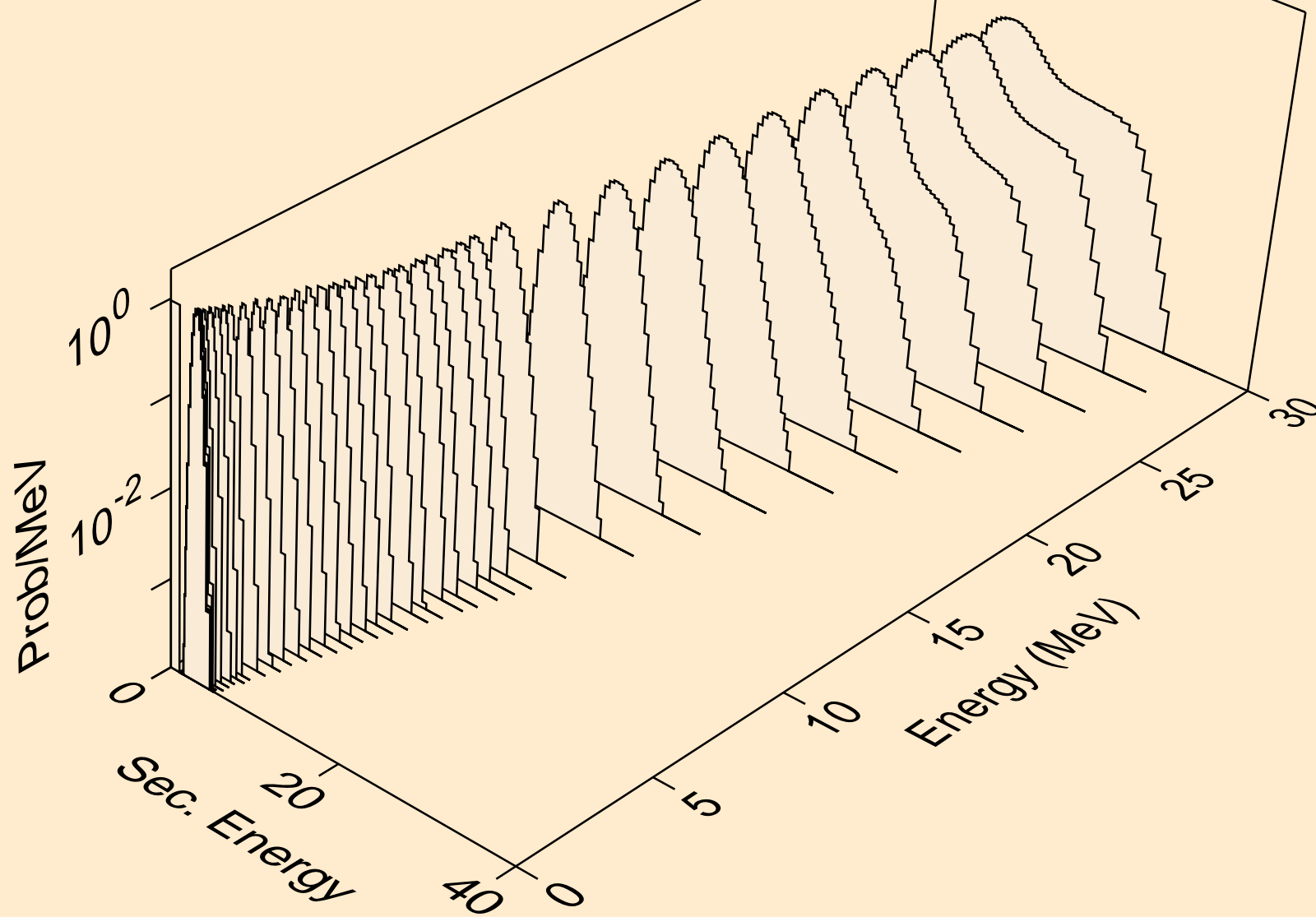

IR174 NEUTRON ACER TENDL-2024 LIBRARY; T=0.K
protons from (n,p)

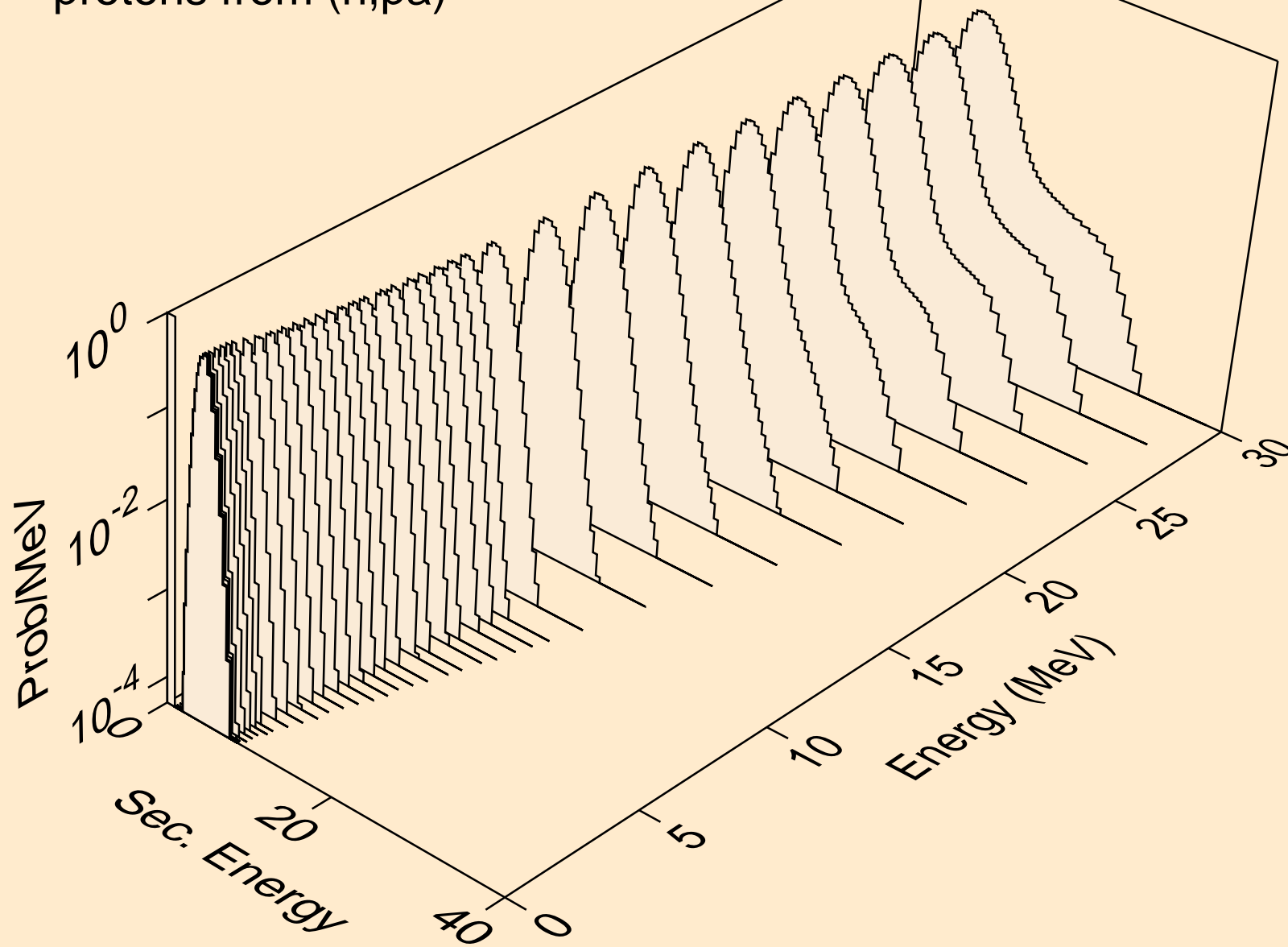

IR174 NEUTRON ACER TENDL-2024 LIBRARY; T=0.K
protons from (n,pd)

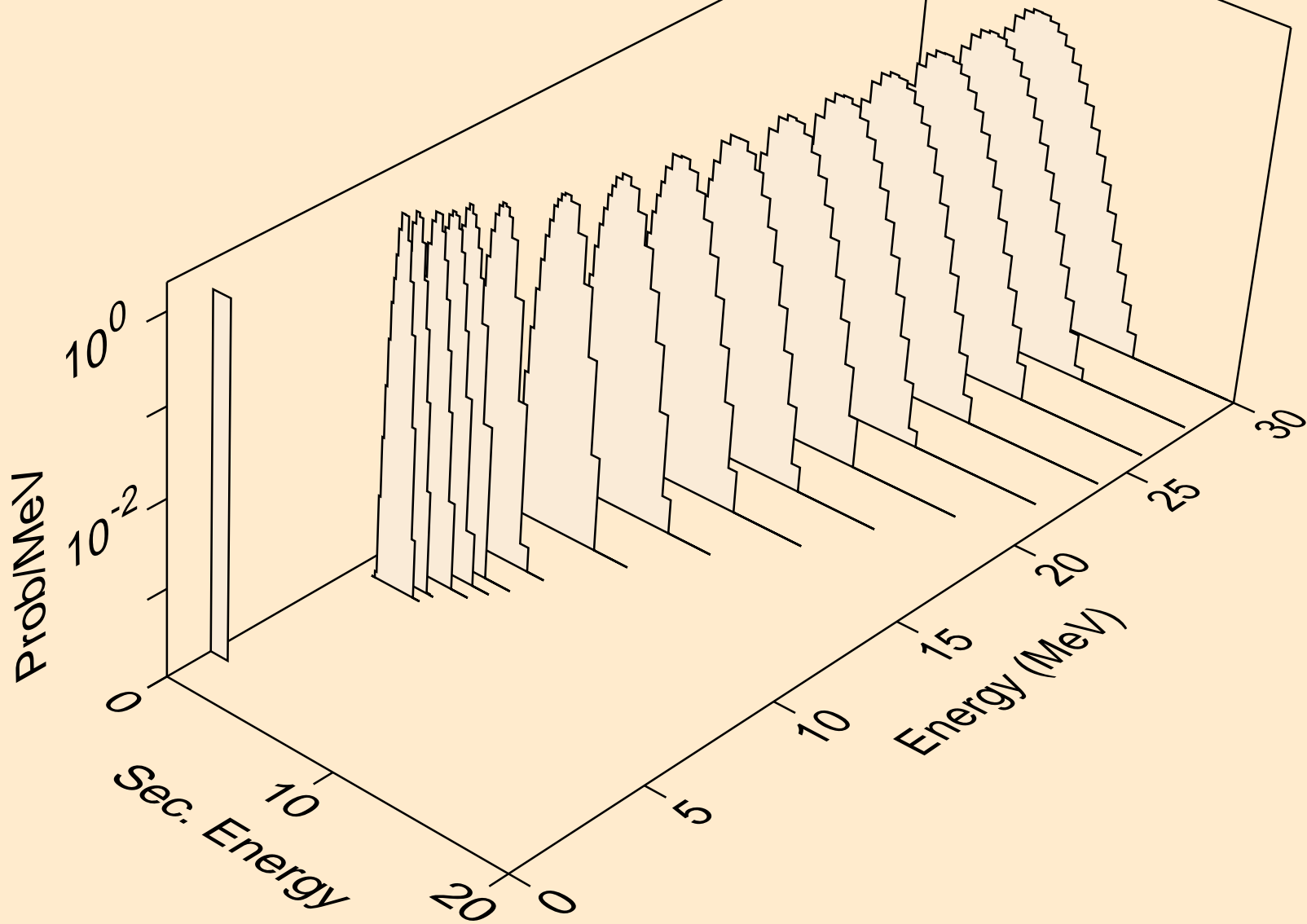

IR174 NEUTRON ACER TENDL-2024 LIBRARY; T=0.K
protons from (n,pt)

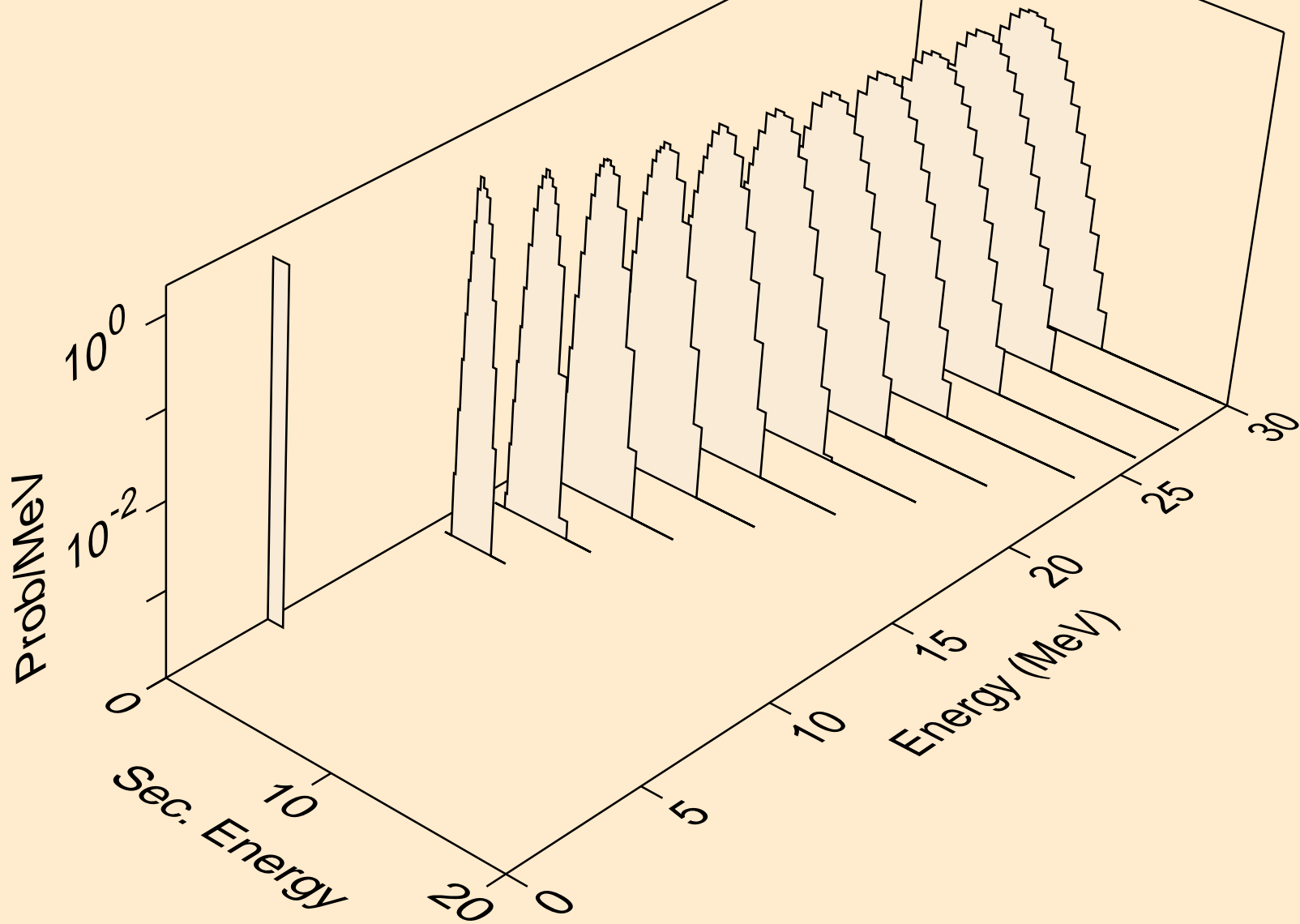

IR174 NEUTRON ACER TENDL-2024 LIBRARY; T=0.K
deuterons from (n,x)

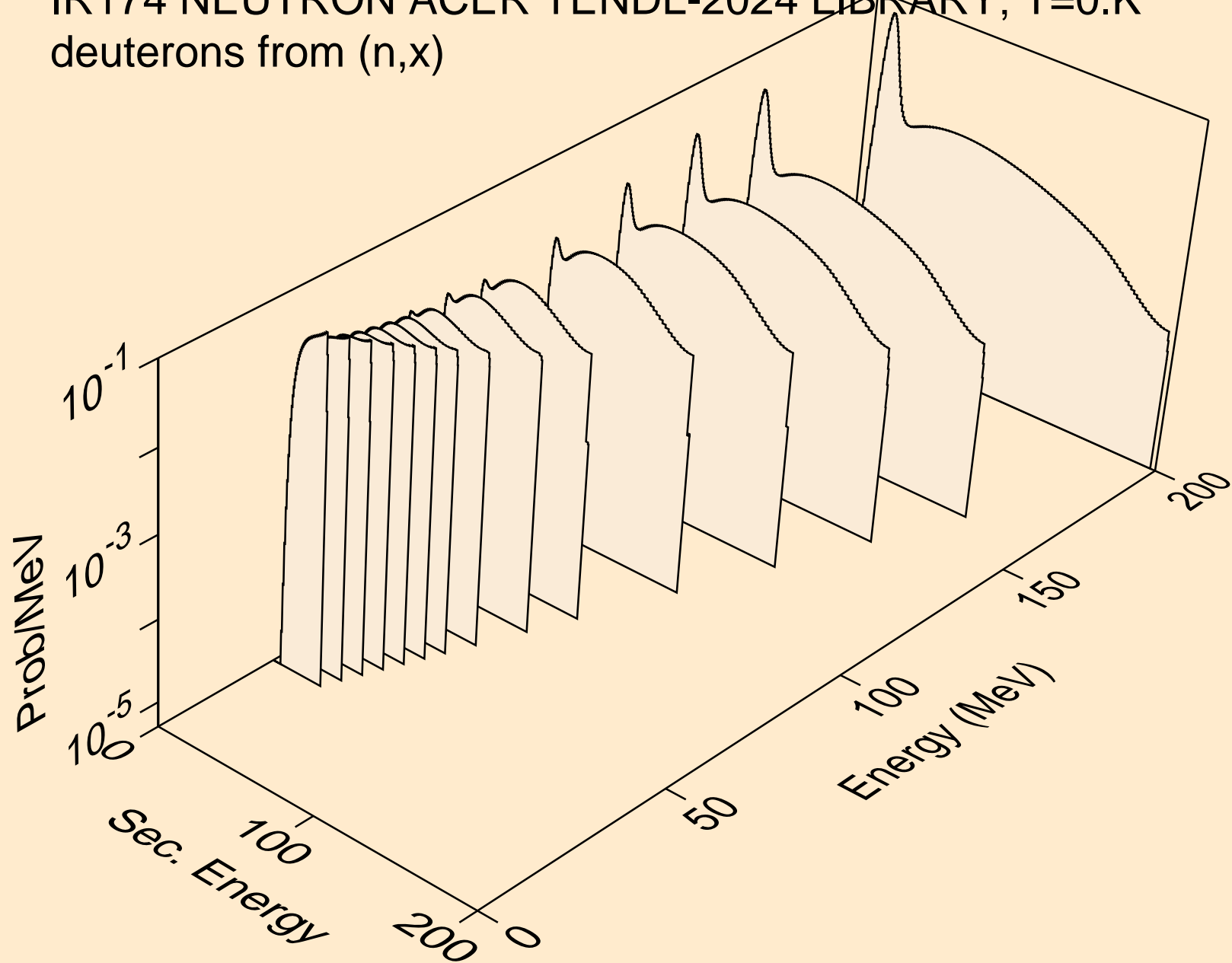

IR174 NEUTRON ACER TENDL-2024 LIBRARY; T=0.K
deuterons from (n,2nd)

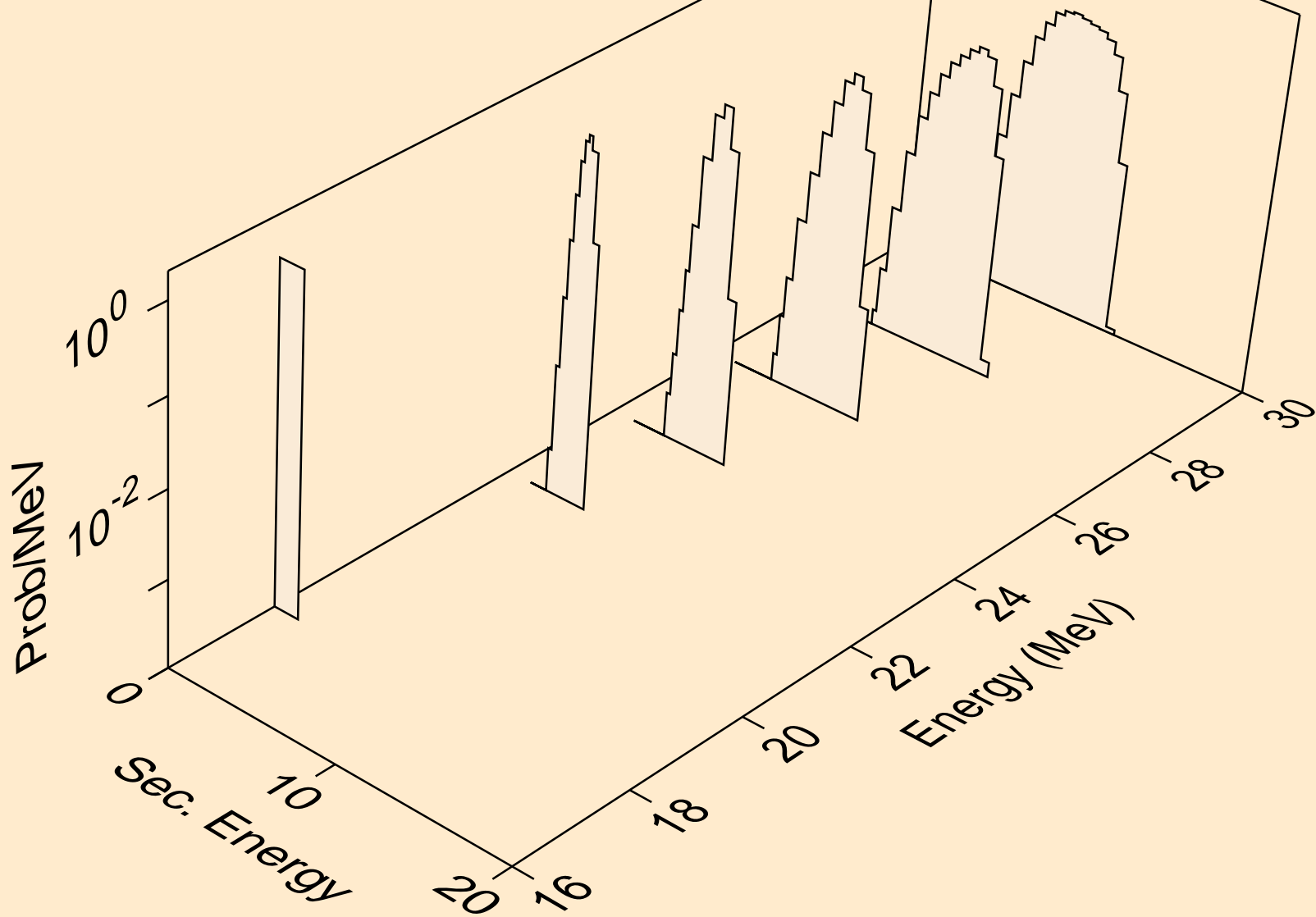

IR174 NEUTRON ACER TENDL-2024 LIBRARY; T=0.K
deuterons from (n,n*)d

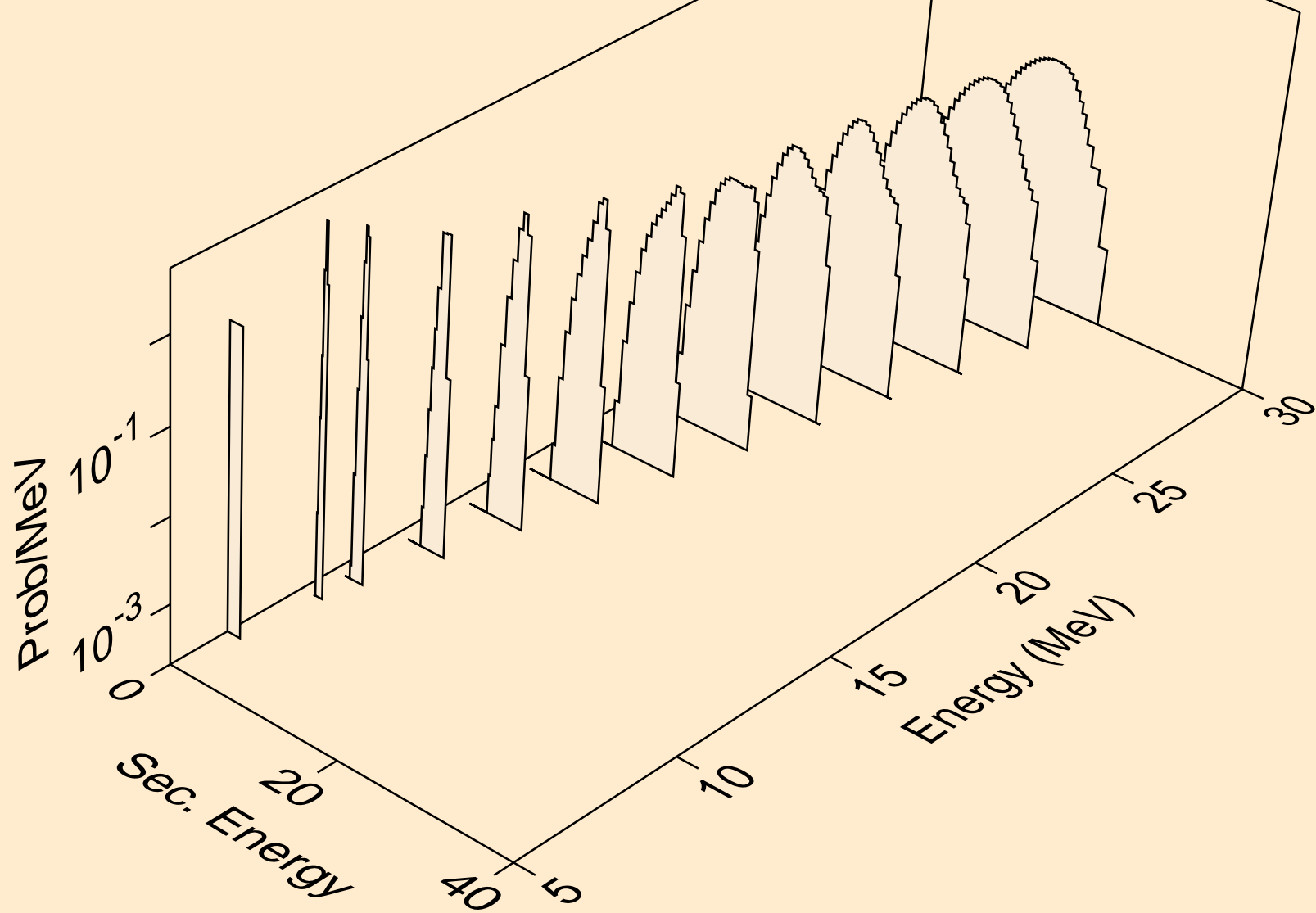

IR174 NEUTRON ACER TENDL-2024 LIBRARY; T=0.K
deuterons from (n,d)

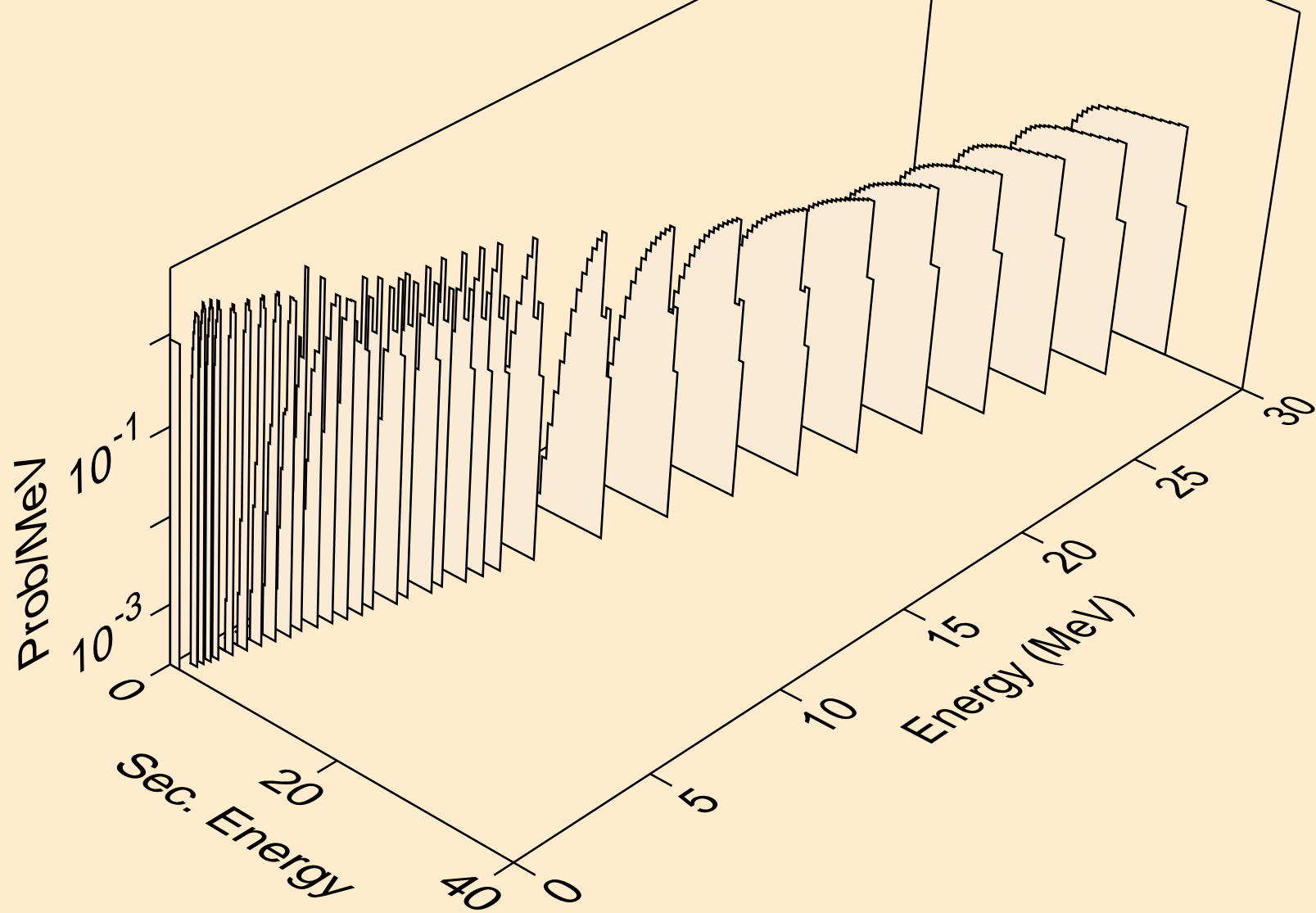

IR174 NEUTRON ACER TENDL-2024 LIBRARY; T=0.K
deuterons from (n,d2a)

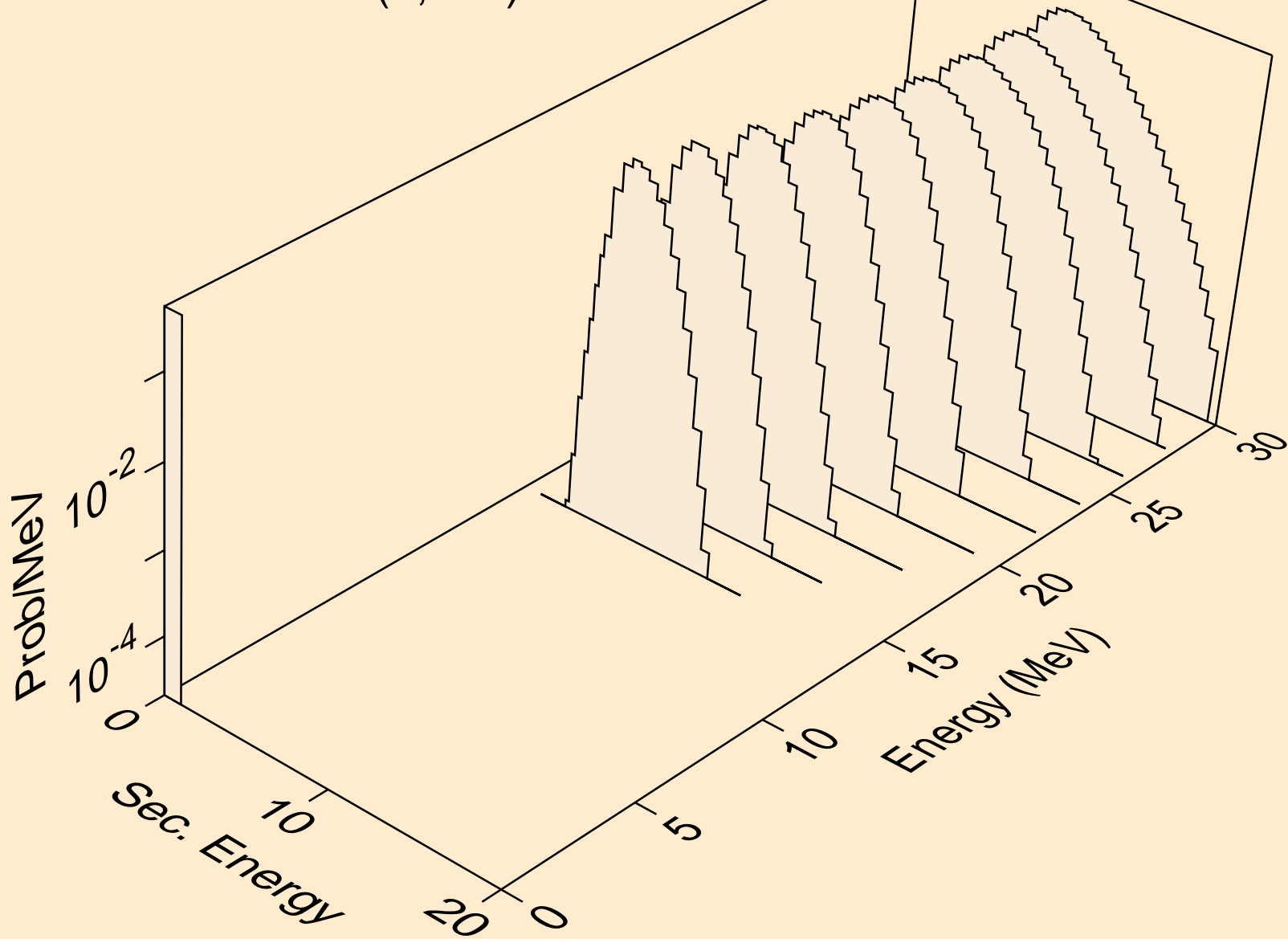

IR174 NEUTRON ACER TENDL-2024 LIBRARY; T=0.K
deuterons from (n,pd)

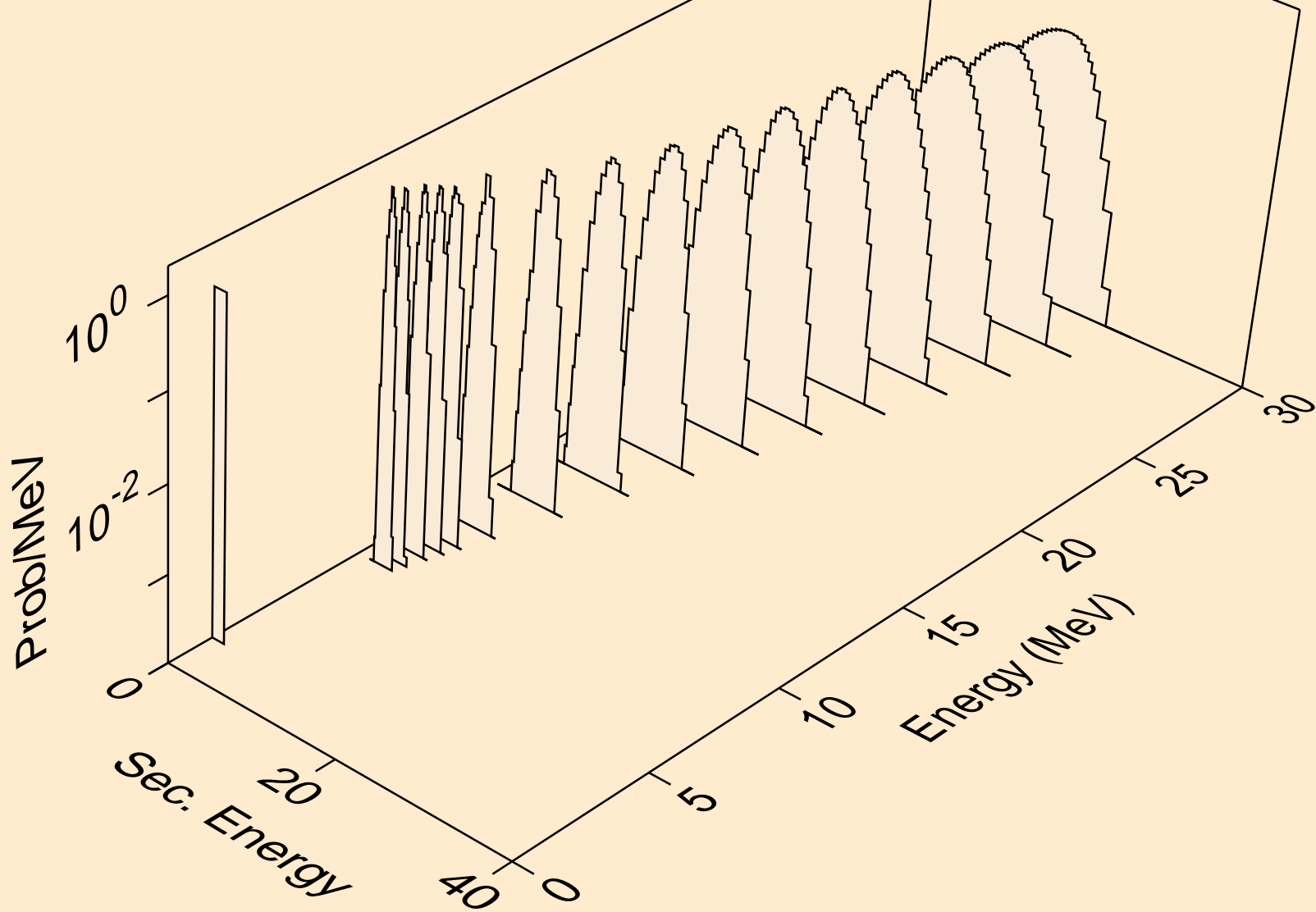

IR174 NEUTRON ACER TENDL-2024 LIBRARY; T=0.K
deuterons from (n,da)

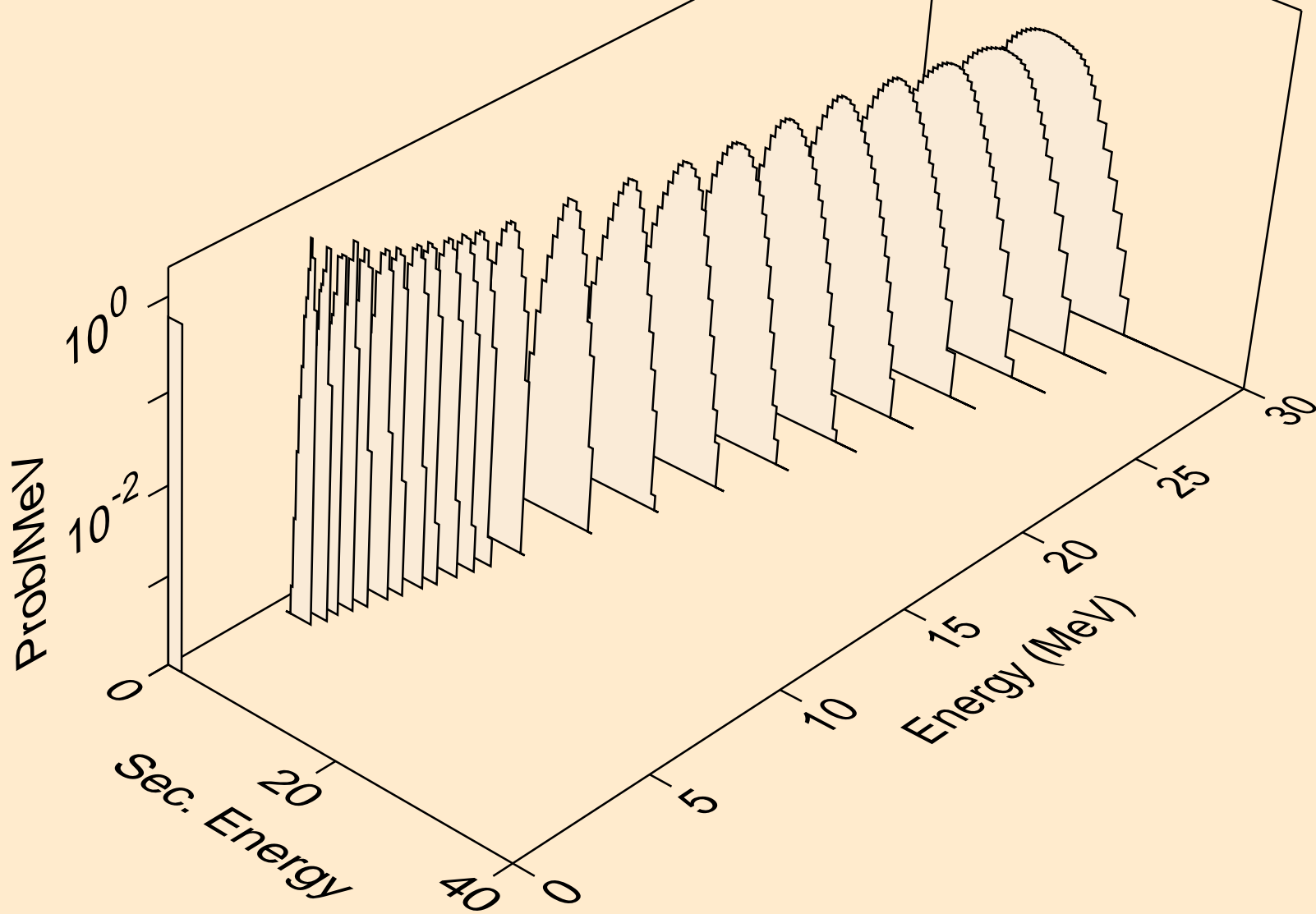

IR174 NEUTRON ACER TENDL-2024 LIBRARY; T=0.K
tritons from (n,x)

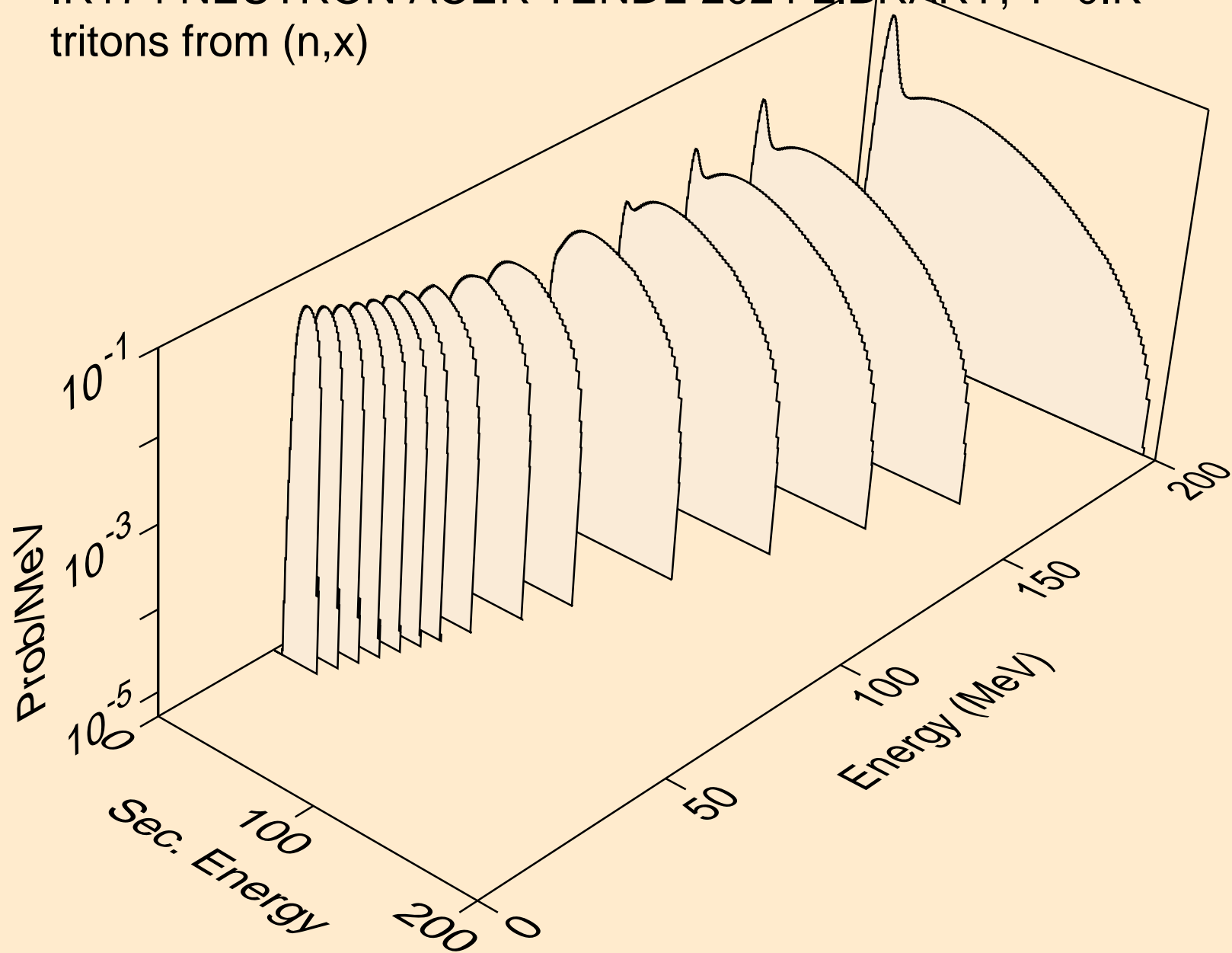

IR174 NEUTRON ACER TENDL-2024 LIBRARY; T=0.K
tritons from (n,n*)t

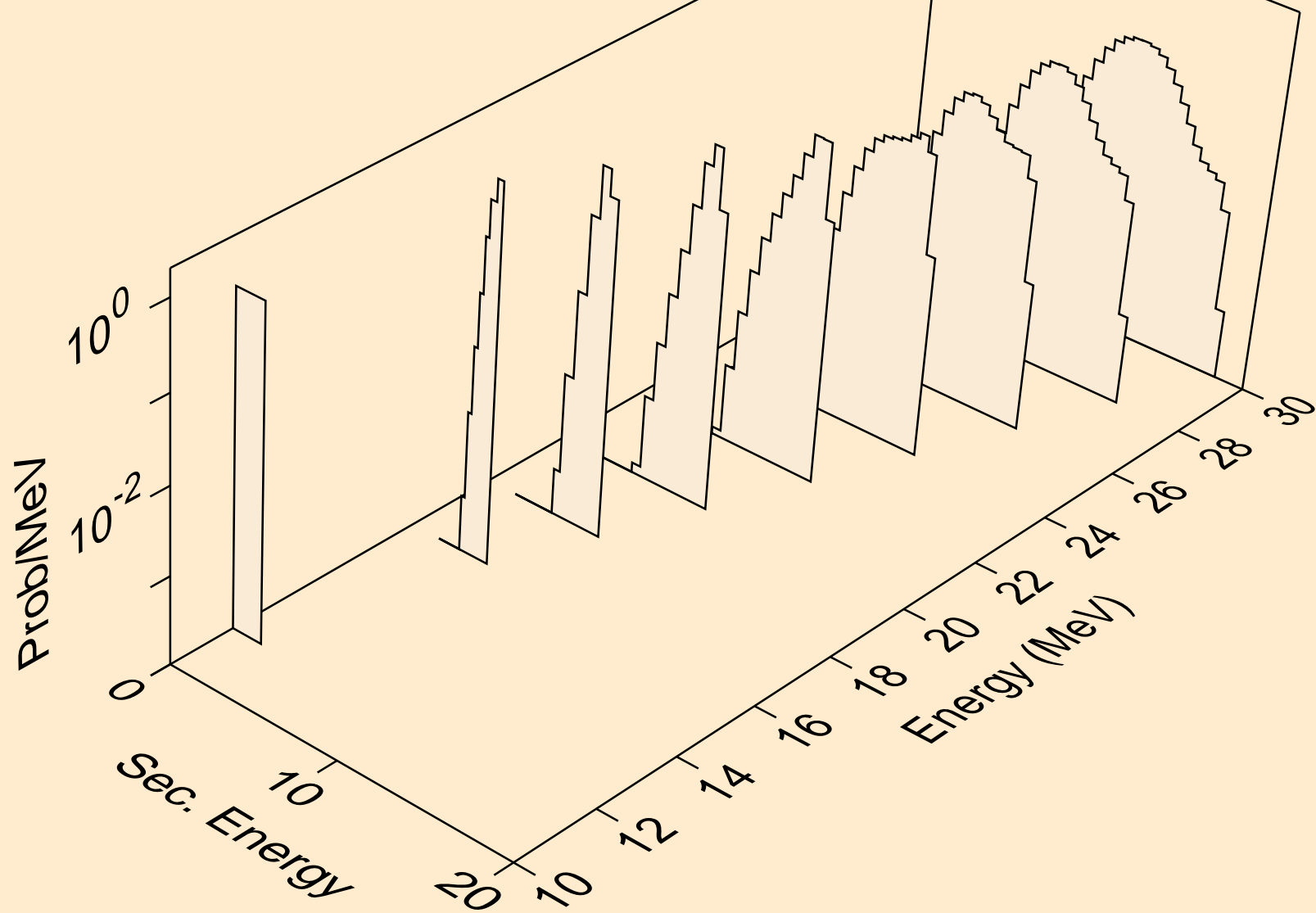

IR174 NEUTRON ACER TENDL-2024 LIBRARY; T=0.K
tritons from (n,t)

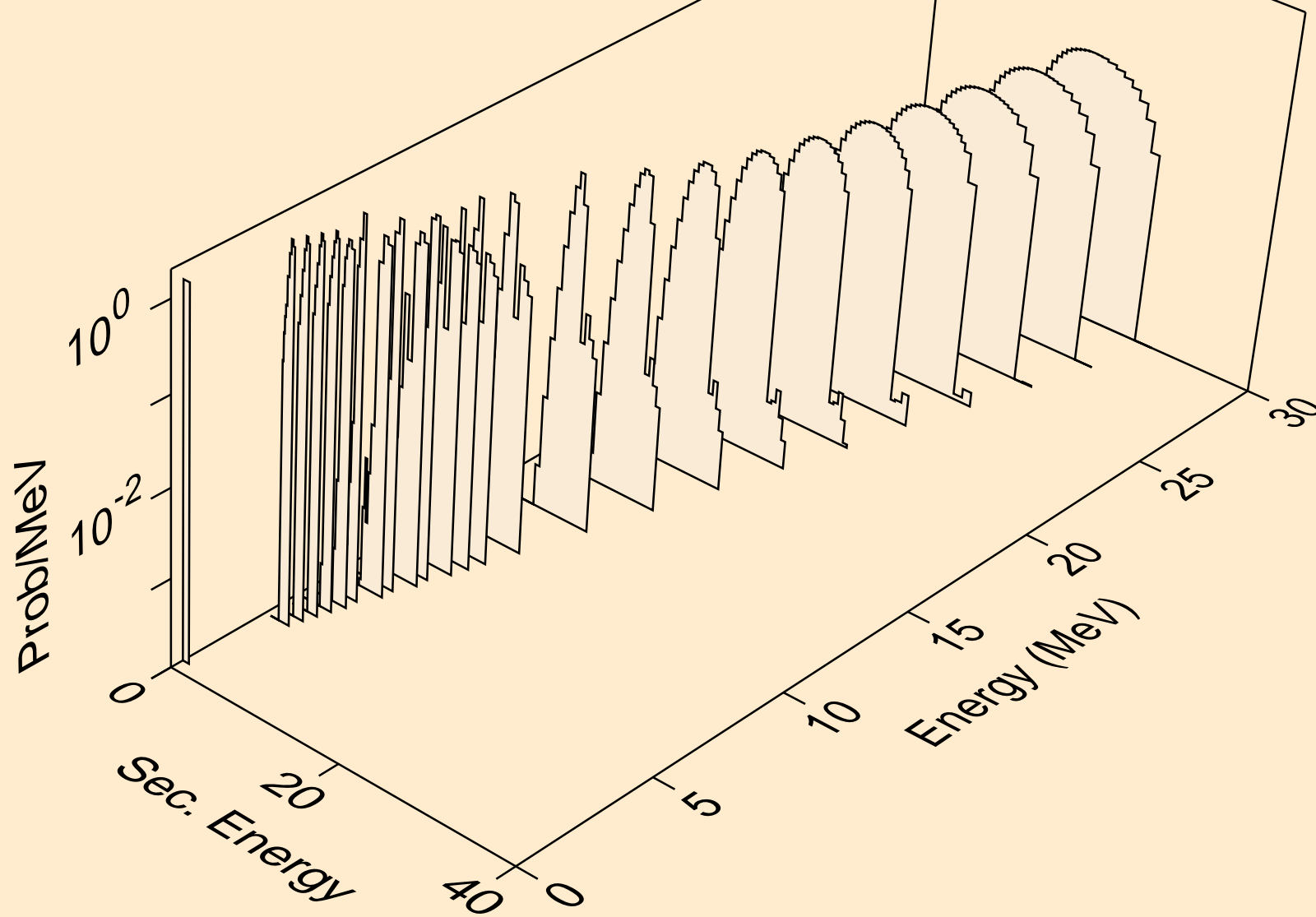

IR174 NEUTRON ACER TENDL-2024 LIBRARY; T=0.K
tritons from (n,t2a)

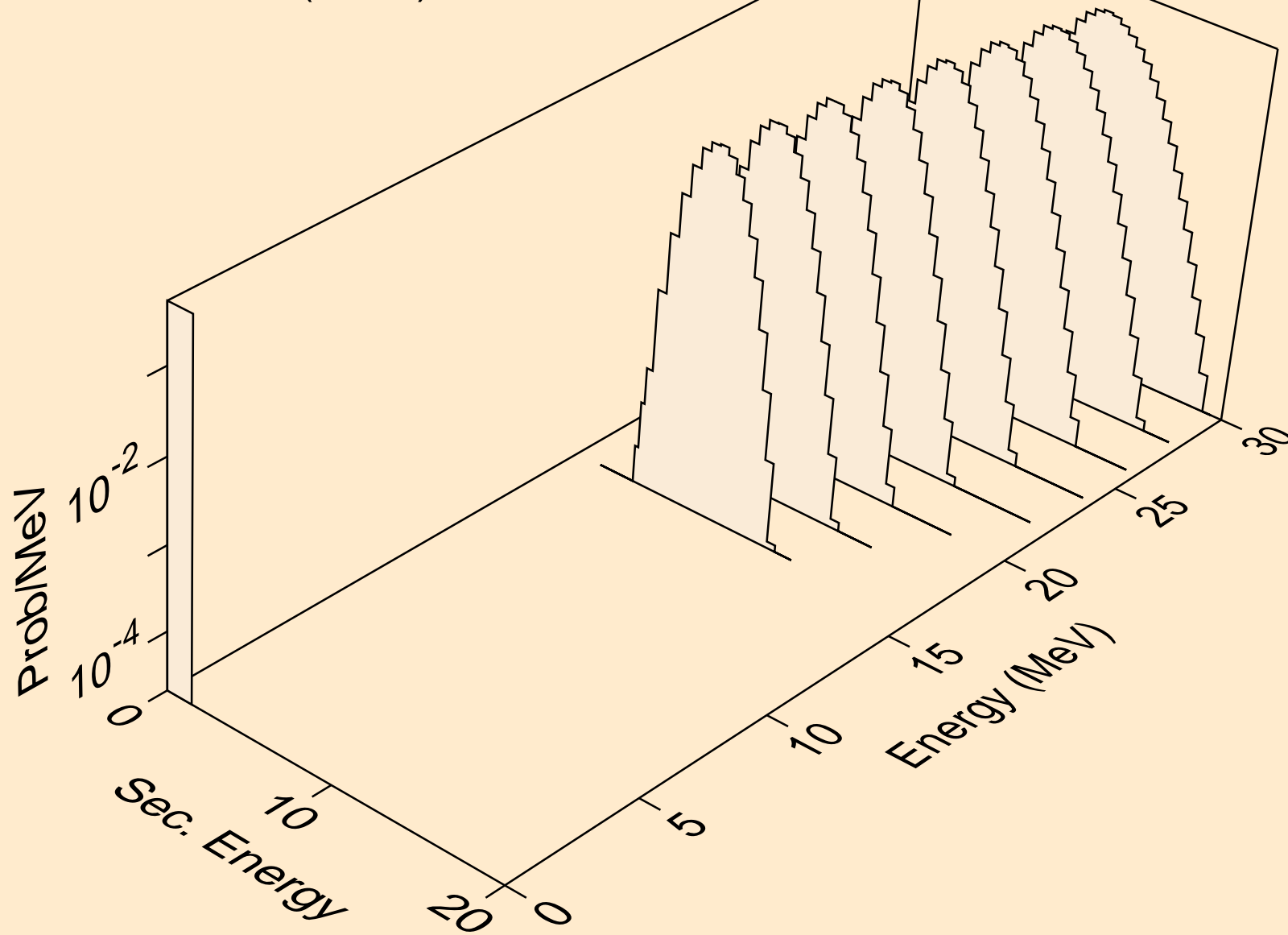

IR174 NEUTRON ACER TENDL-2024 LIBRARY; T=0.K
tritons from (n,pt)

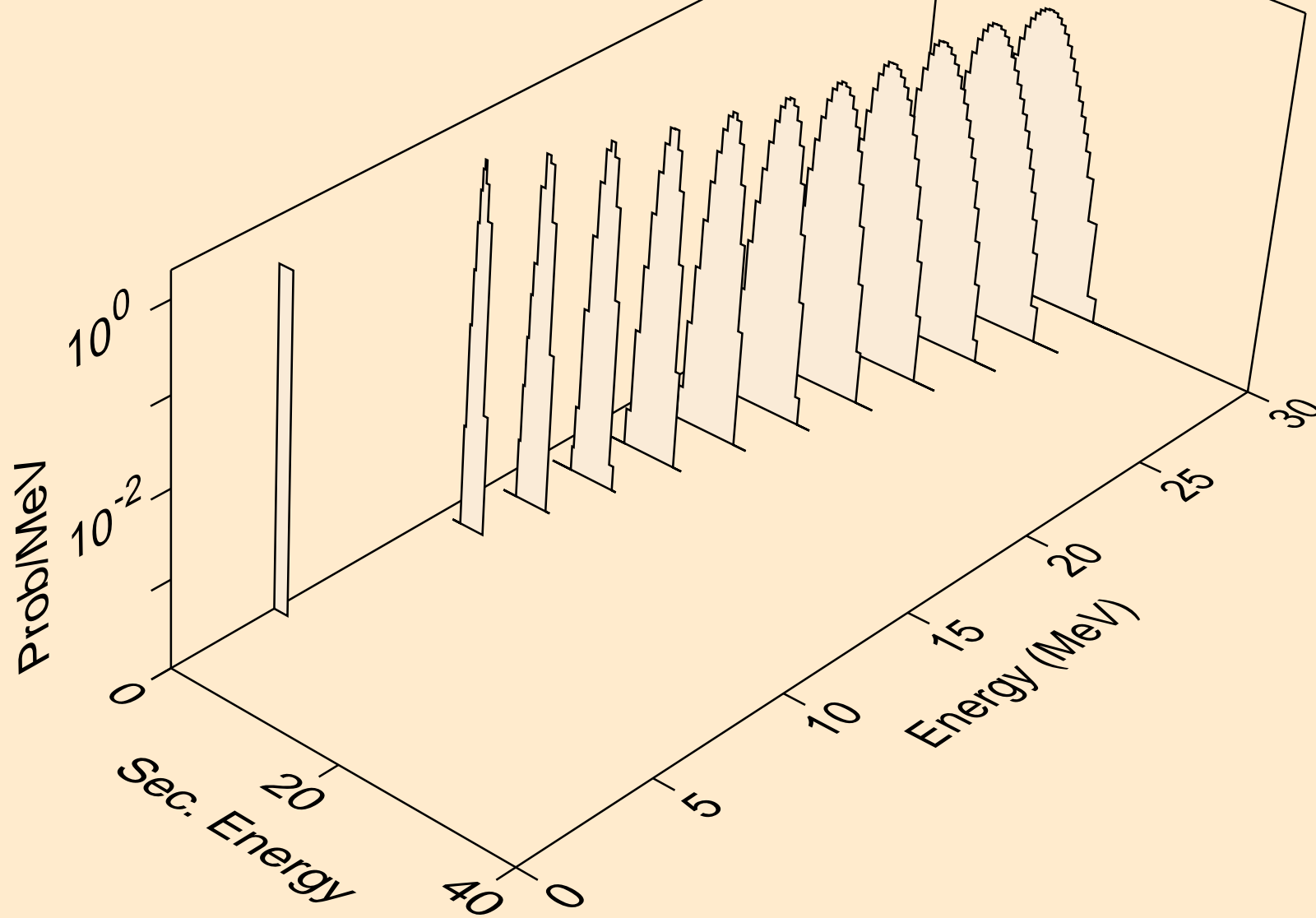

IR174 NEUTRON ACER TENDL-2024 LIBRARY; T=0.K
he3s from (n,x)

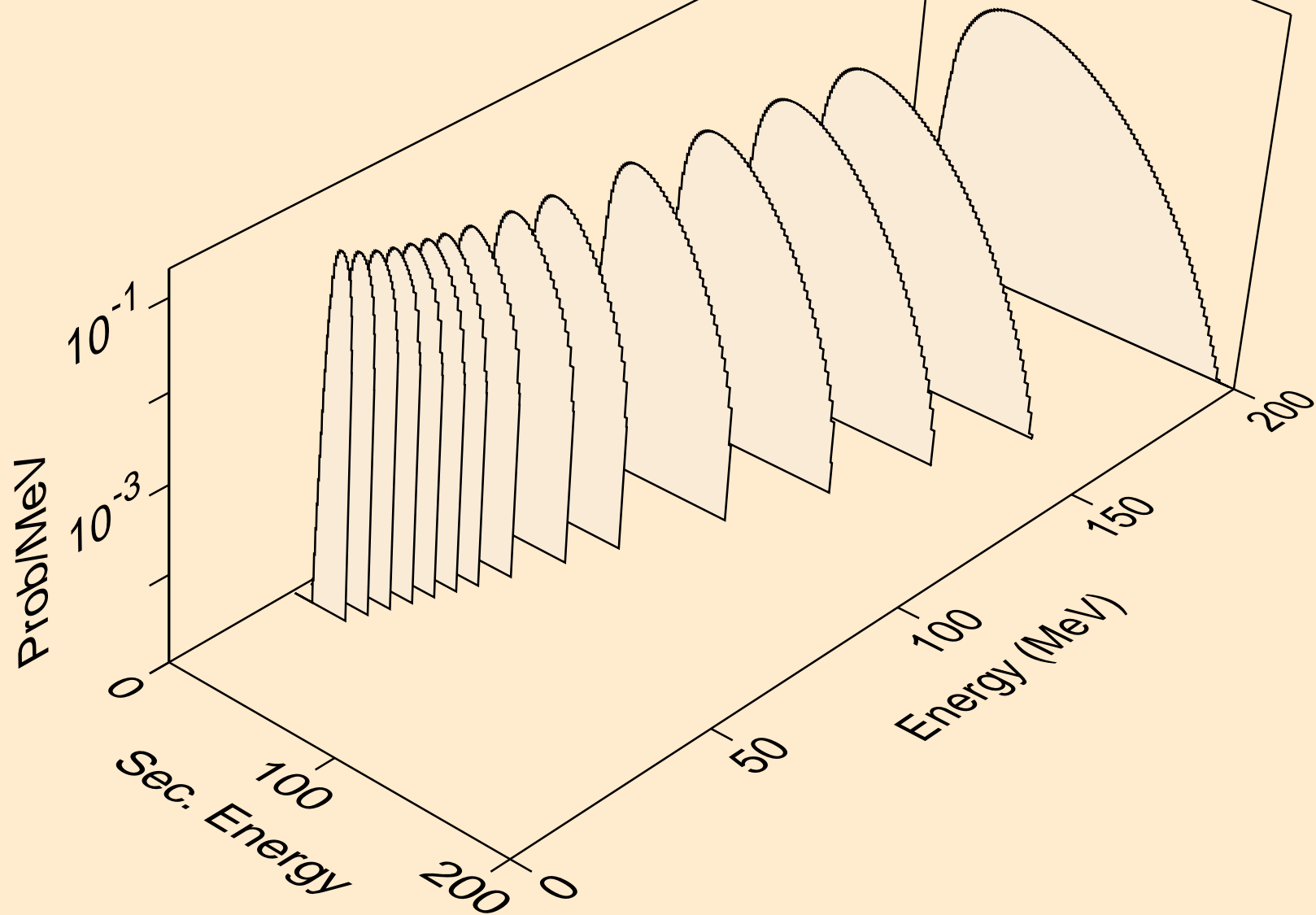

IR174 NEUTRON ACER TENDL-2024 LIBRARY; T=0.K
he3s from (n,n*)he3

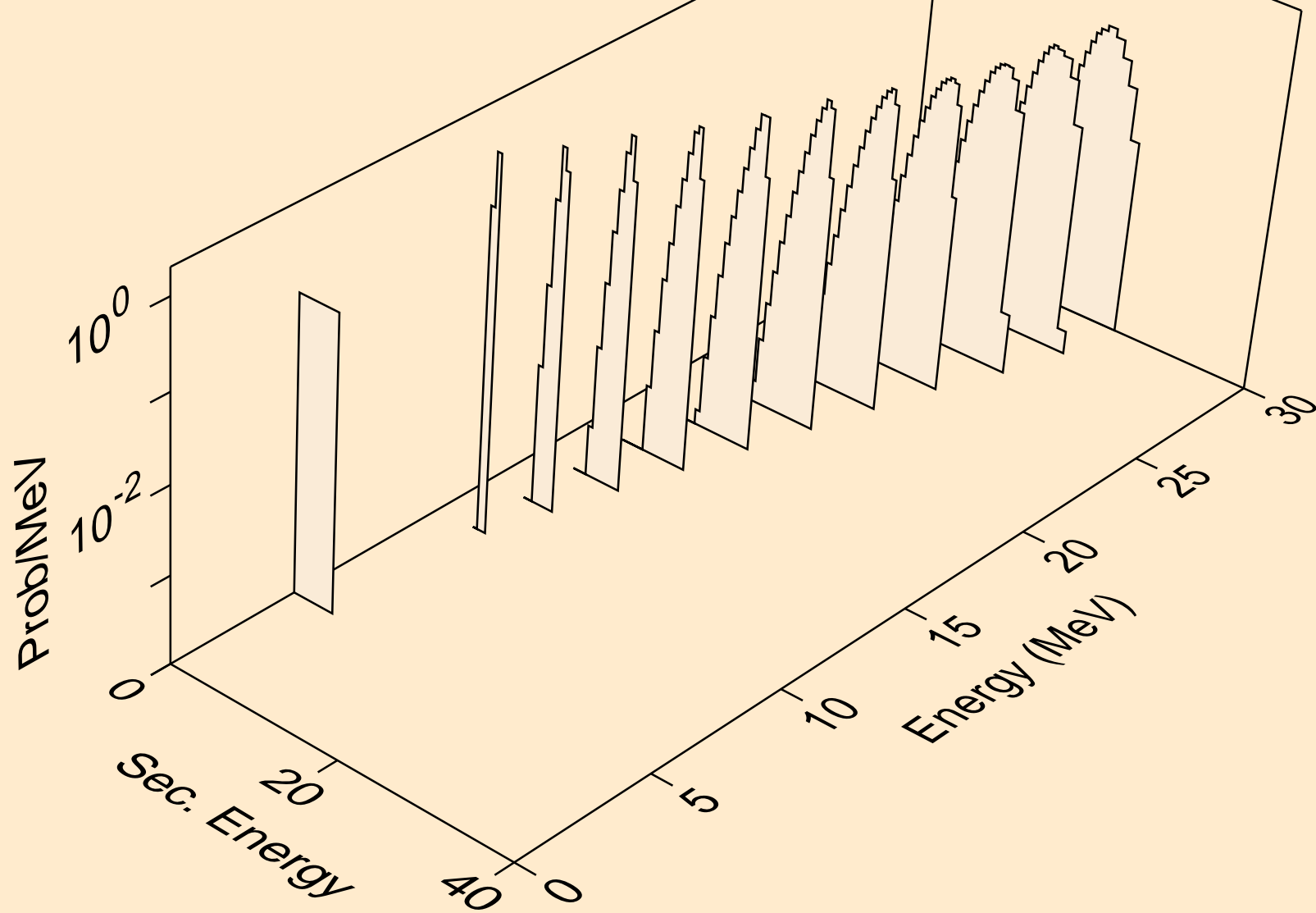

IR174 NEUTRON ACER TENDL-2024 LIBRARY; T=0.K
he3s from (n,he3)

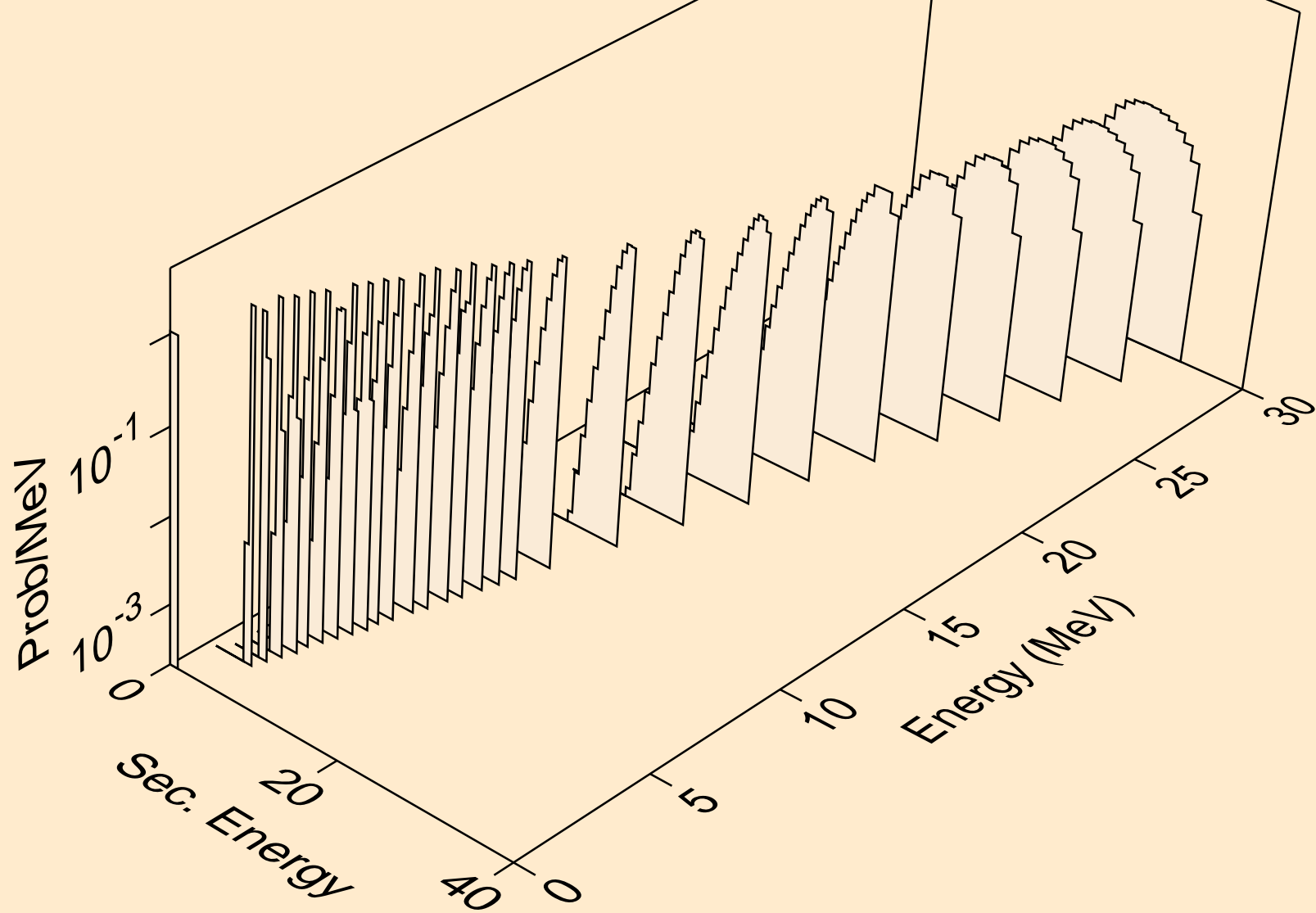

IR174 NEUTRON ACER TENDL-2024 LIBRARY; T=0.K
alphas from (n,x)

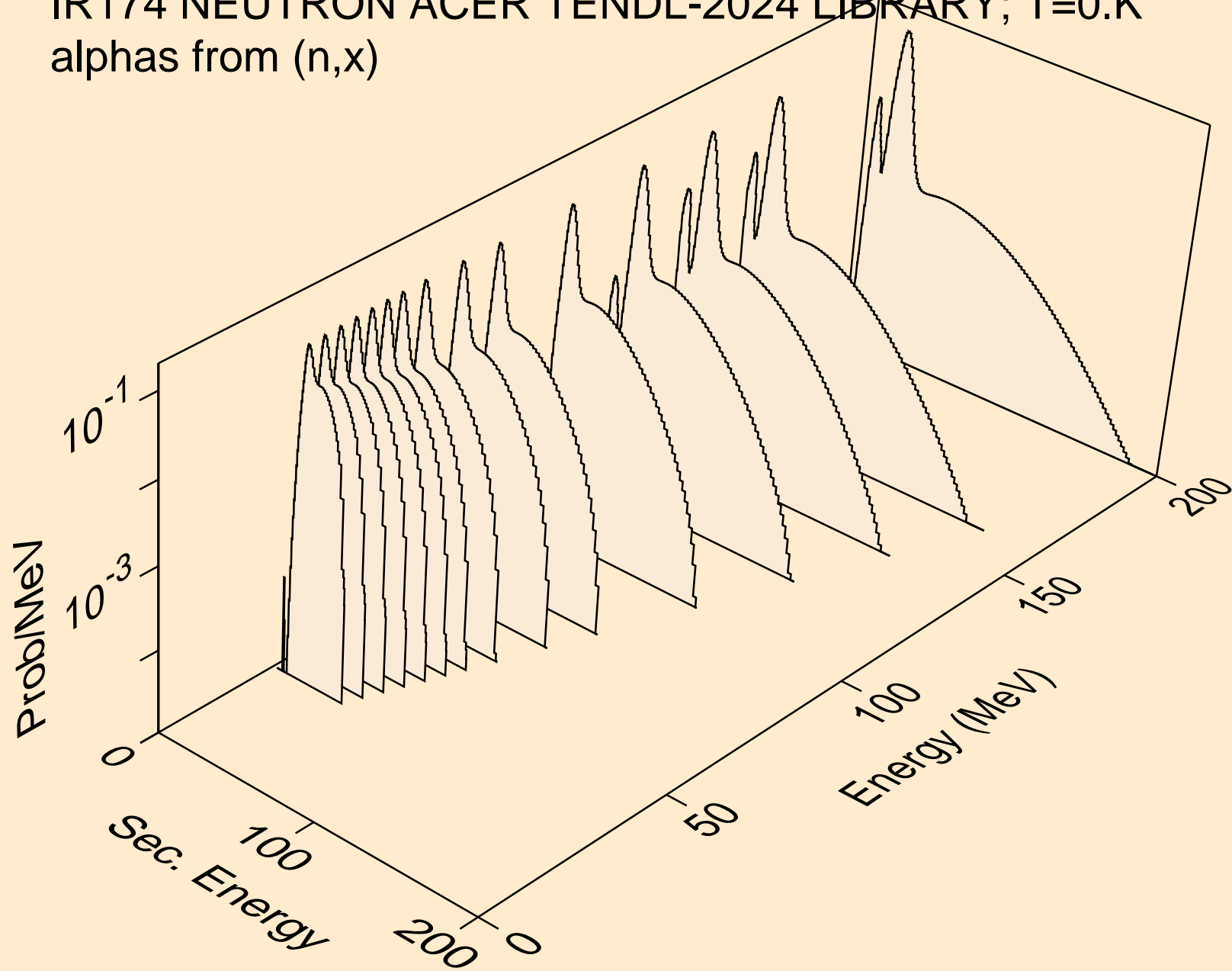

IR174 NEUTRON ACER TENDL-2024 LIBRARY; T=0.K
alphas from (n,n*)a

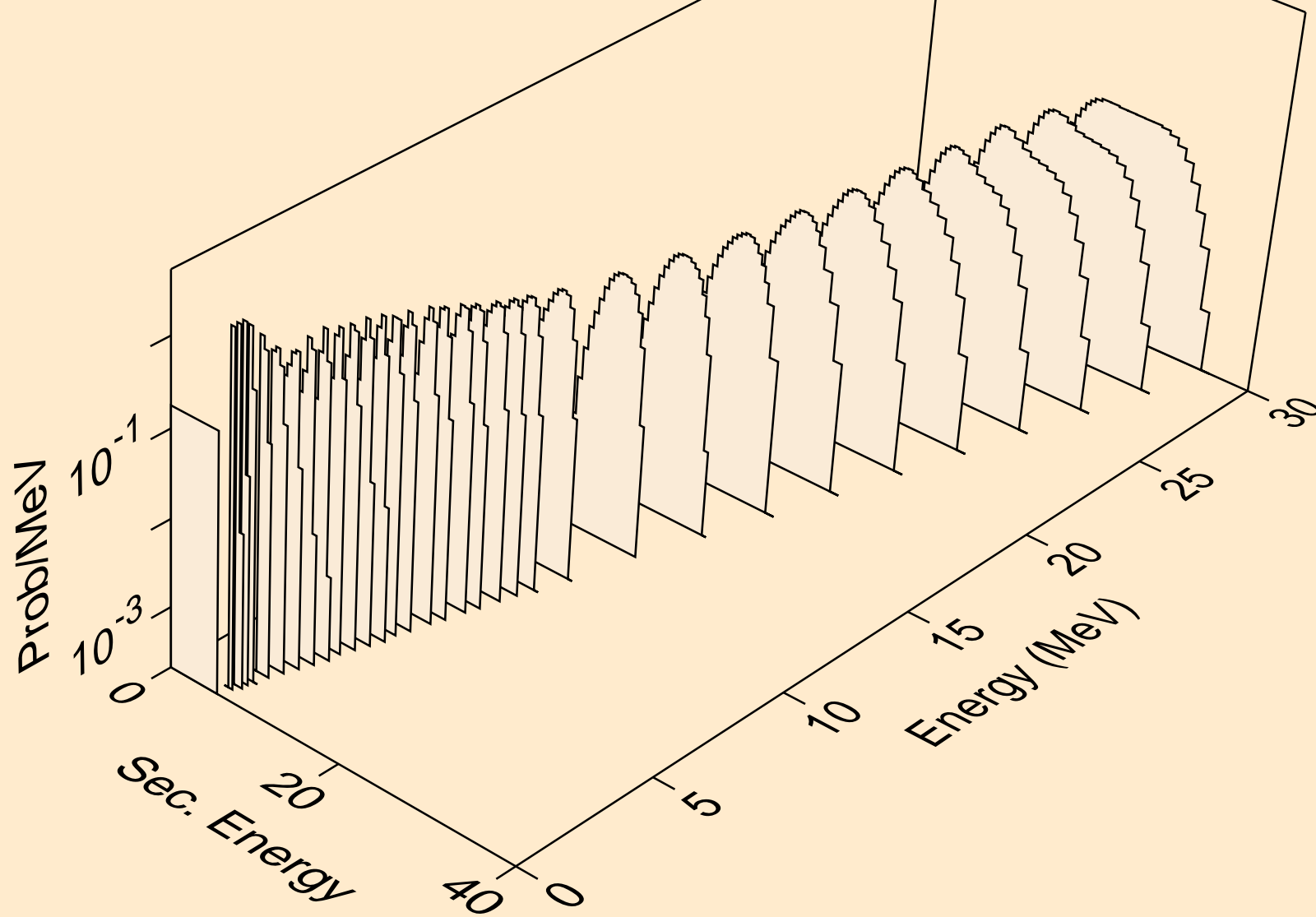

IR174 NEUTRON ACER TENDL-2024 LIBRARY; T=0.K
alphas from (n,n*)3a

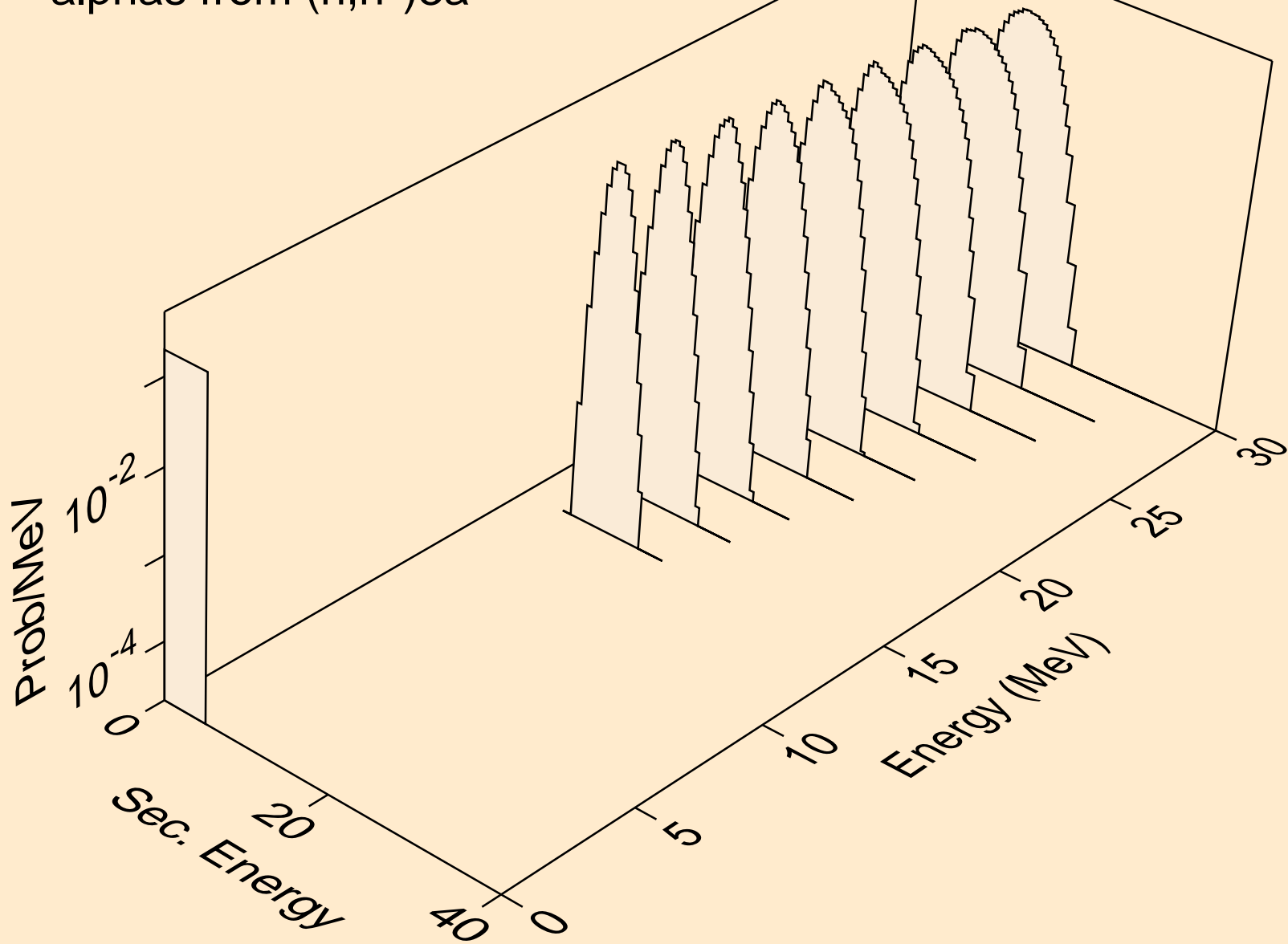

IR174 NEUTRON ACER TENDL-2024 LIBRARY; T=0.K
alphas from (n,2n)a

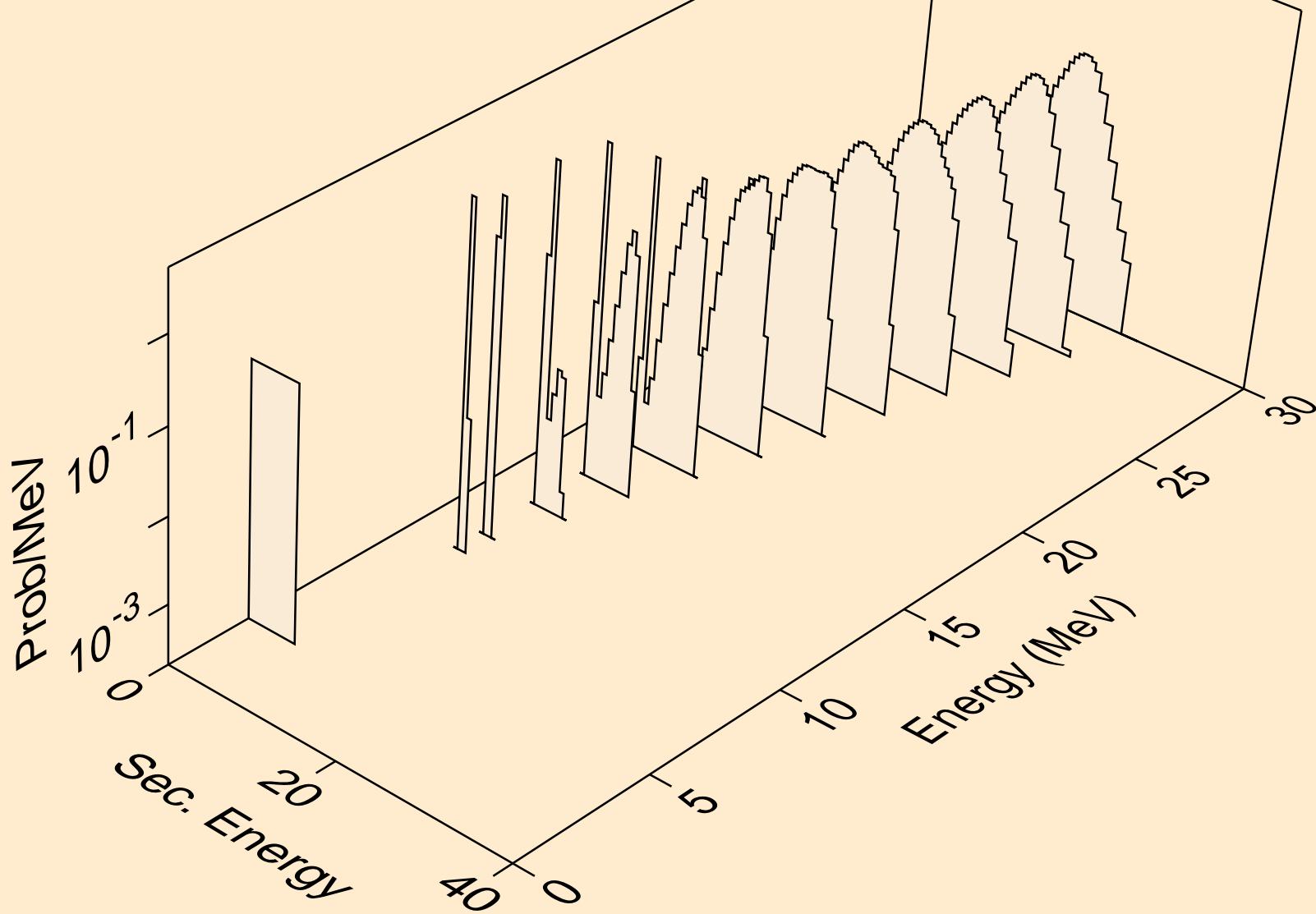

IR174 NEUTRON ACER TENDL-2024 LIBRARY; T=0.K
alphas from (n,3n)a

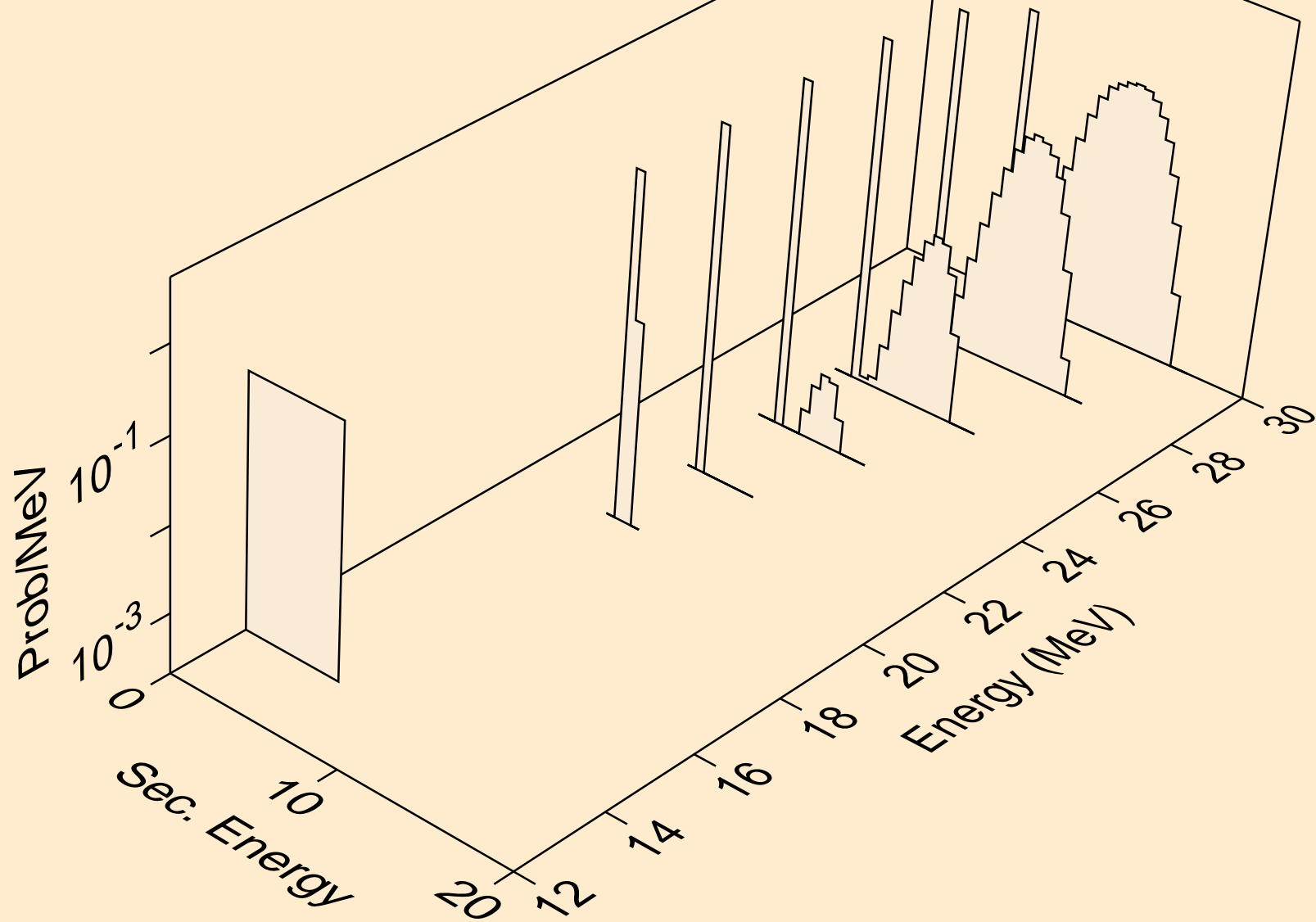

IR174 NEUTRON ACER TENDL-2024 LIBRARY; T=0.K
alphas from (n,n*)2a

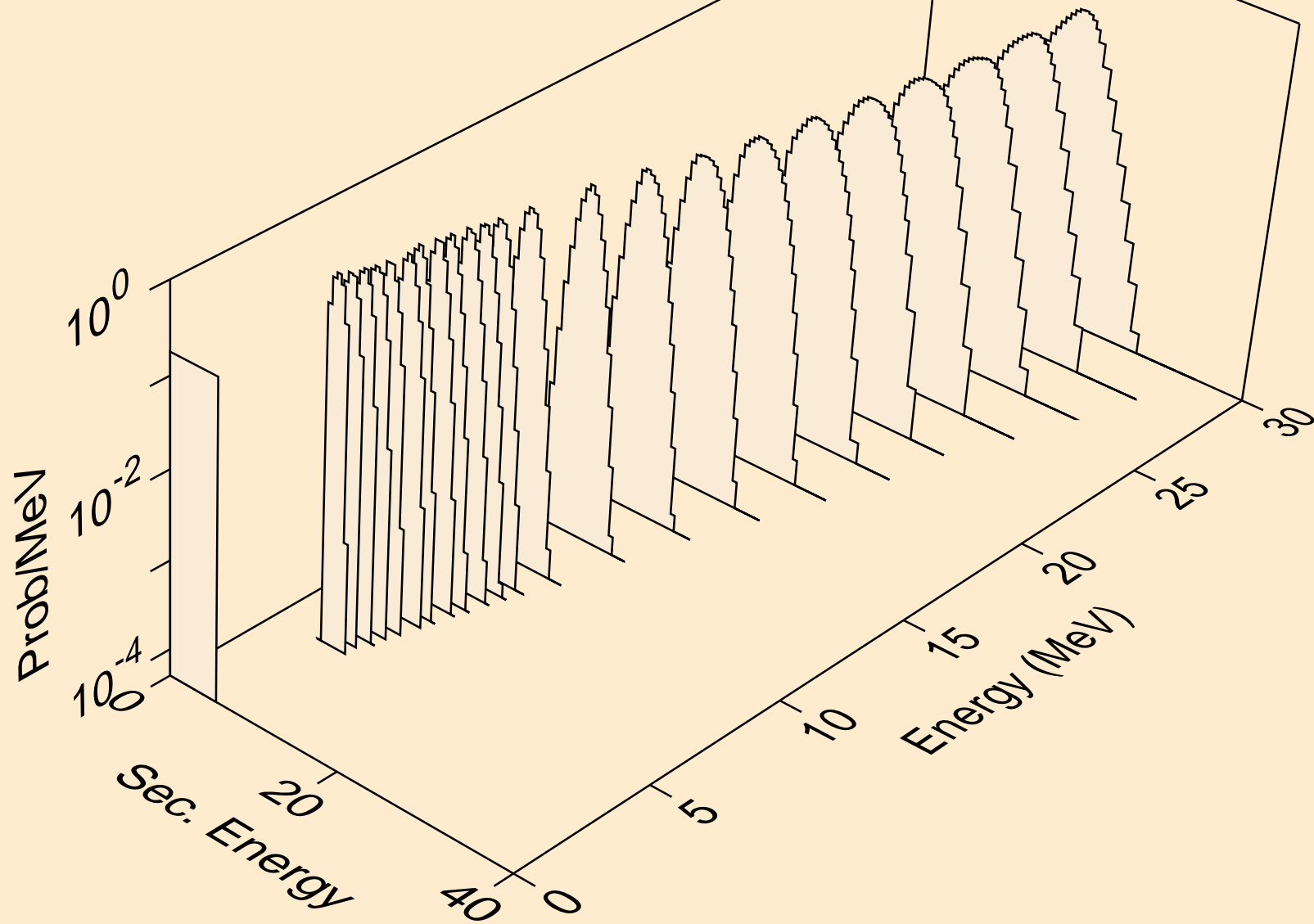

IR174 NEUTRON ACER TENDL-2024 LIBRARY; T=0.K
alphas from (n,2n)2a

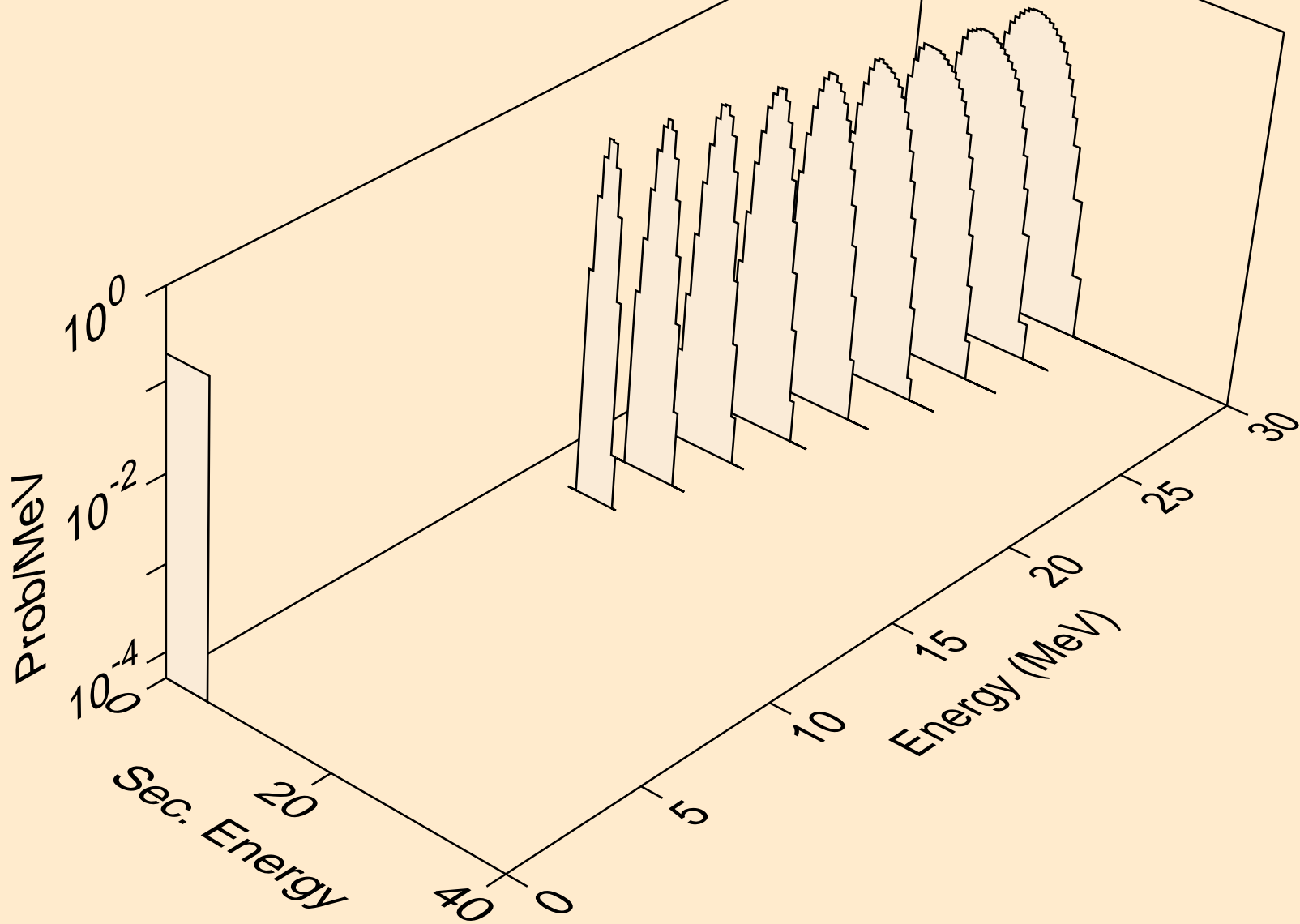

IR174 NEUTRON ACER TENDL-2024 LIBRARY; T=0.K
alphas from (n,npa)

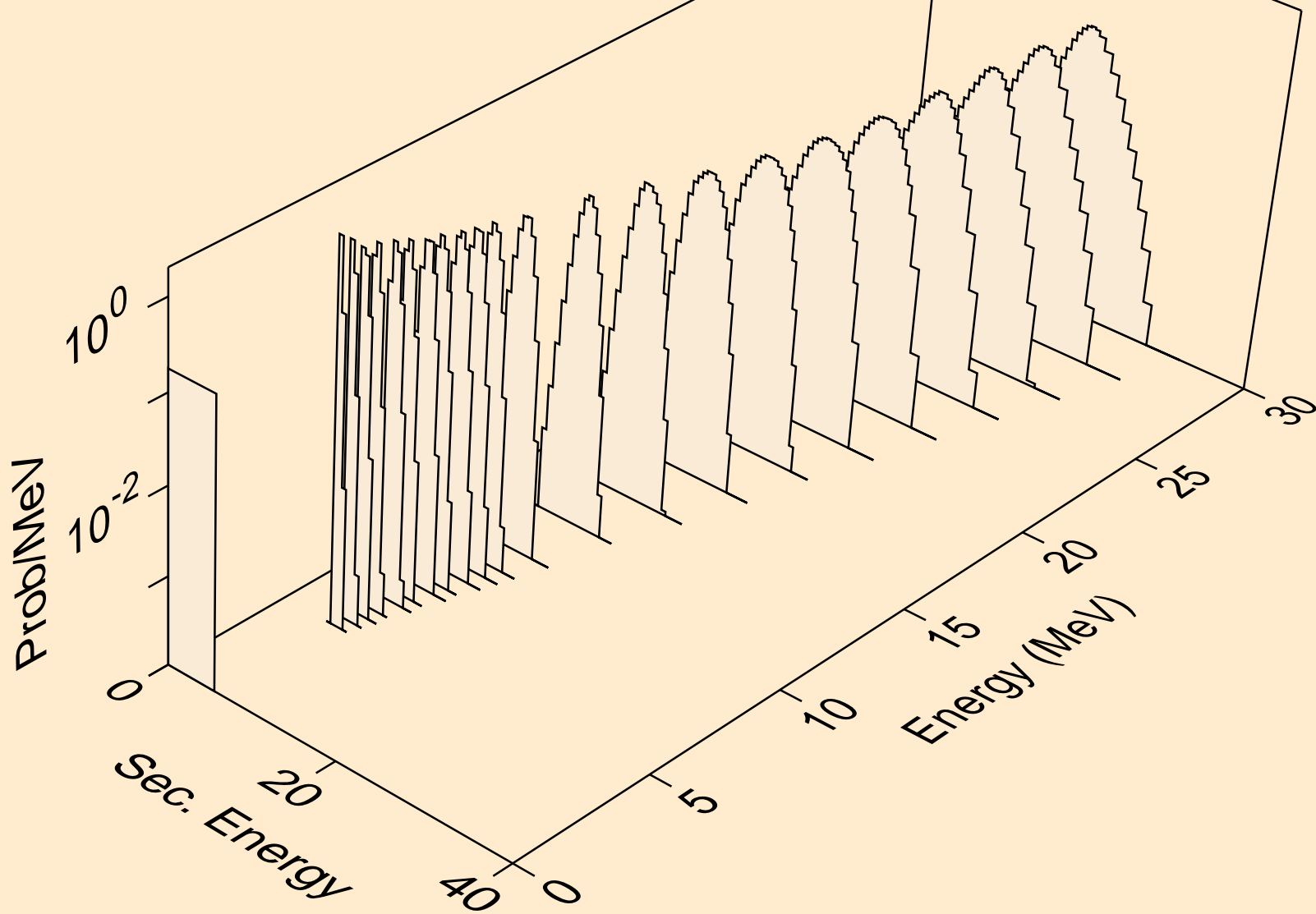

IR174 NEUTRON ACER TENDL-2024 LIBRARY; T=0.K
alphas from (n,a)

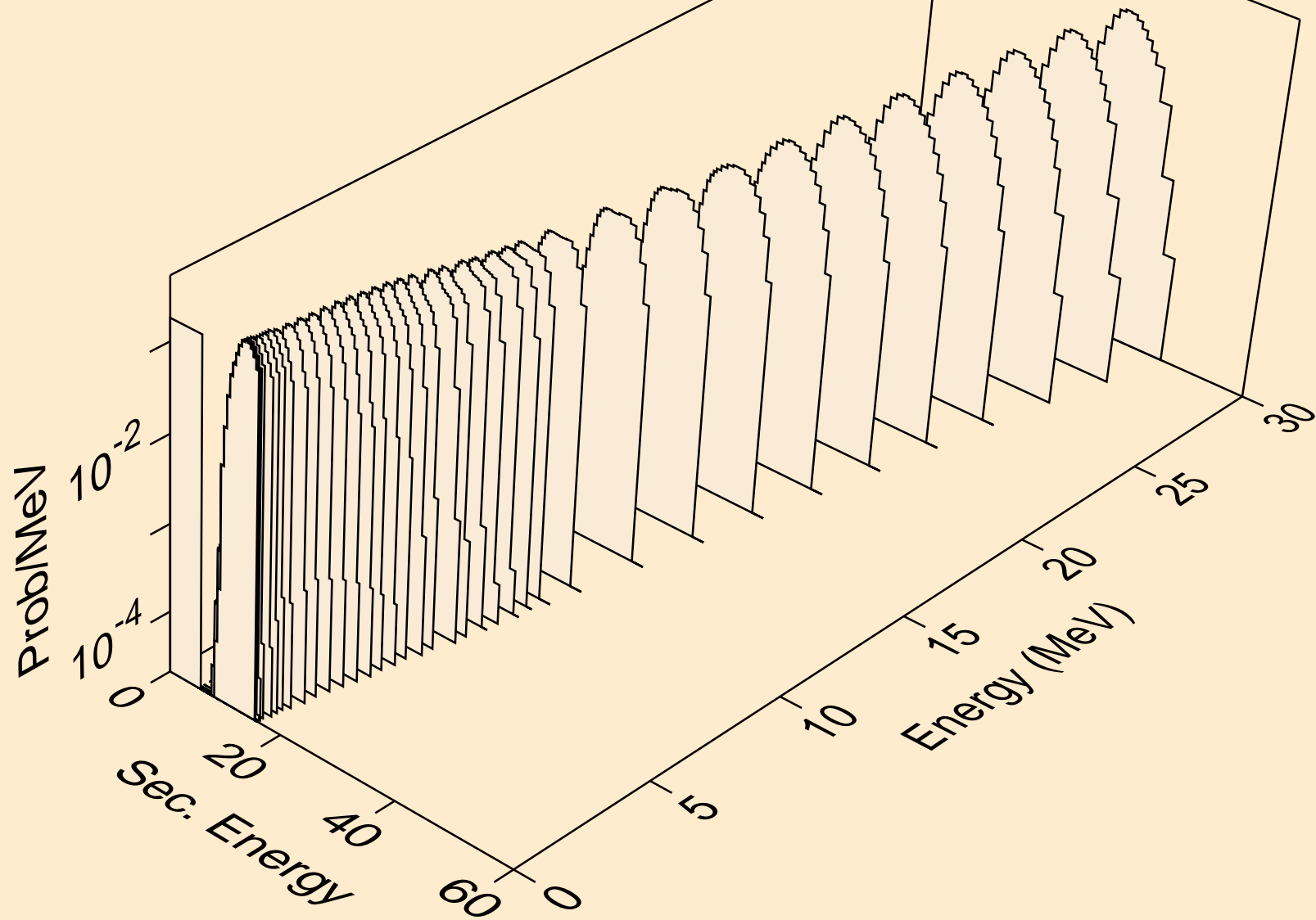

IR174 NEUTRON ACER TENDL-2024 LIBRARY; T=0.K
alphas from (n,2a)

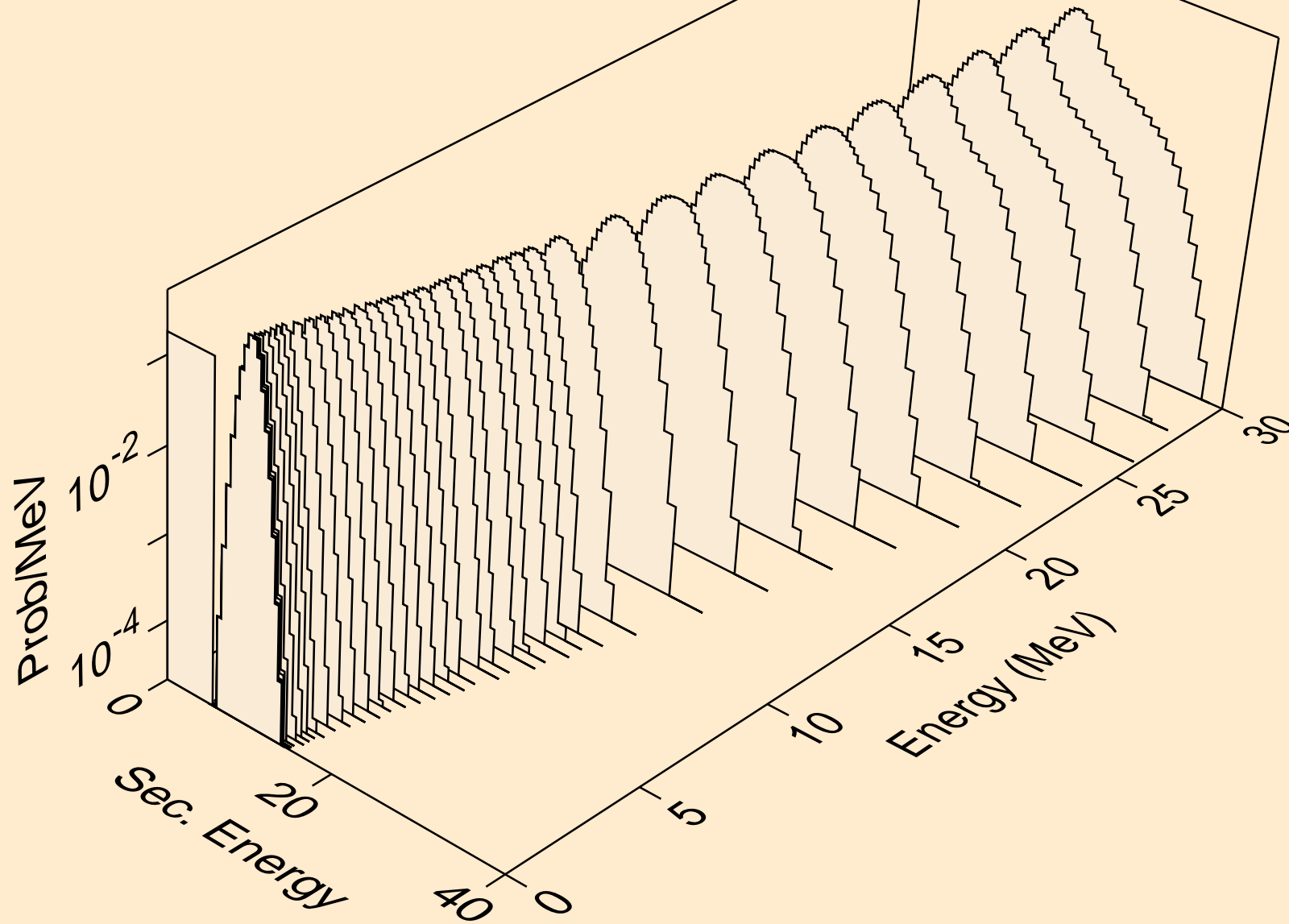

IR174 NEUTRON ACER TENDL-2024 LIBRARY; T=0.K
alphas from (n,3a)

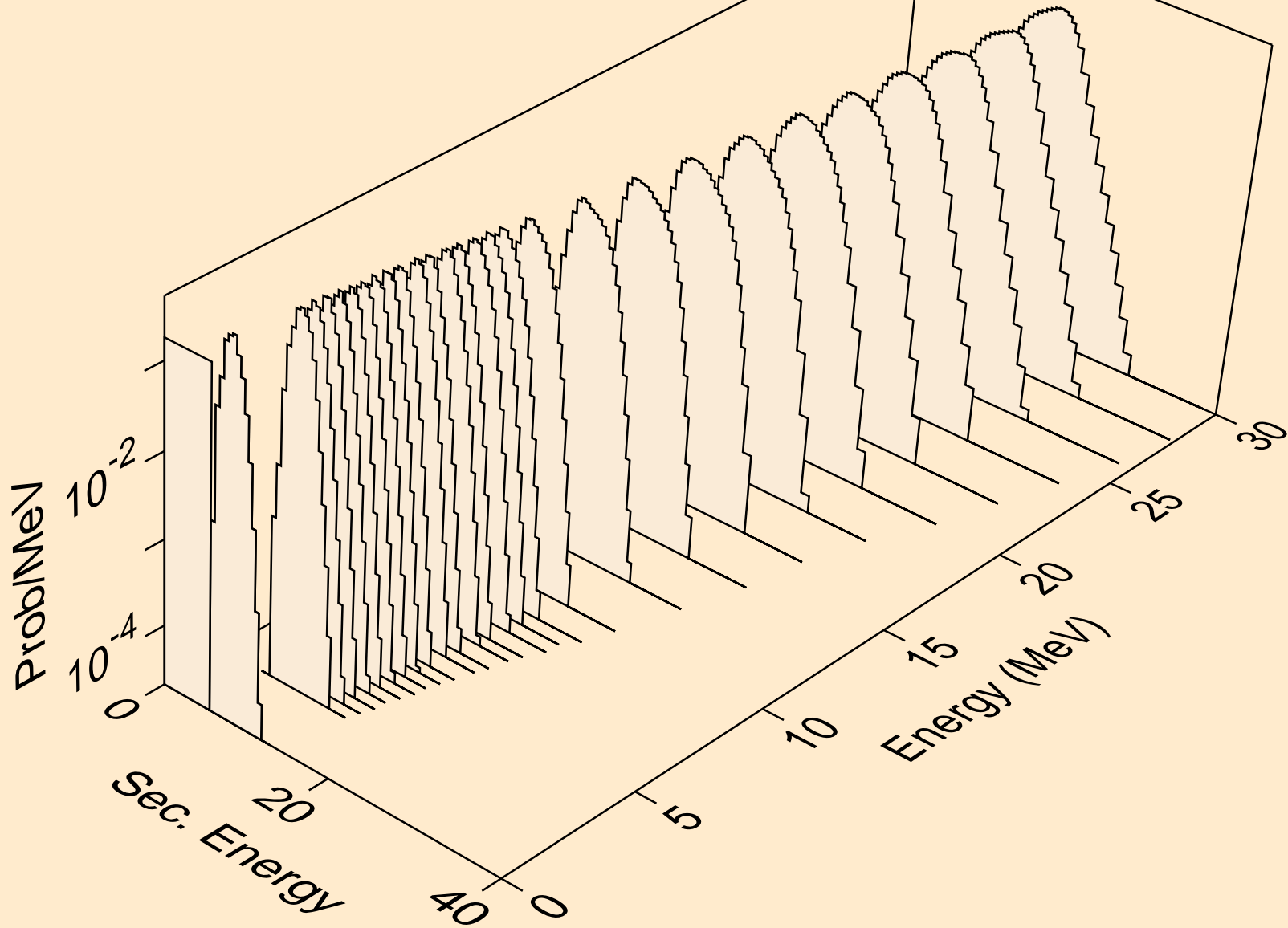

IR174 NEUTRON ACER TENDL-2024 LIBRARY; T=0.K
alphas from (n,pa)

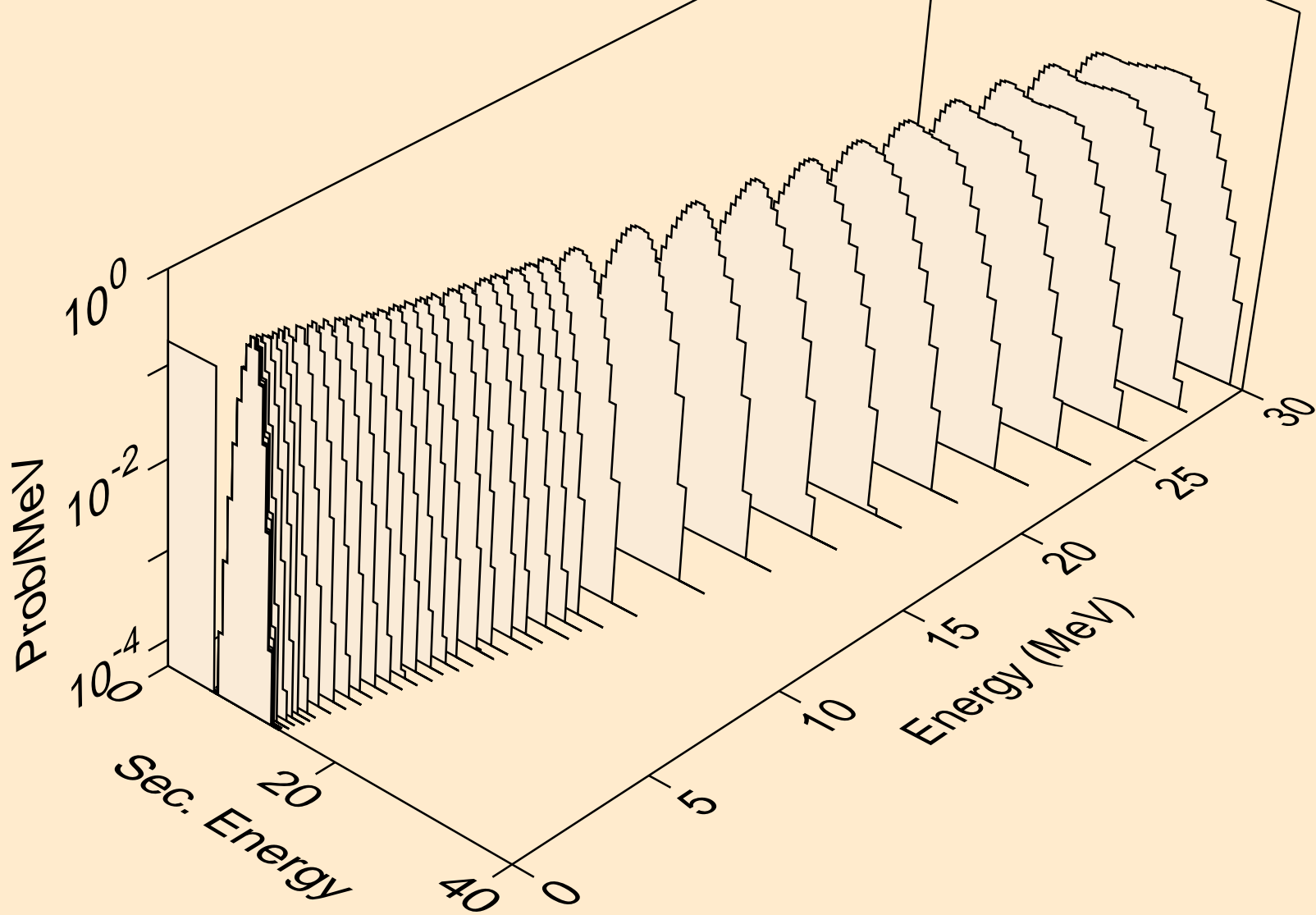

IR174 NEUTRON ACER TENDL-2024 LIBRARY; T=0.K
alphas from (n,t2a)

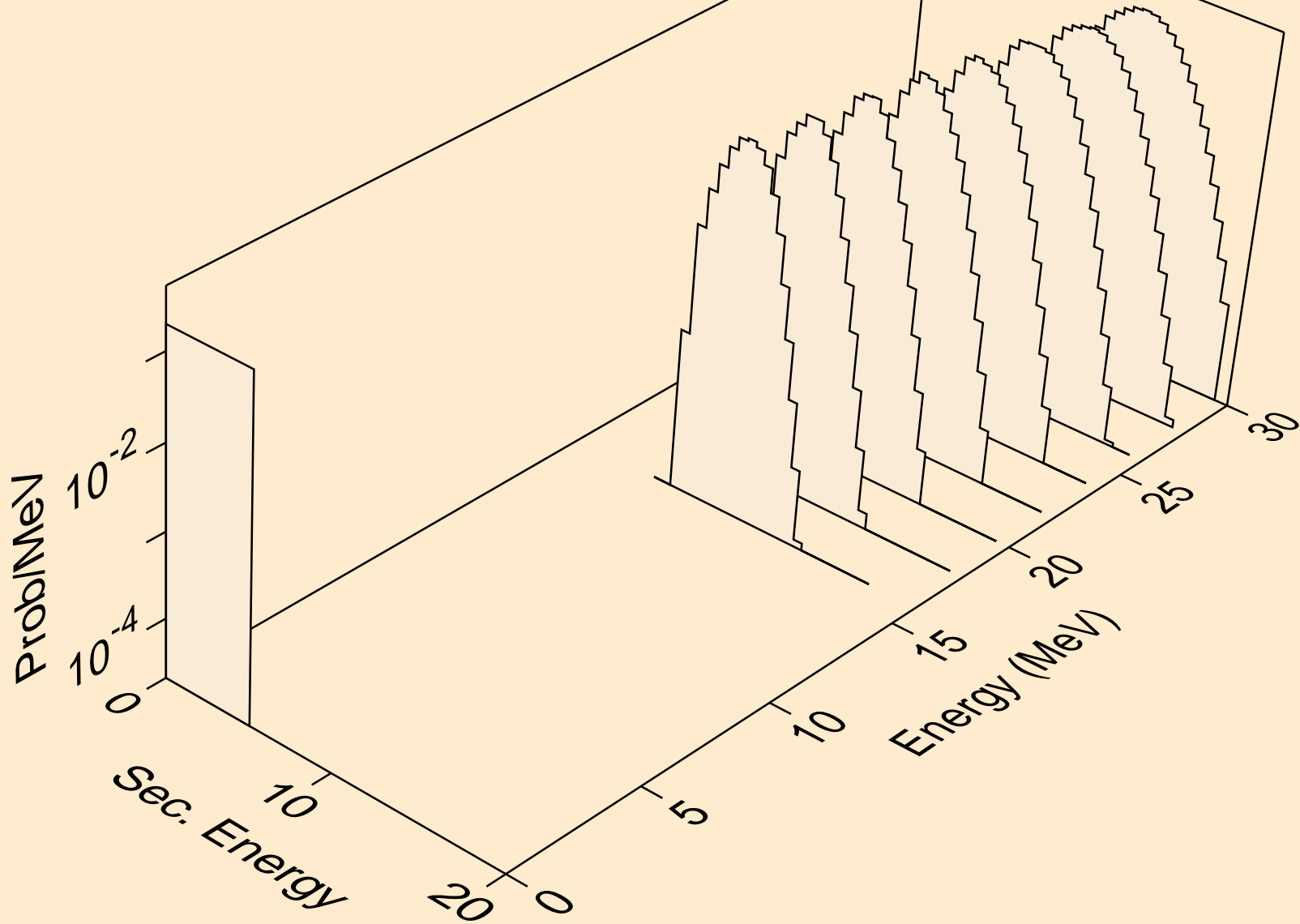

IR174 NEUTRON ACER TENDL-2024 LIBRARY; T=0.K
alphas from (n,d2a)

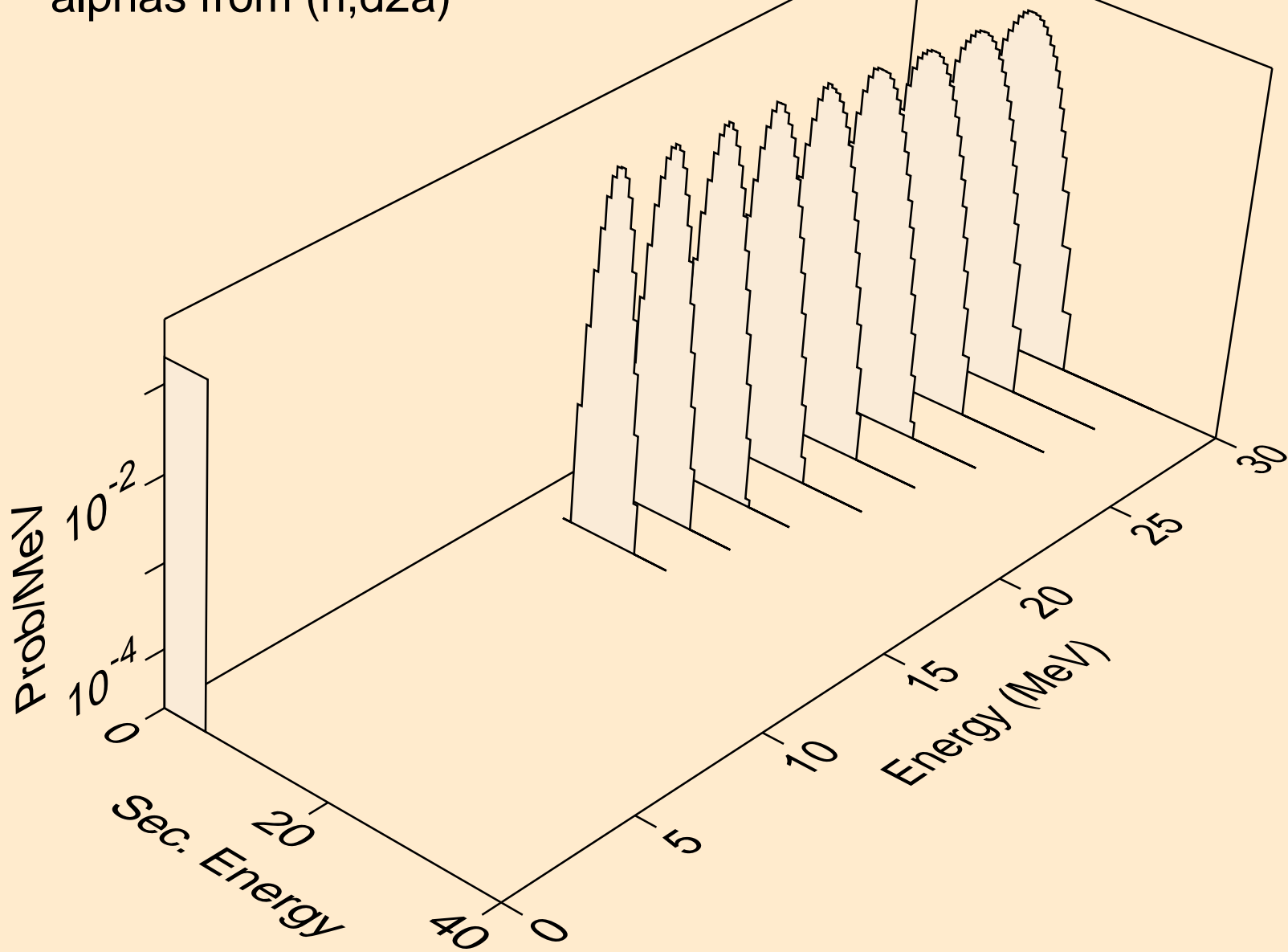

IR174 NEUTRON ACER TENDL-2024 LIBRARY; T=0.K
alphas from (n,da)

