

Program EVALPLOT
(Version 2021-1)

by

Dermott E. Cullen
(Present Contact Information)

Dermott E. Cullen
1466 Hudson Way
Livermore, CA 94550
U.S.A.

Tele: 925-443-1911

E.Mail:redcullen1@comcast.net

Web:redcullen1.net/HOMEPAGE.NEW

Press Mouse Button to Start

MAT 7695

Neutron Major
293 Kelvin Cross Sections

⁷⁷Ir-181

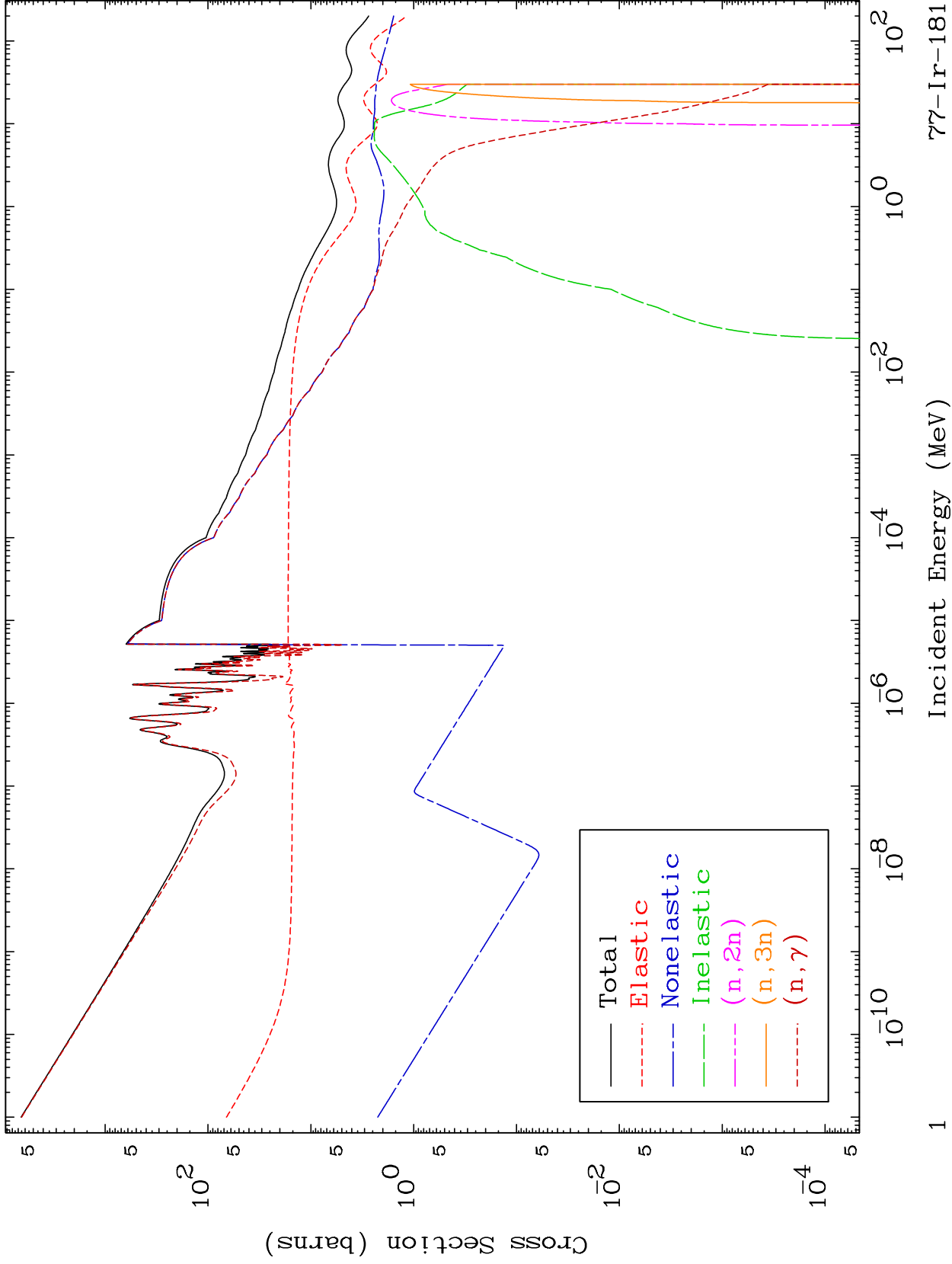

MAT 7695

Neutron Absorption
293 Kelvin Cross Sections

77-Ir-181

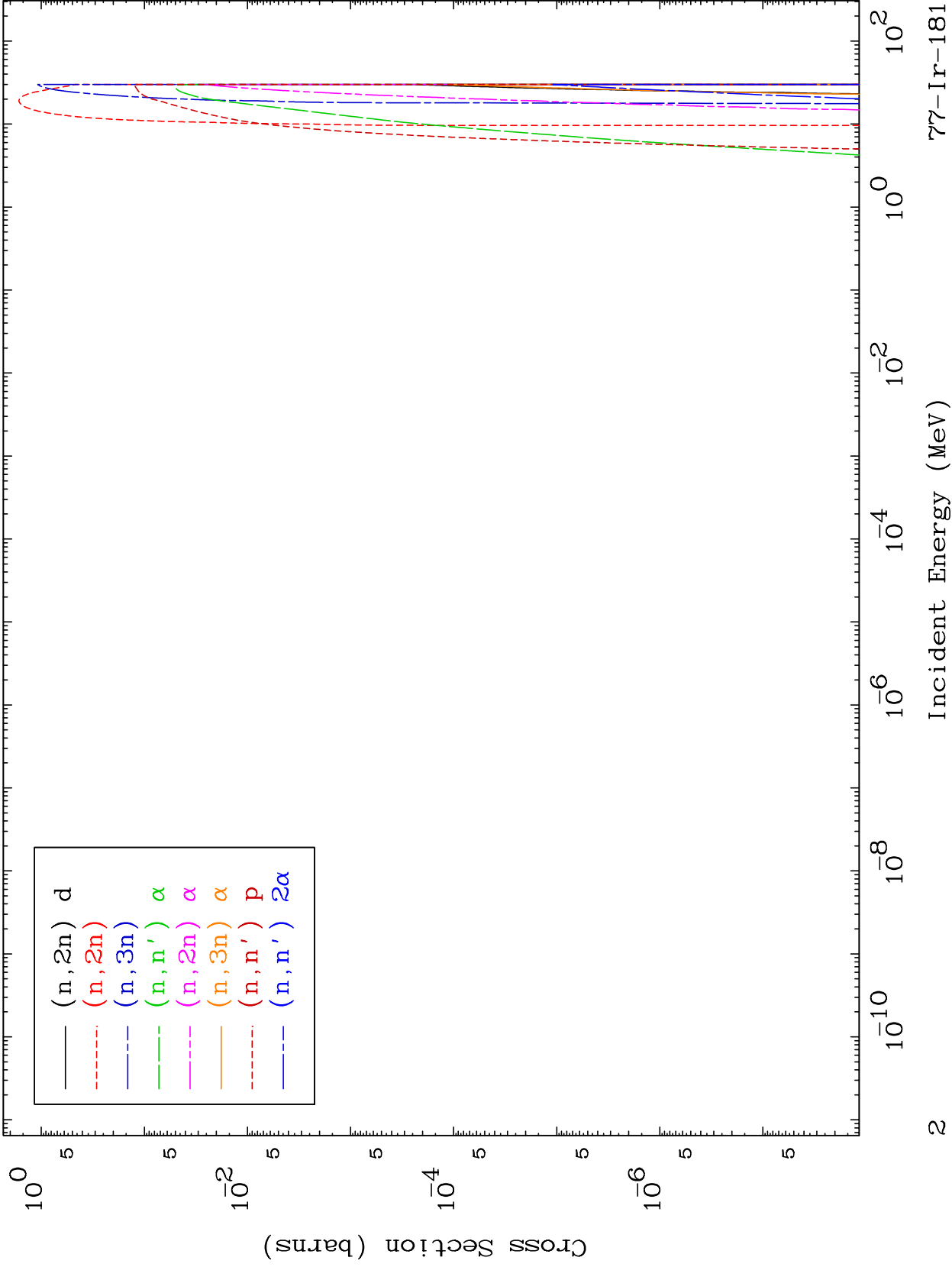

MAT 7695

Neutron Absorption
293 Kelvin Cross Sections

⁷⁷Ir-181

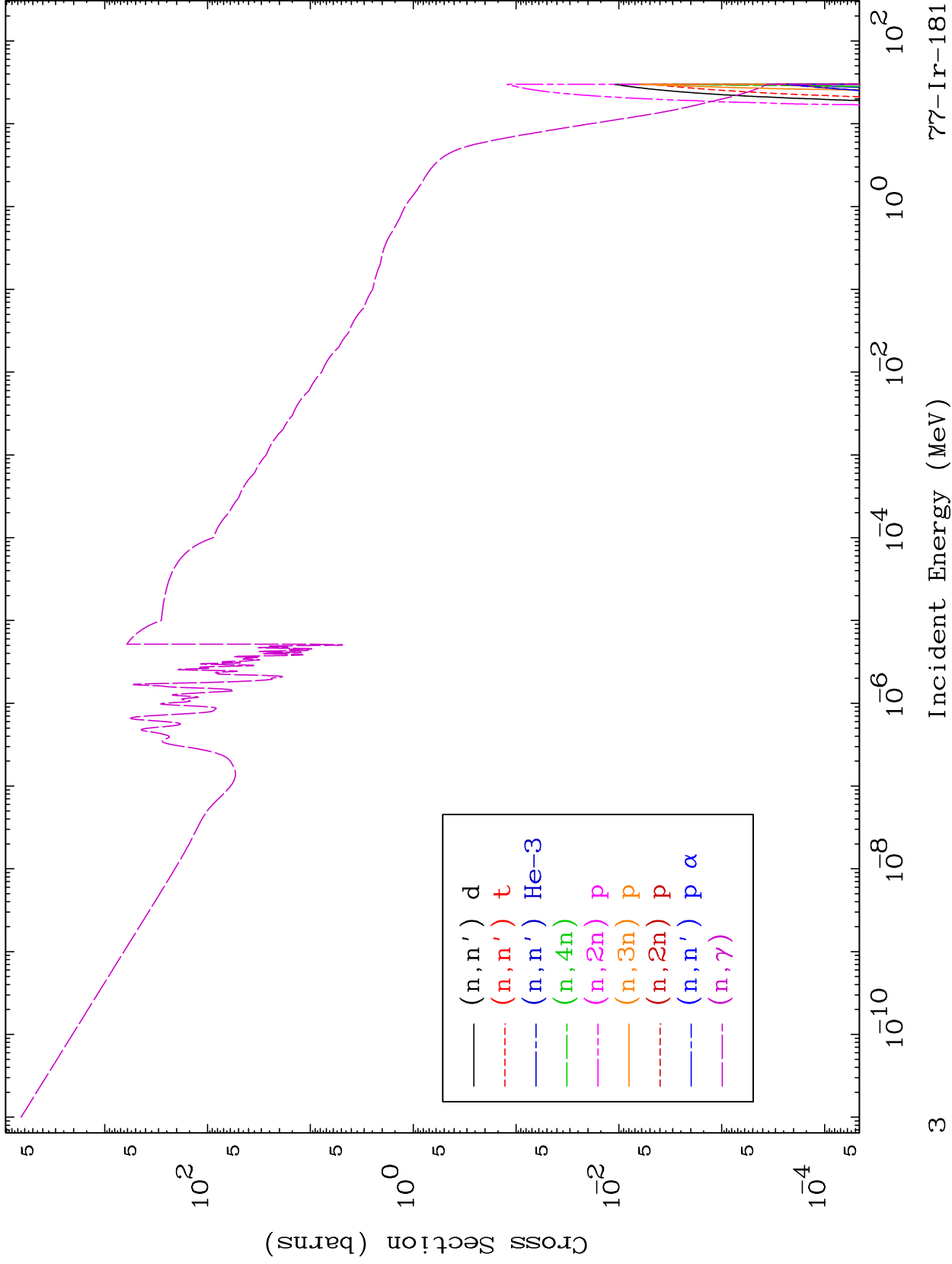

MAT 7695

Neutron Absorption
293 Kelvin Cross Sections

⁷⁷Ir-181

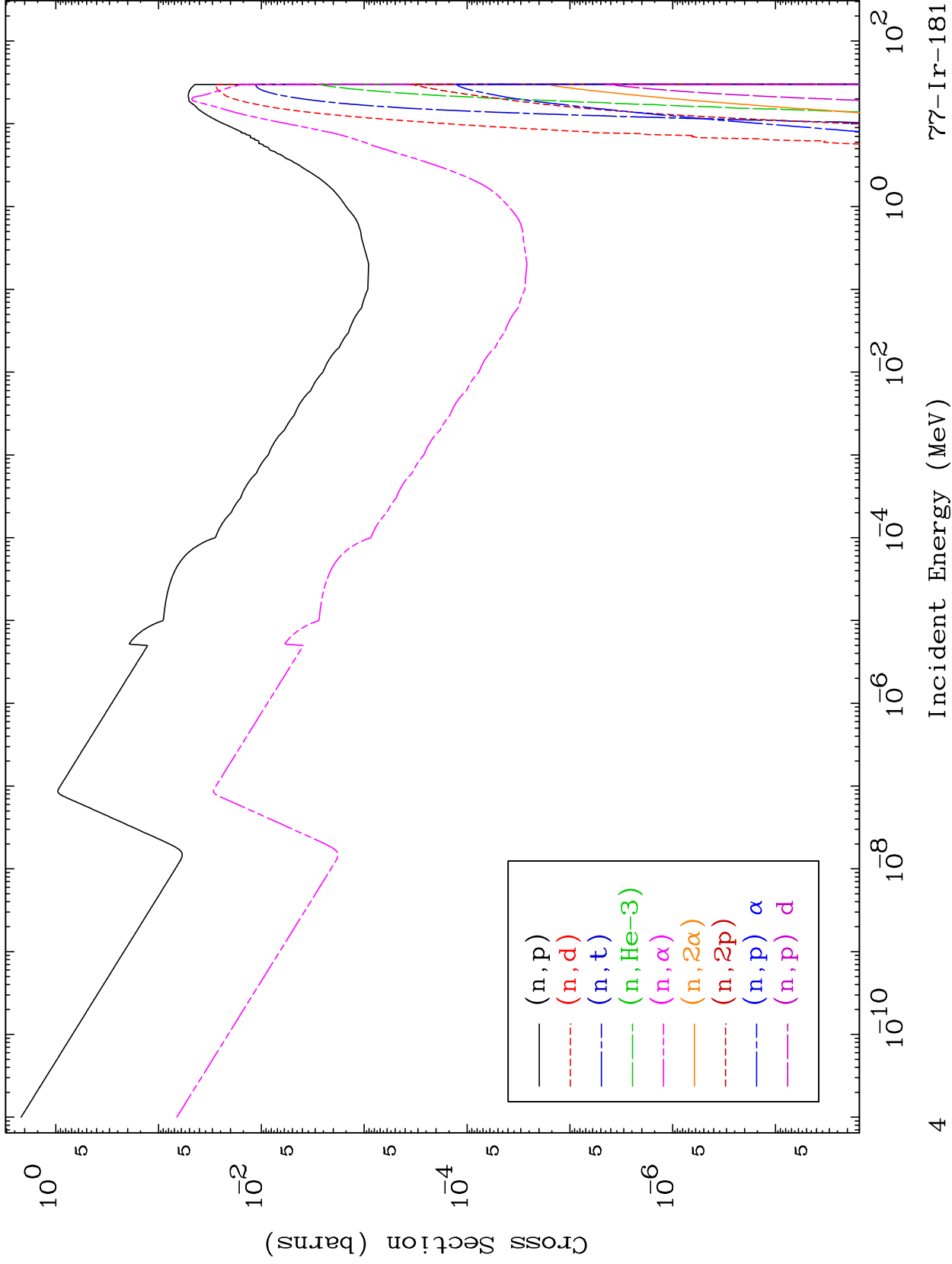

MAT 7695

Neutron Absorption
293 Kelvin Cross Sections

77-Ir-181

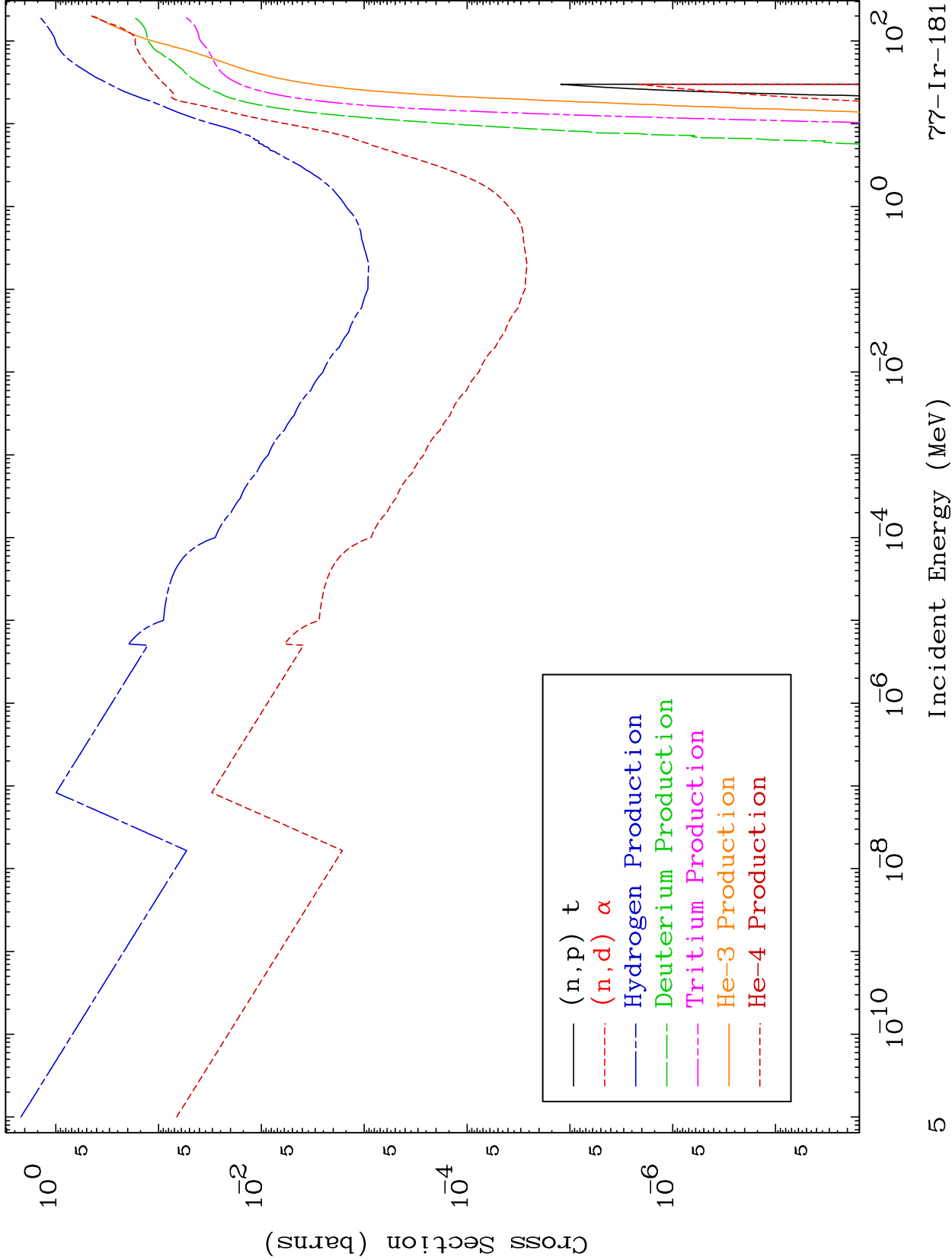

MAT 7695

Charged Particle
293 Kelvin Cross Sections

77-Ir-181

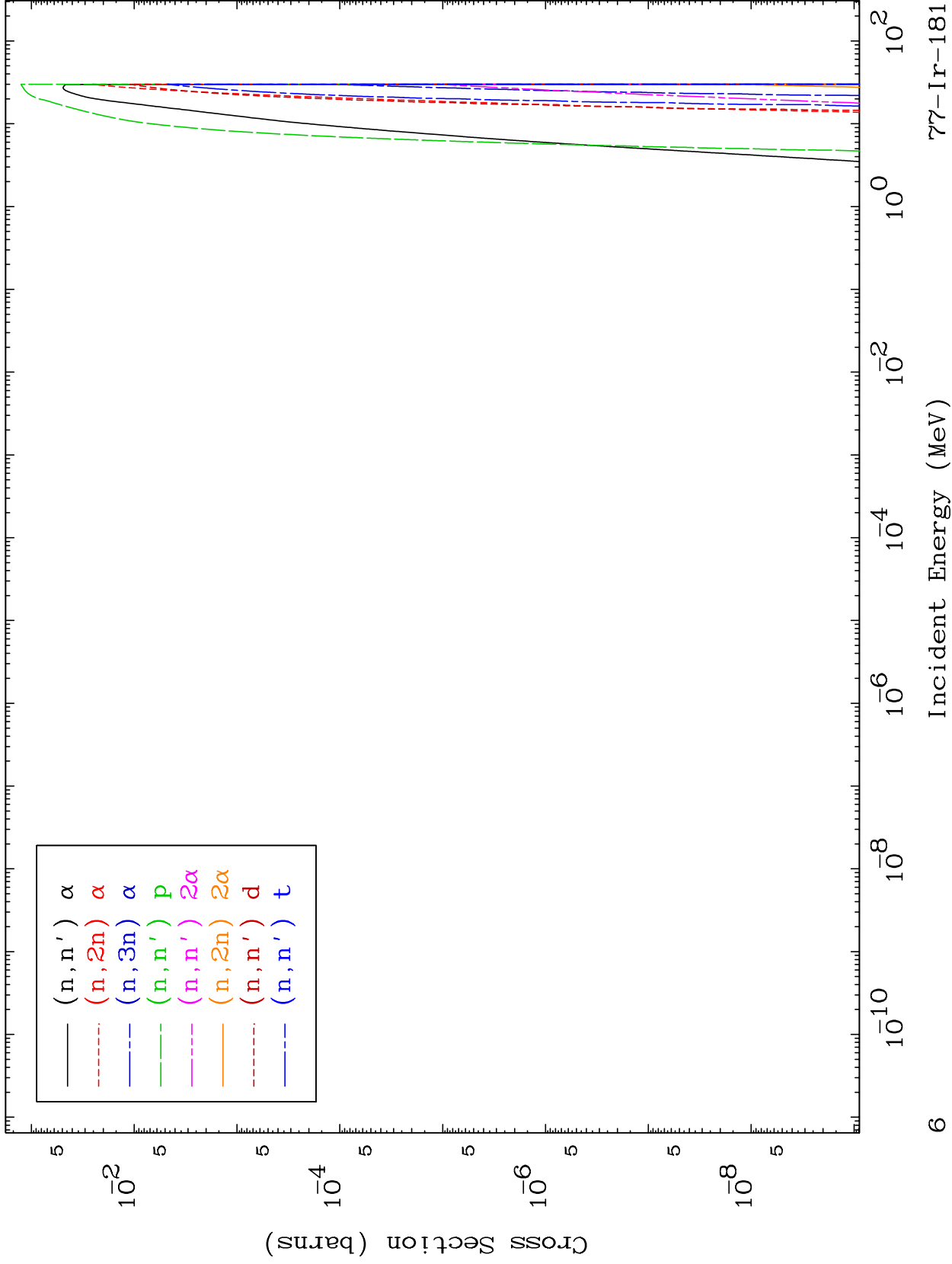

MAT 7695

Charged Particle
293 Kelvin Cross Sections

⁷⁷Ir-181

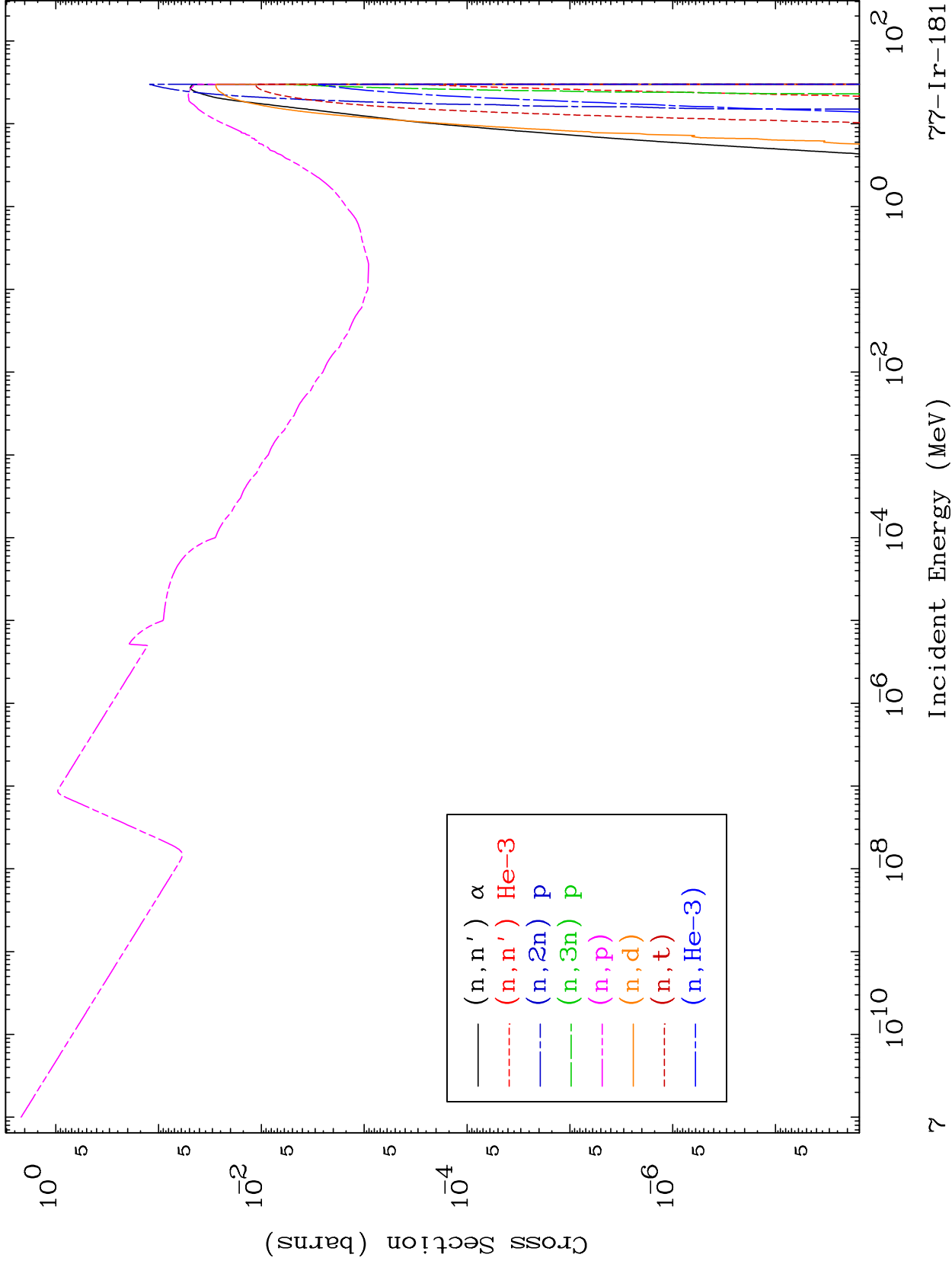

MAT 7695

Charged Particle
293 Kelvin Cross Sections

77-Ir-181

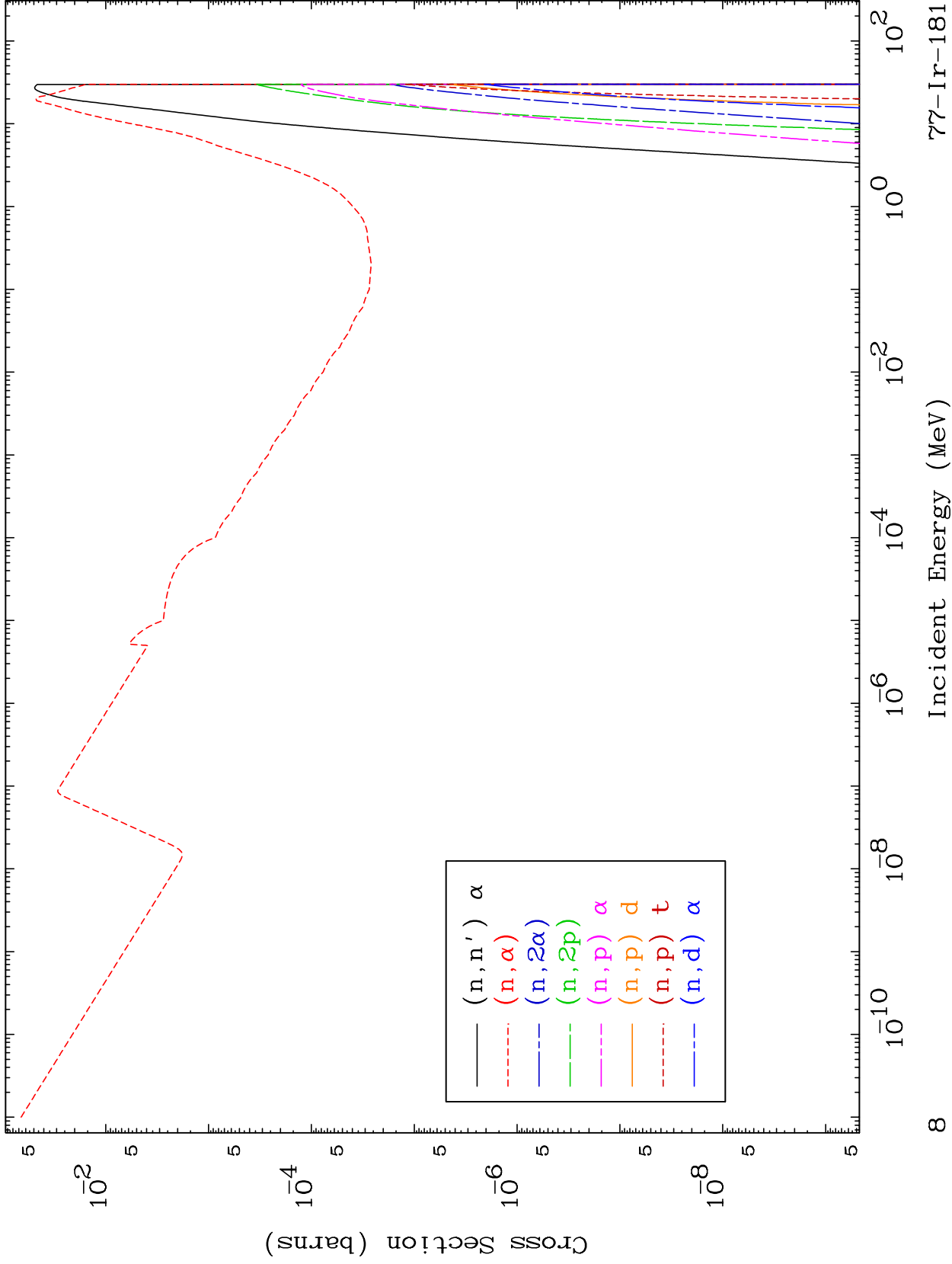

MAT 7695

Particle Production
293 Kelvin Cross Sections

⁷⁷Ir-181

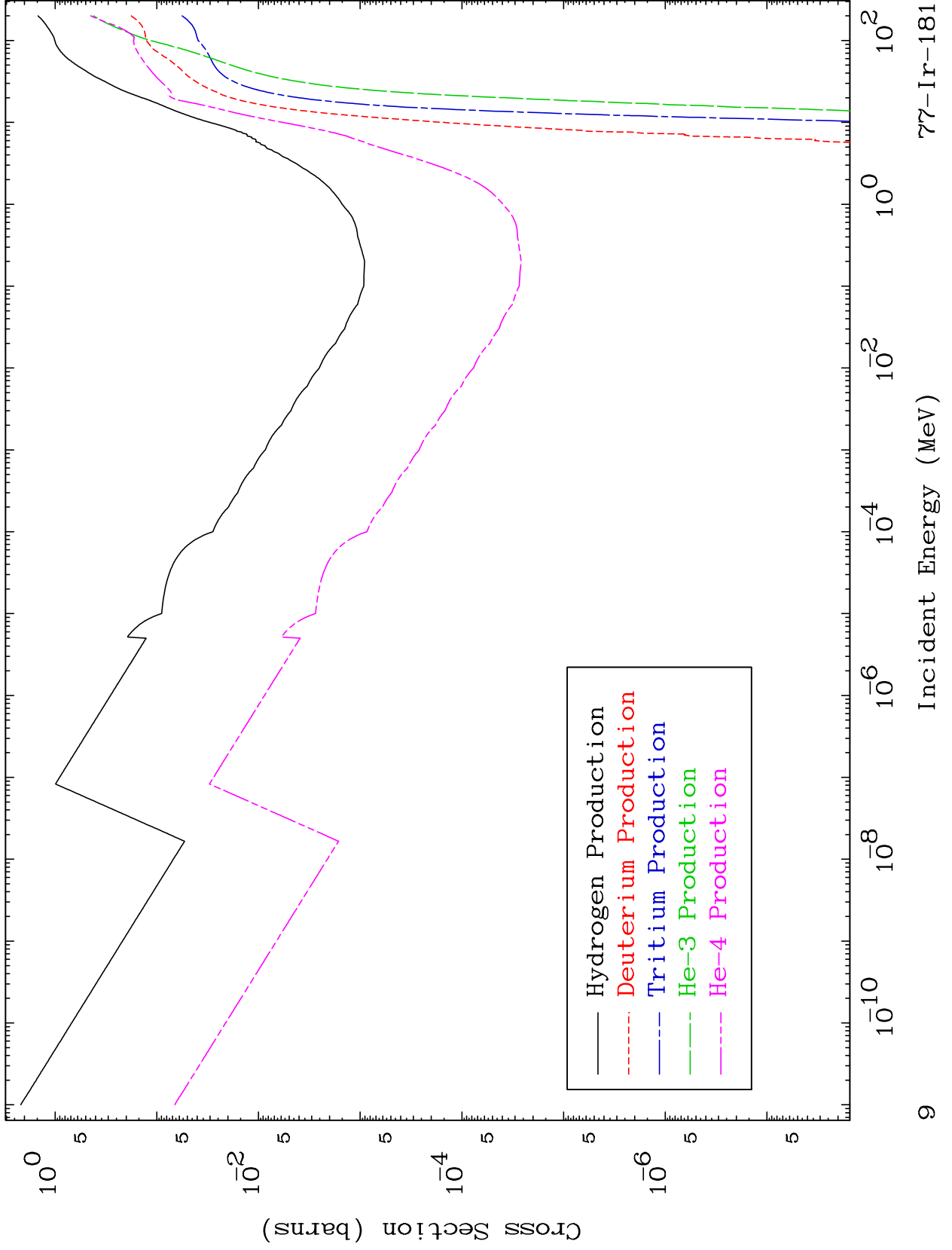

MAT 7695

(n,n') Levels
293 Kelvin Cross Sections

77-Ir-181

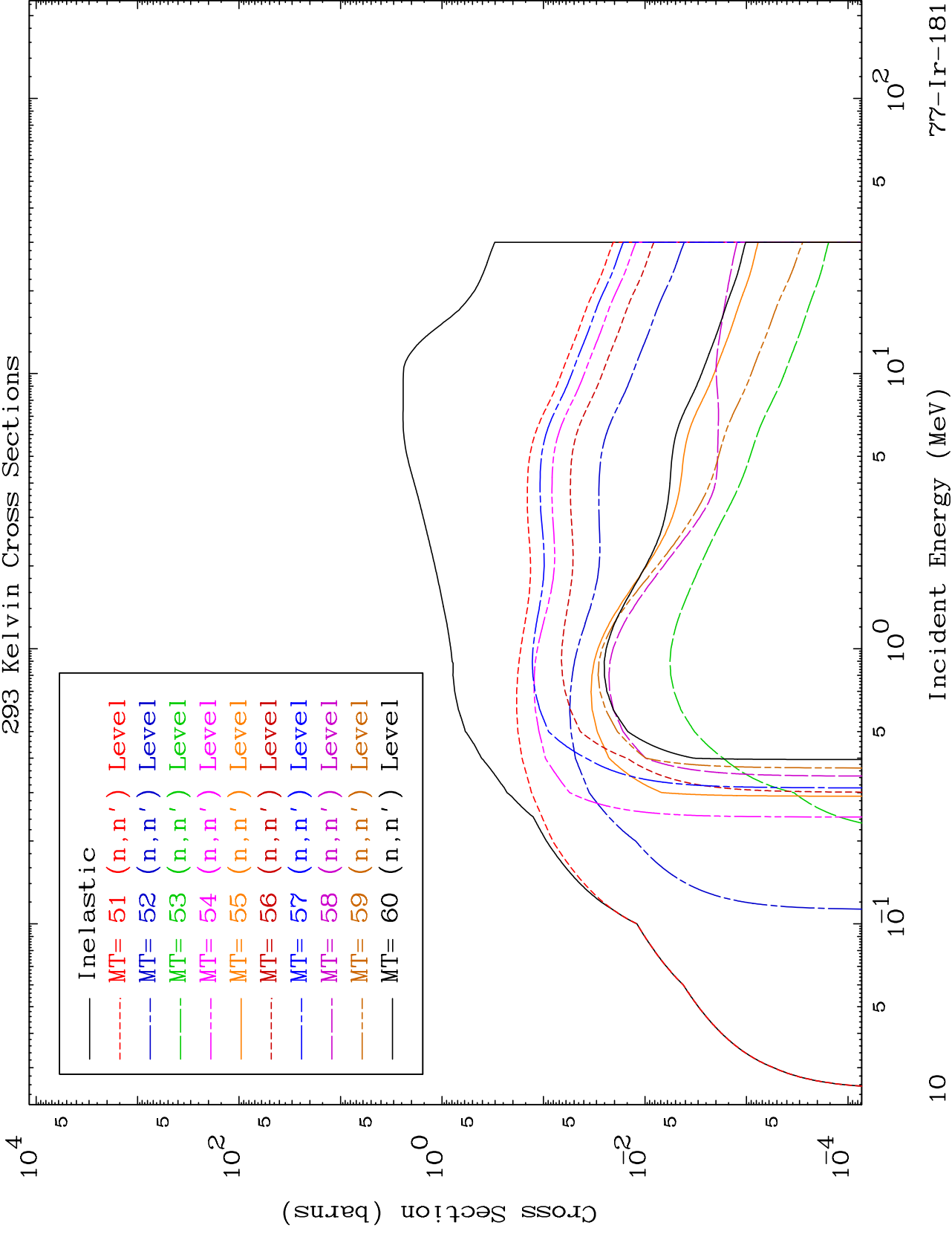

10

Incident Energy (MeV)

77-Ir-181

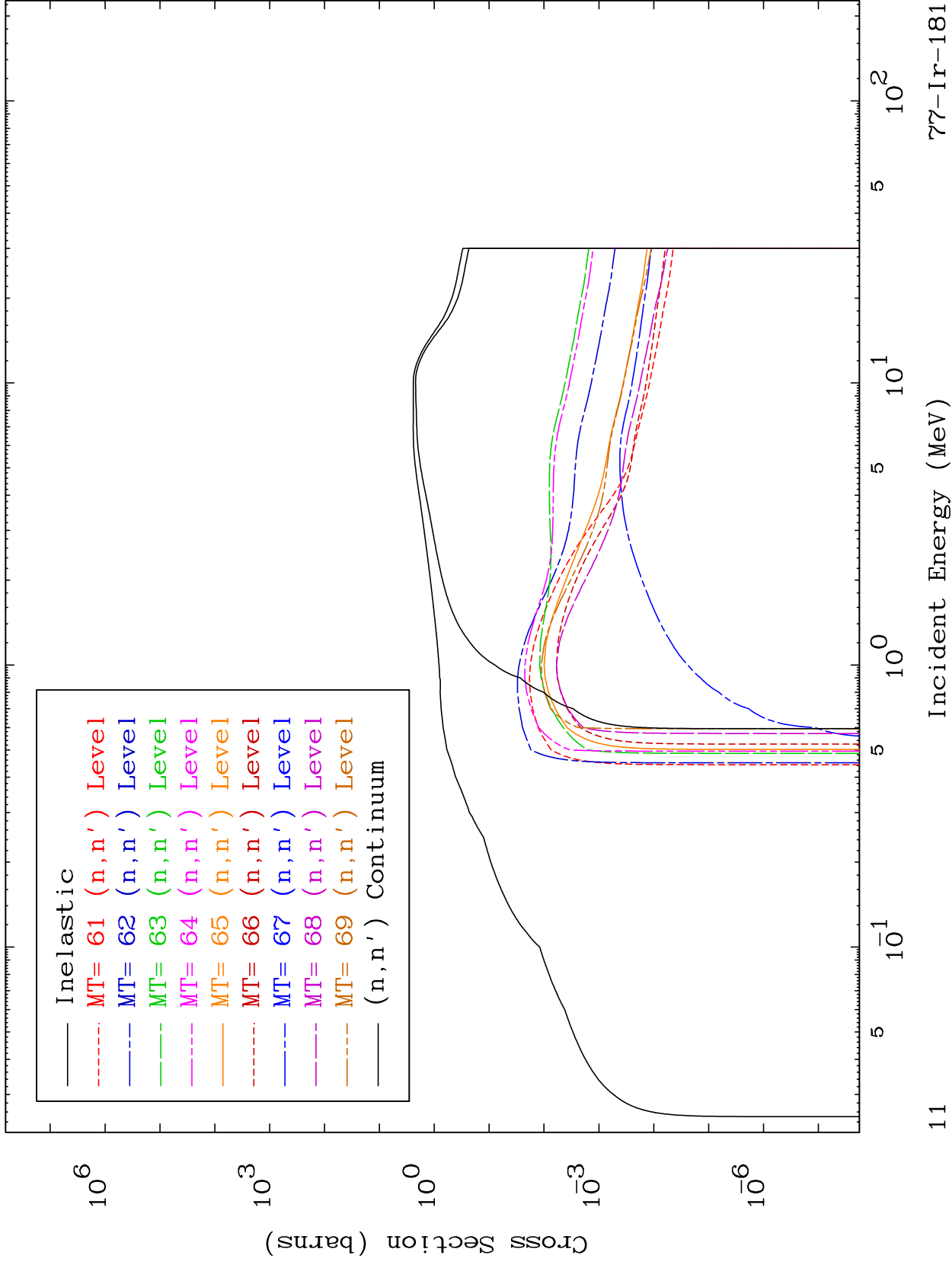

MAT 7695

(n,p) Levels
293 Kelvin Cross Sections

⁷⁷Ir-181

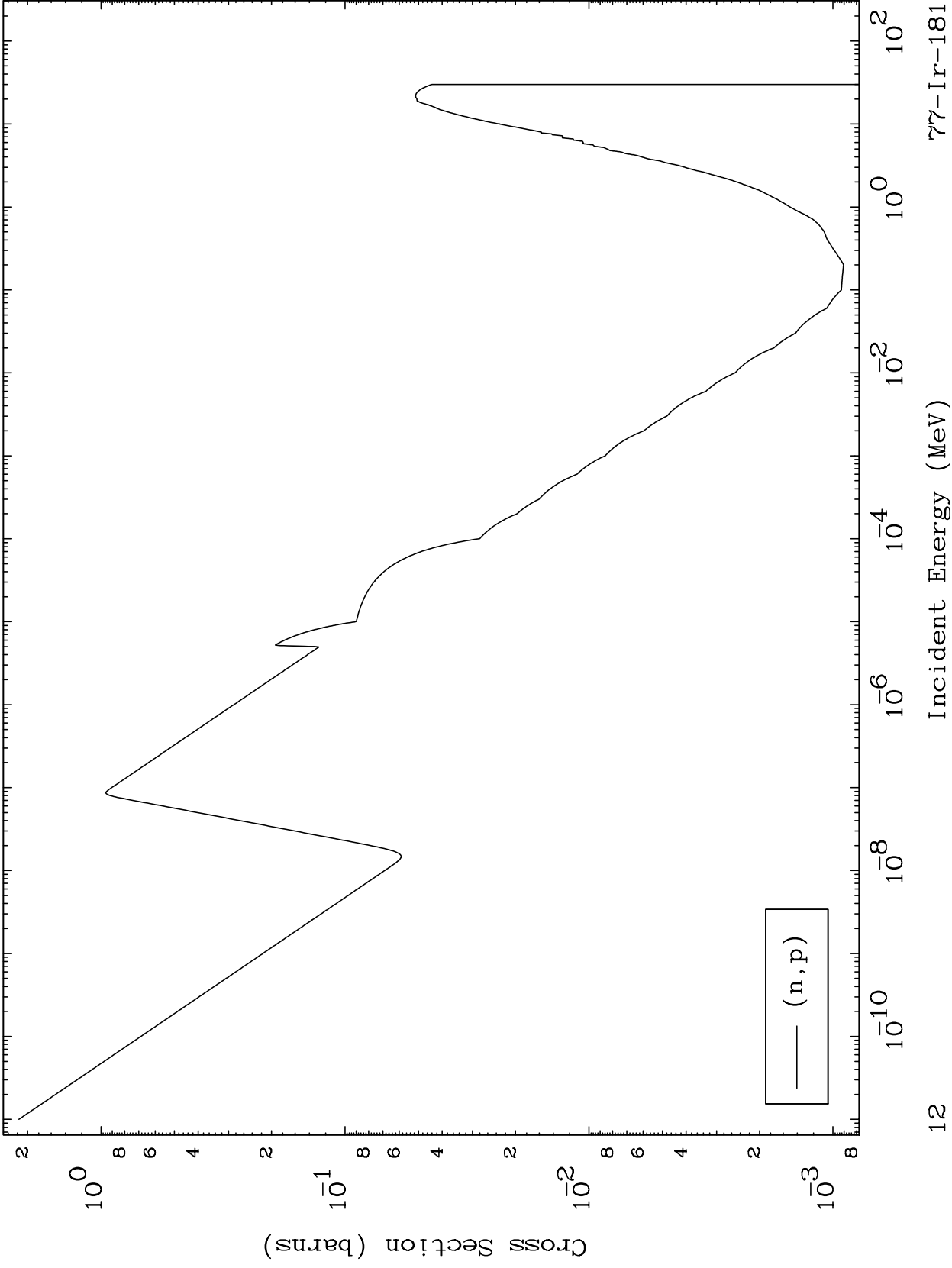

MAT 7695

(n,d) Levels
293 Kelvin Cross Sections

77-Ir-181

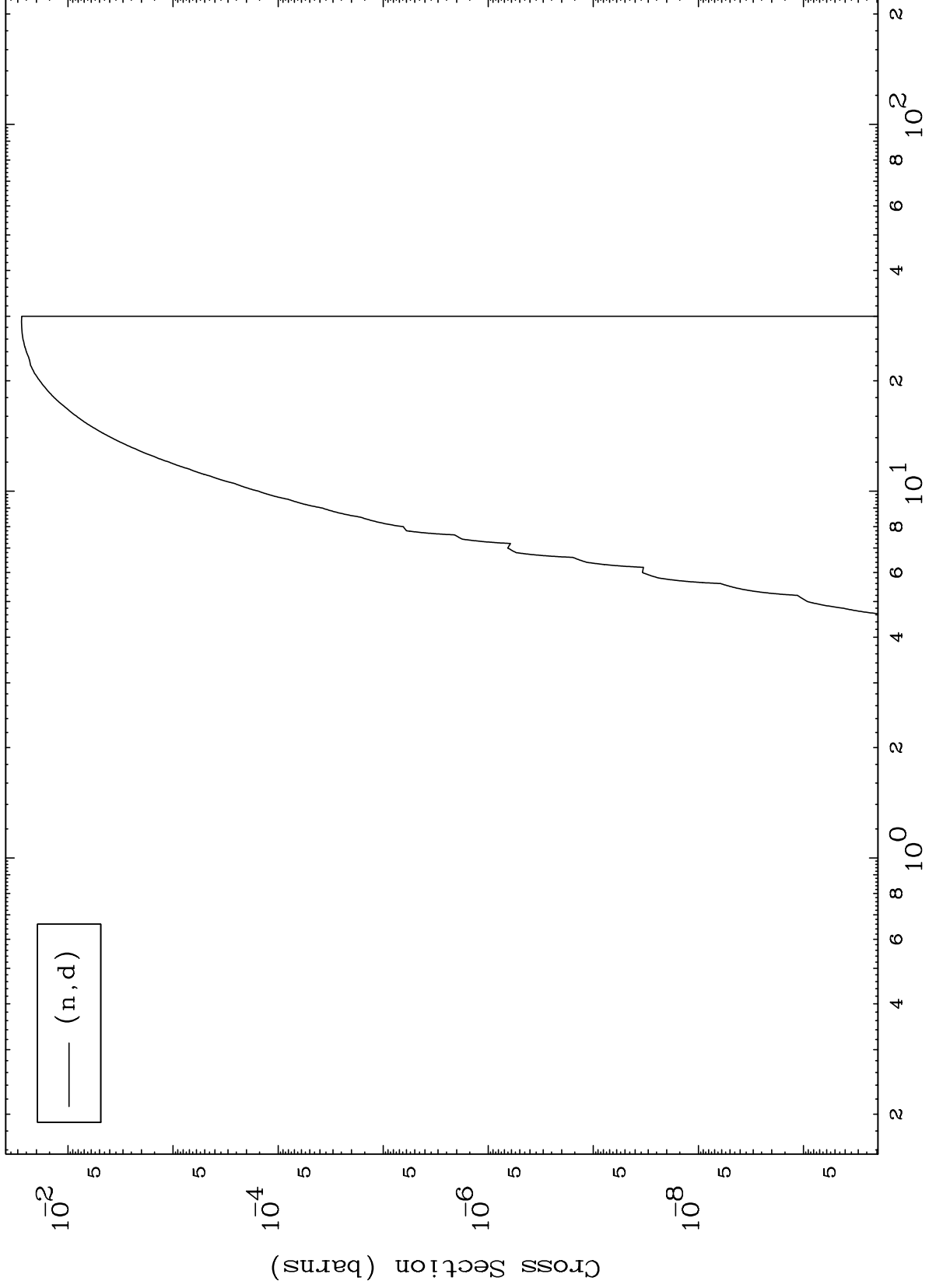

13

Incident Energy (MeV)

77-Ir-181

MAT 7695

(n,t) Levels
293 Kelvin Cross Sections

77-Ir-181

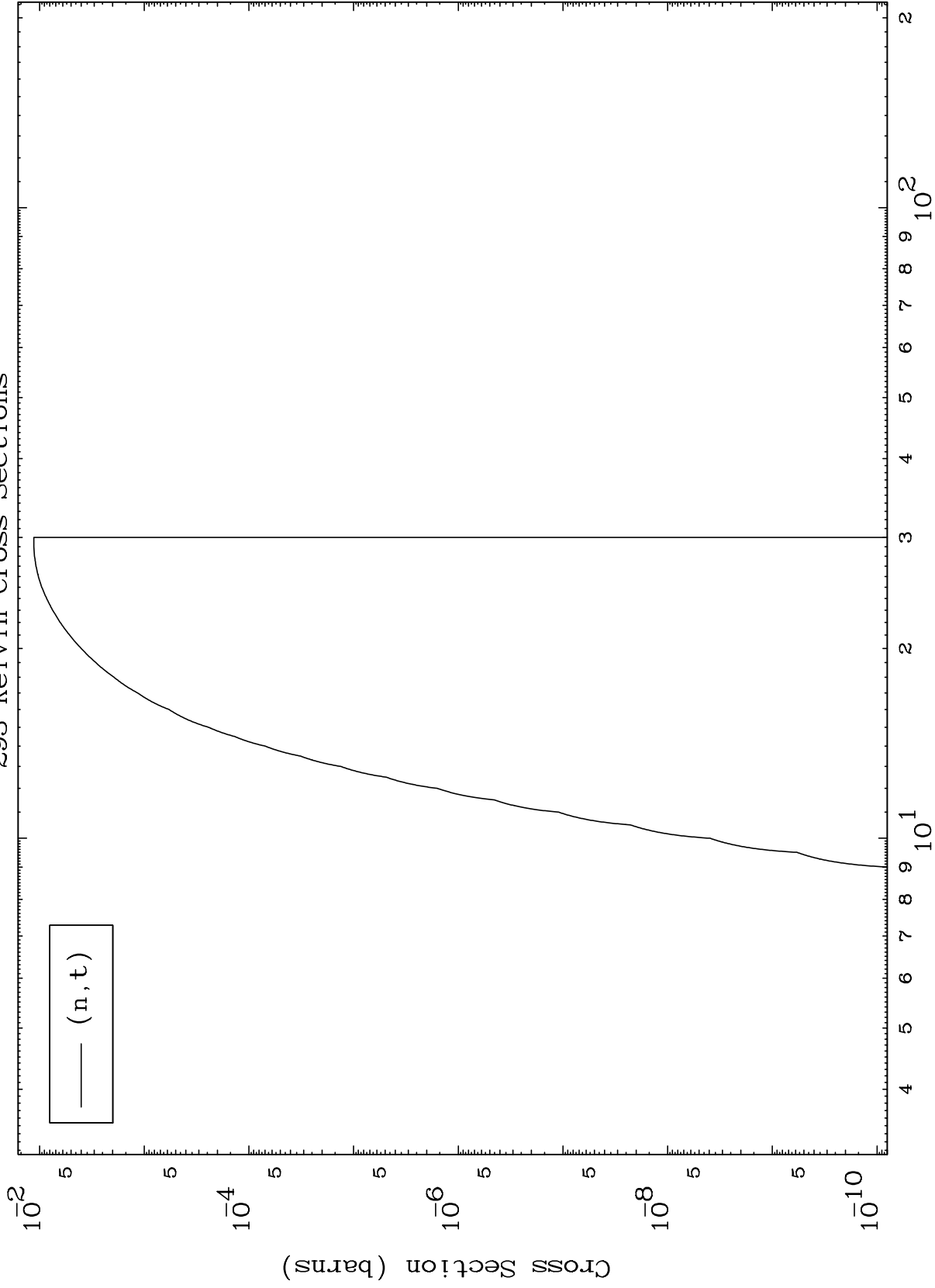

14

Incident Energy (MeV)

77-Ir-181

MAT 7695

(n,He3) Levels
293 Kelvin Cross Sections

⁷⁷Ir-181

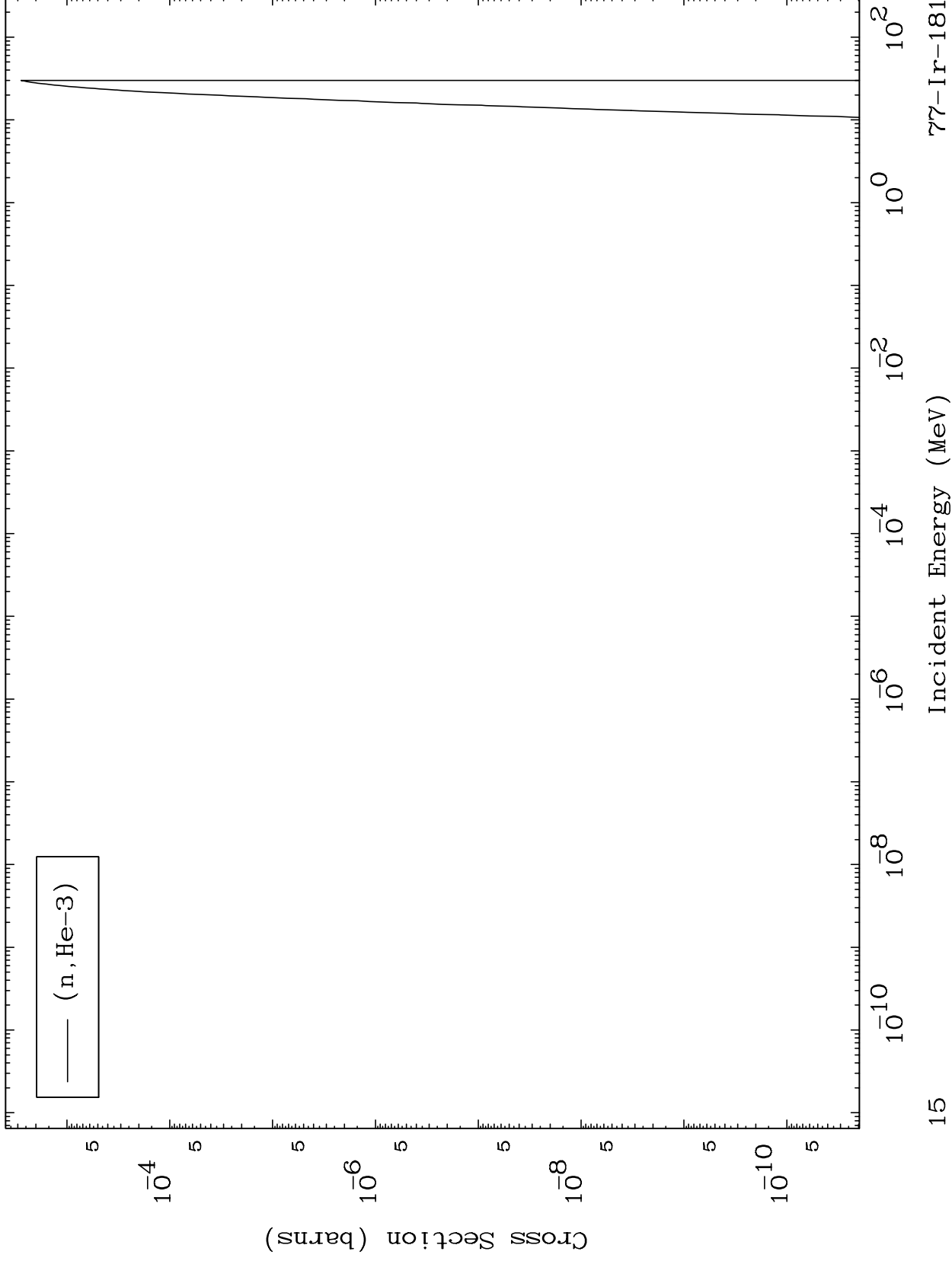

15

Incident Energy (MeV)

⁷⁷Ir-181

MAT 7695

(n, α) Levels
293 Kelvin Cross Sections

⁷⁷Ir-181

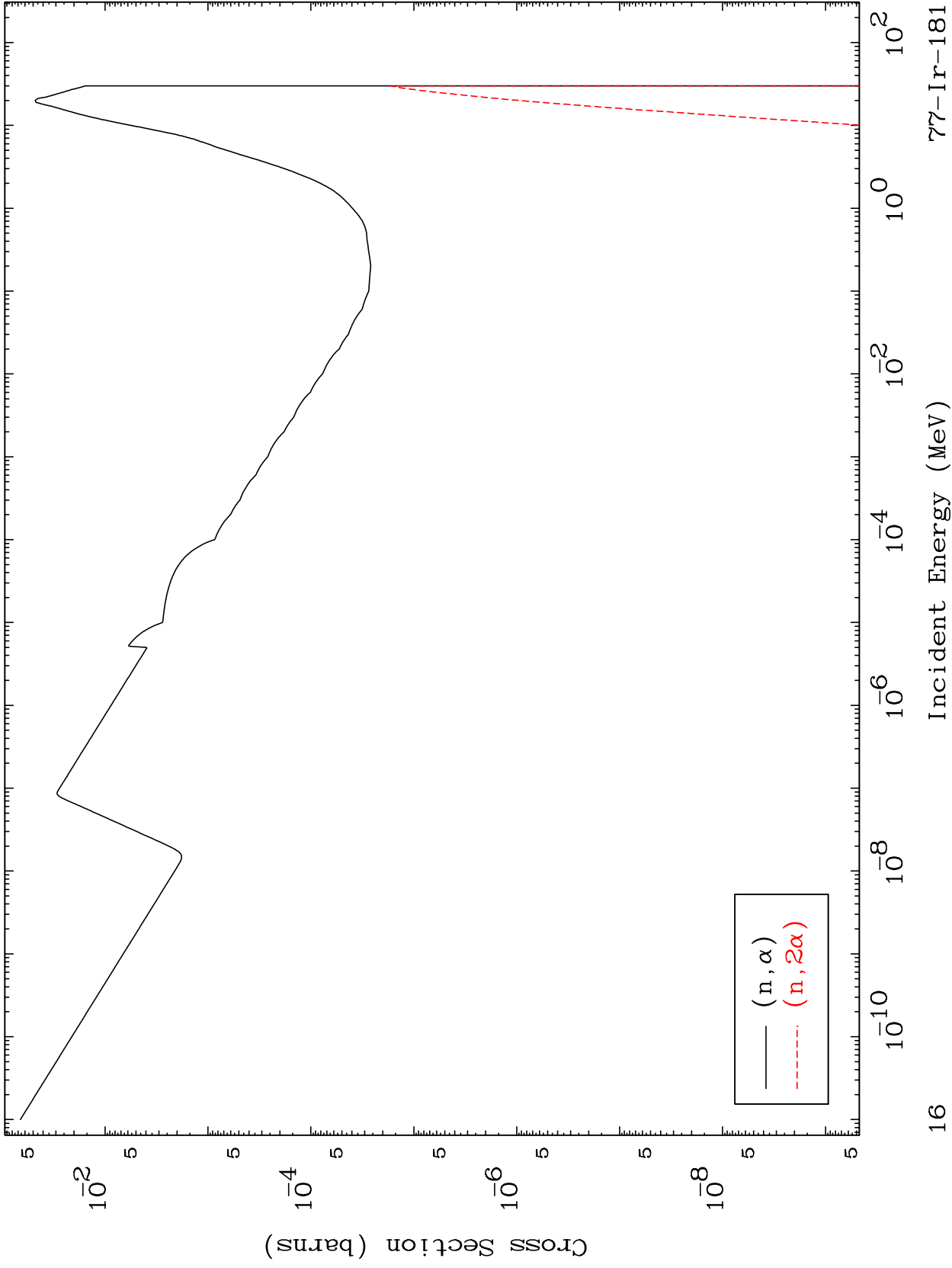

MAT 7695

77-Ir-181

Elastic Legendre Coefficients

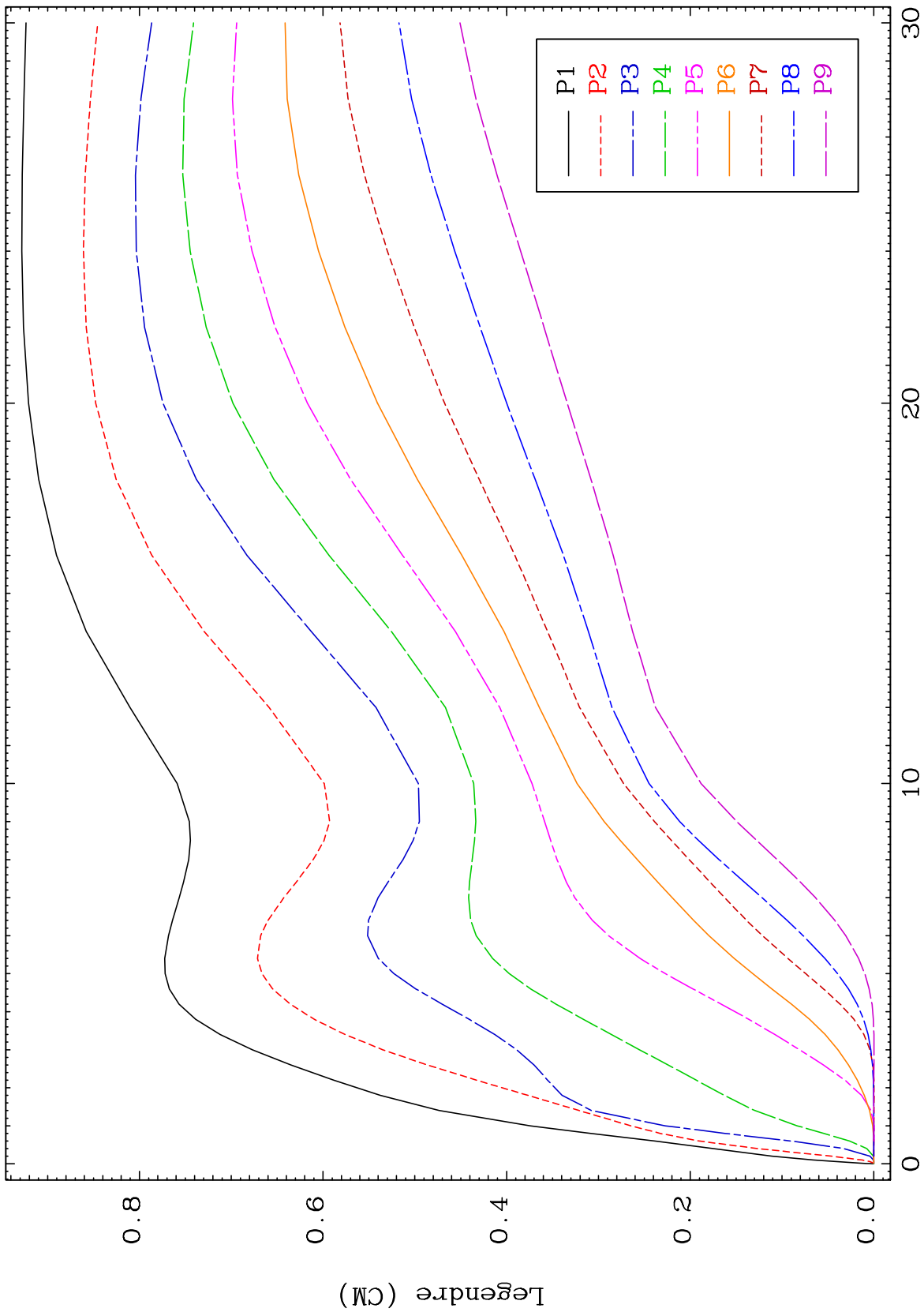

17

Incident Energy (MeV)

77-Ir-181

MAT 7695

Elastic Legendre Coefficients

⁷⁷Ir-181

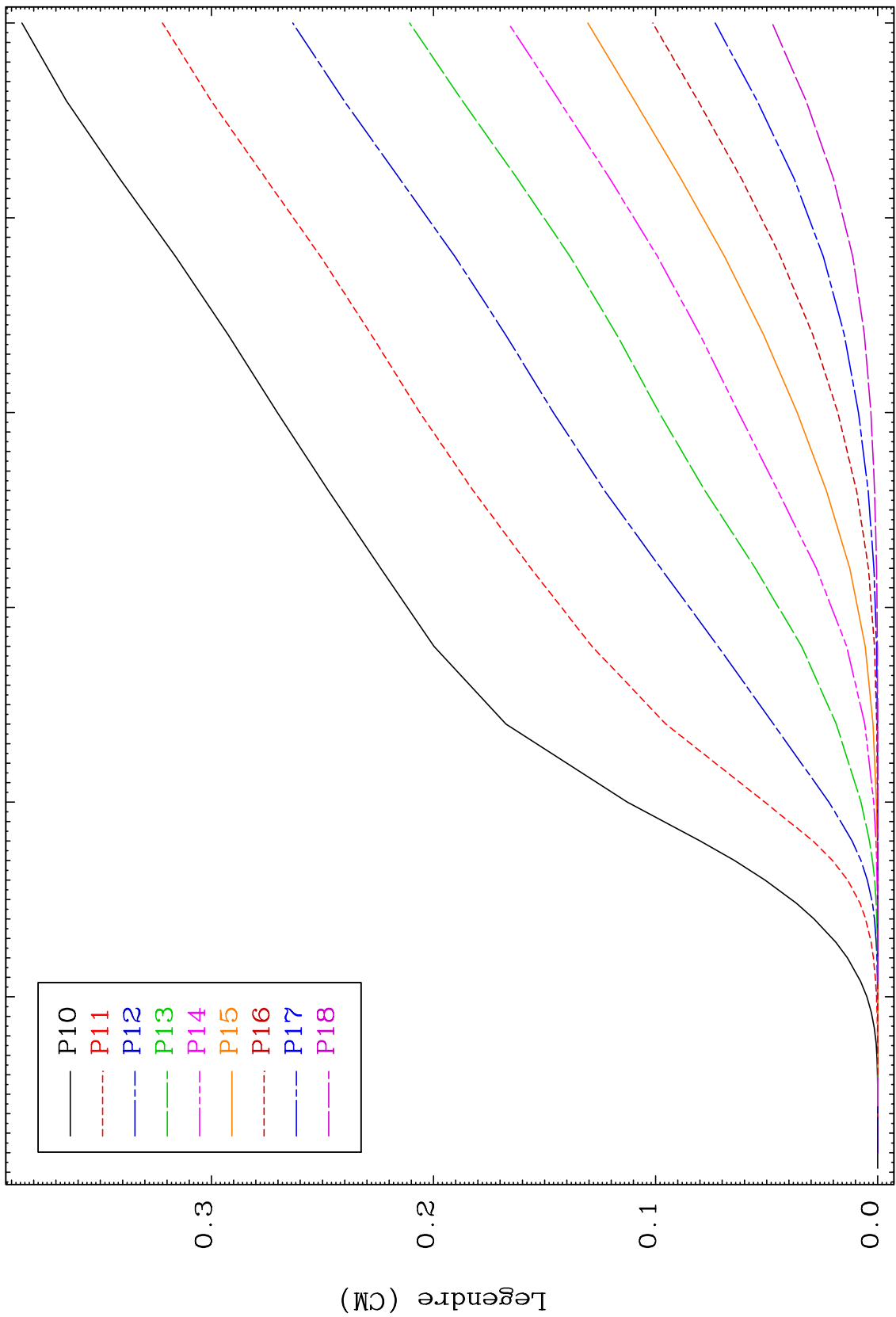

18

Incident Energy (MeV)

⁷⁷Ir-181

MAT 7695

Elastic Legendre Coefficients

⁷⁷Ir-181

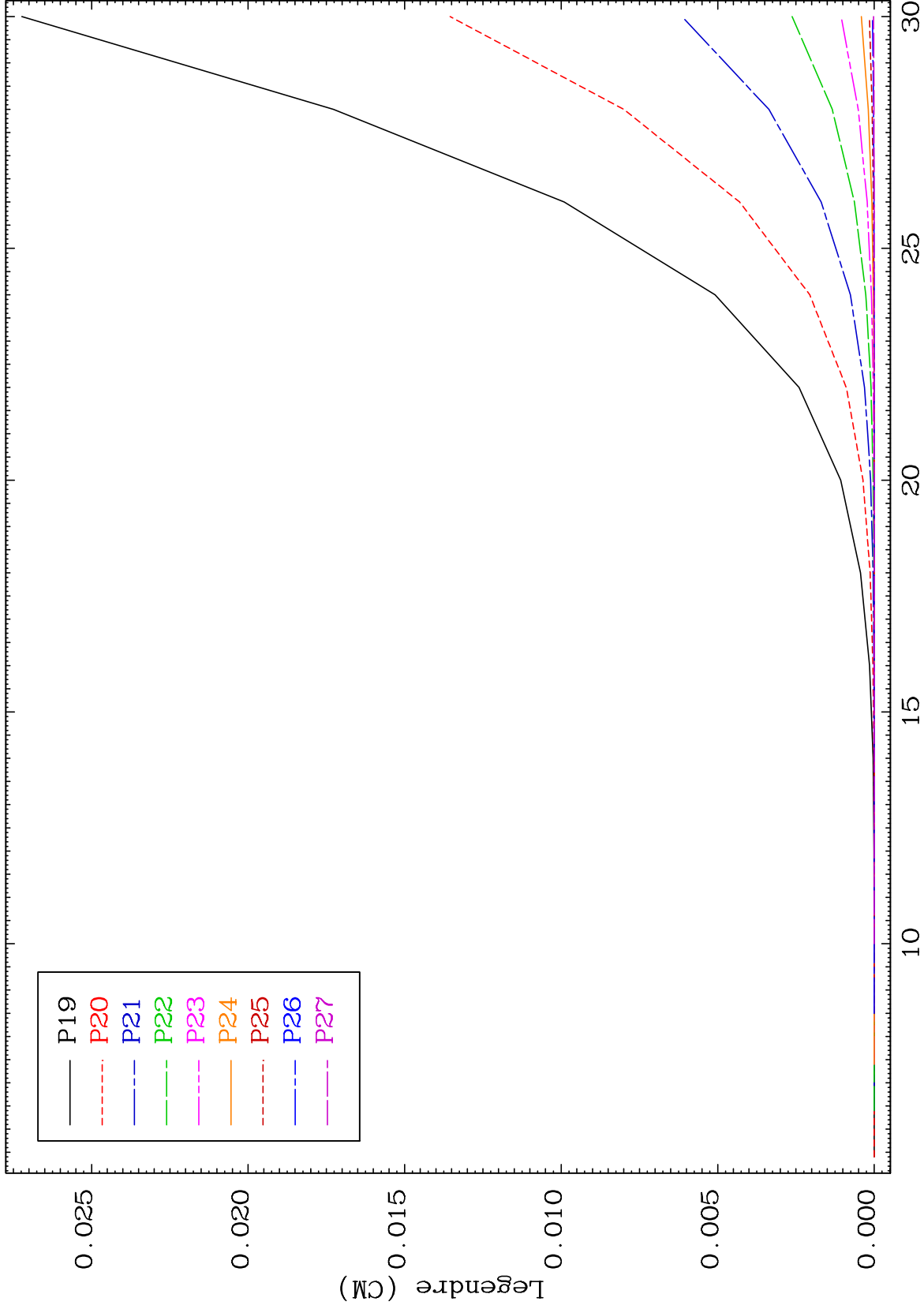

19

Incident Energy (MeV)

⁷⁷Ir-181

MAT 7695

Elastic Legendre Coefficients

⁷⁷Ir-181

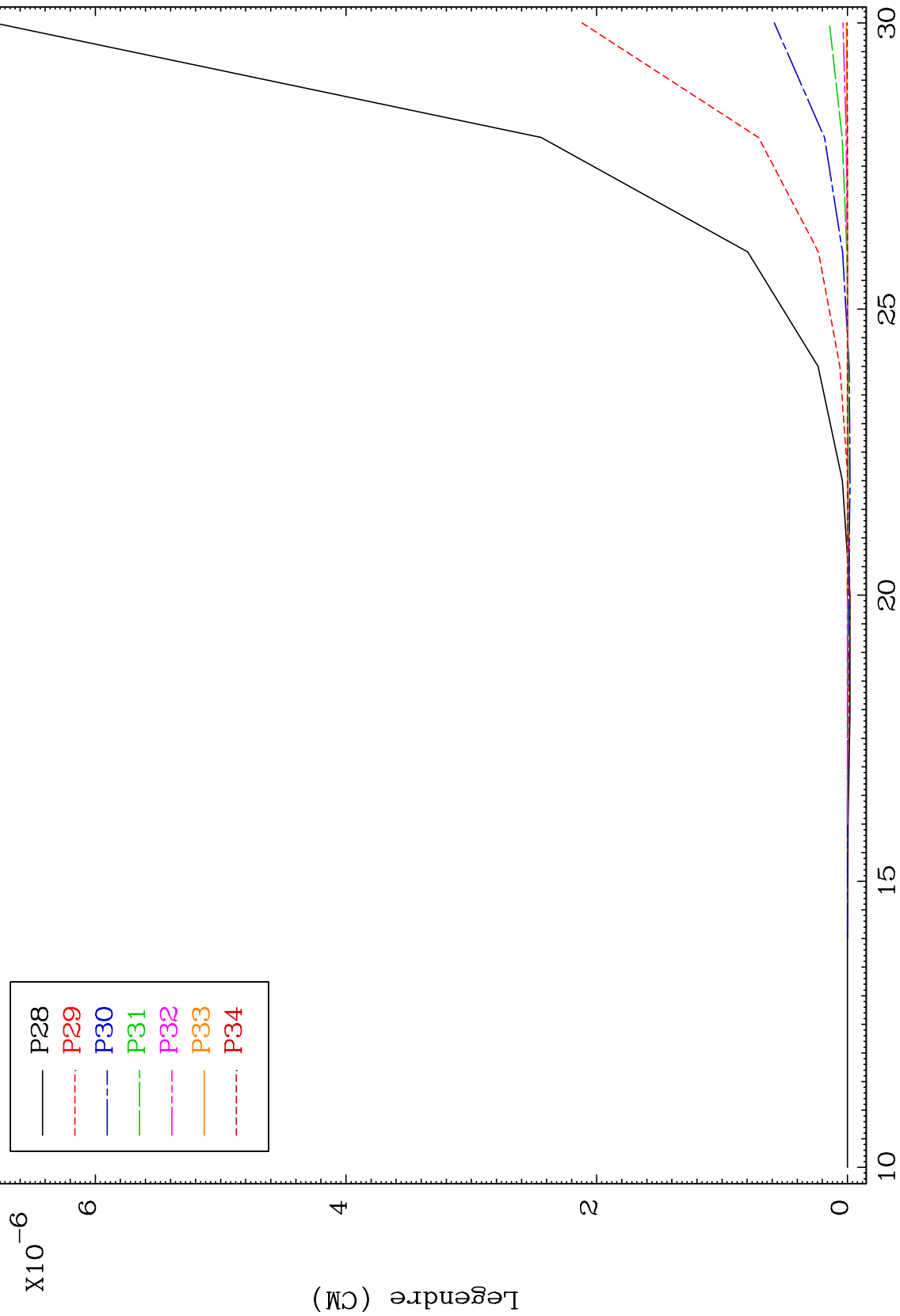
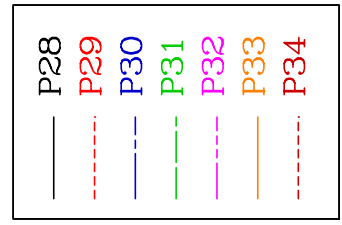

20

Incident Energy (MeV)

⁷⁷Ir-181

MAT 7695

MT= 51 (n,n') Level
Legendre Coefficients

⁷⁷Ir-181

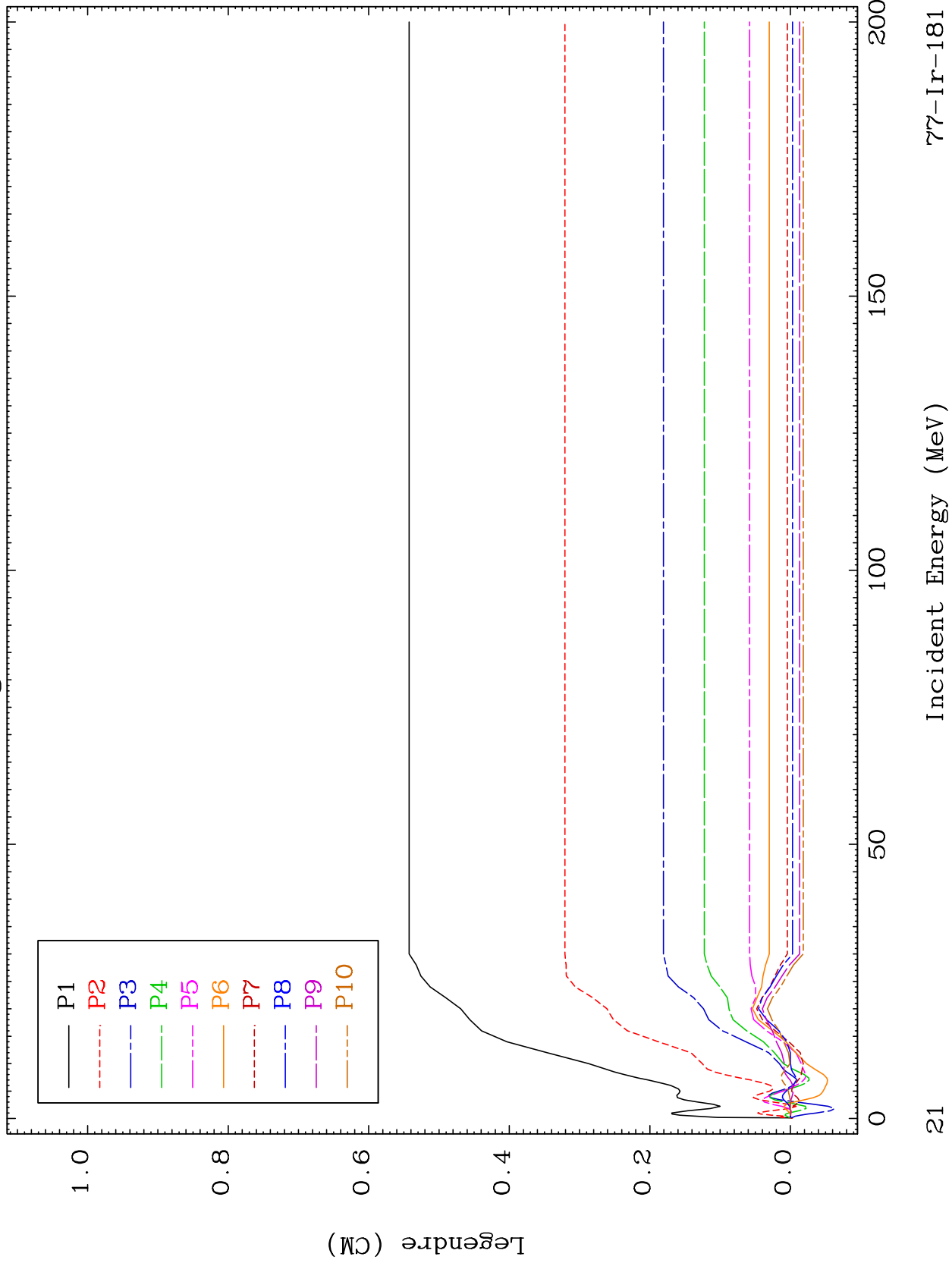

21

MAT 7695

MT= 51 (n,n') Level
Legendre Coefficients

77-Ir-181

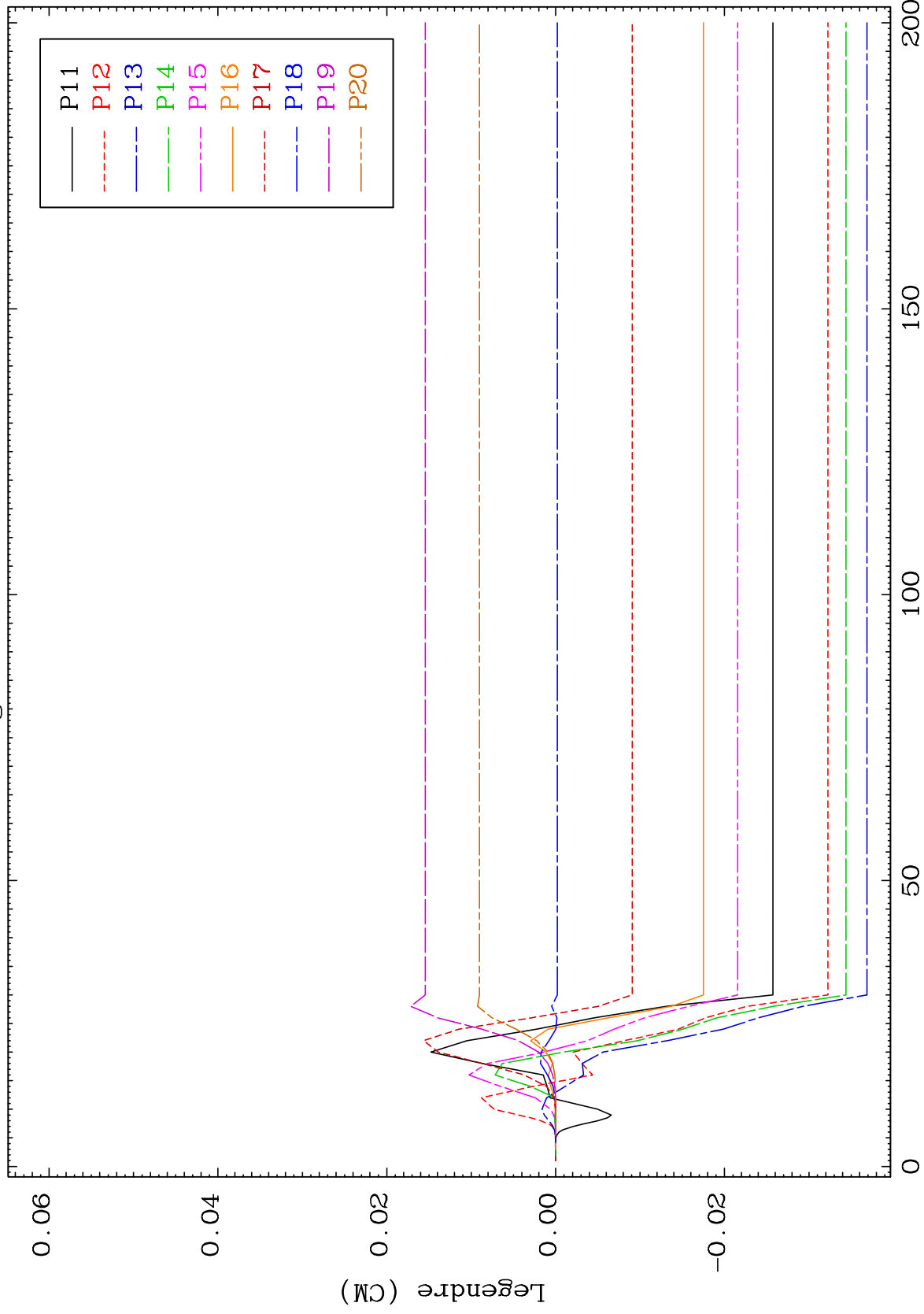

22

Incident Energy (MeV)

77-Ir-181

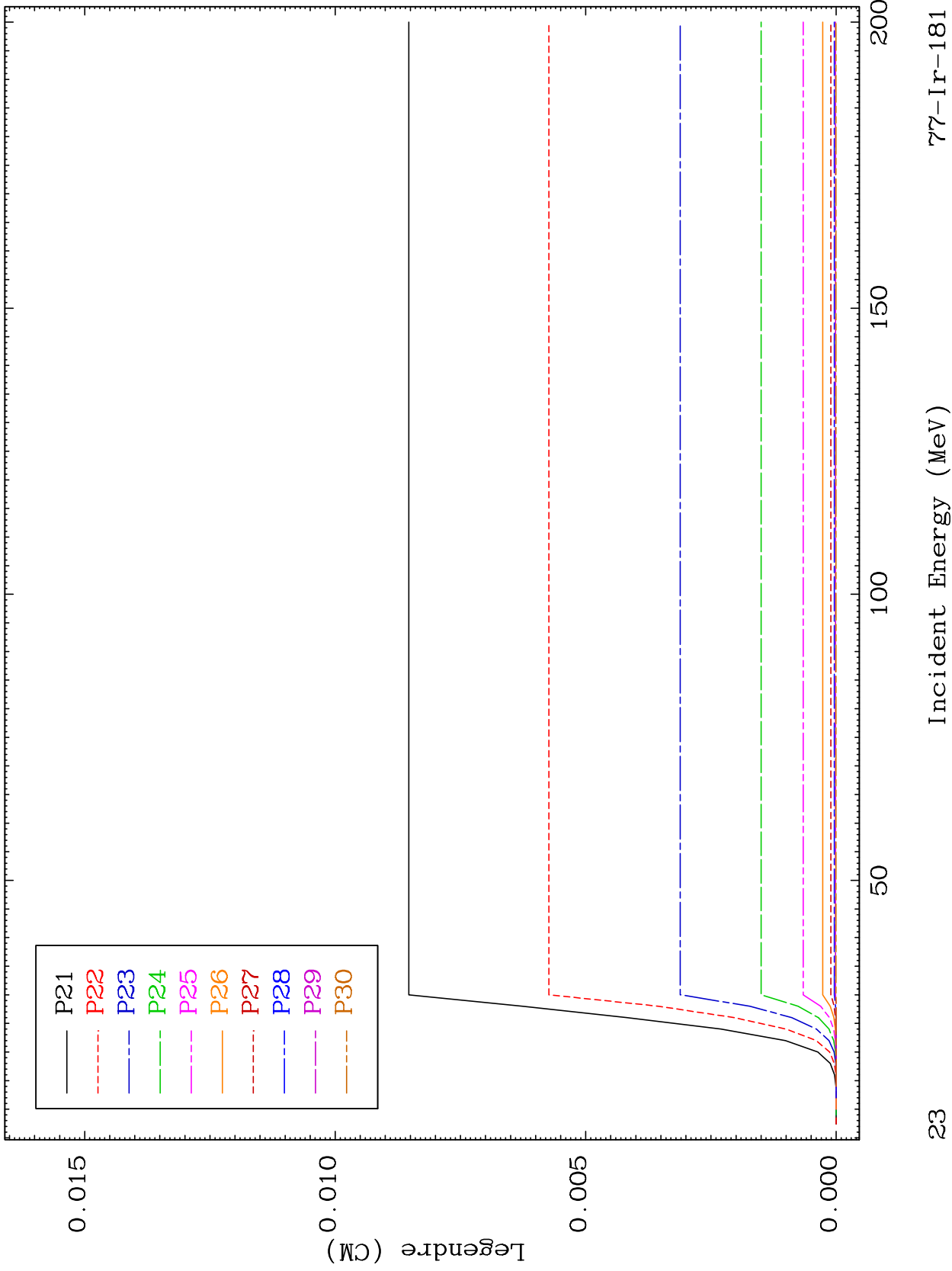

MAT 7695

MT= 51 (n,n') Level
Legendre Coefficients

77-Ir-181

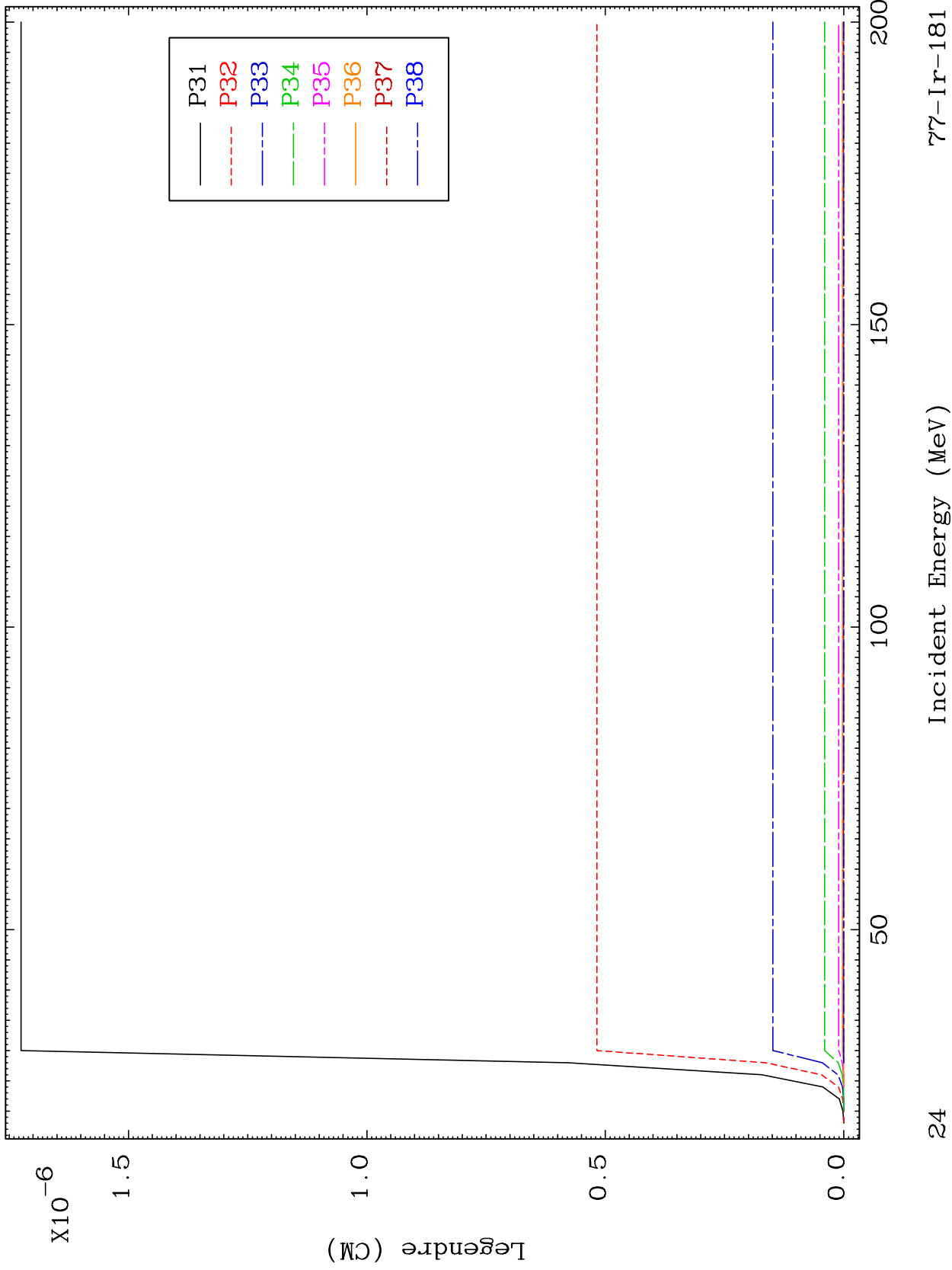

24

Incident Energy (MeV)

77-Ir-181

MAT 7695

MT= 52 (n,n') Level
Legendre Coefficients

⁷⁷Ir-181

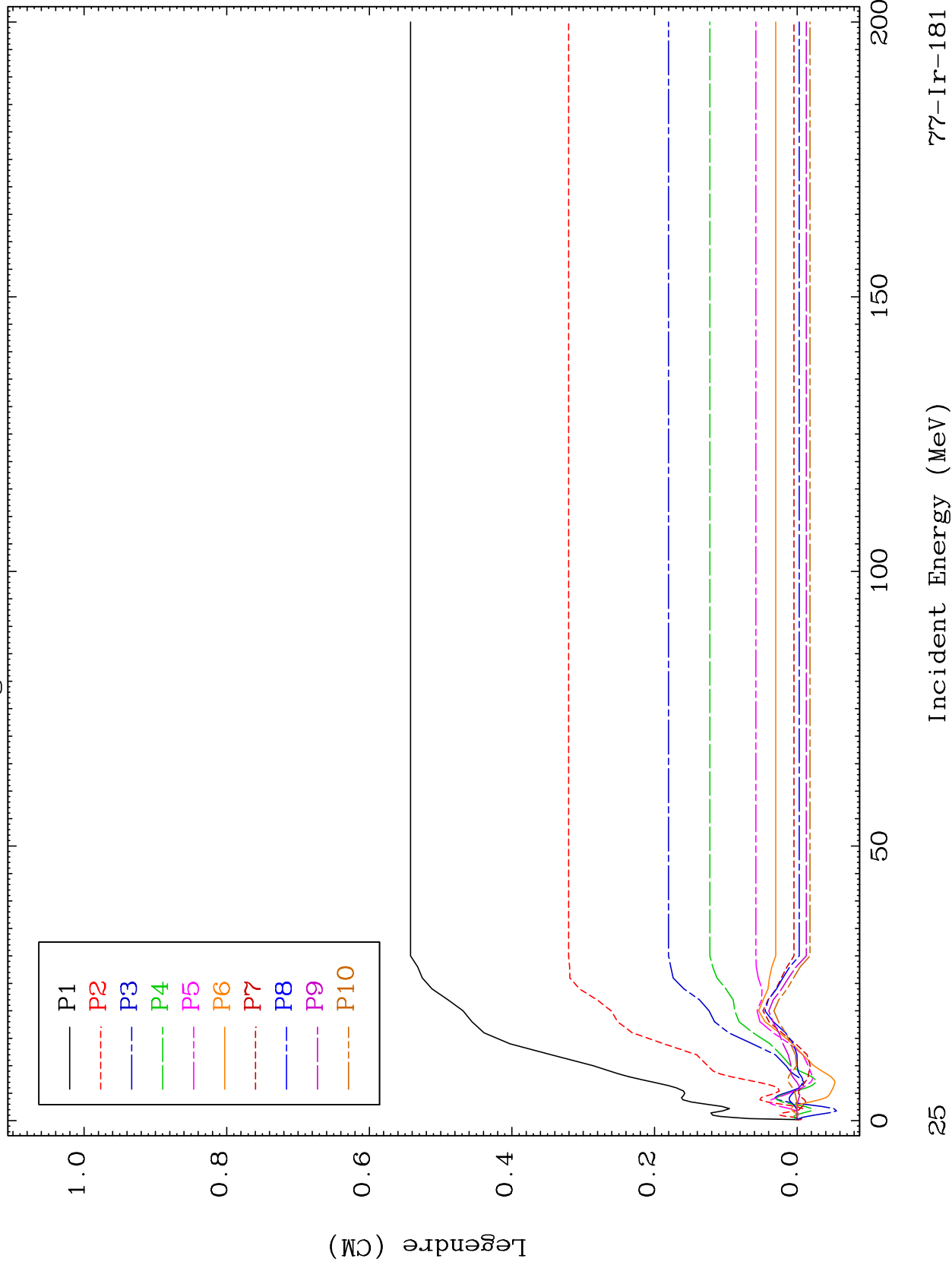

MAT 7695

MT= 52 (n,n') Level
Legendre Coefficients

77-Ir-181

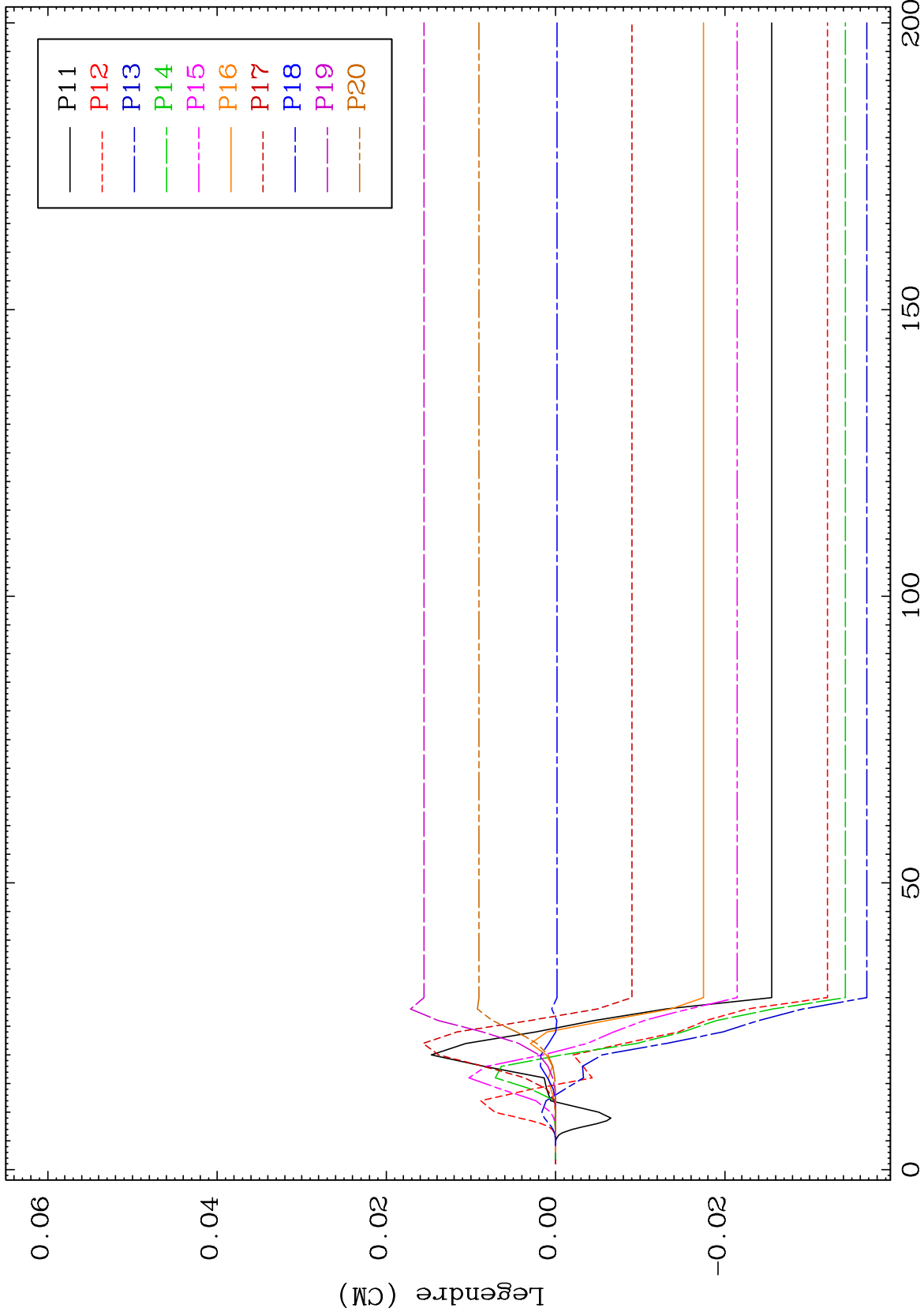

26

Incident Energy (MeV)

77-Ir-181

MAT 7695

MT= 52 (n,n') Level
Legendre Coefficients

77-Ir-181

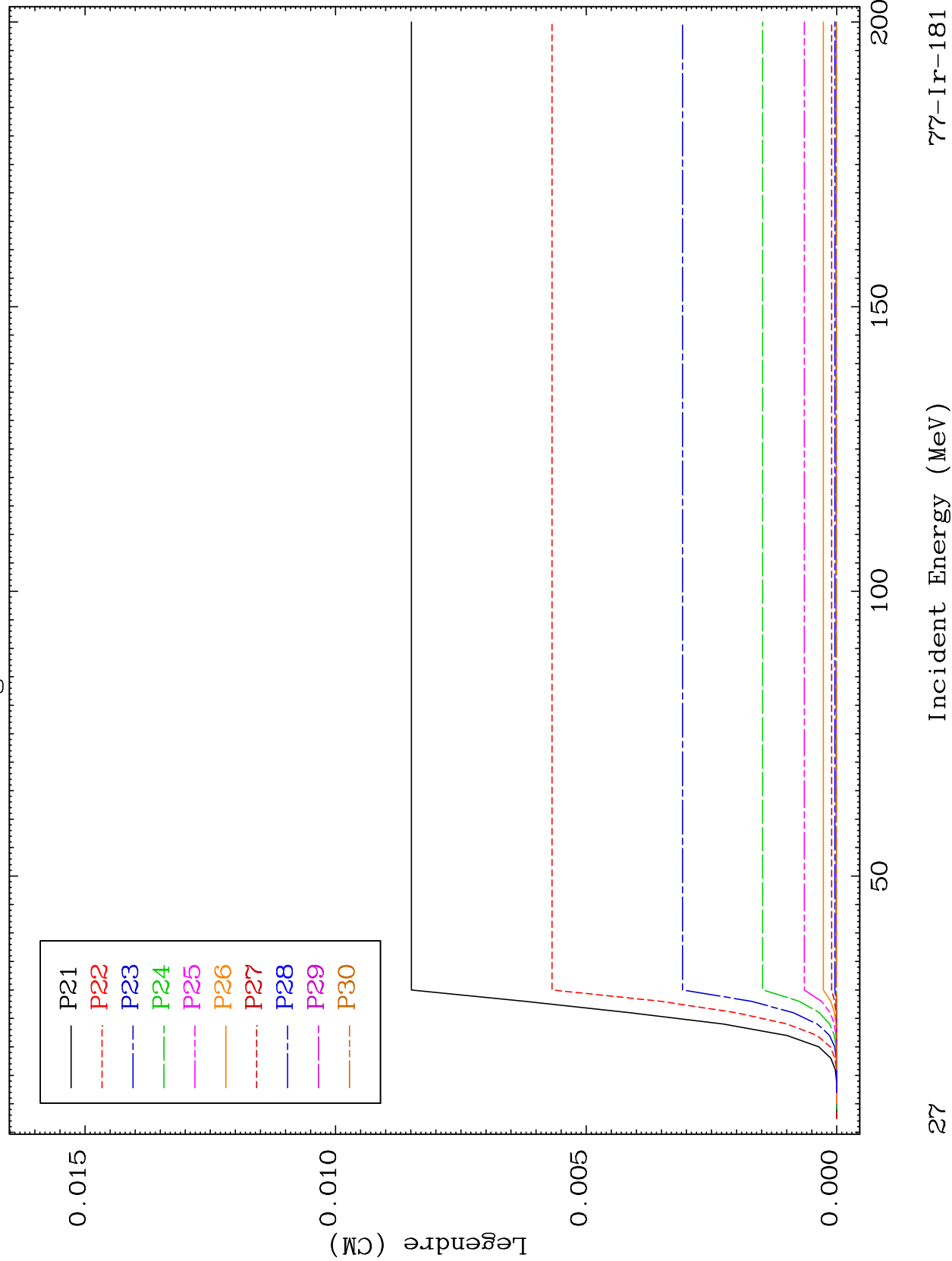

27

77-Ir-181

MAT 7695

MT= 52 (n,n') Level
Legendre Coefficients

77-Ir-181

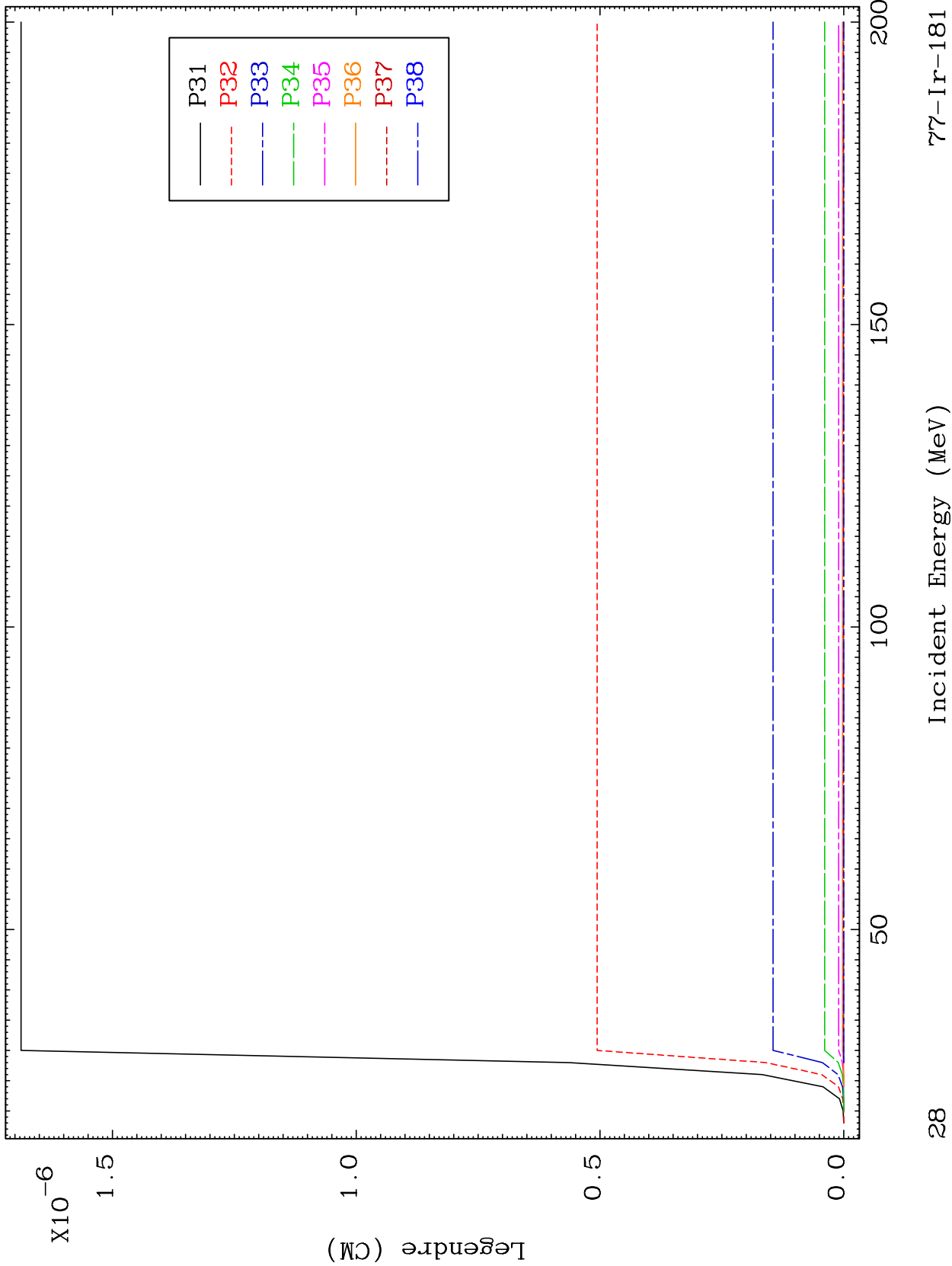

28

Incident Energy (MeV)

77-Ir-181

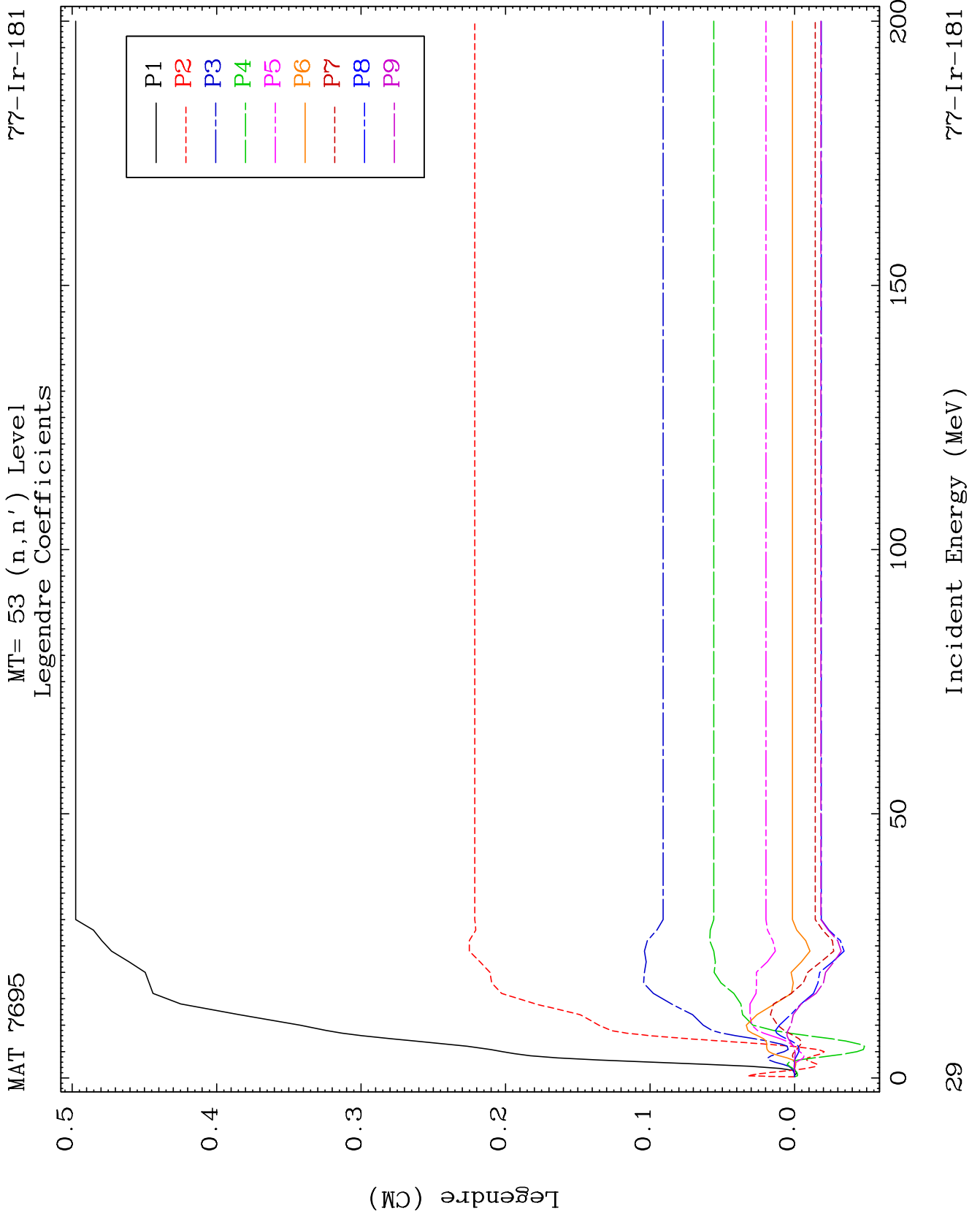

MAT 7695

MT= 53 (n,n') Level
Legendre Coefficients

77-Ir-181

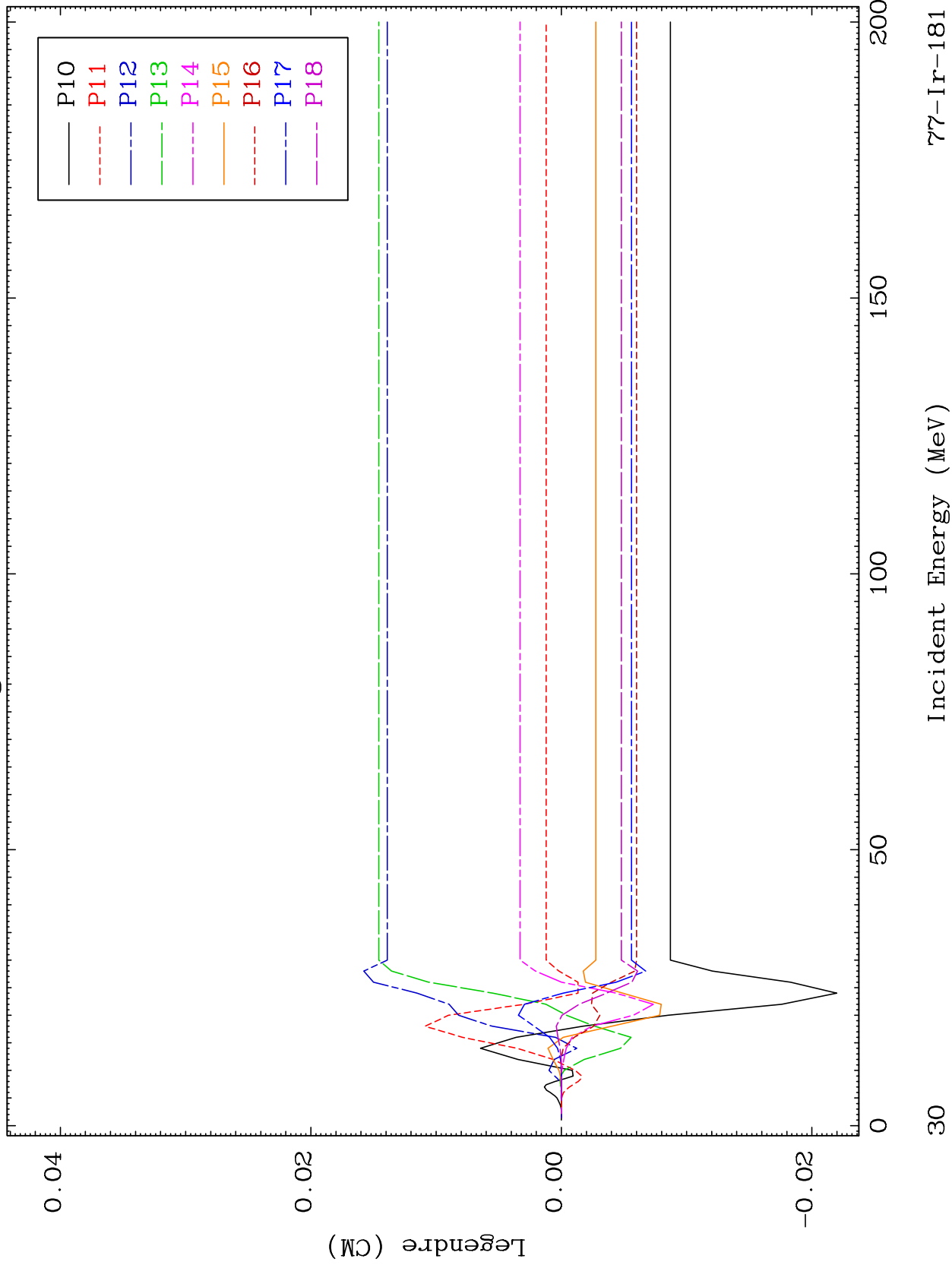

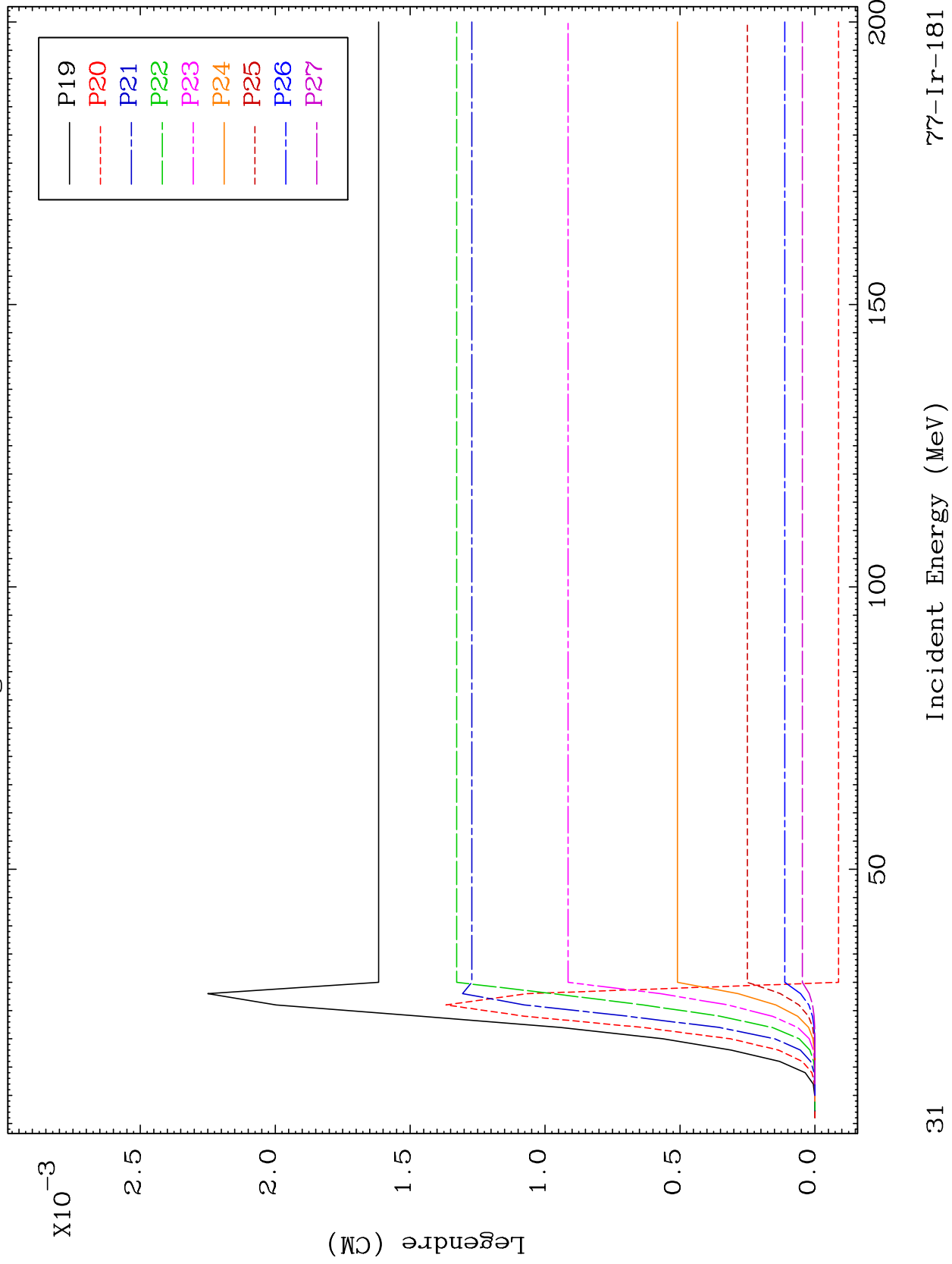

MAT 7695

MT= 53 (n,n') Level
Legendre Coefficients

77-Ir-181

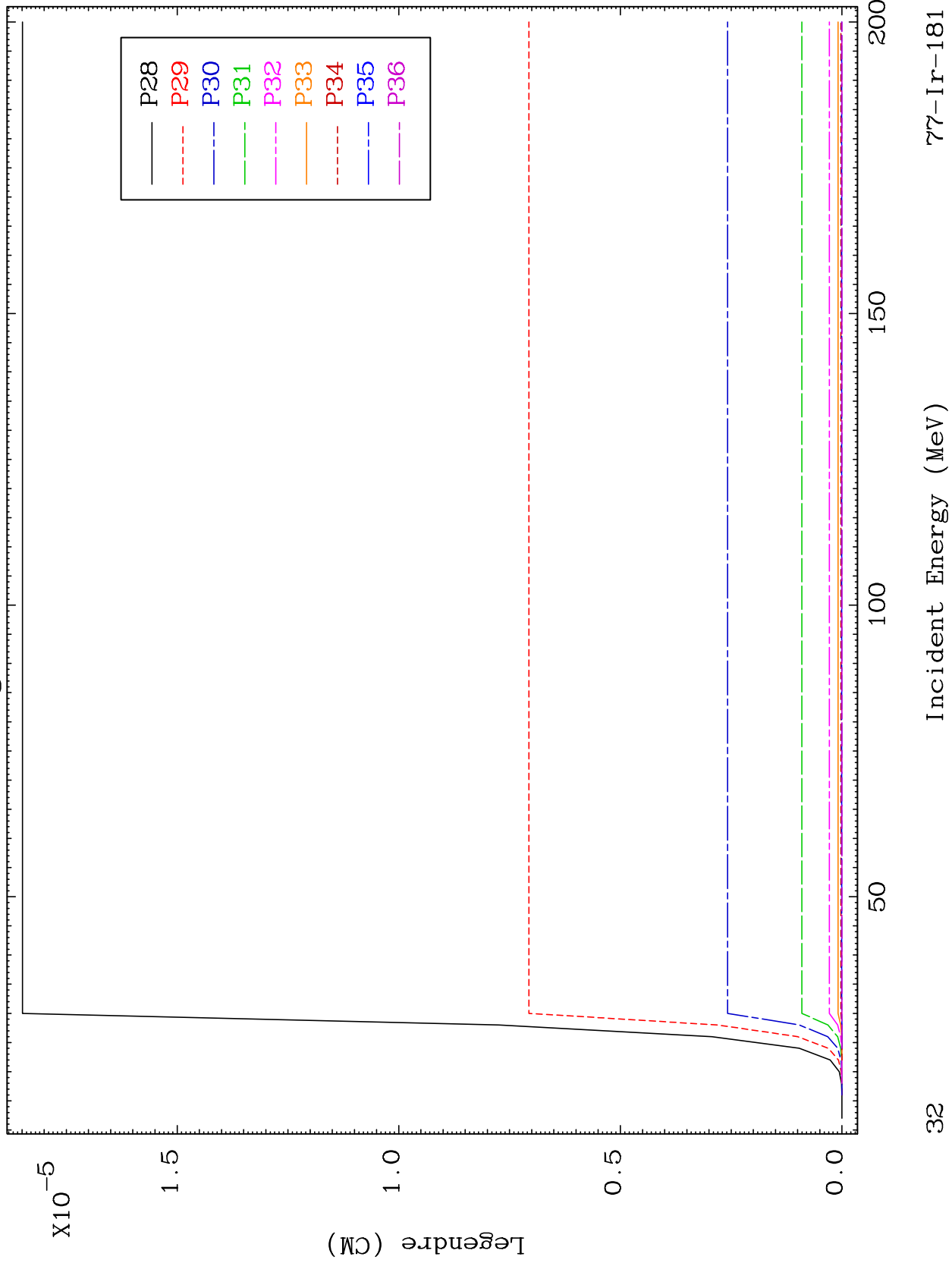

32

Incident Energy (MeV)

77-Ir-181

MAT 7695

MT= 54 (n,n') Level
Legendre Coefficients

⁷⁷Ir-181

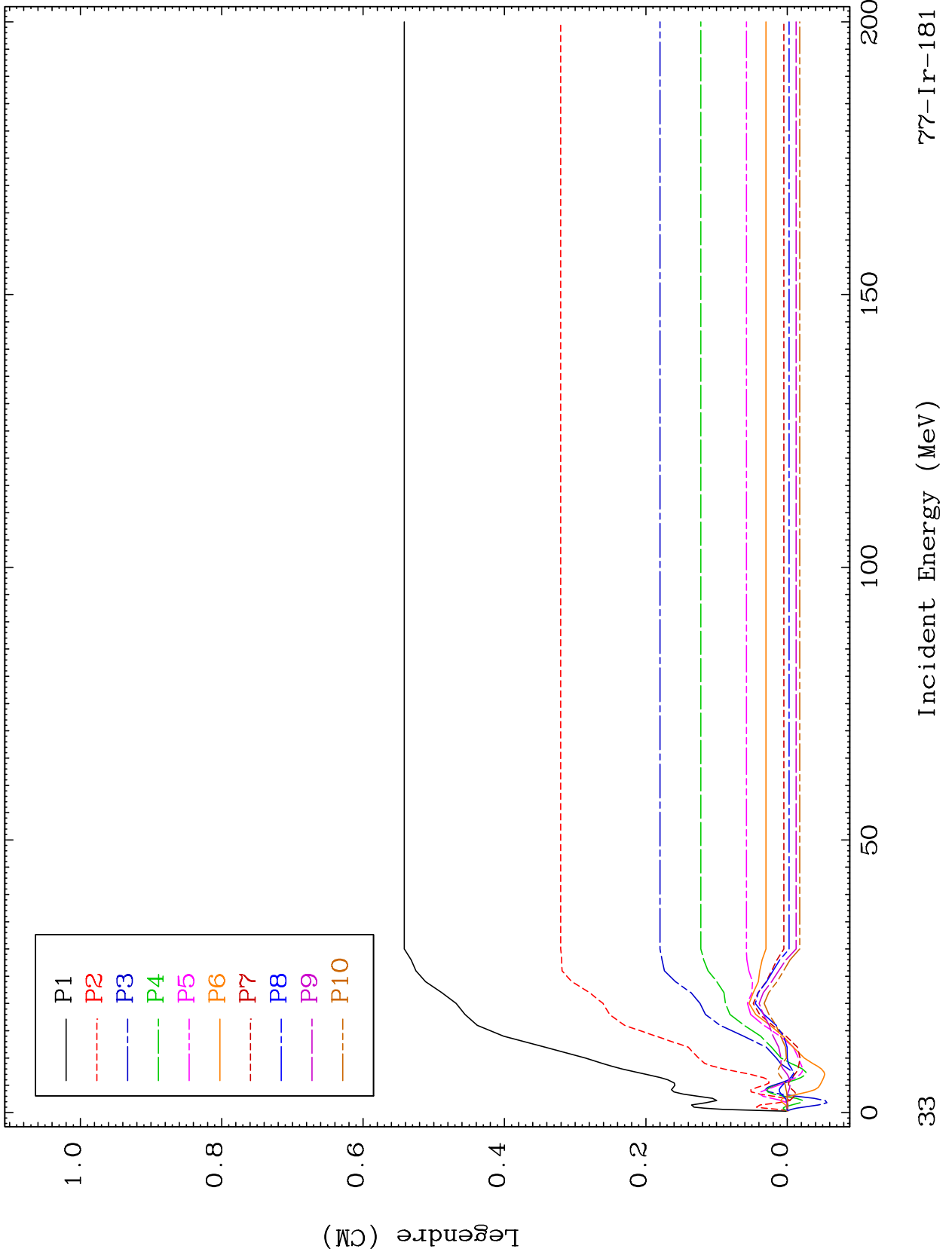

33

Incident Energy (MeV)

⁷⁷Ir-181

MAT 7695

MT= 54 (n,n') Level
Legendre Coefficients

77-Ir-181

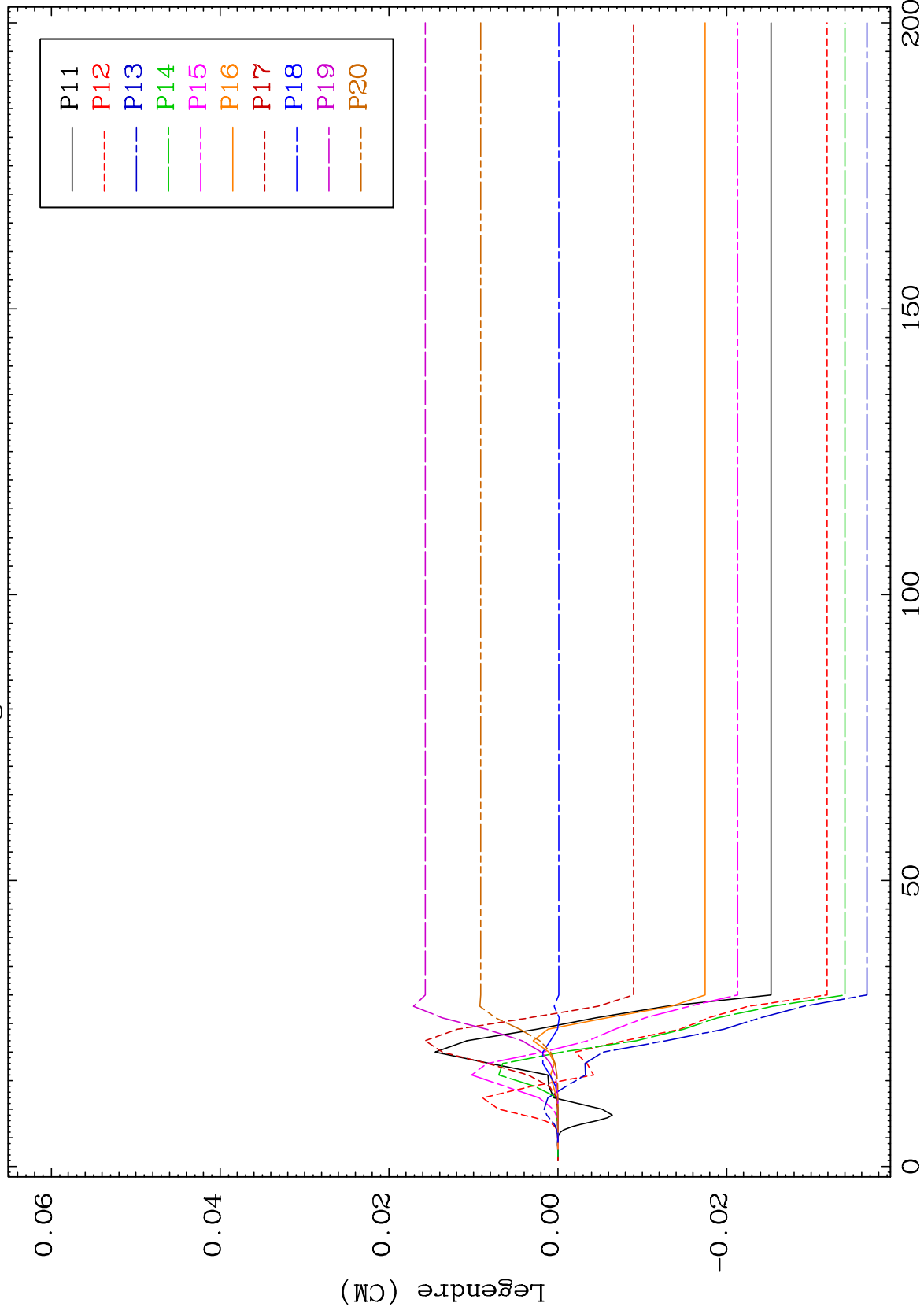

34

Incident Energy (MeV)

77-Ir-181

MAT 7695

MT= 54 (n,n') Level
Legendre Coefficients

77-Ir-181

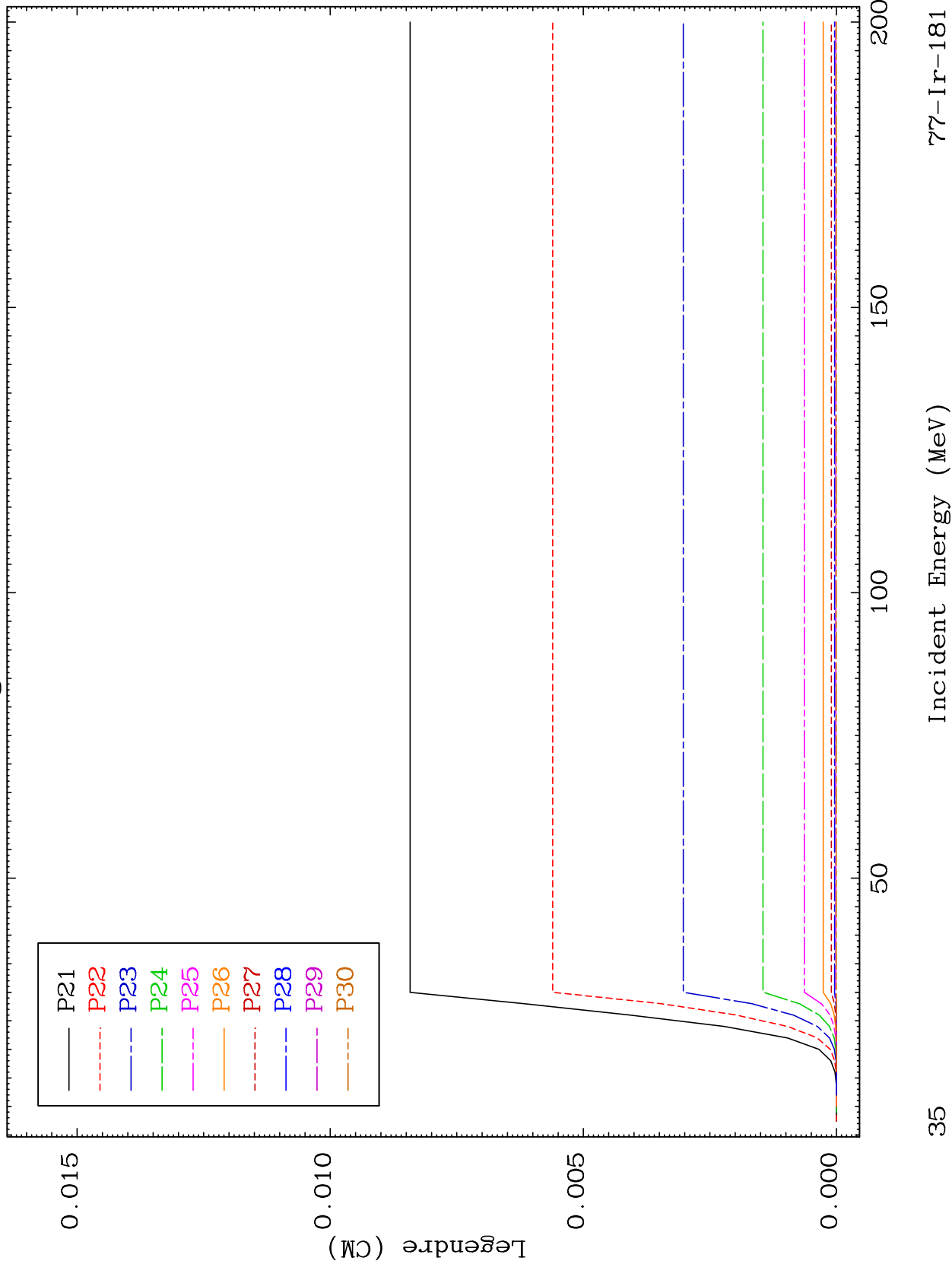

35

Incident Energy (MeV)

77-Ir-181

MAT 7695

MT= 54 (n,n') Level
Legendre Coefficients

77-Ir-181

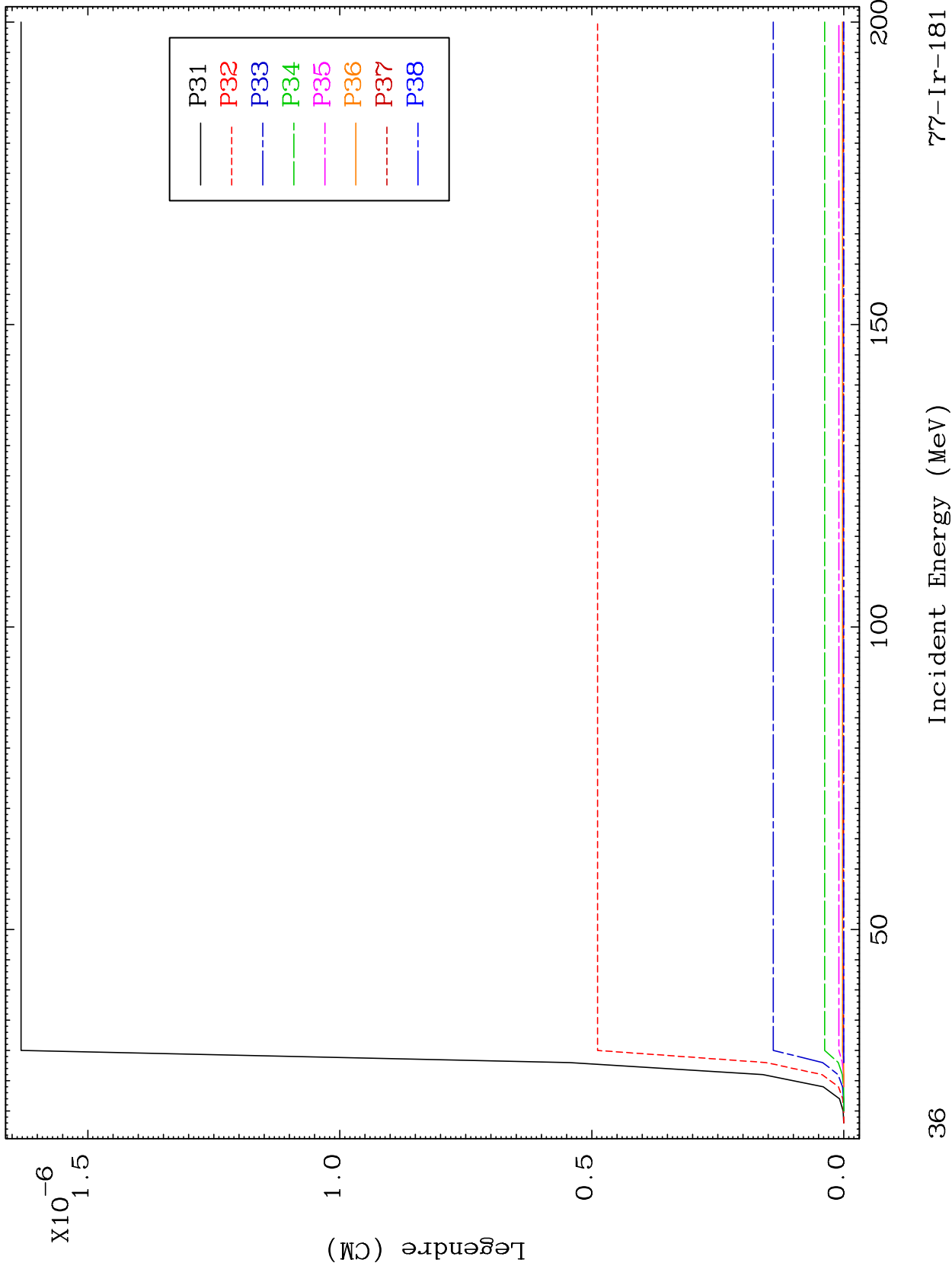

36

77-Ir-181

MAT 7695

MT= 55 (n,n') Level
Legendre Coefficients

77-Ir-181

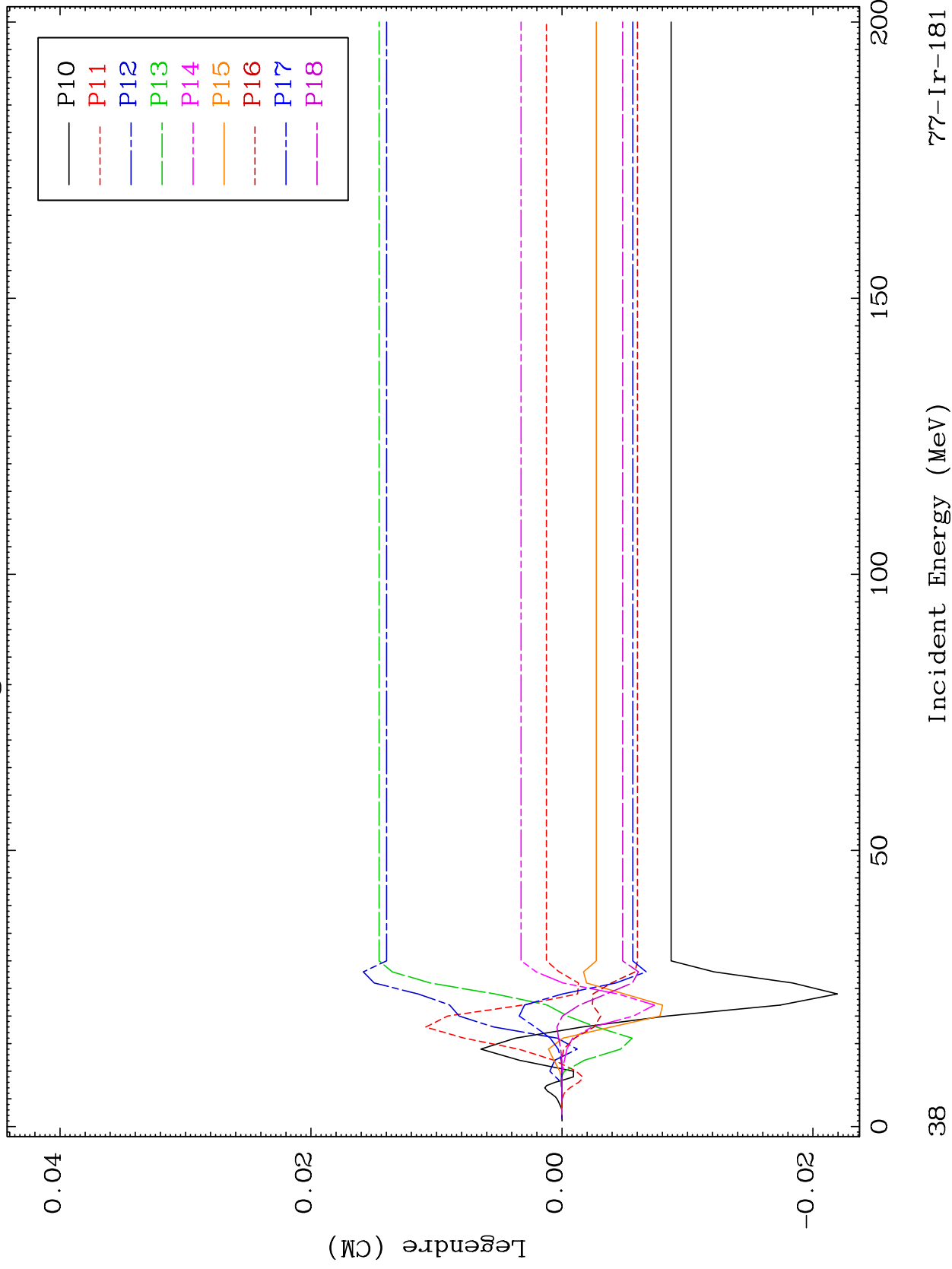

77-Ir-181

Incident Energy (MeV)

38

MAT 7695

MT= 55 (n,n') Level
Legendre Coefficients

77-Ir-181

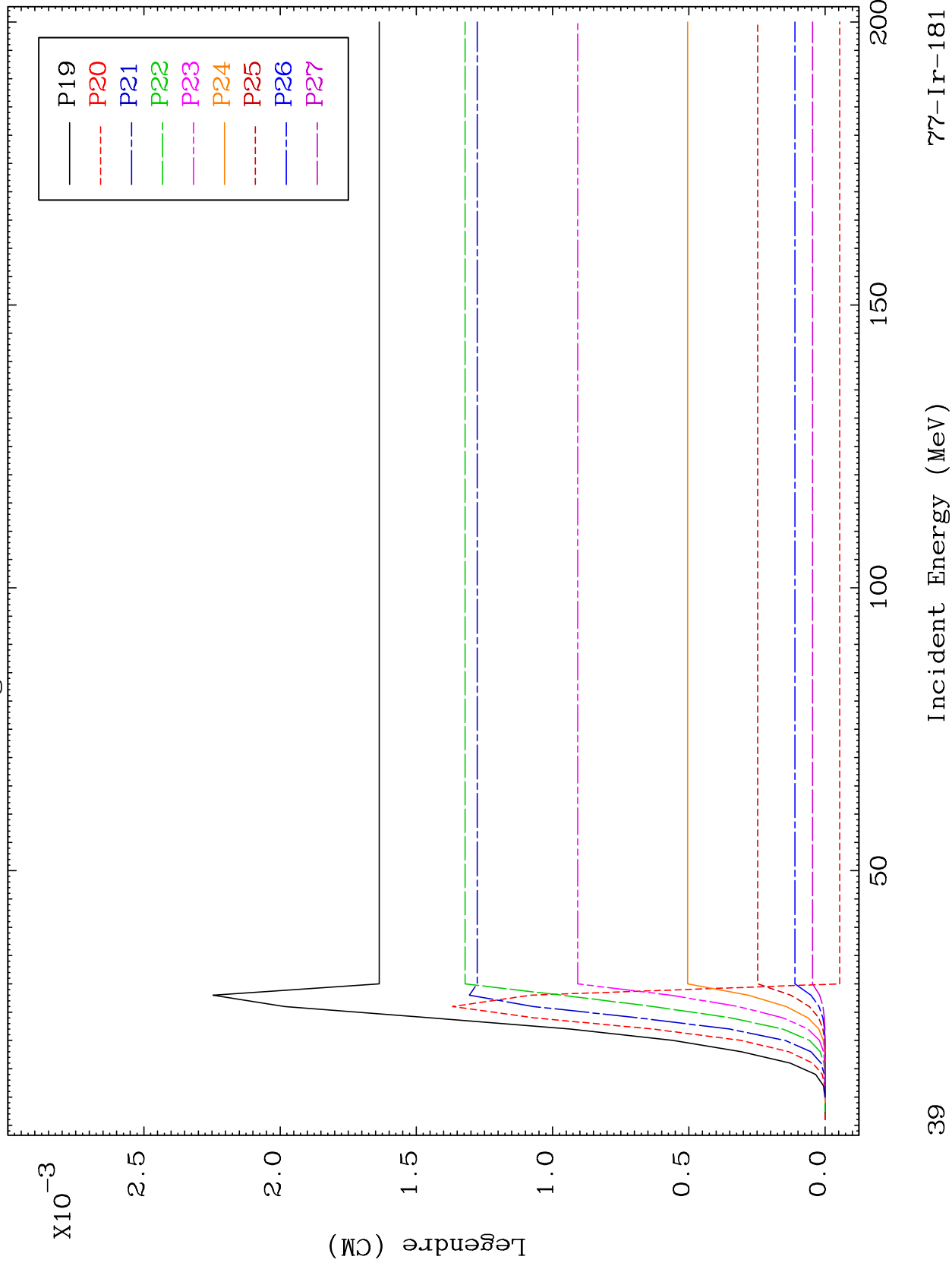

39

Incident Energy (MeV)

77-Ir-181

MAT 7695

MT= 55 (n,n') Level
Legendre Coefficients

77-Ir-181

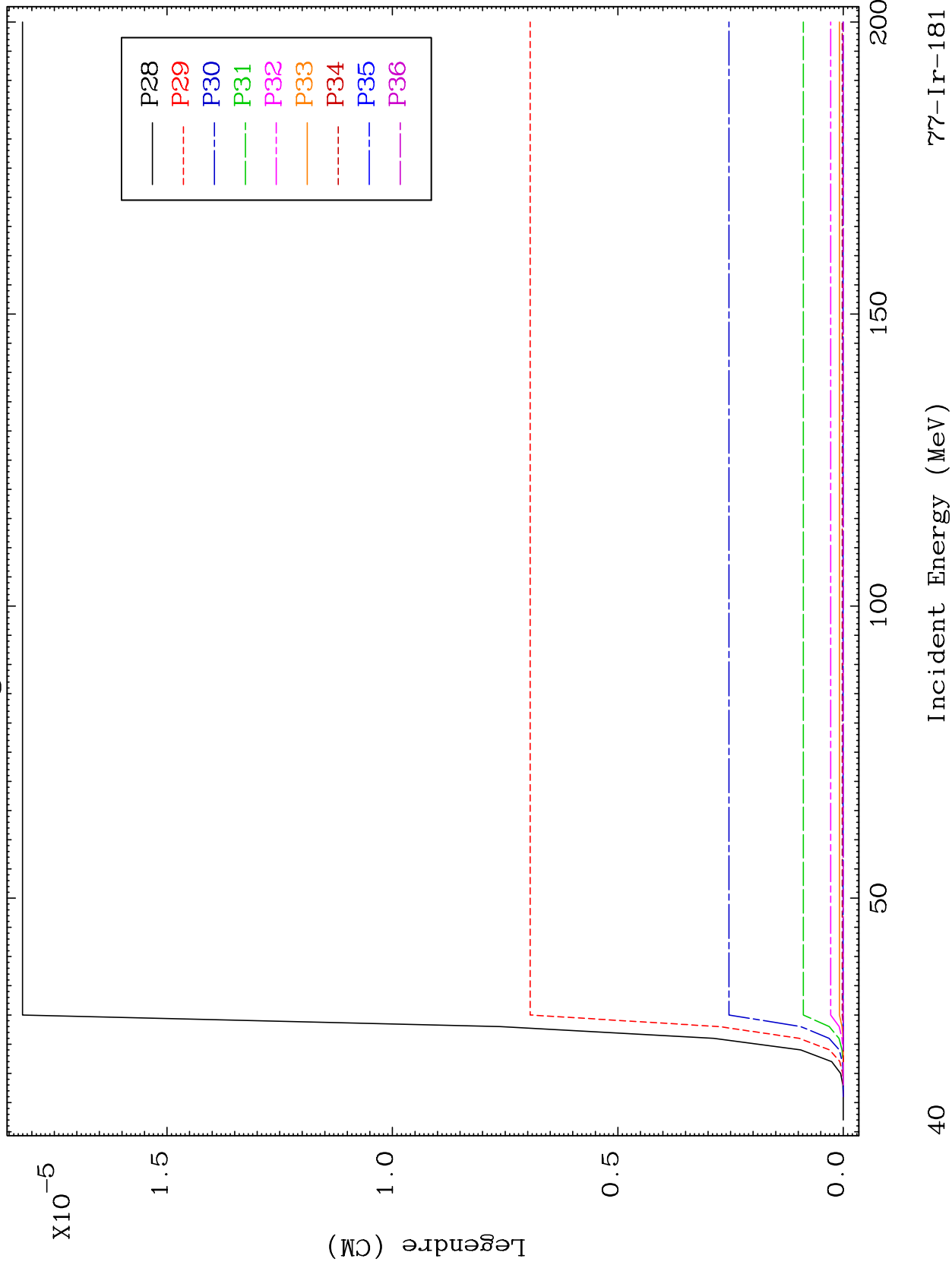

MAT 7695

MT= 56 (n,n') Level
Legendre Coefficients

⁷⁷Ir-181

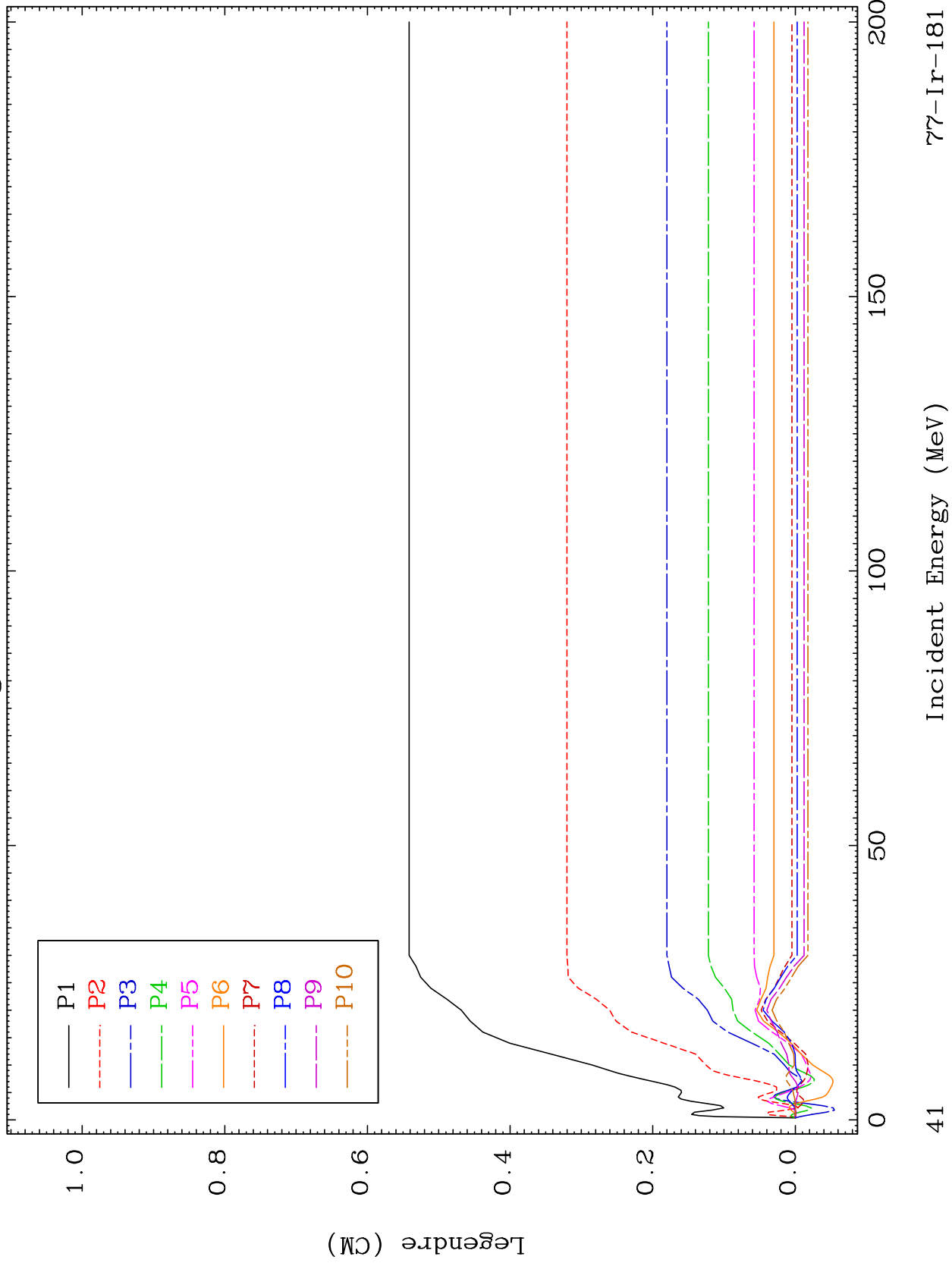

41

Incident Energy (MeV)

⁷⁷Ir-181

MAT 7695

MT= 56 (n,n') Level
Legendre Coefficients

77-Ir-181

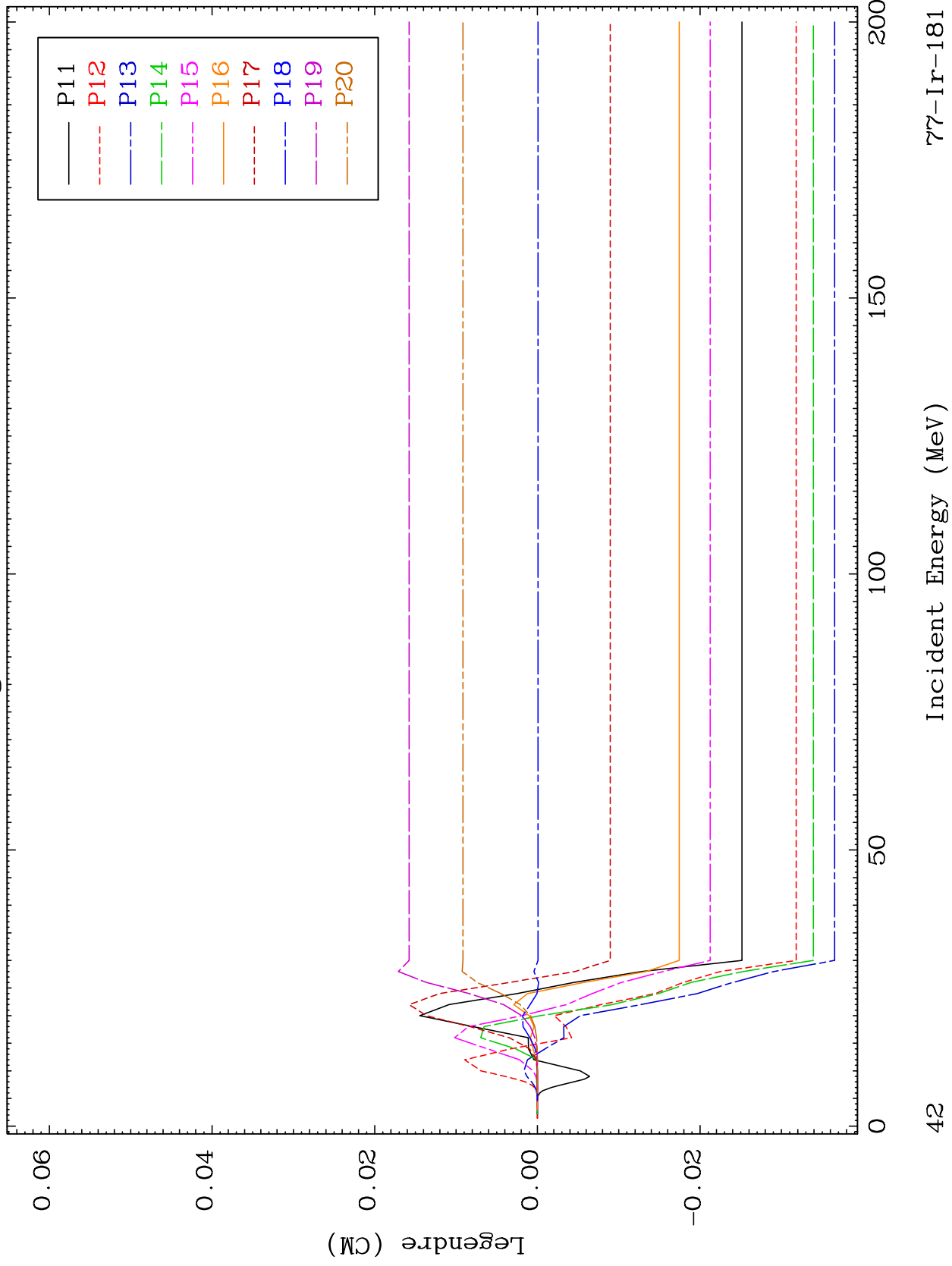

42

77-Ir-181

MAT 7695

MT= 56 (n,n') Level
Legendre Coefficients

77-Ir-181

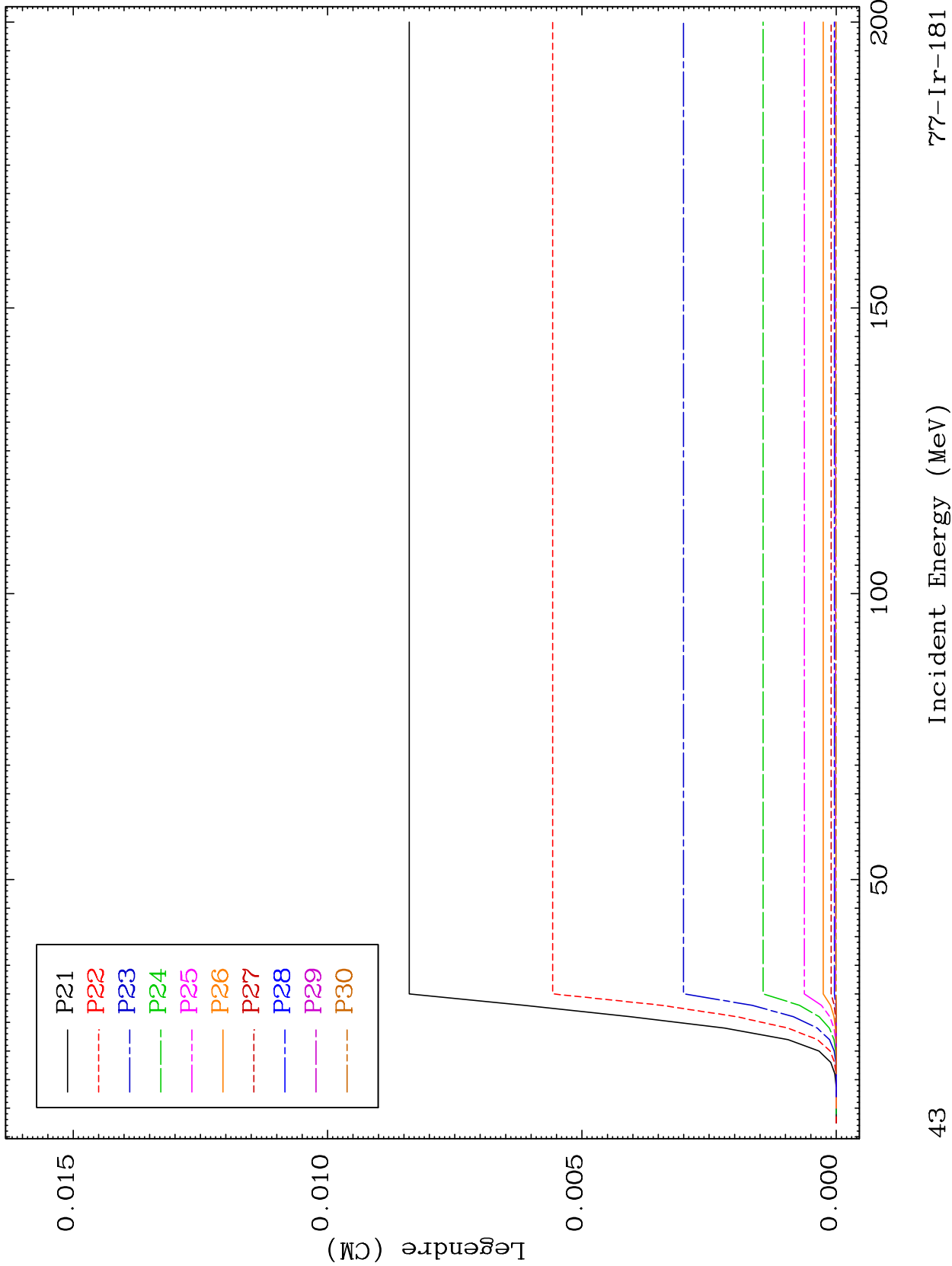

43

77-Ir-181

MAT 7695

MT= 56 (n,n') Level
Legendre Coefficients

77-Ir-181

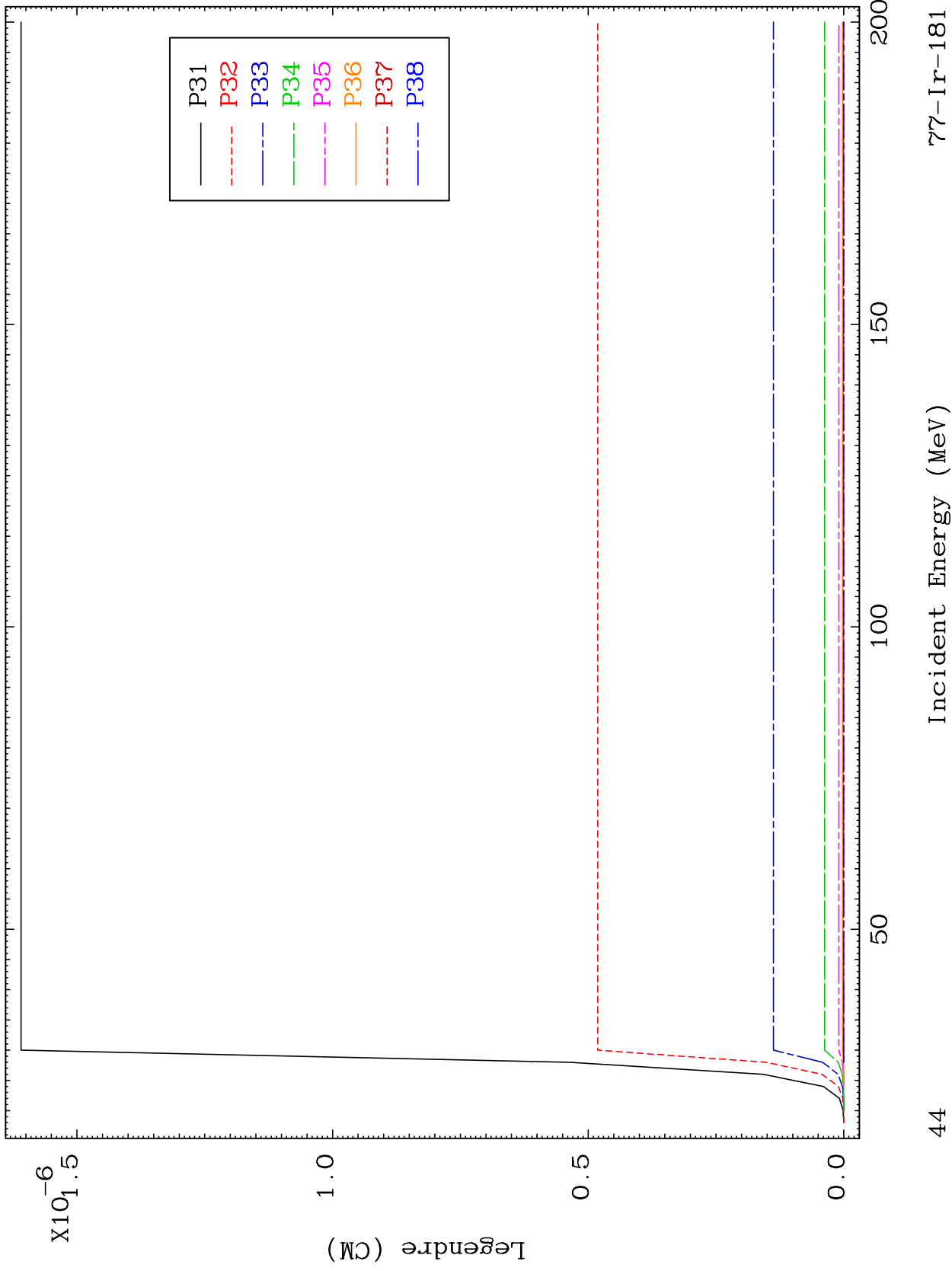

44

Incident Energy (MeV)

77-Ir-181

MAT 7695

MT= 57 (n,n') Level
Legendre Coefficients

⁷⁷Ir-181

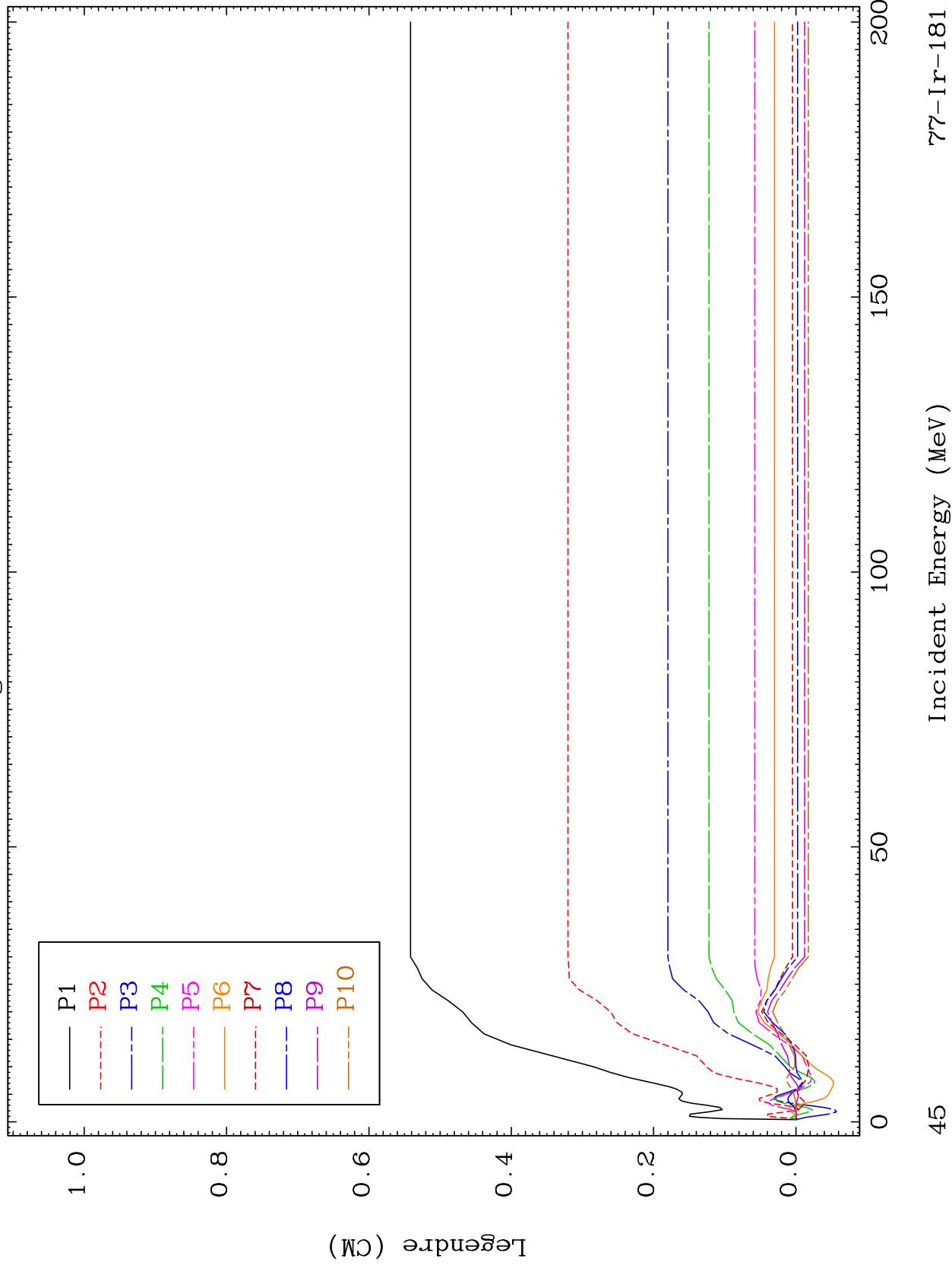

MAT 7695

MT= 57 (n,n') Level
Legendre Coefficients

77-Ir-181

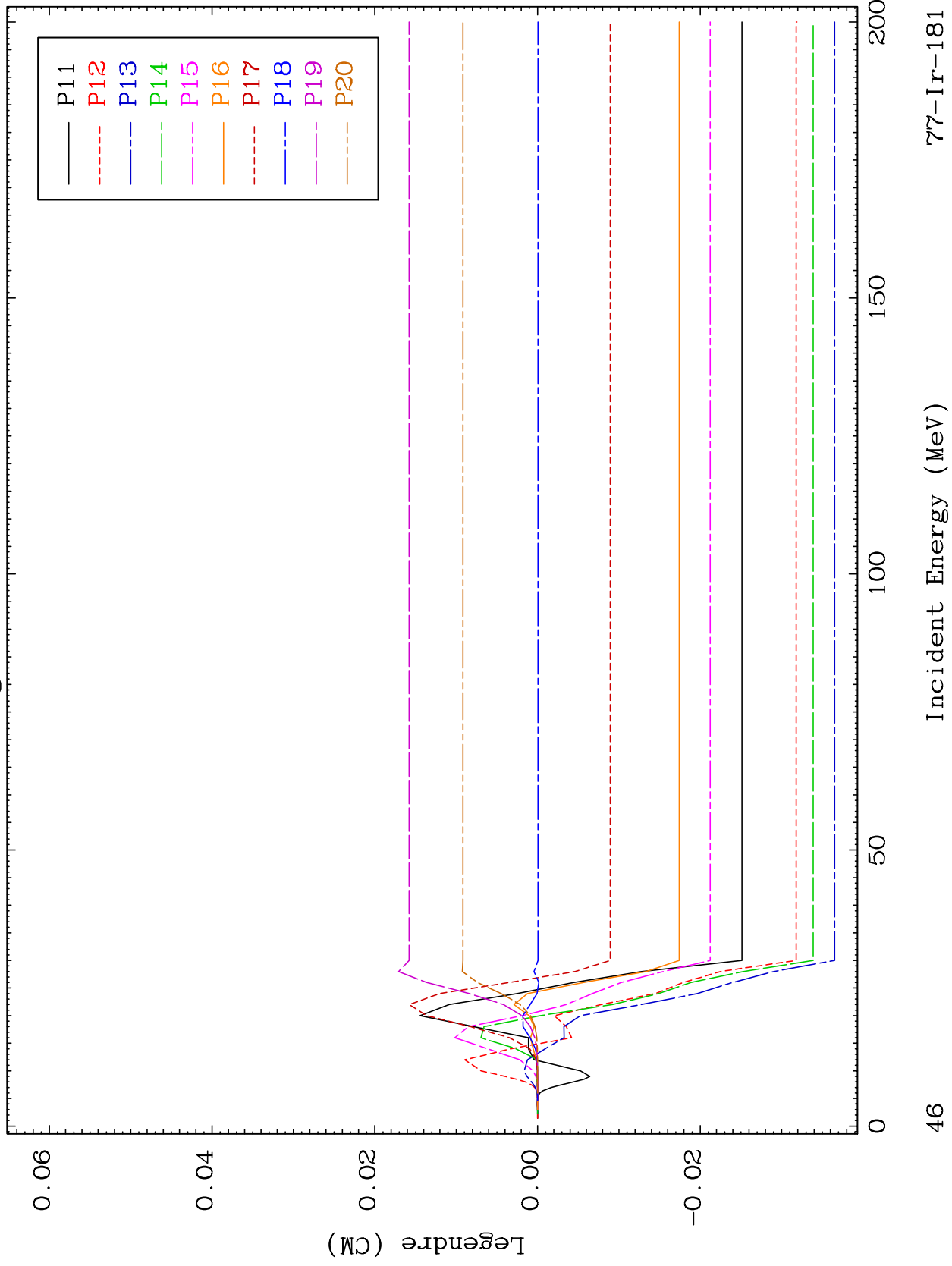

77-Ir-181

Incident Energy (MeV)

46

MAT 7695

MT= 57 (n,n') Level
Legendre Coefficients

77-Ir-181

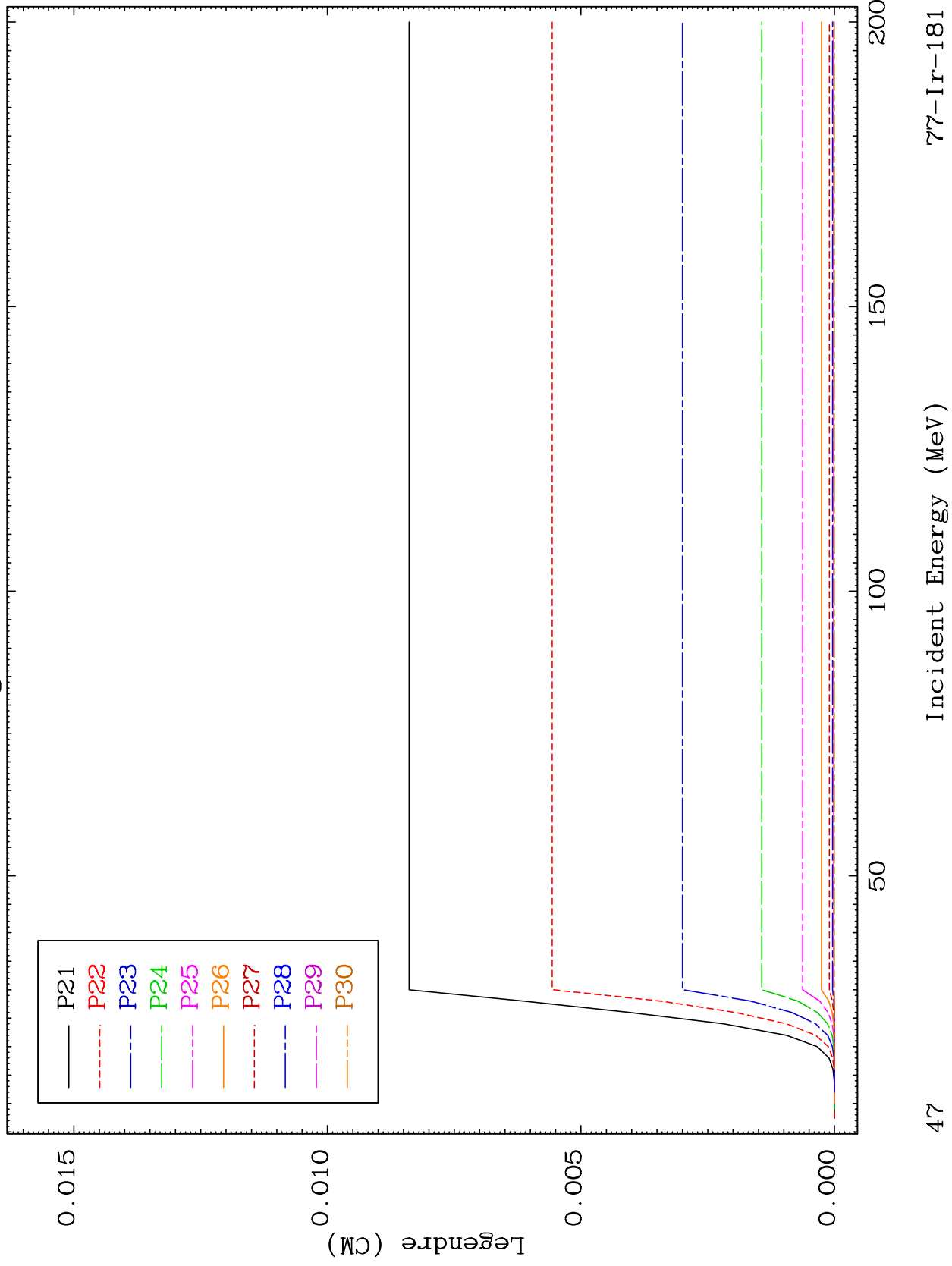

47

Incident Energy (MeV)

77-Ir-181

MAT 7695

MT= 57 (n,n') Level
Legendre Coefficients

77-Ir-181

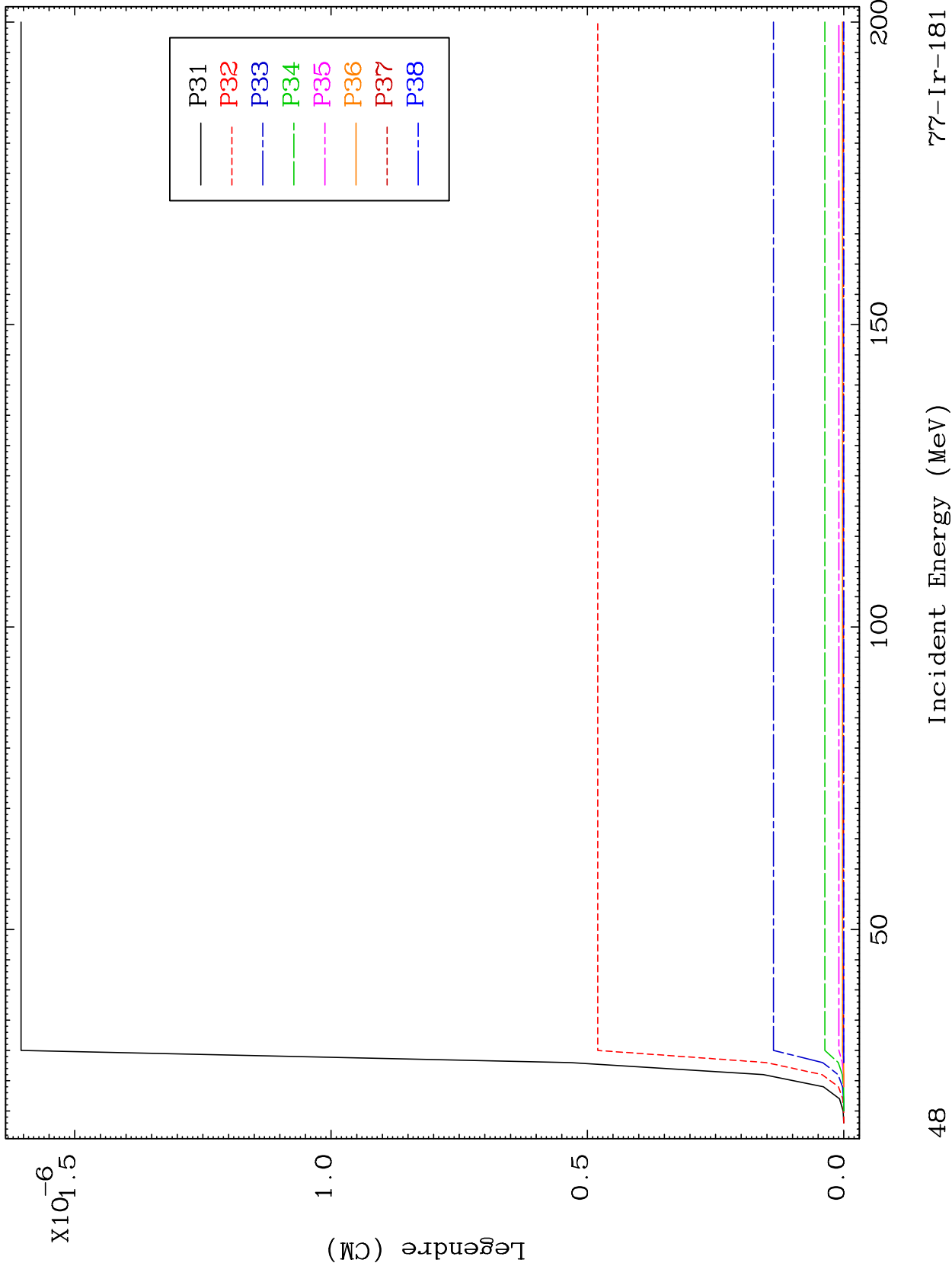

MAT 7695

MT= 58 (n,n') Level
Legendre Coefficients

77-Ir-181

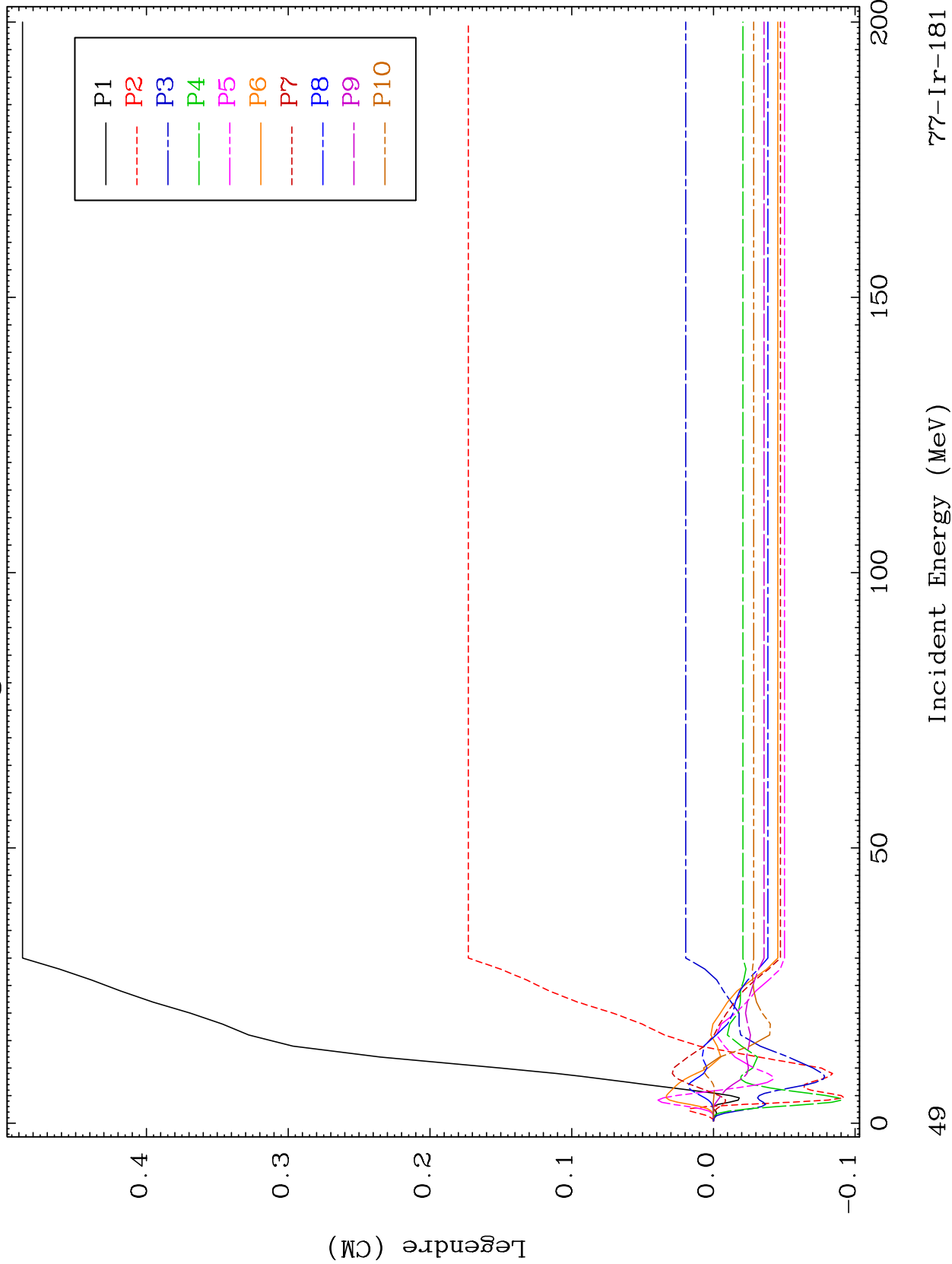

49

77-Ir-181

MAT 7695

MT= 58 (n,n') Level
Legendre Coefficients

77-Ir-181

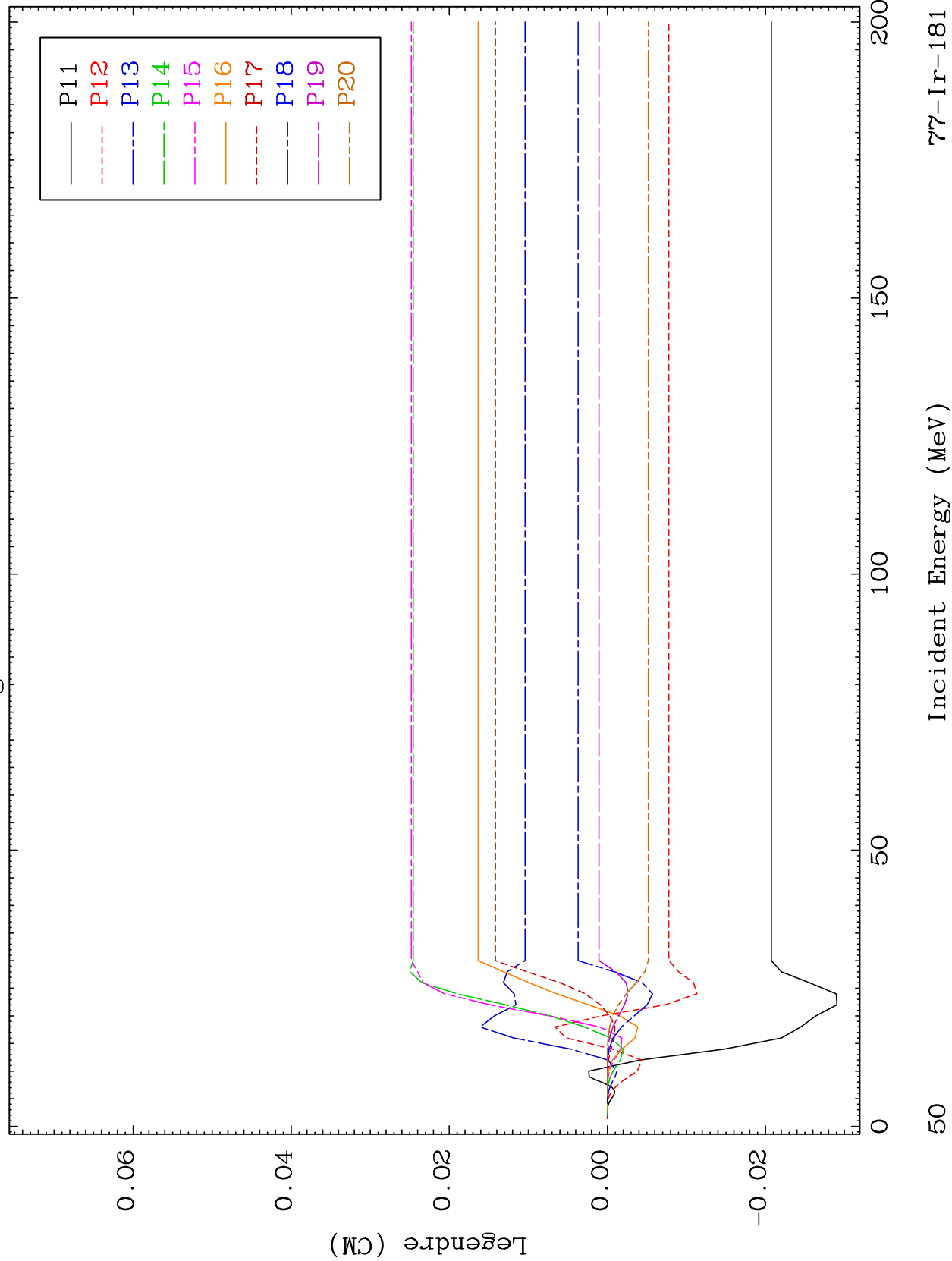

77-Ir-181

Incident Energy (MeV)

MAT 7695

MT= 58 (n,n') Level
Legendre Coefficients

77-Ir-181

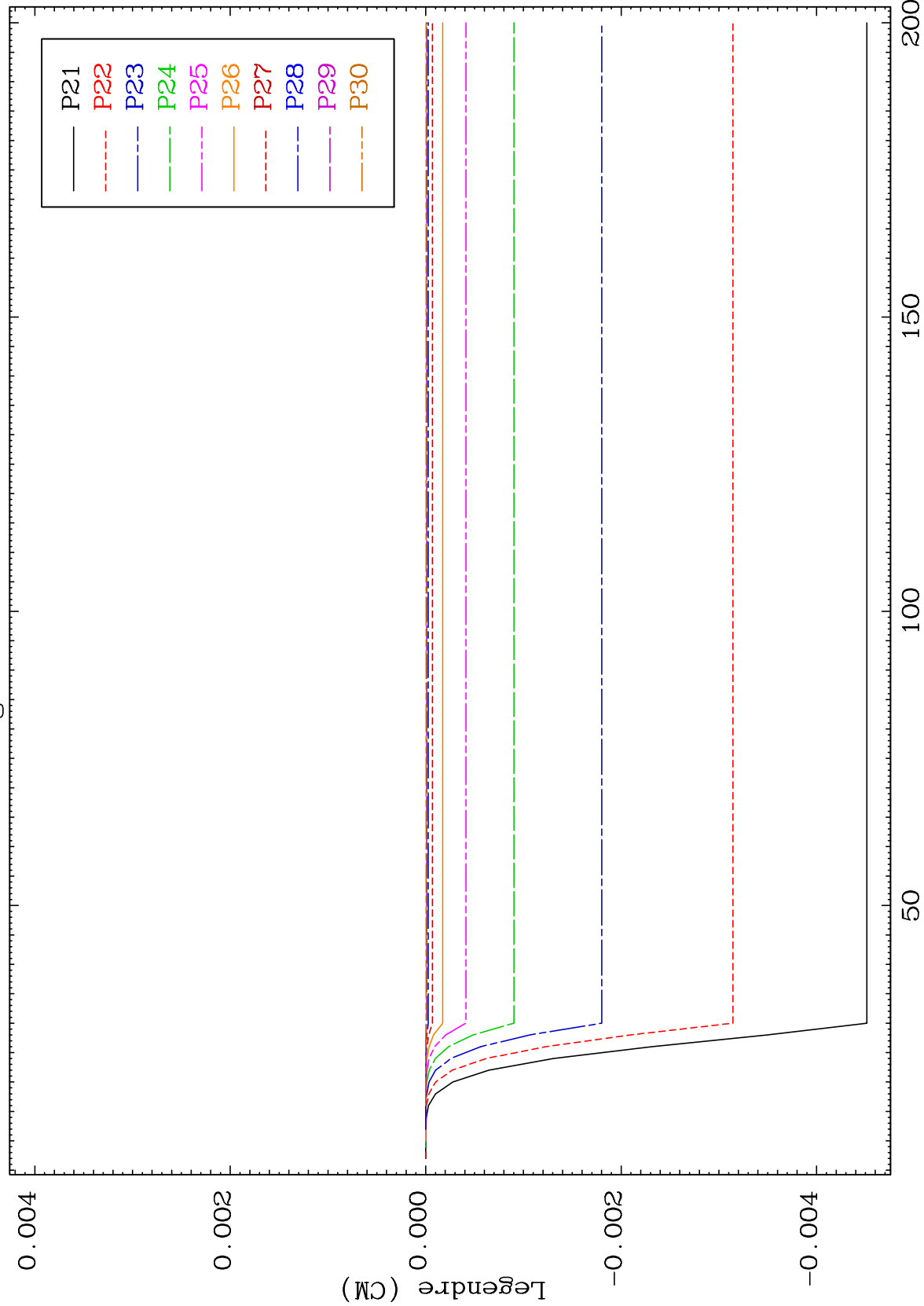

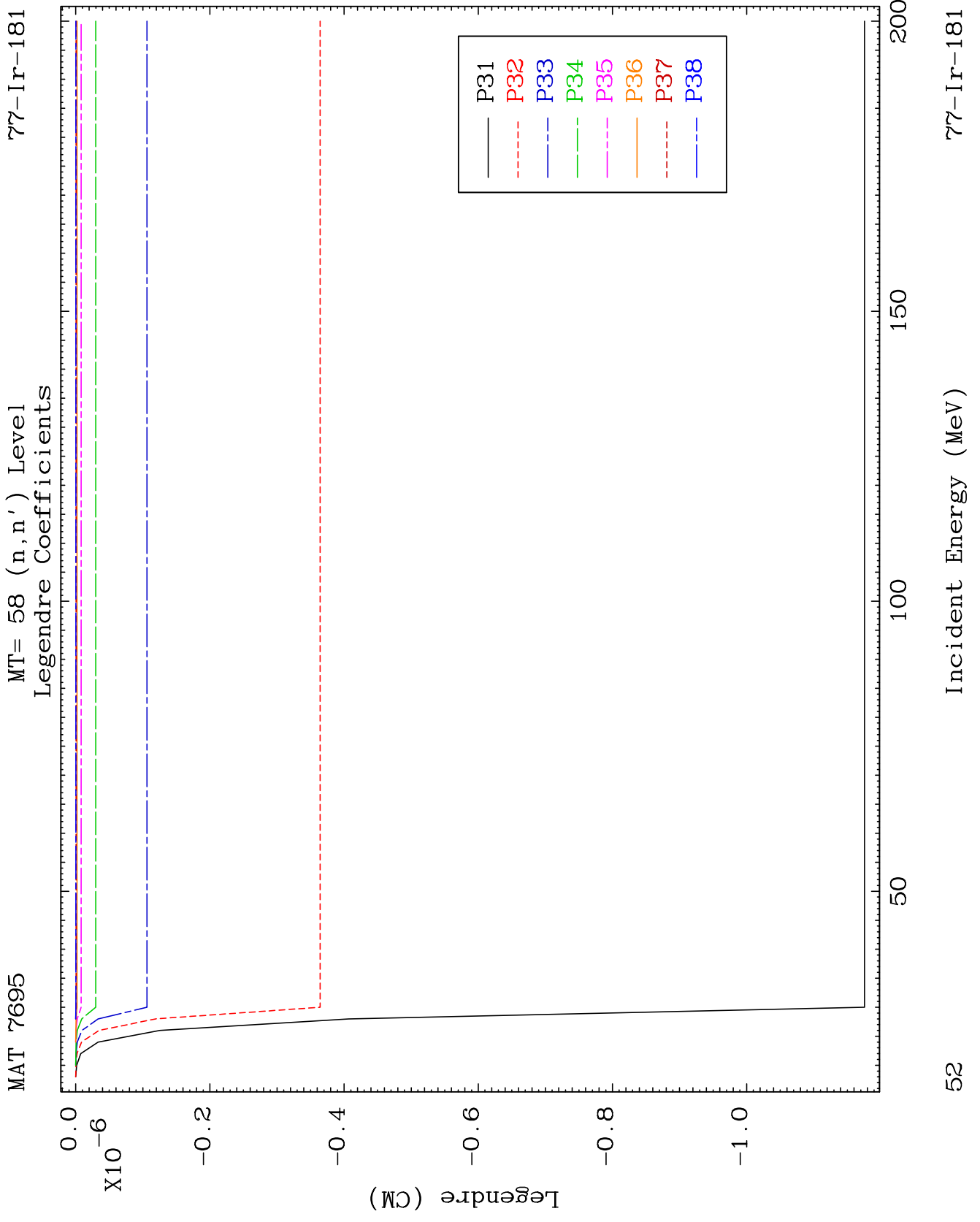

MAT 7695

MT= 59 (n,n') Level
Legendre Coefficients

77-Ir-181

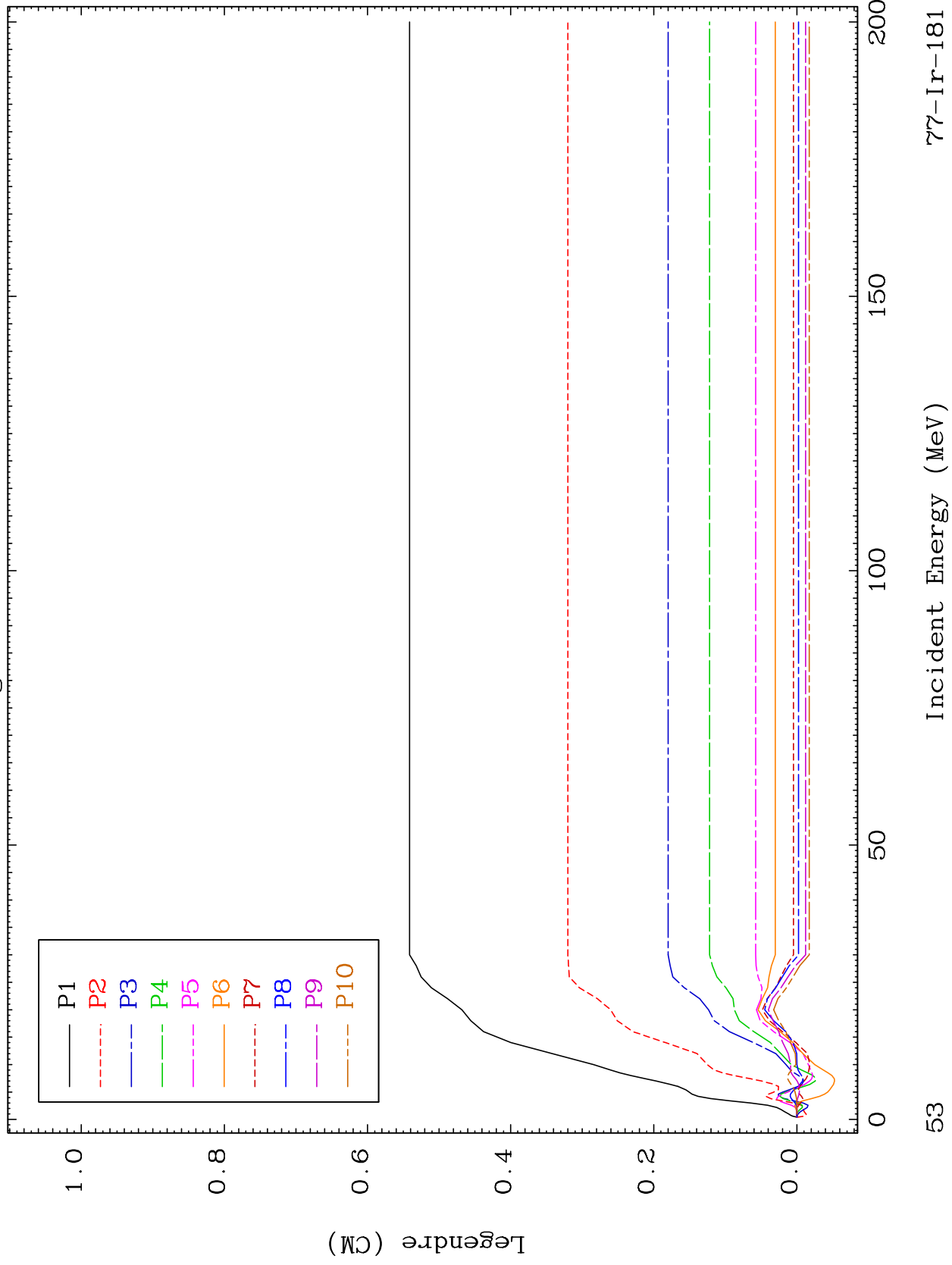

MAT 7695

MT= 59 (n,n') Level
Legendre Coefficients

77-Ir-181

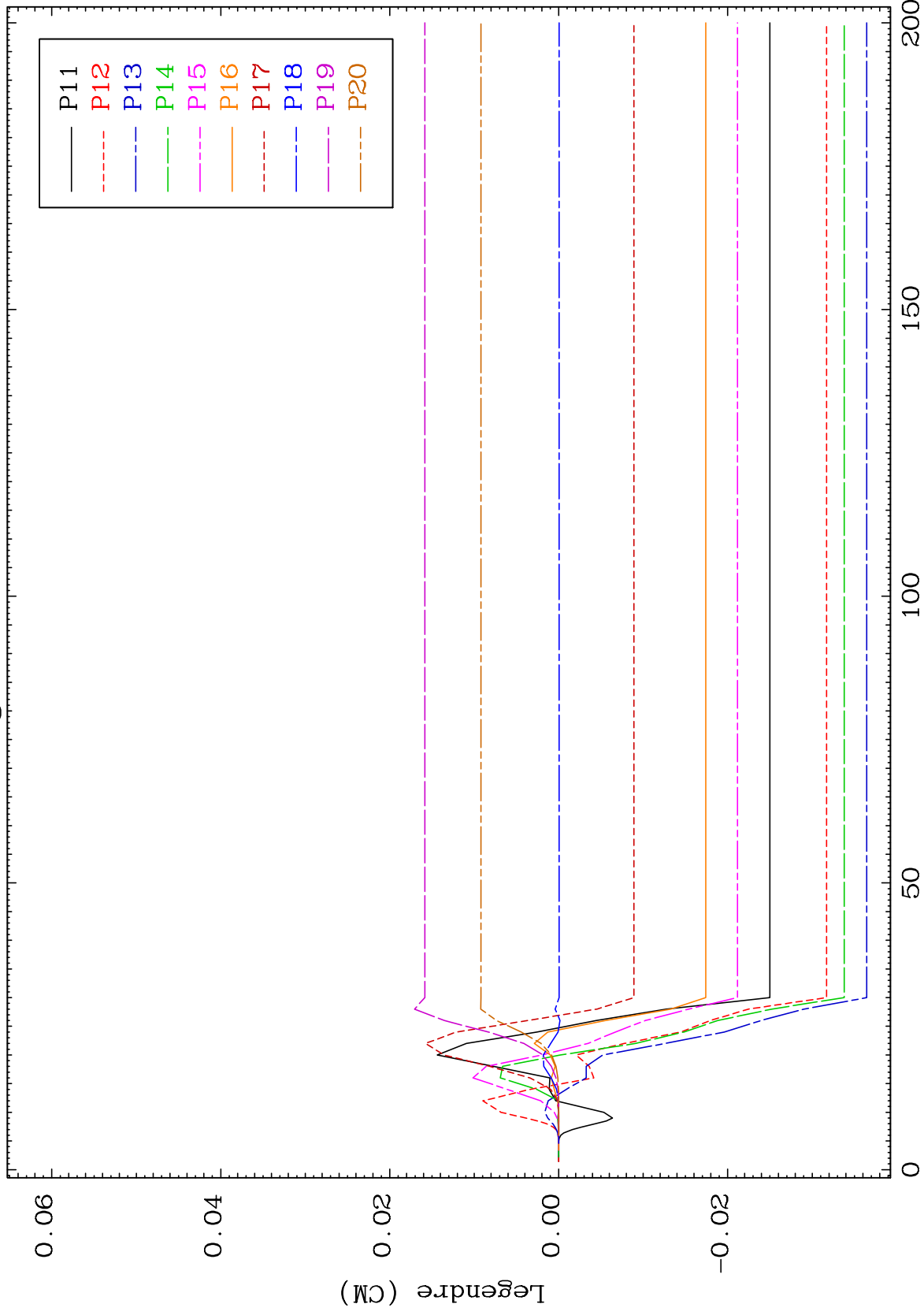

54

Incident Energy (MeV)

77-Ir-181

MAT 7695

MT= 59 (n,n') Level
Legendre Coefficients

77-Ir-181

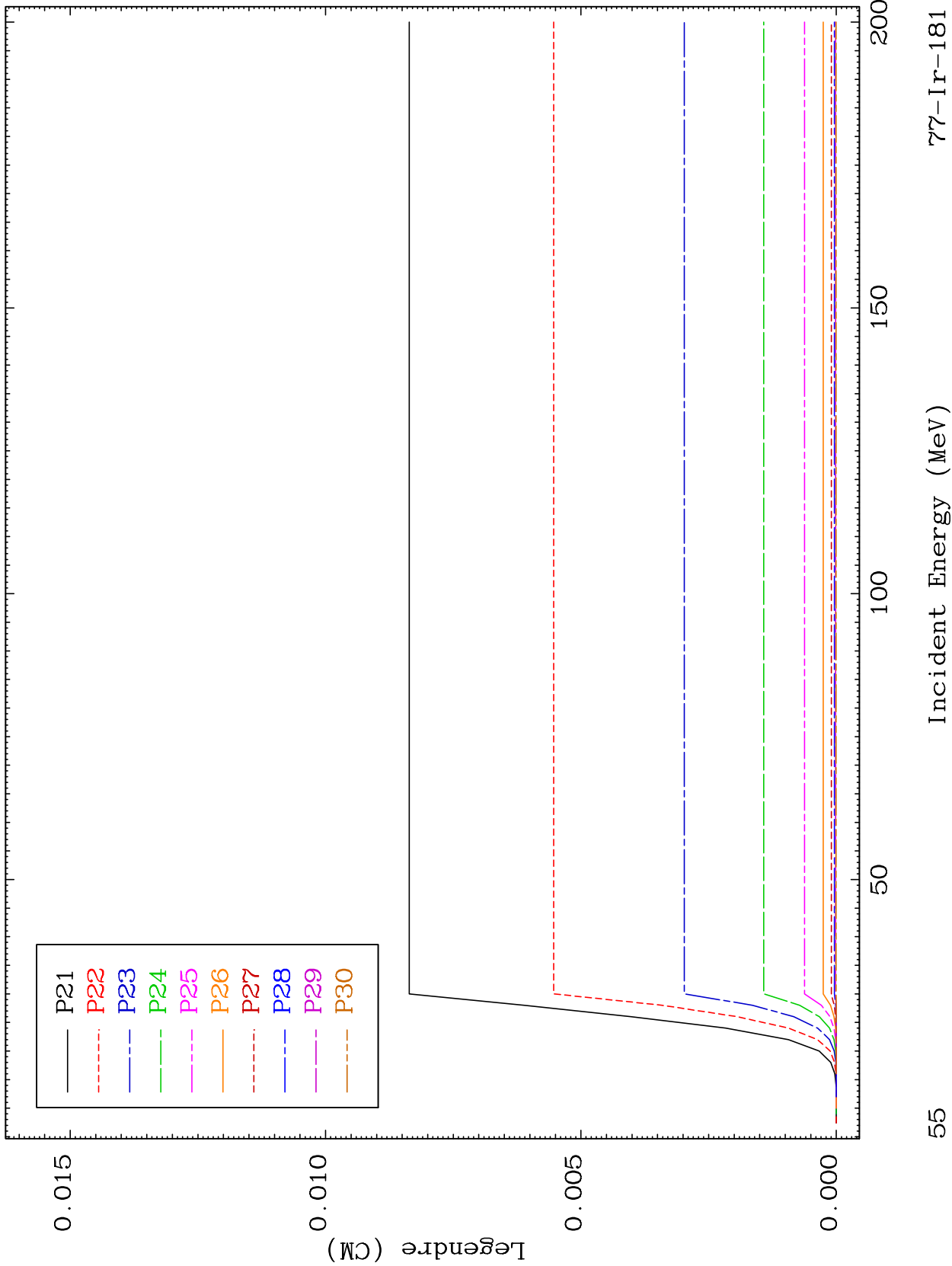

55

Incident Energy (MeV)

77-Ir-181

MAT 7695

MT= 59 (n,n') Level
Legendre Coefficients

77-Ir-181

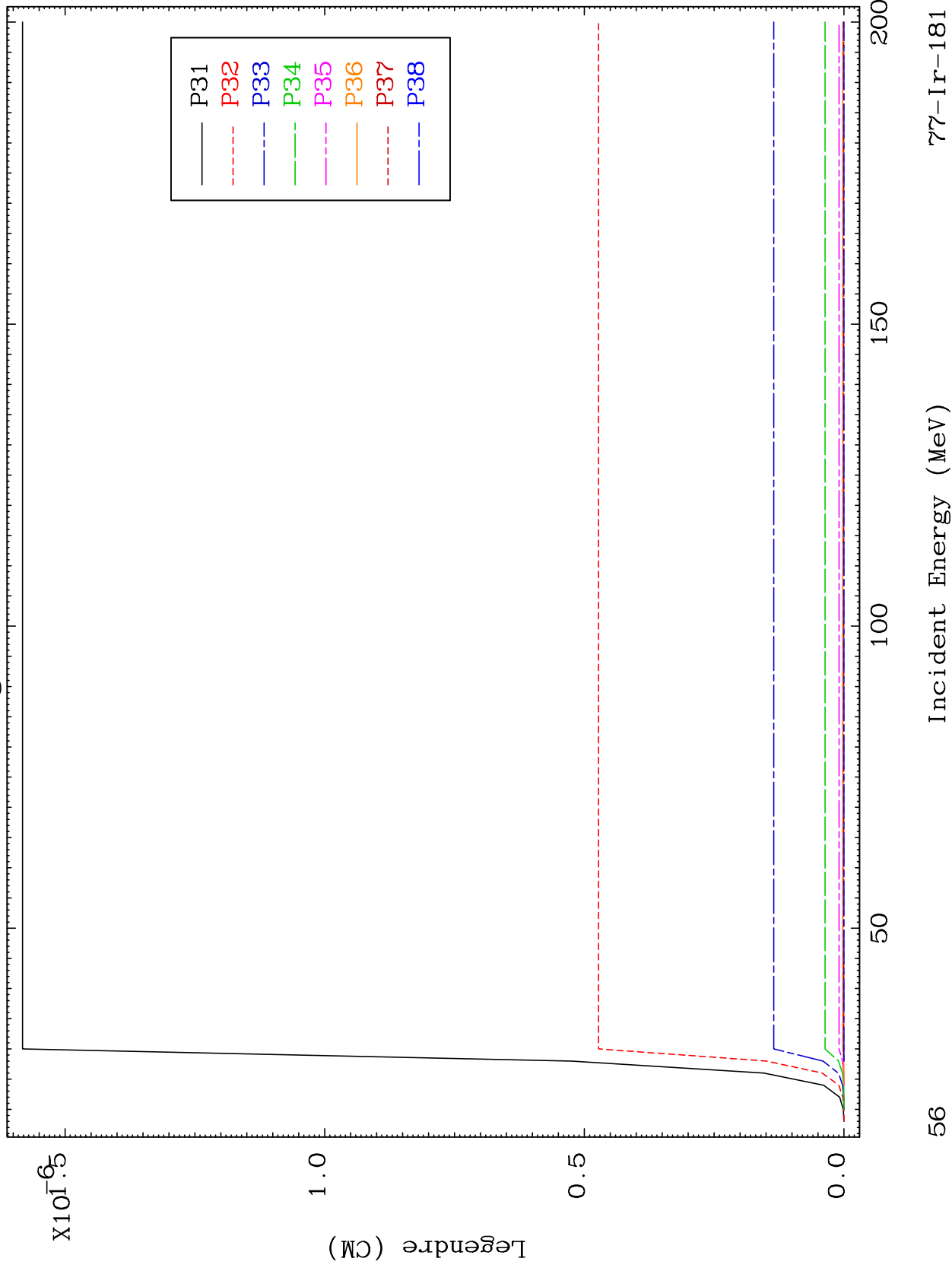

56

Incident Energy (MeV)

77-Ir-181

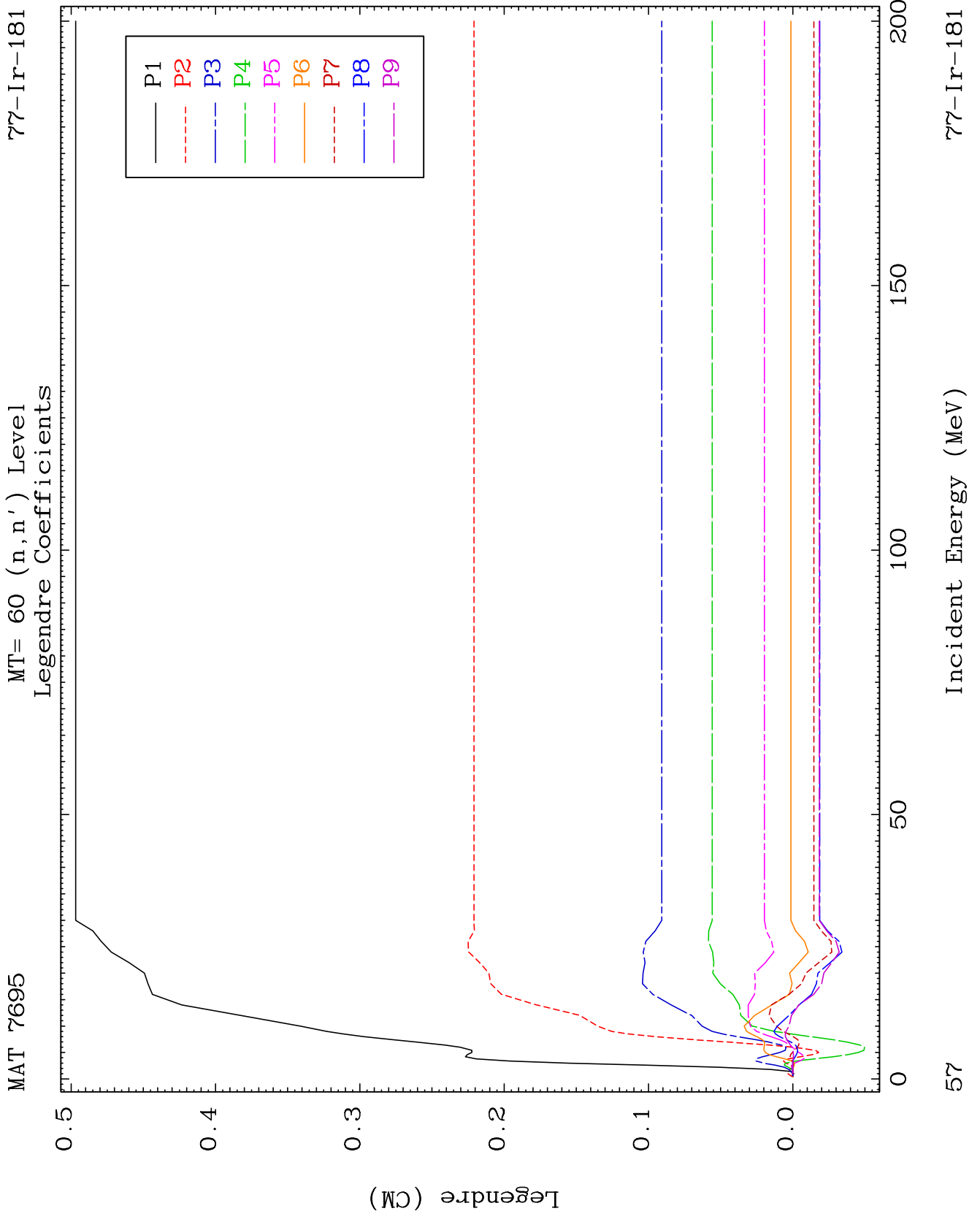

MAT 7695

MT= 60 (n,n') Level
Legendre Coefficients

77-Ir-181

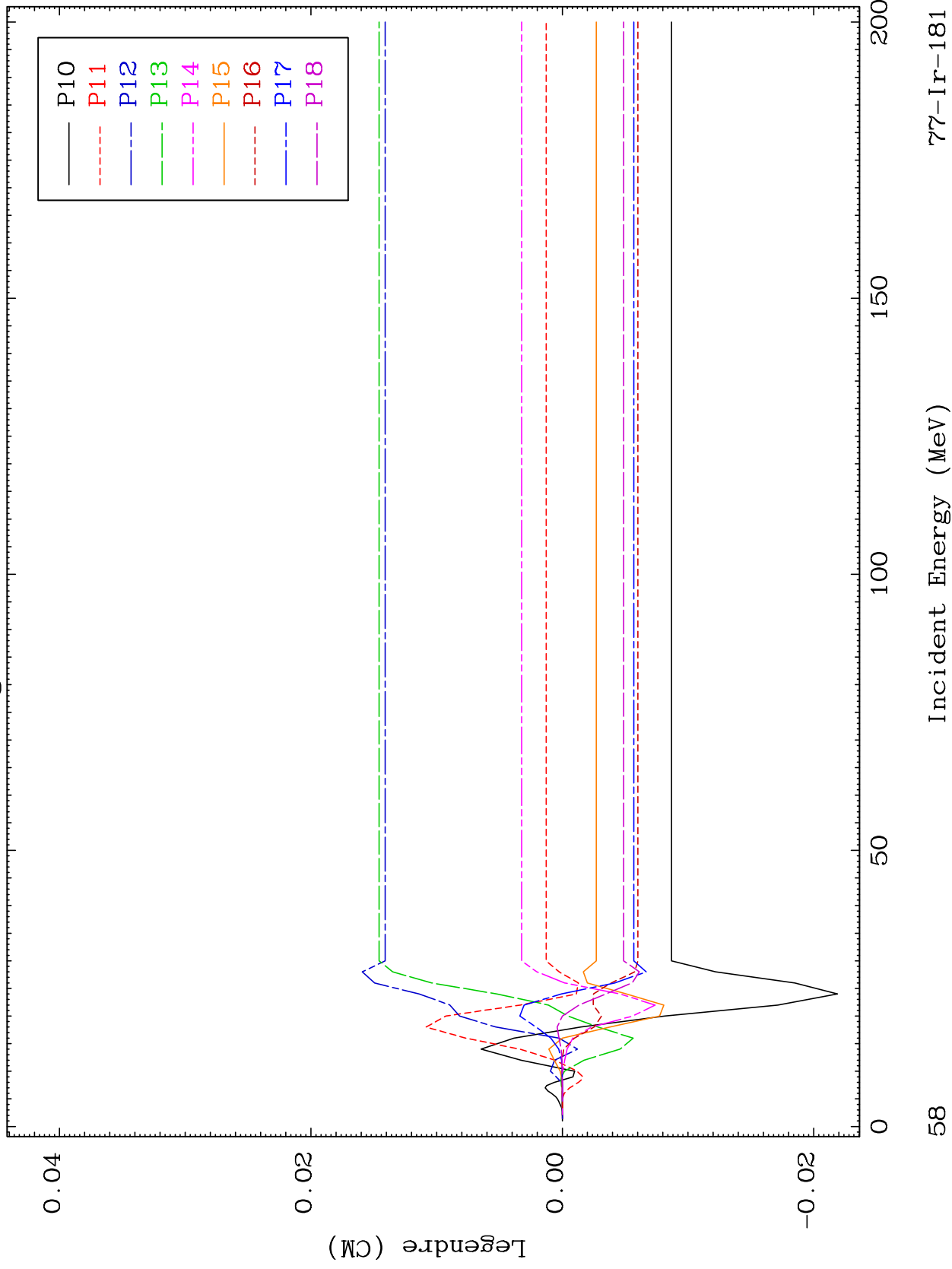

77-Ir-181

Incident Energy (MeV)

58

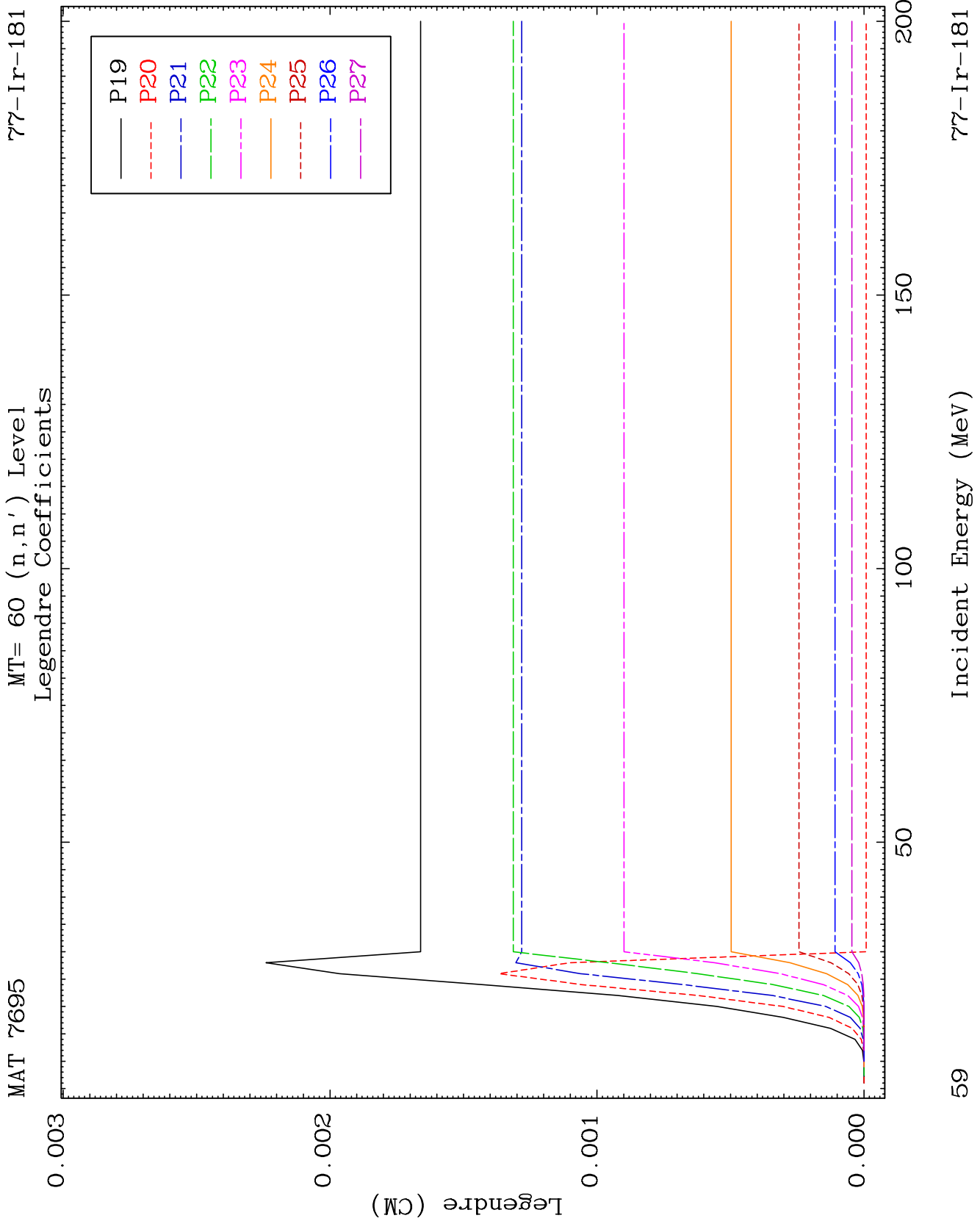

MAT 7695

MT= 60 (n,n') Level
Legendre Coefficients

77-Ir-181

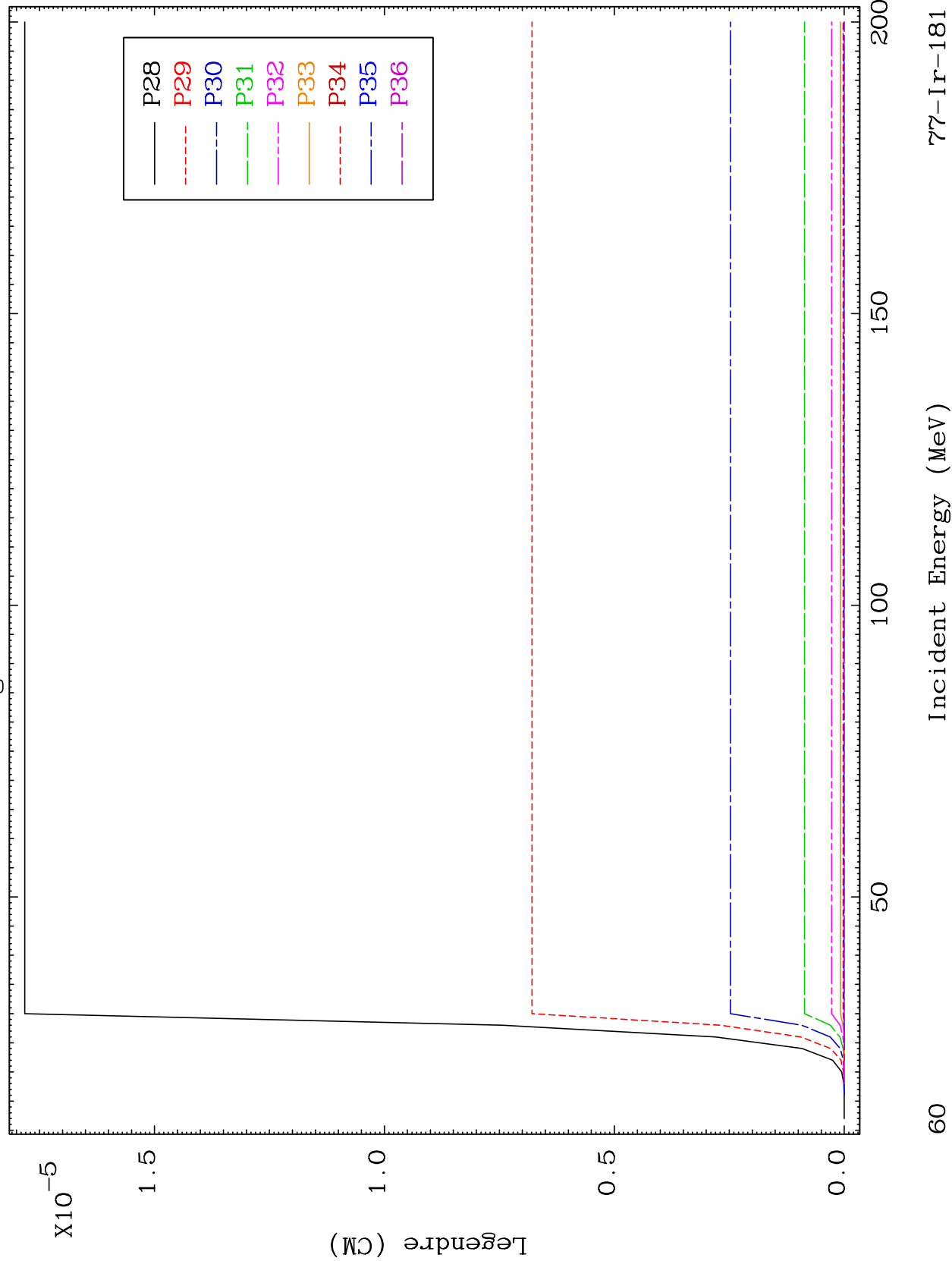

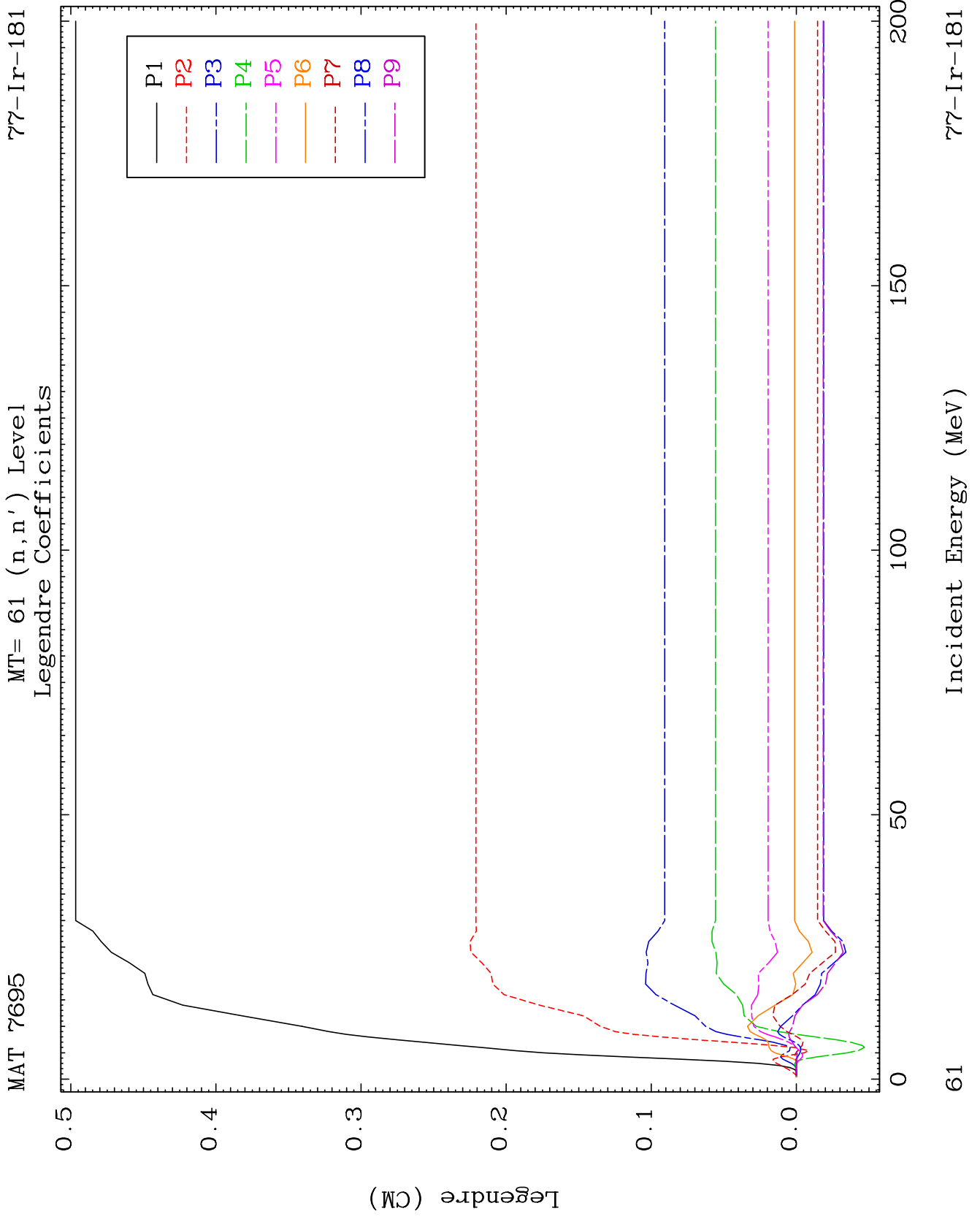

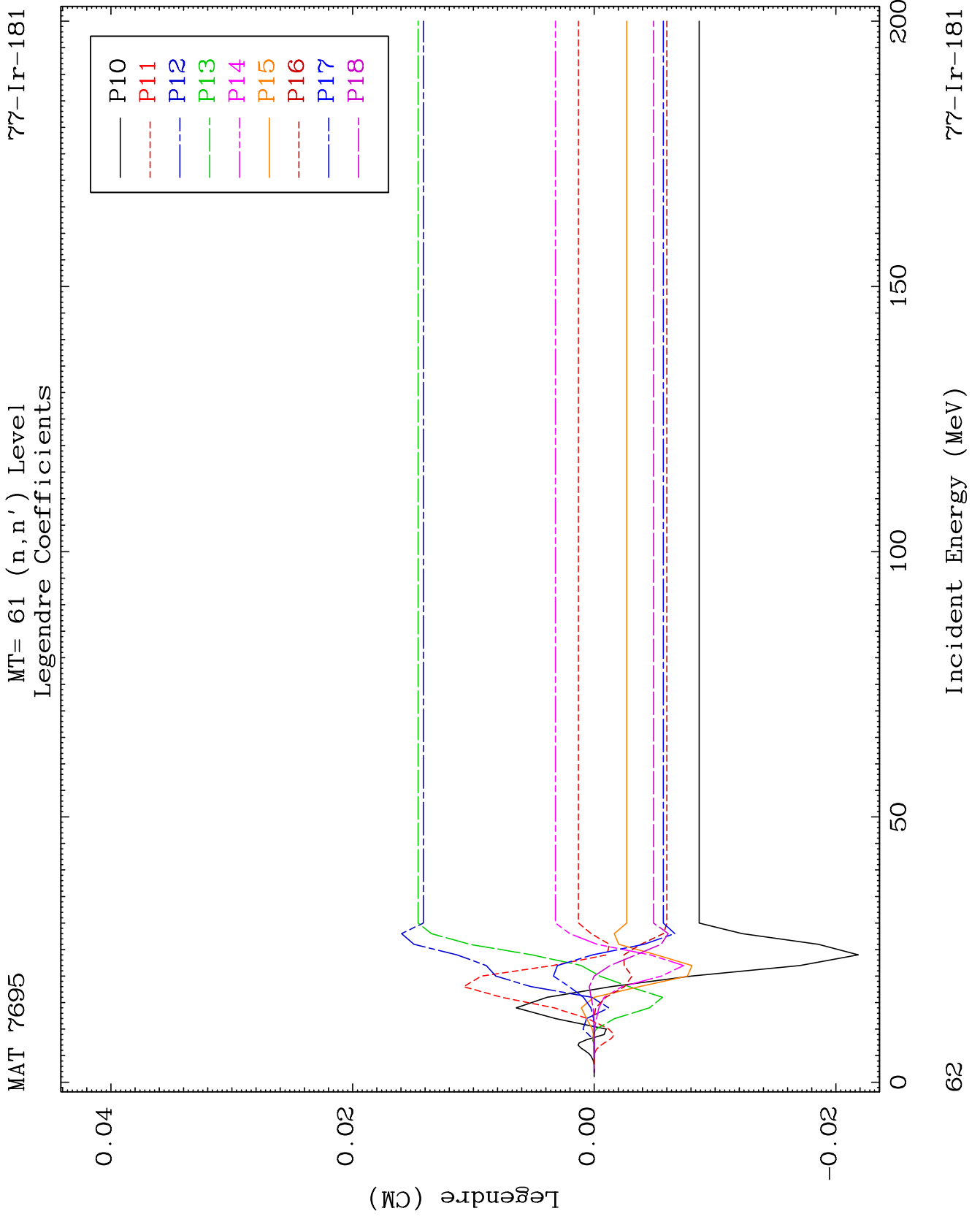

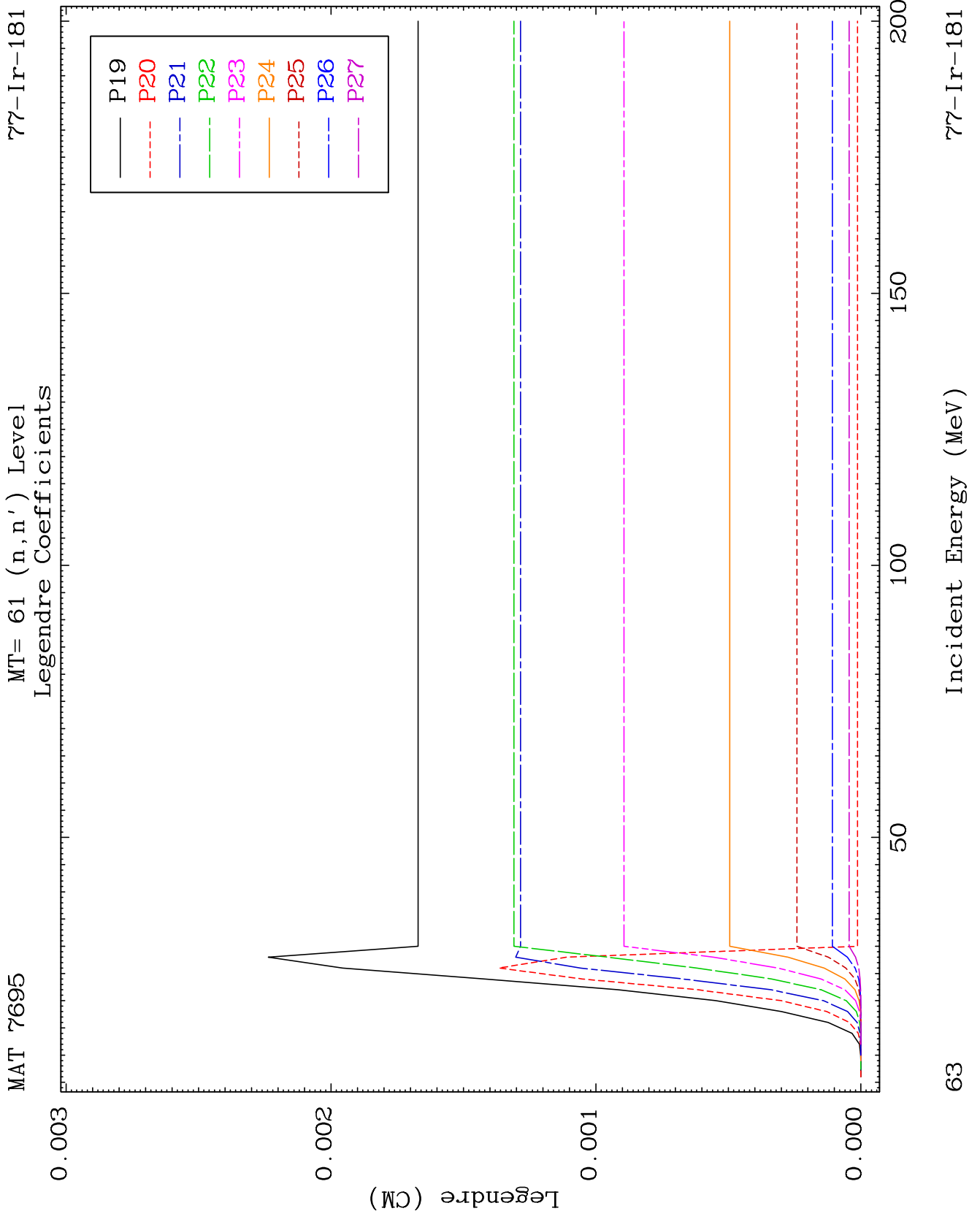

MAT 7695

MT= 61 (n,n') Level
Legendre Coefficients

77-Ir-181

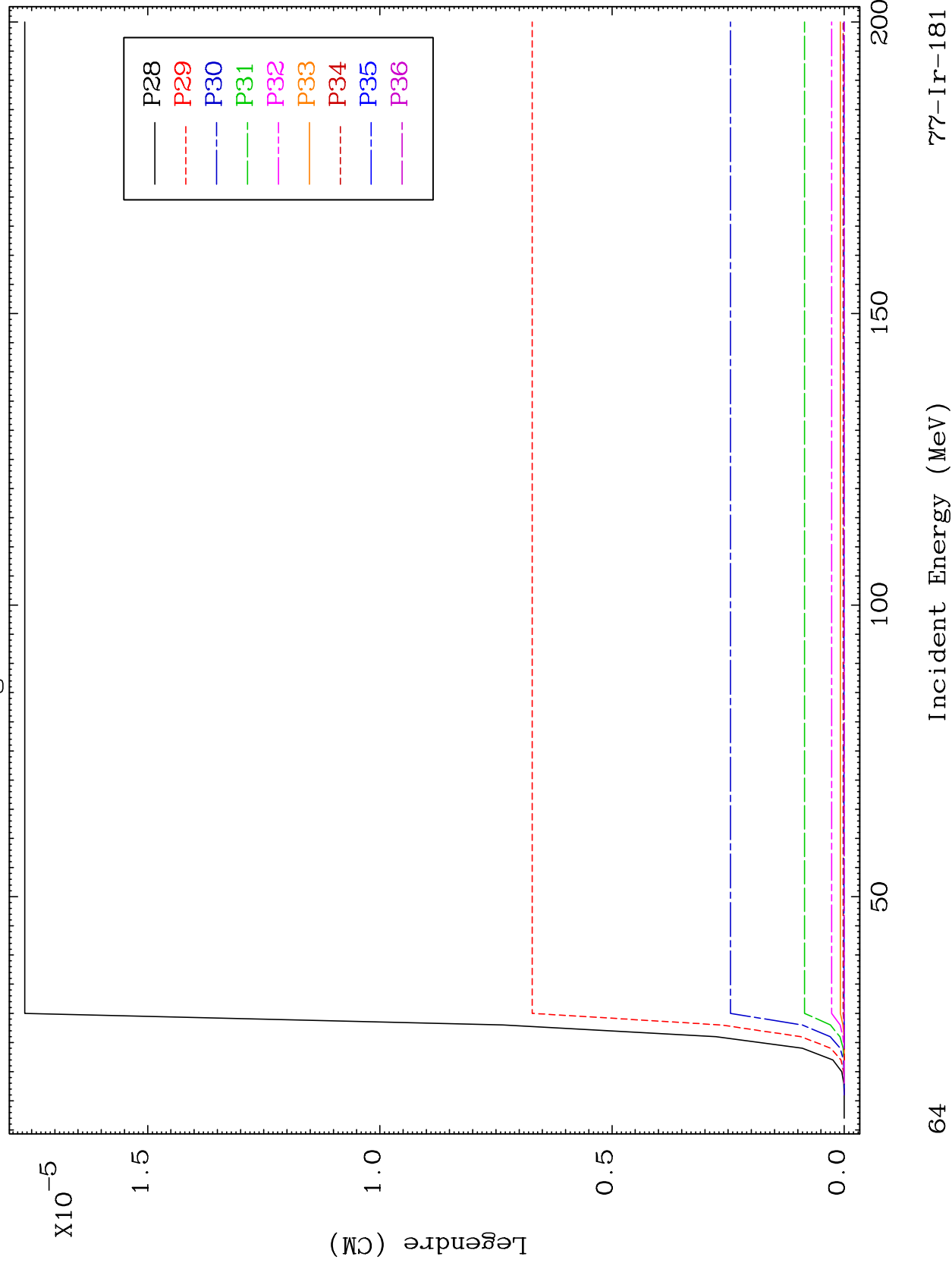

64

77-Ir-181

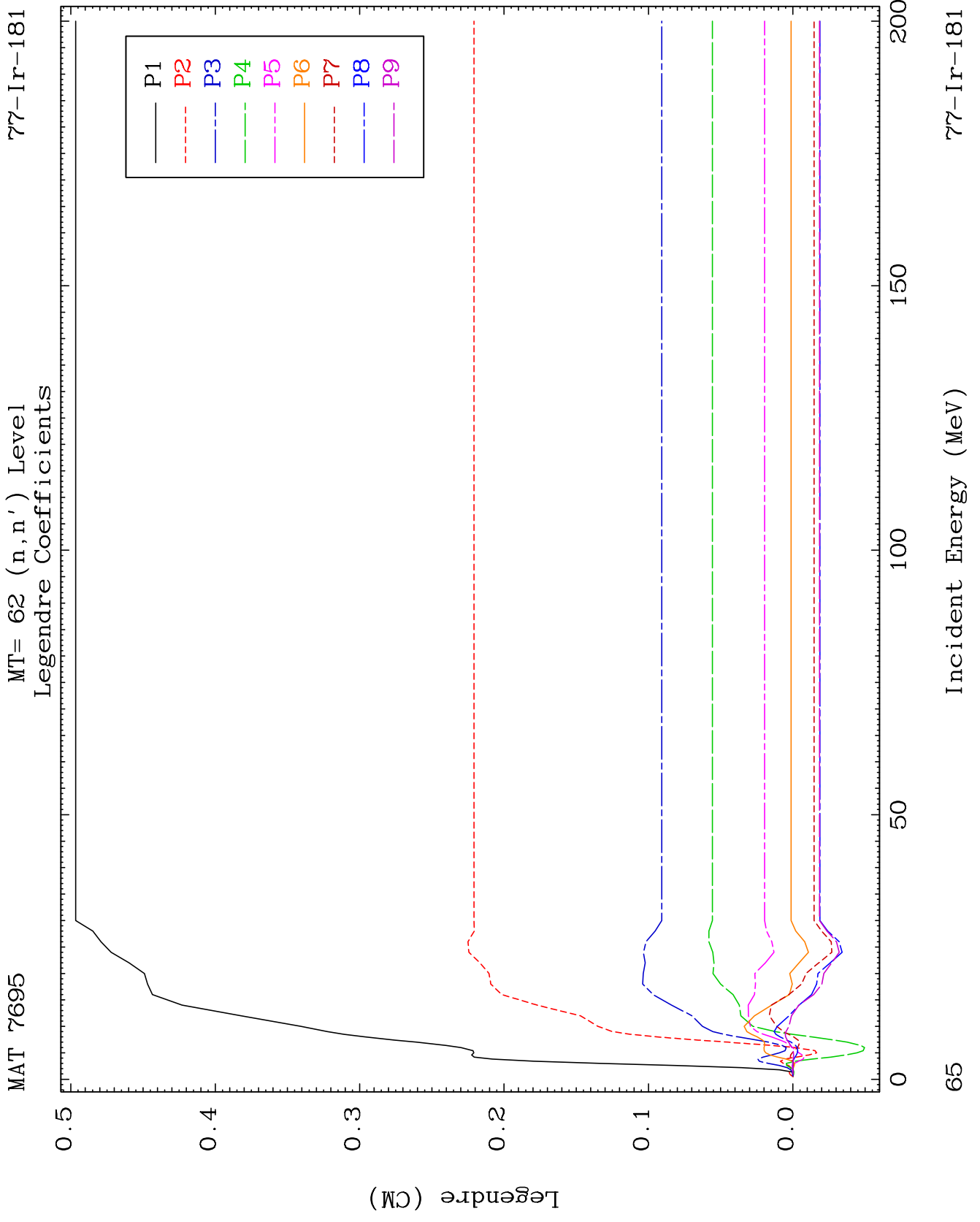

MAT 7695

MT= 62 (n,n') Level
Legendre Coefficients

77-Ir-181

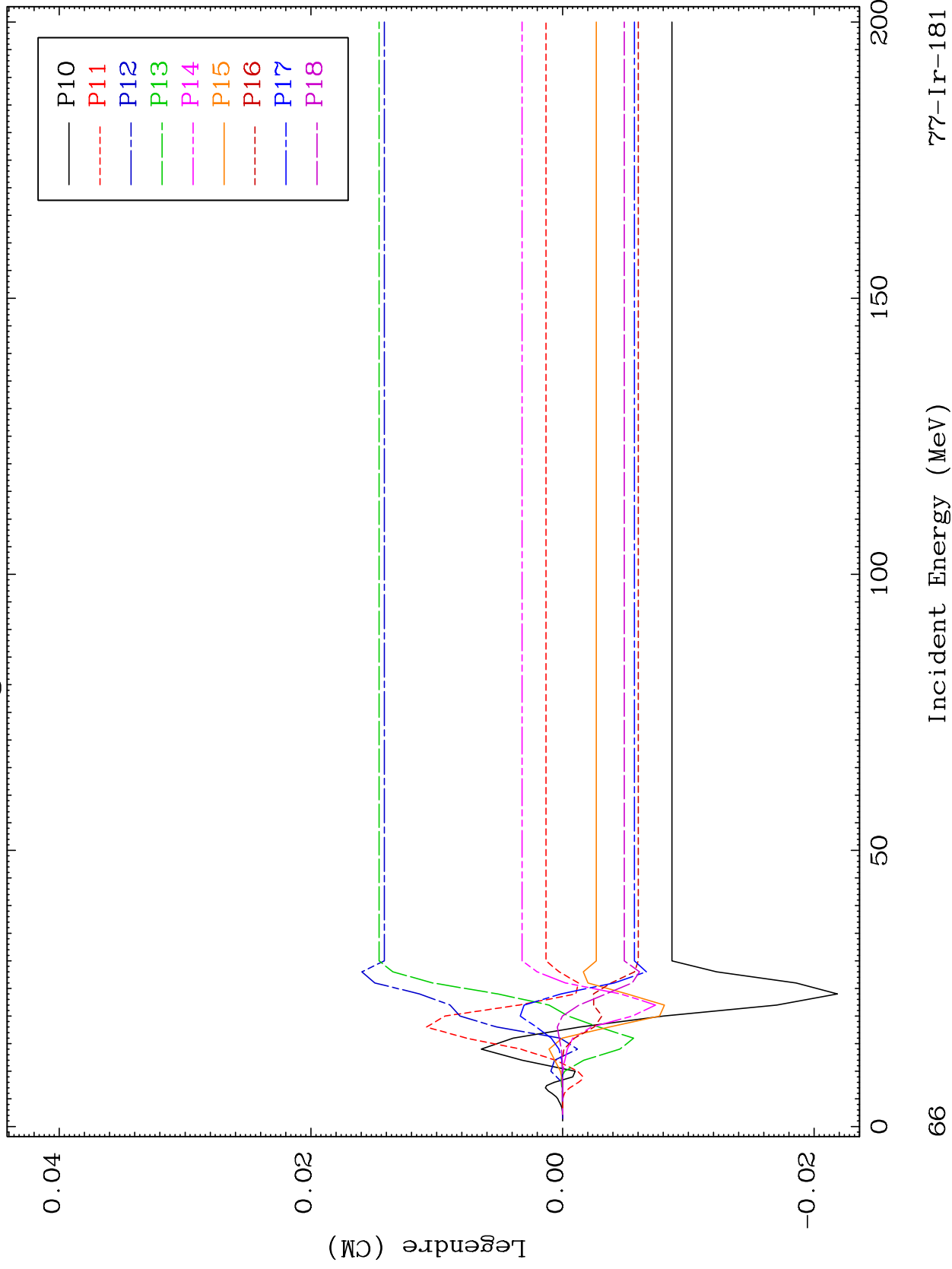

77-Ir-181

Incident Energy (MeV)

66

MAT 7695

MT= 62 (n,n') Level
Legendre Coefficients

77-Ir-181

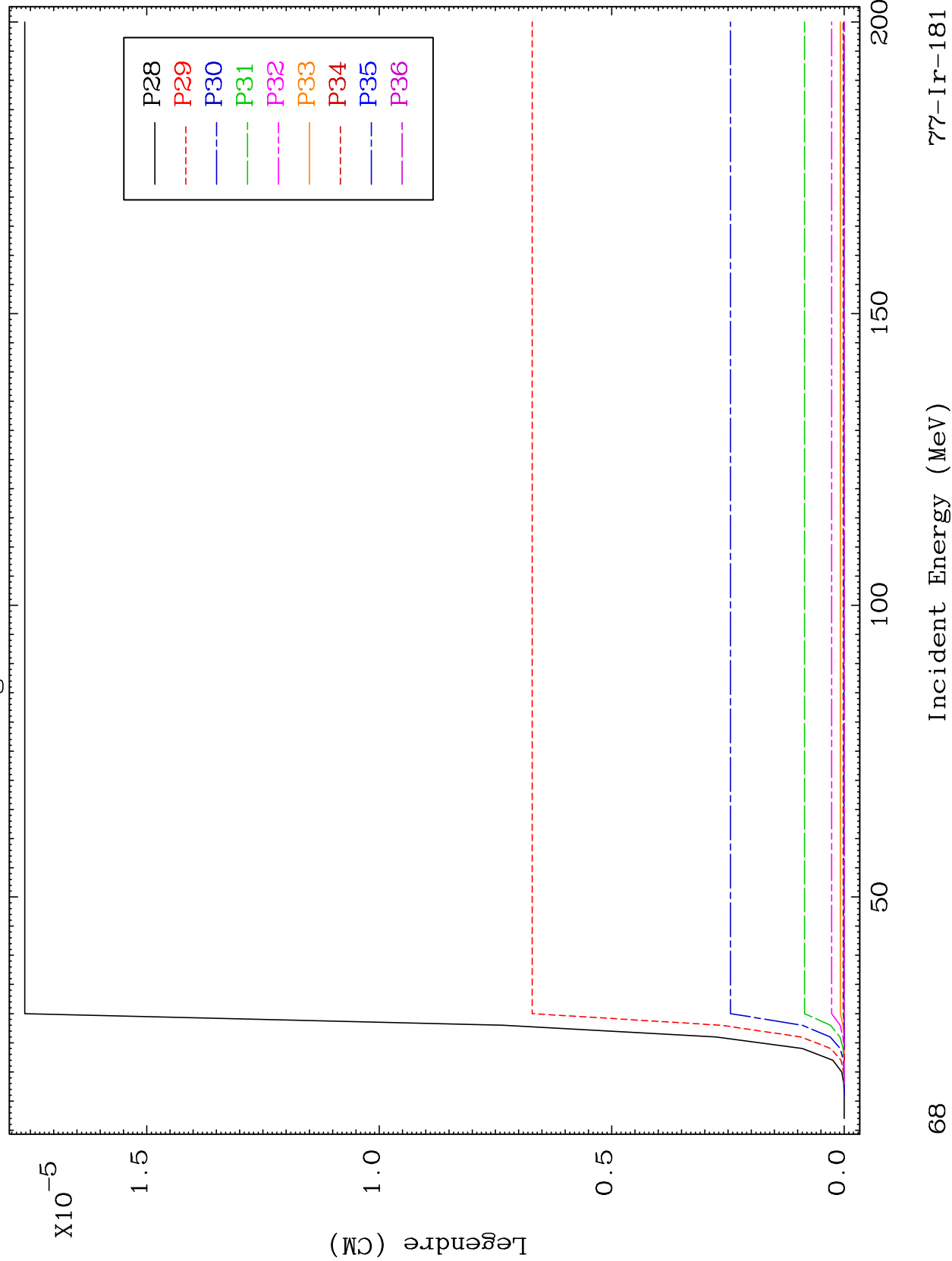

68

77-Ir-181

MAT 7695

MT= 63 (n,n') Level
Legendre Coefficients

77-Ir-181

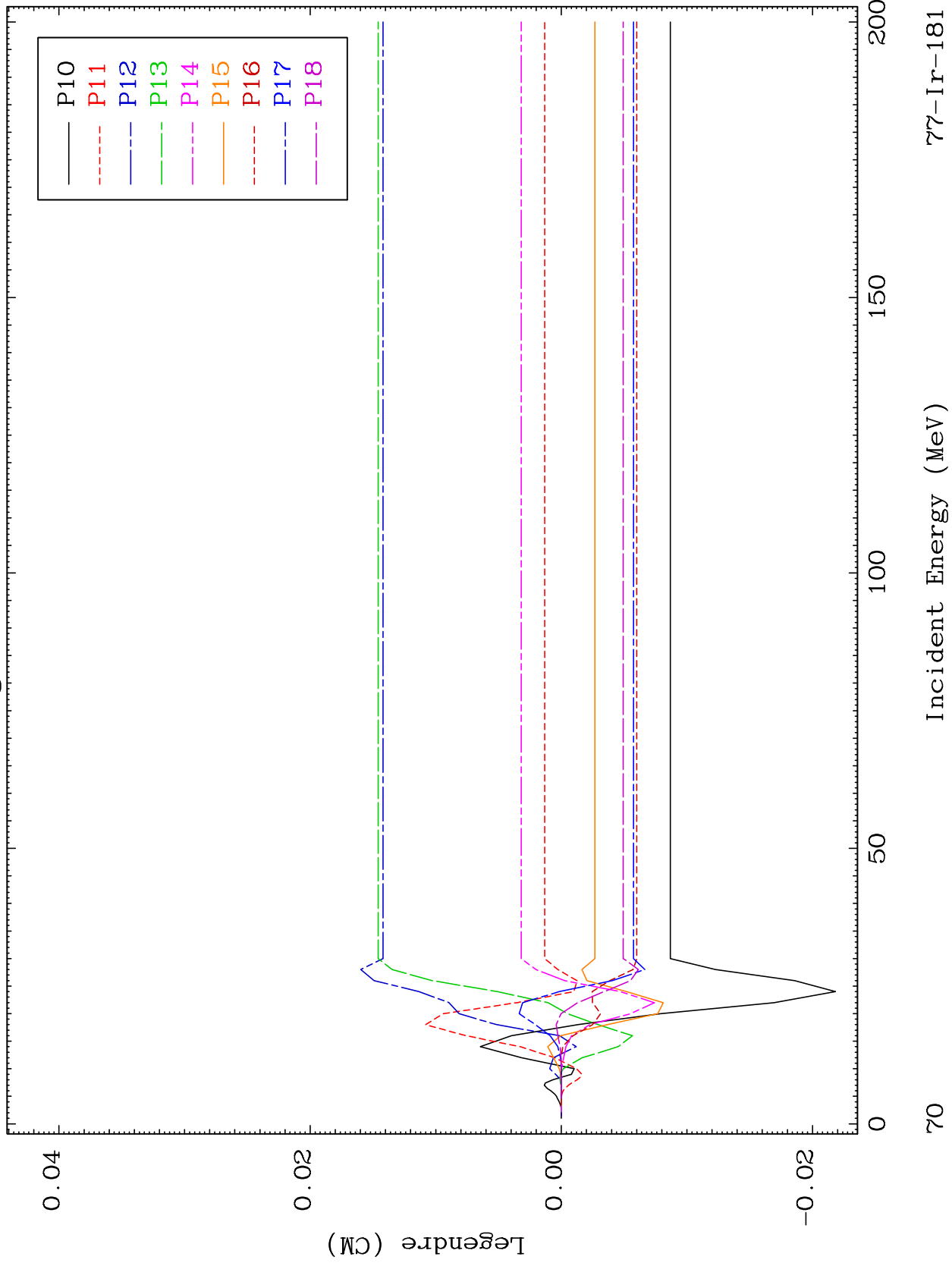

MAT 7695

MT= 63 (n,n') Level
Legendre Coefficients

77-Ir-181

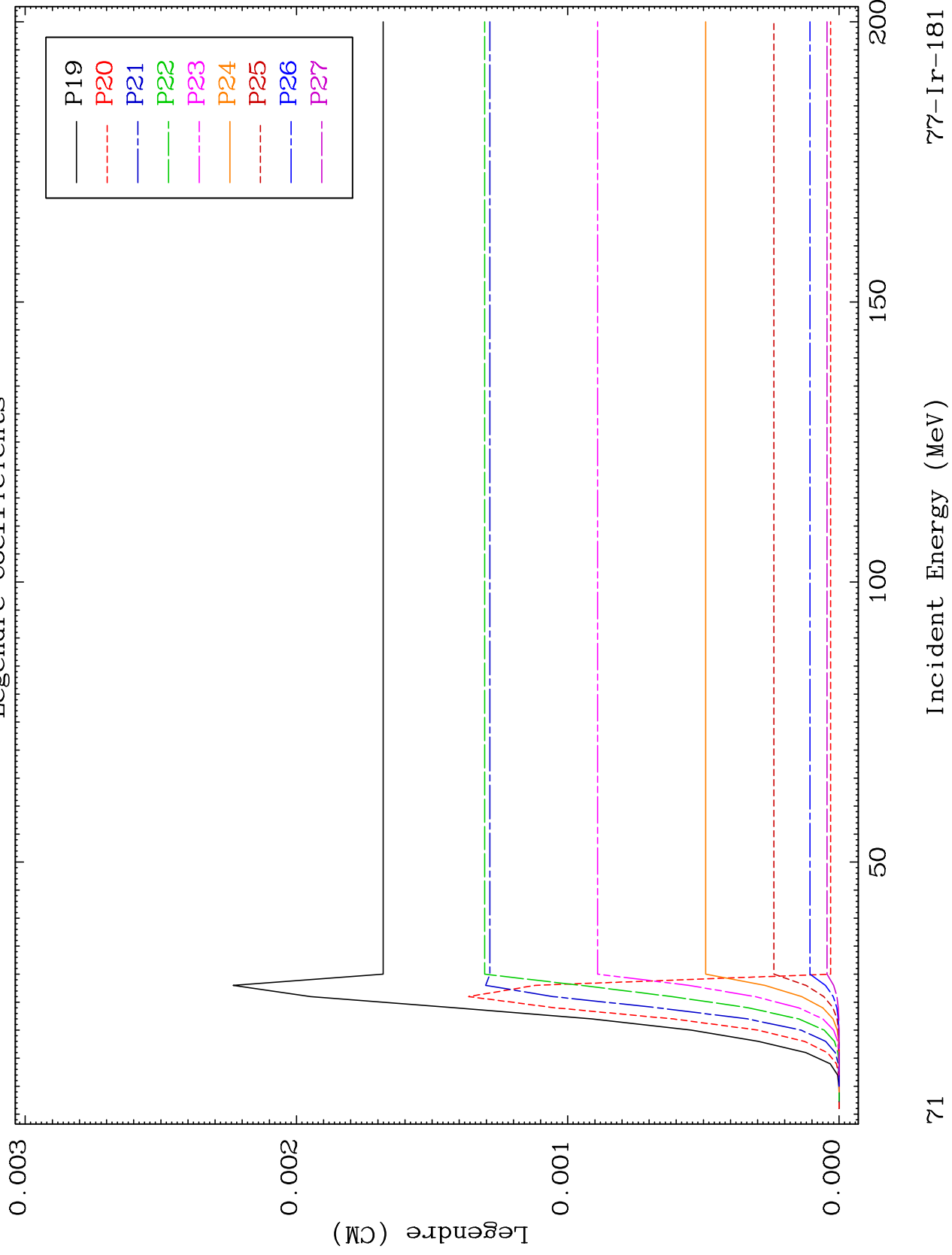

71

Incident Energy (MeV)

77-Ir-181

MAT 7695

MT= 63 (n,n') Level
Legendre Coefficients

77-Ir-181

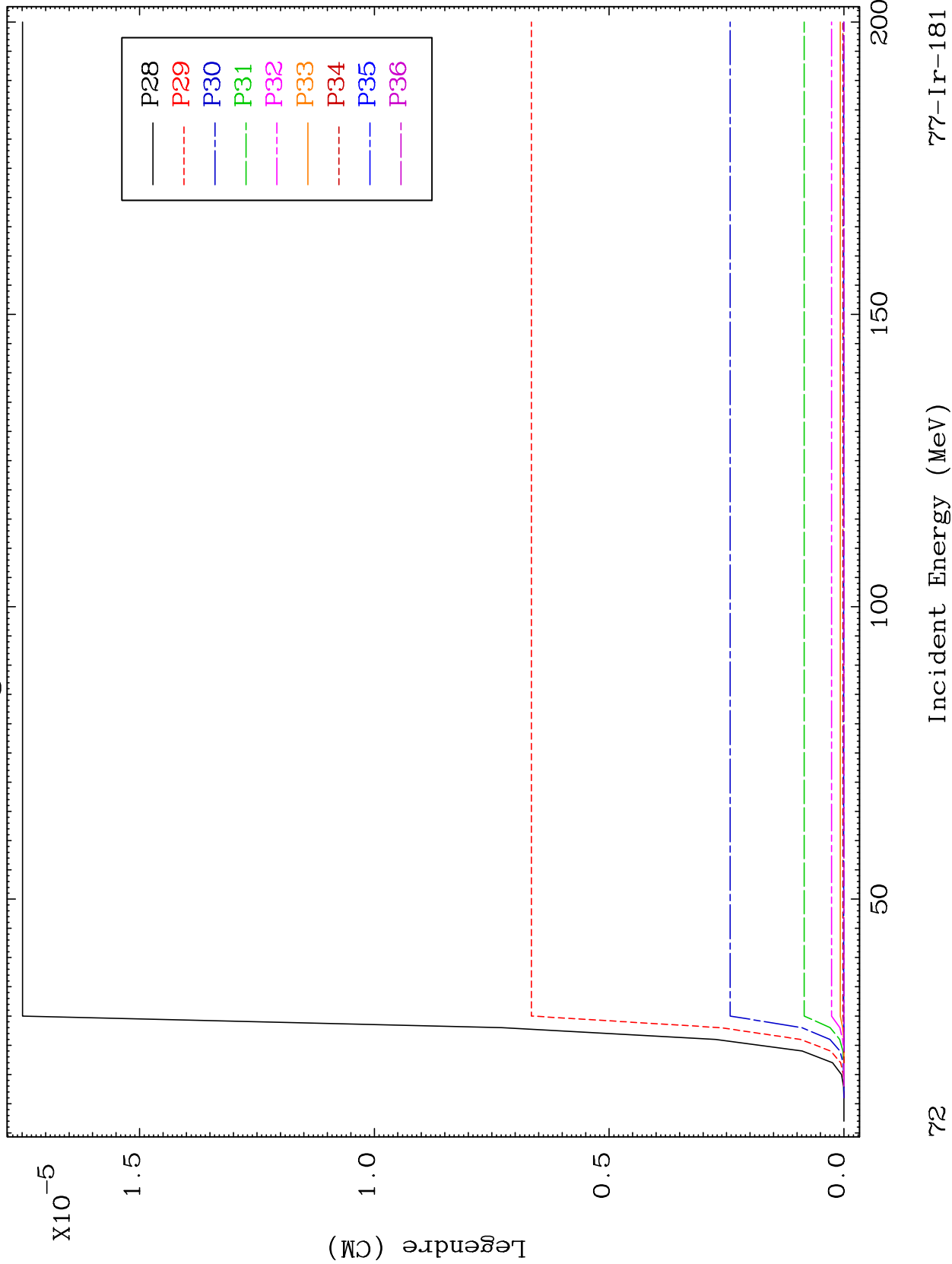

72

77-Ir-181

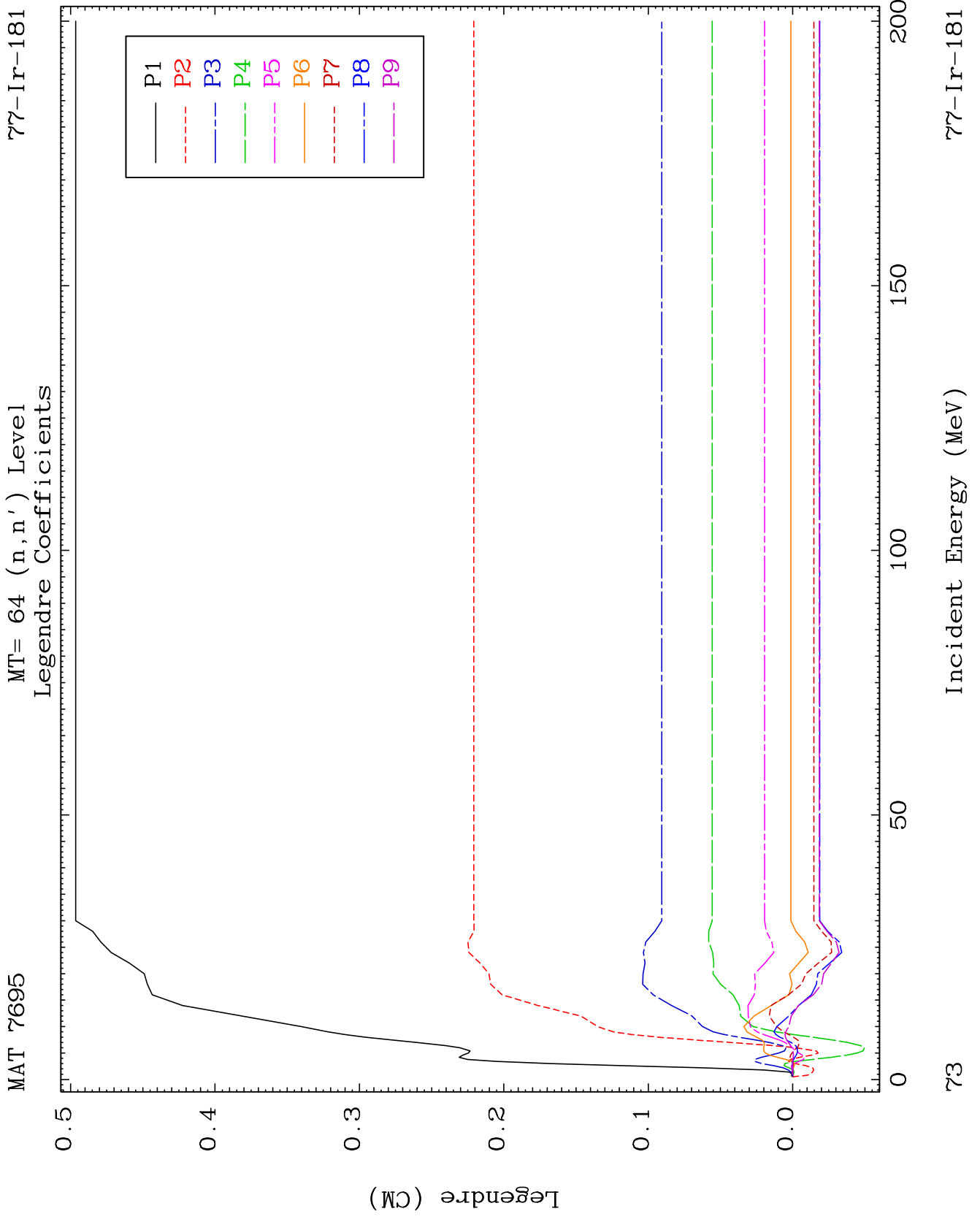

MAT 7695

MT= 64 (n,n') Level
Legendre Coefficients

77-Ir-181

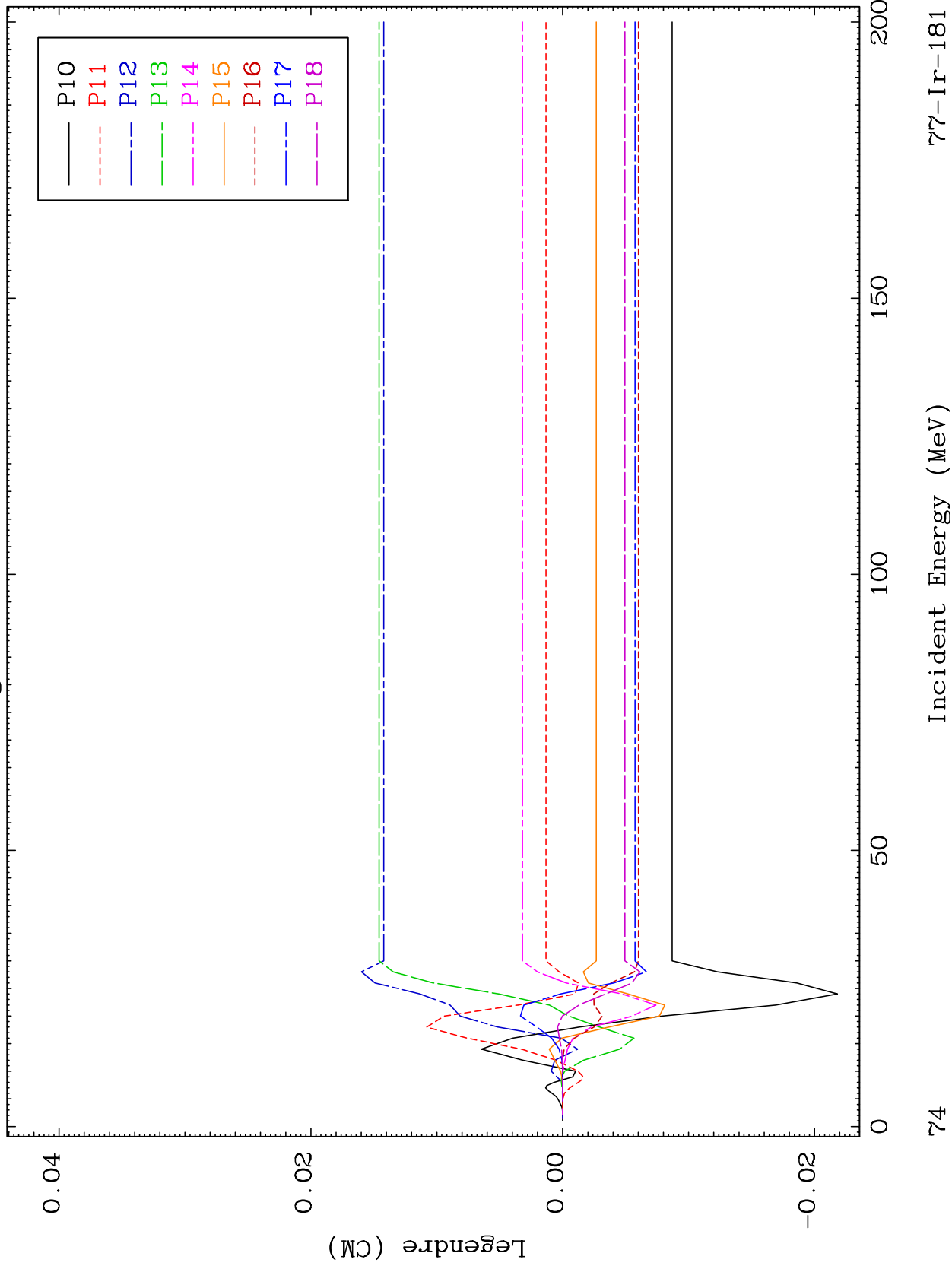

74

Incident Energy (MeV)

77-Ir-181

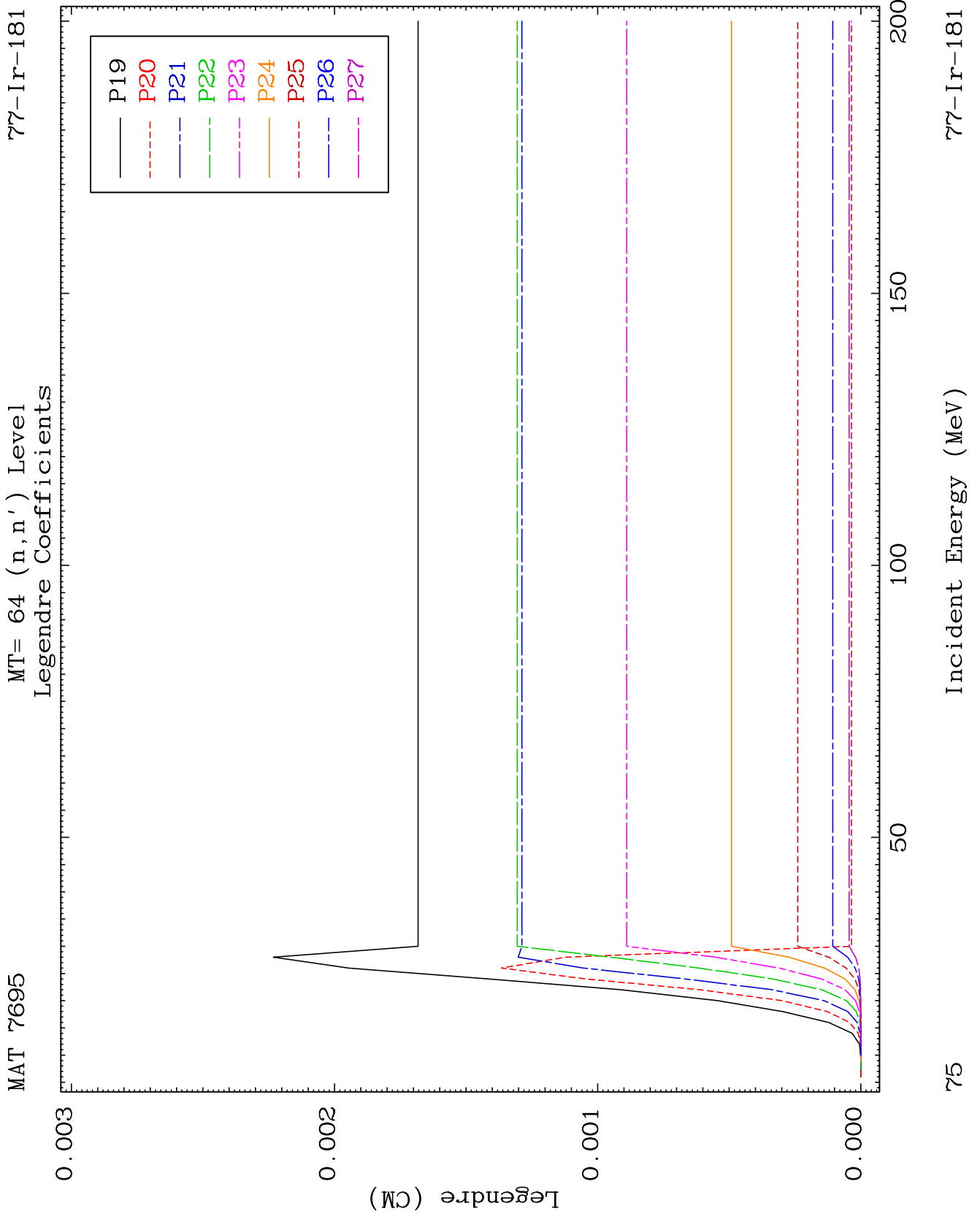

MAT 7695

MT= 64 (n,n') Level
Legendre Coefficients

77-Ir-181

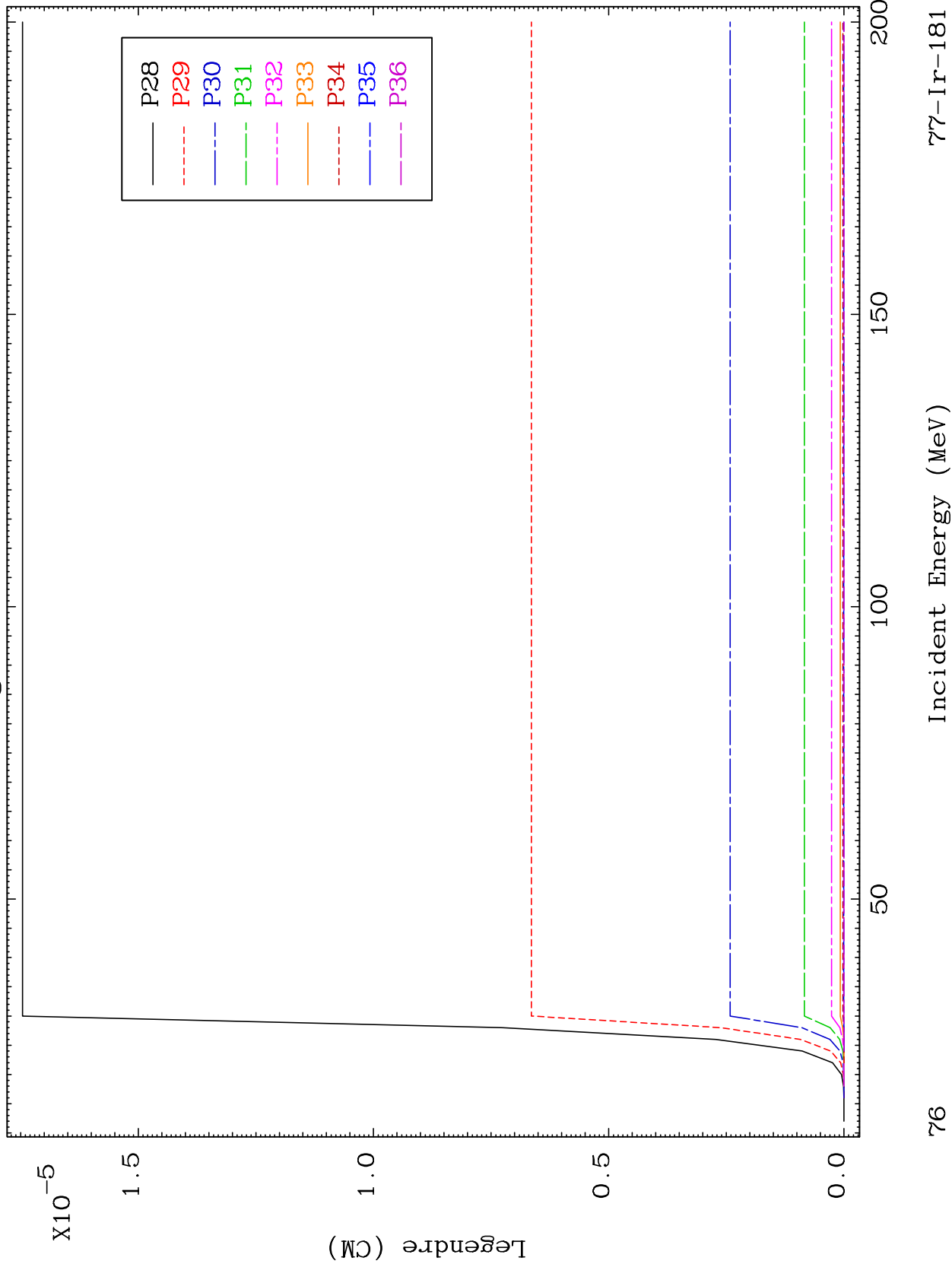

76

77-Ir-181

MAT 7695

MT= 65 (n,n') Level
Legendre Coefficients

77-Ir-181

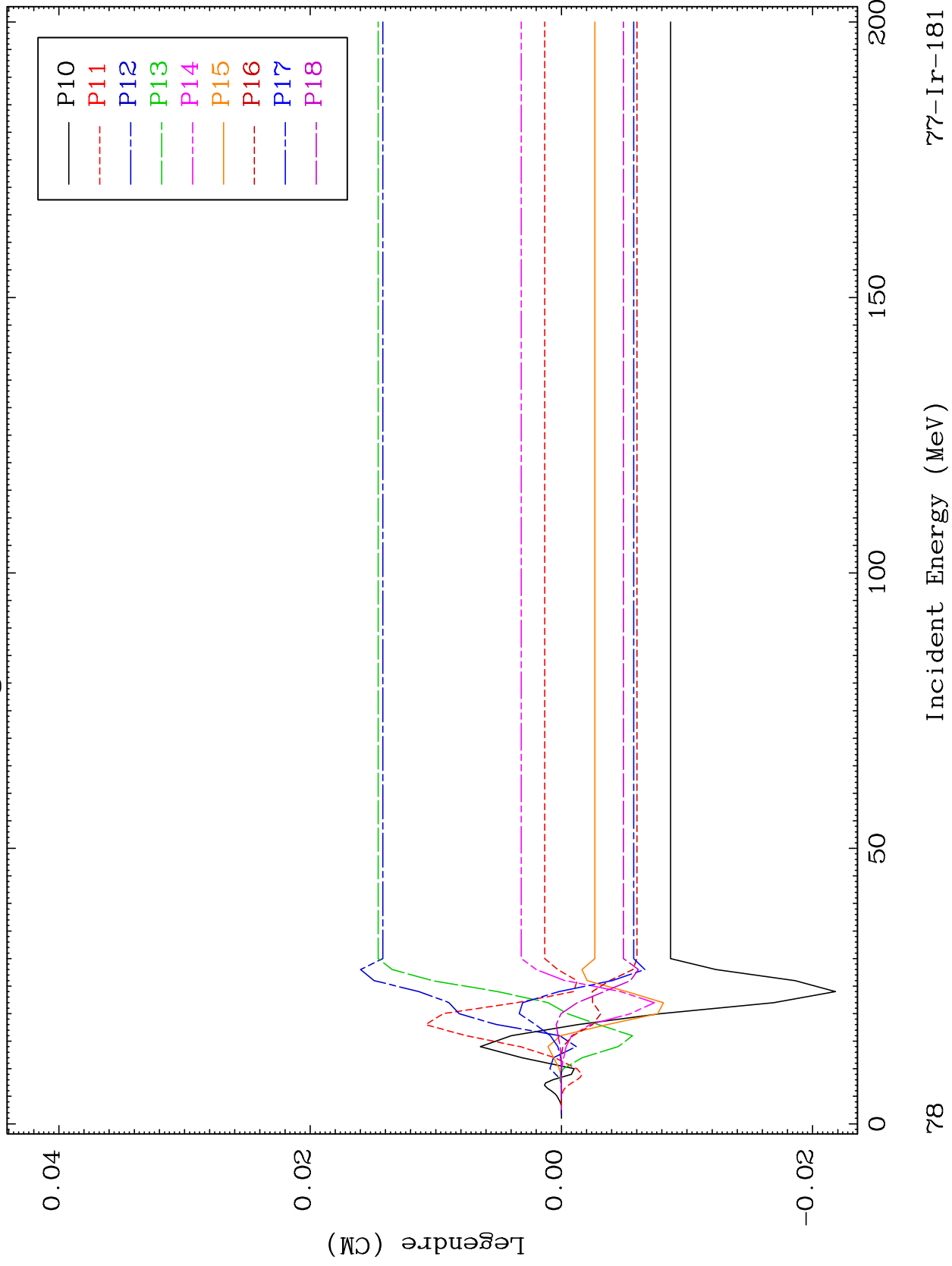

77-Ir-181

Incident Energy (MeV)

78

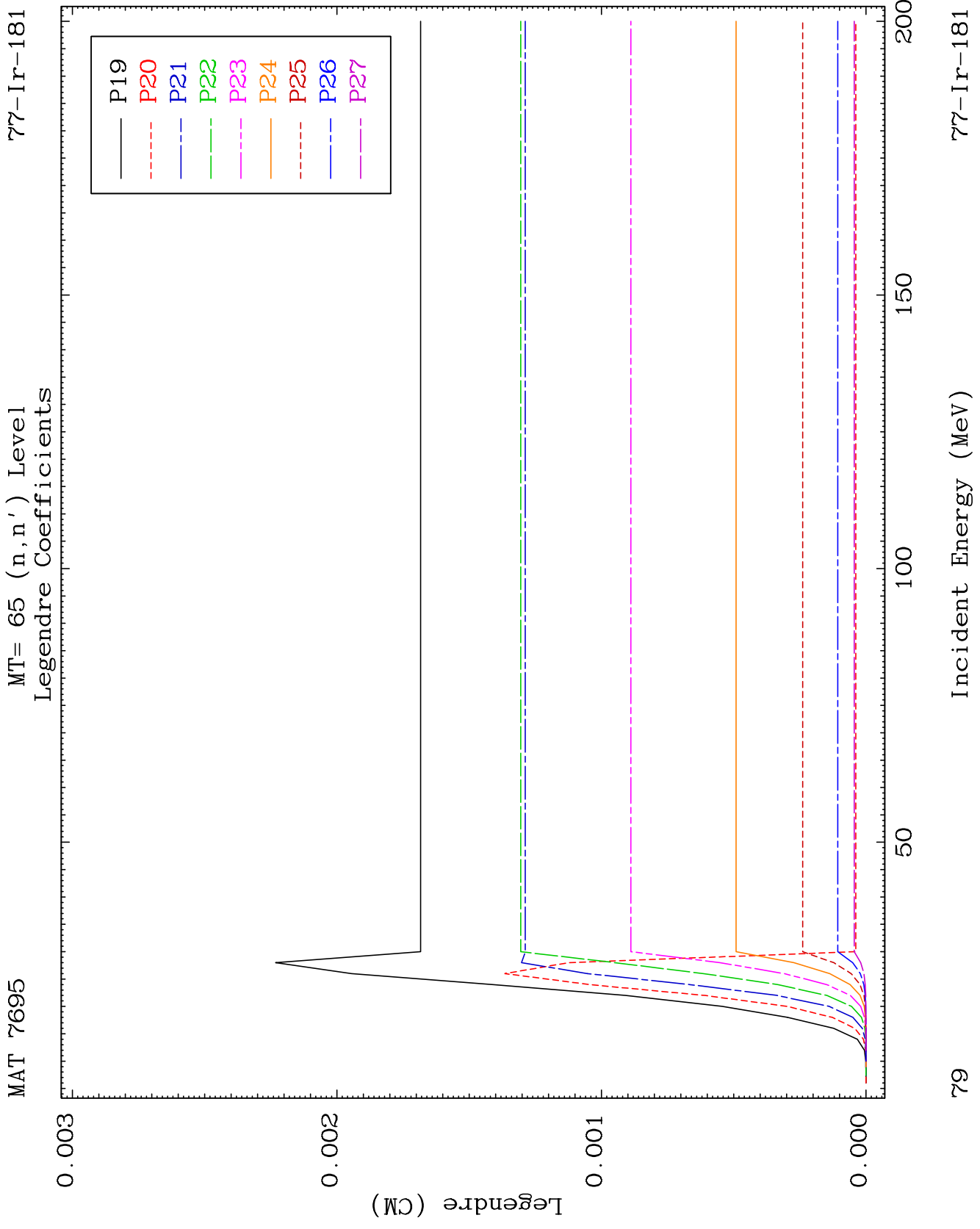

MAT 7695

MT= 65 (n,n') Level
Legendre Coefficients

77-Ir-181

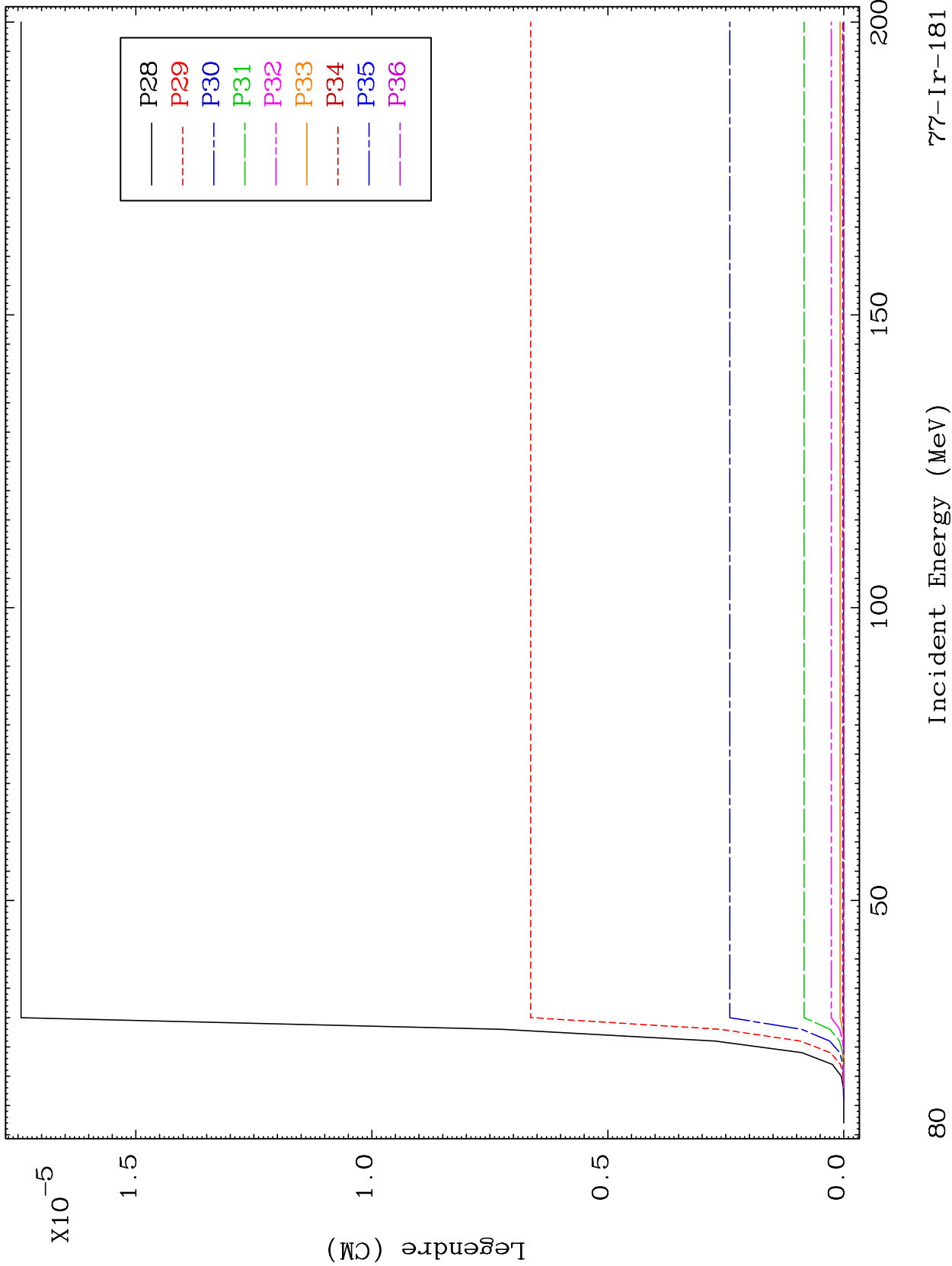

MAT 7695

MT= 66 (n,n') Level
Legendre Coefficients

⁷⁷Ir-181

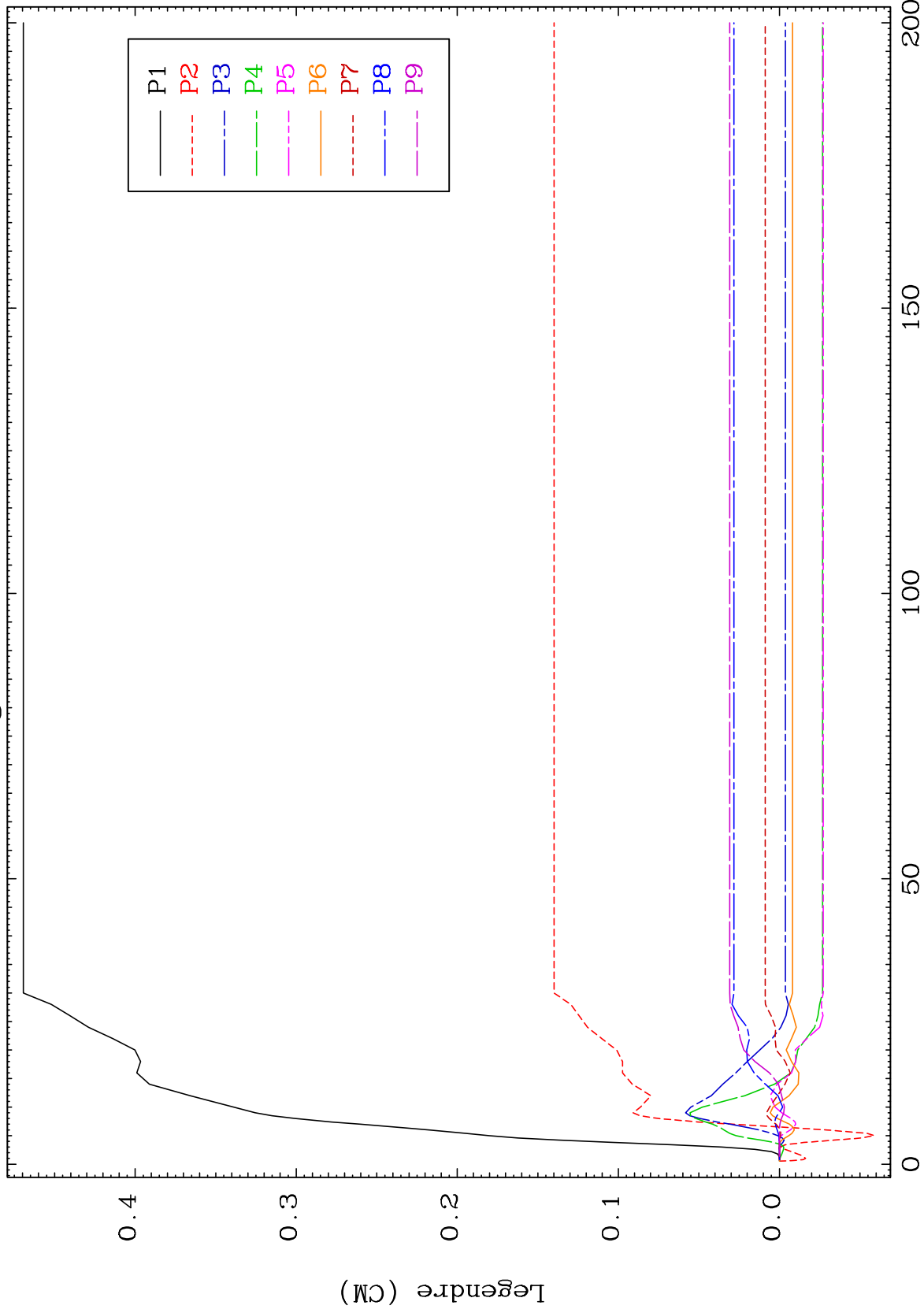

81

Incident Energy (MeV)

⁷⁷Ir-181

MAT 7695

MT= 66 (n,n') Level
Legendre Coefficients

77-Ir-181

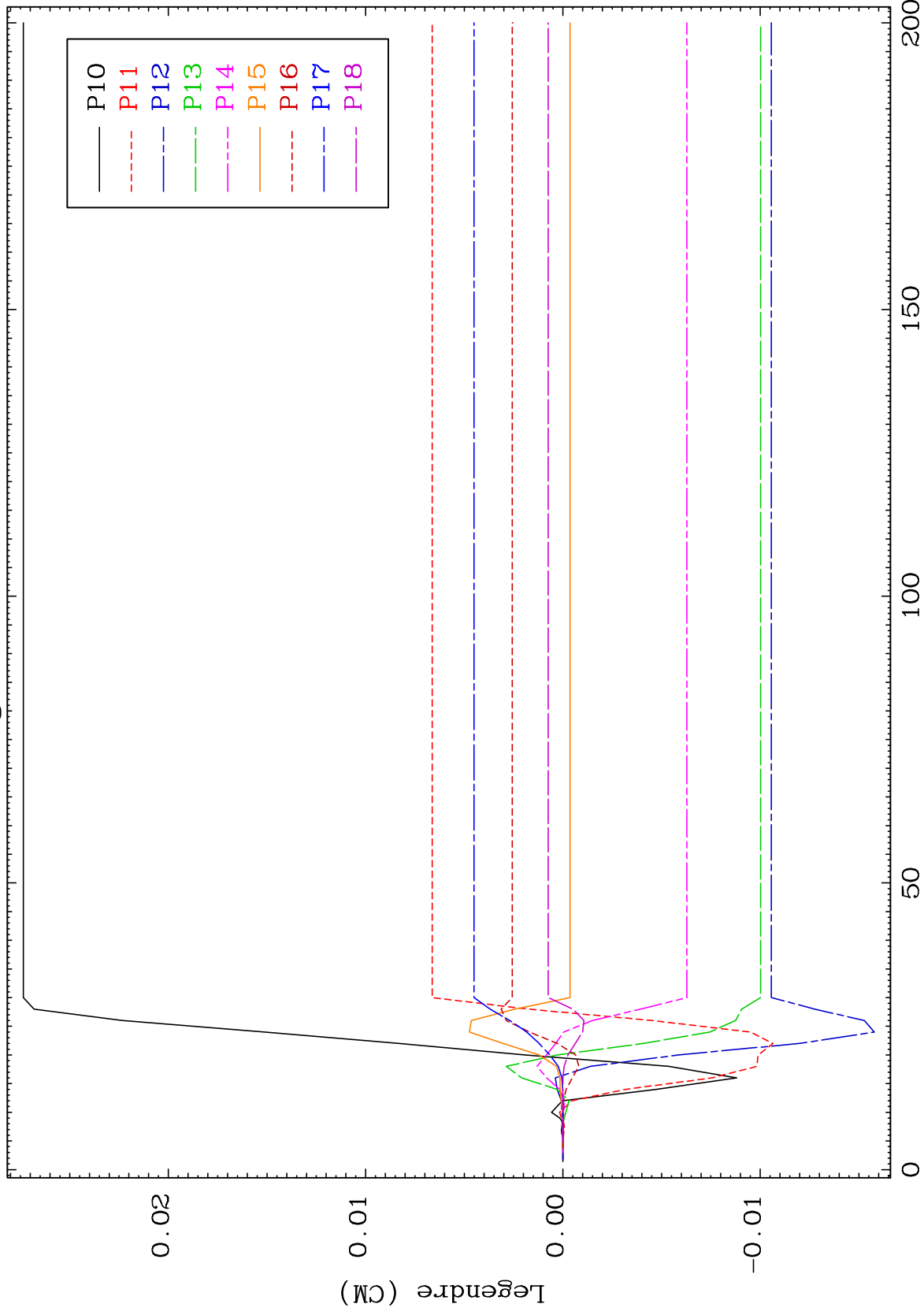

82

Incident Energy (MeV)

77-Ir-181

MAT 7695

MT= 66 (n,n') Level
Legendre Coefficients

77-Ir-181

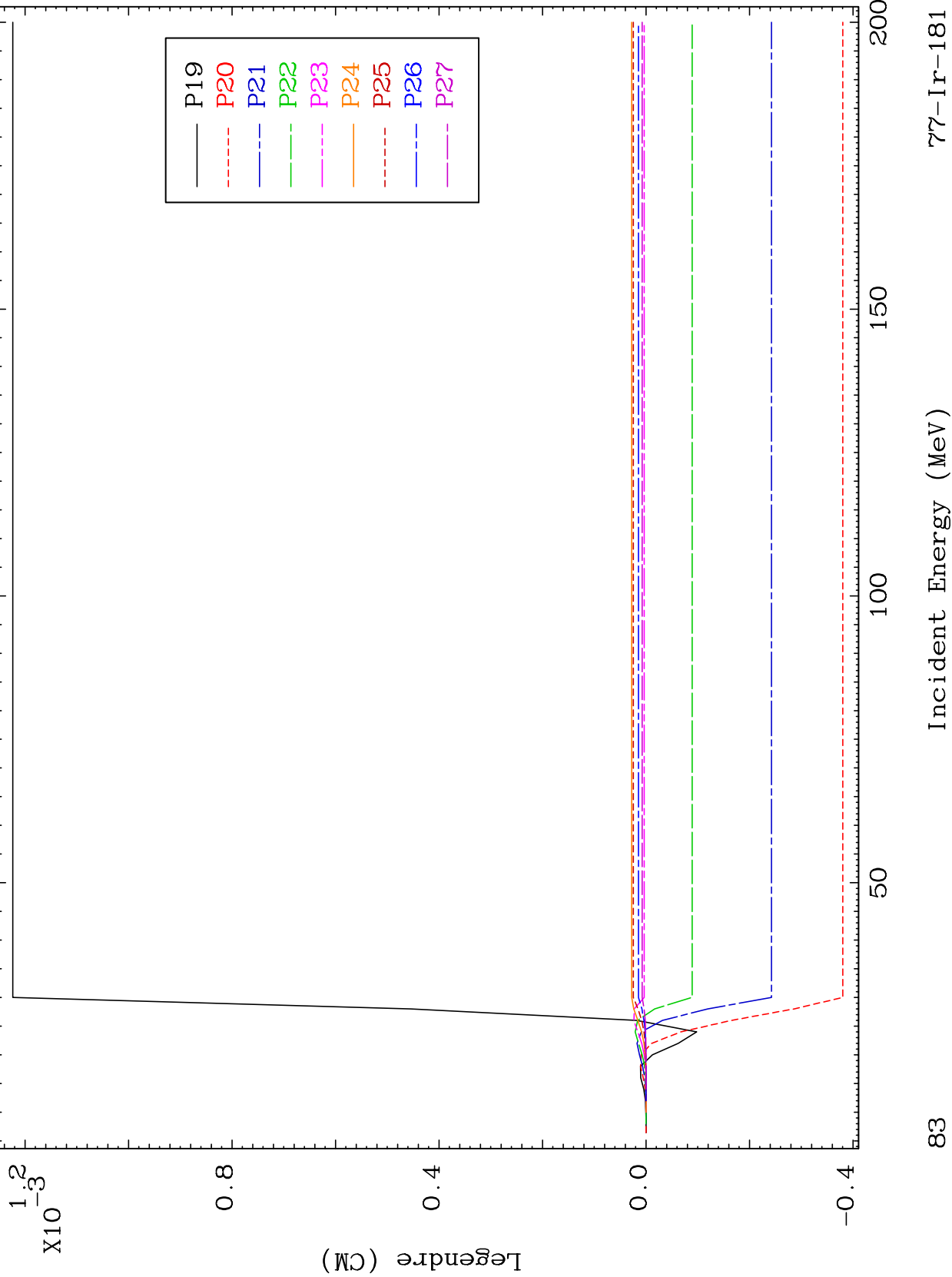

83

77-Ir-181

MAT 7695

MT= 66 (n,n') Level
Legendre Coefficients

77-Ir-181

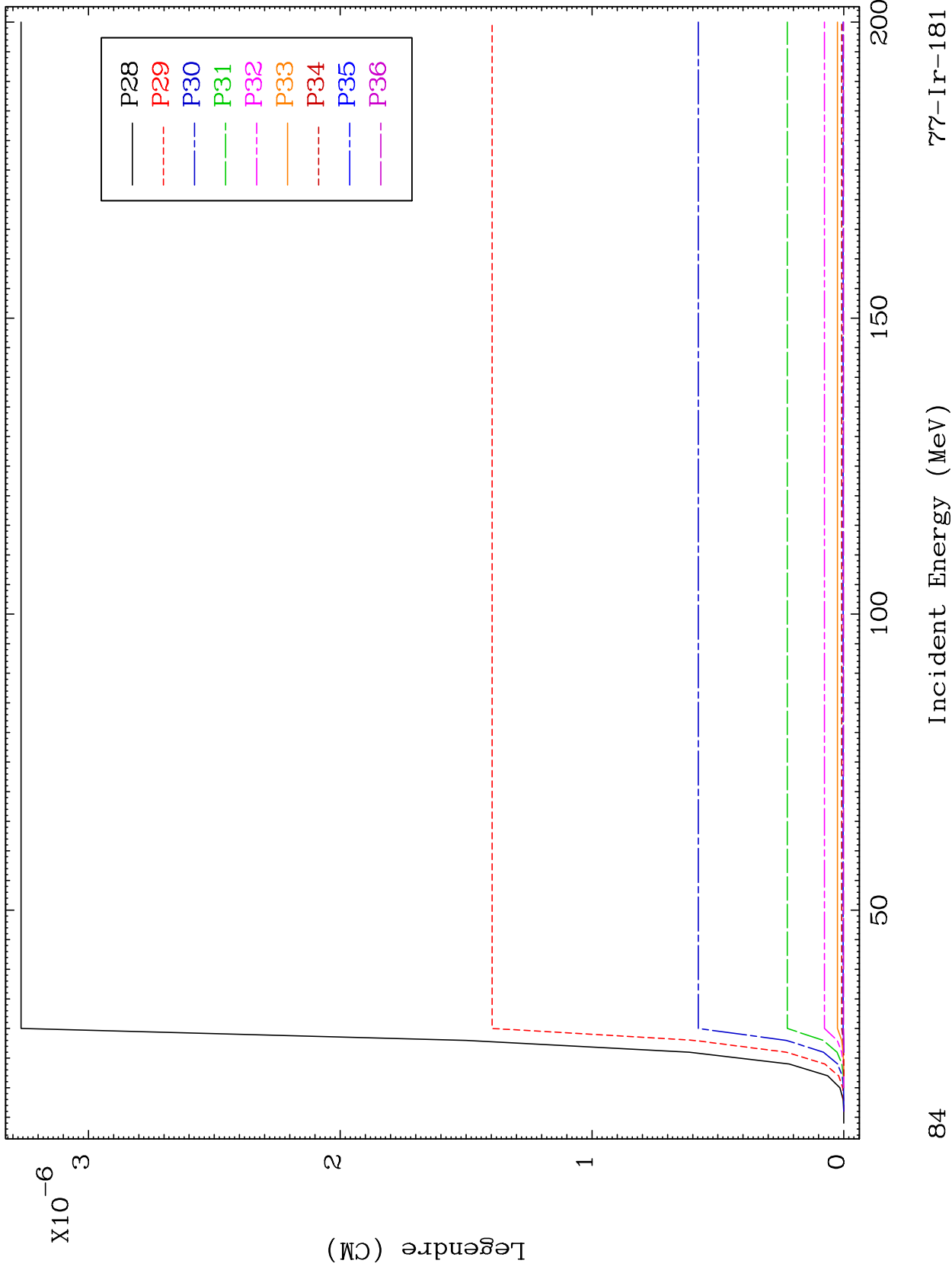

MAT 7695

MT= 67 (n,n') Level
Legendre Coefficients

⁷⁷Ir-181

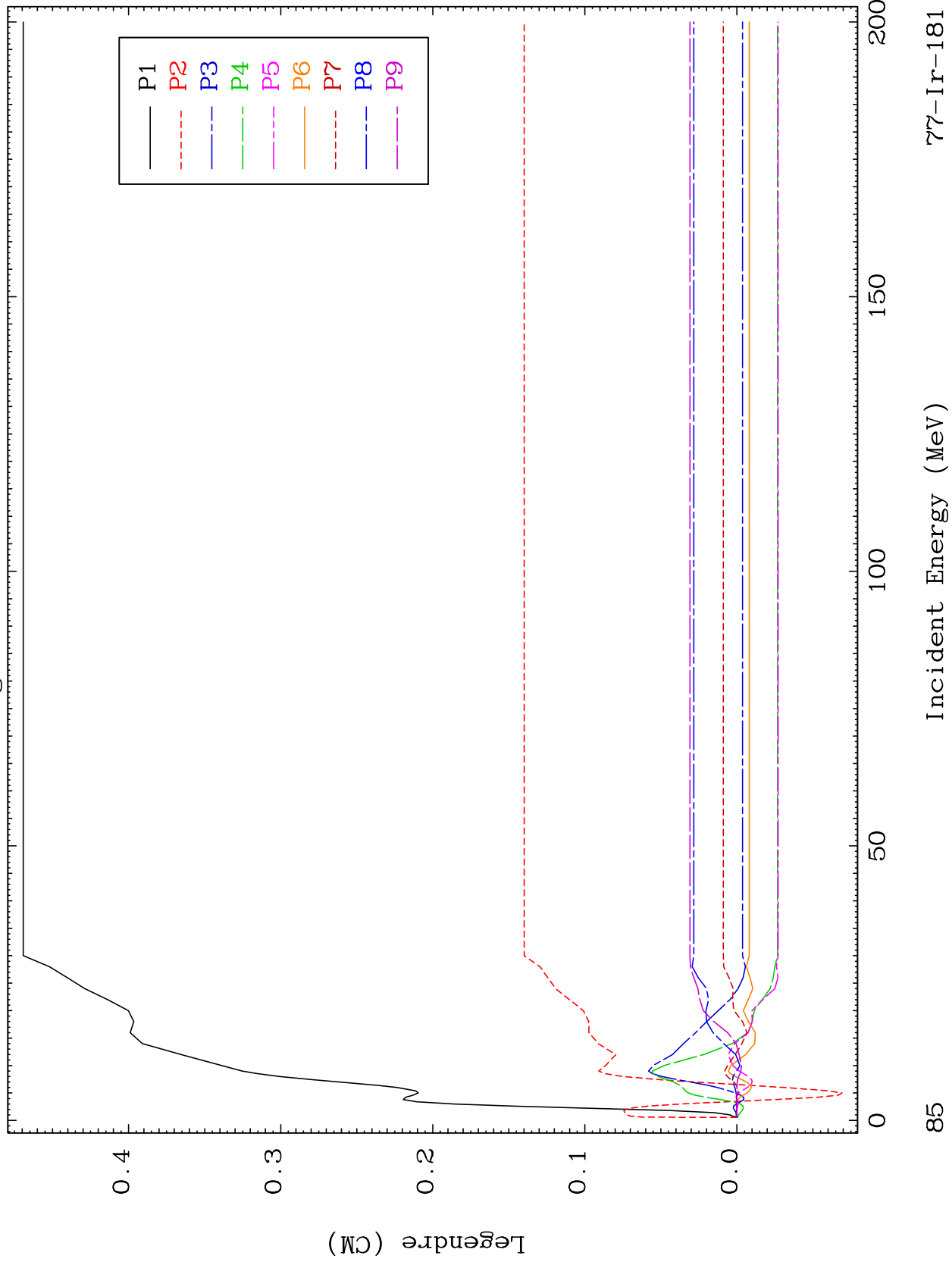

⁷⁷Ir-181

Incident Energy (MeV)

85

MAT 7695

MT= 67 (n,n') Level
Legendre Coefficients

77-Ir-181

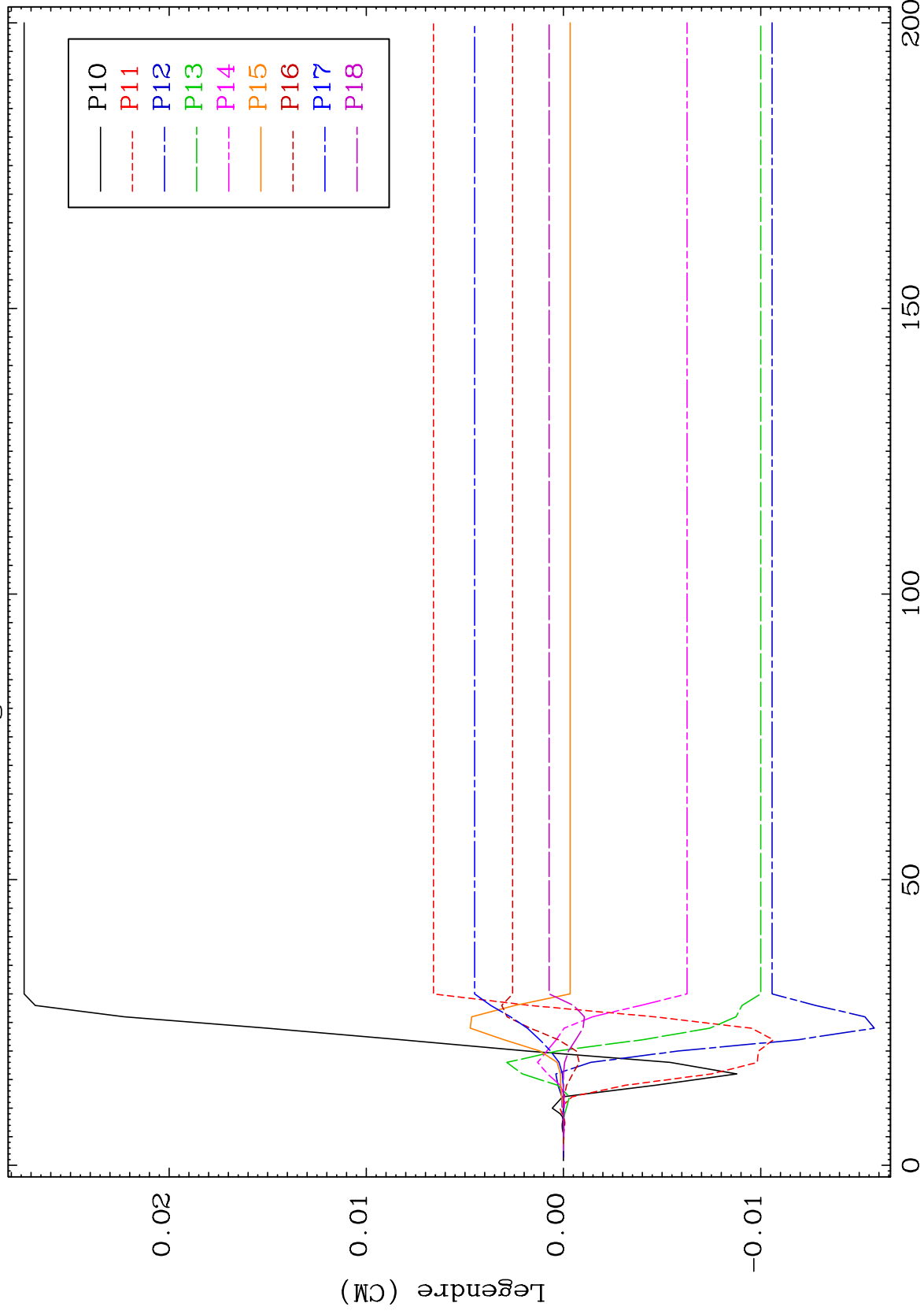

86

Incident Energy (MeV)

77-Ir-181

MAT 7695

MT= 67 (n,n') Level
Legendre Coefficients

77-Ir-181

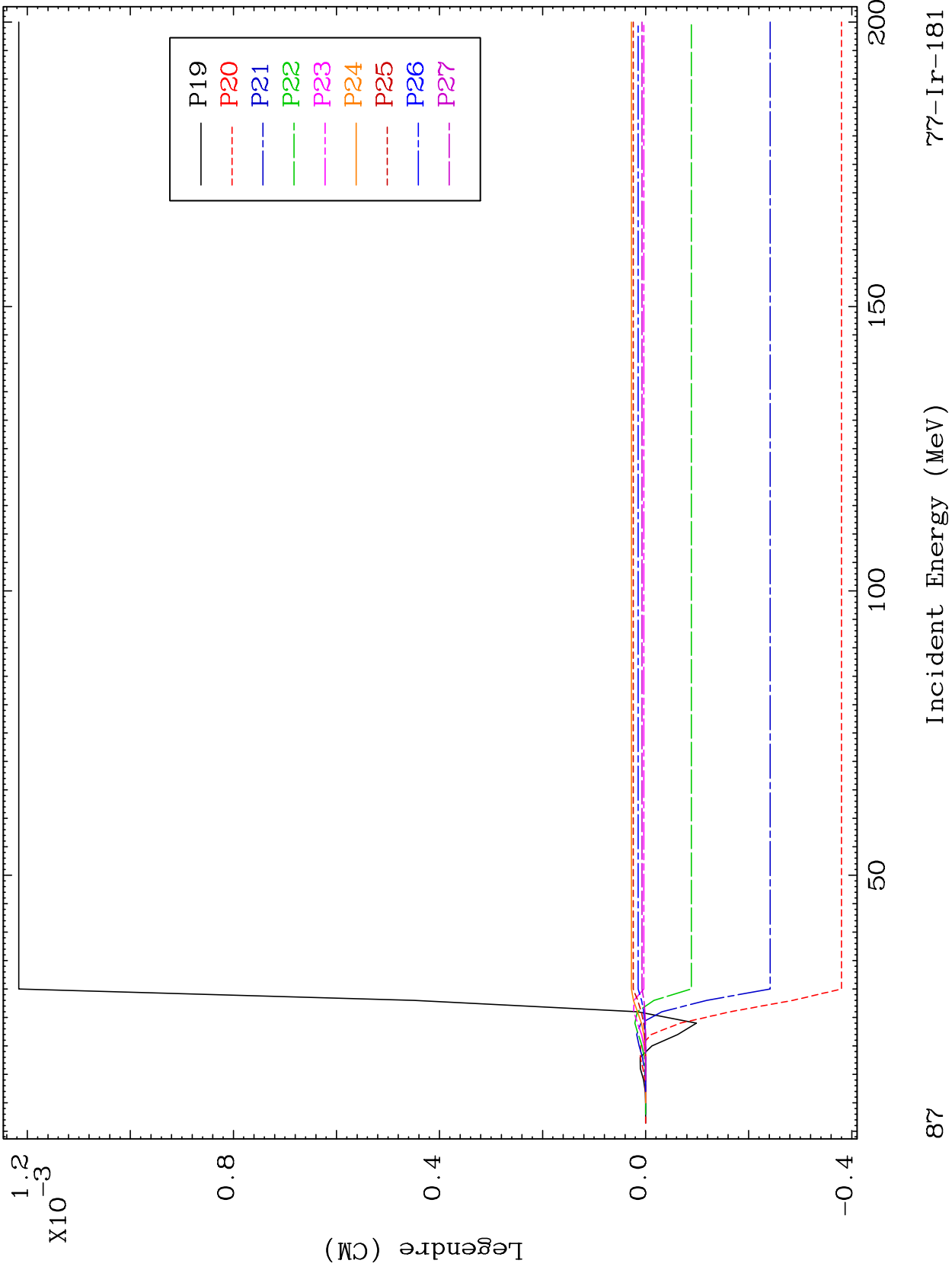

87

Incident Energy (MeV)

77-Ir-181

MAT 7695

MT= 67 (n,n') Level
Legendre Coefficients

77-Ir-181

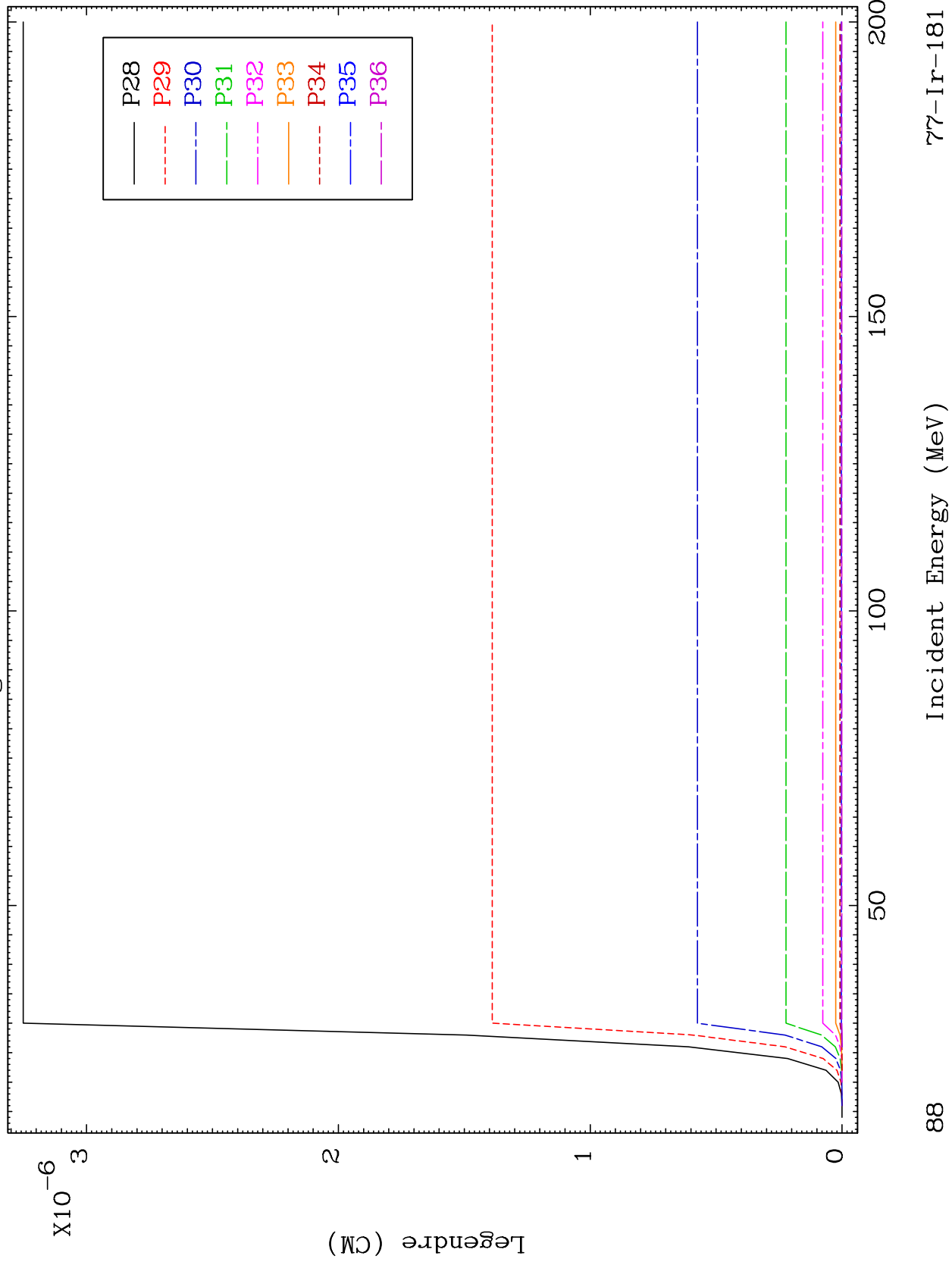

88

MAT 7695

MT= 68 (n,n') Level
Legendre Coefficients

77-Ir-181

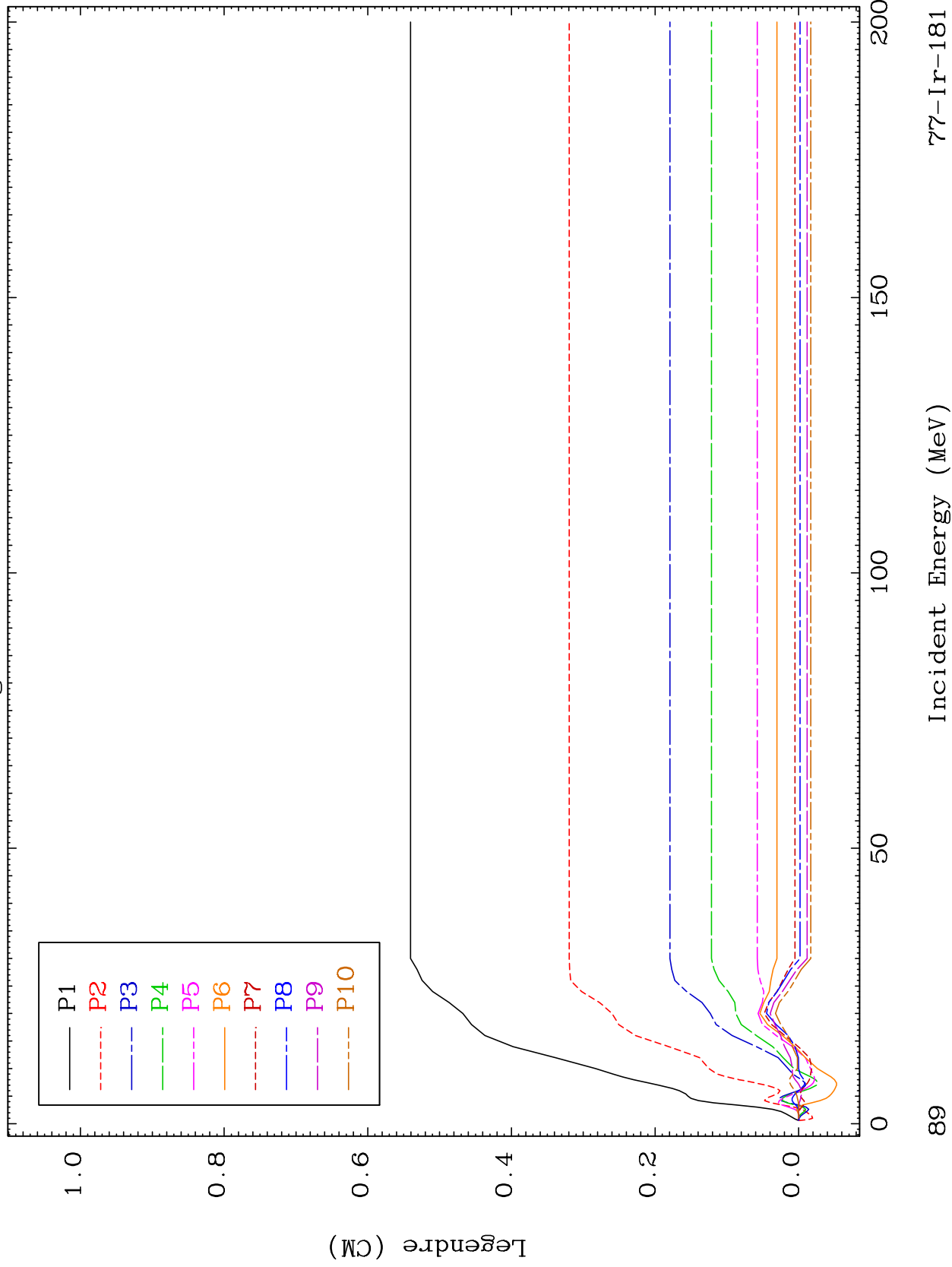

89

MAT 7695

MT= 68 (n,n') Level
Legendre Coefficients

77-Ir-181

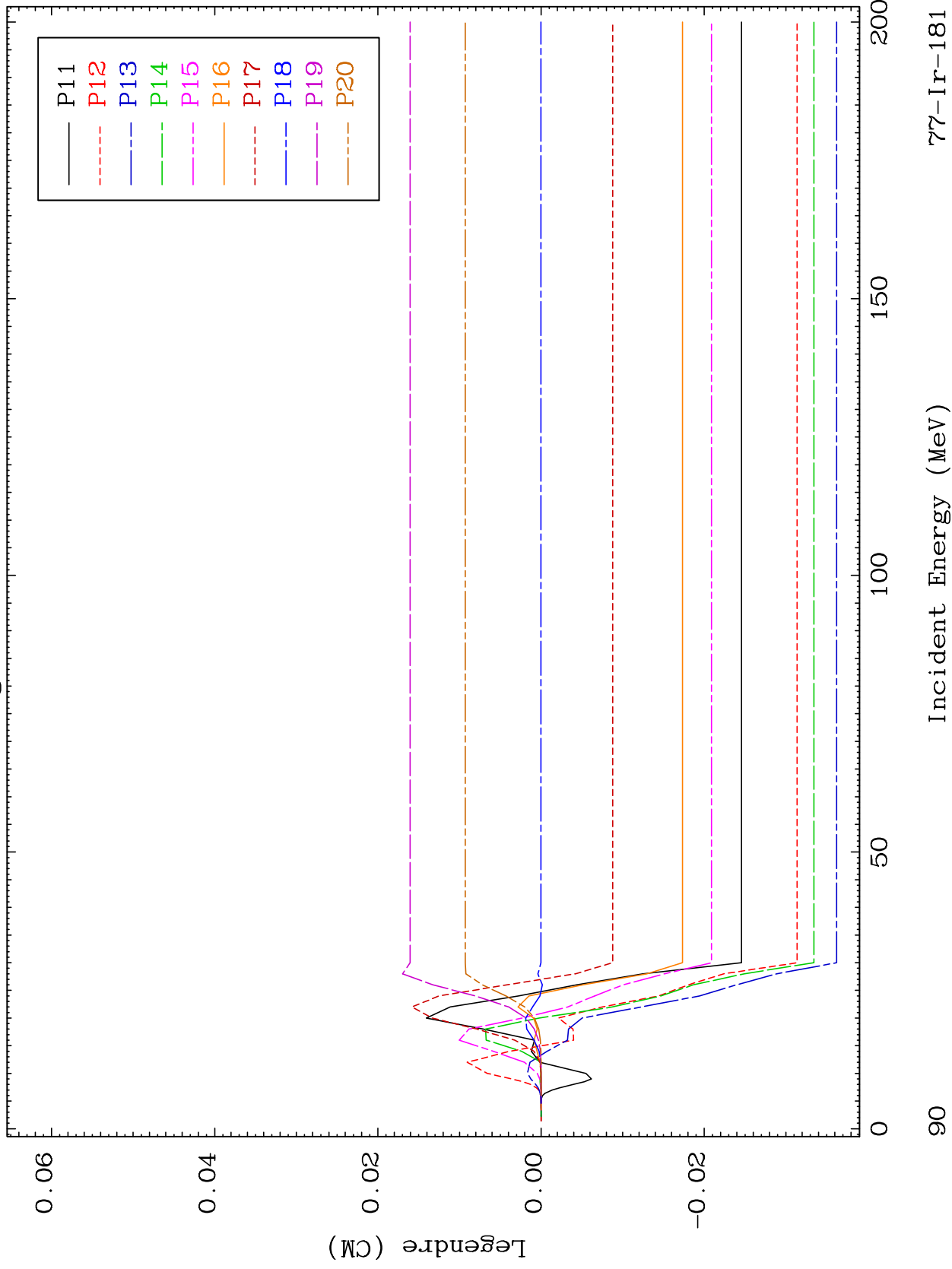

77-Ir-181

Incident Energy (MeV)

90

MAT 7695

MT= 68 (n,n') Level
Legendre Coefficients

77-Ir-181

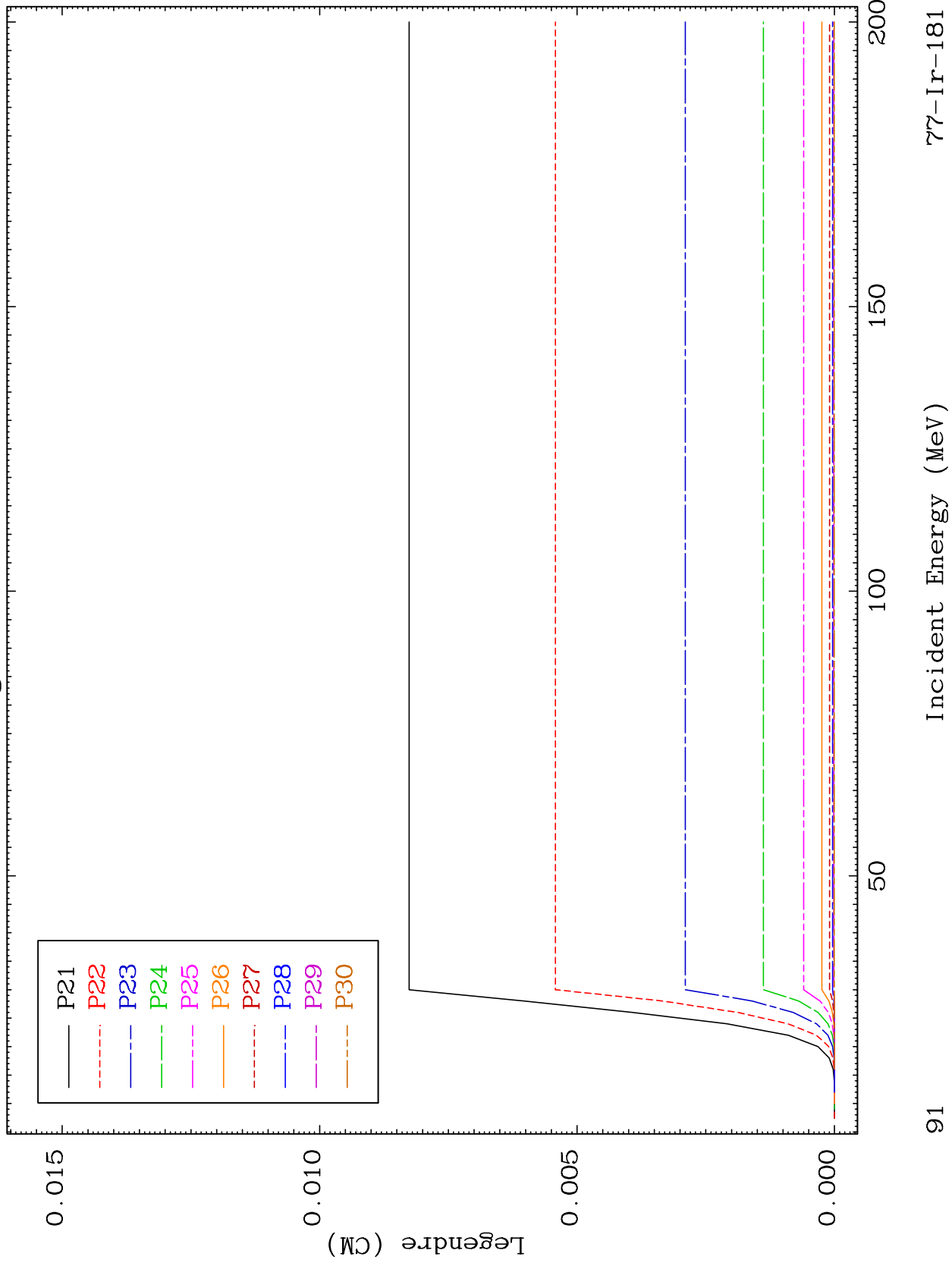

91

77-Ir-181

MAT 7695

MT= 68 (n,n') Level
Legendre Coefficients

77-Ir-181

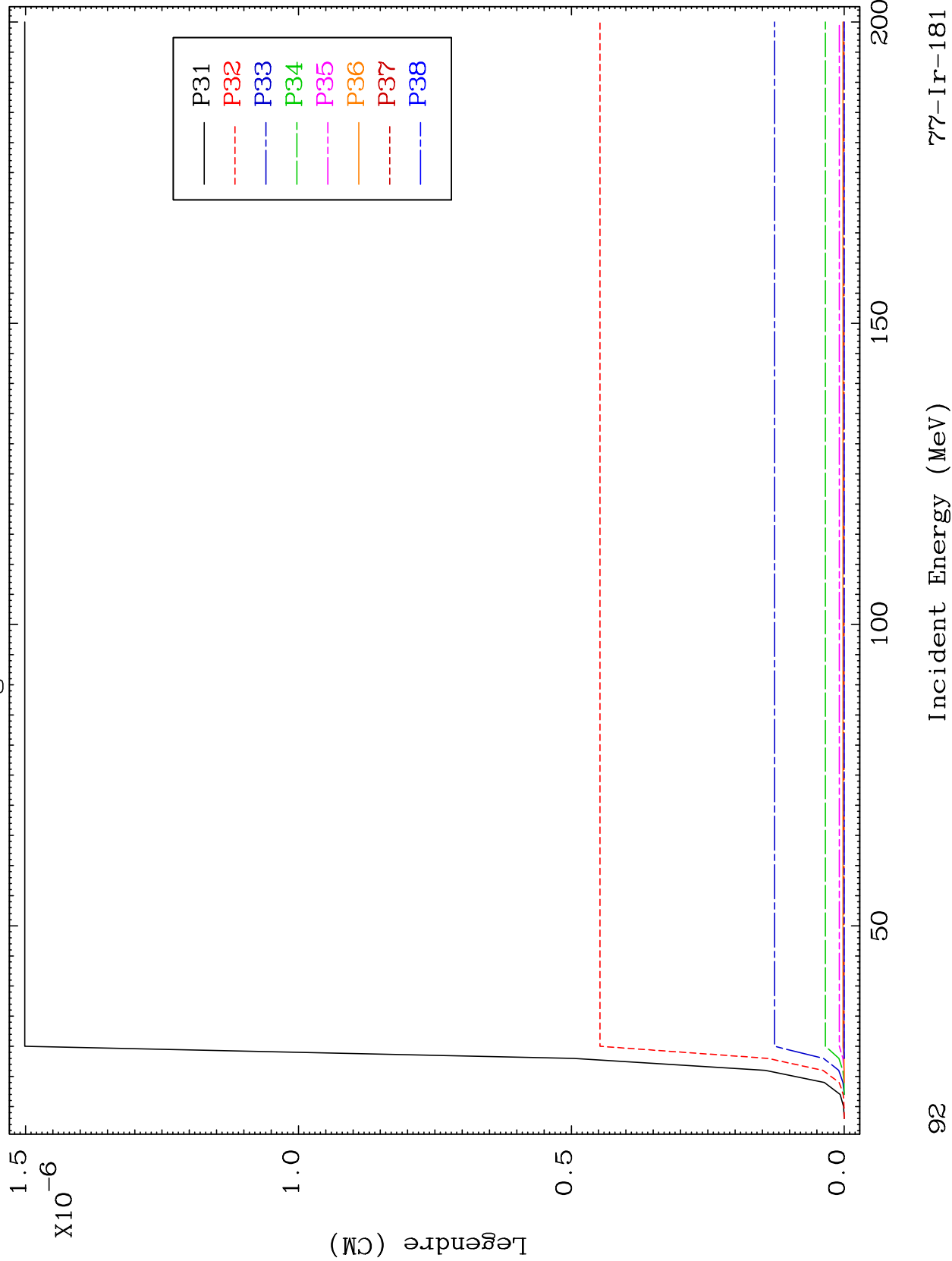

92

Incident Energy (MeV)

77-Ir-181

MAT 7695

MT= 69 (n,n') Level
Legendre Coefficients

77-Ir-181

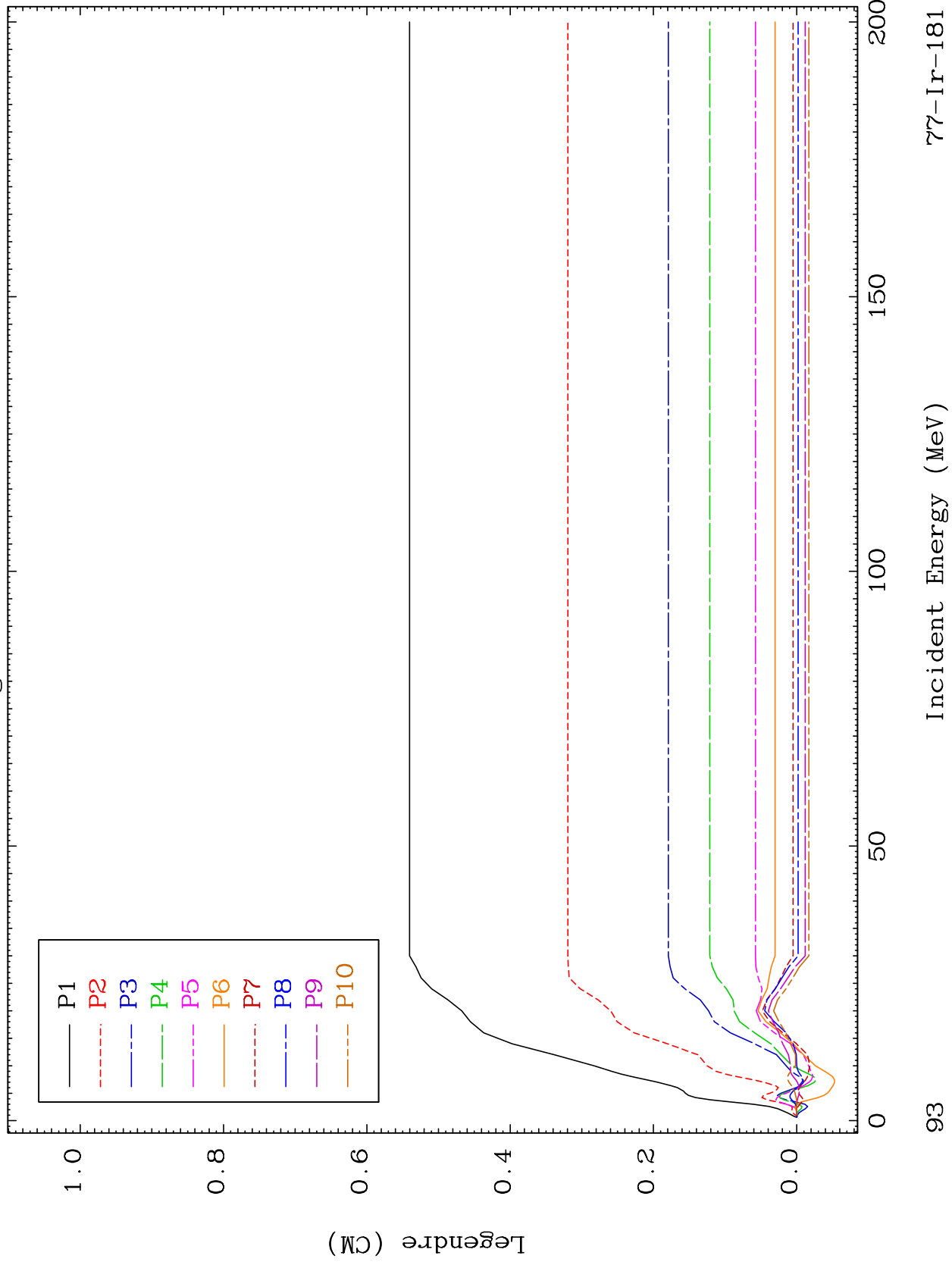

93

Incident Energy (MeV)

77-Ir-181

MAT 7695

MT= 69 (n,n') Level
Legendre Coefficients

77-Ir-181

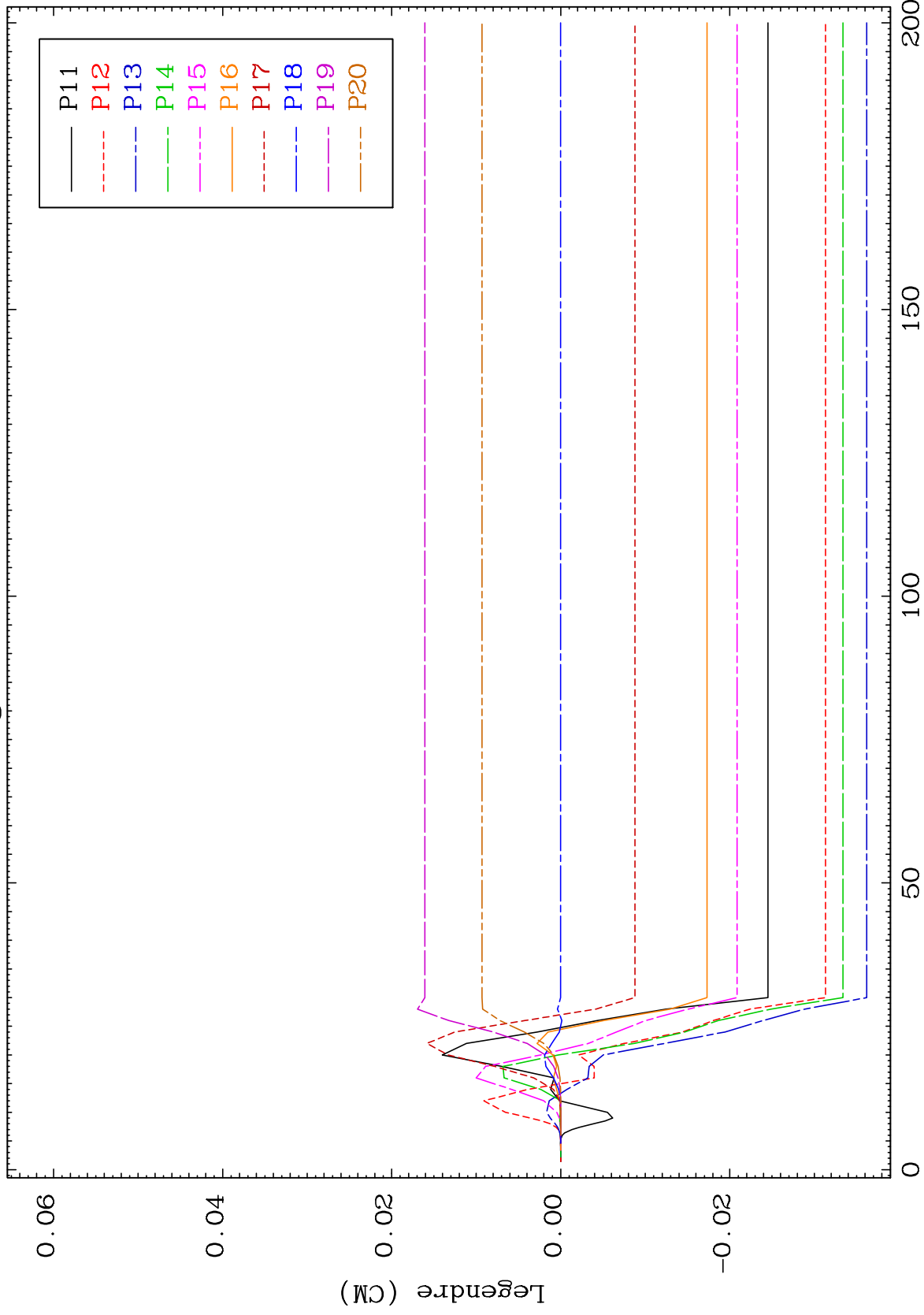

94

Incident Energy (MeV)

77-Ir-181

MAT 7695

MT= 69 (n,n') Level
Legendre Coefficients

77-Ir-181

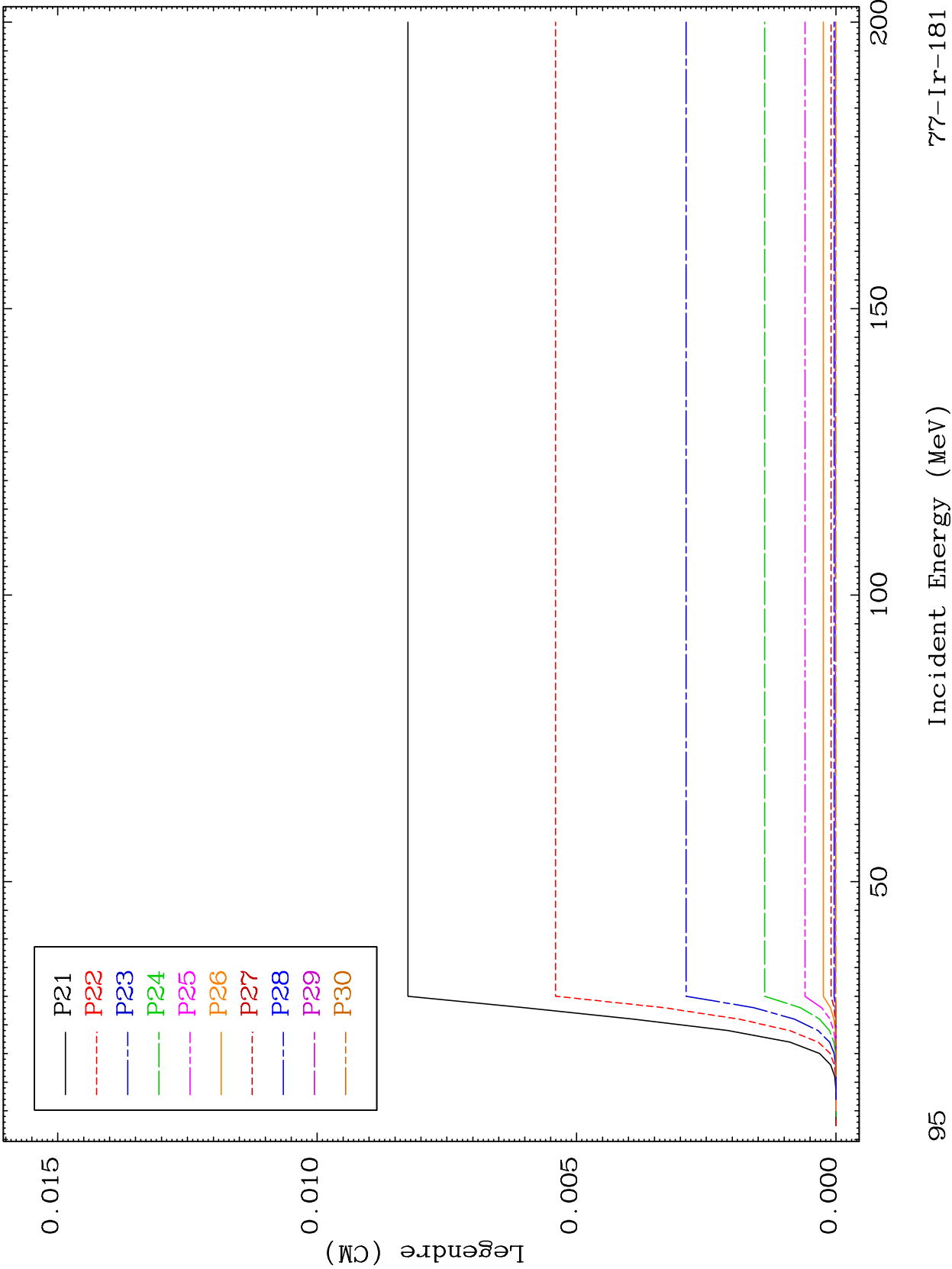

95

Incident Energy (MeV)

77-Ir-181

MAT 7695

MT= 69 (n,n') Level
Legendre Coefficients

77-Ir-181

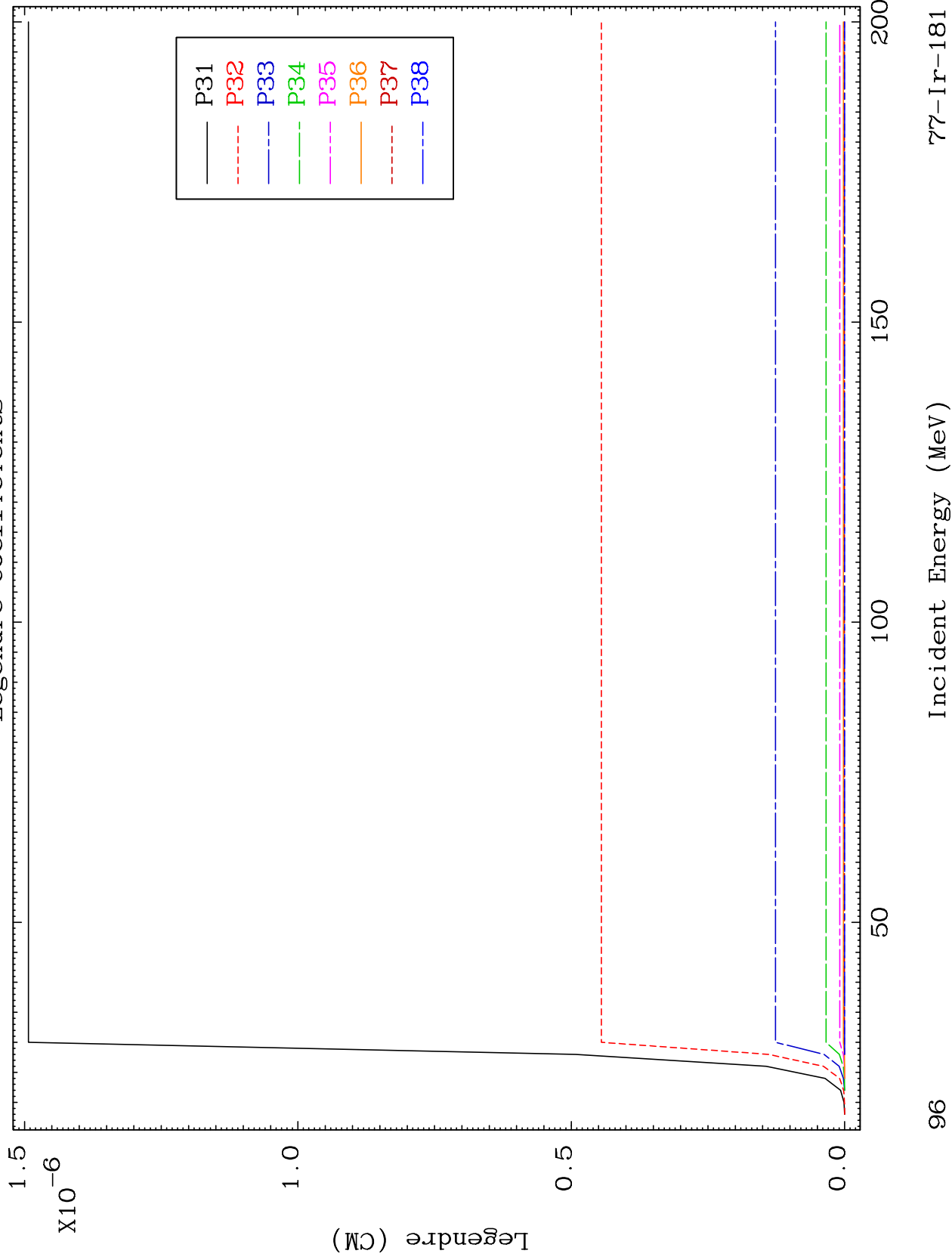

MAT 7695

Fission

⁷⁷Ir-181

Radionuclide Production Cross Section

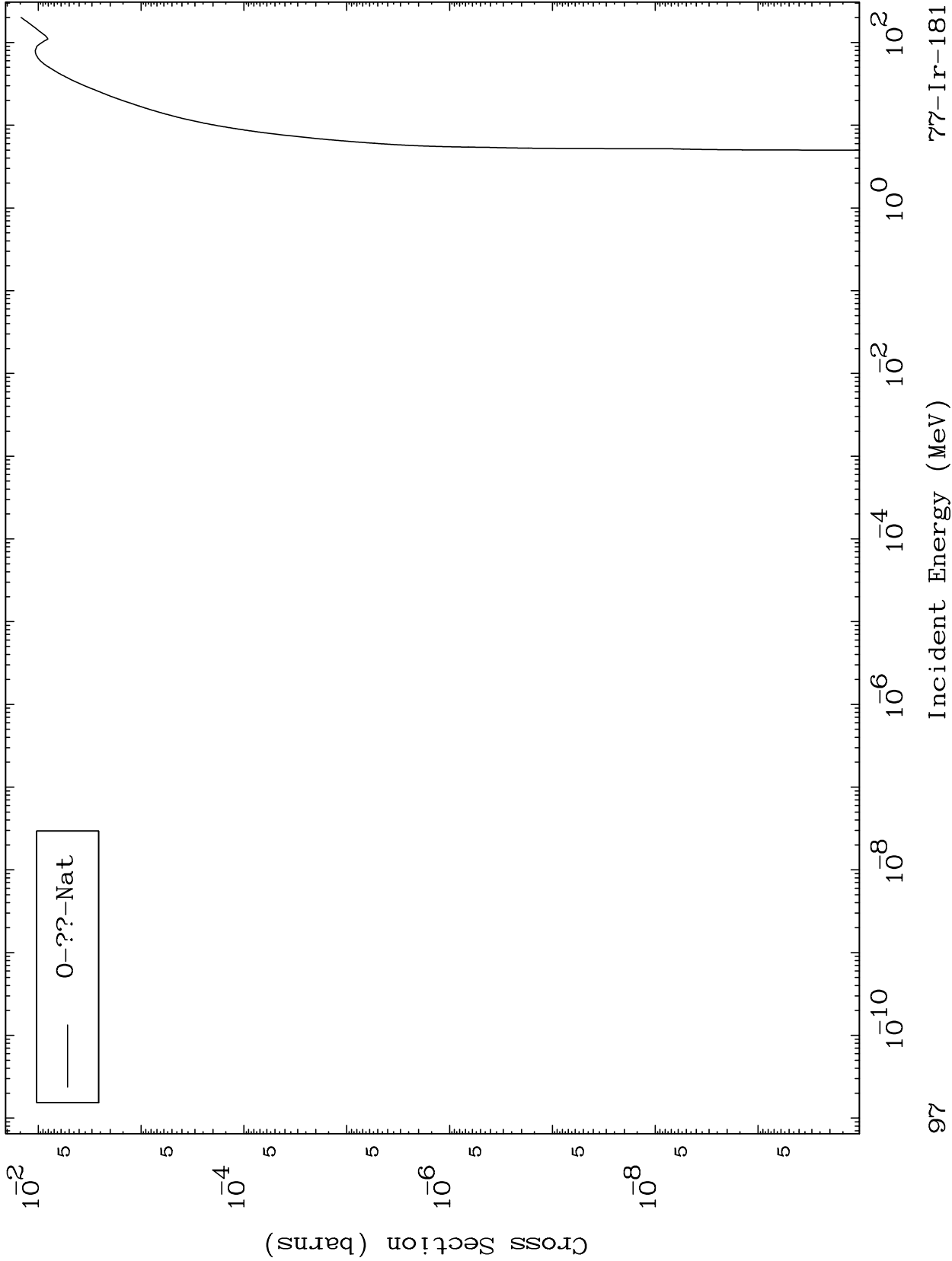

97

⁷⁷Ir-181

MAT 7695

⁷⁷Ir-181

(n,p)
Radionuclide Production Cross Section

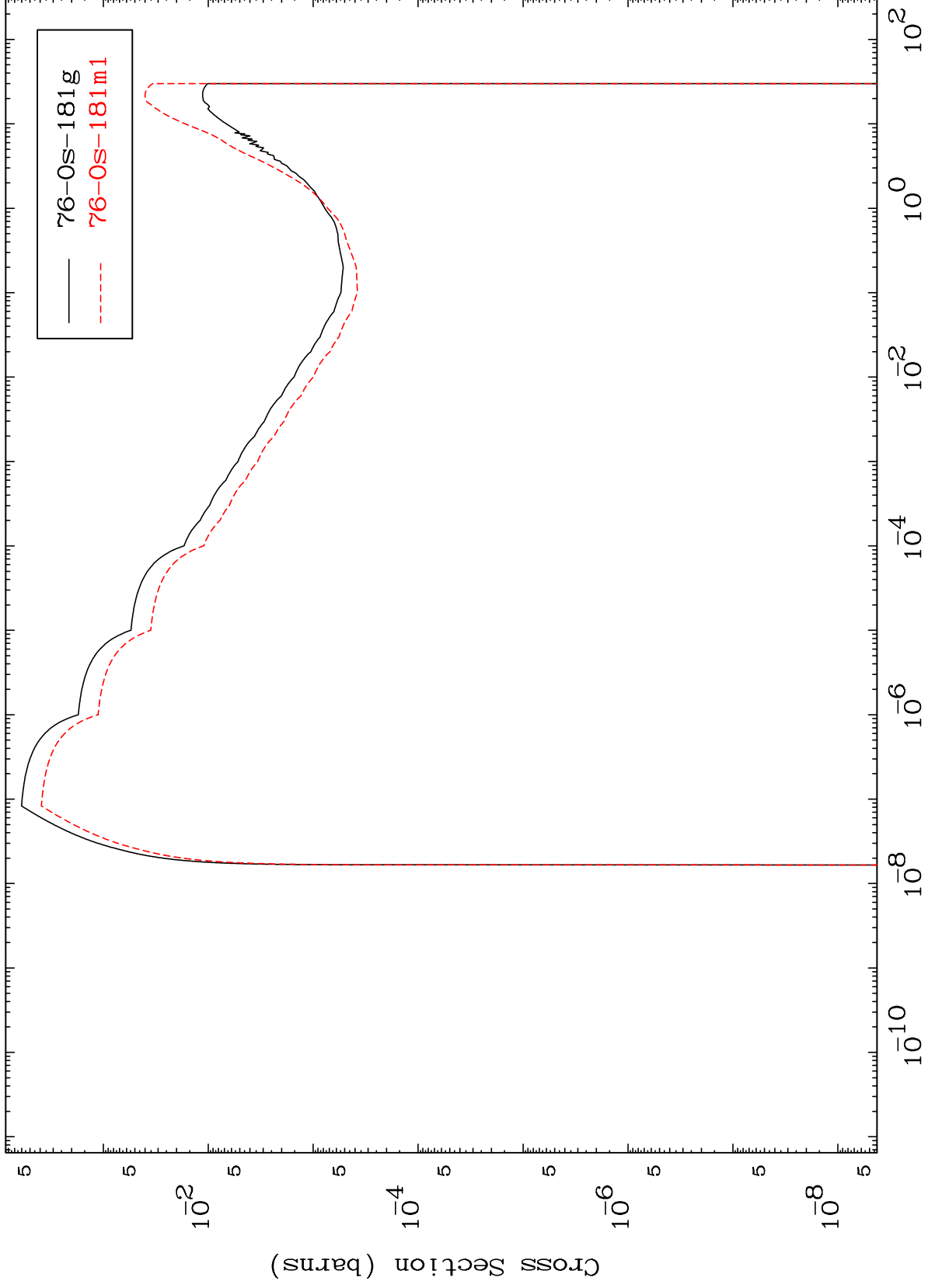

98

⁷⁷Ir-181