

IR182 NEUTRON ACER TENDL-2024 LIBRARY; T=0.K

Principal cross sections

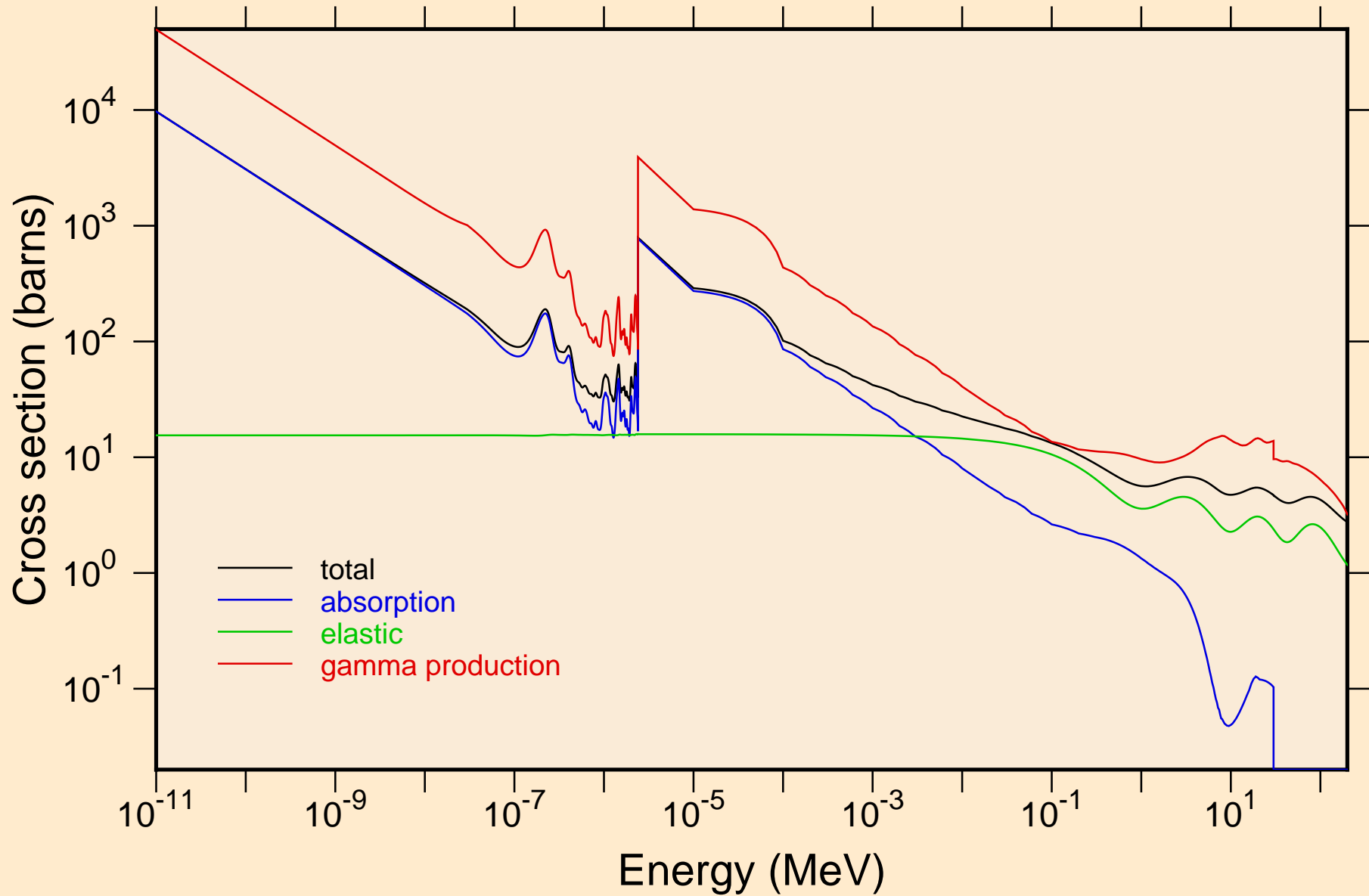

IR182 NEUTRON ACER TENDL-2024 LIBRARY; T=0.K

Heating

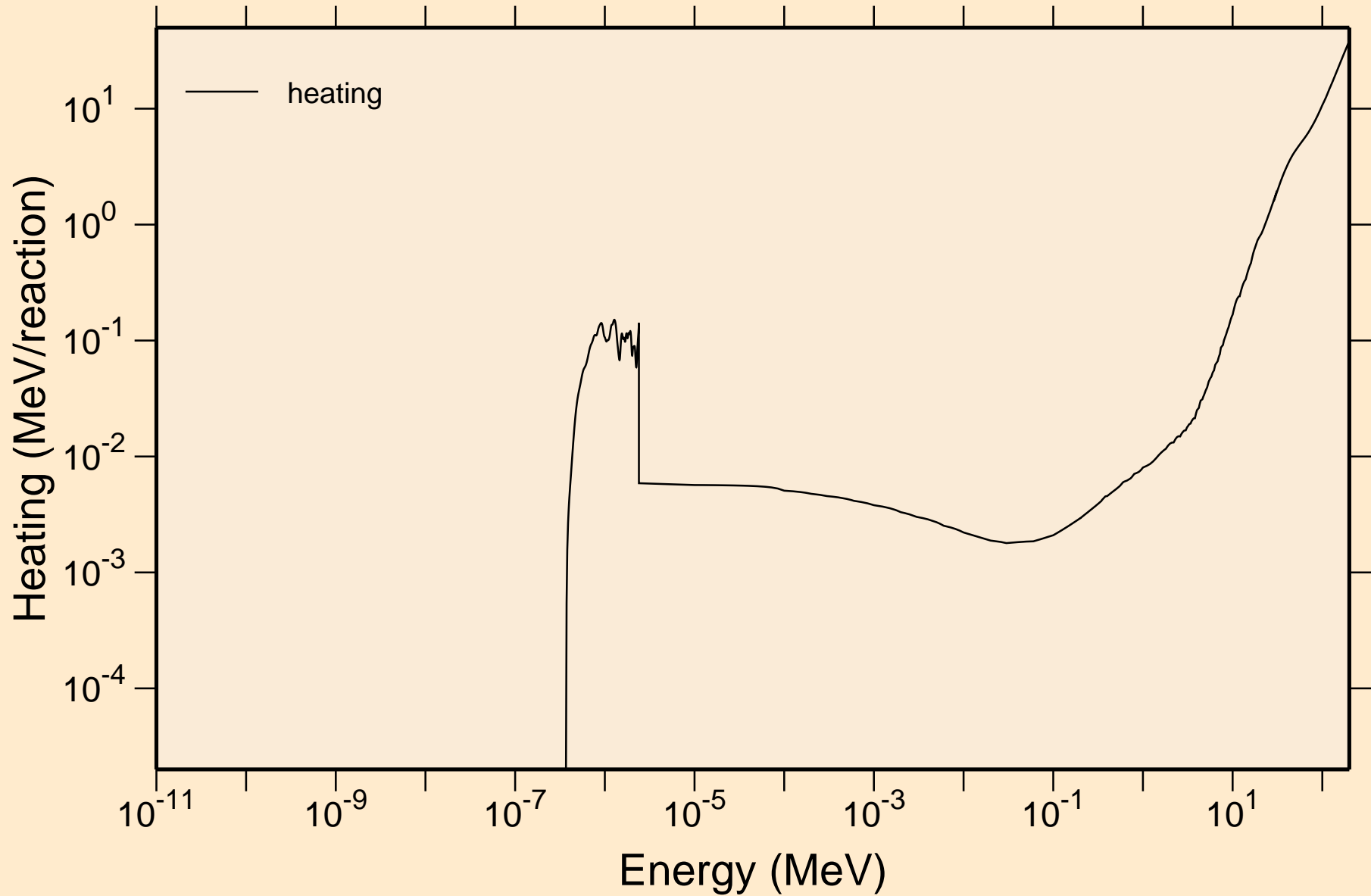

IR182 NEUTRON ACER TENDL-2024 LIBRARY; T=0.K

Damage

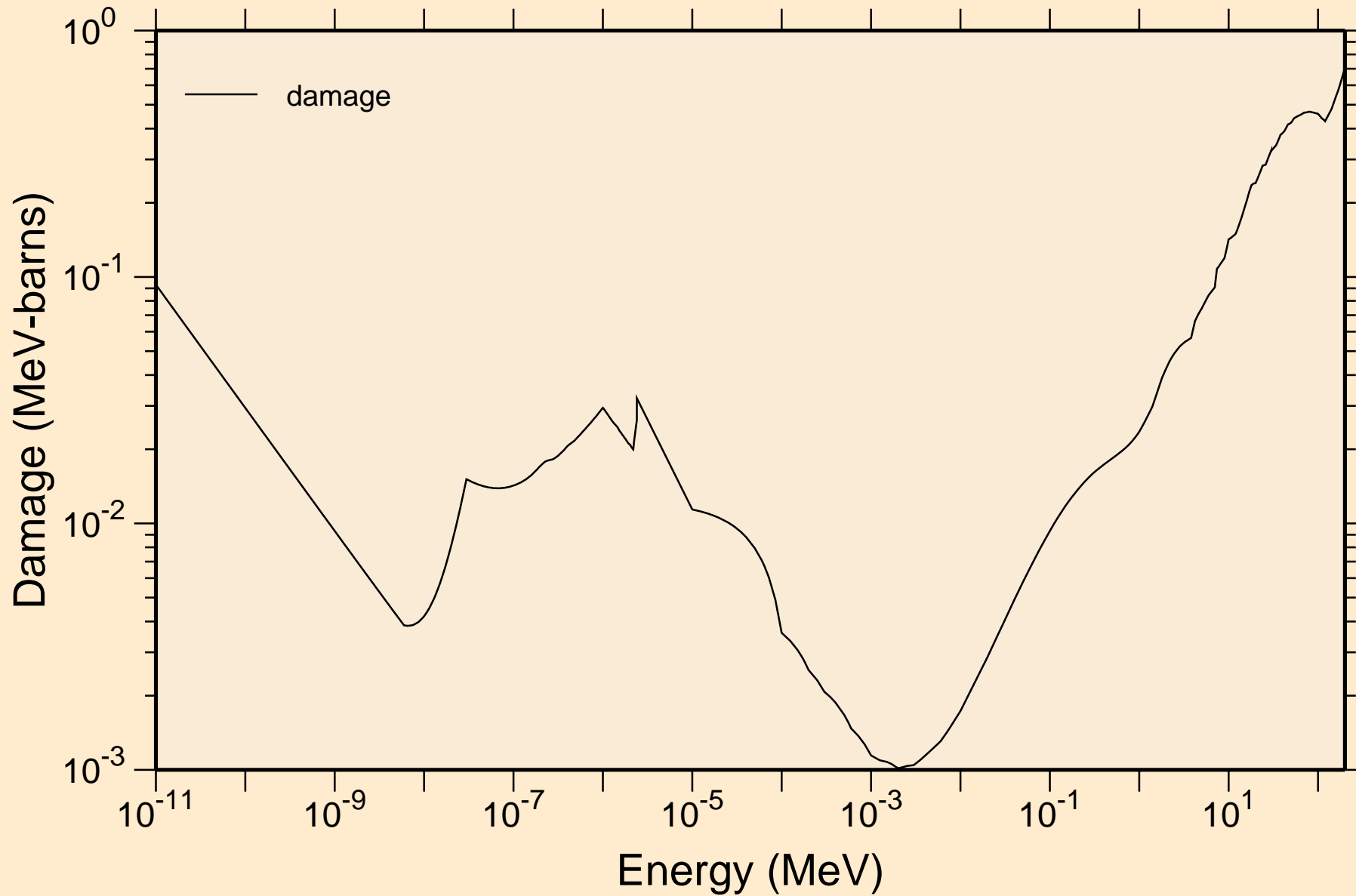

IR182 NEUTRON ACER TENDL-2024 LIBRARY; T=0.K
Non-threshold reactions

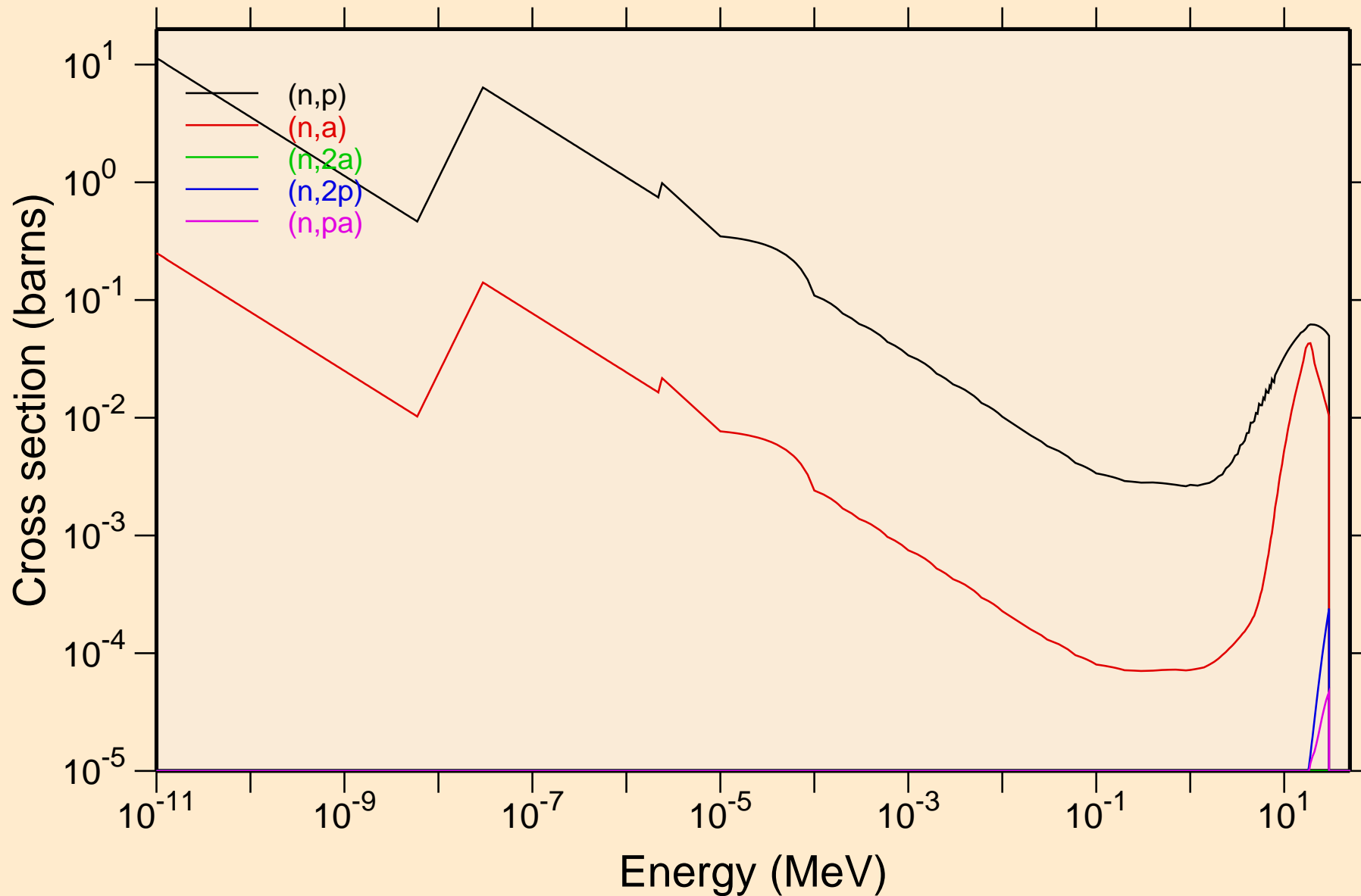

IR182 NEUTRON ACER TENDL-2024 LIBRARY; T=0.K
Non-threshold reactions

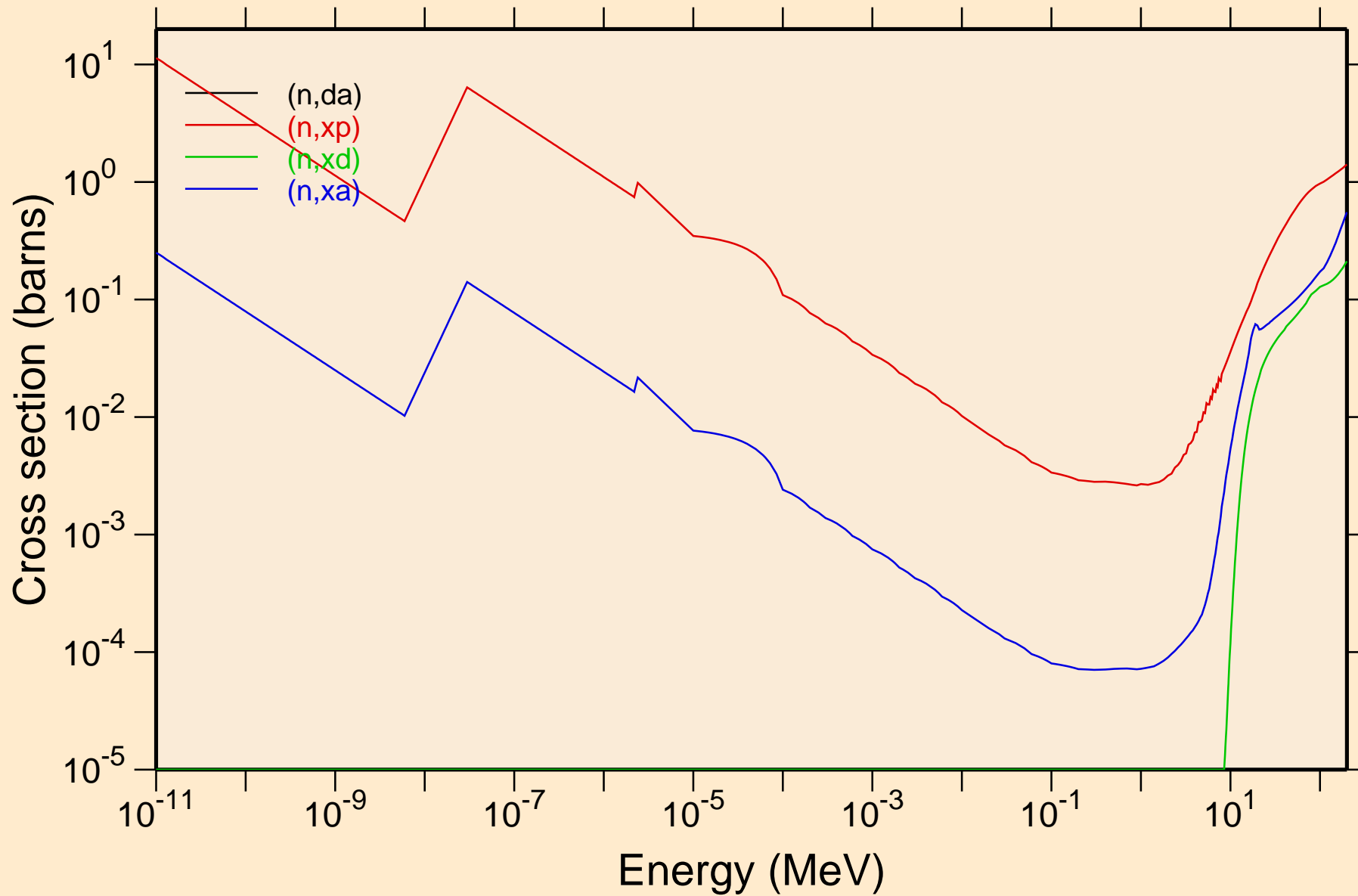

IR182 NEUTRON ACER TENDL-2024 LIBRARY; T=0.K

Principal cross sections

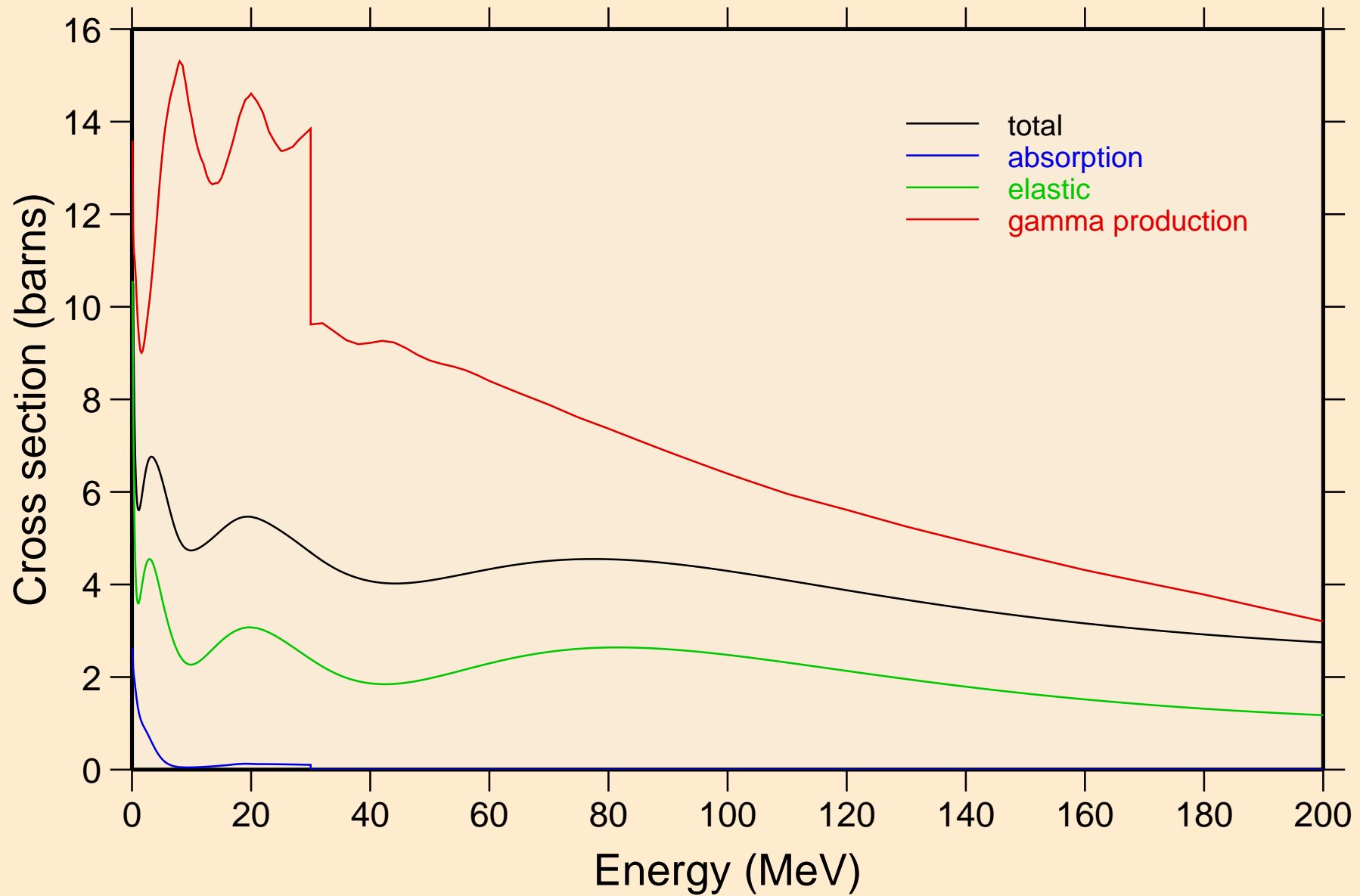

IR182 NEUTRON ACER TENDL-2024 LIBRARY; T=0.K

Heating

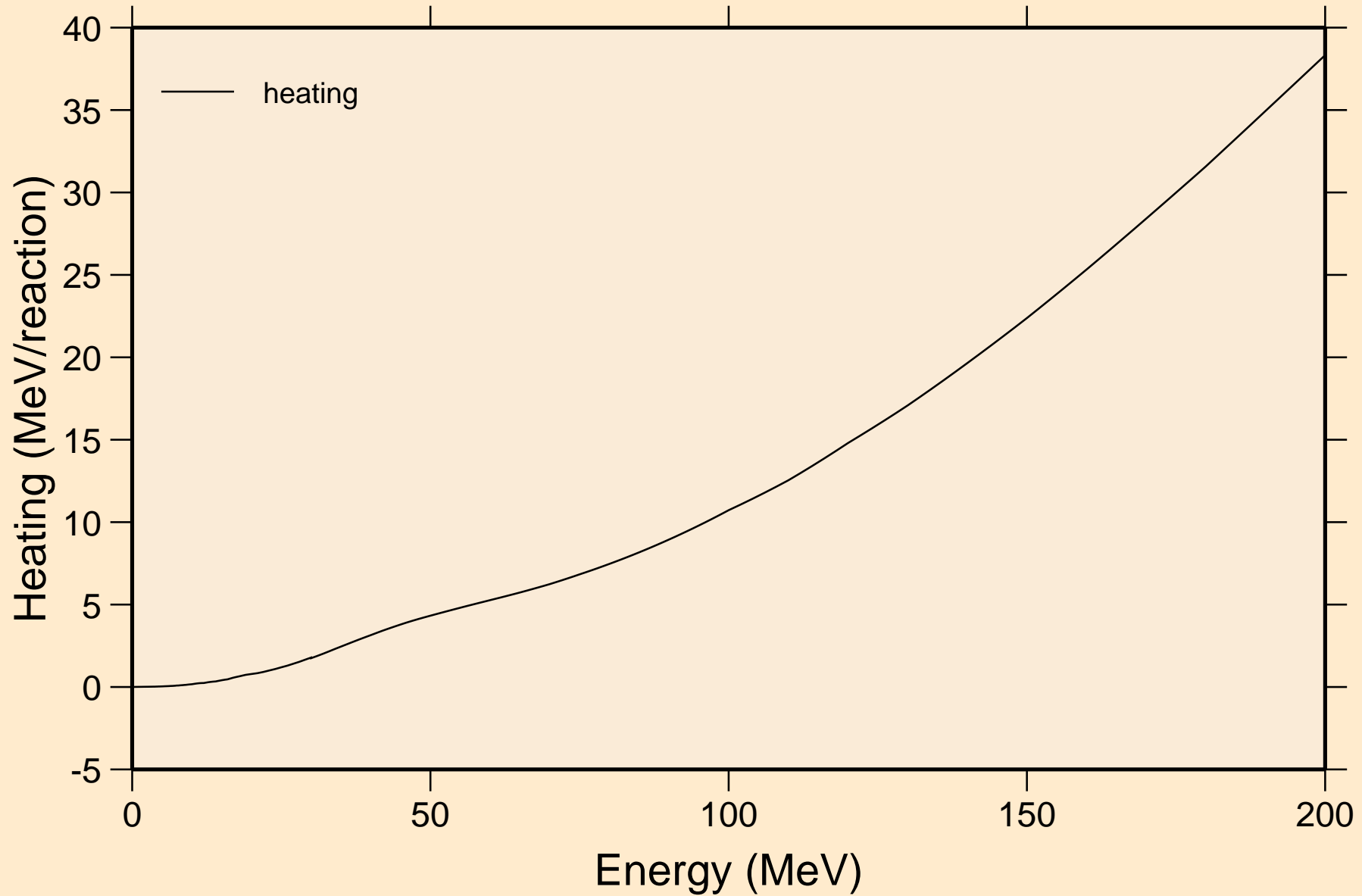

IR182 NEUTRON ACER TENDL-2024 LIBRARY; T=0.K

Damage

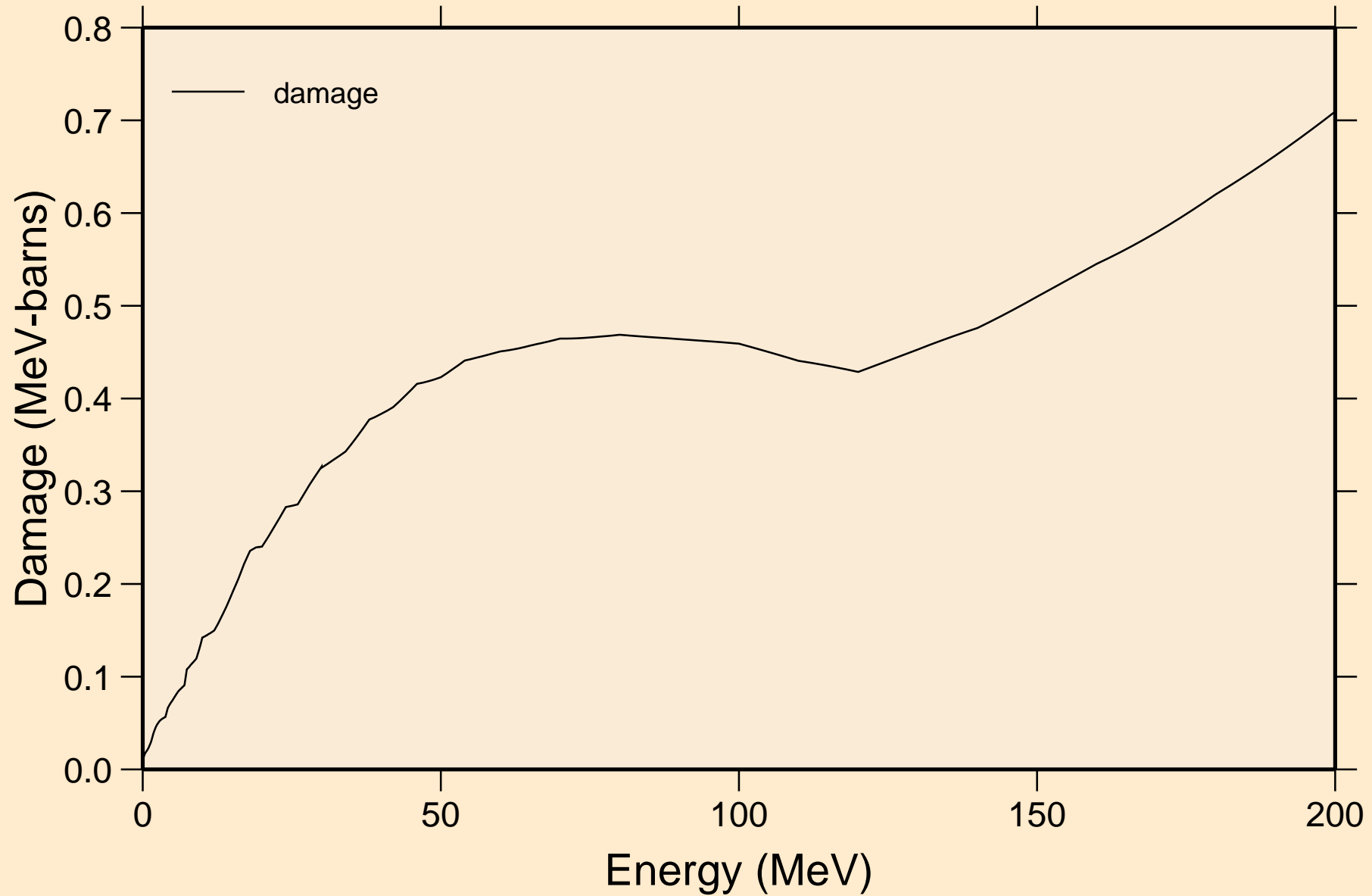

IR182 NEUTRON ACER TENDL-2024 LIBRARY; T=0.K
Non-threshold reactions

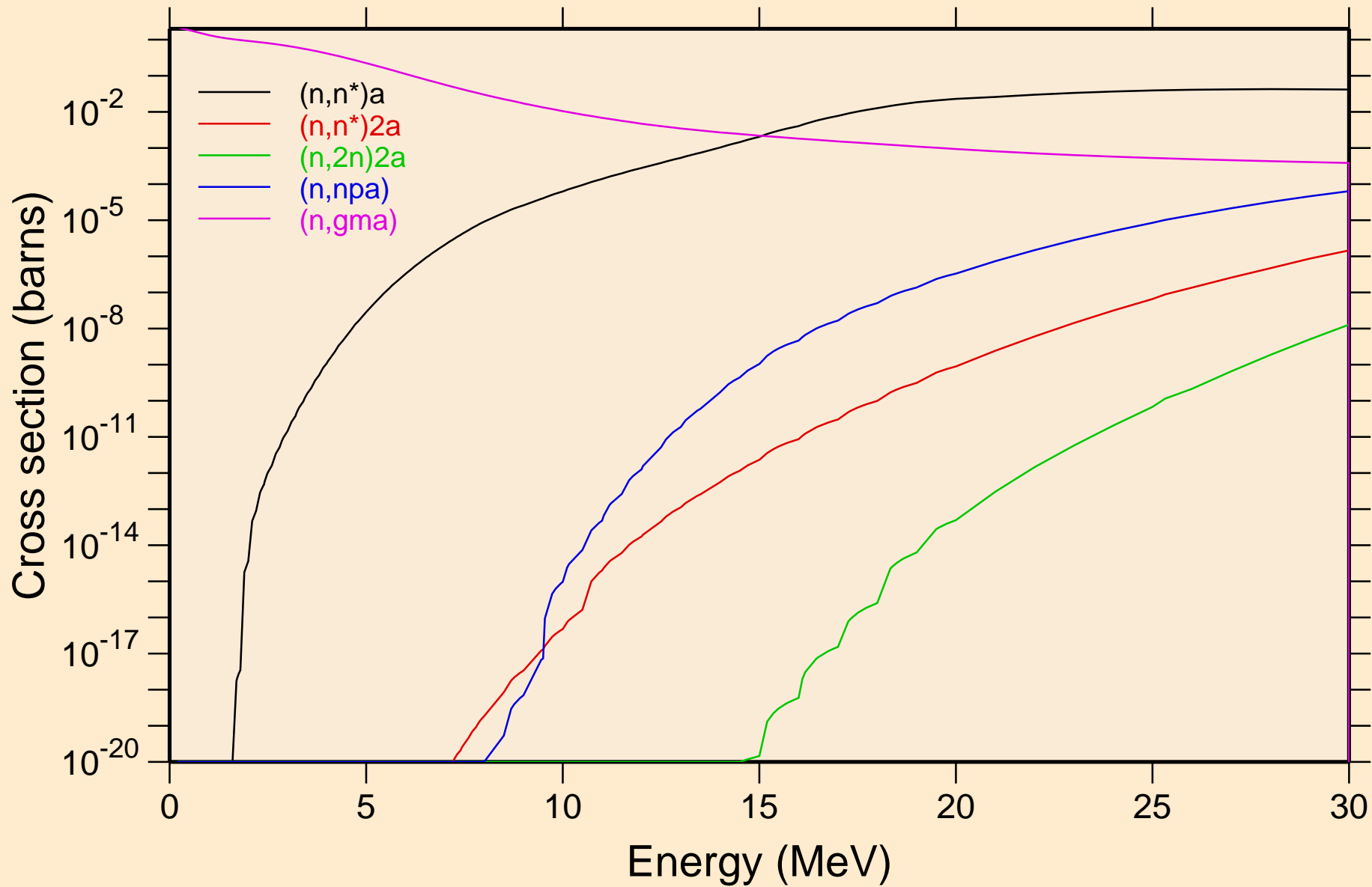

IR182 NEUTRON ACER TENDL-2024 LIBRARY; T=0.K

Non-threshold reactions

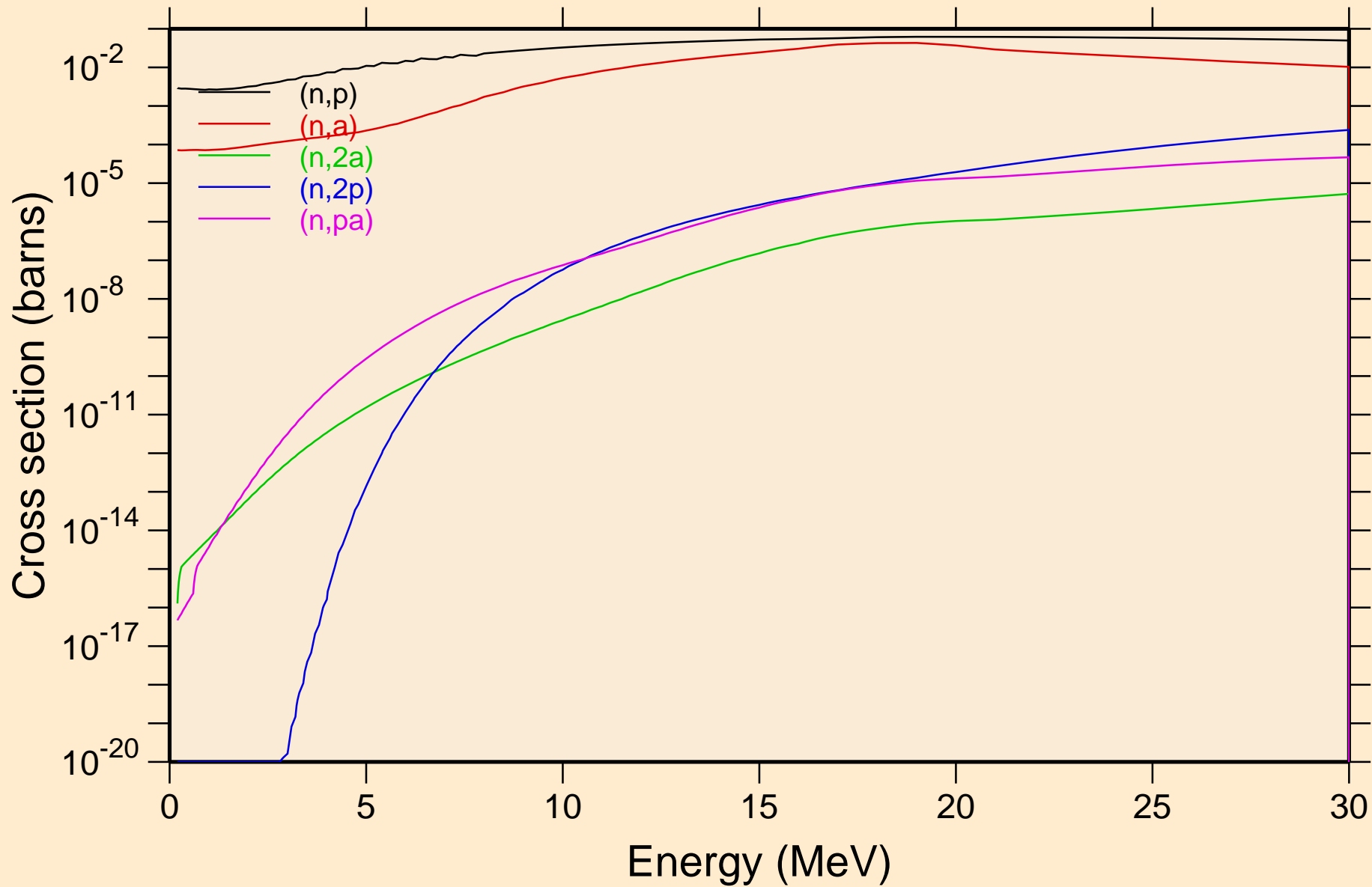

IR182 NEUTRON ACER TENDL-2024 LIBRARY; T=0.K

Non-threshold reactions

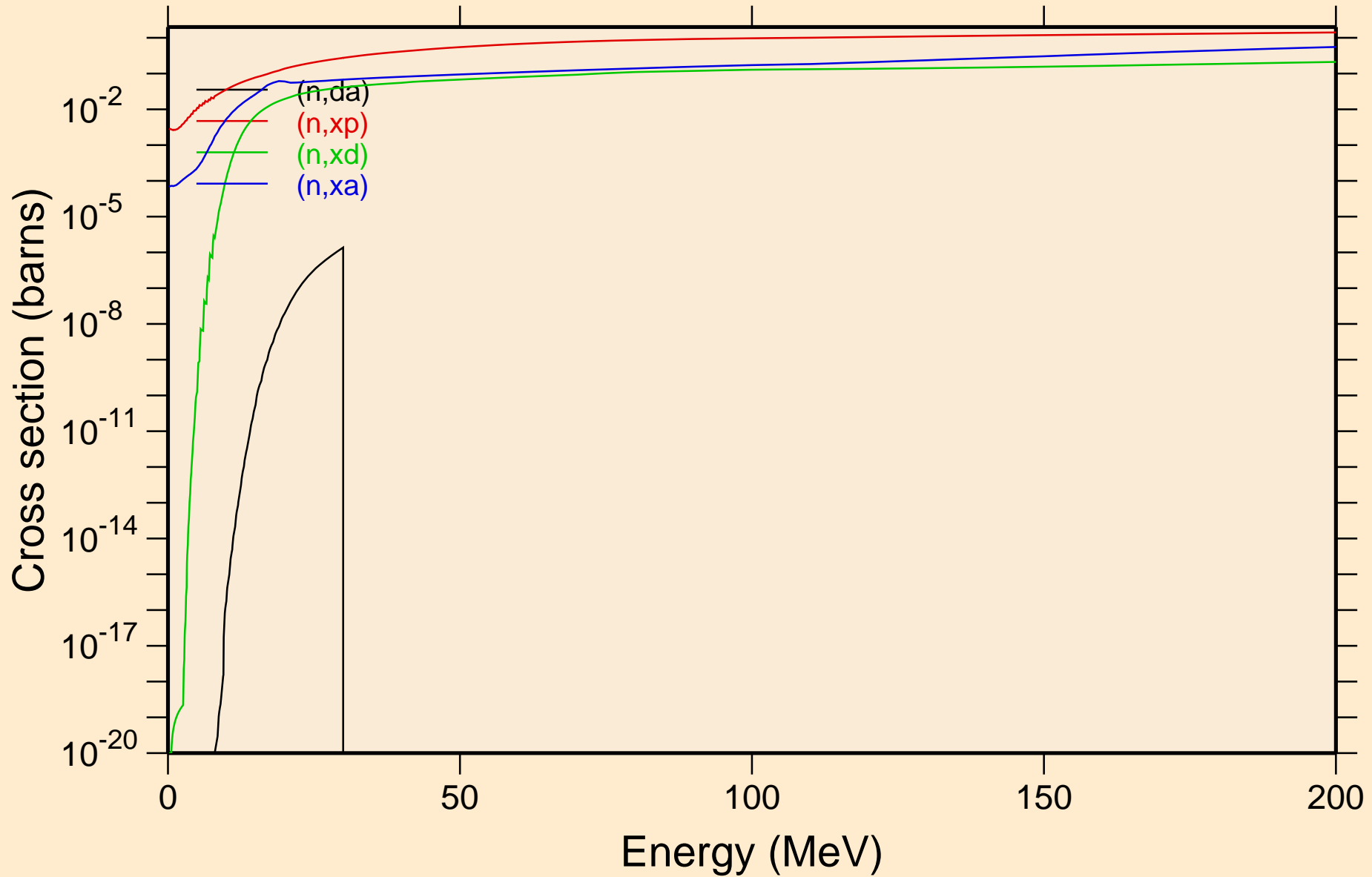

IR182 NEUTRON ACER TENDL-2024 LIBRARY; T=0.K
Inelastic levels

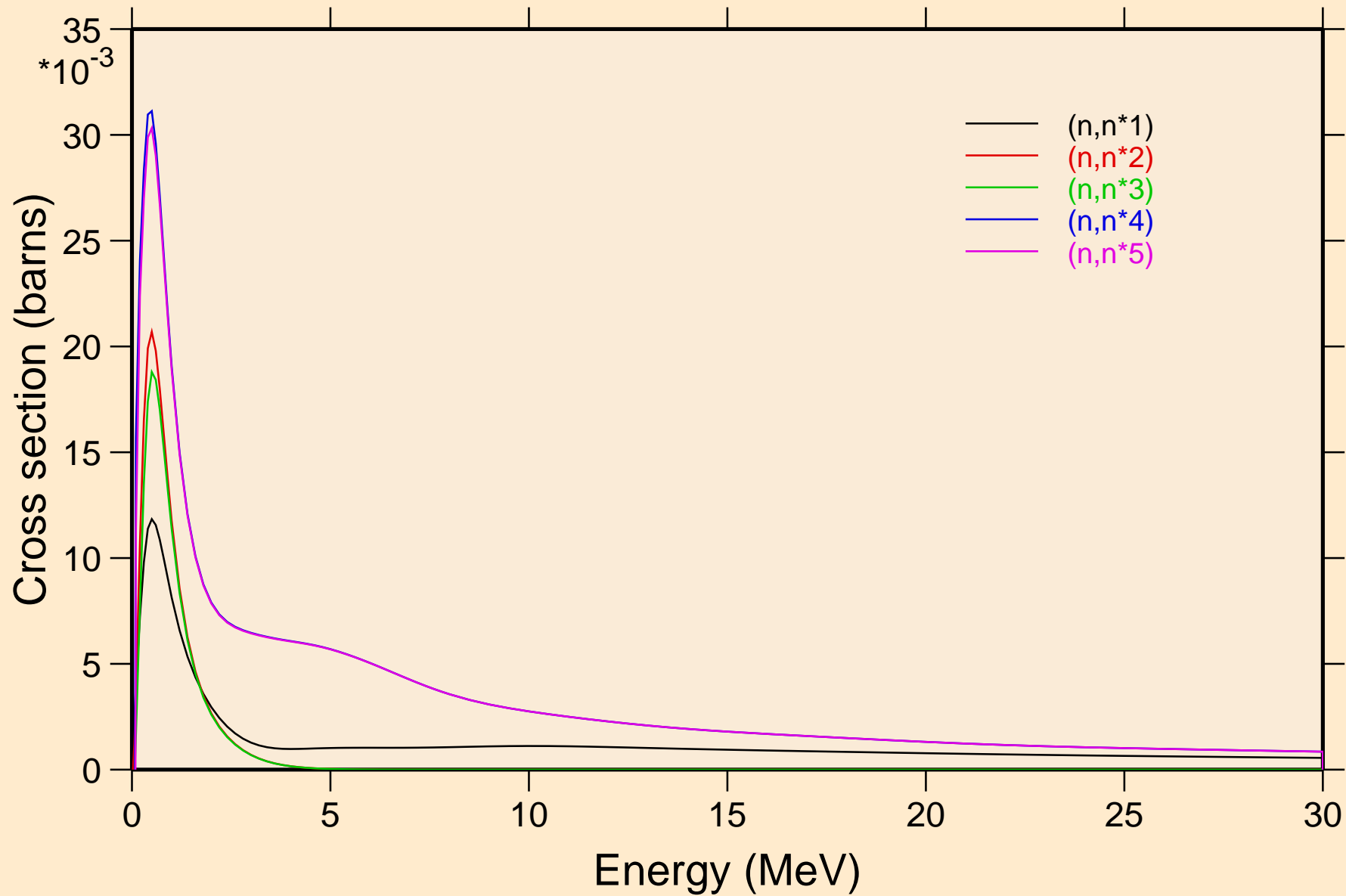

IR182 NEUTRON ACER TENDL-2024 LIBRARY; T=0.K
Inelastic levels

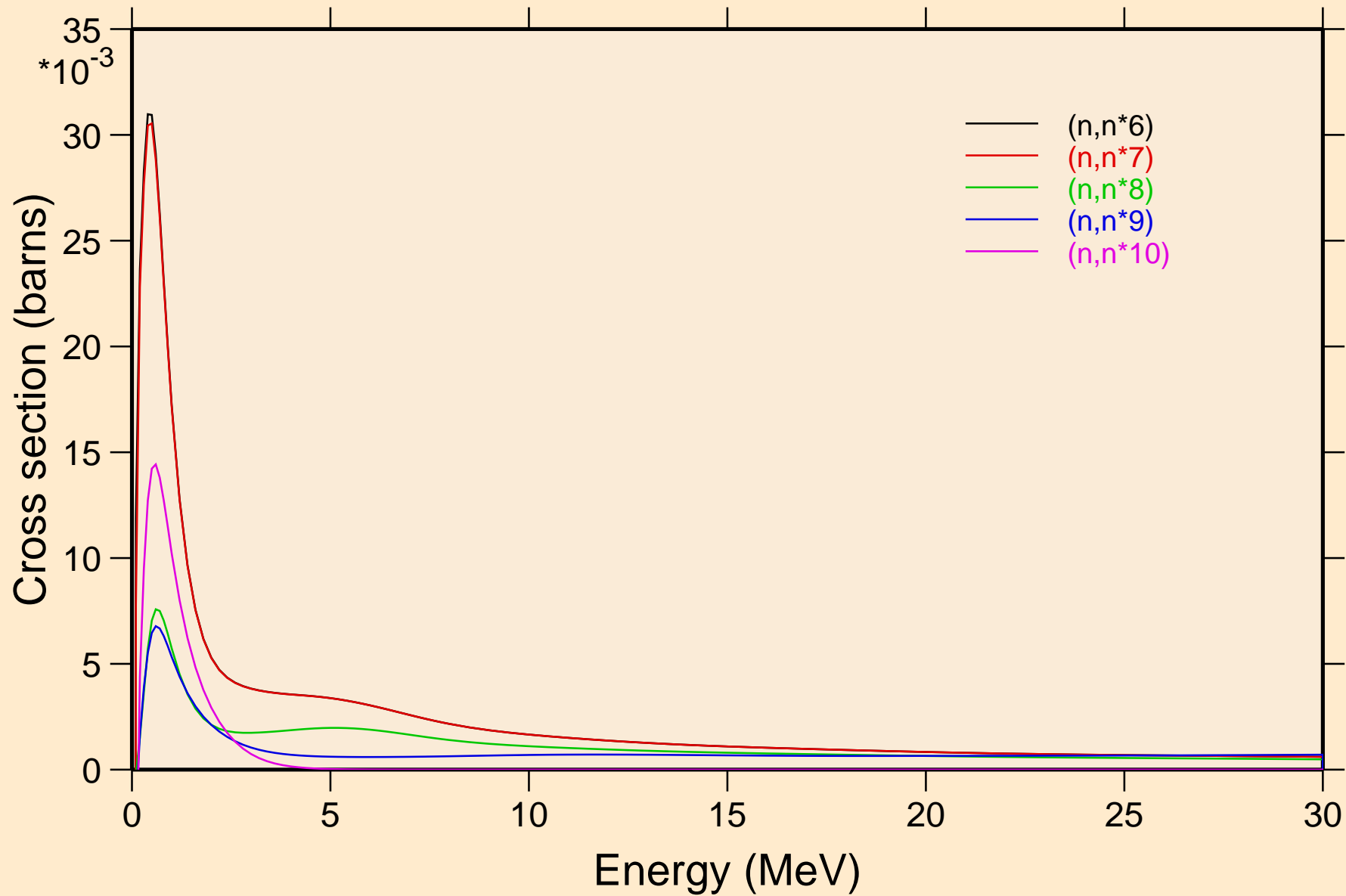

IR182 NEUTRON ACER TENDL-2024 LIBRARY; T=0.K
Inelastic levels

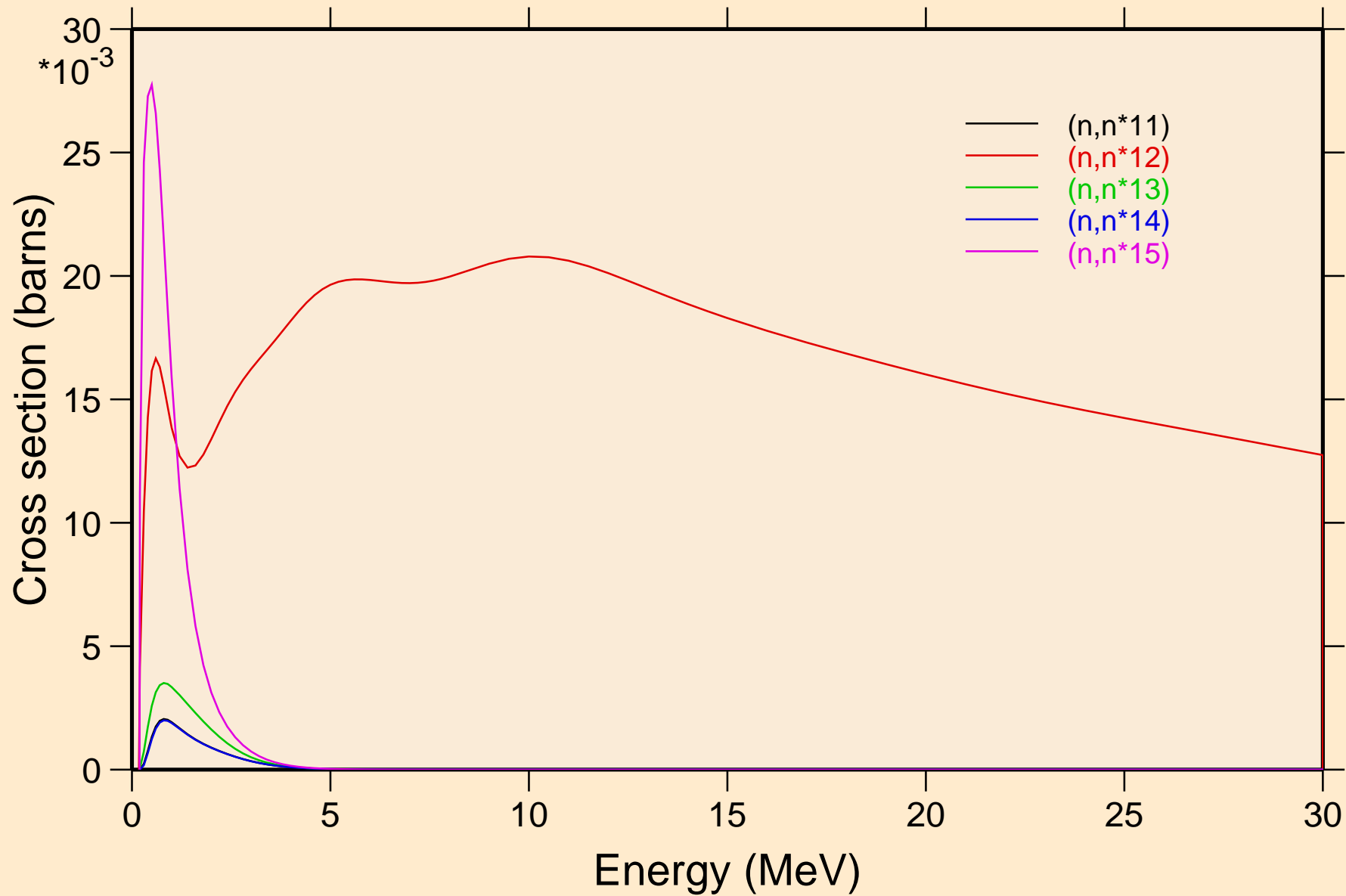

IR182 NEUTRON ACER TENDL-2024 LIBRARY; T=0.K
Inelastic levels

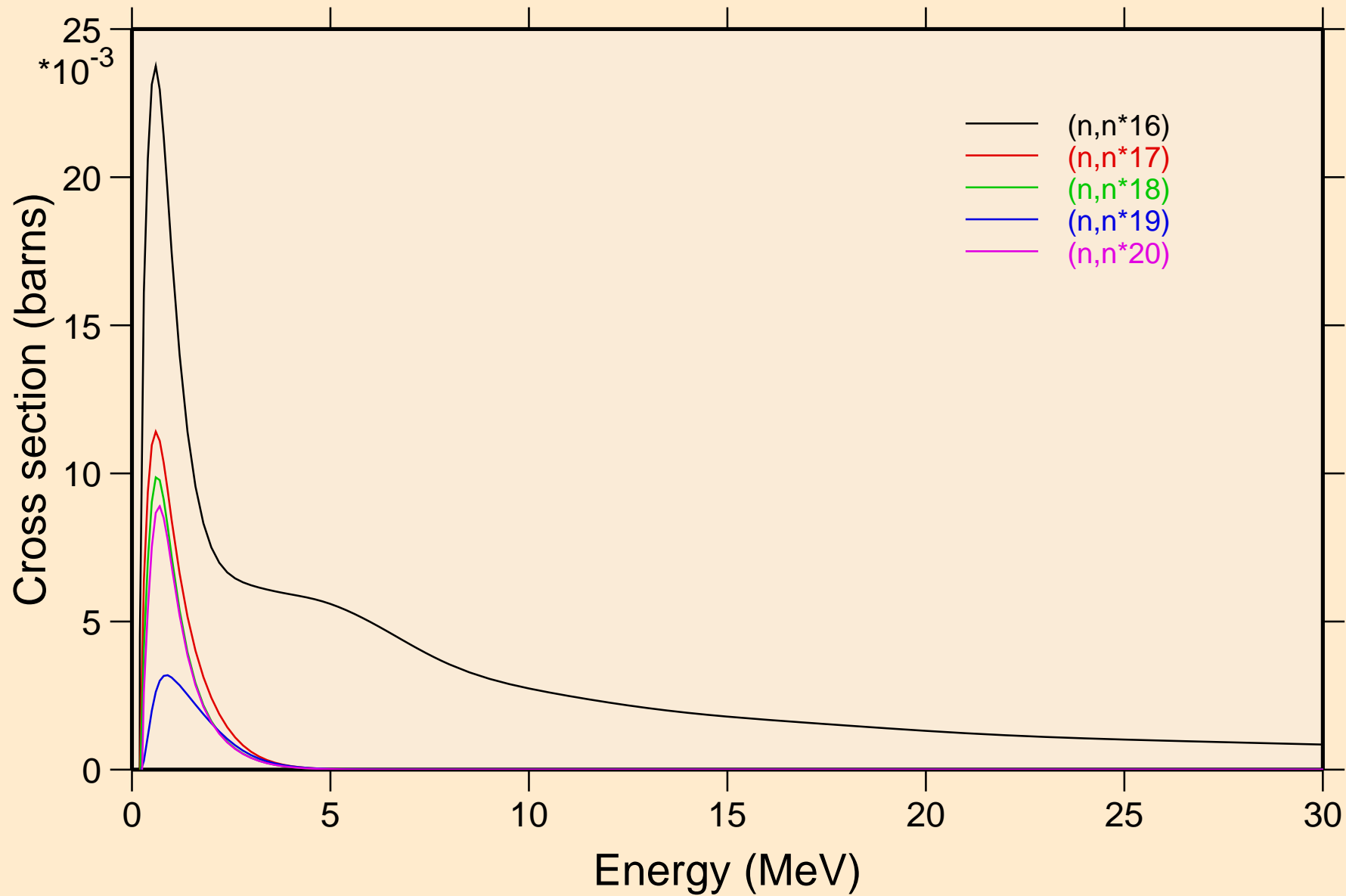

IR182 NEUTRON ACER TENDL-2024 LIBRARY; T=0.K
Inelastic levels

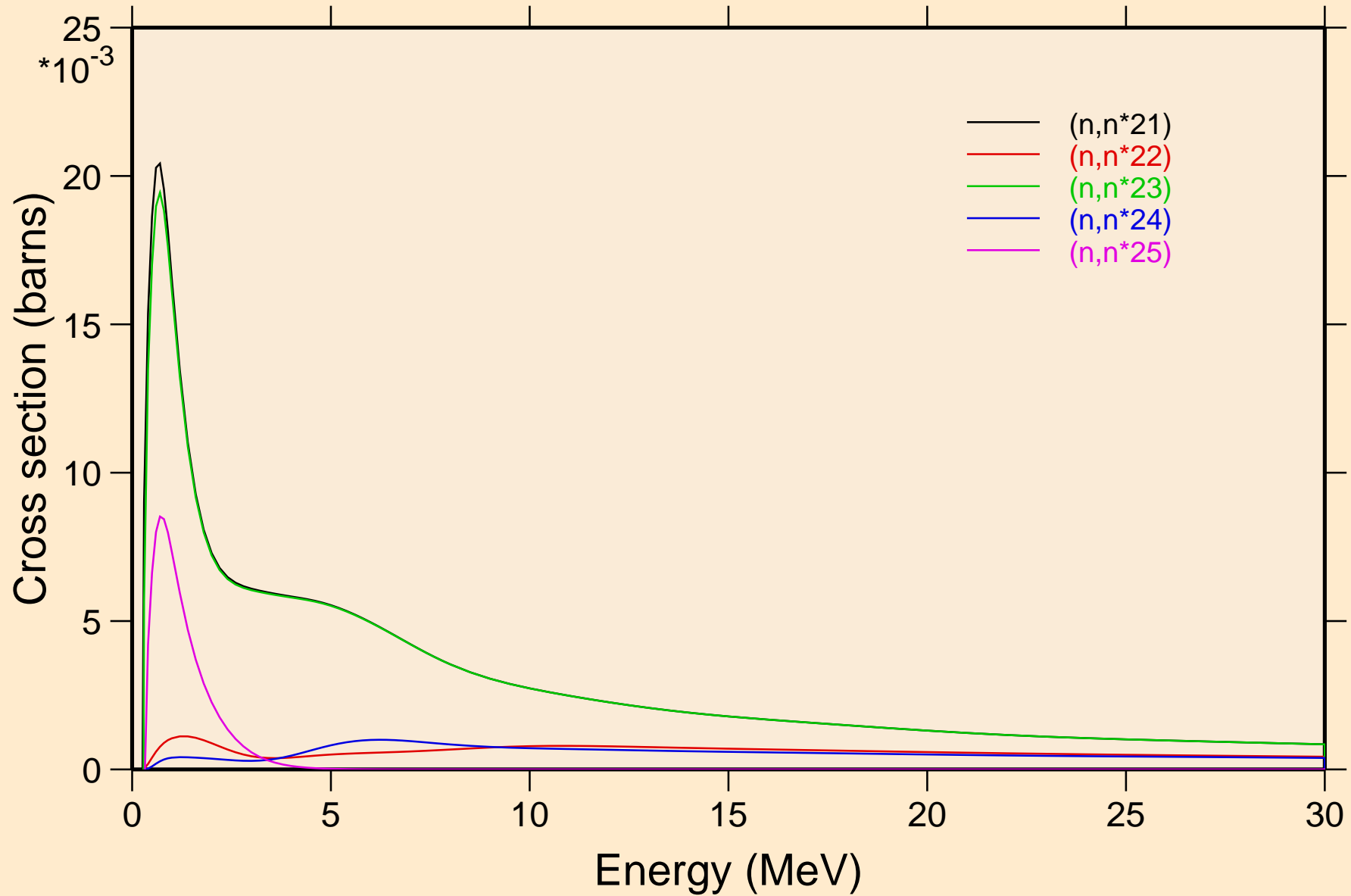

IR182 NEUTRON ACER TENDL-2024 LIBRARY; T=0.K
Inelastic levels

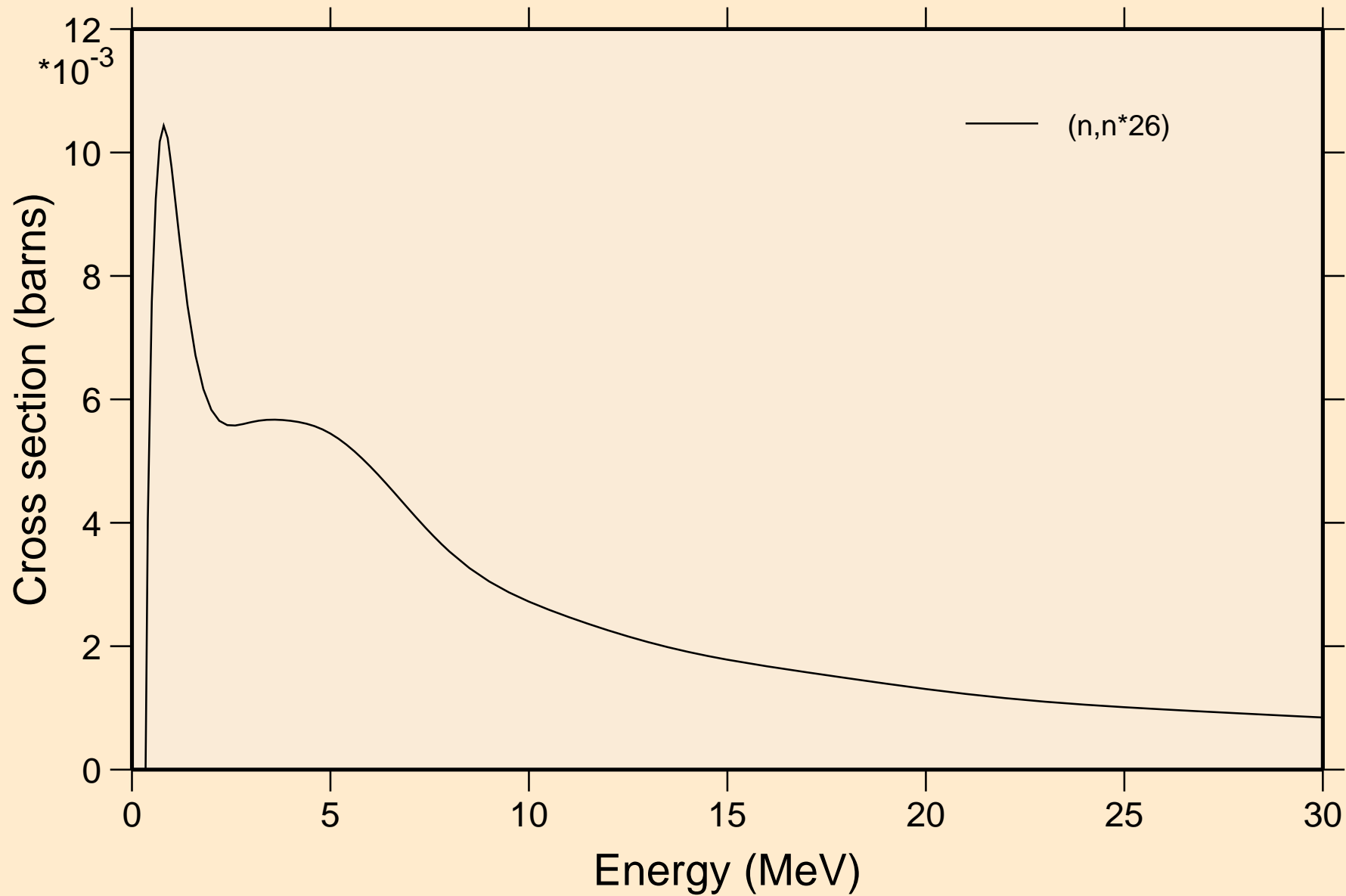

IR182 NEUTRON ACER TENDL-2024 LIBRARY; T=0.K

Threshold reactions

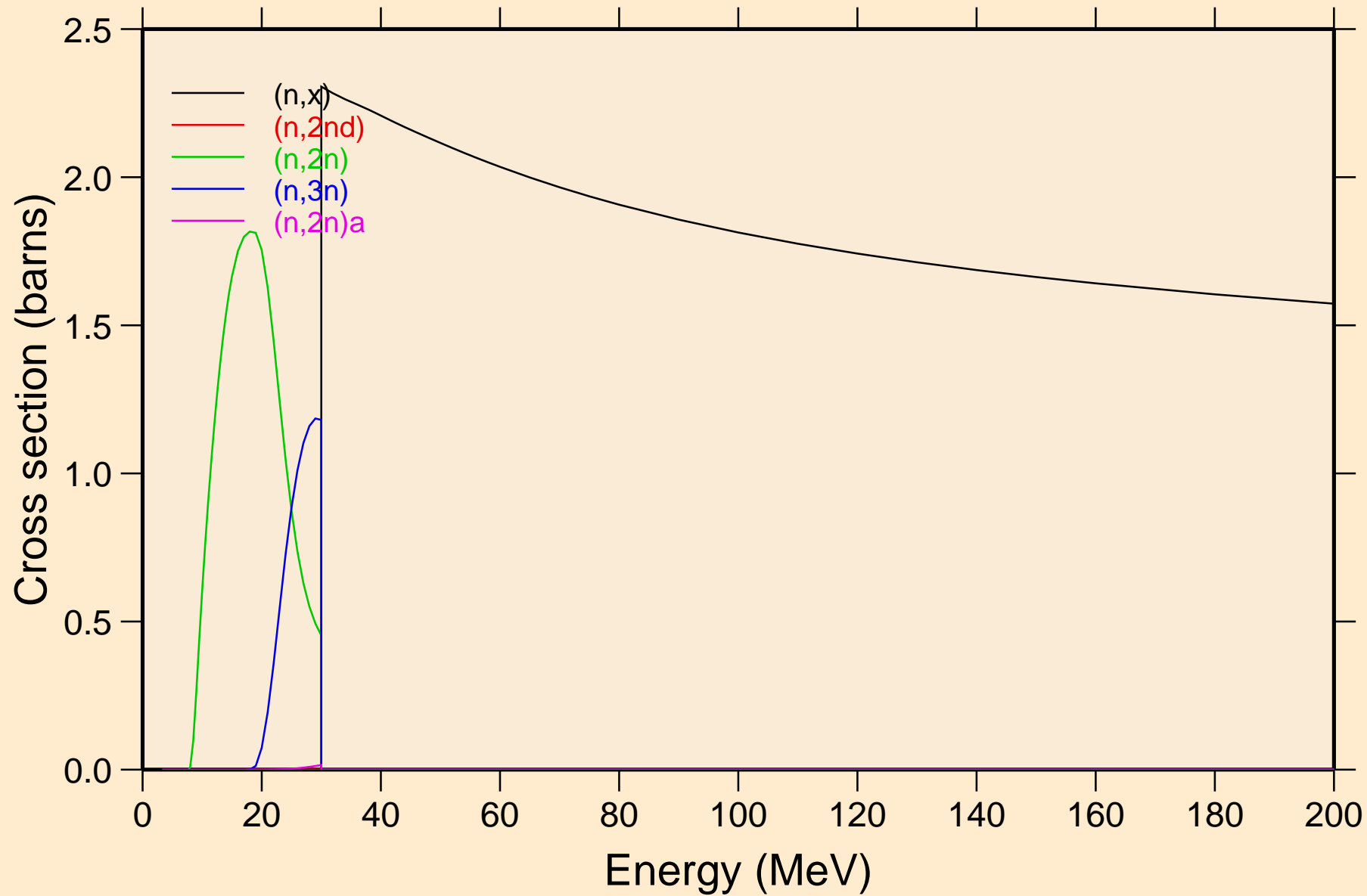

IR182 NEUTRON ACER TENDL-2024 LIBRARY; T=0.K

Threshold reactions

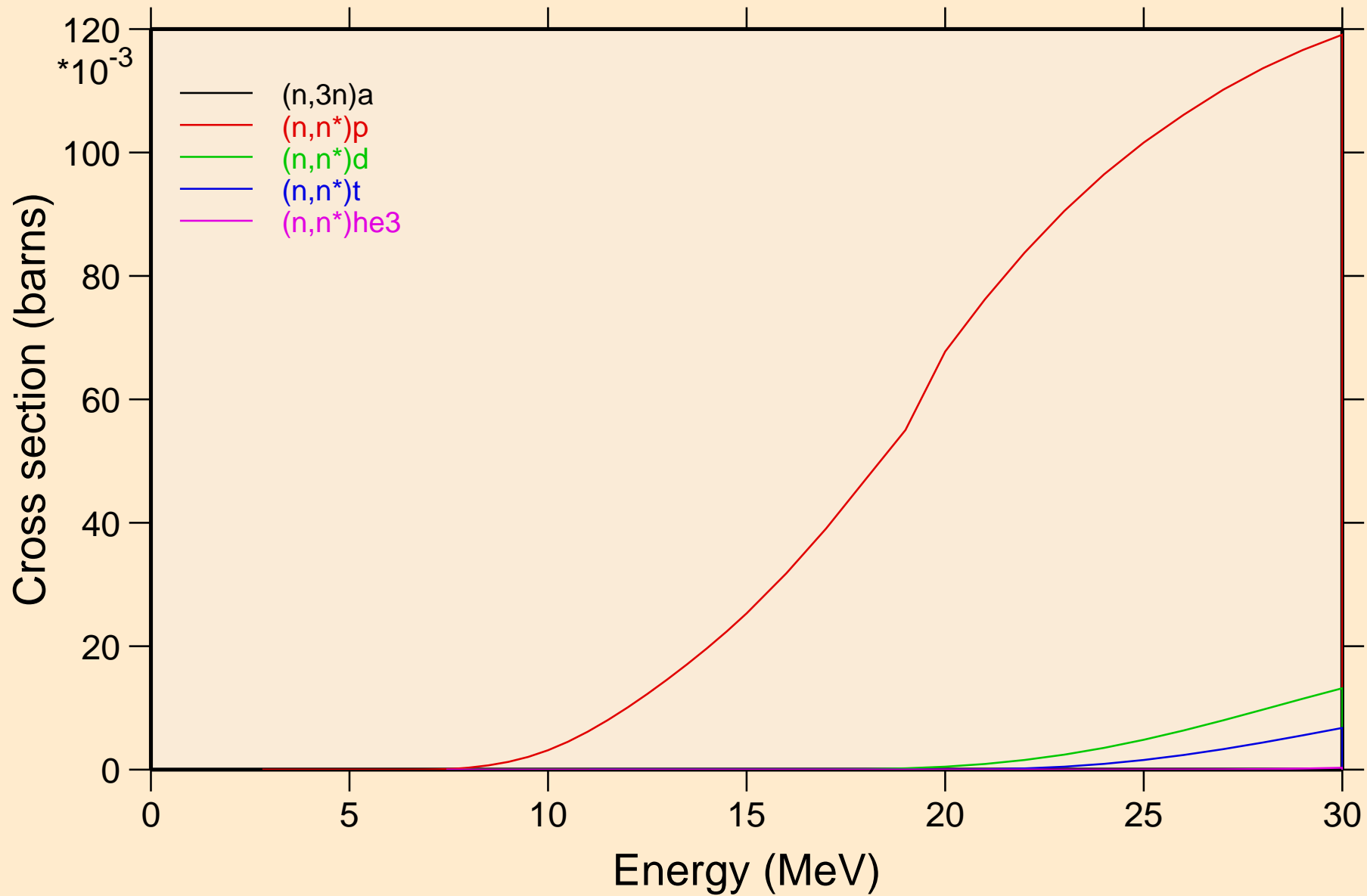

IR182 NEUTRON ACER TENDL-2024 LIBRARY; T=0.K
Threshold reactions

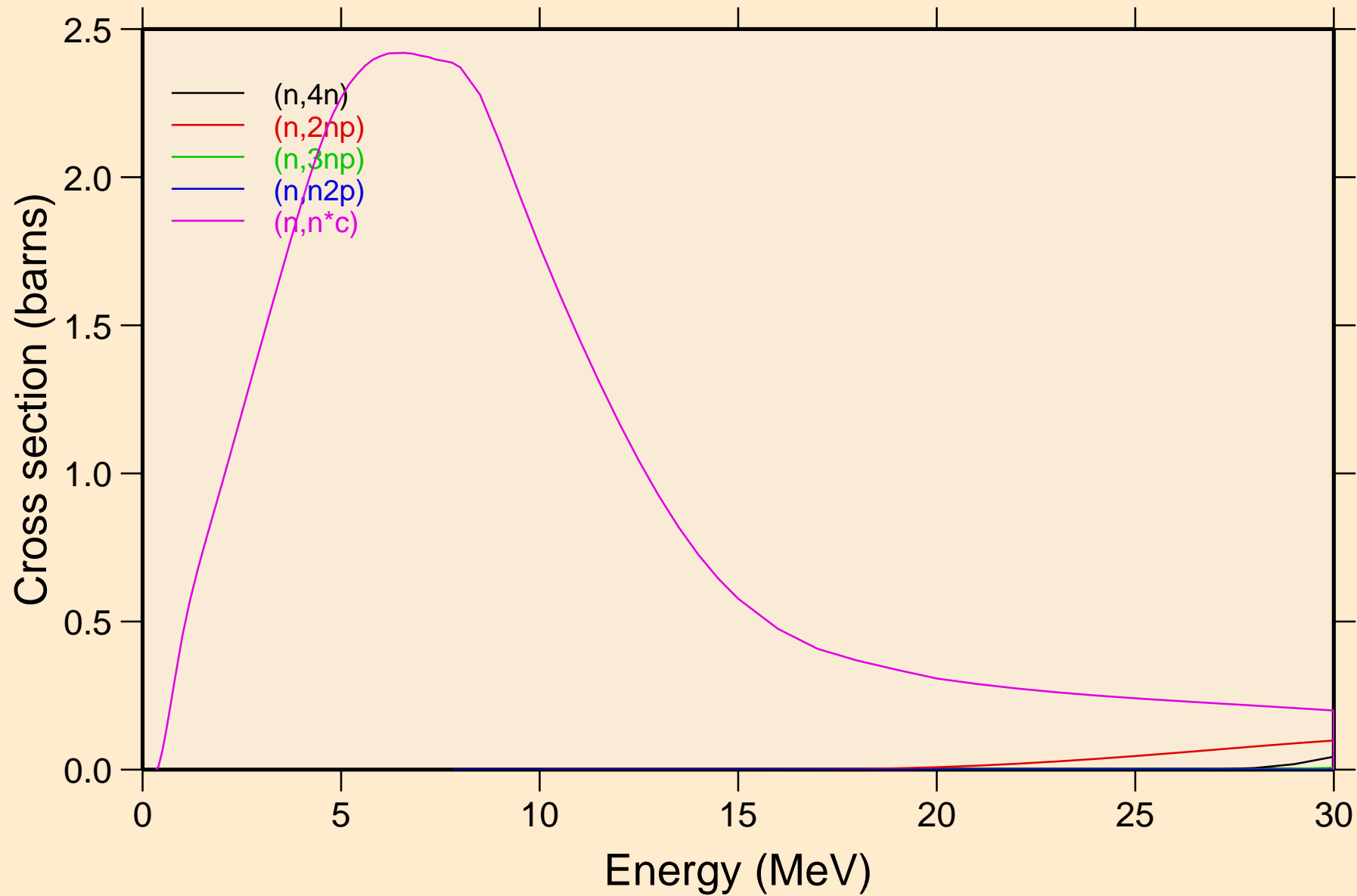

IR182 NEUTRON ACER TENDL-2024 LIBRARY; T=0.K
Threshold reactions

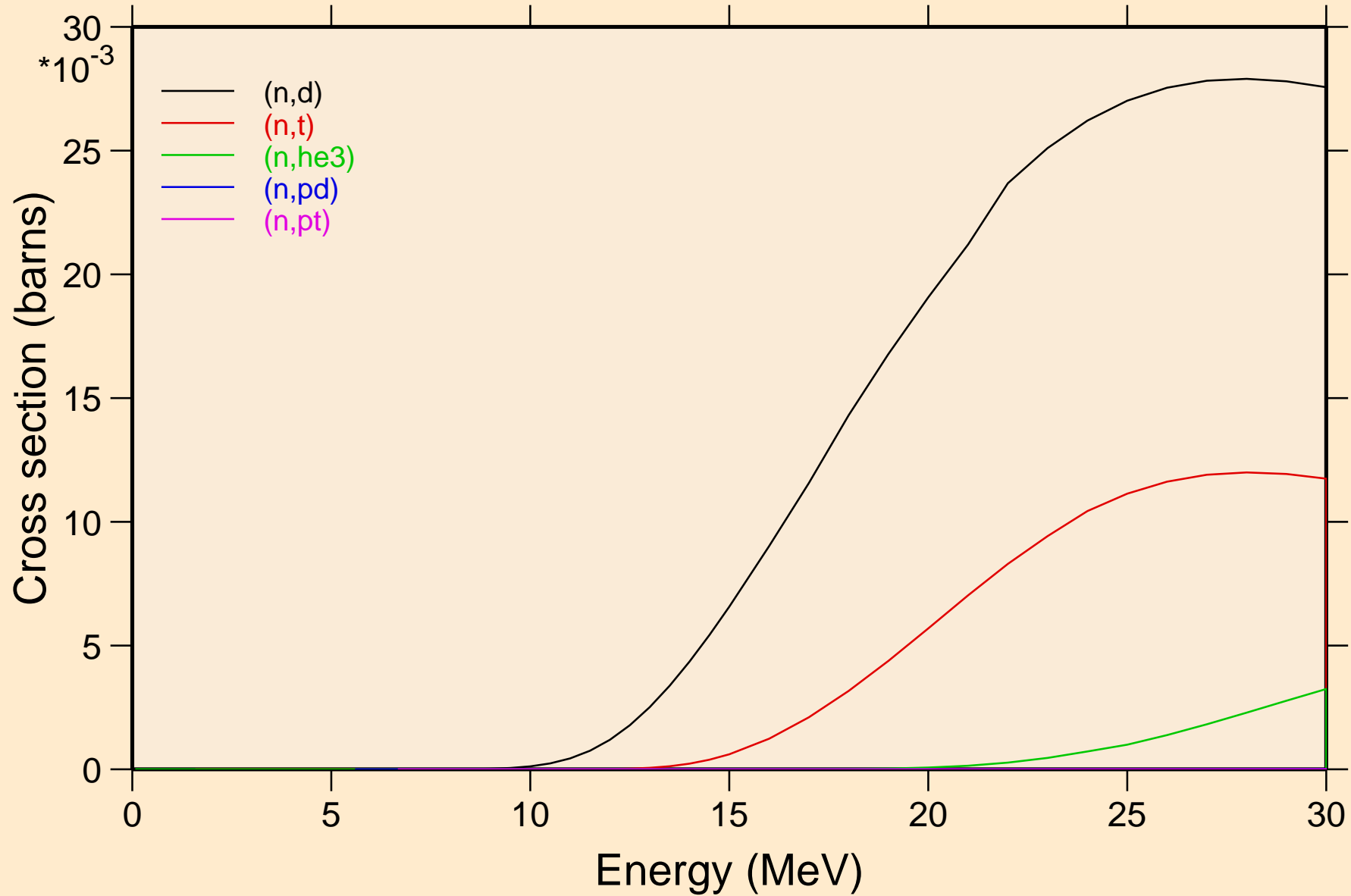

IR182 NEUTRON ACER TENDL-2024 LIBRARY; T=0.K
Threshold reactions

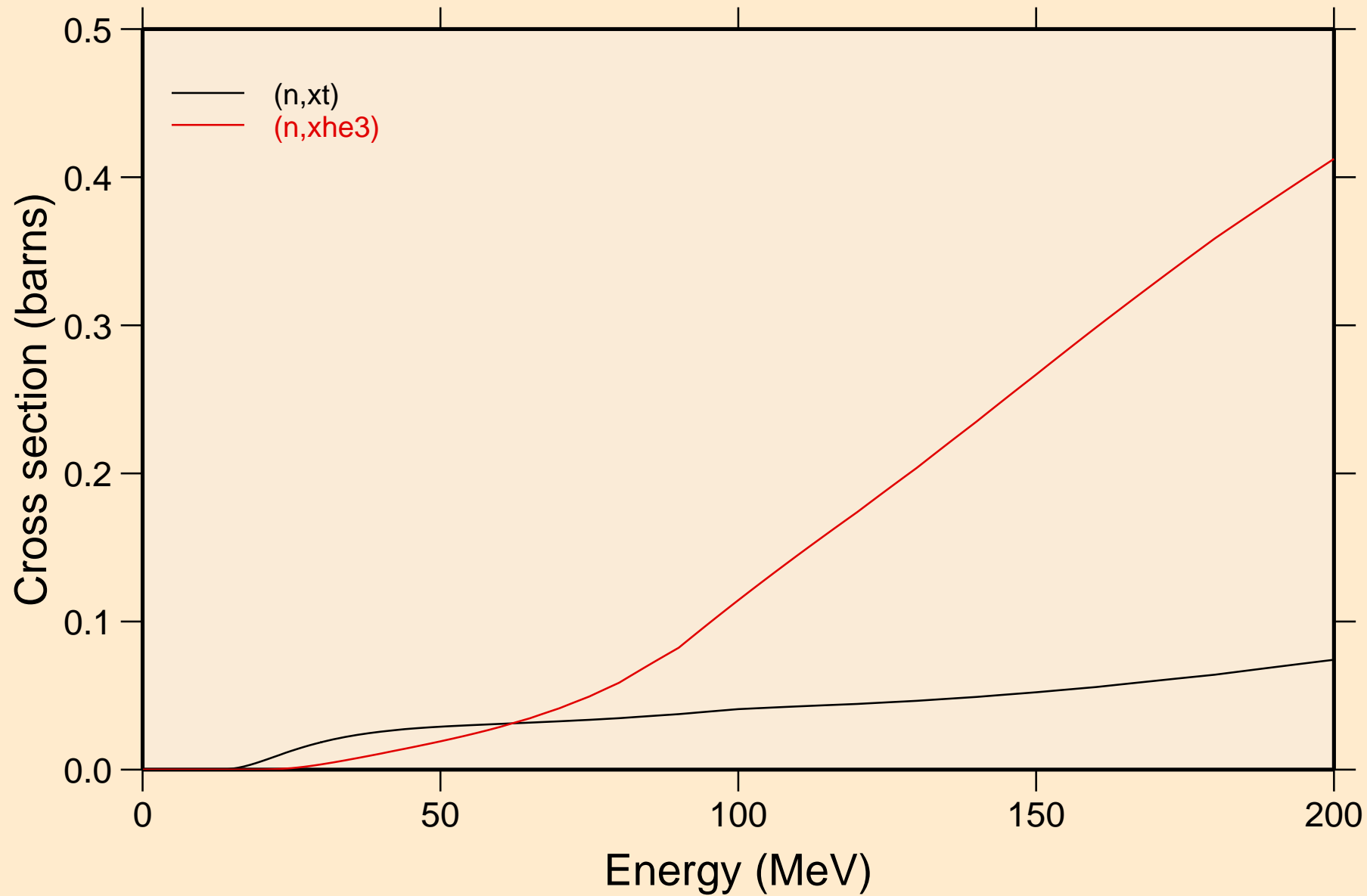

IR182 NEUTRON ACER TENDL-2024 LIBRARY; T=0.K
angular distribution for elastic

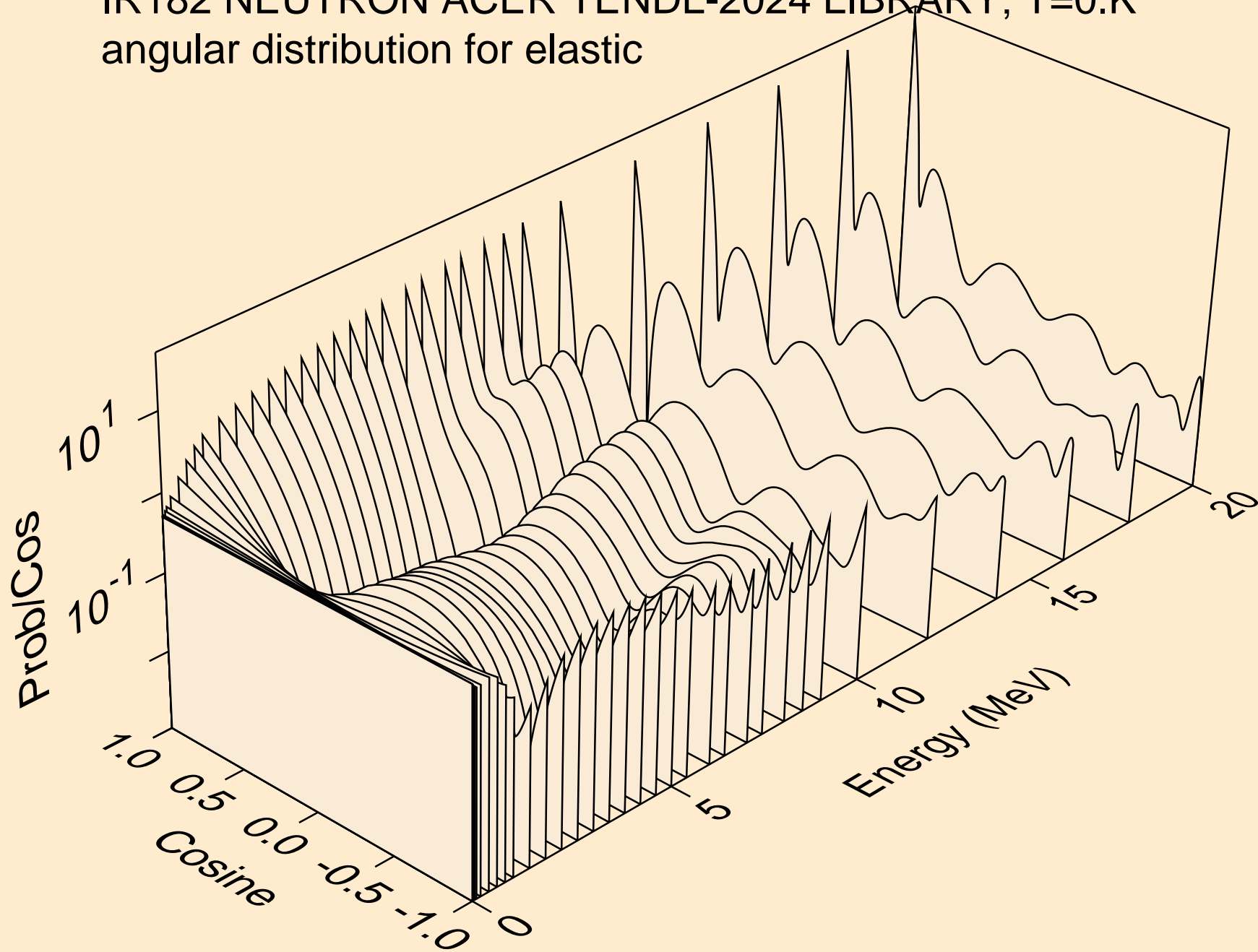

IR182 NEUTRON ACER TENDL-2024 LIBRARY; T=0.K
angular distribution for elastic

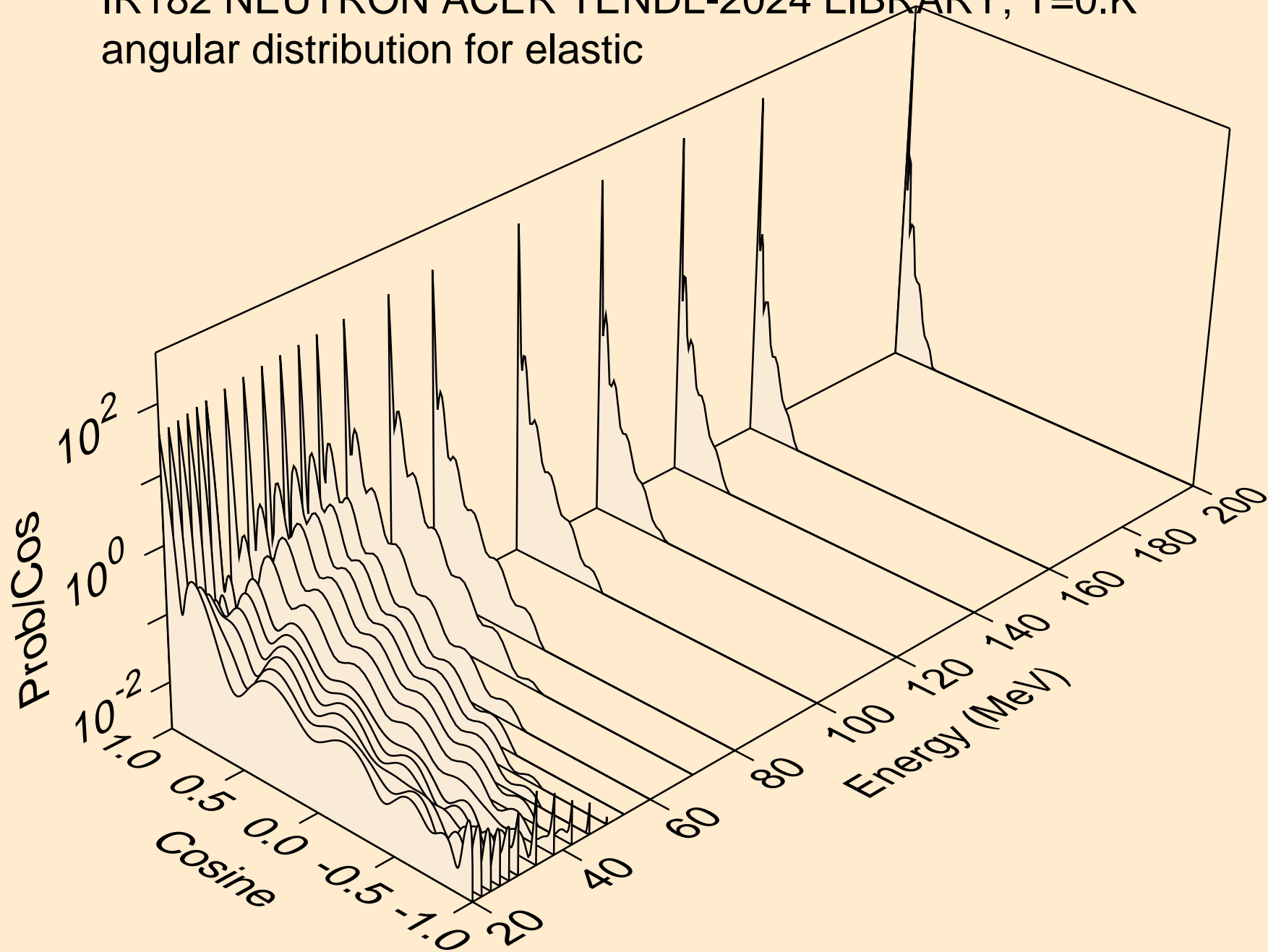

IR182 NEUTRON ACER TENDL-2024 LIBRARY; T=0.K
angular distribution for (n,n*1)

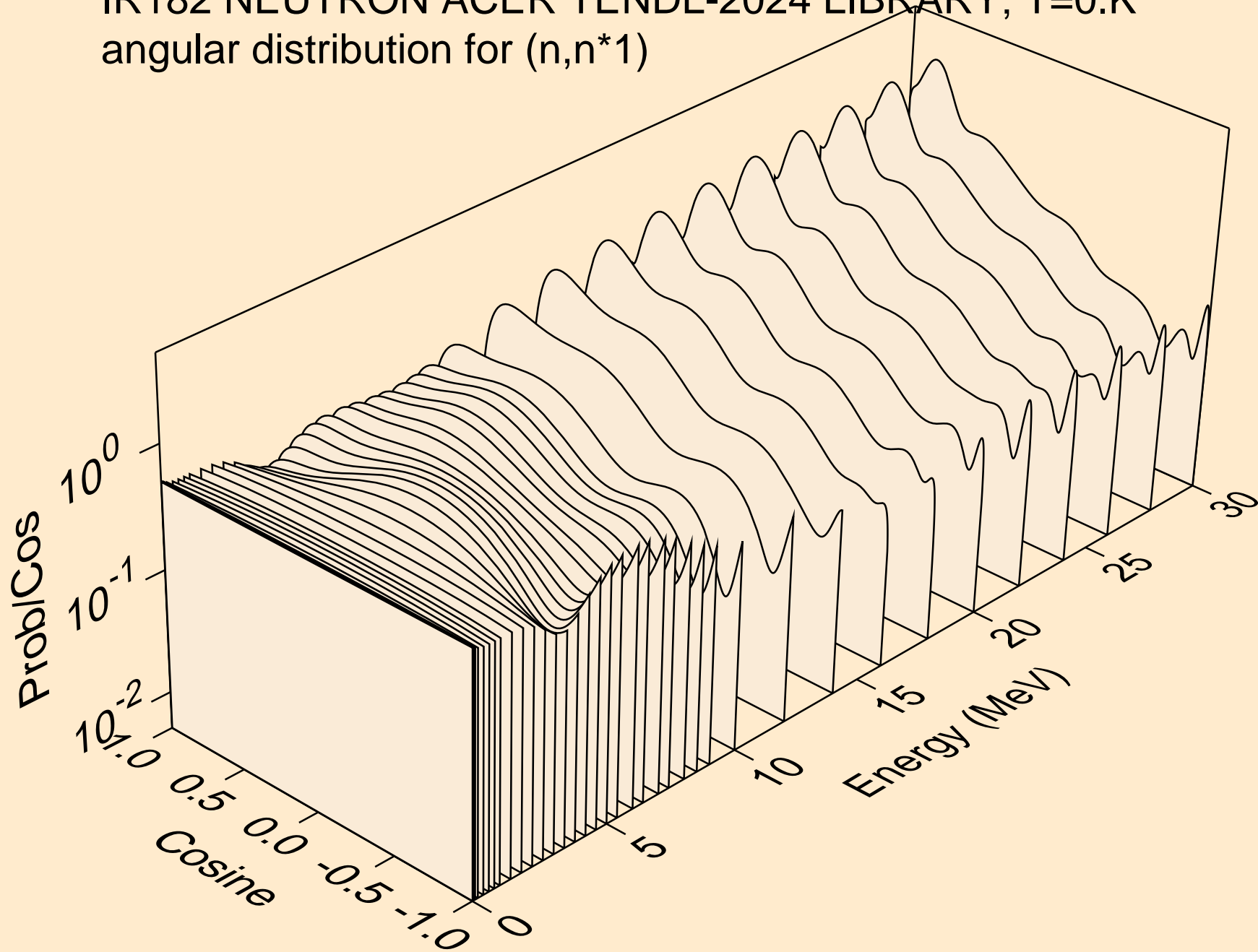

IR182 NEUTRON ACER TENDL-2024 LIBRARY; T=0.K
angular distribution for (n,n*2)

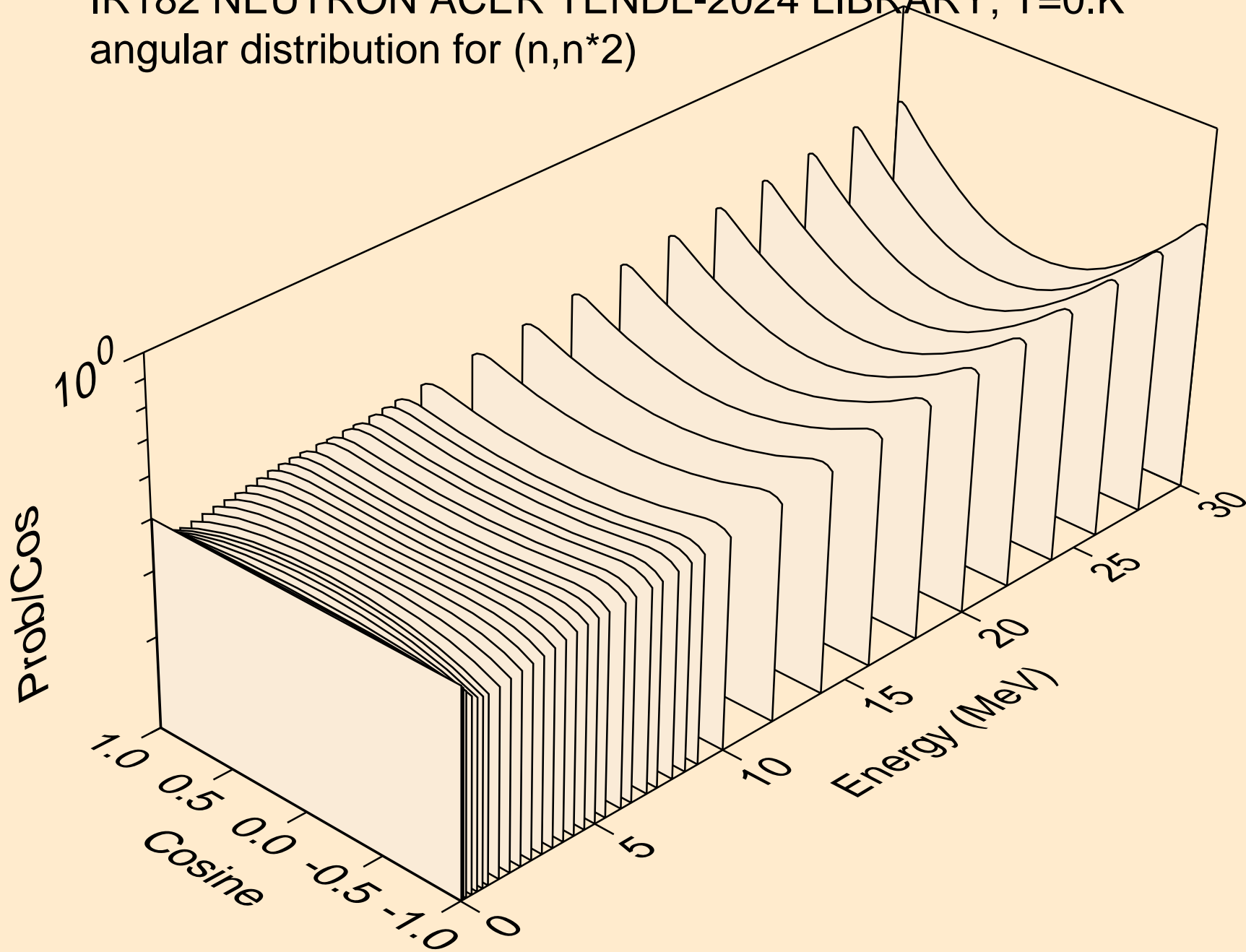

IR182 NEUTRON ACER TENDL-2024 LIBRARY; T=0.K
angular distribution for (n,n*3)

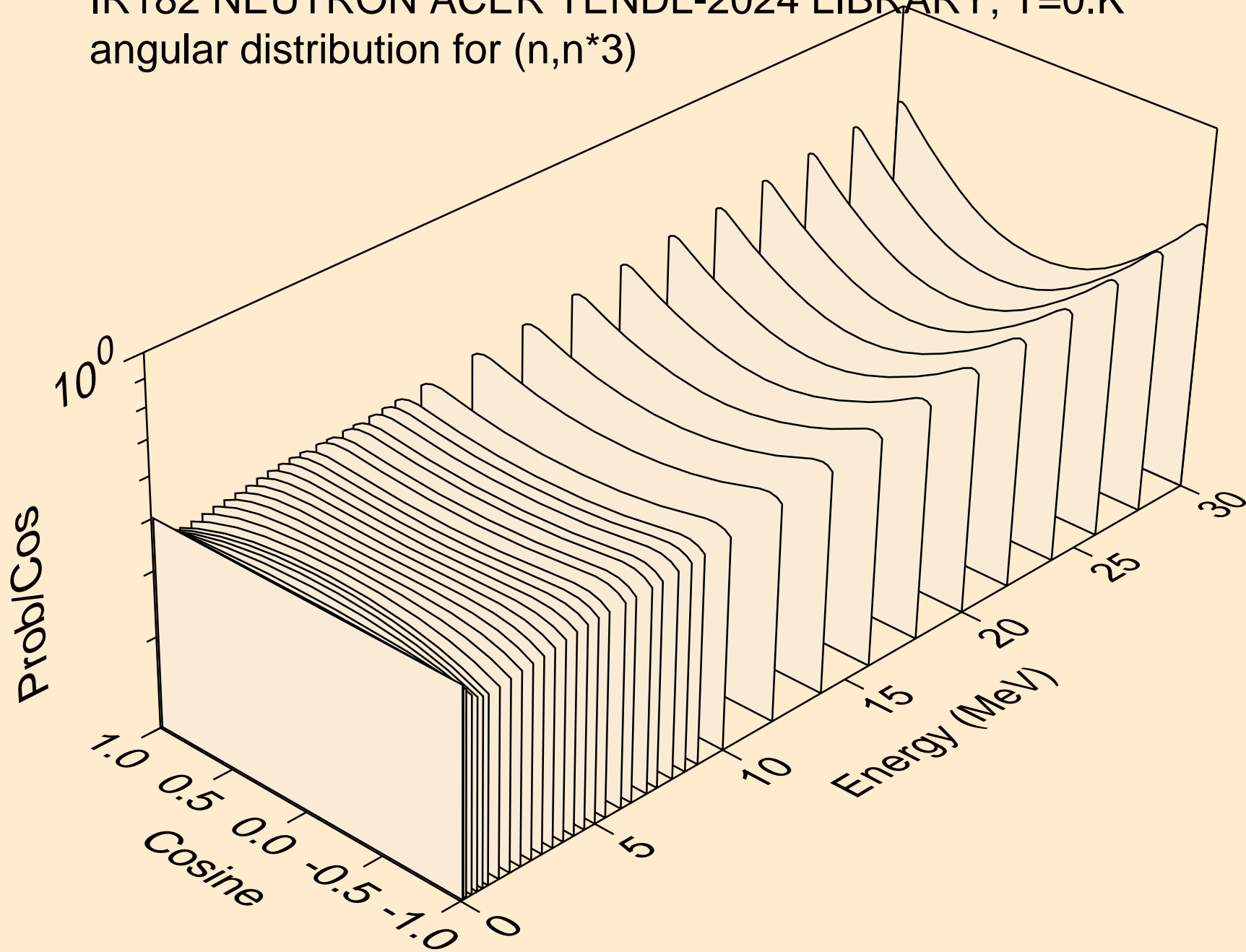

IR182 NEUTRON ACER TENDL-2024 LIBRARY; T=0.K
angular distribution for (n,n*4)

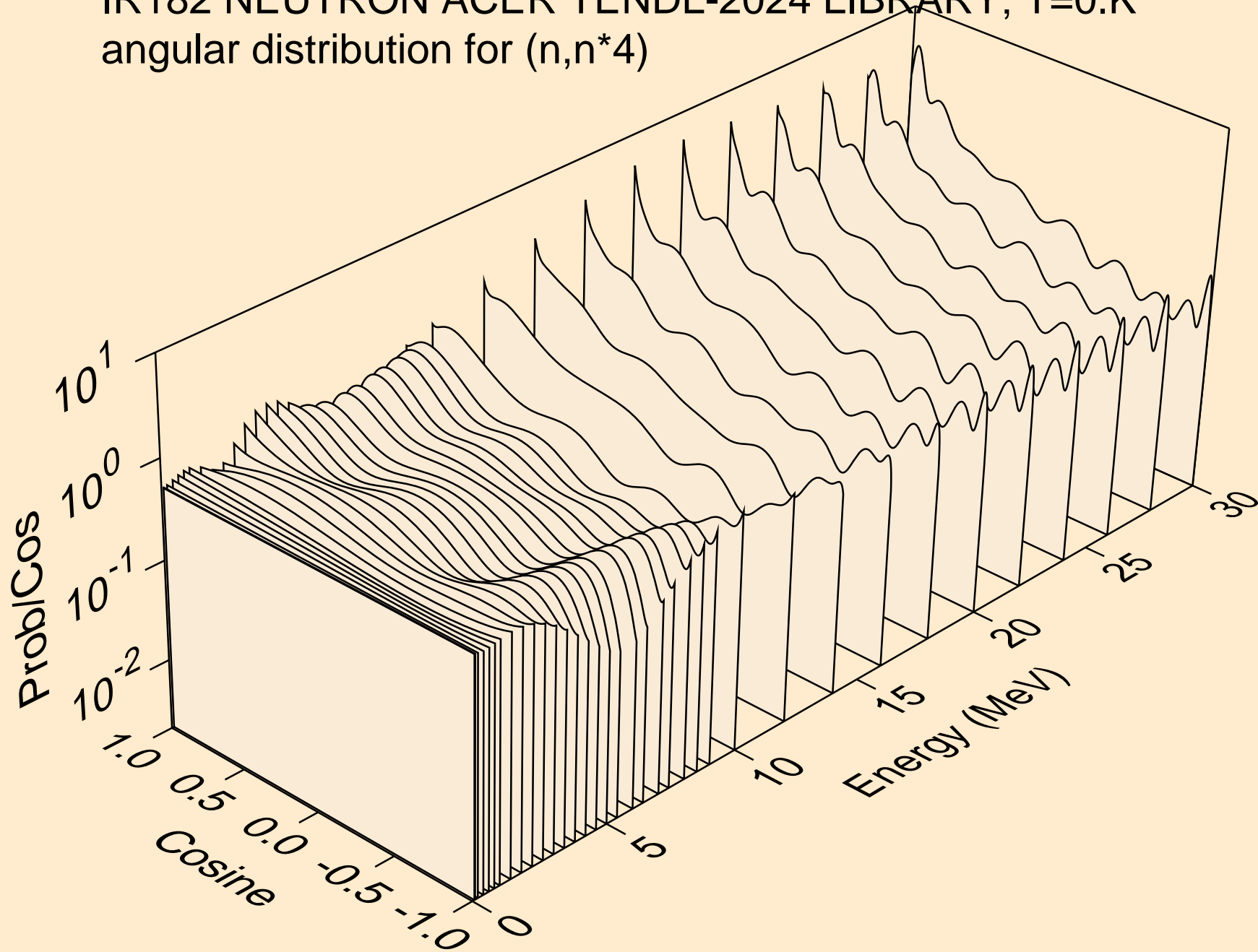

IR182 NEUTRON ACER TENDL-2024 LIBRARY; T=0.K
angular distribution for (n,n*5)

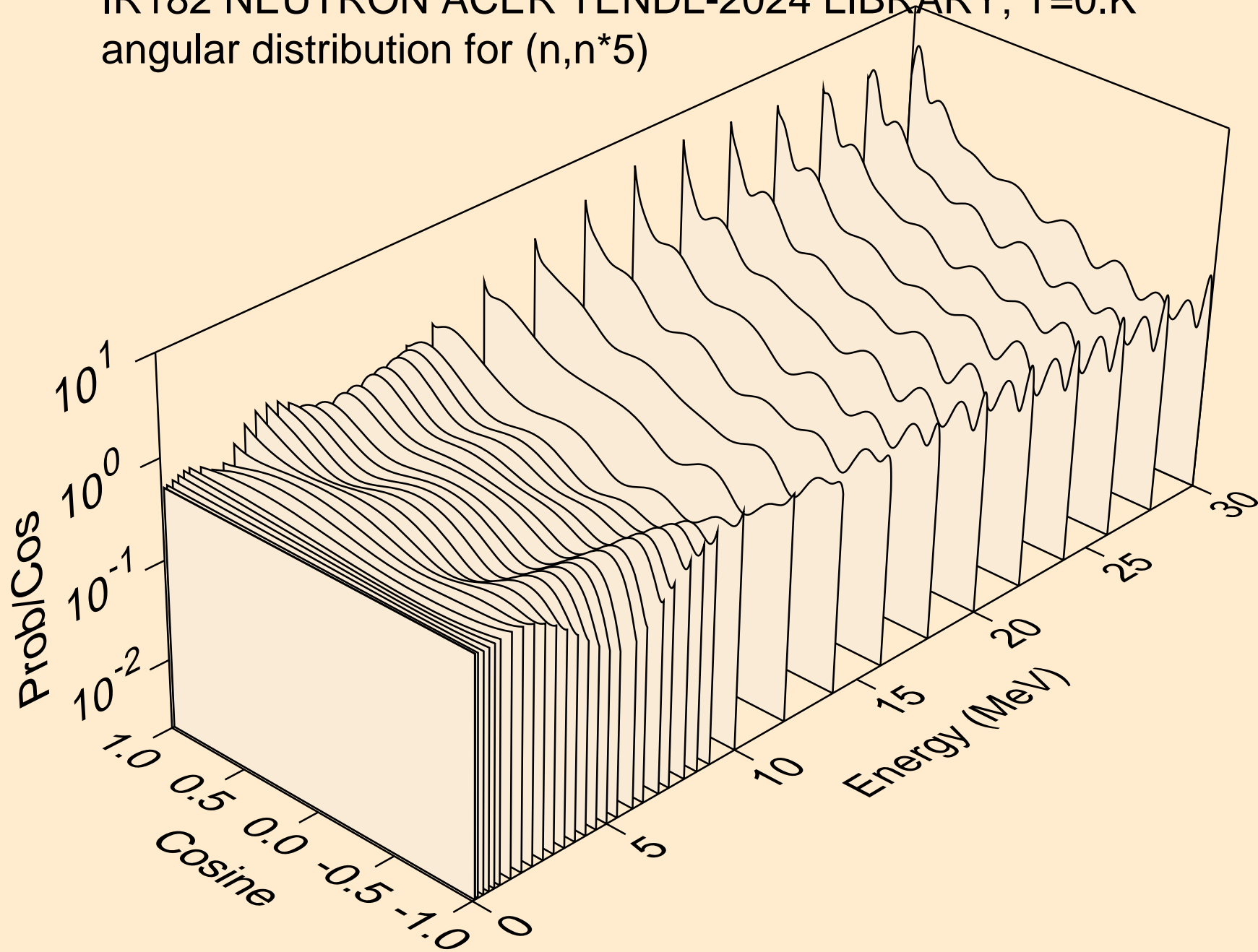

IR182 NEUTRON ACER TENDL-2024 LIBRARY; T=0.K
angular distribution for (n,n*6)

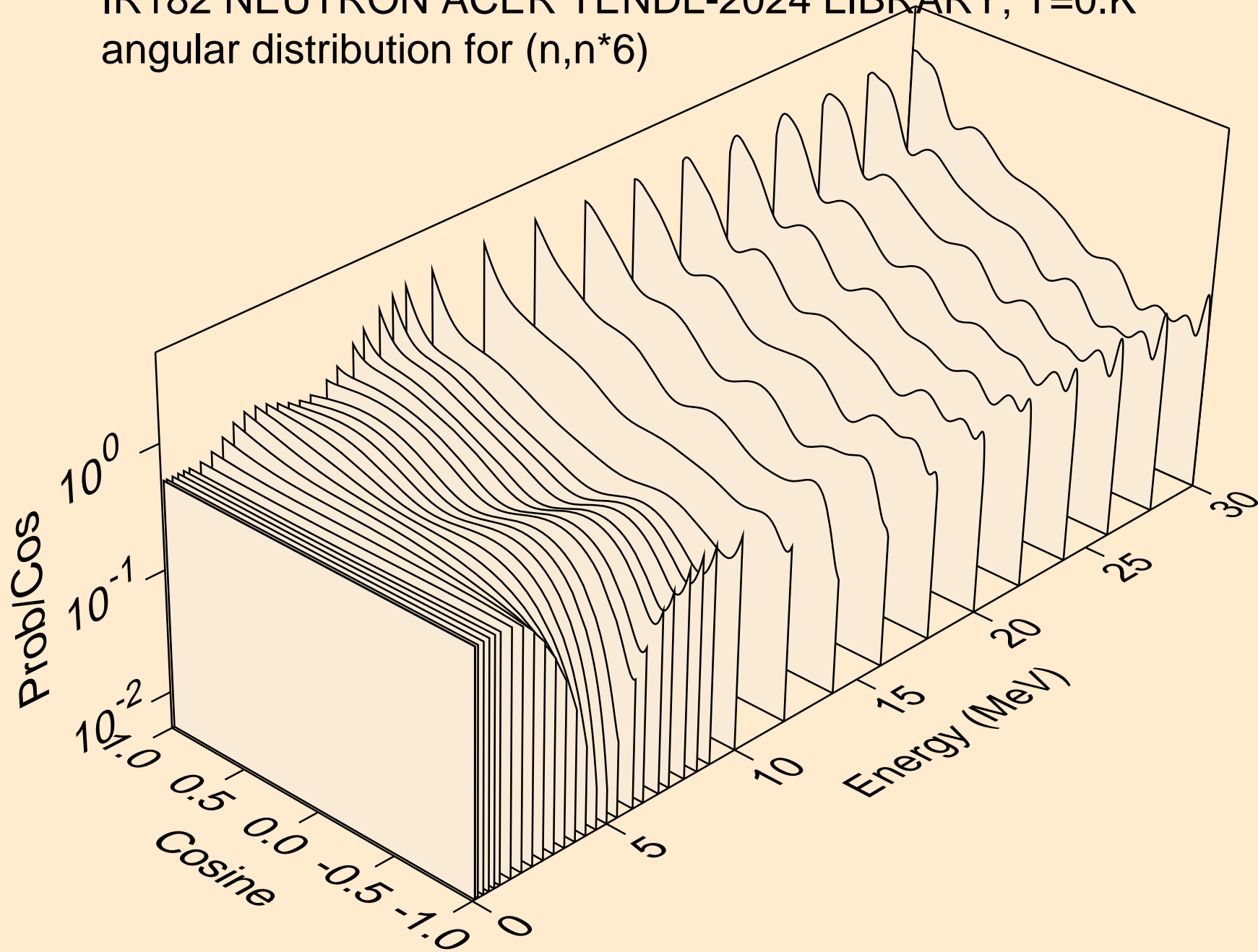

IR182 NEUTRON ACER TENDL-2024 LIBRARY; T=0.K
angular distribution for (n,n*7)

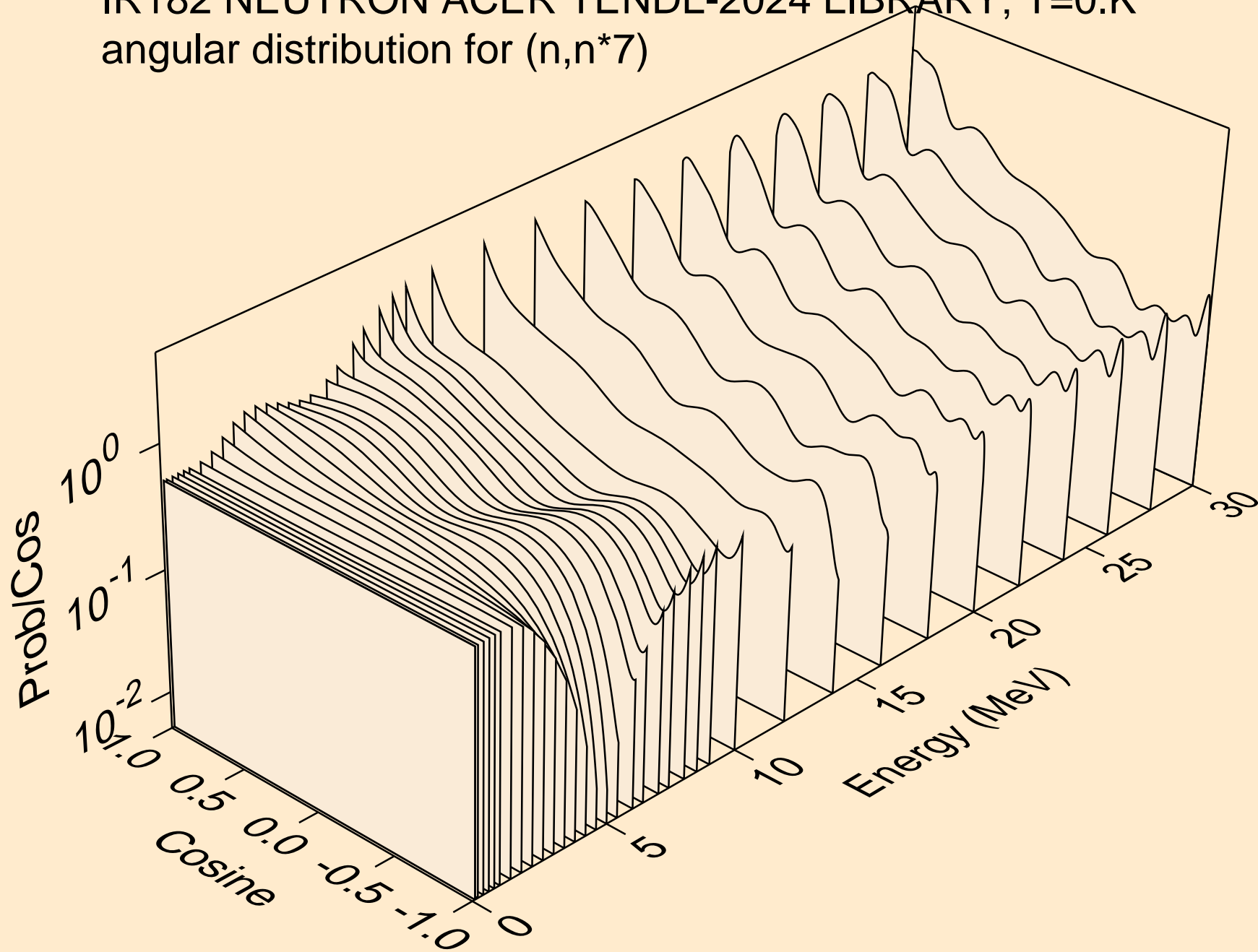

IR182 NEUTRON ACER TENDL-2024 LIBRARY; T=0.K
angular distribution for (n,n*8)

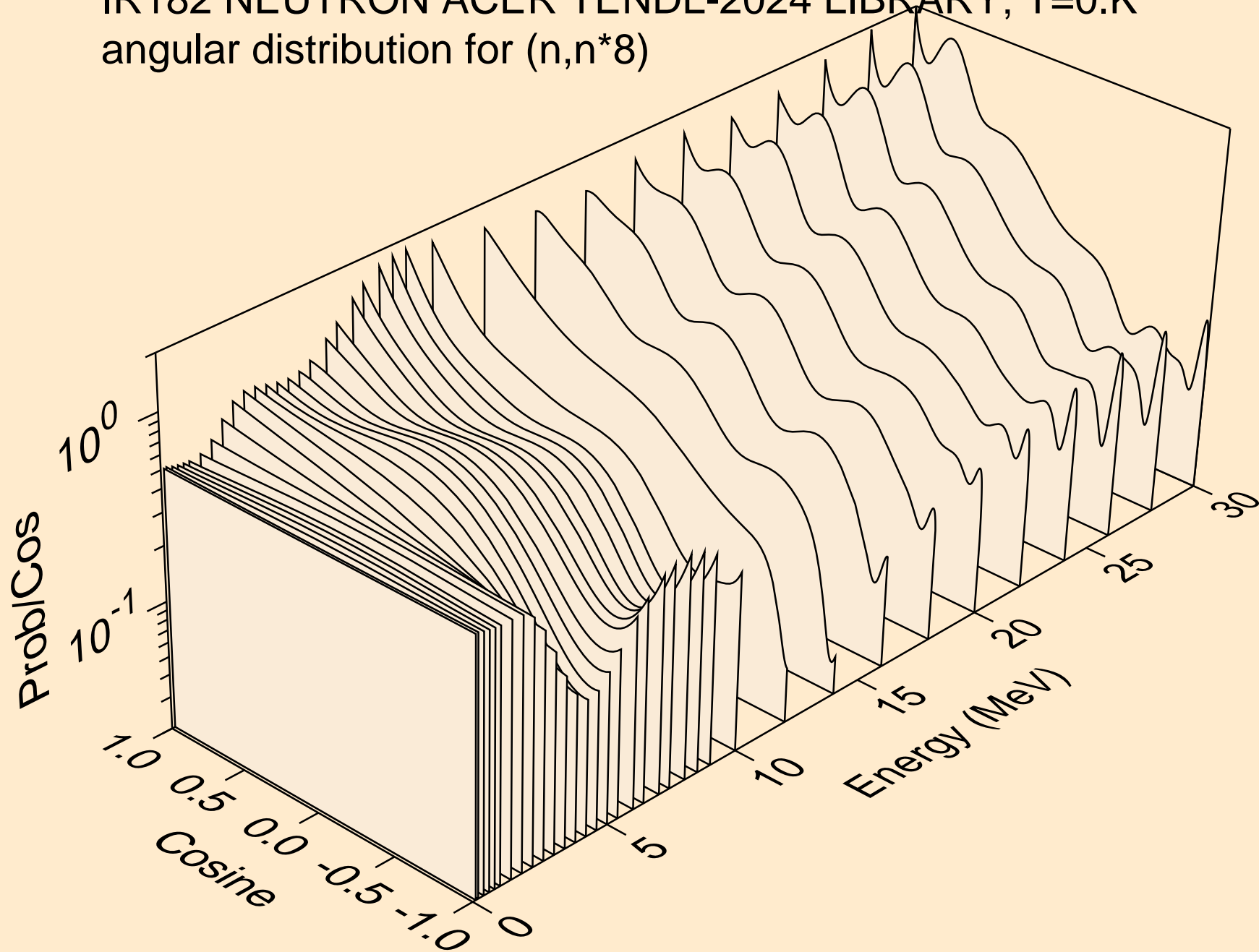

IR182 NEUTRON ACER TENDL-2024 LIBRARY; T=0.K
angular distribution for (n,n*9)

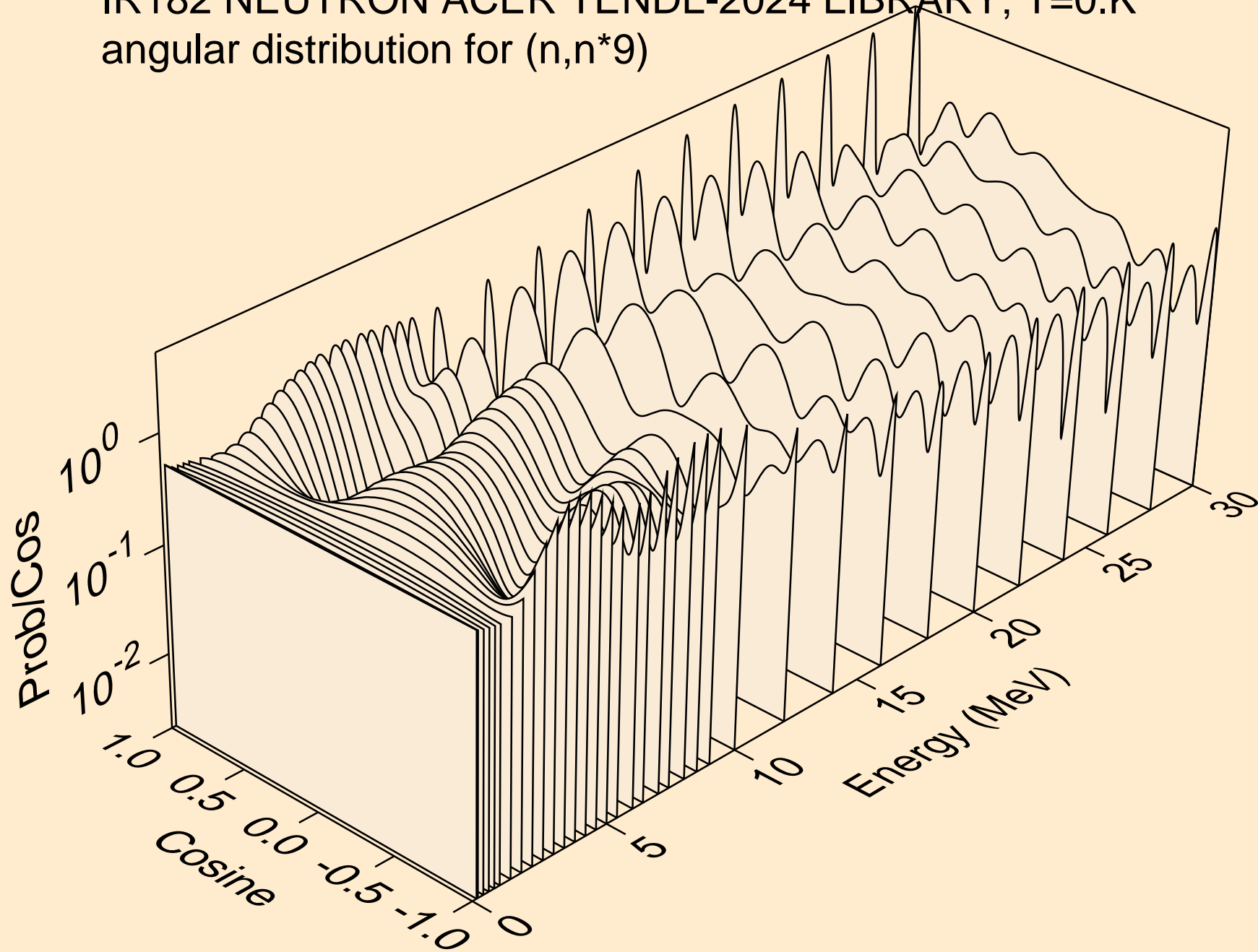

IR182 NEUTRON ACER TENDL-2024 LIBRARY; T=0.K
angular distribution for (n,n*10)

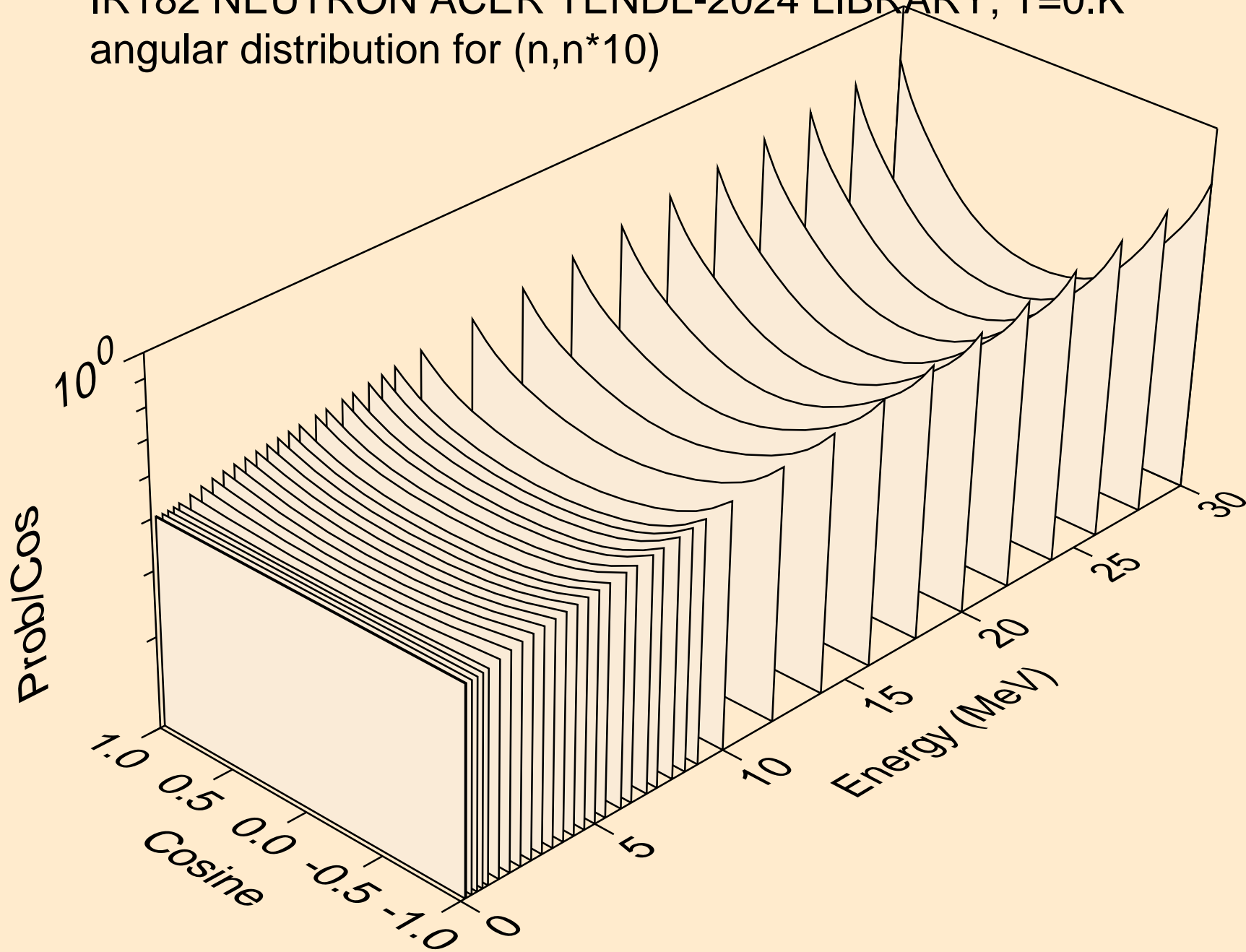

IR182 NEUTRON ACER TENDL-2024 LIBRARY; T=0.K
angular distribution for (n,n*11)

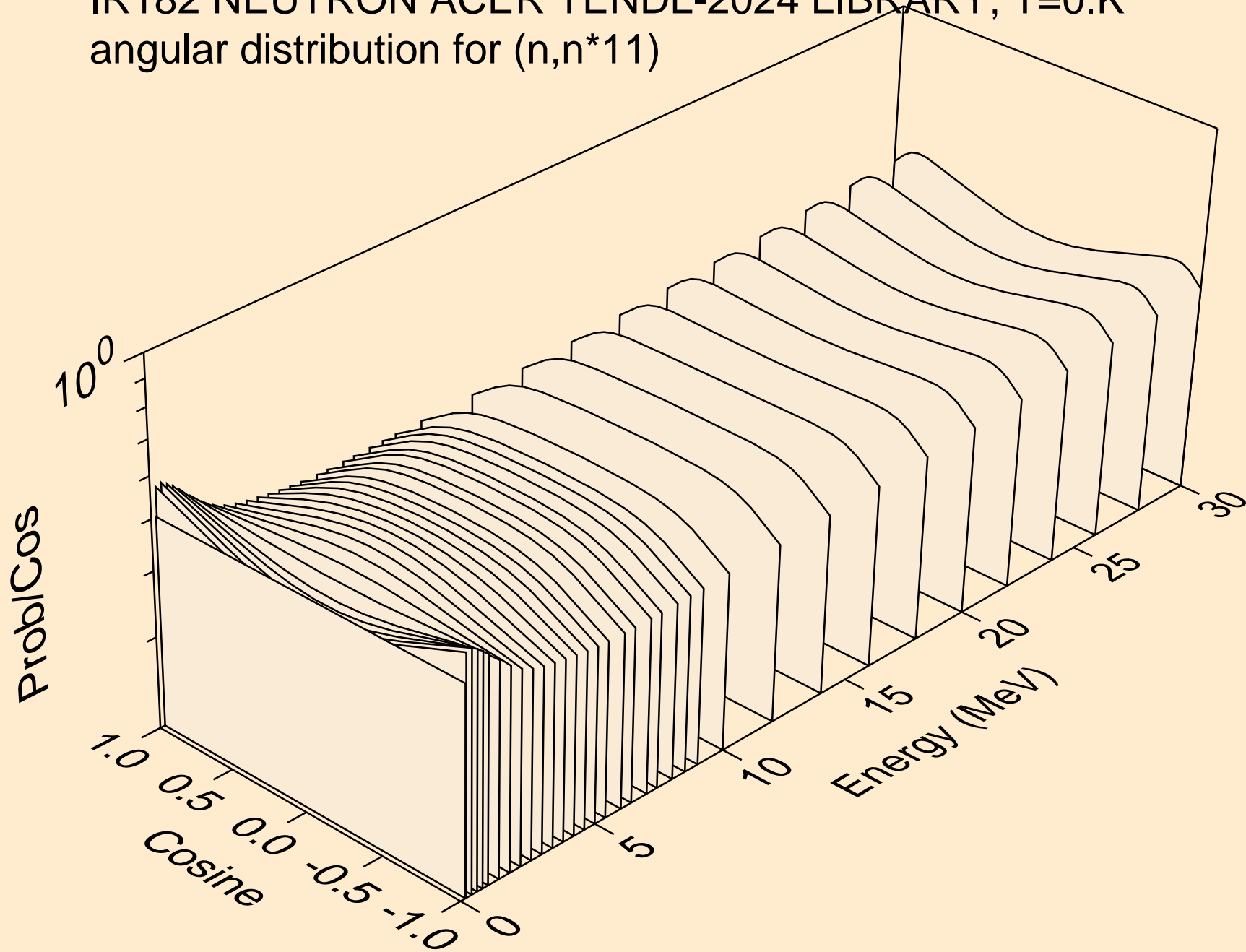

IR182 NEUTRON ACER TENDL-2024 LIBRARY; T=0.K
angular distribution for (n,n*12)

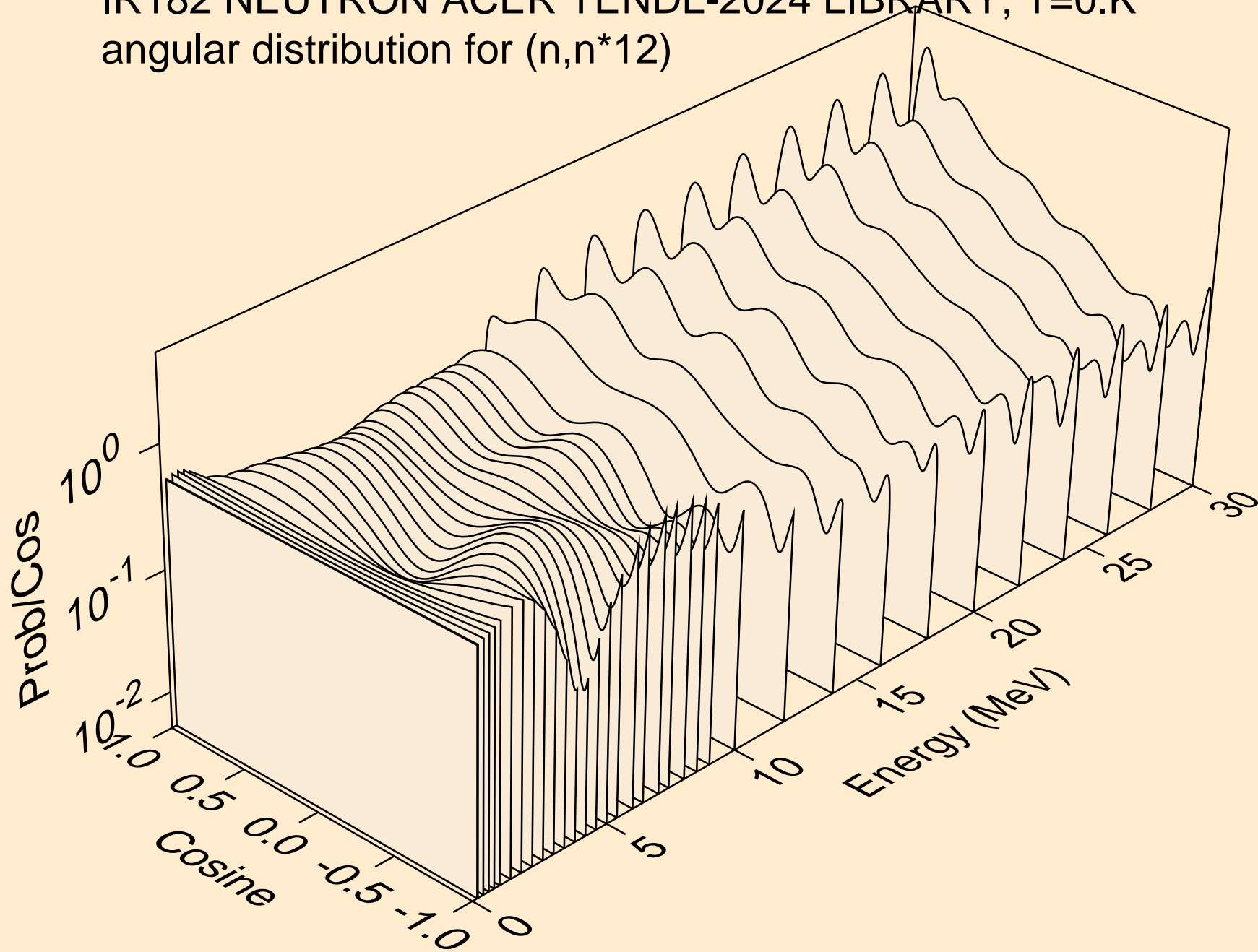

IR182 NEUTRON ACER TENDL-2024 LIBRARY; T=0.K
angular distribution for (n,n*13)

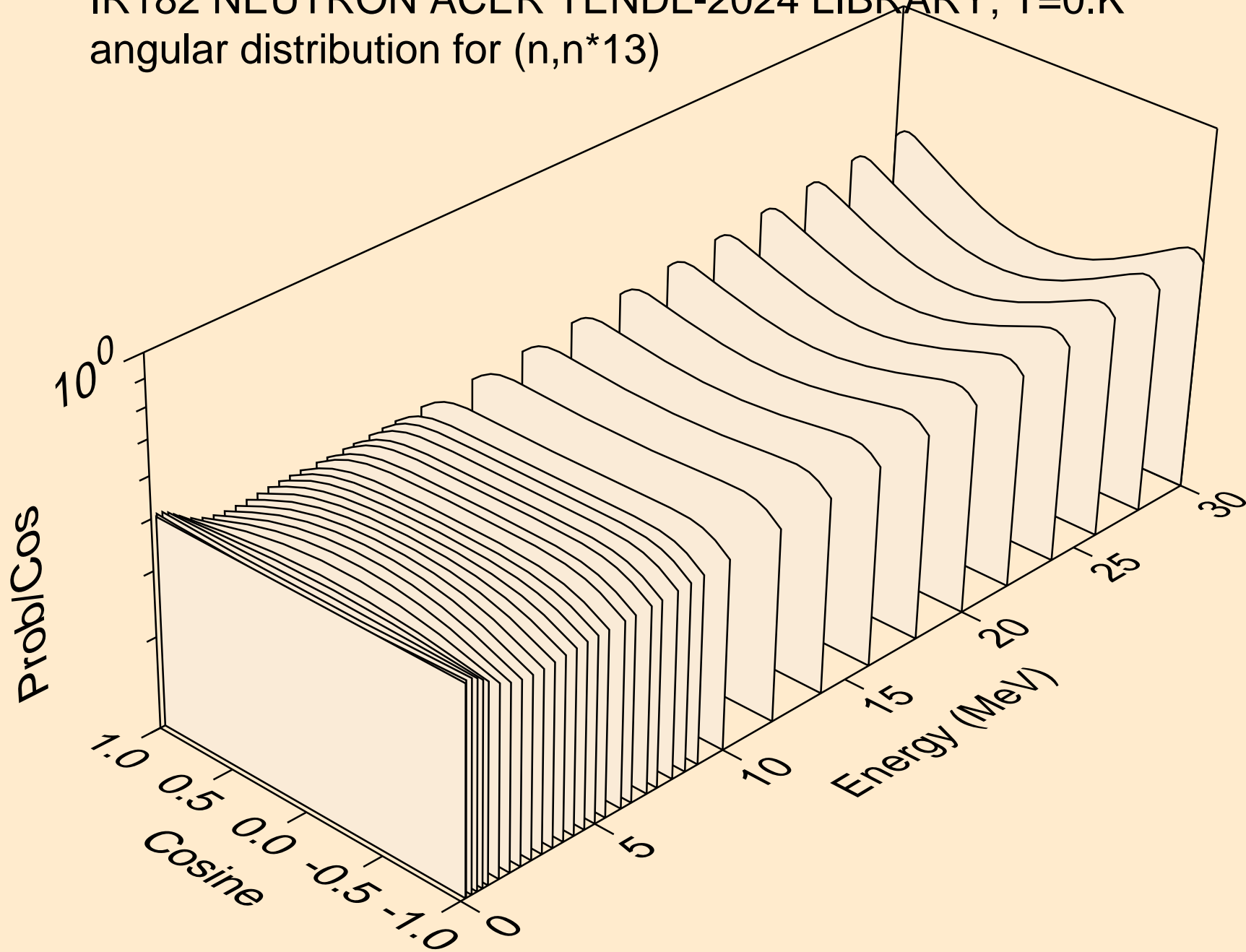

IR182 NEUTRON ACER TENDL-2024 LIBRARY; T=0.K
angular distribution for (n,n*14)

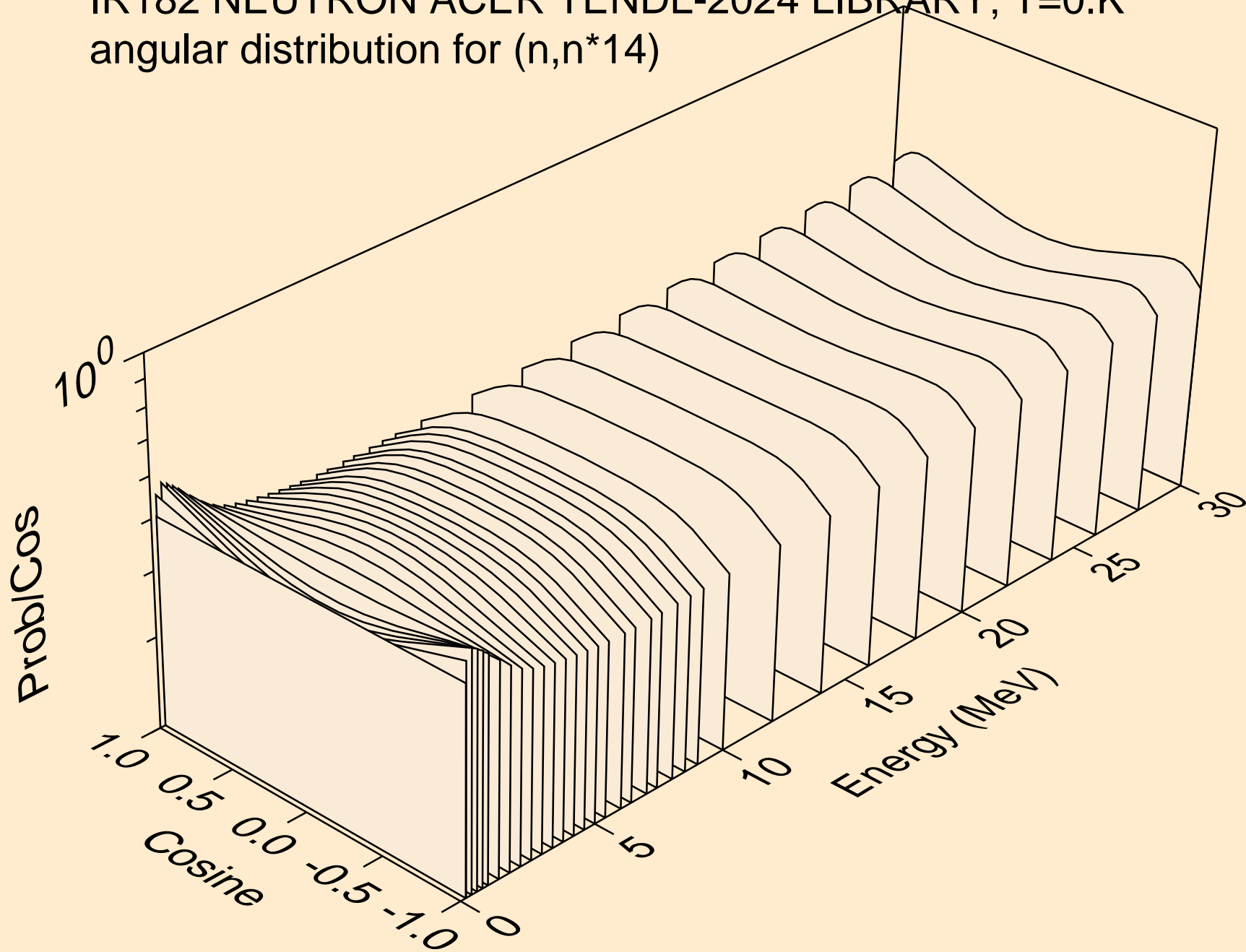

IR182 NEUTRON ACER TENDL-2024 LIBRARY; T=0.K
angular distribution for (n,n*15)

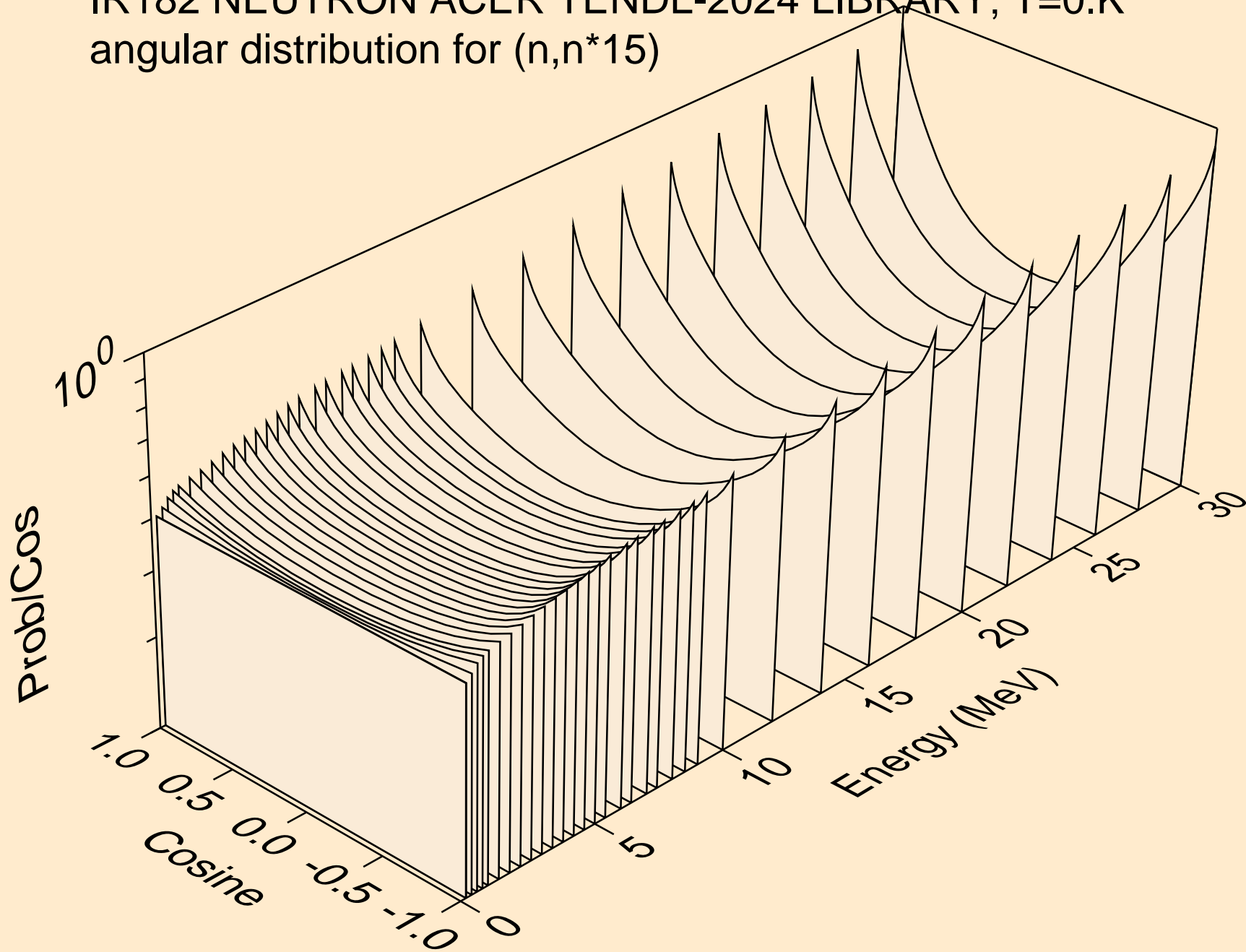

IR182 NEUTRON ACER TENDL-2024 LIBRARY; T=0.K
angular distribution for (n,n*16)

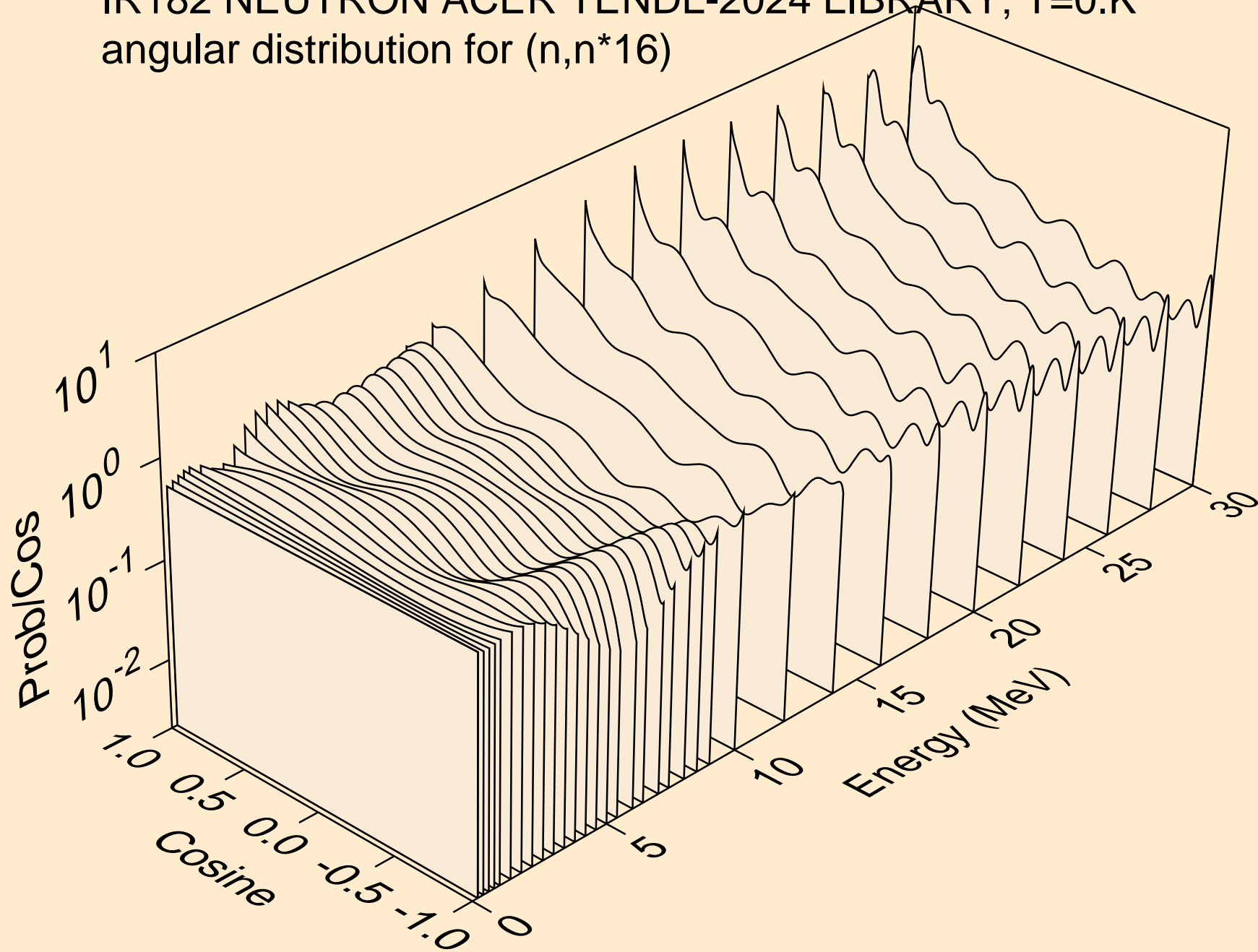

IR182 NEUTRON ACER TENDL-2024 LIBRARY; T=0.K
angular distribution for (n,n*17)

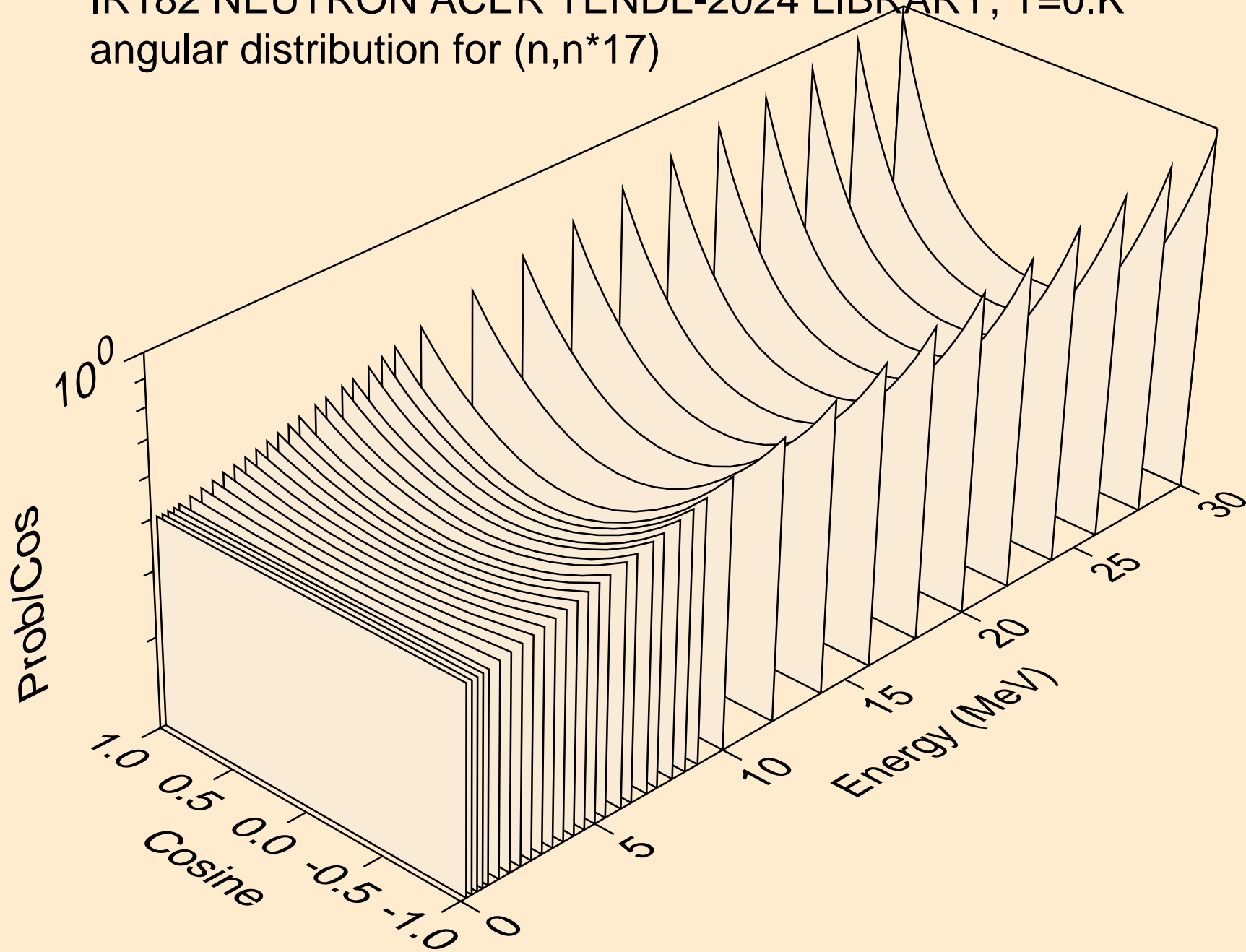

IR182 NEUTRON ACER TENDL-2024 LIBRARY; T=0.K
angular distribution for (n,n*18)

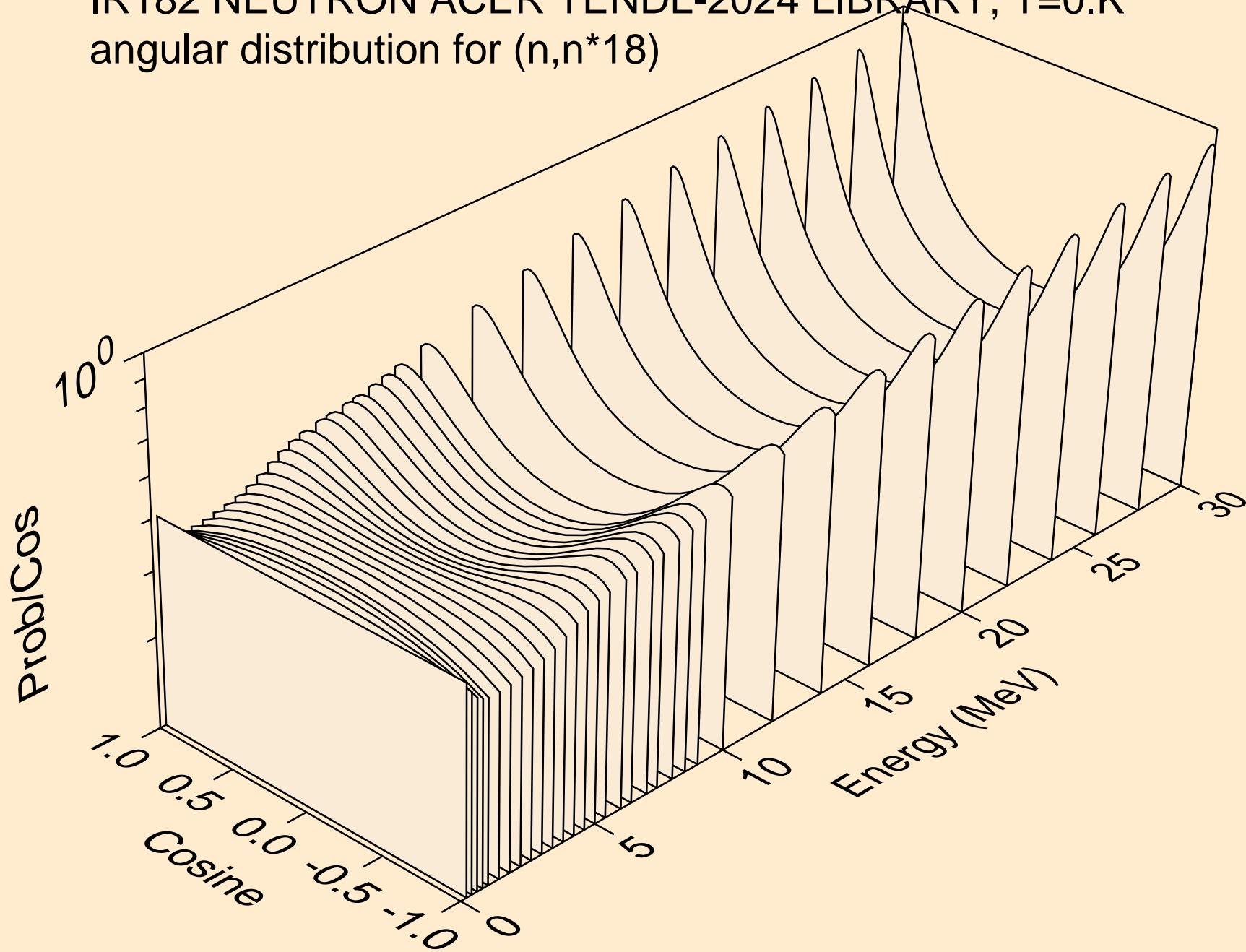

IR182 NEUTRON ACER TENDL-2024 LIBRARY; T=0.K
angular distribution for (n,n*19)

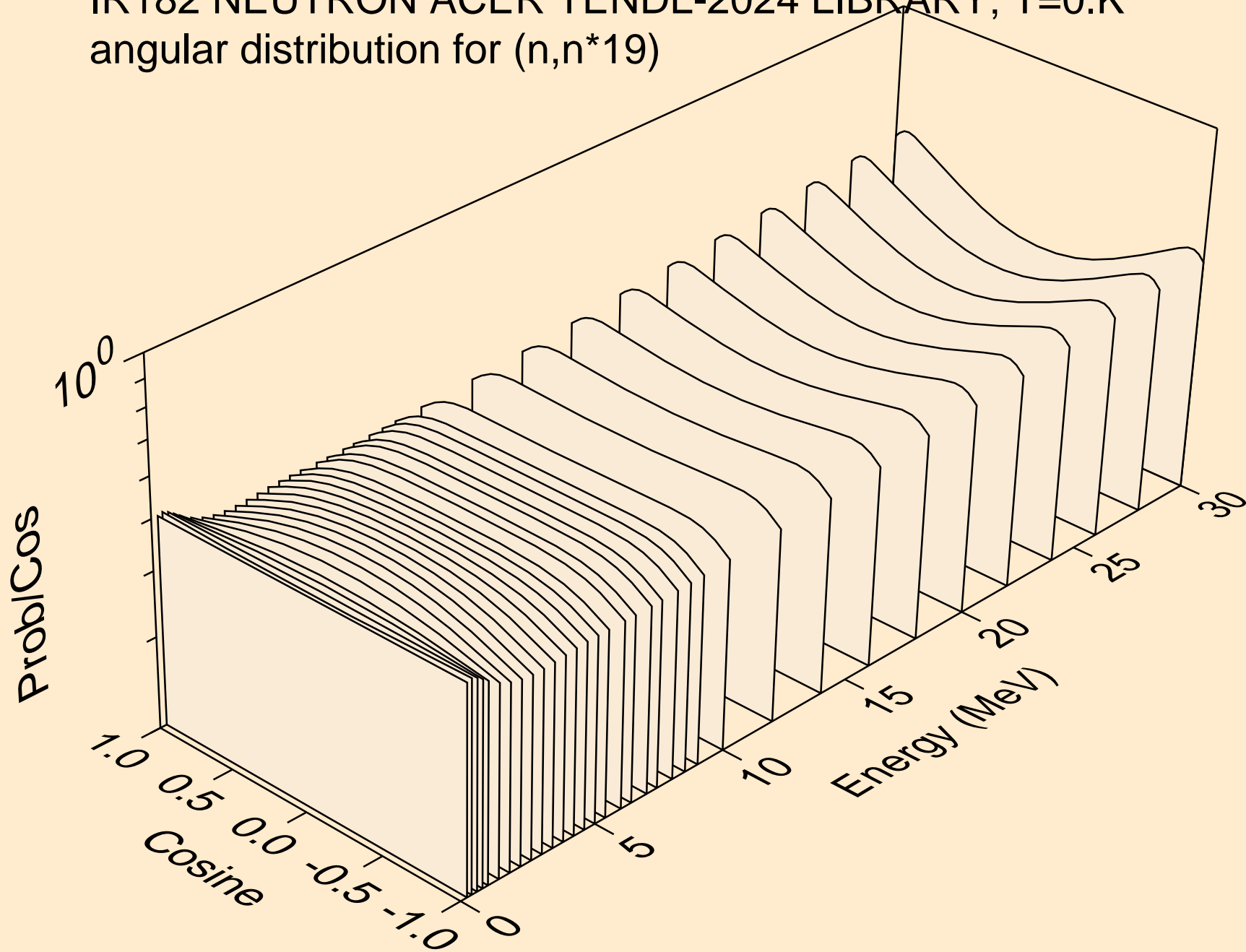

IR182 NEUTRON ACER TENDL-2024 LIBRARY; T=0.K
angular distribution for (n,n*20)

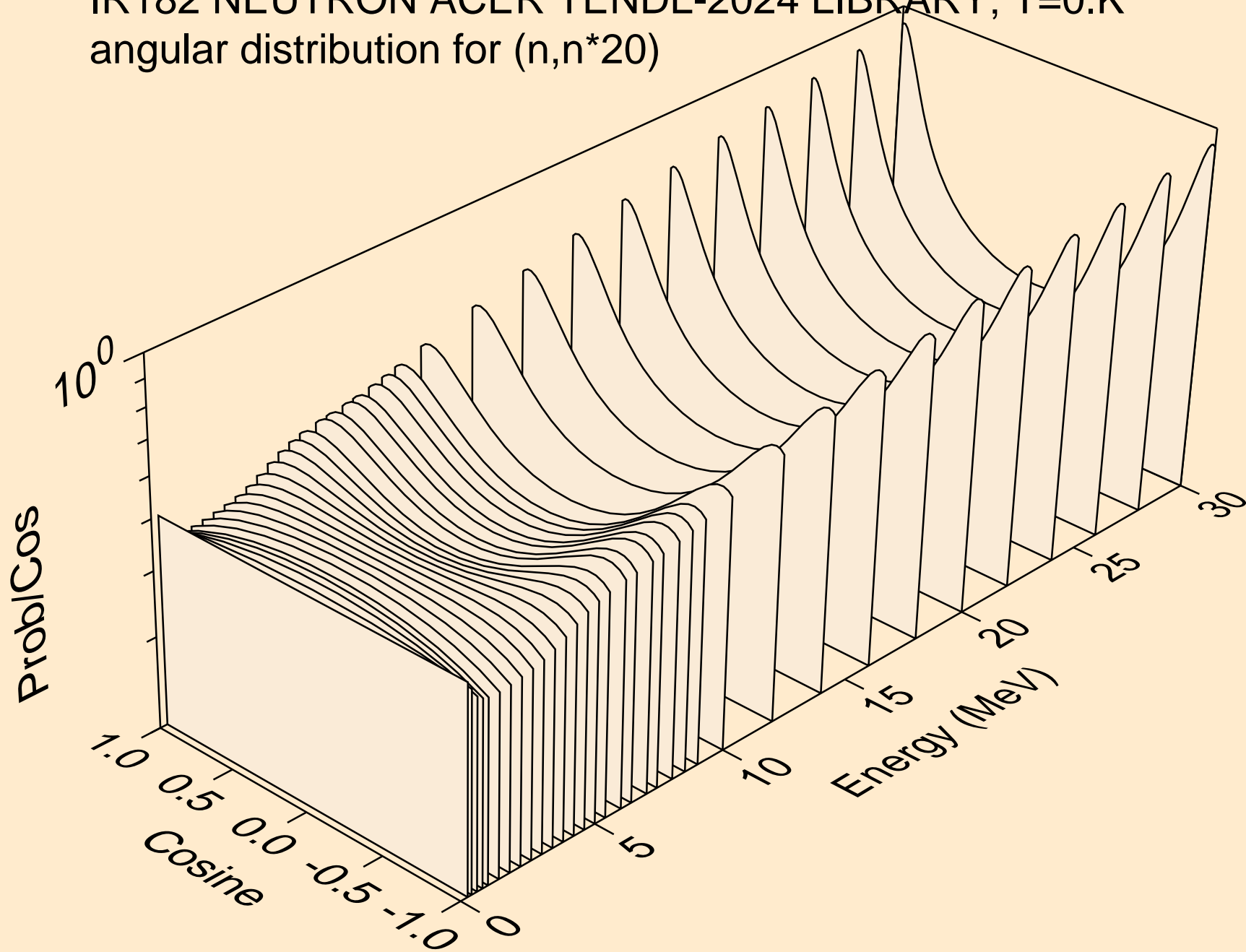

IR182 NEUTRON ACER TENDL-2024 LIBRARY; T=0.K
angular distribution for (n,n*21)

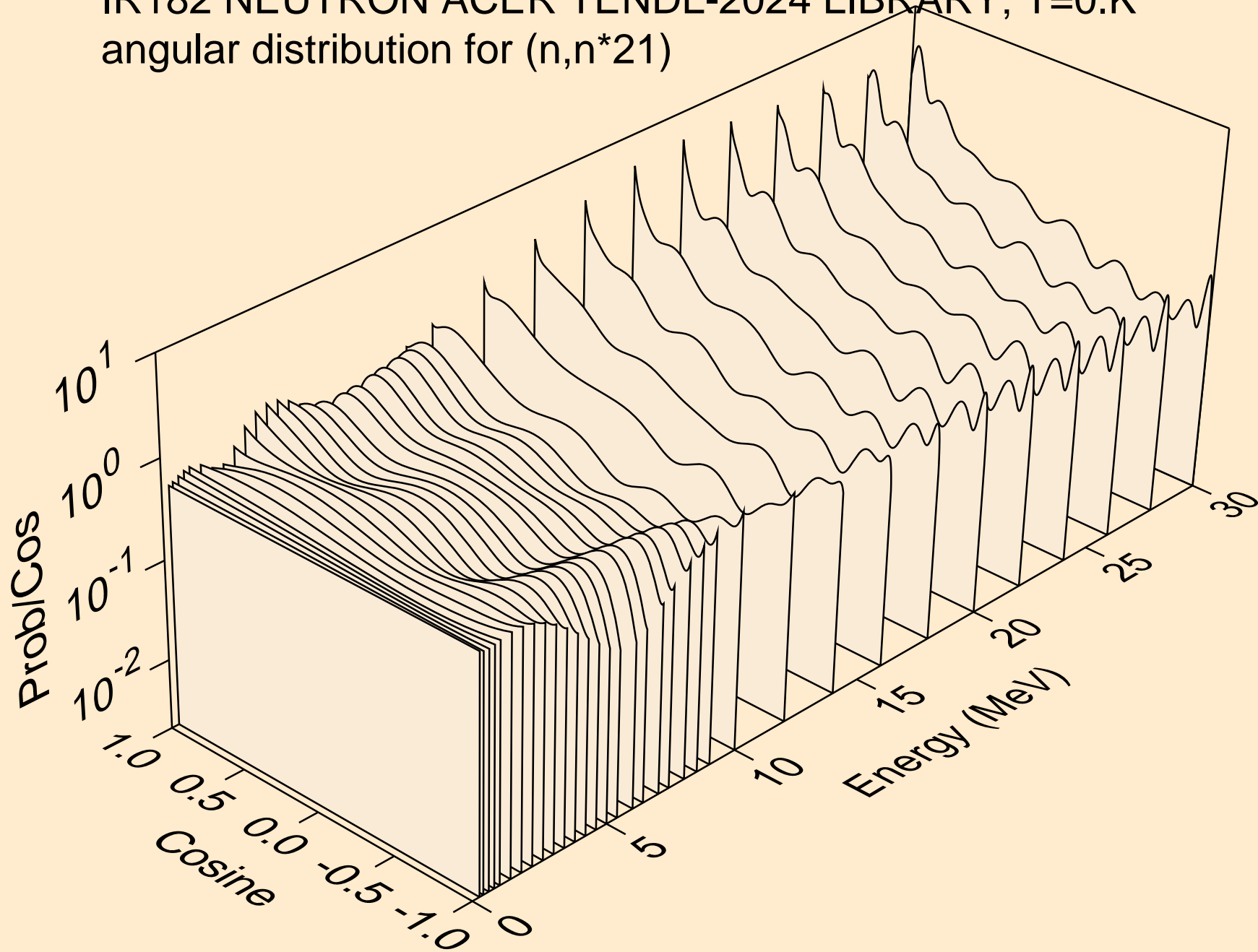

IR182 NEUTRON ACER TENDL-2024 LIBRARY; T=0.K
angular distribution for (n,n*22)

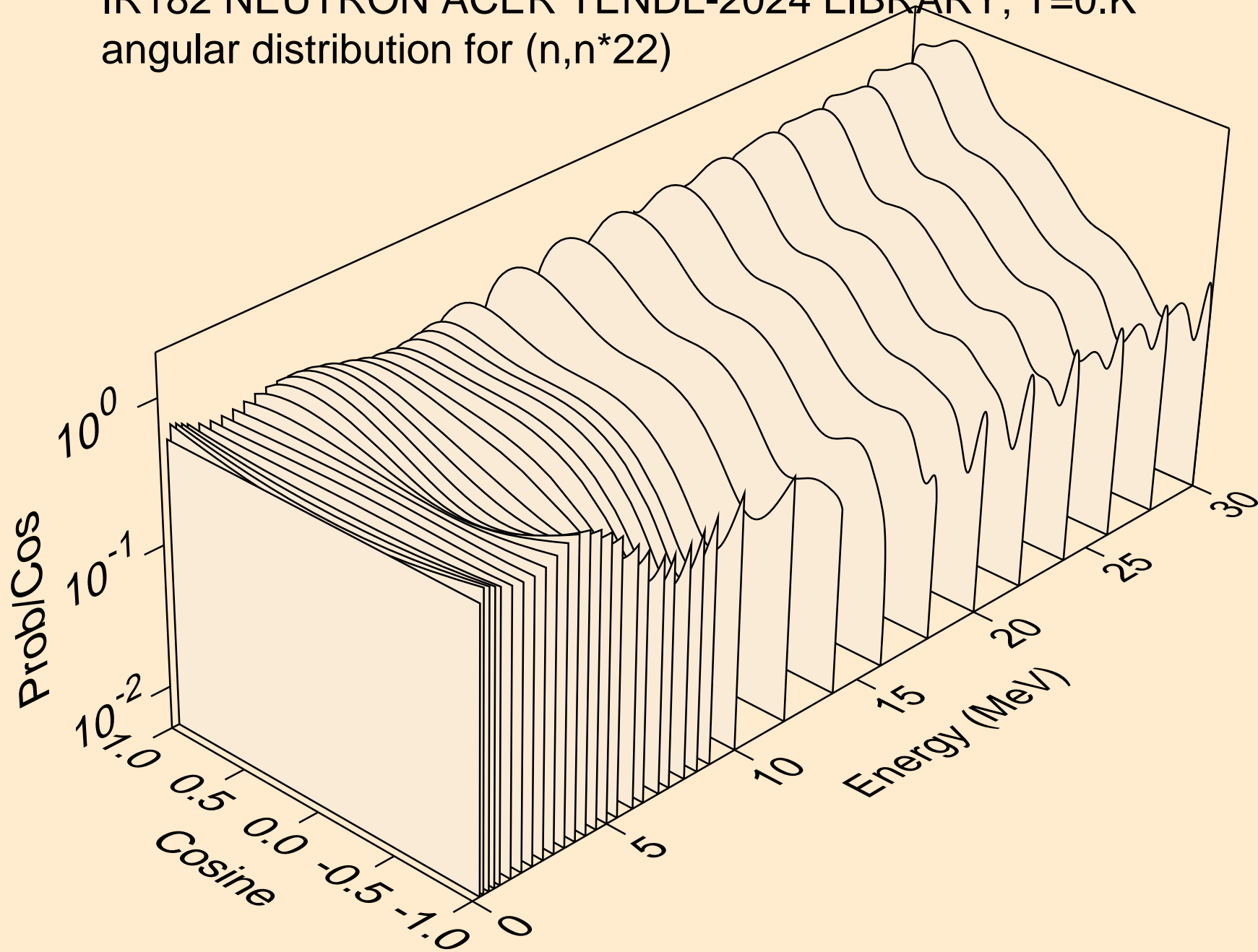

IR182 NEUTRON ACER TENDL-2024 LIBRARY; T=0.K
angular distribution for (n,n*23)

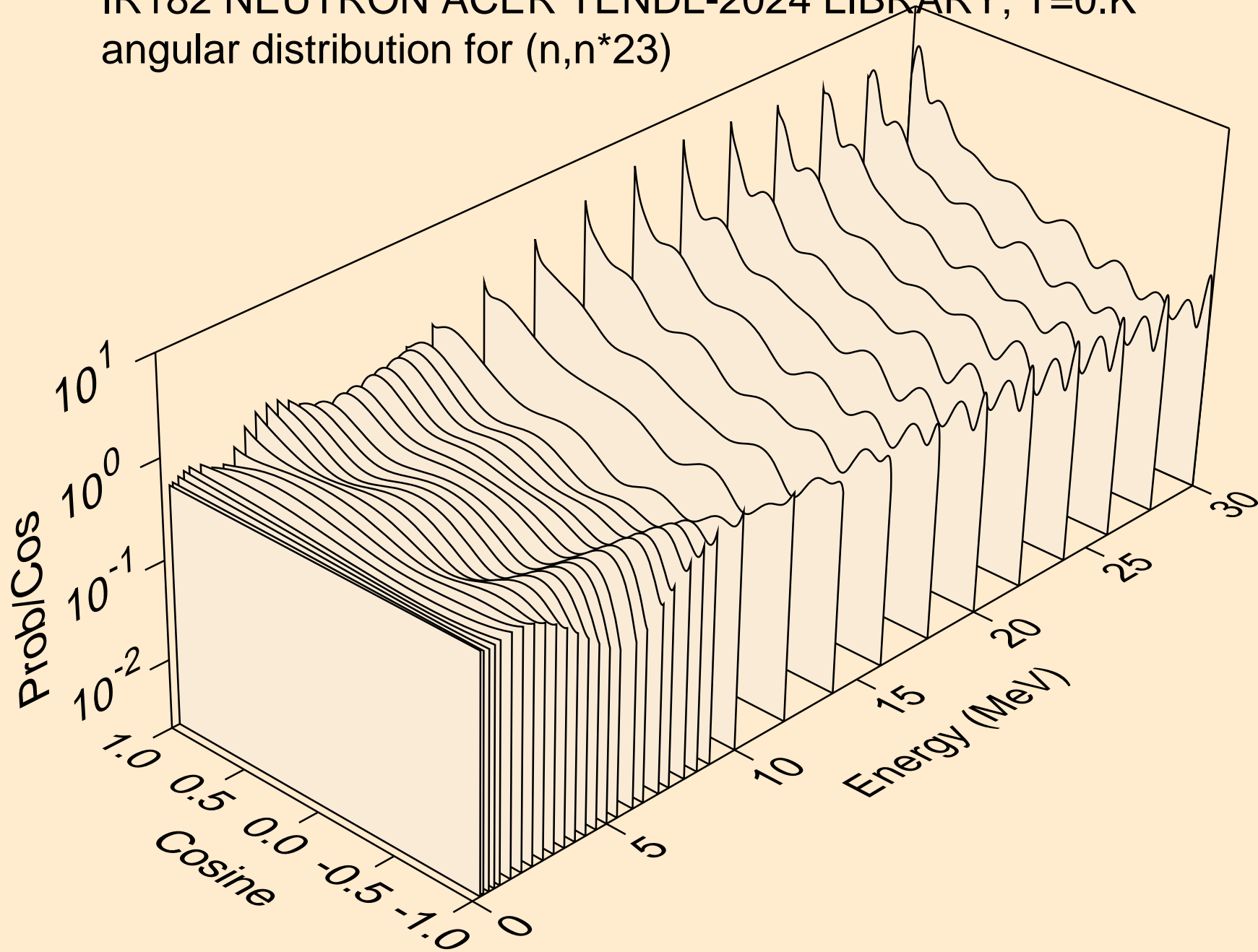

IR182 NEUTRON ACER TENDL-2024 LIBRARY; T=0.K
angular distribution for (n,n*24)

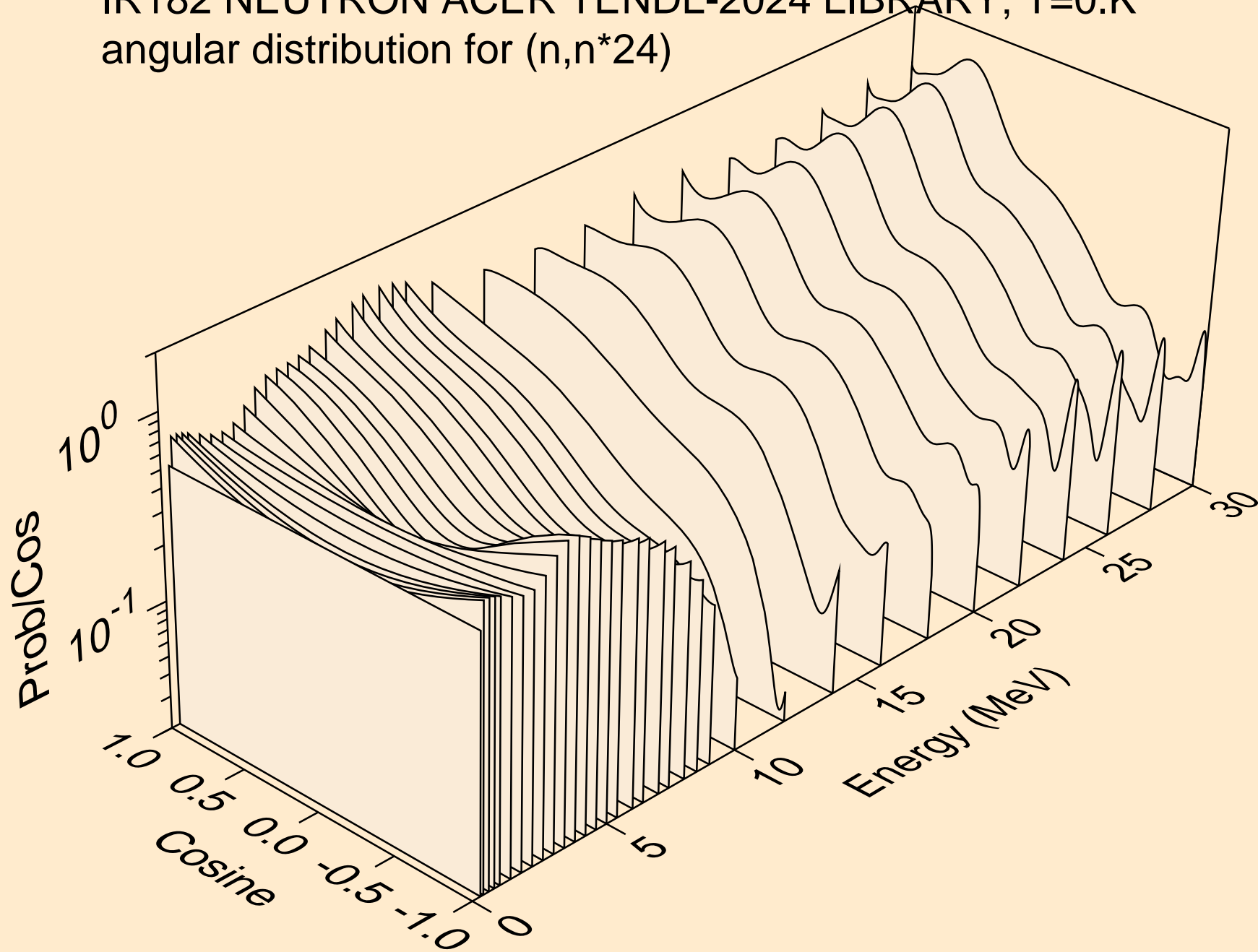

IR182 NEUTRON ACER TENDL-2024 LIBRARY; T=0.K
angular distribution for (n,n*25)

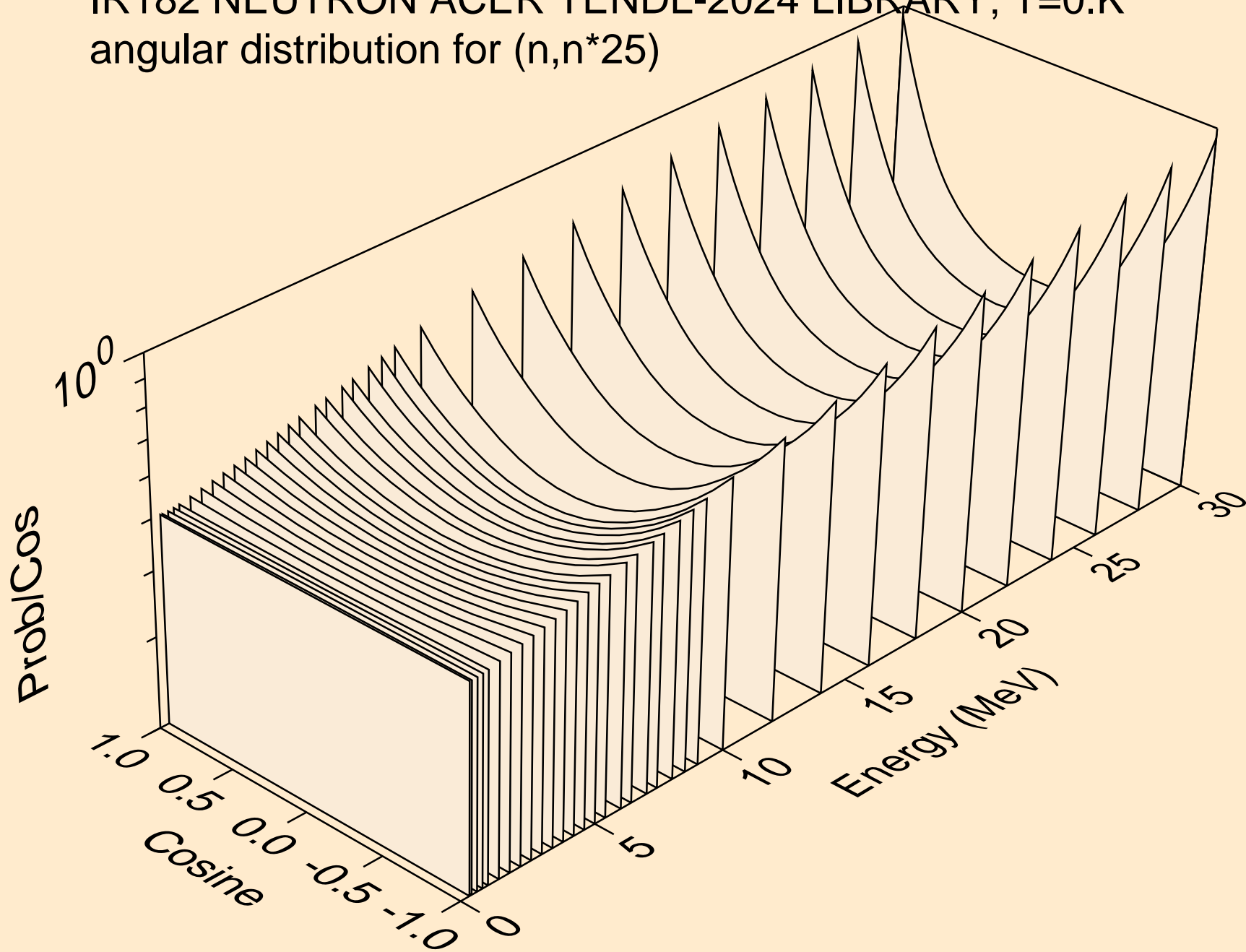

IR182 NEUTRON ACER TENDL-2024 LIBRARY; T=0.K
angular distribution for (n,n*26)

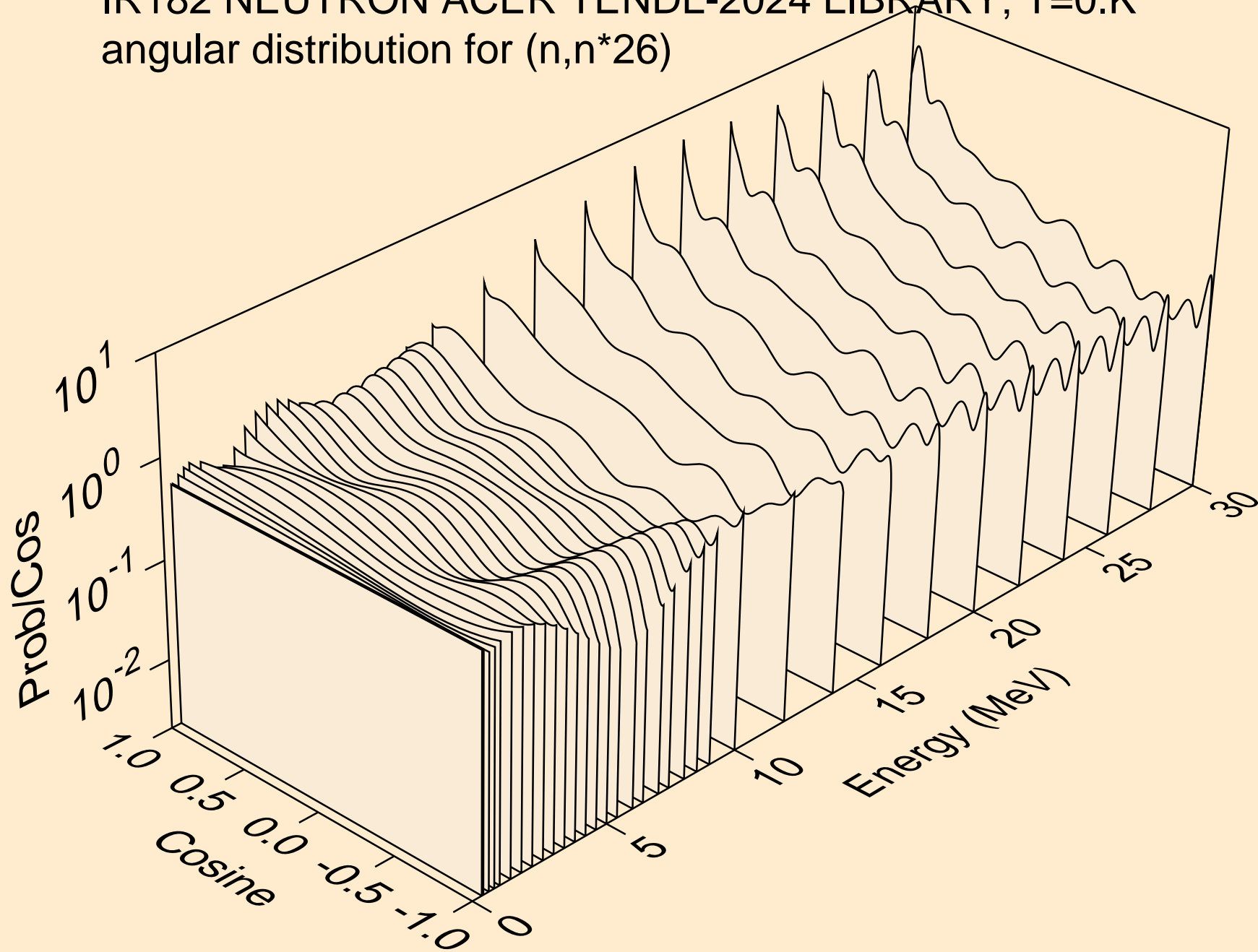

IR182 NEUTRON ACER TENDL-2024 LIBRARY; T=0.K
Neutron emission for (n,x)

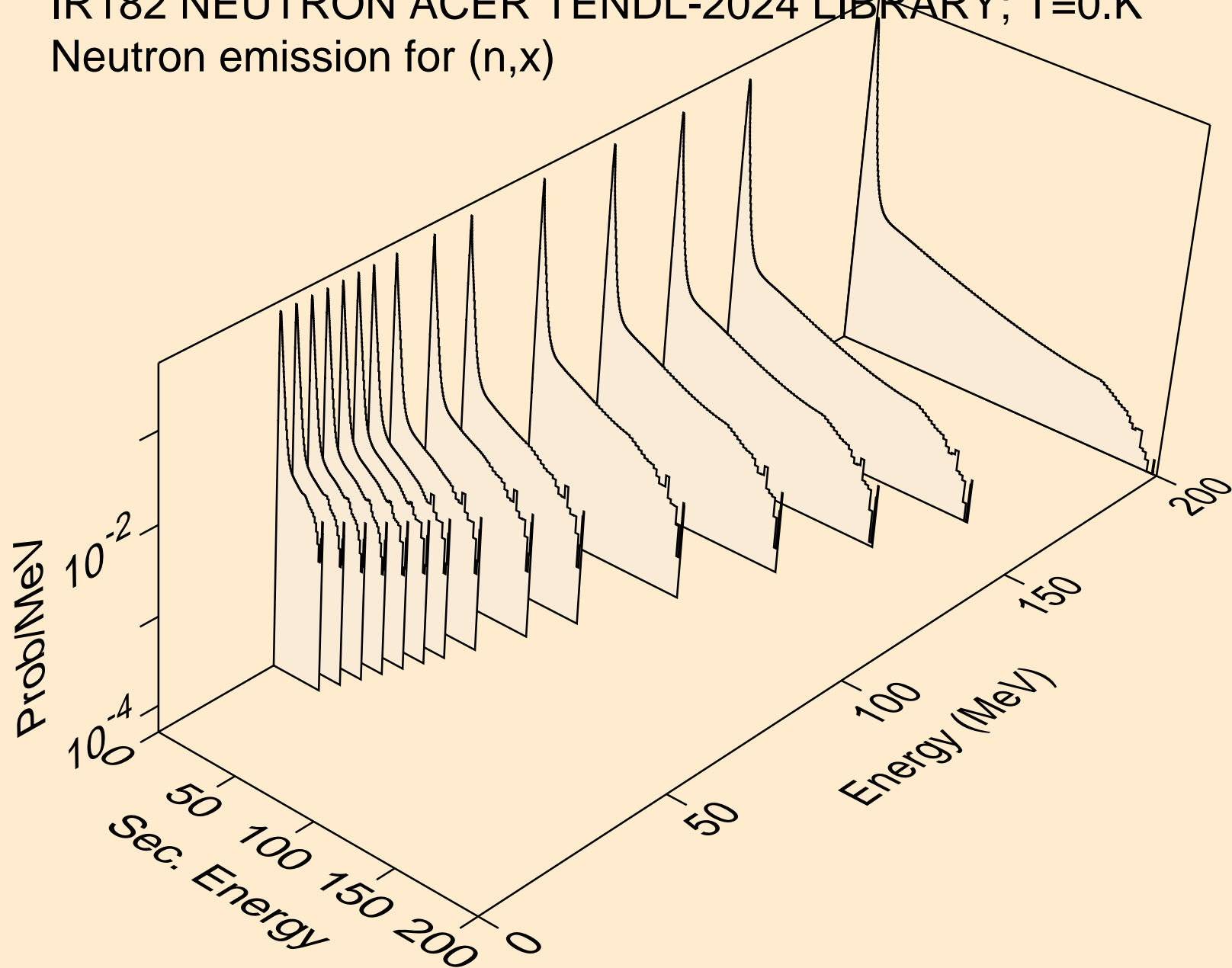

IR182 NEUTRON ACER TENDL-2024 LIBRARY; T=0.K
Neutron emission for (n,2nd)

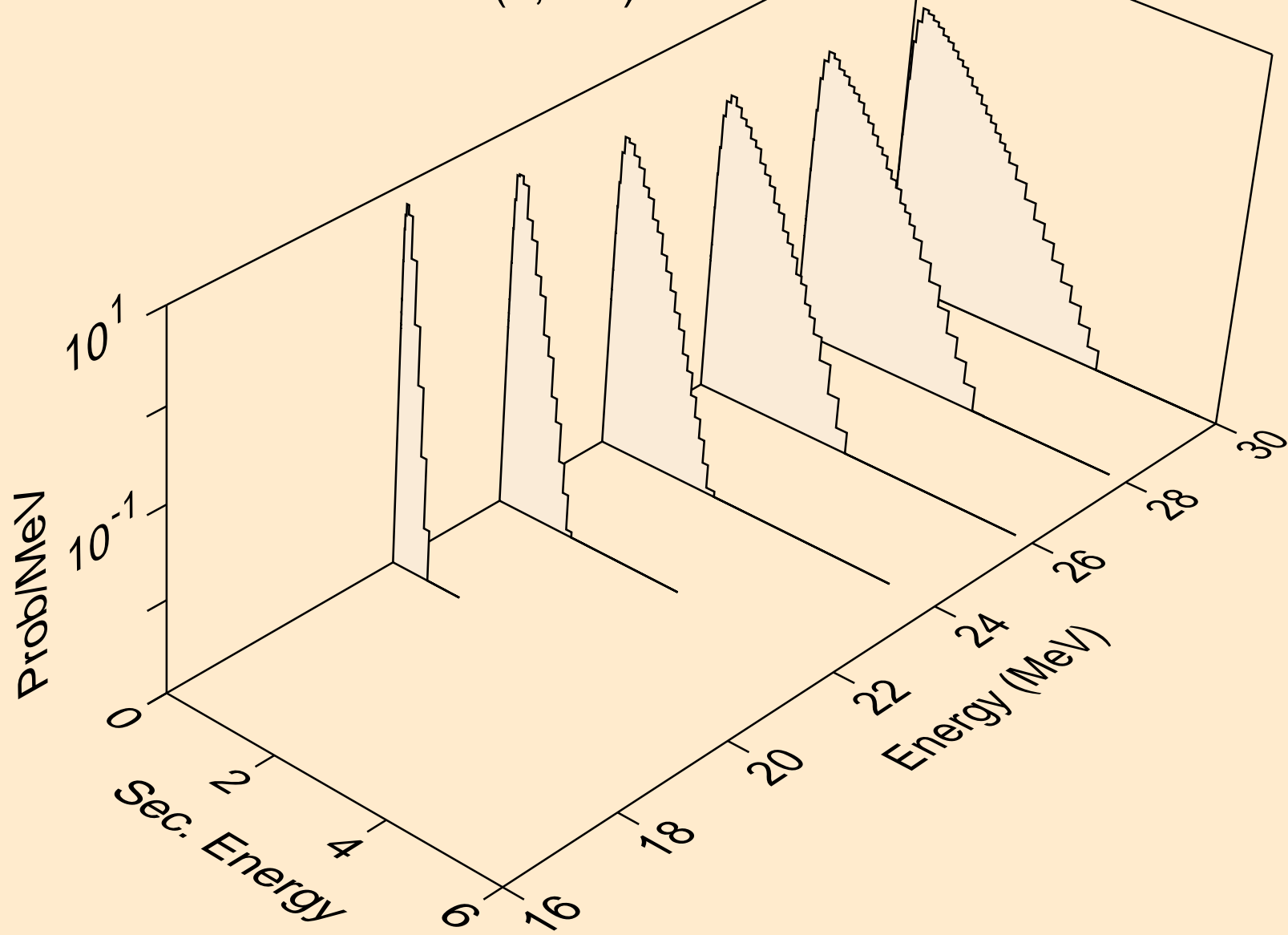

IR182 NEUTRON ACER TENDL-2024 LIBRARY; T=0.K
Neutron emission for (n,2n)

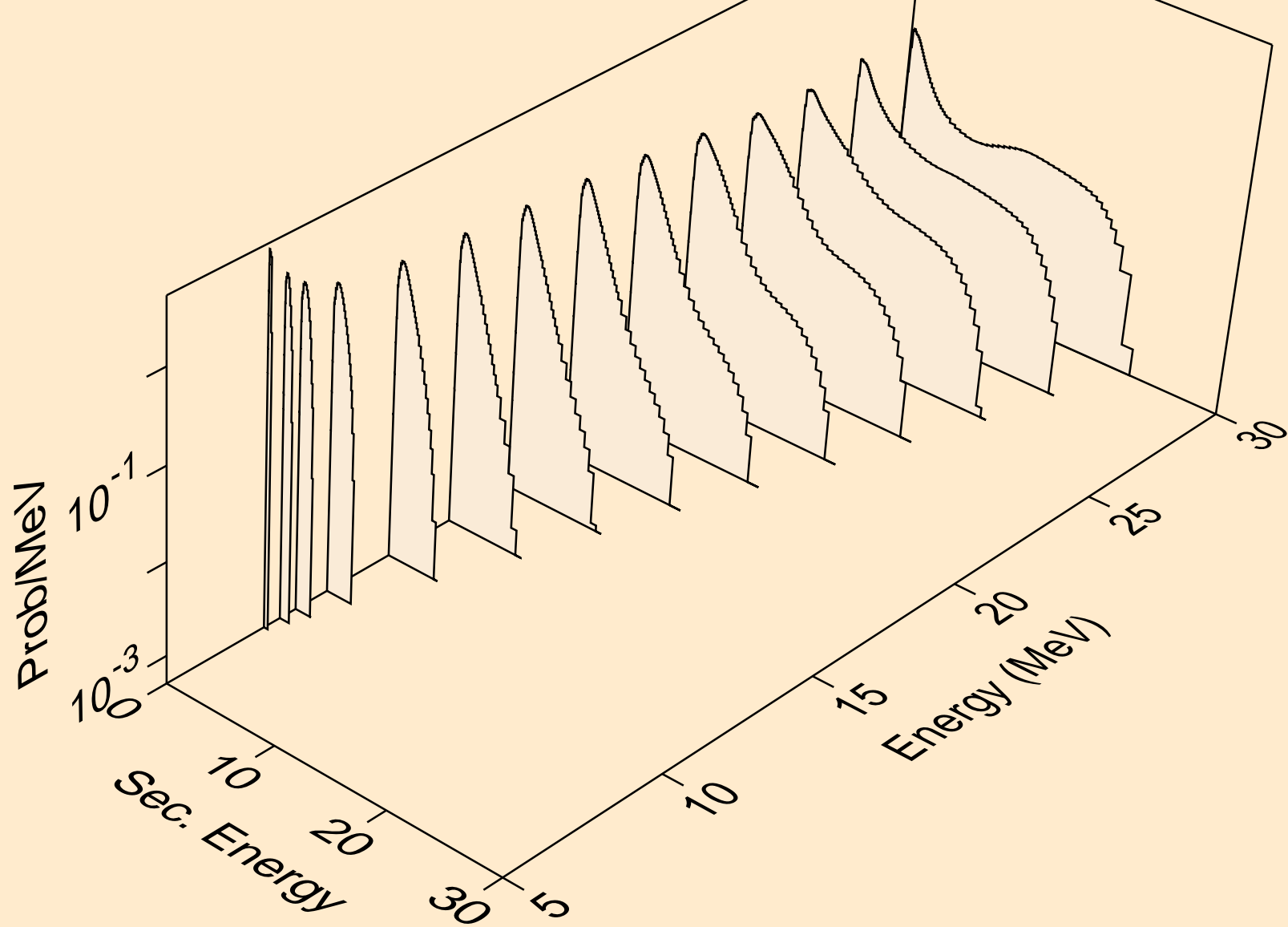

IR182 NEUTRON ACER TENDL-2024 LIBRARY; T=0.K
Neutron emission for (n,3n)

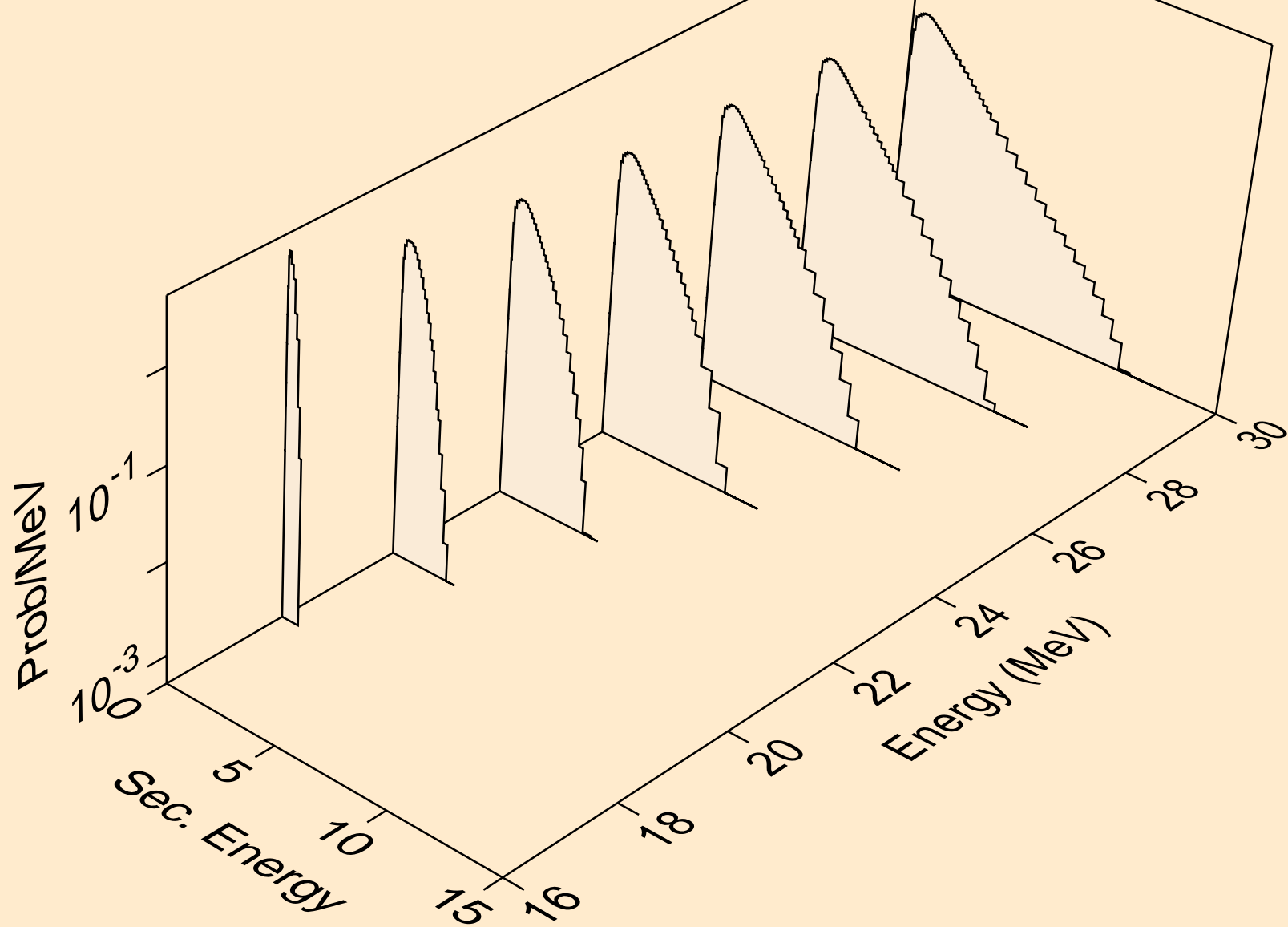

IR182 NEUTRON ACER TENDL-2024 LIBRARY; T=0.K
Neutron emission for (n,n*)a

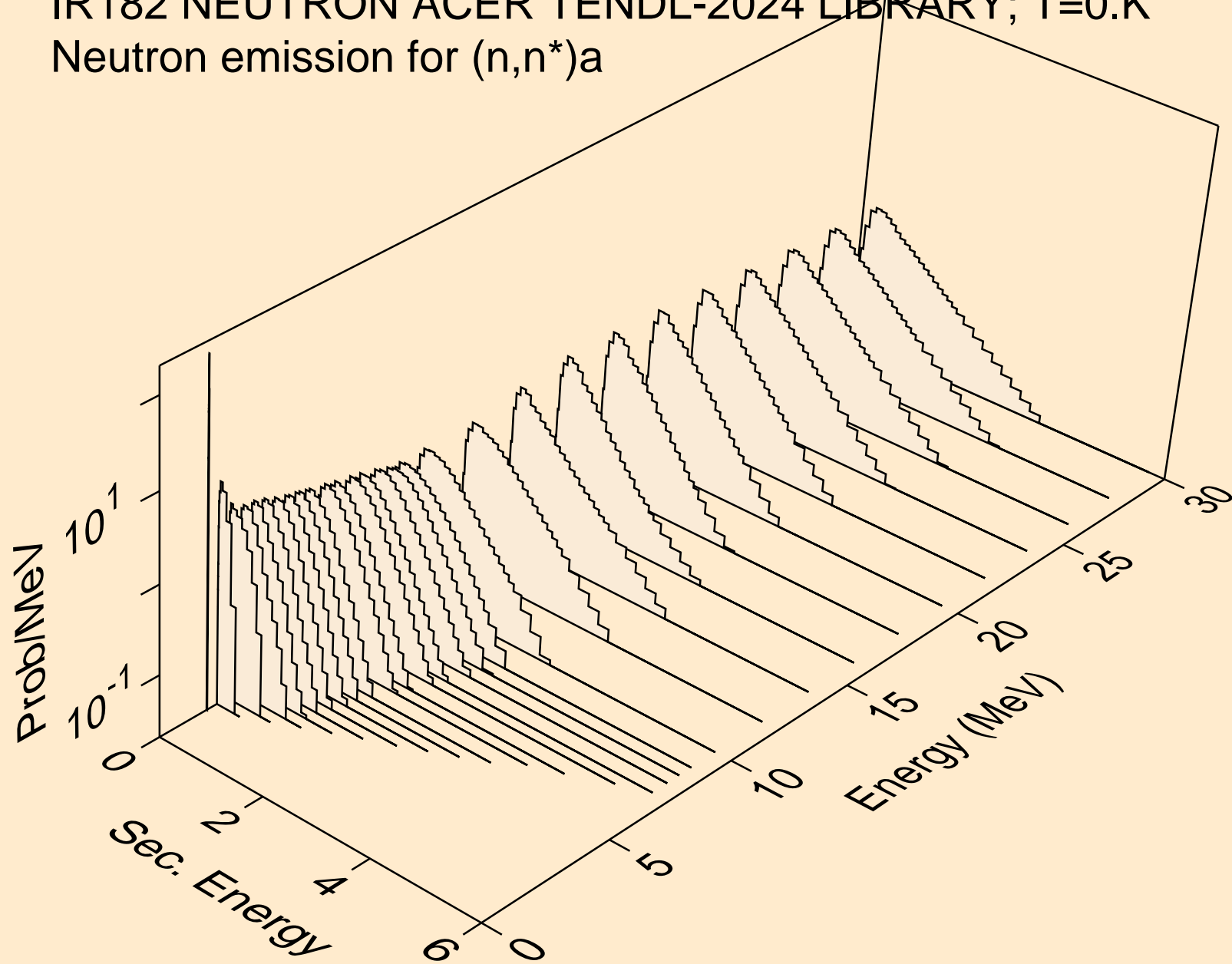

IR182 NEUTRON ACER TENDL-2024 LIBRARY; T=0.K
Neutron emission for (n,2n)a

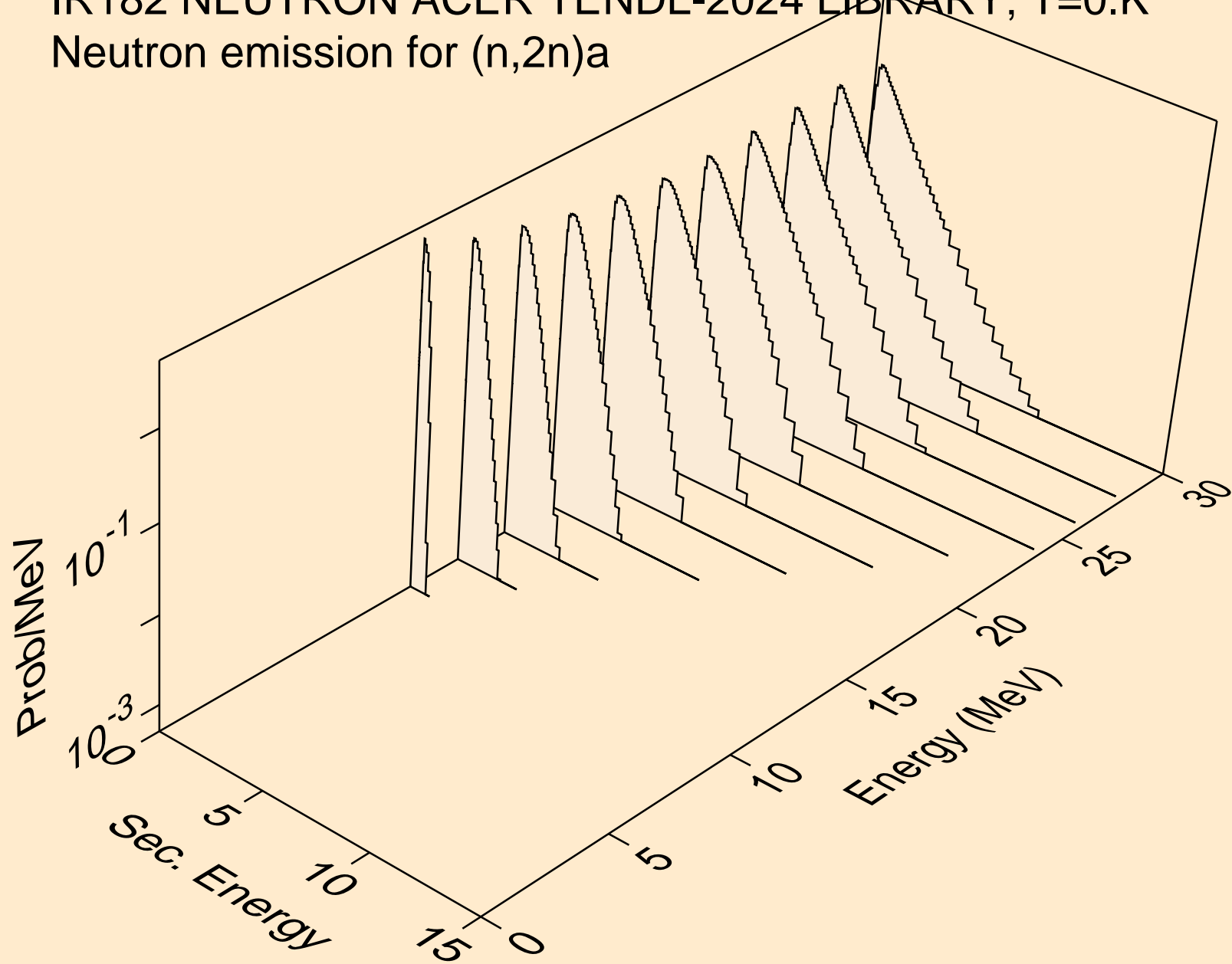

IR182 NEUTRON ACER TENDL-2024 LIBRARY; T=0.K
Neutron emission for (n,3n)a

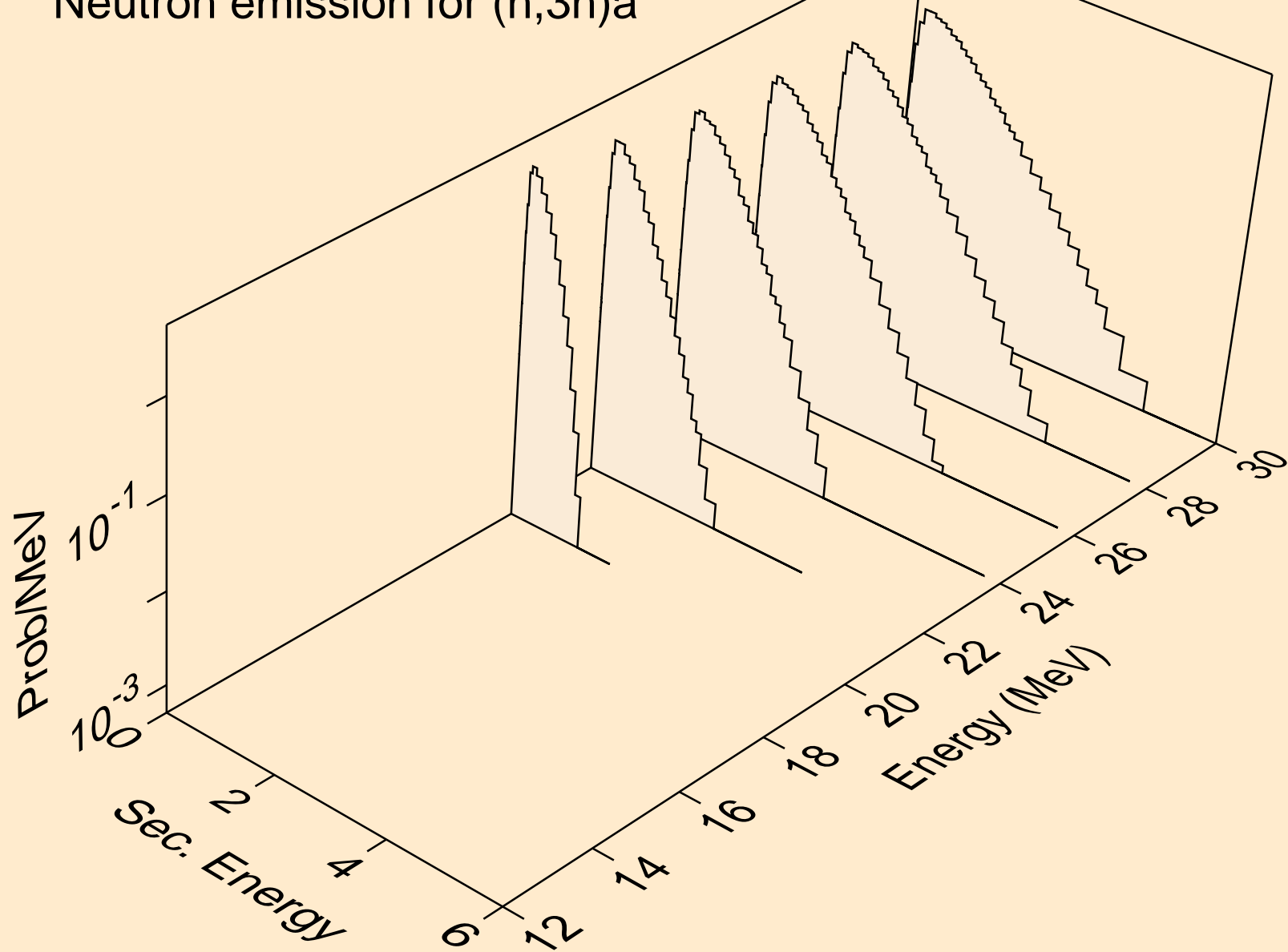

IR182 NEUTRON ACER TENDL-2024 LIBRARY; T=0.K
Neutron emission for (n,n*)p

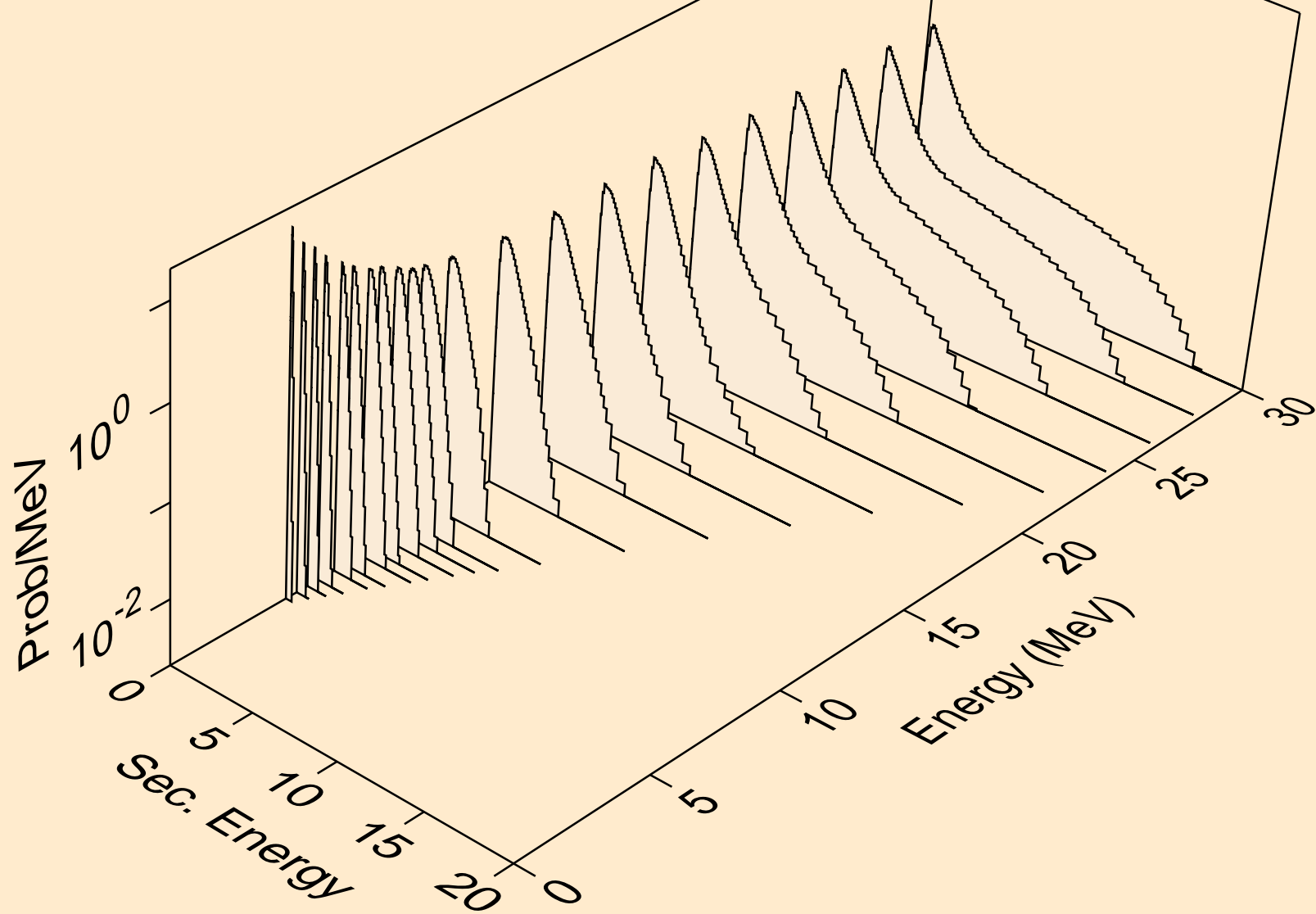

IR182 NEUTRON ACER TENDL-2024 LIBRARY; T=0.K
Neutron emission for (n,n*)2a

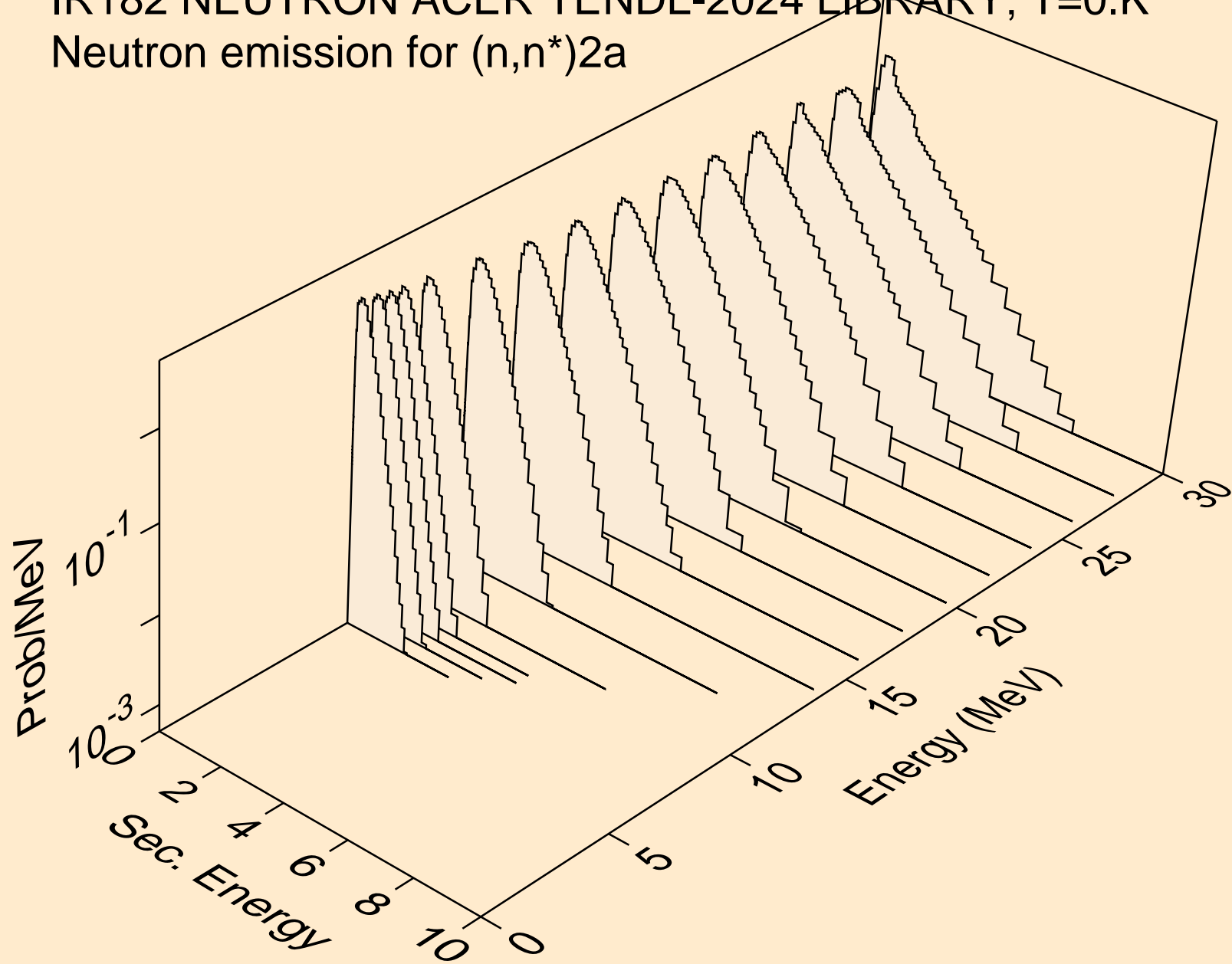

IR182 NEUTRON ACER TENDL-2024 LIBRARY; T=0.K
Neutron emission for (n,2n)2a

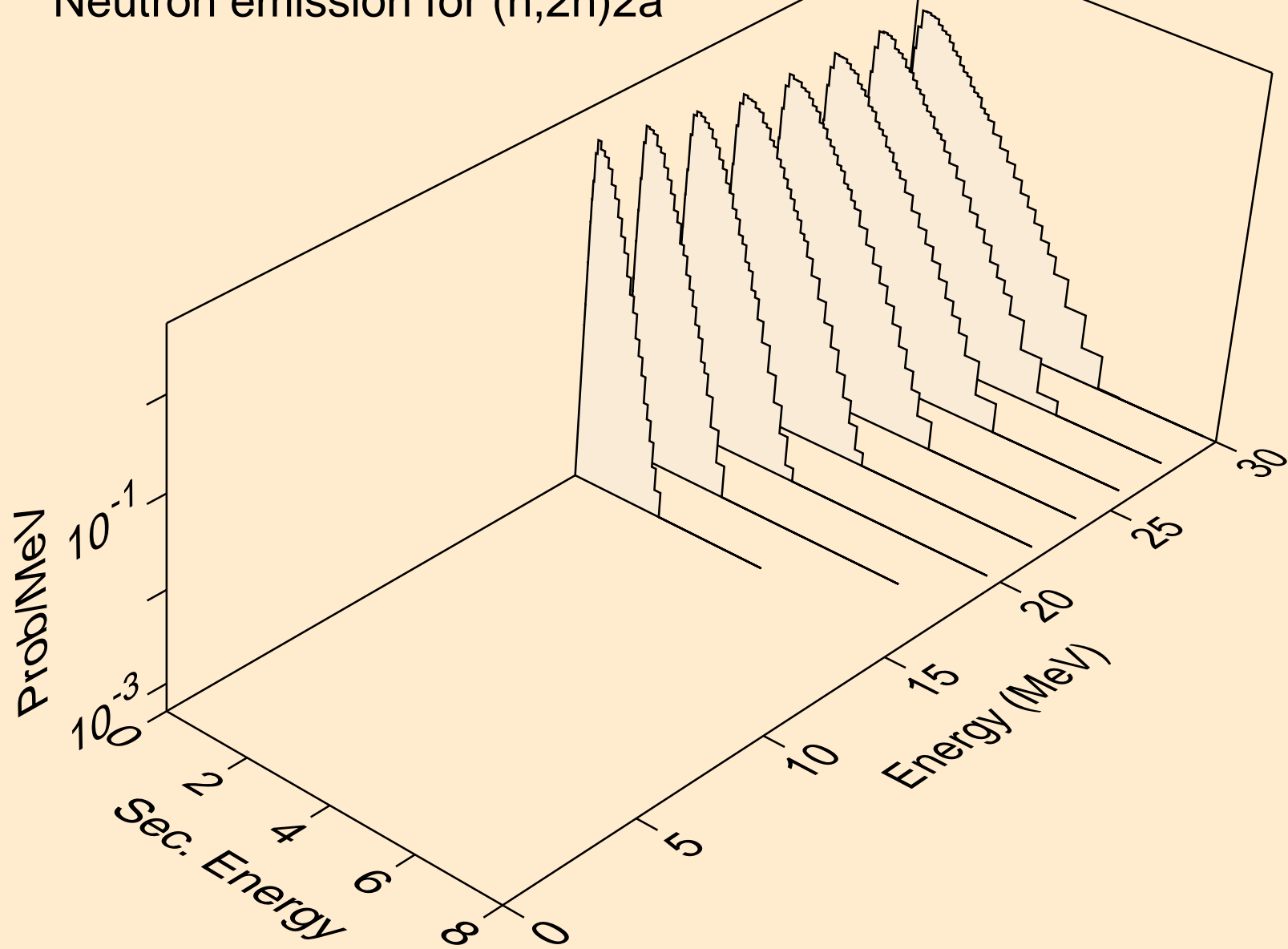

IR182 NEUTRON ACER TENDL-2024 LIBRARY; T=0.K
Neutron emission for (n,n*)d

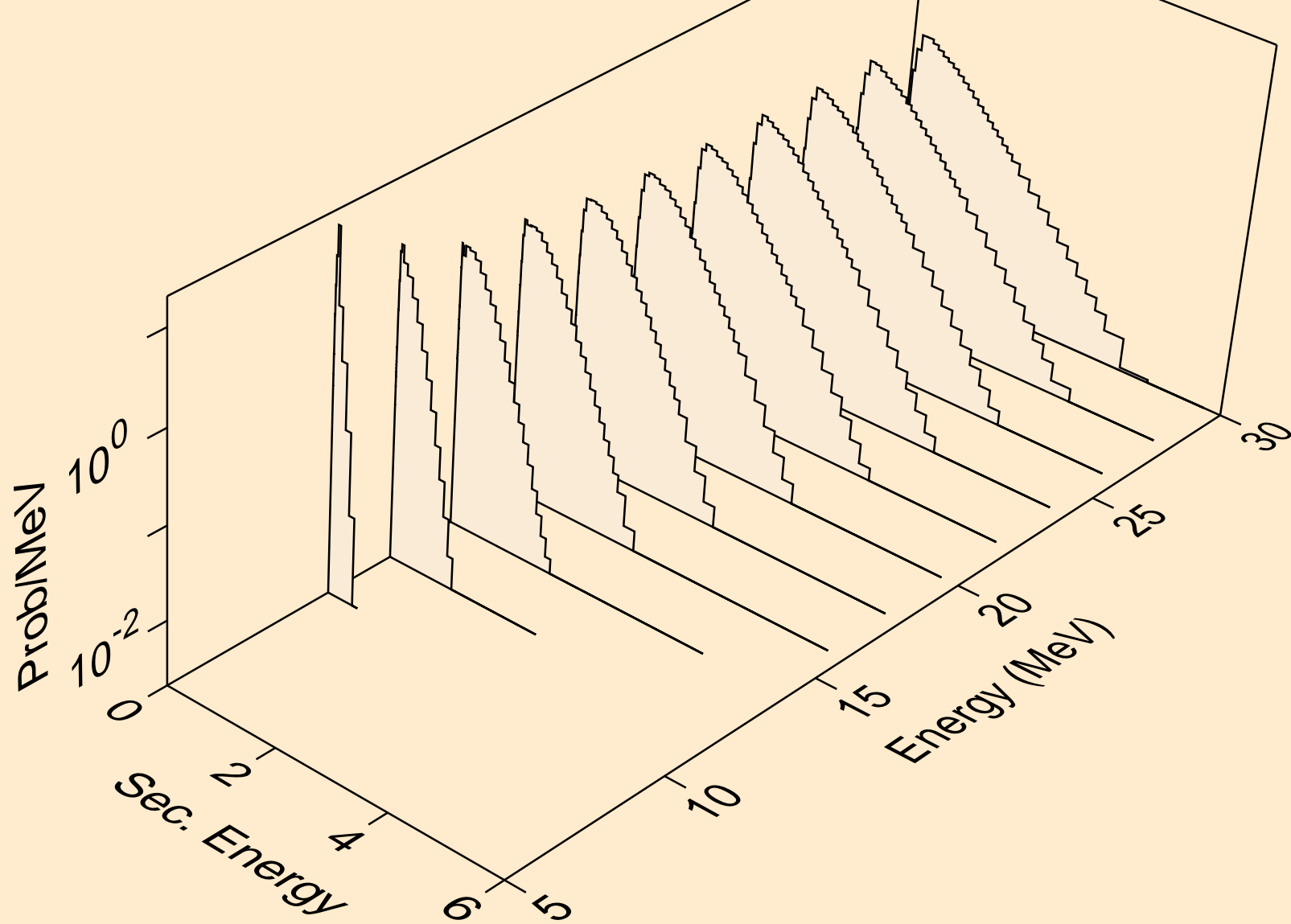

IR182 NEUTRON ACER TENDL-2024 LIBRARY; T=0.K
Neutron emission for (n,n*)t

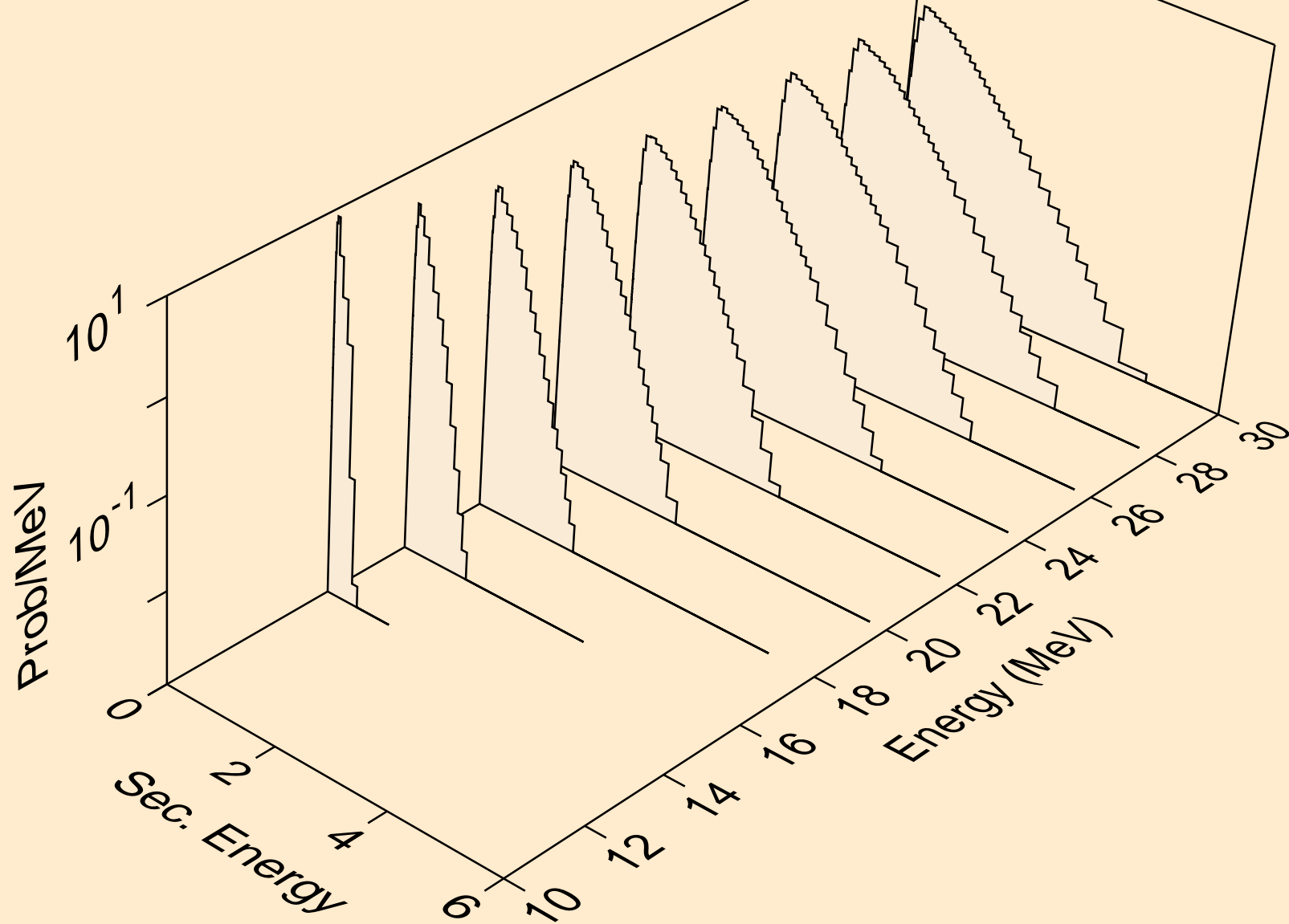

IR182 NEUTRON ACER TENDL-2024 LIBRARY; T=0.K
Neutron emission for (n,n*)he3

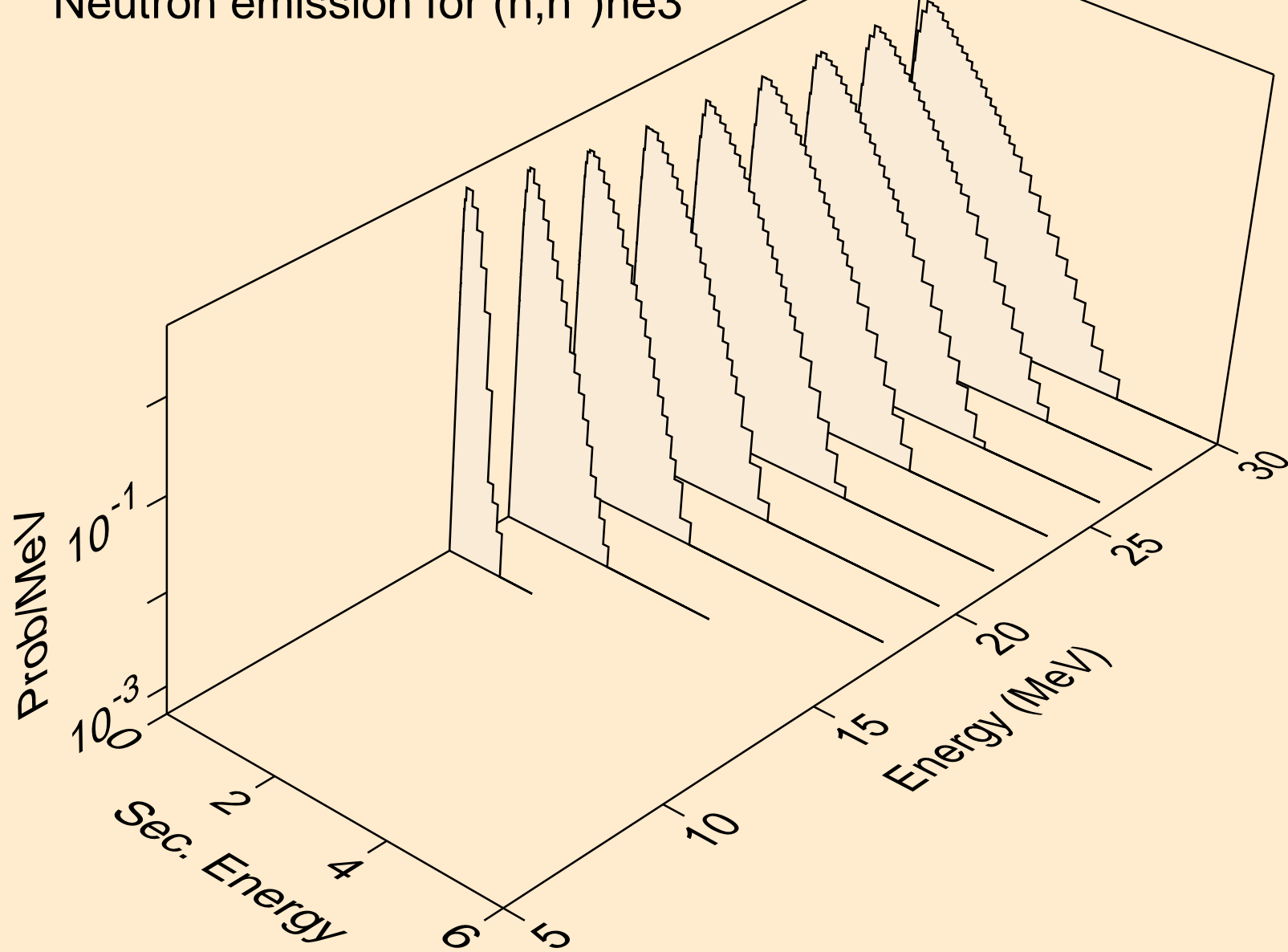

IR182 NEUTRON ACER TENDL-2024 LIBRARY; T=0.K
Neutron emission for (n,4n)

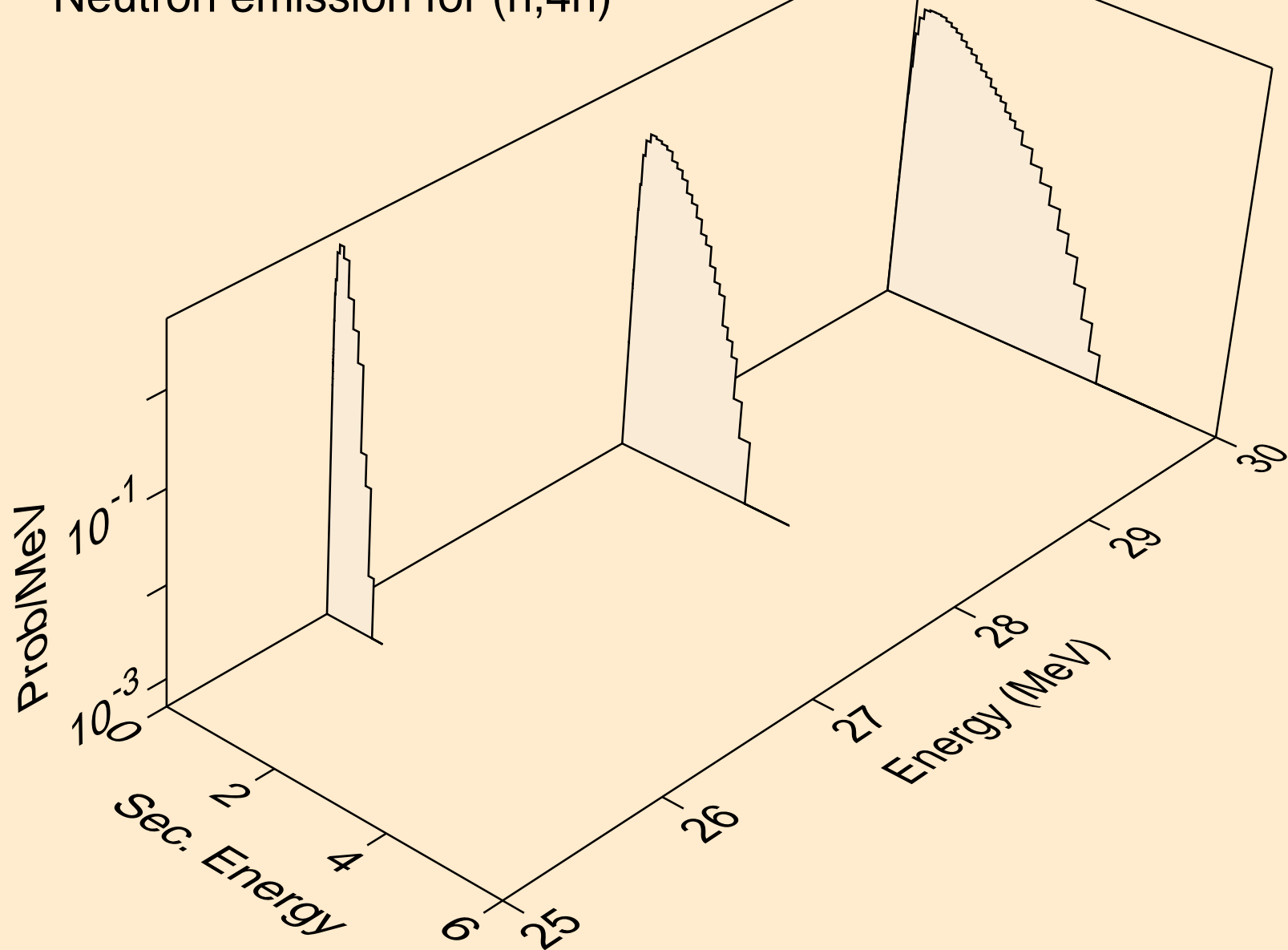

IR182 NEUTRON ACER TENDL-2024 LIBRARY; T=0.K
Neutron emission for (n,2np)

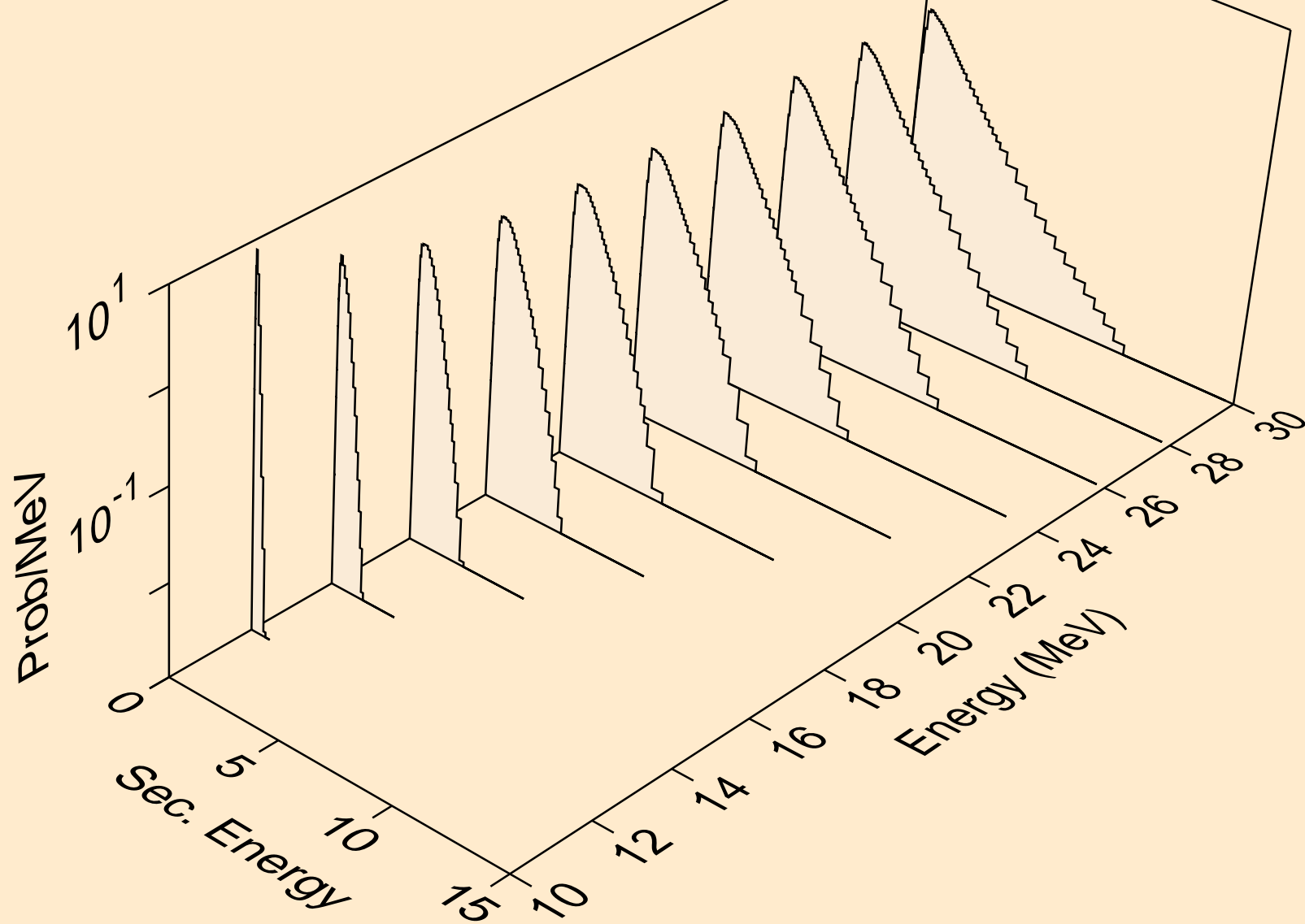

IR182 NEUTRON ACER TENDL-2024 LIBRARY; T=0.K
Neutron emission for (n,3np)

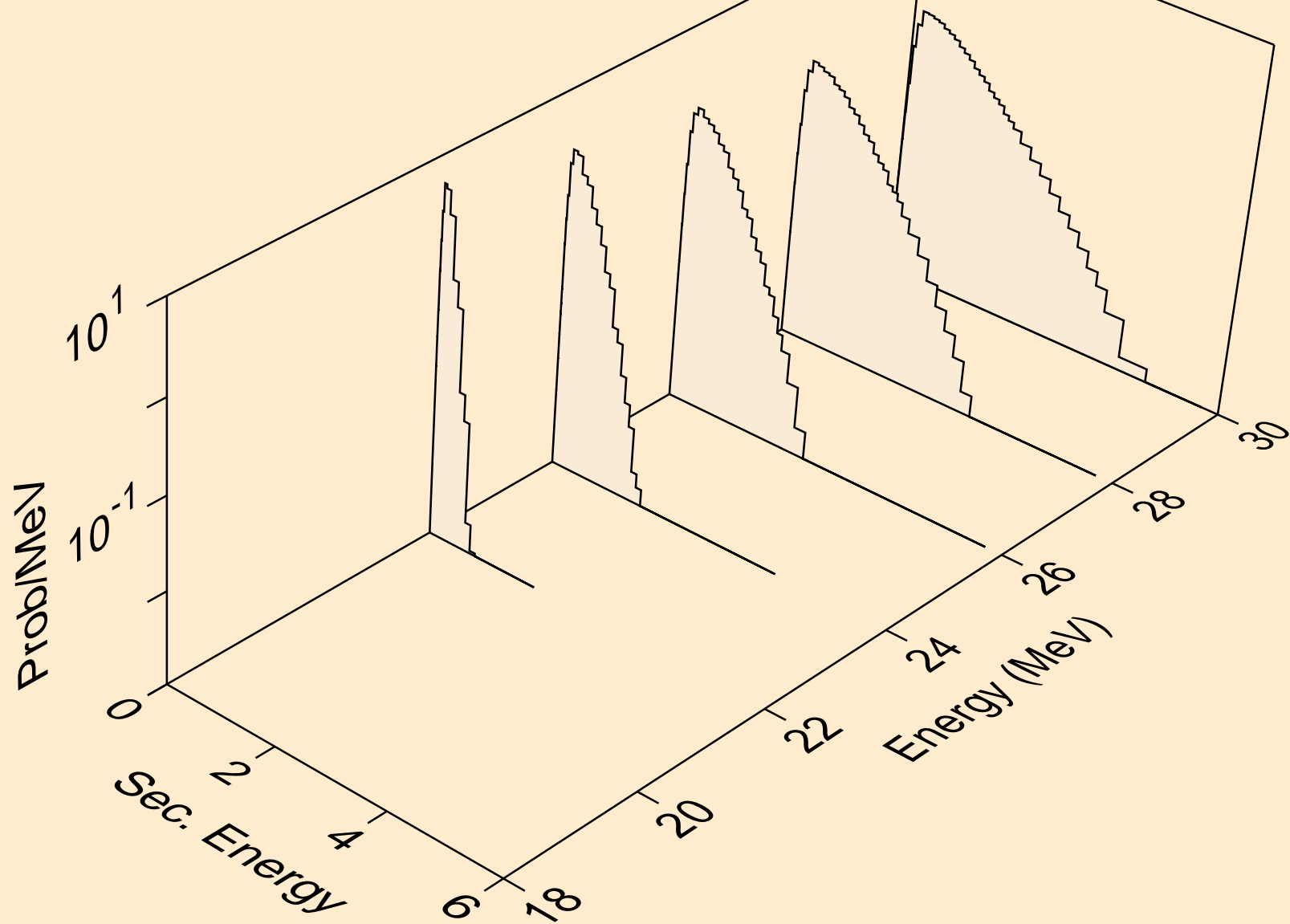

IR182 NEUTRON ACER TENDL-2024 LIBRARY; T=0.K
Neutron emission for (n,n2p)

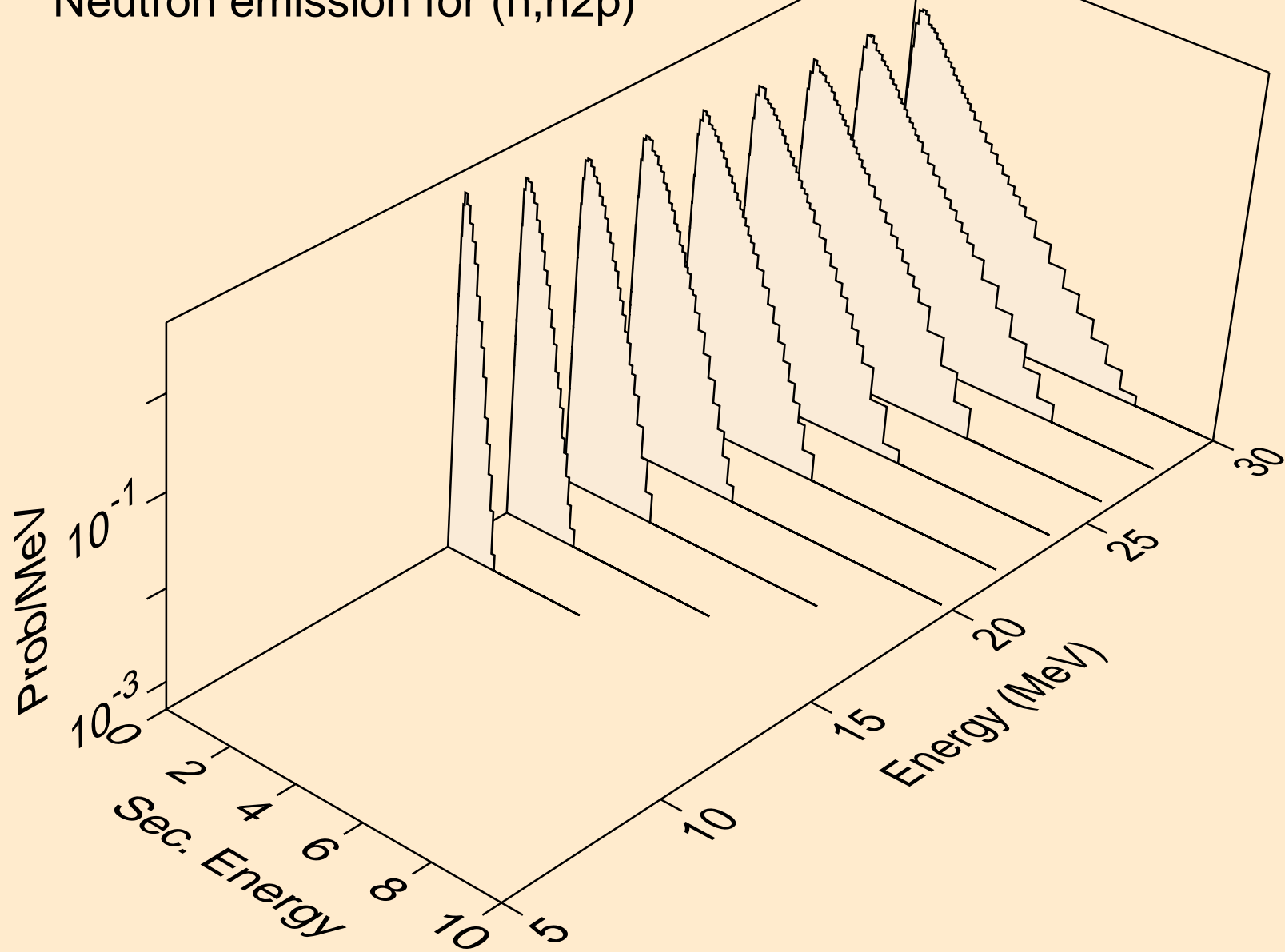

IR182 NEUTRON ACER TENDL-2024 LIBRARY; T=0.K
Neutron emission for (n,npa)

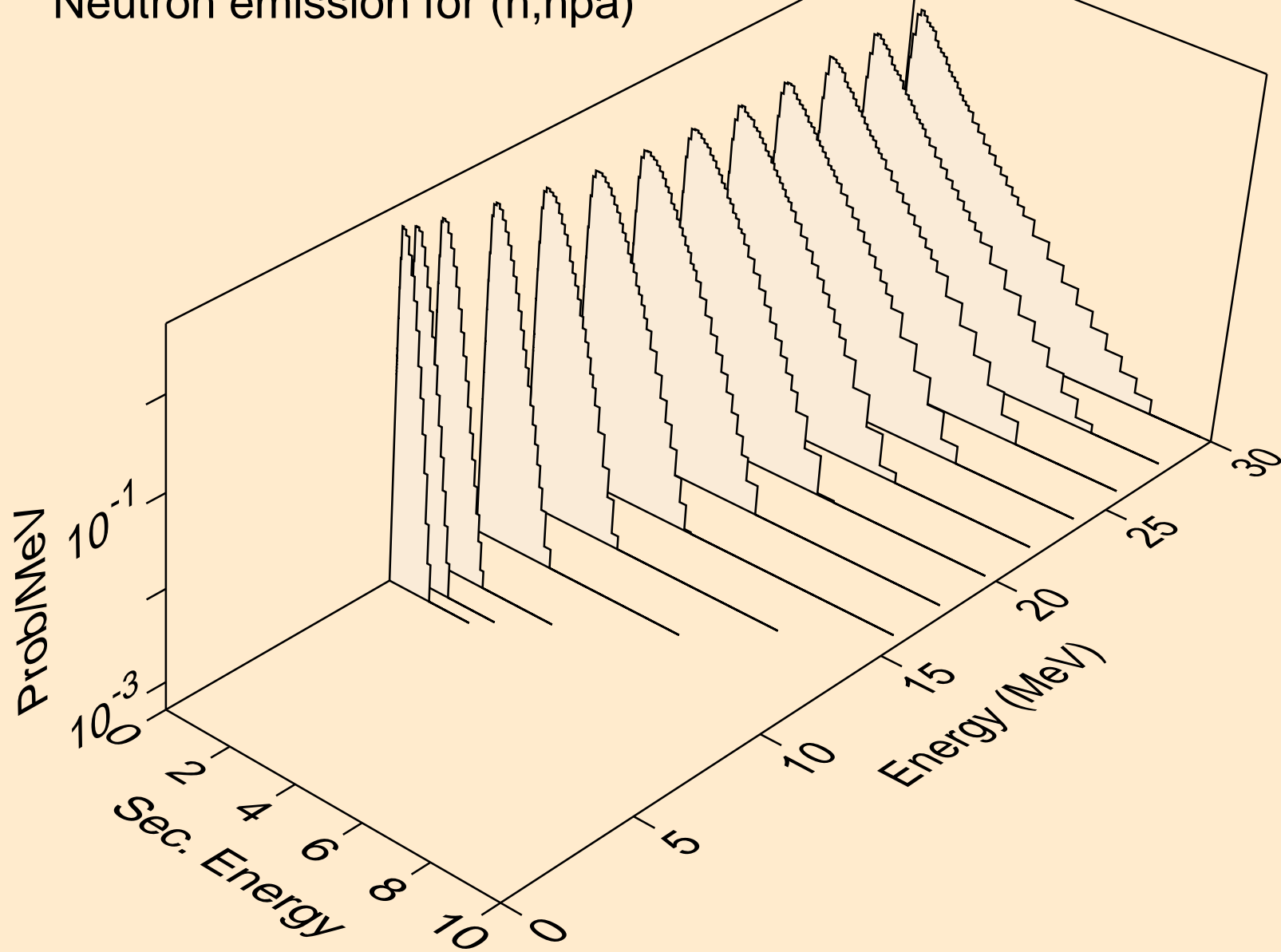

IR182 NEUTRON ACER TENDL-2024 LIBRARY; T=0.K
Neutron emission for (n,n*c)

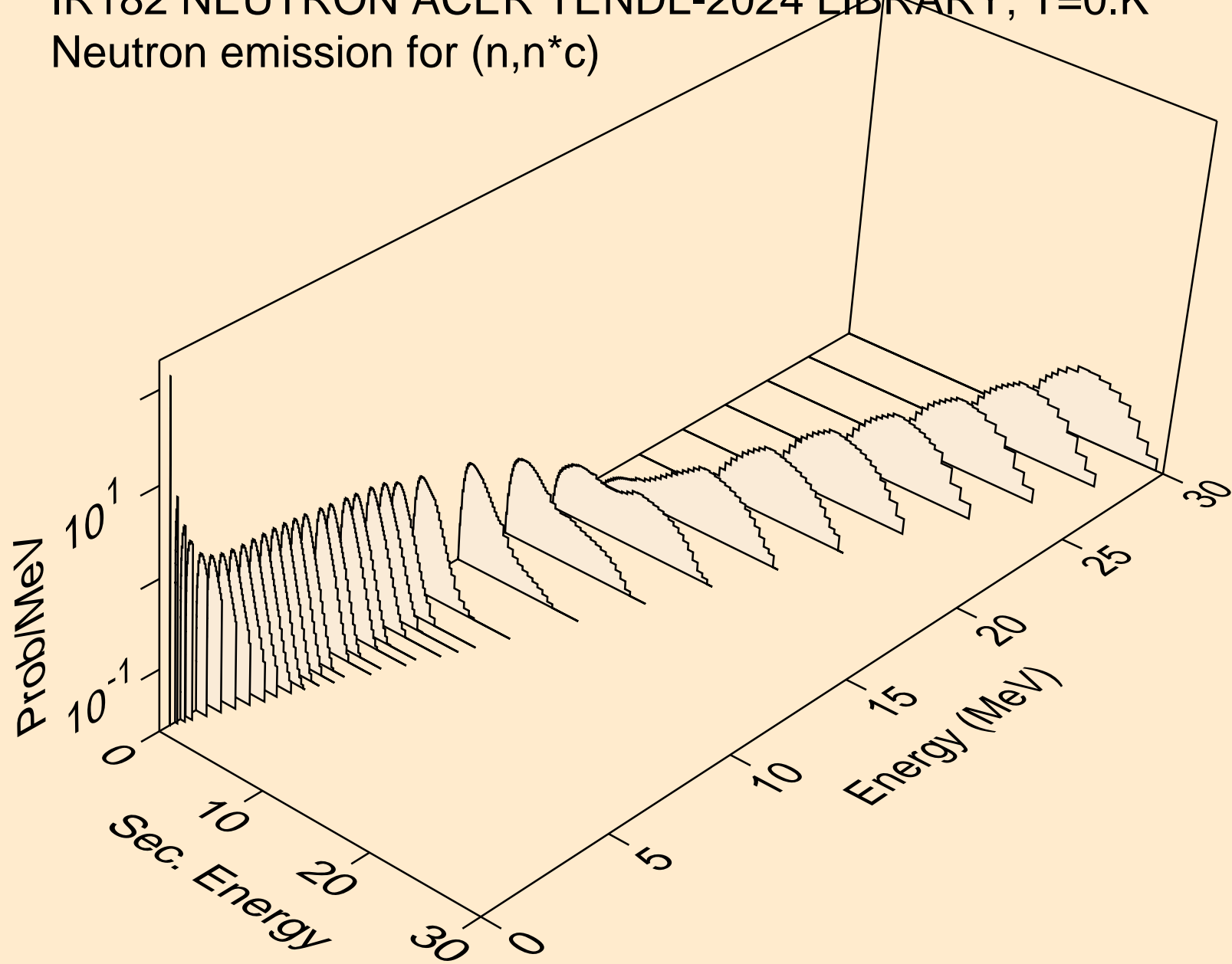

IR182 NEUTRON ACER TENDL-2024 LIBRARY; T=0.K
Photon emission for (n,x)

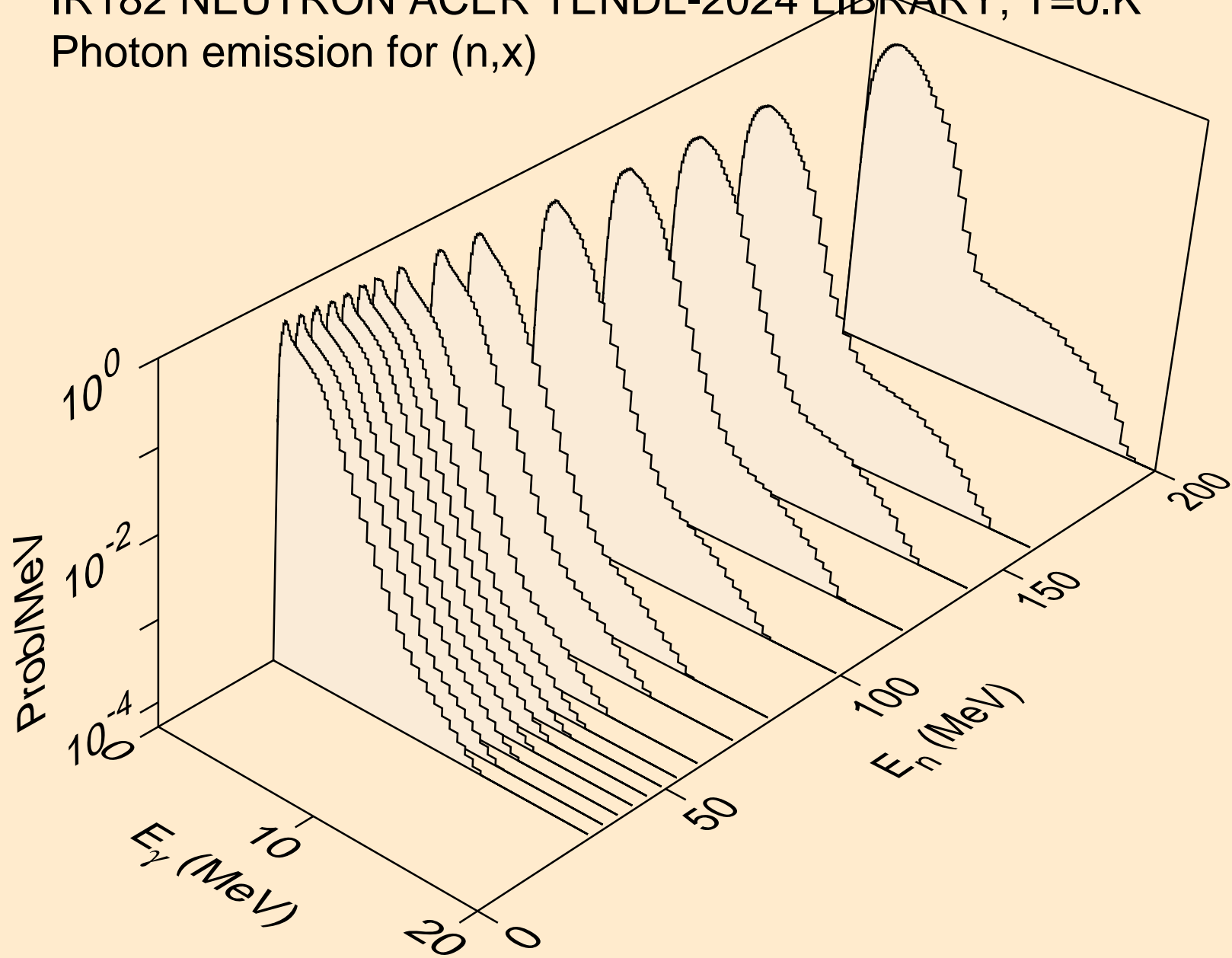

IR182 NEUTRON ACER TENDL-2024 LIBRARY; T=0.K
Photon emission for (n,2nd)

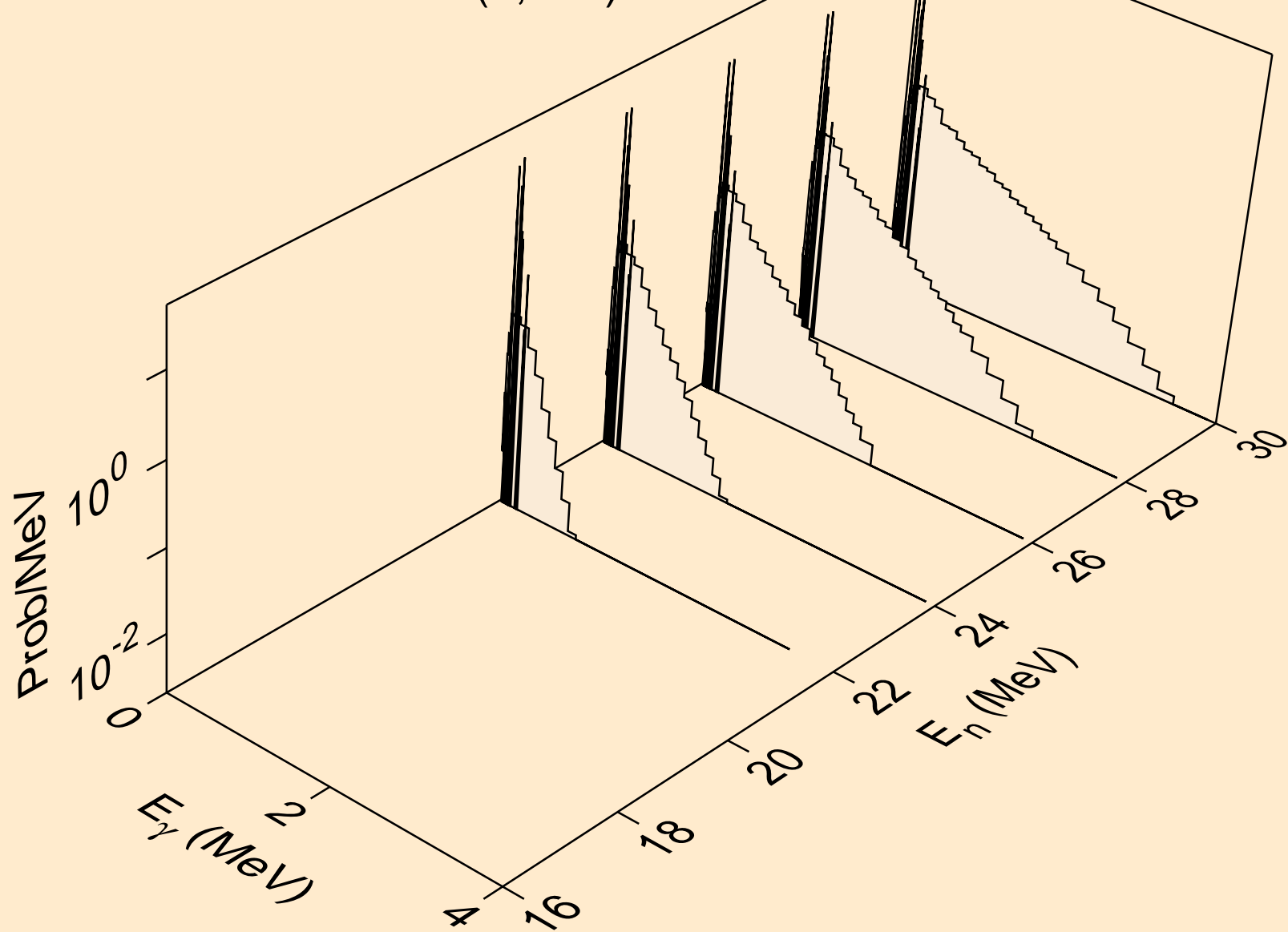

IR182 NEUTRON ACER TENDL-2024 LIBRARY; T=0.K
Photon emission for (n,2n)

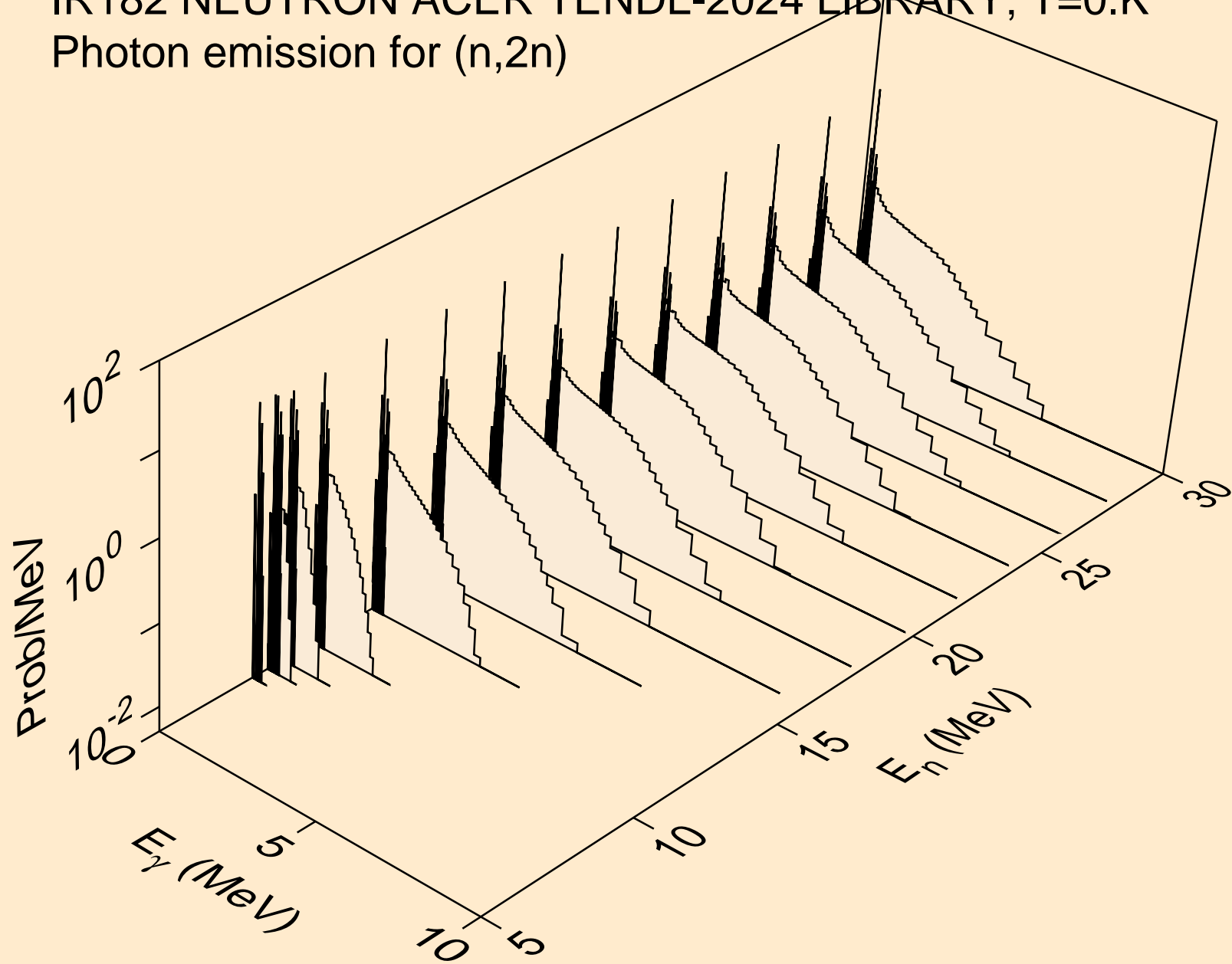

IR182 NEUTRON ACER TENDL-2024 LIBRARY; T=0.K
Photon emission for (n,3n)

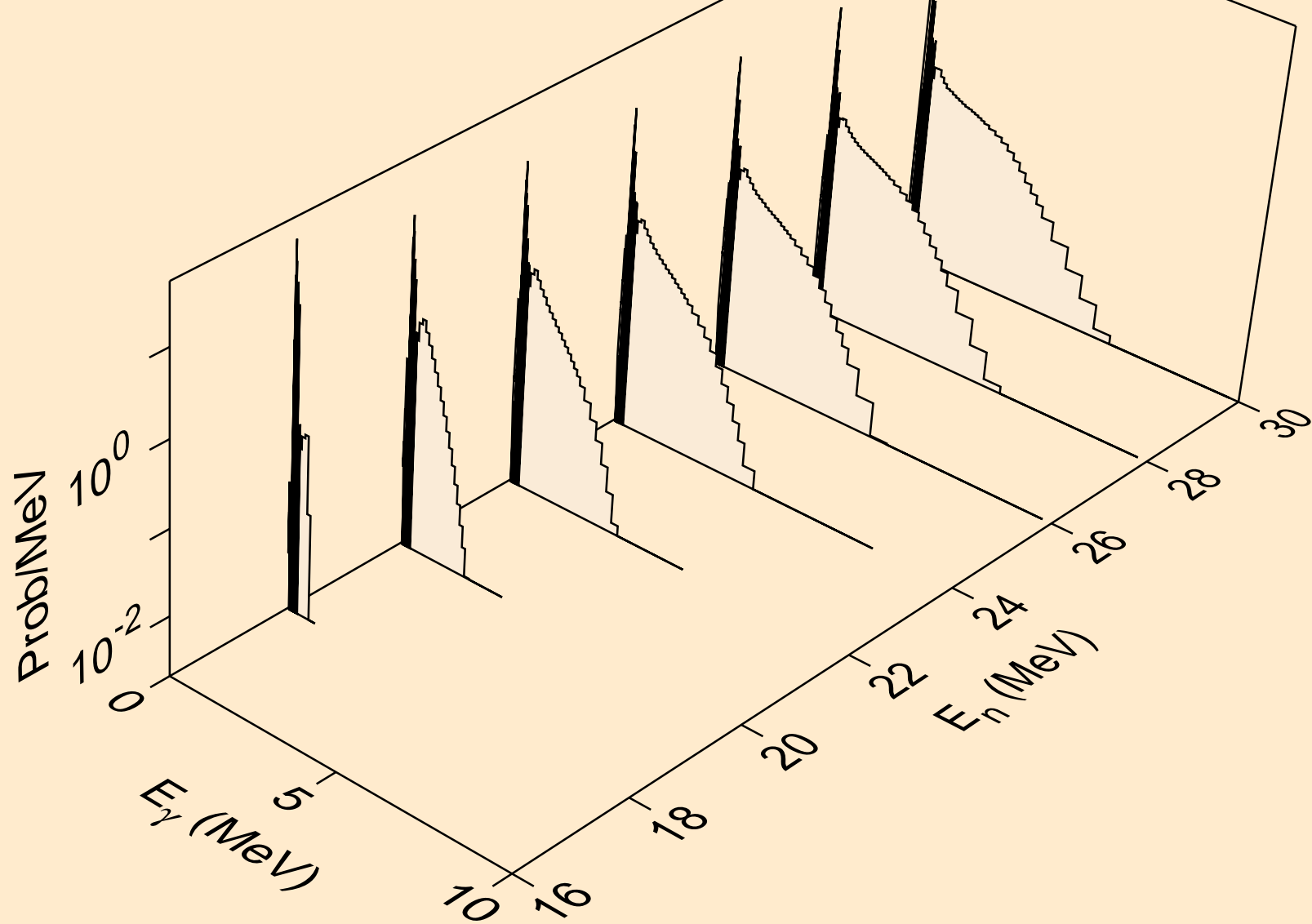

IR182 NEUTRON ACER TENDL-2024 LIBRARY; T=0.K
Photon emission for (n,n*)a

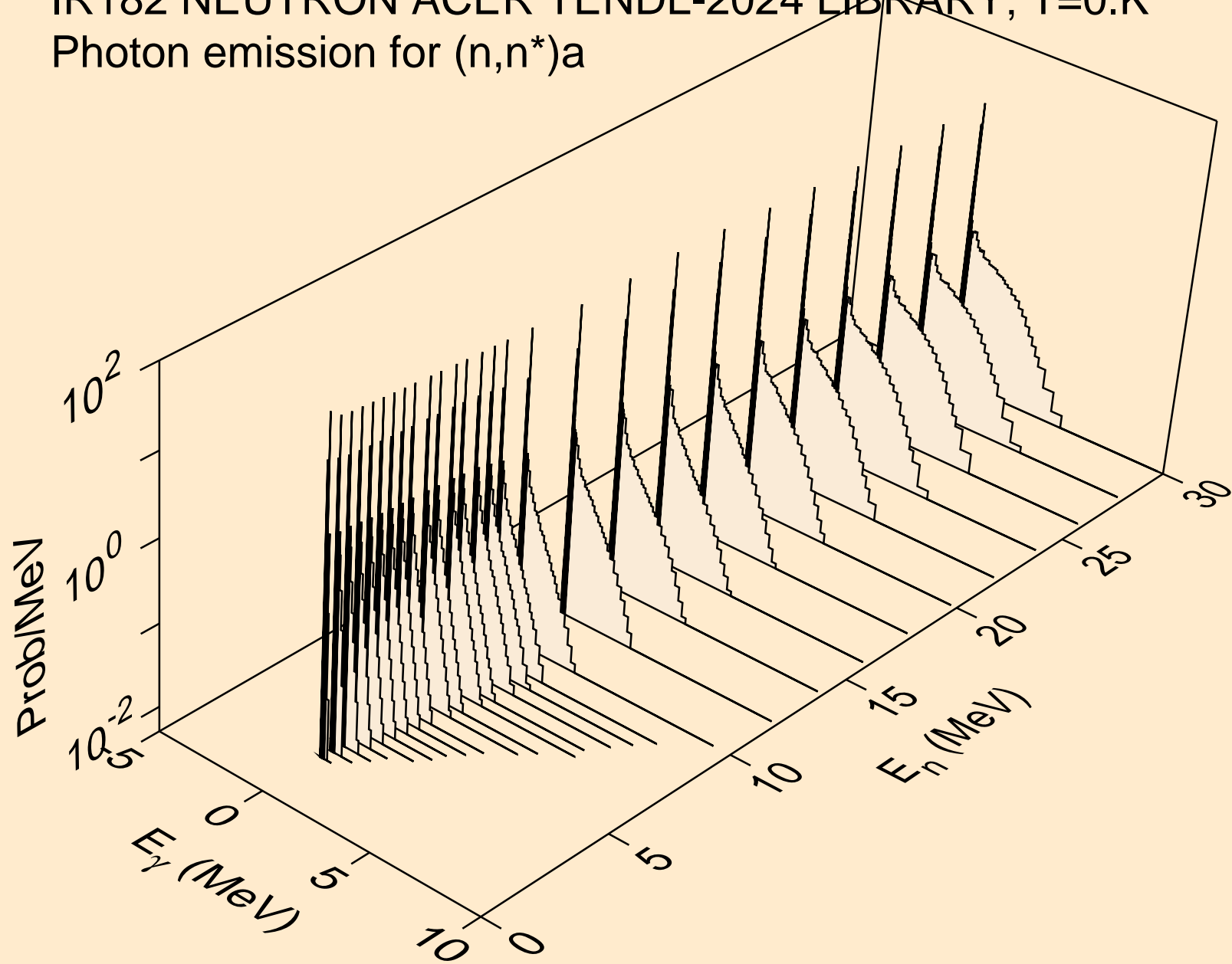

IR182 NEUTRON ACER TENDL-2024 LIBRARY; T=0.K
Photon emission for (n,2n)a

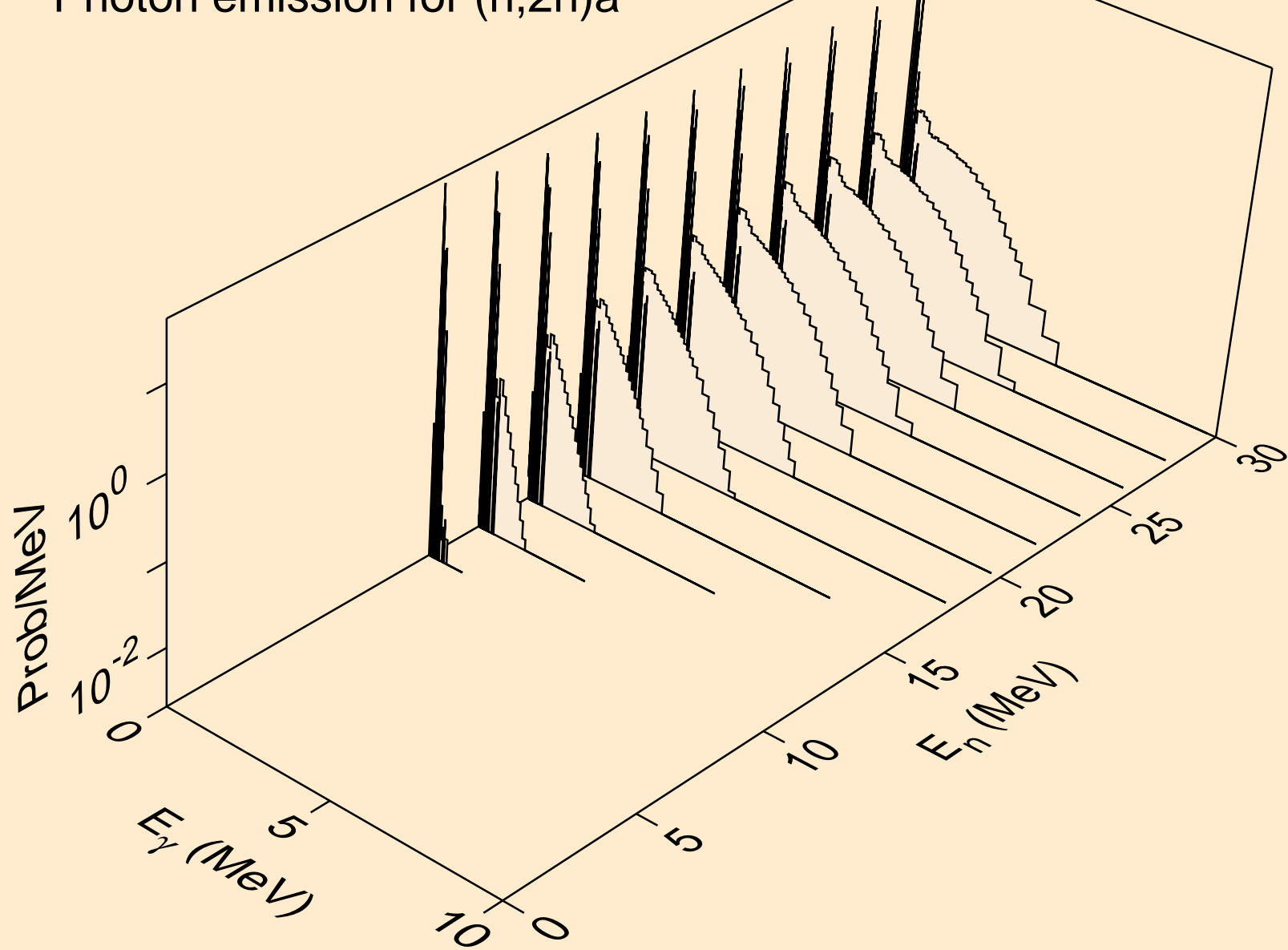

IR182 NEUTRON ACER TENDL-2024 LIBRARY; T=0.K
Photon emission for (n,3n)a

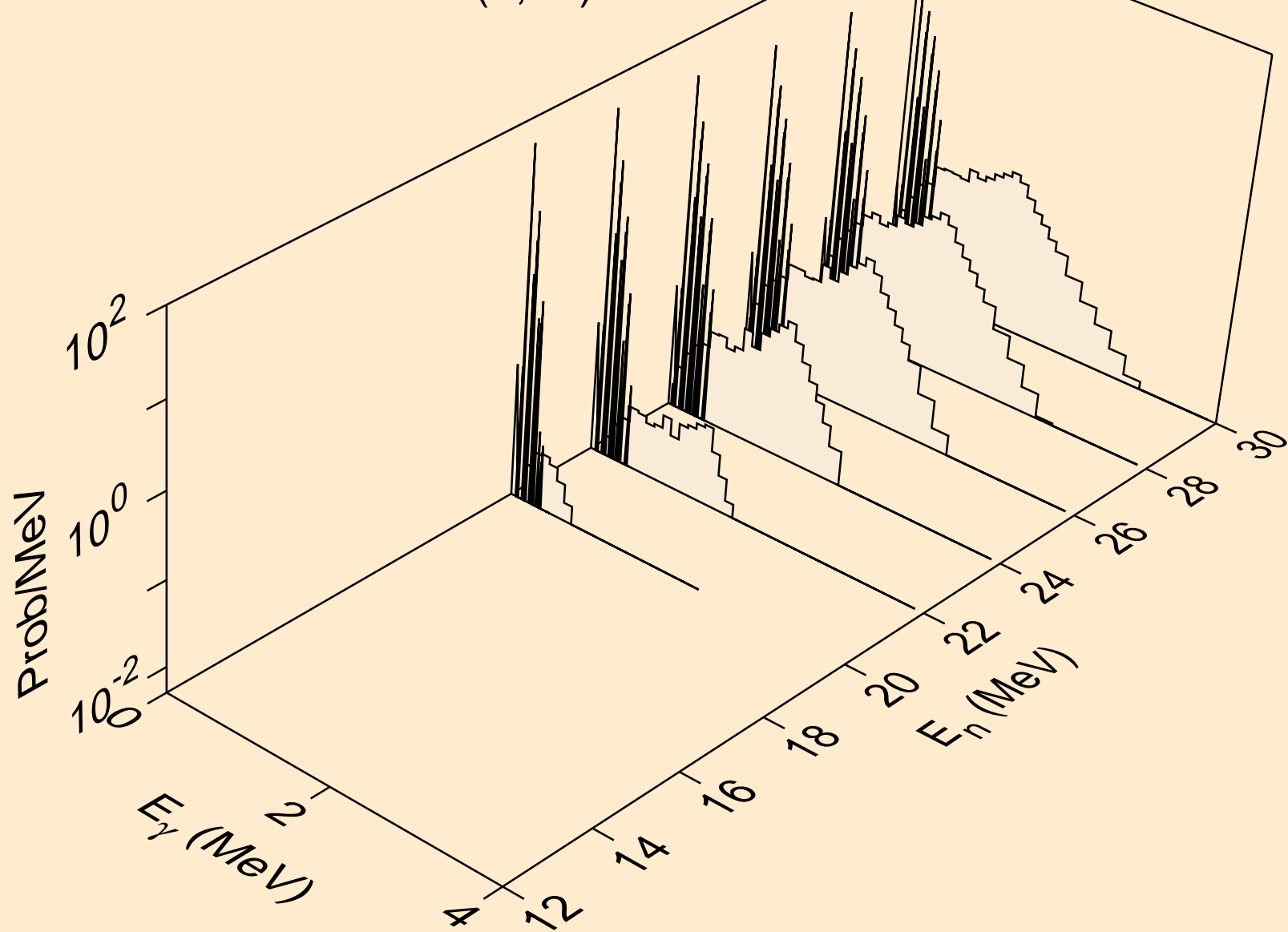

IR182 NEUTRON ACER TENDL-2024 LIBRARY; T=0.K
Photon emission for (n,n*)p

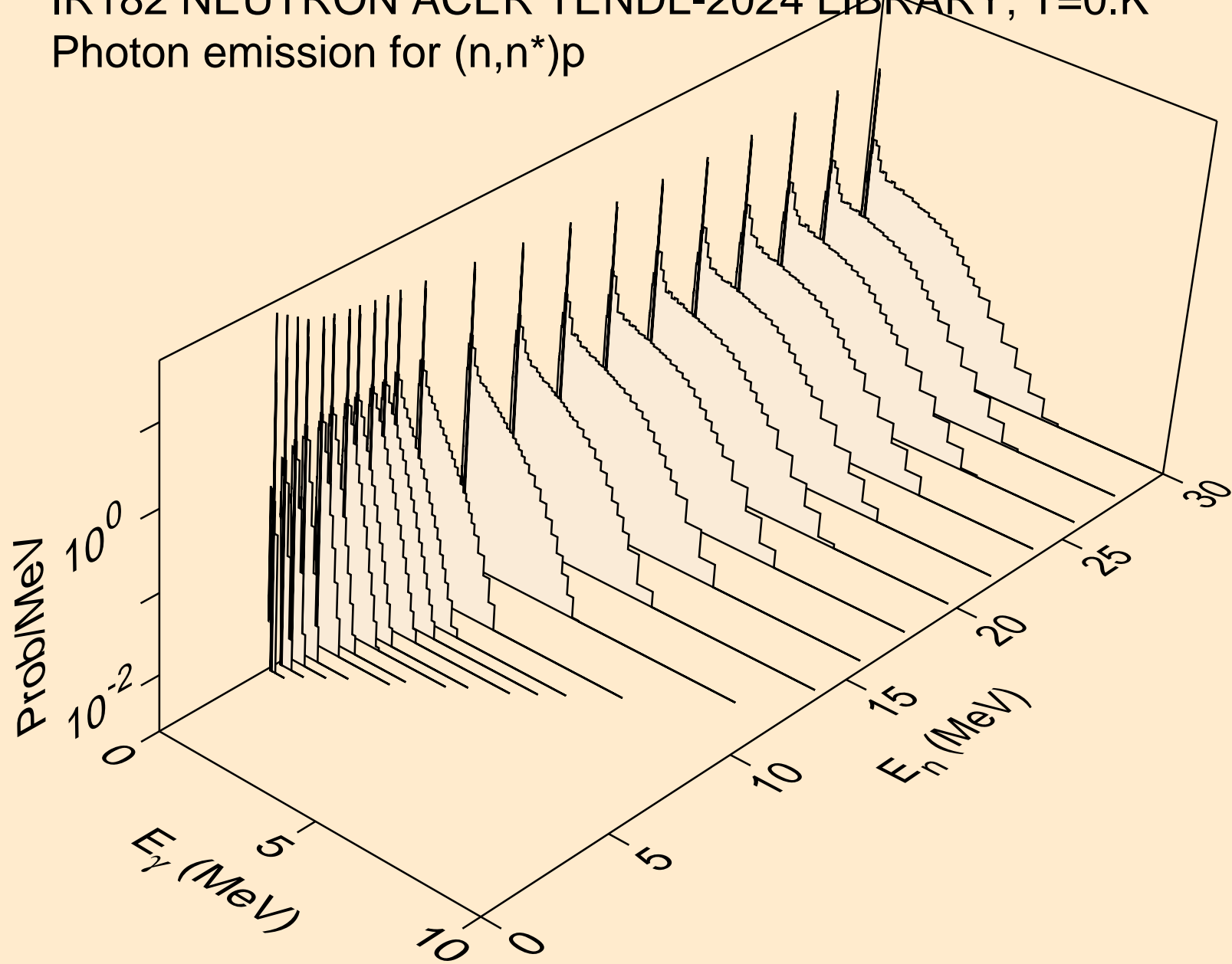

IR182 NEUTRON ACER TENDL-2024 LIBRARY; T=0.K
Photon emission for (n,n*)2a

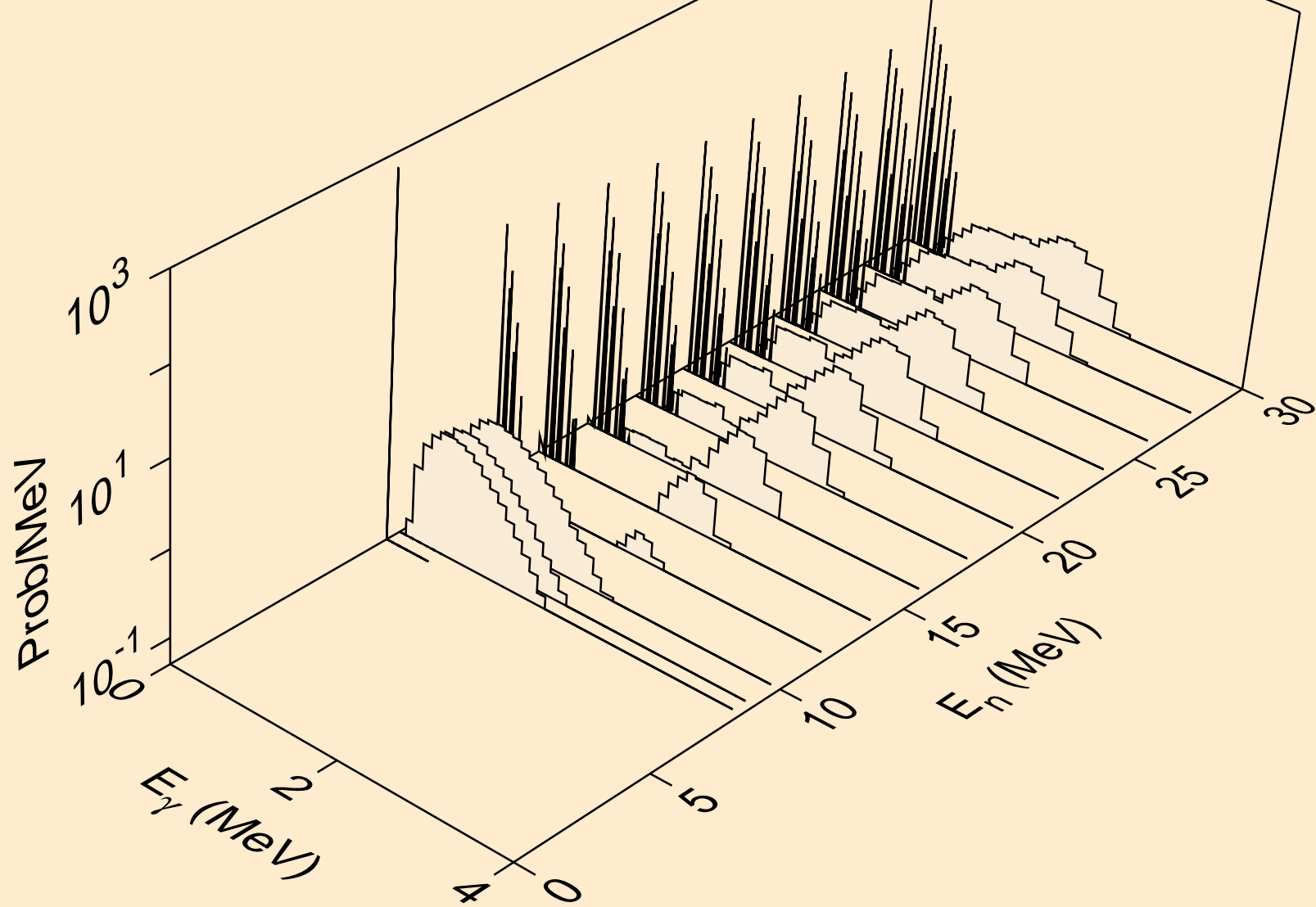

IR182 NEUTRON ACER TENDL-2024 LIBRARY; T=0.K
Photon emission for (n,2n)2a

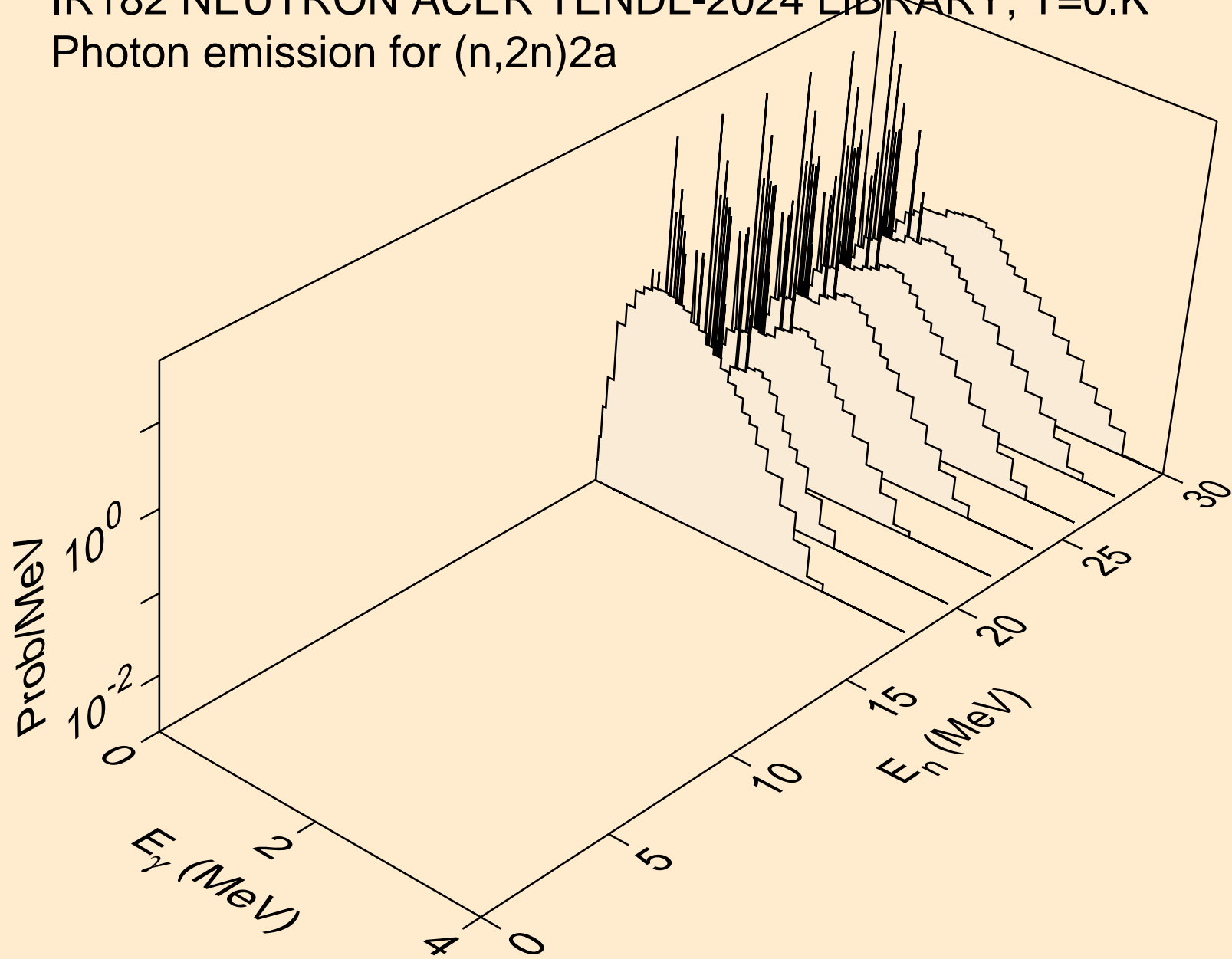

IR182 NEUTRON ACER TENDL-2024 LIBRARY; T=0.K
Photon emission for (n,n*)d

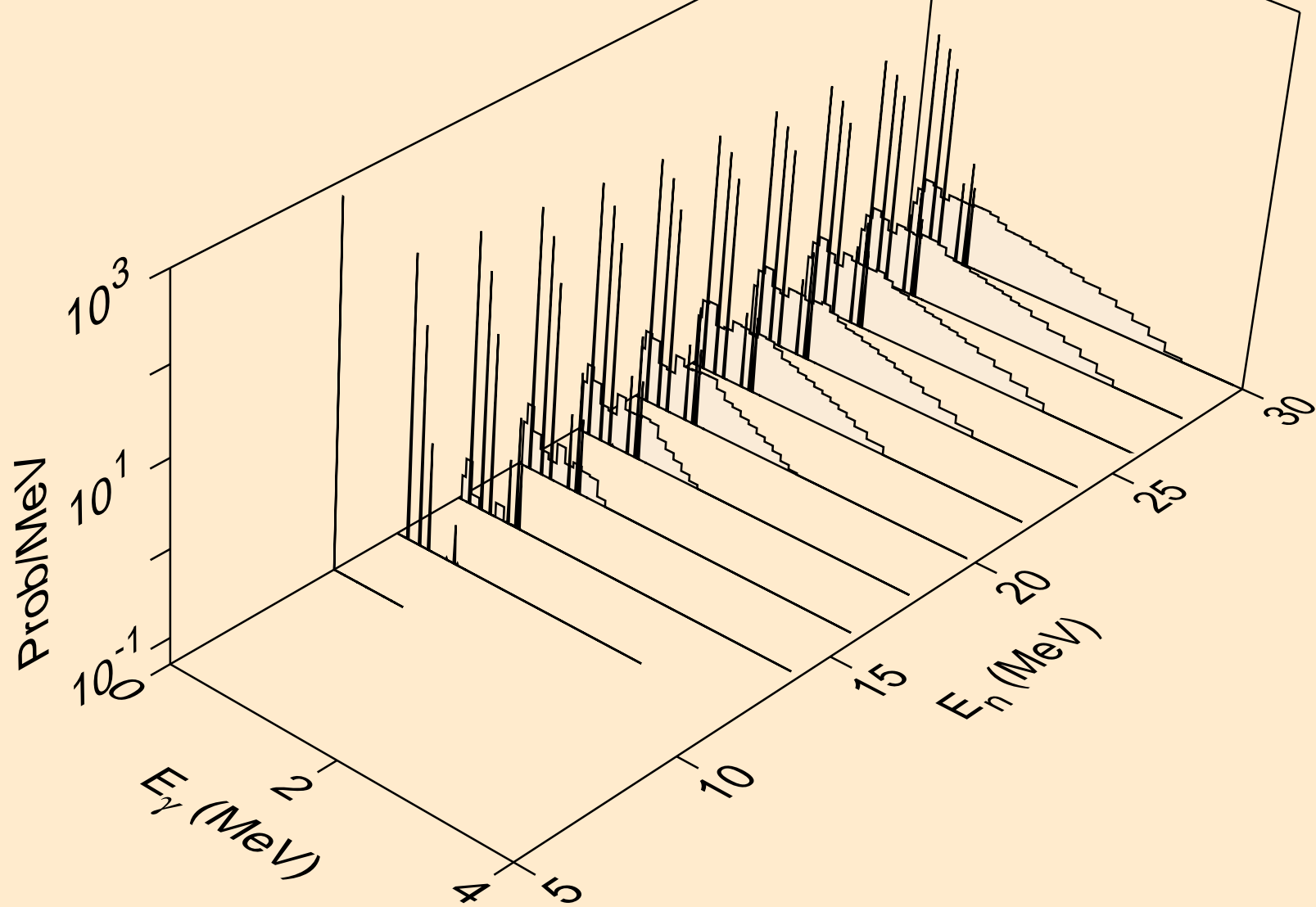

IR182 NEUTRON ACER TENDL-2024 LIBRARY; T=0.K
Photon emission for (n,n*)t

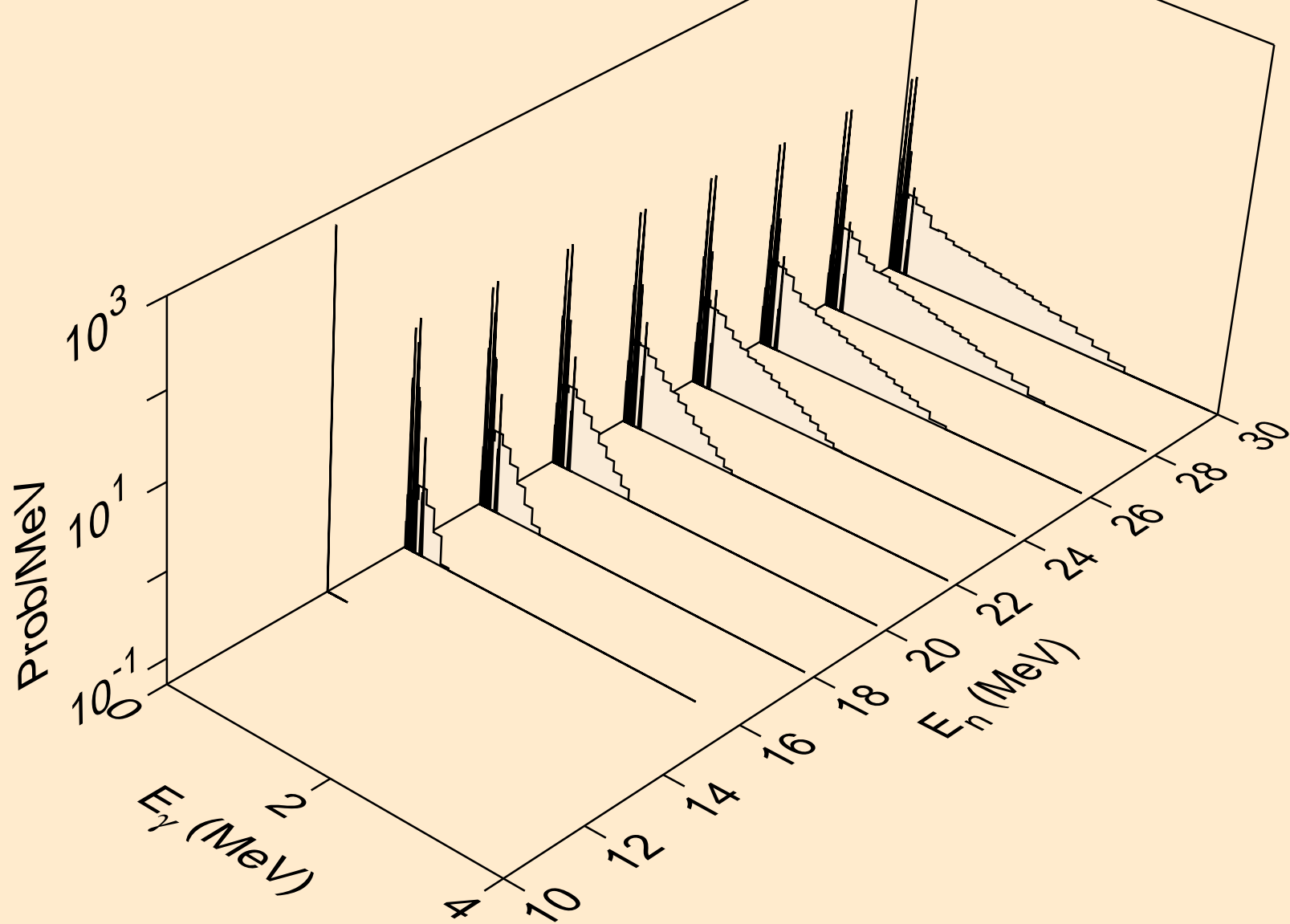

IR182 NEUTRON ACER TENDL-2024 LIBRARY; T=0.K
Photon emission for (n,n*)he3

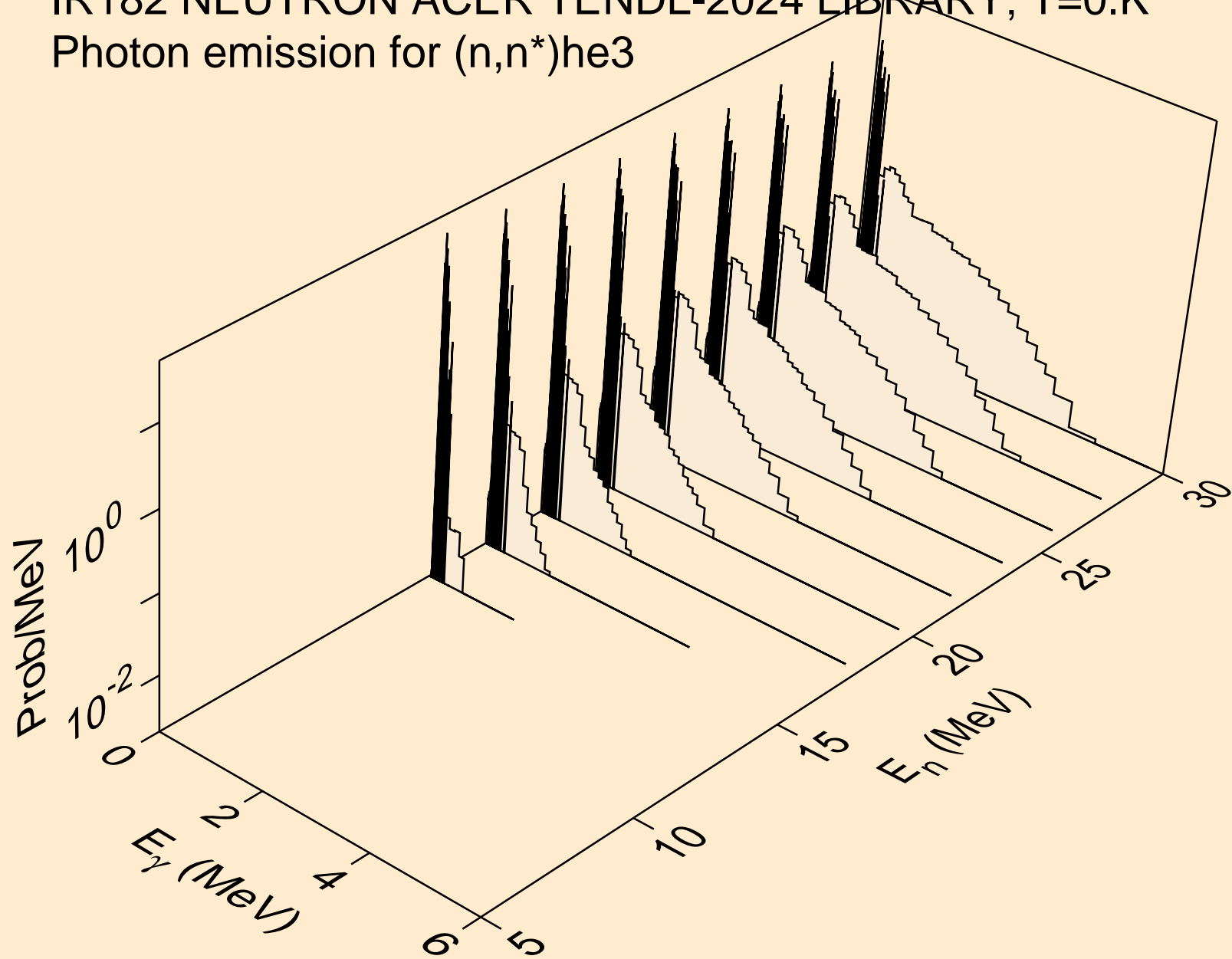

IR182 NEUTRON ACER TENDL-2024 LIBRARY; T=0.K
Photon emission for (n,4n)

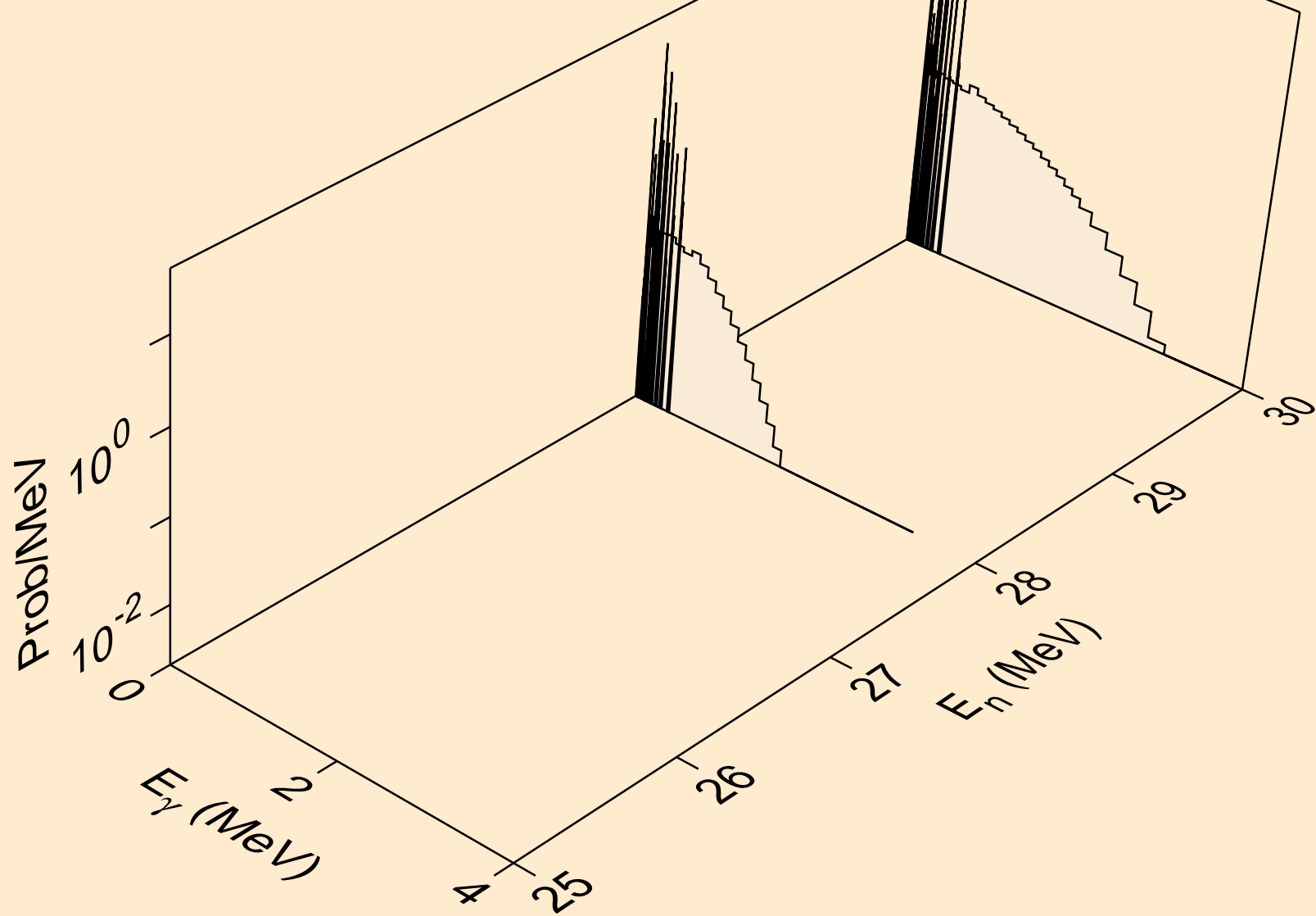

IR182 NEUTRON ACER TENDL-2024 LIBRARY; T=0.K
Photon emission for (n,2np)

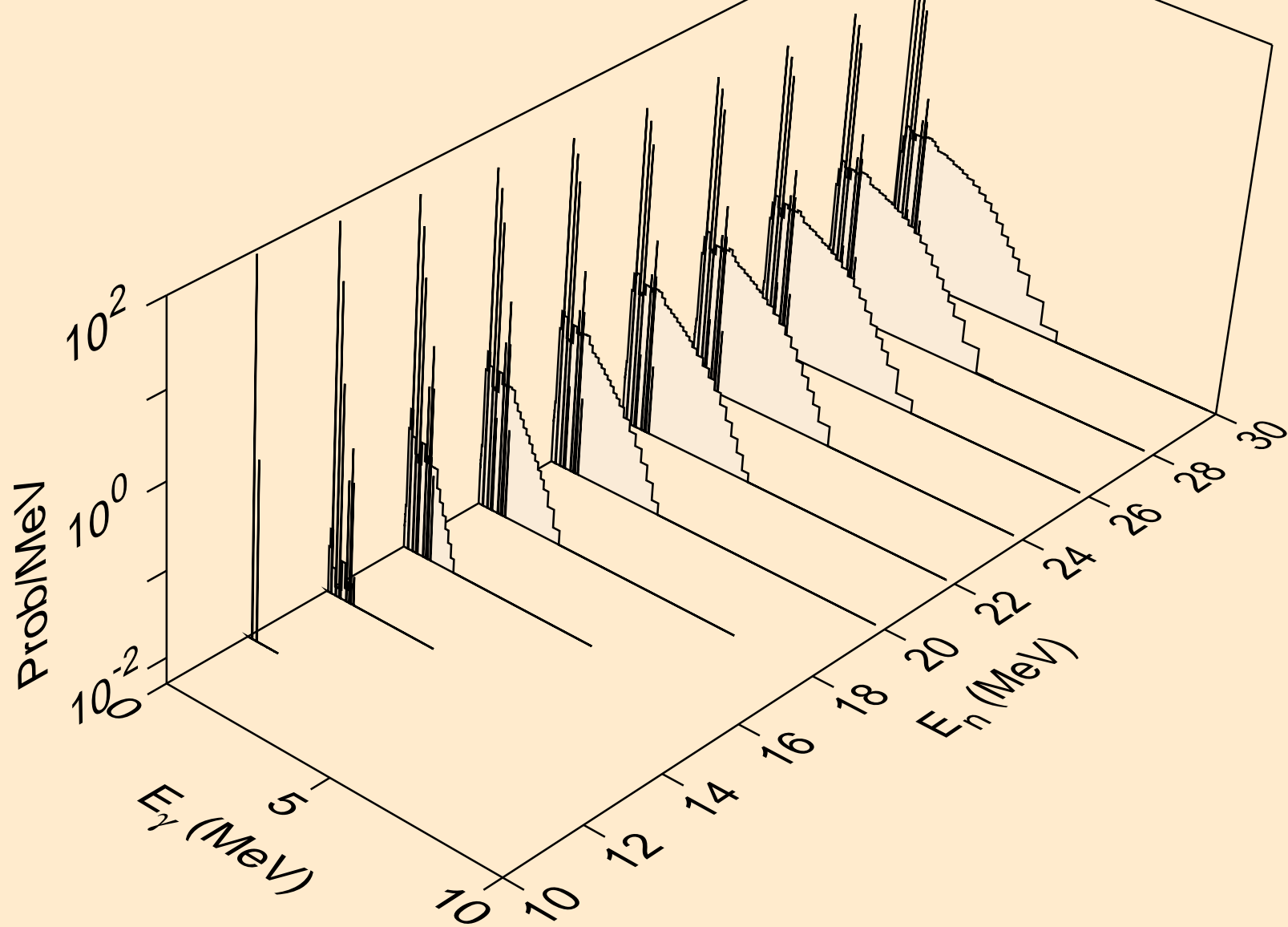

IR182 NEUTRON ACER TENDL-2024 LIBRARY; T=0.K
Photon emission for (n,3np)

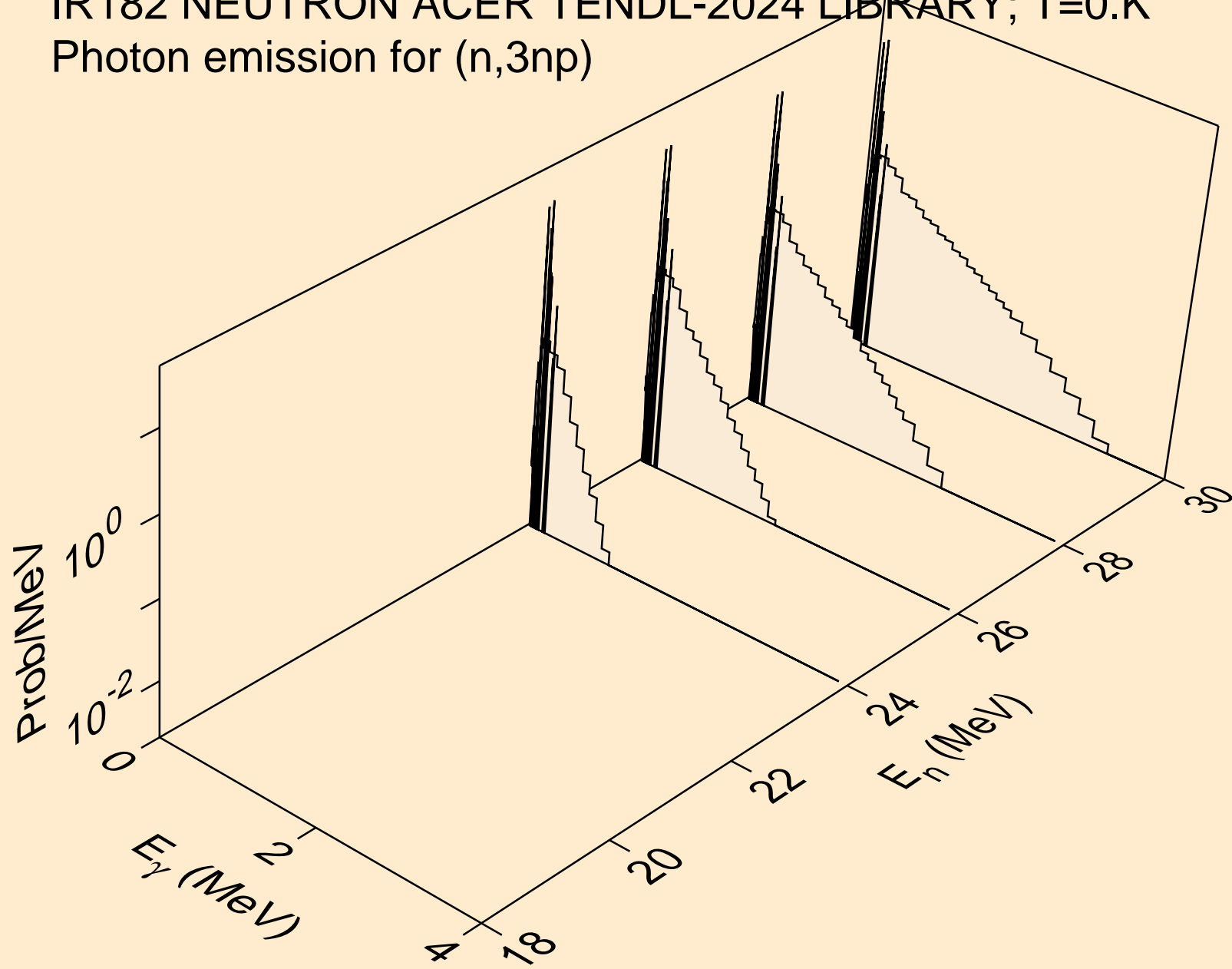

IR182 NEUTRON ACER TENDL-2024 LIBRARY; T=0.K
Photon emission for (n,n2p)

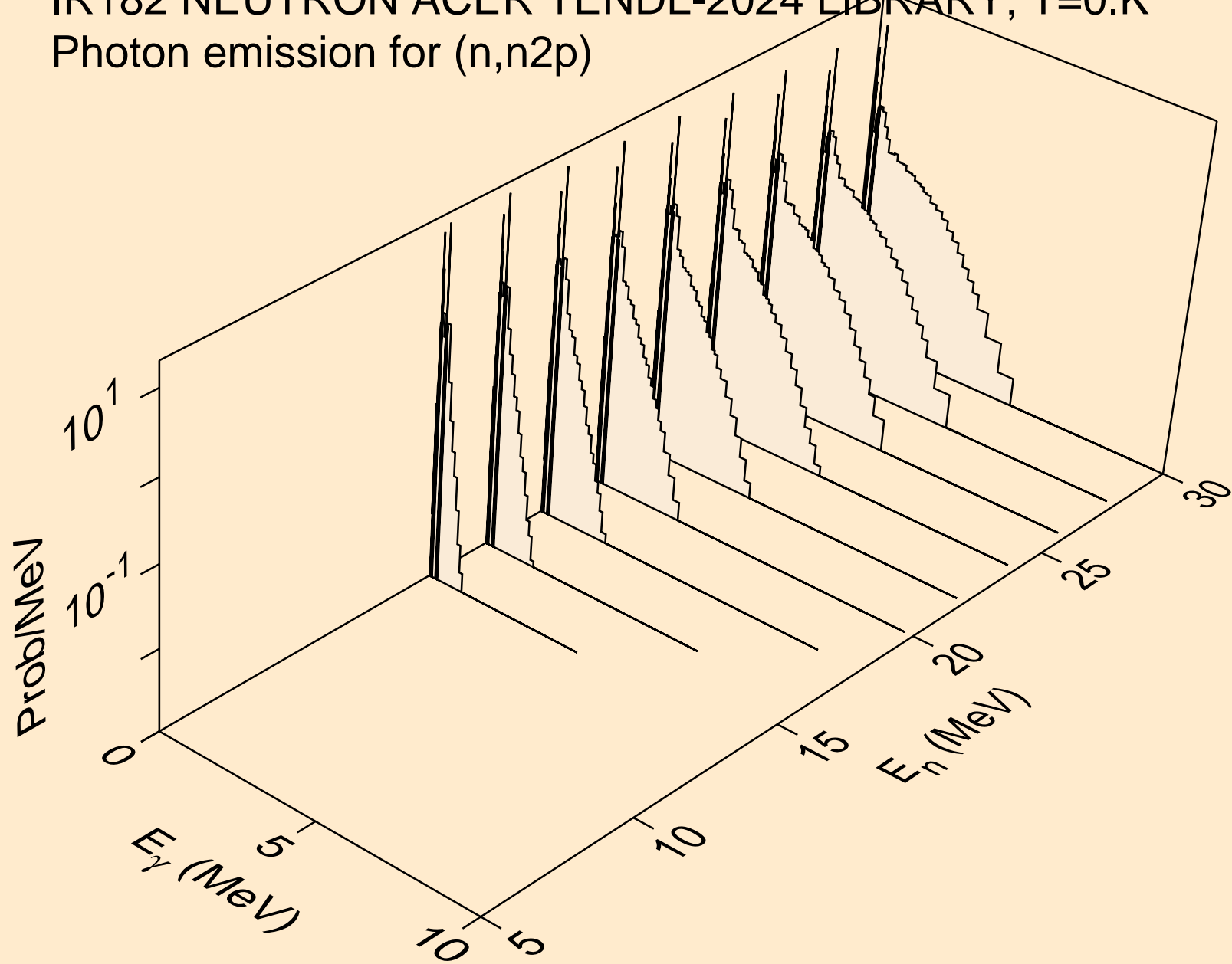

IR182 NEUTRON ACER TENDL-2024 LIBRARY; T=0.K
Photon emission for (n,npa)

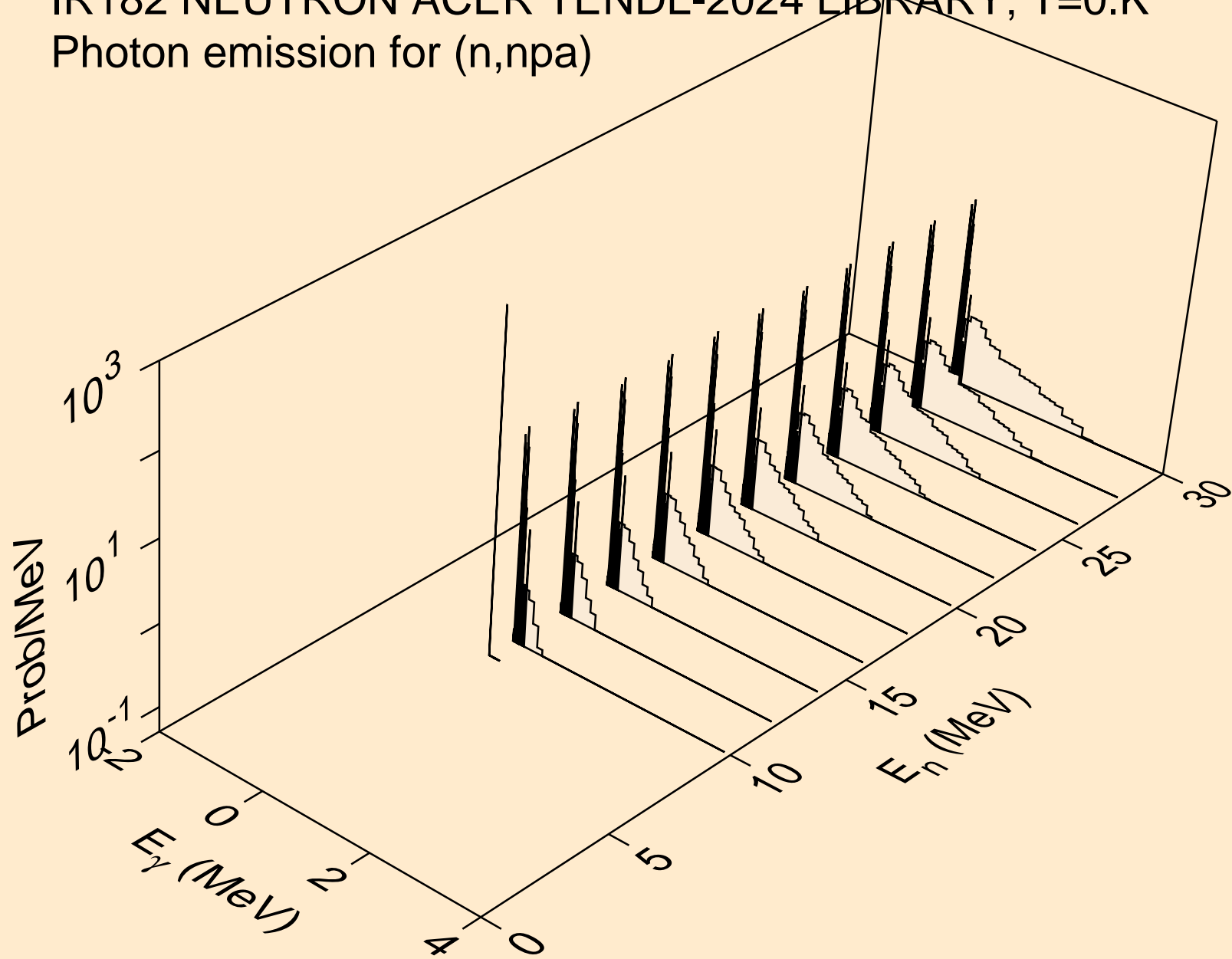

IR182 NEUTRON ACER TENDL-2024 LIBRARY; T=0.K
Photon emission for (n,n*c)

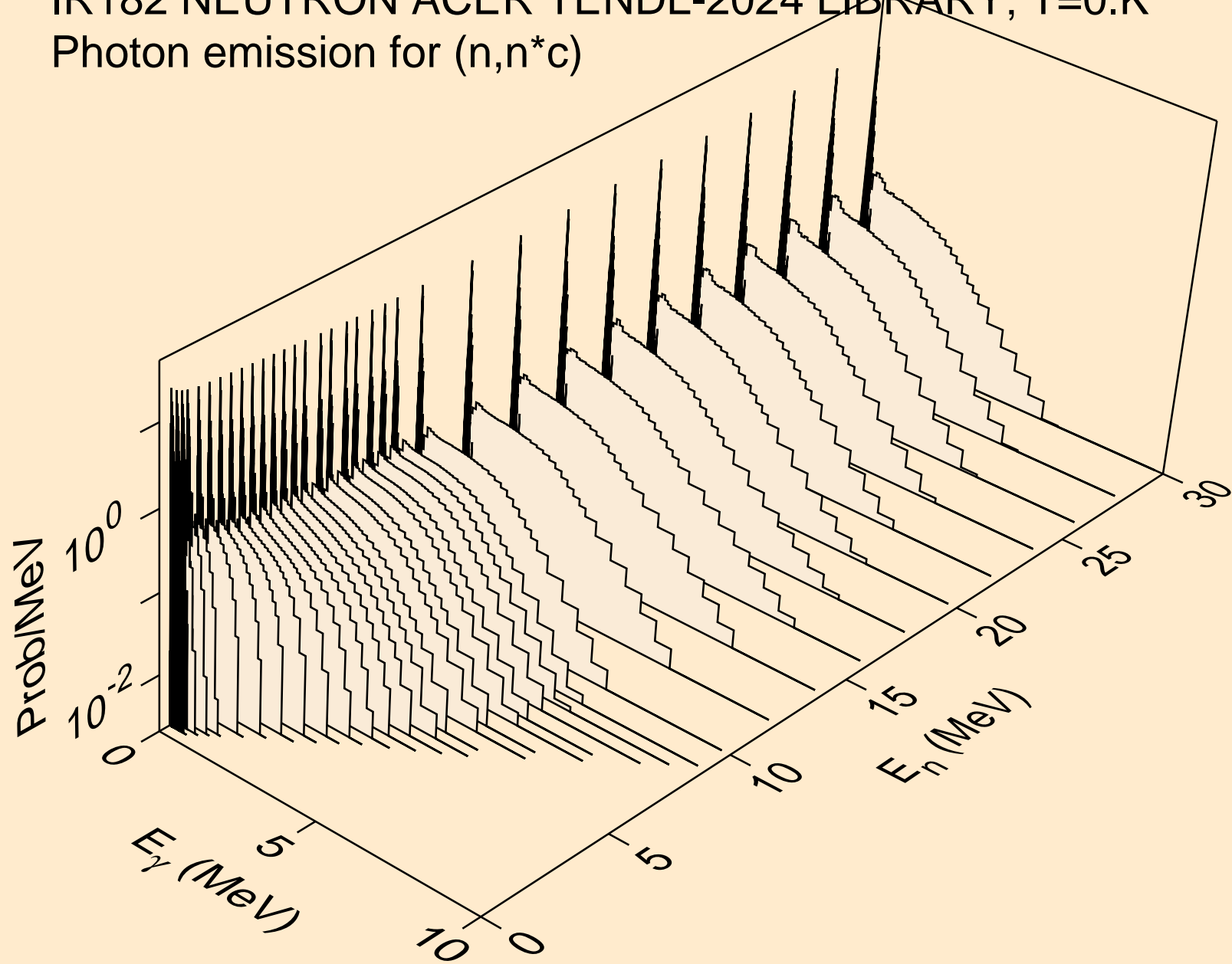

IR182 NEUTRON ACER TENDL-2024 LIBRARY; T=0.K
Photon emission for (n,gma)

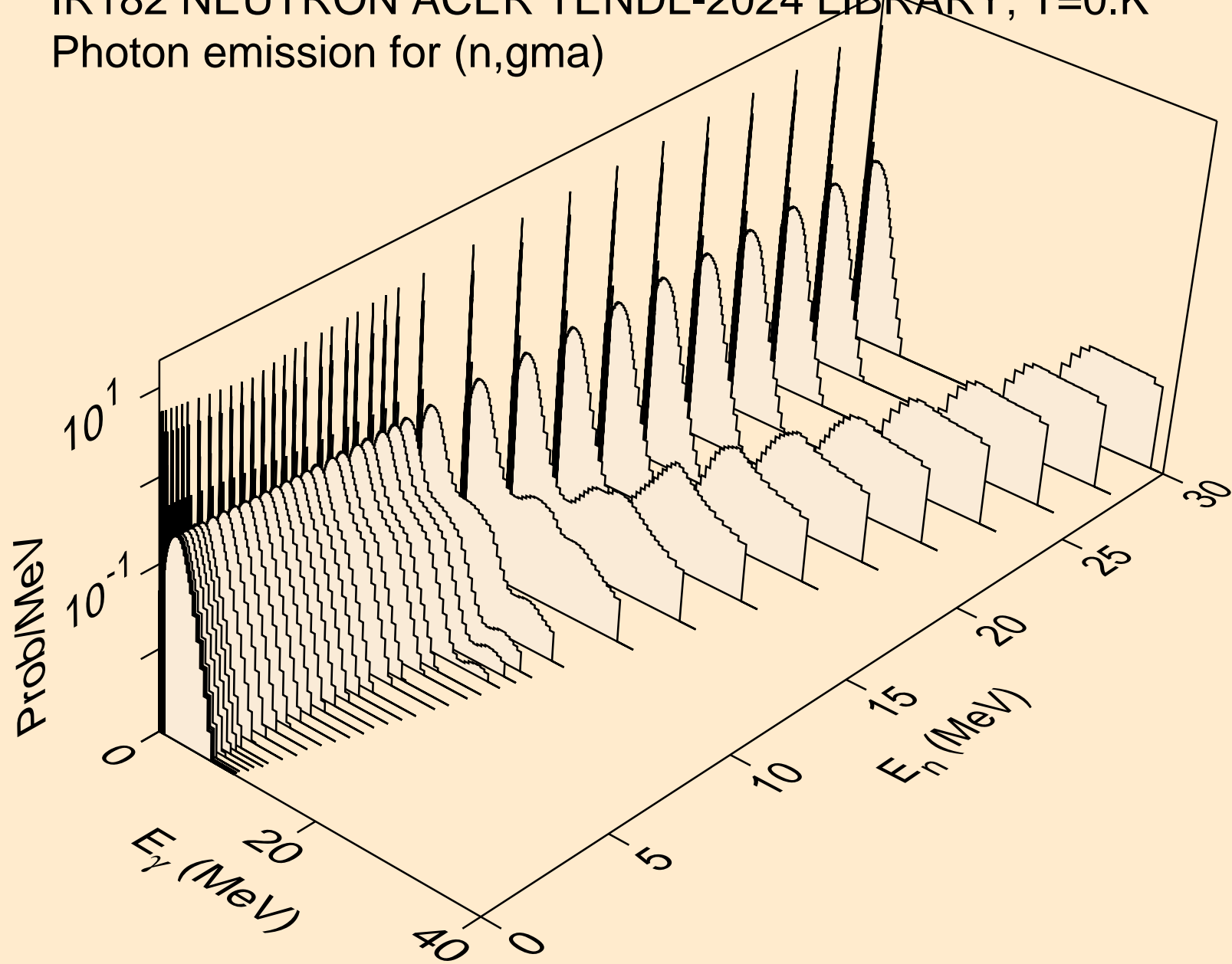

IR182 NEUTRON ACER TENDL-2024 LIBRARY; T=0.K
Photon emission for (n,p)

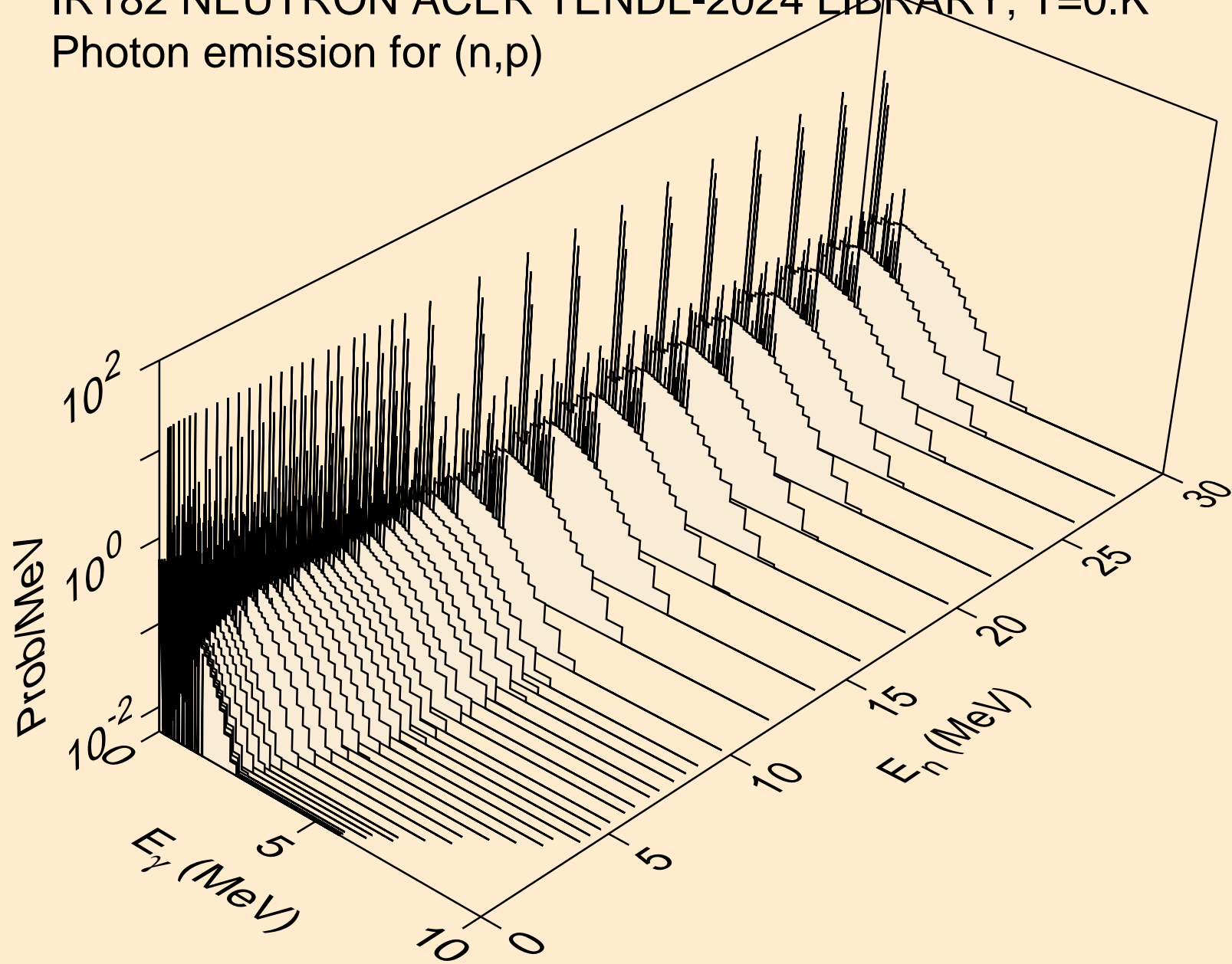

IR182 NEUTRON ACER TENDL-2024 LIBRARY; T=0.K
Photon emission for (n,d)

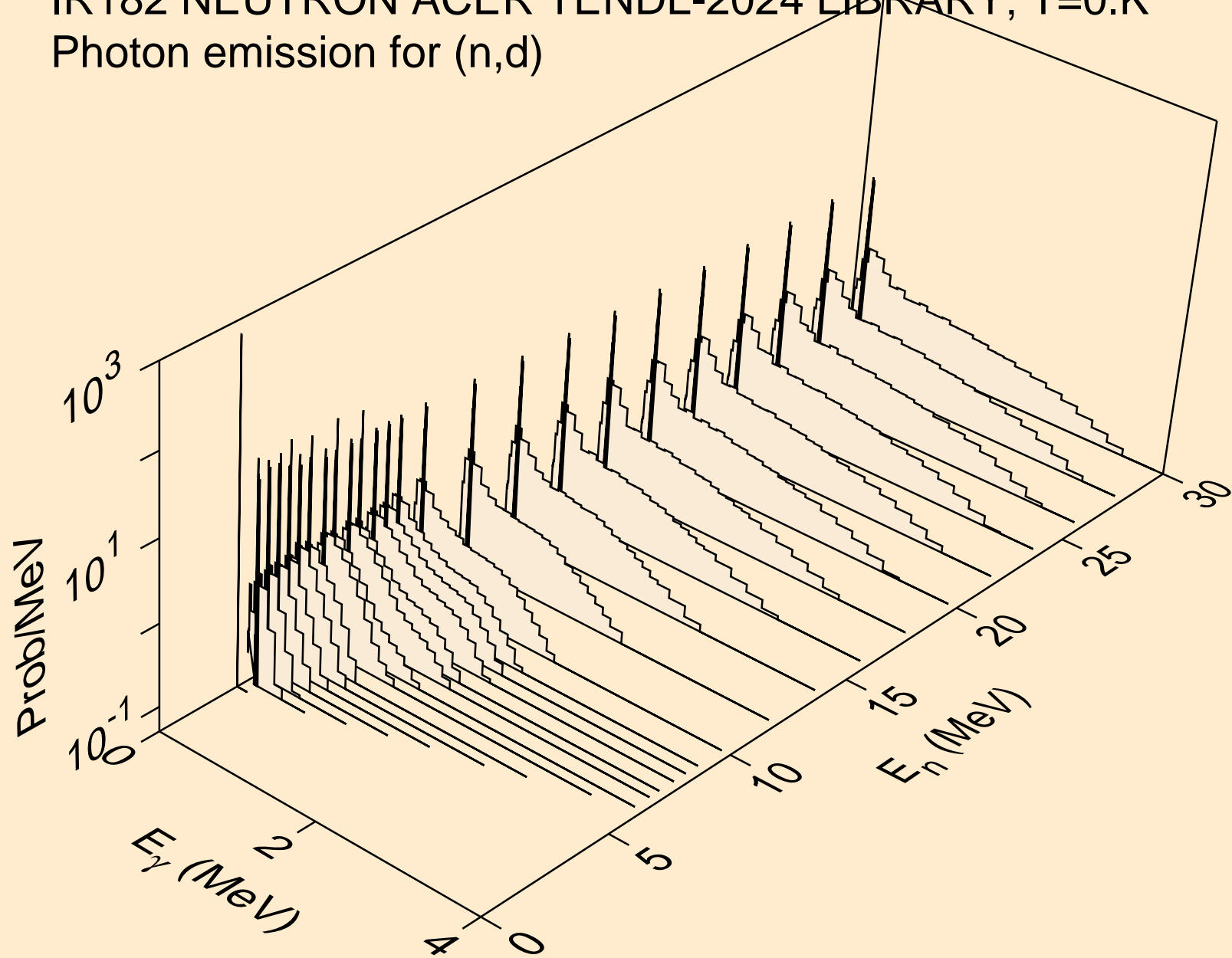

IR182 NEUTRON ACER TENDL-2024 LIBRARY; T=0.K
Photon emission for (n,t)

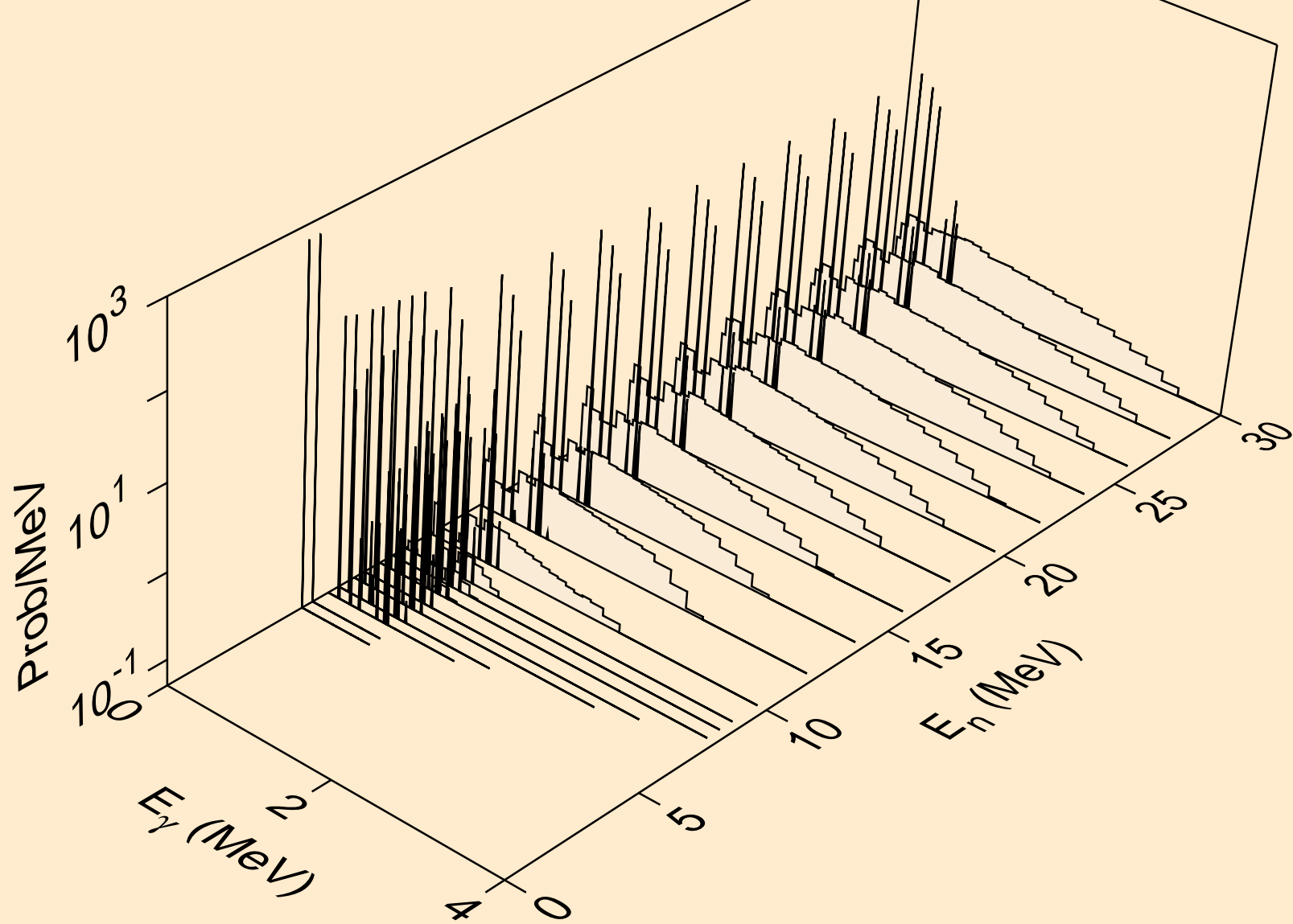

IR182 NEUTRON ACER TENDL-2024 LIBRARY; T=0.K
Photon emission for (n,he3)

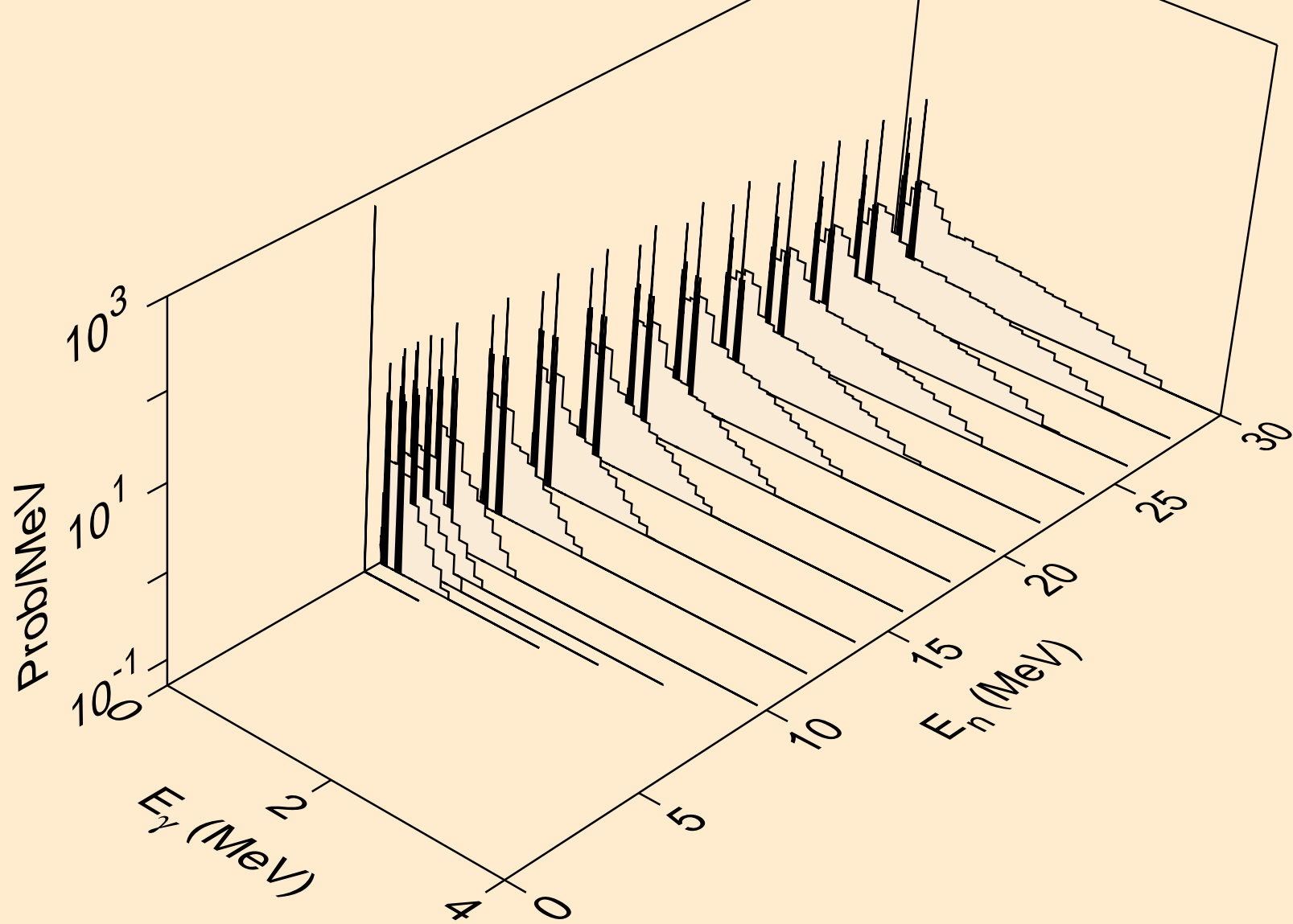

IR182 NEUTRON ACER TENDL-2024 LIBRARY; T=0.K
Photon emission for (n,a)

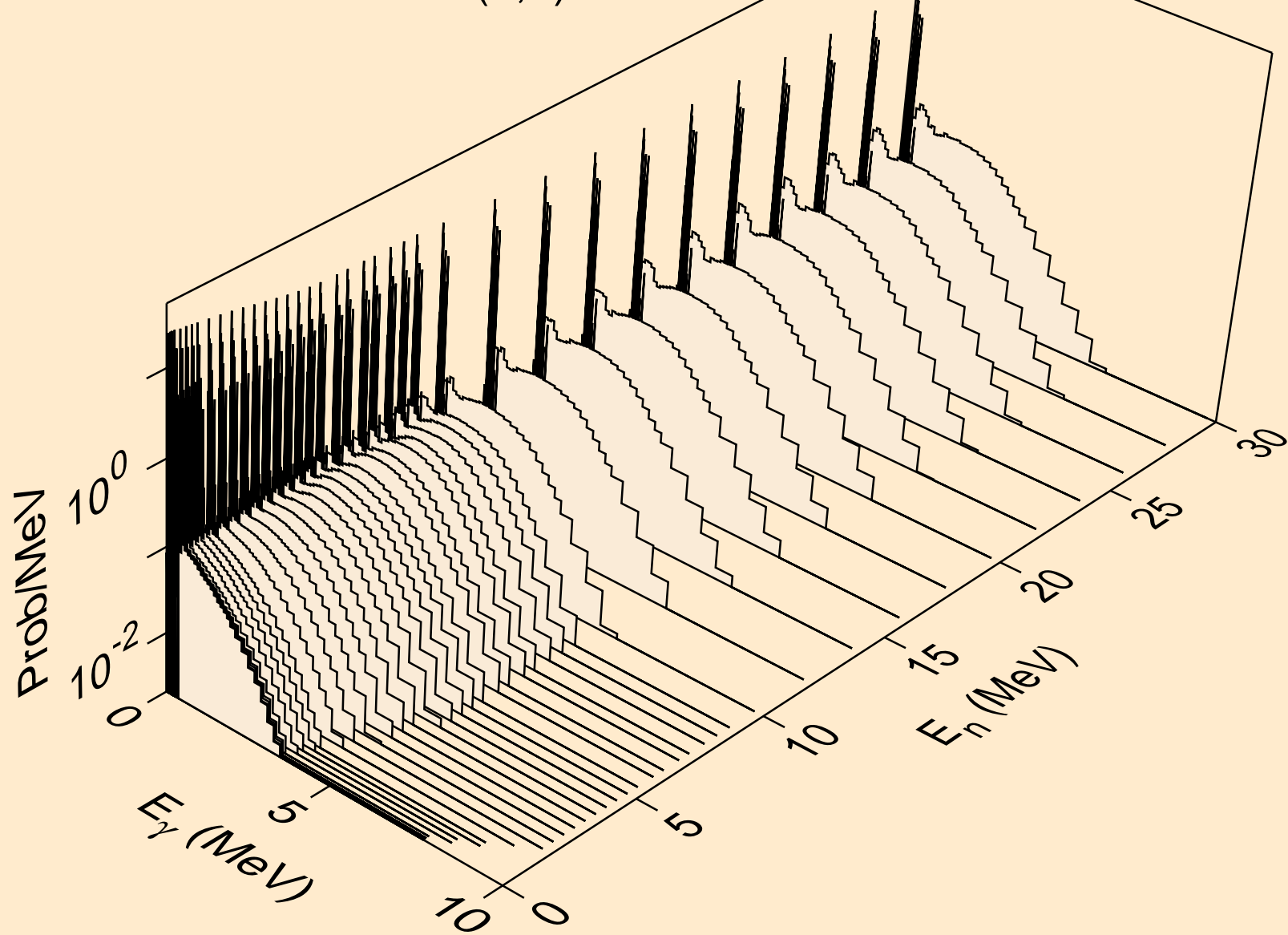

IR182 NEUTRON ACER TENDL-2024 LIBRARY; T=0.K
Photon emission for (n,2a)

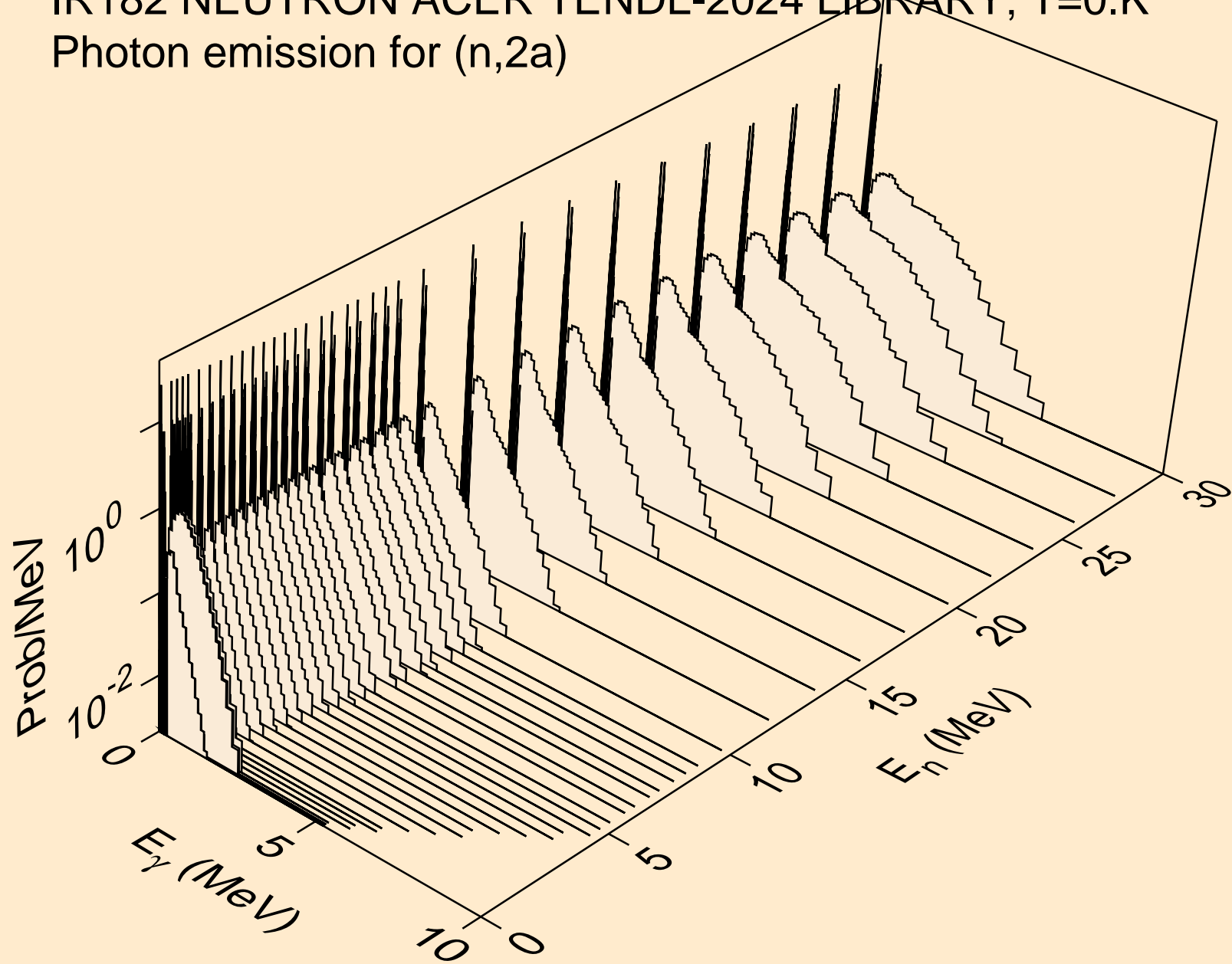

IR182 NEUTRON ACER TENDL-2024 LIBRARY; T=0.K
Photon emission for (n,2p)

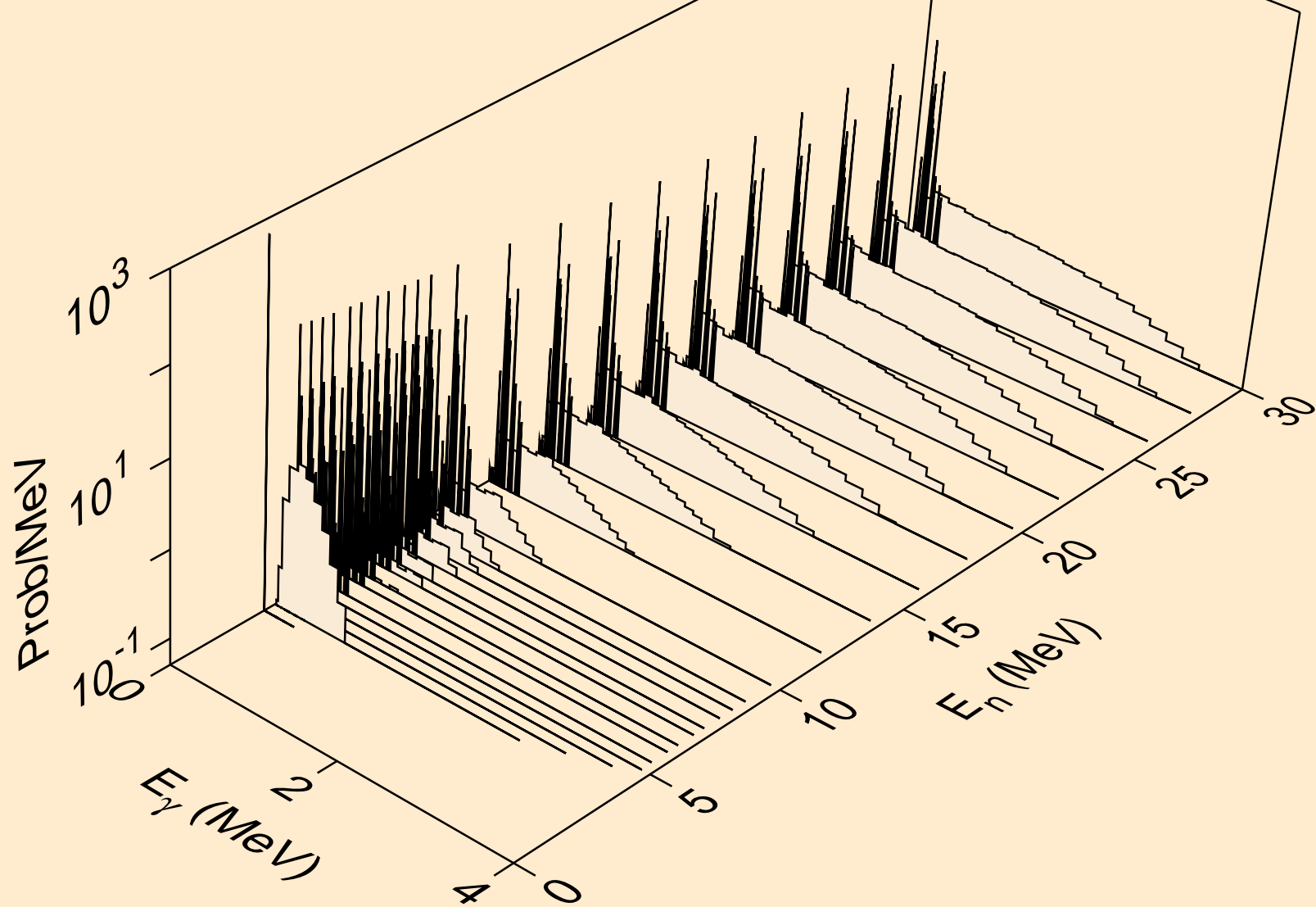

IR182 NEUTRON ACER TENDL-2024 LIBRARY; T=0.K
Photon emission for (n,p)

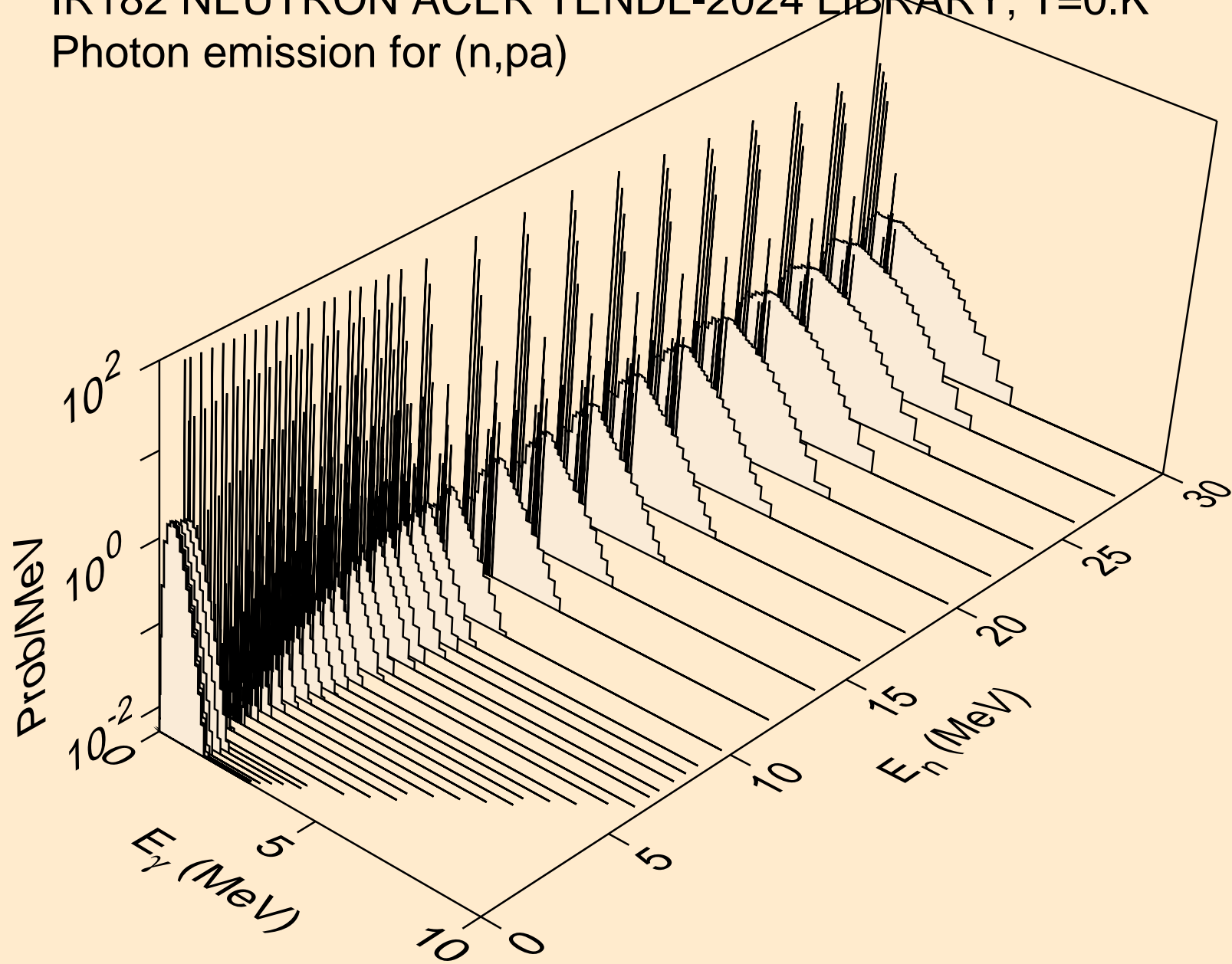

IR182 NEUTRON ACER TENDL-2024 LIBRARY; T=0.K
Photon emission for (n,pd)

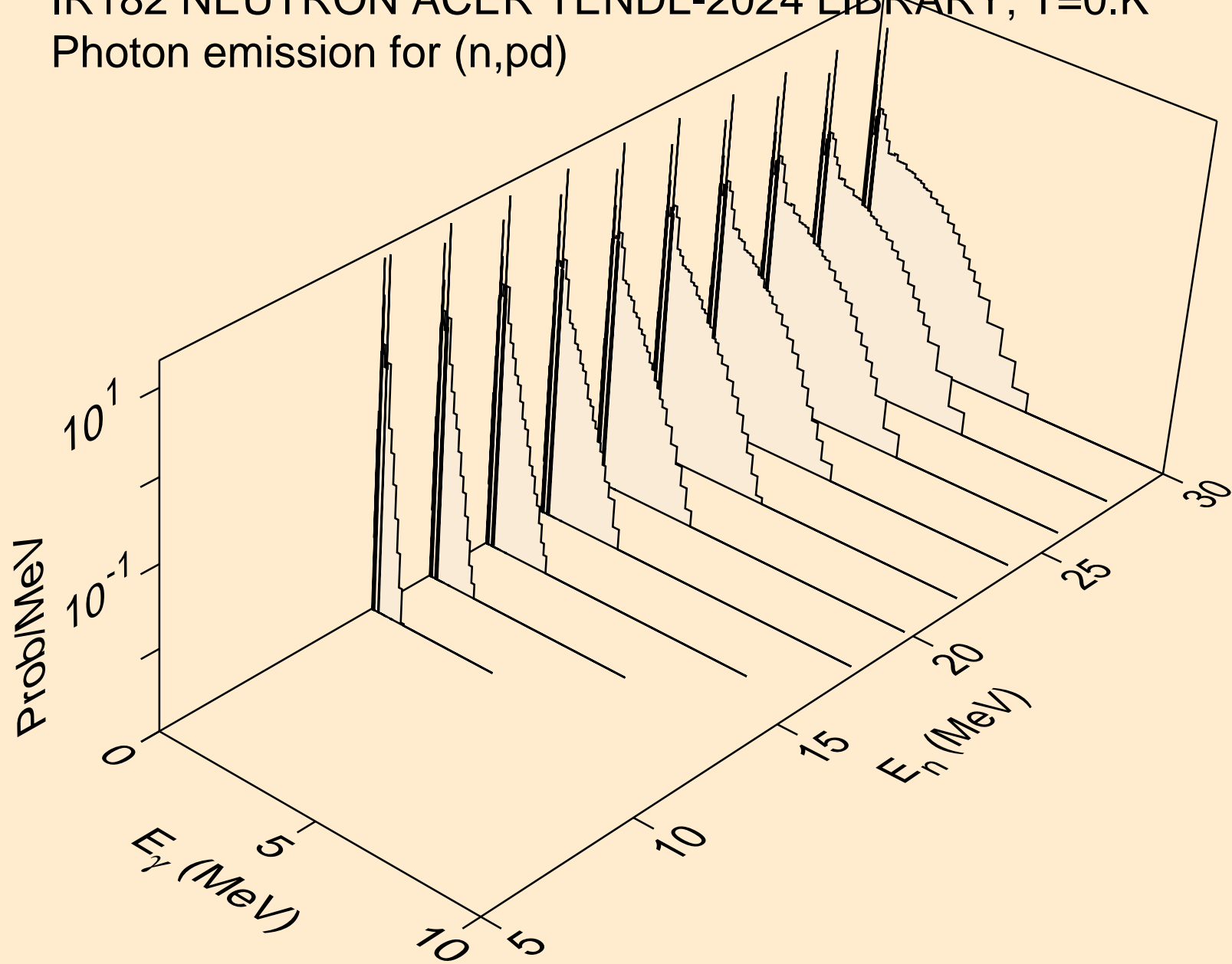

IR182 NEUTRON ACER TENDL-2024 LIBRARY; T=0.K
Photon emission for (n,pt)

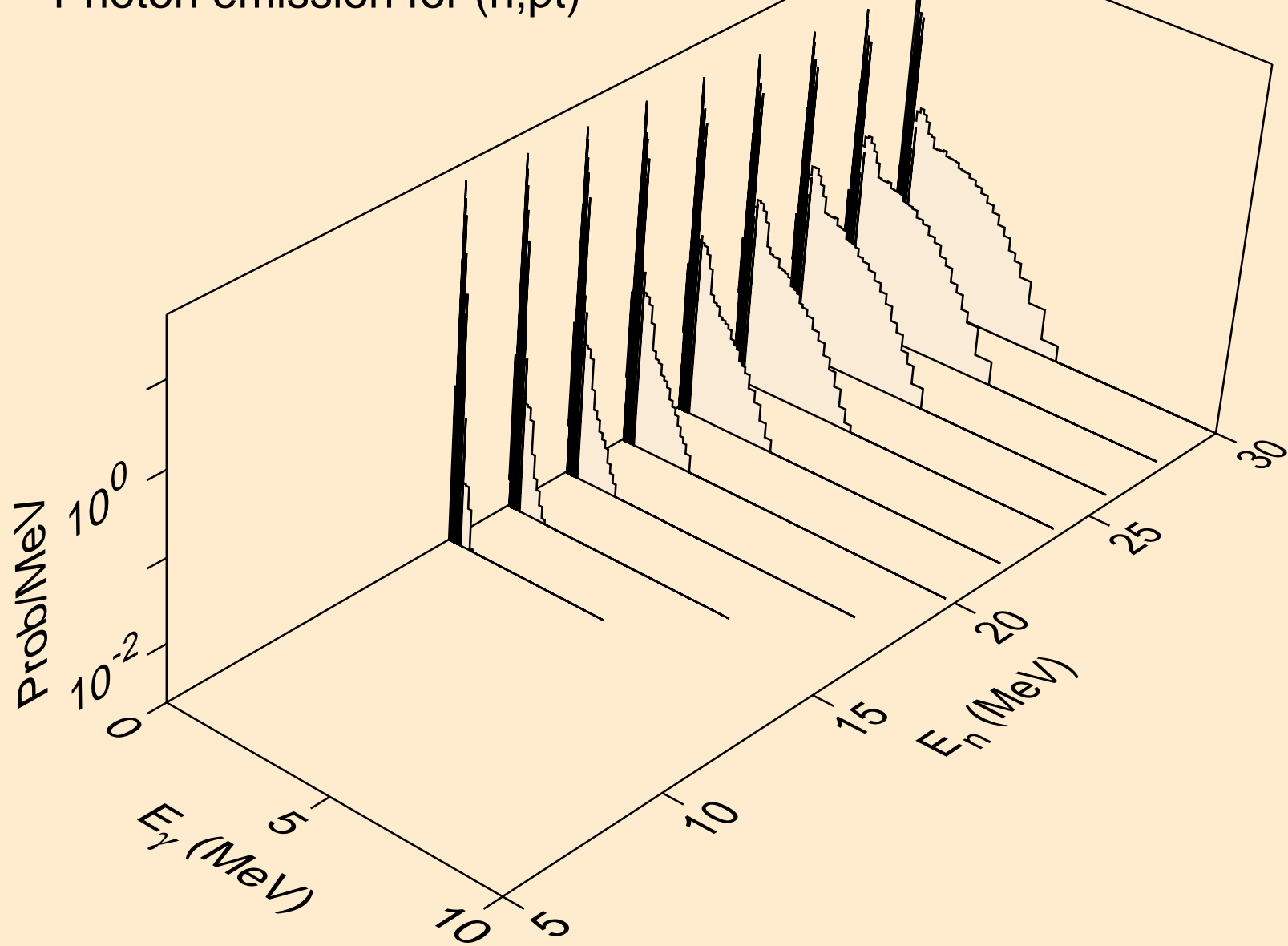

IR182 NEUTRON ACER TENDL-2024 LIBRARY; T=0.K
Photon emission for (n,da)

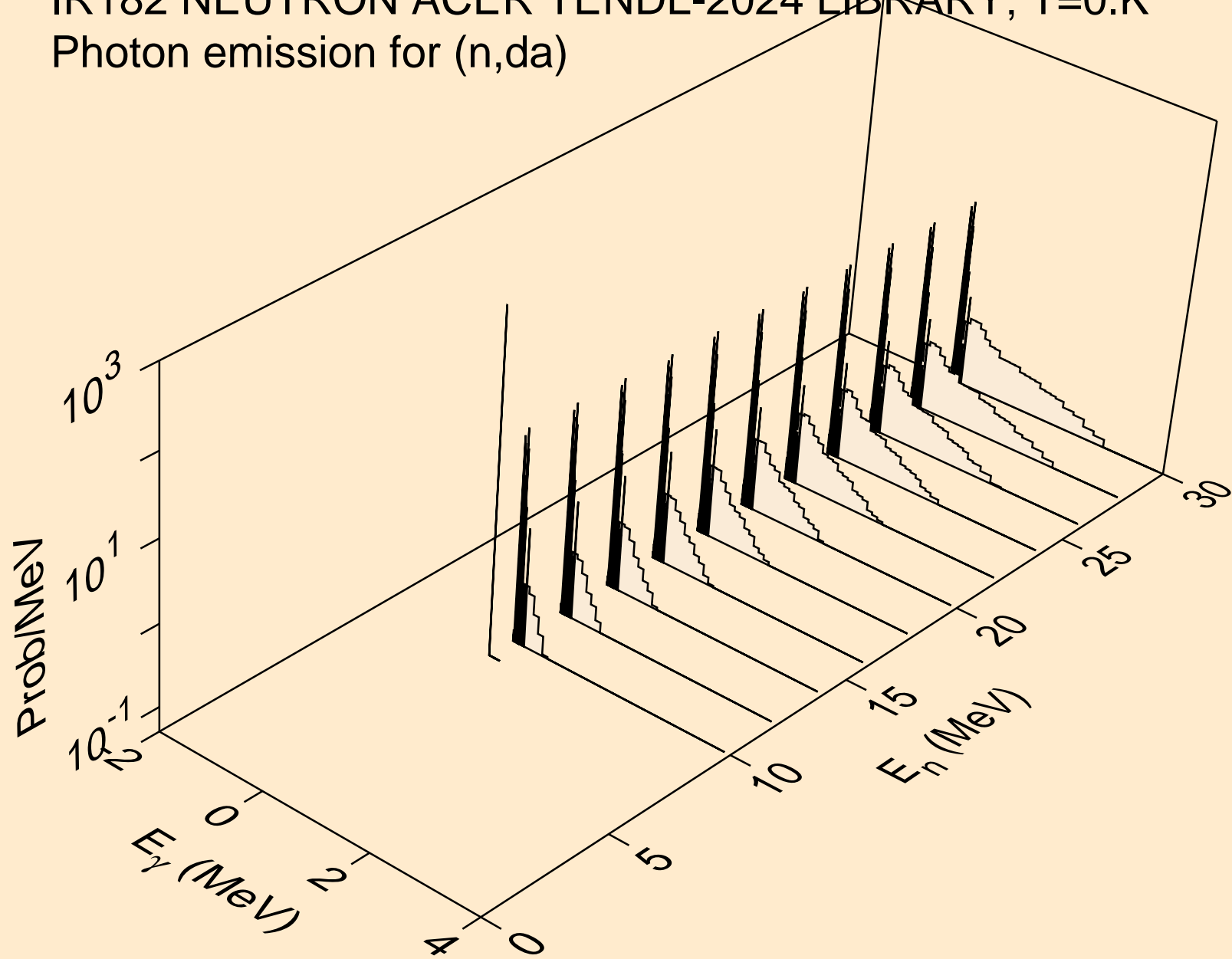

IR182 NEUTRON ACER TENDL-2024 LIBRARY; T=0.K
thermal capture photon spectrum

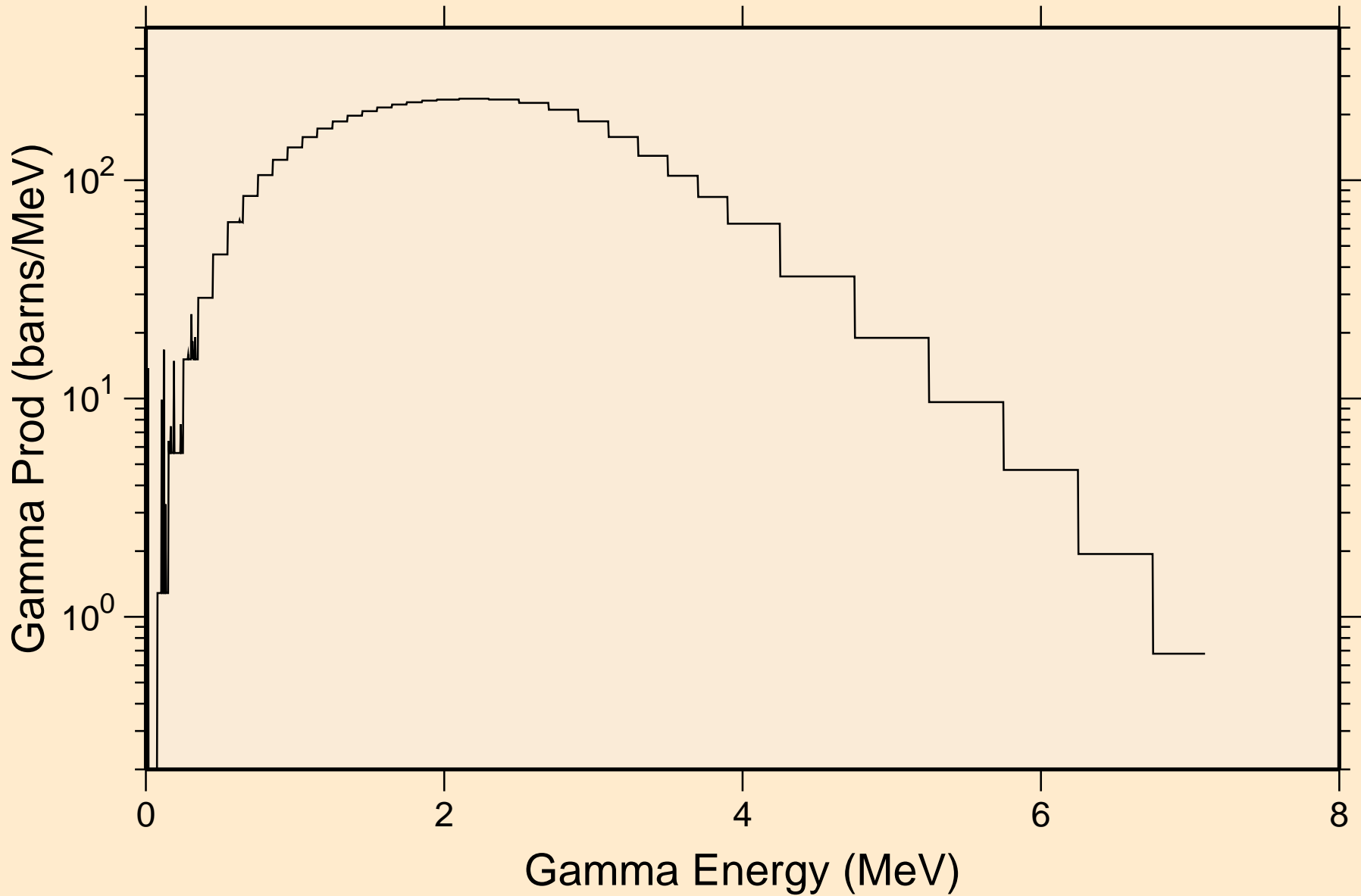

IR182 NEUTRON ACER TENDL-2024 LIBRARY; T=0.K
14 MeV photon spectrum

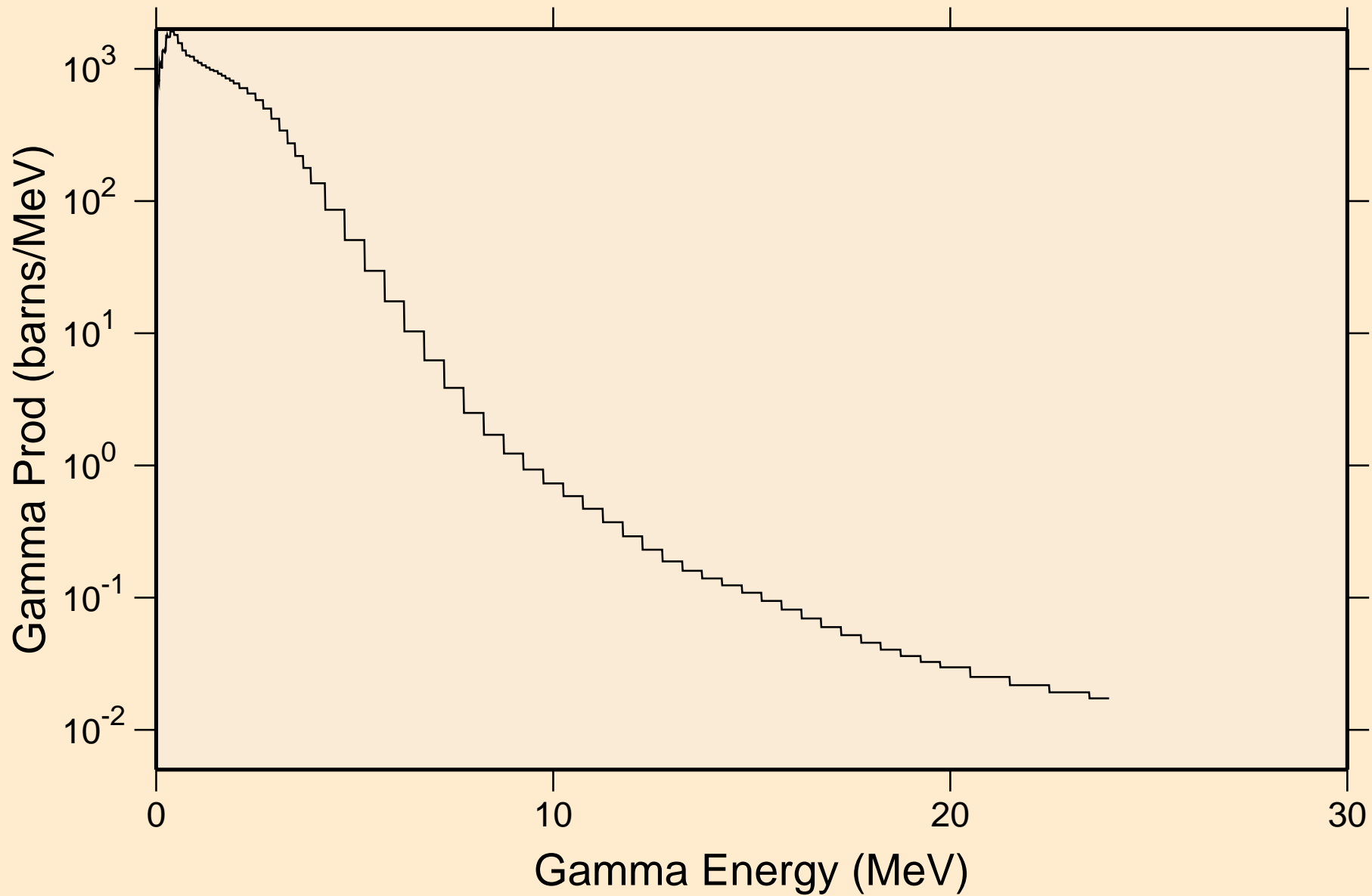

IR182 NEUTRON ACER TENDL-2024 LIBRARY; T=0.K

Particle heating contributions

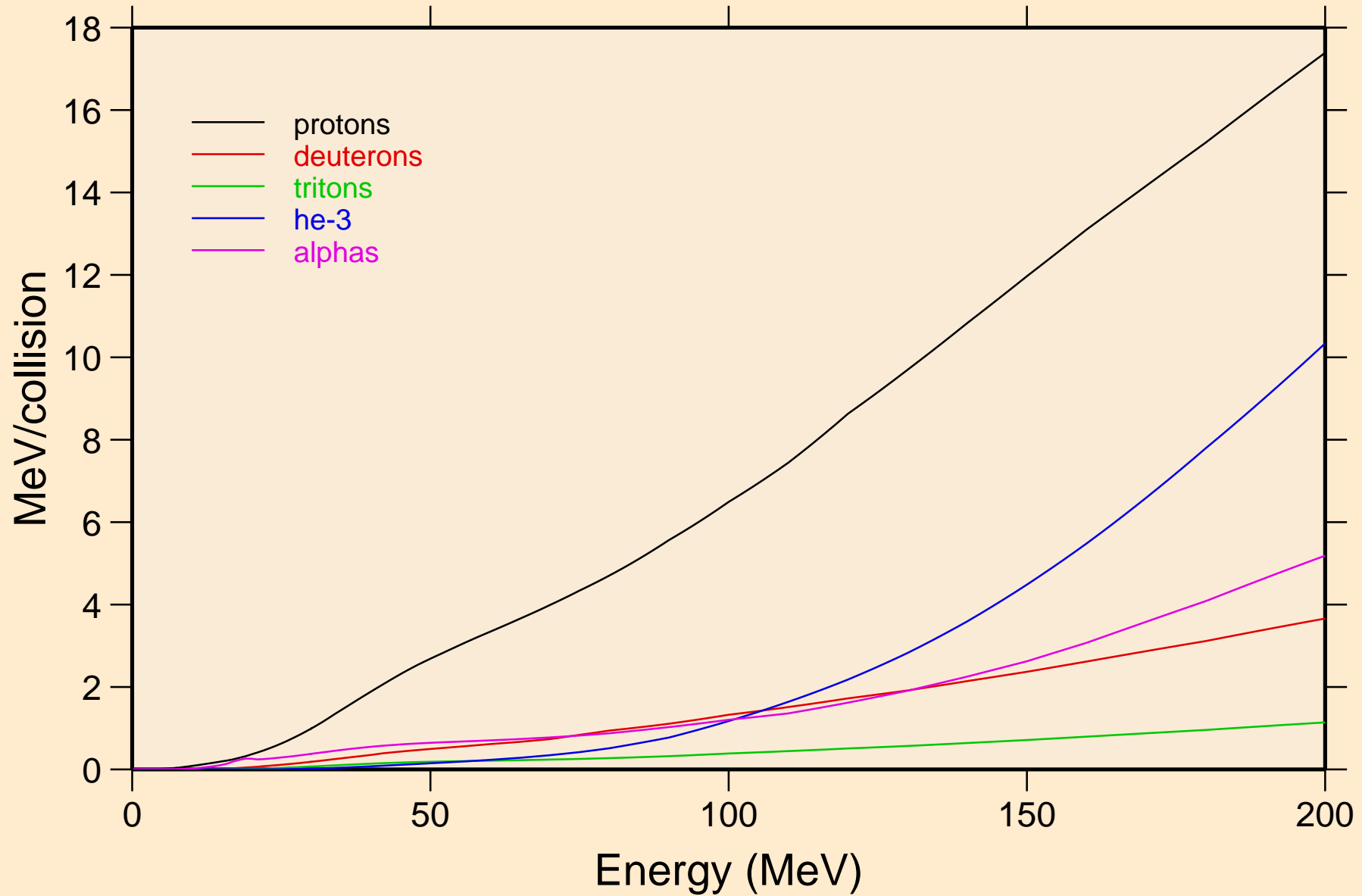

IR182 NEUTRON ACER TENDL-2024 LIBRARY; T=0.K
Recoil Heating

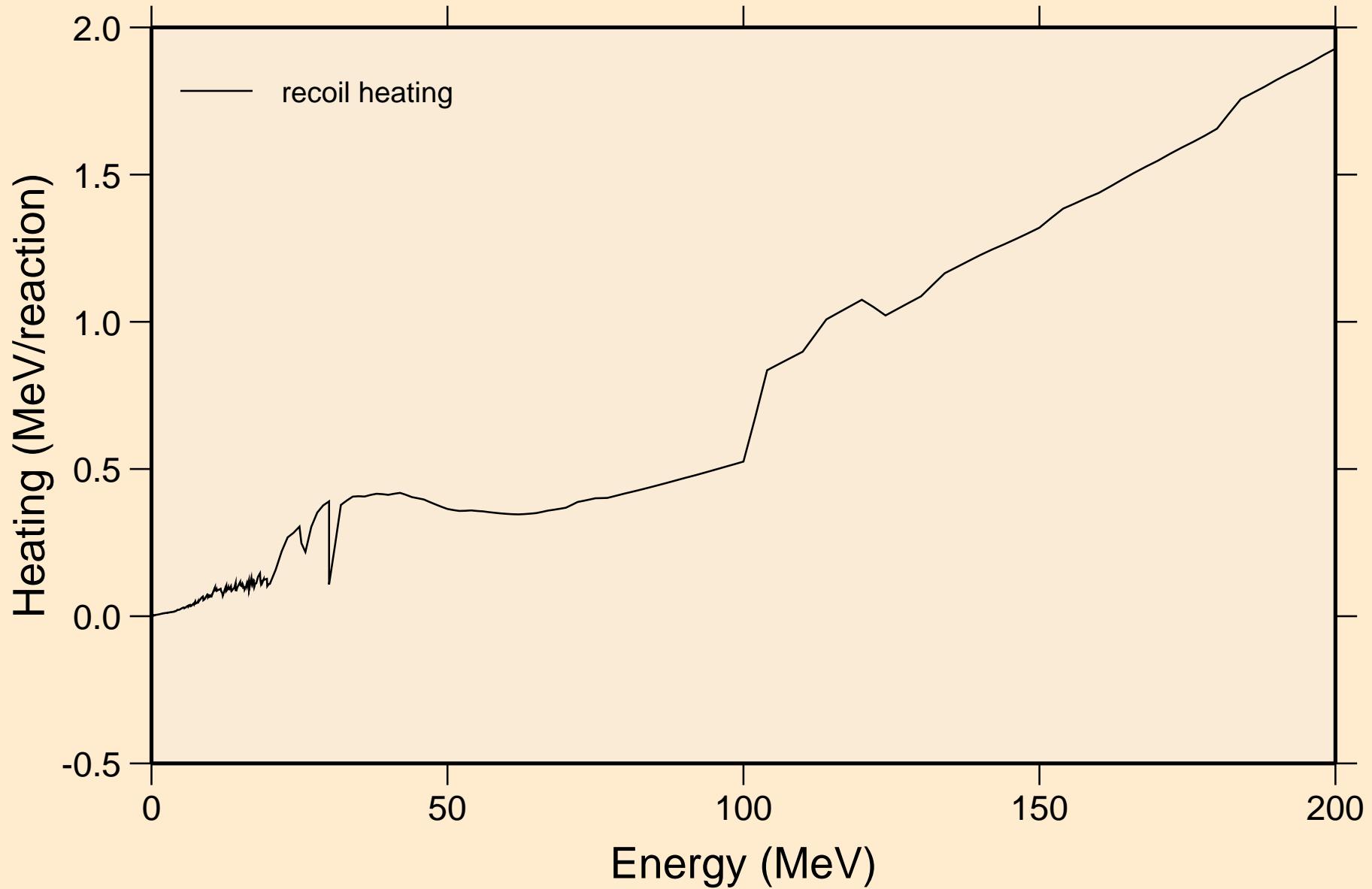

IR182 NEUTRON ACER TENDL-2024 LIBRARY; T=0.K
Particle production cross sections

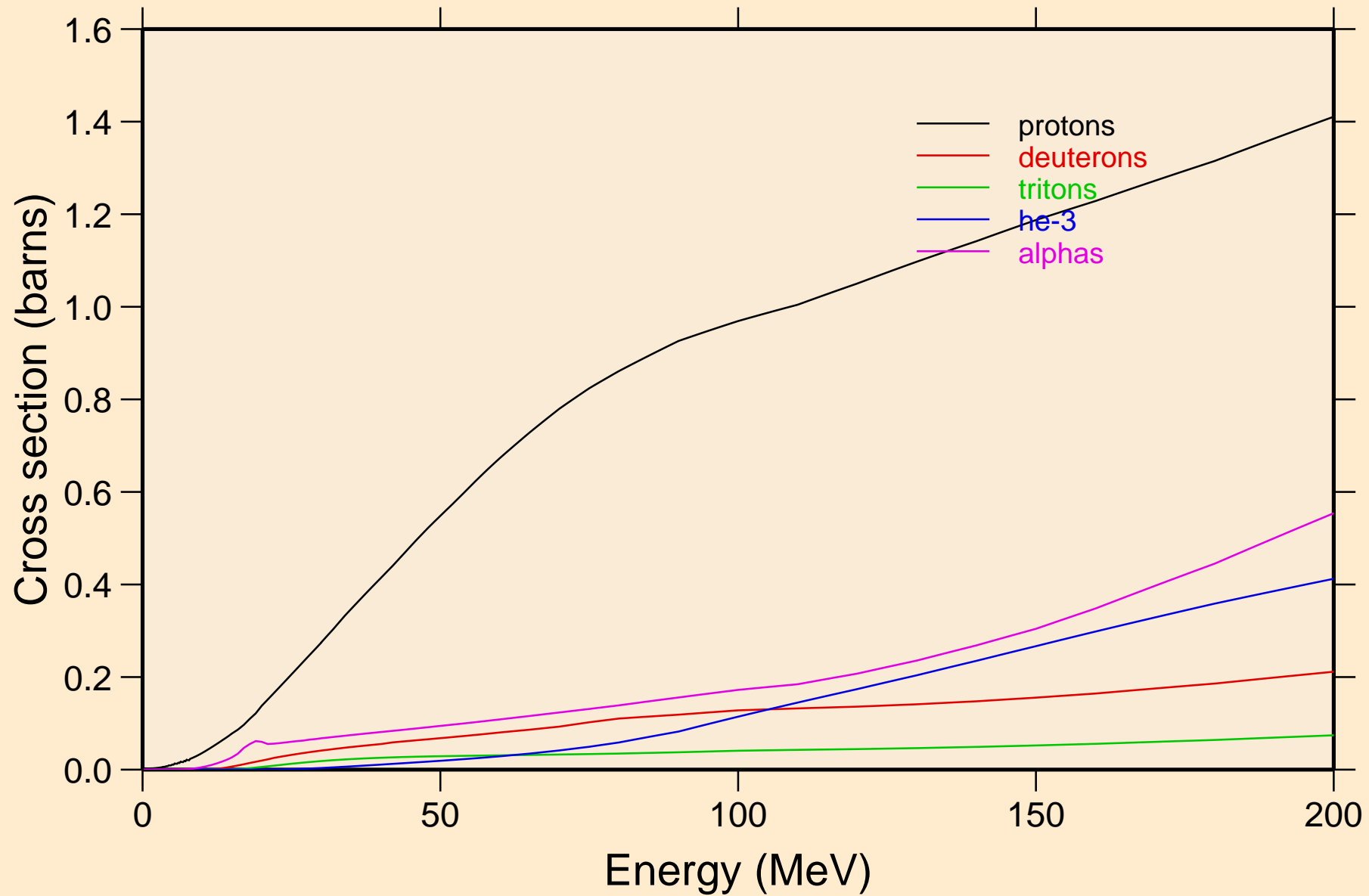

IR182 NEUTRON ACER TENDL-2024 LIBRARY; T=0.K
protons from (n,x)

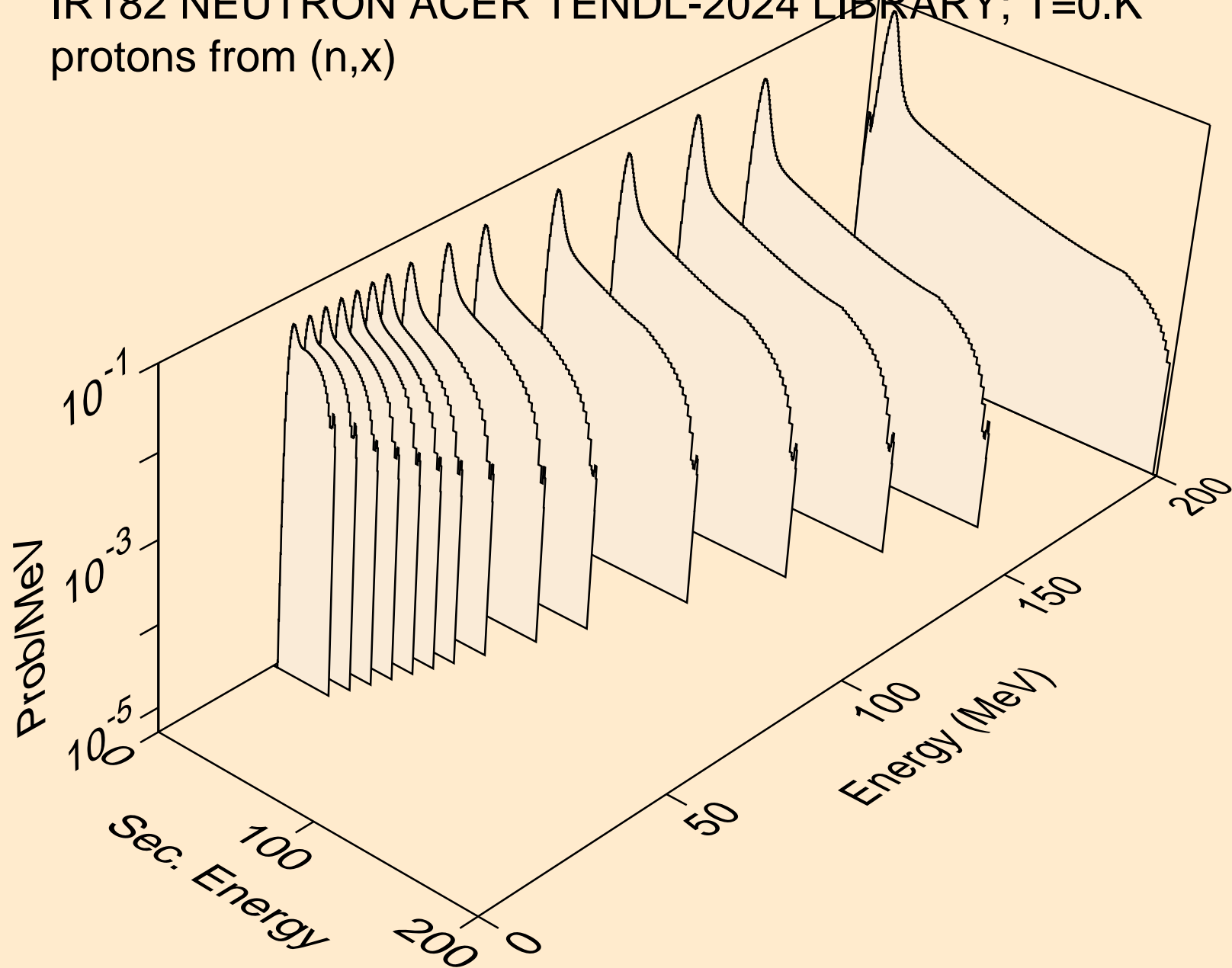

IR182 NEUTRON ACER TENDL-2024 LIBRARY; T=0.K
protons from (n,n*)p

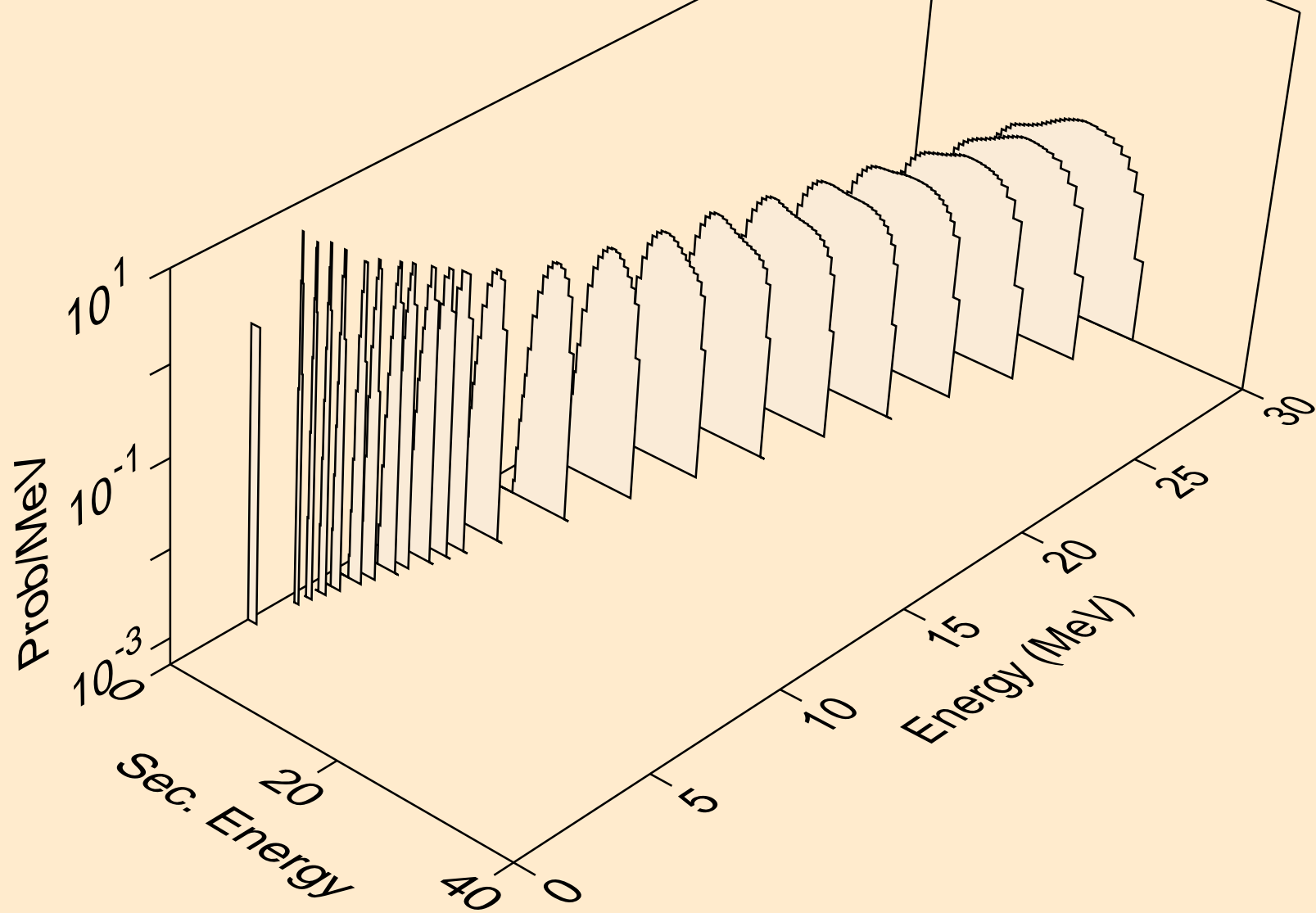

IR182 NEUTRON ACER TENDL-2024 LIBRARY; T=0.K
protons from (n,2np)

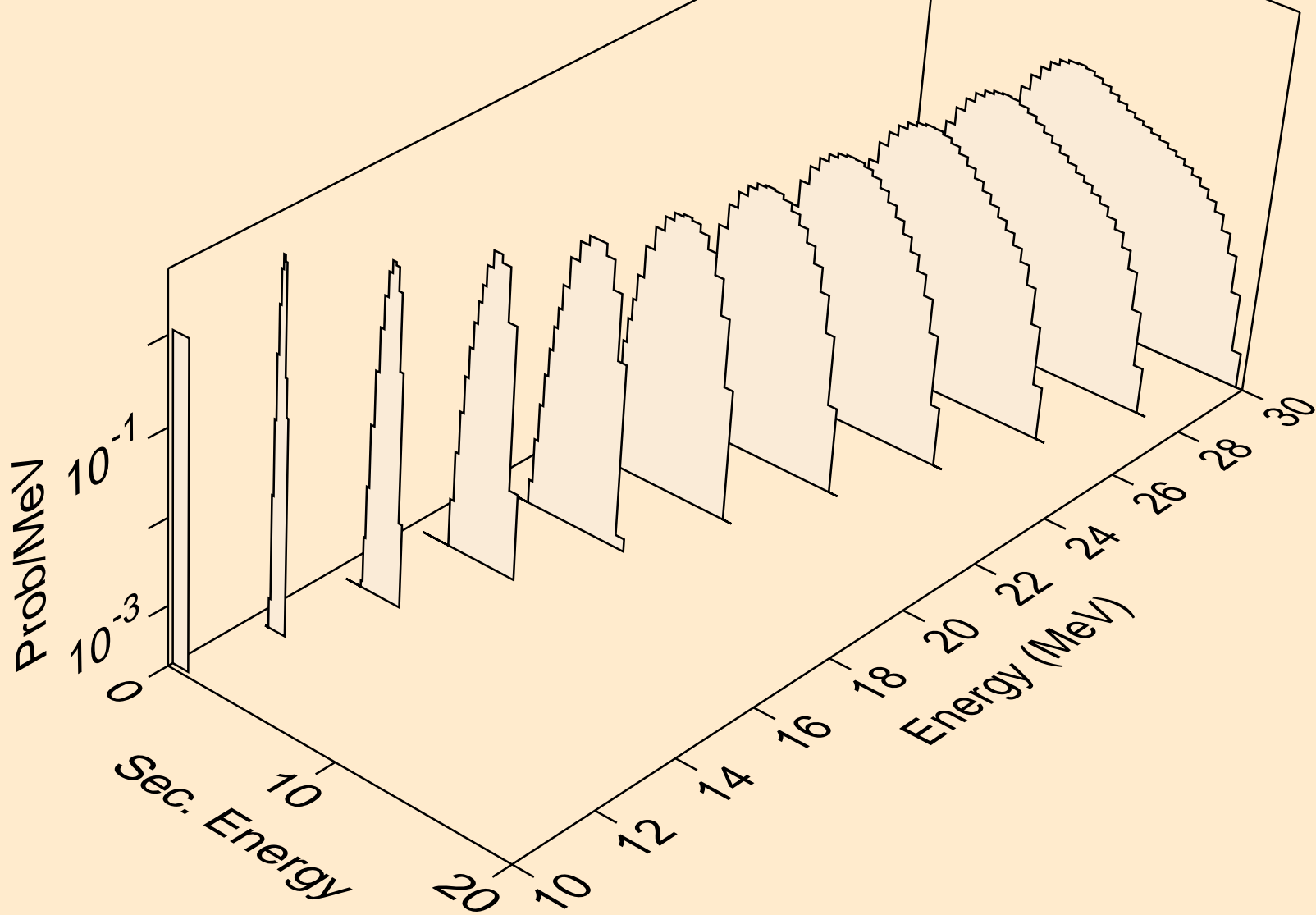

IR182 NEUTRON ACER TENDL-2024 LIBRARY; T=0.K
protons from (n,3np)

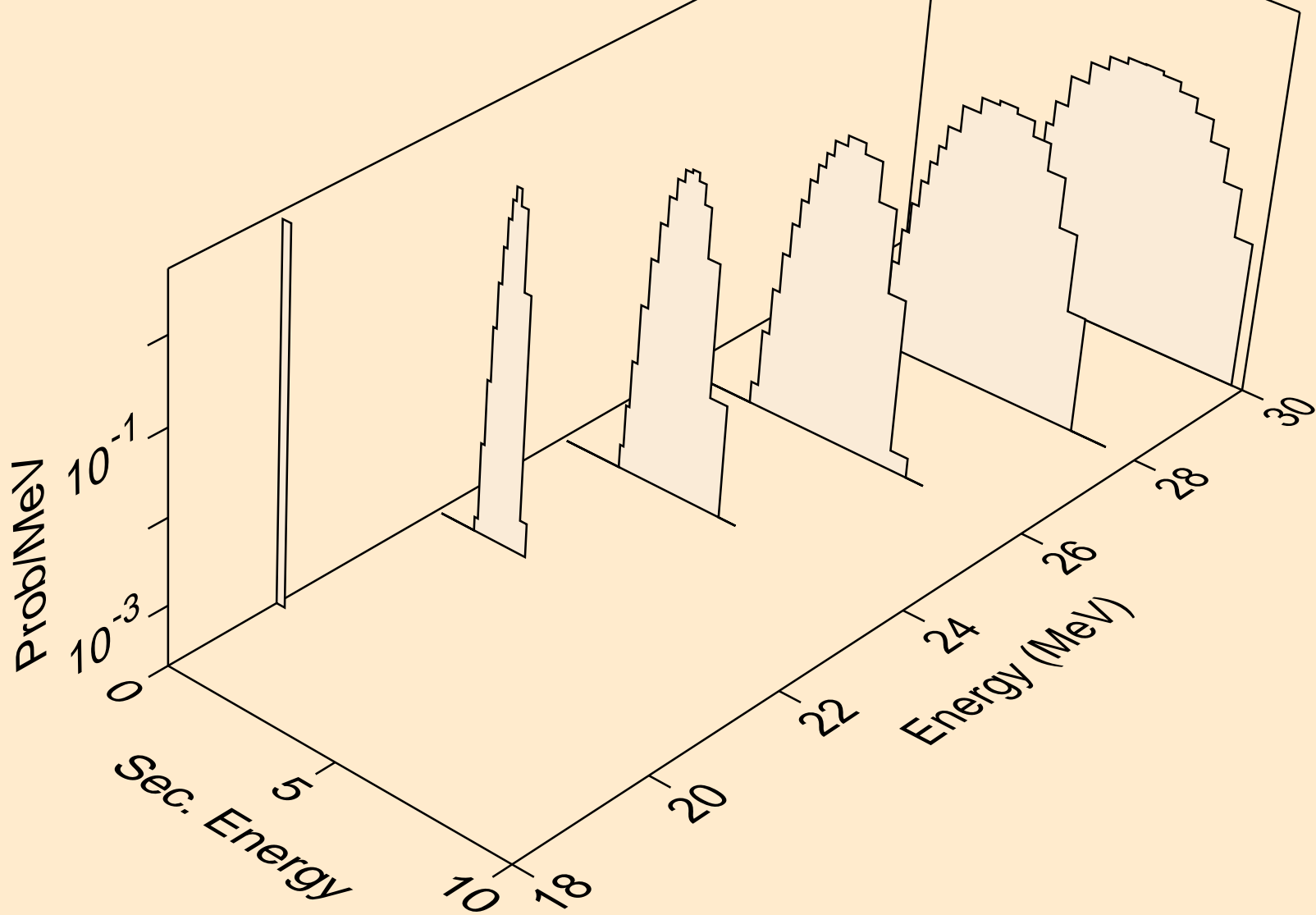

IR182 NEUTRON ACER TENDL-2024 LIBRARY; T=0.K
protons from (n,n2p)

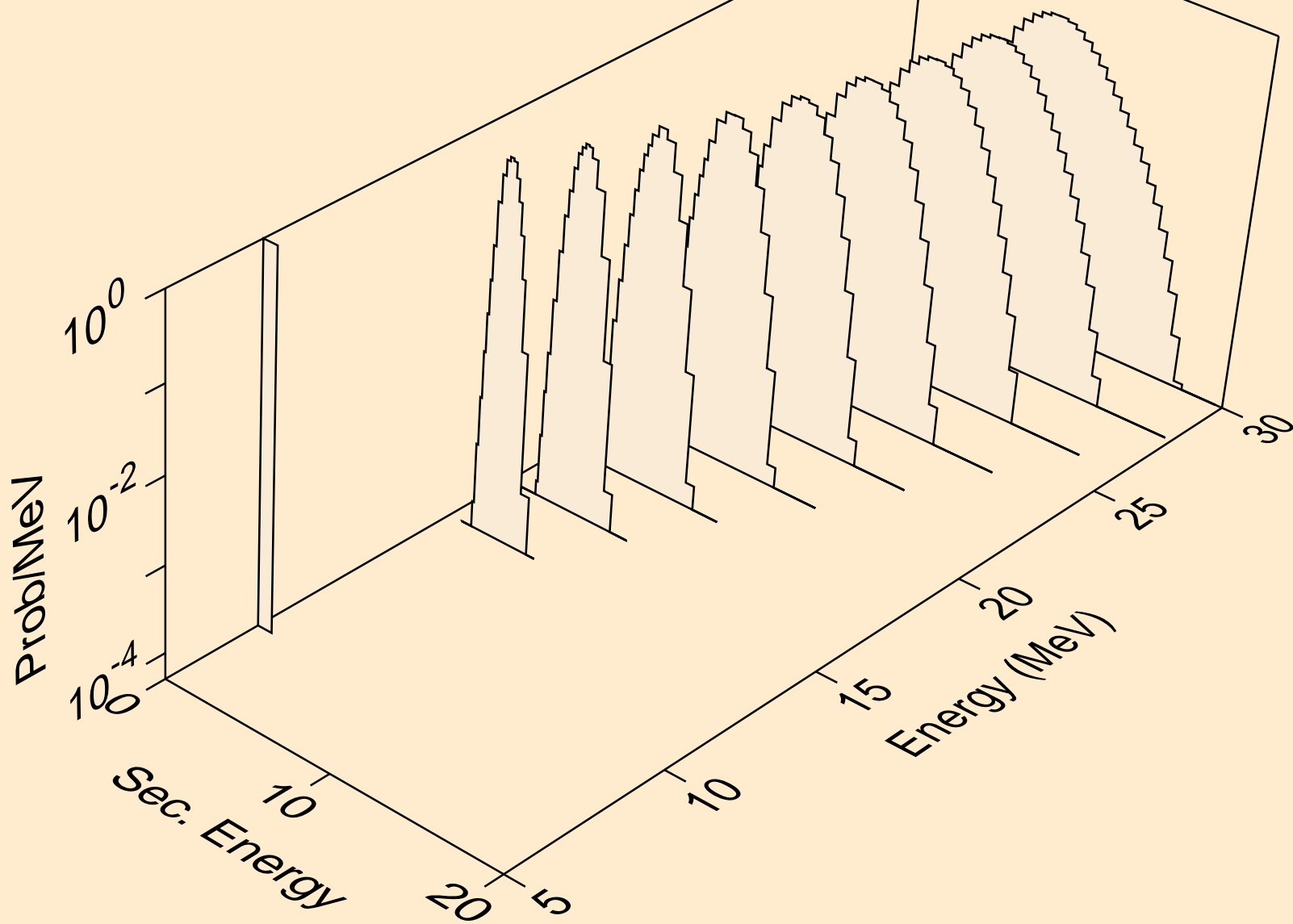

IR182 NEUTRON ACER TENDL-2024 LIBRARY; T=0.K
protons from (n,npa)

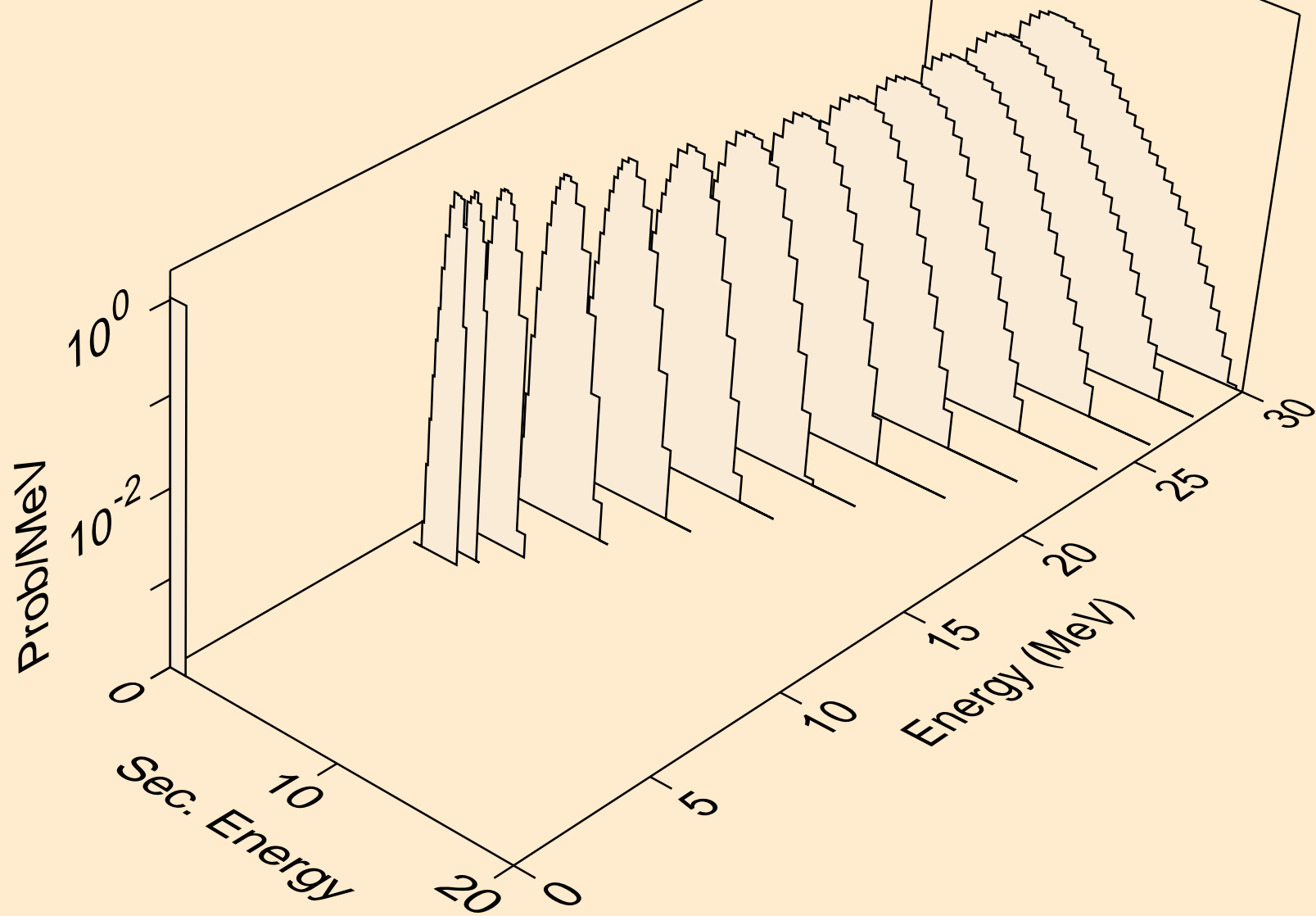

IR182 NEUTRON ACER TENDL-2024 LIBRARY; T=0.K
protons from (n,p)

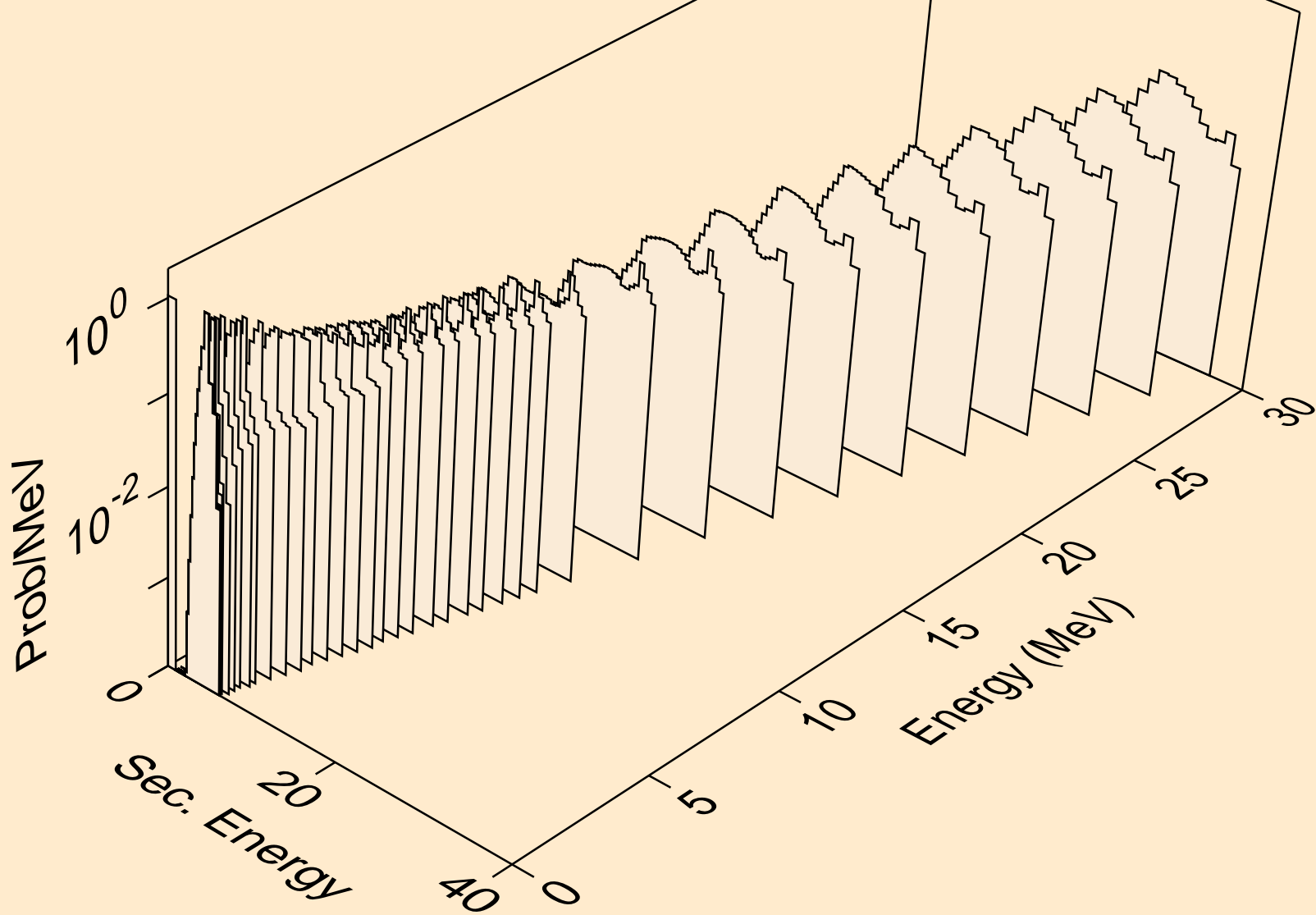

IR182 NEUTRON ACER TENDL-2024 LIBRARY; T=0.K
protons from (n,2p)

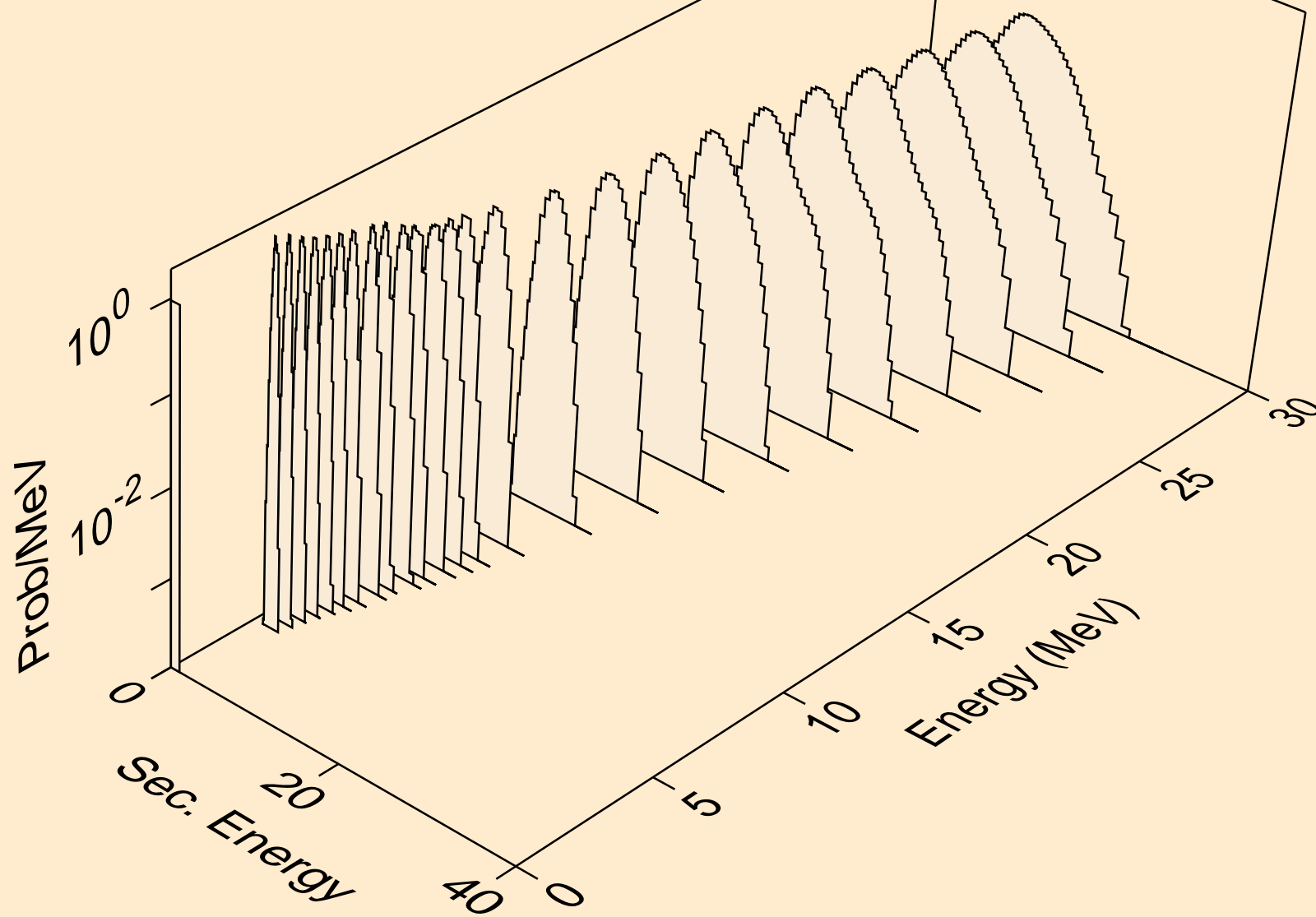

IR182 NEUTRON ACER TENDL-2024 LIBRARY; T=0.K
protons from (n,p)

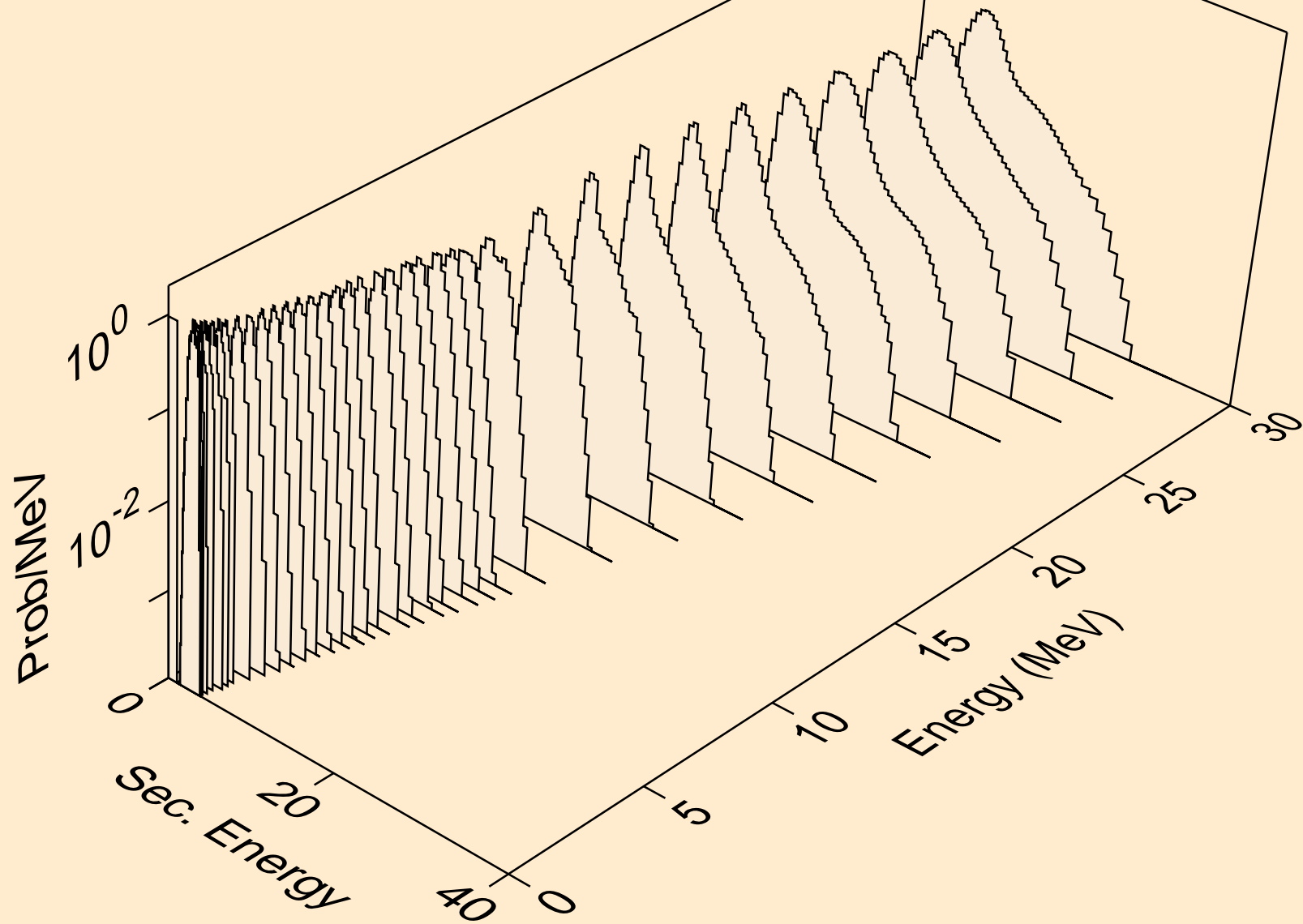

IR182 NEUTRON ACER TENDL-2024 LIBRARY; T=0.K
protons from (n,pd)

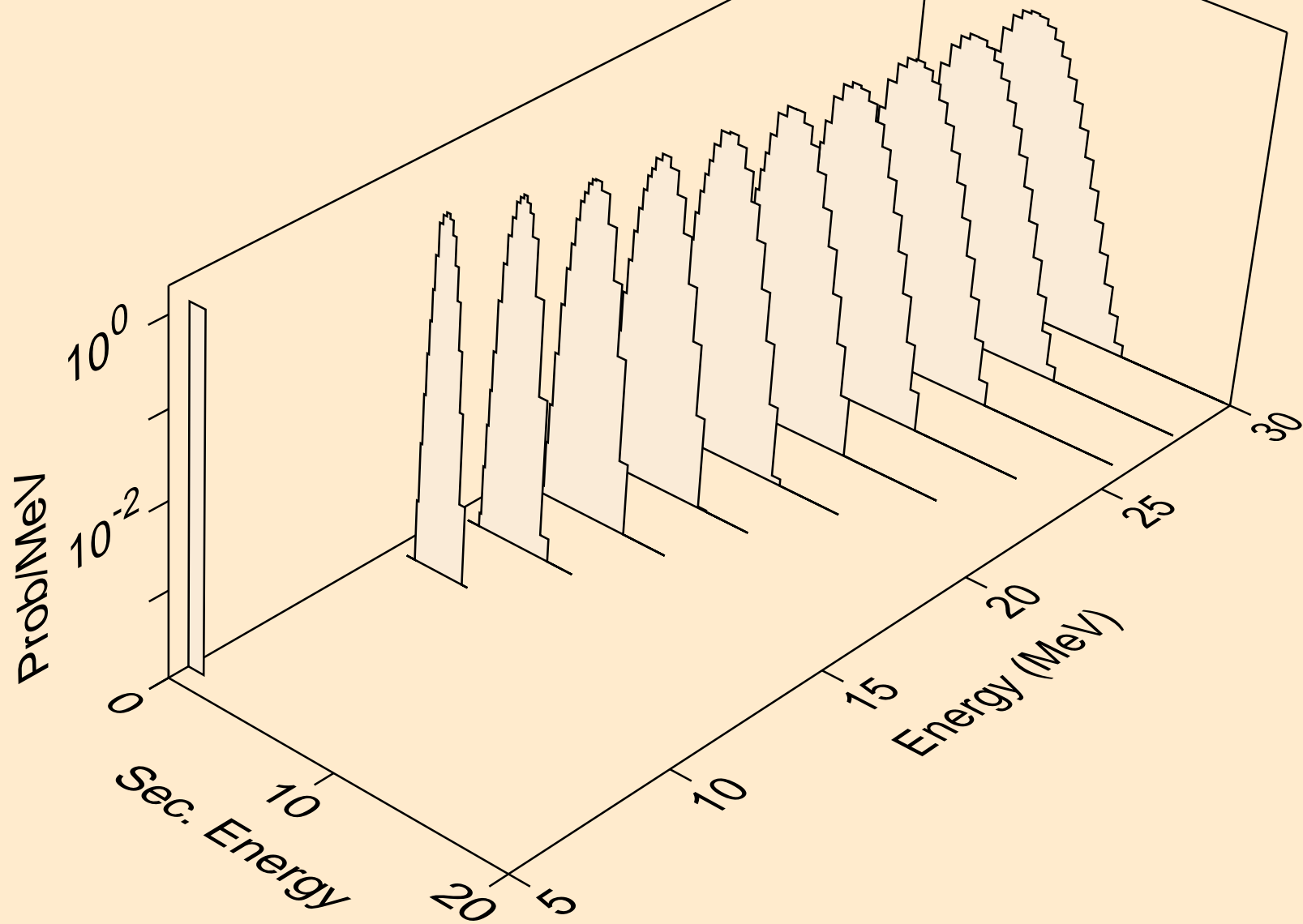

IR182 NEUTRON ACER TENDL-2024 LIBRARY; T=0.K
protons from (n,pt)

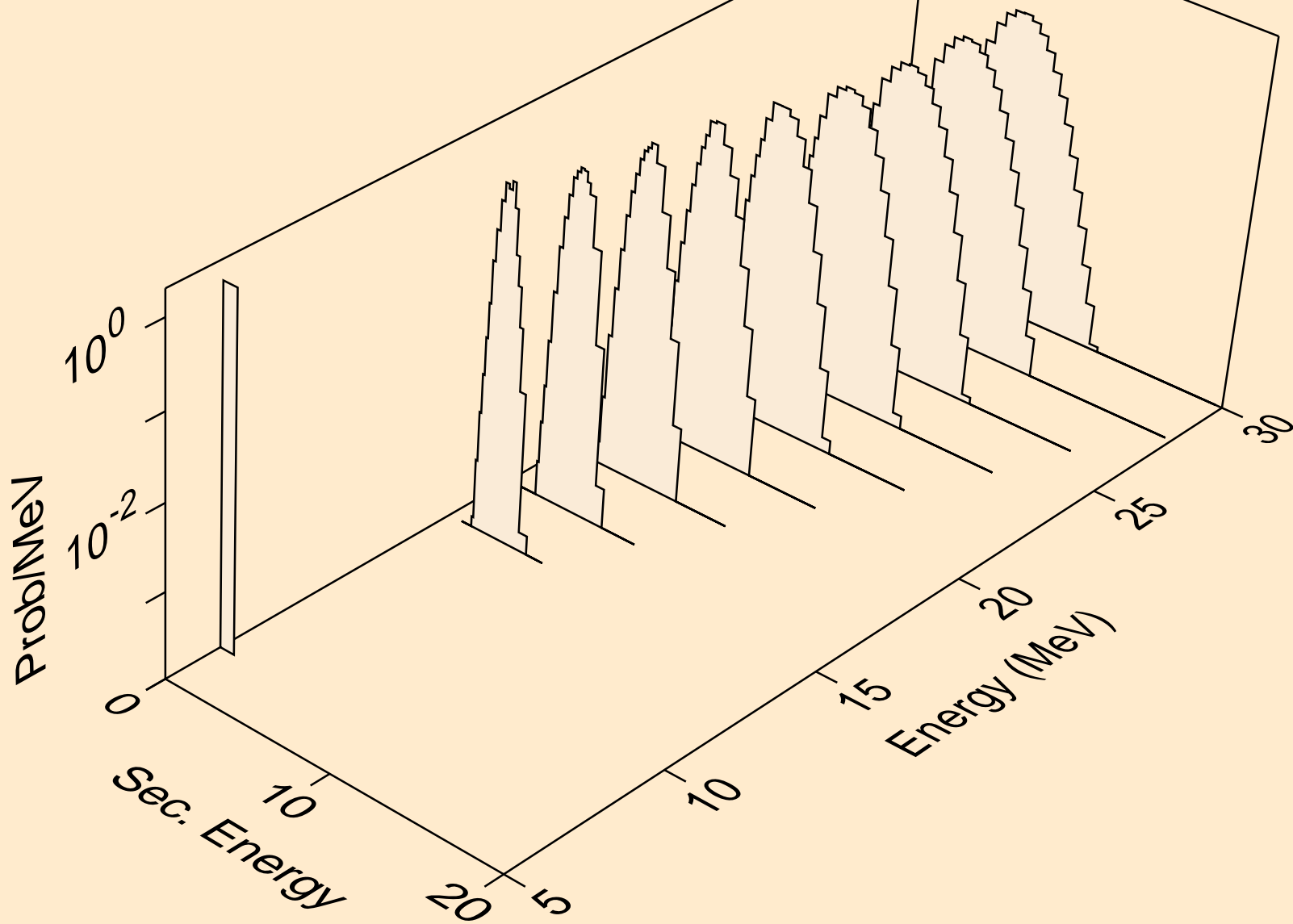

IR182 NEUTRON ACER TENDL-2024 LIBRARY; T=0.K
deuterons from (n,x)

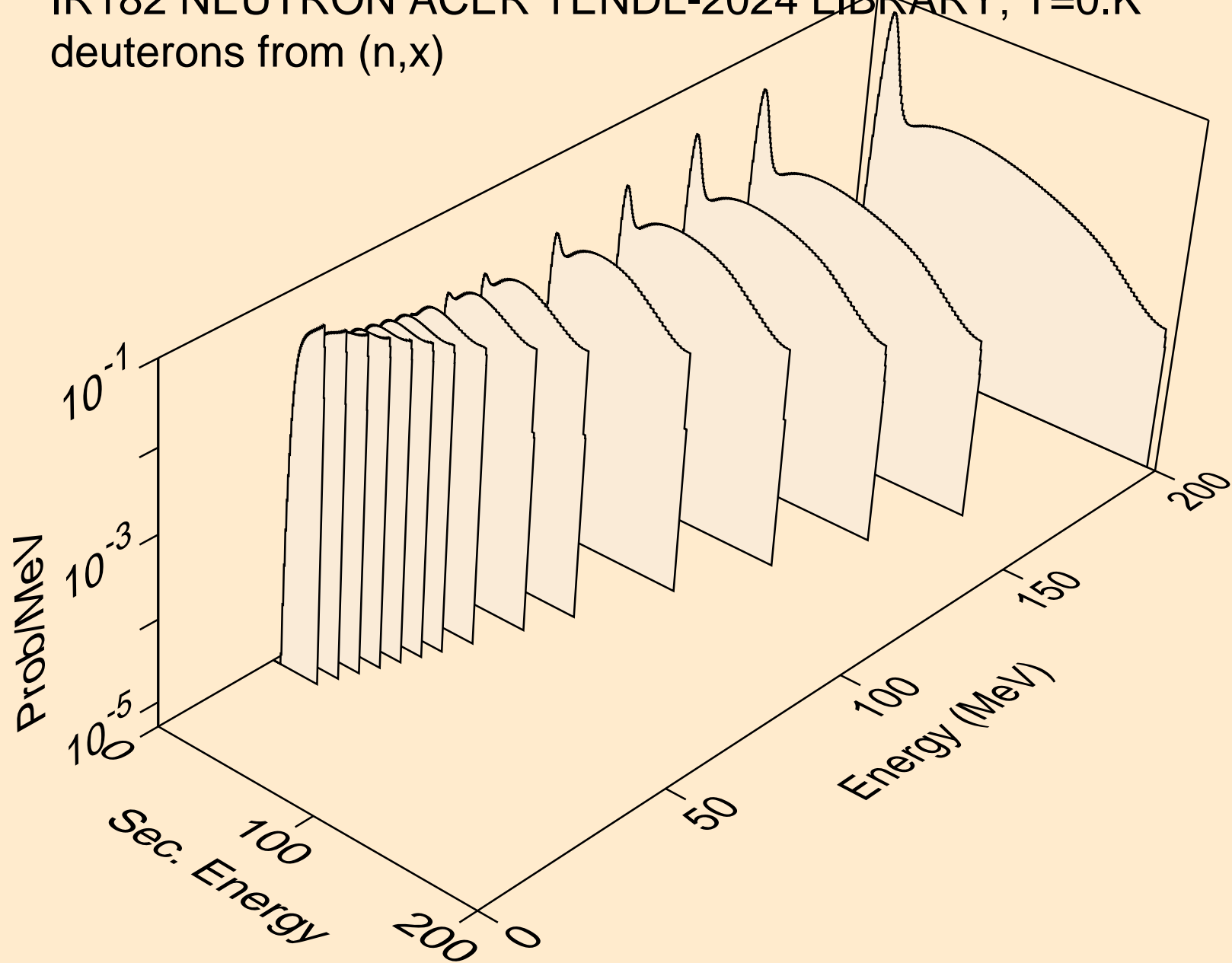

IR182 NEUTRON ACER TENDL-2024 LIBRARY; T=0.K
deuterons from (n,2nd)

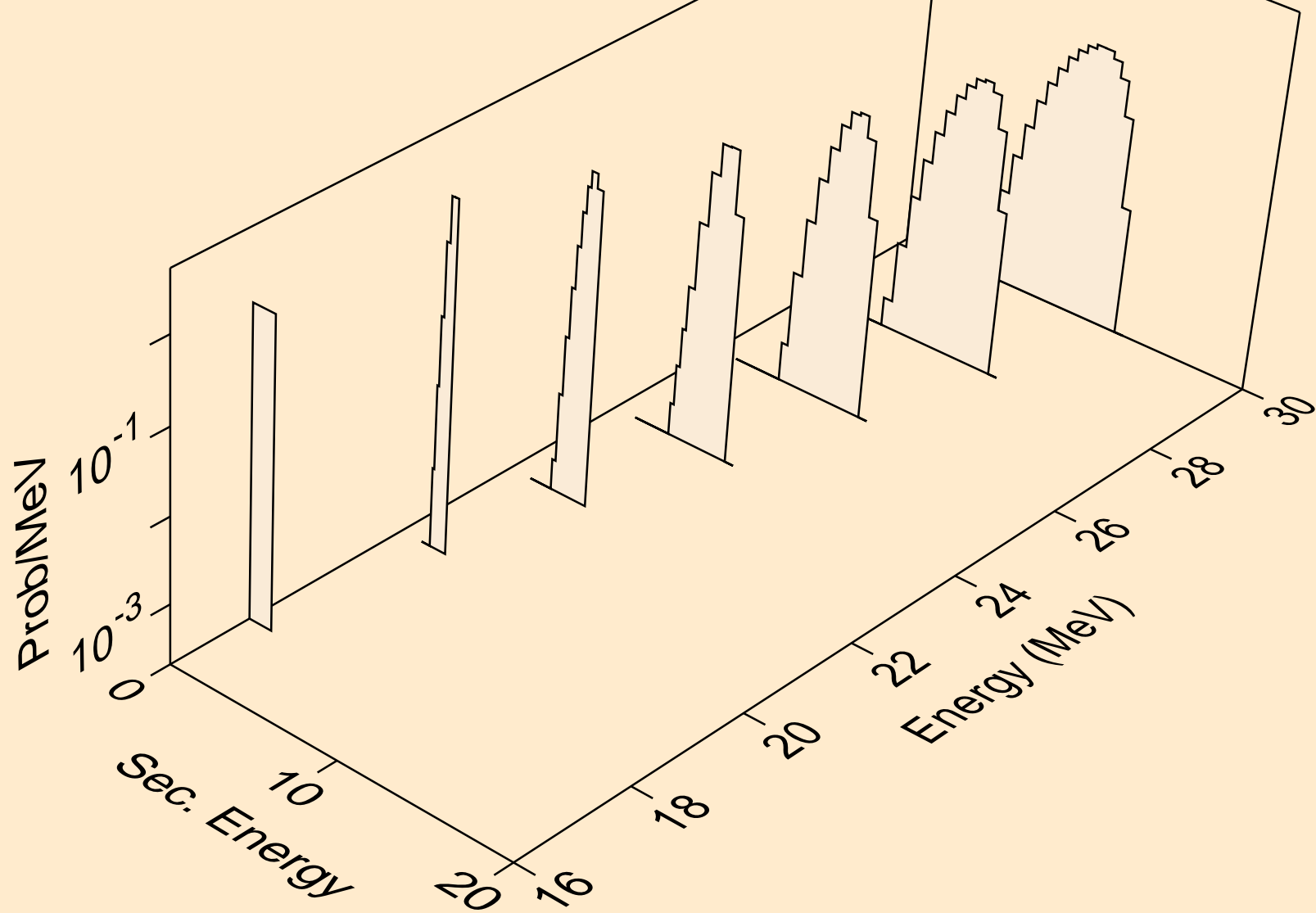

IR182 NEUTRON ACER TENDL-2024 LIBRARY; T=0.K
deuterons from (n,n*)d

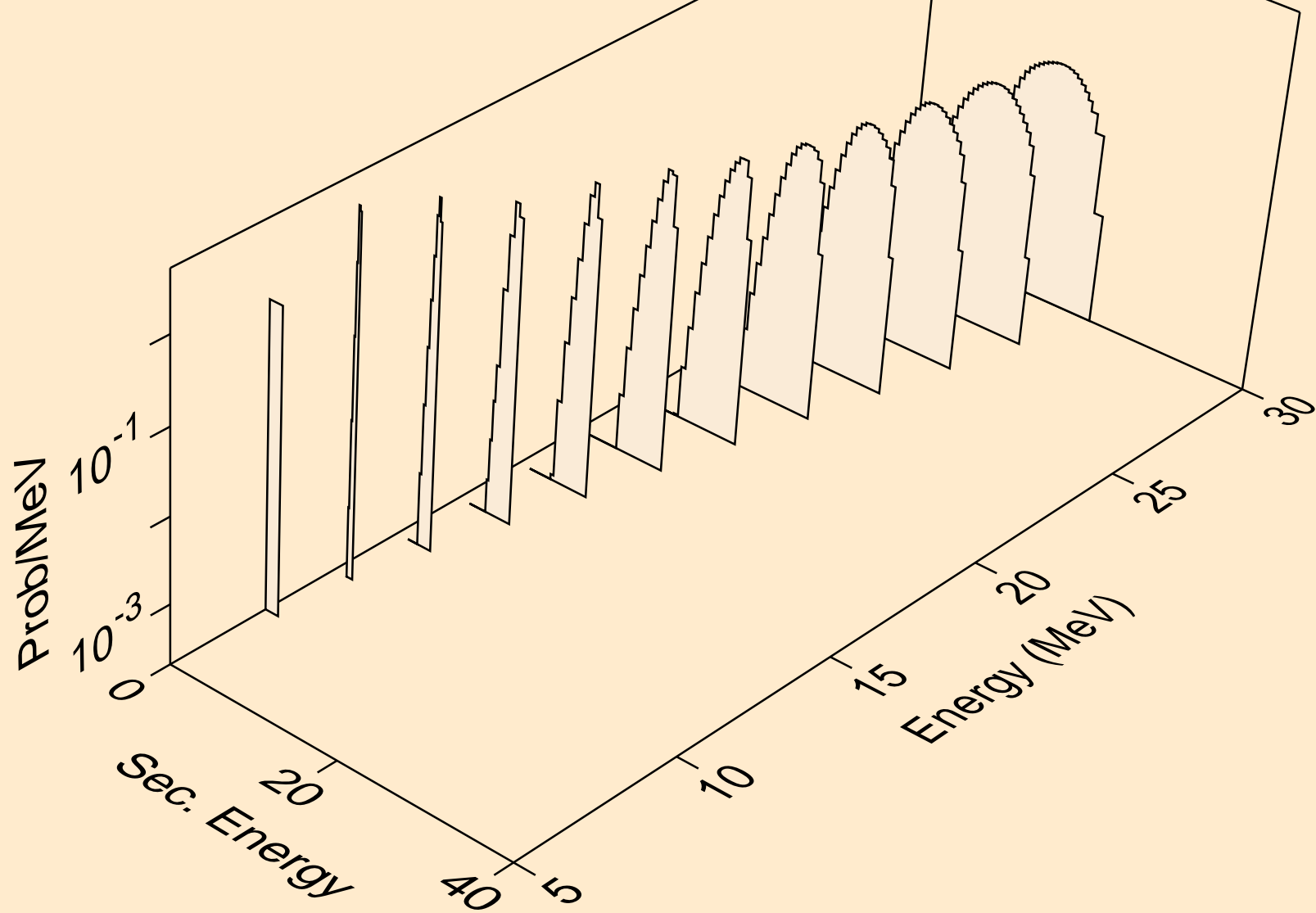

IR182 NEUTRON ACER TENDL-2024 LIBRARY; T=0.K
deuterons from (n,d)

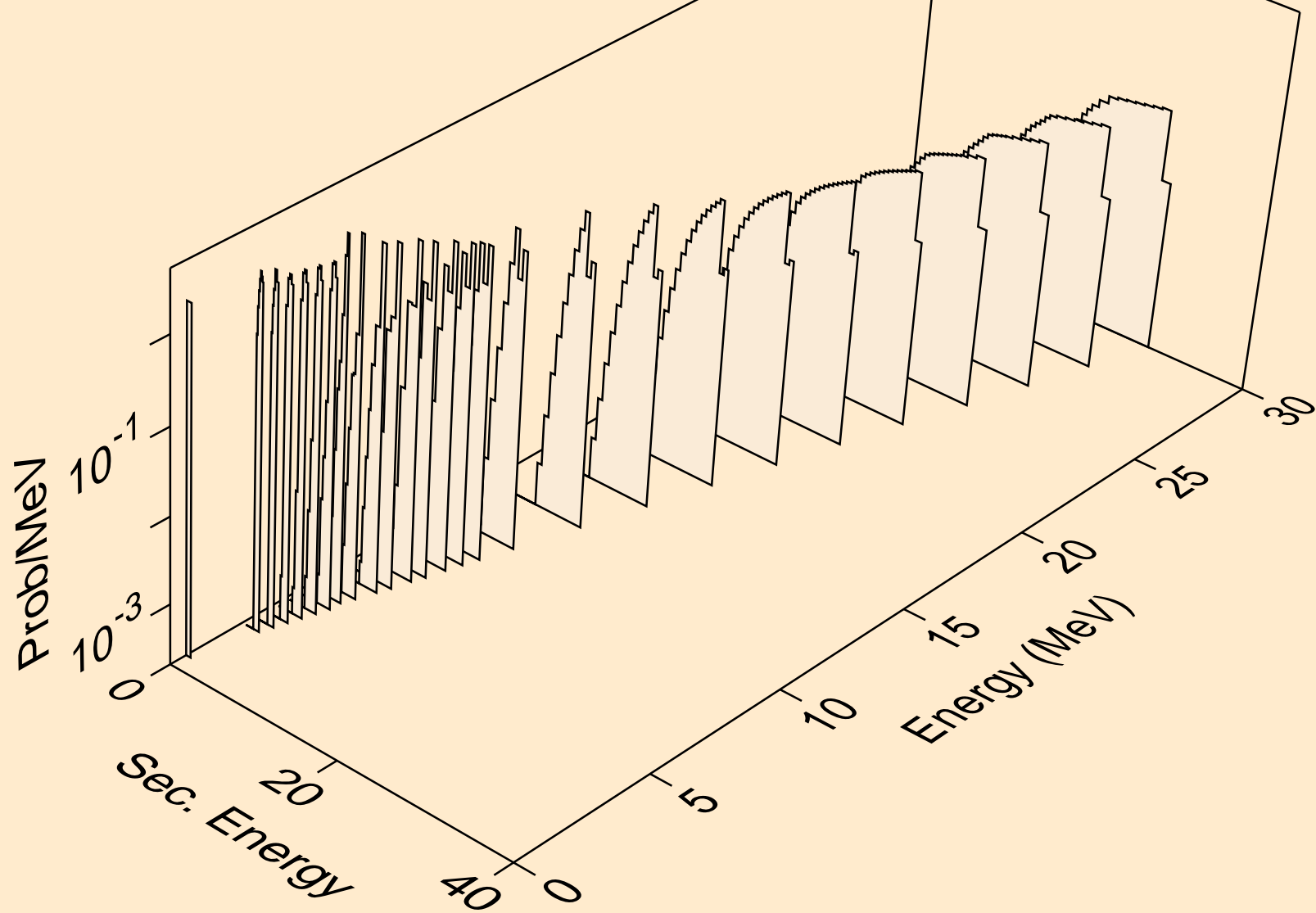

IR182 NEUTRON ACER TENDL-2024 LIBRARY; T=0.K
deuterons from (n,pd)

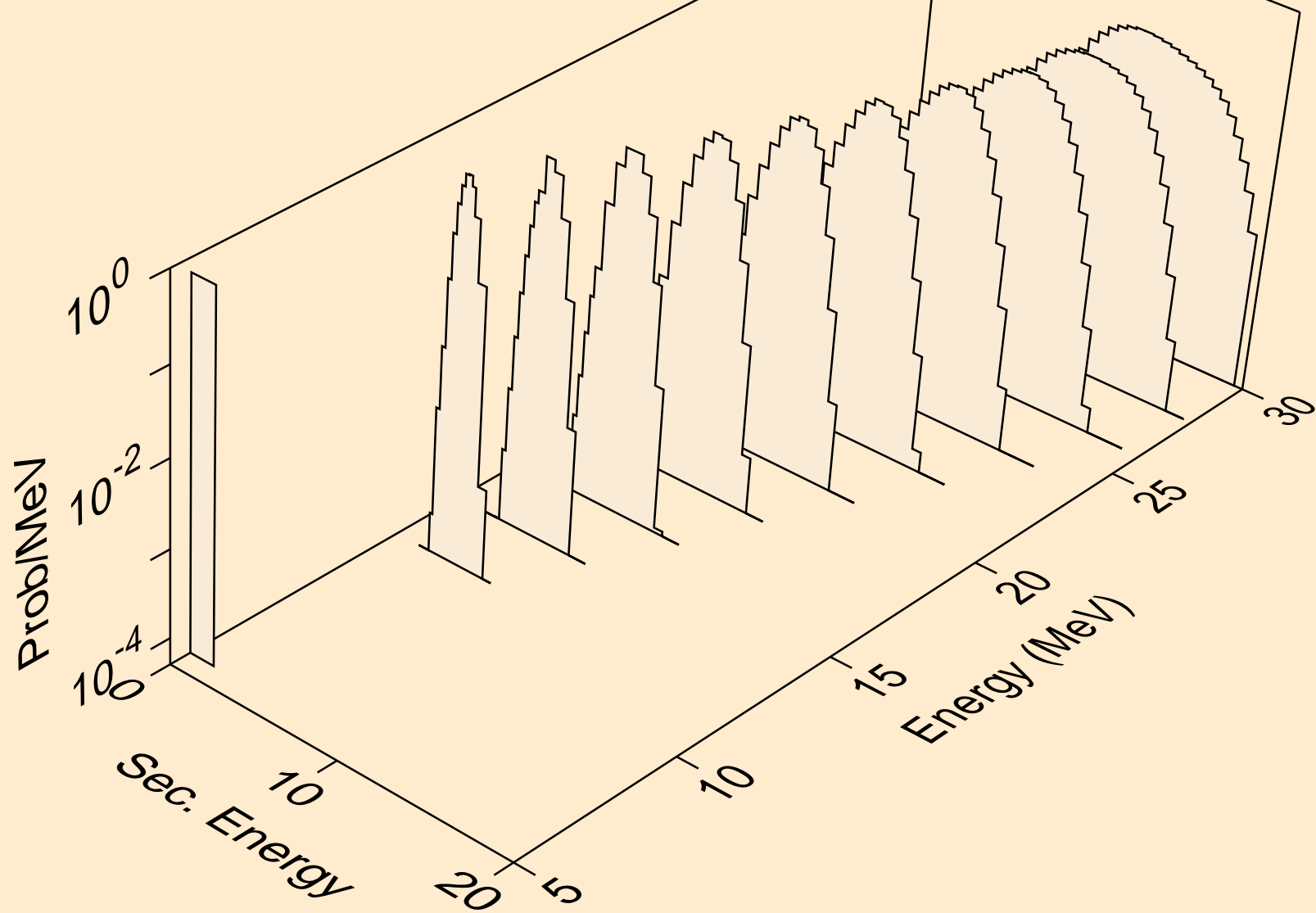

IR182 NEUTRON ACER TENDL-2024 LIBRARY; T=0.K
deuterons from (n,da)

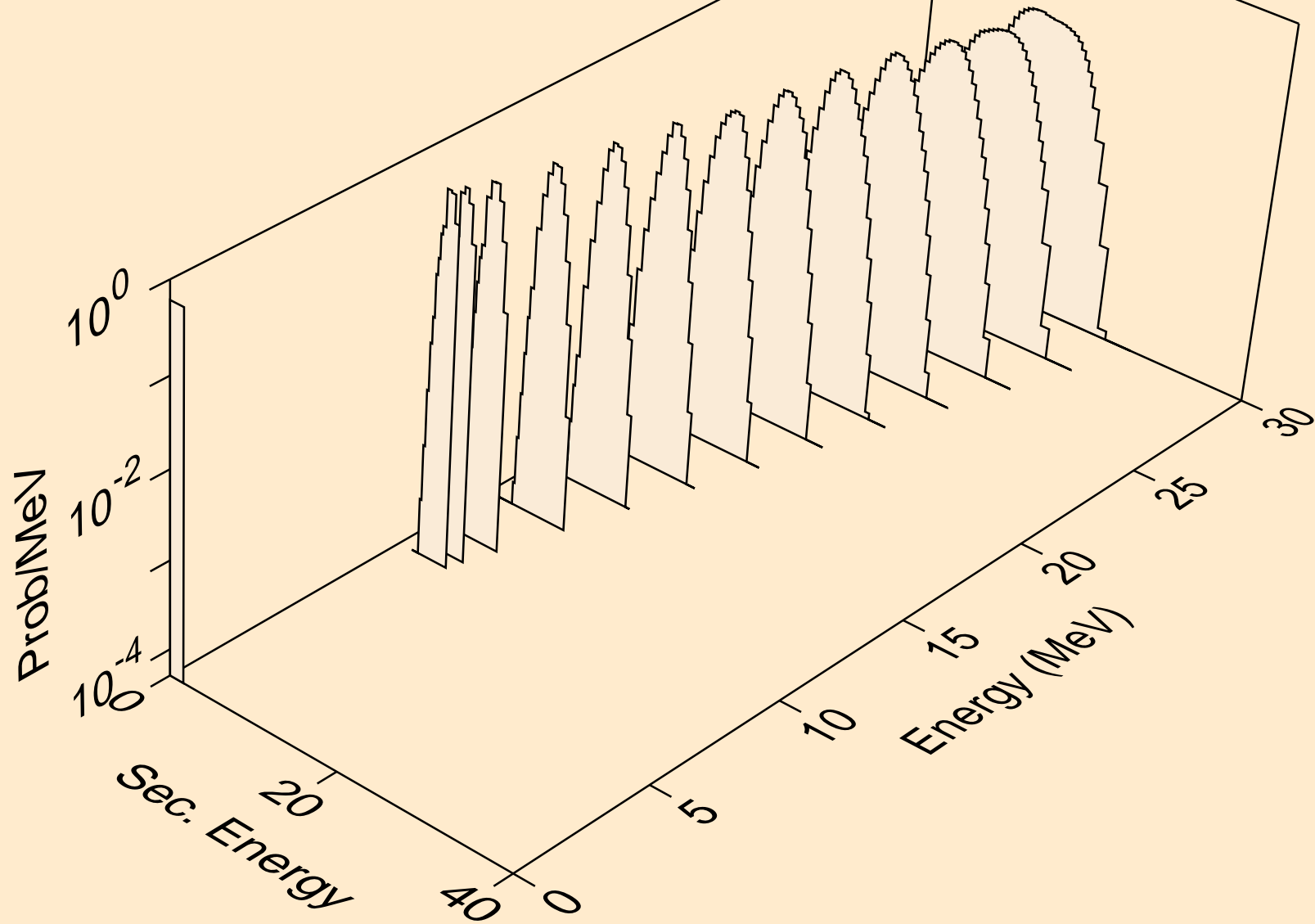

IR182 NEUTRON ACER TENDL-2024 LIBRARY; T=0.K
tritons from (n,x)

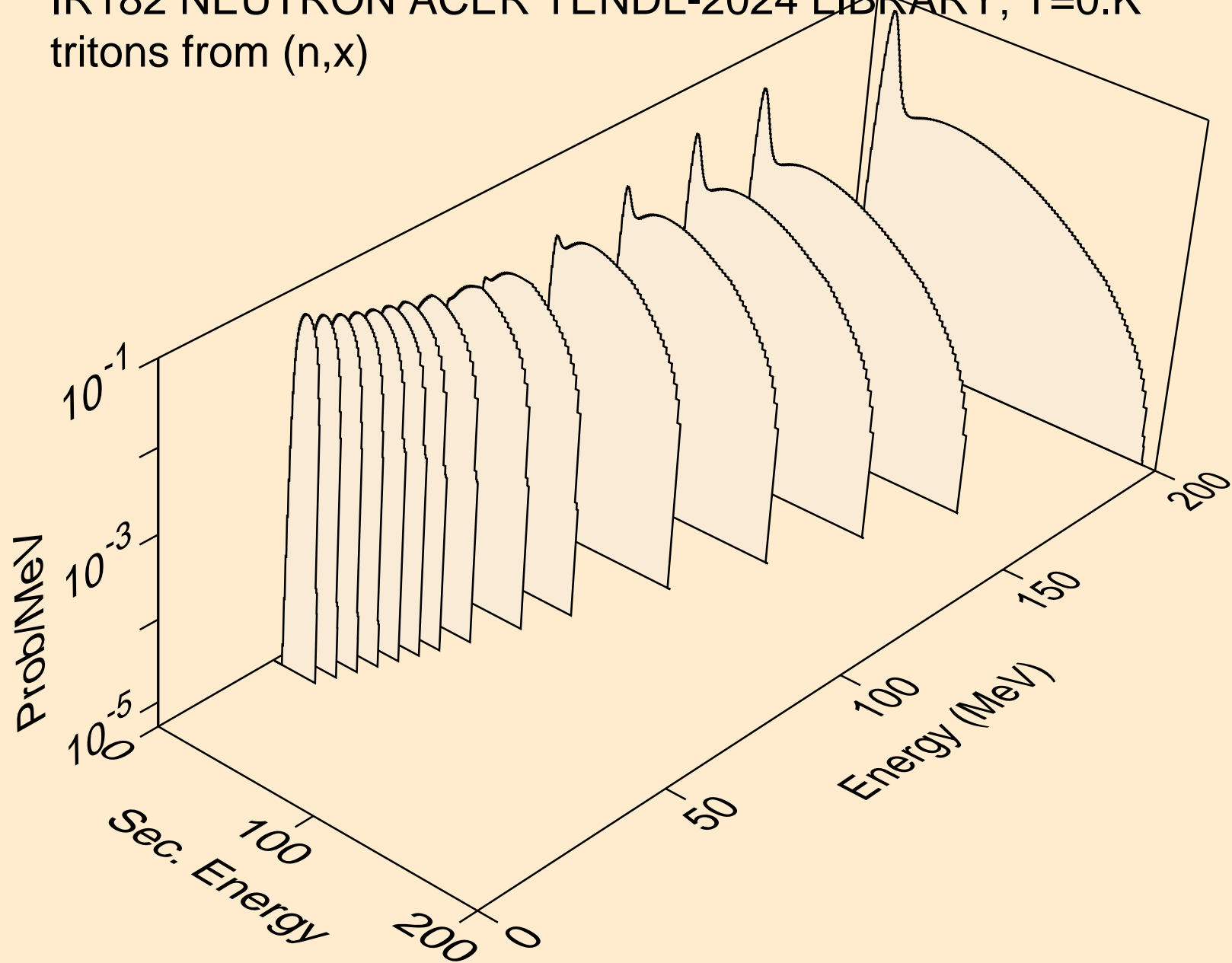

IR182 NEUTRON ACER TENDL-2024 LIBRARY; T=0.K
tritons from (n,n*)t

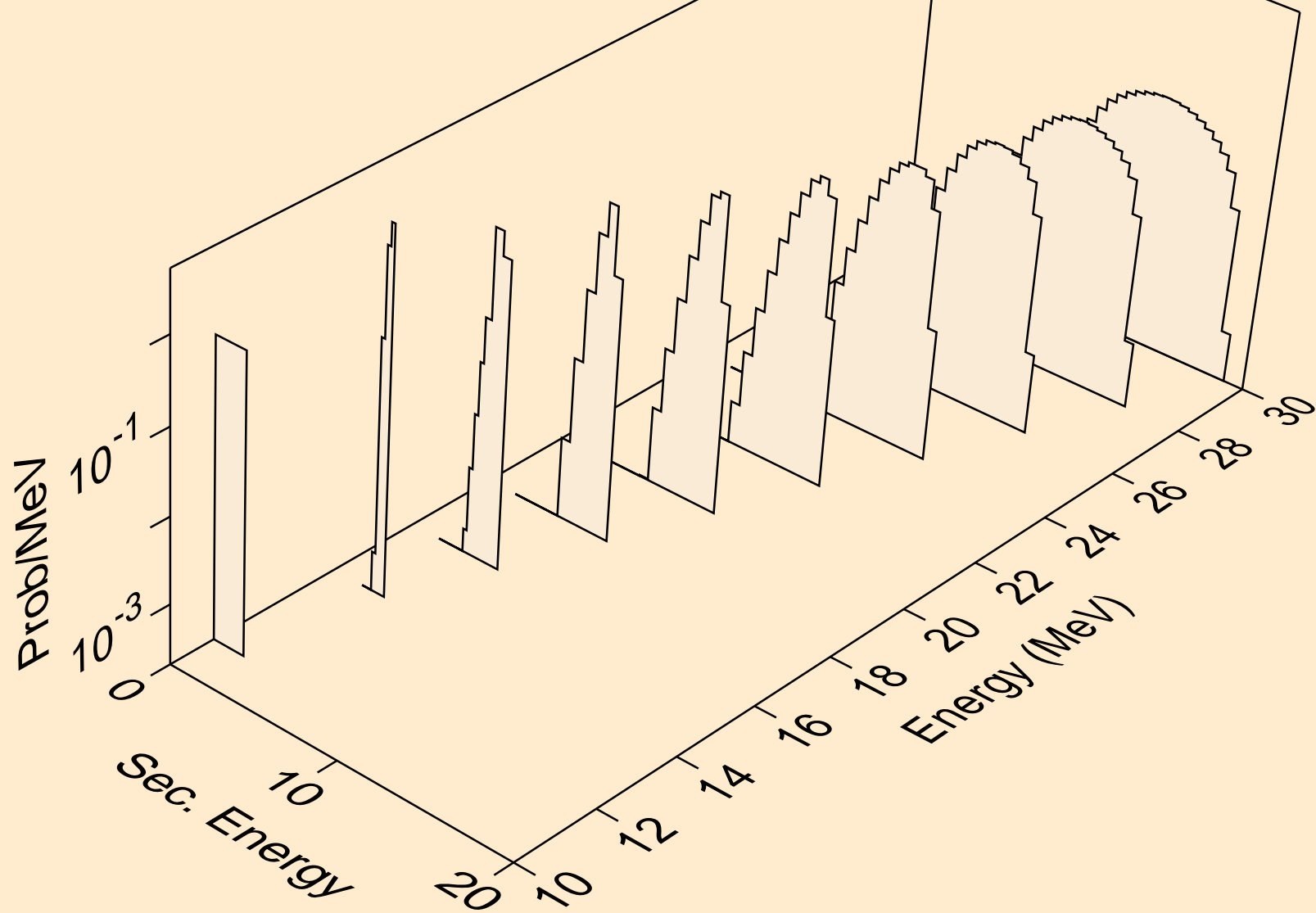

IR182 NEUTRON ACER TENDL-2024 LIBRARY; T=0.K
tritons from (n,t)

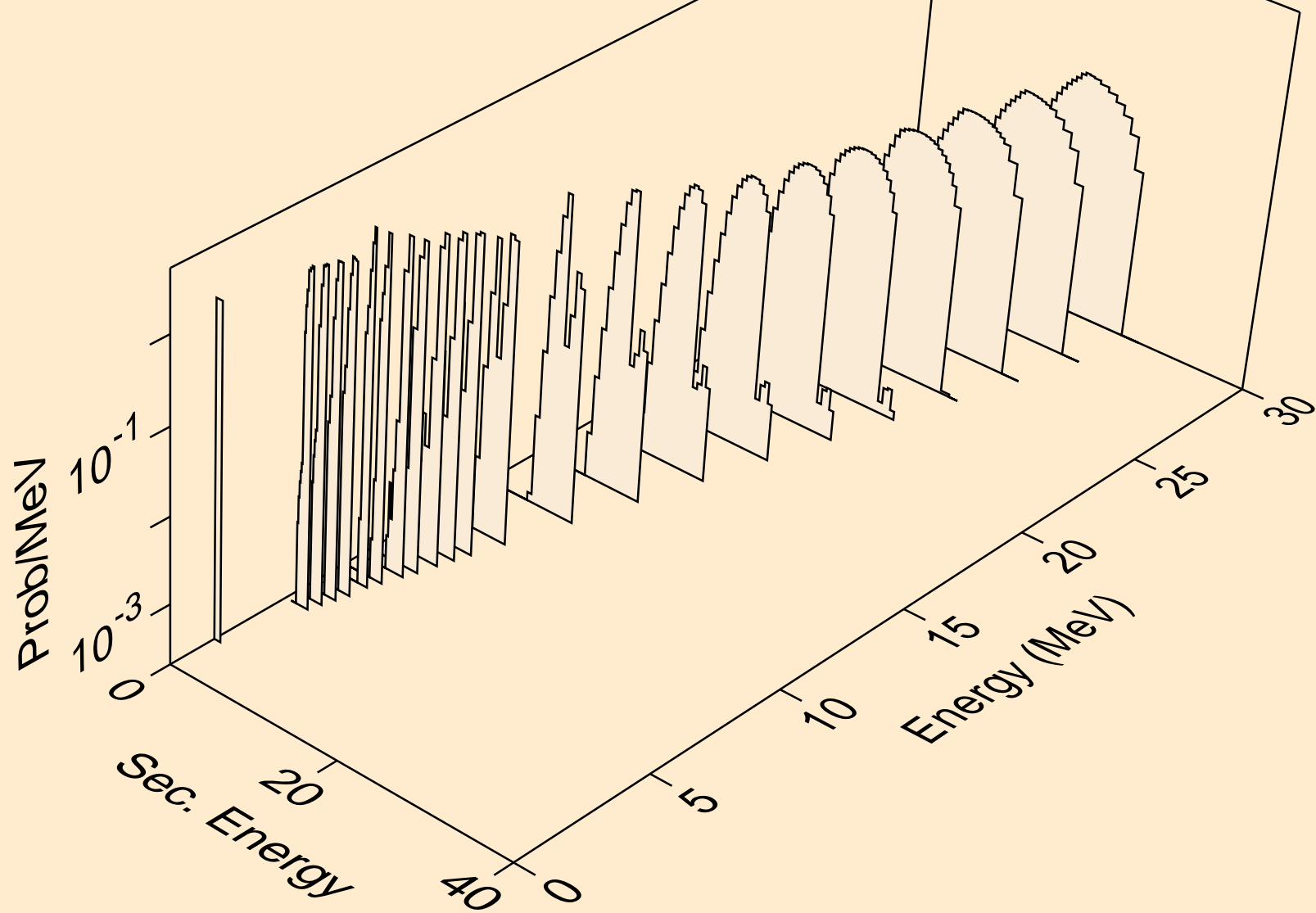

IR182 NEUTRON ACER TENDL-2024 LIBRARY; T=0.K
tritons from (n,pt)

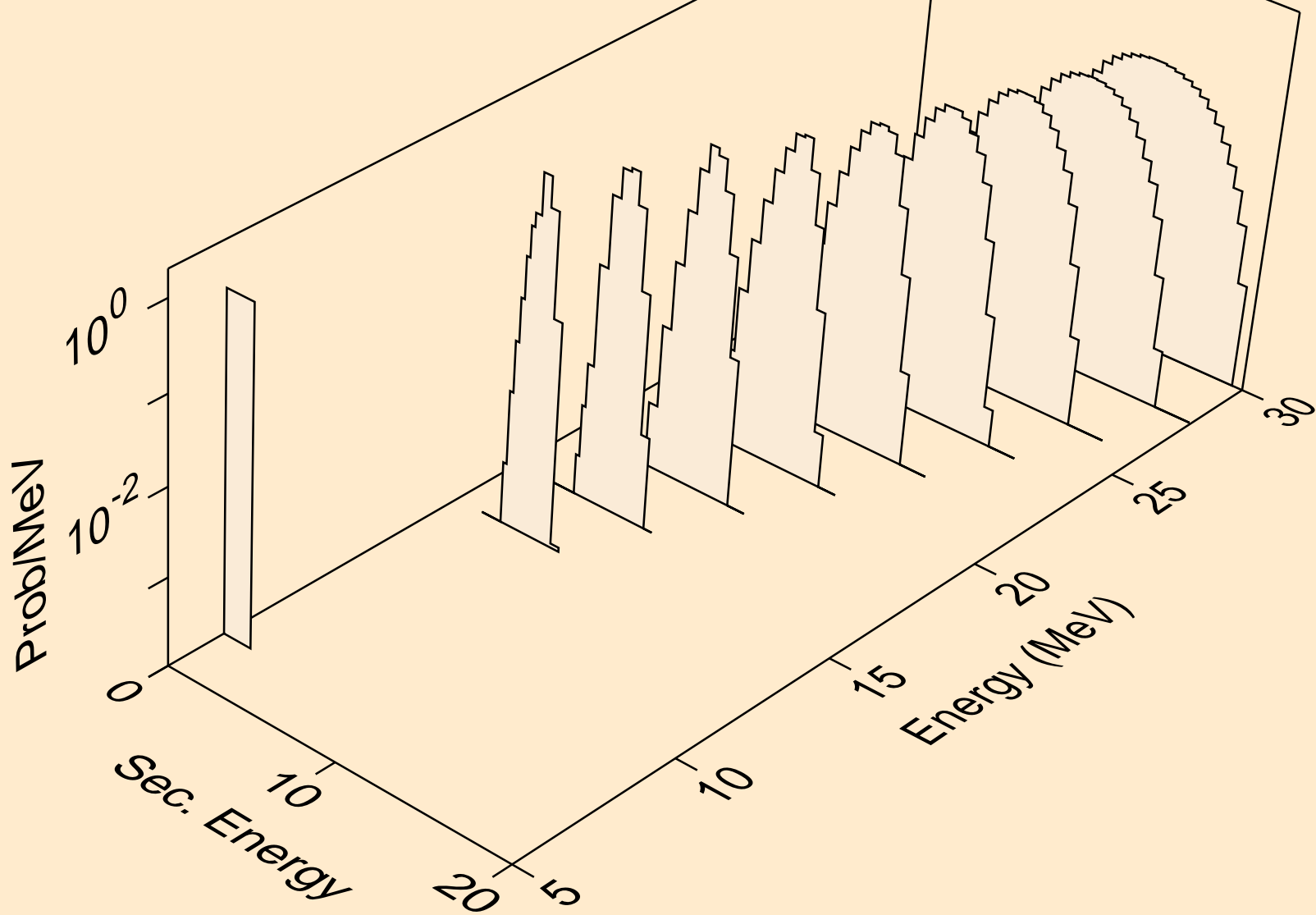

IR182 NEUTRON ACER TENDL-2024 LIBRARY; T=0.K
he3s from (n,x)

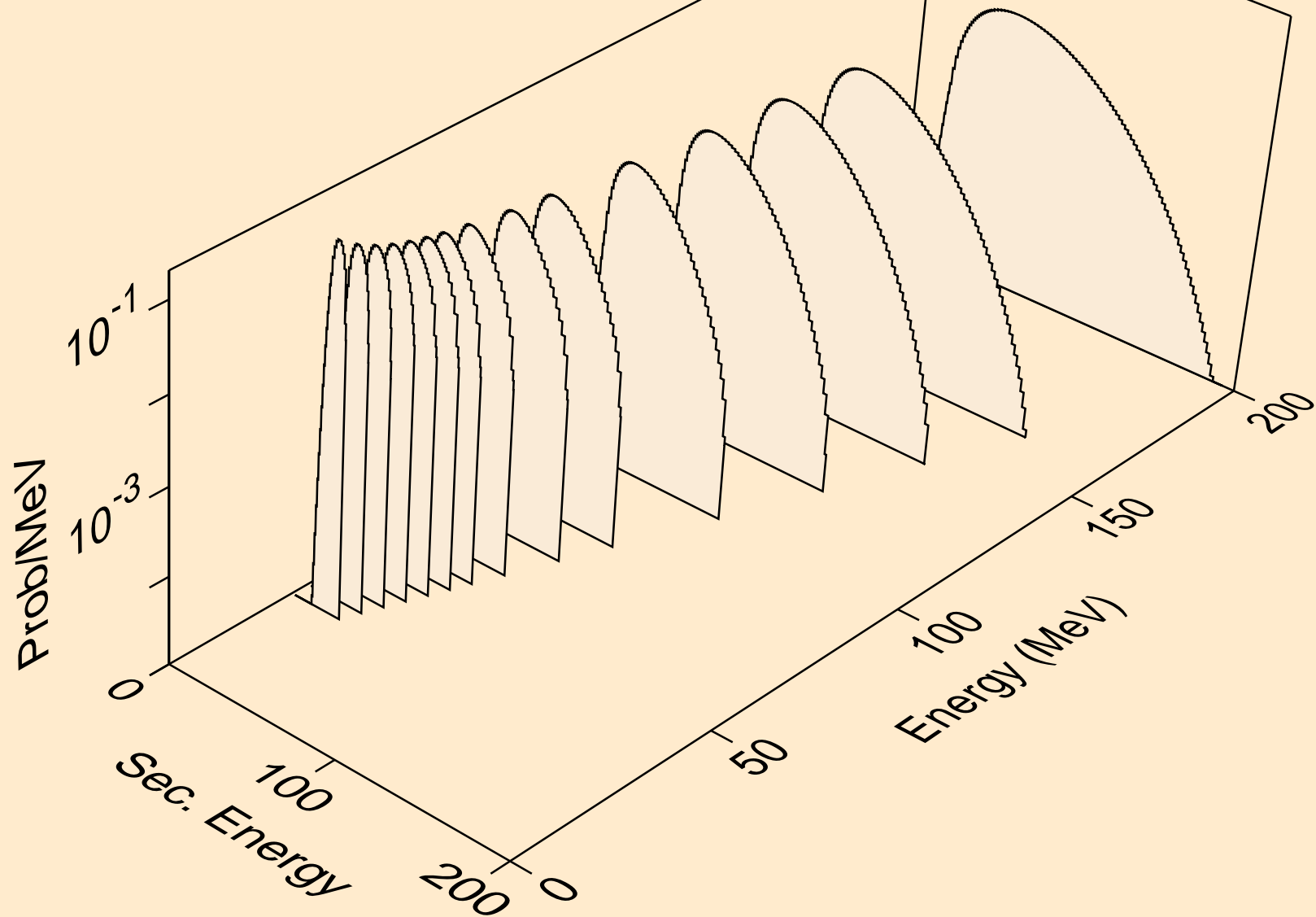

IR182 NEUTRON ACER TENDL-2024 LIBRARY; T=0.K
he3s from (n,n*)he3

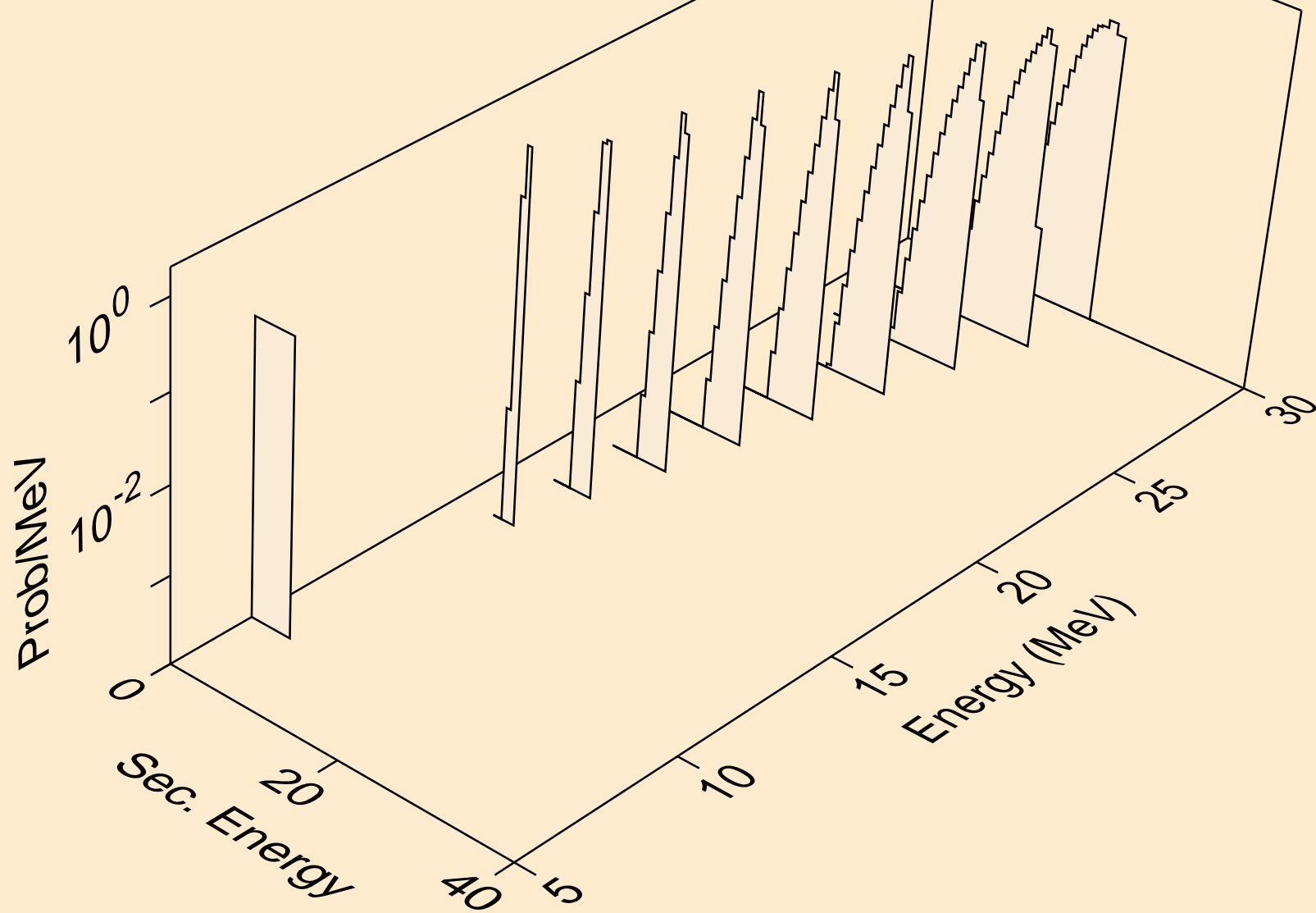

IR182 NEUTRON ACER TENDL-2024 LIBRARY; T=0.K
he3s from (n,he3)

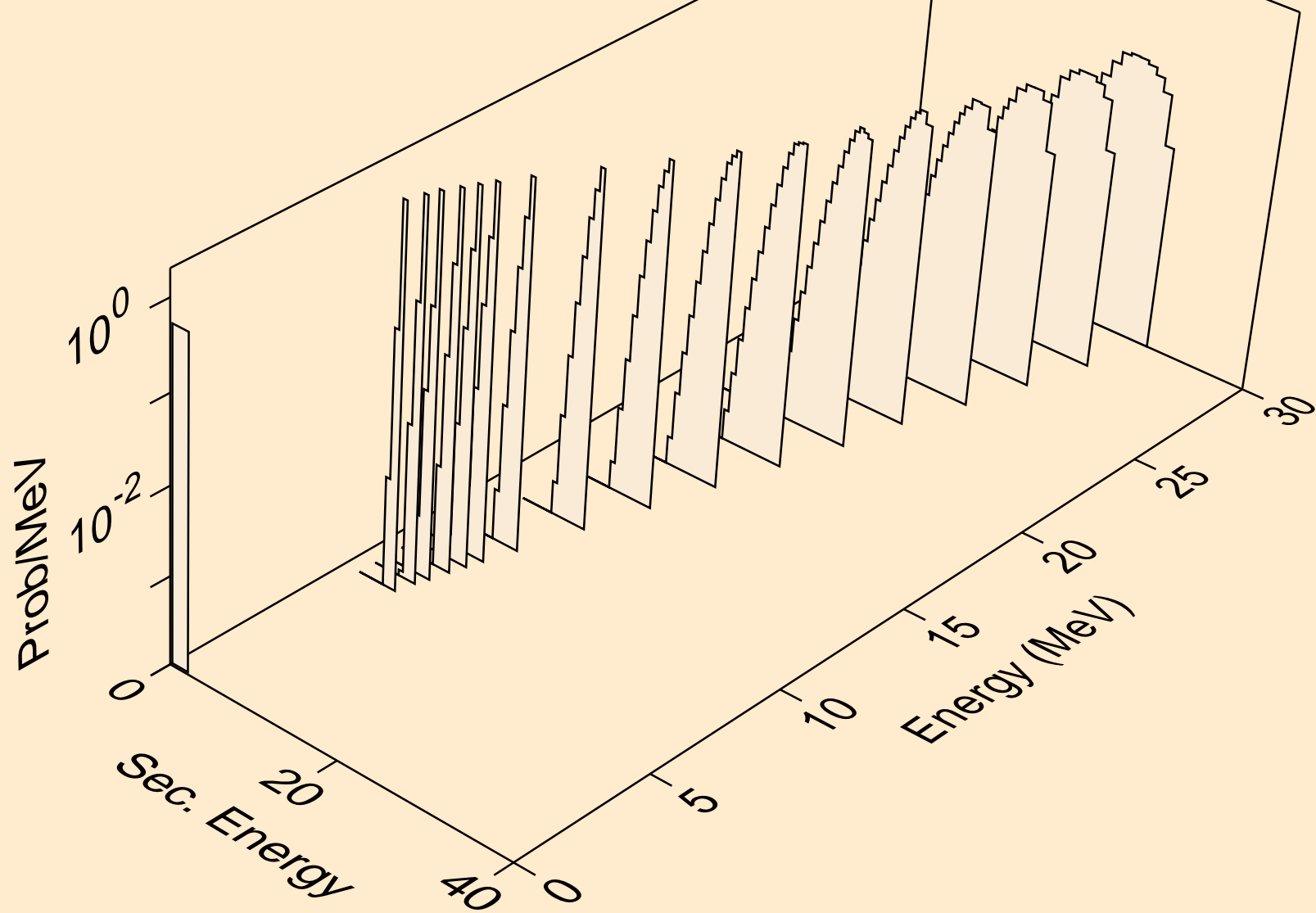

IR182 NEUTRON ACER TENDL-2024 LIBRARY; T=0.K
alphas from (n,x)

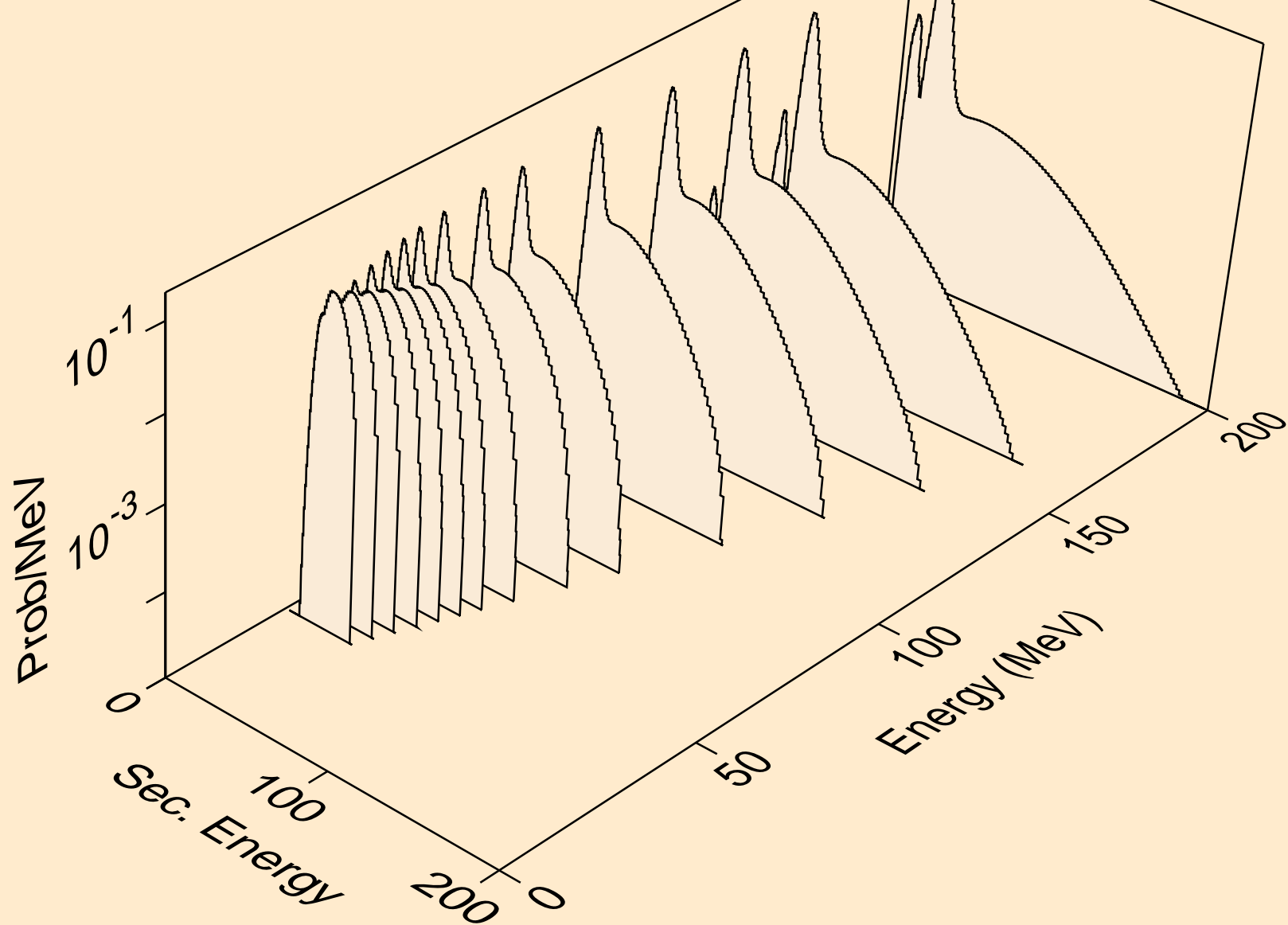

IR182 NEUTRON ACER TENDL-2024 LIBRARY; T=0.K
alphas from (n,n*)a

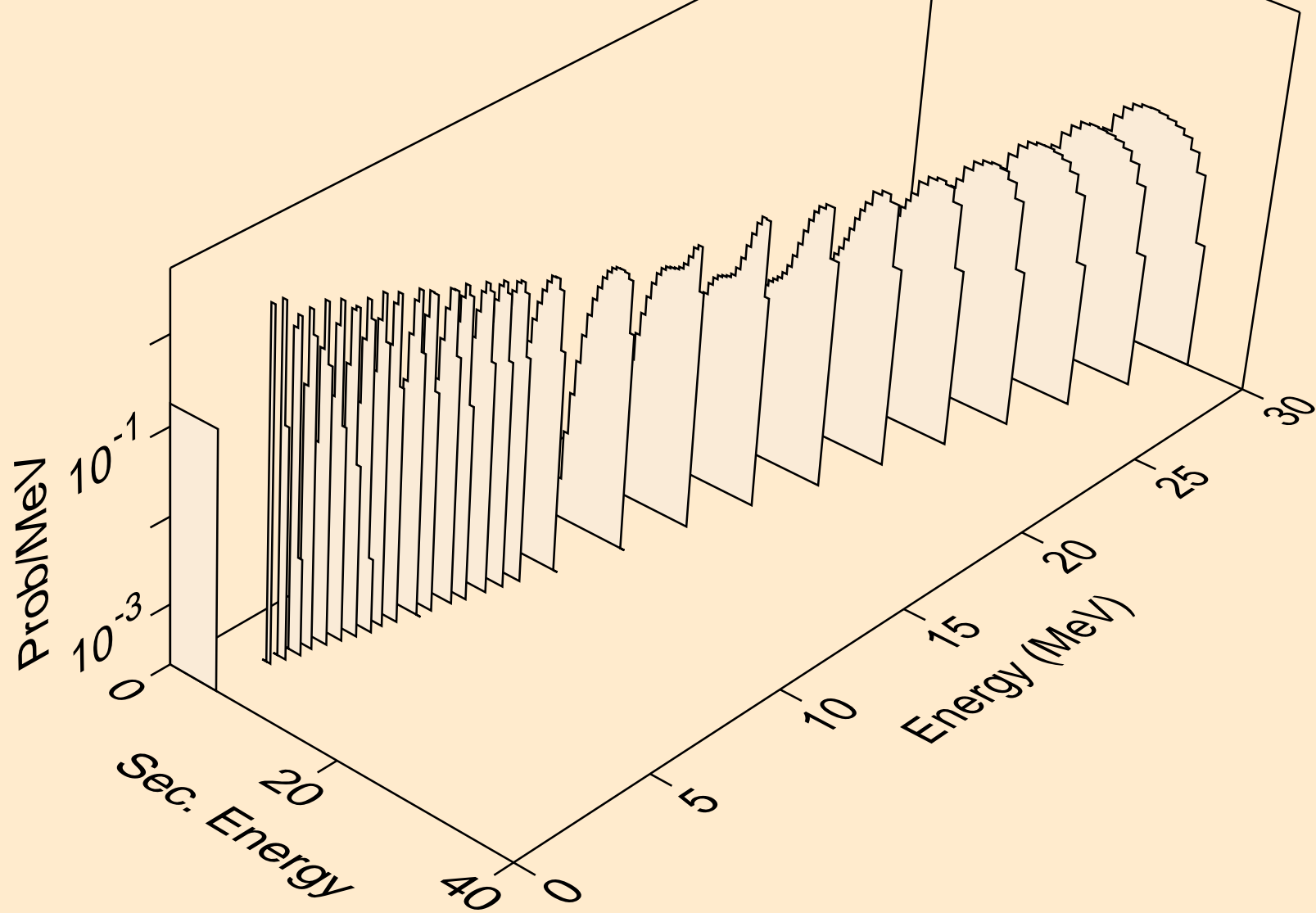

IR182 NEUTRON ACER TENDL-2024 LIBRARY; T=0.K
alphas from (n,2n)a

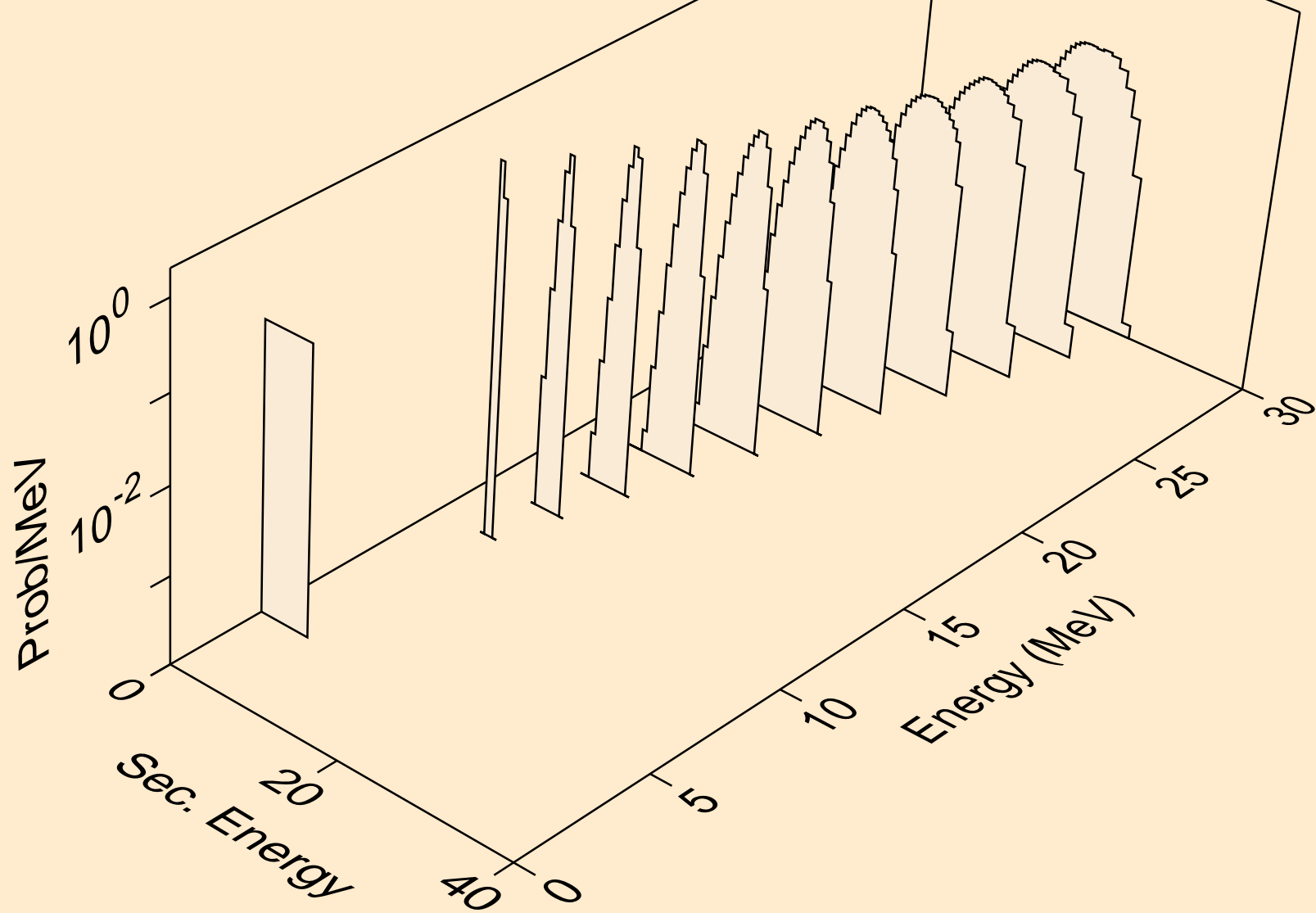

IR182 NEUTRON ACER TENDL-2024 LIBRARY; T=0.K
alphas from (n,3n)a

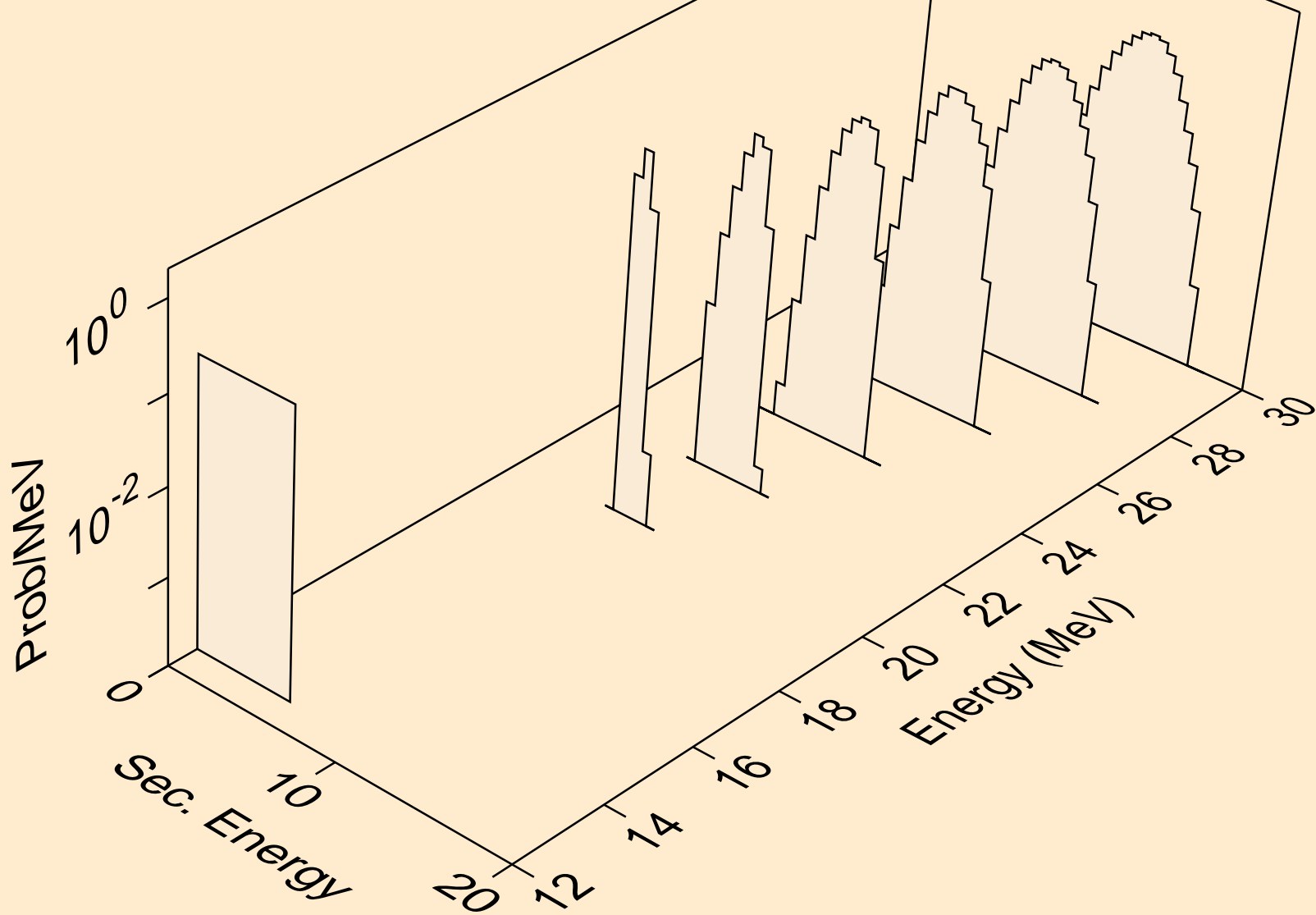

IR182 NEUTRON ACER TENDL-2024 LIBRARY; T=0.K
alphas from (n,n*)2a

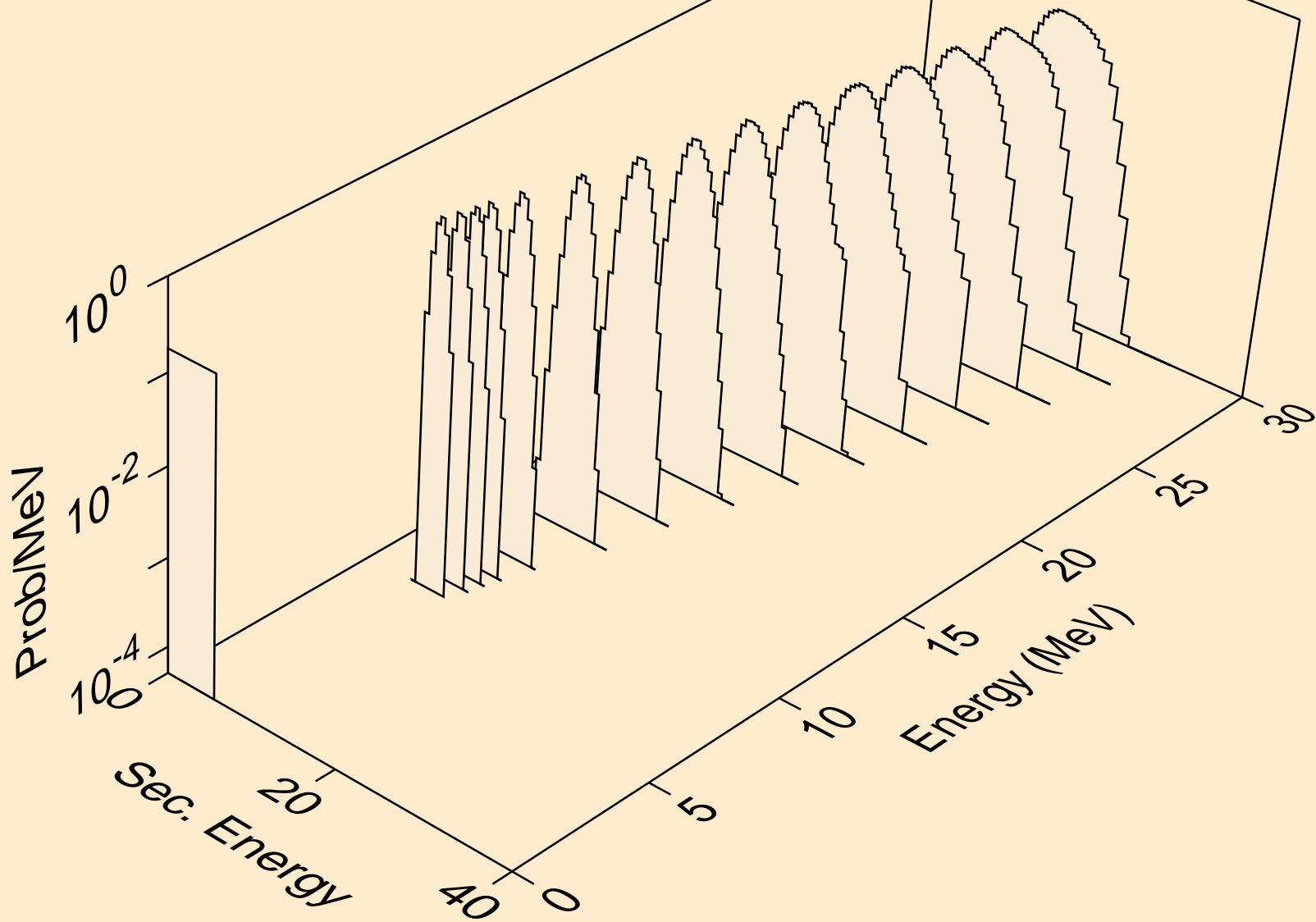

IR182 NEUTRON ACER TENDL-2024 LIBRARY; T=0.K
alphas from (n,2n)2a

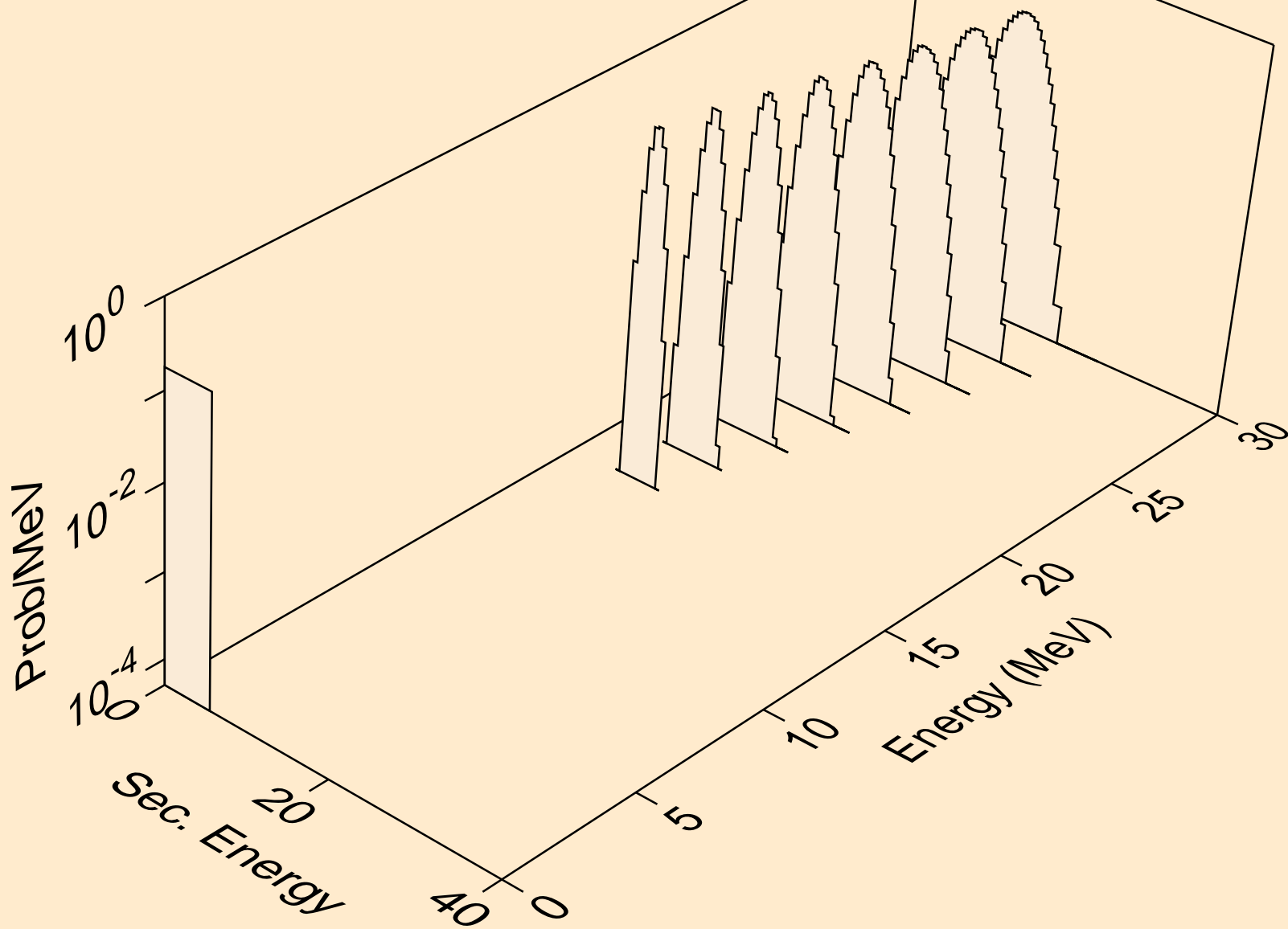

IR182 NEUTRON ACER TENDL-2024 LIBRARY; T=0.K
alphas from (n,npa)

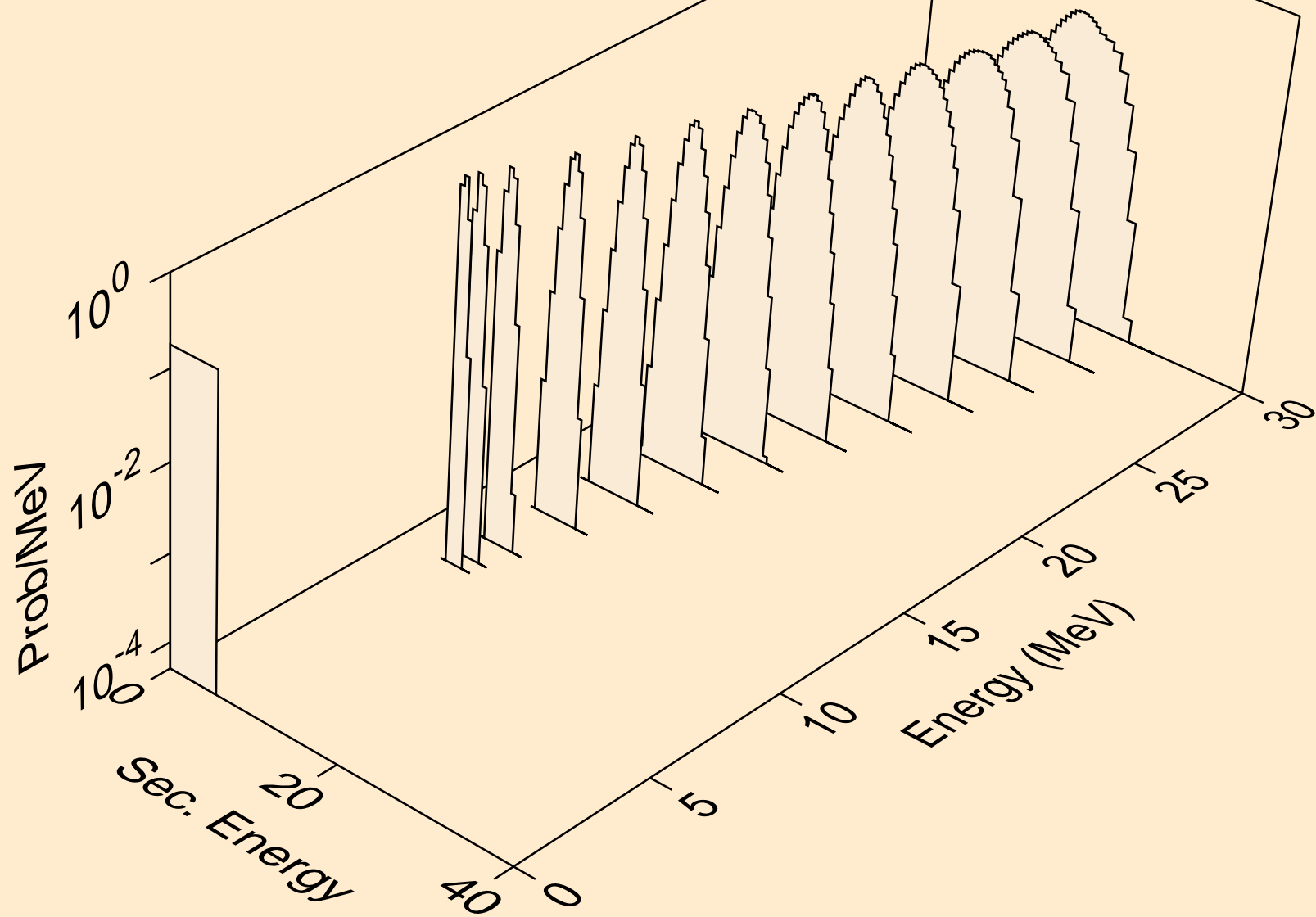

IR182 NEUTRON ACER TENDL-2024 LIBRARY; T=0.K
alphas from (n,a)

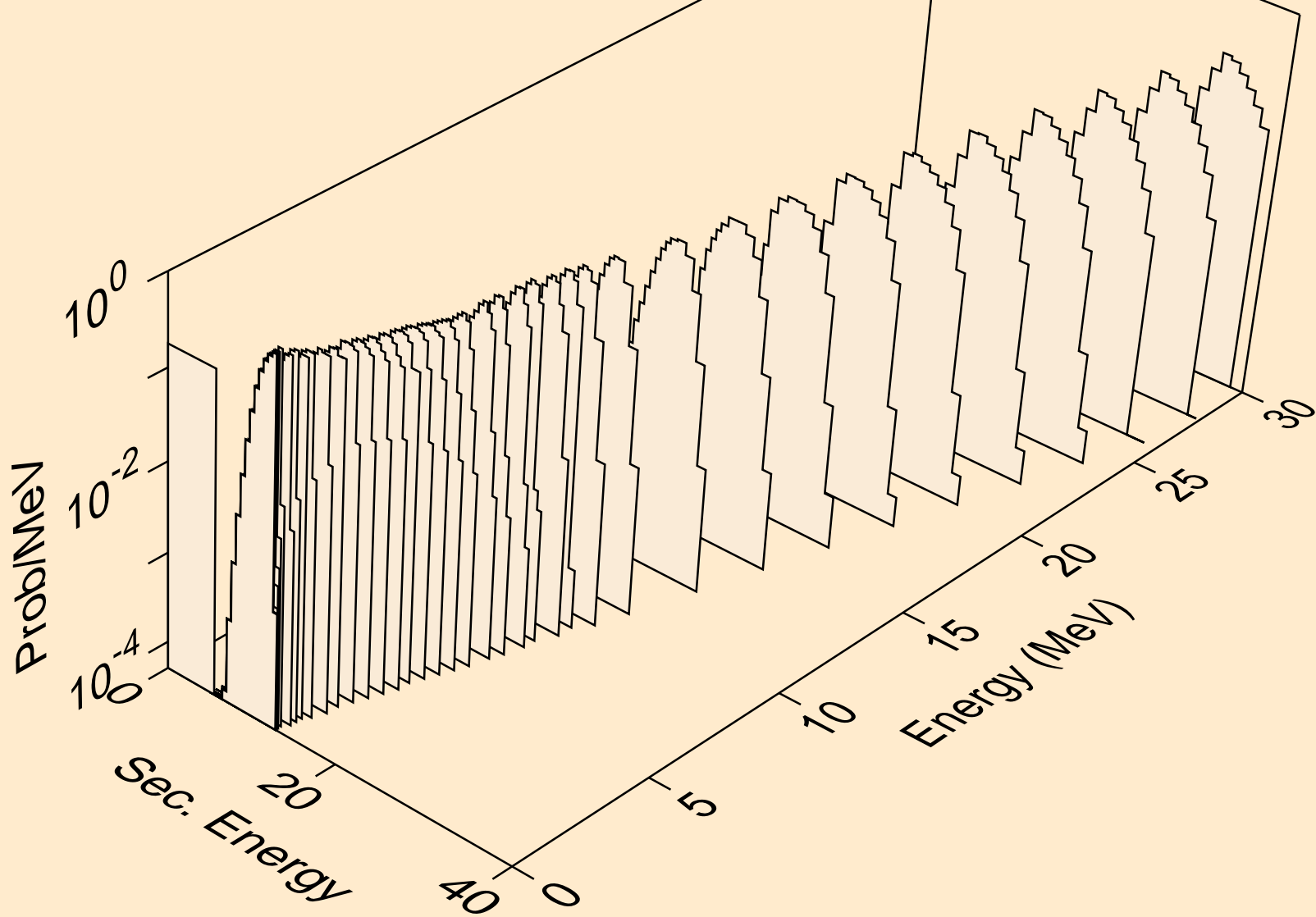

IR182 NEUTRON ACER TENDL-2024 LIBRARY; T=0.K
alphas from (n,2a)

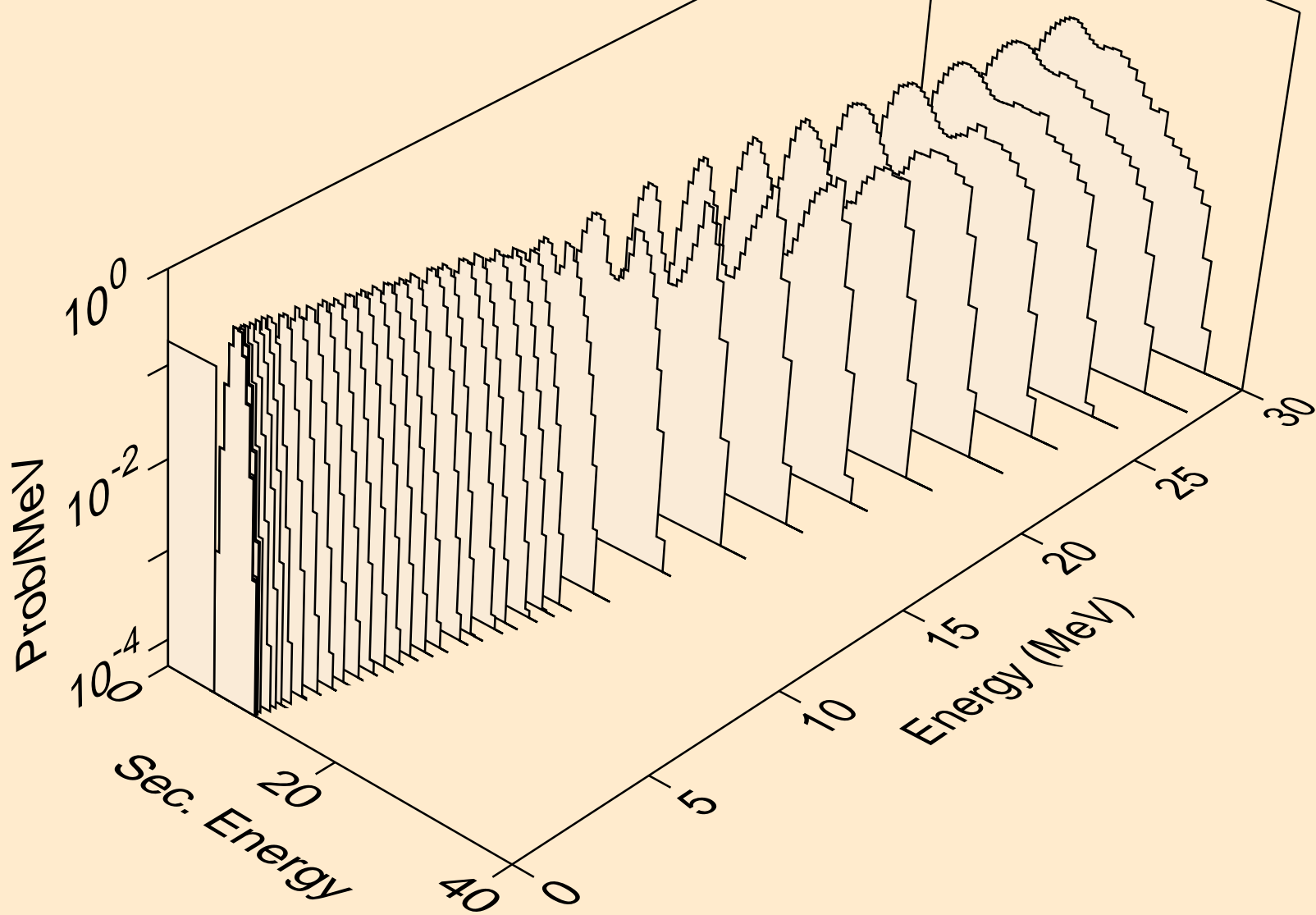

IR182 NEUTRON ACER TENDL-2024 LIBRARY; T=0.K
alphas from (n,pa)

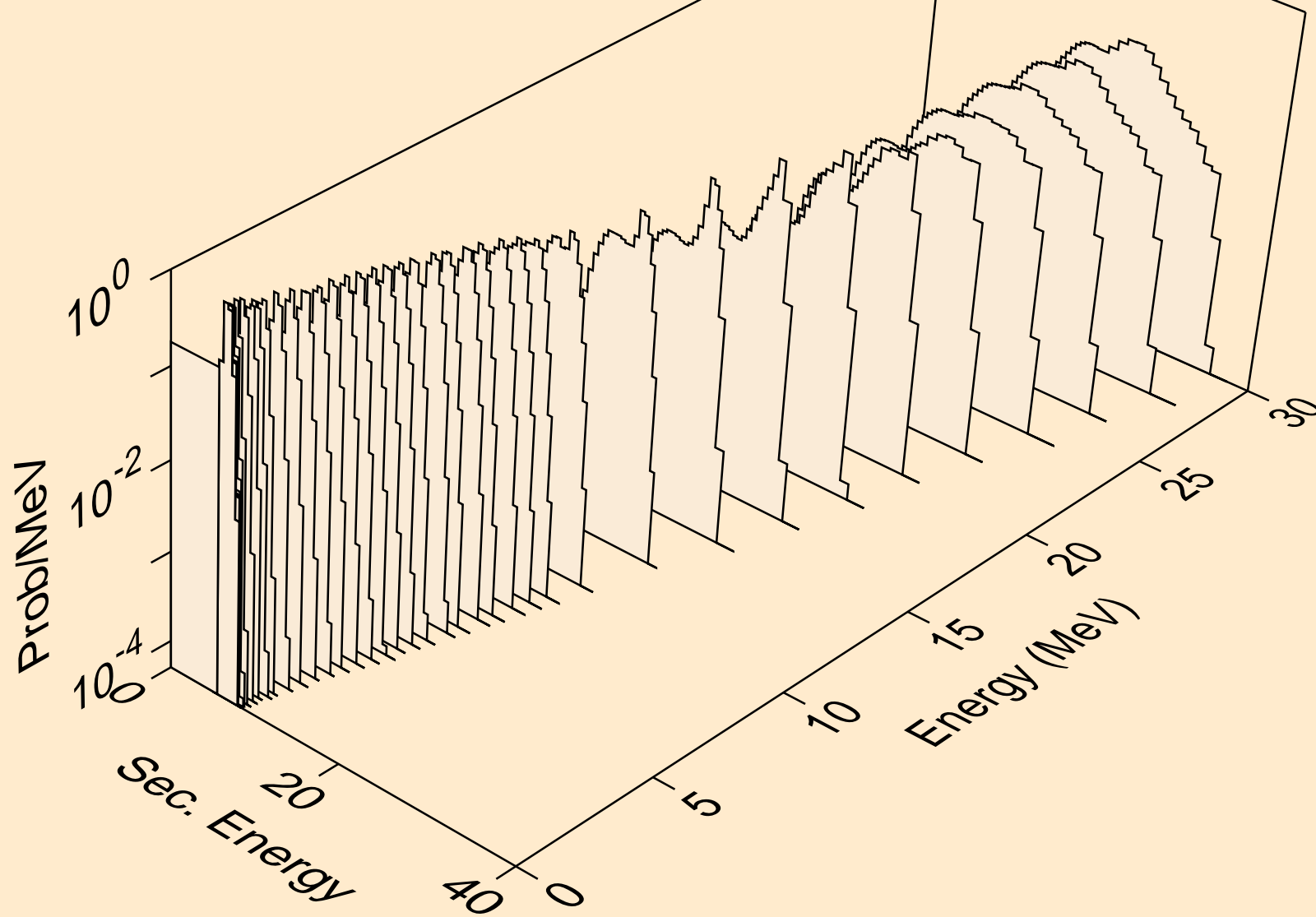

IR182 NEUTRON ACER TENDL-2024 LIBRARY; T=0.K
alphas from (n,da)

