

IR197 NEUTRON ACER TENDL-2024 LIBRARY; T=0.K

Principal cross sections

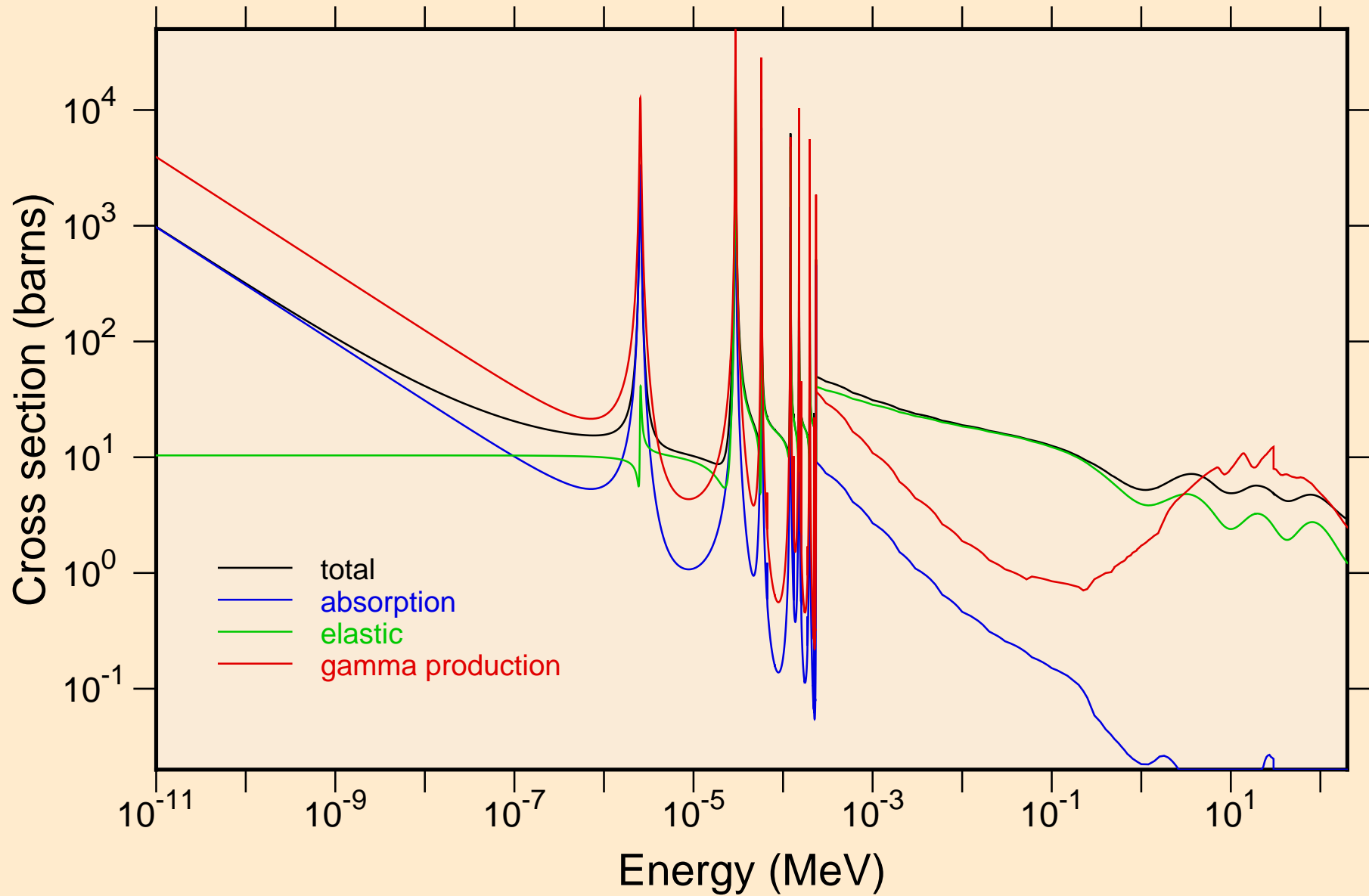

IR197 NEUTRON ACER TENDL-2024 LIBRARY; T=0.K
resonance total cross section

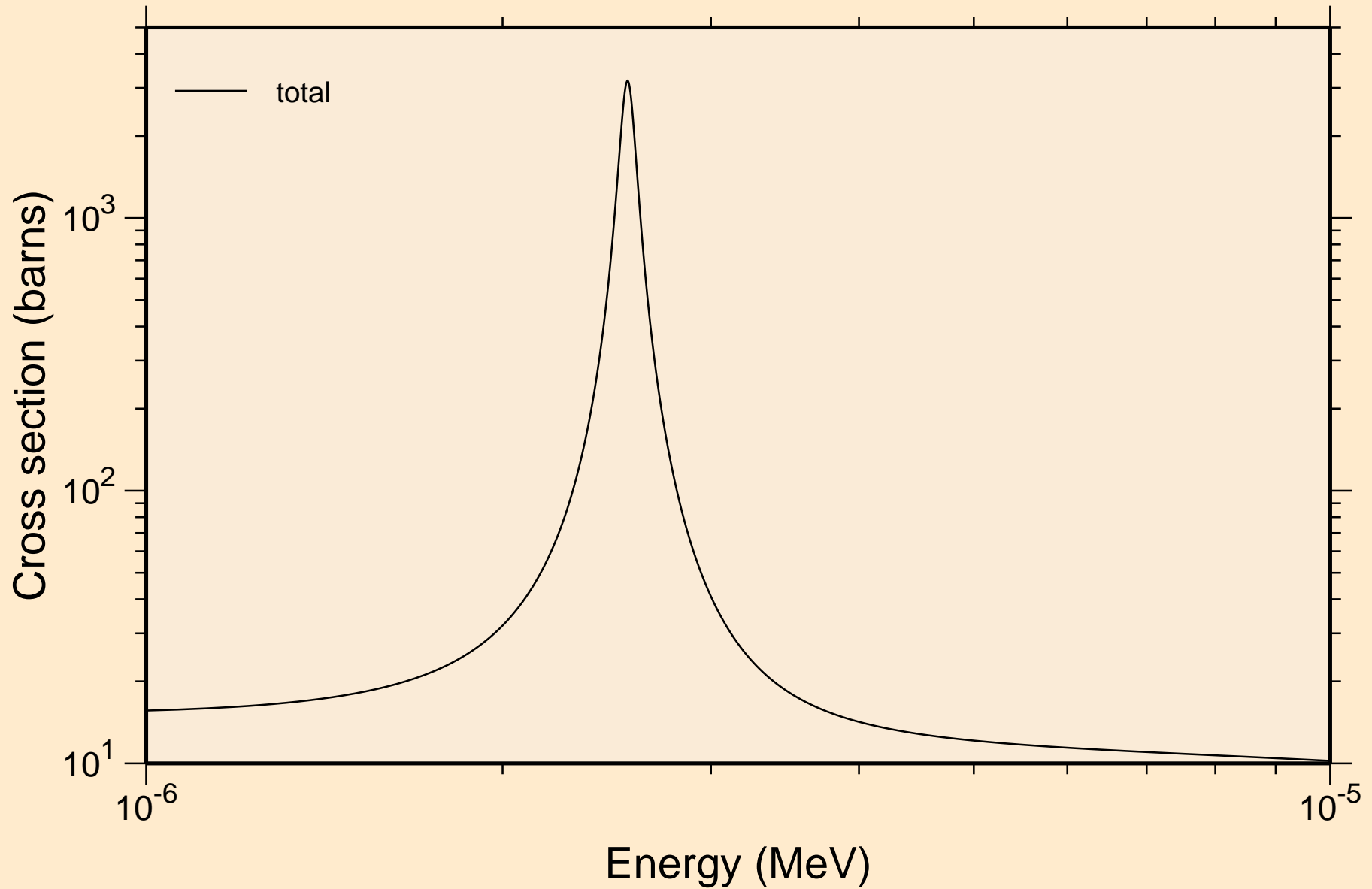

IR197 NEUTRON ACER TENDL-2024 LIBRARY; T=0.K
resonance total cross section

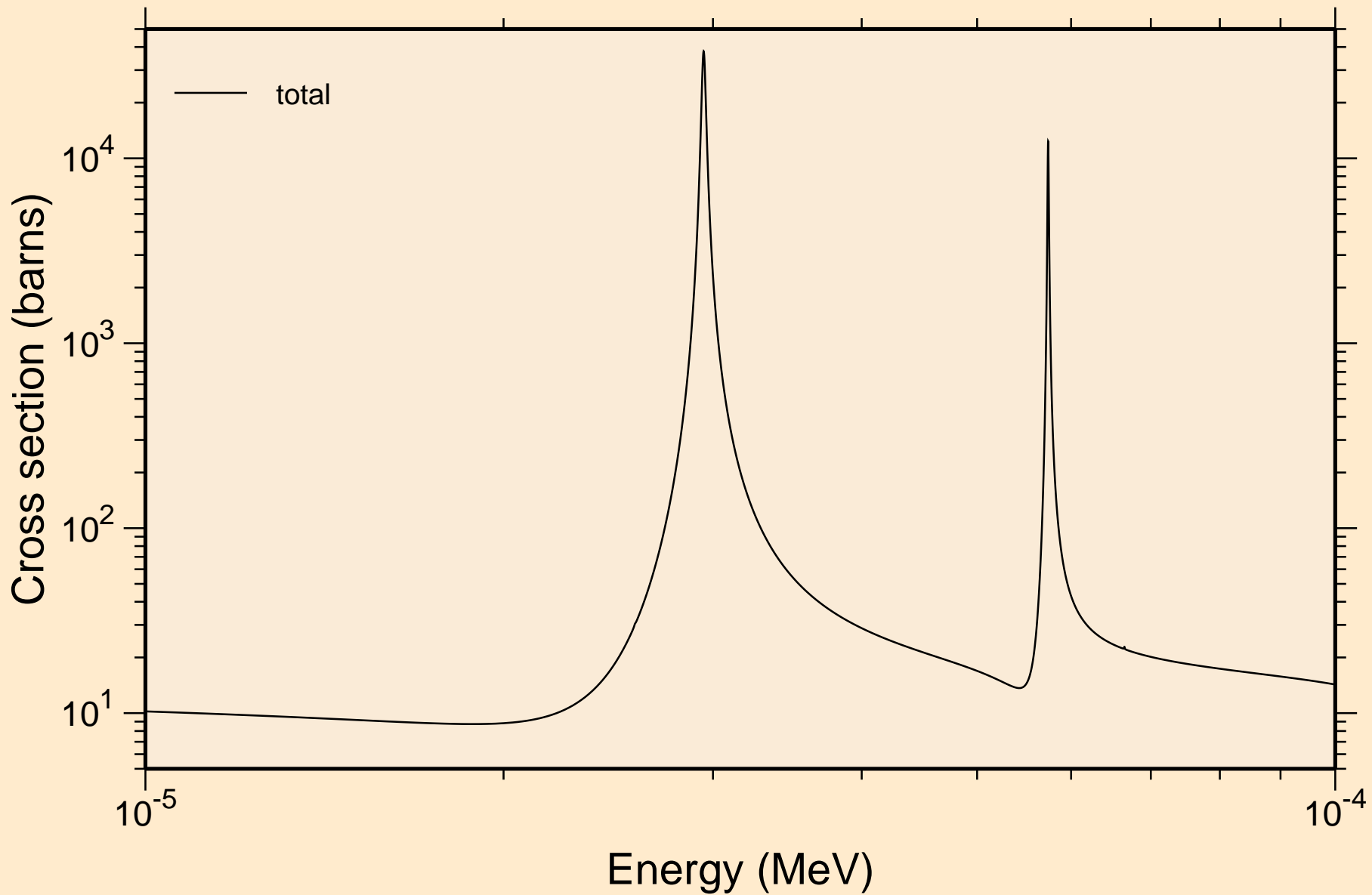

IR197 NEUTRON ACER TENDL-2024 LIBRARY; T=0.K
resonance total cross section

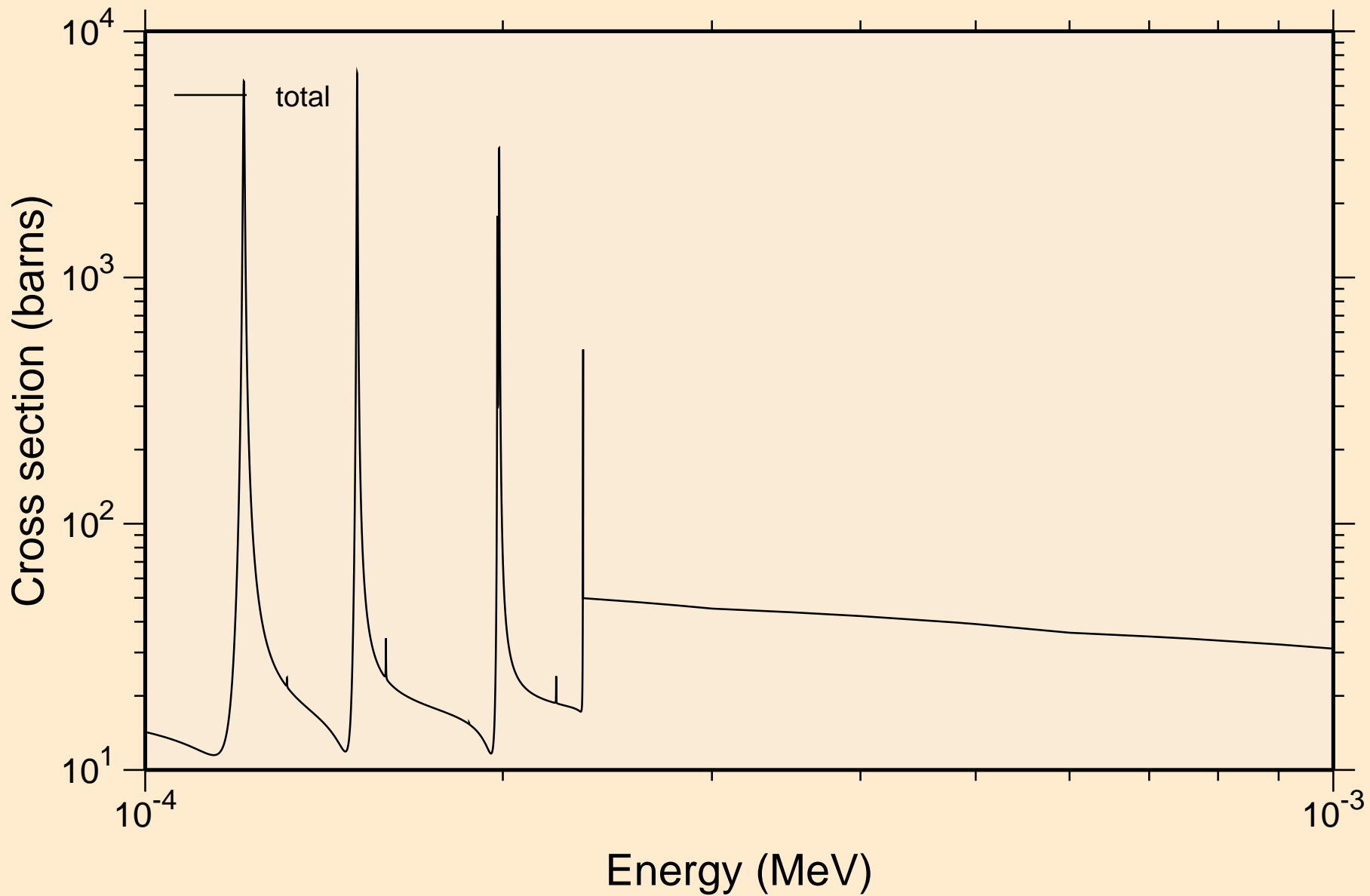

IR197 NEUTRON ACER TENDL-2024 LIBRARY; T=0.K
resonance total cross section

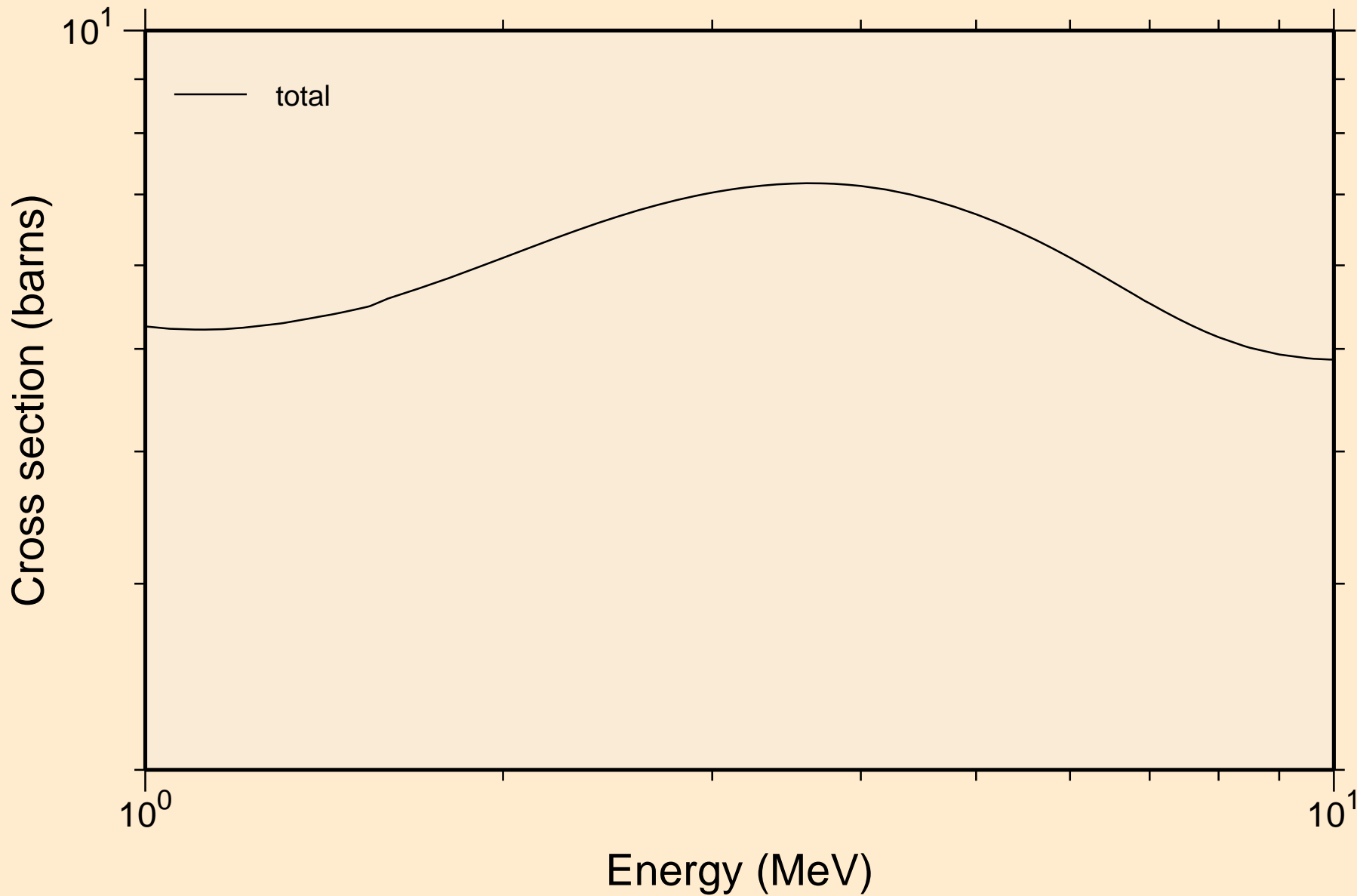

IR197 NEUTRON ACER TENDL-2024 LIBRARY; T=0.K
resonance absorption cross sections

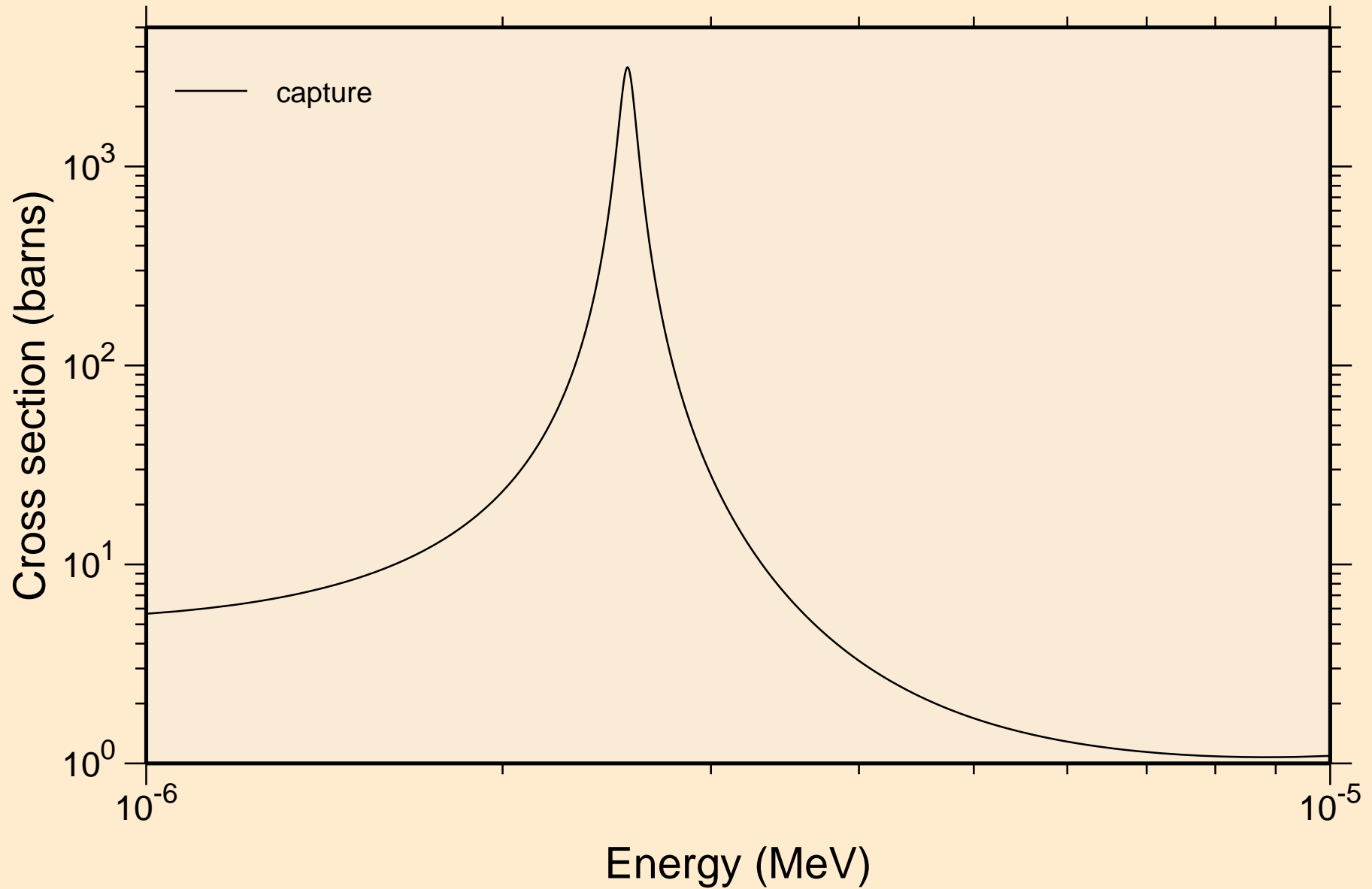

IR197 NEUTRON ACER TENDL-2024 LIBRARY; T=0.K
resonance absorption cross sections

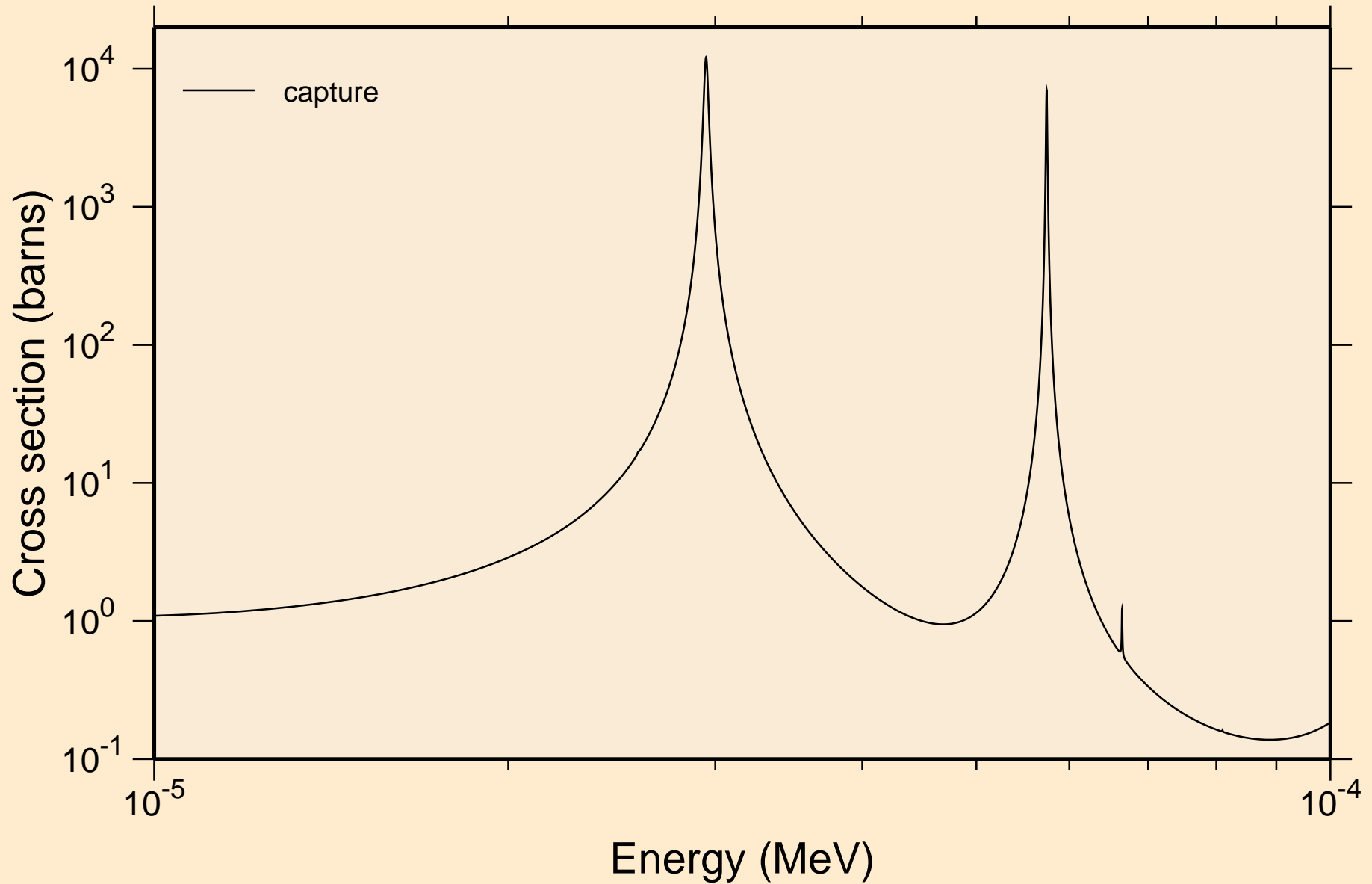

IR197 NEUTRON ACER TENDL-2024 LIBRARY; T=0.K
resonance absorption cross sections

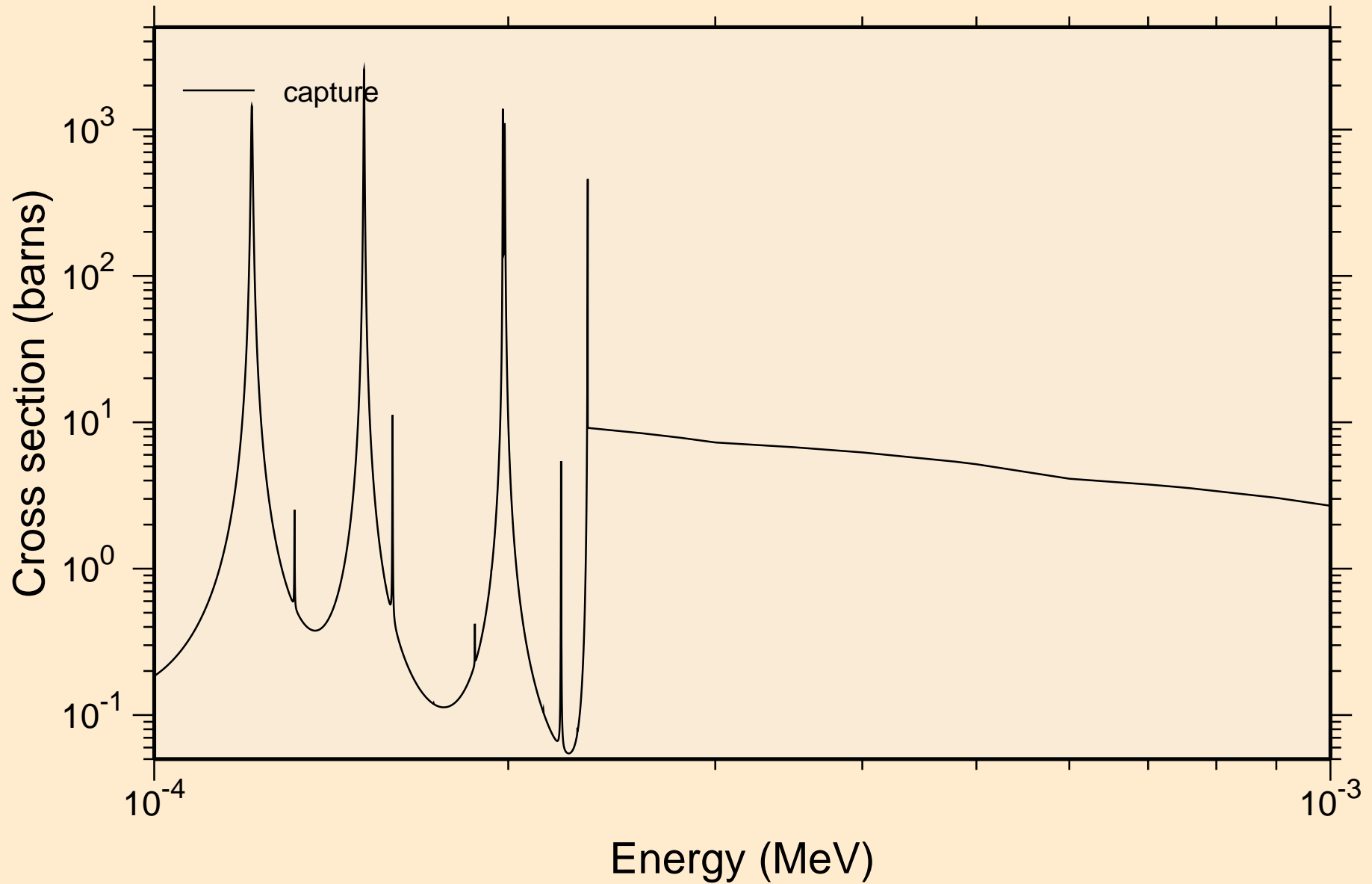

IR197 NEUTRON ACER TENDL-2024 LIBRARY; T=0.K
resonance absorption cross sections

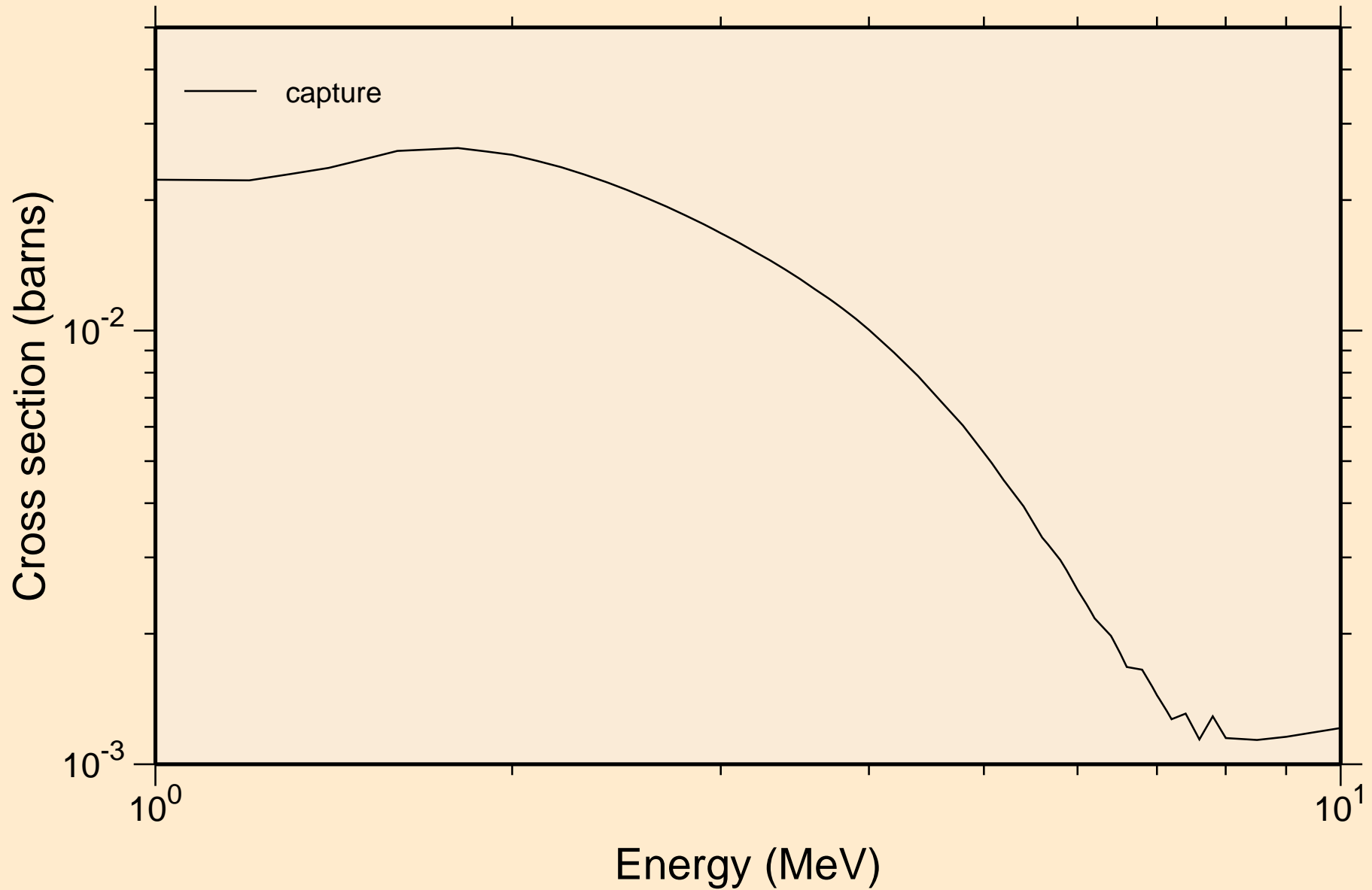

IR197 NEUTRON ACER TENDL-2024 LIBRARY; T=0.K
Heating

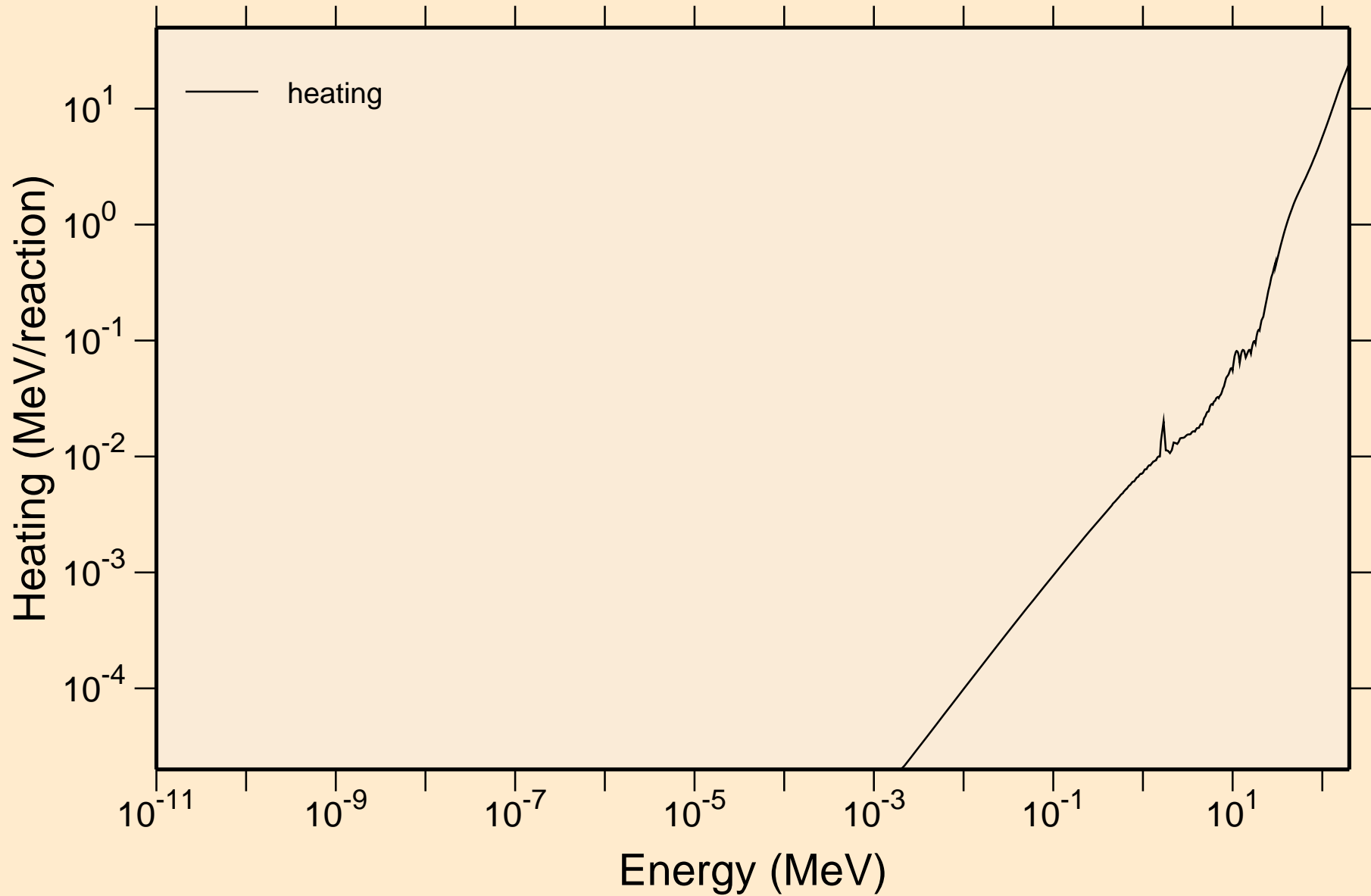

IR197 NEUTRON ACER TENDL-2024 LIBRARY; T=0.K

Damage

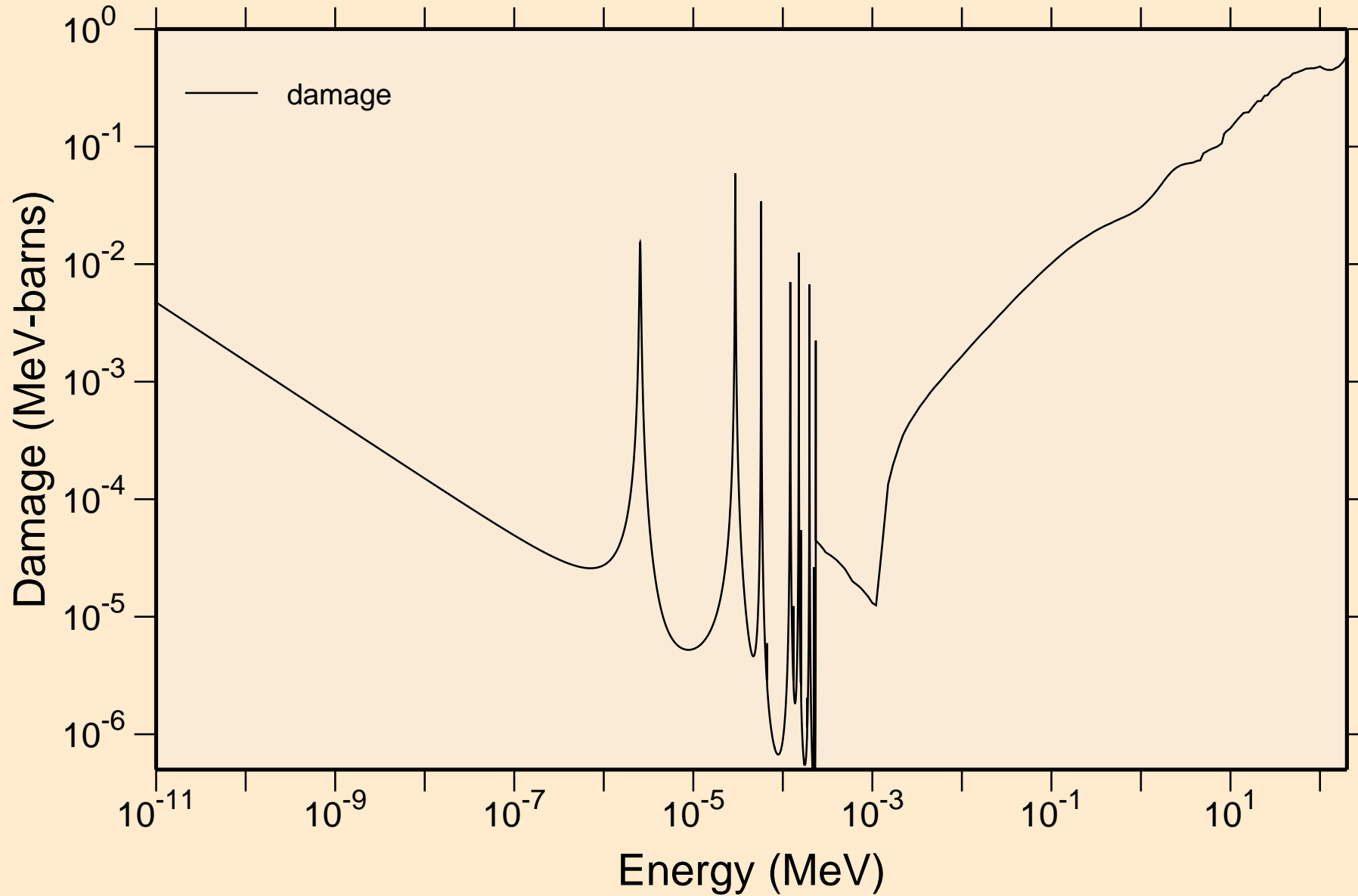

IR197 NEUTRON ACER TENDL-2024 LIBRARY; T=0.K
Non-threshold reactions

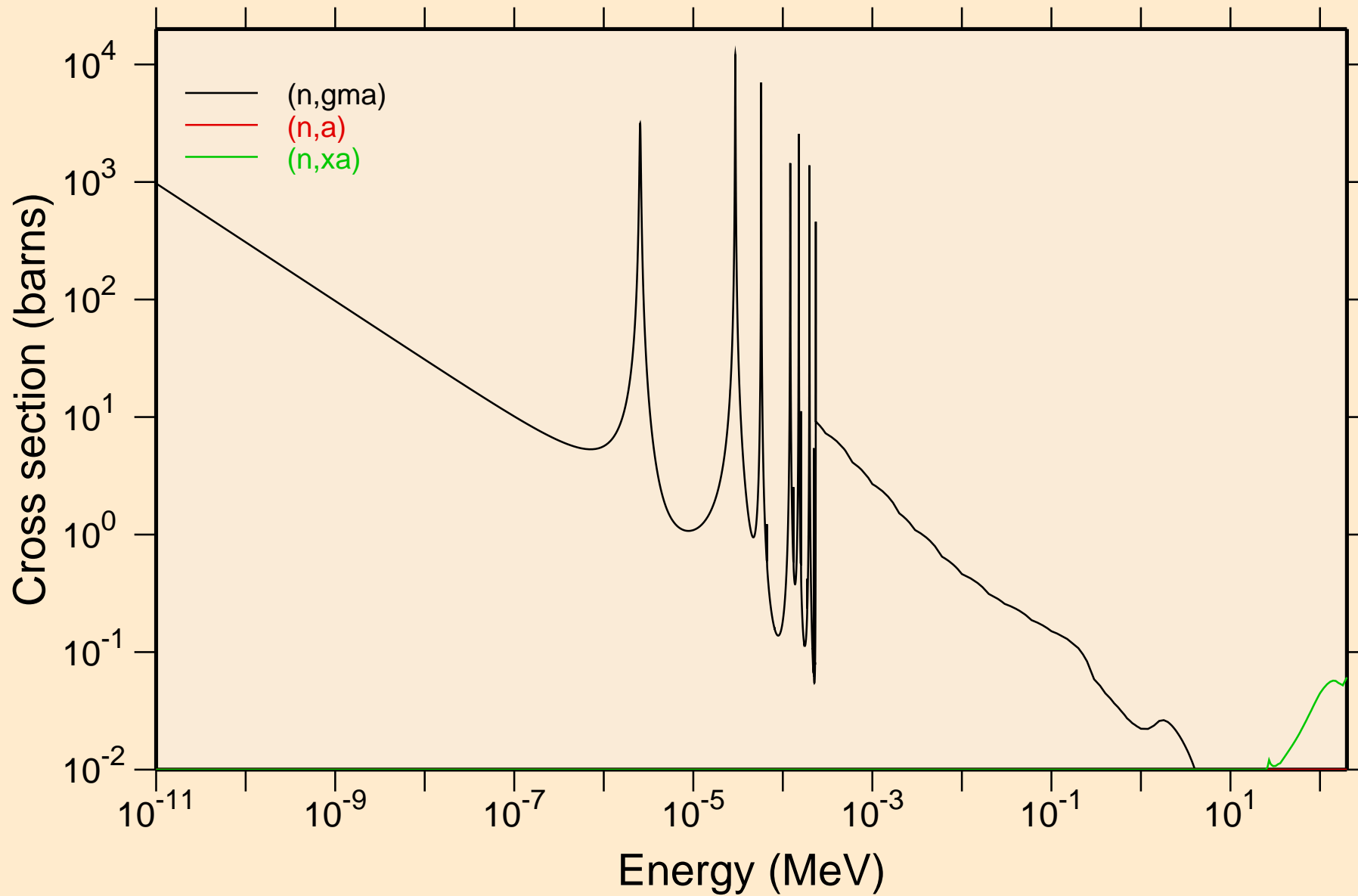

IR197 NEUTRON ACER TENDL-2024 LIBRARY; T=0.K

Principal cross sections

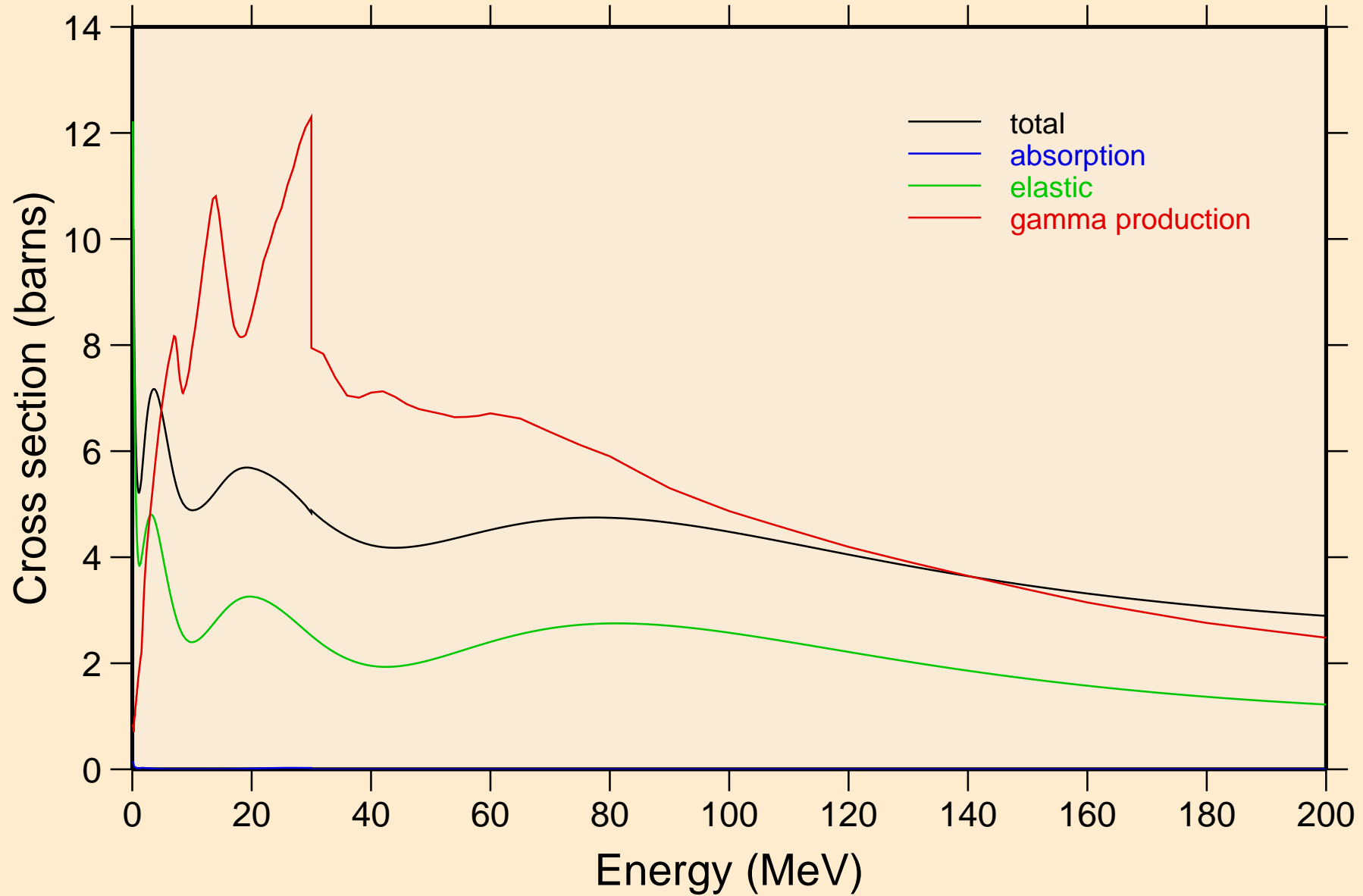

IR197 NEUTRON ACER TENDL-2024 LIBRARY; T=0.K

Heating

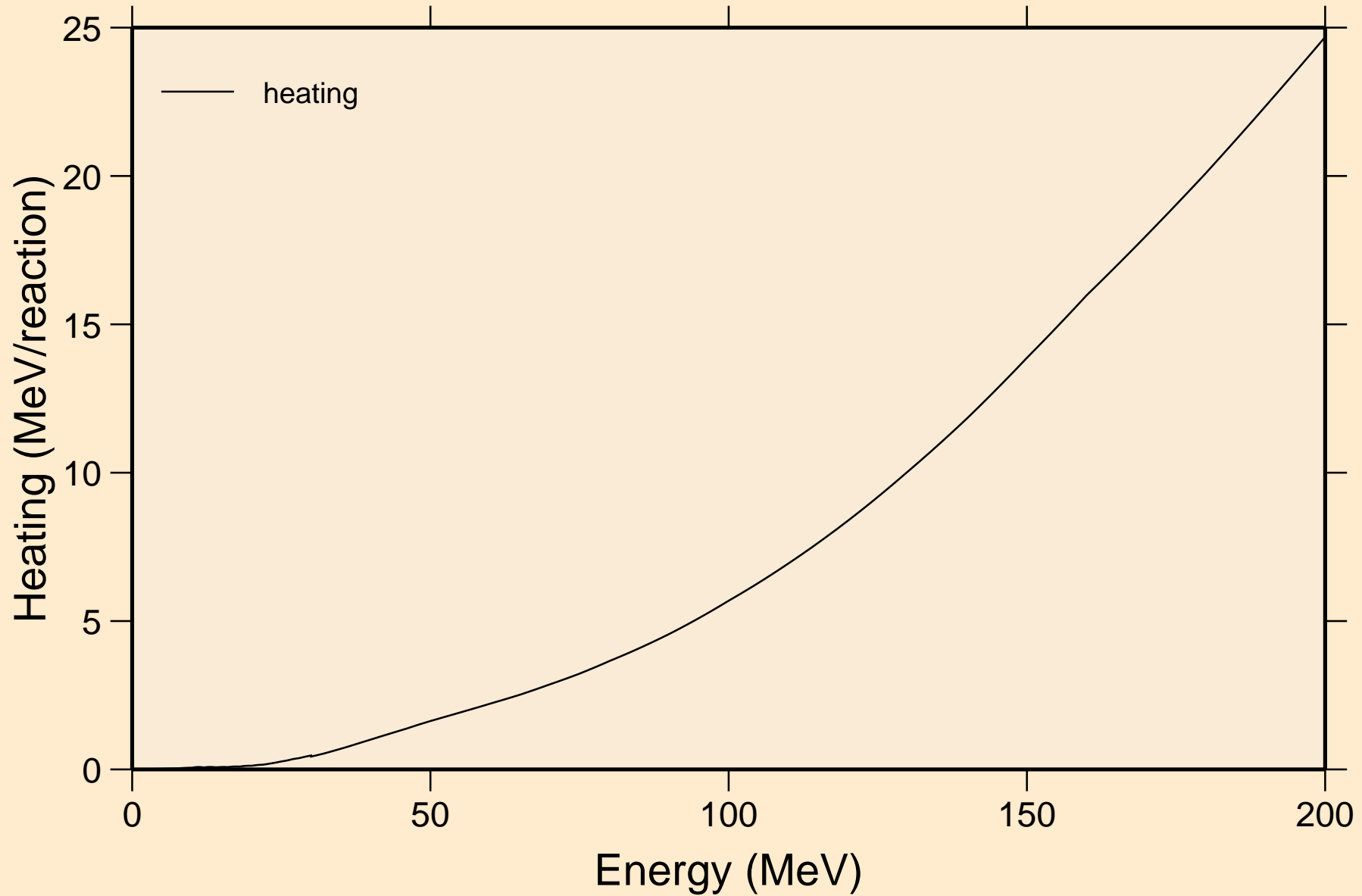

IR197 NEUTRON ACER TENDL-2024 LIBRARY; T=0.K
Damage

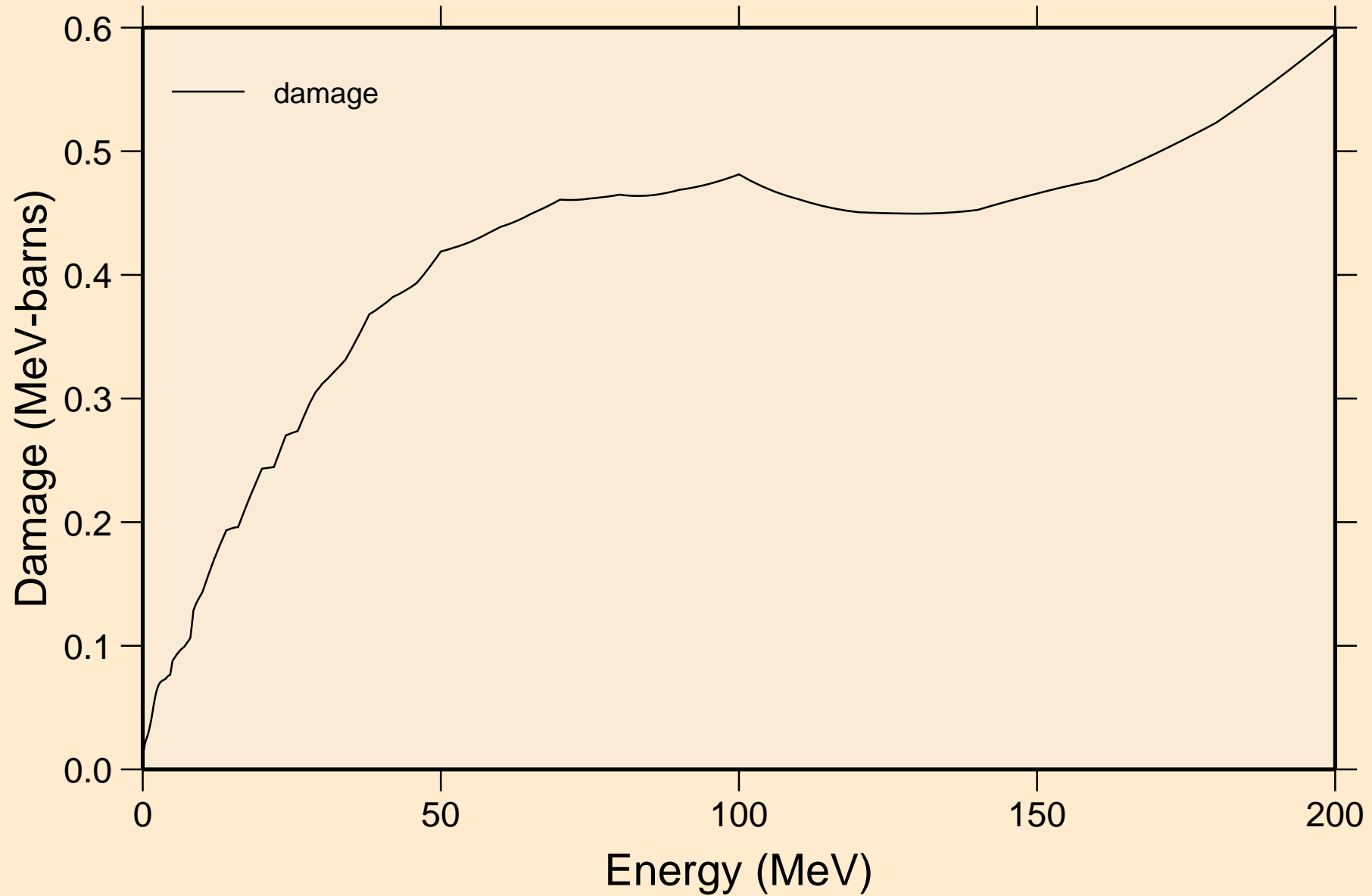

IR197 NEUTRON ACER TENDL-2024 LIBRARY; T=0.K
Non-threshold reactions

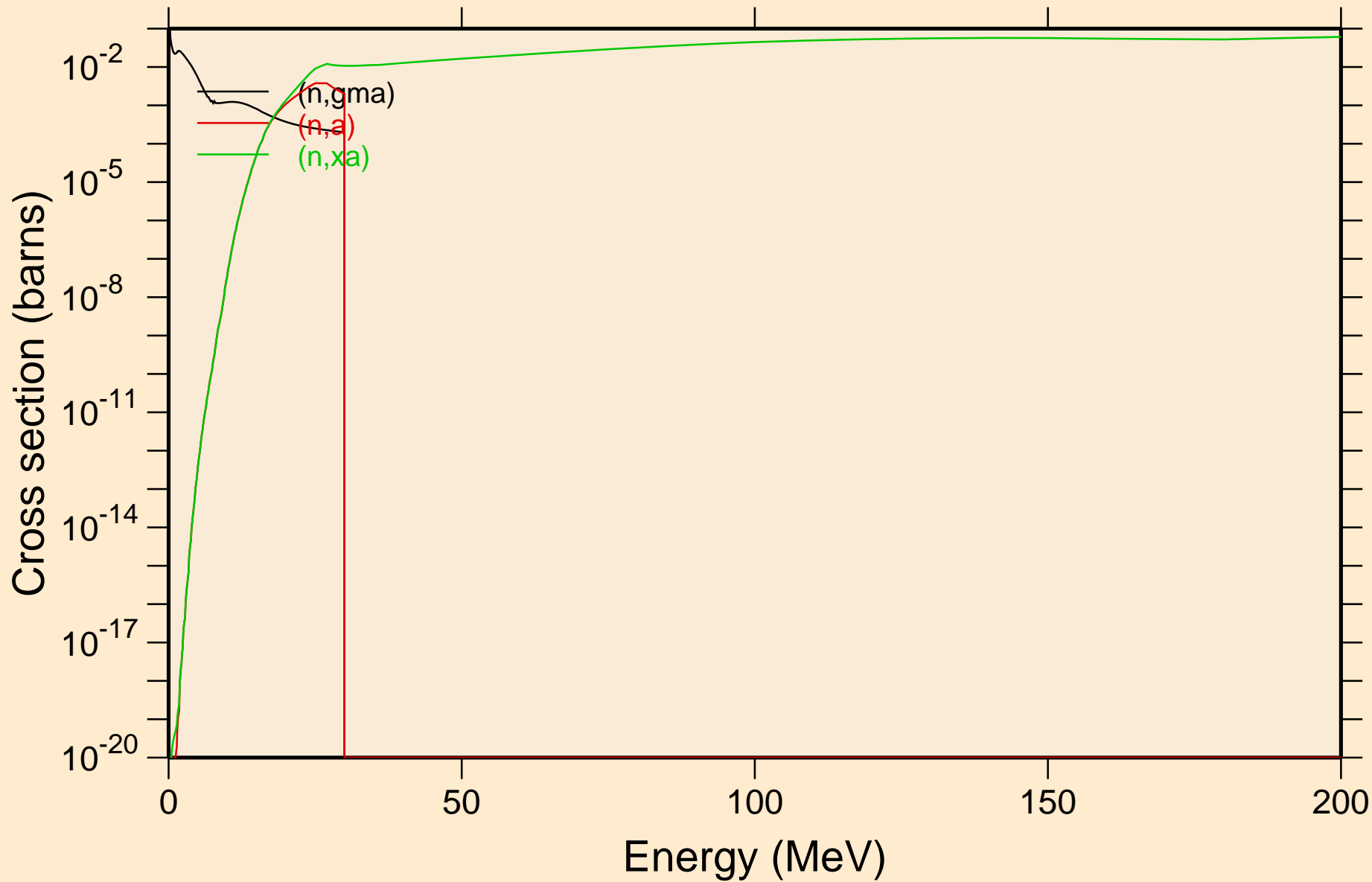

IR197 NEUTRON ACER TENDL-2024 LIBRARY; T=0.K
Inelastic levels

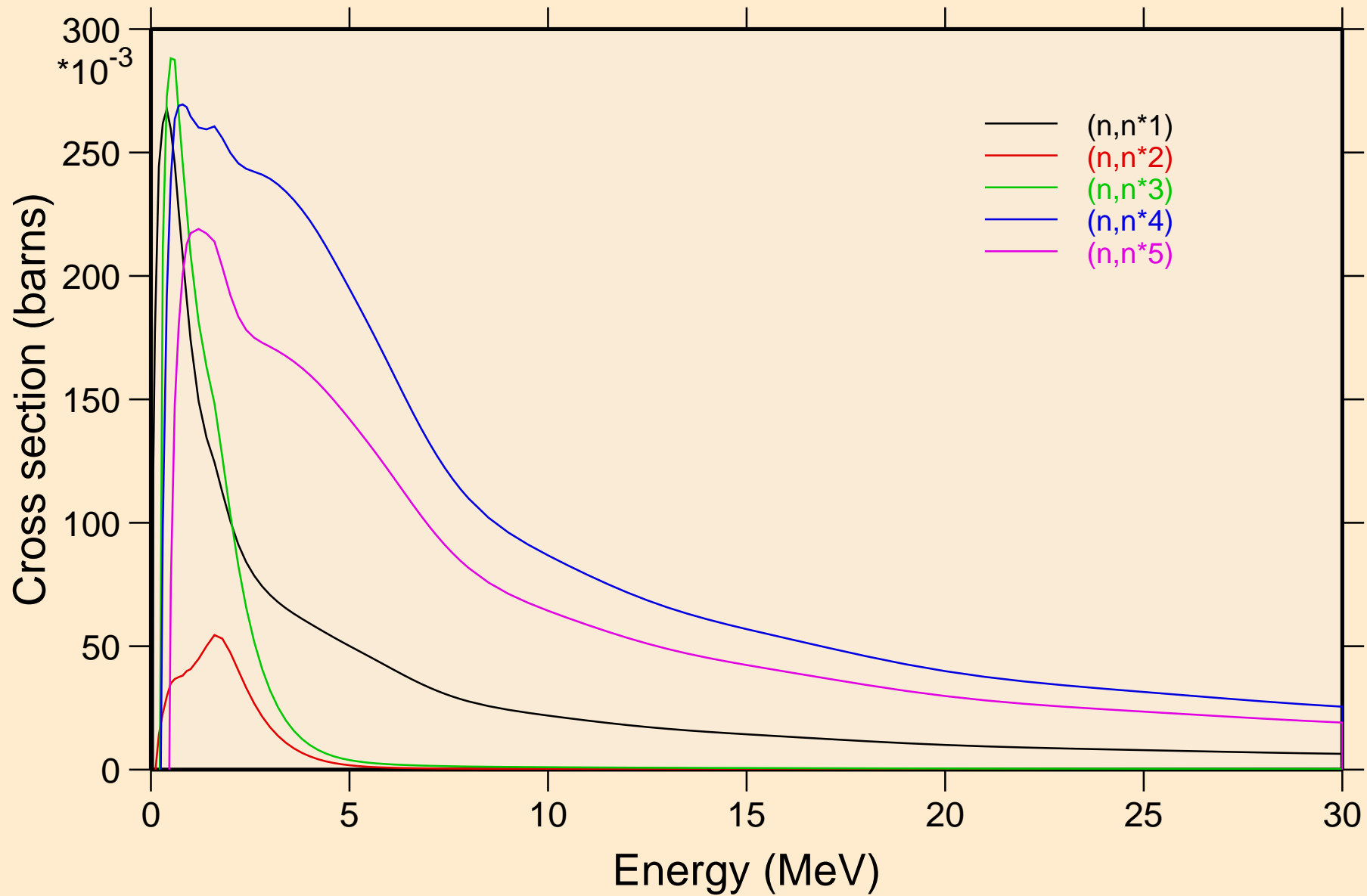

IR197 NEUTRON ACER TENDL-2024 LIBRARY; T=0.K
Inelastic levels

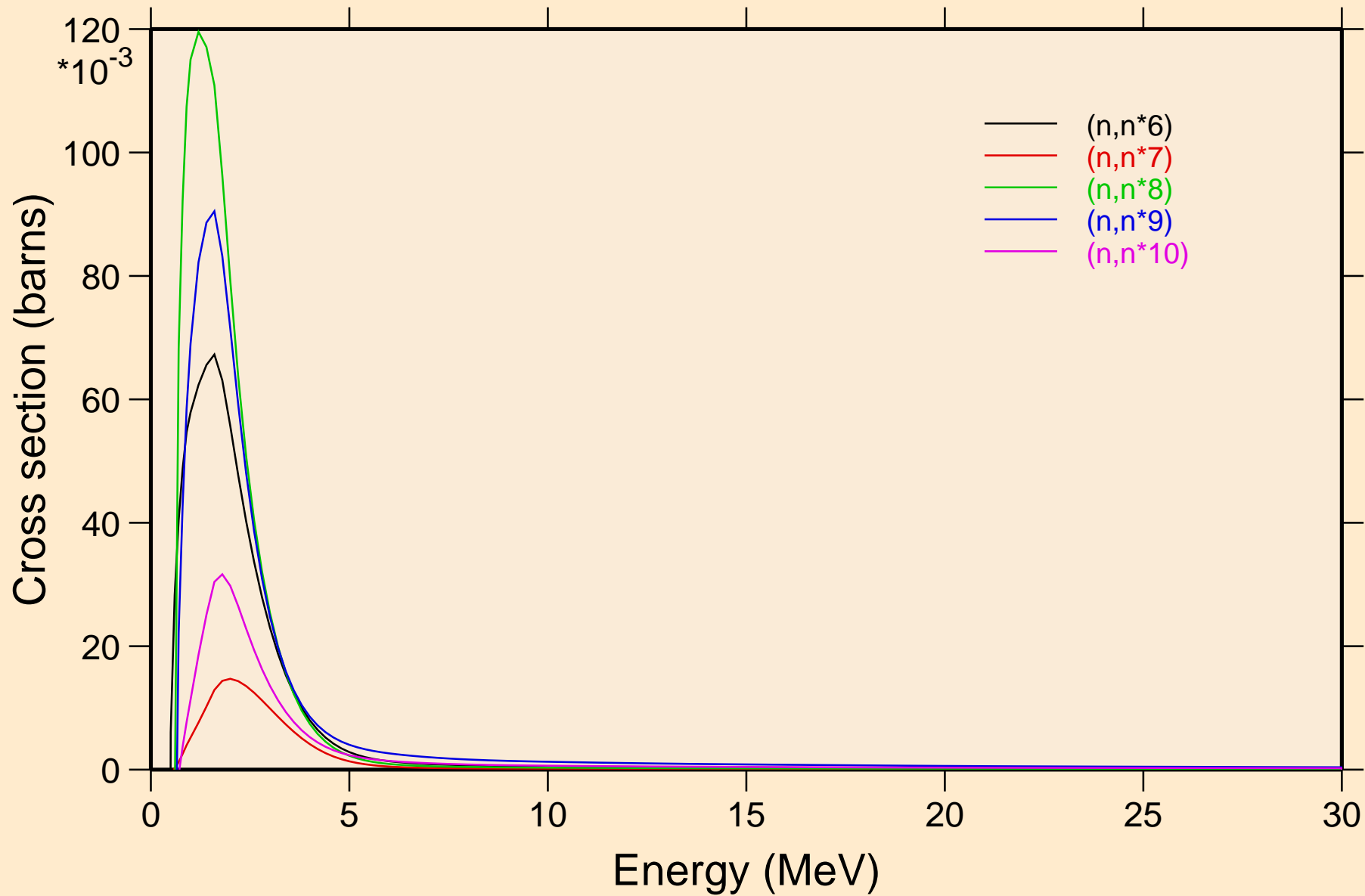

IR197 NEUTRON ACER TENDL-2024 LIBRARY; T=0.K
Inelastic levels

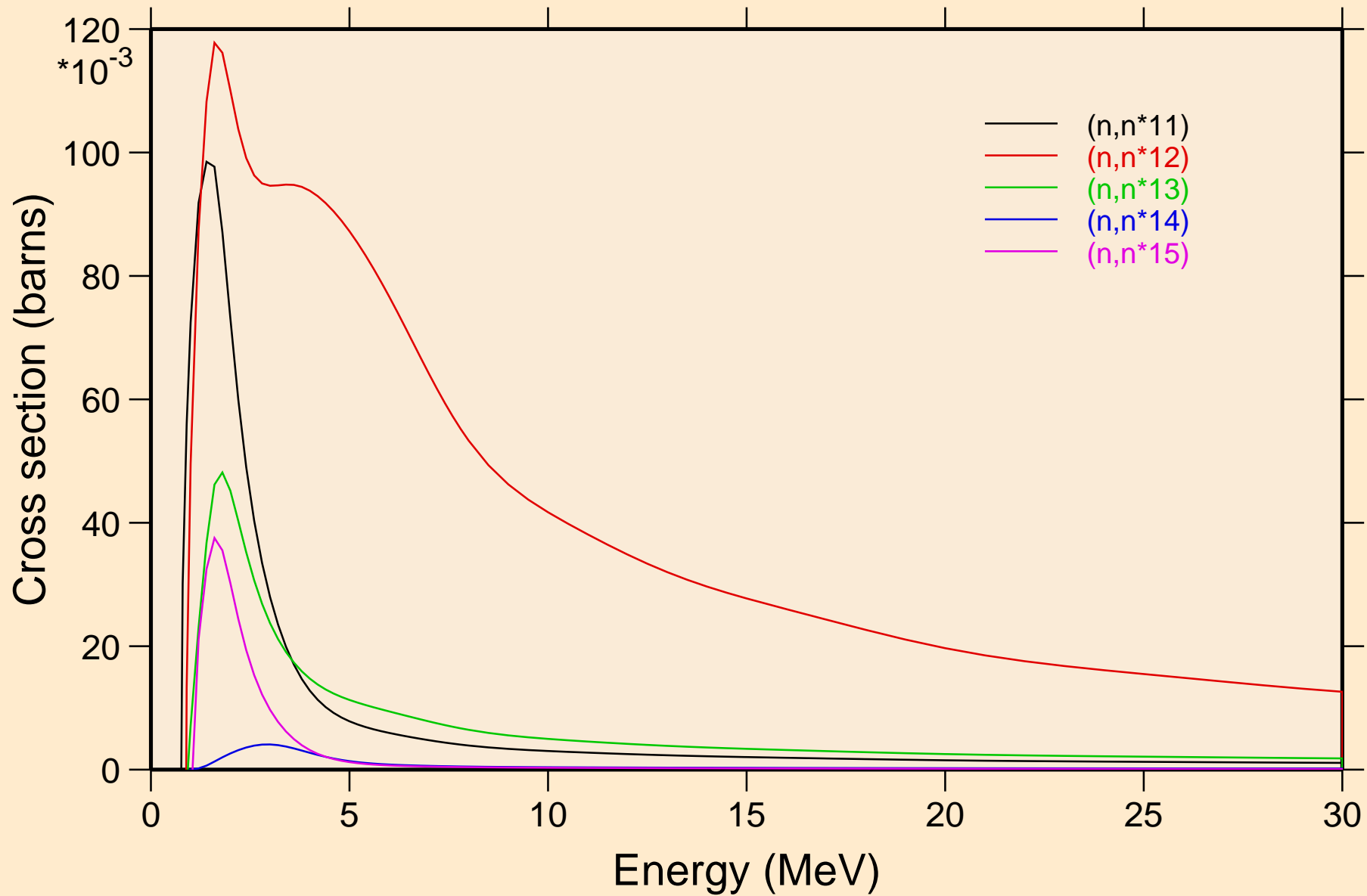

IR197 NEUTRON ACER TENDL-2024 LIBRARY; T=0.K
Inelastic levels

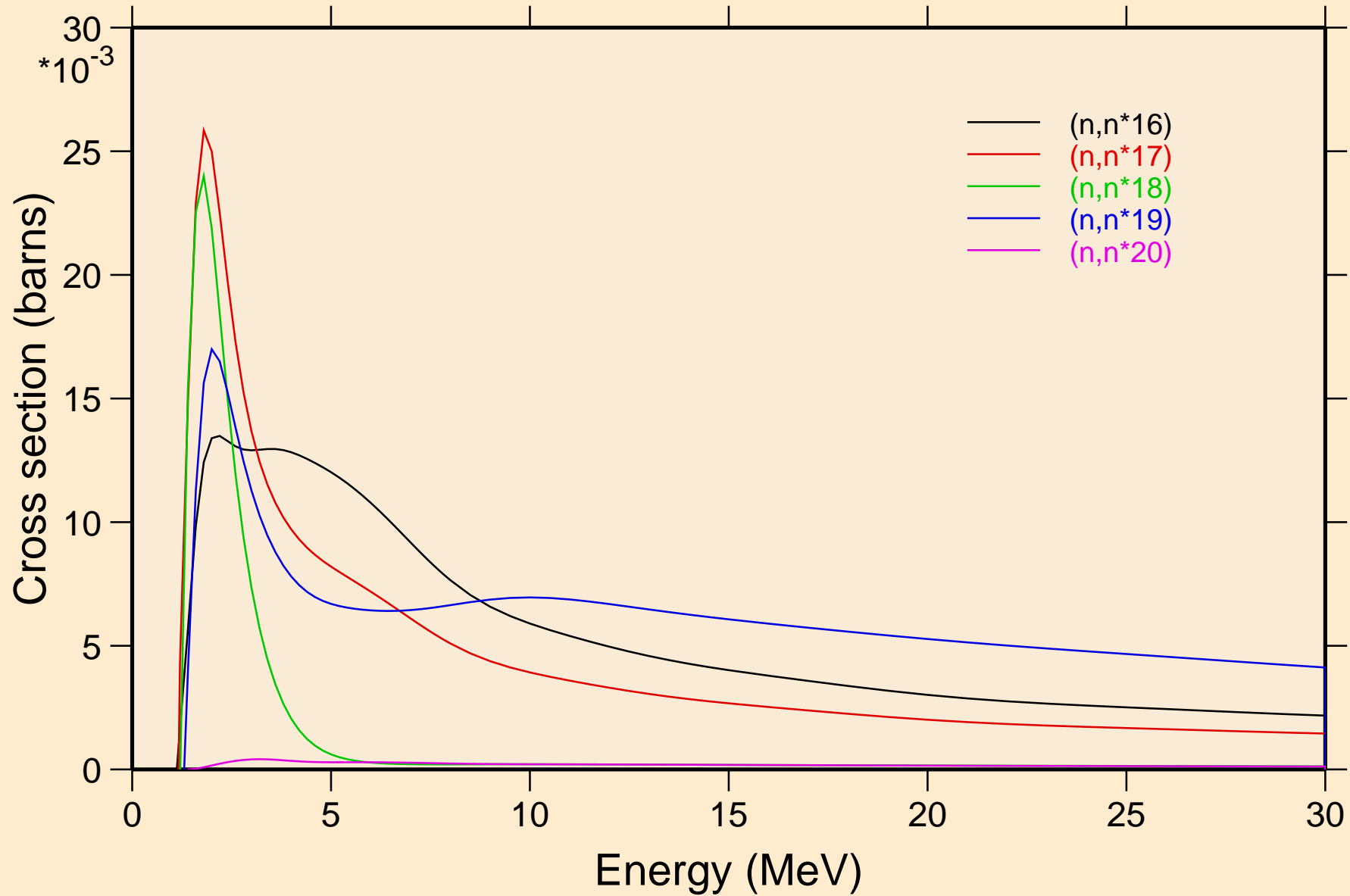

IR197 NEUTRON ACER TENDL-2024 LIBRARY; T=0.K
Inelastic levels

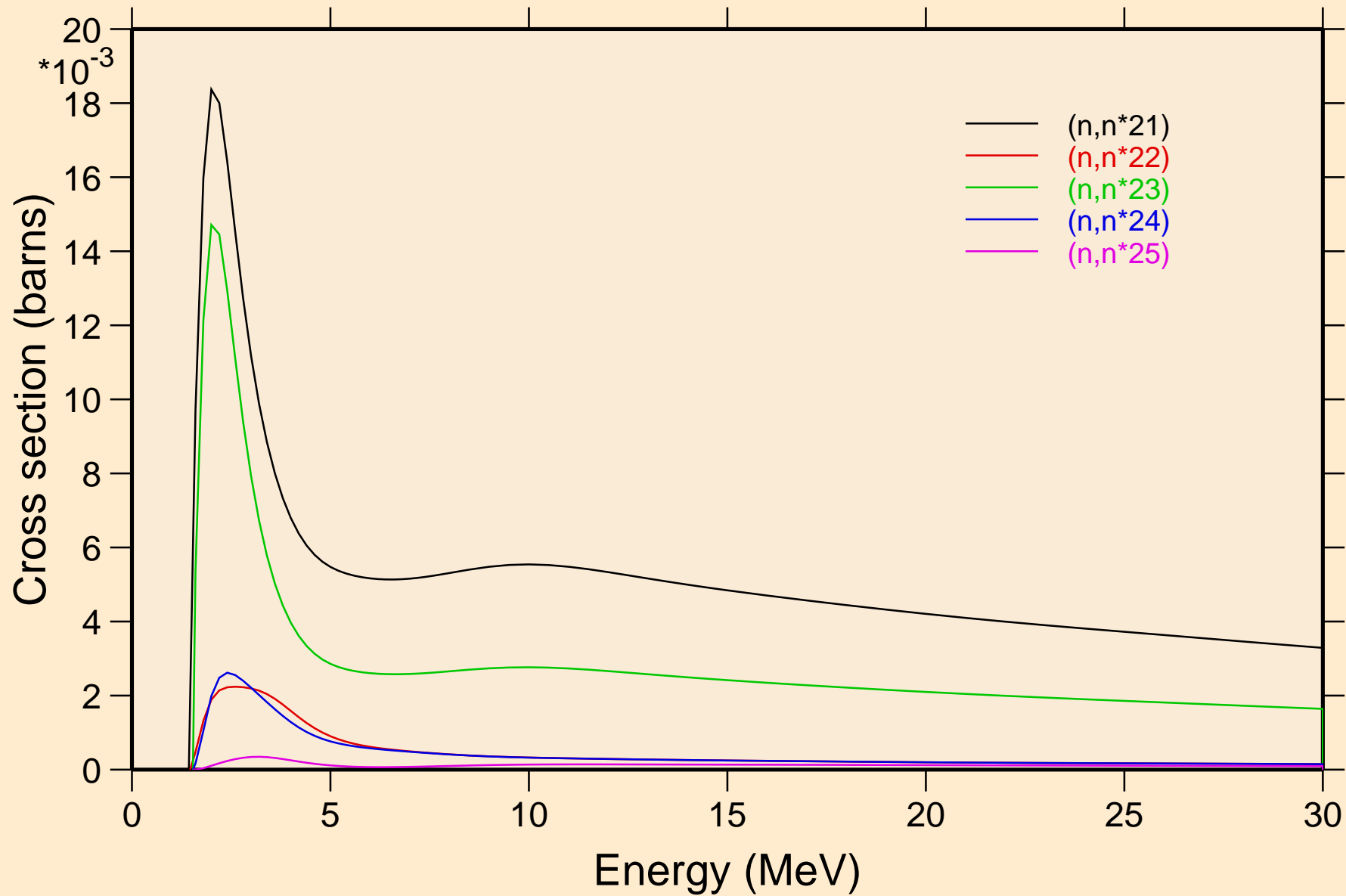

IR197 NEUTRON ACER TENDL-2024 LIBRARY; T=0.K
Inelastic levels

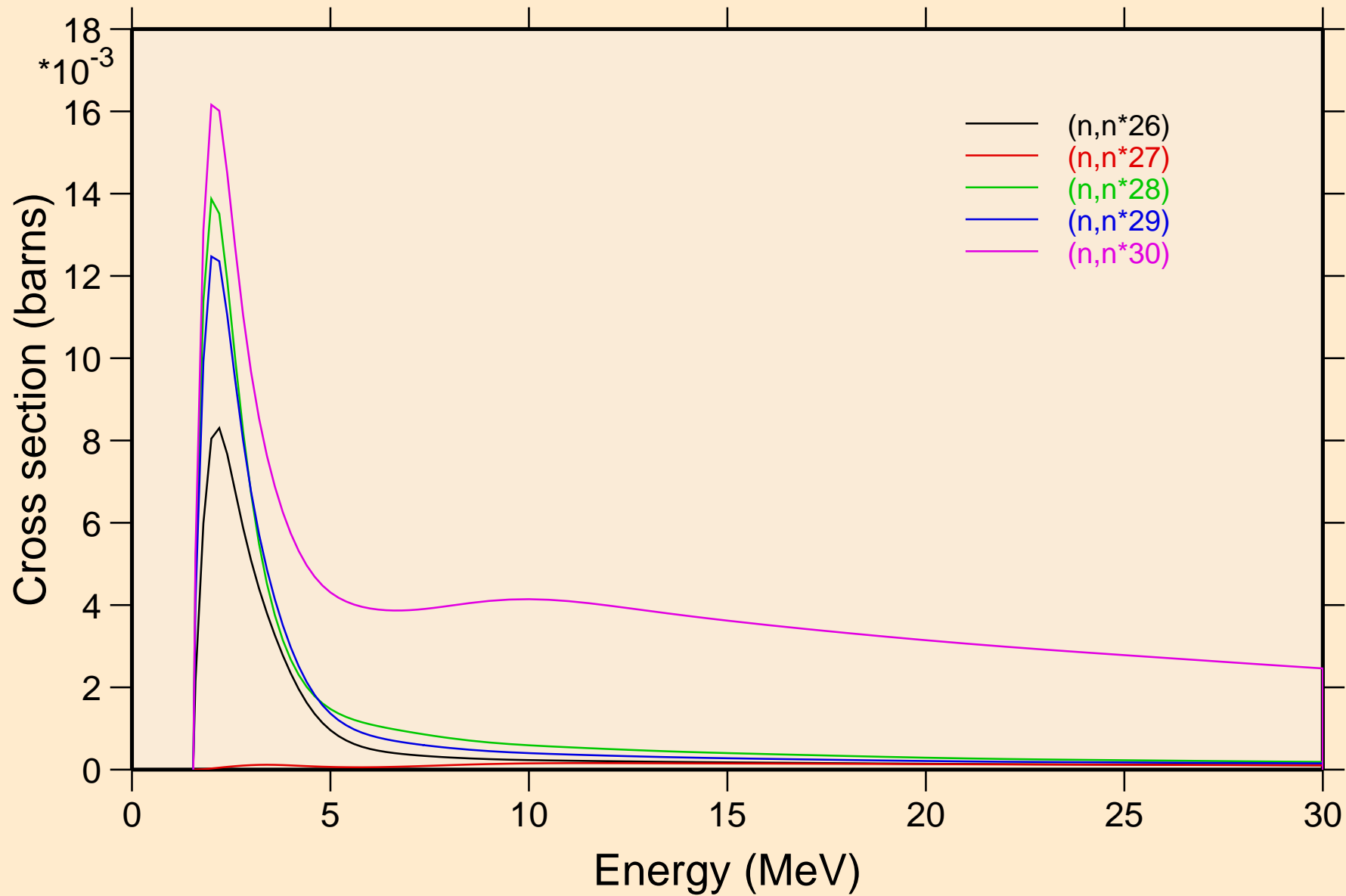

IR197 NEUTRON ACER TENDL-2024 LIBRARY; T=0.K
Threshold reactions

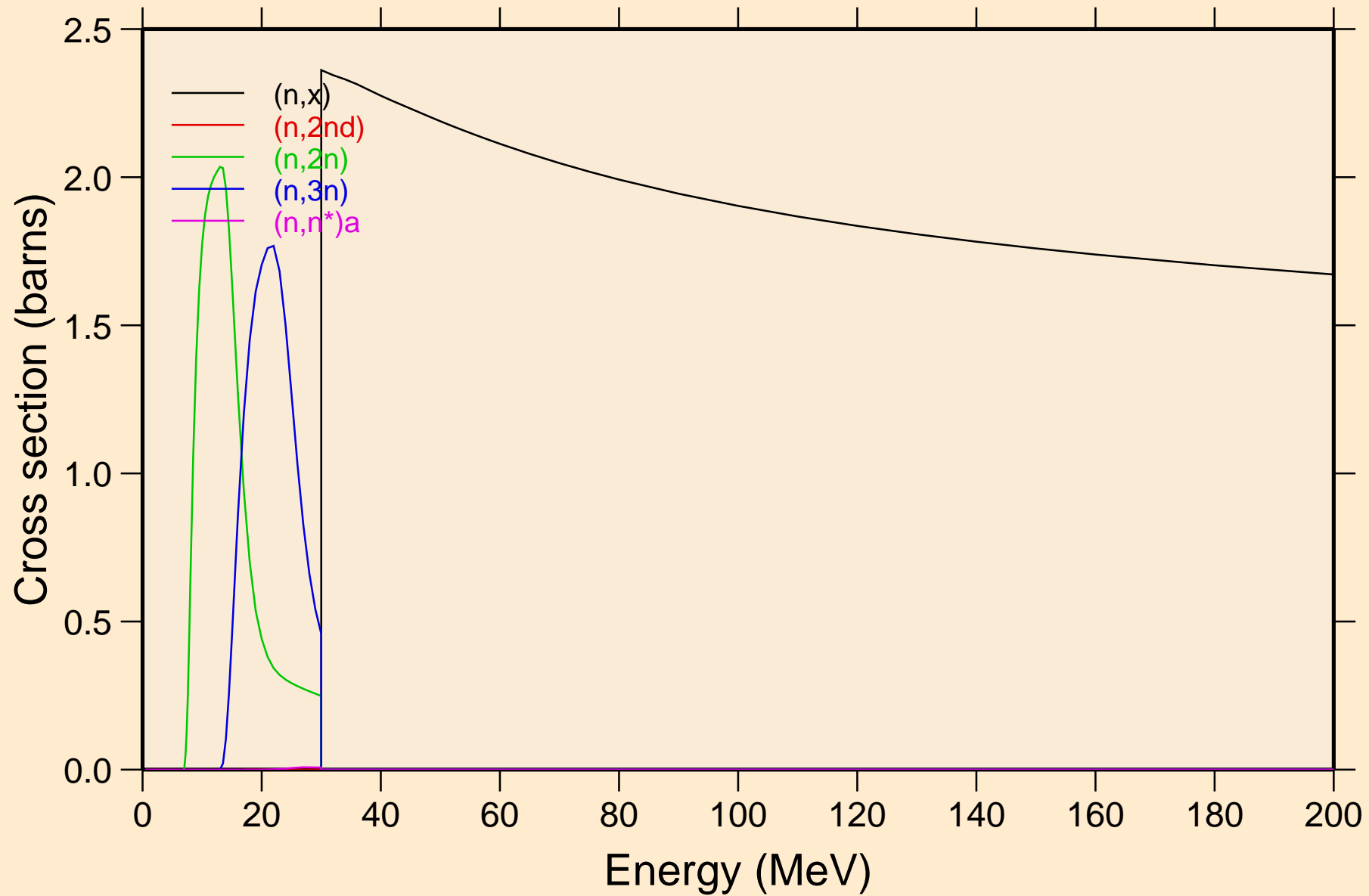

IR197 NEUTRON ACER TENDL-2024 LIBRARY; T=0.K
Threshold reactions

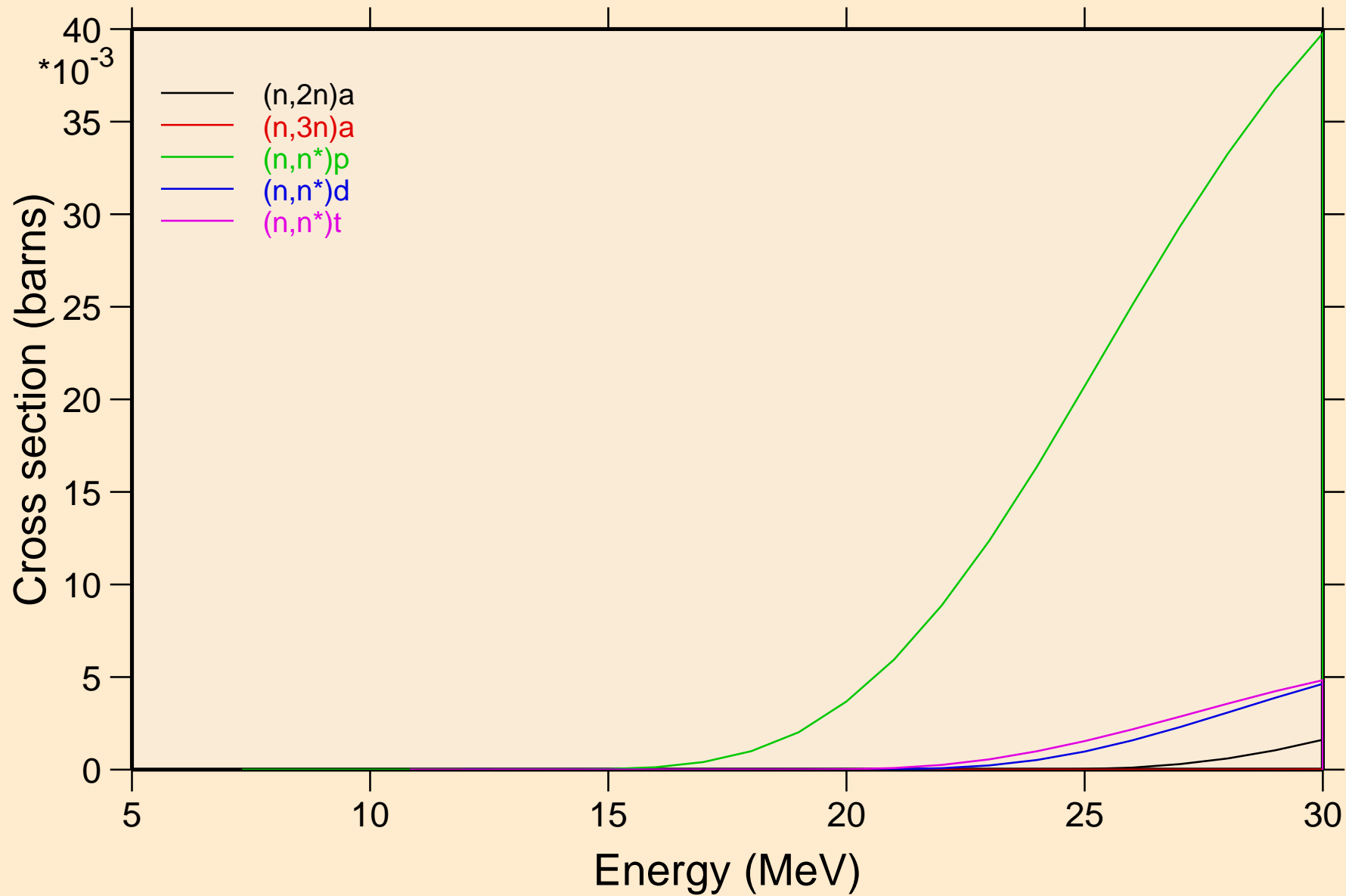

IR197 NEUTRON ACER TENDL-2024 LIBRARY; T=0.K
Threshold reactions

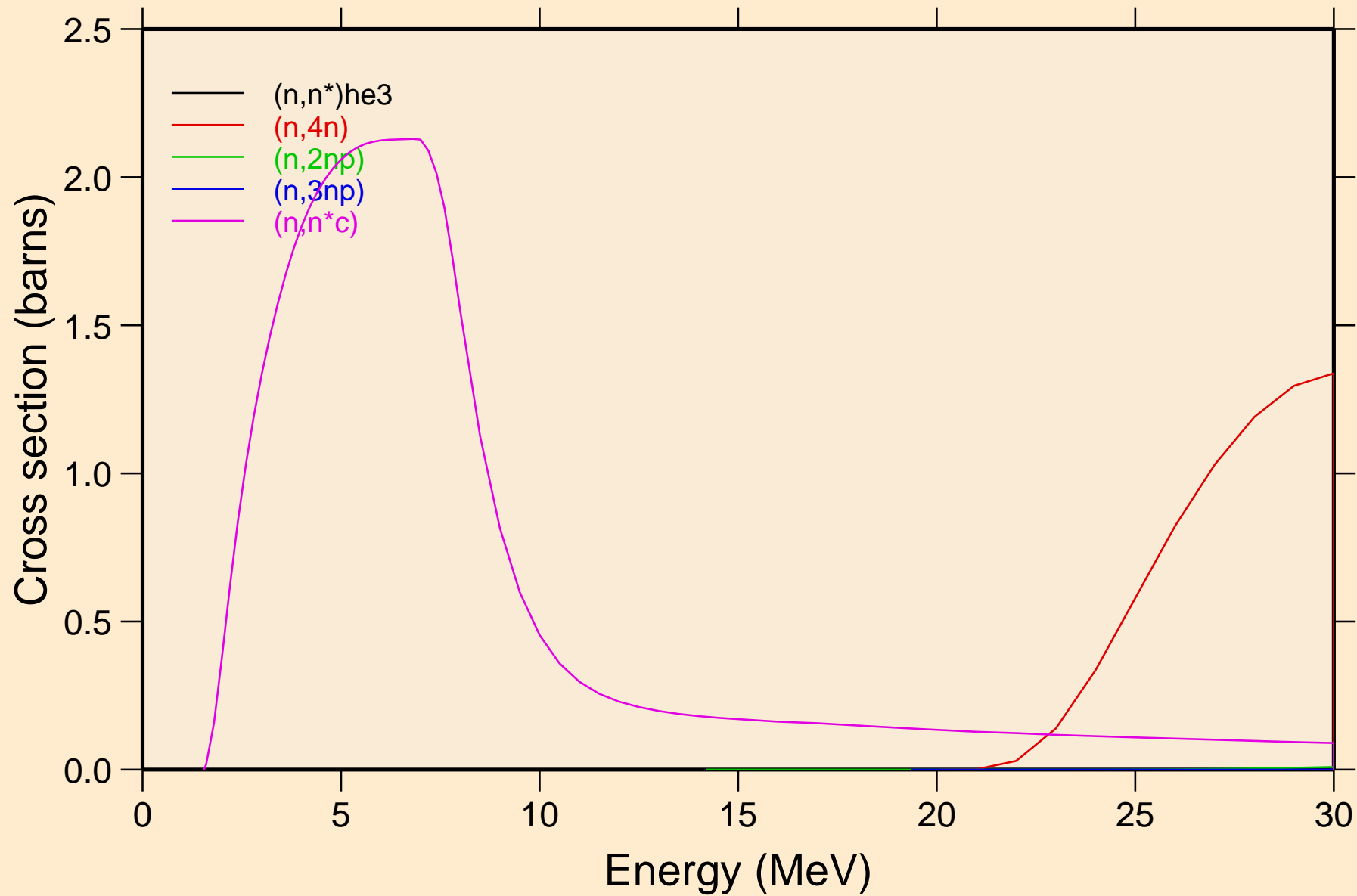

IR197 NEUTRON ACER TENDL-2024 LIBRARY; T=0.K
Threshold reactions

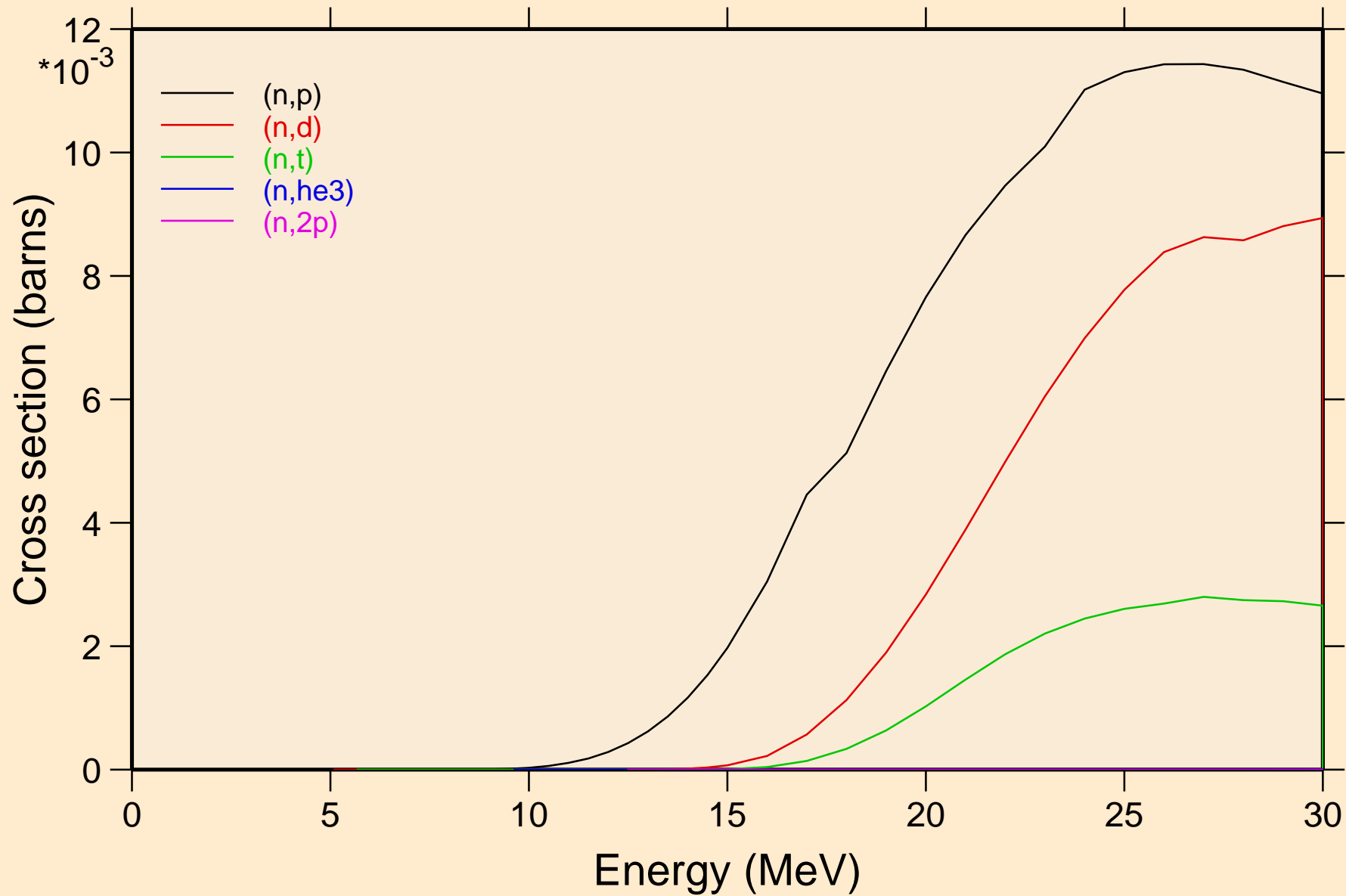

IR197 NEUTRON ACER TENDL-2024 LIBRARY; T=0.K

Threshold reactions

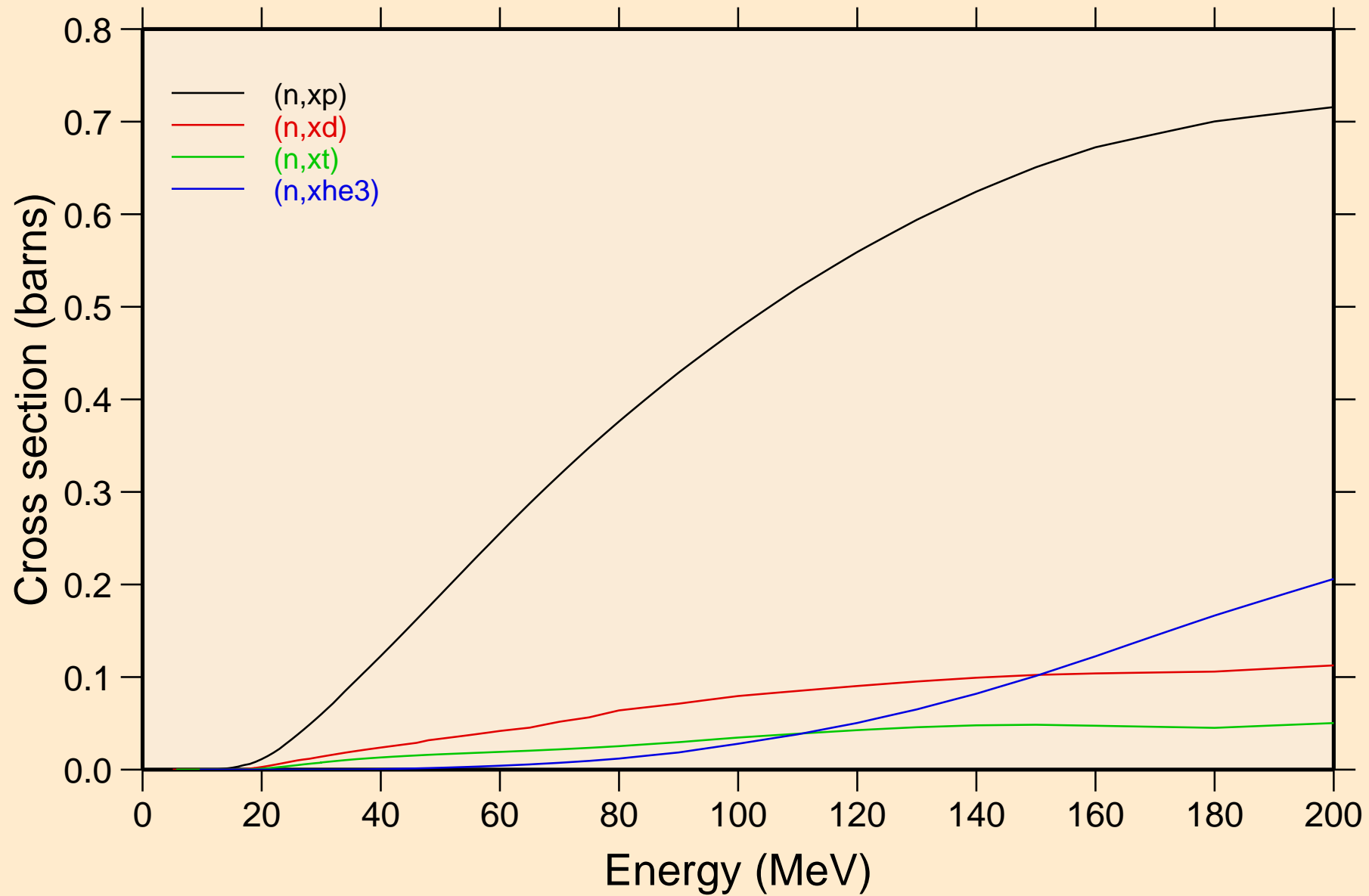

IR197 NEUTRON ACER TENDL-2024 LIBRARY; T=0.K
angular distribution for elastic

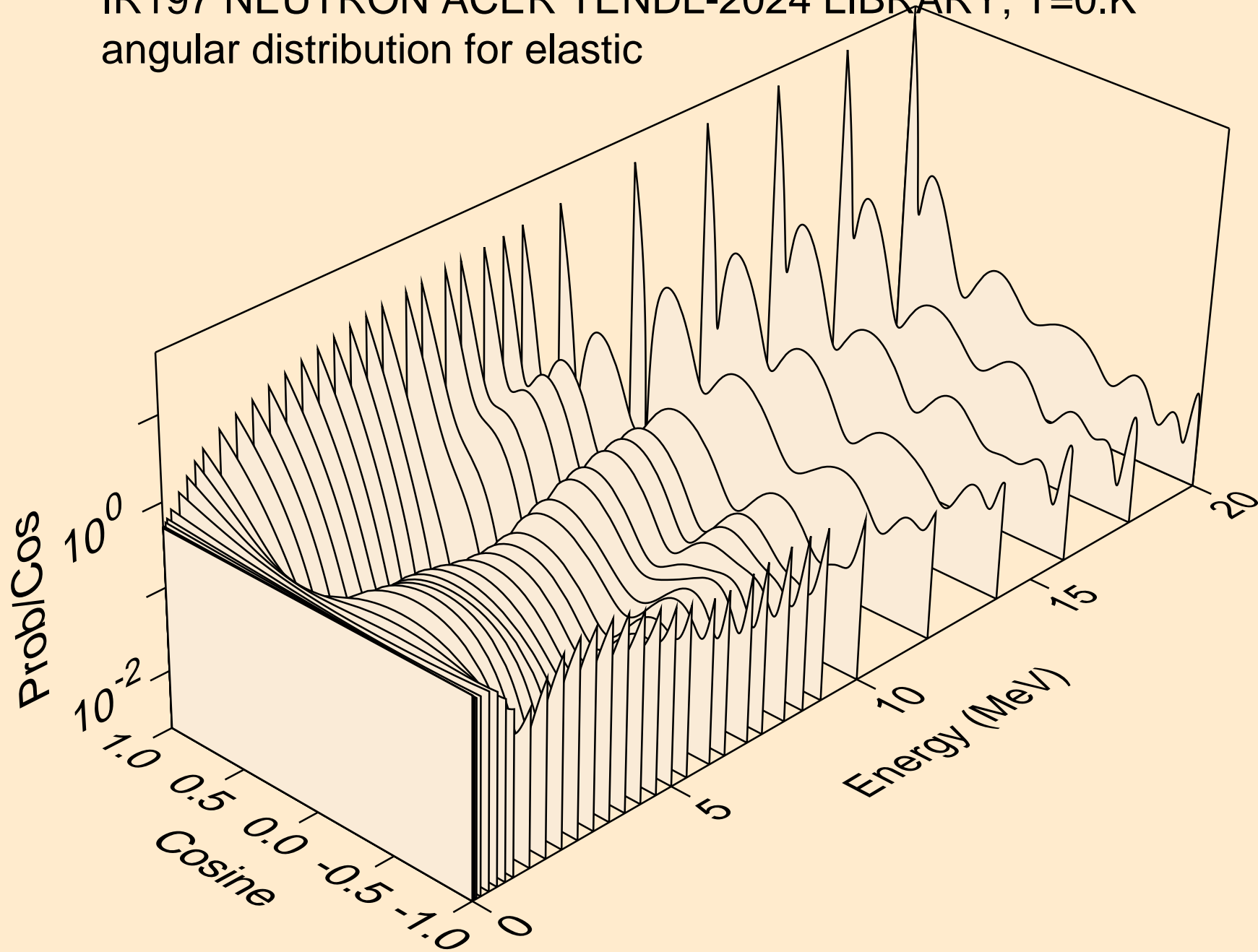

IR197 NEUTRON ACER TENDL-2024 LIBRARY; T=0.K
angular distribution for elastic

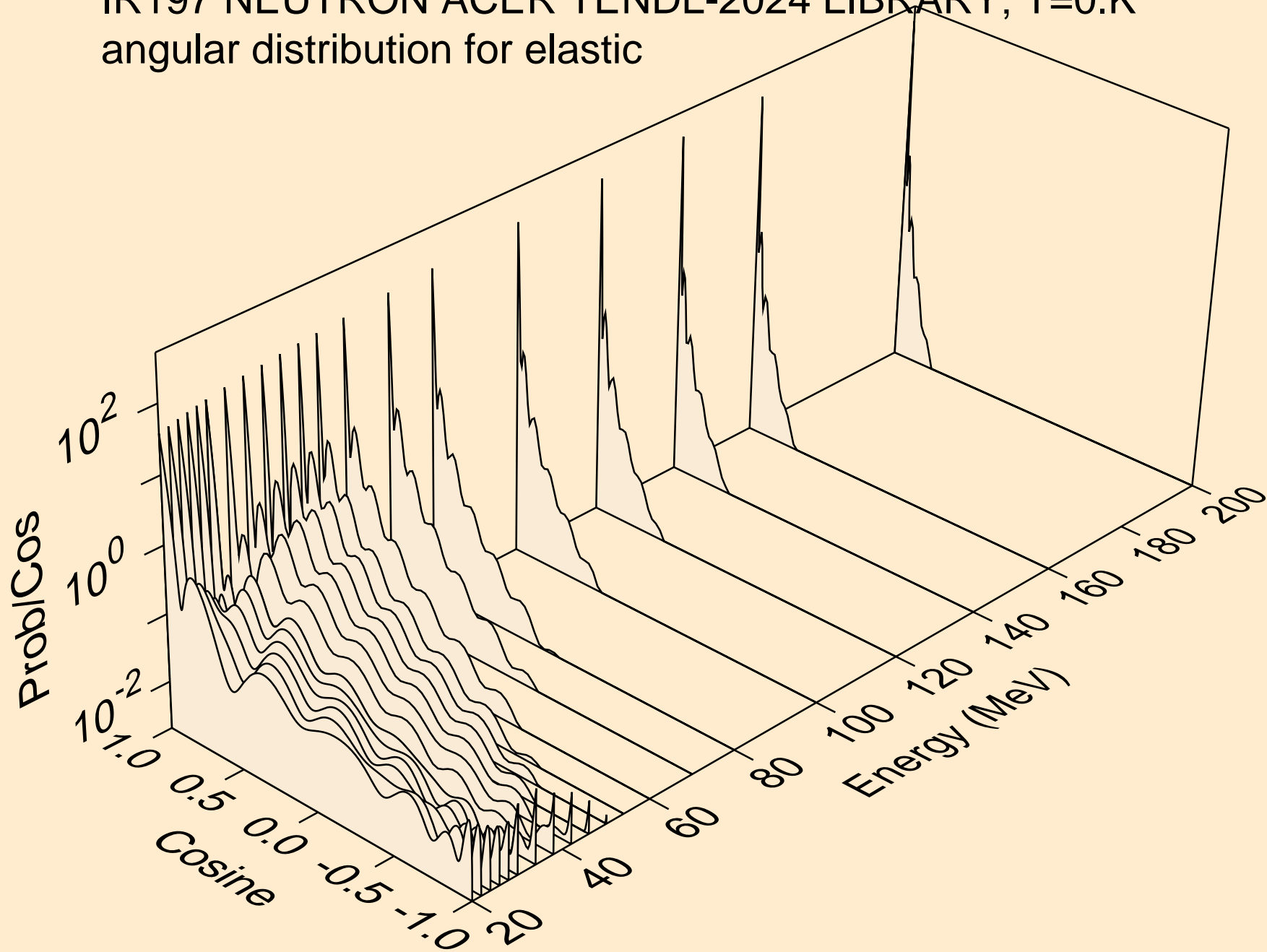

IR197 NEUTRON ACER TENDL-2024 LIBRARY; T=0.K
angular distribution for (n,n*1)

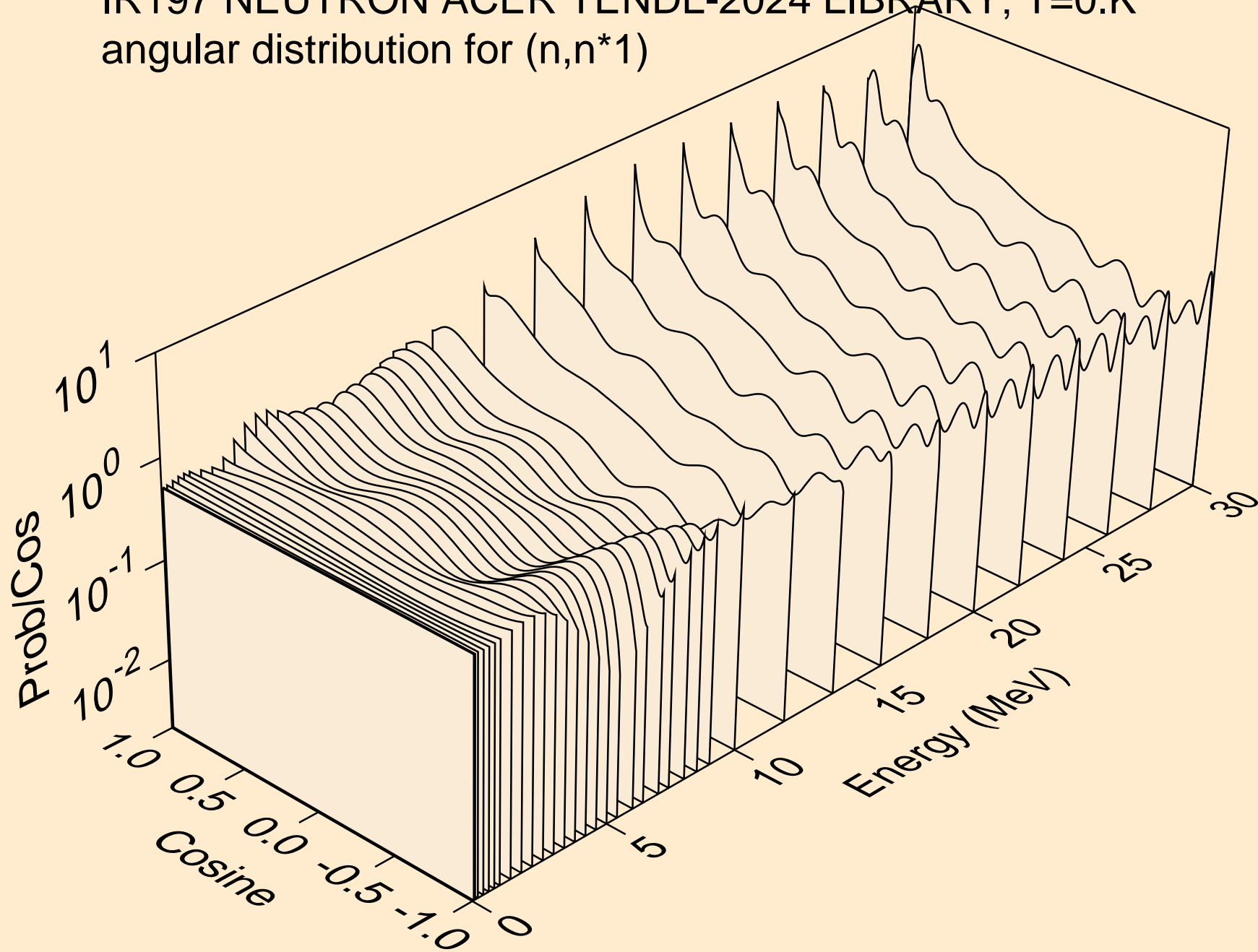

IR197 NEUTRON ACER TENDL-2024 LIBRARY; T=0.K
angular distribution for (n,n*2)

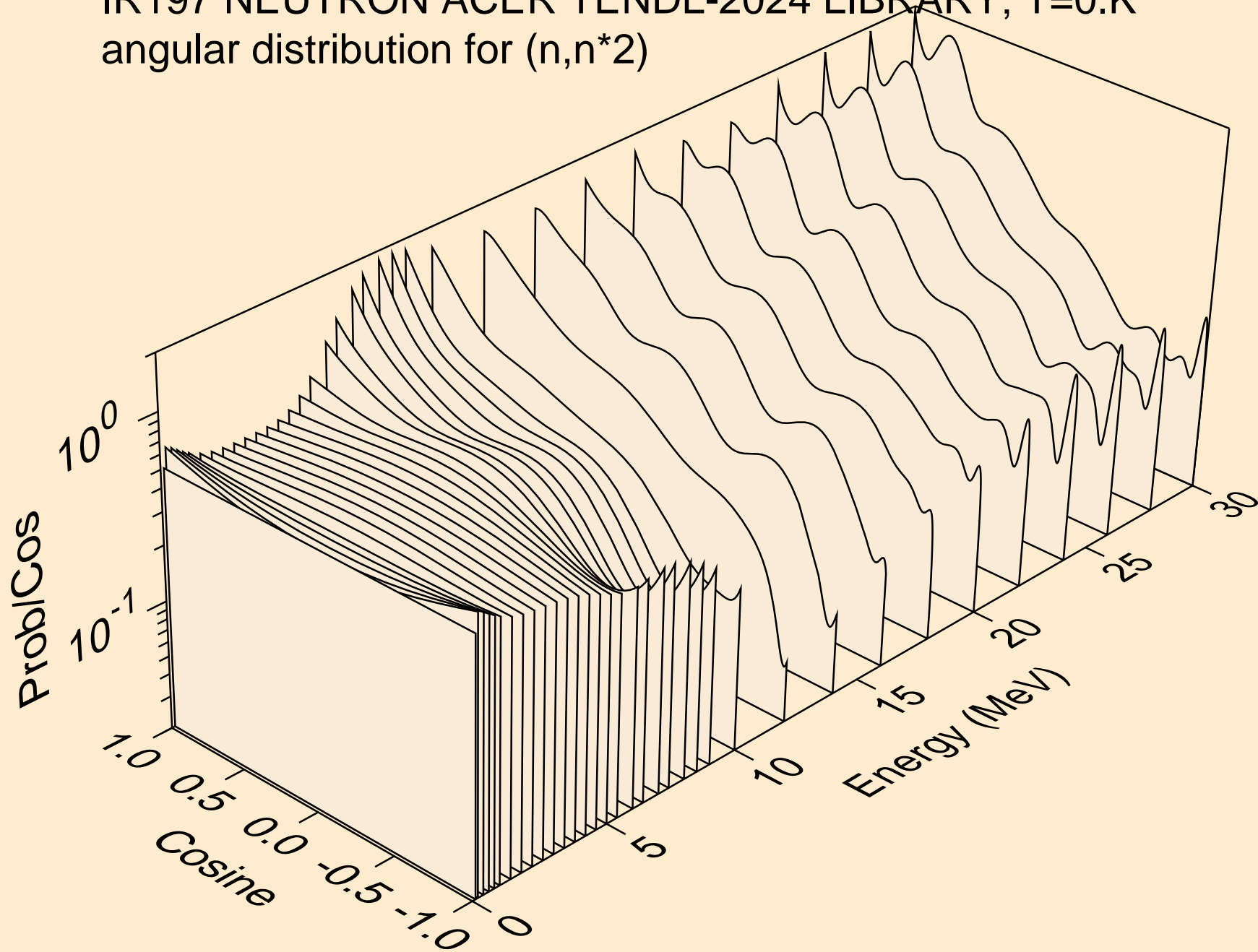

IR197 NEUTRON ACER TENDL-2024 LIBRARY; T=0.K
angular distribution for (n,n*3)

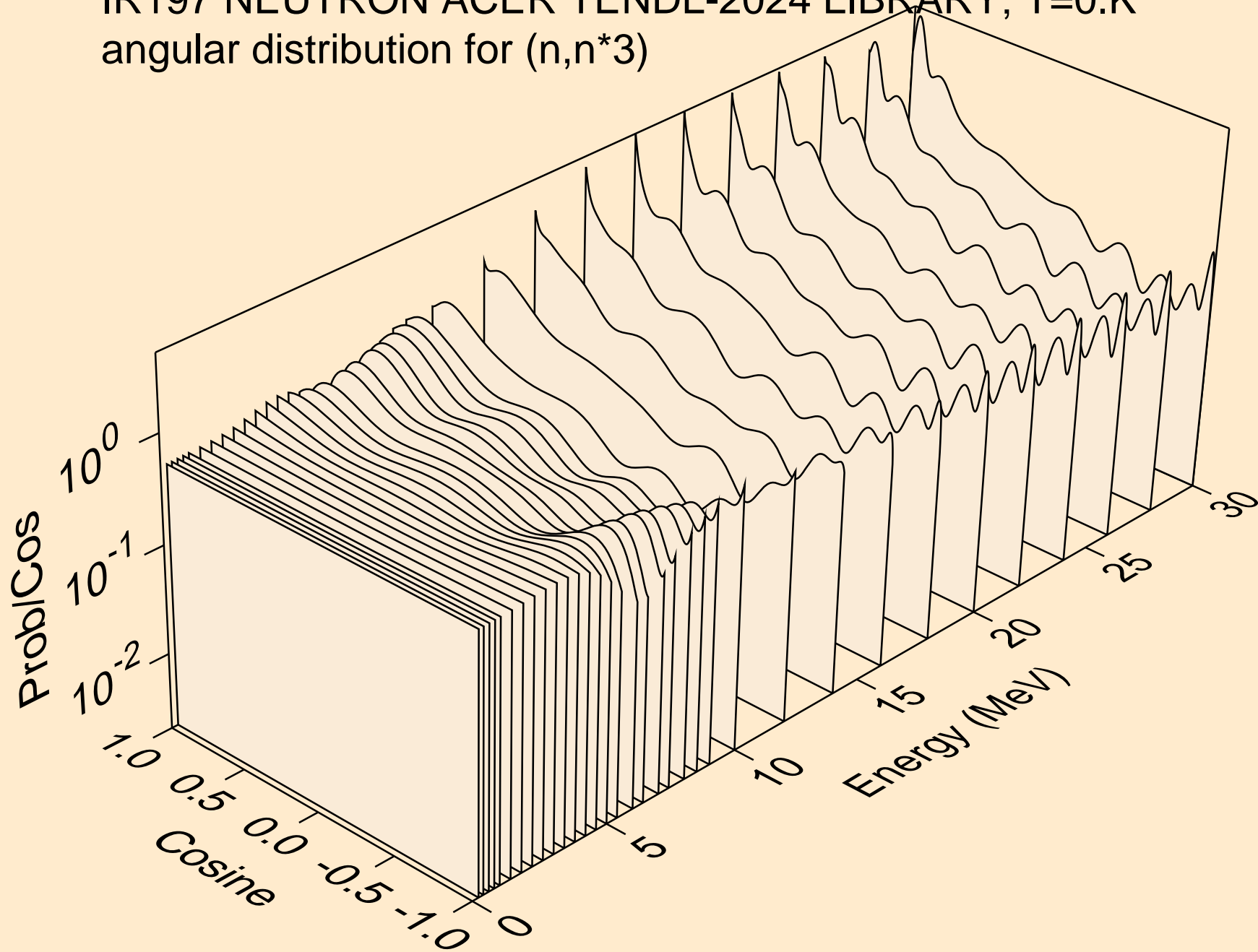

IR197 NEUTRON ACER TENDL-2024 LIBRARY; T=0.K
angular distribution for (n,n*4)

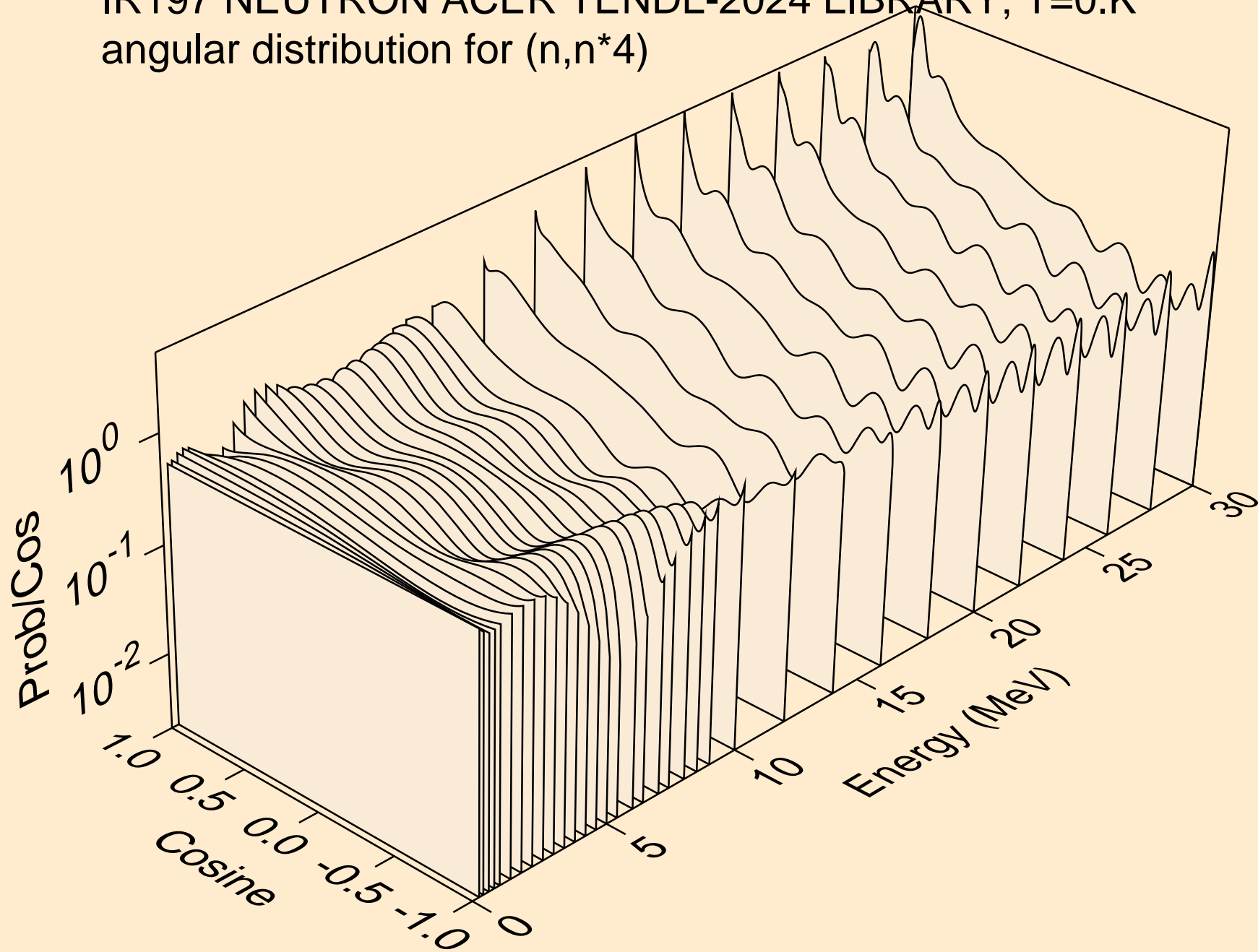

IR197 NEUTRON ACER TENDL-2024 LIBRARY; T=0.K
angular distribution for (n,n*5)

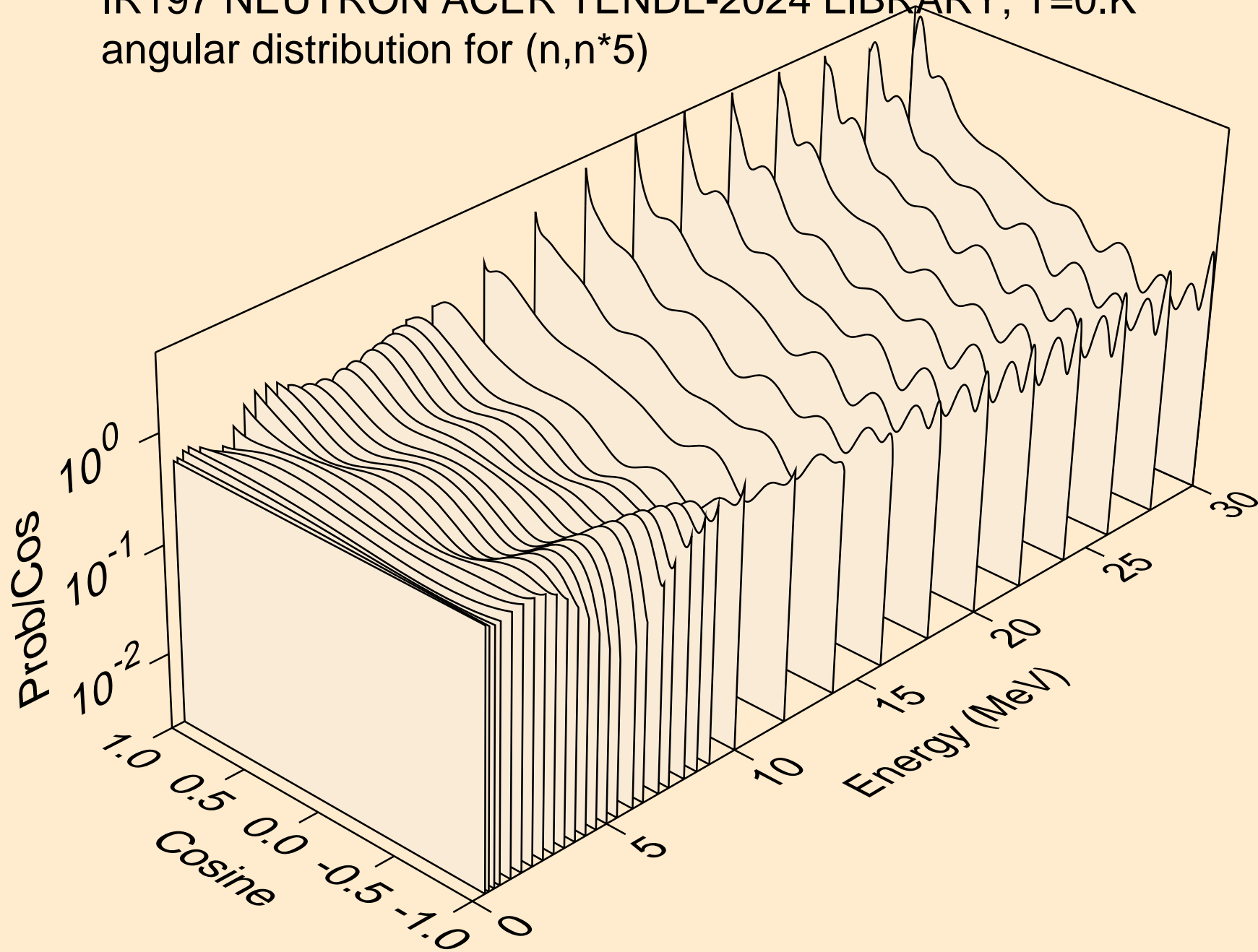

IR197 NEUTRON ACER TENDL-2024 LIBRARY; T=0.K
angular distribution for (n,n*6)

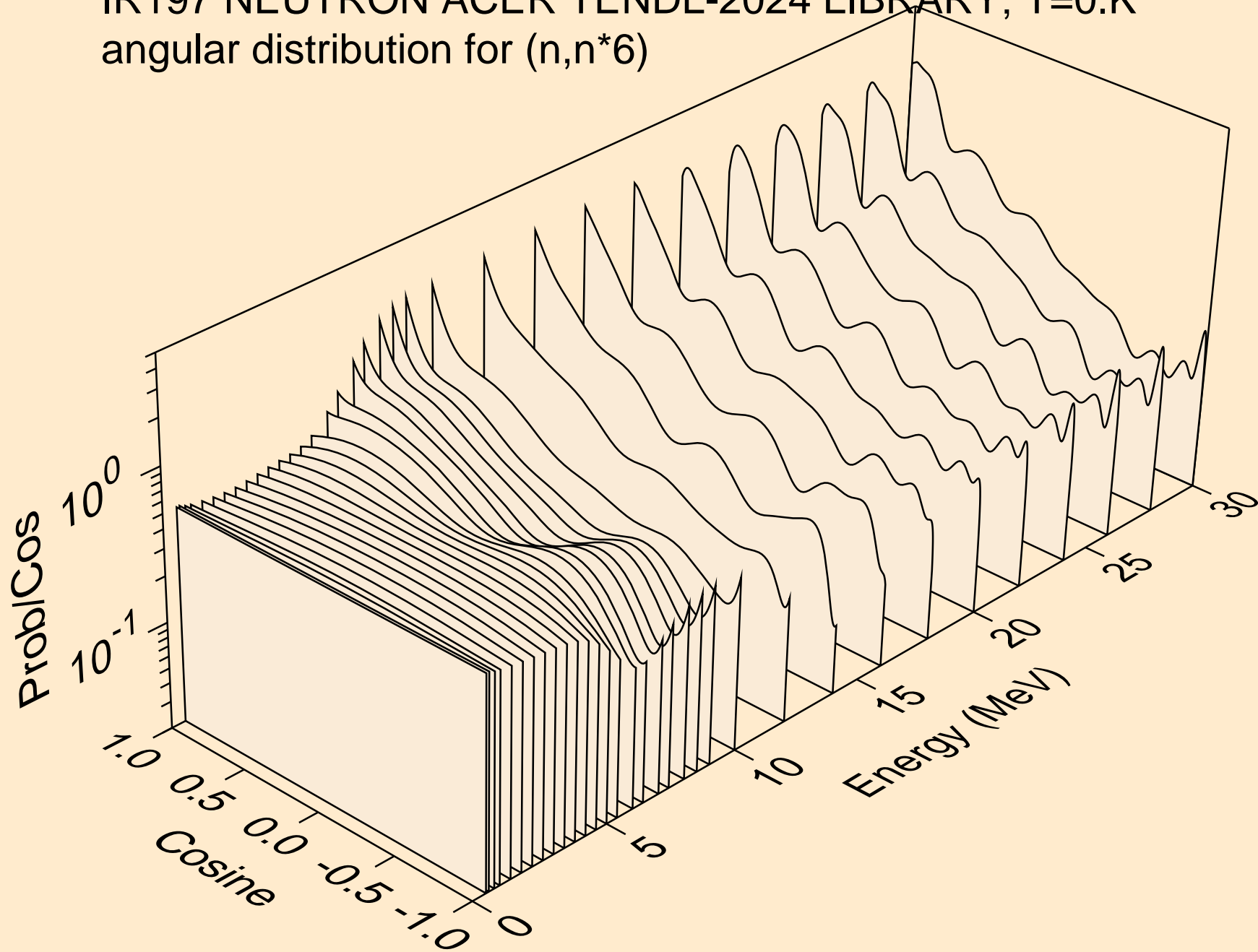

IR197 NEUTRON ACER TENDL-2024 LIBRARY; T=0.K
angular distribution for (n,n*7)

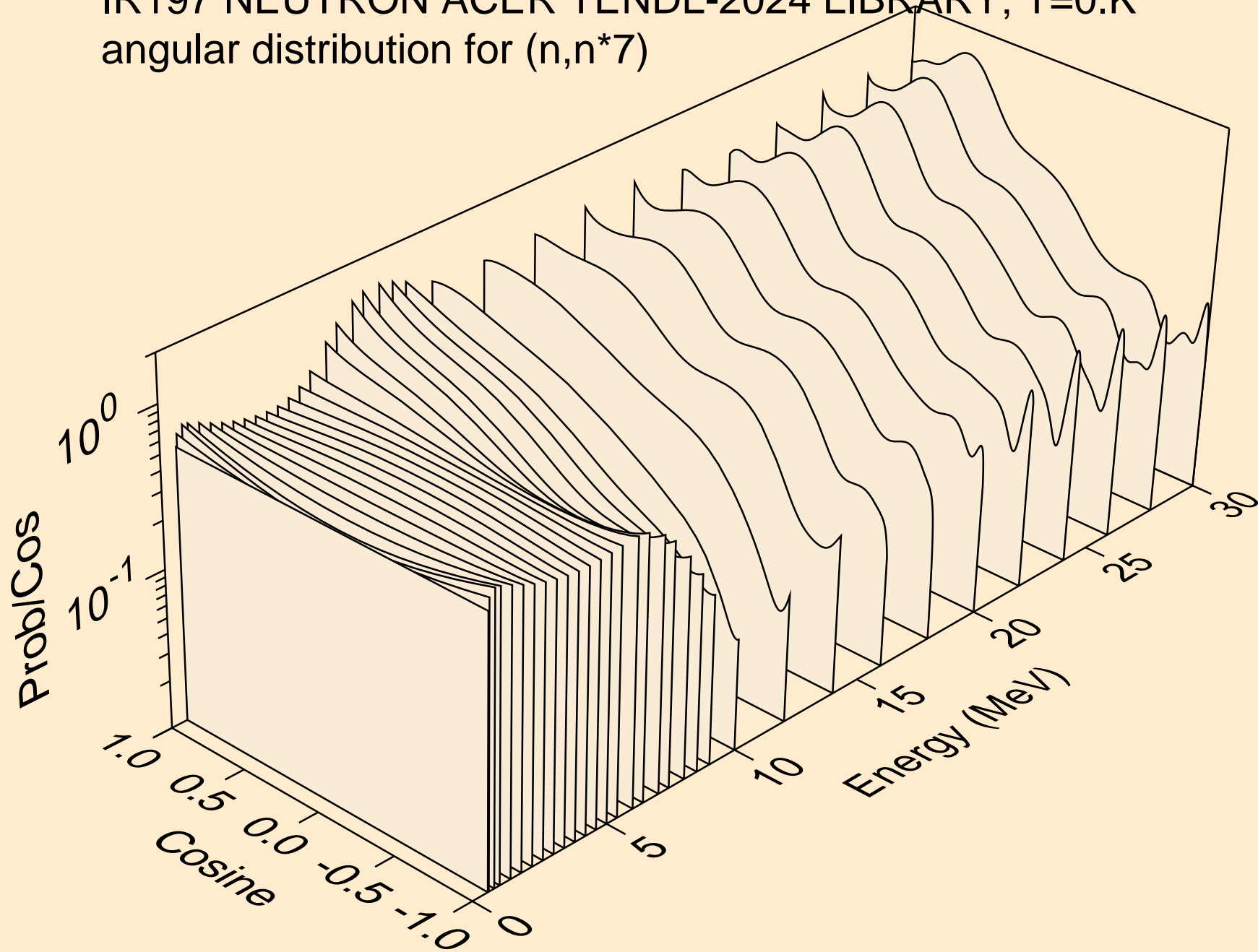

IR197 NEUTRON ACER TENDL-2024 LIBRARY; T=0.K
angular distribution for (n,n*8)

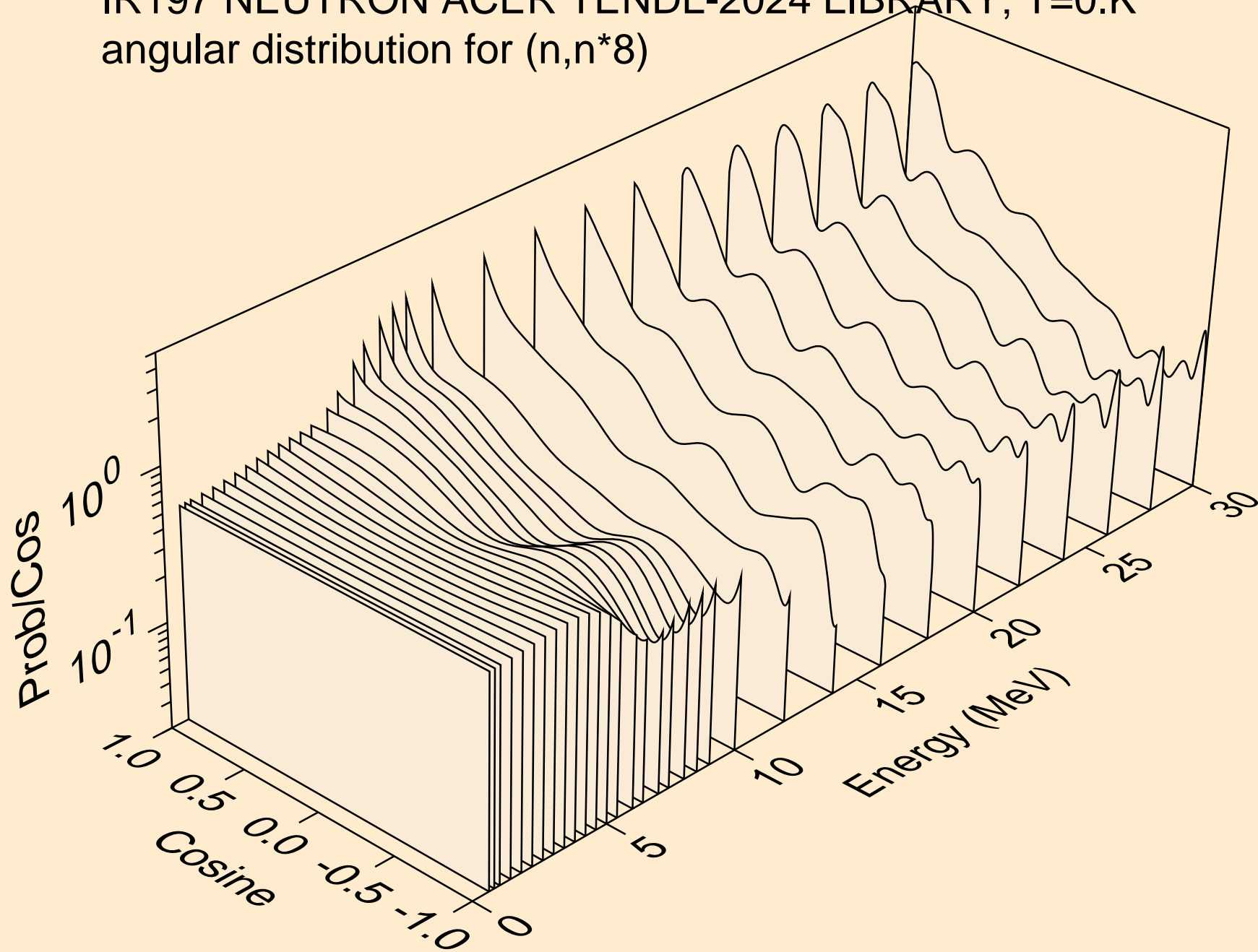

IR197 NEUTRON ACER TENDL-2024 LIBRARY; T=0.K
angular distribution for (n,n*9)

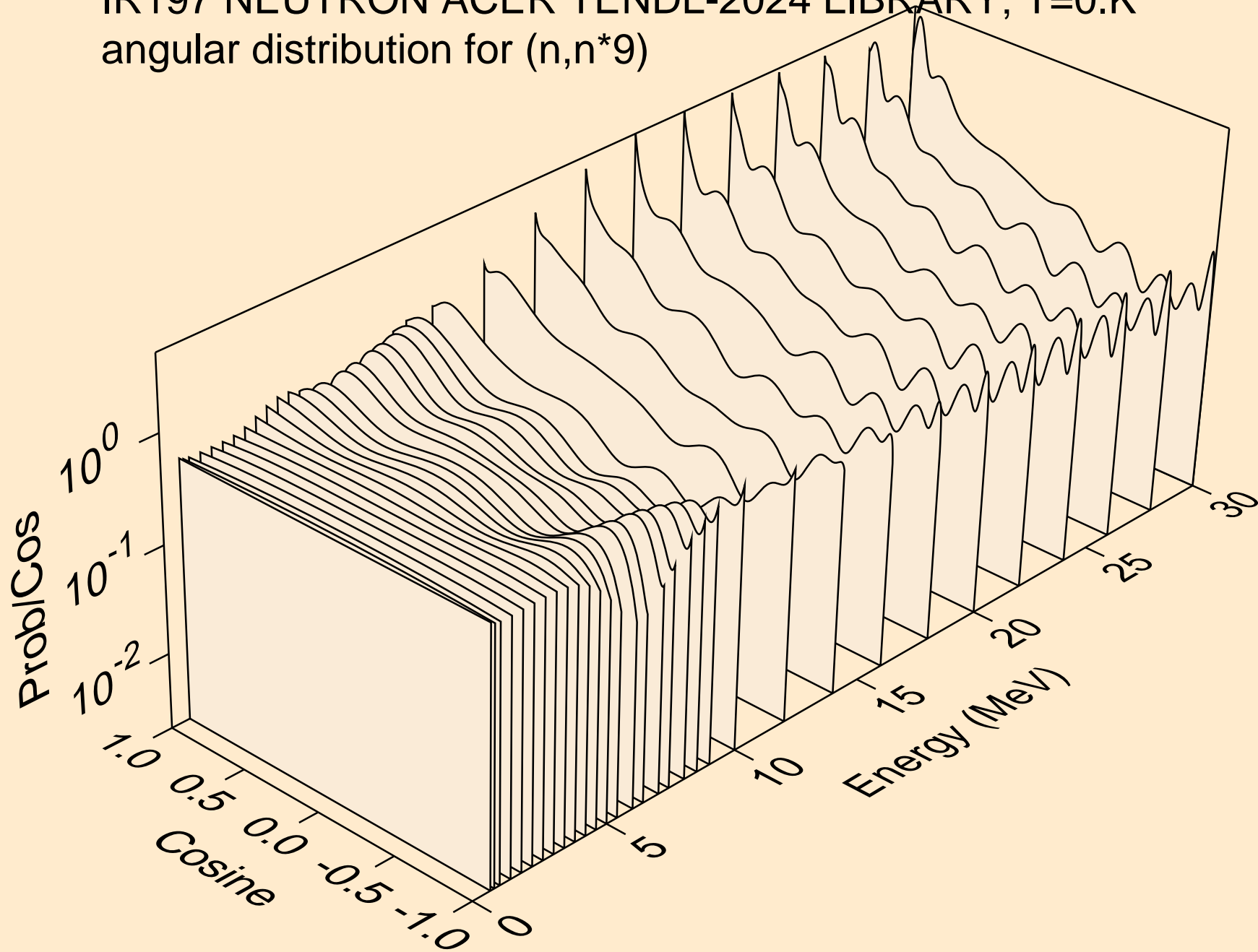

IR197 NEUTRON ACER TENDL-2024 LIBRARY; T=0.K
angular distribution for (n,n*10)

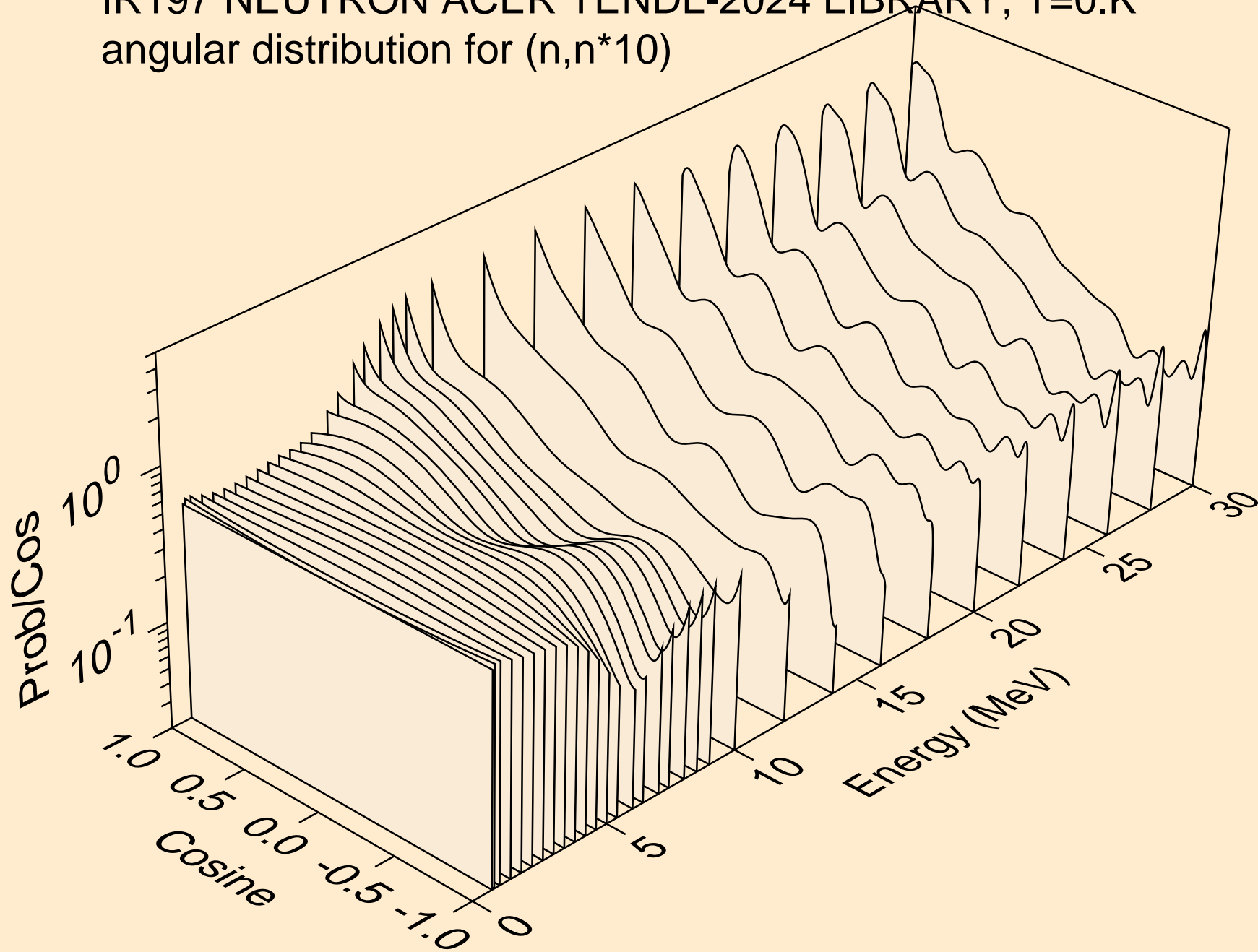

IR197 NEUTRON ACER TENDL-2024 LIBRARY; T=0.K
angular distribution for (n,n*11)

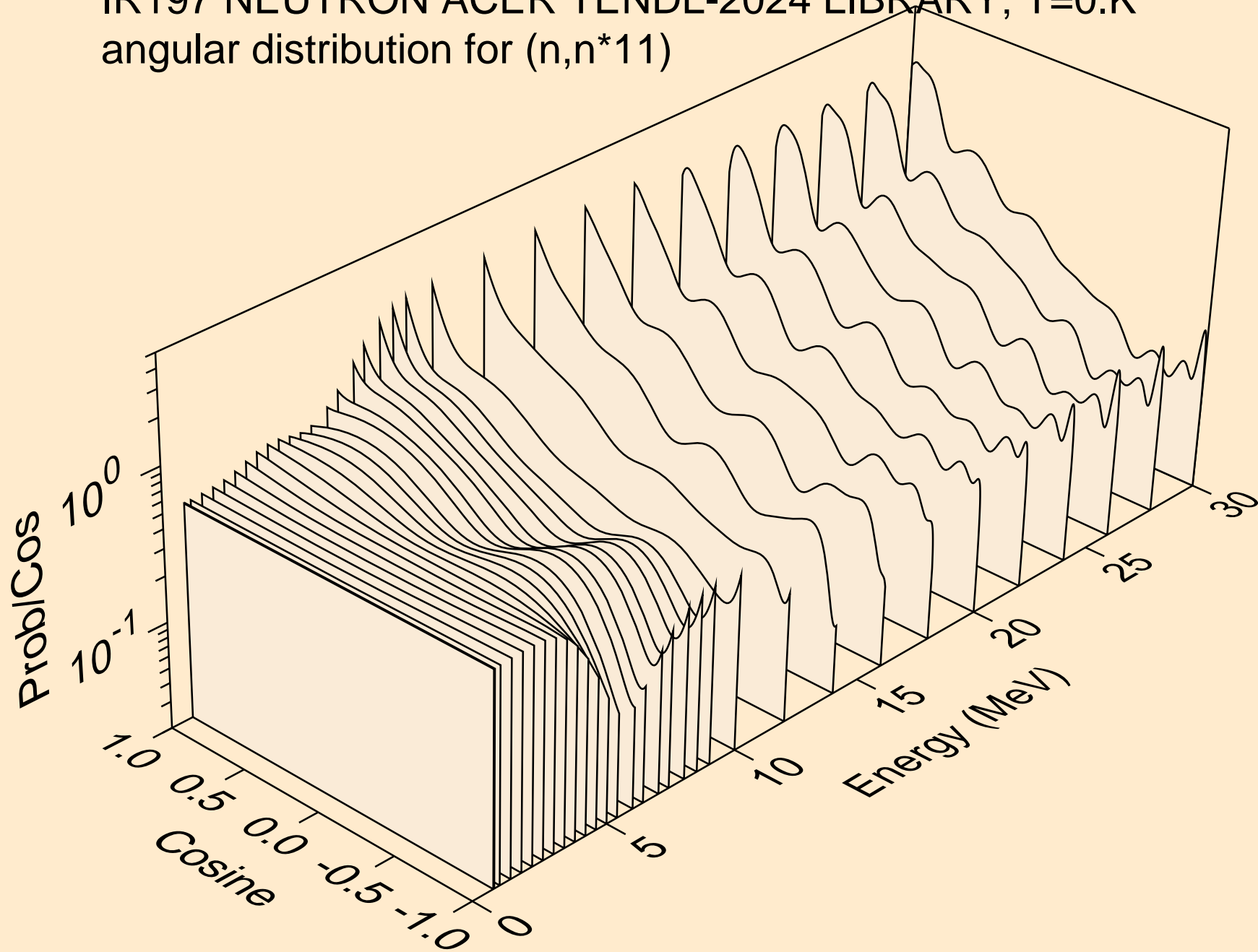

IR197 NEUTRON ACER TENDL-2024 LIBRARY; T=0.K
angular distribution for (n,n*12)

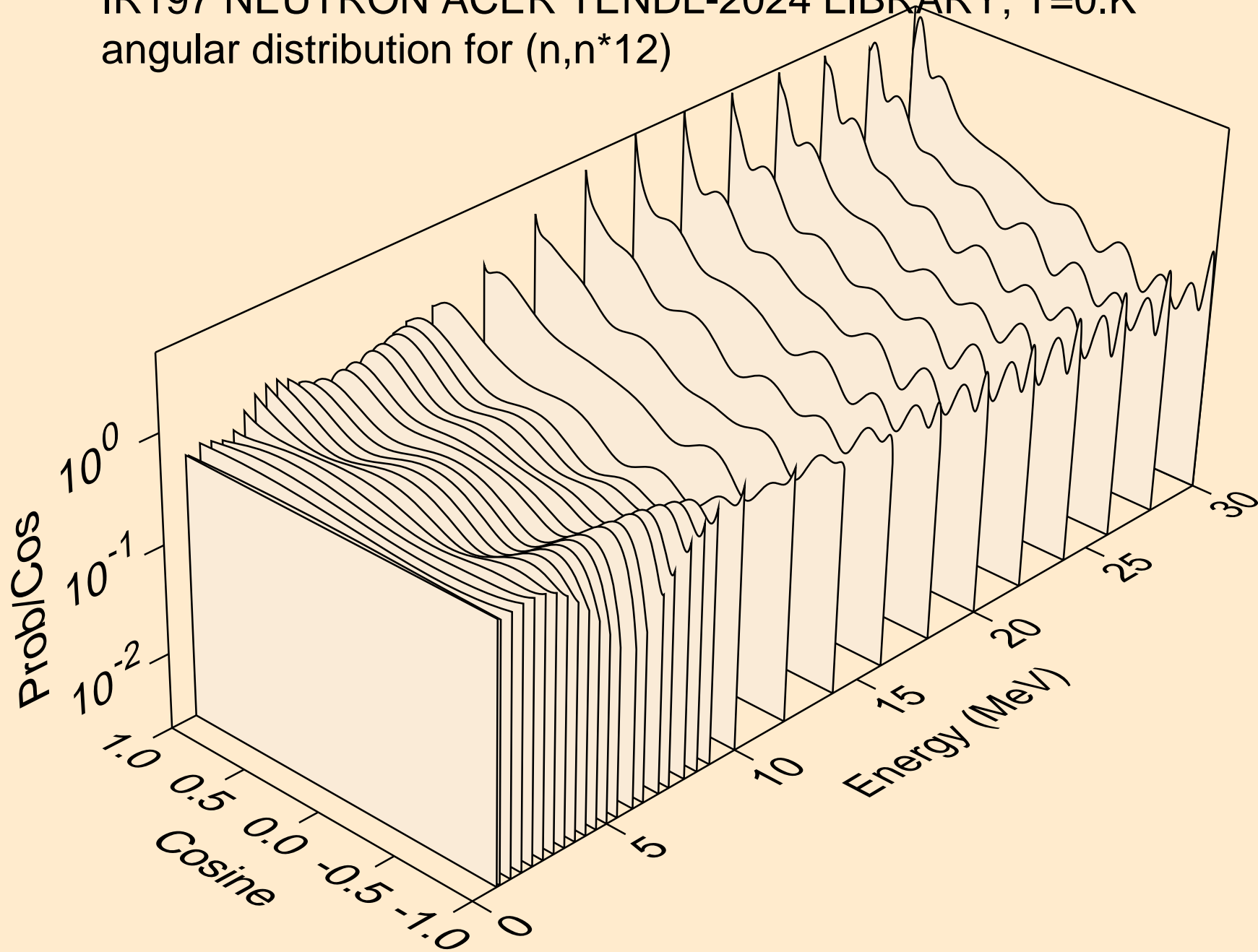

IR197 NEUTRON ACER TENDL-2024 LIBRARY; T=0.K
angular distribution for (n,n*13)

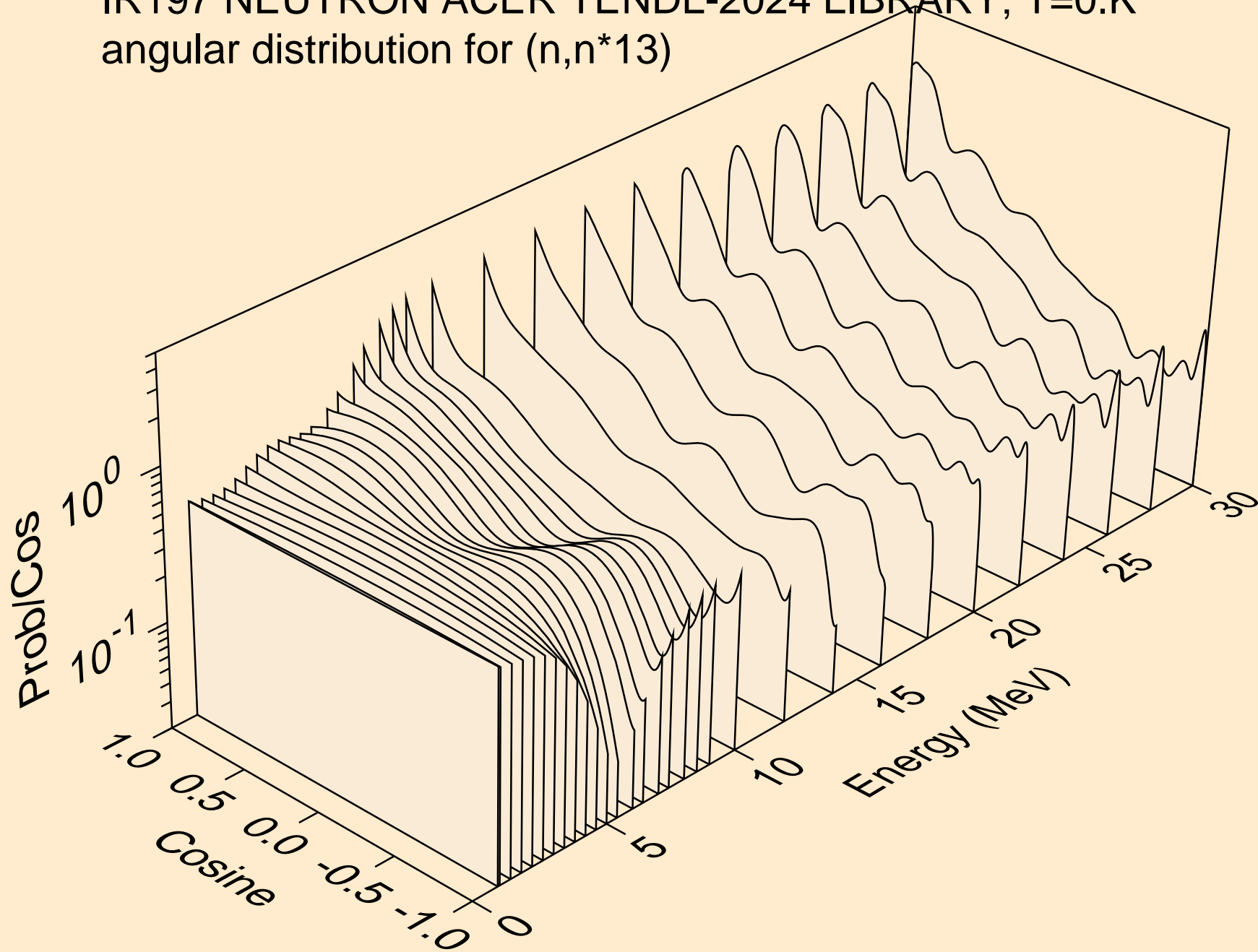

IR197 NEUTRON ACER TENDL-2024 LIBRARY; T=0.K
angular distribution for (n,n*14)

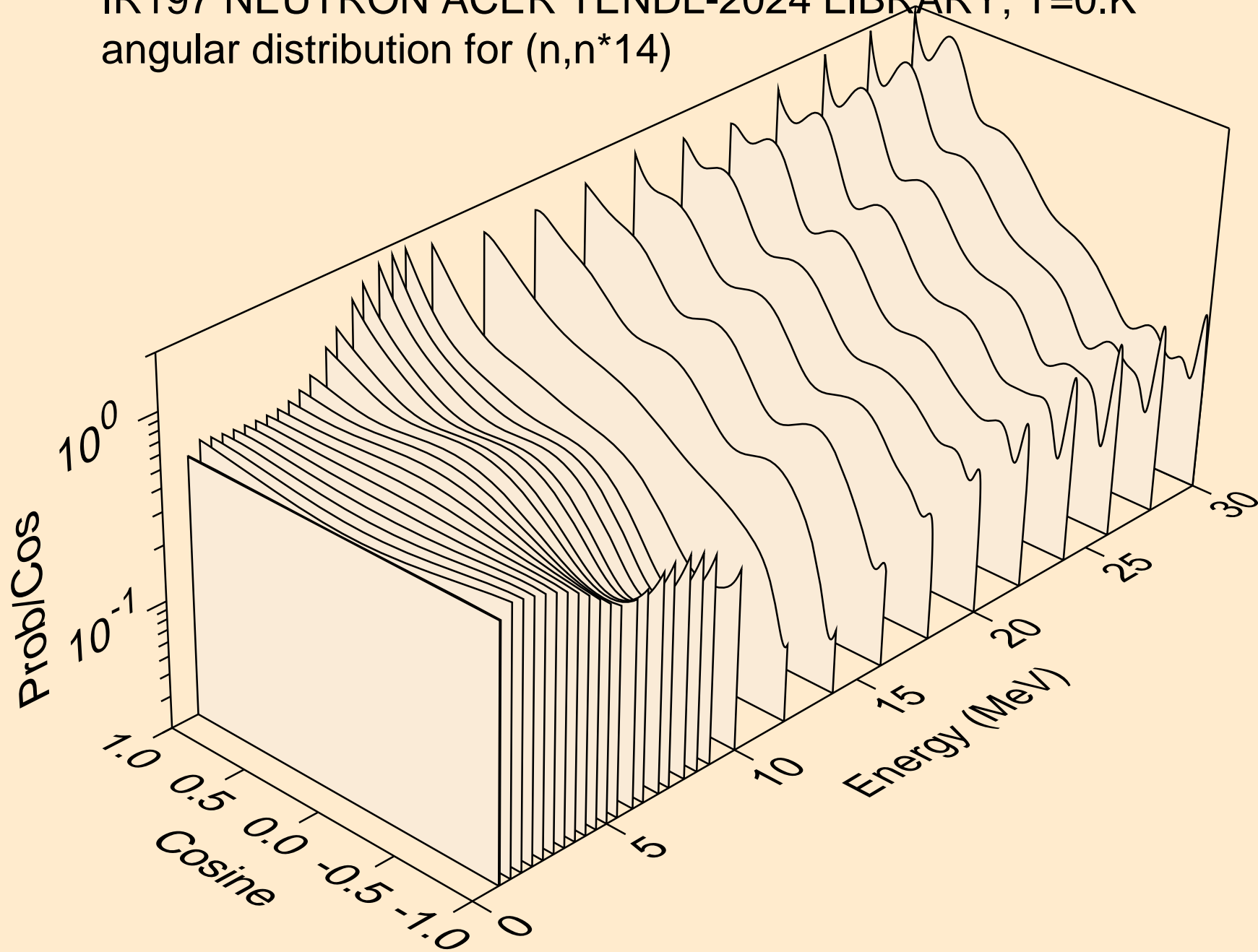

IR197 NEUTRON ACER TENDL-2024 LIBRARY; T=0.K
angular distribution for (n,n*15)

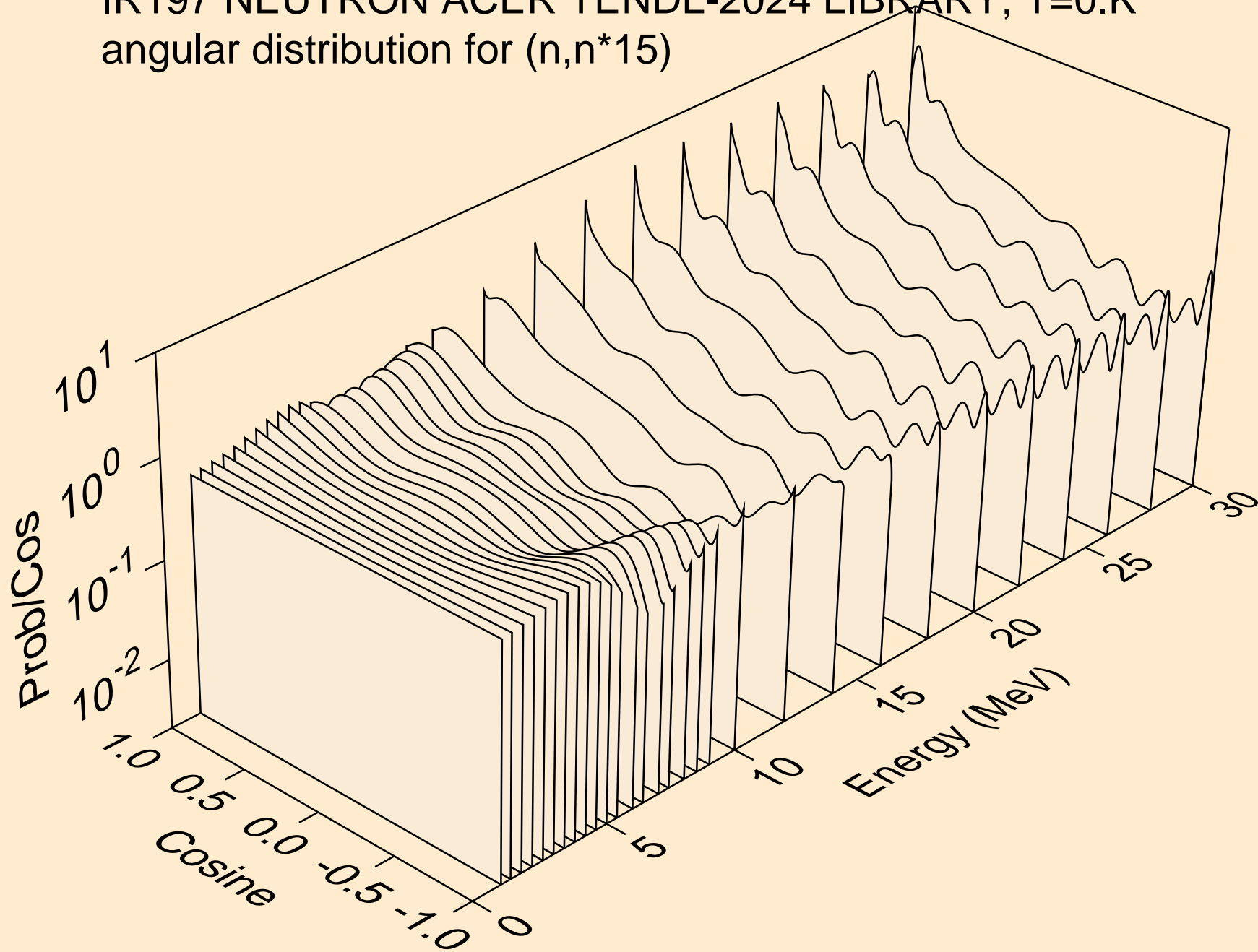

IR197 NEUTRON ACER TENDL-2024 LIBRARY; T=0.K
angular distribution for (n,n*16)

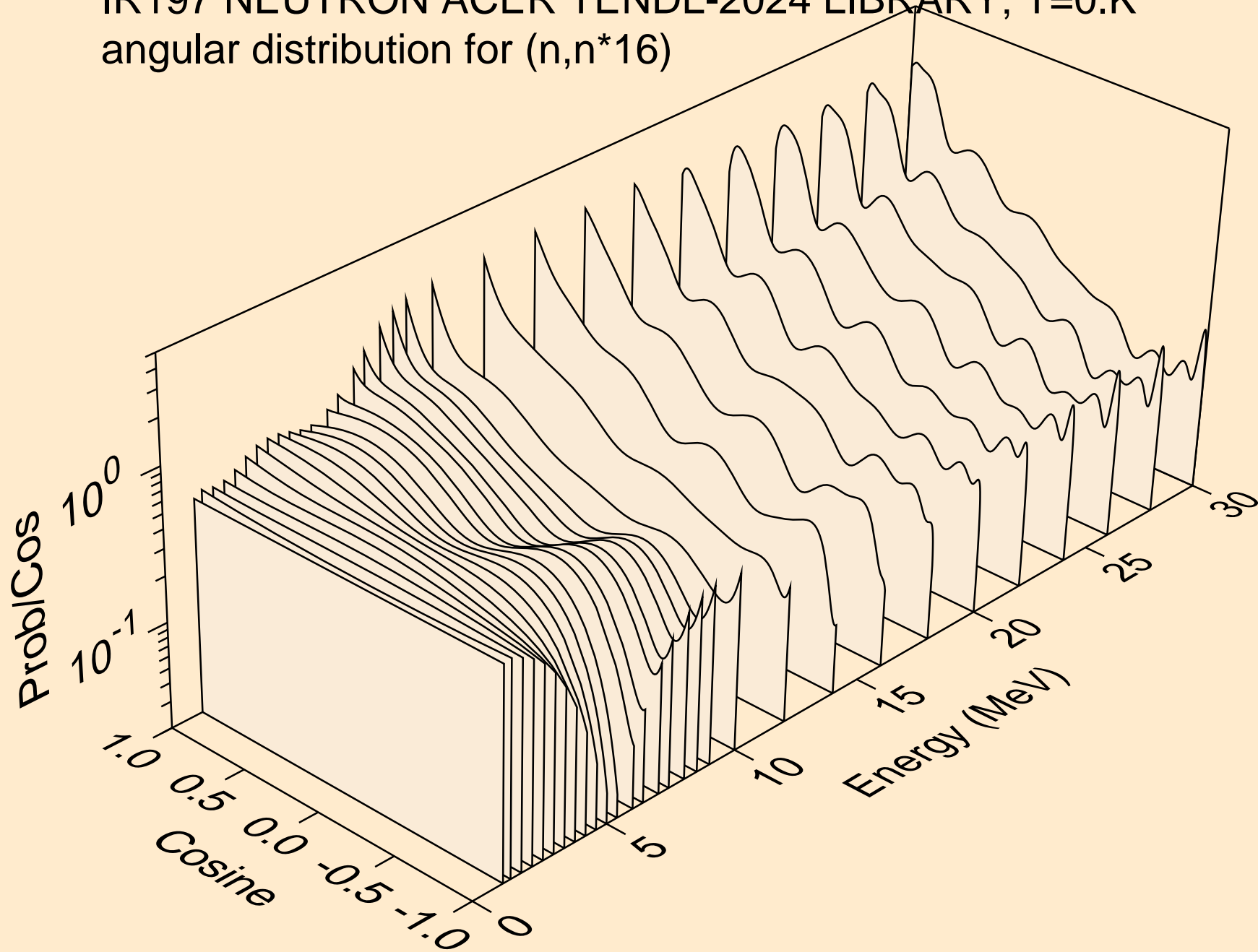

IR197 NEUTRON ACER TENDL-2024 LIBRARY; T=0.K
angular distribution for (n,n*17)

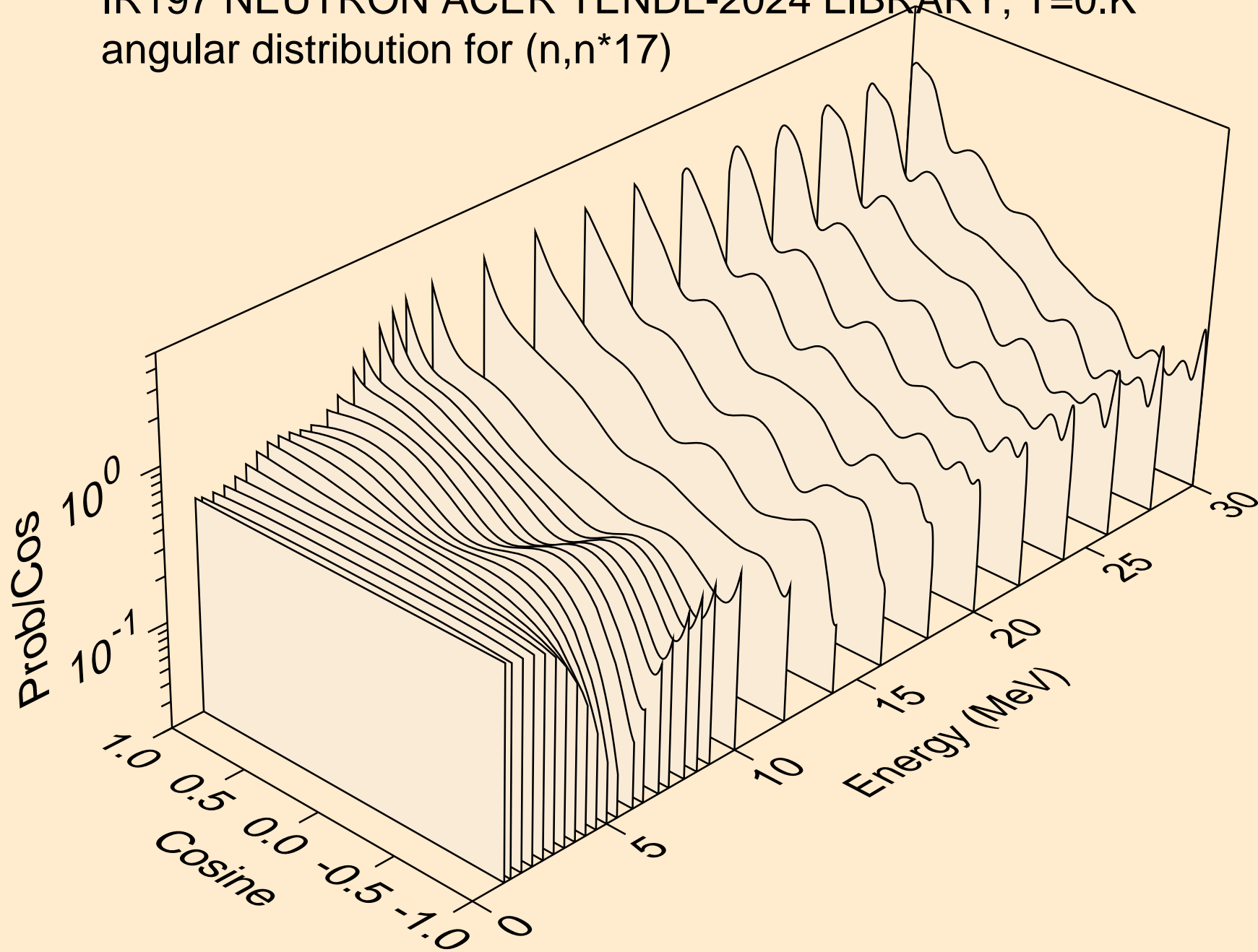

IR197 NEUTRON ACER TENDL-2024 LIBRARY; T=0.K
angular distribution for (n,n*18)

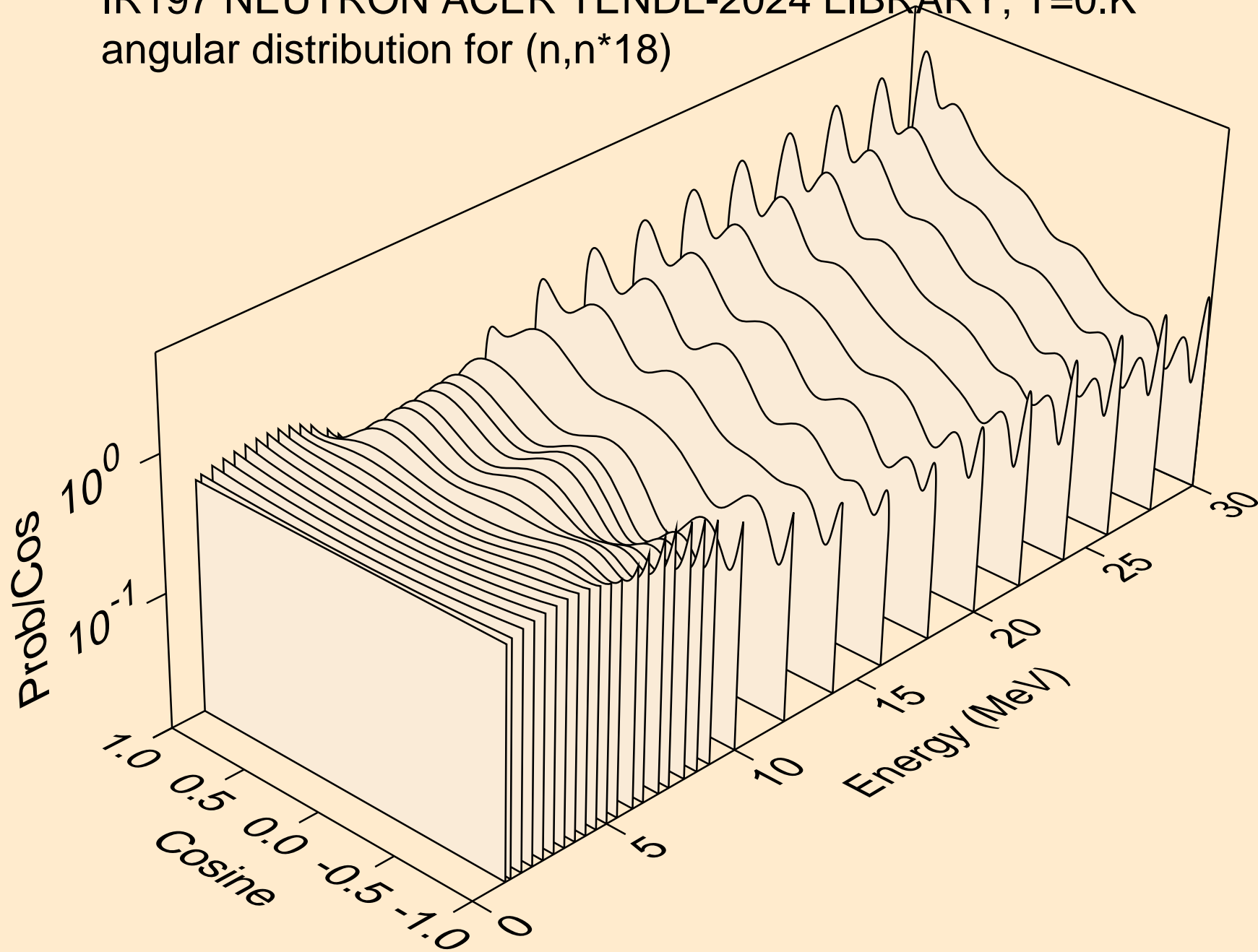

IR197 NEUTRON ACER TENDL-2024 LIBRARY; T=0.K
angular distribution for (n,n*19)

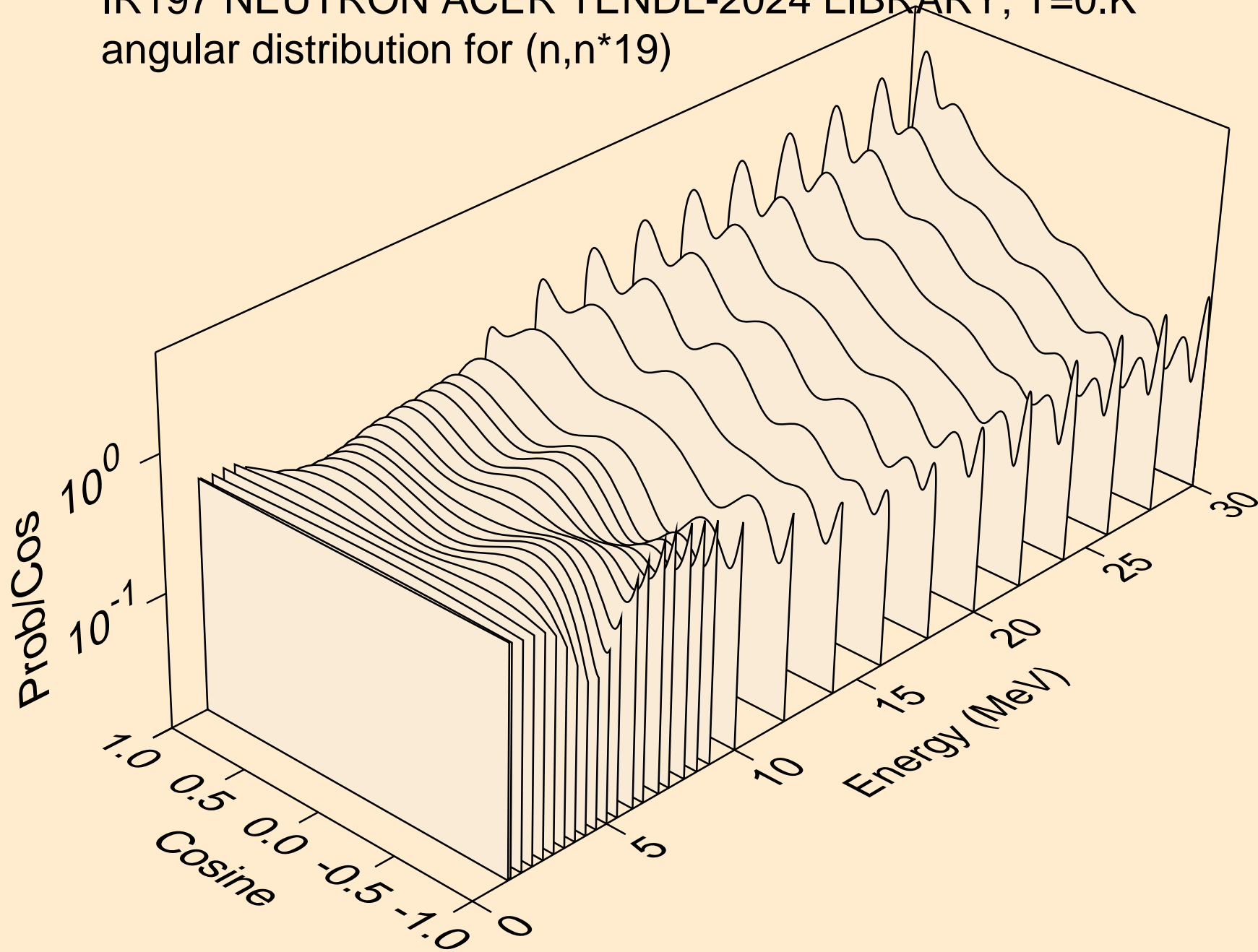

IR197 NEUTRON ACER TENDL-2024 LIBRARY; T=0.K
angular distribution for (n,n*20)

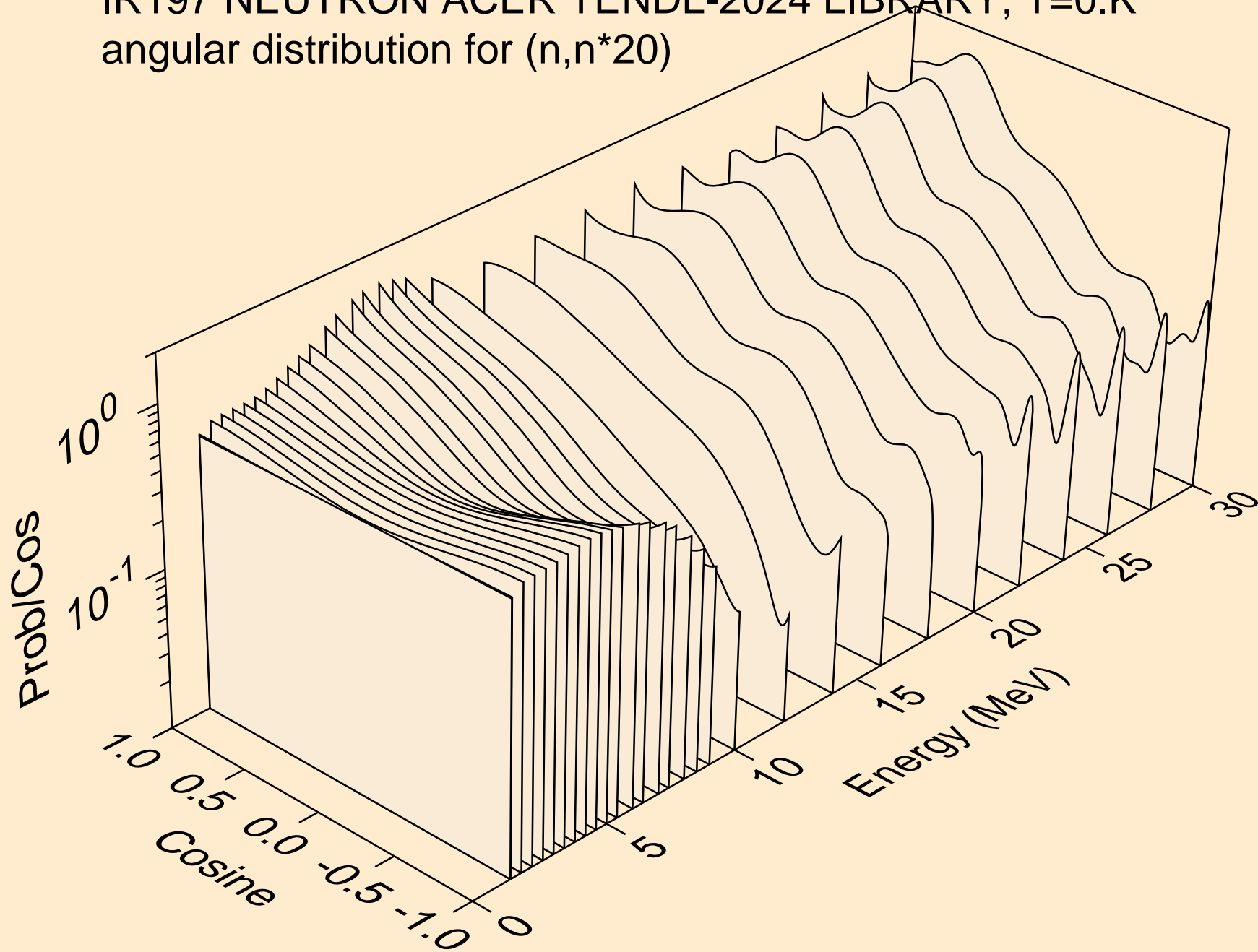

IR197 NEUTRON ACER TENDL-2024 LIBRARY; T=0.K
angular distribution for (n,n*21)

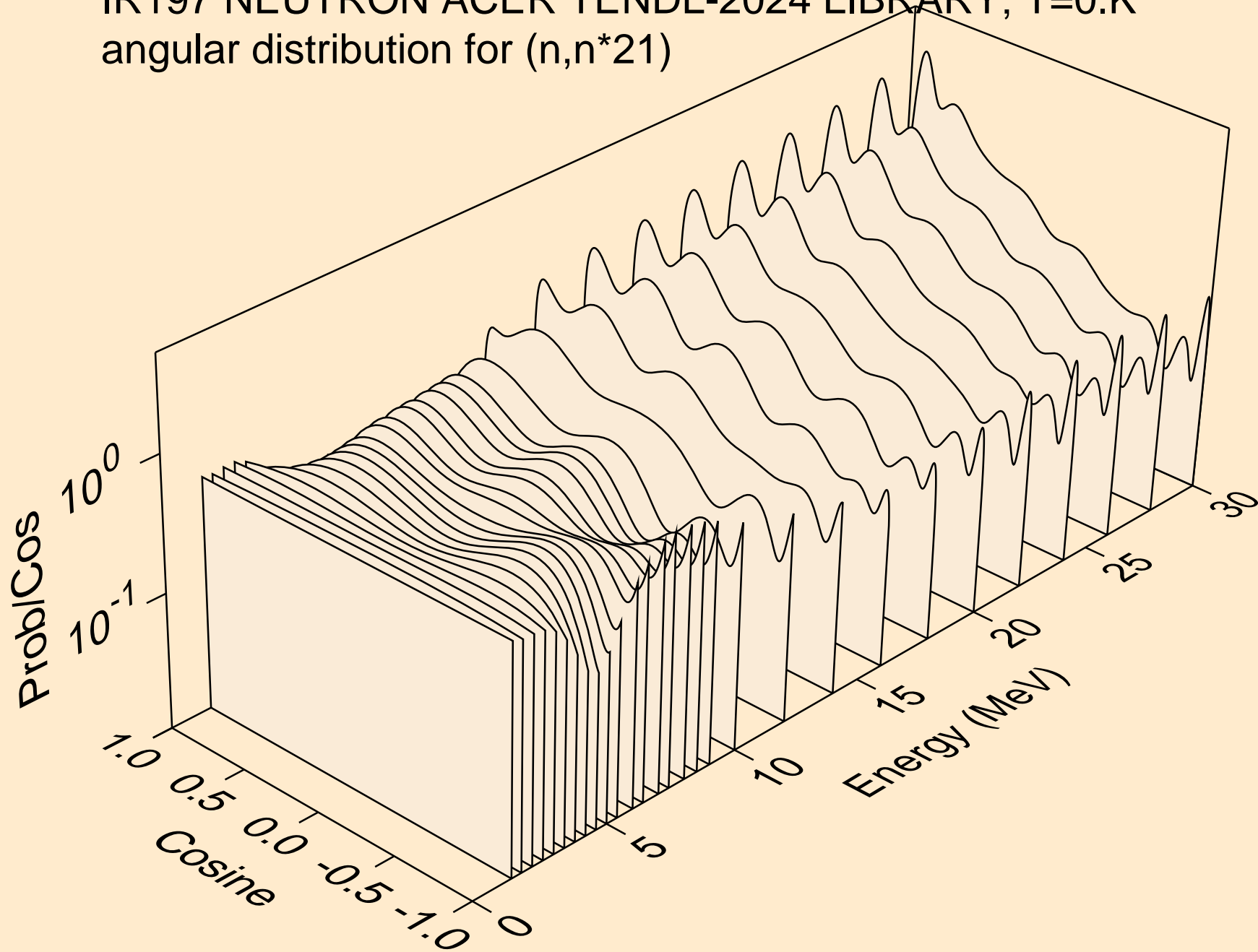

IR197 NEUTRON ACER TENDL-2024 LIBRARY; T=0.K
angular distribution for (n,n*22)

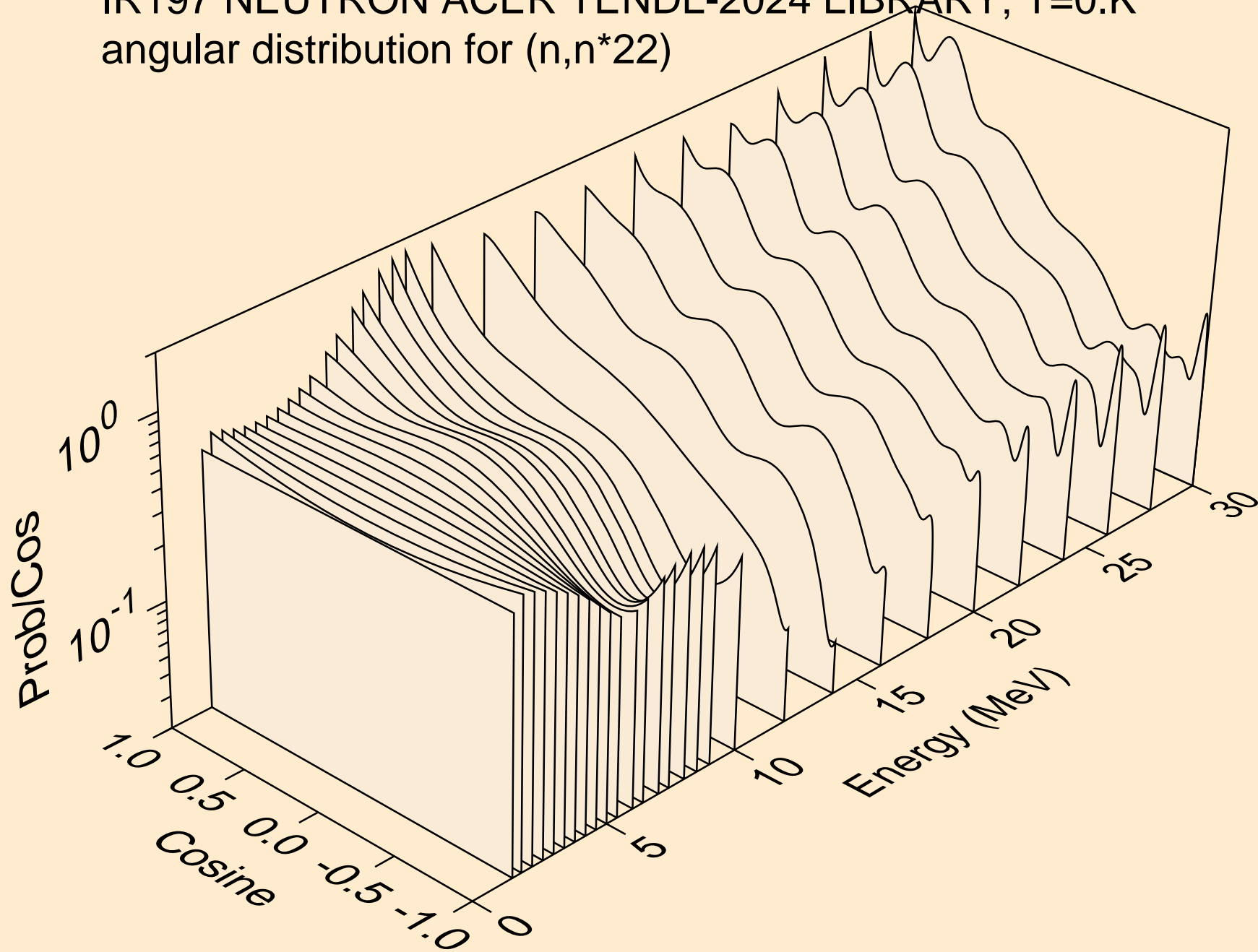

IR197 NEUTRON ACER TENDL-2024 LIBRARY; T=0.K
angular distribution for (n,n*23)

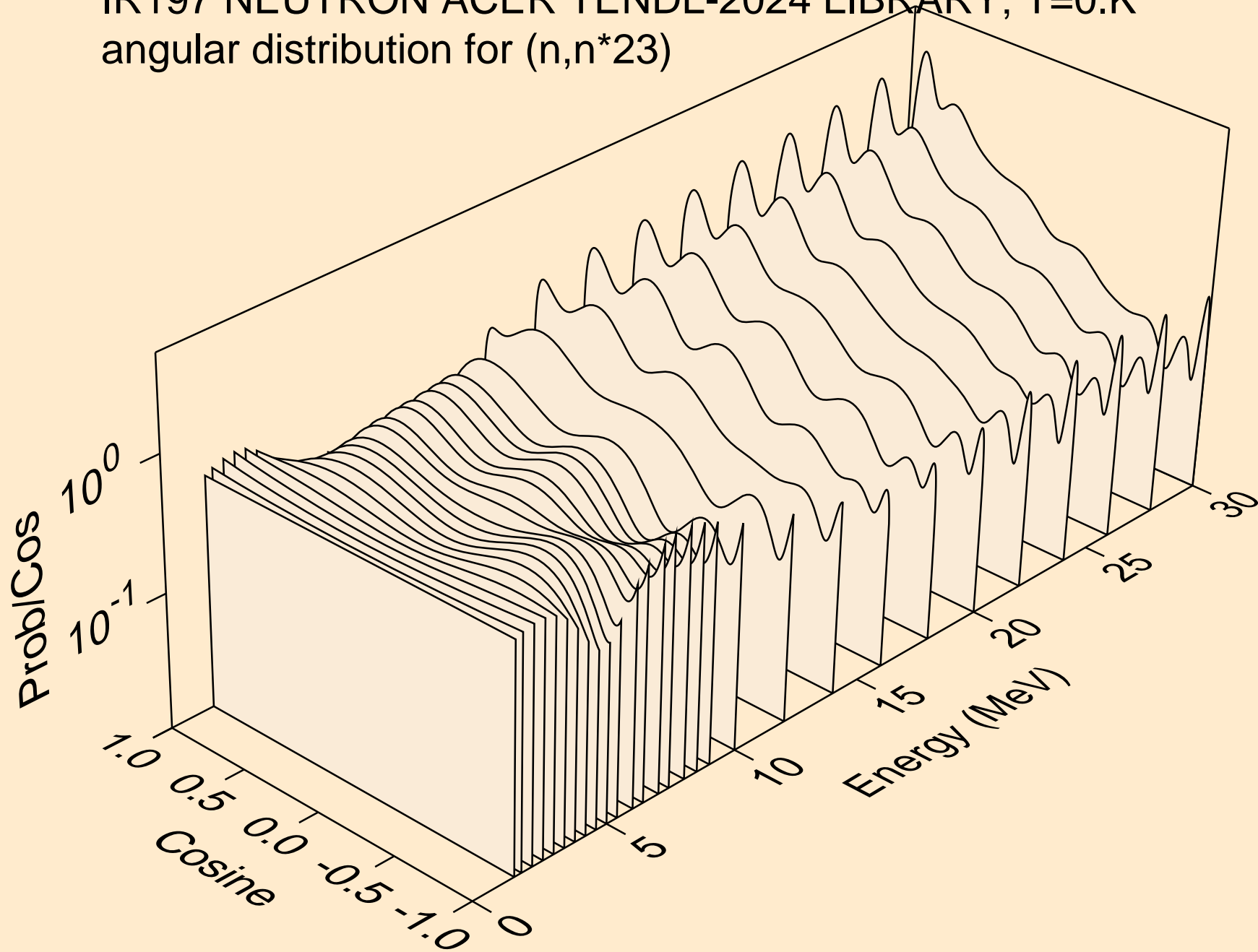

IR197 NEUTRON ACER TENDL-2024 LIBRARY; T=0.K
angular distribution for (n,n*24)

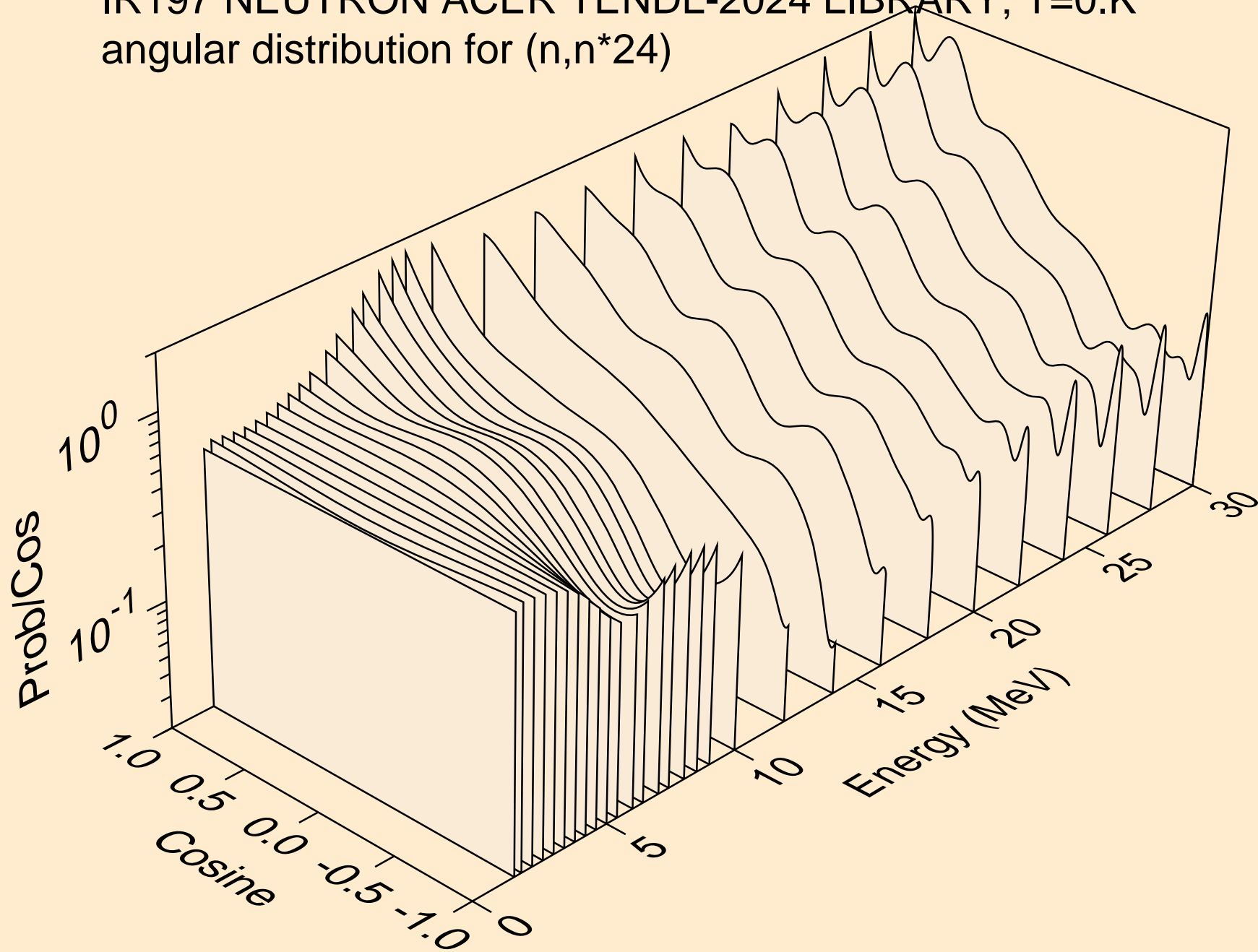

IR197 NEUTRON ACER TENDL-2024 LIBRARY; T=0.K
angular distribution for (n,n*25)

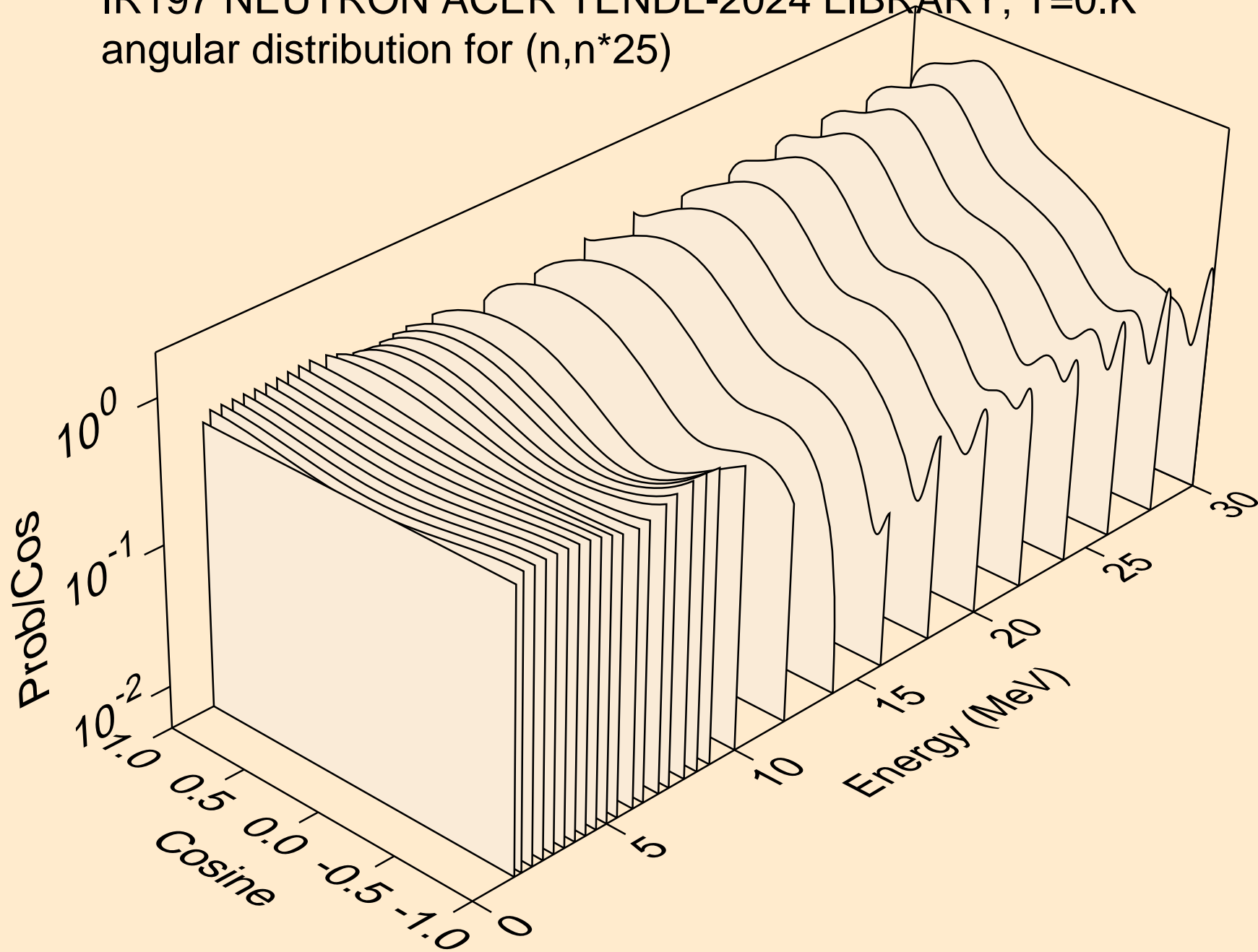

IR197 NEUTRON ACER TENDL-2024 LIBRARY; T=0.K
angular distribution for (n,n*26)

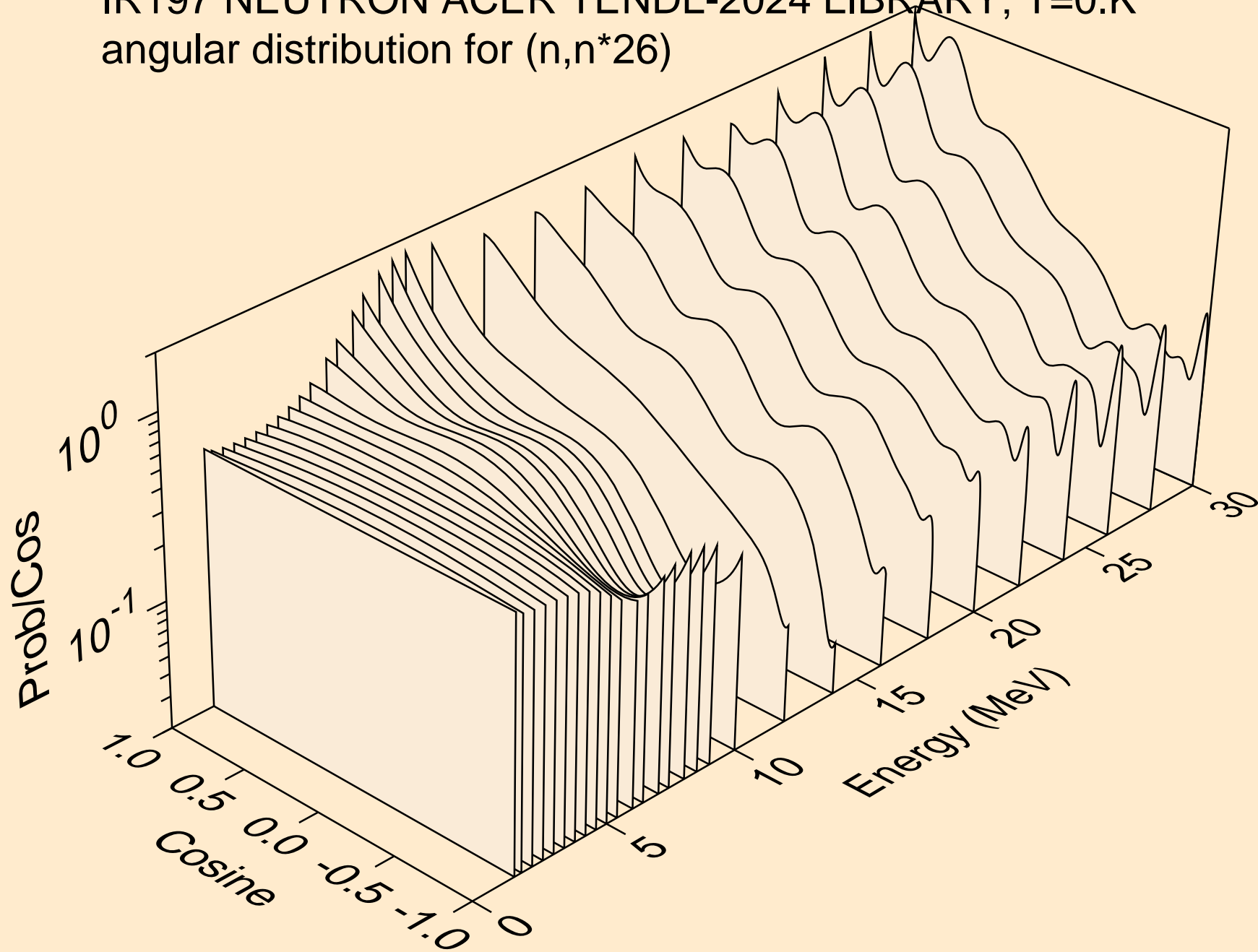

IR197 NEUTRON ACER TENDL-2024 LIBRARY; T=0.K
angular distribution for (n,n*27)

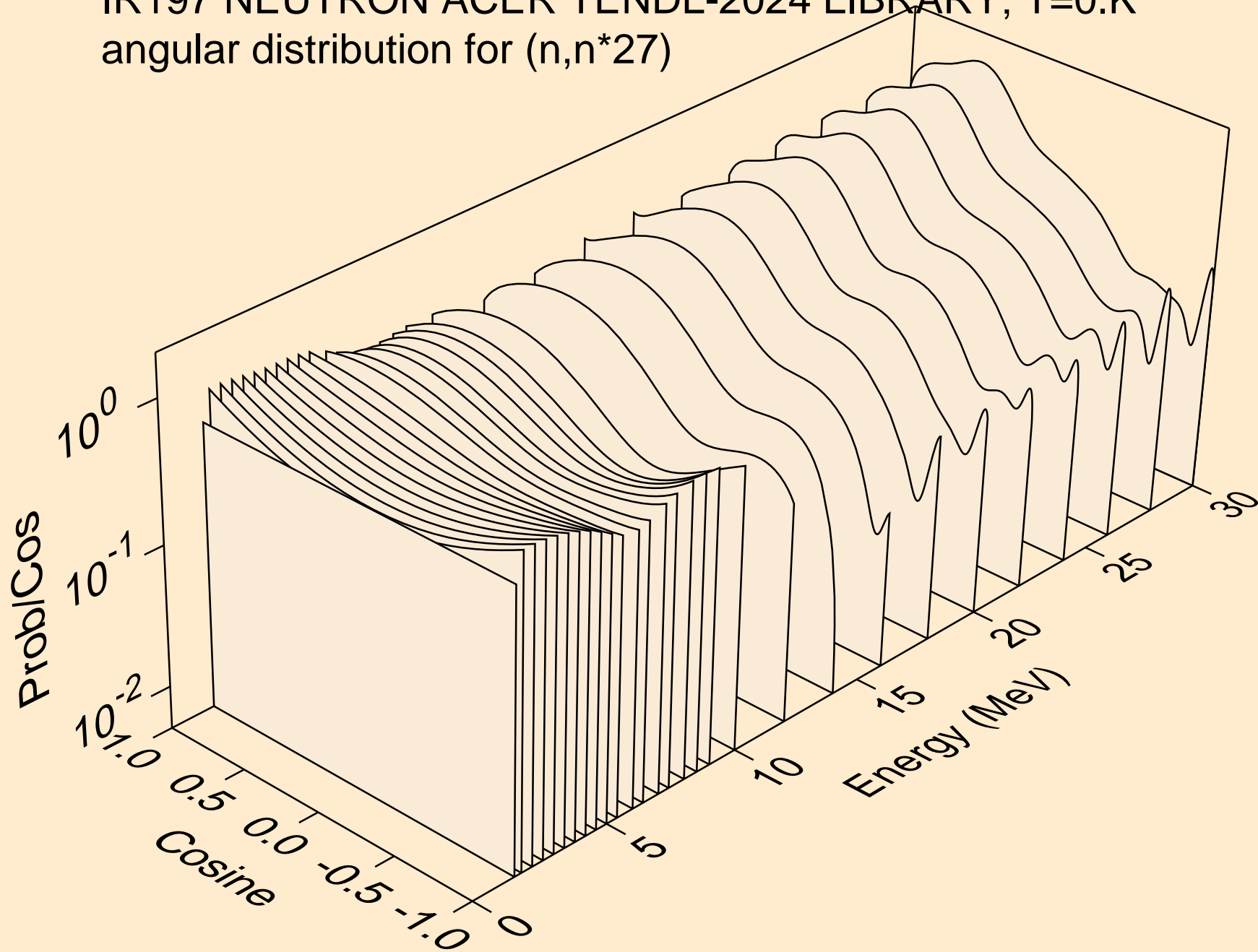

IR197 NEUTRON ACER TENDL-2024 LIBRARY; T=0.K
angular distribution for (n,n*28)

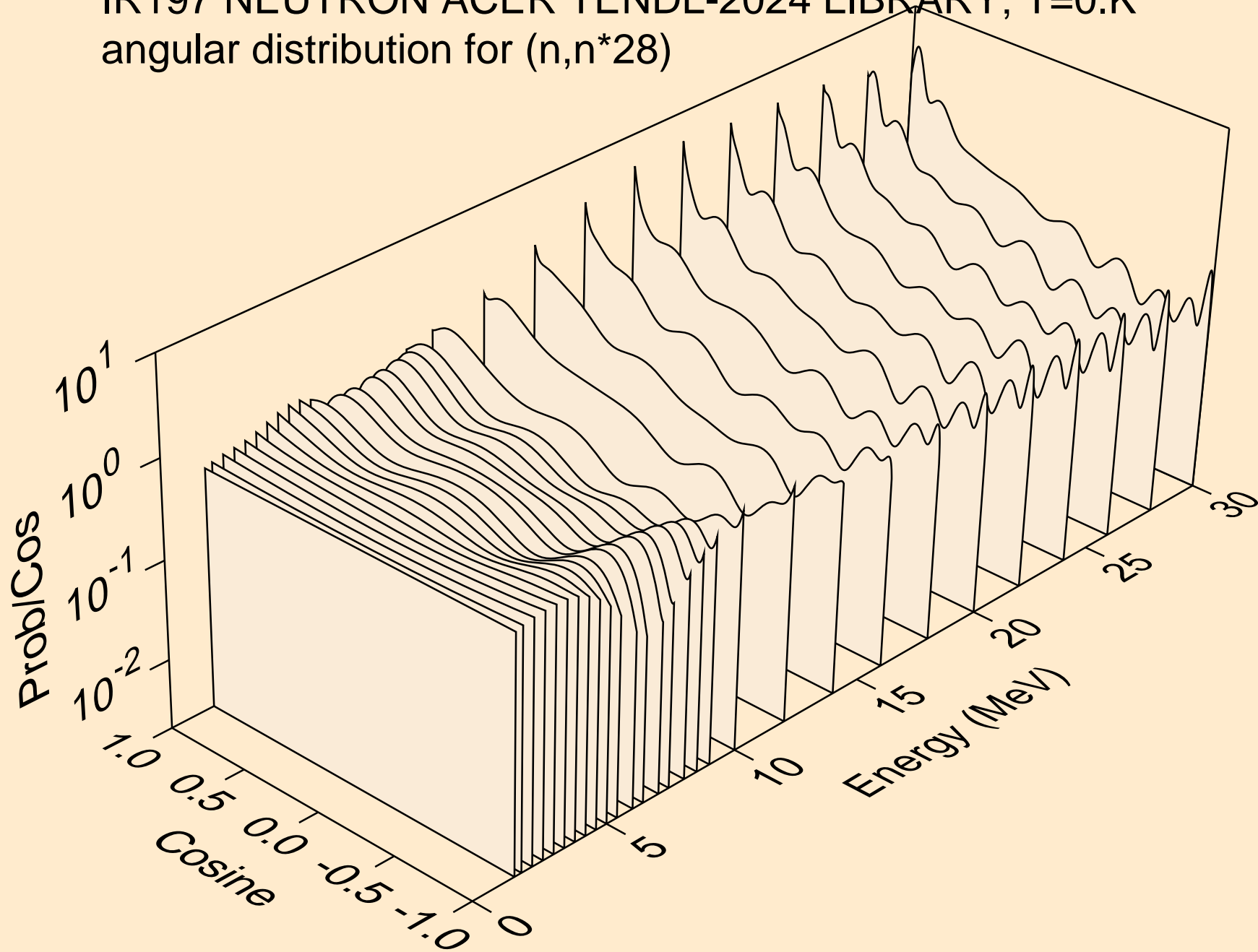

IR197 NEUTRON ACER TENDL-2024 LIBRARY; T=0.K
angular distribution for (n,n*29)

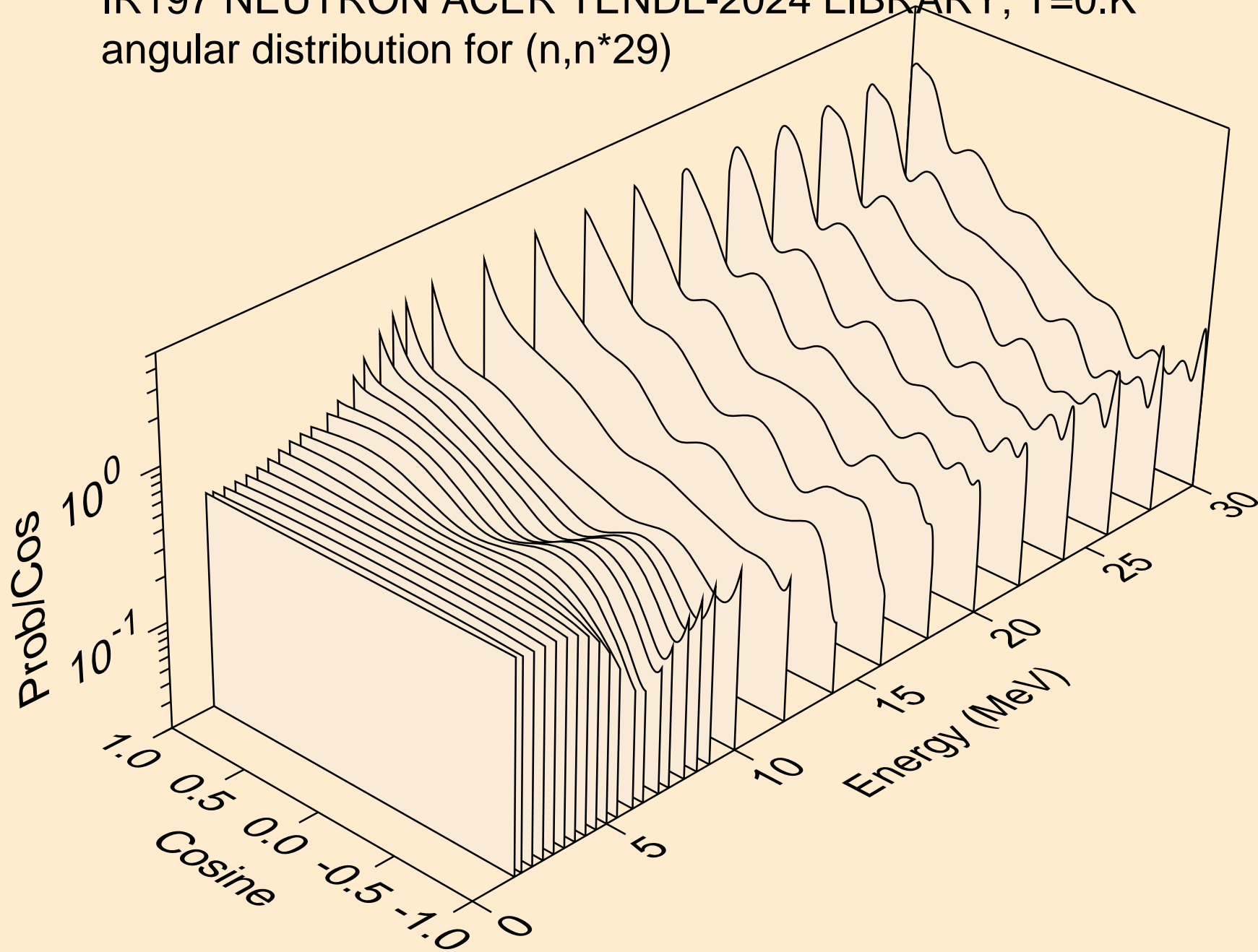

IR197 NEUTRON ACER TENDL-2024 LIBRARY; T=0.K
angular distribution for (n,n*30)

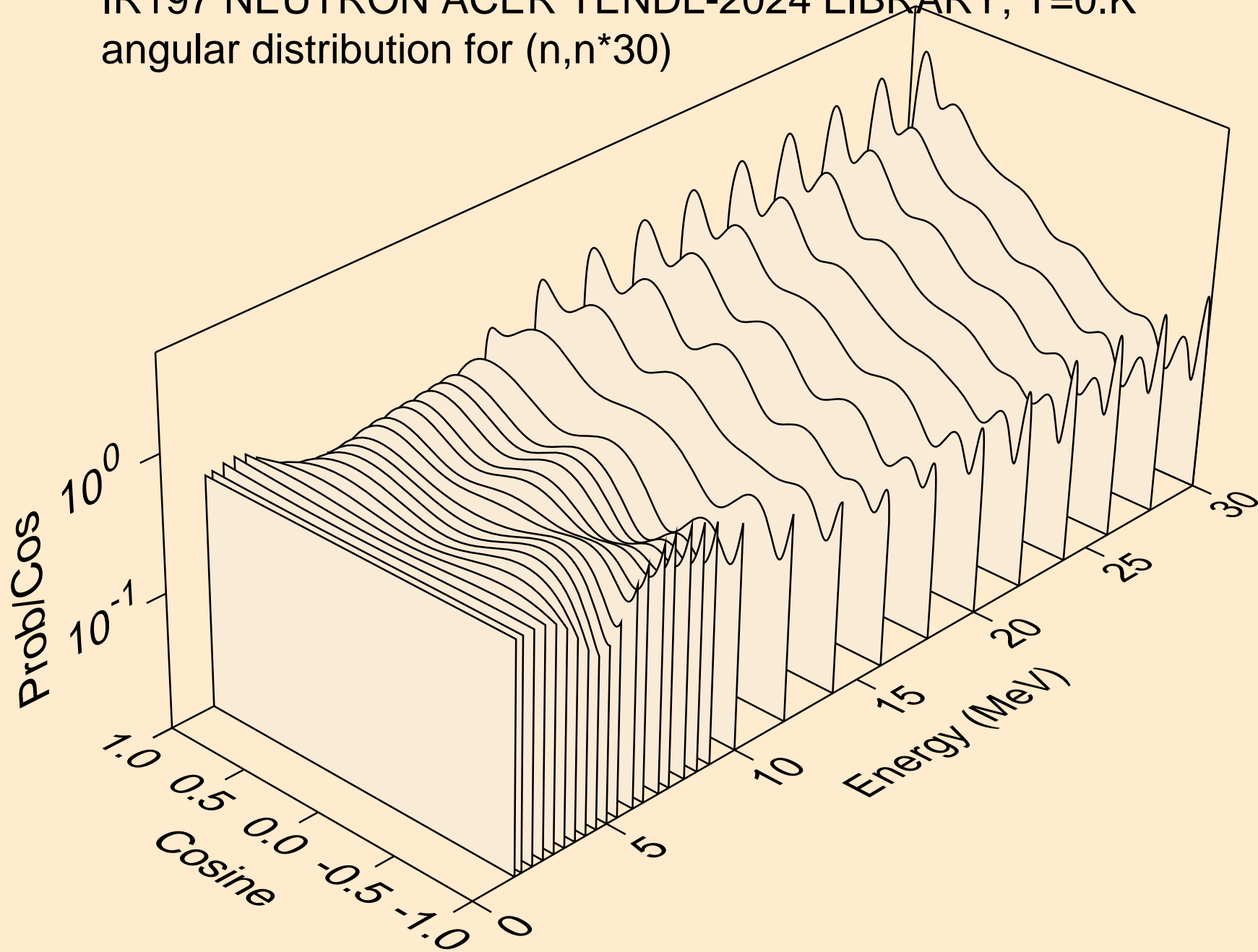

IR197 NEUTRON ACER TENDL-2024 LIBRARY; T=0.K
Neutron emission for (n,x)

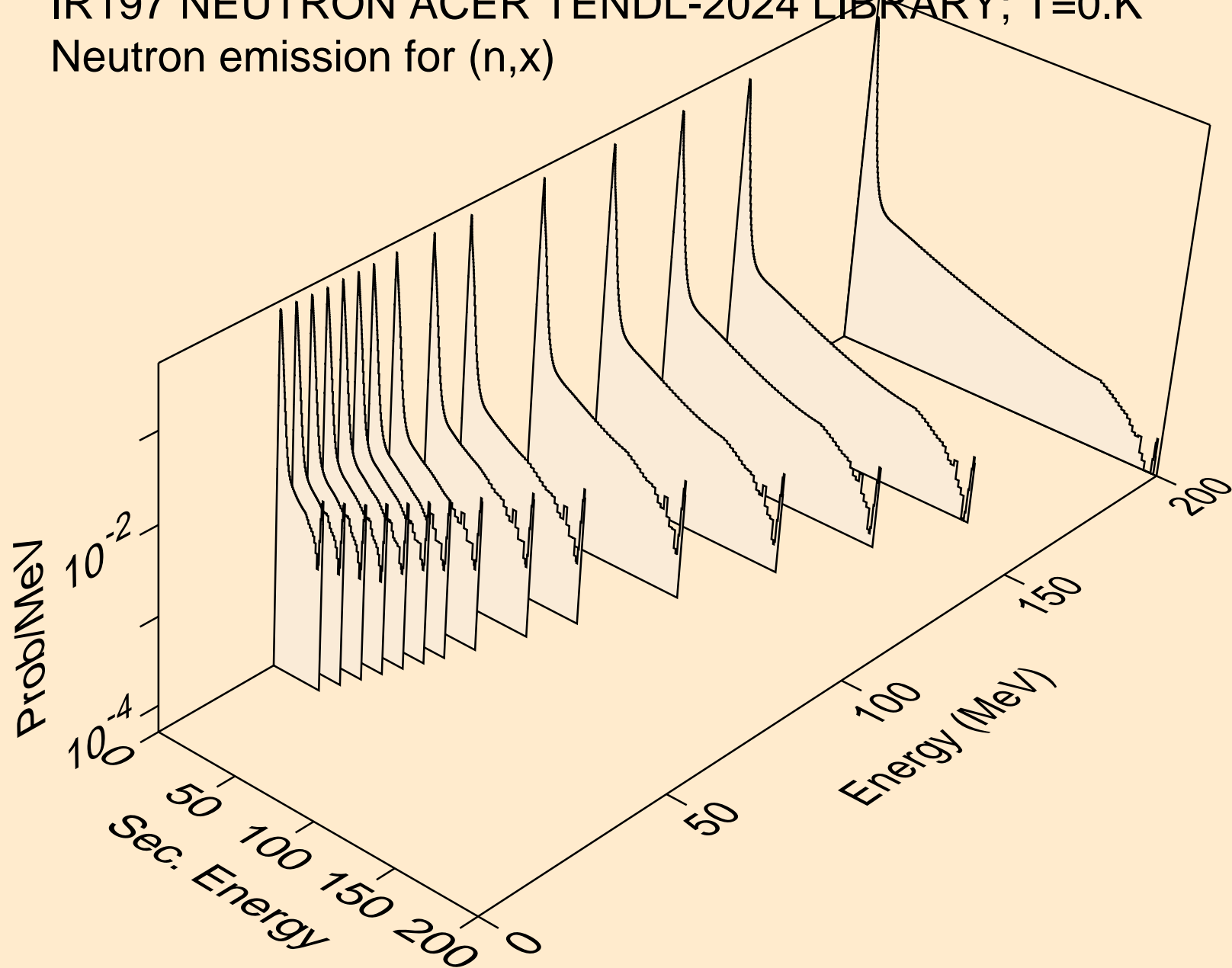

IR197 NEUTRON ACER TENDL-2024 LIBRARY; T=0.K
Neutron emission for (n,2nd)

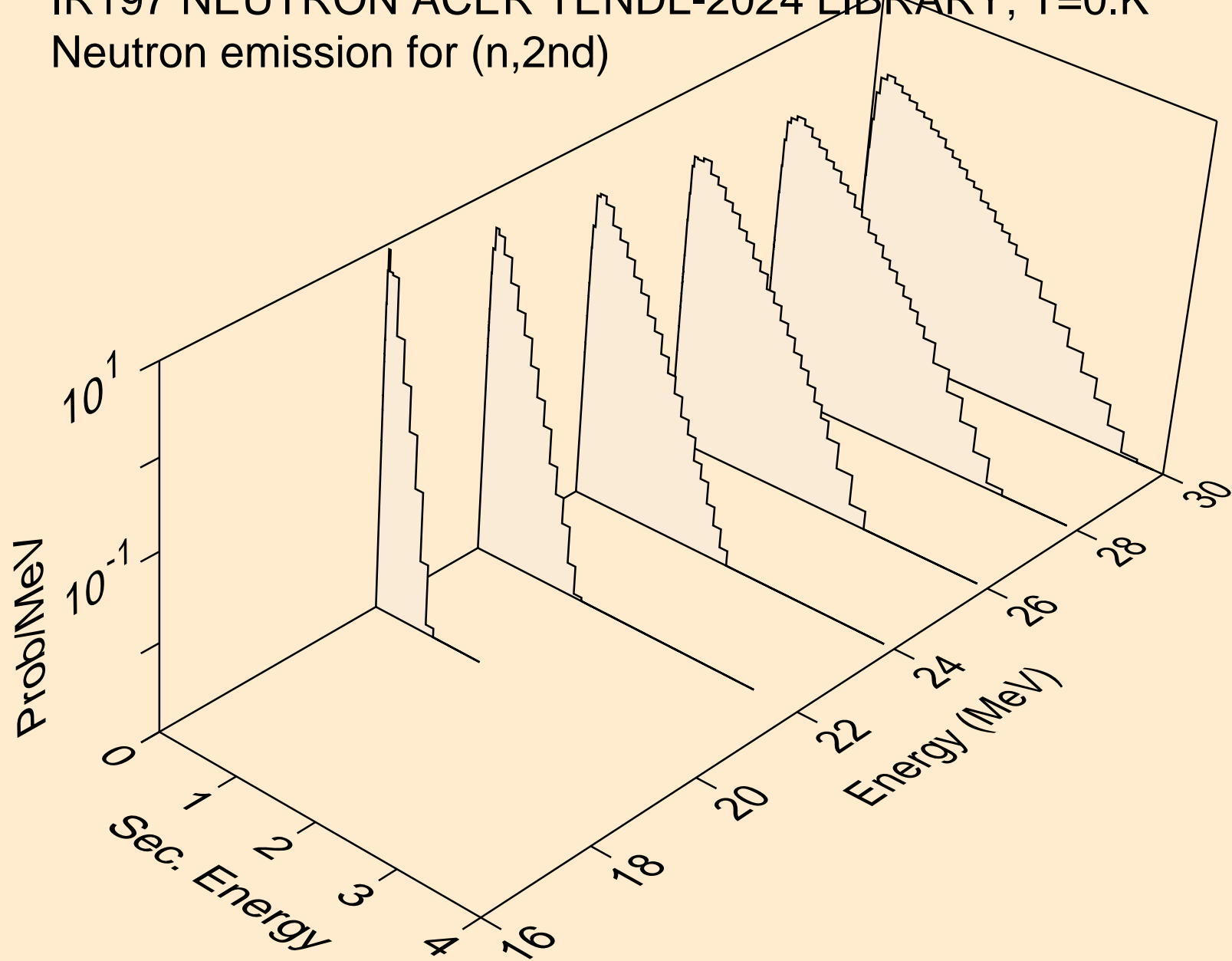

IR197 NEUTRON ACER TENDL-2024 LIBRARY; T=0.K
Neutron emission for (n,2n)

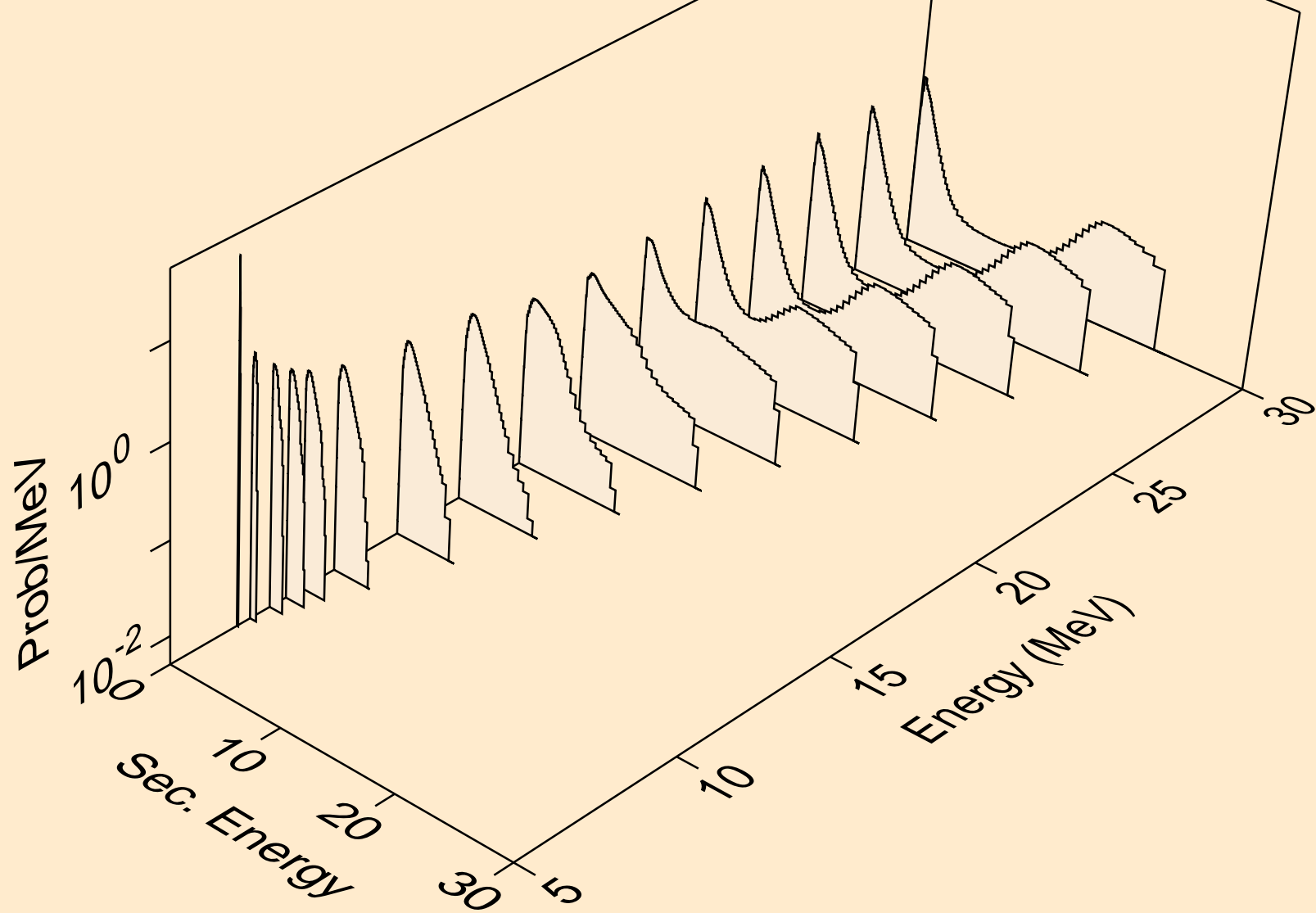

IR197 NEUTRON ACER TENDL-2024 LIBRARY; T=0.K
Neutron emission for (n,3n)

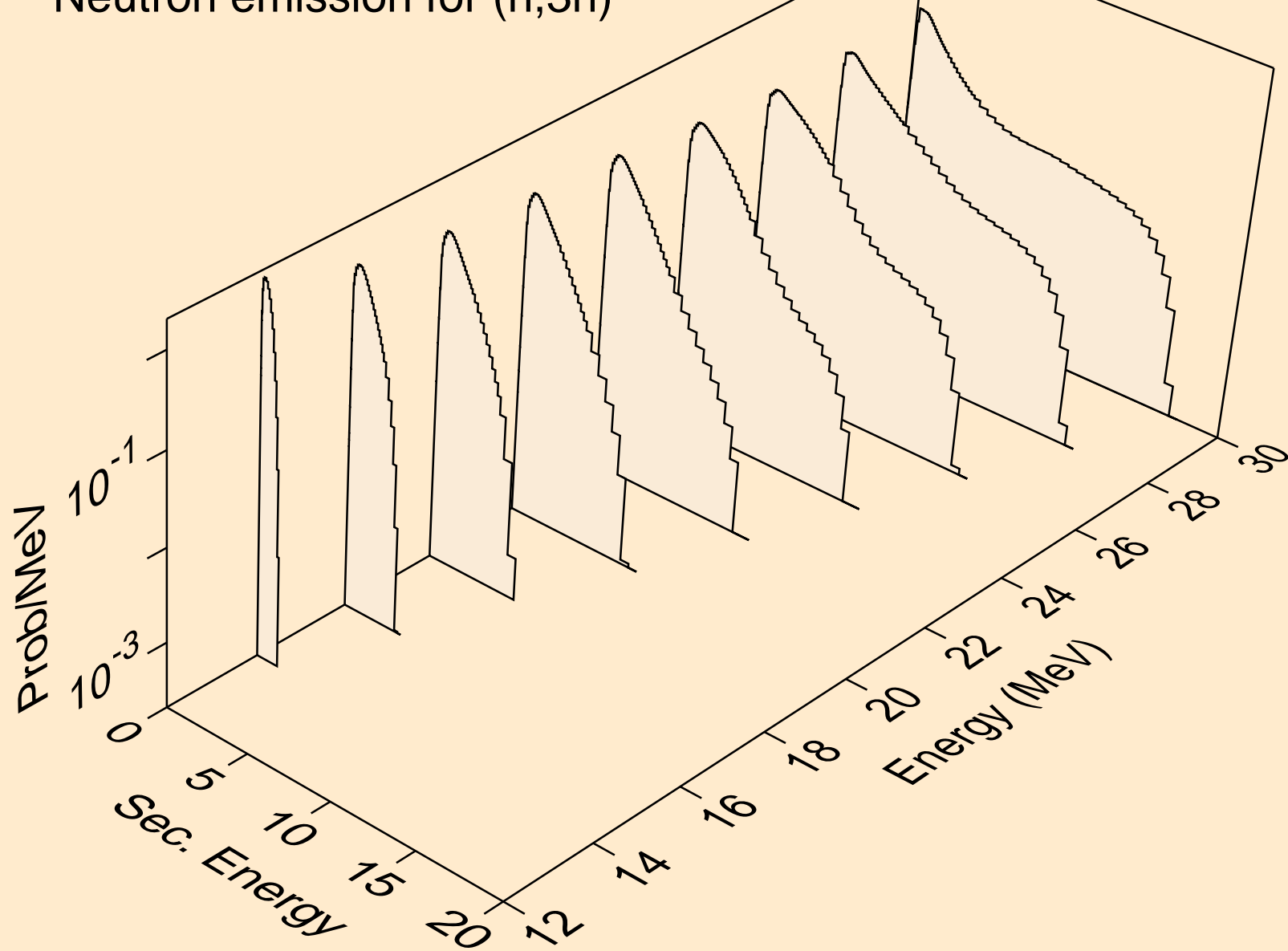

IR197 NEUTRON ACER TENDL-2024 LIBRARY; T=0.K
Neutron emission for (n,n*)a

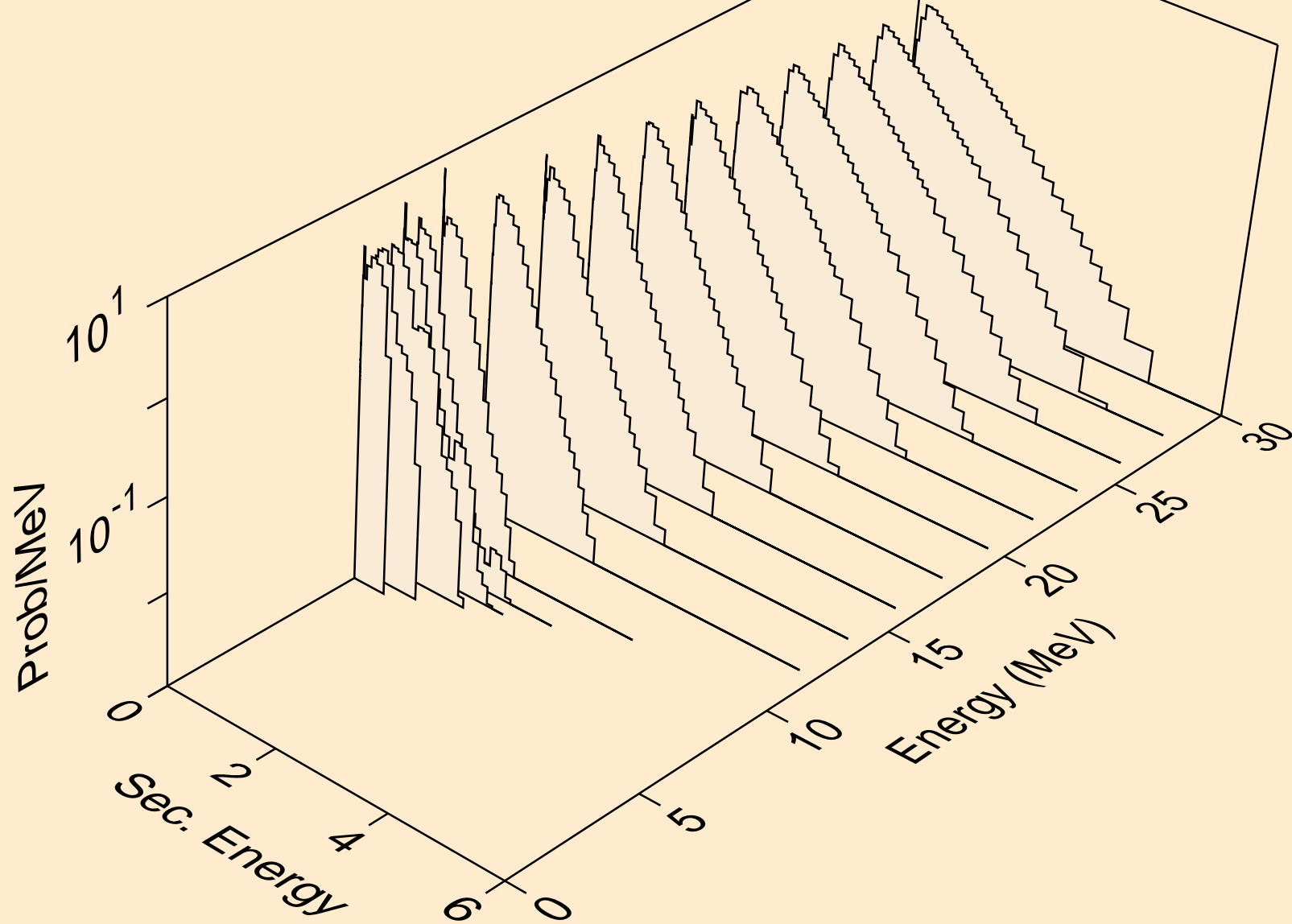

IR197 NEUTRON ACER TENDL-2024 LIBRARY; T=0.K
Neutron emission for (n,2n)a

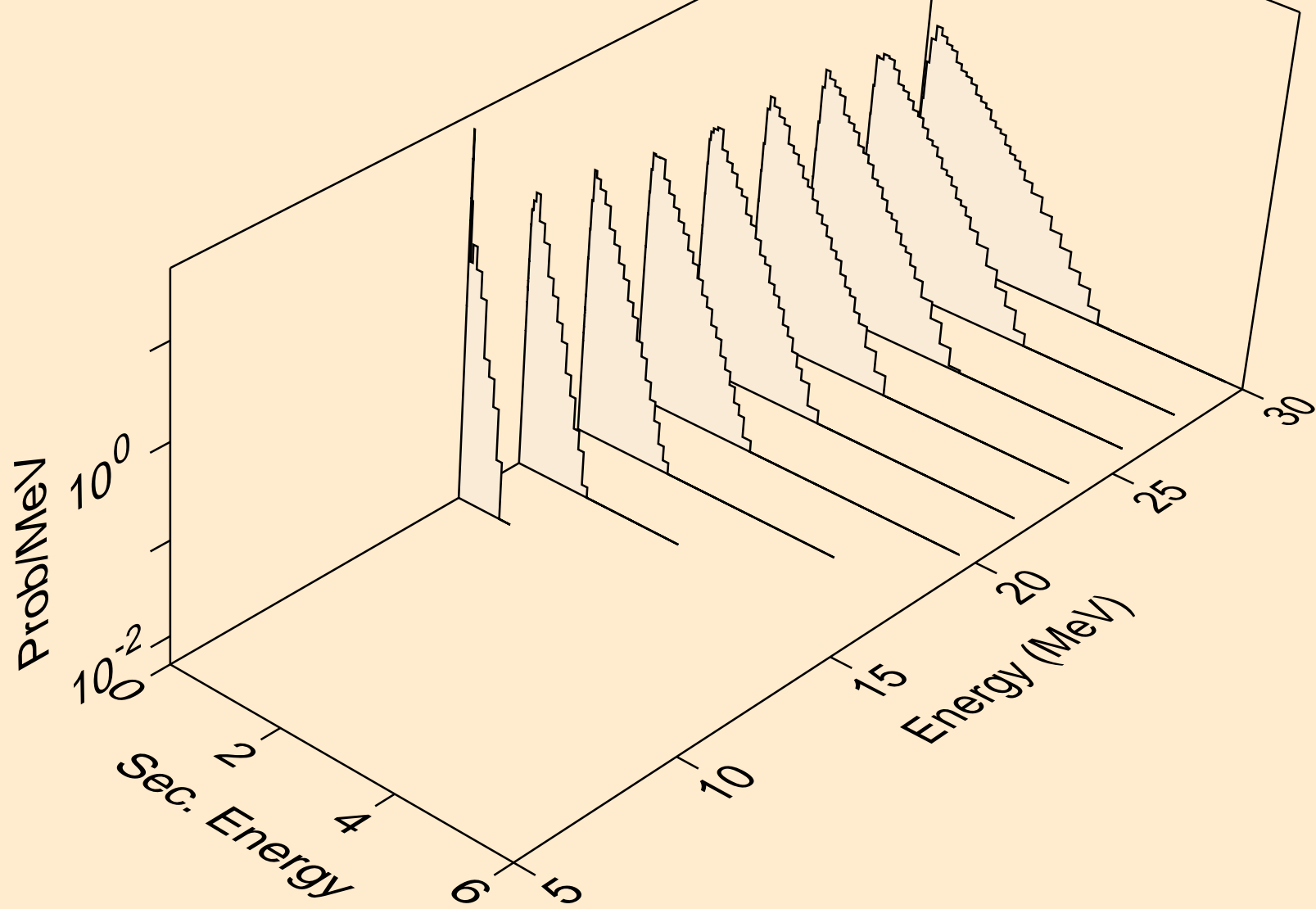

IR197 NEUTRON ACER TENDL-2024 LIBRARY; T=0.K
Neutron emission for (n,3n)a

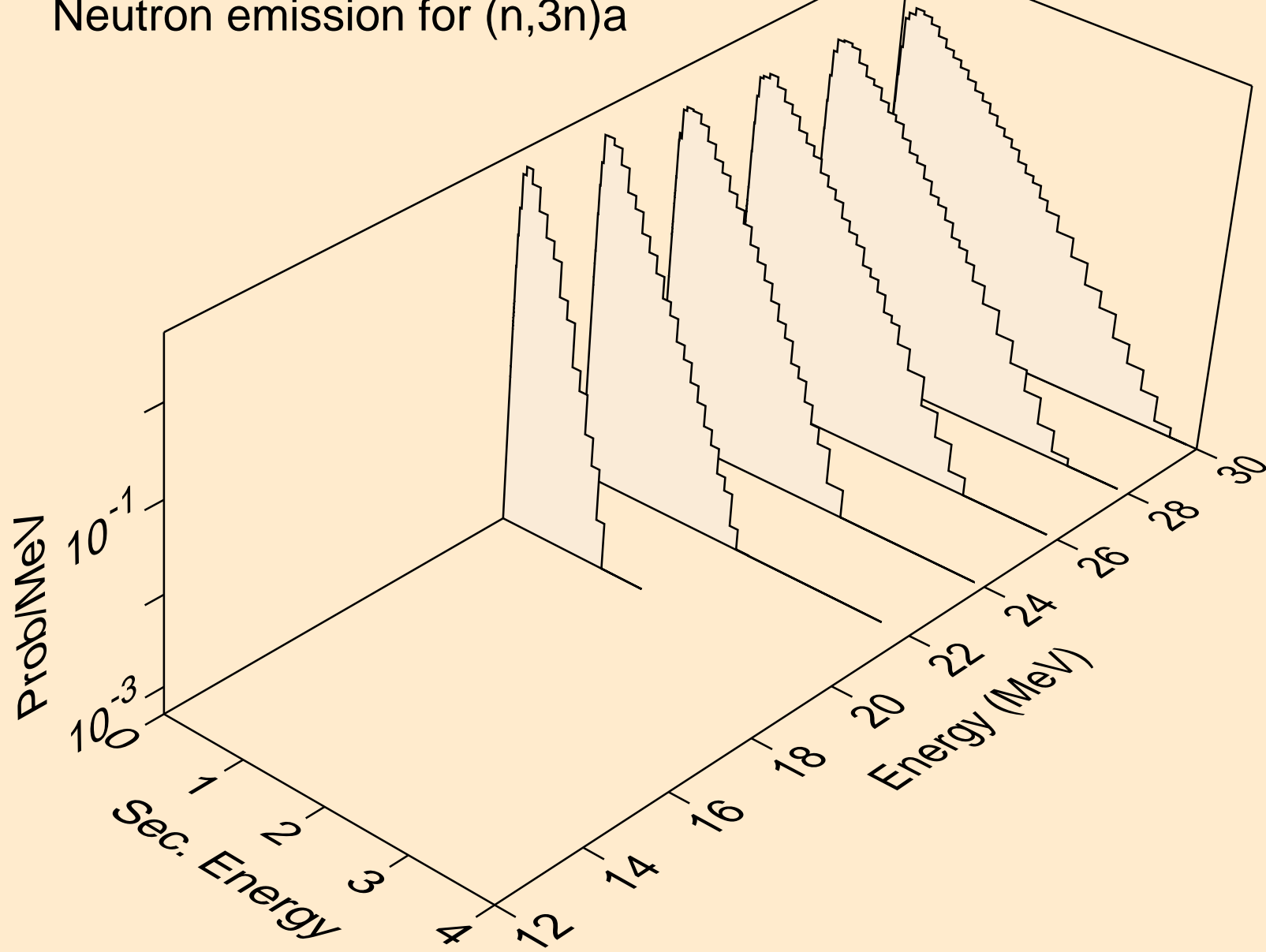

IR197 NEUTRON ACER TENDL-2024 LIBRARY; T=0.K
Neutron emission for (n,n*)p

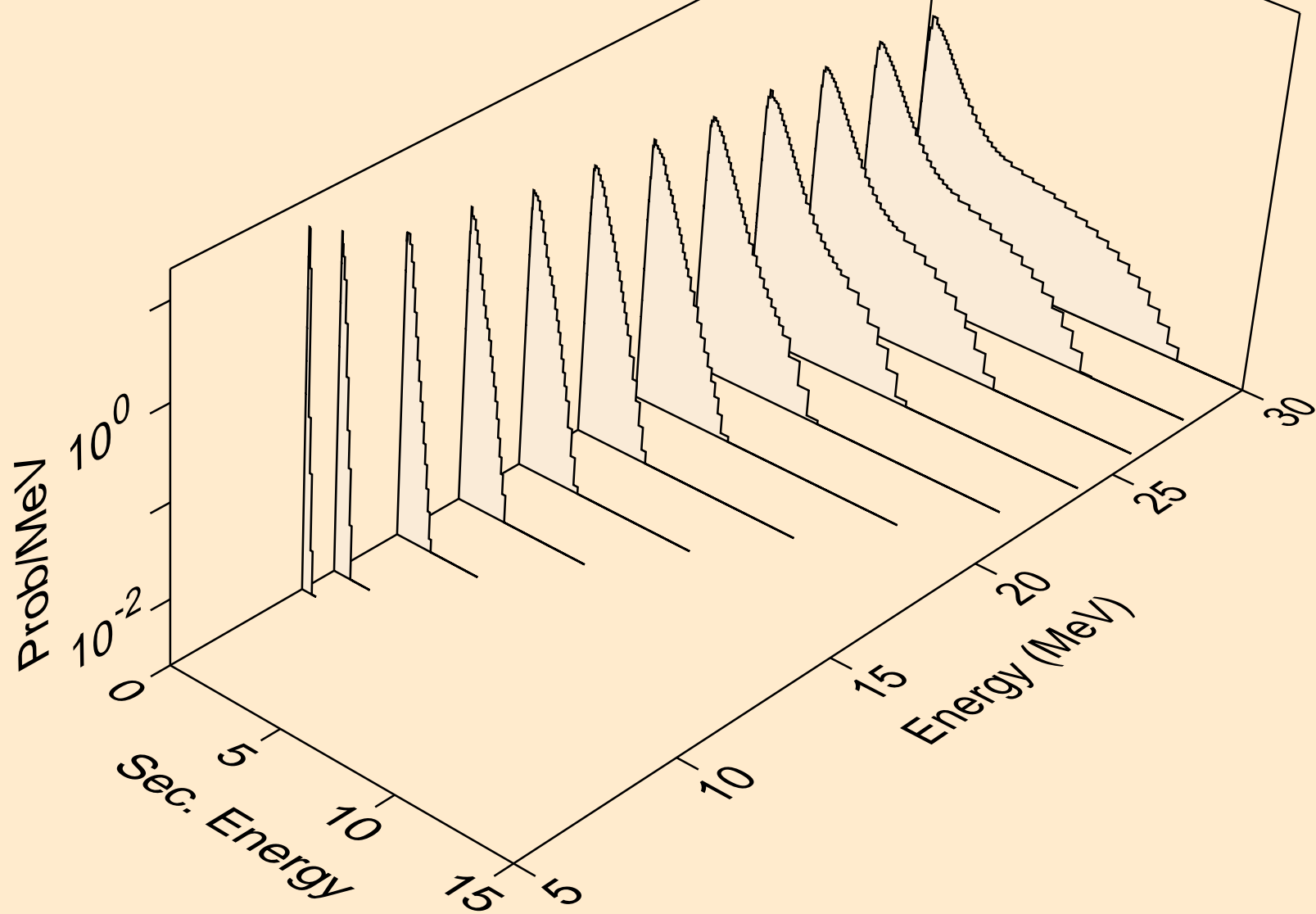

IR197 NEUTRON ACER TENDL-2024 LIBRARY; T=0.K
Neutron emission for (n,n*)d

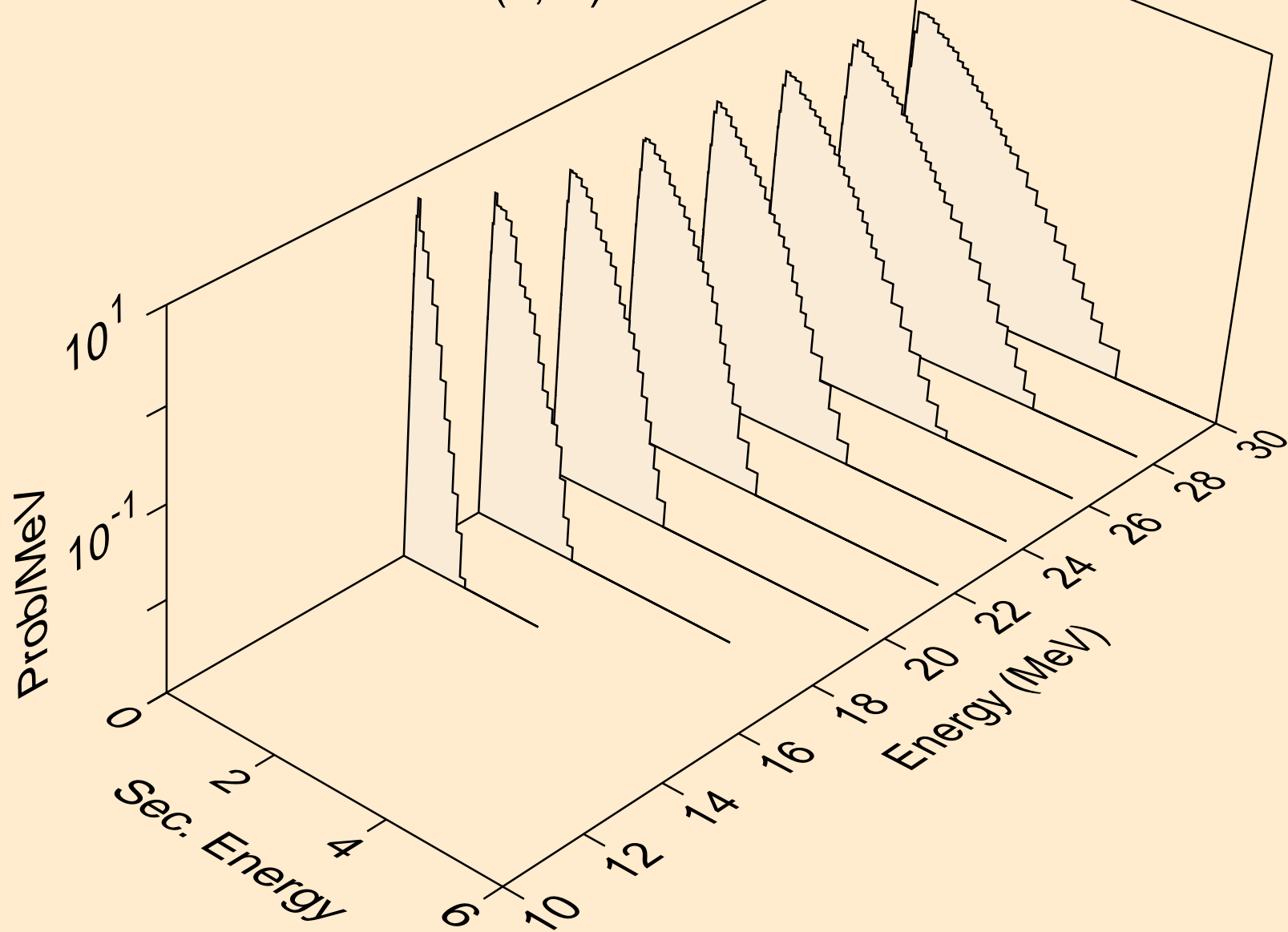

IR197 NEUTRON ACER TENDL-2024 LIBRARY; T=0.K
Neutron emission for (n,n*)t

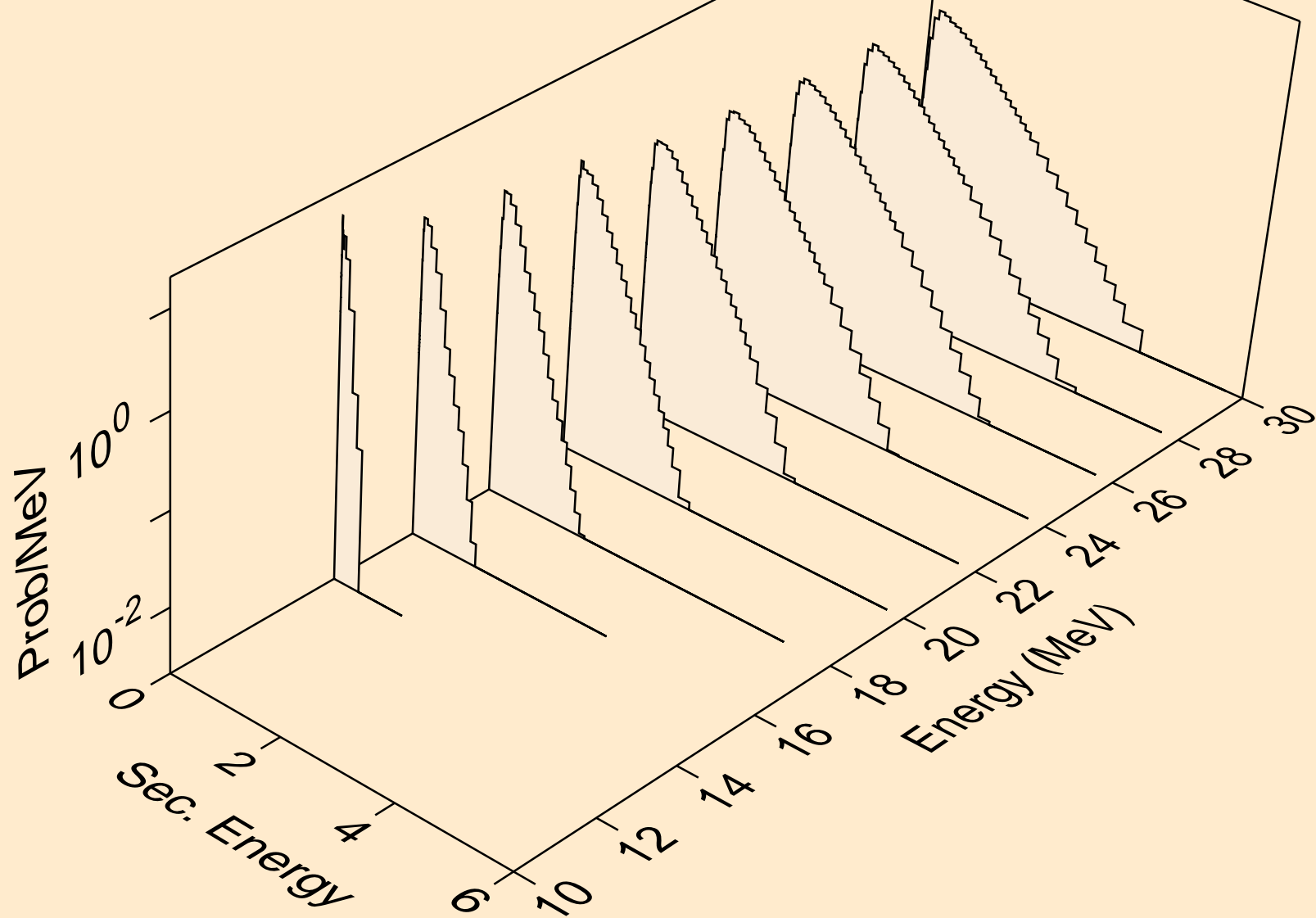

IR197 NEUTRON ACER TENDL-2024 LIBRARY; T=0.K
Neutron emission for (n,n*)he3

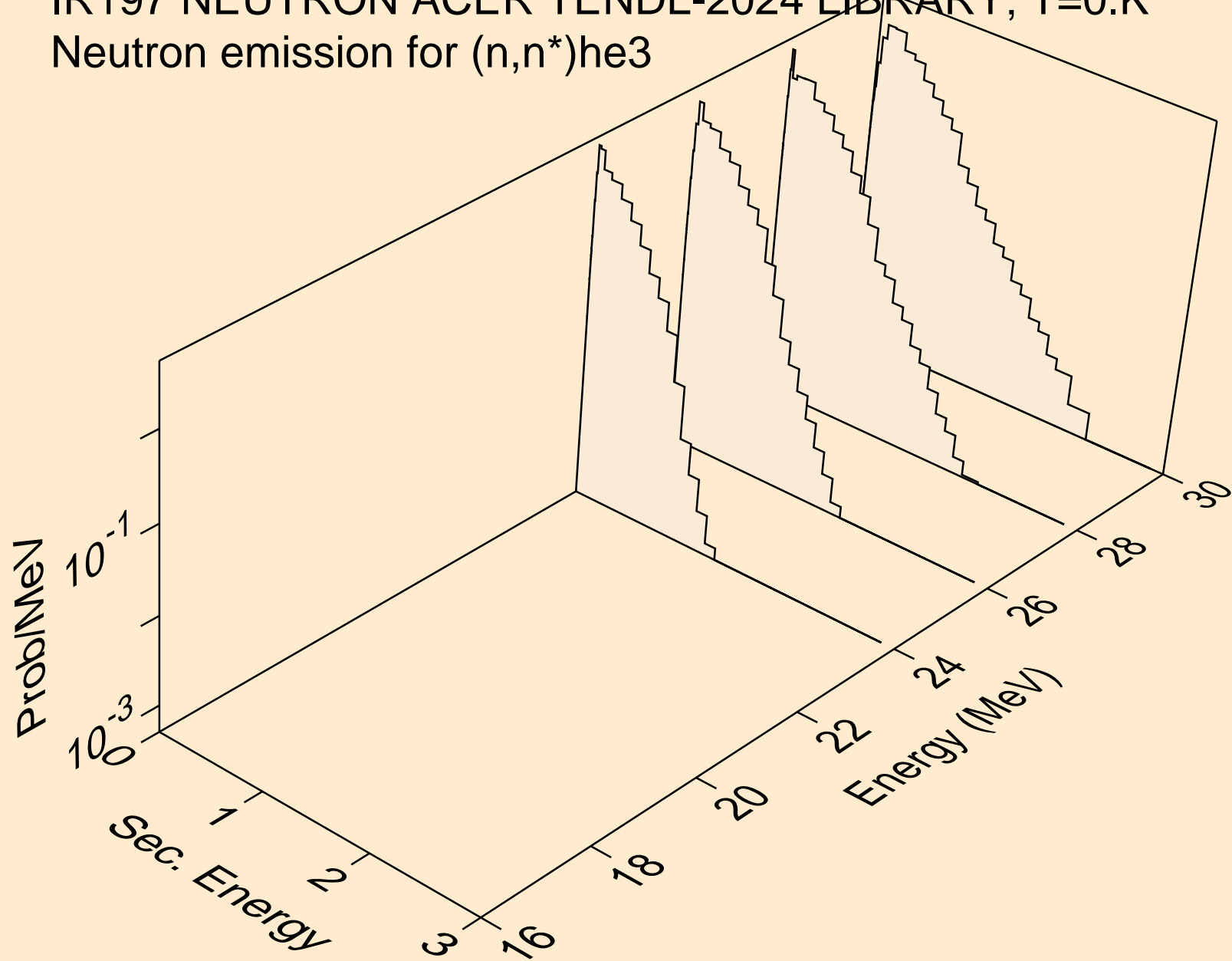

IR197 NEUTRON ACER TENDL-2024 LIBRARY; T=0.K
Neutron emission for (n,4n)

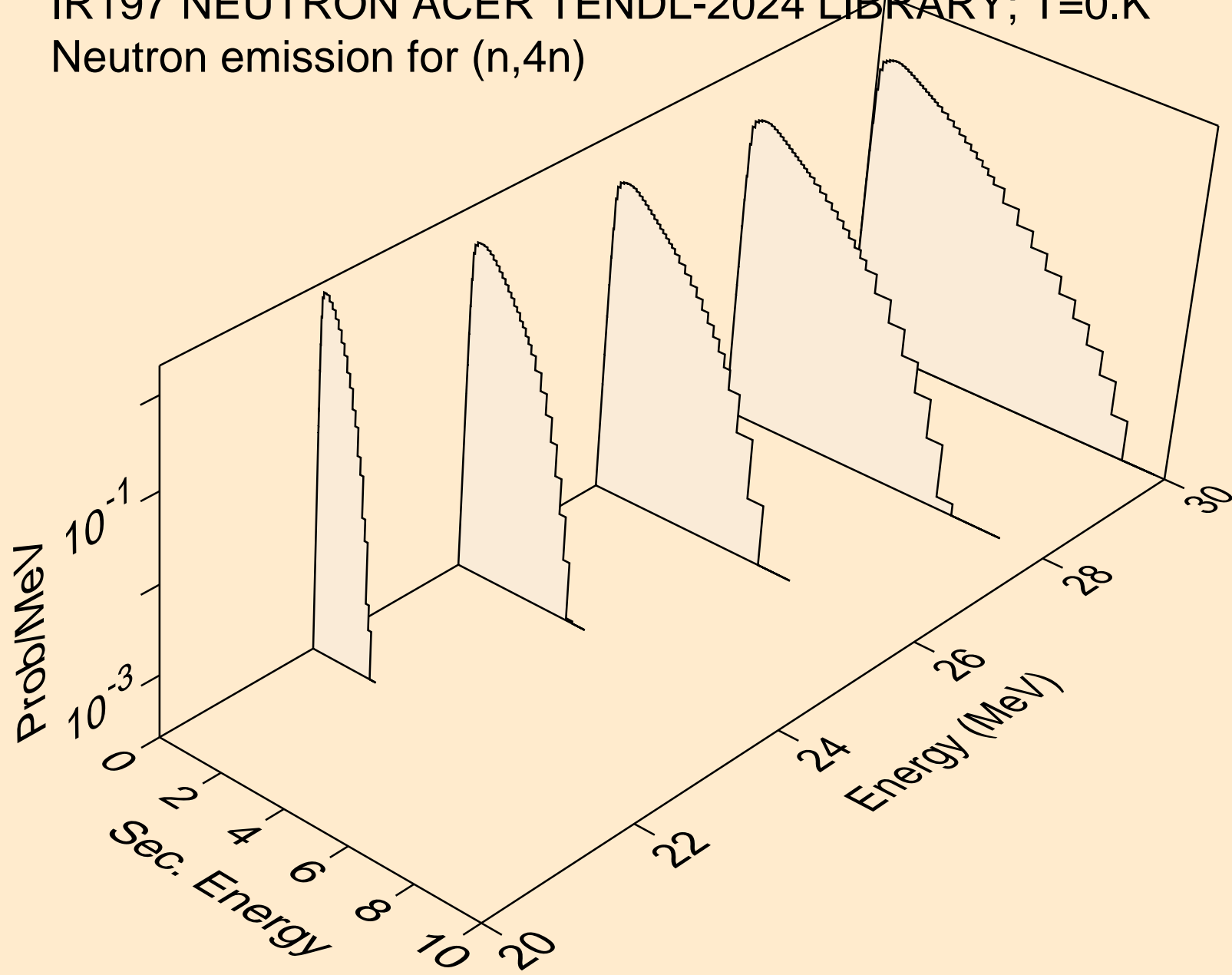

IR197 NEUTRON ACER TENDL-2024 LIBRARY; T=0.K
Neutron emission for (n,2np)

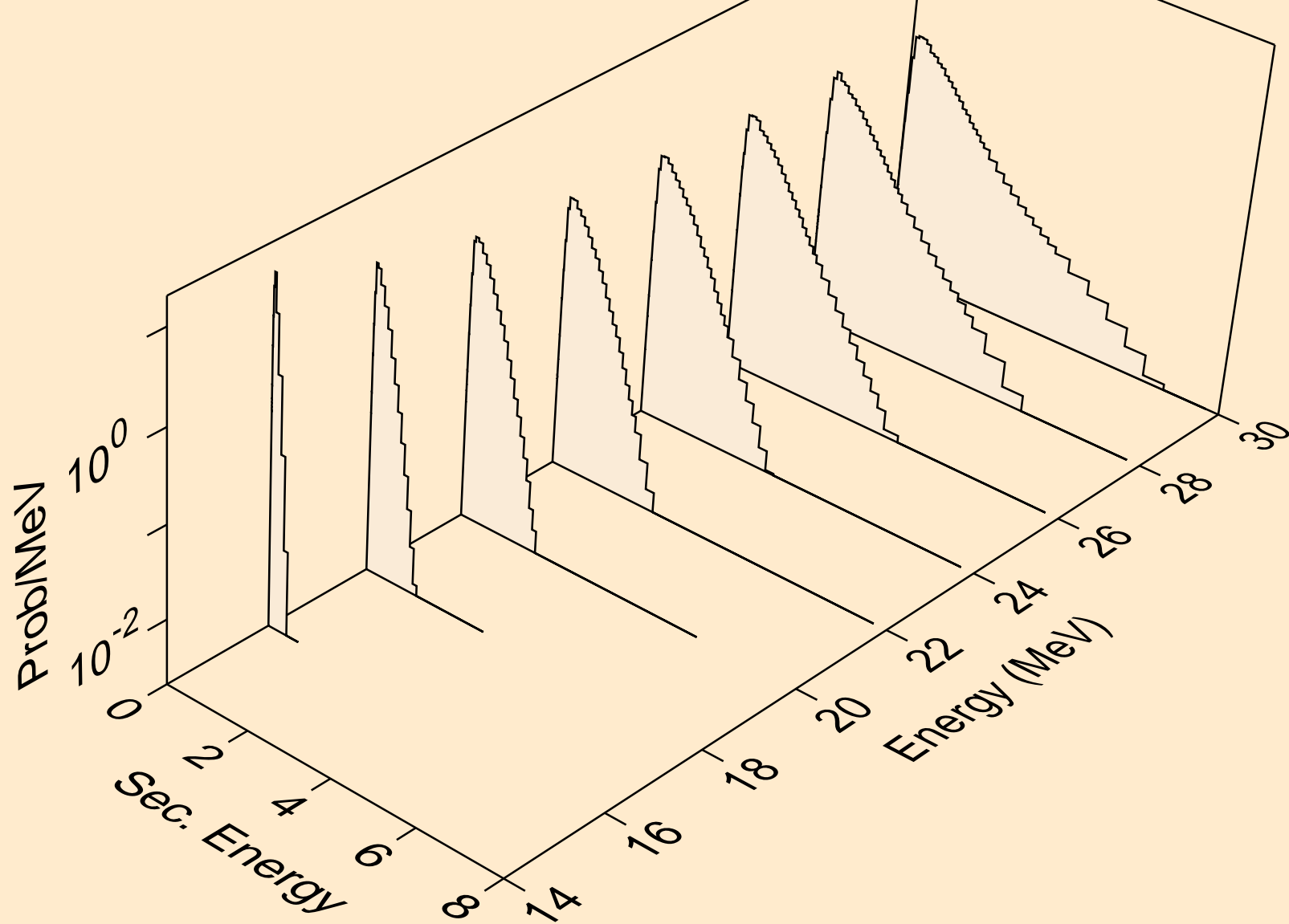

IR197 NEUTRON ACER TENDL-2024 LIBRARY; T=0.K
Neutron emission for (n,3np)

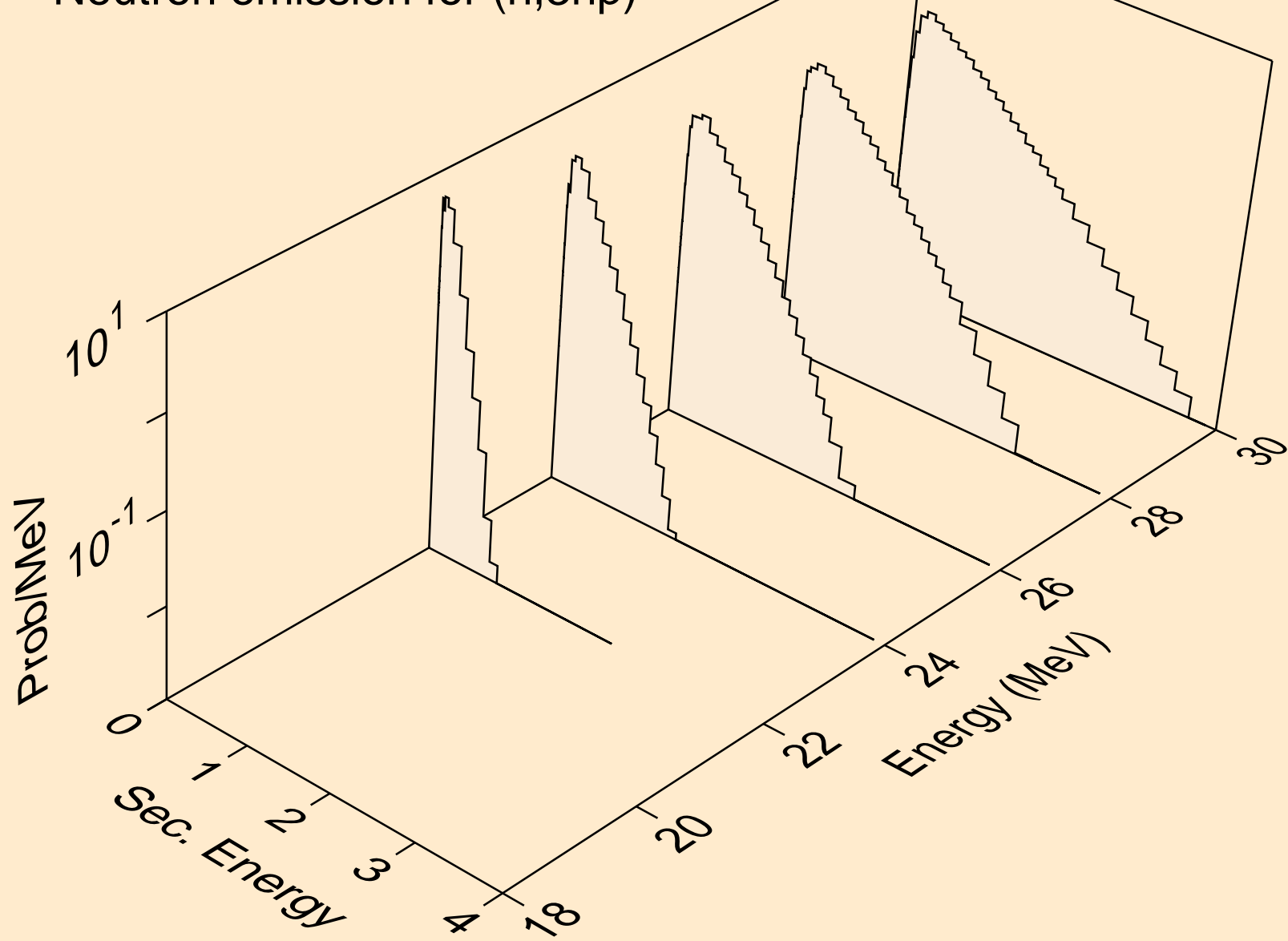

IR197 NEUTRON ACER TENDL-2024 LIBRARY; T=0.K
Neutron emission for (n,n*c)

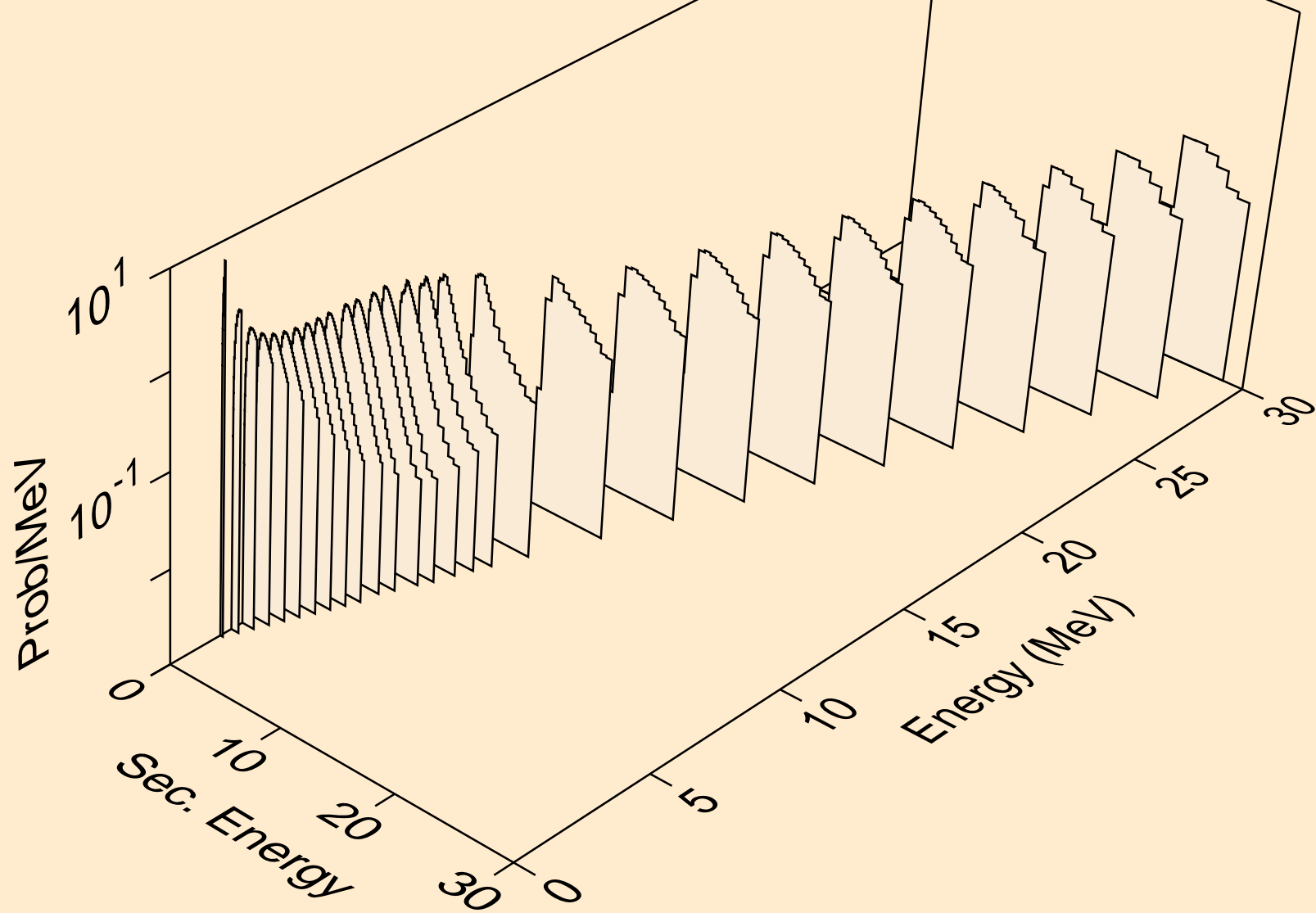

IR197 NEUTRON ACER TENDL-2024 LIBRARY; T=0.K
Photon emission for (n,x)

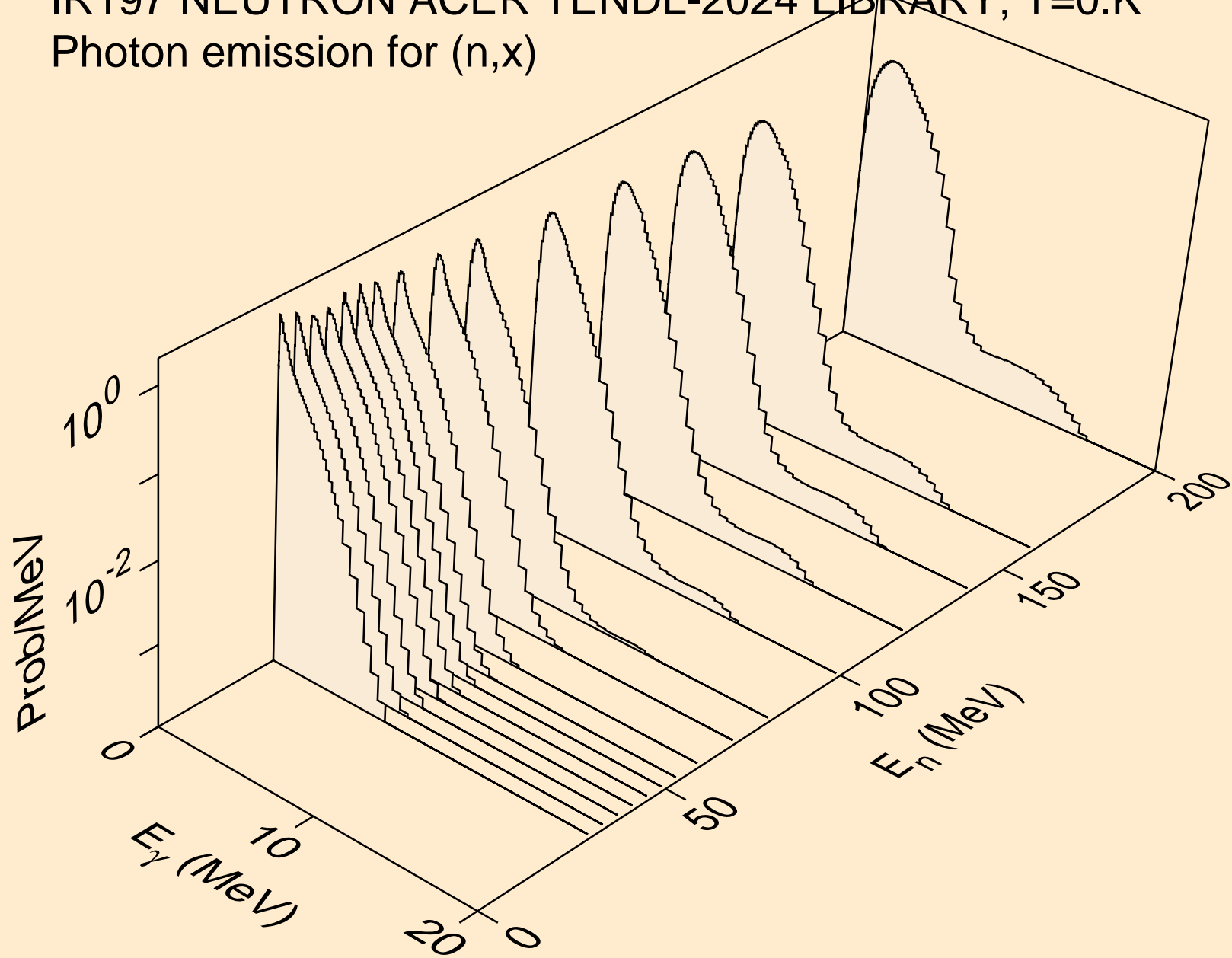

IR197 NEUTRON ACER TENDL-2024 LIBRARY; T=0.K
Photon emission for (n,2nd)

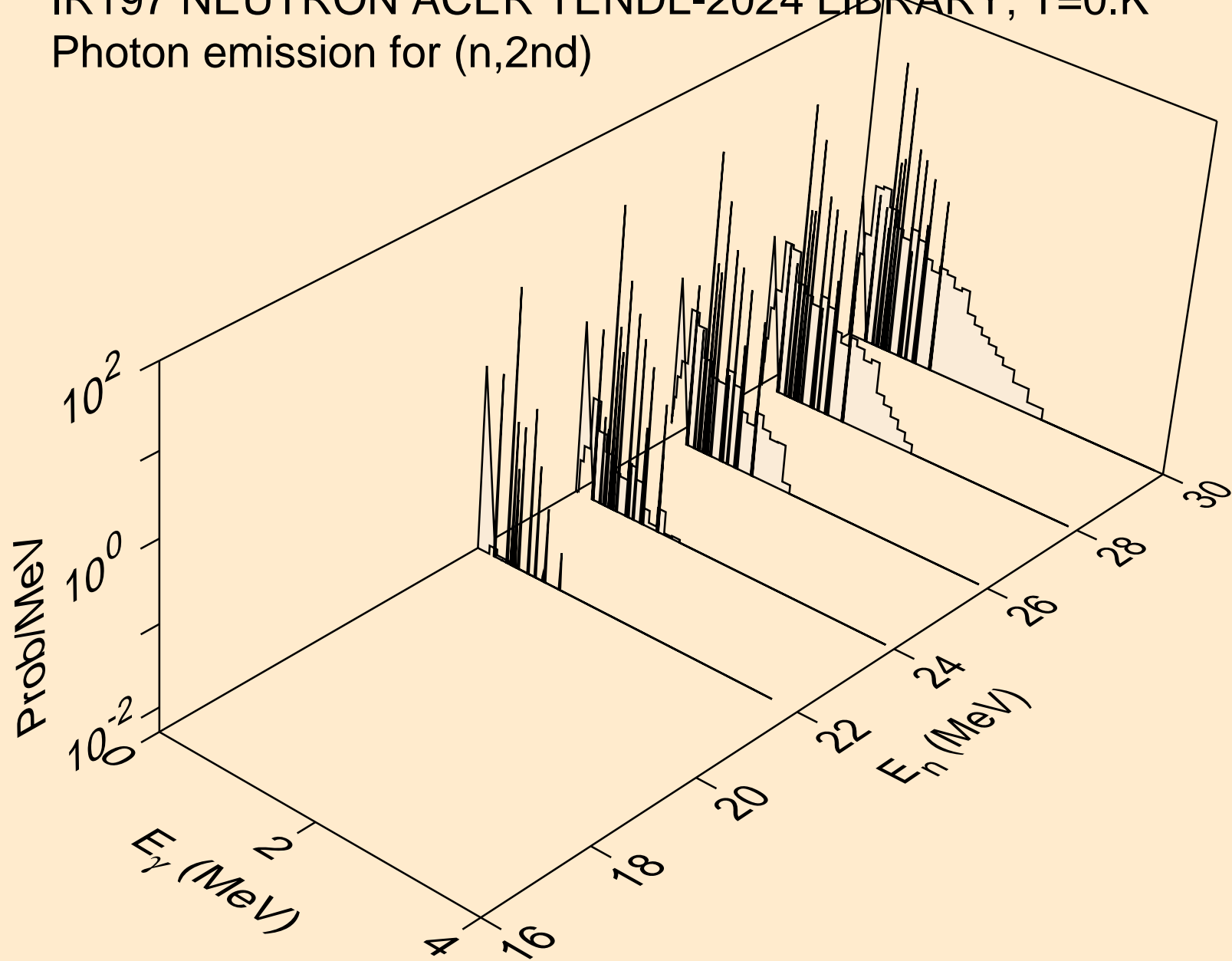

IR197 NEUTRON ACER TENDL-2024 LIBRARY; T=0.K
Photon emission for (n,2n)

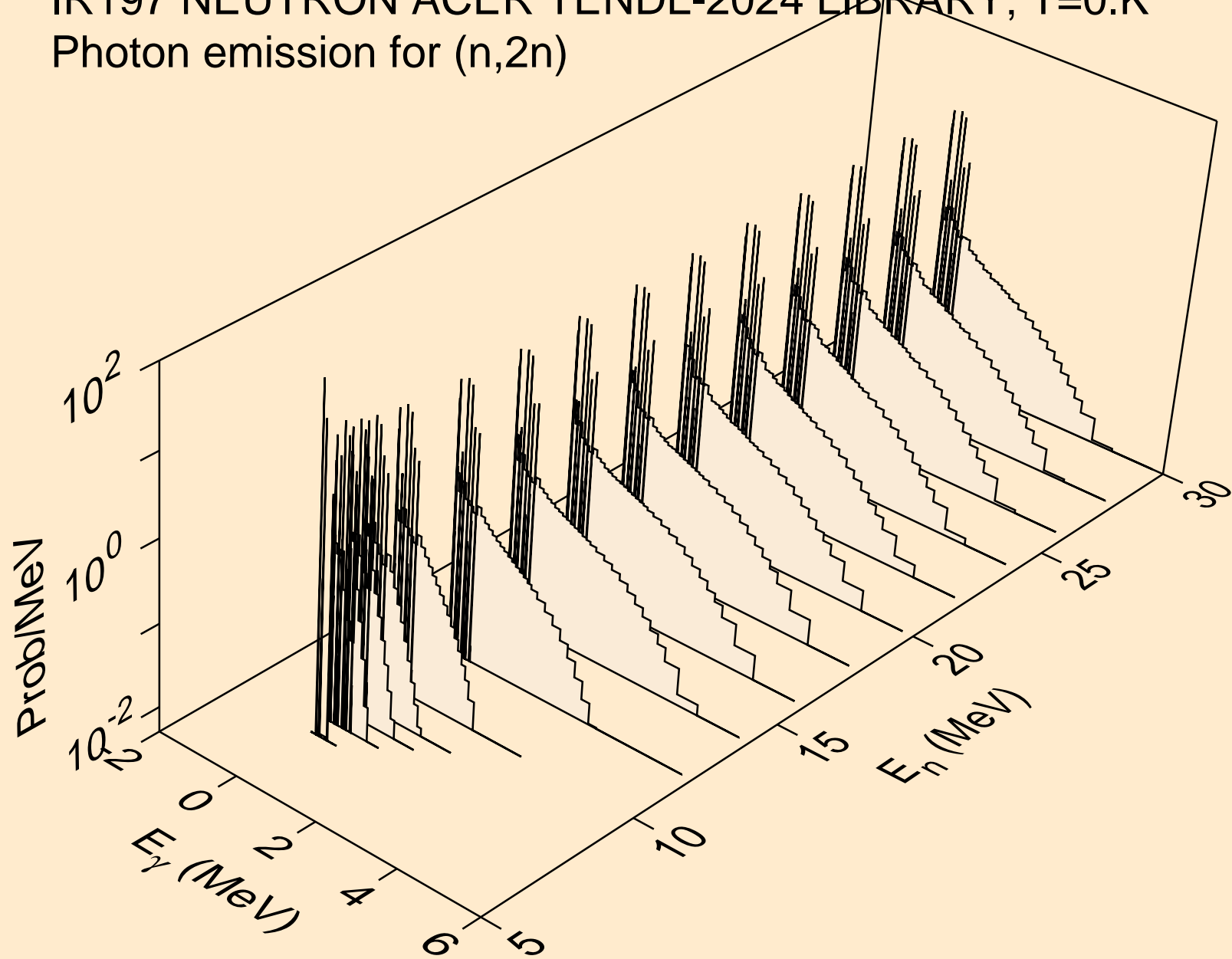

IR197 NEUTRON ACER TENDL-2024 LIBRARY; T=0.K
Photon emission for (n,3n)

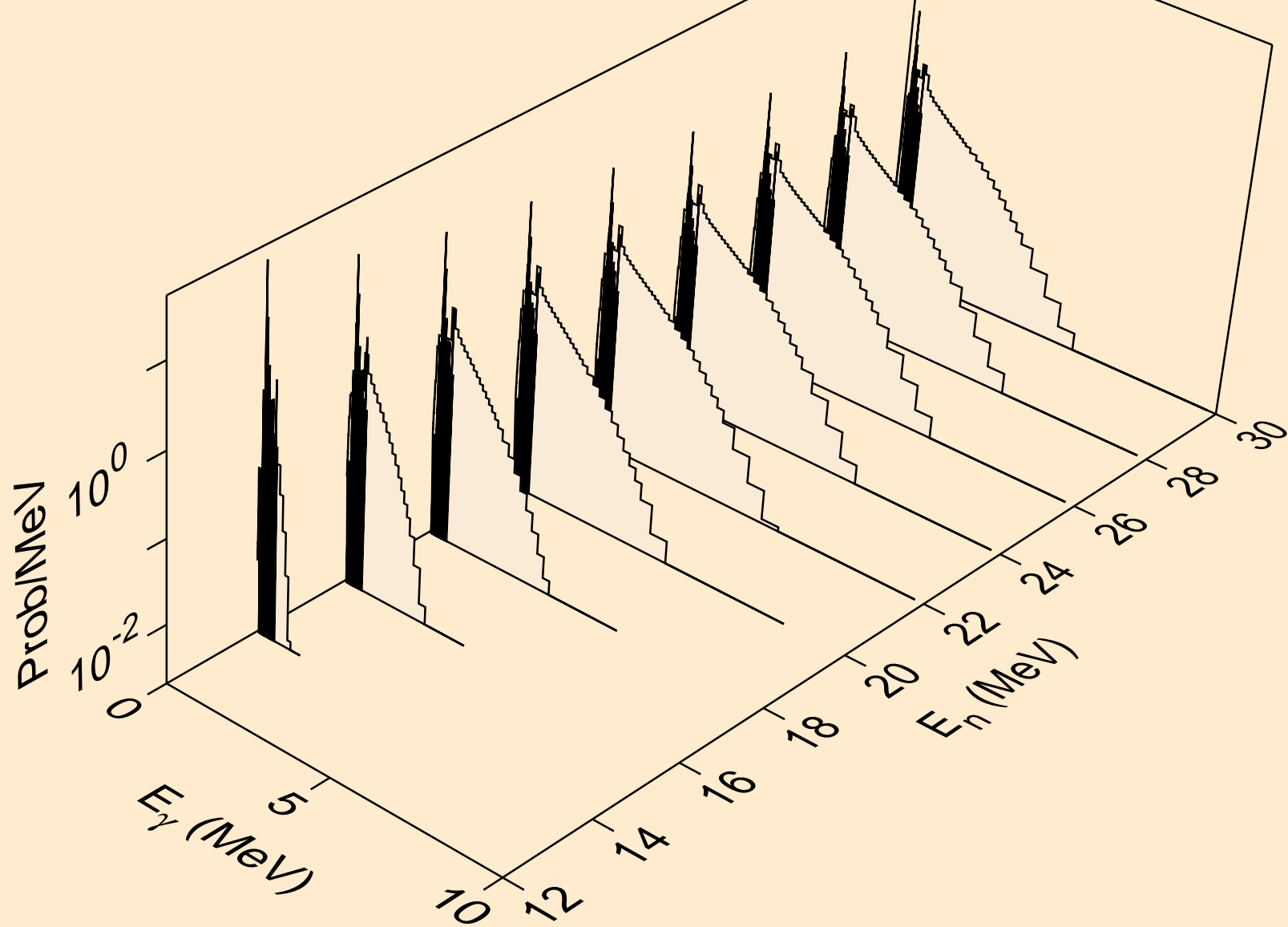

IR197 NEUTRON ACER TENDL-2024 LIBRARY; T=0.K
Photon emission for (n,n*)a

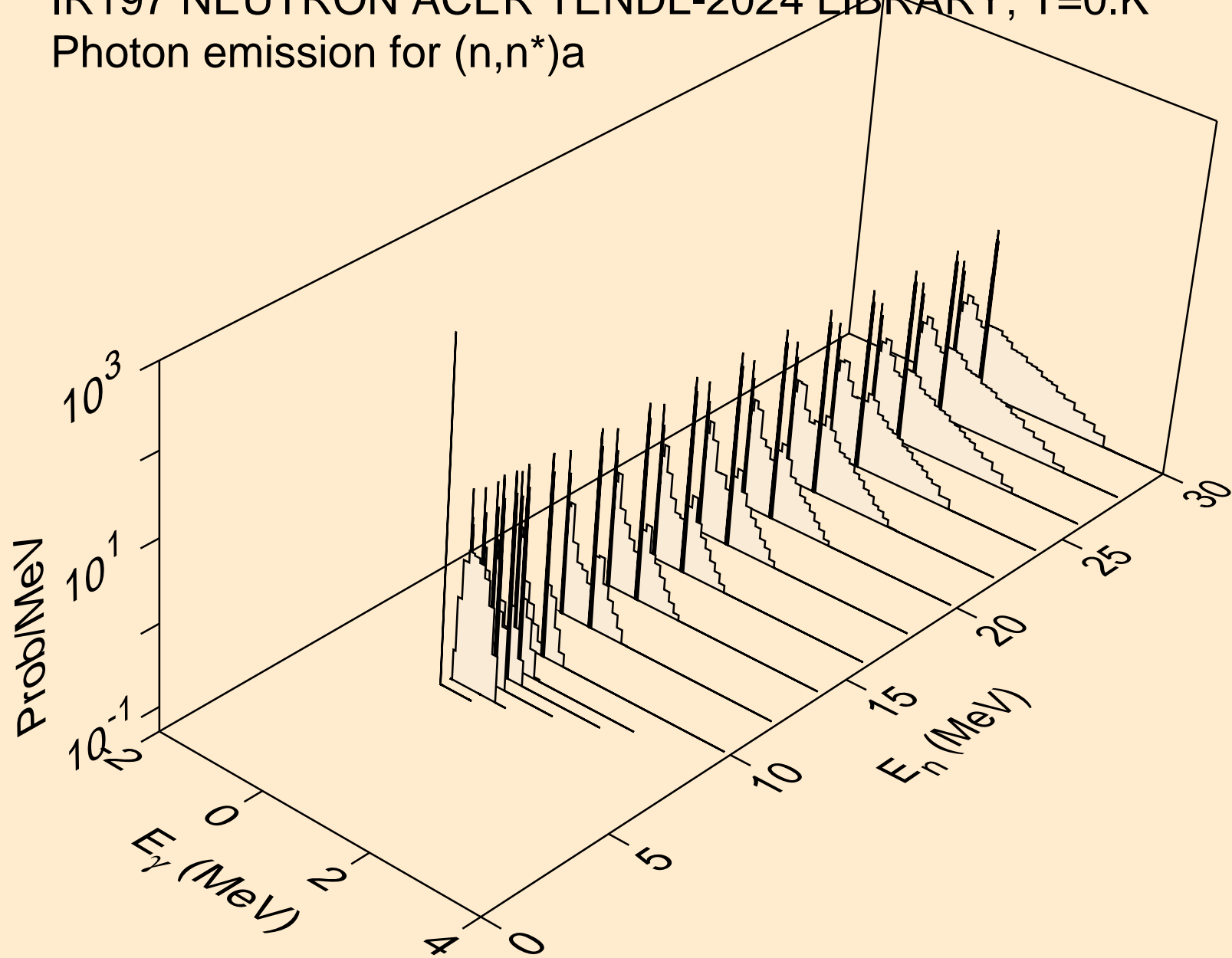

IR197 NEUTRON ACER TENDL-2024 LIBRARY; T=0.K
Photon emission for (n,2n)a

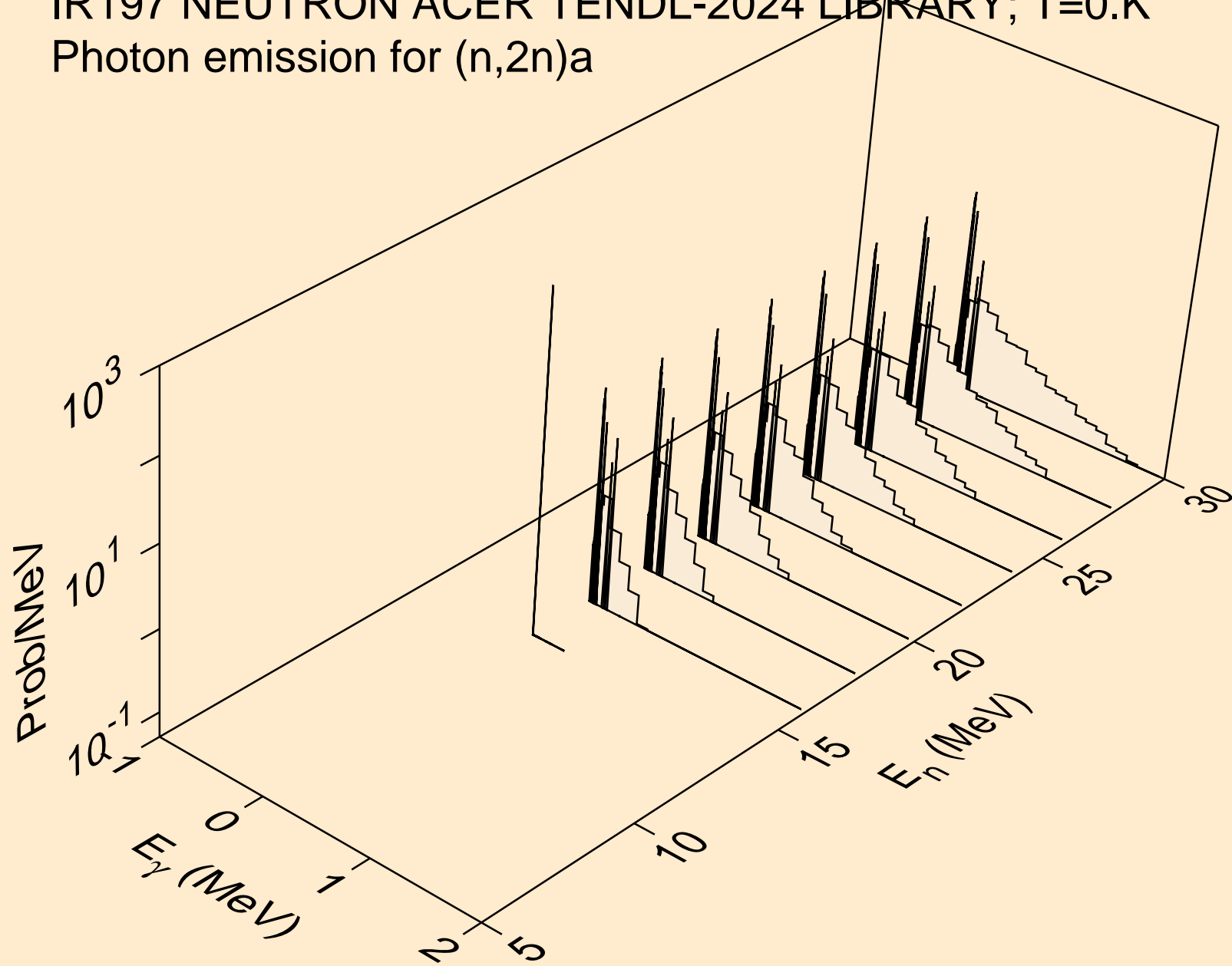

IR197 NEUTRON ACER TENDL-2024 LIBRARY; T=0.K
Photon emission for (n,3n)a

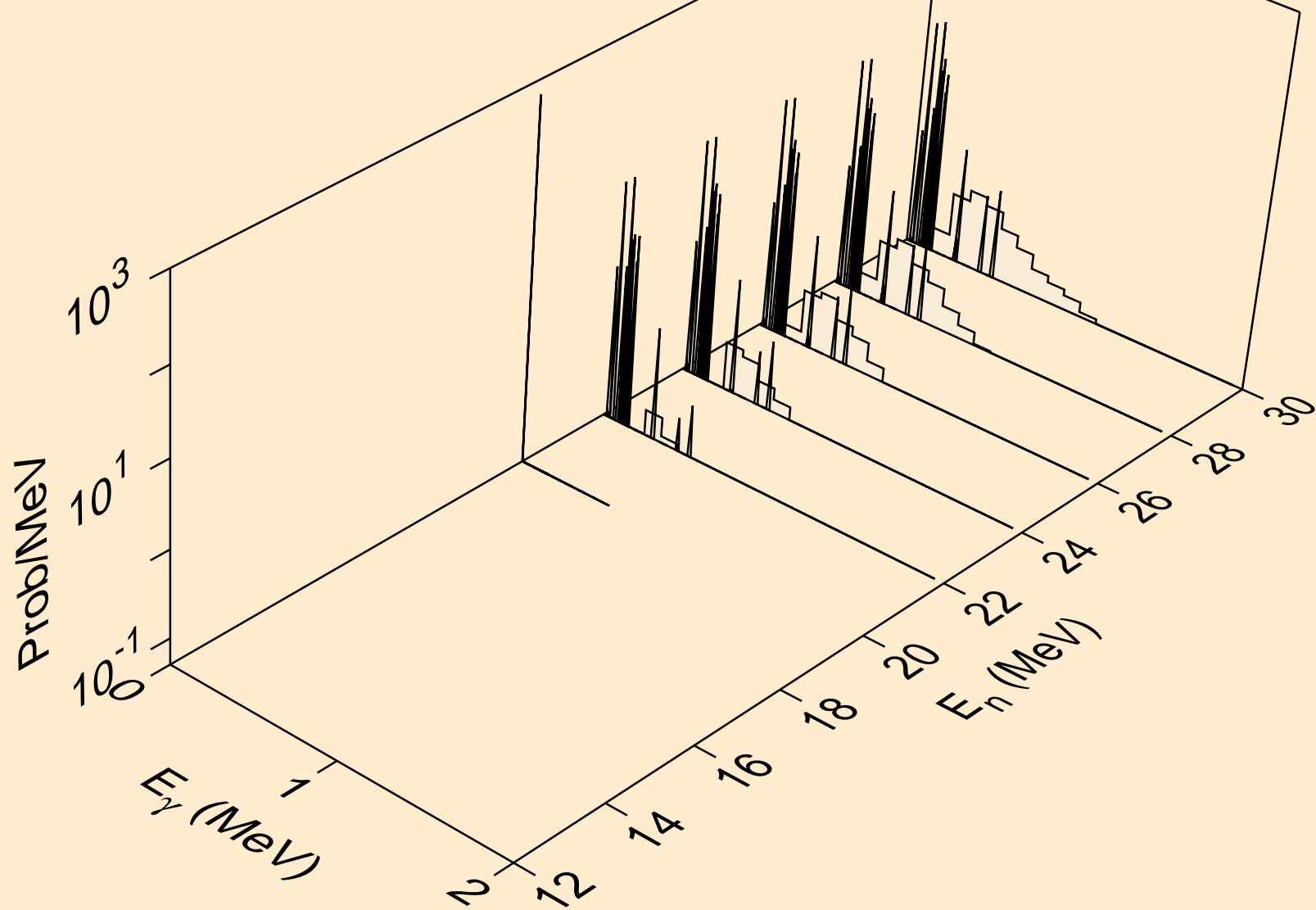

IR197 NEUTRON ACER TENDL-2024 LIBRARY; T=0.K
Photon emission for (n,n*)p

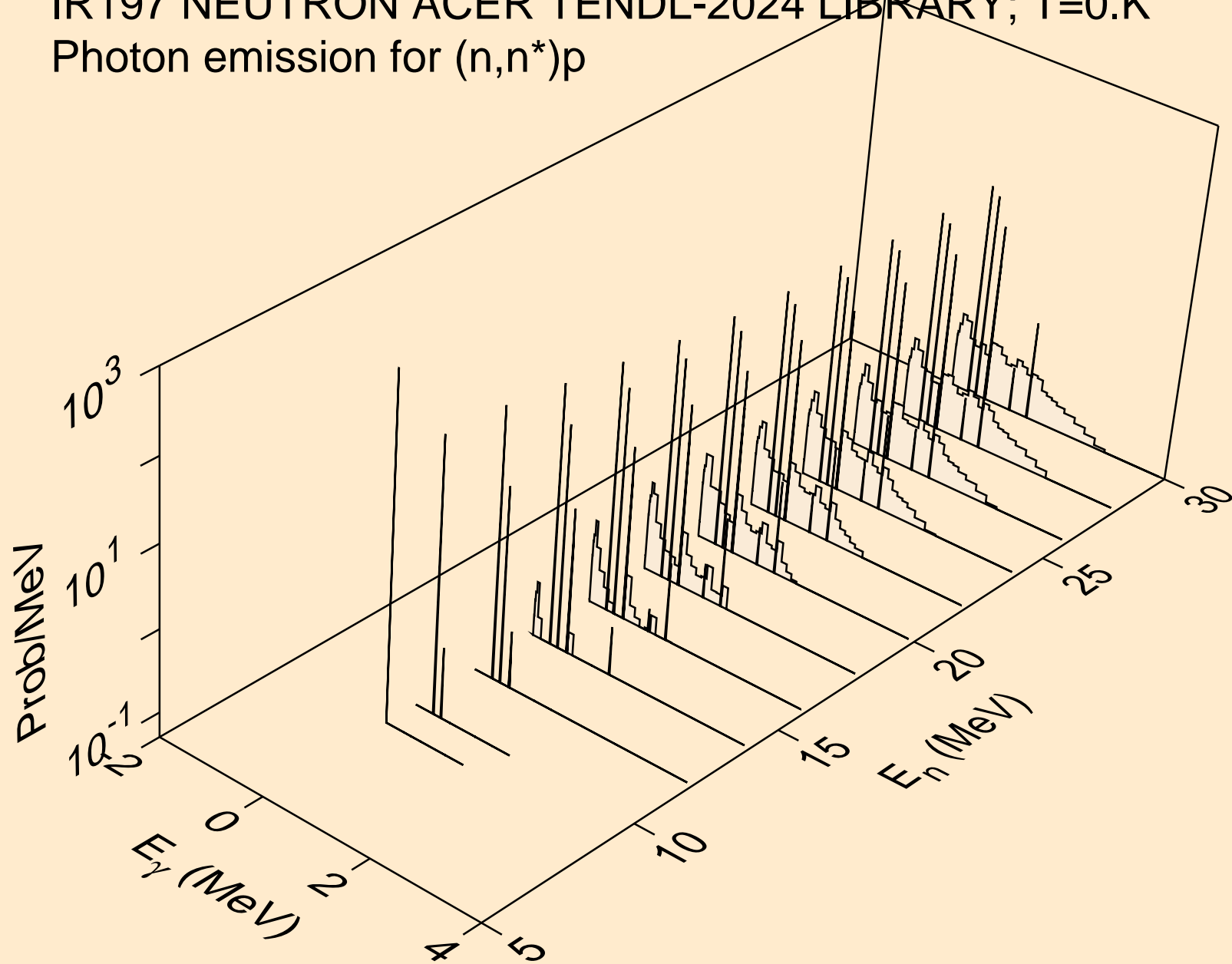

IR197 NEUTRON ACER TENDL-2024 LIBRARY; T=0.K
Photon emission for (n,n*)d

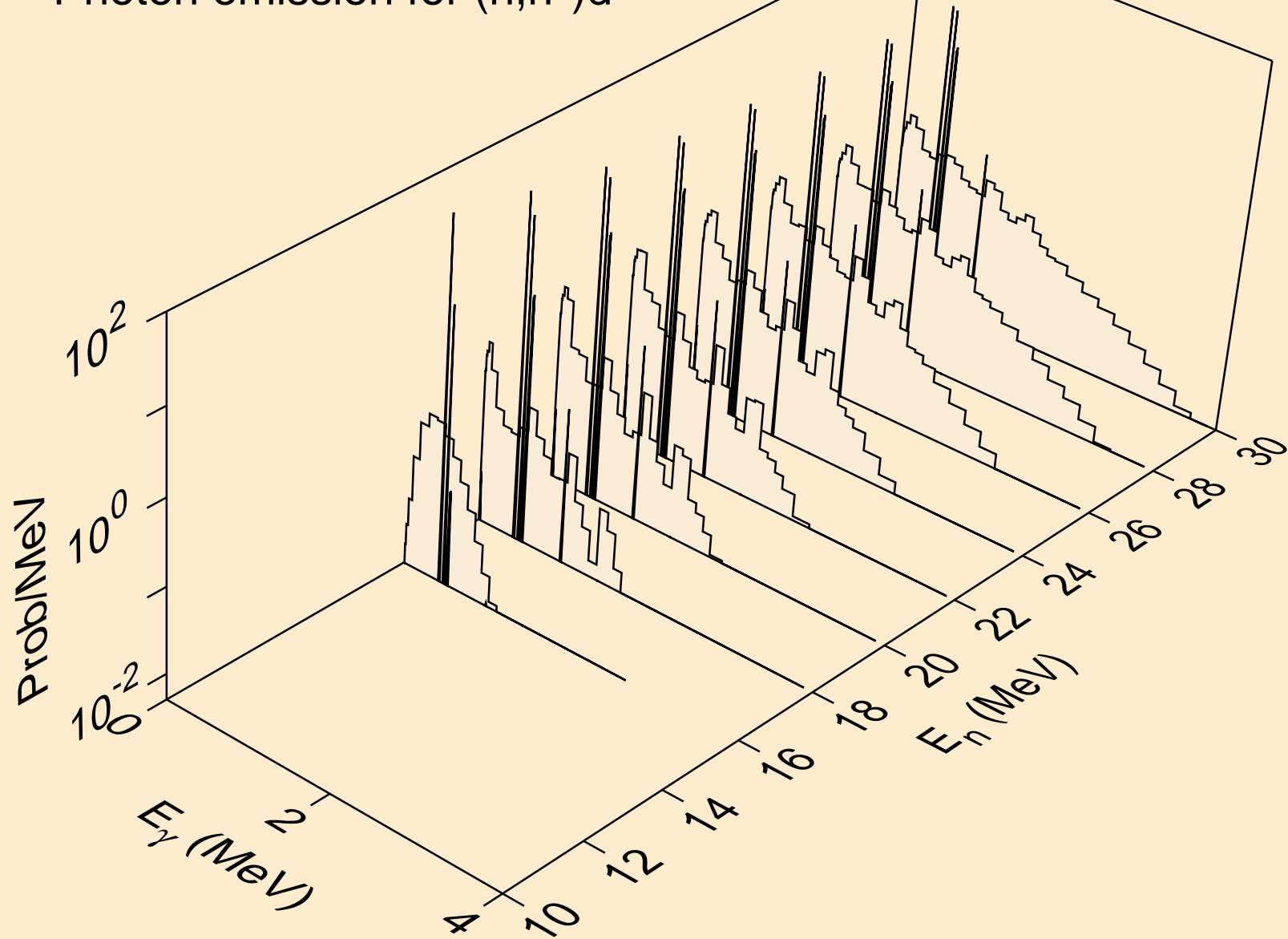

IR197 NEUTRON ACER TENDL-2024 LIBRARY; T=0.K
Photon emission for (n,n*)t

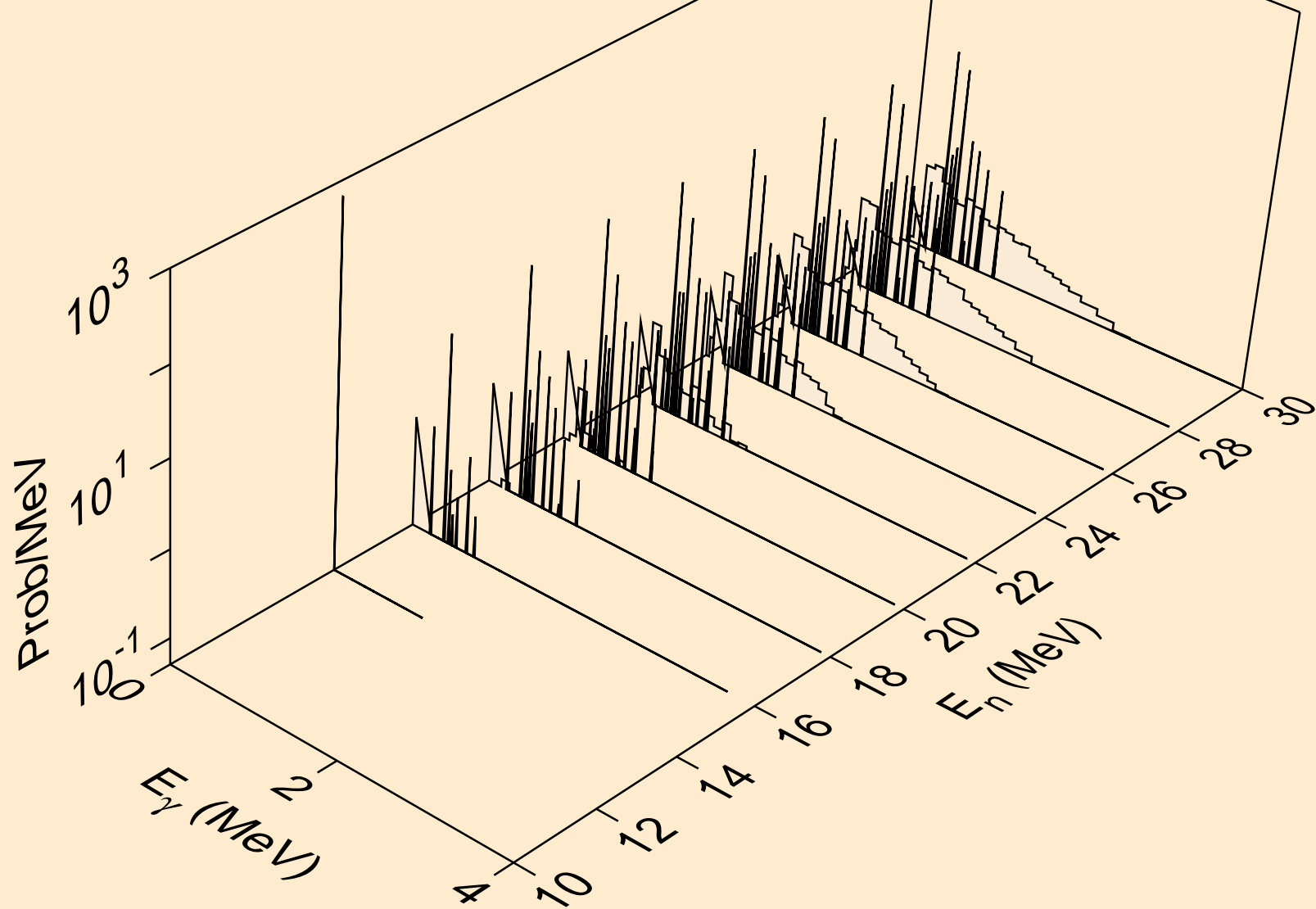

IR197 NEUTRON ACER TENDL-2024 LIBRARY; T=0.K
Photon emission for (n,n*)he3

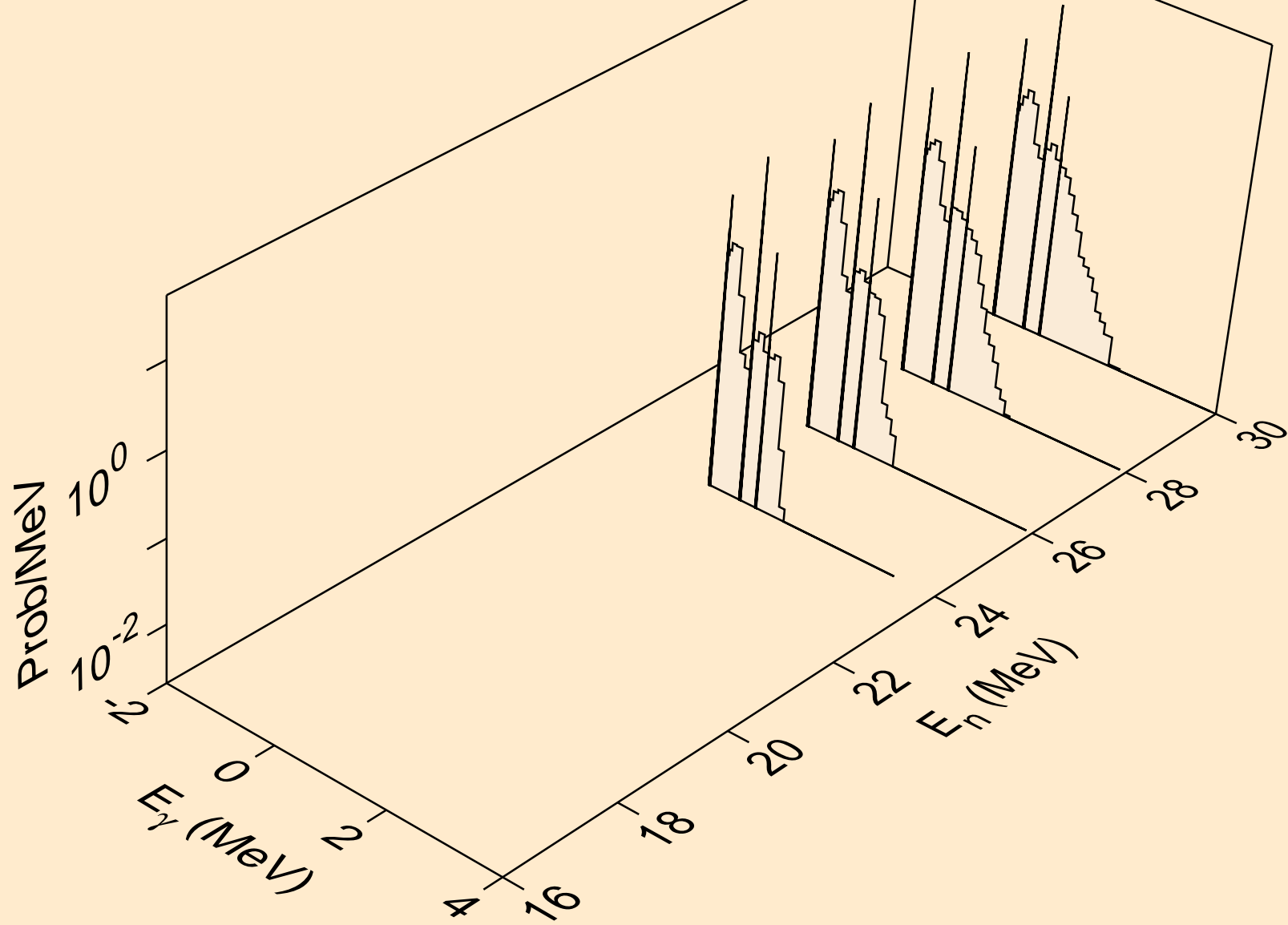

IR197 NEUTRON ACER TENDL-2024 LIBRARY; T=0.K
Photon emission for (n,4n)

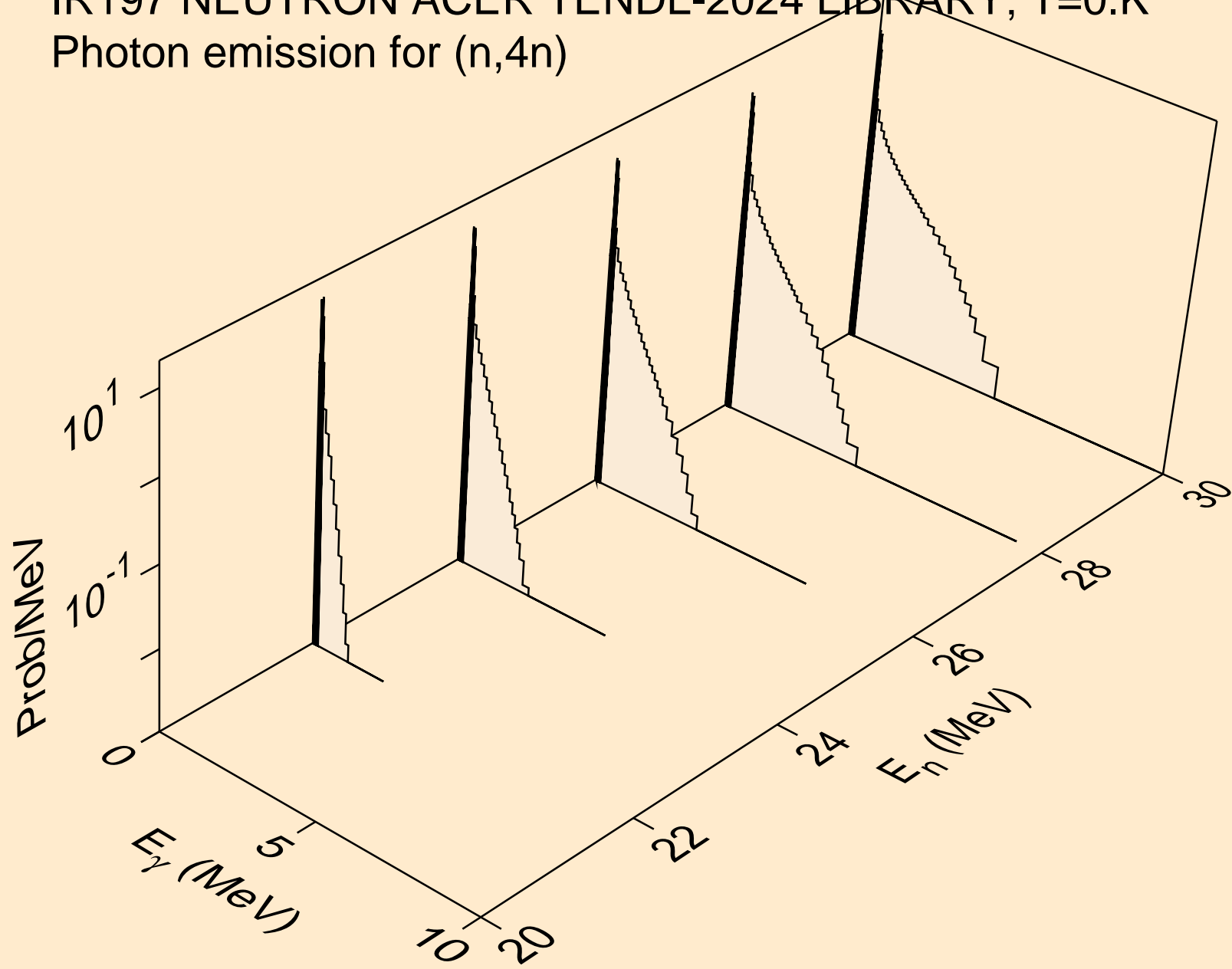

IR197 NEUTRON ACER TENDL-2024 LIBRARY; T=0.K
Photon emission for (n,2np)

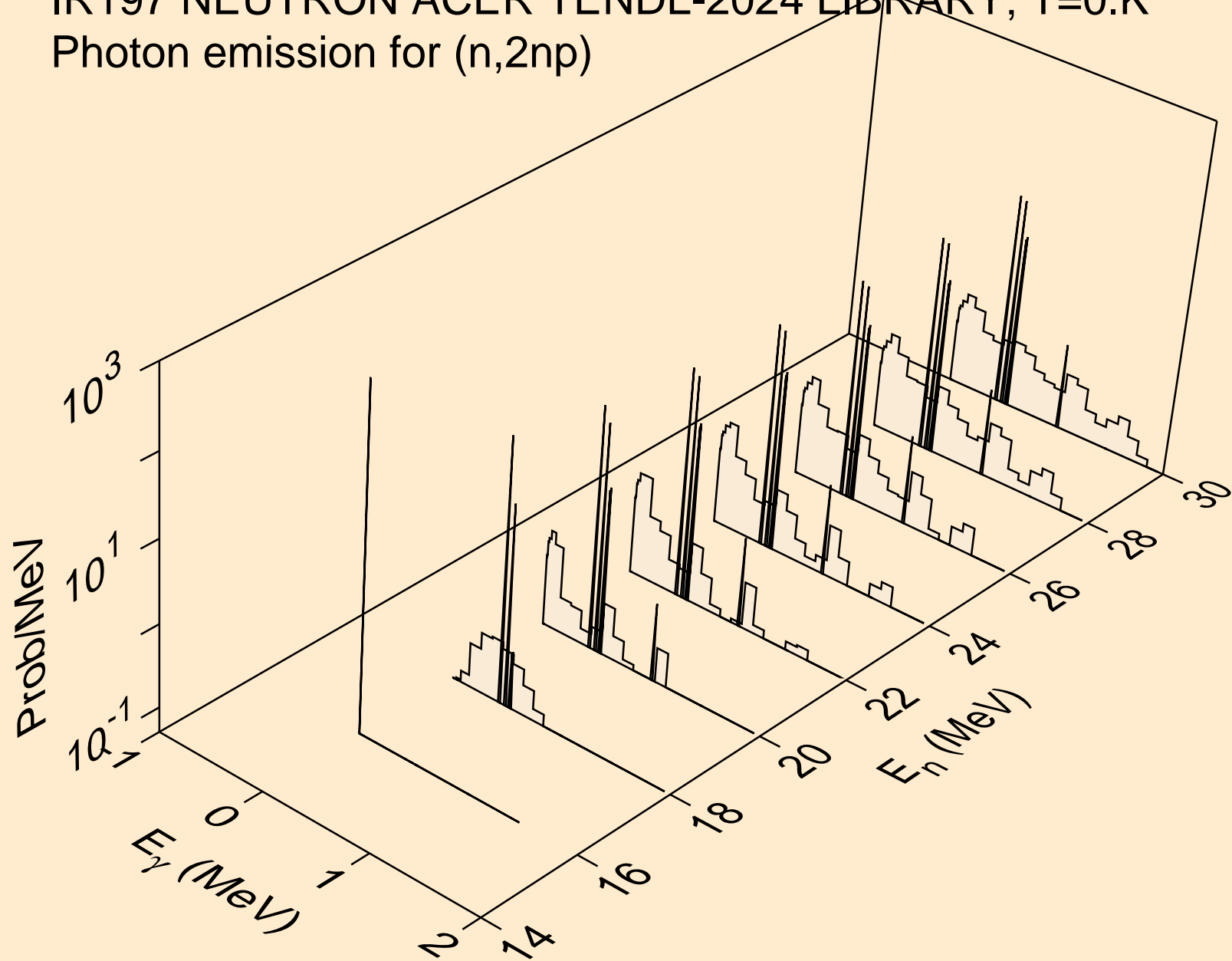

IR197 NEUTRON ACER TENDL-2024 LIBRARY; T=0.K
Photon emission for (n,3np)

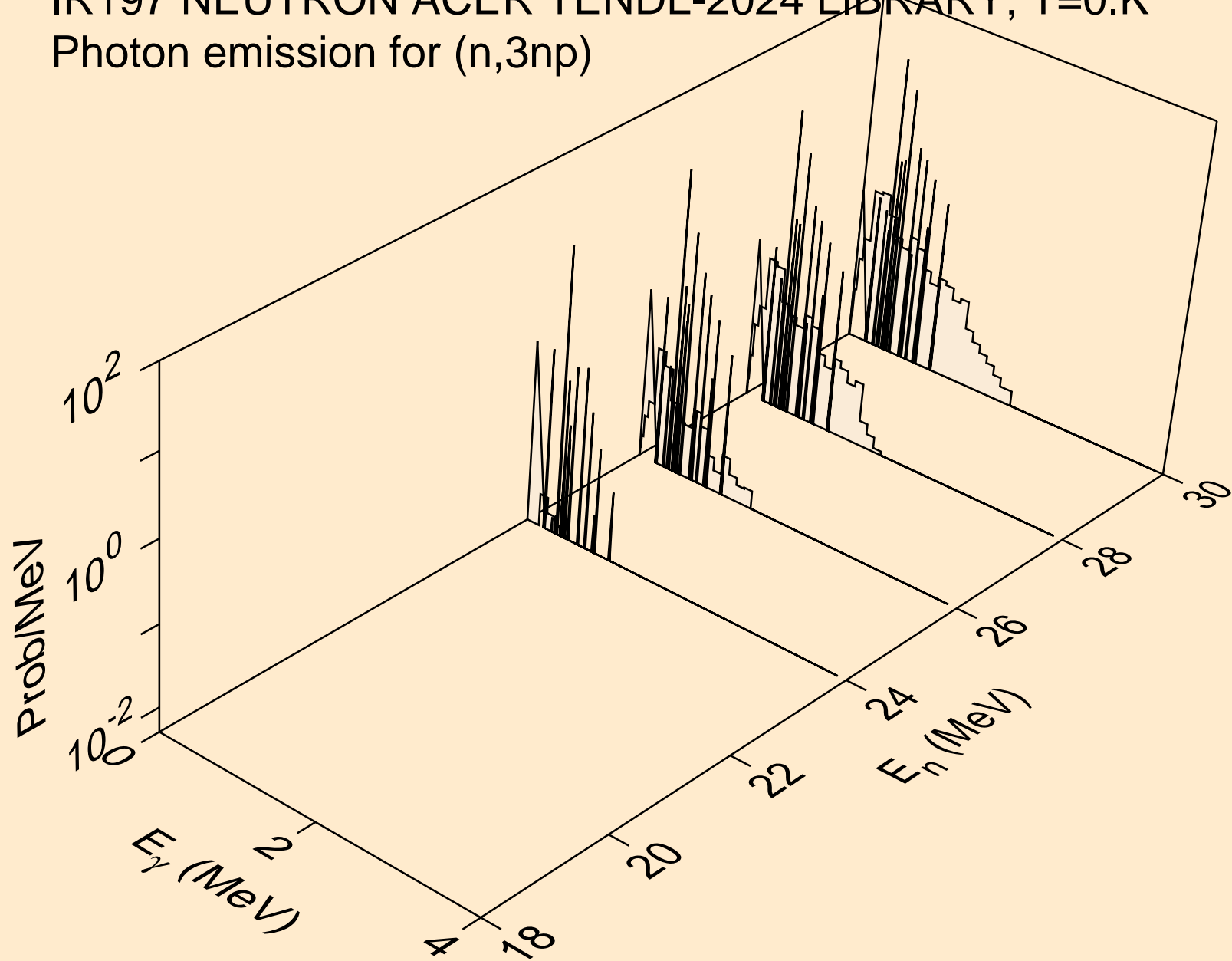

IR197 NEUTRON ACER TENDL-2024 LIBRARY; T=0.K
Photon emission for (n,n*c)

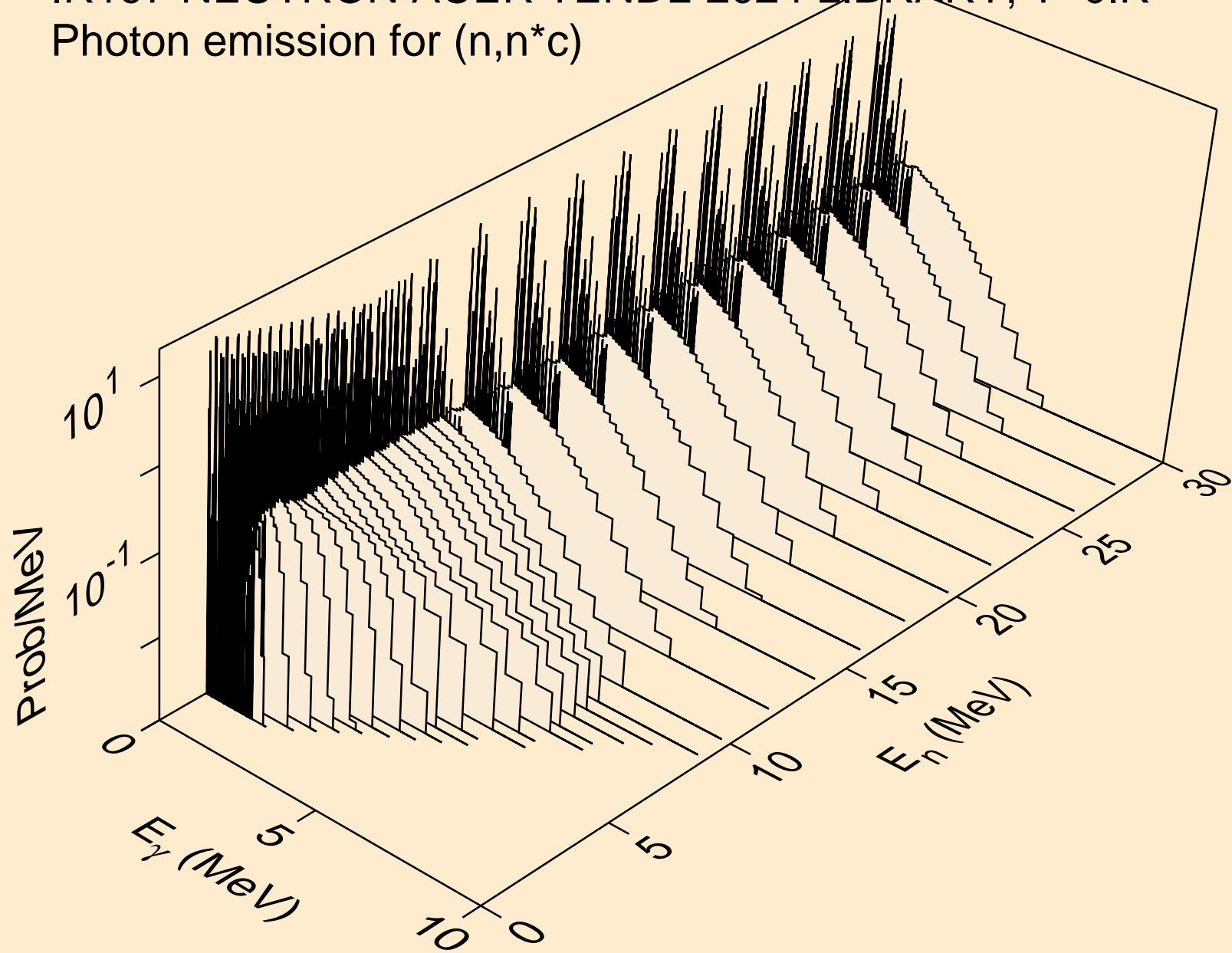

IR197 NEUTRON ACER TENDL-2024 LIBRARY; T=0.K
Photon emission for (n,gma)

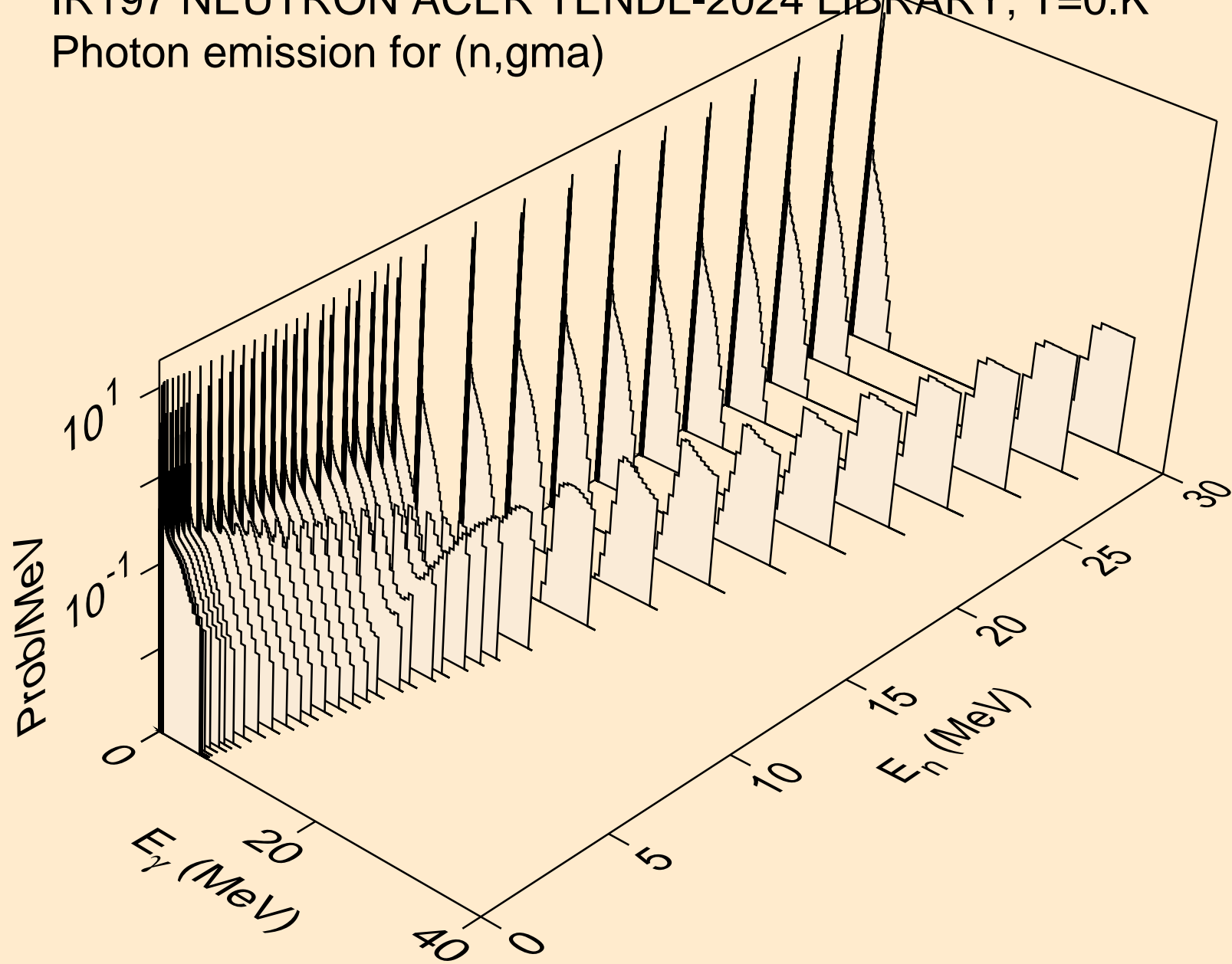

IR197 NEUTRON ACER TENDL-2024 LIBRARY; T=0.K
Photon emission for (n,p)

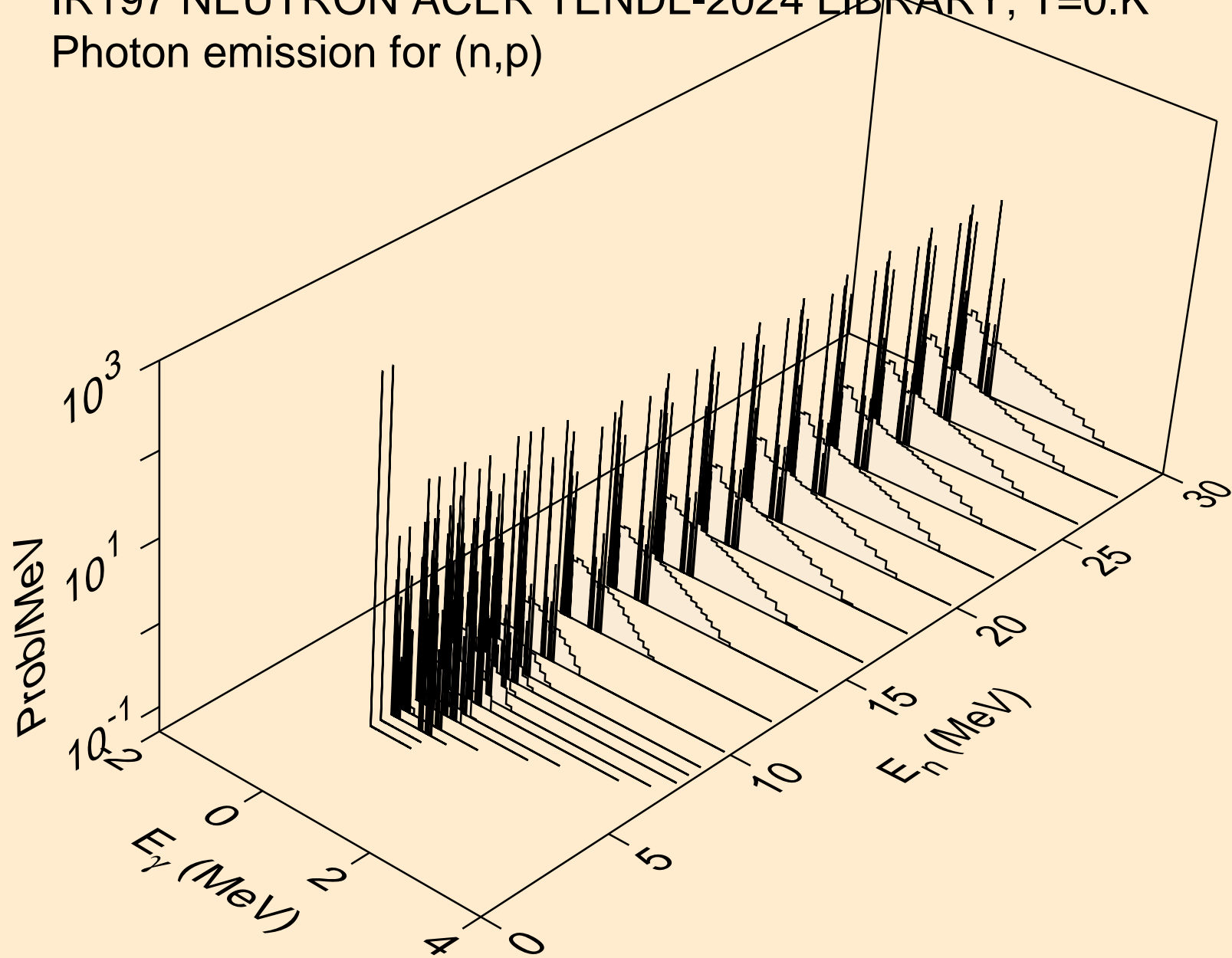

IR197 NEUTRON ACER TENDL-2024 LIBRARY; T=0.K
Photon emission for (n,d)

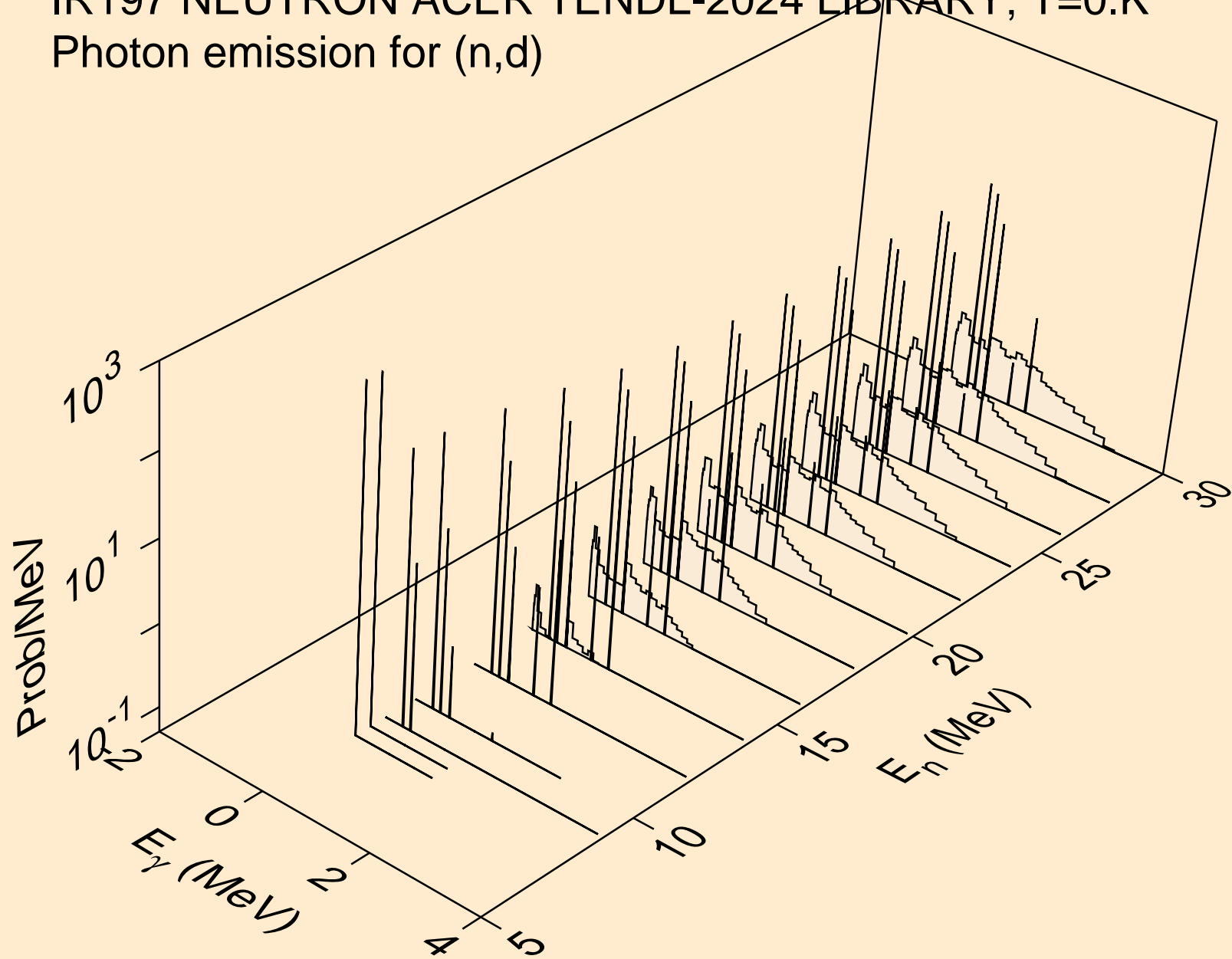

IR197 NEUTRON ACER TENDL-2024 LIBRARY; T=0.K
Photon emission for (n,t)

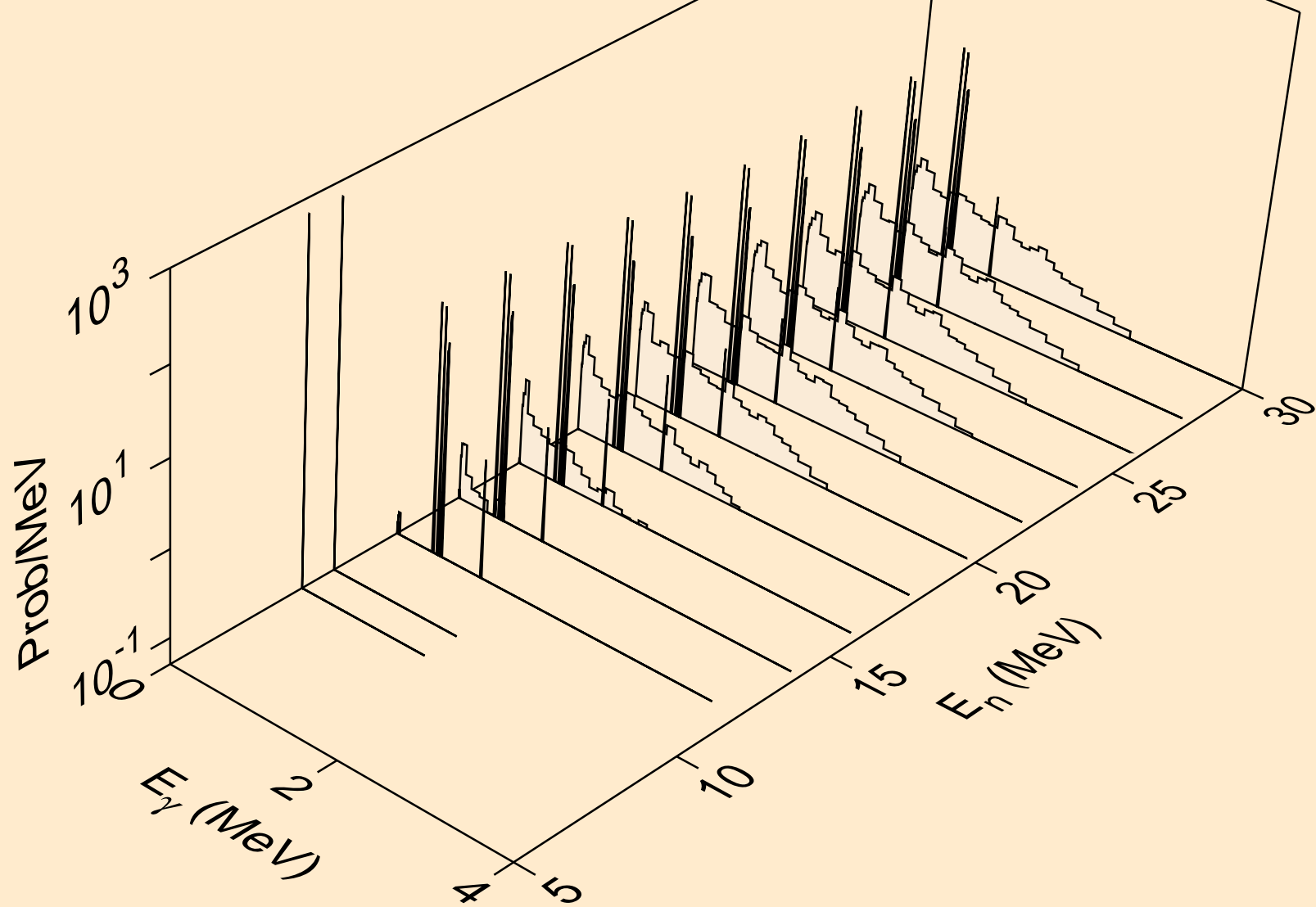

IR197 NEUTRON ACER TENDL-2024 LIBRARY; T=0.K
Photon emission for (n,he3)

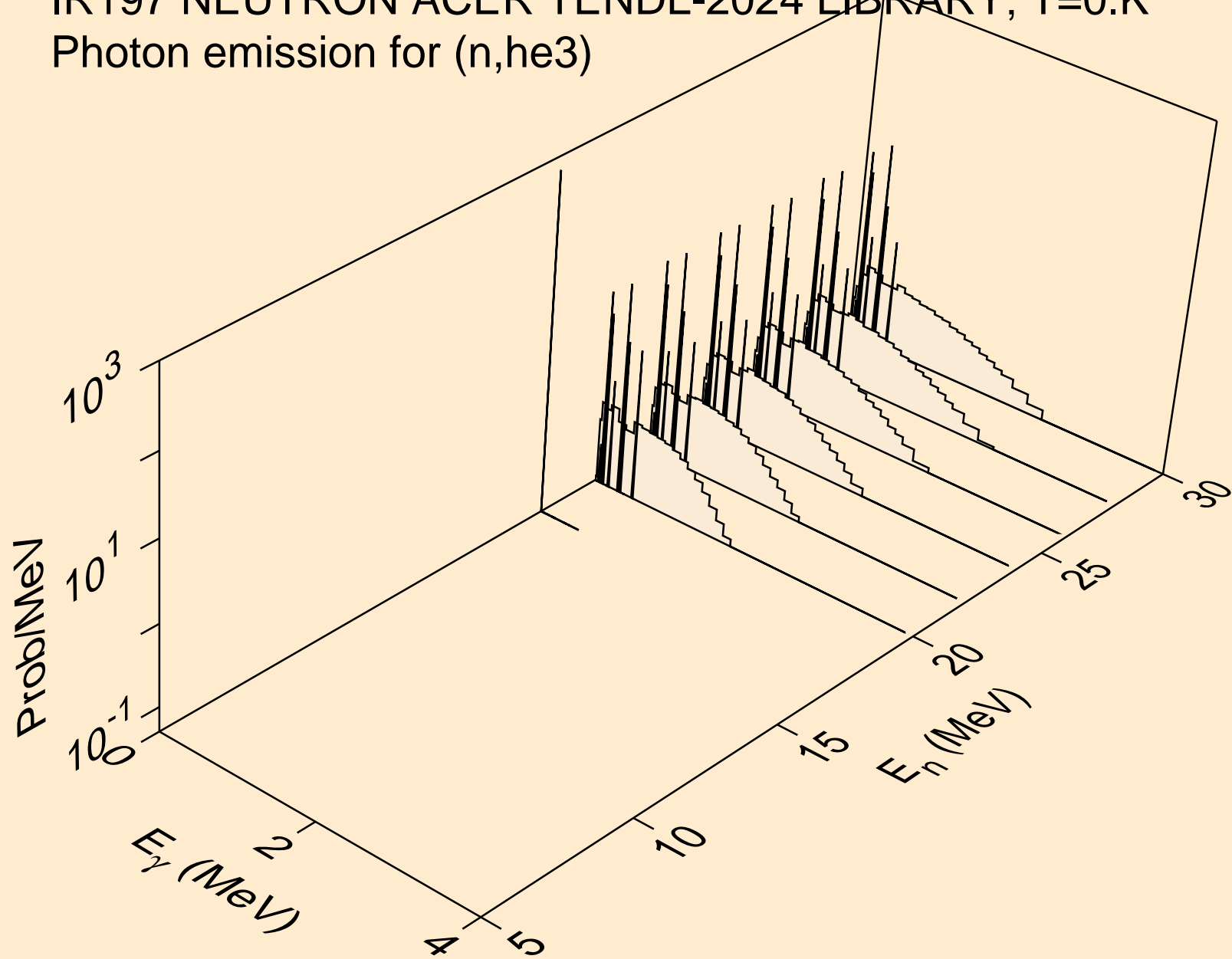

IR197 NEUTRON ACER TENDL-2024 LIBRARY; T=0.K
Photon emission for (n,a)

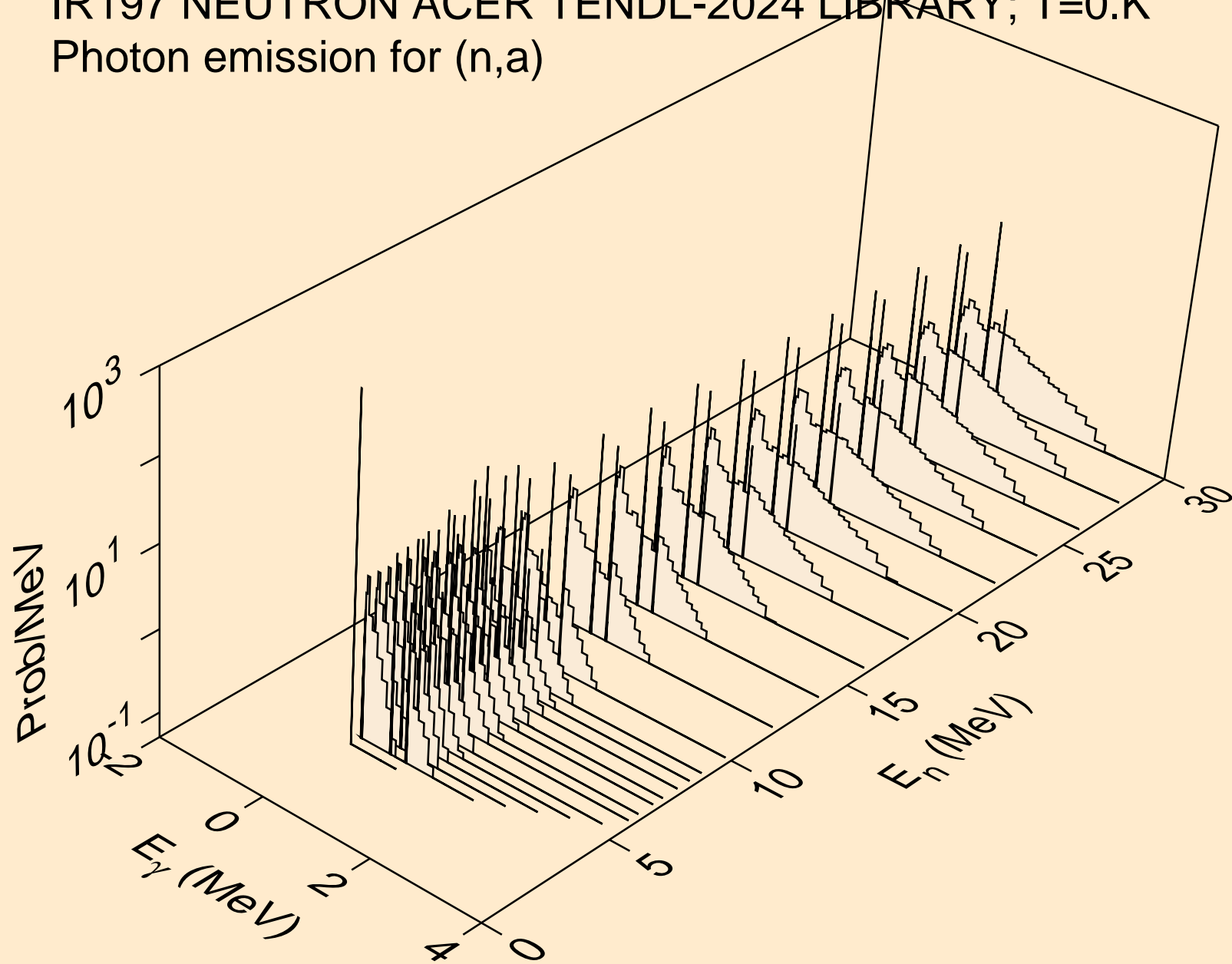

IR197 NEUTRON ACER TENDL-2024 LIBRARY; T=0.K
Photon emission for (n,2p)

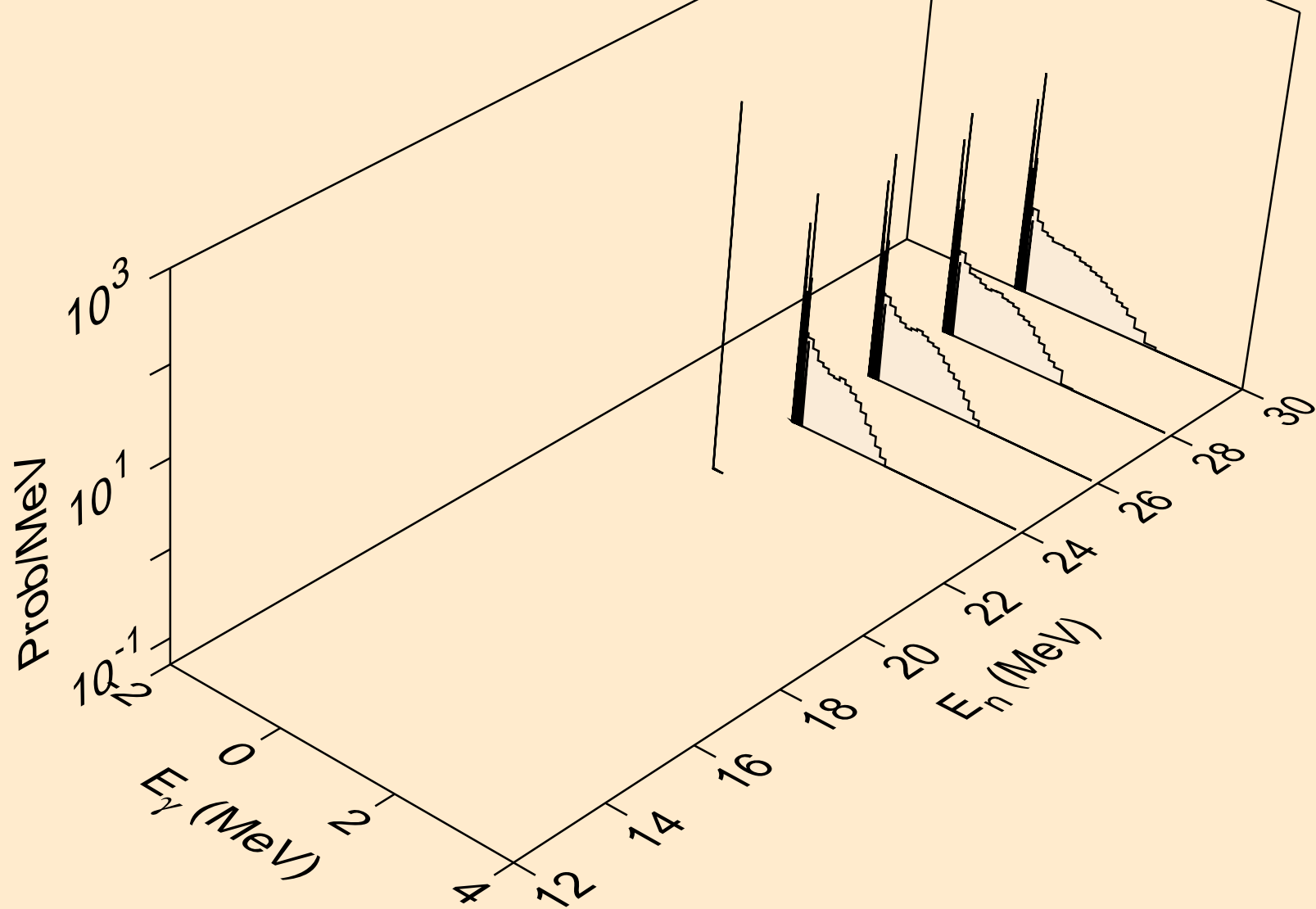

IR197 NEUTRON ACER TENDL-2024 LIBRARY; T=0.K
thermal capture photon spectrum

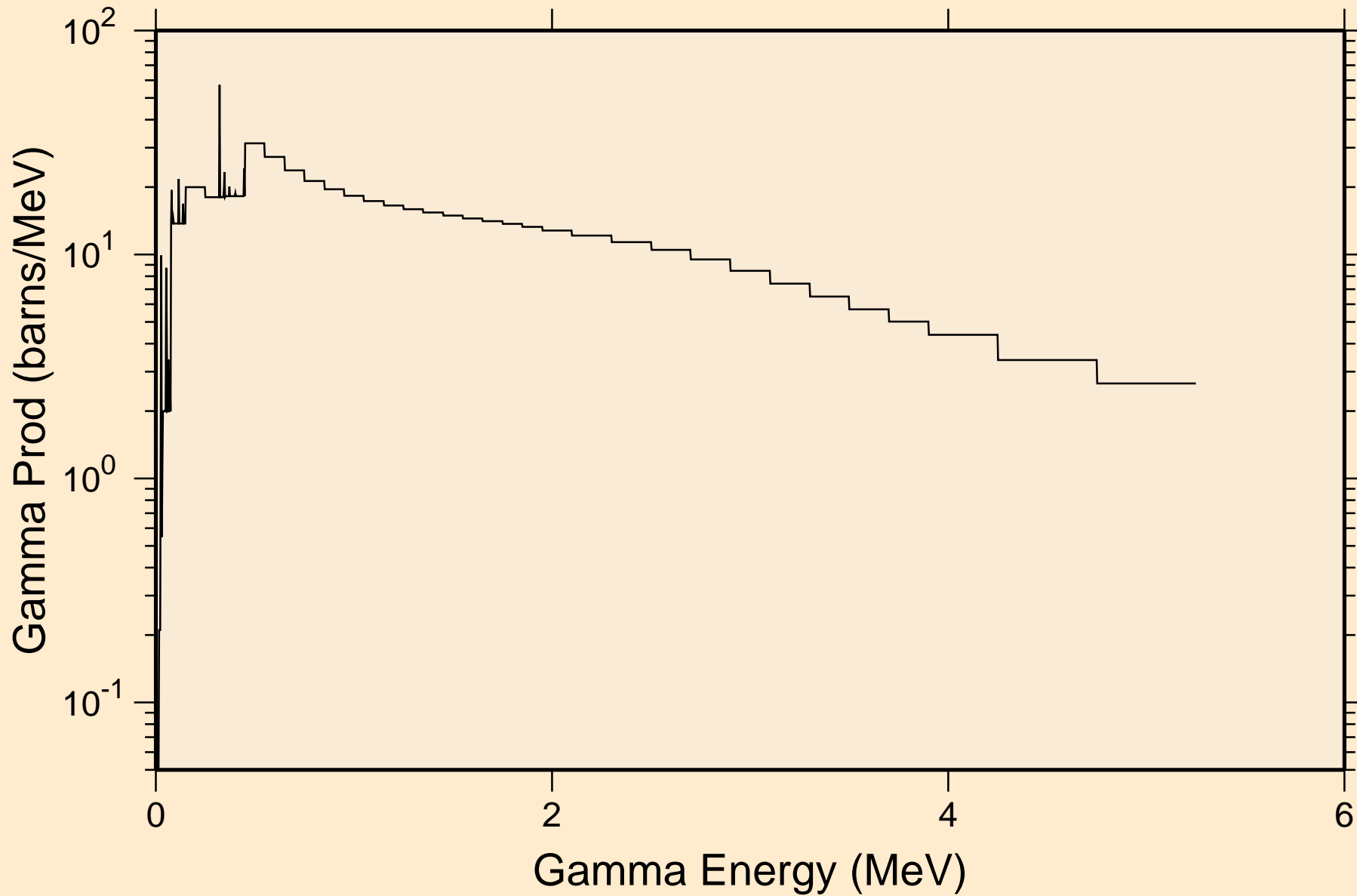

IR197 NEUTRON ACER TENDL-2024 LIBRARY; T=0.K
14 MeV photon spectrum

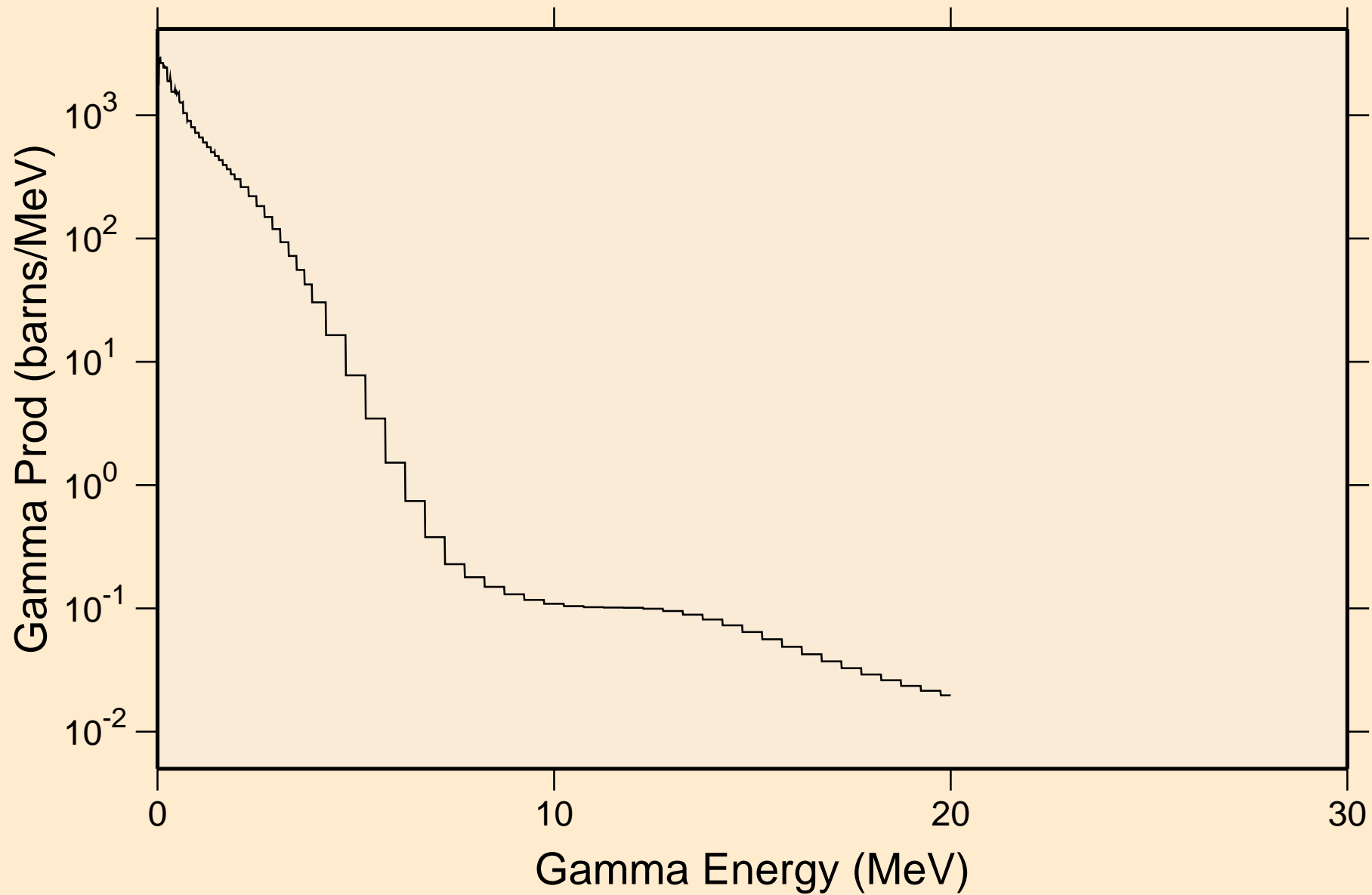

IR197 NEUTRON ACER TENDL-2024 LIBRARY; T=0.K
Particle heating contributions

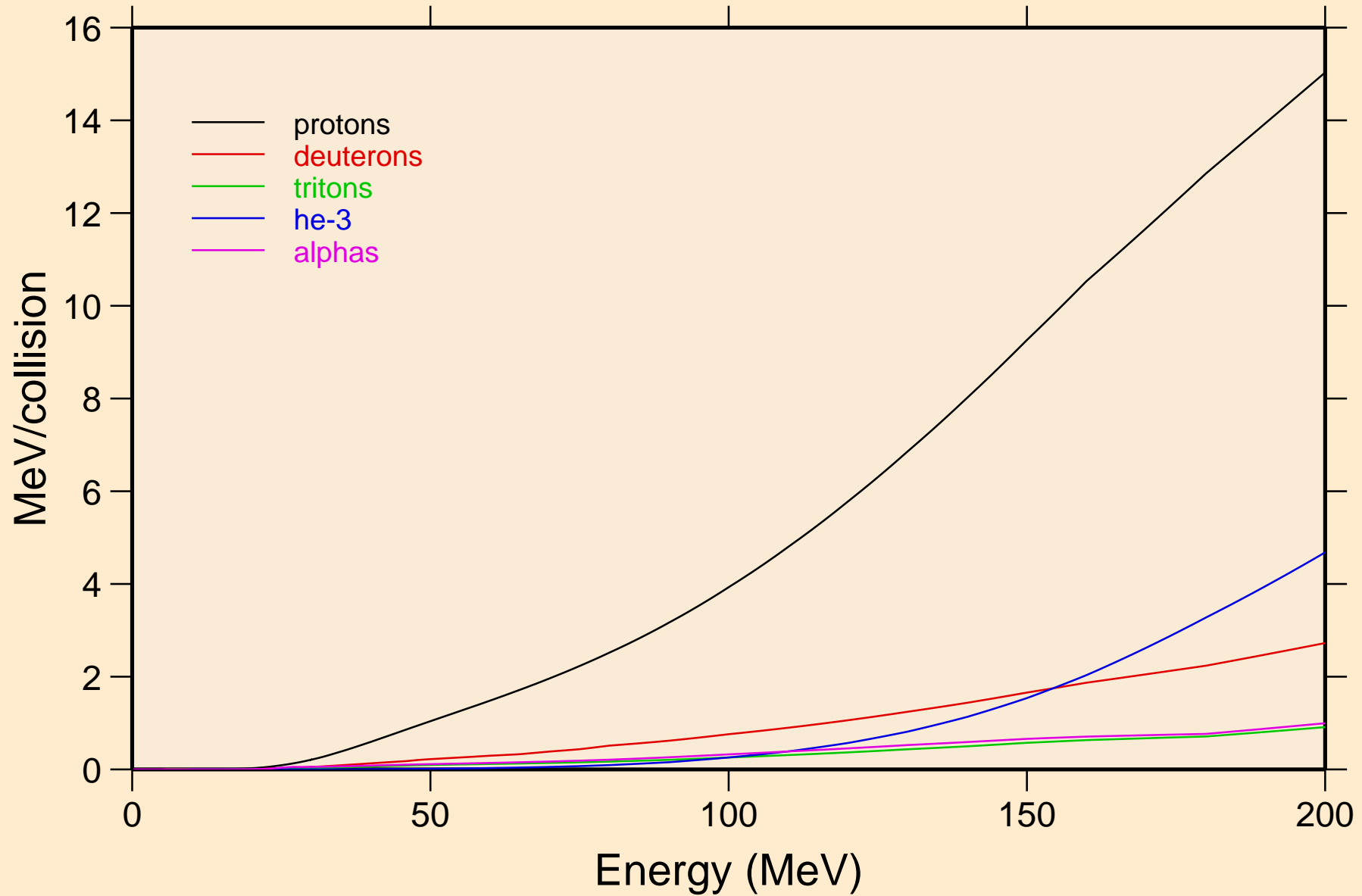

IR197 NEUTRON ACER TENDL-2024 LIBRARY; T=0.K
Recoil Heating

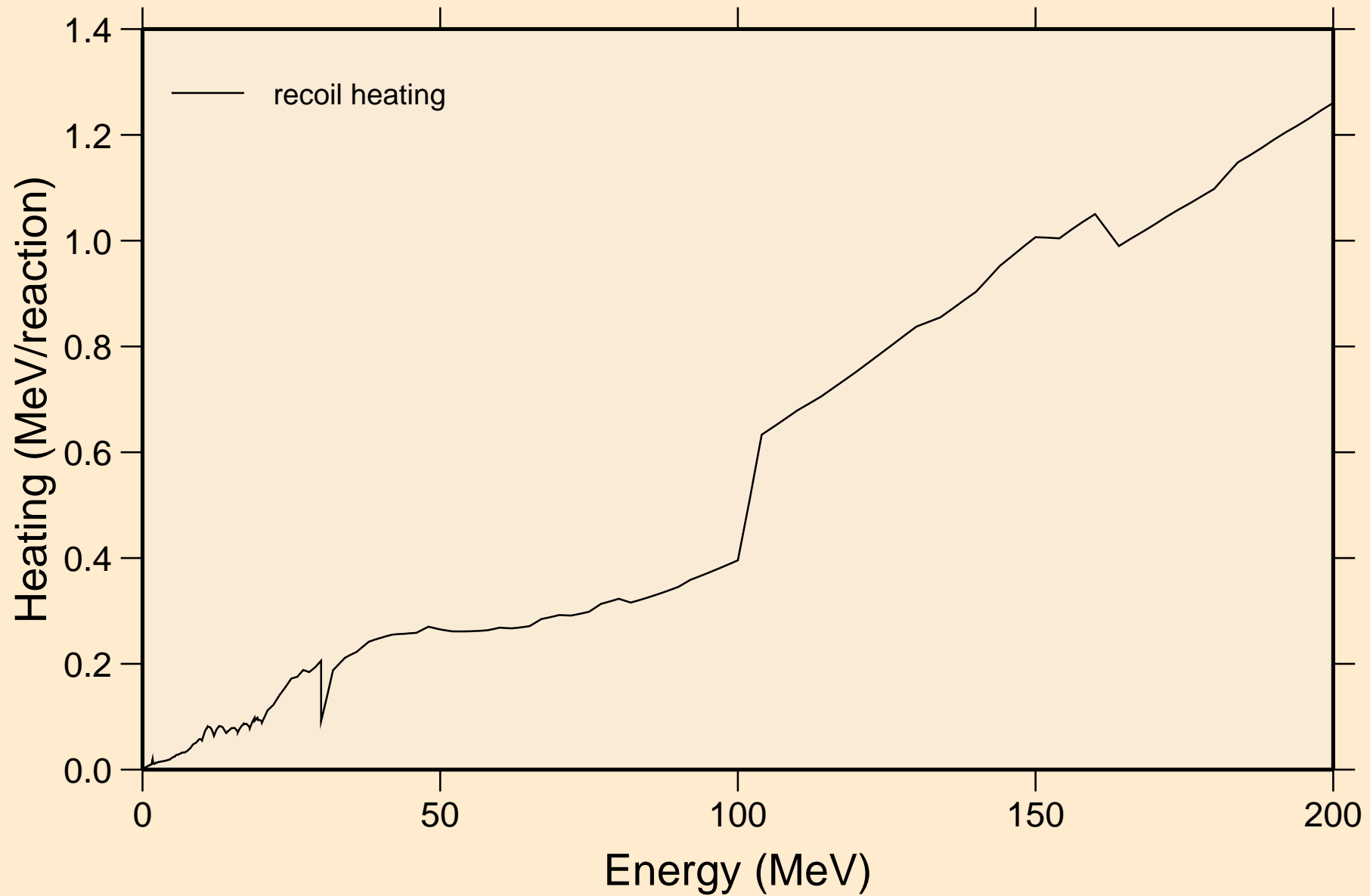

IR197 NEUTRON ACER TENDL-2024 LIBRARY; T=0.K

Particle production cross sections

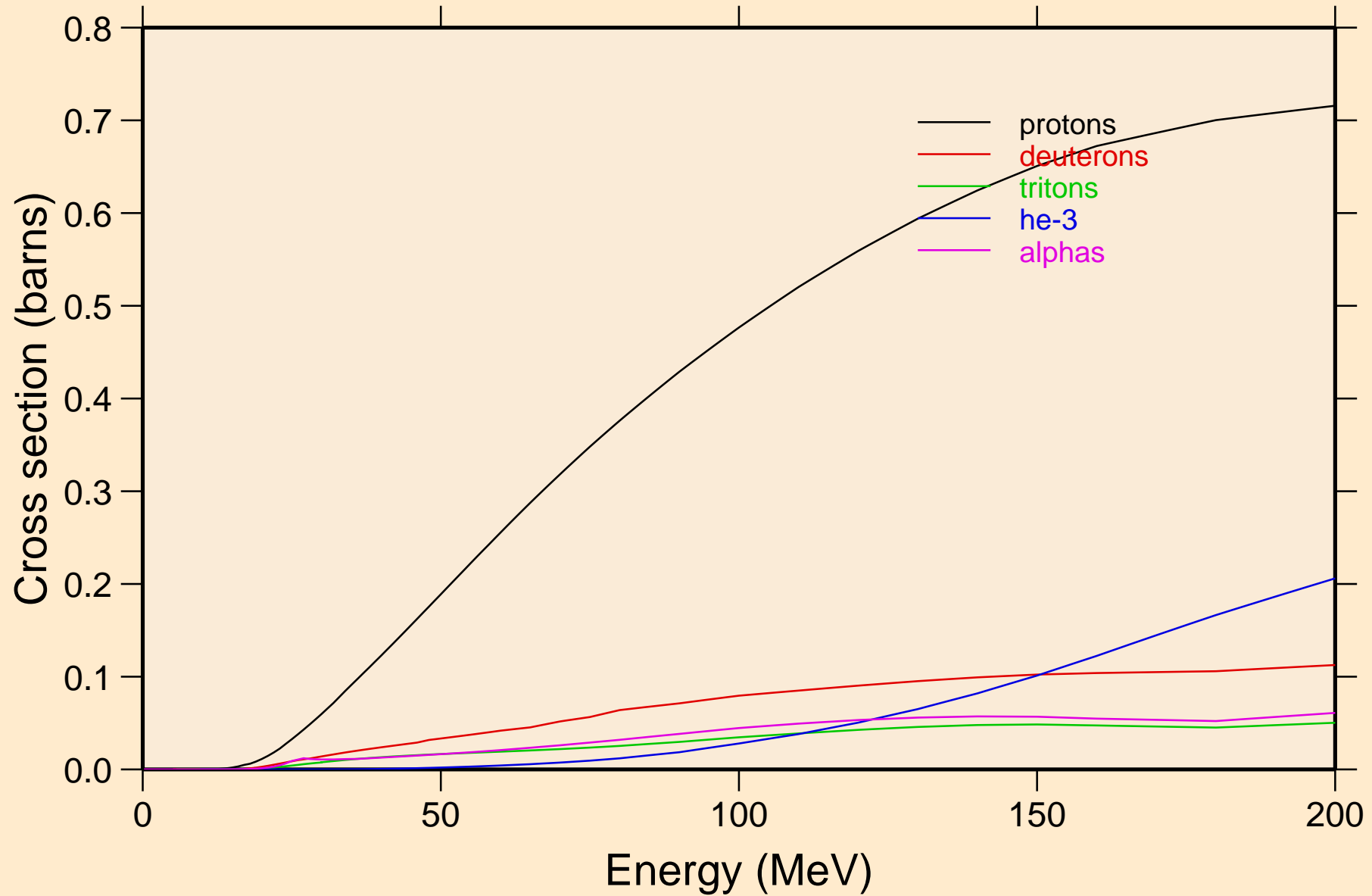

IR197 NEUTRON ACER TENDL-2024 LIBRARY; T=0.K
protons from (n,x)

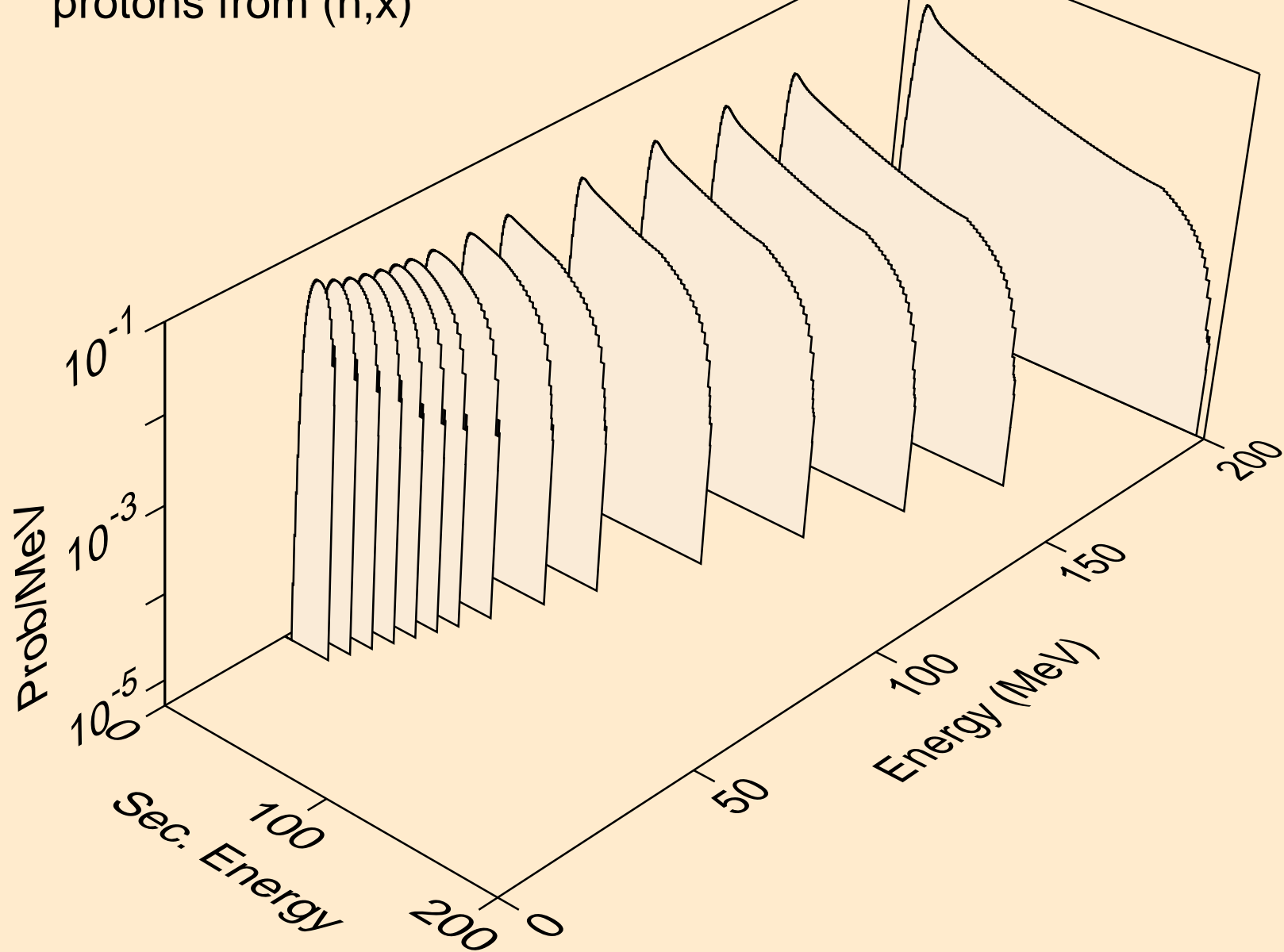

IR197 NEUTRON ACER TENDL-2024 LIBRARY; T=0.K
protons from (n,n*)p

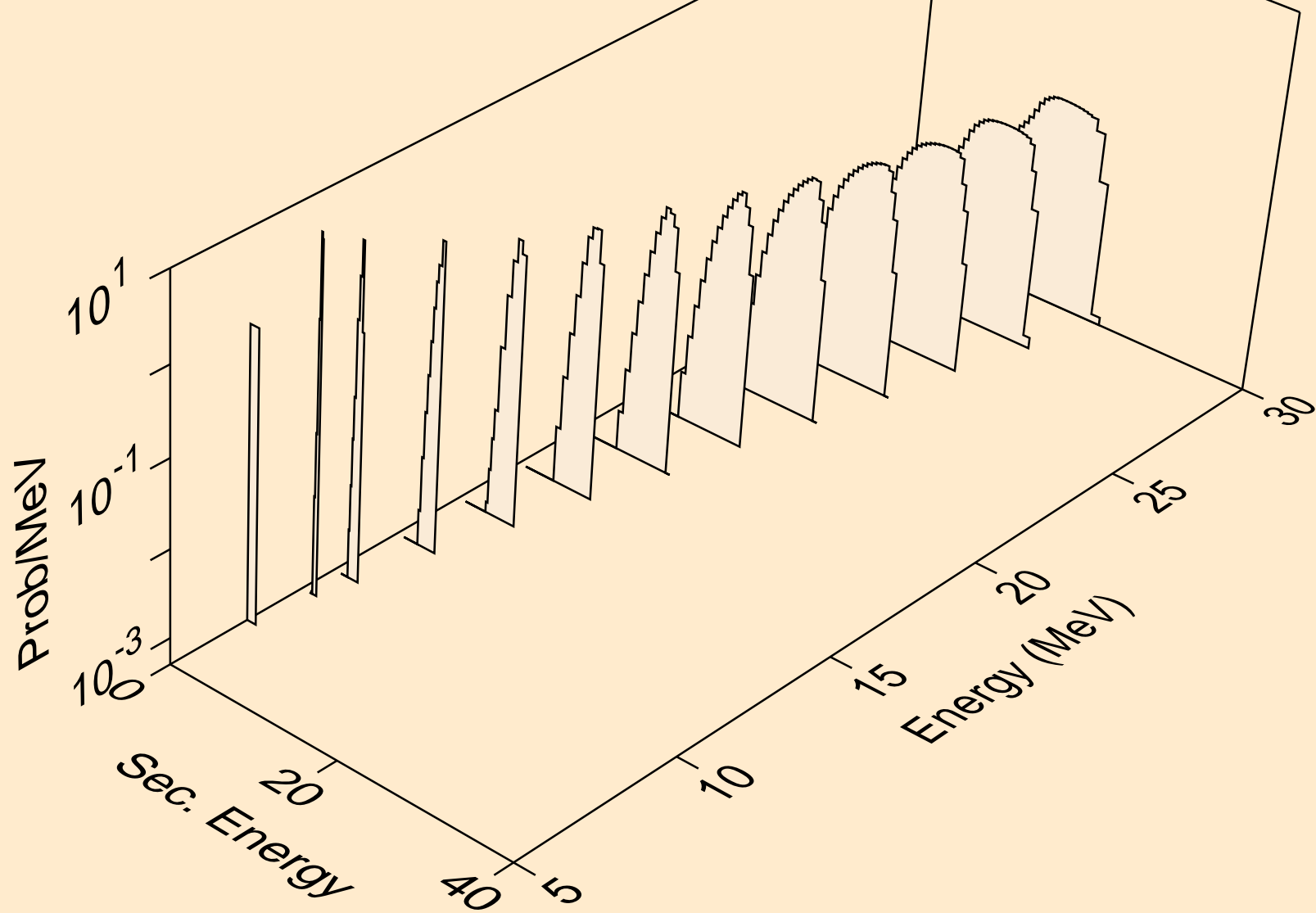

IR197 NEUTRON ACER TENDL-2024 LIBRARY; T=0.K
protons from (n,2np)

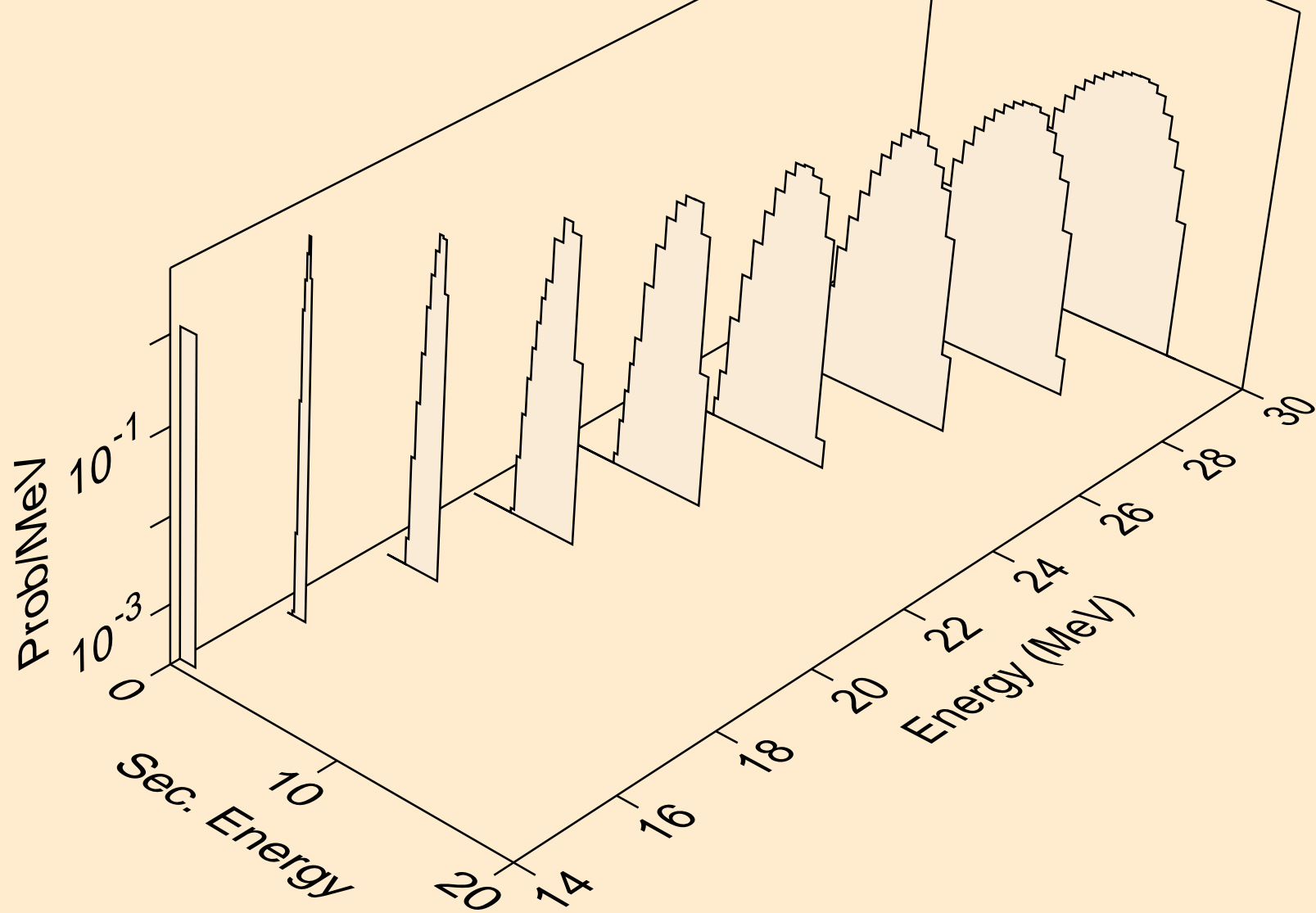

IR197 NEUTRON ACER TENDL-2024 LIBRARY; T=0.K
protons from (n,3np)

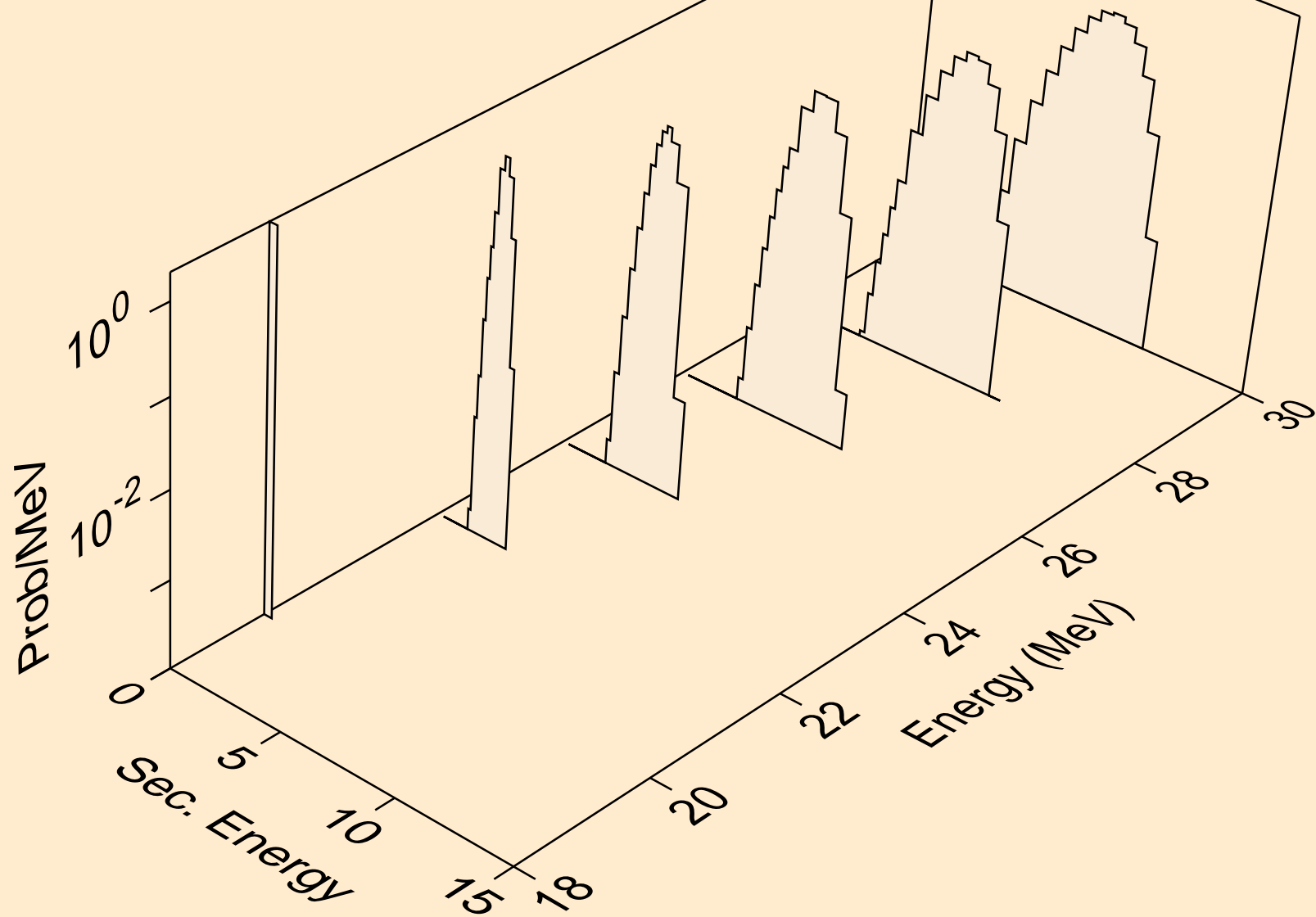

IR197 NEUTRON ACER TENDL-2024 LIBRARY; T=0.K
protons from (n,p)

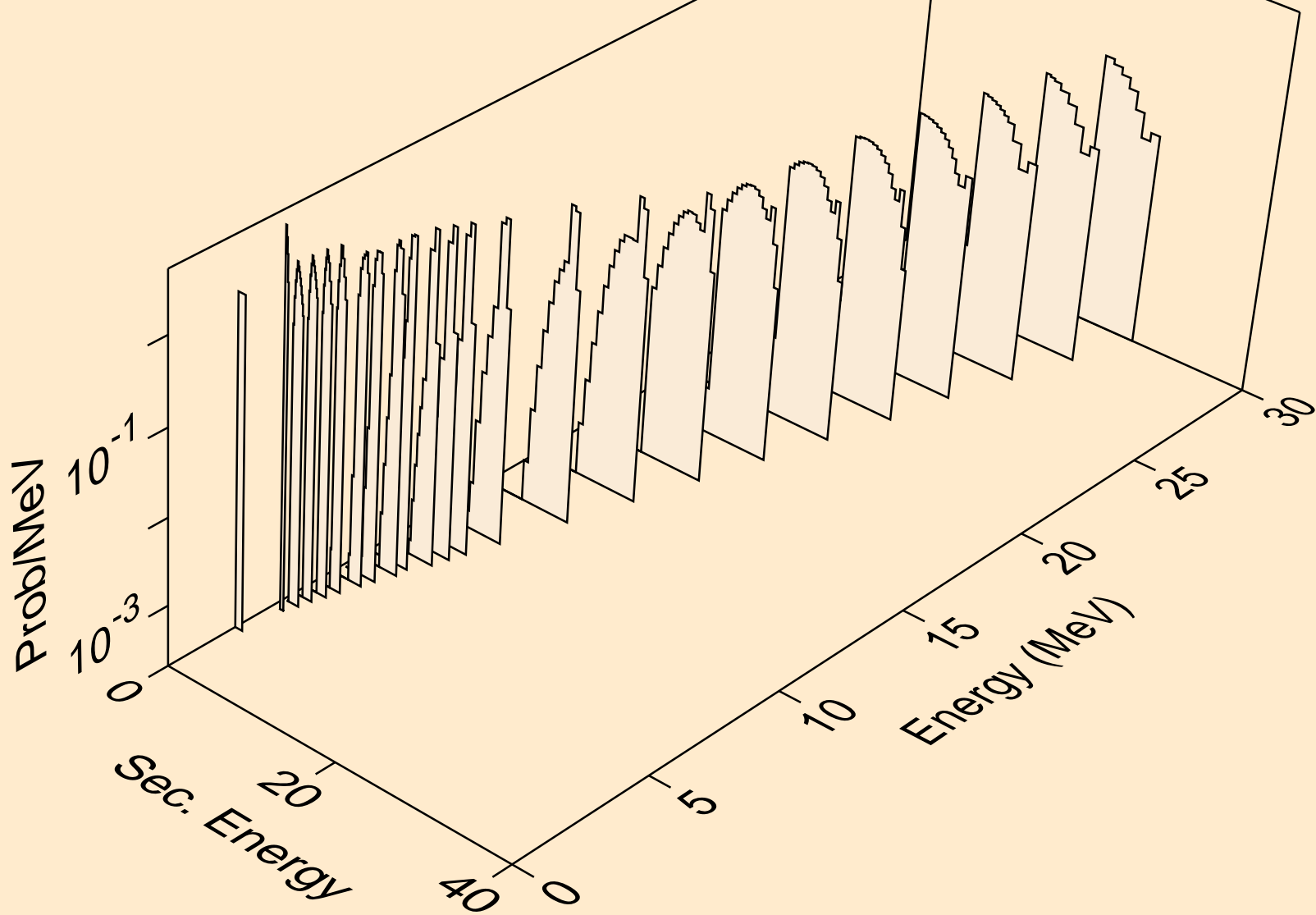

IR197 NEUTRON ACER TENDL-2024 LIBRARY; T=0.K
protons from (n,2p)

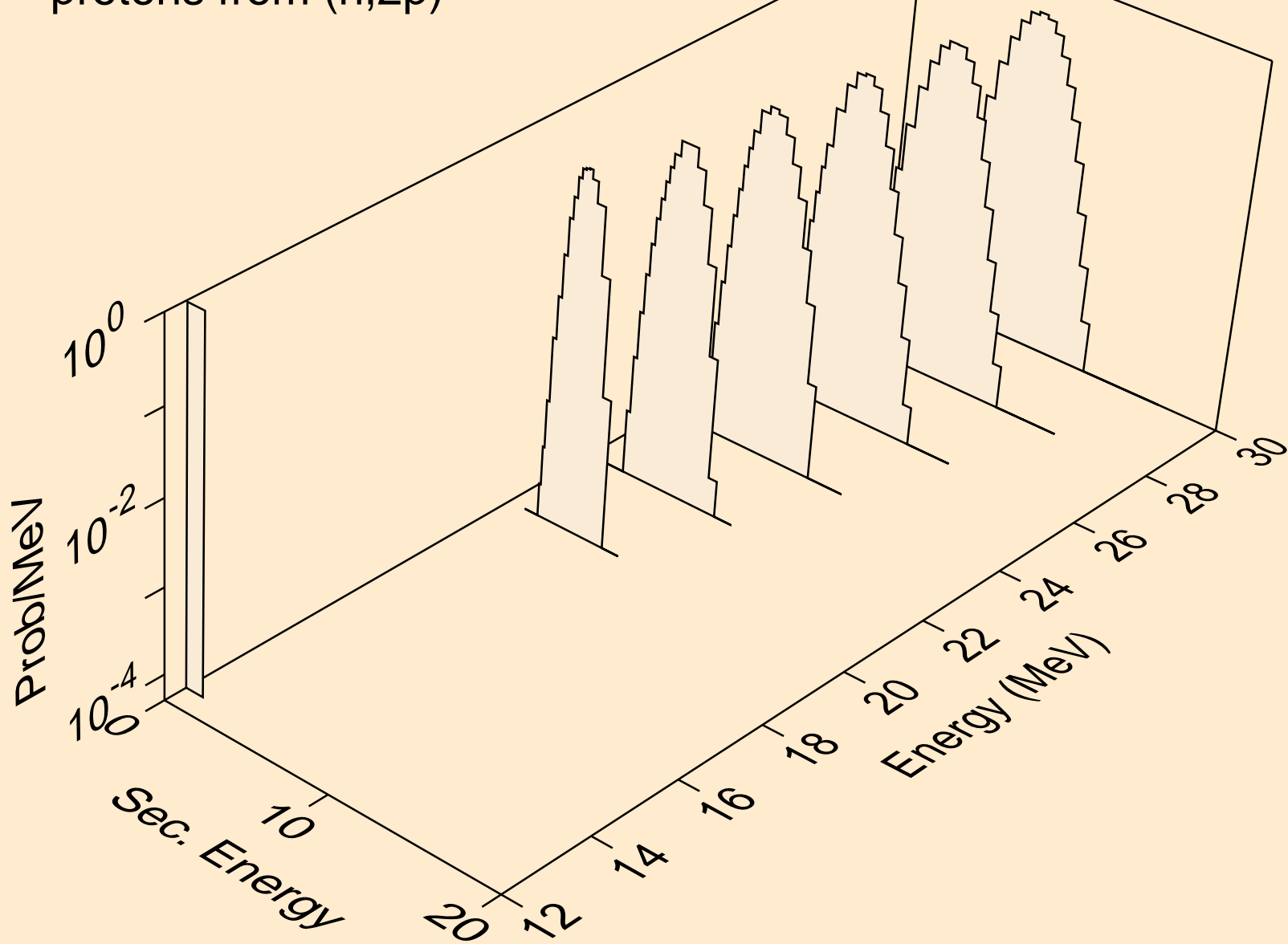

IR197 NEUTRON ACER TENDL-2024 LIBRARY; T=0.K
deuterons from (n,x)

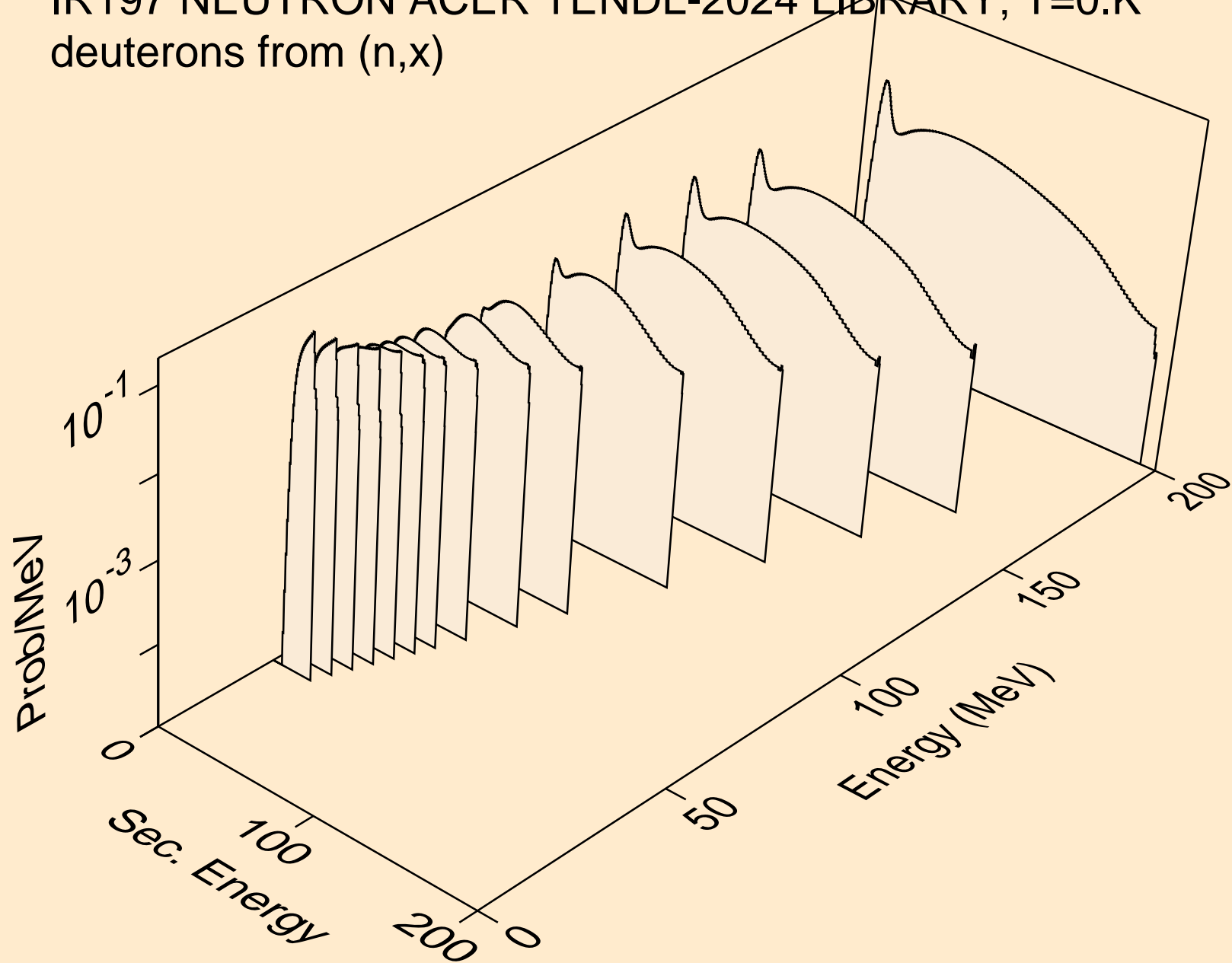

IR197 NEUTRON ACER TENDL-2024 LIBRARY; T=0.K
deuterons from (n,2nd)

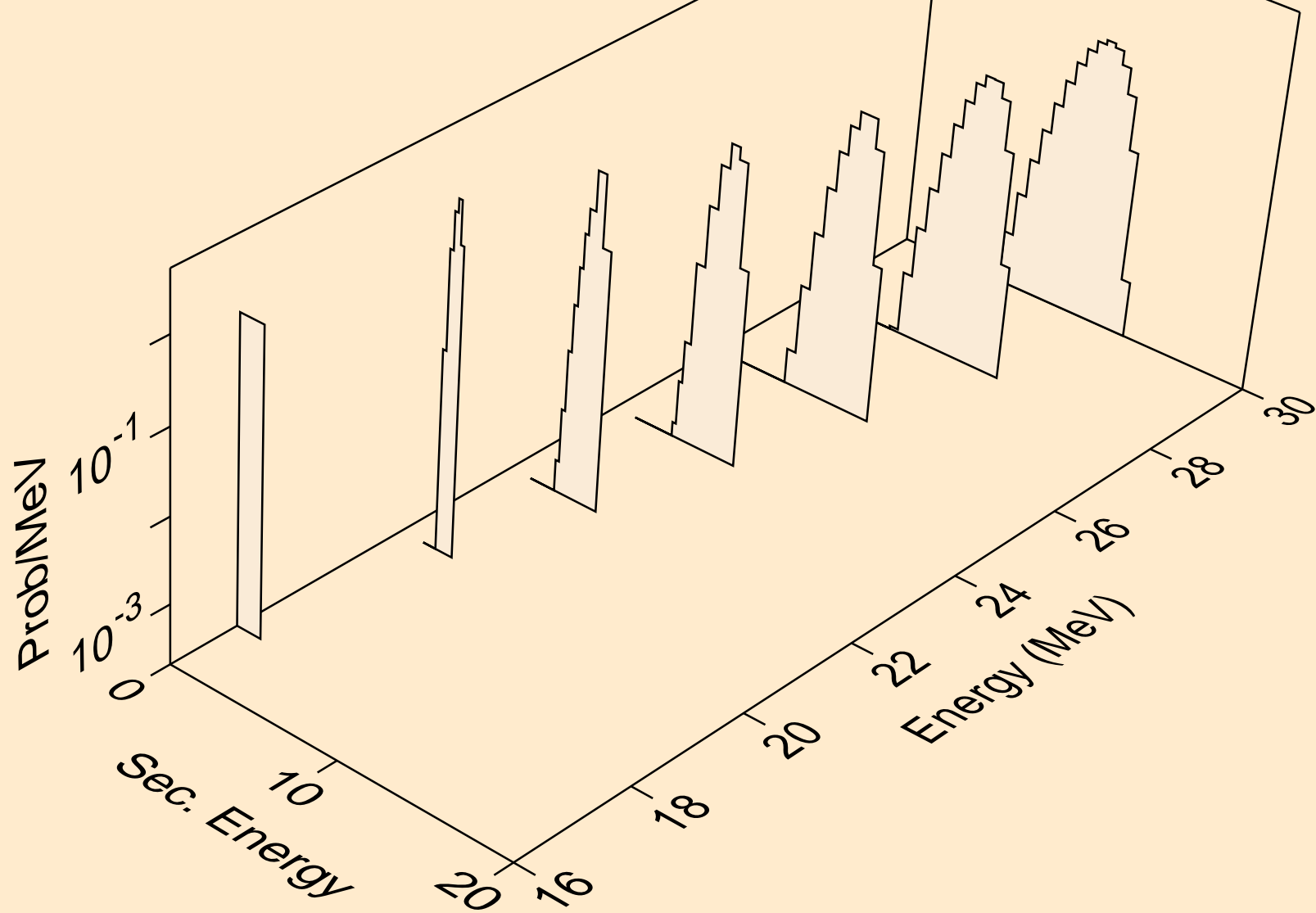

IR197 NEUTRON ACER TENDL-2024 LIBRARY; T=0.K
deuterons from (n,n*)d

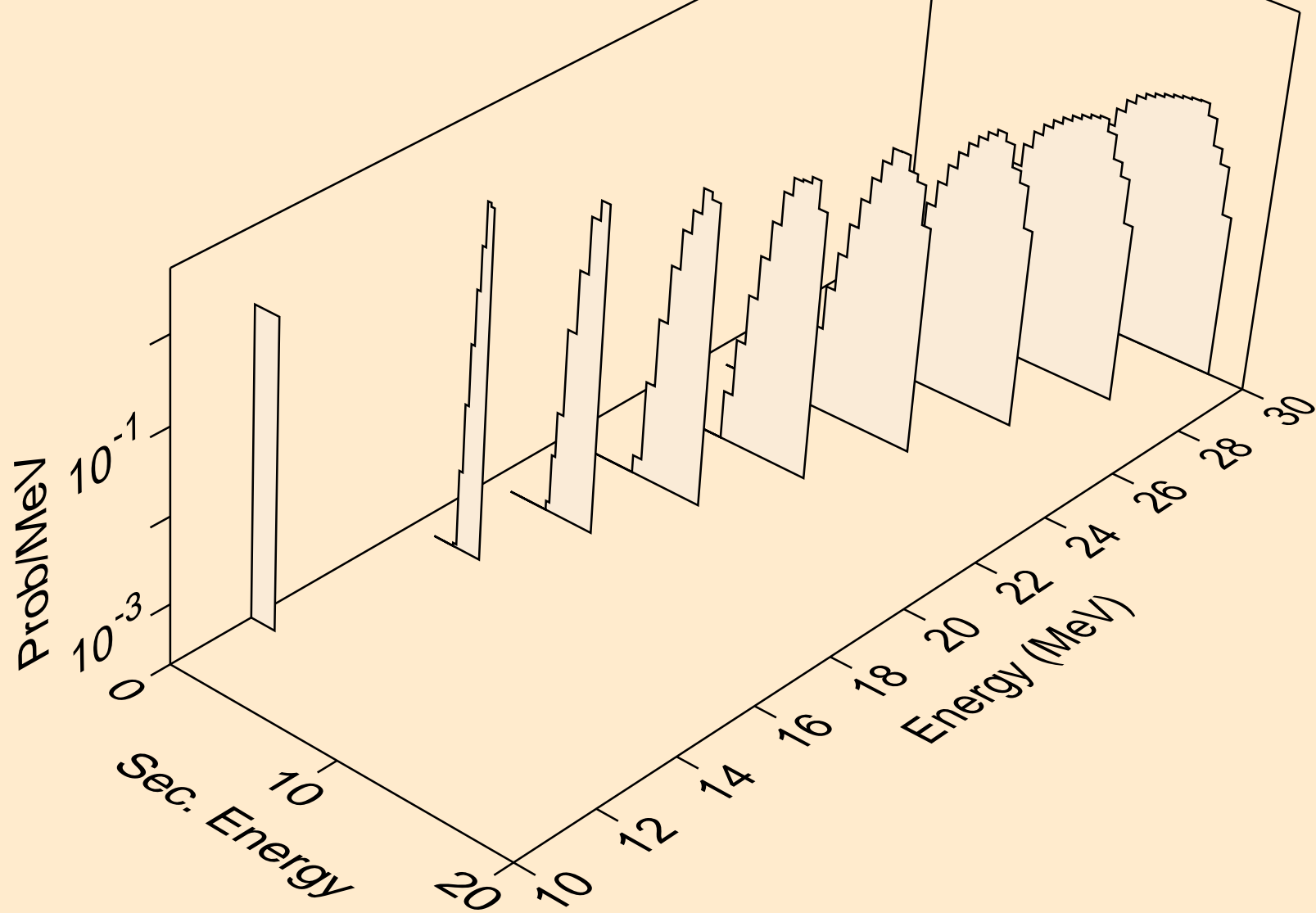

IR197 NEUTRON ACER TENDL-2024 LIBRARY; T=0.K
deuterons from (n,d)

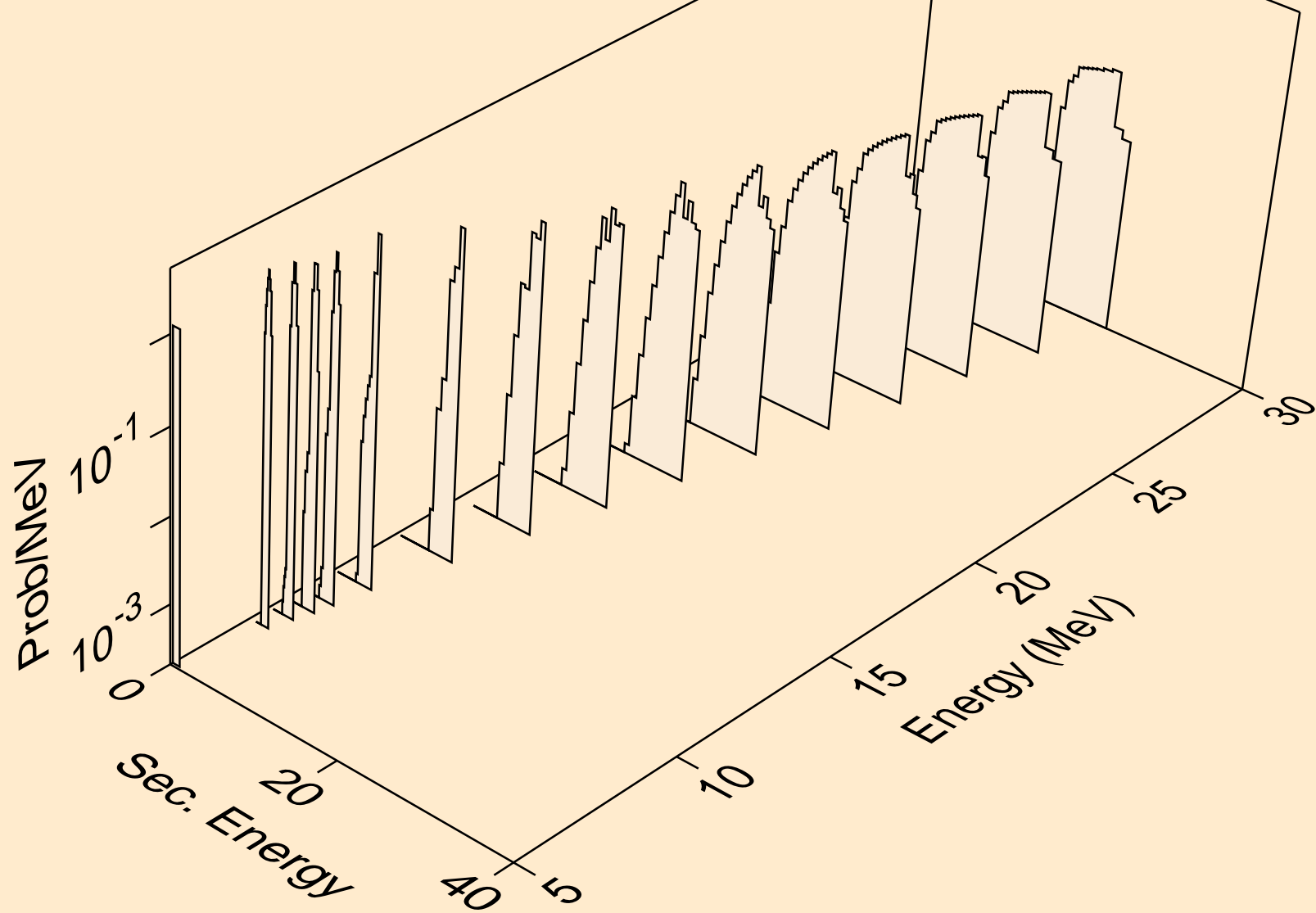

IR197 NEUTRON ACER TENDL-2024 LIBRARY; T=0.K
tritons from (n,x)

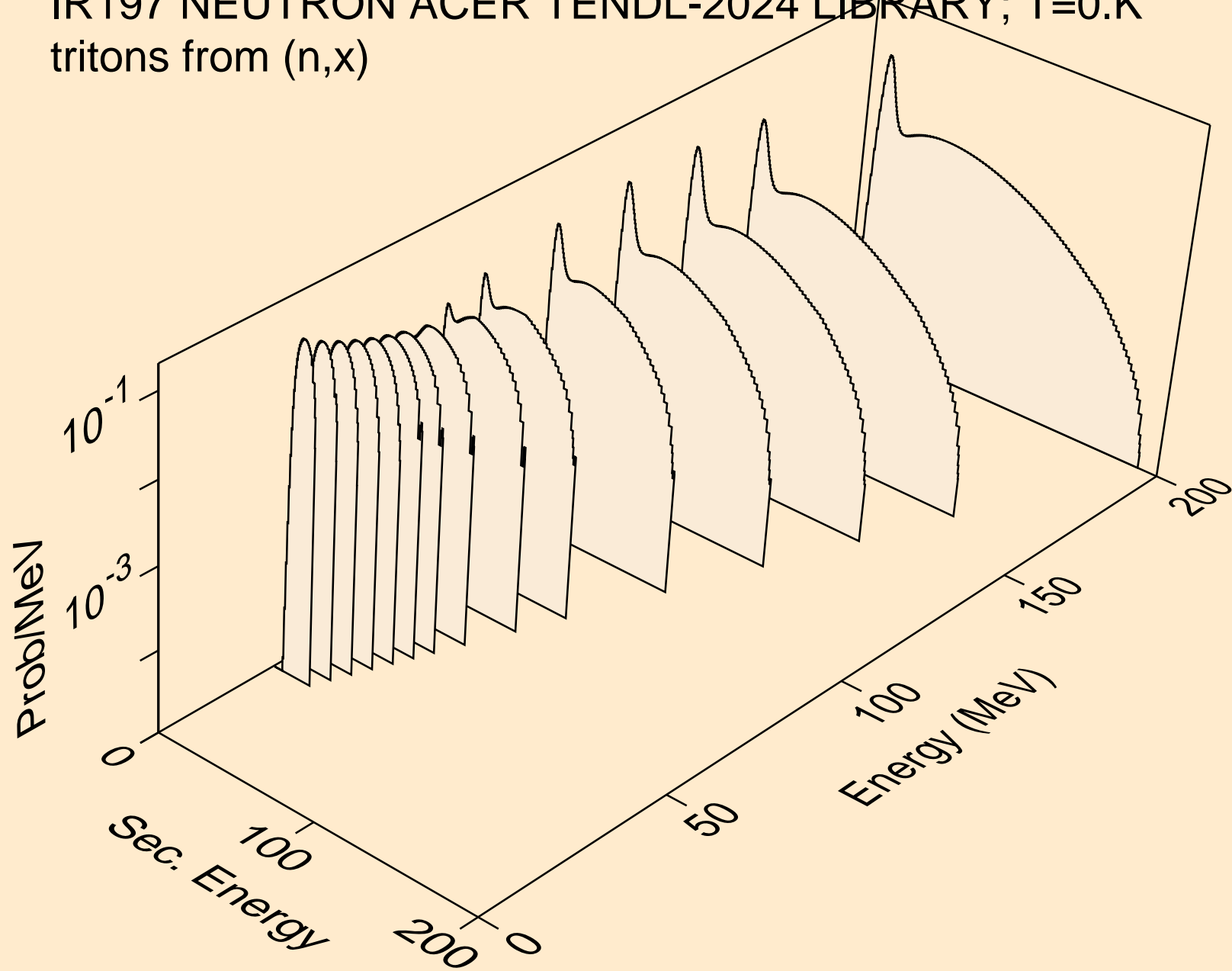

IR197 NEUTRON ACER TENDL-2024 LIBRARY; T=0.K
tritons from (n,n*)t

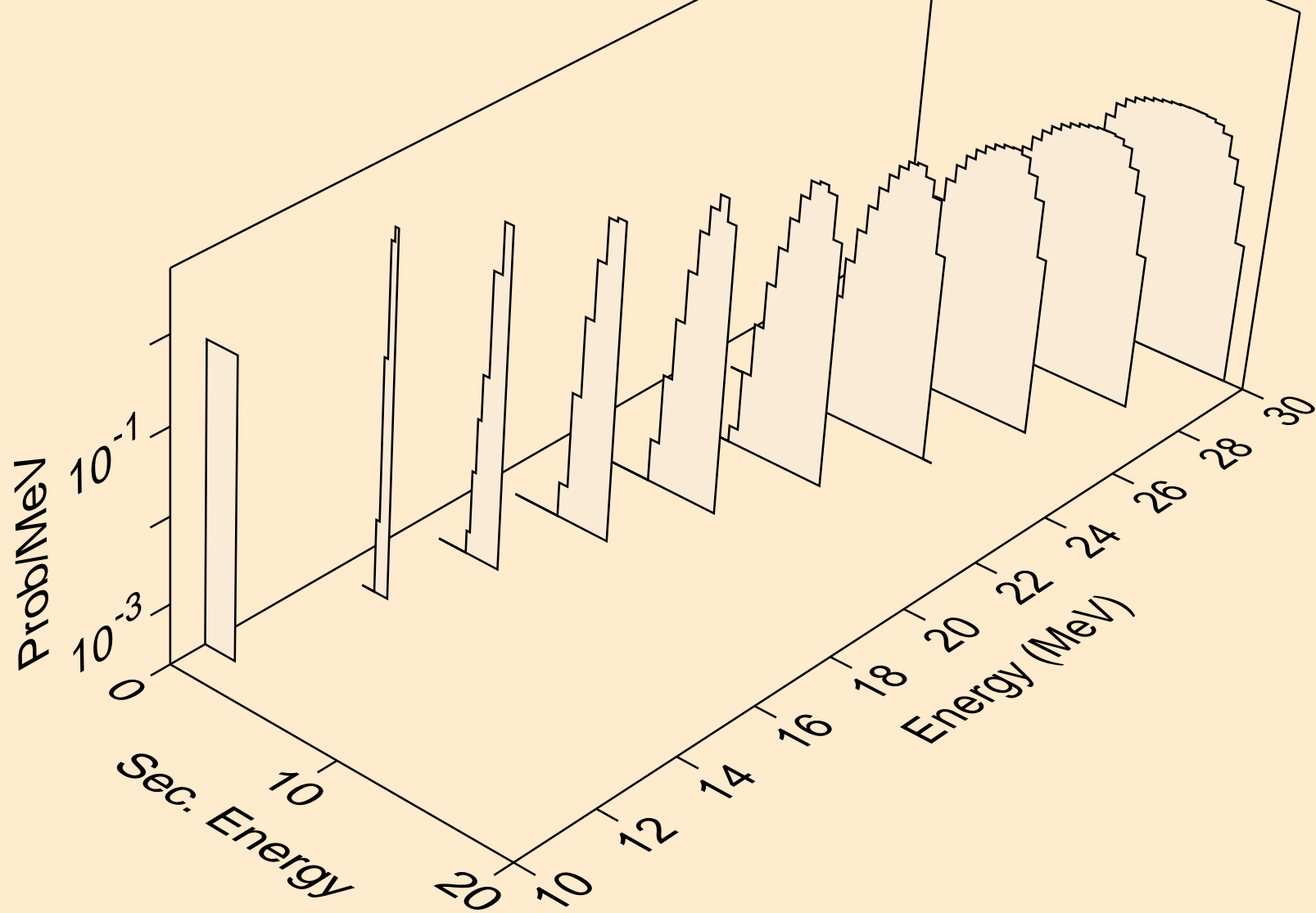

IR197 NEUTRON ACER TENDL-2024 LIBRARY; T=0.K
tritons from (n,t)

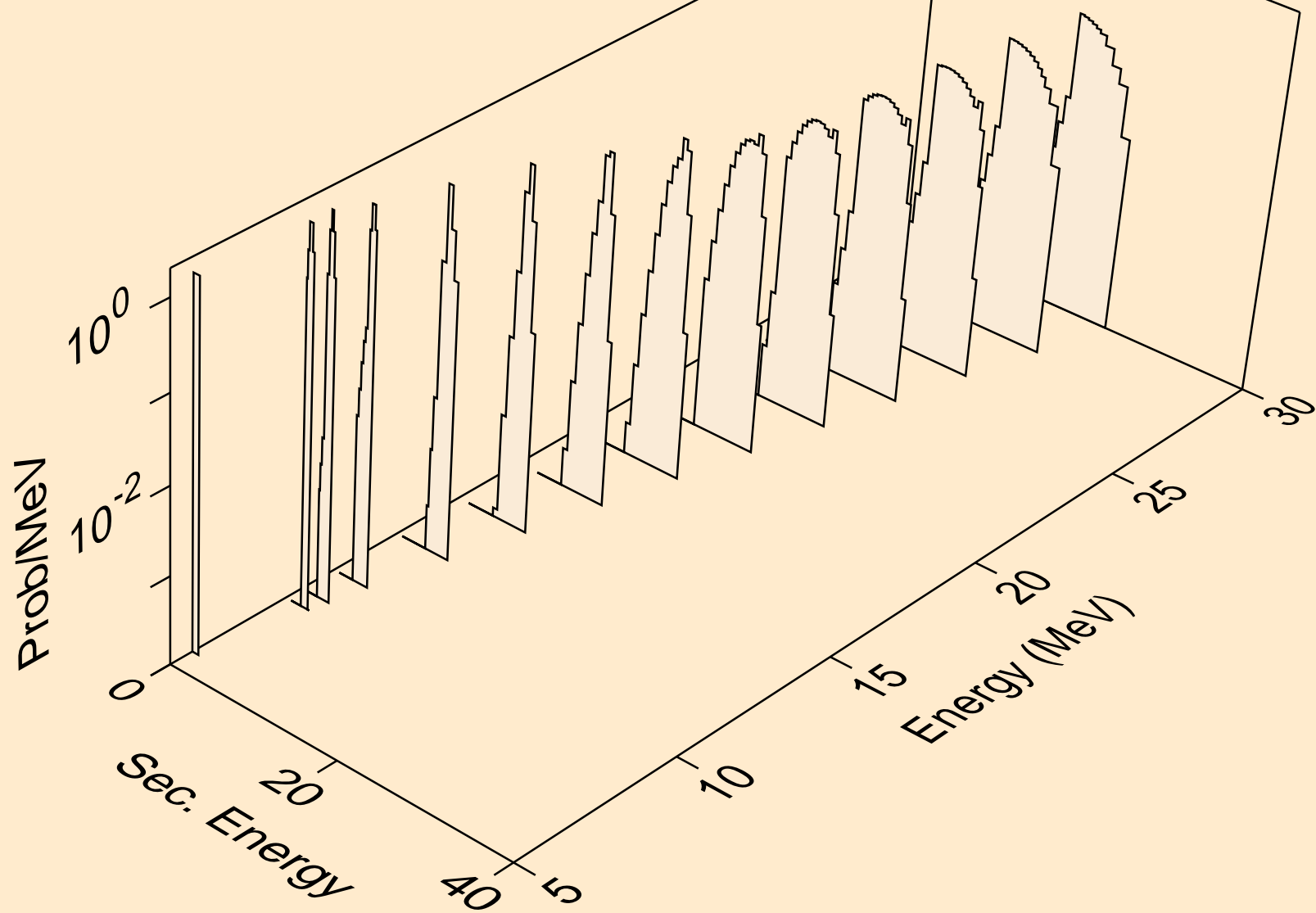

IR197 NEUTRON ACER TENDL-2024 LIBRARY; T=0.K
he3s from (n,x)

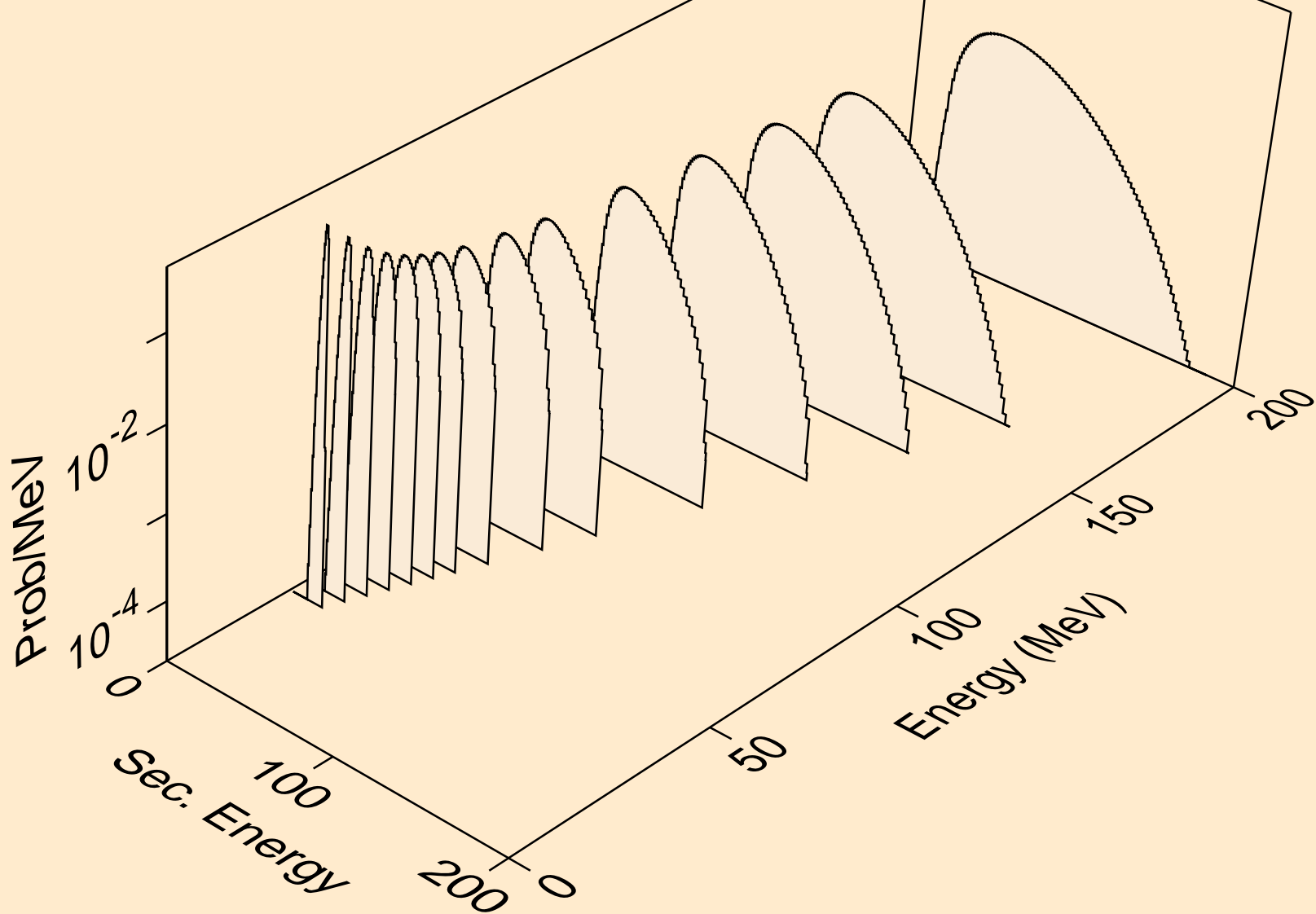

IR197 NEUTRON ACER TENDL-2024 LIBRARY; T=0.K
he3s from (n,n*)he3

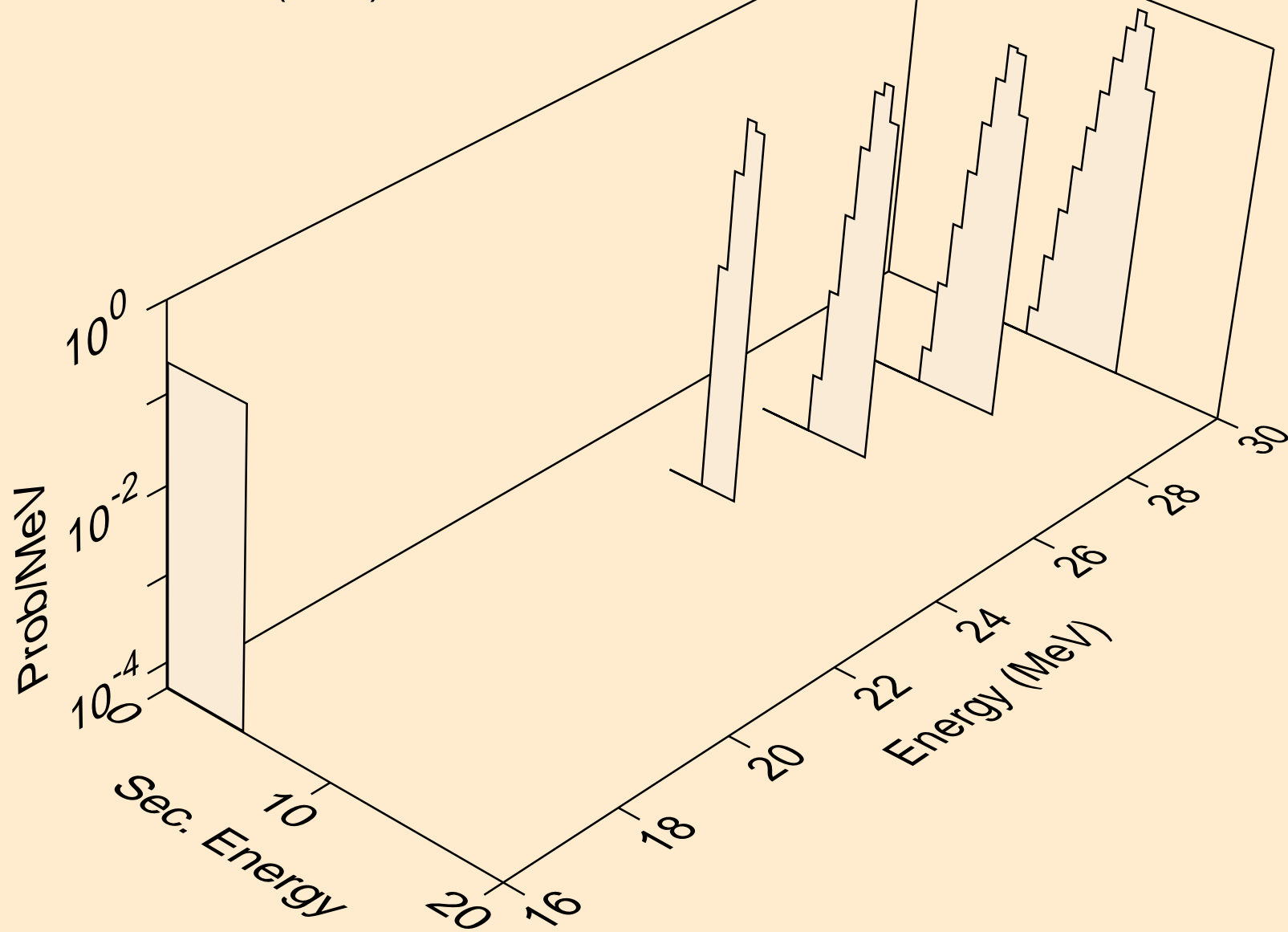

IR197 NEUTRON ACER TENDL-2024 LIBRARY; T=0.K
he3s from (n,he3)

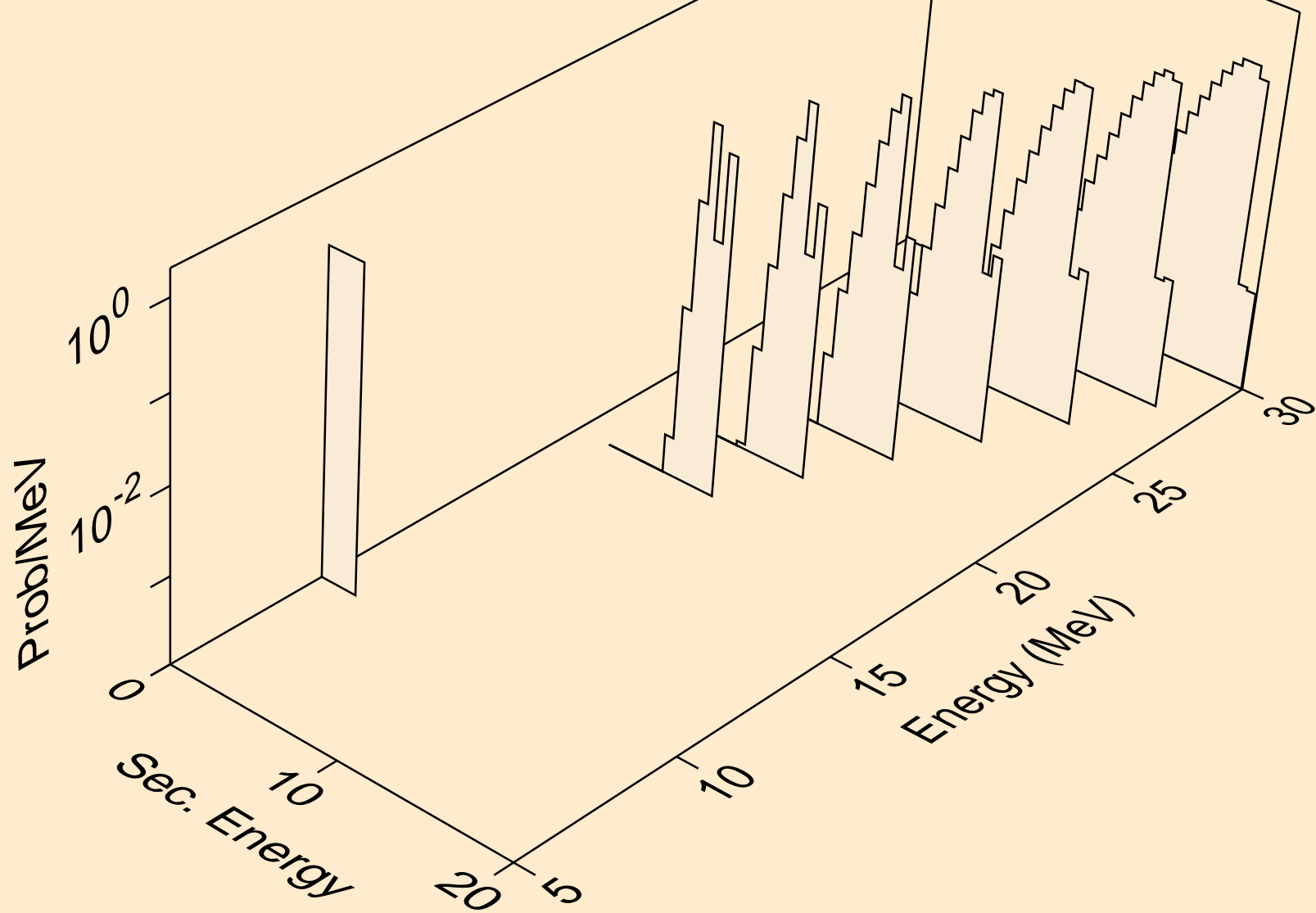

IR197 NEUTRON ACER TENDL-2024 LIBRARY; T=0.K
alphas from (n,x)

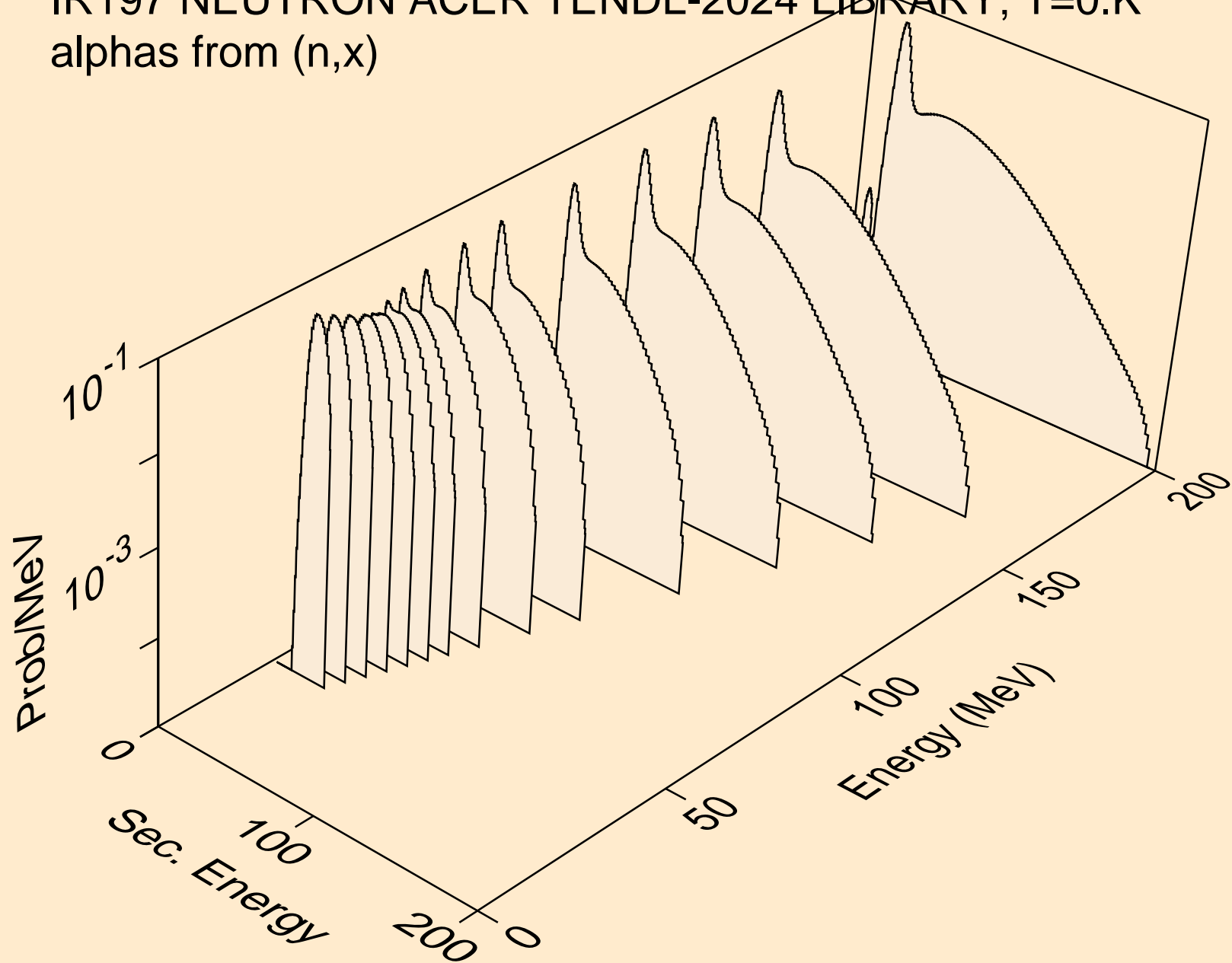

IR197 NEUTRON ACER TENDL-2024 LIBRARY; T=0.K
alphas from (n,n*)a

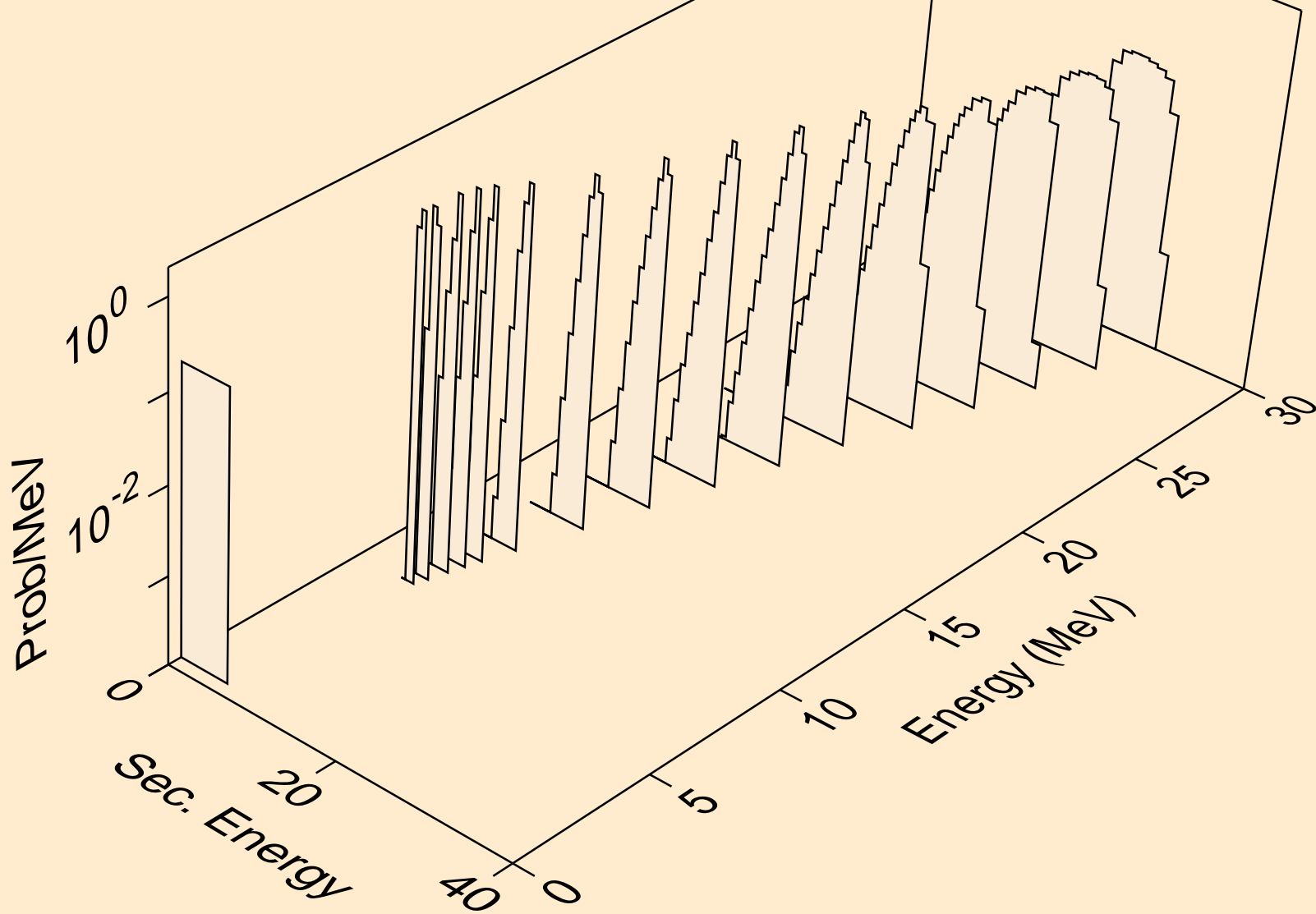

IR197 NEUTRON ACER TENDL-2024 LIBRARY; T=0.K
alphas from (n,2n)a

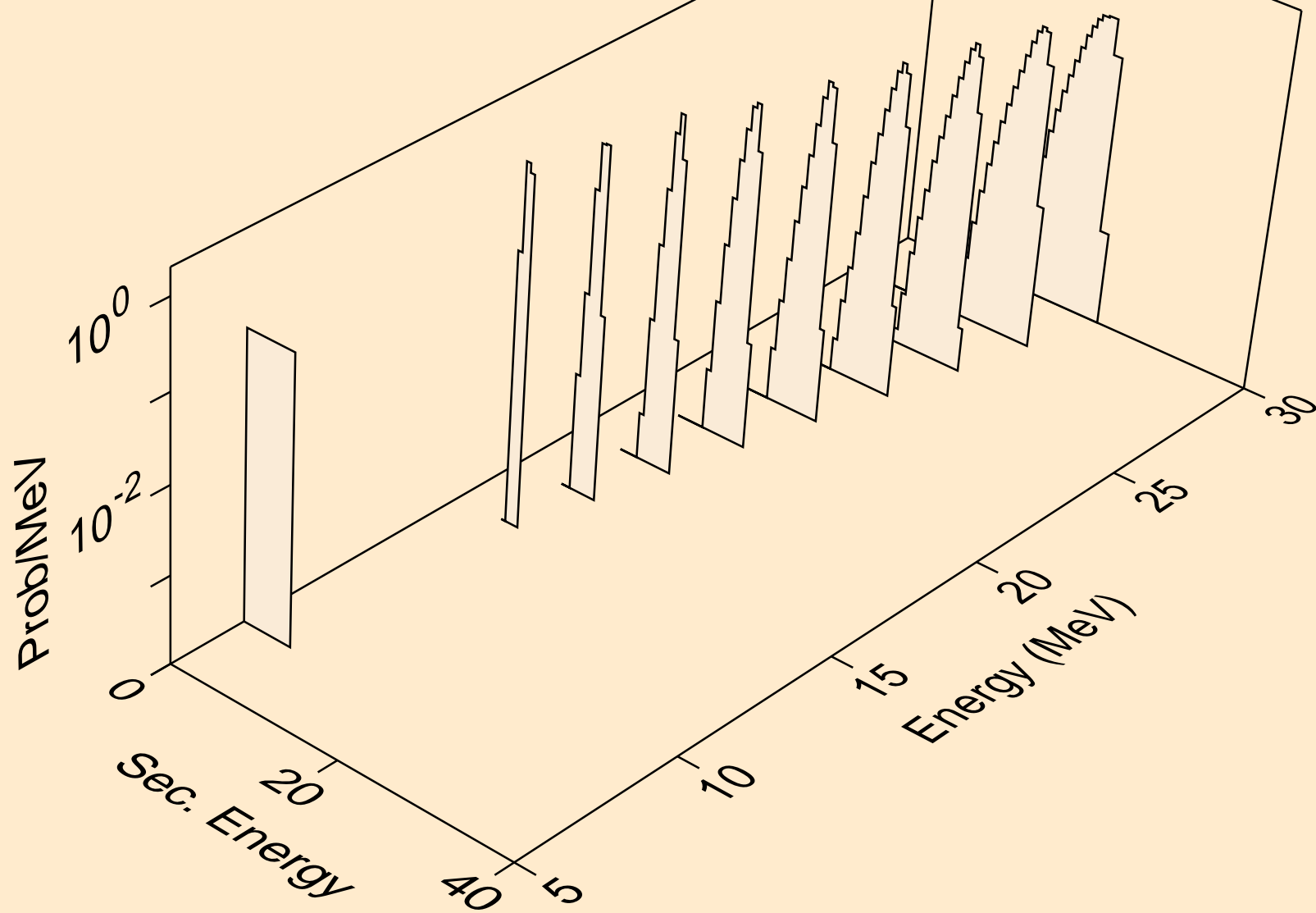

IR197 NEUTRON ACER TENDL-2024 LIBRARY; T=0.K
alphas from (n,3n)a

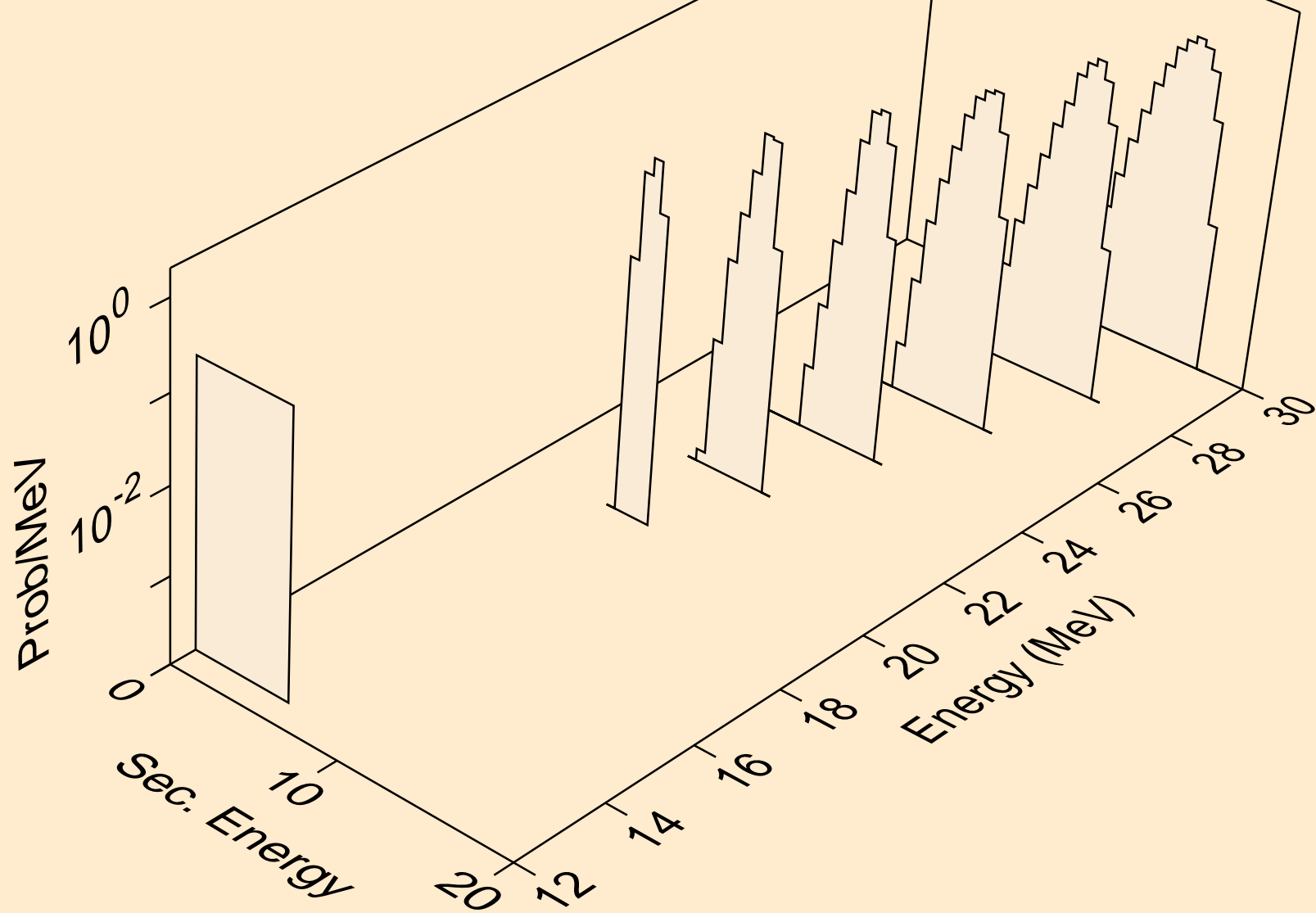

IR197 NEUTRON ACER TENDL-2024 LIBRARY; T=0.K
alphas from (n,a)

