

K043 NEUTRON ACER TENDL-2024 LIBRARY; T=0.K

Principal cross sections

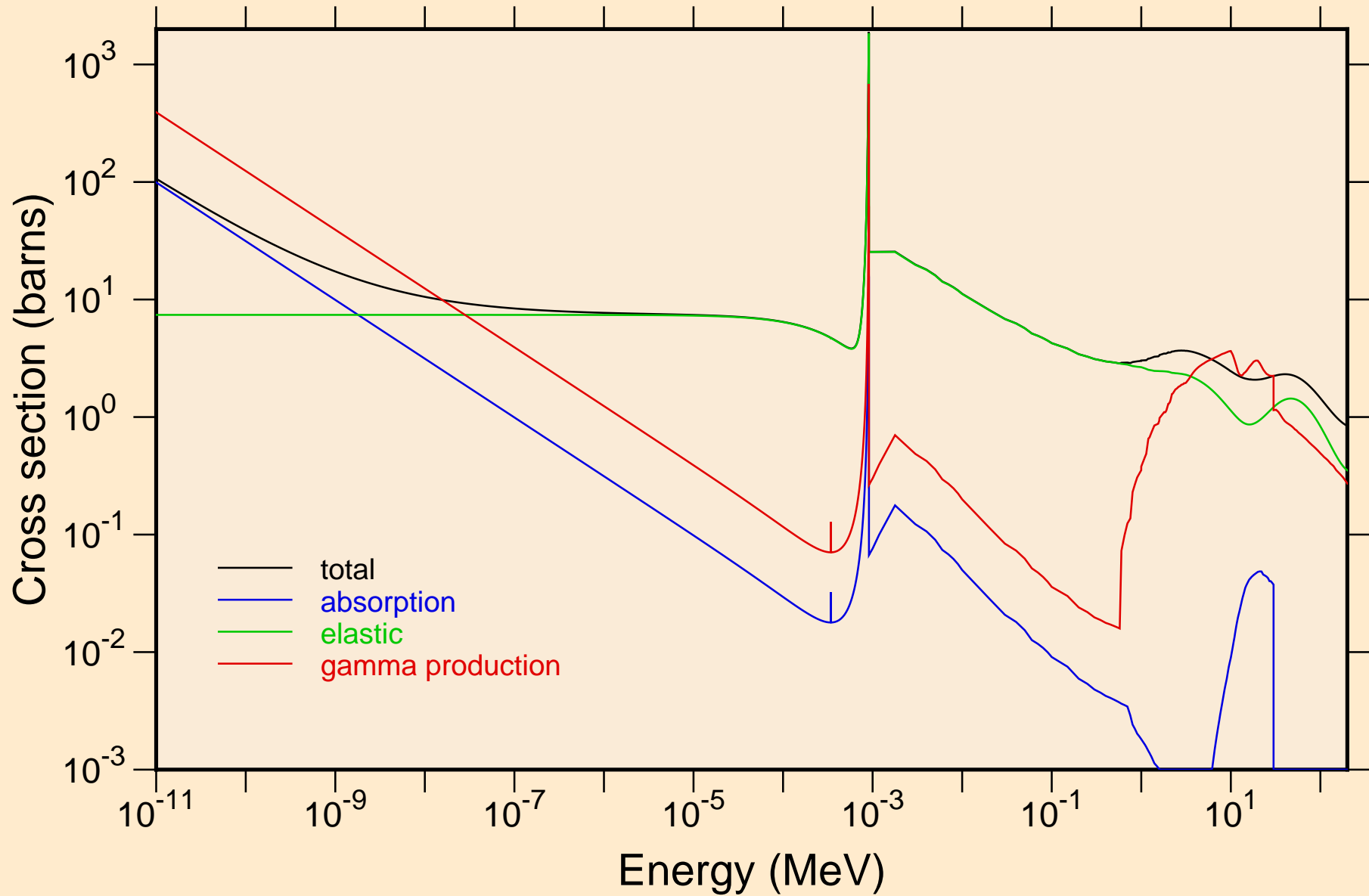

K043 NEUTRON ACER TENDL-2024 LIBRARY; T=0.K

Heating

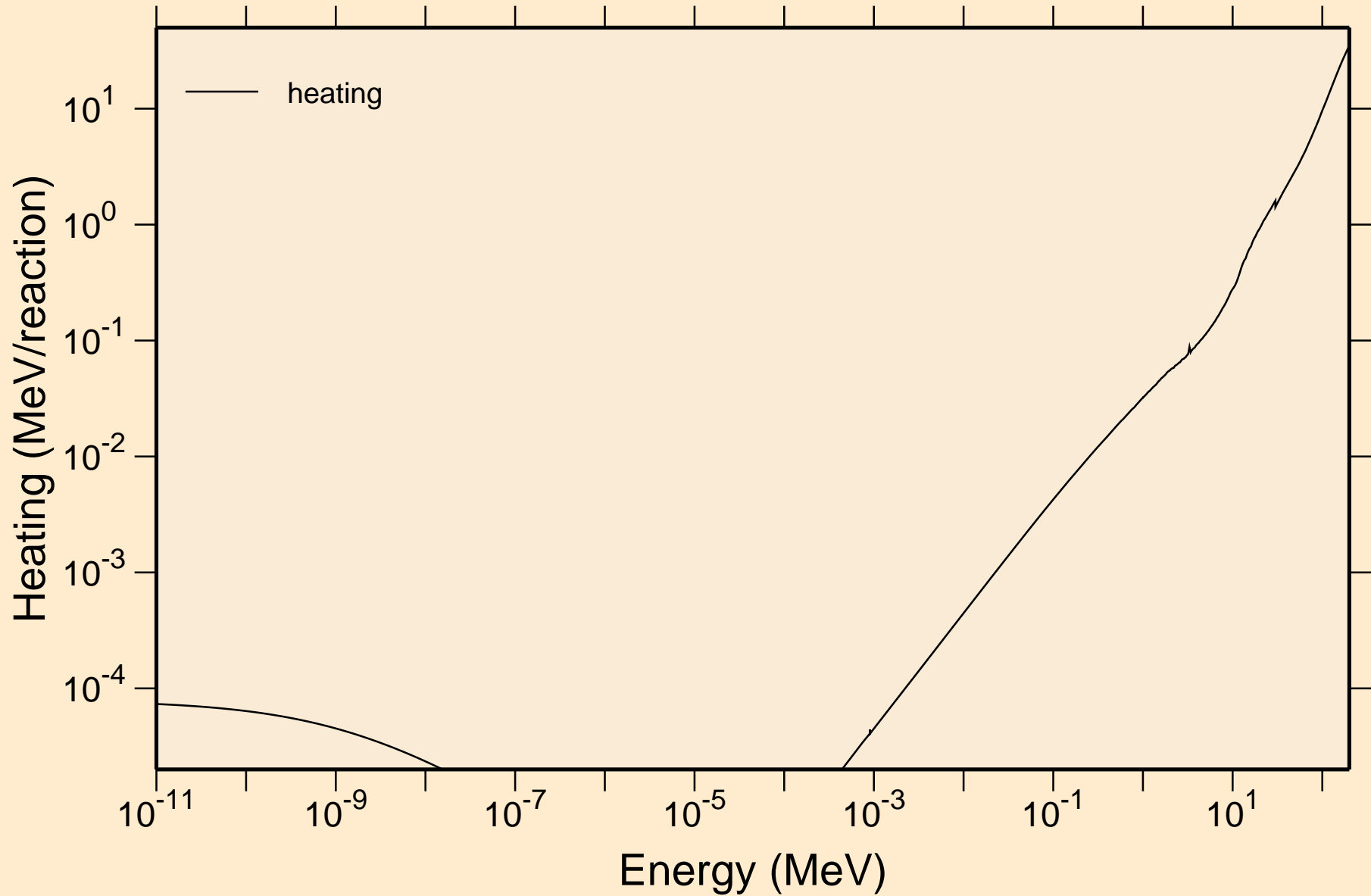

K043 NEUTRON ACER TENDL-2024 LIBRARY; T=0.K
Damage

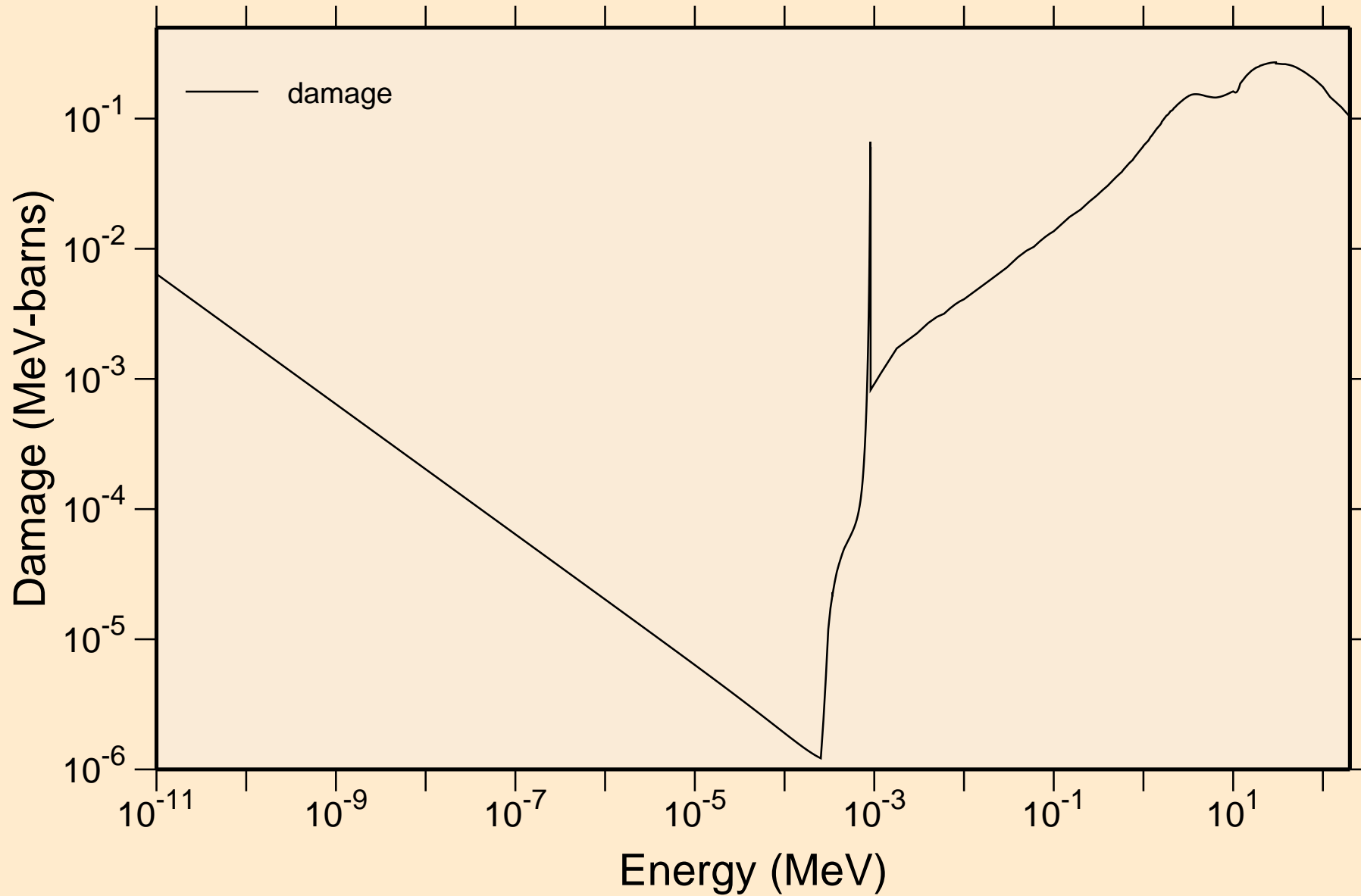

K043 NEUTRON ACER TENDL-2024 LIBRARY; T=0.K
Non-threshold reactions

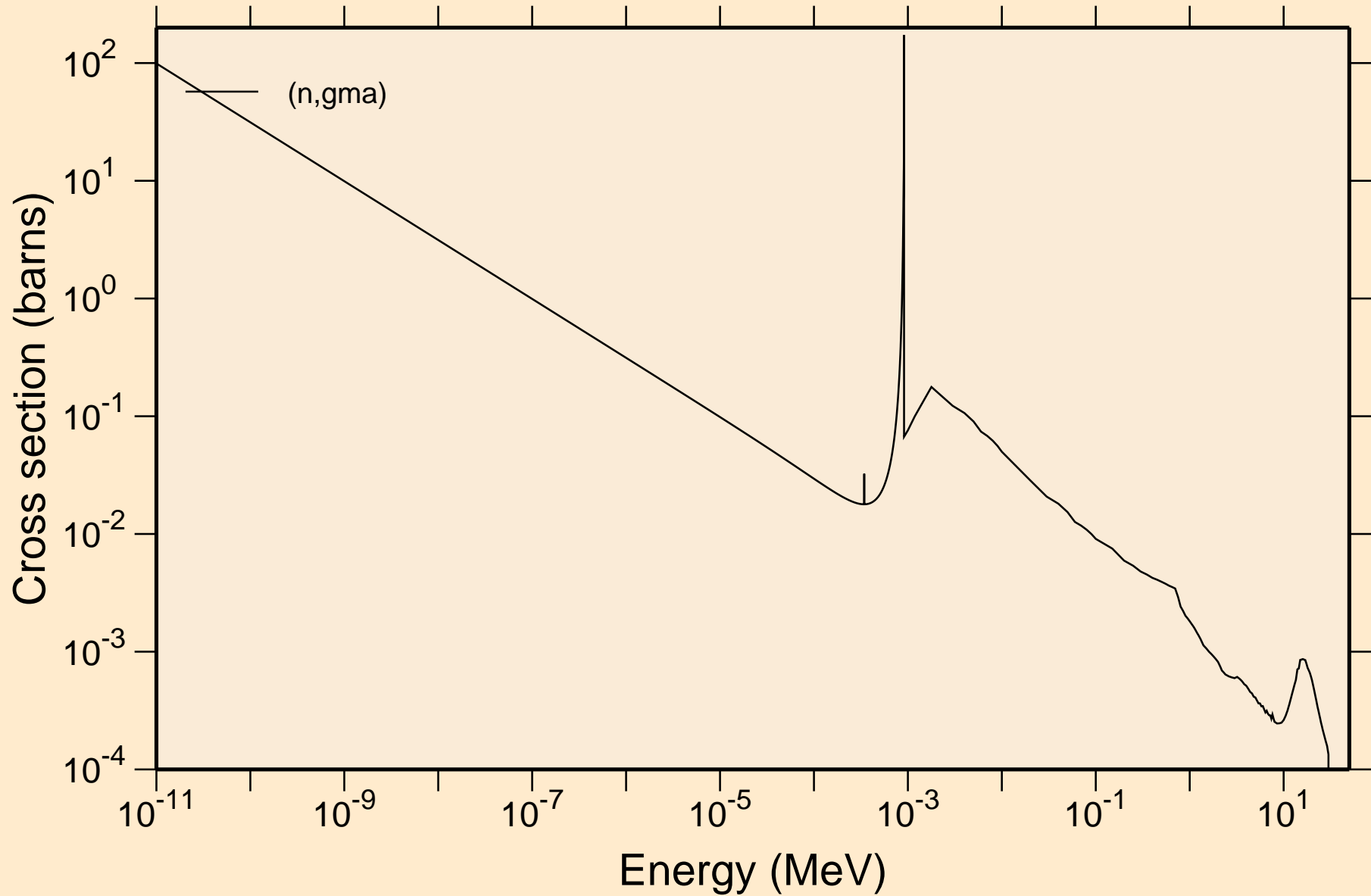

K043 NEUTRON ACER TENDL-2024 LIBRARY; T=0.K

Principal cross sections

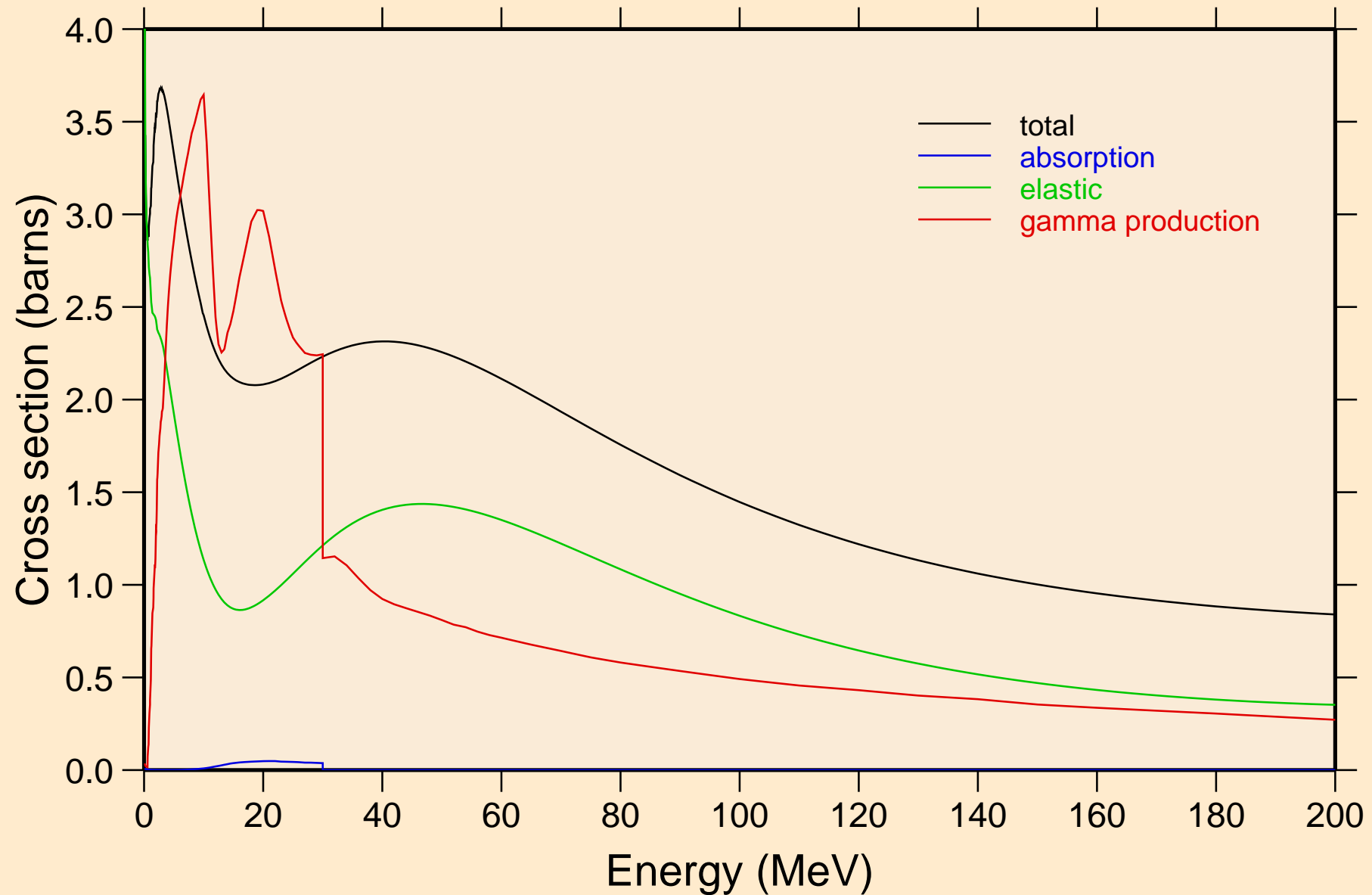

K043 NEUTRON ACER TENDL-2024 LIBRARY; T=0.K

Heating

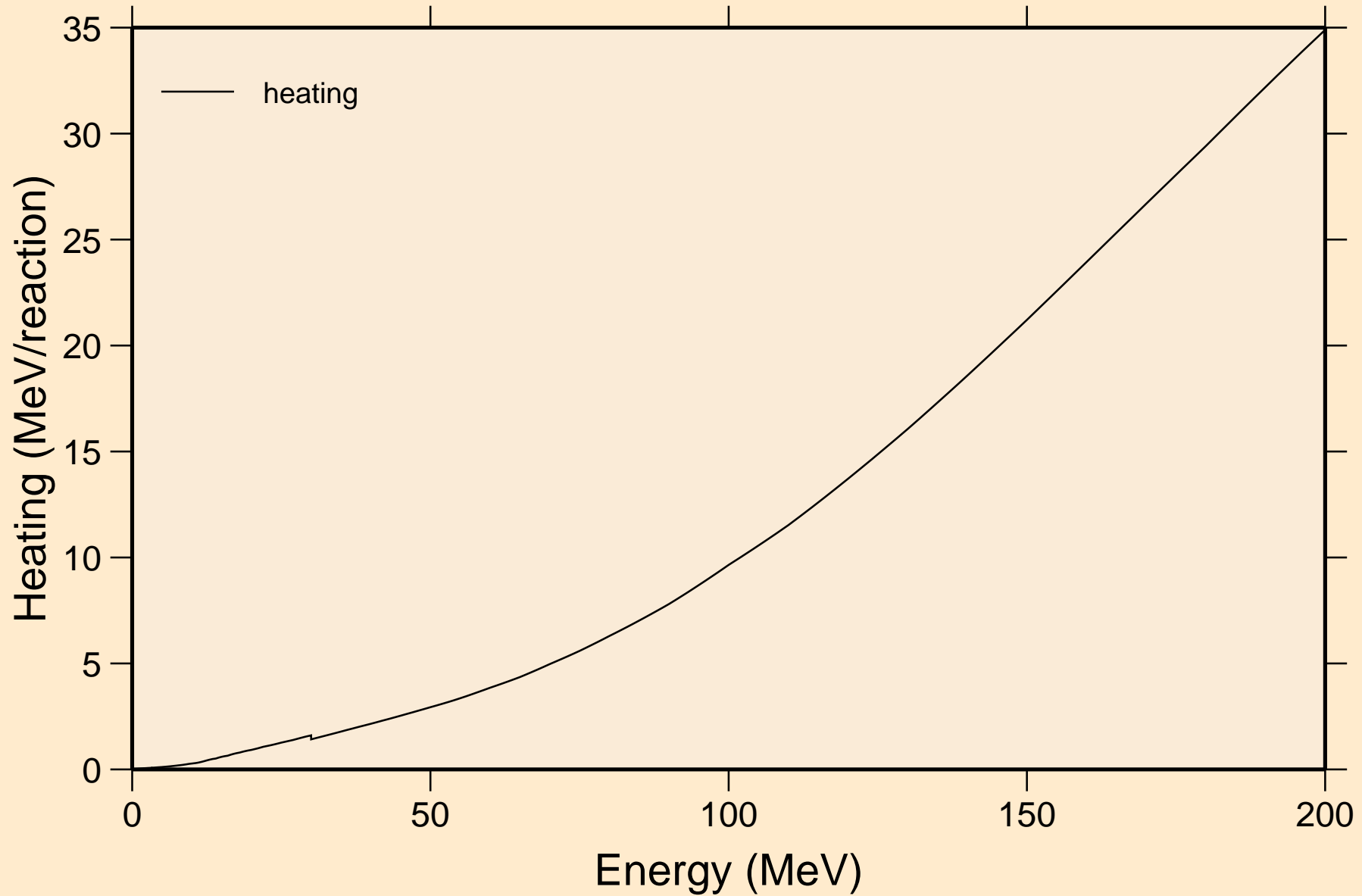

K043 NEUTRON ACER TENDL-2024 LIBRARY; T=0.K

Damage

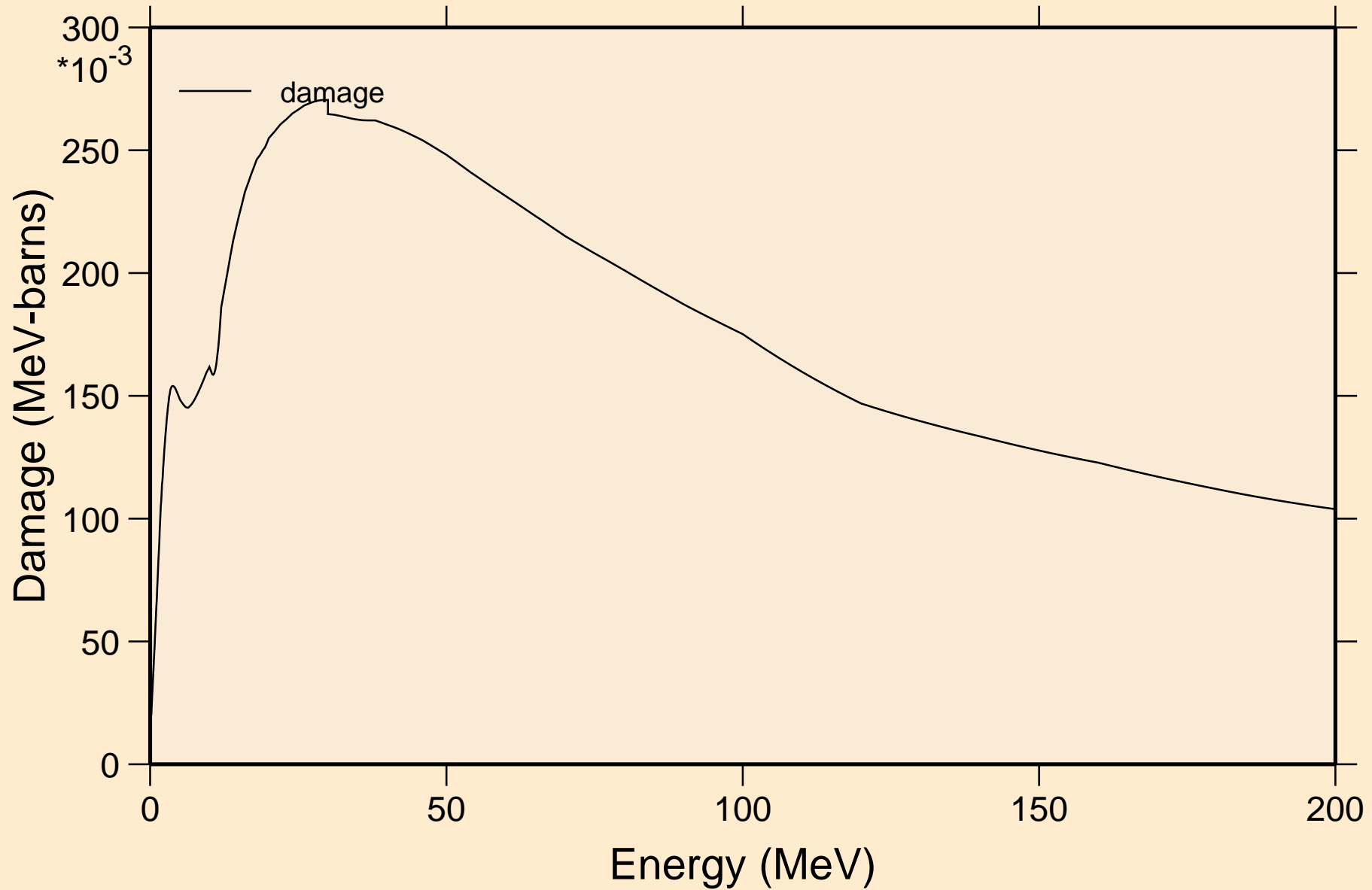

K043 NEUTRON ACER TENDL-2024 LIBRARY; T=0.K
Non-threshold reactions

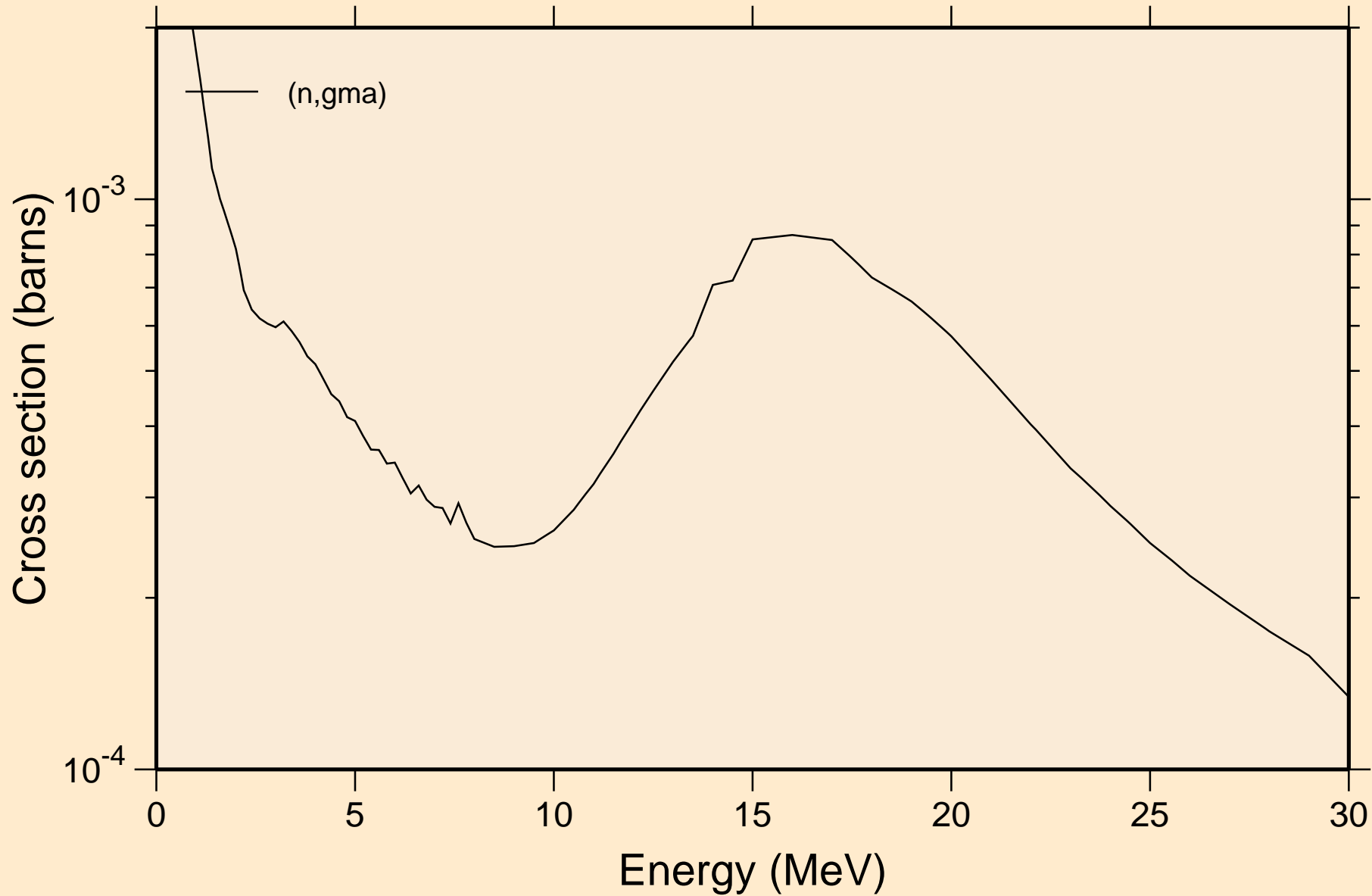

K043 NEUTRON ACER TENDL-2024 LIBRARY; T=0.K
Inelastic levels

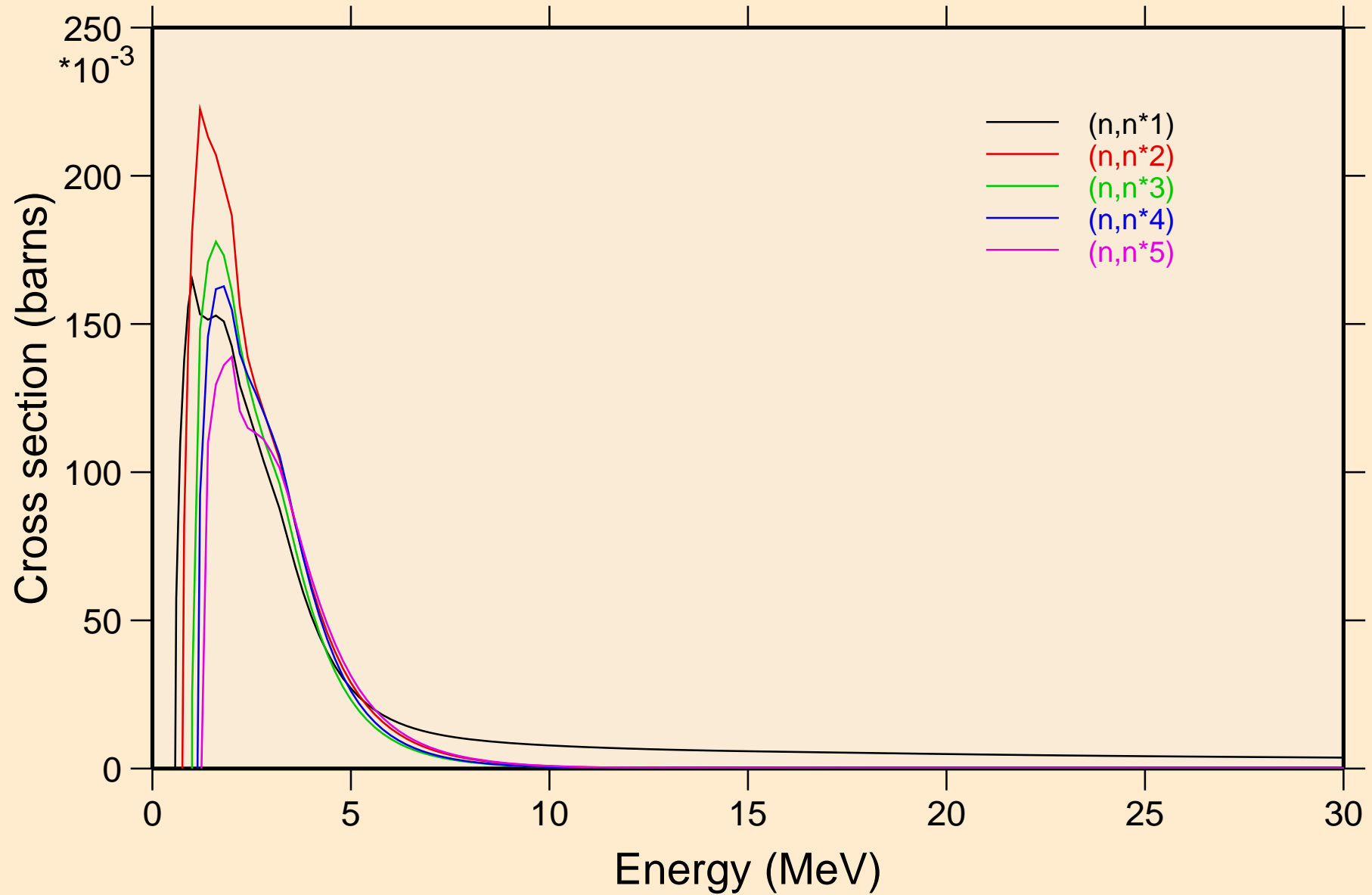

K043 NEUTRON ACER TENDL-2024 LIBRARY; T=0.K
Inelastic levels

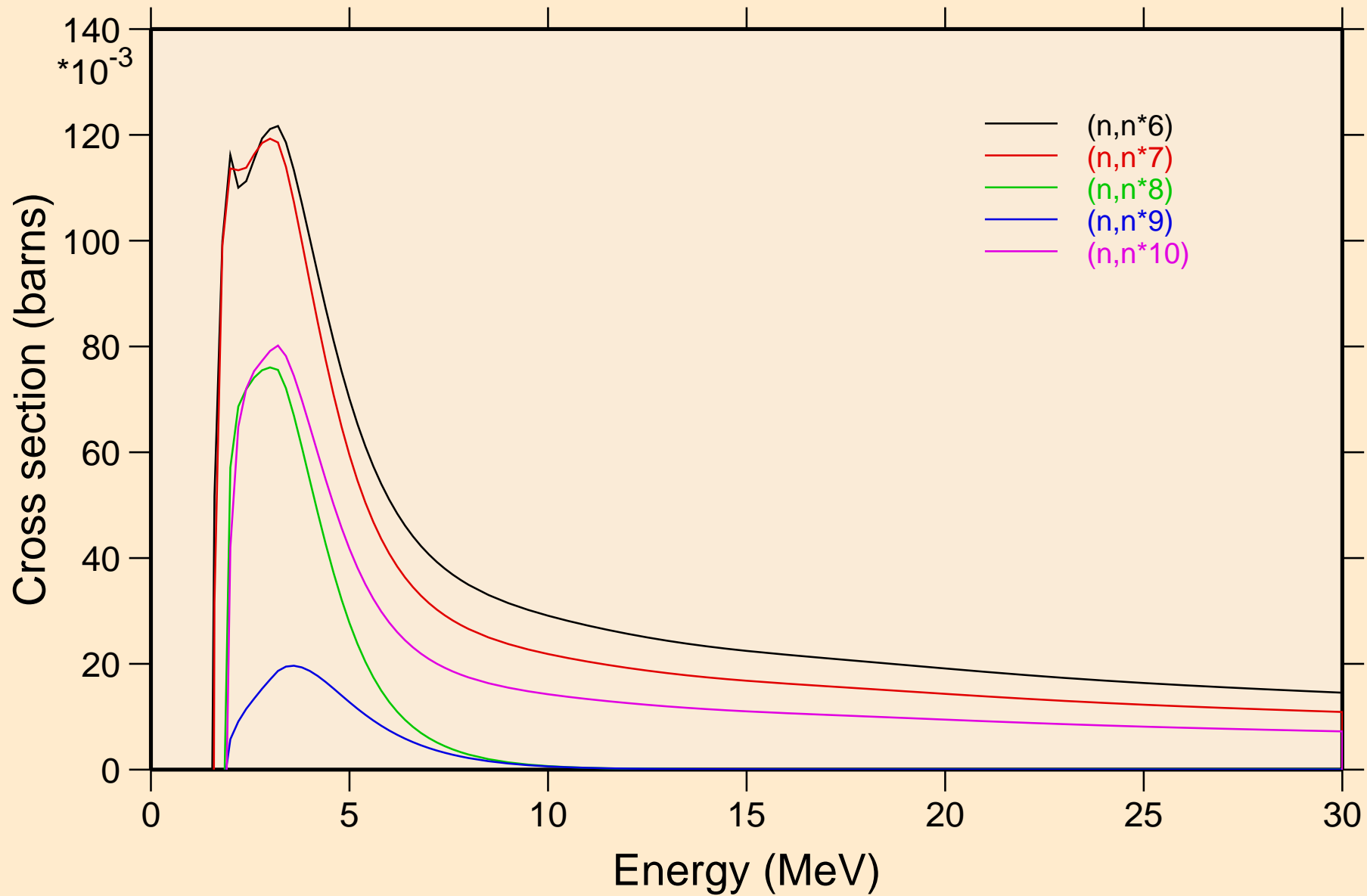

K043 NEUTRON ACER TENDL-2024 LIBRARY; T=0.K
Inelastic levels

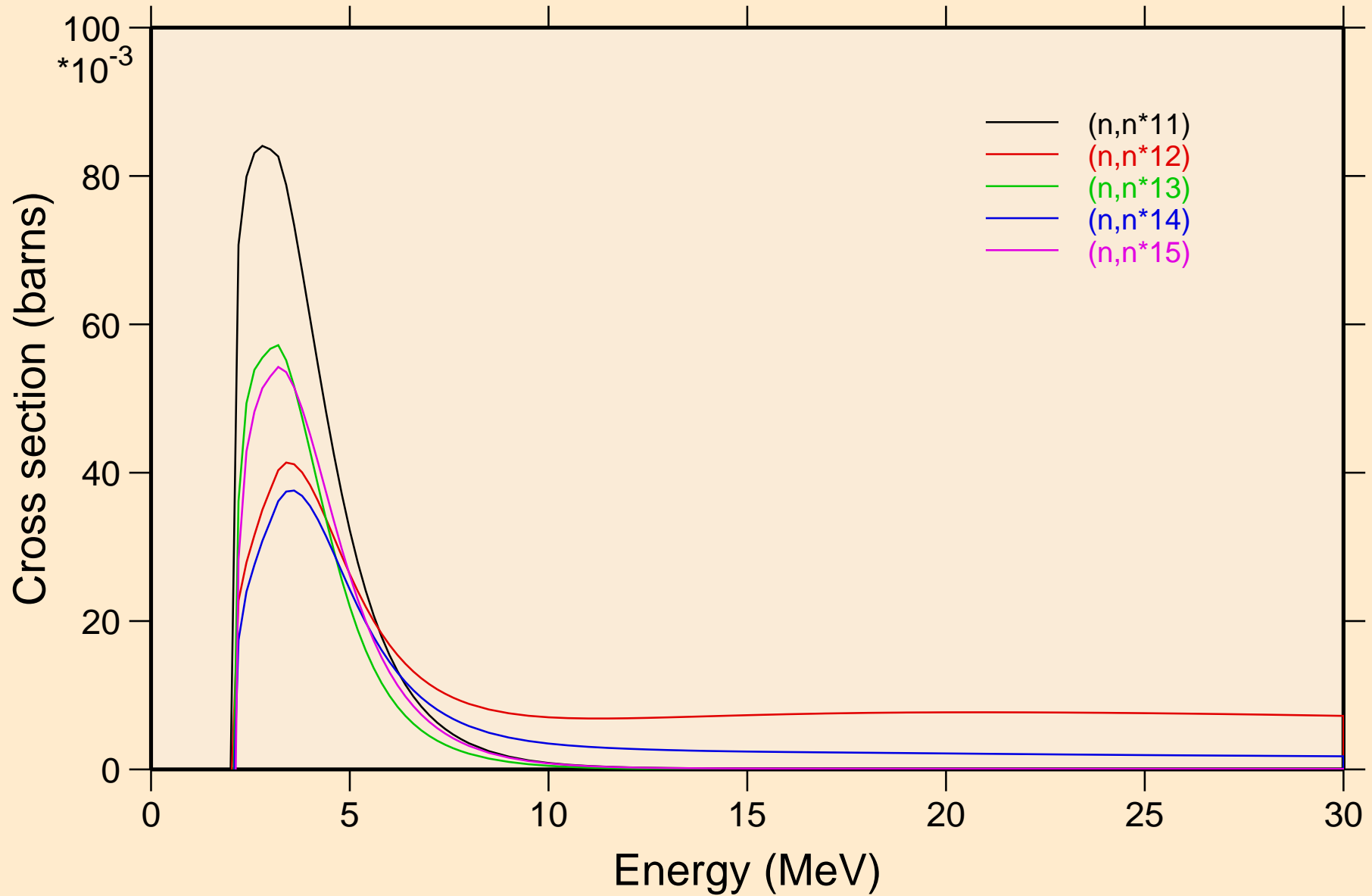

K043 NEUTRON ACER TENDL-2024 LIBRARY; T=0.K
Inelastic levels

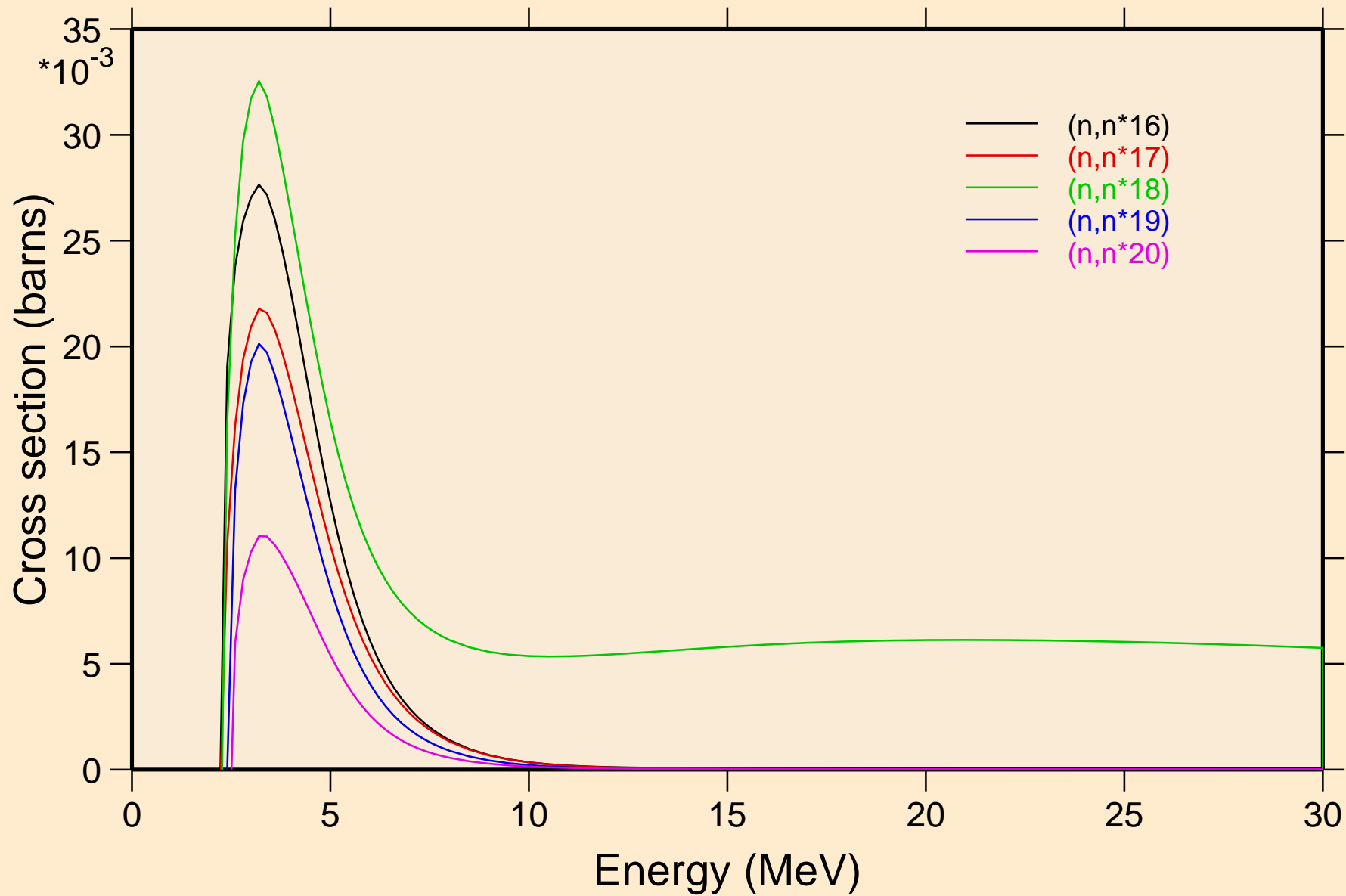

K043 NEUTRON ACER TENDL-2024 LIBRARY; T=0.K
Inelastic levels

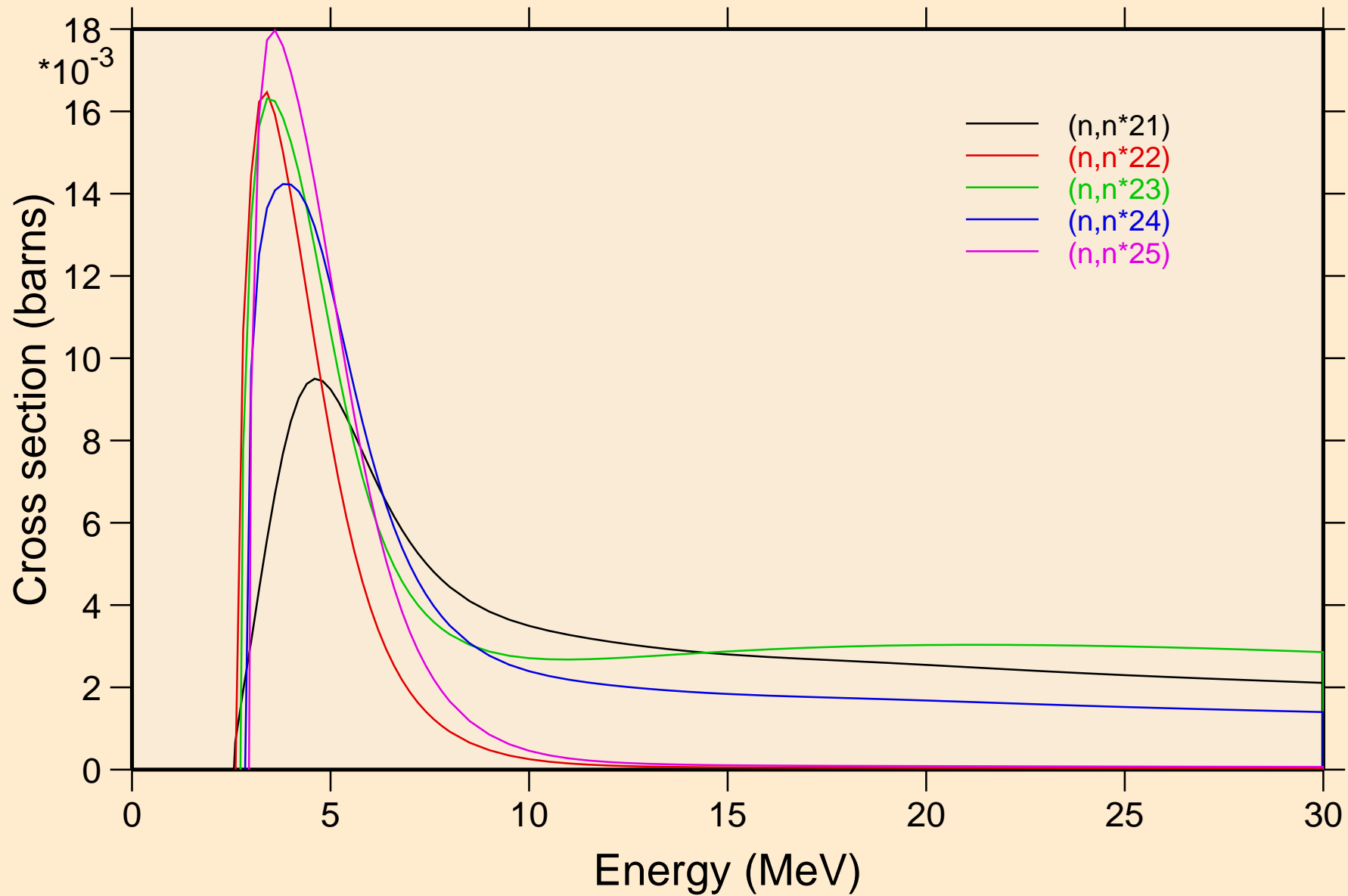

K043 NEUTRON ACER TENDL-2024 LIBRARY; T=0.K
Inelastic levels

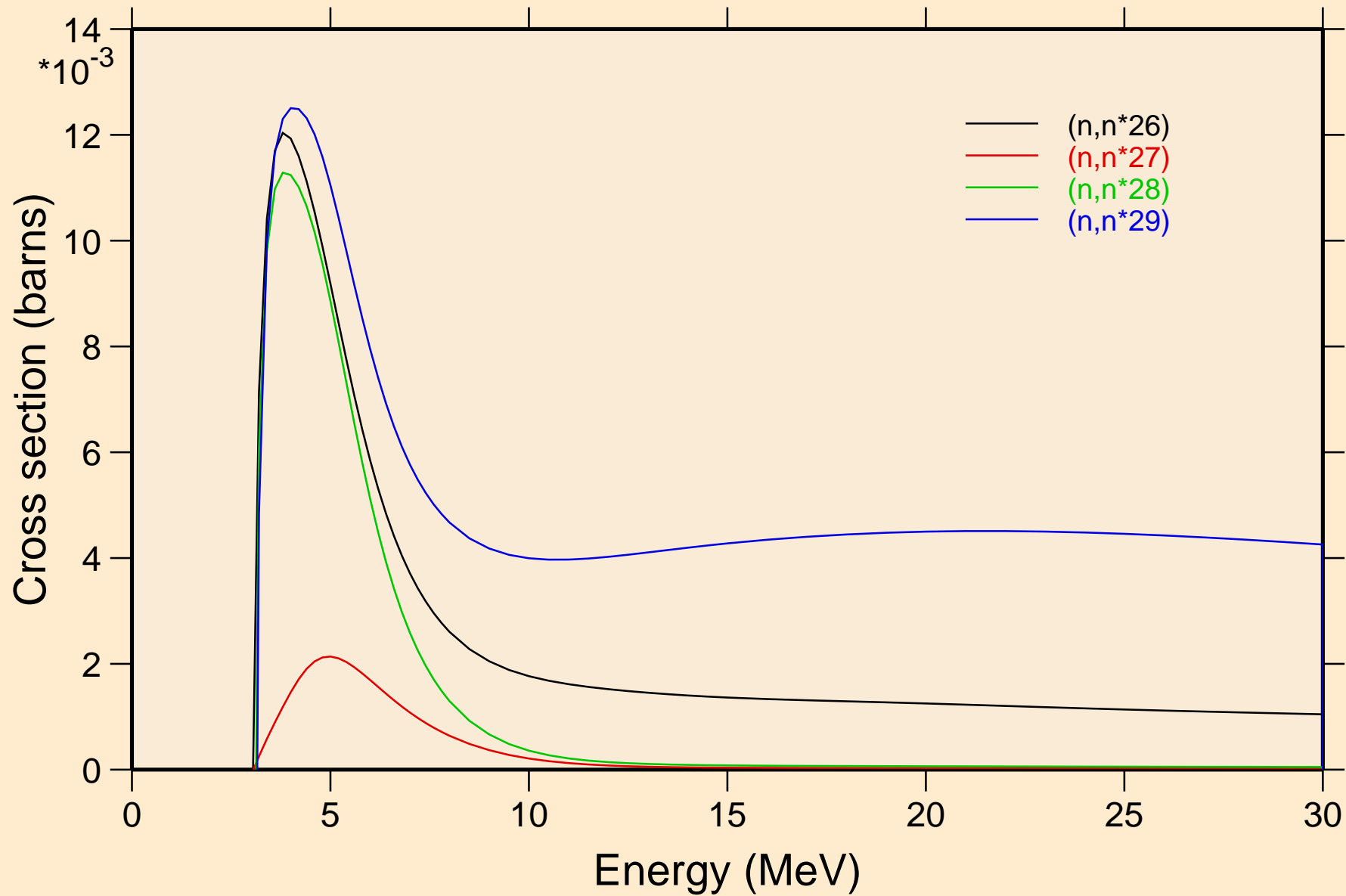

K043 NEUTRON ACER TENDL-2024 LIBRARY; T=0.K

Threshold reactions

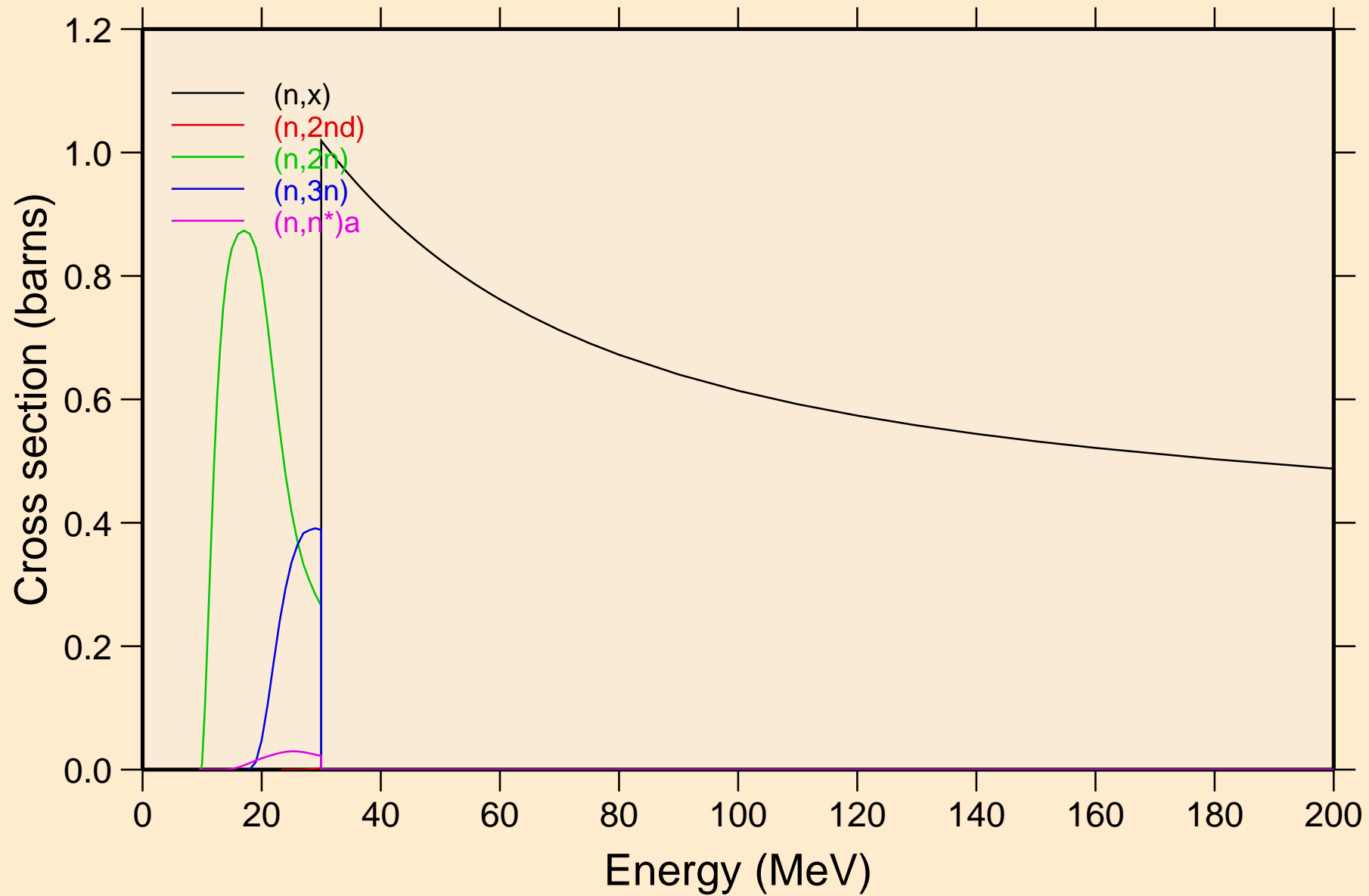

K043 NEUTRON ACER TENDL-2024 LIBRARY; T=0.K

Threshold reactions

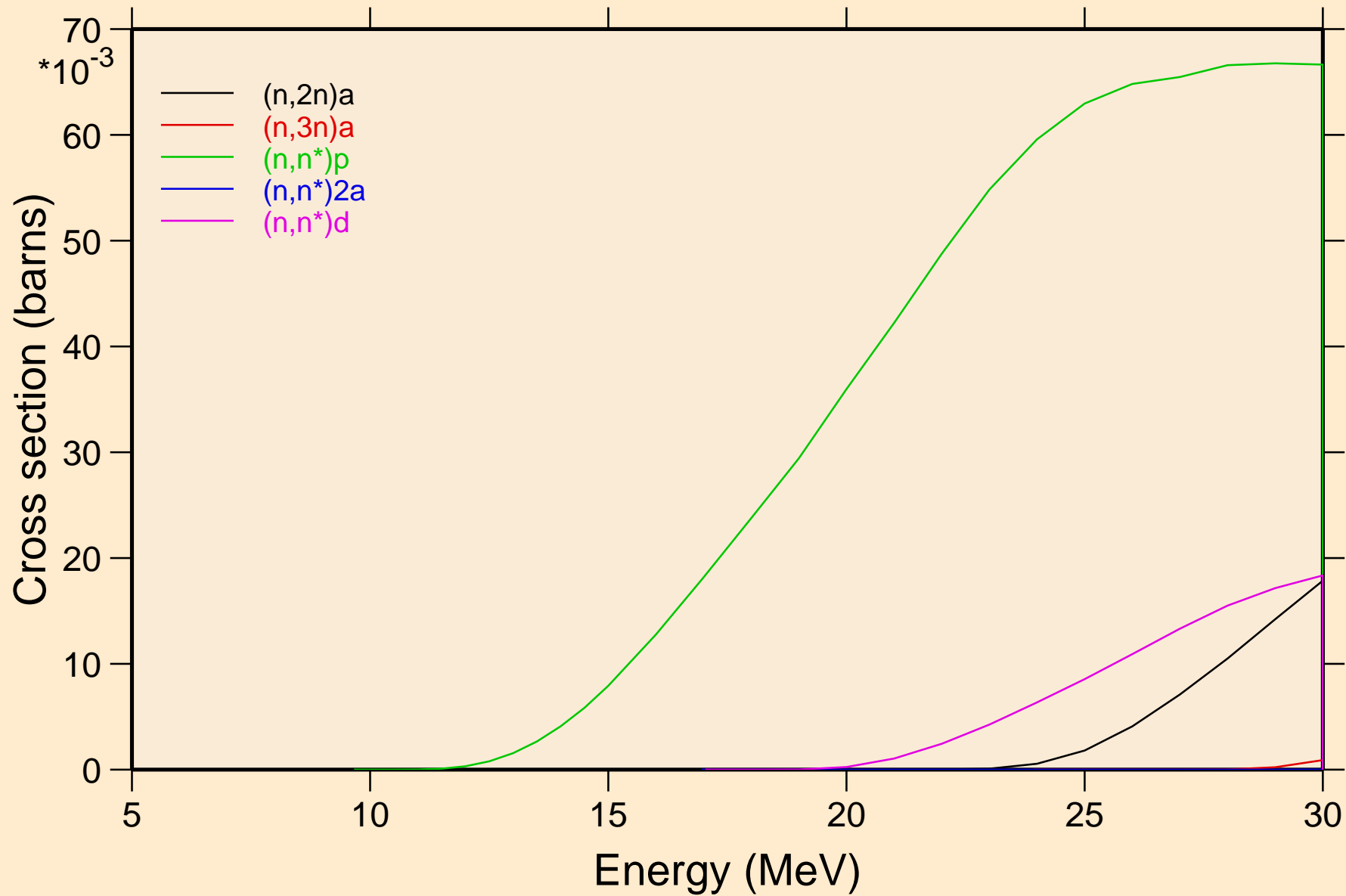

K043 NEUTRON ACER TENDL-2024 LIBRARY; T=0.K

Threshold reactions

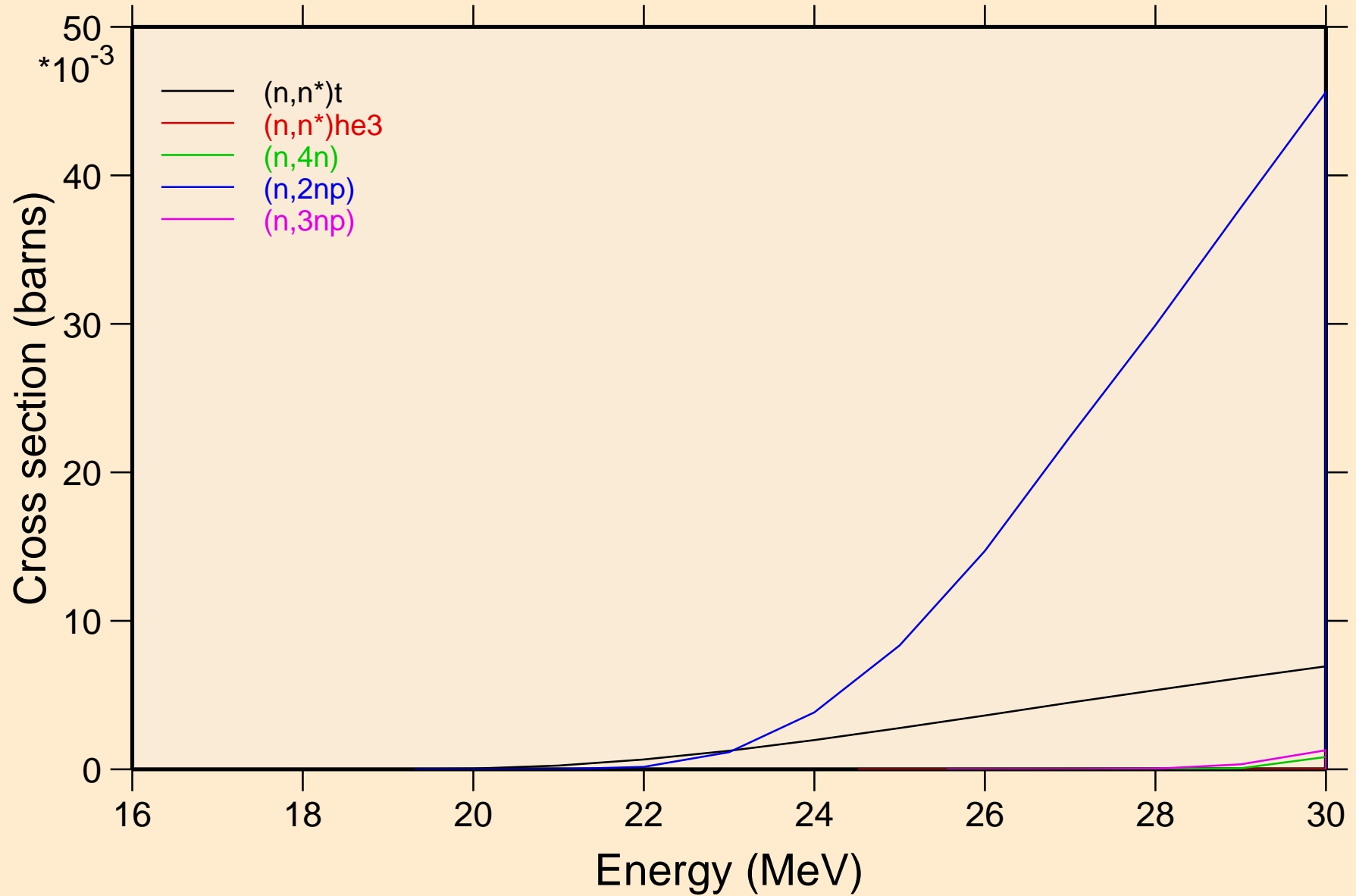

K043 NEUTRON ACER TENDL-2024 LIBRARY; T=0.K
Threshold reactions

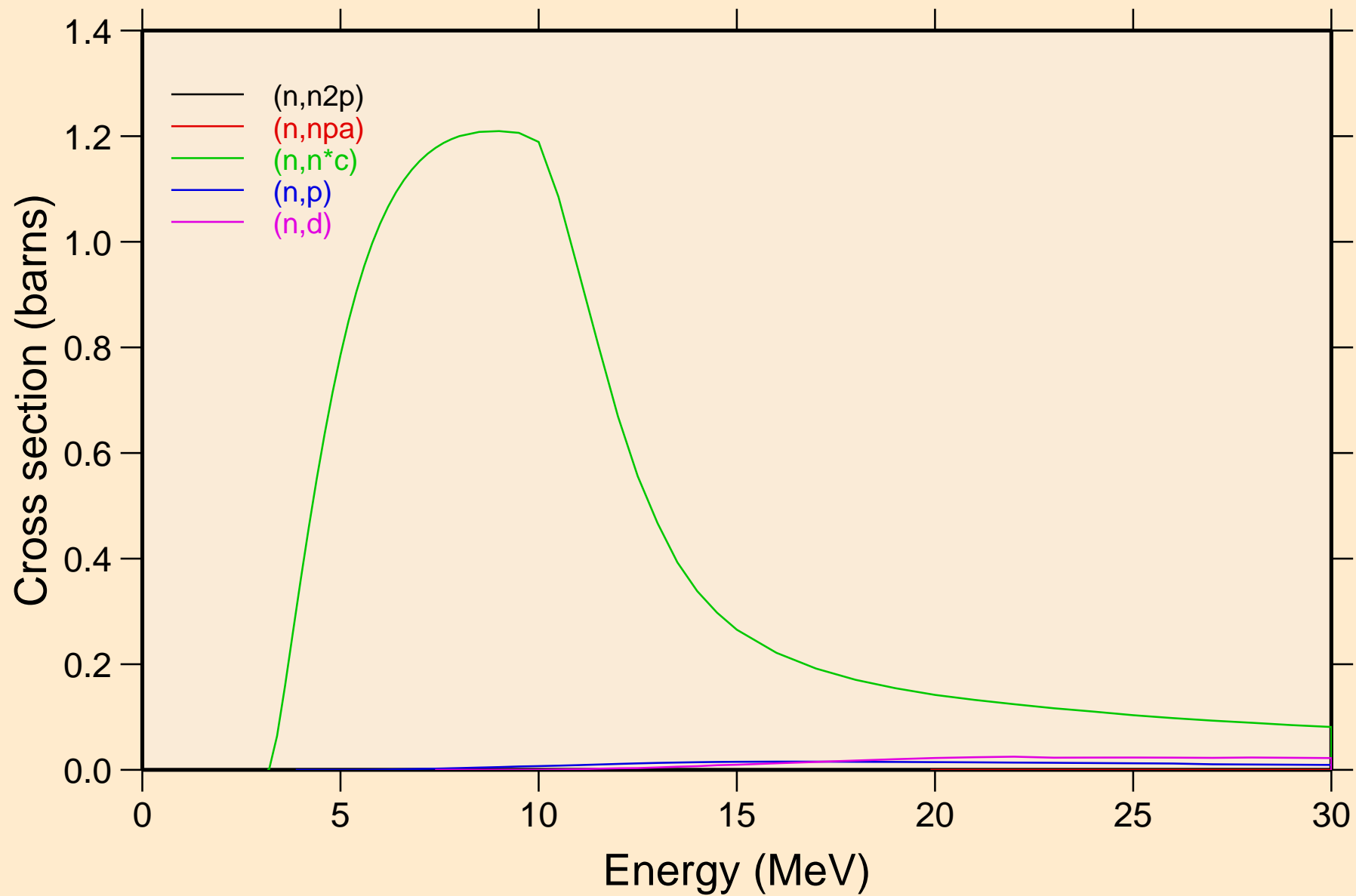

K043 NEUTRON ACER TENDL-2024 LIBRARY; T=0.K
Threshold reactions

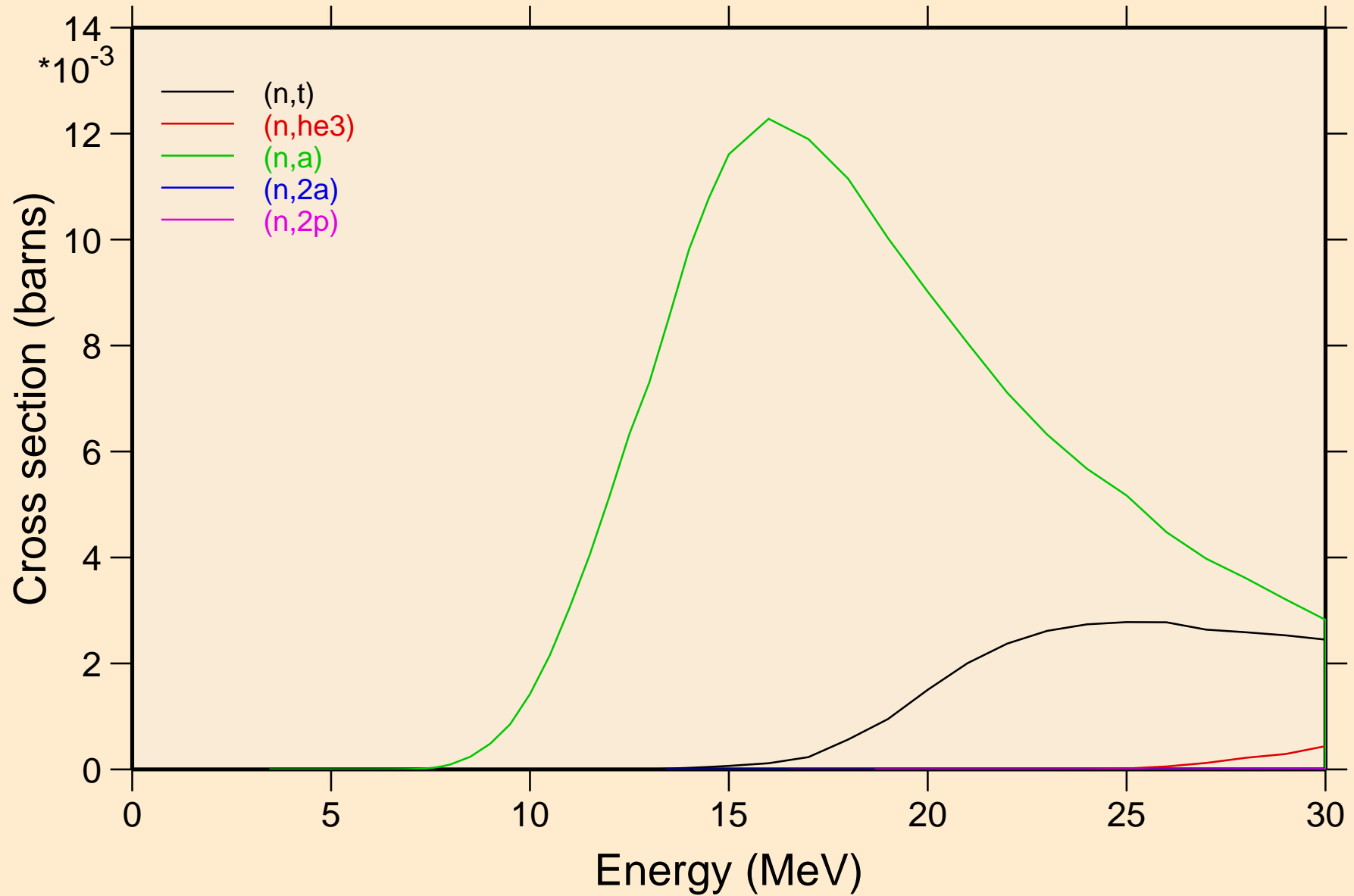

K043 NEUTRON ACER TENDL-2024 LIBRARY; T=0.K

Threshold reactions

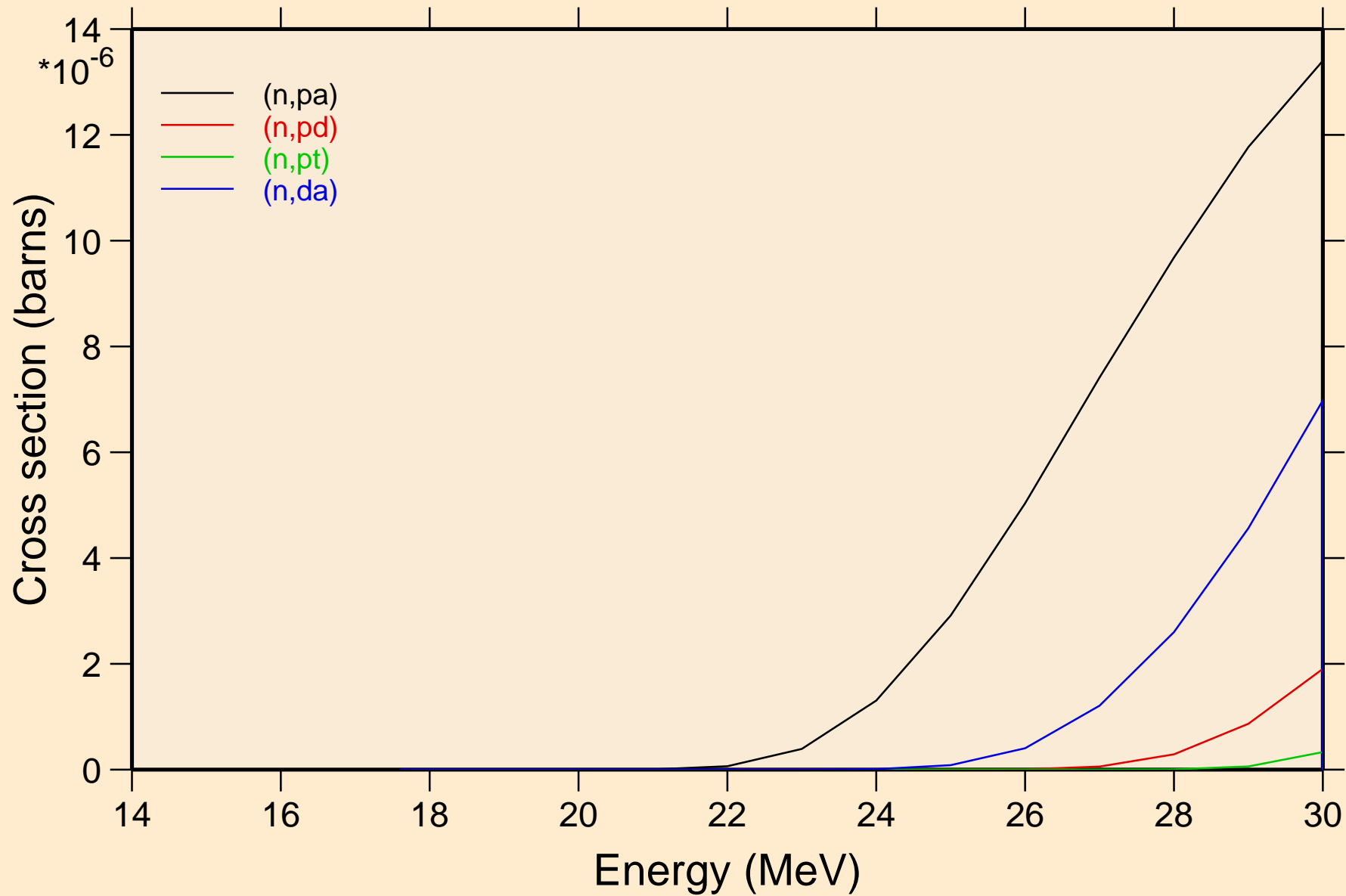

K043 NEUTRON ACER TENDL-2024 LIBRARY; T=0.K

Threshold reactions

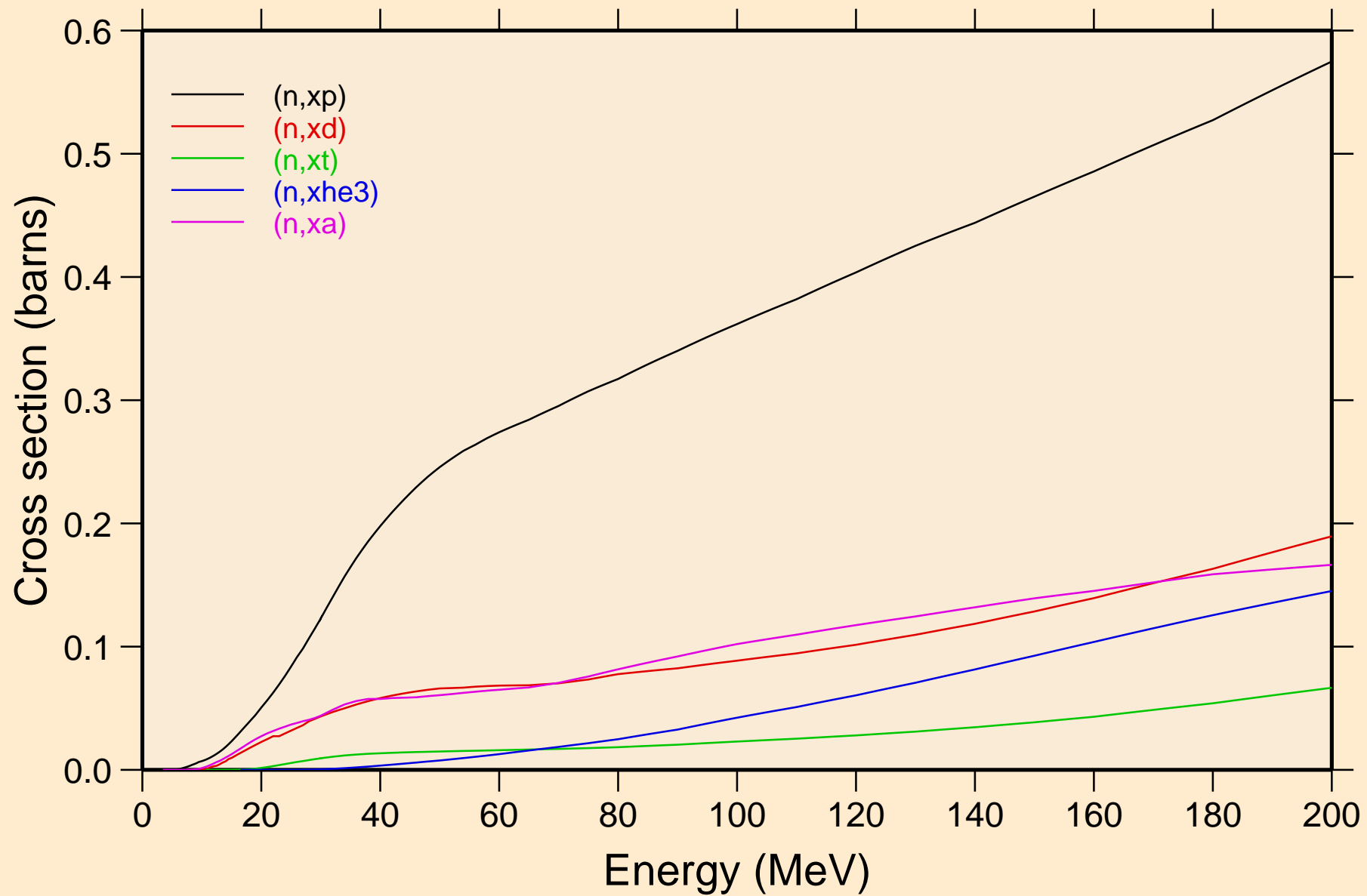

K043 NEUTRON ACER TENDL-2024 LIBRARY; T=0.K
angular distribution for elastic

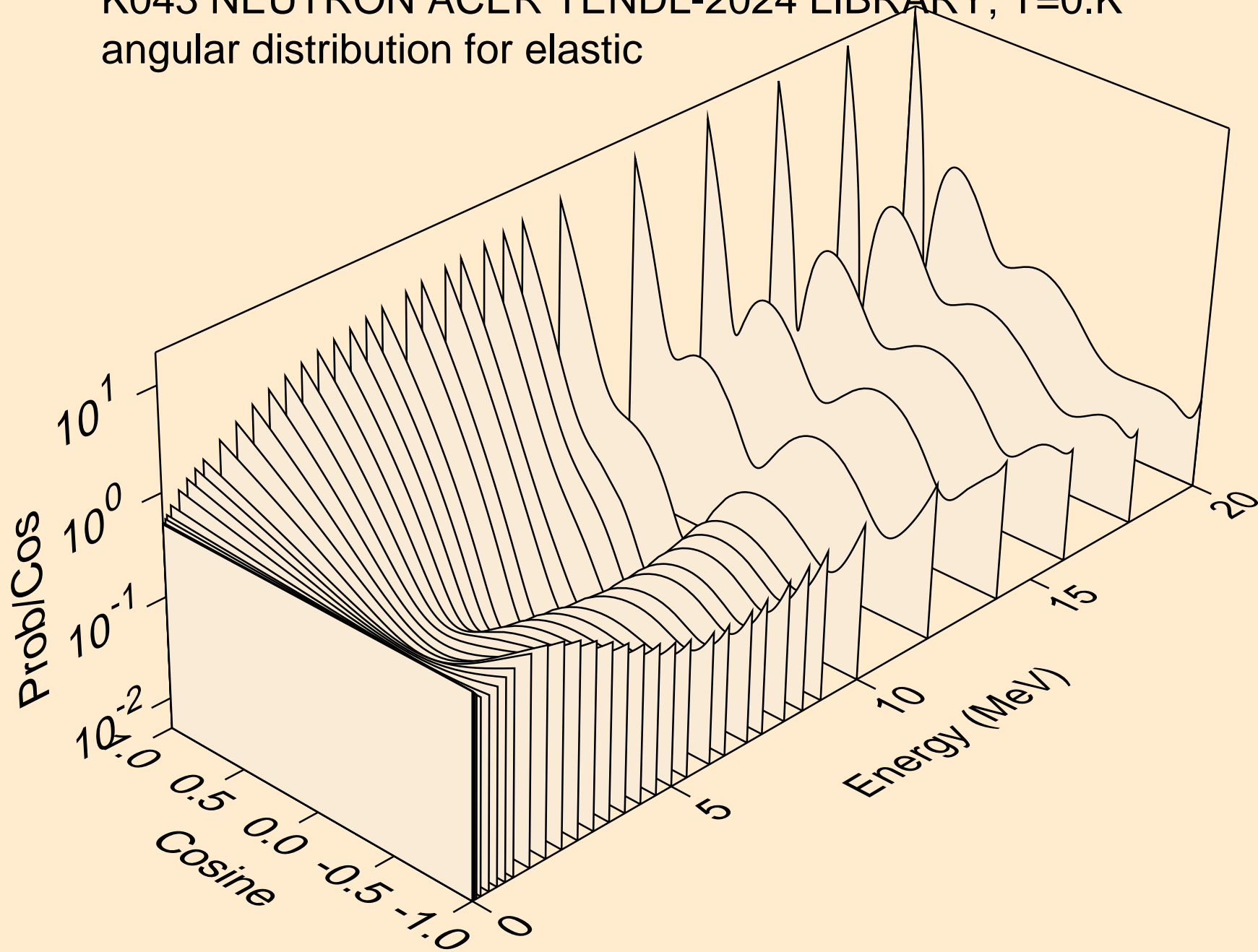

K043 NEUTRON ACER TENDL-2024 LIBRARY; T=0.K
angular distribution for elastic

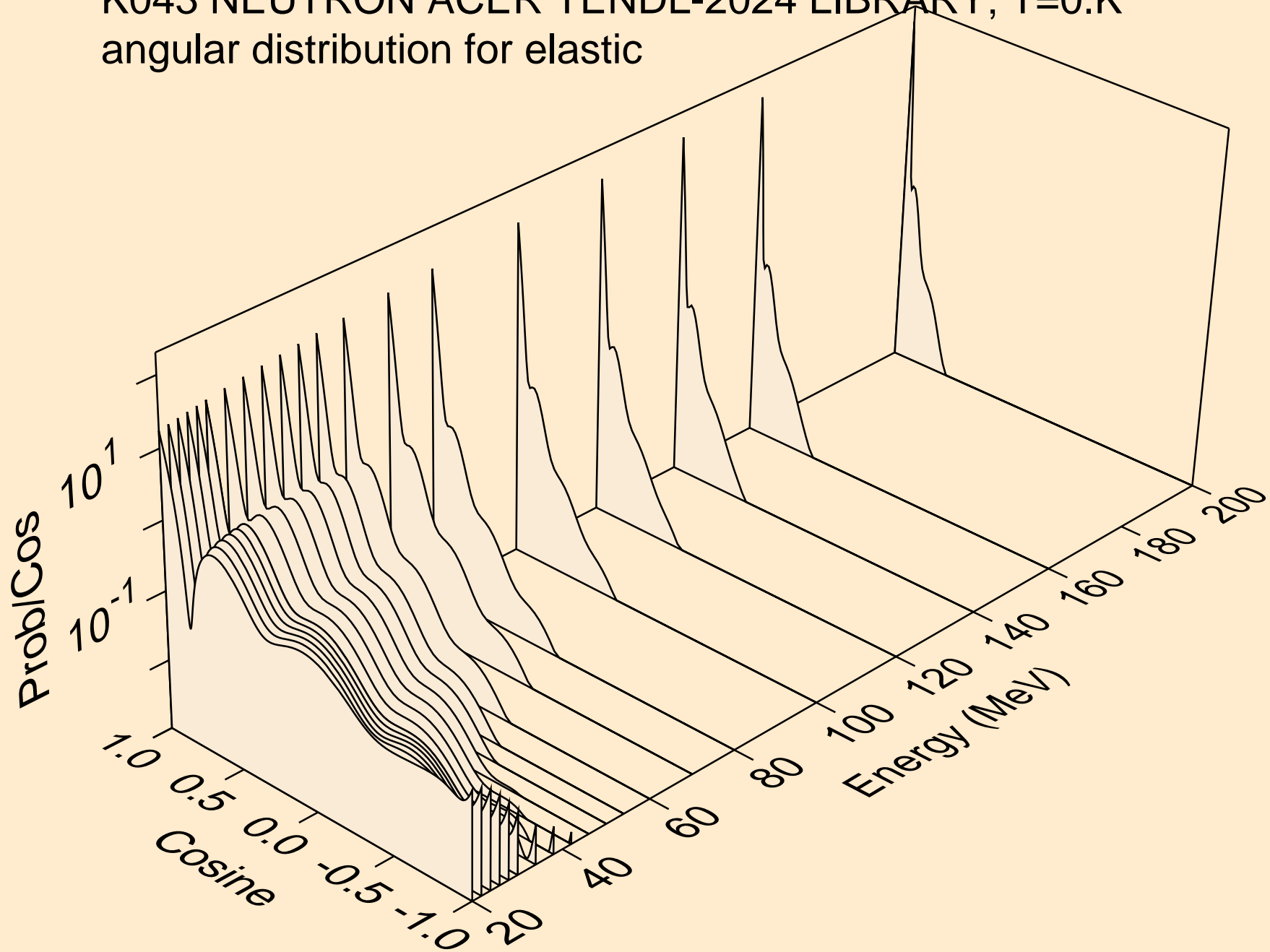

K043 NEUTRON ACER TENDL-2024 LIBRARY; T=0.K
angular distribution for (n,n*1)

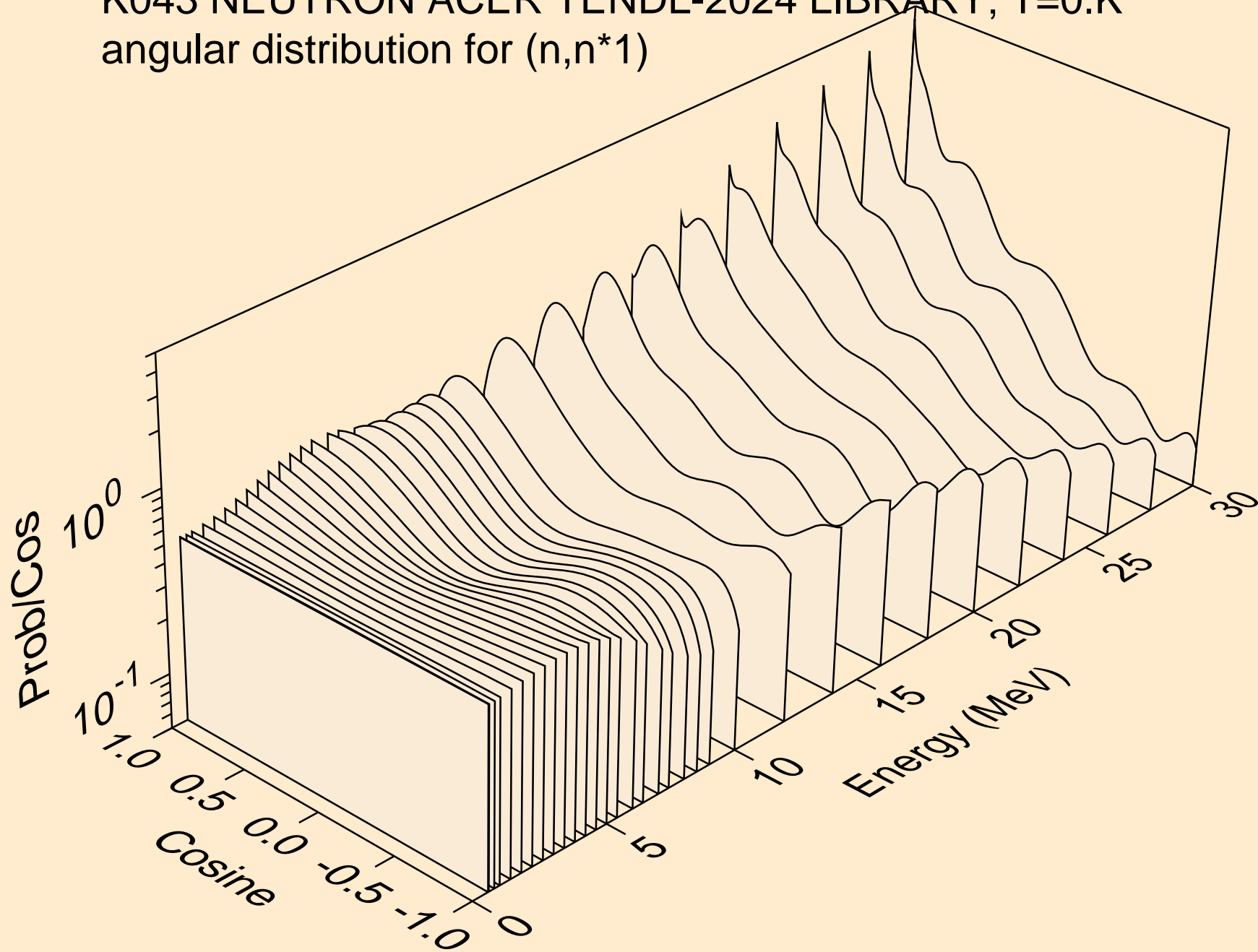

K043 NEUTRON ACER TENDL-2024 LIBRARY; T=0.K
angular distribution for (n,n*2)

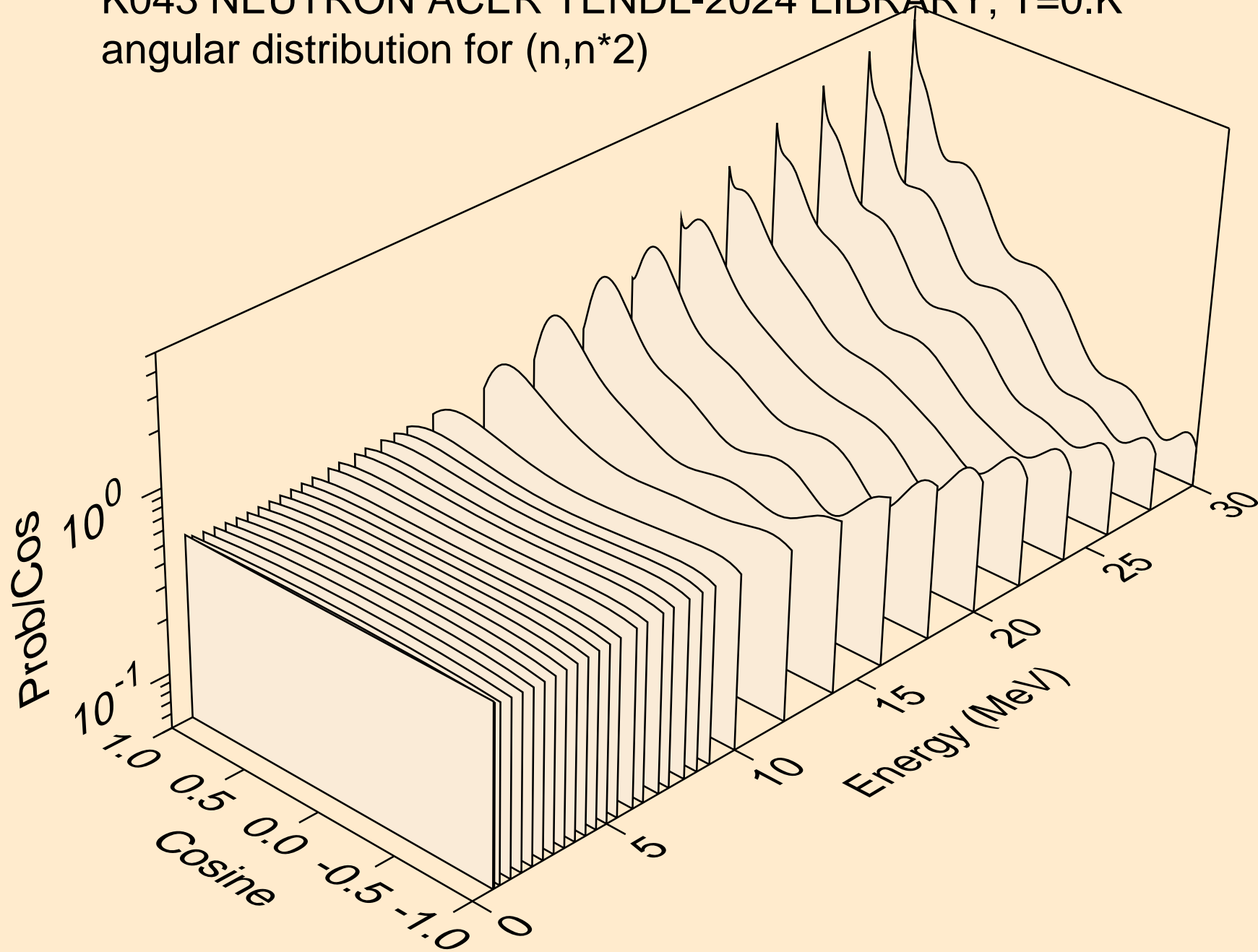

K043 NEUTRON ACER TENDL-2024 LIBRARY; T=0.K
angular distribution for (n,n*3)

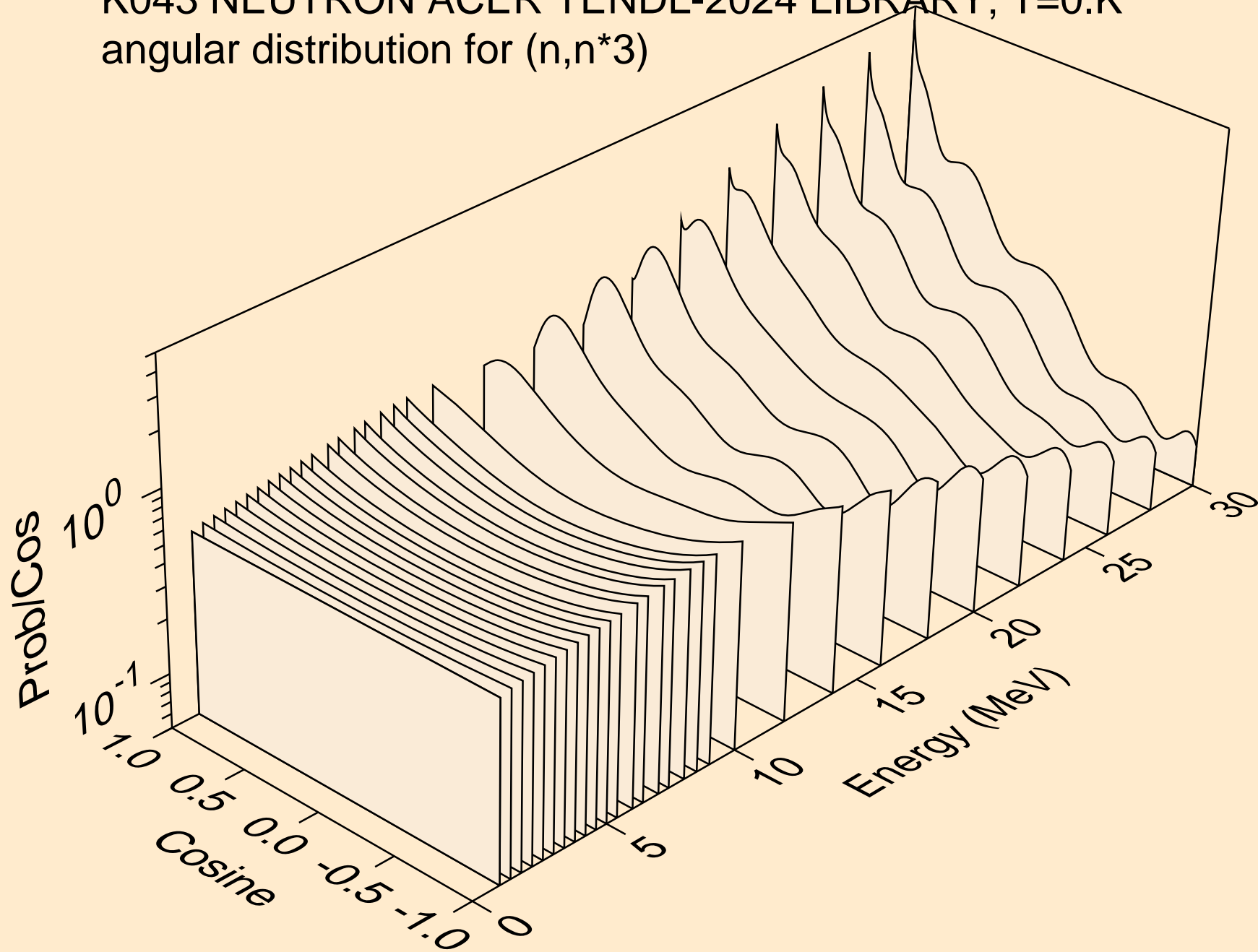

K043 NEUTRON ACER TENDL-2024 LIBRARY; T=0.K
angular distribution for (n,n*4)

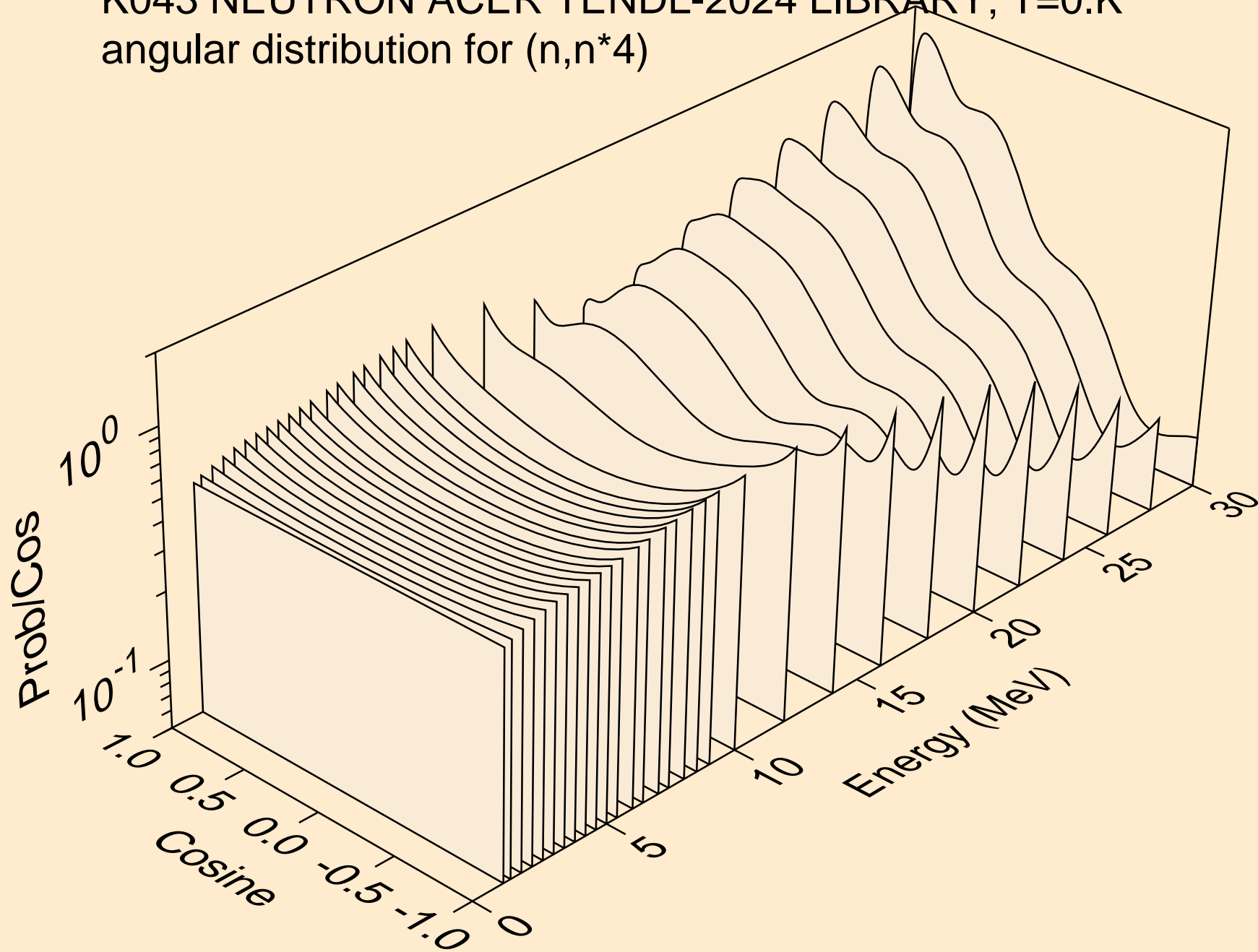

K043 NEUTRON ACER TENDL-2024 LIBRARY; T=0.K
angular distribution for (n,n*5)

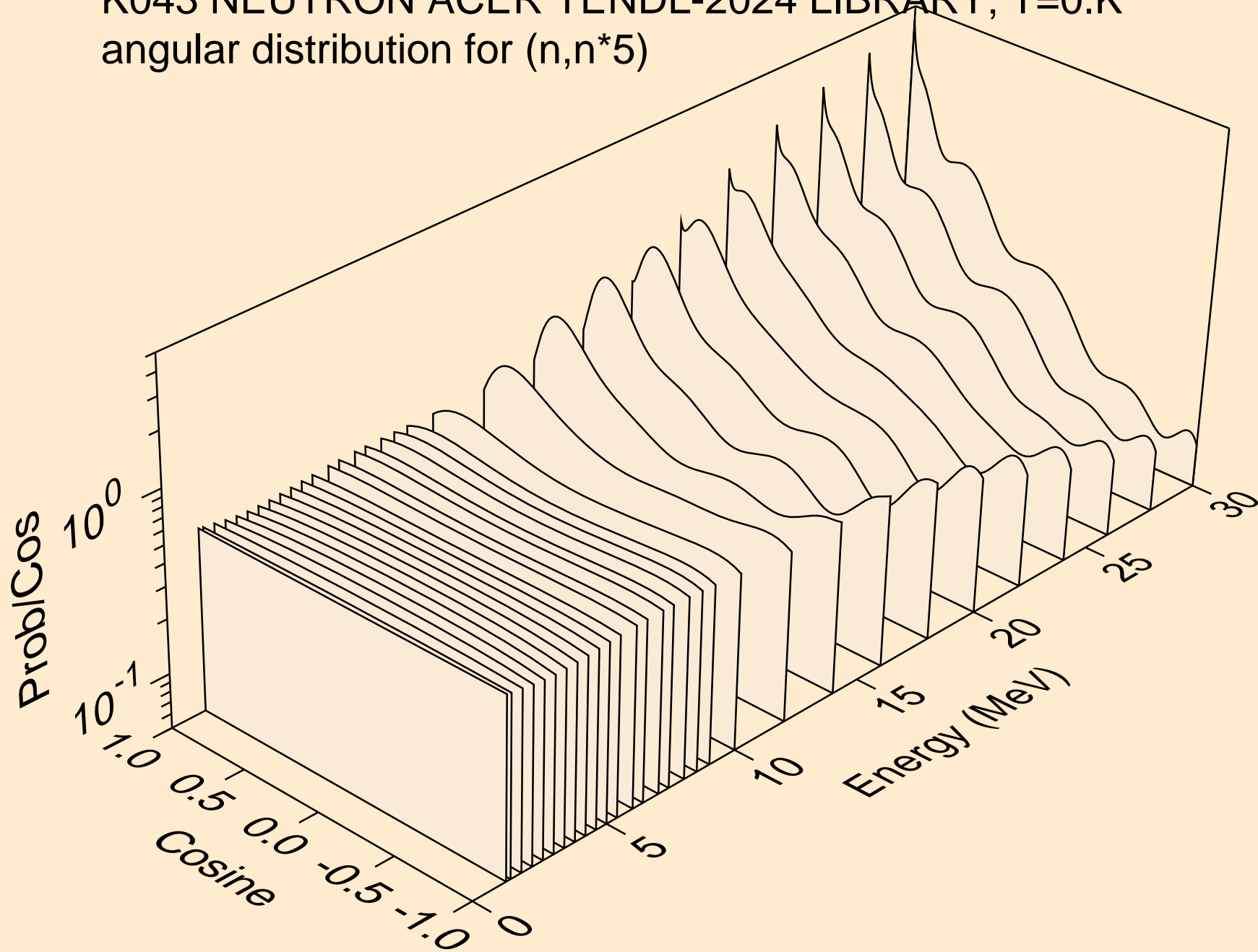

K043 NEUTRON ACER TENDL-2024 LIBRARY; T=0.K
angular distribution for (n,n*6)

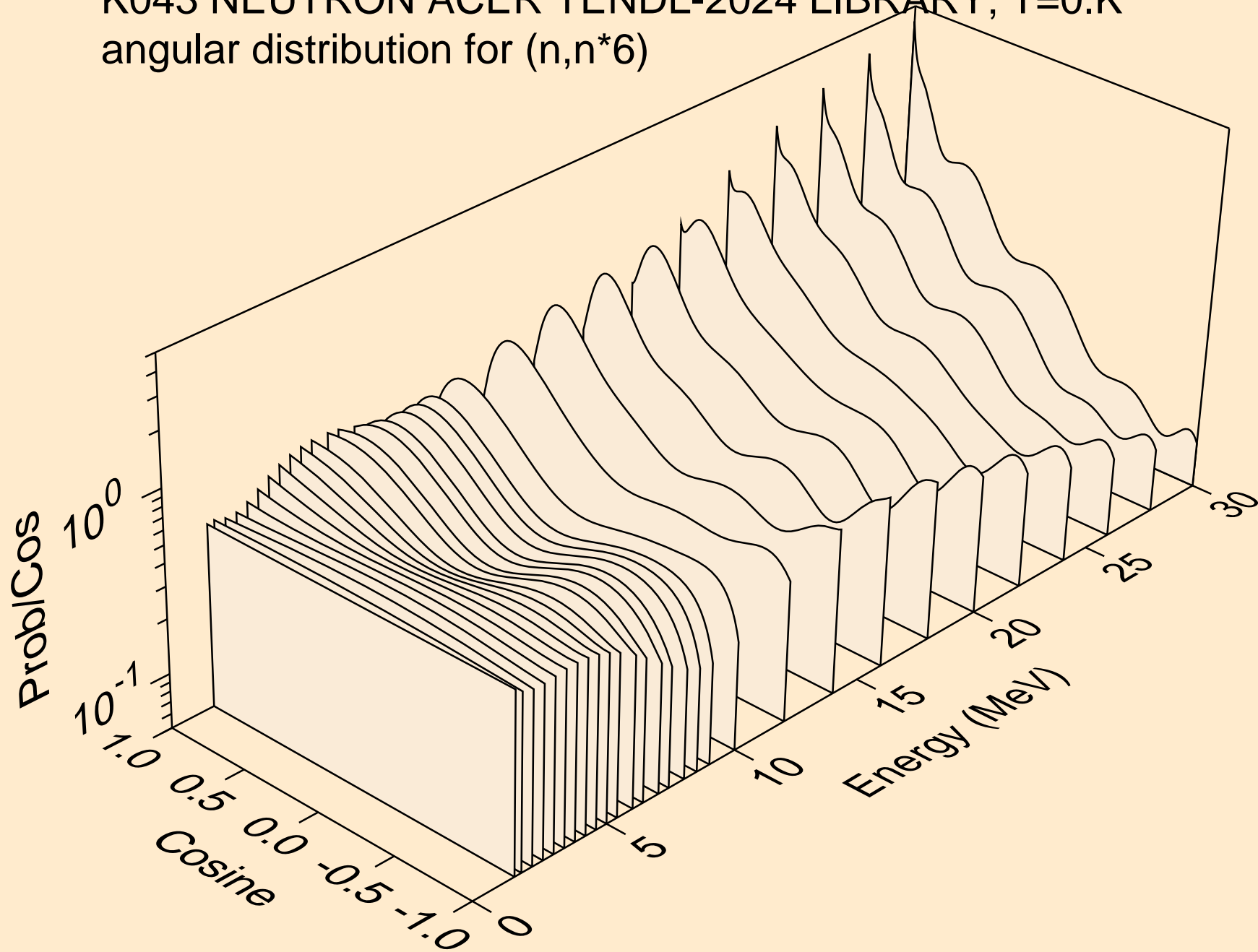

K043 NEUTRON ACER TENDL-2024 LIBRARY; T=0.K
angular distribution for (n,n*7)

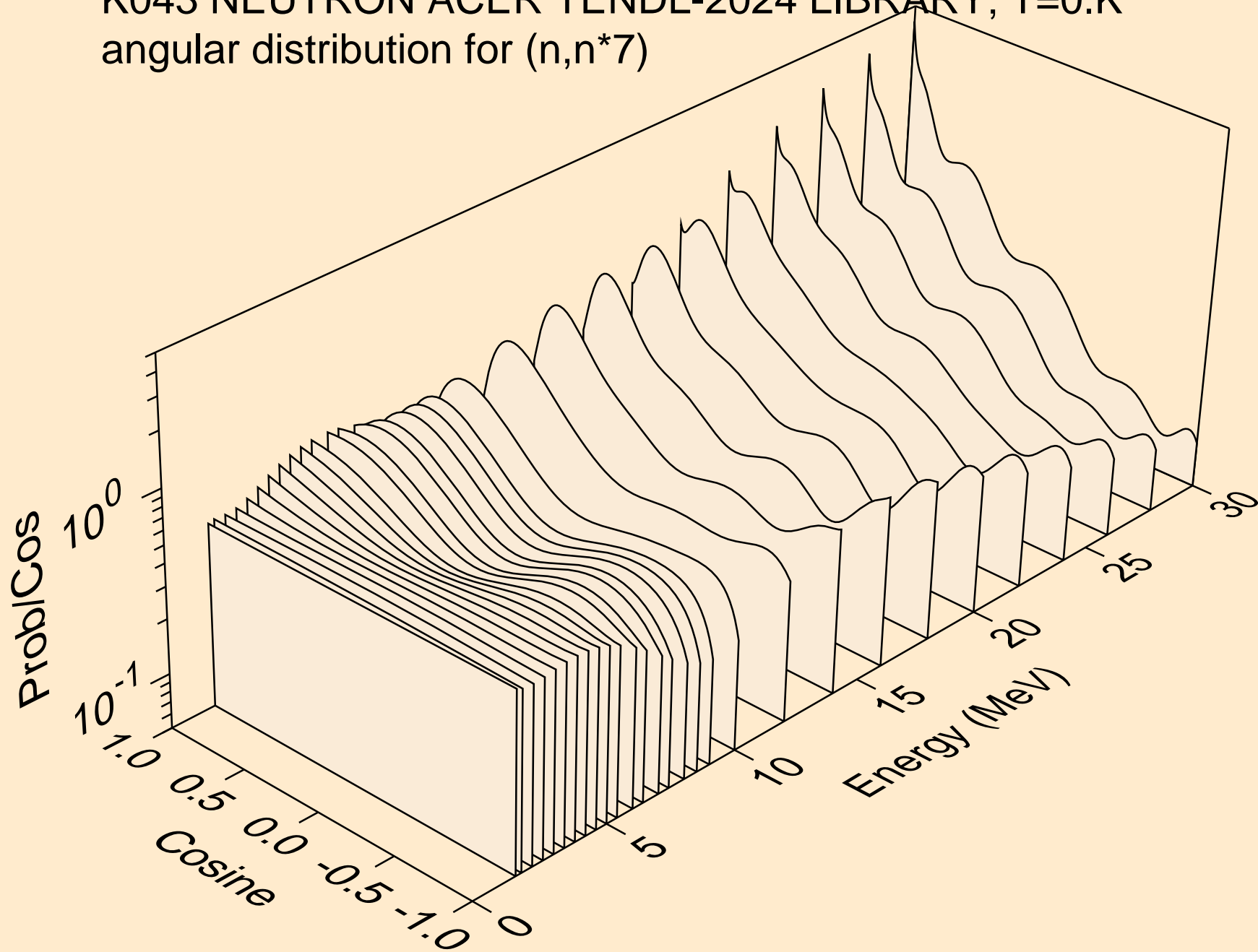

K043 NEUTRON ACER TENDL-2024 LIBRARY; T=0.K
angular distribution for (n,n*8)

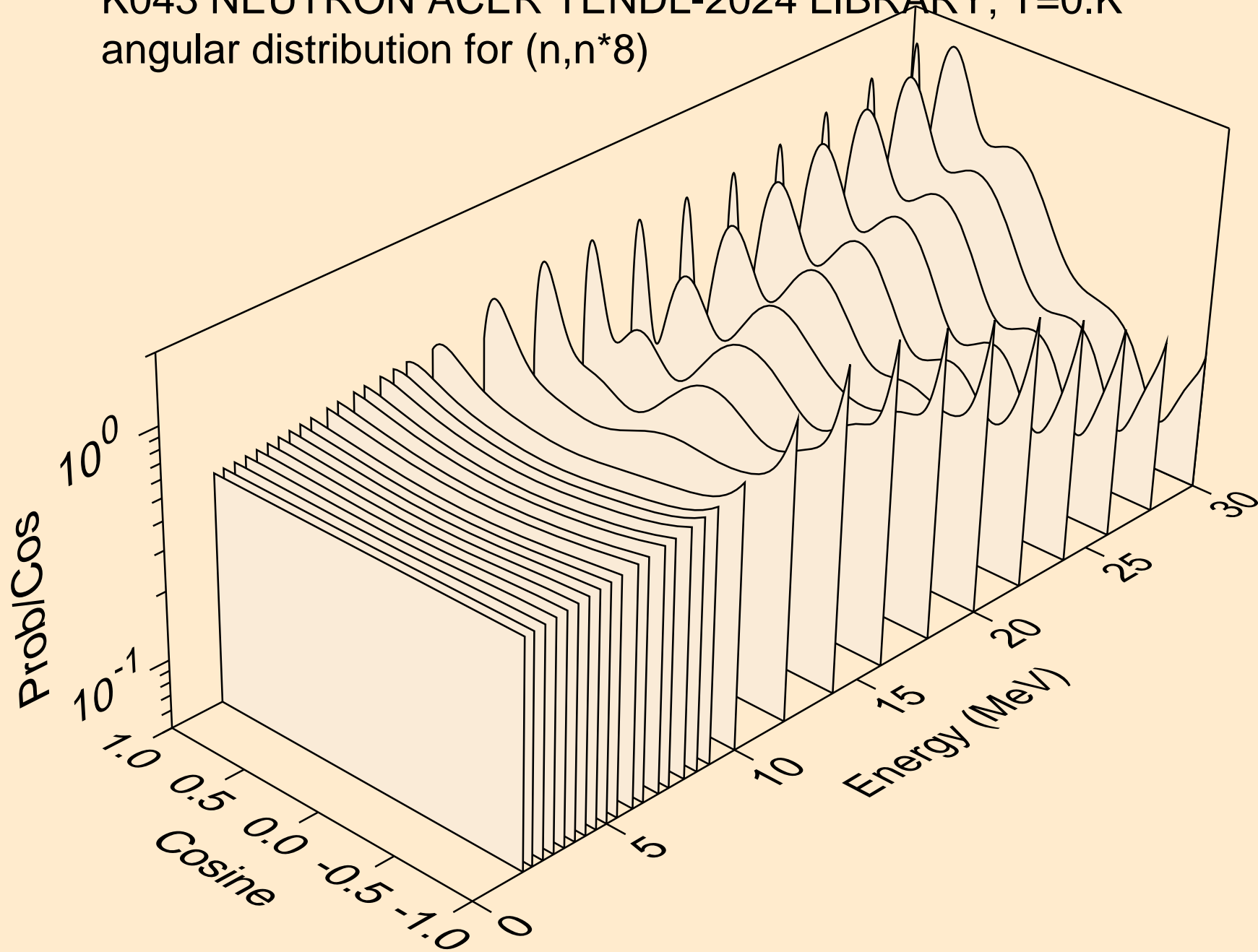

K043 NEUTRON ACER TENDL-2024 LIBRARY; T=0.K
angular distribution for (n,n*9)

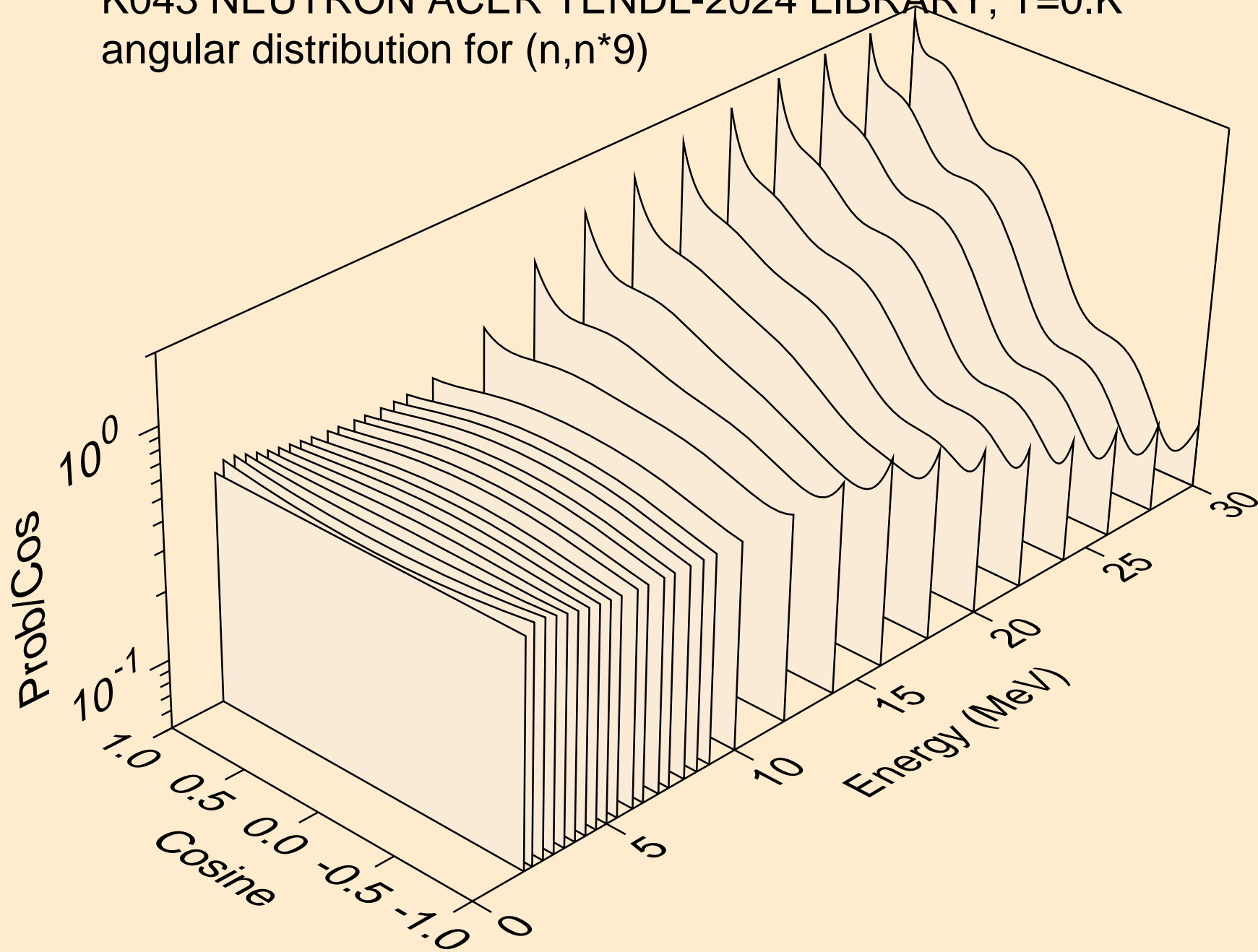

K043 NEUTRON ACER TENDL-2024 LIBRARY; T=0.K
angular distribution for (n,n*10)

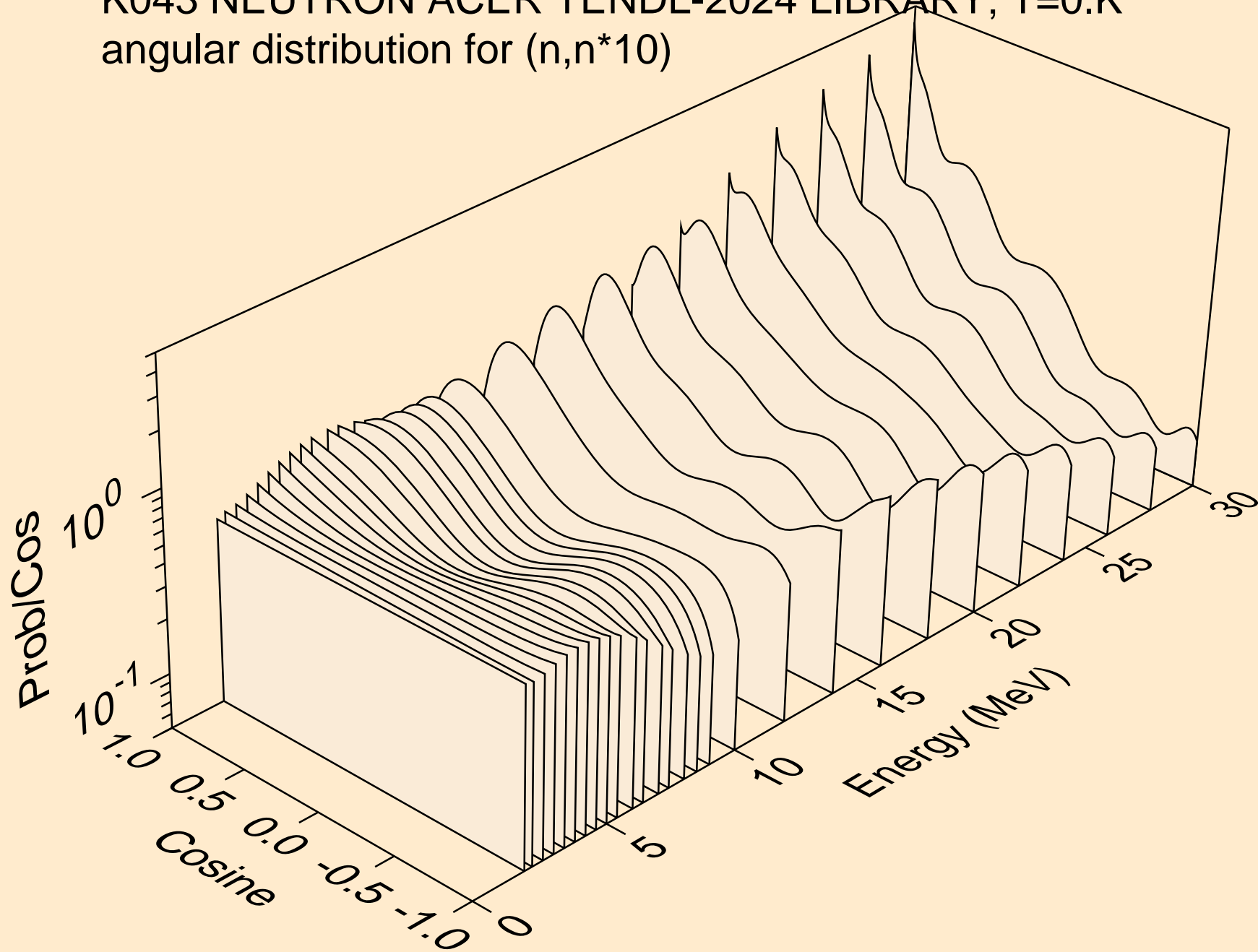

K043 NEUTRON ACER TENDL-2024 LIBRARY; T=0.K
angular distribution for (n,n*11)

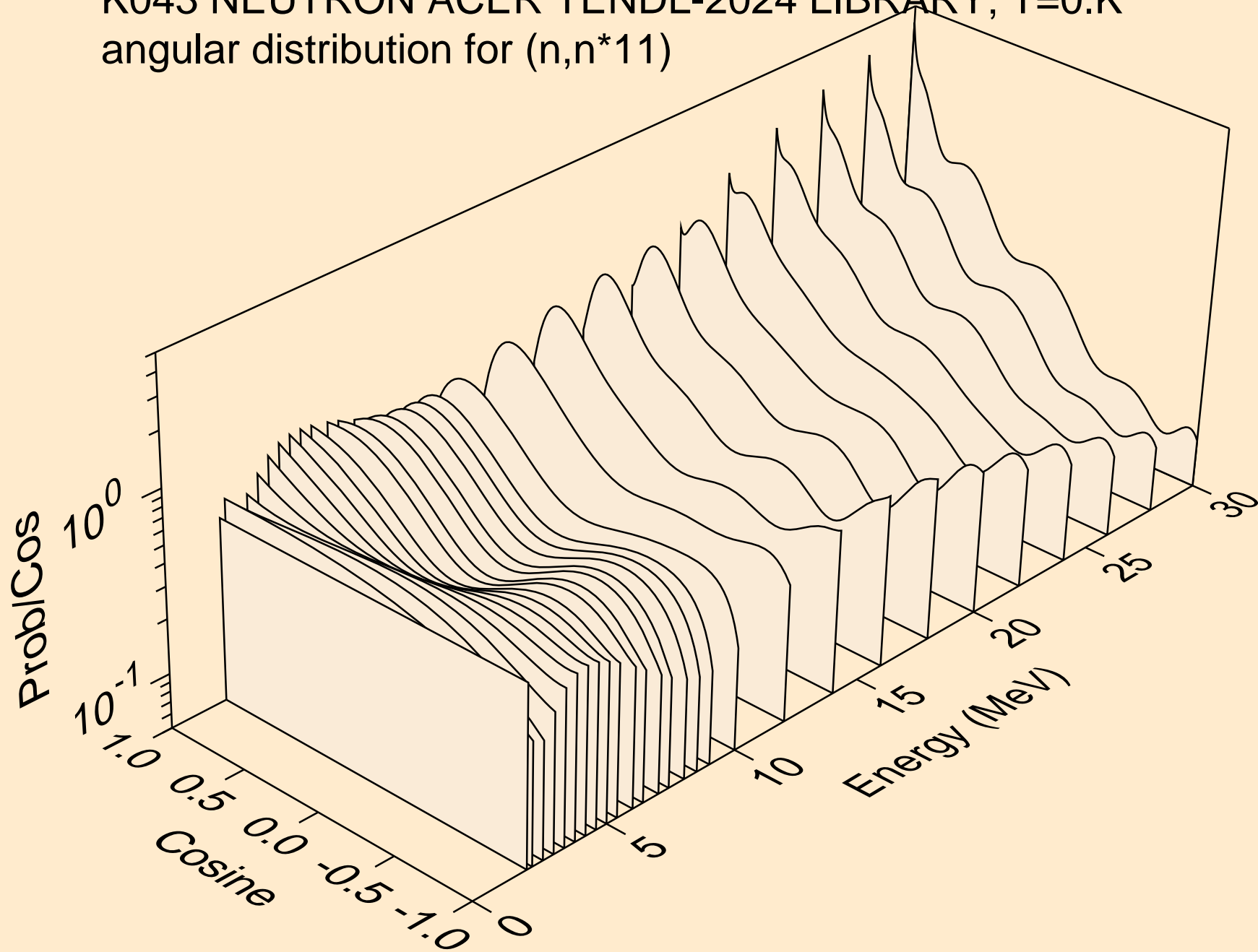

K043 NEUTRON ACER TENDL-2024 LIBRARY; T=0.K
angular distribution for (n,n*12)

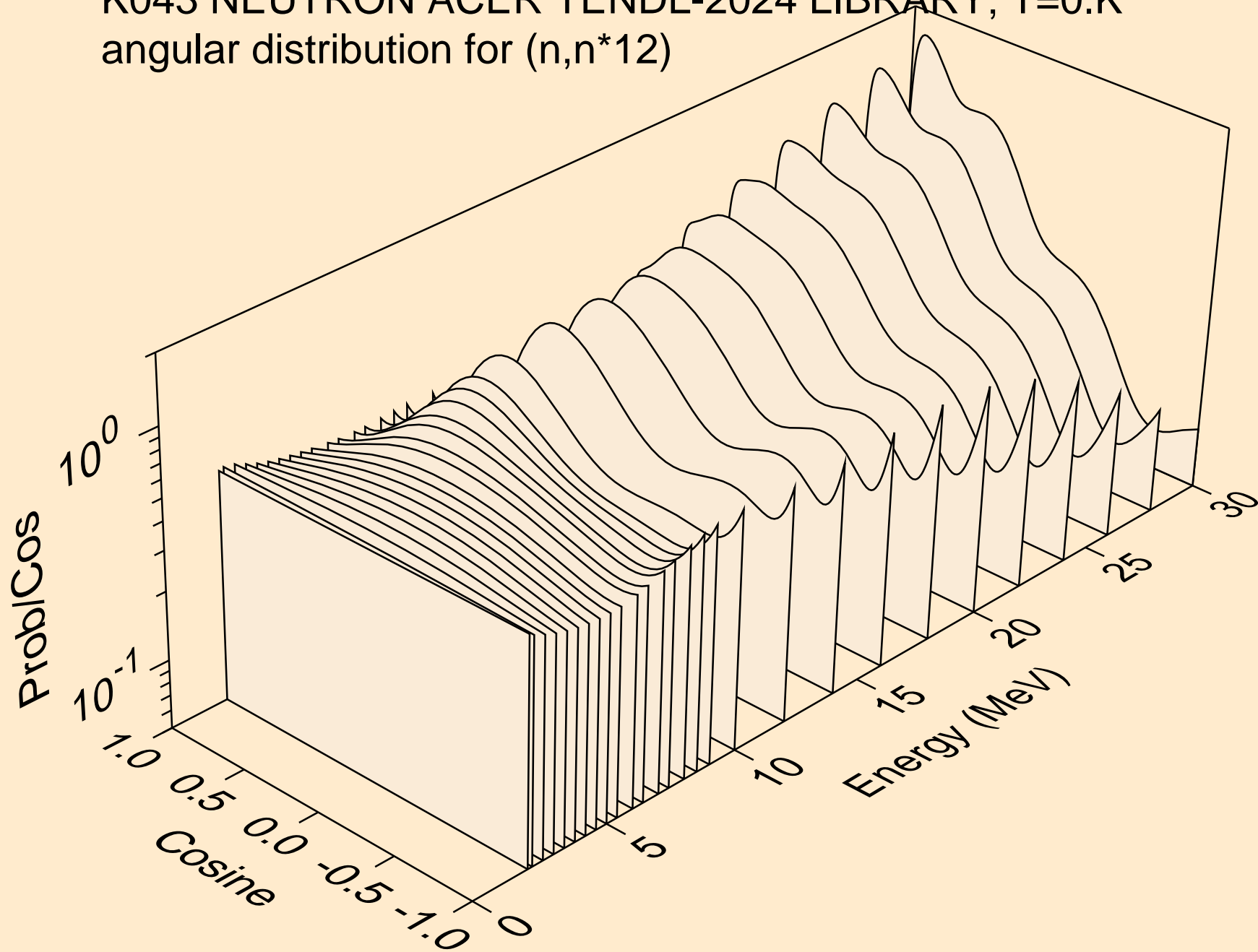

K043 NEUTRON ACER TENDL-2024 LIBRARY; T=0.K
angular distribution for (n,n*13)

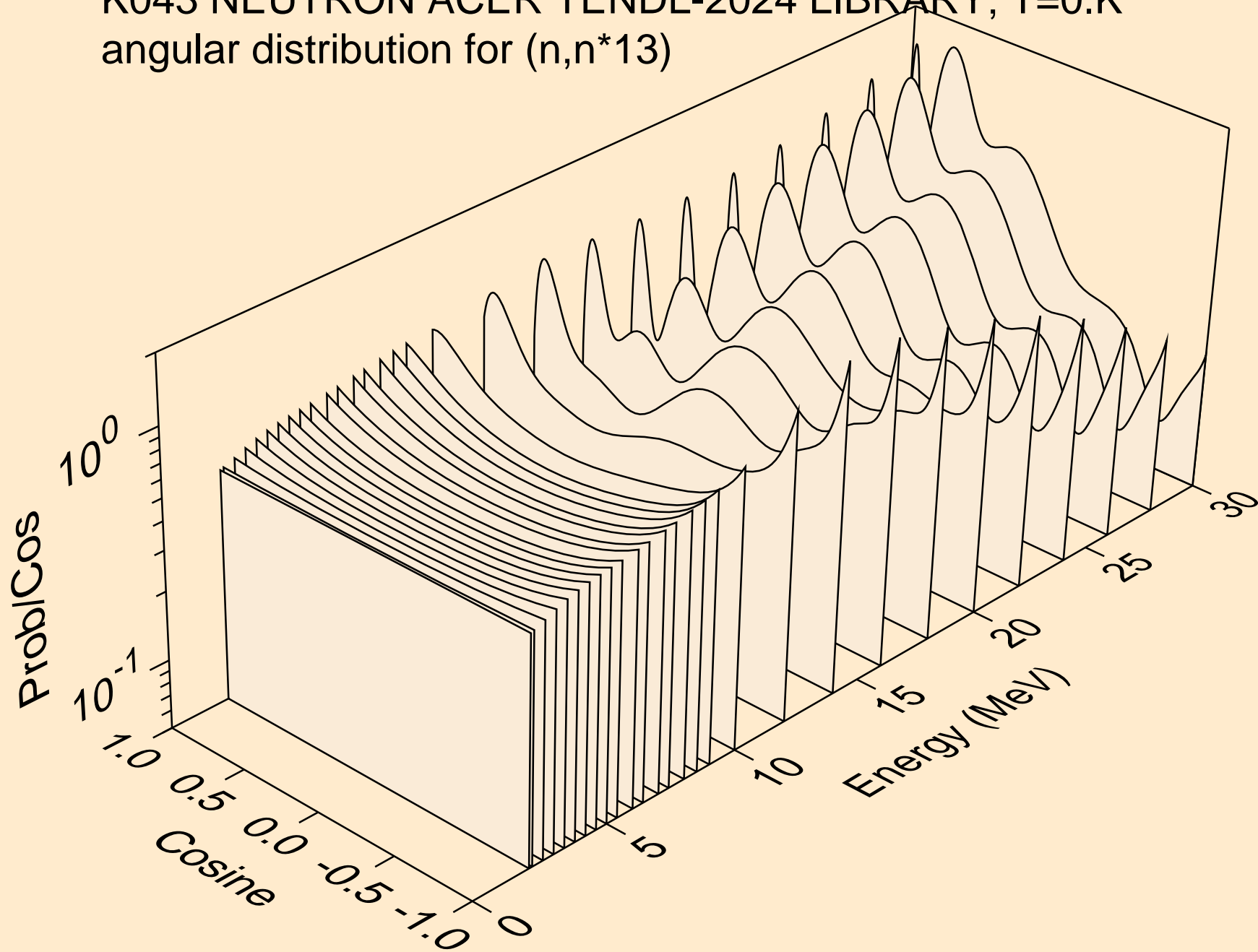

K043 NEUTRON ACER TENDL-2024 LIBRARY; T=0.K
angular distribution for (n,n*14)

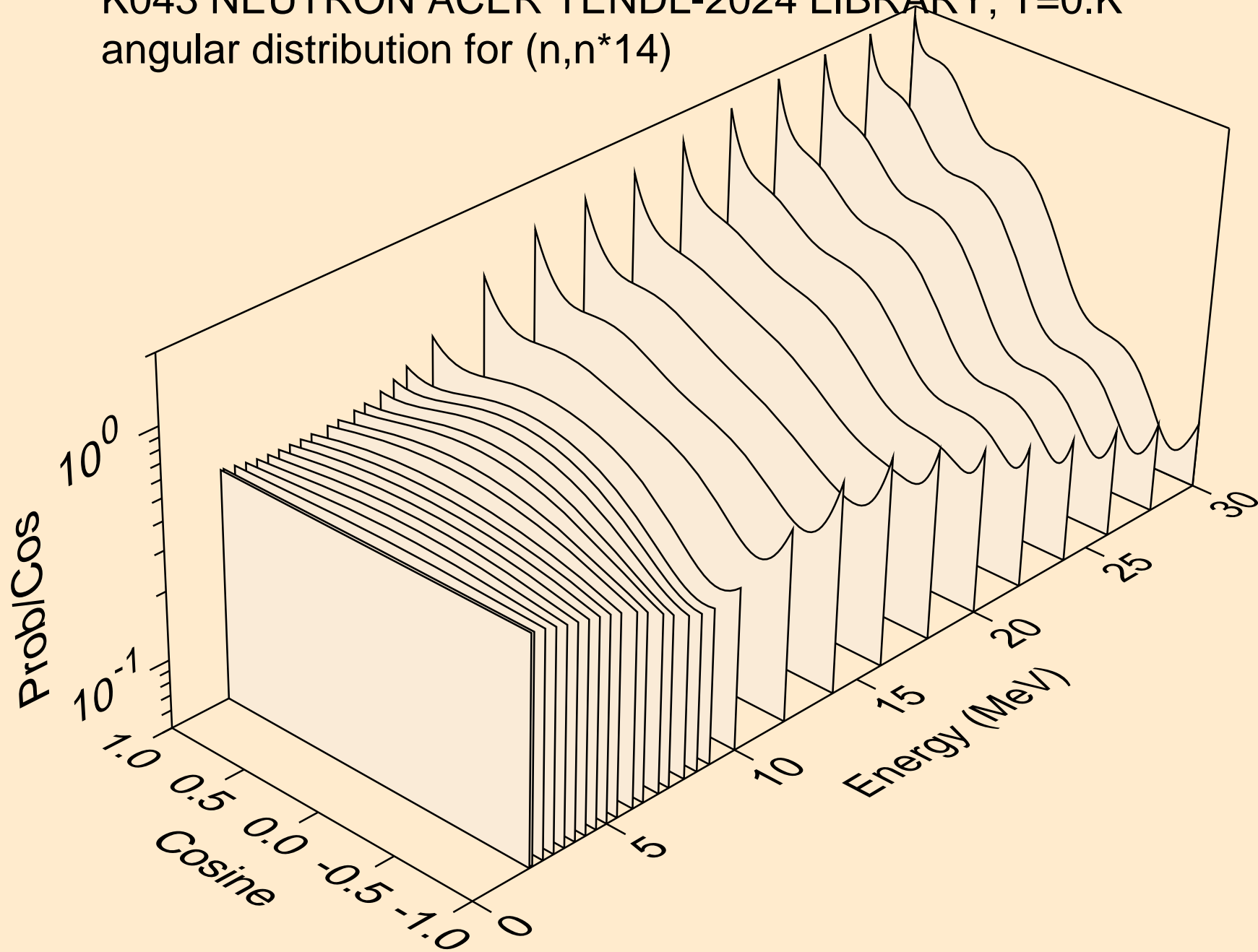

K043 NEUTRON ACER TENDL-2024 LIBRARY; T=0.K
angular distribution for (n,n*15)

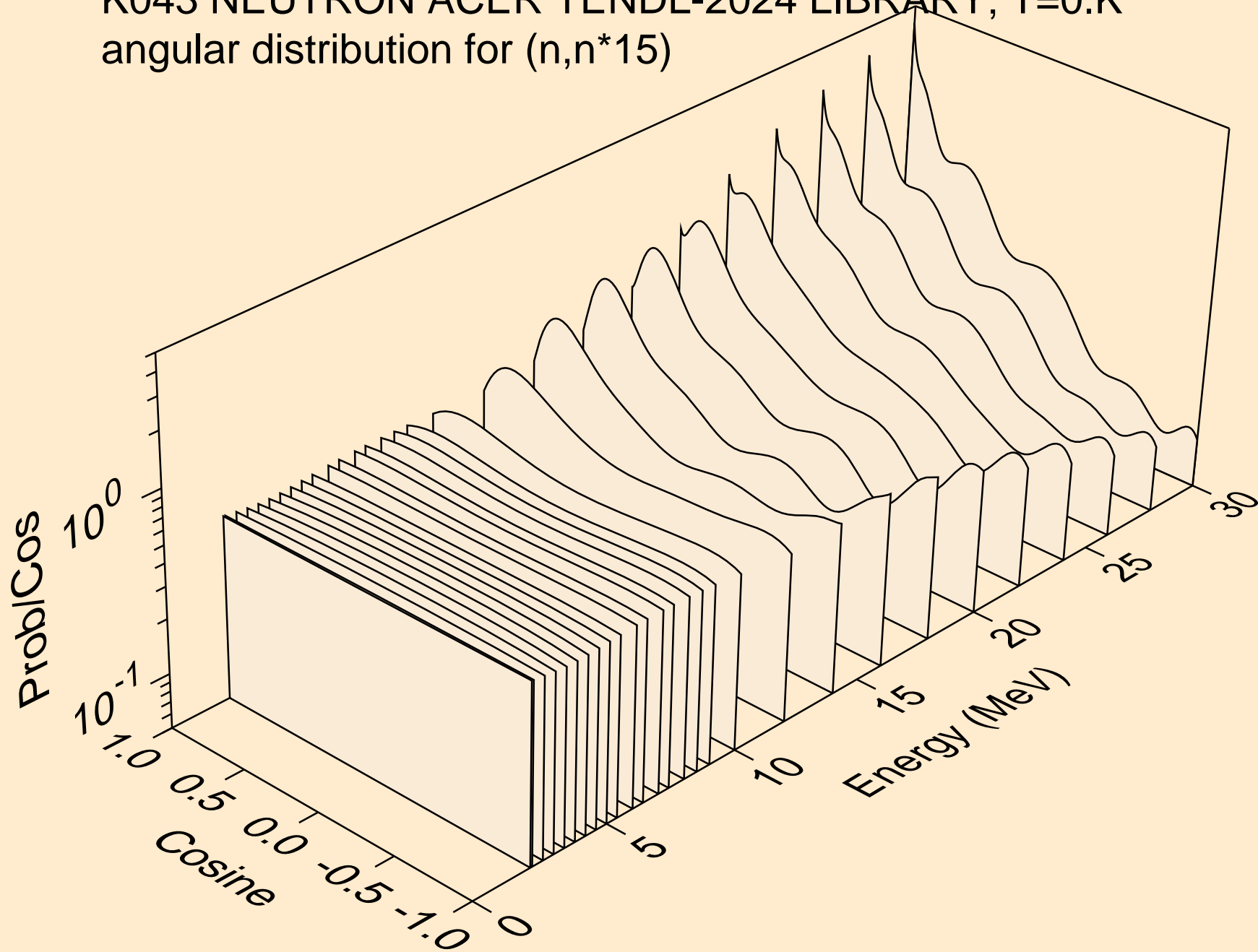

K043 NEUTRON ACER TENDL-2024 LIBRARY; T=0.K
angular distribution for (n,n*16)

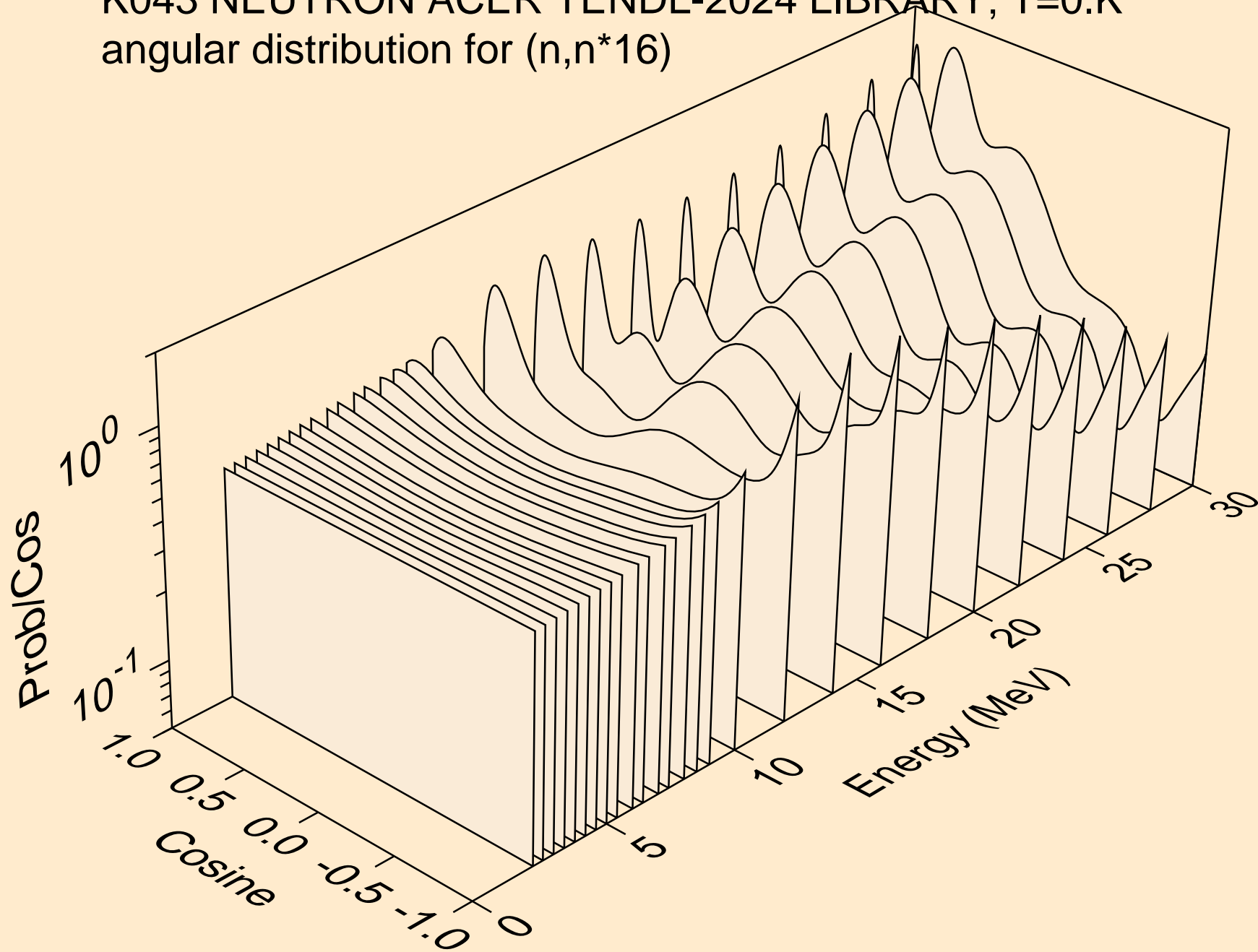

K043 NEUTRON ACER TENDL-2024 LIBRARY; T=0.K
angular distribution for (n,n*17)

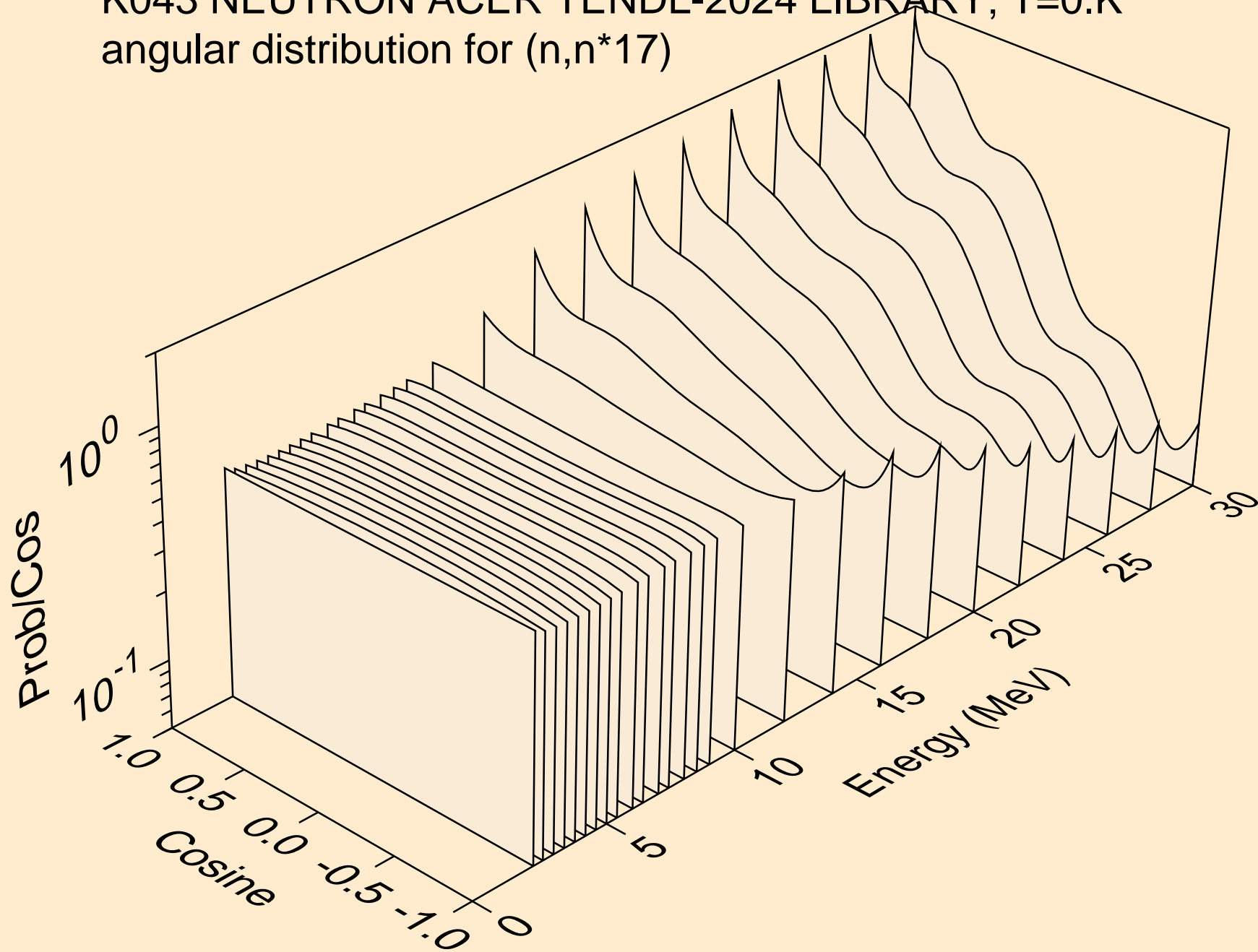

K043 NEUTRON ACER TENDL-2024 LIBRARY; T=0.K
angular distribution for (n,n*18)

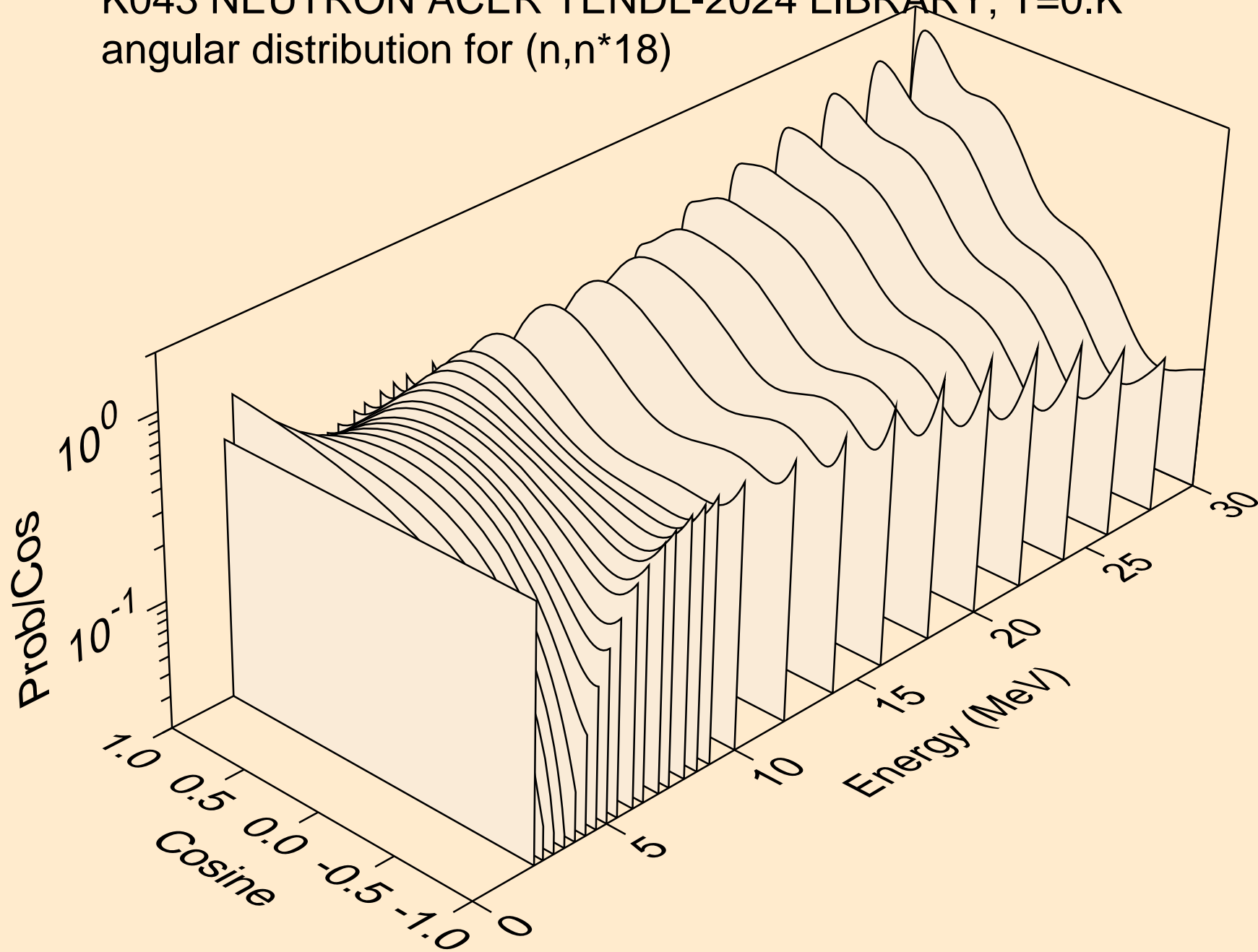

K043 NEUTRON ACER TENDL-2024 LIBRARY; T=0.K
angular distribution for (n,n*19)

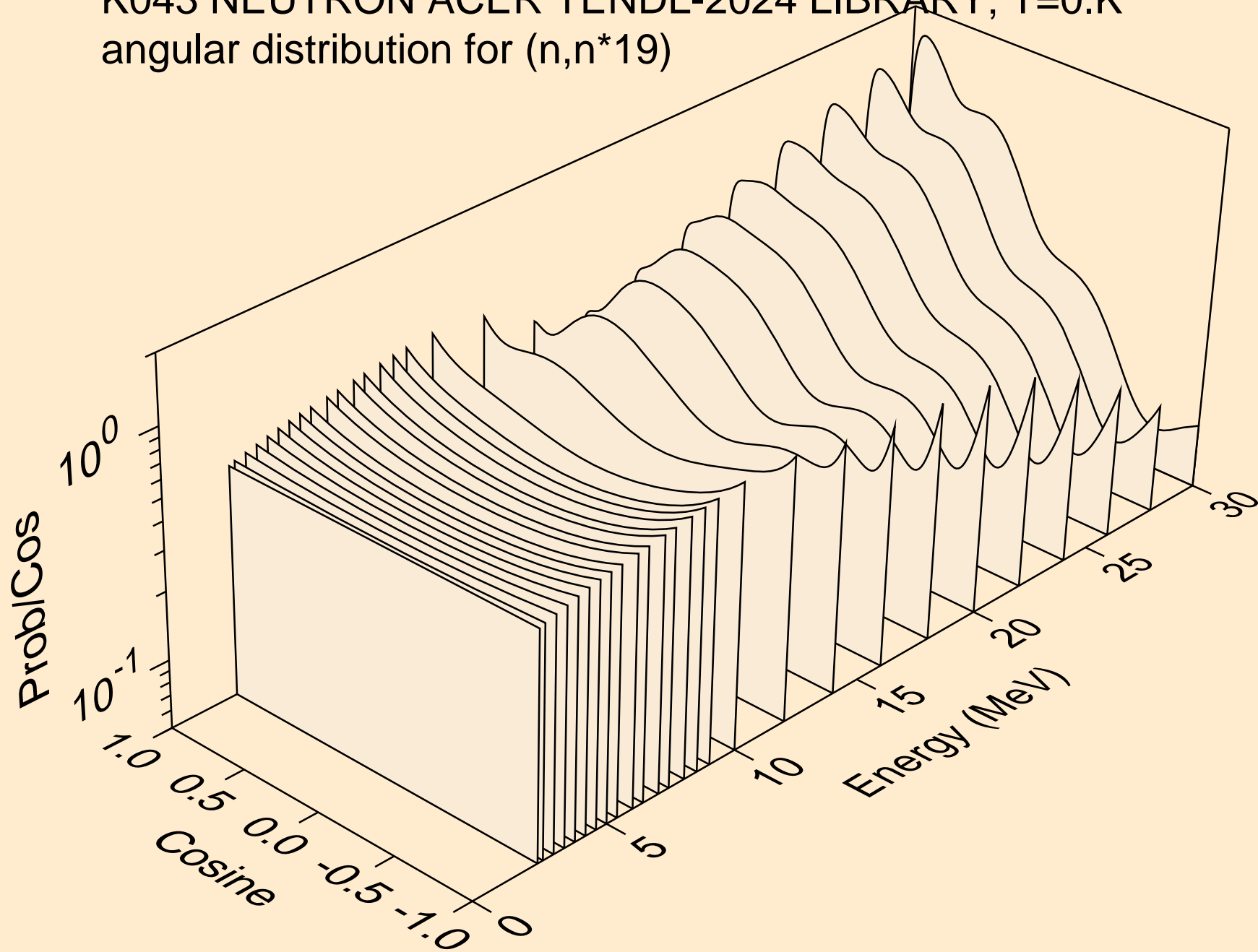

K043 NEUTRON ACER TENDL-2024 LIBRARY; T=0.K
angular distribution for (n,n*20)

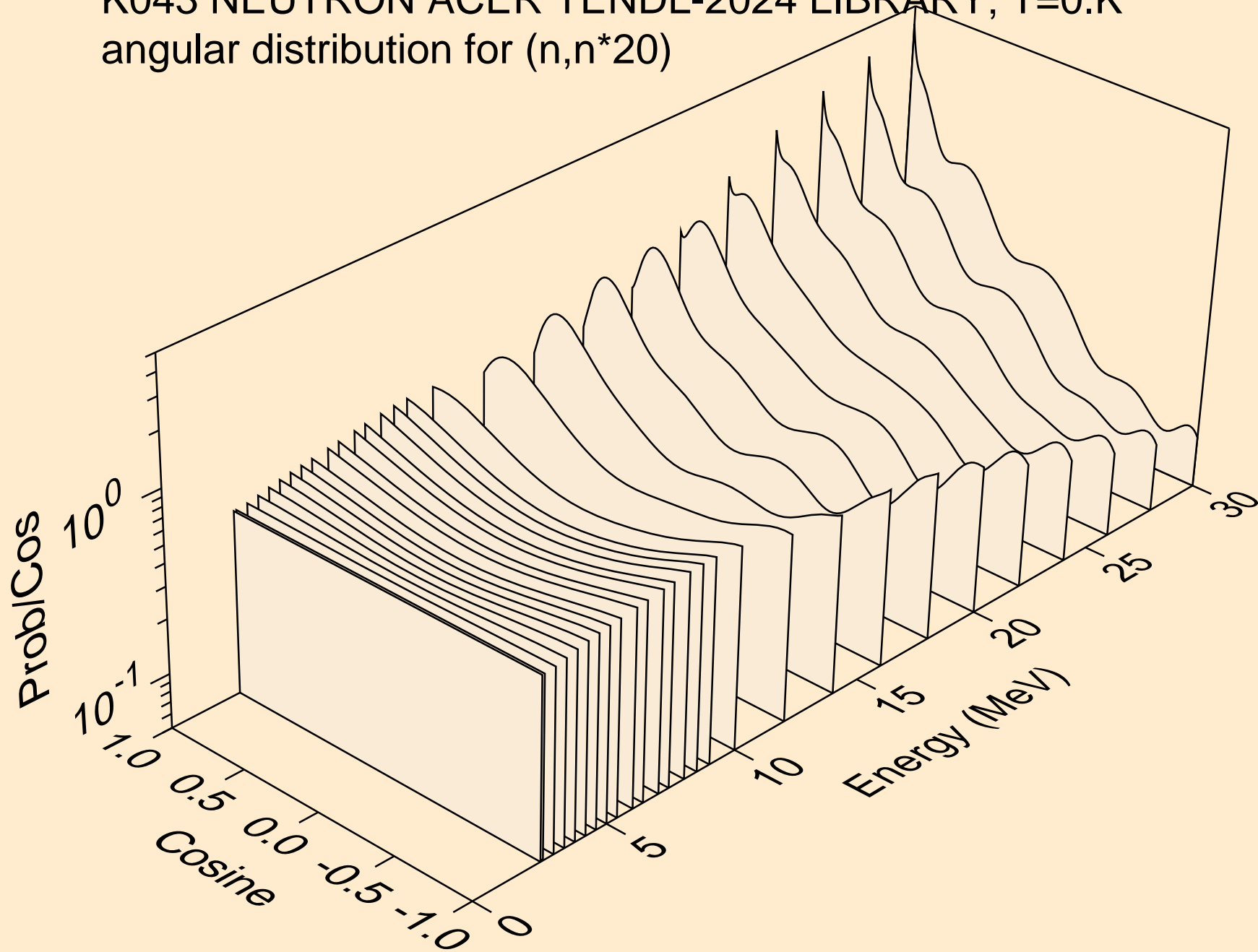

K043 NEUTRON ACER TENDL-2024 LIBRARY; T=0.K
angular distribution for (n,n*21)

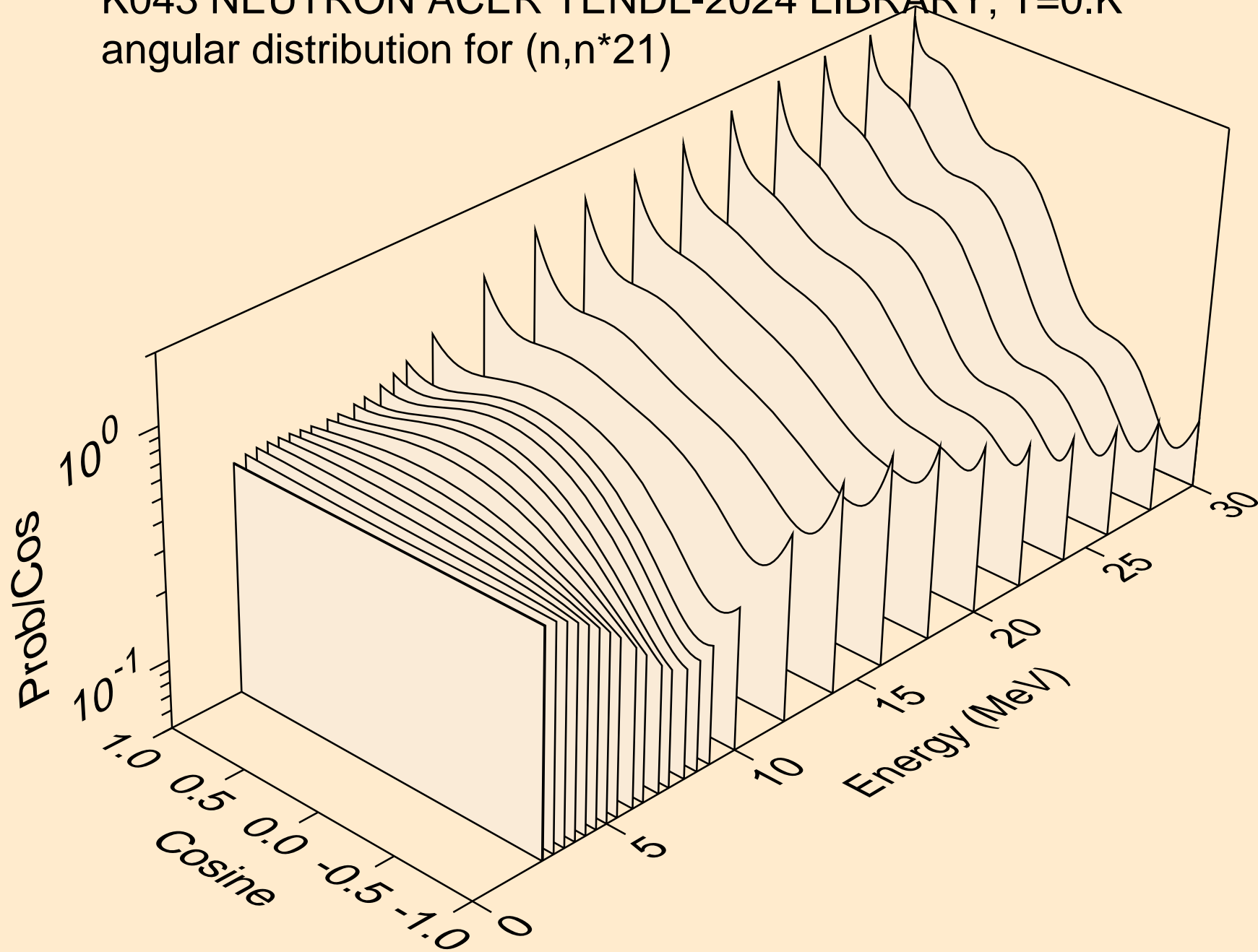

K043 NEUTRON ACER TENDL-2024 LIBRARY; T=0.K
angular distribution for (n,n*22)

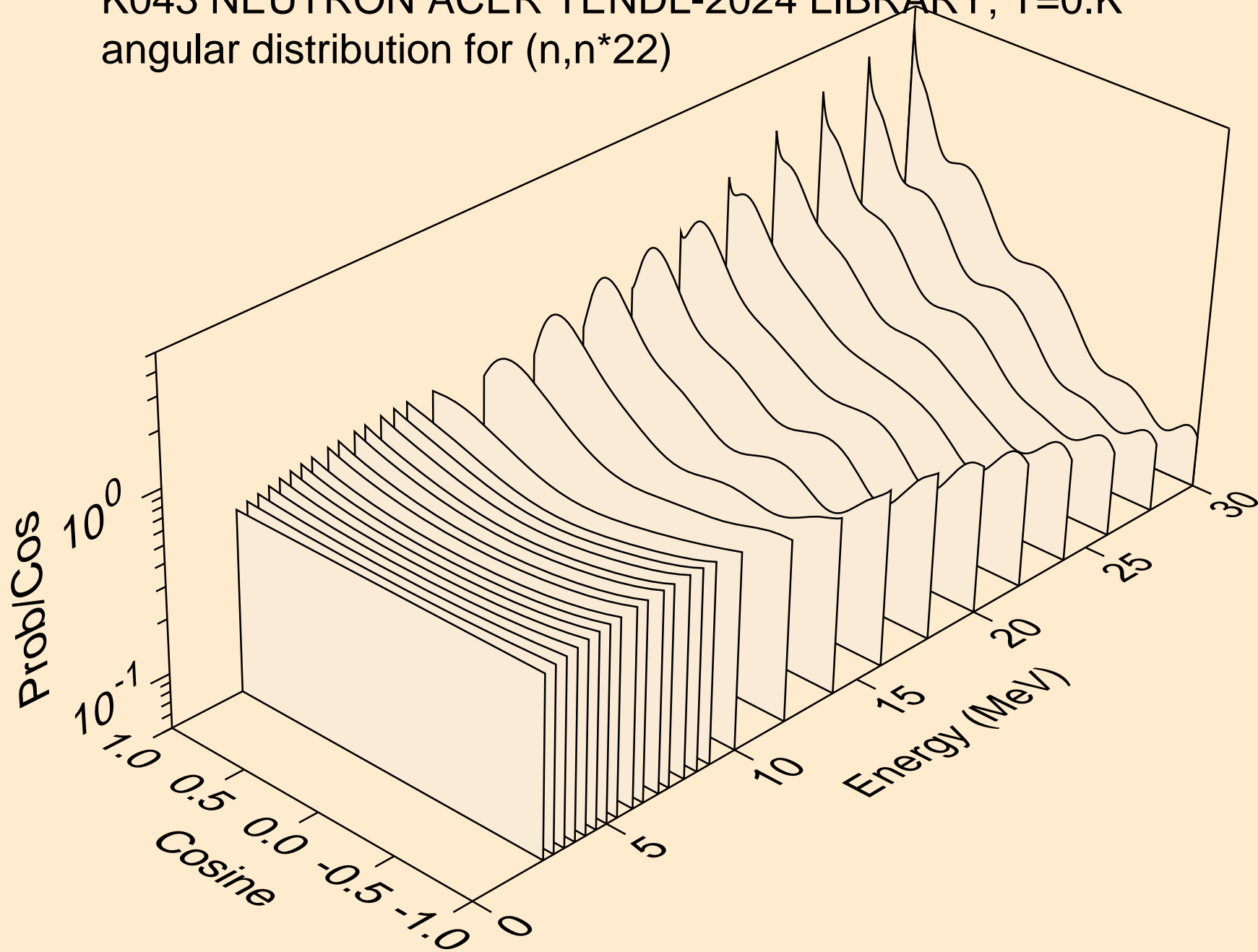

K043 NEUTRON ACER TENDL-2024 LIBRARY; T=0.K
angular distribution for (n,n*23)

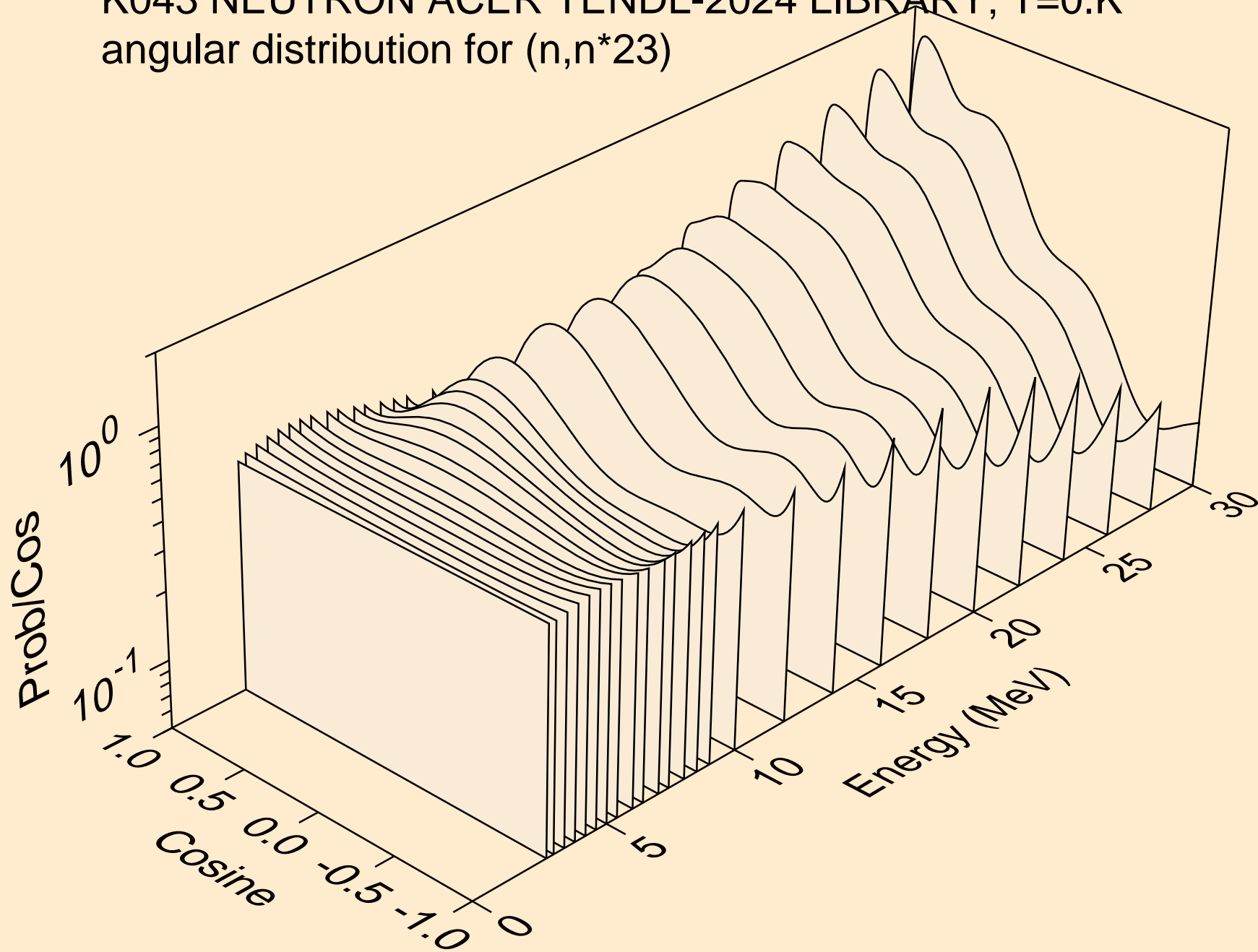

K043 NEUTRON ACER TENDL-2024 LIBRARY; T=0.K
angular distribution for (n,n*24)

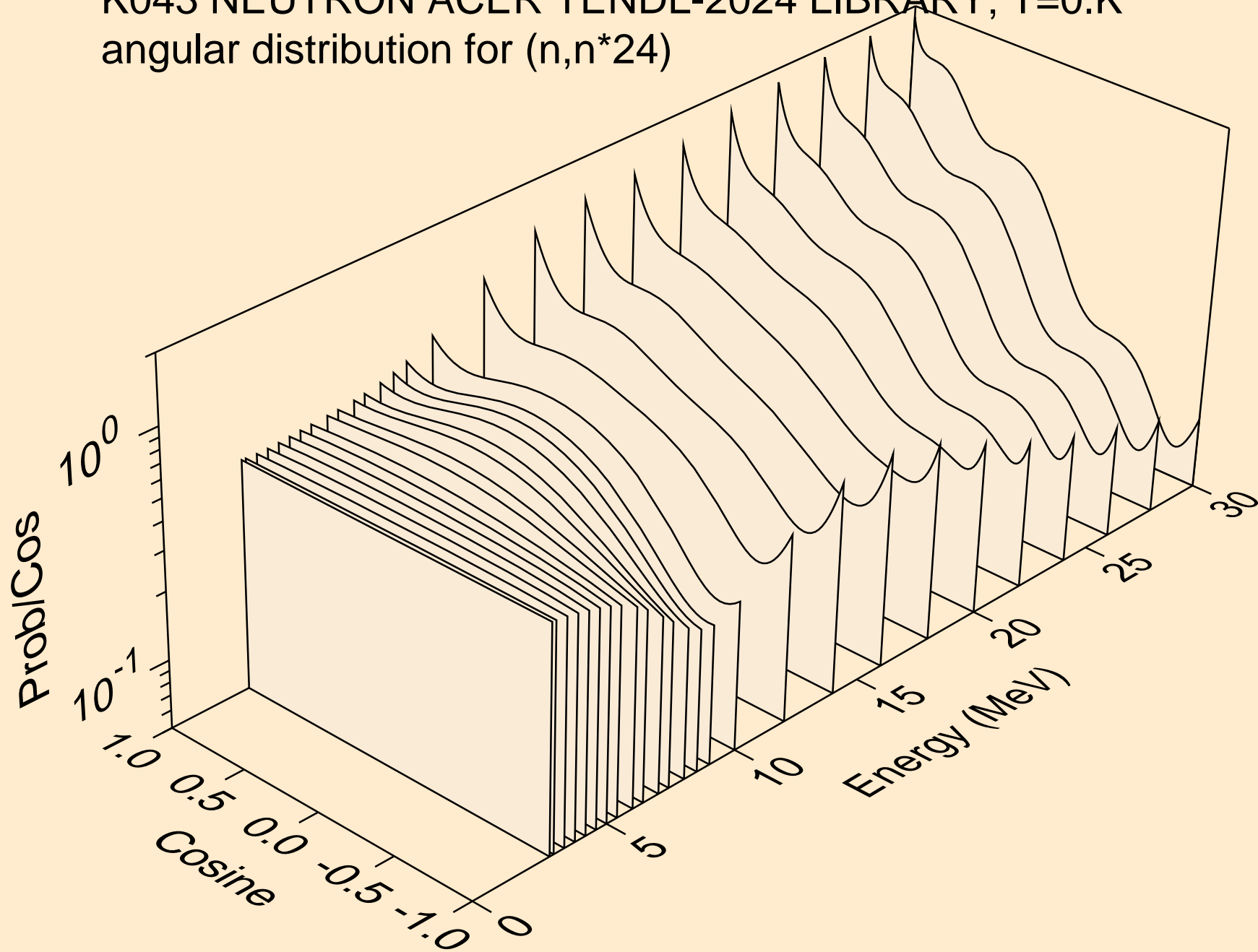

K043 NEUTRON ACER TENDL-2024 LIBRARY; T=0.K
angular distribution for (n,n*25)

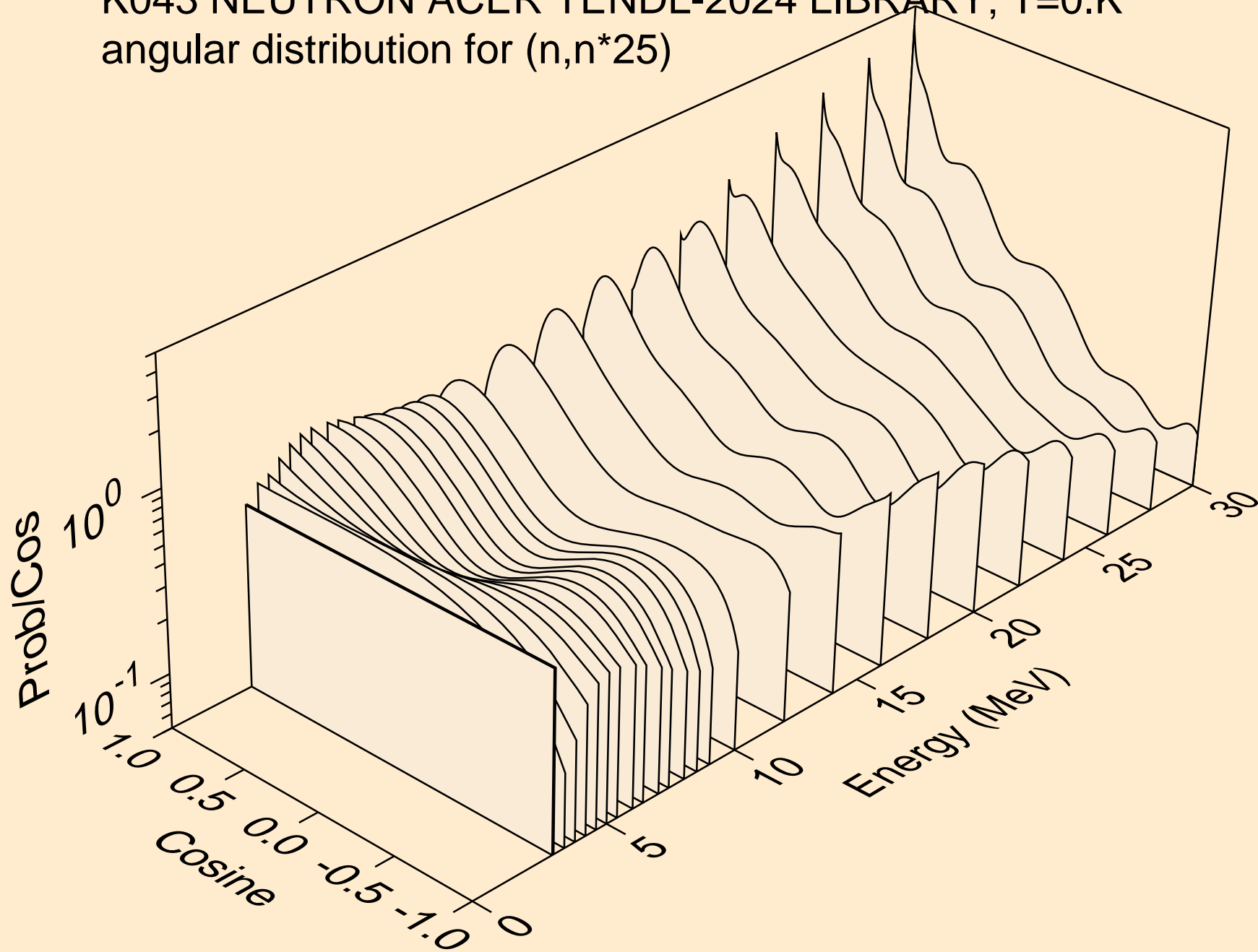

K043 NEUTRON ACER TENDL-2024 LIBRARY; T=0.K
angular distribution for (n,n*26)

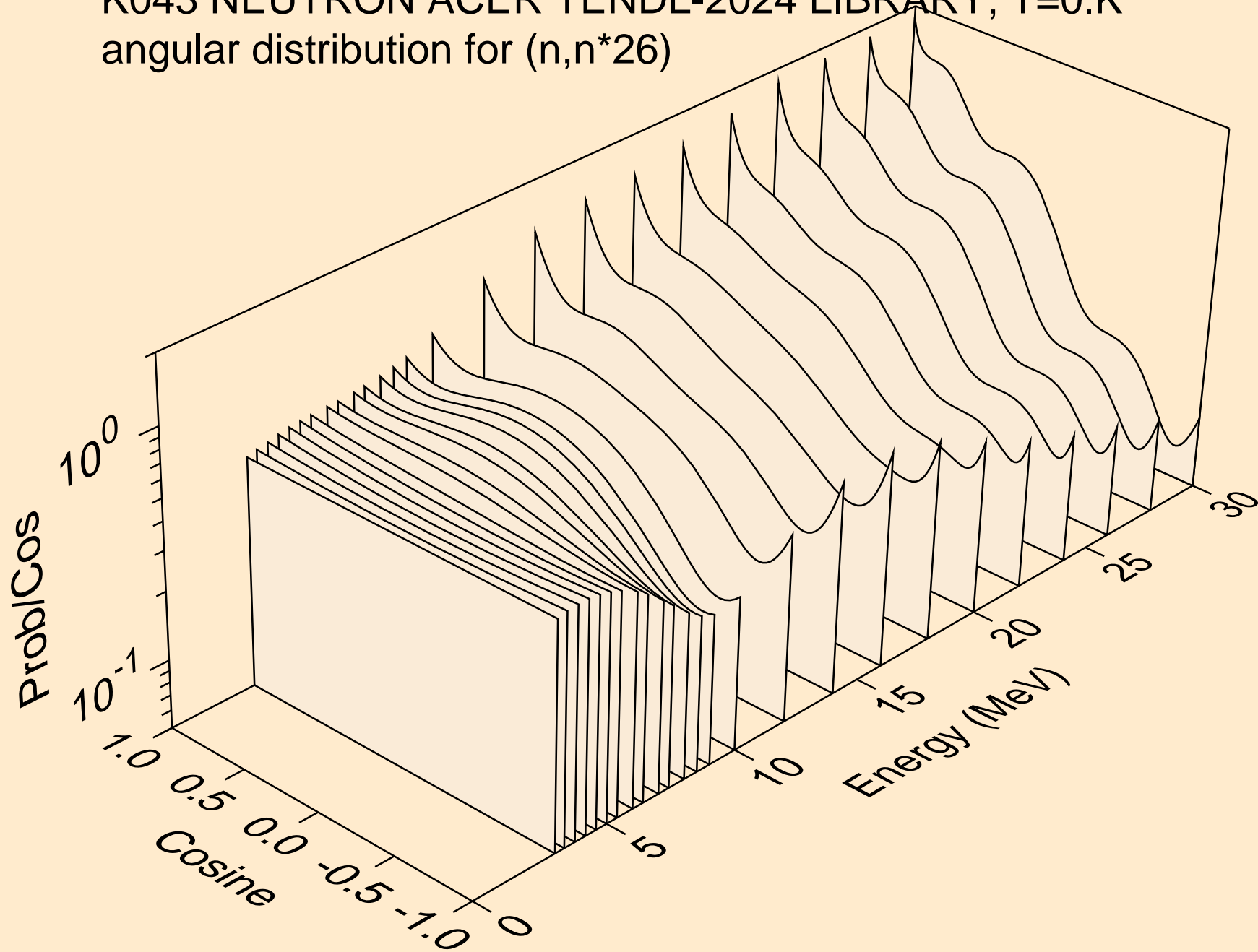

K043 NEUTRON ACER TENDL-2024 LIBRARY; T=0.K
angular distribution for (n,n*27)

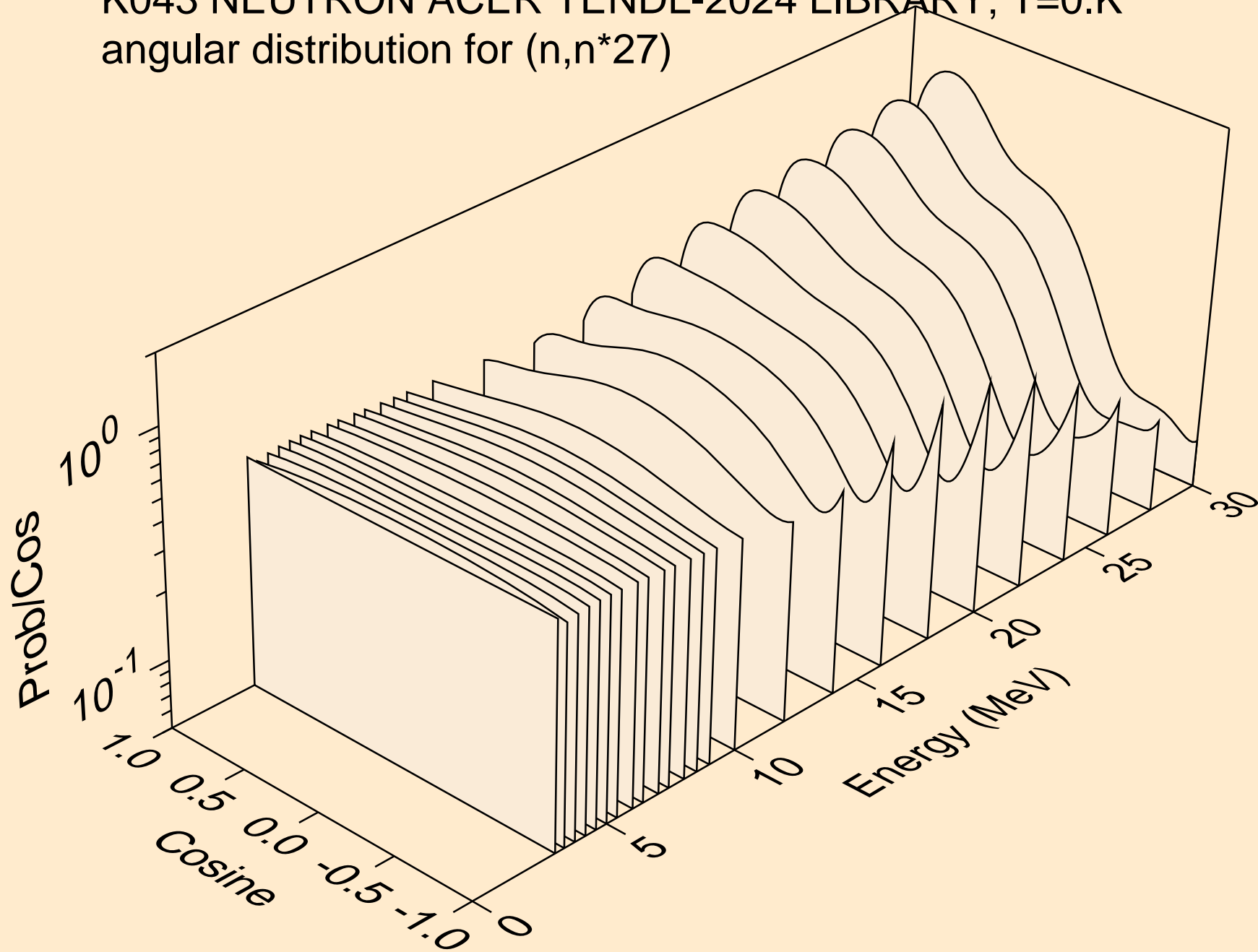

K043 NEUTRON ACER TENDL-2024 LIBRARY; T=0.K
angular distribution for (n,n*28)

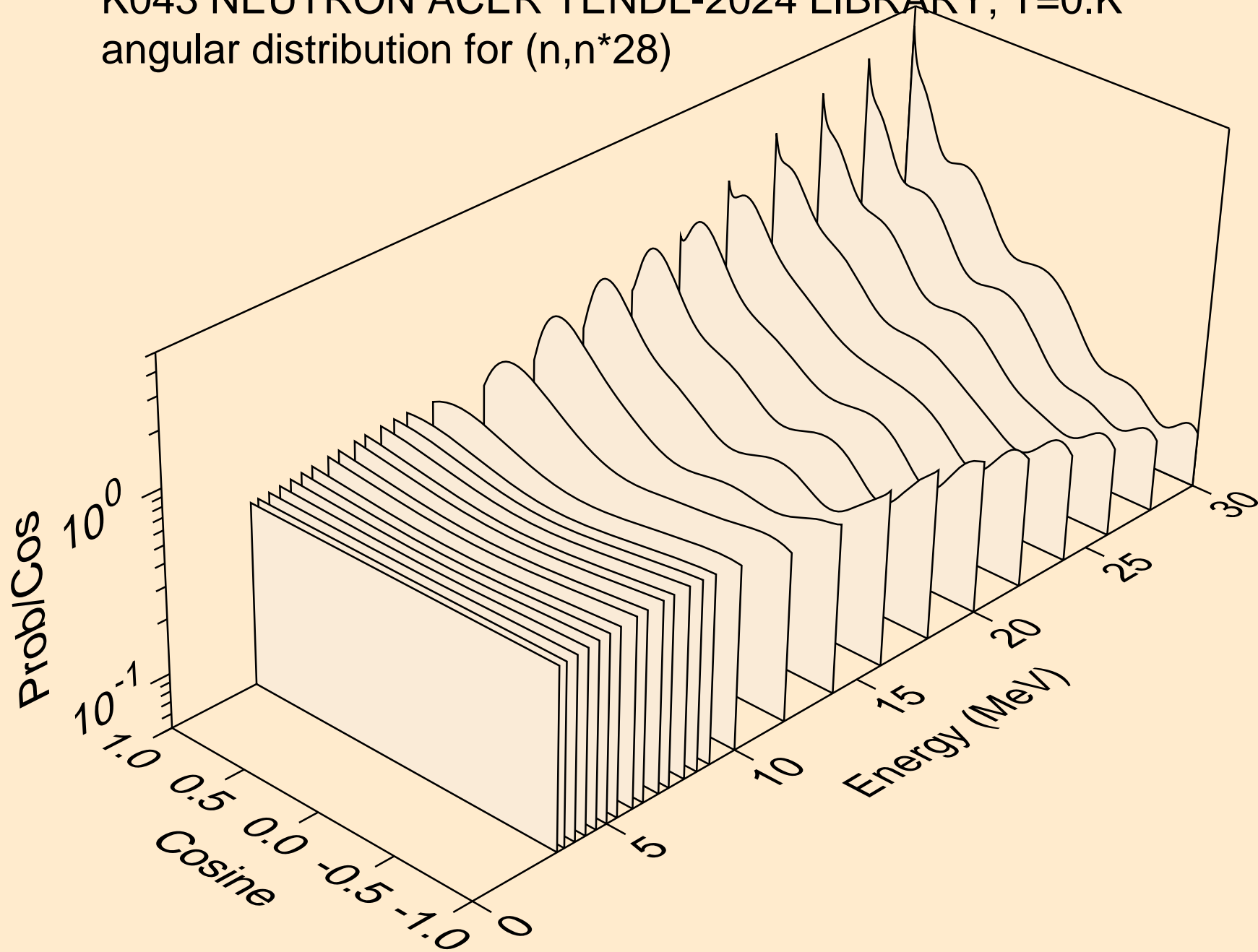

K043 NEUTRON ACER TENDL-2024 LIBRARY; T=0.K
angular distribution for (n,n*29)

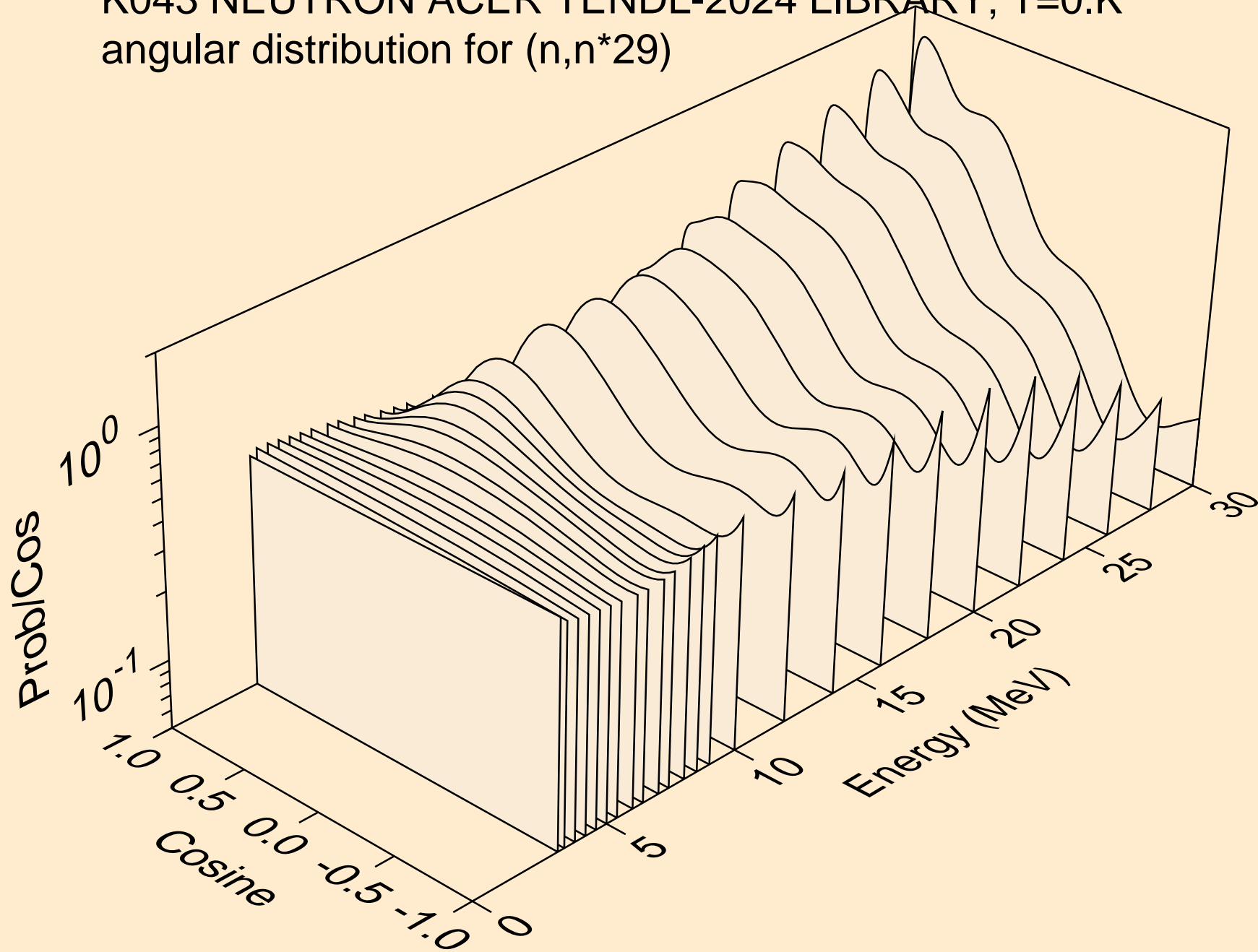

K043 NEUTRON ACER TENDL-2024 LIBRARY; T=0.K
Neutron emission for (n,x)

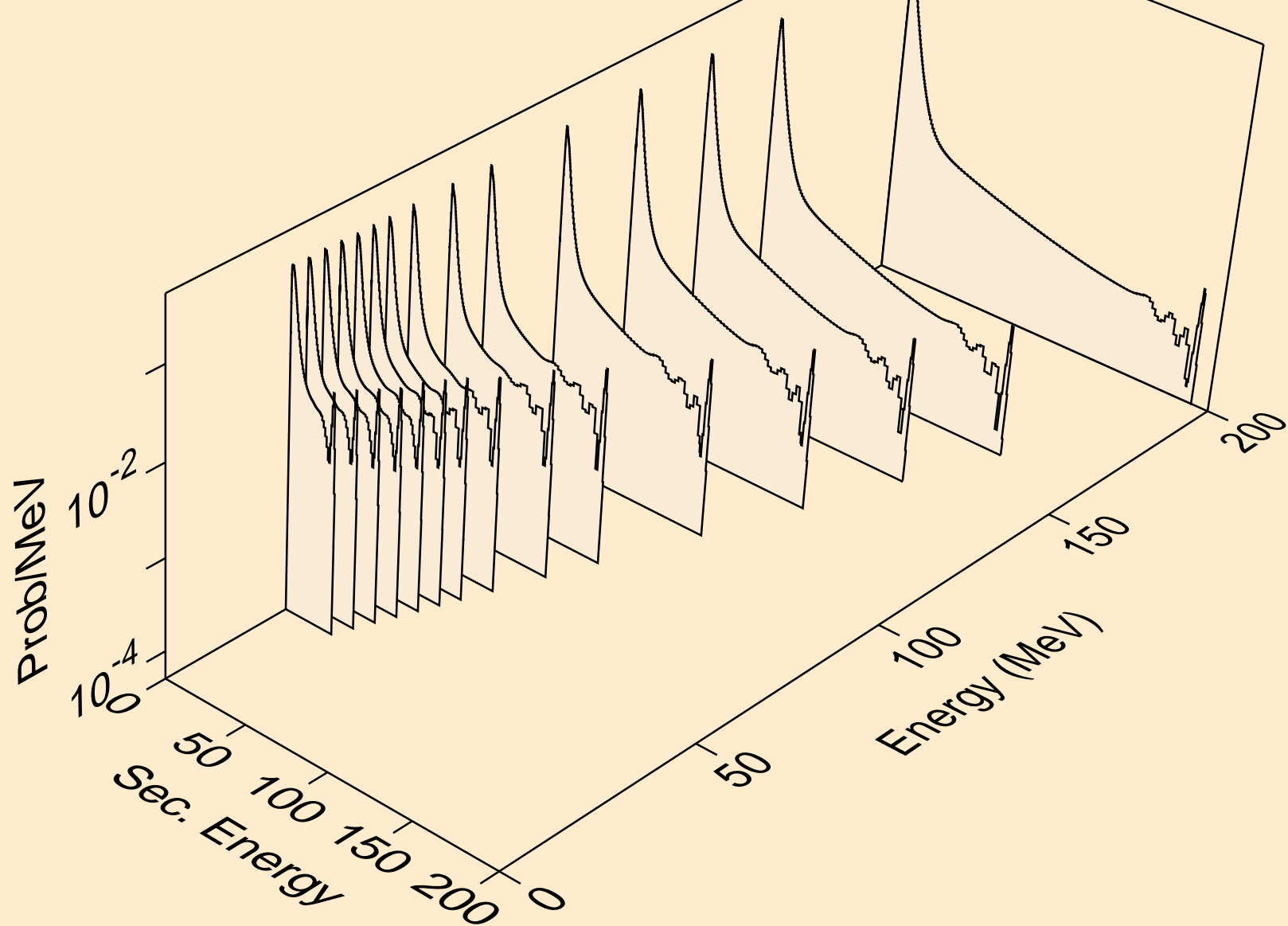

K043 NEUTRON ACER TENDL-2024 LIBRARY; T=0.K
Neutron emission for (n,2nd)

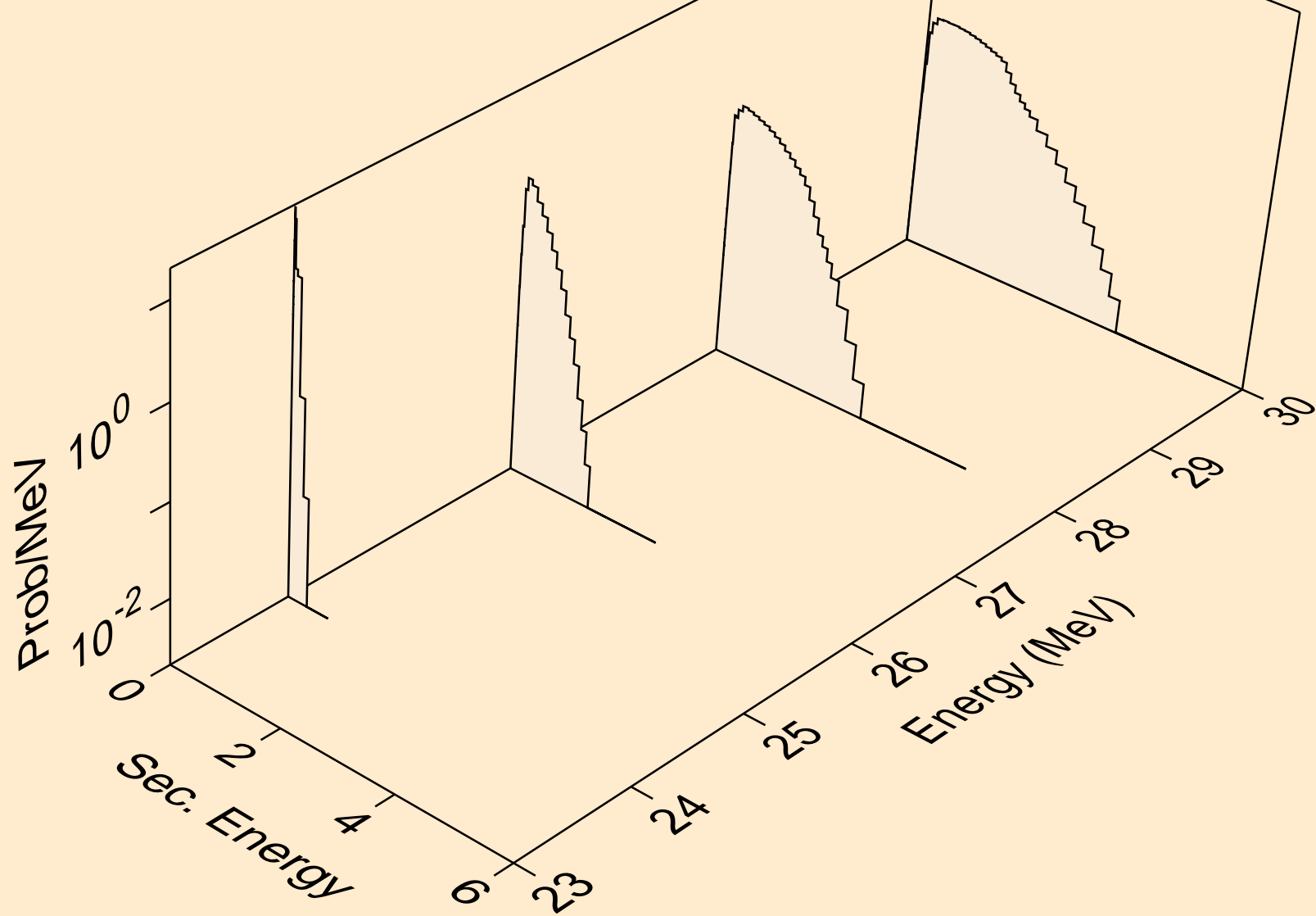

K043 NEUTRON ACER TENDL-2024 LIBRARY; T=0.K
Neutron emission for (n,2n)

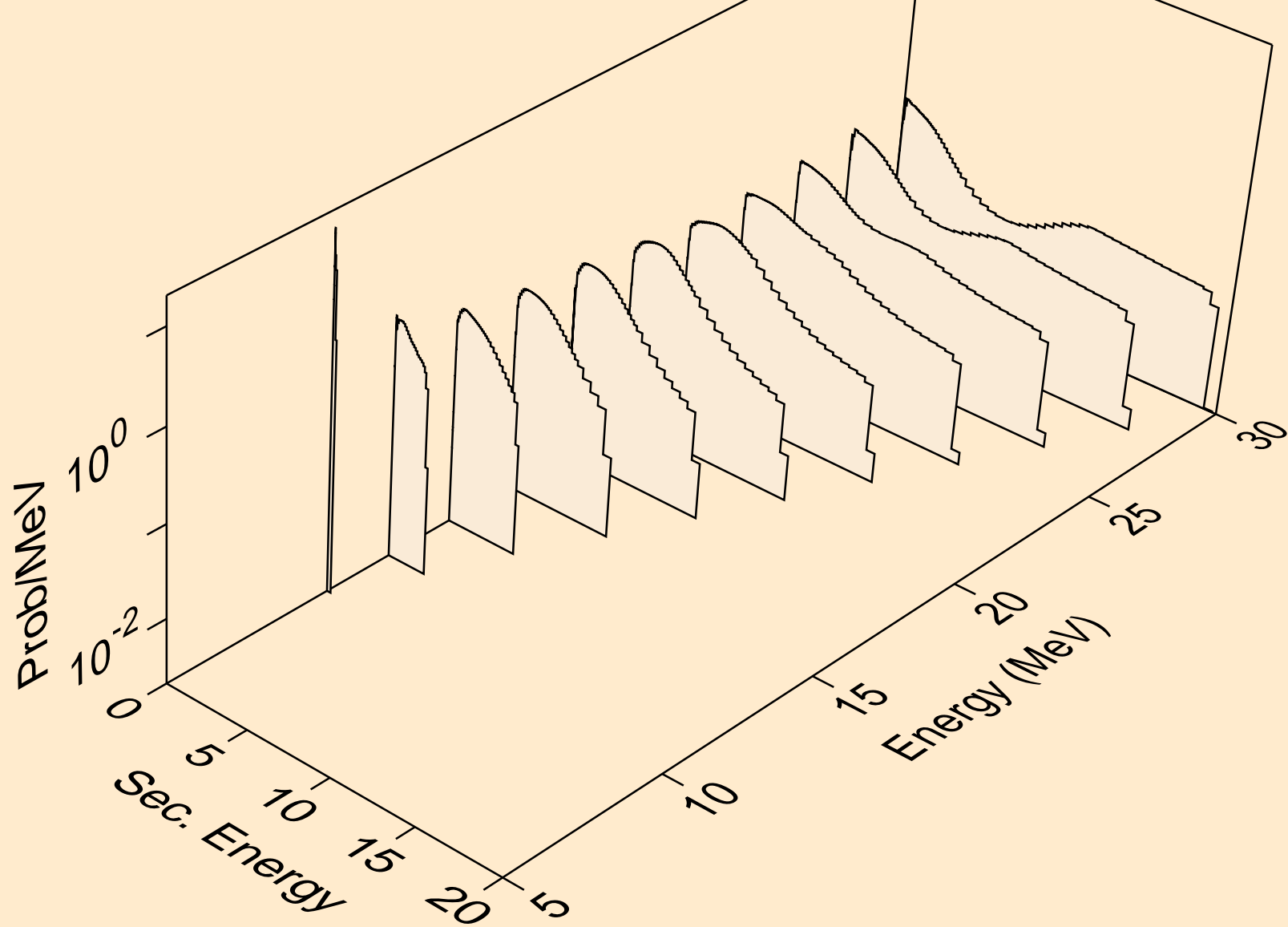

K043 NEUTRON ACER TENDL-2024 LIBRARY; T=0.K
Neutron emission for (n,3n)

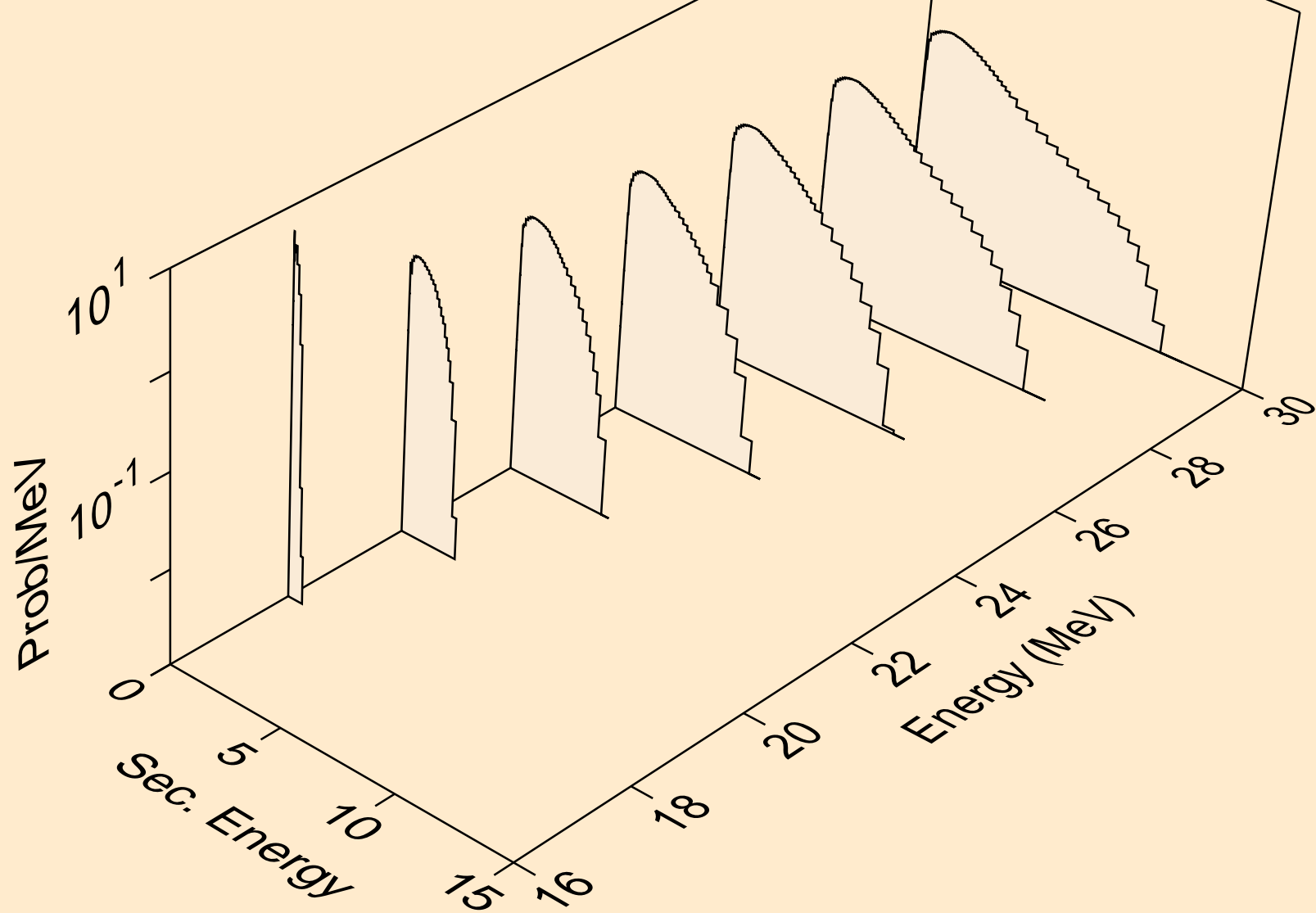

K043 NEUTRON ACER TENDL-2024 LIBRARY; T=0.K
Neutron emission for (n,n*)a

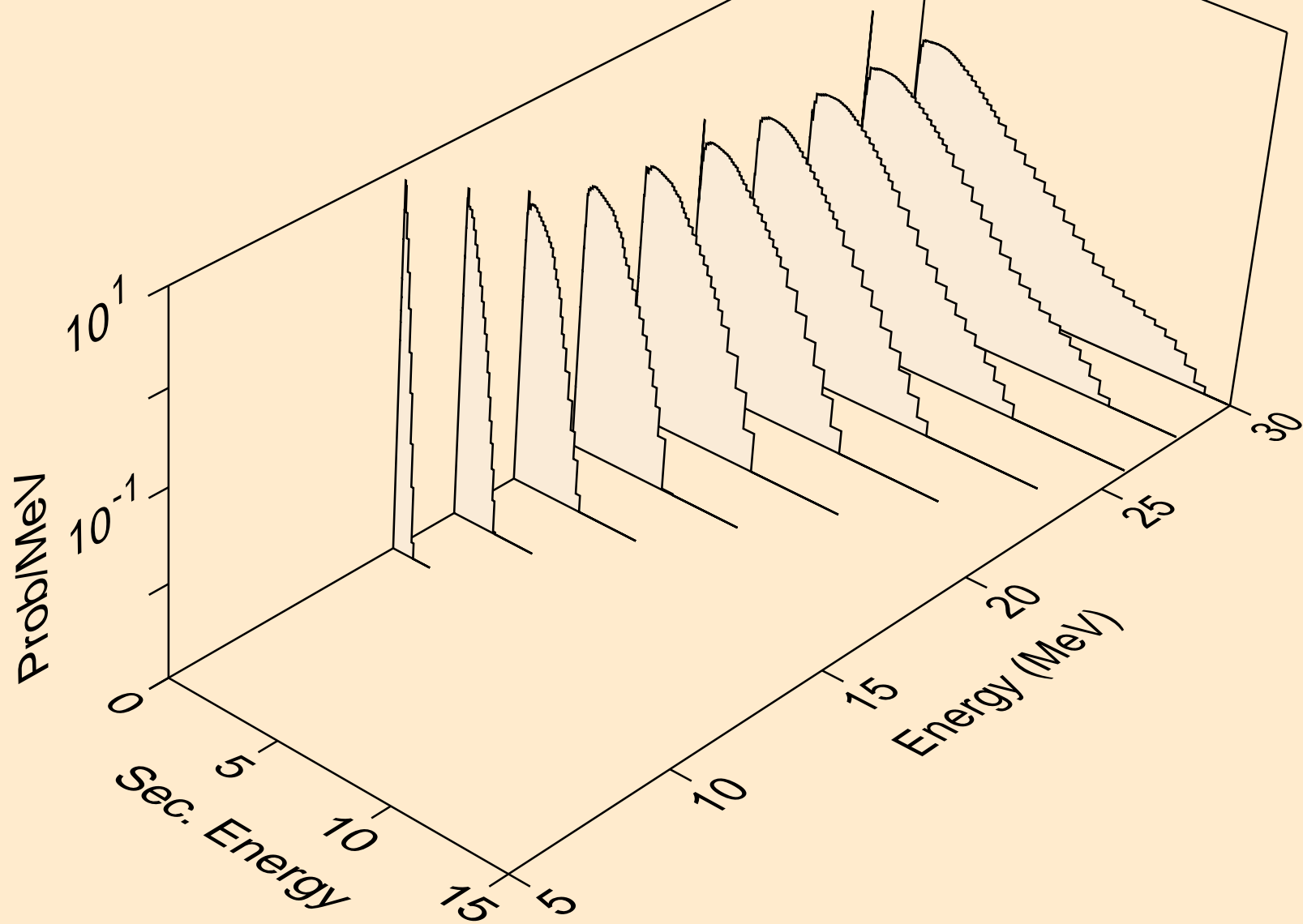

K043 NEUTRON ACER TENDL-2024 LIBRARY; T=0.K
Neutron emission for (n,2n)a

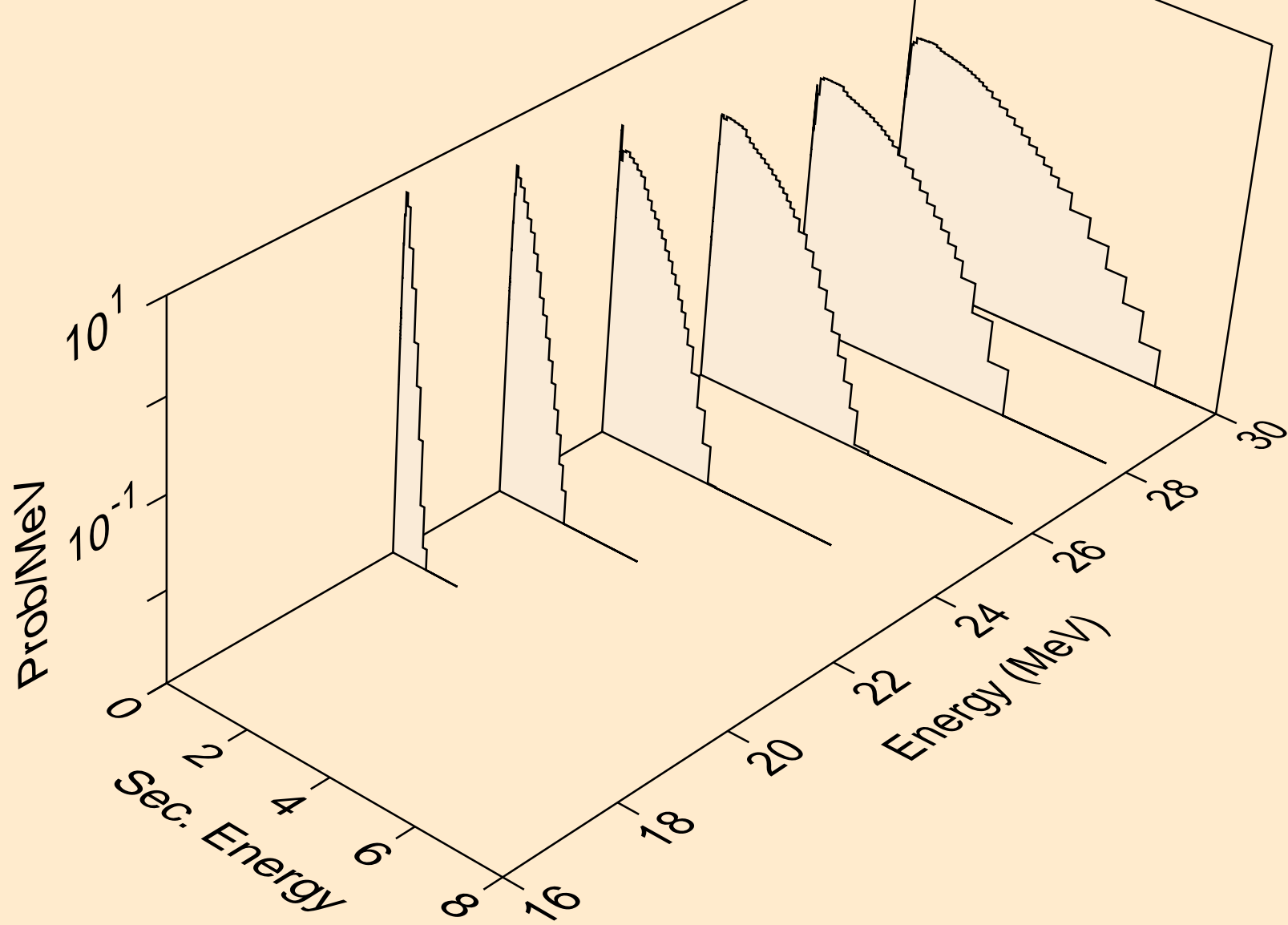

K043 NEUTRON ACER TENDL-2024 LIBRARY; T=0.K
Neutron emission for (n,3n)a

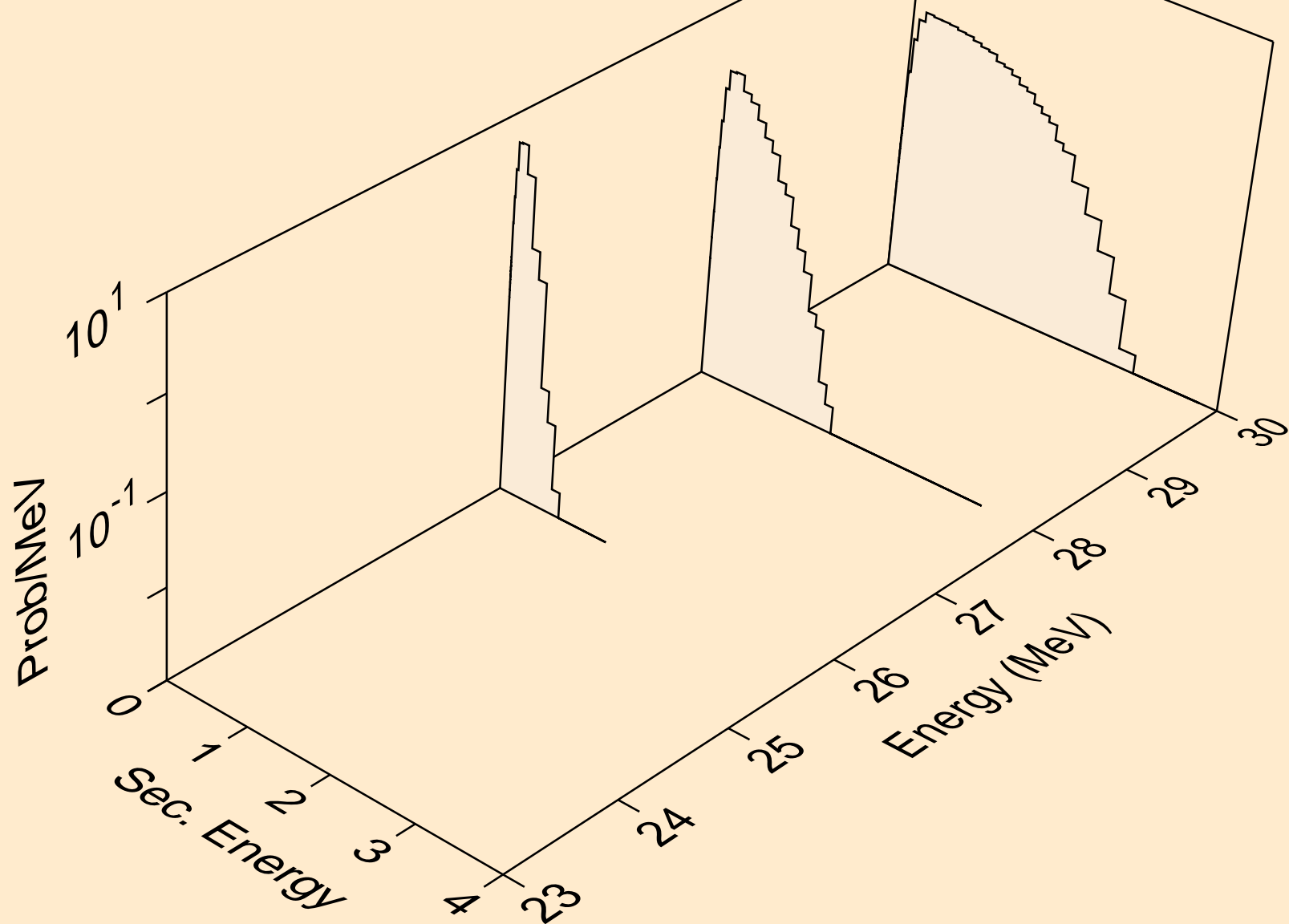

K043 NEUTRON ACER TENDL-2024 LIBRARY; T=0.K
Neutron emission for (n,n*)p

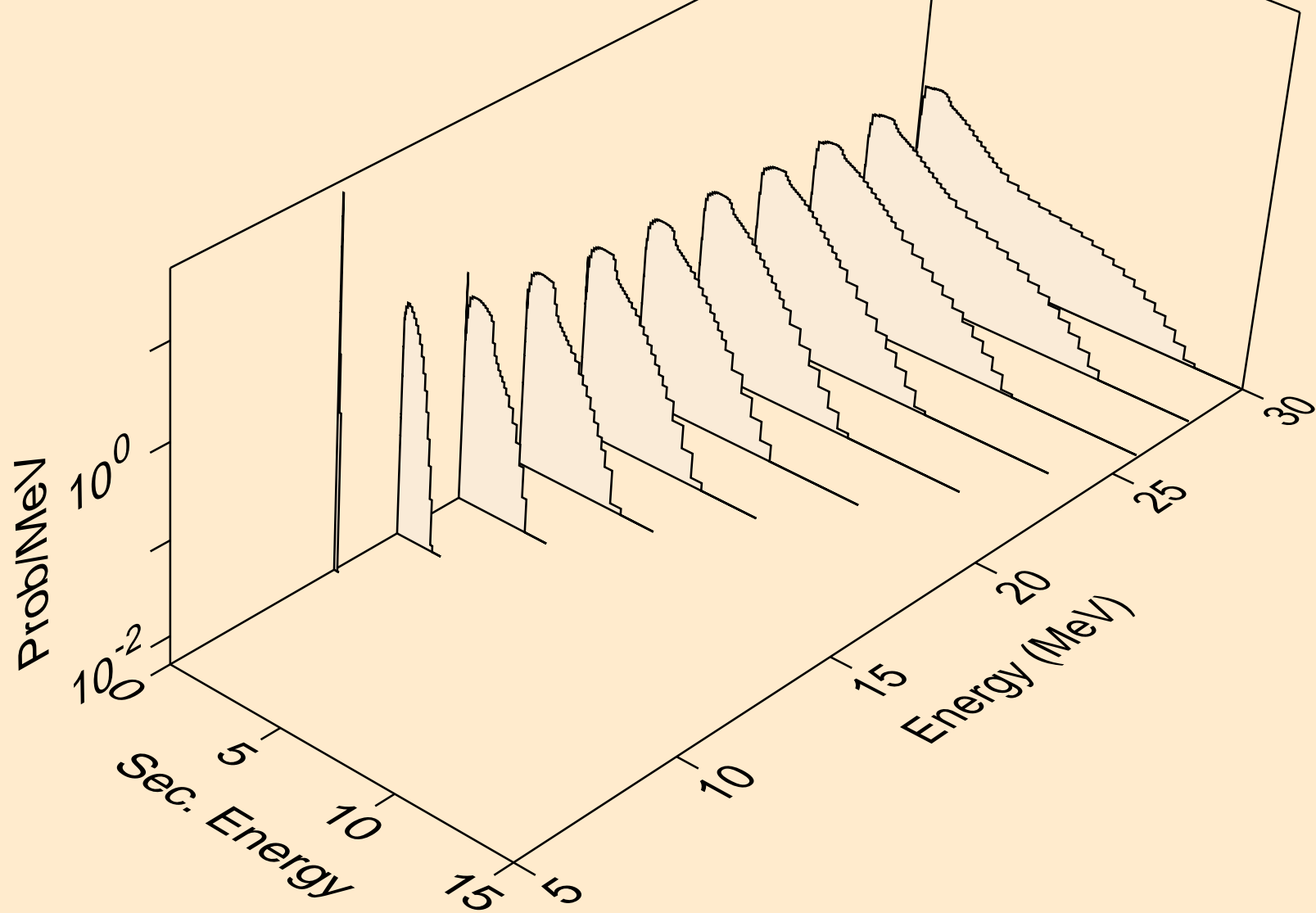

K043 NEUTRON ACER TENDL-2024 LIBRARY; T=0.K
Neutron emission for (n,n*)2a

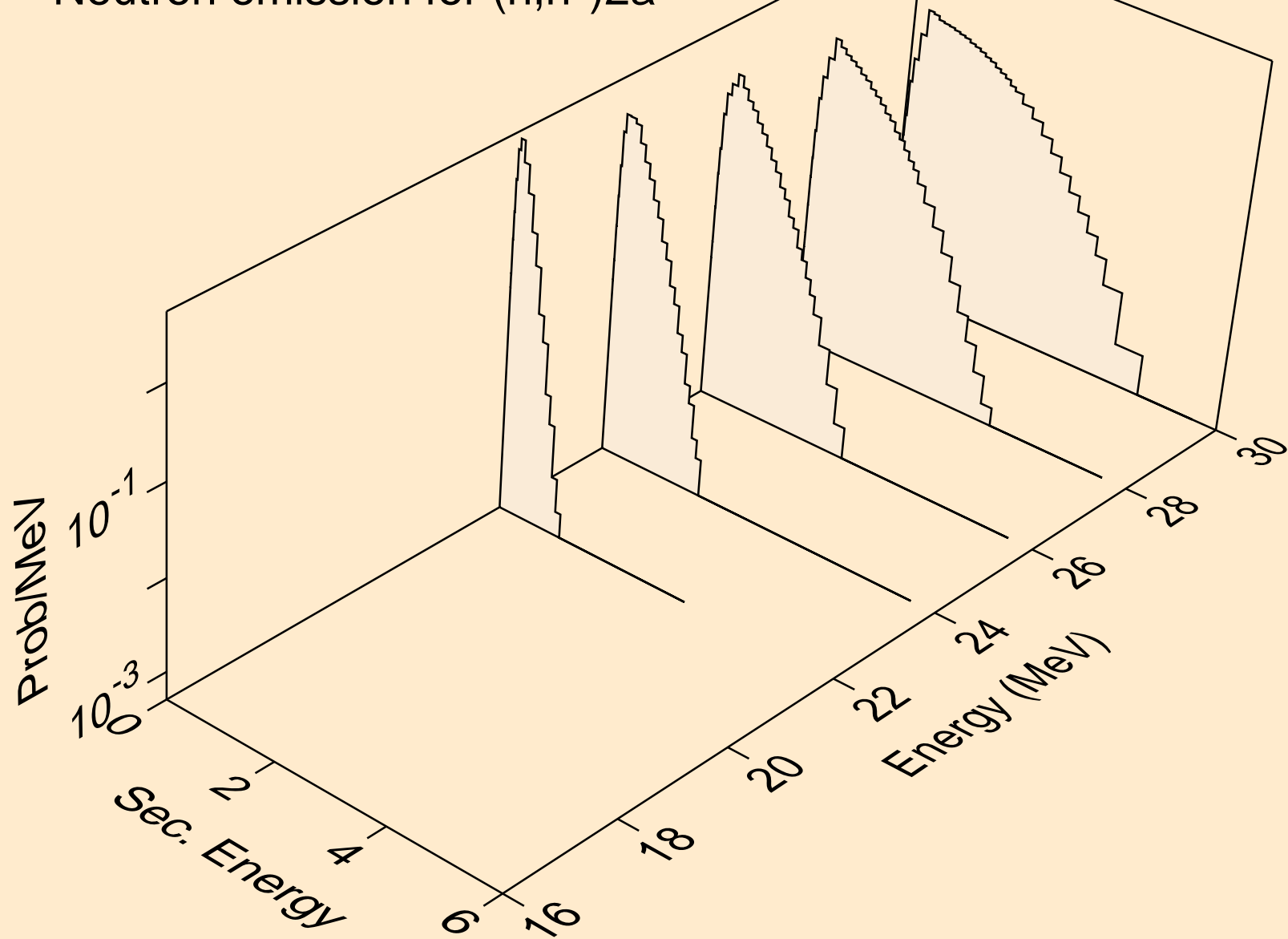

K043 NEUTRON ACER TENDL-2024 LIBRARY; T=0.K
Neutron emission for (n,n*)d

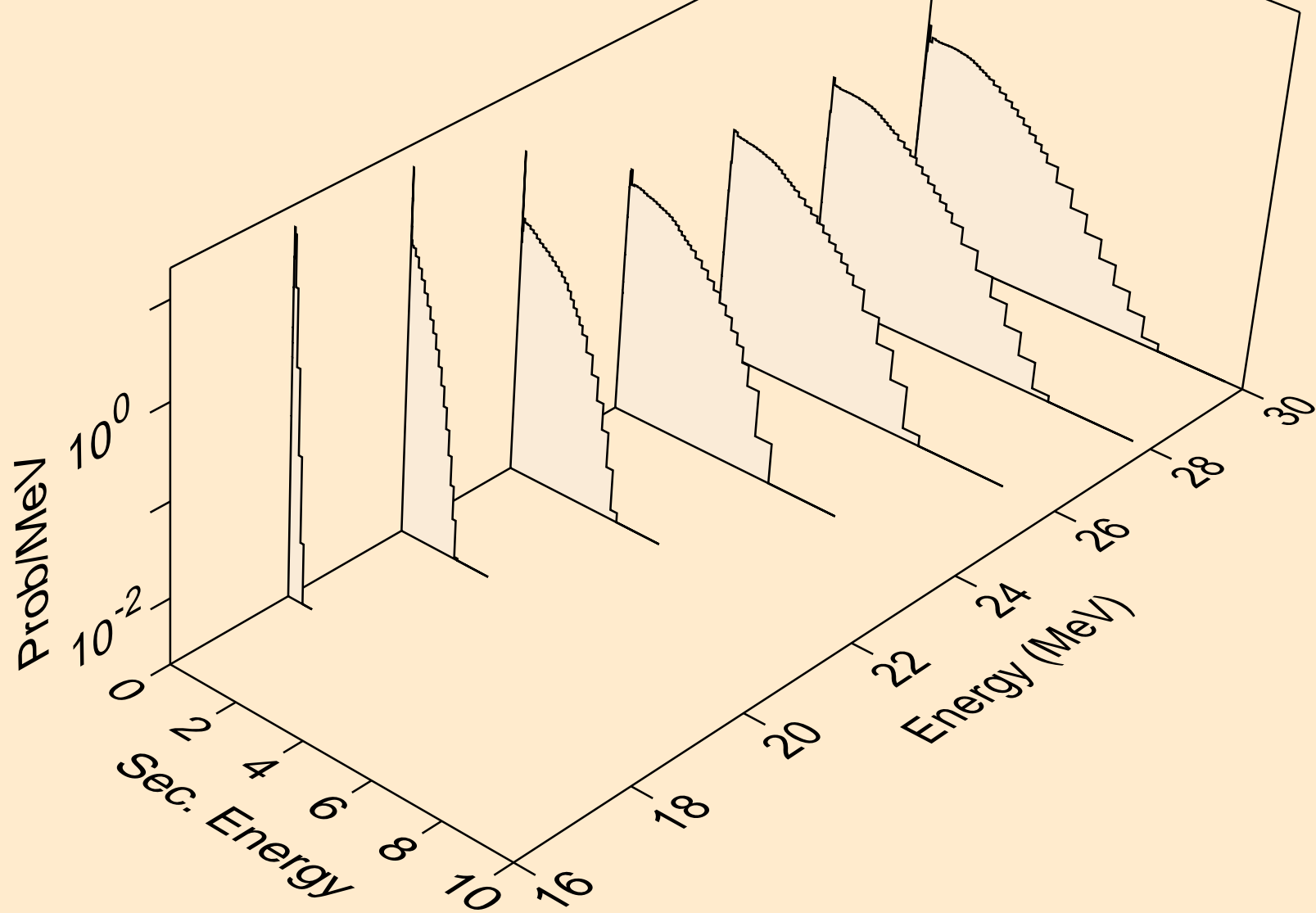

K043 NEUTRON ACER TENDL-2024 LIBRARY; T=0.K
Neutron emission for (n,n*)t

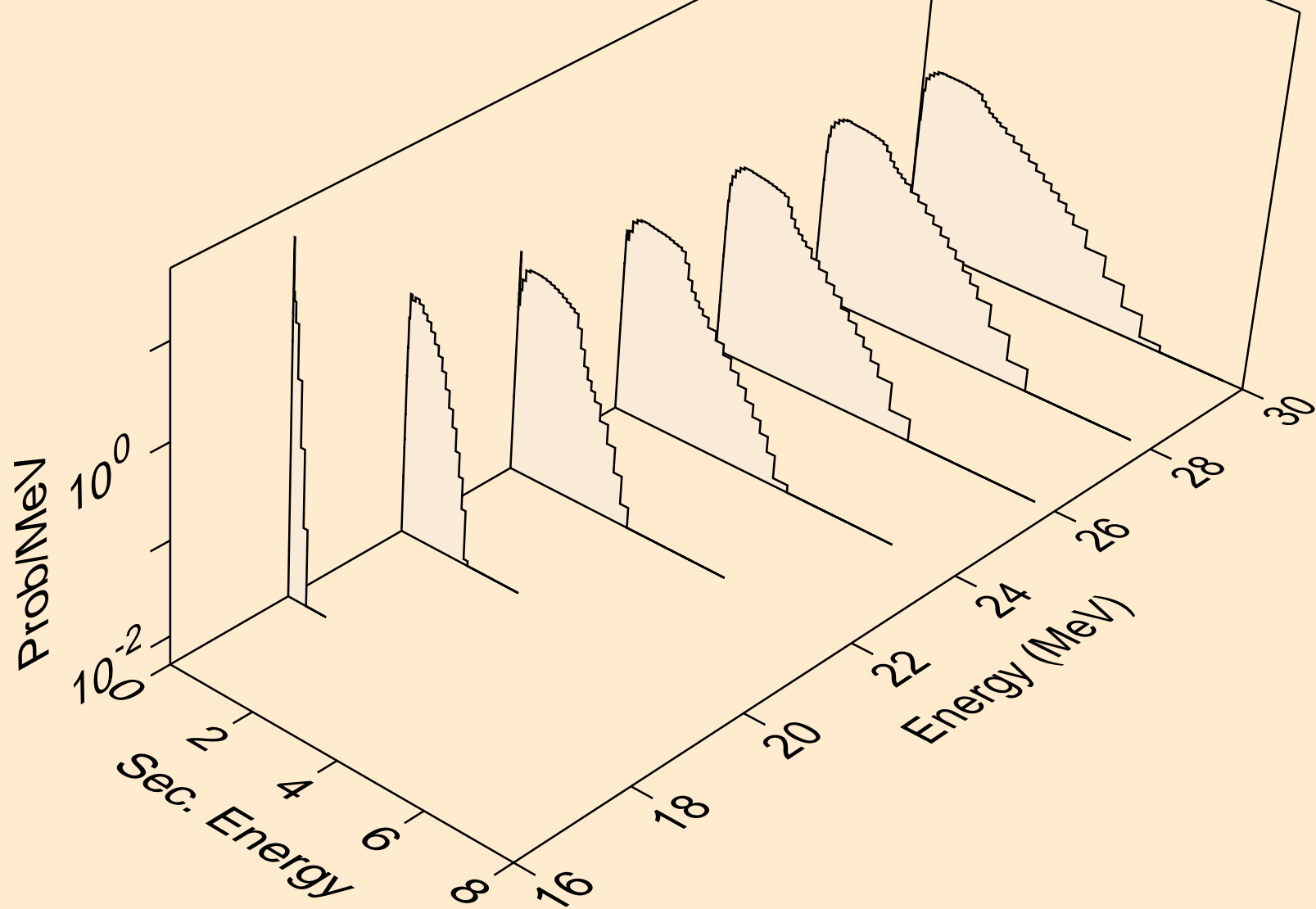

K043 NEUTRON ACER TENDL-2024 LIBRARY; T=0.K
Neutron emission for (n,n*)he3

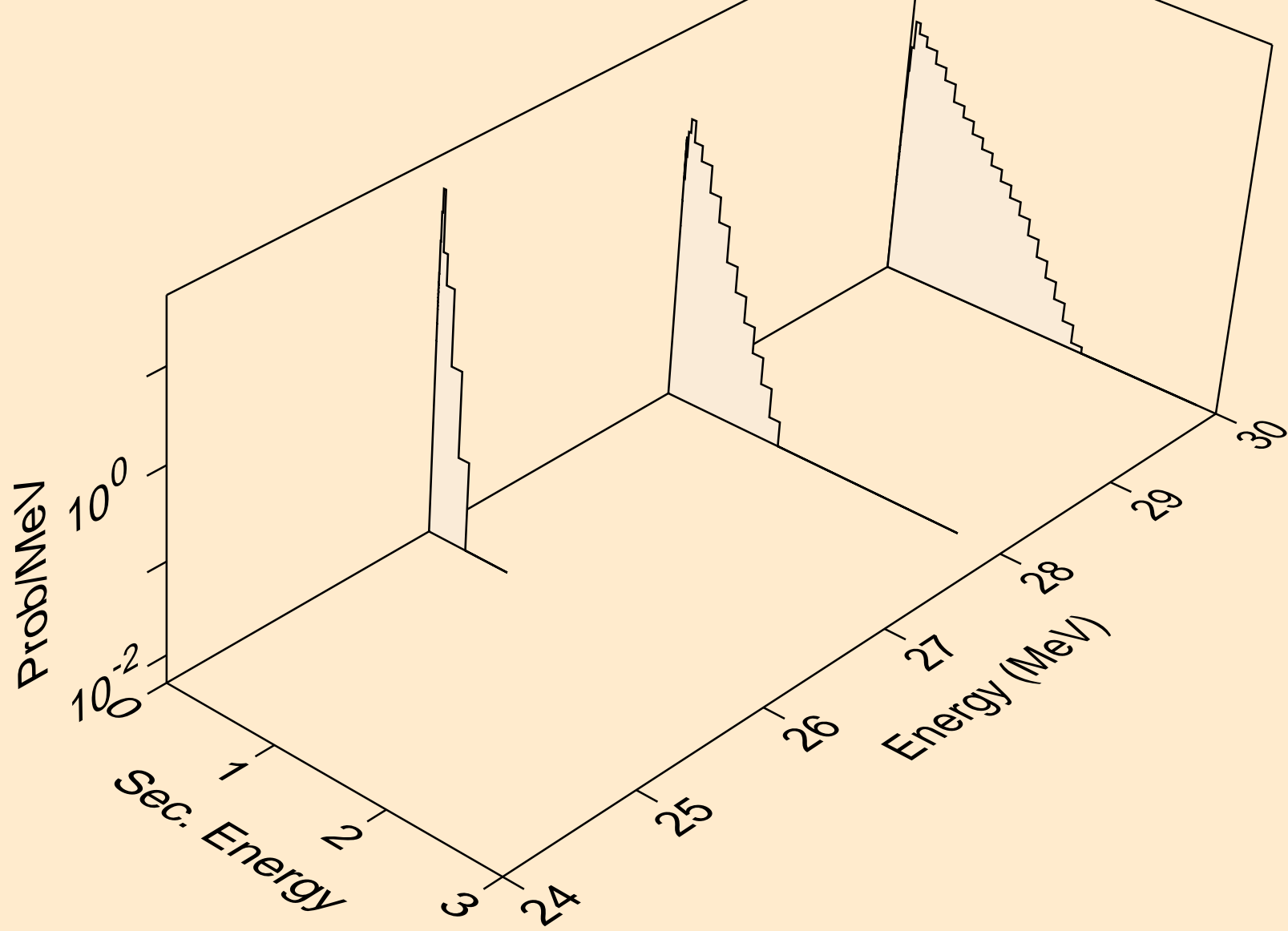

K043 NEUTRON ACER TENDL-2024 LIBRARY; T=0.K
Neutron emission for (n,4n)

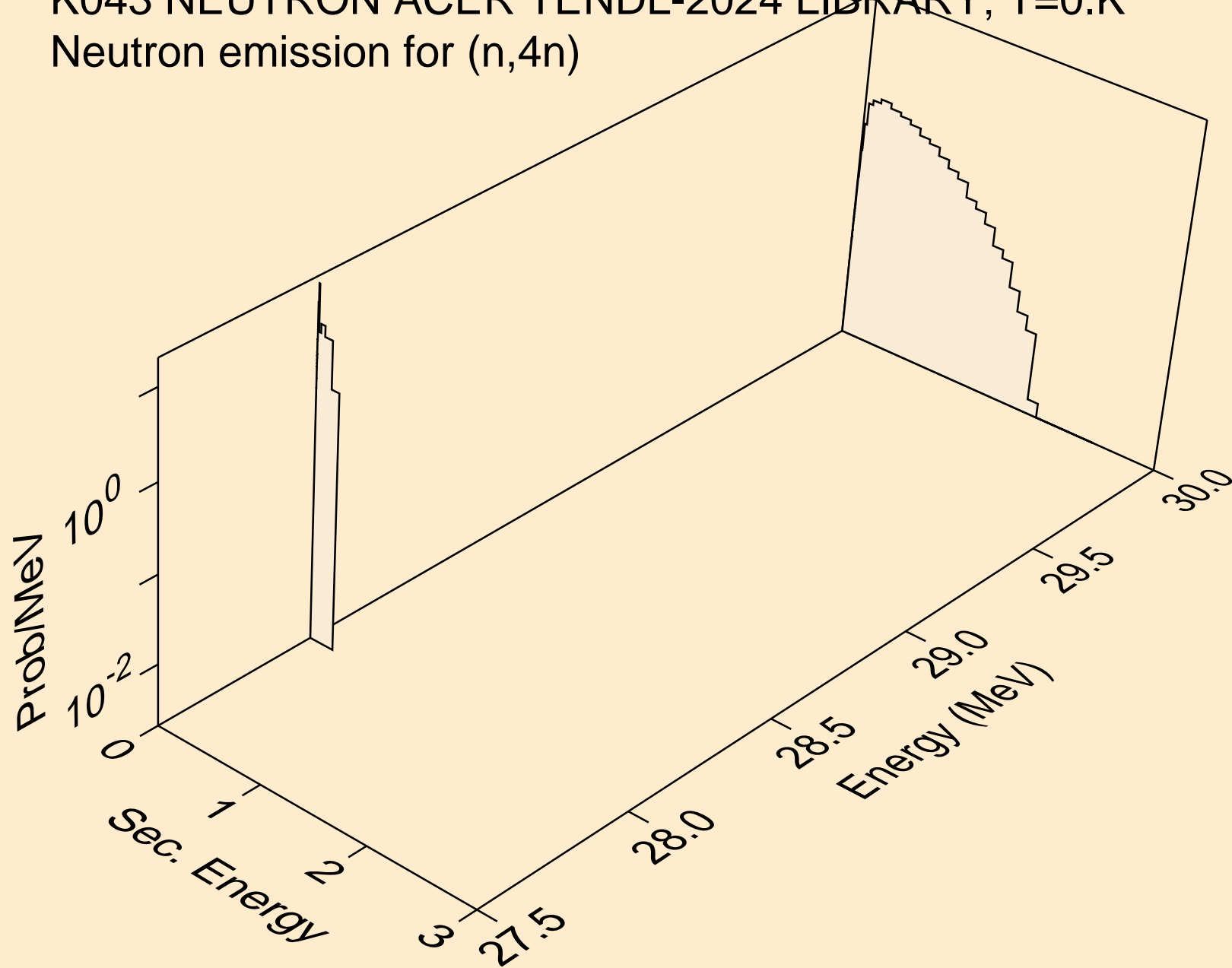

K043 NEUTRON ACER TENDL-2024 LIBRARY; T=0.K
Neutron emission for (n,2np)

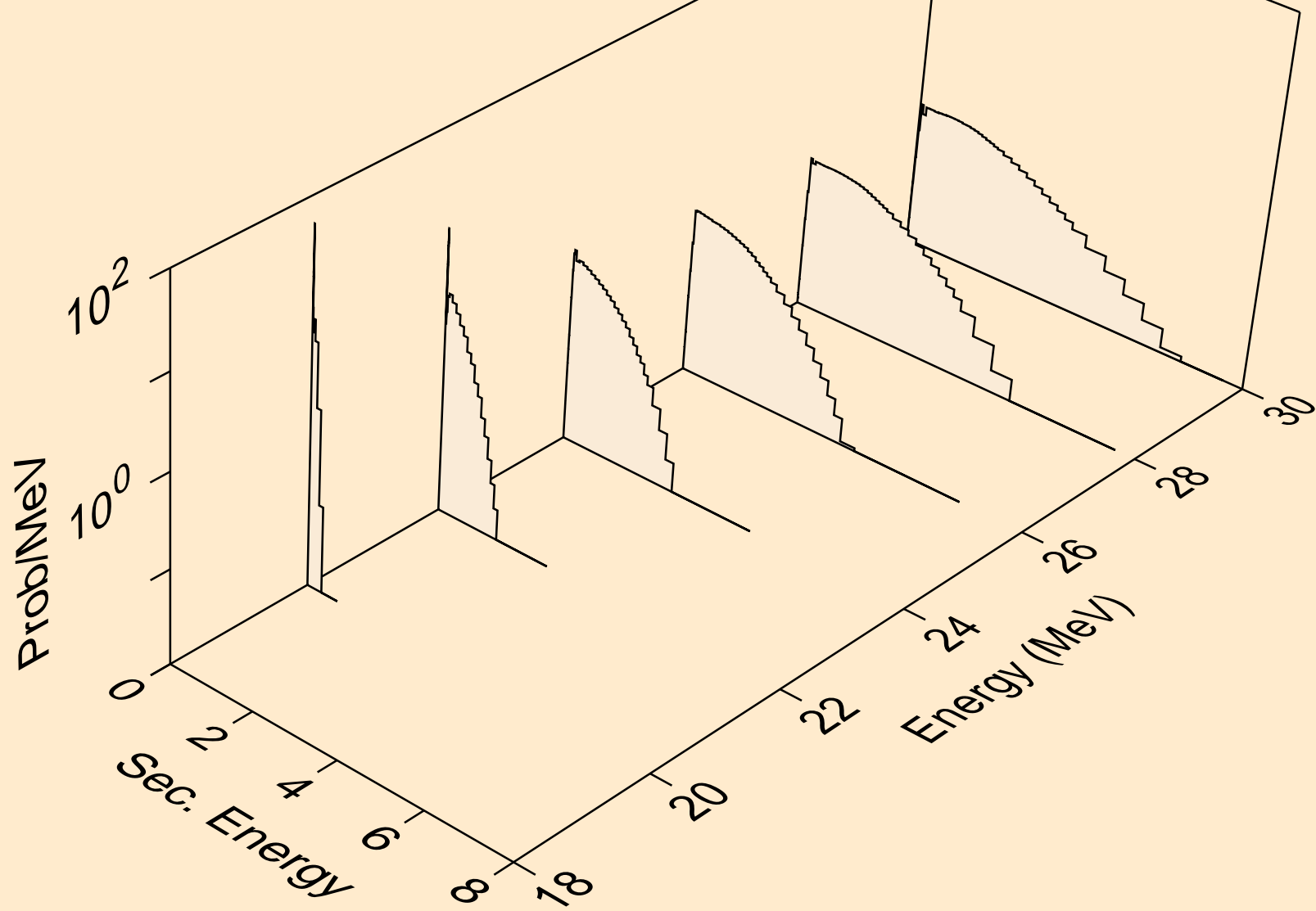

K043 NEUTRON ACER TENDL-2024 LIBRARY; T=0.K
Neutron emission for (n,3np)

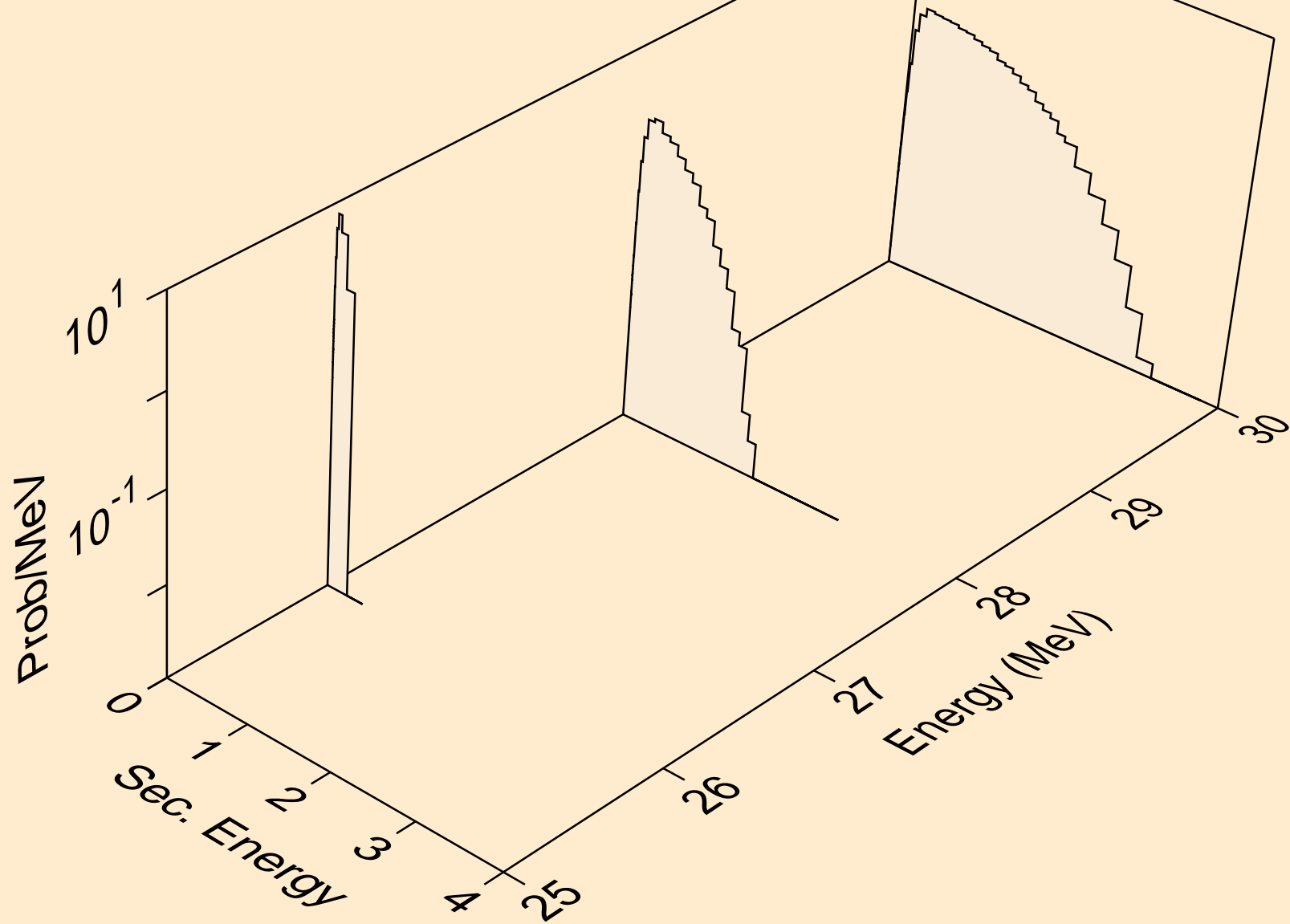

K043 NEUTRON ACER TENDL-2024 LIBRARY; T=0.K
Neutron emission for (n,n2p)

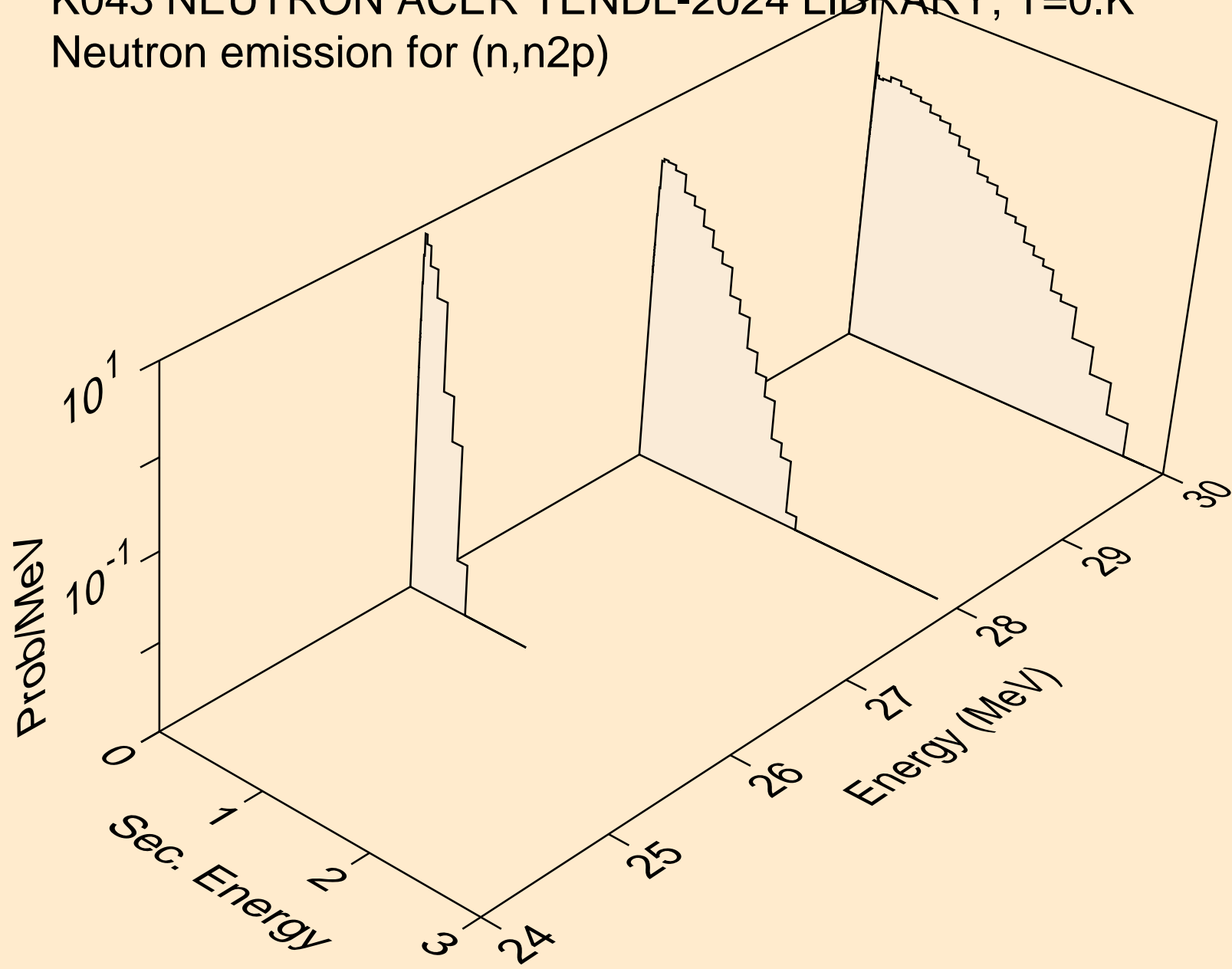

K043 NEUTRON ACER TENDL-2024 LIBRARY; T=0.K
Neutron emission for (n,npa)

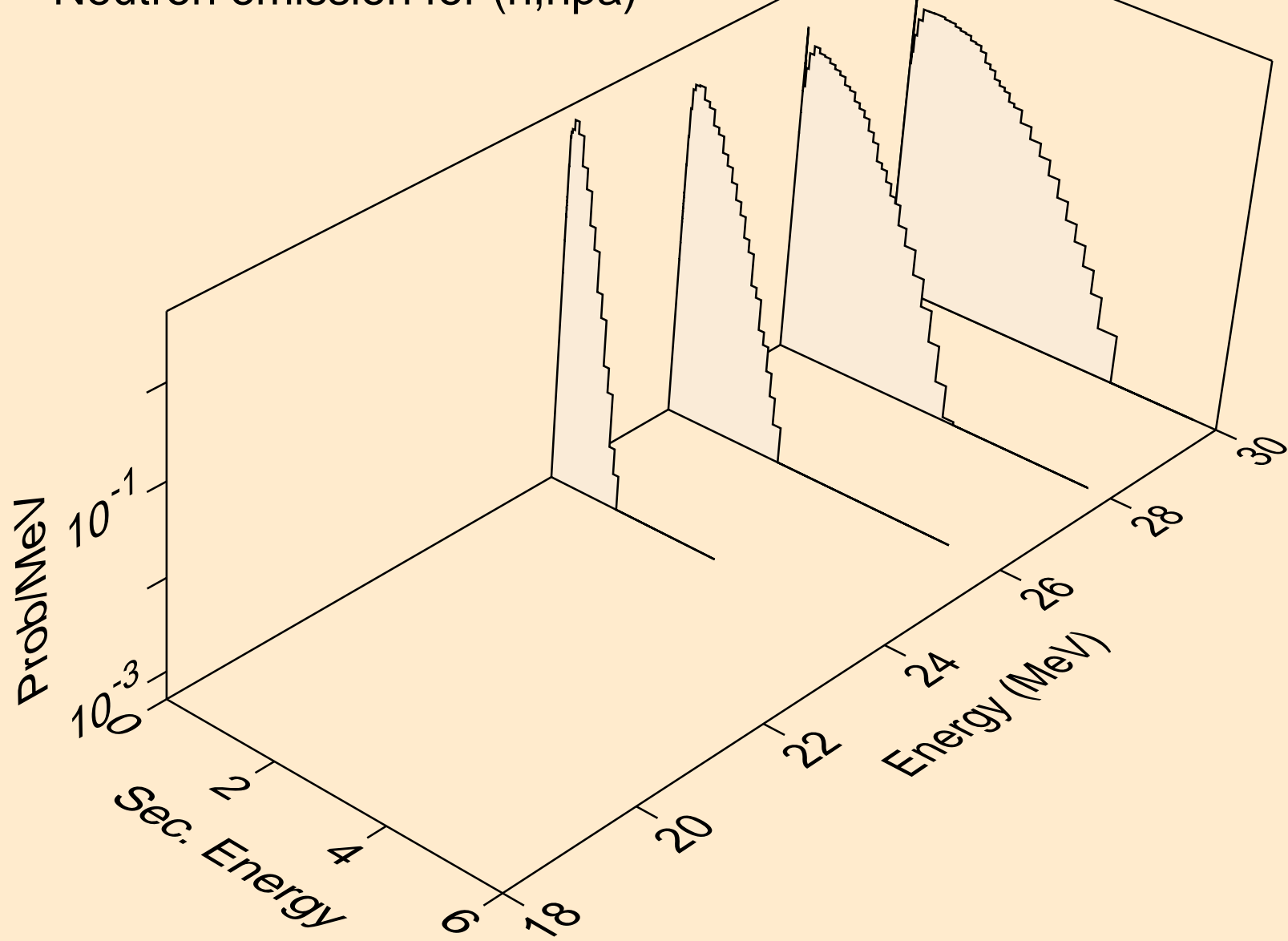

K043 NEUTRON ACER TENDL-2024 LIBRARY; T=0.K
Neutron emission for (n,n*c)

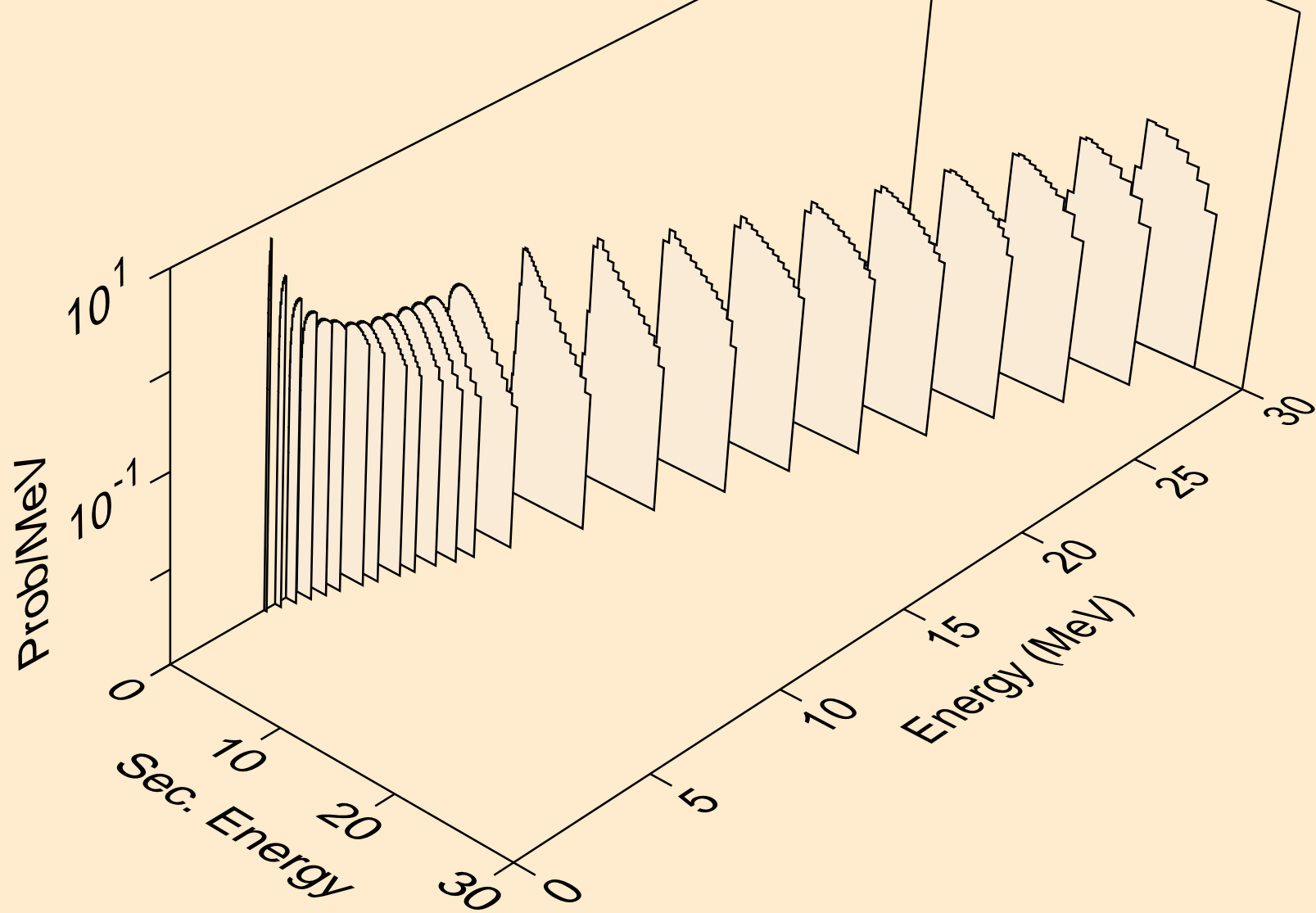

K043 NEUTRON ACER TENDL-2024 LIBRARY; T=0.K
Photon emission for (n,x)

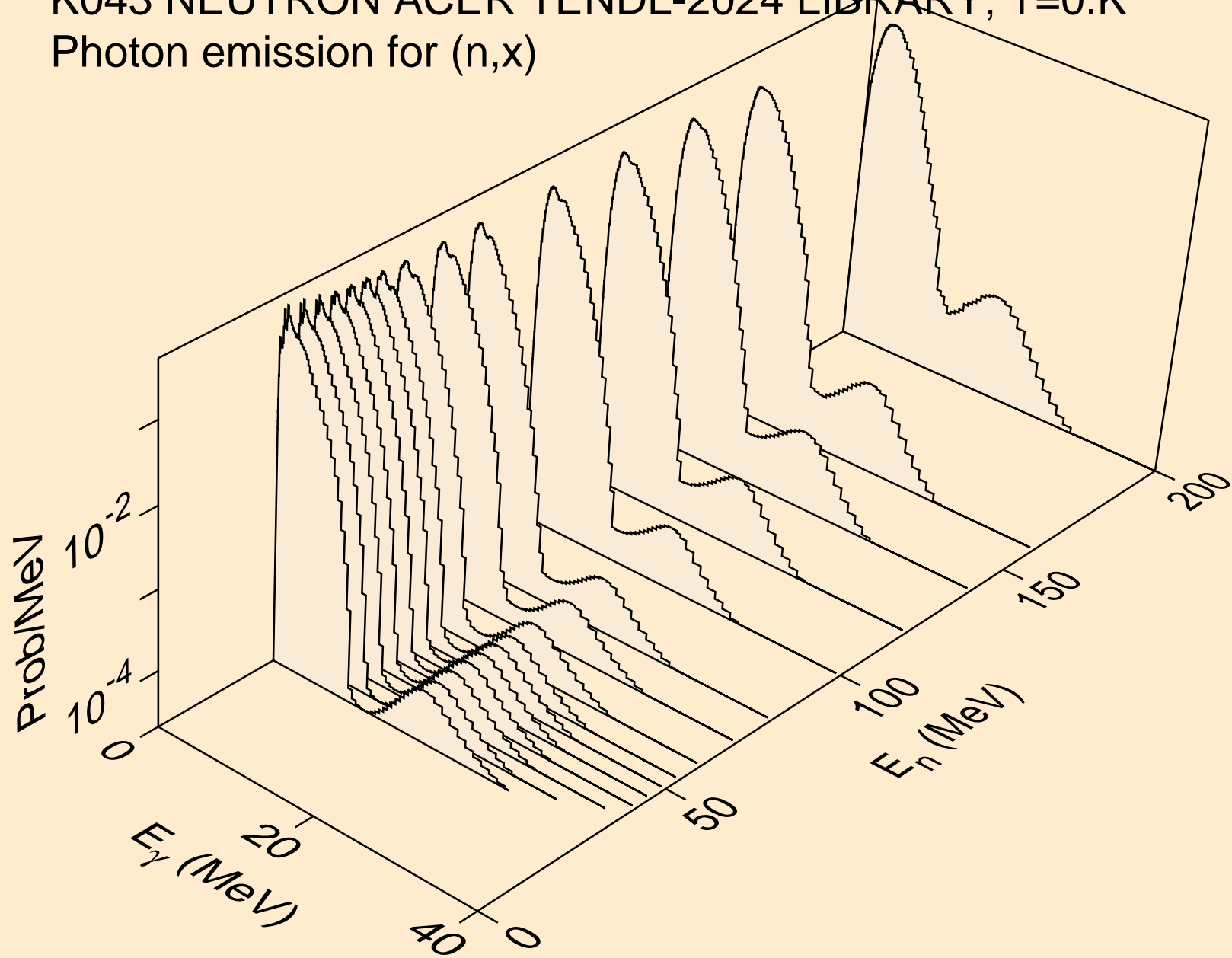

K043 NEUTRON ACER TENDL-2024 LIBRARY; T=0.K
Photon emission for (n,2nd)

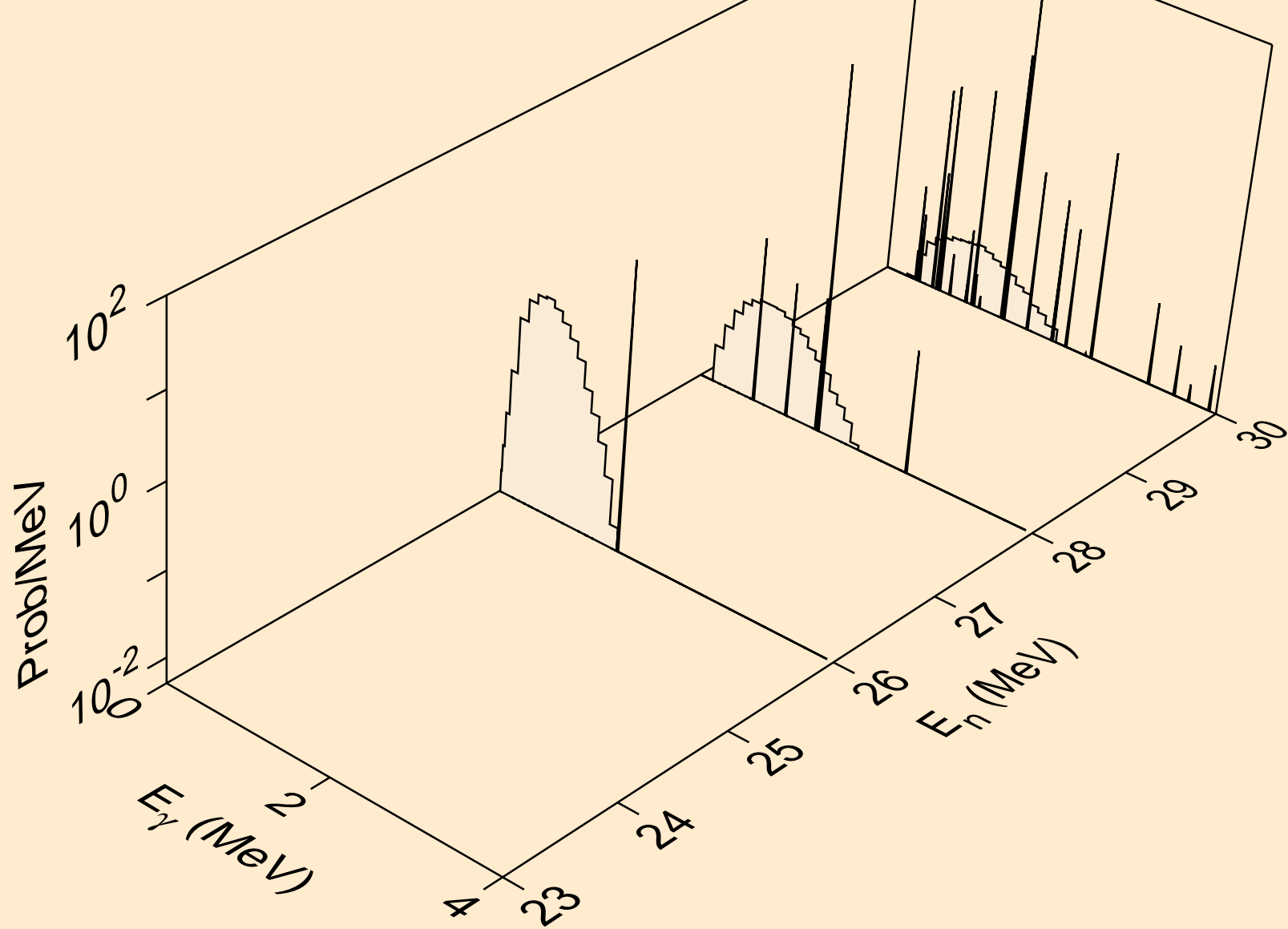

K043 NEUTRON ACER TENDL-2024 LIBRARY; T=0.K
Photon emission for (n,2n)

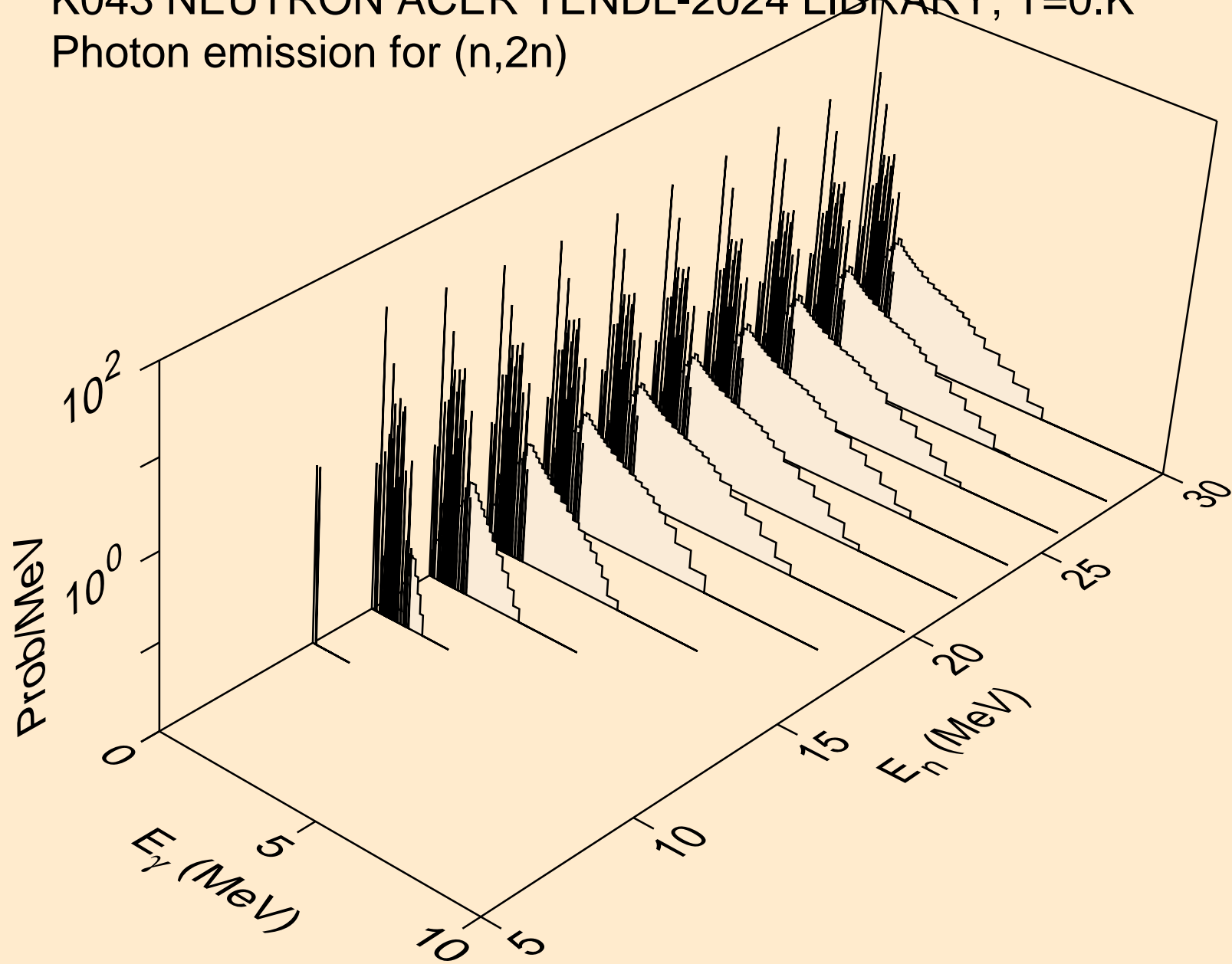

K043 NEUTRON ACER TENDL-2024 LIBRARY; T=0.K
Photon emission for (n,3n)

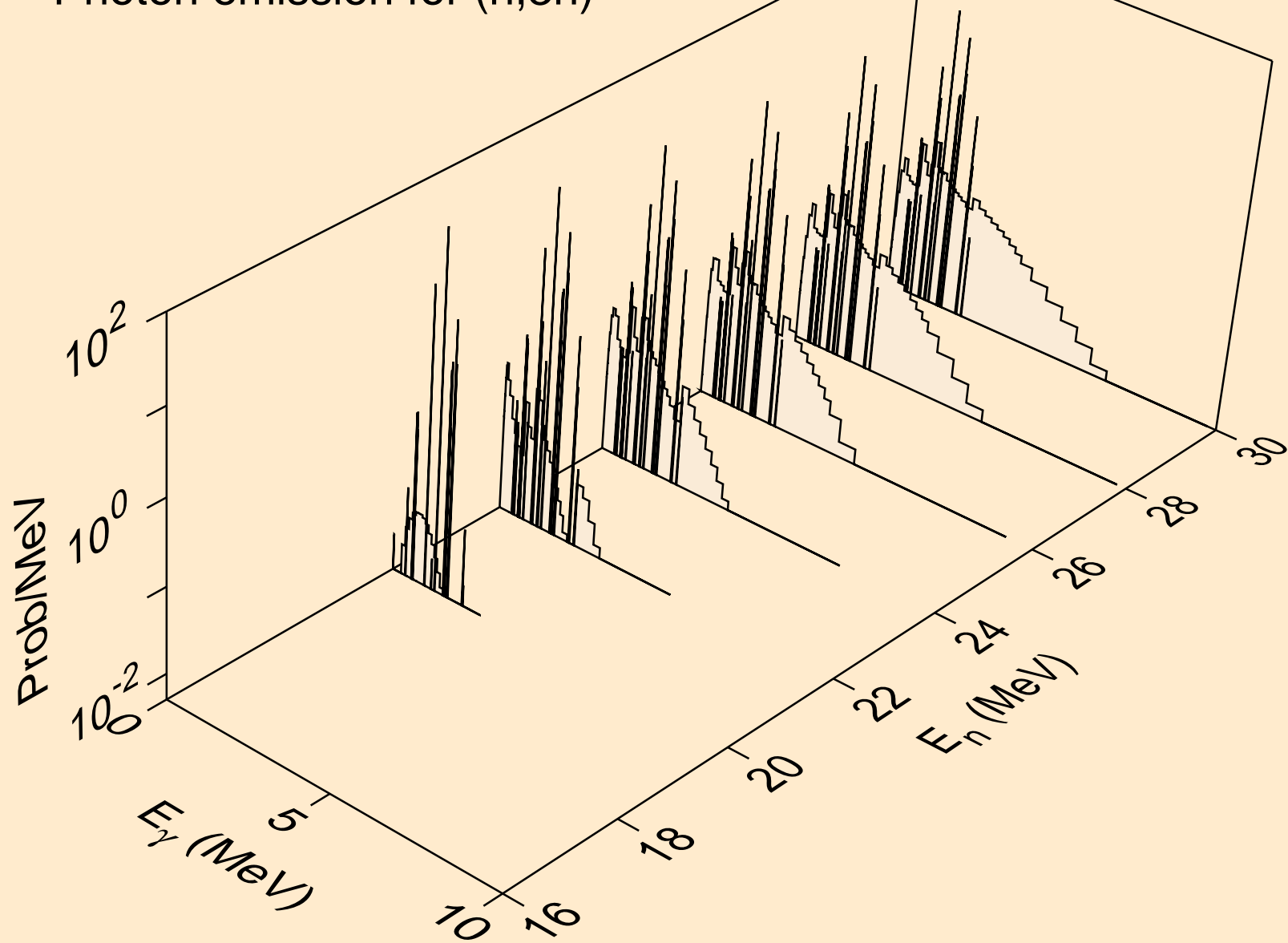

K043 NEUTRON ACER TENDL-2024 LIBRARY; T=0.K
Photon emission for (n,n*)a

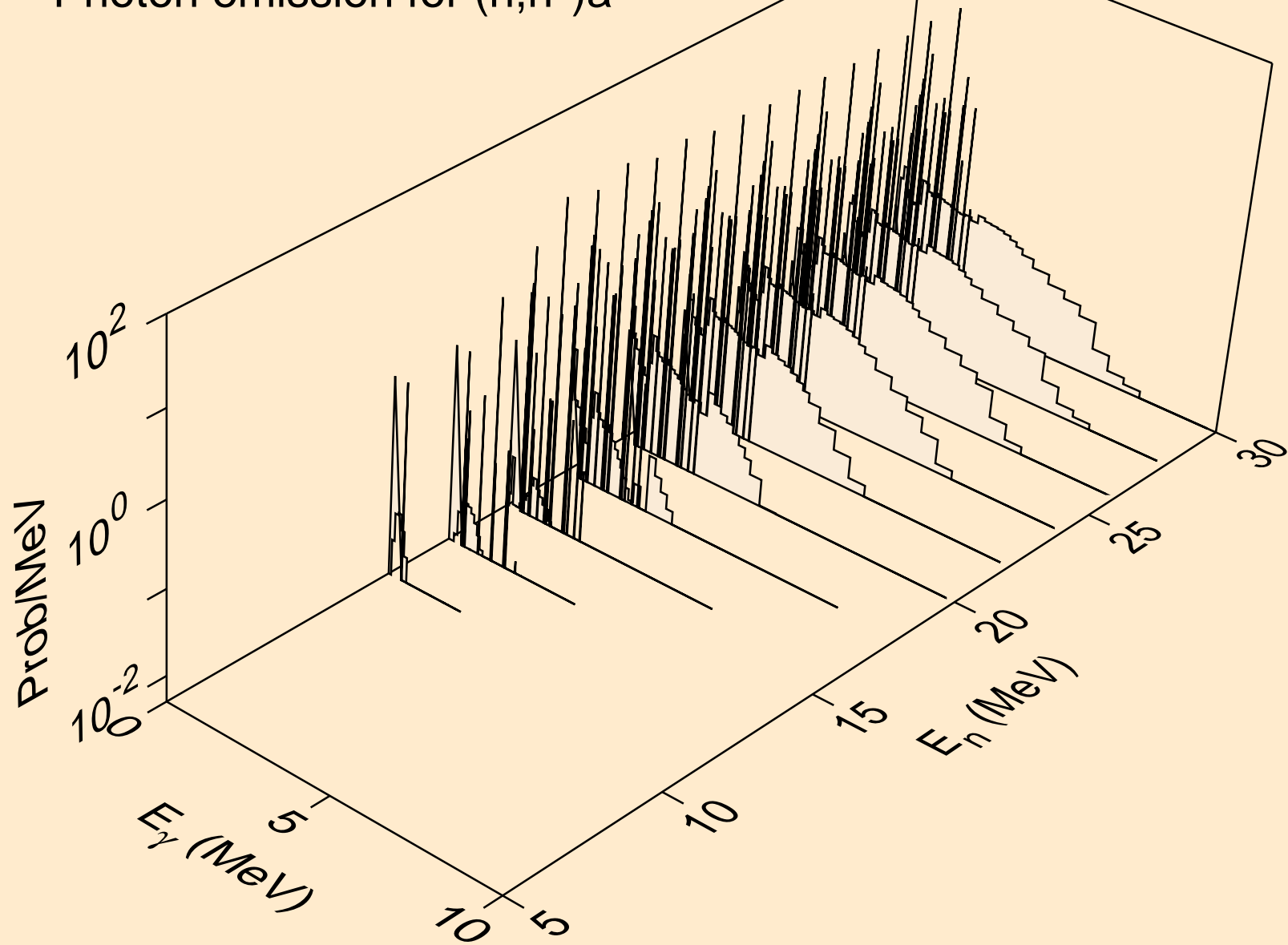

K043 NEUTRON ACER TENDL-2024 LIBRARY; T=0.K
Photon emission for (n,2n)a

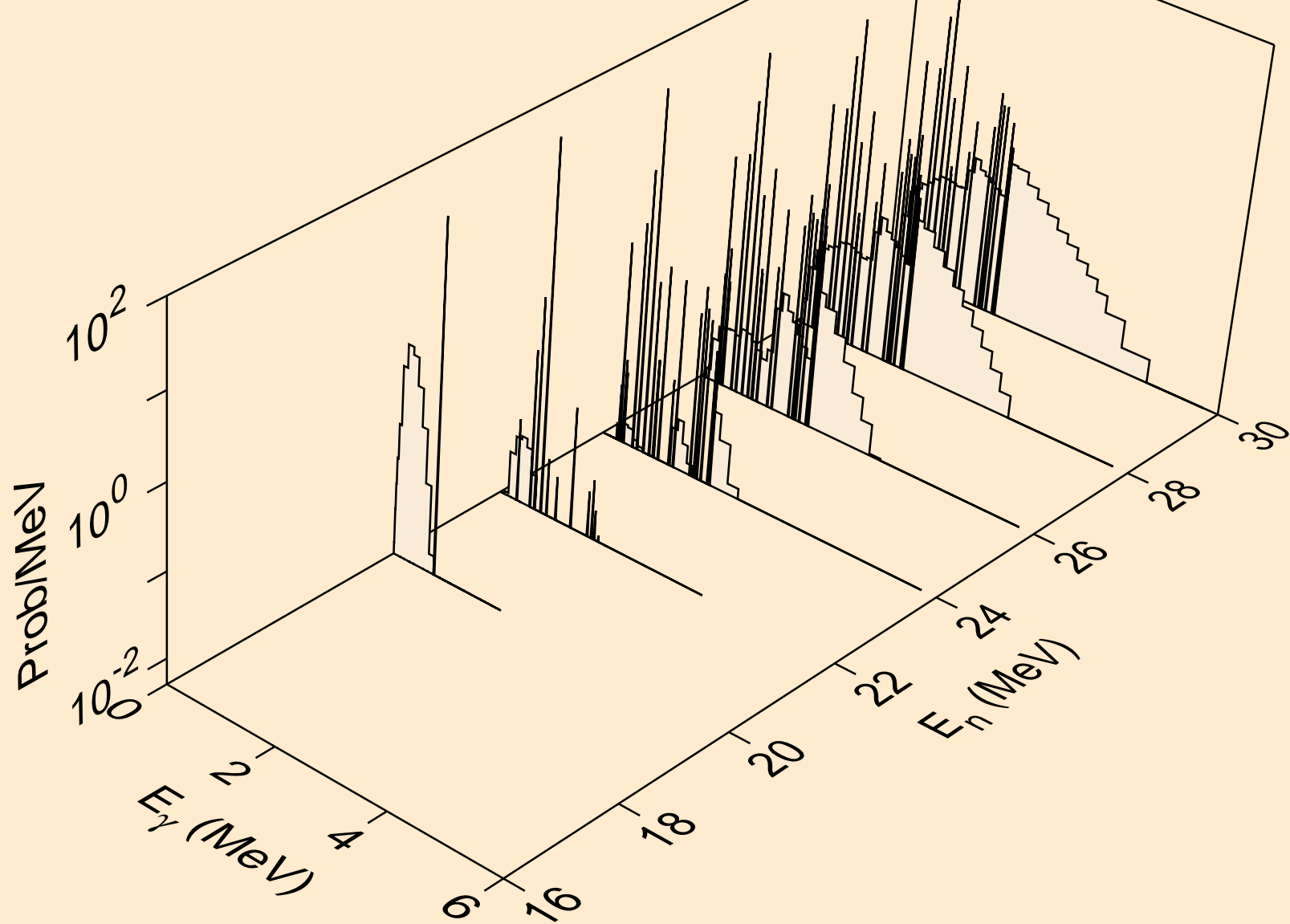

K043 NEUTRON ACER TENDL-2024 LIBRARY; T=0.K
Photon emission for (n,3n)a

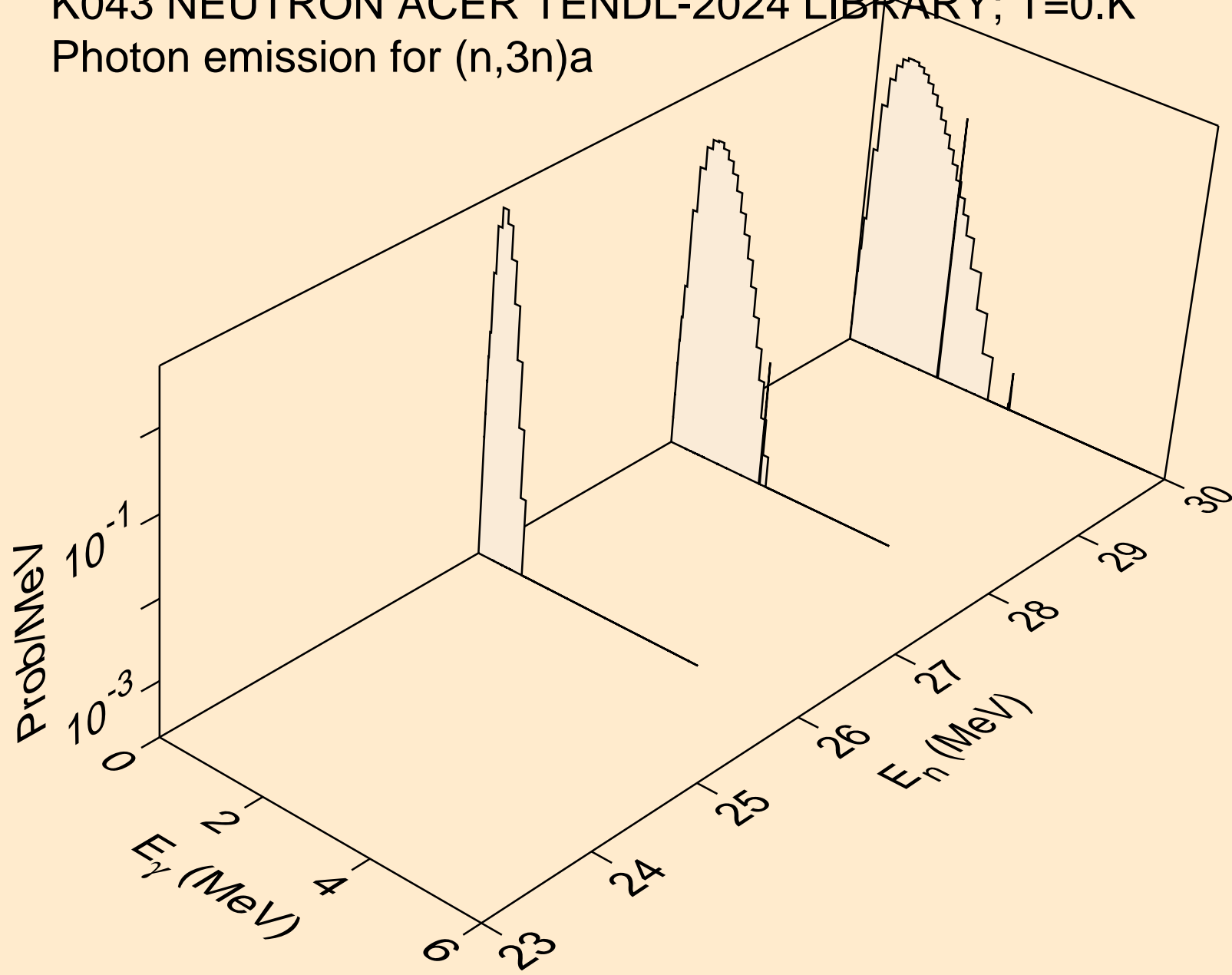

K043 NEUTRON ACER TENDL-2024 LIBRARY; T=0.K
Photon emission for (n,n*)p

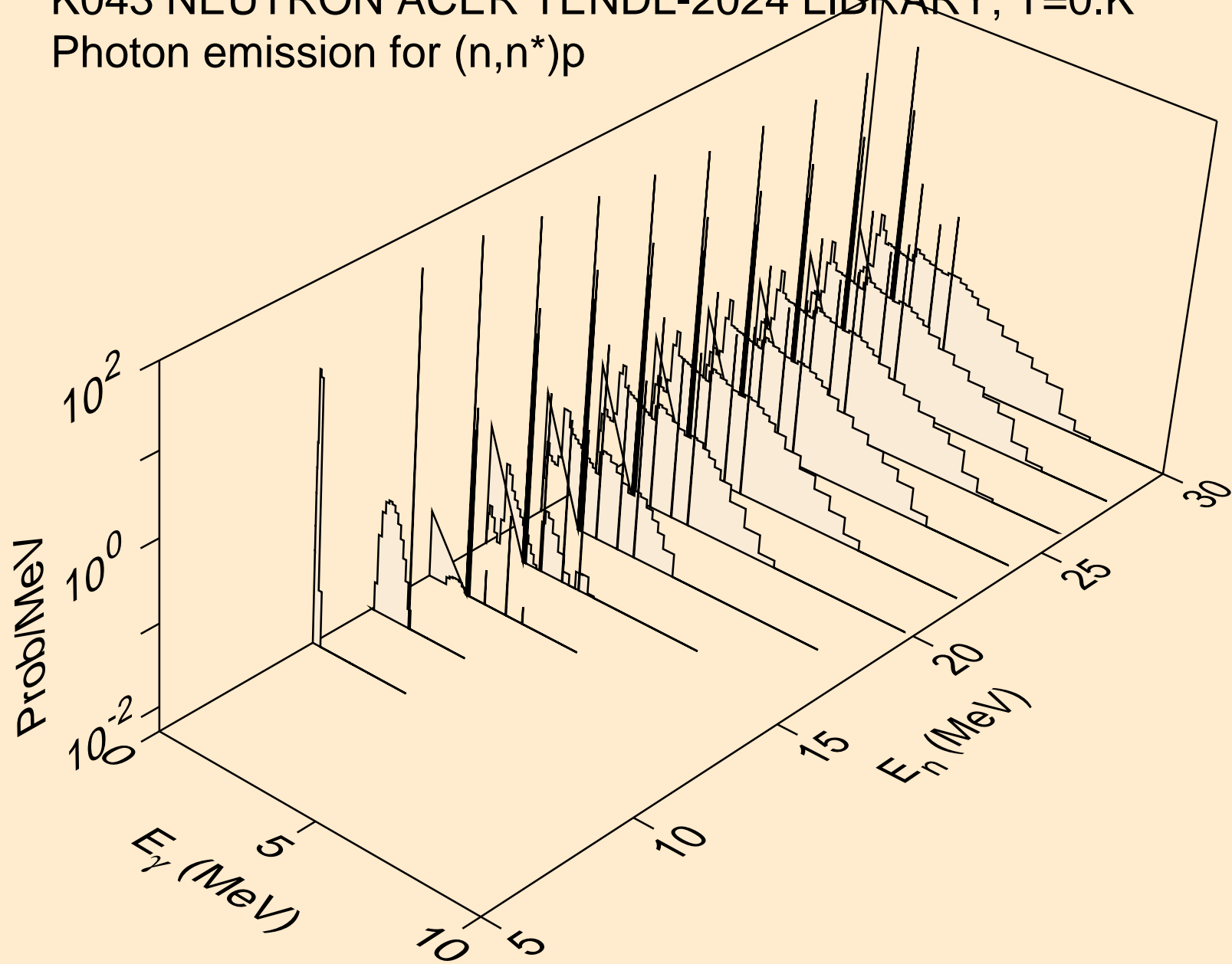

K043 NEUTRON ACER TENDL-2024 LIBRARY; T=0.K
Photon emission for (n,n*)2a

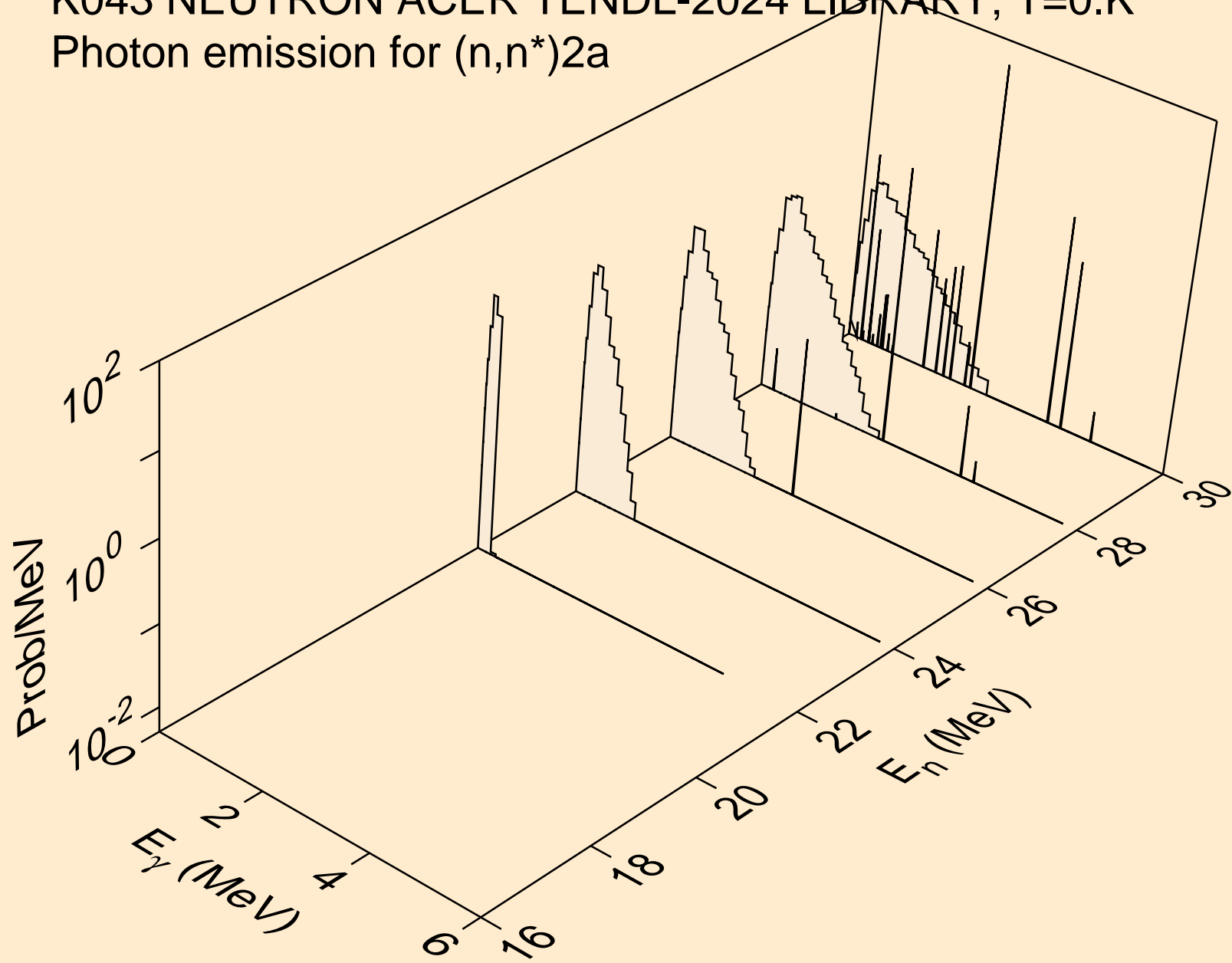

K043 NEUTRON ACER TENDL-2024 LIBRARY; T=0.K
Photon emission for (n,n*)d

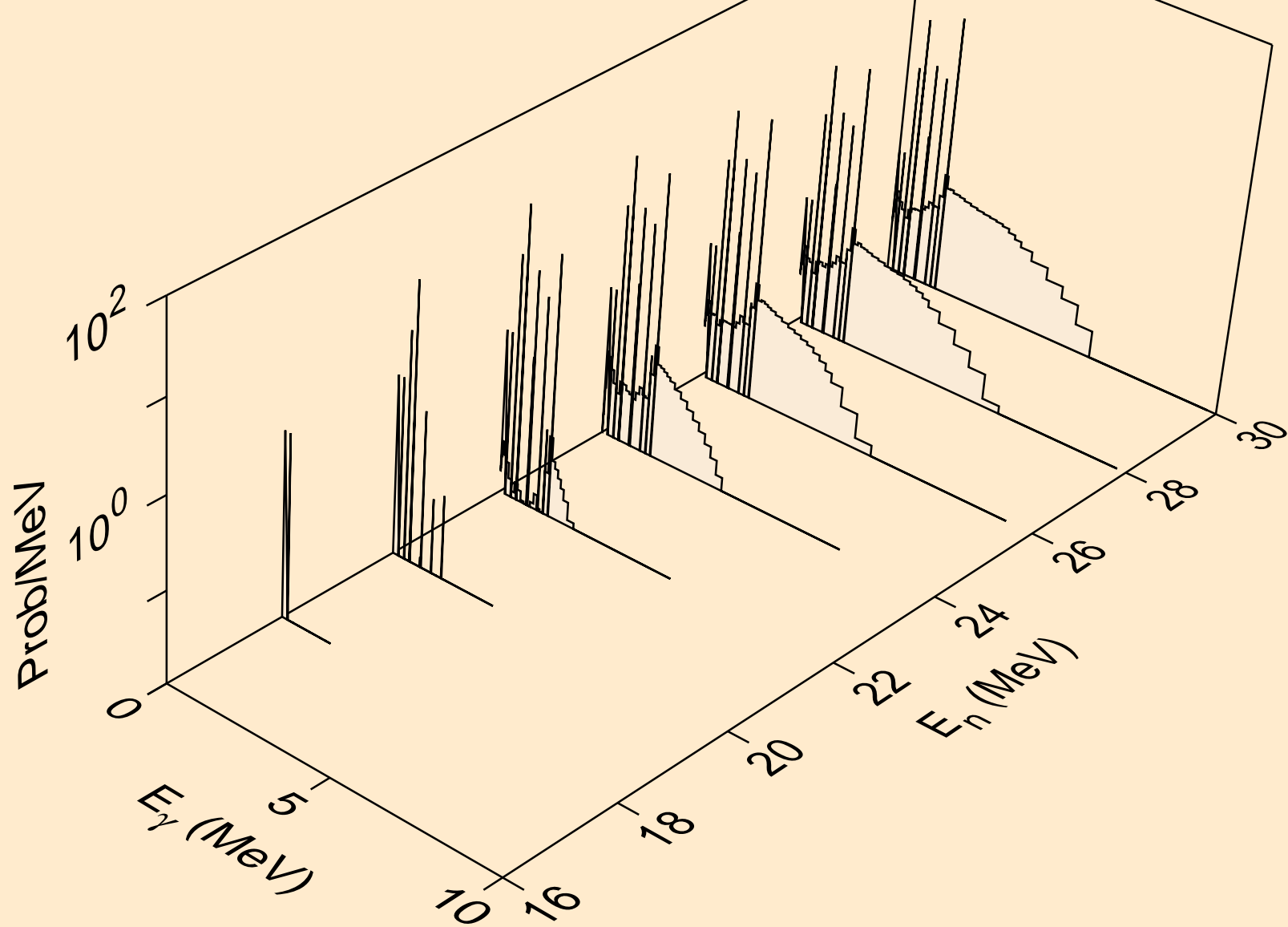

K043 NEUTRON ACER TENDL-2024 LIBRARY; T=0.K
Photon emission for (n,n*)t

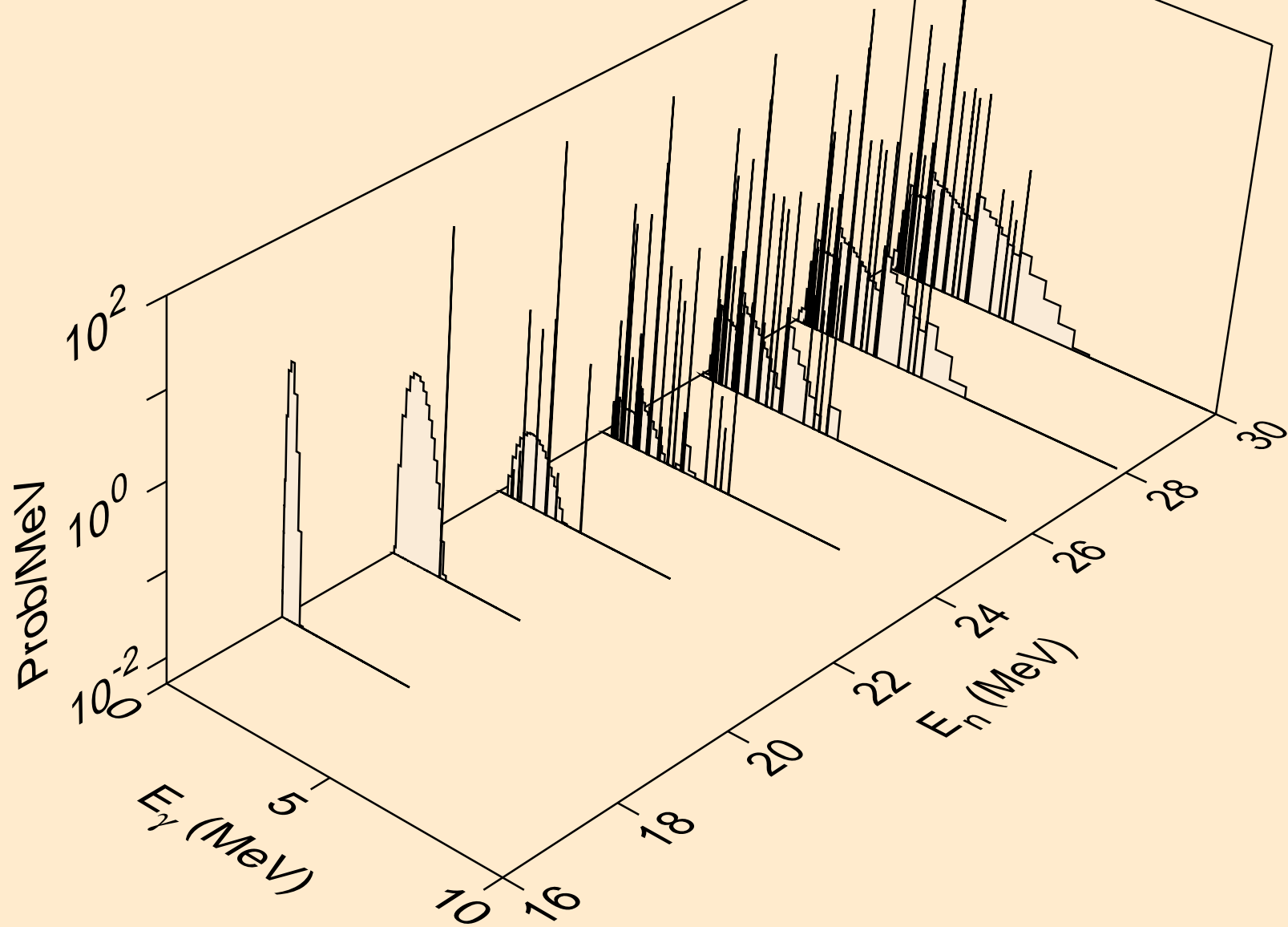

K043 NEUTRON ACER TENDL-2024 LIBRARY; T=0.K
Photon emission for (n,n*)he3

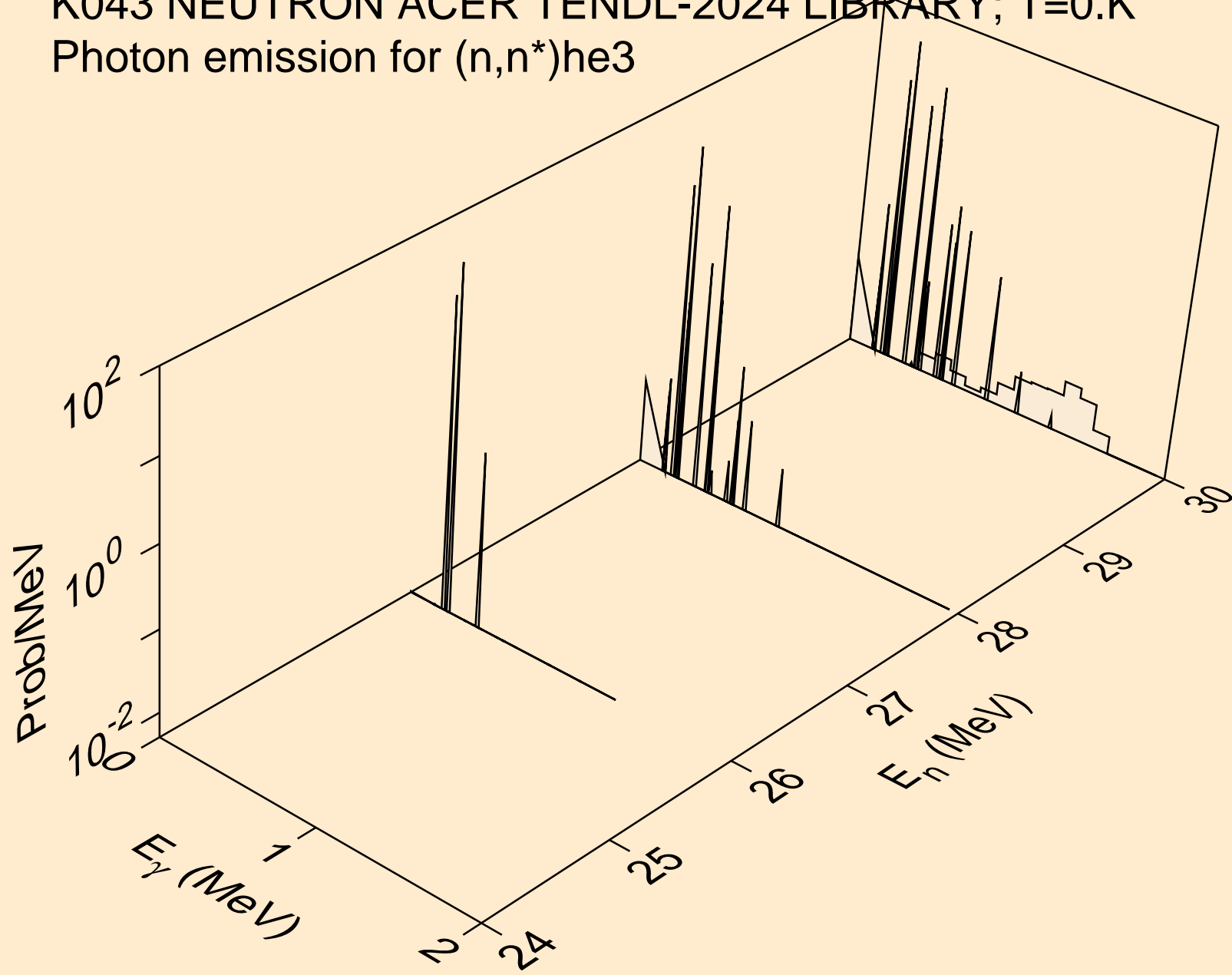

K043 NEUTRON ACER TENDL-2024 LIBRARY; T=0.K
Photon emission for (n,4n)

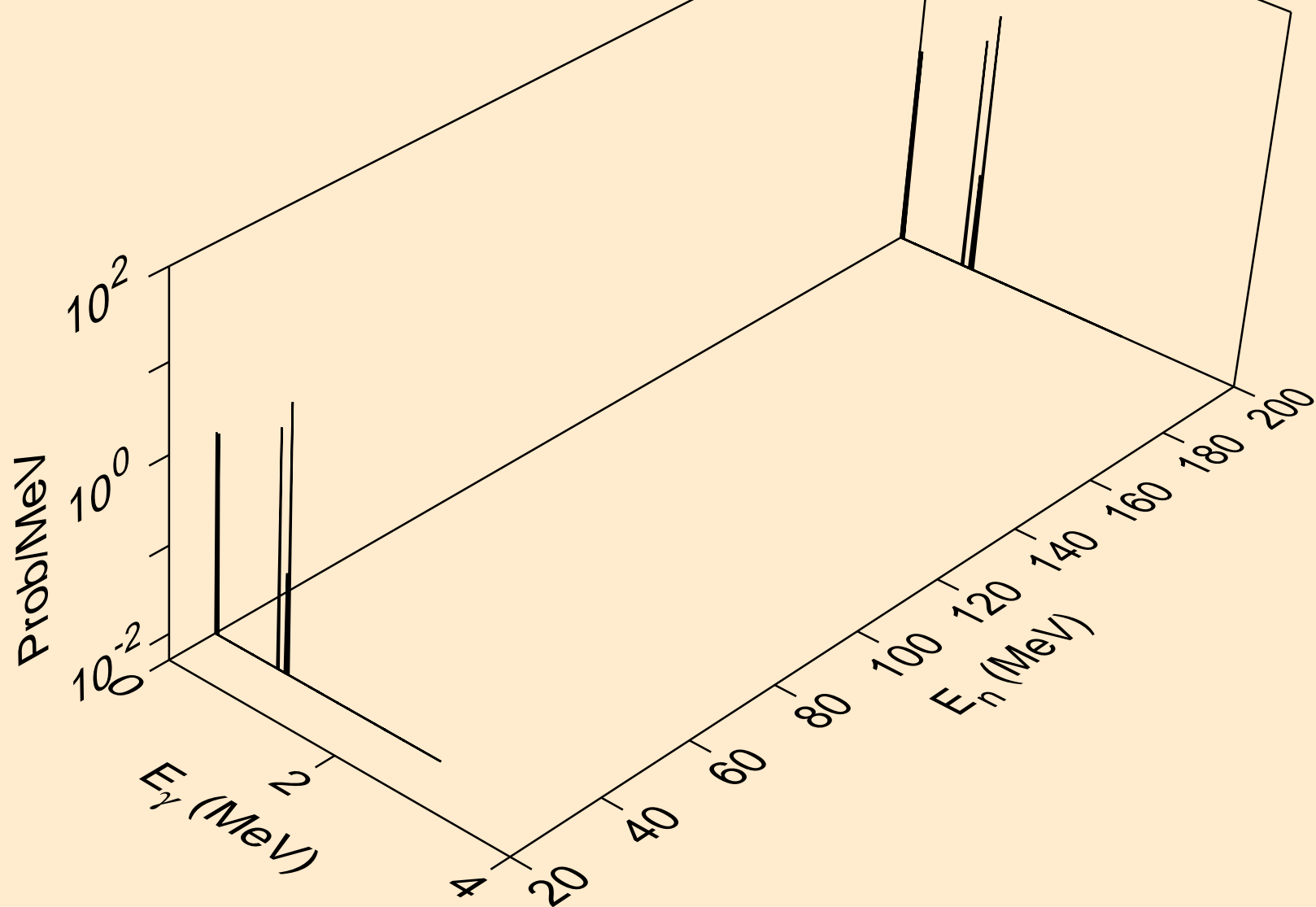

K043 NEUTRON ACER TENDL-2024 LIBRARY; T=0.K
Photon emission for (n,2np)

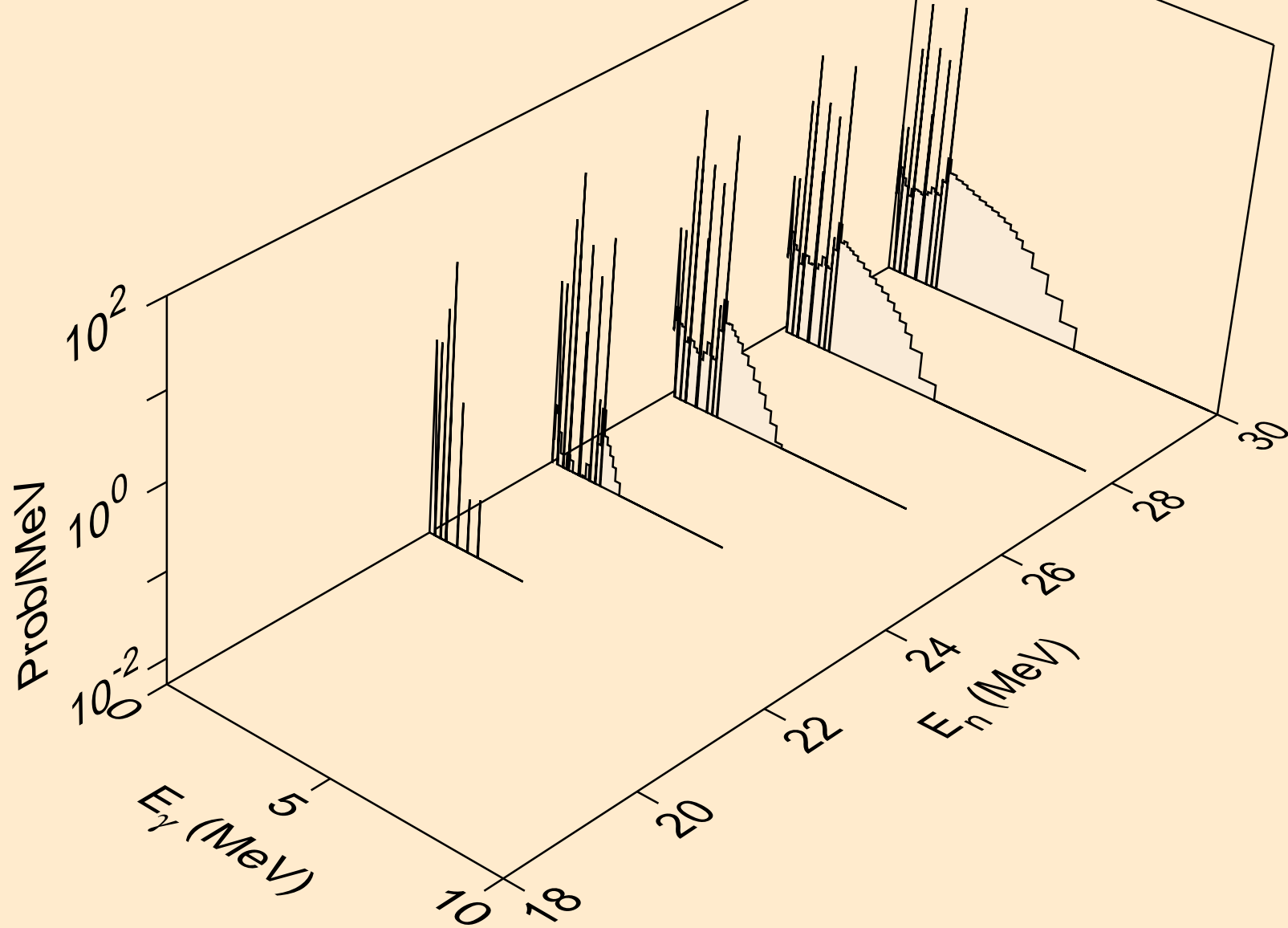

K043 NEUTRON ACER TENDL-2024 LIBRARY; T=0.K
Photon emission for (n,3np)

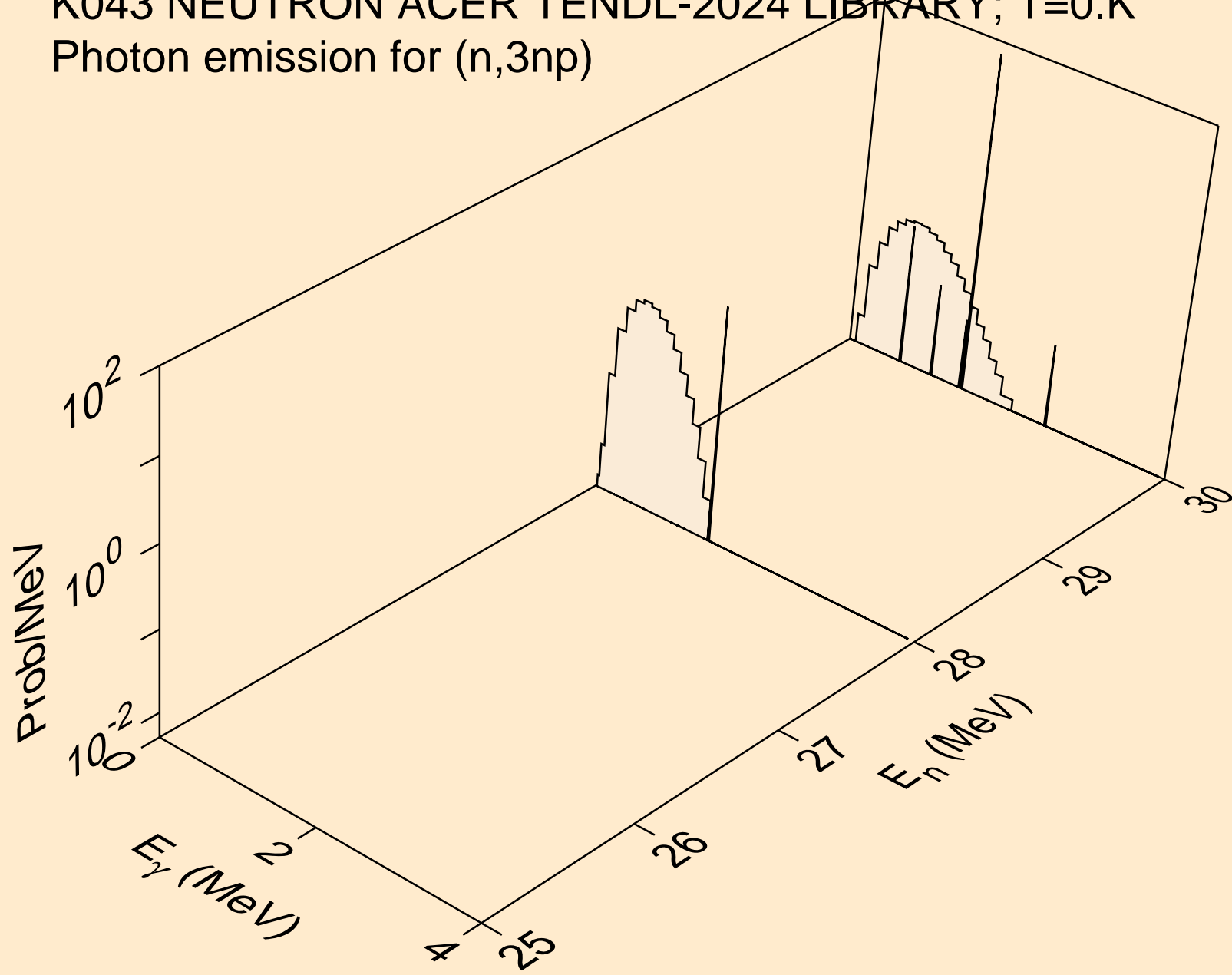

K043 NEUTRON ACER TENDL-2024 LIBRARY; T=0.K
Photon emission for (n,n2p)

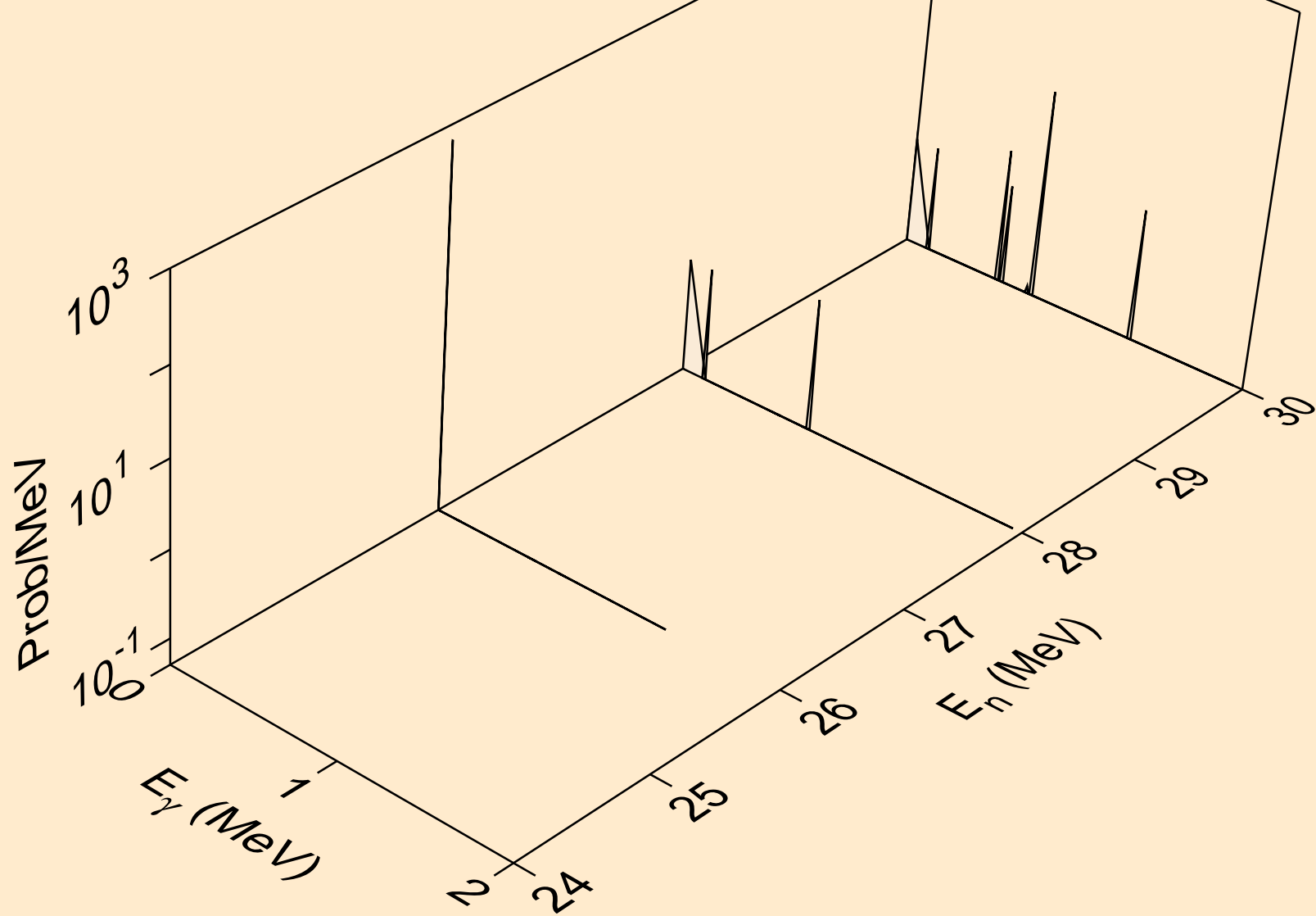

K043 NEUTRON ACER TENDL-2024 LIBRARY; T=0.K
Photon emission for (n,npa)

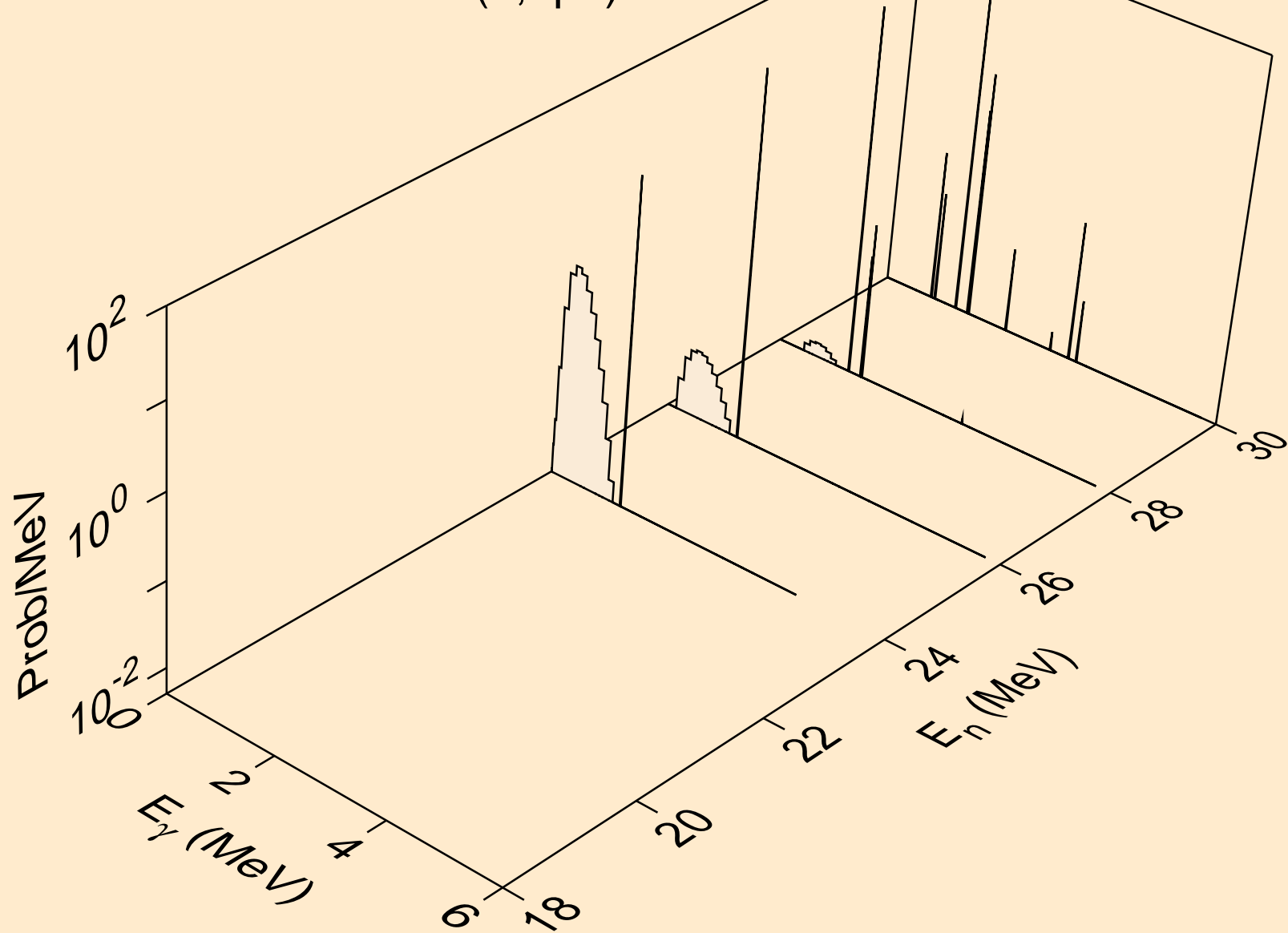

K043 NEUTRON ACER TENDL-2024 LIBRARY; T=0.K
Photon emission for (n,n*c)

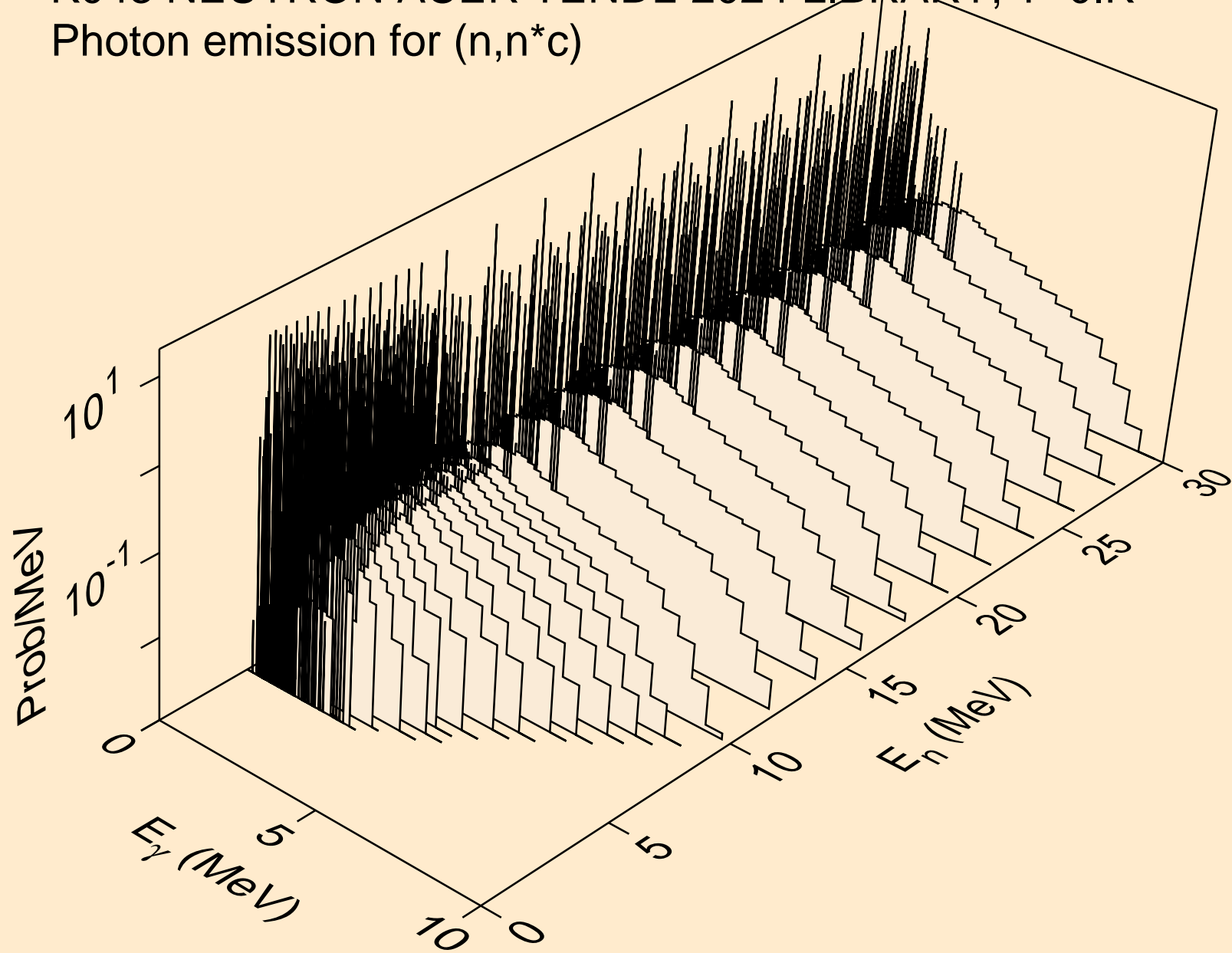

K043 NEUTRON ACER TENDL-2024 LIBRARY; T=0.K
Photon emission for (n,gma)

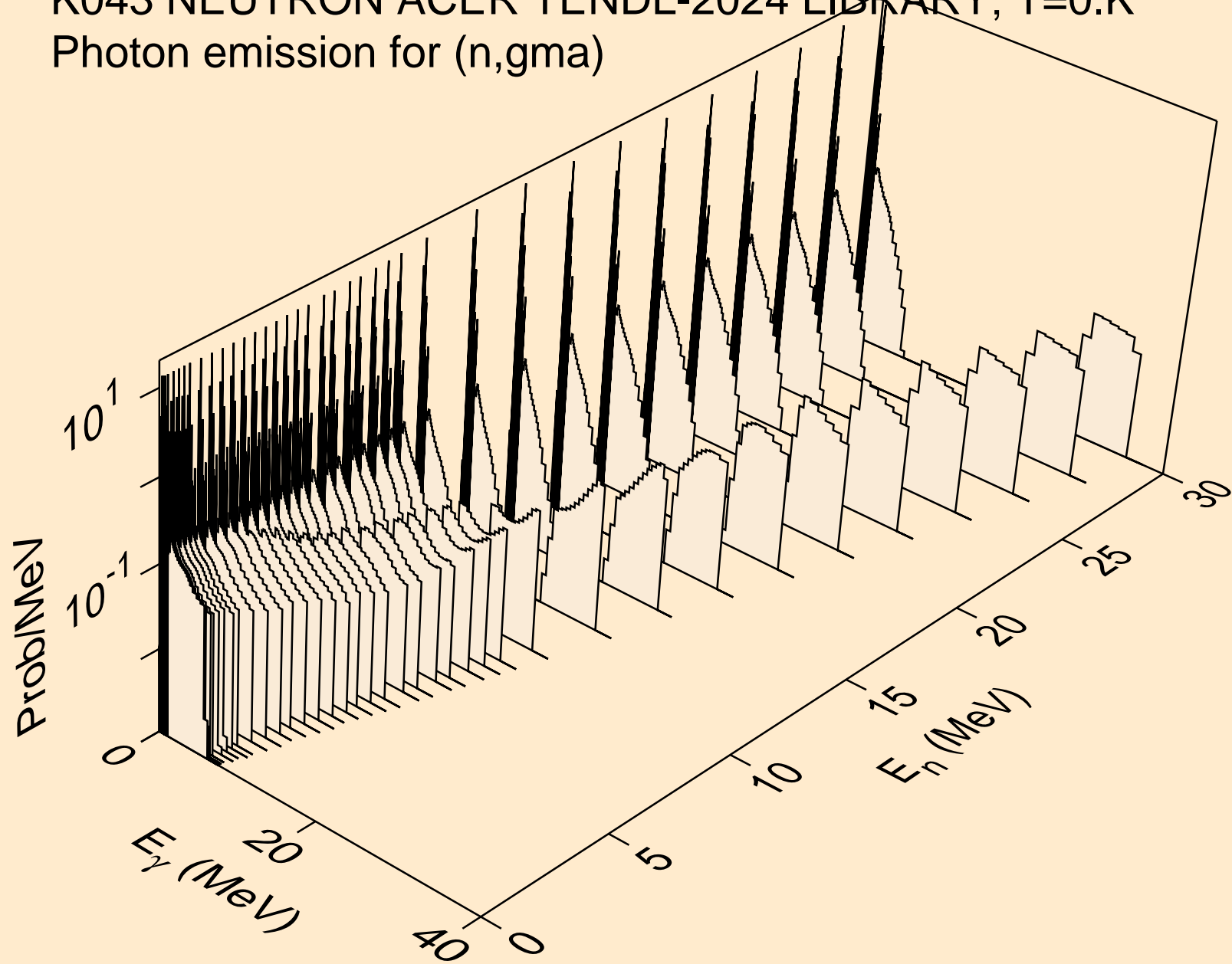

K043 NEUTRON ACER TENDL-2024 LIBRARY; T=0.K
Photon emission for (n,p)

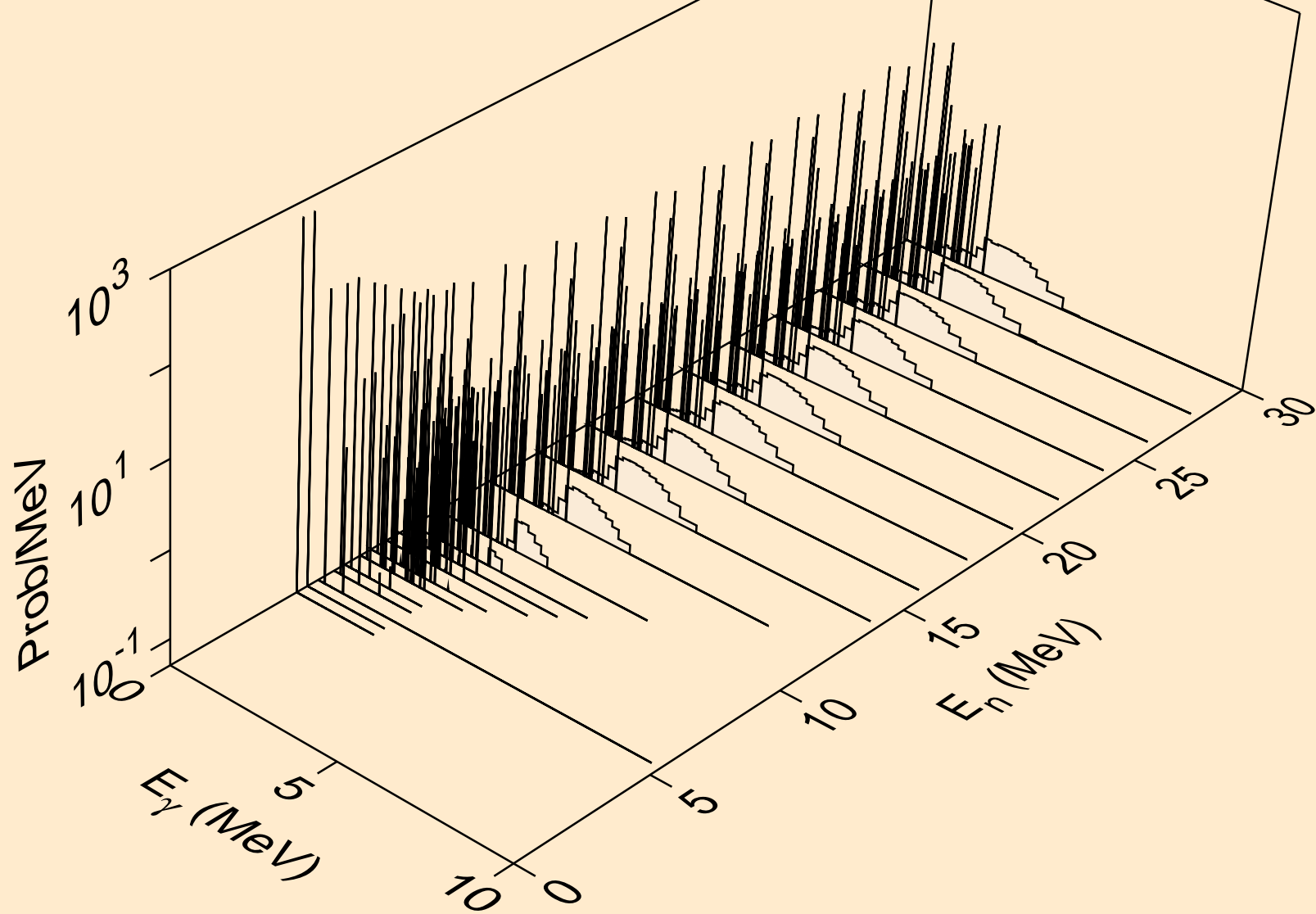

K043 NEUTRON ACER TENDL-2024 LIBRARY; T=0.K
Photon emission for (n,d)

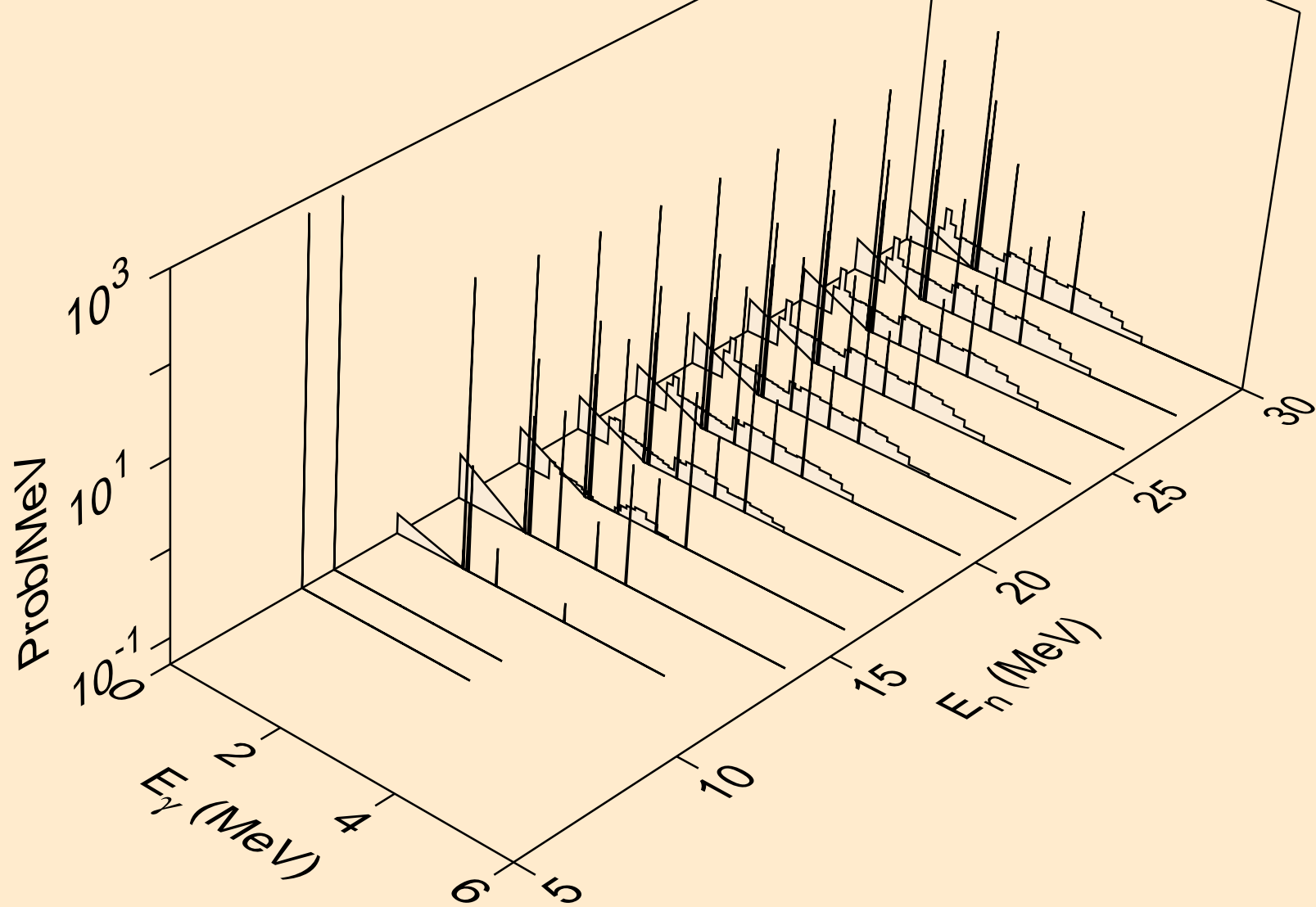

K043 NEUTRON ACER TENDL-2024 LIBRARY; T=0.K
Photon emission for (n,t)

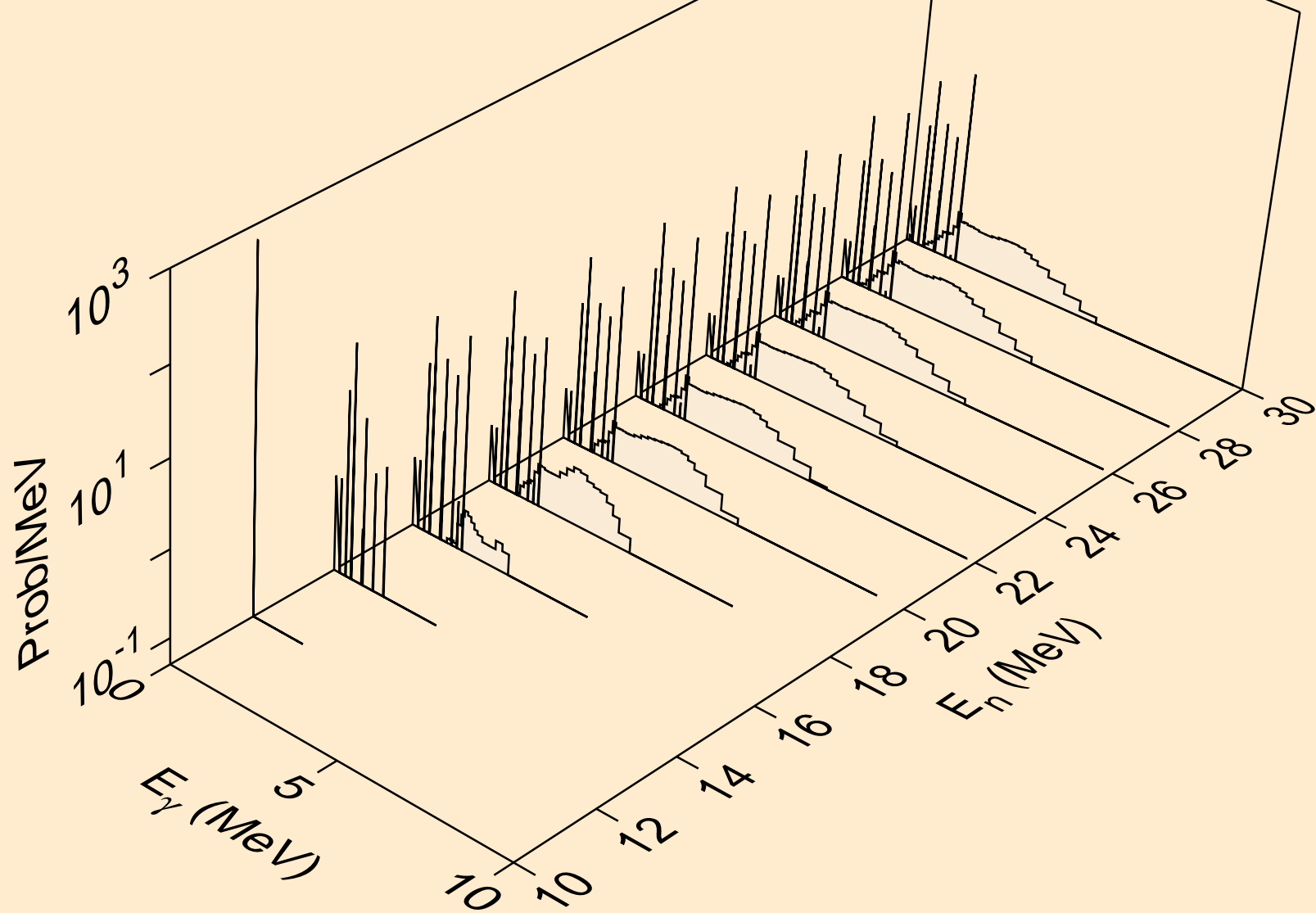

K043 NEUTRON ACER TENDL-2024 LIBRARY; T=0.K
Photon emission for (n,he3)

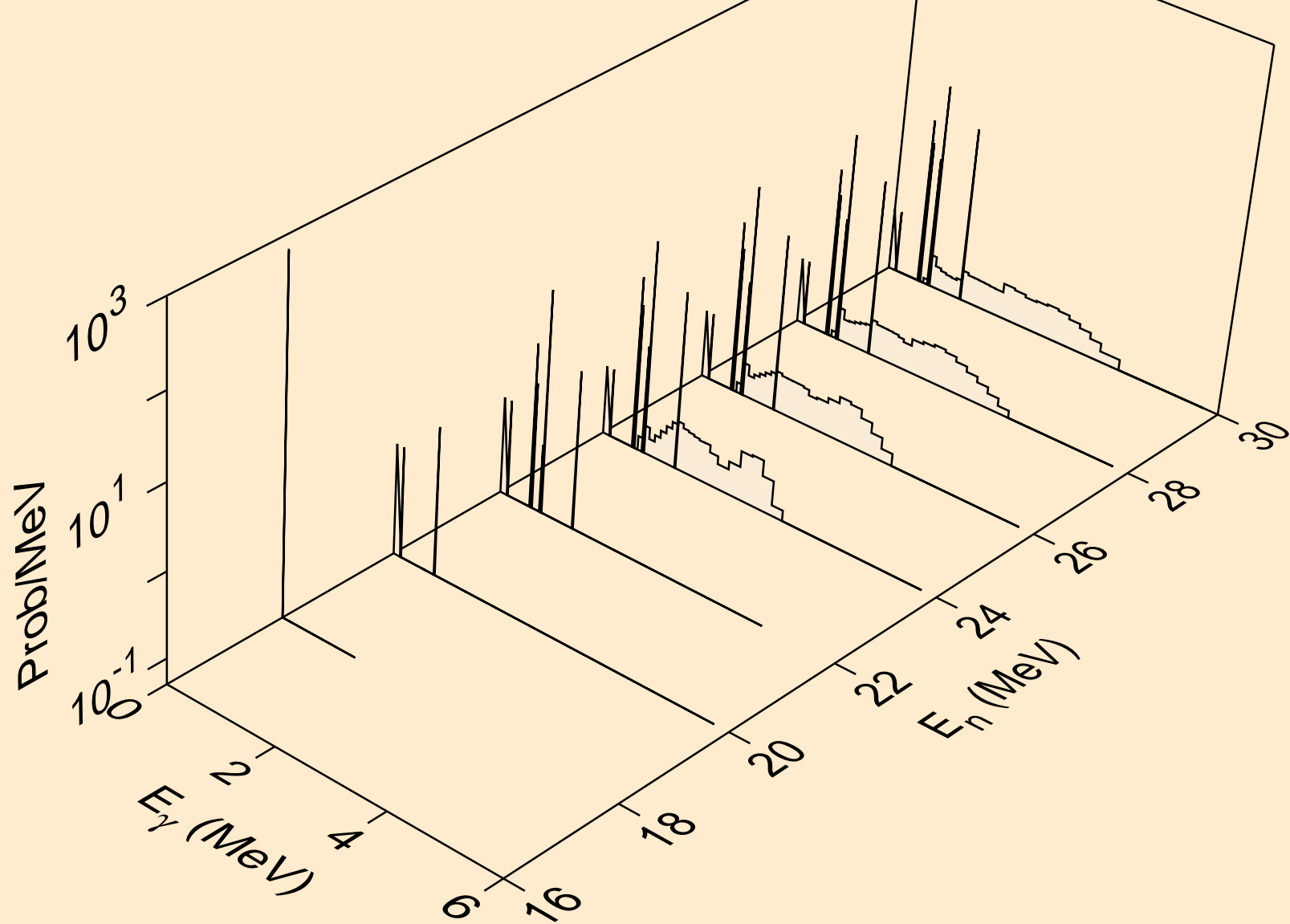

K043 NEUTRON ACER TENDL-2024 LIBRARY; T=0.K
Photon emission for (n,a)

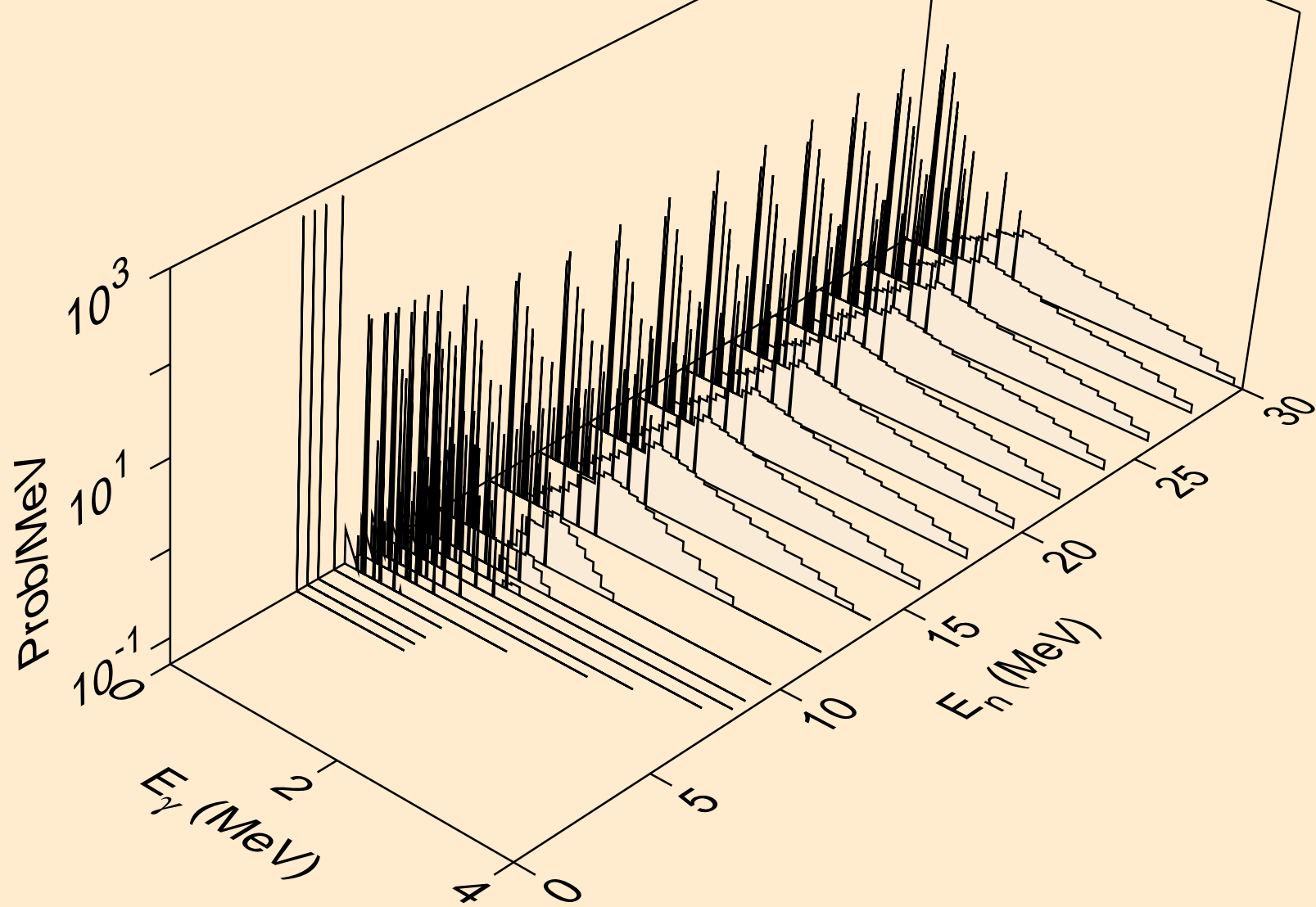

K043 NEUTRON ACER TENDL-2024 LIBRARY; T=0.K
Photon emission for (n,2a)

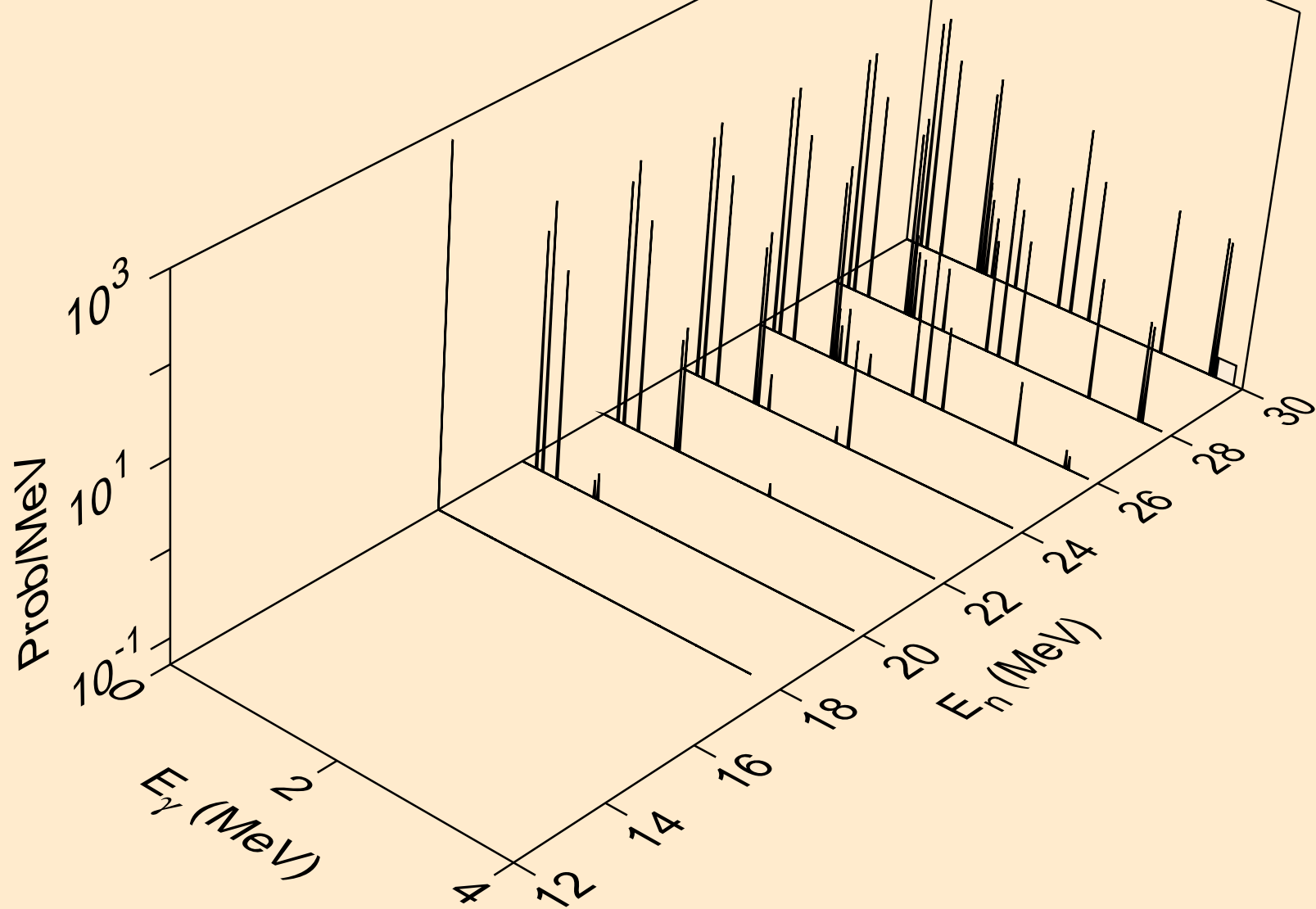

K043 NEUTRON ACER TENDL-2024 LIBRARY; T=0.K
Photon emission for (n,2p)

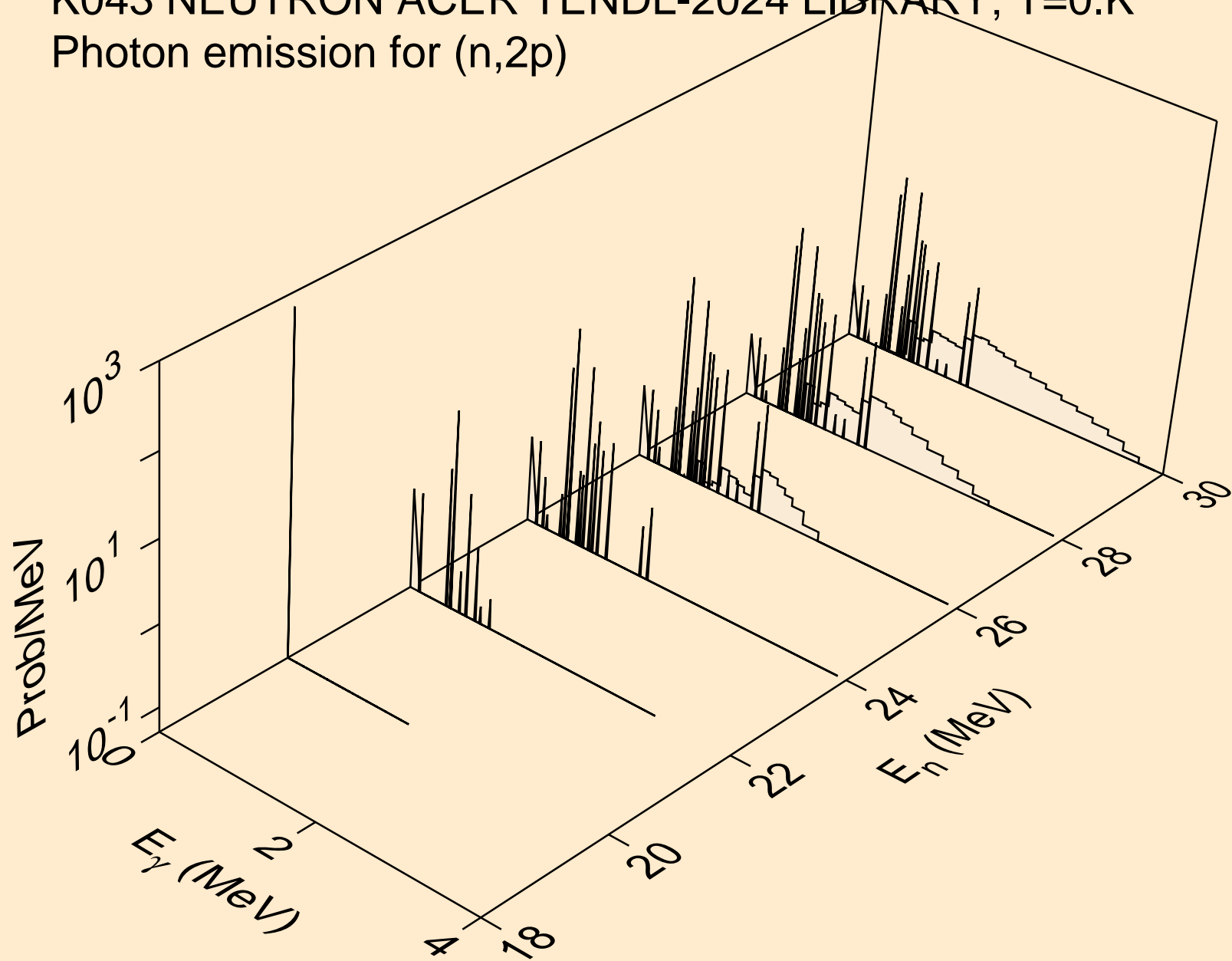

K043 NEUTRON ACER TENDL-2024 LIBRARY; T=0.K
Photon emission for (n,p α)

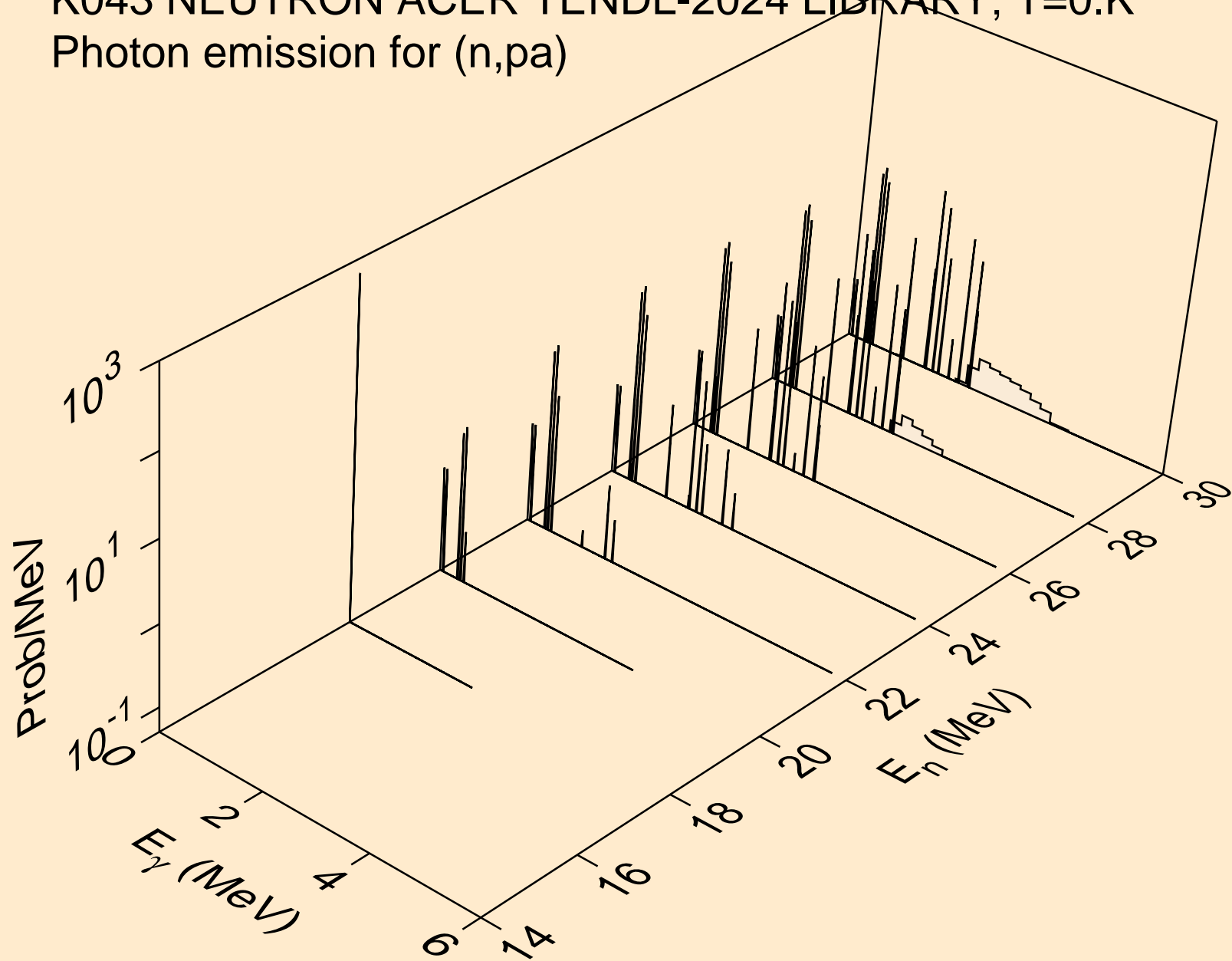

K043 NEUTRON ACER TENDL-2024 LIBRARY; T=0.K
Photon emission for (n,pd)

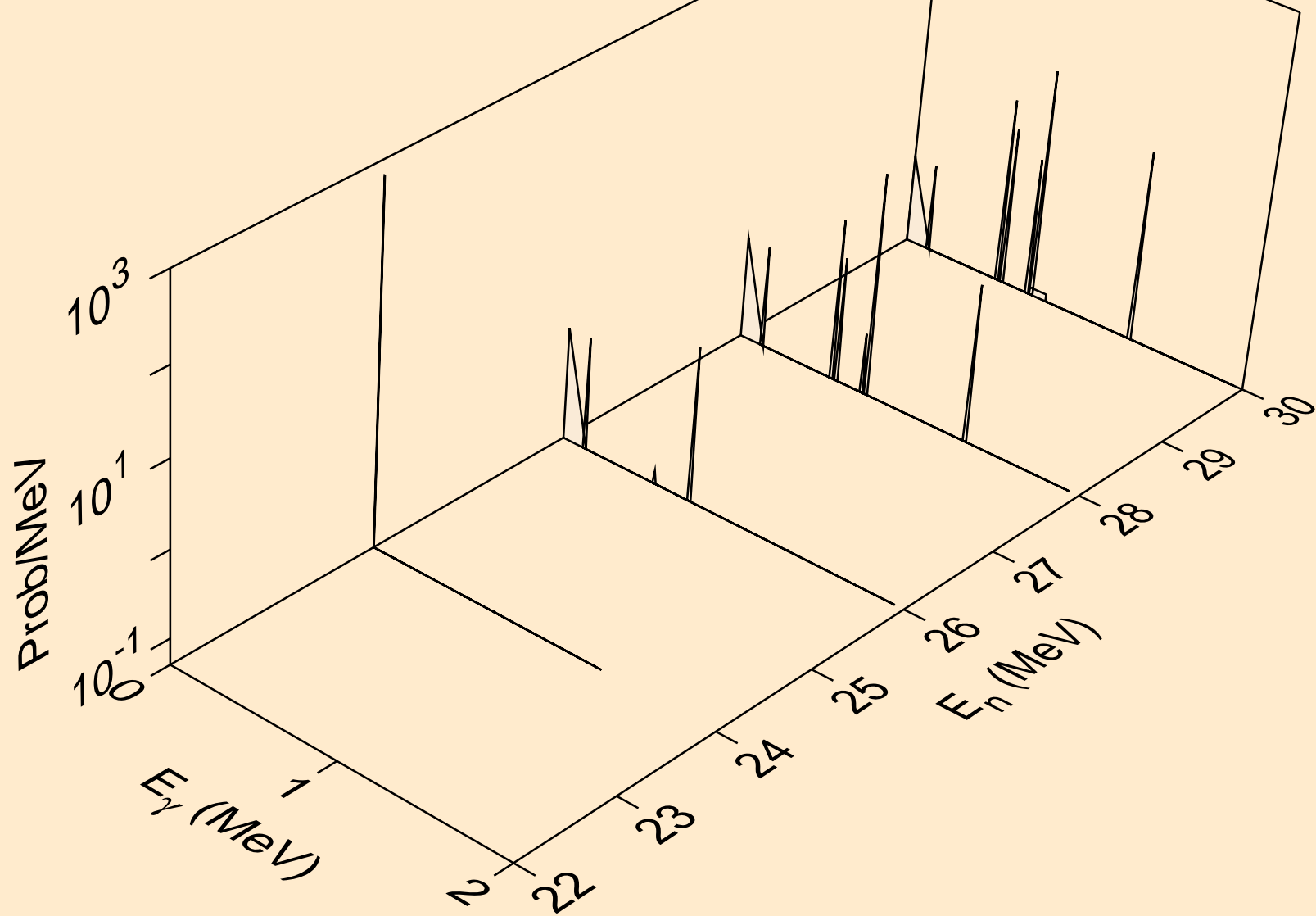

K043 NEUTRON ACER TENDL-2024 LIBRARY; T=0.K
Photon emission for (n,pt)

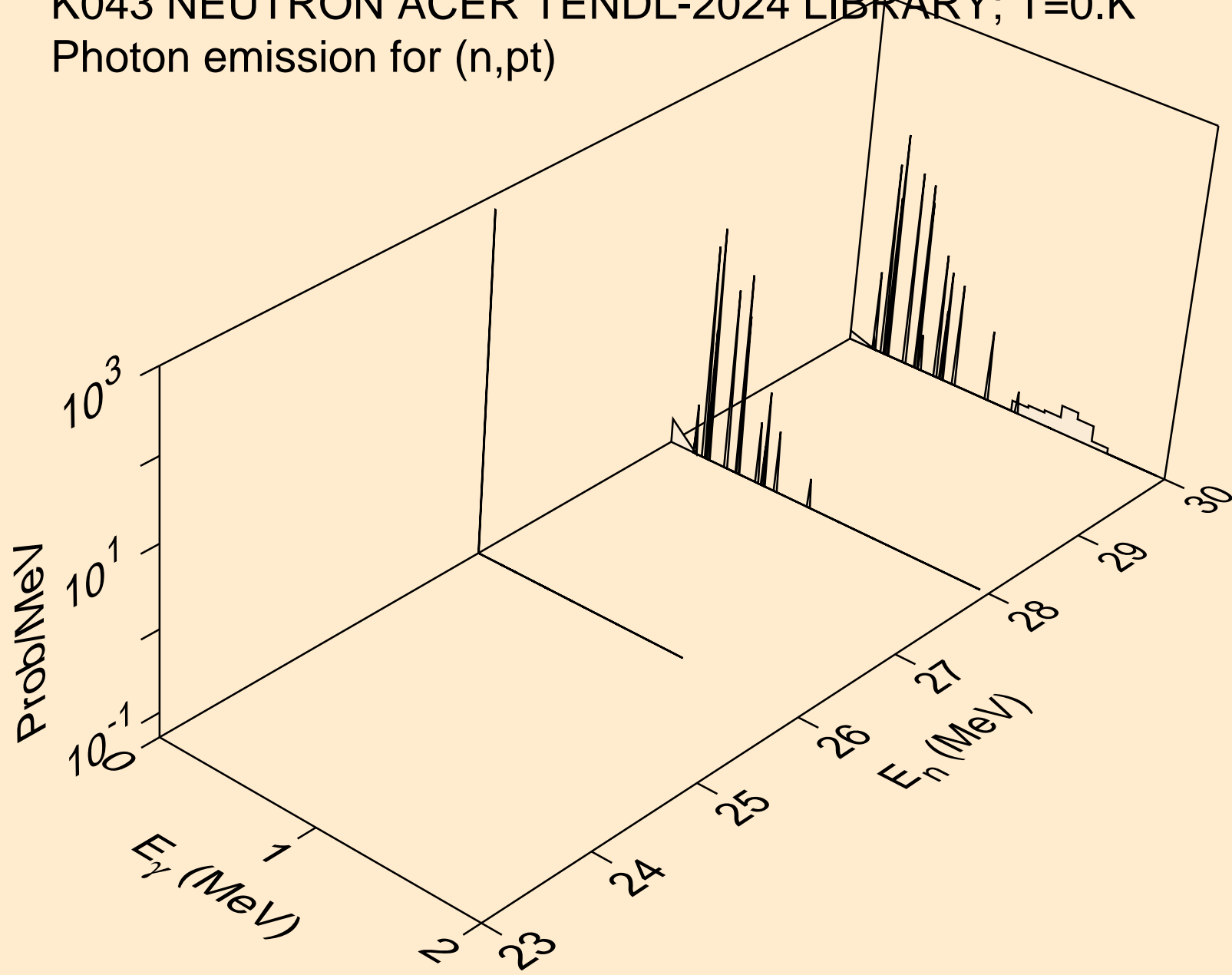

K043 NEUTRON ACER TENDL-2024 LIBRARY; T=0.K
Photon emission for (n,da)

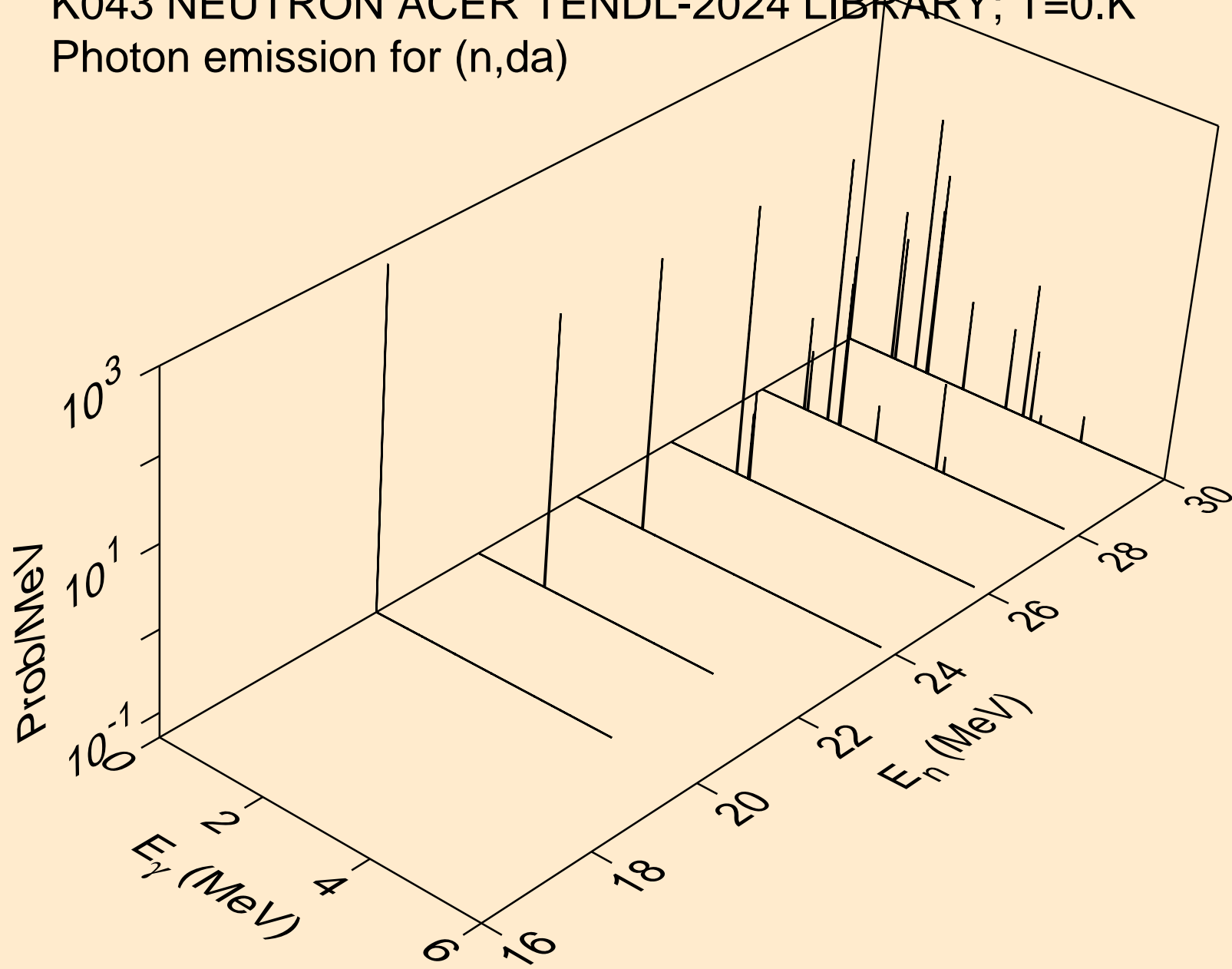

K043 NEUTRON ACER TENDL-2024 LIBRARY; T=0.K
thermal capture photon spectrum

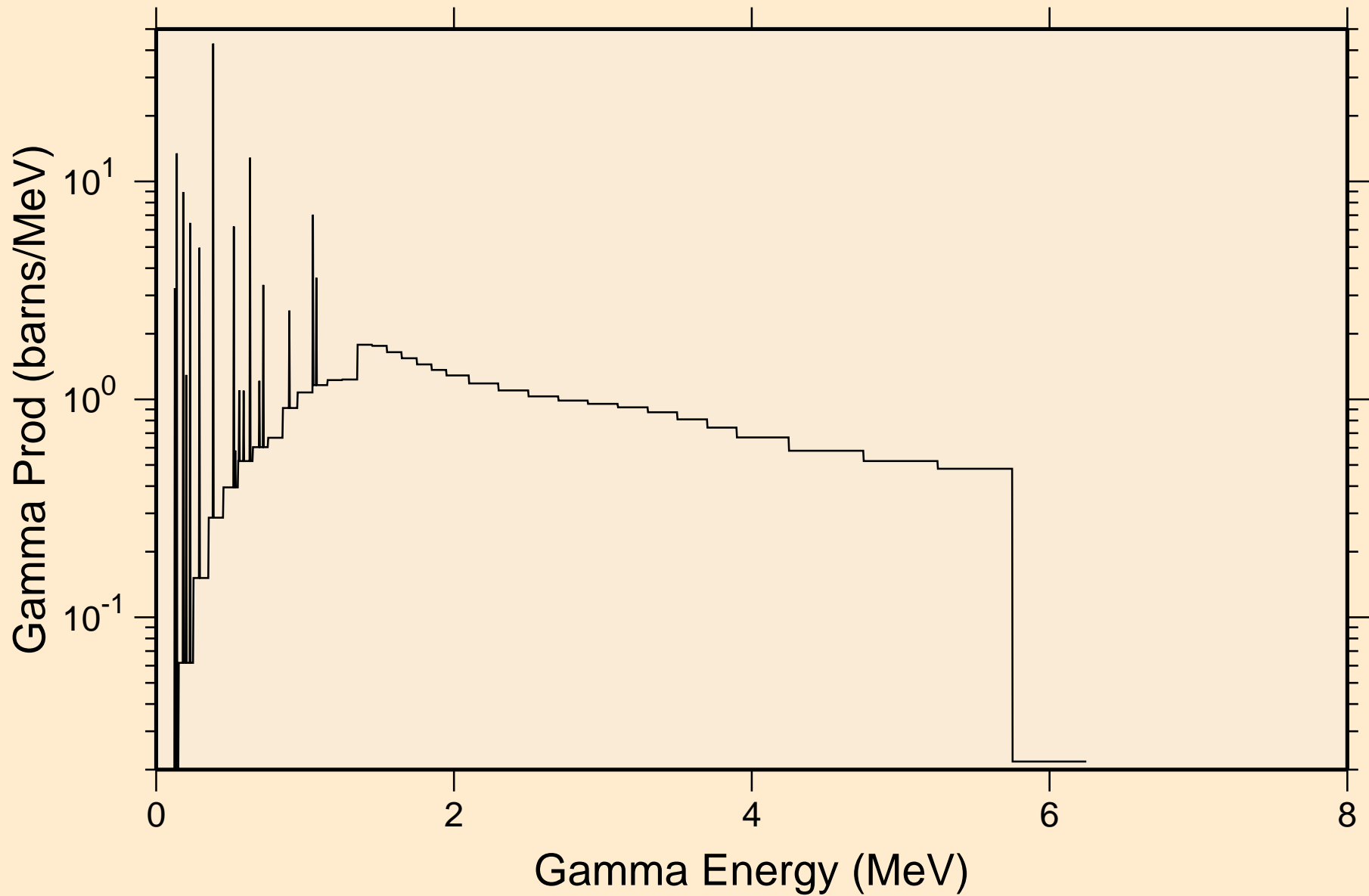

K043 NEUTRON ACER TENDL-2024 LIBRARY; T=0.K
14 MeV photon spectrum

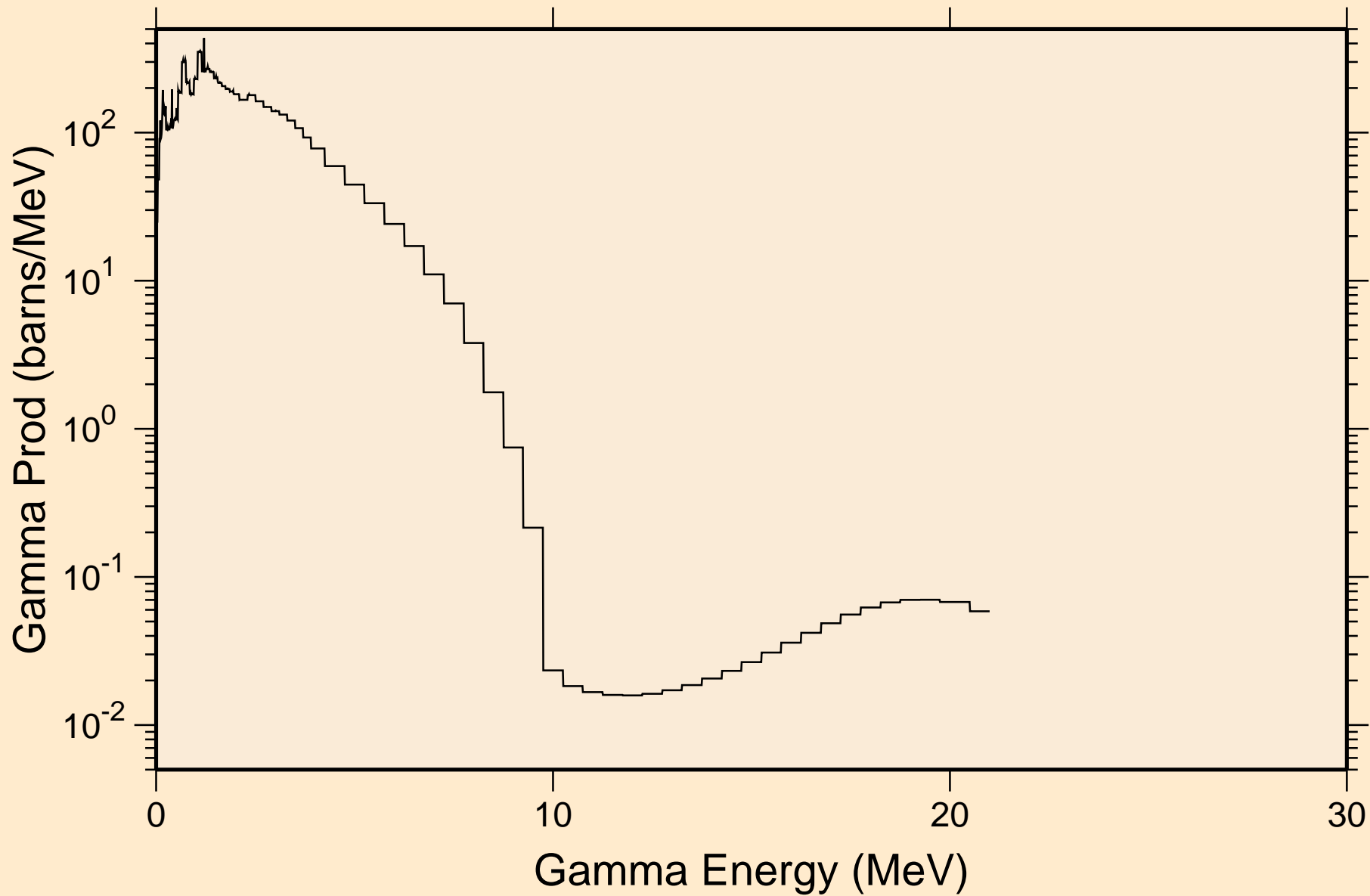

K043 NEUTRON ACER TENDL-2024 LIBRARY; T=0.K

Particle heating contributions

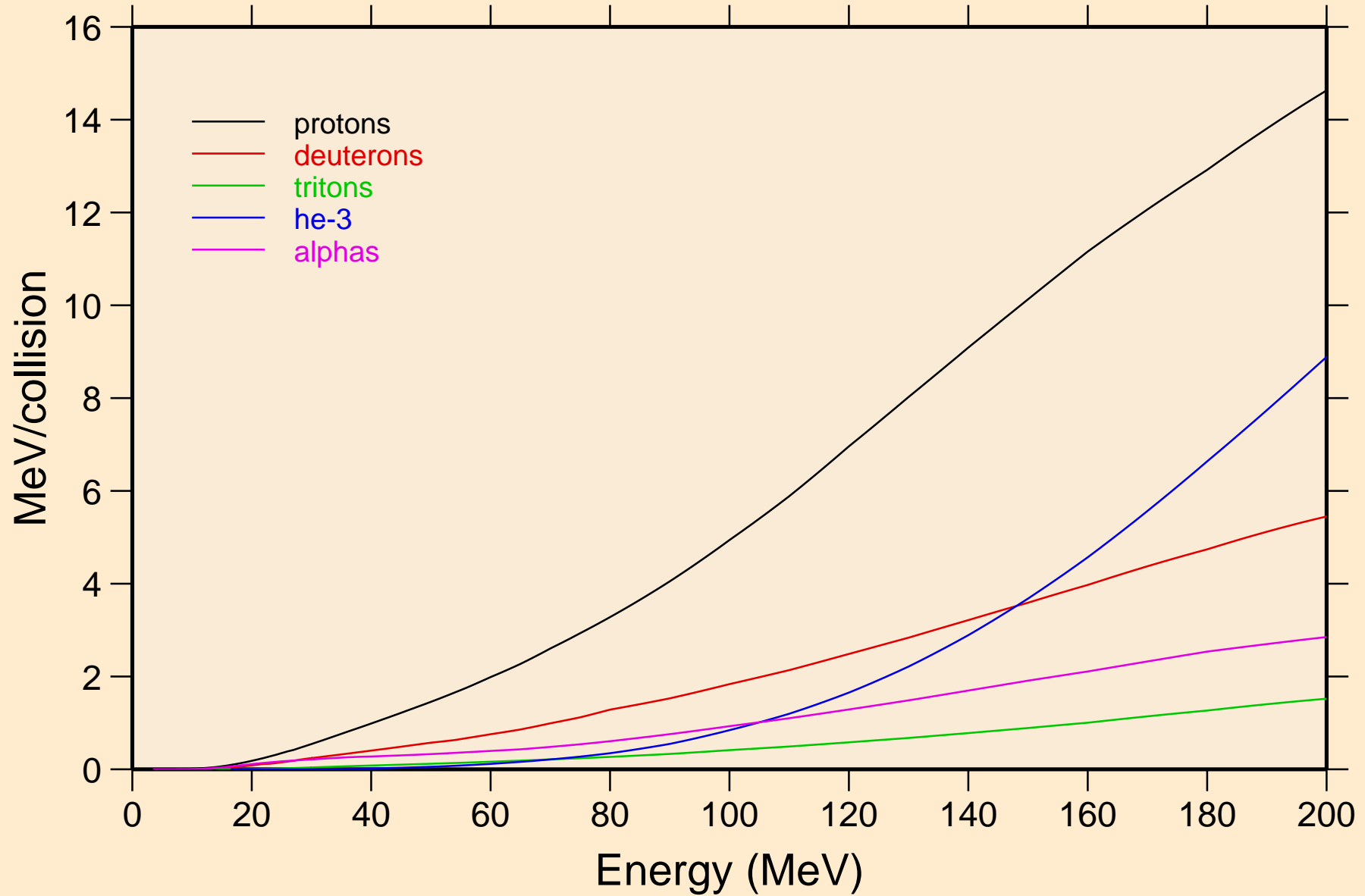

K043 NEUTRON ACER TENDL-2024 LIBRARY; T=0.K
Recoil Heating

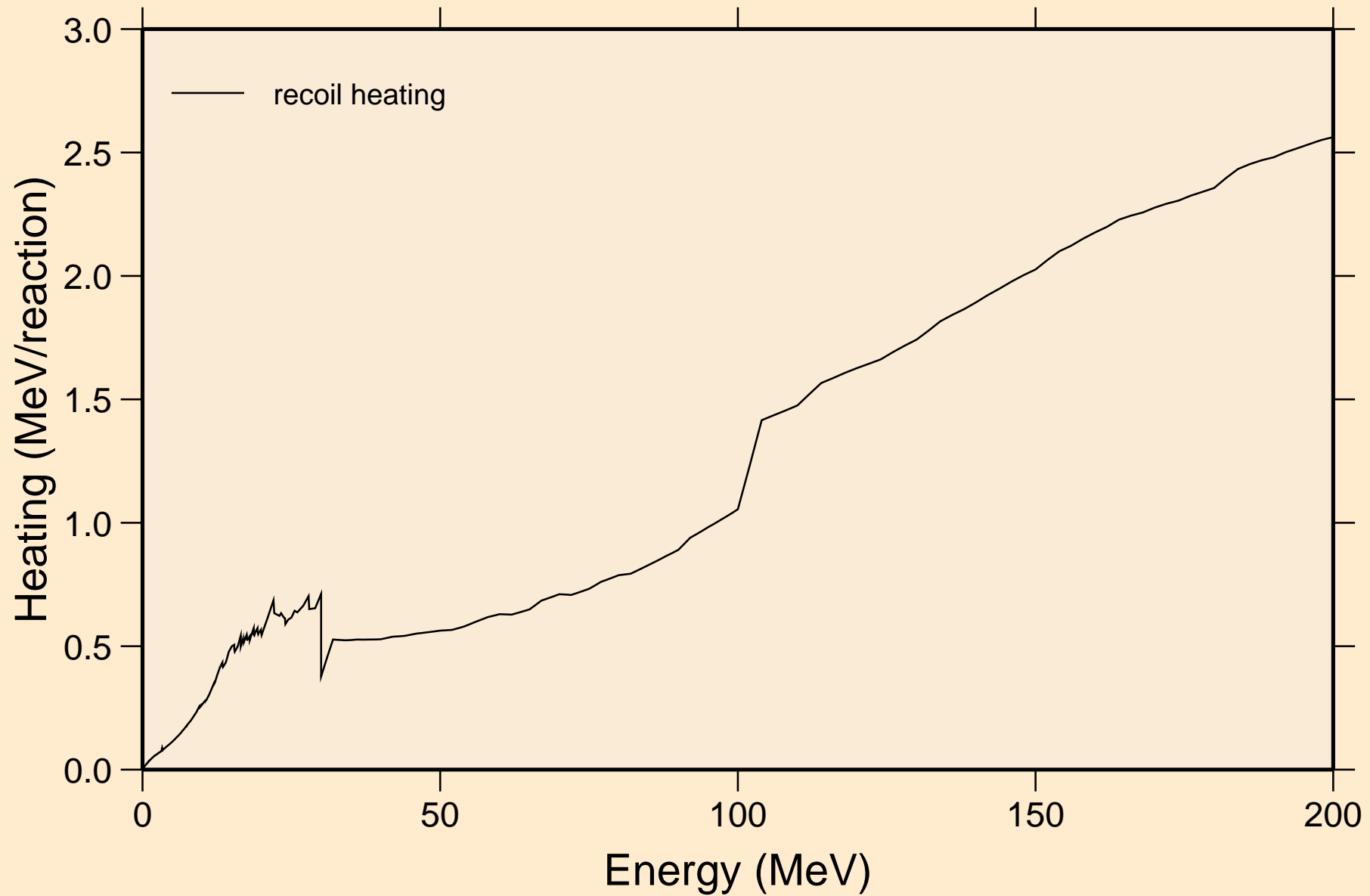

K043 NEUTRON ACER TENDL-2024 LIBRARY; T=0.K

Particle production cross sections

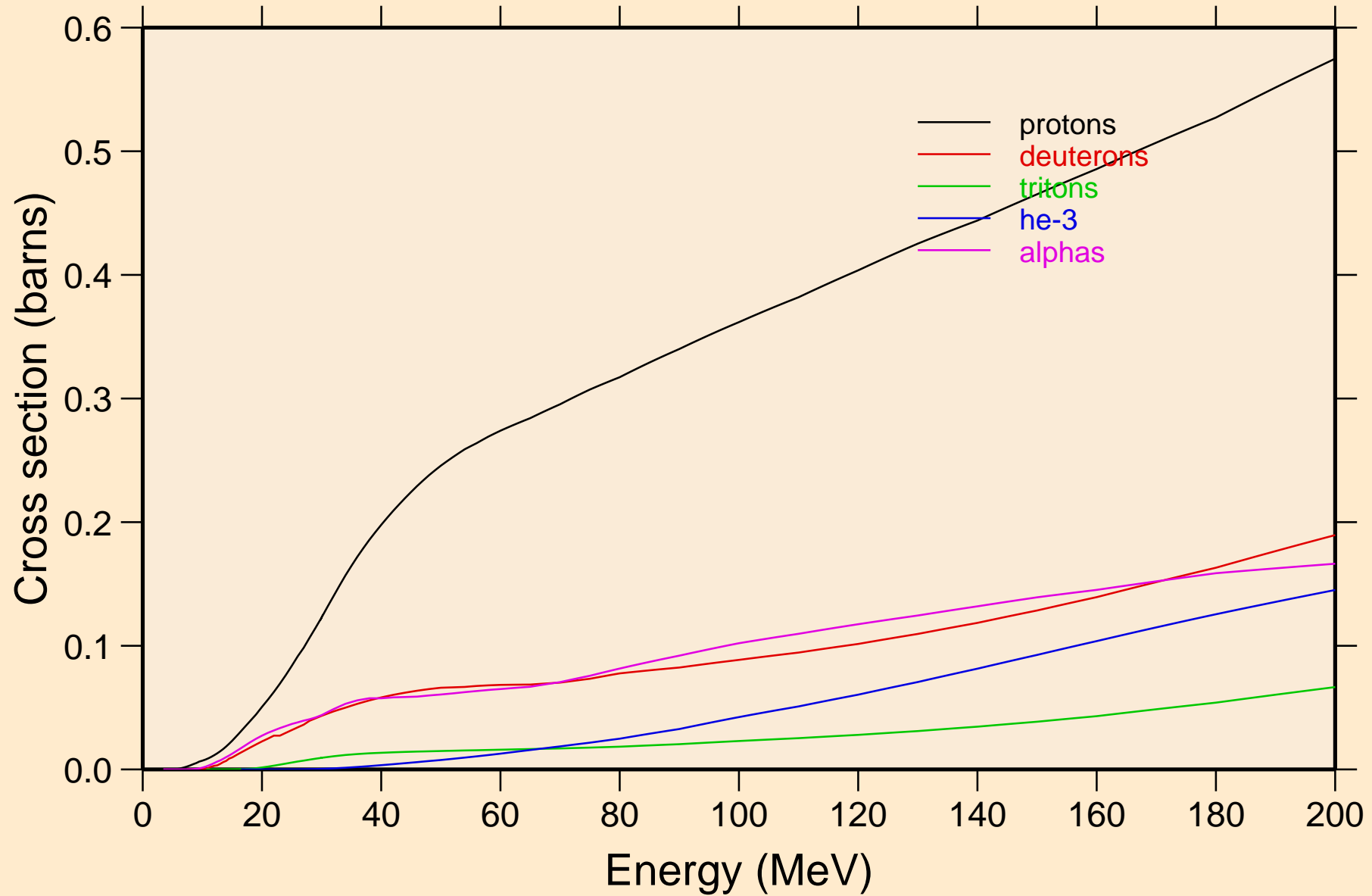

K043 NEUTRON ACER TENDL-2024 LIBRARY; T=0.K
protons from (n,x)

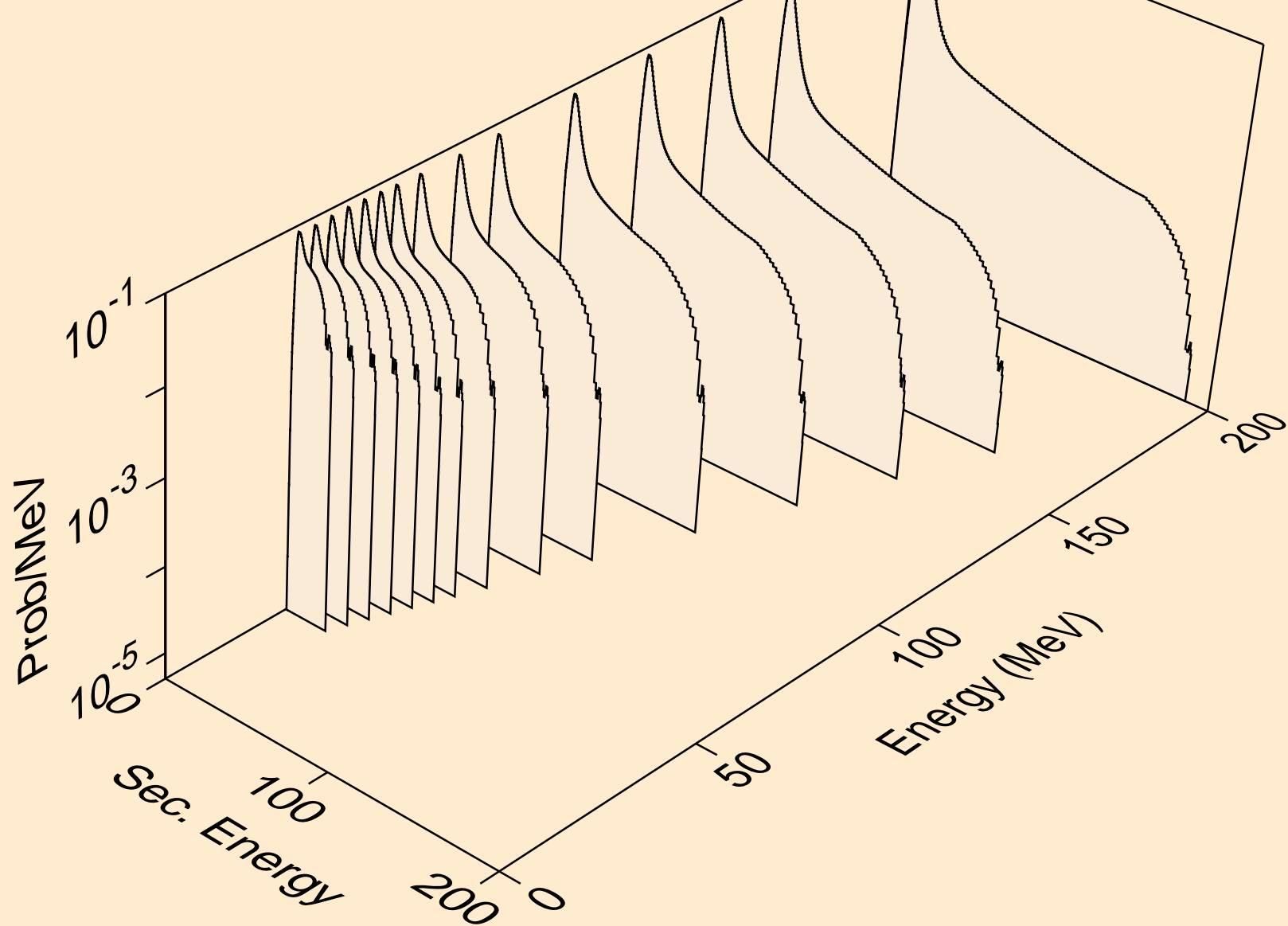

K043 NEUTRON ACER TENDL-2024 LIBRARY; T=0.K
protons from (n,n*)p

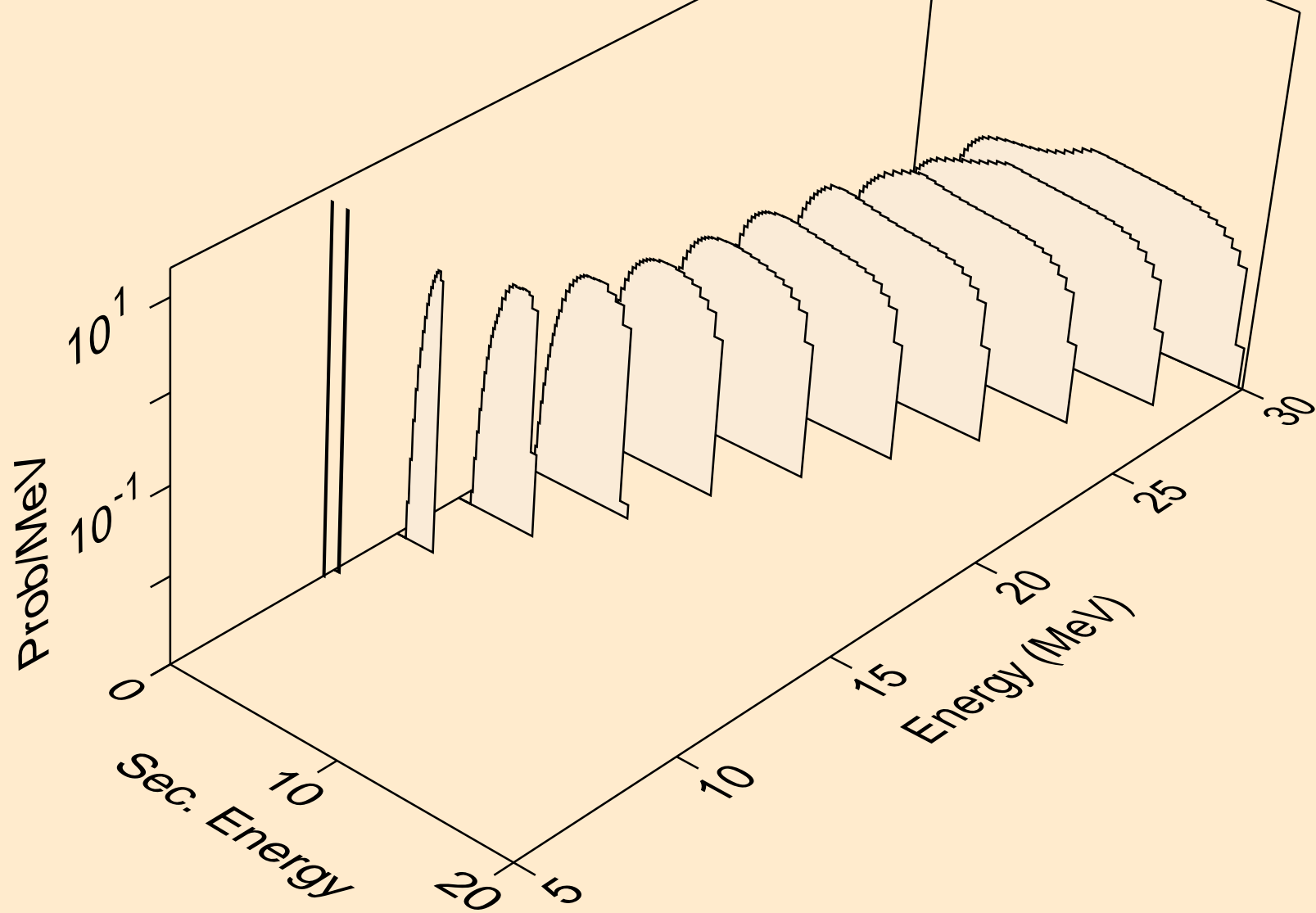

K043 NEUTRON ACER TENDL-2024 LIBRARY; T=0.K
protons from (n,2np)

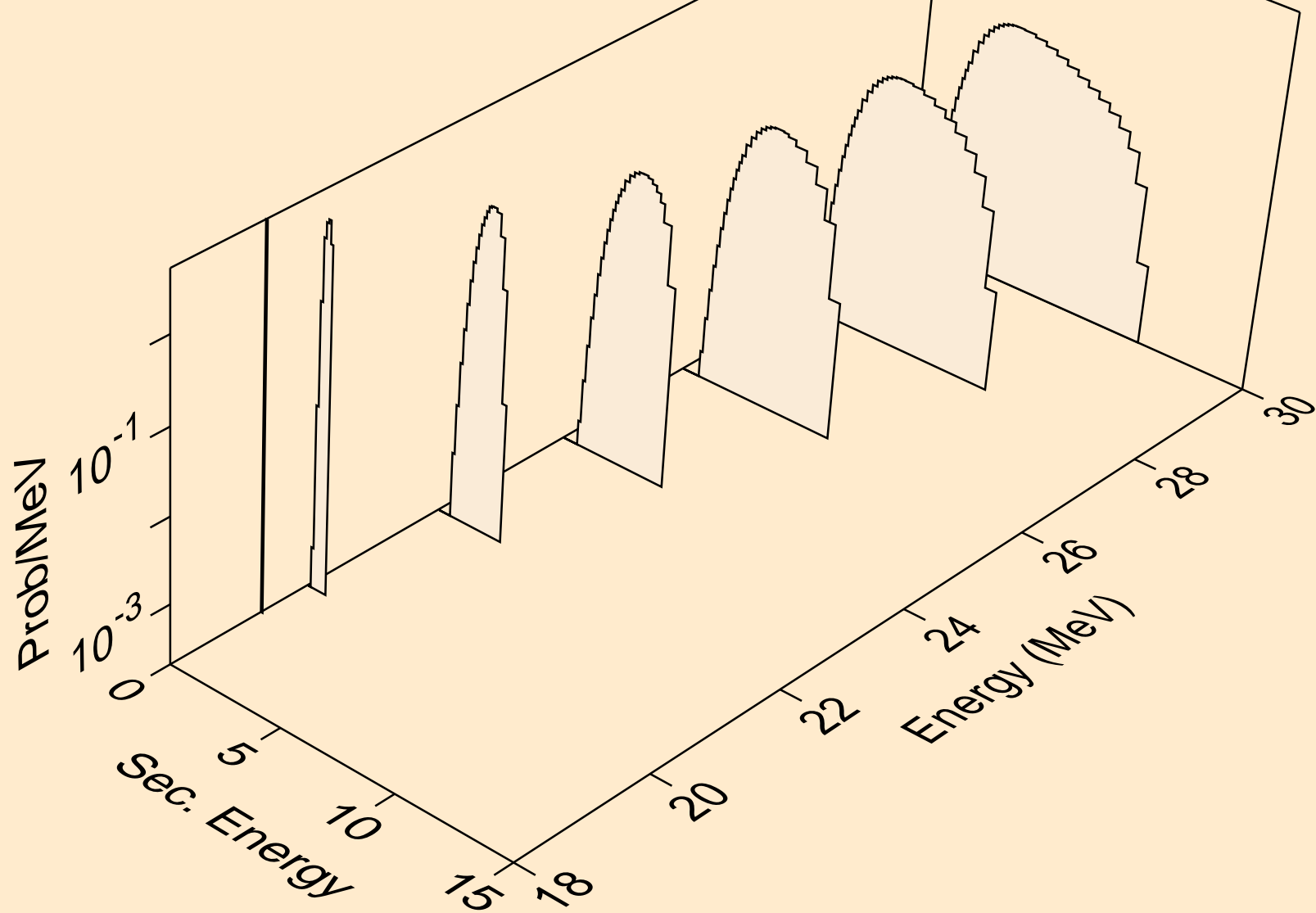

K043 NEUTRON ACER TENDL-2024 LIBRARY; T=0.K
protons from (n,3np)

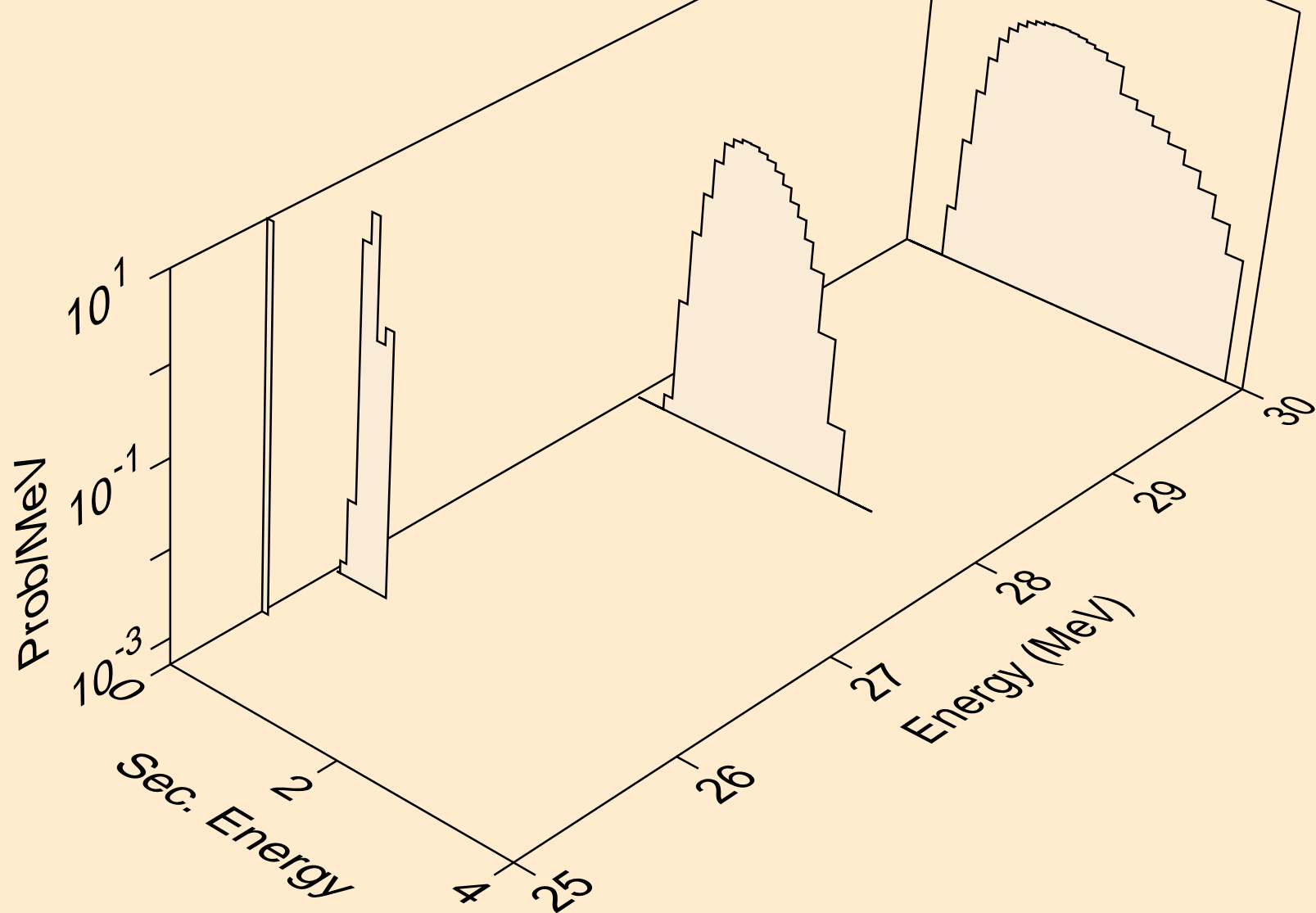

K043 NEUTRON ACER TENDL-2024 LIBRARY; T=0.K
protons from (n,n2p)

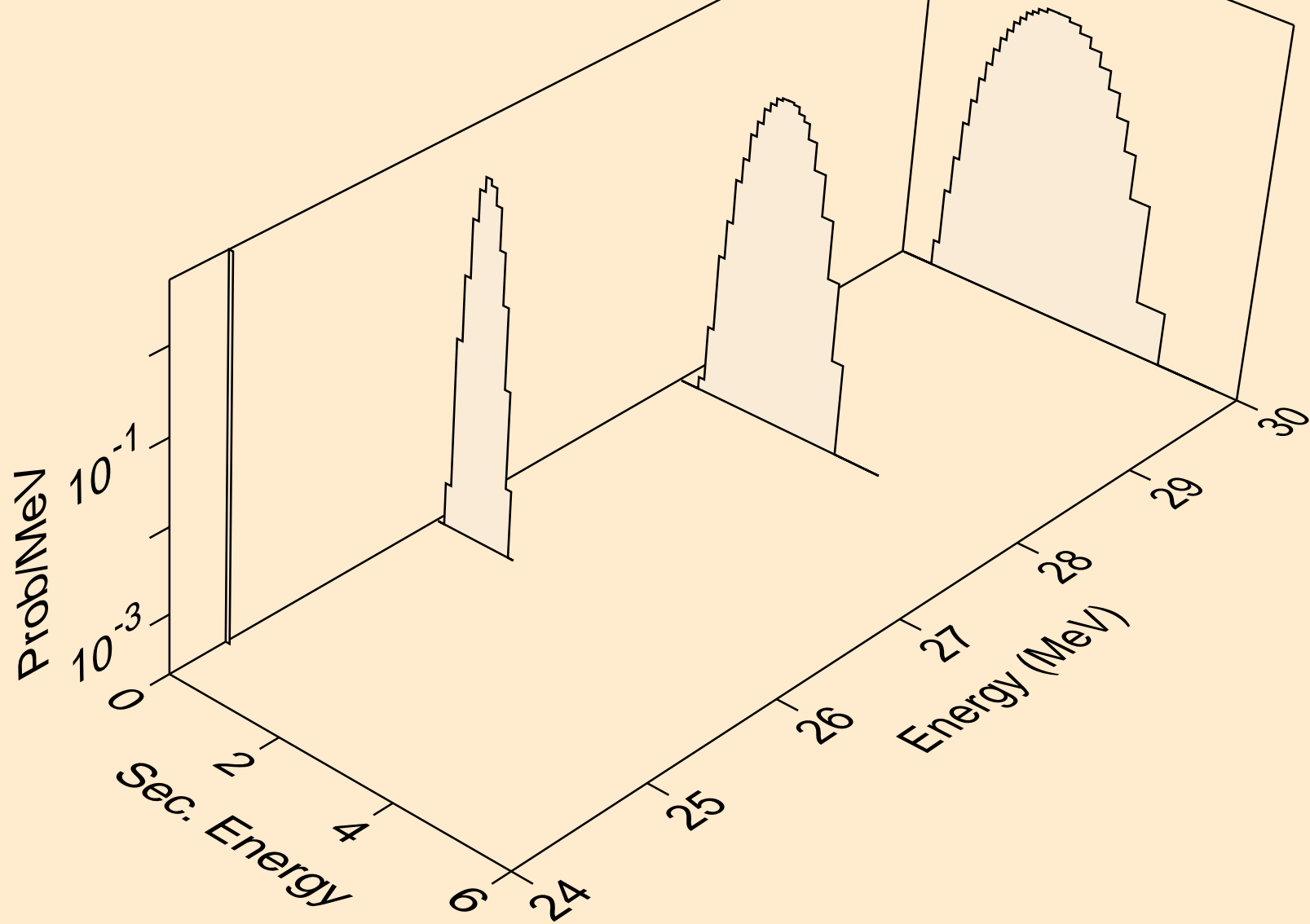

K043 NEUTRON ACER TENDL-2024 LIBRARY; T=0.K
protons from (n,npa)

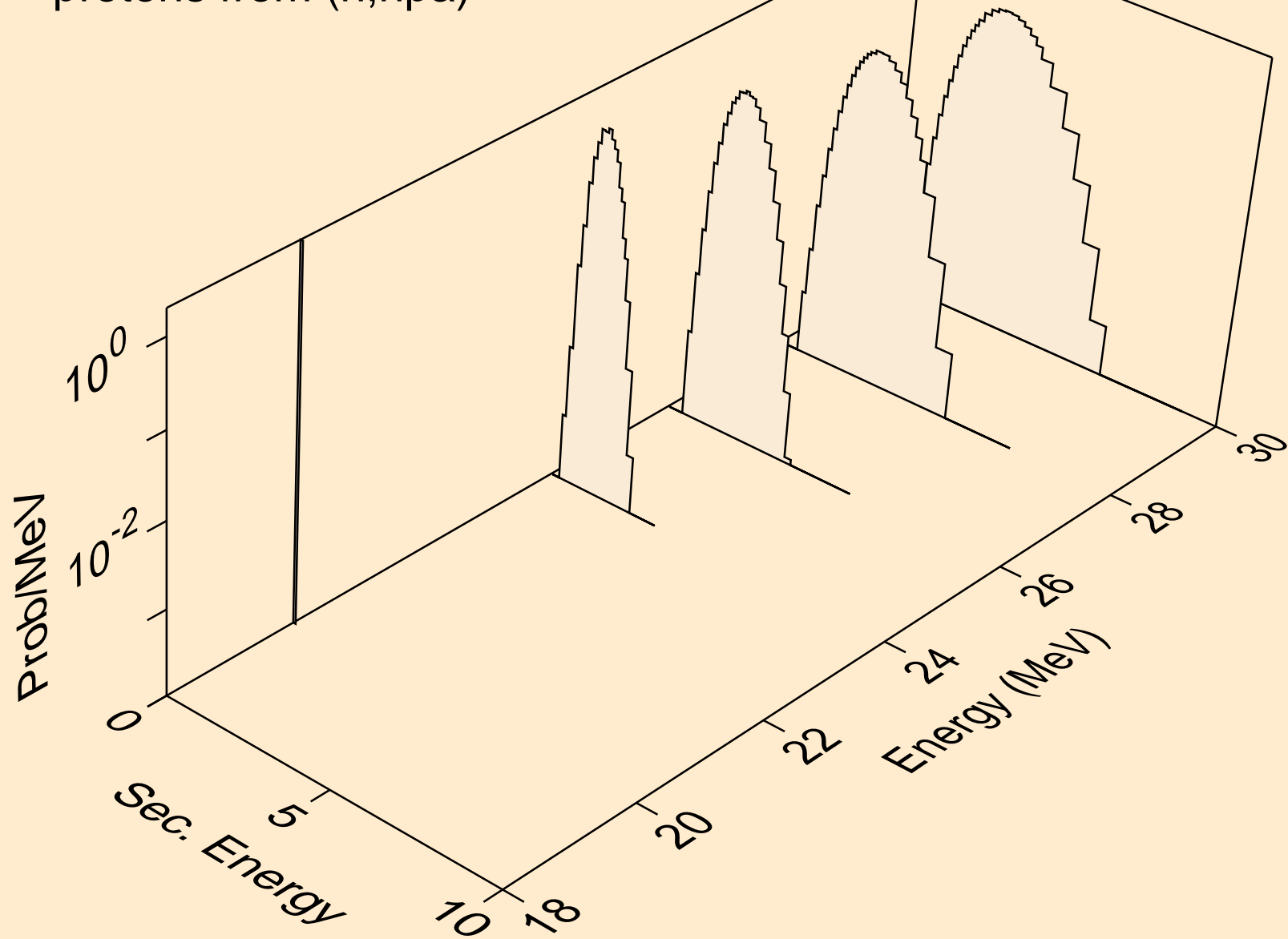

K043 NEUTRON ACER TENDL-2024 LIBRARY; T=0.K
protons from (n,p)

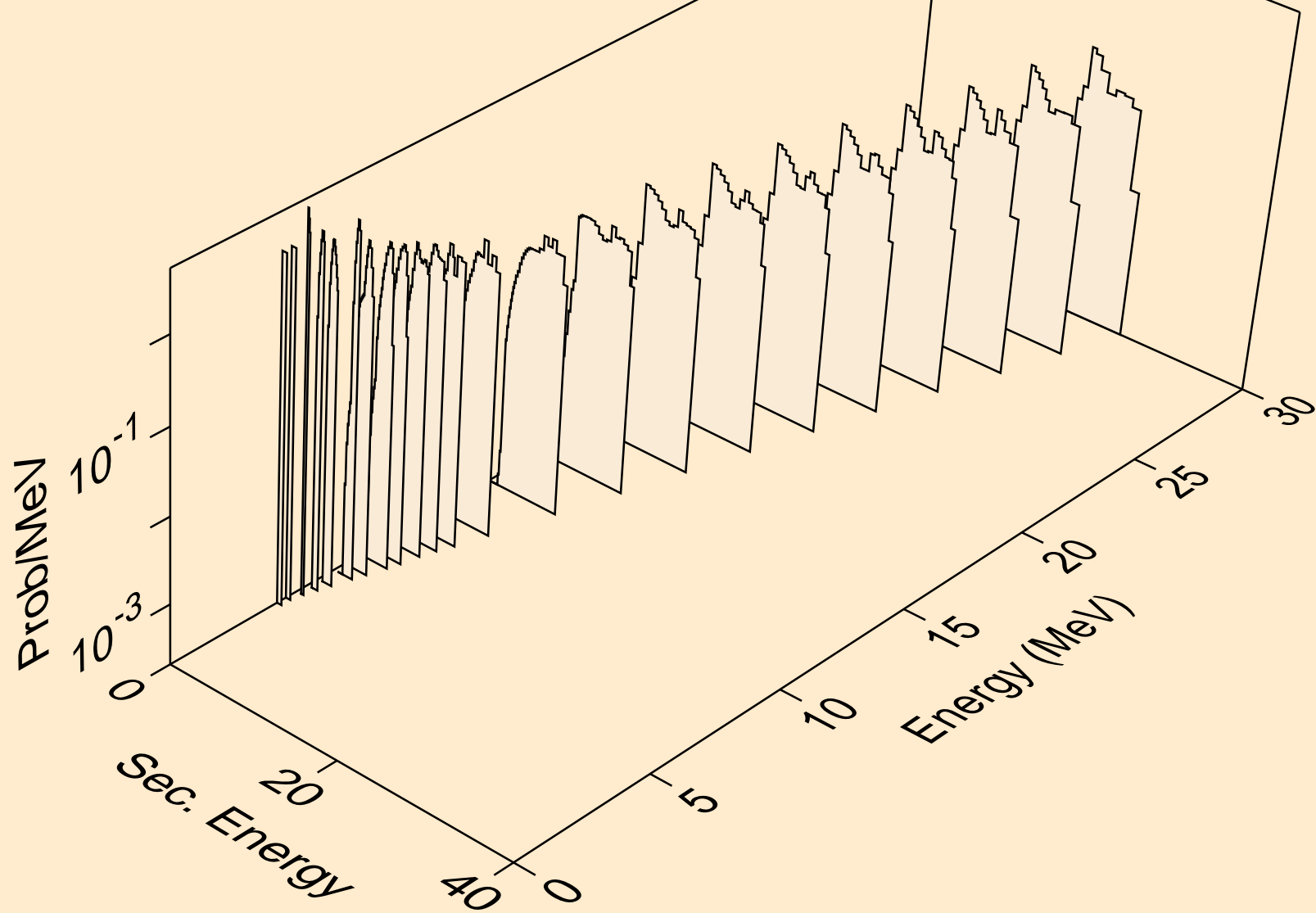

K043 NEUTRON ACER TENDL-2024 LIBRARY; T=0.K
protons from (n,2p)

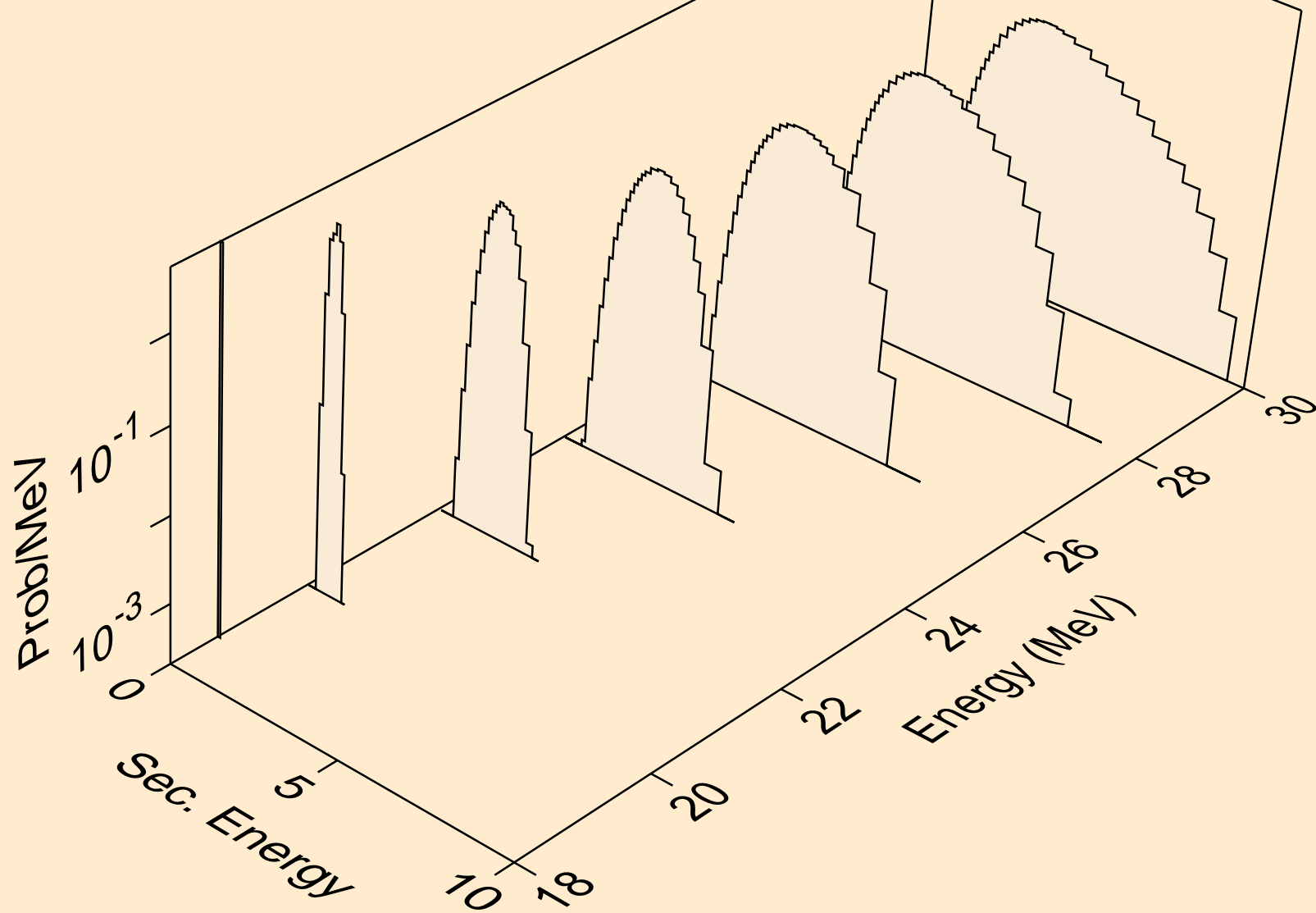

K043 NEUTRON ACER TENDL-2024 LIBRARY; T=0.K
protons from (n,pa)

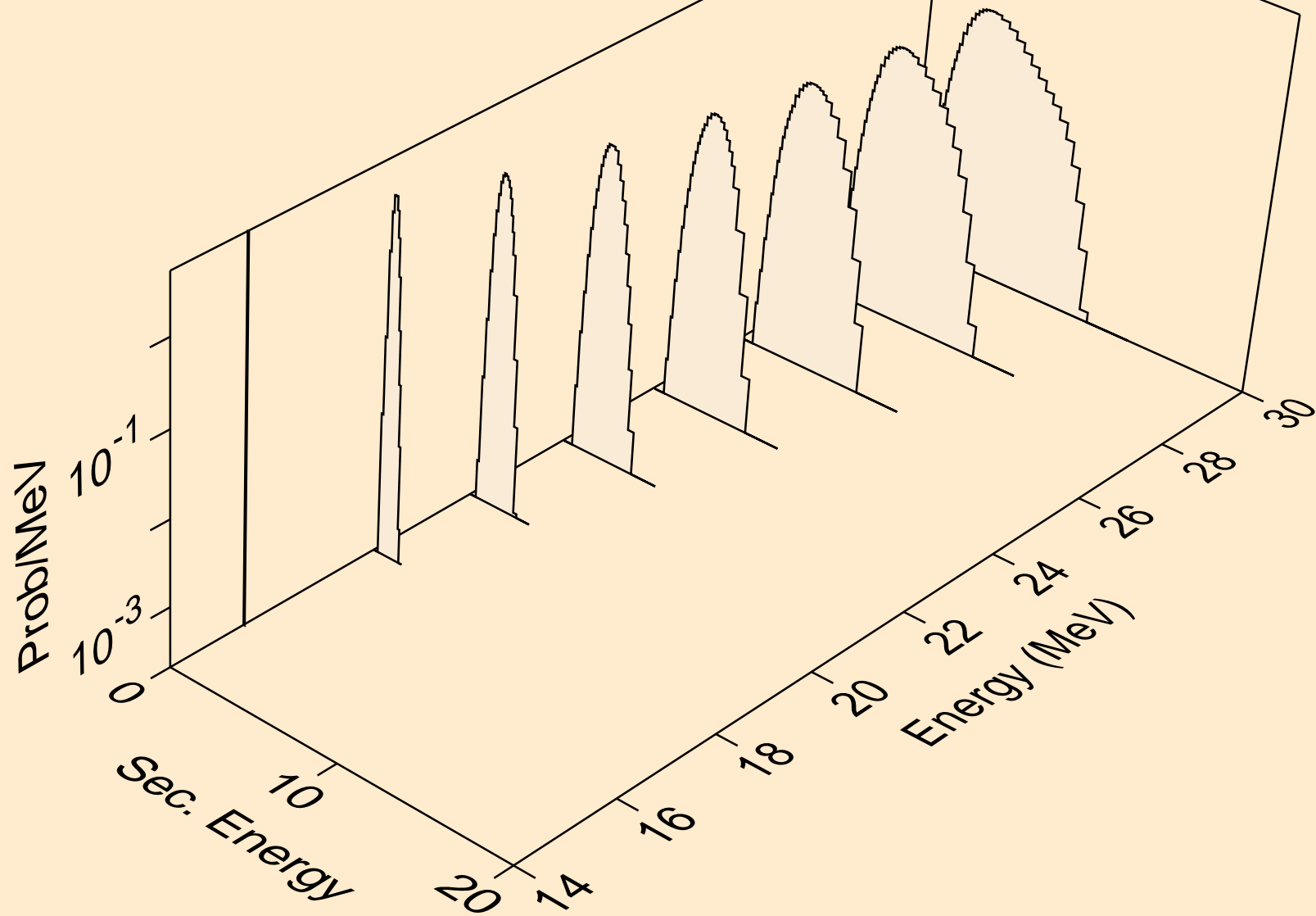

K043 NEUTRON ACER TENDL-2024 LIBRARY; T=0.K
protons from (n,pd)

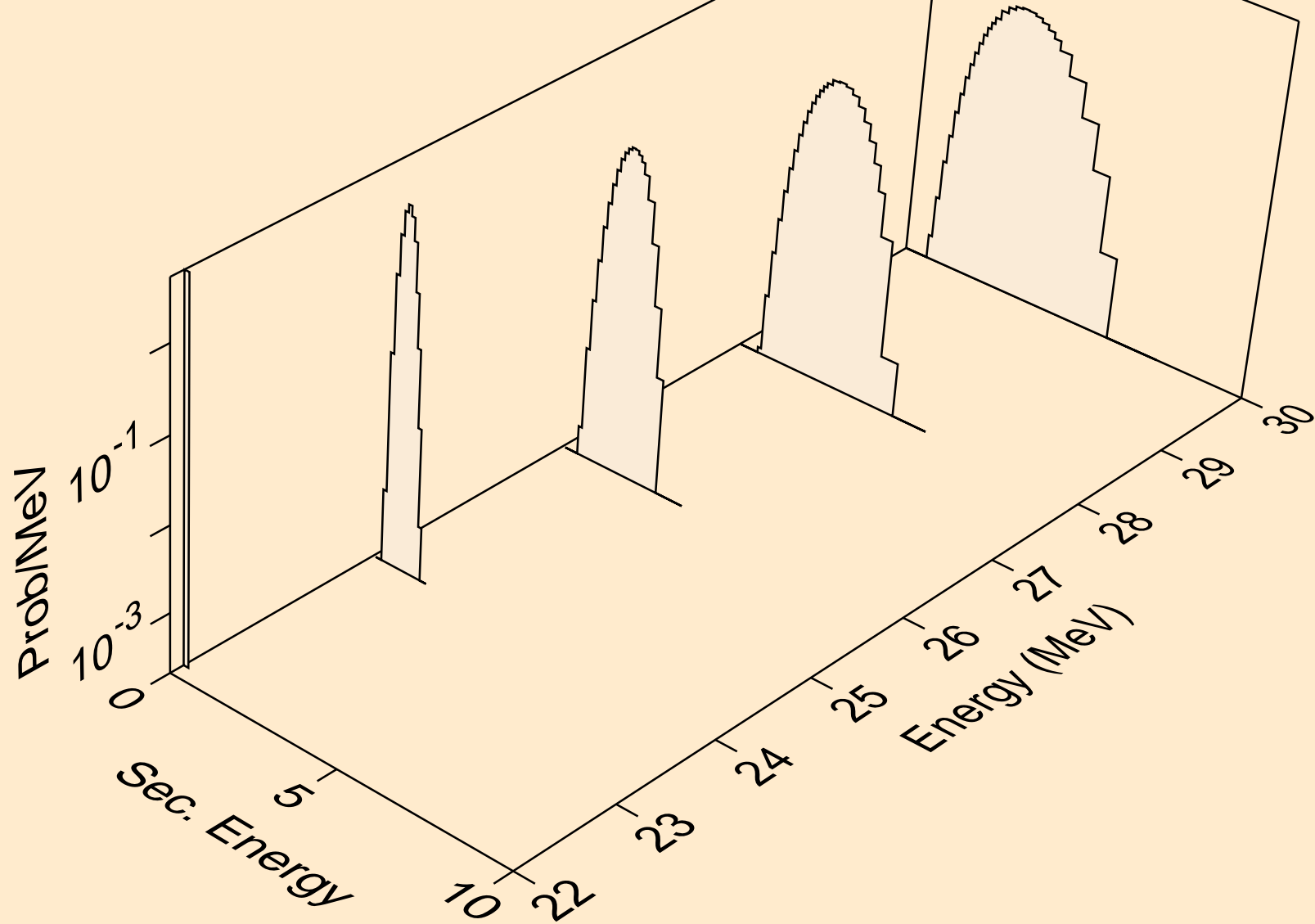

K043 NEUTRON ACER TENDL-2024 LIBRARY; T=0.K
protons from (n,pt)

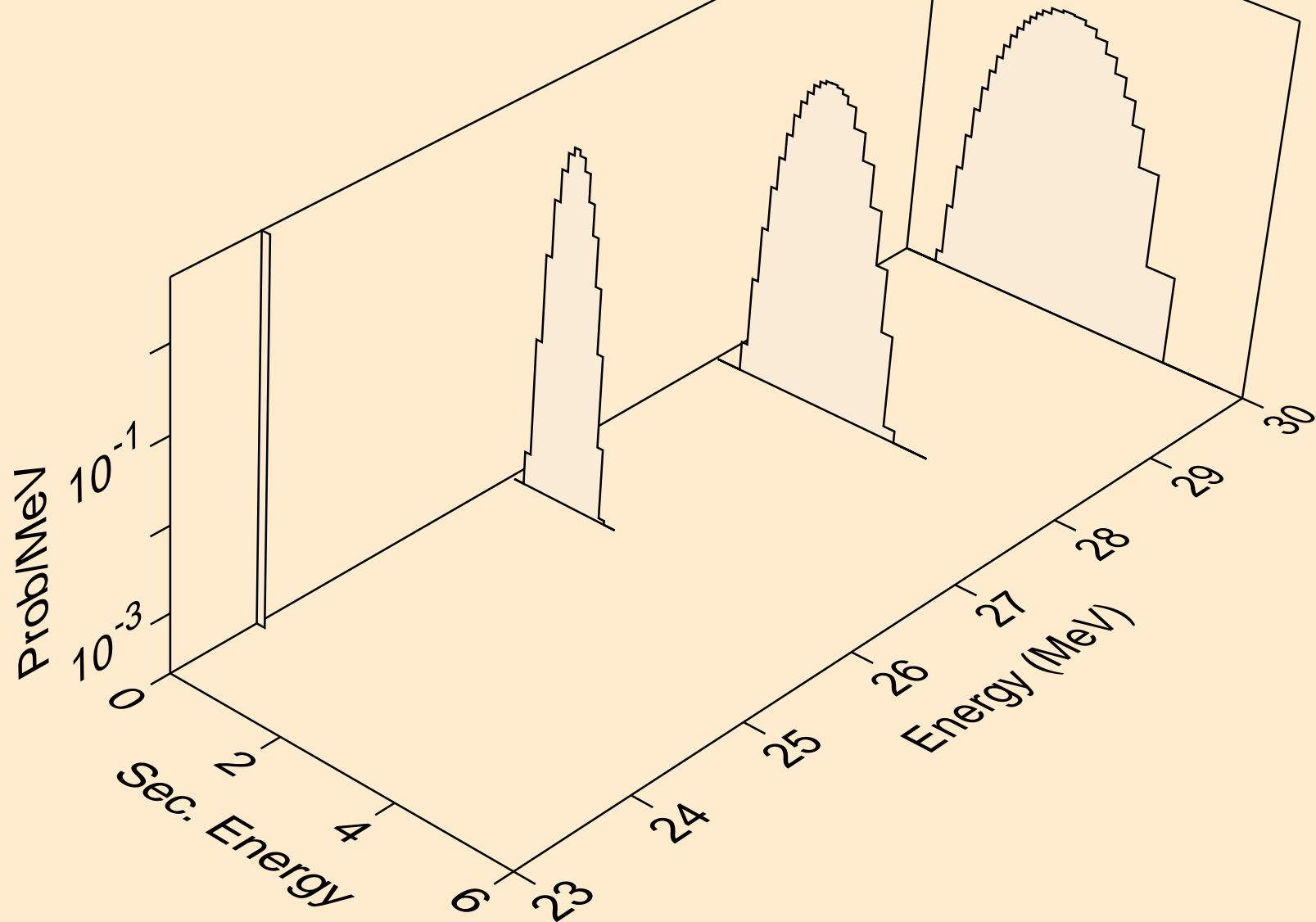

K043 NEUTRON ACER TENDL-2024 LIBRARY; T=0.K
deuterons from (n,x)

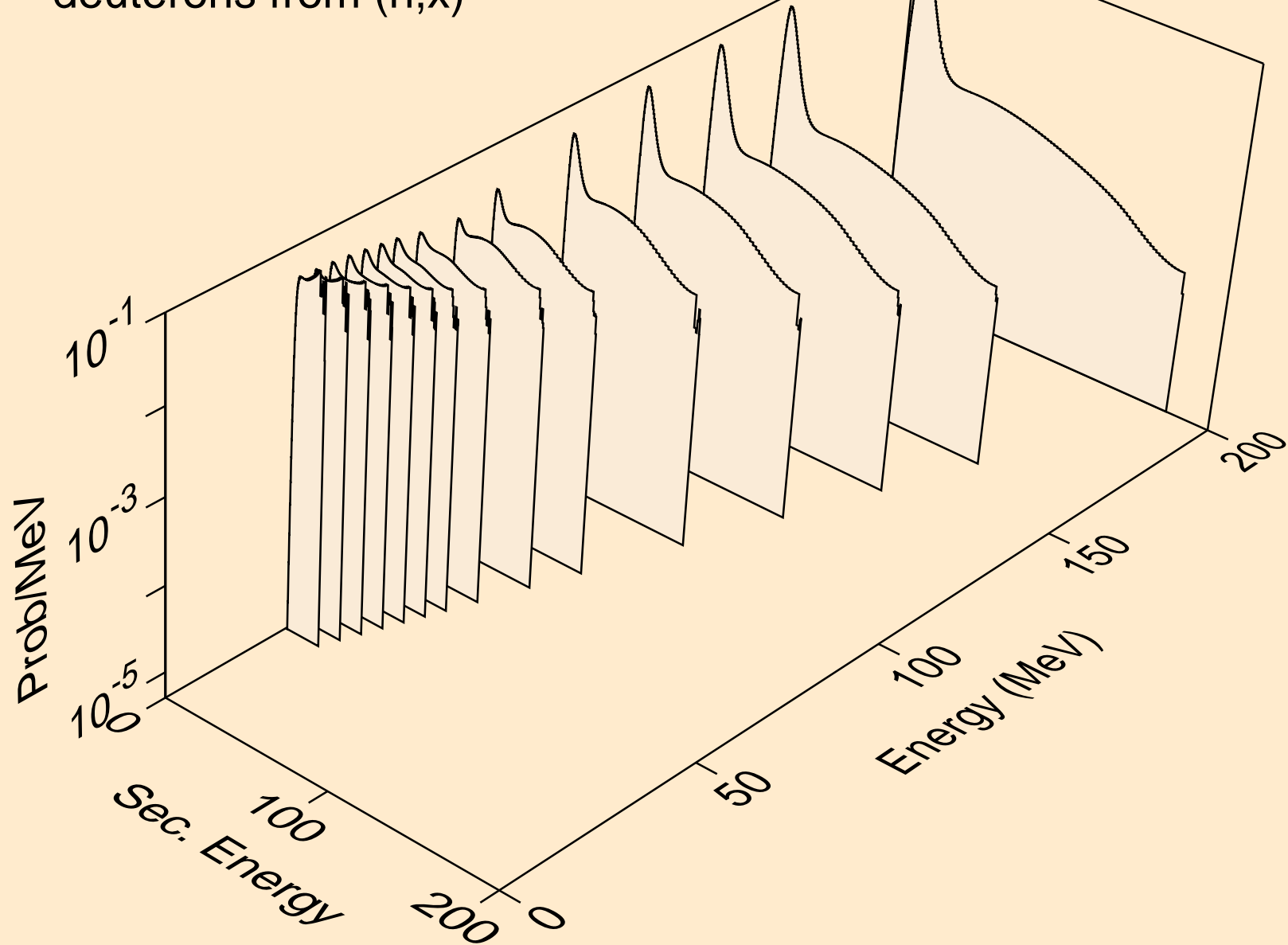

K043 NEUTRON ACER TENDL-2024 LIBRARY; T=0.K
deuterons from (n,2nd)

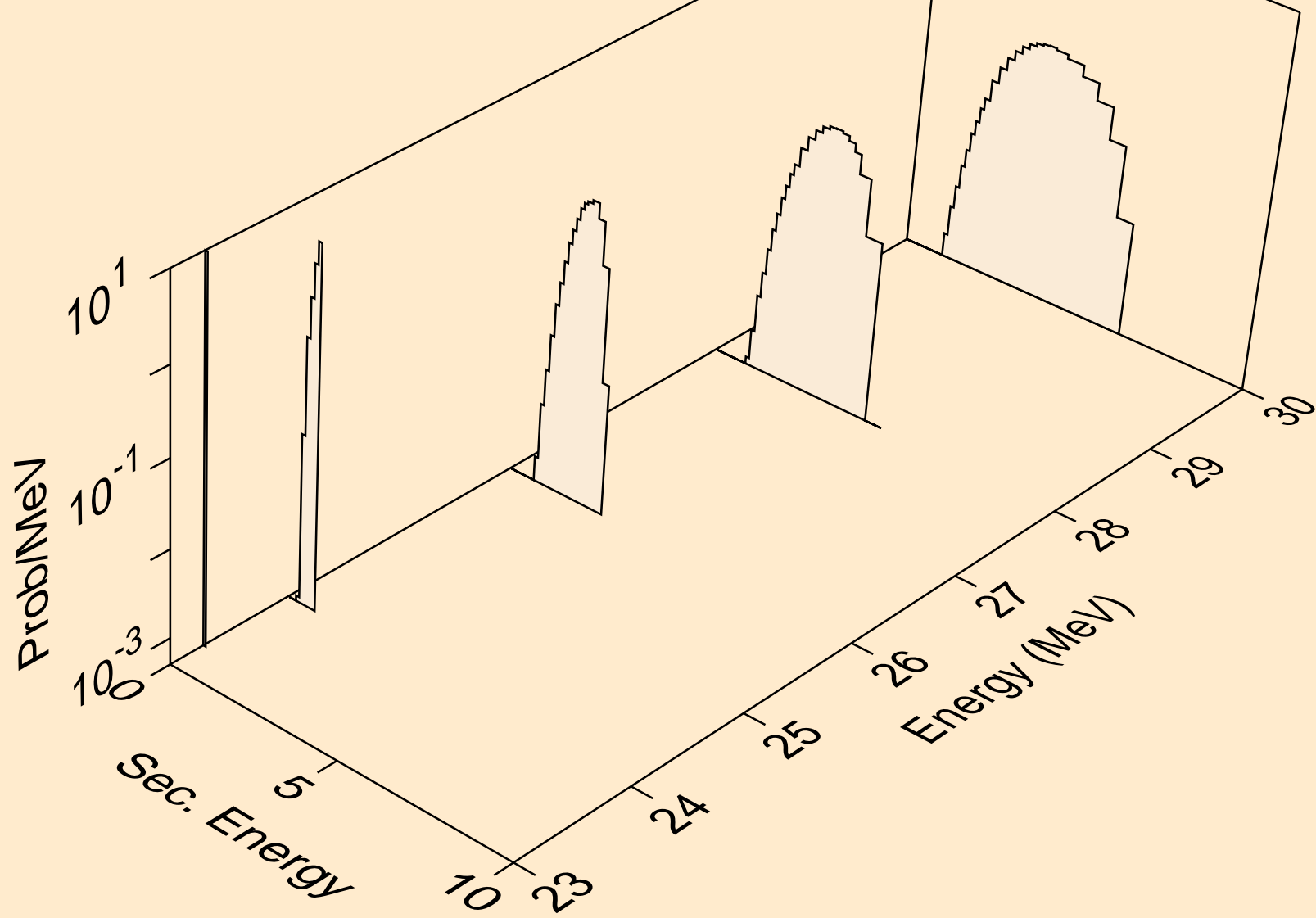

K043 NEUTRON ACER TENDL-2024 LIBRARY; T=0.K
deuterons from (n,n*)d

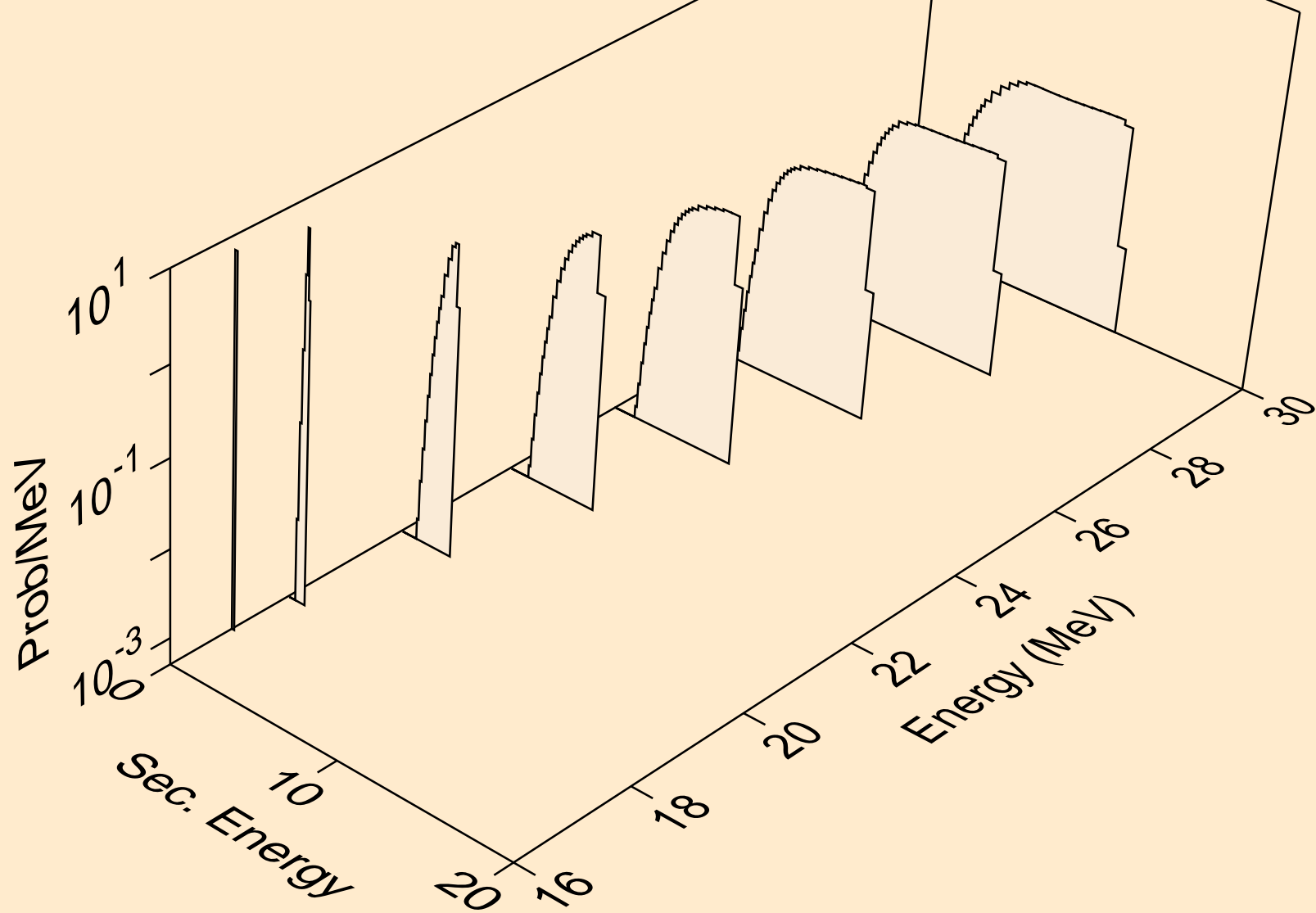

K043 NEUTRON ACER TENDL-2024 LIBRARY; T=0.K
deuterons from (n,d)

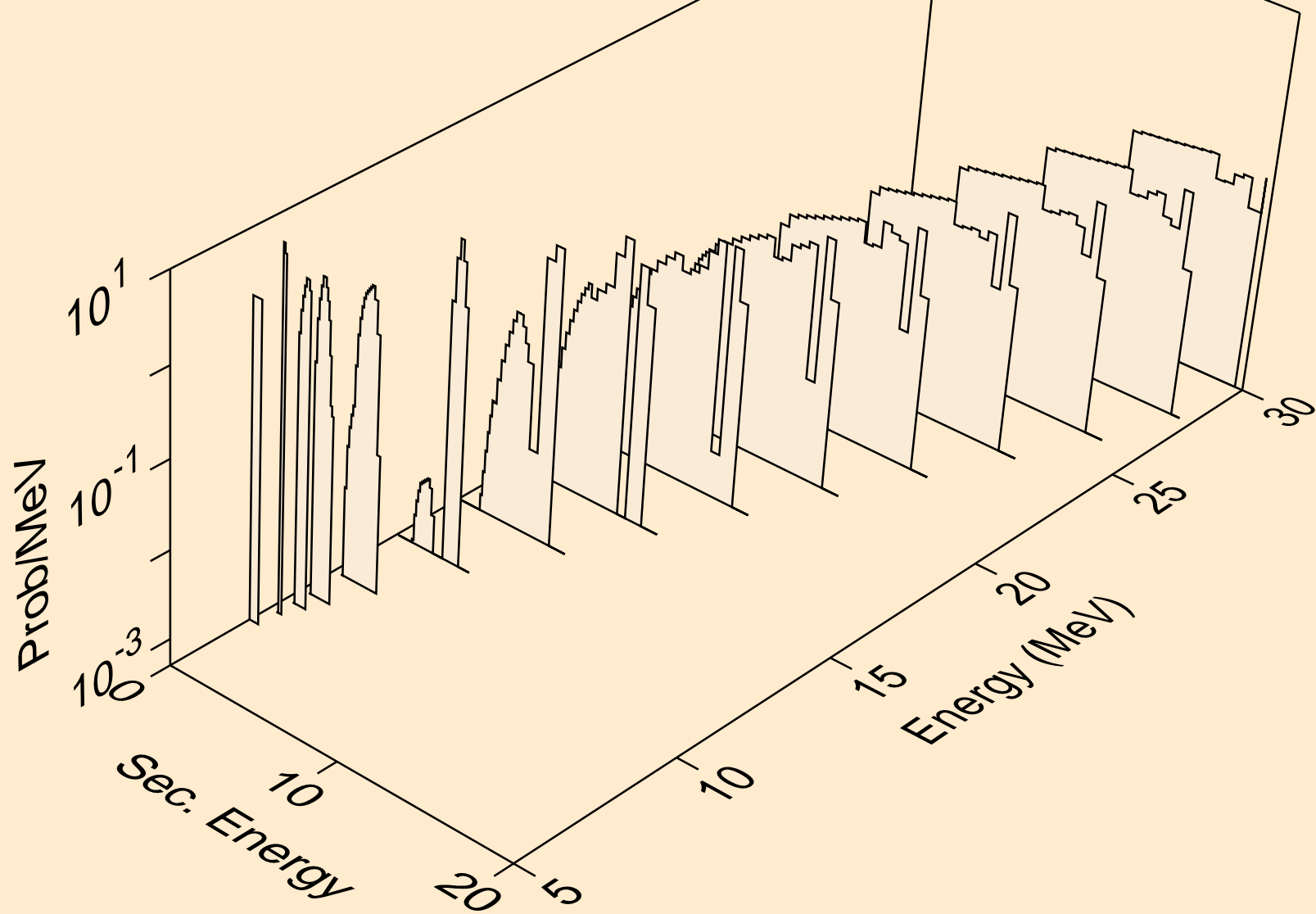

K043 NEUTRON ACER TENDL-2024 LIBRARY; T=0.K
deuterons from (n,pd)

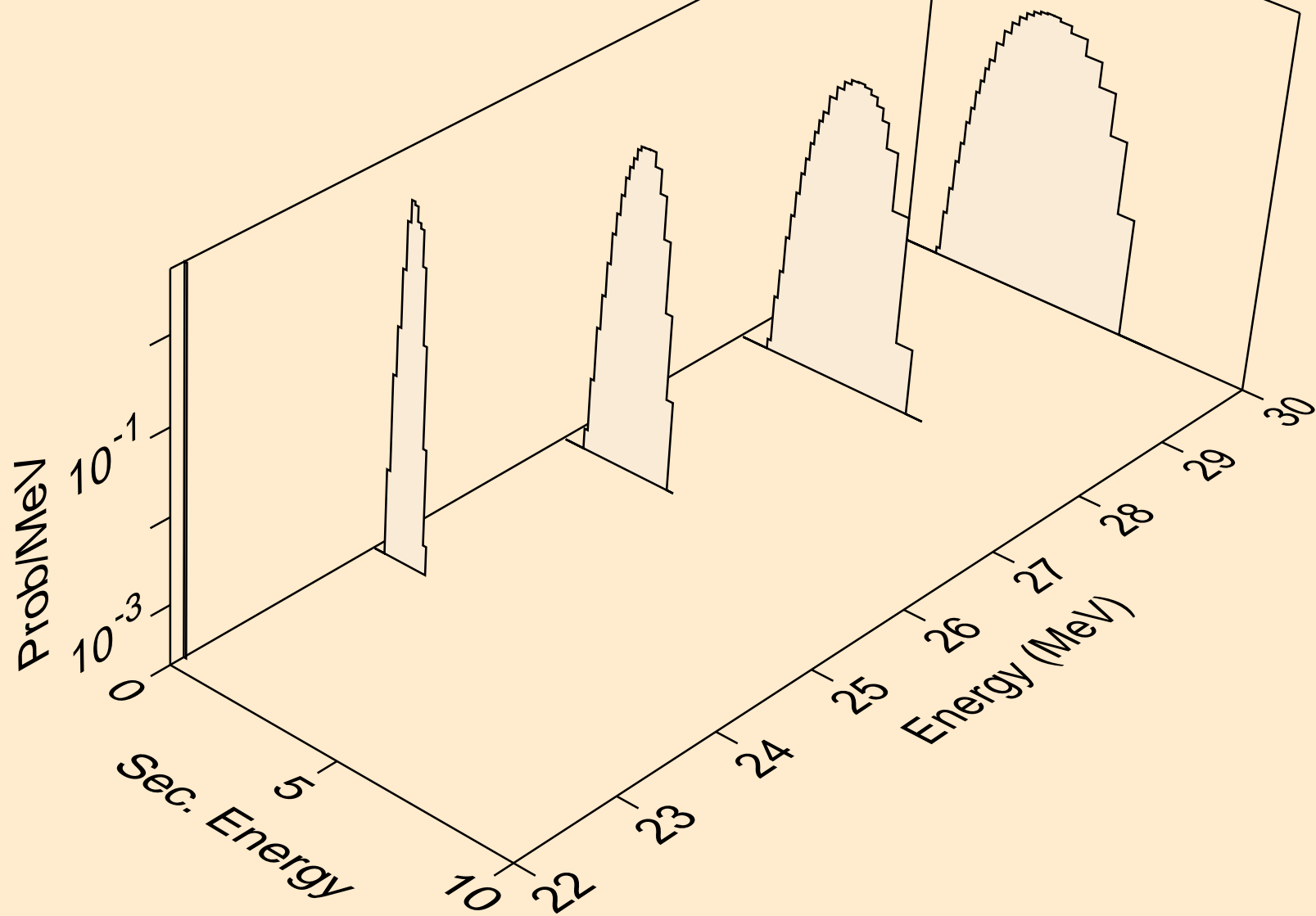

K043 NEUTRON ACER TENDL-2024 LIBRARY; T=0.K
deuterons from (n,da)

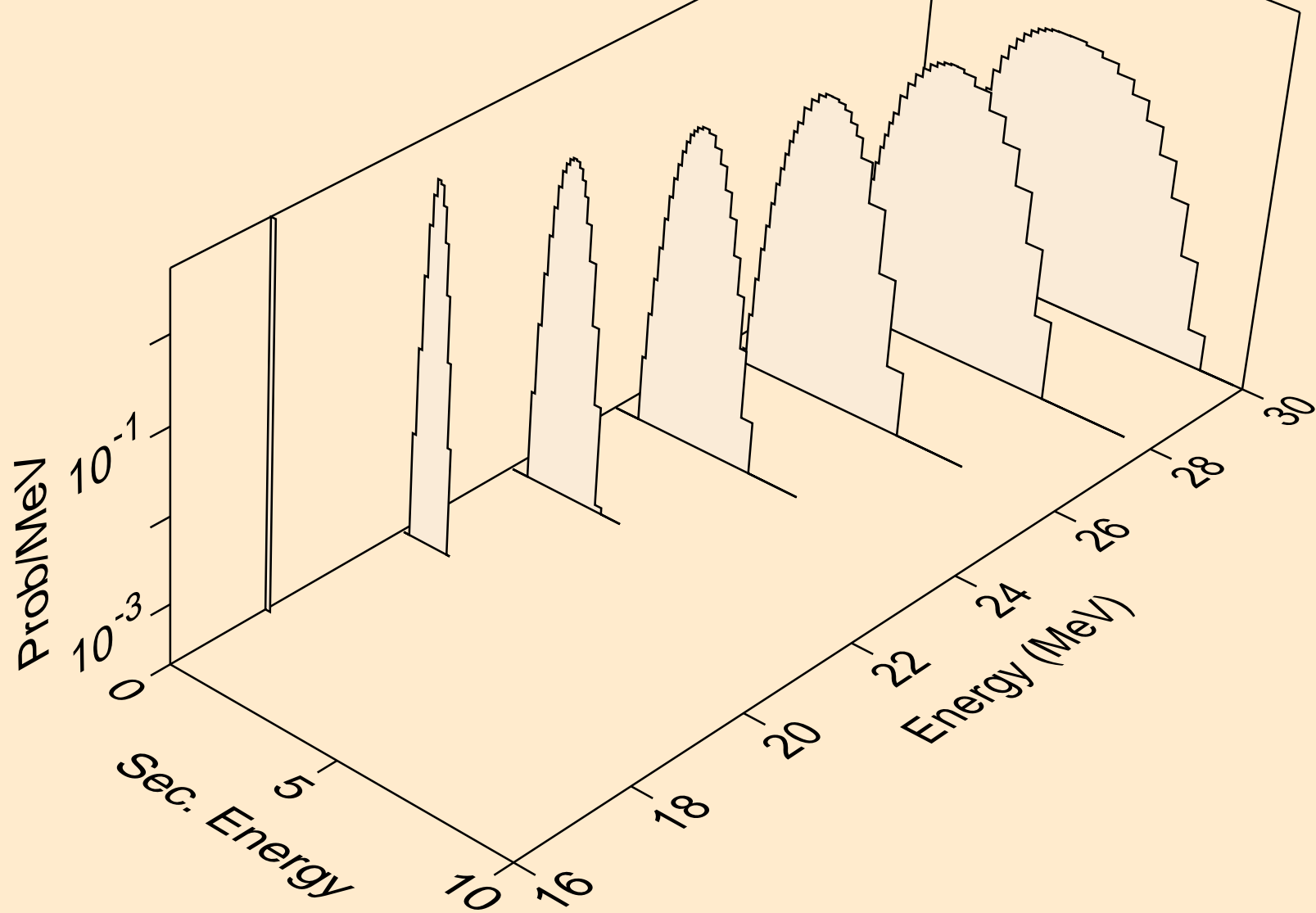

K043 NEUTRON ACER TENDL-2024 LIBRARY; T=0.K
tritons from (n,x)

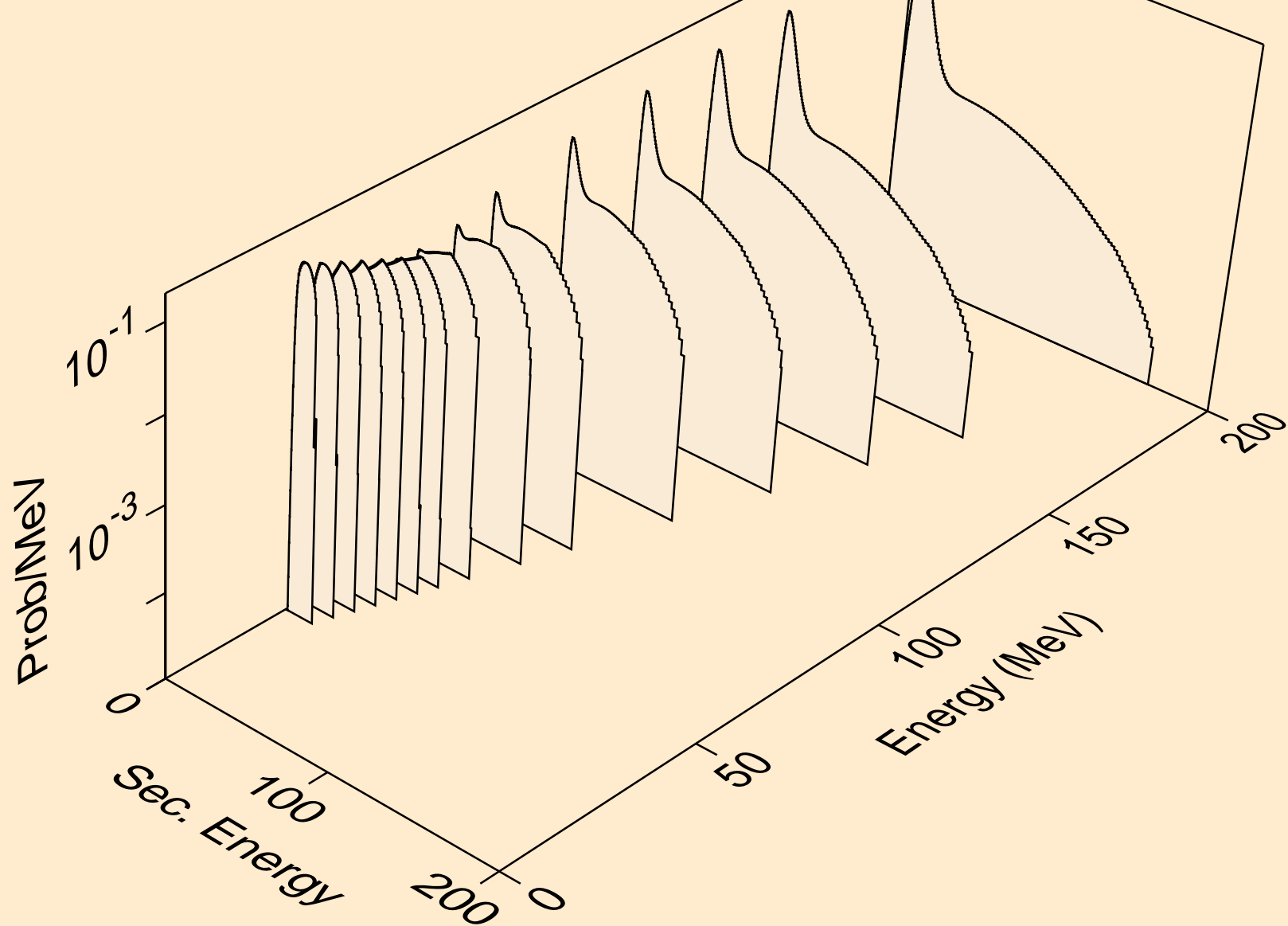

K043 NEUTRON ACER TENDL-2024 LIBRARY; T=0.K
tritons from (n,n*)t

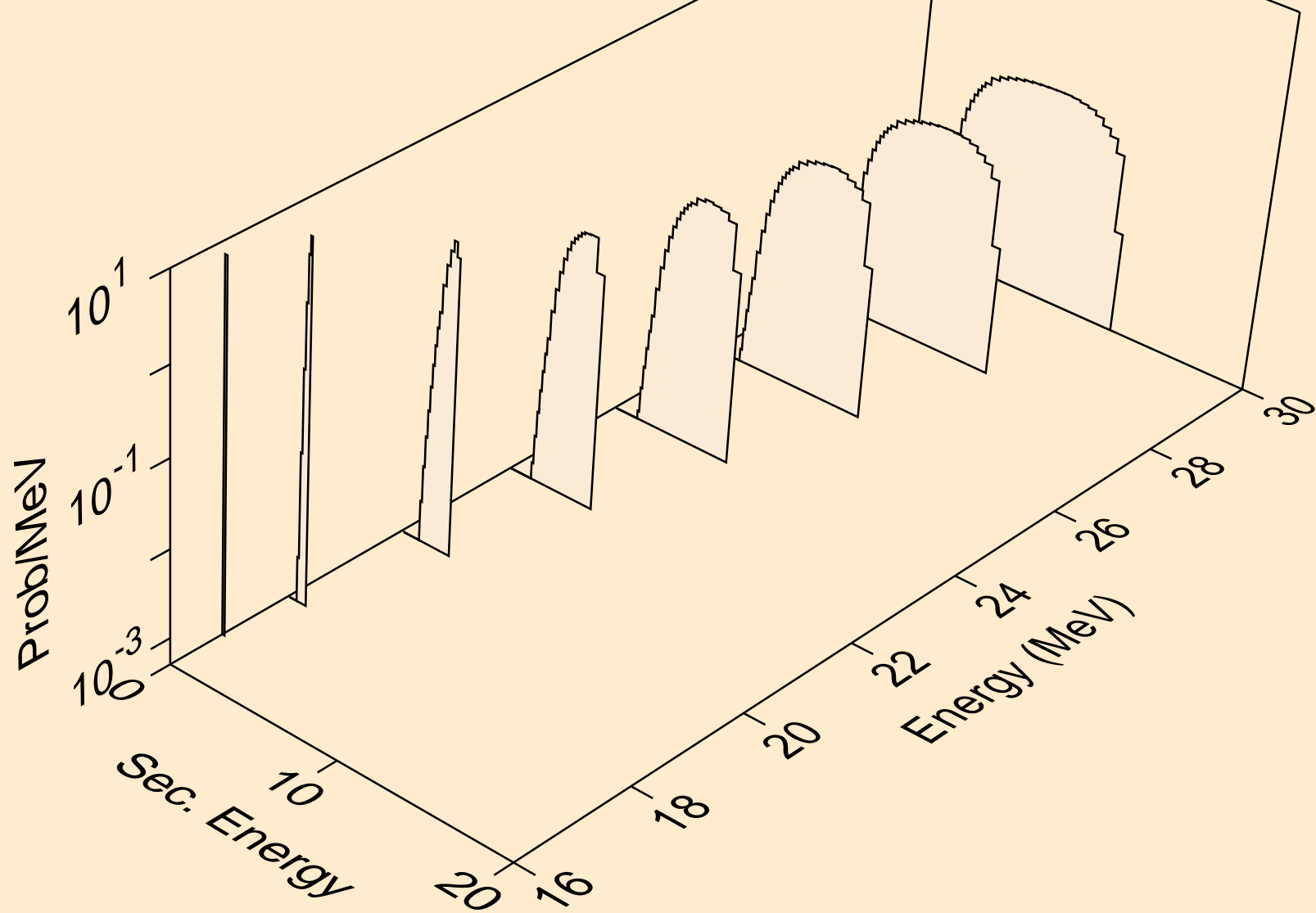

K043 NEUTRON ACER TENDL-2024 LIBRARY; T=0.K
tritons from (n,t)

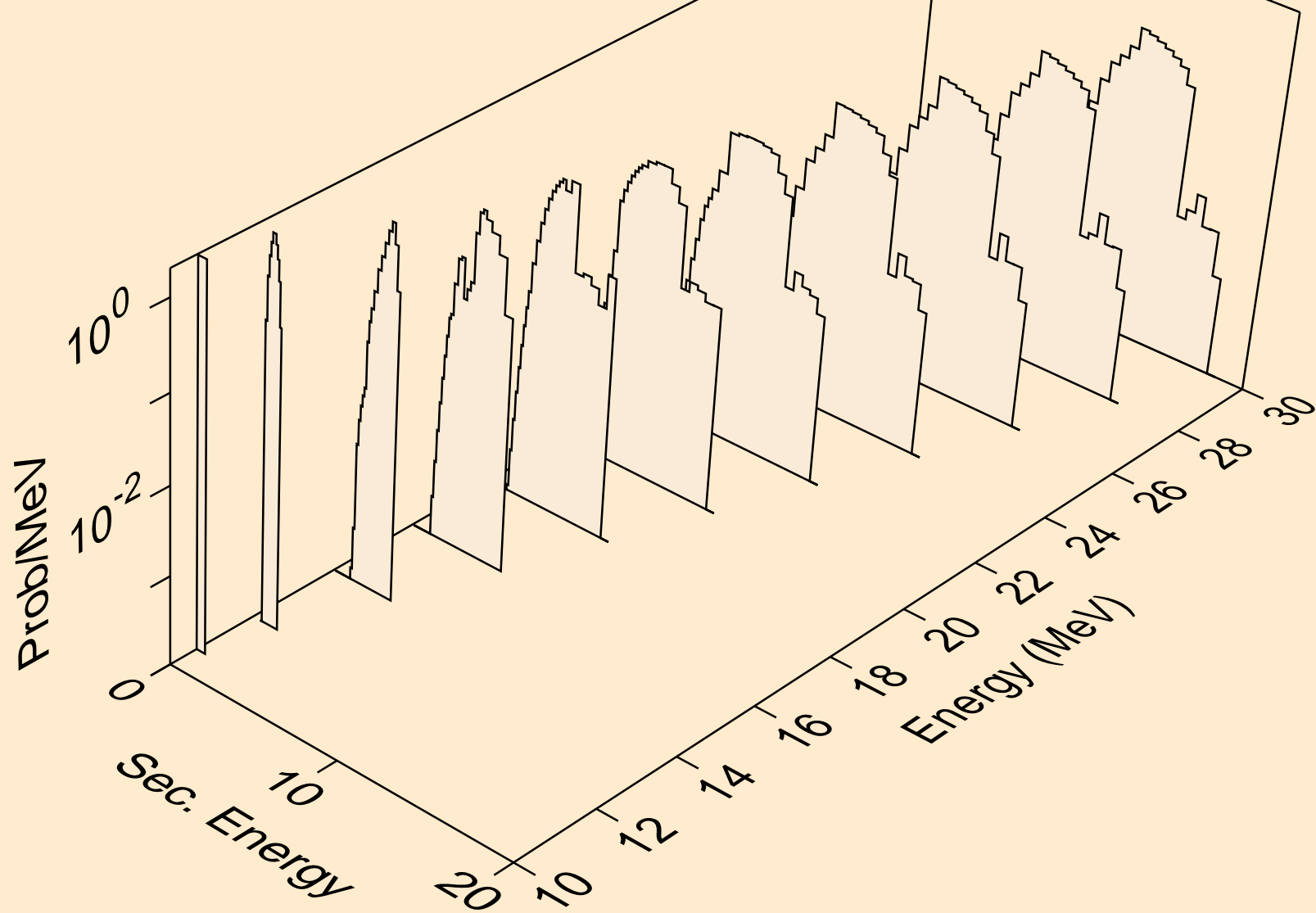

K043 NEUTRON ACER TENDL-2024 LIBRARY; T=0.K
tritons from (n,pt)

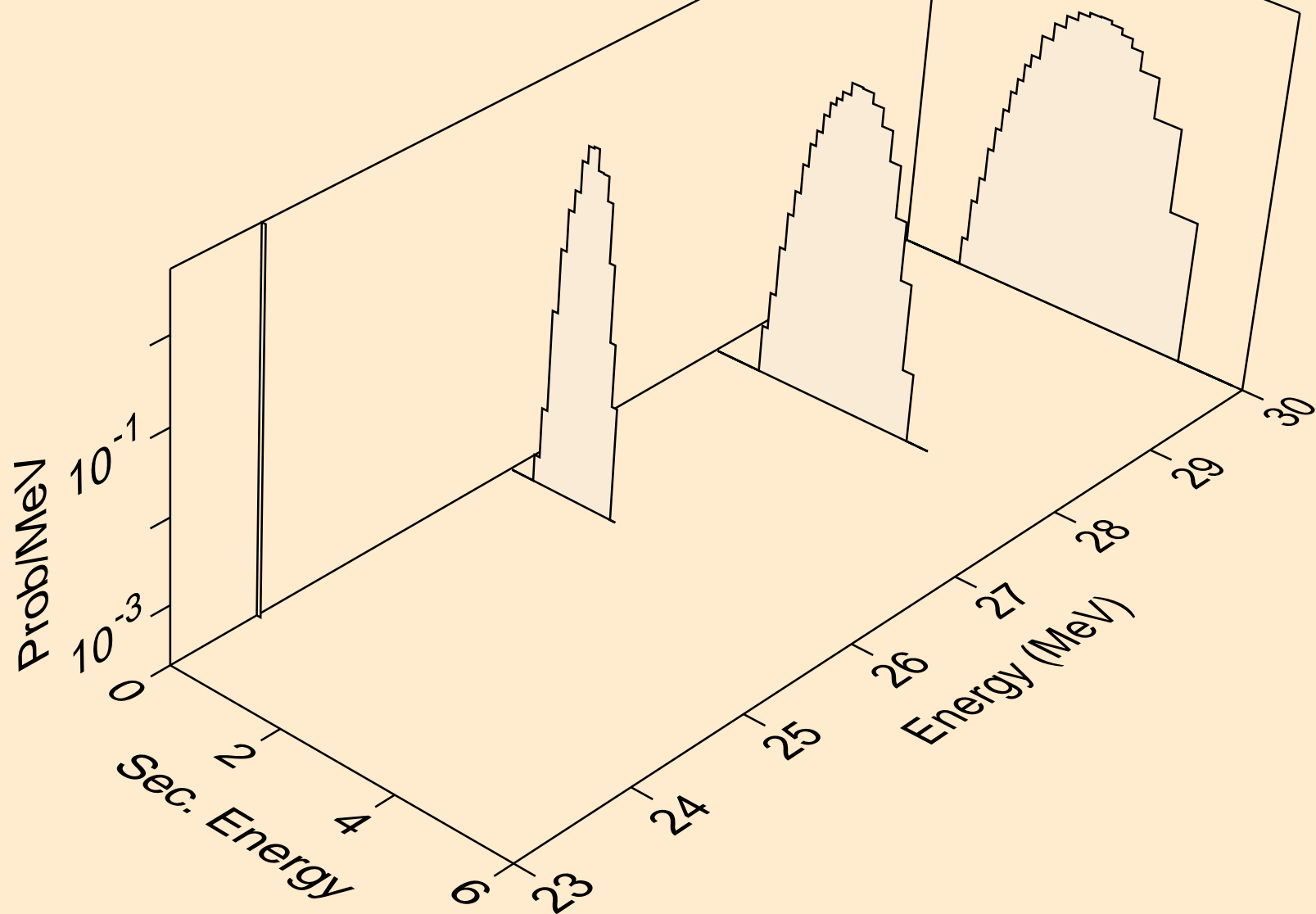

K043 NEUTRON ACER TENDL-2024 LIBRARY; T=0.K
he3s from (n,x)

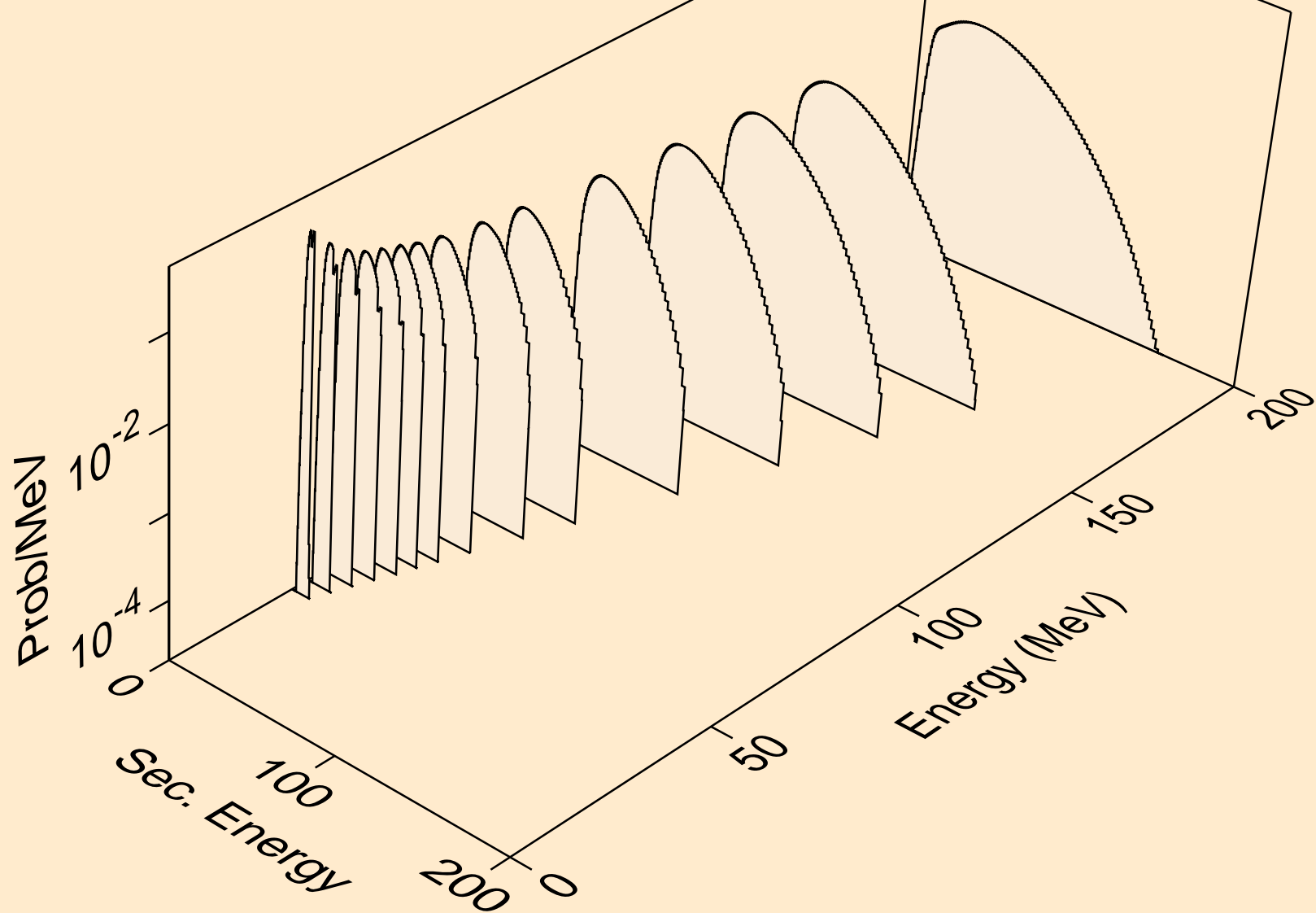

K043 NEUTRON ACER TENDL-2024 LIBRARY; T=0.K
he3s from (n,n*)he3

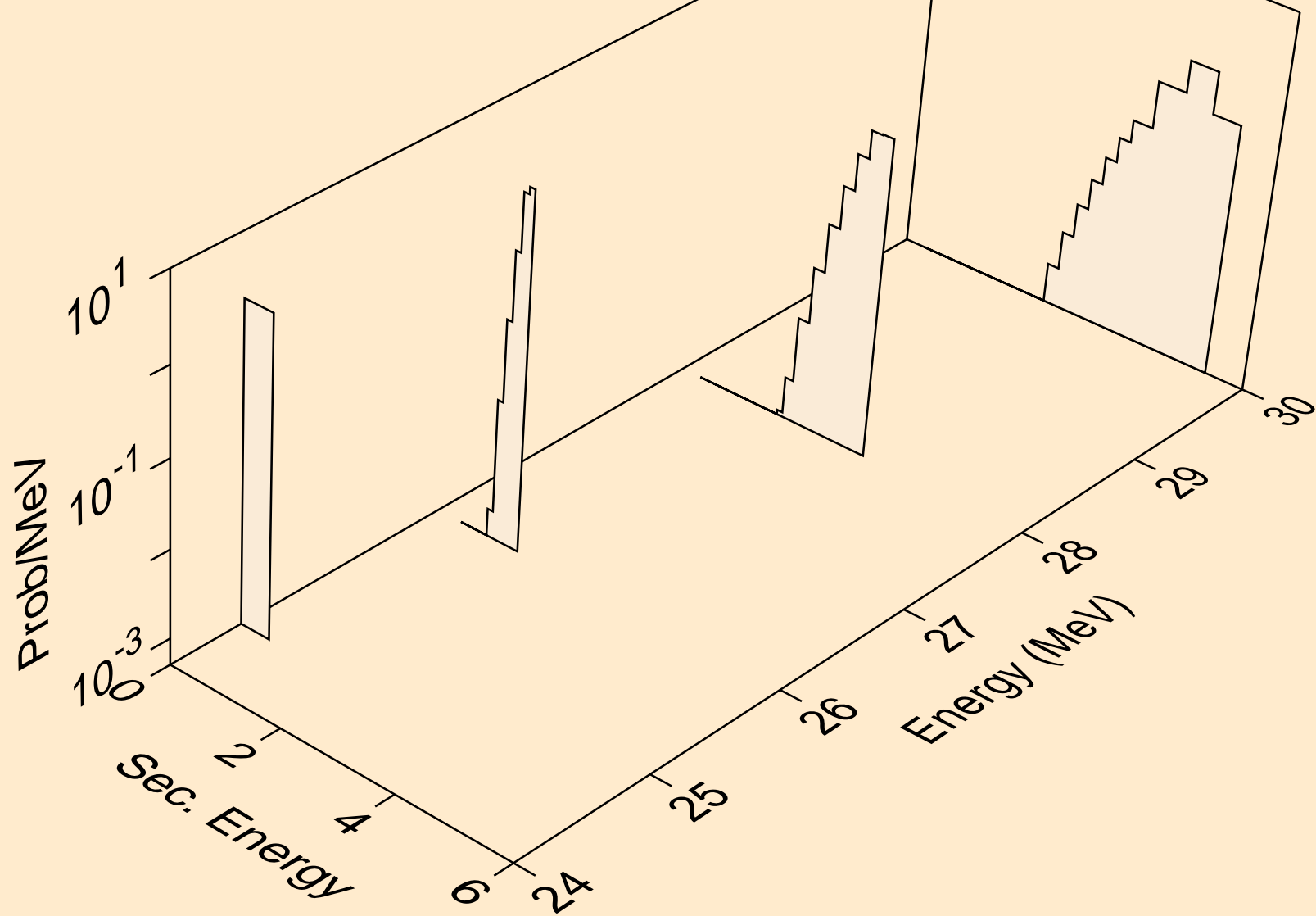

K043 NEUTRON ACER TENDL-2024 LIBRARY; T=0.K
he3s from (n,he3)

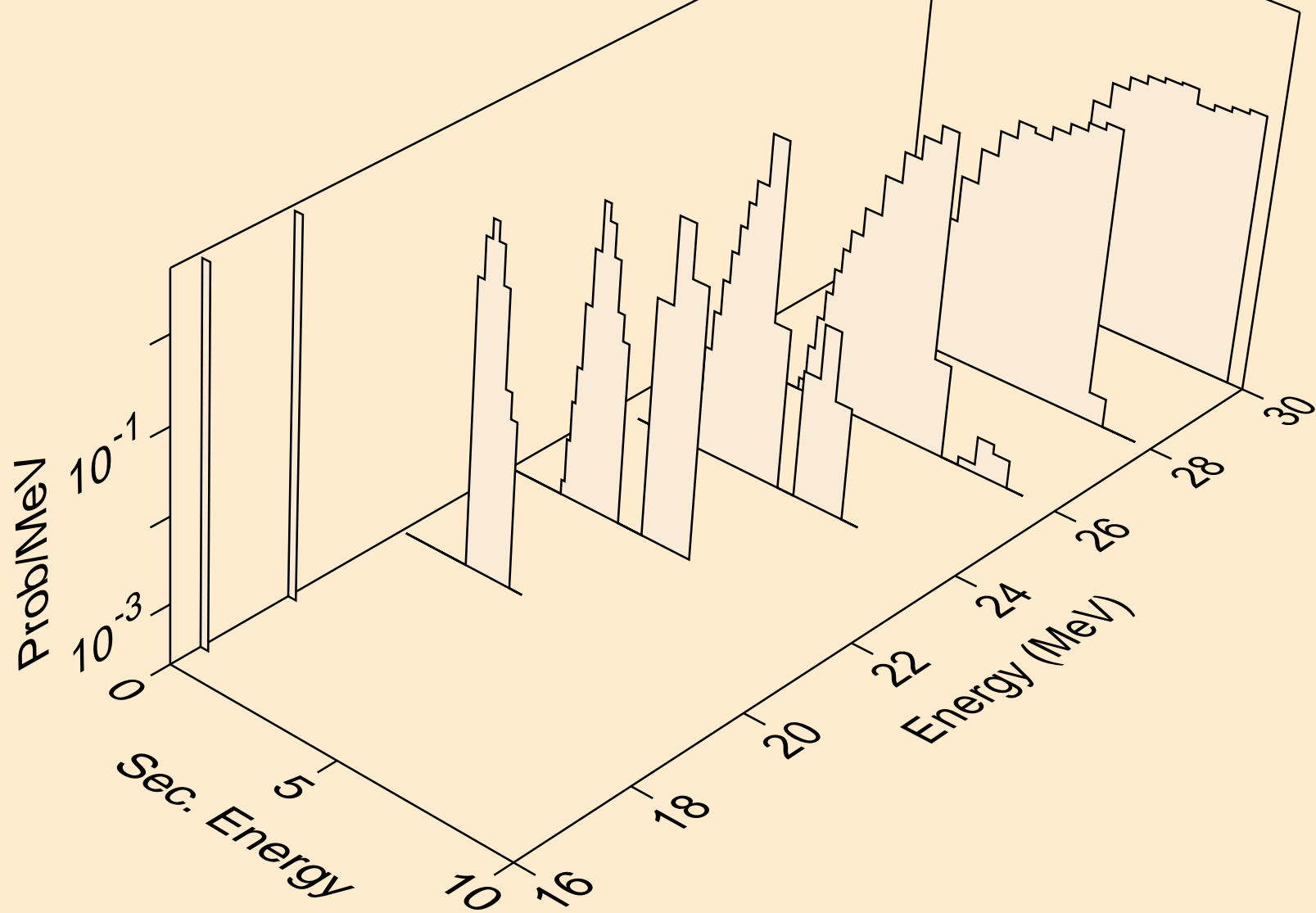

K043 NEUTRON ACER TENDL-2024 LIBRARY; T=0.K
alphas from (n,x)

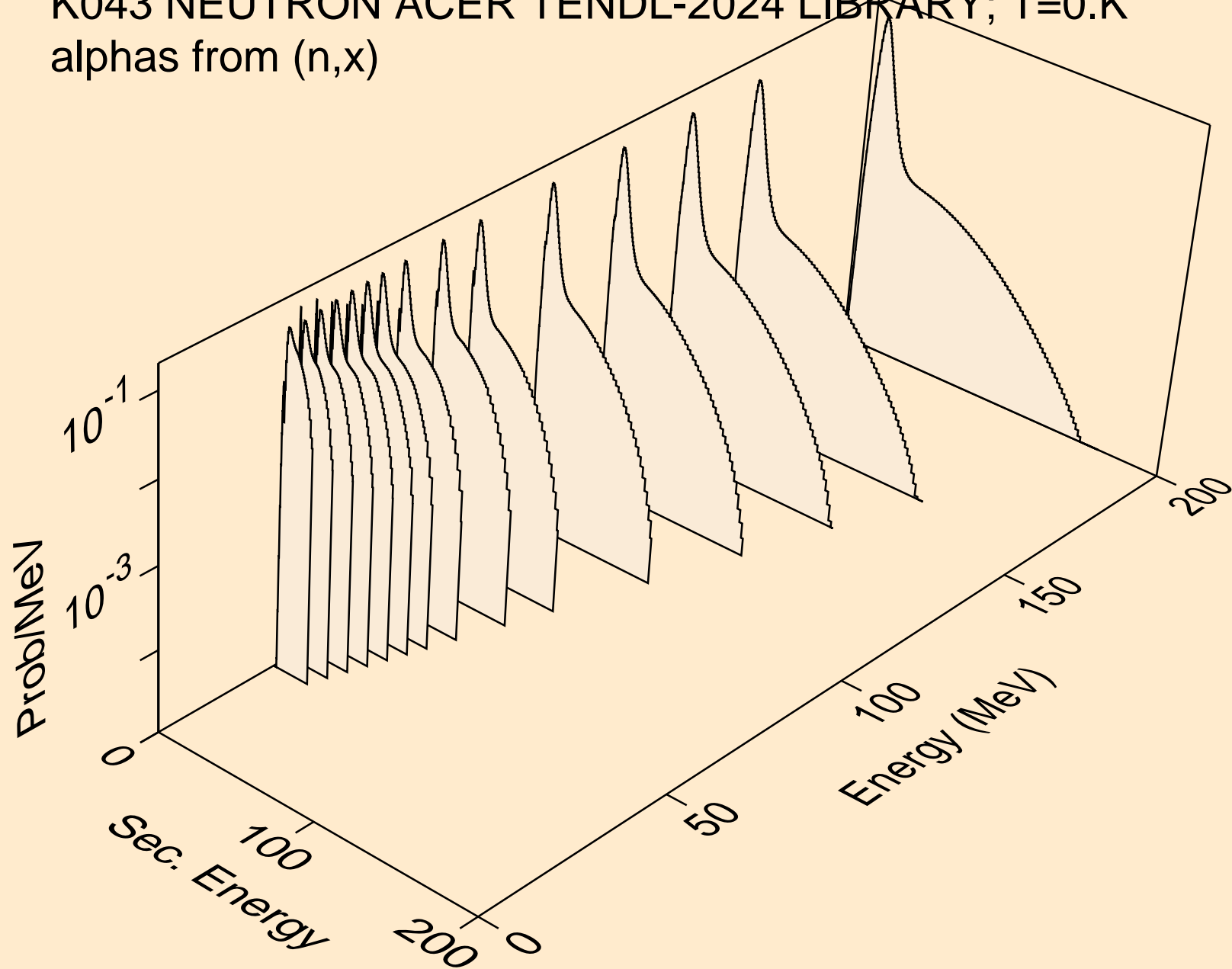

K043 NEUTRON ACER TENDL-2024 LIBRARY; T=0.K
alphas from (n,n*)a

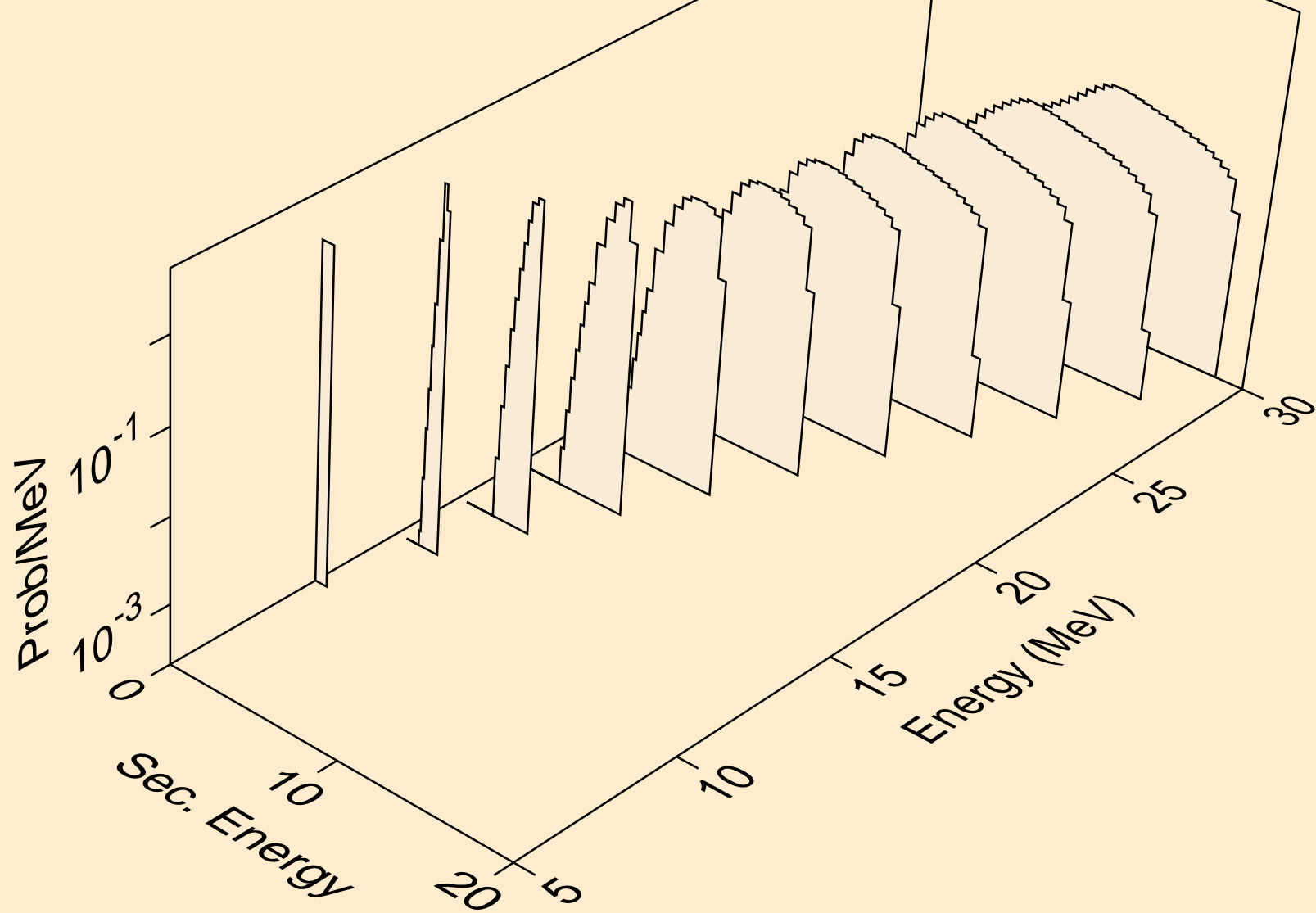

K043 NEUTRON ACER TENDL-2024 LIBRARY; T=0.K
alphas from (n,2n)a

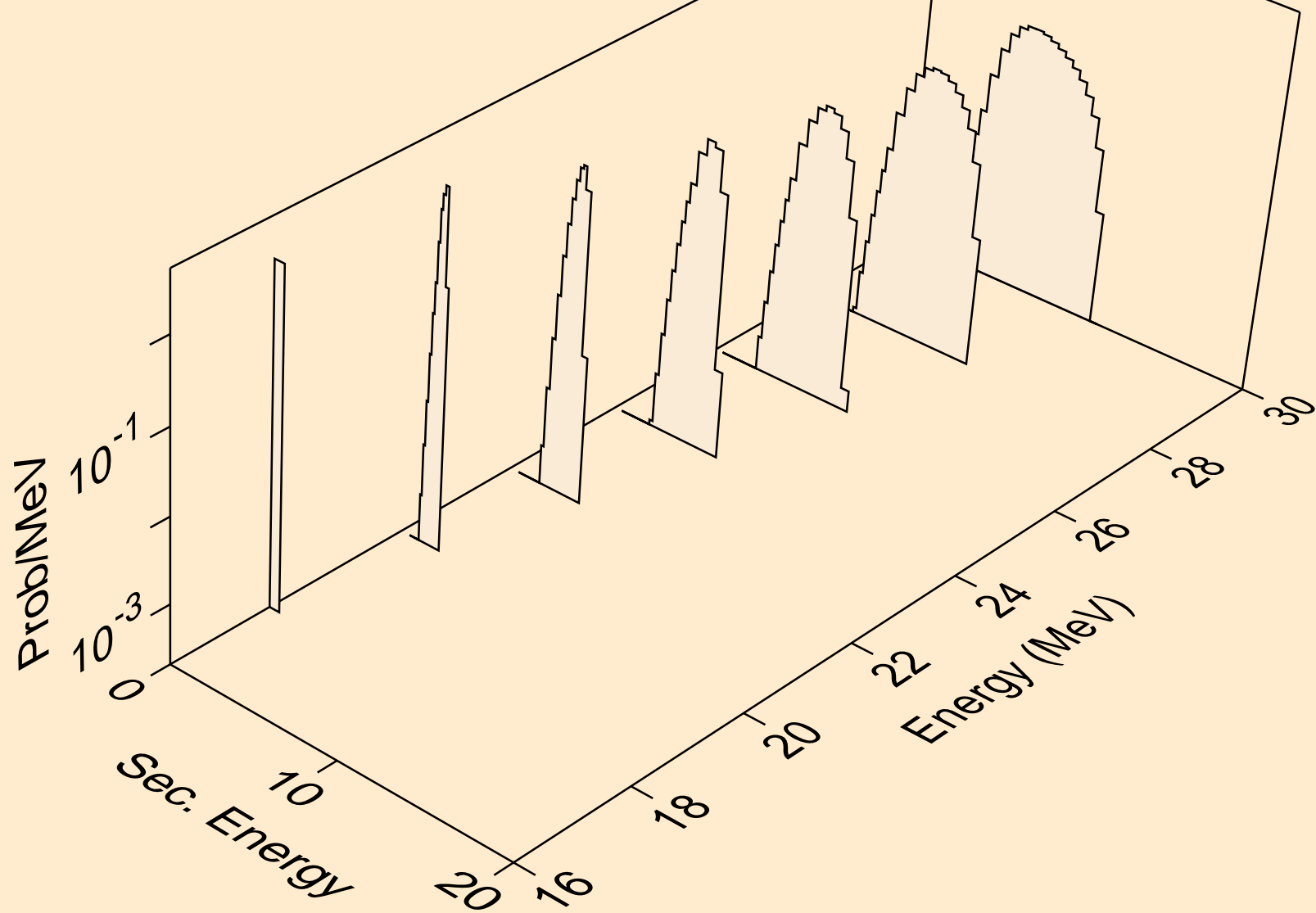

K043 NEUTRON ACER TENDL-2024 LIBRARY; T=0.K
alphas from (n,3n)a

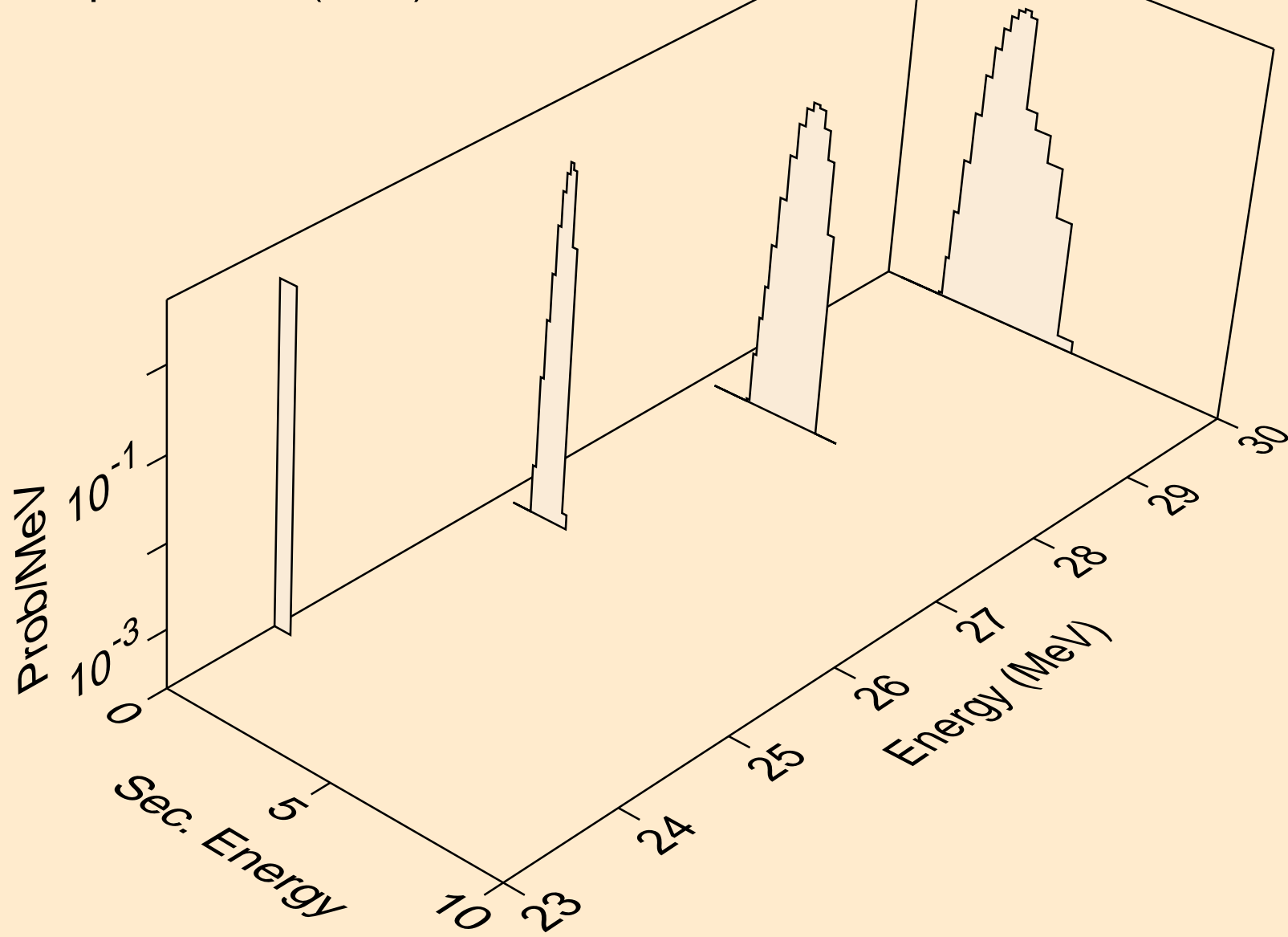

K043 NEUTRON ACER TENDL-2024 LIBRARY; T=0.K
alphas from (n,n*)2a

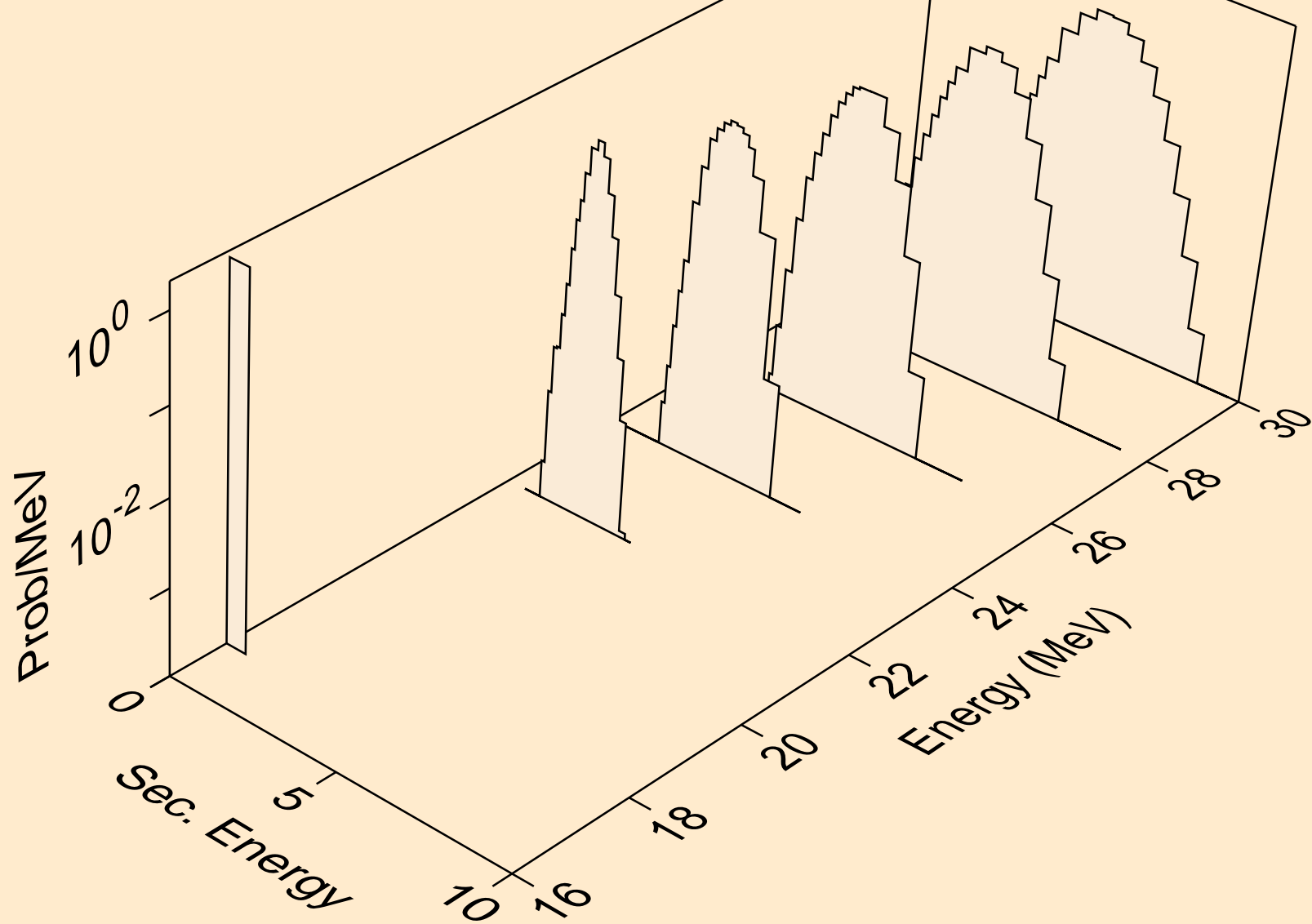

K043 NEUTRON ACER TENDL-2024 LIBRARY; T=0.K
alphas from (n,npa)

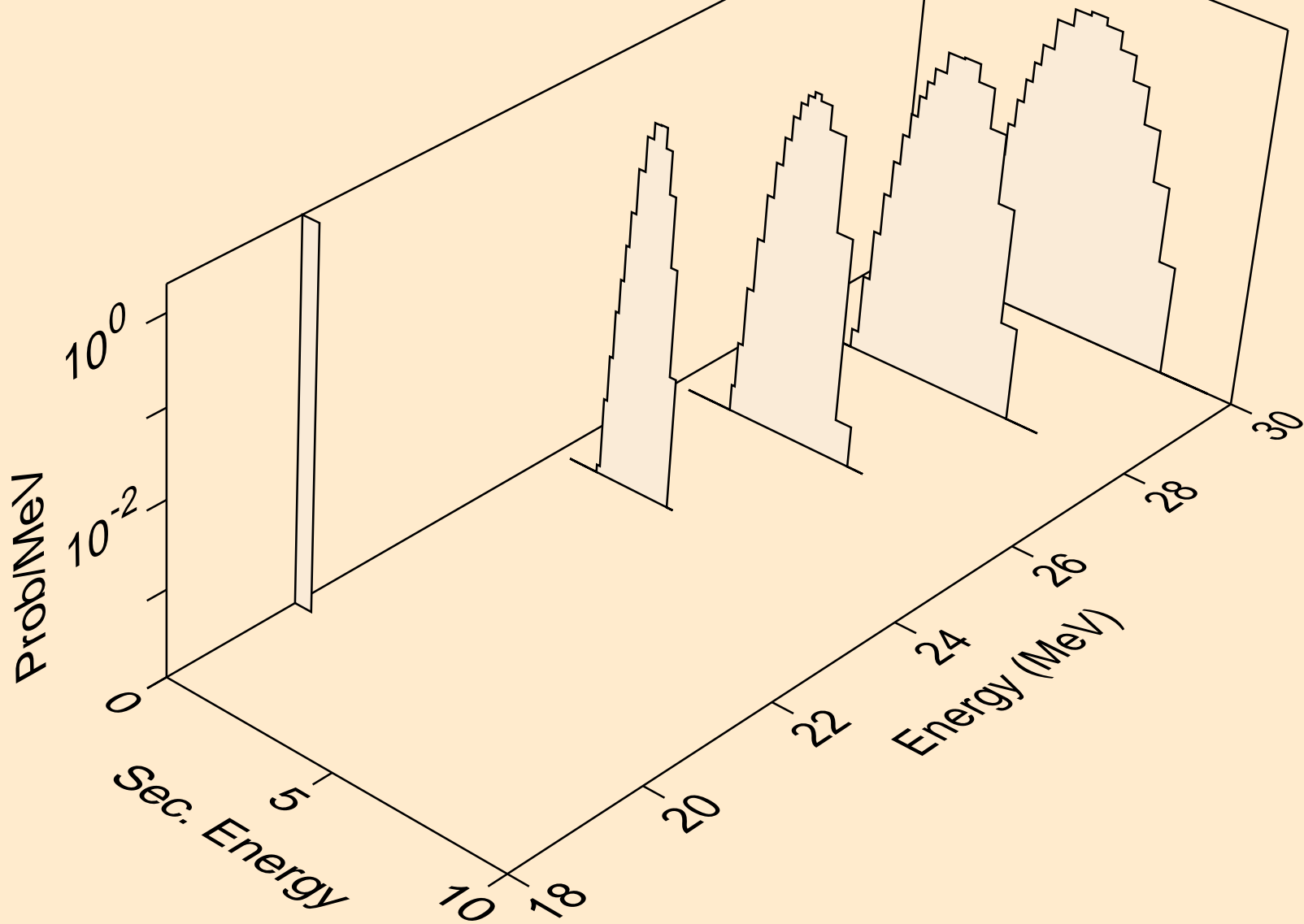

K043 NEUTRON ACER TENDL-2024 LIBRARY; T=0.K
alphas from (n,a)

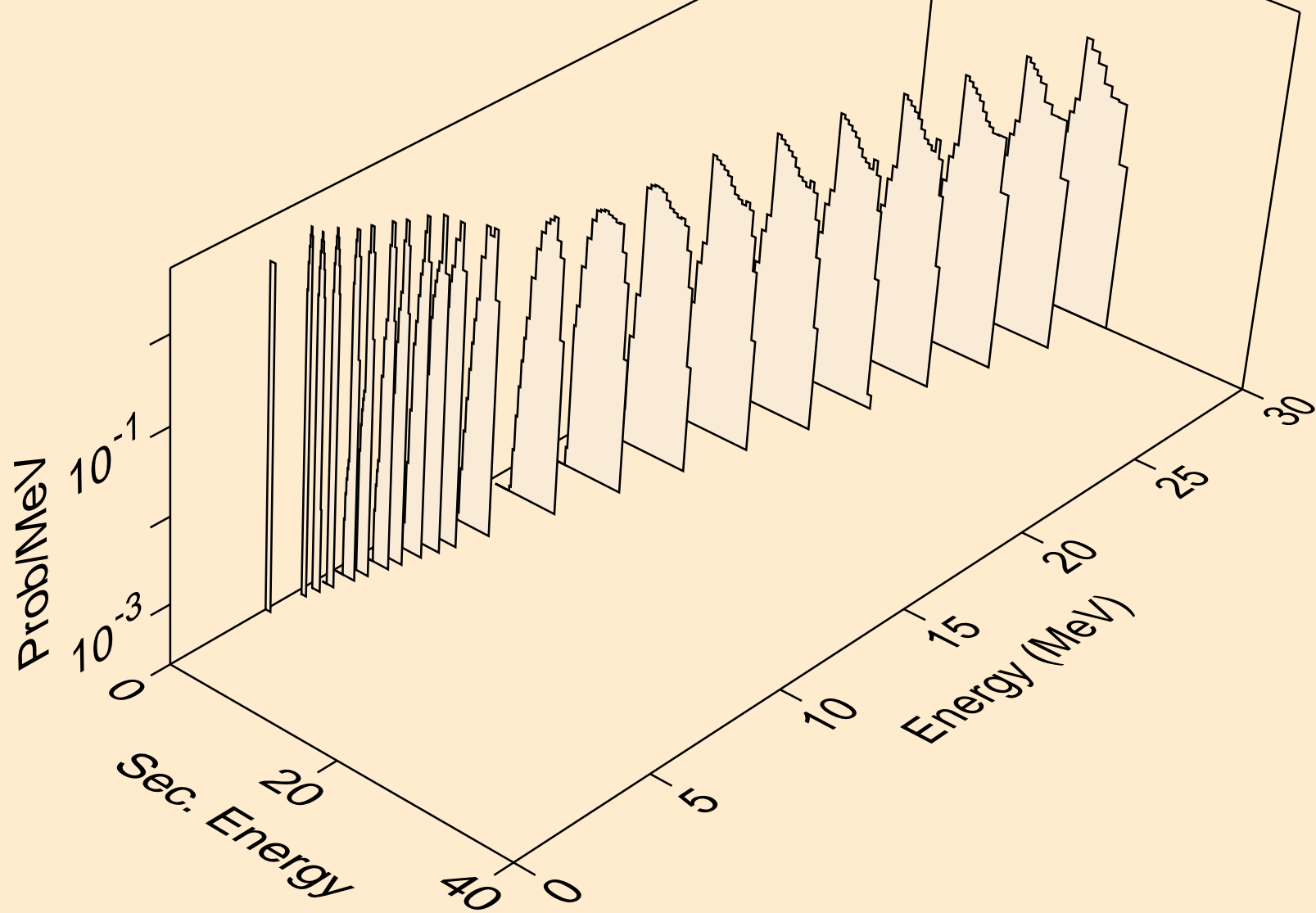

K043 NEUTRON ACER TENDL-2024 LIBRARY; T=0.K
alphas from (n,2a)

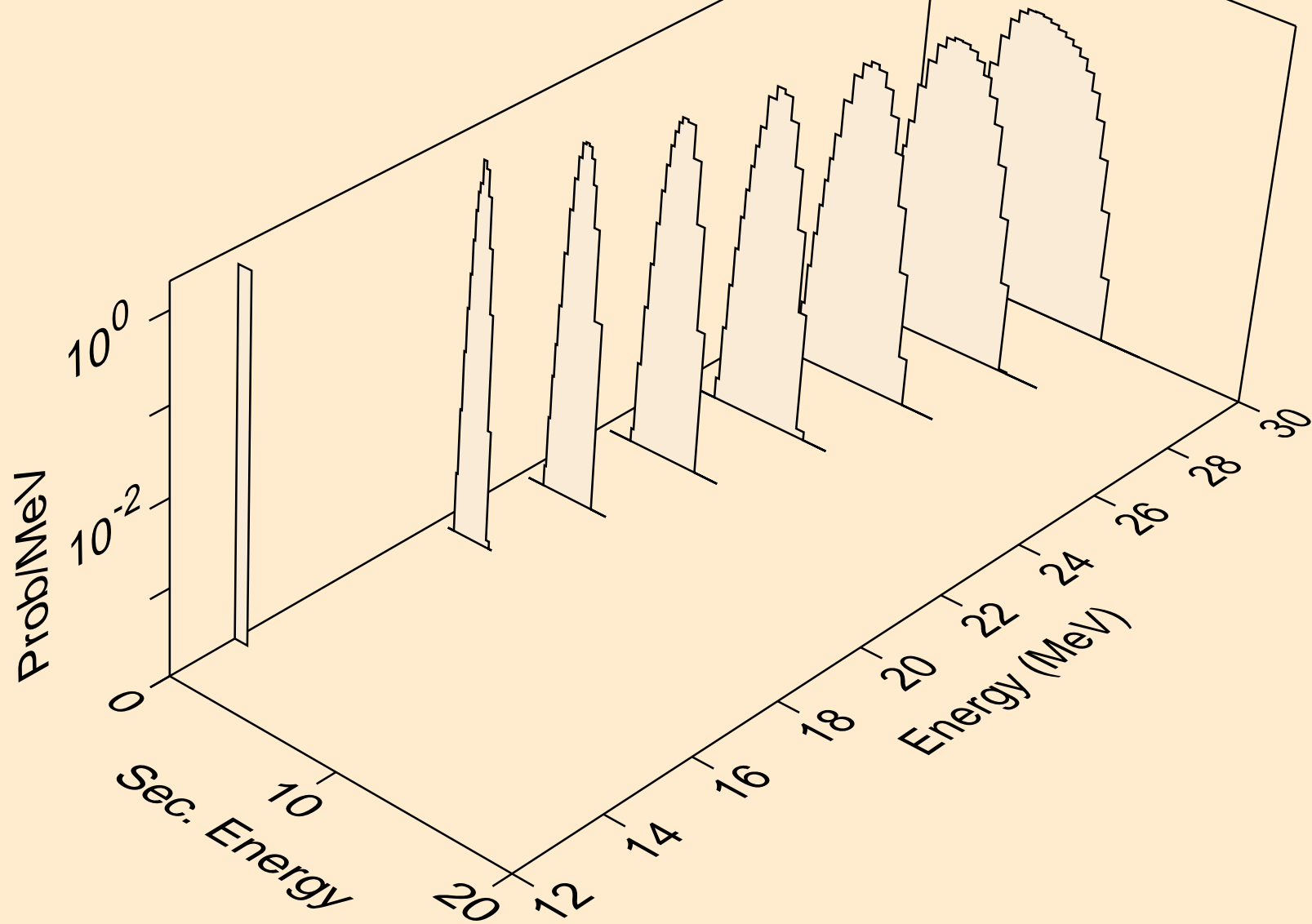

K043 NEUTRON ACER TENDL-2024 LIBRARY; T=0.K
alphas from (n,pa)

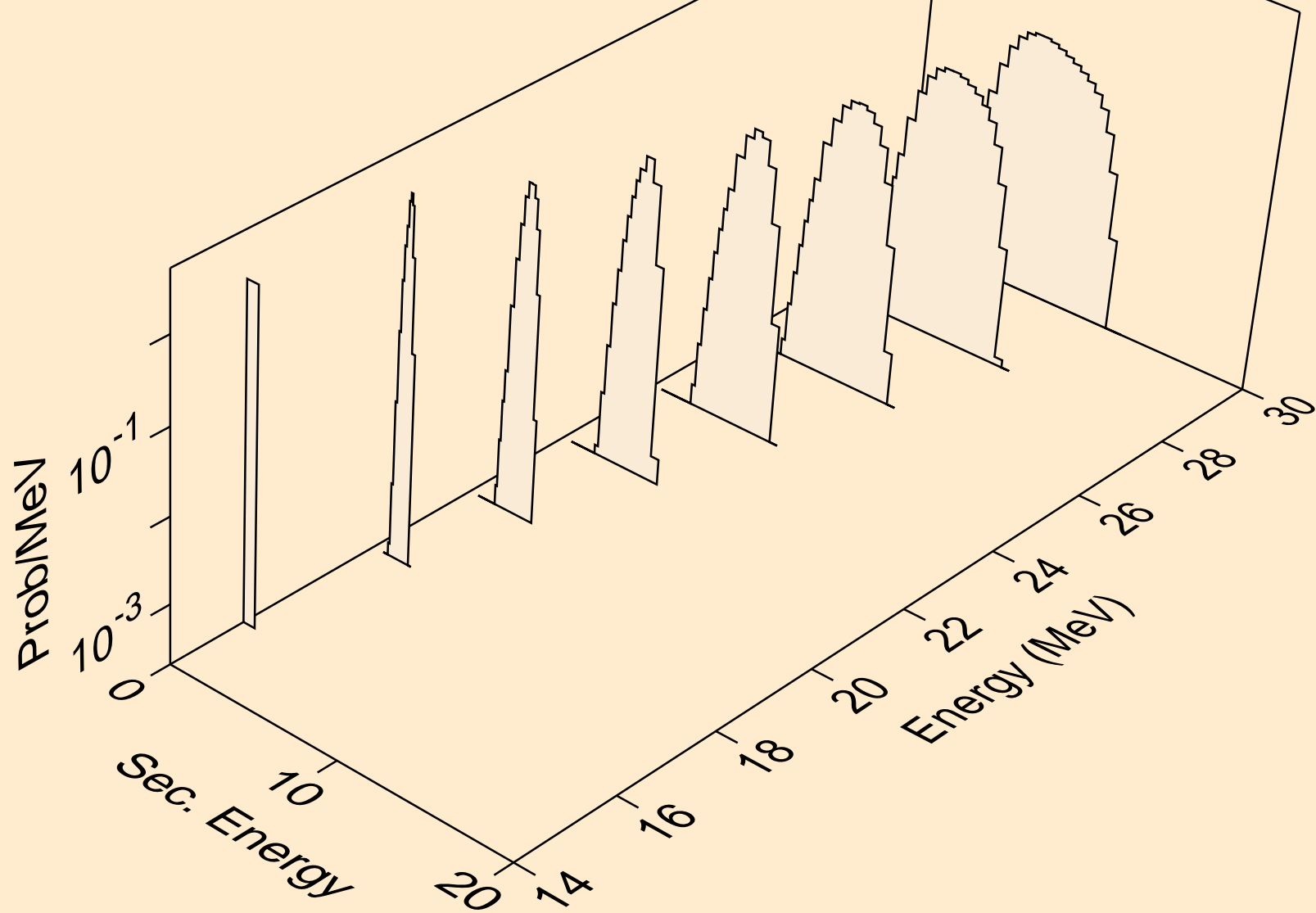

K043 NEUTRON ACER TENDL-2024 LIBRARY; T=0.K
alphas from (n,da)

