

KR082 NEUTRON ACER TENDL-2024 LIBRARY; T=0.K

Principal cross sections

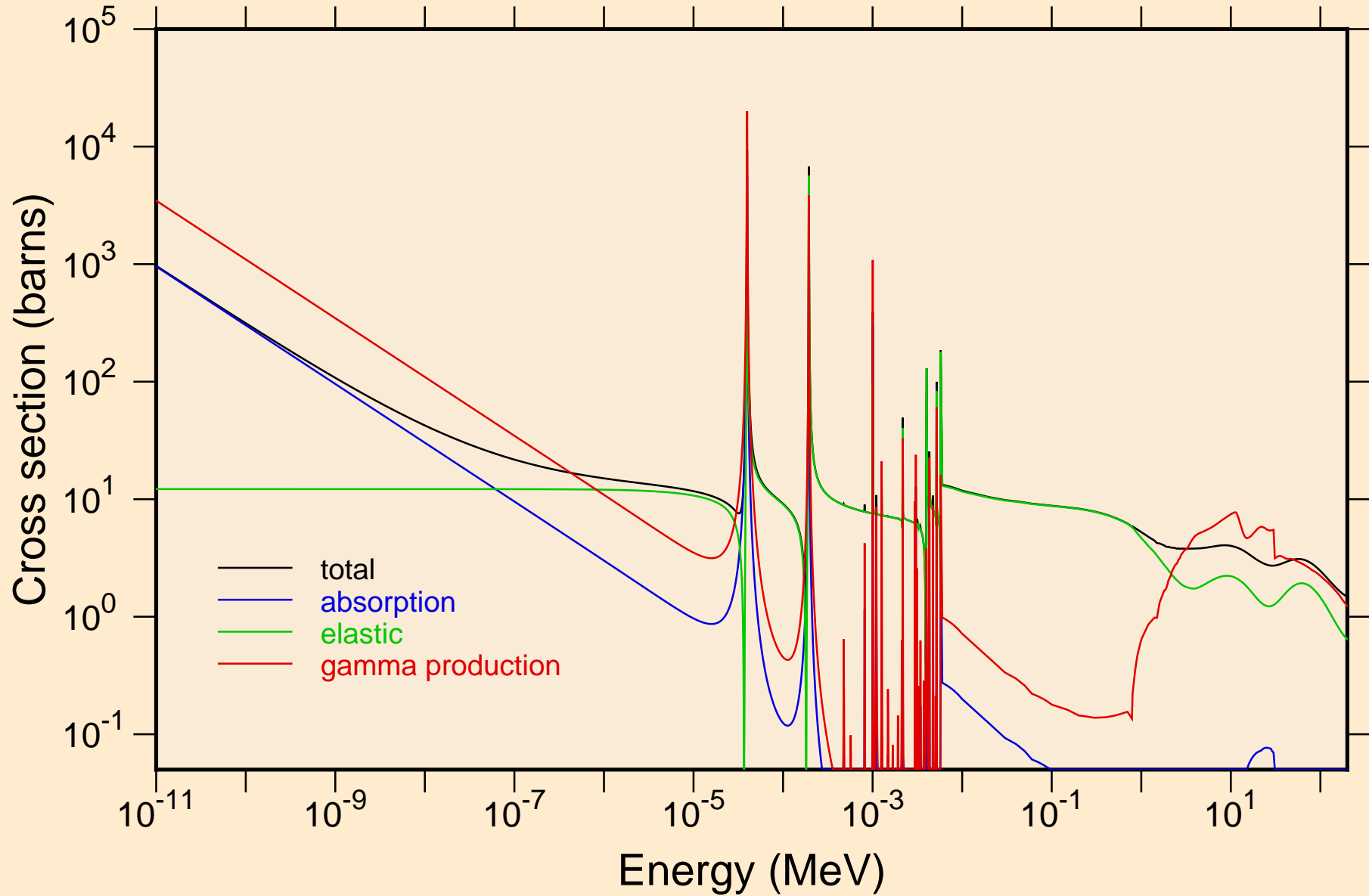

KR082 NEUTRON ACER TENDL-2024 LIBRARY; T=0.K
resonance total cross section

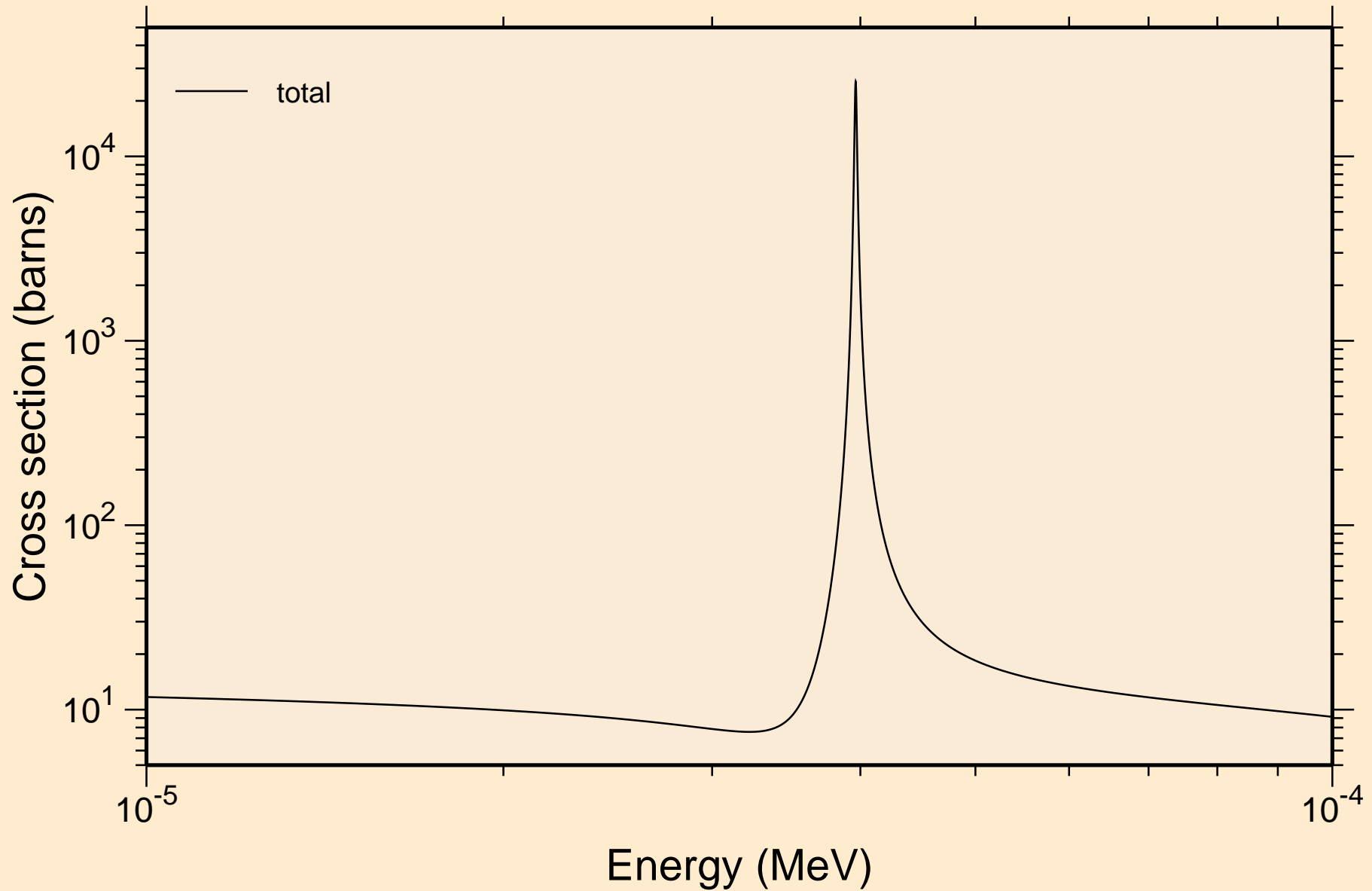

KR082 NEUTRON ACER TENDL-2024 LIBRARY; T=0.K
resonance total cross section

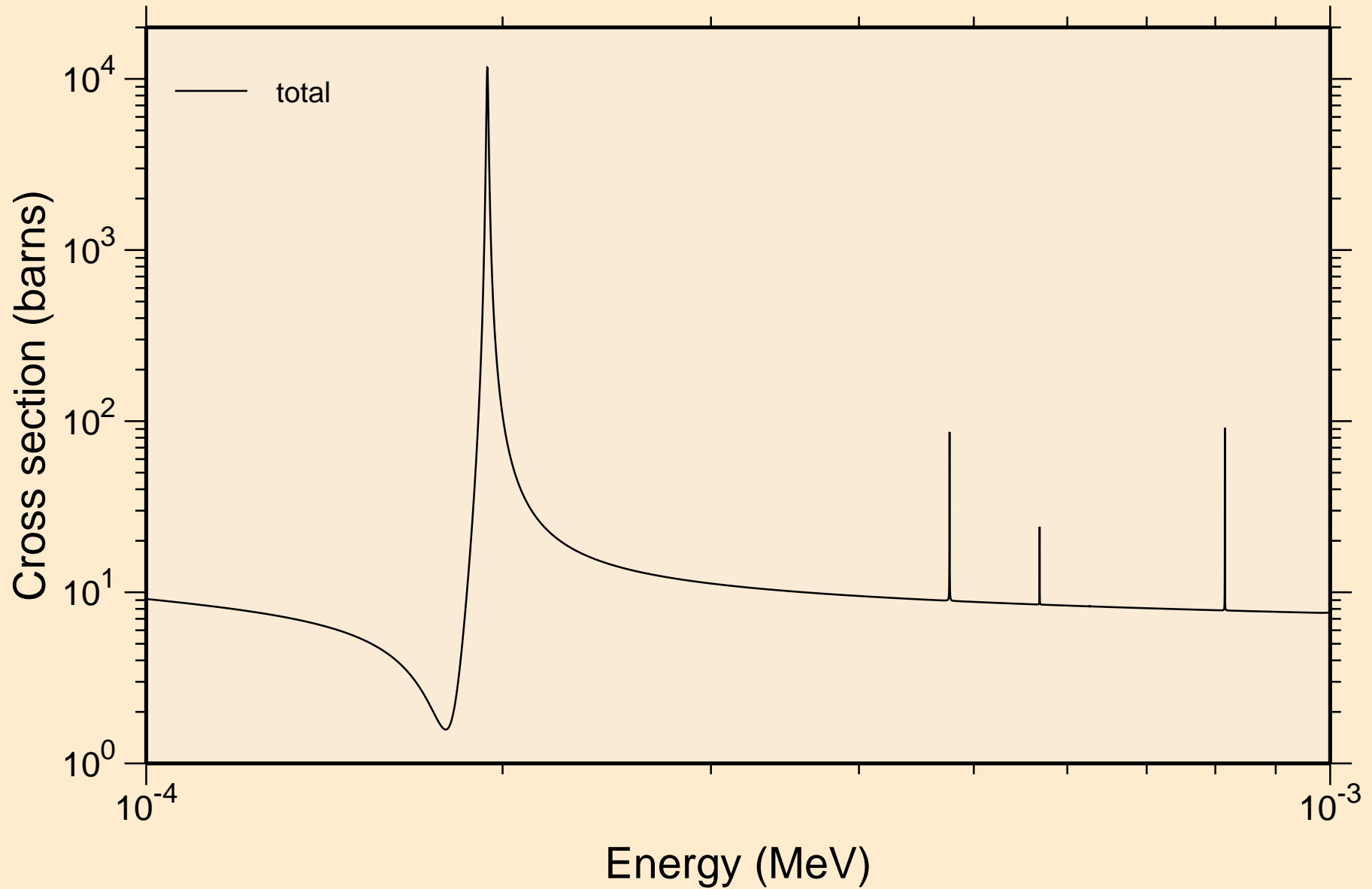

KR082 NEUTRON ACER TENDL-2024 LIBRARY; T=0.K
resonance total cross section

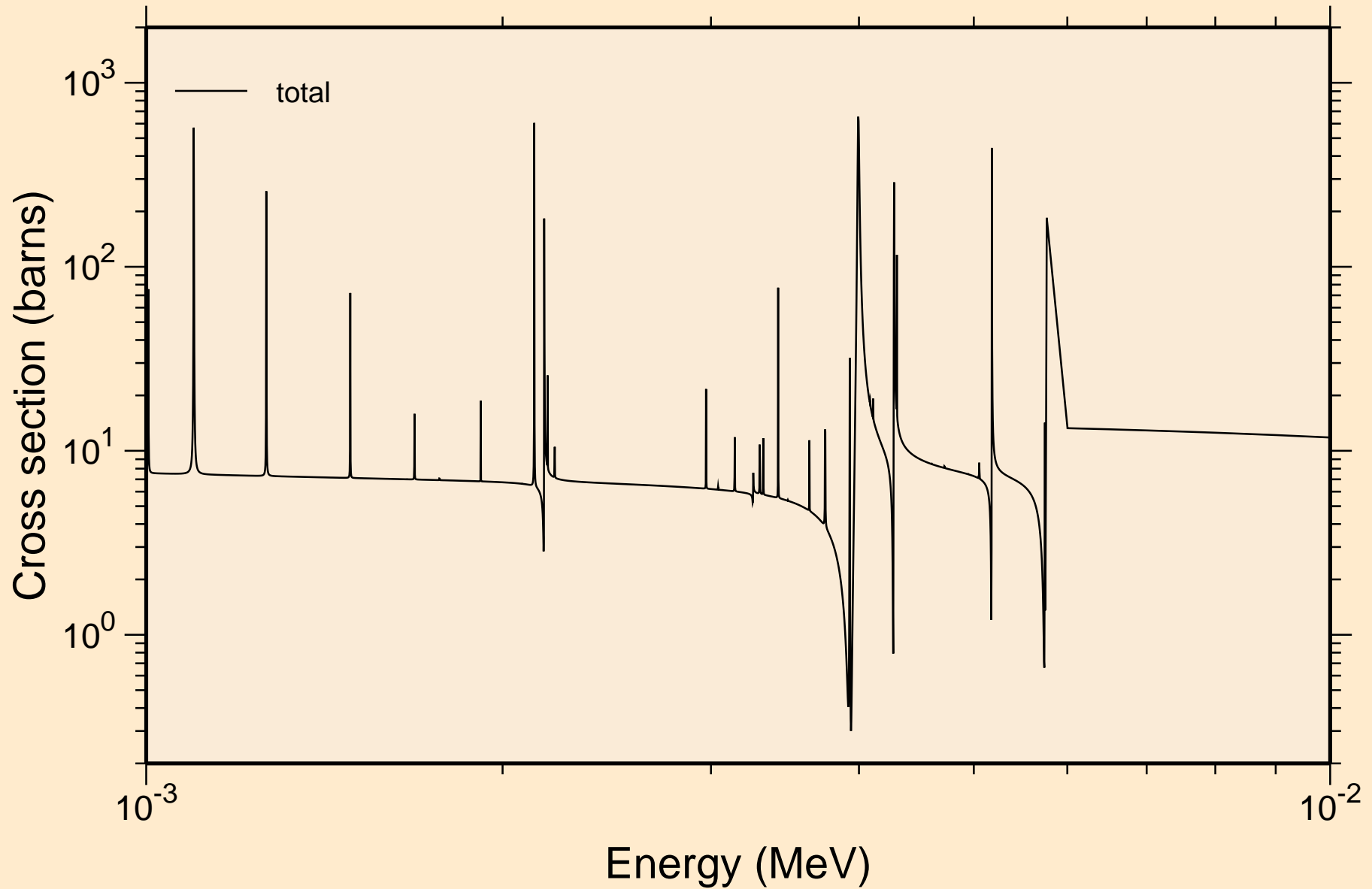

KR082 NEUTRON ACER TENDL-2024 LIBRARY; T=0.K
resonance total cross section

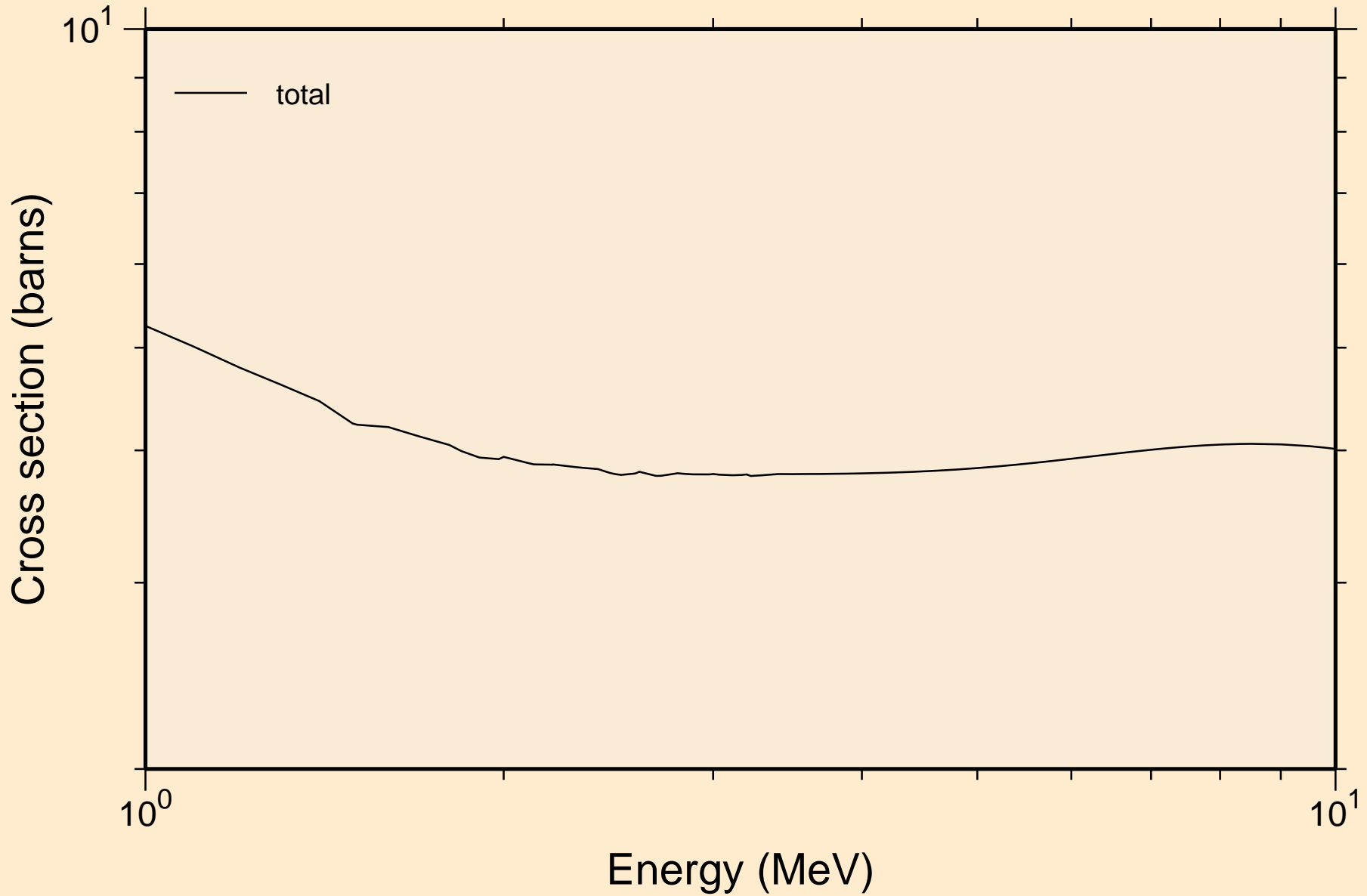

KR082 NEUTRON ACER TENDL-2024 LIBRARY; T=0.K
resonance absorption cross sections

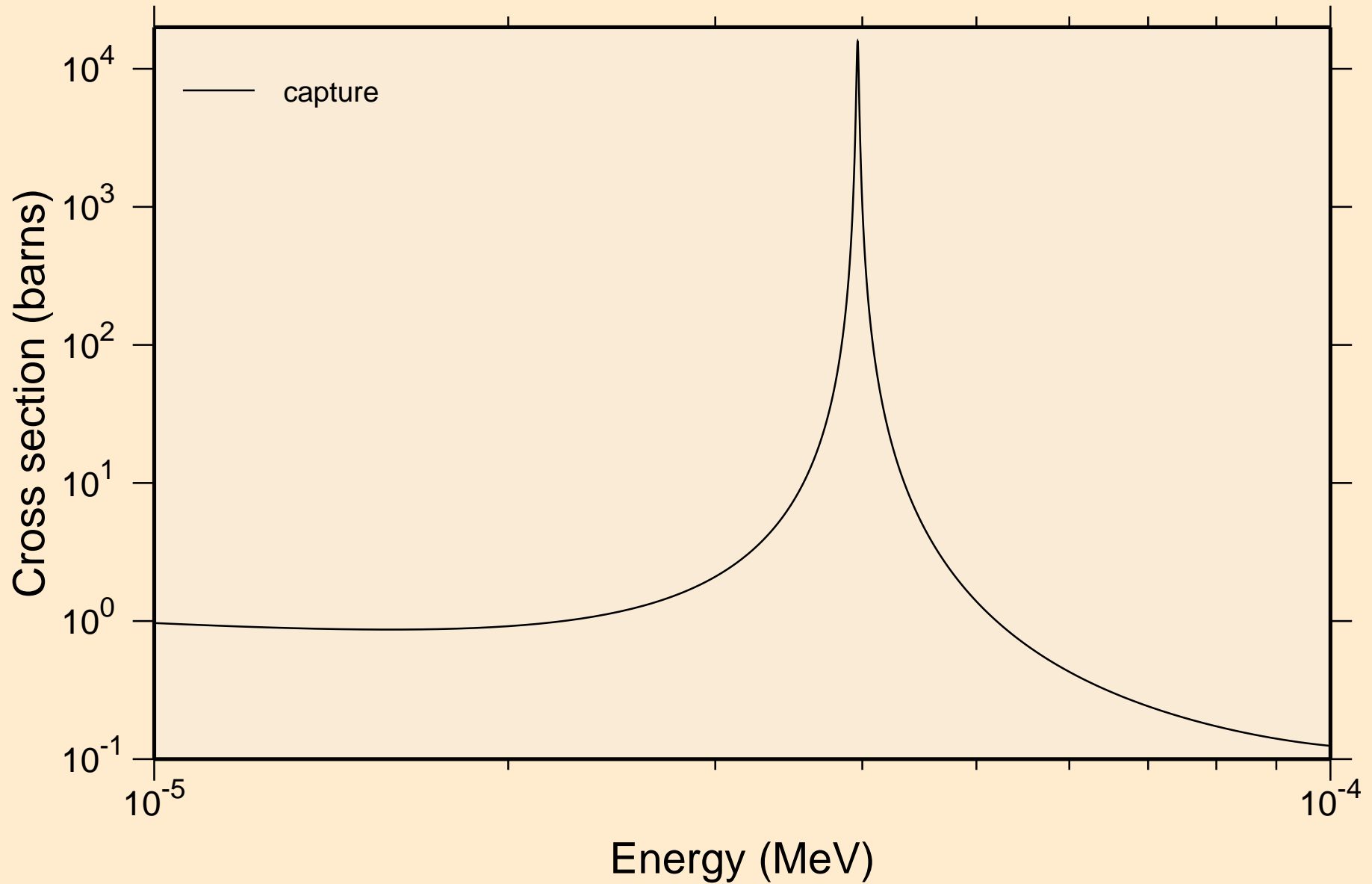

KR082 NEUTRON ACER TENDL-2024 LIBRARY; T=0.K
resonance absorption cross sections

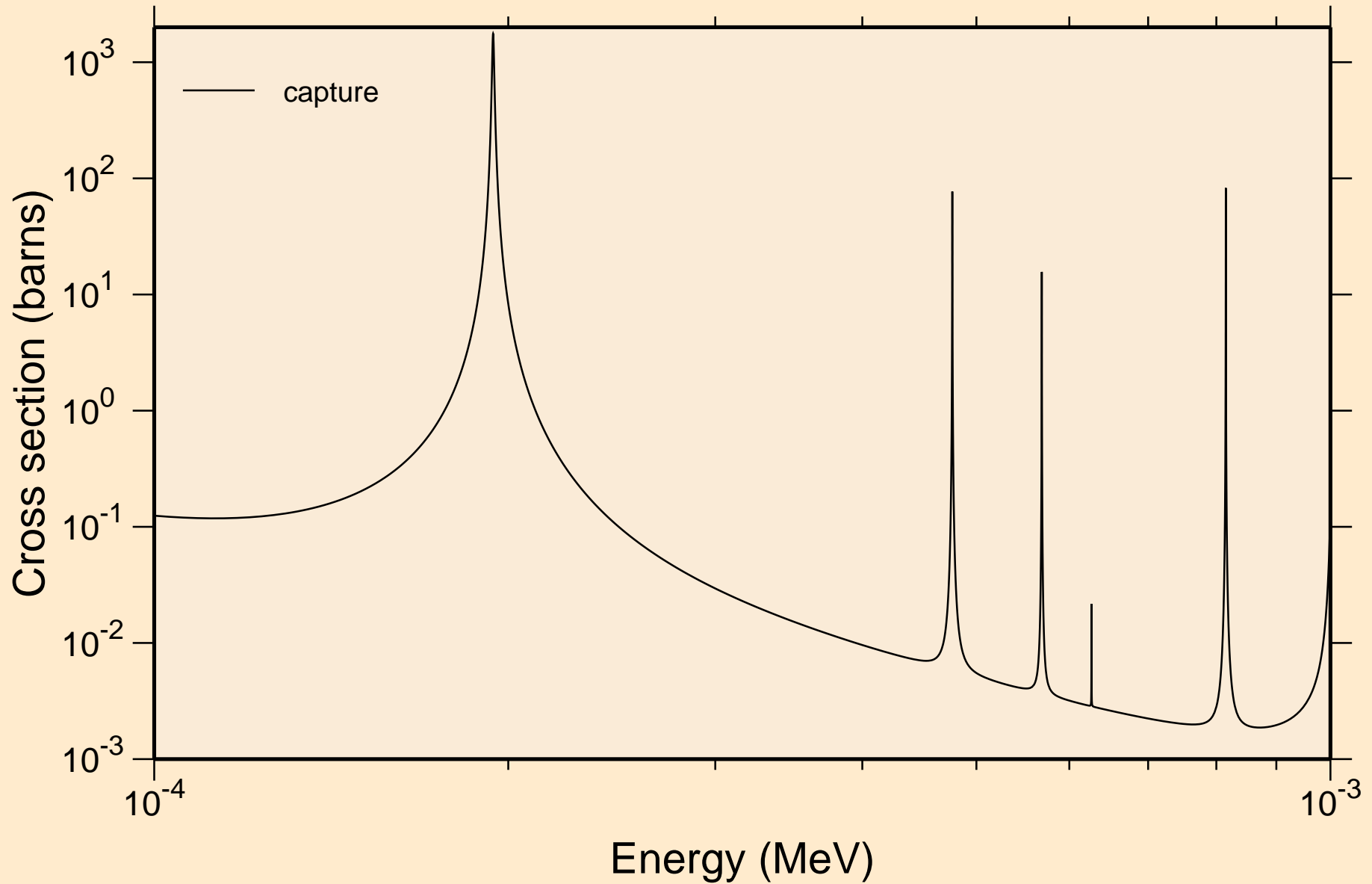

KR082 NEUTRON ACER TENDL-2024 LIBRARY; T=0.K
resonance absorption cross sections

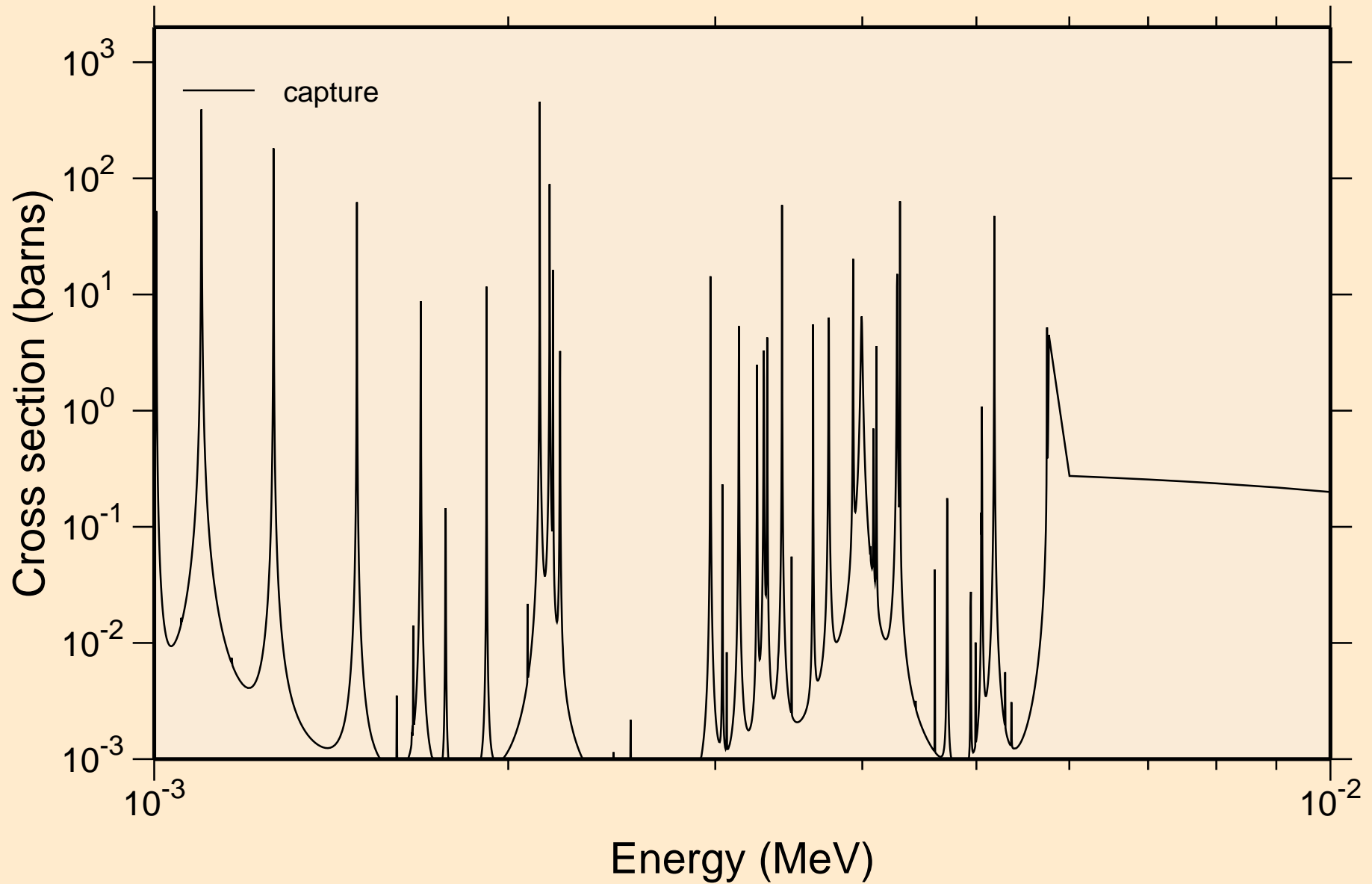

KR082 NEUTRON ACER TENDL-2024 LIBRARY; T=0.K
resonance absorption cross sections

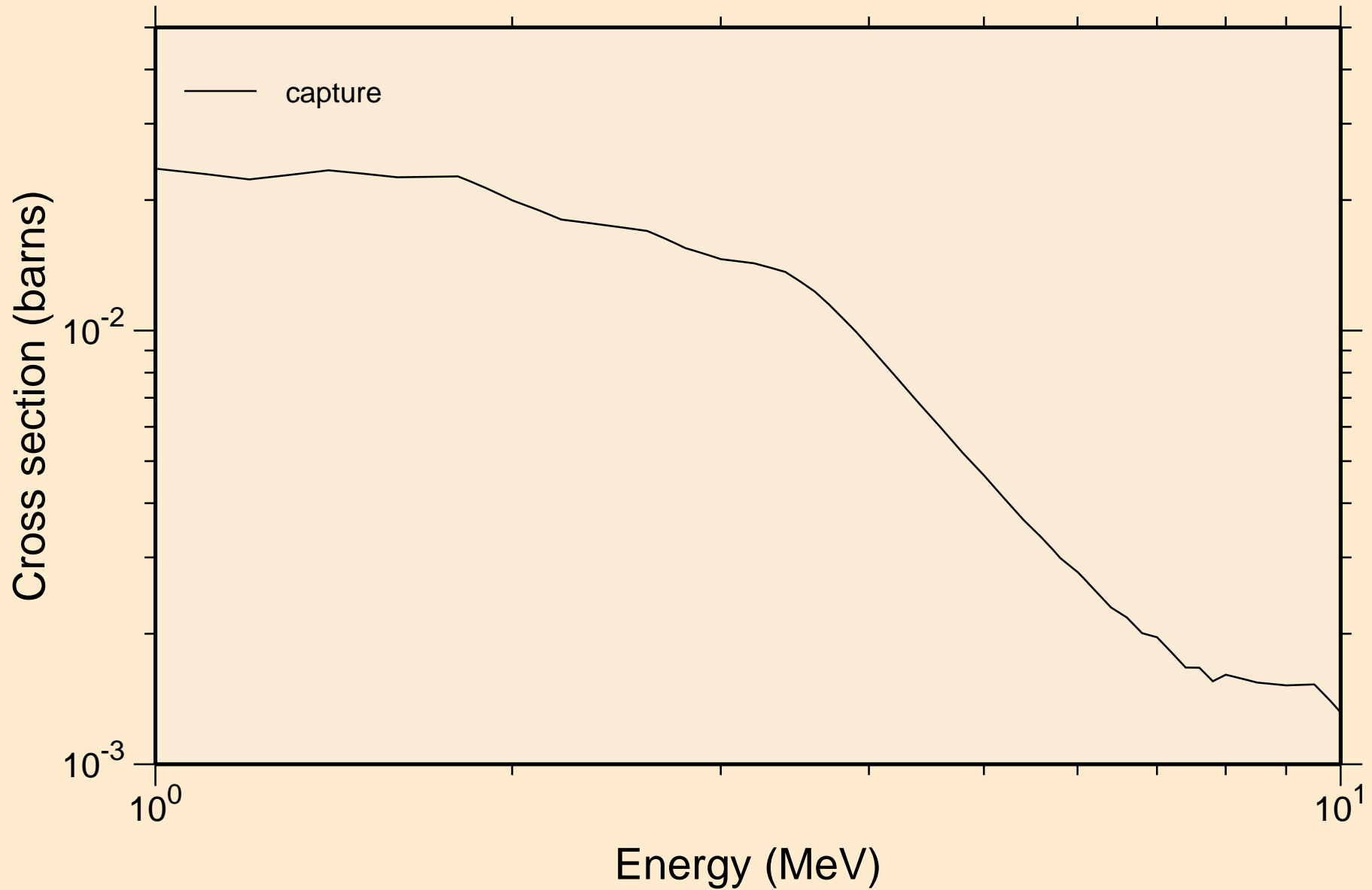

KR082 NEUTRON ACER TENDL-2024 LIBRARY; T=0.K

Heating

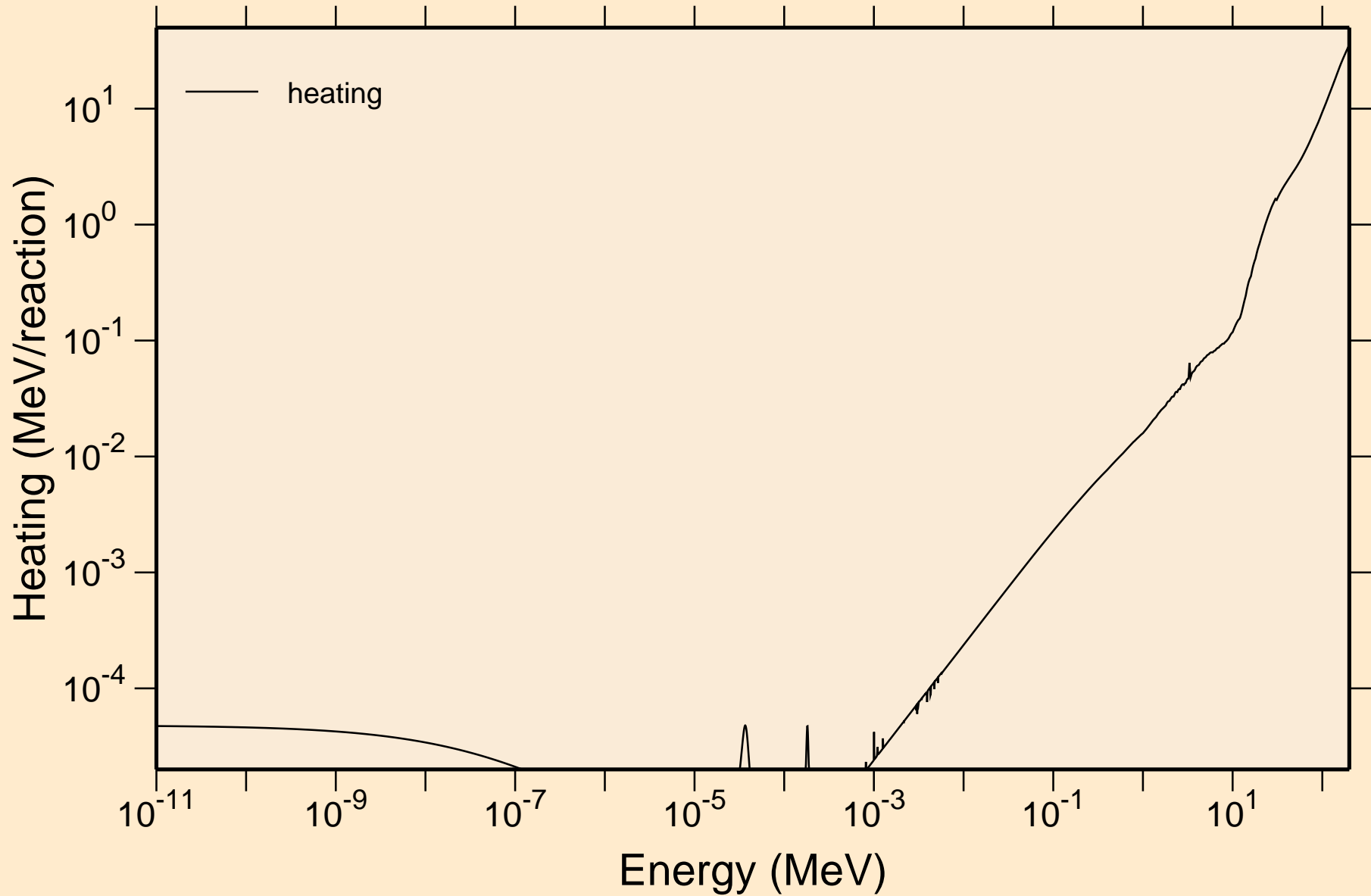

KR082 NEUTRON ACER TENDL-2024 LIBRARY; T=0.K

Damage

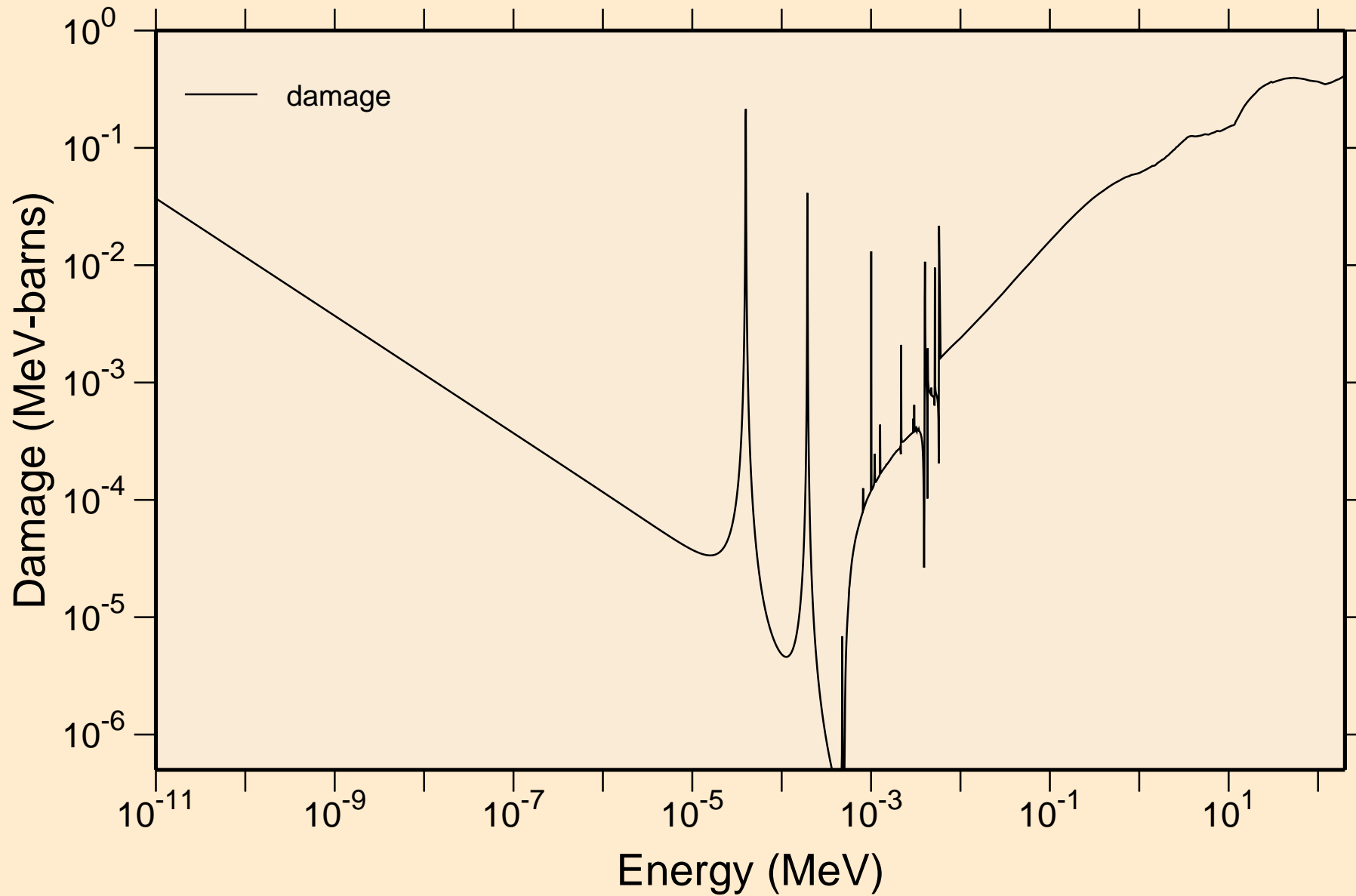

KR082 NEUTRON ACER TENDL-2024 LIBRARY; T=0.K

Non-threshold reactions

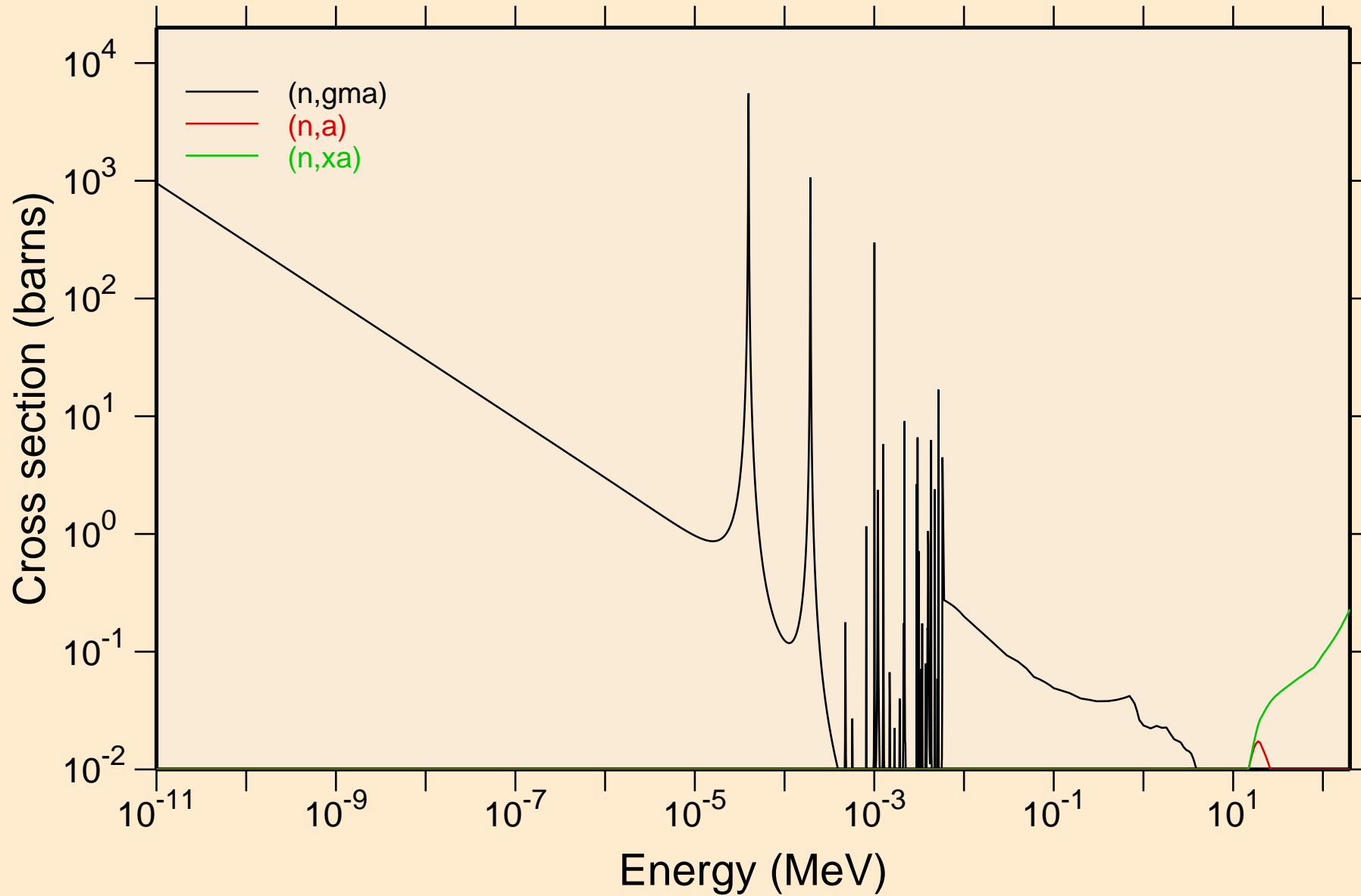

KR082 NEUTRON ACER TENDL-2024 LIBRARY; T=0.K

Principal cross sections

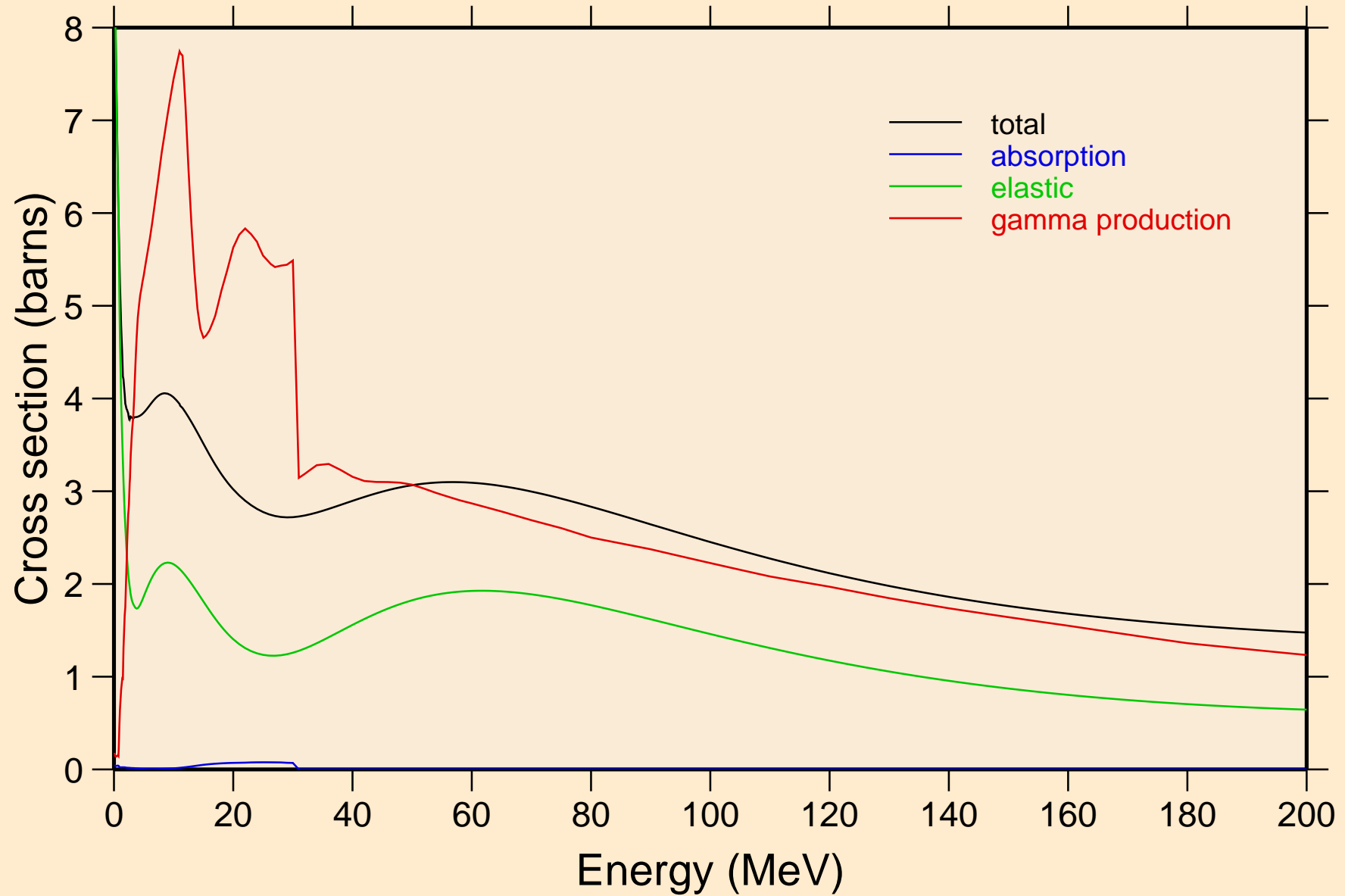

KR082 NEUTRON ACER TENDL-2024 LIBRARY; T=0.K

Heating

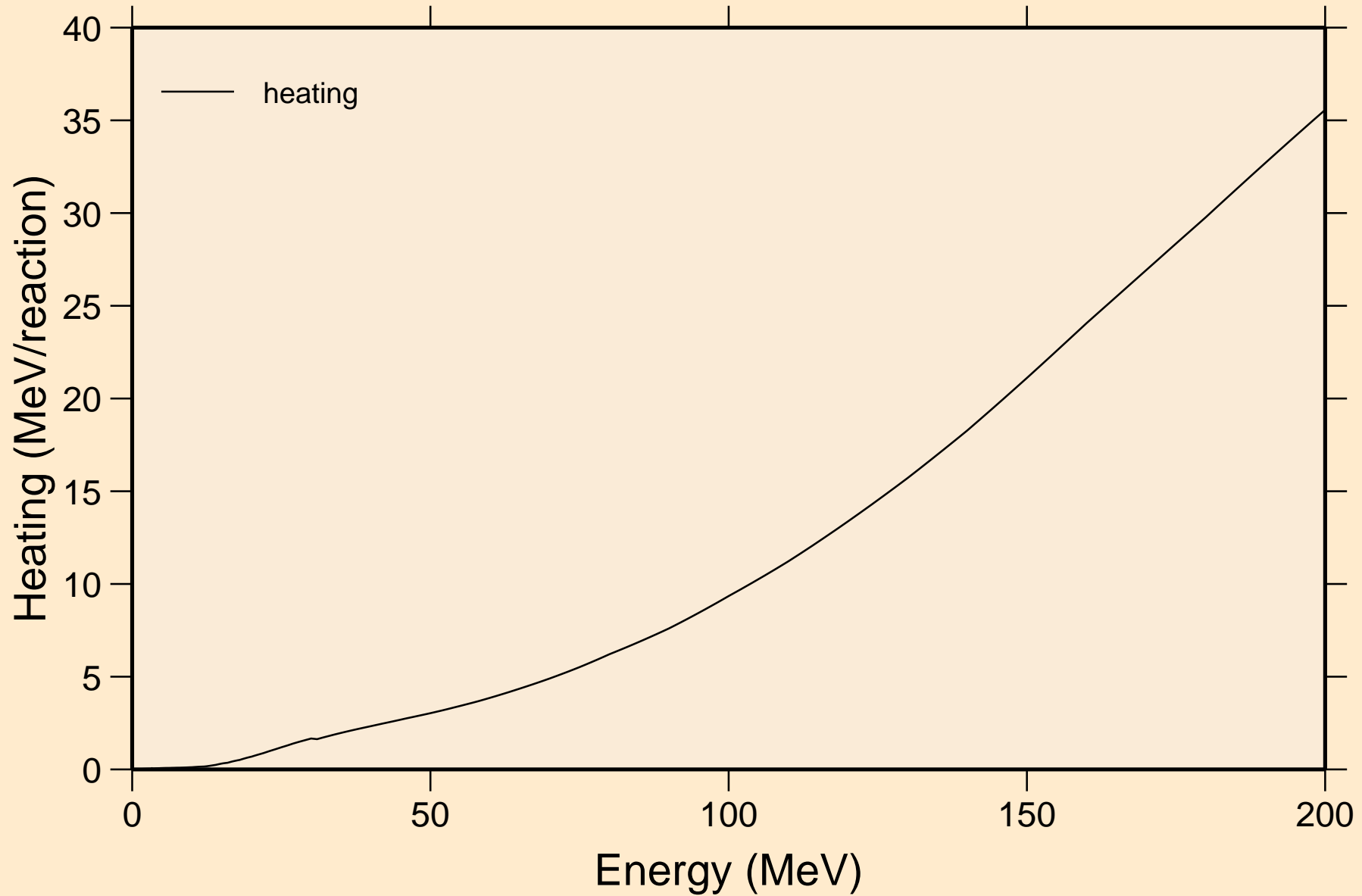

KR082 NEUTRON ACER TENDL-2024 LIBRARY; T=0.K

Damage

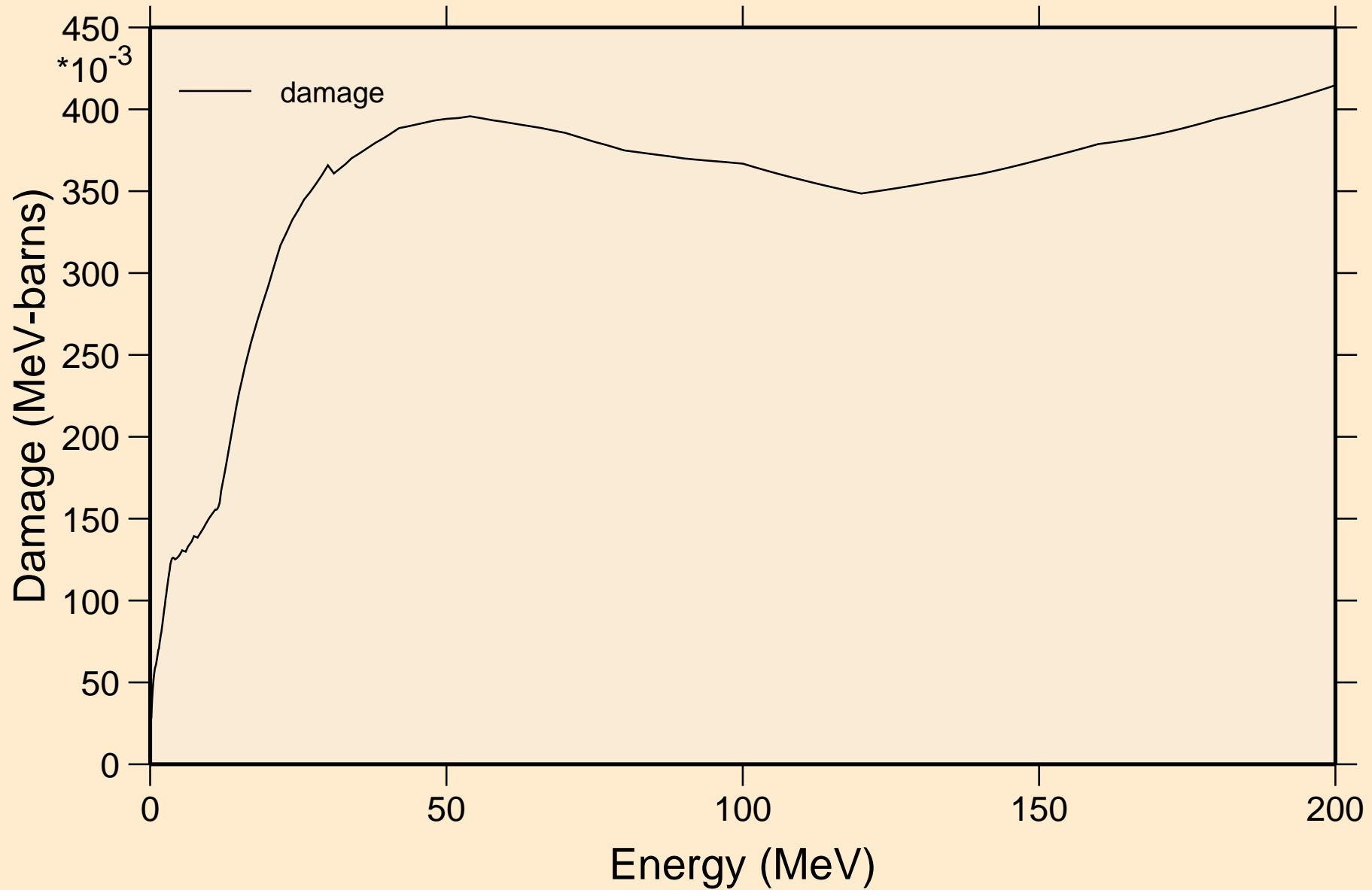

KR082 NEUTRON ACER TENDL-2024 LIBRARY; T=0.K
Non-threshold reactions

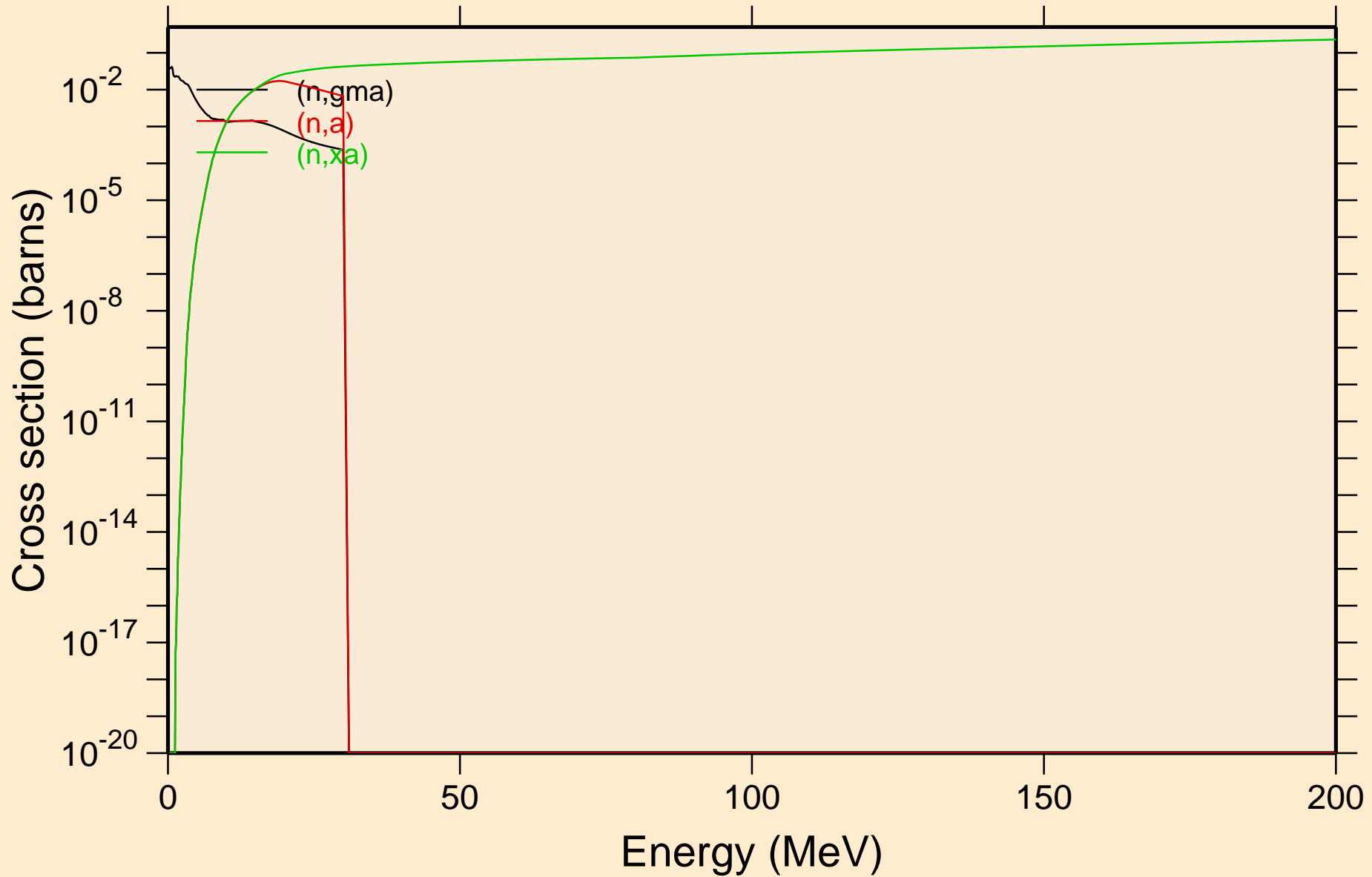

KR082 NEUTRON ACER TENDL-2024 LIBRARY; T=0.K
Inelastic levels

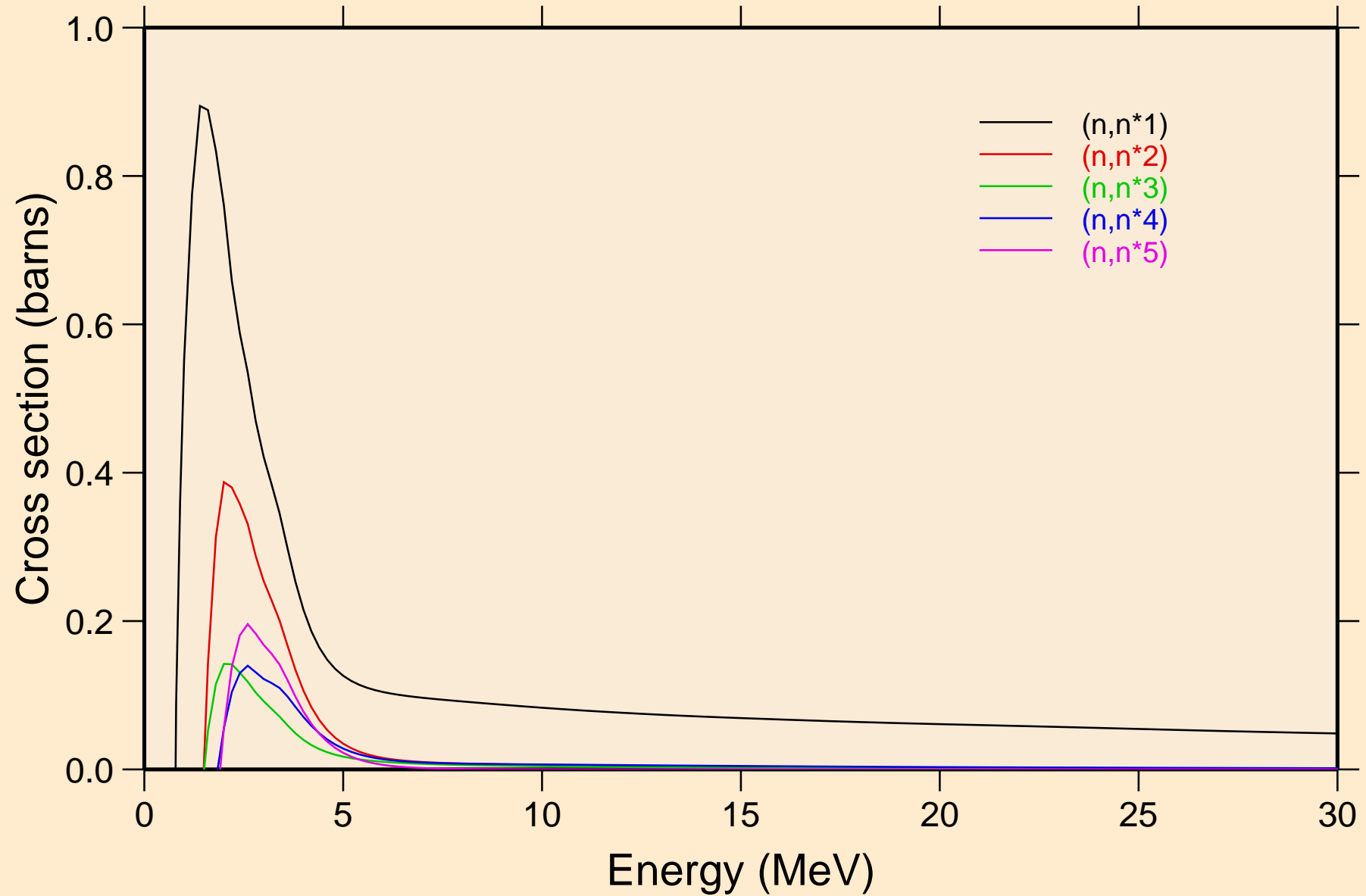

KR082 NEUTRON ACER TENDL-2024 LIBRARY; T=0.K

Inelastic levels

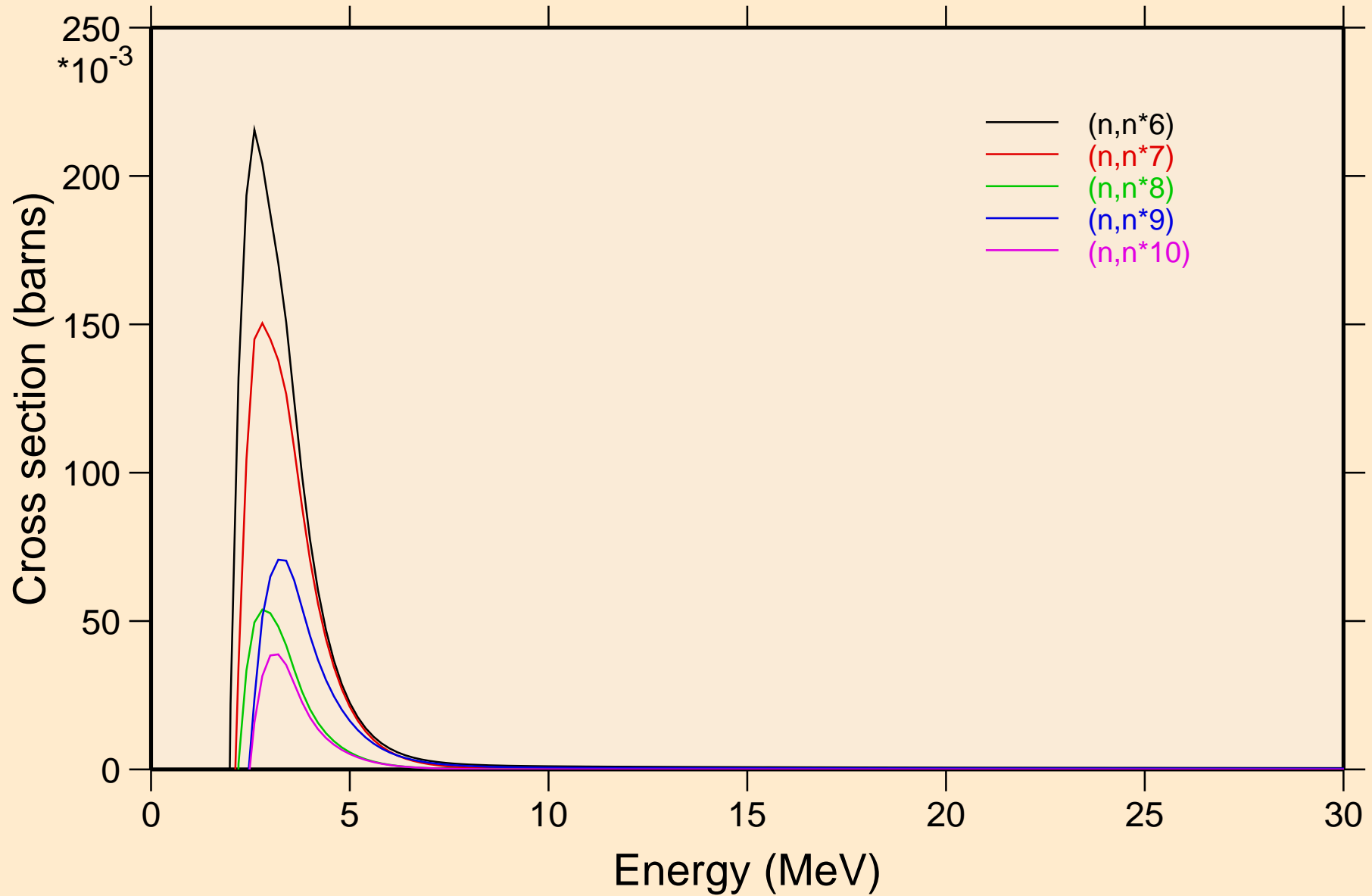

KR082 NEUTRON ACER TENDL-2024 LIBRARY; T=0.K
Inelastic levels

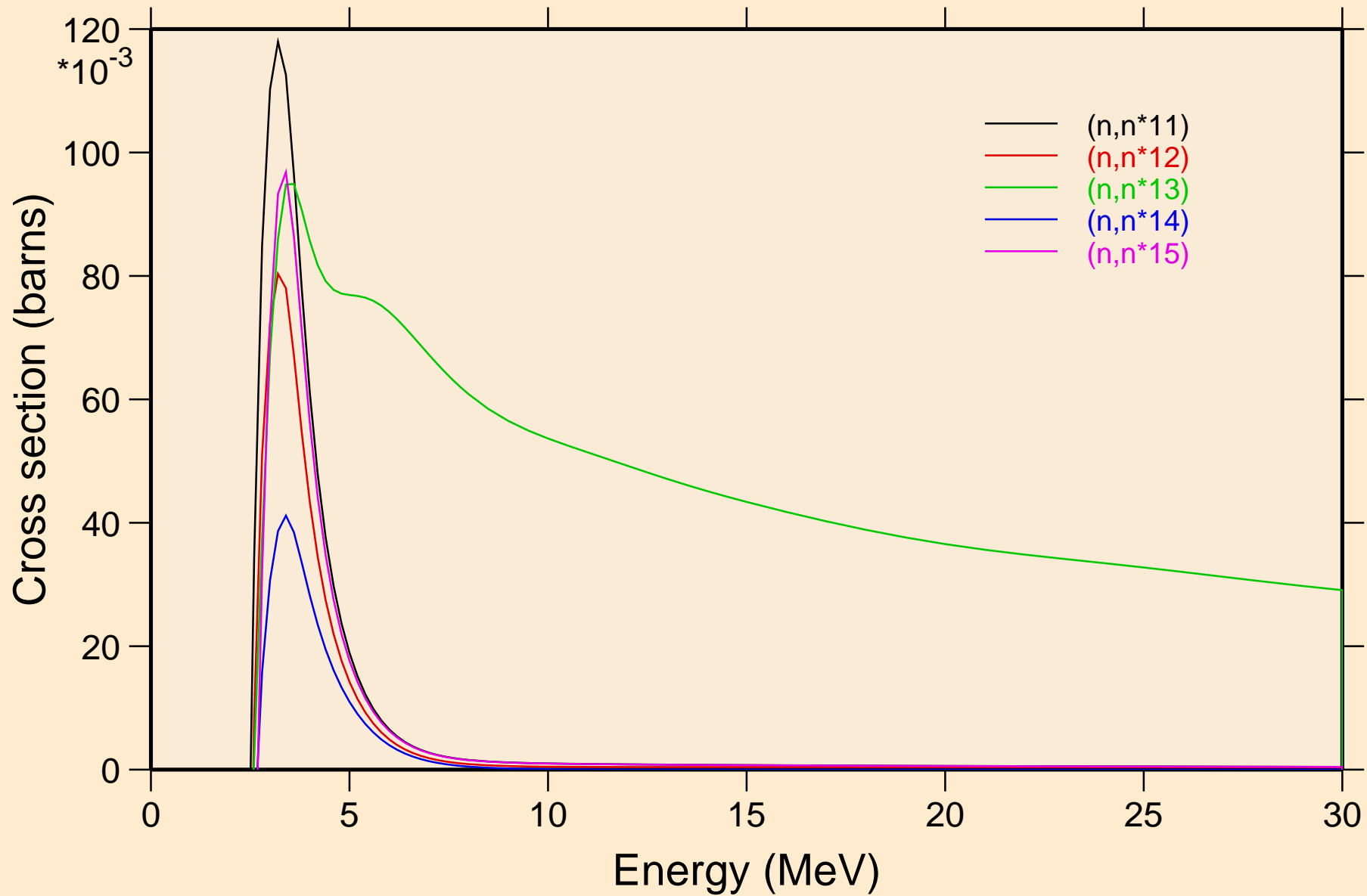

KR082 NEUTRON ACER TENDL-2024 LIBRARY; T=0.K
Inelastic levels

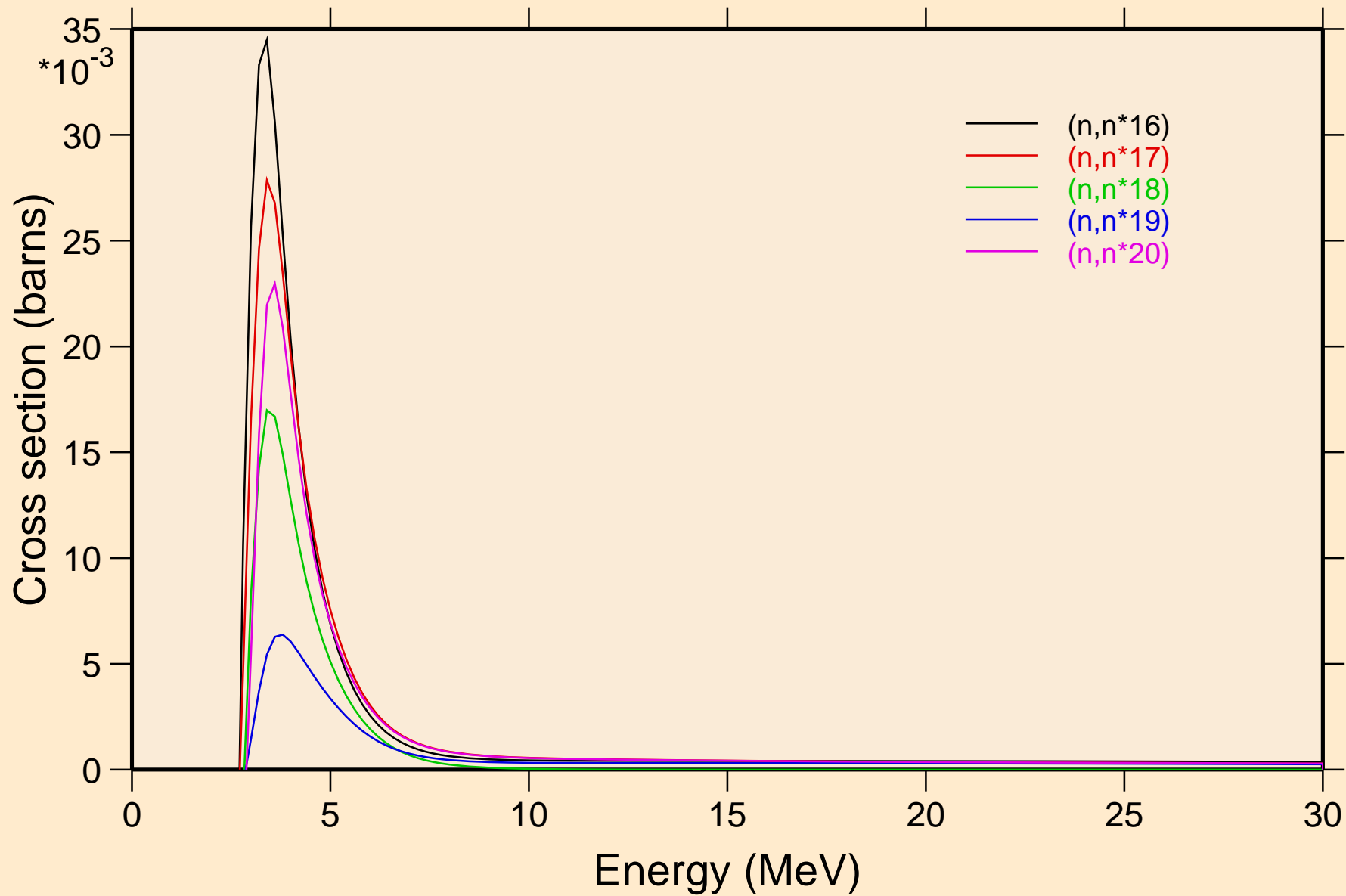

KR082 NEUTRON ACER TENDL-2024 LIBRARY; T=0.K
Inelastic levels

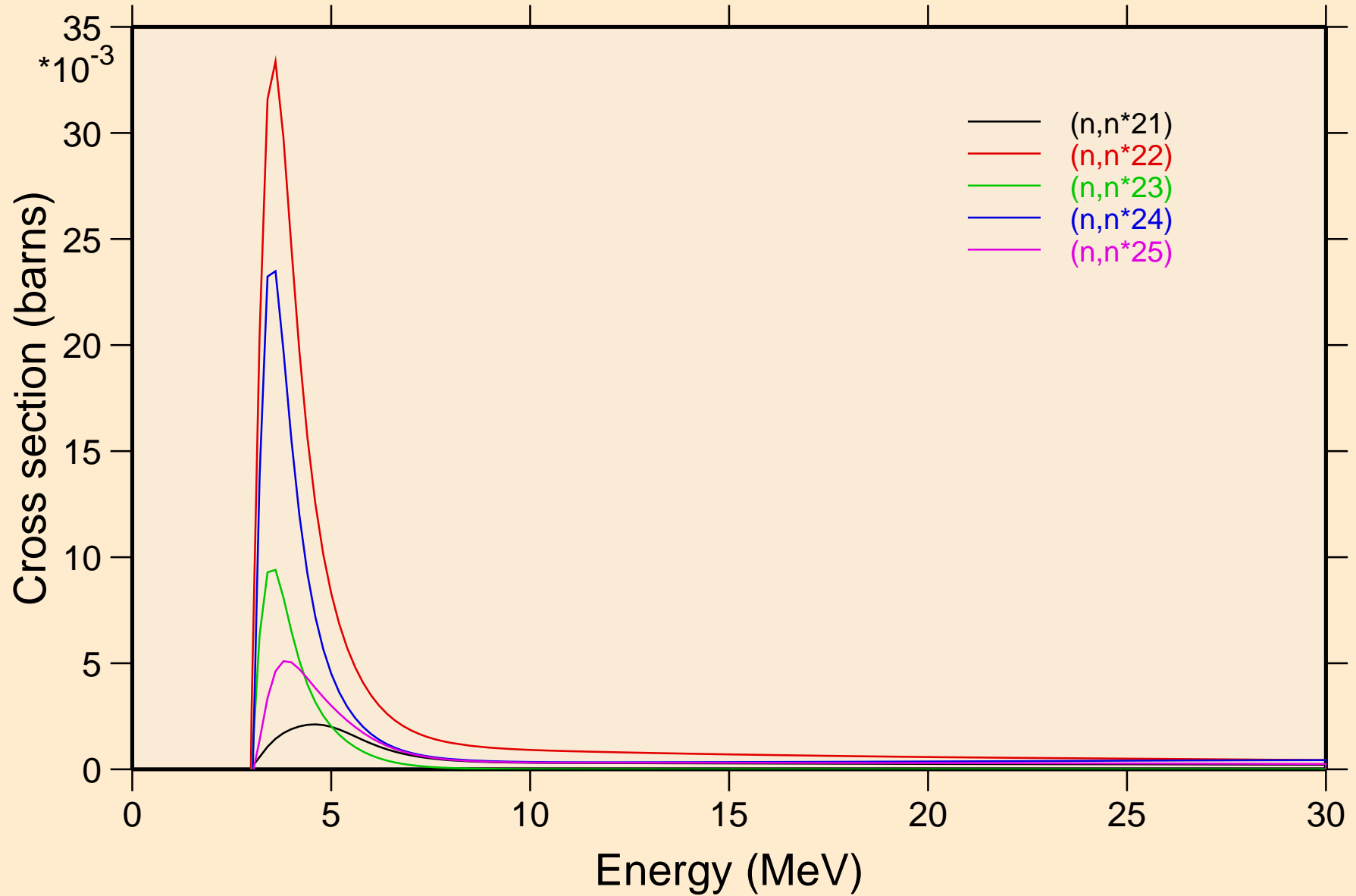

KR082 NEUTRON ACER TENDL-2024 LIBRARY; T=0.K
Inelastic levels

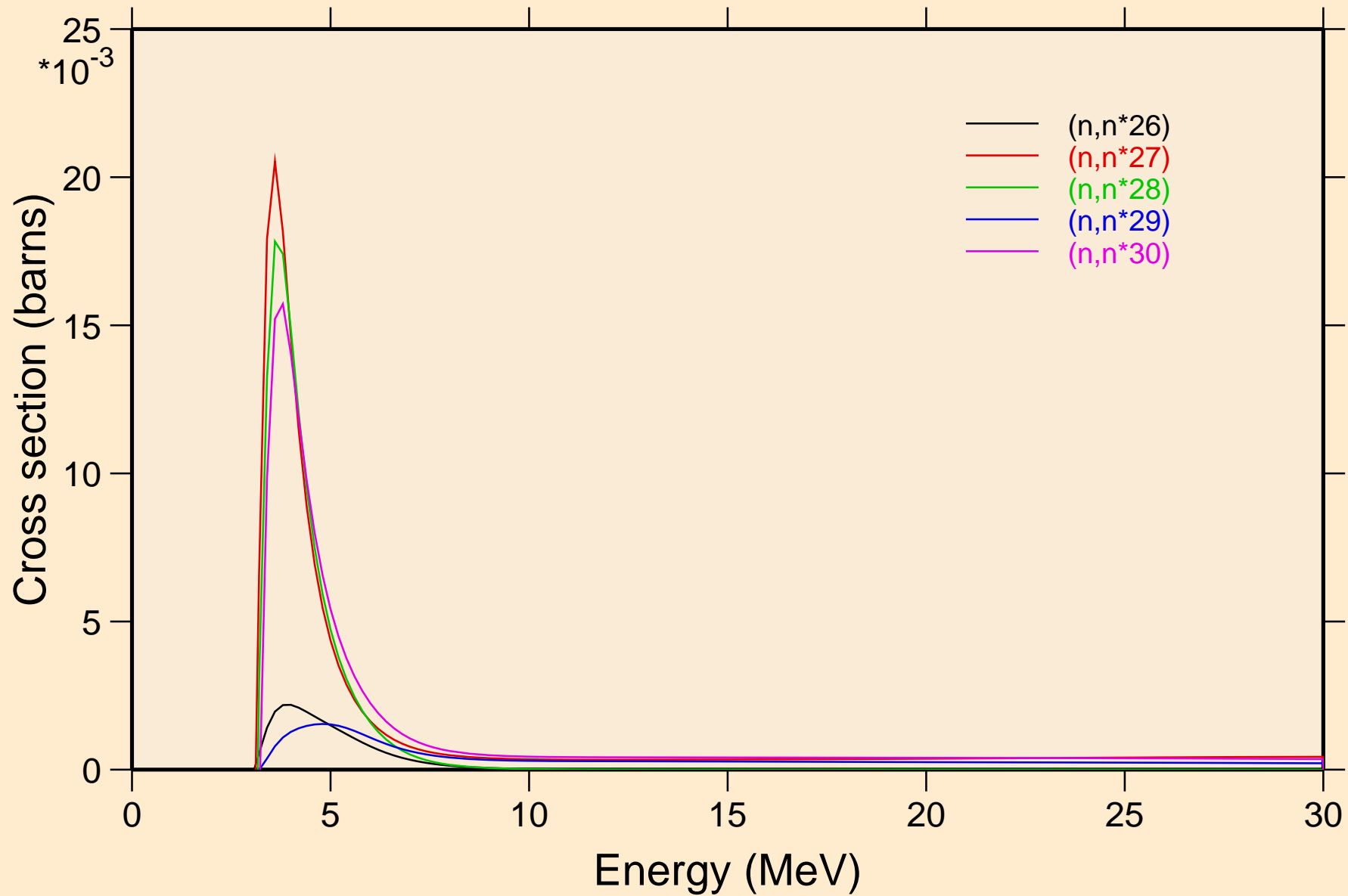

KR082 NEUTRON ACER TENDL-2024 LIBRARY; T=0.K
Threshold reactions

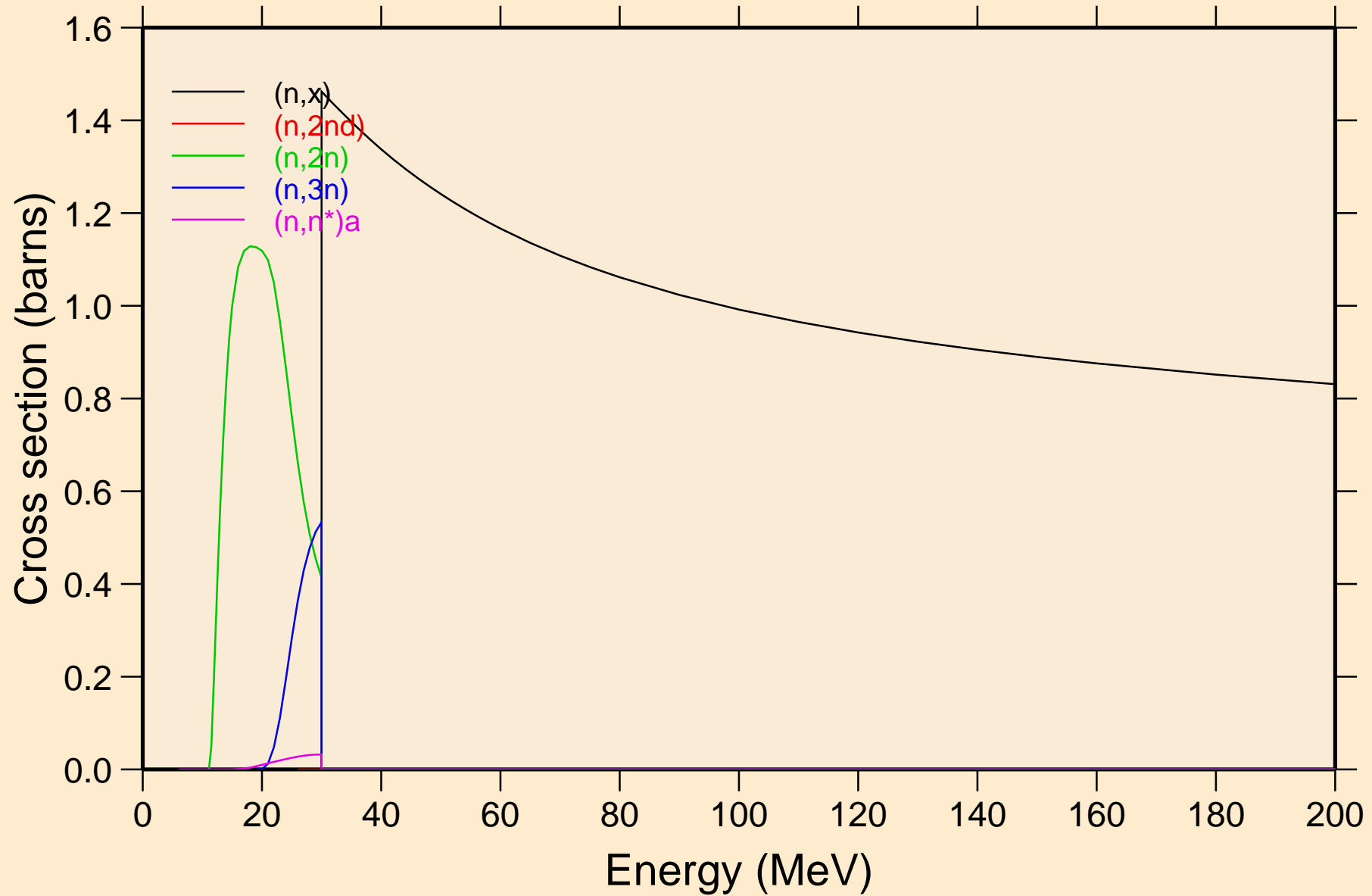

KR082 NEUTRON ACER TENDL-2024 LIBRARY; T=0.K
Threshold reactions

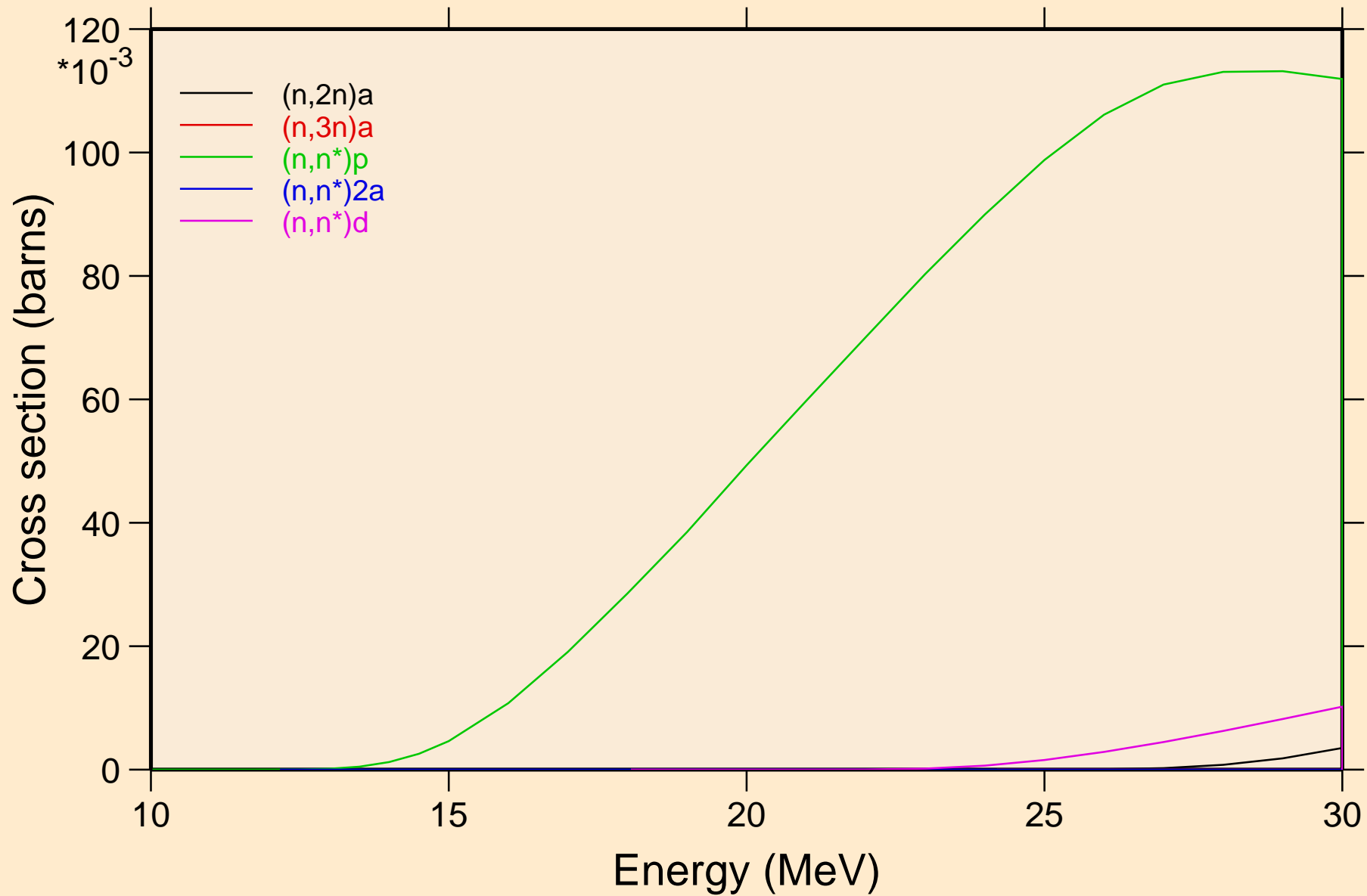

KR082 NEUTRON ACER TENDL-2024 LIBRARY; T=0.K
Threshold reactions

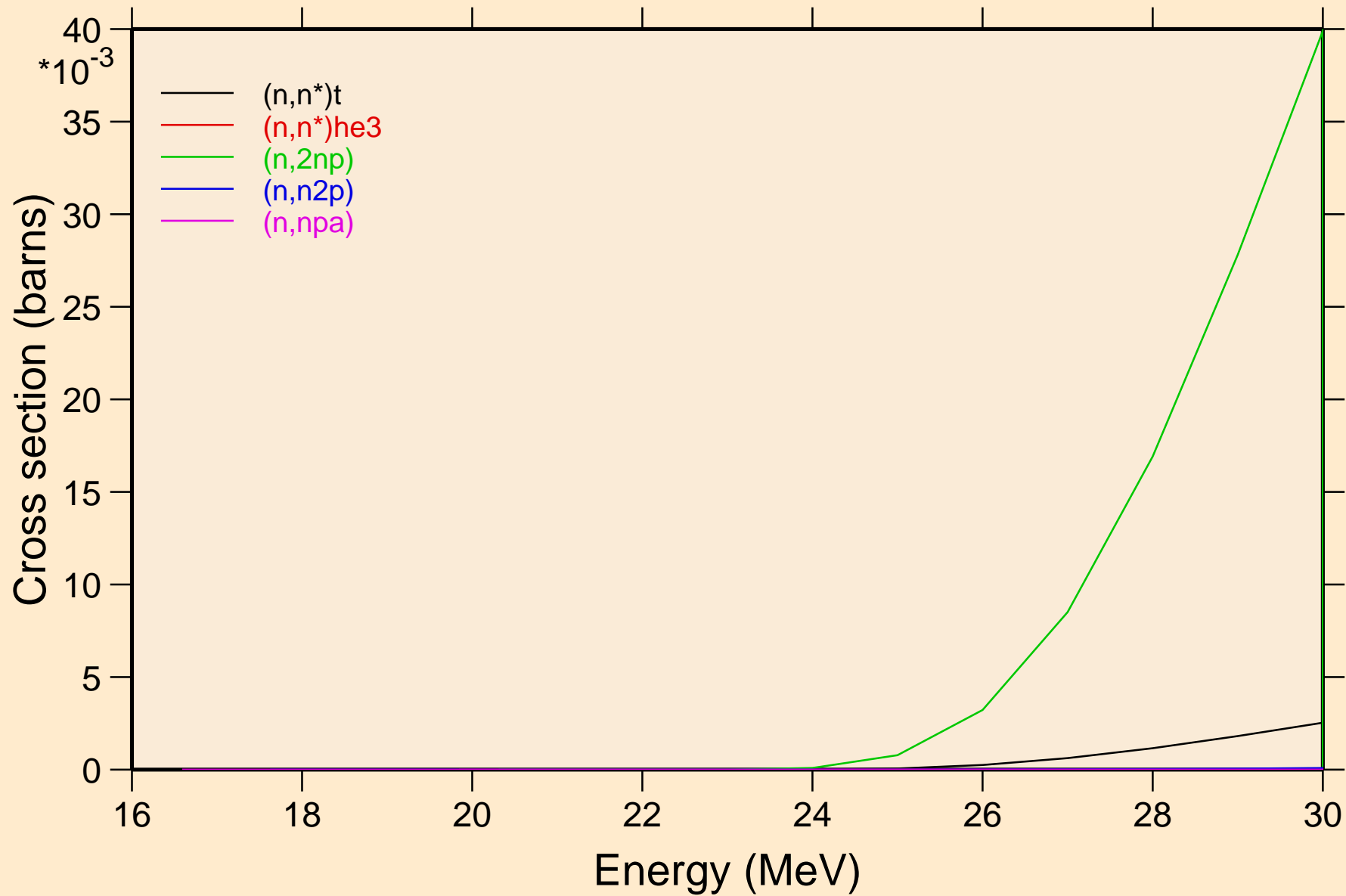

KR082 NEUTRON ACER TENDL-2024 LIBRARY; T=0.K
Threshold reactions

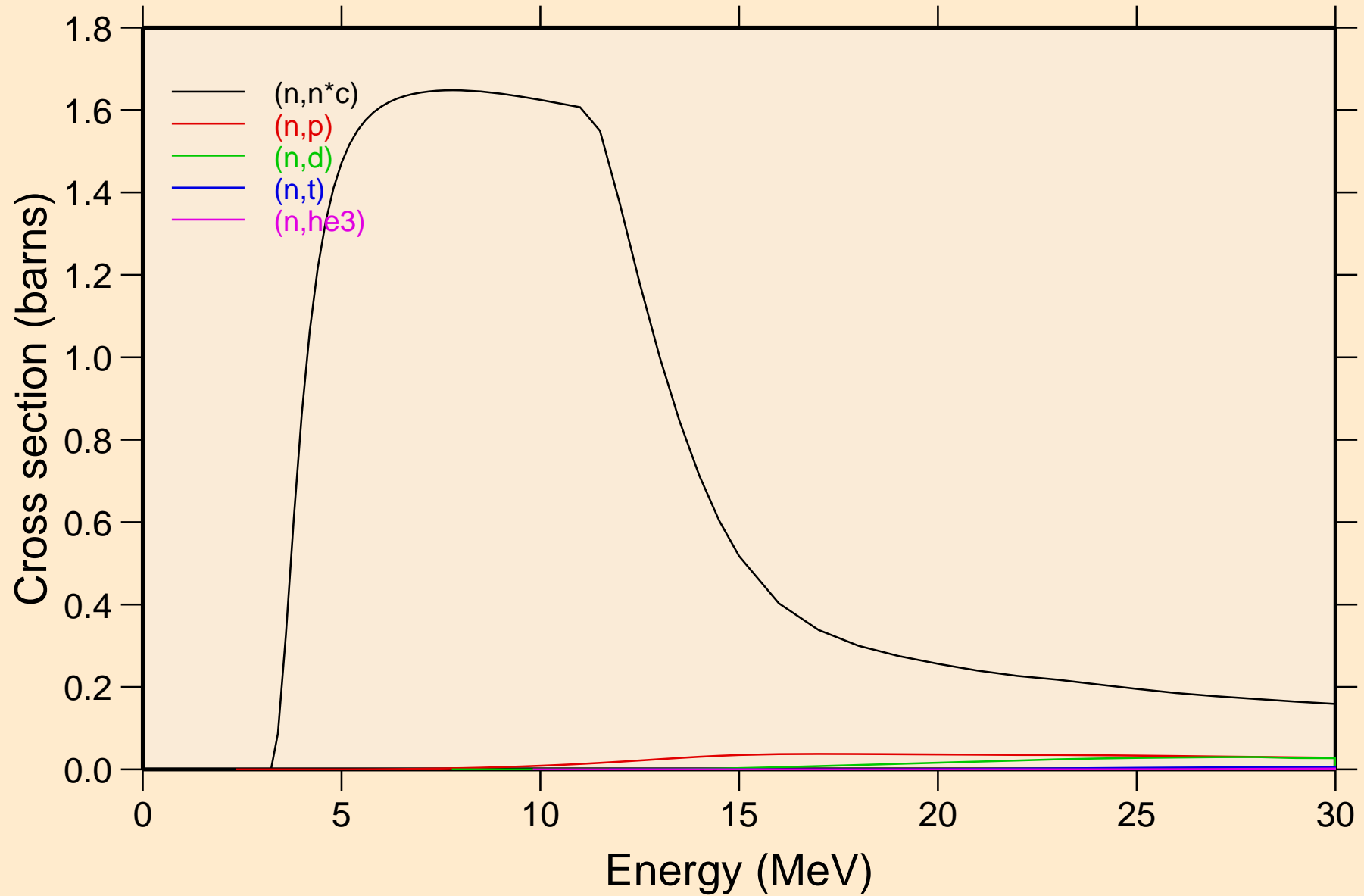

KR082 NEUTRON ACER TENDL-2024 LIBRARY; T=0.K

Threshold reactions

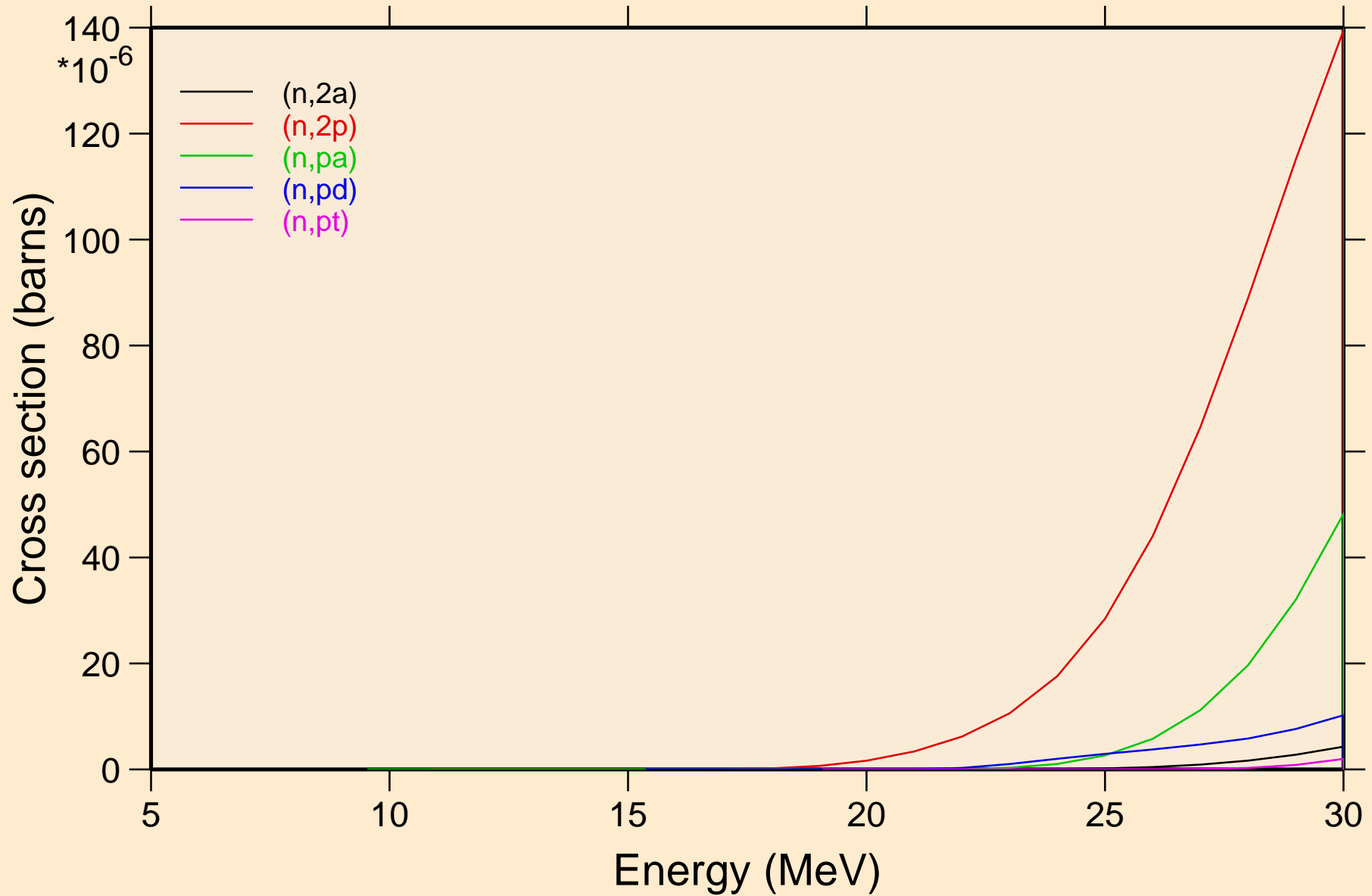

KR082 NEUTRON ACER TENDL-2024 LIBRARY; T=0.K
Threshold reactions

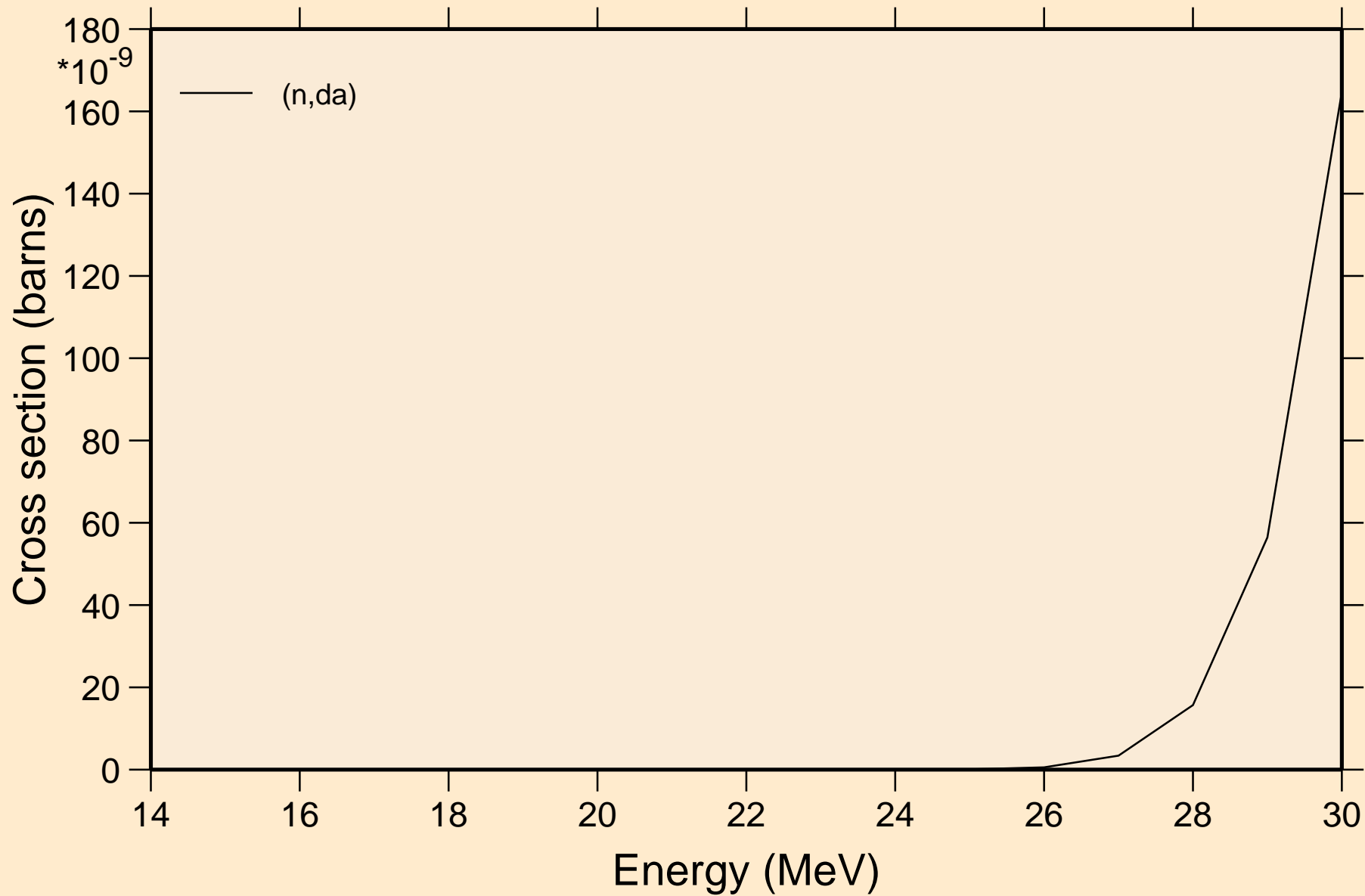

KR082 NEUTRON ACER TENDL-2024 LIBRARY; T=0.K
Threshold reactions

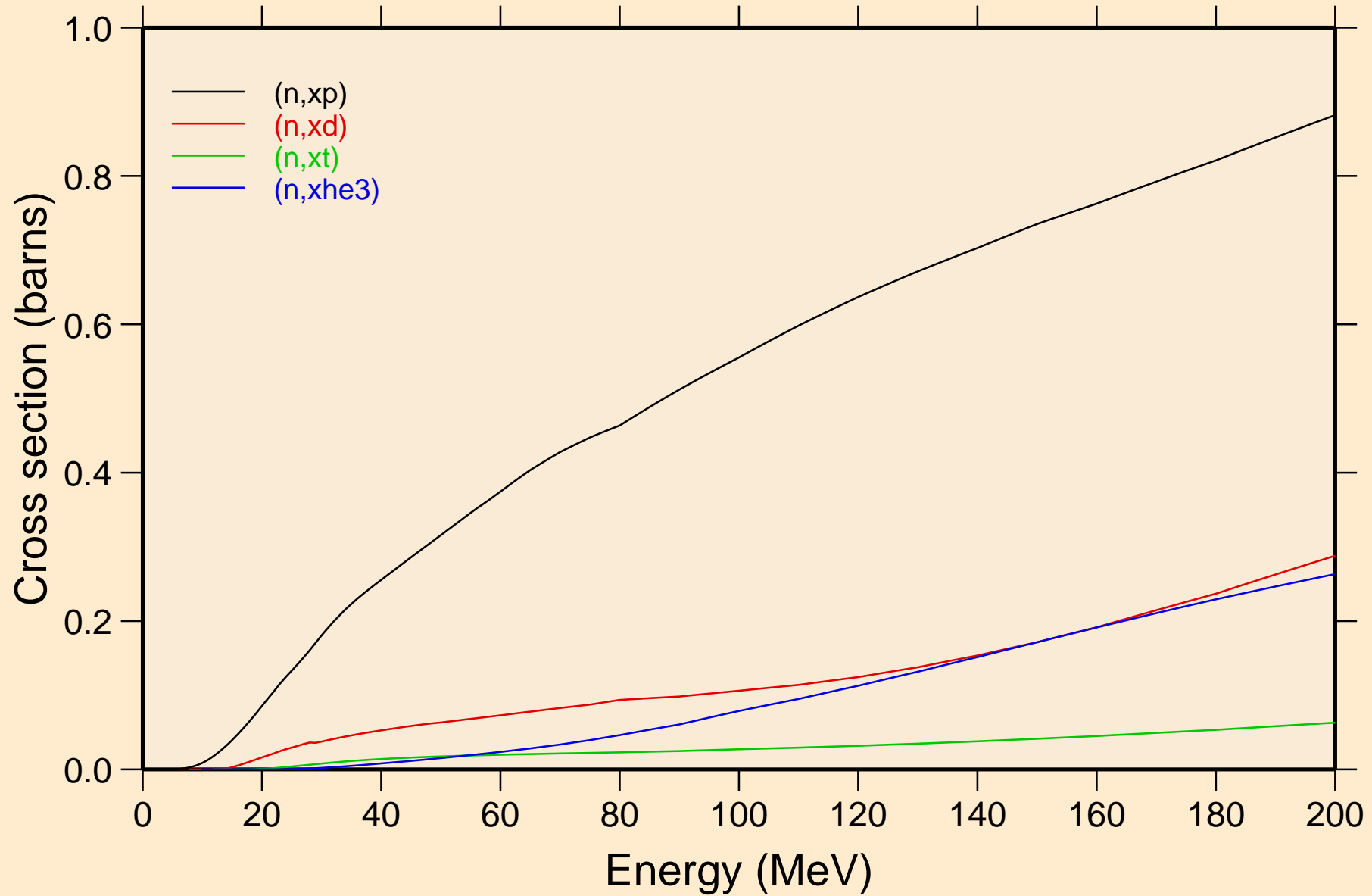

KR082 NEUTRON ACER TENDL-2024 LIBRARY; T=0.K
angular distribution for elastic

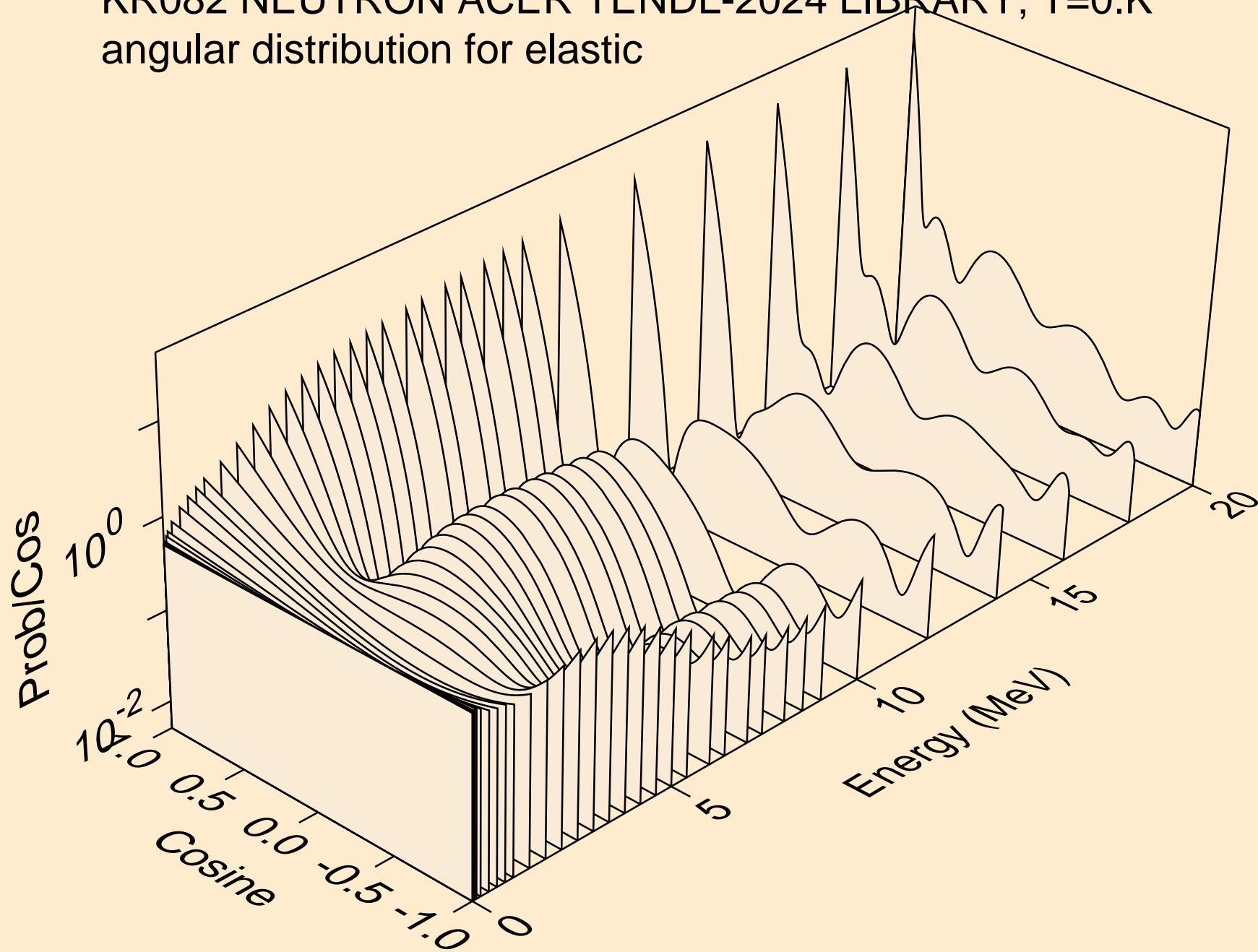

KR082 NEUTRON ACER TENDL-2024 LIBRARY; T=0.K
angular distribution for elastic

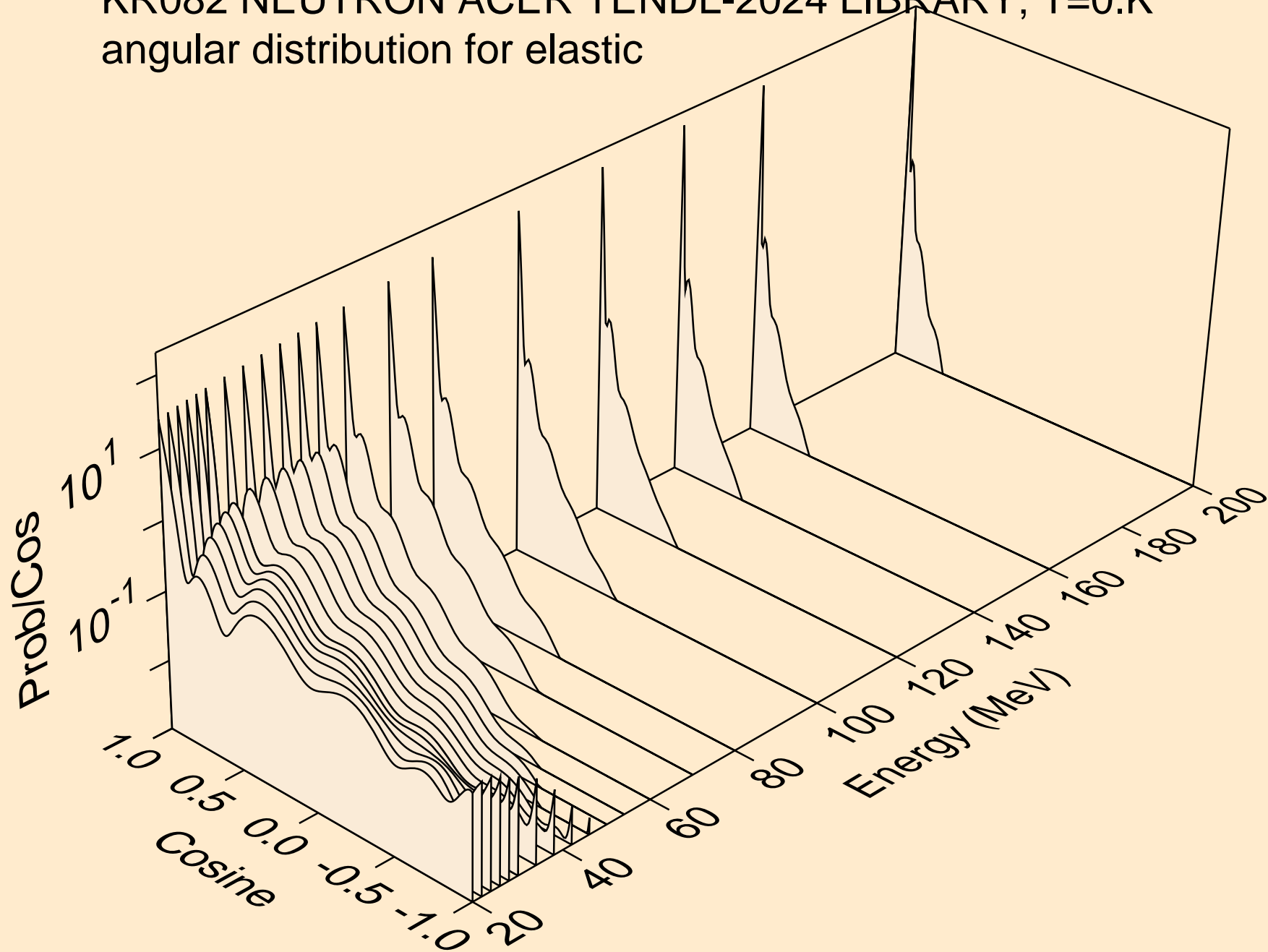

KR082 NEUTRON ACER TENDL-2024 LIBRARY; T=0.K
angular distribution for (n,n*1)

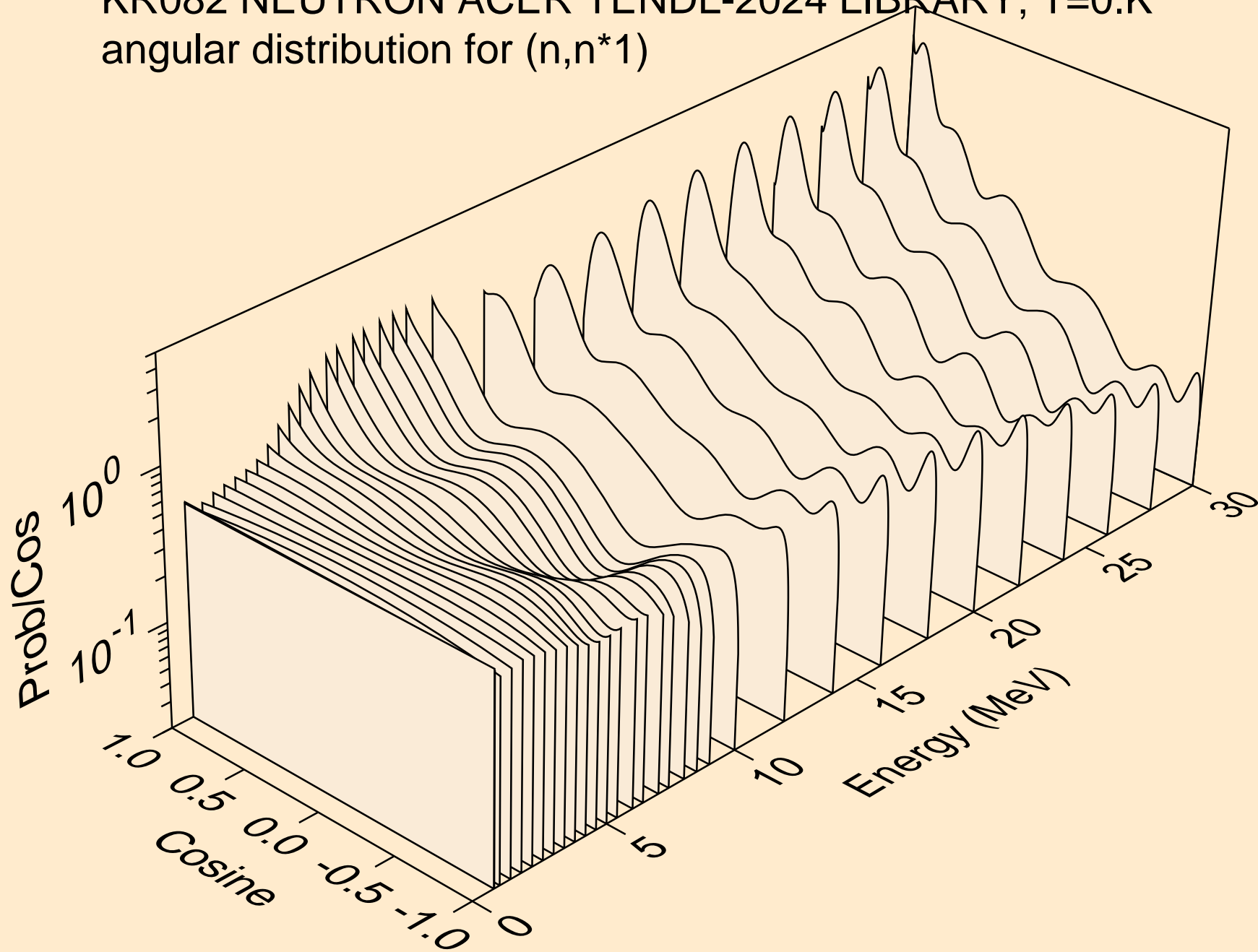

KR082 NEUTRON ACER TENDL-2024 LIBRARY; T=0.K
angular distribution for (n,n*2)

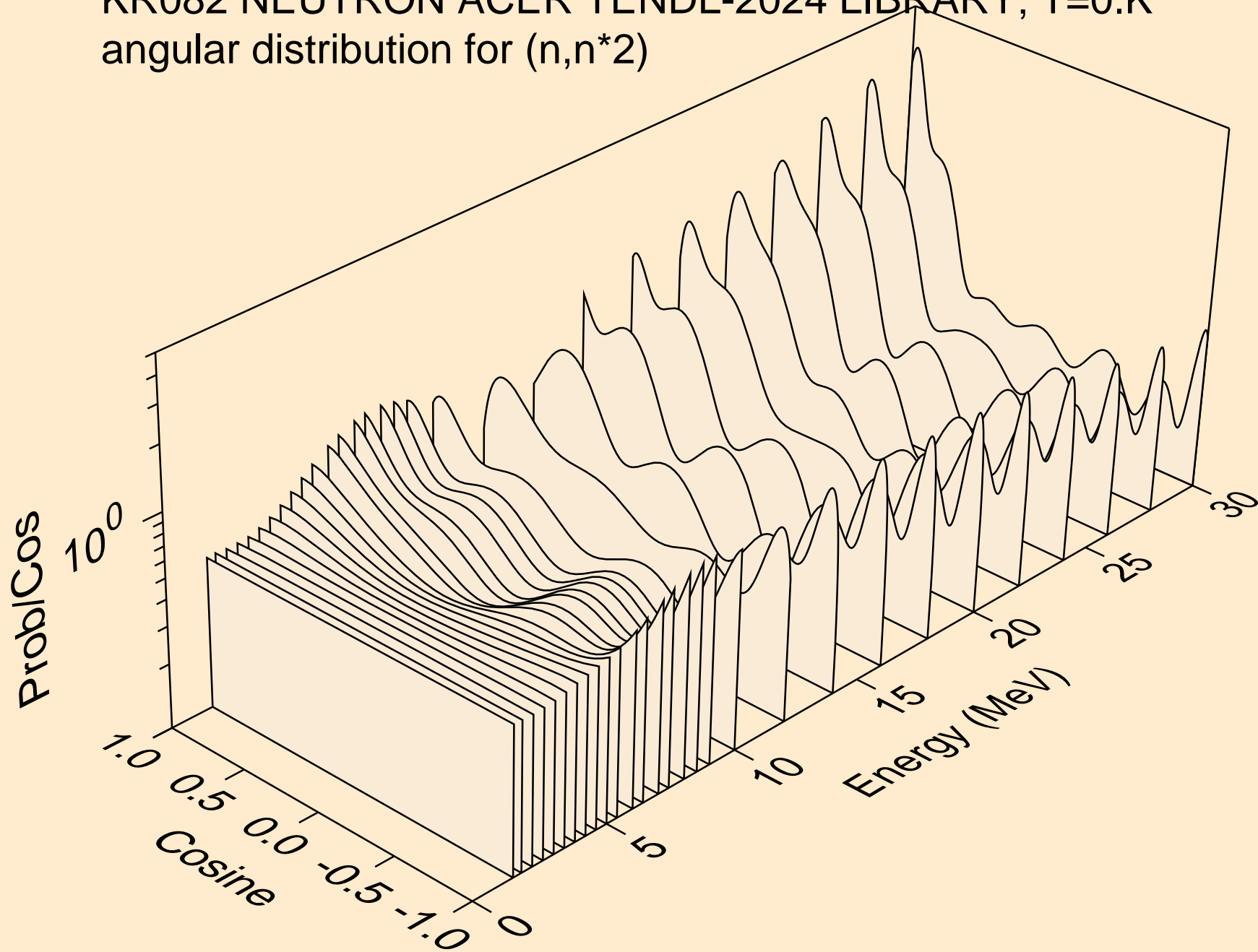

KR082 NEUTRON ACER TENDL-2024 LIBRARY; T=0.K
angular distribution for (n,n*3)

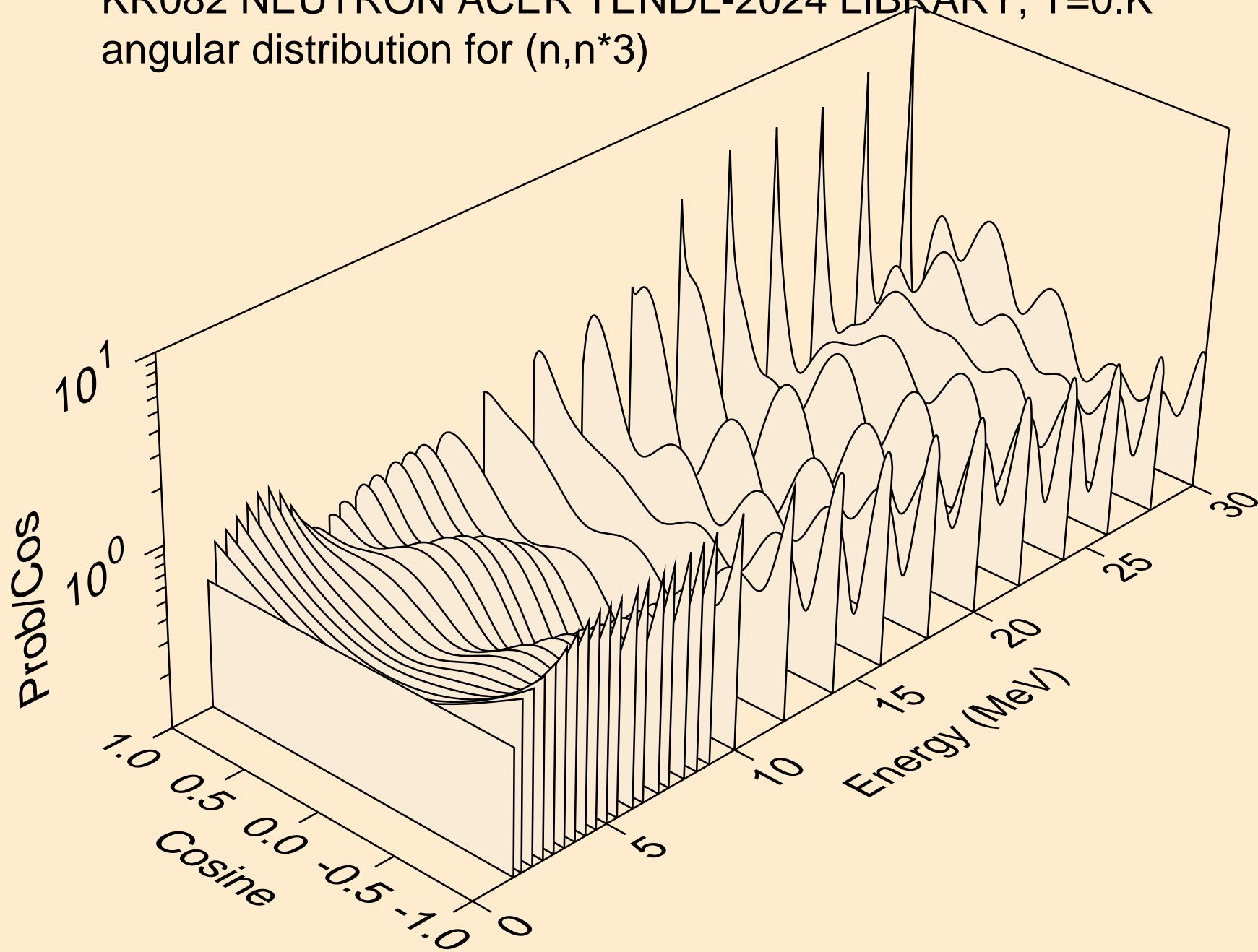

KR082 NEUTRON ACER TENDL-2024 LIBRARY; T=0.K
angular distribution for (n,n*4)

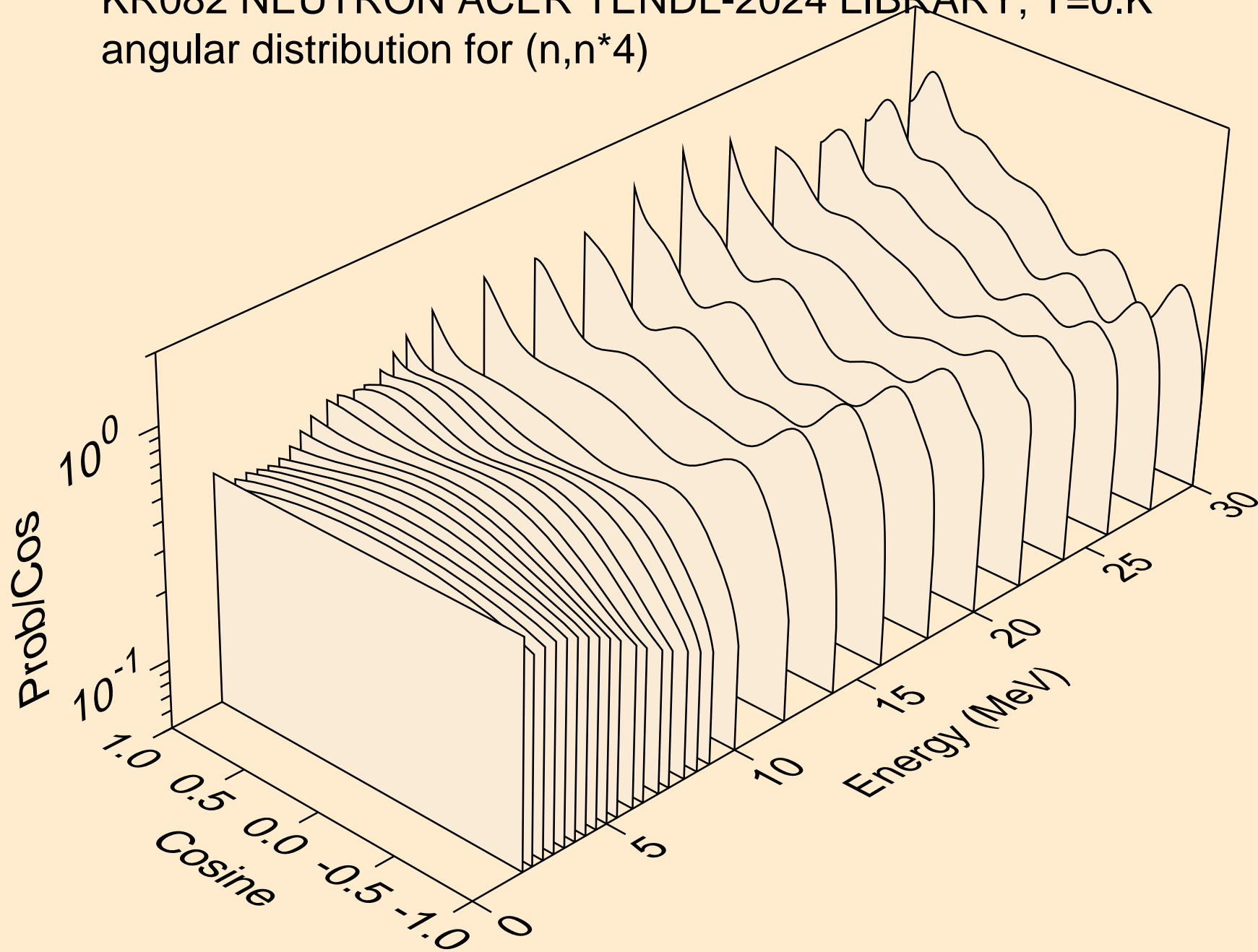

KR082 NEUTRON ACER TENDL-2024 LIBRARY; T=0.K
angular distribution for (n,n*5)

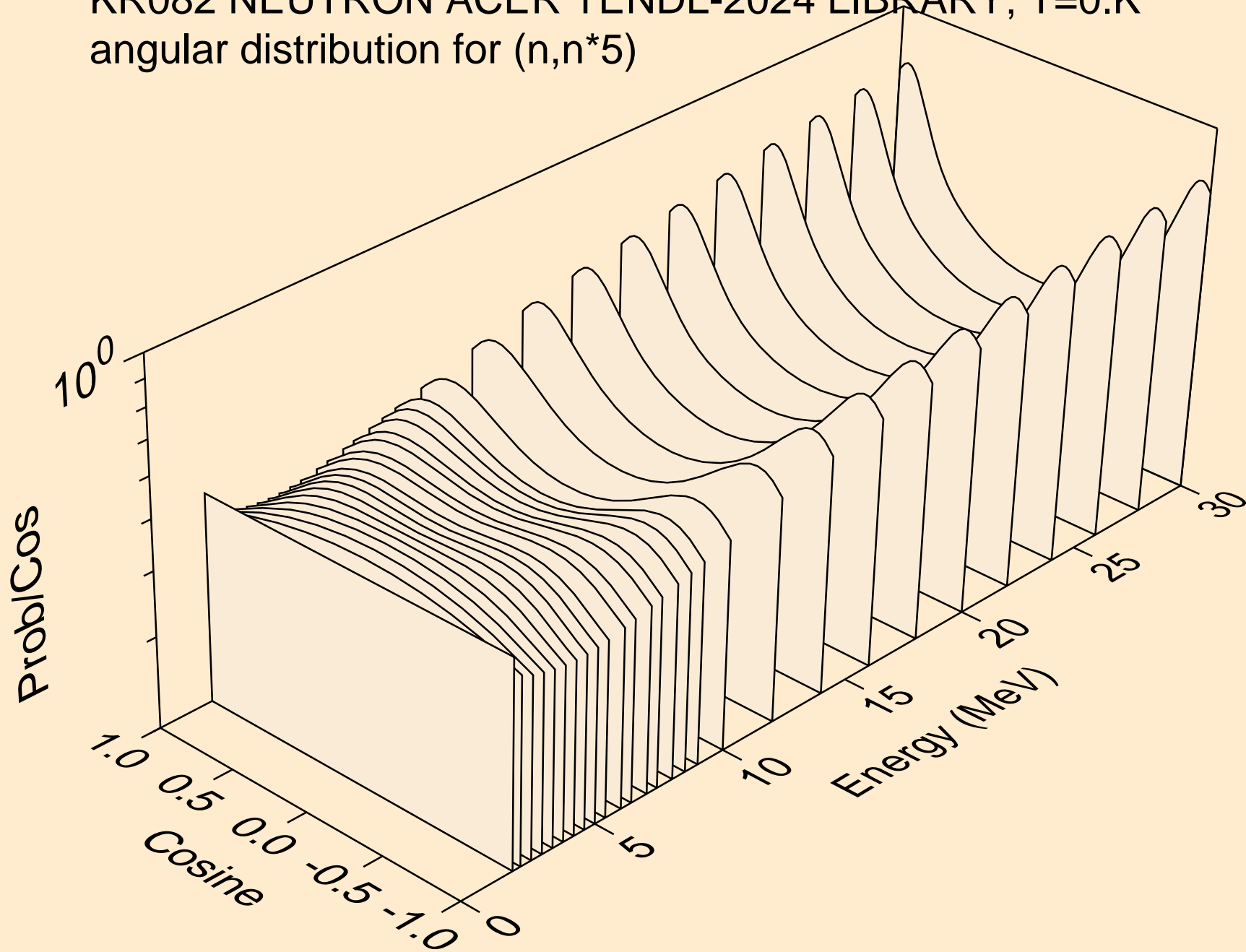

KR082 NEUTRON ACER TENDL-2024 LIBRARY; T=0.K
angular distribution for (n,n*6)

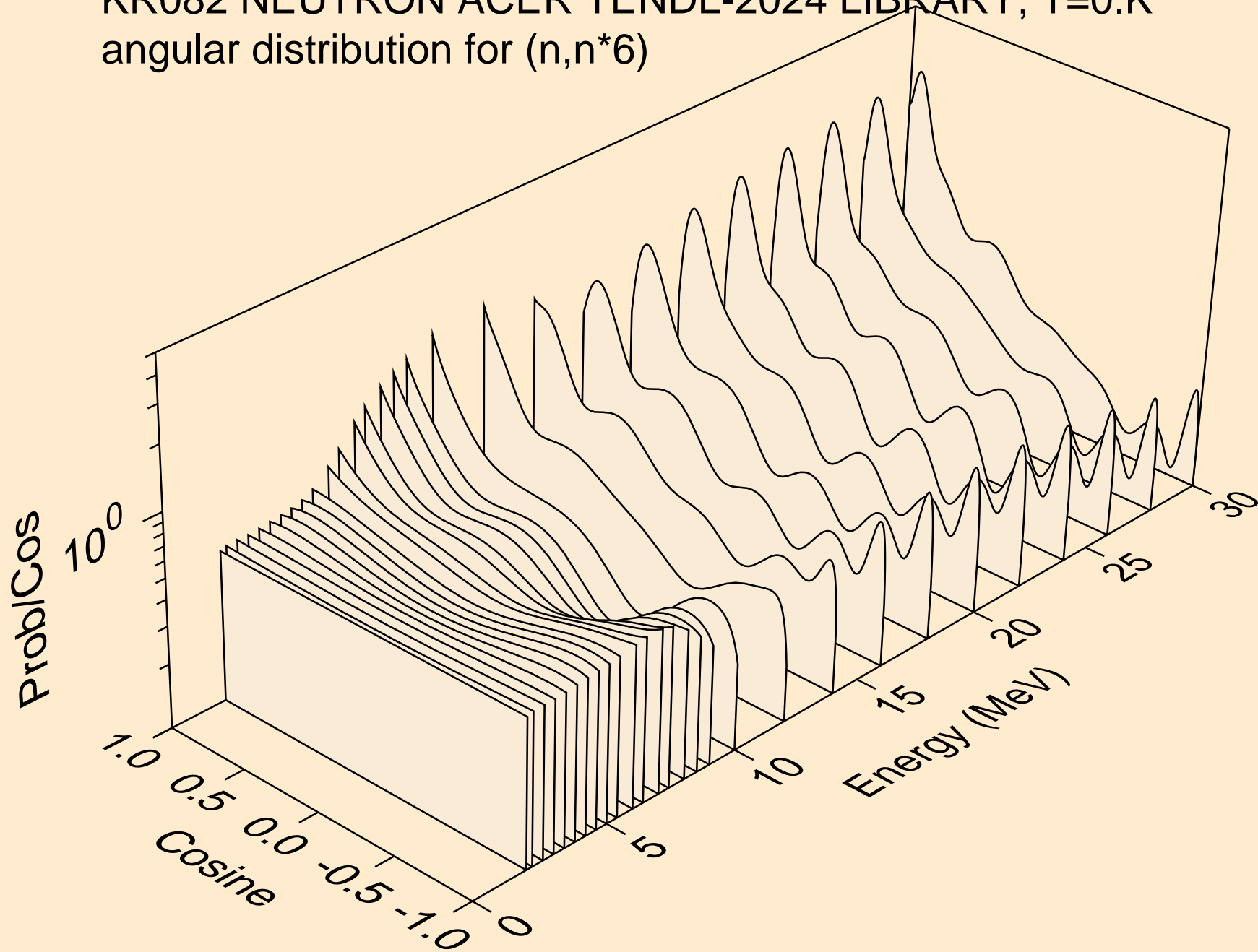

KR082 NEUTRON ACER TENDL-2024 LIBRARY; T=0.K
angular distribution for (n,n*7)

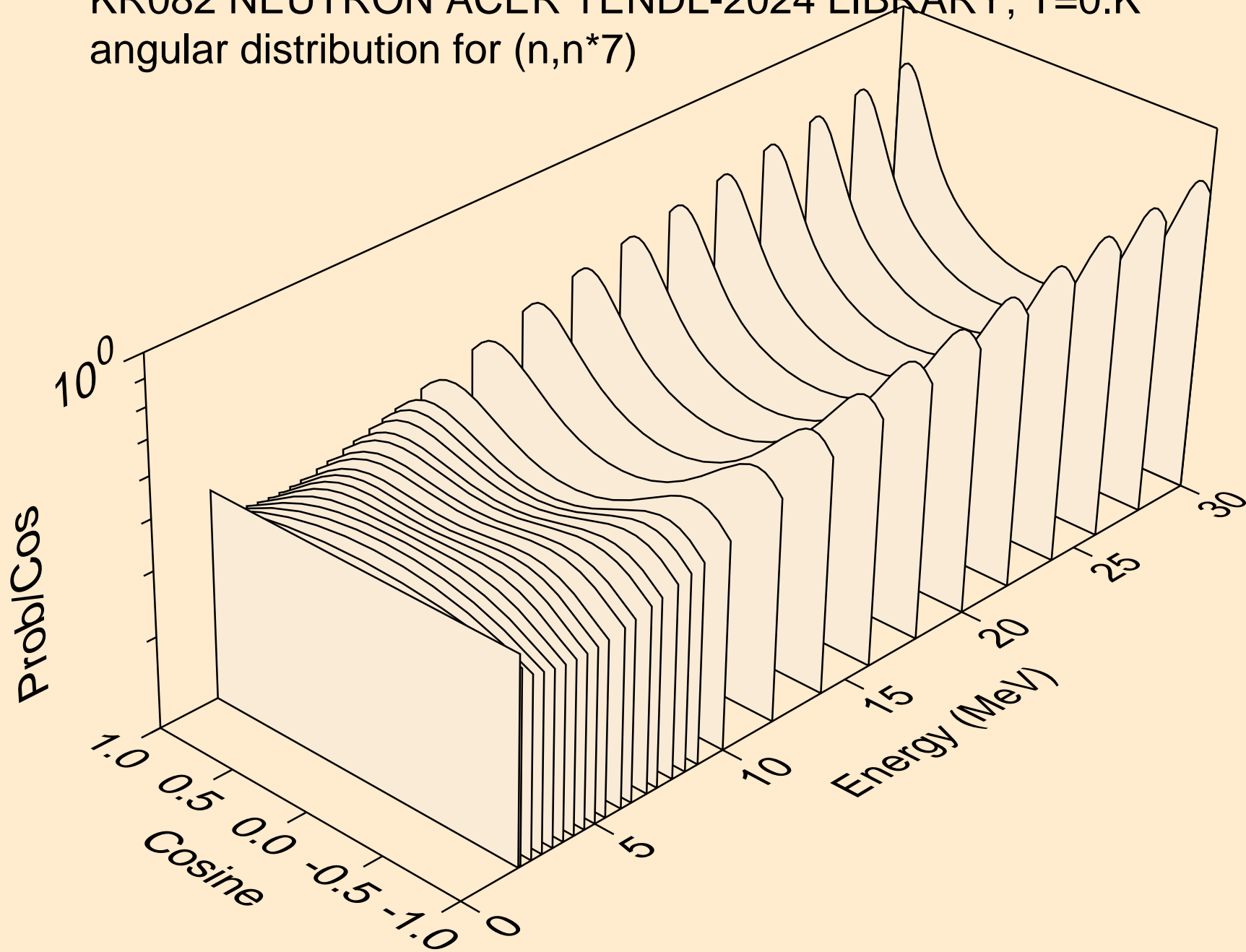

KR082 NEUTRON ACER TENDL-2024 LIBRARY; T=0.K
angular distribution for (n,n*8)

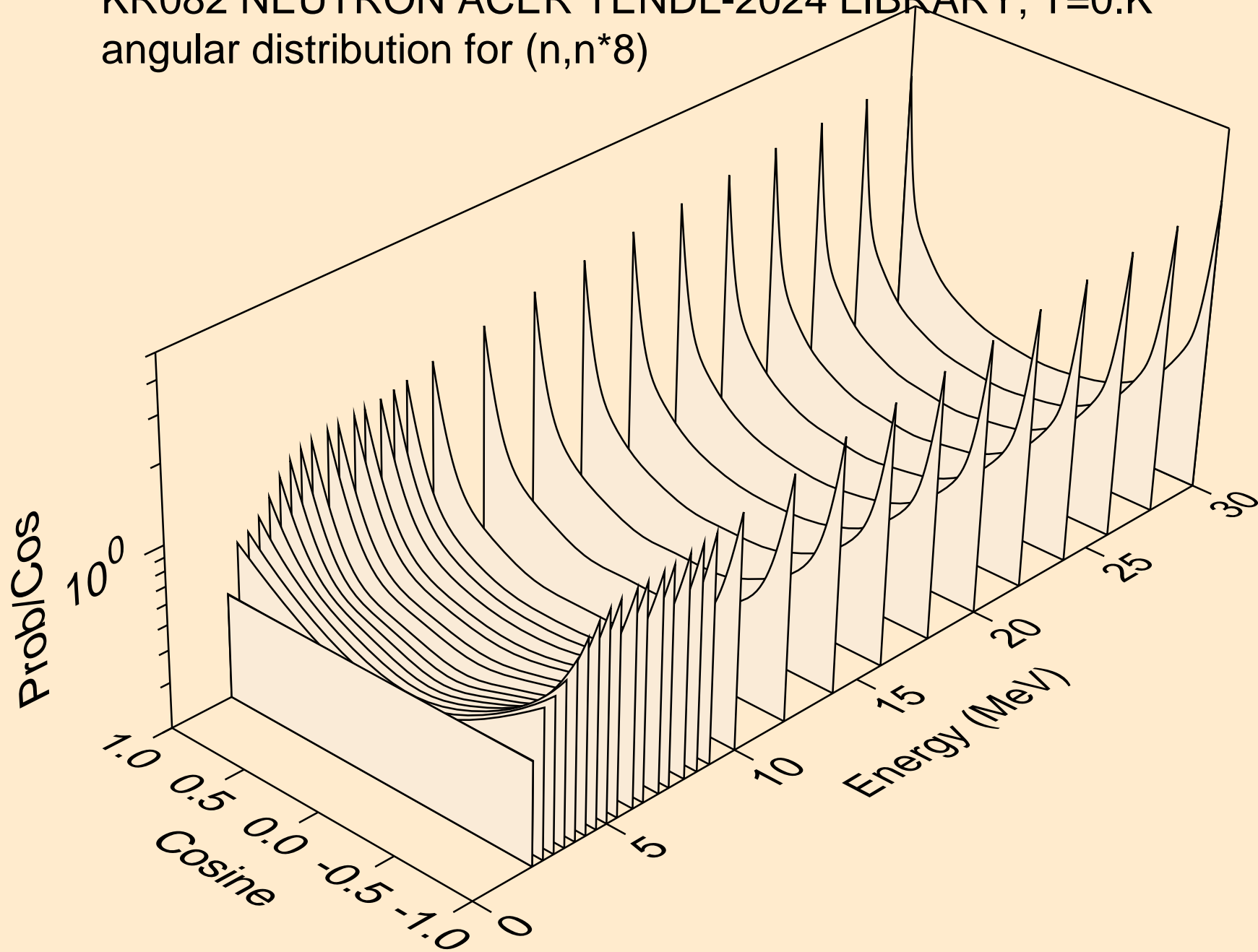

KR082 NEUTRON ACER TENDL-2024 LIBRARY; T=0.K
angular distribution for (n,n*9)

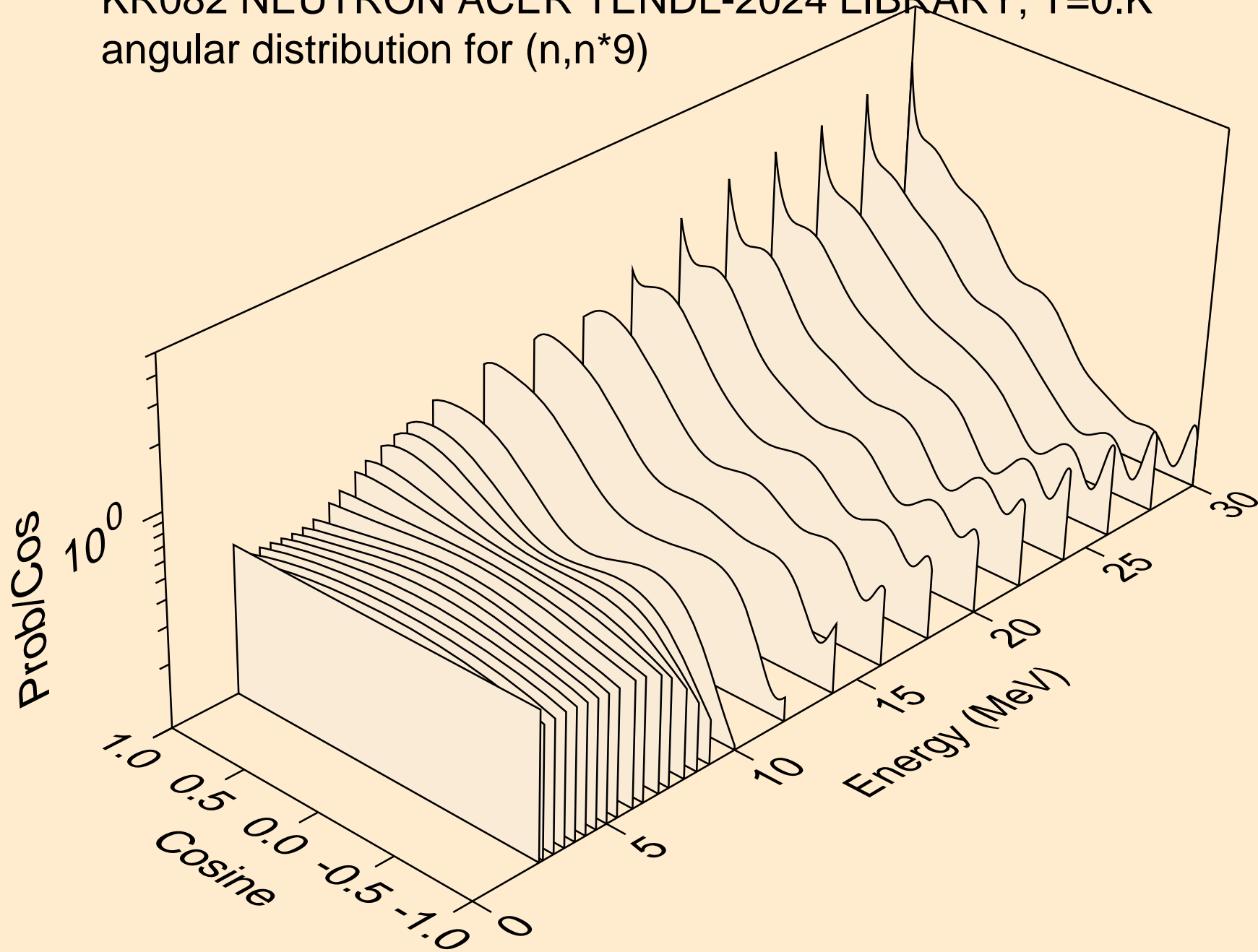

KR082 NEUTRON ACER TENDL-2024 LIBRARY; T=0.K
angular distribution for (n,n*10)

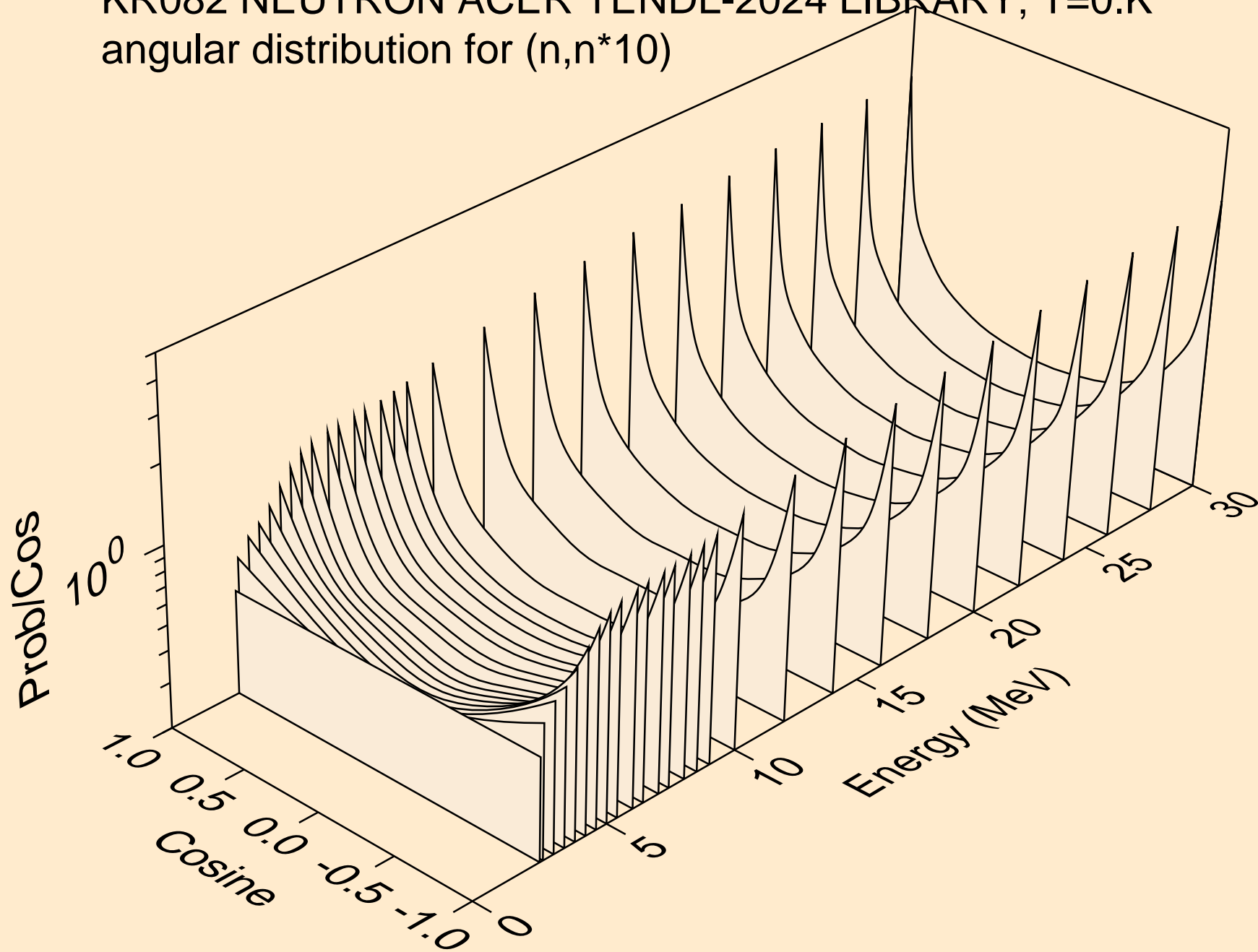

KR082 NEUTRON ACER TENDL-2024 LIBRARY; T=0.K
angular distribution for (n,n*11)

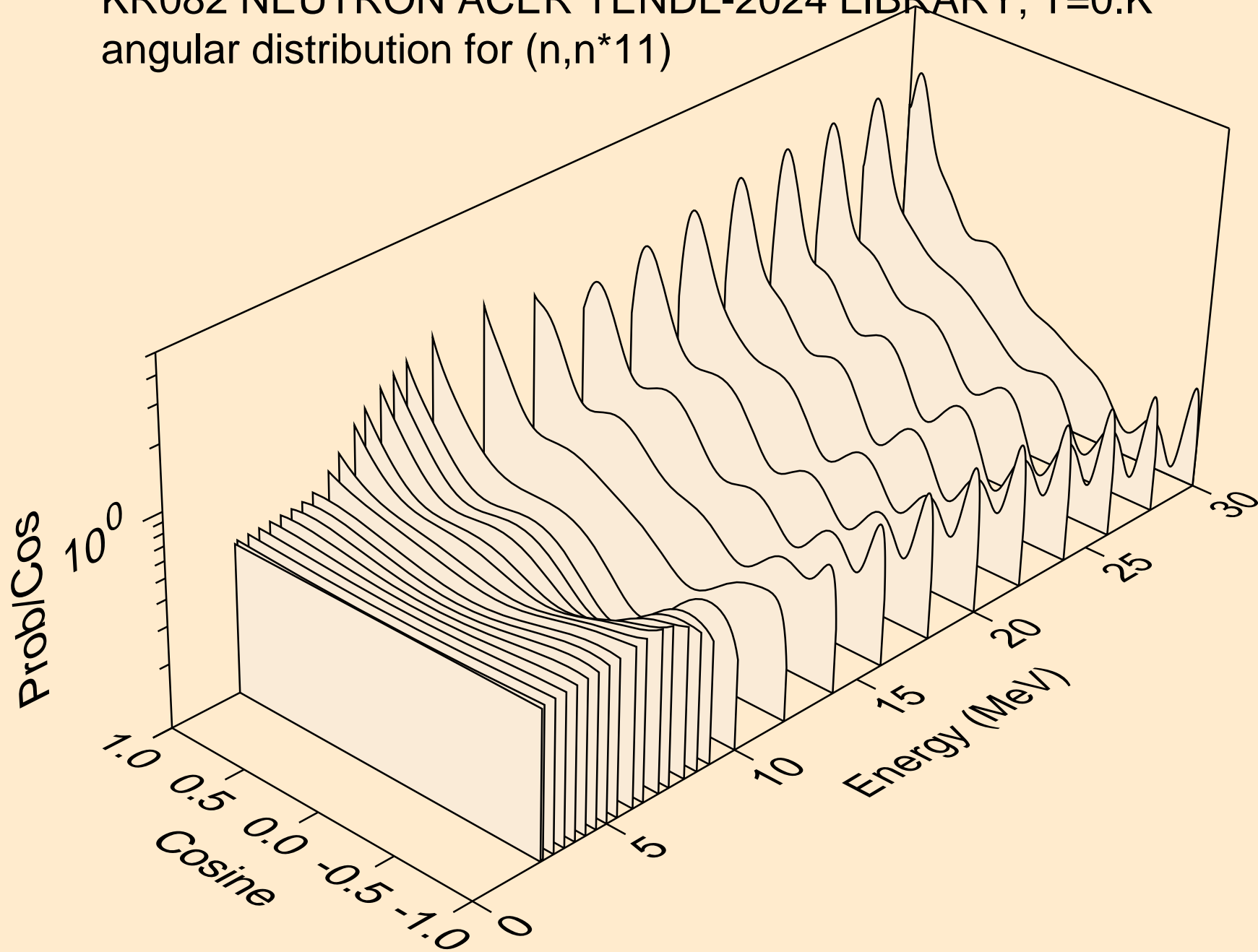

KR082 NEUTRON ACER TENDL-2024 LIBRARY; T=0.K
angular distribution for (n,n*12)

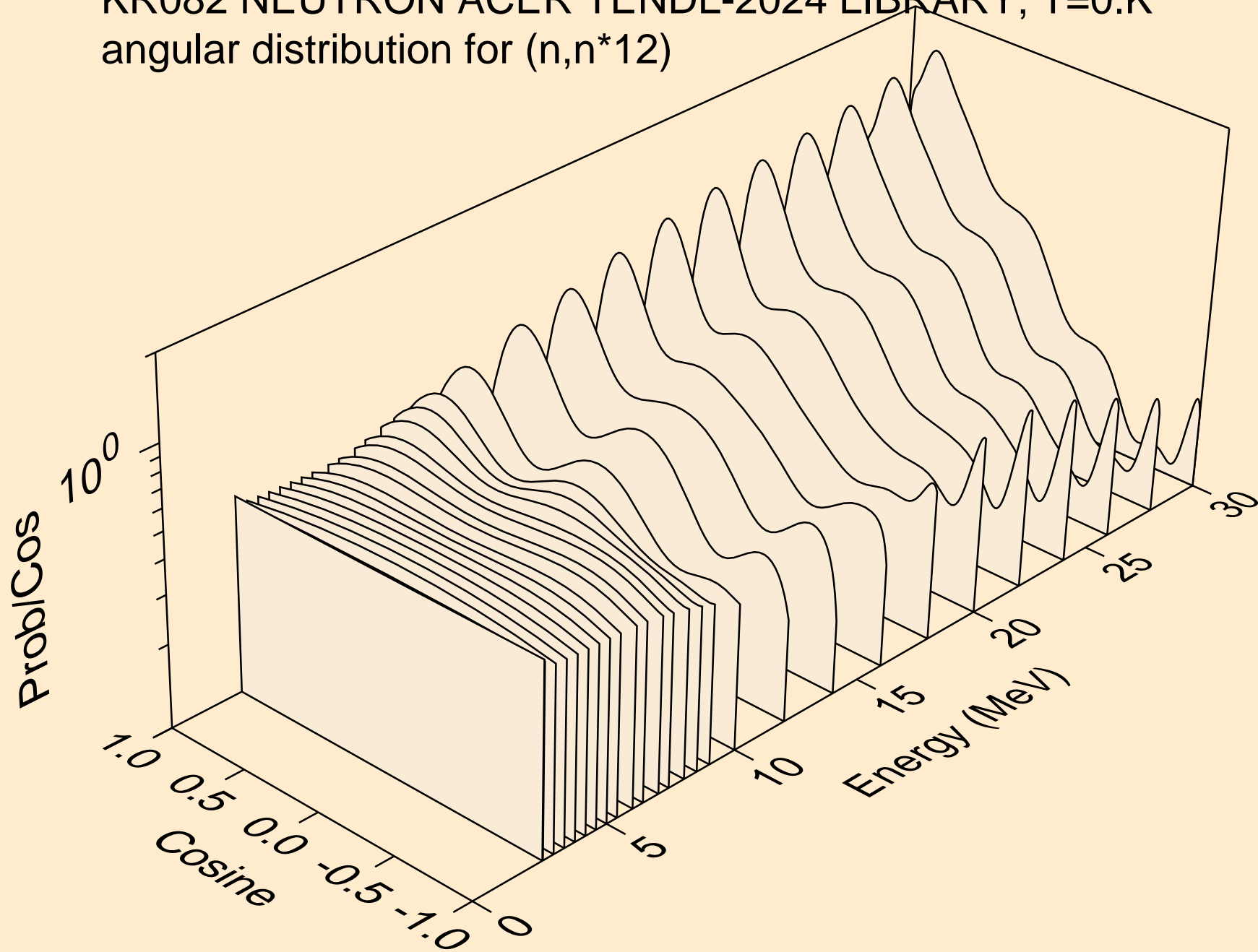

KR082 NEUTRON ACER TENDL-2024 LIBRARY; T=0.K
angular distribution for (n,n*13)

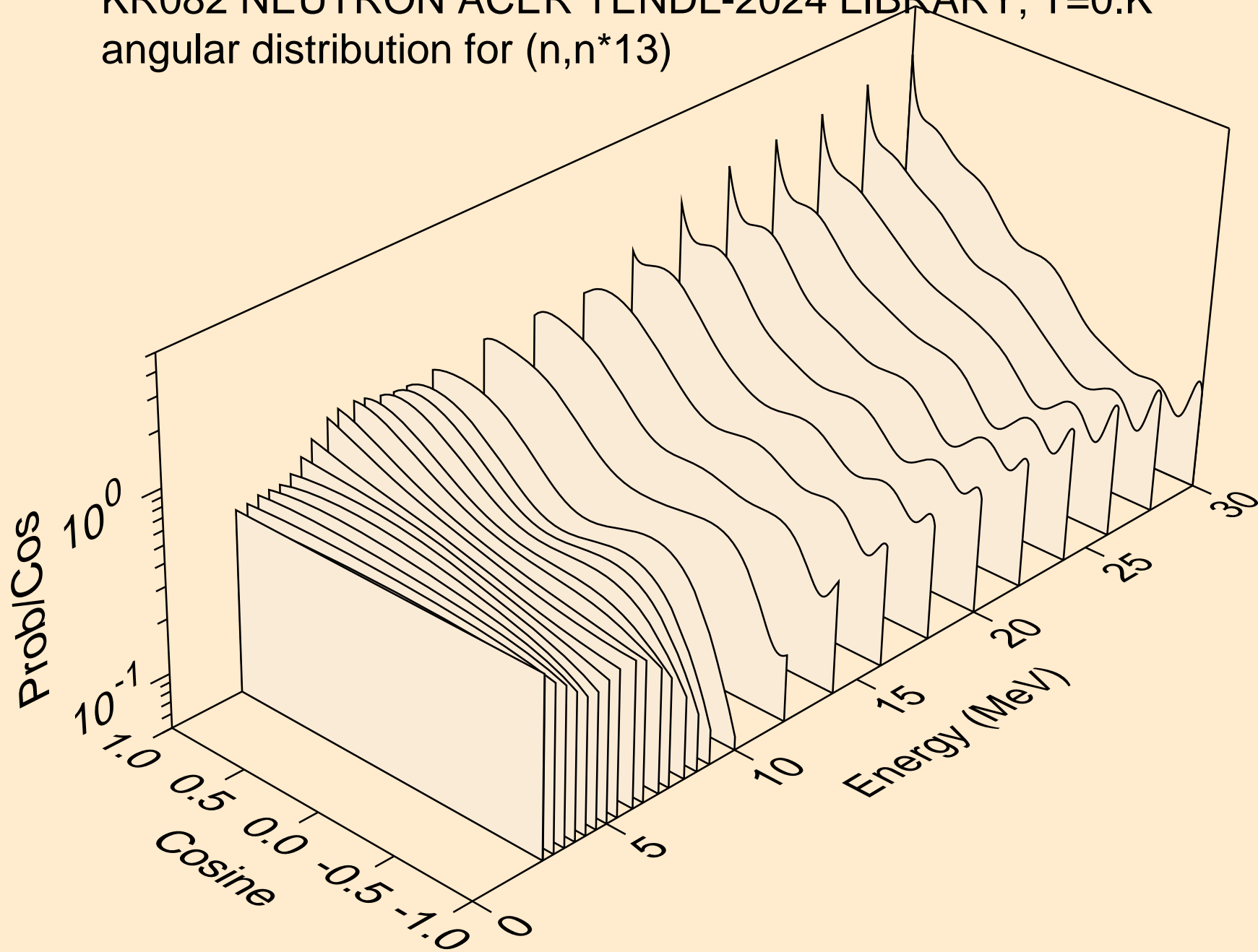

KR082 NEUTRON ACER TENDL-2024 LIBRARY; T=0.K
angular distribution for (n,n*14)

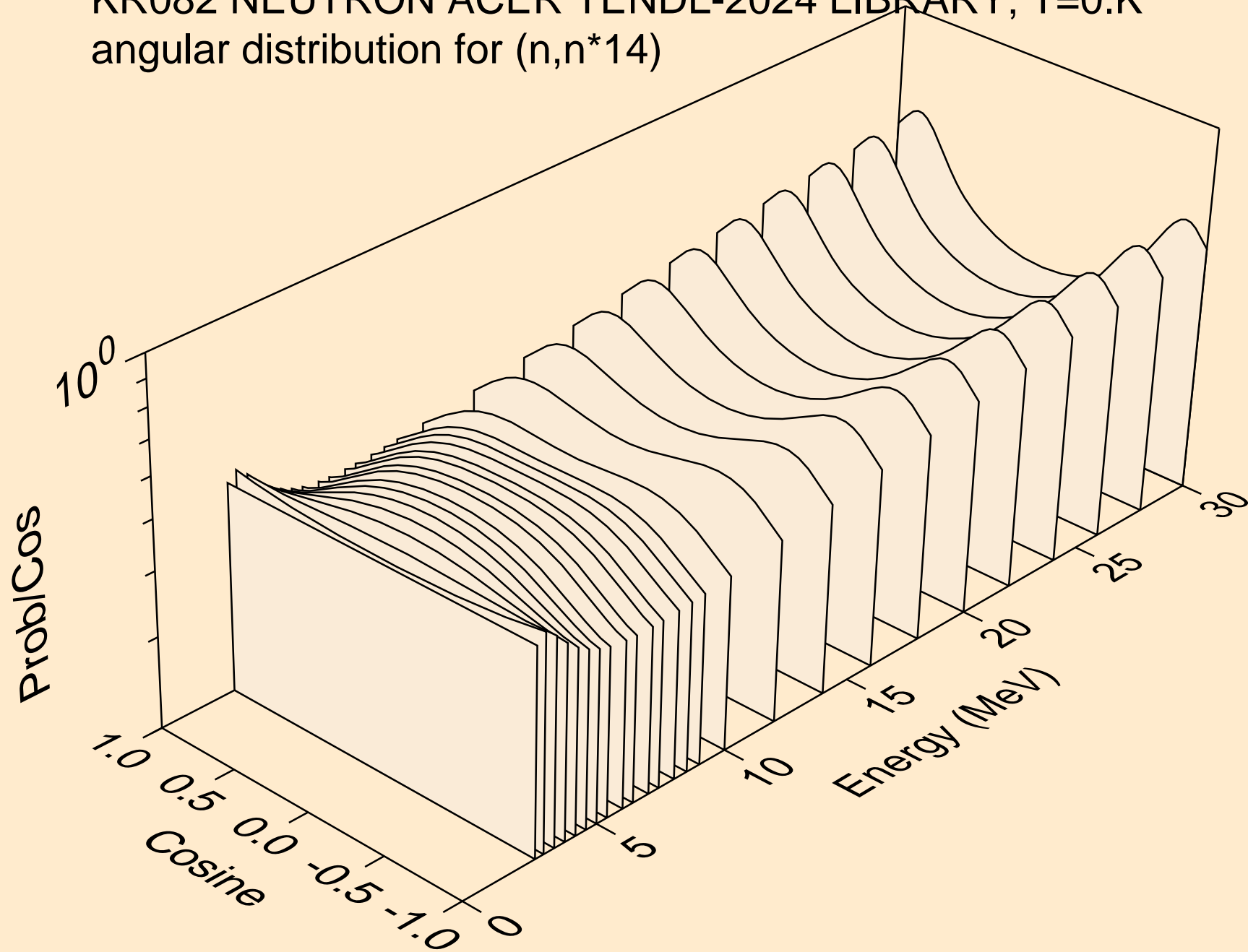

KR082 NEUTRON ACER TENDL-2024 LIBRARY; T=0.K
angular distribution for (n,n*15)

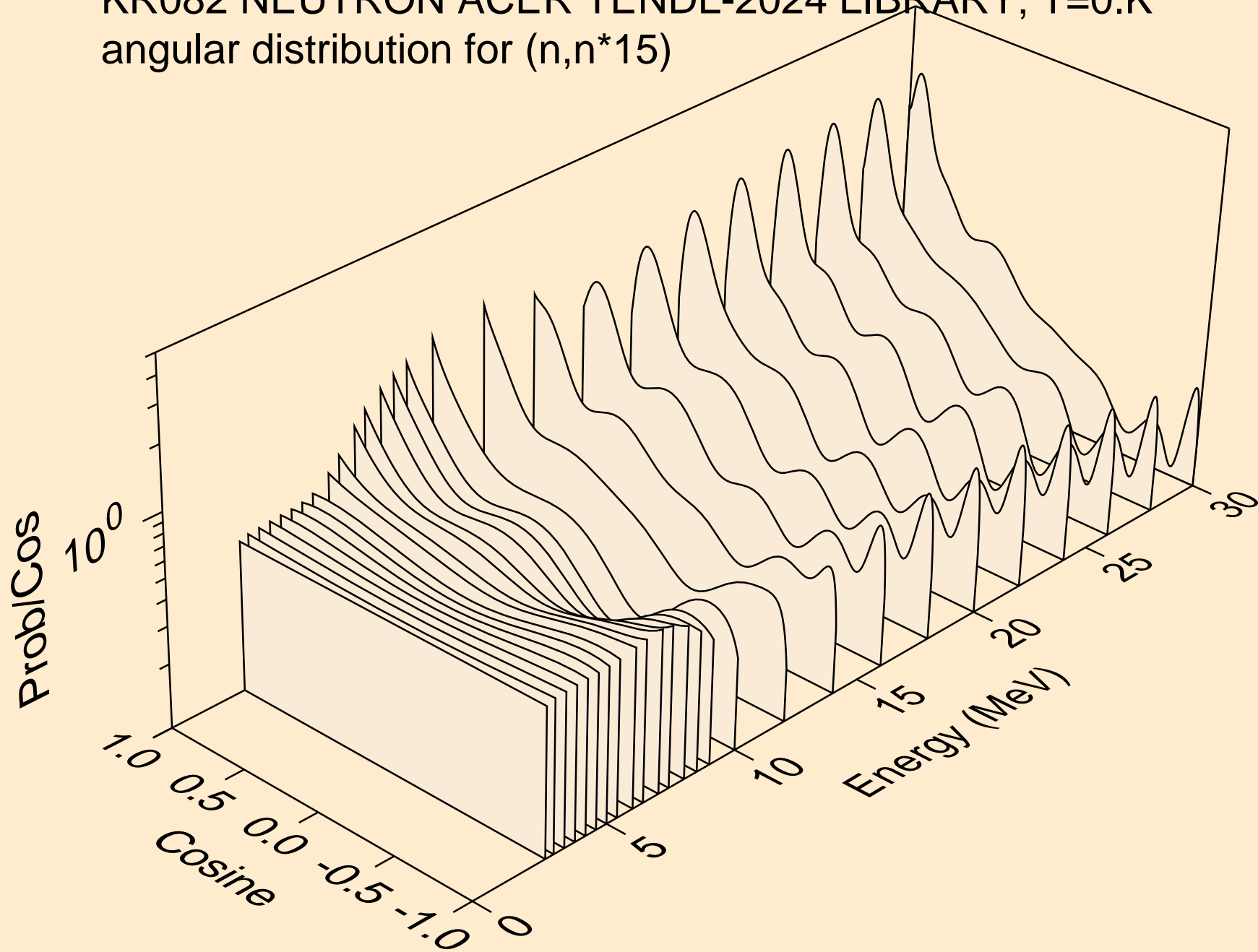

KR082 NEUTRON ACER TENDL-2024 LIBRARY; T=0.K
angular distribution for (n,n*16)

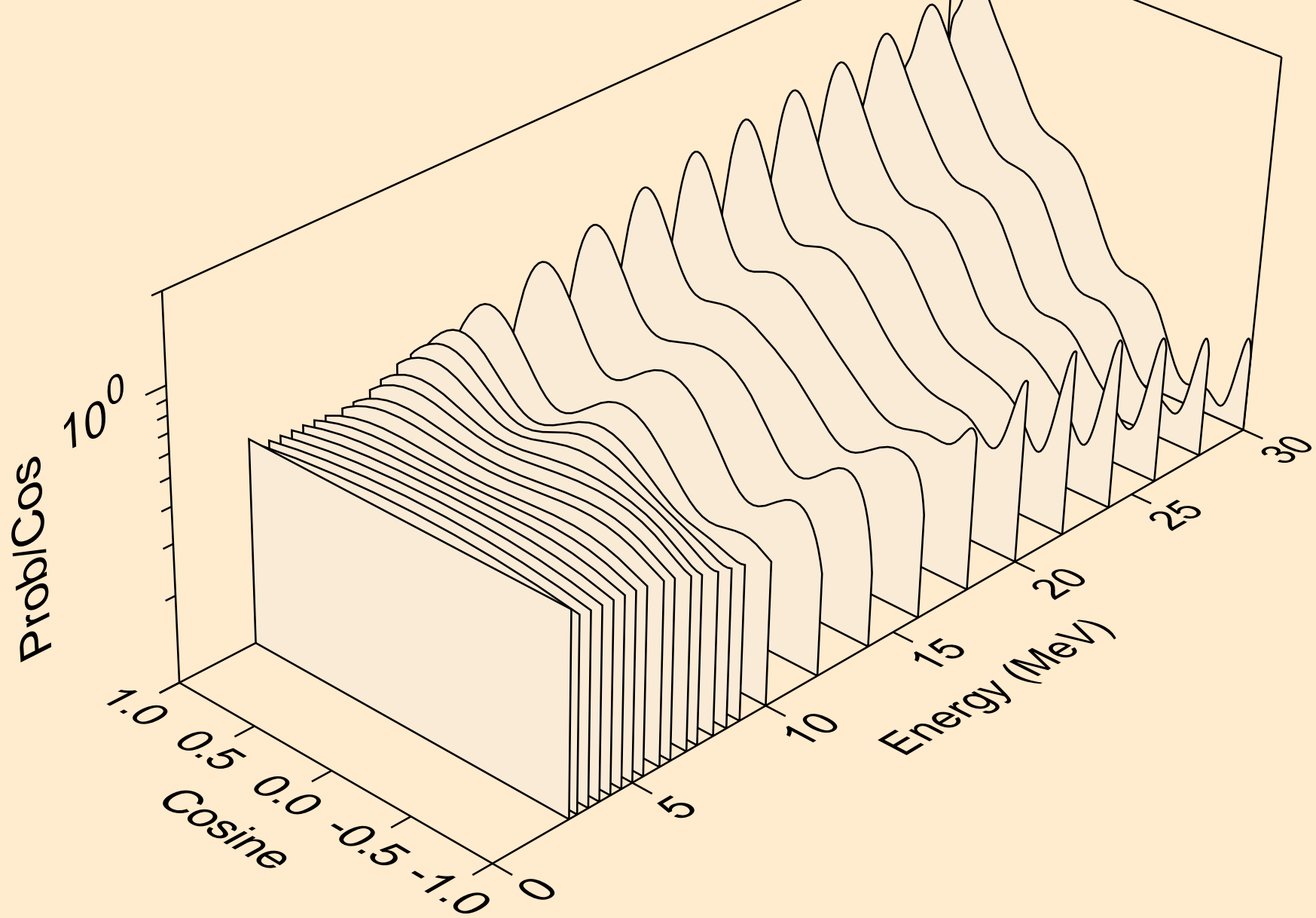

KR082 NEUTRON ACER TENDL-2024 LIBRARY; T=0.K
angular distribution for (n,n*17)

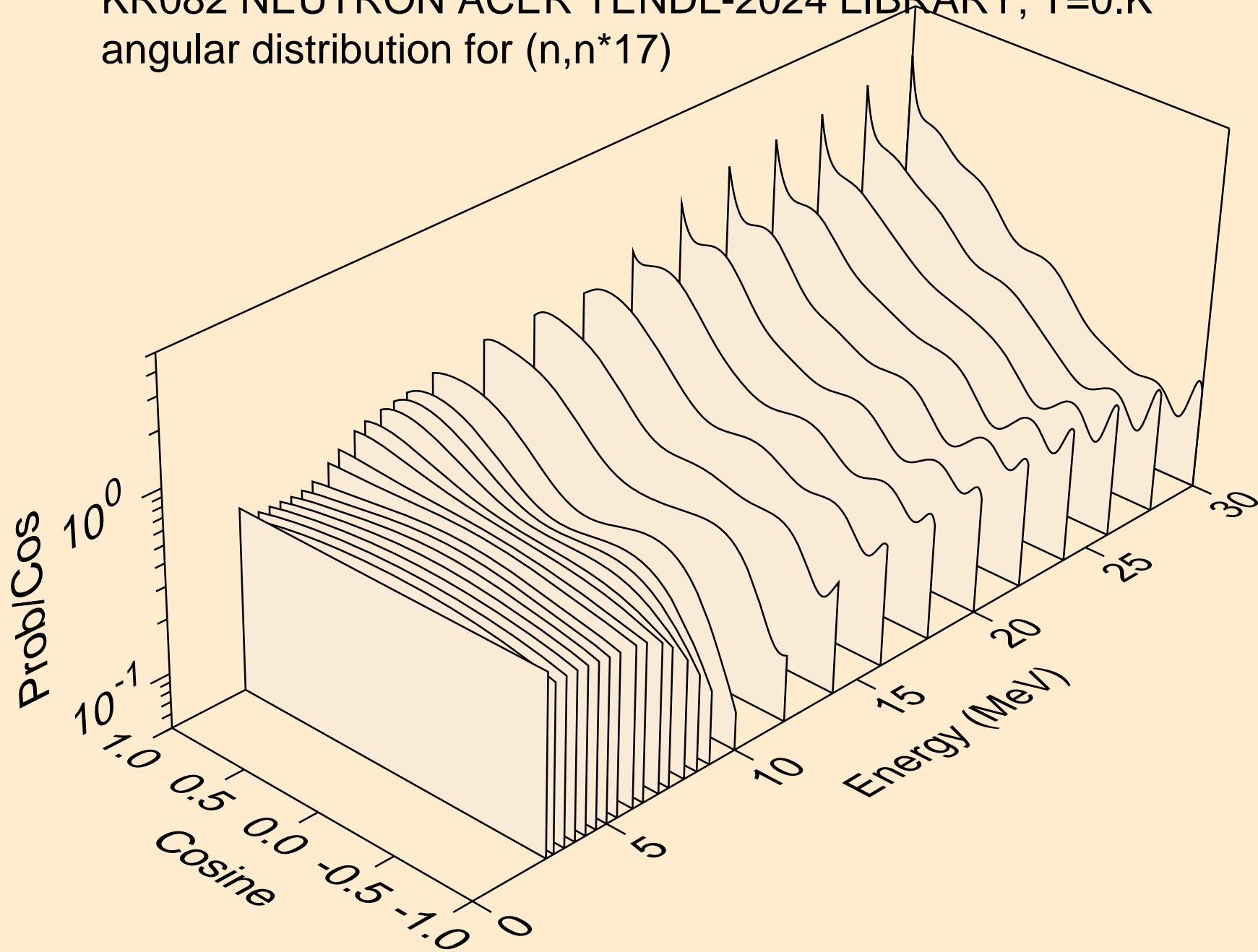

KR082 NEUTRON ACER TENDL-2024 LIBRARY; T=0.K
angular distribution for (n,n*18)

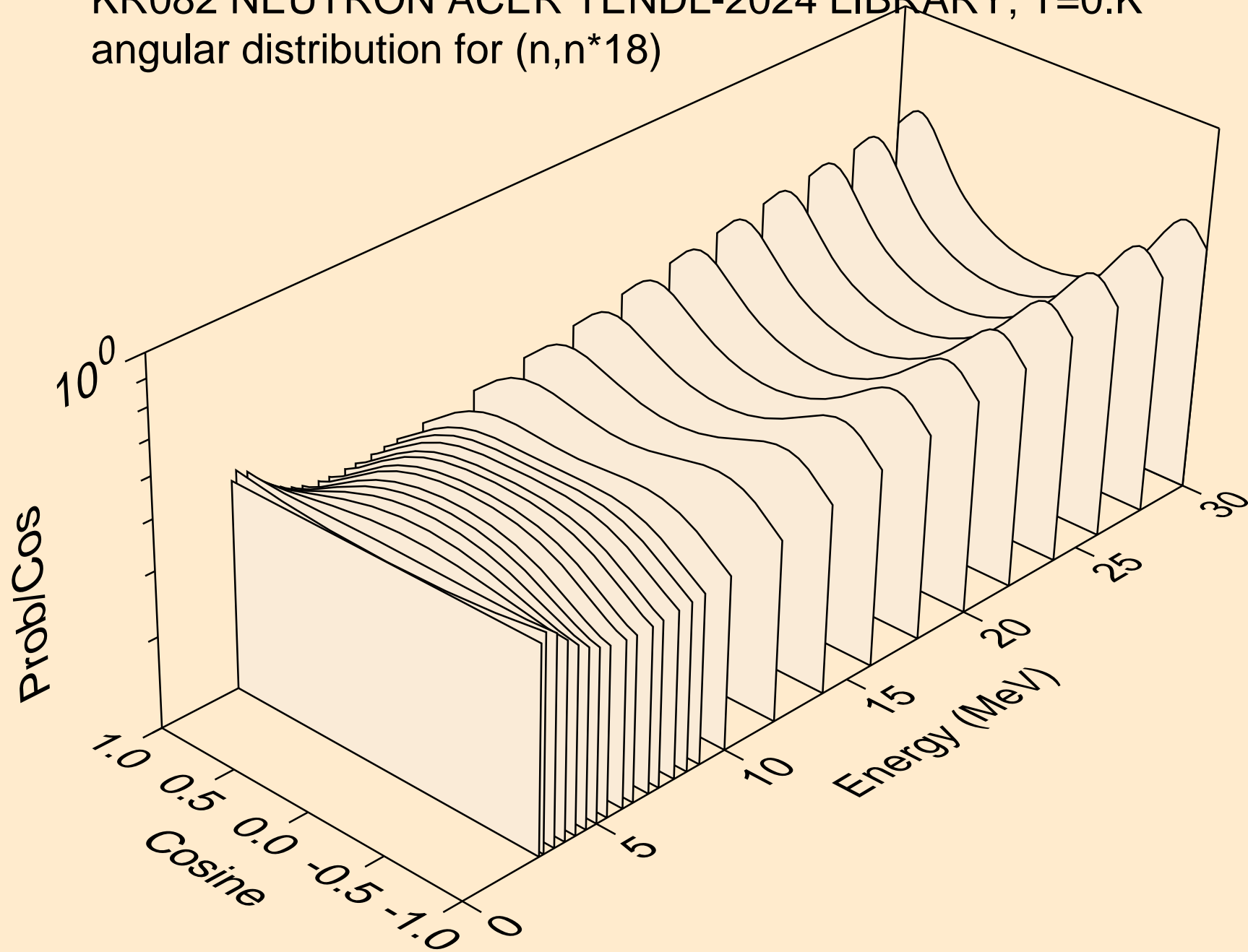

KR082 NEUTRON ACER TENDL-2024 LIBRARY; T=0.K
angular distribution for (n,n*19)

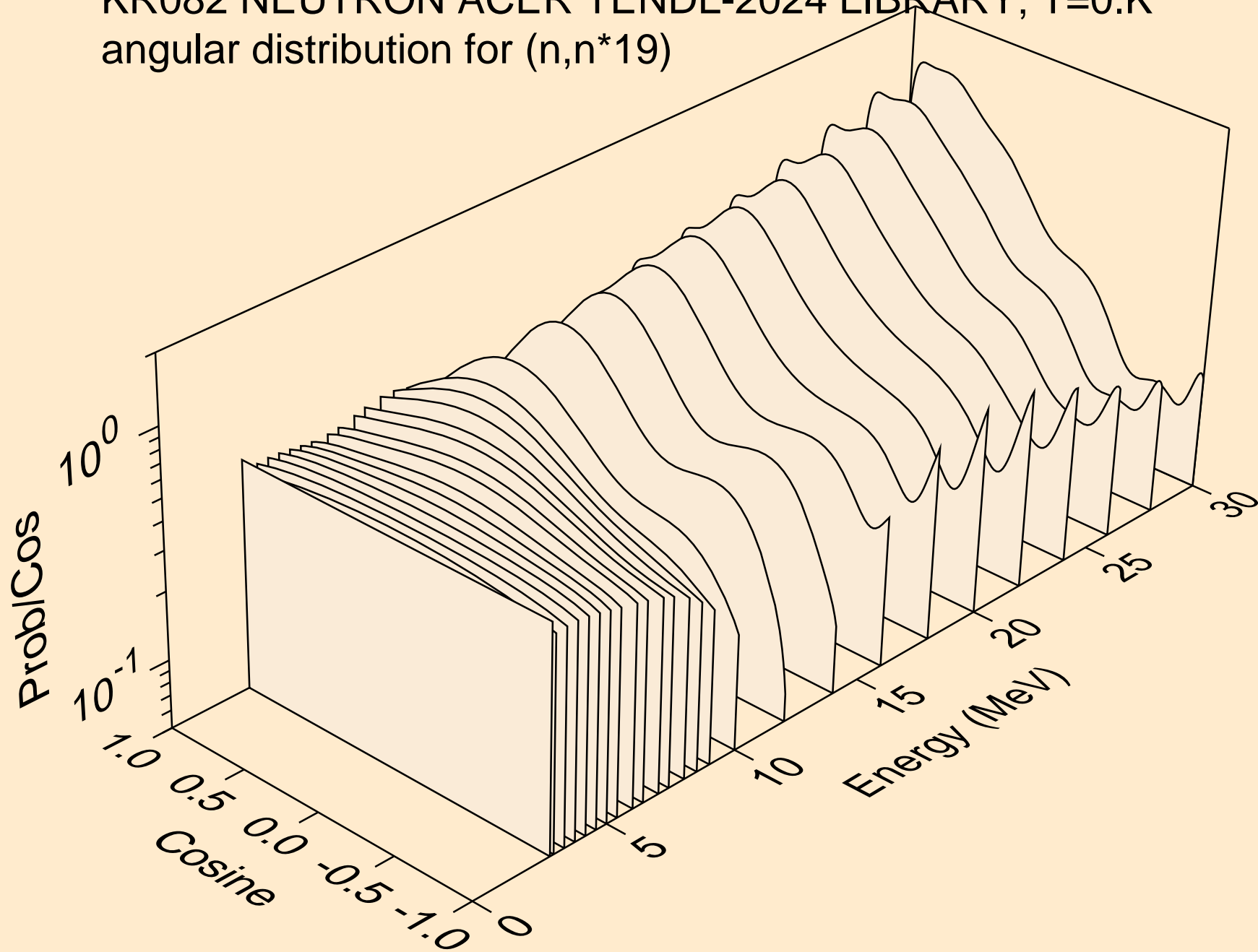

KR082 NEUTRON ACER TENDL-2024 LIBRARY; T=0.K
angular distribution for (n,n*20)

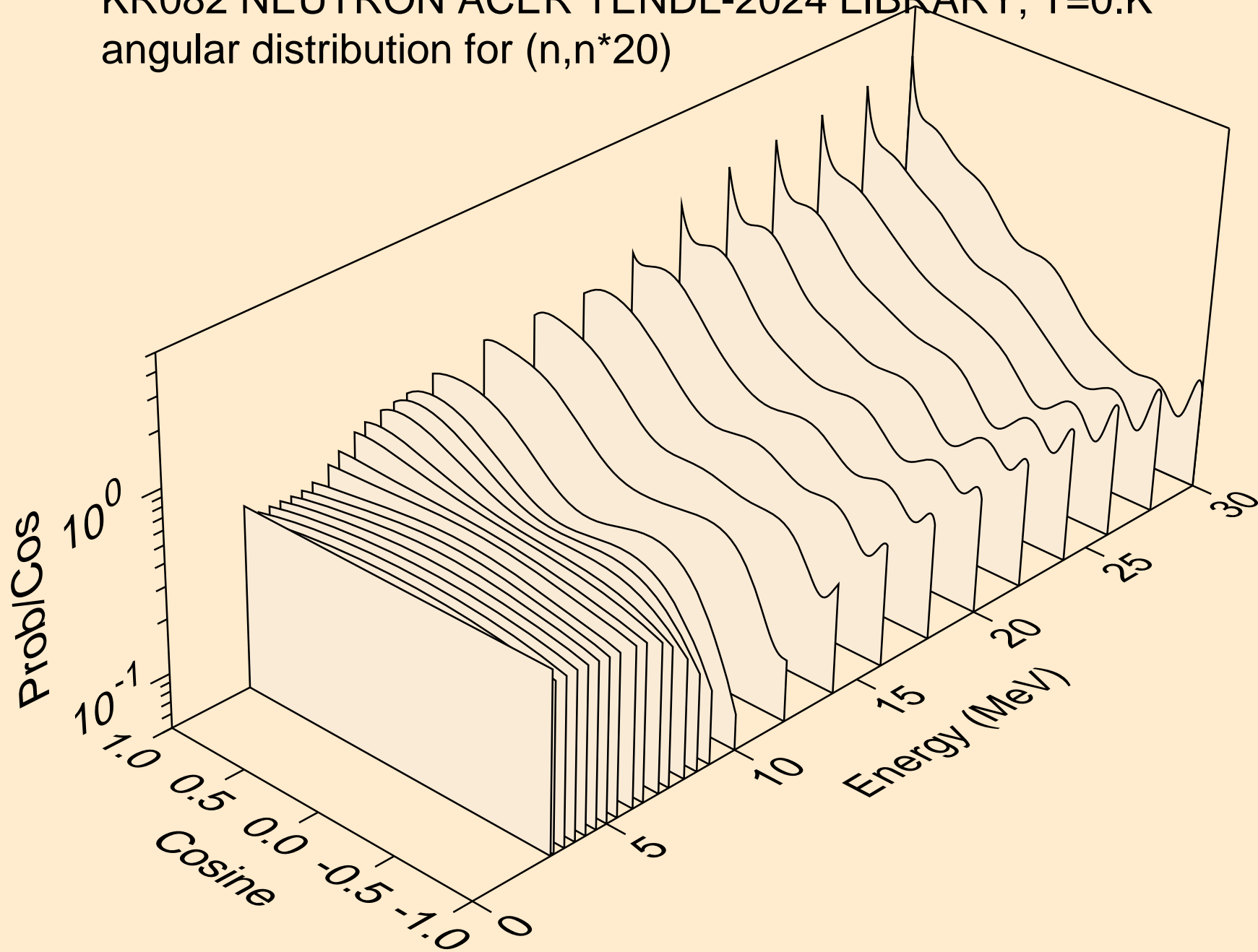

KR082 NEUTRON ACER TENDL-2024 LIBRARY; T=0.K
angular distribution for (n,n*21)

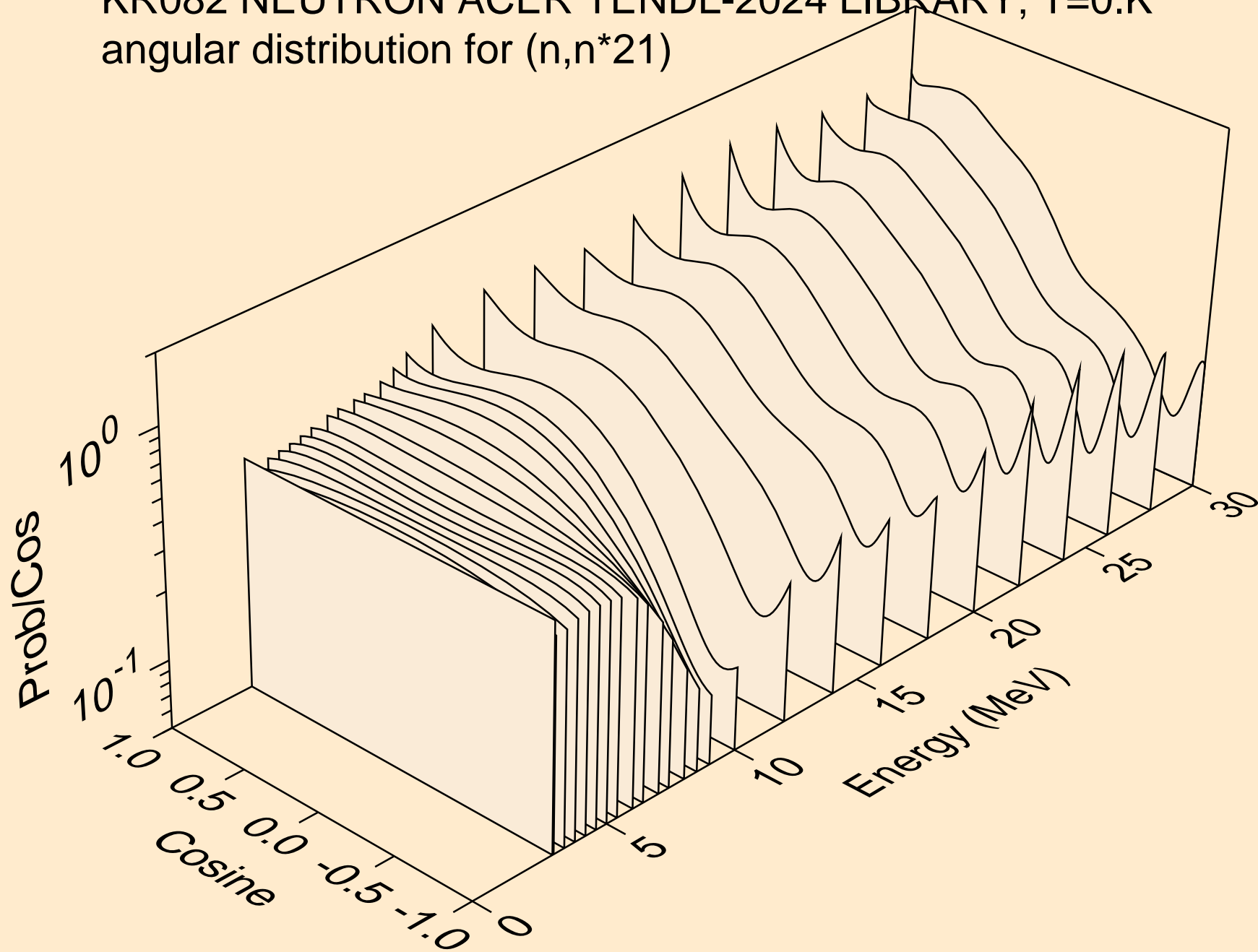

KR082 NEUTRON ACER TENDL-2024 LIBRARY; T=0.K
angular distribution for (n,n*22)

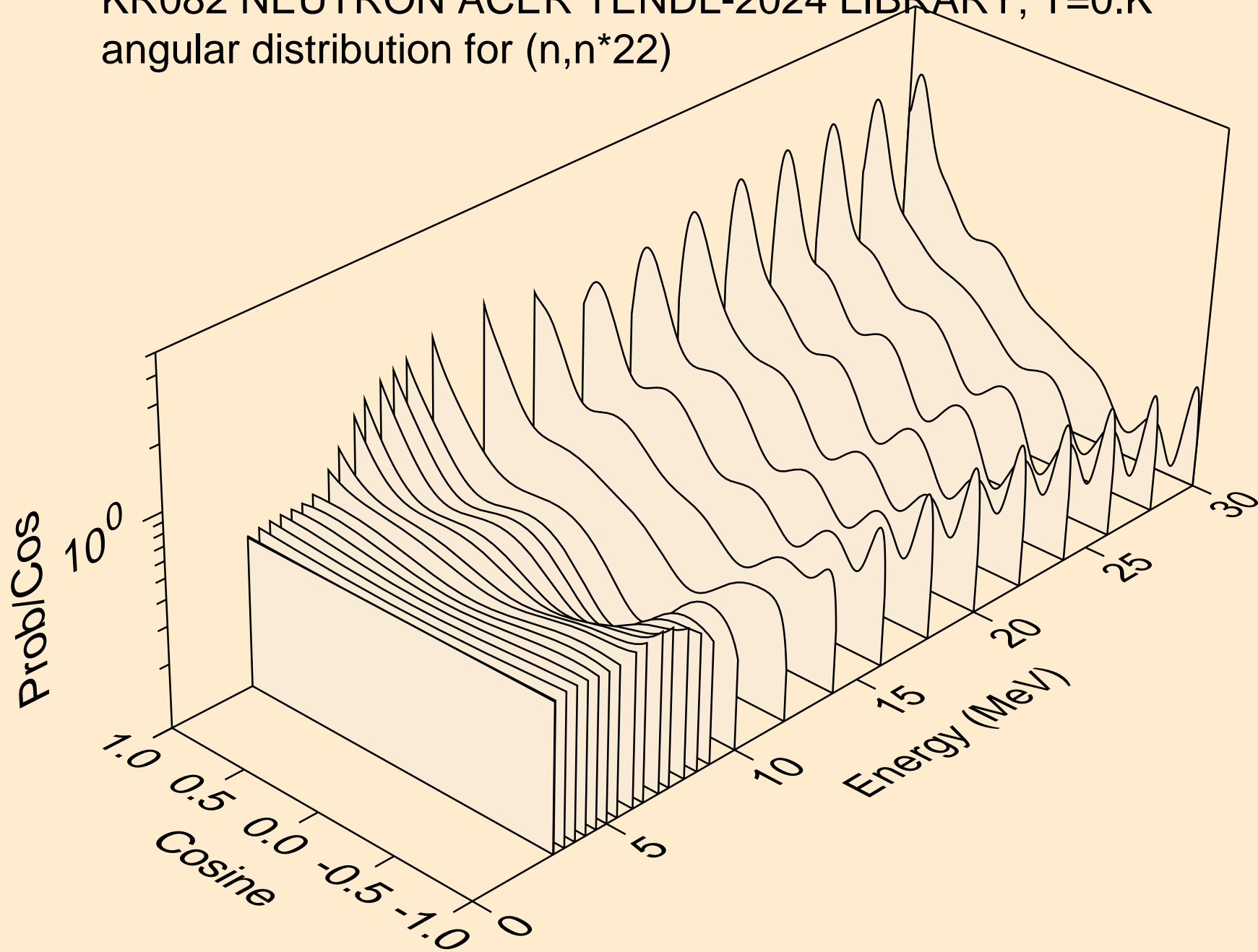

KR082 NEUTRON ACER TENDL-2024 LIBRARY; T=0.K
angular distribution for (n,n*23)

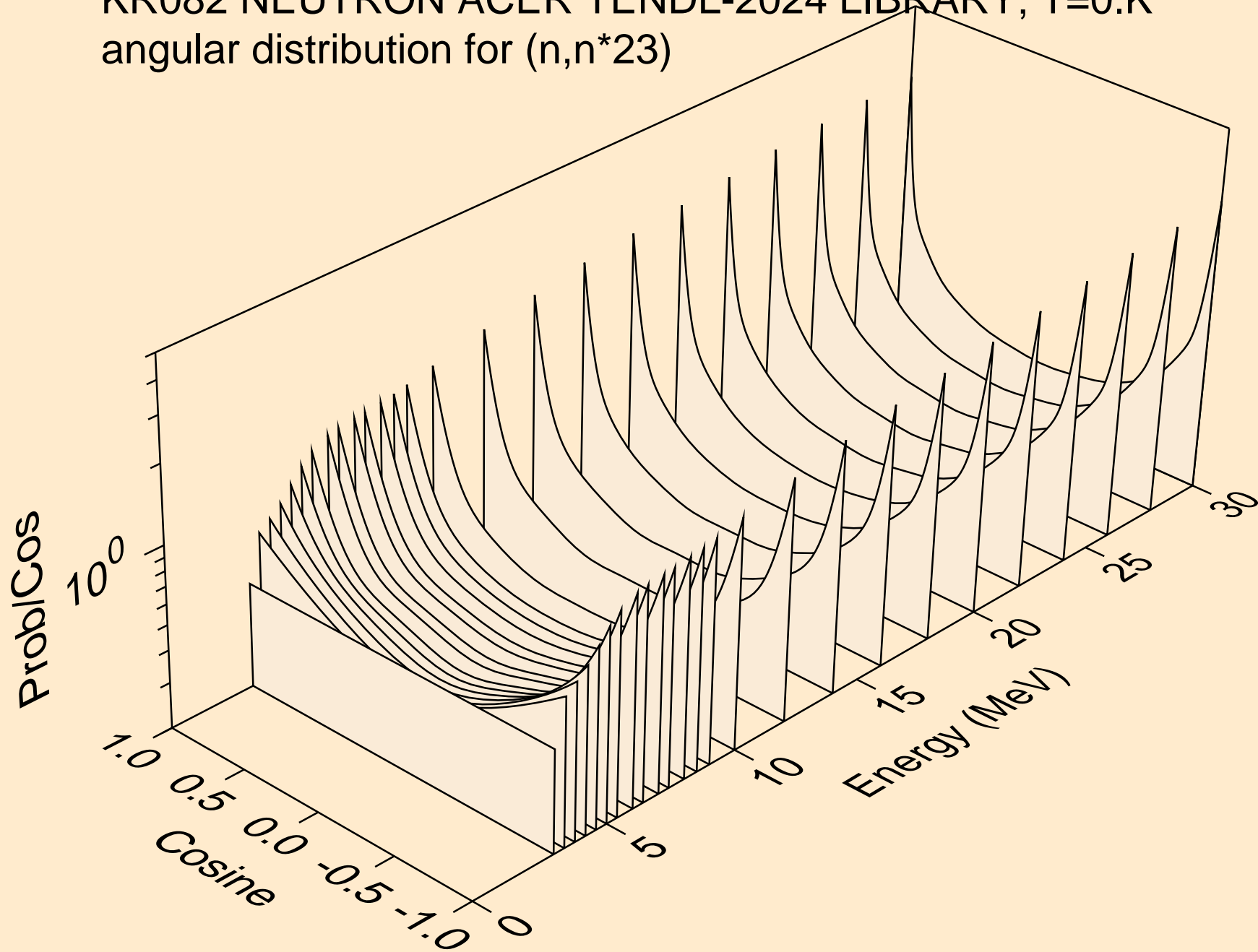

KR082 NEUTRON ACER TENDL-2024 LIBRARY; T=0.K
angular distribution for (n,n*24)

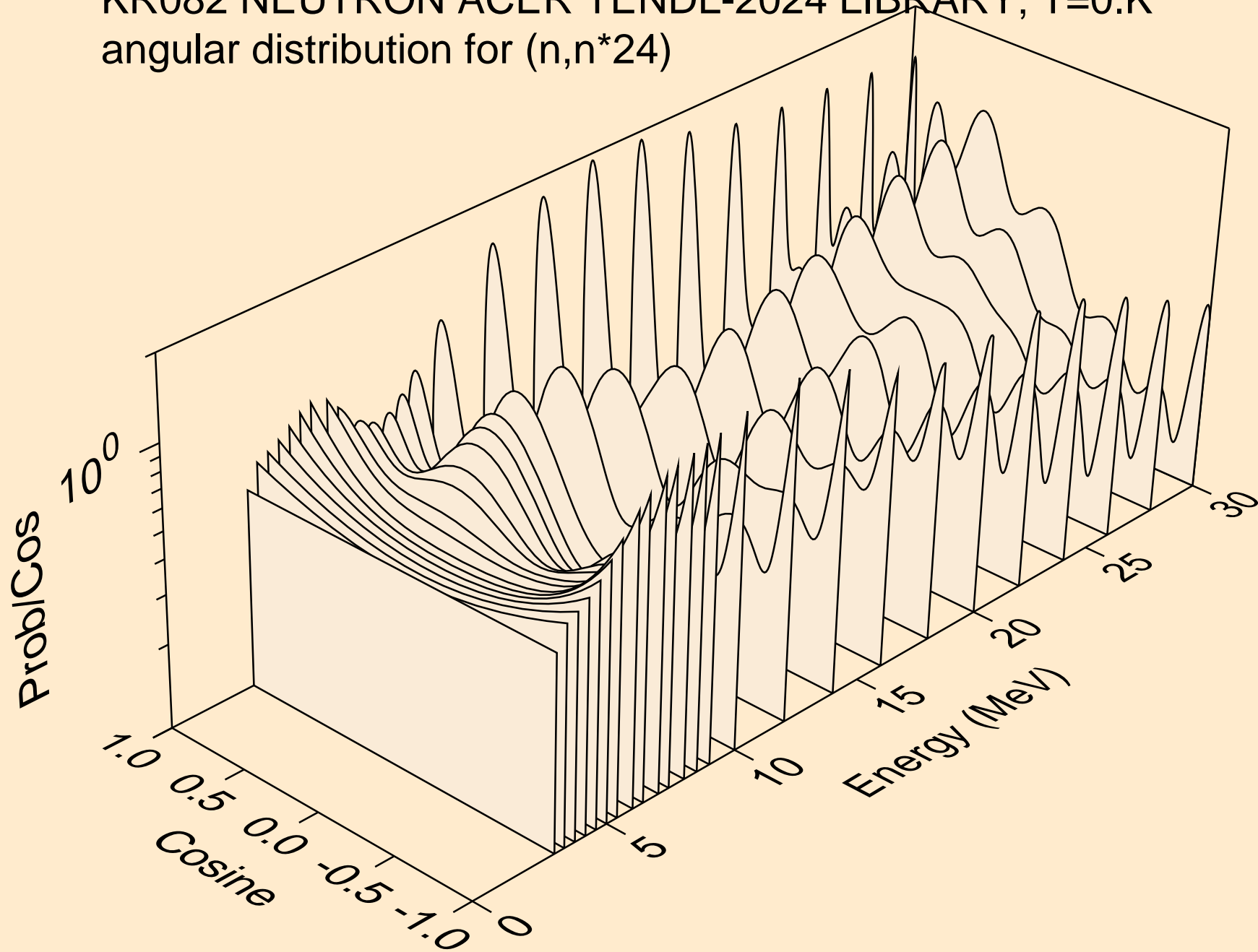

KR082 NEUTRON ACER TENDL-2024 LIBRARY; T=0.K
angular distribution for (n,n*25)

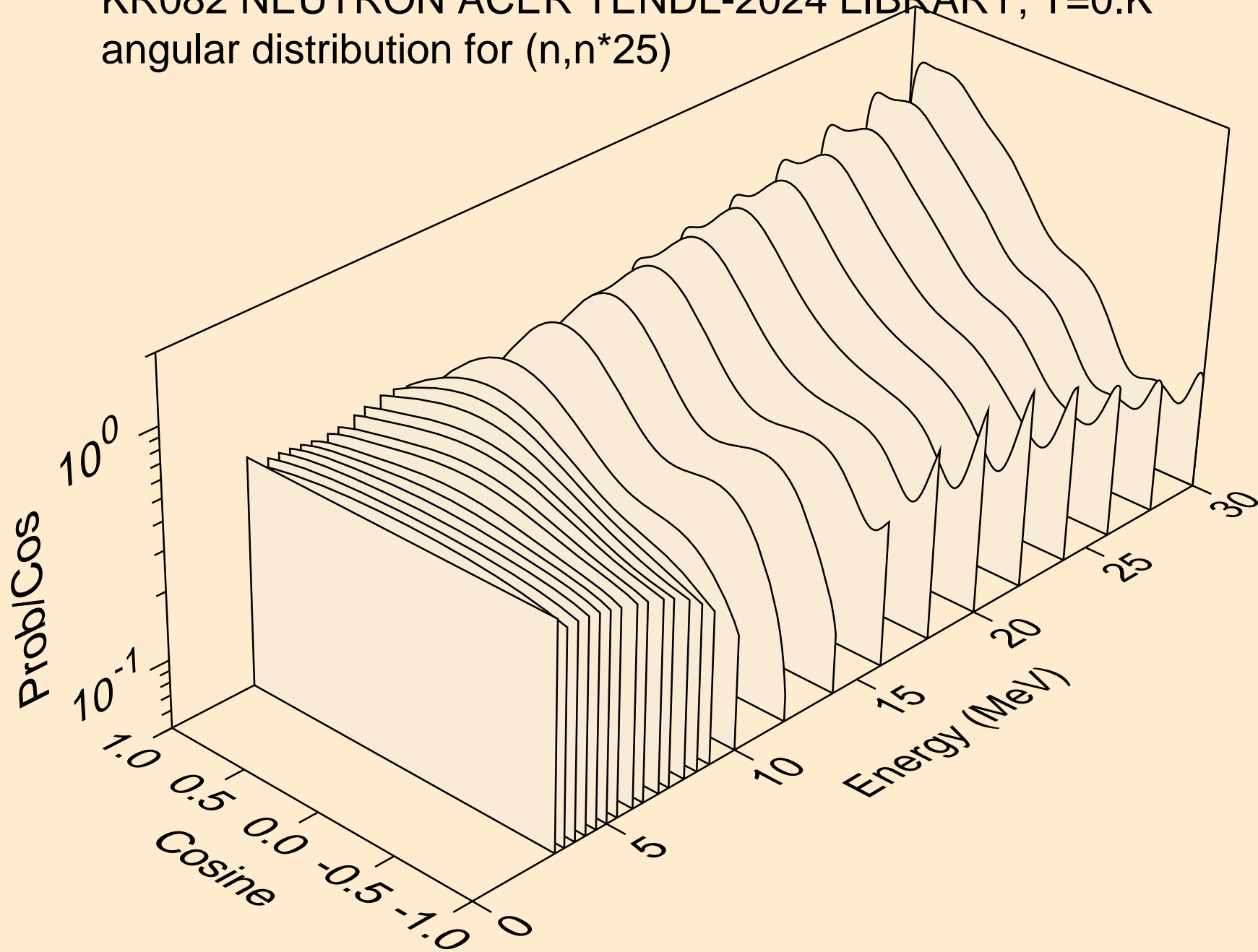

KR082 NEUTRON ACER TENDL-2024 LIBRARY; T=0.K
angular distribution for (n,n*26)

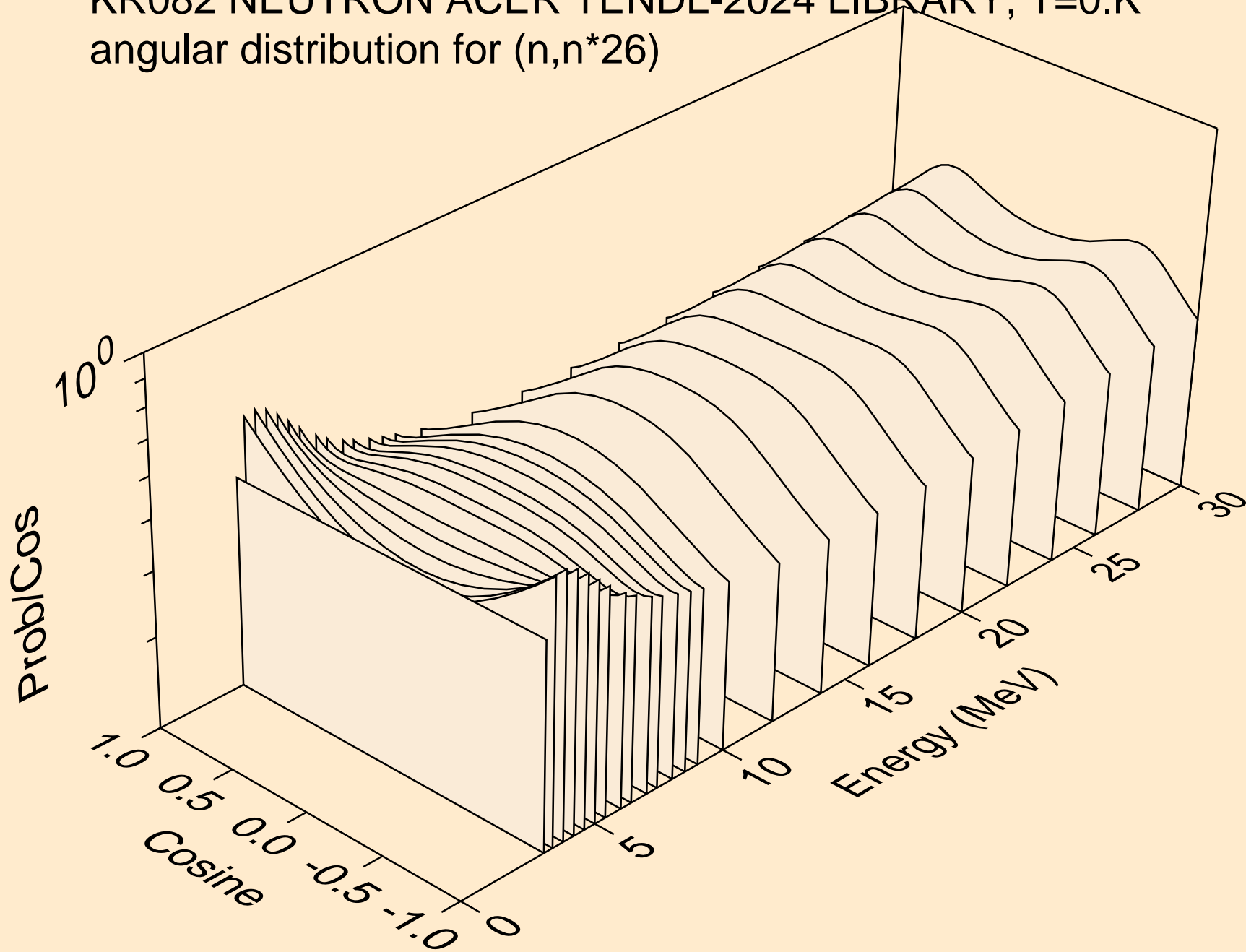

KR082 NEUTRON ACER TENDL-2024 LIBRARY; T=0.K
angular distribution for (n,n*27)

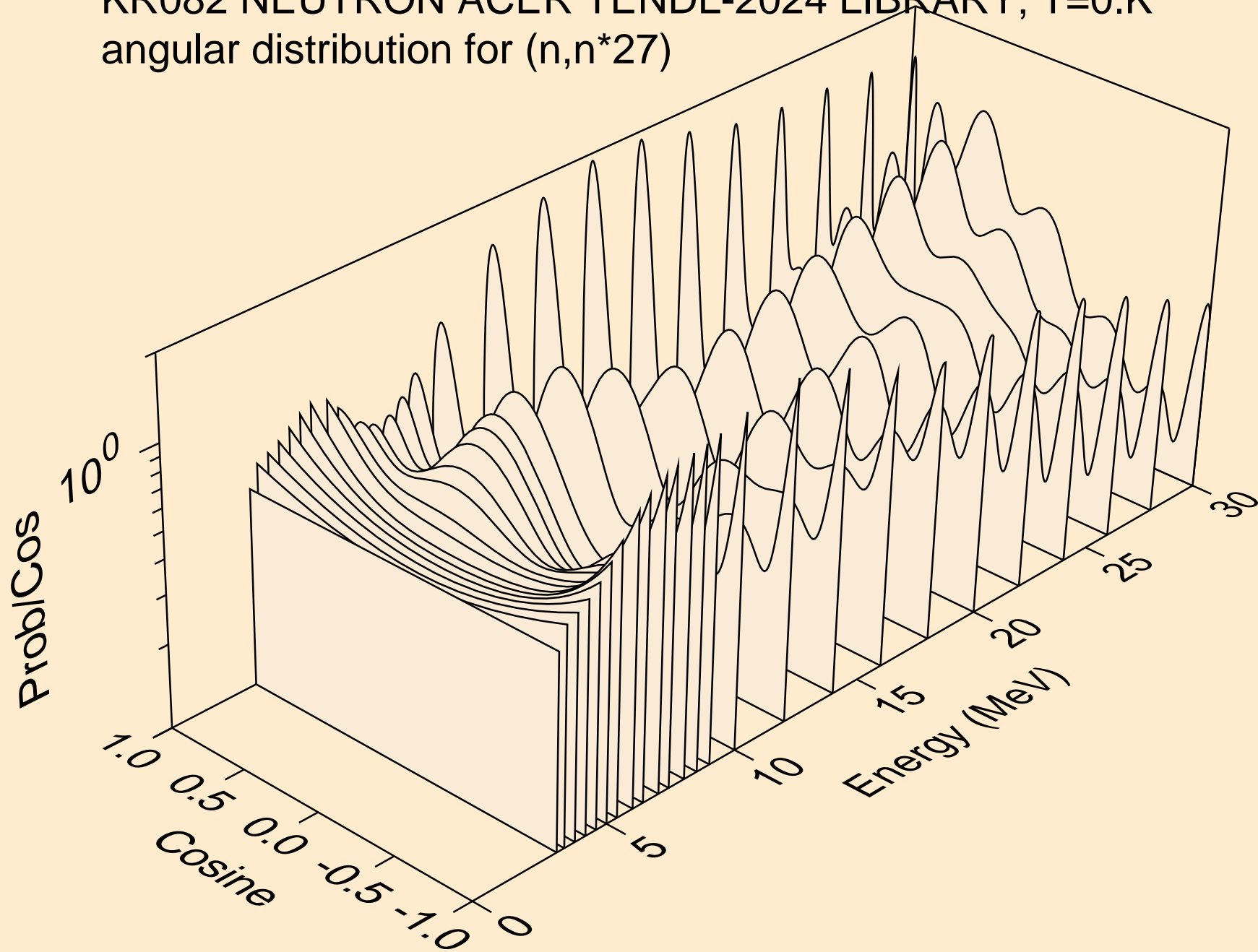

KR082 NEUTRON ACER TENDL-2024 LIBRARY; T=0.K
angular distribution for (n,n*28)

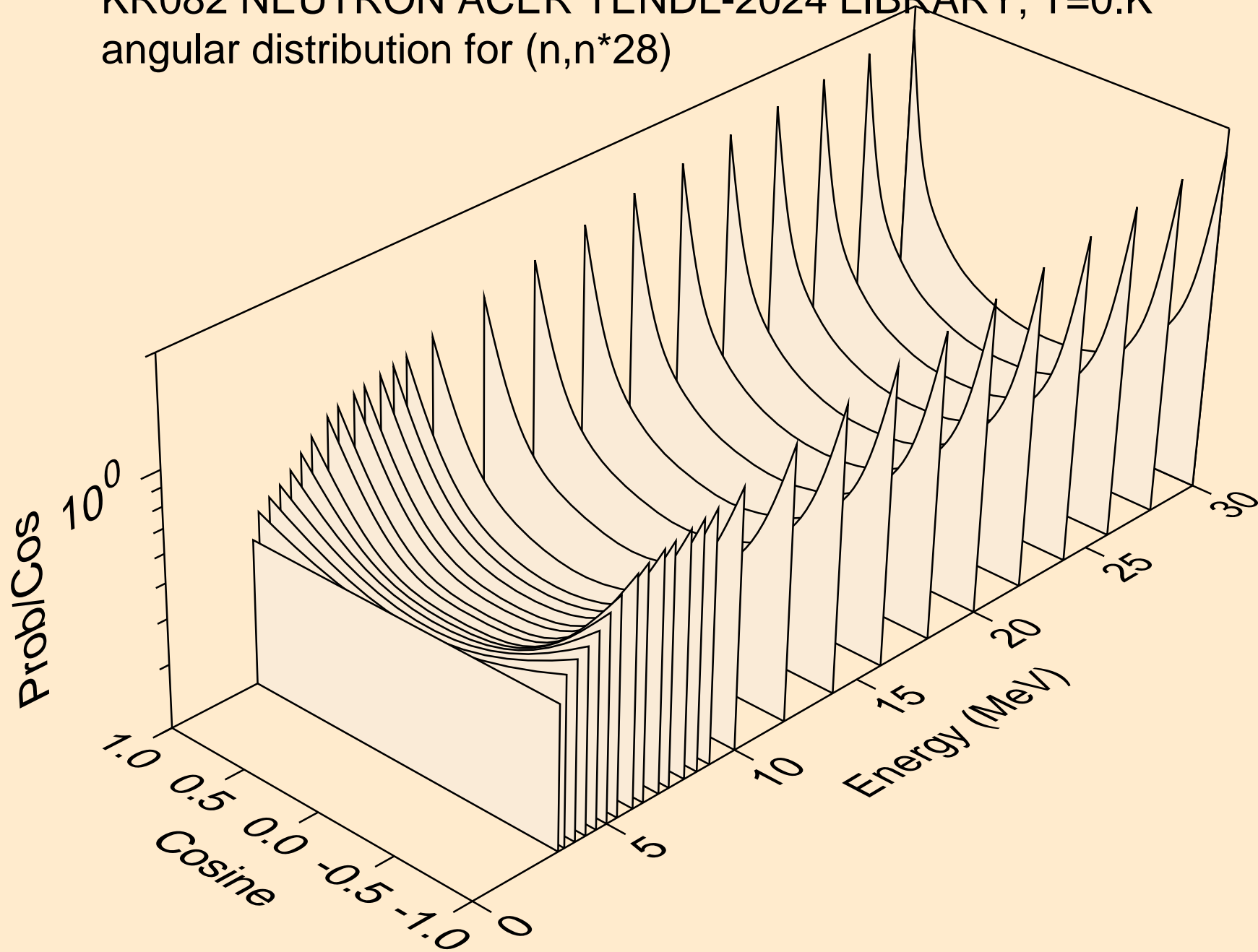

KR082 NEUTRON ACER TENDL-2024 LIBRARY; T=0.K
angular distribution for (n,n*29)

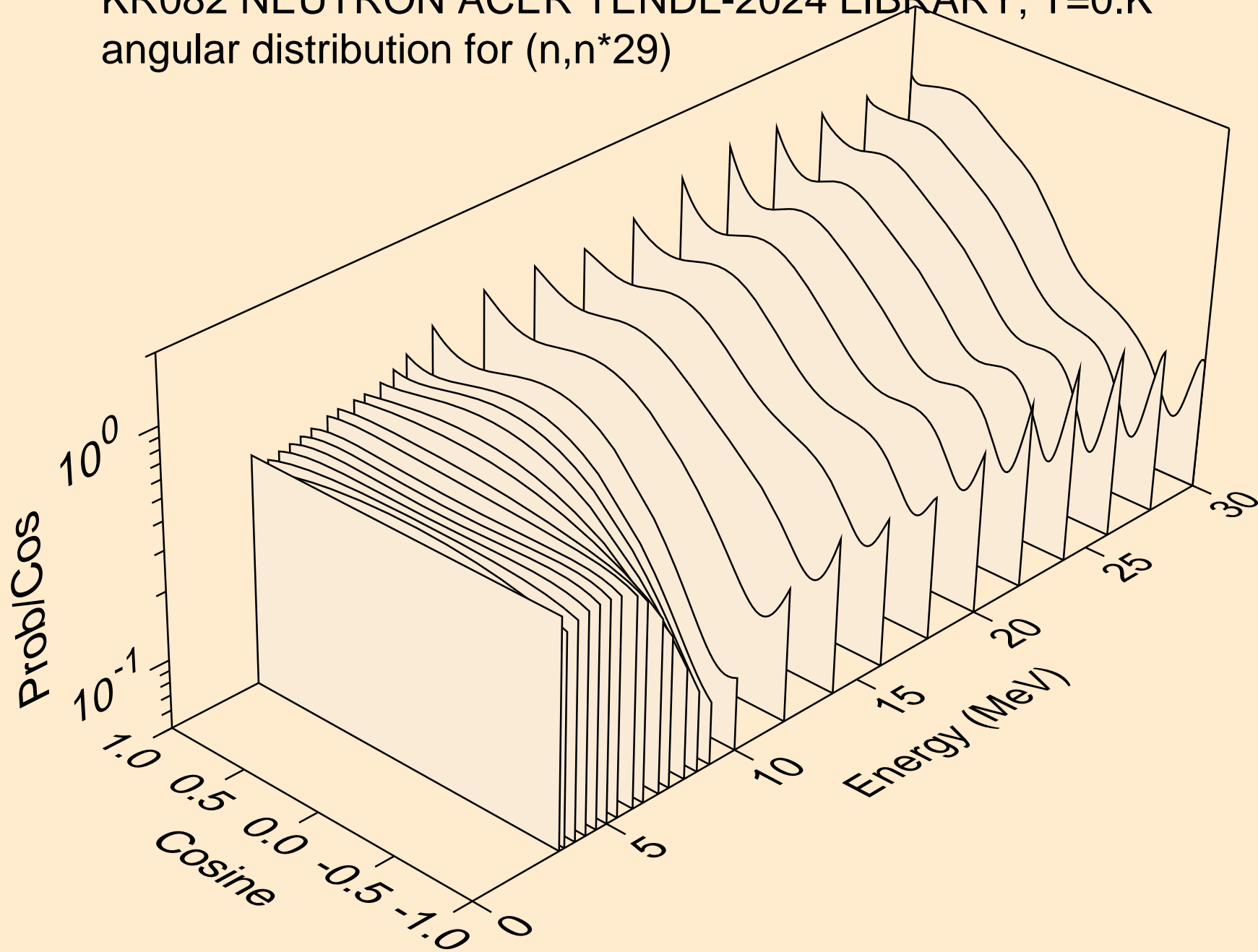

KR082 NEUTRON ACER TENDL-2024 LIBRARY; T=0.K
angular distribution for (n,n*30)

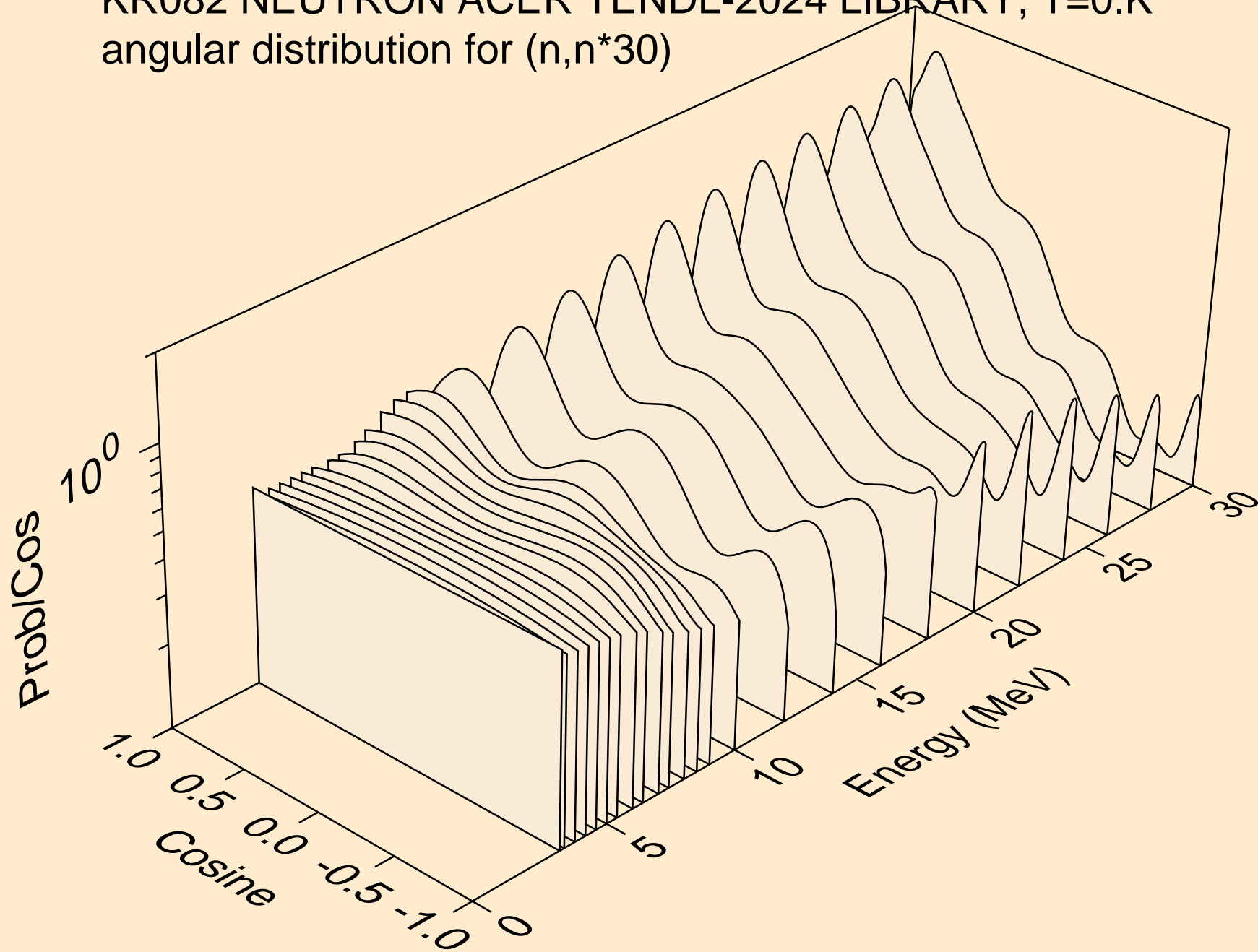

KR082 NEUTRON ACER TENDL-2024 LIBRARY; T=0.K
Neutron emission for (n,x)

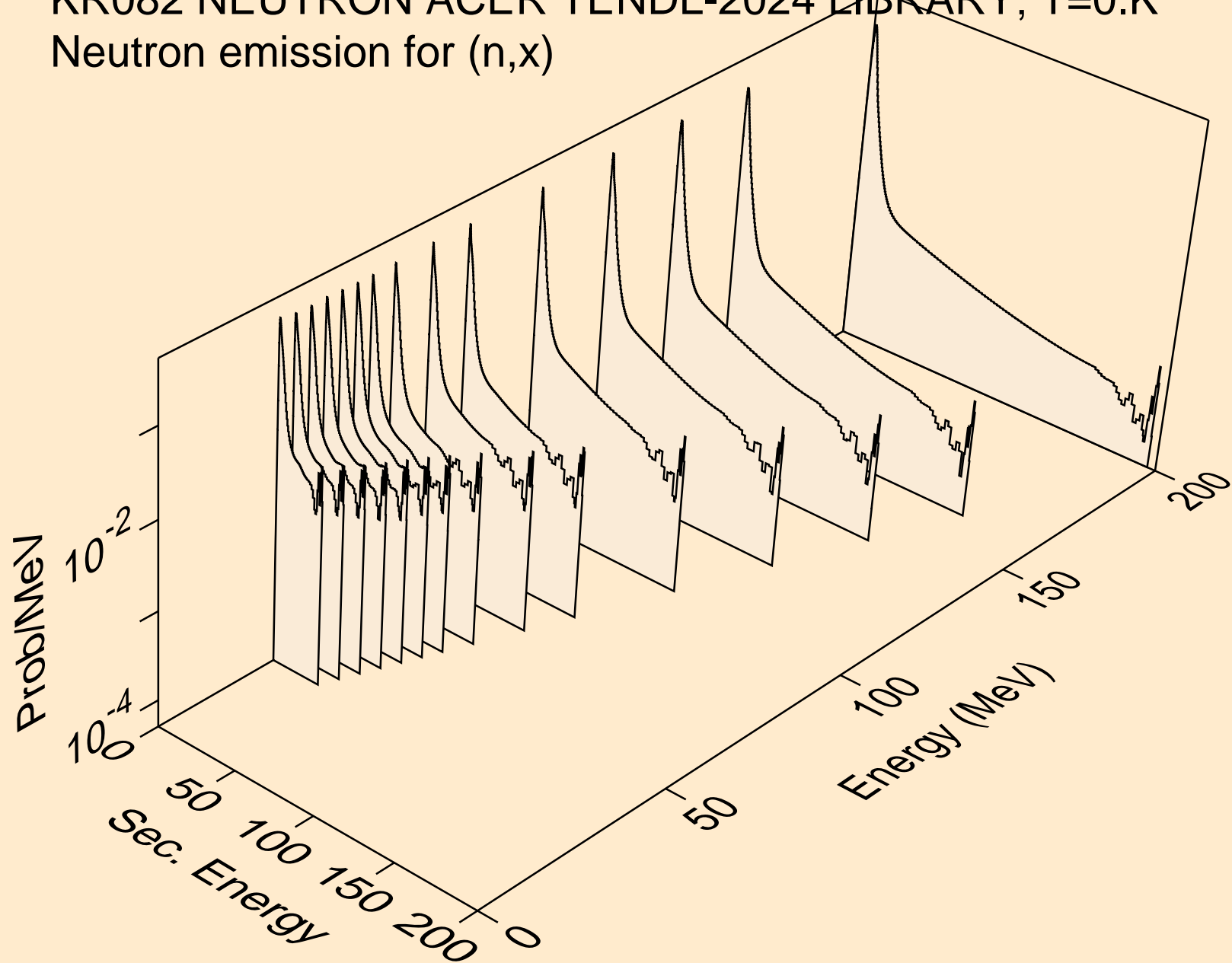

KR082 NEUTRON ACER TENDL-2024 LIBRARY; T=0.K
Neutron emission for (n,2nd)

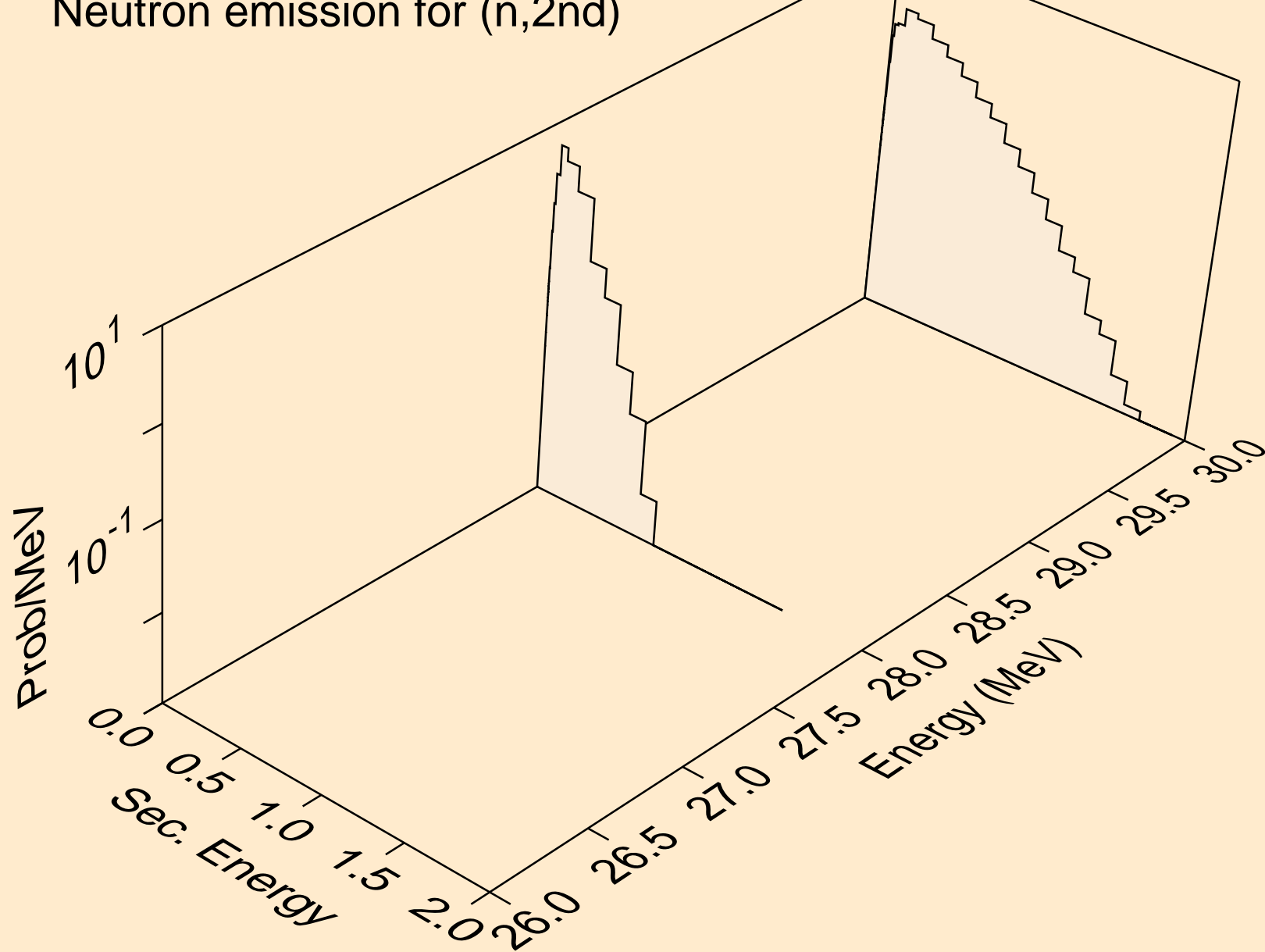

KR082 NEUTRON ACER TENDL-2024 LIBRARY; T=0.K
Neutron emission for (n,2n)

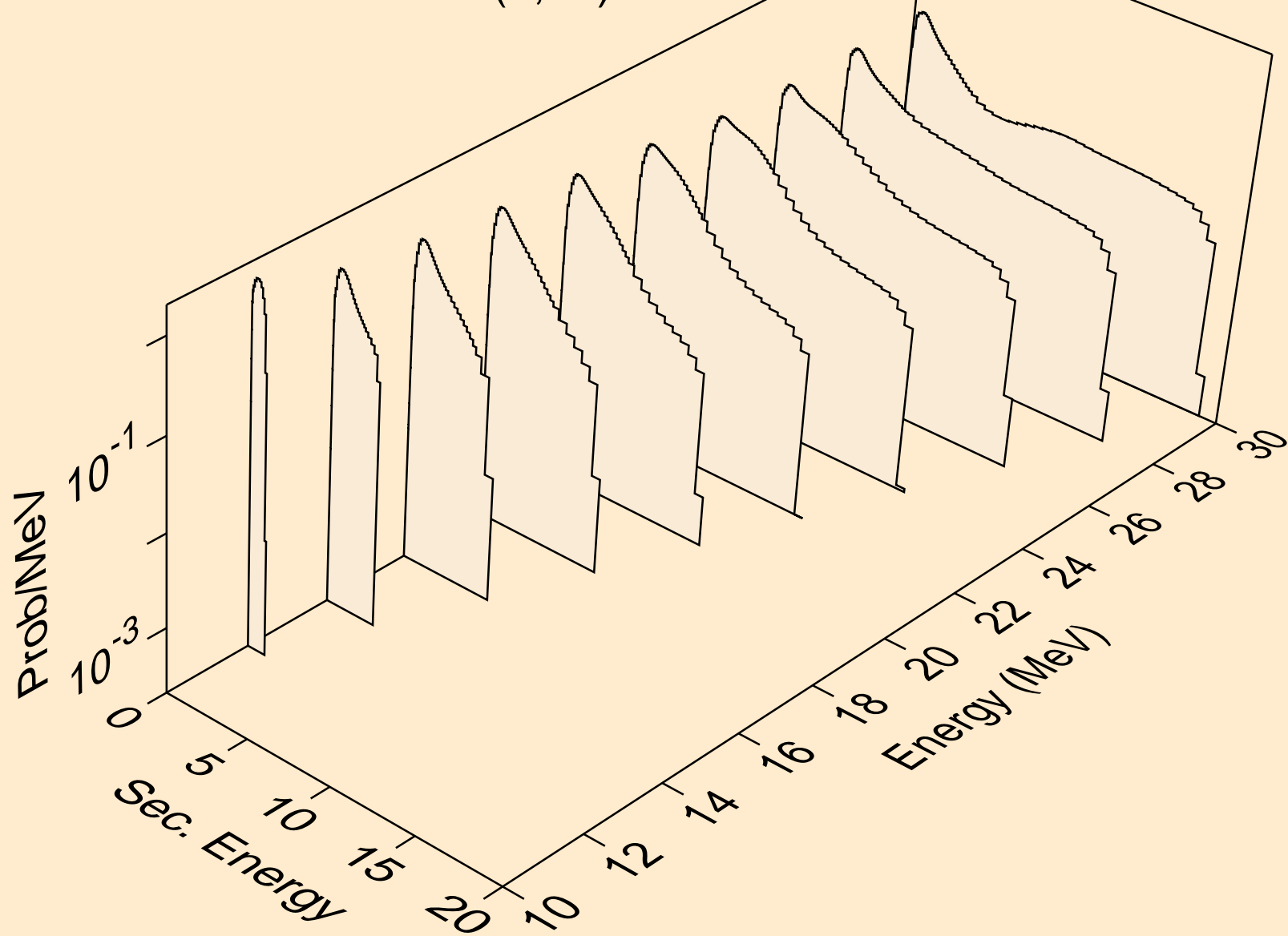

KR082 NEUTRON ACER TENDL-2024 LIBRARY; T=0.K
Neutron emission for (n,3n)

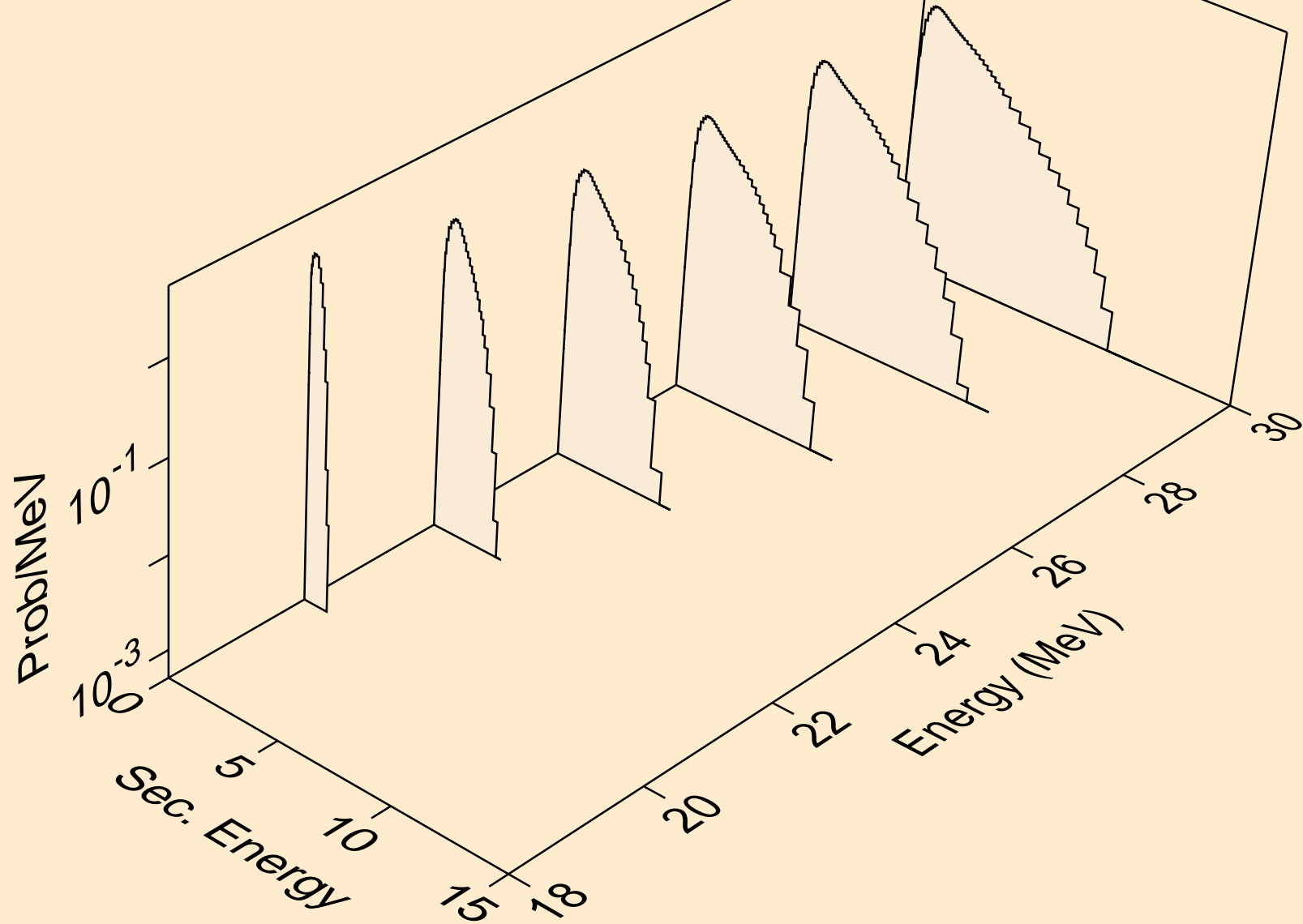

KR082 NEUTRON ACER TENDL-2024 LIBRARY; T=0.K
Neutron emission for (n,n*)a

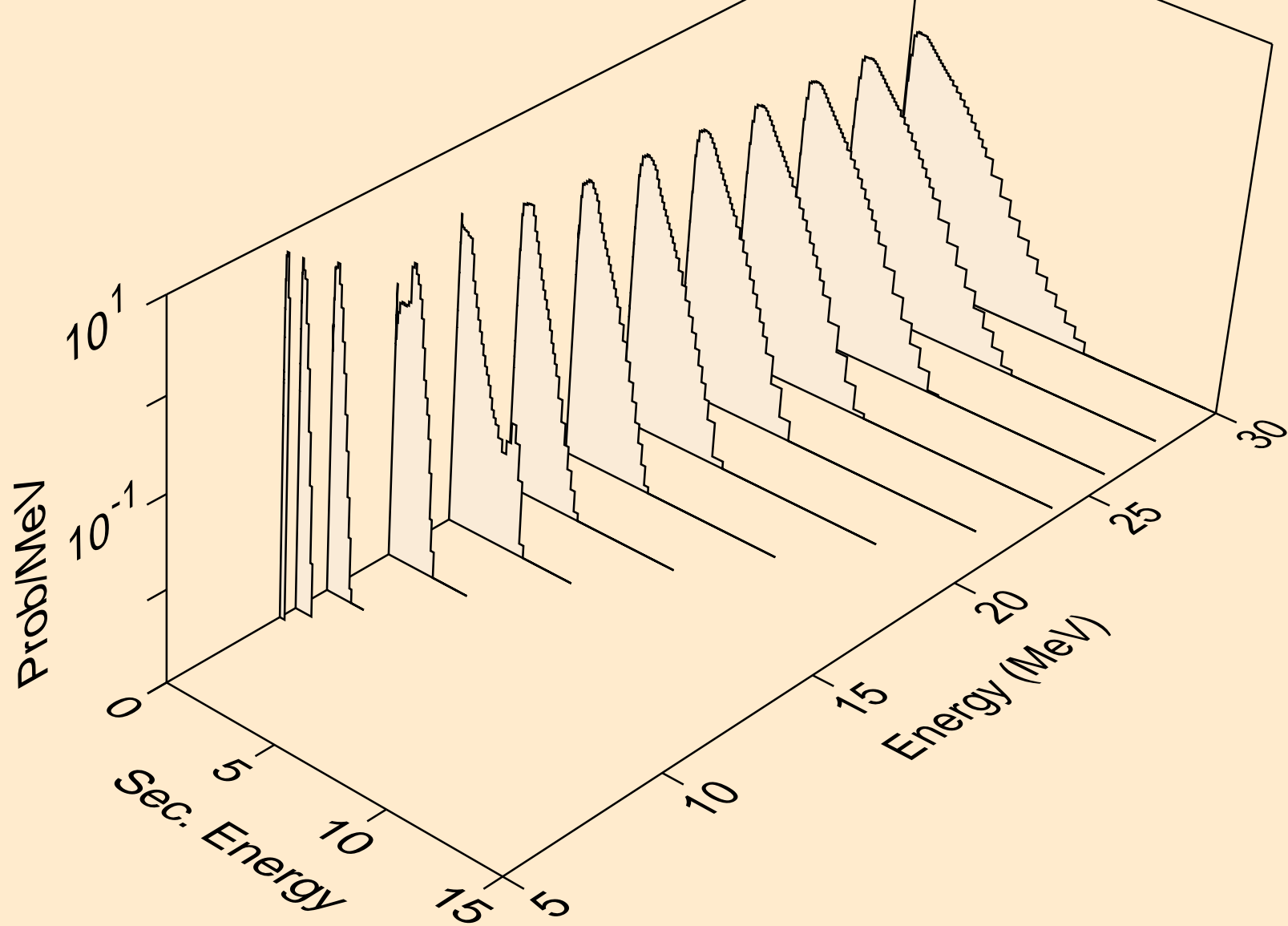

KR082 NEUTRON ACER TENDL-2024 LIBRARY; T=0.K
Neutron emission for (n,2n)a

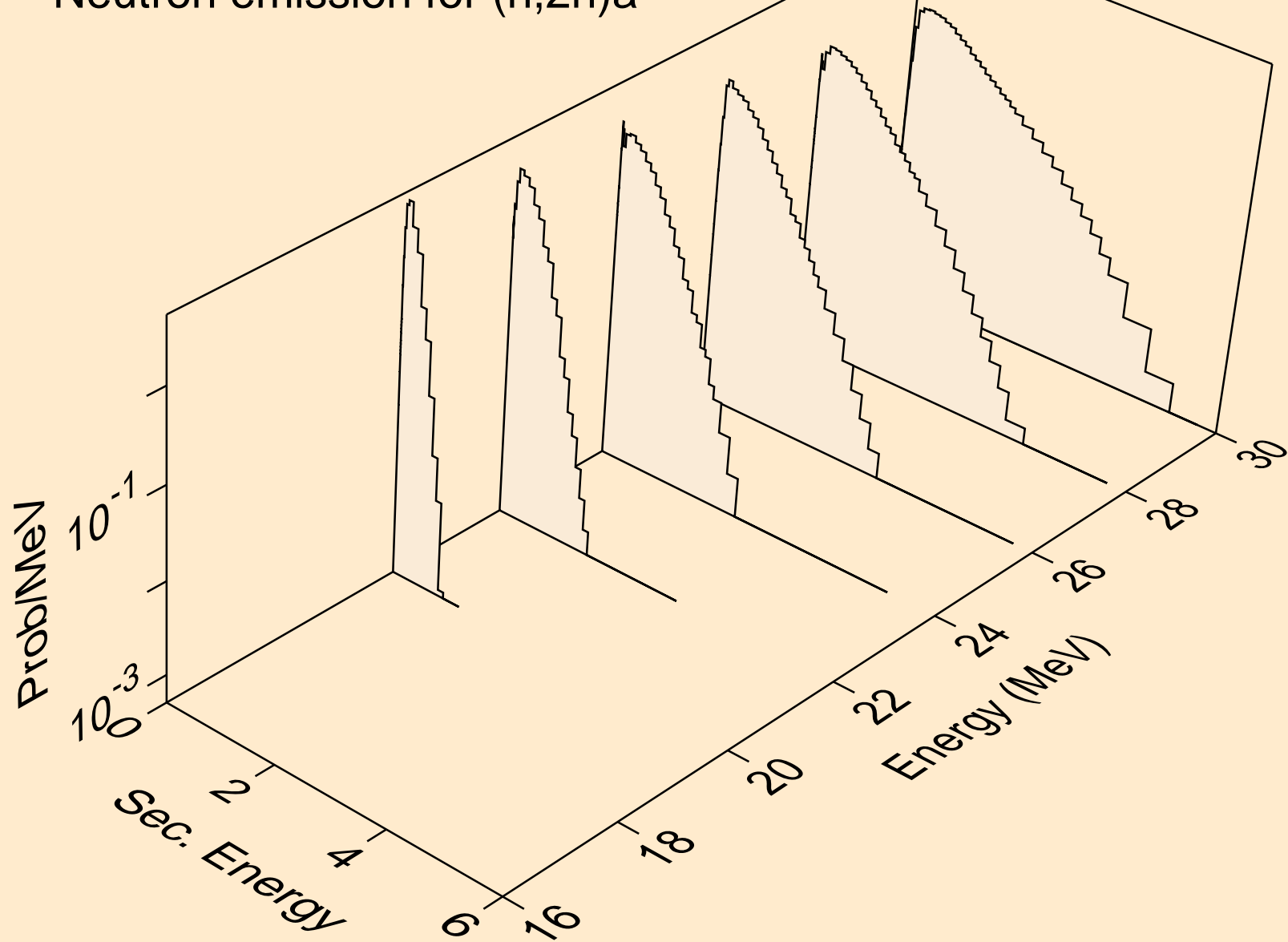

KR082 NEUTRON ACER TENDL-2024 LIBRARY; T=0.K
Neutron emission for (n,3n)a

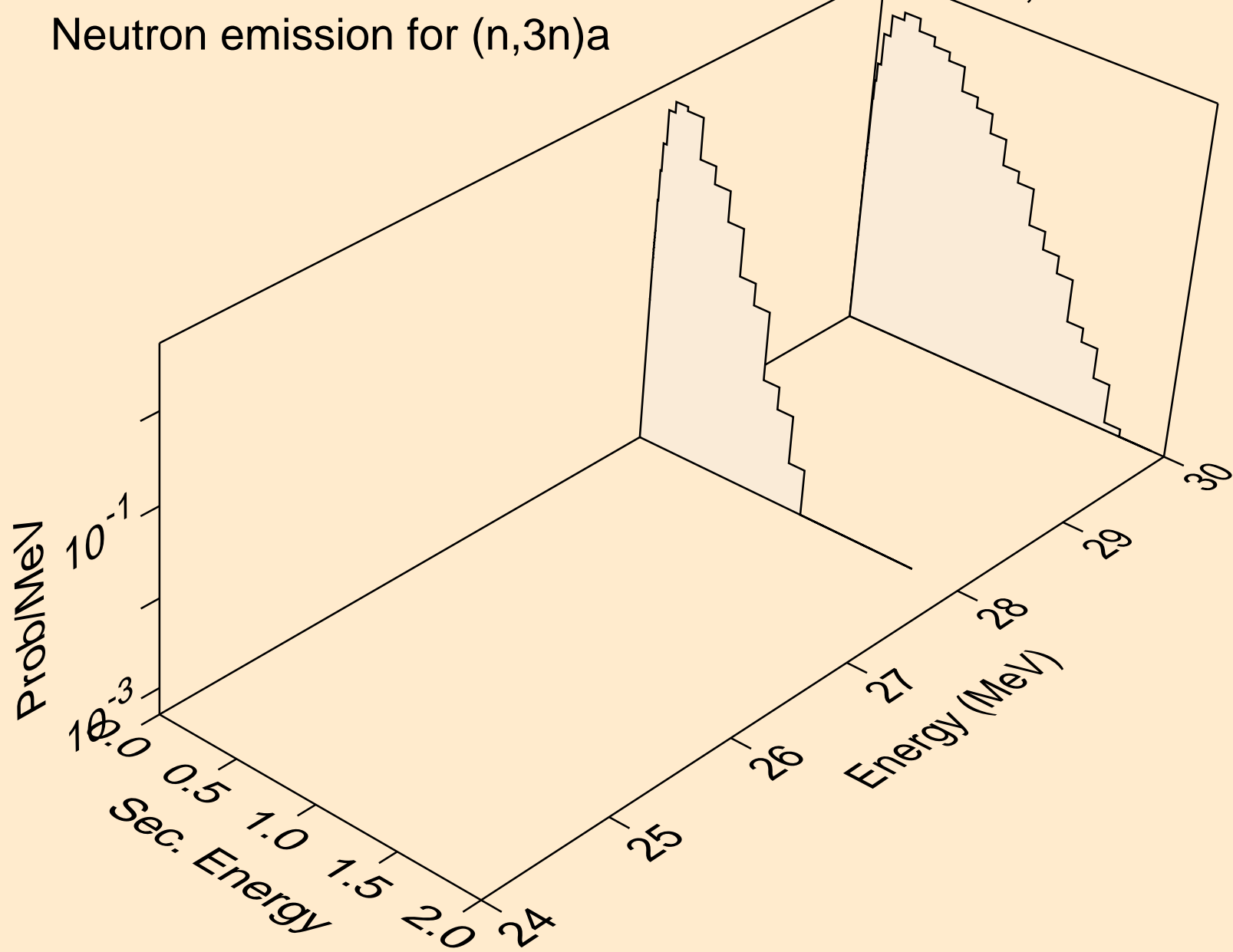

KR082 NEUTRON ACER TENDL-2024 LIBRARY; T=0.K
Neutron emission for (n,n*)p

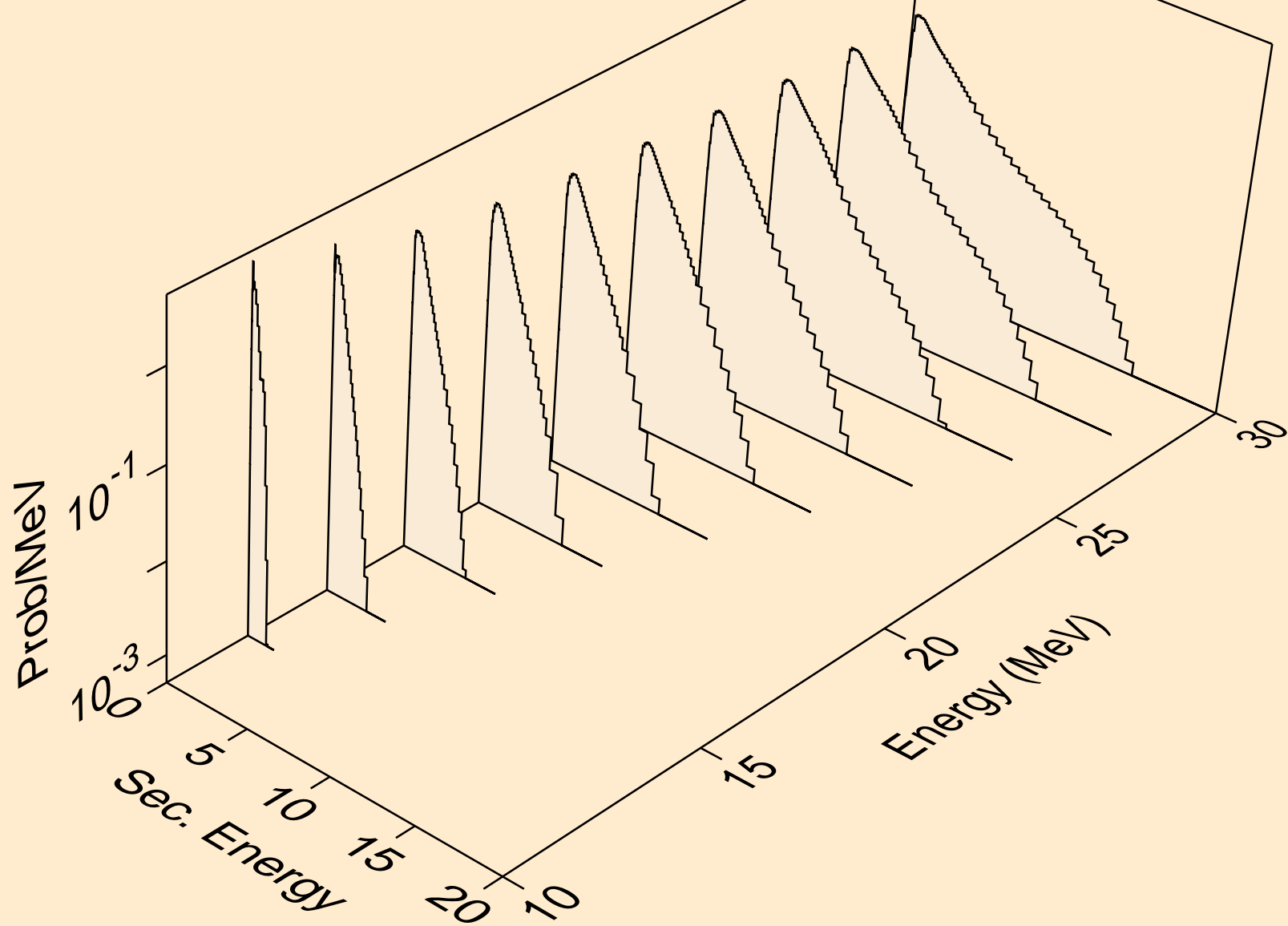

KR082 NEUTRON ACER TENDL-2024 LIBRARY; T=0.K
Neutron emission for (n,n*)2a

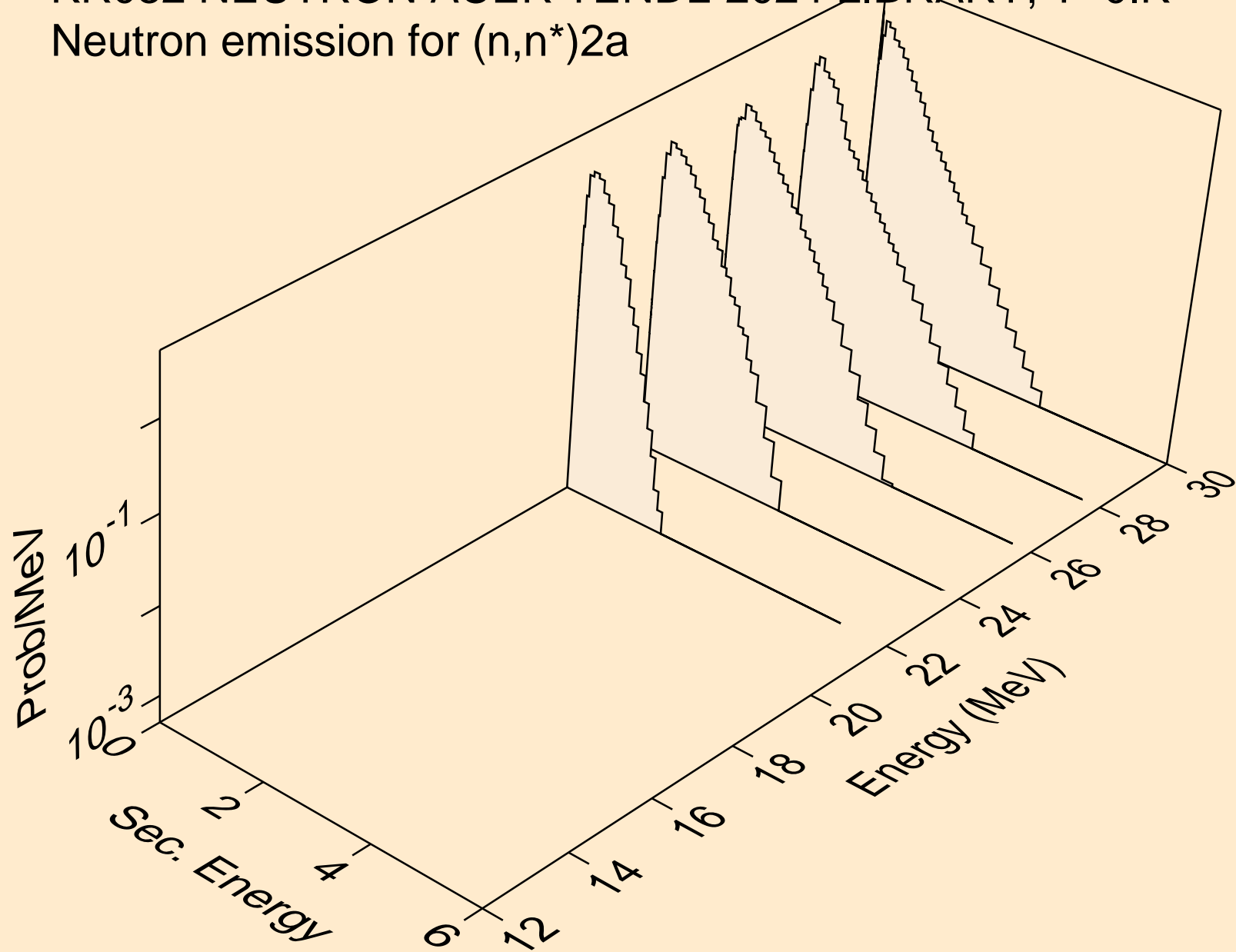

KR082 NEUTRON ACER TENDL-2024 LIBRARY; T=0.K
Neutron emission for (n,n*)d

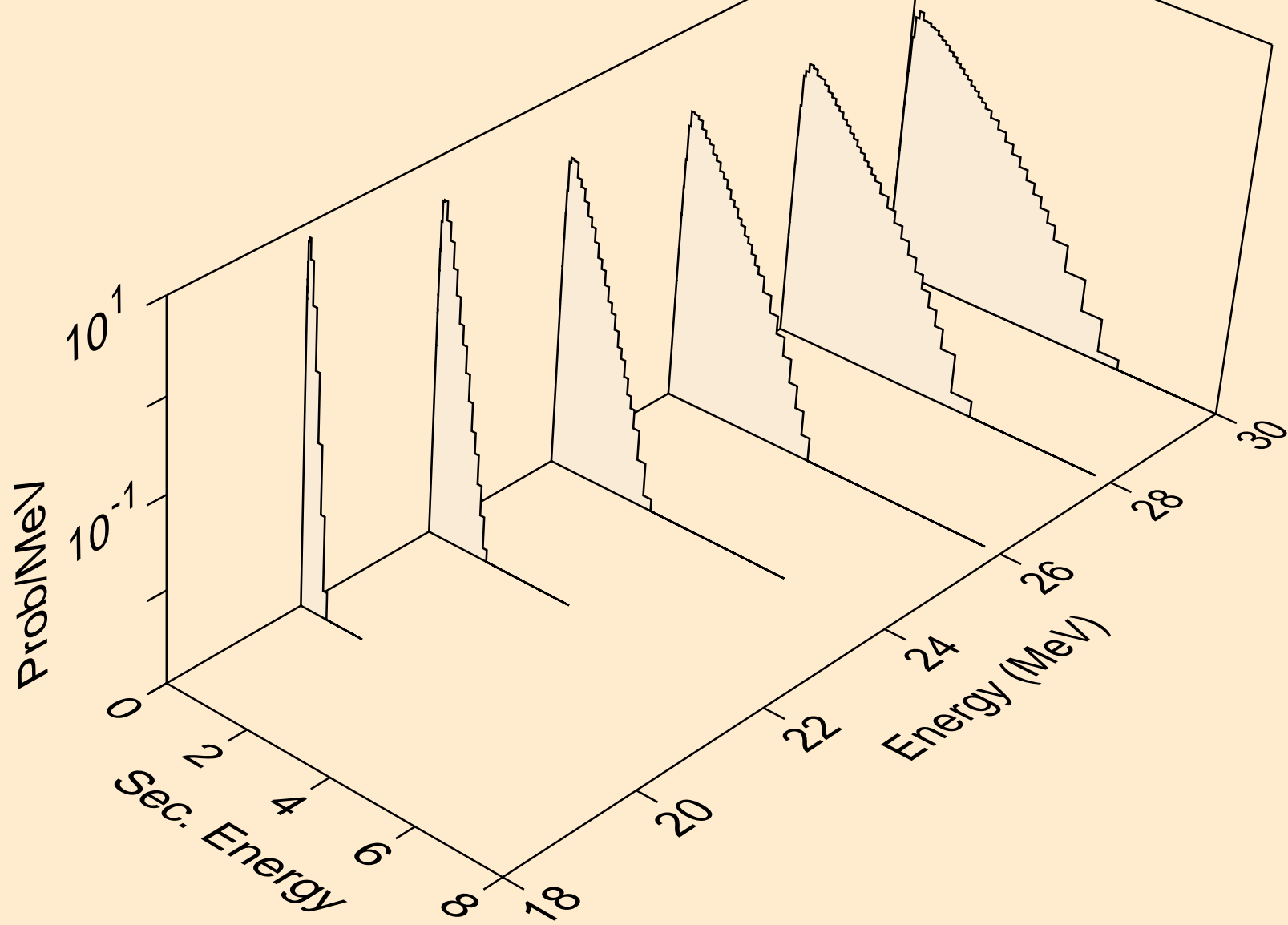

KR082 NEUTRON ACER TENDL-2024 LIBRARY; T=0.K
Neutron emission for (n,n*)t

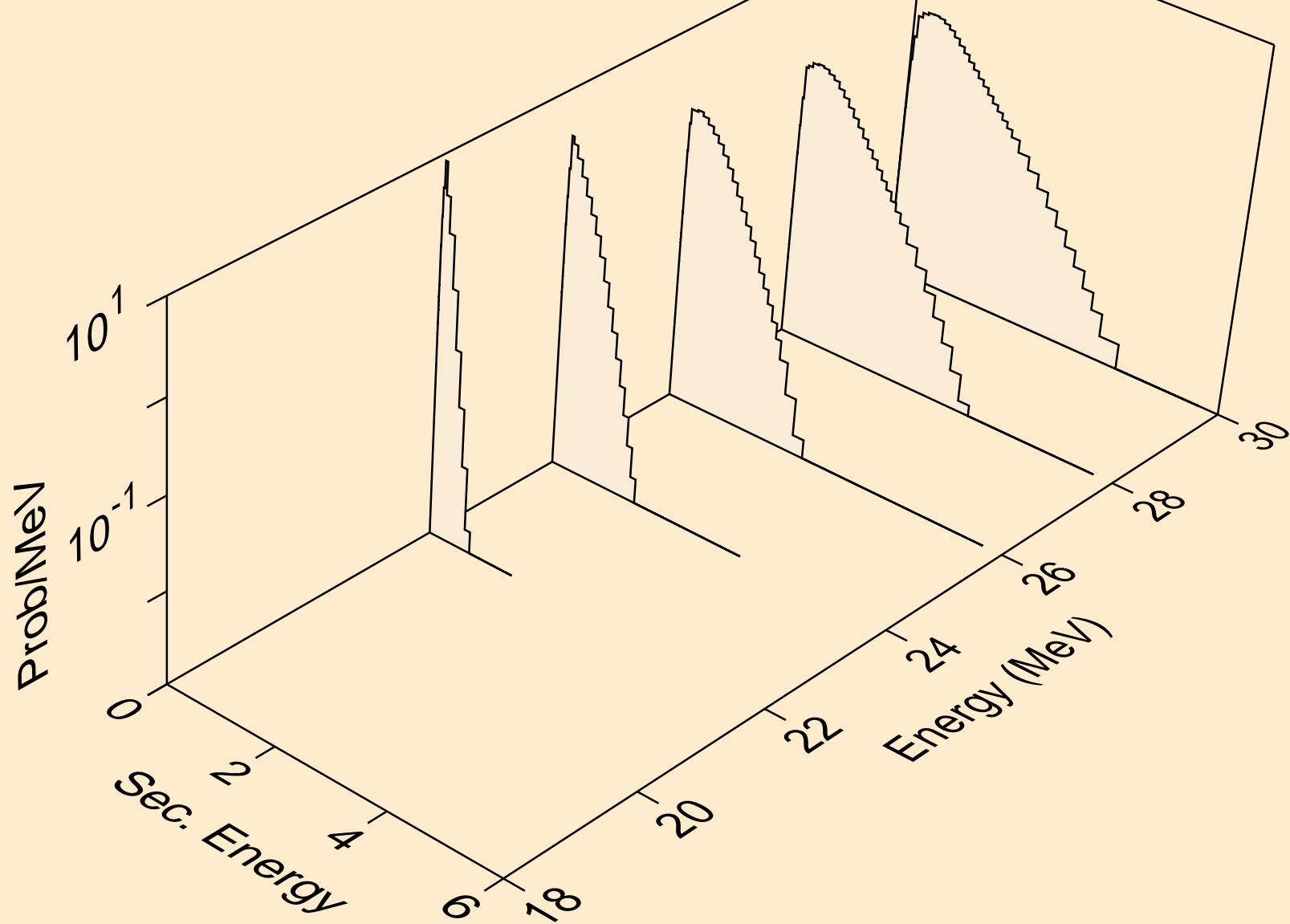

KR082 NEUTRON ACER TENDL-2024 LIBRARY; T=0.K
Neutron emission for (n,n*)he3

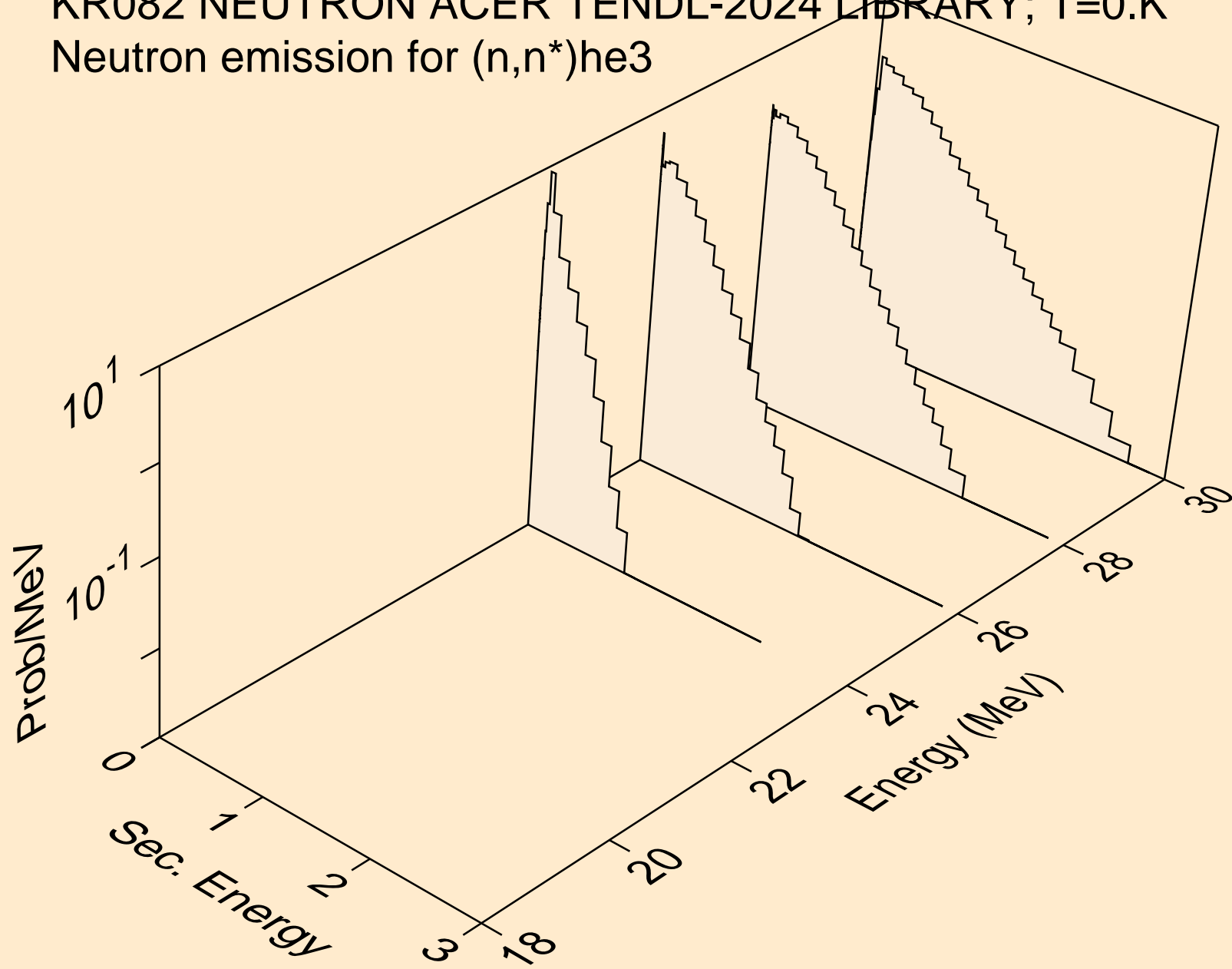

KR082 NEUTRON ACER TENDL-2024 LIBRARY; T=0.K
Neutron emission for (n,2np)

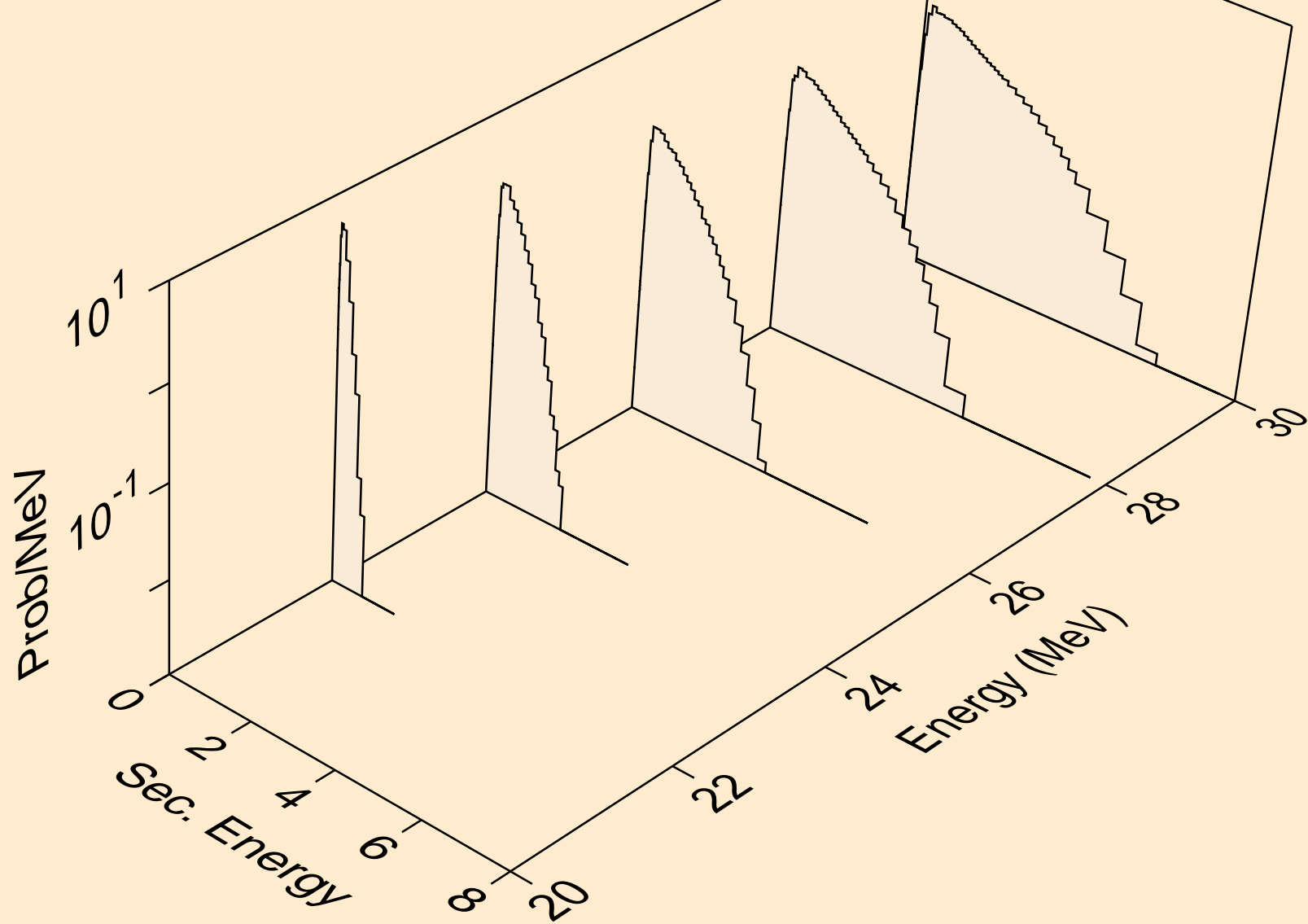

KR082 NEUTRON ACER TENDL-2024 LIBRARY; T=0.K
Neutron emission for (n,n2p)

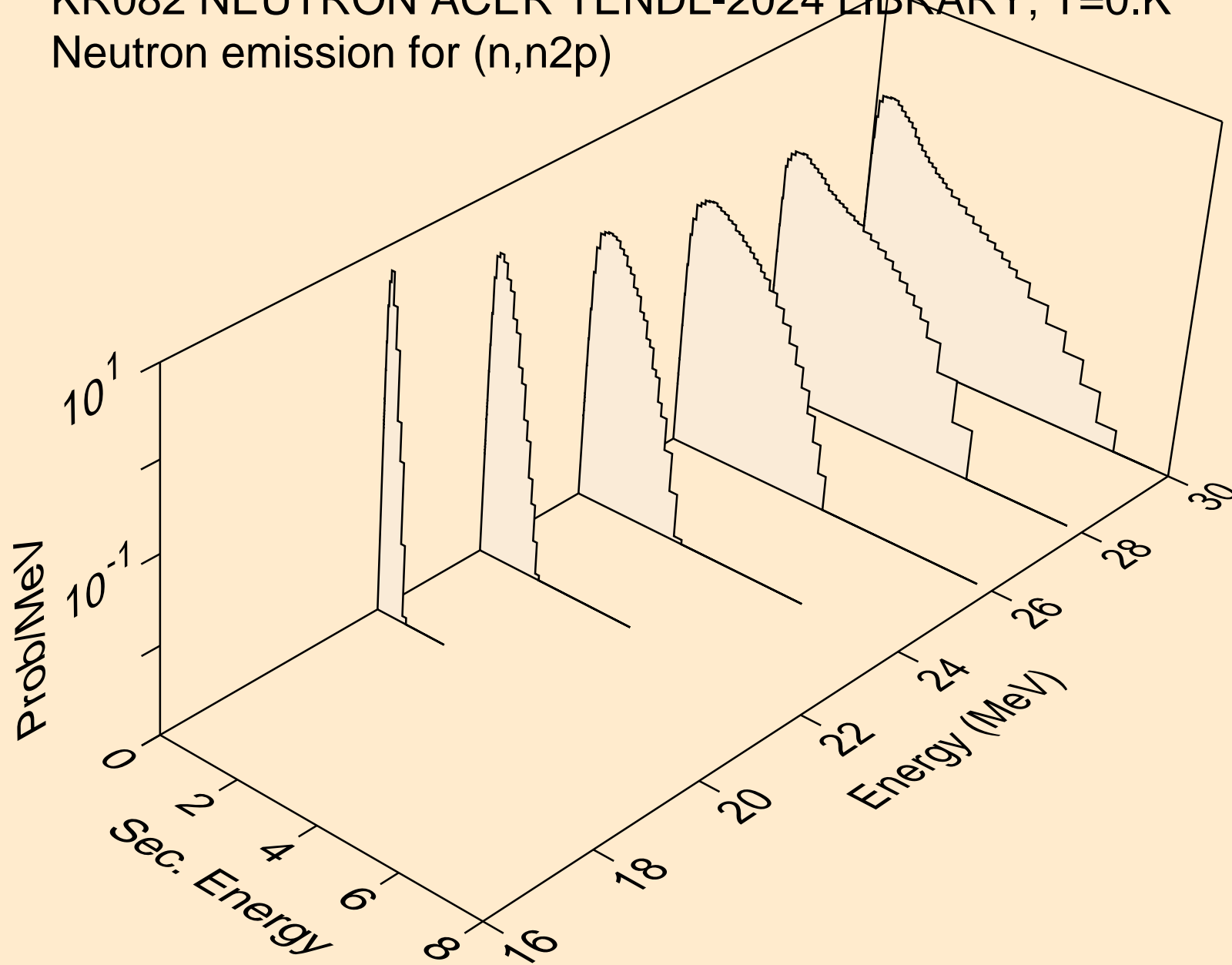

KR082 NEUTRON ACER TENDL-2024 LIBRARY; T=0.K
Neutron emission for (n,npa)

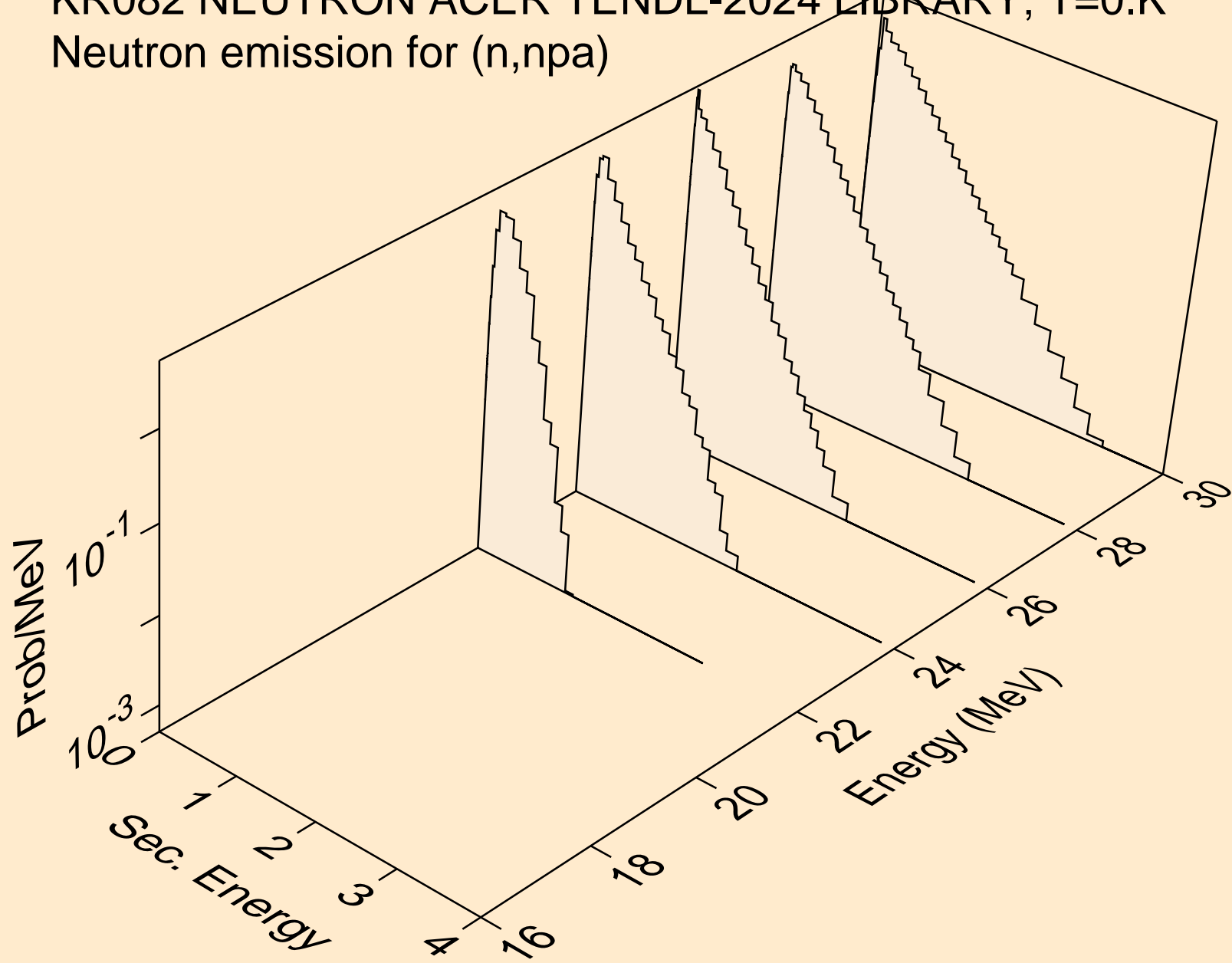

KR082 NEUTRON ACER TENDL-2024 LIBRARY; T=0.K
Neutron emission for (n,n*c)

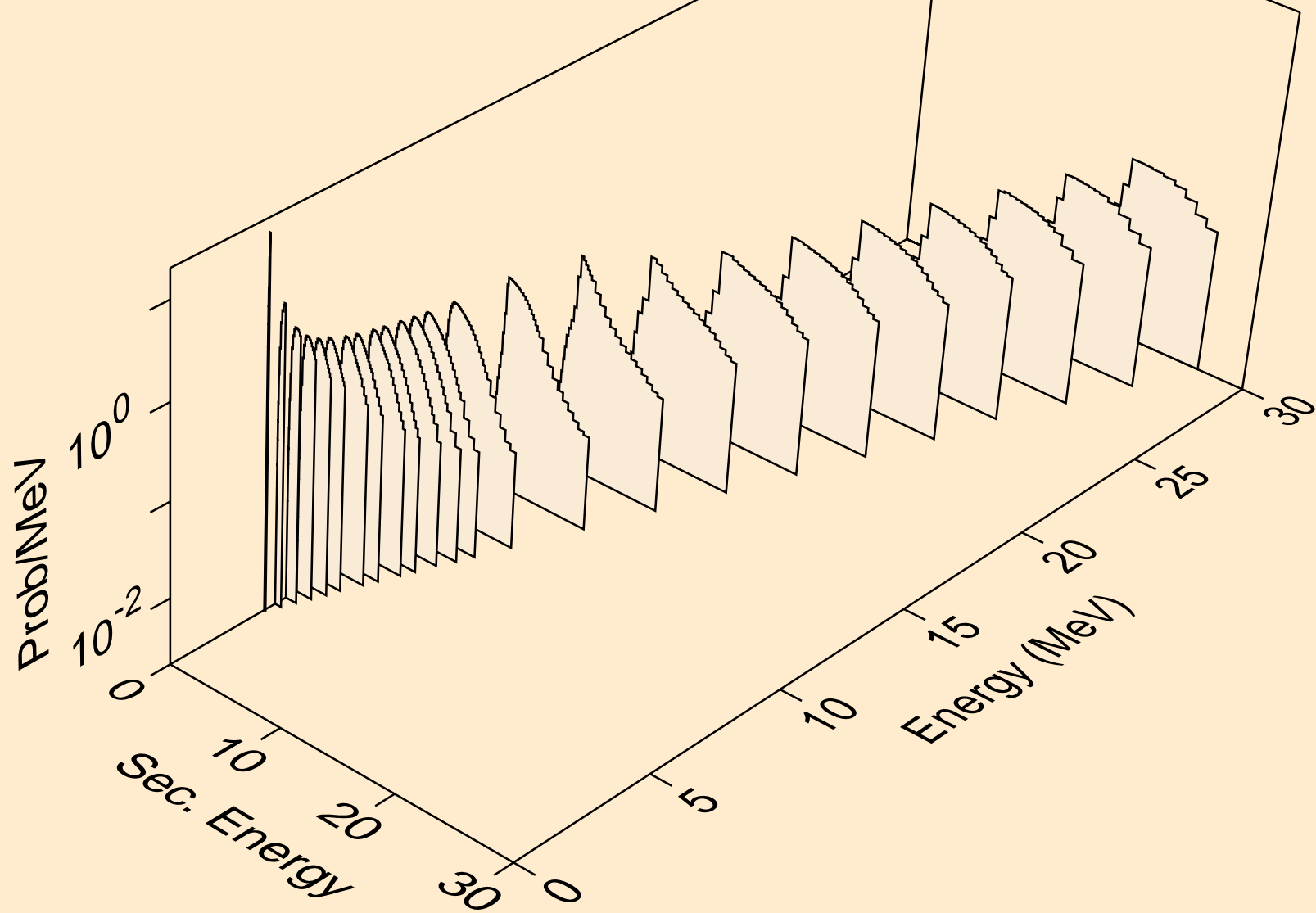

KR082 NEUTRON ACER TENDL-2024 LIBRARY; T=0.K
Photon emission for (n,x)

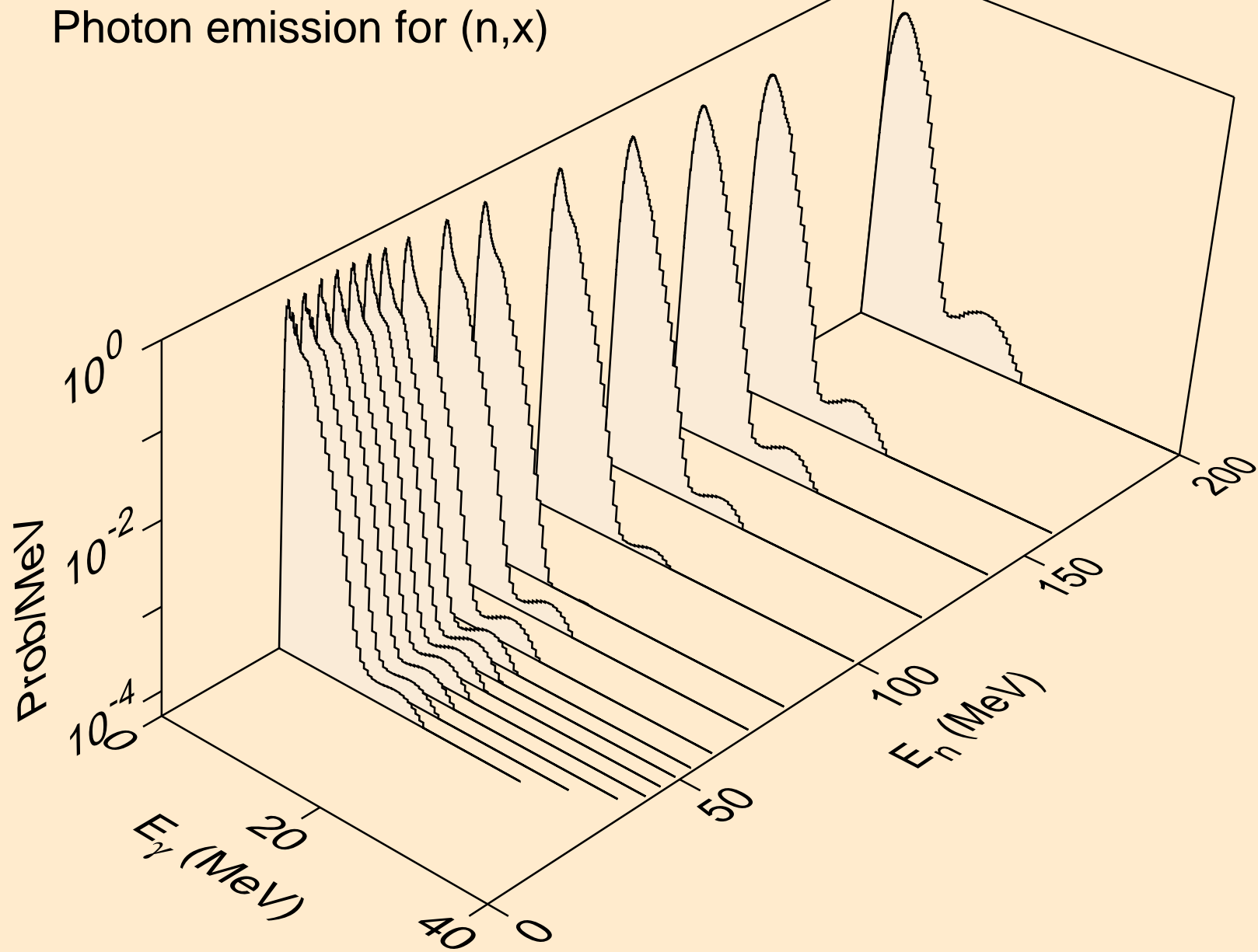

KR082 NEUTRON ACER TENDL-2024 LIBRARY; T=0.K
Photon emission for (n,2nd)

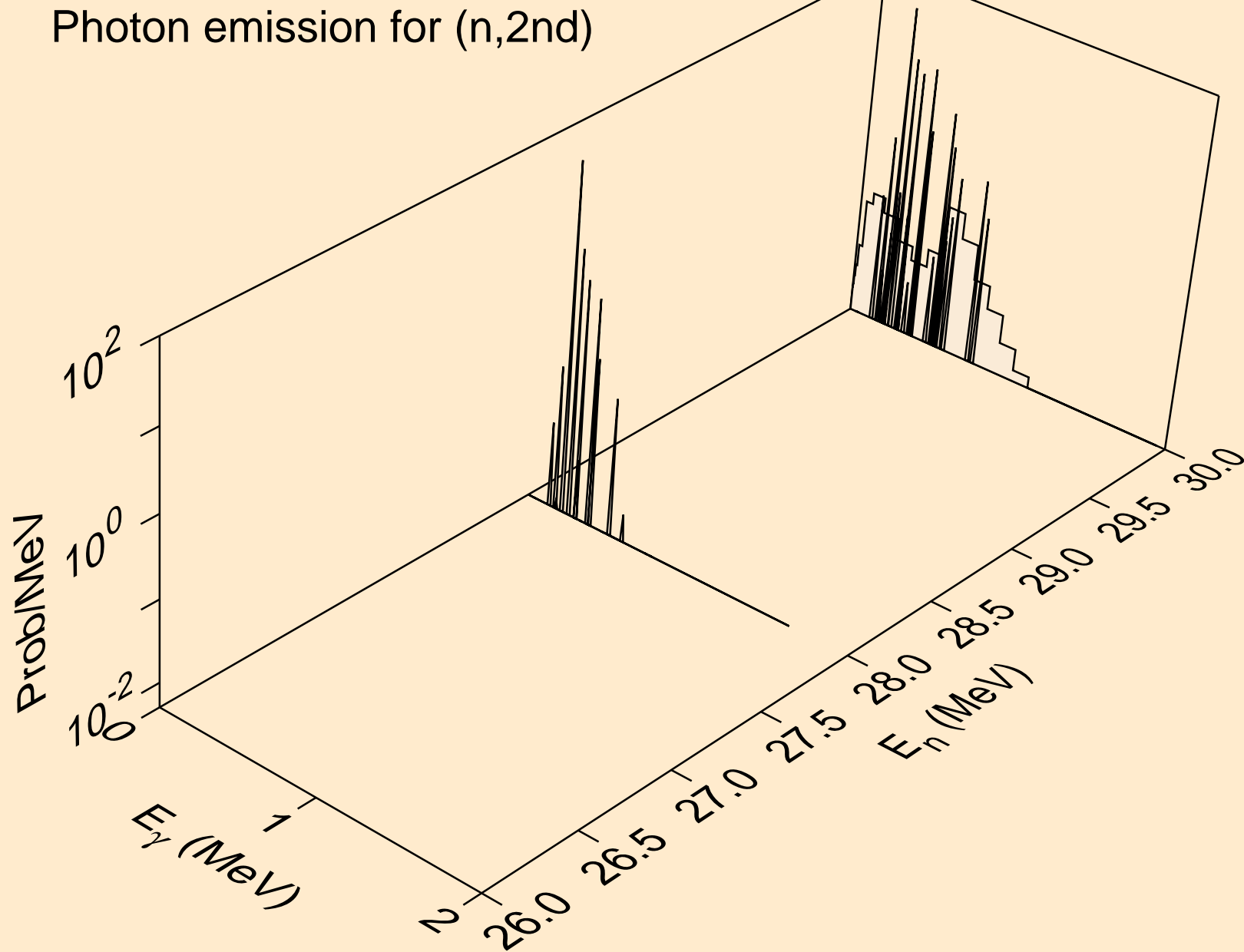

KR082 NEUTRON ACER TENDL-2024 LIBRARY; T=0.K
Photon emission for (n,2n)

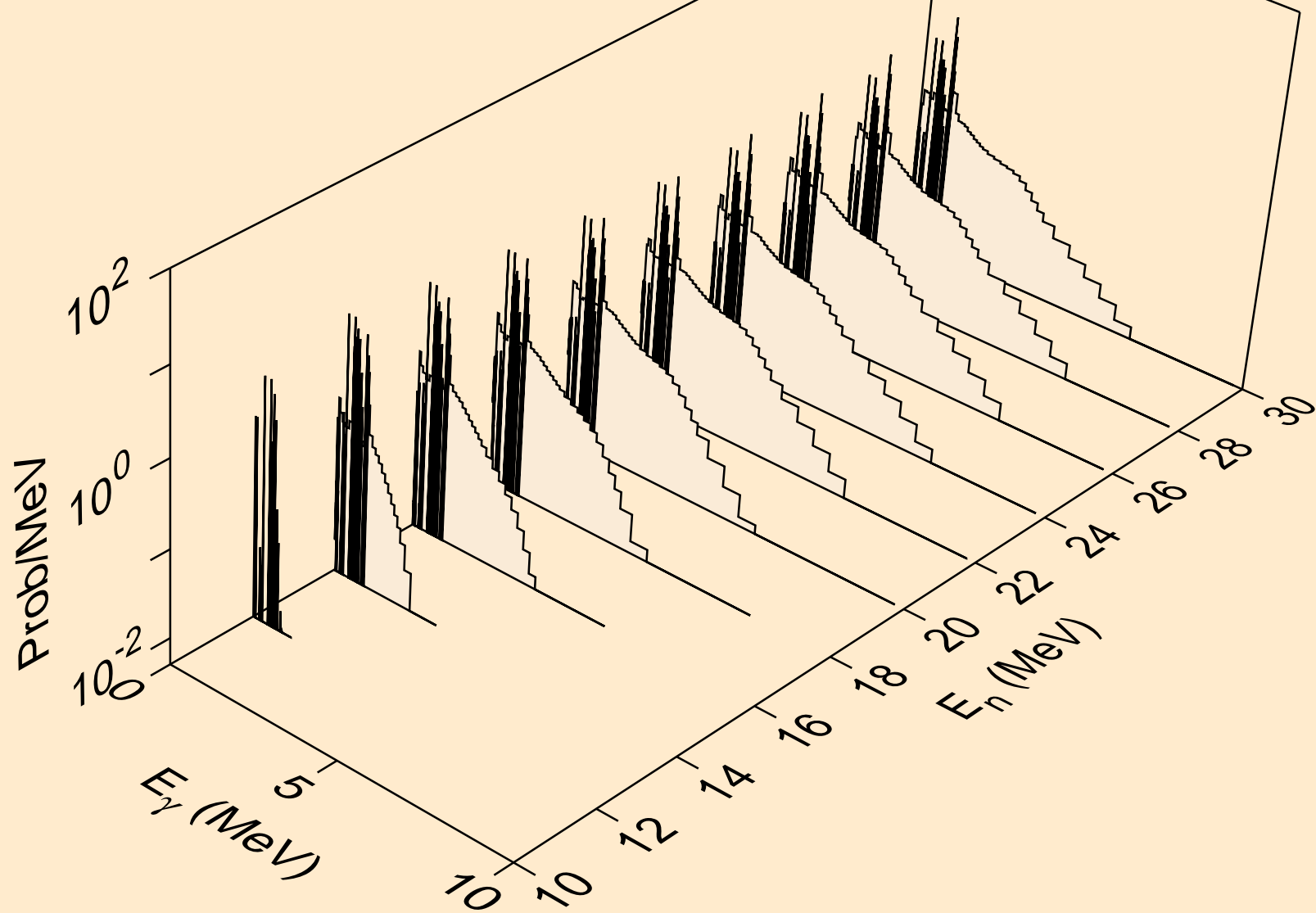

KR082 NEUTRON ACER TENDL-2024 LIBRARY; T=0.K
Photon emission for (n,3n)

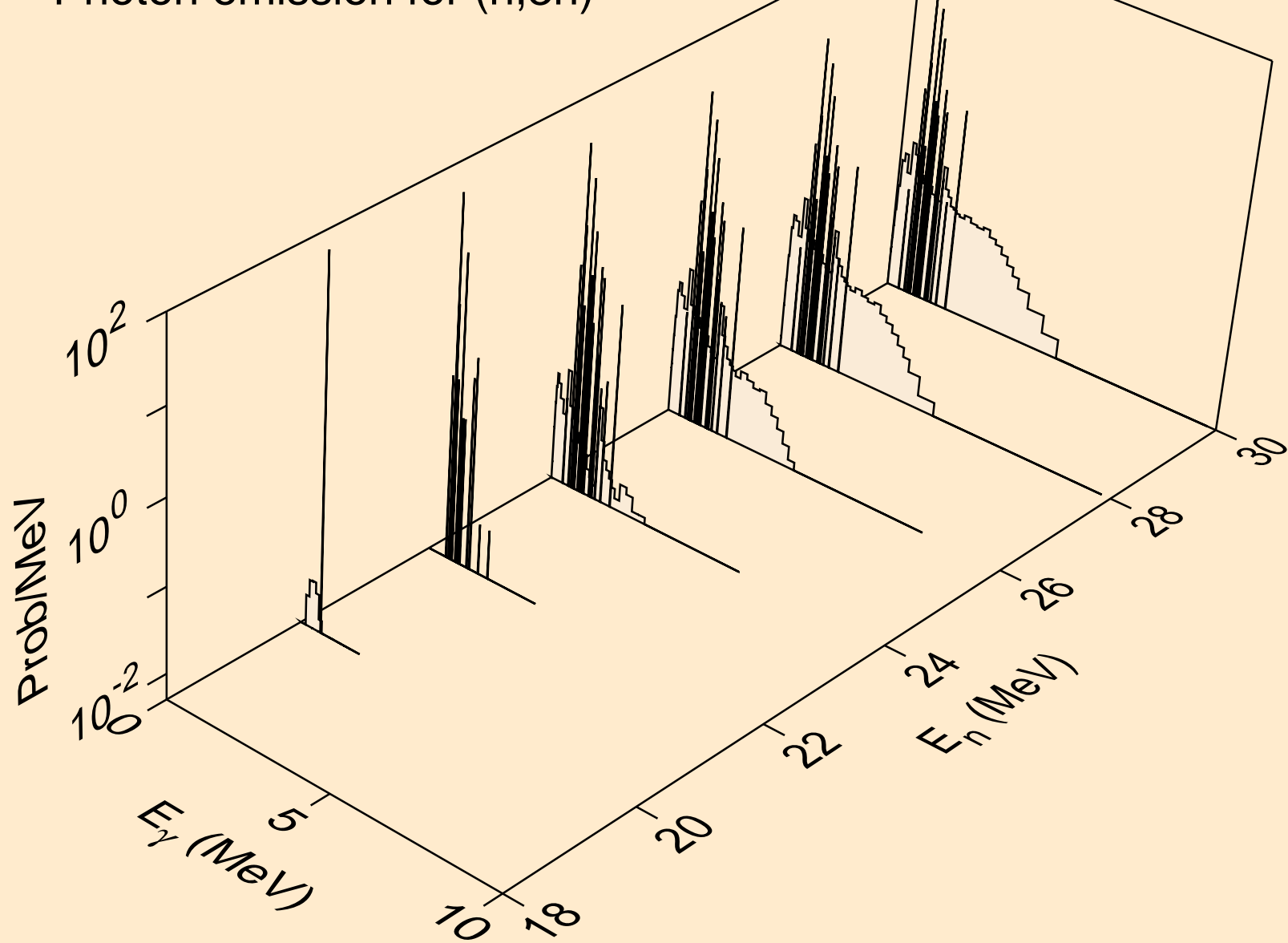

KR082 NEUTRON ACER TENDL-2024 LIBRARY; T=0.K
Photon emission for (n,n*)a

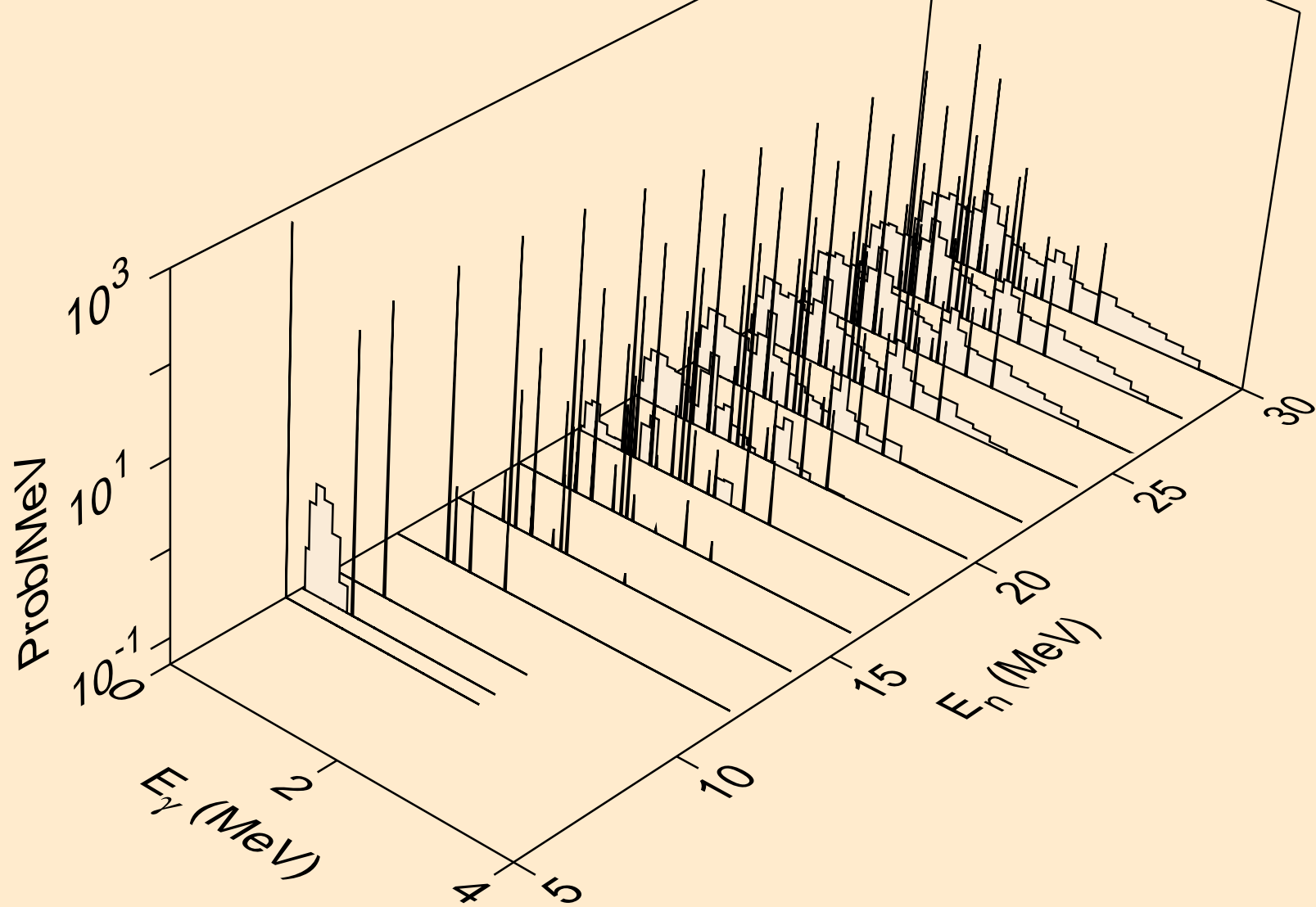

KR082 NEUTRON ACER TENDL-2024 LIBRARY; T=0.K
Photon emission for (n,2n)a

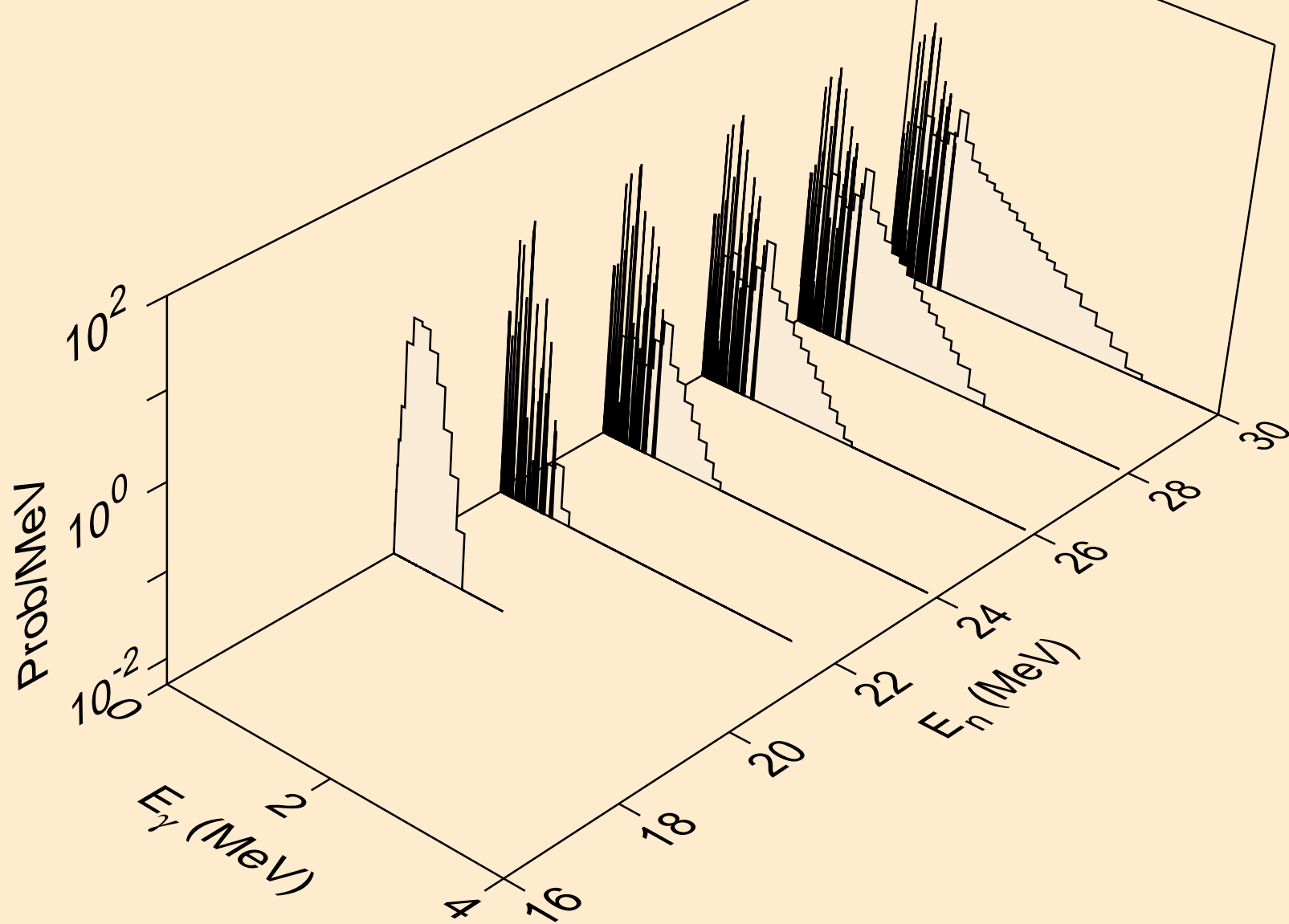

KR082 NEUTRON ACER TENDL-2024 LIBRARY; T=0.K
Photon emission for (n,3n)a

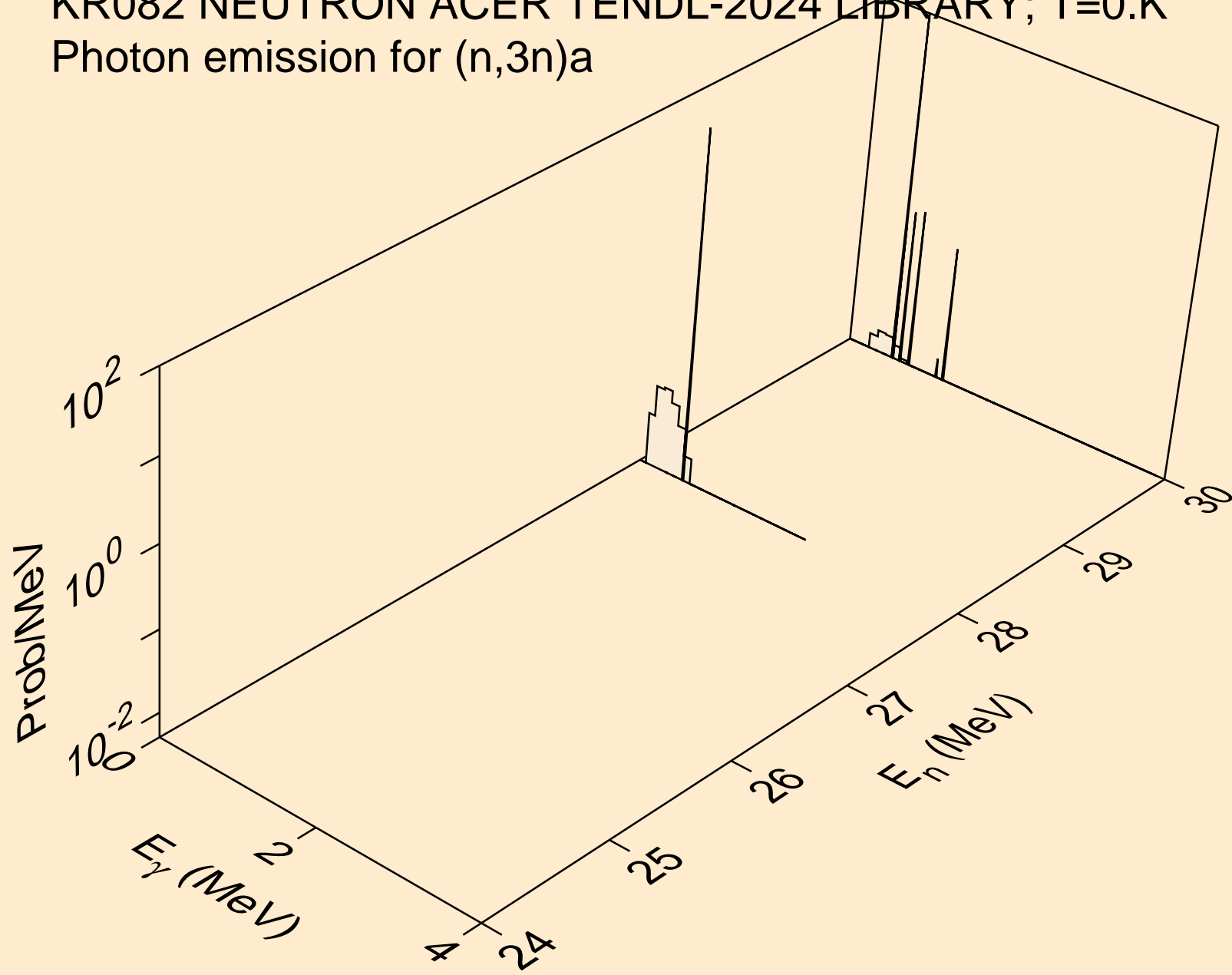

KR082 NEUTRON ACER TENDL-2024 LIBRARY; T=0.K
Photon emission for (n,n*)p

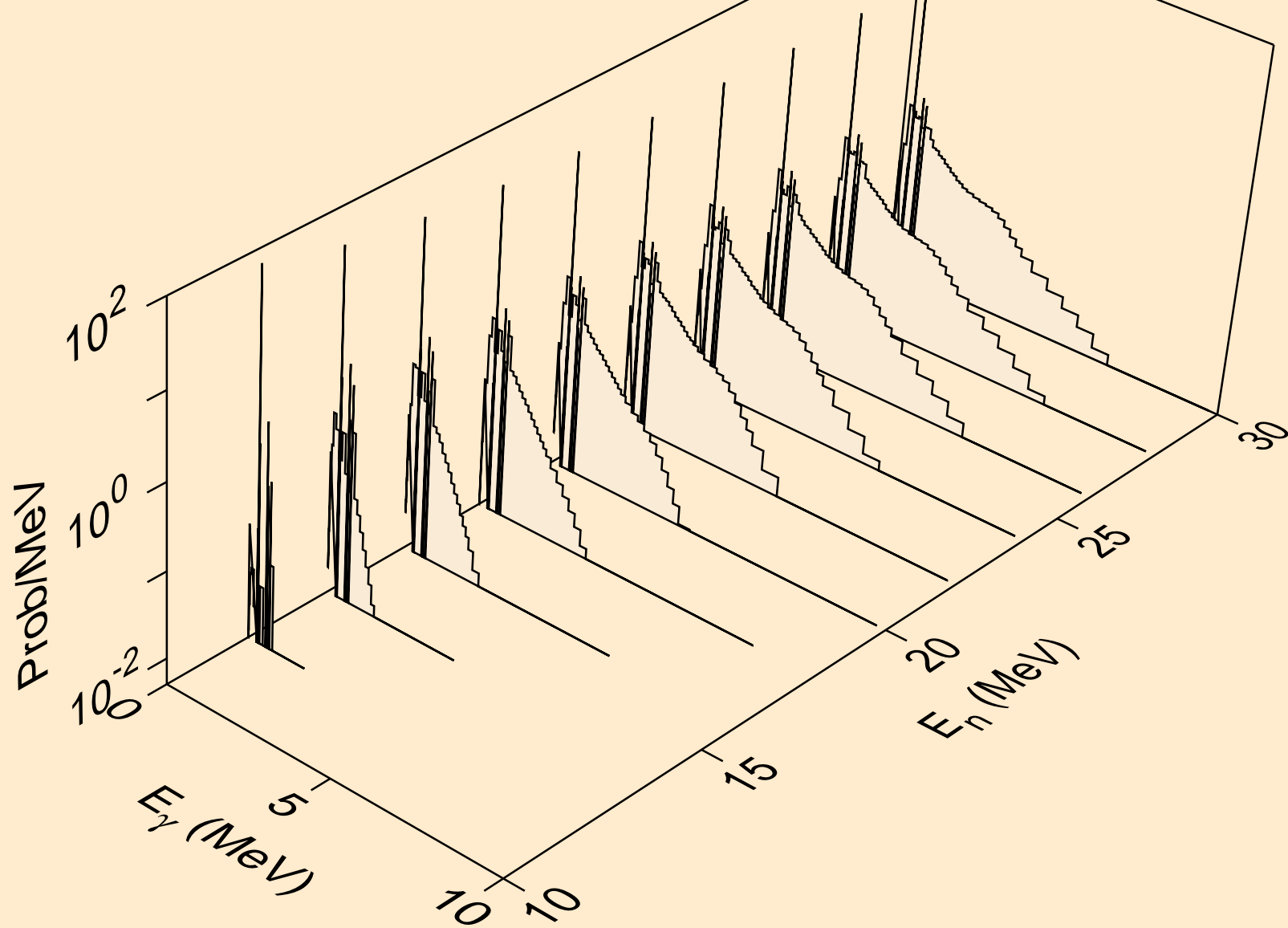

KR082 NEUTRON ACER TENDL-2024 LIBRARY; T=0.K
Photon emission for (n,n*)2a

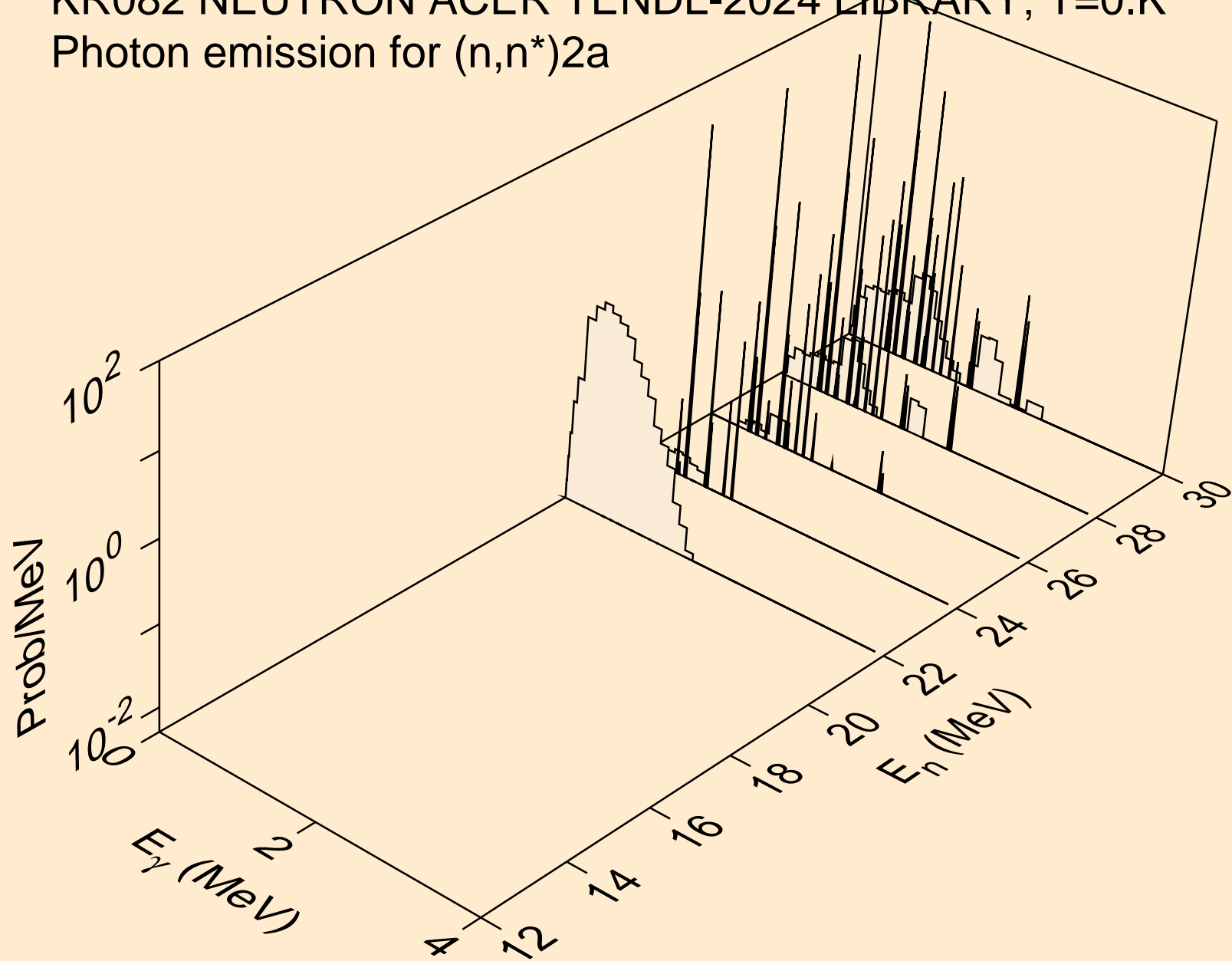

KR082 NEUTRON ACER TENDL-2024 LIBRARY; T=0.K
Photon emission for (n,n*)d

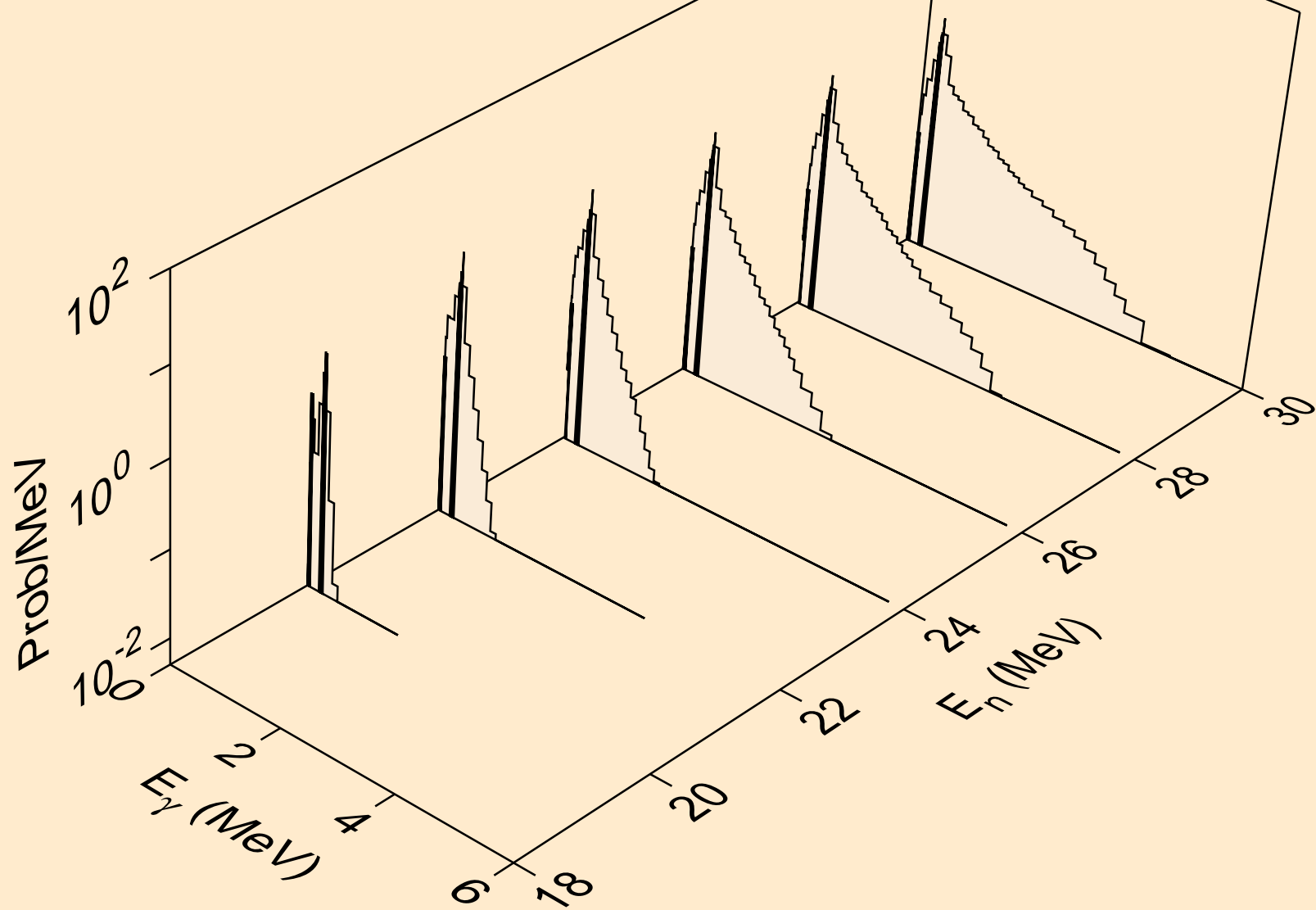

KR082 NEUTRON ACER TENDL-2024 LIBRARY; T=0.K
Photon emission for (n,n*)t

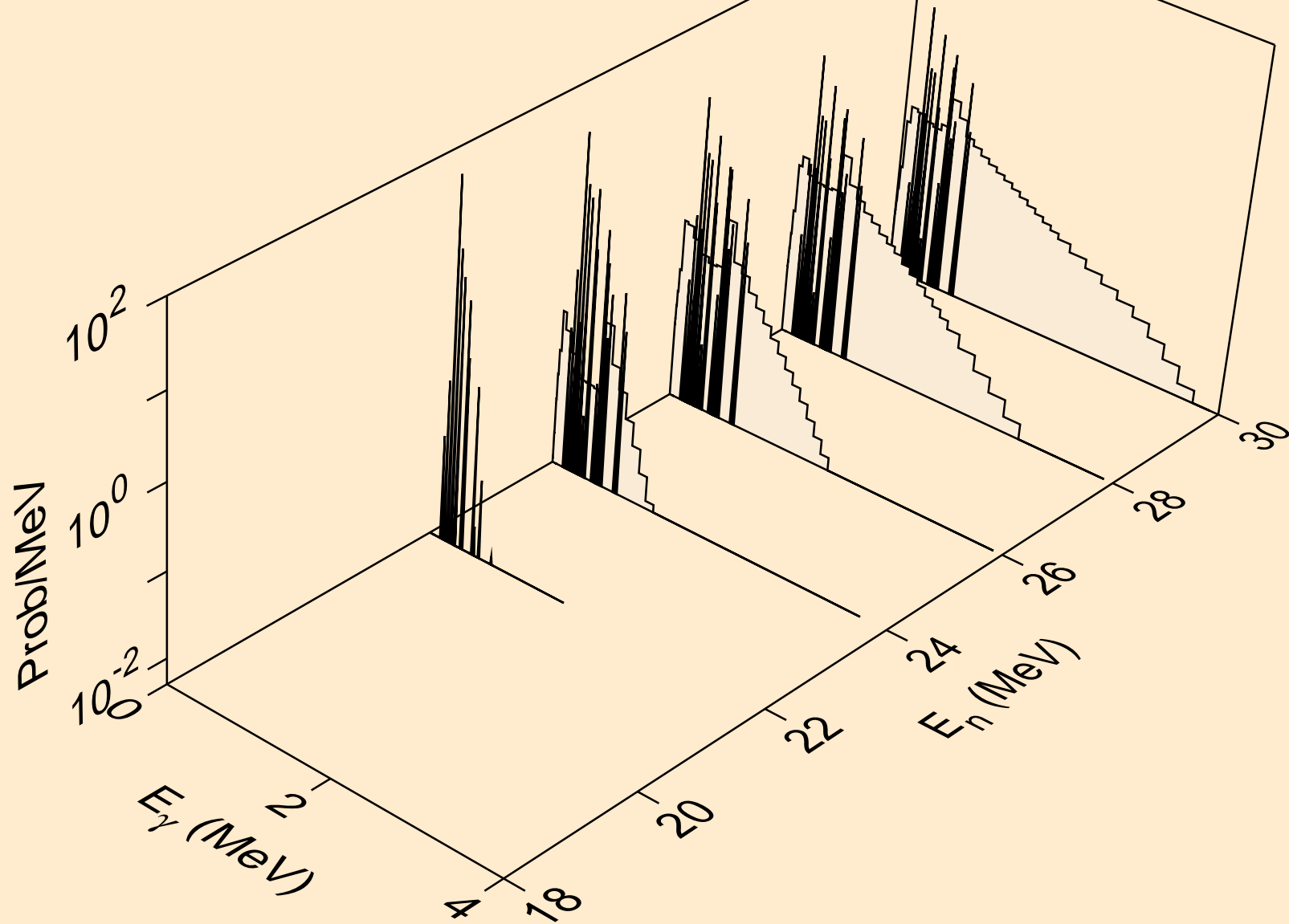

KR082 NEUTRON ACER TENDL-2024 LIBRARY; T=0.K
Photon emission for (n,n*)he3

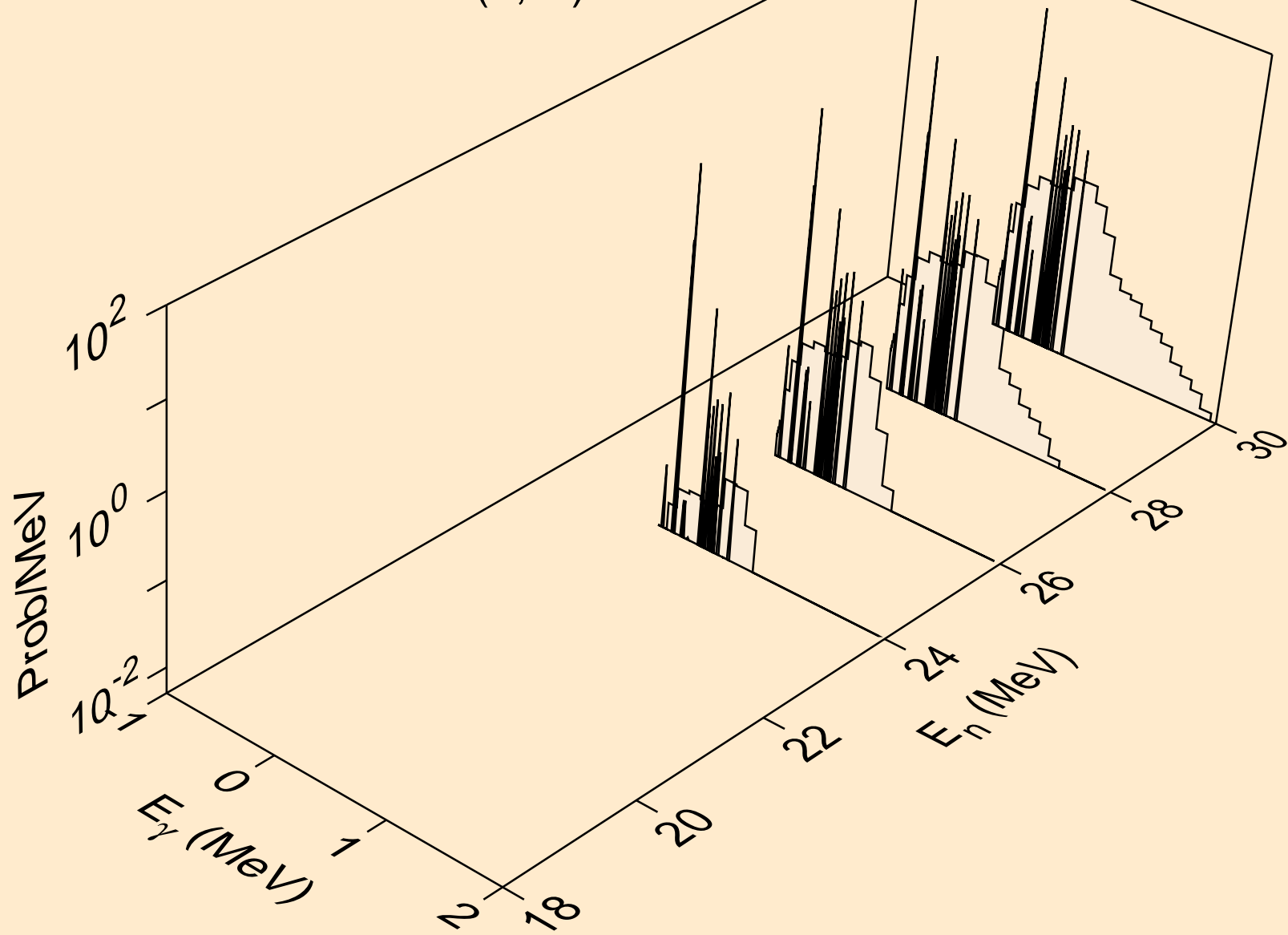

KR082 NEUTRON ACER TENDL-2024 LIBRARY; T=0.K
Photon emission for (n,2np)

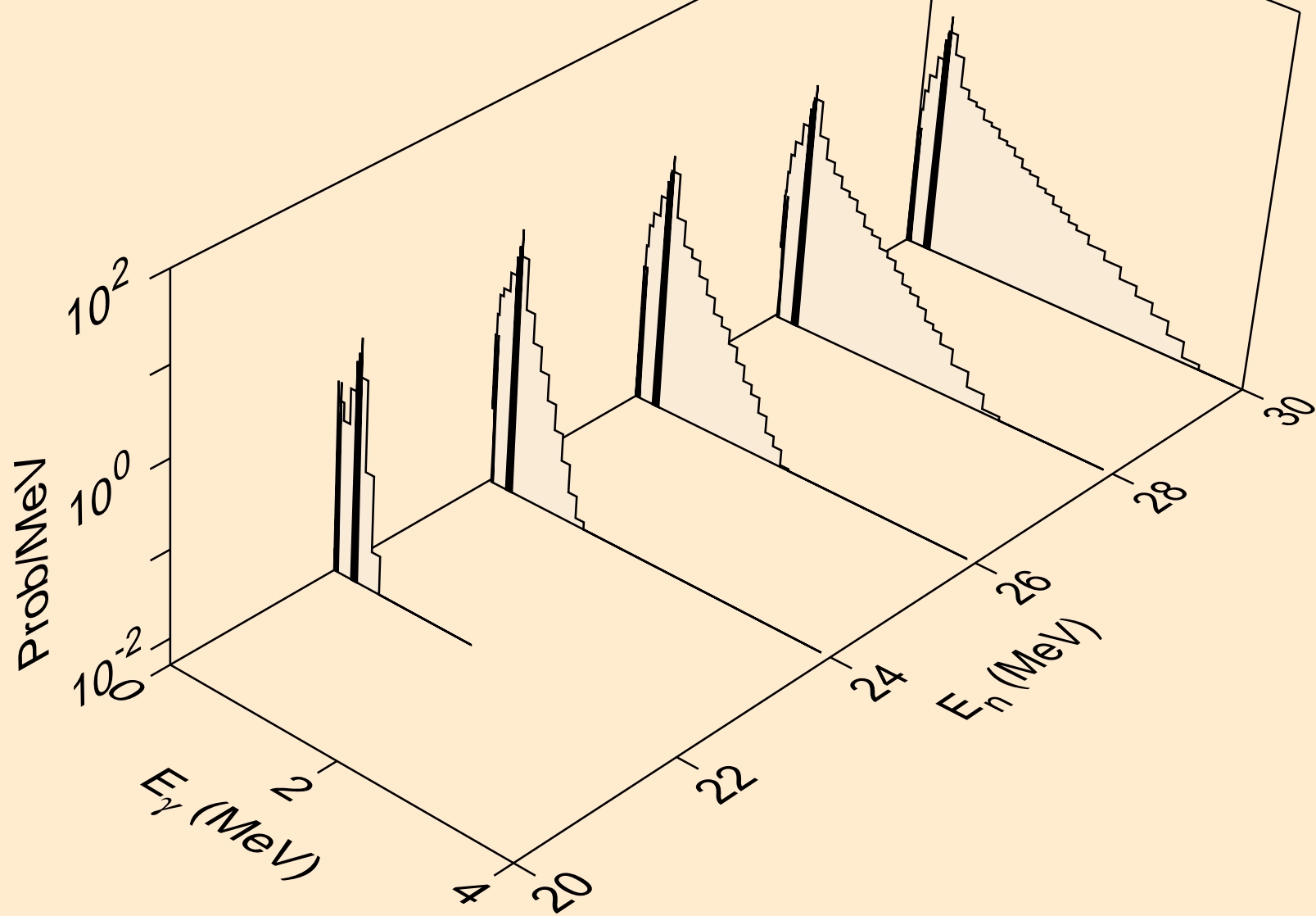

KR082 NEUTRON ACER TENDL-2024 LIBRARY; T=0.K
Photon emission for (n,n2p)

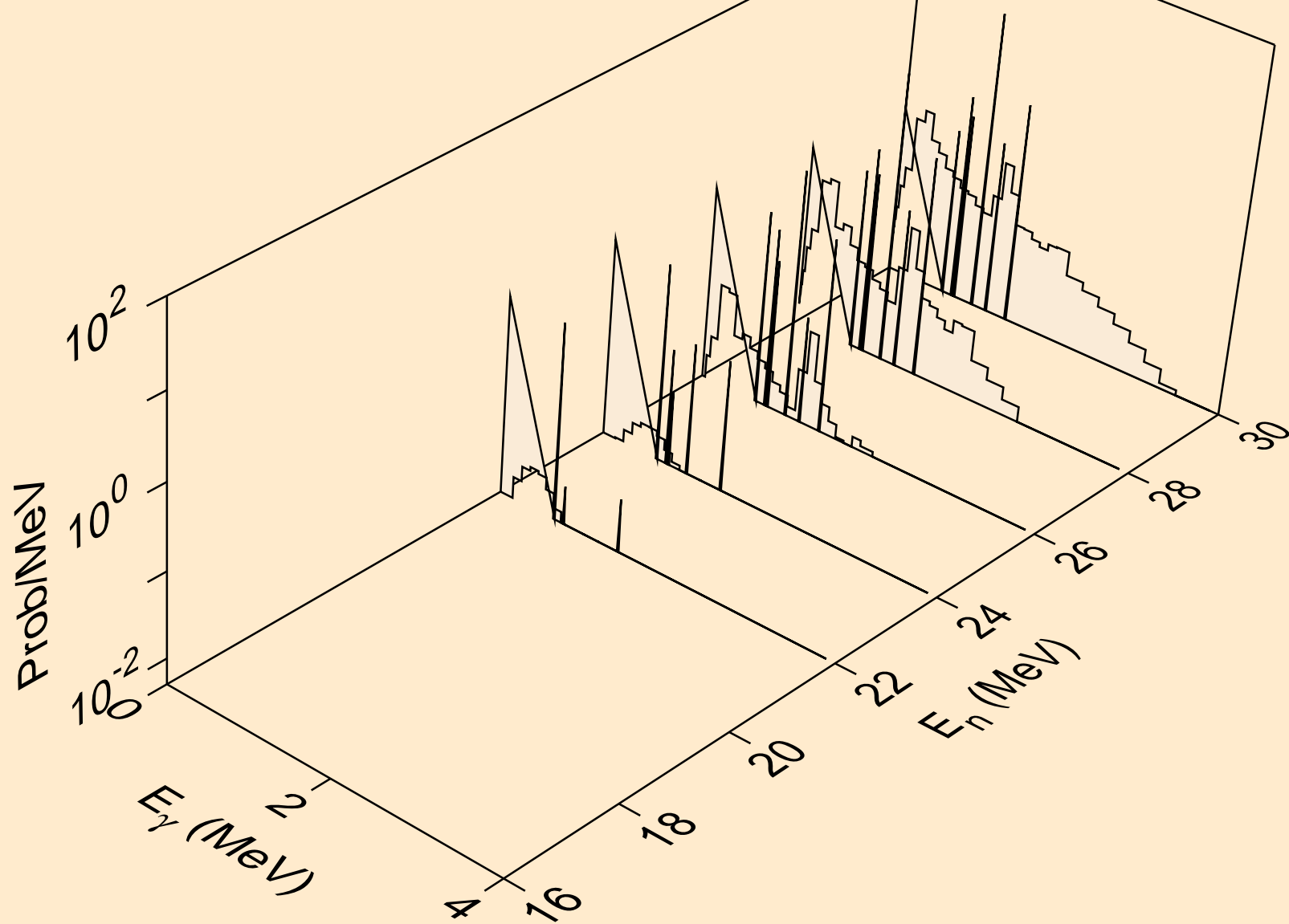

KR082 NEUTRON ACER TENDL-2024 LIBRARY; T=0.K
Photon emission for (n,npa)

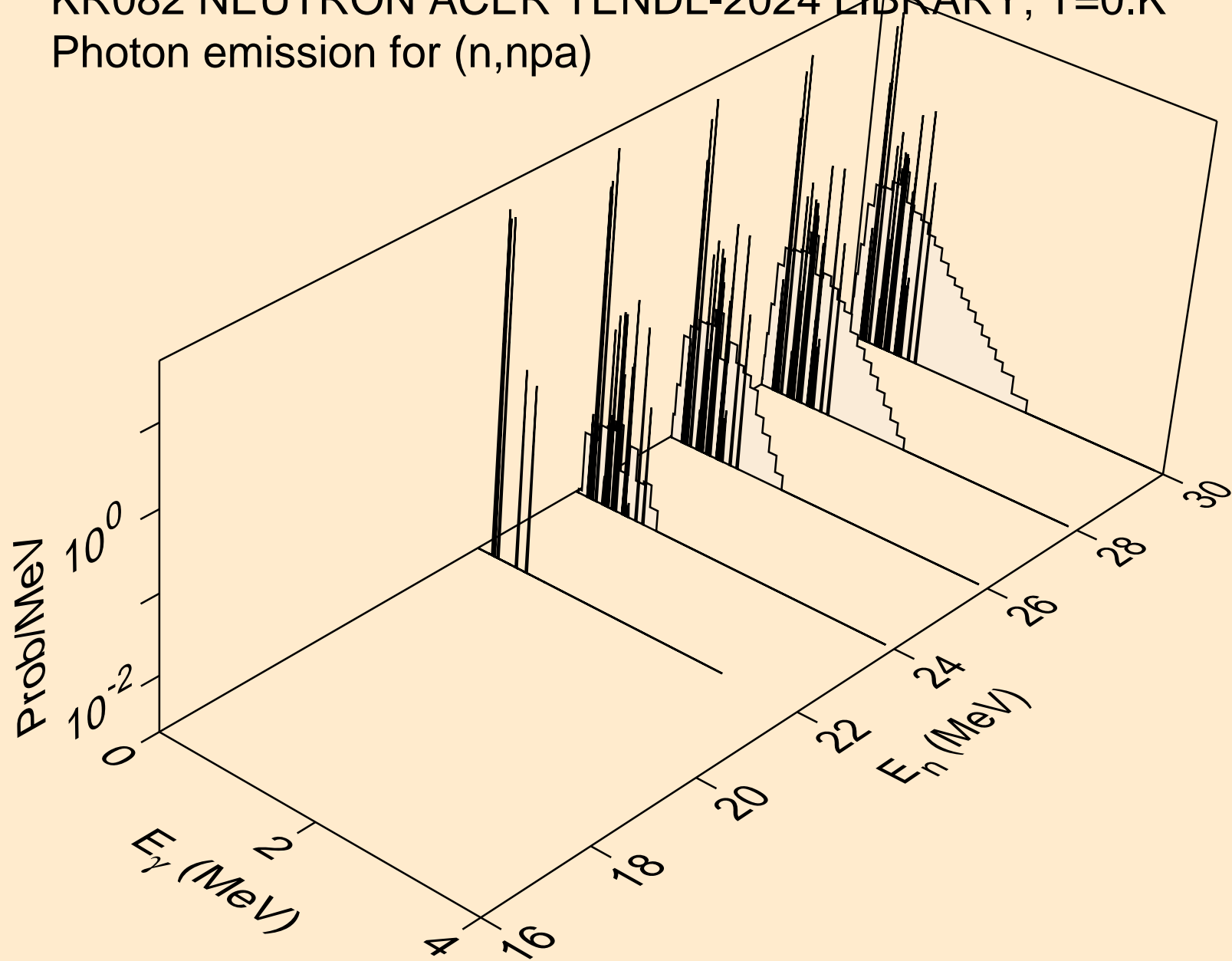

KR082 NEUTRON ACER TENDL-2024 LIBRARY; T=0.K
Photon emission for (n,n*c)

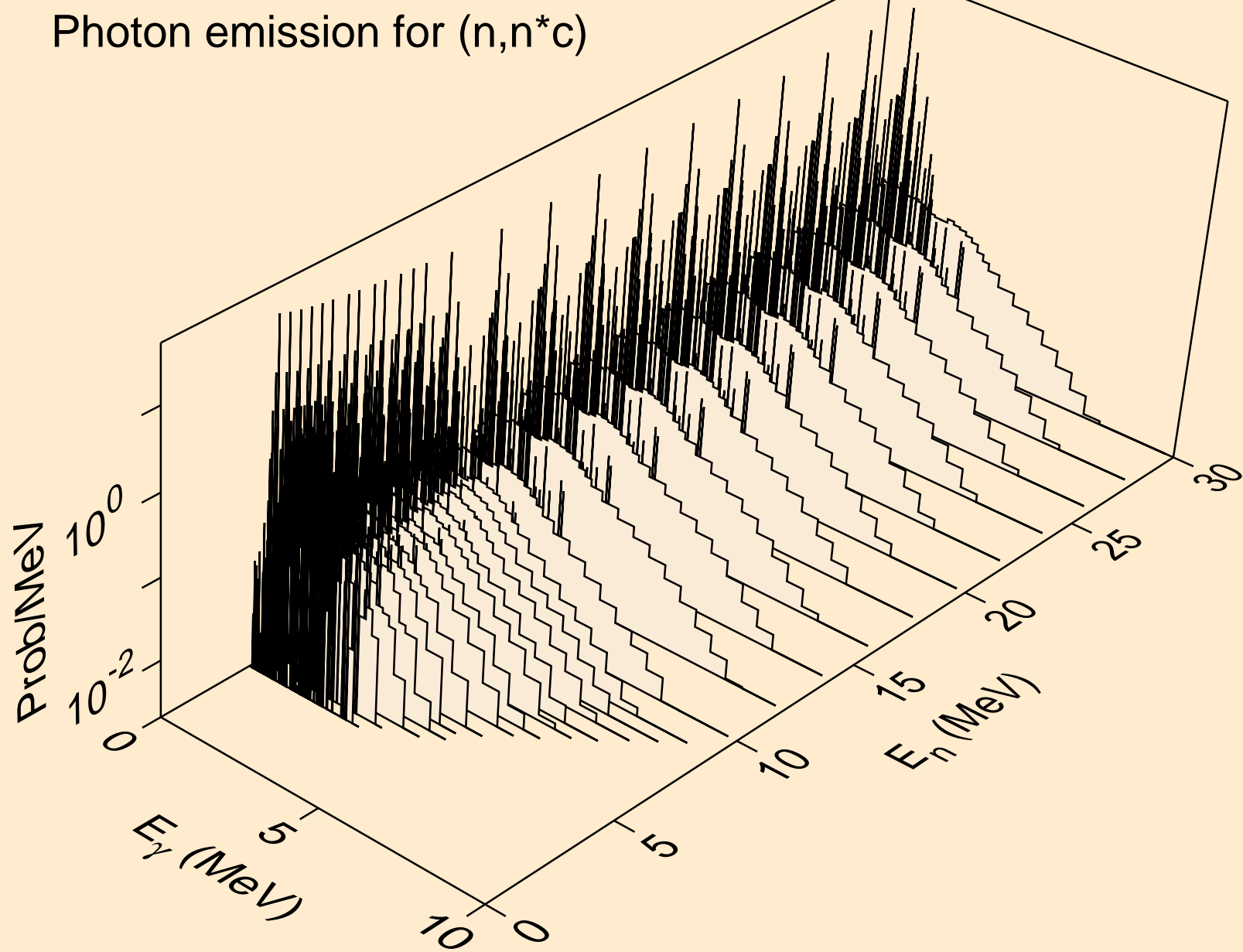

KR082 NEUTRON ACER TENDL-2024 LIBRARY; T=0.K
Photon emission for (n,gma)

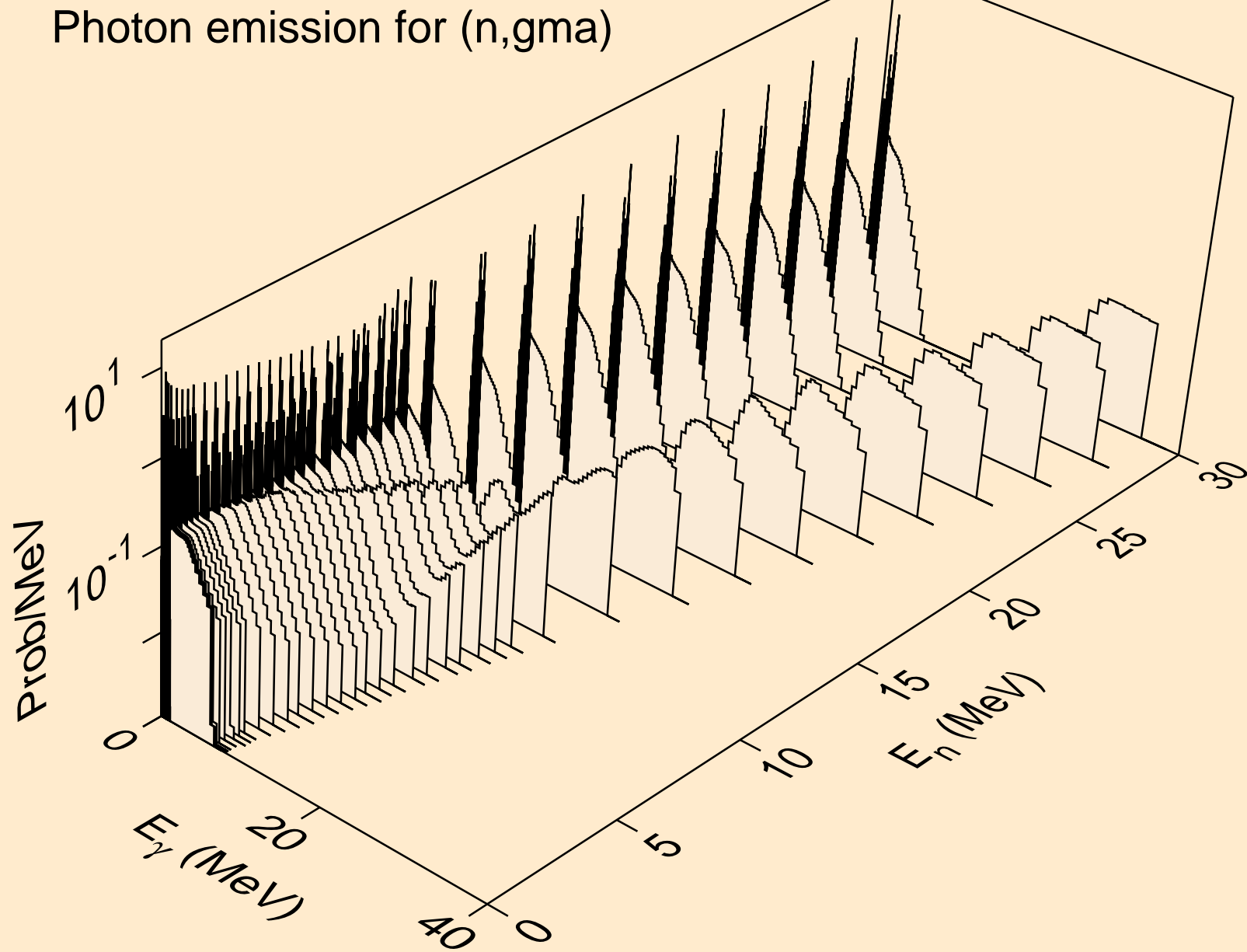

KR082 NEUTRON ACER TENDL-2024 LIBRARY; T=0.K
Photon emission for (n,p)

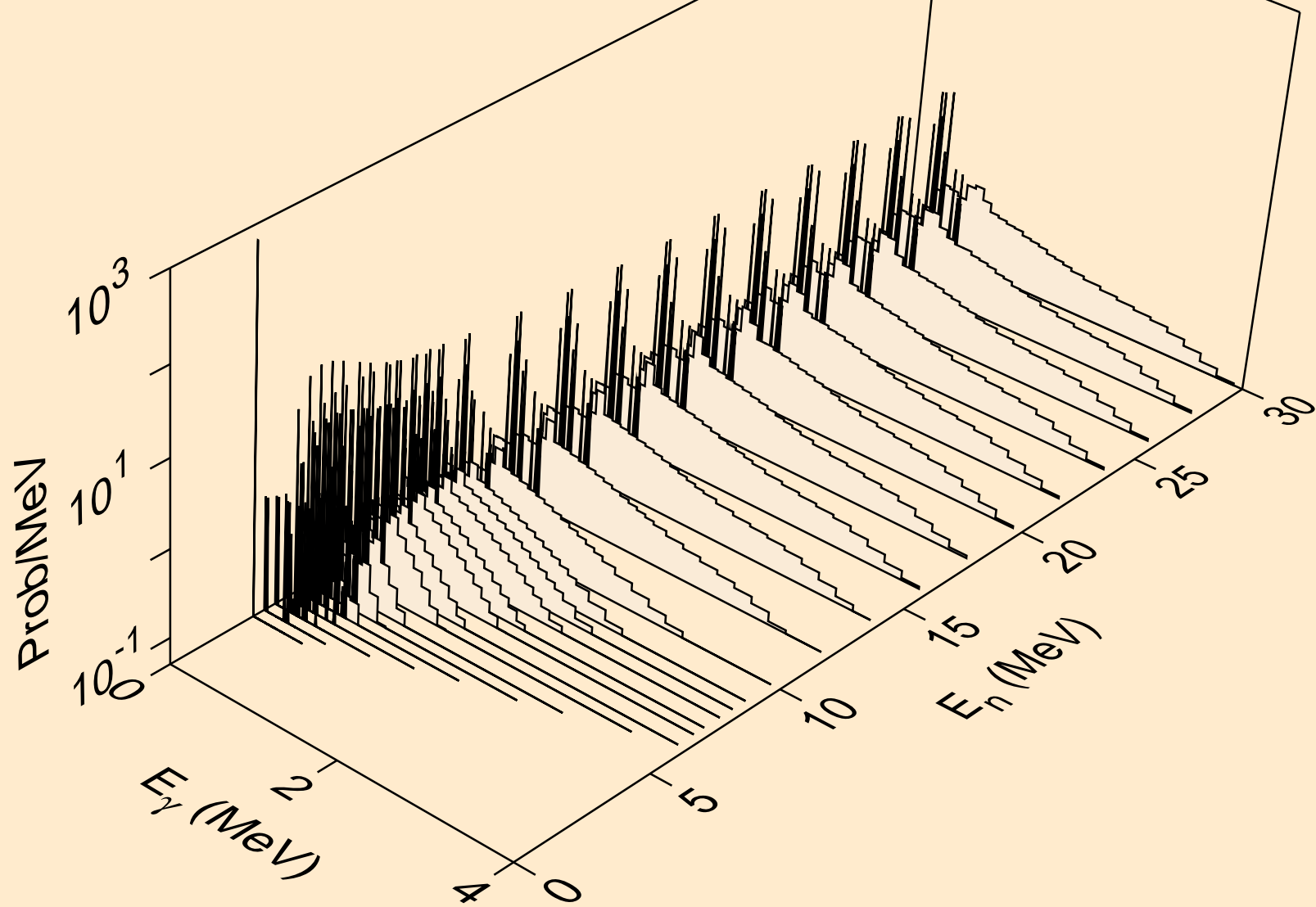

KR082 NEUTRON ACER TENDL-2024 LIBRARY; T=0.K
Photon emission for (n,d)

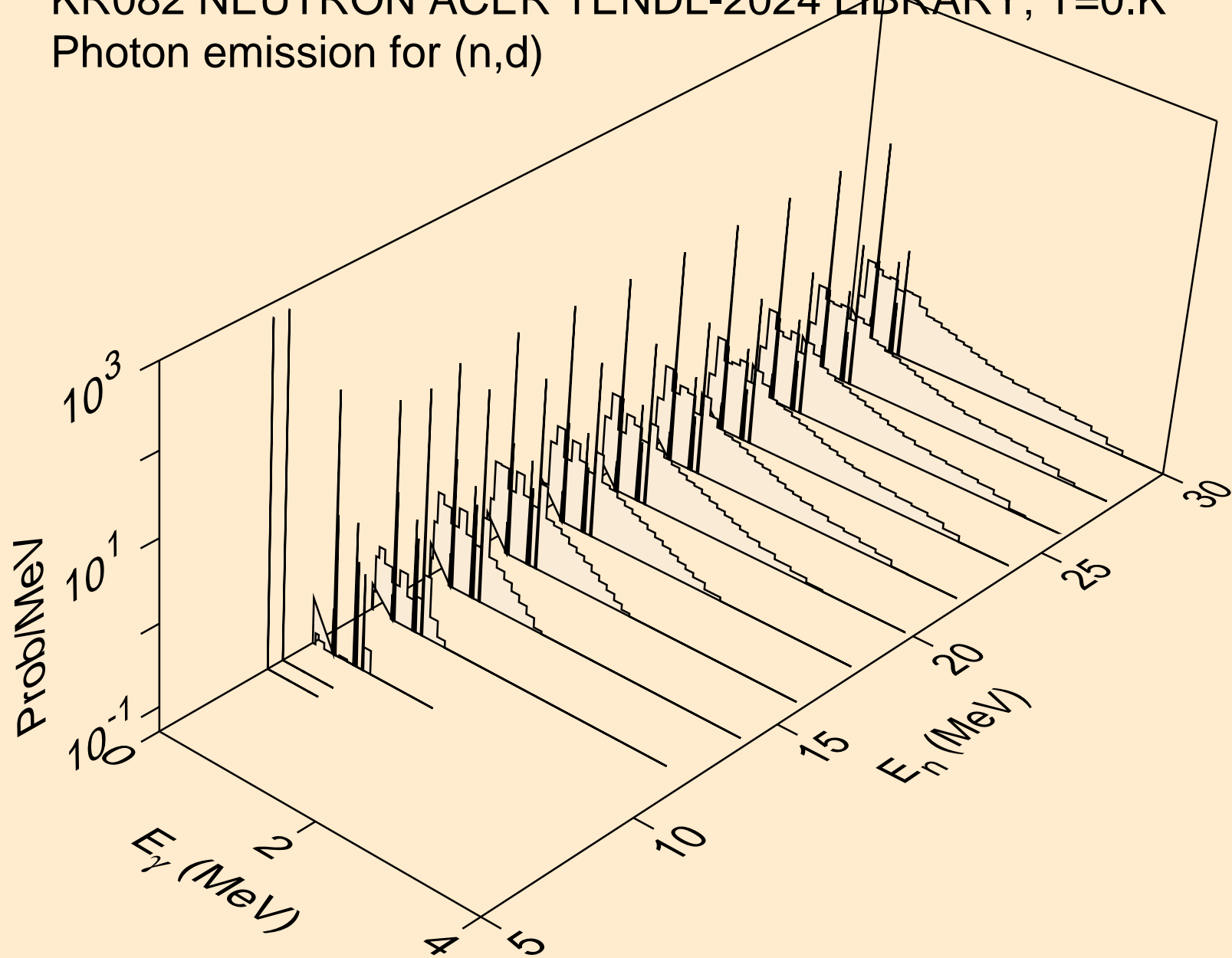

KR082 NEUTRON ACER TENDL-2024 LIBRARY; T=0.K
Photon emission for (n,t)

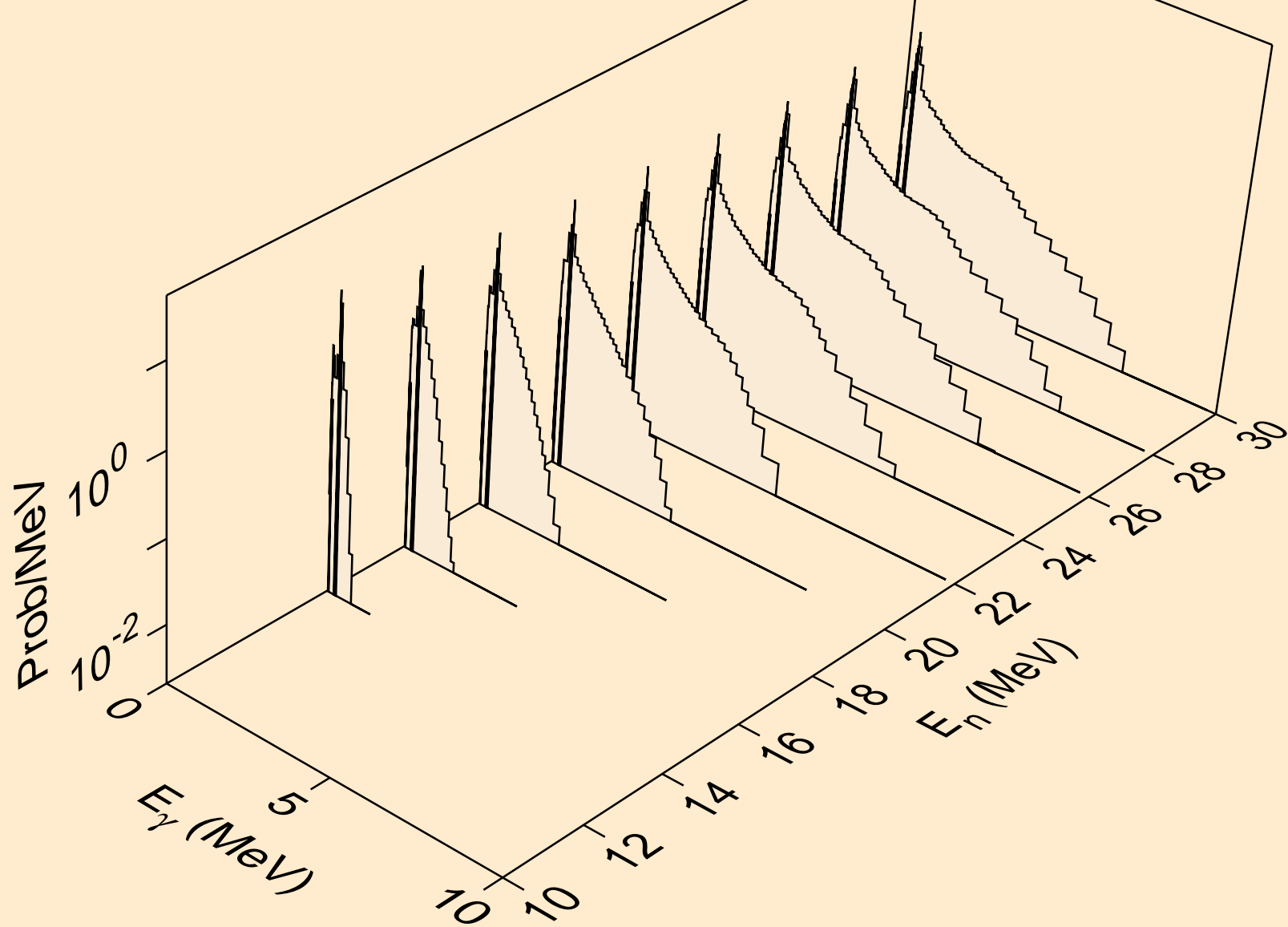

KR082 NEUTRON ACER TENDL-2024 LIBRARY; T=0.K
Photon emission for (n,he3)

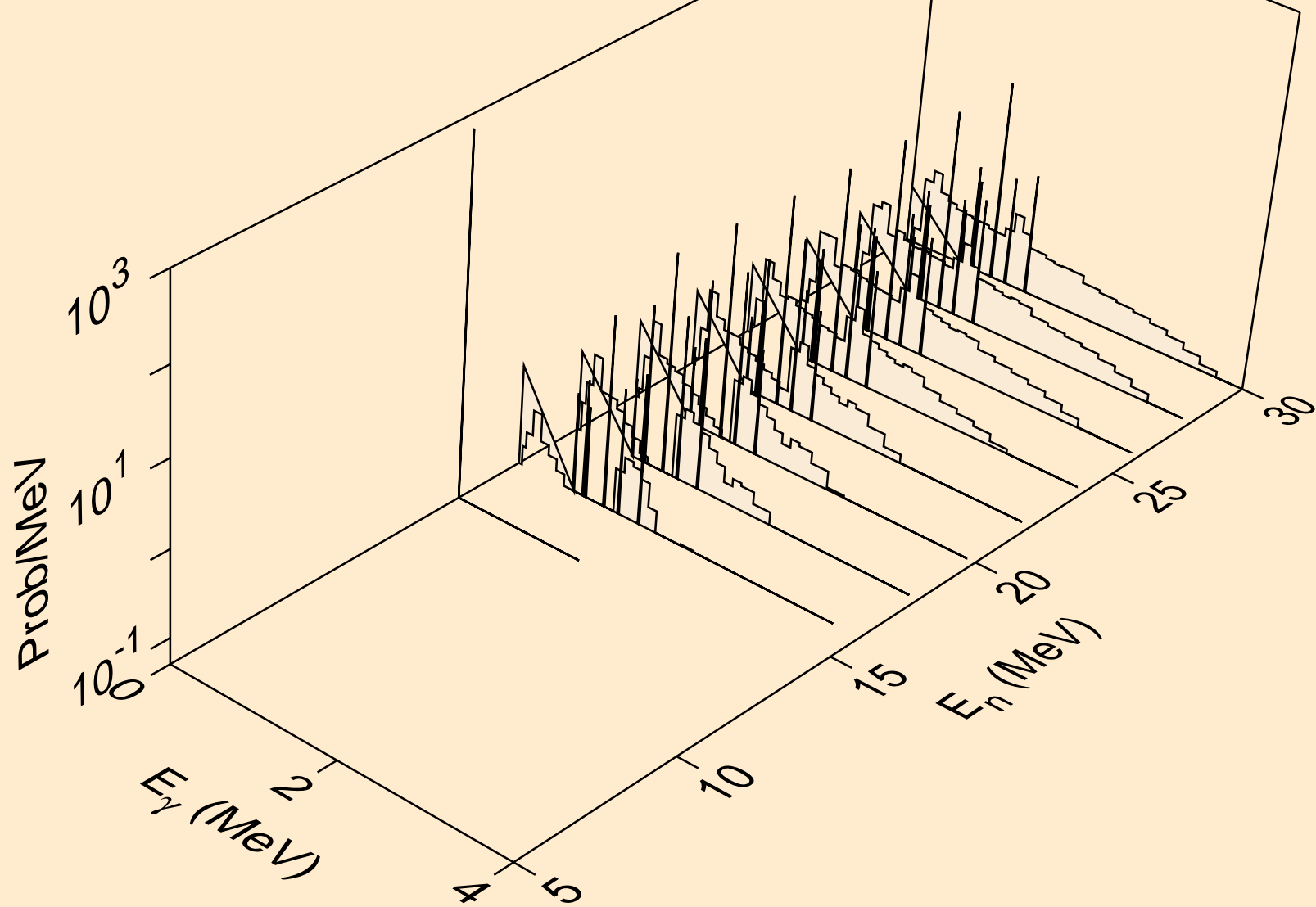

KR082 NEUTRON ACER TENDL-2024 LIBRARY; T=0.K
Photon emission for (n,a)

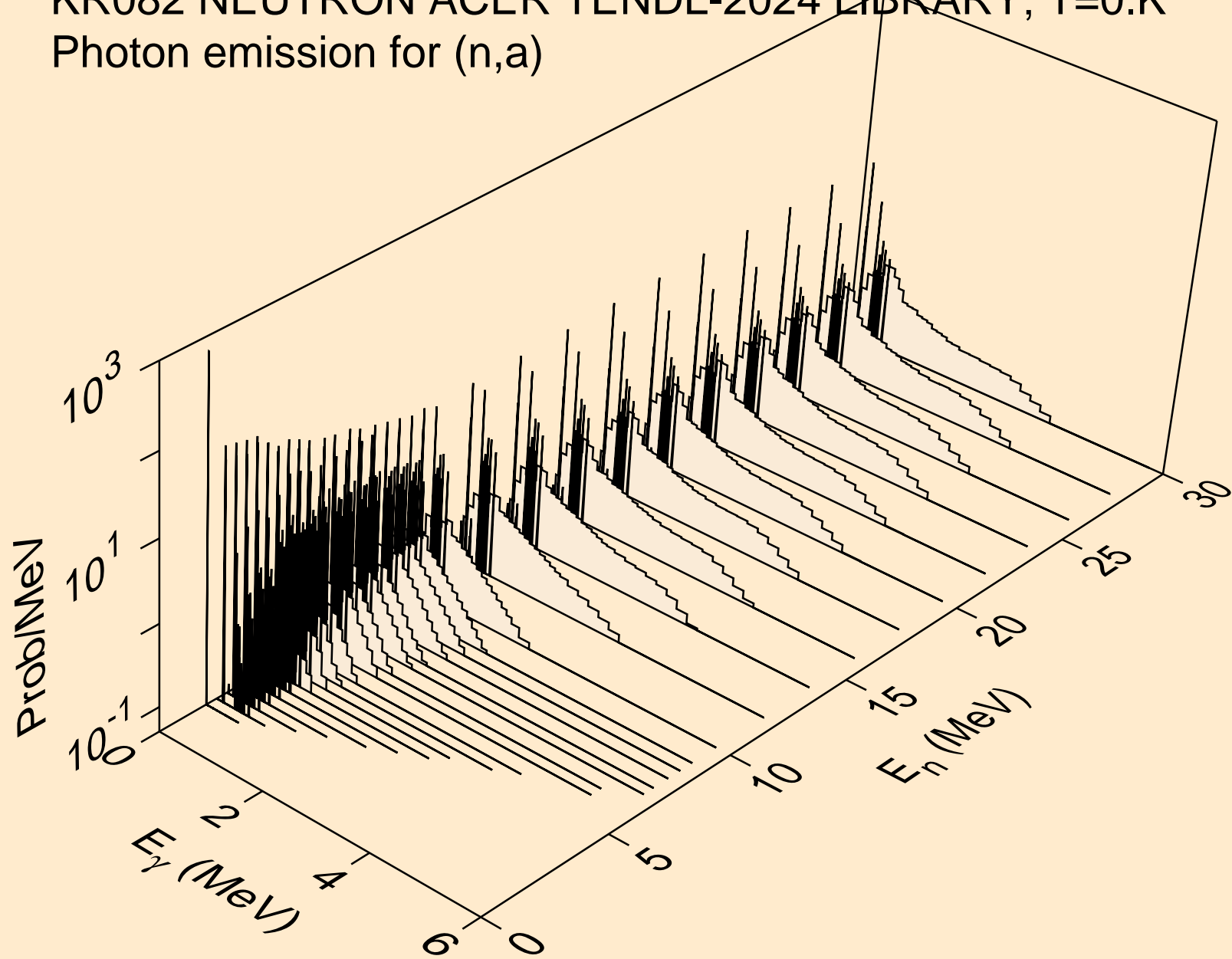

KR082 NEUTRON ACER TENDL-2024 LIBRARY; T=0.K
Photon emission for (n,2a)

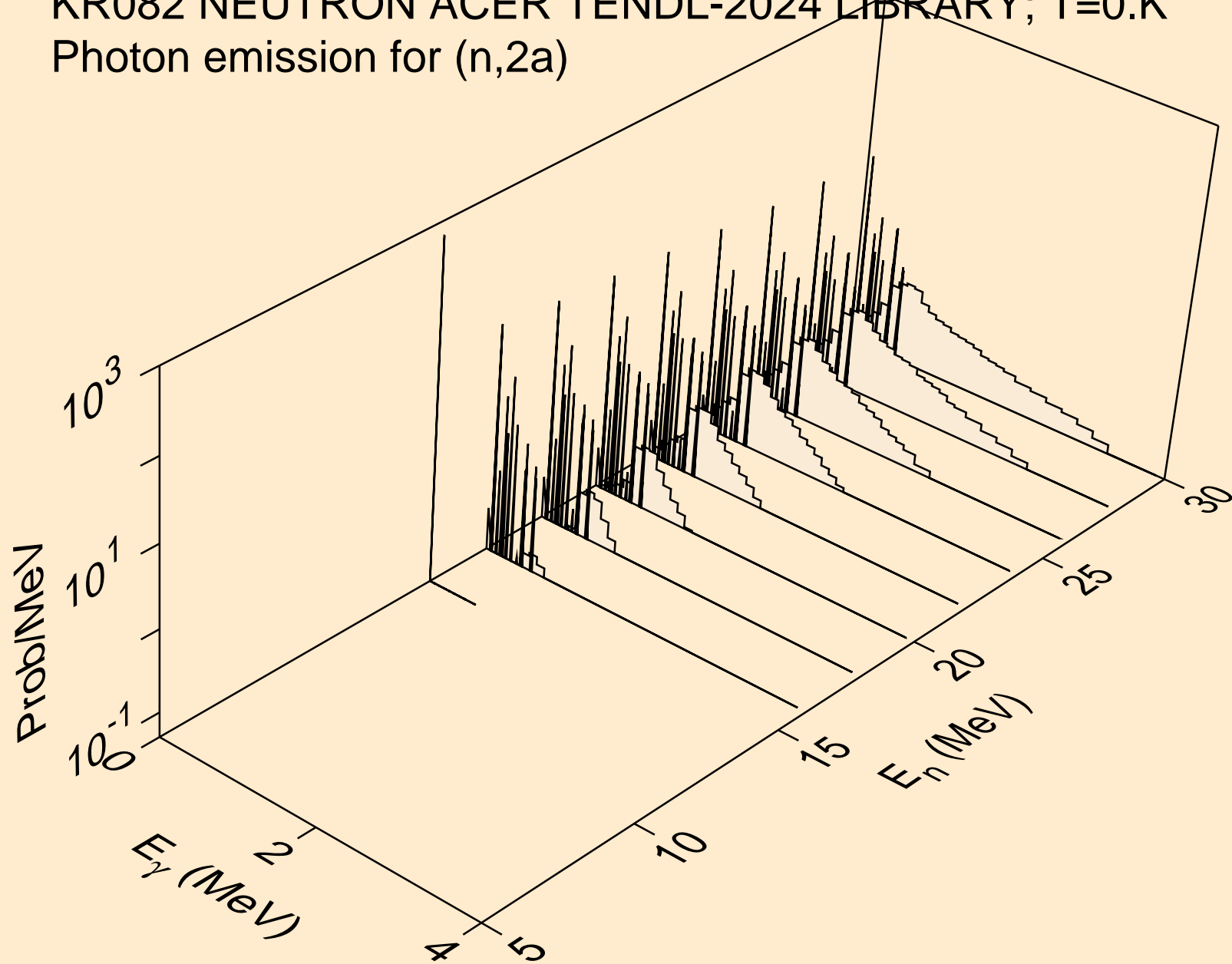

KR082 NEUTRON ACER TENDL-2024 LIBRARY; T=0.K
Photon emission for (n,2p)

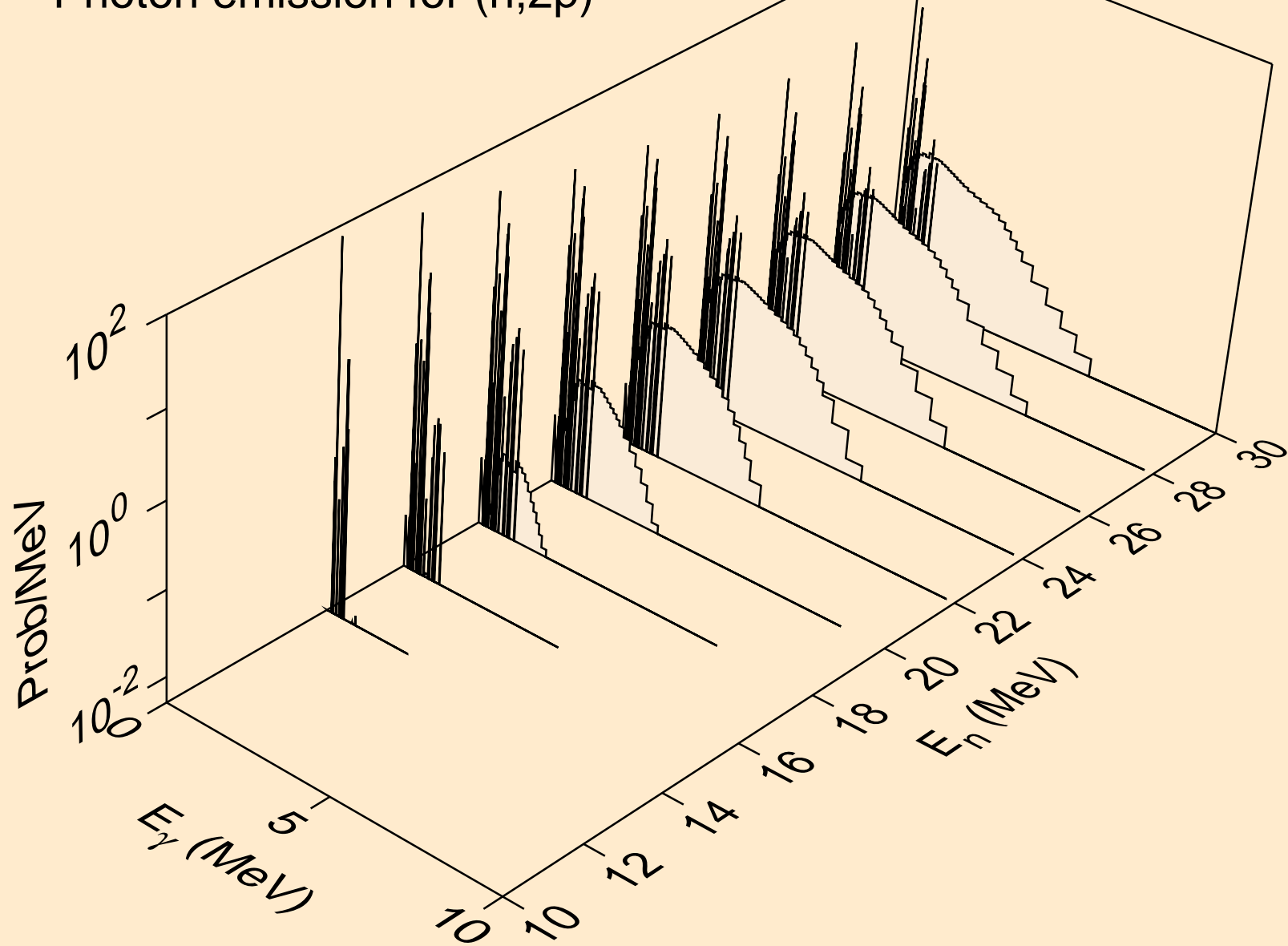

KR082 NEUTRON ACER TENDL-2024 LIBRARY; T=0.K
Photon emission for (n,p α)

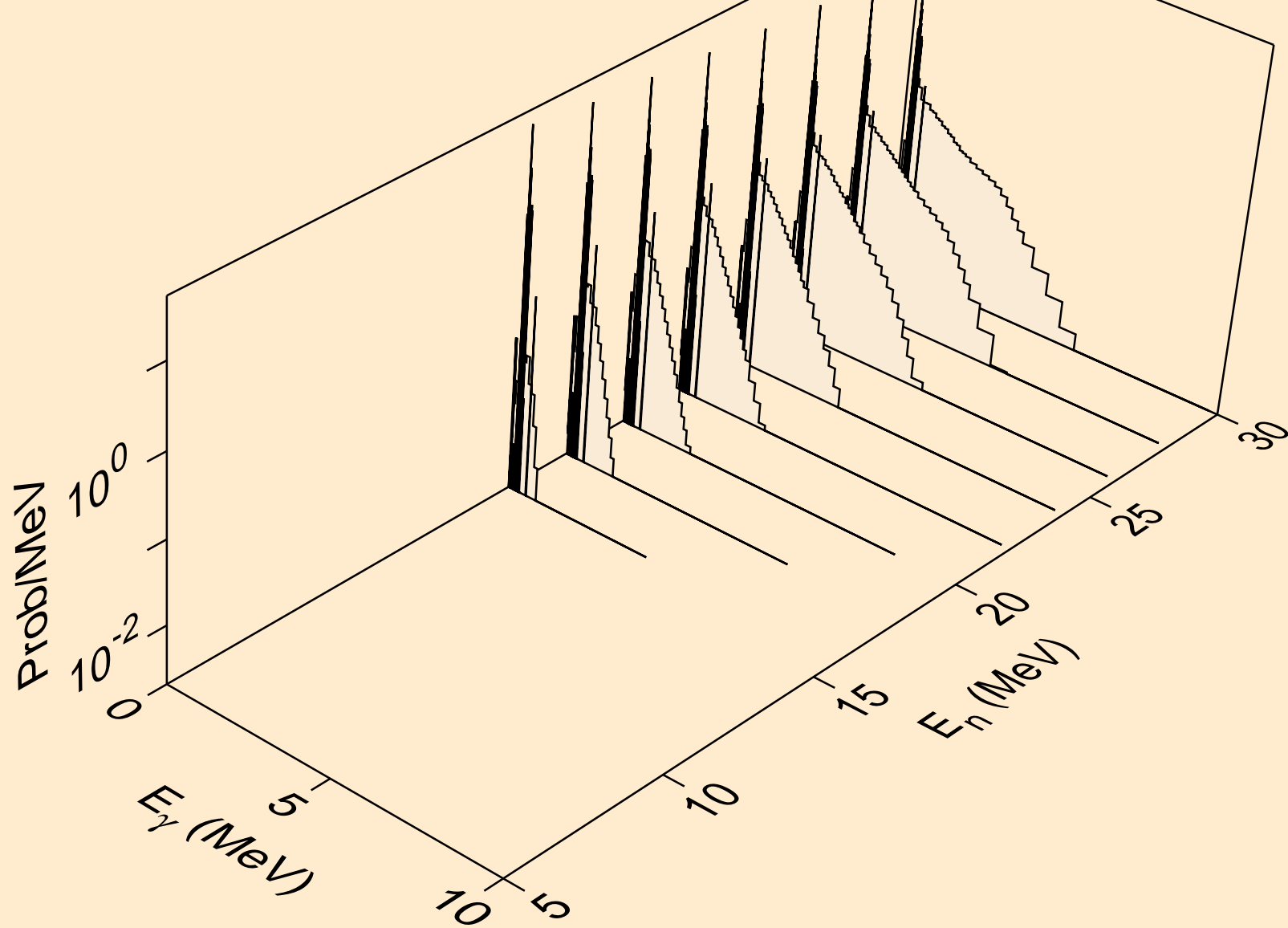

KR082 NEUTRON ACER TENDL-2024 LIBRARY; T=0.K
Photon emission for (n,pd)

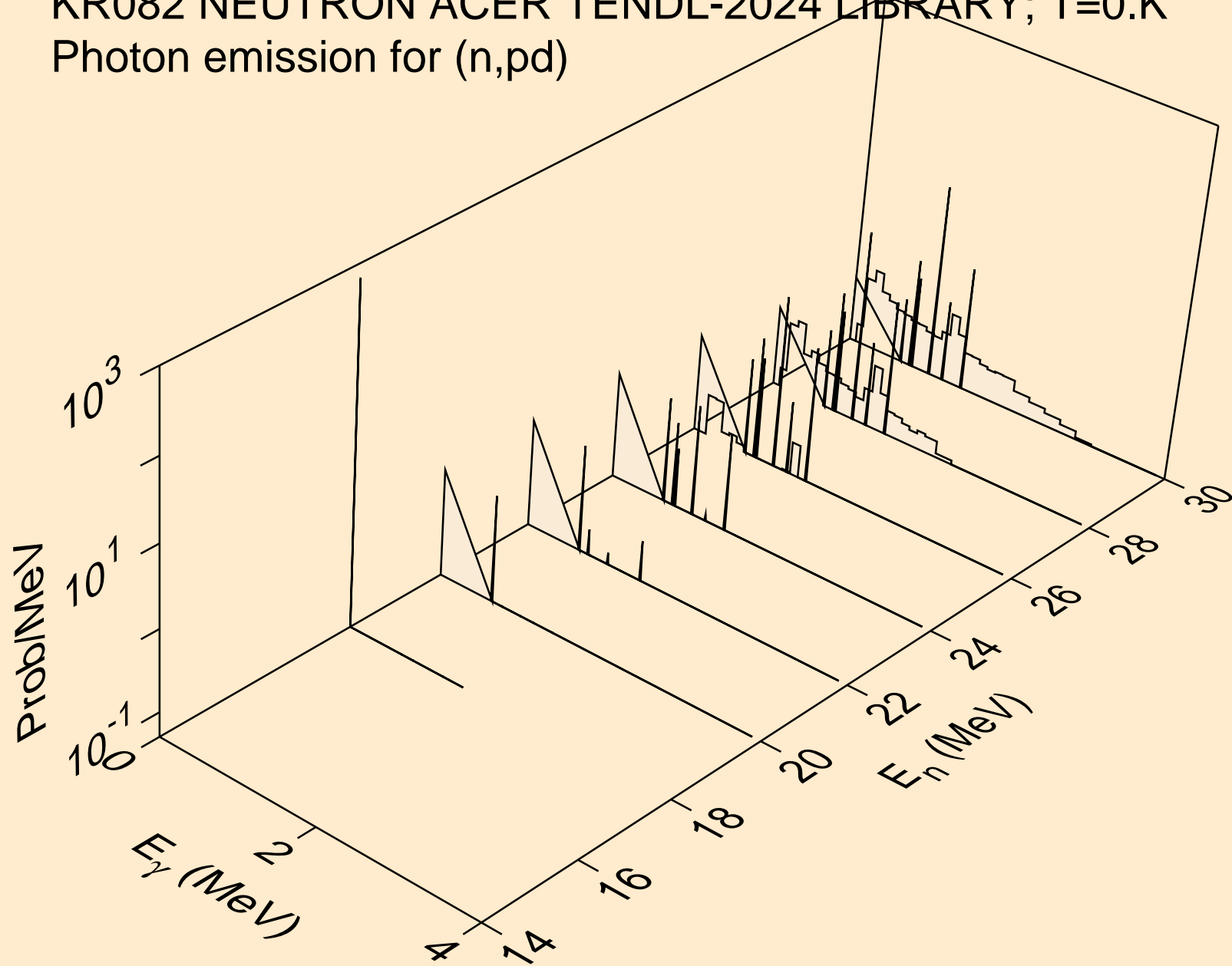

KR082 NEUTRON ACER TENDL-2024 LIBRARY; T=0.K
Photon emission for (n,pt)

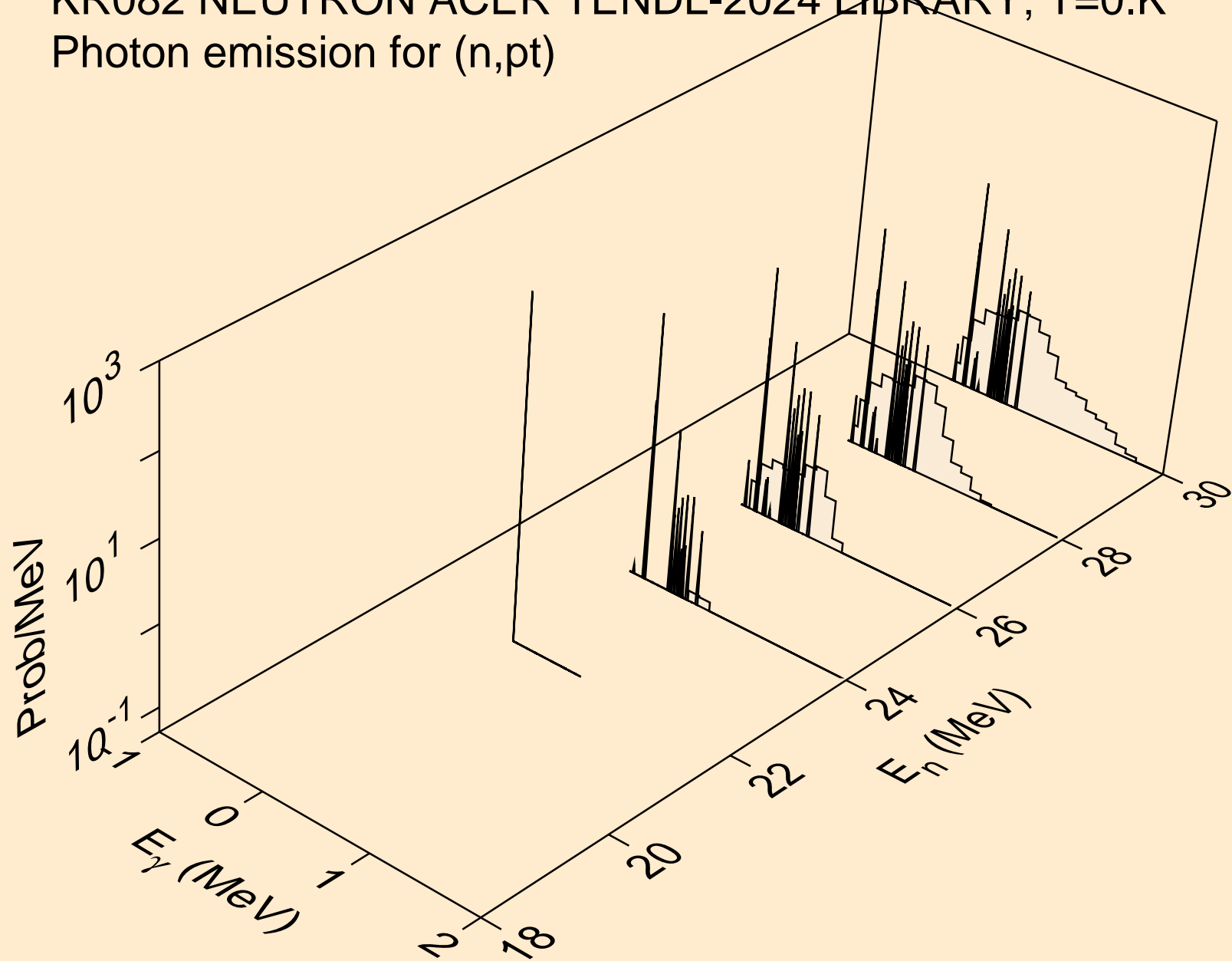

KR082 NEUTRON ACER TENDL-2024 LIBRARY; T=0.K
Photon emission for (n,da)

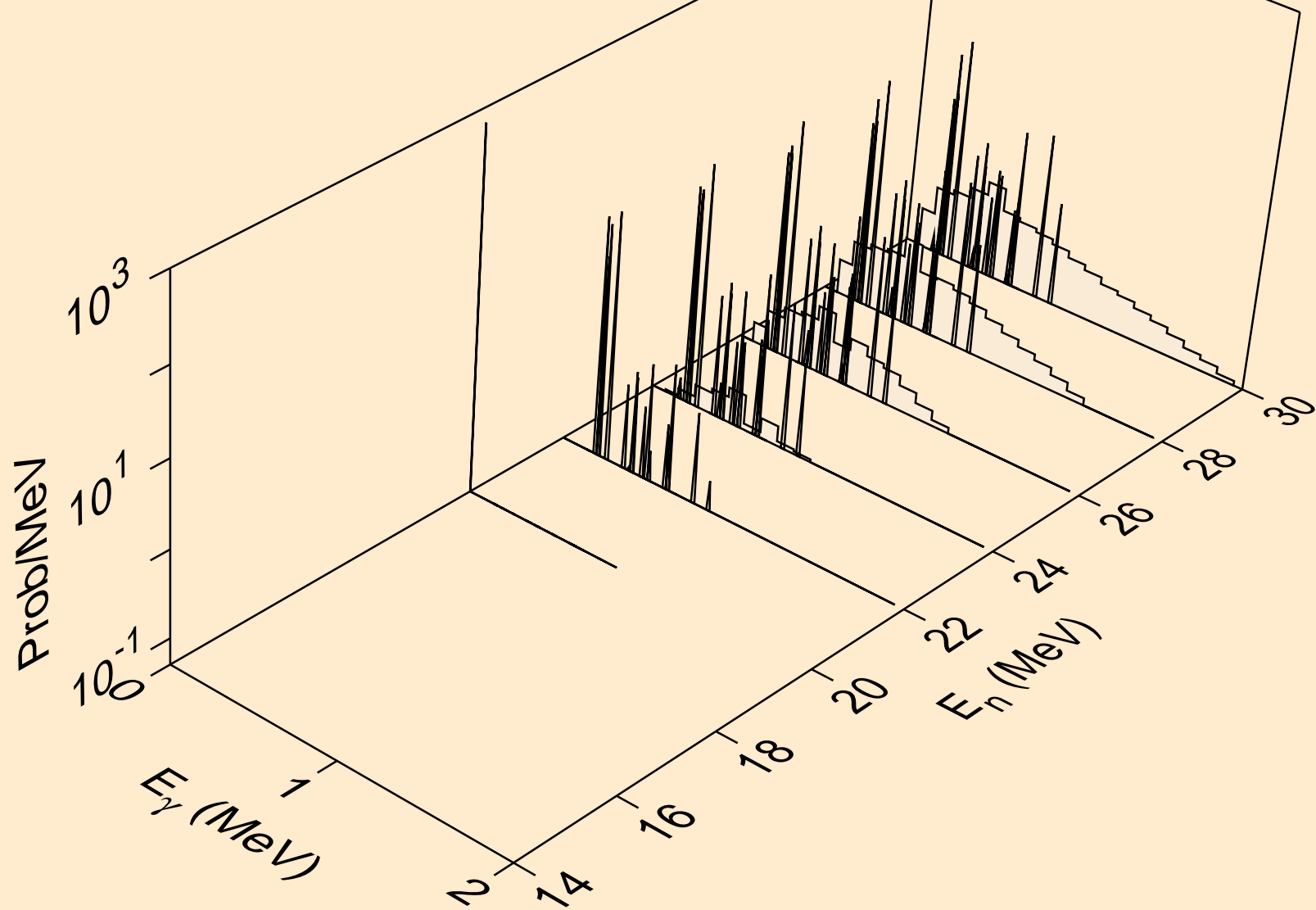

KR082 NEUTRON ACER TENDL-2024 LIBRARY; T=0.K
thermal capture photon spectrum

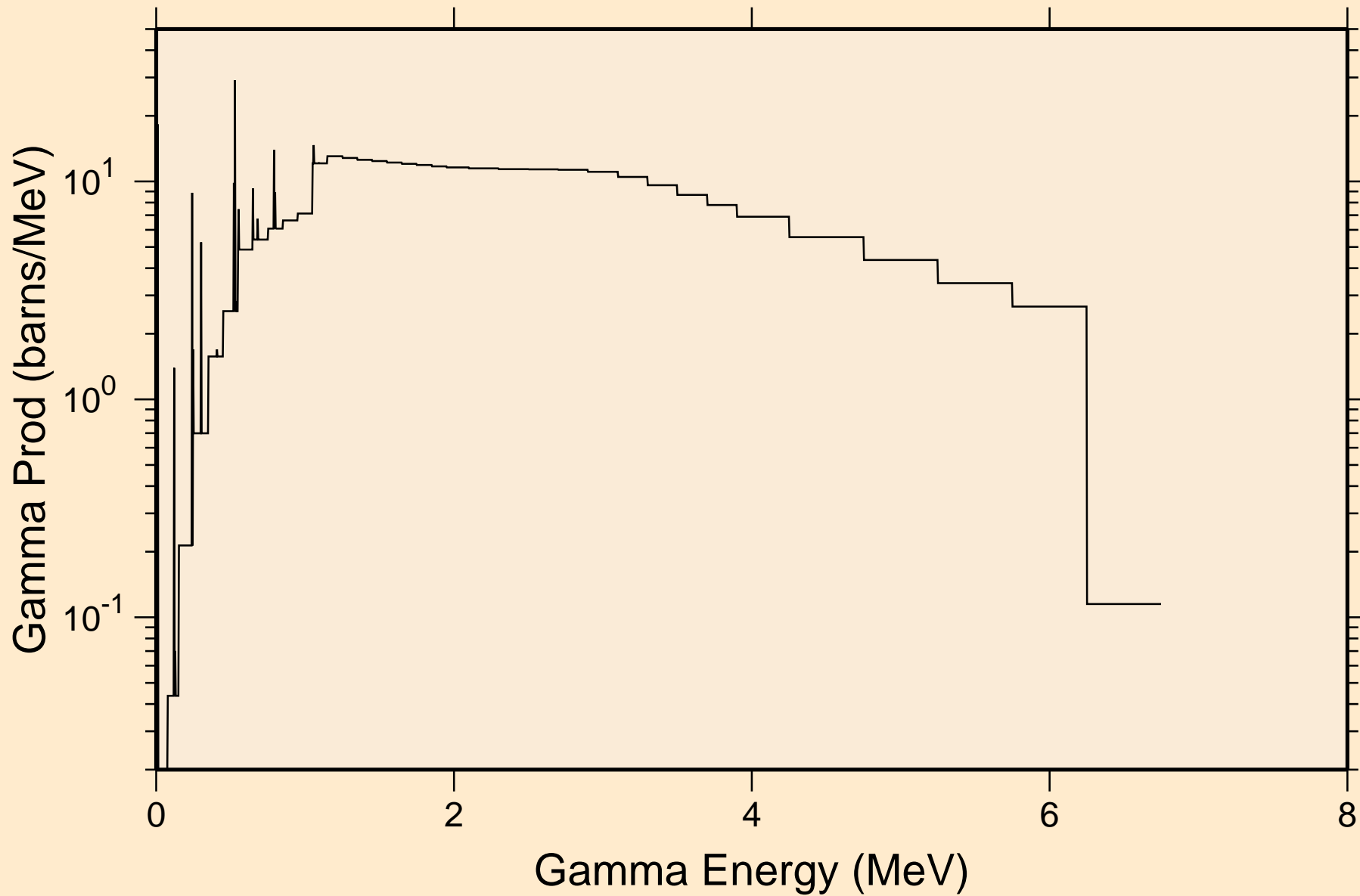

KR082 NEUTRON ACER TENDL-2024 LIBRARY; T=0.K
14 MeV photon spectrum

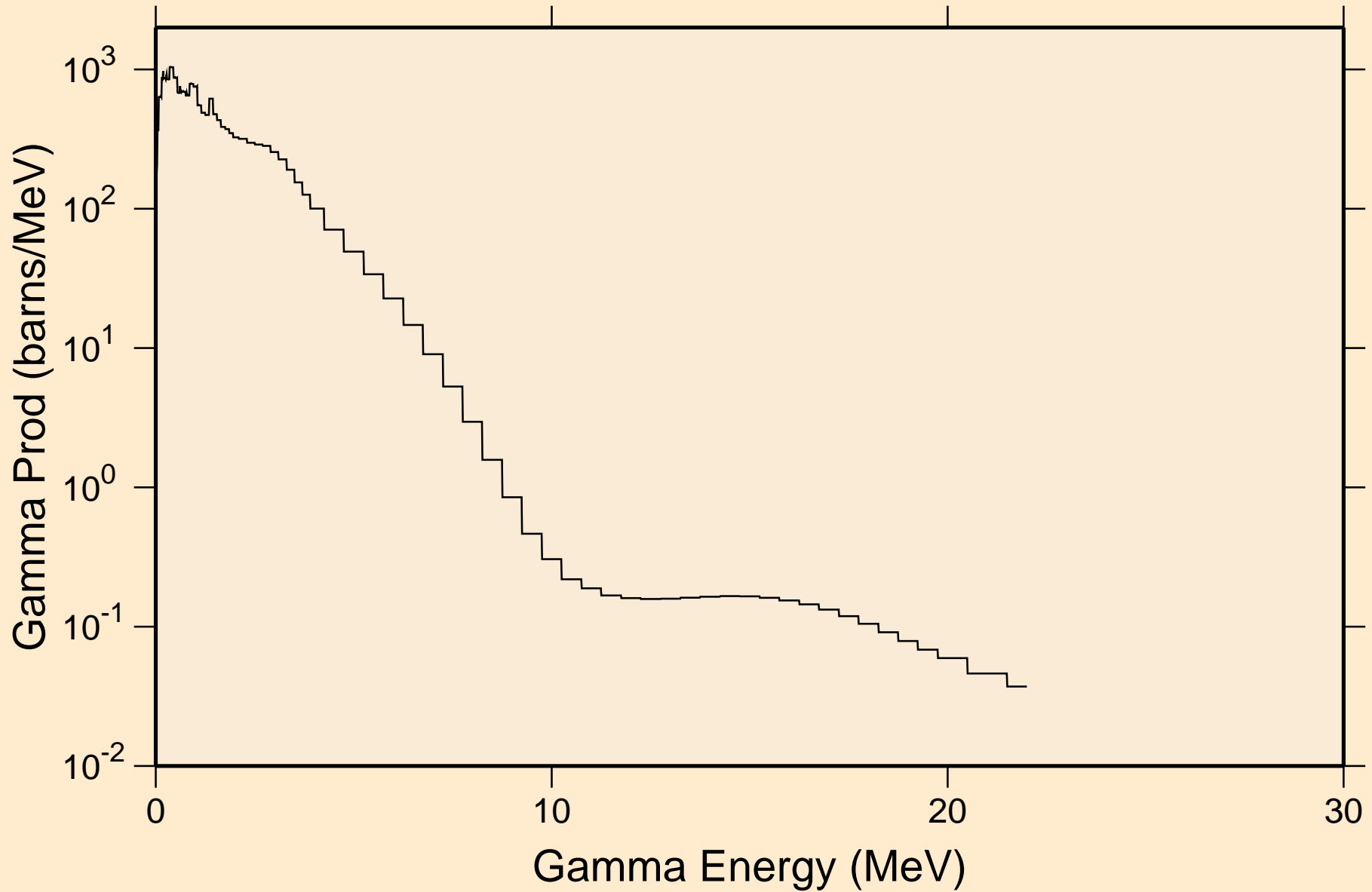

KR082 NEUTRON ACER TENDL-2024 LIBRARY; T=0.K

Particle heating contributions

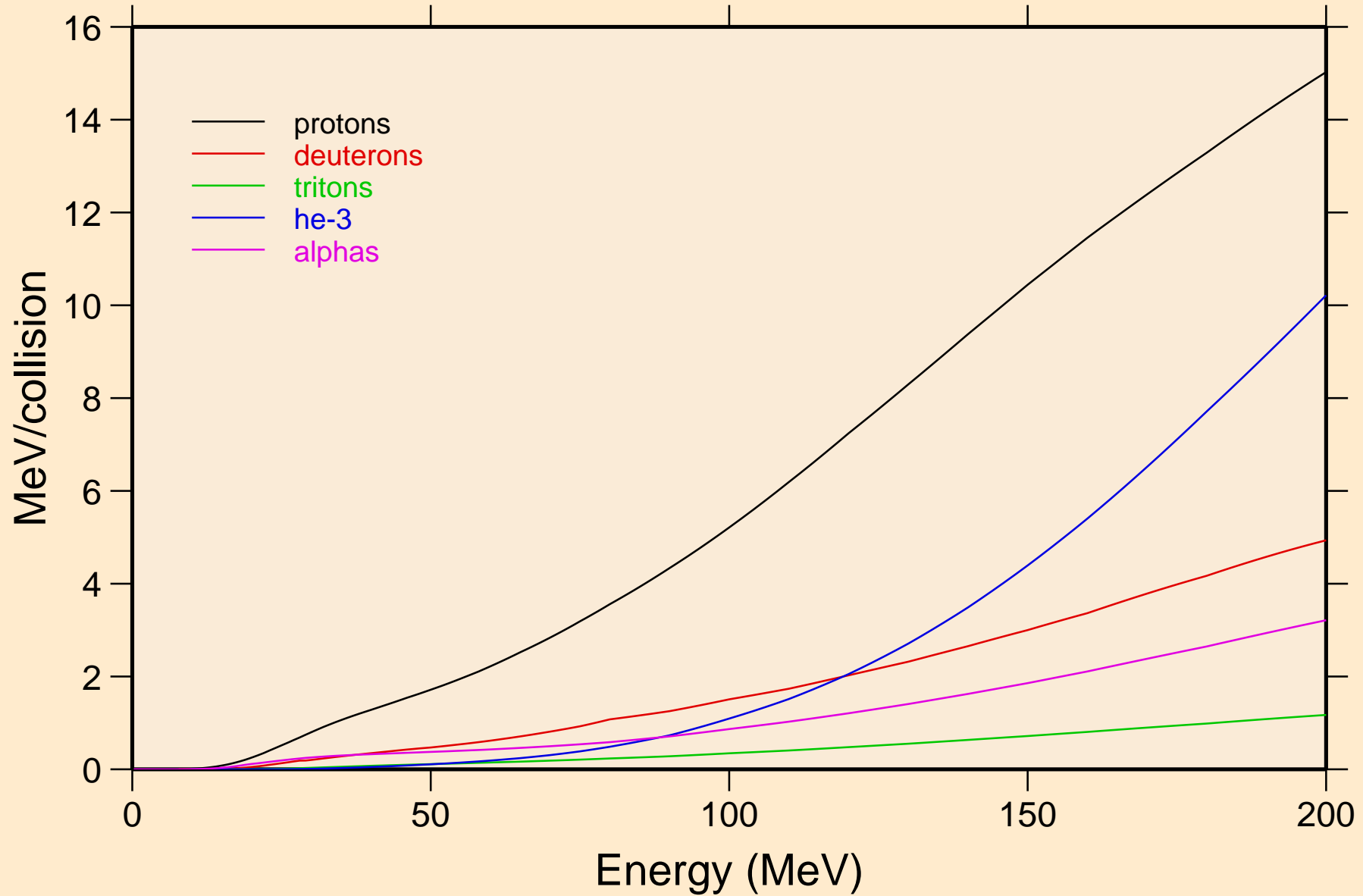

KR082 NEUTRON ACER TENDL-2024 LIBRARY; T=0.K
Recoil Heating

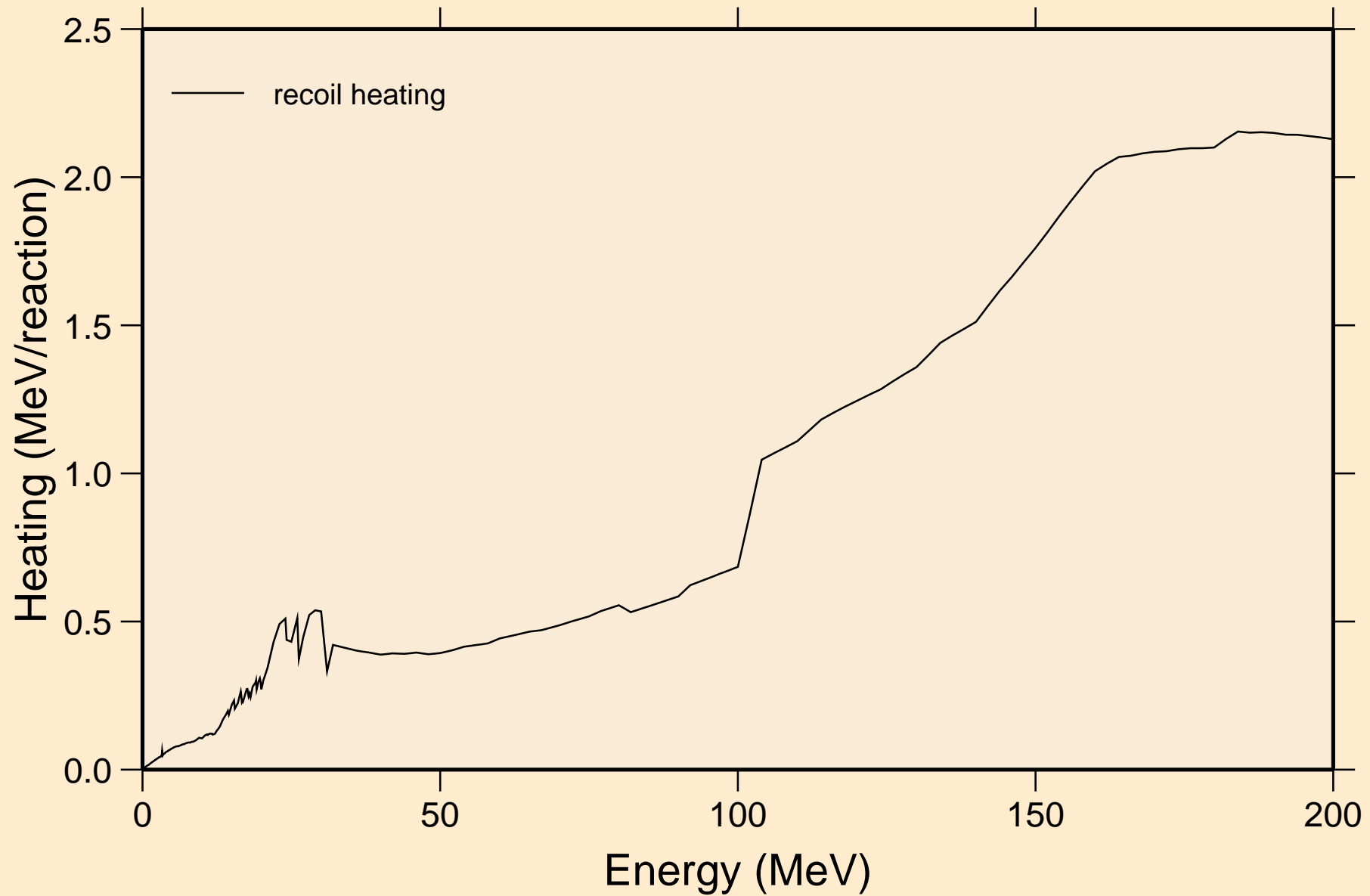

KR082 NEUTRON ACER TENDL-2024 LIBRARY; T=0.K
Particle production cross sections

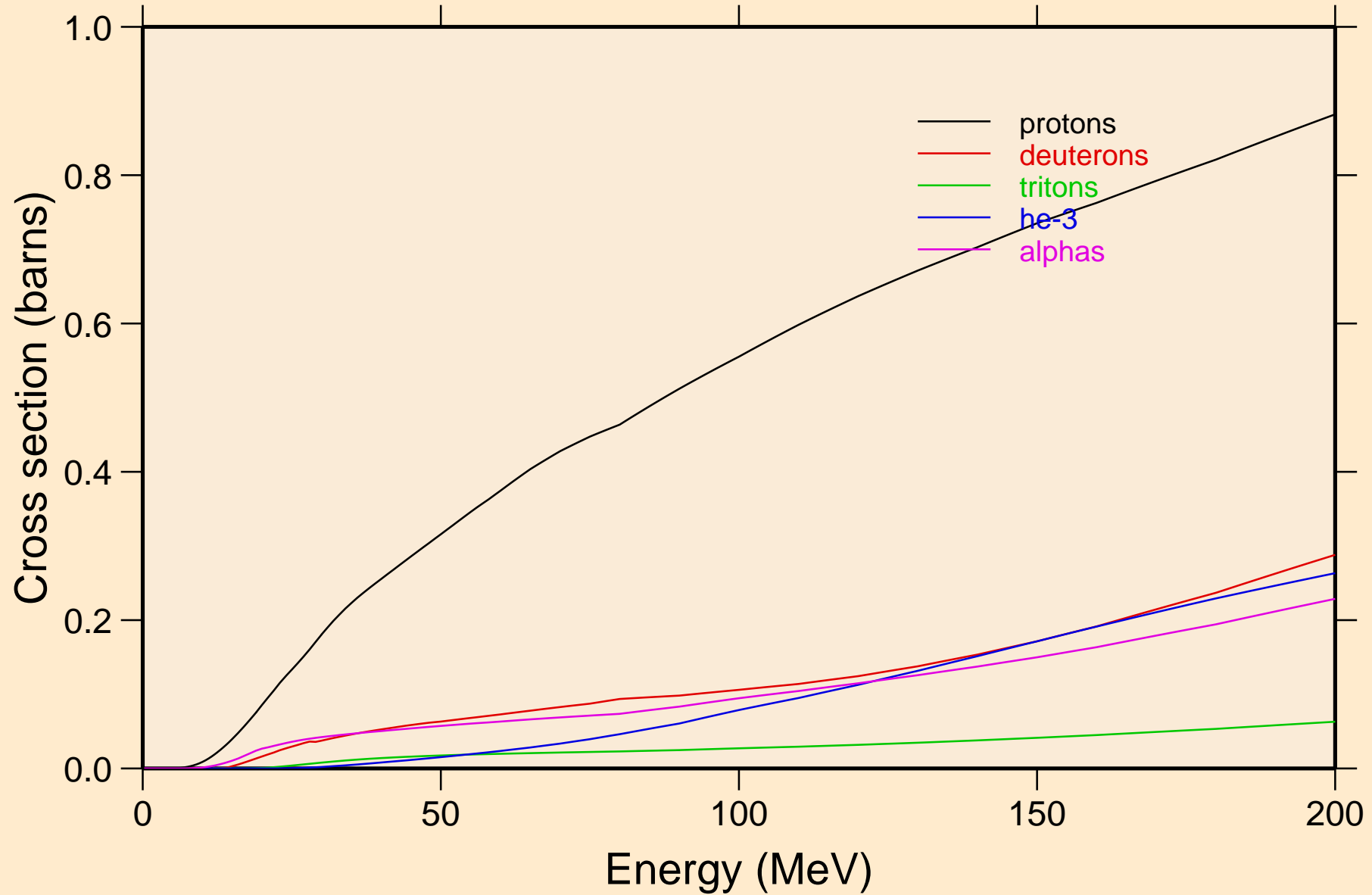

KR082 NEUTRON ACER TENDL-2024 LIBRARY; T=0.K
protons from (n,x)

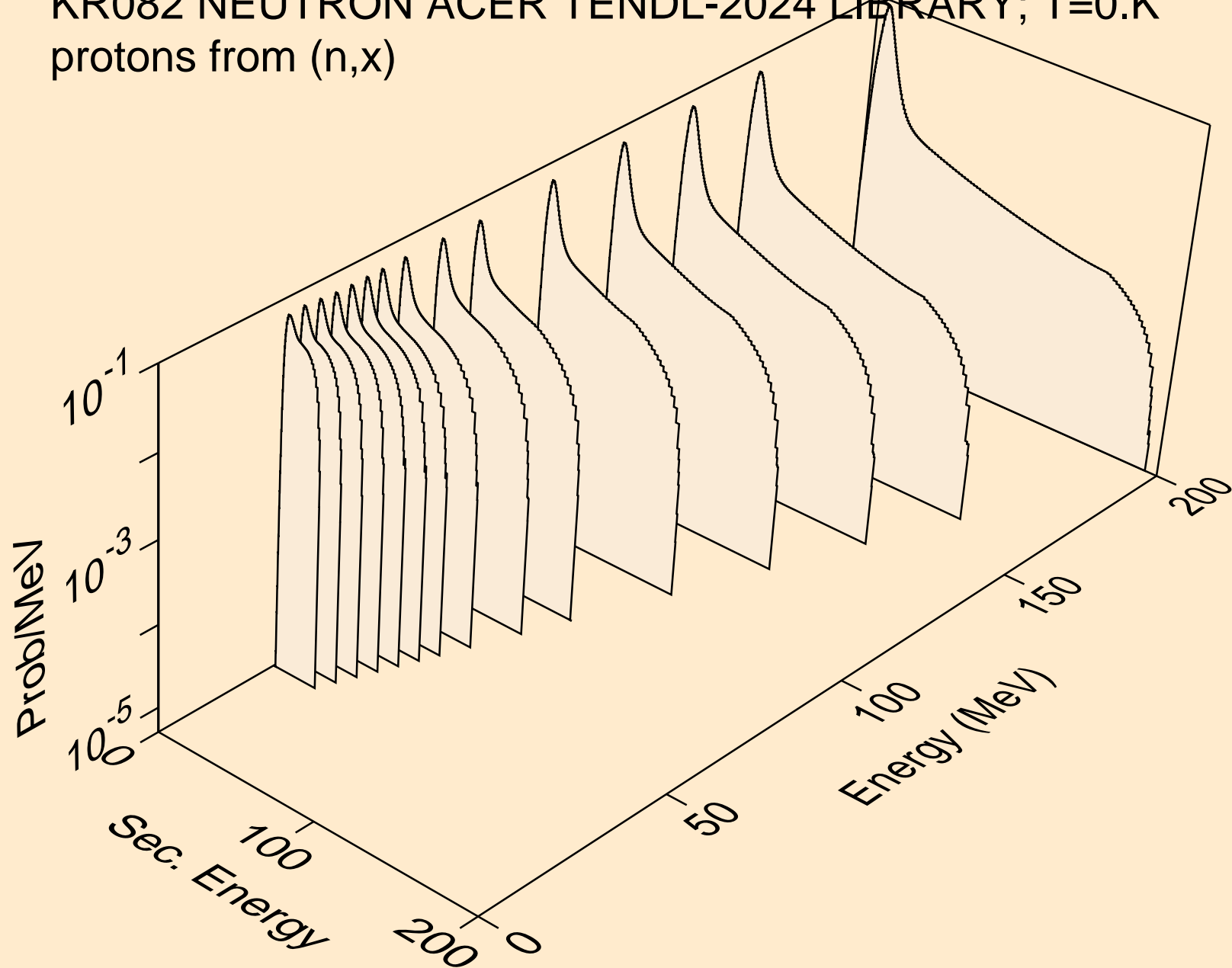

KR082 NEUTRON ACER TENDL-2024 LIBRARY; T=0.K
protons from (n,n*)p

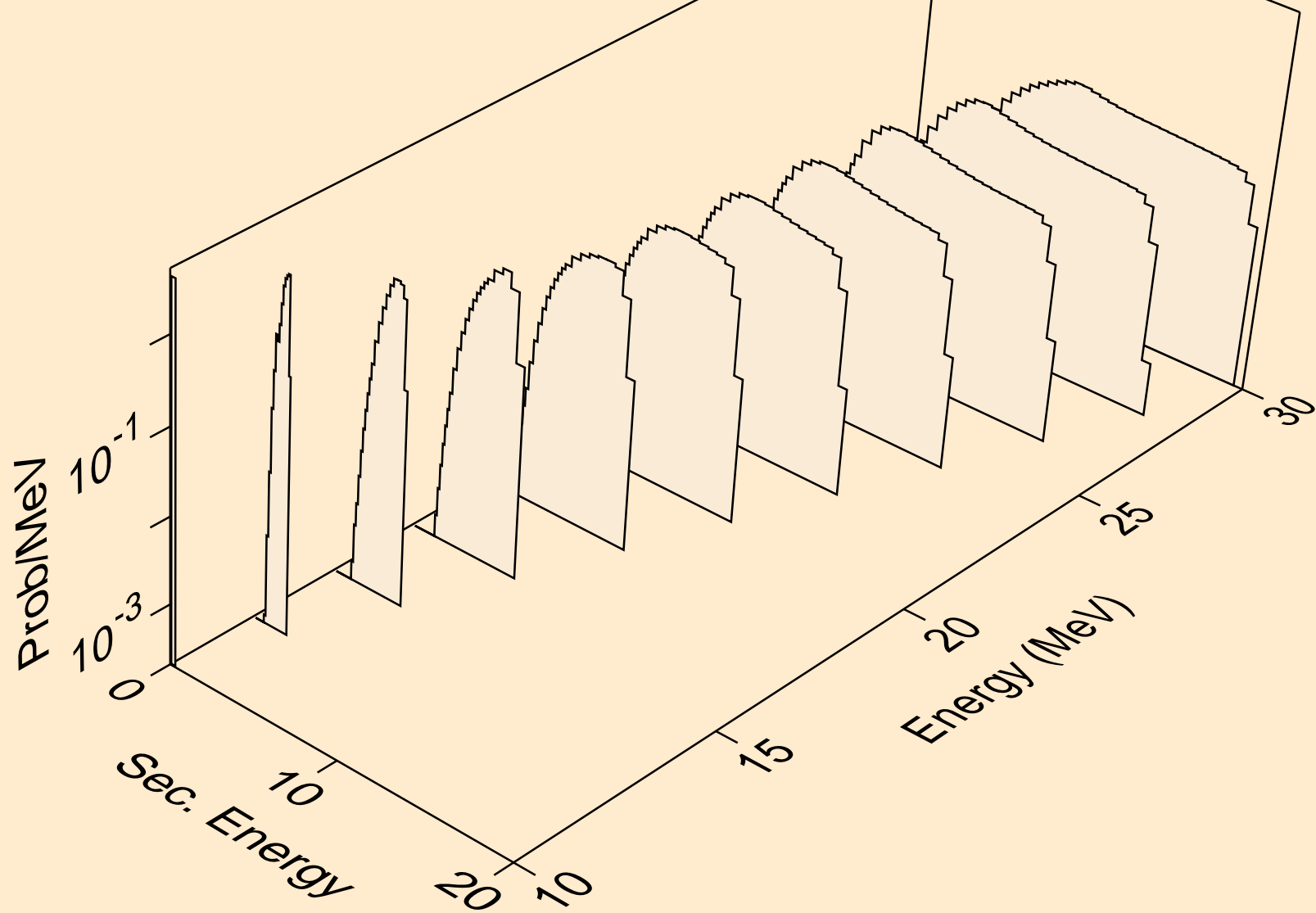

KR082 NEUTRON ACER TENDL-2024 LIBRARY; T=0.K
protons from (n,2np)

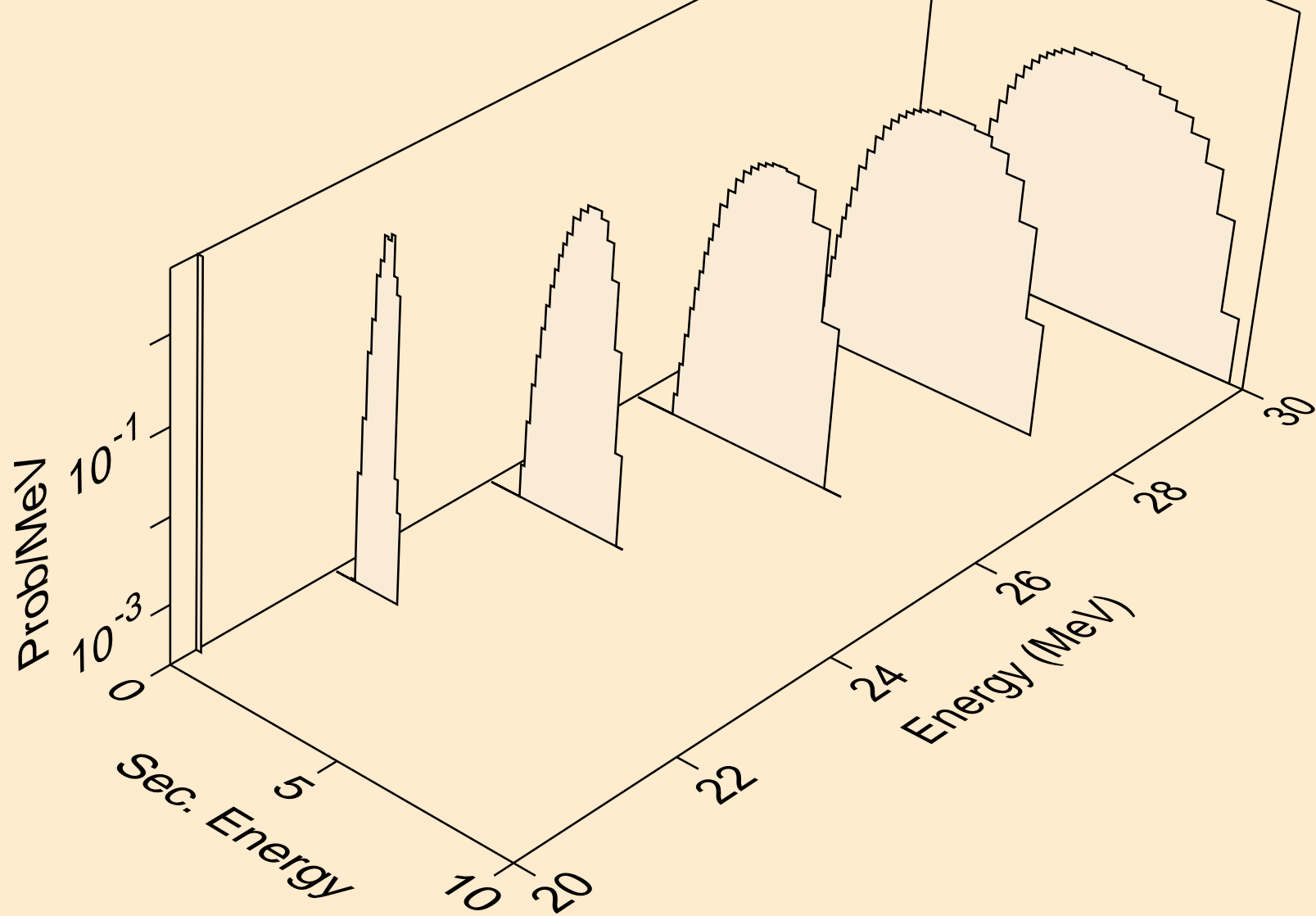

KR082 NEUTRON ACER TENDL-2024 LIBRARY; T=0.K
protons from (n,n2p)

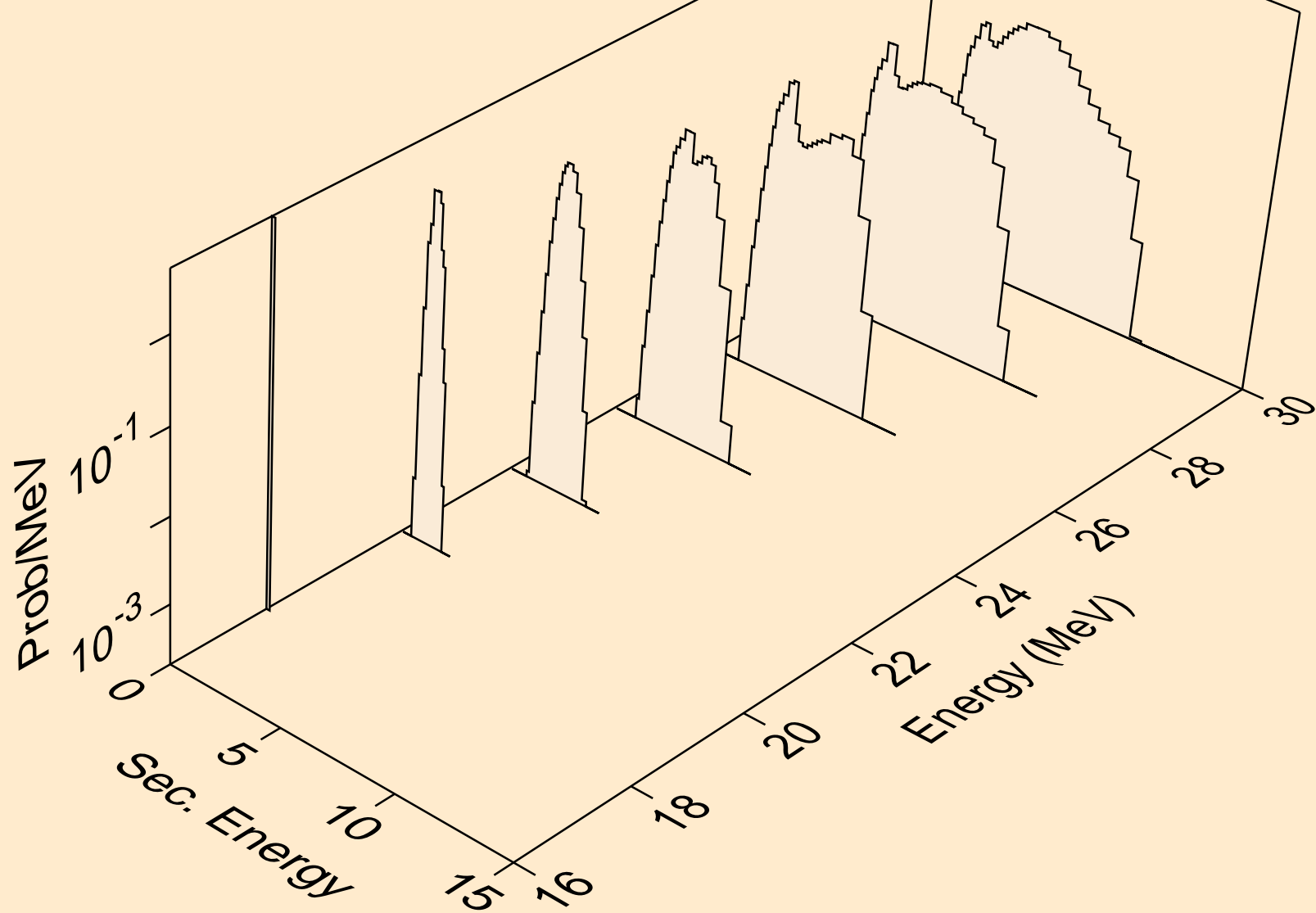

KR082 NEUTRON ACER TENDL-2024 LIBRARY; T=0.K
protons from (n,npa)

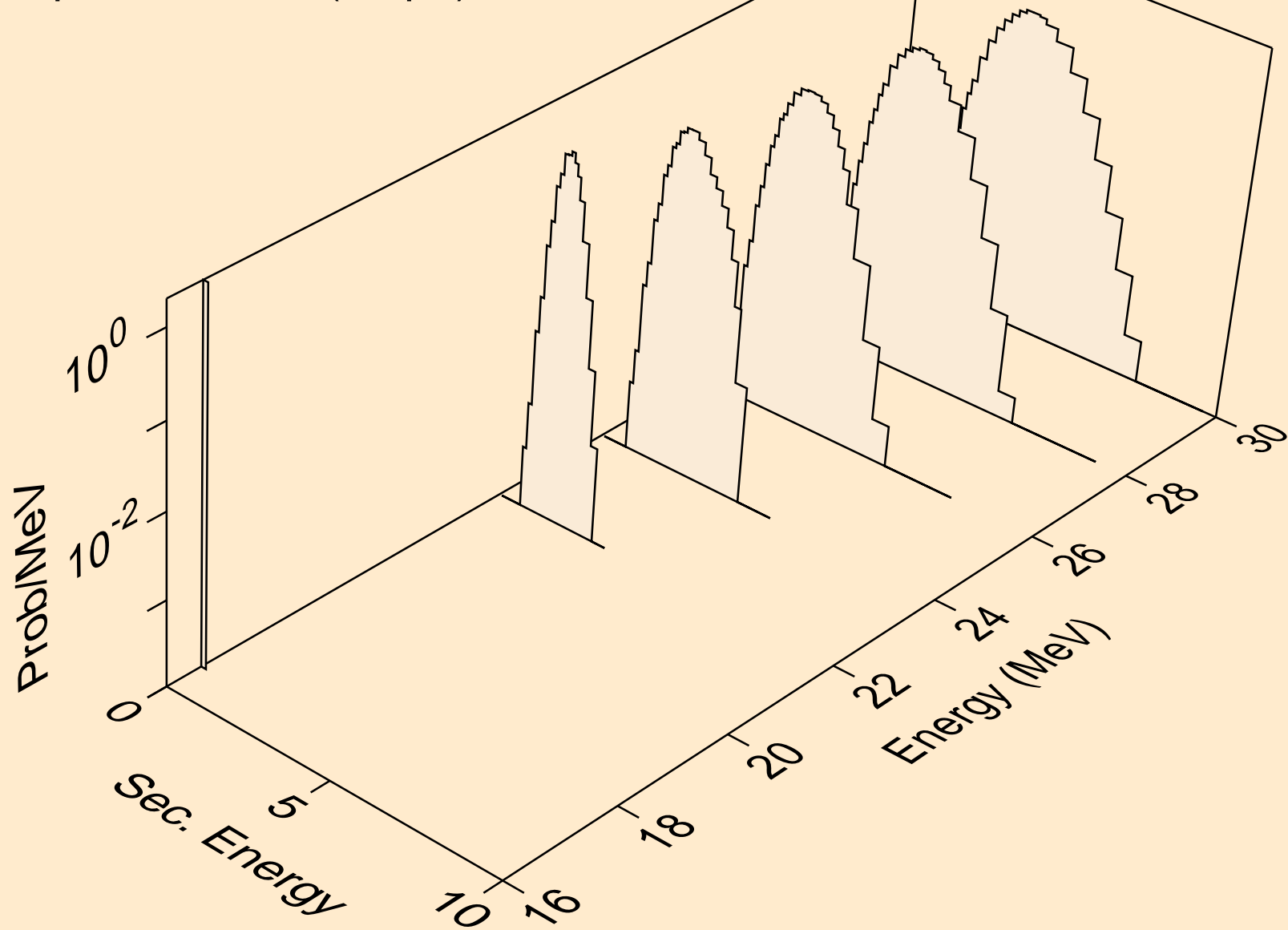

KR082 NEUTRON ACER TENDL-2024 LIBRARY; T=0.K
protons from (n,p)

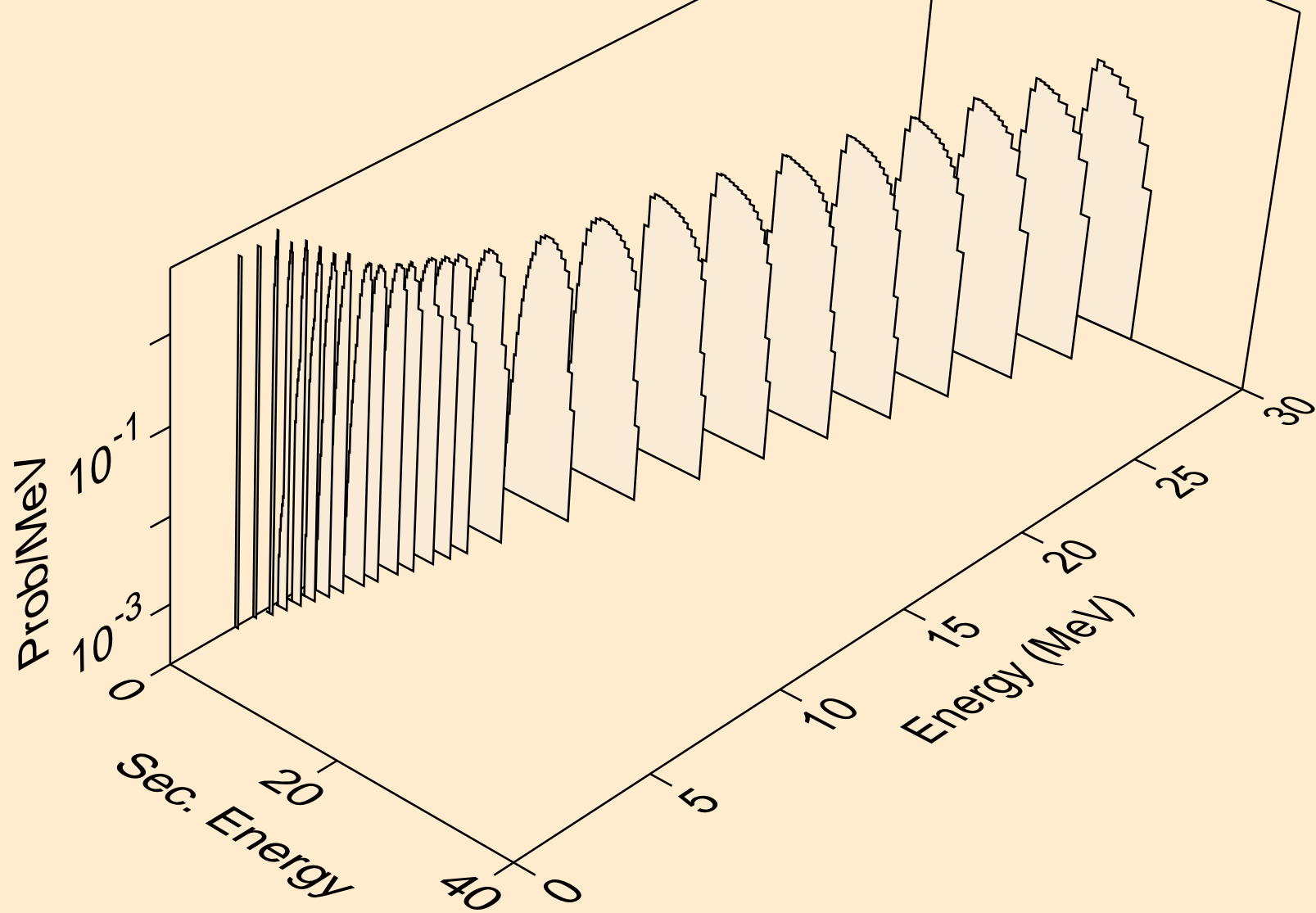

KR082 NEUTRON ACER TENDL-2024 LIBRARY; T=0.K
protons from (n,2p)

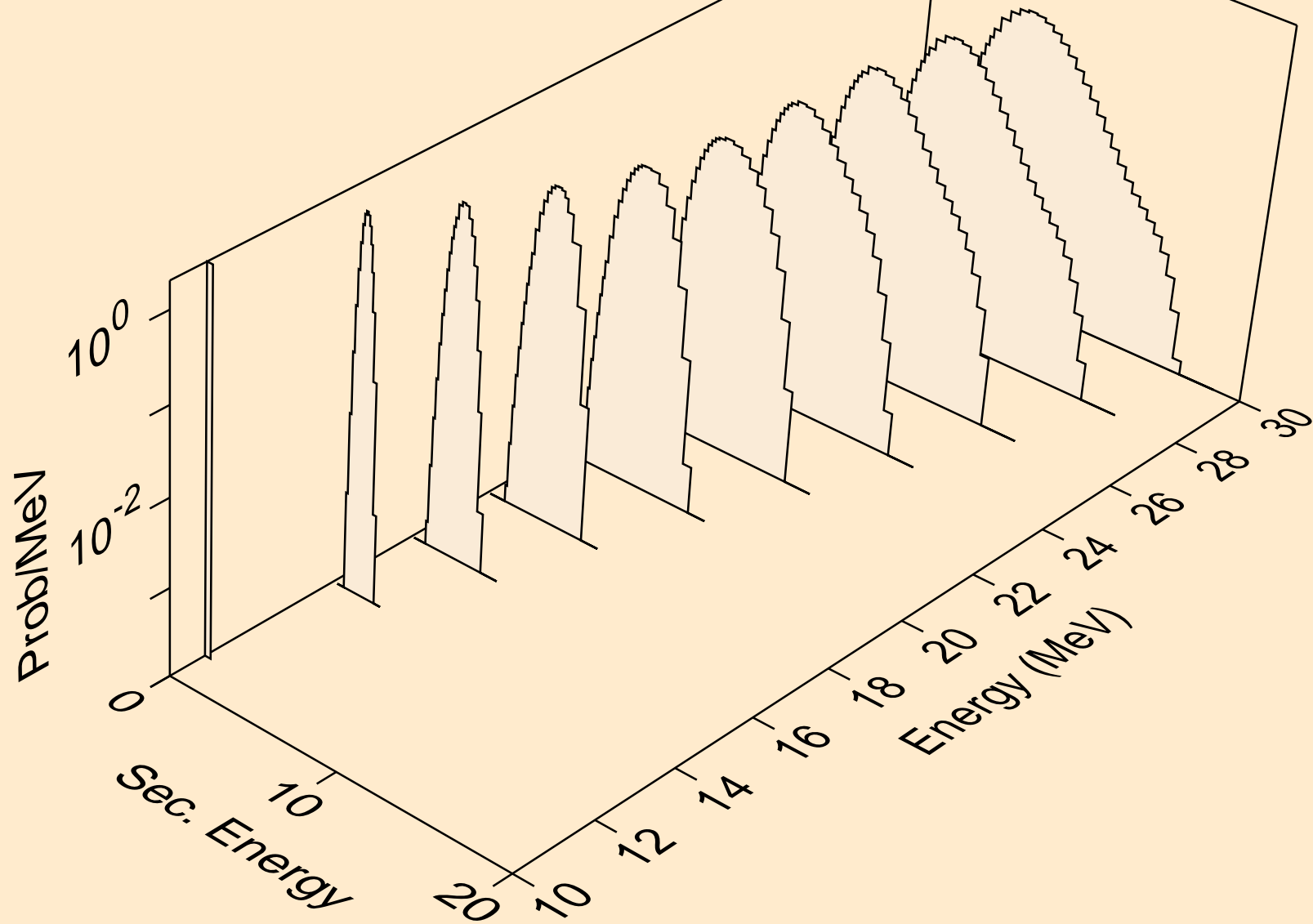

KR082 NEUTRON ACER TENDL-2024 LIBRARY; T=0.K
protons from (n,p)

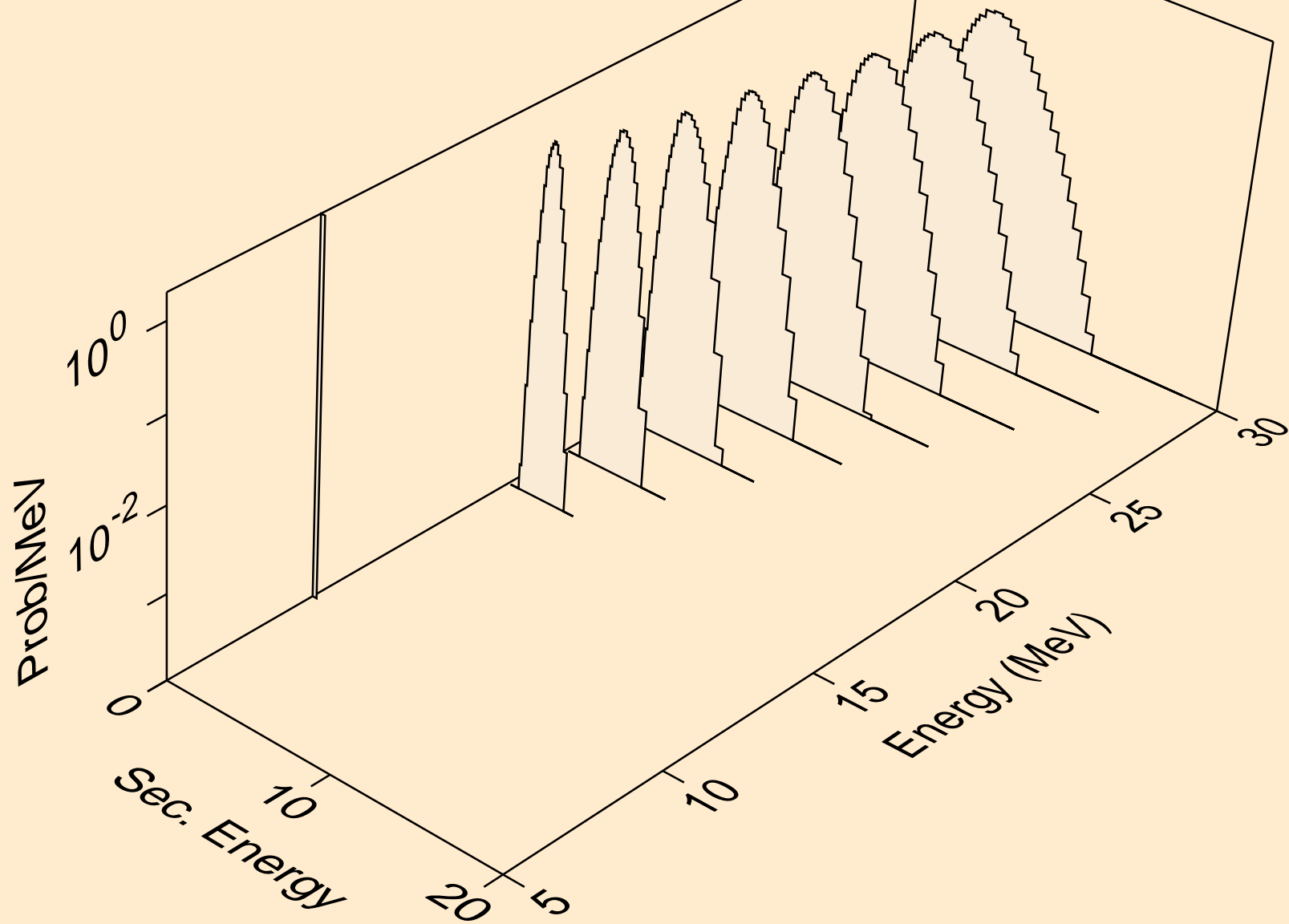

KR082 NEUTRON ACER TENDL-2024 LIBRARY; T=0.K
protons from (n,pd)

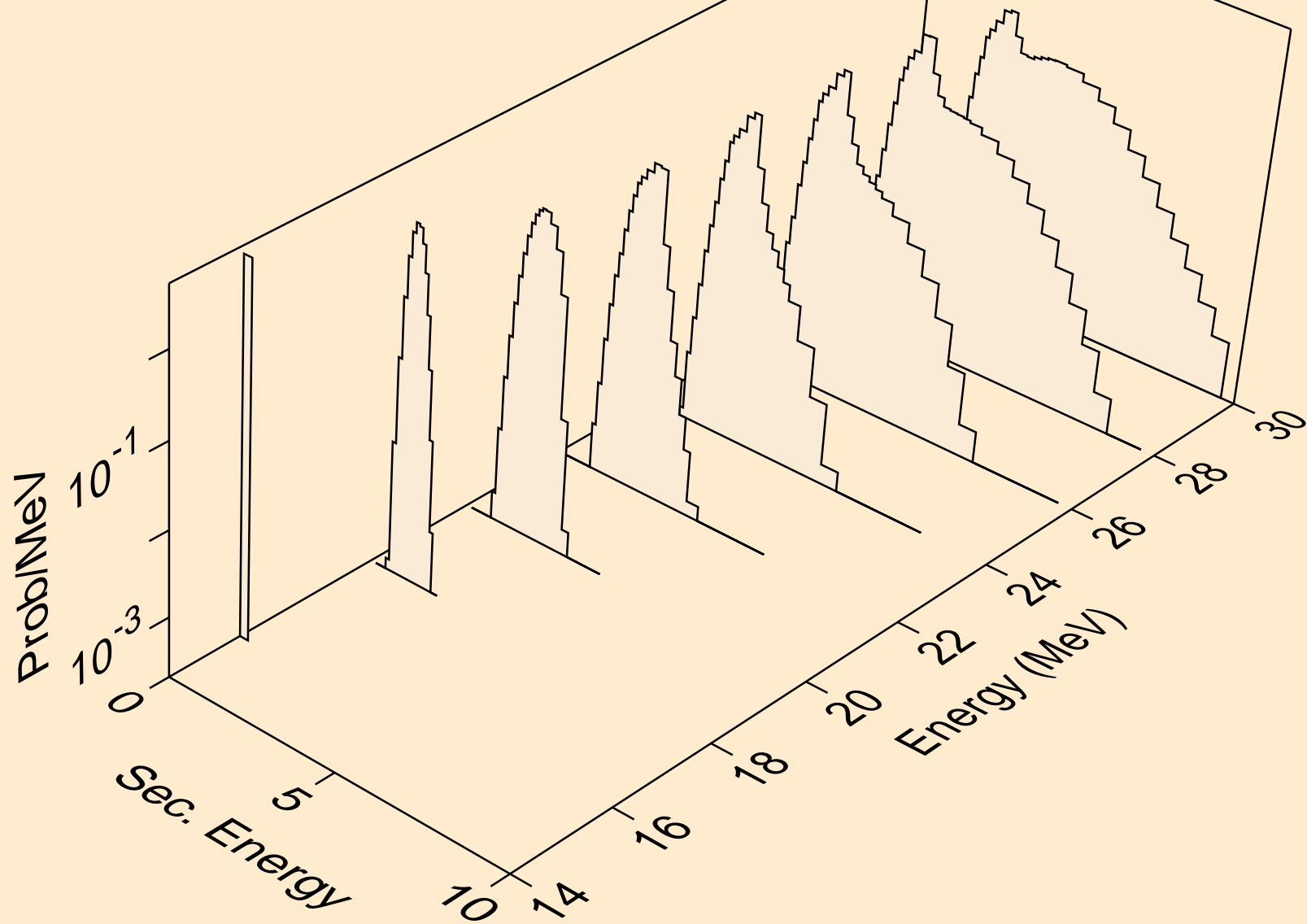

KR082 NEUTRON ACER TENDL-2024 LIBRARY; T=0.K
protons from (n,pt)

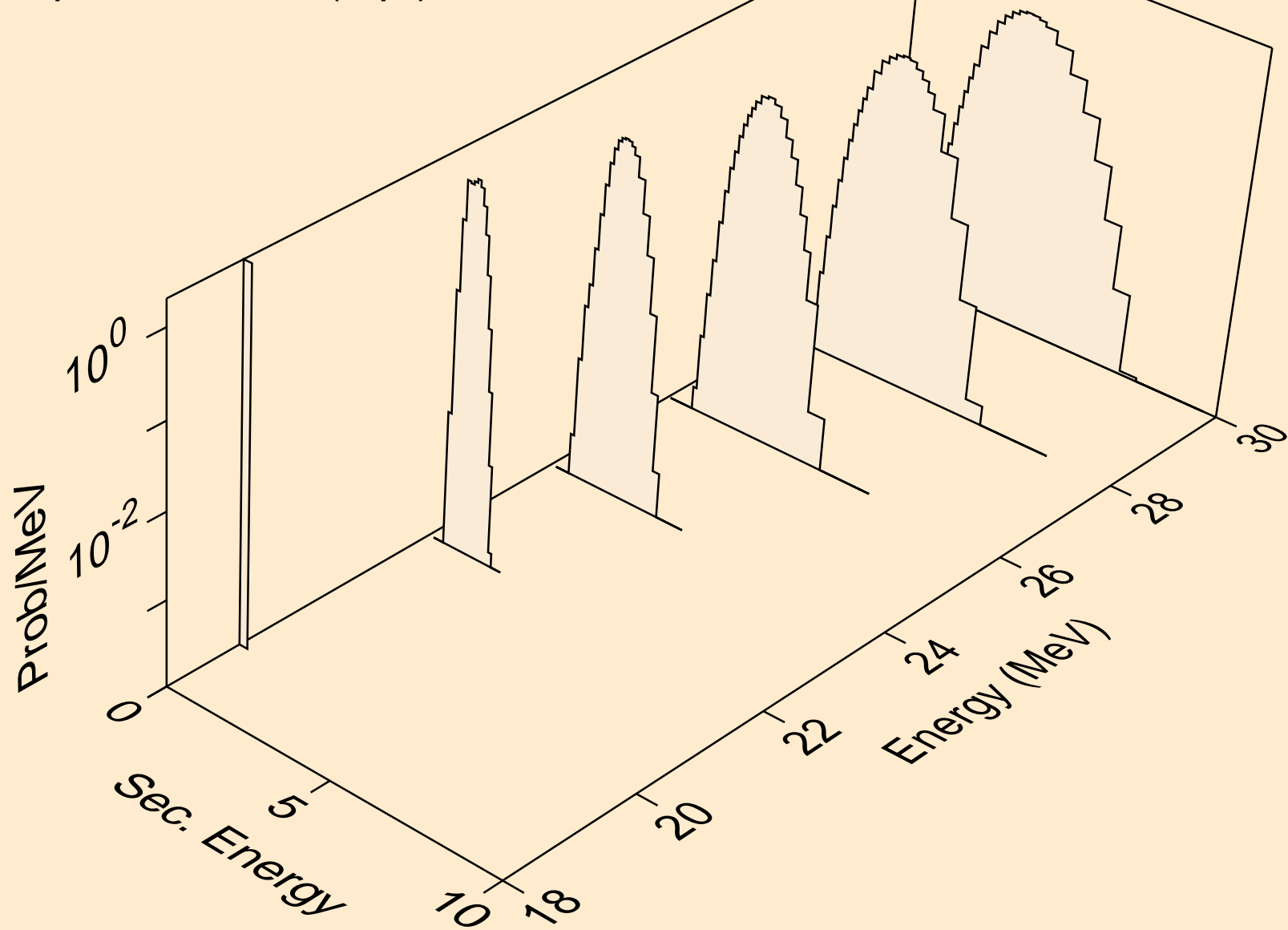

KR082 NEUTRON ACER TENDL-2024 LIBRARY; T=0.K
deuterons from (n,x)

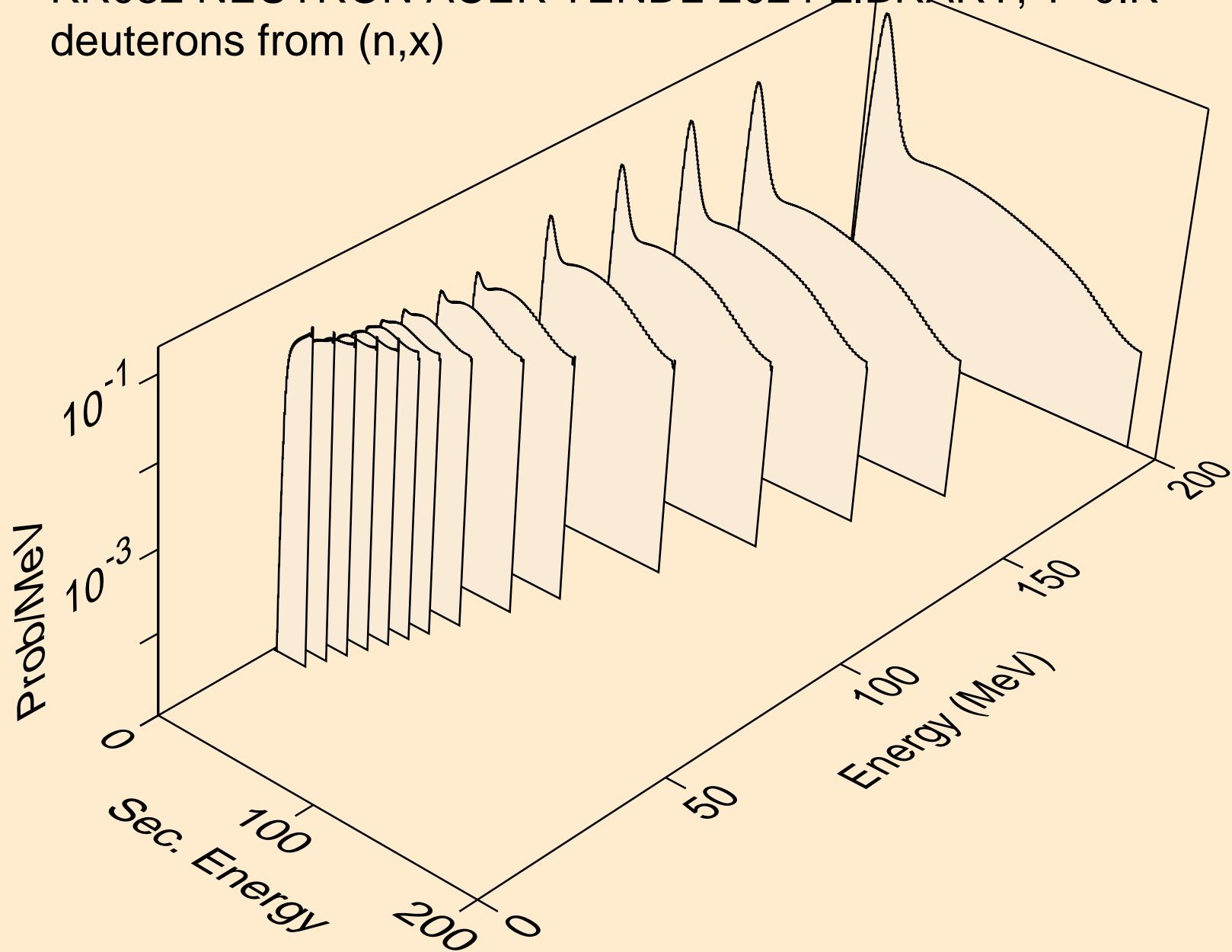

KR082 NEUTRON ACER TENDL-2024 LIBRARY; T=0.K
deuterons from (n,2nd)

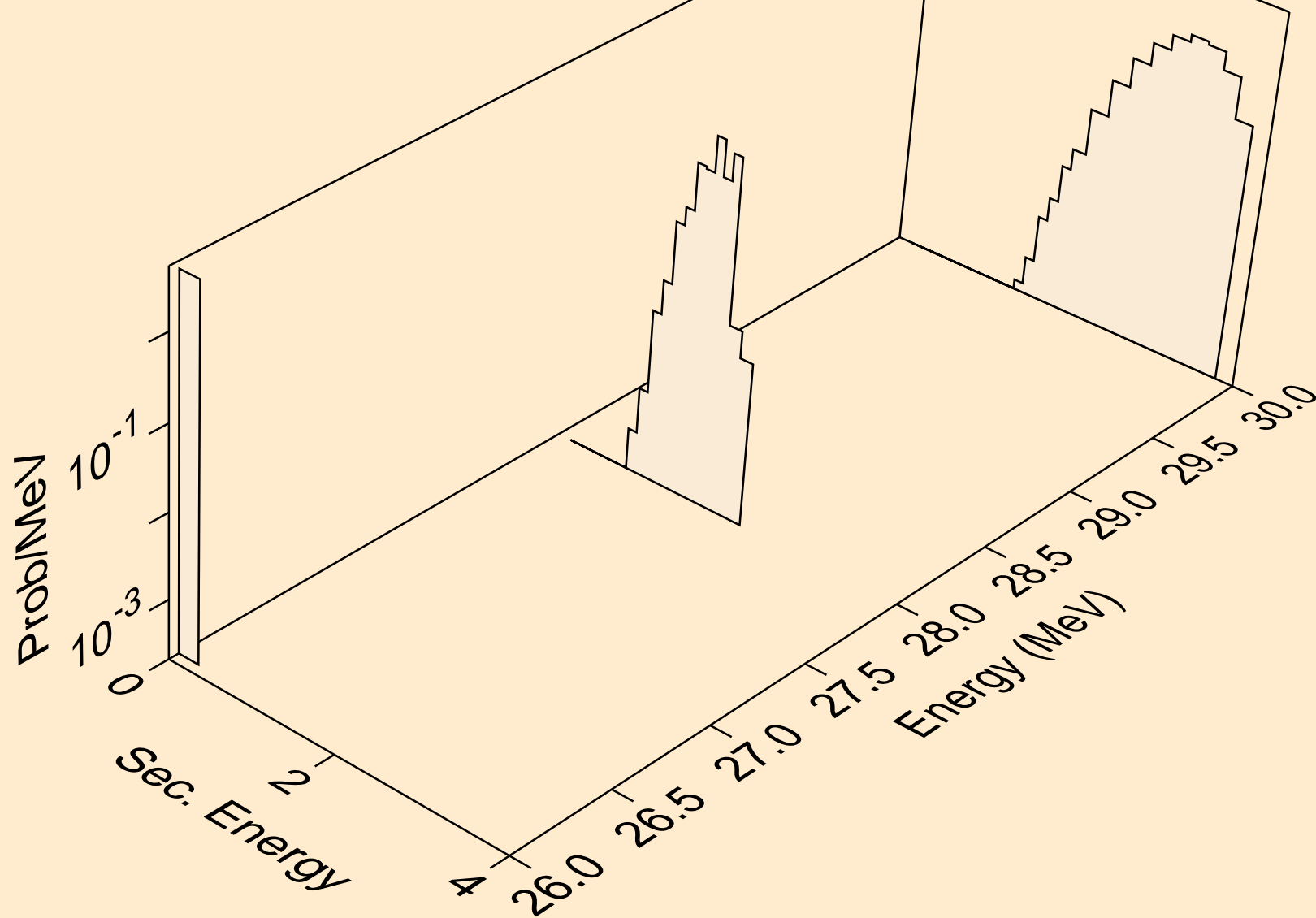

KR082 NEUTRON ACER TENDL-2024 LIBRARY; T=0.K
deuterons from (n,n*)d

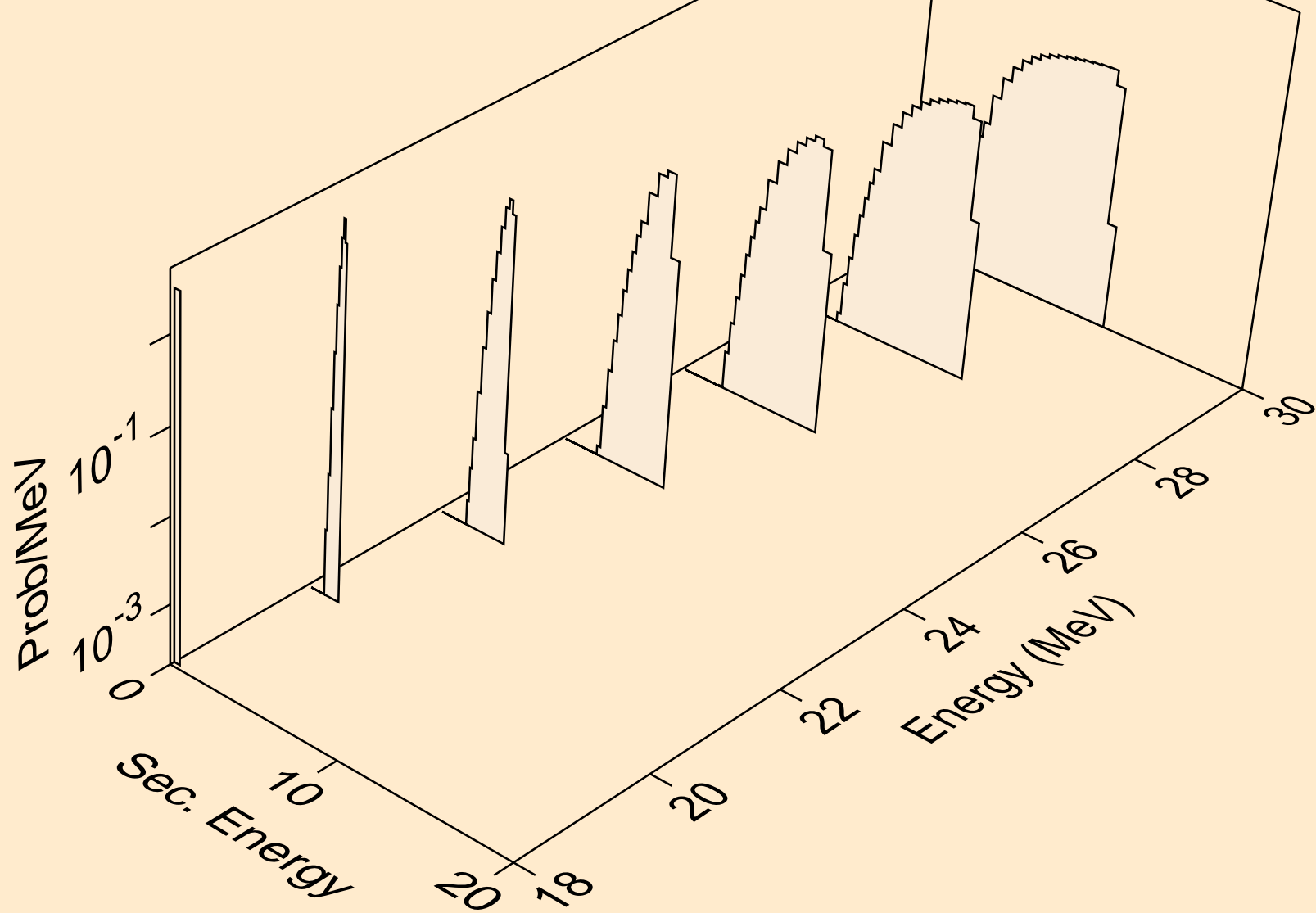

KR082 NEUTRON ACER TENDL-2024 LIBRARY; T=0.K
deuterons from (n,d)

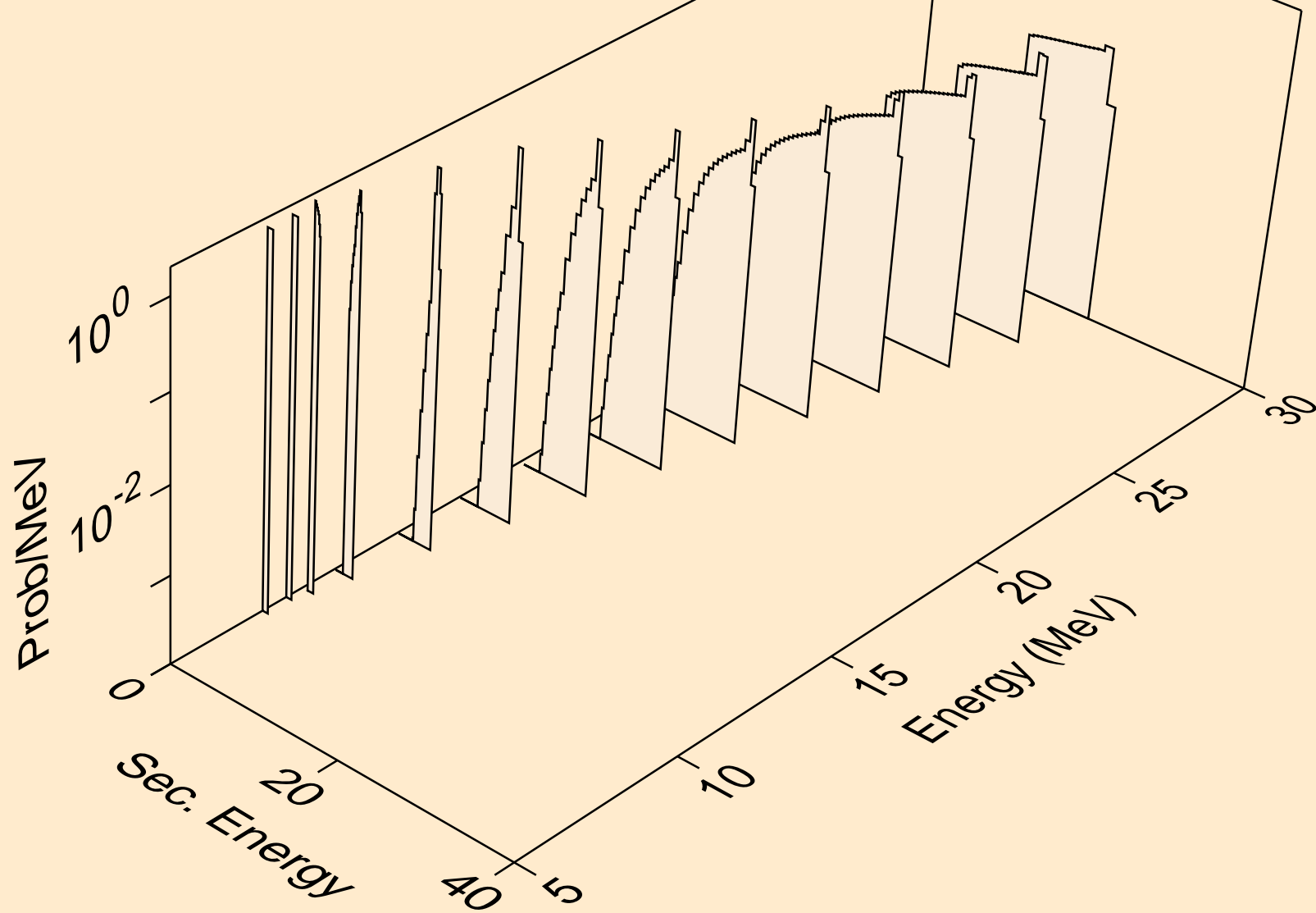

KR082 NEUTRON ACER TENDL-2024 LIBRARY; T=0.K
deuterons from (n,pd)

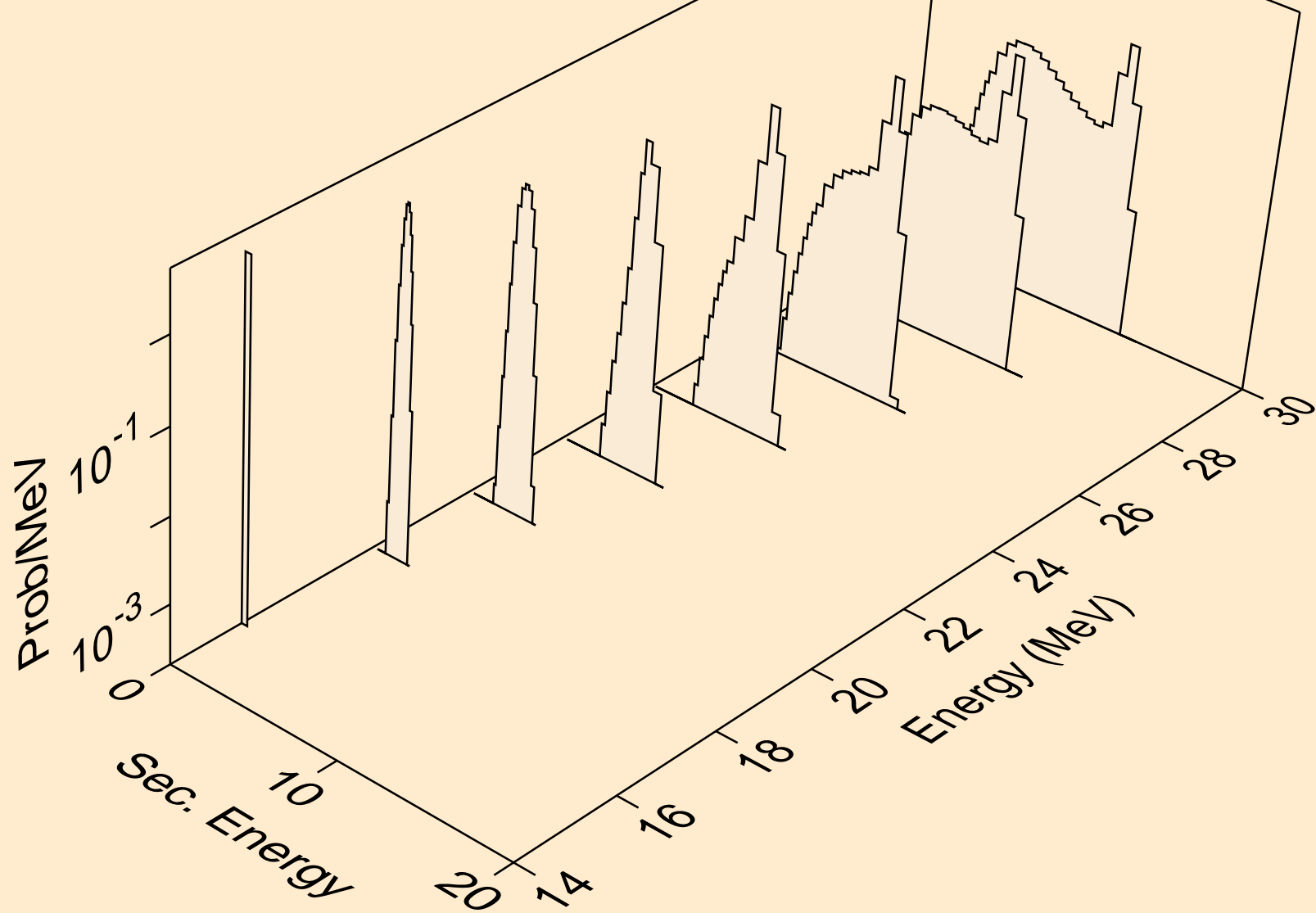

KR082 NEUTRON ACER TENDL-2024 LIBRARY; T=0.K
deuterons from (n,da)

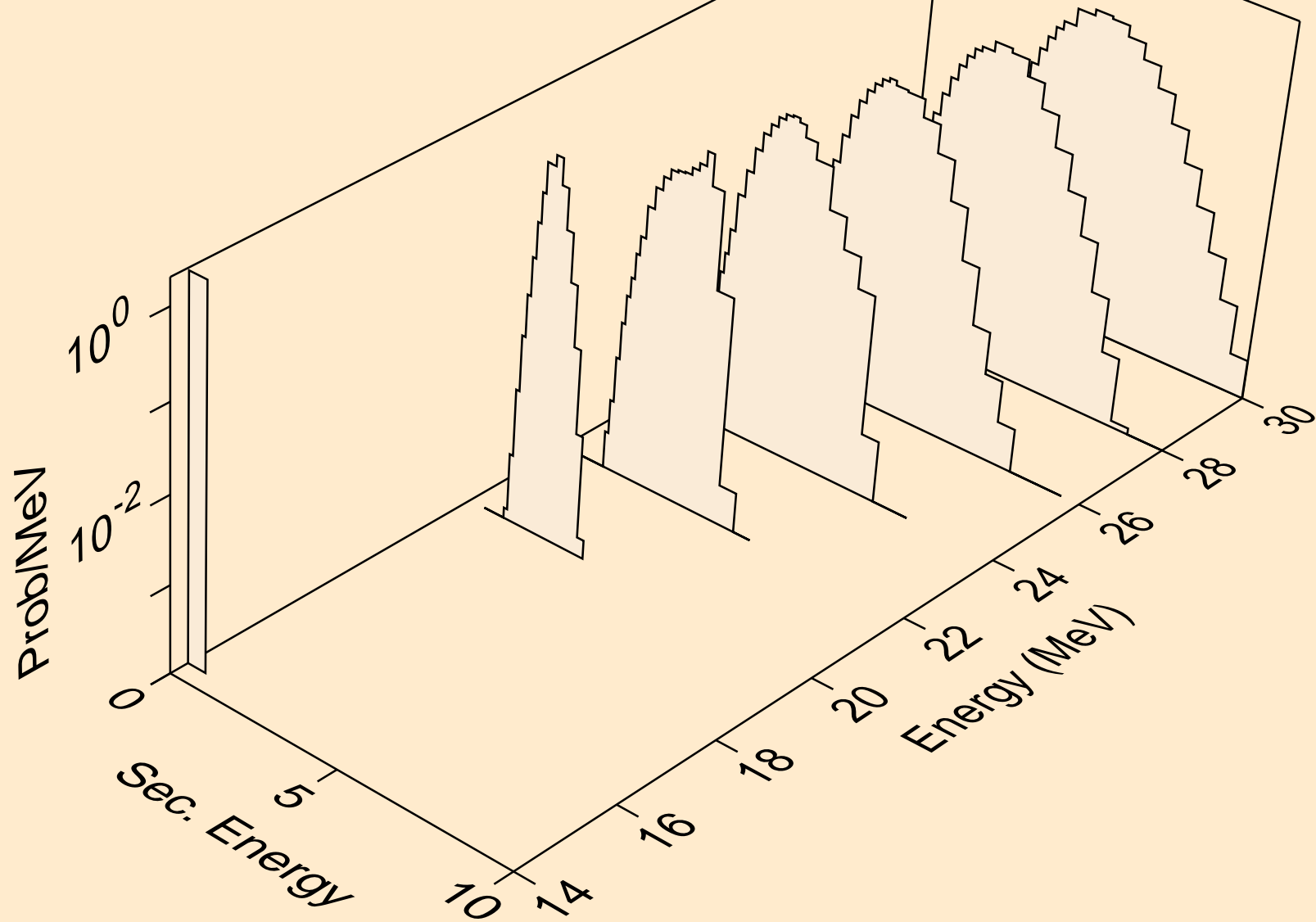

KR082 NEUTRON ACER TENDL-2024 LIBRARY; T=0.K
tritons from (n,x)

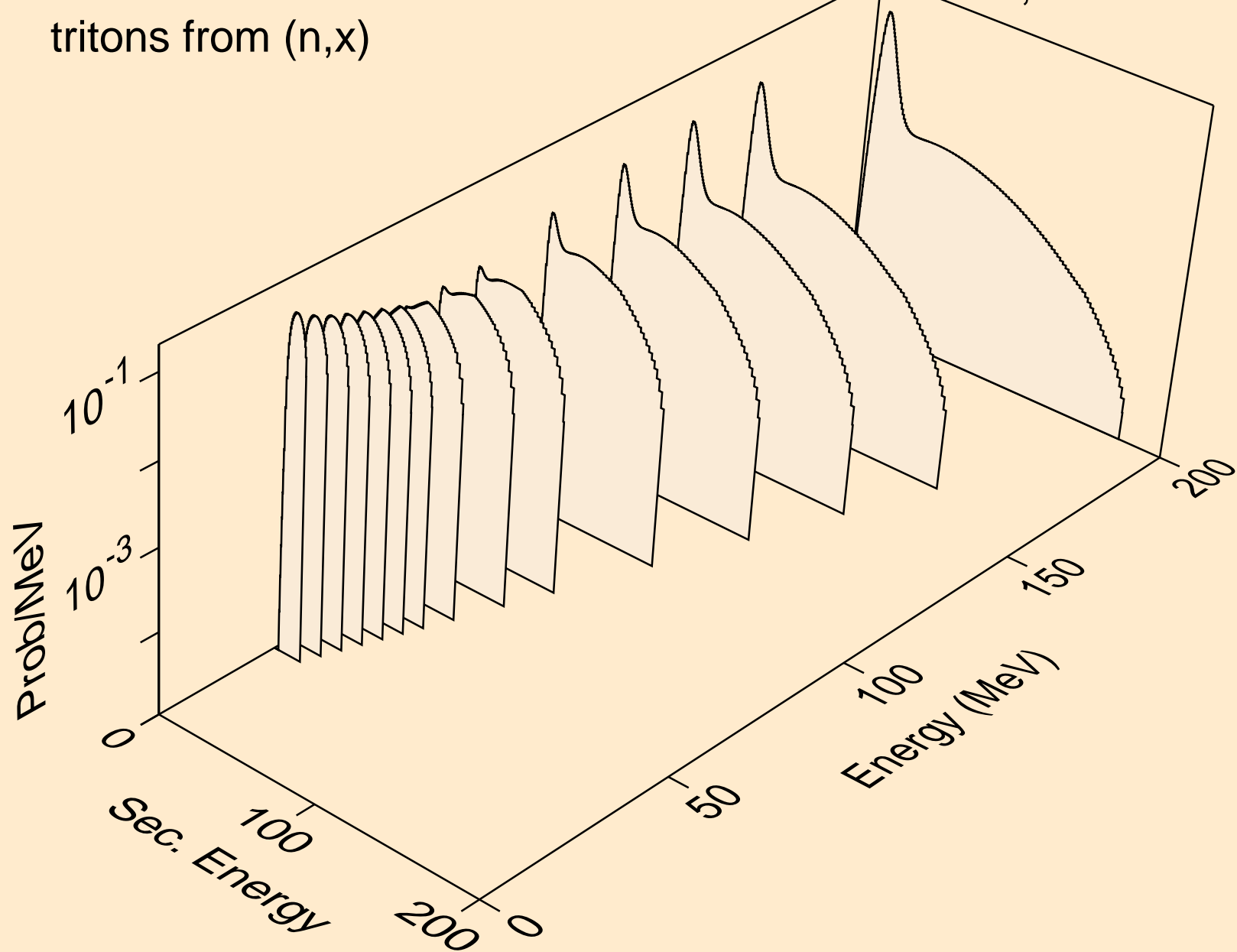

KR082 NEUTRON ACER TENDL-2024 LIBRARY; T=0.K
tritons from (n,n*)t

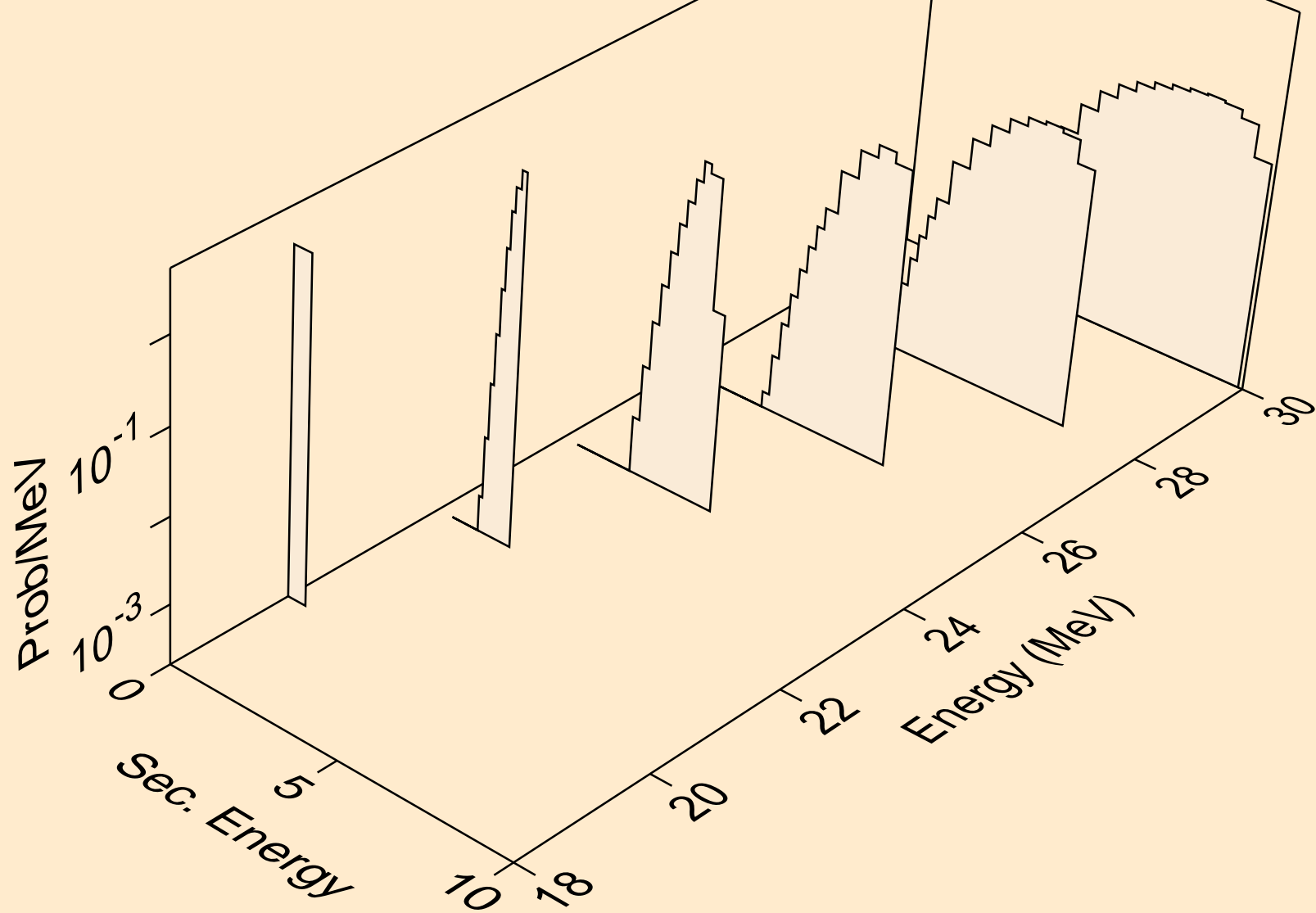

KR082 NEUTRON ACER TENDL-2024 LIBRARY; T=0.K
tritons from (n,t)

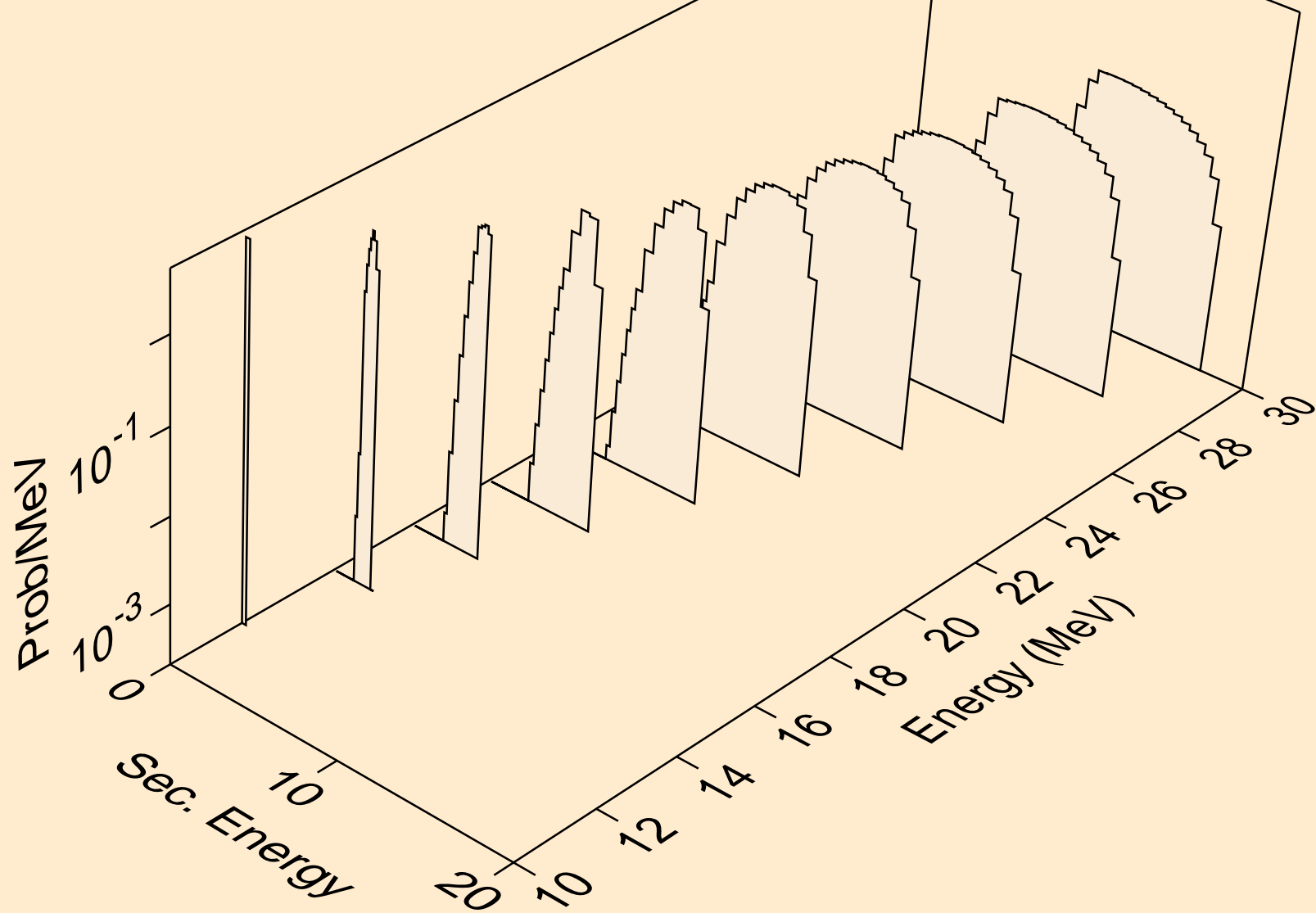

KR082 NEUTRON ACER TENDL-2024 LIBRARY; T=0.K
tritons from (n,pt)

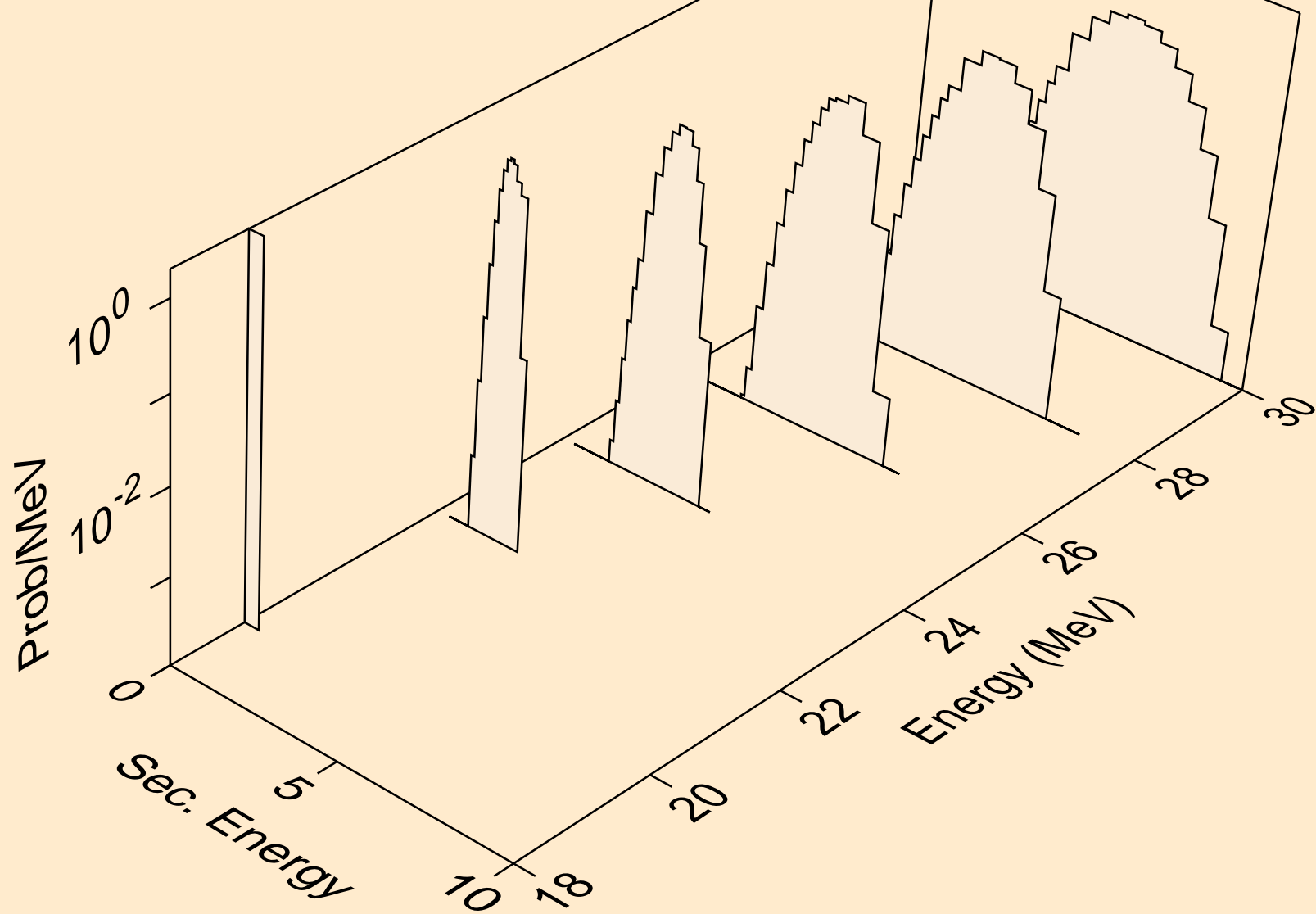

KR082 NEUTRON ACER TENDL-2024 LIBRARY; T=0.K
he3s from (n,x)

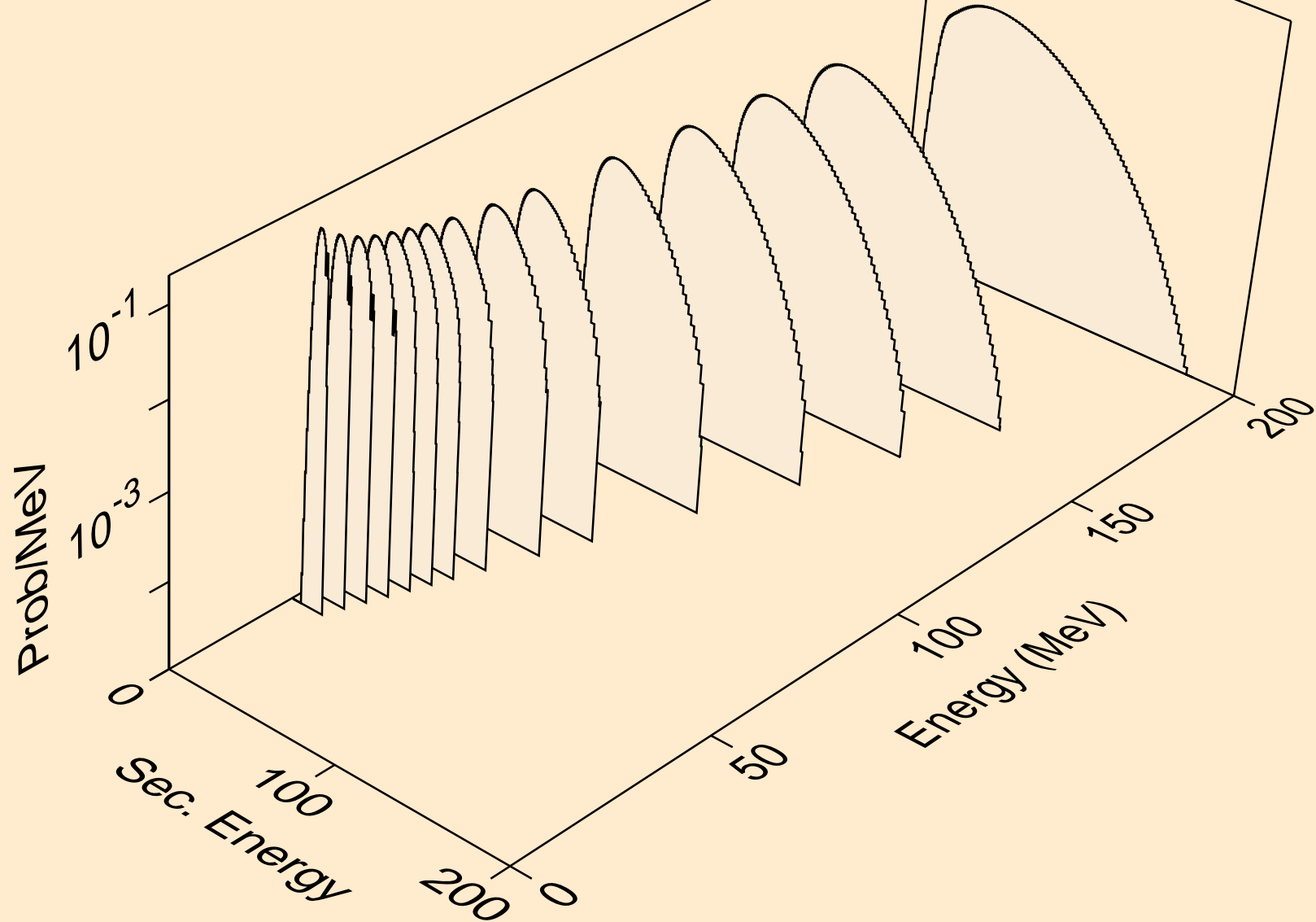

KR082 NEUTRON ACER TENDL-2024 LIBRARY; T=0.K
he3s from (n,n*)he3

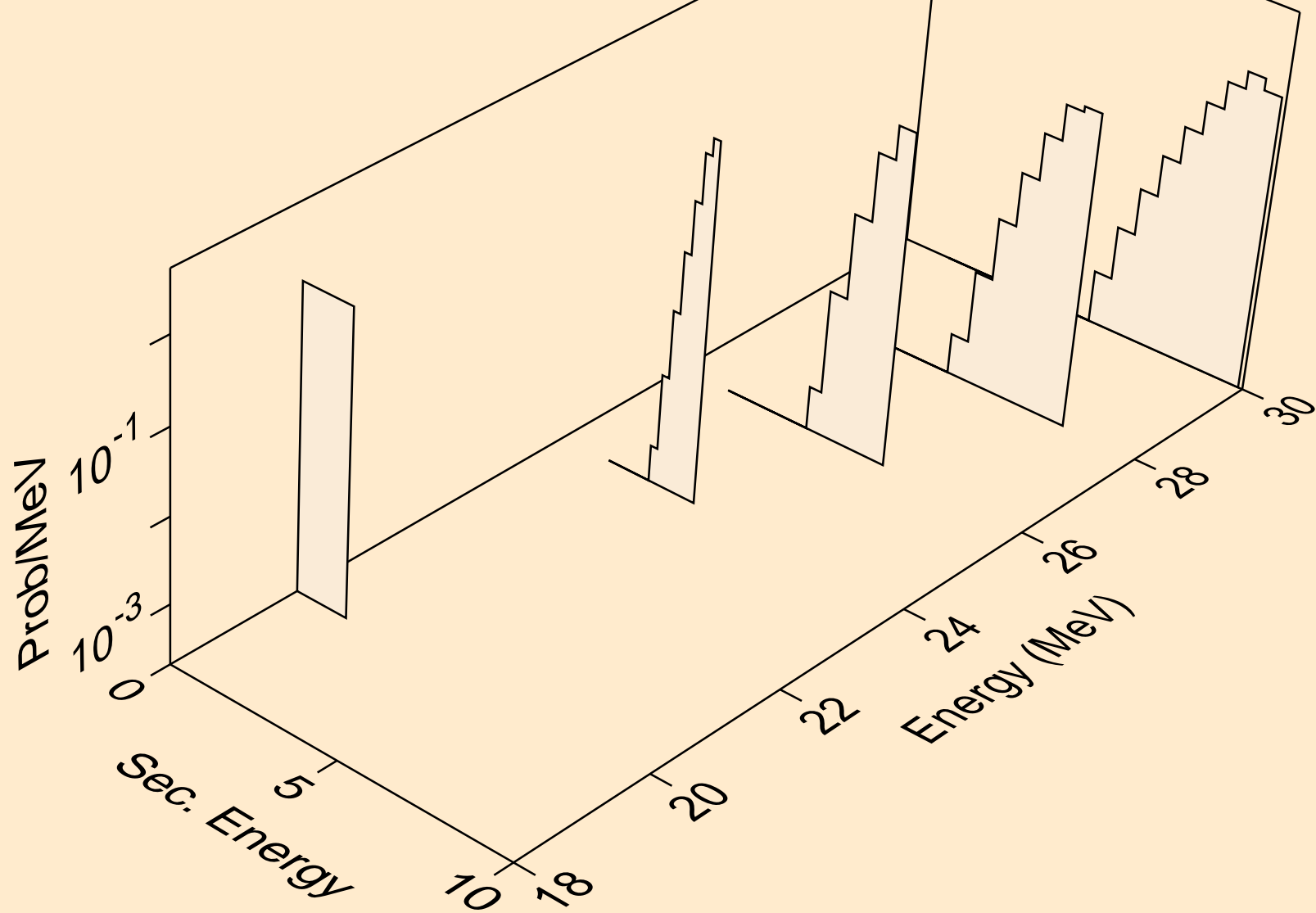

KR082 NEUTRON ACER TENDL-2024 LIBRARY; T=0.K
he3s from (n,he3)

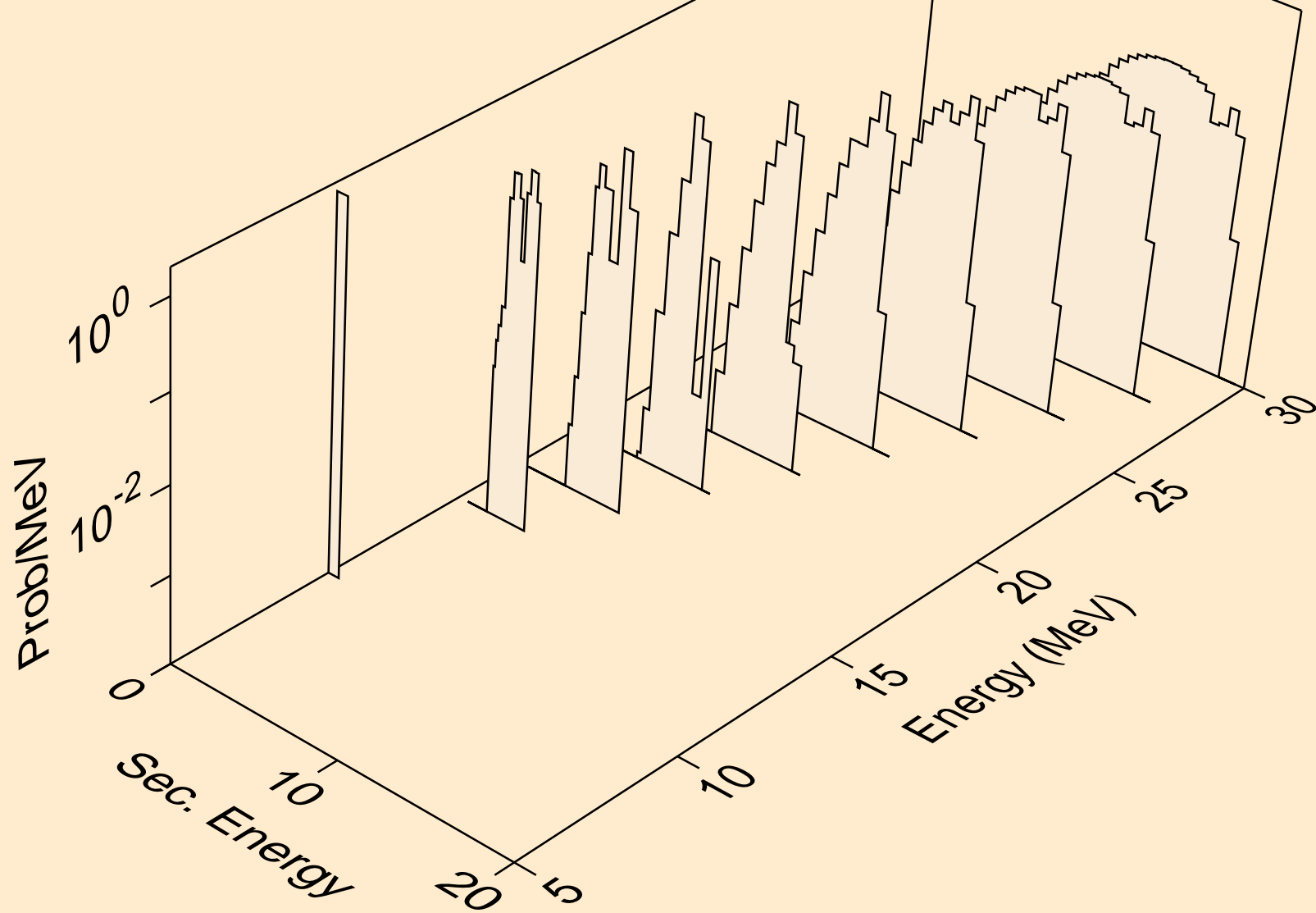

KR082 NEUTRON ACER TENDL-2024 LIBRARY; T=0.K
alphas from (n,x)

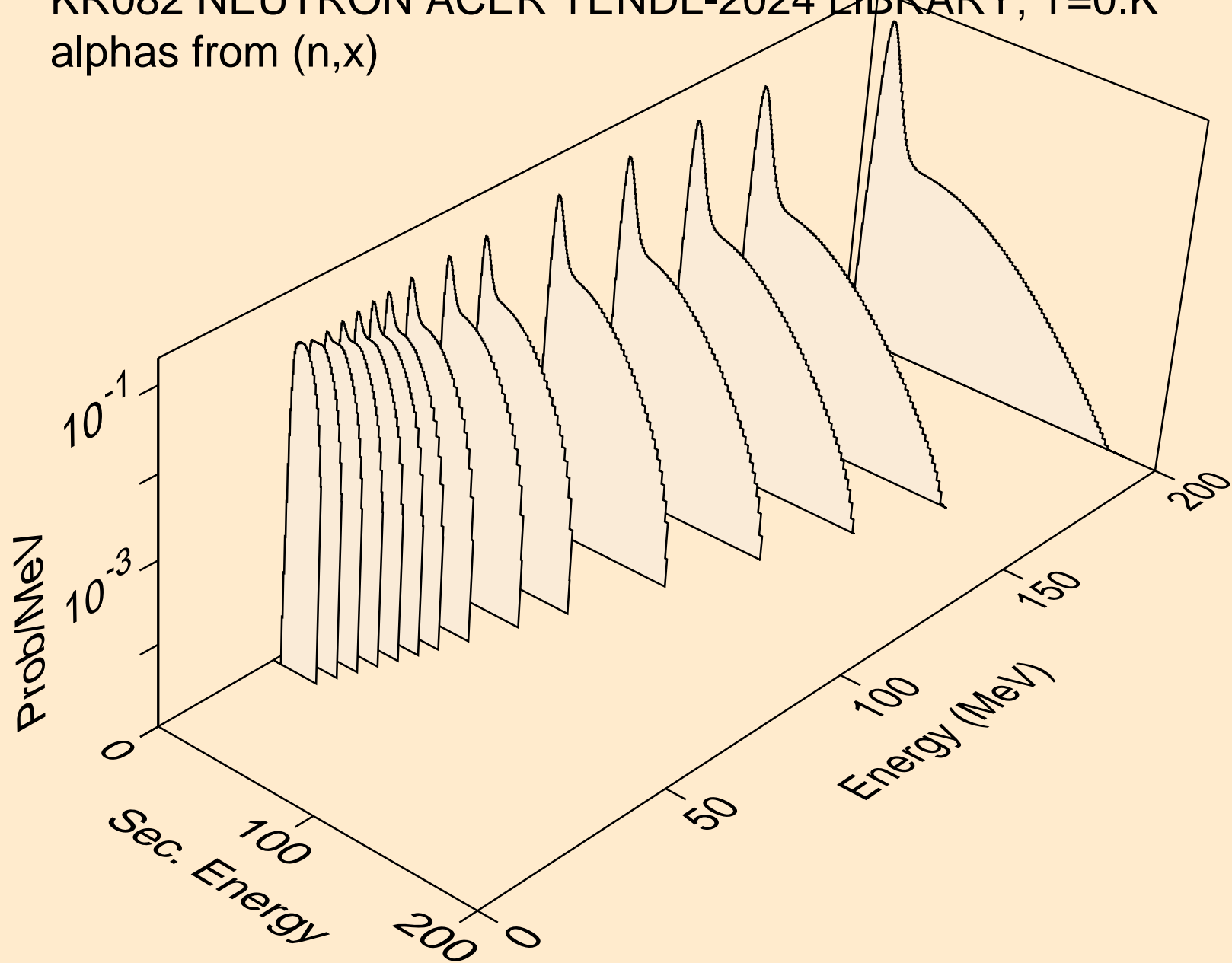

KR082 NEUTRON ACER TENDL-2024 LIBRARY; T=0.K
alphas from (n,n*)a

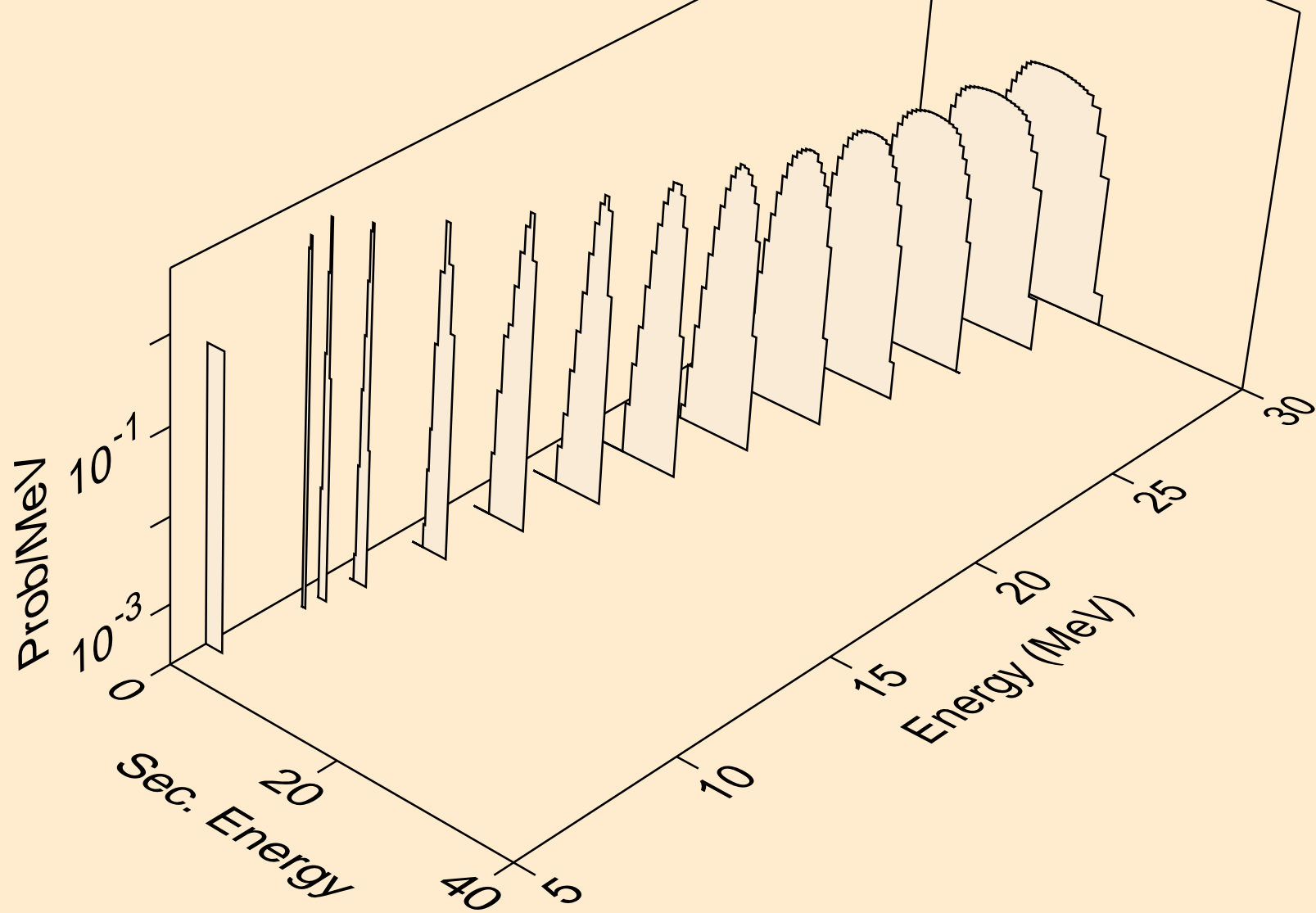

KR082 NEUTRON ACER TENDL-2024 LIBRARY; T=0.K
alphas from (n,2n)a

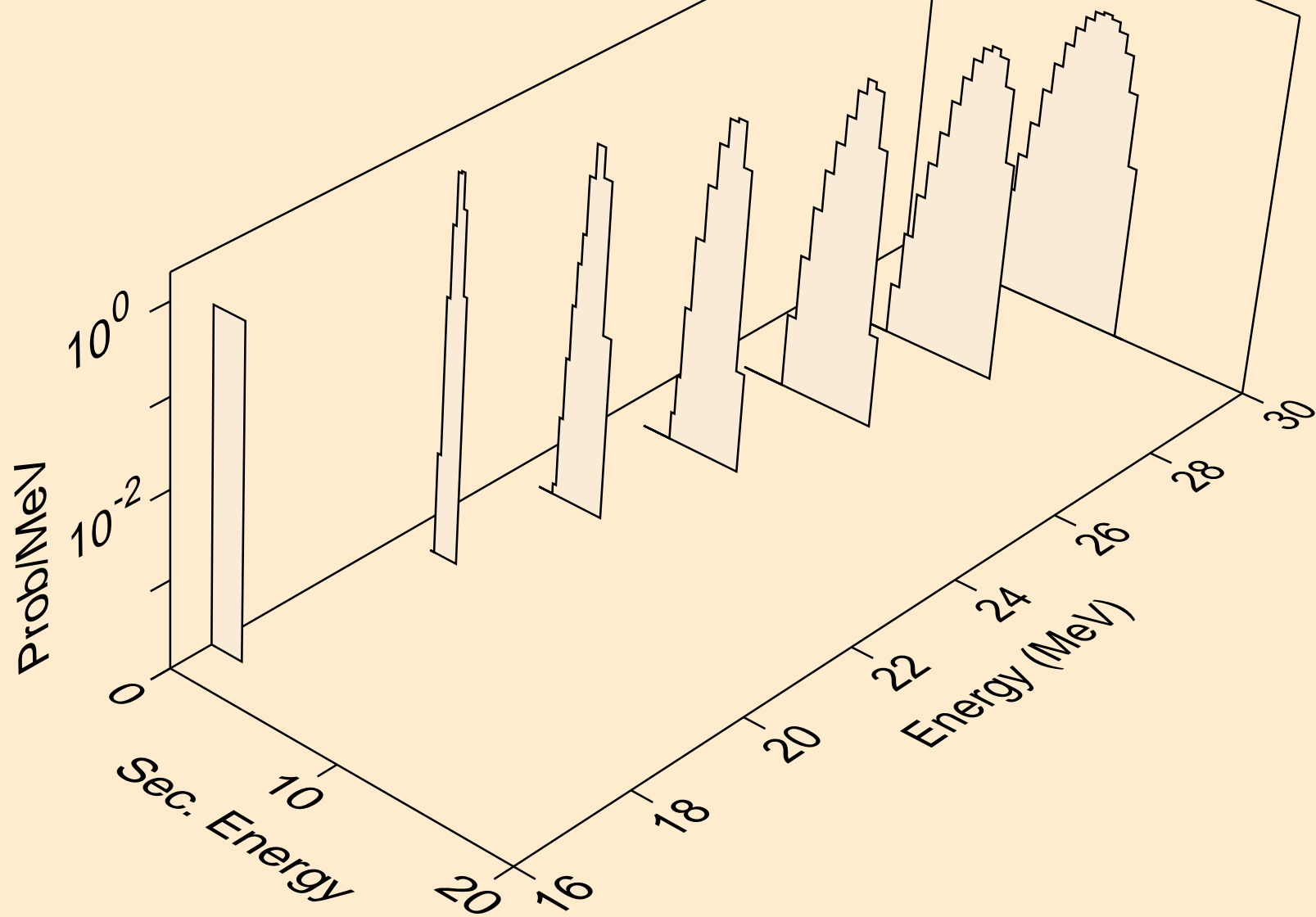

KR082 NEUTRON ACER TENDL-2024 LIBRARY; T=0.K
alphas from (n,3n)a

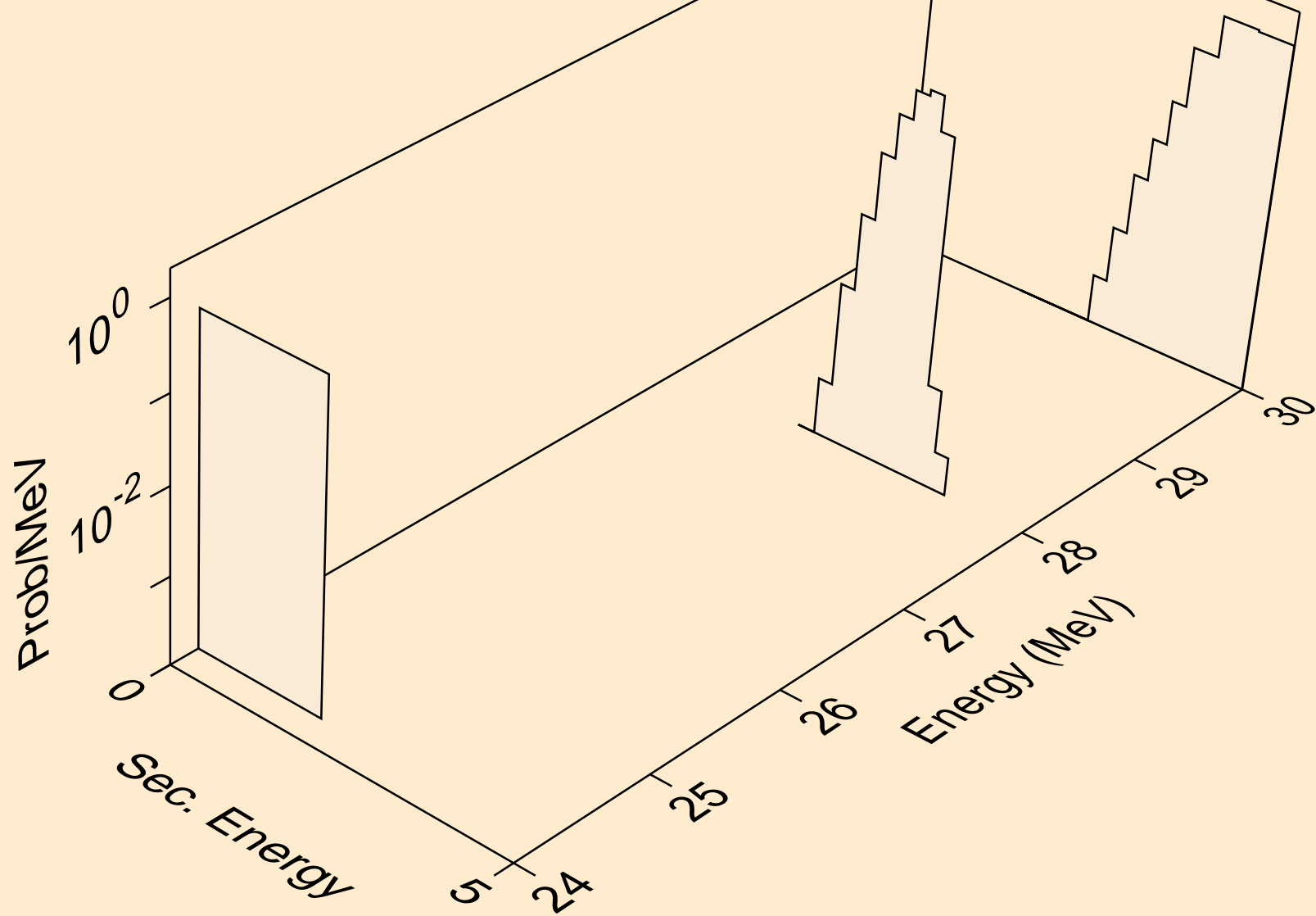

KR082 NEUTRON ACER TENDL-2024 LIBRARY; T=0.K
alphas from (n,n*)2a

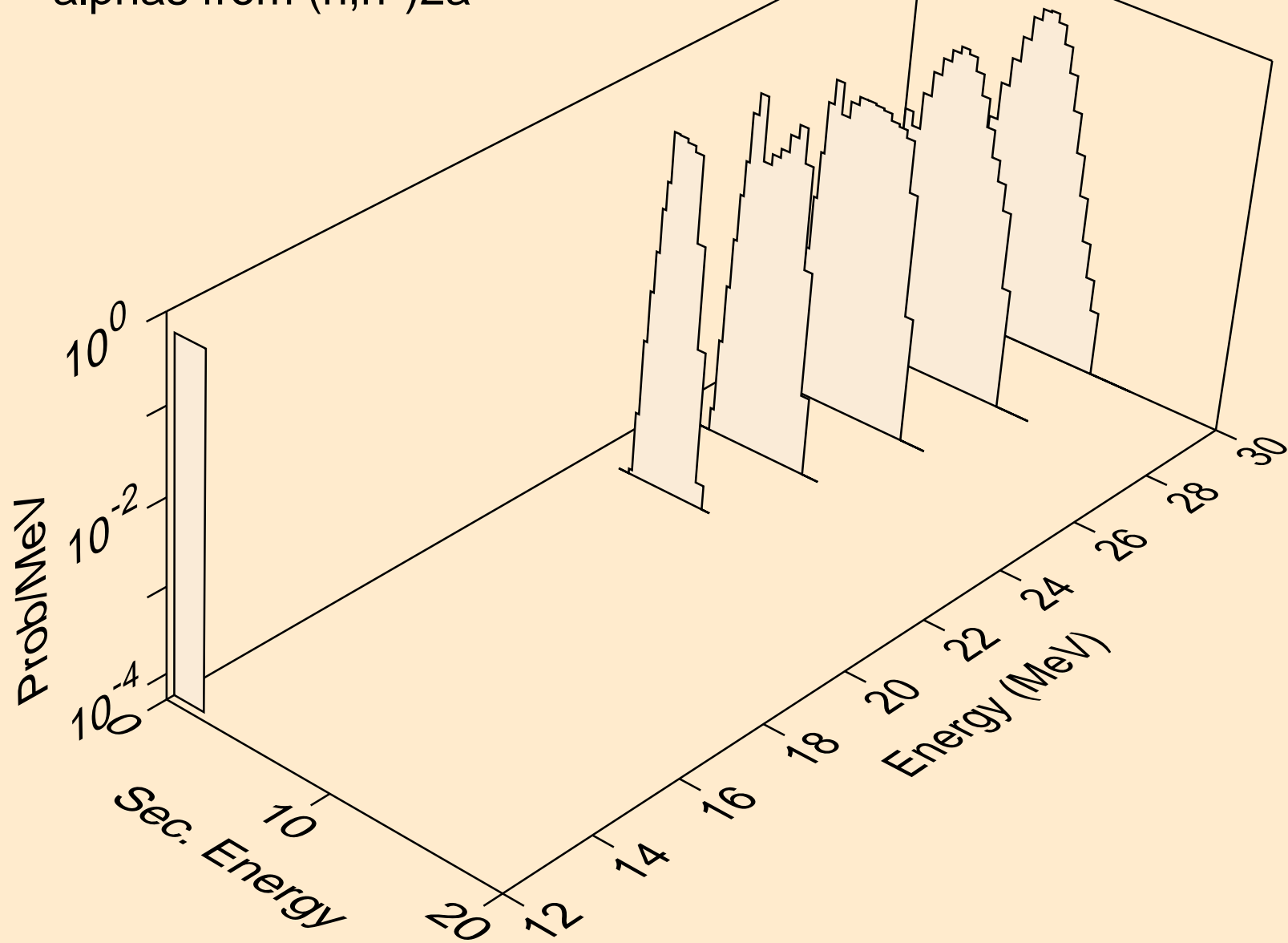

KR082 NEUTRON ACER TENDL-2024 LIBRARY; T=0.K
alphas from (n,npa)

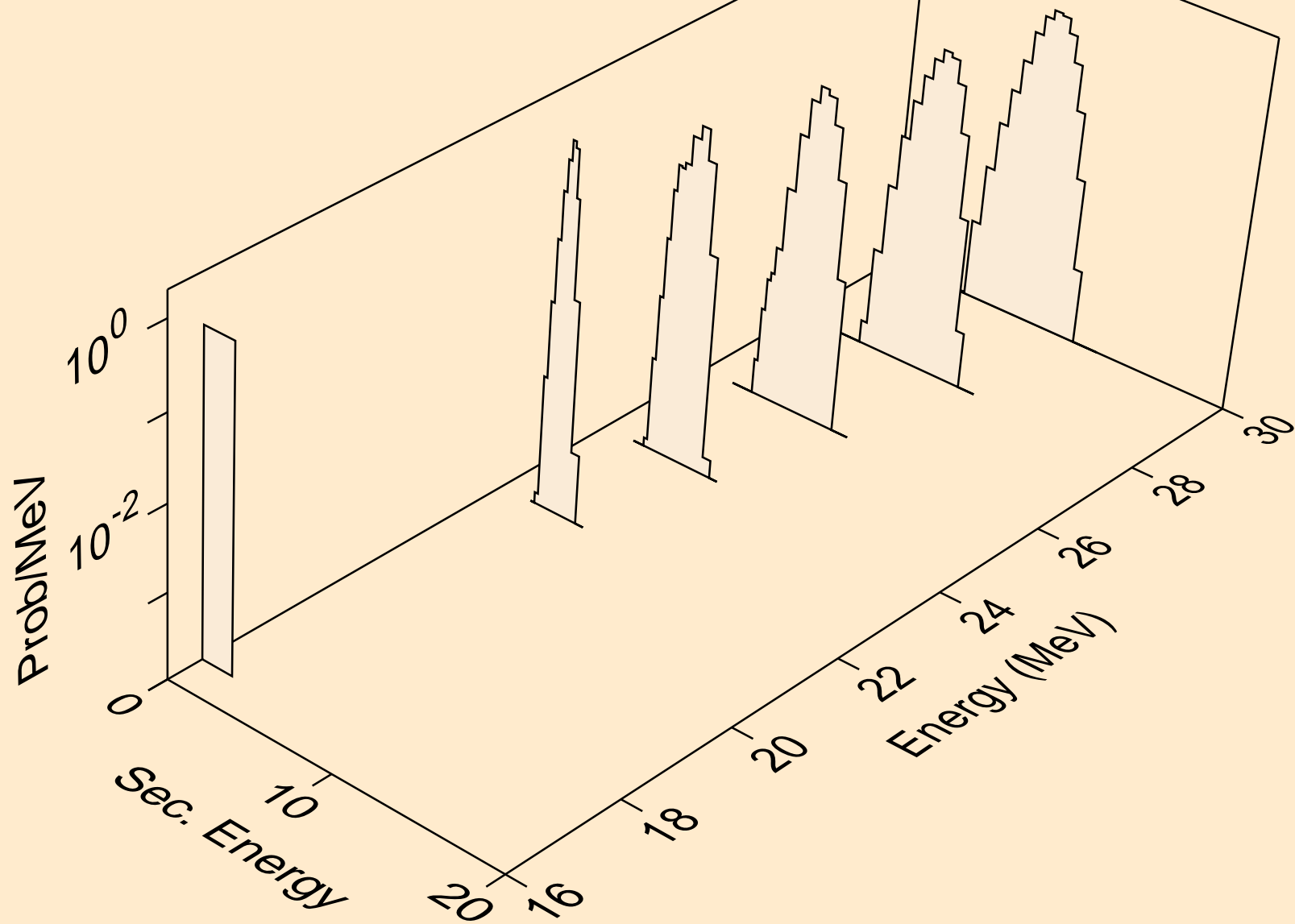

KR082 NEUTRON ACER TENDL-2024 LIBRARY; T=0.K
alphas from (n,a)

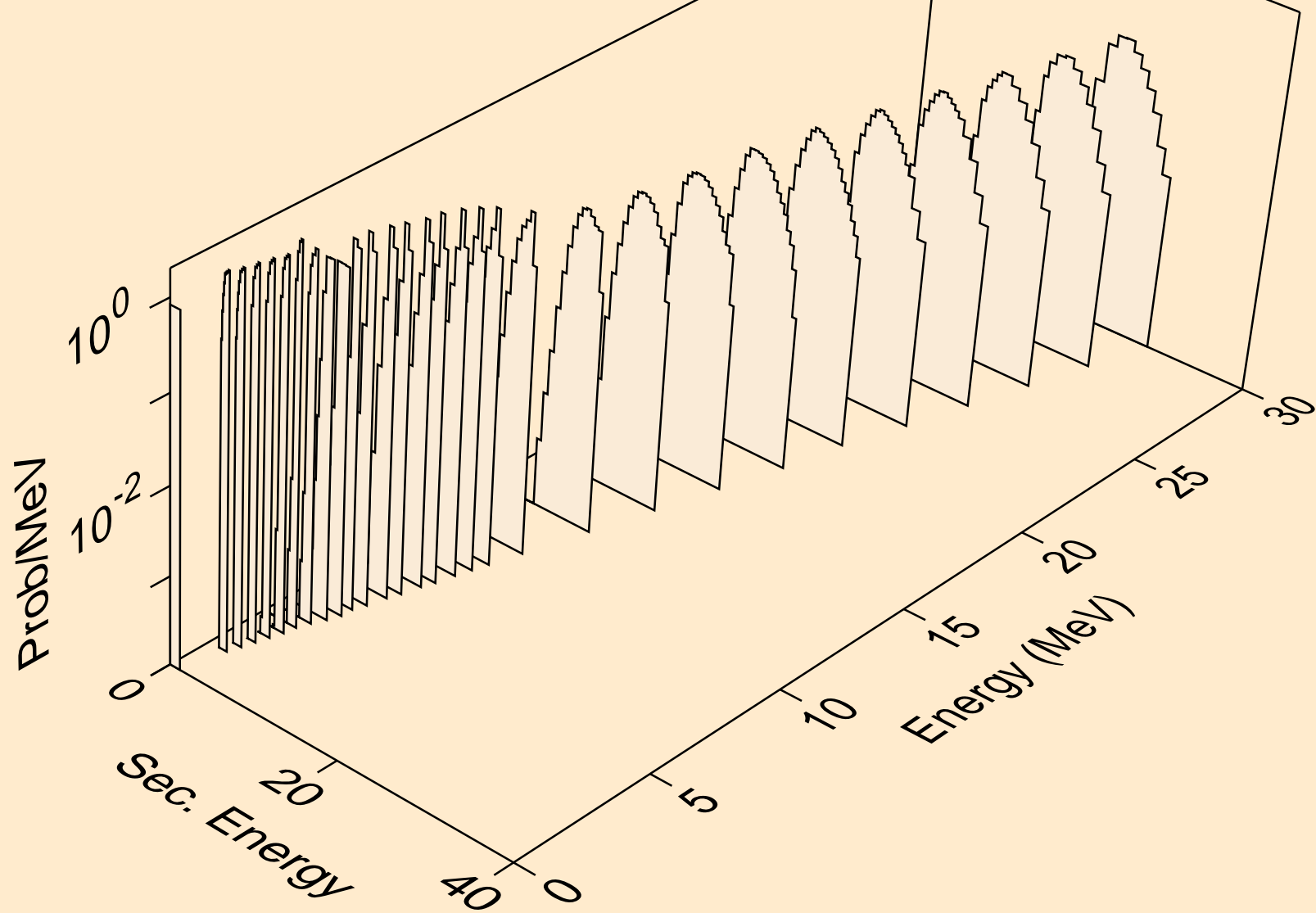

KR082 NEUTRON ACER TENDL-2024 LIBRARY; T=0.K
alphas from (n,2a)

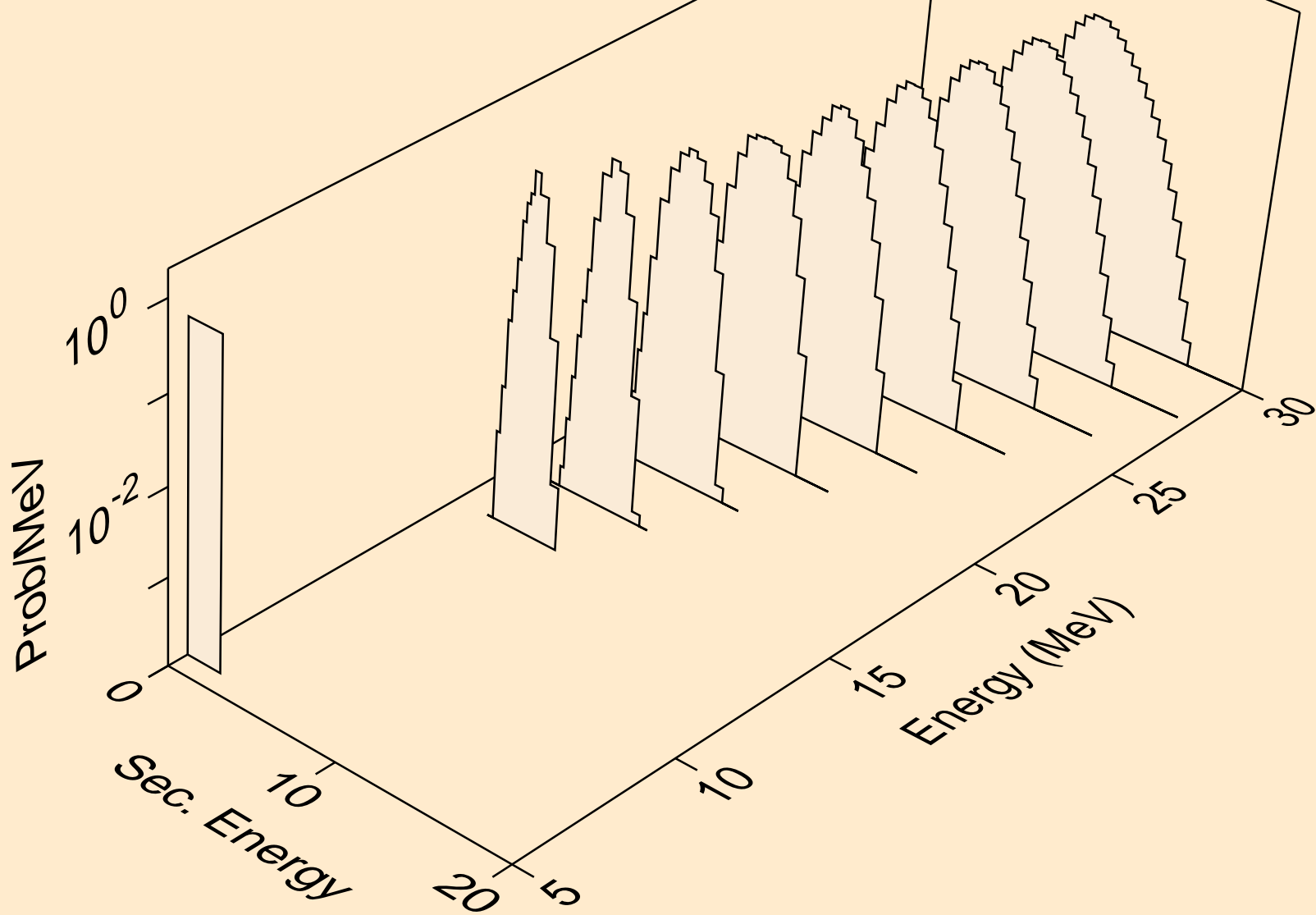

KR082 NEUTRON ACER TENDL-2024 LIBRARY; T=0.K
alphas from (n,pa)

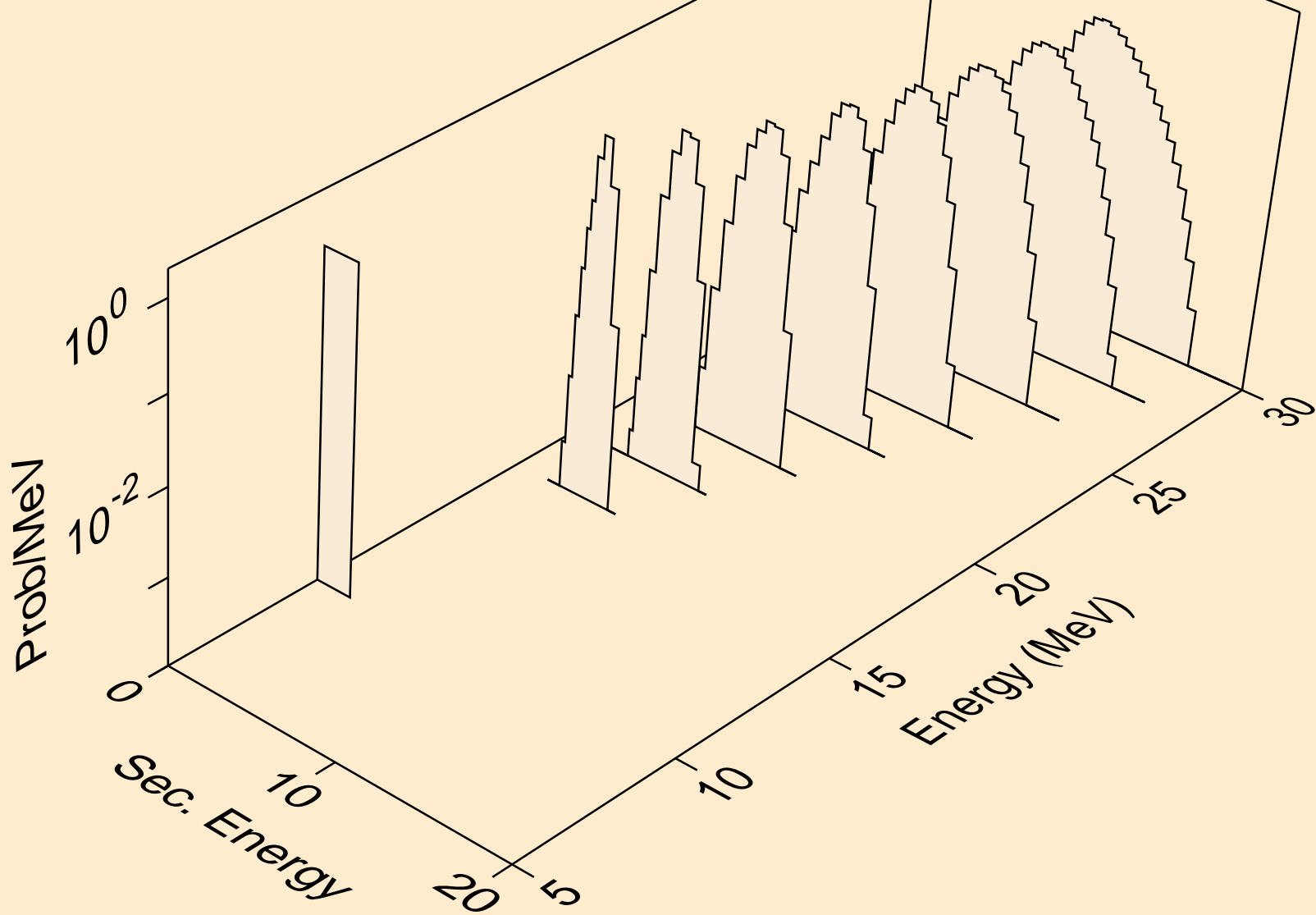

KR082 NEUTRON ACER TENDL-2024 LIBRARY; T=0.K
alphas from (n,da)

