

LA132 NEUTRON ACER TENDL-2024 LIBRARY; T=0.K
Principal cross sections

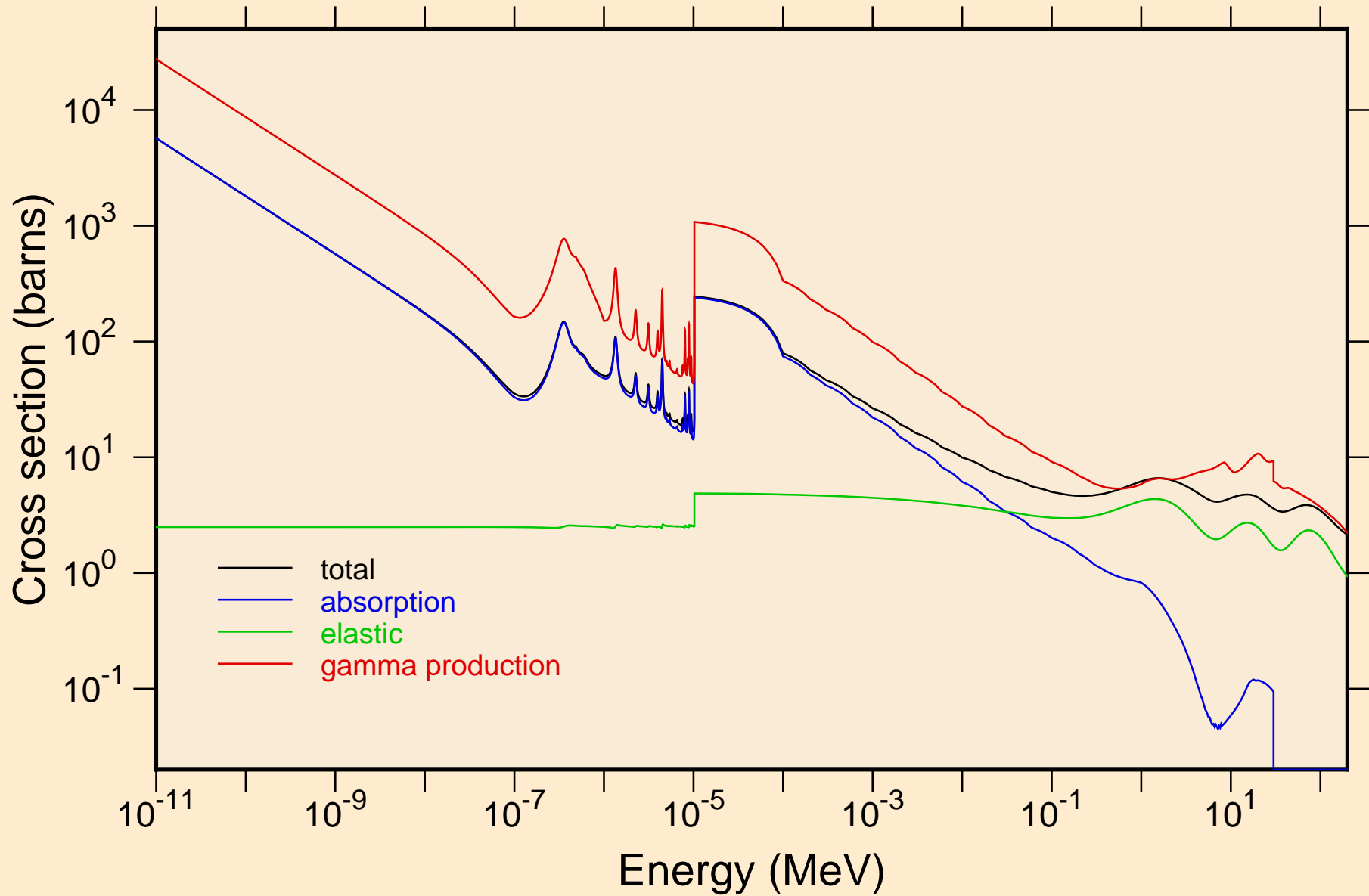

LA132 NEUTRON ACER TENDL-2024 LIBRARY; T=0.K
resonance total cross section

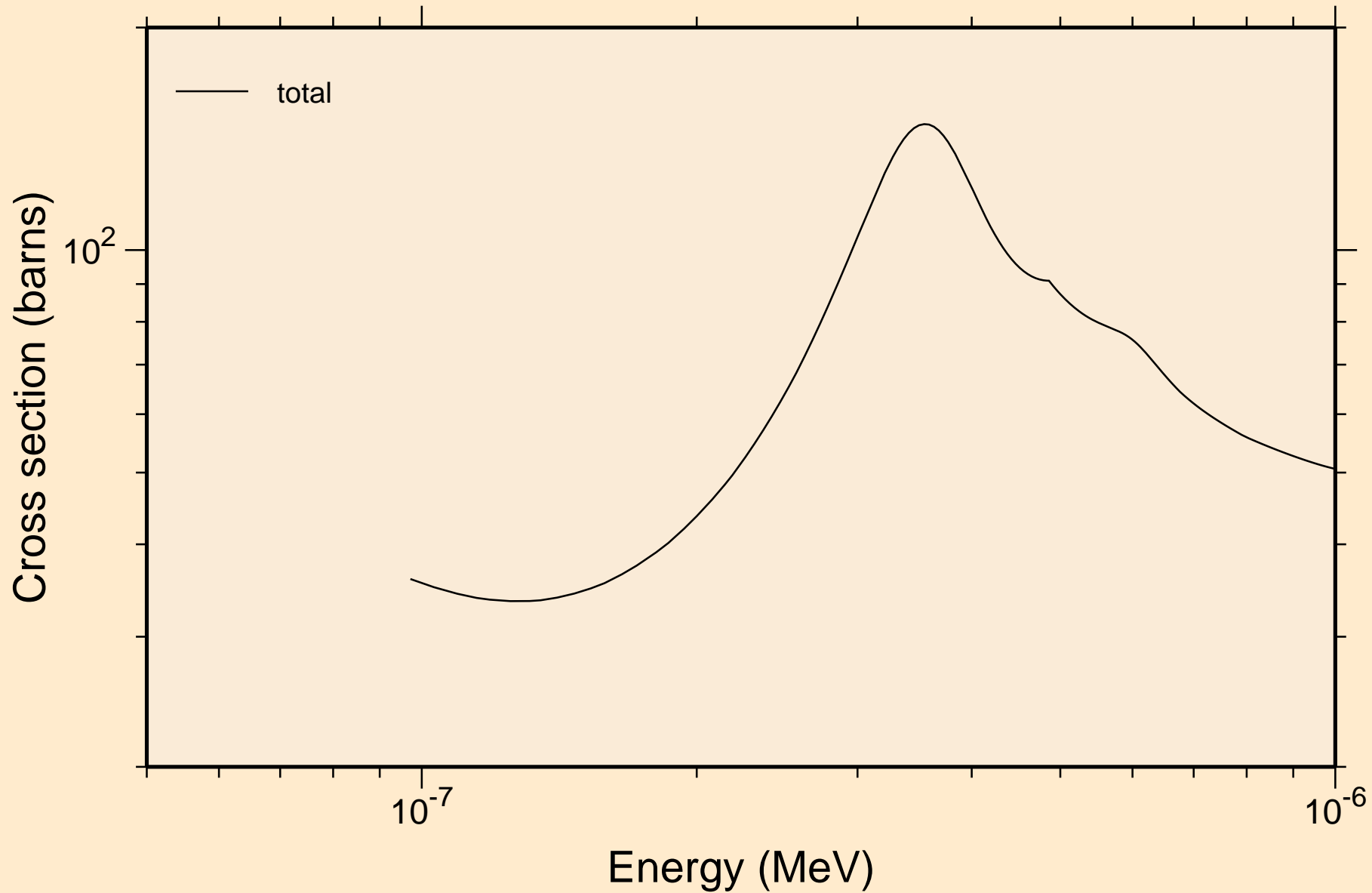

LA132 NEUTRON ACER TENDL-2024 LIBRARY; T=0.K
resonance total cross section

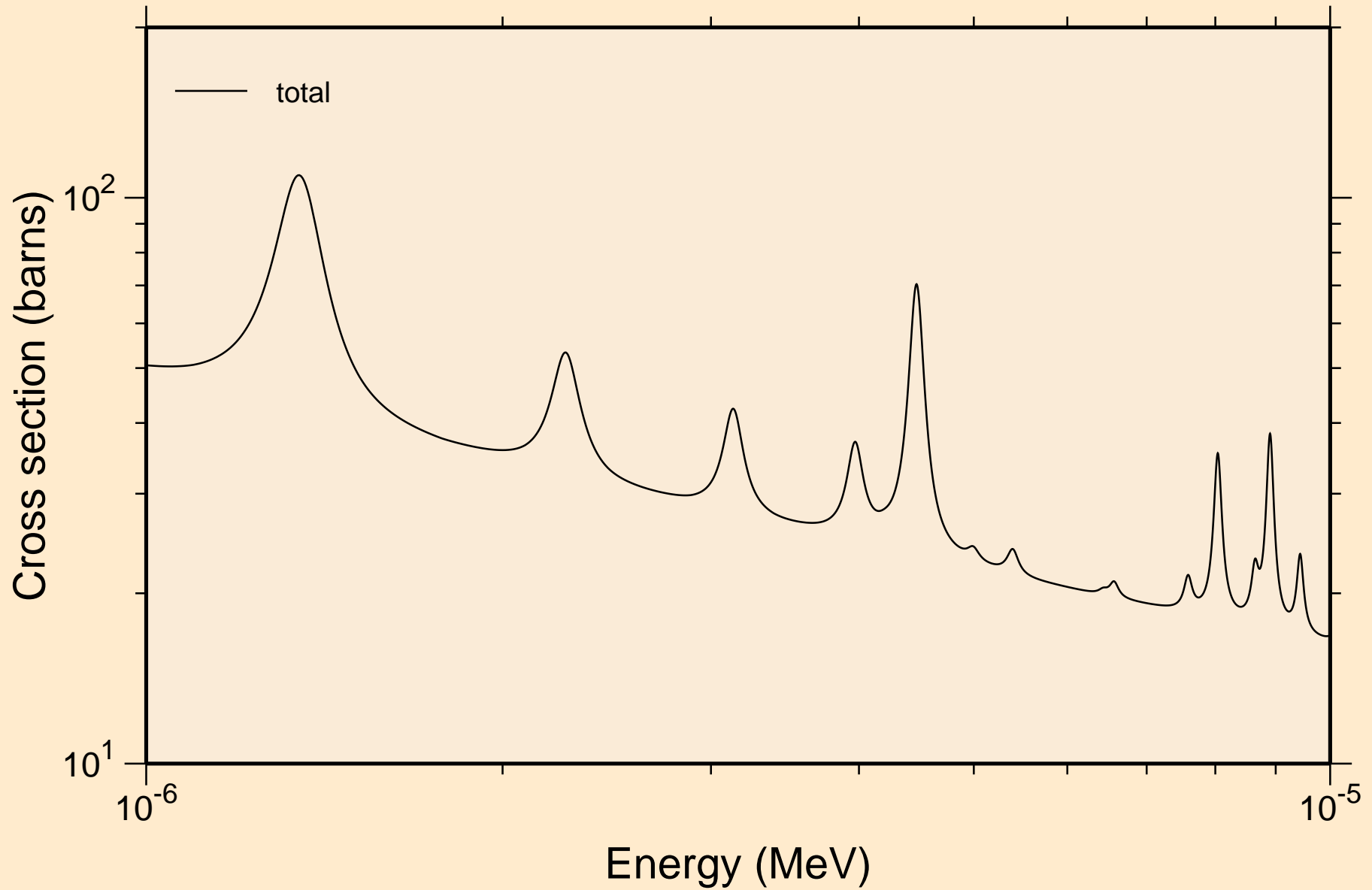

L̄A132 NEUTRON ACER TENDL-2024 LIBRARY; T=0.K
resonance total cross section

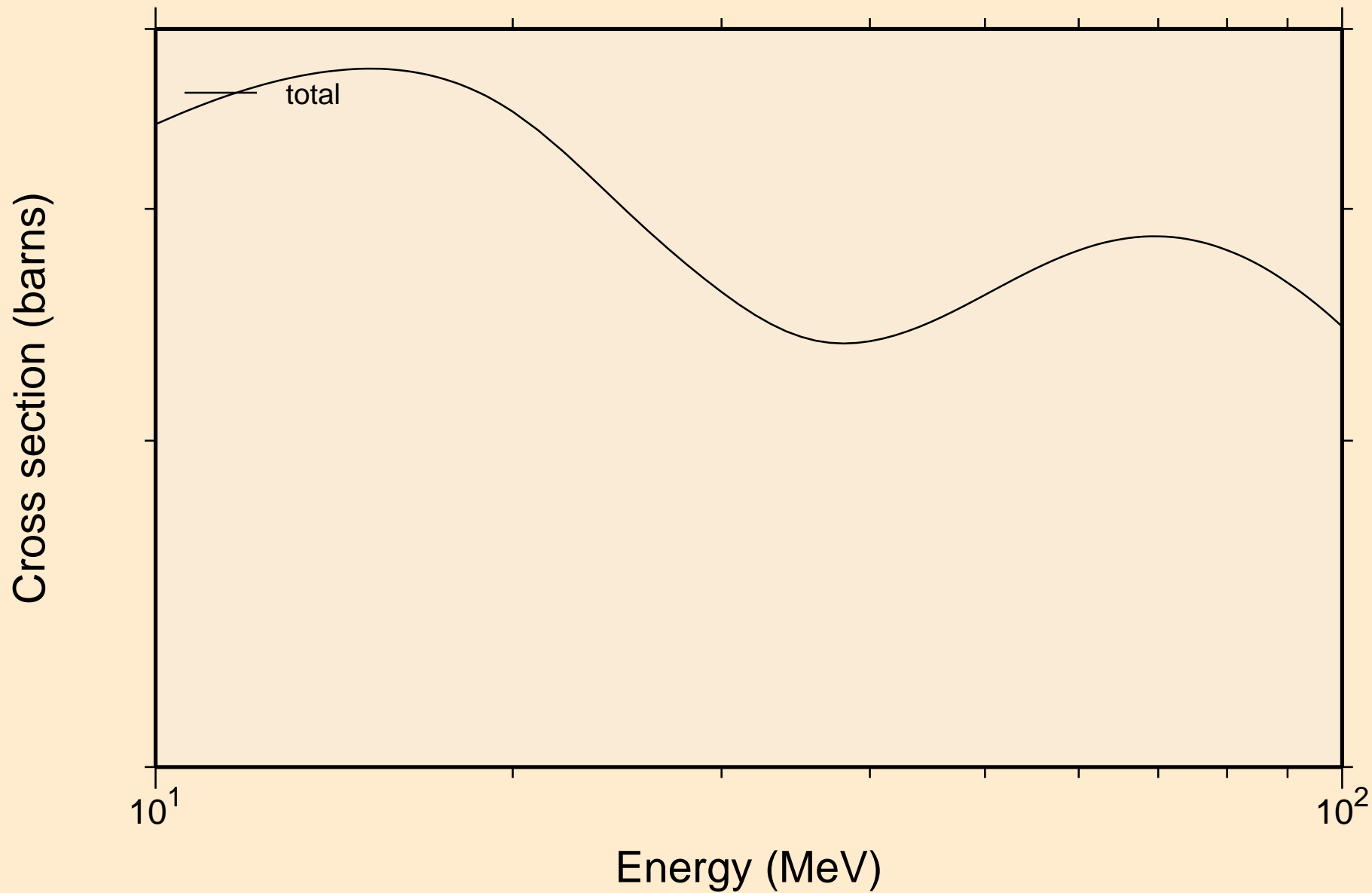

LA132 NEUTRON ACER TENDL-2024 LIBRARY; T=0.K
resonance absorption cross sections

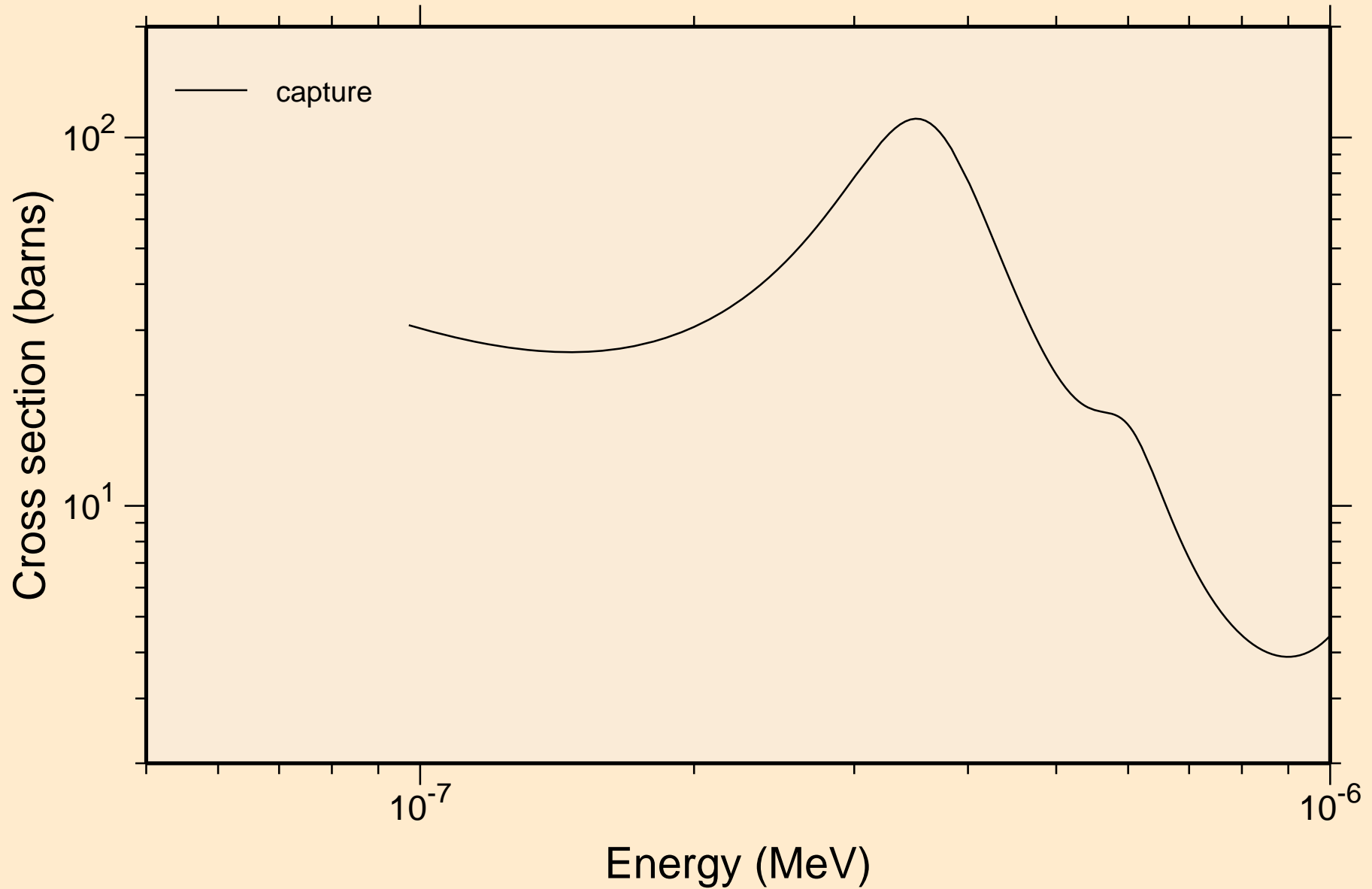

LA132 NEUTRON ACER TENDL-2024 LIBRARY; T=0.K
resonance absorption cross sections

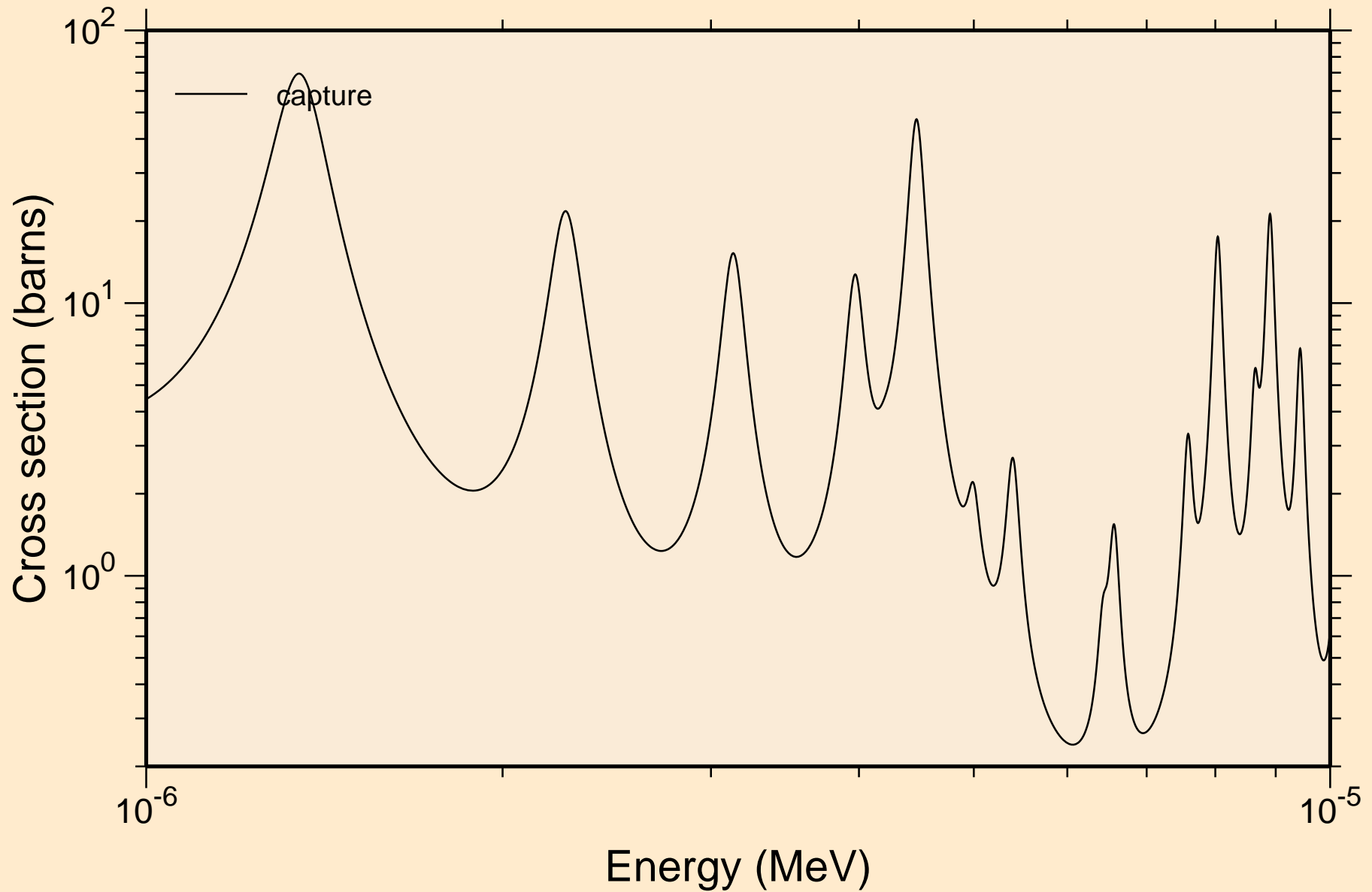

LA132 NEUTRON ACER TENDL-2024 LIBRARY; T=0.K
resonance absorption cross sections

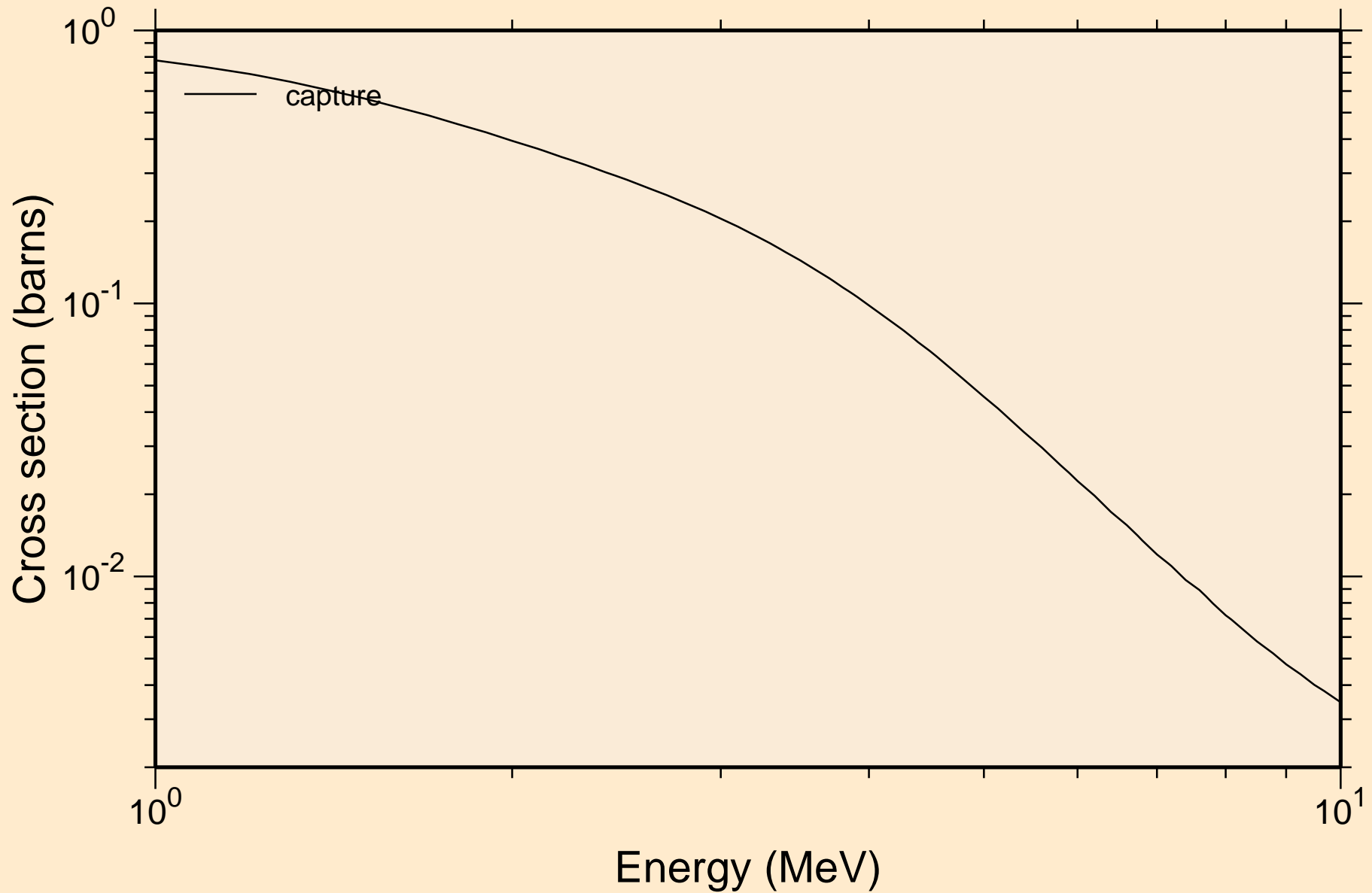

LA132 NEUTRON ACER TENDL-2024 LIBRARY; T=0.K

Heating

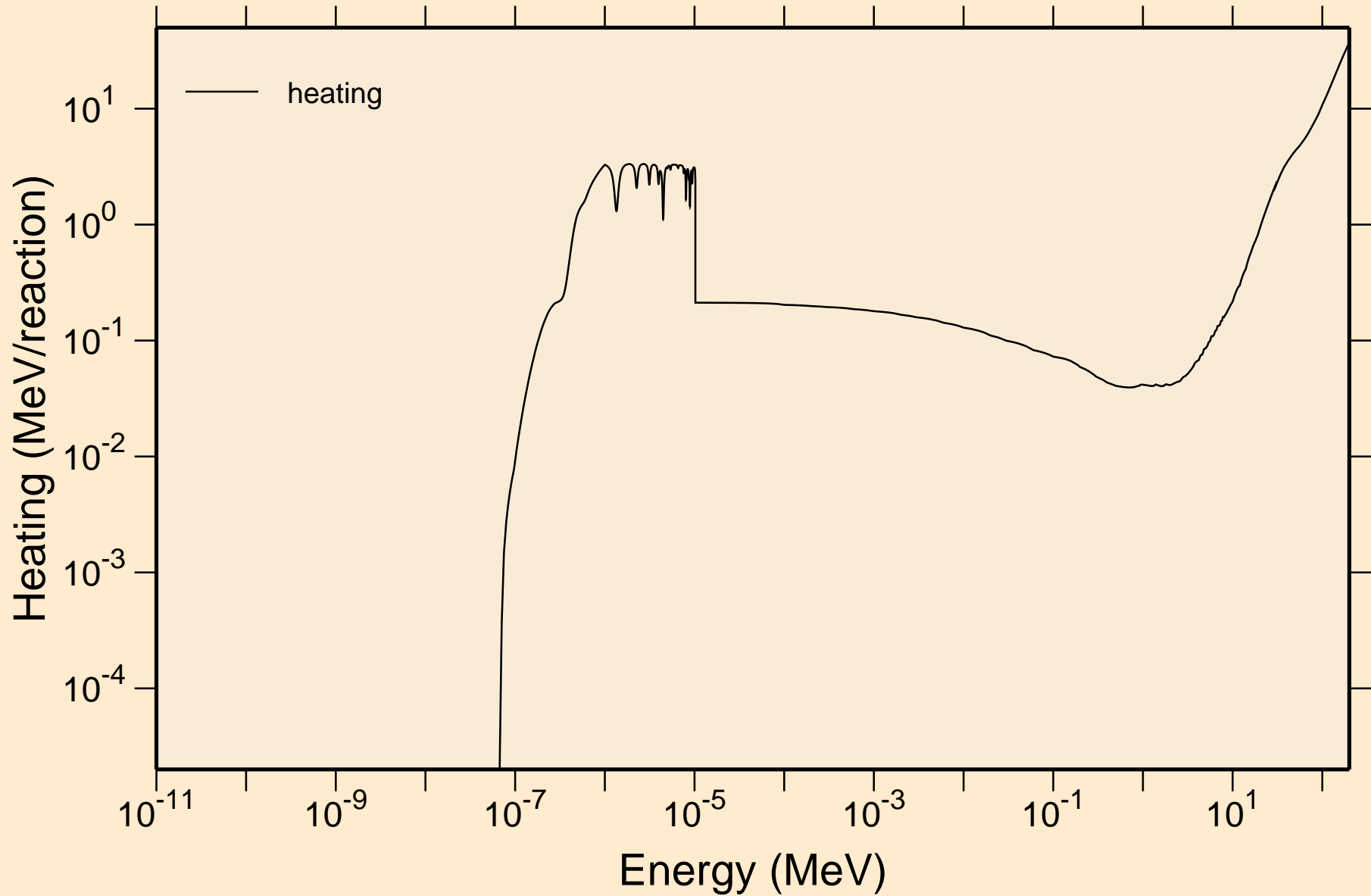

LA132 NEUTRON ACER TENDL-2024 LIBRARY; T=0.K
Damage

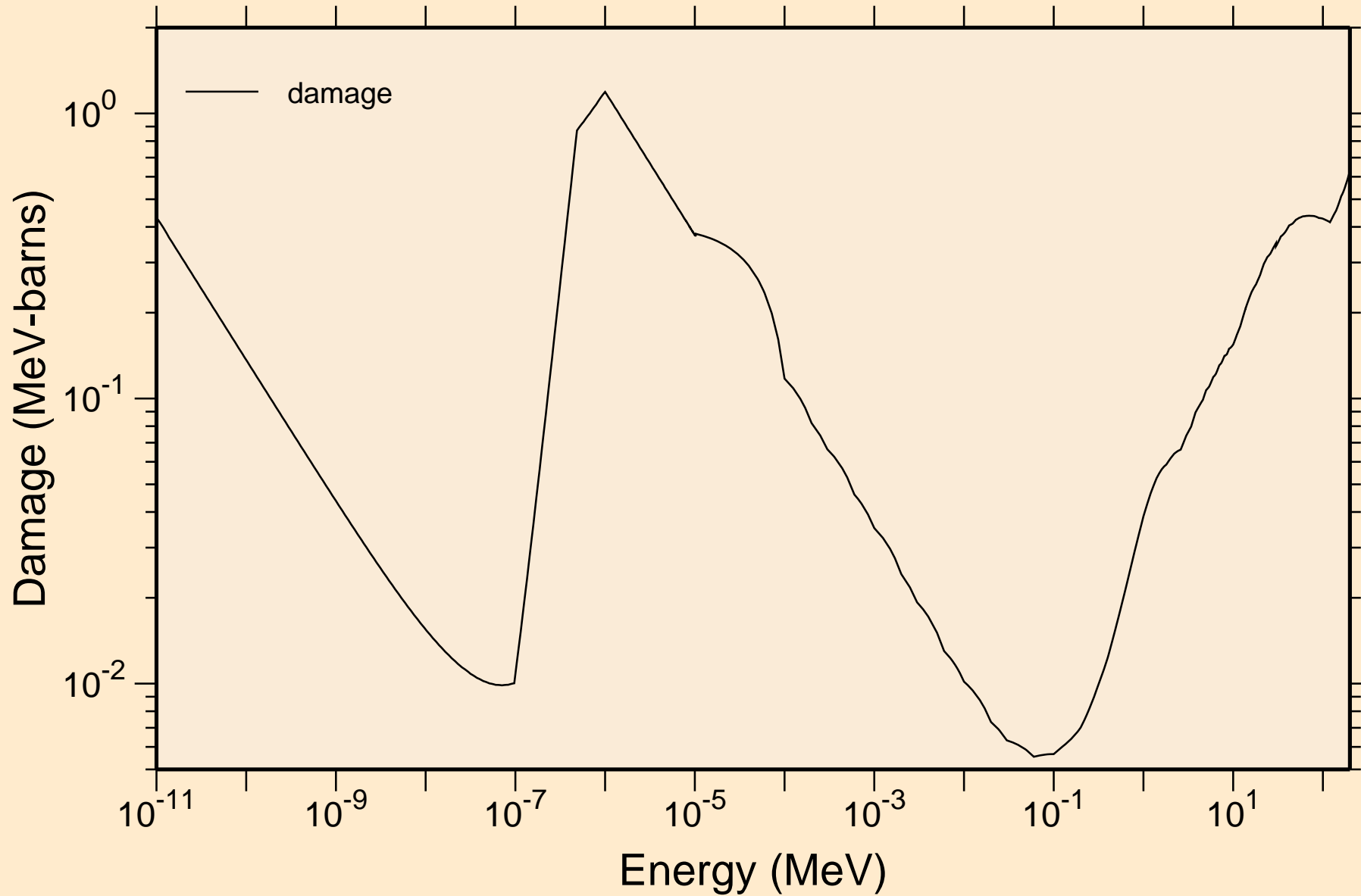

LA132 NEUTRON ACER TENDL-2024 LIBRARY; T=0.K
Non-threshold reactions

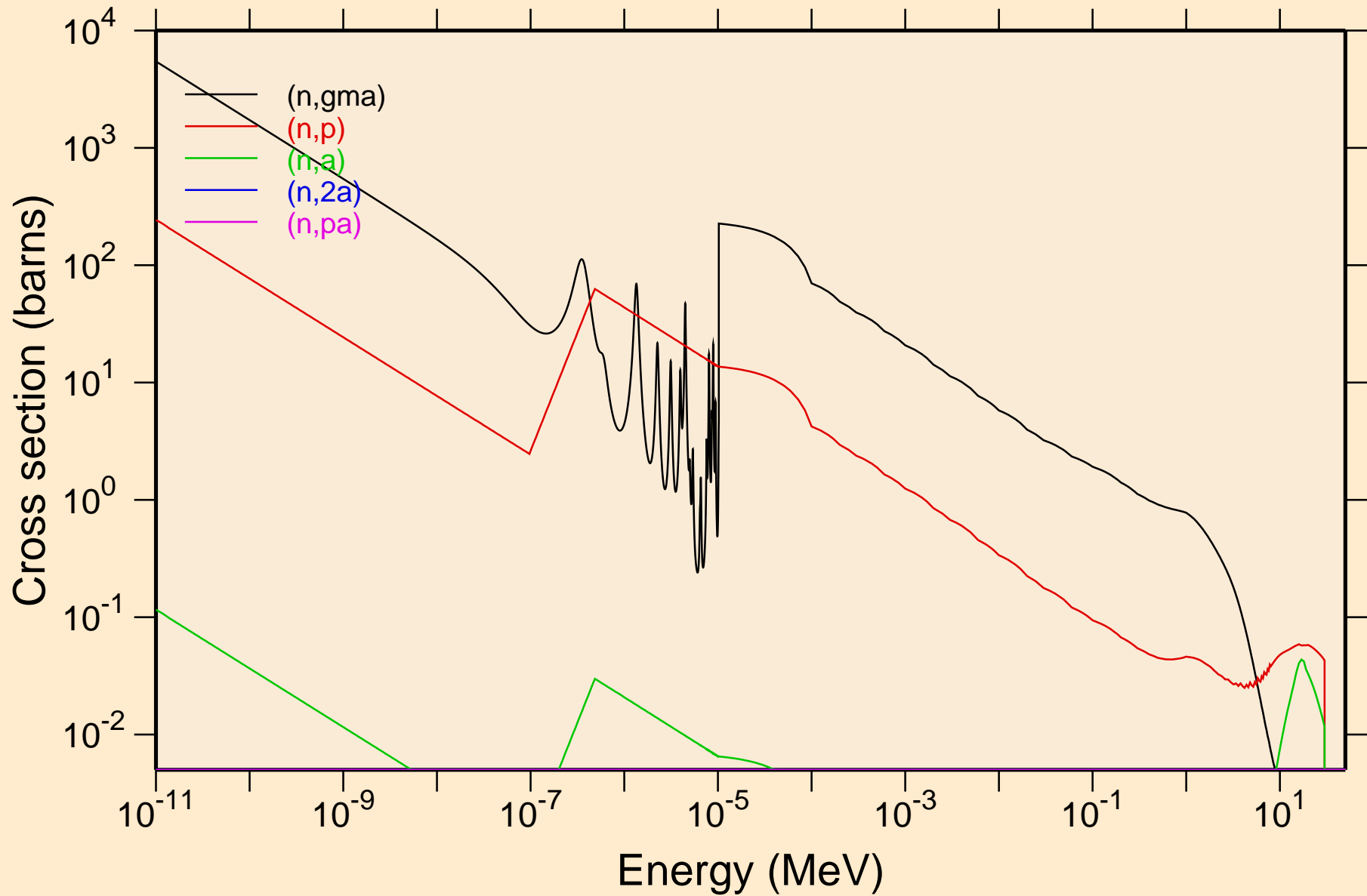

LA132 NEUTRON ACER TENDL-2024 LIBRARY; T=0.K
Non-threshold reactions

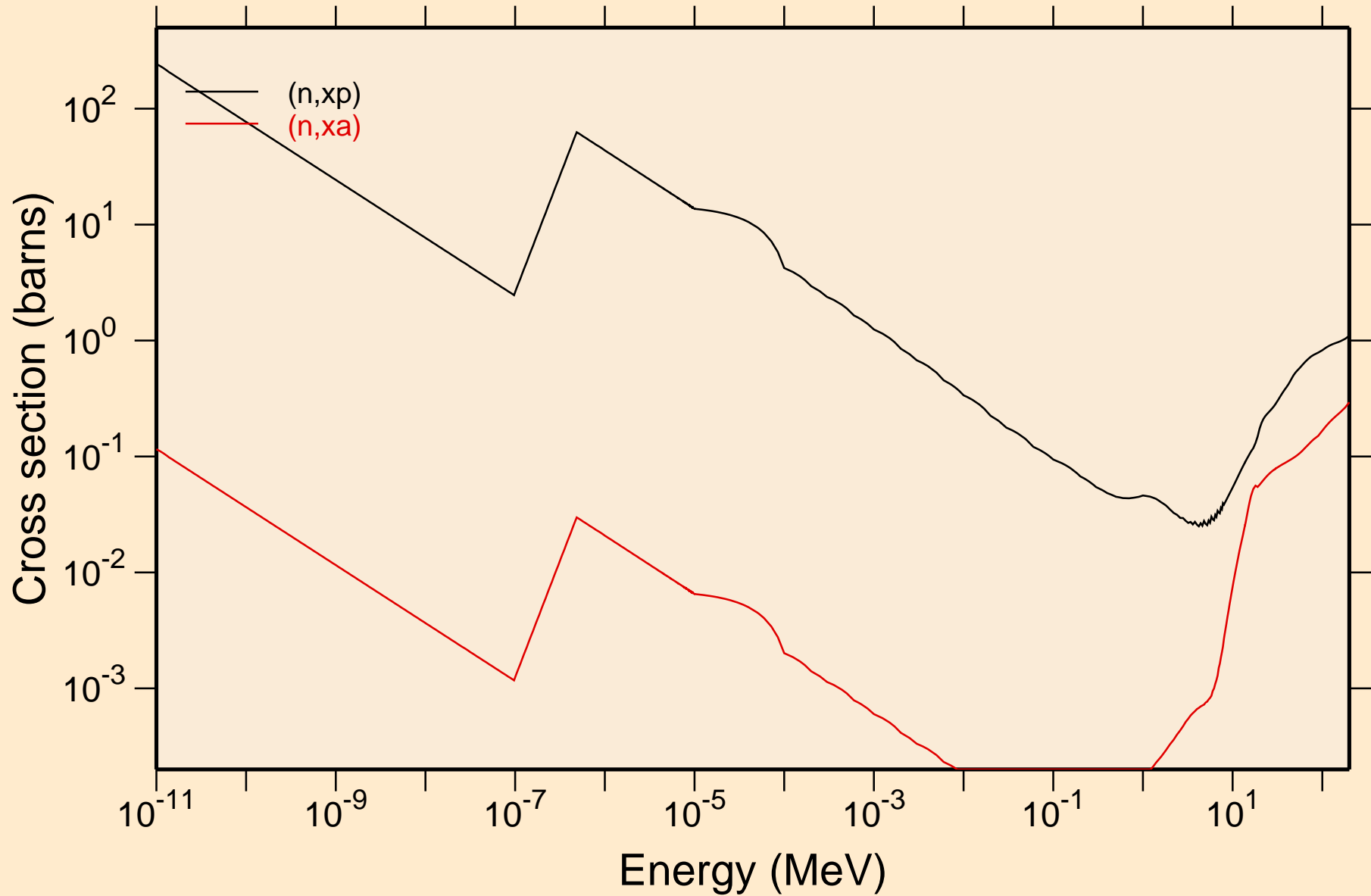

LA132 NEUTRON ACER TENDL-2024 LIBRARY; T=0.K

Principal cross sections

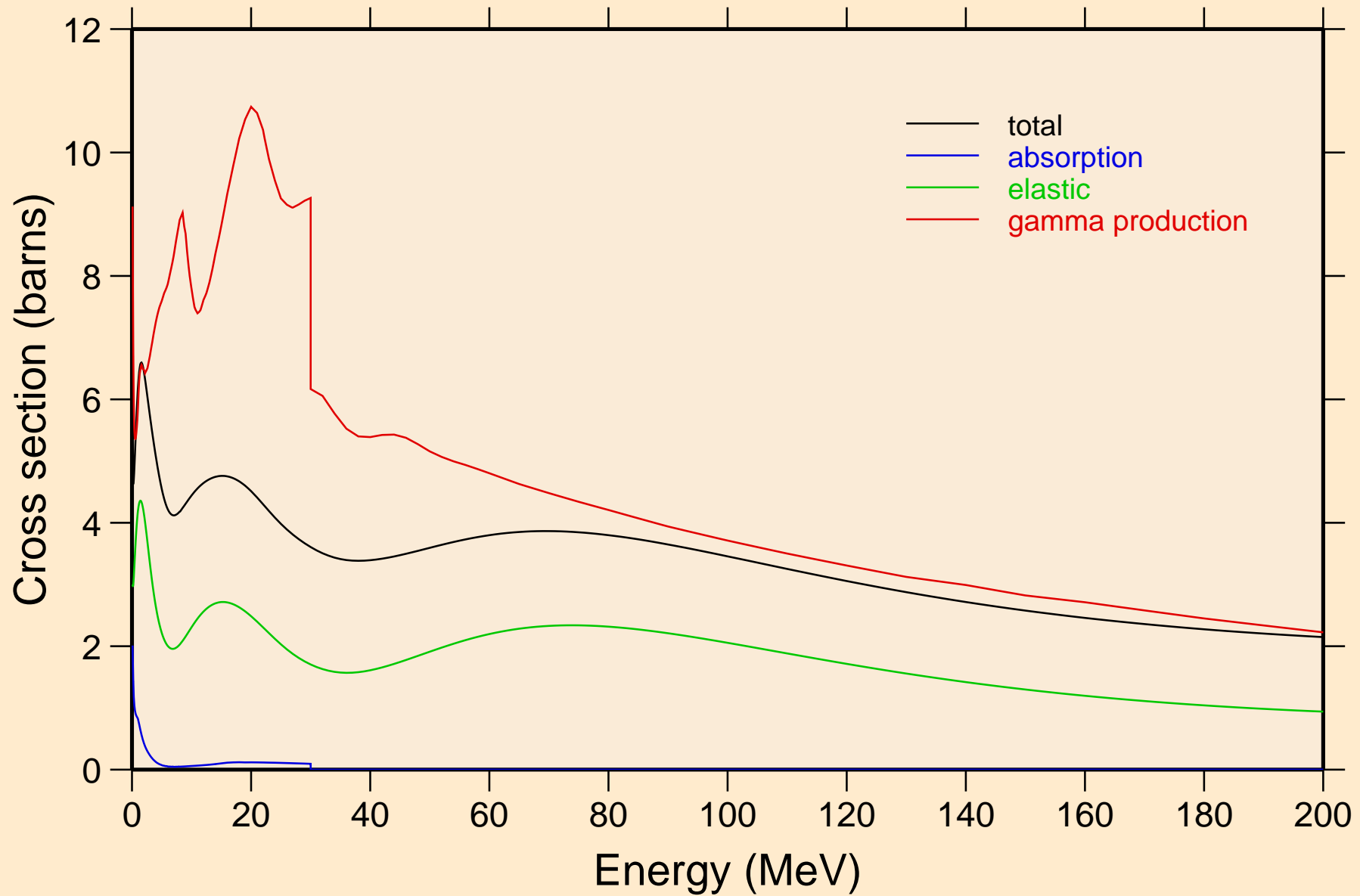

LA132 NEUTRON ACER TENDL-2024 LIBRARY; T=0.K

Heating

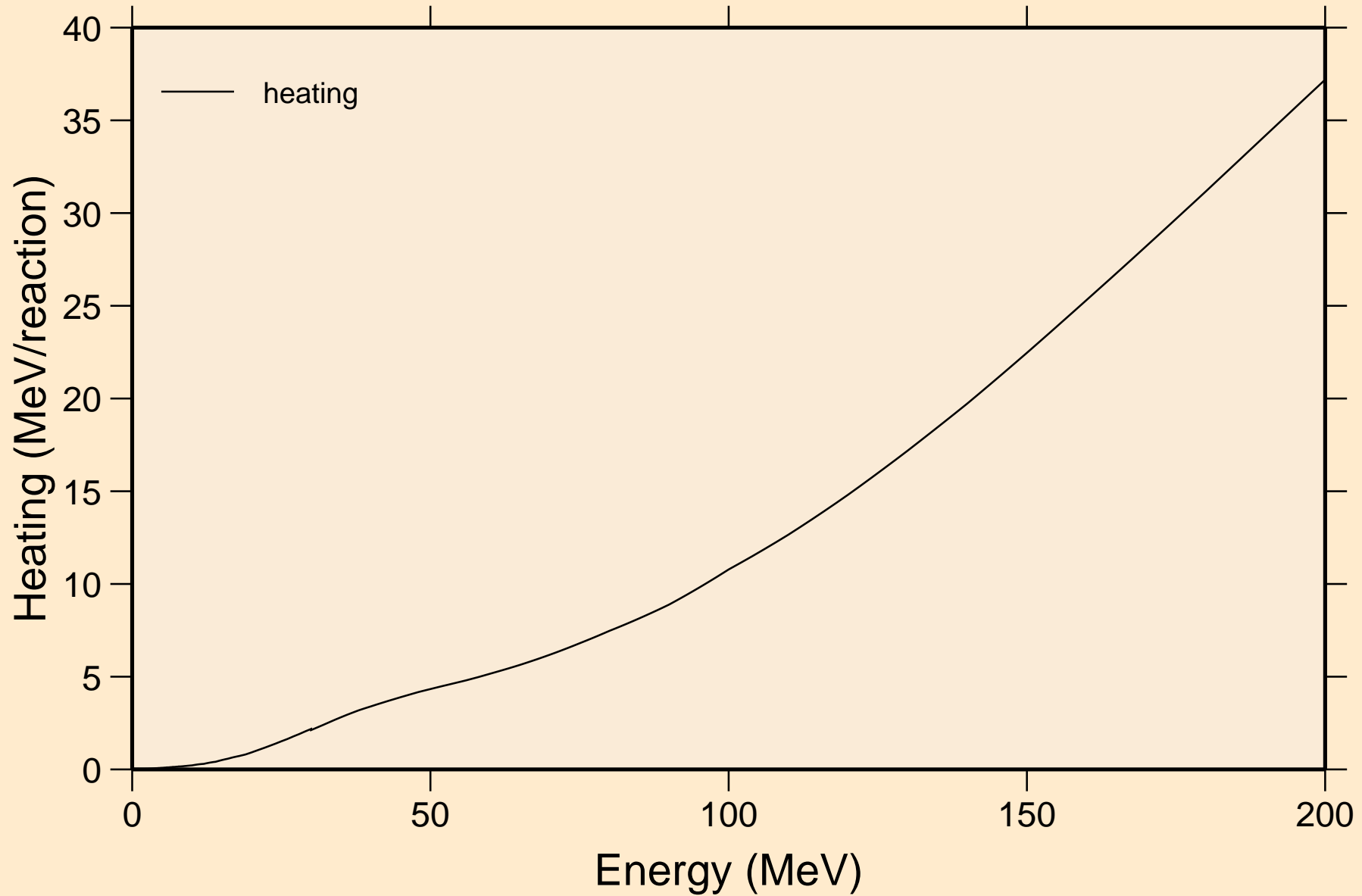

LA132 NEUTRON ACER TENDL-2024 LIBRARY; T=0.K

Damage

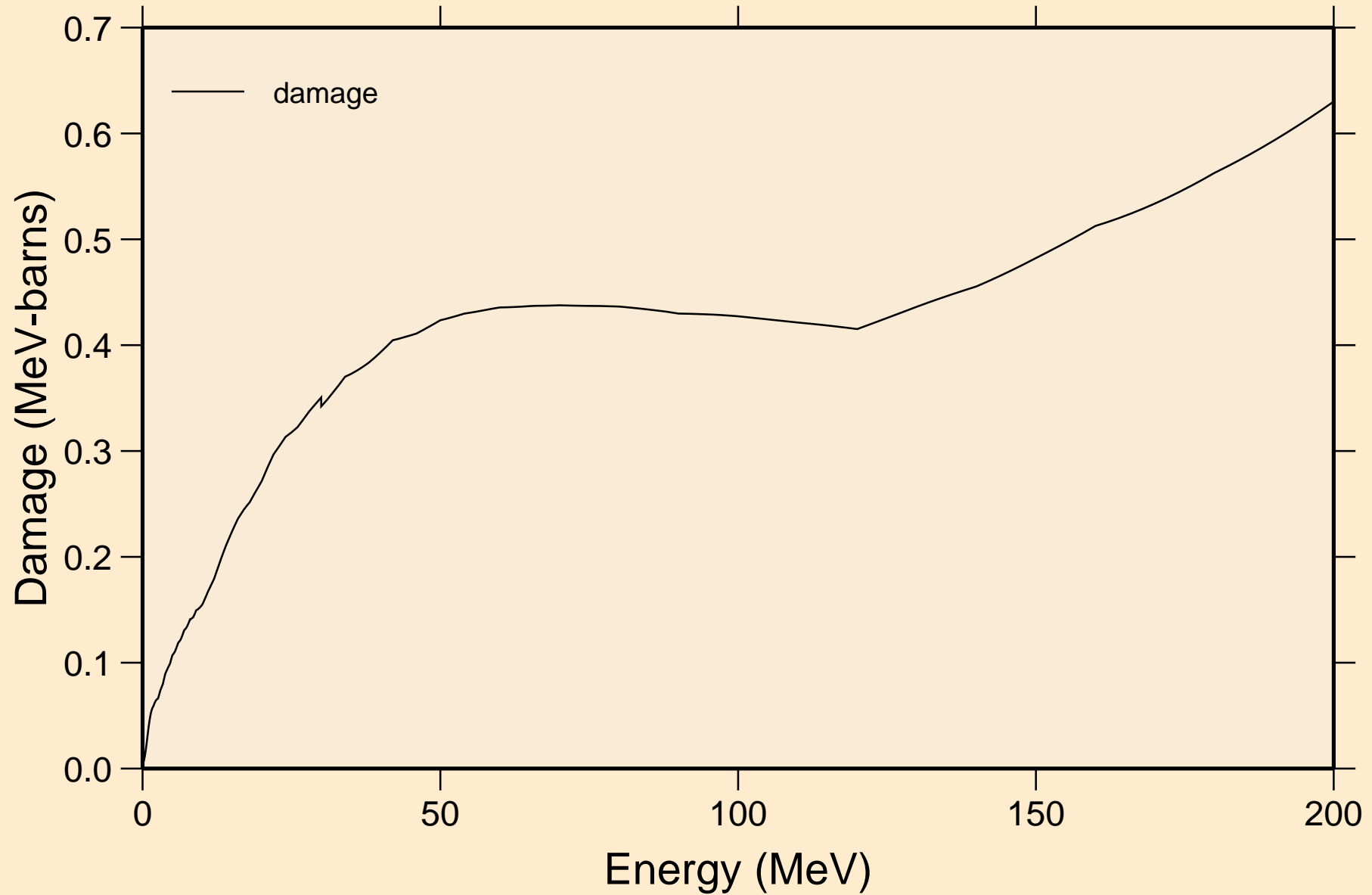

LA132 NEUTRON ACER TENDL-2024 LIBRARY; T=0.K
Non-threshold reactions

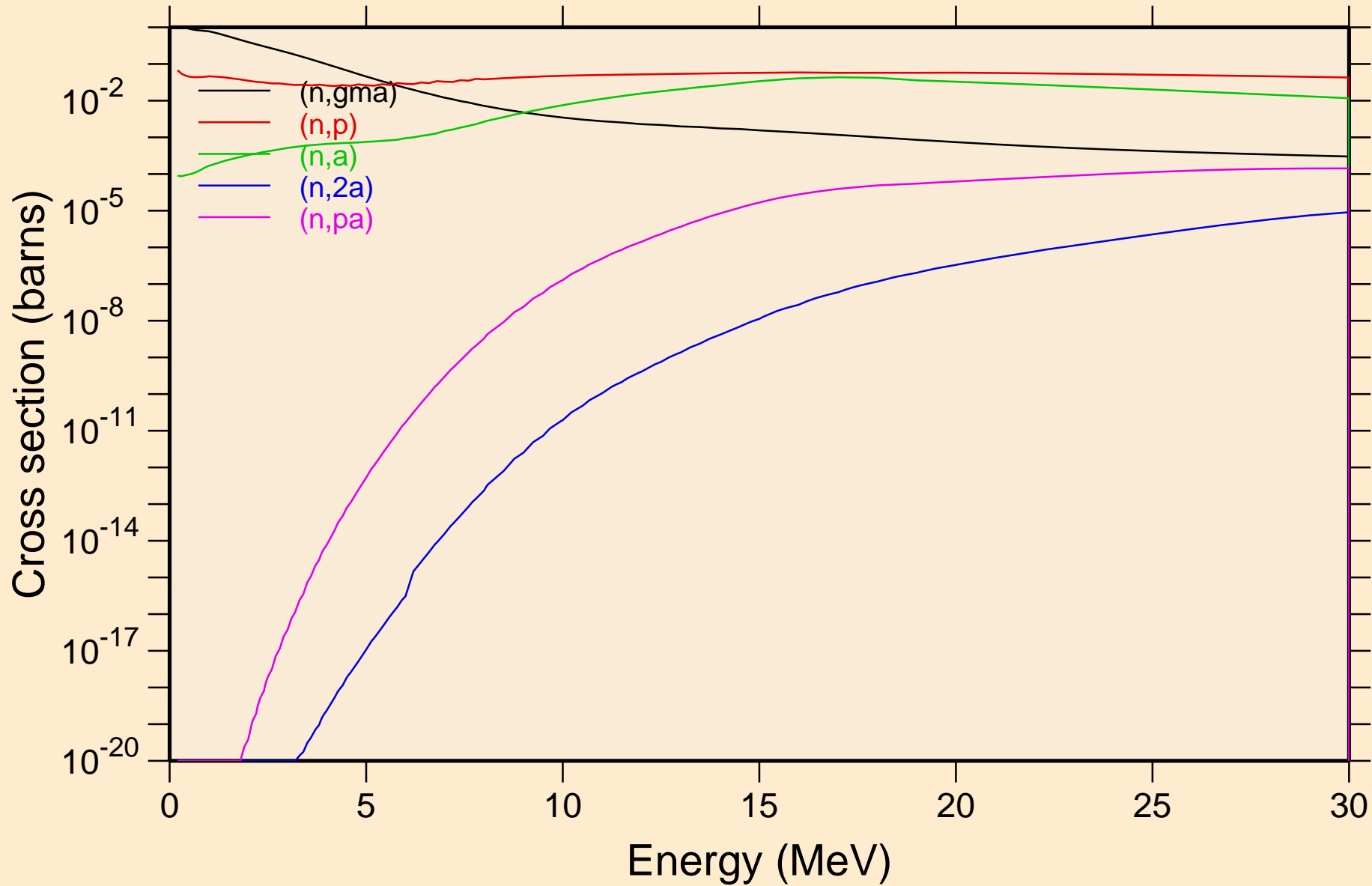

LA132 NEUTRON ACER TENDL-2024 LIBRARY; T=0.K
Non-threshold reactions

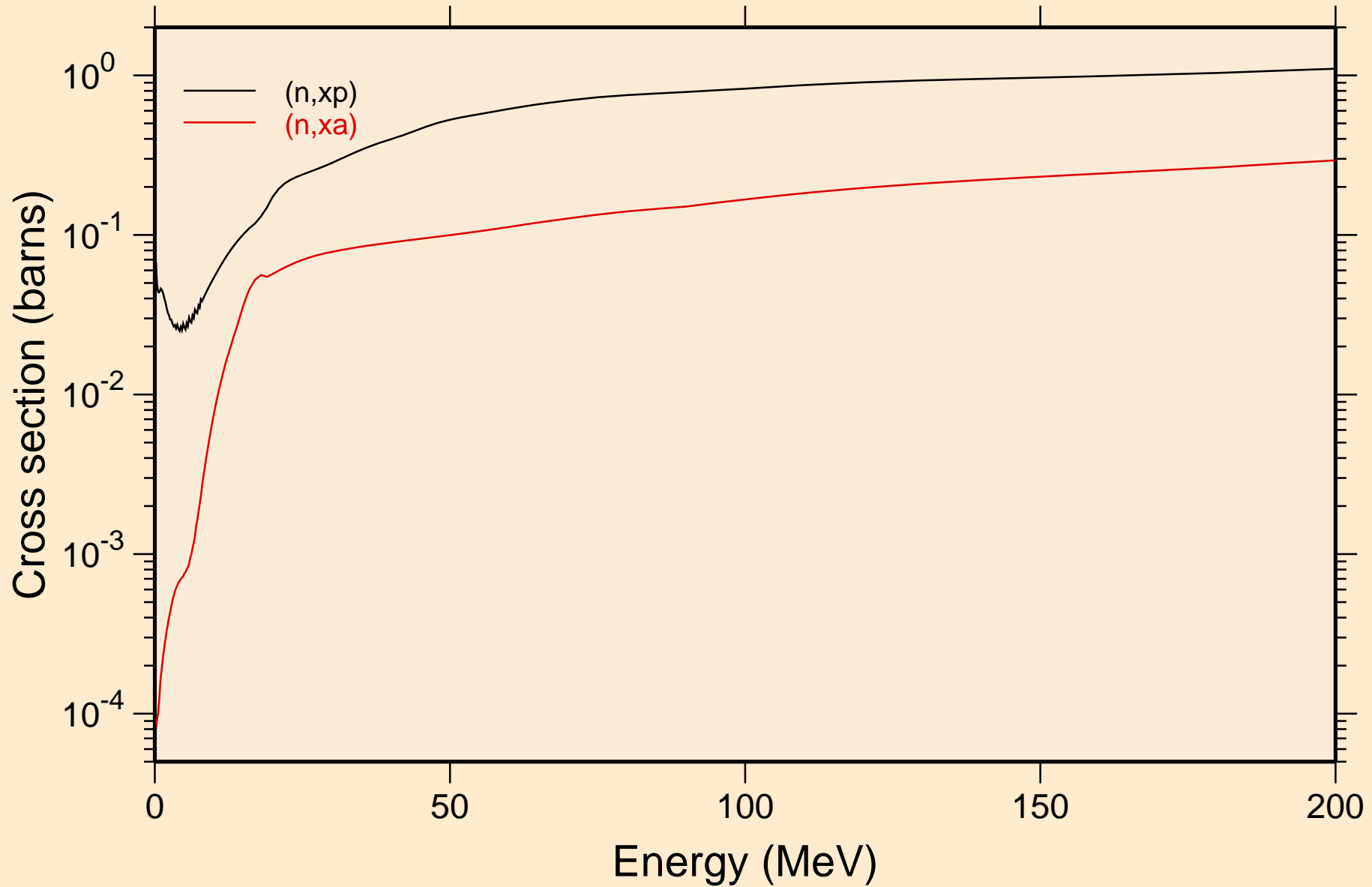

LA132 NEUTRON ACER TENDL-2024 LIBRARY; T=0.K
Inelastic levels

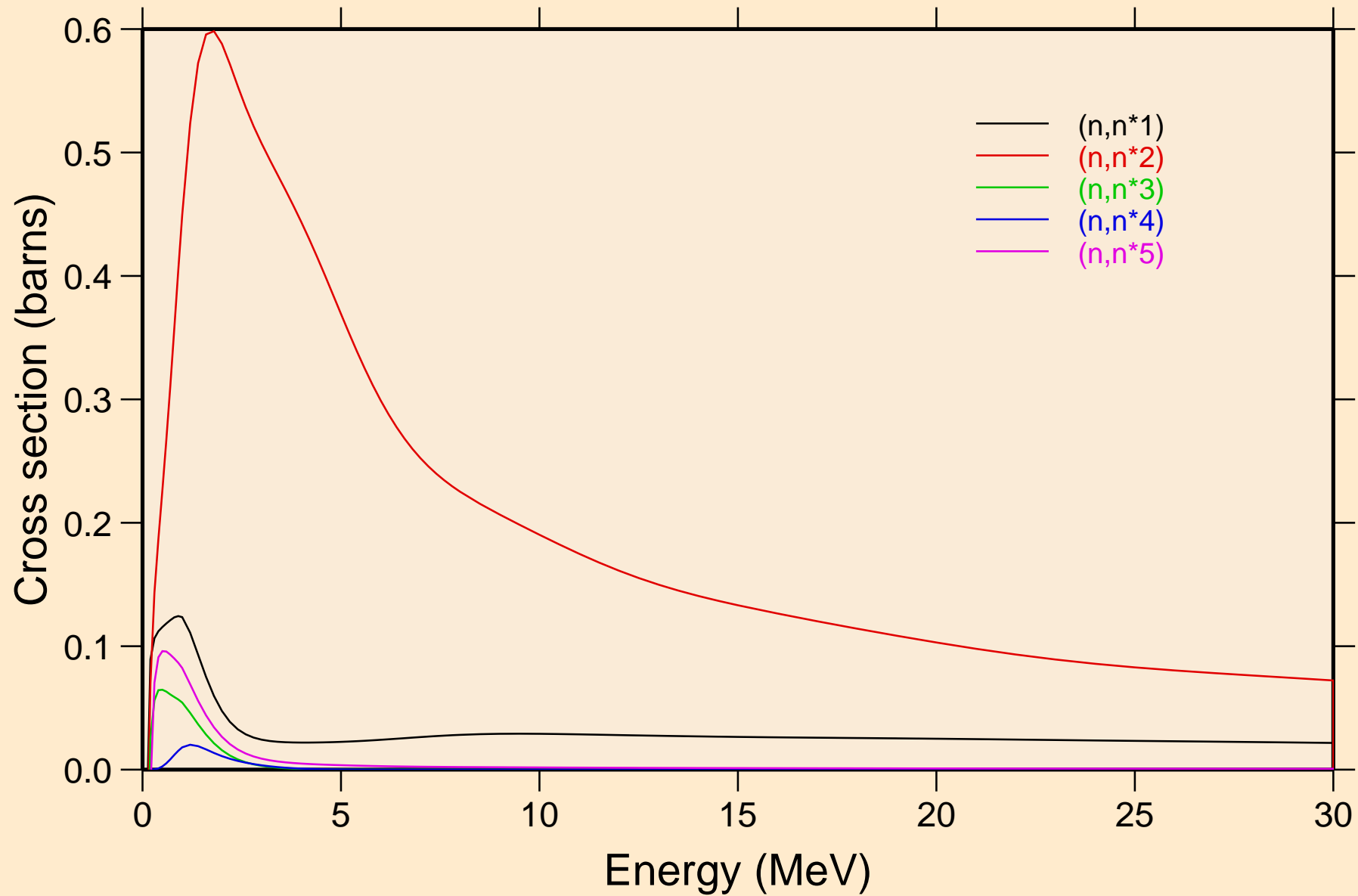

LA132 NEUTRON ACER TENDL-2024 LIBRARY; T=0.K
Inelastic levels

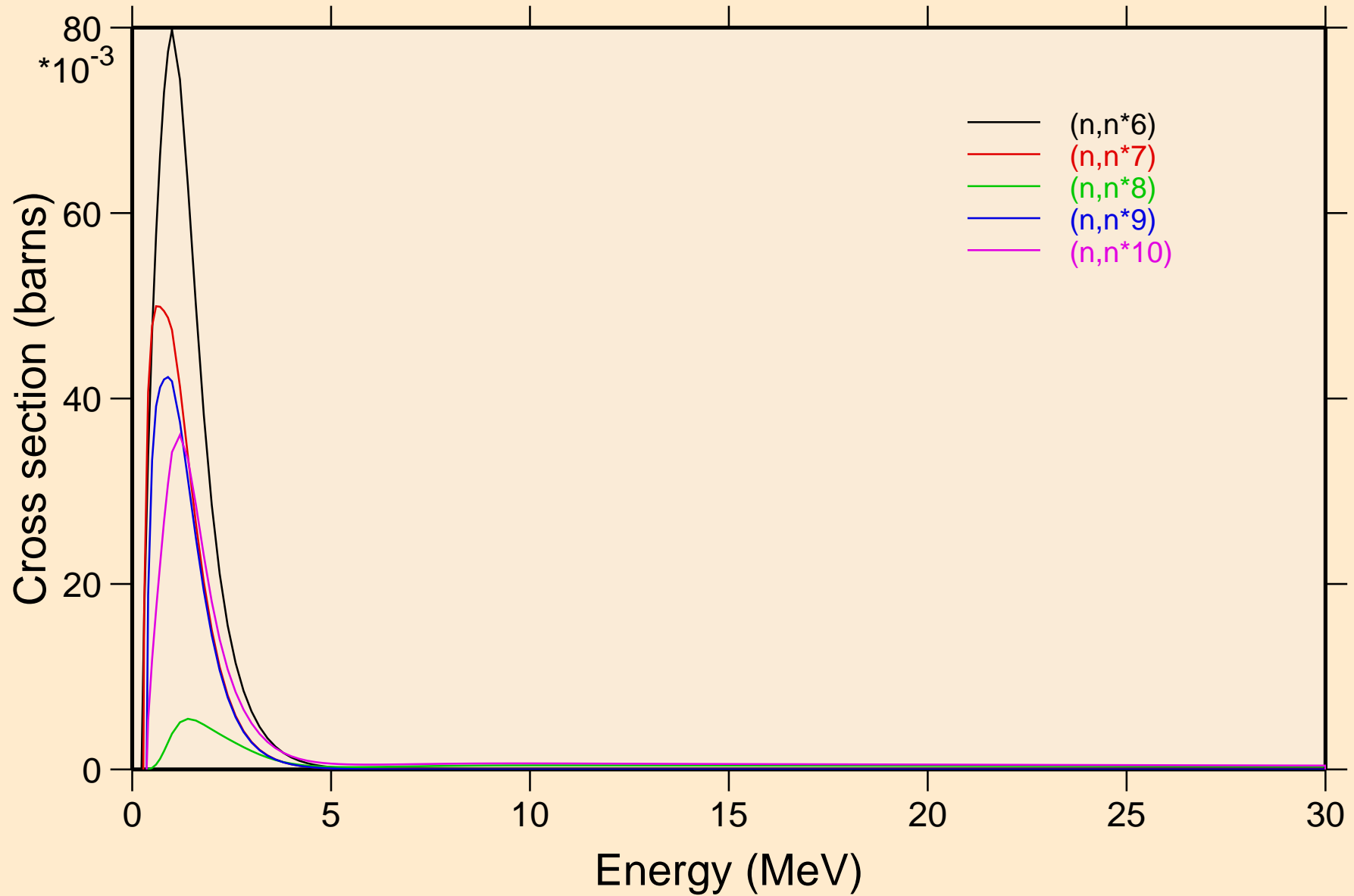

LA132 NEUTRON ACER TENDL-2024 LIBRARY; T=0.K
Inelastic levels

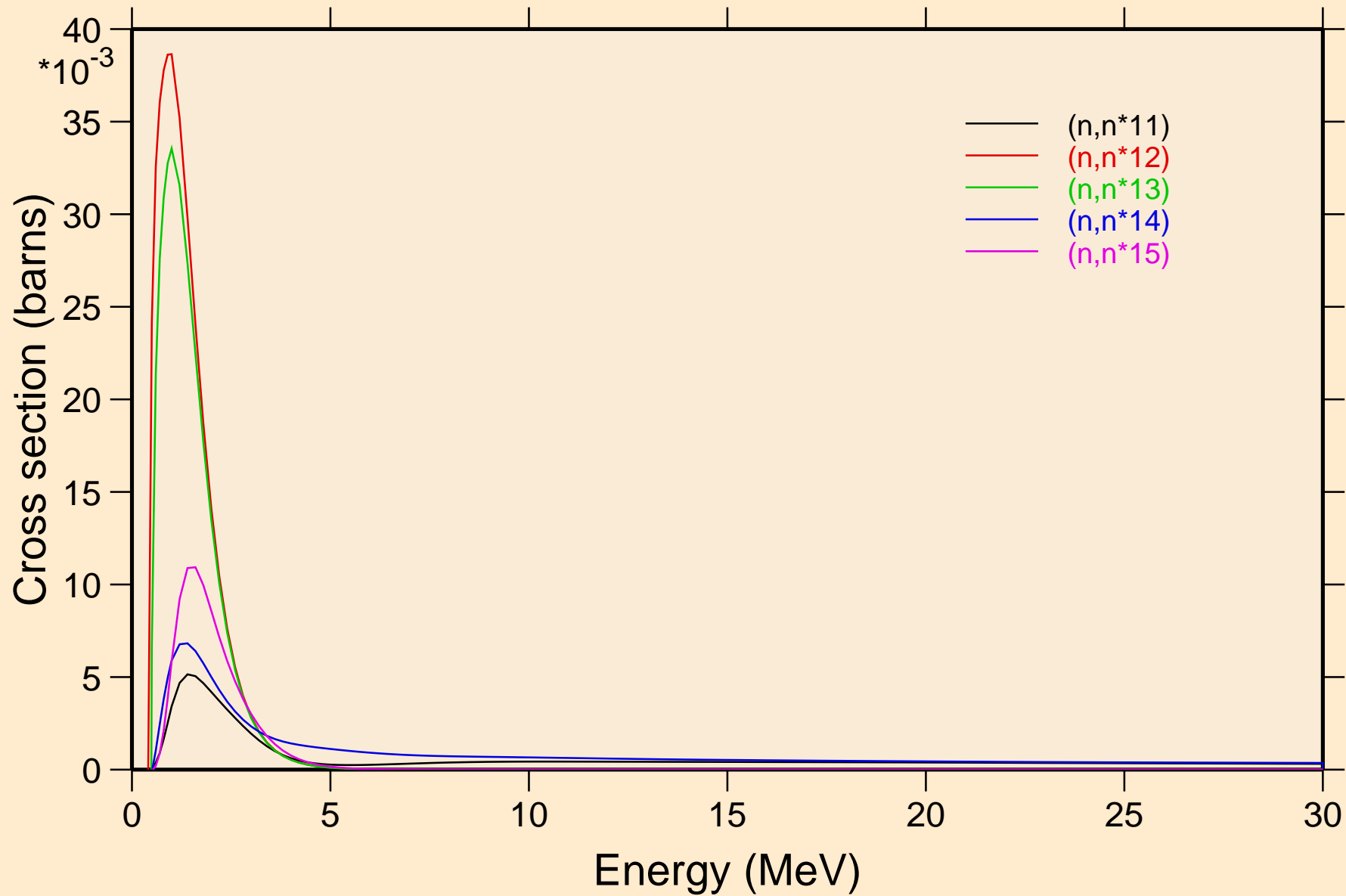

LA132 NEUTRON ACER TENDL-2024 LIBRARY; T=0.K
Inelastic levels

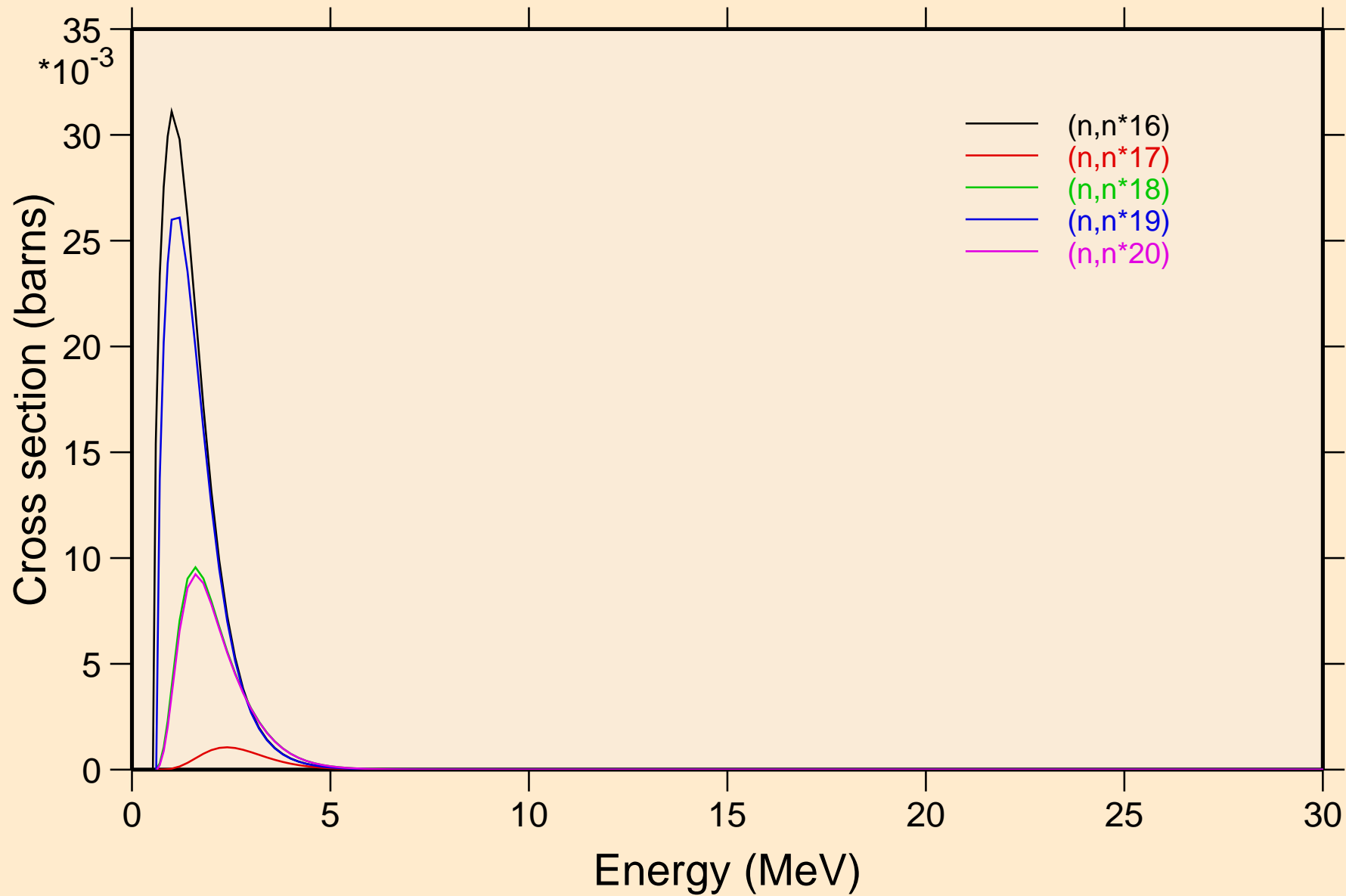

LA132 NEUTRON ACER TENDL-2024 LIBRARY; T=0.K
Inelastic levels

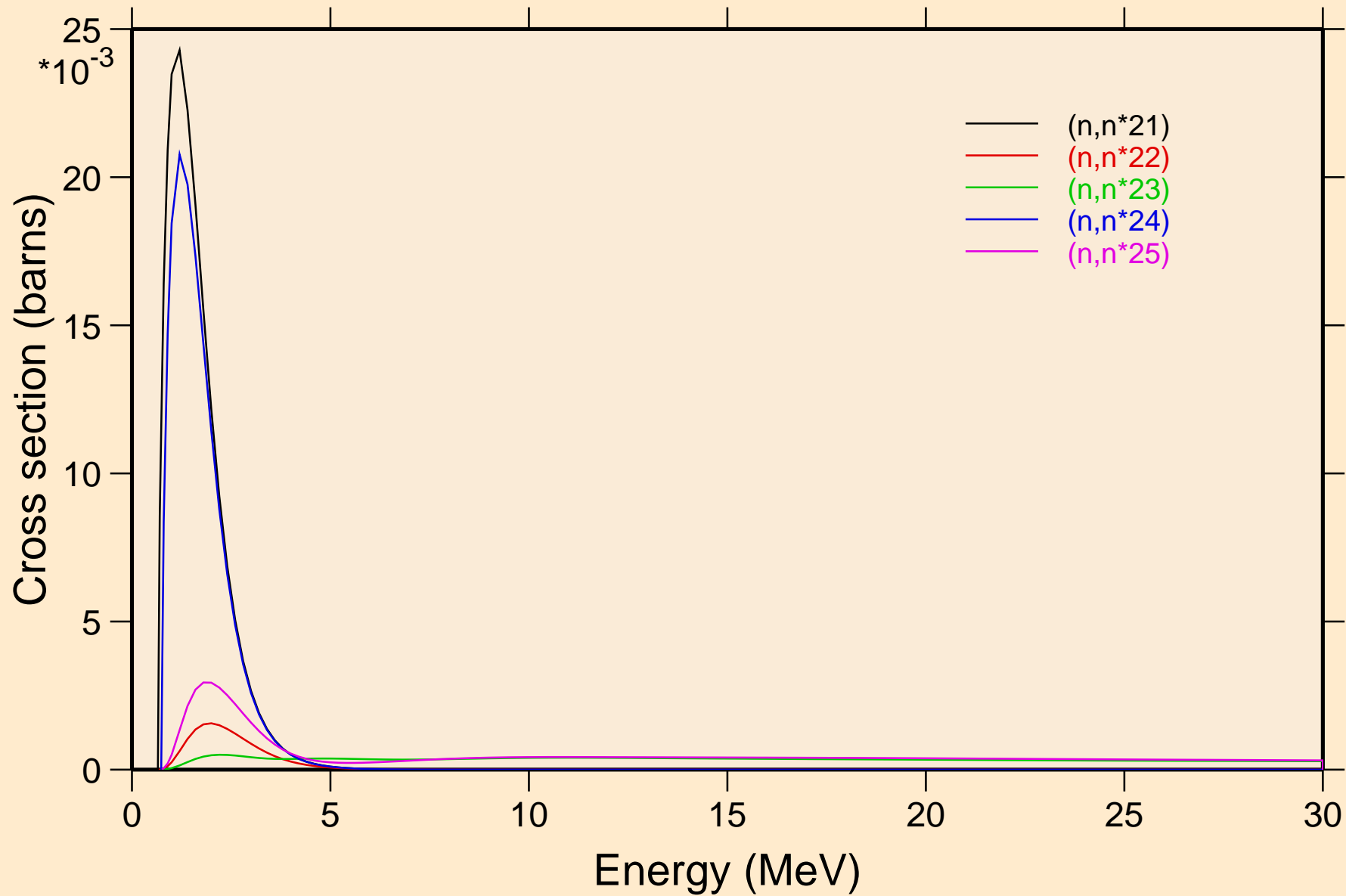

LA132 NEUTRON ACER TENDL-2024 LIBRARY; T=0.K
Inelastic levels

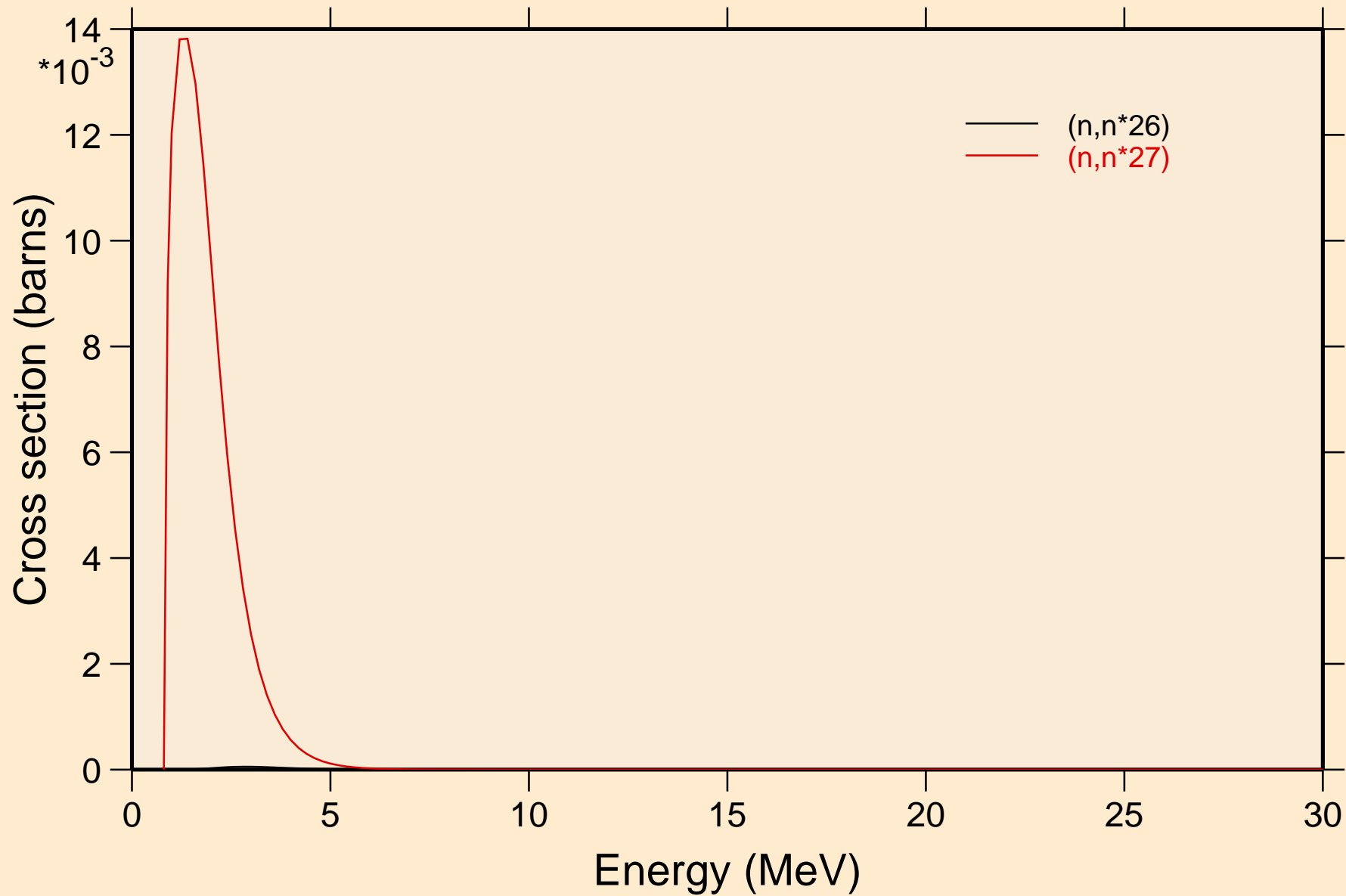

LA132 NEUTRON ACER TENDL-2024 LIBRARY; T=0.K
Threshold reactions

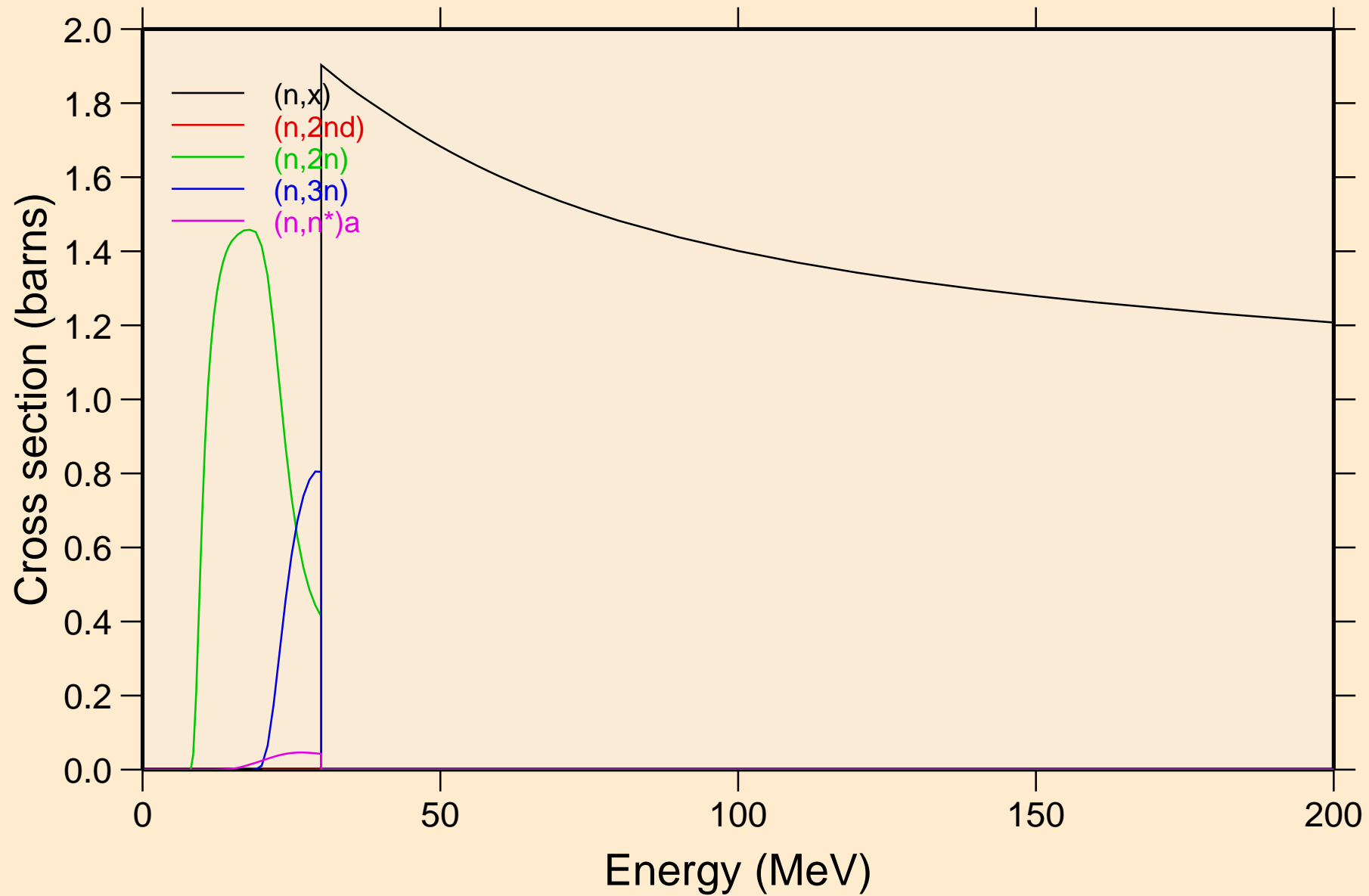

LA132 NEUTRON ACER TENDL-2024 LIBRARY; T=0.K
Threshold reactions

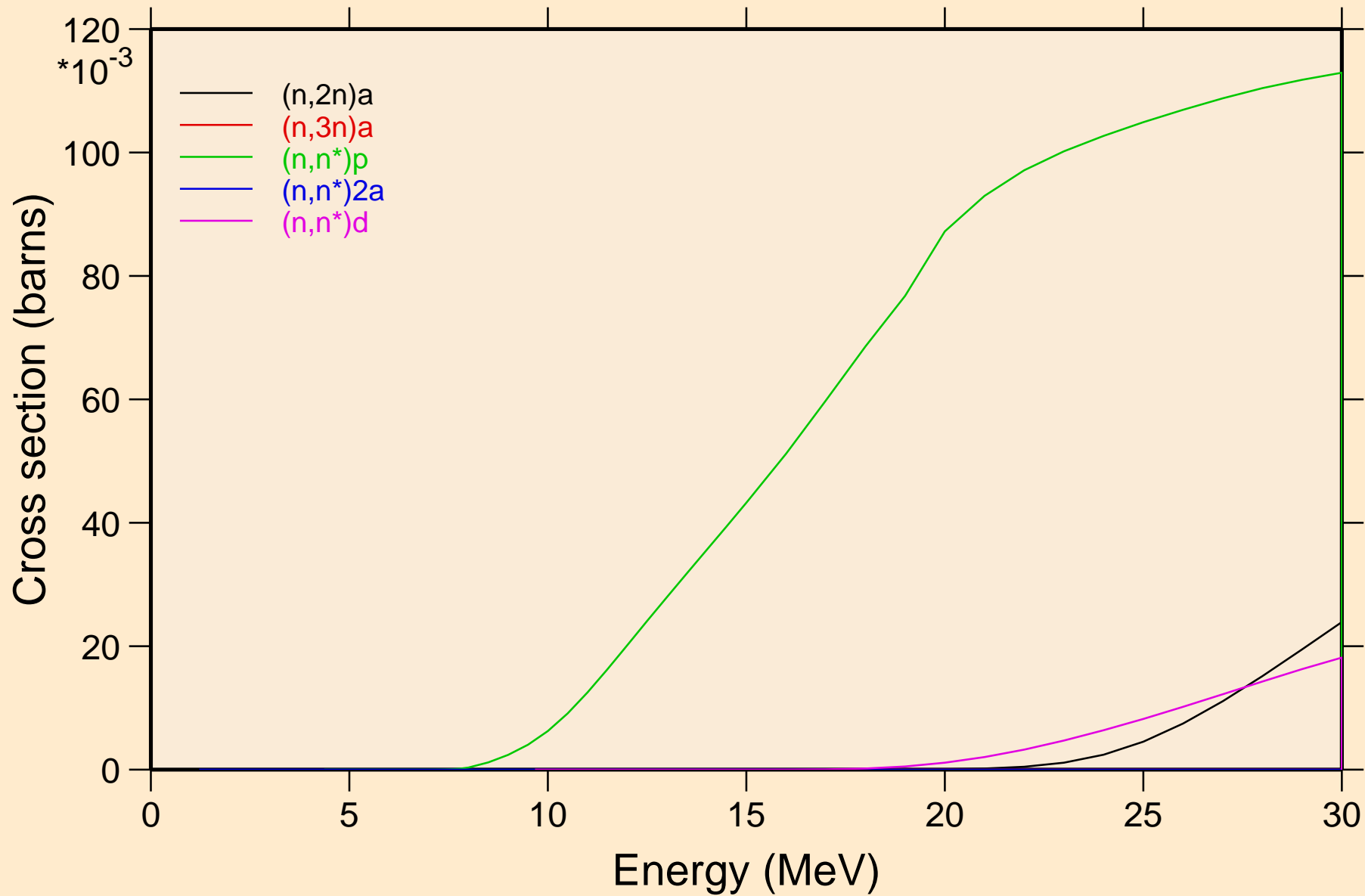

LA132 NEUTRON ACER TENDL-2024 LIBRARY; T=0.K
Threshold reactions

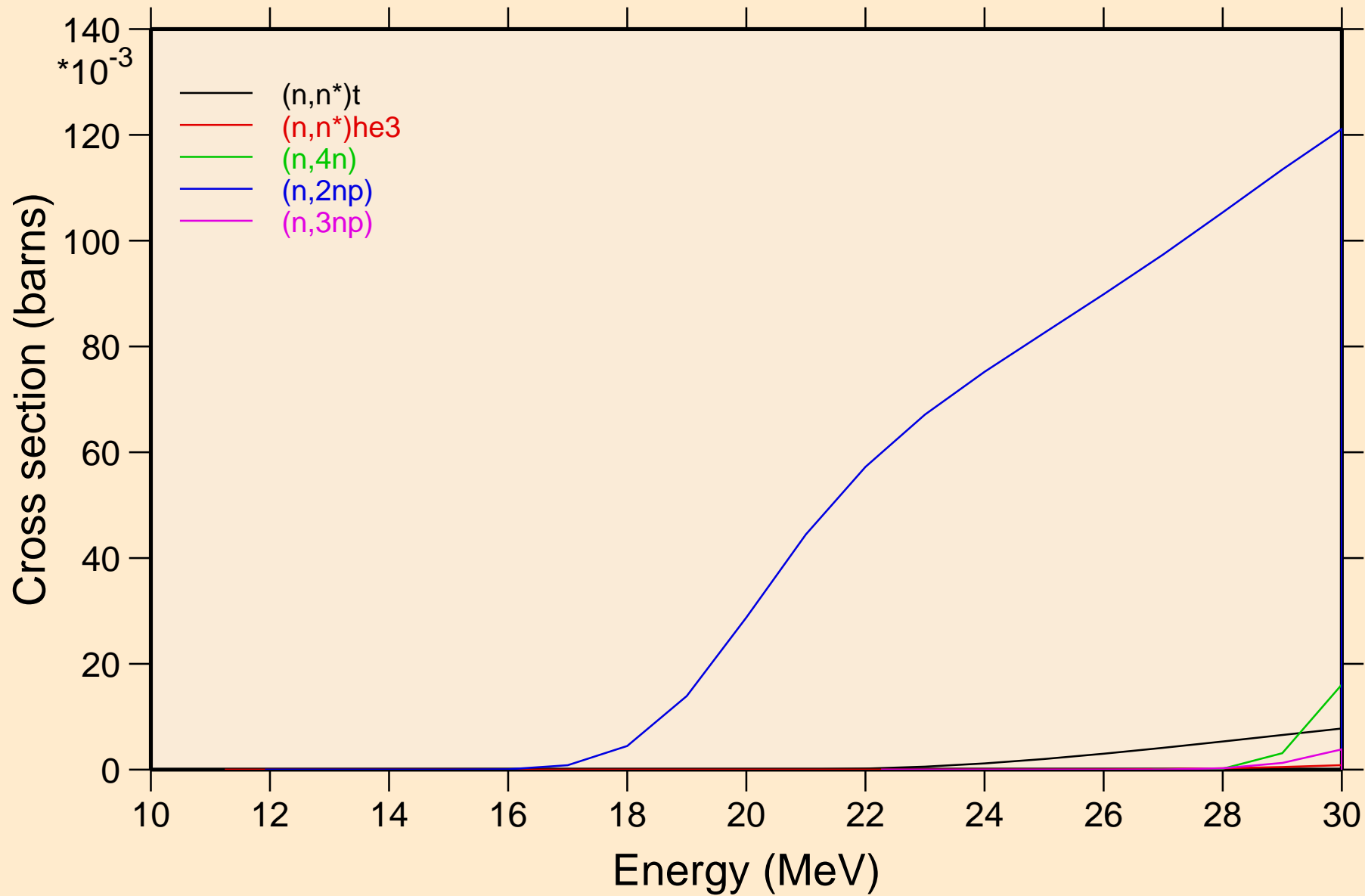

LA132 NEUTRON ACER TENDL-2024 LIBRARY; T=0.K
Threshold reactions

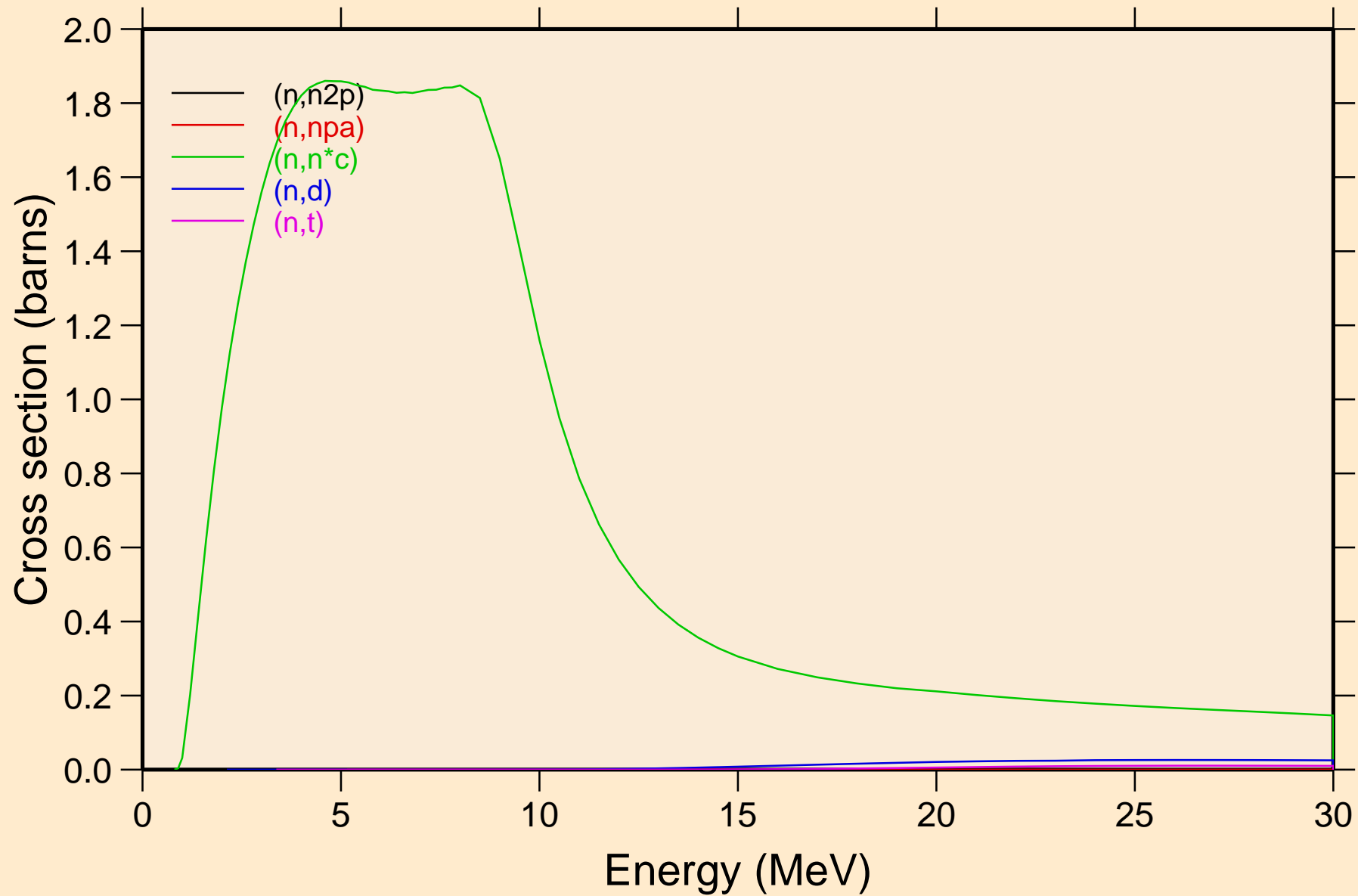

LA132 NEUTRON ACER TENDL-2024 LIBRARY; T=0.K

Threshold reactions

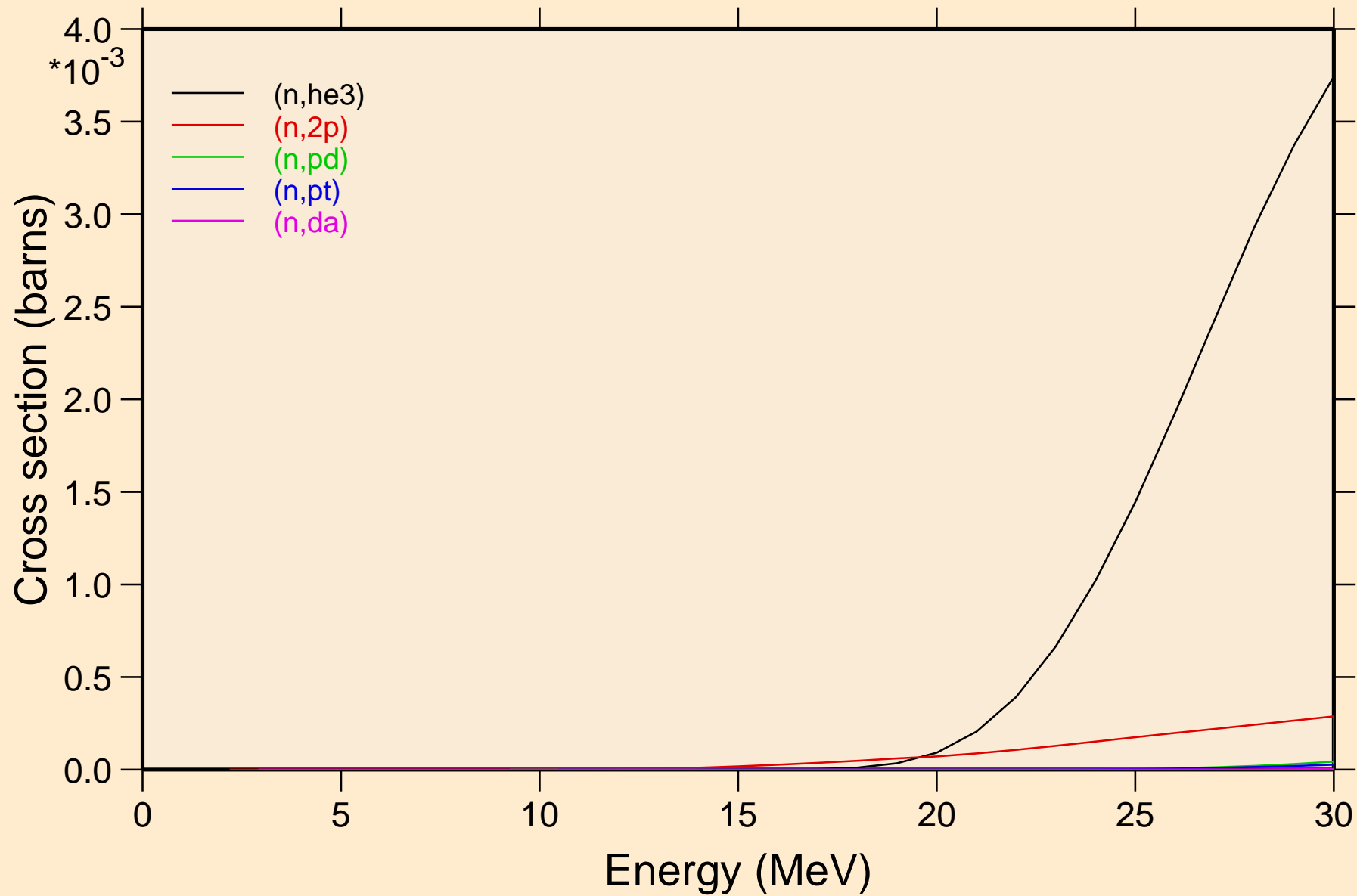

LA132 NEUTRON ACER TENDL-2024 LIBRARY; T=0.K

Threshold reactions

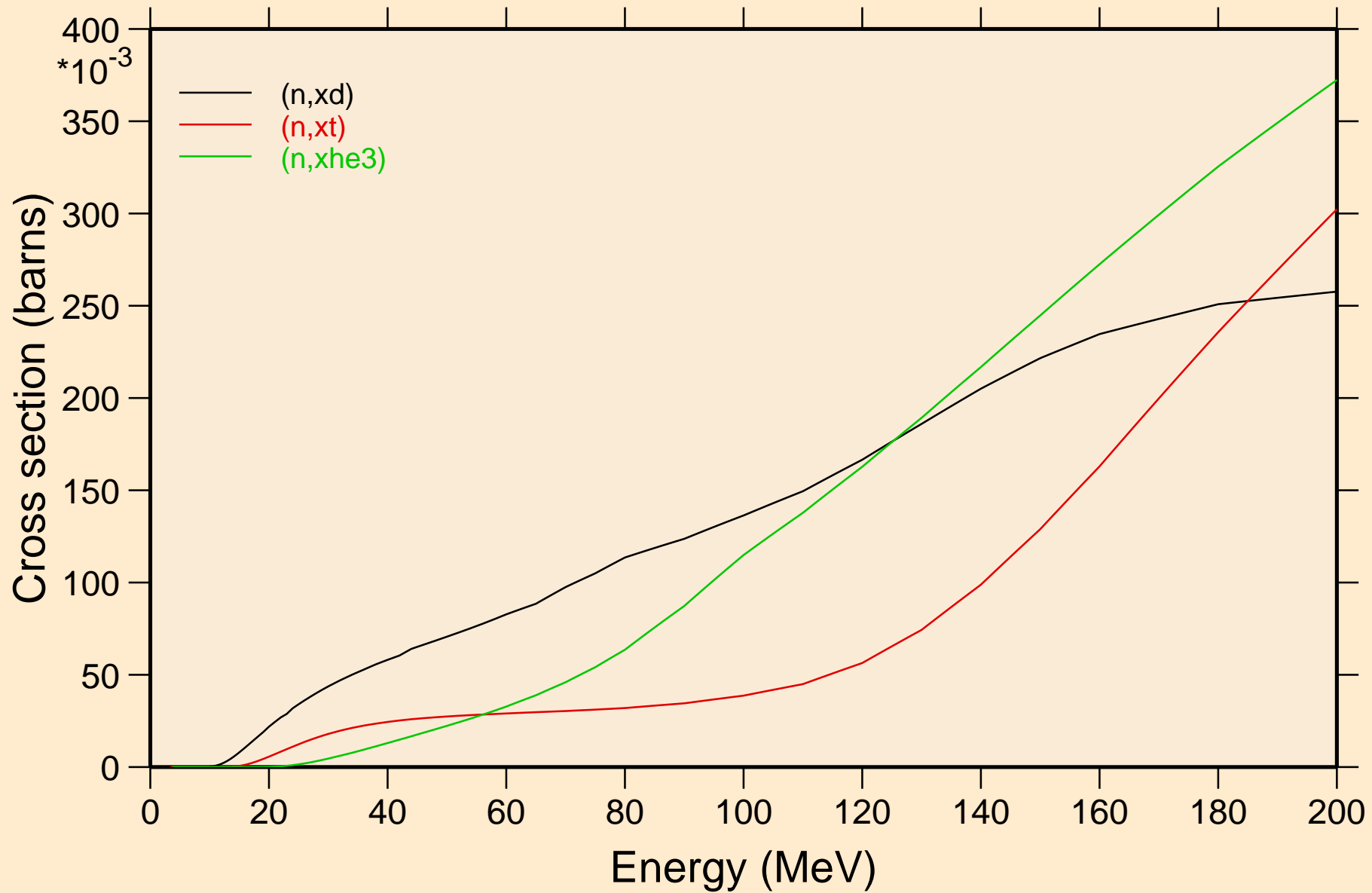

LA132 NEUTRON ACER TENDL-2024 LIBRARY; T=0.K
angular distribution for elastic

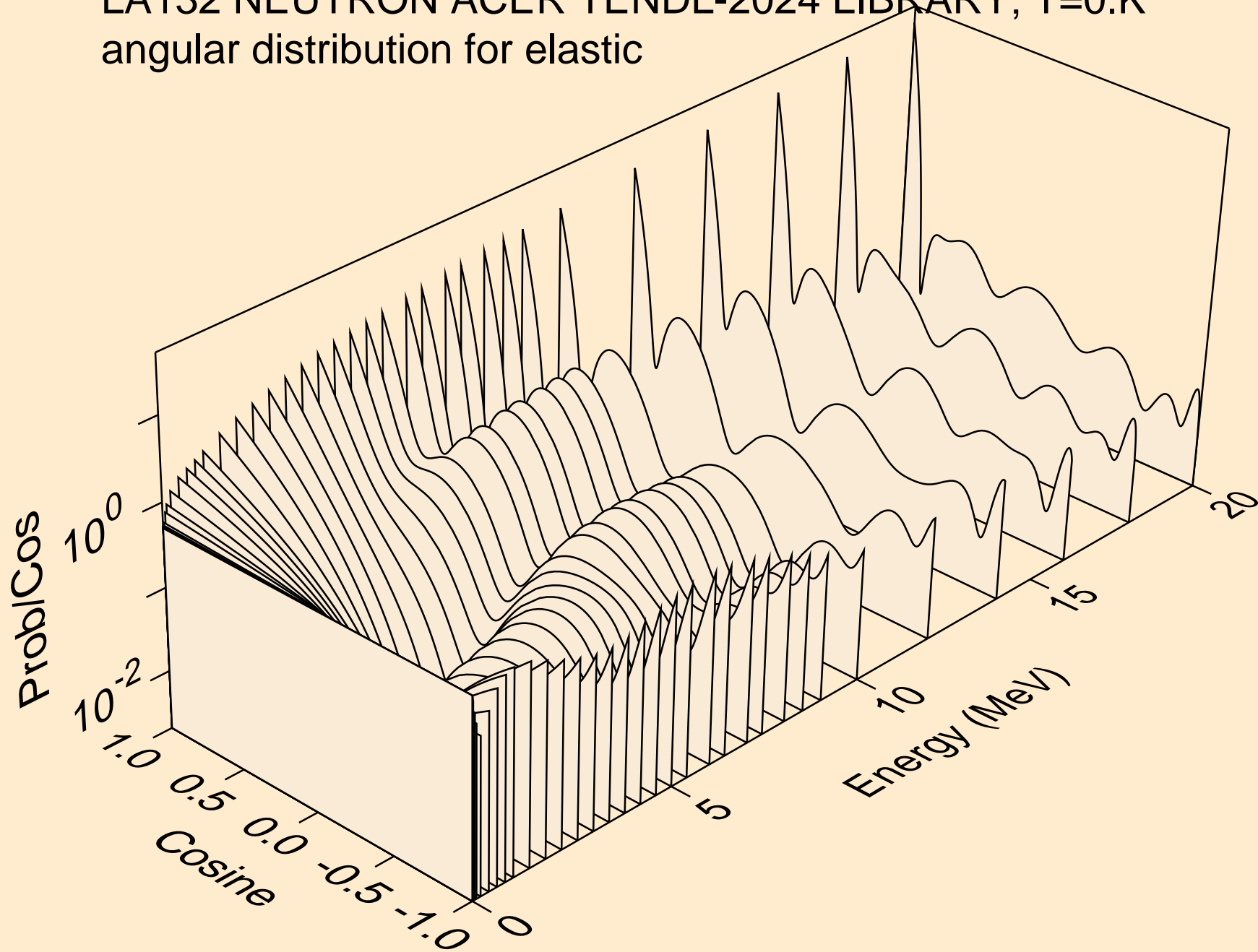

LA132 NEUTRON ACER TENDL-2024 LIBRARY; T=0.K
angular distribution for elastic

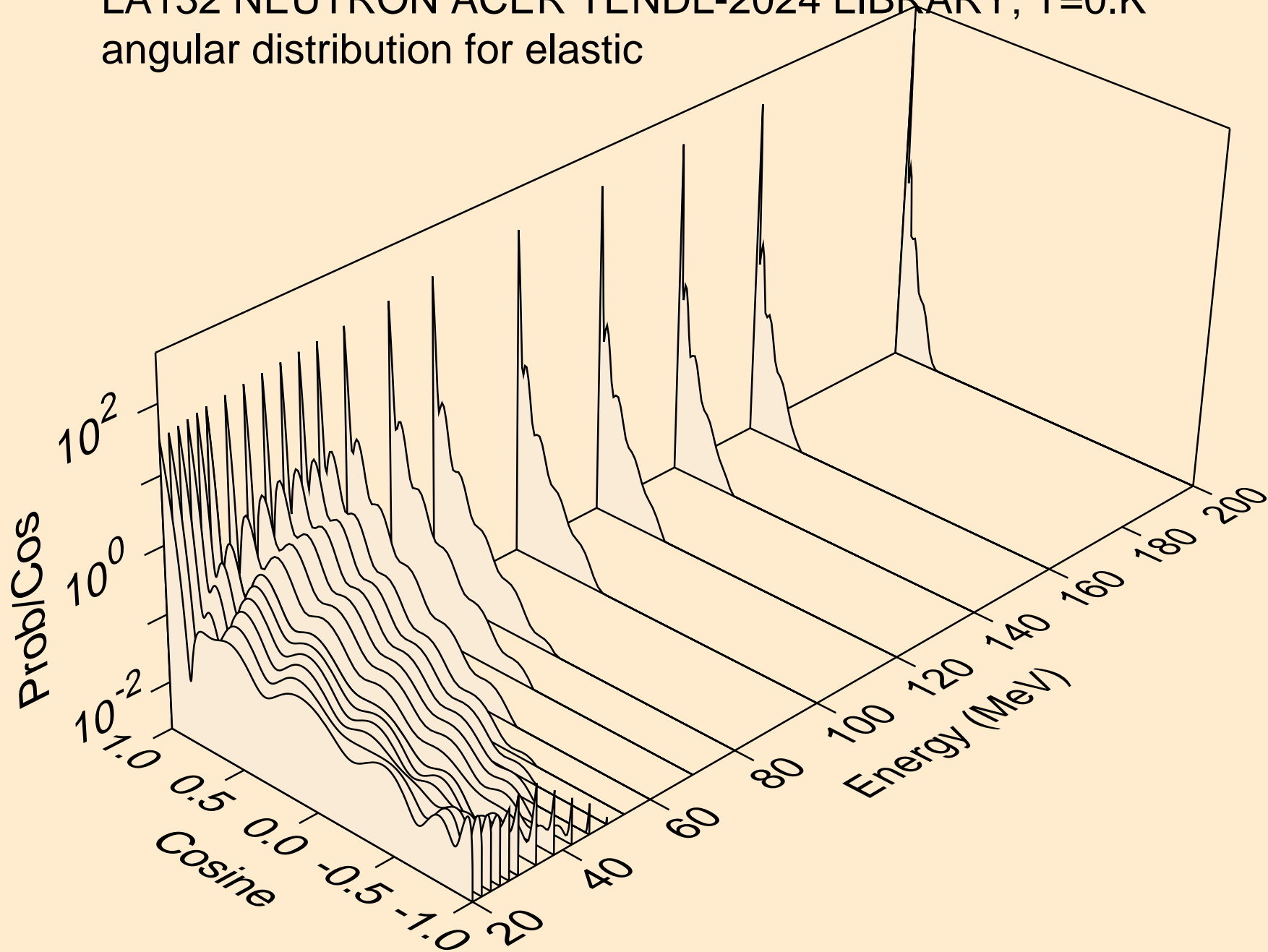

LA132 NEUTRON ACER TENDL-2024 LIBRARY; T=0.K
angular distribution for (n,n*1)

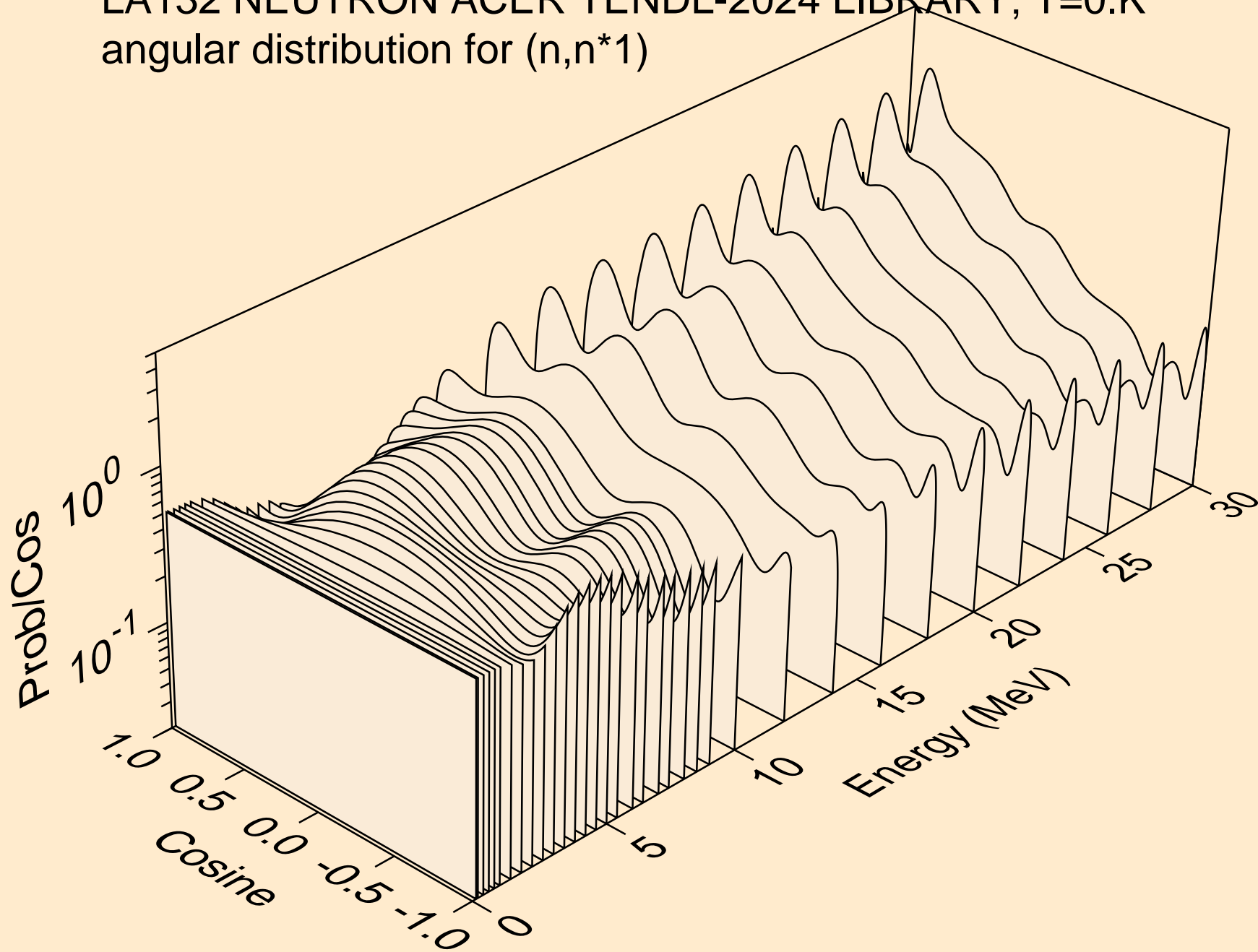

LA132 NEUTRON ACER TENDL-2024 LIBRARY; T=0.K
angular distribution for (n,n*2)

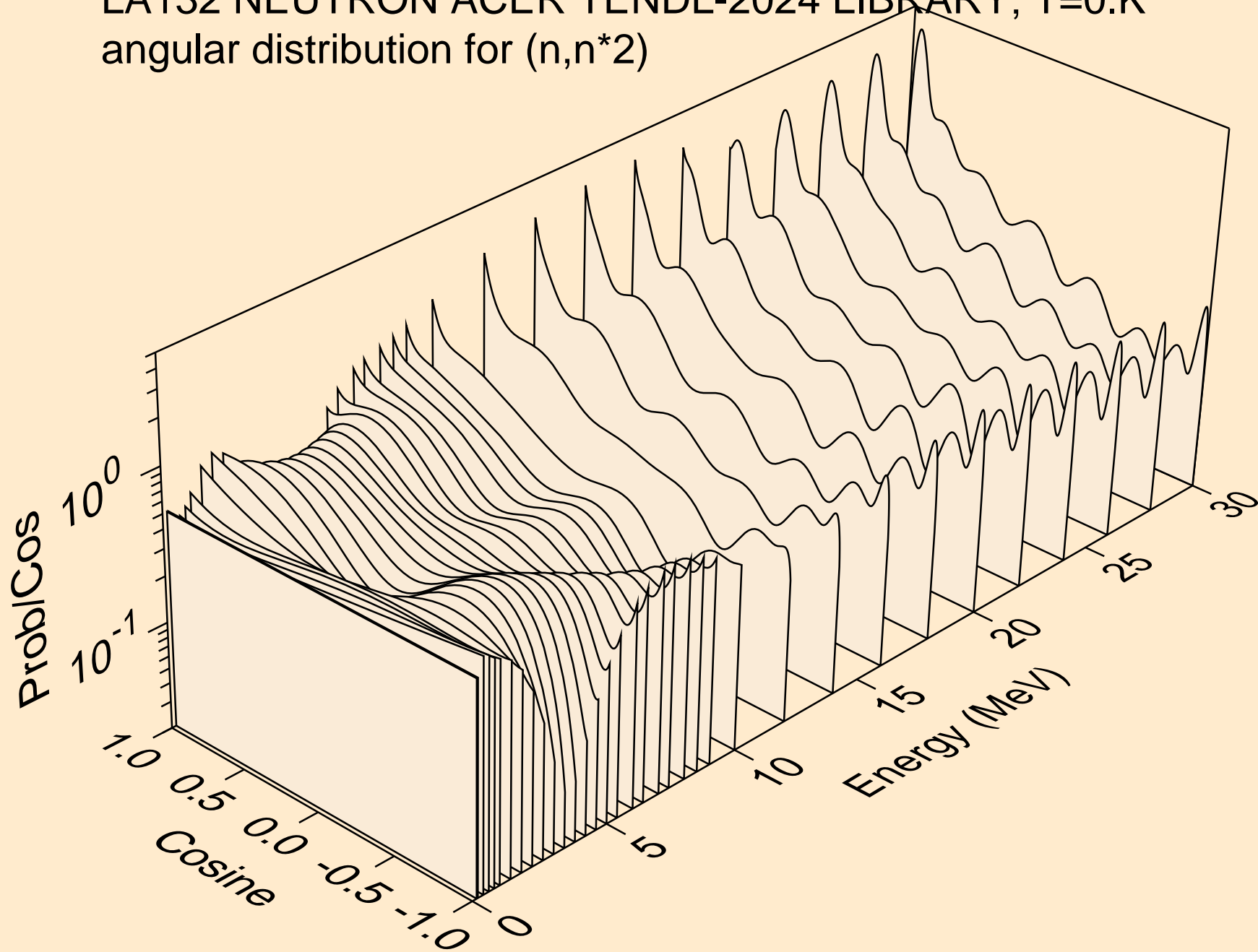

LA132 NEUTRON ACER TENDL-2024 LIBRARY; T=0.K
angular distribution for (n,n*3)

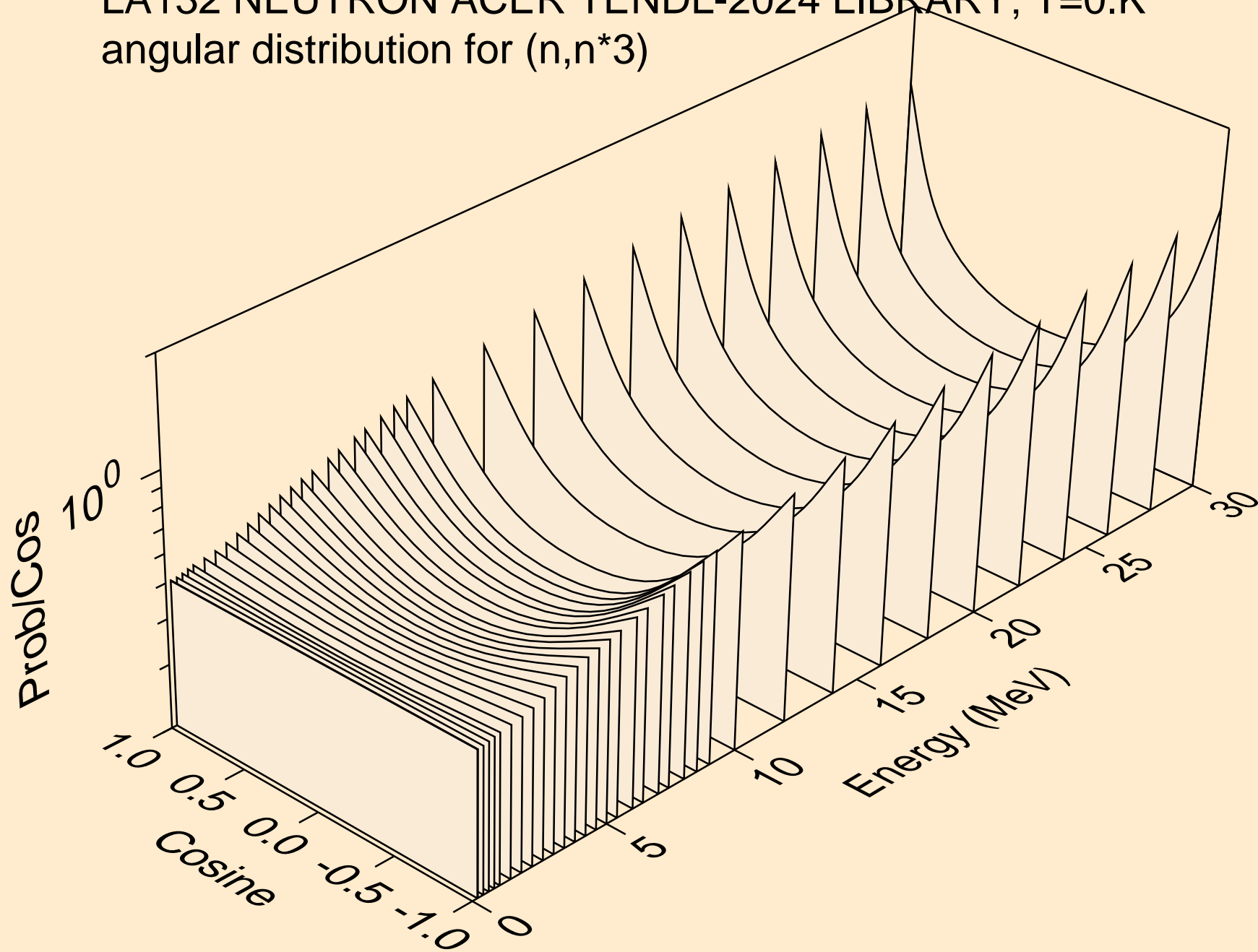

LA132 NEUTRON ACER TENDL-2024 LIBRARY; T=0.K
angular distribution for (n,n*4)

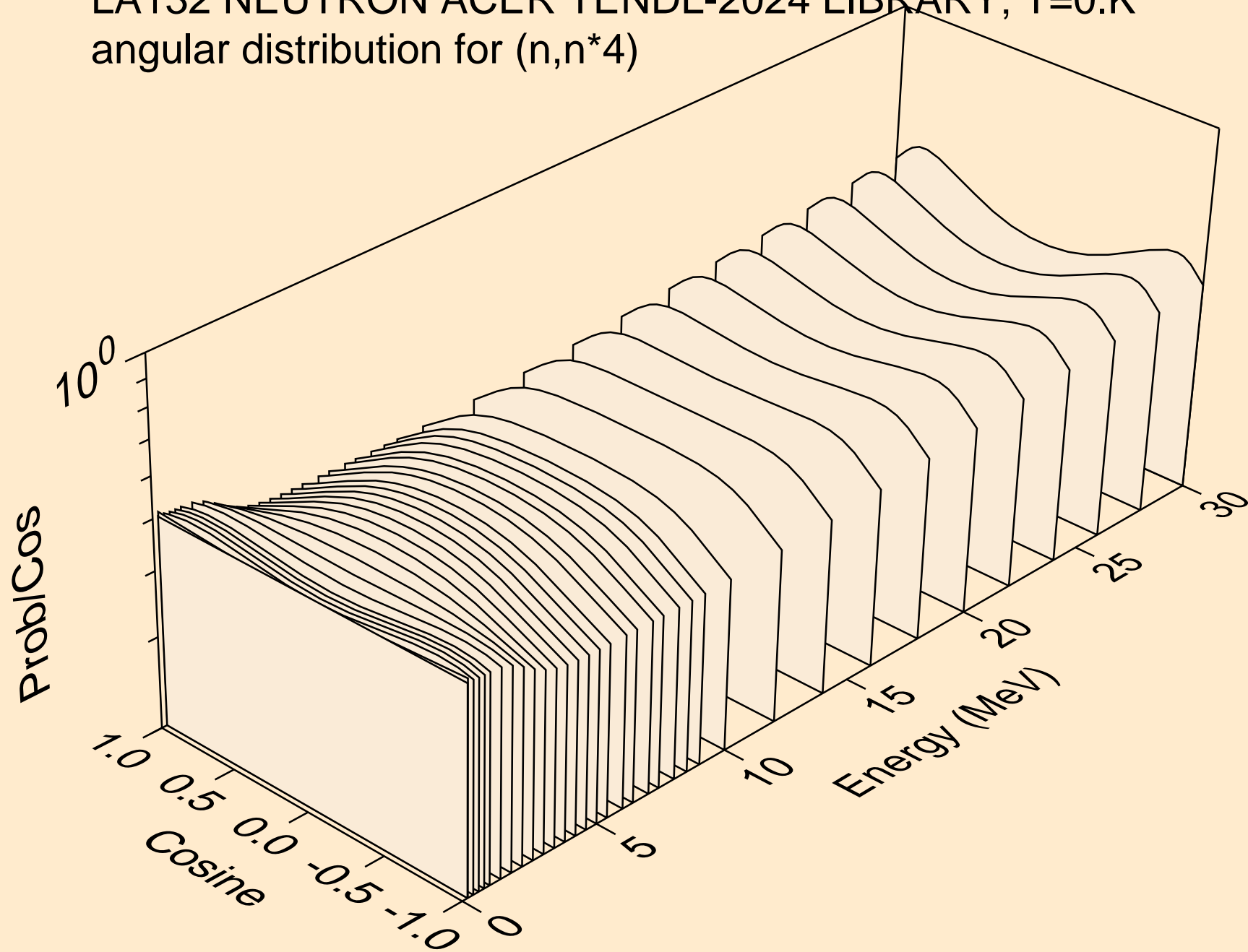

LA132 NEUTRON ACER TENDL-2024 LIBRARY; T=0.K
angular distribution for (n,n*5)

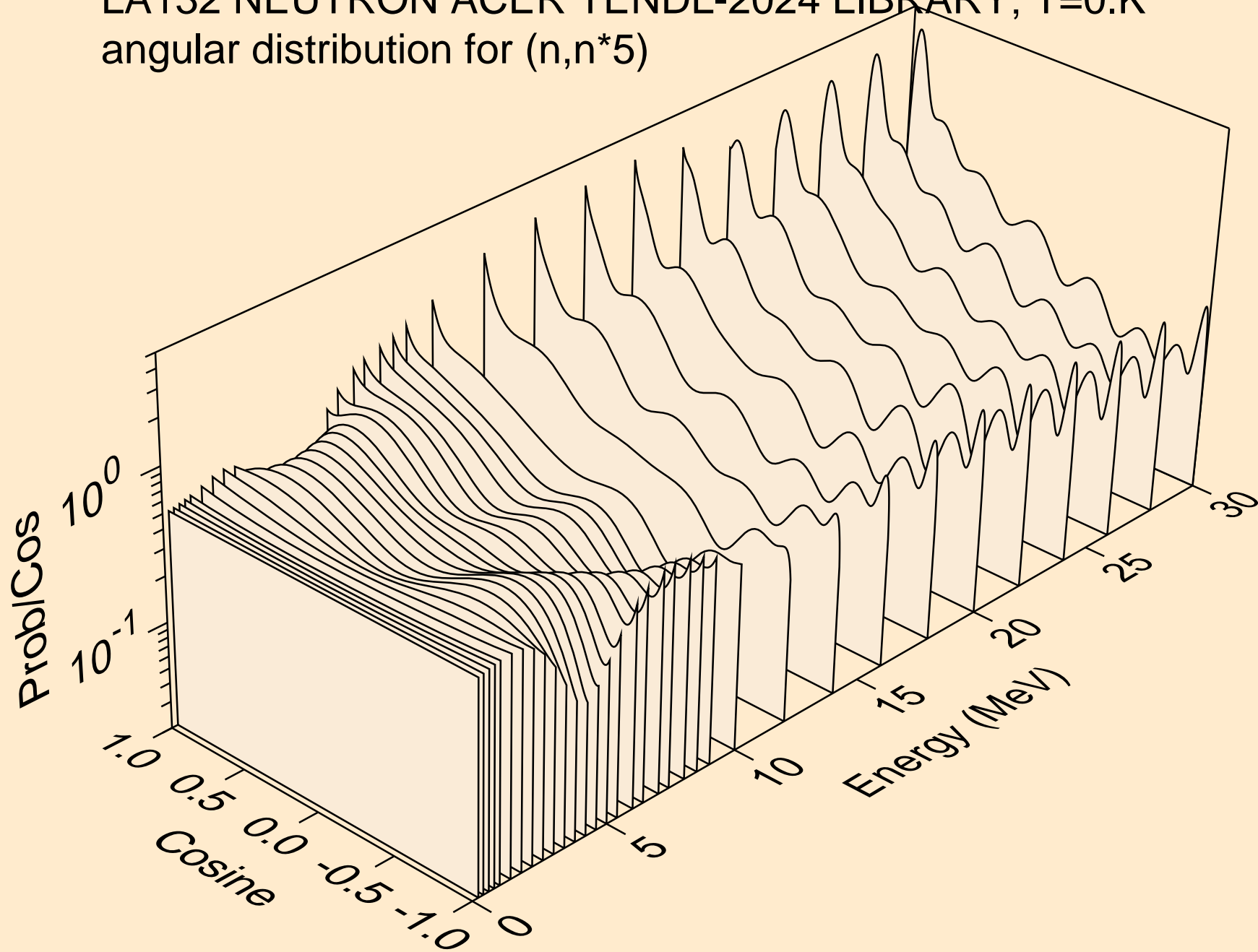

LA132 NEUTRON ACER TENDL-2024 LIBRARY; T=0.K
angular distribution for (n,n*6)

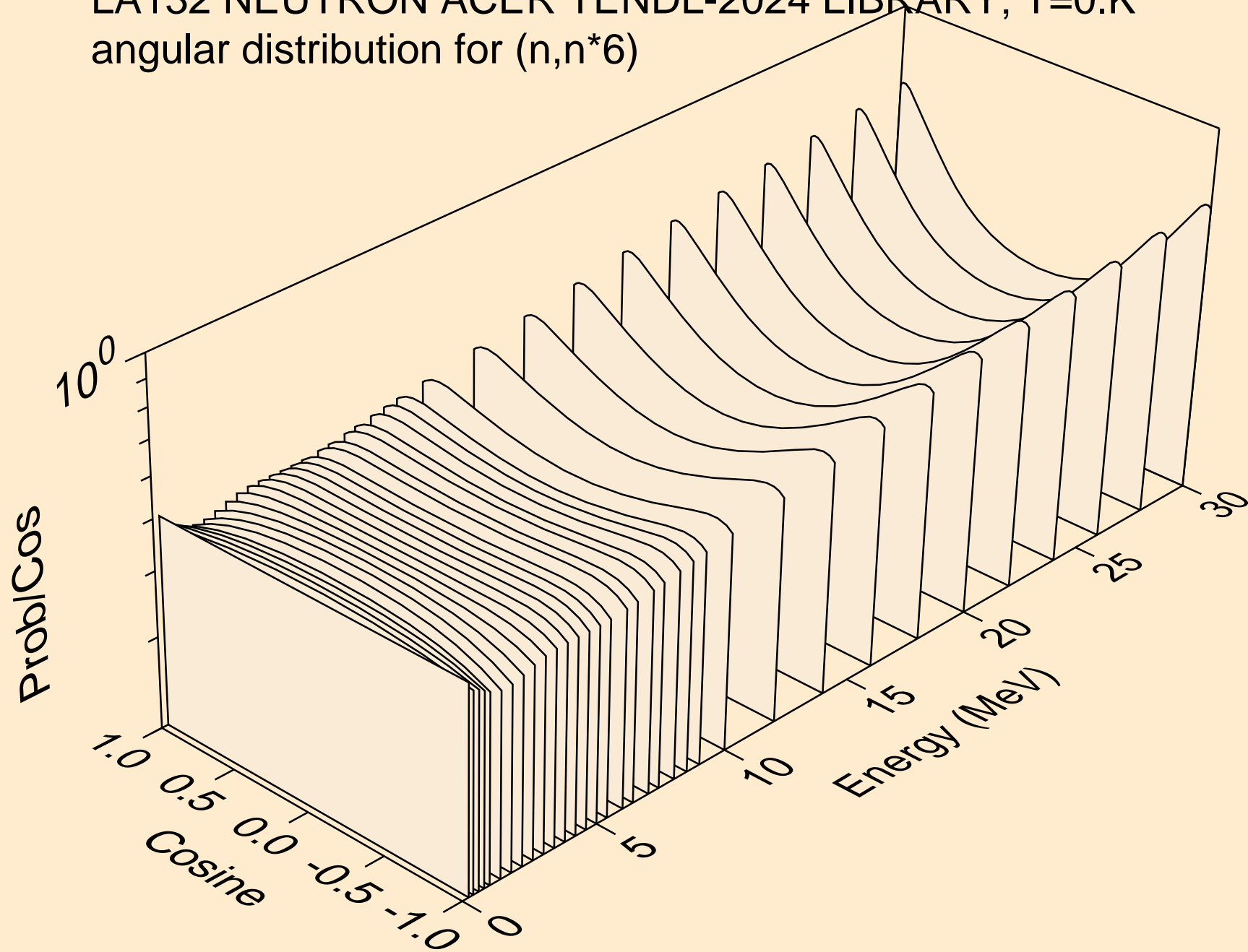

LA132 NEUTRON ACER TENDL-2024 LIBRARY; T=0.K
angular distribution for (n,n*7)

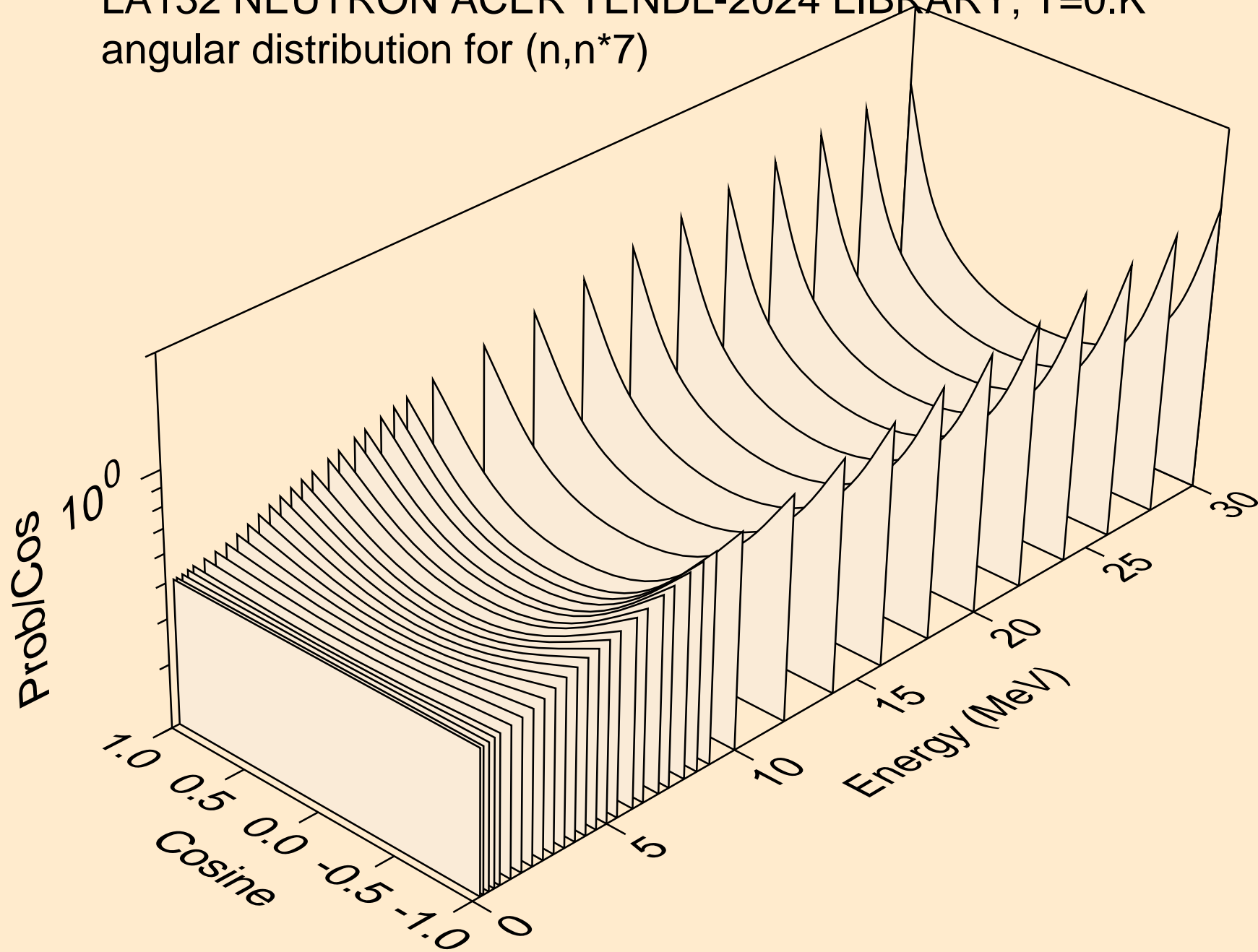

LA132 NEUTRON ACER TENDL-2024 LIBRARY; T=0.K
angular distribution for (n,n*8)

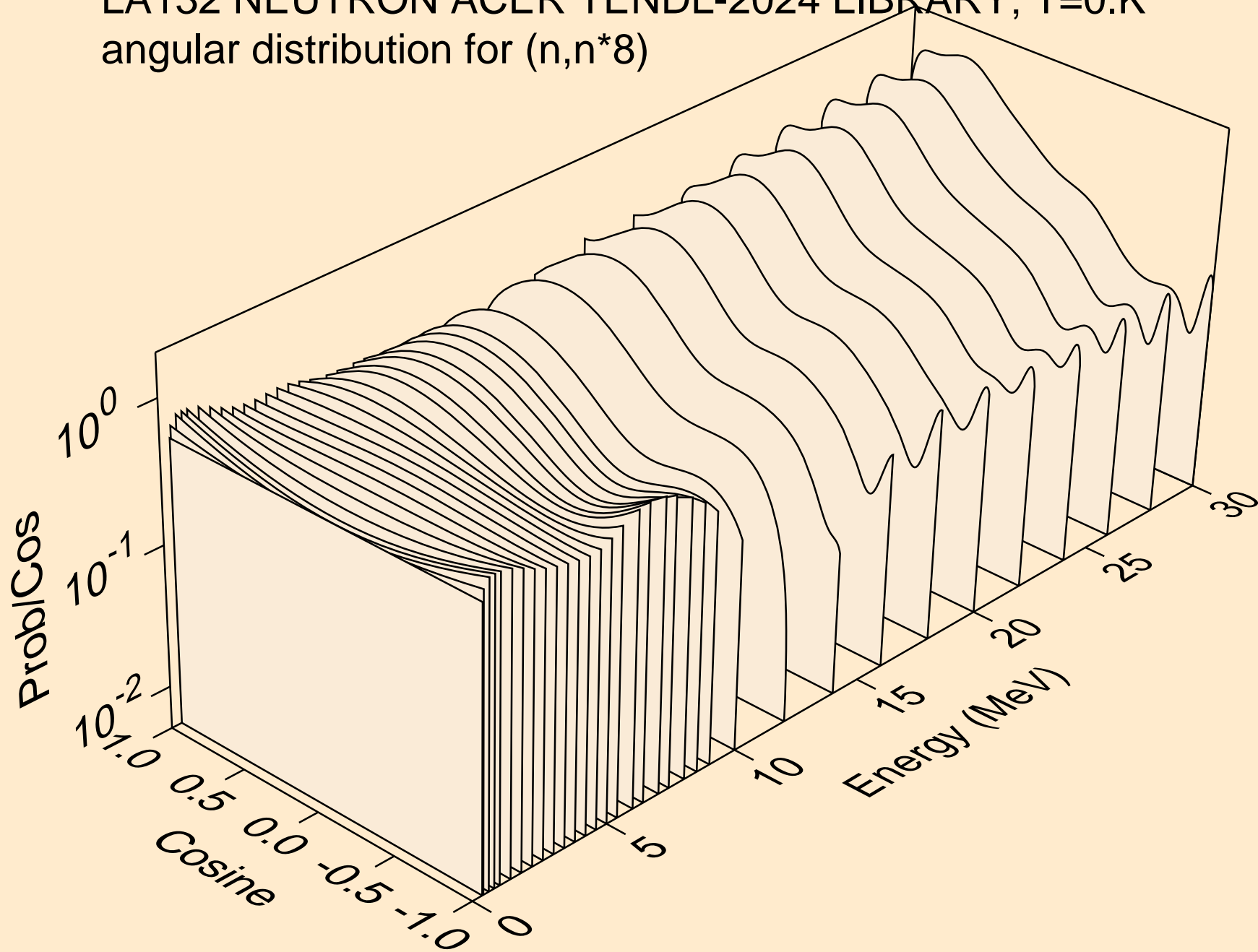

LA132 NEUTRON ACER TENDL-2024 LIBRARY; T=0.K
angular distribution for (n,n*9)

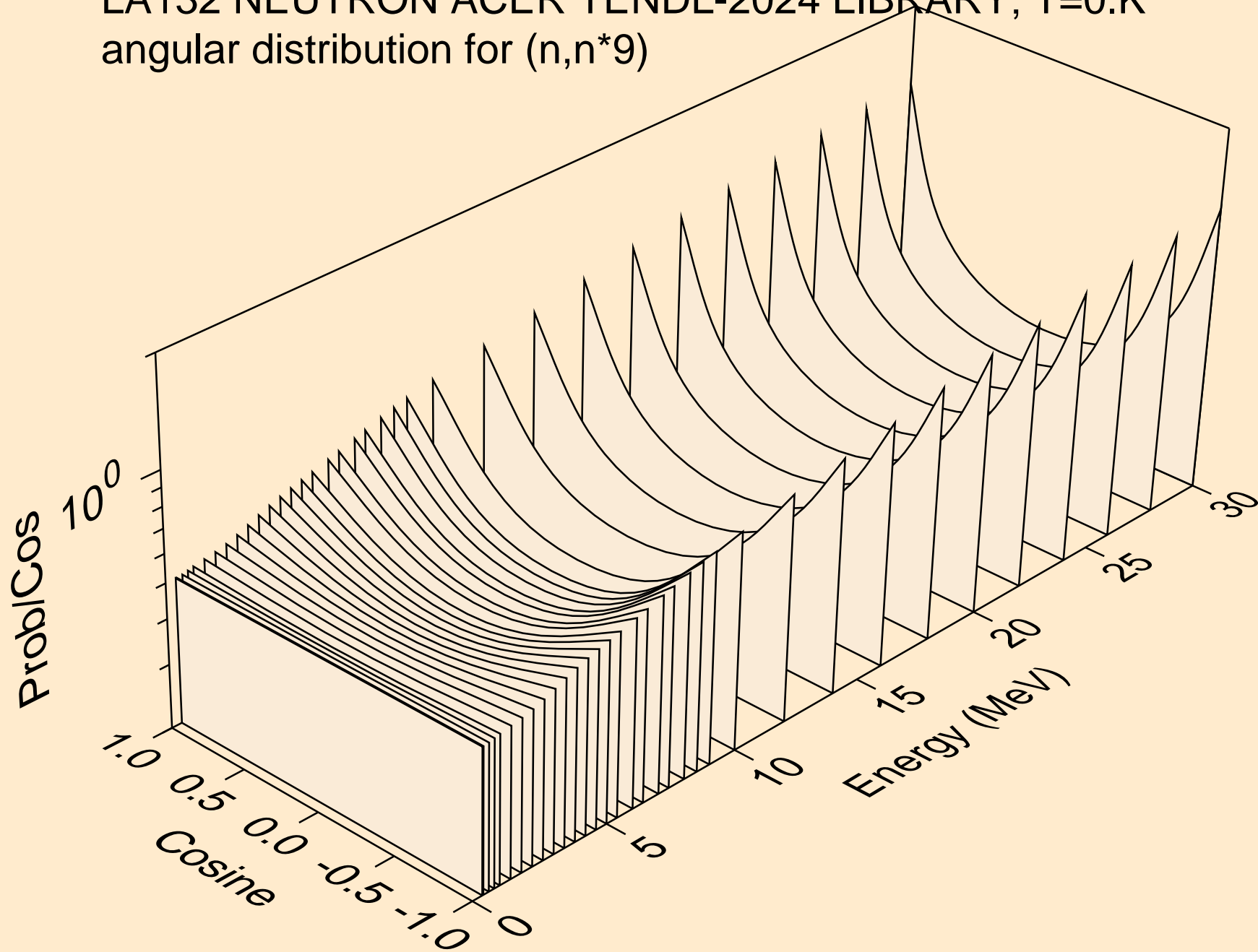

LA132 NEUTRON ACER TENDL-2024 LIBRARY; T=0.K
angular distribution for (n,n*10)

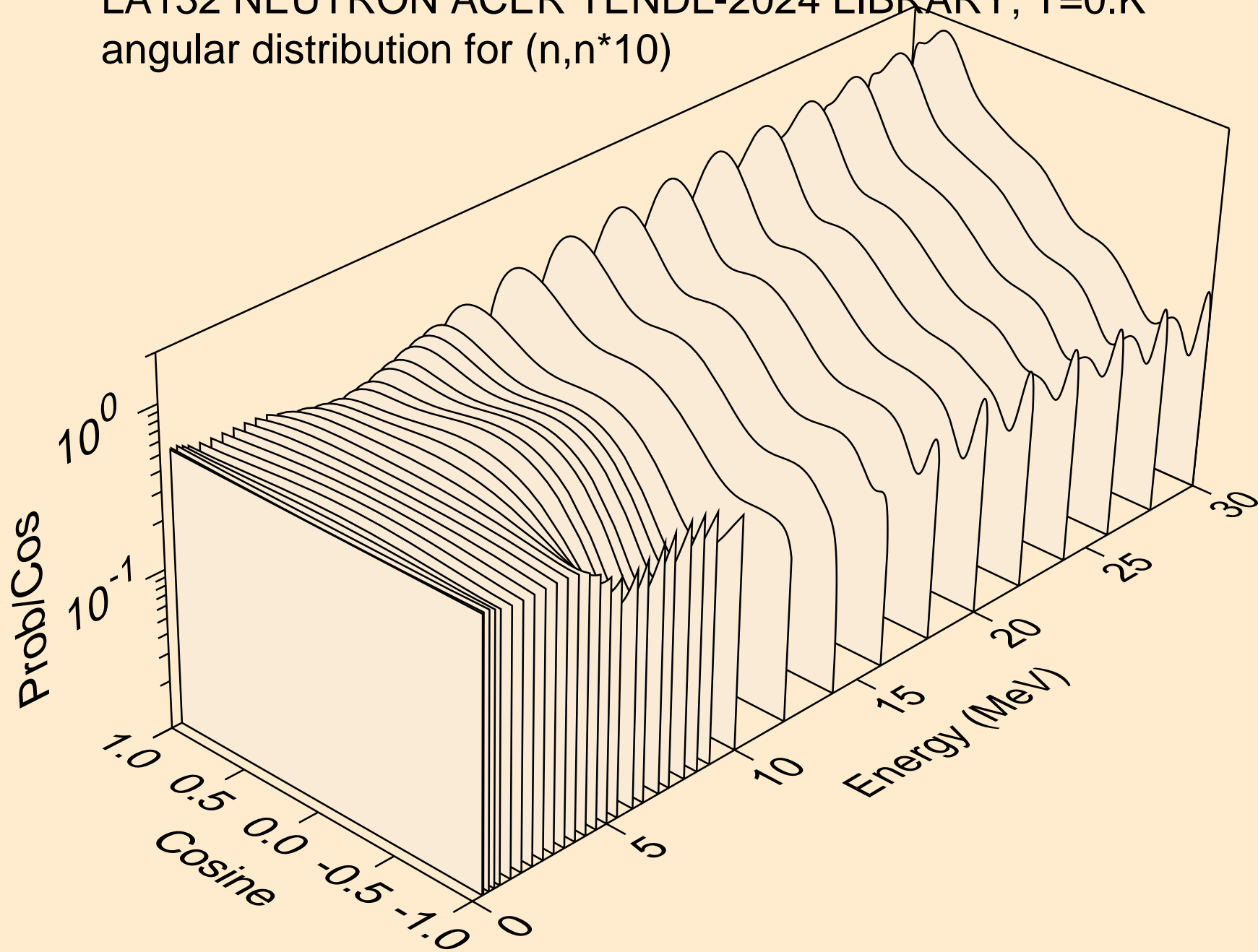

LA132 NEUTRON ACER TENDL-2024 LIBRARY; T=0.K
angular distribution for (n,n*11)

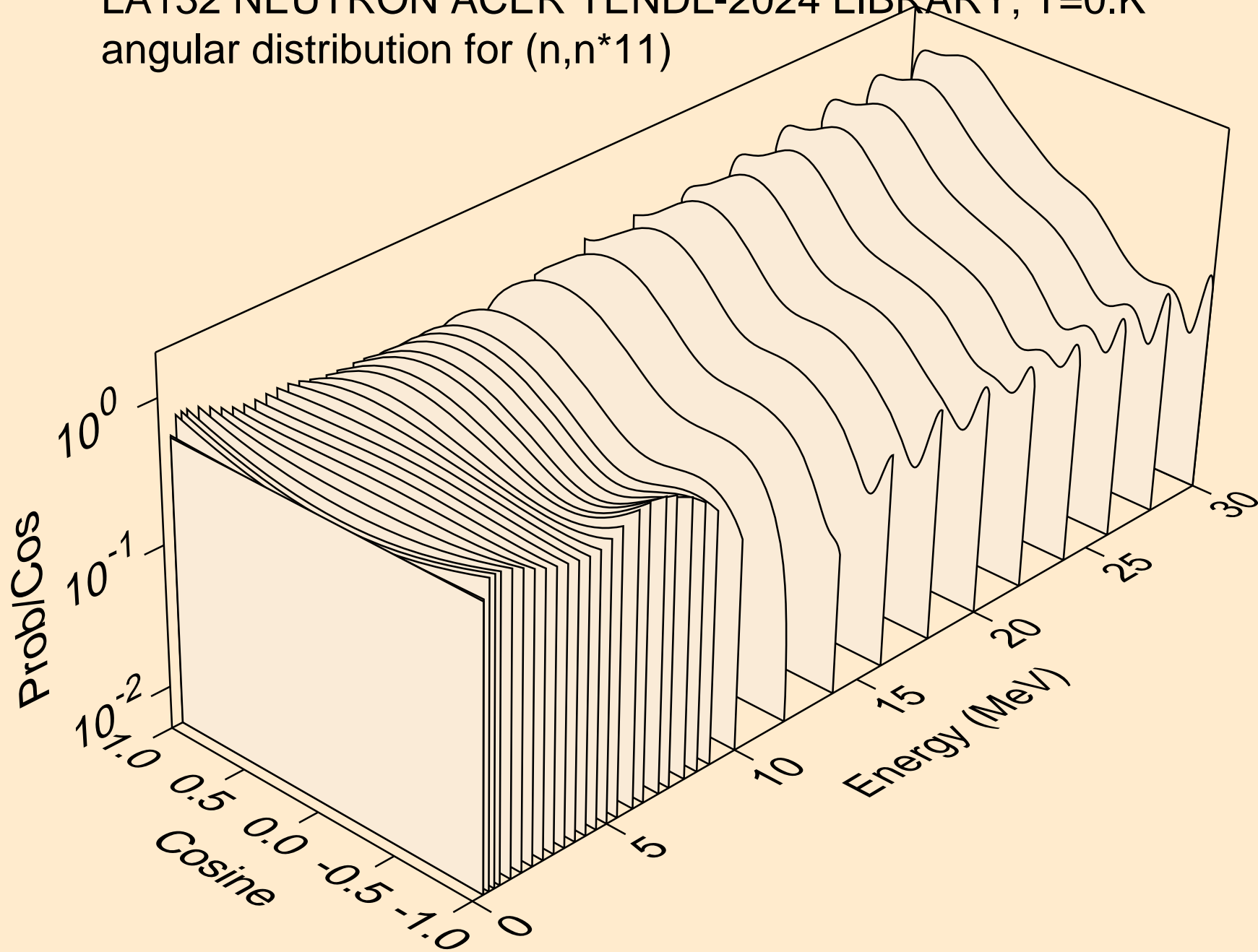

LA132 NEUTRON ACER TENDL-2024 LIBRARY; T=0.K
angular distribution for (n,n*12)

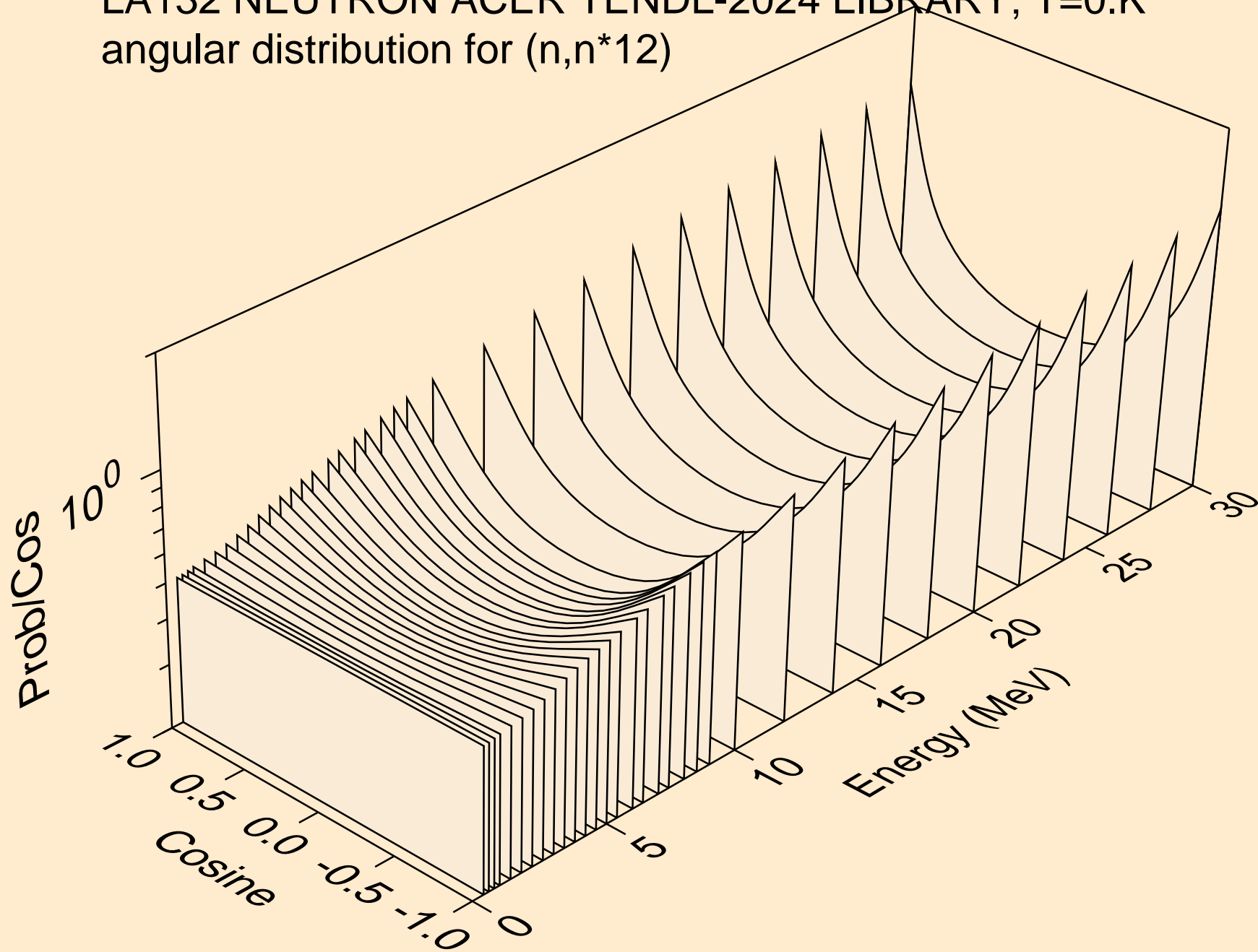

LA132 NEUTRON ACER TENDL-2024 LIBRARY; T=0.K
angular distribution for (n,n*13)

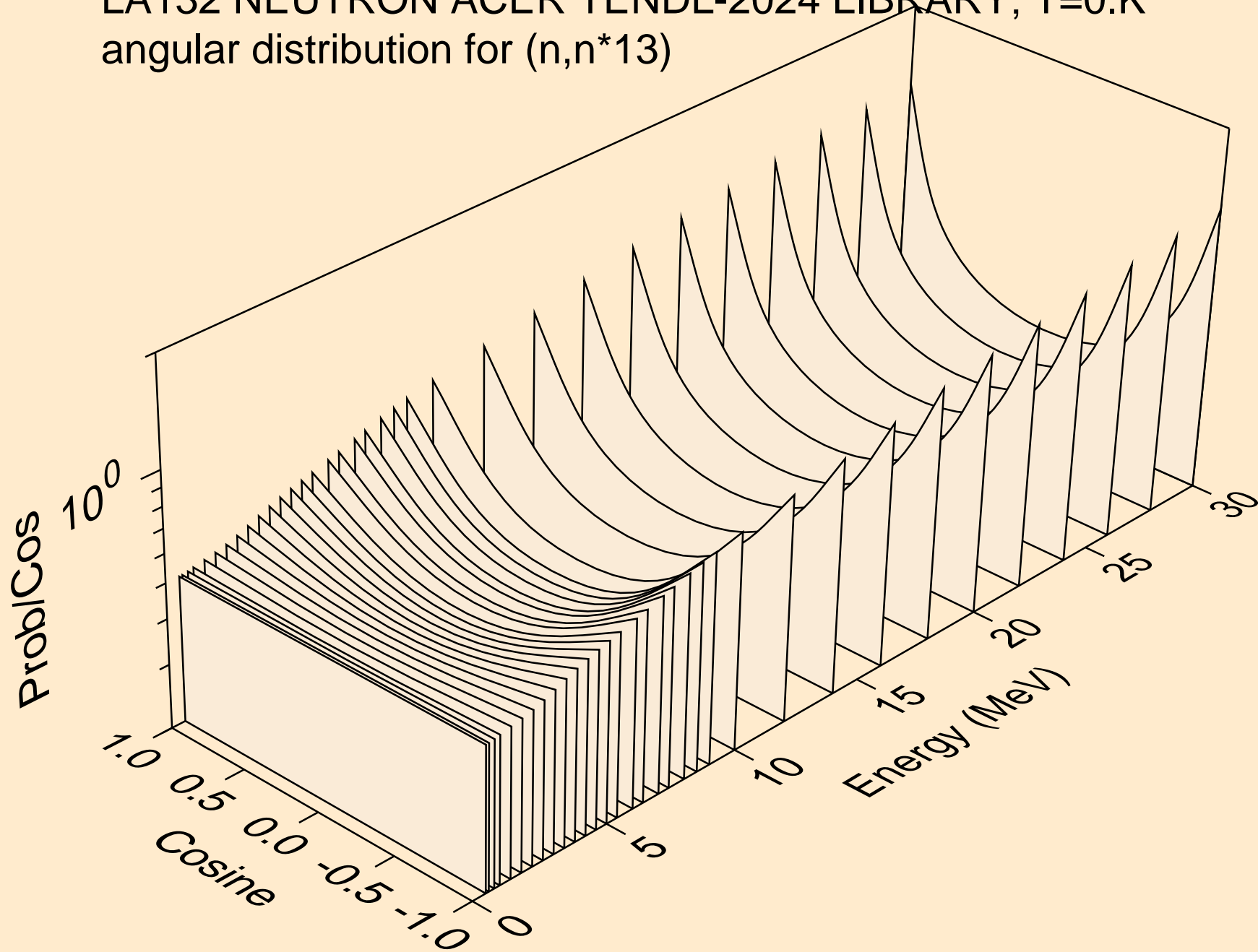

LA132 NEUTRON ACER TENDL-2024 LIBRARY; T=0.K
angular distribution for (n,n*14)

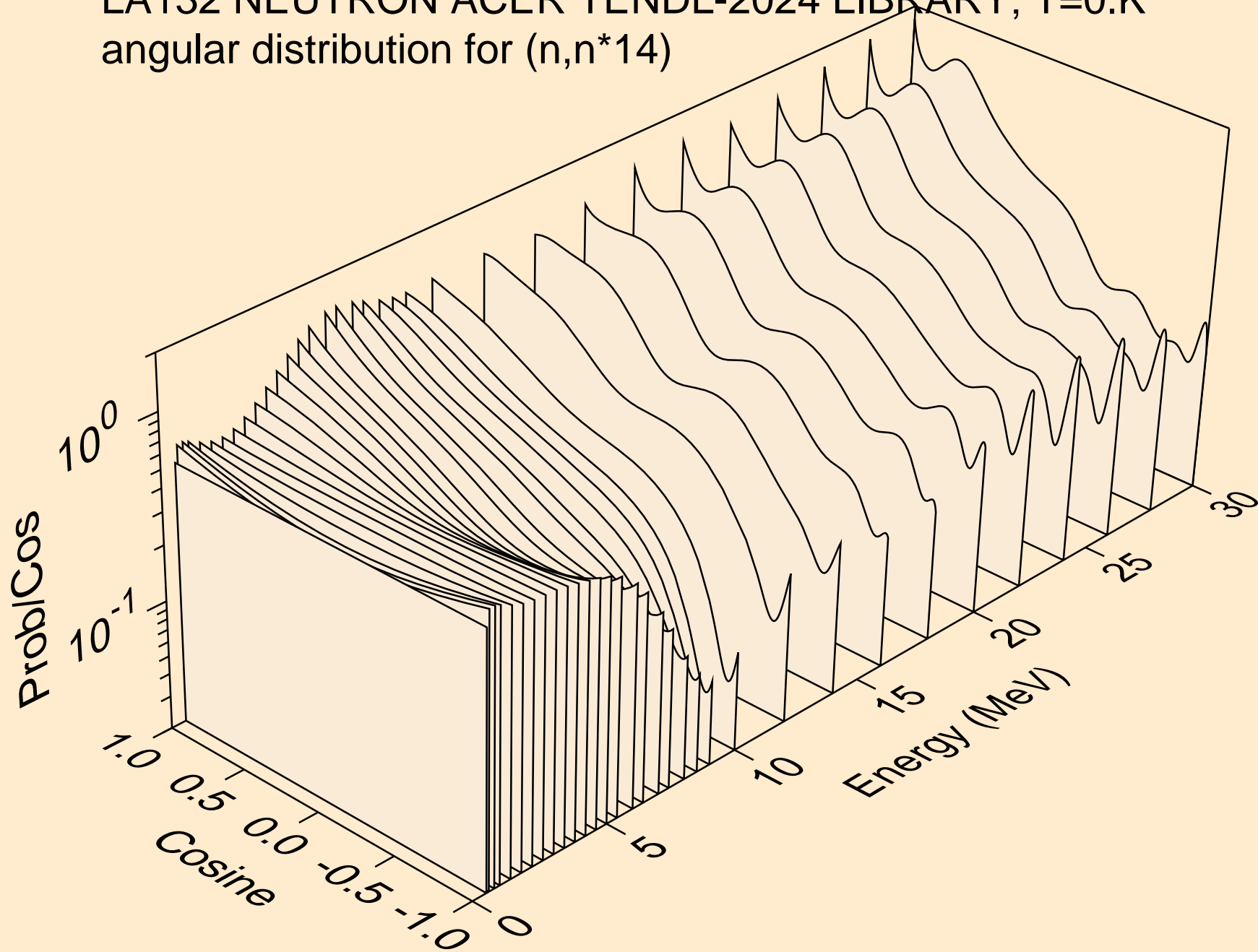

LA132 NEUTRON ACER TENDL-2024 LIBRARY; T=0.K
angular distribution for (n,n*15)

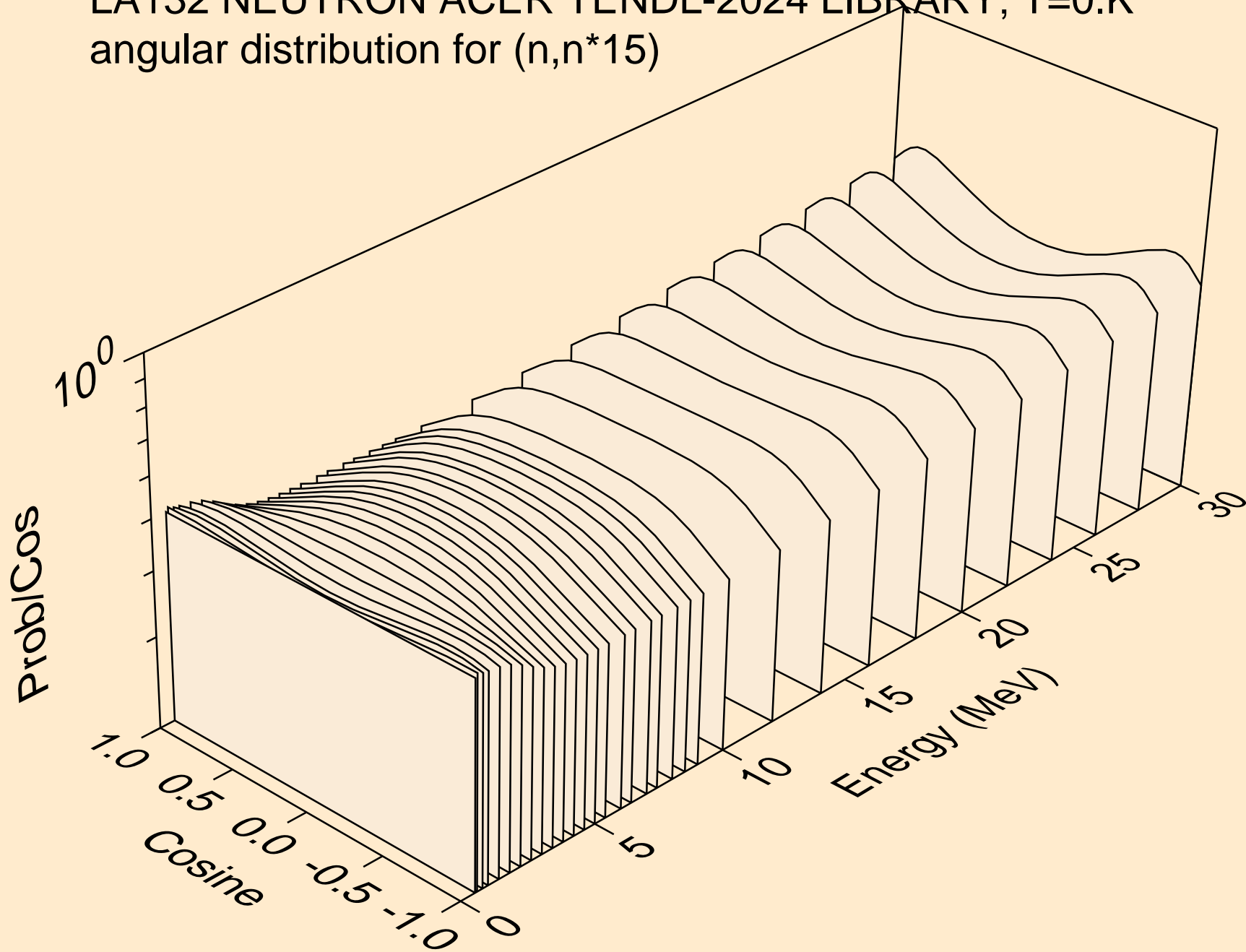

LA132 NEUTRON ACER TENDL-2024 LIBRARY; T=0.K
angular distribution for (n,n*16)

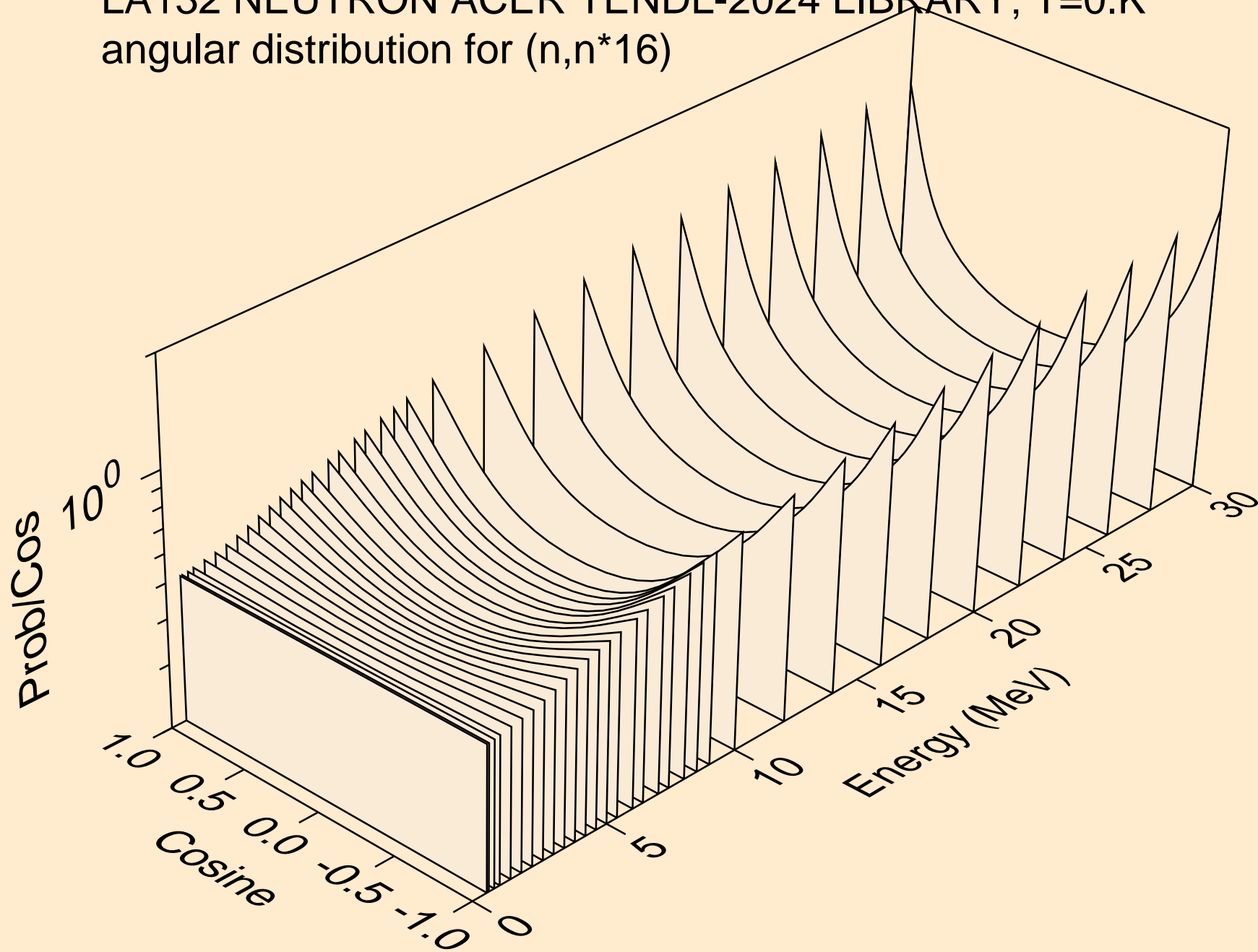

LA132 NEUTRON ACER TENDL-2024 LIBRARY; T=0.K
angular distribution for (n,n*17)

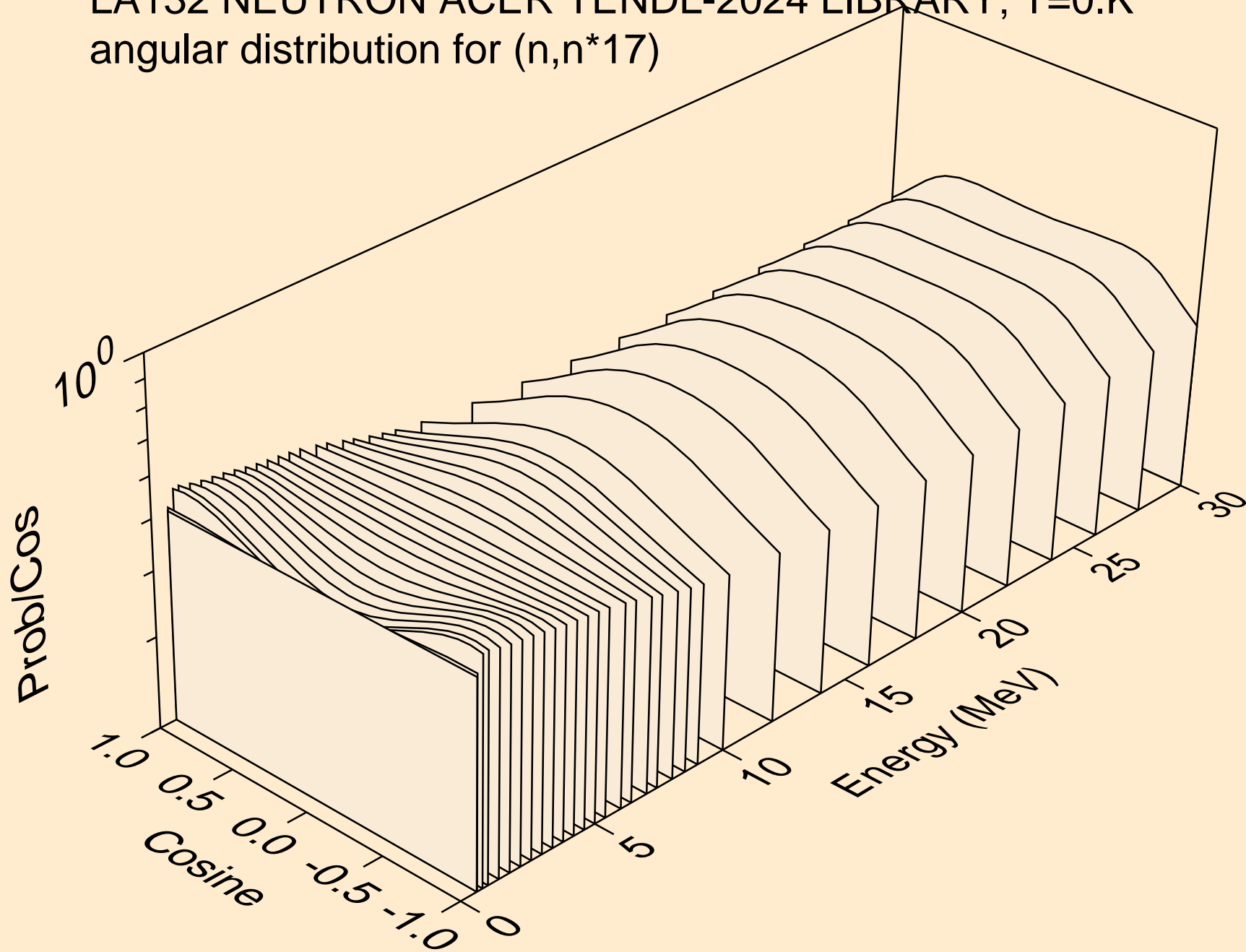

LA132 NEUTRON ACER TENDL-2024 LIBRARY; T=0.K
angular distribution for (n,n*18)

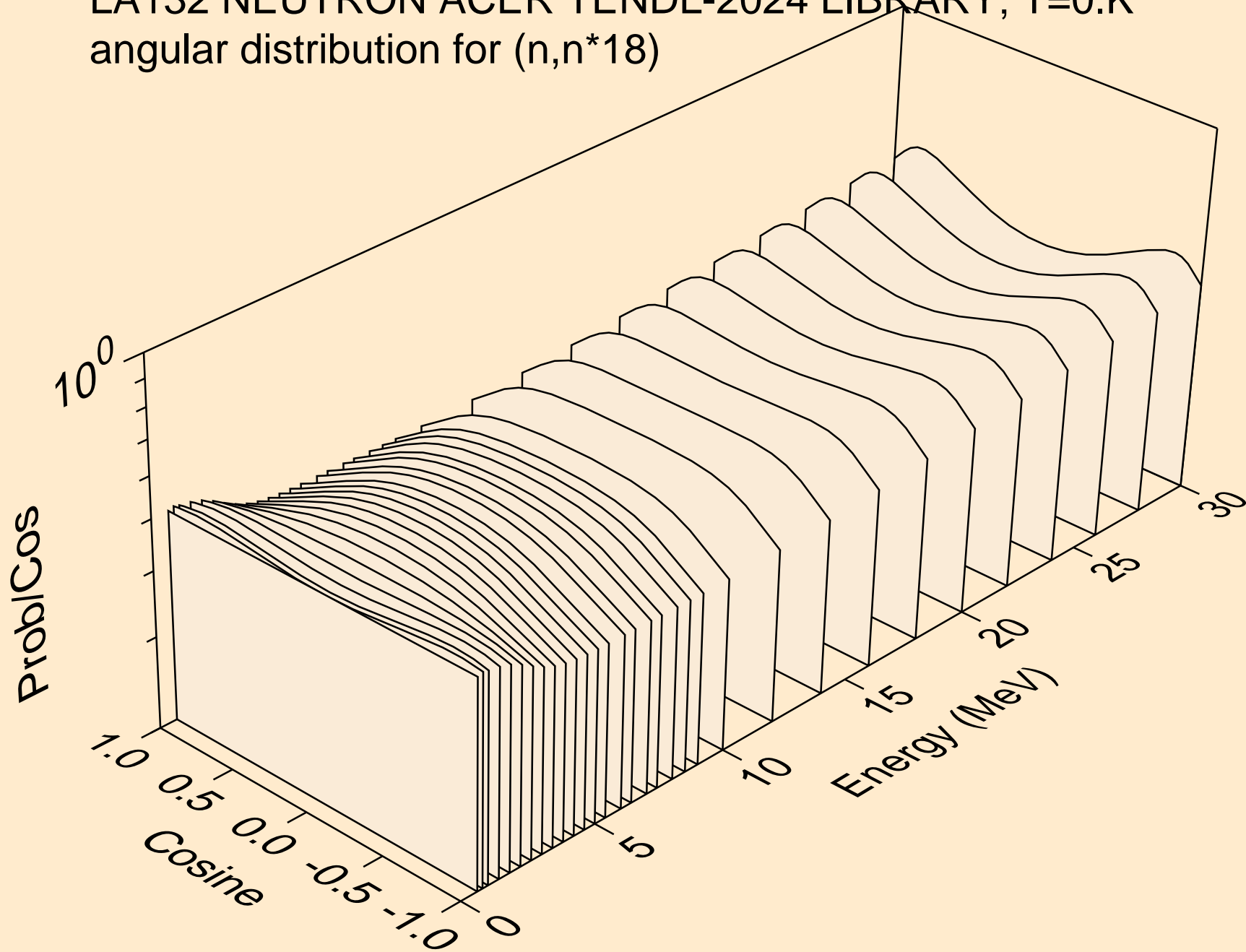

LA132 NEUTRON ACER TENDL-2024 LIBRARY; T=0.K
angular distribution for (n,n*19)

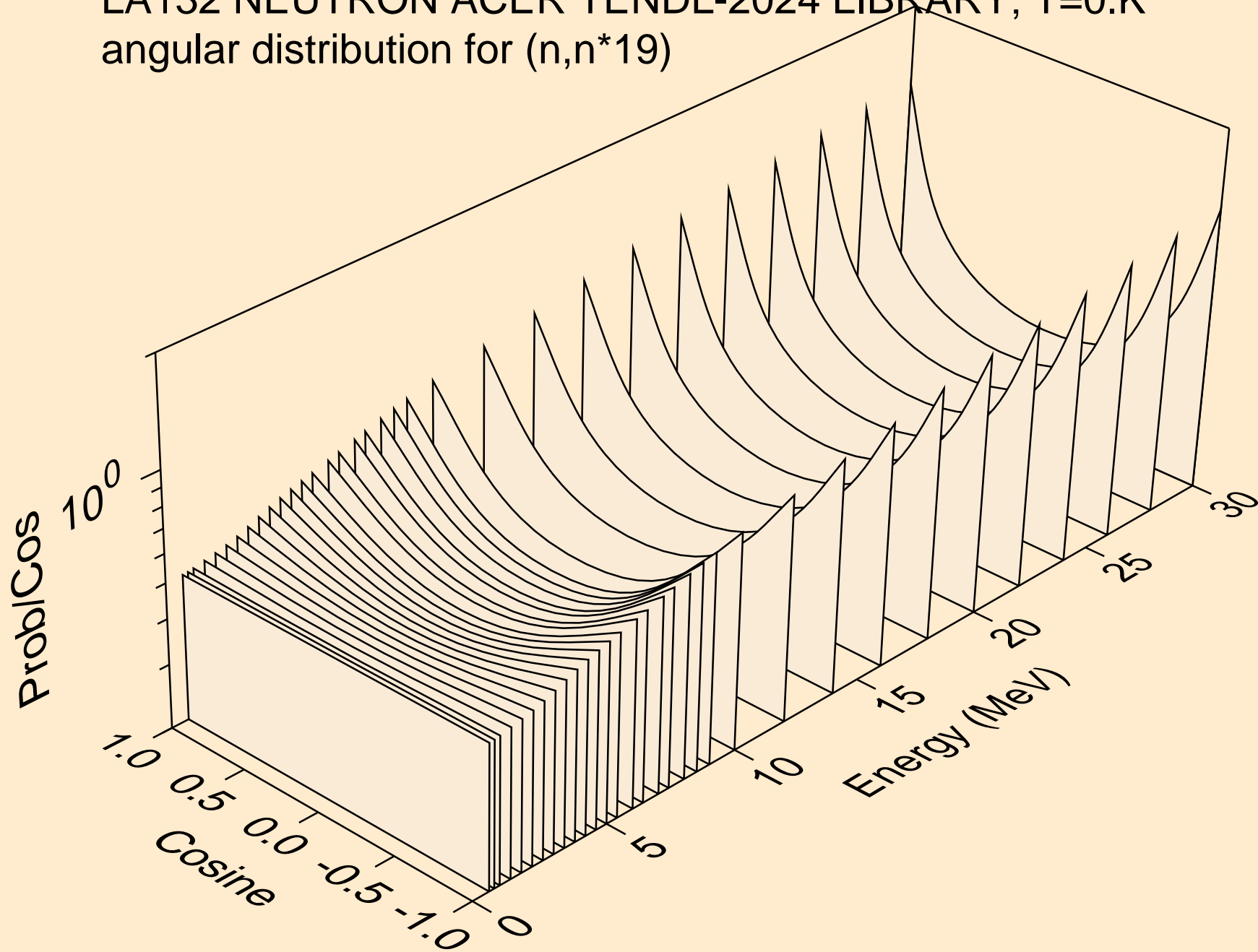

LA132 NEUTRON ACER TENDL-2024 LIBRARY; T=0.K
angular distribution for (n,n*20)

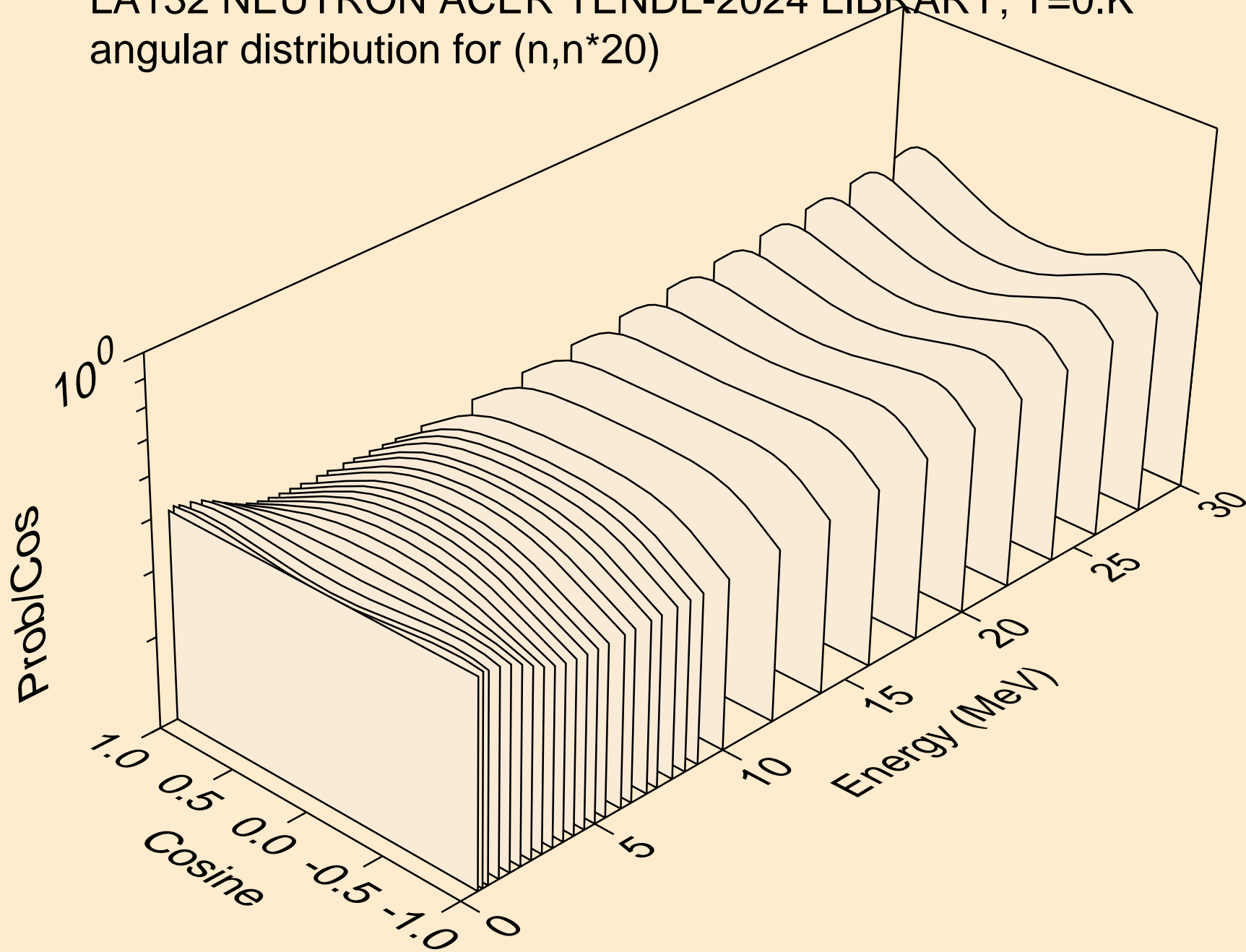

LA132 NEUTRON ACER TENDL-2024 LIBRARY; T=0.K
angular distribution for (n,n*21)

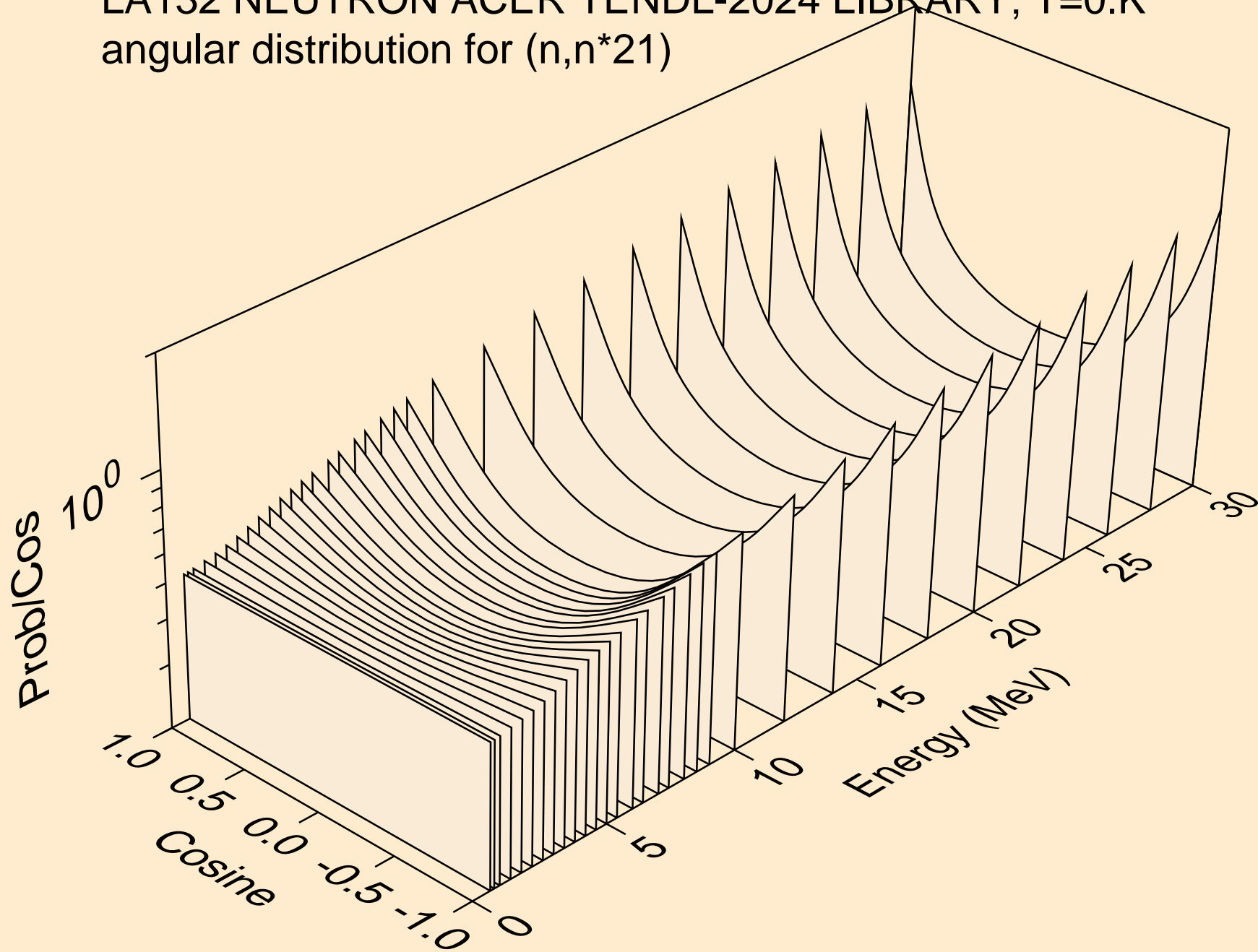

LA132 NEUTRON ACER TENDL-2024 LIBRARY; T=0.K
angular distribution for (n,n*22)

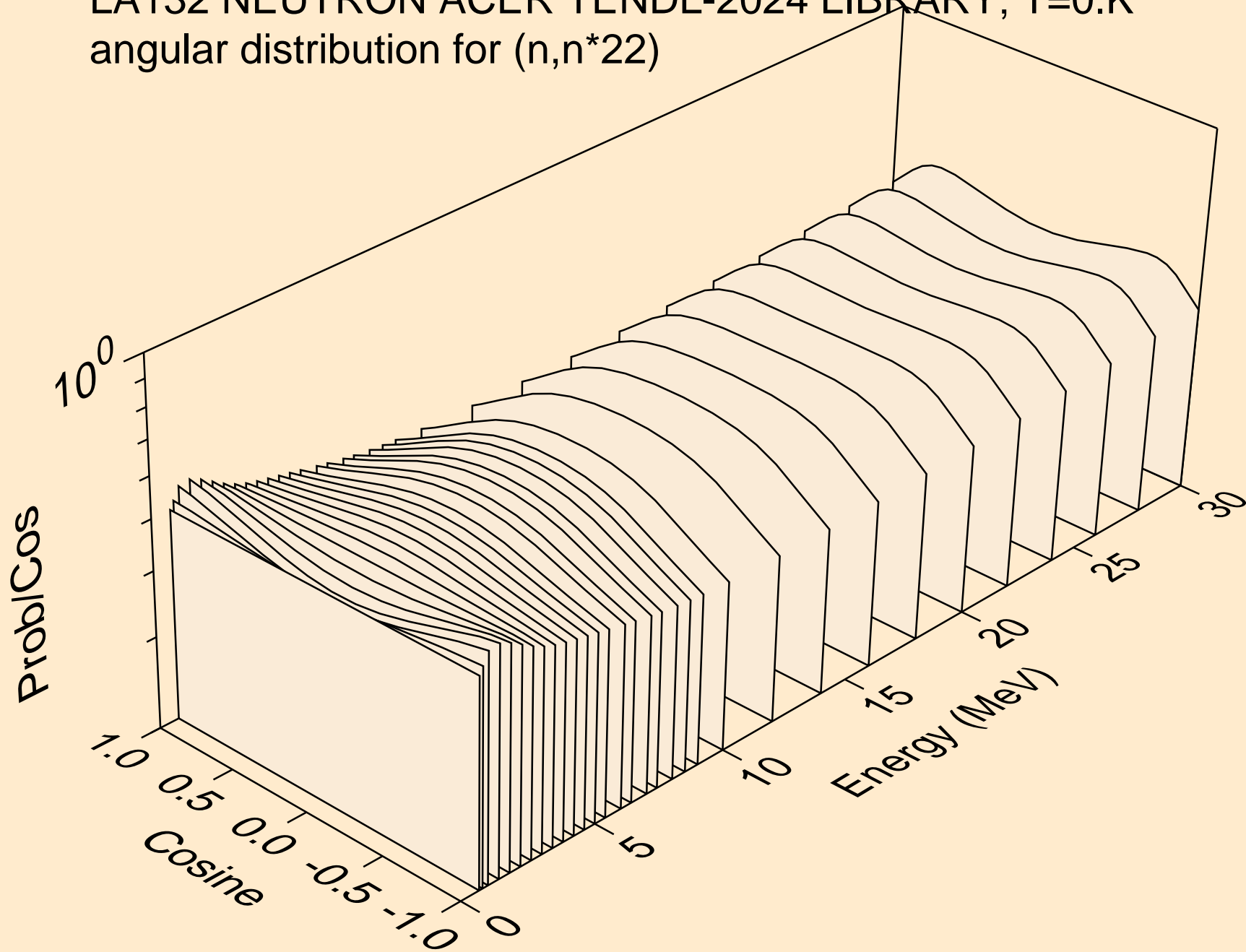

LA132 NEUTRON ACER TENDL-2024 LIBRARY; T=0.K
angular distribution for (n,n*23)

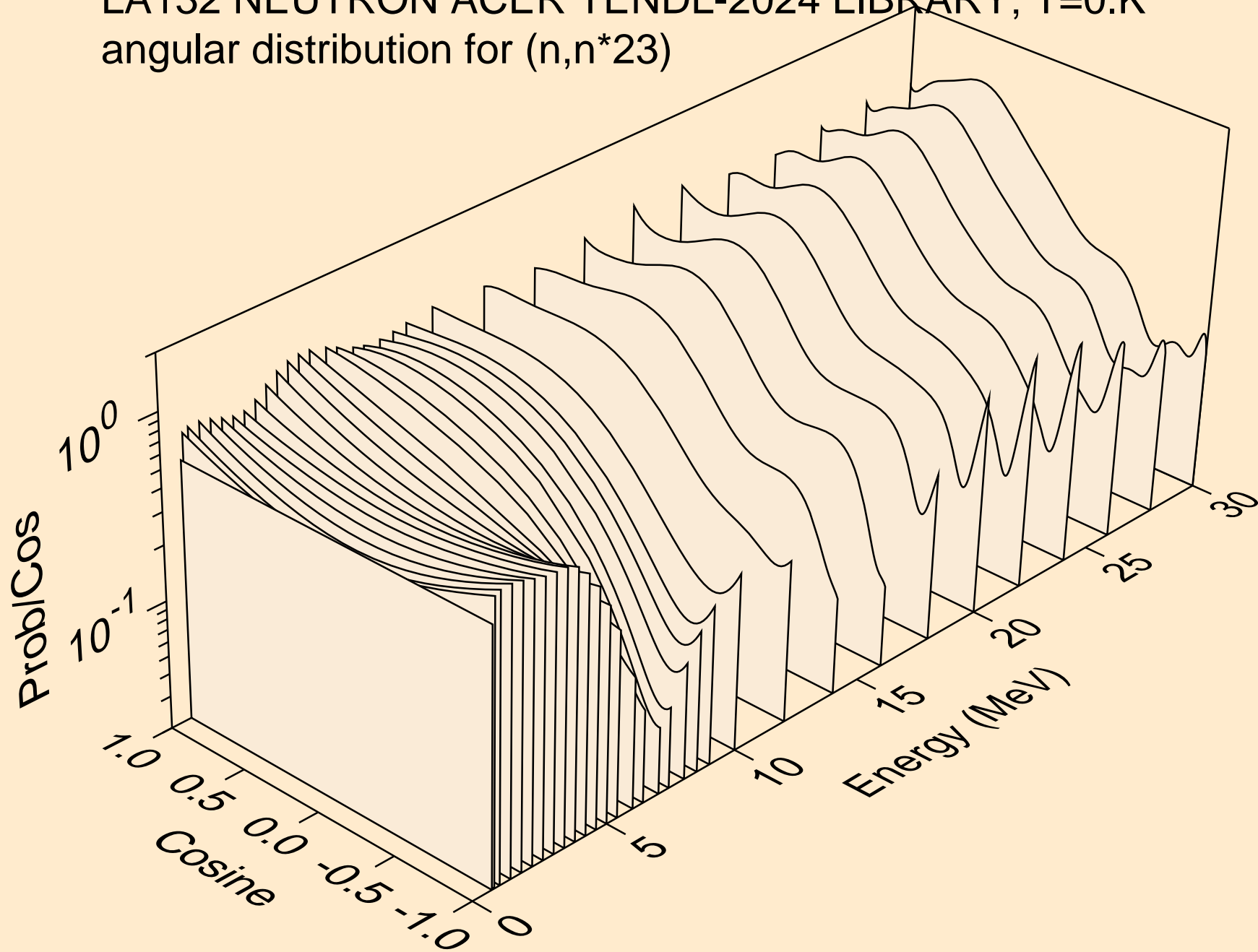

LA132 NEUTRON ACER TENDL-2024 LIBRARY; T=0.K
angular distribution for (n,n*24)

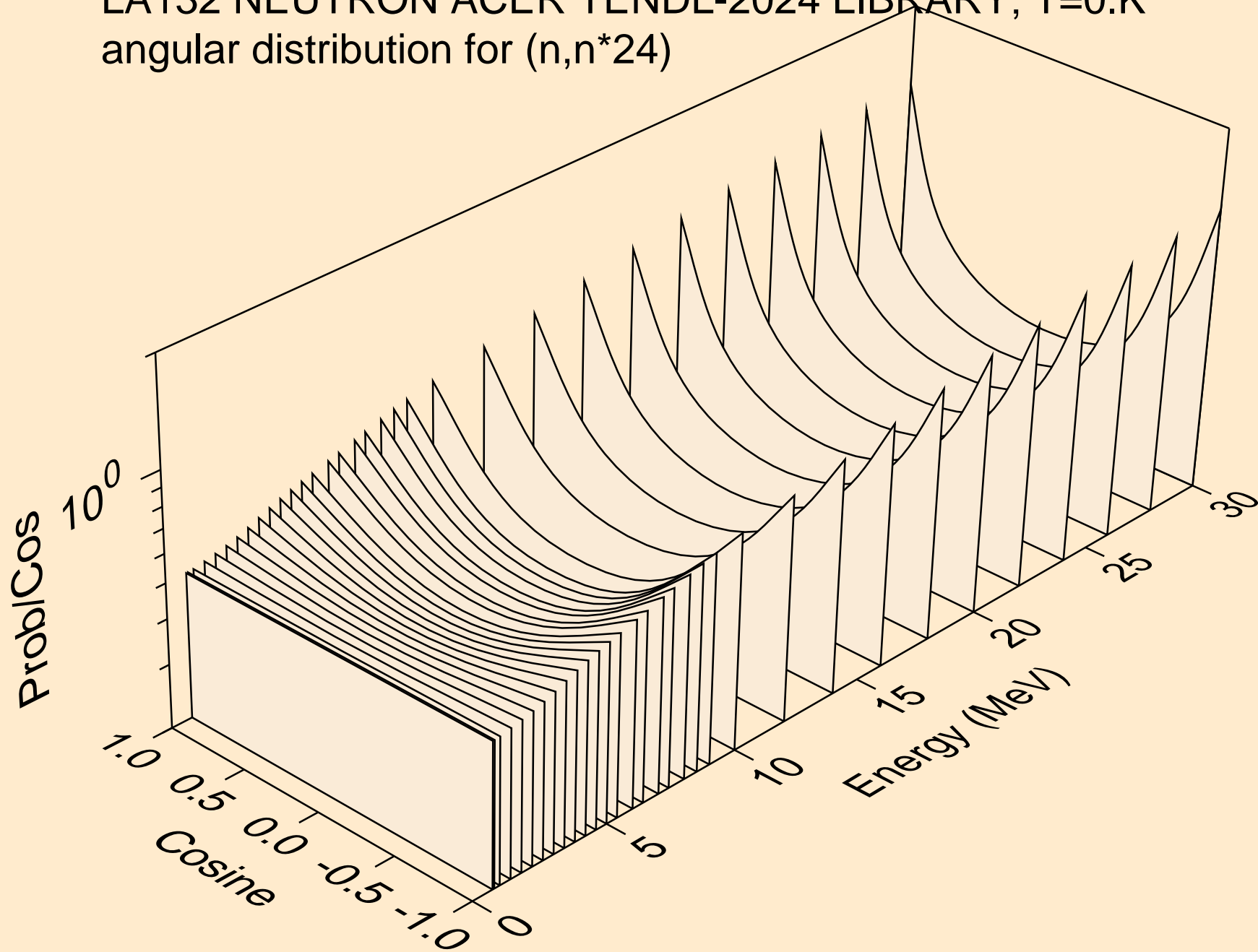

LA132 NEUTRON ACER TENDL-2024 LIBRARY; T=0.K
angular distribution for (n,n*25)

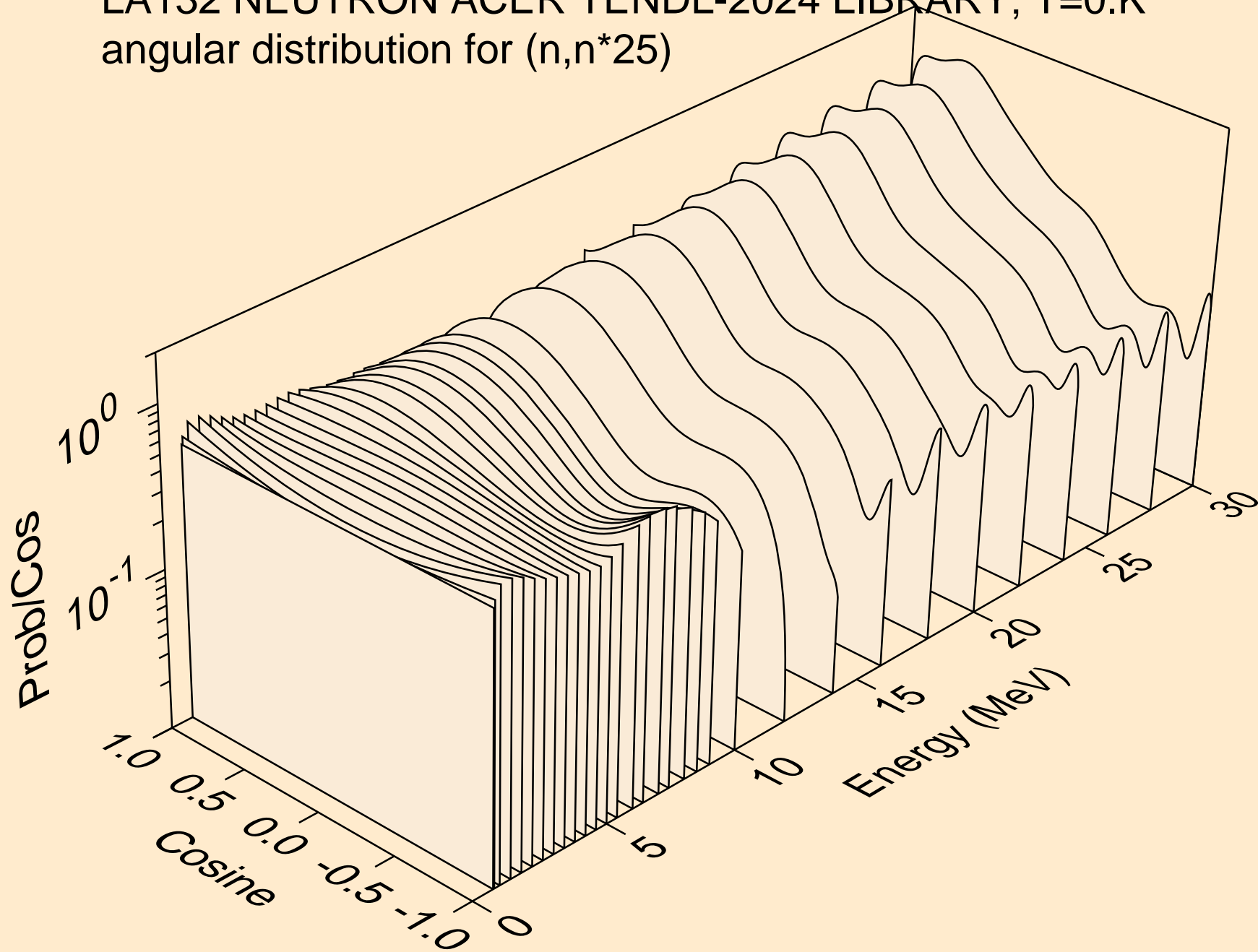

LA132 NEUTRON ACER TENDL-2024 LIBRARY; T=0.K
angular distribution for (n,n*26)

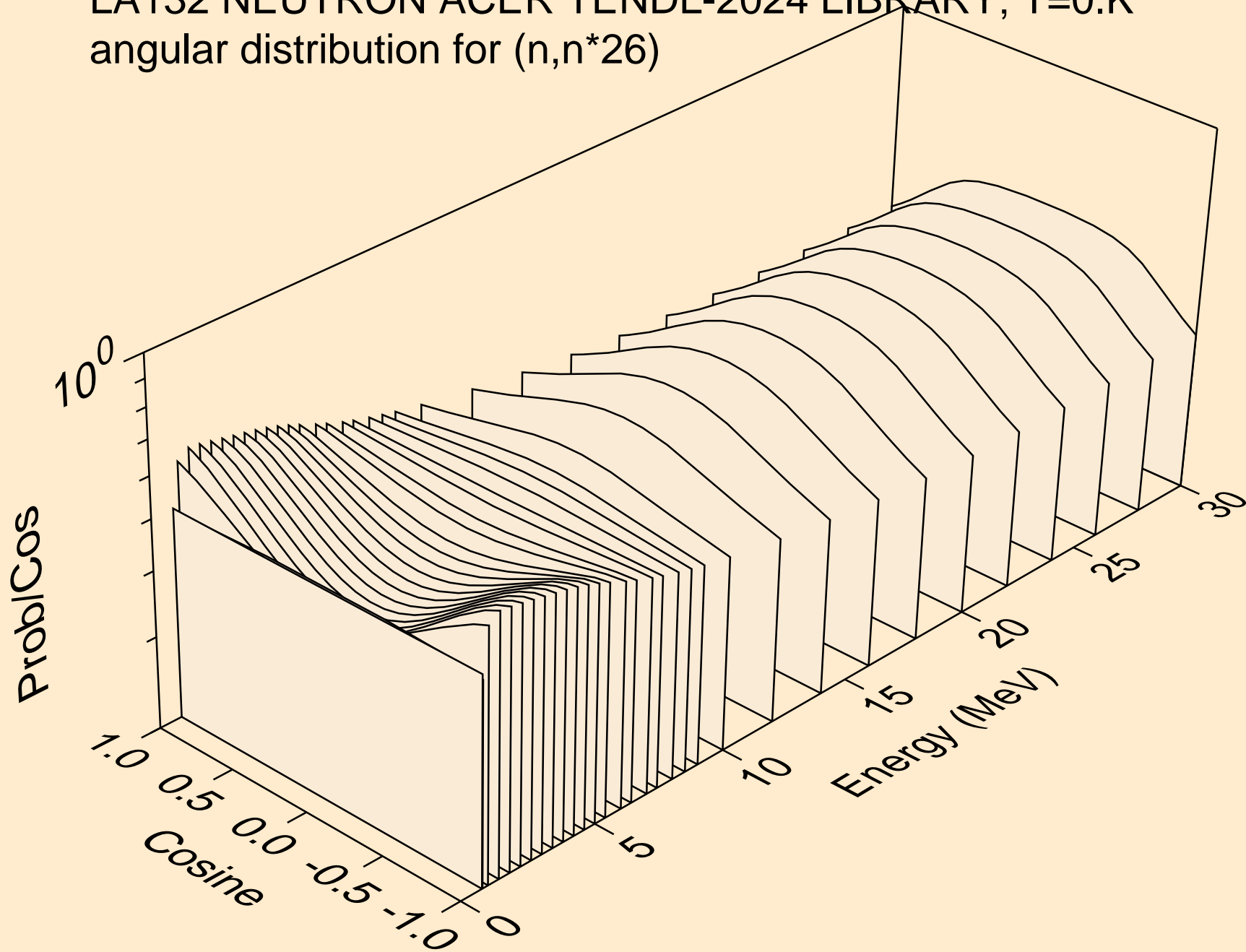

LA132 NEUTRON ACER TENDL-2024 LIBRARY; T=0.K
angular distribution for (n,n*27)

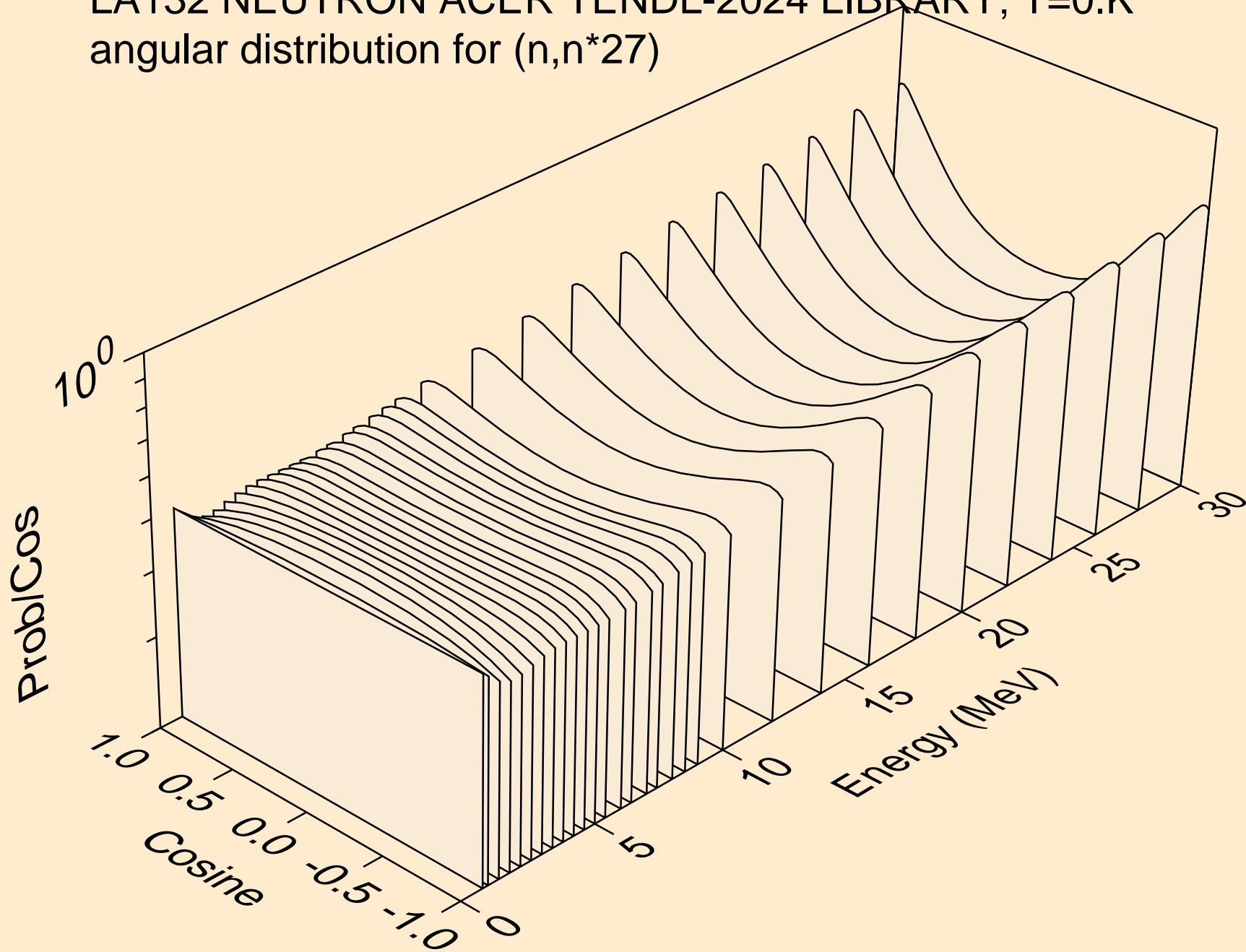

LA132 NEUTRON ACER TENDL-2024 LIBRARY; T=0.K
Neutron emission for (n,x)

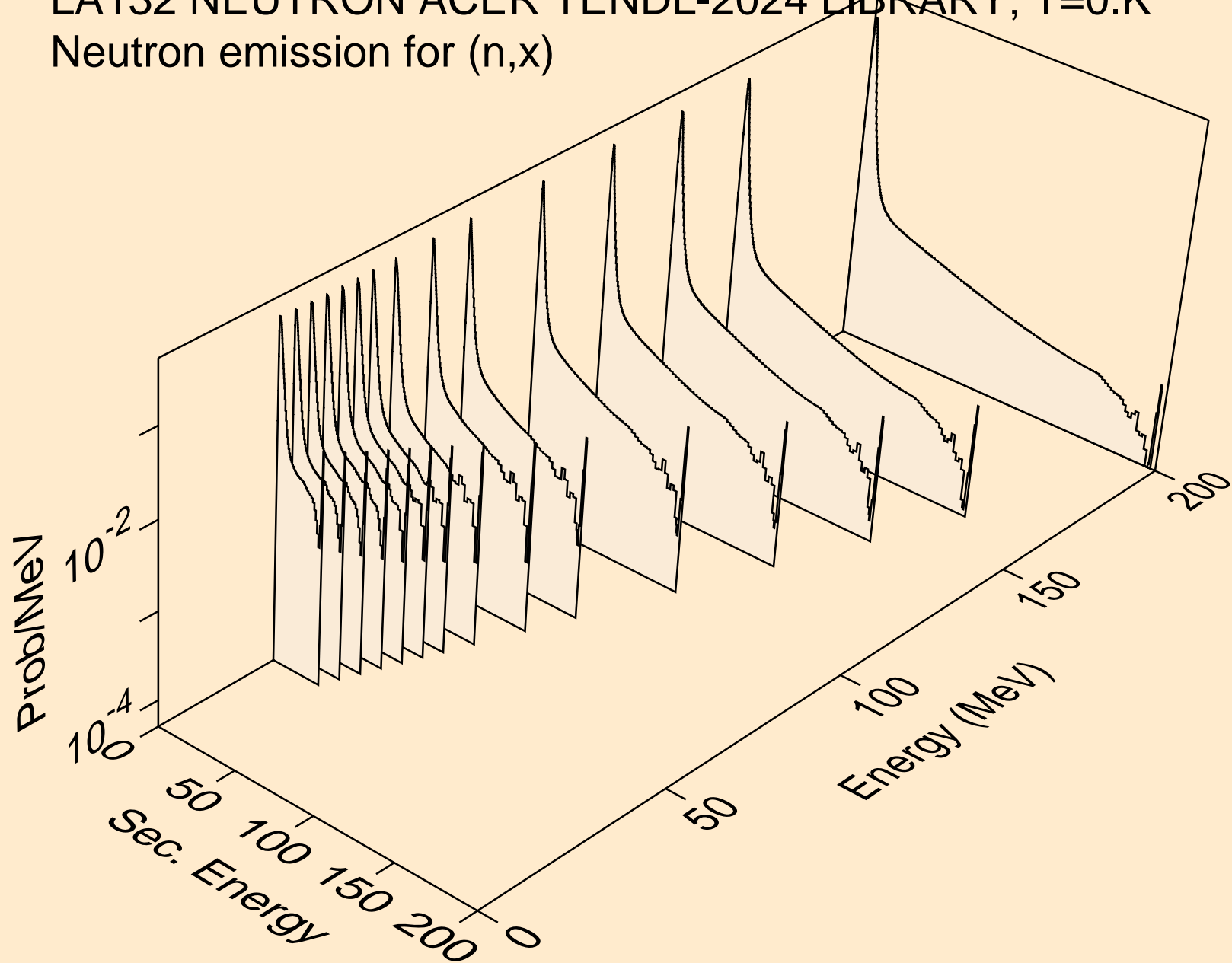

LA132 NEUTRON ACER TENDL-2024 LIBRARY; T=0.K
Neutron emission for (n,2nd)

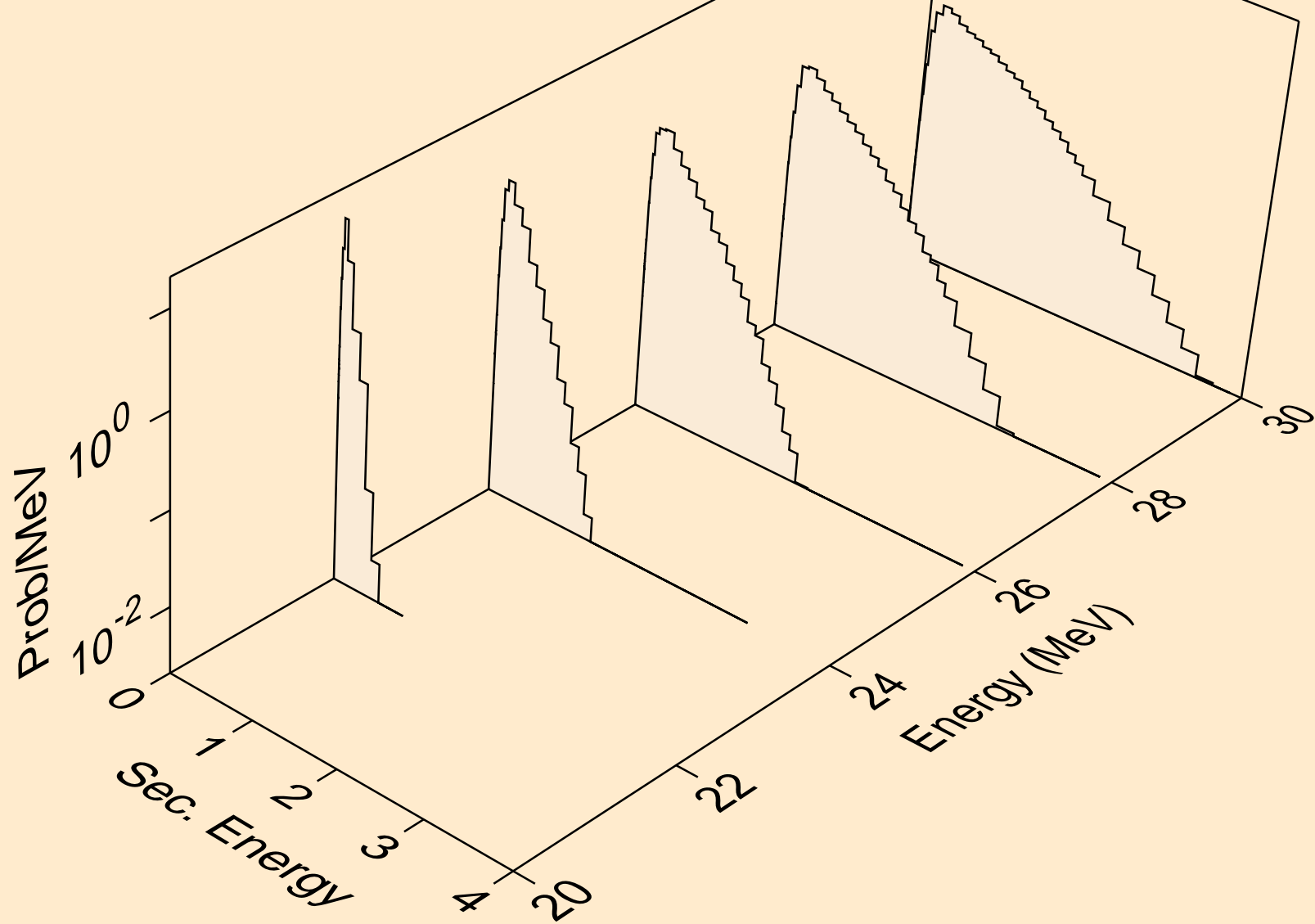

LA132 NEUTRON ACER TENDL-2024 LIBRARY; T=0.K
Neutron emission for (n,2n)

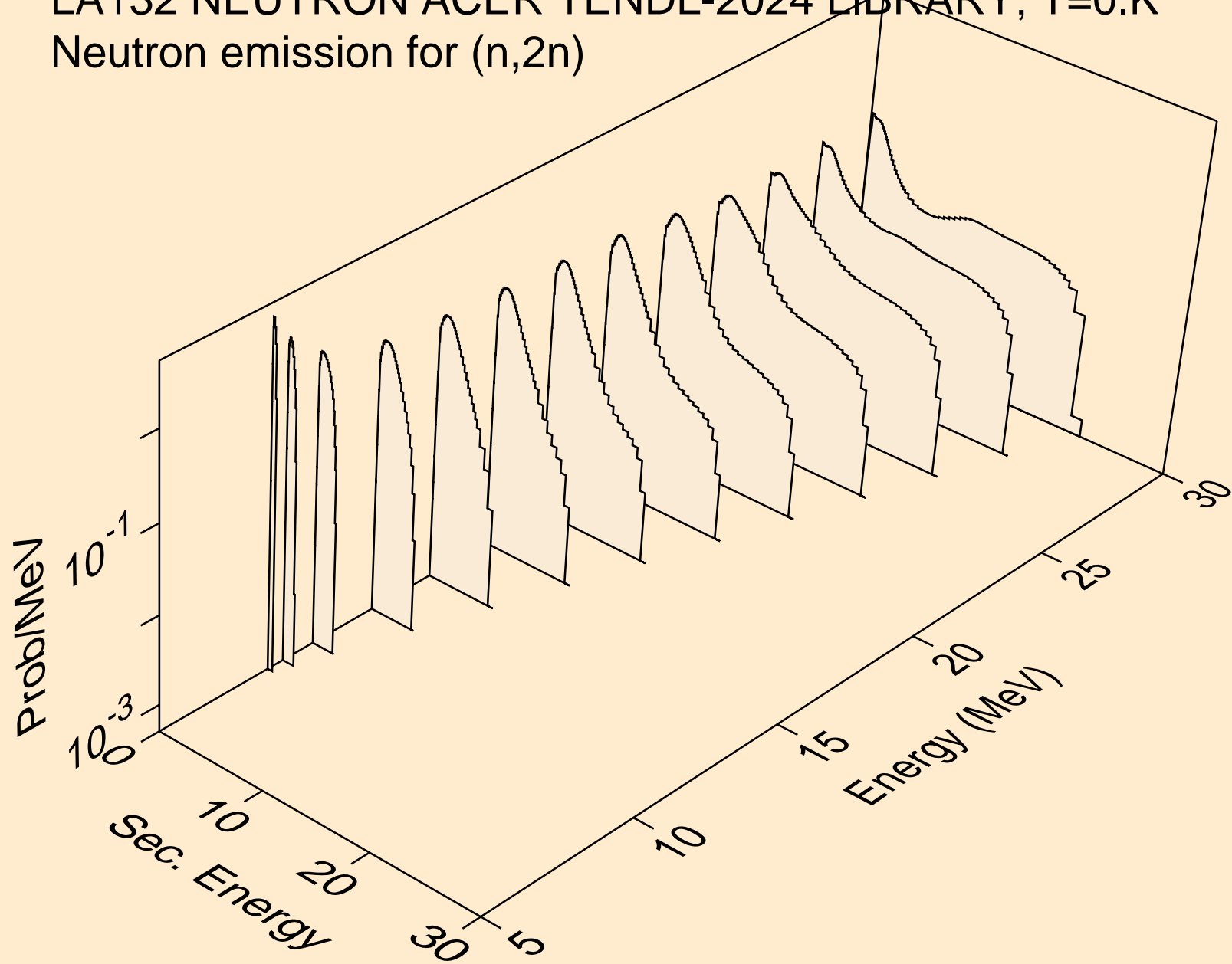

LA132 NEUTRON ACER TENDL-2024 LIBRARY; T=0.K
Neutron emission for (n,3n)

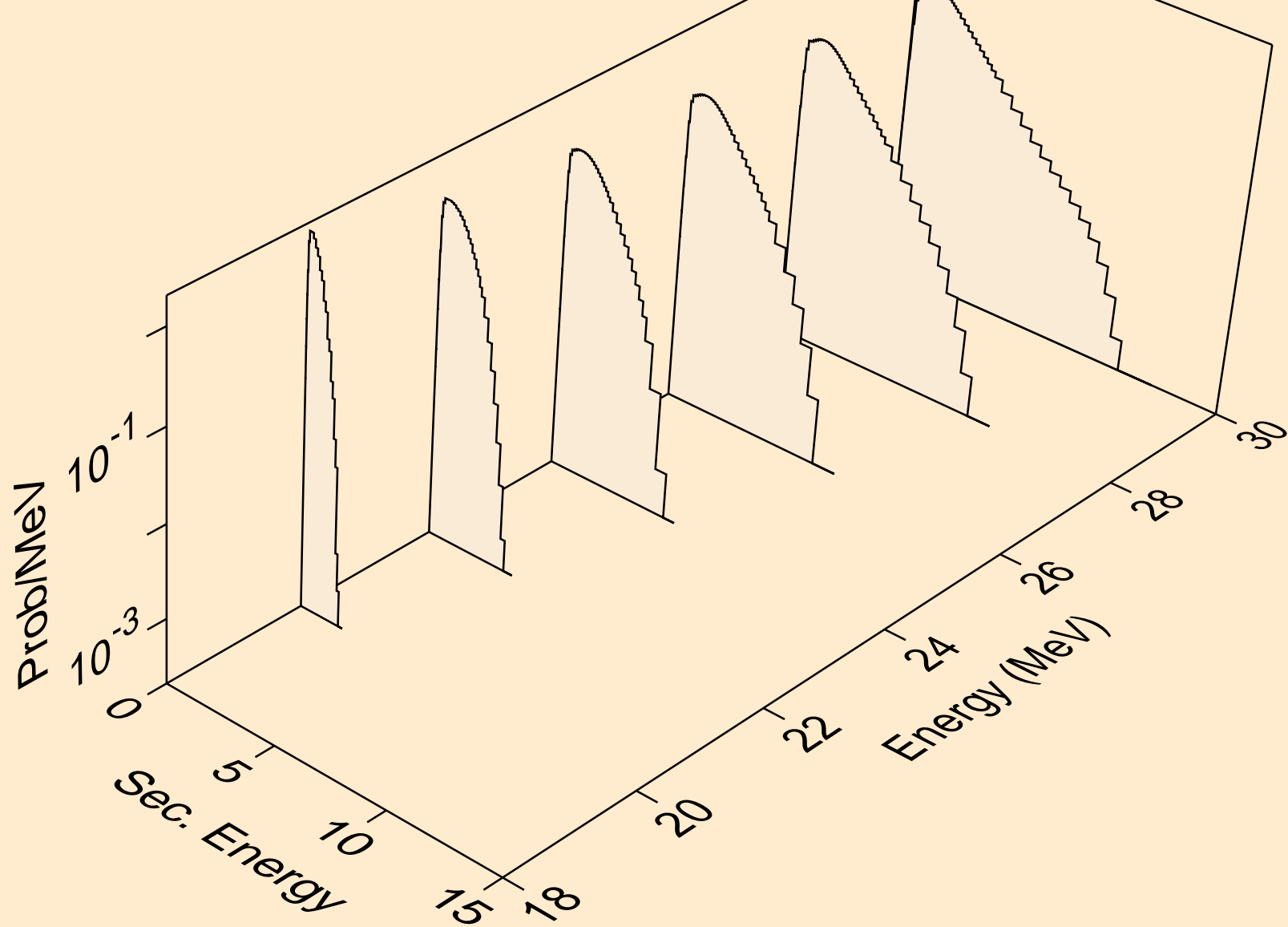

LA132 NEUTRON ACER TENDL-2024 LIBRARY; T=0.K
Neutron emission for (n,n*)a

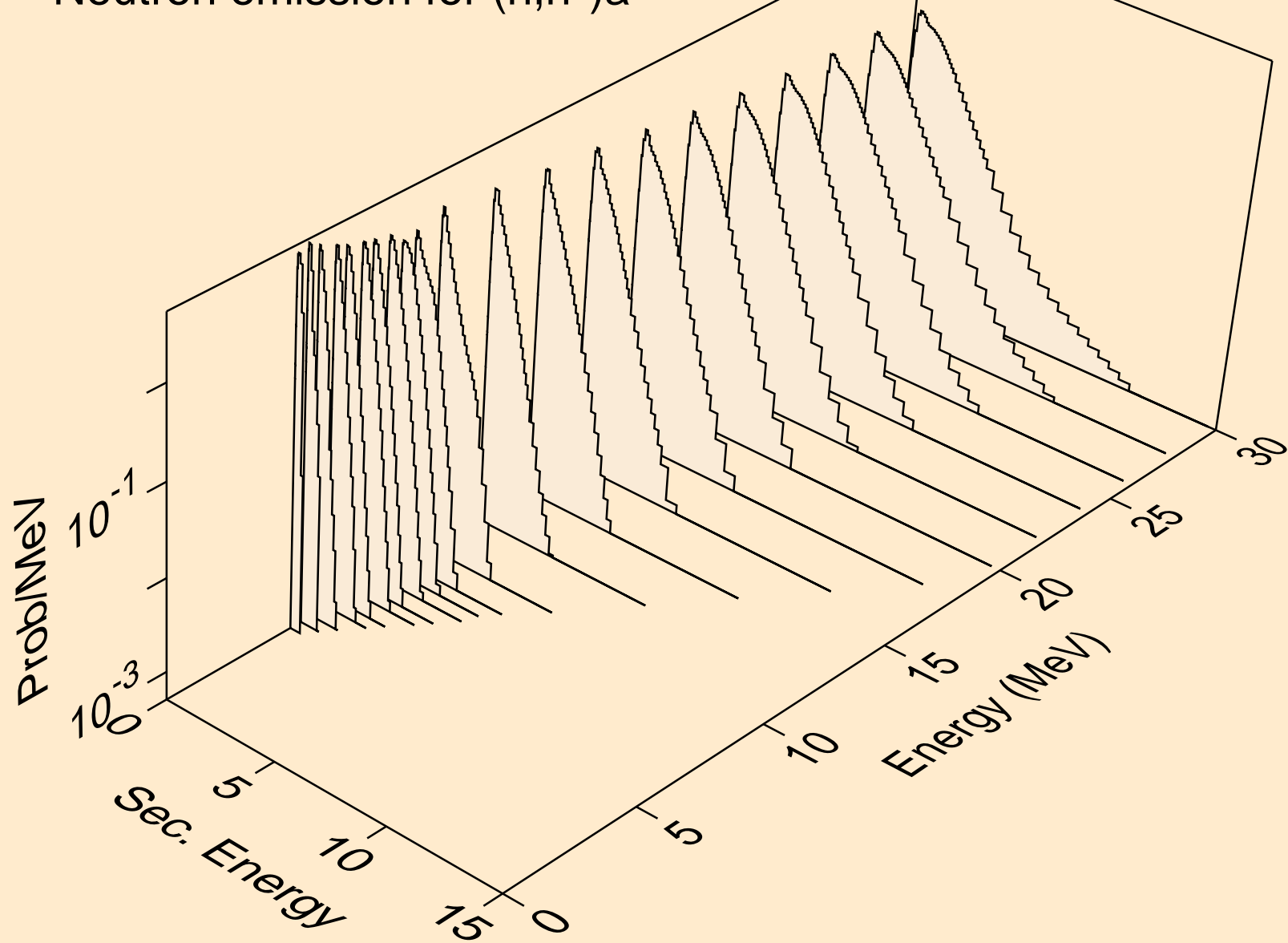

LA132 NEUTRON ACER TENDL-2024 LIBRARY; T=0.K
Neutron emission for (n,2n)a

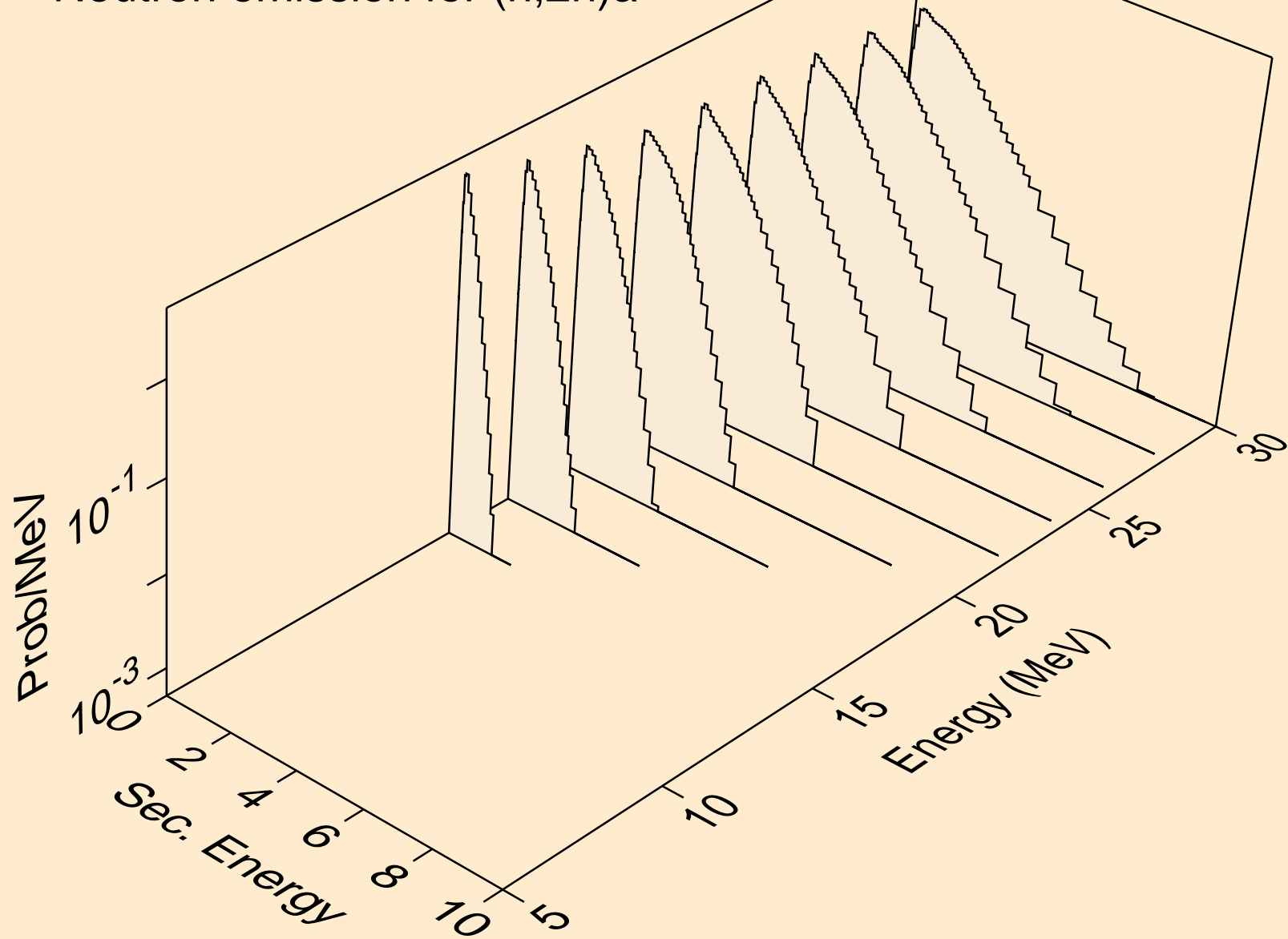

LA132 NEUTRON ACER TENDL-2024 LIBRARY; T=0.K
Neutron emission for (n,3n)a

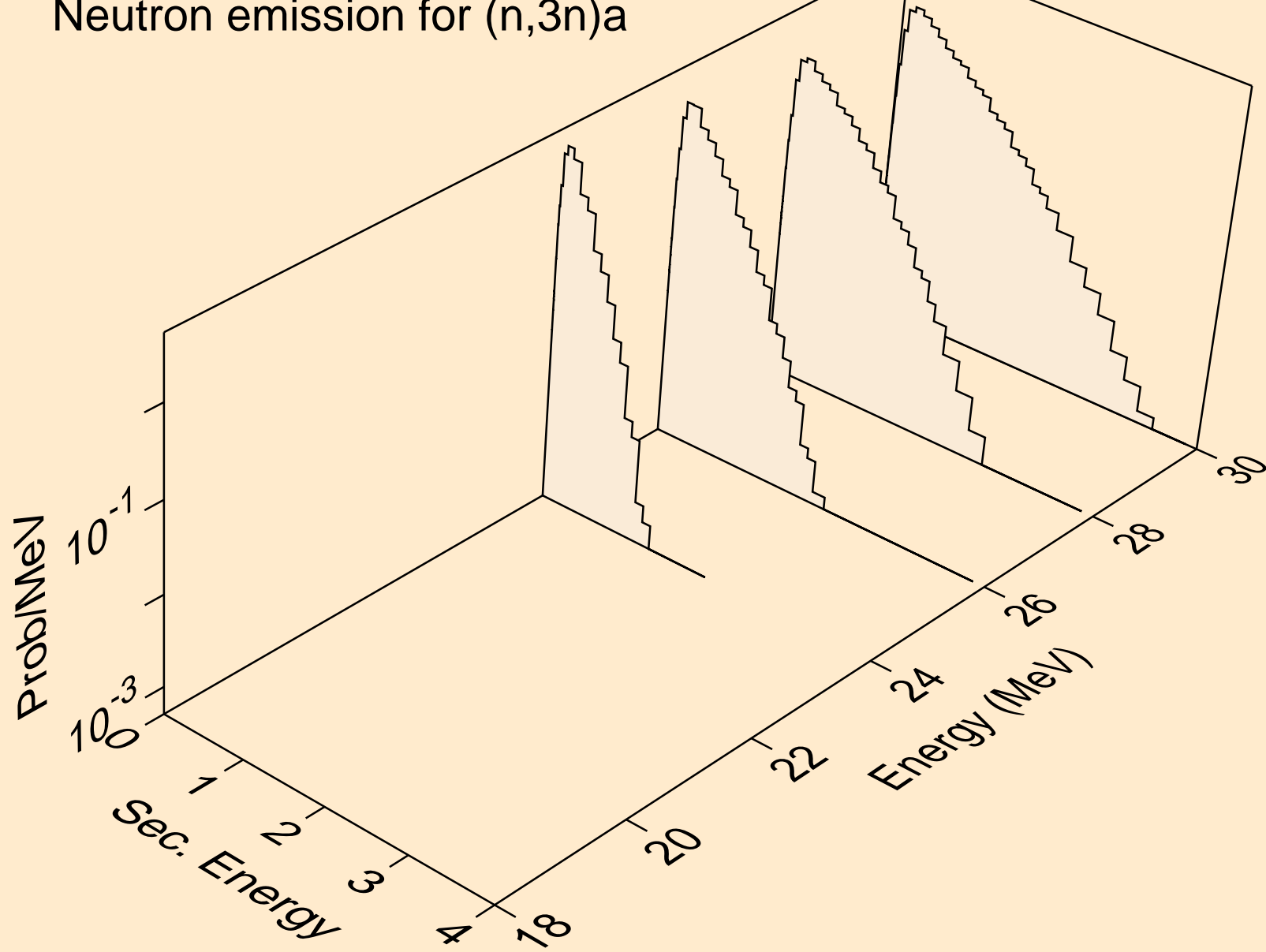

LA132 NEUTRON ACER TENDL-2024 LIBRARY; T=0.K
Neutron emission for (n,n*)p

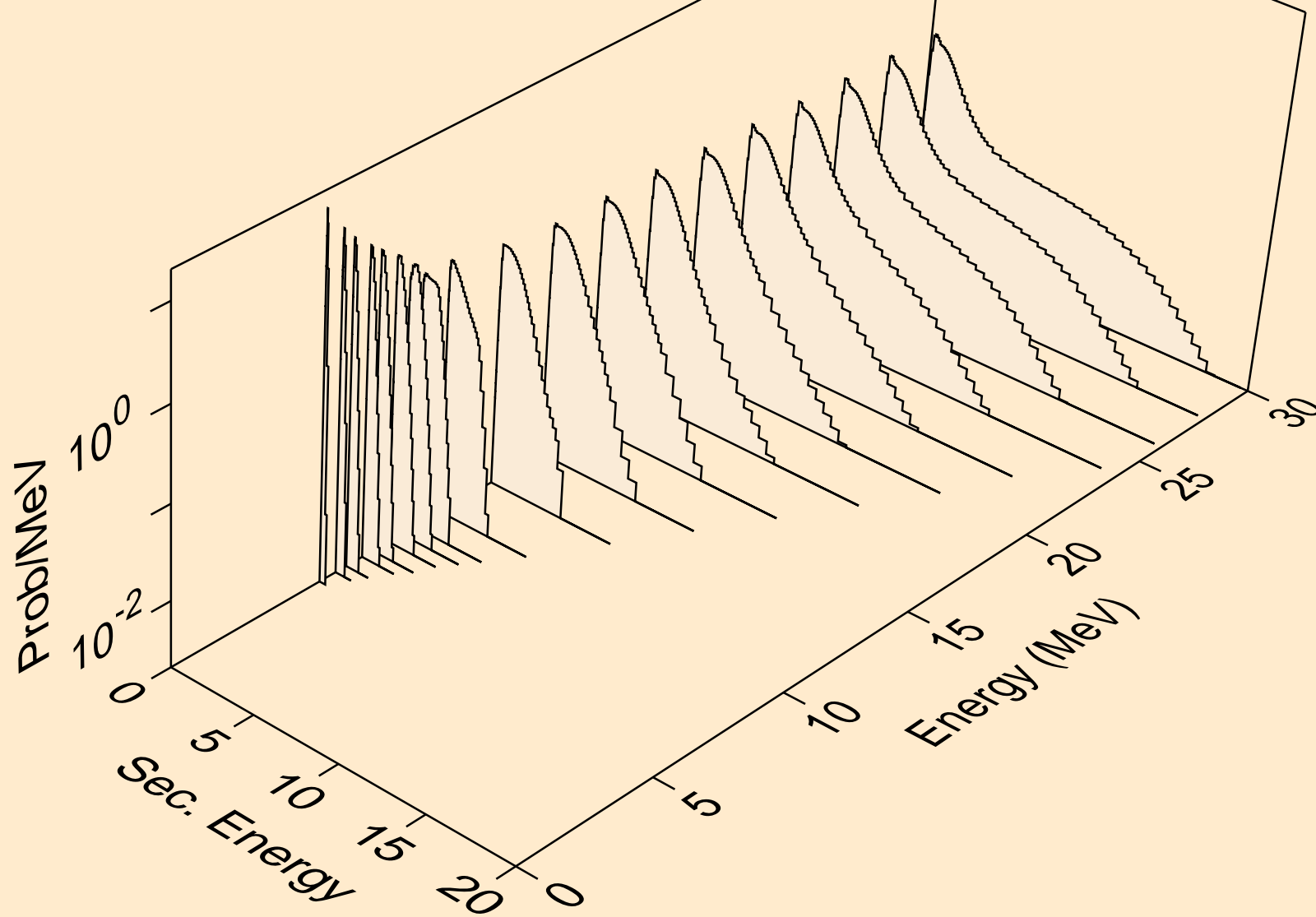

LA132 NEUTRON ACER TENDL-2024 LIBRARY; T=0.K
Neutron emission for (n,n*)2a

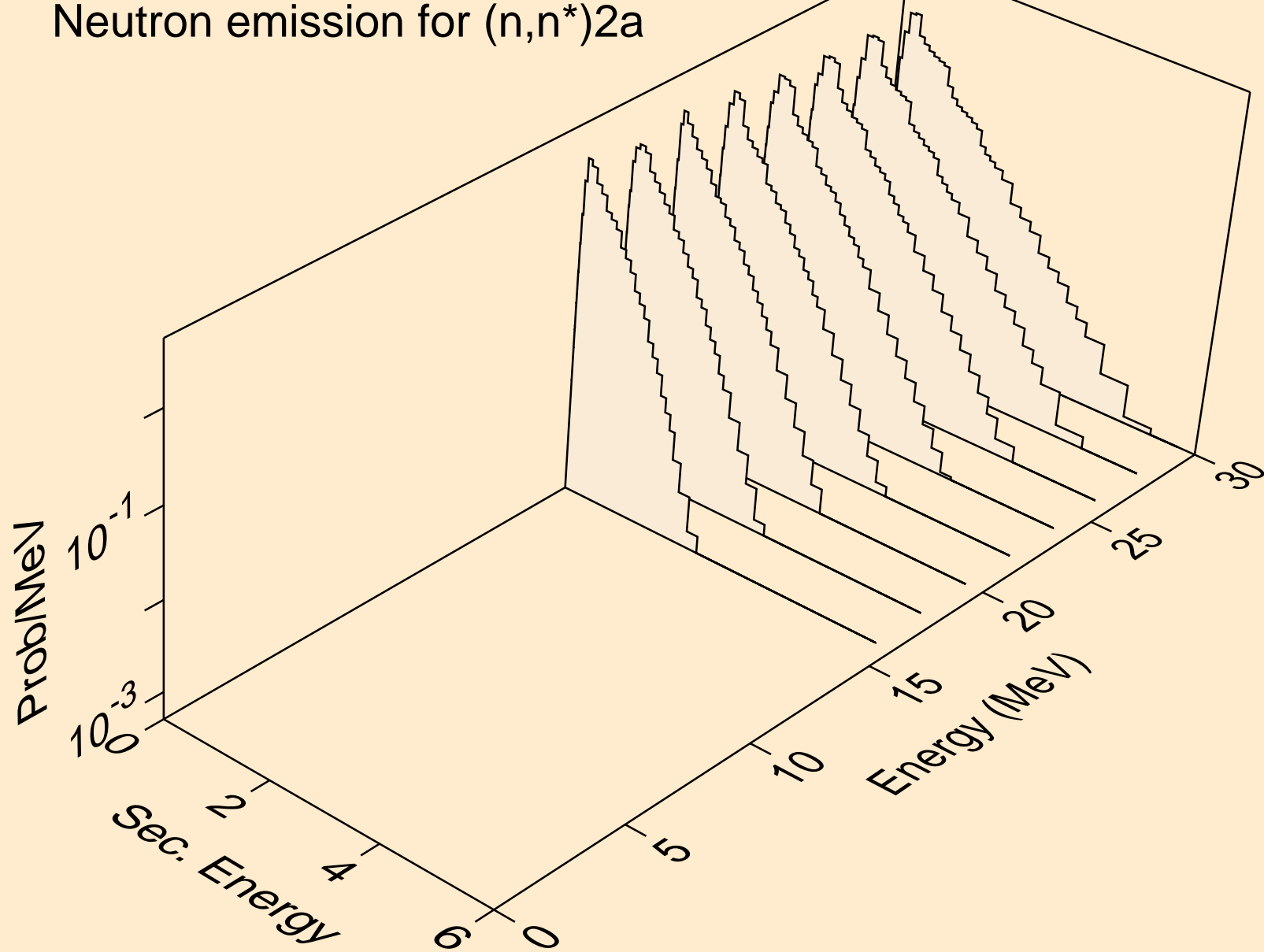

LA132 NEUTRON ACER TENDL-2024 LIBRARY; T=0.K
Neutron emission for (n,n*)d

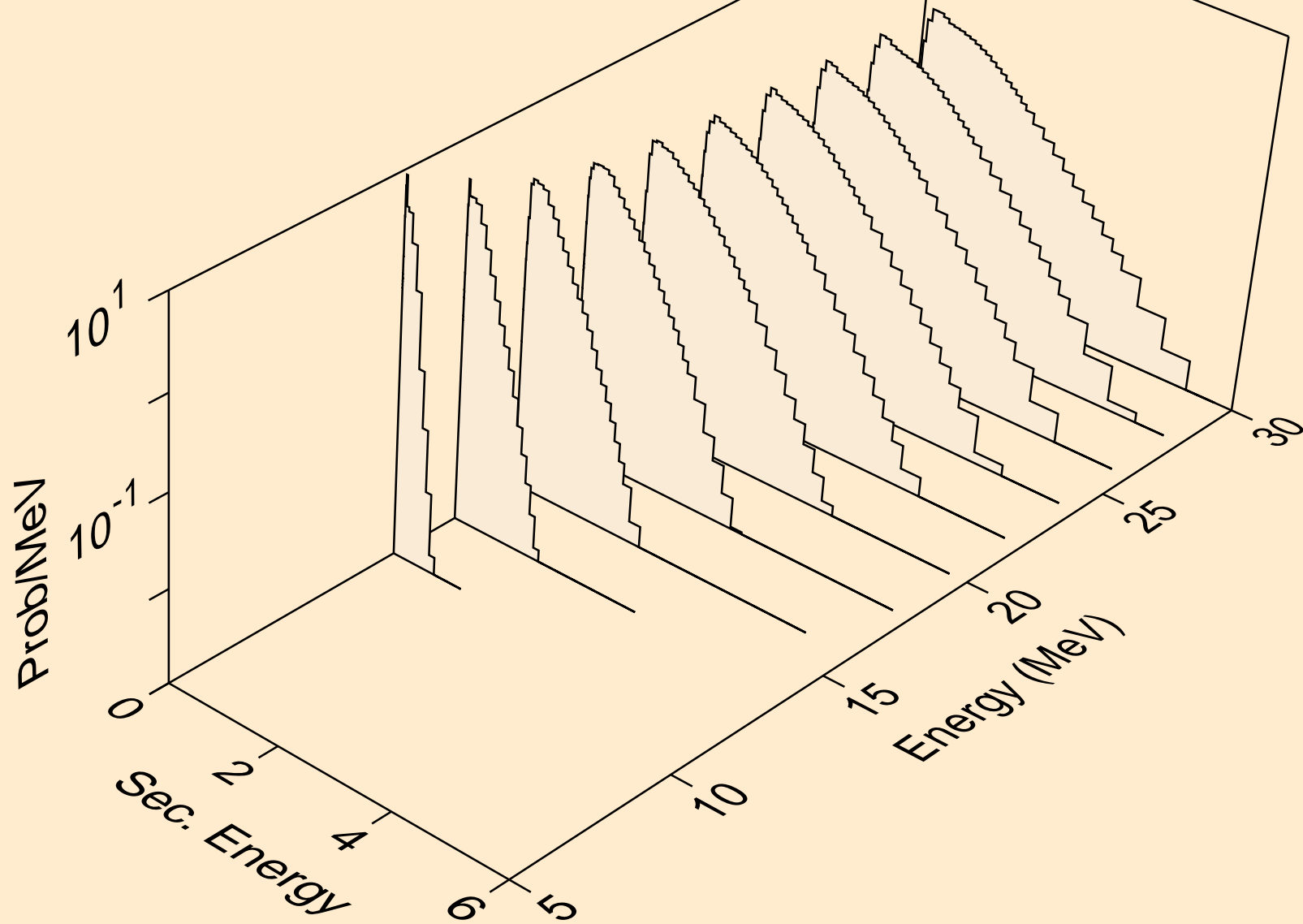

LA132 NEUTRON ACER TENDL-2024 LIBRARY; T=0.K
Neutron emission for (n,n*)t

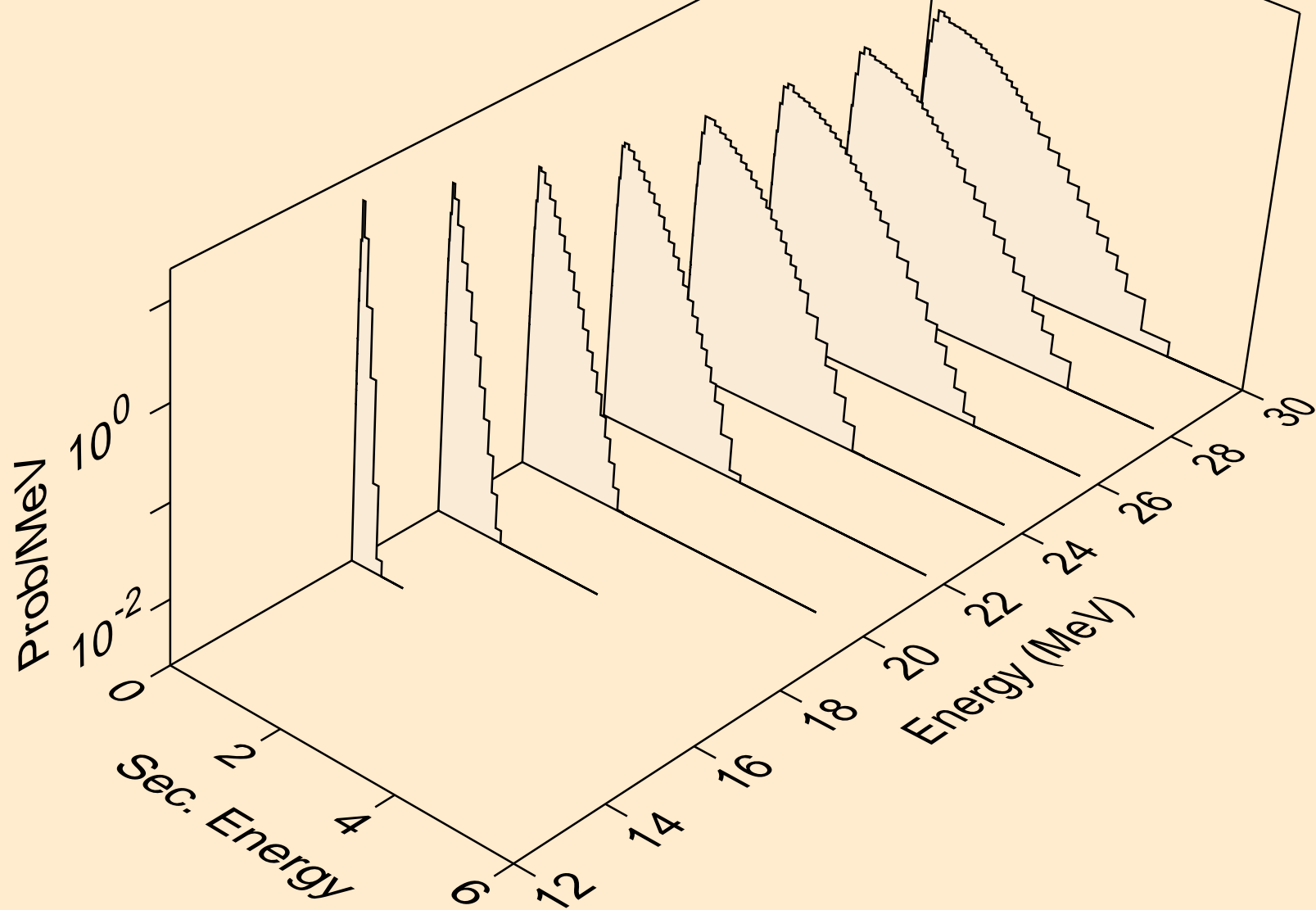

LA132 NEUTRON ACER TENDL-2024 LIBRARY; T=0.K
Neutron emission for (n,n*)he3

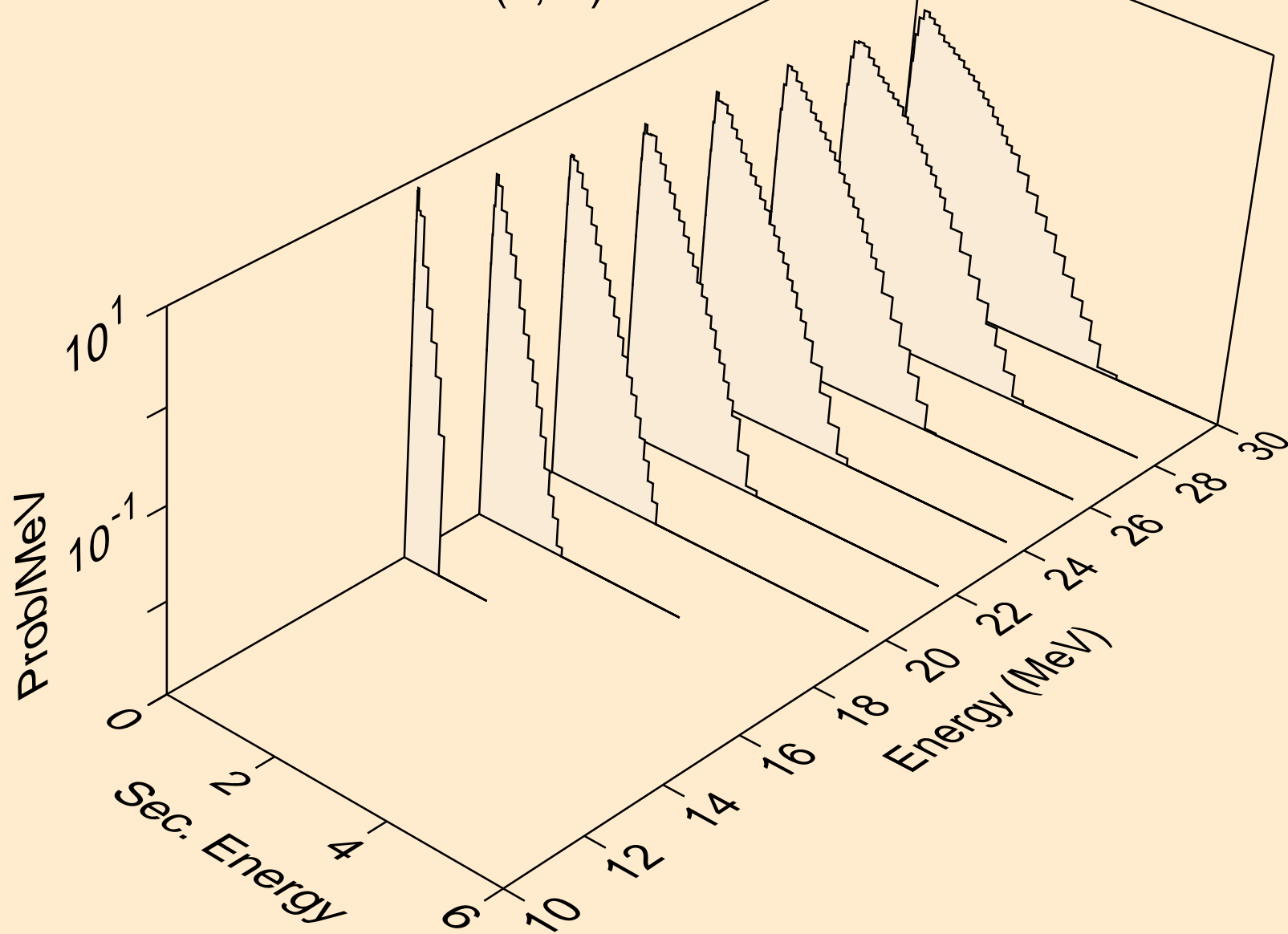

LA132 NEUTRON ACER TENDL-2024 LIBRARY; T=0.K
Neutron emission for (n,4n)

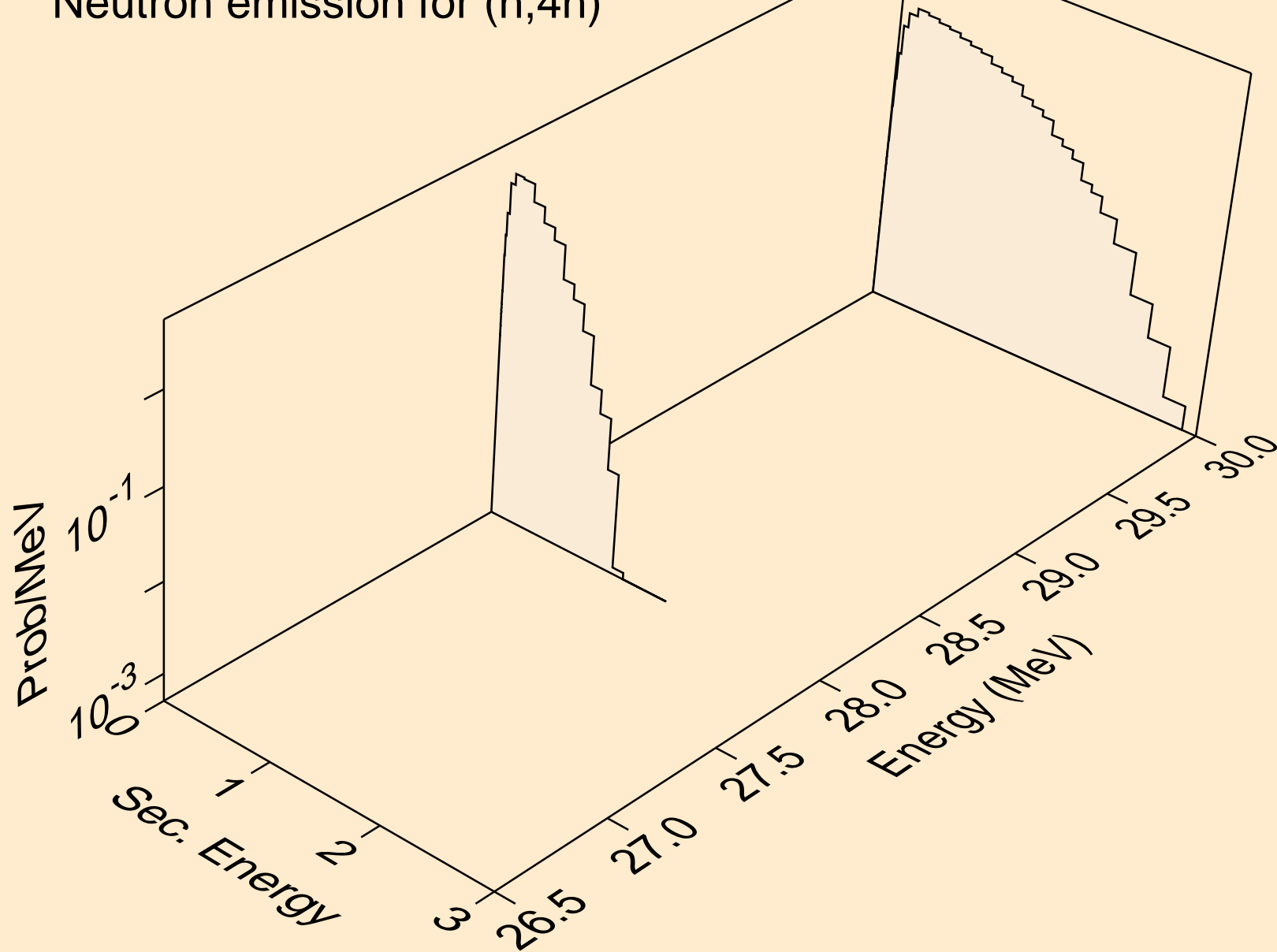

LA132 NEUTRON ACER TENDL-2024 LIBRARY; T=0.K
Neutron emission for (n,2np)

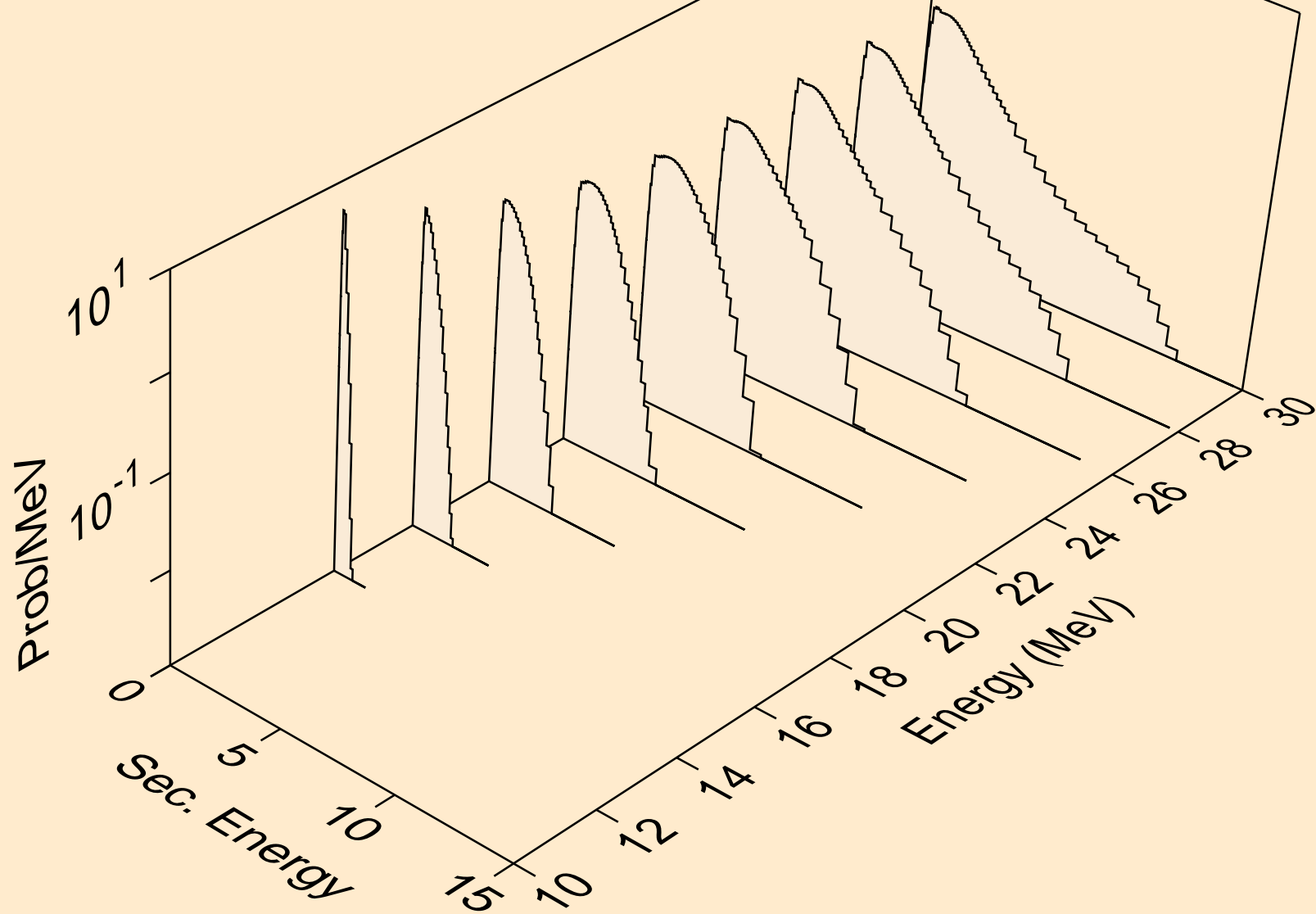

LA132 NEUTRON ACER TENDL-2024 LIBRARY; T=0.K
Neutron emission for (n,3np)

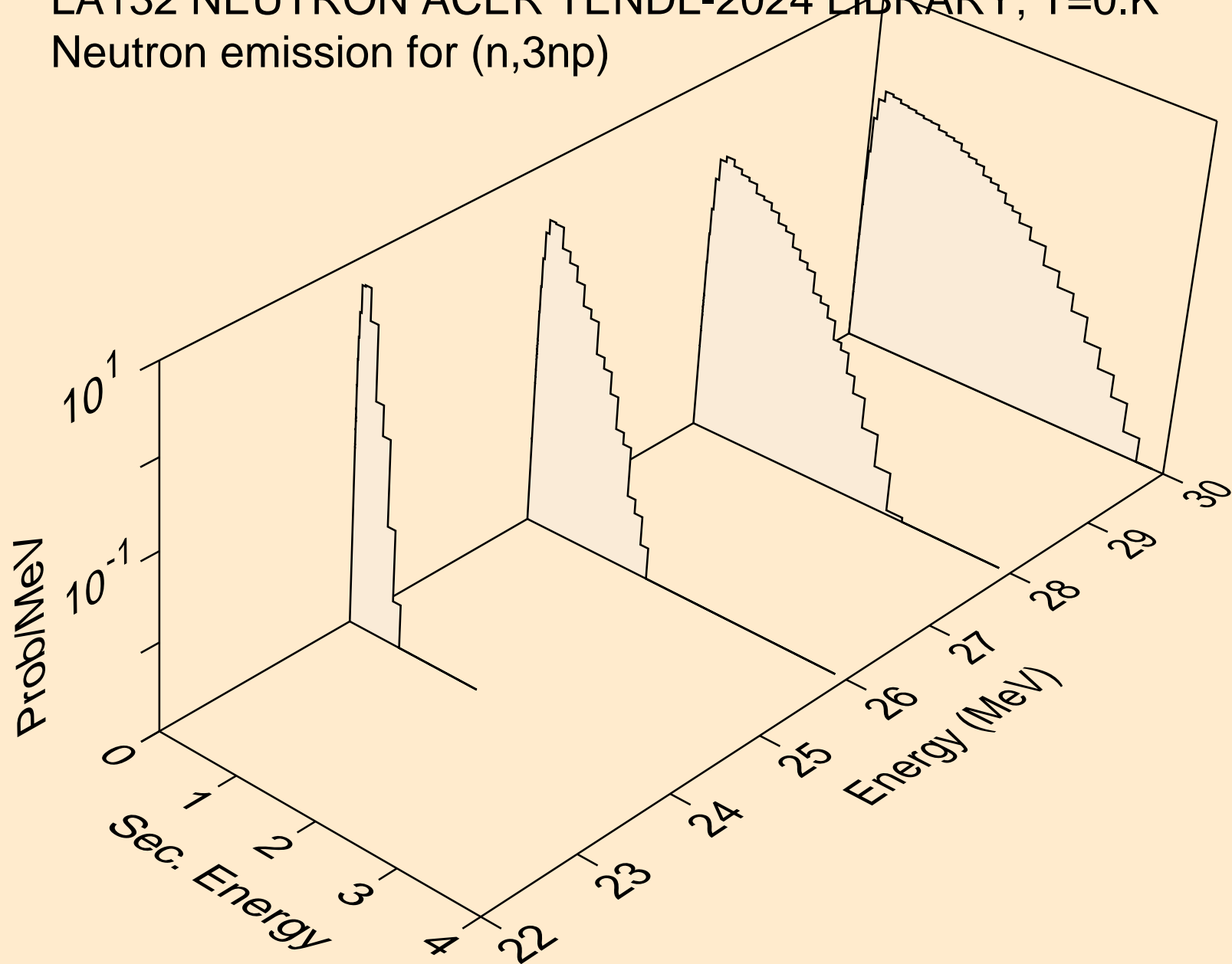

LA132 NEUTRON ACER TENDL-2024 LIBRARY; T=0.K
Neutron emission for (n,n2p)

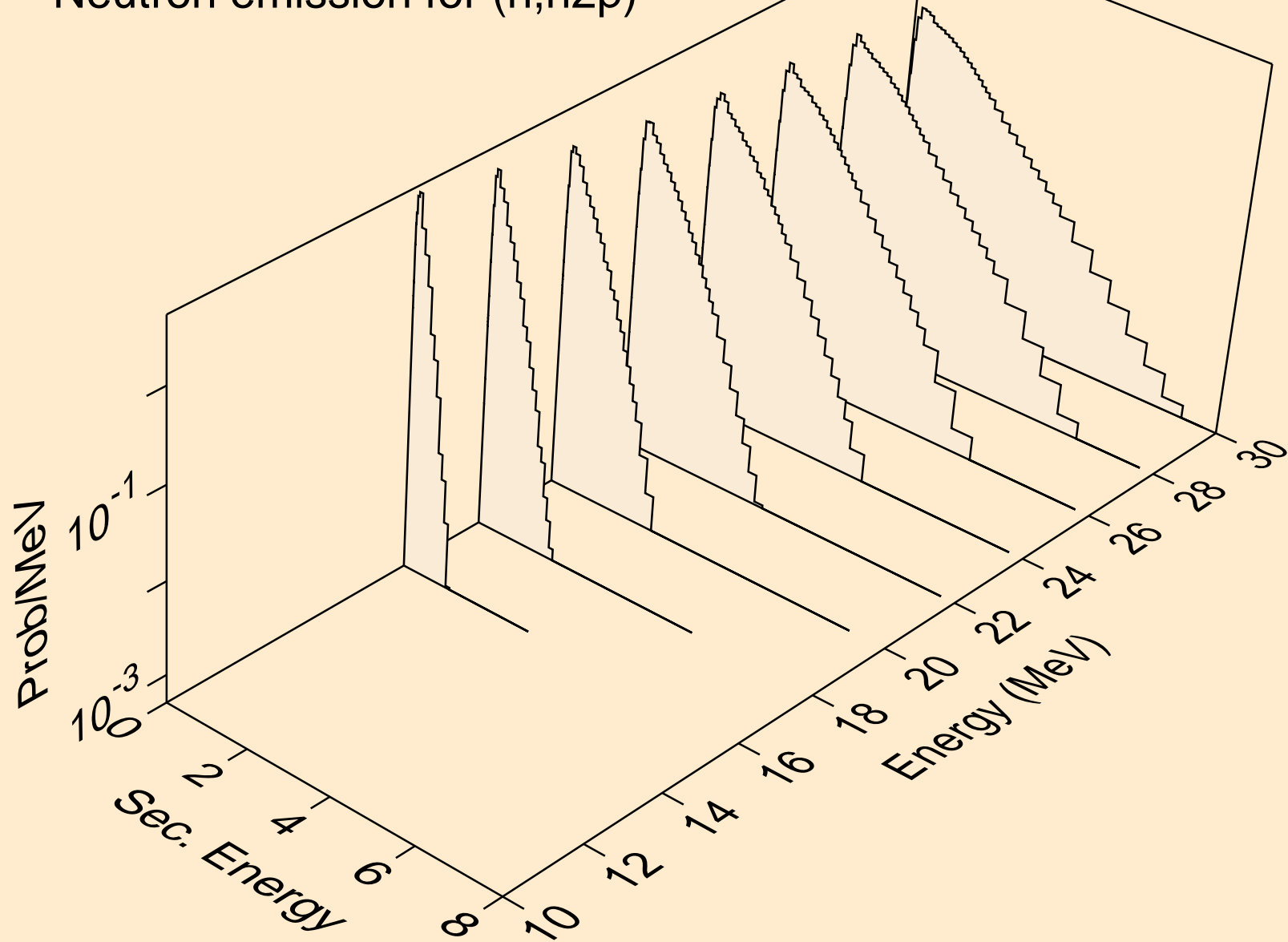

LA132 NEUTRON ACER TENDL-2024 LIBRARY; T=0.K
Neutron emission for (n,npa)

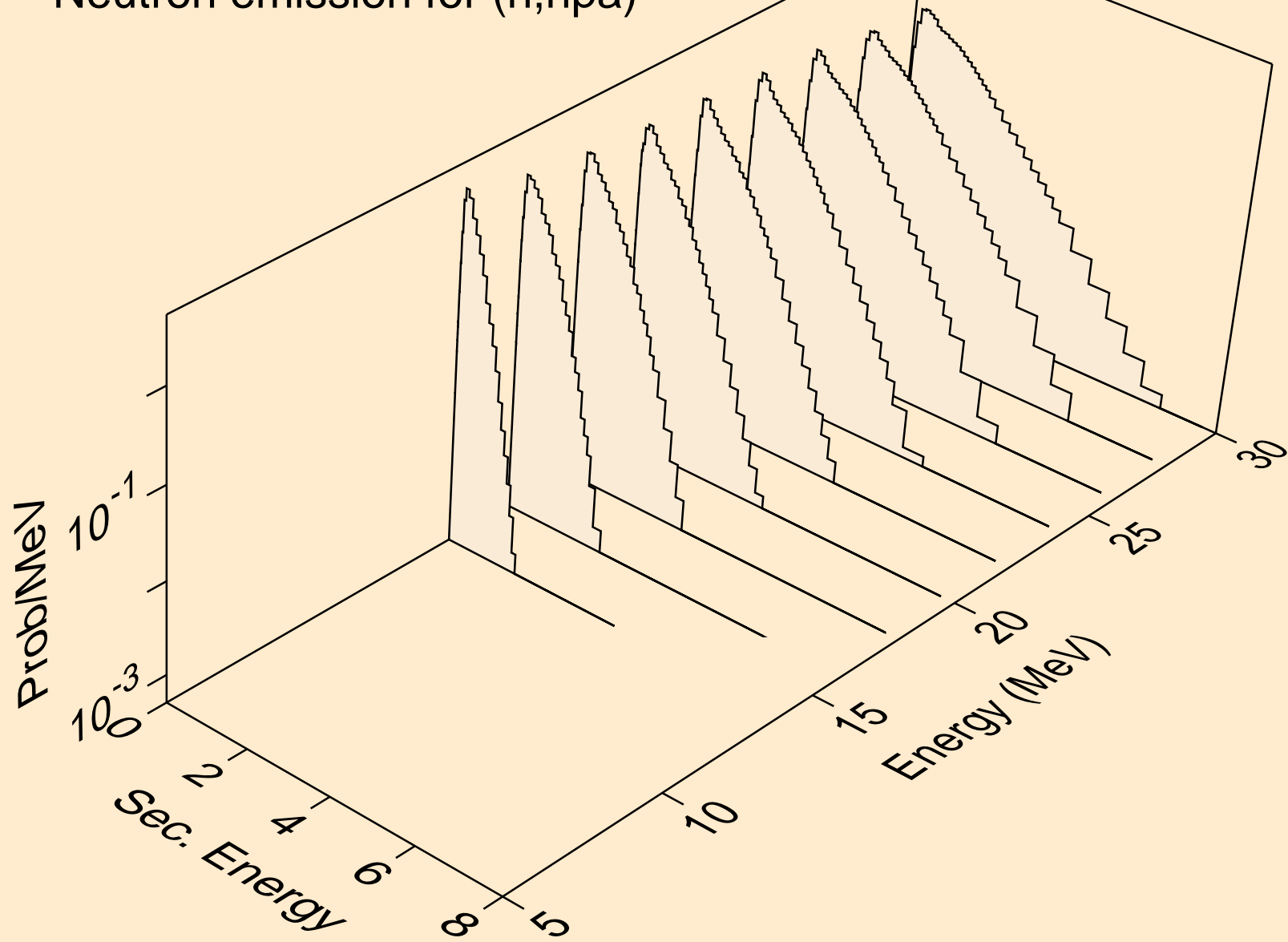

LA132 NEUTRON ACER TENDL-2024 LIBRARY; T=0.K
Neutron emission for (n,n*c)

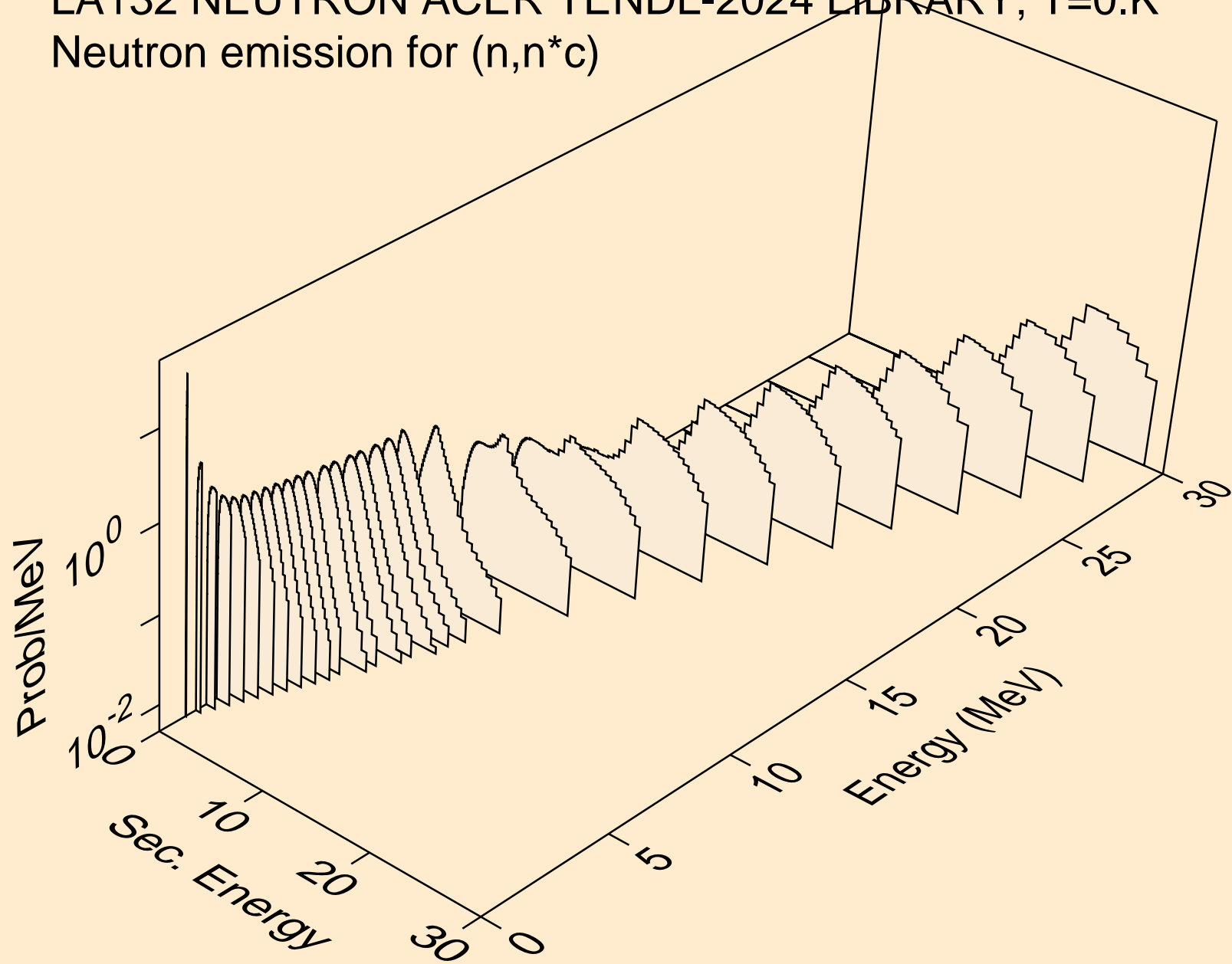

LA132 NEUTRON ACER TENDL-2024 LIBRARY; T=0.K
Photon emission for (n,x)

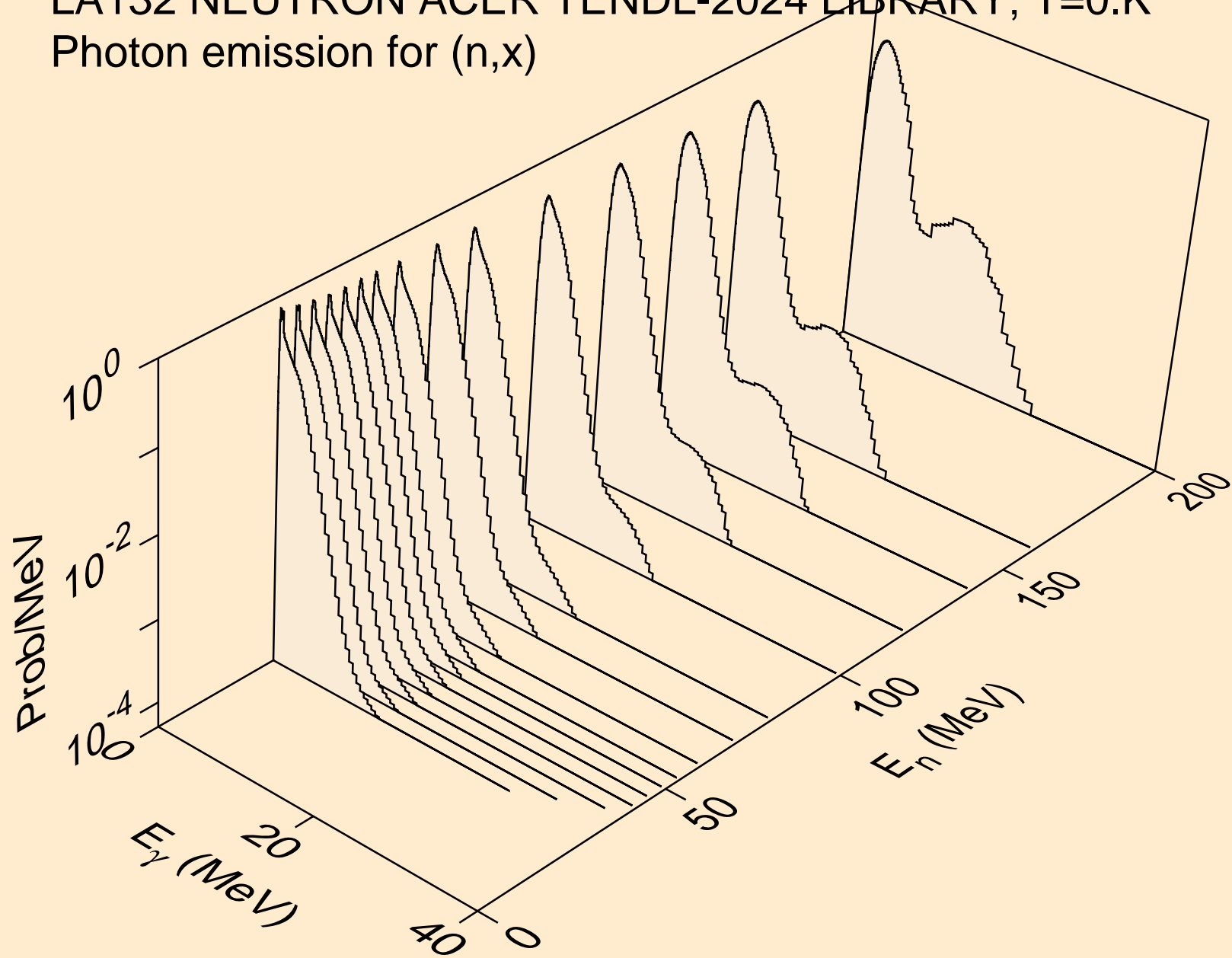

LA132 NEUTRON ACER TENDL-2024 LIBRARY; T=0.K
Photon emission for (n,2nd)

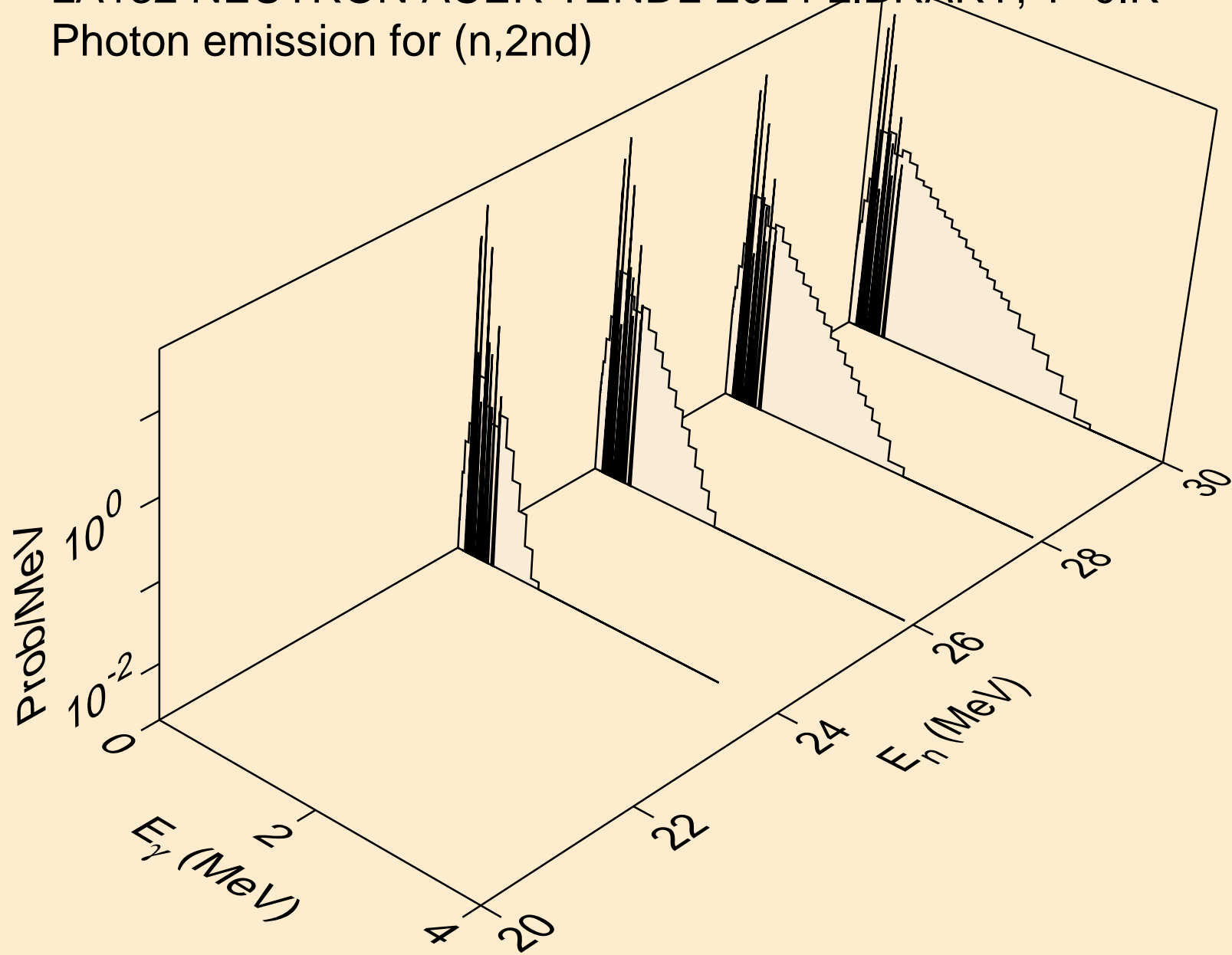

LA132 NEUTRON ACER TENDL-2024 LIBRARY; T=0.K
Photon emission for (n,2n)

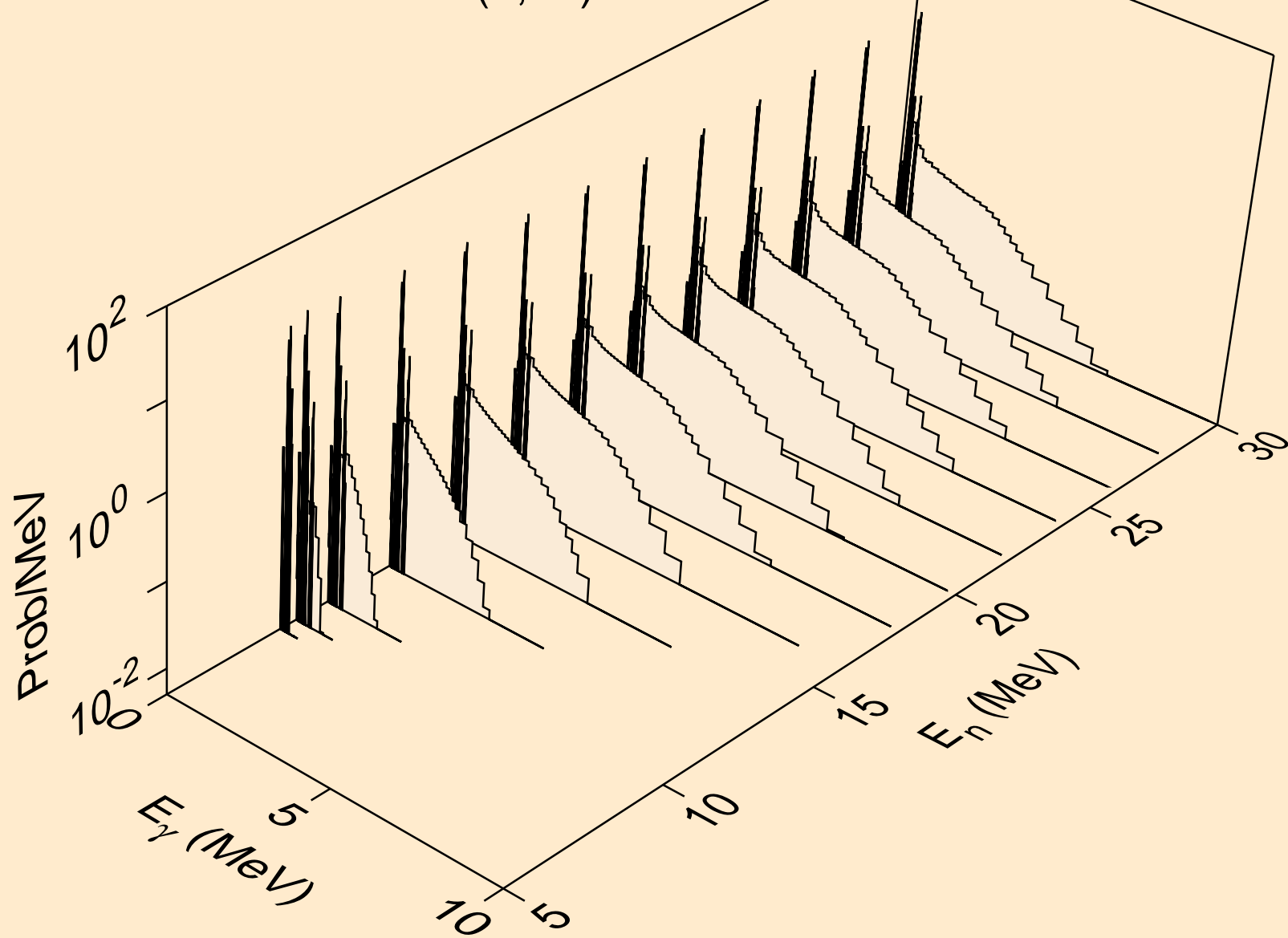

LA132 NEUTRON ACER TENDL-2024 LIBRARY; T=0.K
Photon emission for (n,3n)

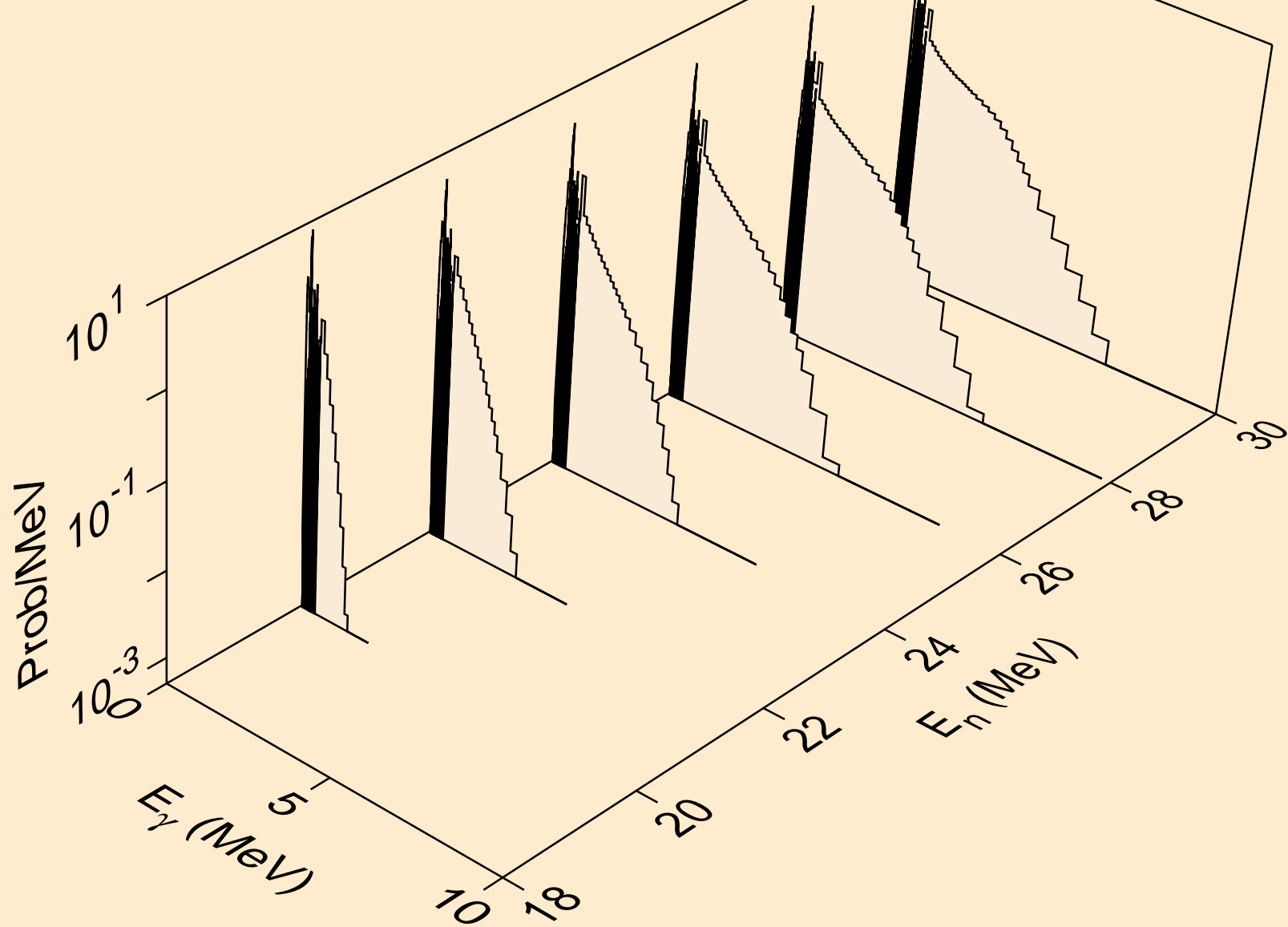

LA132 NEUTRON ACER TENDL-2024 LIBRARY; T=0.K
Photon emission for (n,n*)a

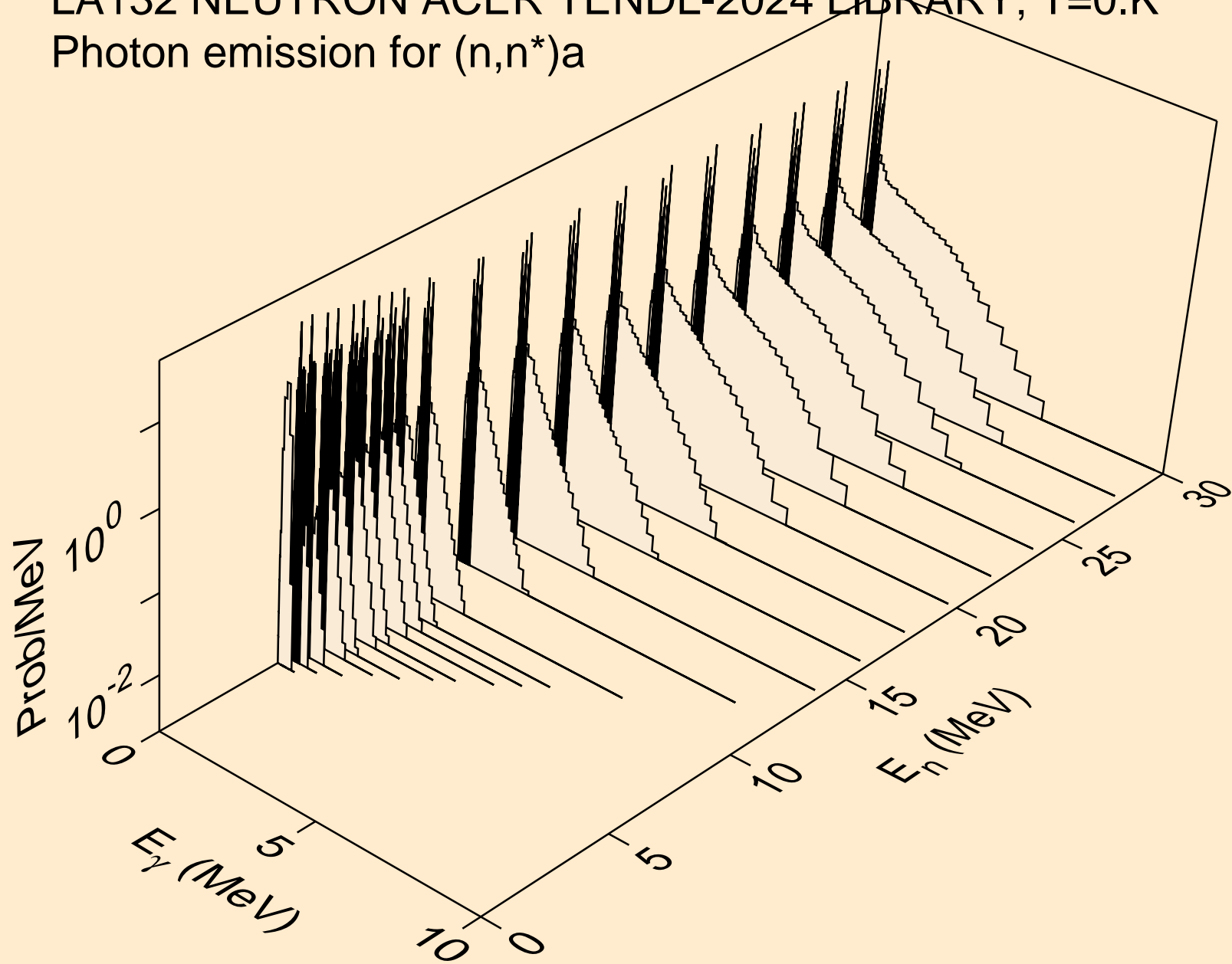

LA132 NEUTRON ACER TENDL-2024 LIBRARY; T=0.K
Photon emission for (n,2n)a

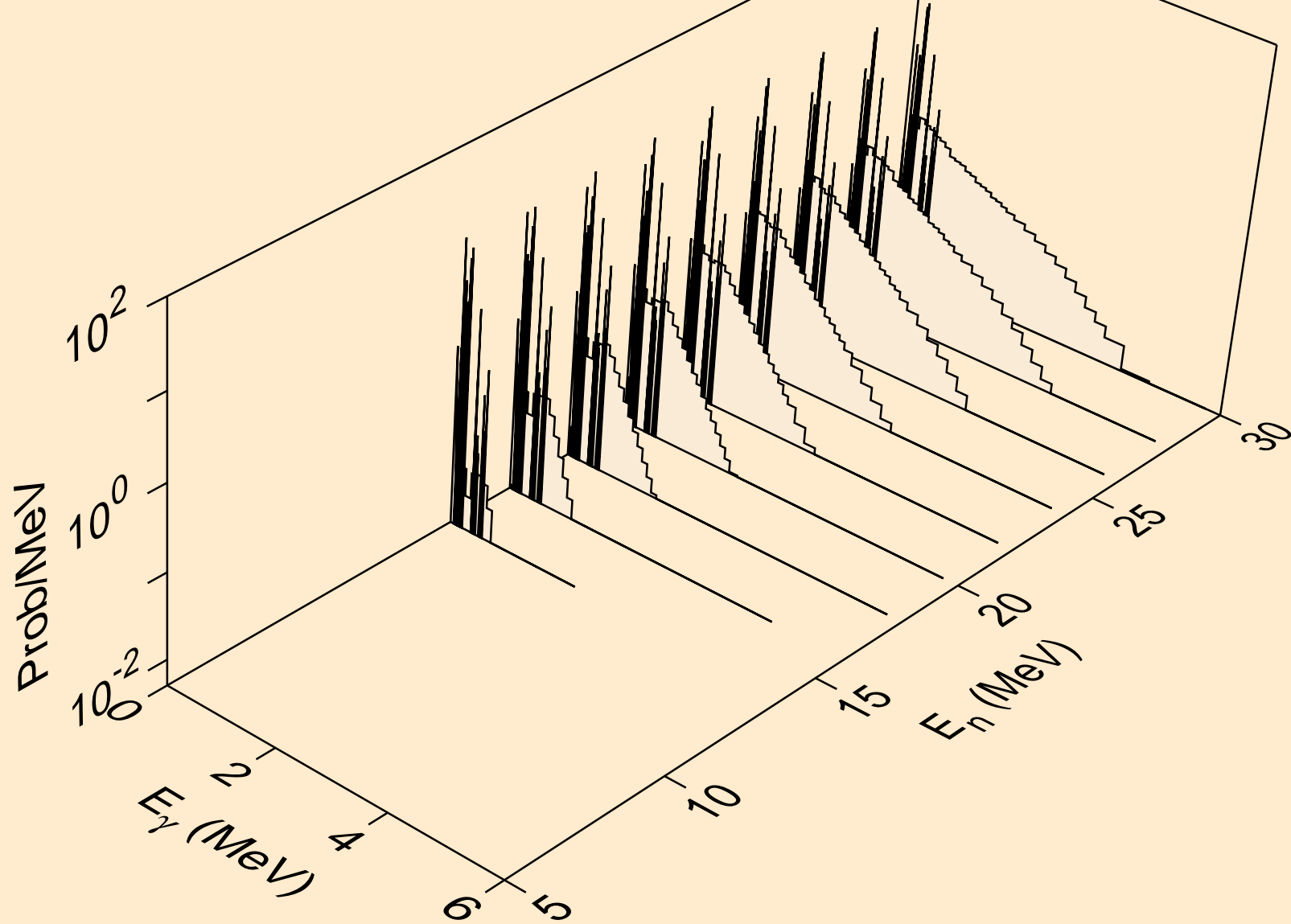

LA132 NEUTRON ACER TENDL-2024 LIBRARY; T=0.K
Photon emission for (n,3n)a

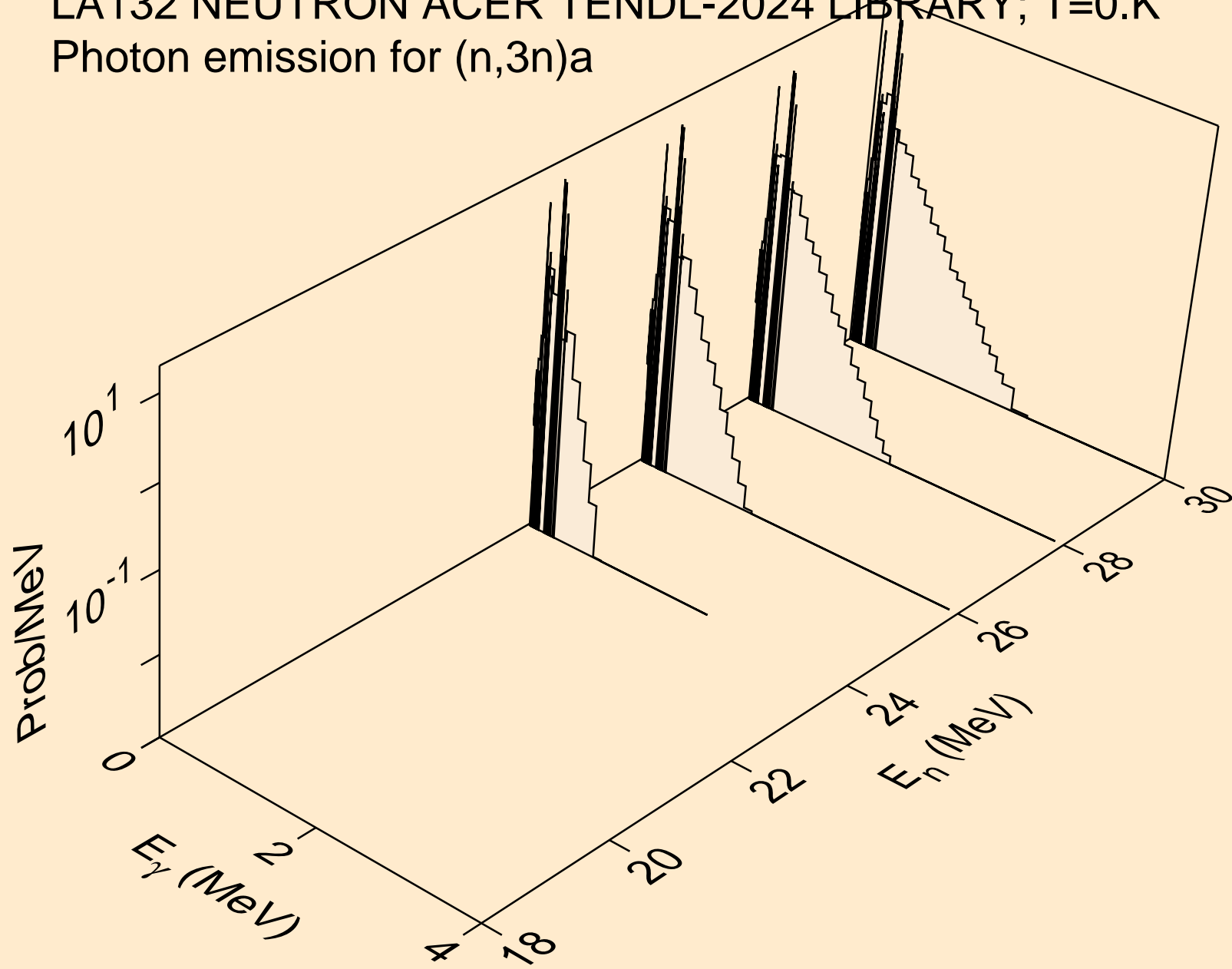

LA132 NEUTRON ACER TENDL-2024 LIBRARY; T=0.K
Photon emission for (n,n*)p

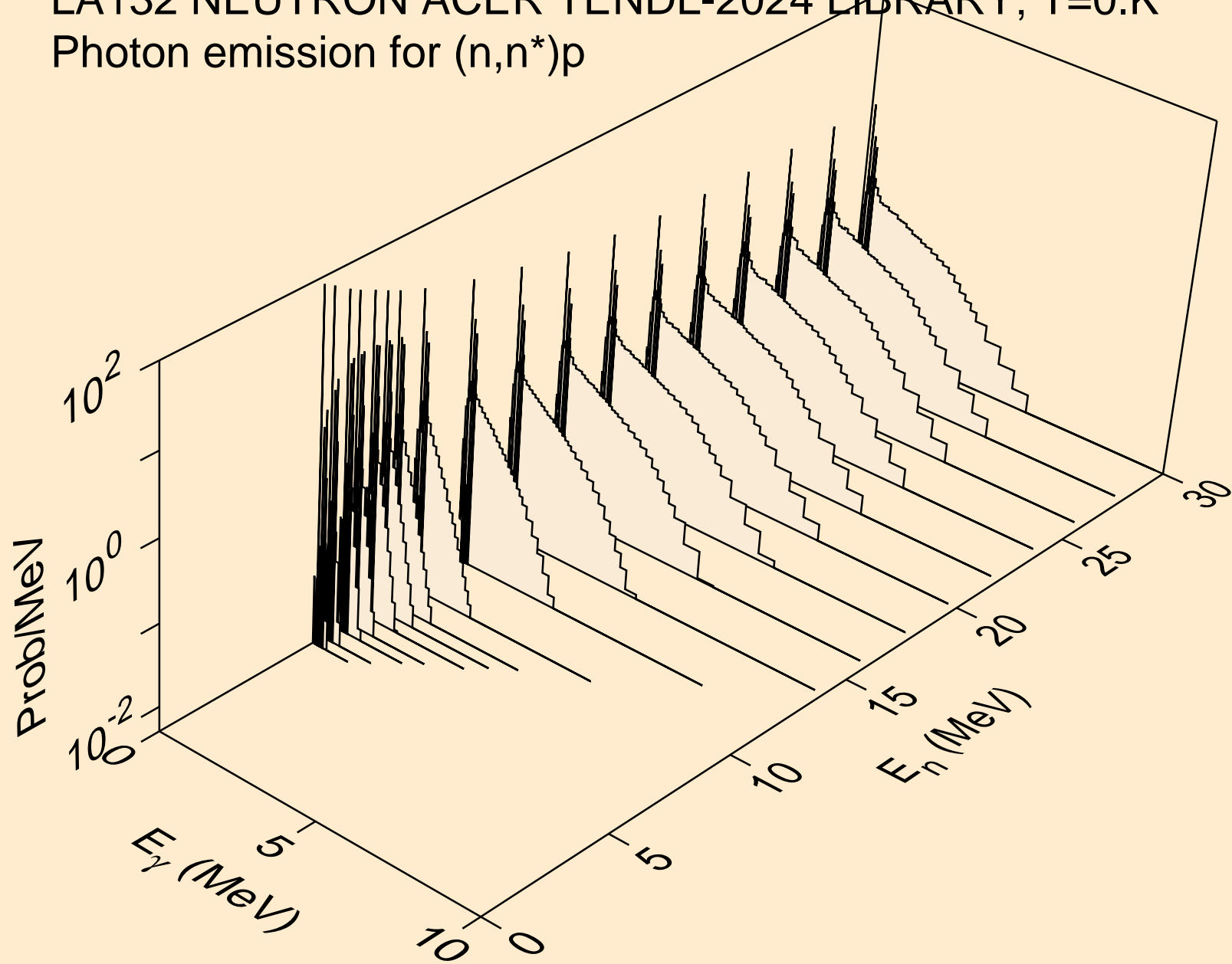

LA132 NEUTRON ACER TENDL-2024 LIBRARY; T=0.K
Photon emission for (n,n*)2a

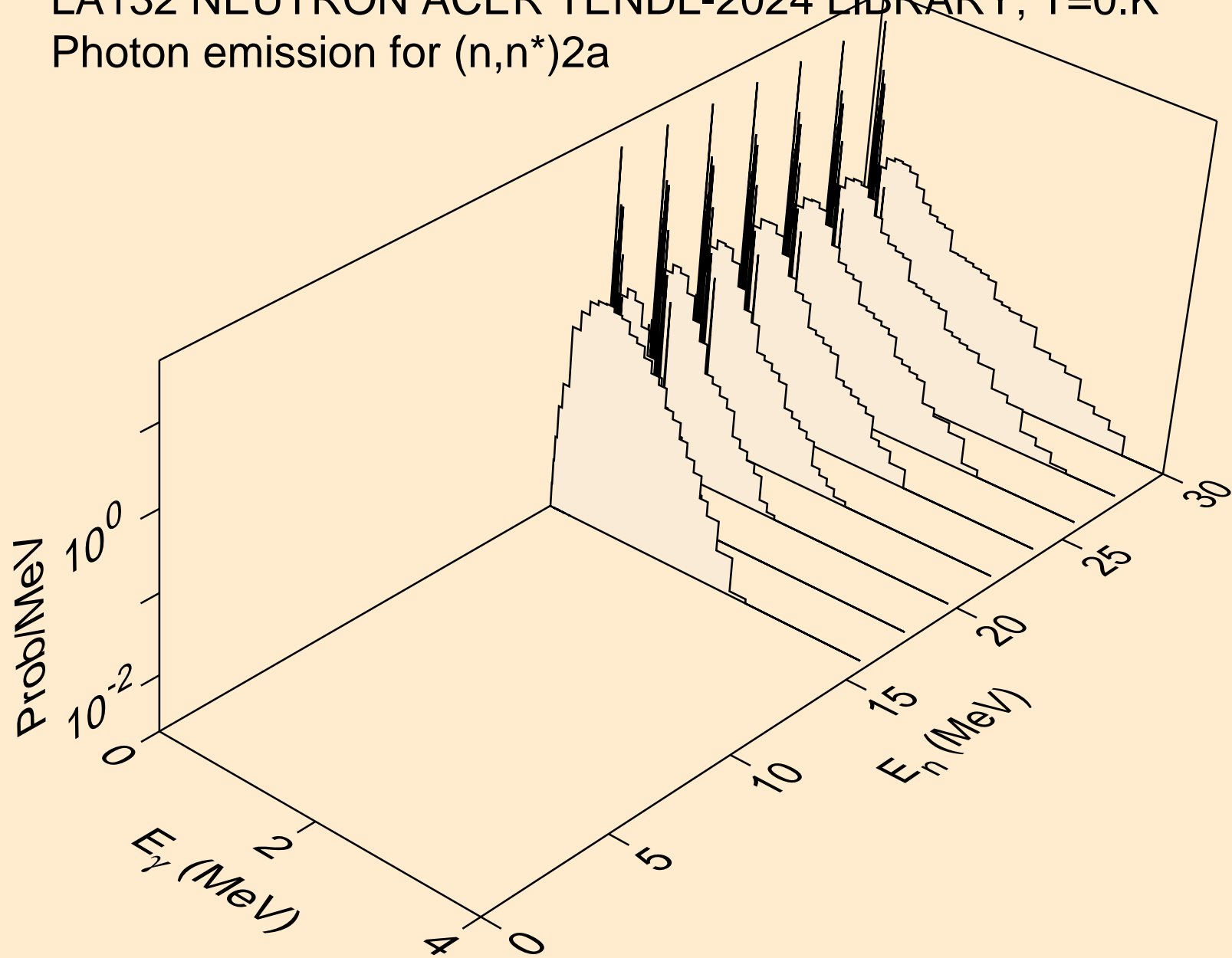

LA132 NEUTRON ACER TENDL-2024 LIBRARY; T=0.K
Photon emission for (n,n*)d

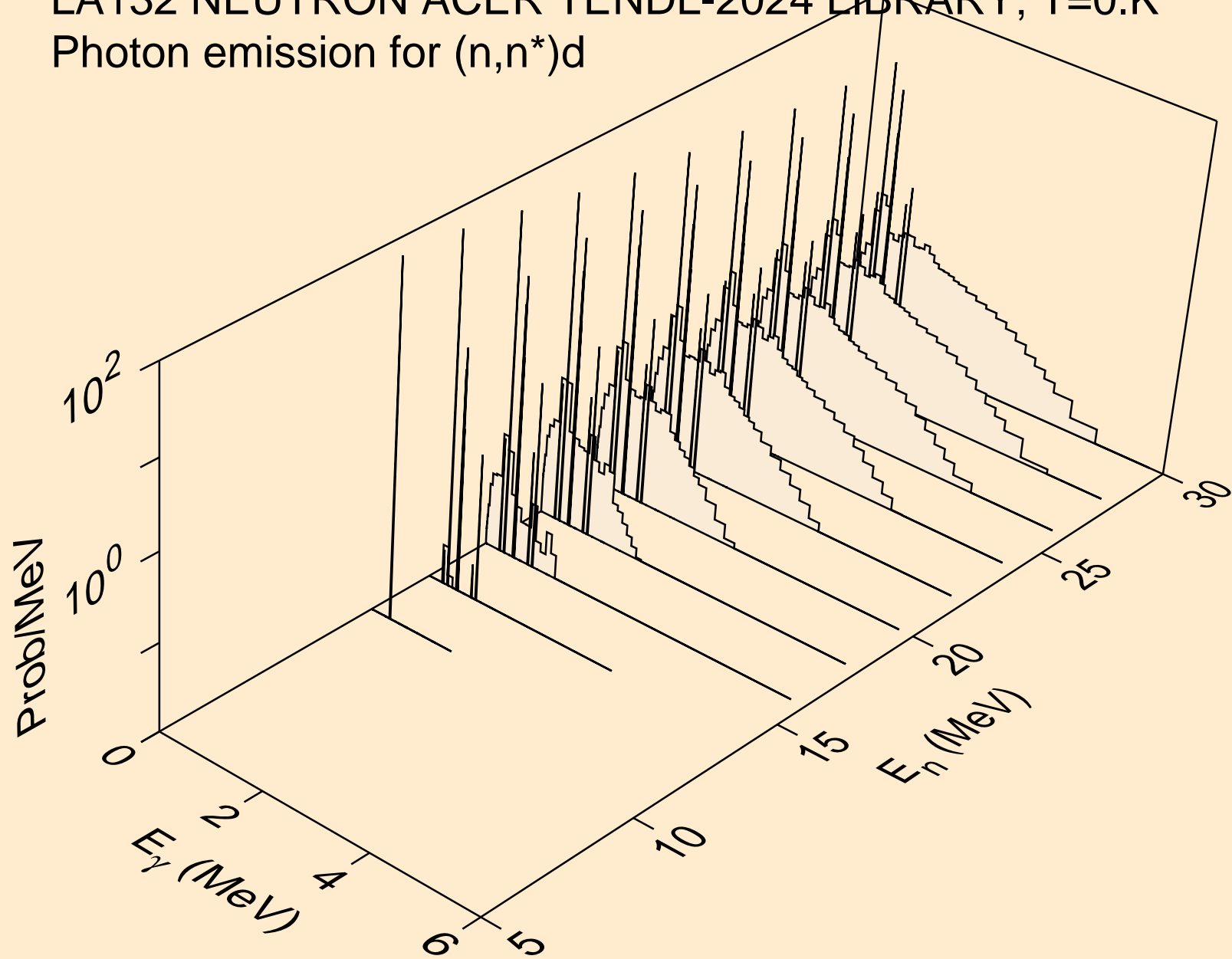

LA132 NEUTRON ACER TENDL-2024 LIBRARY; T=0.K
Photon emission for (n,n*)t

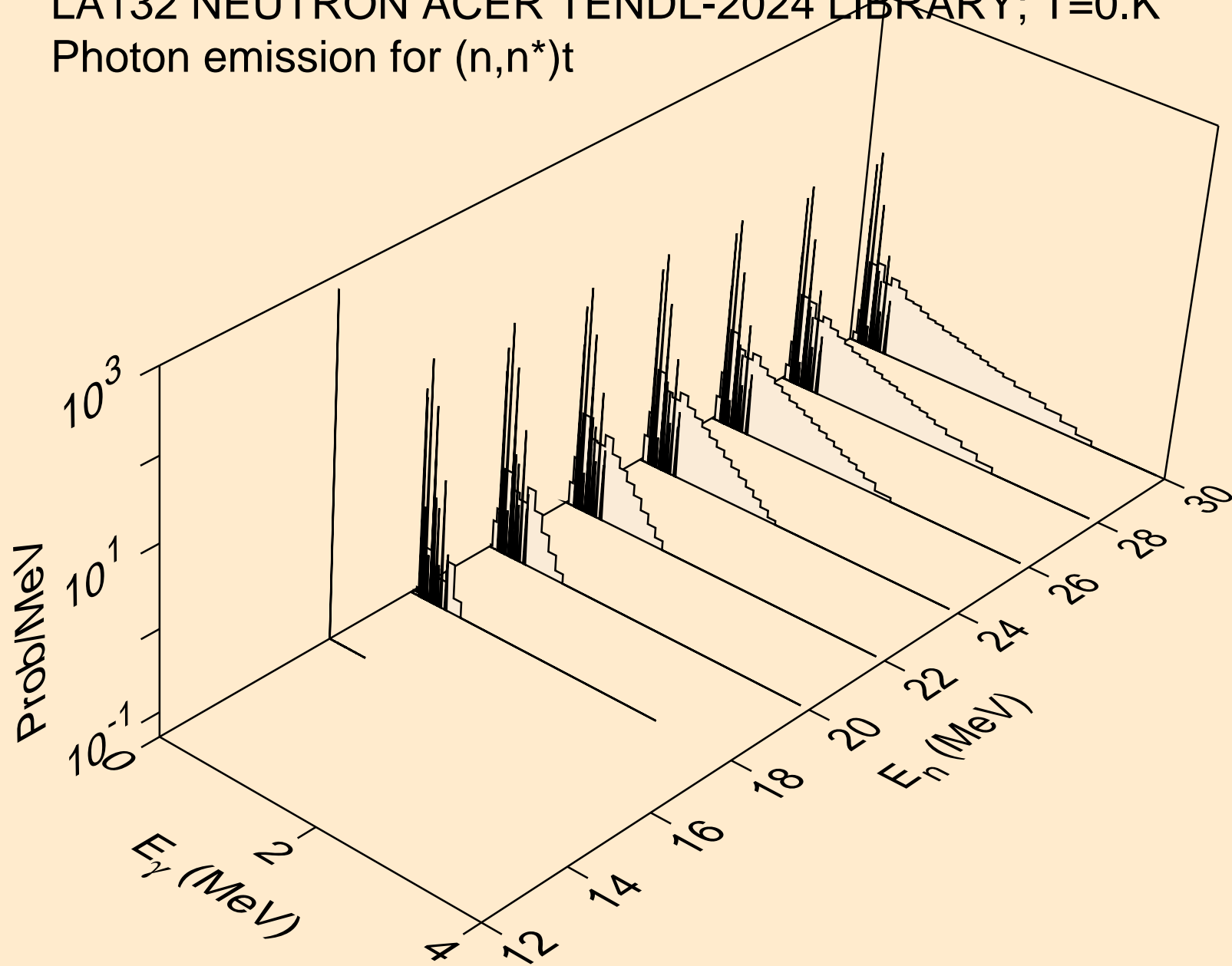

LA132 NEUTRON ACER TENDL-2024 LIBRARY; T=0.K
Photon emission for (n,n*)he3

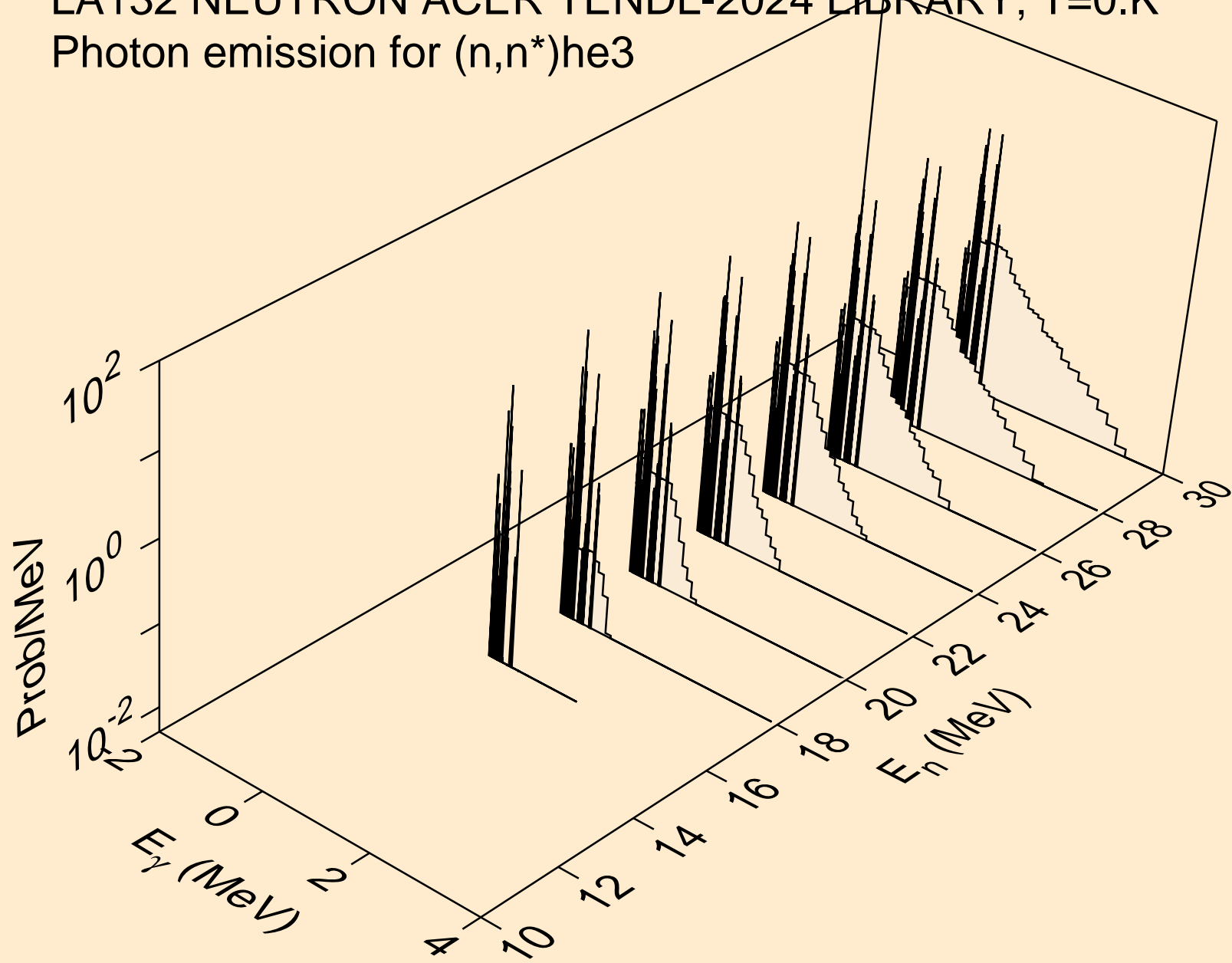

LA132 NEUTRON ACER TENDL-2024 LIBRARY; T=0.K
Photon emission for (n,4n)

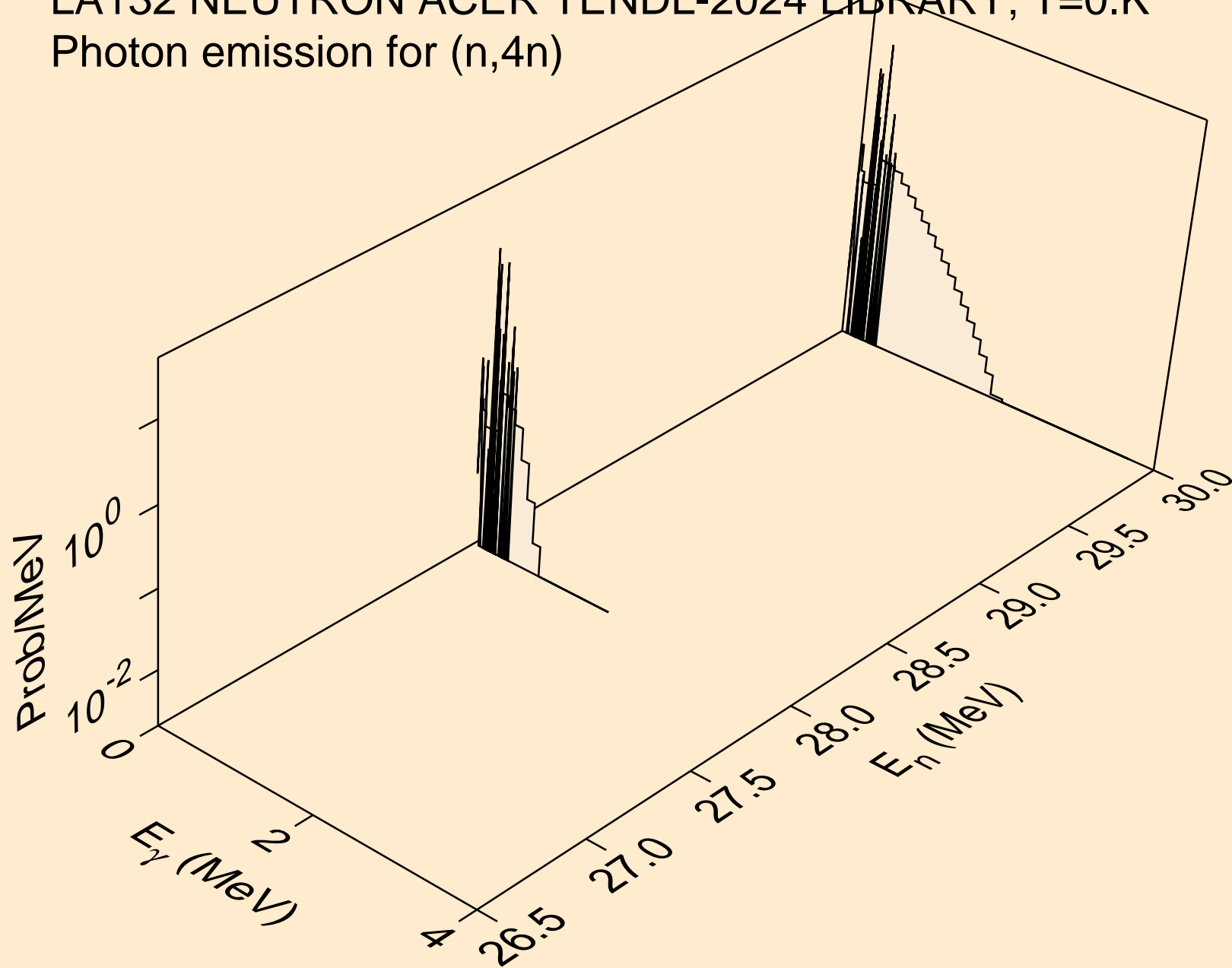

LA132 NEUTRON ACER TENDL-2024 LIBRARY; T=0.K
Photon emission for (n,2np)

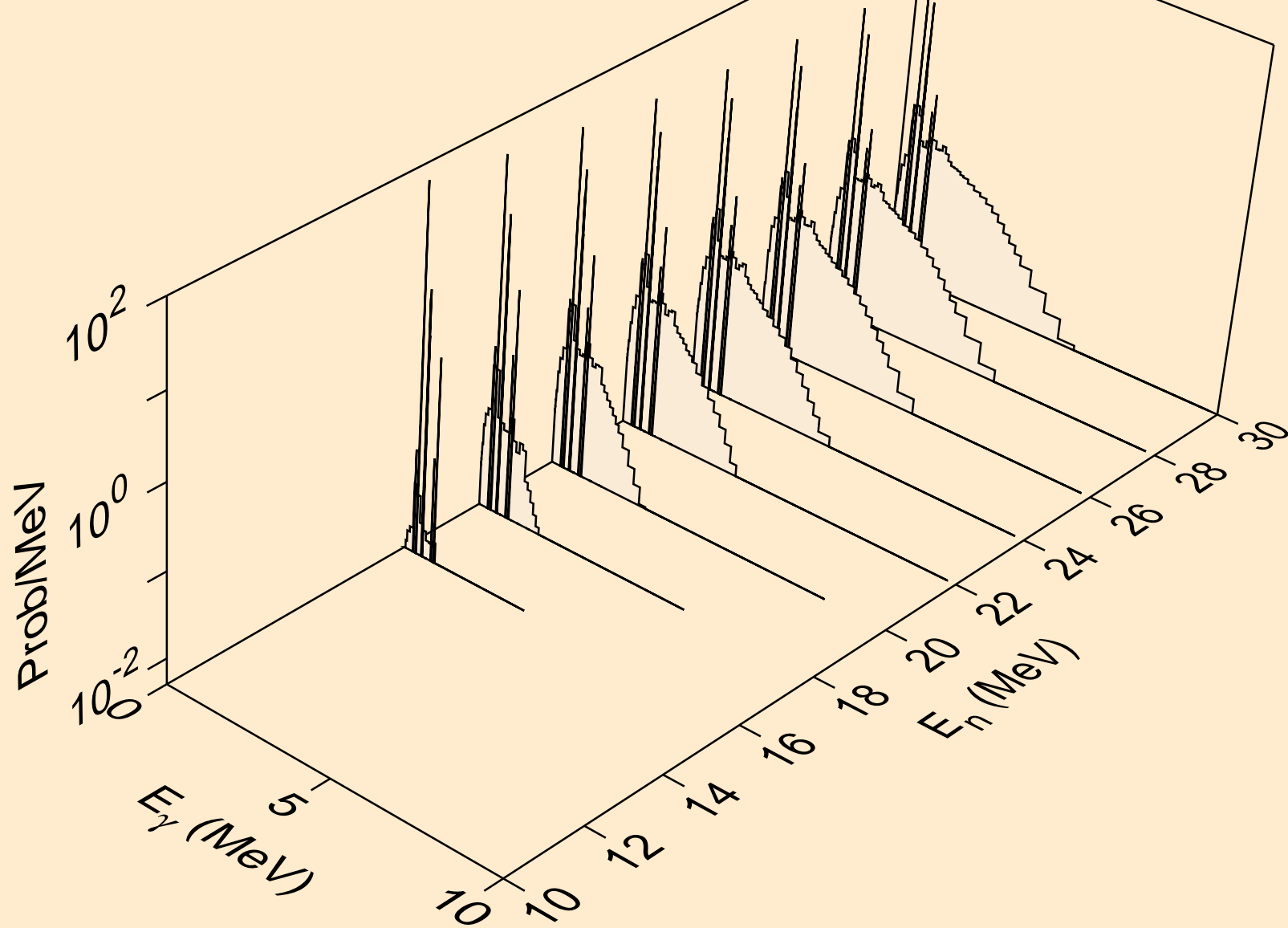

LA132 NEUTRON ACER TENDL-2024 LIBRARY; T=0.K
Photon emission for (n,3np)

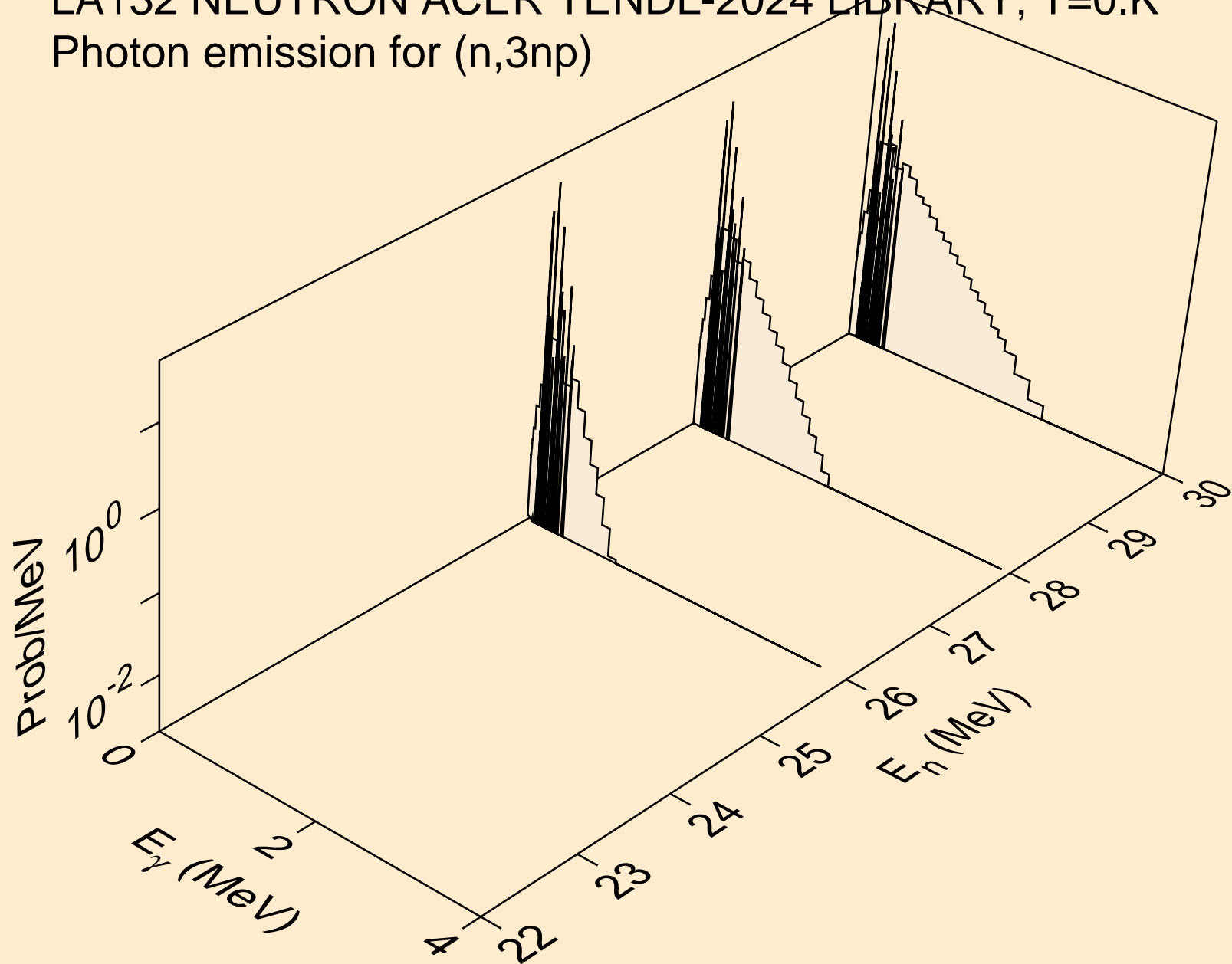

LA132 NEUTRON ACER TENDL-2024 LIBRARY; T=0.K
Photon emission for (n,n2p)

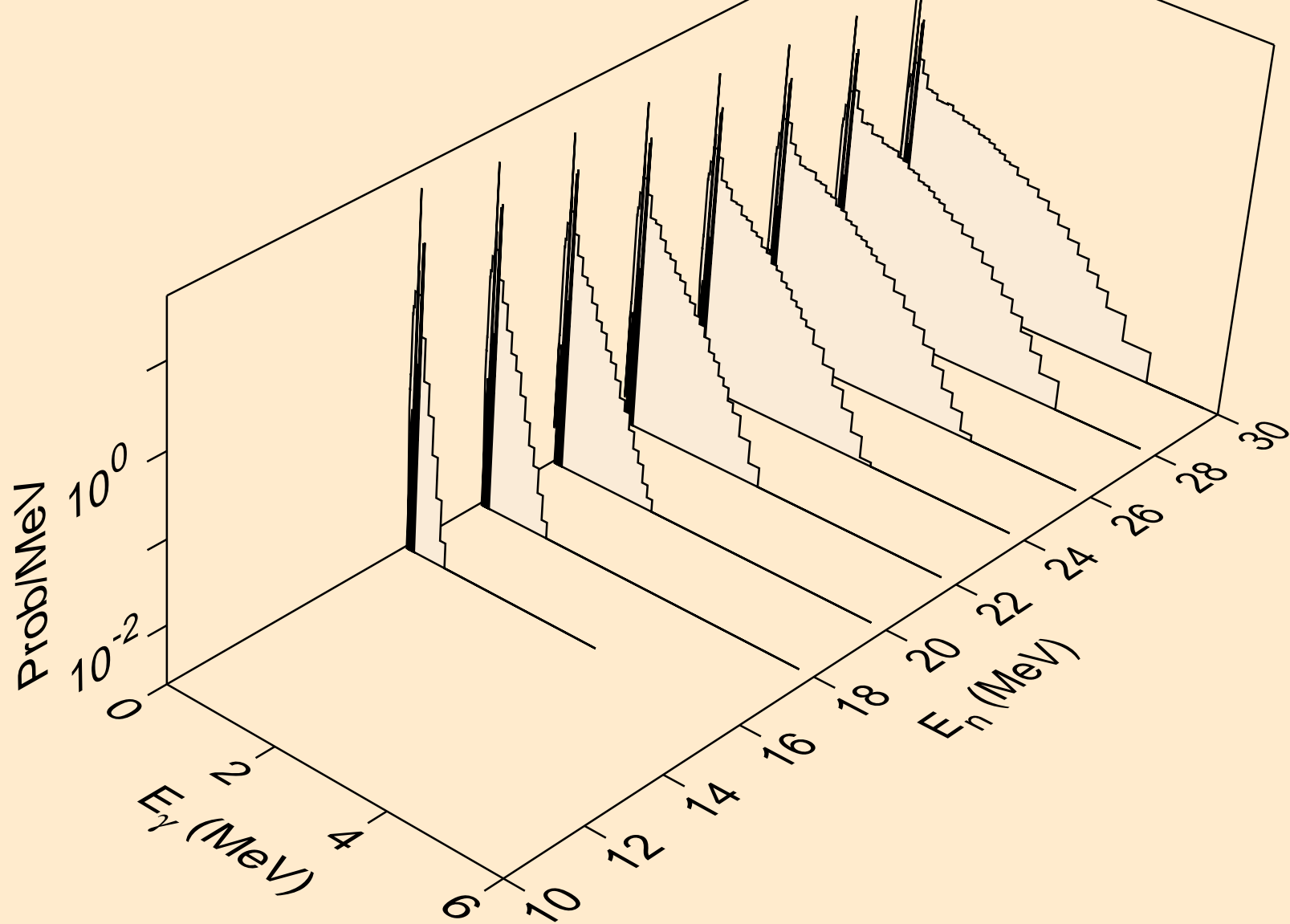

LA132 NEUTRON ACER TENDL-2024 LIBRARY; T=0.K
Photon emission for (n,npa)

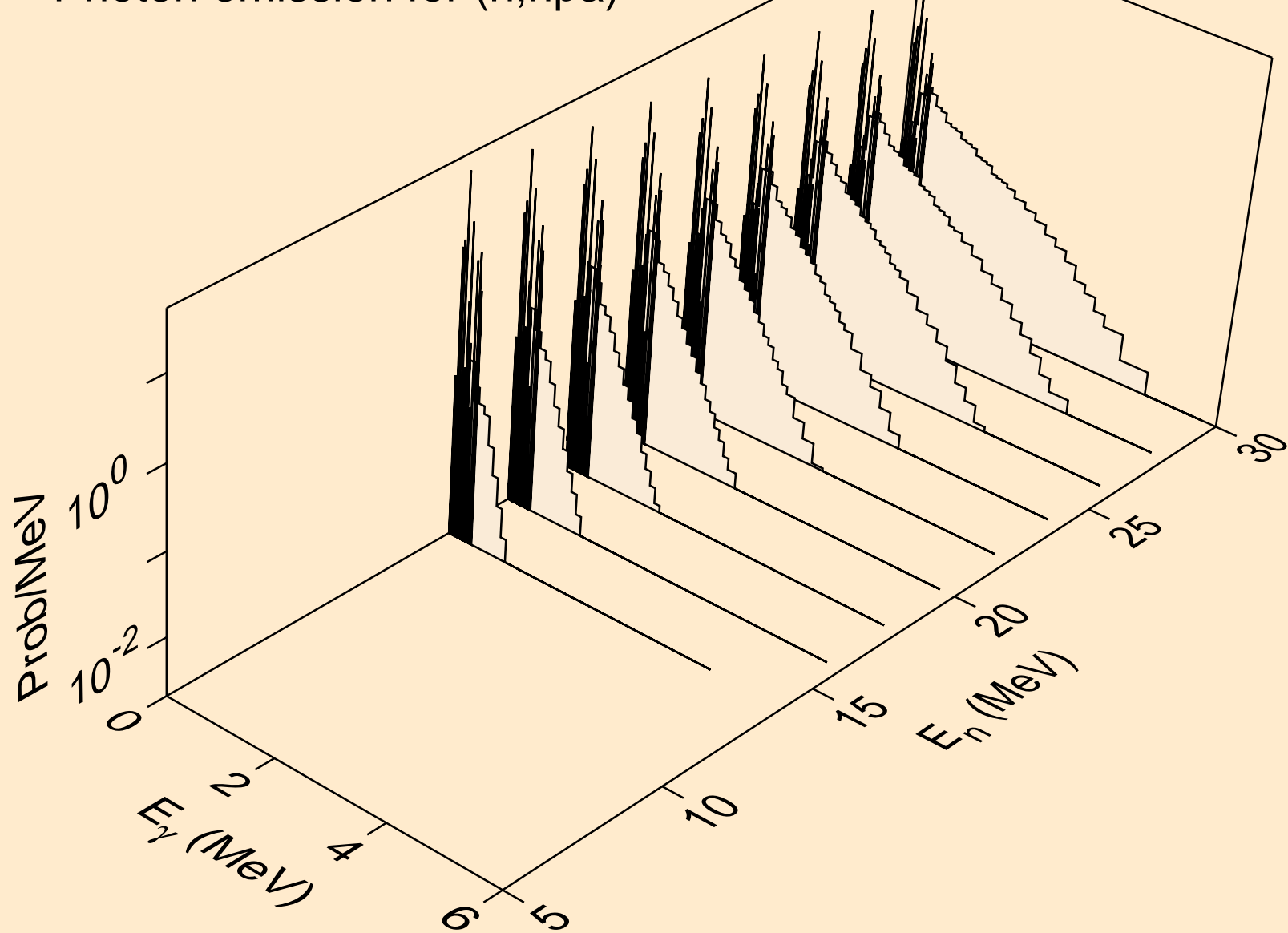

LA132 NEUTRON ACER TENDL-2024 LIBRARY; T=0.K
Photon emission for (n,n*c)

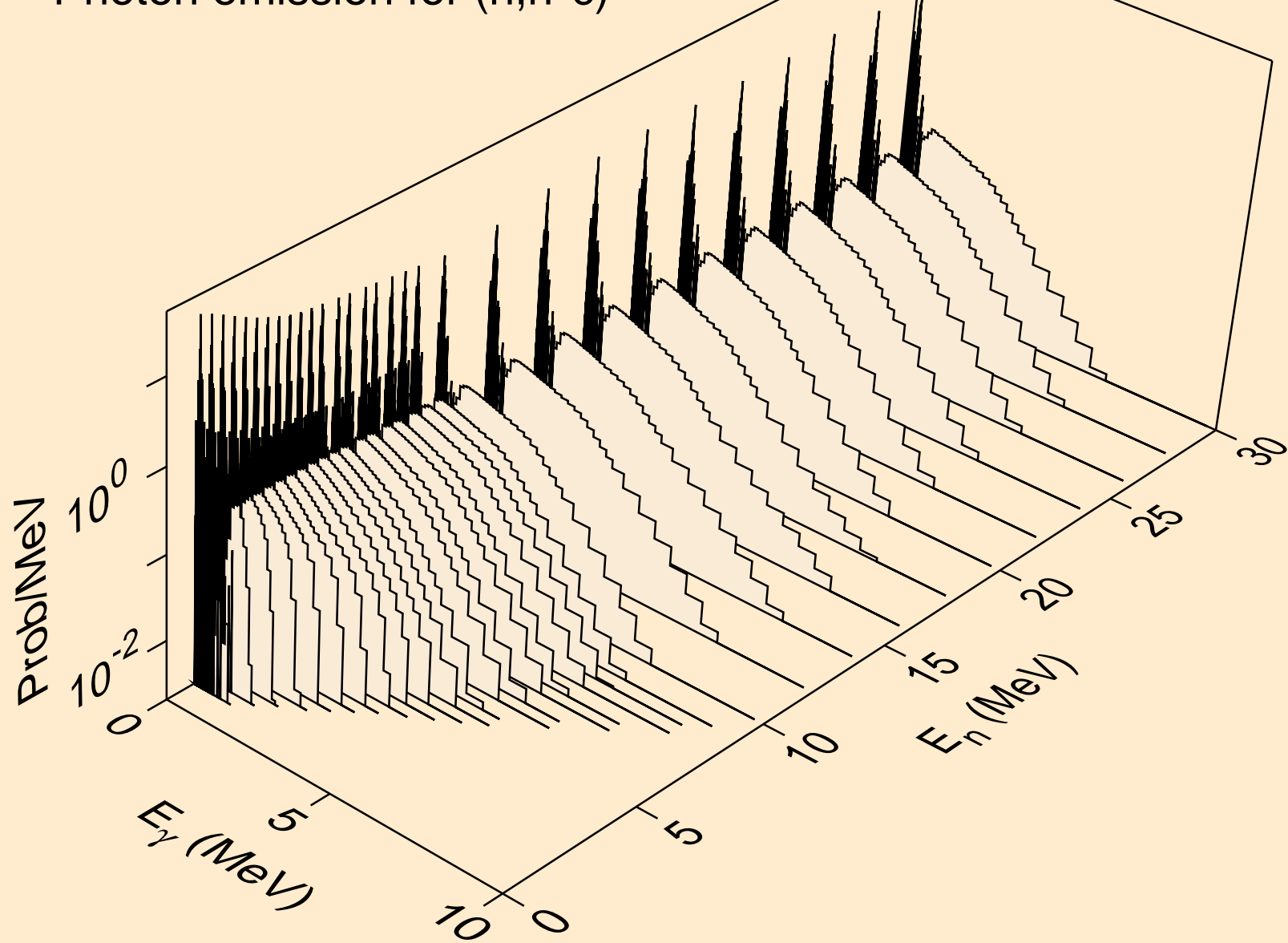

LA132 NEUTRON ACER TENDL-2024 LIBRARY; T=0.K
Photon emission for (n,gma)

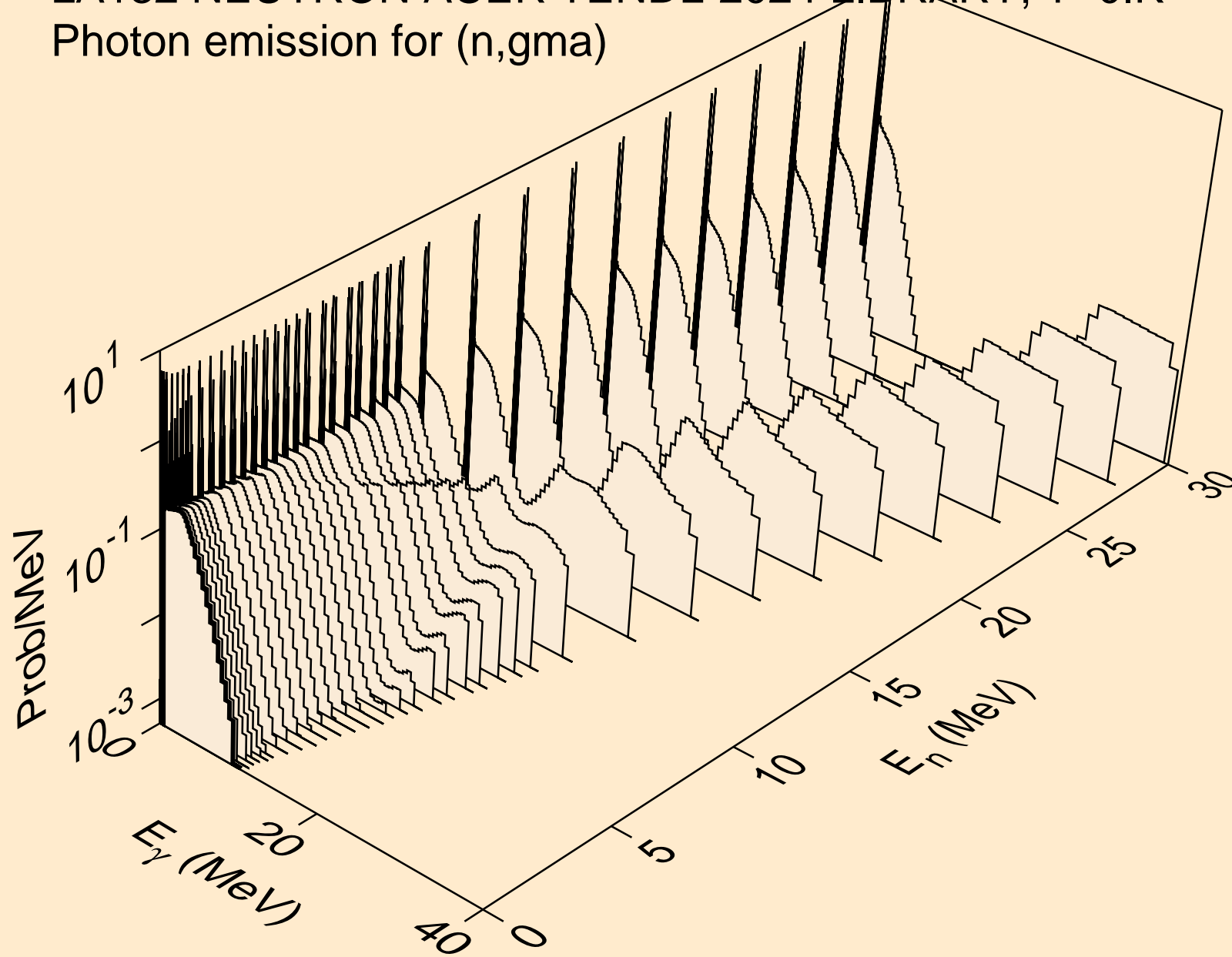

LA132 NEUTRON ACER TENDL-2024 LIBRARY; T=0.K
Photon emission for (n,p)

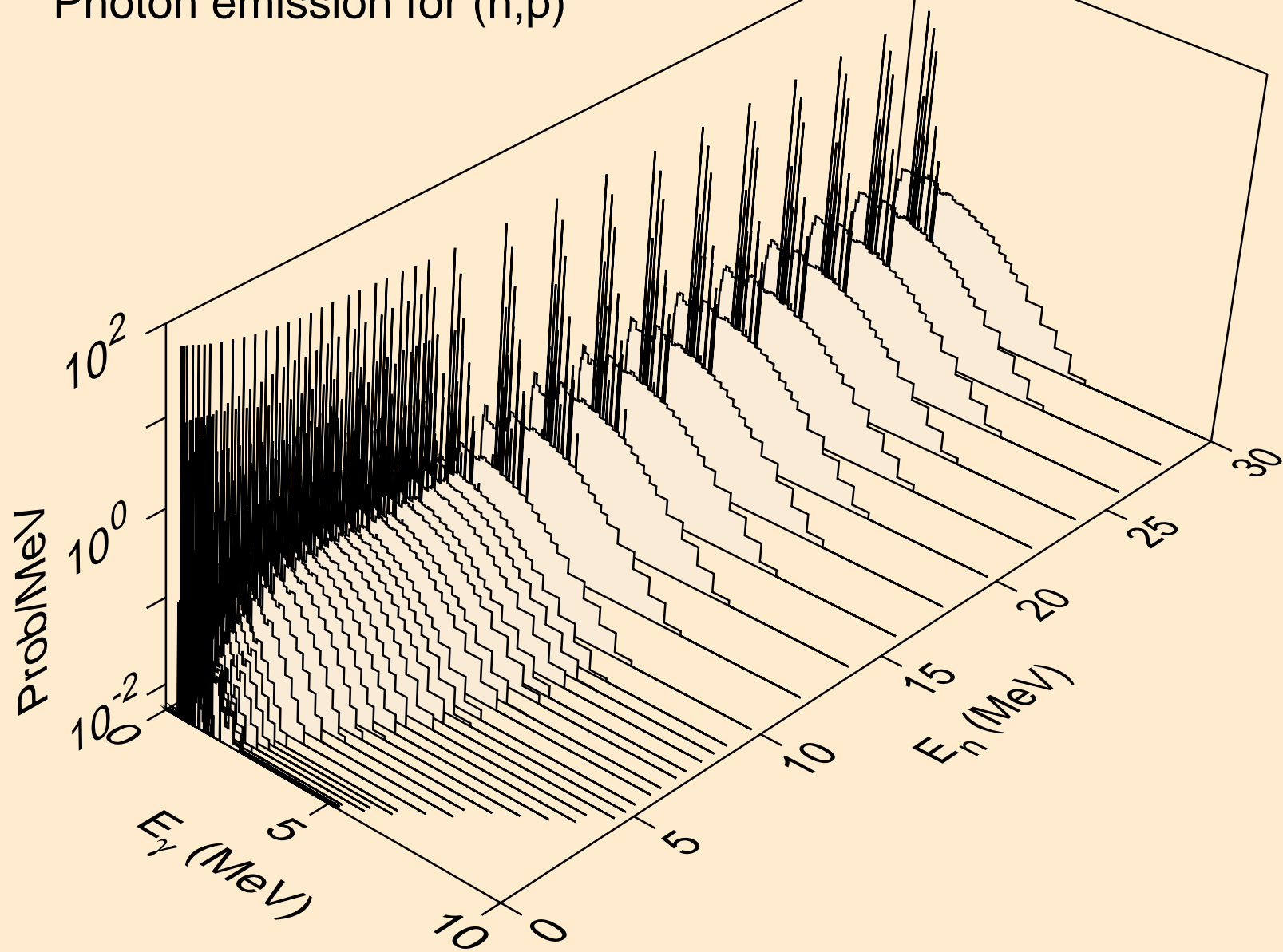

LA132 NEUTRON ACER TENDL-2024 LIBRARY; T=0.K
Photon emission for (n,d)

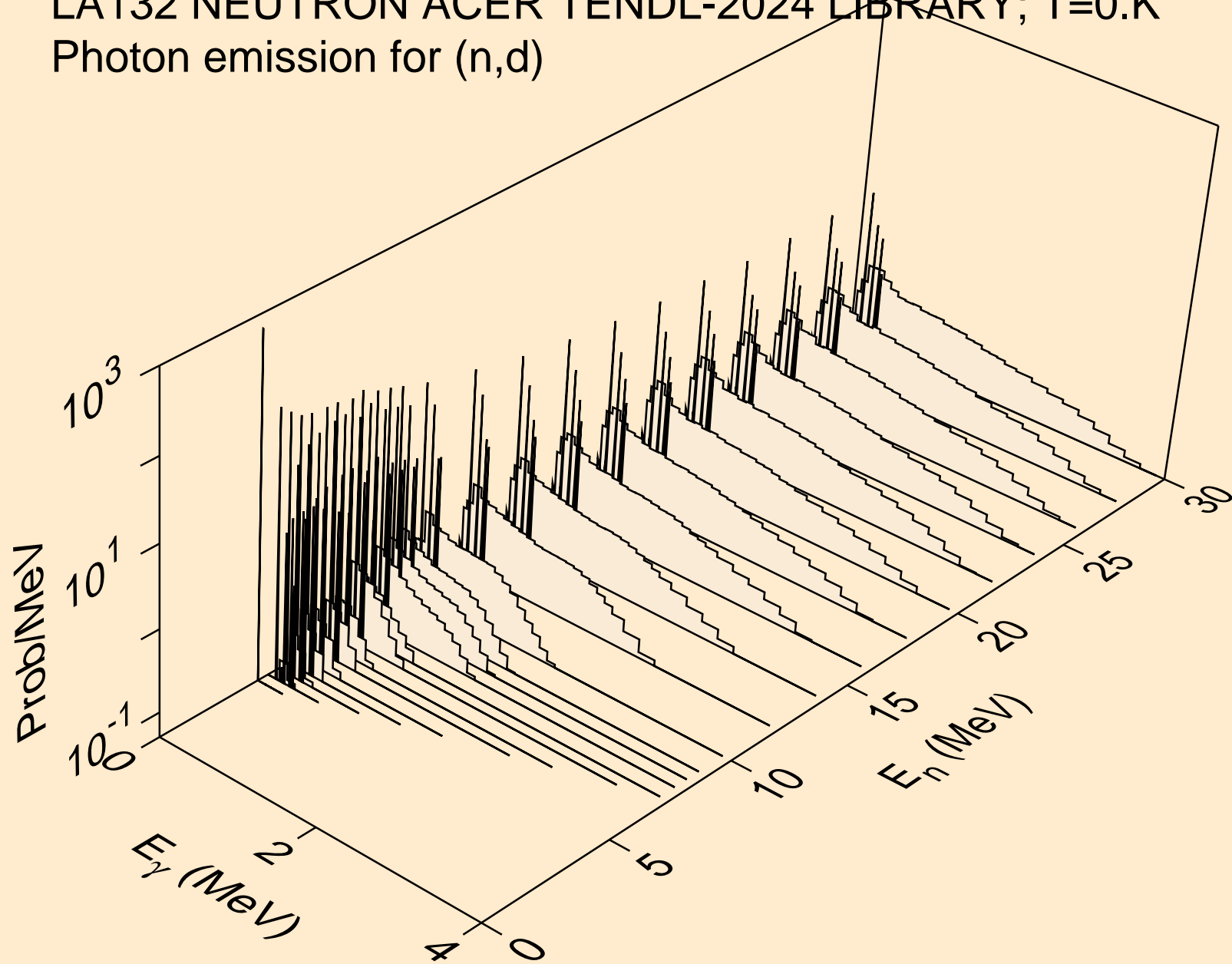

LA132 NEUTRON ACER TENDL-2024 LIBRARY; T=0.K
Photon emission for (n,t)

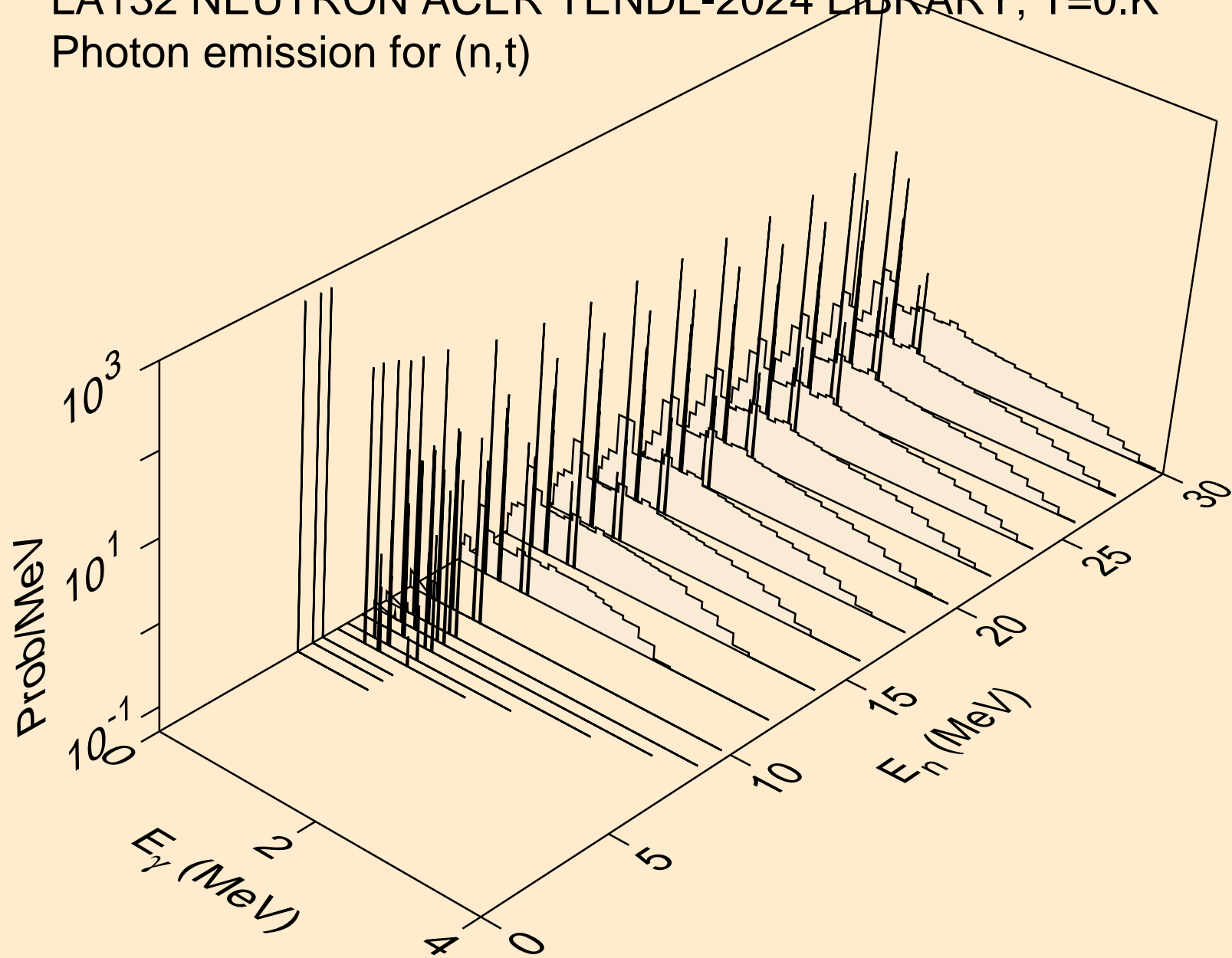

LA132 NEUTRON ACER TENDL-2024 LIBRARY; T=0.K
Photon emission for (n,he3)

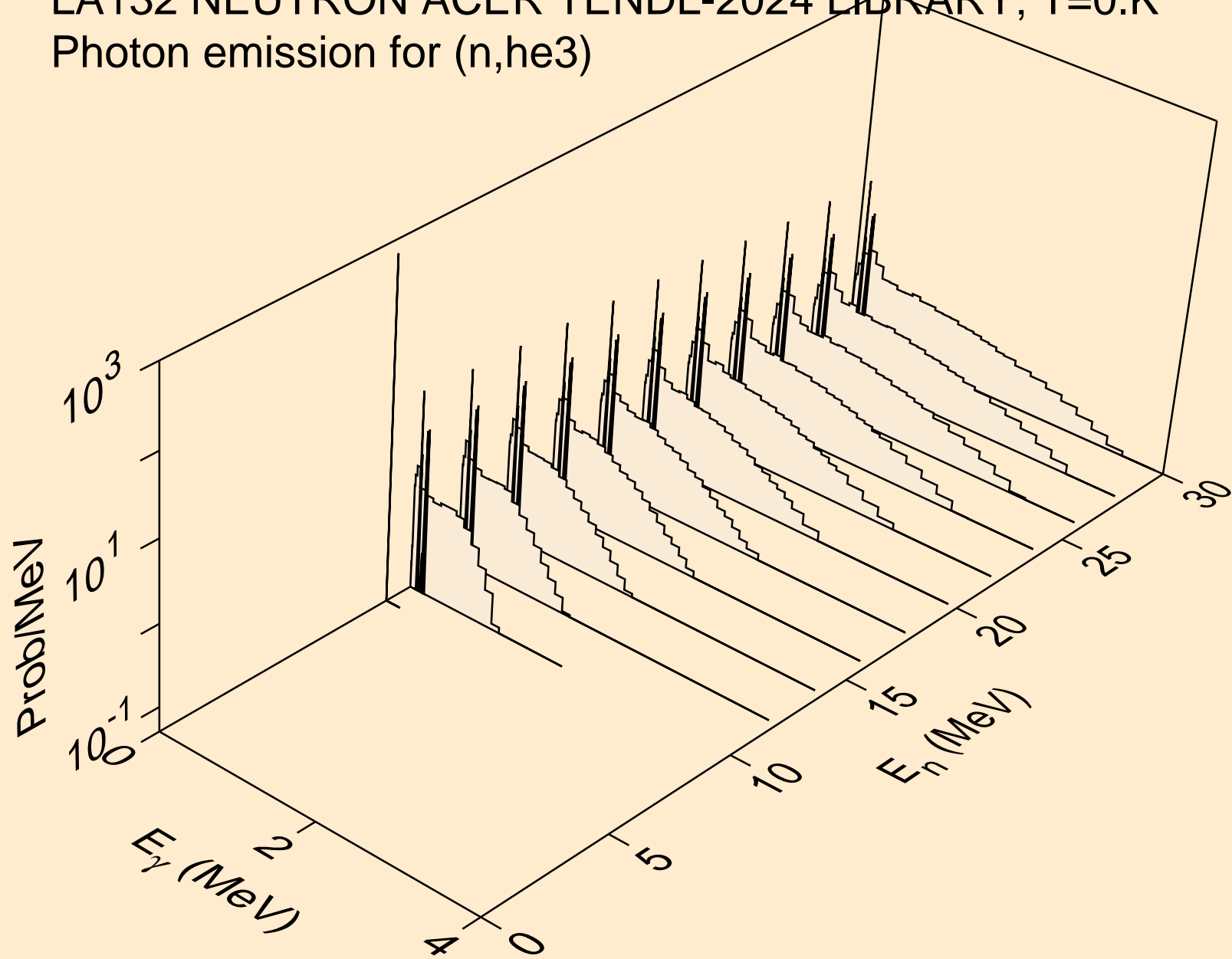

LA132 NEUTRON ACER TENDL-2024 LIBRARY; T=0.K
Photon emission for (n,a)

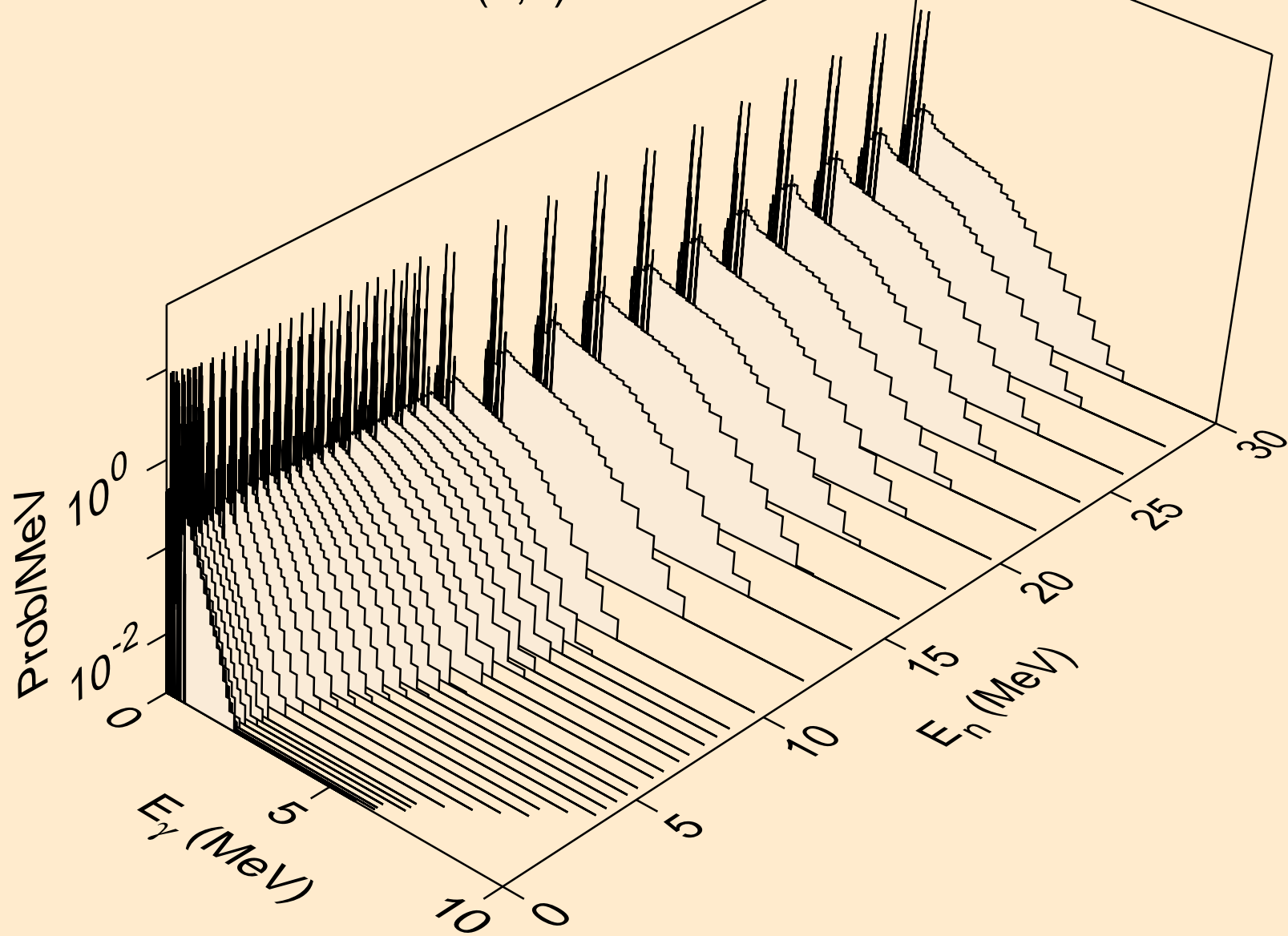

LA132 NEUTRON ACER TENDL-2024 LIBRARY; T=0.K
Photon emission for (n,2a)

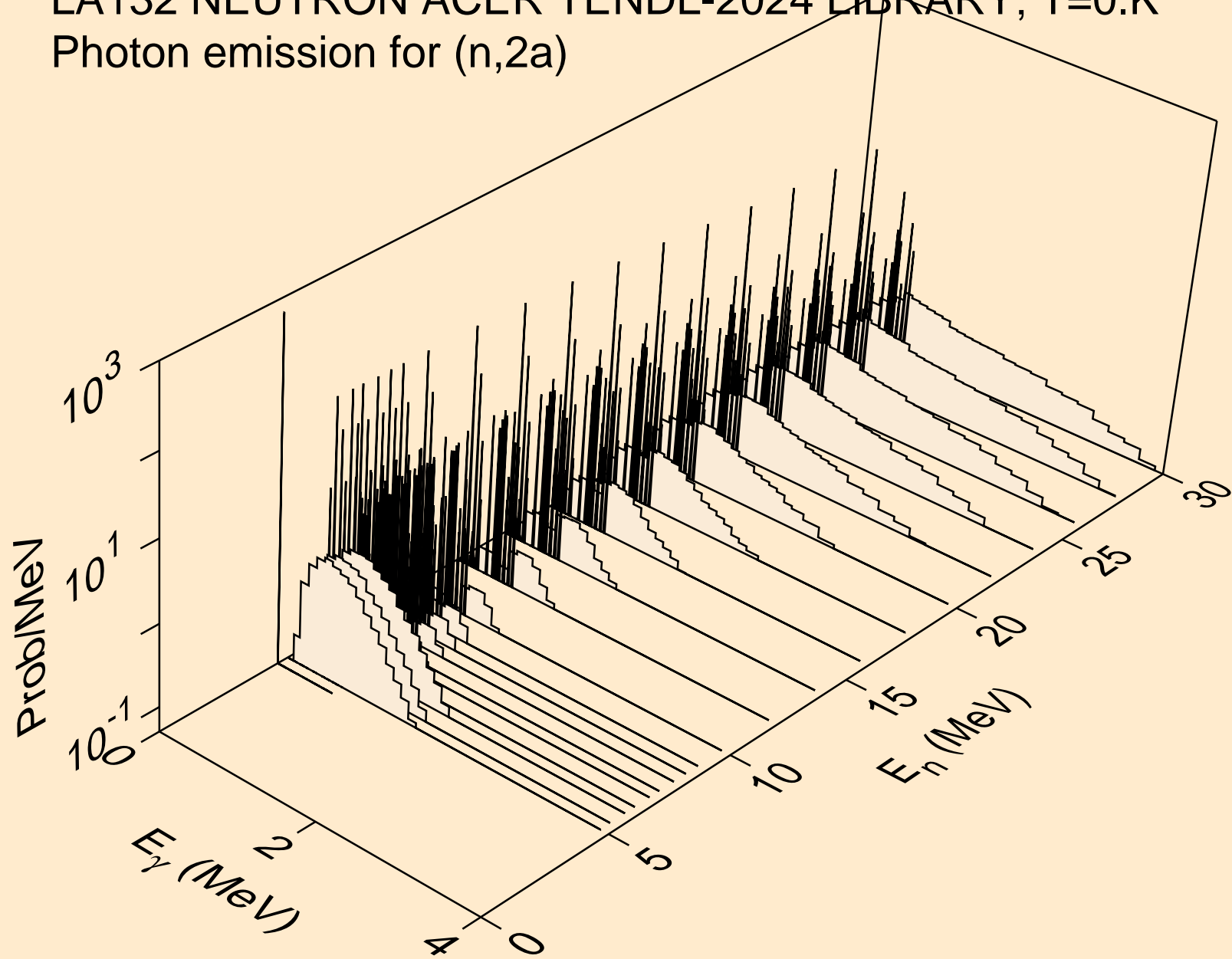

LA132 NEUTRON ACER TENDL-2024 LIBRARY; T=0.K
Photon emission for (n,2p)

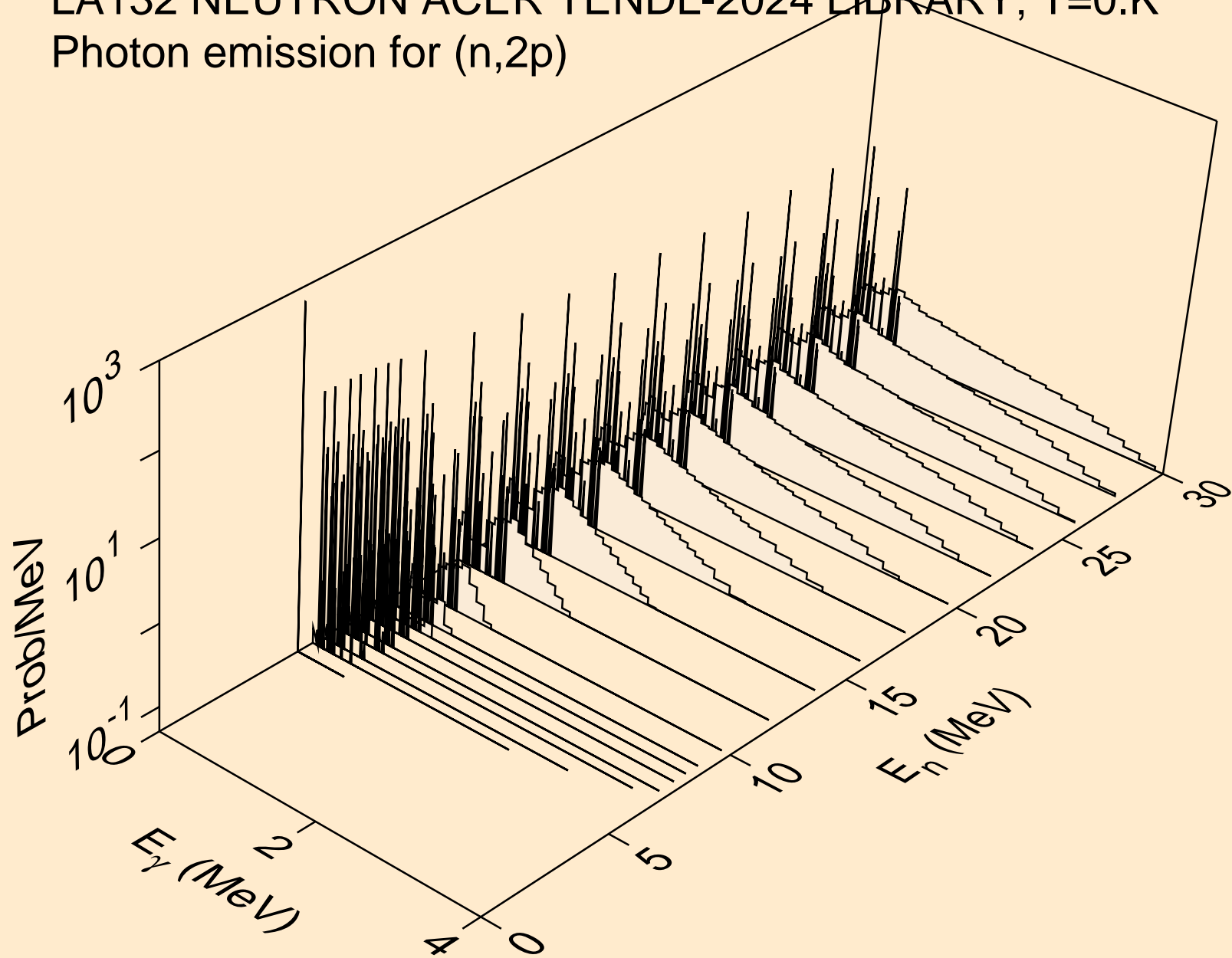

LA132 NEUTRON ACER TENDL-2024 LIBRARY; T=0.K
Photon emission for (n,p α)

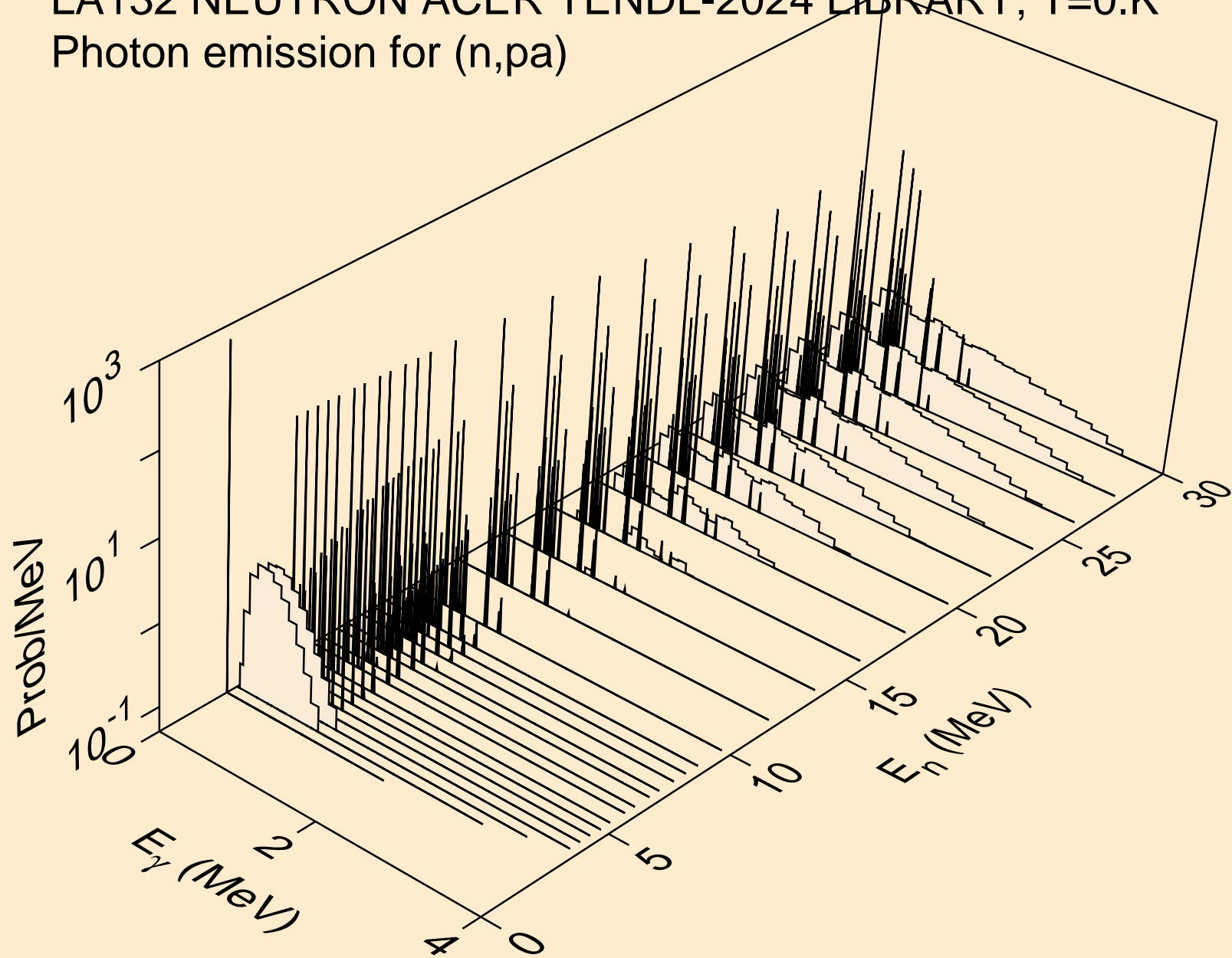

LA132 NEUTRON ACER TENDL-2024 LIBRARY; T=0.K
Photon emission for (n,pd)

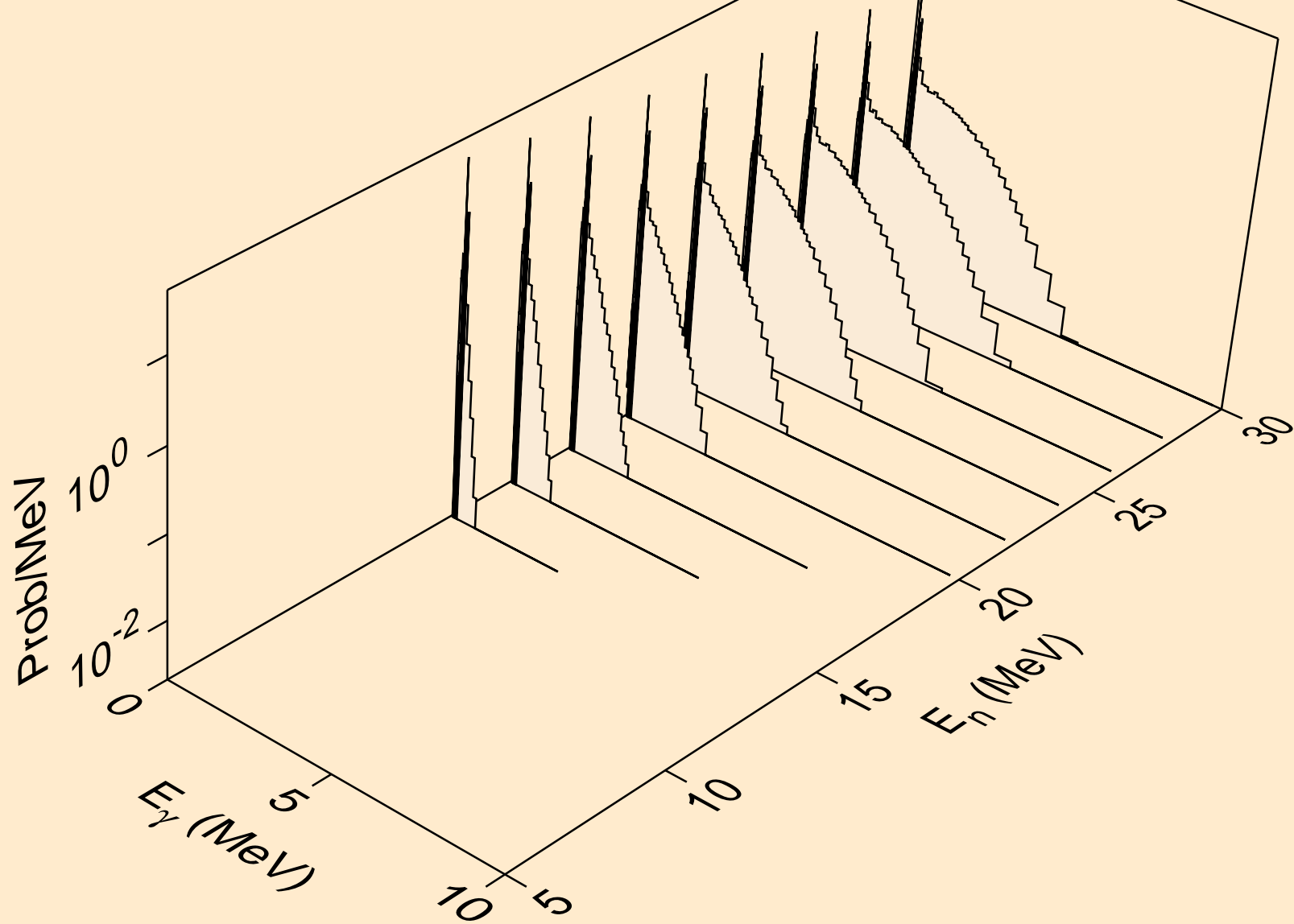

LA132 NEUTRON ACER TENDL-2024 LIBRARY; T=0.K
Photon emission for (n,pt)

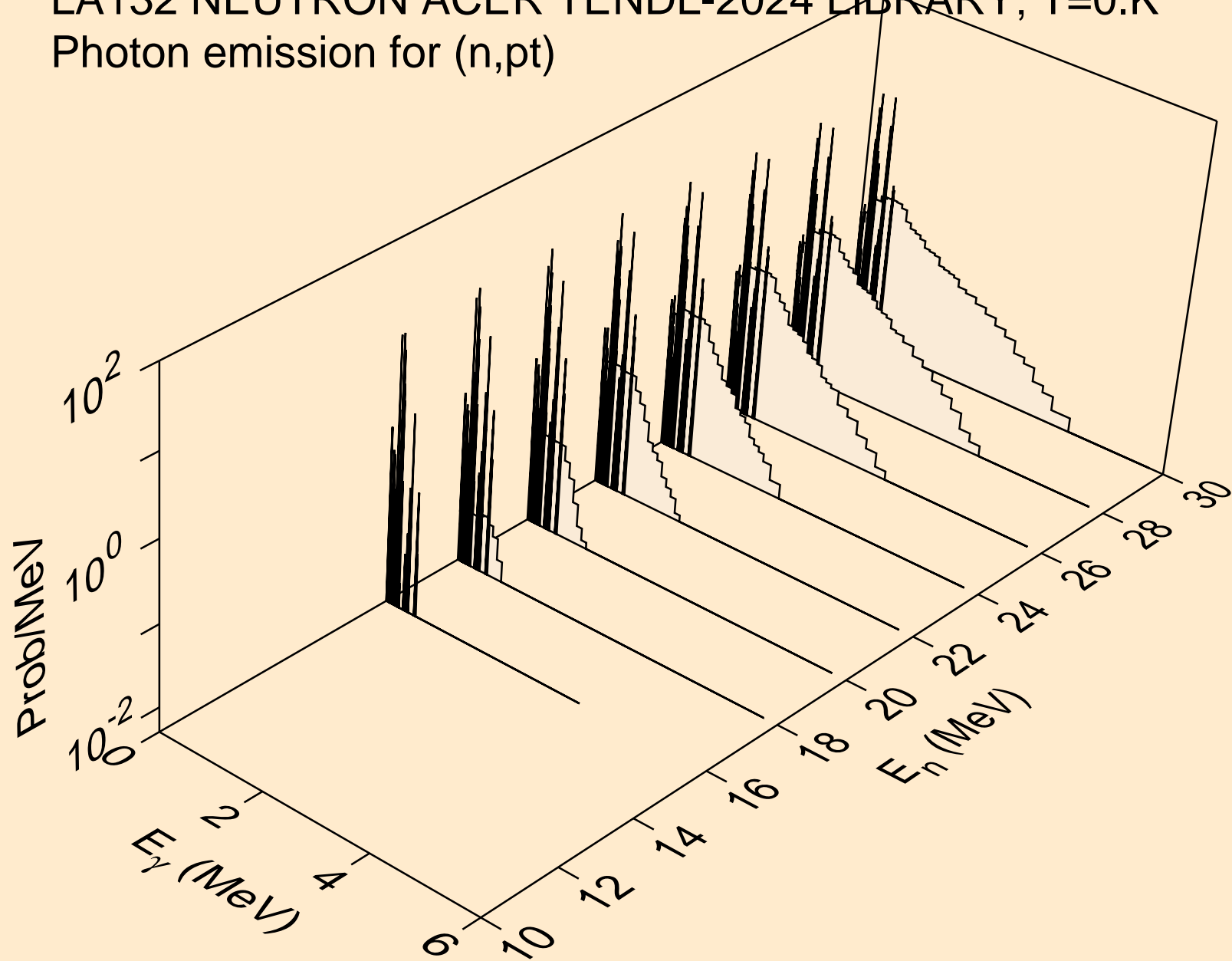

LA132 NEUTRON ACER TENDL-2024 LIBRARY; T=0.K
Photon emission for (n,da)

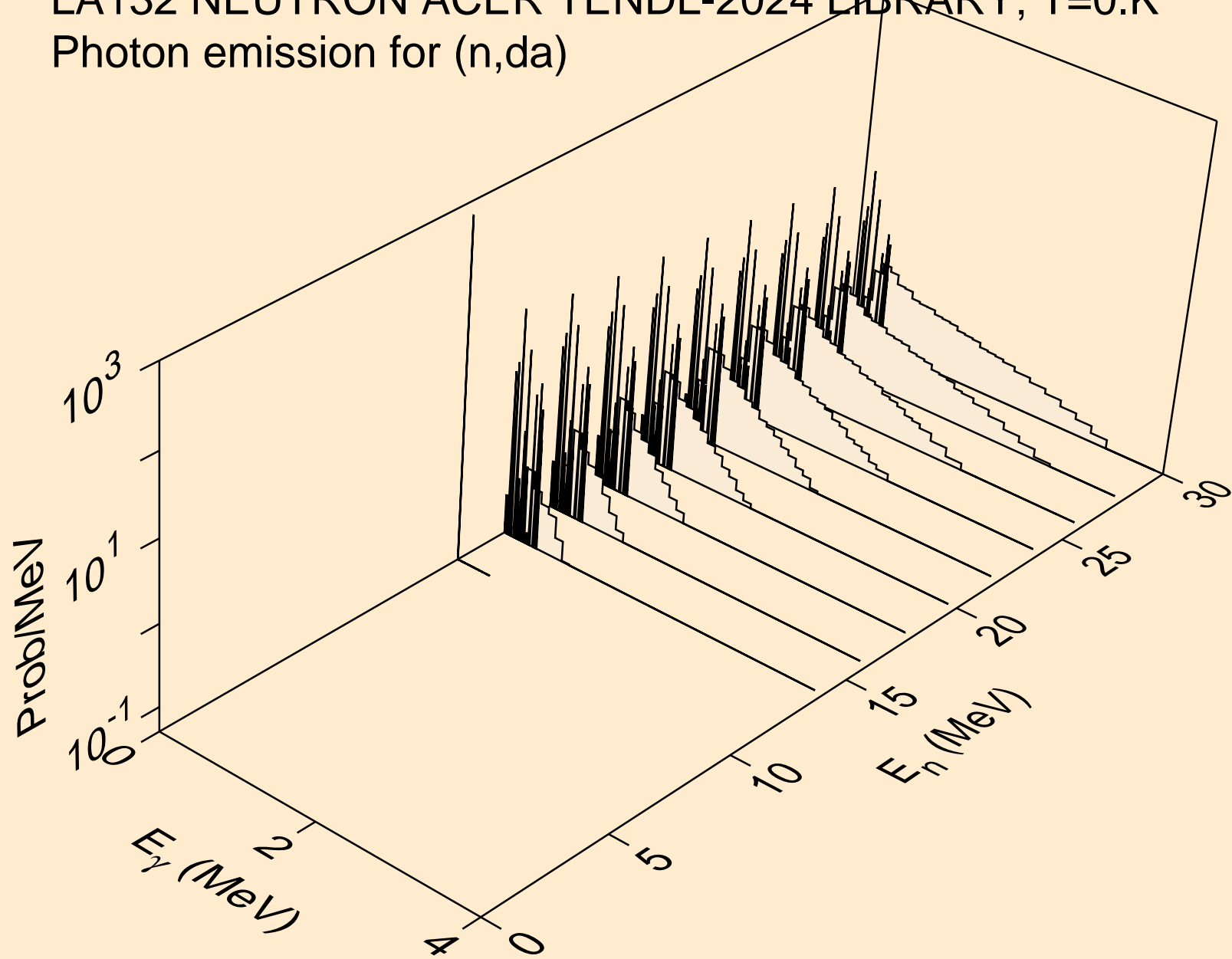

LA132 NEUTRON ACER TENDL-2024 LIBRARY; T=0.K
thermal capture photon spectrum

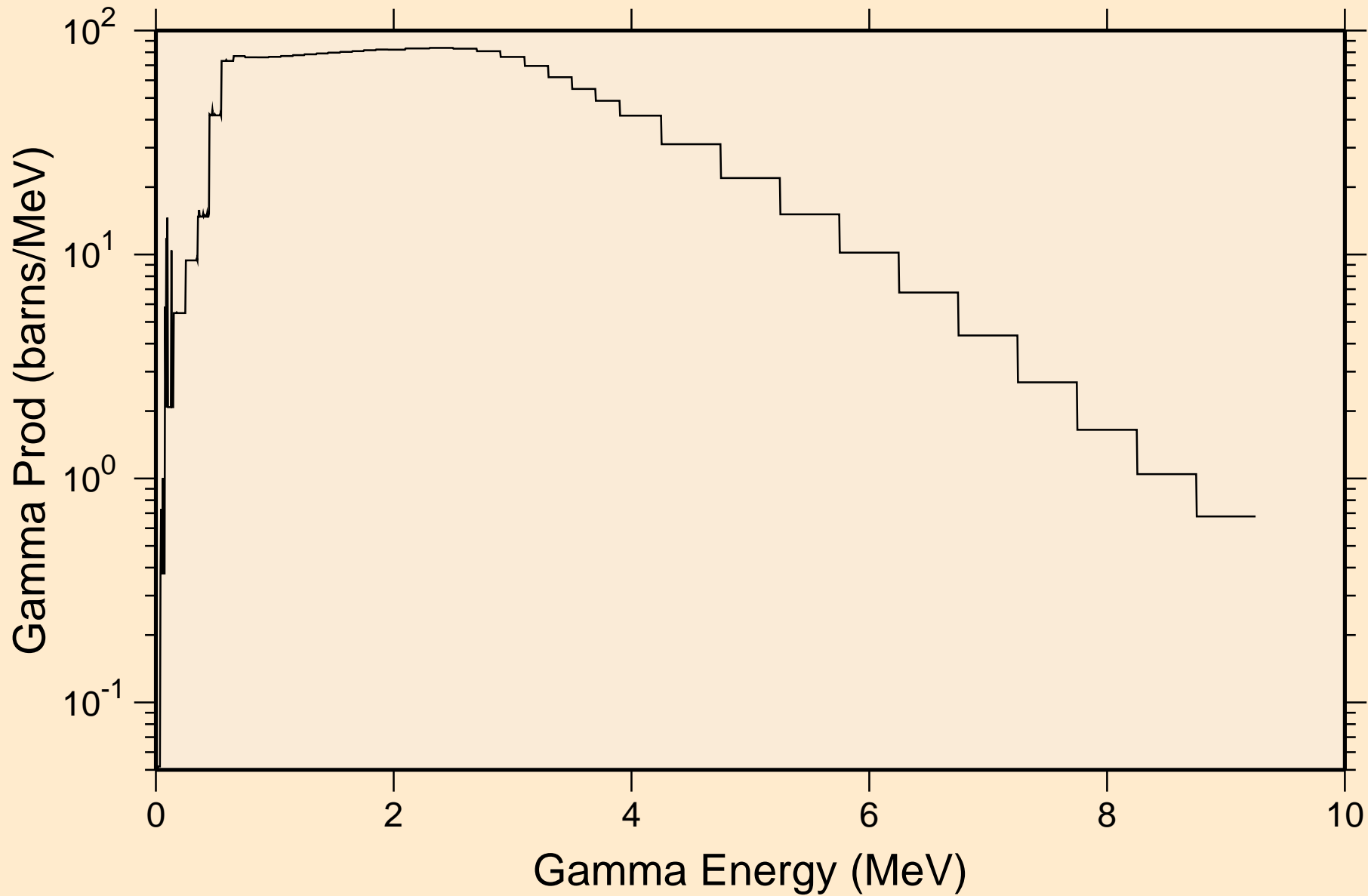

LA132 NEUTRON ACER TENDL-2024 LIBRARY; T=0.K
14 MeV photon spectrum

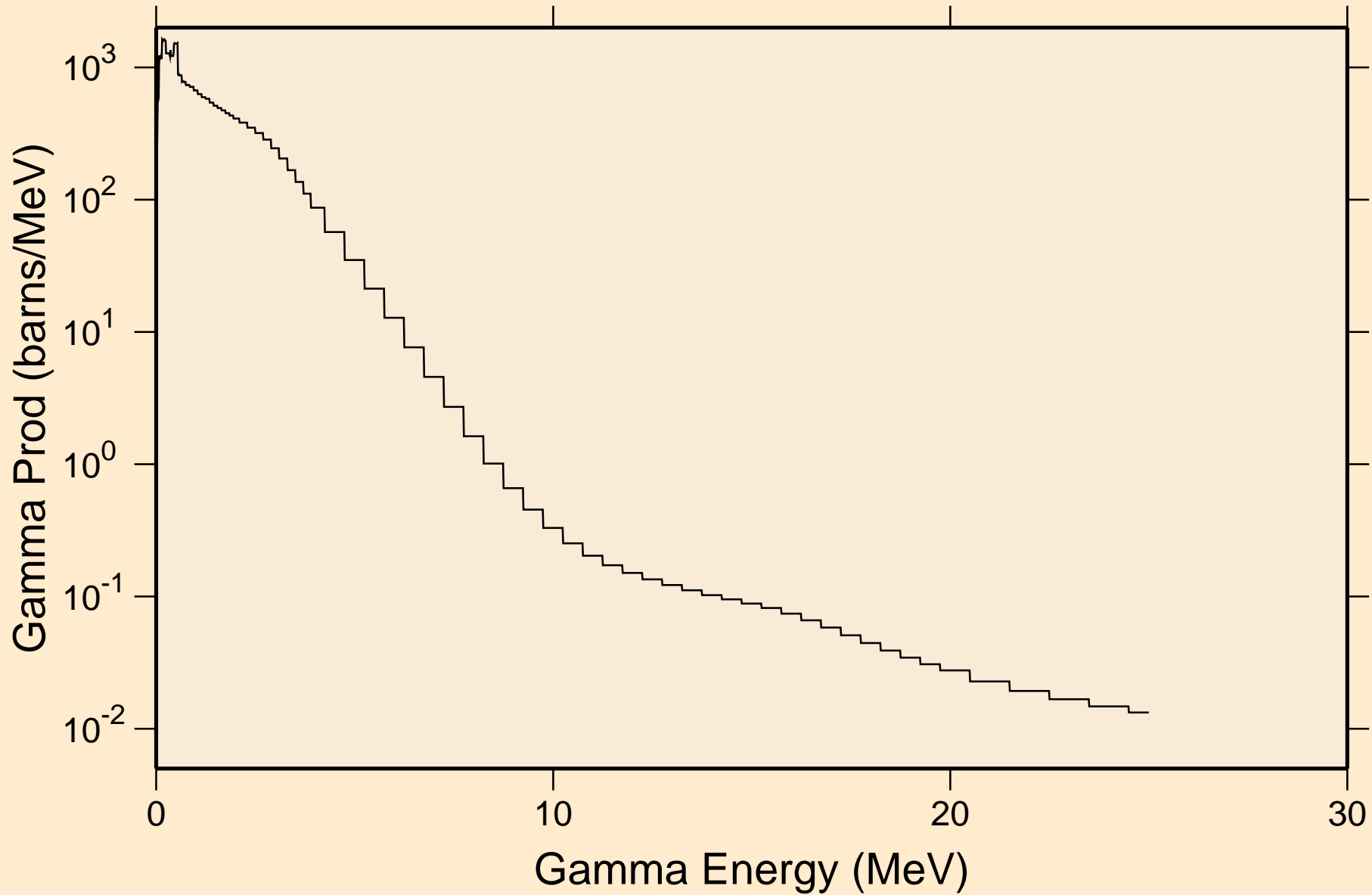

LA132 NEUTRON ACER TENDL-2024 LIBRARY; T=0.K
Particle heating contributions

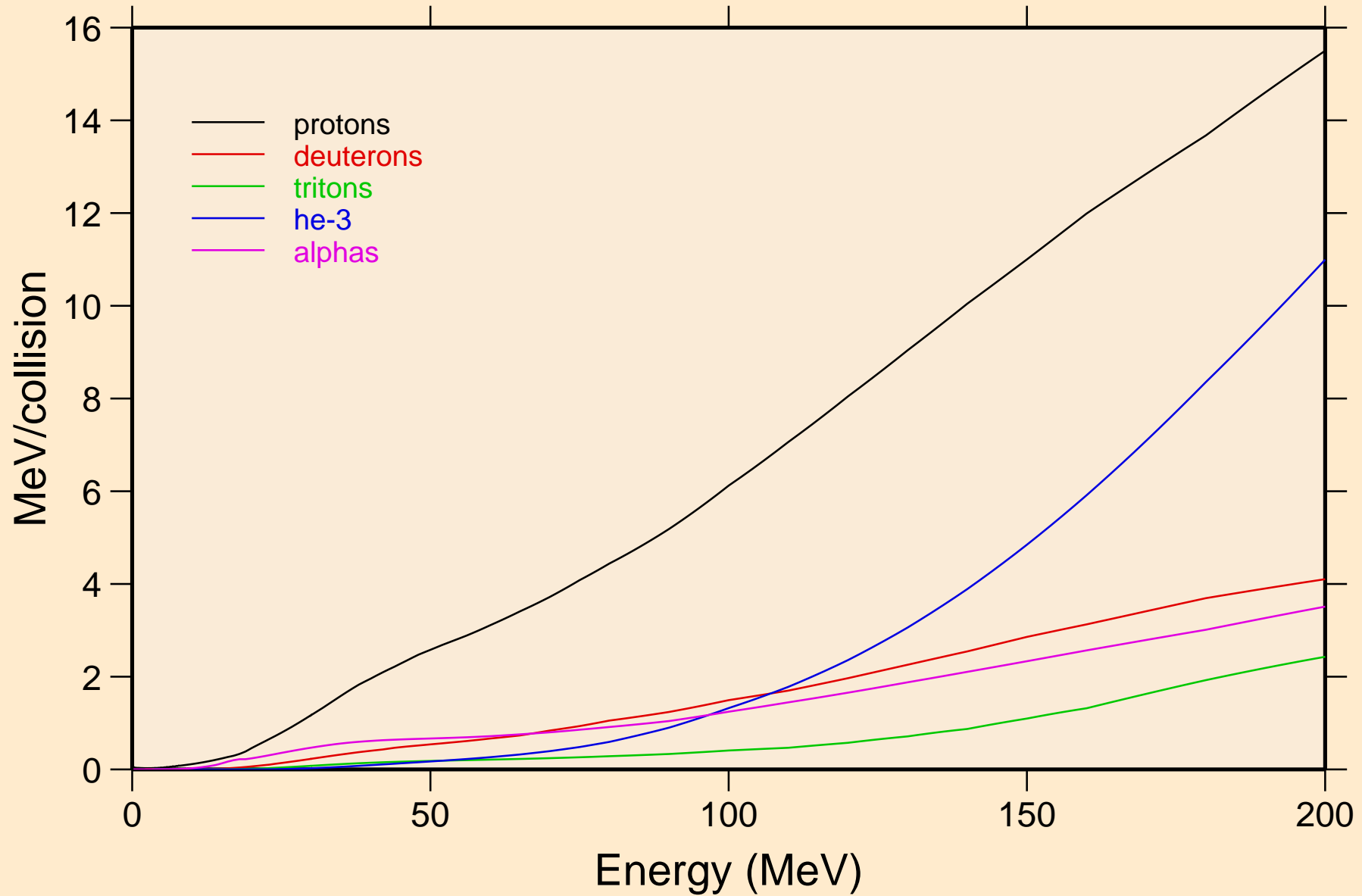

LA132 NEUTRON ACER TENDL-2024 LIBRARY; T=0.K

Recoil Heating

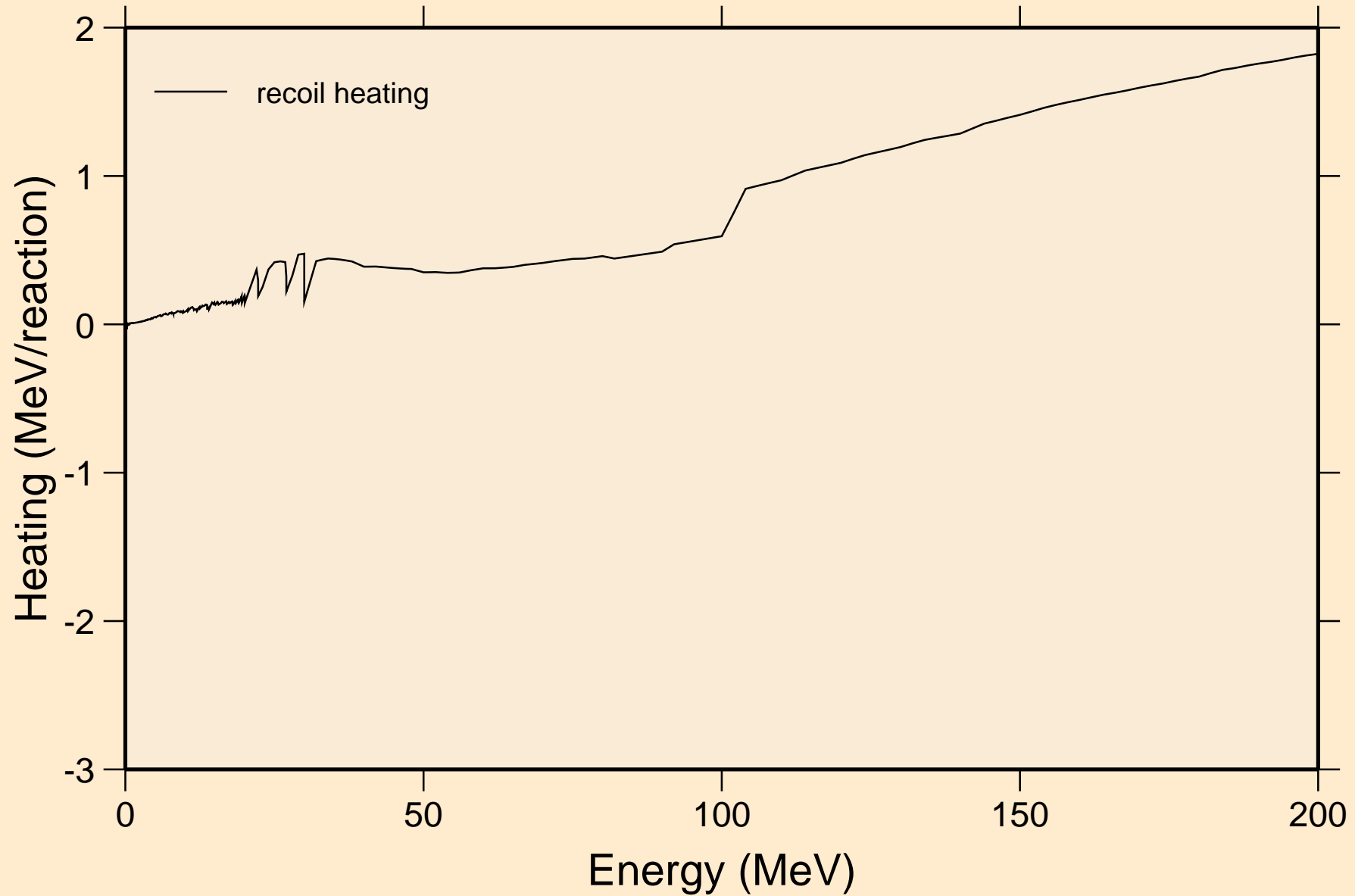

LA132 NEUTRON ACER TENDL-2024 LIBRARY; T=0.K
Particle production cross sections

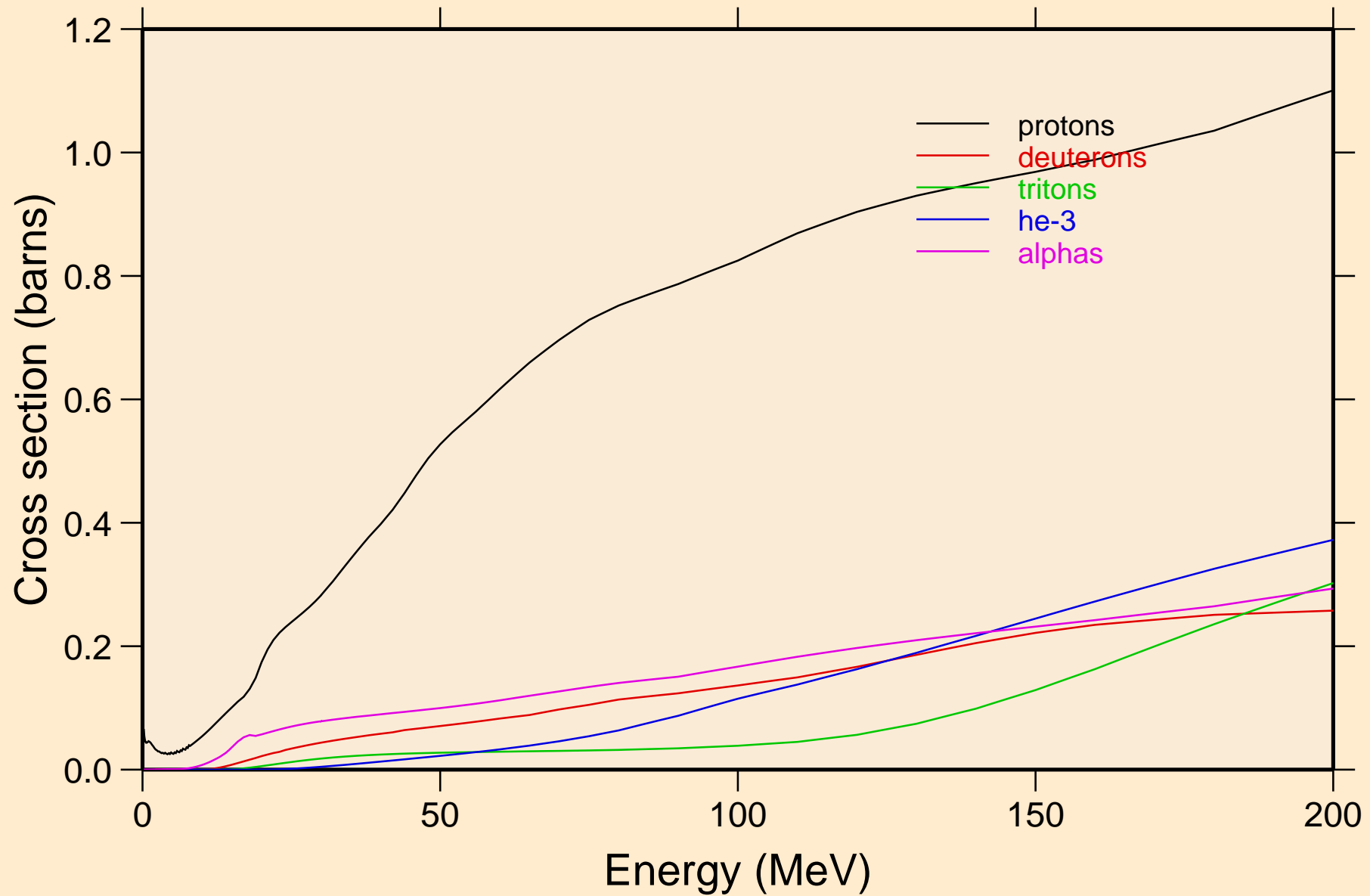

LA132 NEUTRON ACER TENDL-2024 LIBRARY; T=0.K
protons from (n,x)

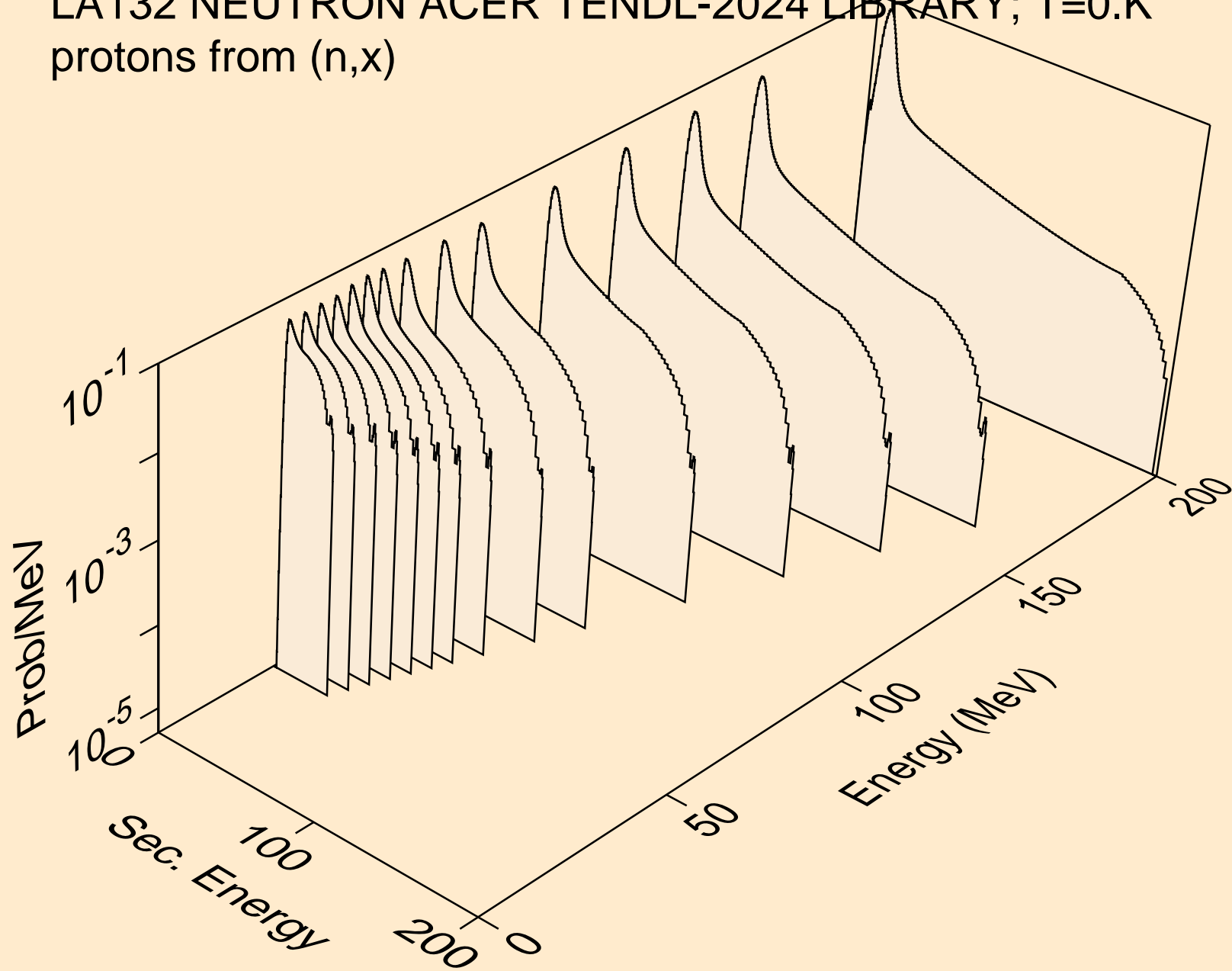

LA132 NEUTRON ACER TENDL-2024 LIBRARY; T=0.K
protons from (n,n*)p

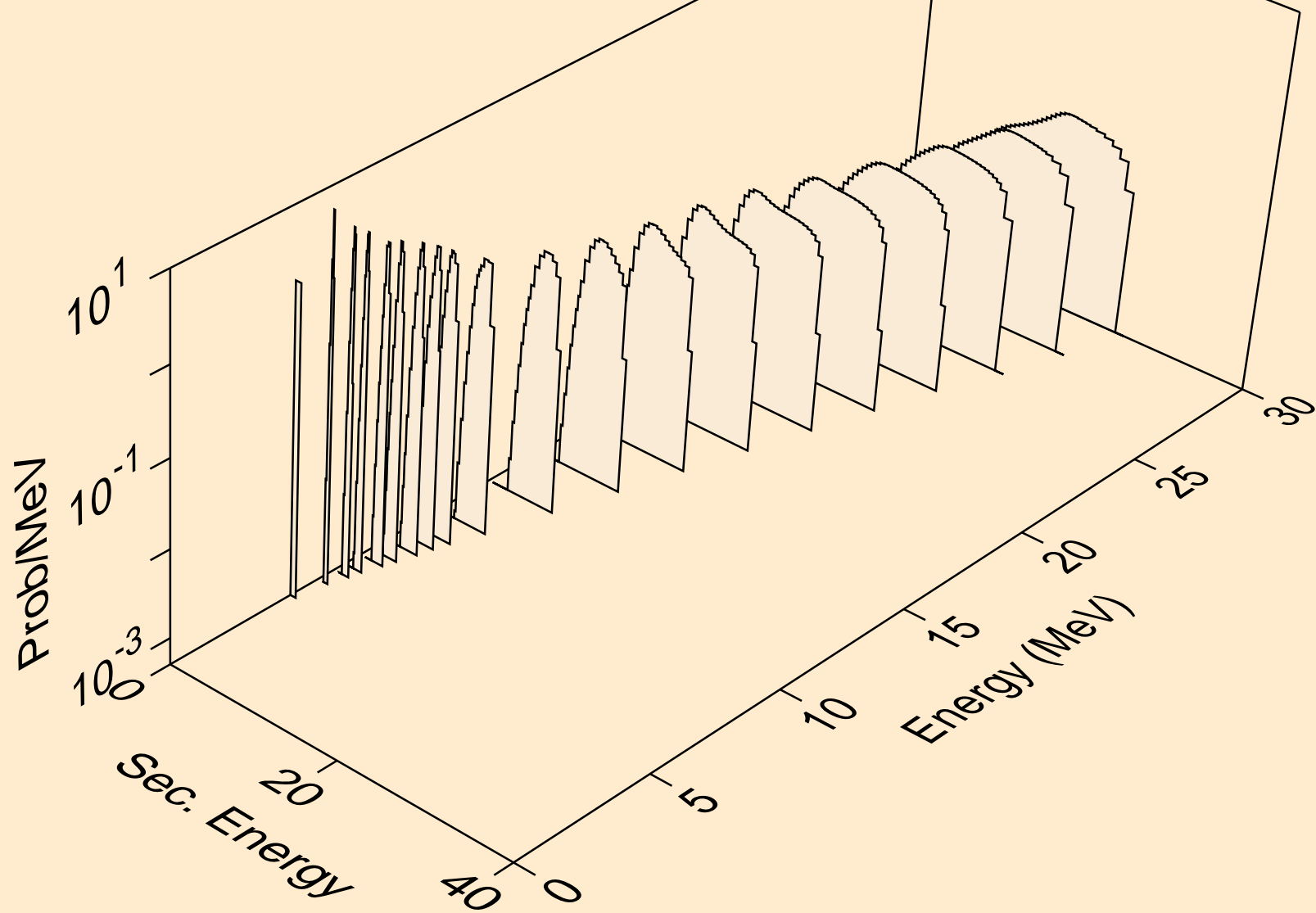

LA132 NEUTRON ACER TENDL-2024 LIBRARY; T=0.K
protons from (n,2np)

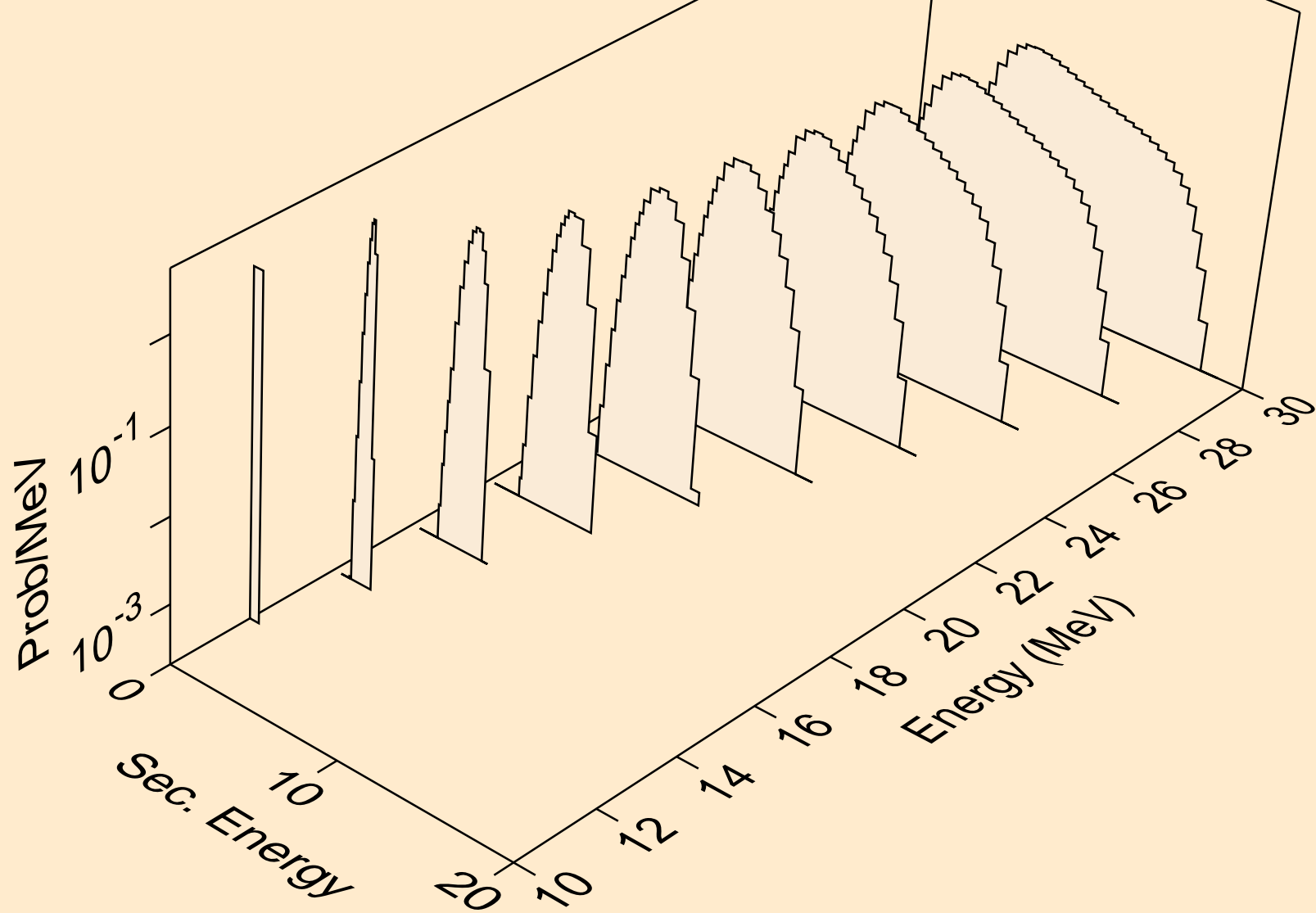

LA132 NEUTRON ACER TENDL-2024 LIBRARY; T=0.K
protons from (n,3np)

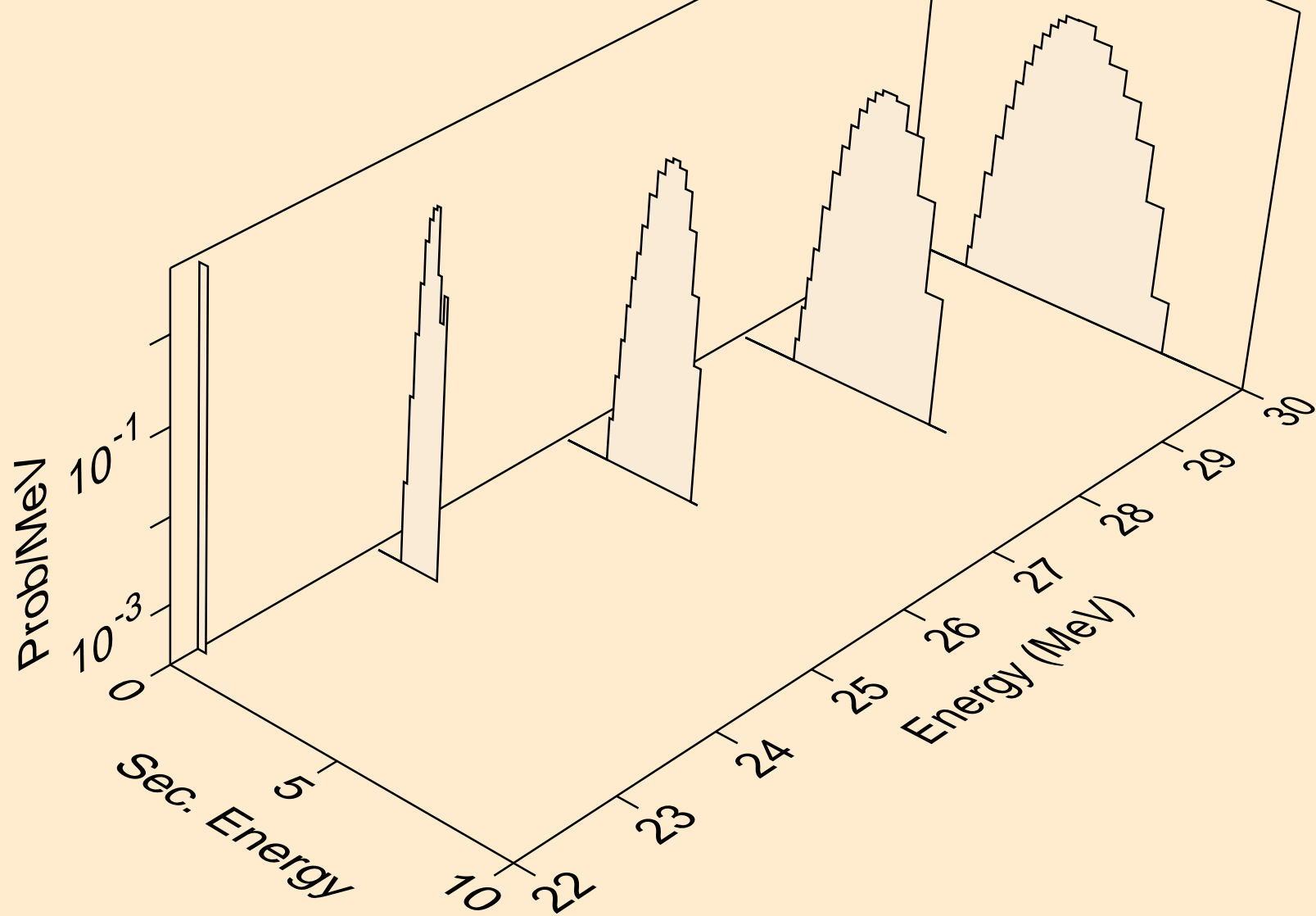

LA132 NEUTRON ACER TENDL-2024 LIBRARY; T=0.K
protons from (n,n2p)

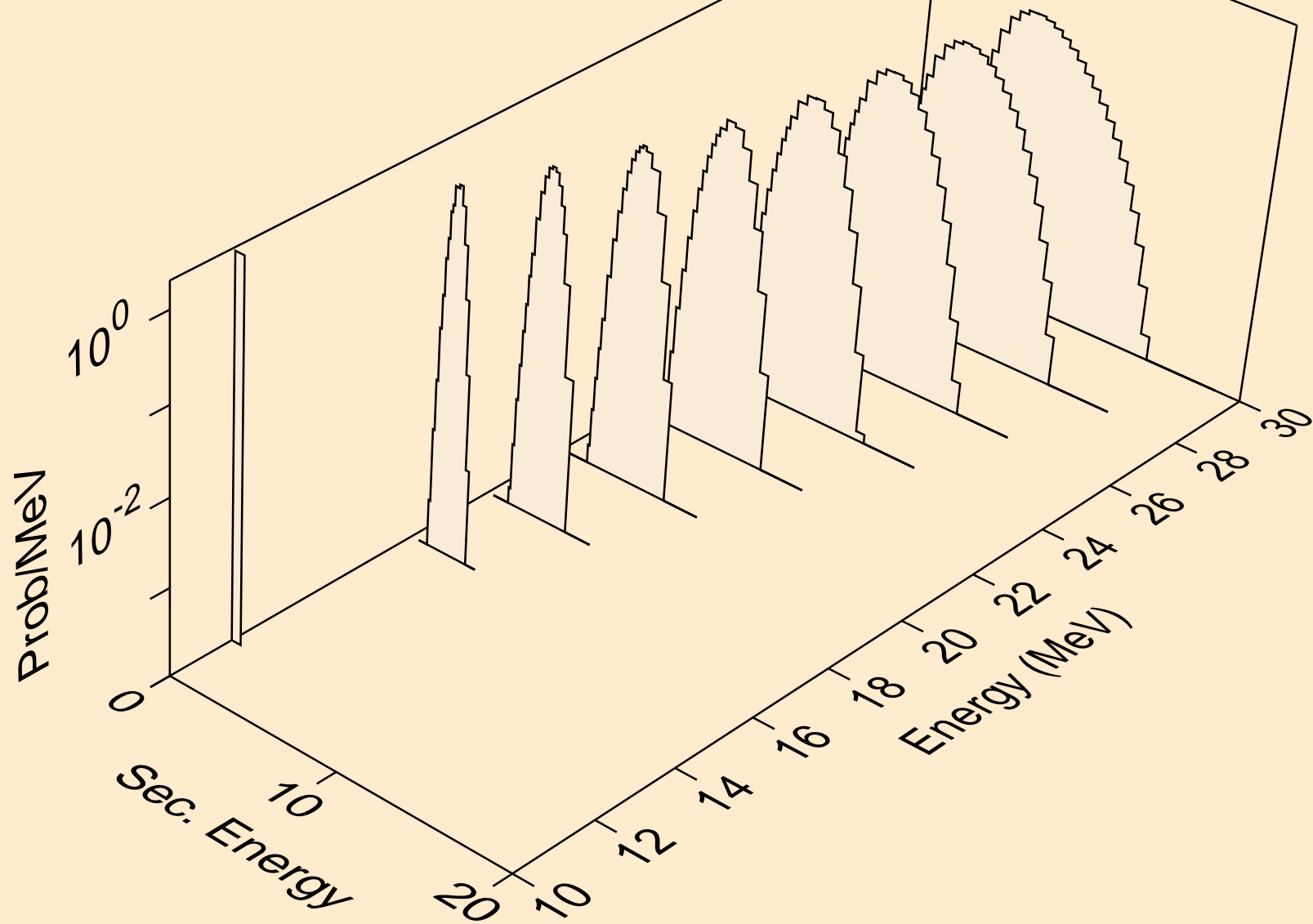

LA132 NEUTRON ACER TENDL-2024 LIBRARY; T=0.K
protons from (n,npa)

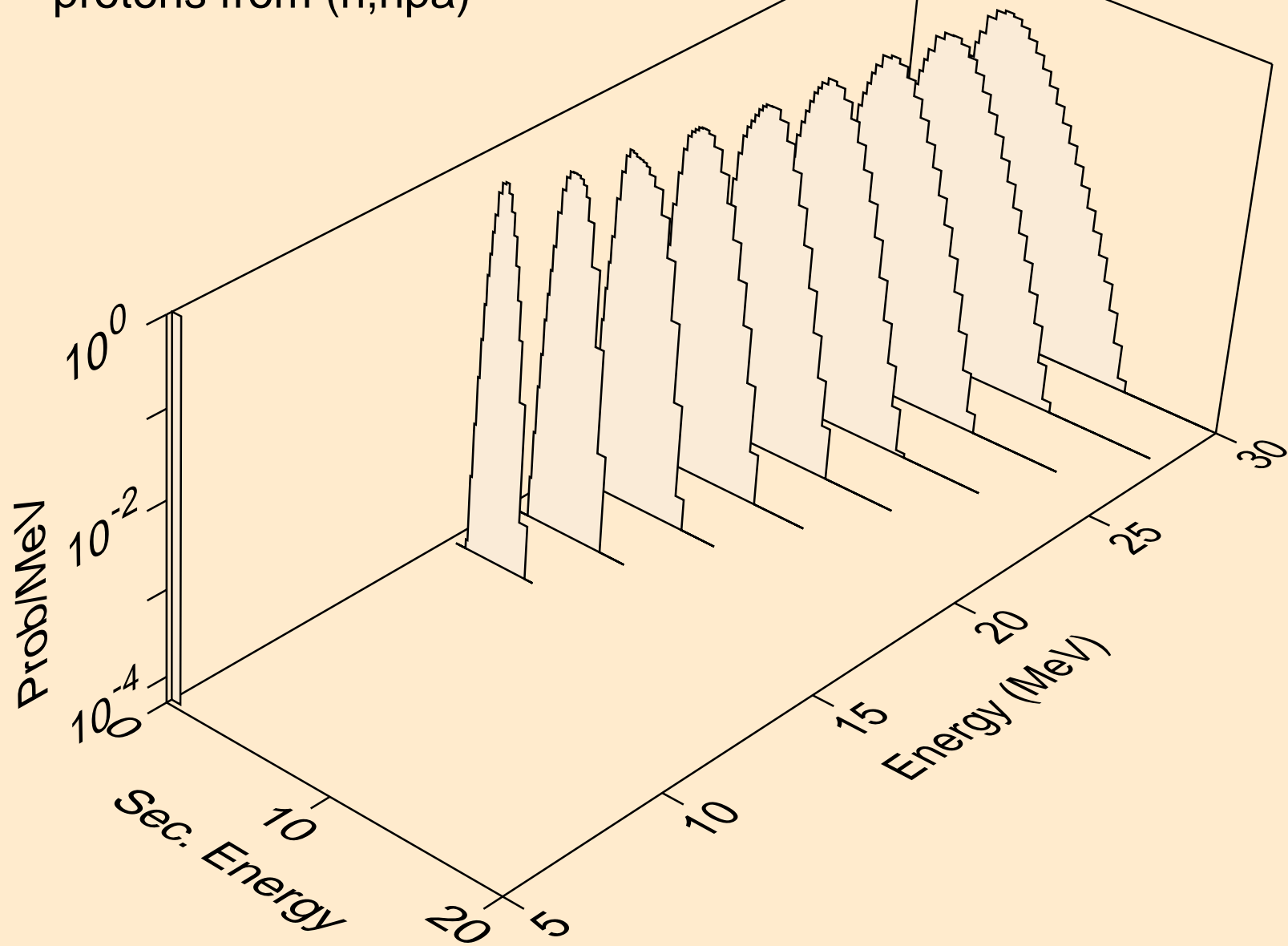

LA132 NEUTRON ACER TENDL-2024 LIBRARY; T=0.K
protons from (n,p)

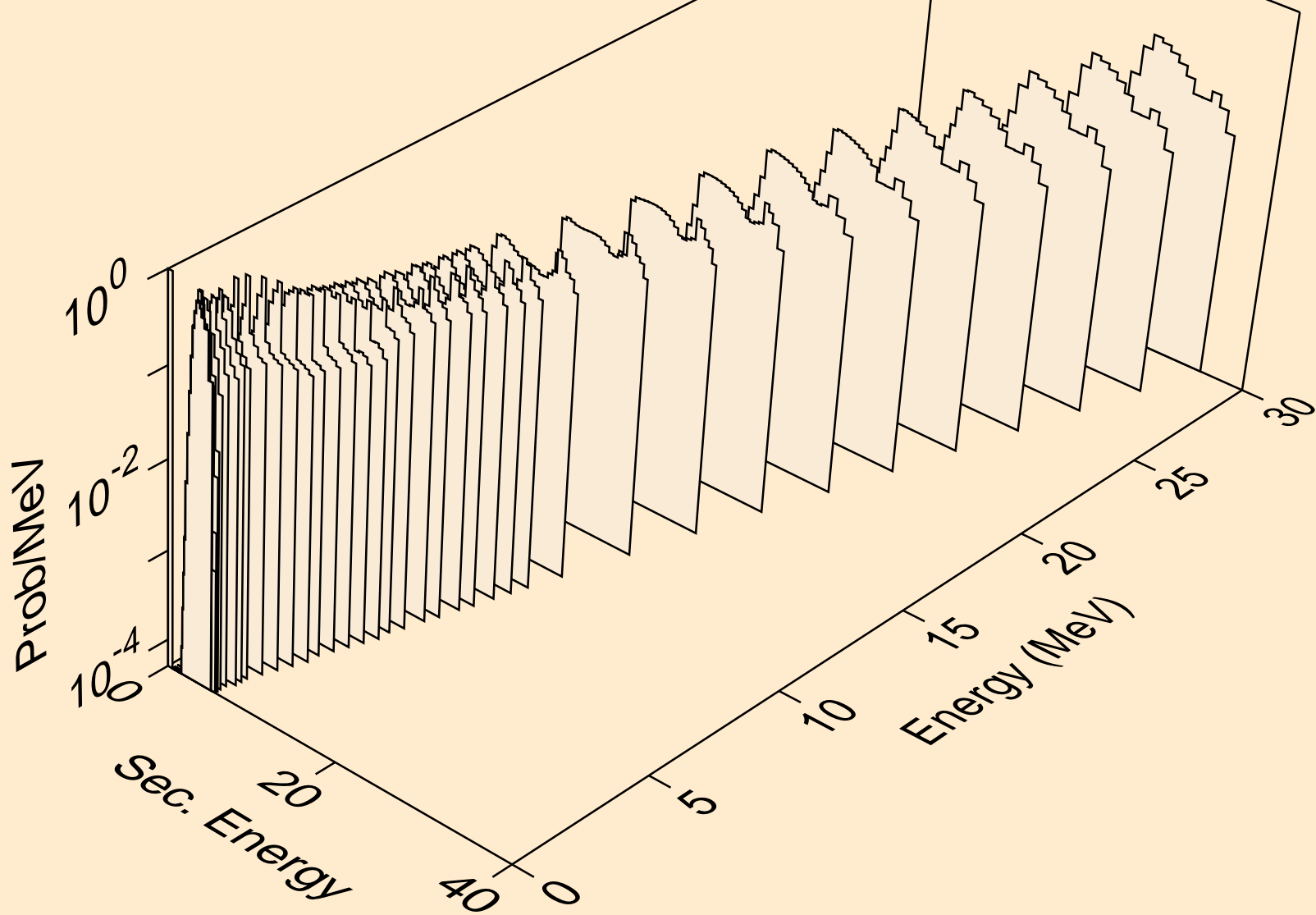

LA132 NEUTRON ACER TENDL-2024 LIBRARY; T=0.K
protons from (n,2p)

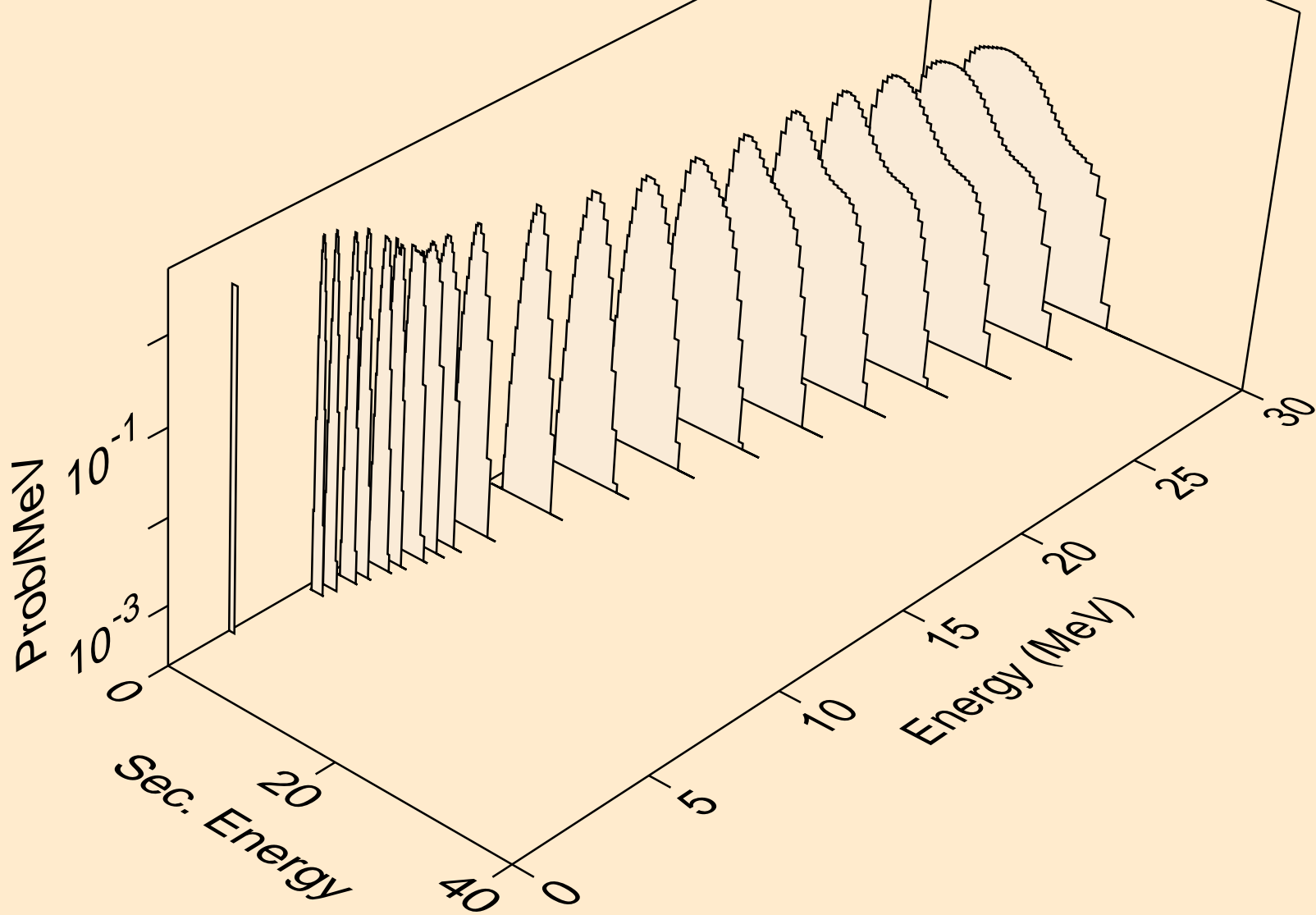

LA132 NEUTRON ACER TENDL-2024 LIBRARY; T=0.K
protons from (n,p)

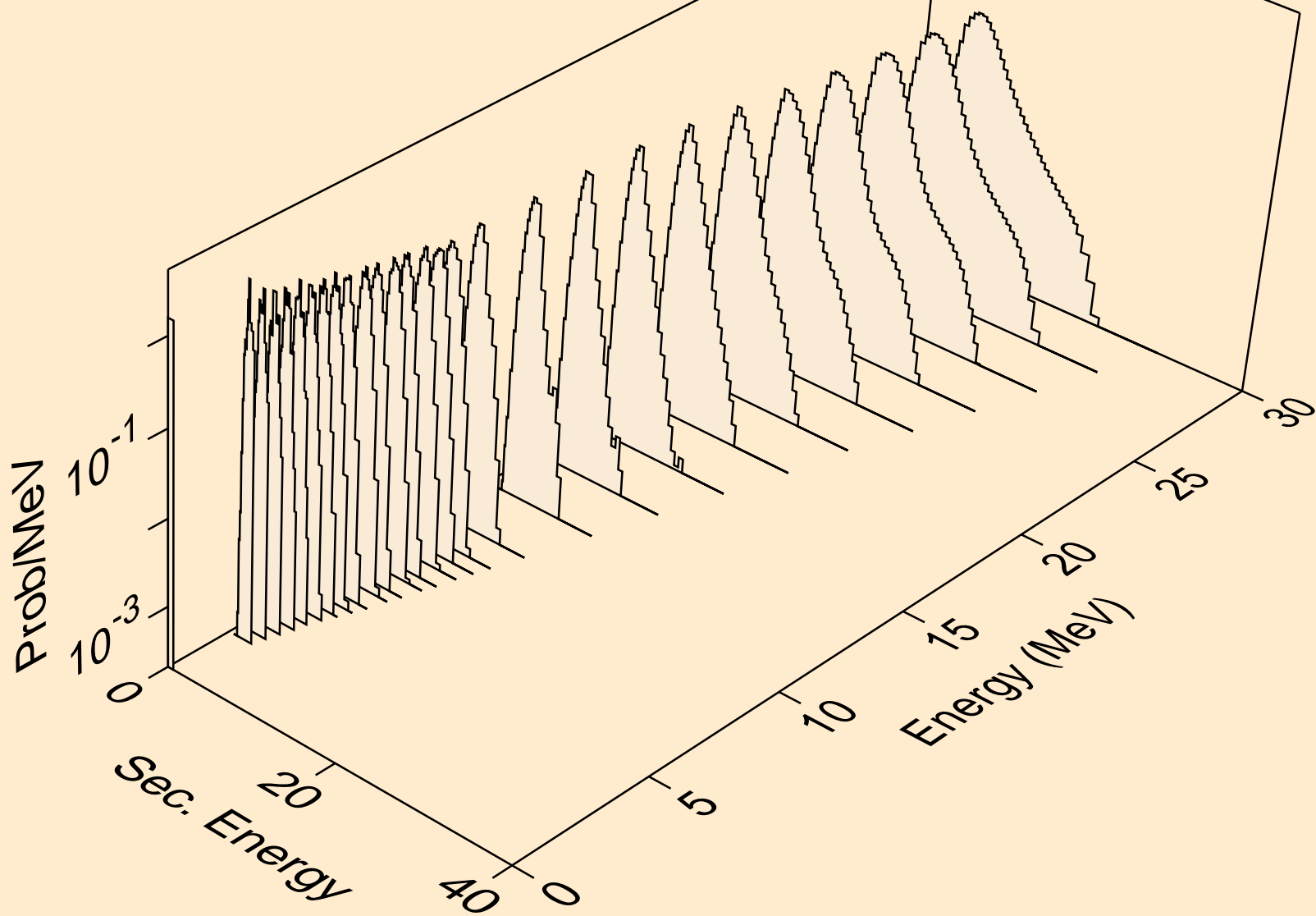

LA132 NEUTRON ACER TENDL-2024 LIBRARY; T=0.K
protons from (n,pd)

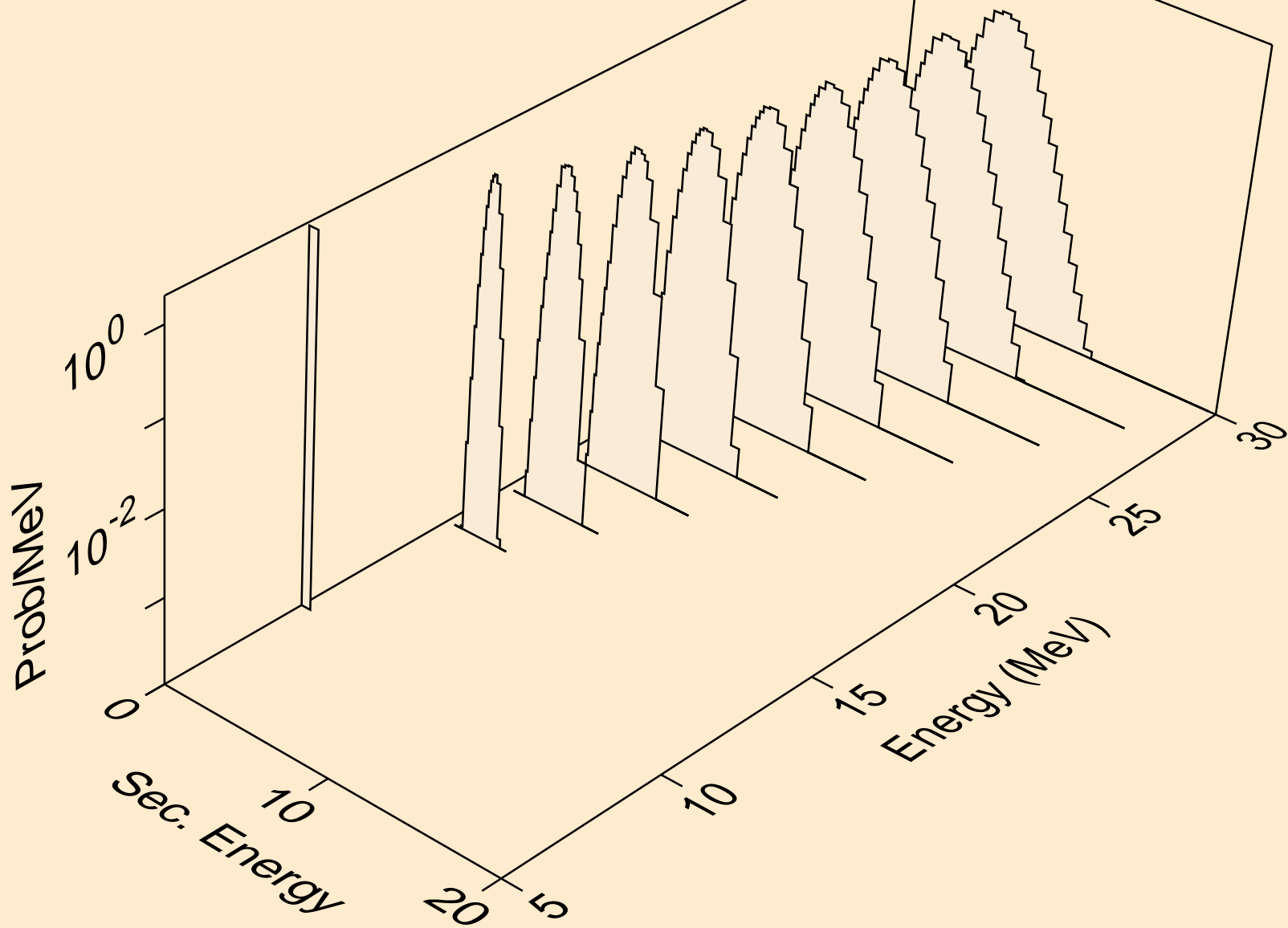

LA132 NEUTRON ACER TENDL-2024 LIBRARY; T=0.K
protons from (n,pt)

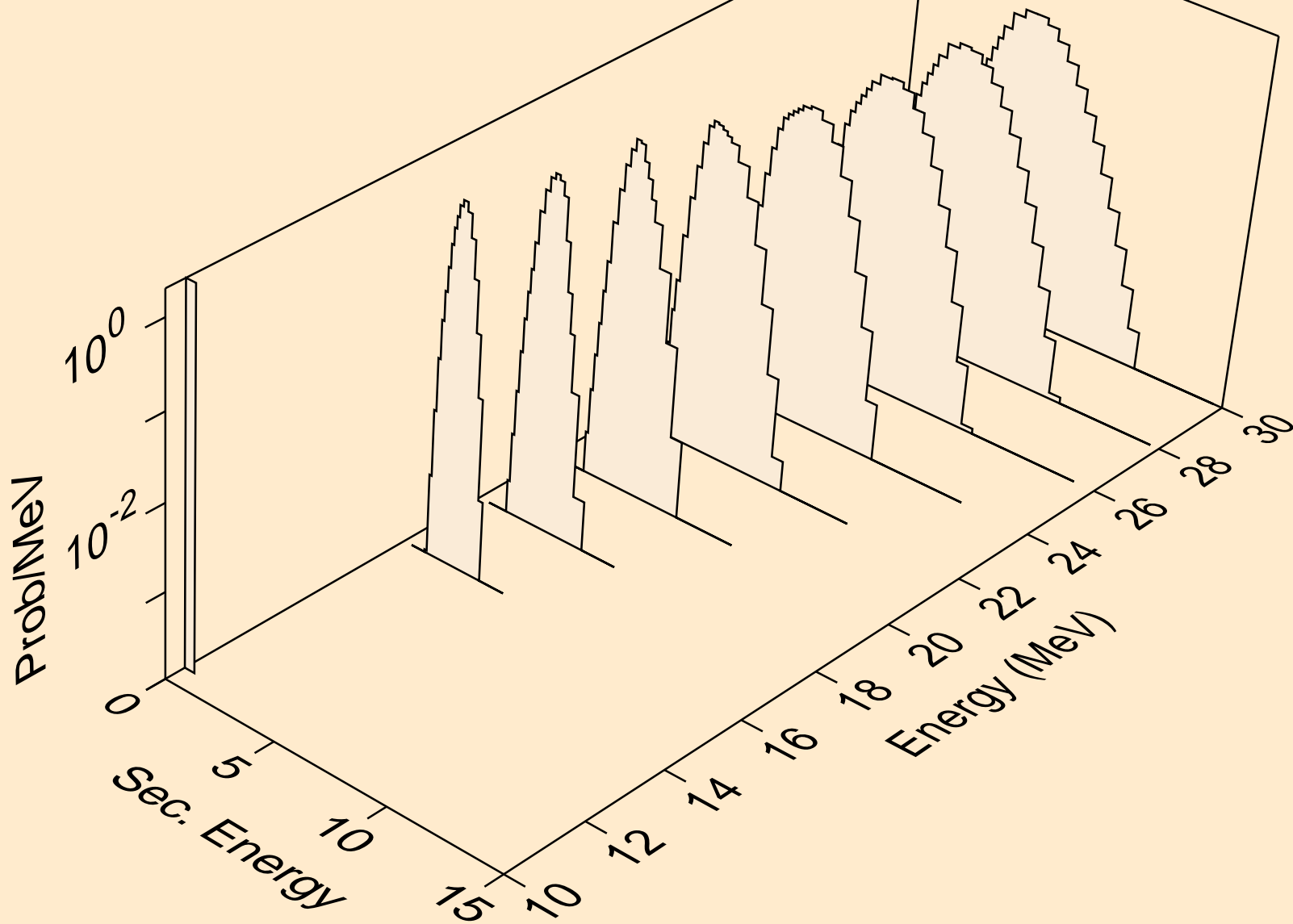

LA132 NEUTRON ACER TENDL-2024 LIBRARY; T=0.K
deuterons from (n,x)

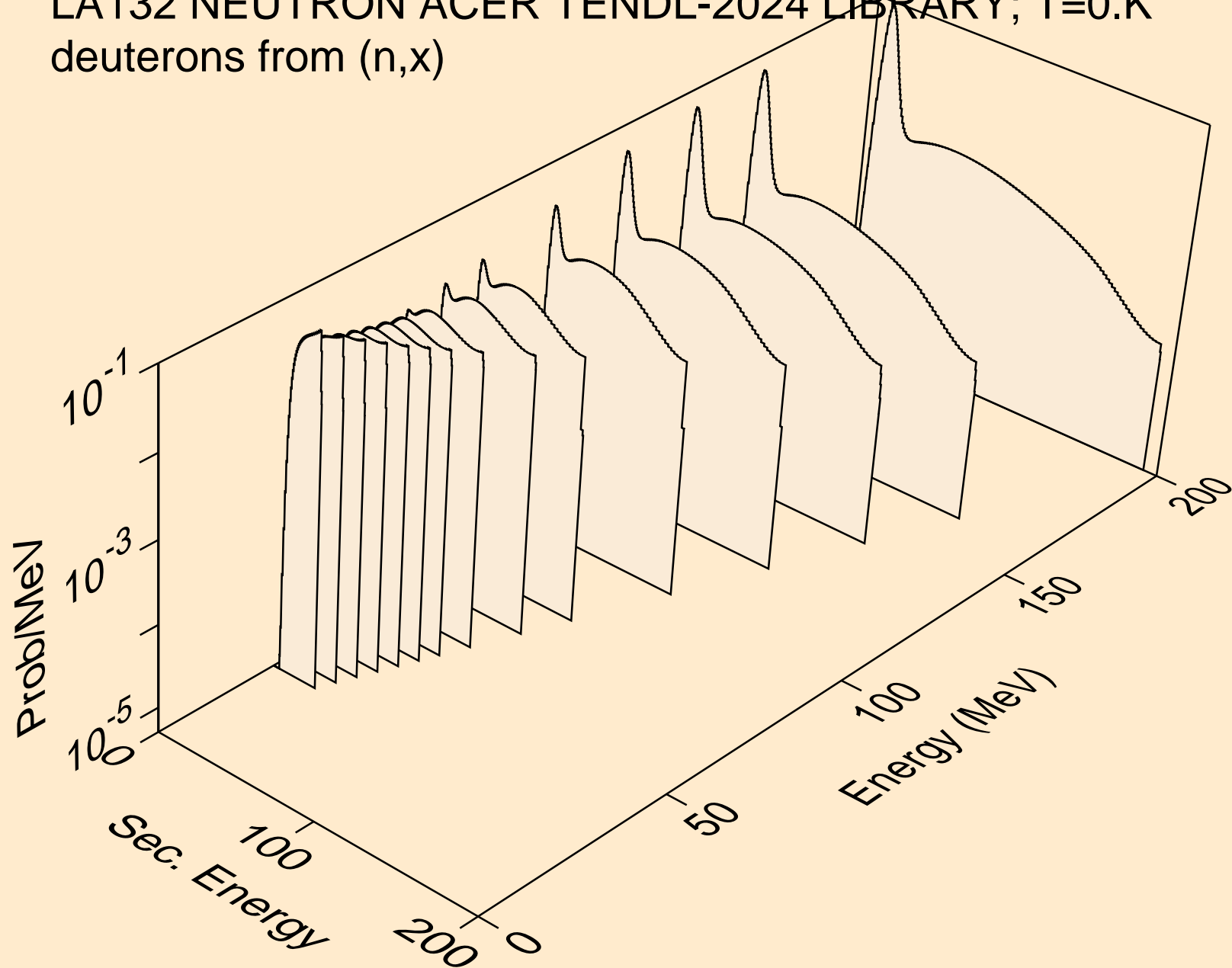

LA132 NEUTRON ACER TENDL-2024 LIBRARY; T=0.K
deuterons from (n,2nd)

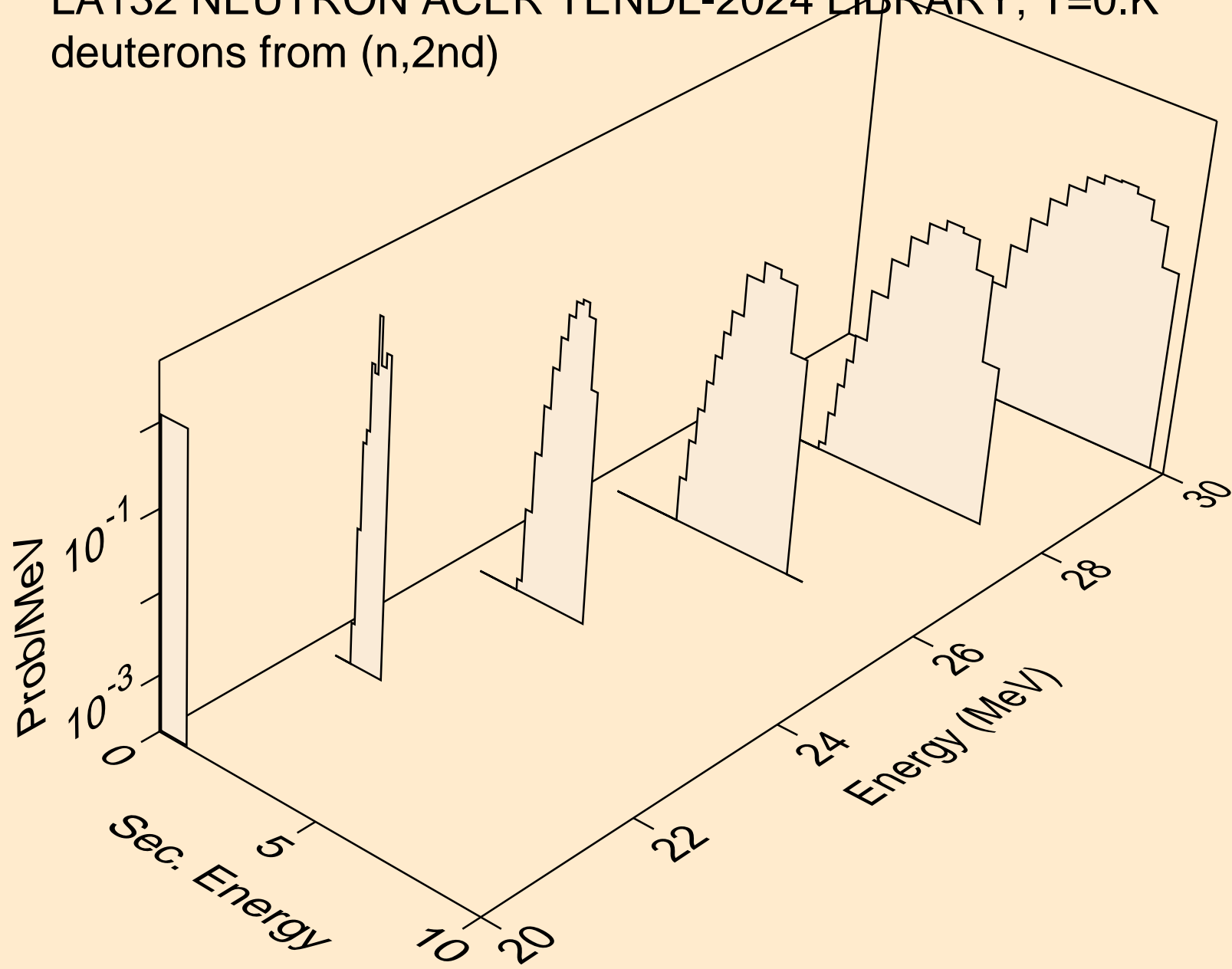

LA132 NEUTRON ACER TENDL-2024 LIBRARY; T=0.K
deuterons from (n,n*)d

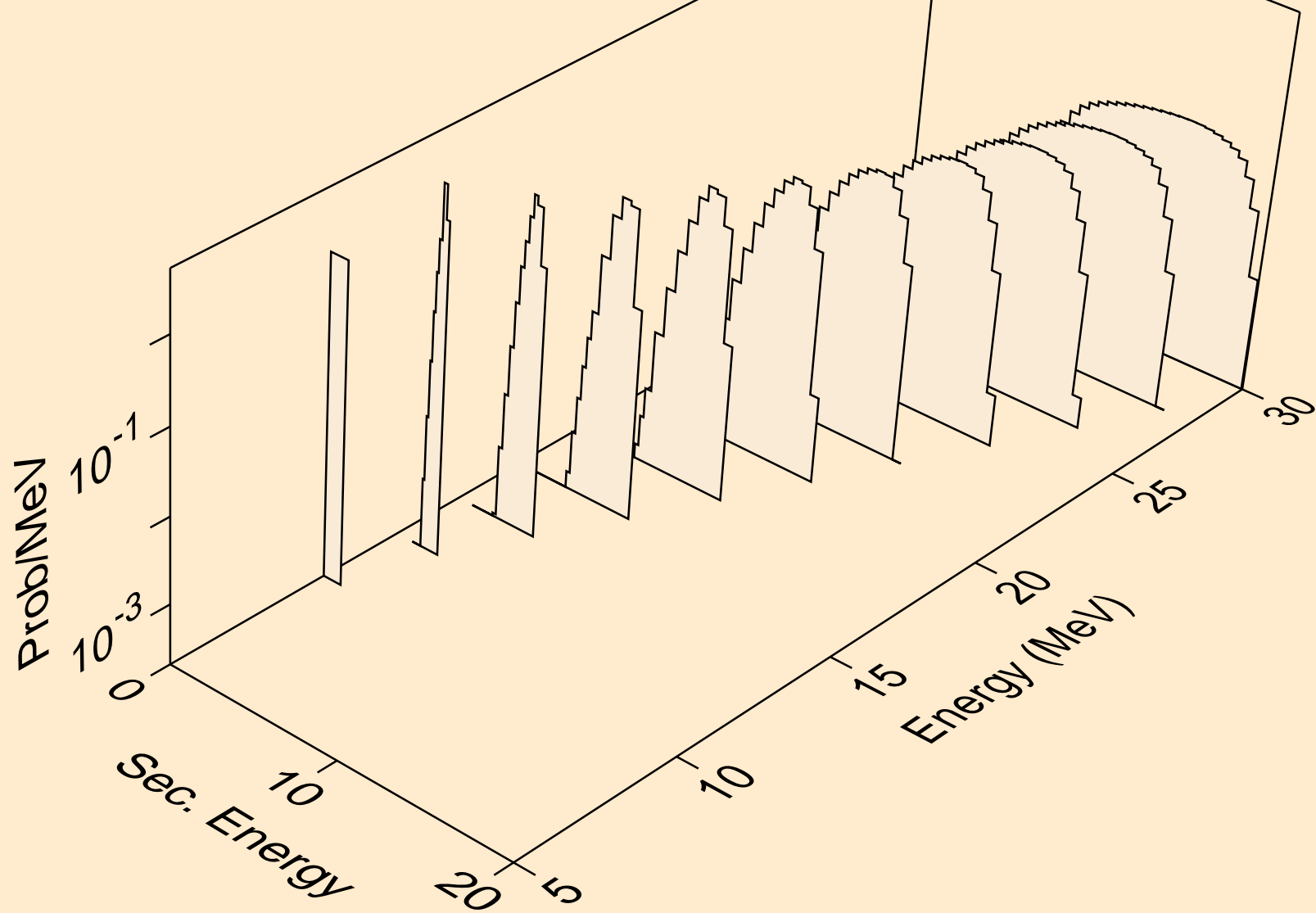

LA132 NEUTRON ACER TENDL-2024 LIBRARY; T=0.K
deuterons from (n,d)

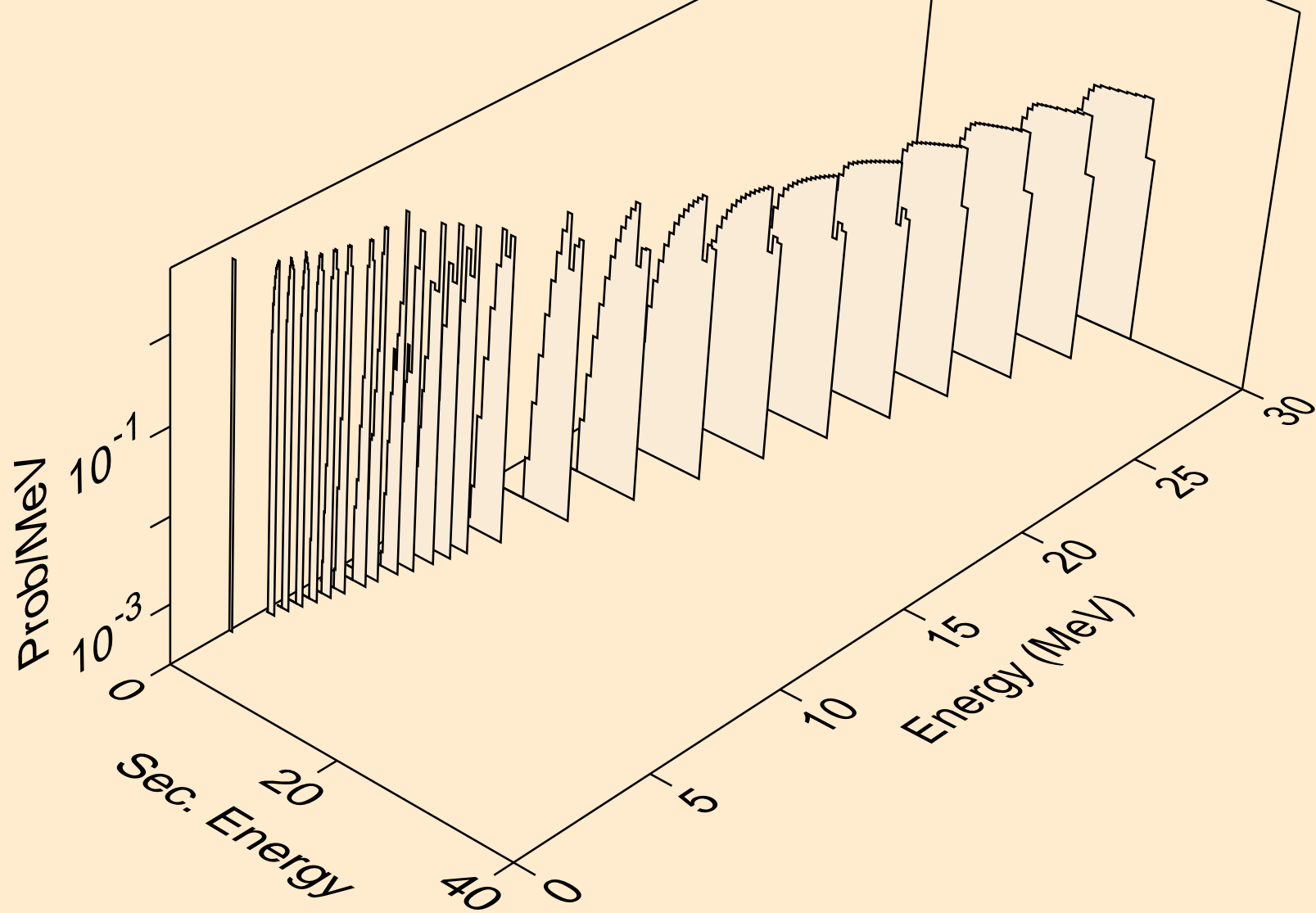

LA132 NEUTRON ACER TENDL-2024 LIBRARY; T=0.K
deuterons from (n,pd)

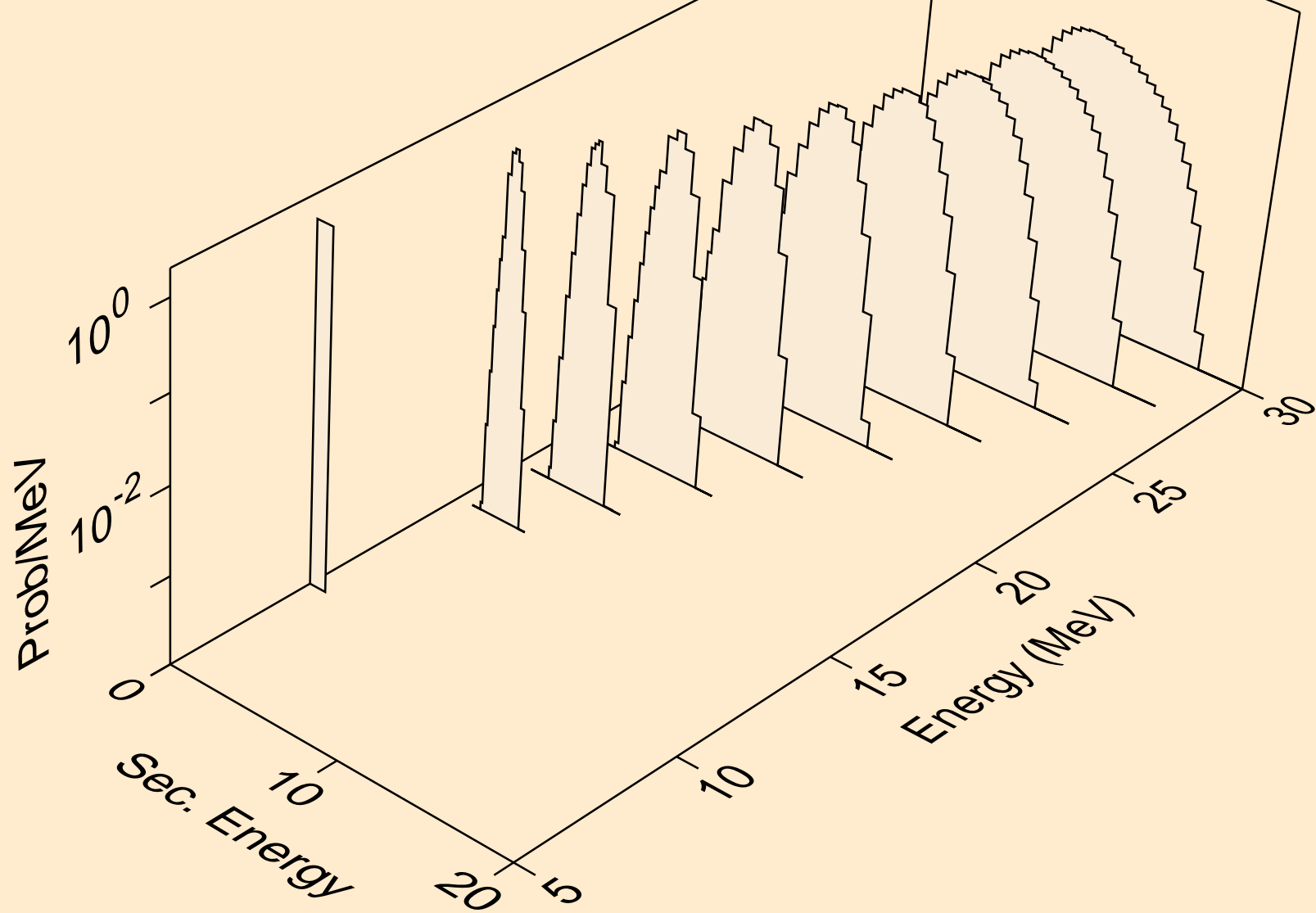

LA132 NEUTRON ACER TENDL-2024 LIBRARY; T=0.K
deuterons from (n,da)

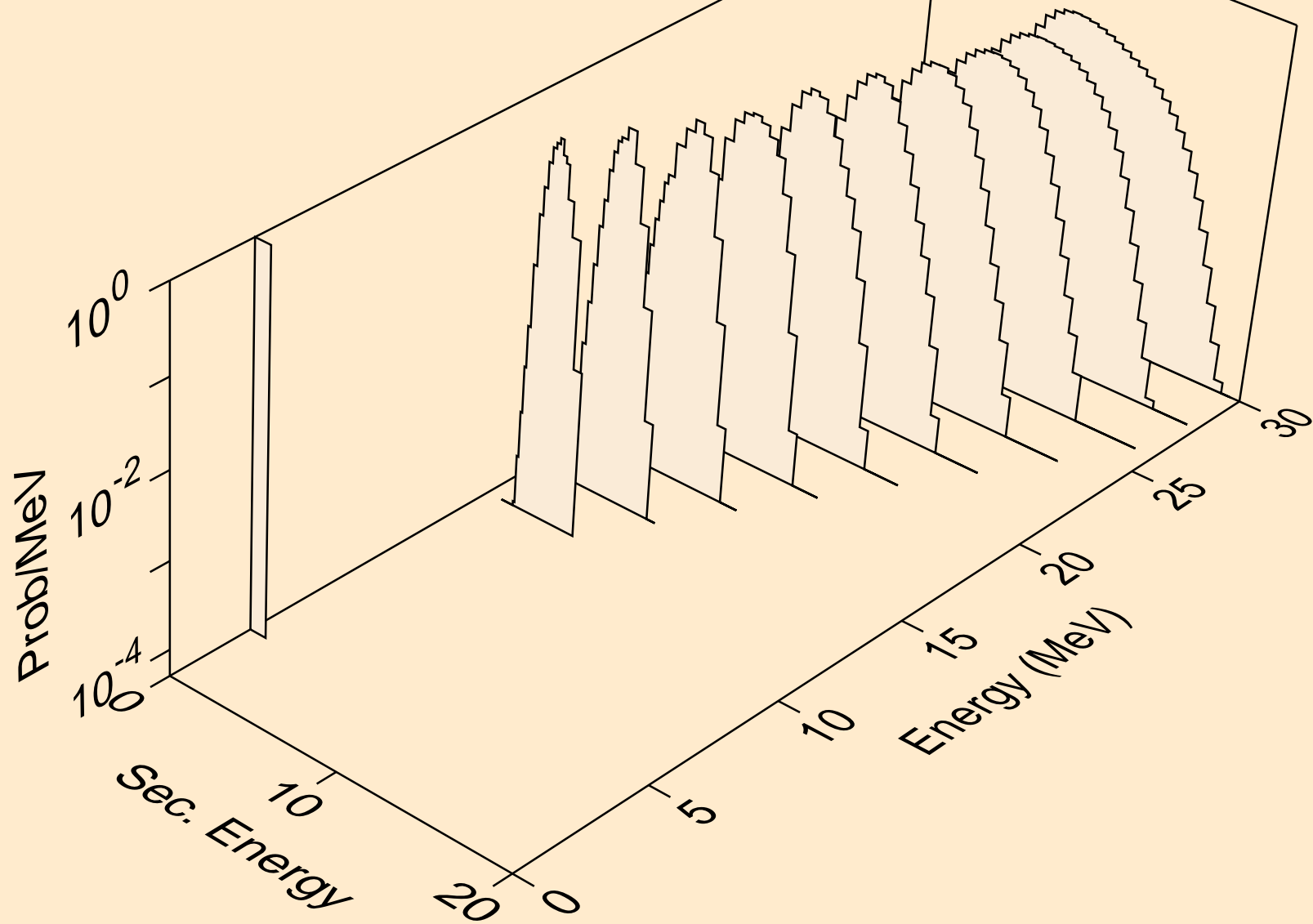

LA132 NEUTRON ACER TENDL-2024 LIBRARY; T=0.K
tritons from (n,x)

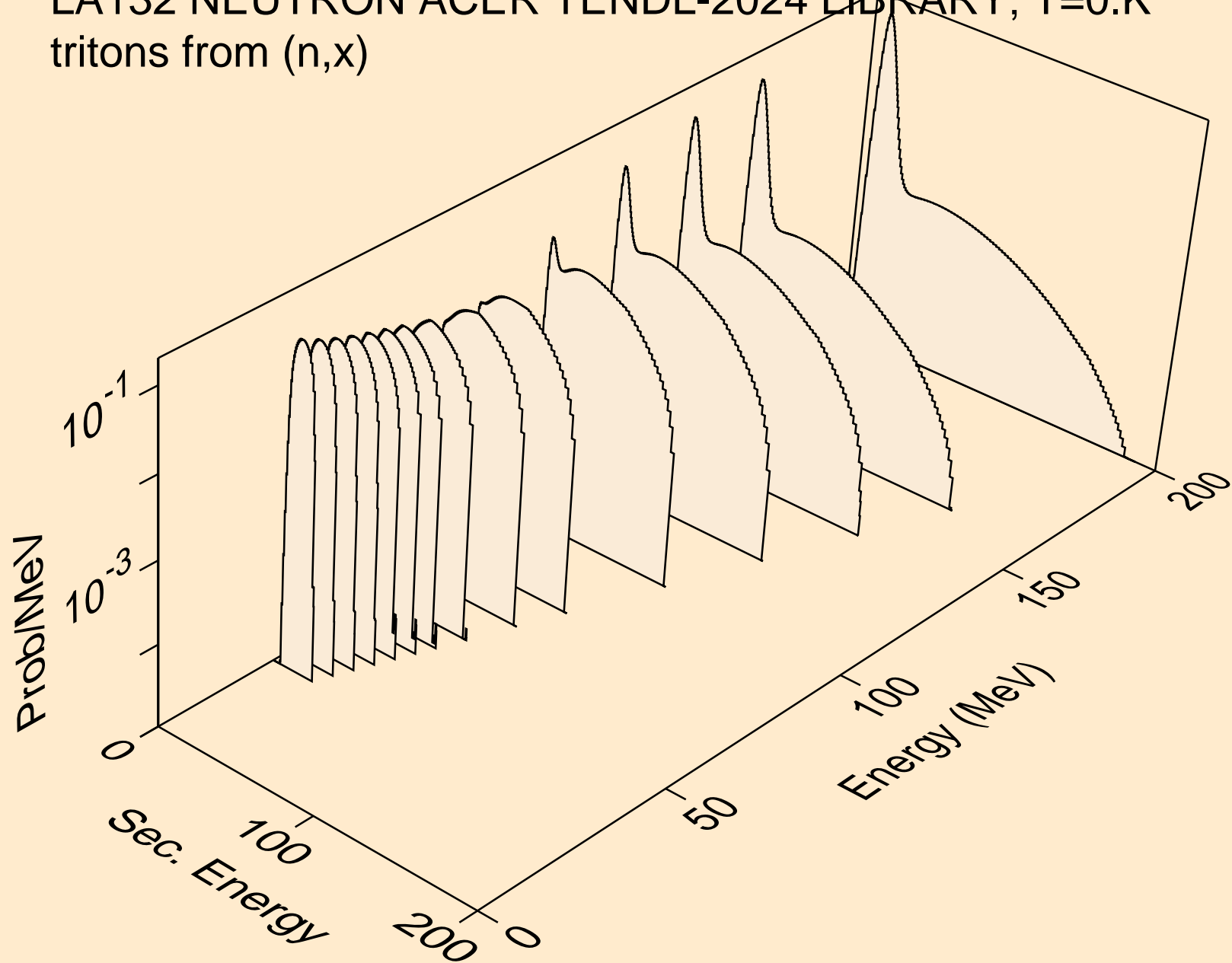

LA132 NEUTRON ACER TENDL-2024 LIBRARY; T=0.K
tritons from (n,n*)t

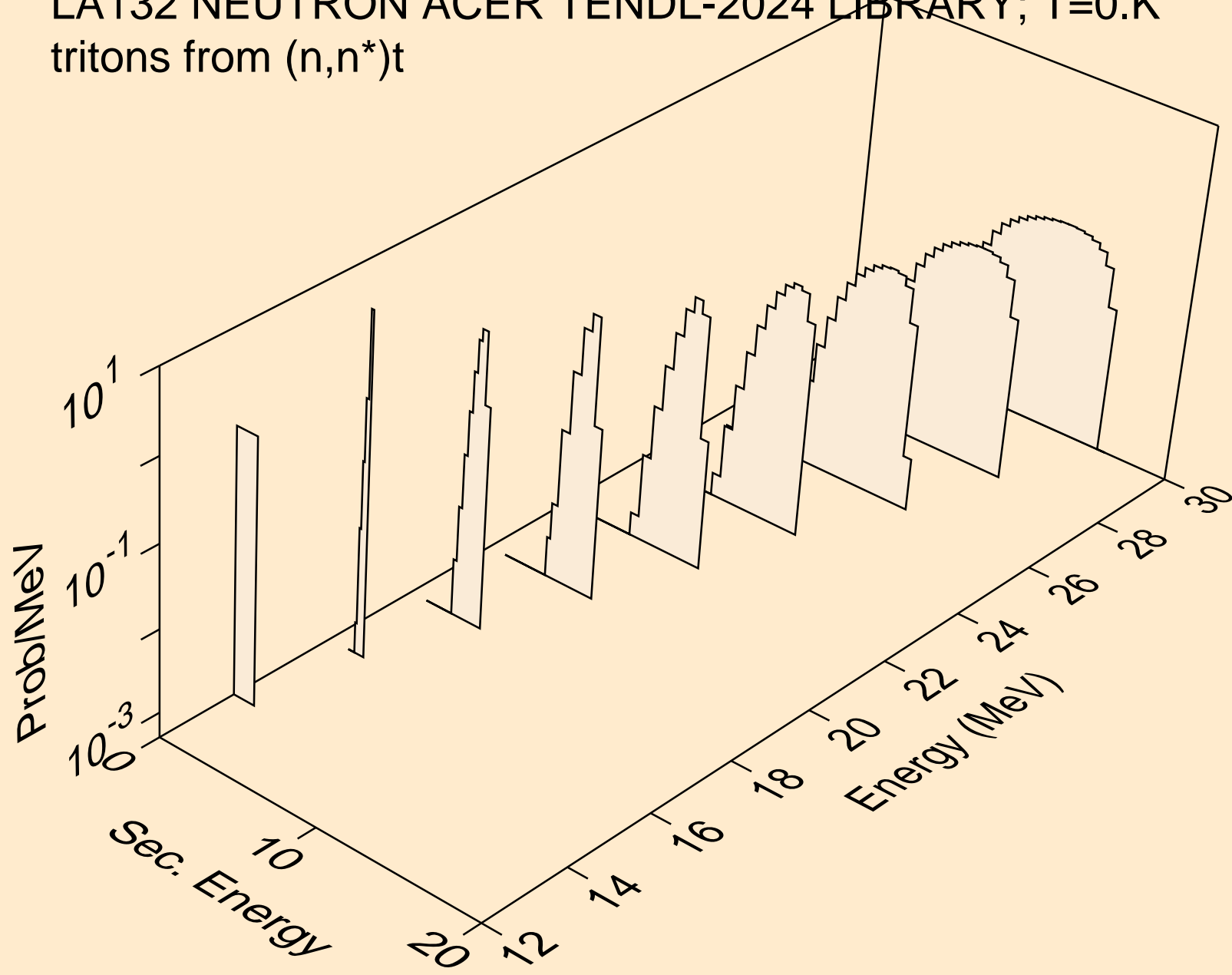

LA132 NEUTRON ACER TENDL-2024 LIBRARY; T=0.K
tritons from (n,t)

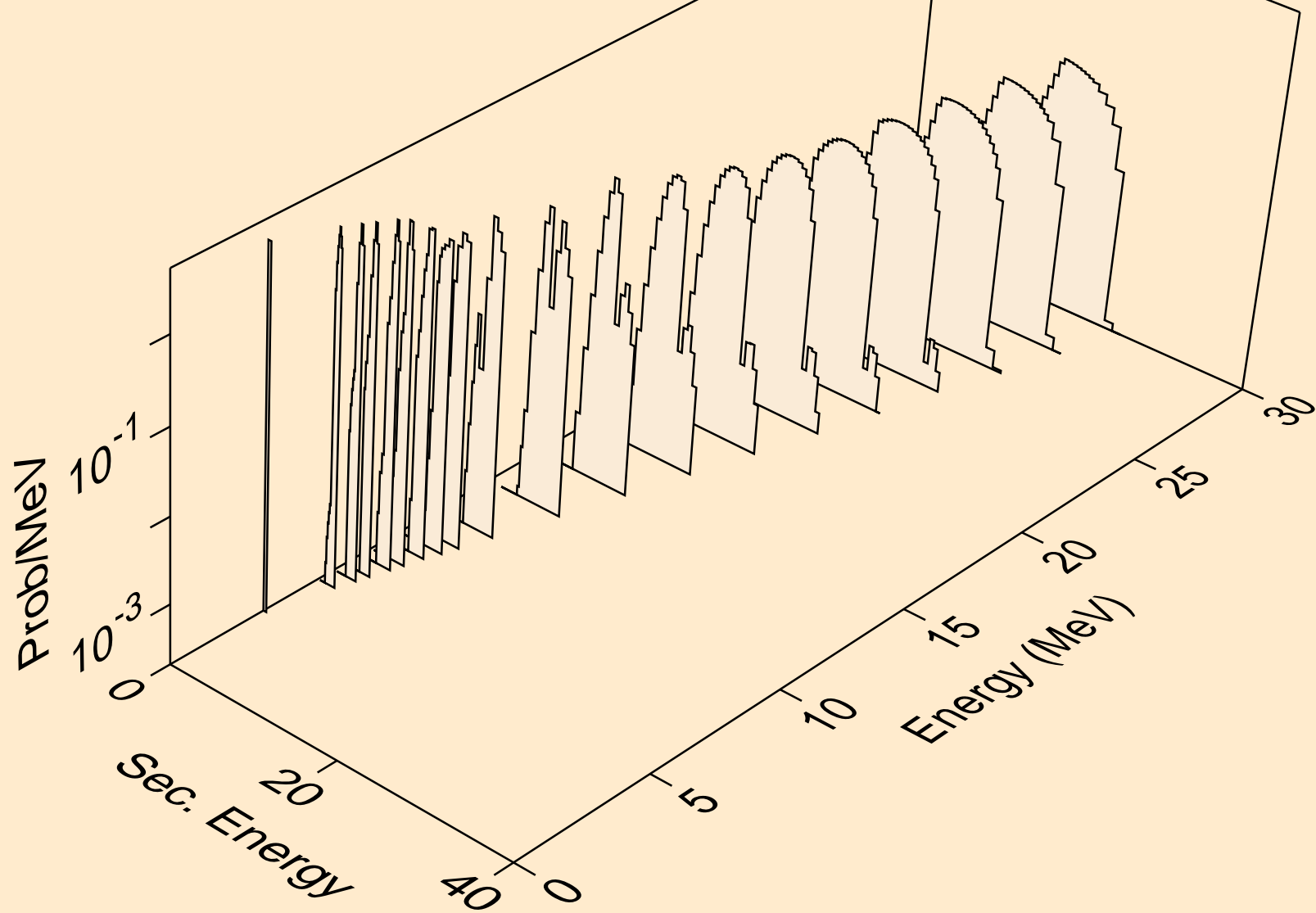

LA132 NEUTRON ACER TENDL-2024 LIBRARY; T=0.K
tritons from (n,pt)

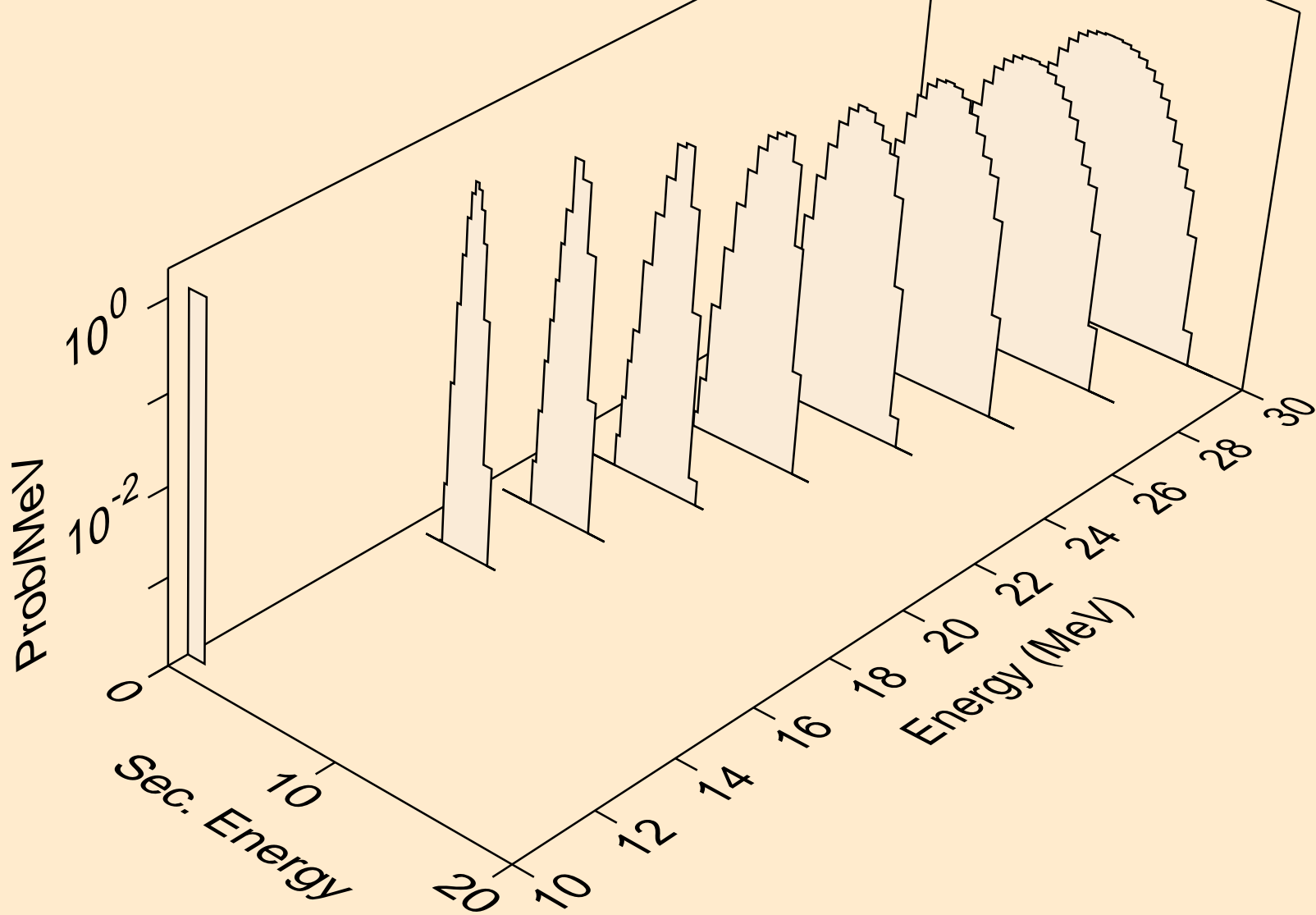

LA132 NEUTRON ACER TENDL-2024 LIBRARY; T=0.K
he3s from (n,x)

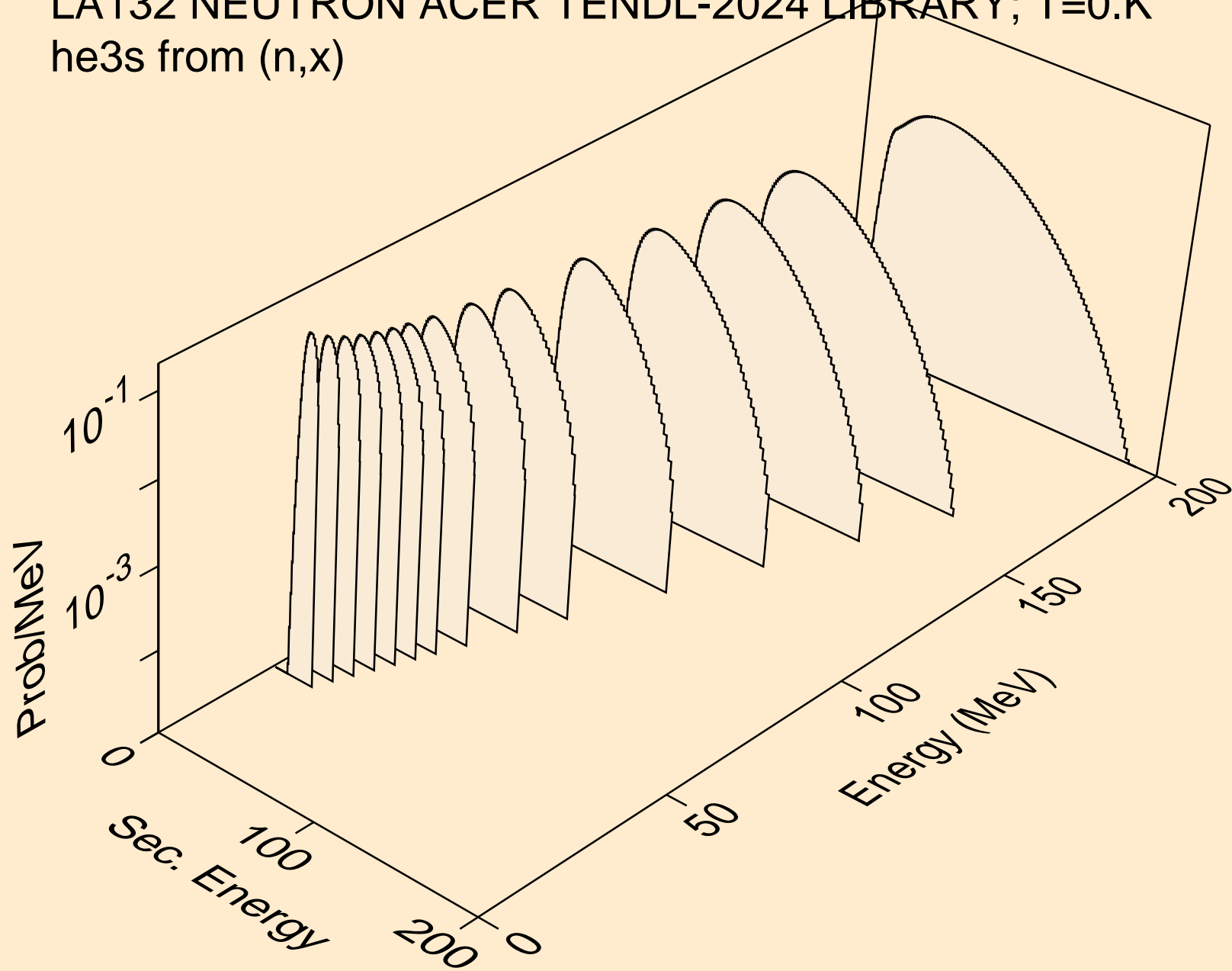

LA132 NEUTRON ACER TENDL-2024 LIBRARY; T=0.K
he3s from (n,n*)he3

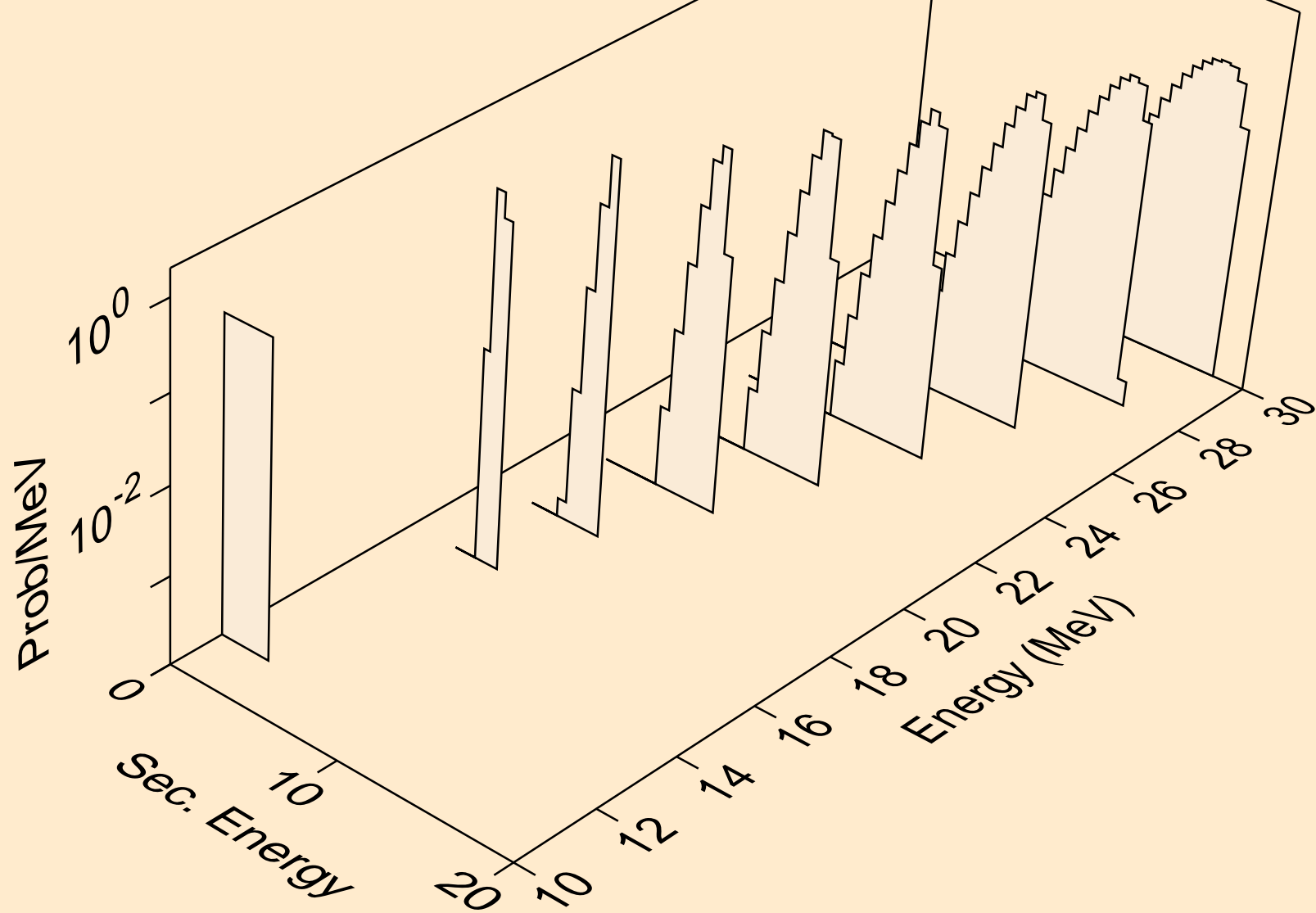

LA132 NEUTRON ACER TENDL-2024 LIBRARY; T=0.K
he3s from (n,he3)

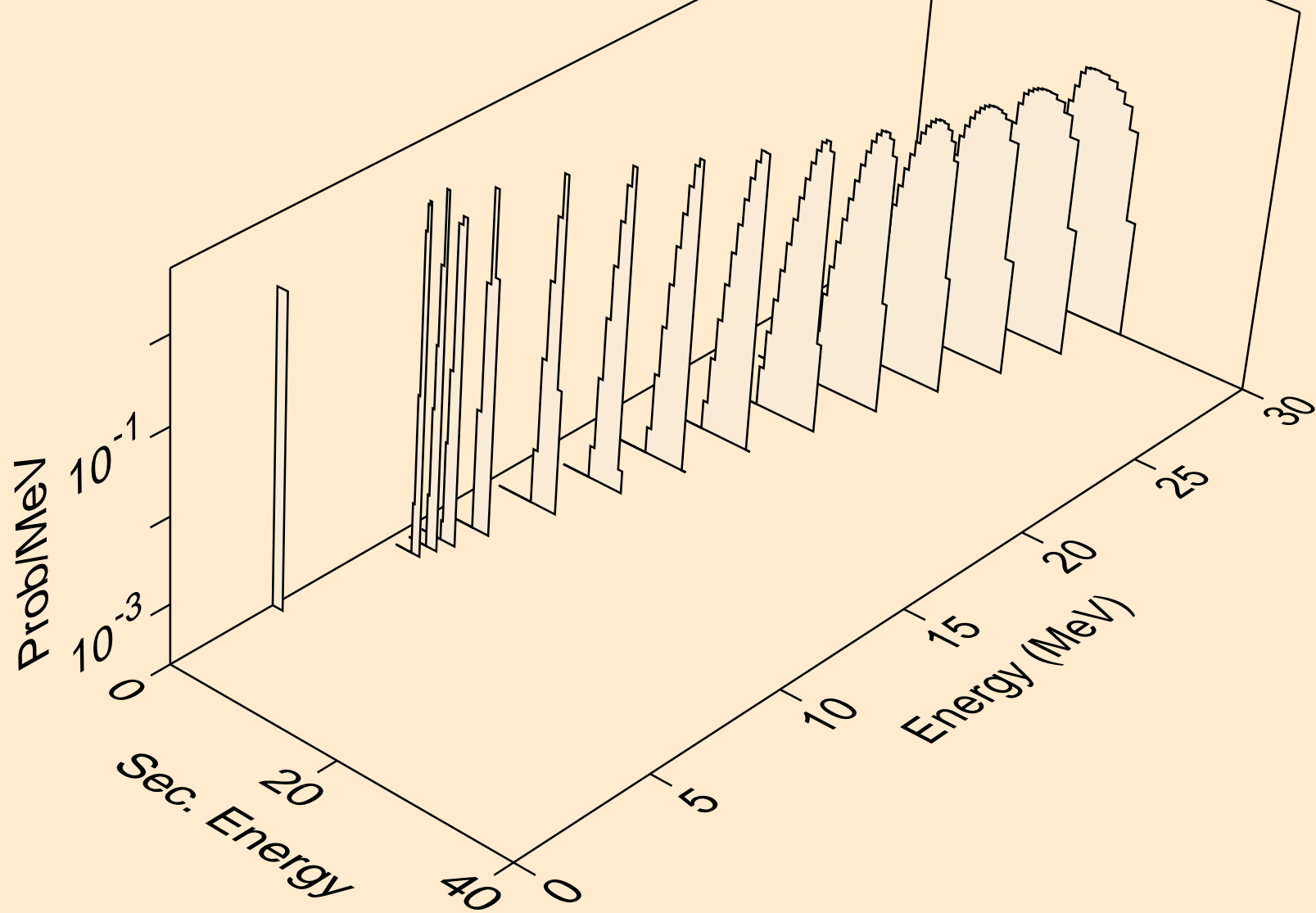

LA132 NEUTRON ACER TENDL-2024 LIBRARY; T=0.K
alphas from (n,x)

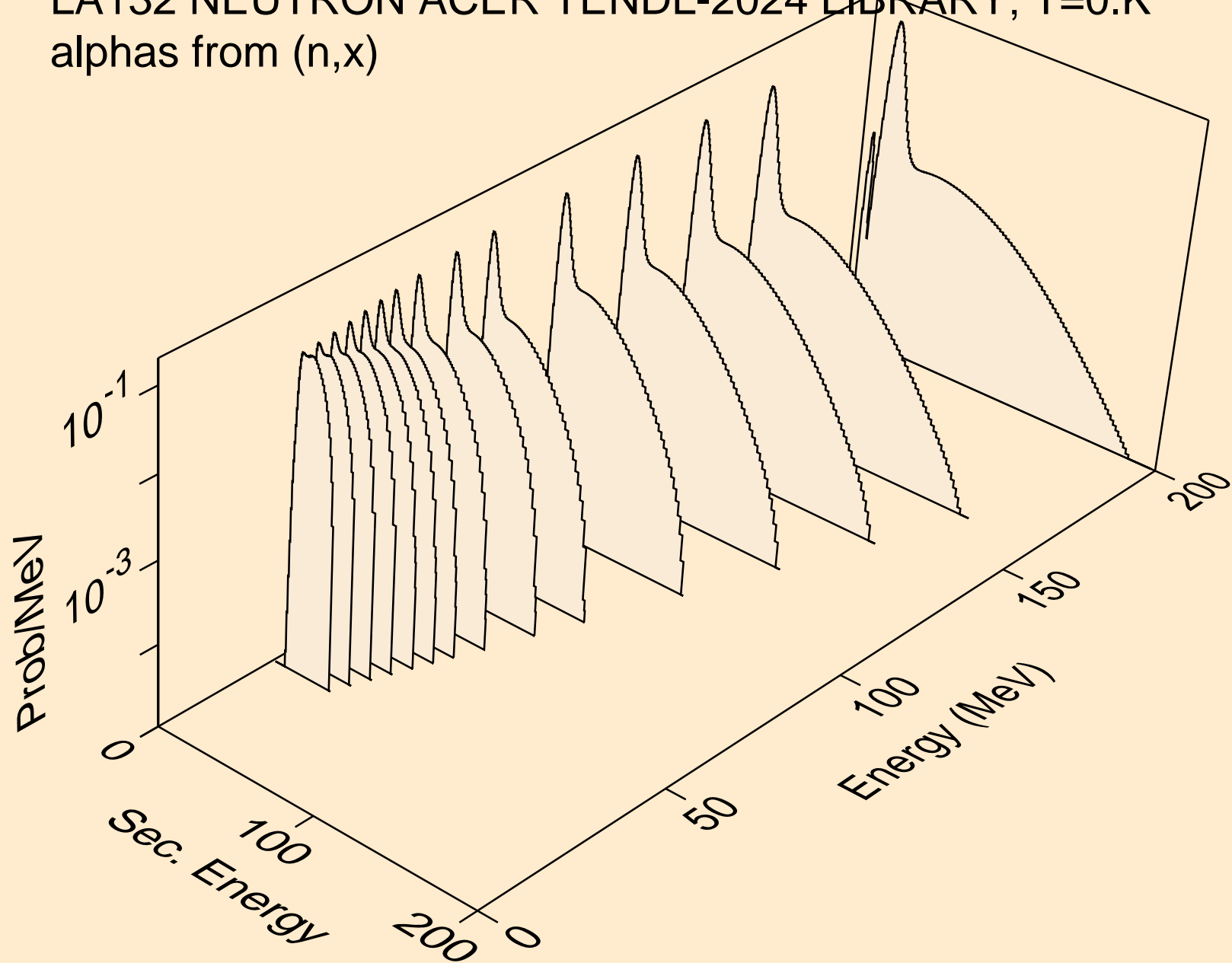

LA132 NEUTRON ACER TENDL-2024 LIBRARY; T=0.K
alphas from (n,n*)a

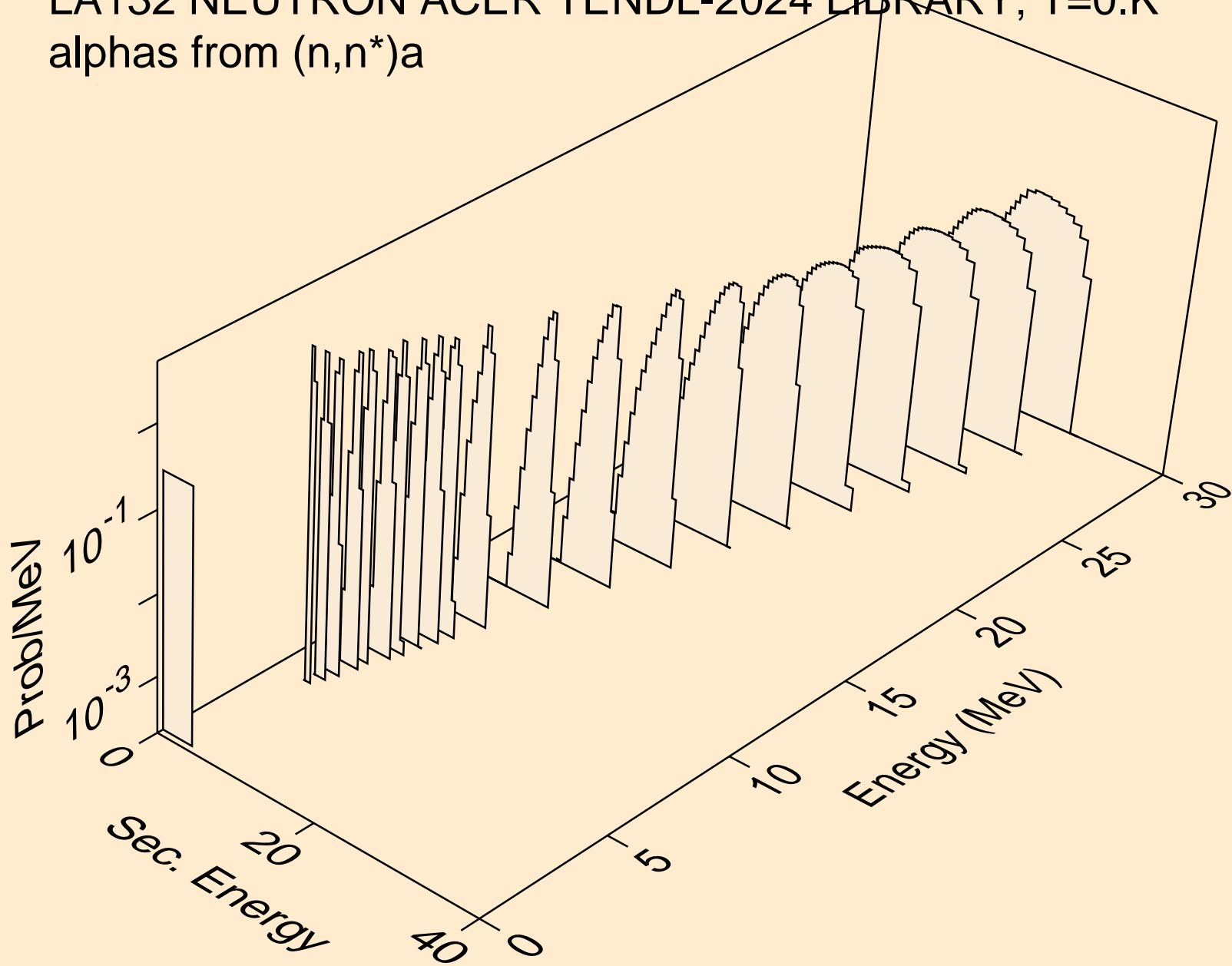

LA132 NEUTRON ACER TENDL-2024 LIBRARY; T=0.K
alphas from (n,2n)a

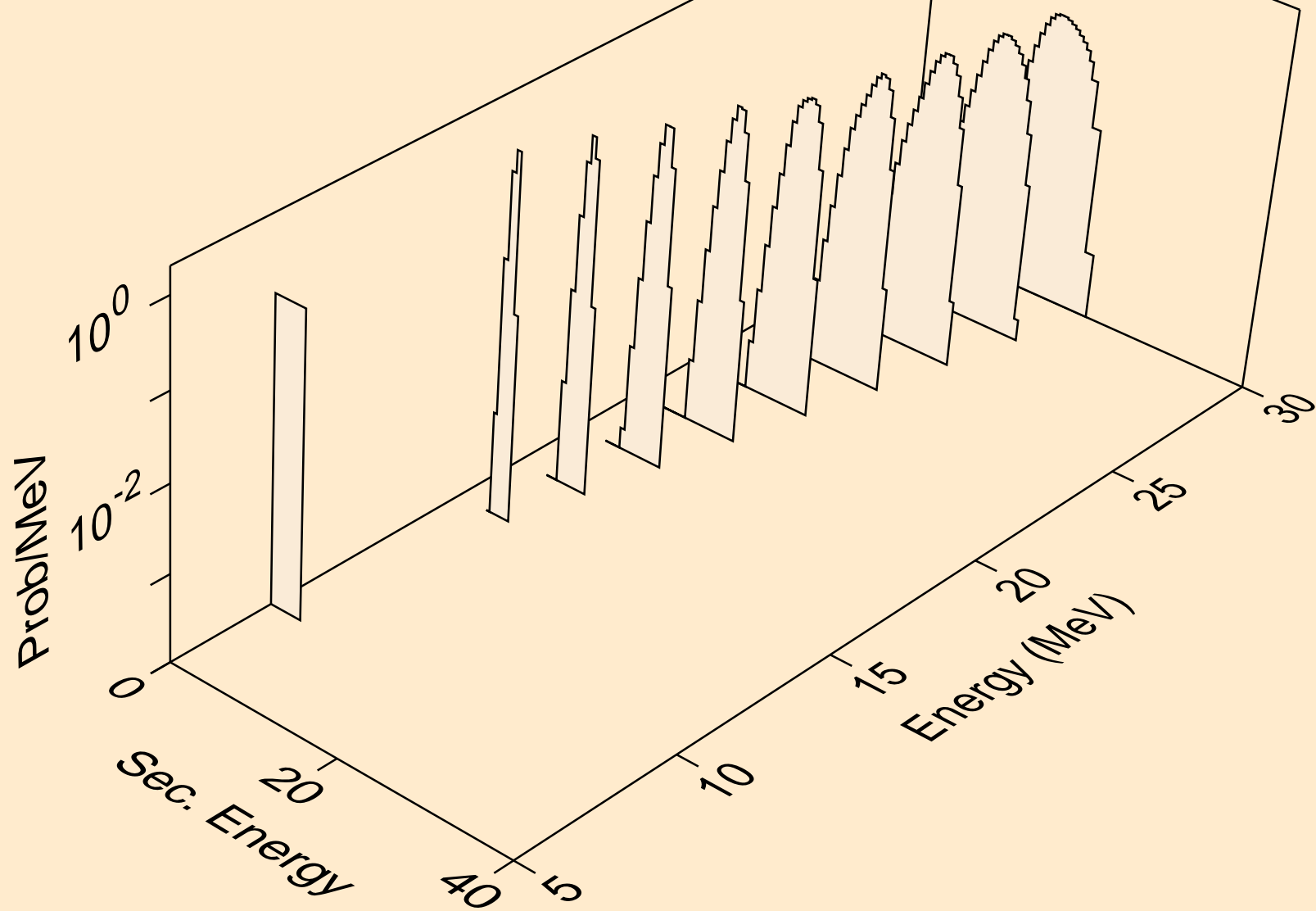

LA132 NEUTRON ACER TENDL-2024 LIBRARY; T=0.K
alphas from (n,3n)a

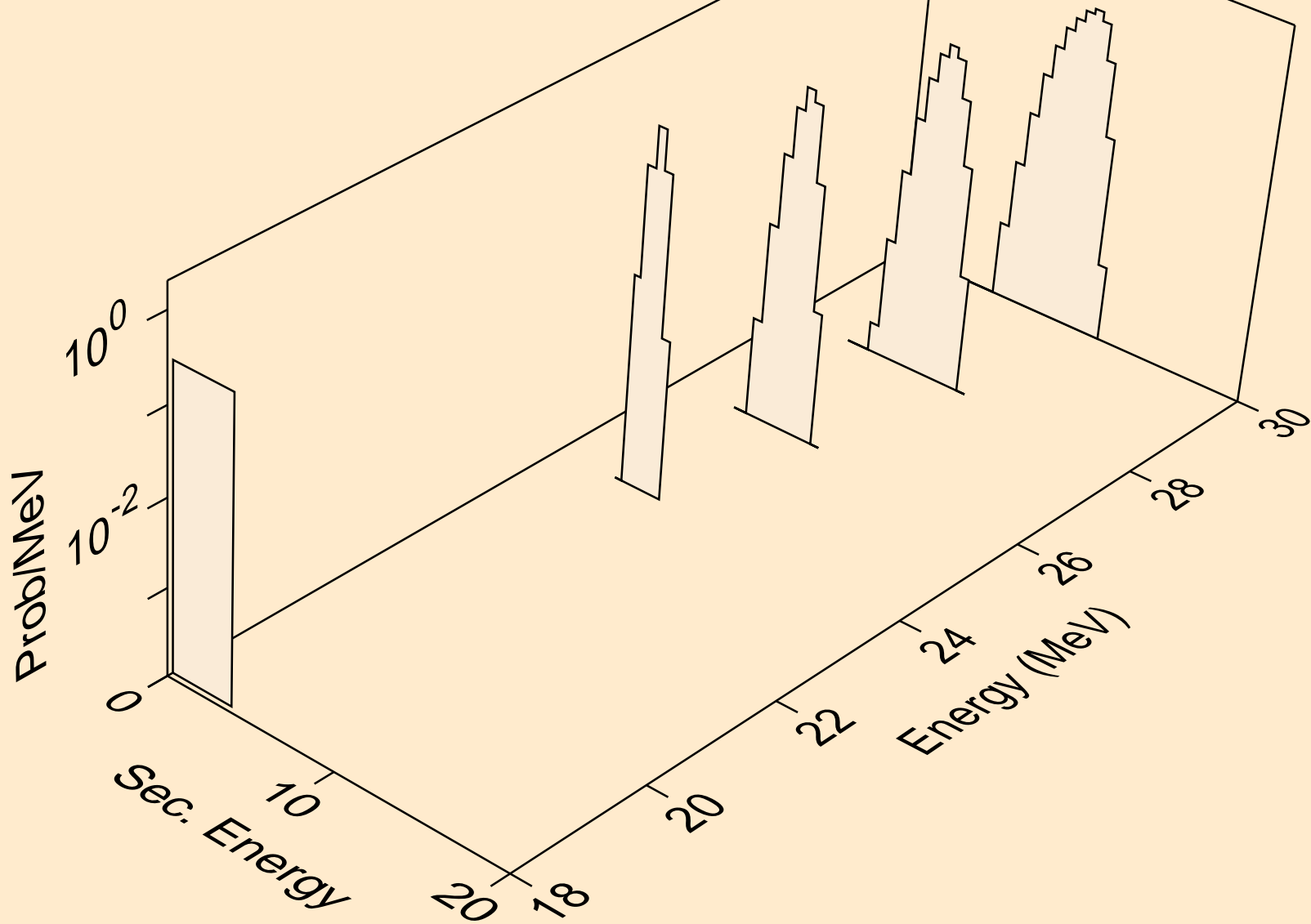

LA132 NEUTRON ACER TENDL-2024 LIBRARY; T=0.K
alphas from (n,n*)2a

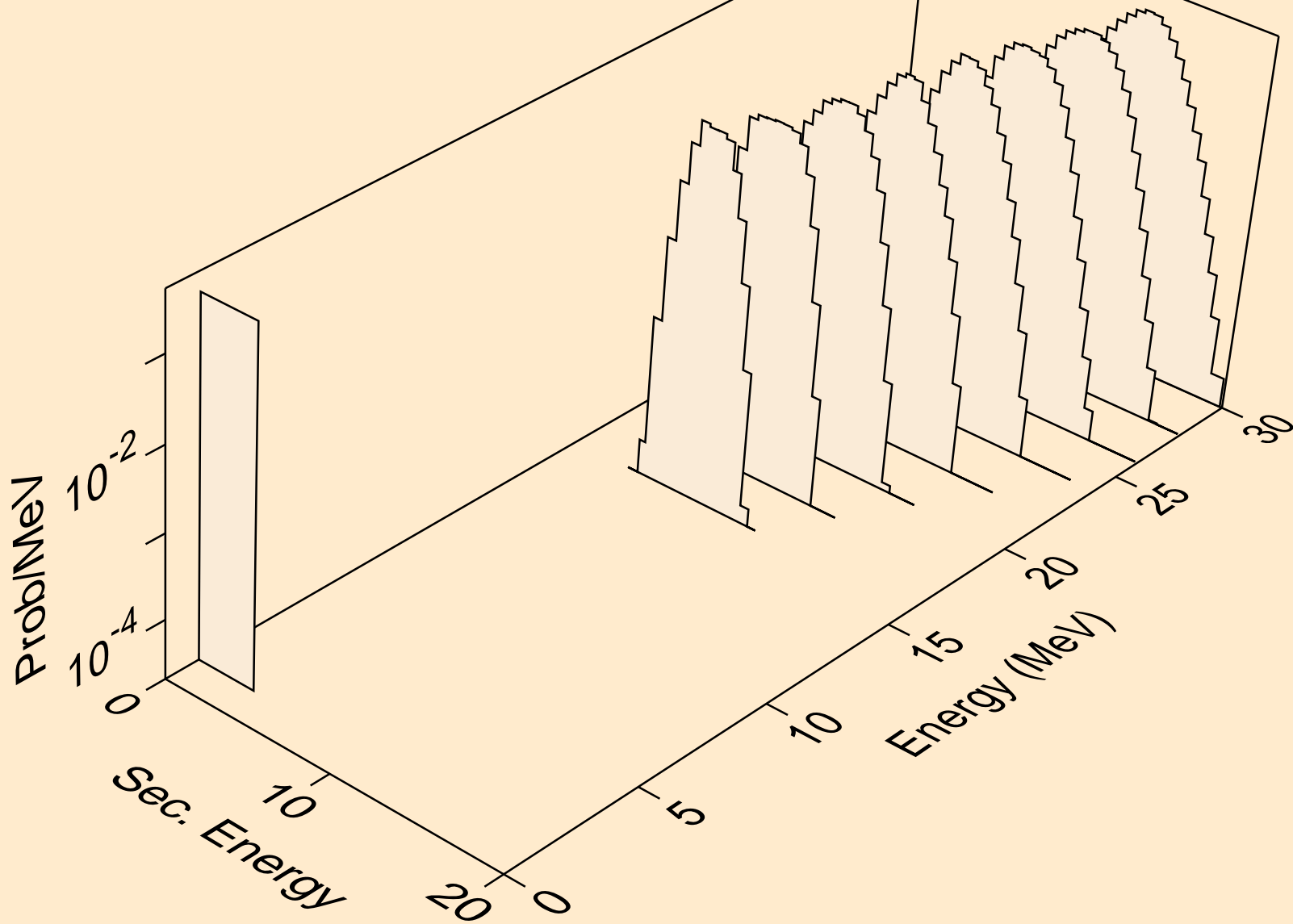

LA132 NEUTRON ACER TENDL-2024 LIBRARY; T=0.K
alphas from (n,npa)

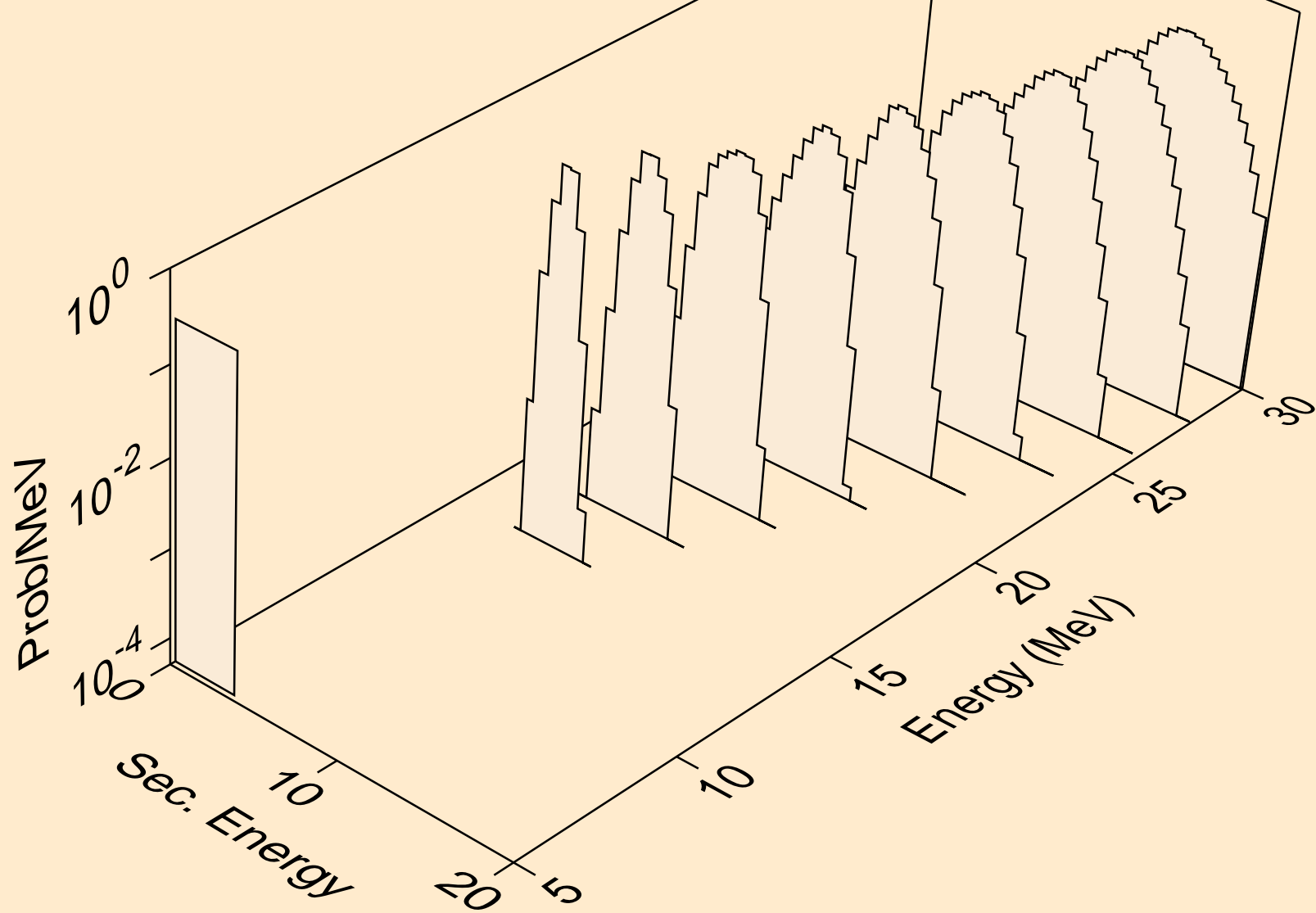

LA132 NEUTRON ACER TENDL-2024 LIBRARY; T=0.K
alphas from (n,a)

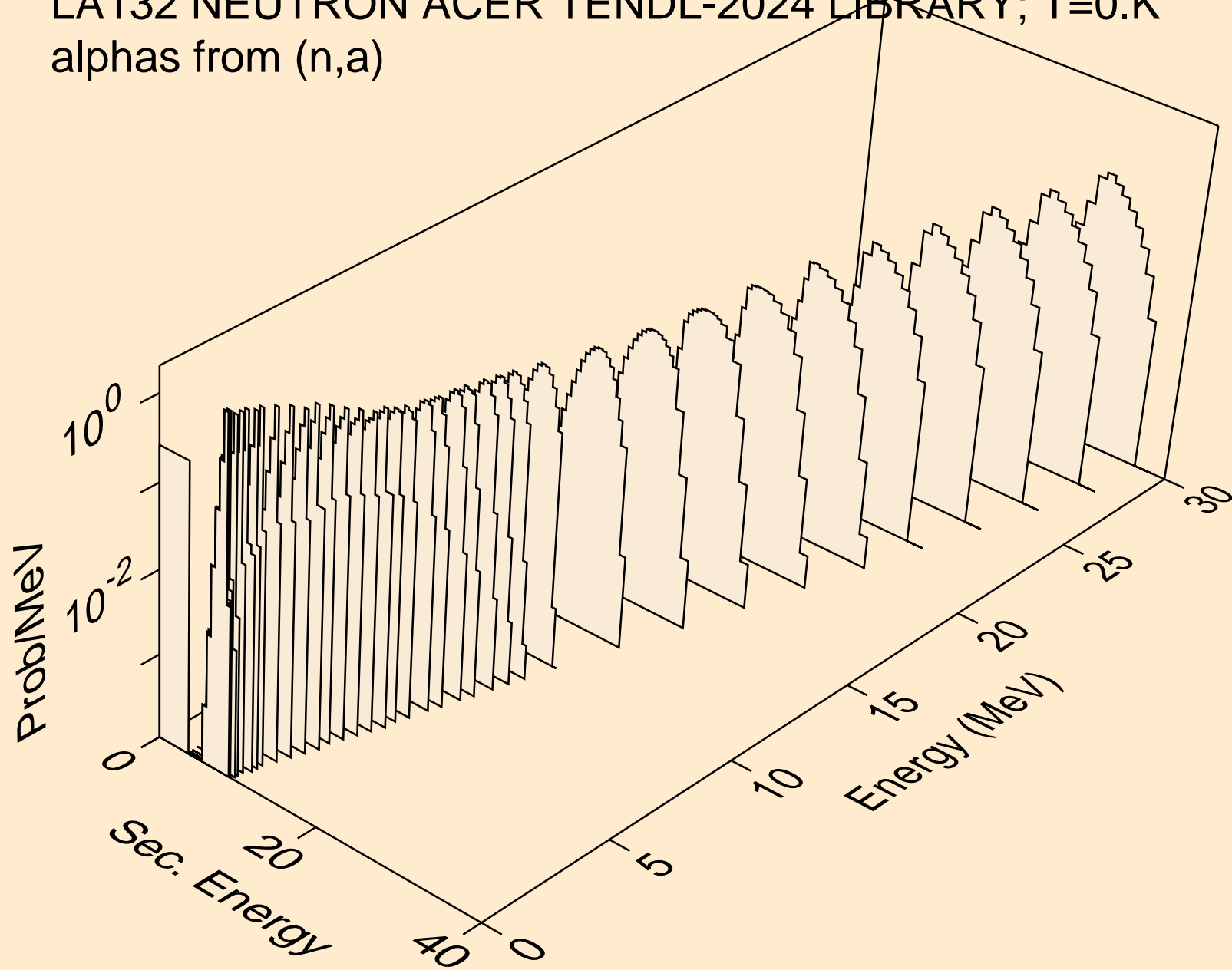

LA132 NEUTRON ACER TENDL-2024 LIBRARY; T=0.K
alphas from (n,2a)

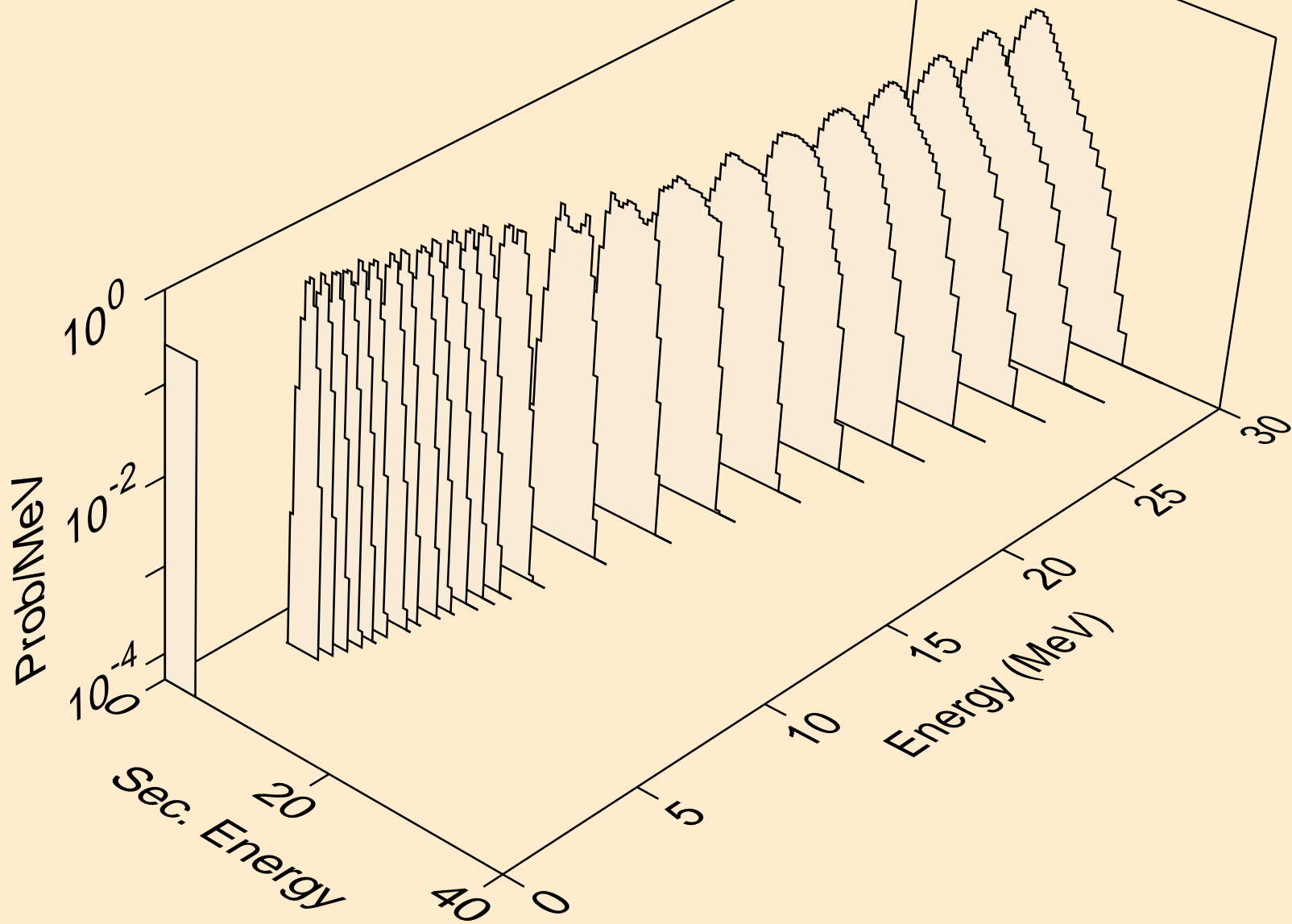

LA132 NEUTRON ACER TENDL-2024 LIBRARY; T=0.K
alphas from (n,pa)

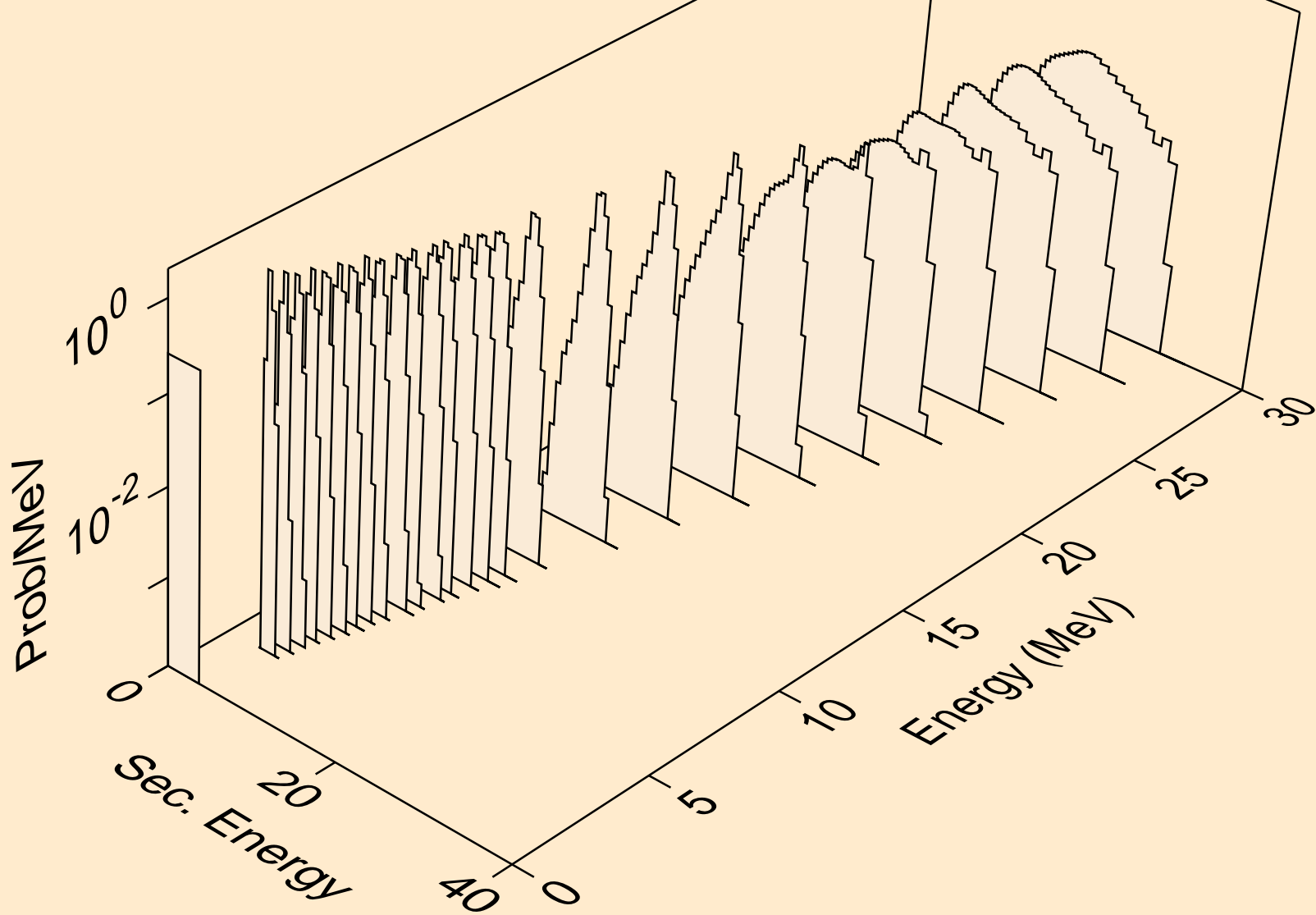

LA132 NEUTRON ACER TENDL-2024 LIBRARY; T=0.K
alphas from (n,da)

