

LR253M NEUTRON ACER TENDL-2024 LIBRARY; T=0.K

Principal cross sections

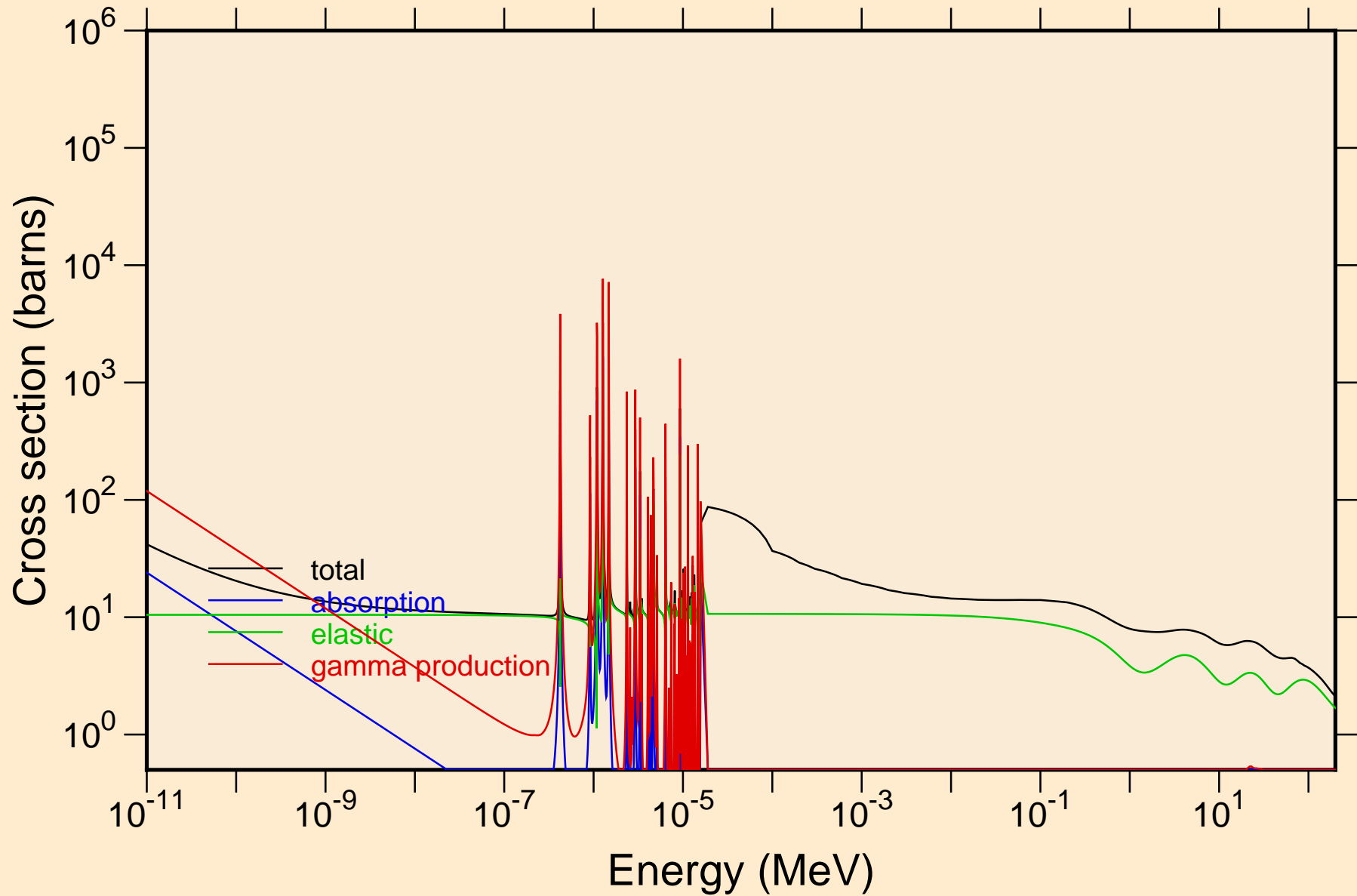

LR253M NEUTRON ACER TENDL-2024 LIBRARY; T=0.K
resonance total cross section

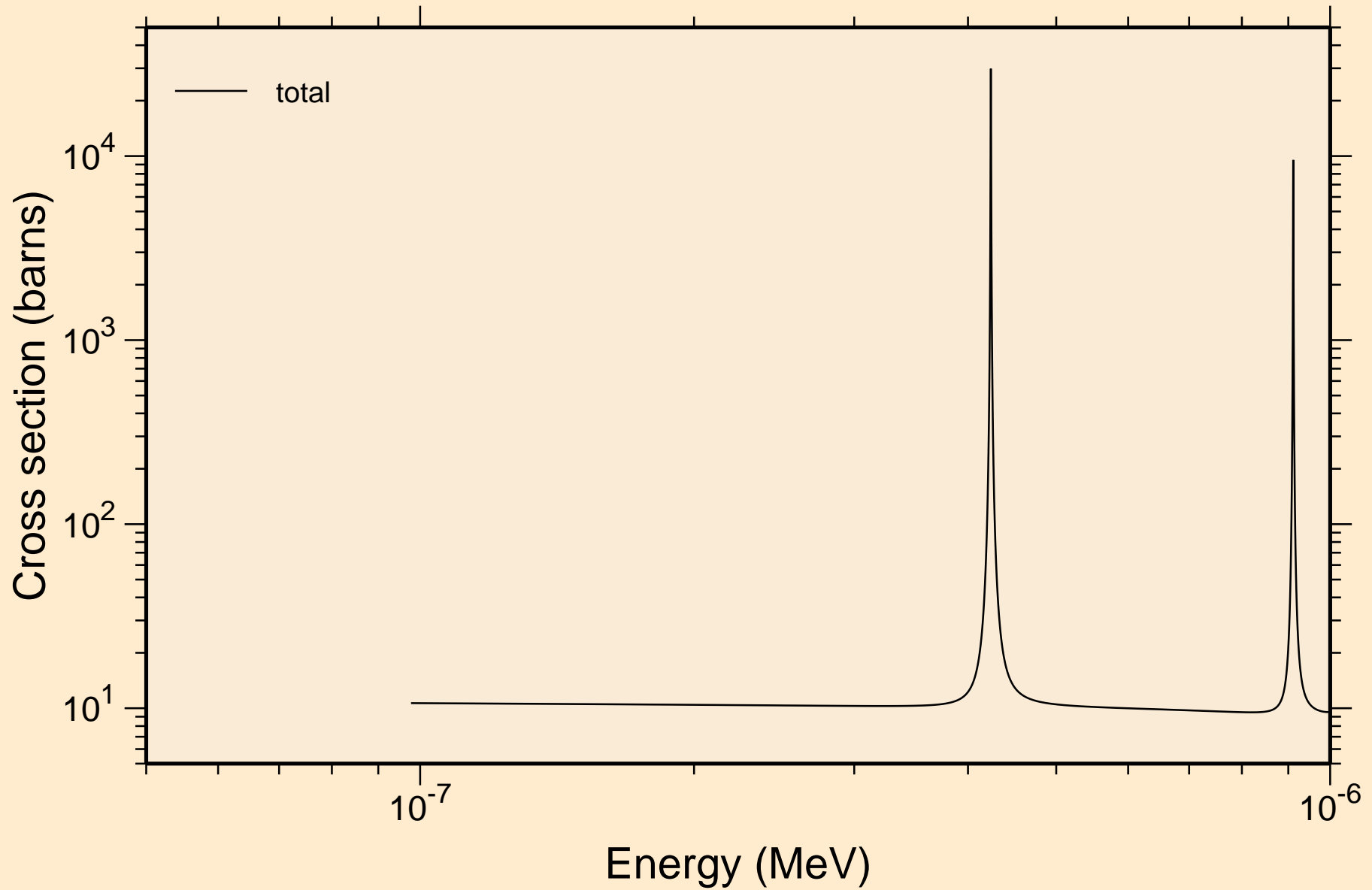

LR253M NEUTRON ACER TENDL-2024 LIBRARY; T=0.K
resonance total cross section

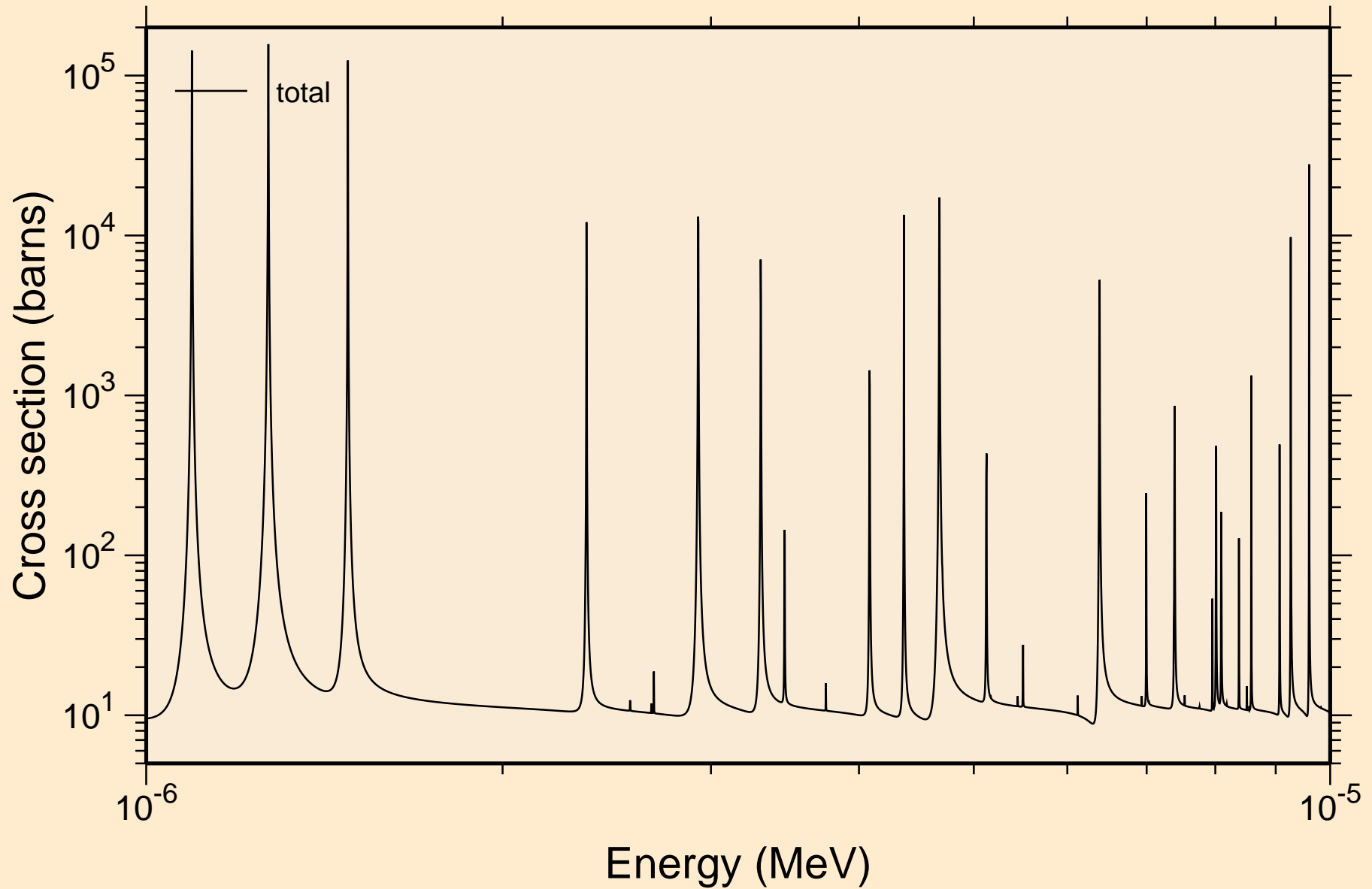

LR253M NEUTRON ACER TENDL-2024 LIBRARY; T=0.K
resonance total cross section

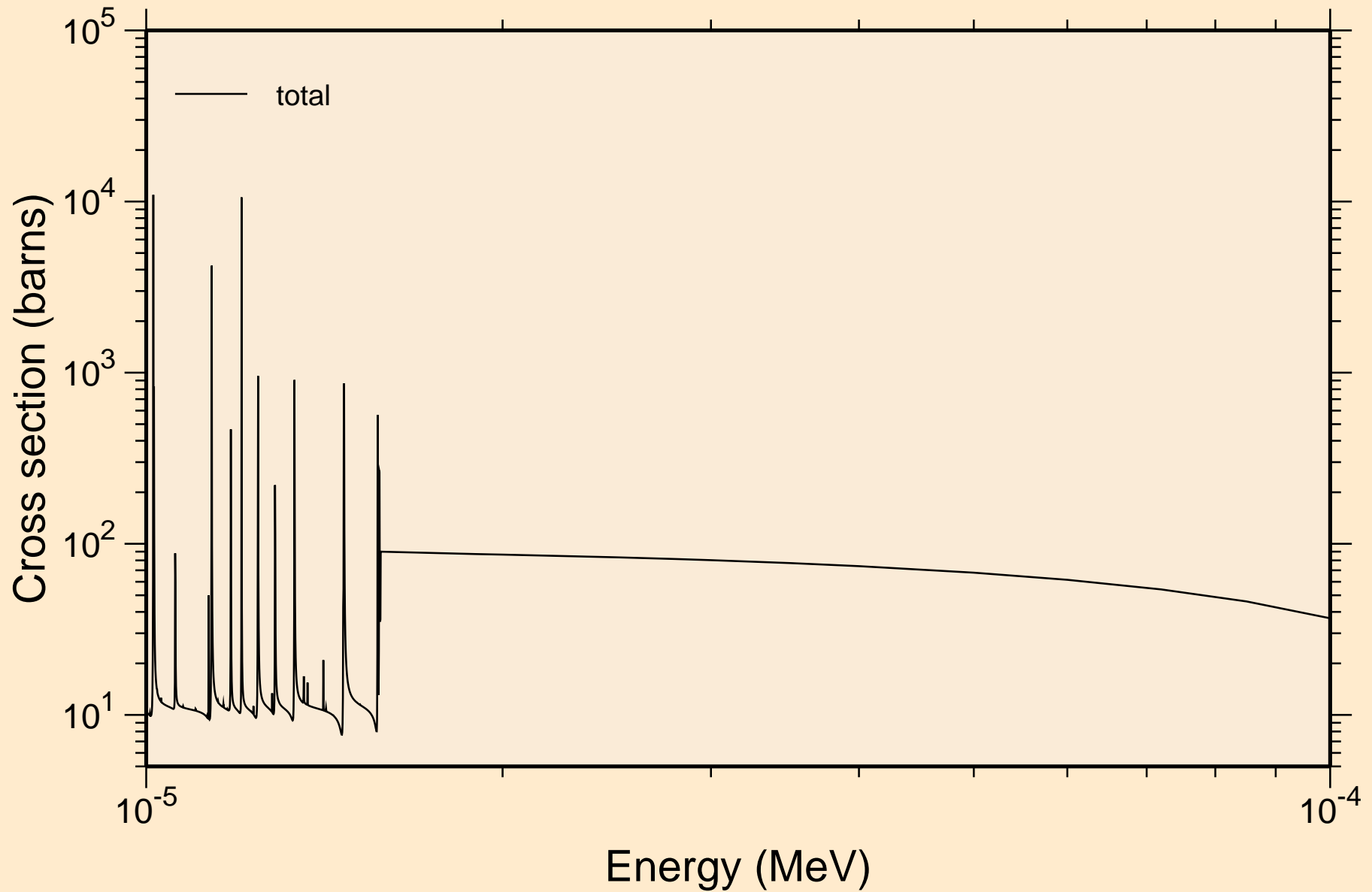

LR253M NEUTRON ACER TENDL-2024 LIBRARY; T=0.K
resonance total cross section

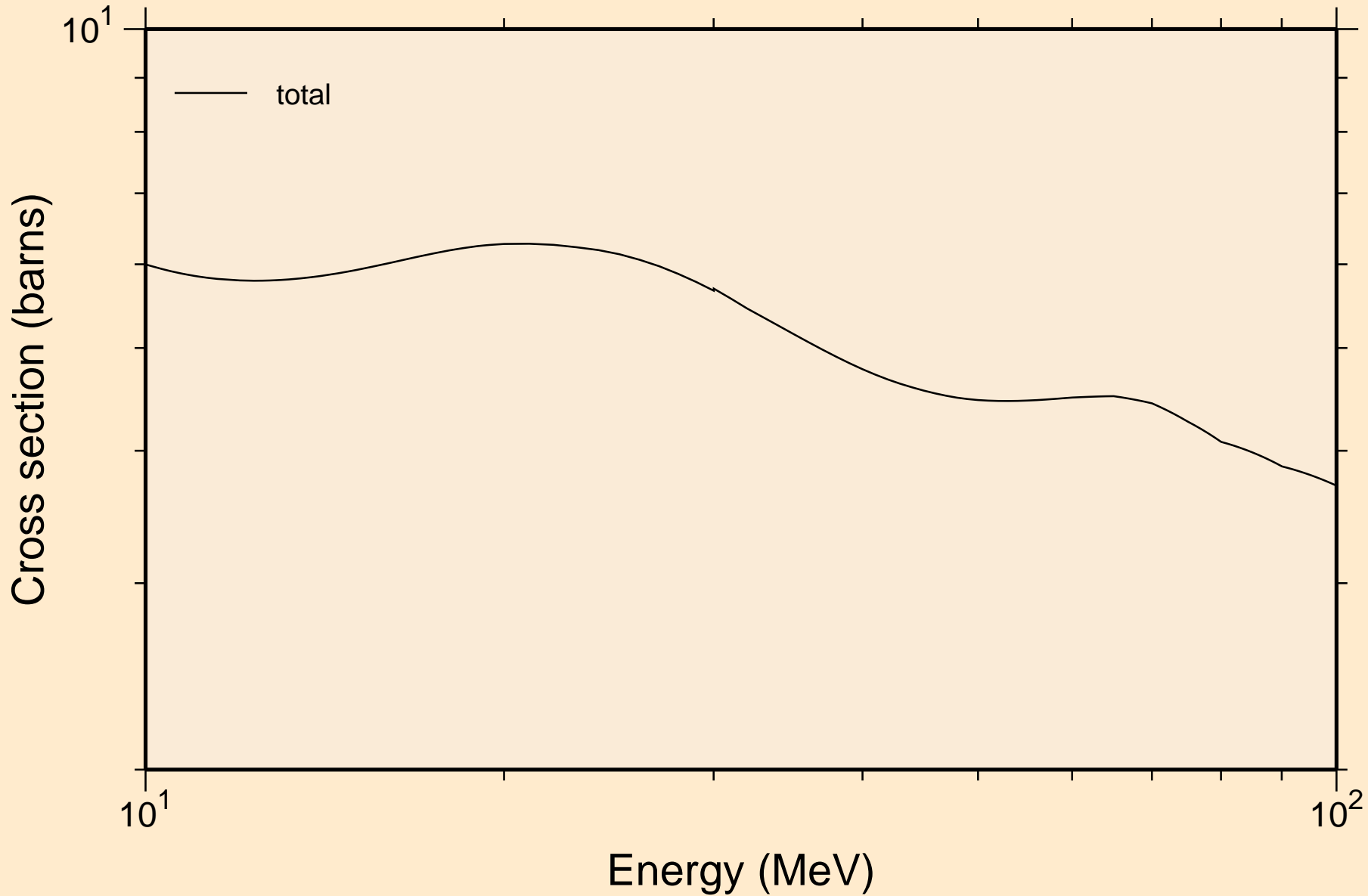

LR253M NEUTRON ACER TENDL-2024 LIBRARY; T=0.K
resonance absorption cross sections

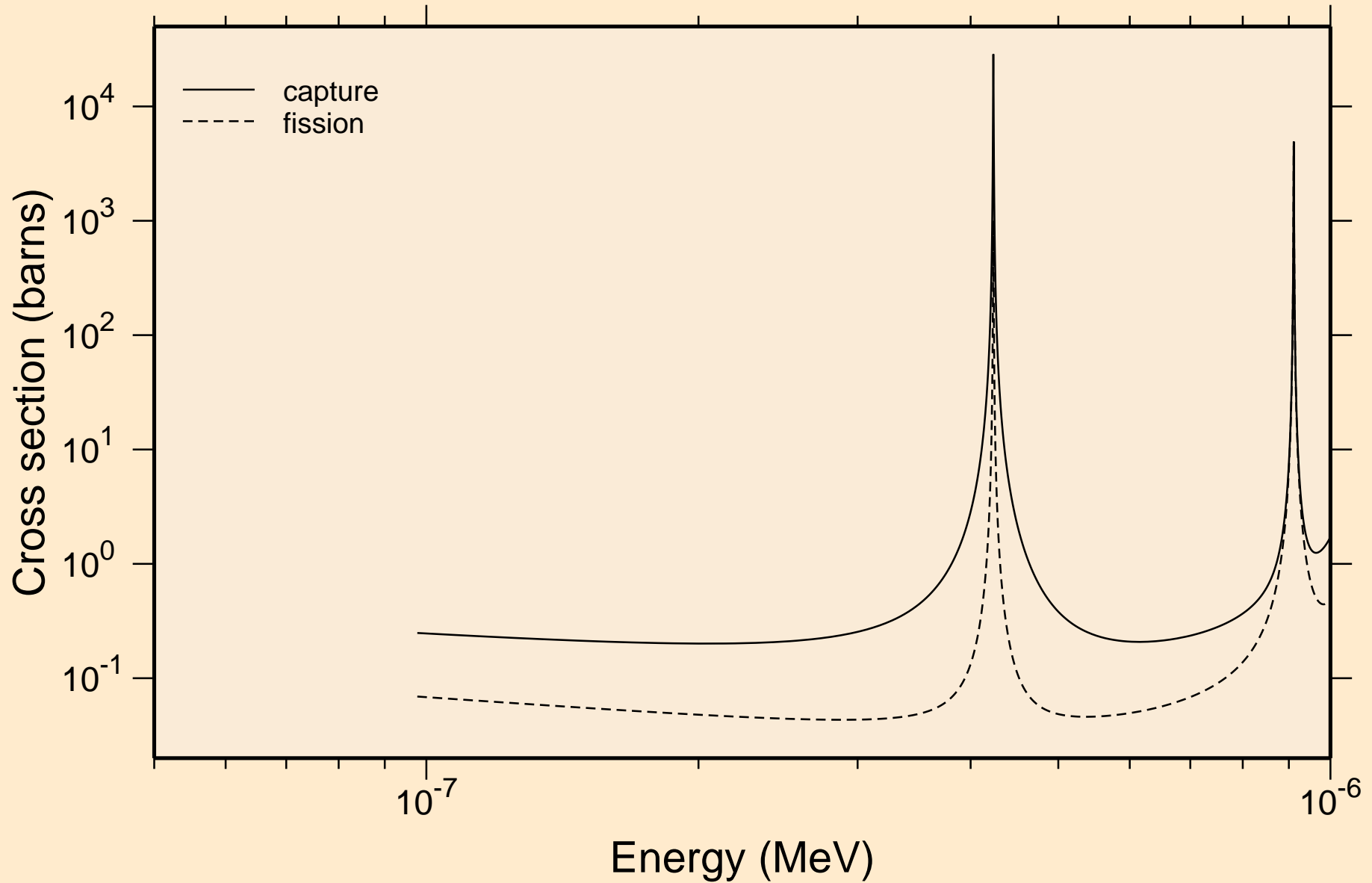

LR253M NEUTRON ACER TENDL-2024 LIBRARY; T=0.K
resonance absorption cross sections

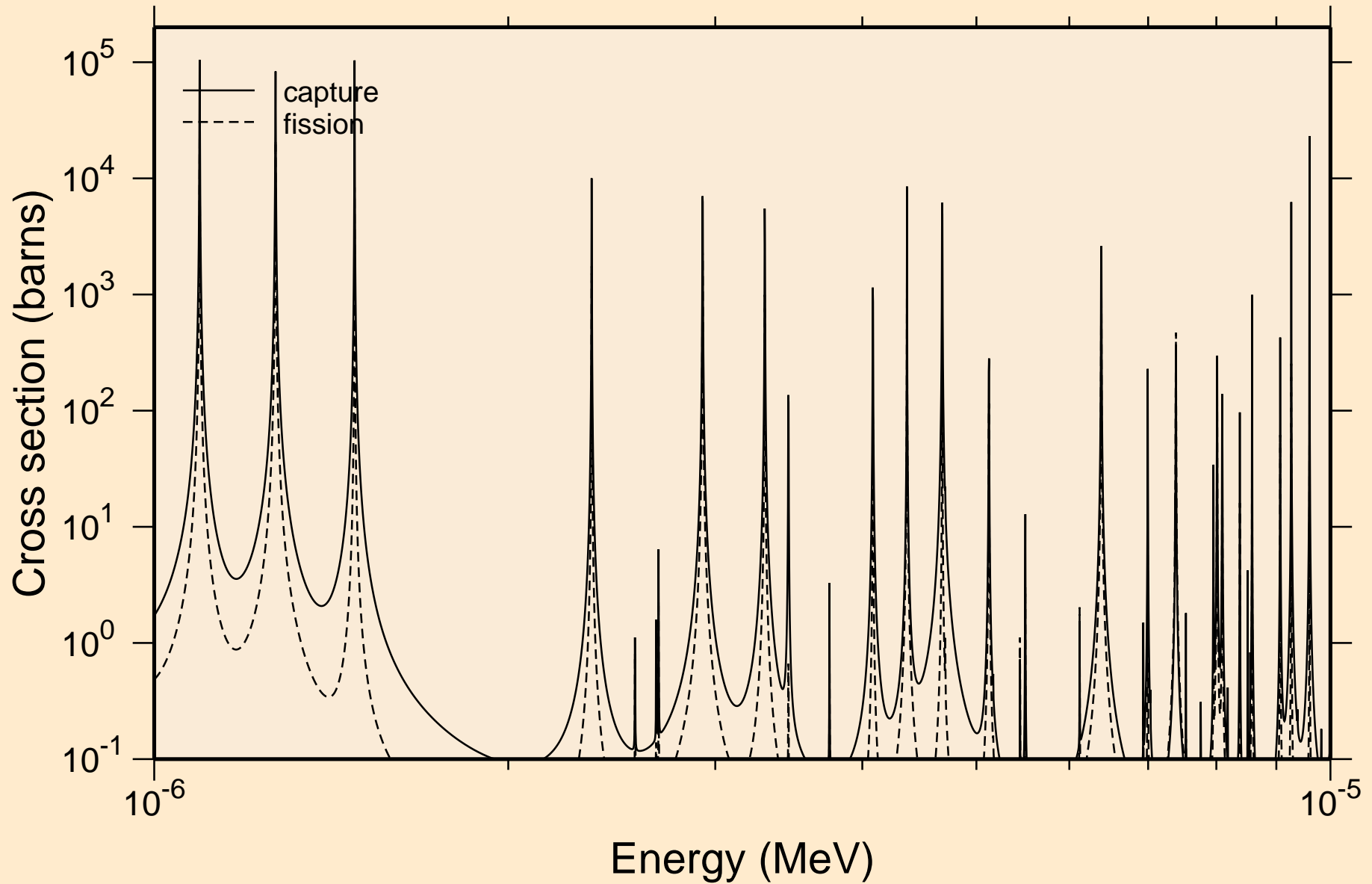

LR253M NEUTRON ACER TENDL-2024 LIBRARY; T=0.K
resonance absorption cross sections

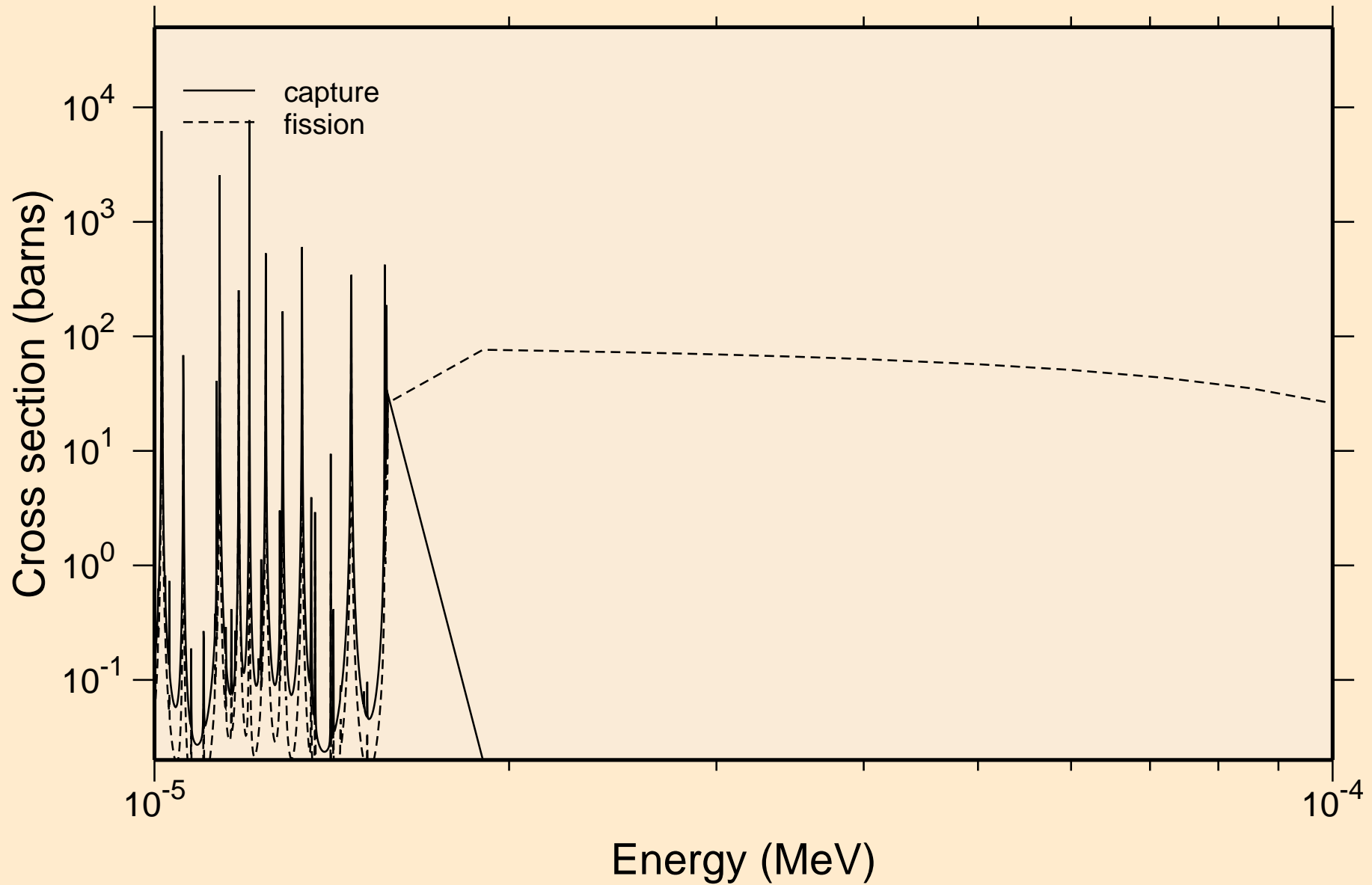

LR253M NEUTRON ACER TENDL-2024 LIBRARY; T=0.K
resonance absorption cross sections

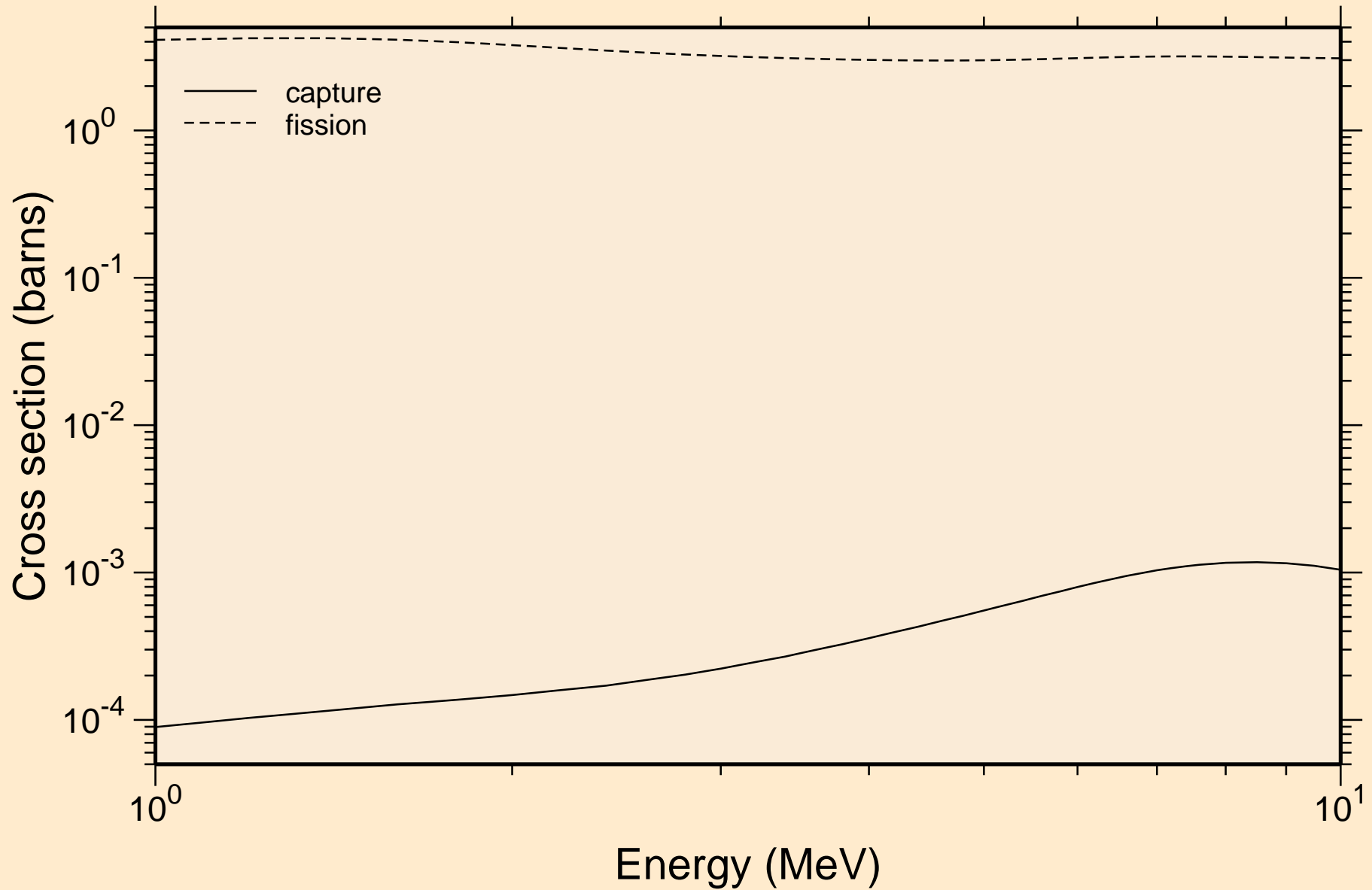

LR253M NEUTRON ACER TENDL-2024 LIBRARY; T=0.K
Heating

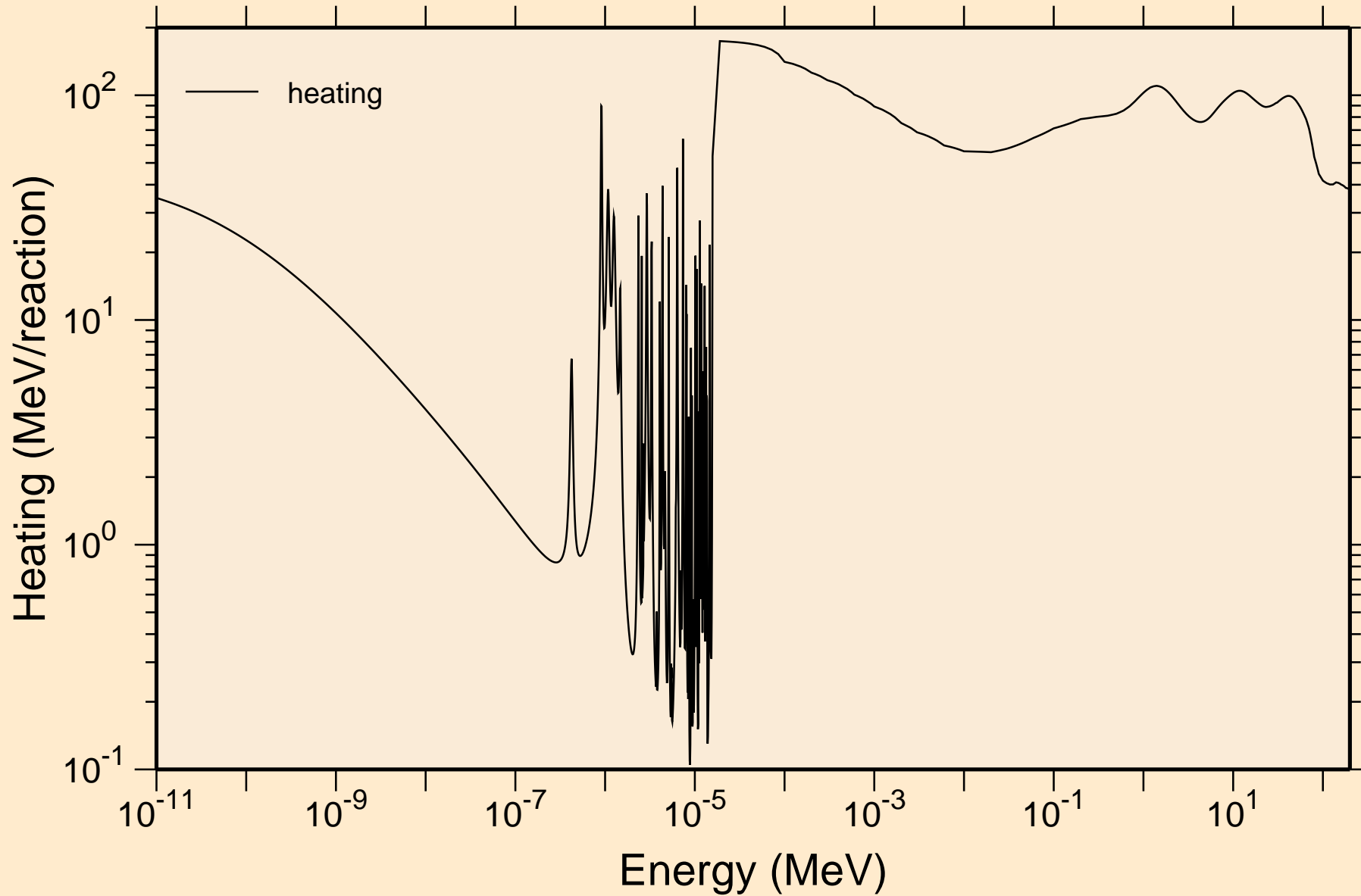

LR253M NEUTRON ACER TENDL-2024 LIBRARY; T=0.K
Damage

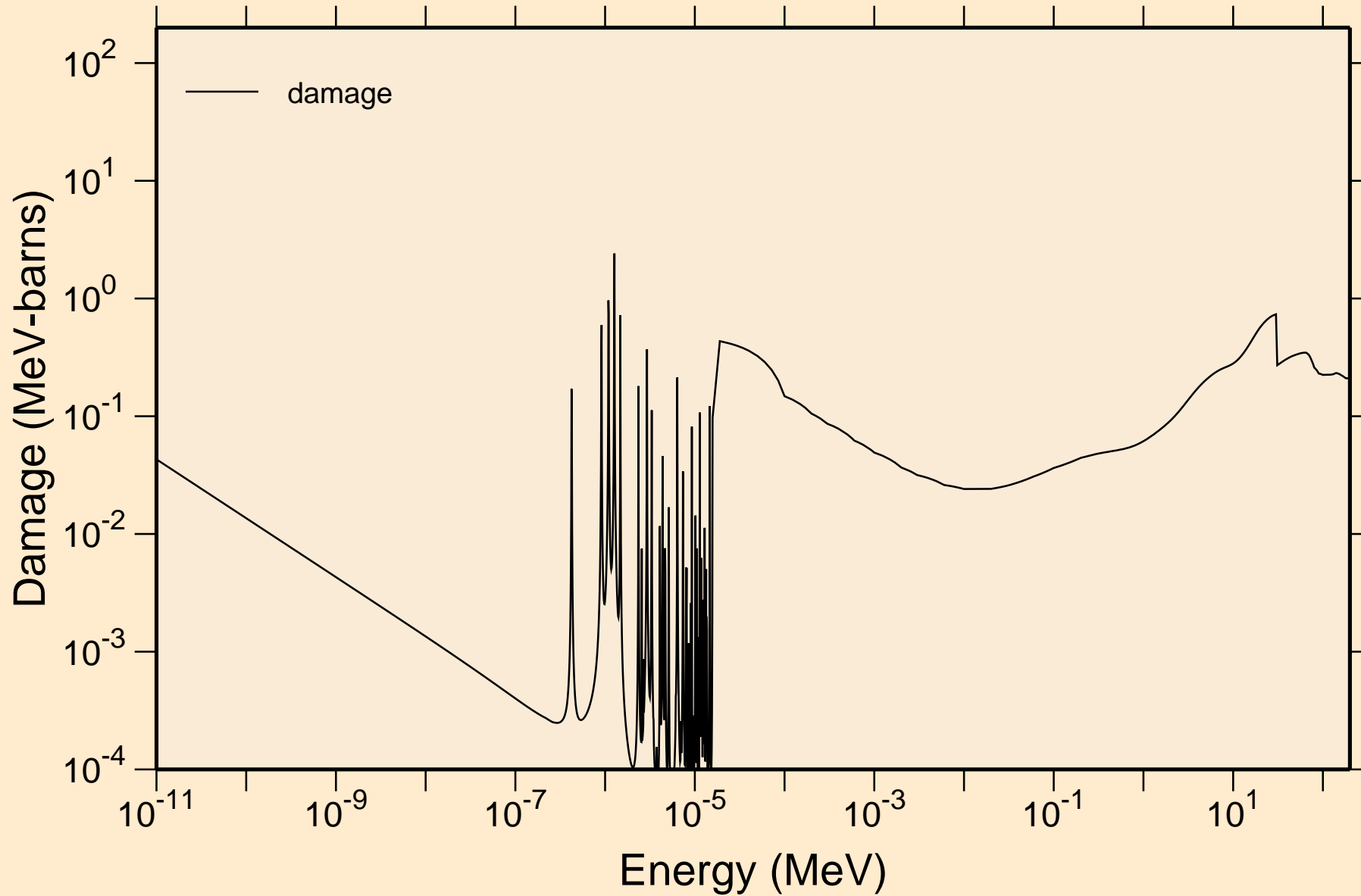

LR253M NEUTRON ACER TENDL-2024 LIBRARY; T=0.K

Non-threshold reactions

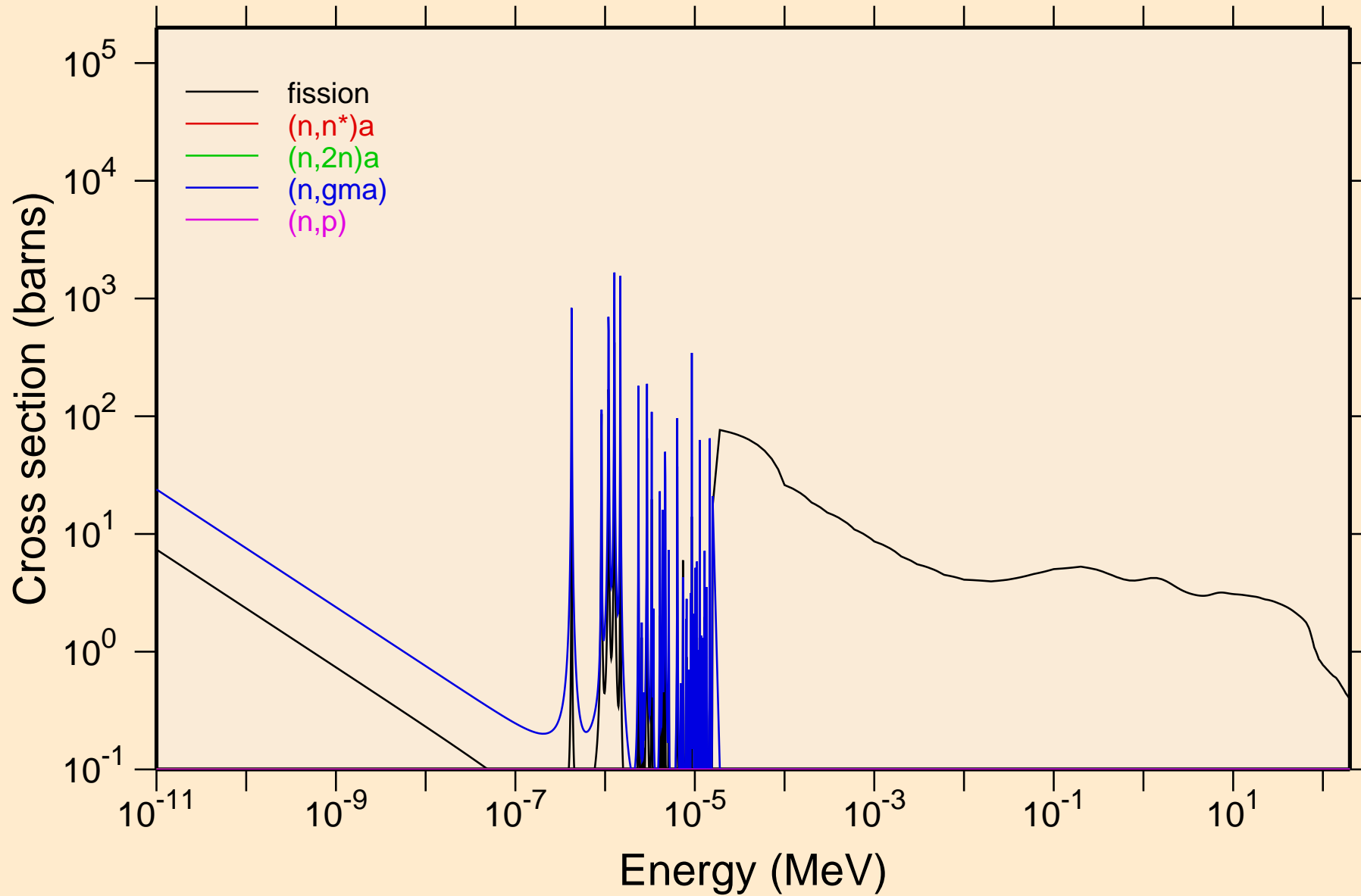

LR253M NEUTRON ACER TENDL-2024 LIBRARY; T=0.K
Non-threshold reactions

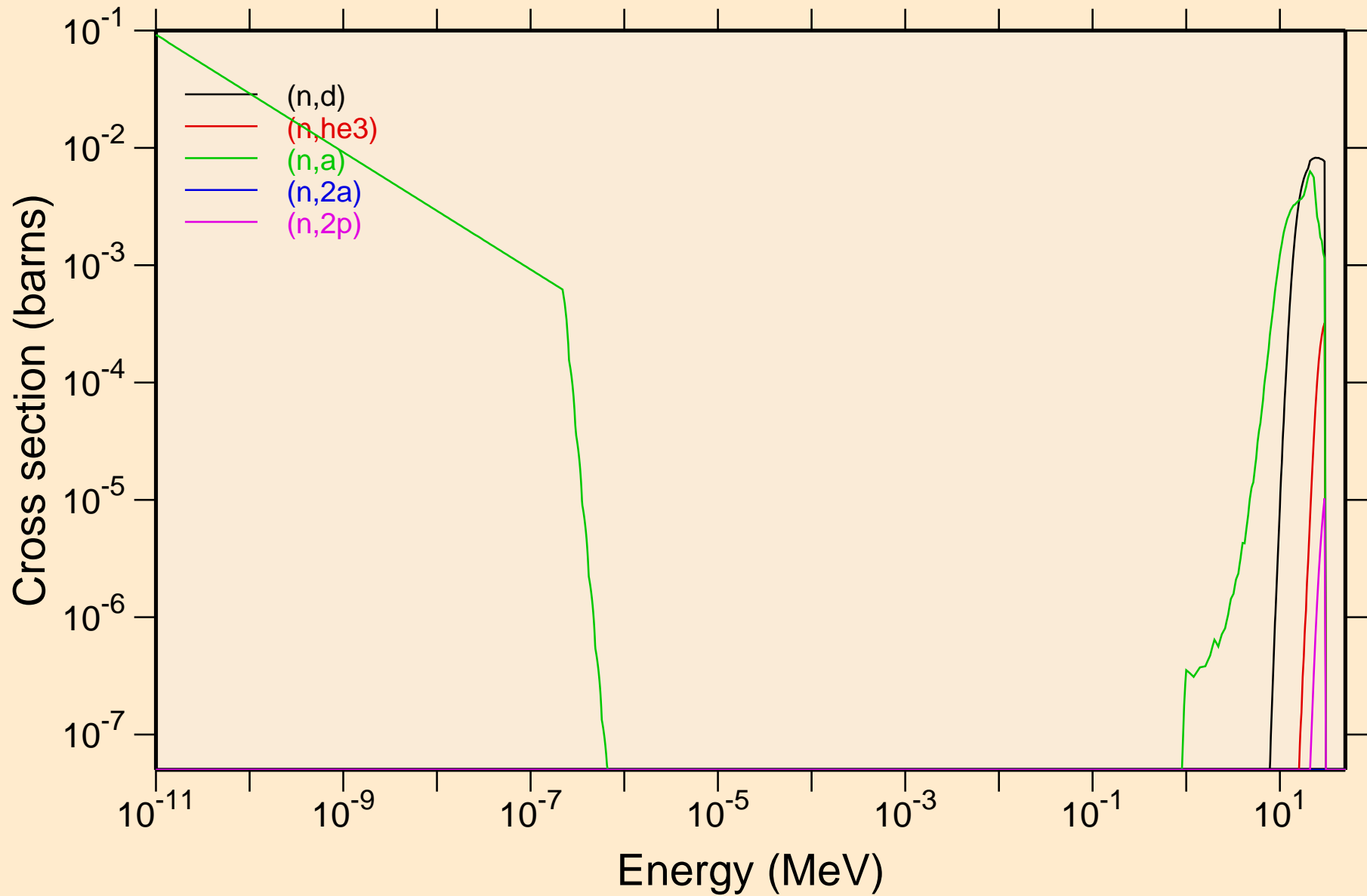

LR253M NEUTRON ACER TENDL-2024 LIBRARY; T=0.K
Non-threshold reactions

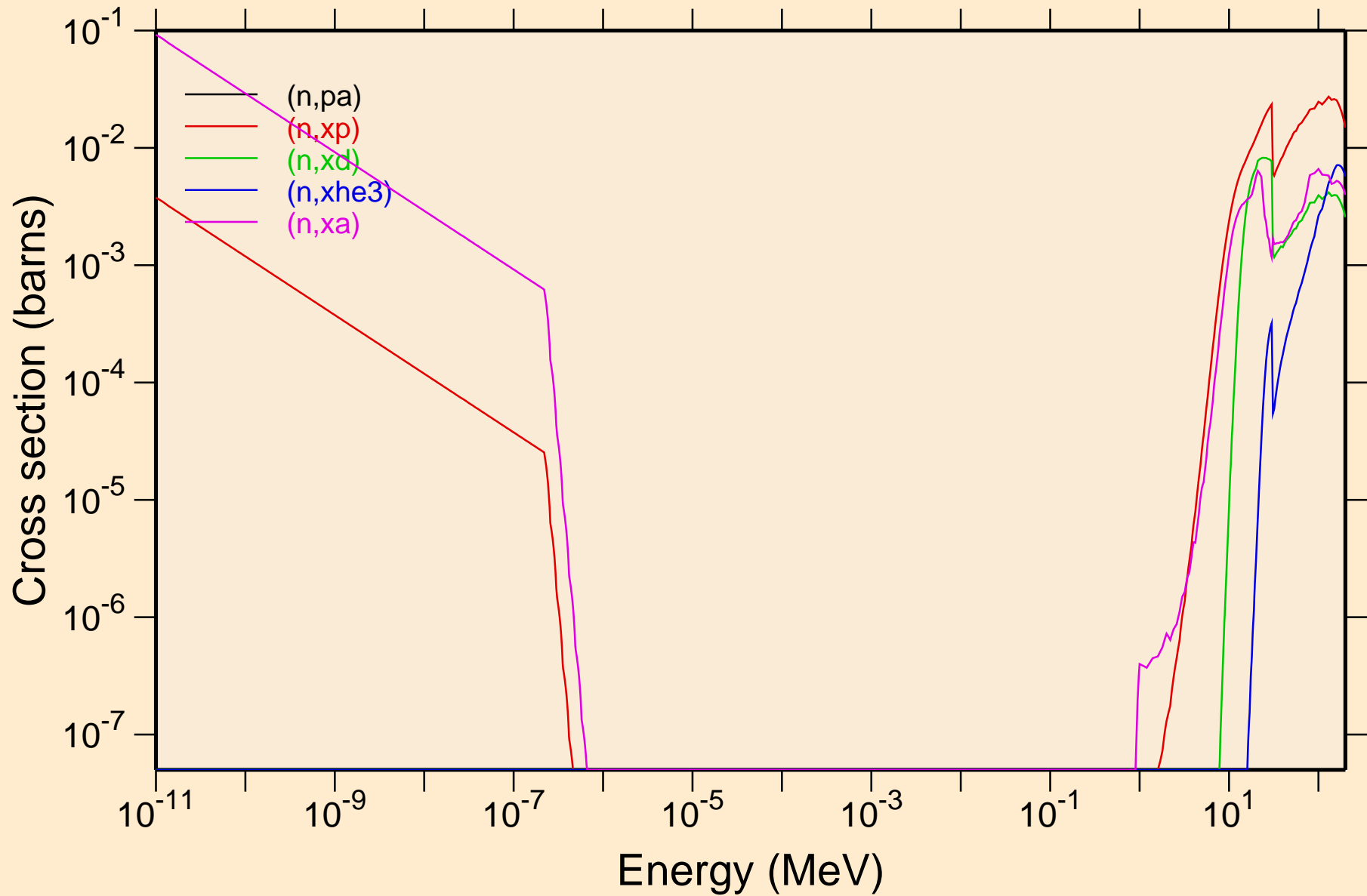

LR253M NEUTRON ACER TENDL-2024 LIBRARY; T=0.K

Principal cross sections

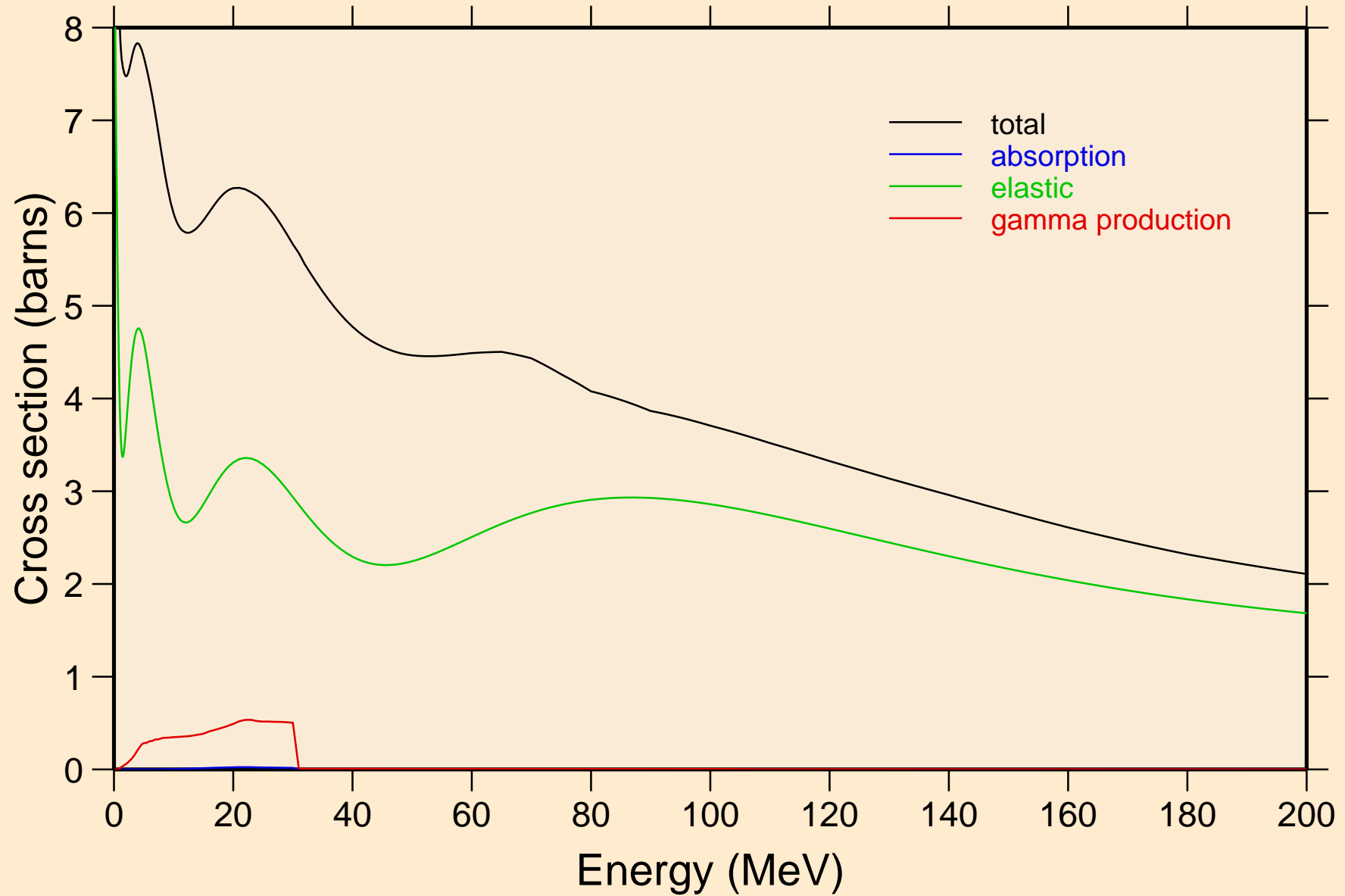

LR253M NEUTRON ACER TENDL-2024 LIBRARY; T=0.K
Heating

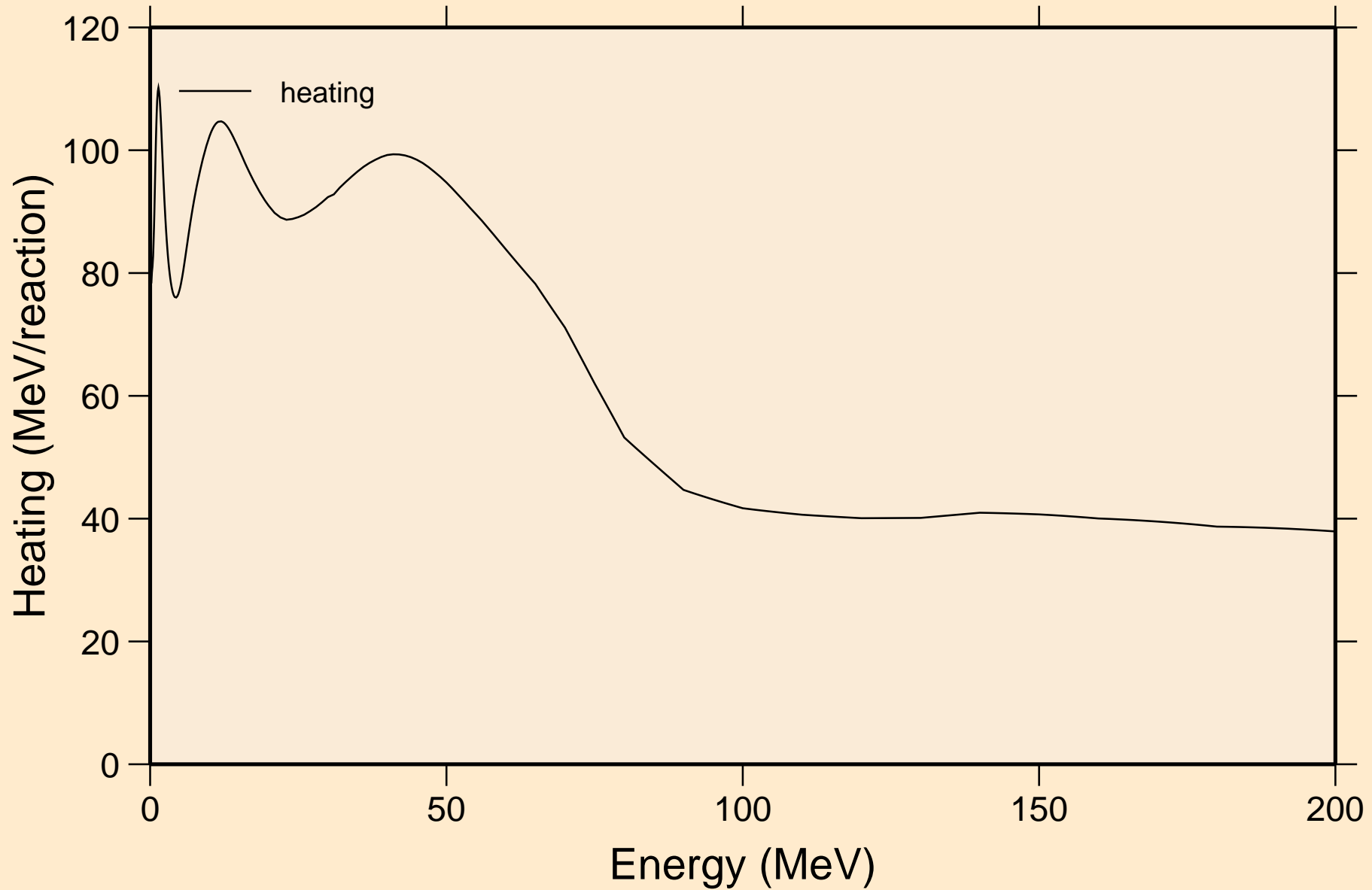

LR253M NEUTRON ACER TENDL-2024 LIBRARY; T=0.K
Damage

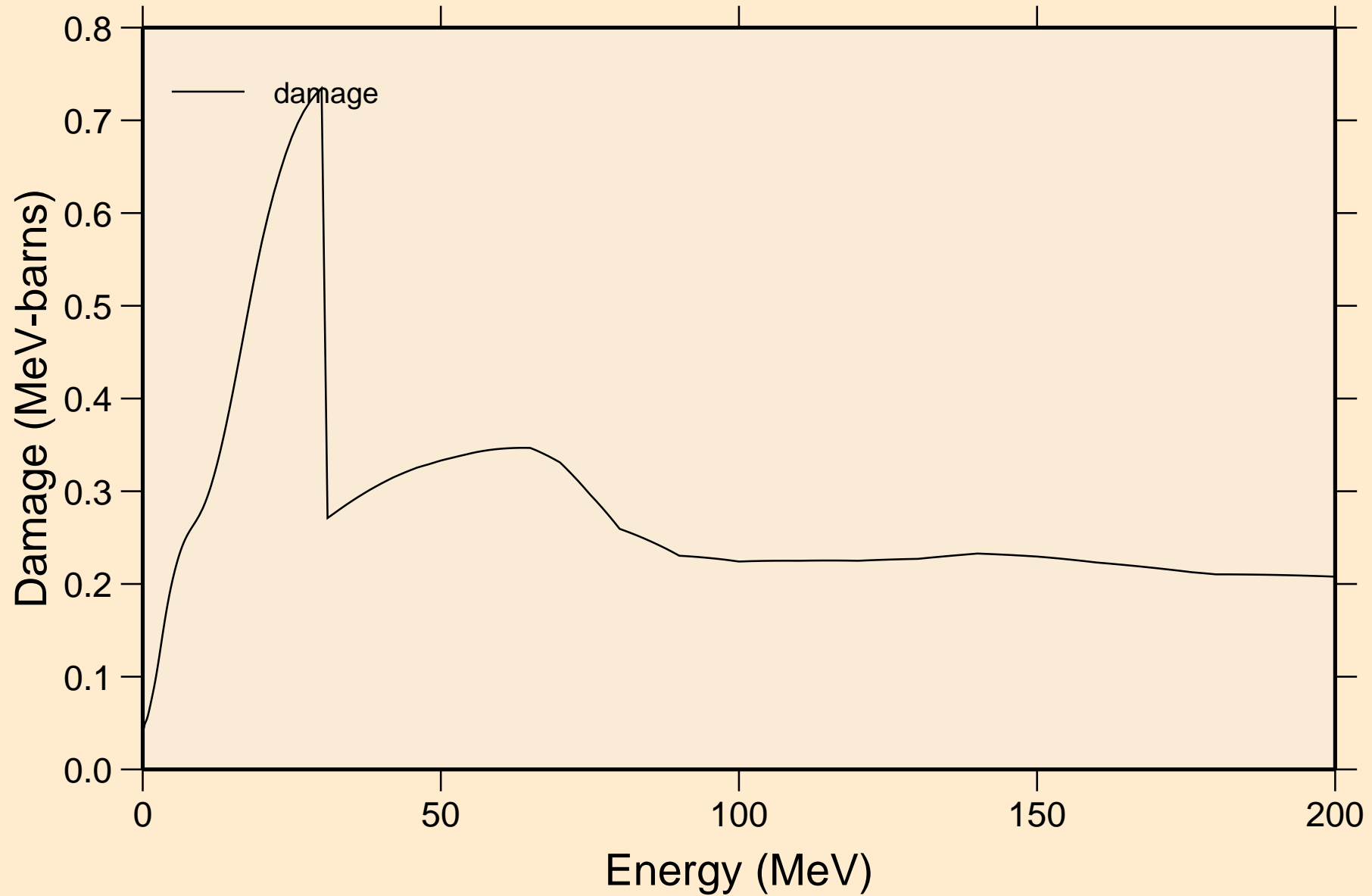

LR253M NEUTRON ACER TENDL-2024 LIBRARY; T=0.K

Non-threshold reactions

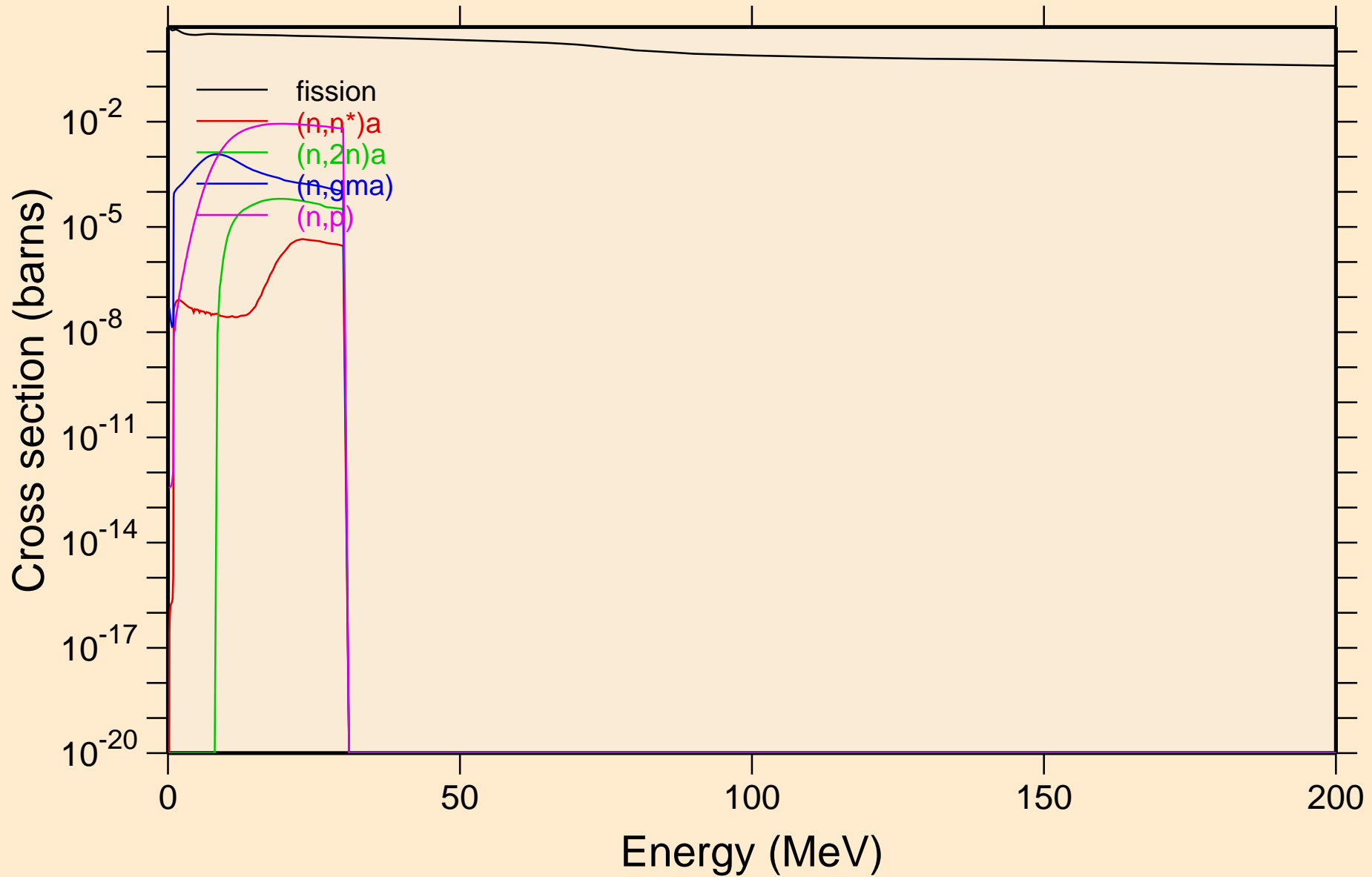

LR253M NEUTRON ACER TENDL-2024 LIBRARY; T=0.K
Non-threshold reactions

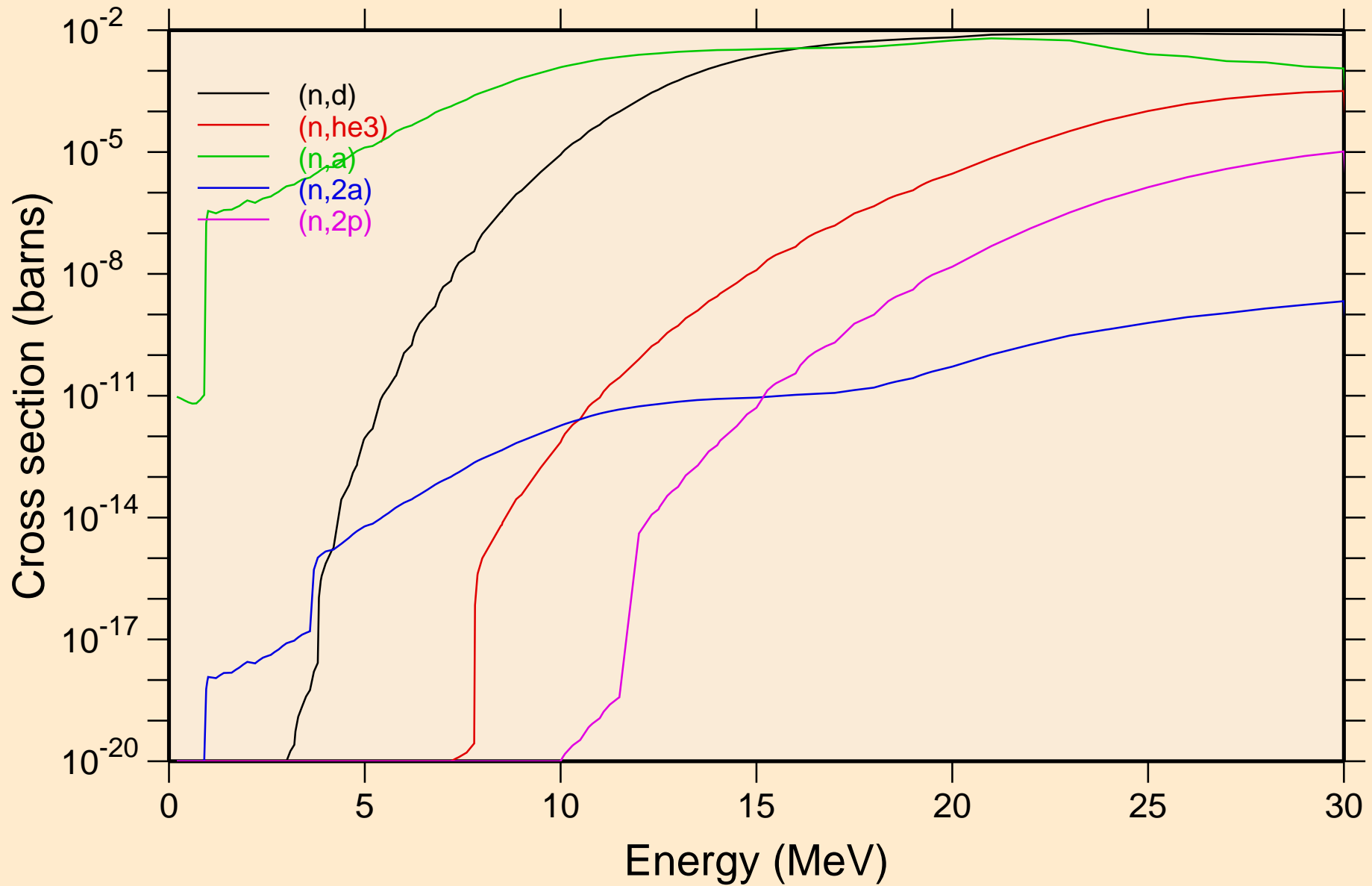

LR253M NEUTRON ACER TENDL-2024 LIBRARY; T=0.K
Non-threshold reactions

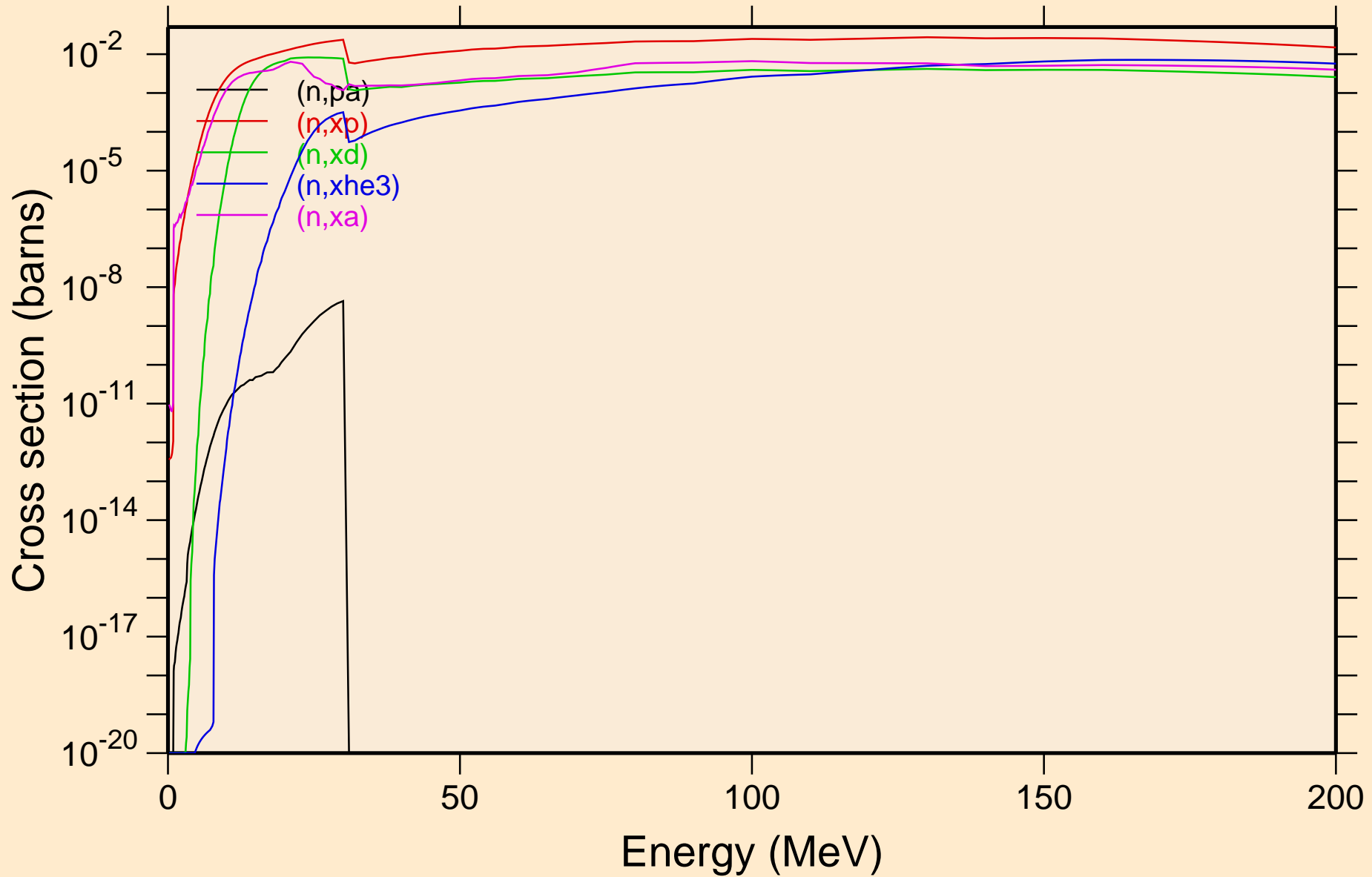

LR253M NEUTRON ACER TENDL-2024 LIBRARY; T=0.K
Inelastic levels

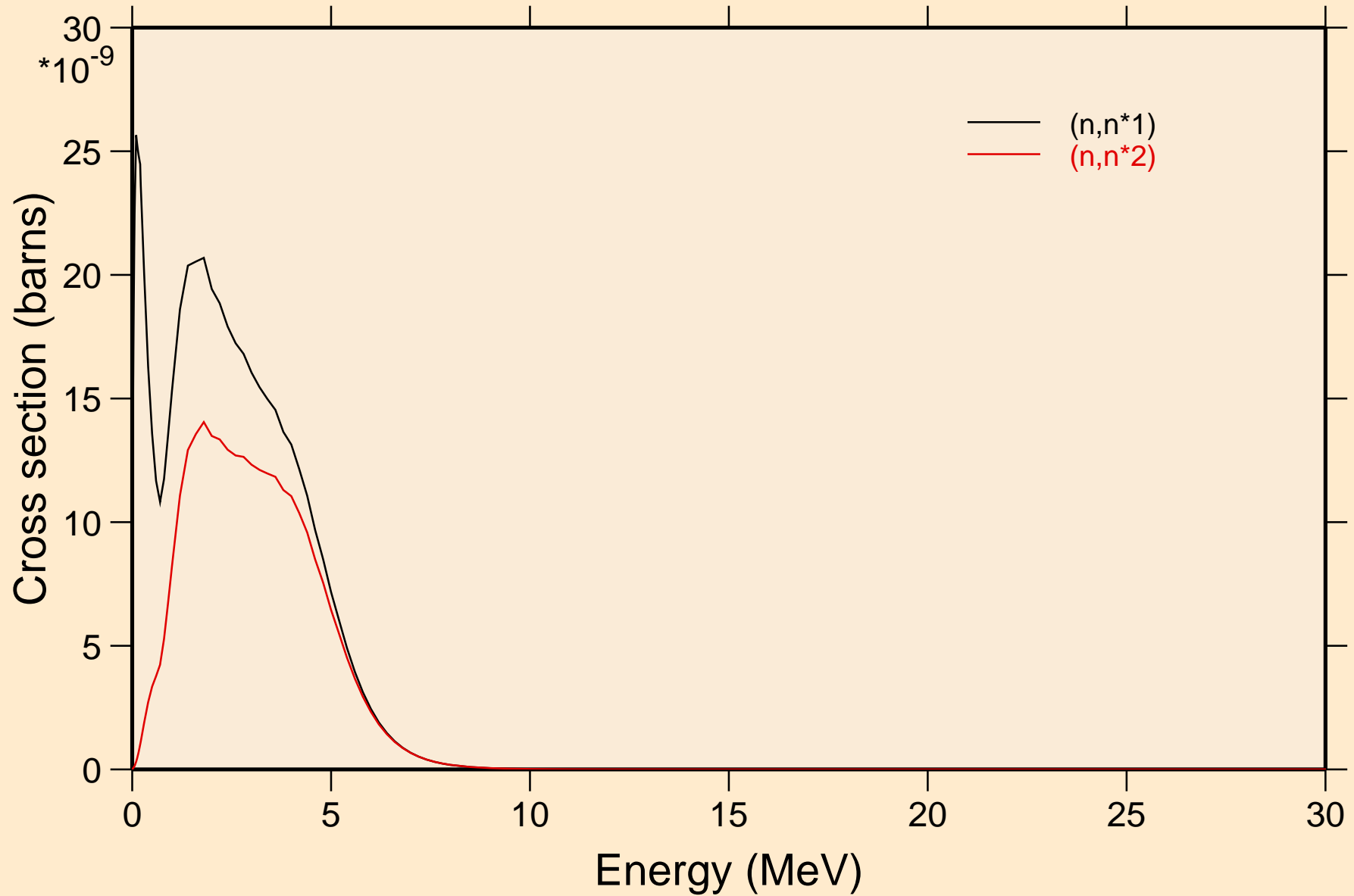

LR253M NEUTRON ACER TENDL-2024 LIBRARY; T=0.K

Threshold reactions

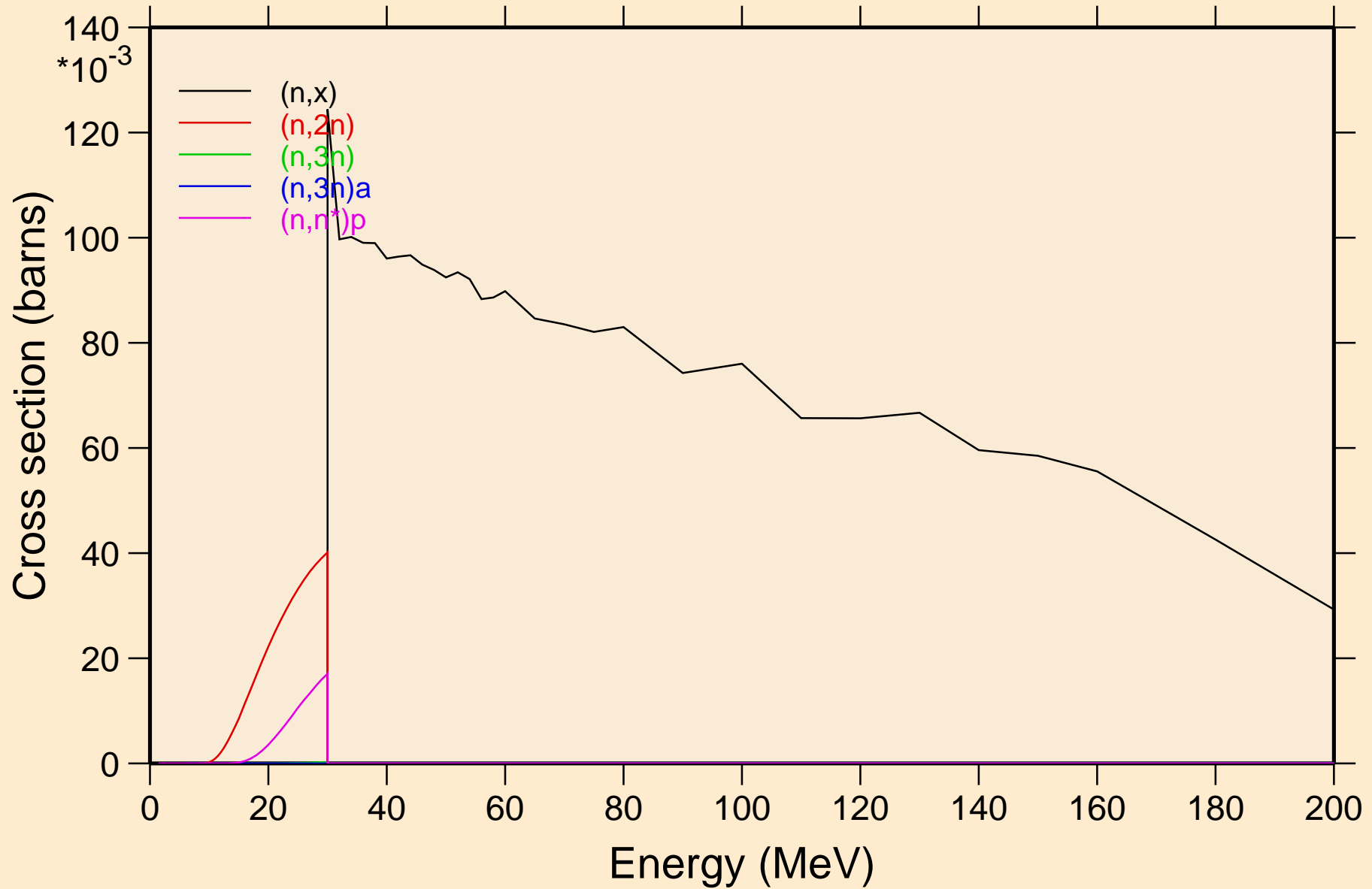

LR253M NEUTRON ACER TENDL-2024 LIBRARY; T=0.K

Threshold reactions

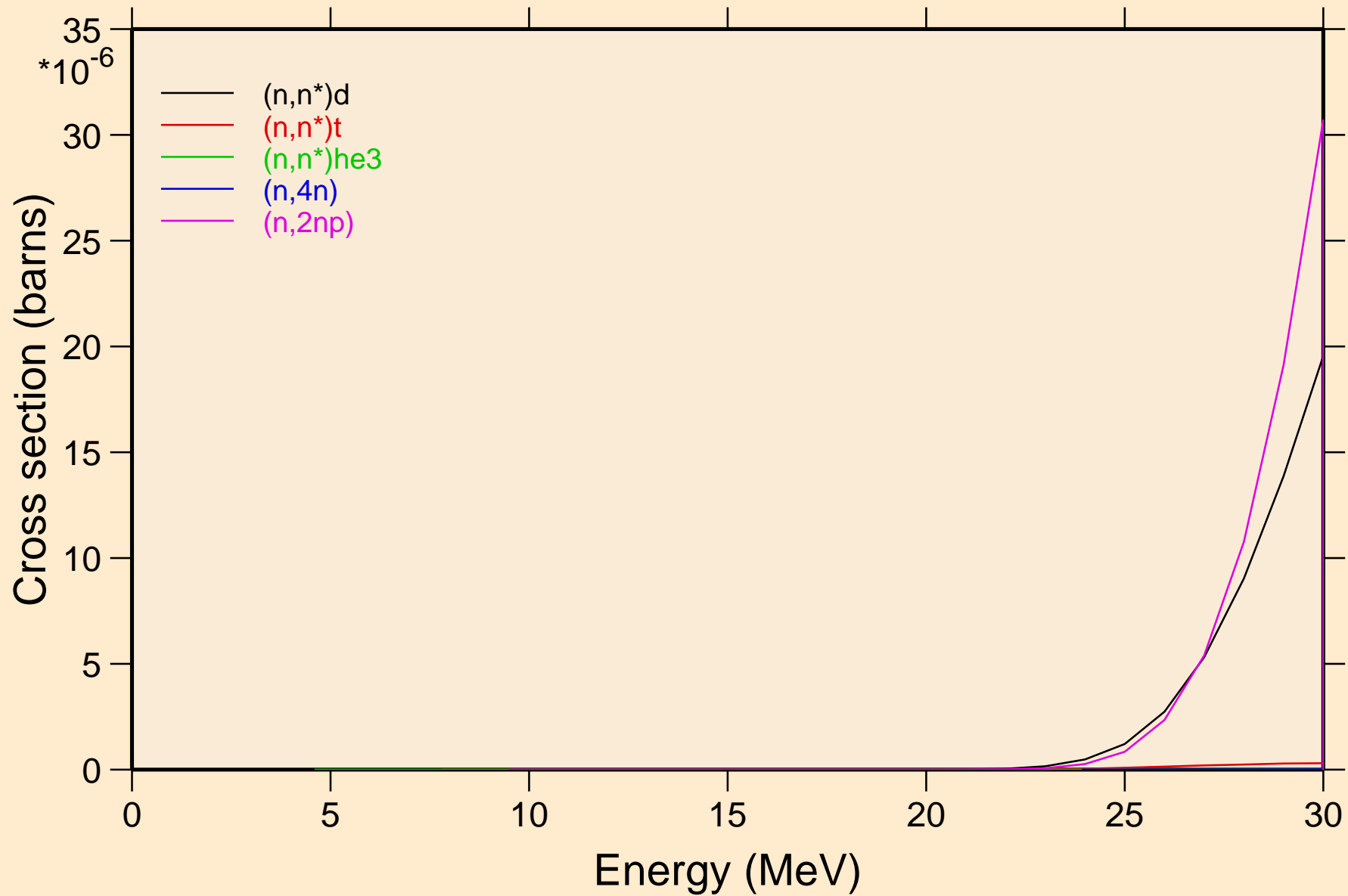

LR253M NEUTRON ACER TENDL-2024 LIBRARY; T=0.K
Threshold reactions

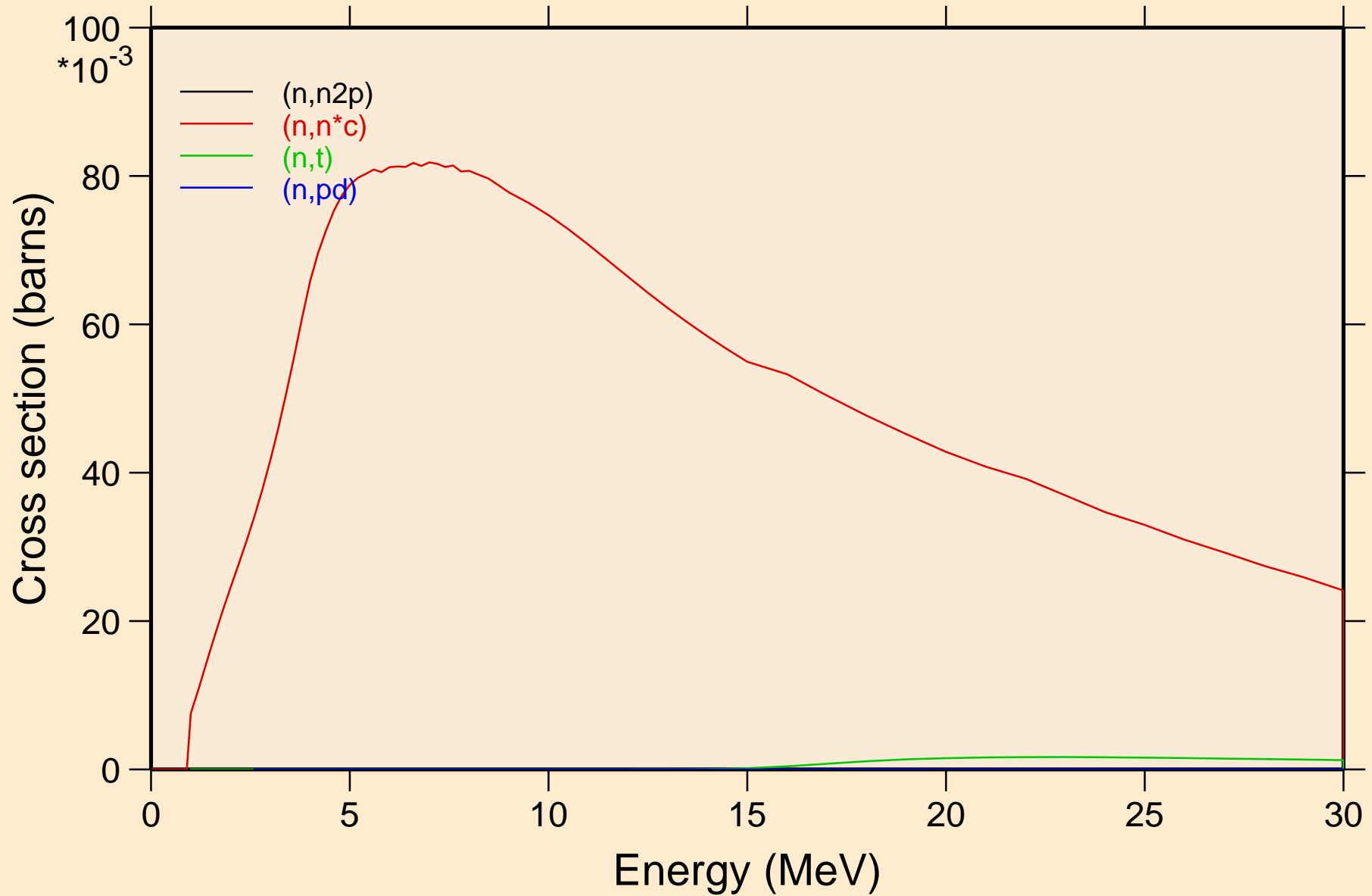

LR253M NEUTRON ACER TENDL-2024 LIBRARY; T=0.K
Threshold reactions

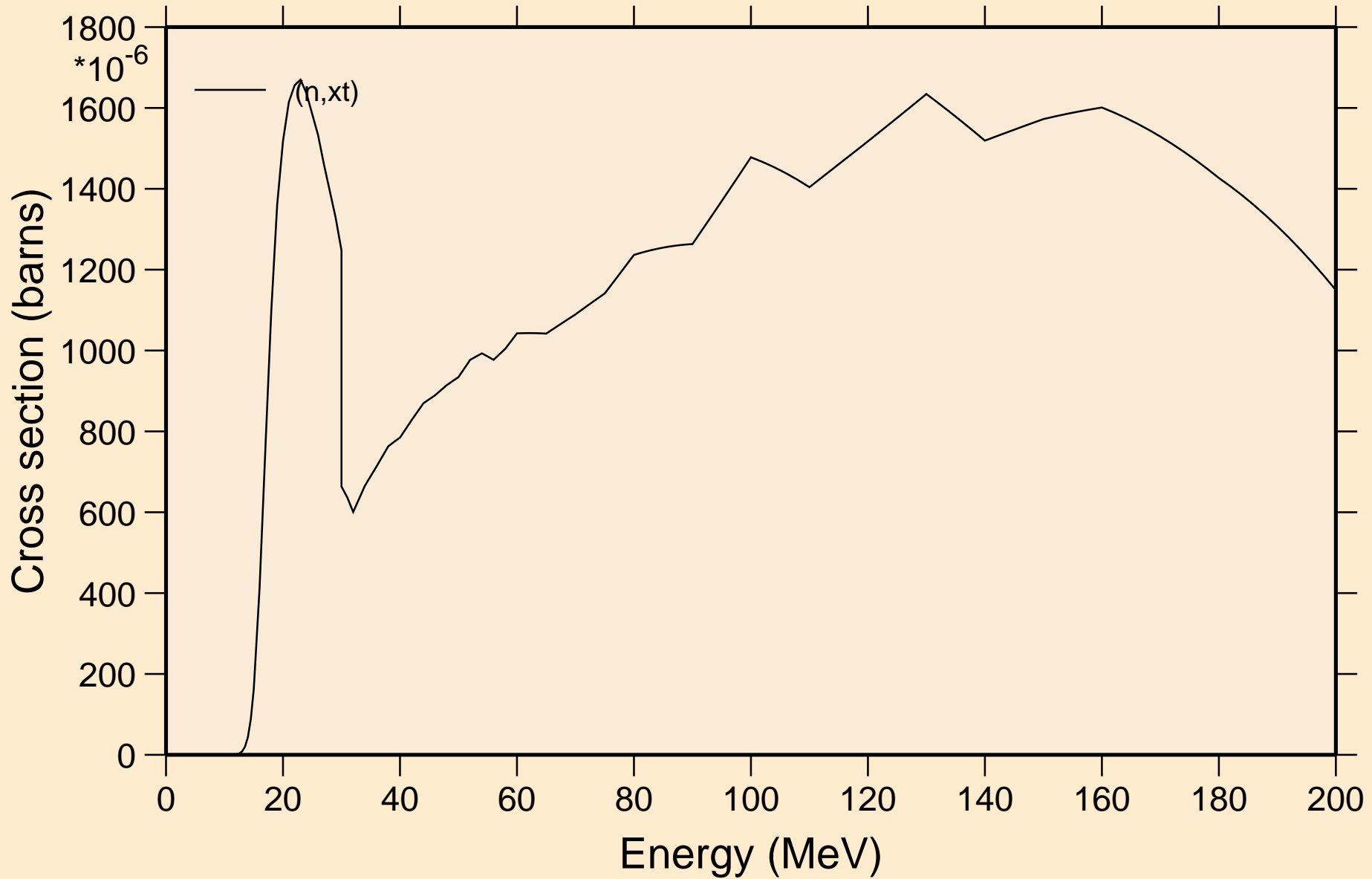

LR253M NEUTRON ACER TENDL-2024 LIBRARY; T=0.K
angular distribution for elastic

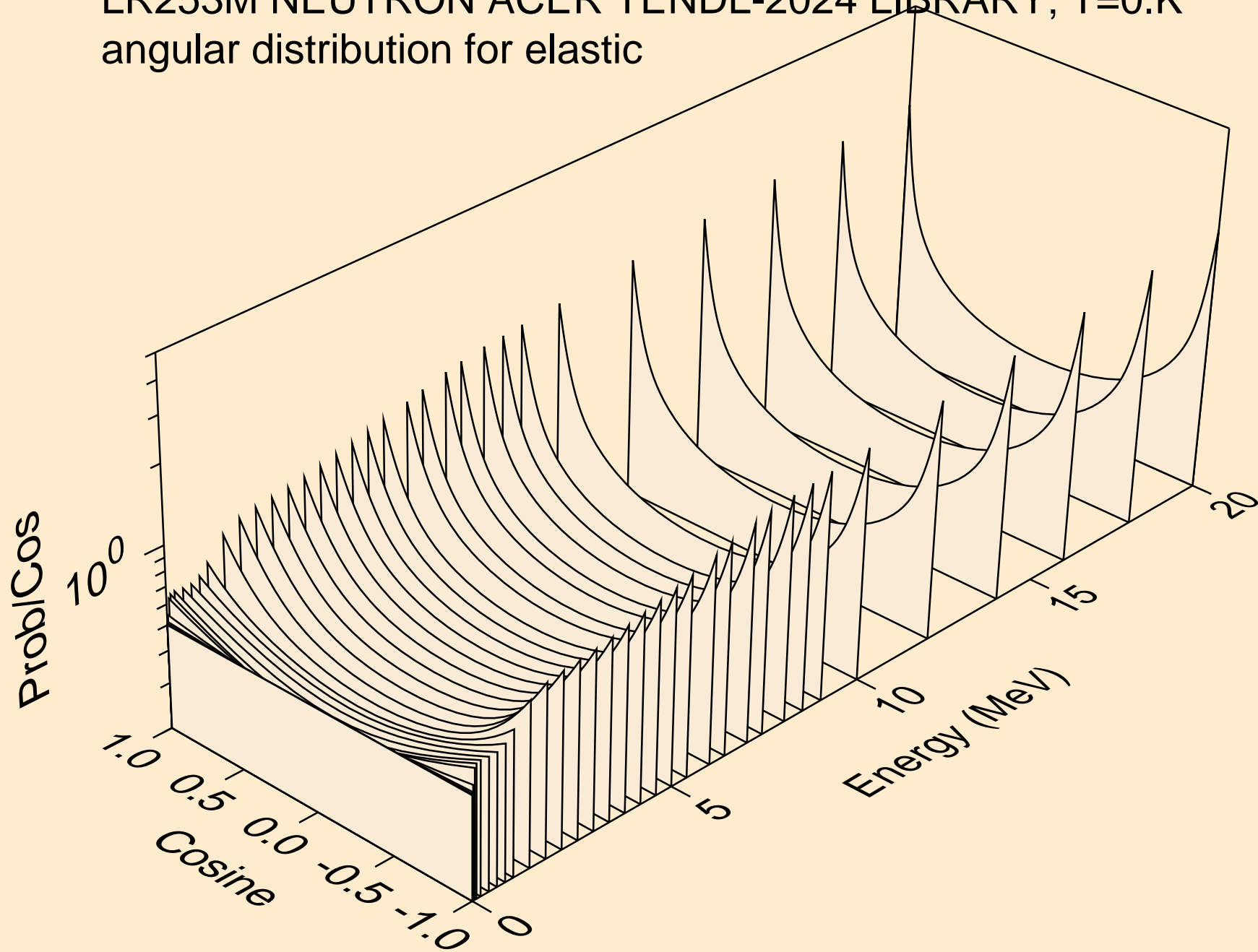

LR253M NEUTRON ACER TENDL-2024 LIBRARY; T=0.K
angular distribution for elastic

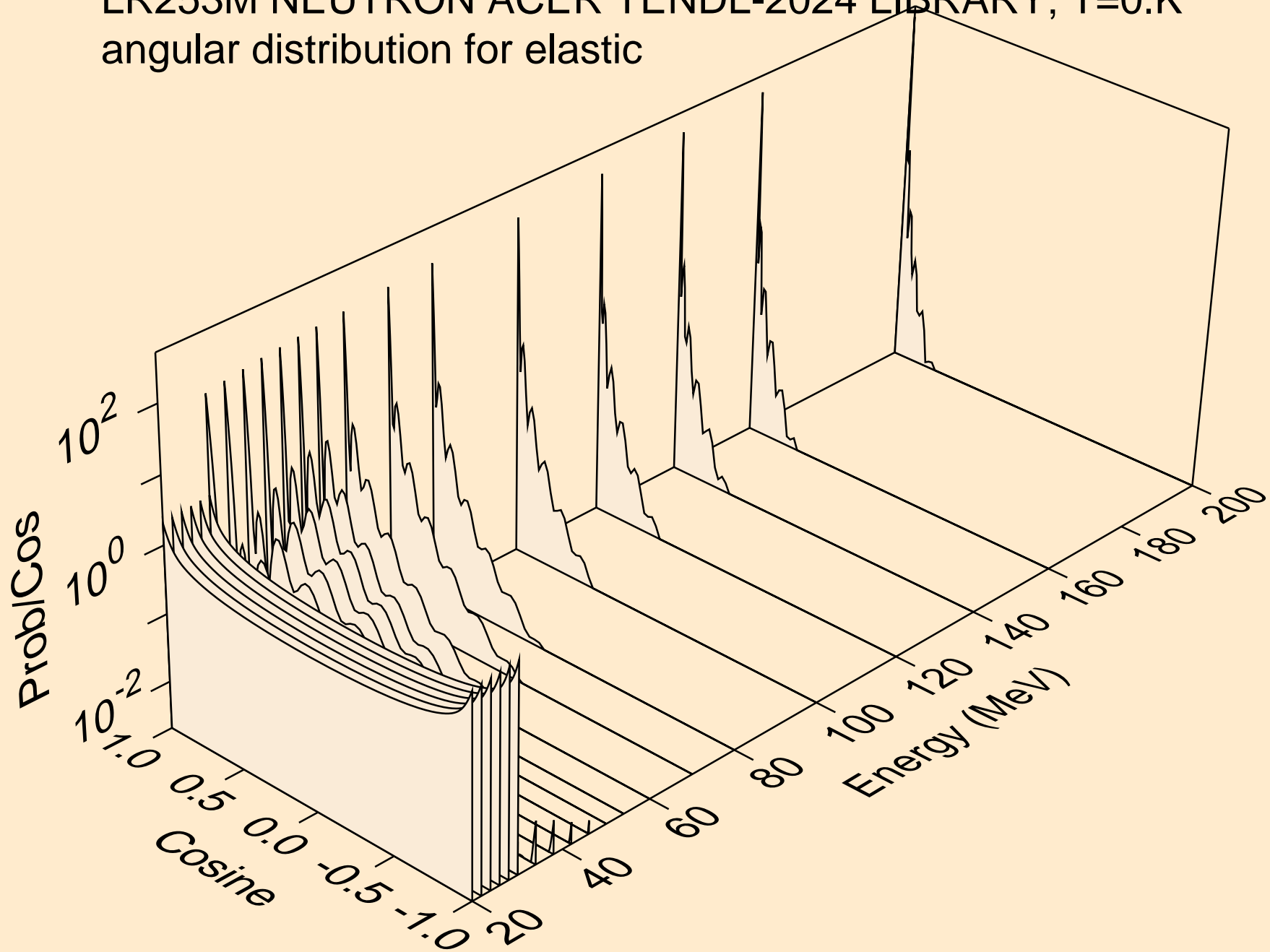

LR253M NEUTRON ACER TENDL-2024 LIBRARY; T=0.K
angular distribution for (n,n*1)

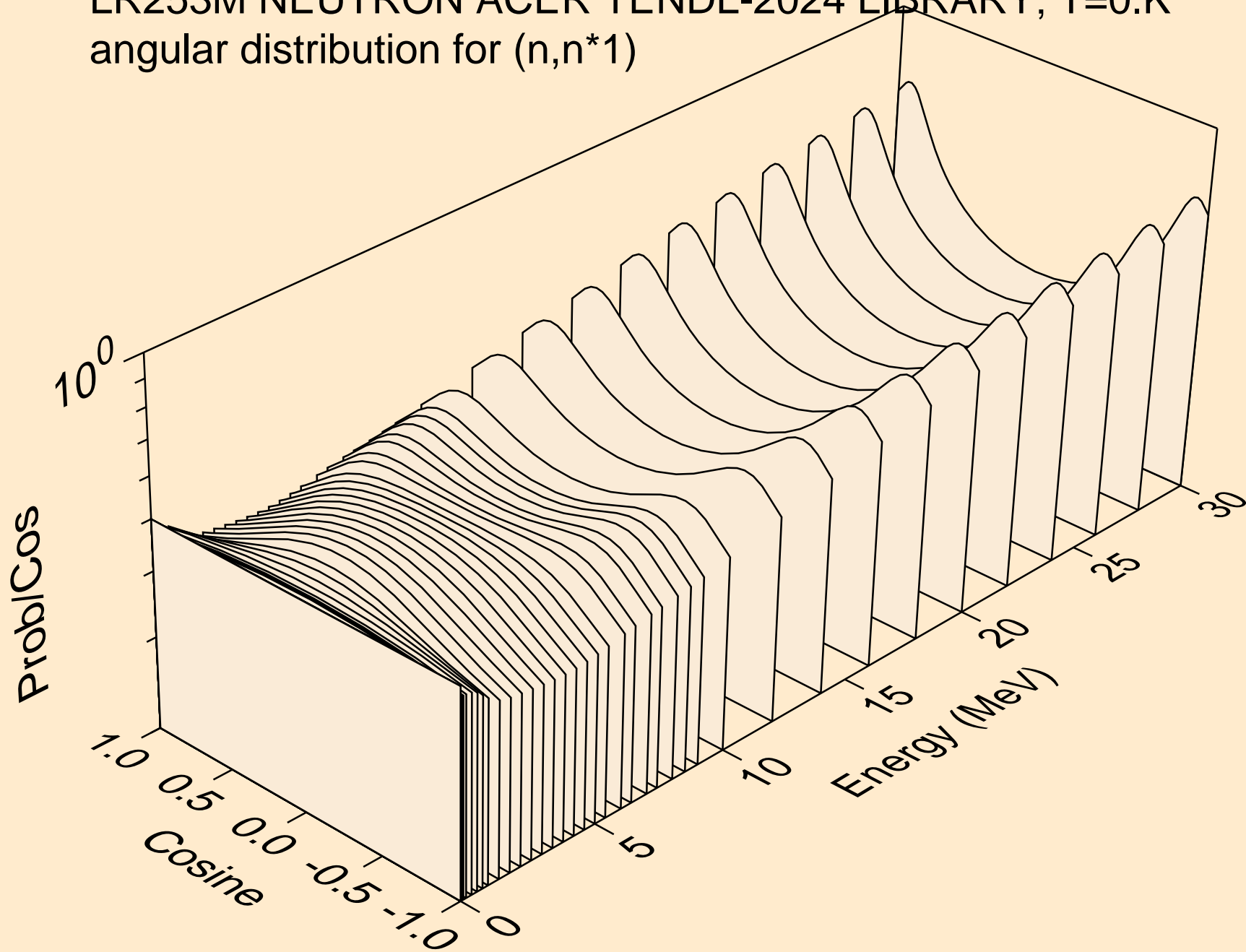

LR253M NEUTRON ACER TENDL-2024 LIBRARY; T=0.K
angular distribution for (n,n*2)

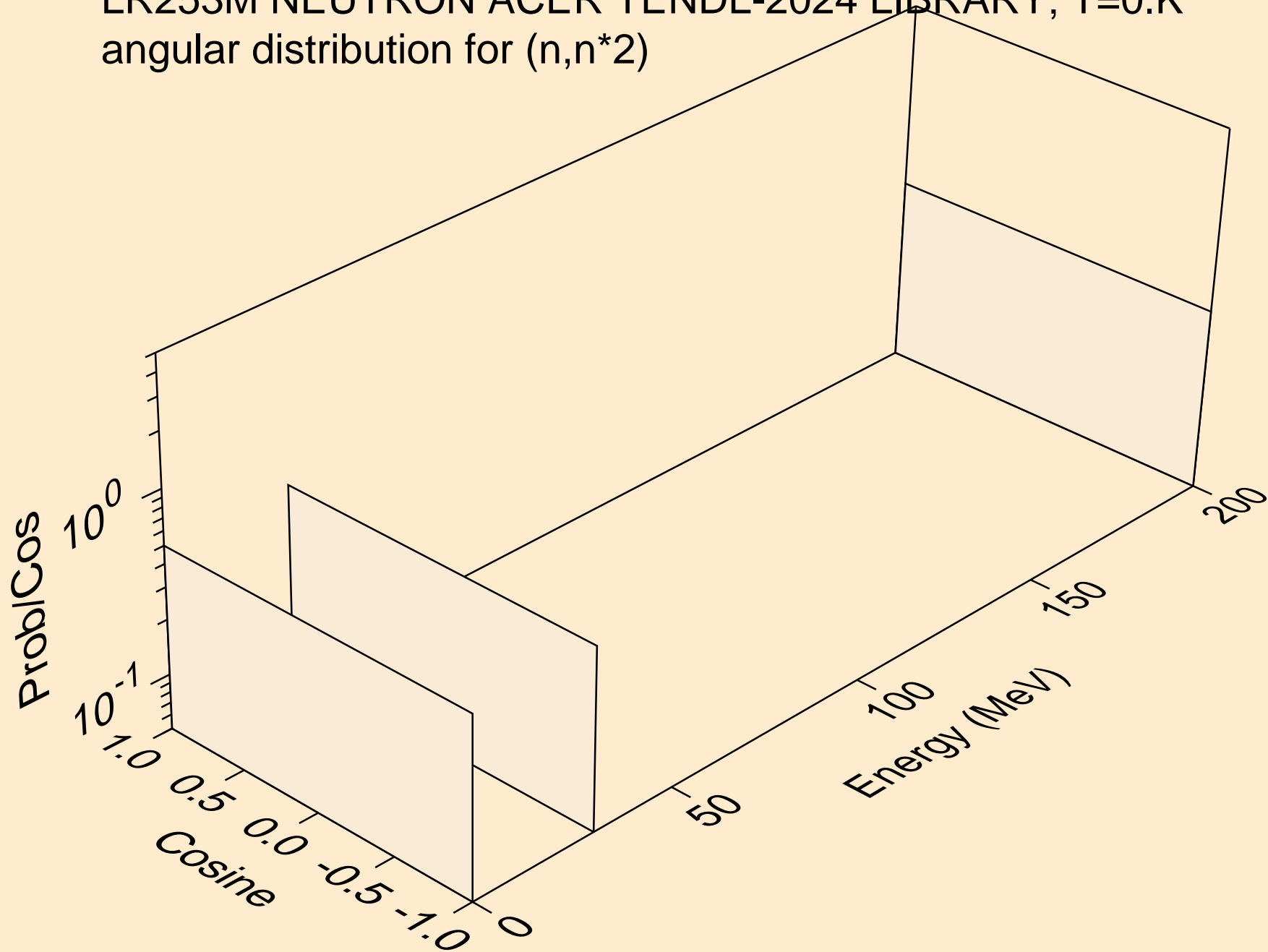

LR253M NEUTRON ACER TENDL-2024 LIBRARY; T=0.K

Total fission nubar

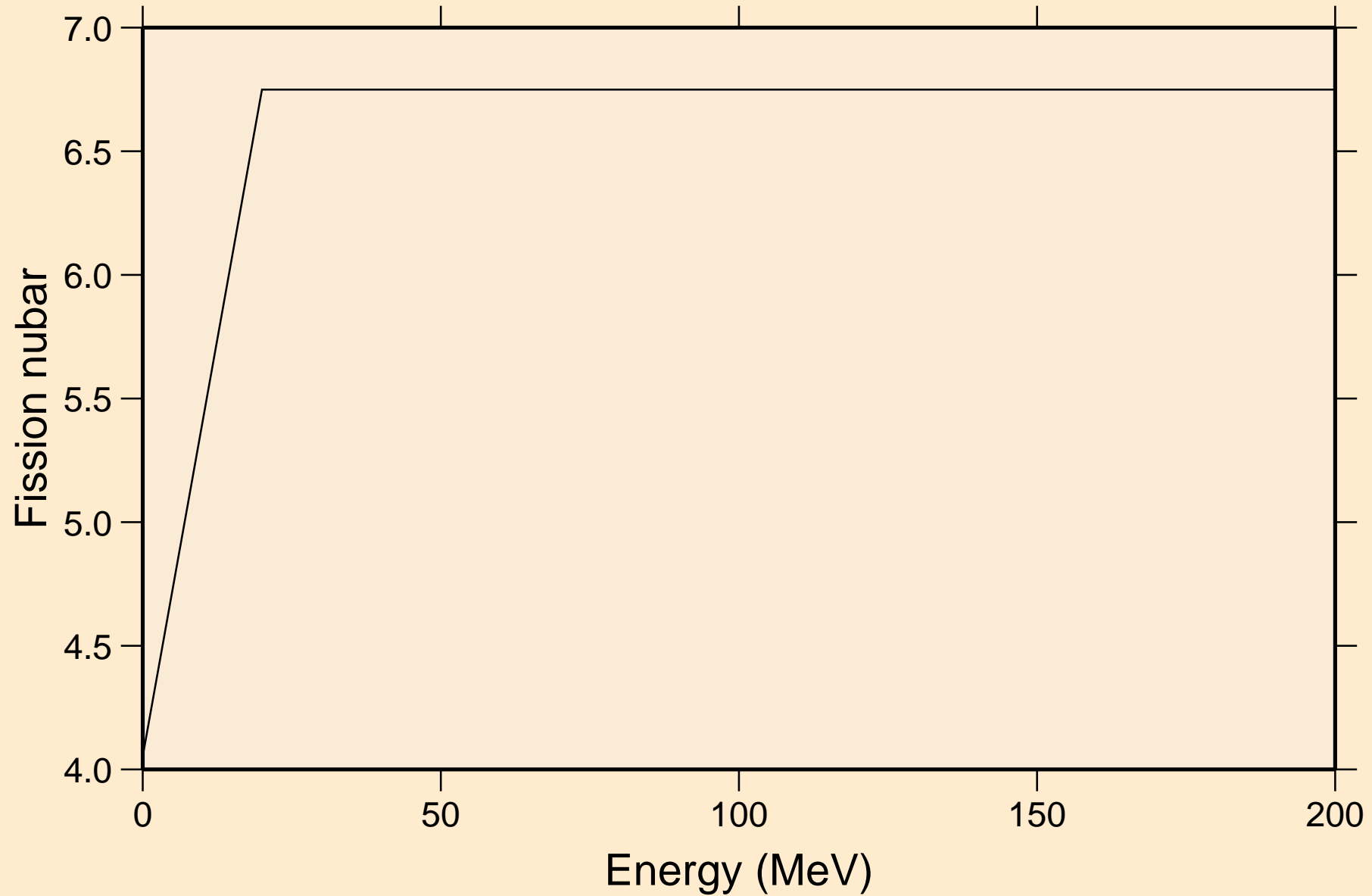

LR253M NEUTRON ACER TENDL-2024 LIBRARY; T=0.K
Neutron emission for (n,x)

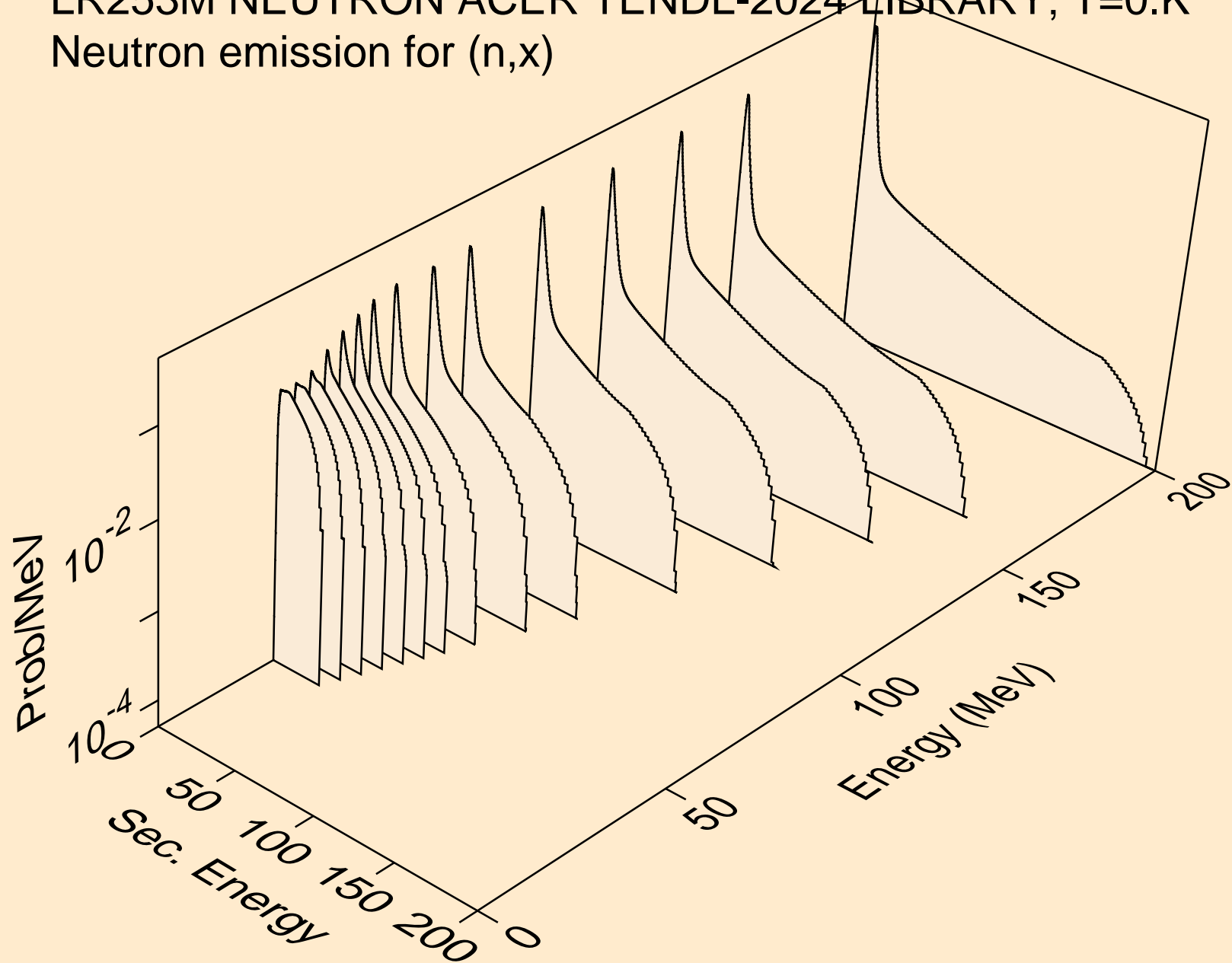

LR253M NEUTRON ACER TENDL-2024 LIBRARY; T=0.K
Neutron emission for (n,2n)

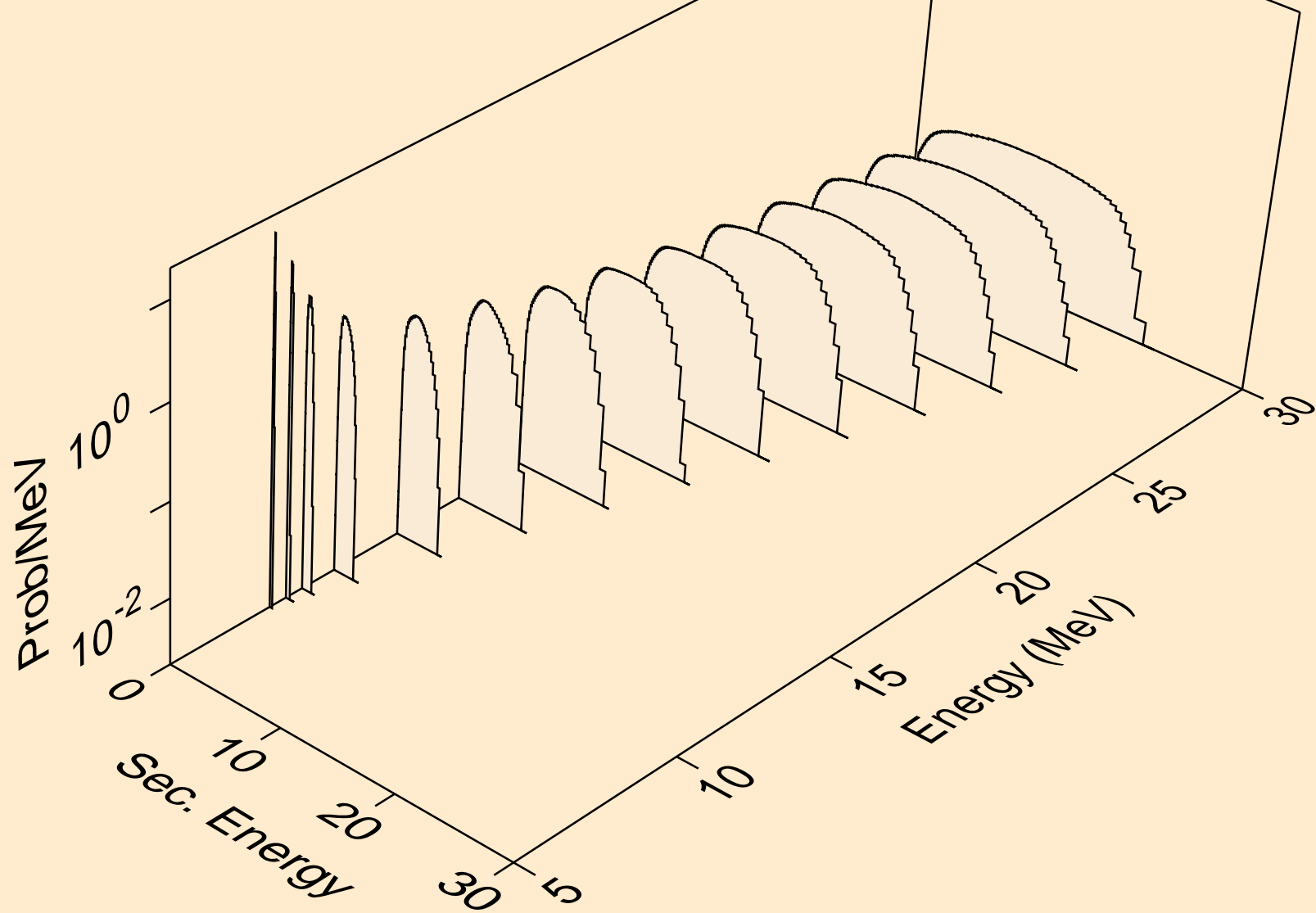

LR253M NEUTRON ACER TENDL-2024 LIBRARY; T=0.K
Neutron emission for (n,3n)

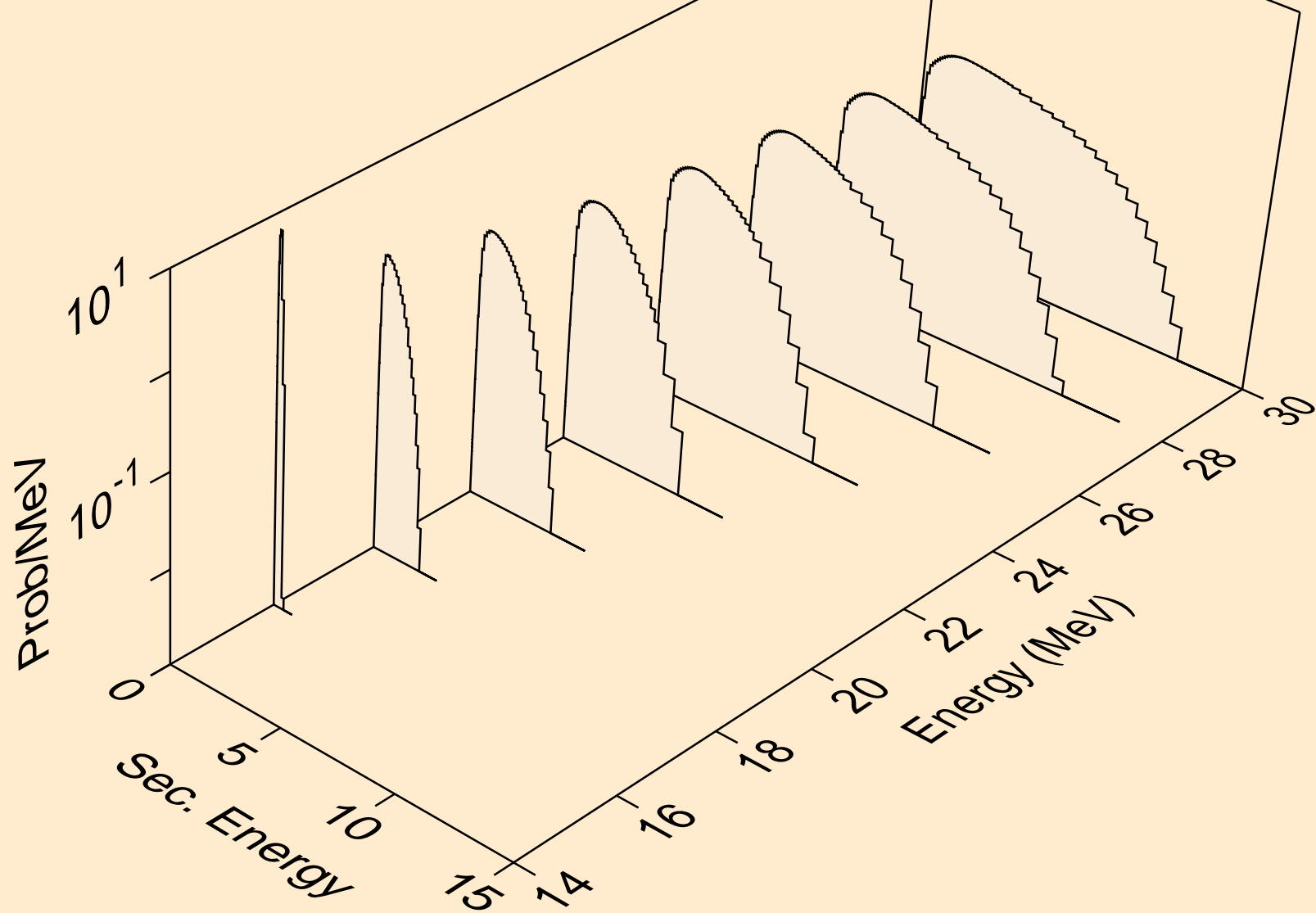

LR253M NEUTRON ACER TENDL-2024 LIBRARY; T=0.K
Neutron emission for fission

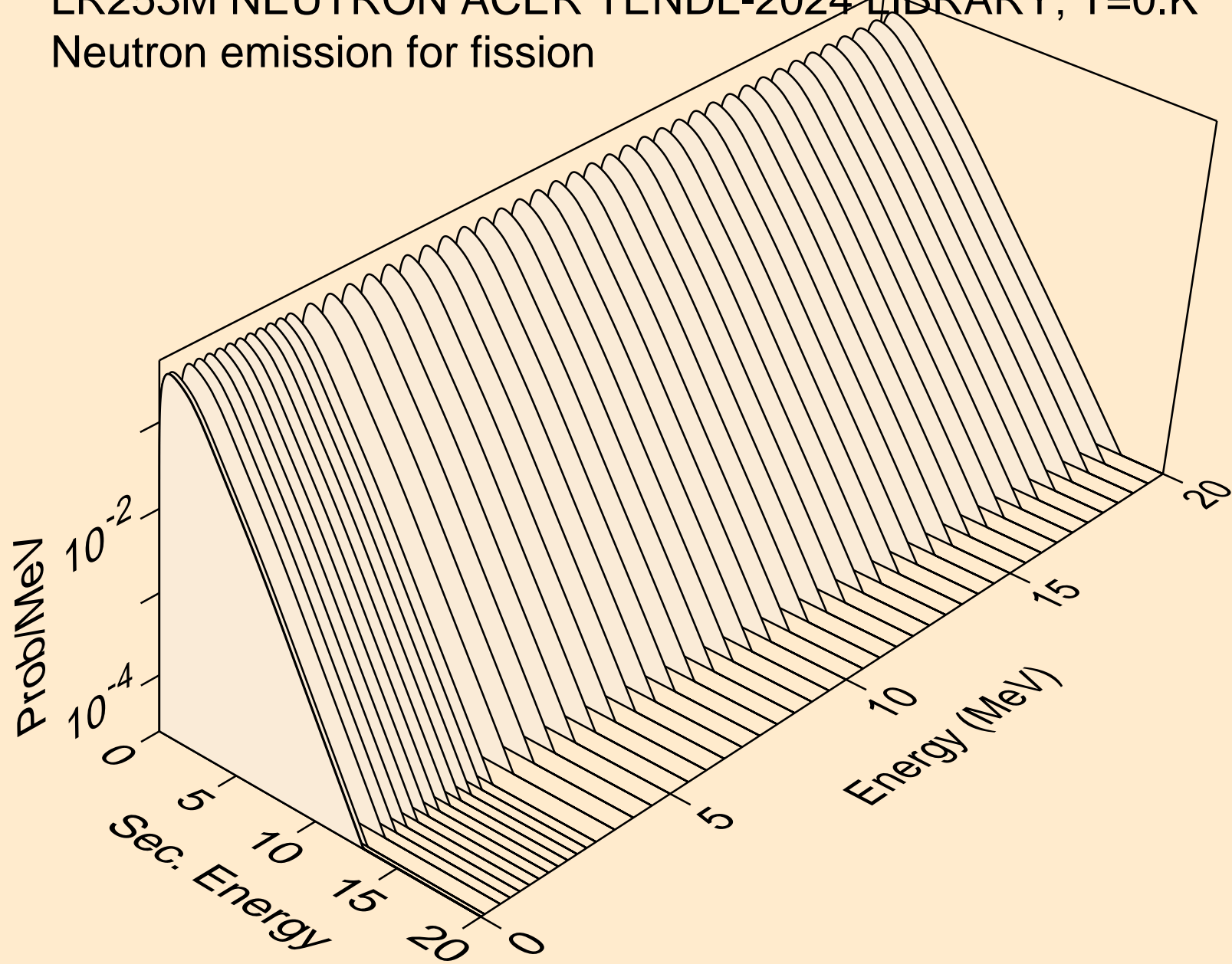

LR253M NEUTRON ACER TENDL-2024 LIBRARY; T=0.K
Neutron emission for (n,n*)a

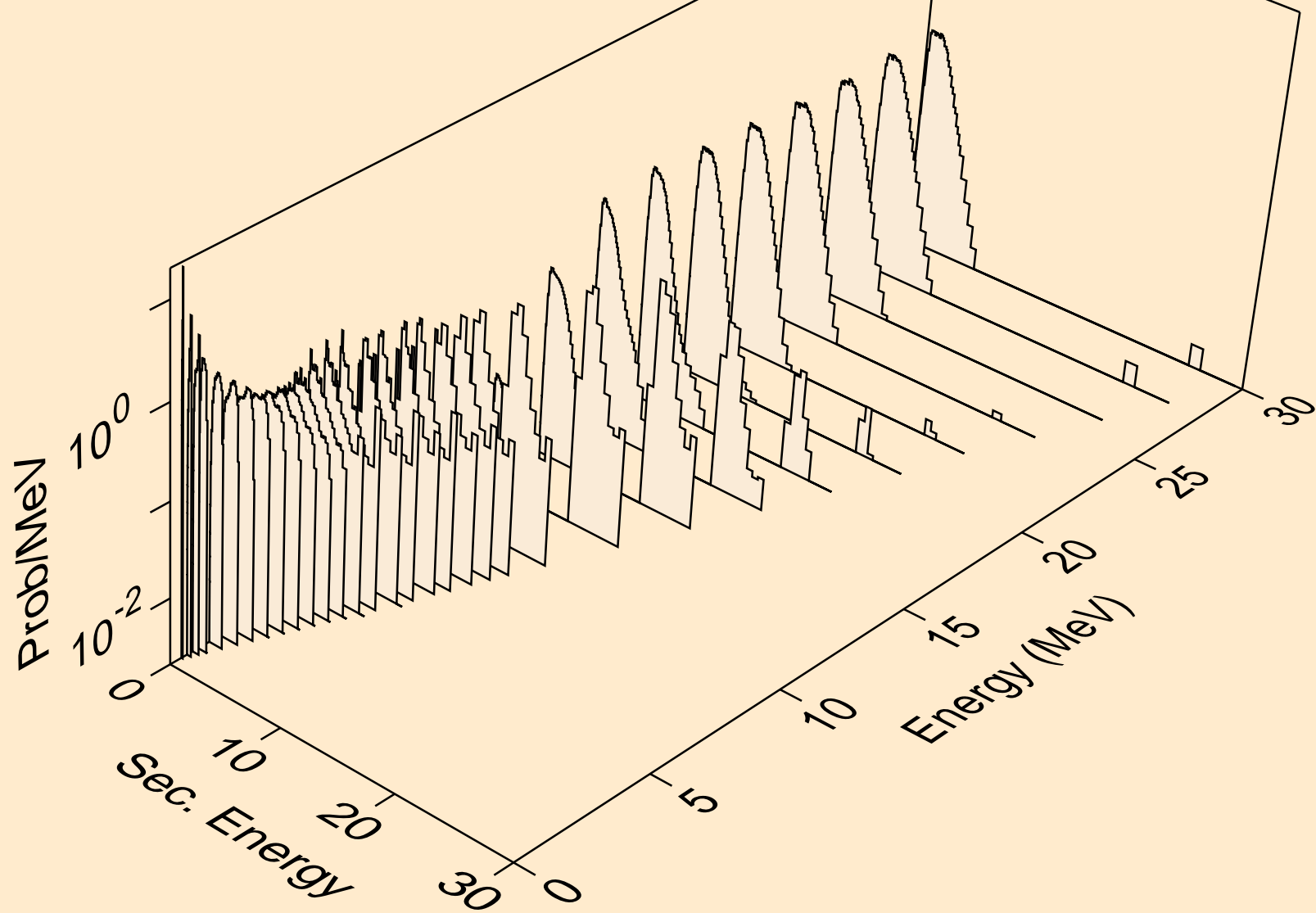

LR253M NEUTRON ACER TENDL-2024 LIBRARY; T=0.K
Neutron emission for (n,2n)a

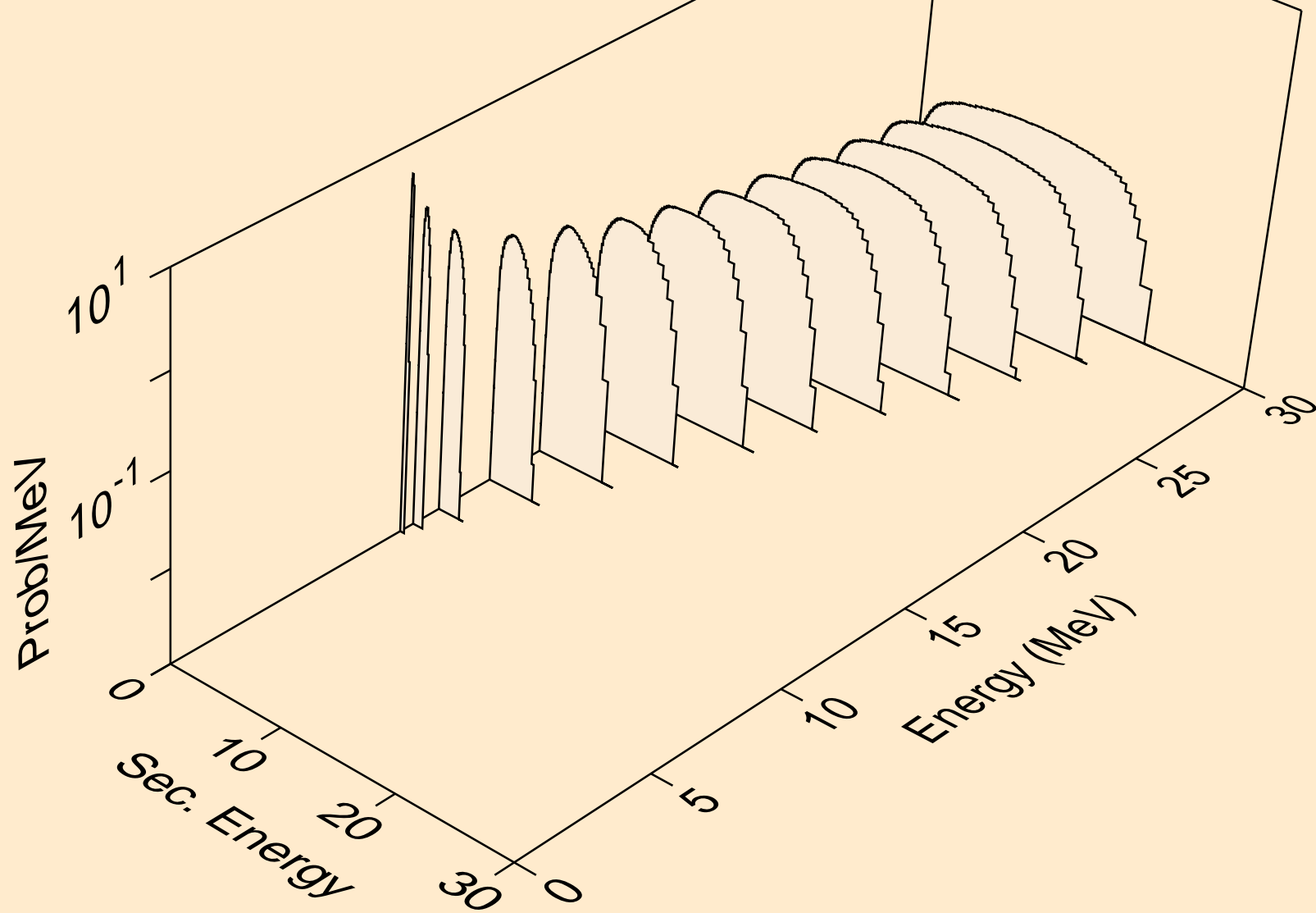

LR253M NEUTRON ACER TENDL-2024 LIBRARY; T=0.K
Neutron emission for (n,3n)a

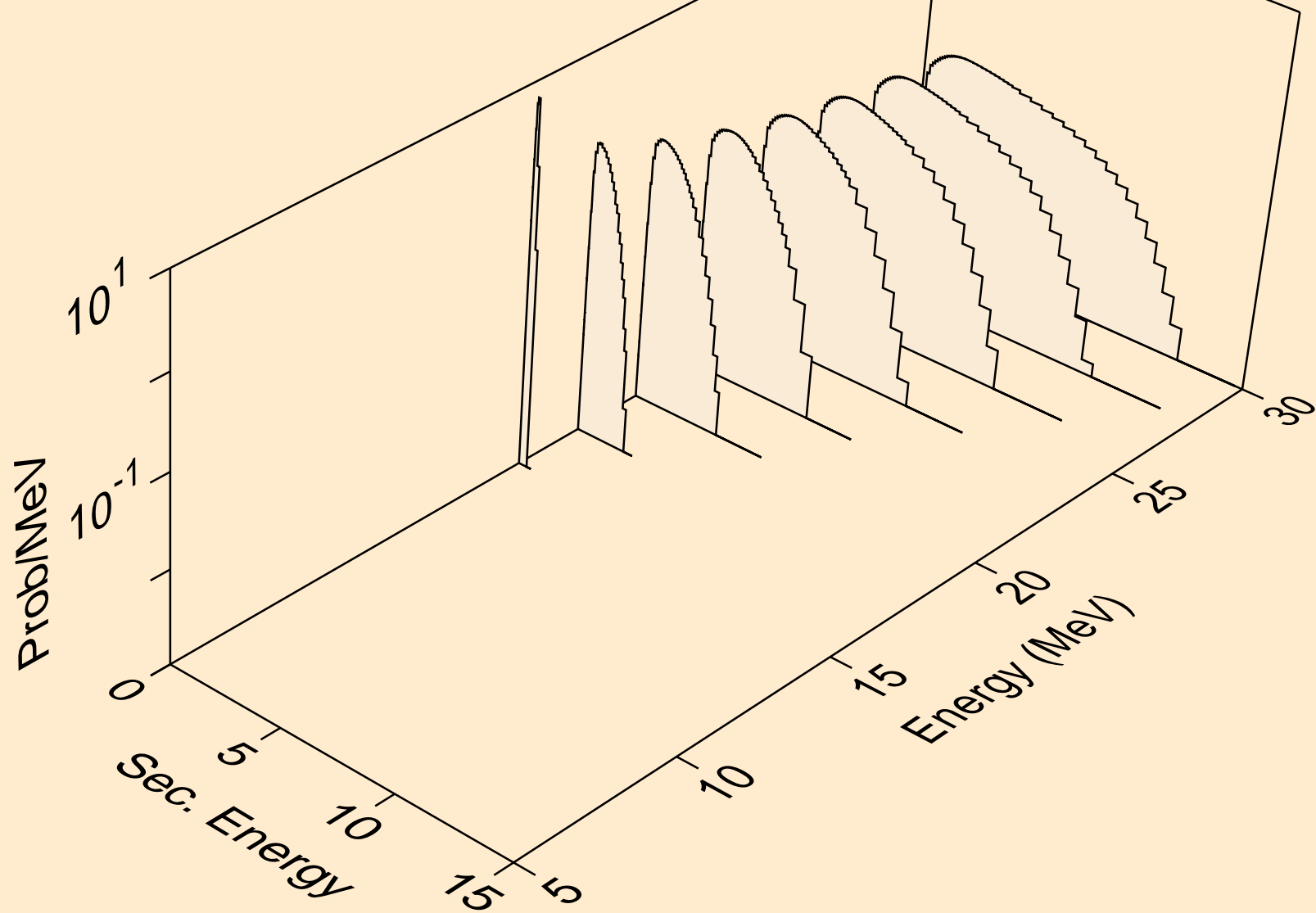

LR253M NEUTRON ACER TENDL-2024 LIBRARY; T=0.K
Neutron emission for (n,n*)p

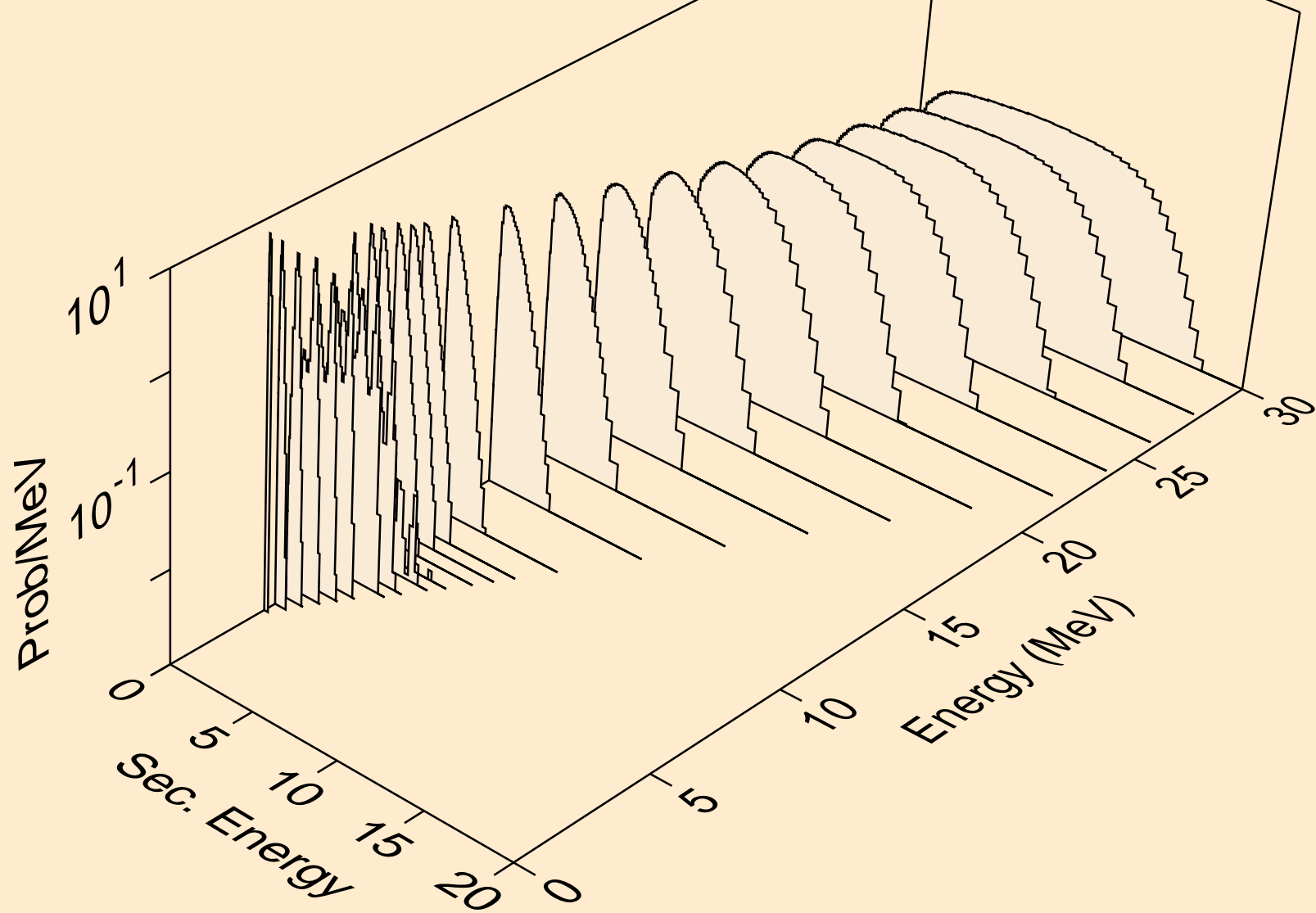

LR253M NEUTRON ACER TENDL-2024 LIBRARY; T=0.K
Neutron emission for (n,n*)d

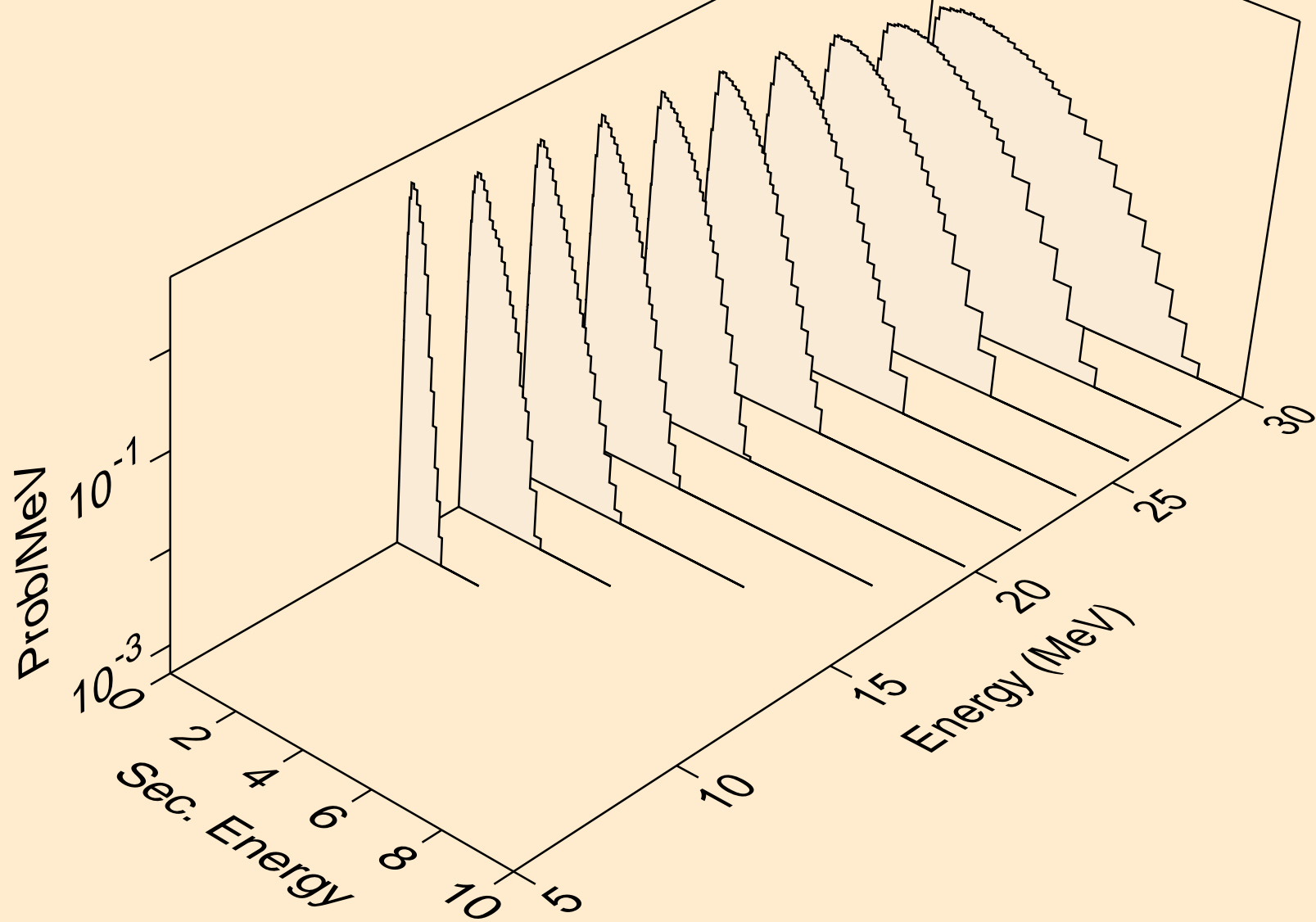

LR253M NEUTRON ACER TENDL-2024 LIBRARY; T=0.K
Neutron emission for (n,n*)t

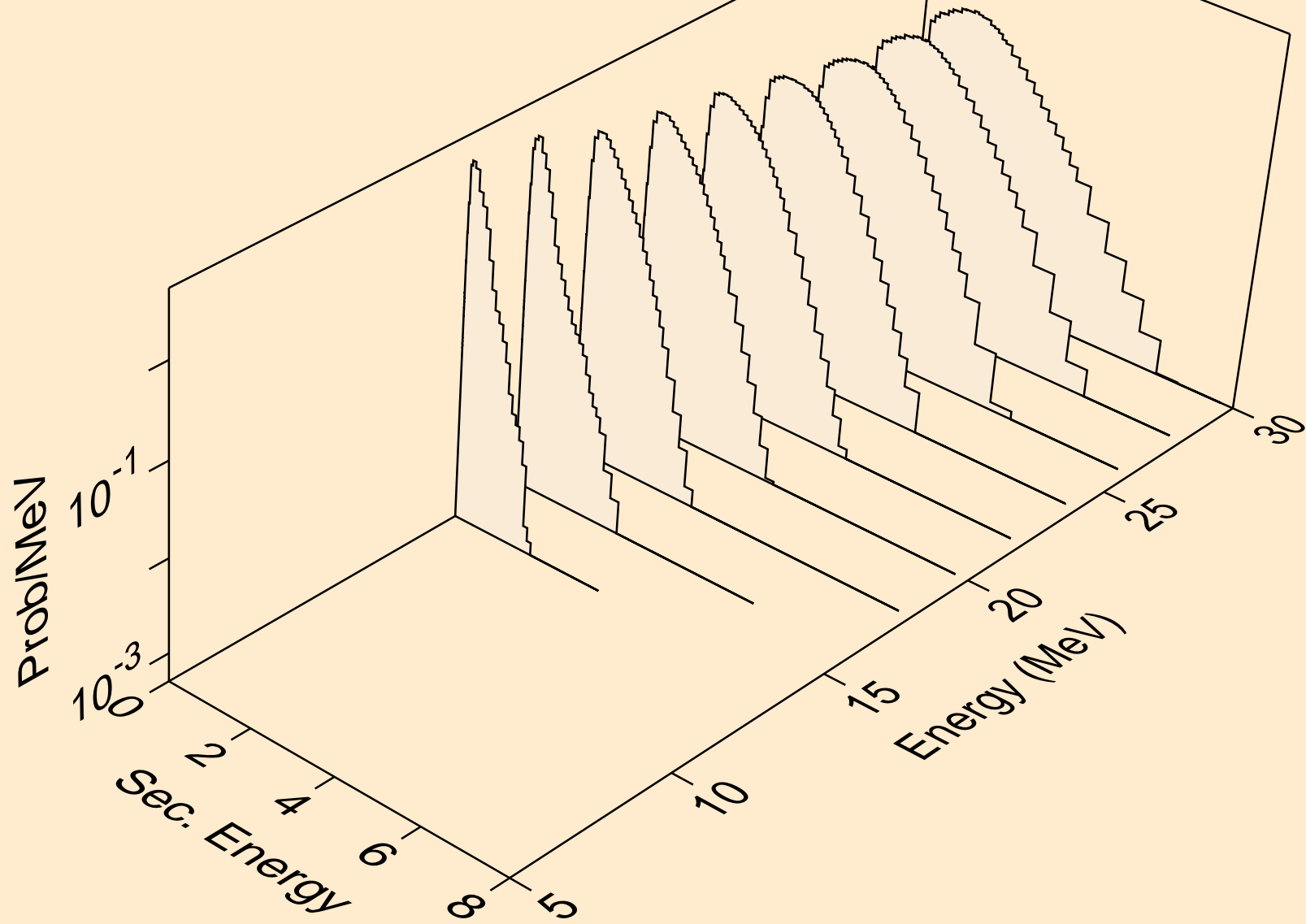

LR253M NEUTRON ACER TENDL-2024 LIBRARY; T=0.K
Neutron emission for (n,n*)he3

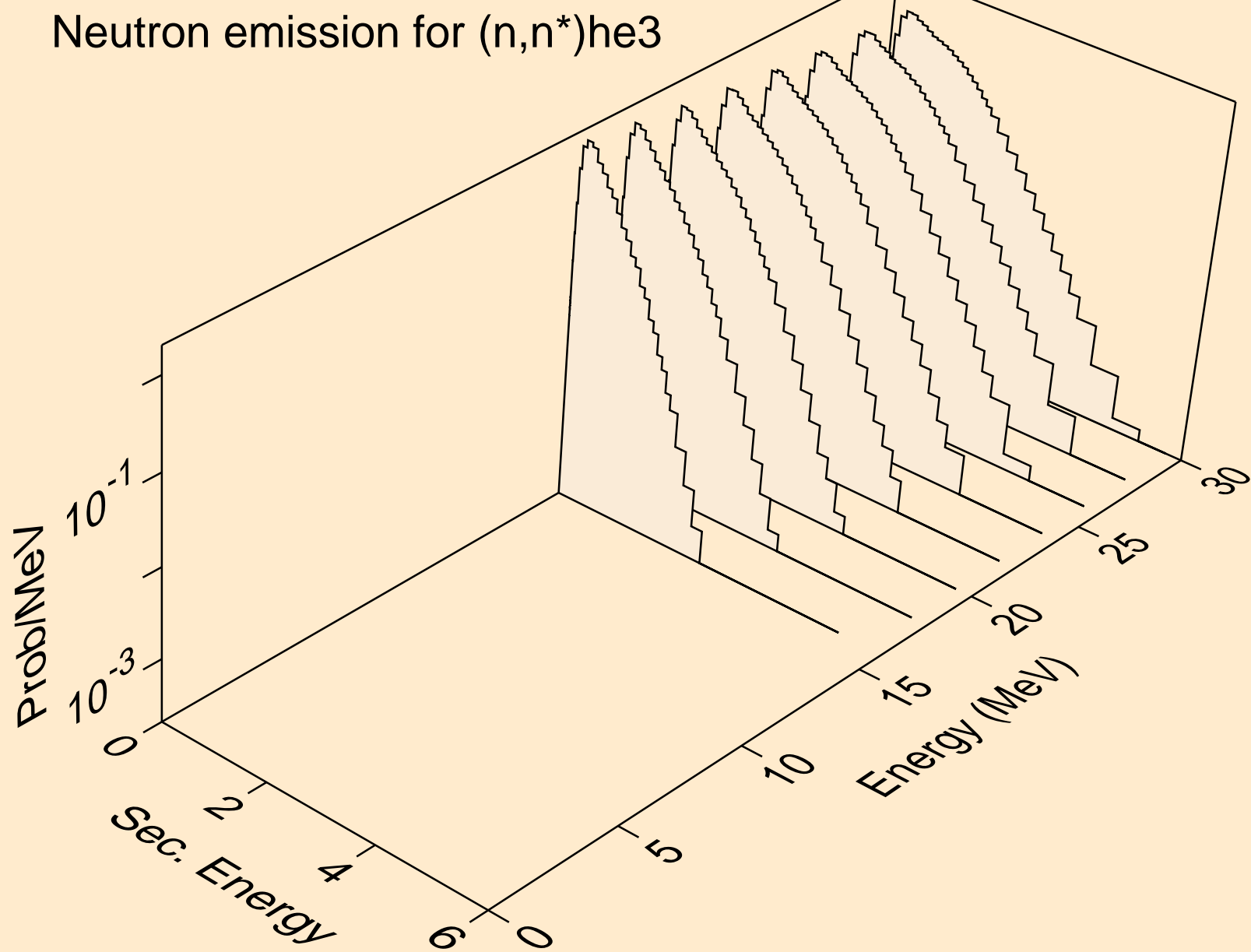

LR253M NEUTRON ACER TENDL-2024 LIBRARY; T=0.K
Neutron emission for (n,4n)

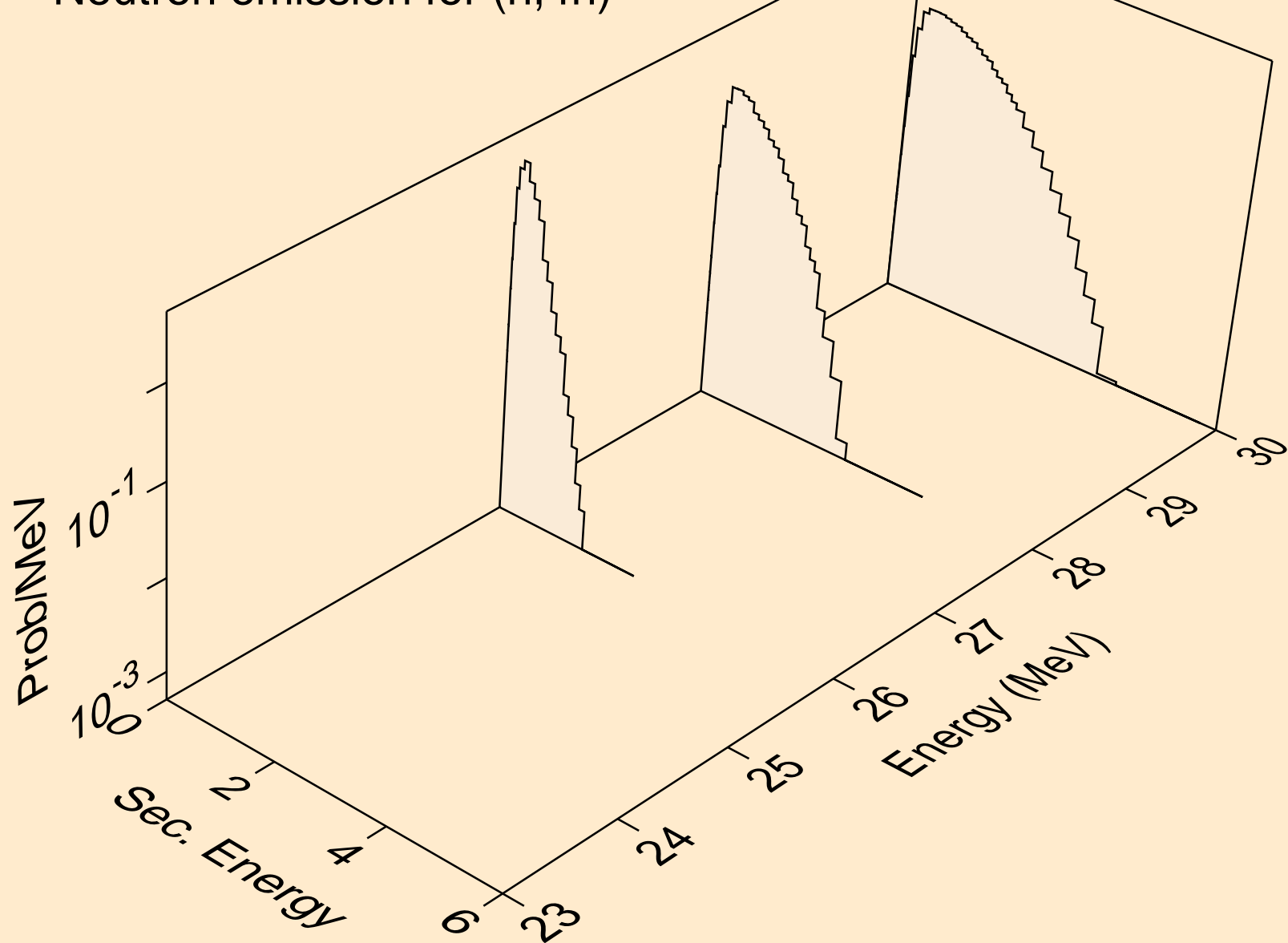

LR253M NEUTRON ACER TENDL-2024 LIBRARY; T=0.K
Neutron emission for (n,2np)

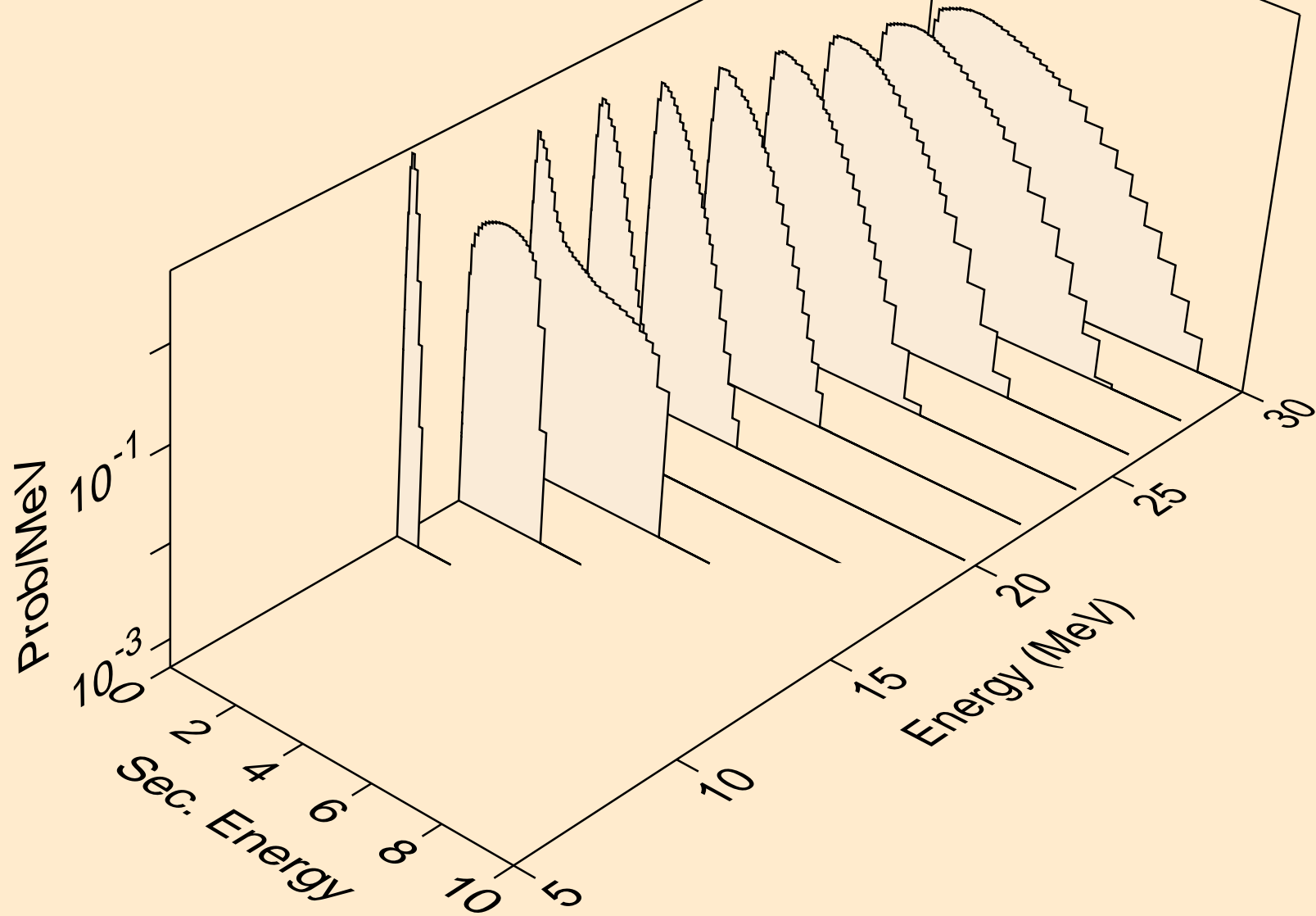

LR253M NEUTRON ACER TENDL-2024 LIBRARY; T=0.K
Neutron emission for (n,n2p)

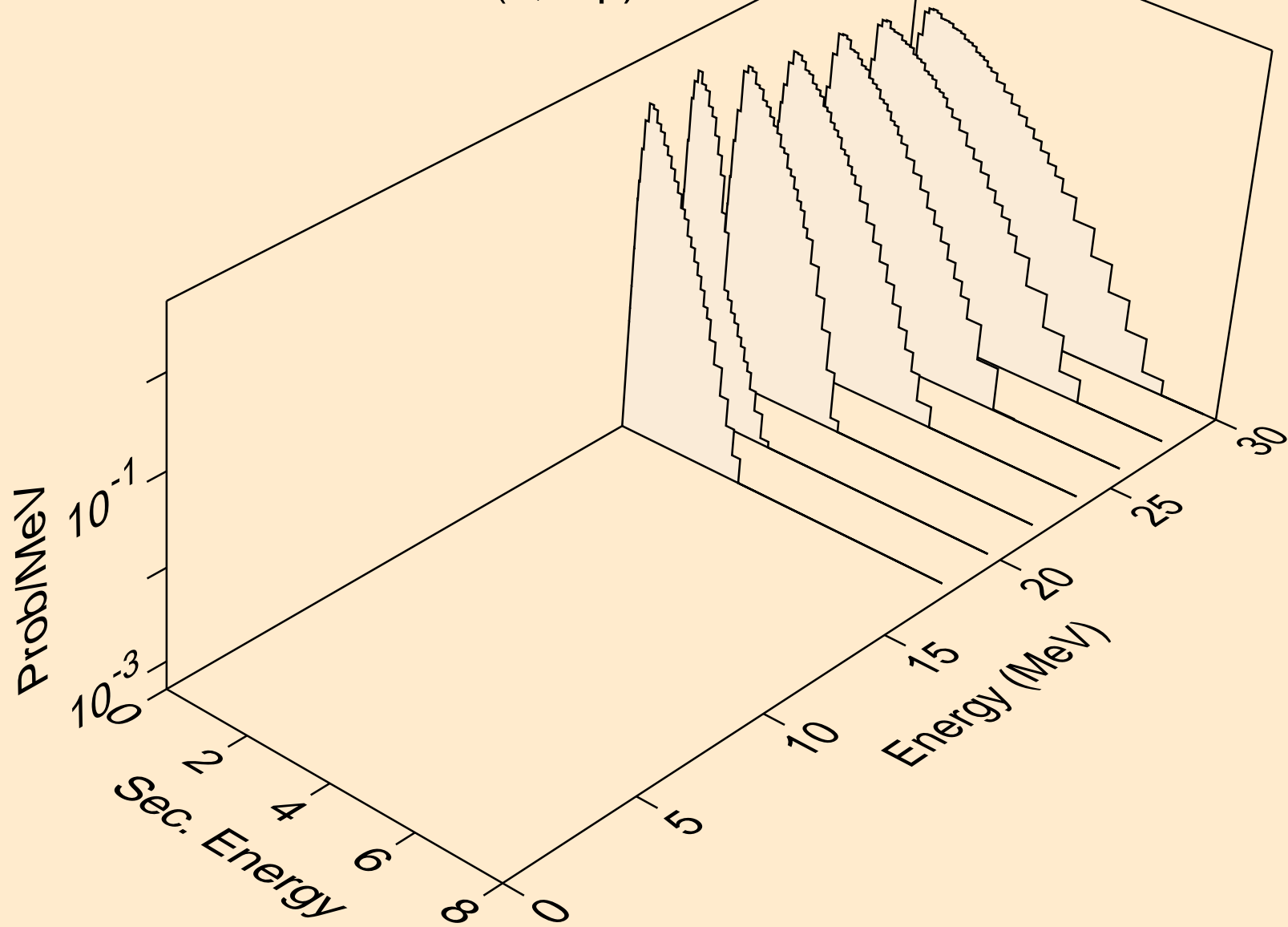

LR253M NEUTRON ACER TENDL-2024 LIBRARY; T=0.K
Neutron emission for (n,n*c)

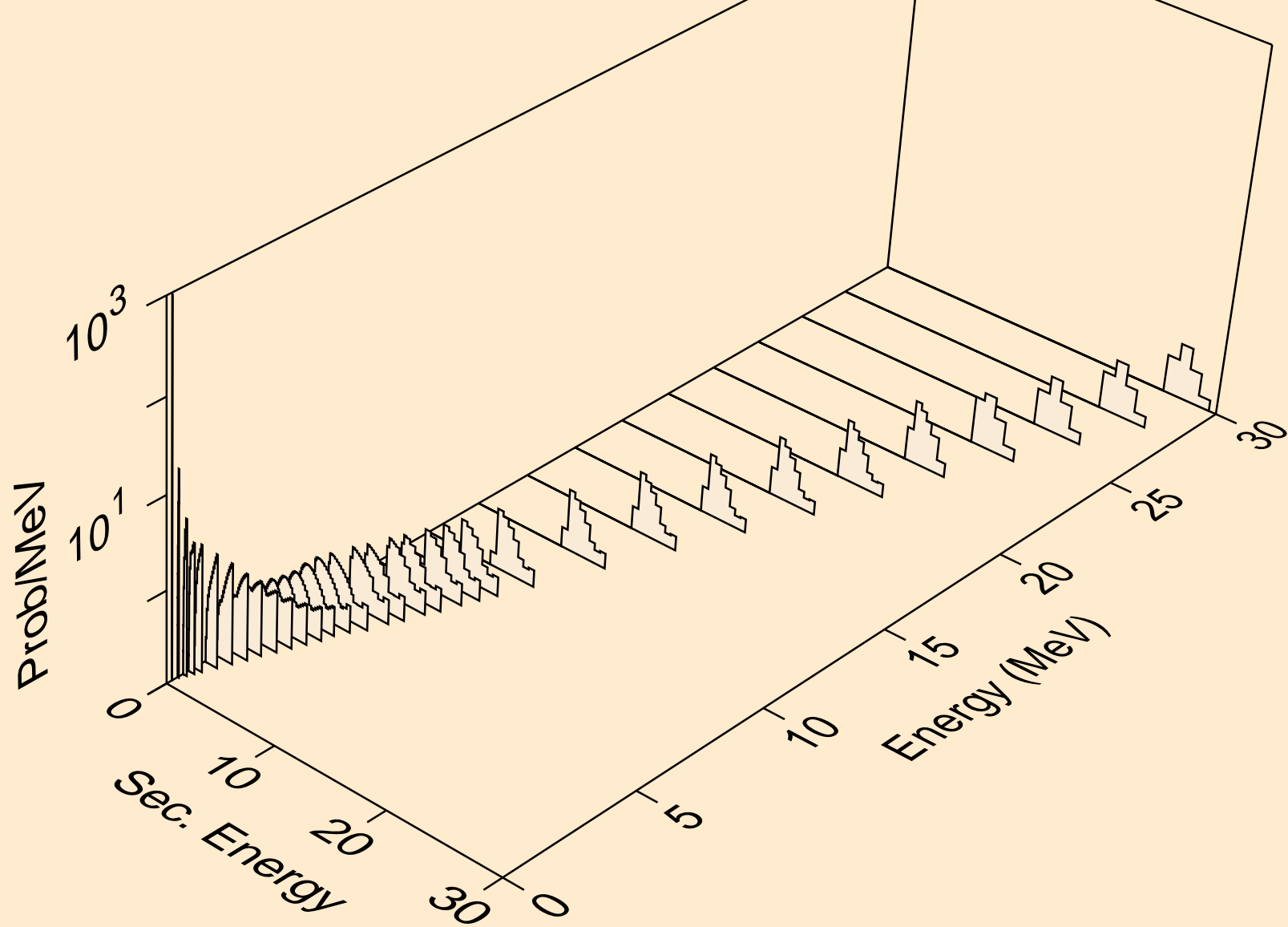

LR253M NEUTRON ACER TENDL-2024 LIBRARY; T=0.K

Delayed nubar

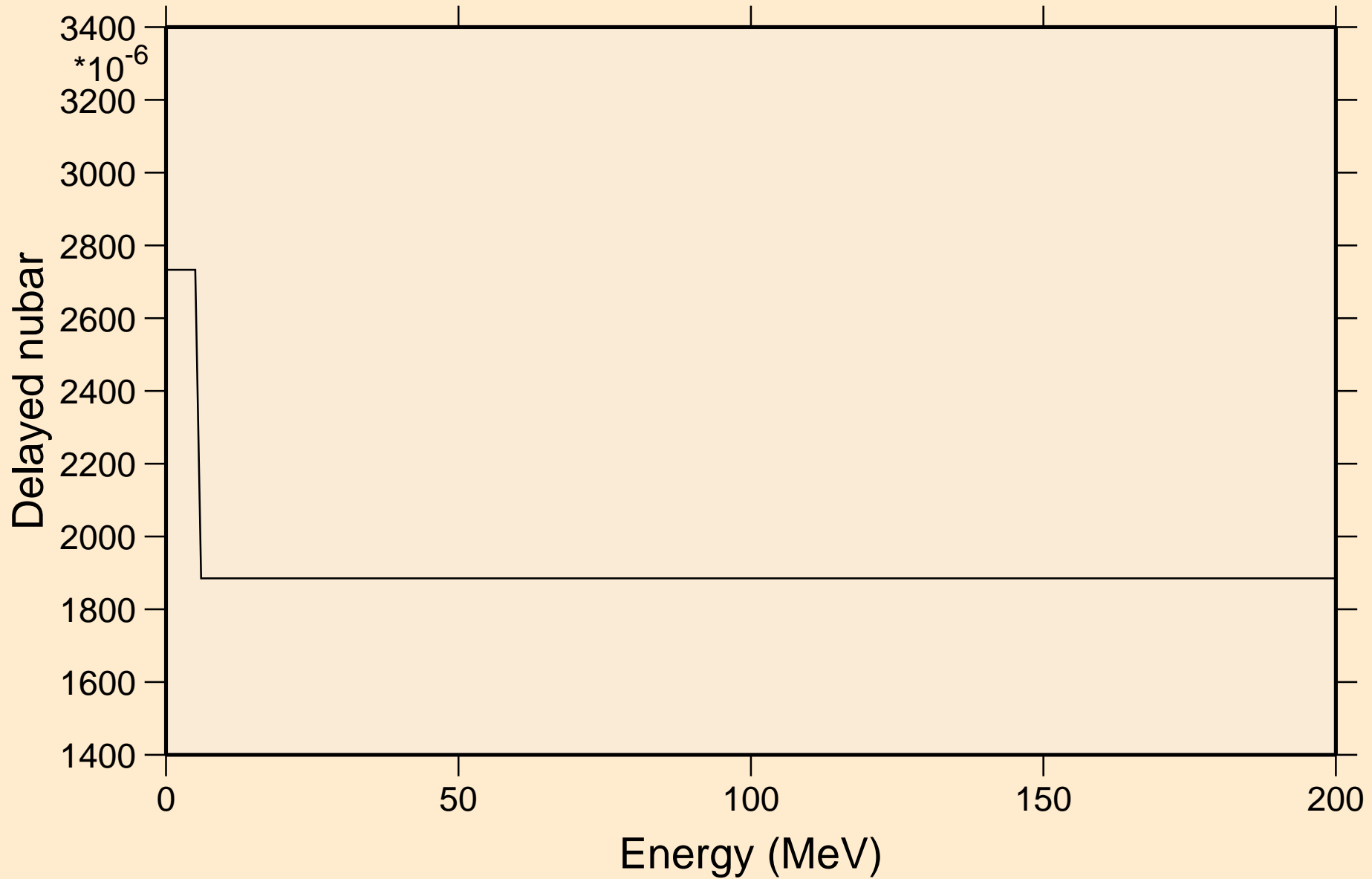

LR253M NEUTRON ACER TENDL-2024 LIBRARY; T=0.K

Delayed neutron spectra

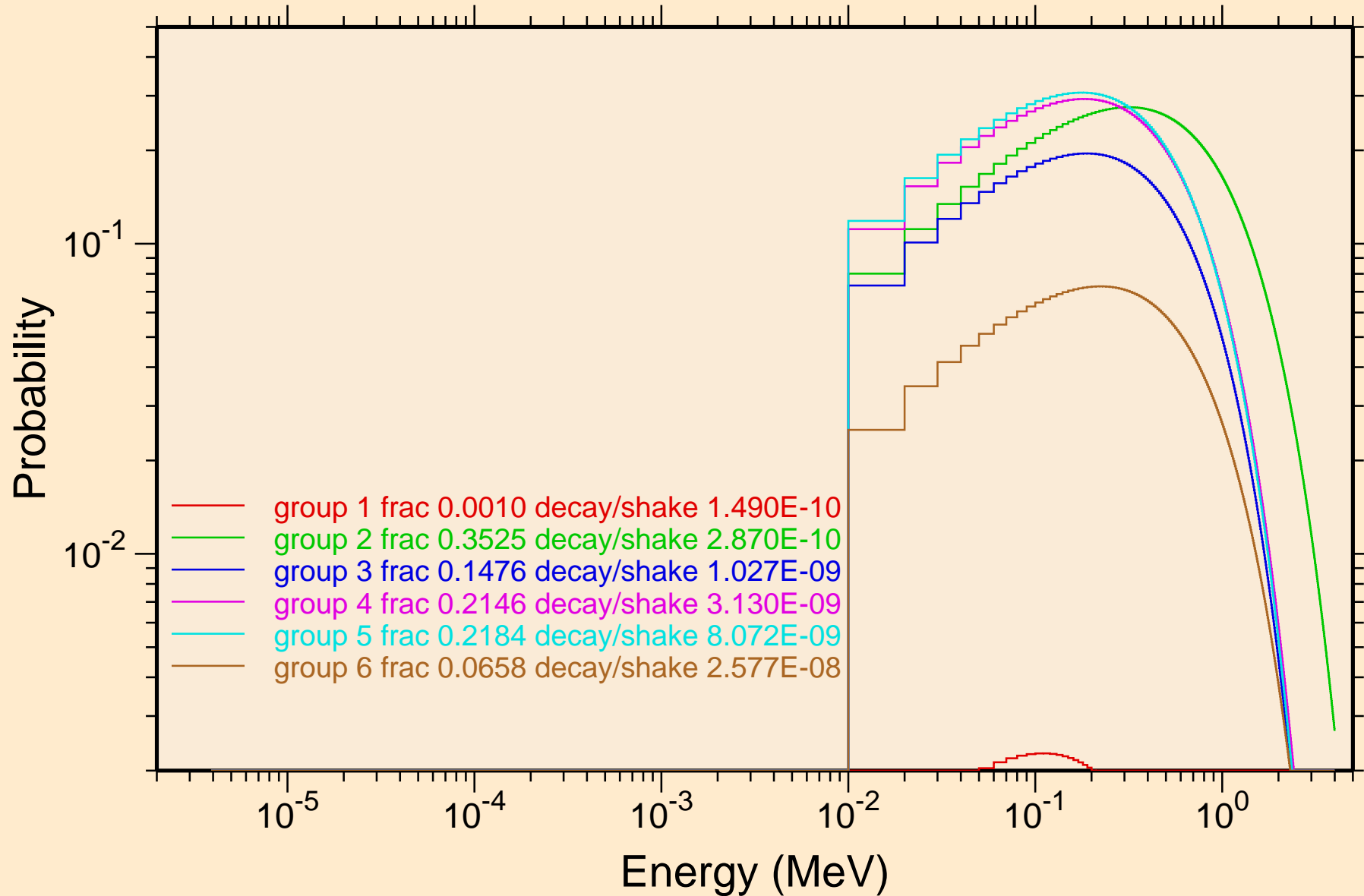

LR253M NEUTRON ACER TENDL-2024 LIBRARY; T=0.K
Photon emission for (n,x)

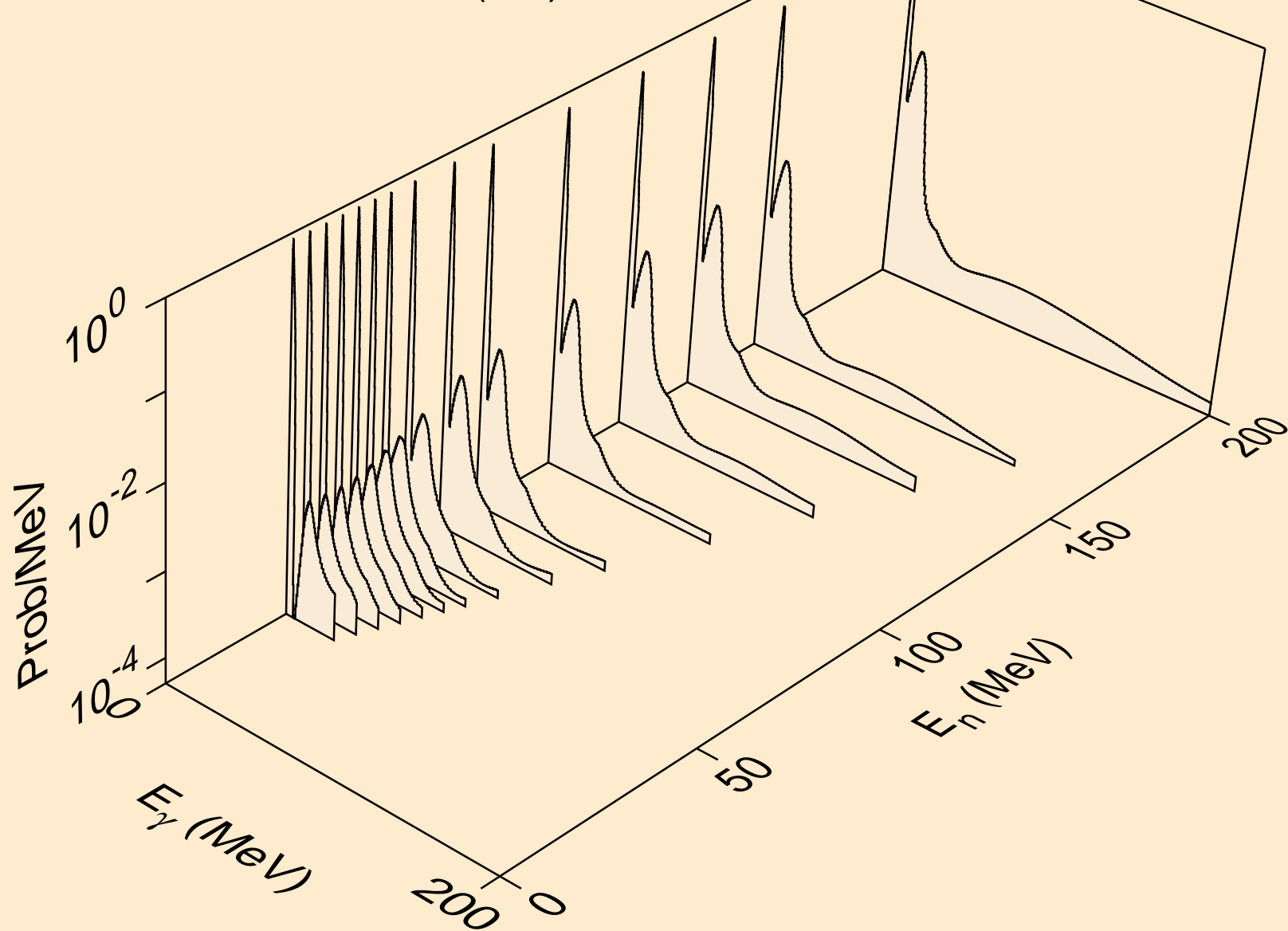

LR253M NEUTRON ACER TENDL-2024 LIBRARY; T=0.K
Photon emission for (n,2n)

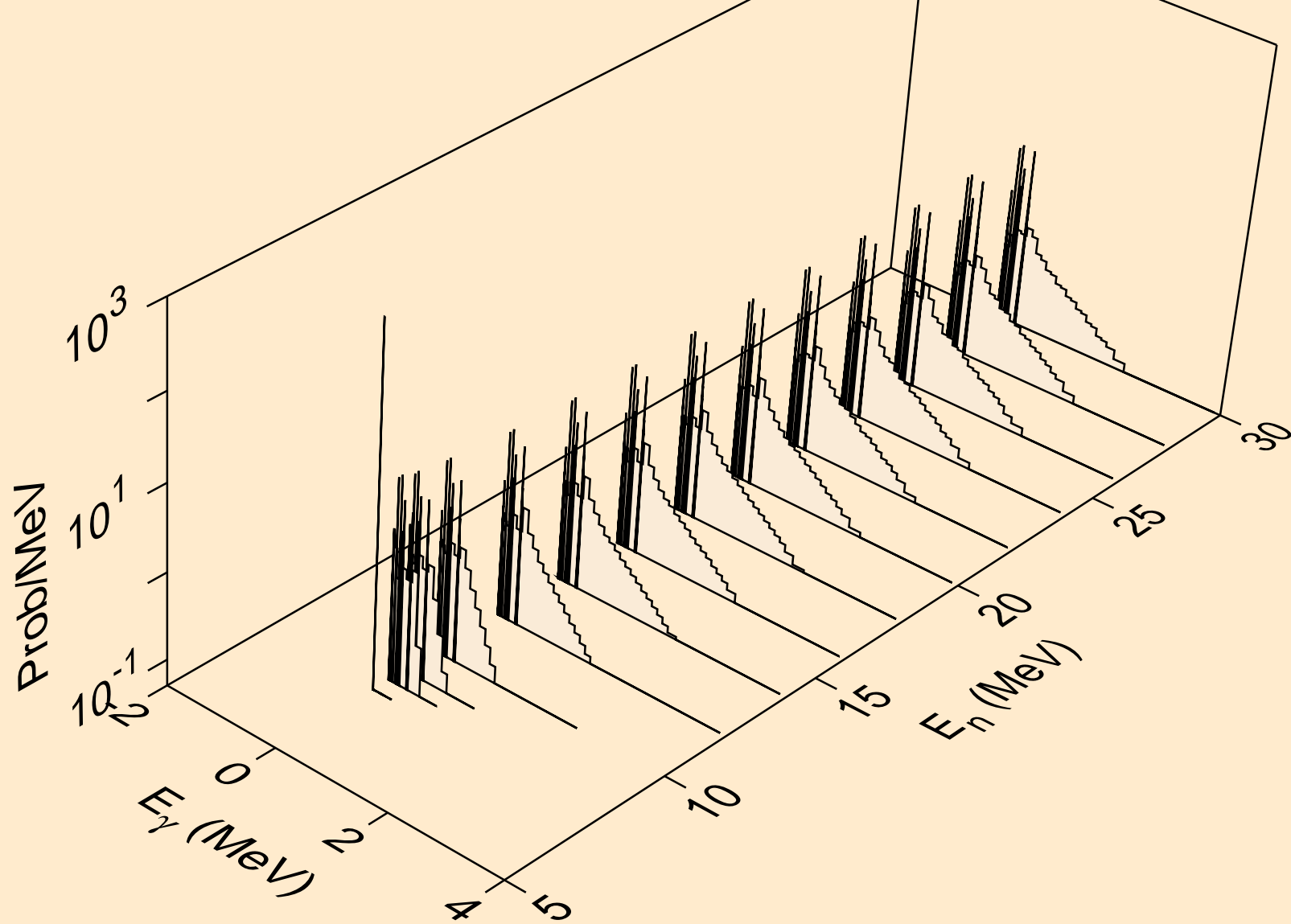

LR253M NEUTRON ACER TENDL-2024 LIBRARY; T=0.K
Photon emission for (n,3n)

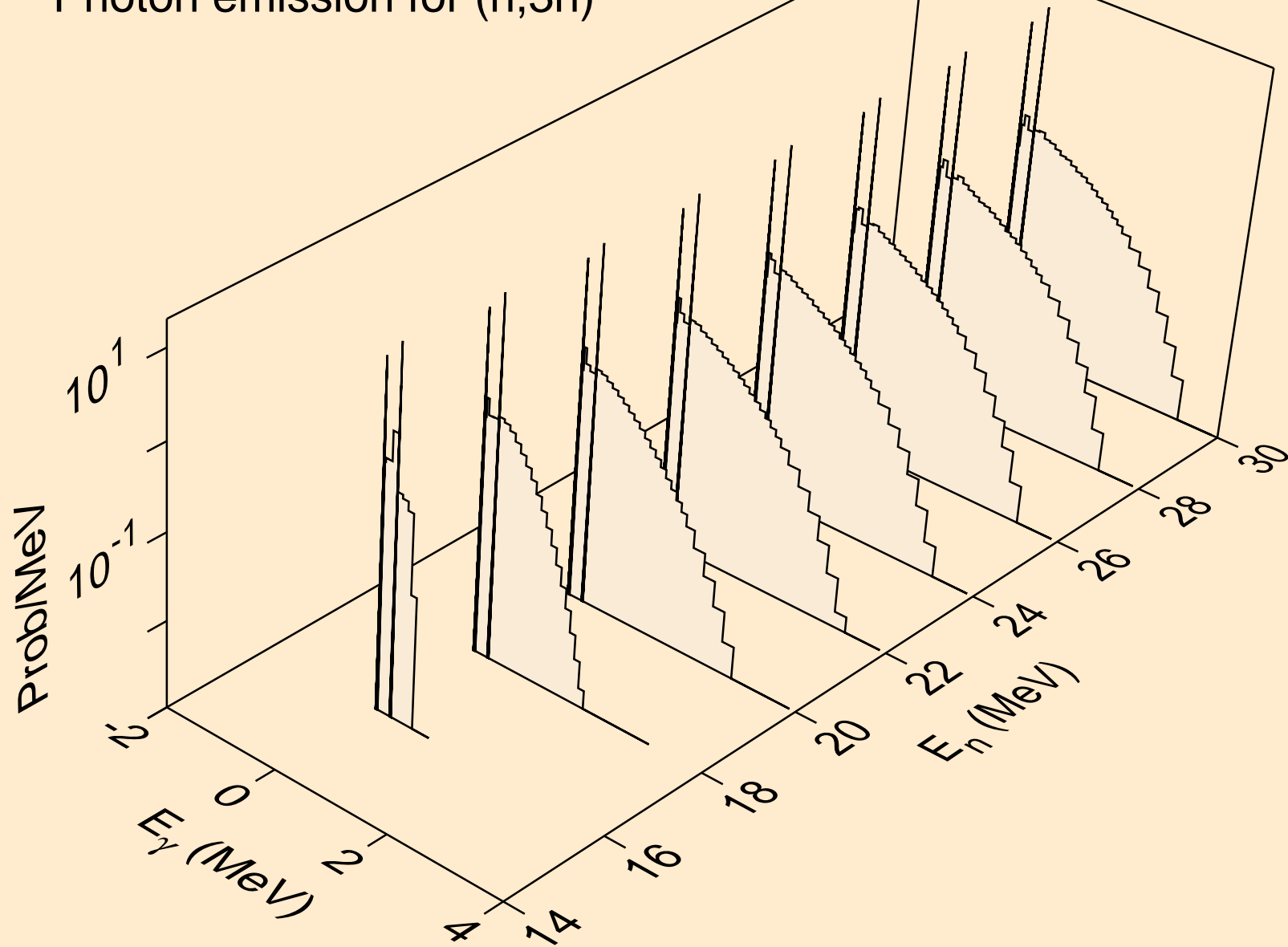

LR253M NEUTRON ACER TENDL-2024 LIBRARY; T=0.K
Photon emission for (n,n*)a

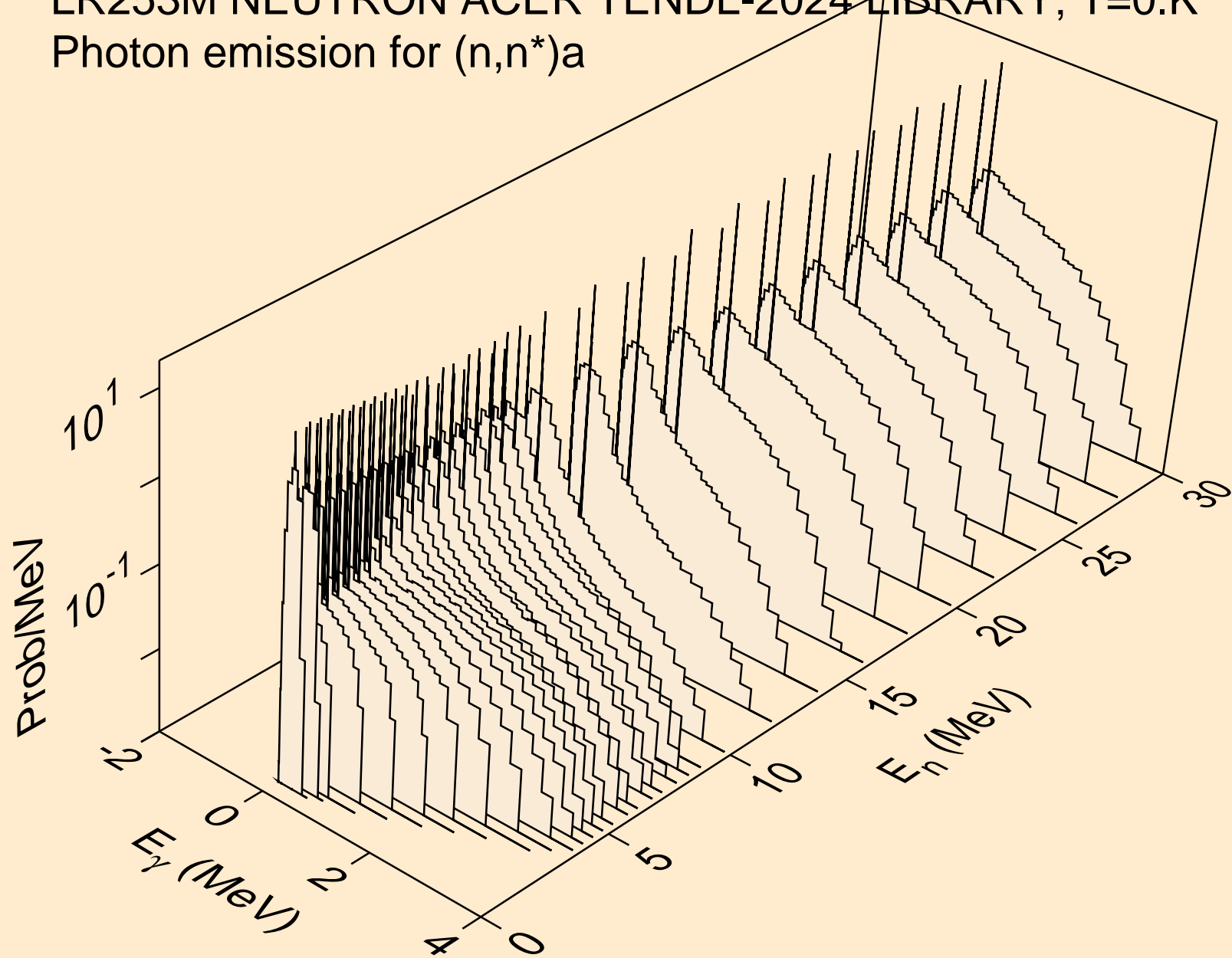

LR253M NEUTRON ACER TENDL-2024 LIBRARY; T=0.K
Photon emission for (n,2n)a

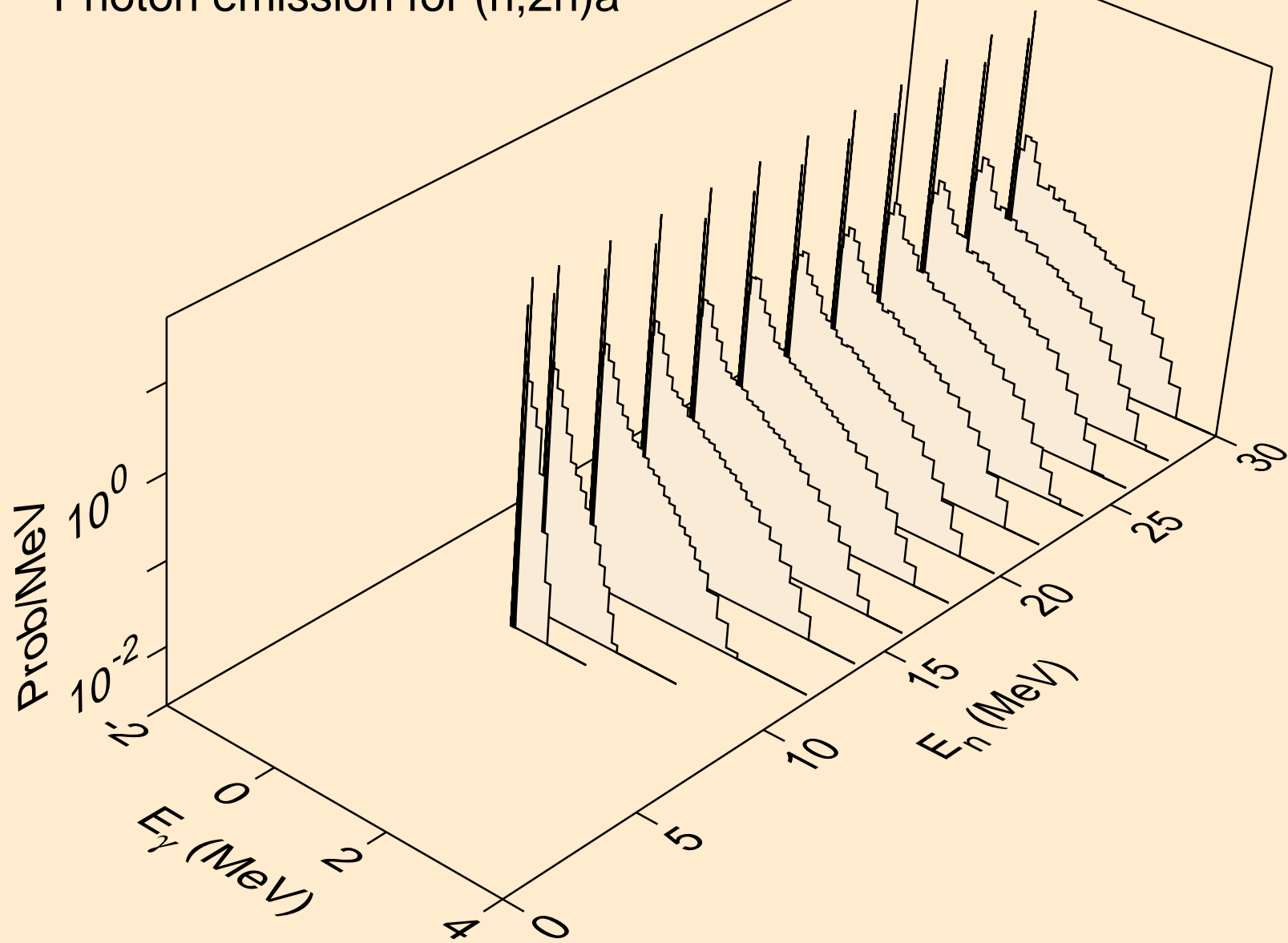

LR253M NEUTRON ACER TENDL-2024 LIBRARY; T=0.K
Photon emission for (n,3n)a

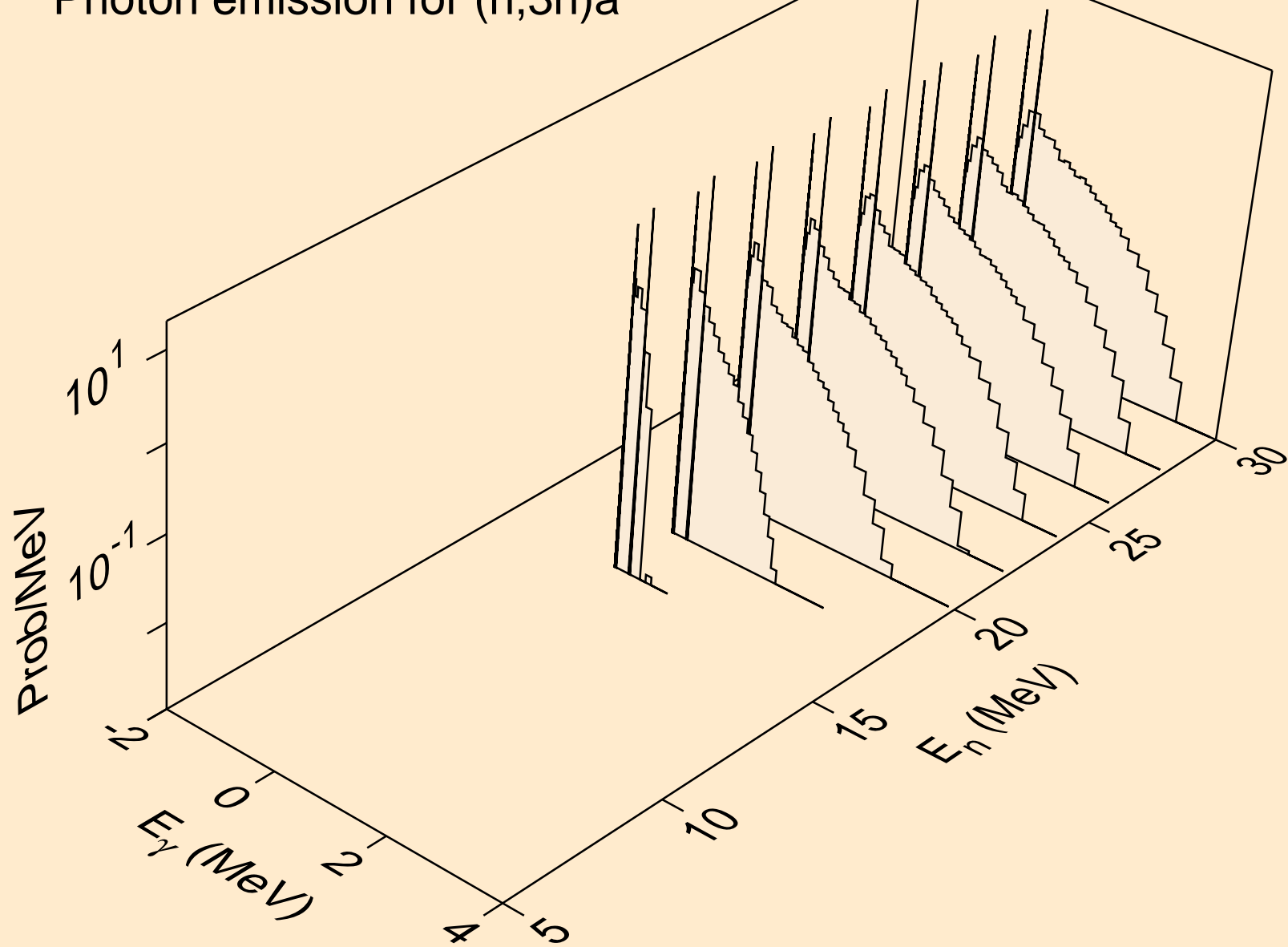

LR253M NEUTRON ACER TENDL-2024 LIBRARY; T=0.K
Photon emission for (n,n*)p

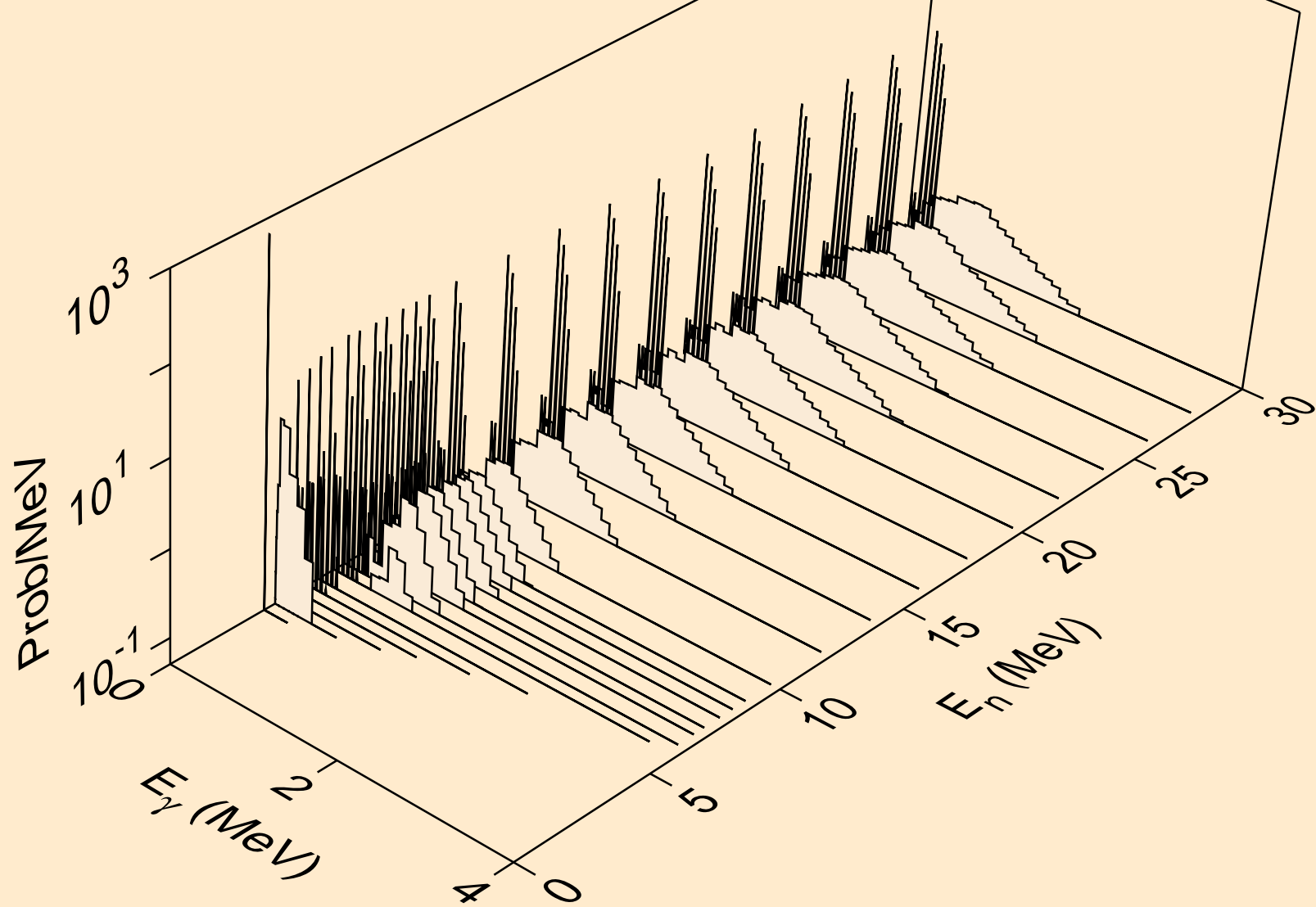

LR253M NEUTRON ACER TENDL-2024 LIBRARY; T=0.K
Photon emission for (n,n*)d

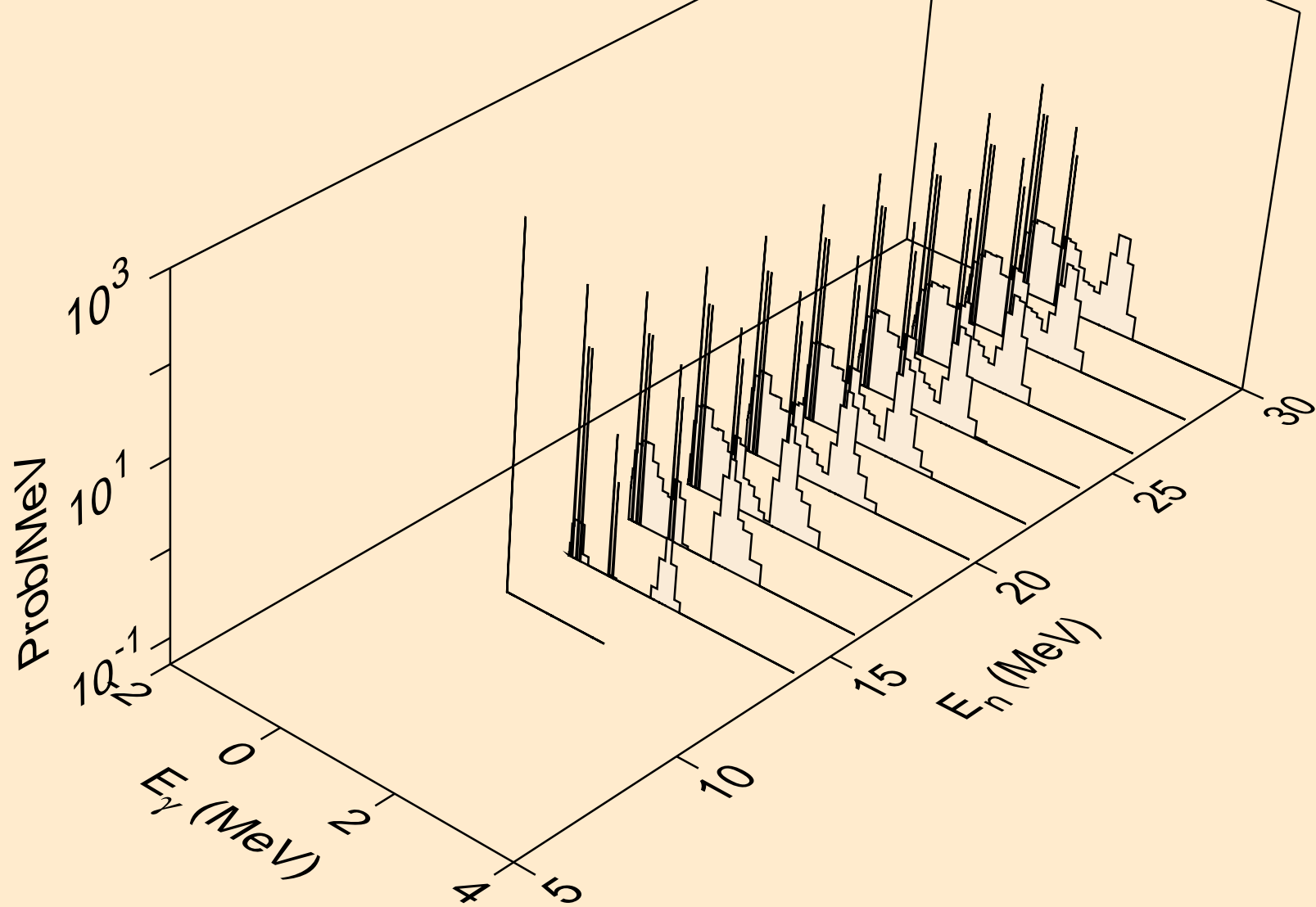

LR253M NEUTRON ACER TENDL-2024 LIBRARY; T=0.K
Photon emission for (n,n*)t

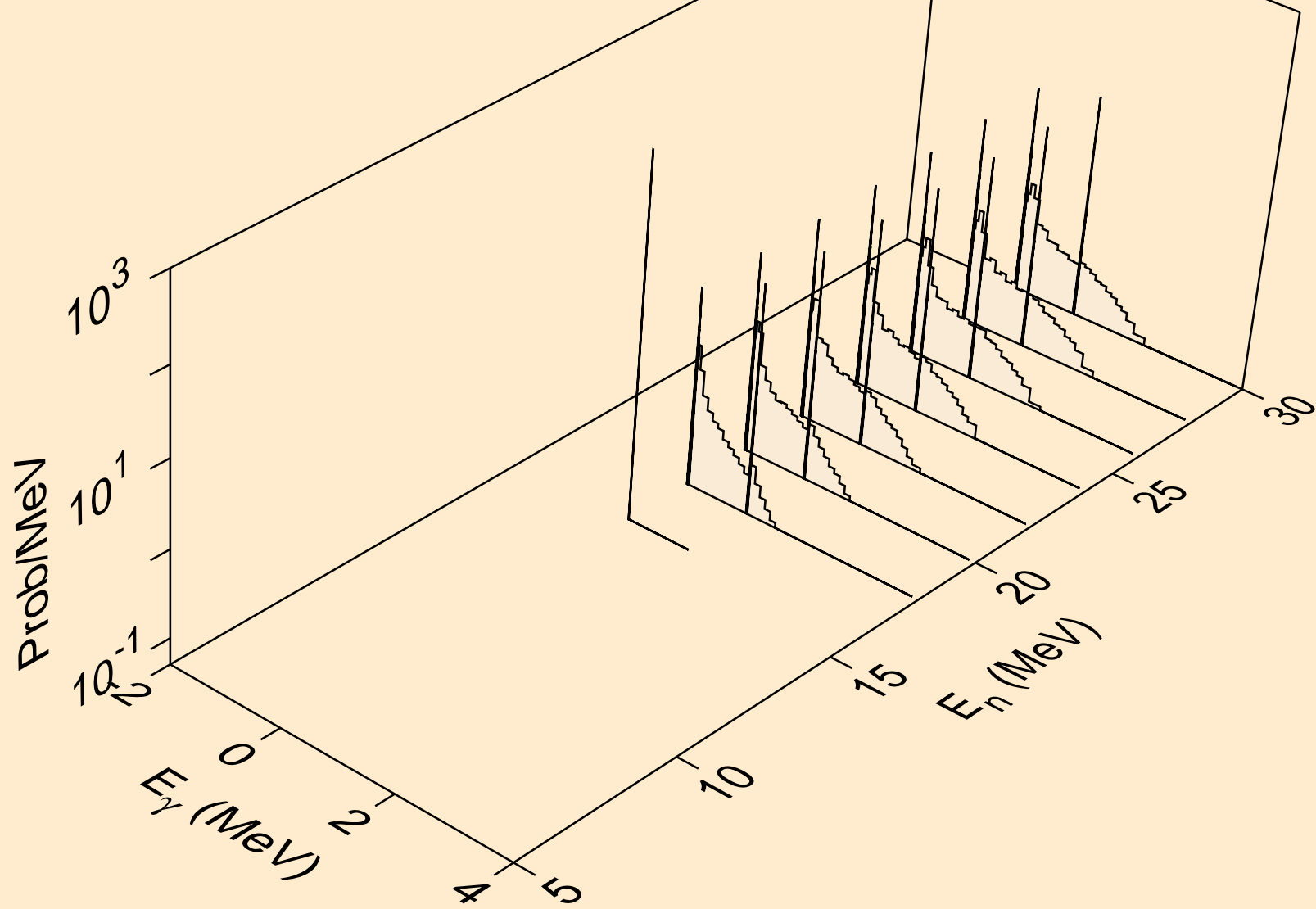

LR253M NEUTRON ACER TENDL-2024 LIBRARY; T=0.K
Photon emission for (n,n*)he3

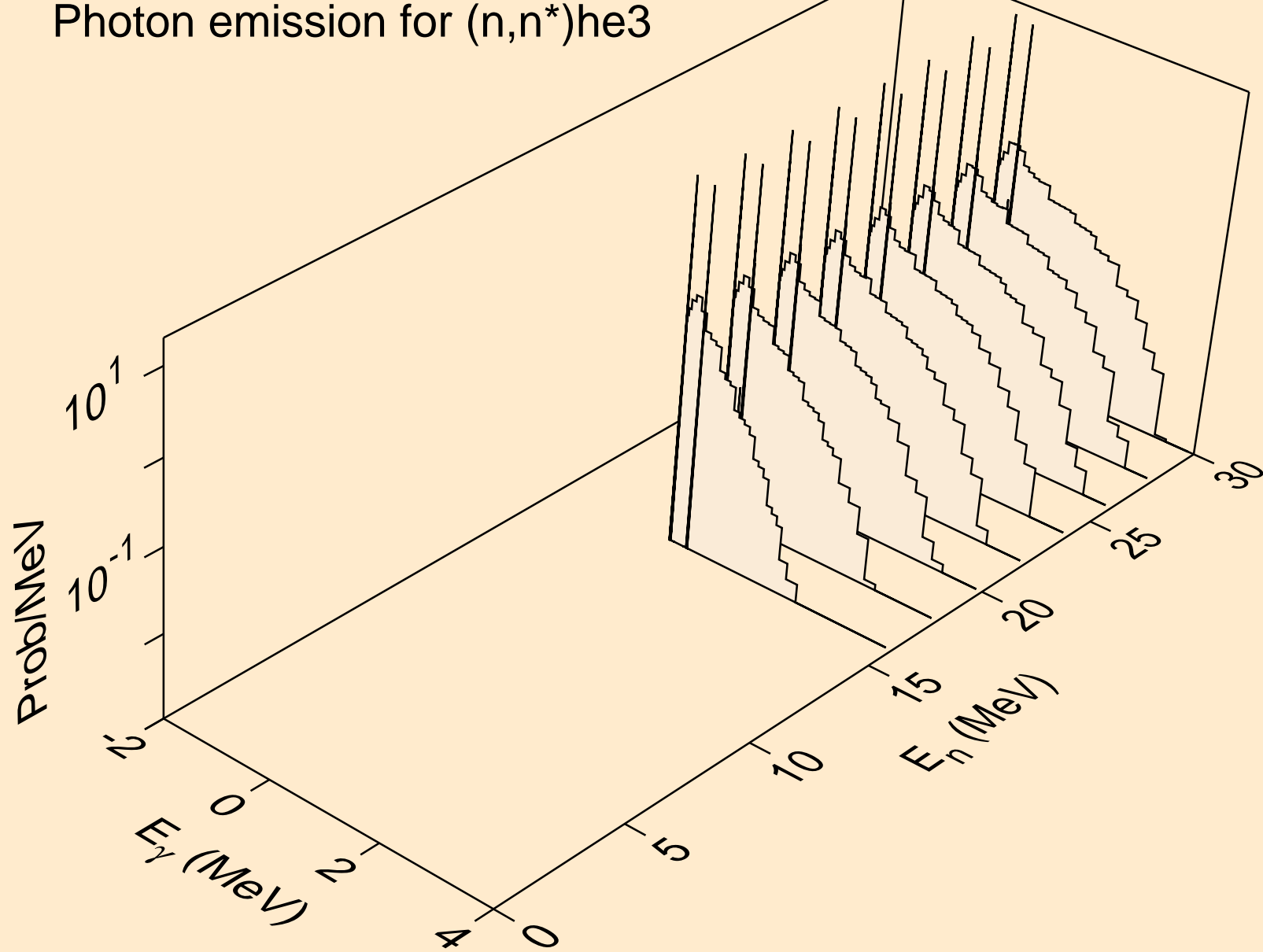

LR253M NEUTRON ACER TENDL-2024 LIBRARY; T=0.K
Photon emission for (n,4n)

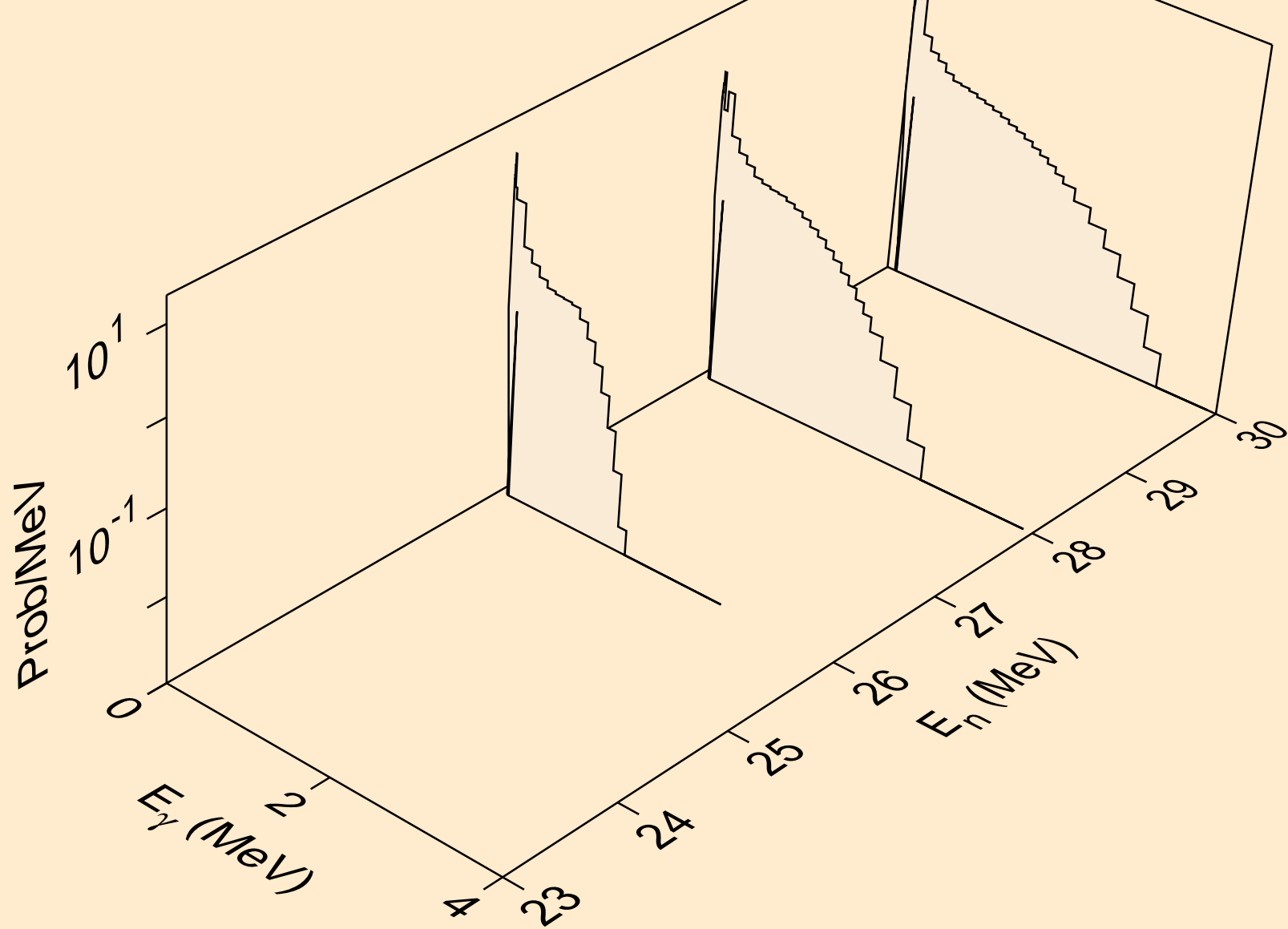

LR253M NEUTRON ACER TENDL-2024 LIBRARY; T=0.K
Photon emission for (n,2np)

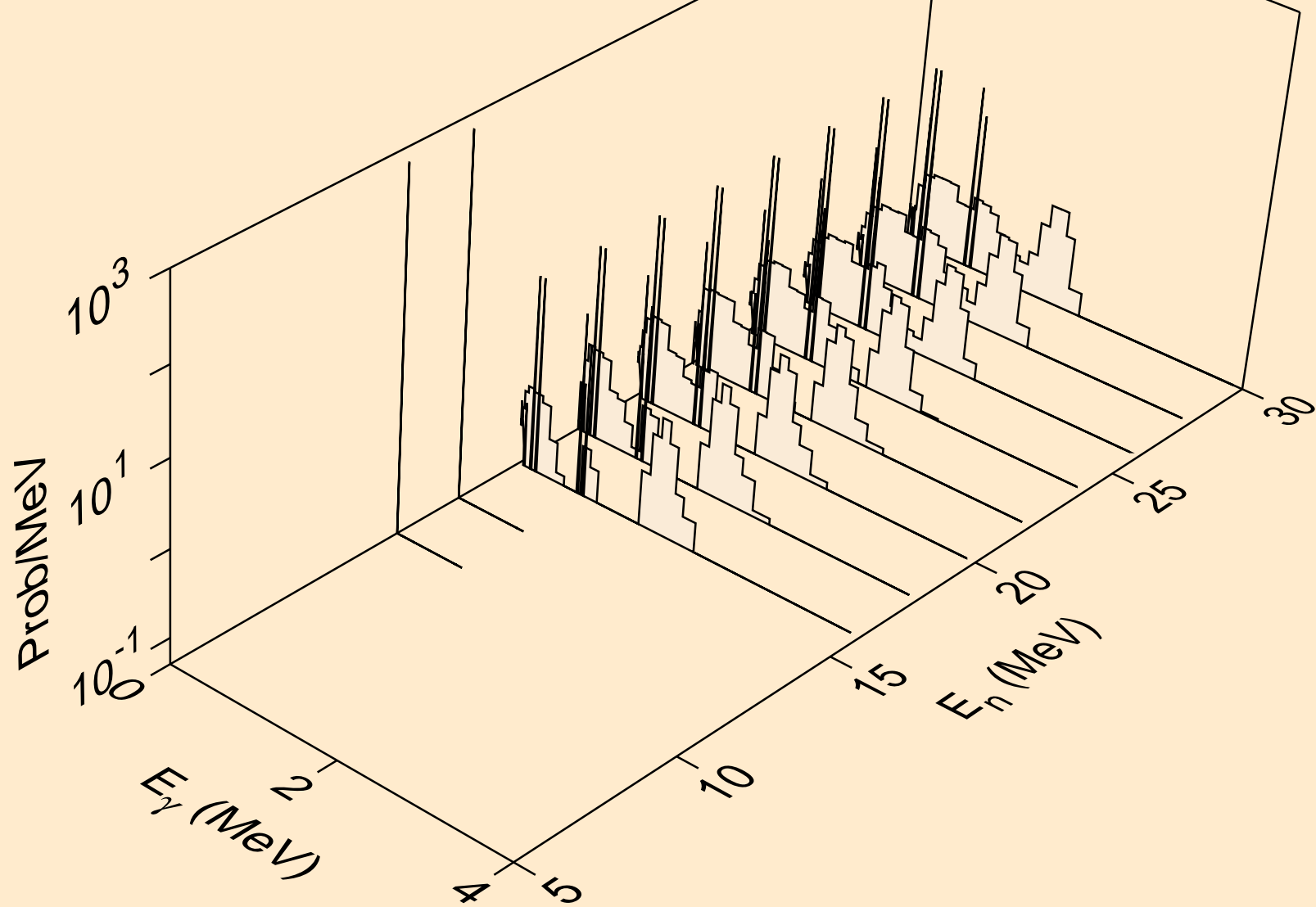

LR253M NEUTRON ACER TENDL-2024 LIBRARY; T=0.K
Photon emission for (n,n2p)

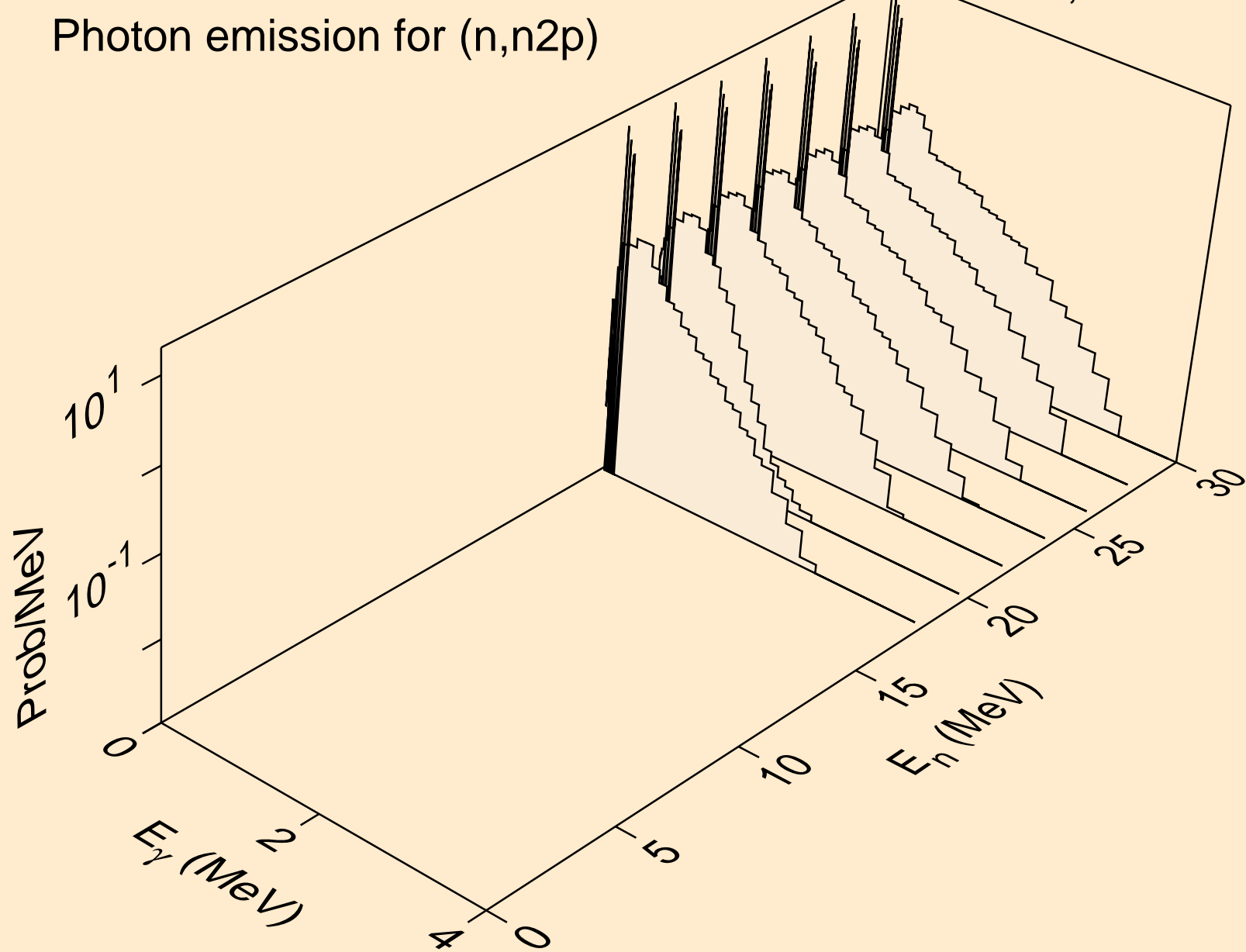

LR253M NEUTRON ACER TENDL-2024 LIBRARY; T=0.K
Photon emission for (n,n*1)

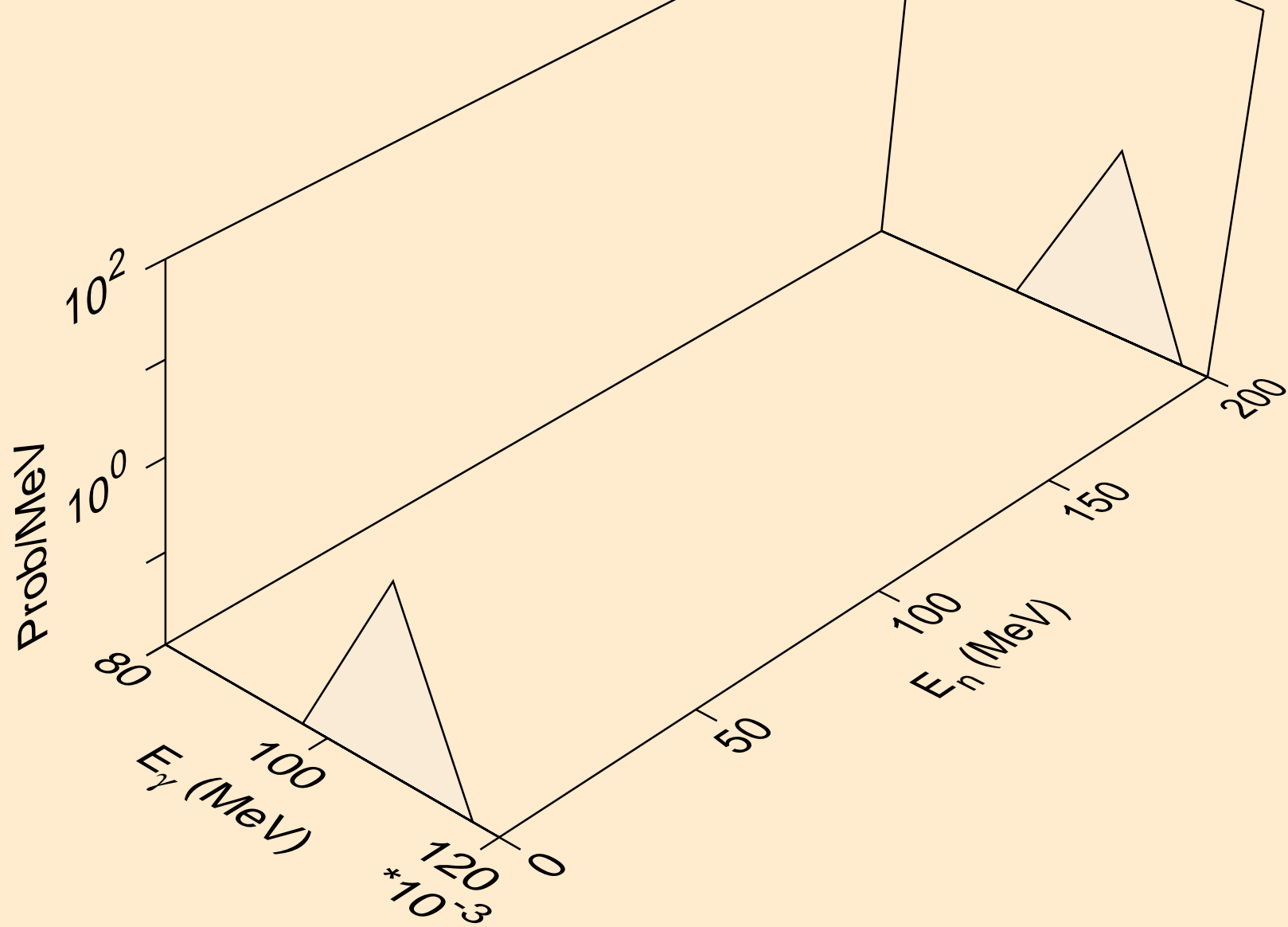

LR253M NEUTRON ACER TENDL-2024 LIBRARY; T=0.K
Photon emission for (n,n*c)

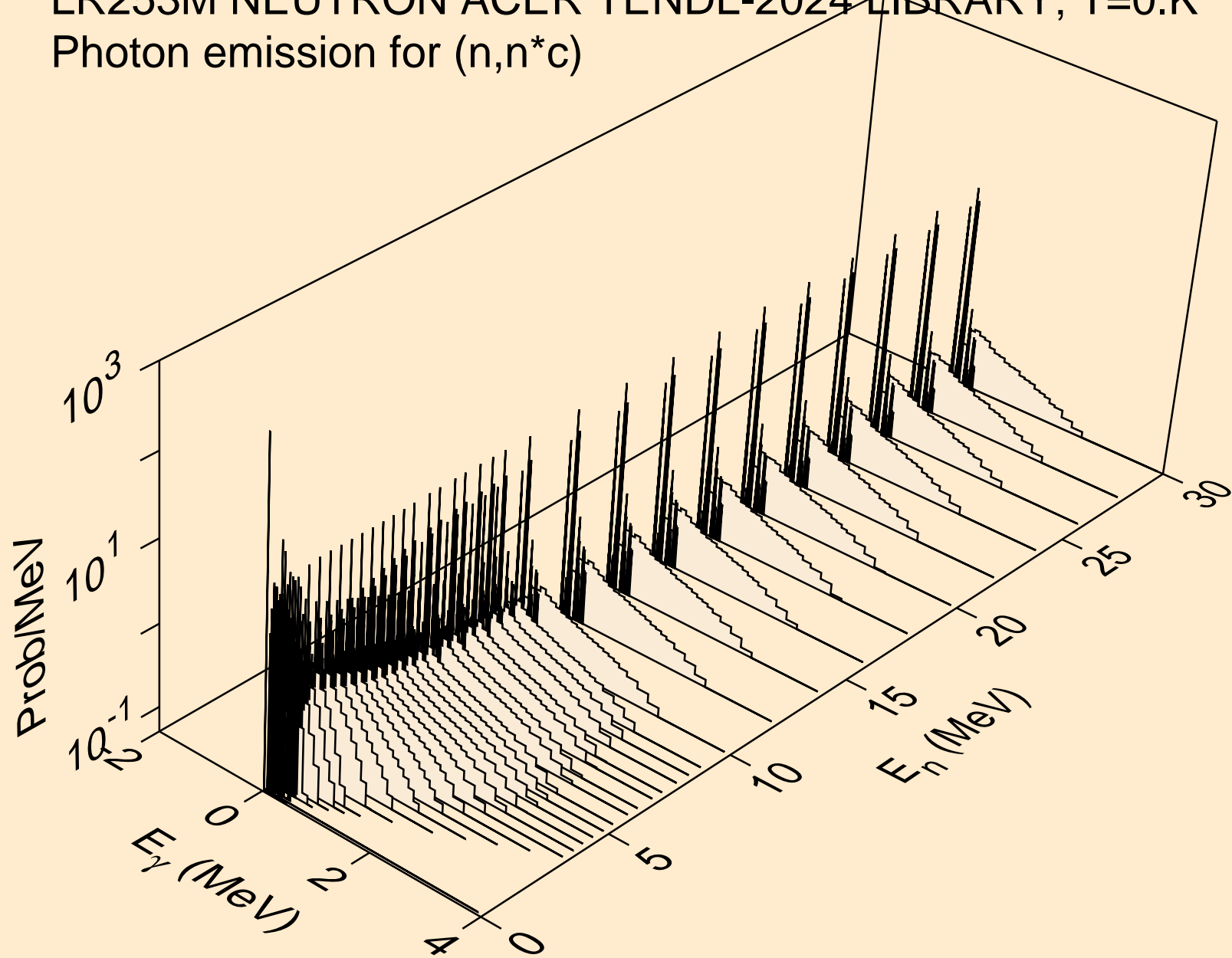

LR253M NEUTRON ACER TENDL-2024 LIBRARY; T=0.K
Photon emission for (n,gma)

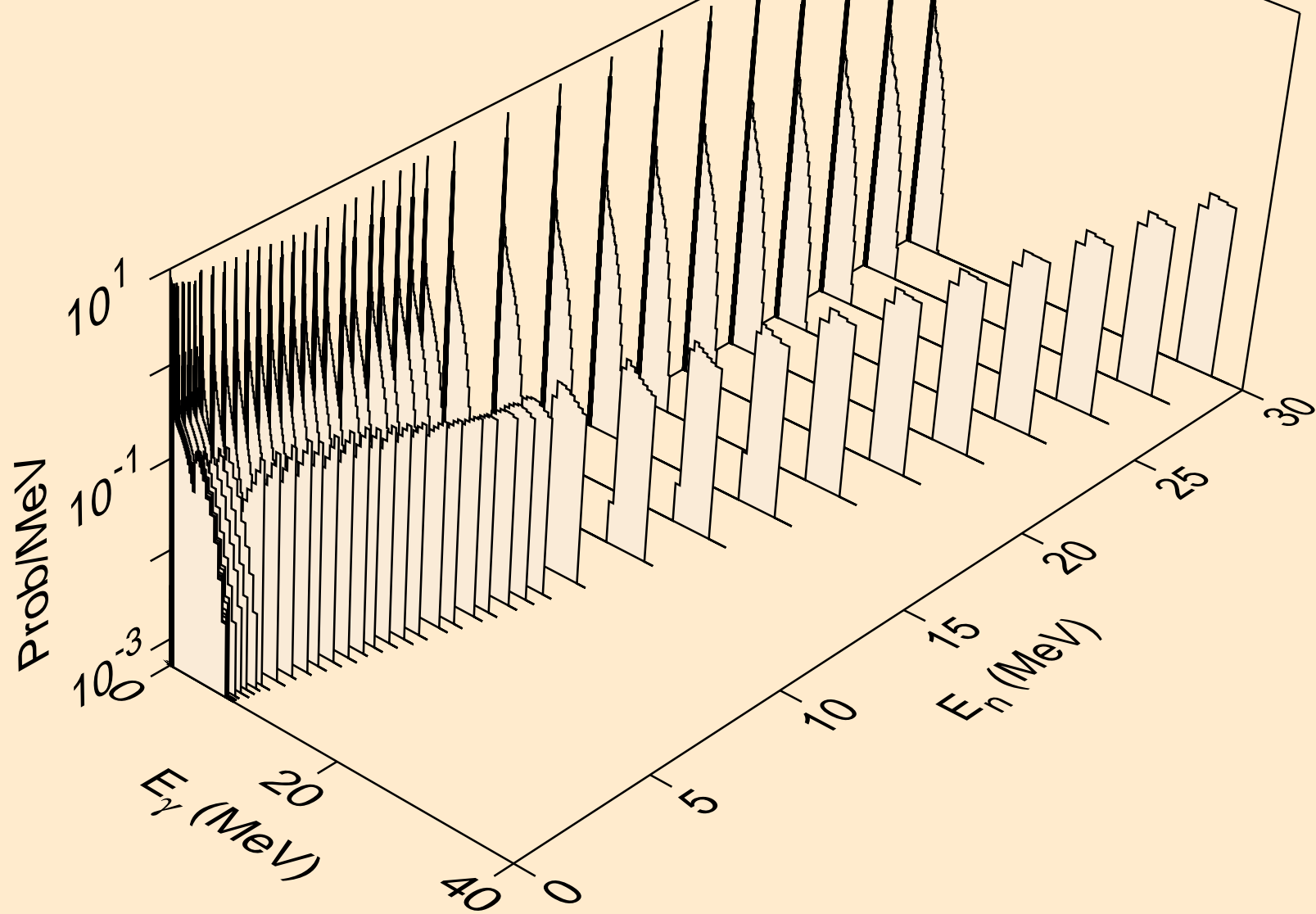

LR253M NEUTRON ACER TENDL-2024 LIBRARY; T=0.K
Photon emission for (n,p)

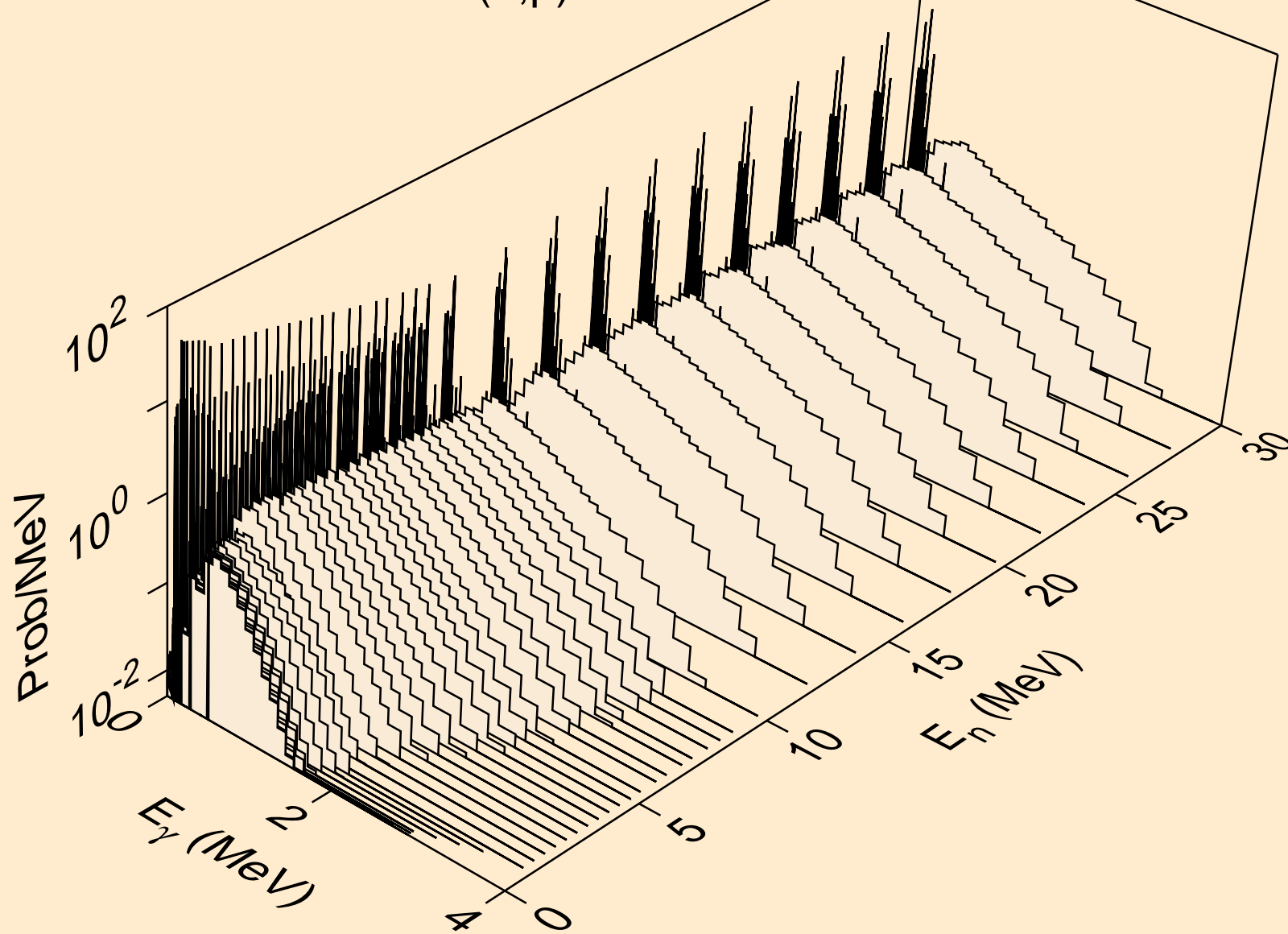

LR253M NEUTRON ACER TENDL-2024 LIBRARY; T=0.K
Photon emission for (n,d)

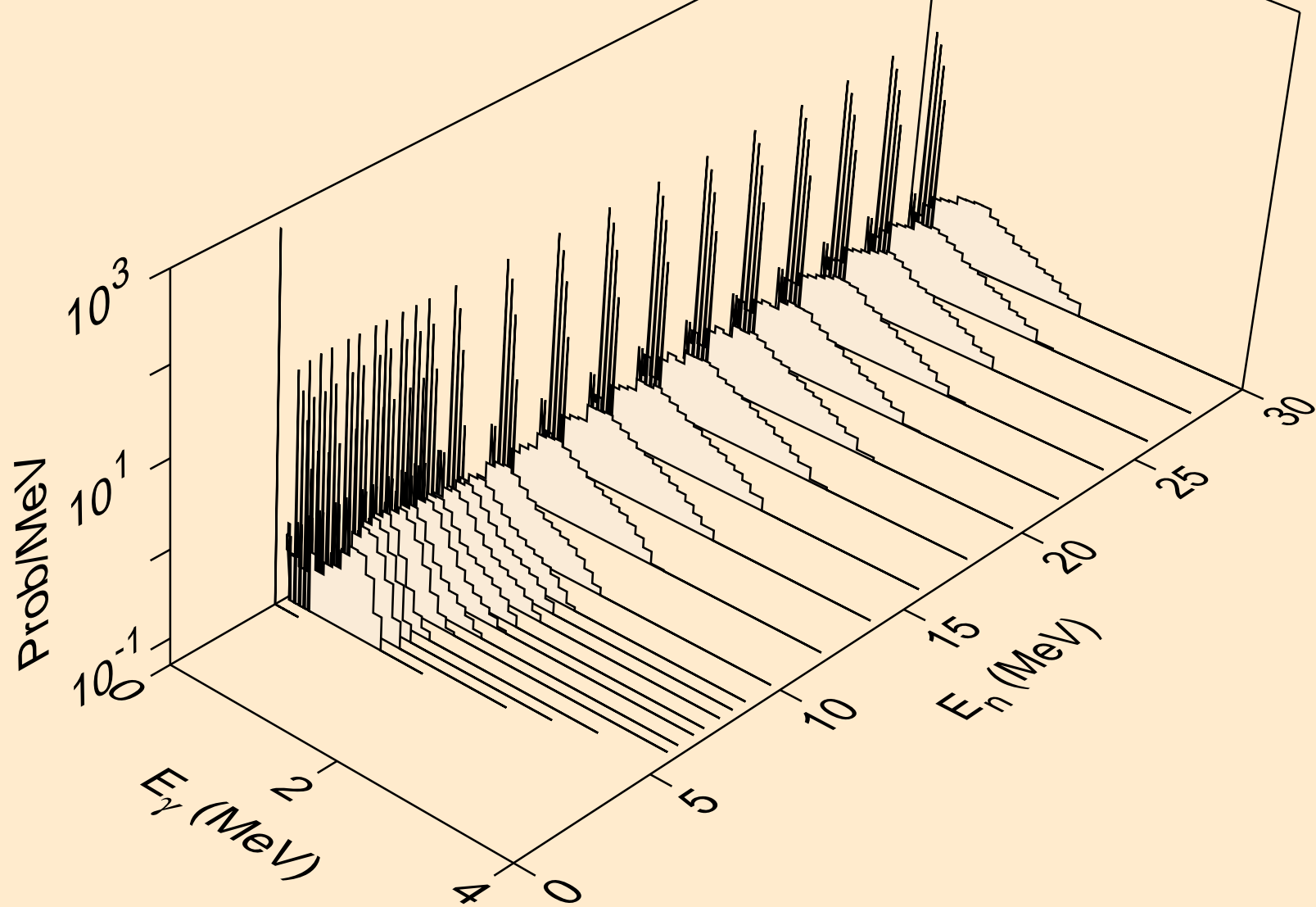

LR253M NEUTRON ACER TENDL-2024 LIBRARY; T=0.K
Photon emission for (n,t)

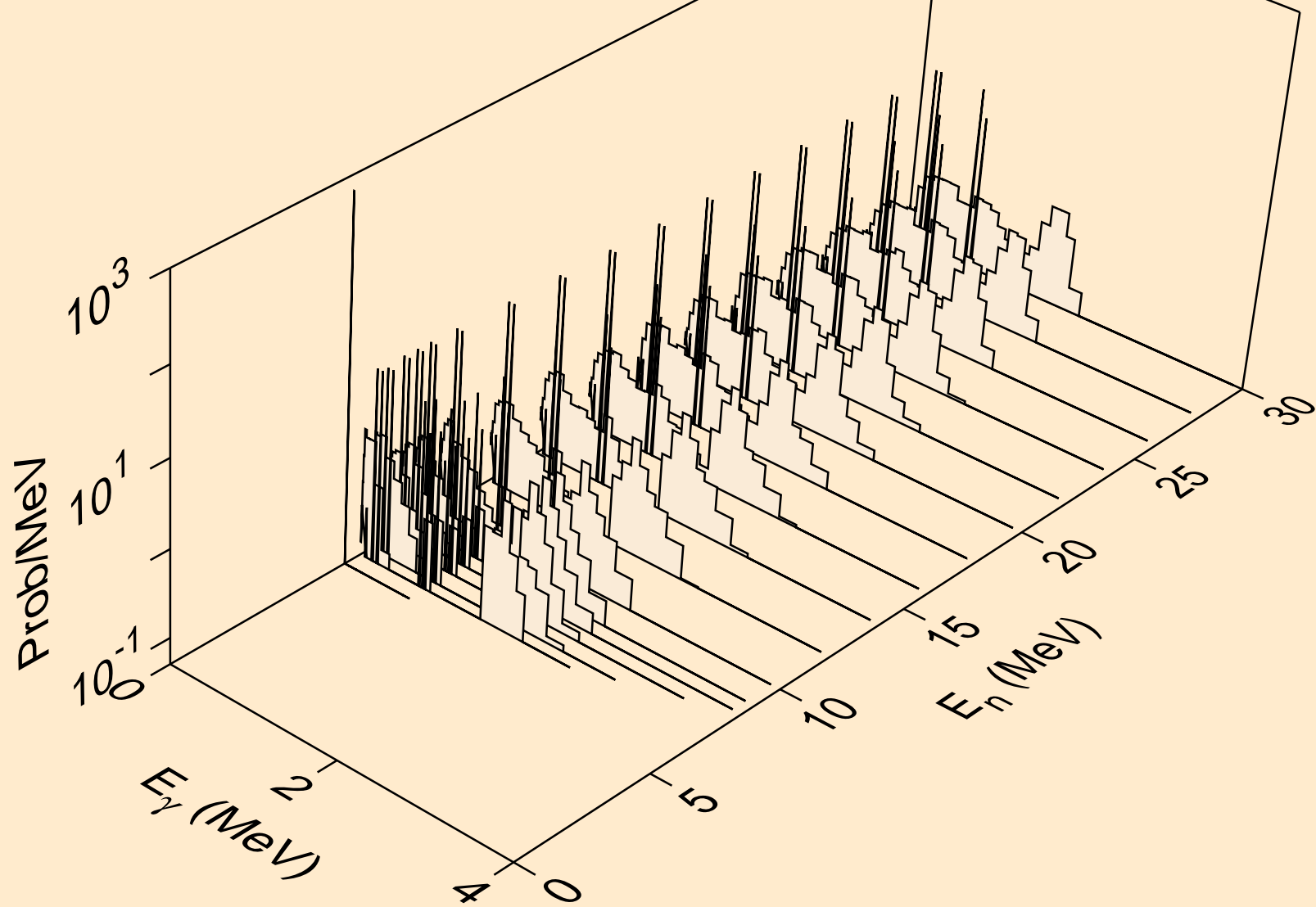

LR253M NEUTRON ACER TENDL-2024 LIBRARY; T=0.K
Photon emission for (n,he3)

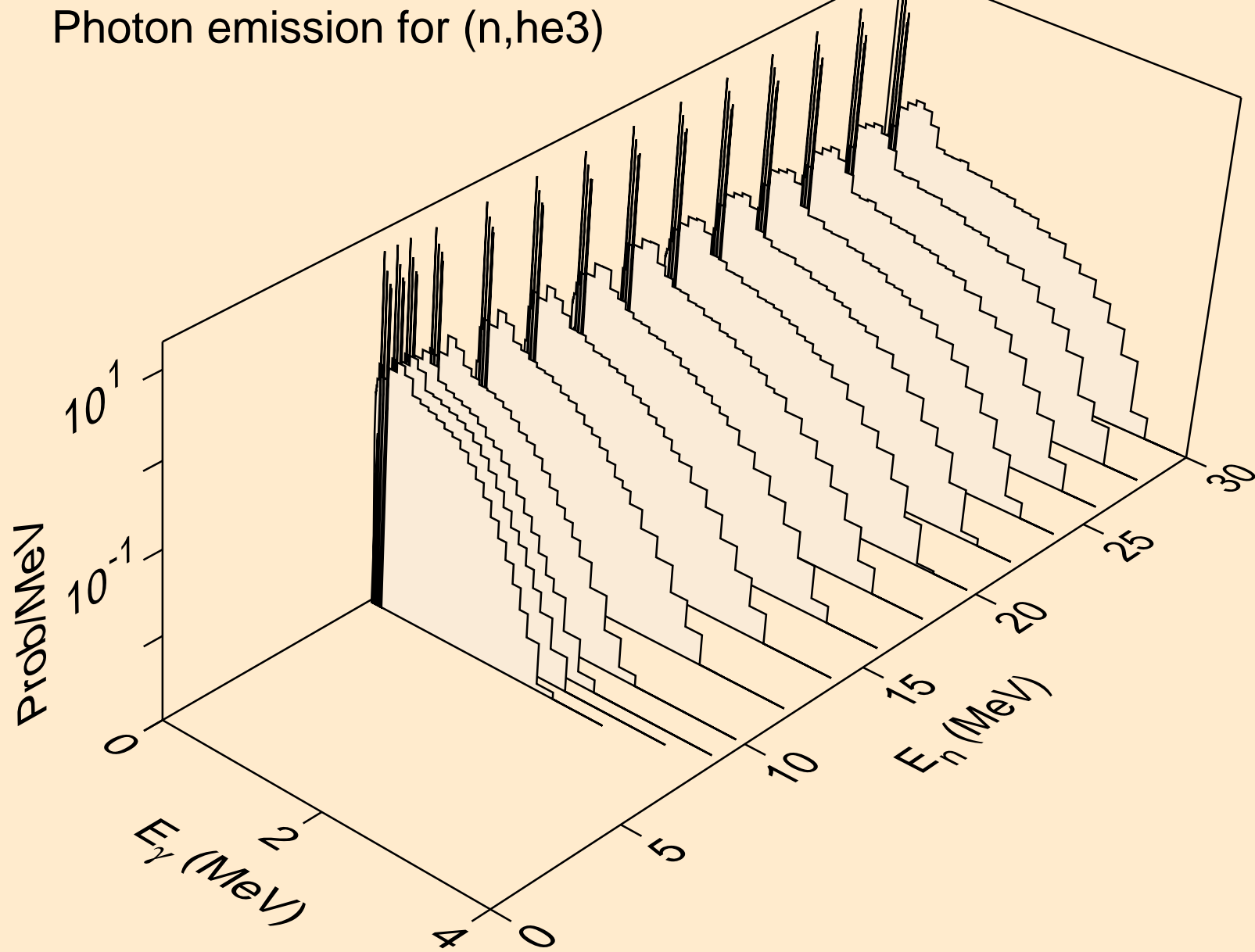

LR253M NEUTRON ACER TENDL-2024 LIBRARY; T=0.K
Photon emission for (n,a)

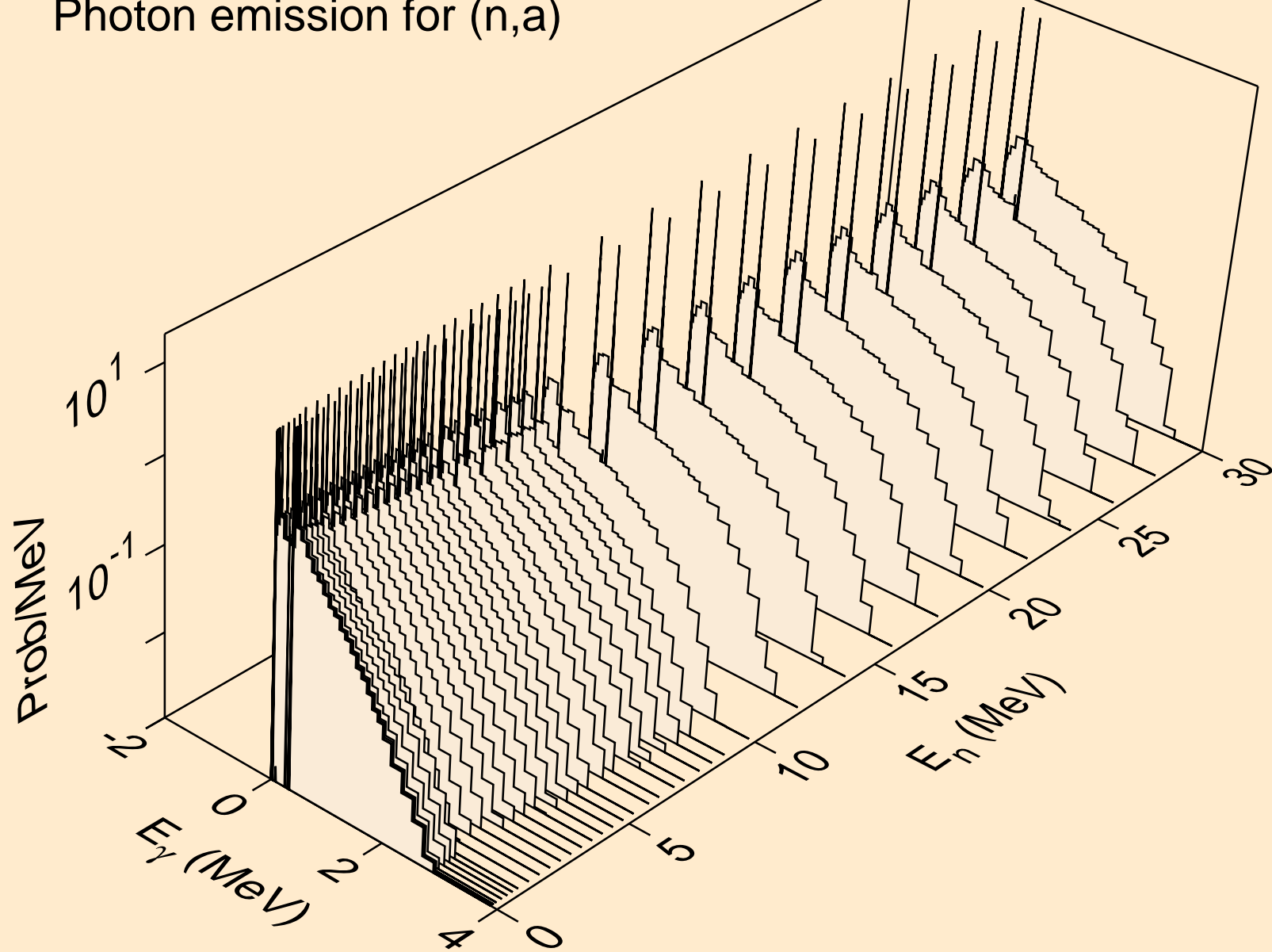

LR253M NEUTRON ACER TENDL-2024 LIBRARY; T=0.K
Photon emission for (n,2a)

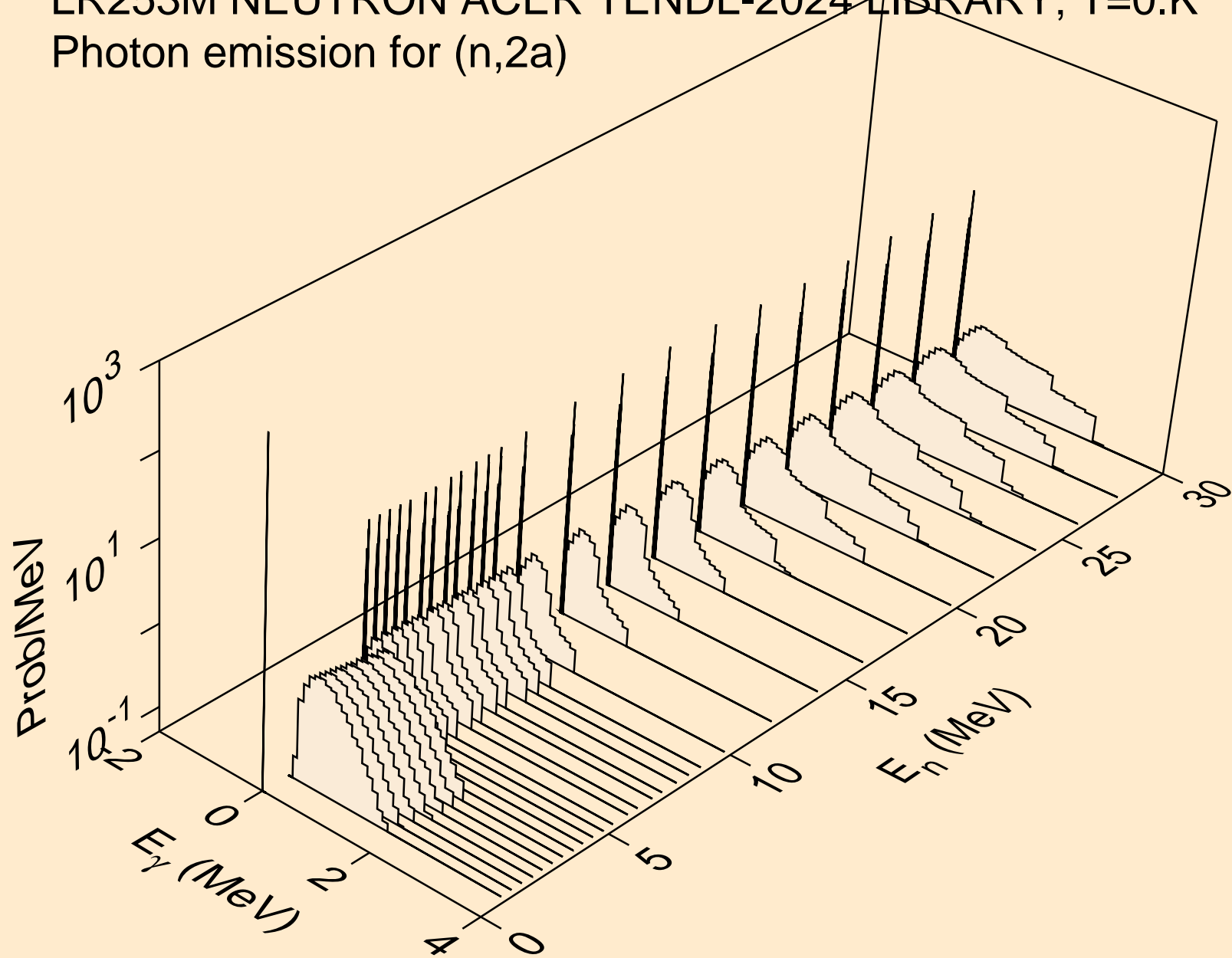

LR253M NEUTRON ACER TENDL-2024 LIBRARY; T=0.K
Photon emission for (n,2p)

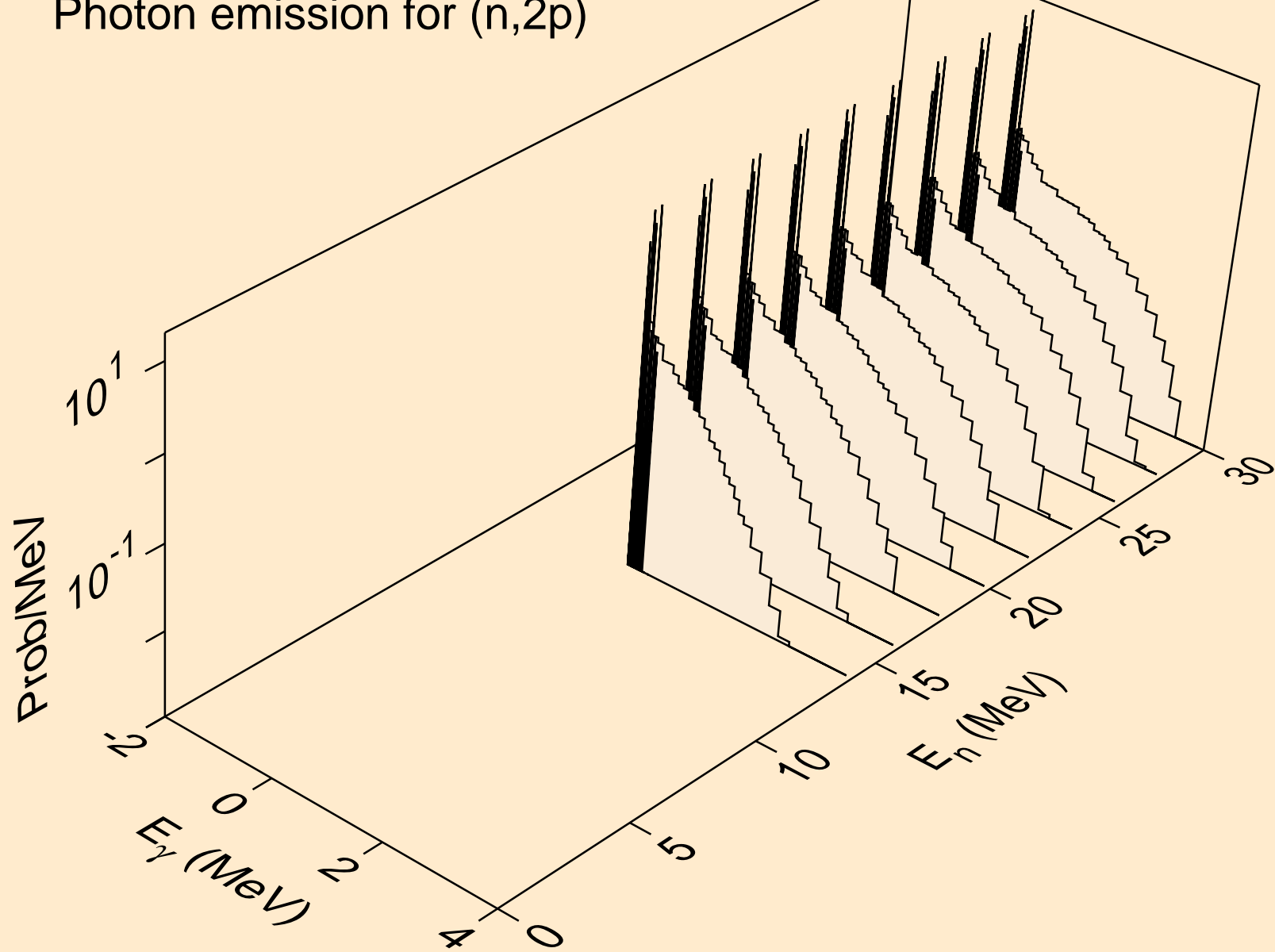

LR253M NEUTRON ACER TENDL-2024 LIBRARY; T=0.K
Photon emission for (n,p α)

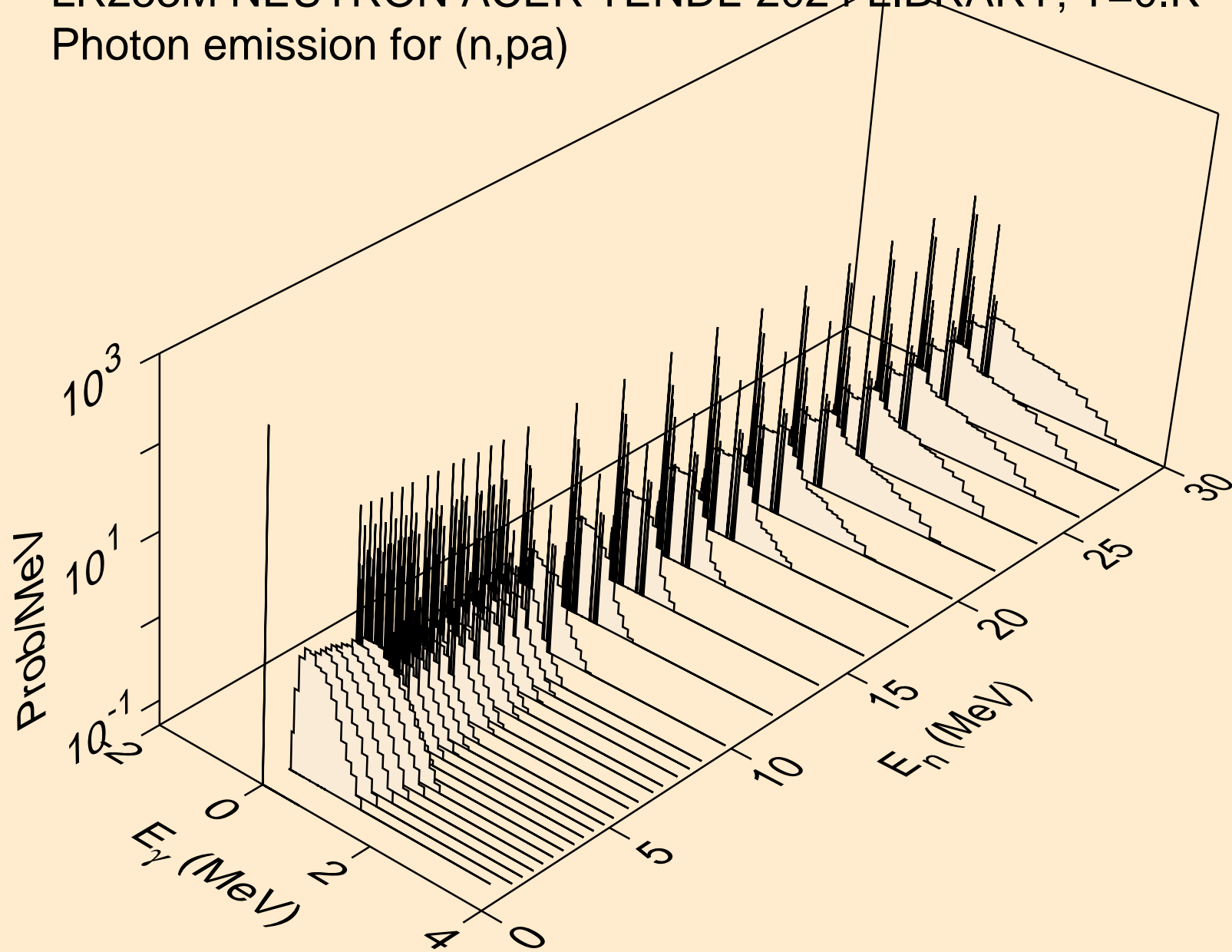

LR253M NEUTRON ACER TENDL-2024 LIBRARY; T=0.K
Photon emission for (n,pd)

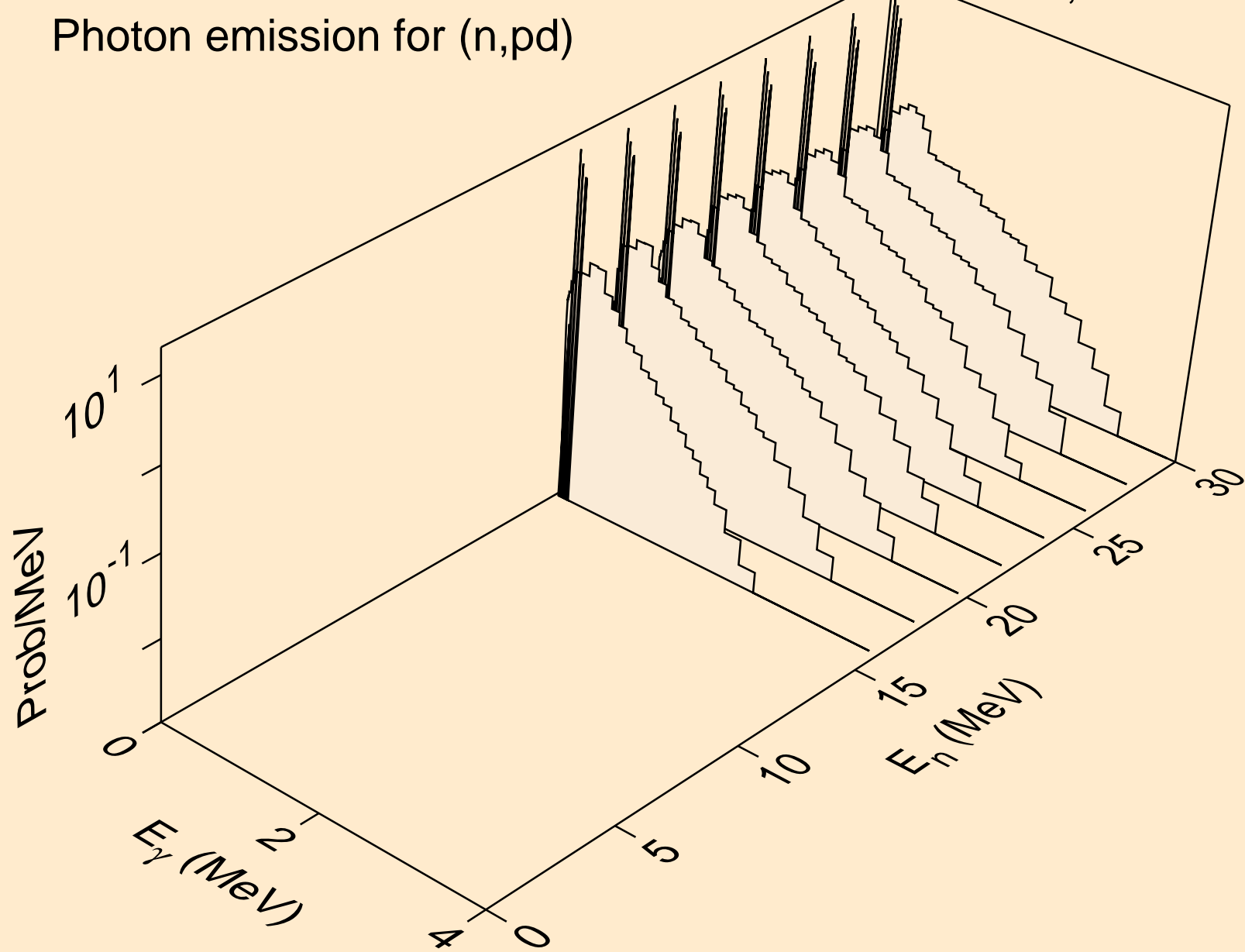

LR253M NEUTRON ACER TENDL-2024 LIBRARY; T=0.K
thermal capture photon spectrum

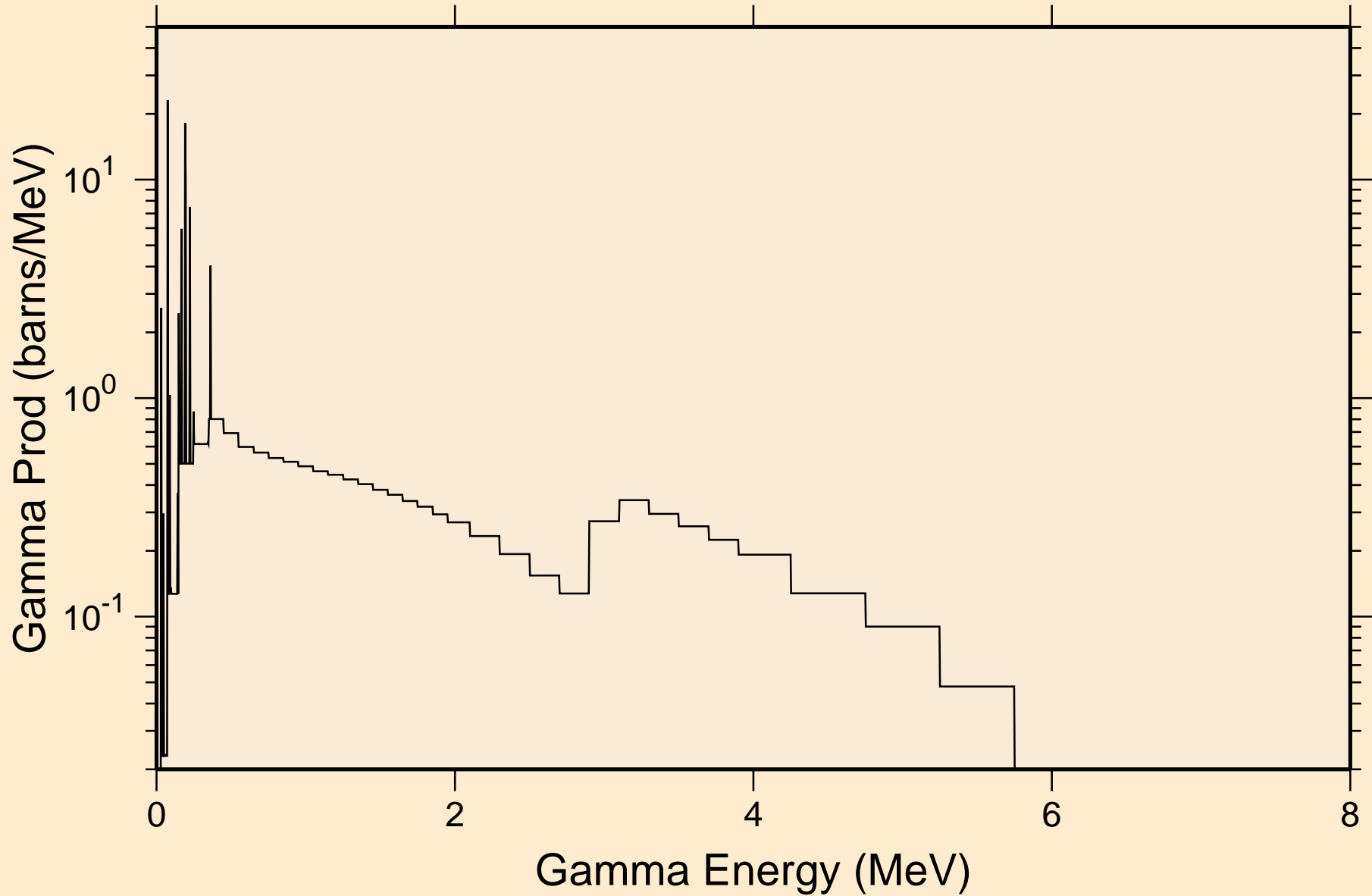

LR253M NEUTRON ACER TENDL-2024 LIBRARY; T=0.K
14 MeV photon spectrum

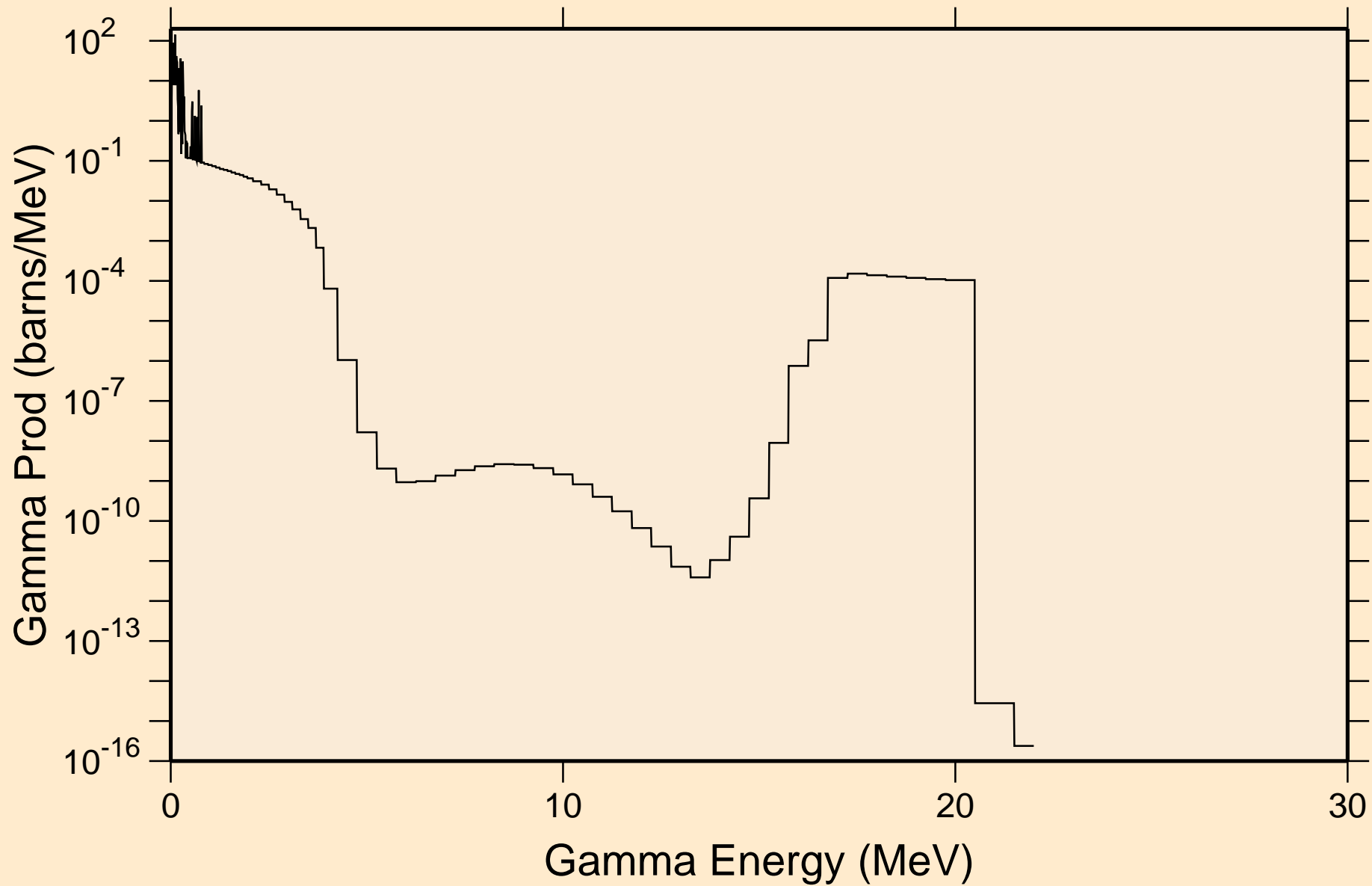

LR253M NEUTRON ACER TENDL-2024 LIBRARY; T=0.K

Particle heating contributions

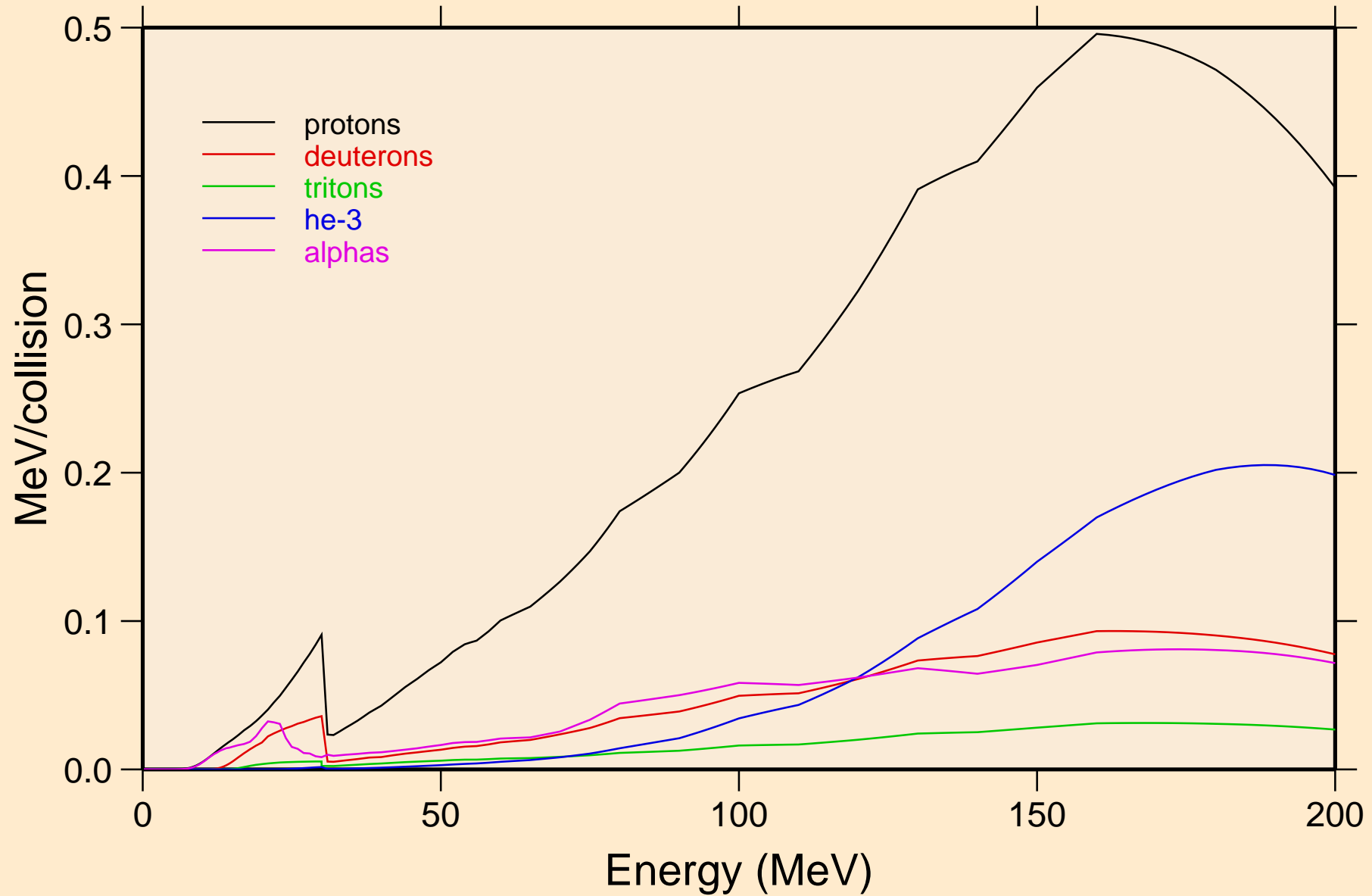

LR253M NEUTRON ACER TENDL-2024 LIBRARY; T=0.K
Recoil Heating

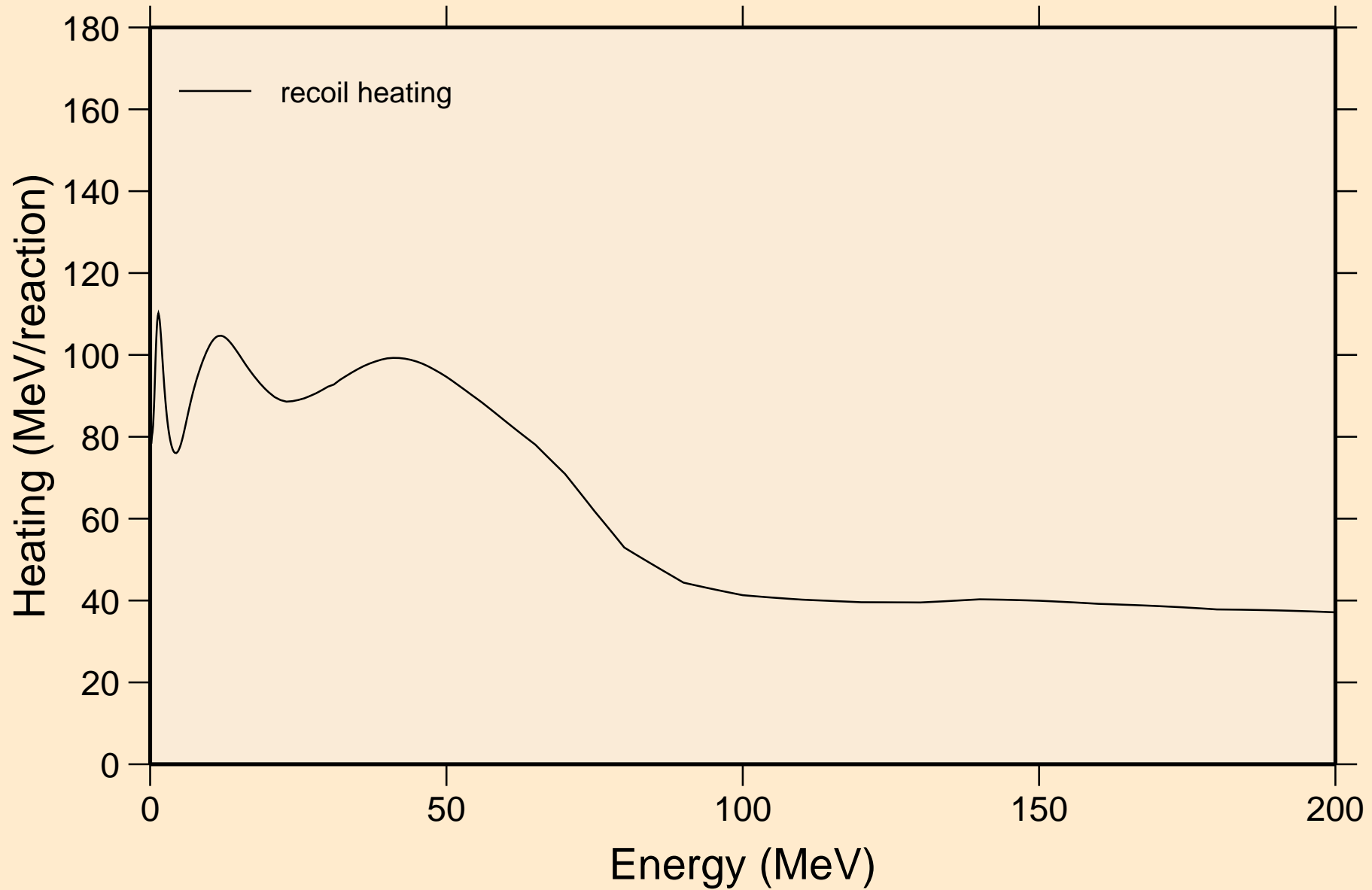

LR253M NEUTRON ACER TENDL-2024 LIBRARY; T=0.K

Particle production cross sections

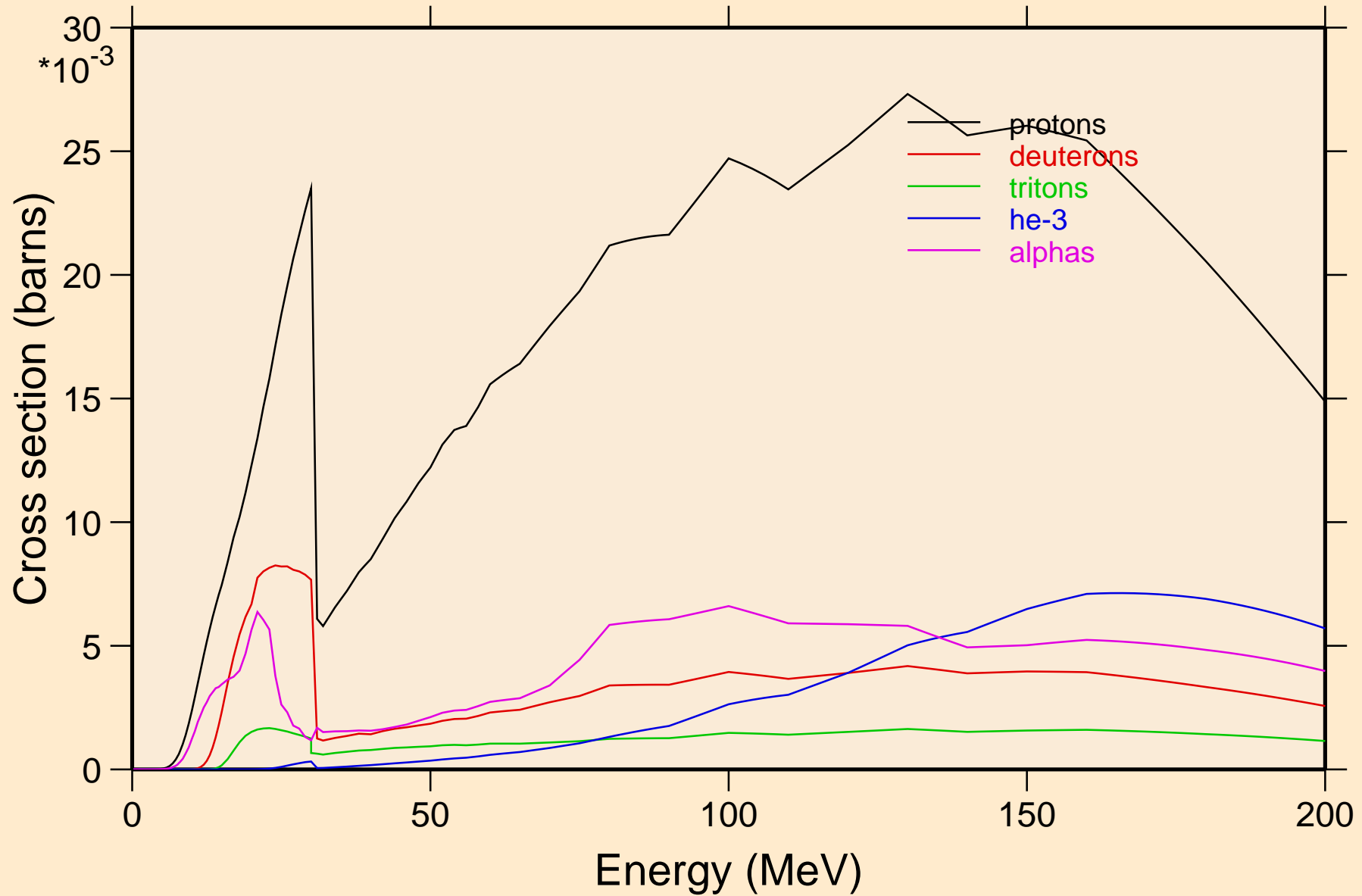

LR253M NEUTRON ACER TENDL-2024 LIBRARY; T=0.K
protons from (n,x)

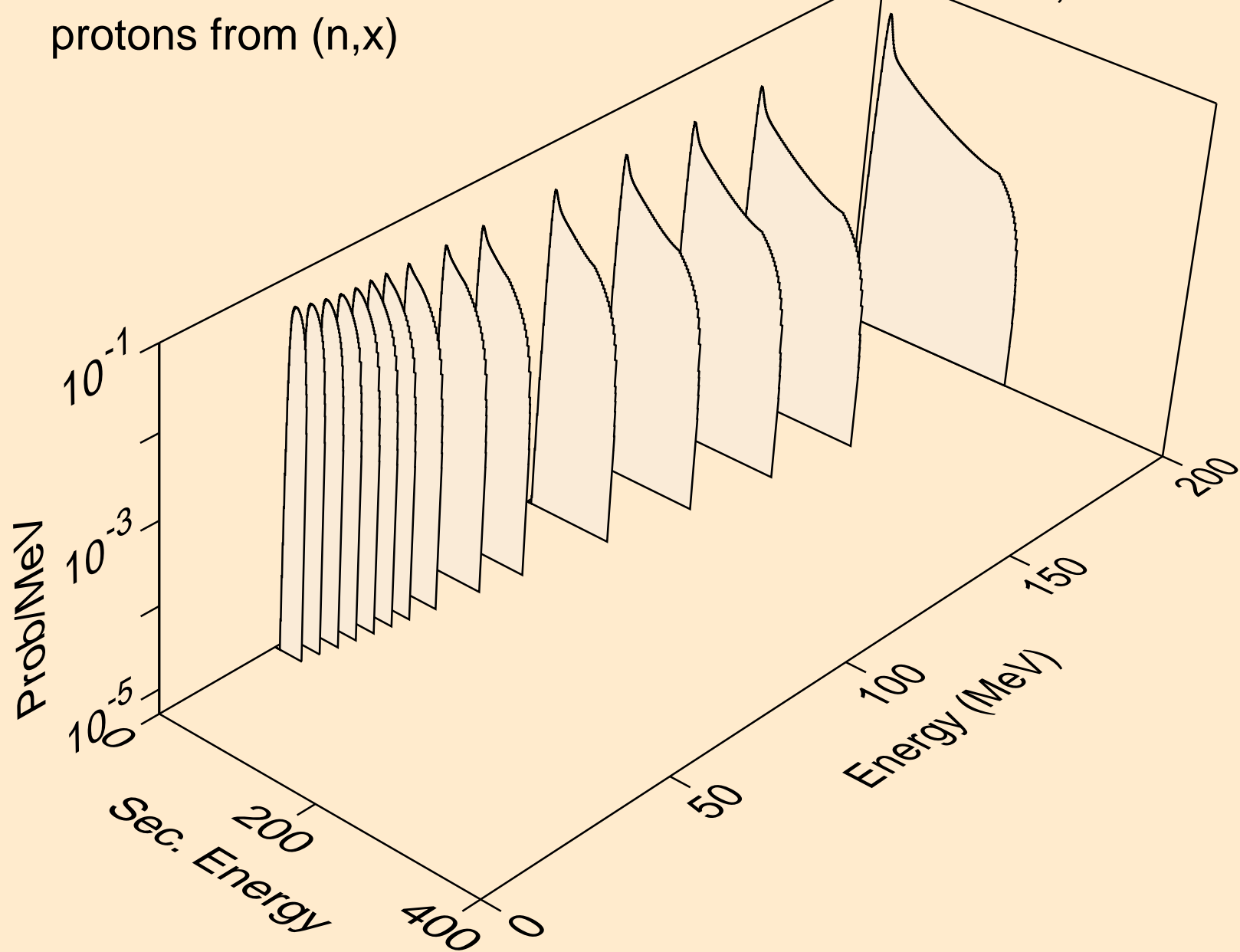

LR253M NEUTRON ACER TENDL-2024 LIBRARY; T=0.K
protons from (n,n*)p

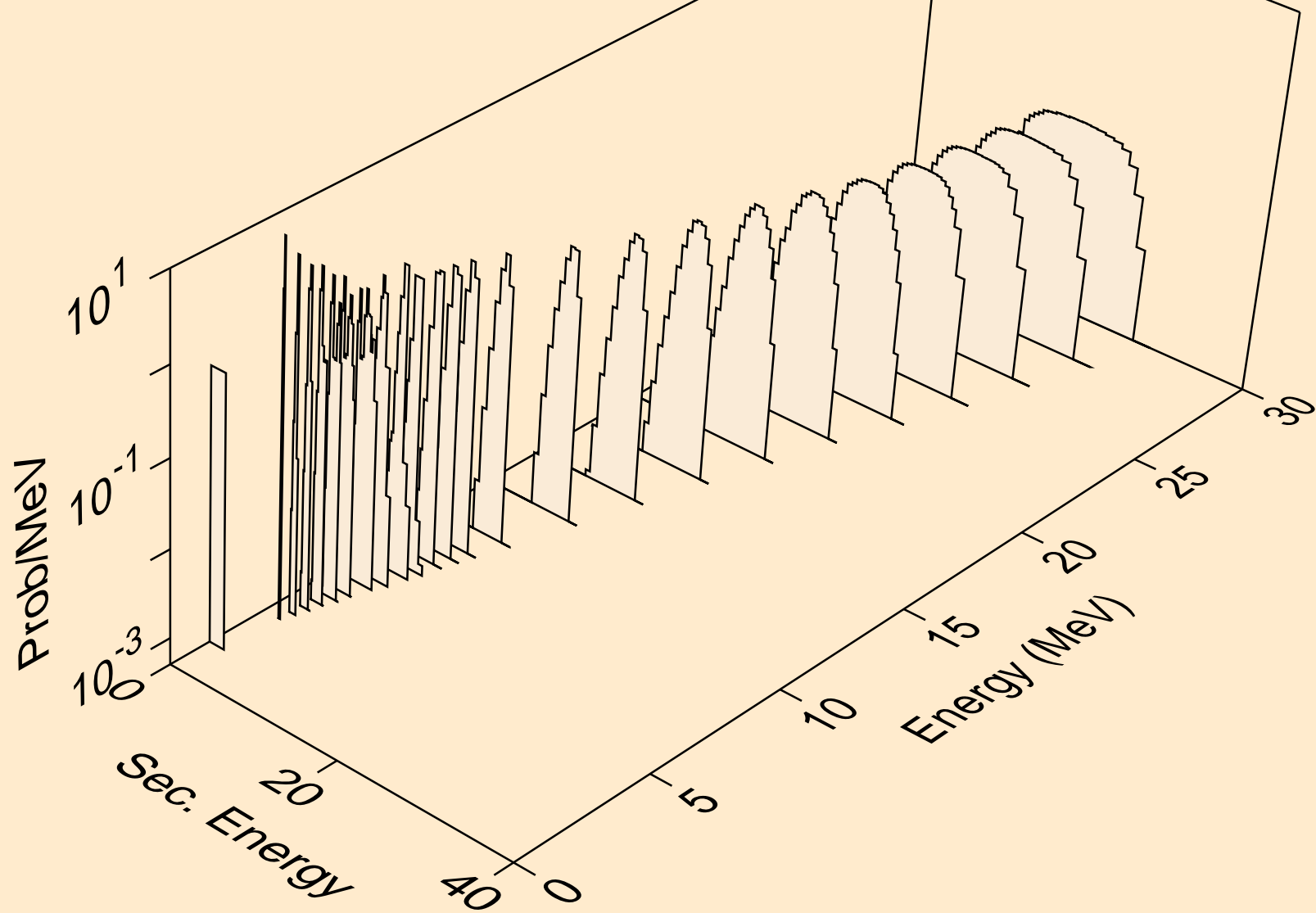

LR253M NEUTRON ACER TENDL-2024 LIBRARY; T=0.K
protons from (n,2np)

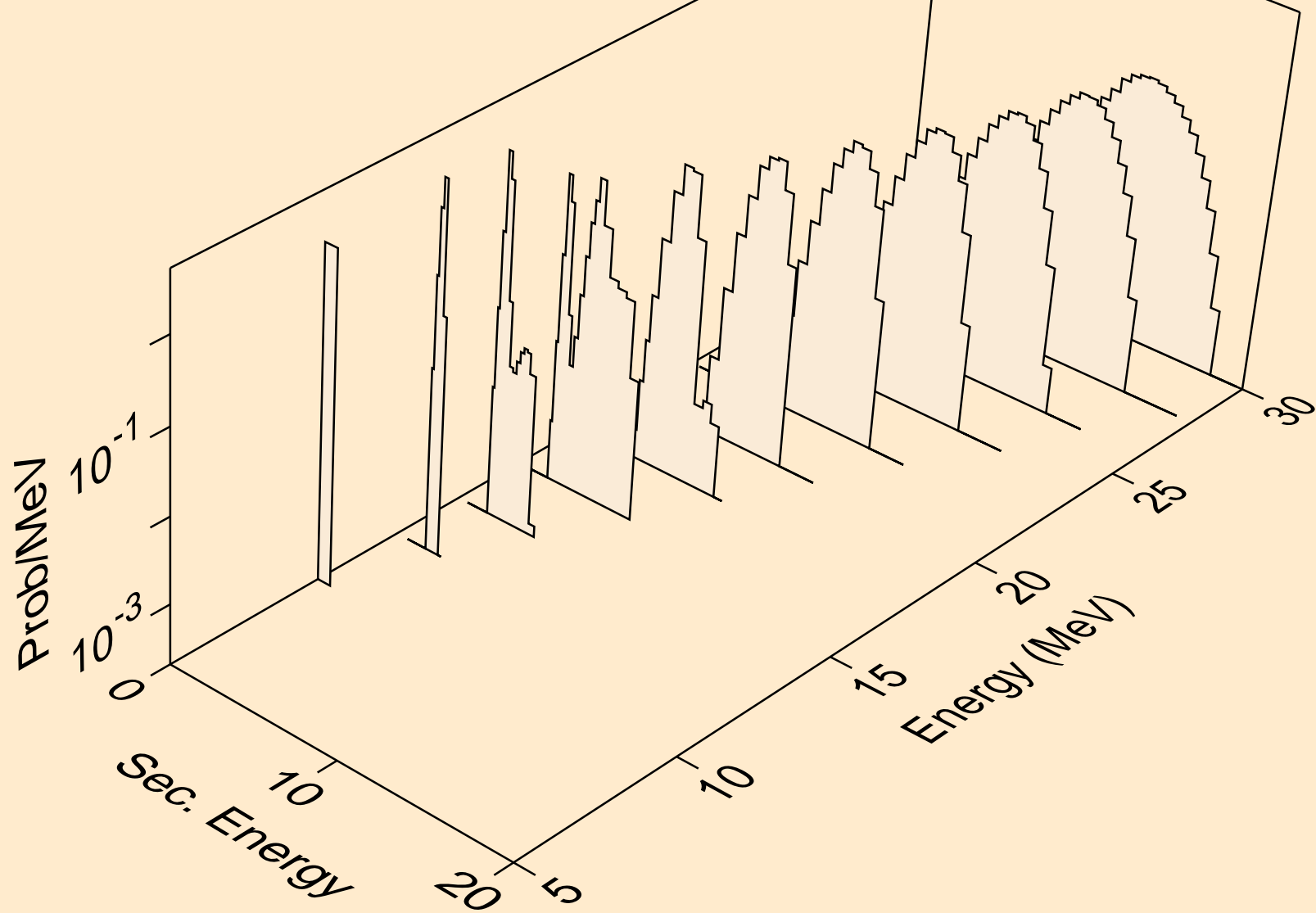

LR253M NEUTRON ACER TENDL-2024 LIBRARY; T=0.K
protons from (n,n2p)

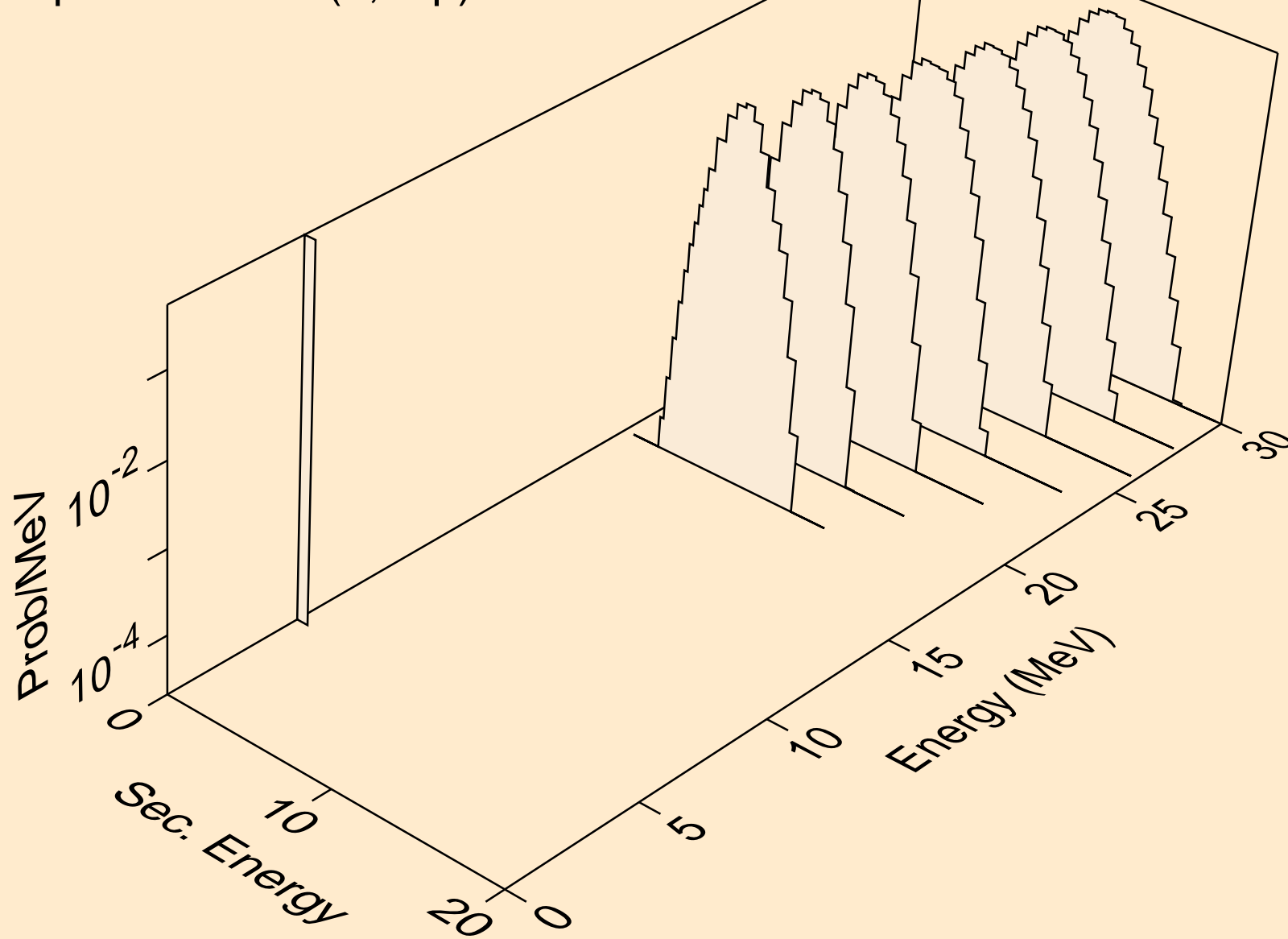

LR253M NEUTRON ACER TENDL-2024 LIBRARY; T=0.K
protons from (n,p)

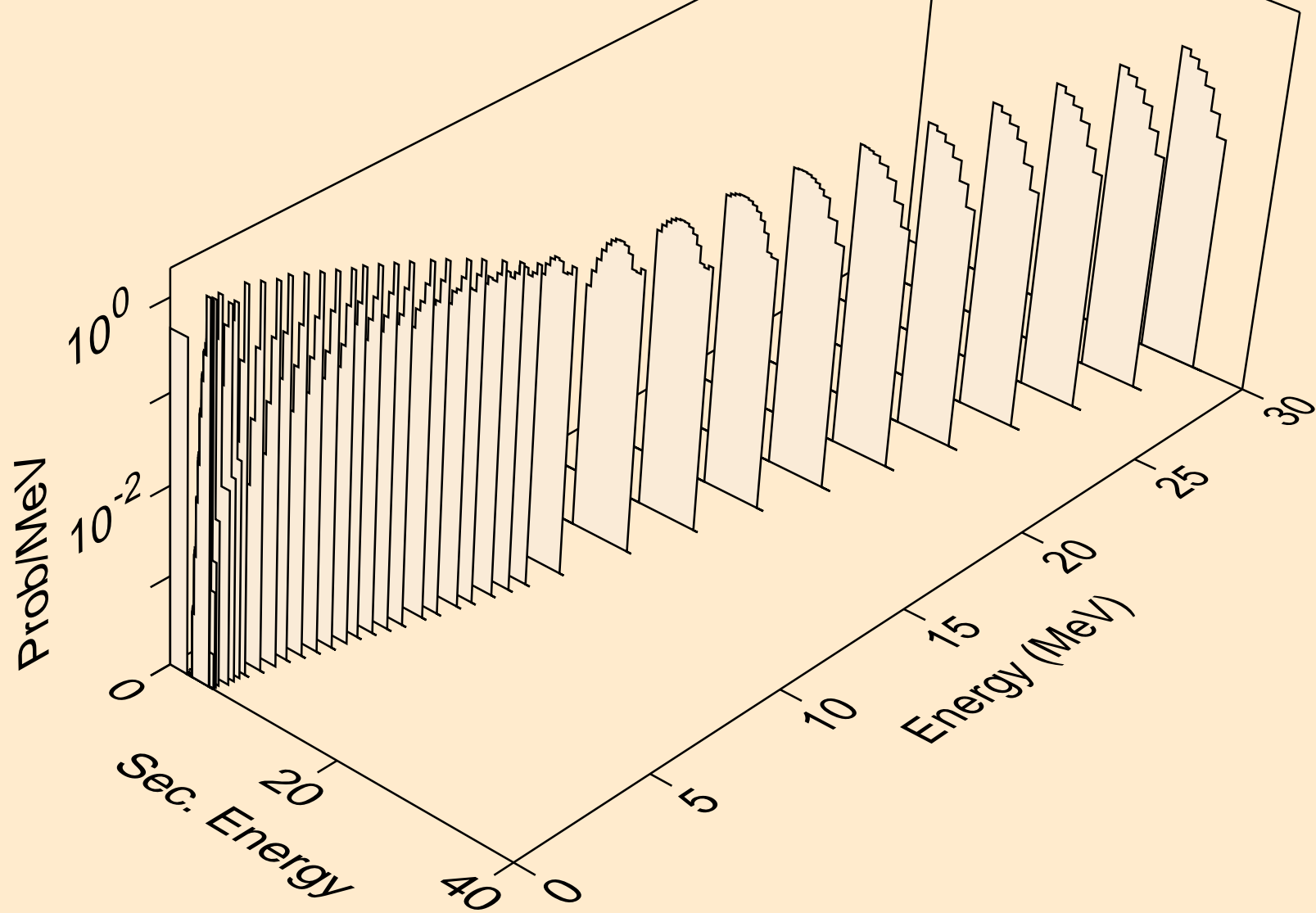

LR253M NEUTRON ACER TENDL-2024 LIBRARY; T=0.K
protons from (n,2p)

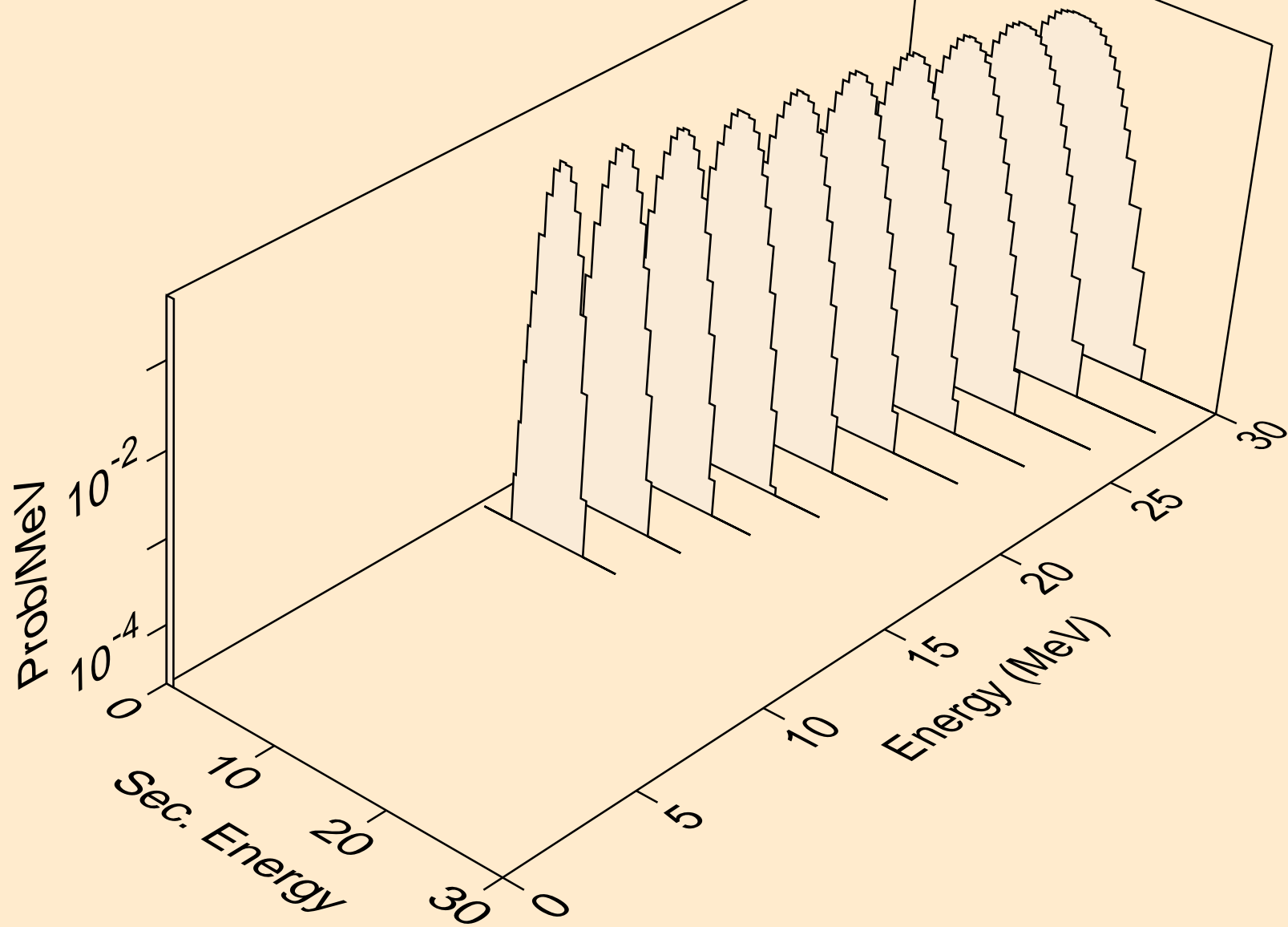

LR253M NEUTRON ACER TENDL-2024 LIBRARY; T=0.K
protons from (n,p)

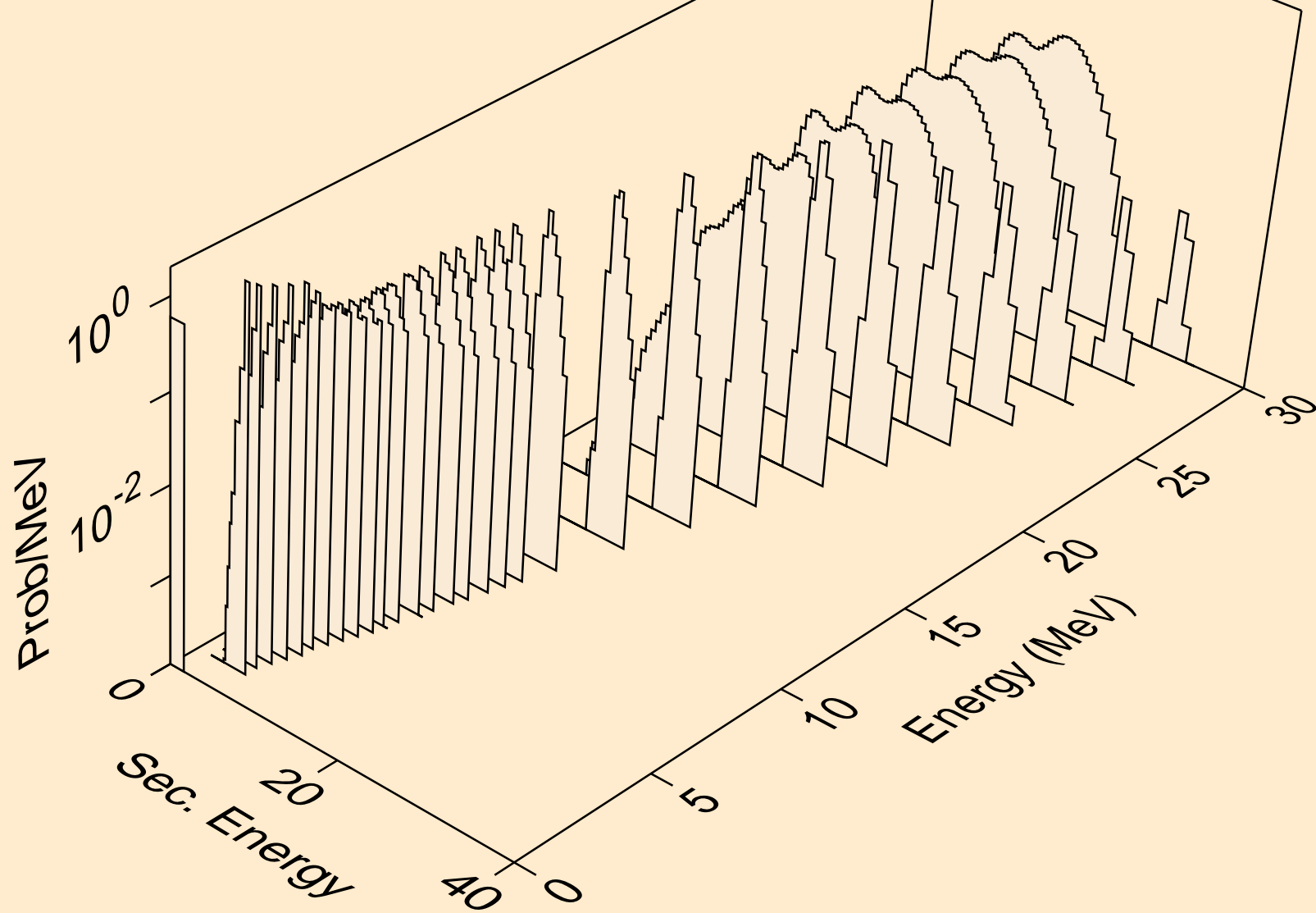

LR253M NEUTRON ACER TENDL-2024 LIBRARY; T=0.K
protons from (n,pd)

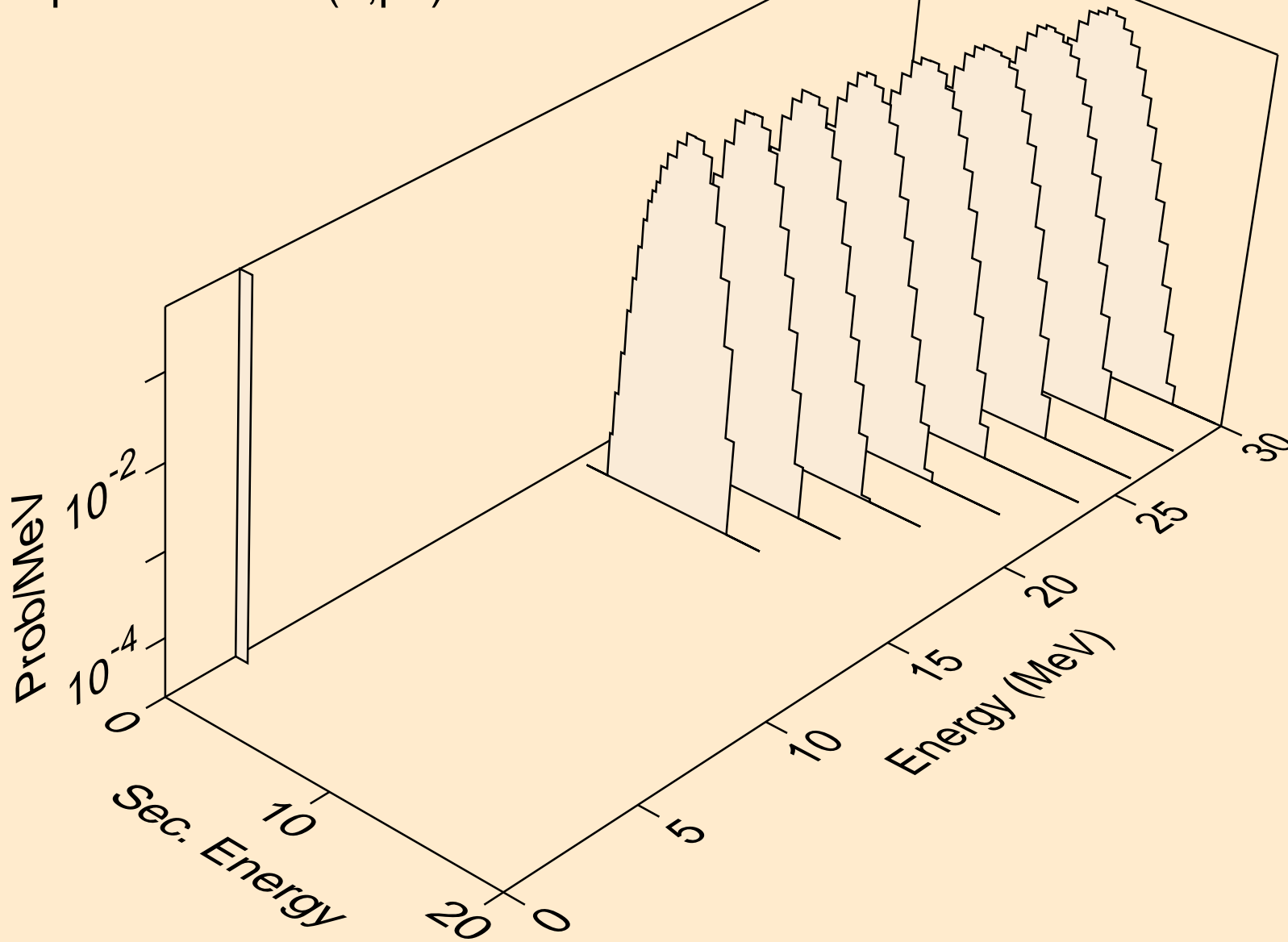

LR253M NEUTRON ACER TENDL-2024 LIBRARY; T=0.K
deuterons from (n,x)

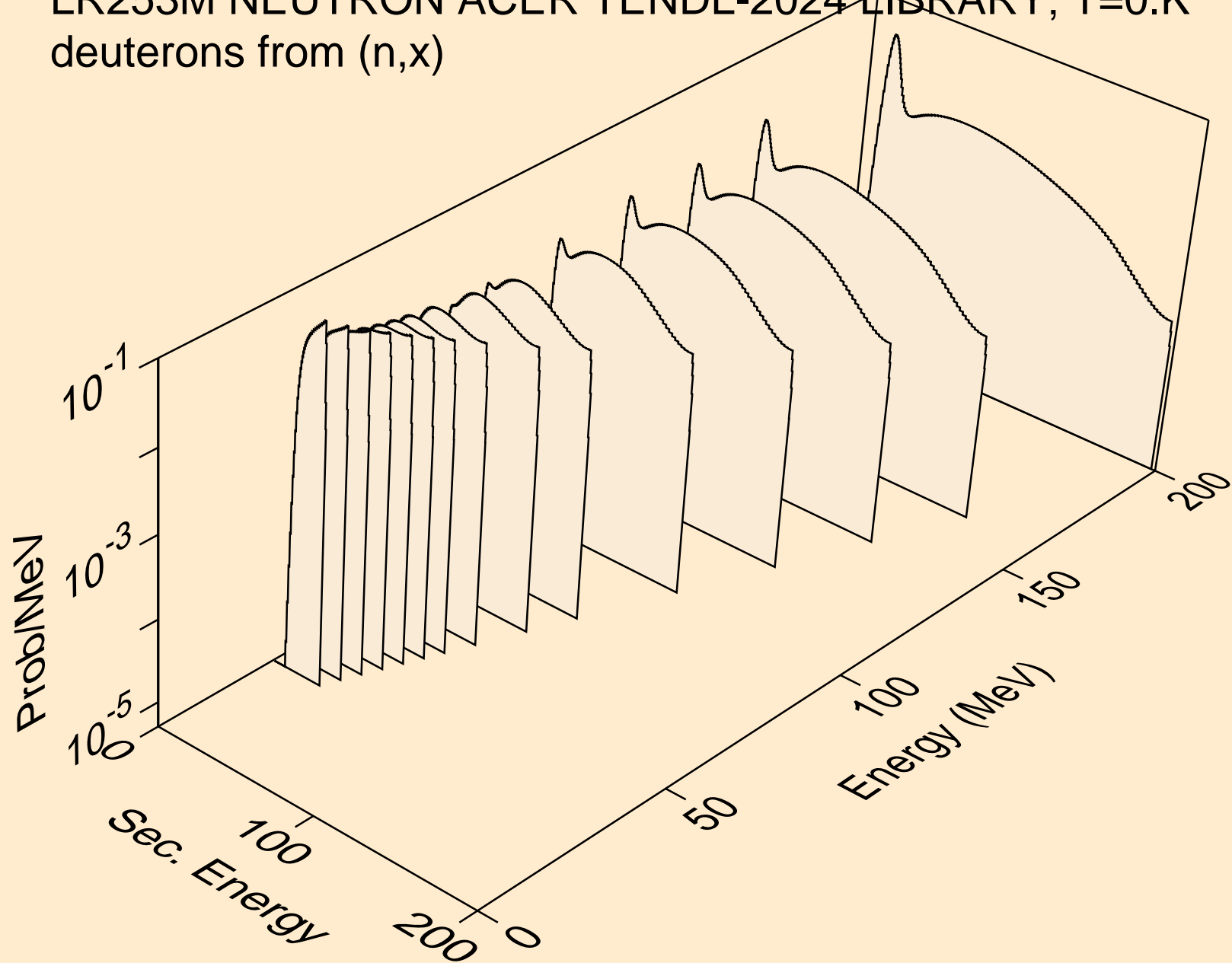

LR253M NEUTRON ACER TENDL-2024 LIBRARY; T=0.K
deuterons from (n,n*)d

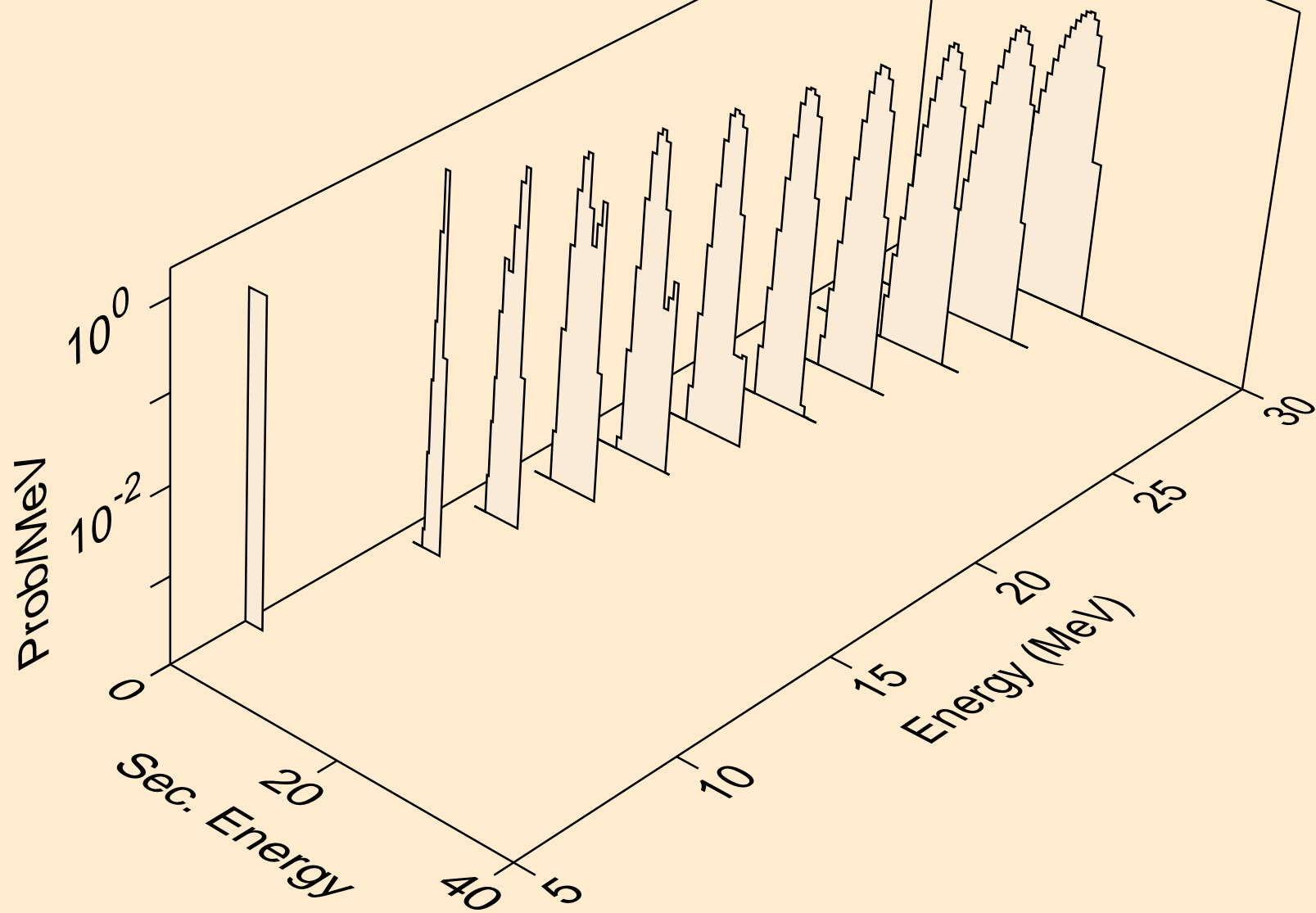

LR253M NEUTRON ACER TENDL-2024 LIBRARY; T=0.K
deuterons from (n,d)

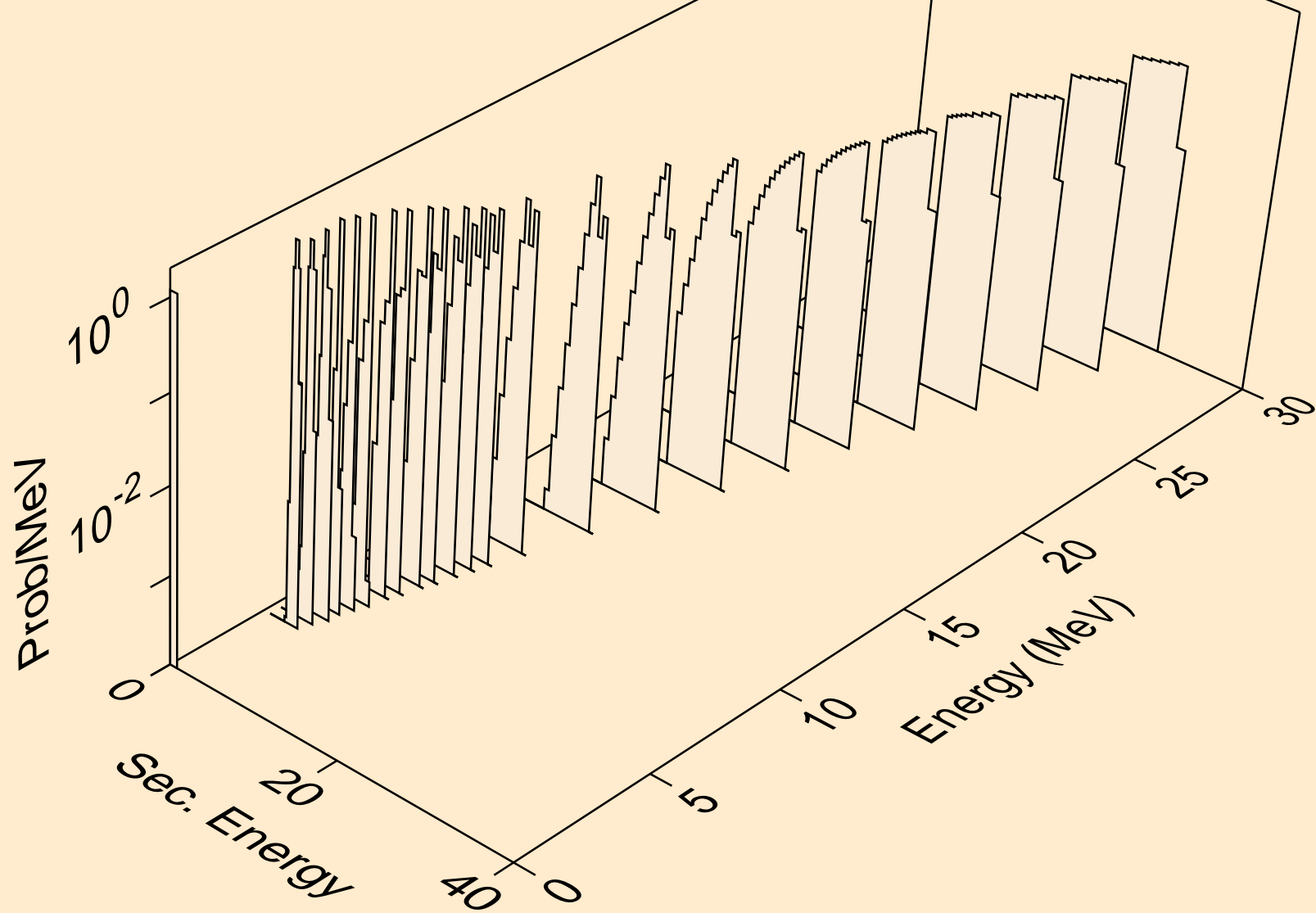

LR253M NEUTRON ACER TENDL-2024 LIBRARY; T=0.K
deuterons from (n,pd)

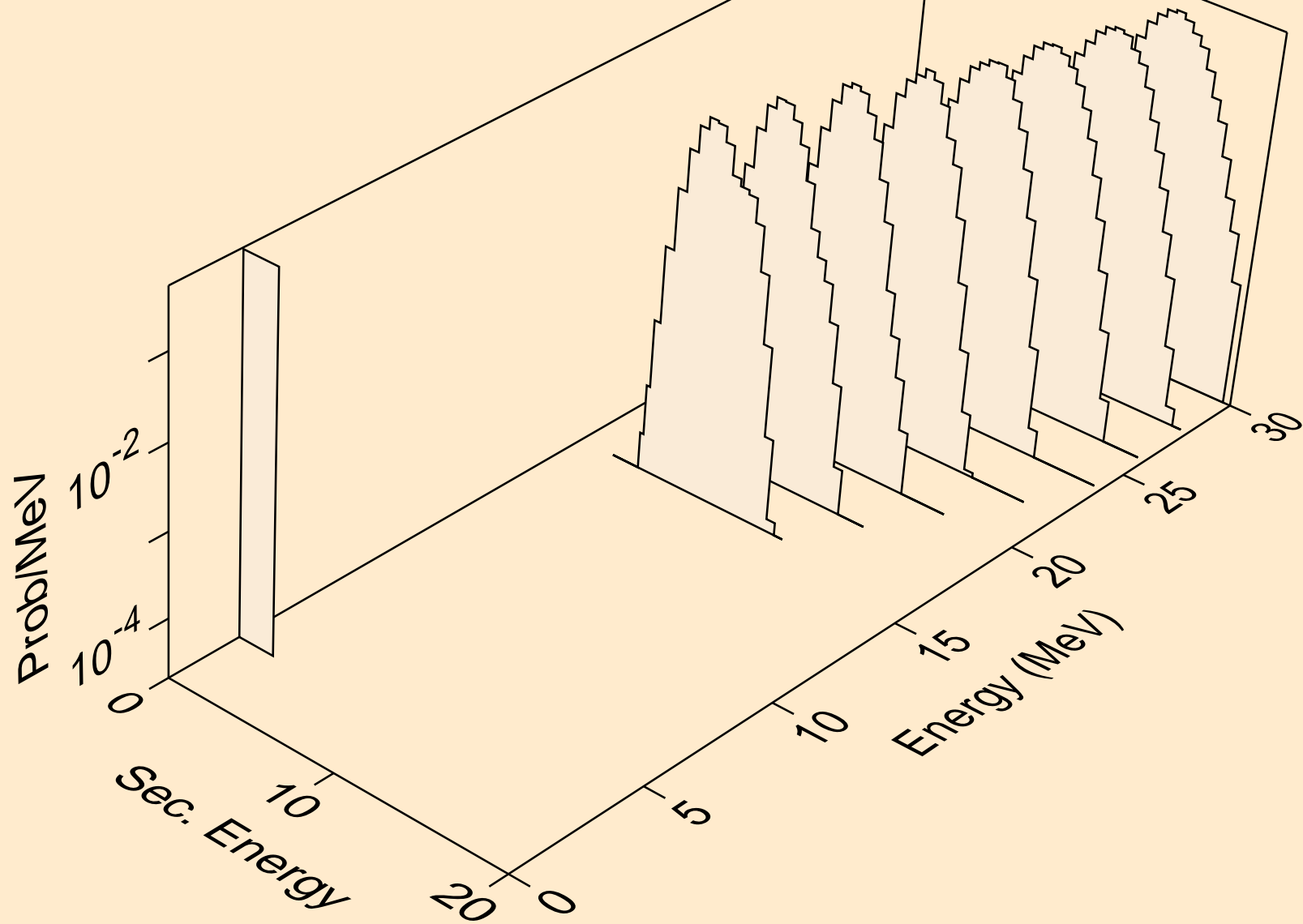

LR253M NEUTRON ACER TENDL-2024 LIBRARY; T=0.K
tritons from (n,x)

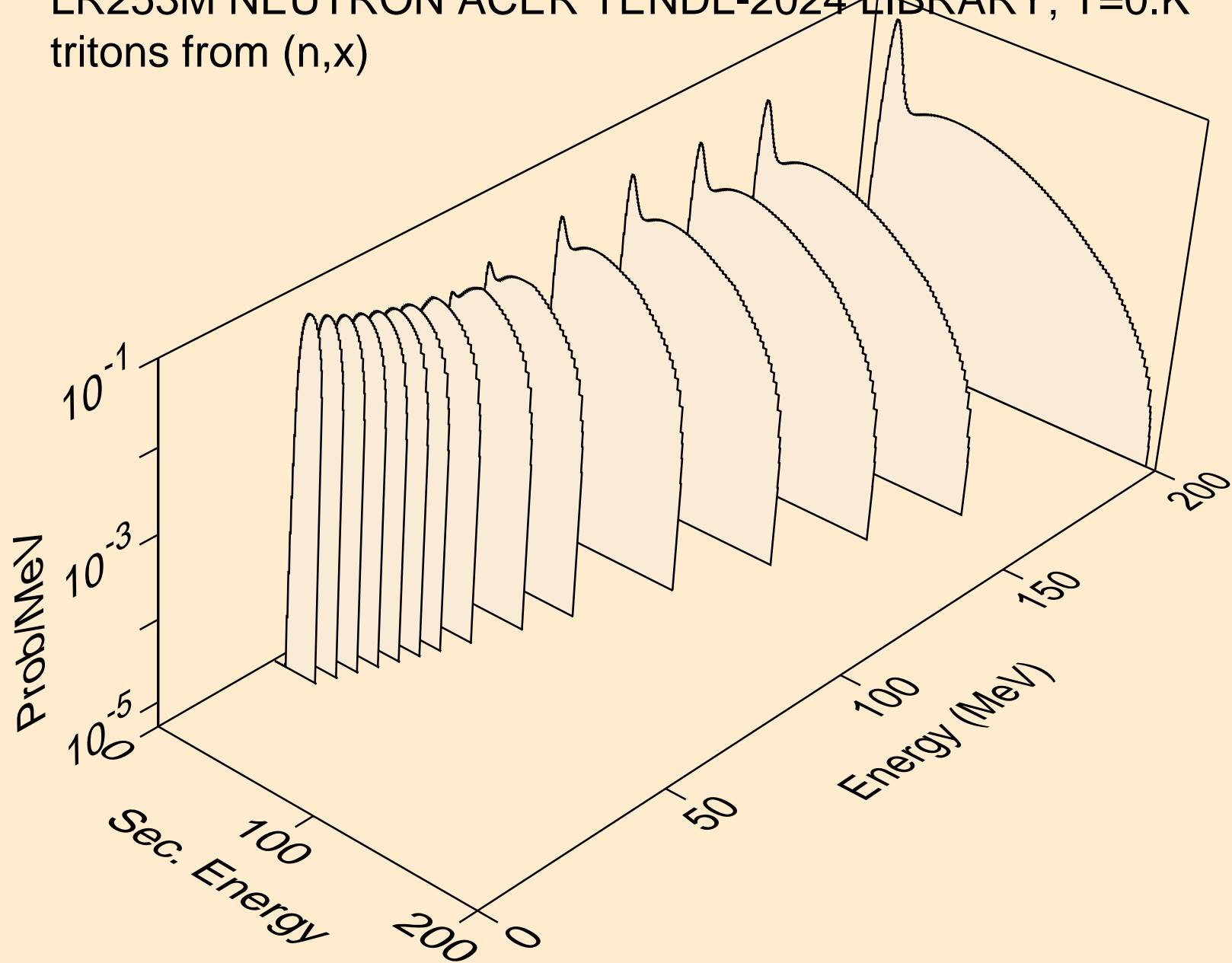

LR253M NEUTRON ACER TENDL-2024 LIBRARY; T=0.K
tritons from (n,n*)t

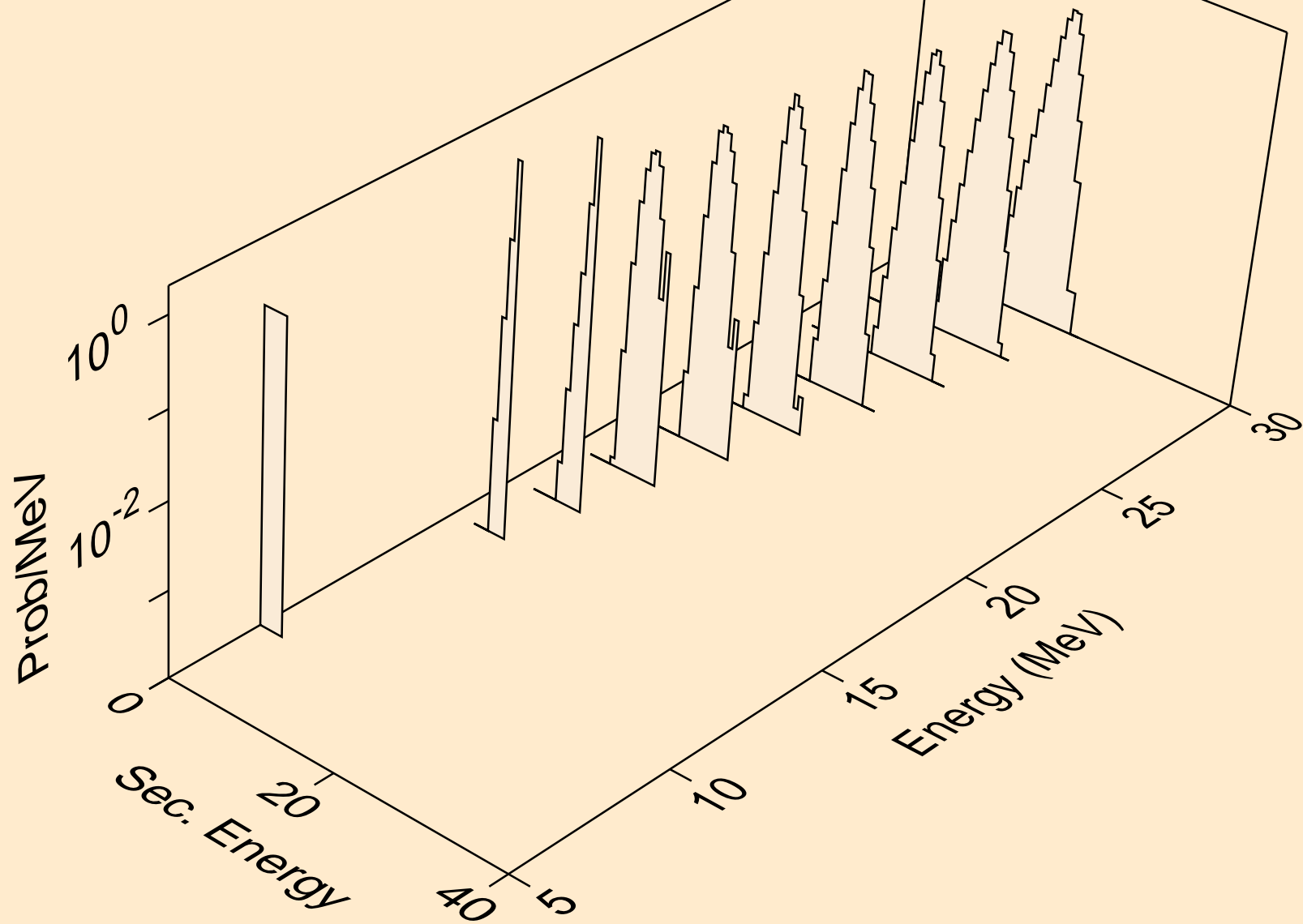

LR253M NEUTRON ACER TENDL-2024 LIBRARY; T=0.K
tritons from (n,t)

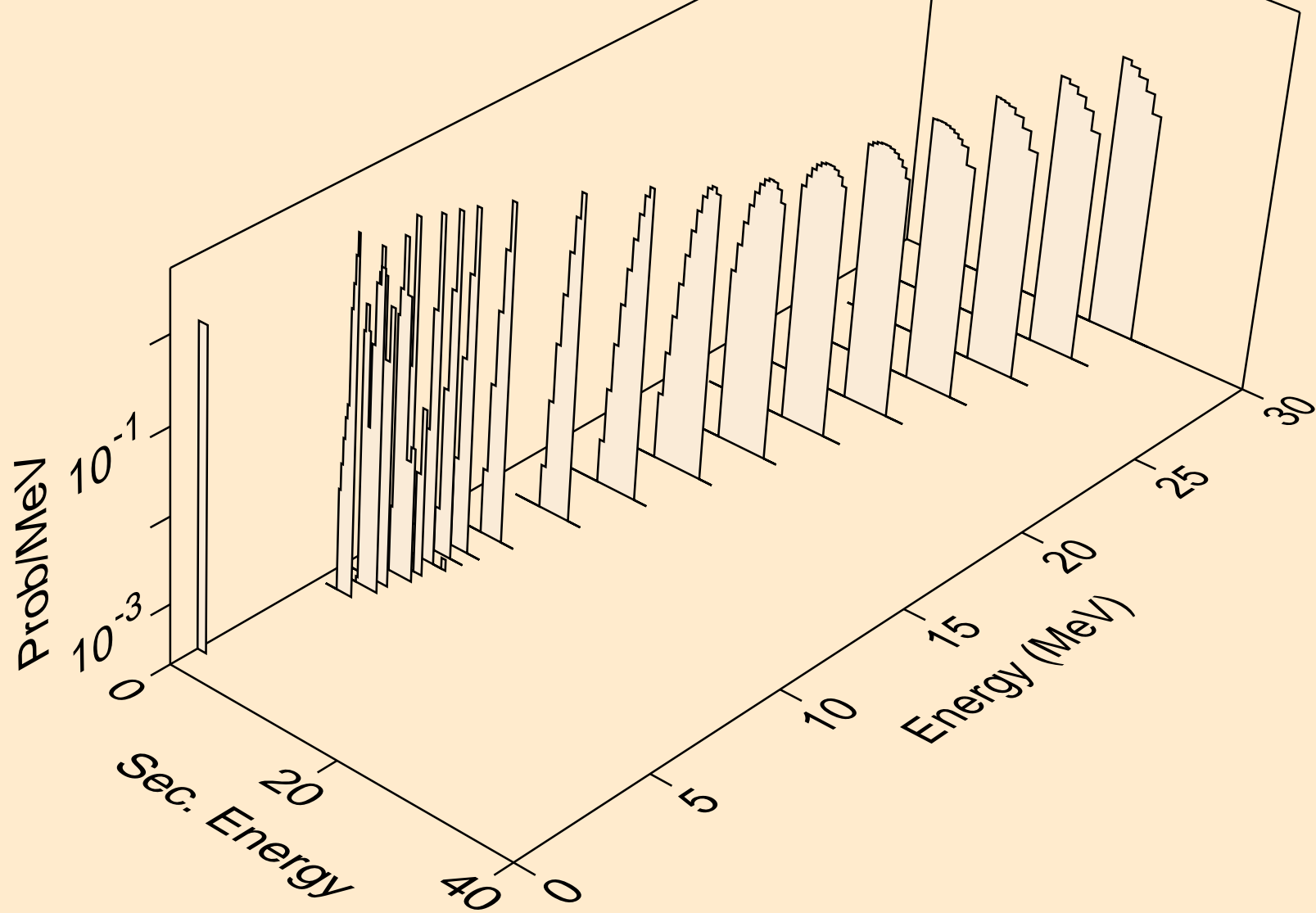

LR253M NEUTRON ACER TENDL-2024 LIBRARY; T=0.K
he3s from (n,x)

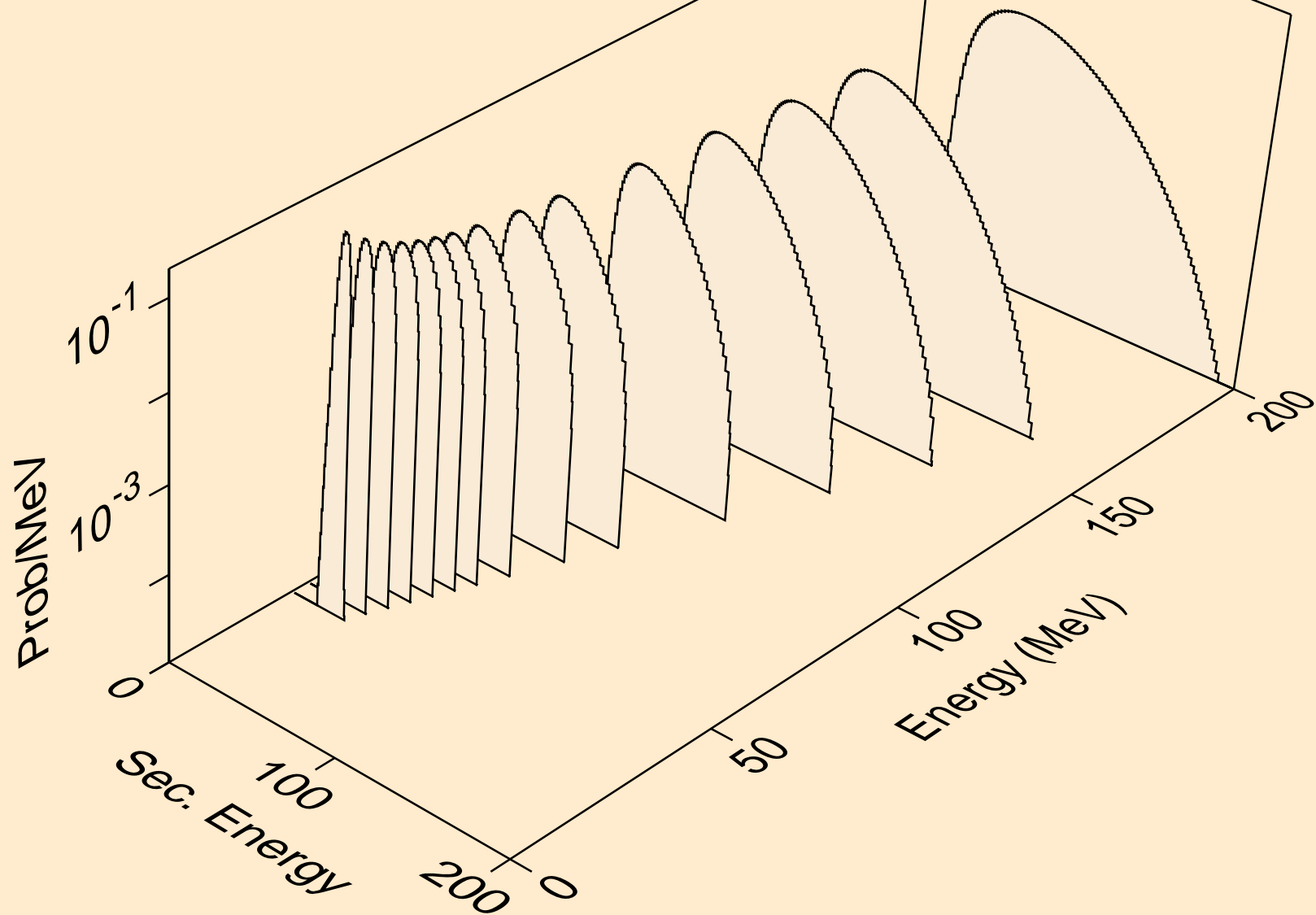

LR253M NEUTRON ACER TENDL-2024 LIBRARY; T=0.K
he3s from (n,n*)he3

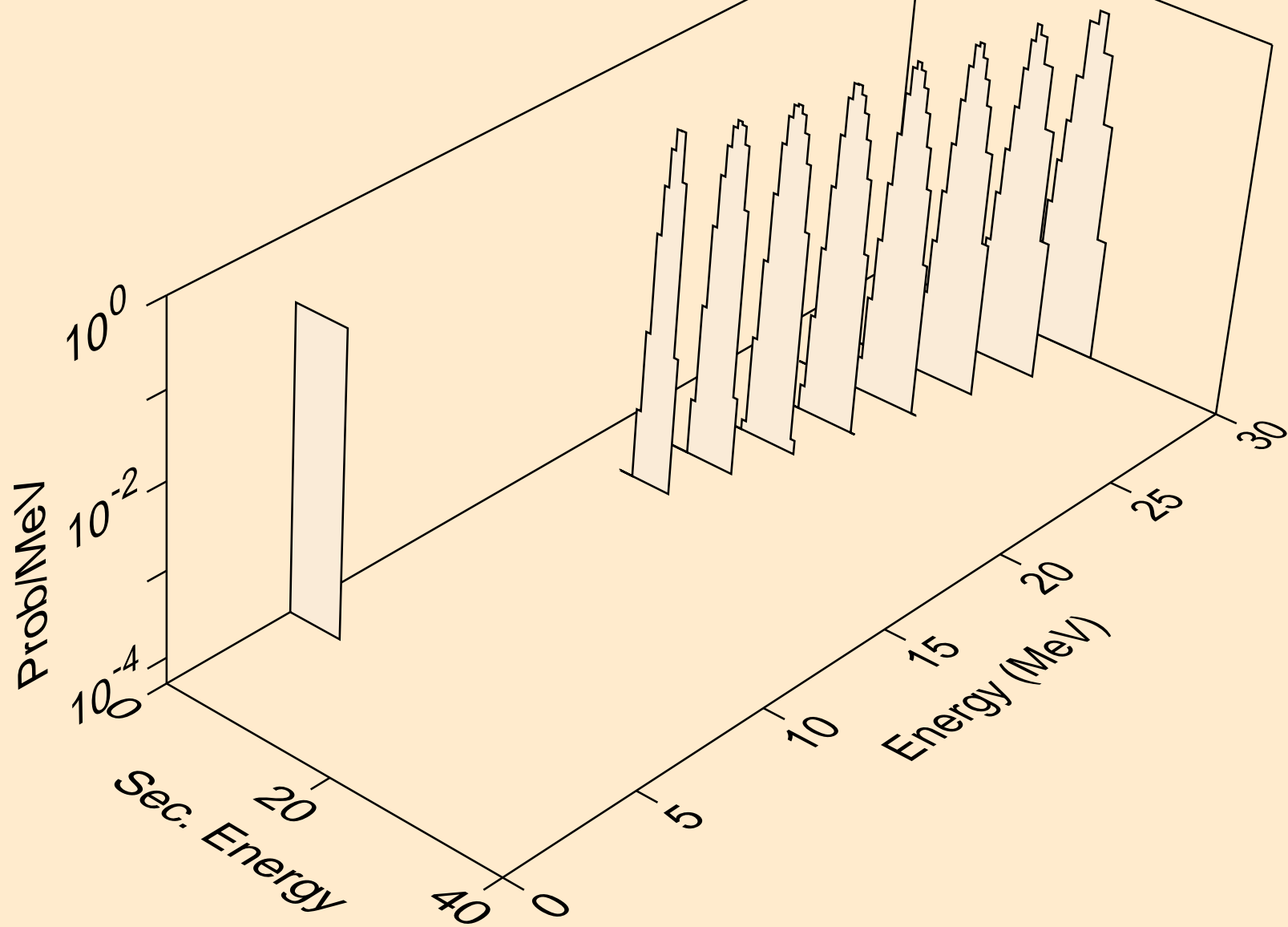

LR253M NEUTRON ACER TENDL-2024 LIBRARY; T=0.K
he3s from (n,he3)

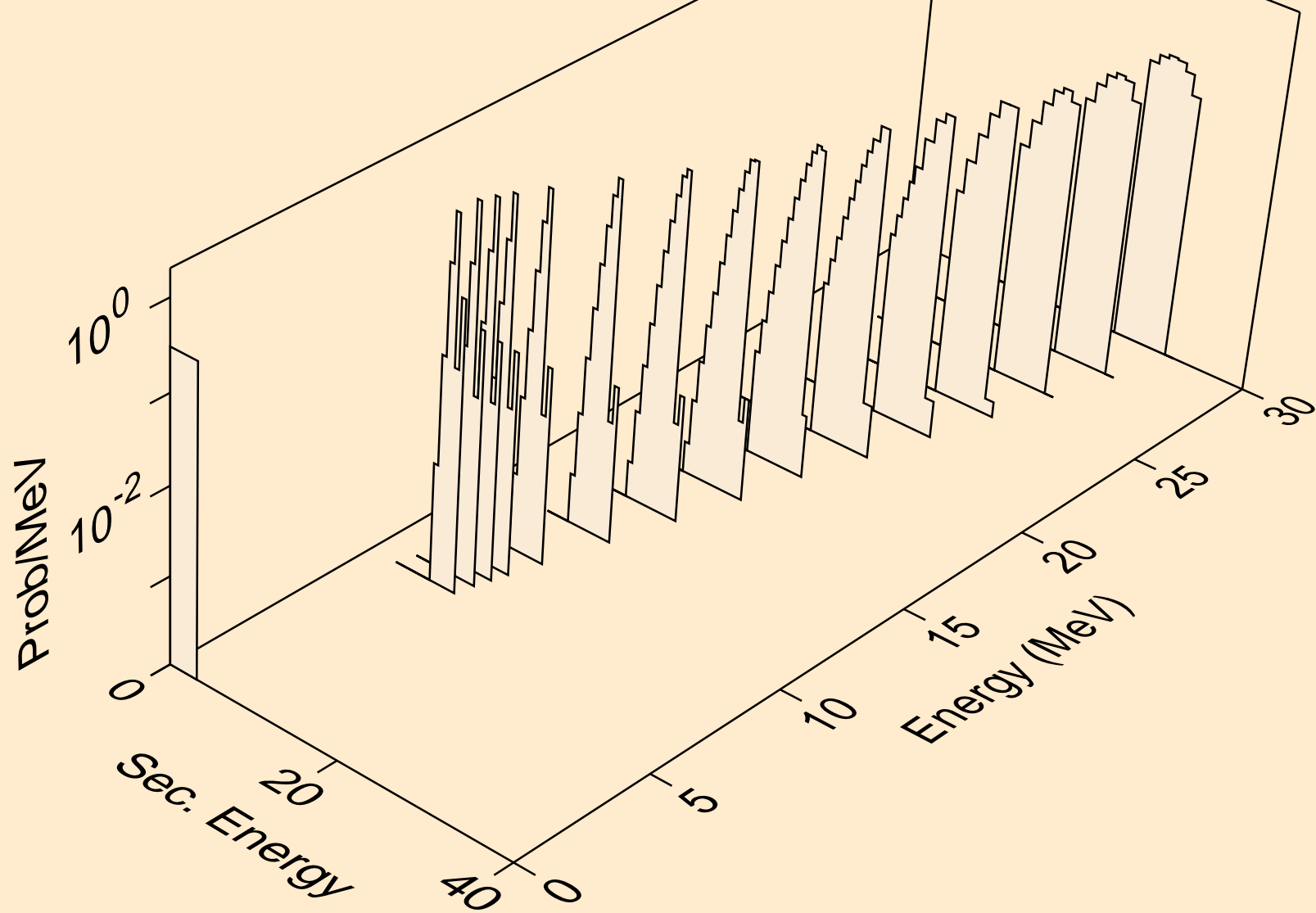

LR253M NEUTRON ACER TENDL-2024 LIBRARY; T=0.K
alphas from (n,x)

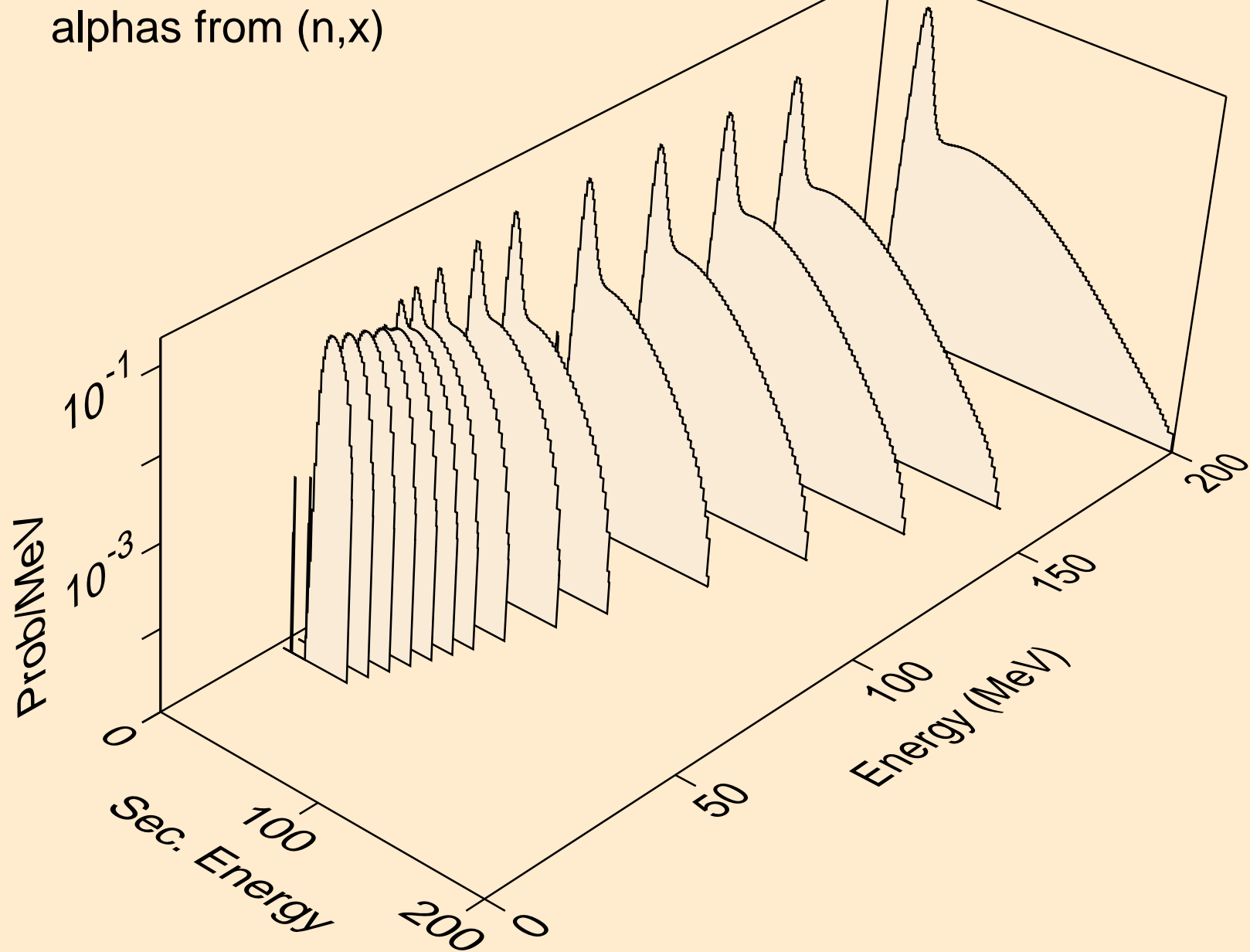

LR253M NEUTRON ACER TENDL-2024 LIBRARY; T=0.K
alphas from (n,n*)a

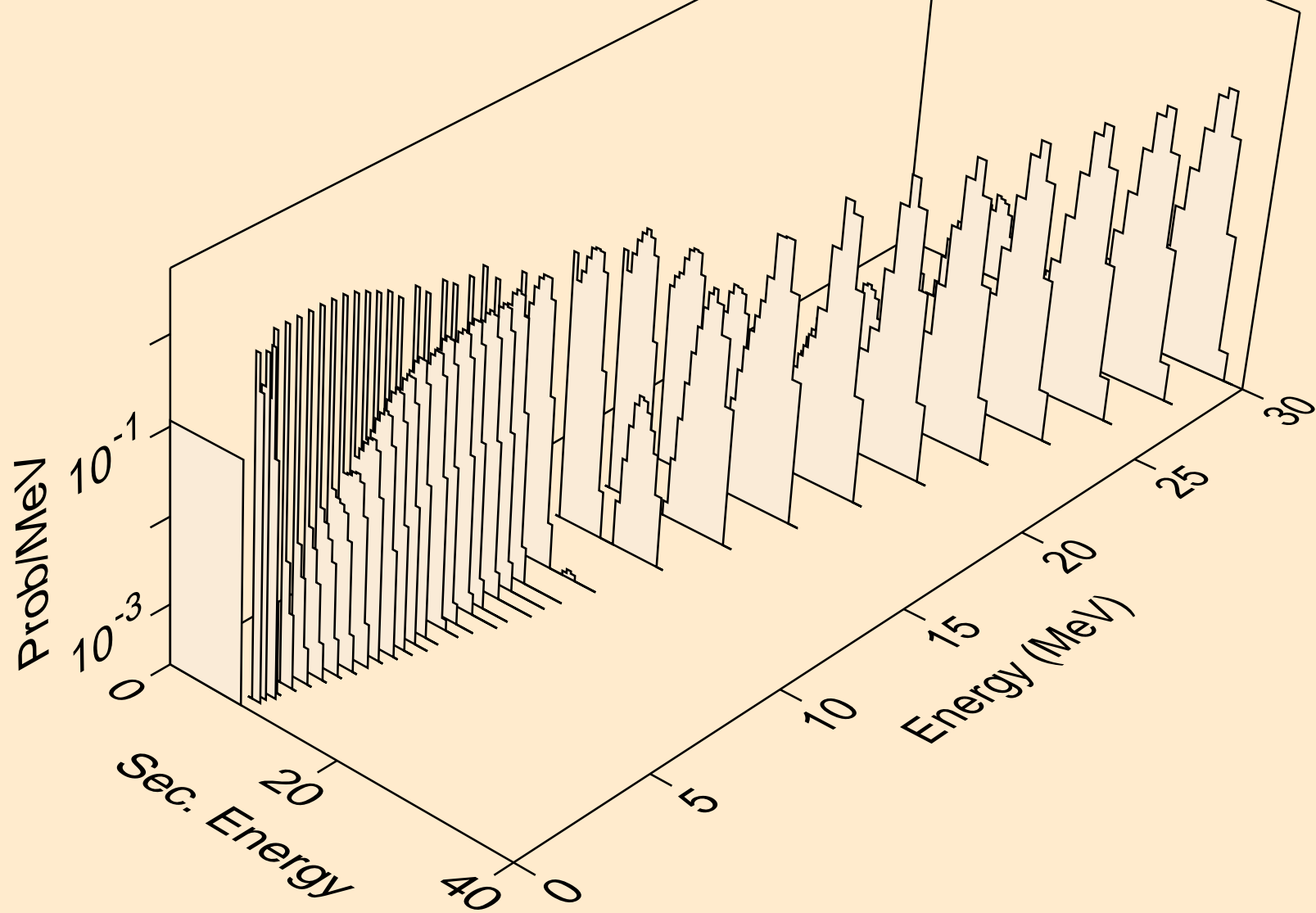

LR253M NEUTRON ACER TENDL-2024 LIBRARY; T=0.K
alphas from (n,2n)a

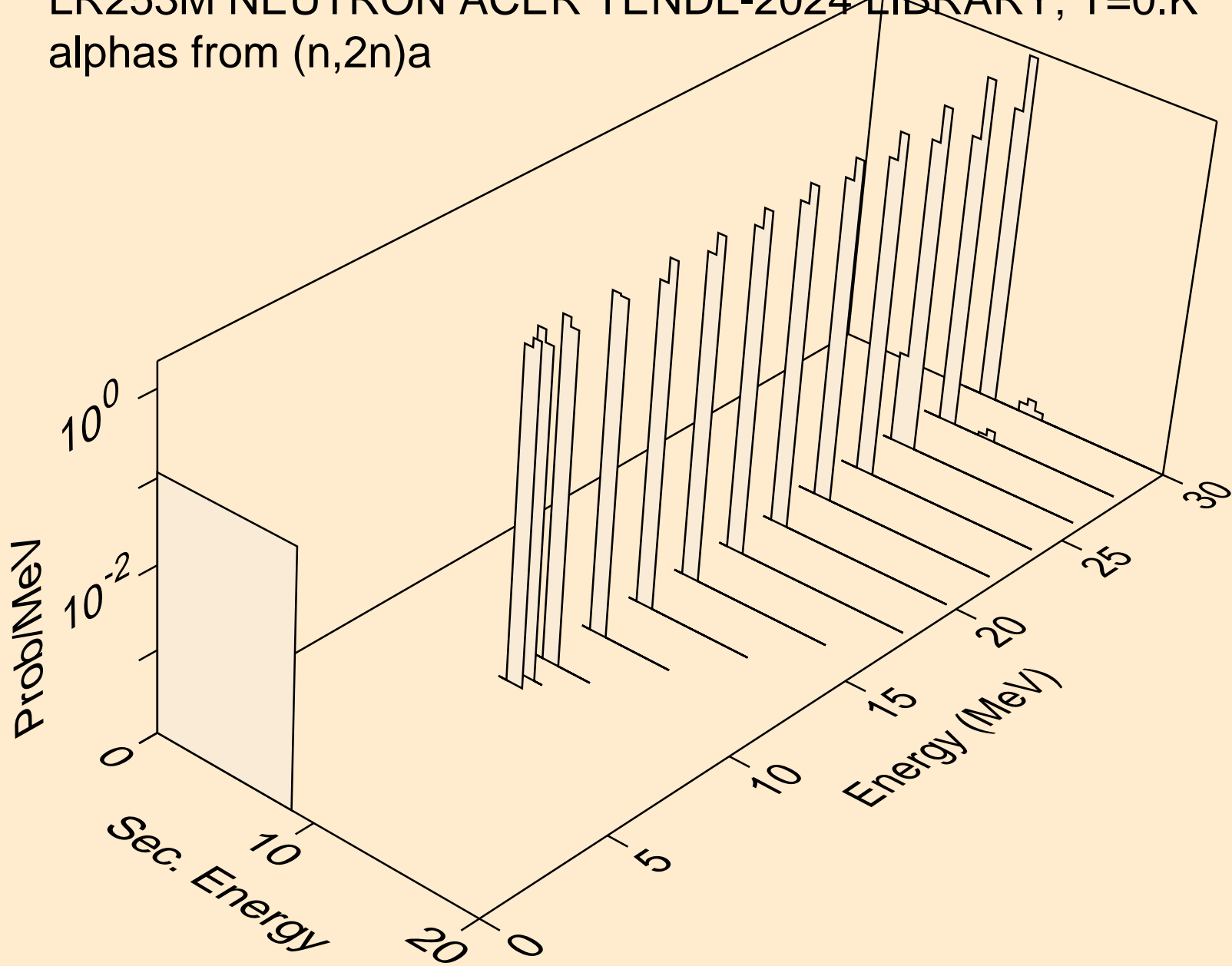

LR253M NEUTRON ACER TENDL-2024 LIBRARY; T=0.K
alphas from (n,3n)a

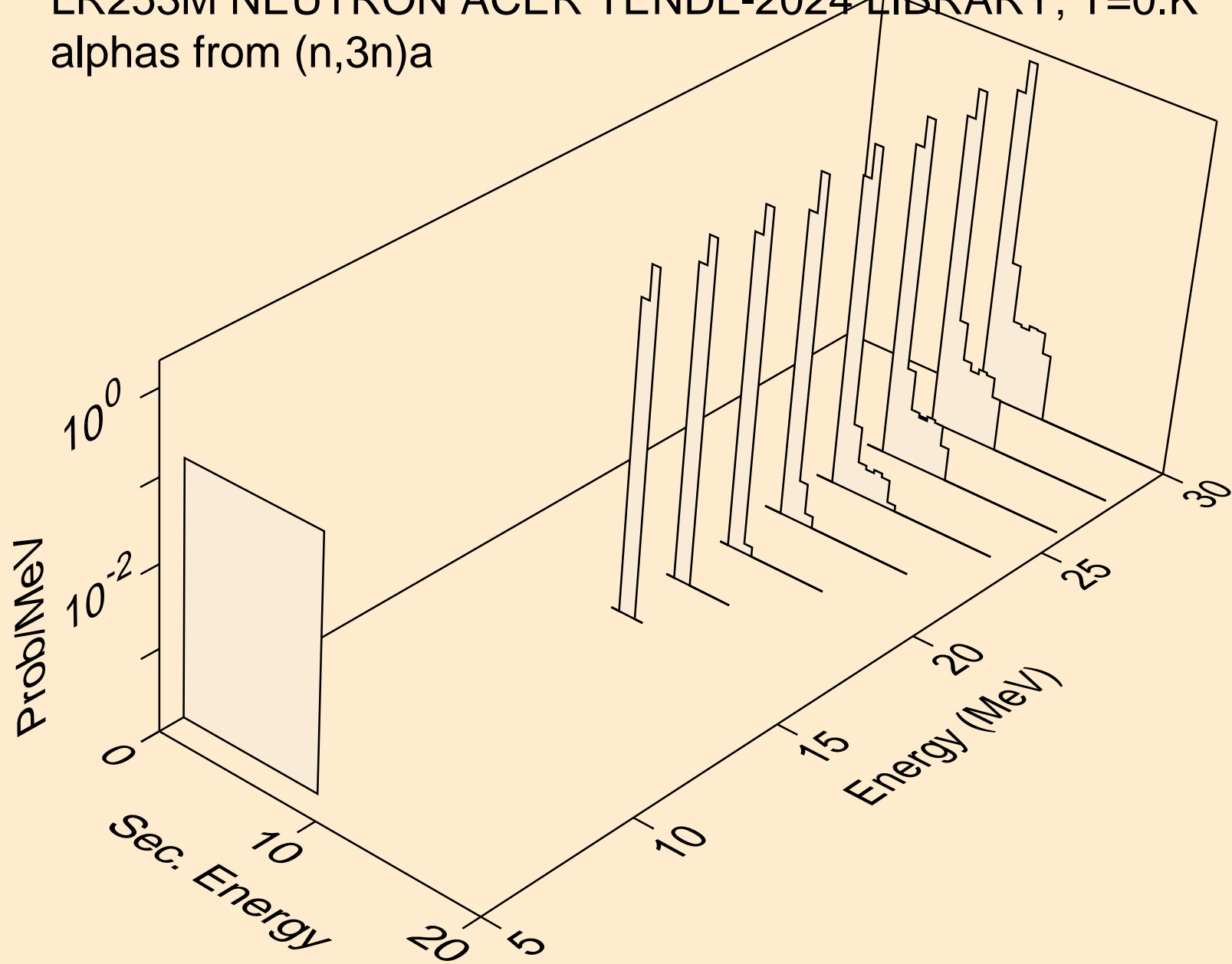

LR253M NEUTRON ACER TENDL-2024 LIBRARY; T=0.K
alphas from (n,a)

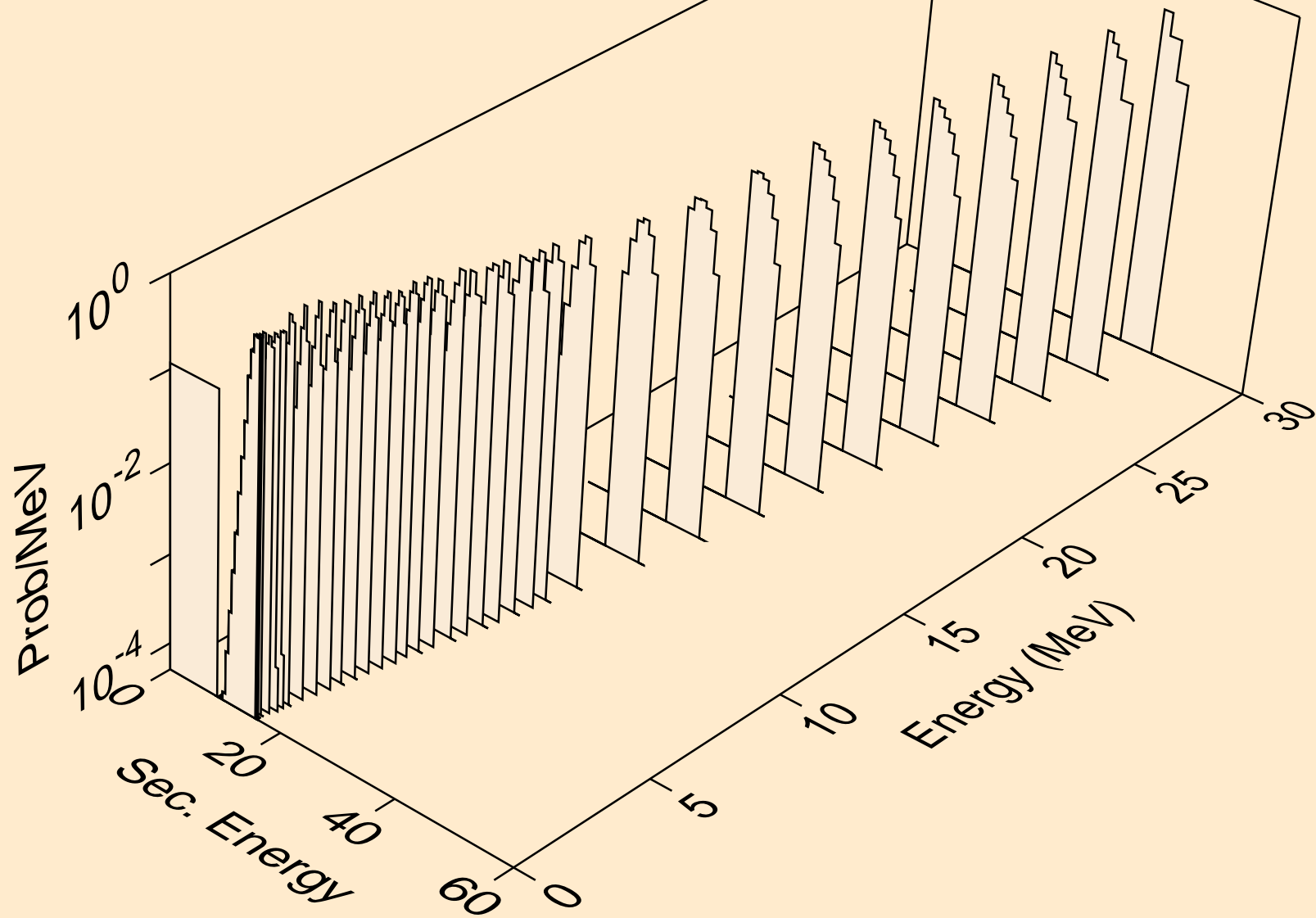

LR253M NEUTRON ACER TENDL-2024 LIBRARY; T=0.K
alphas from (n,2a)

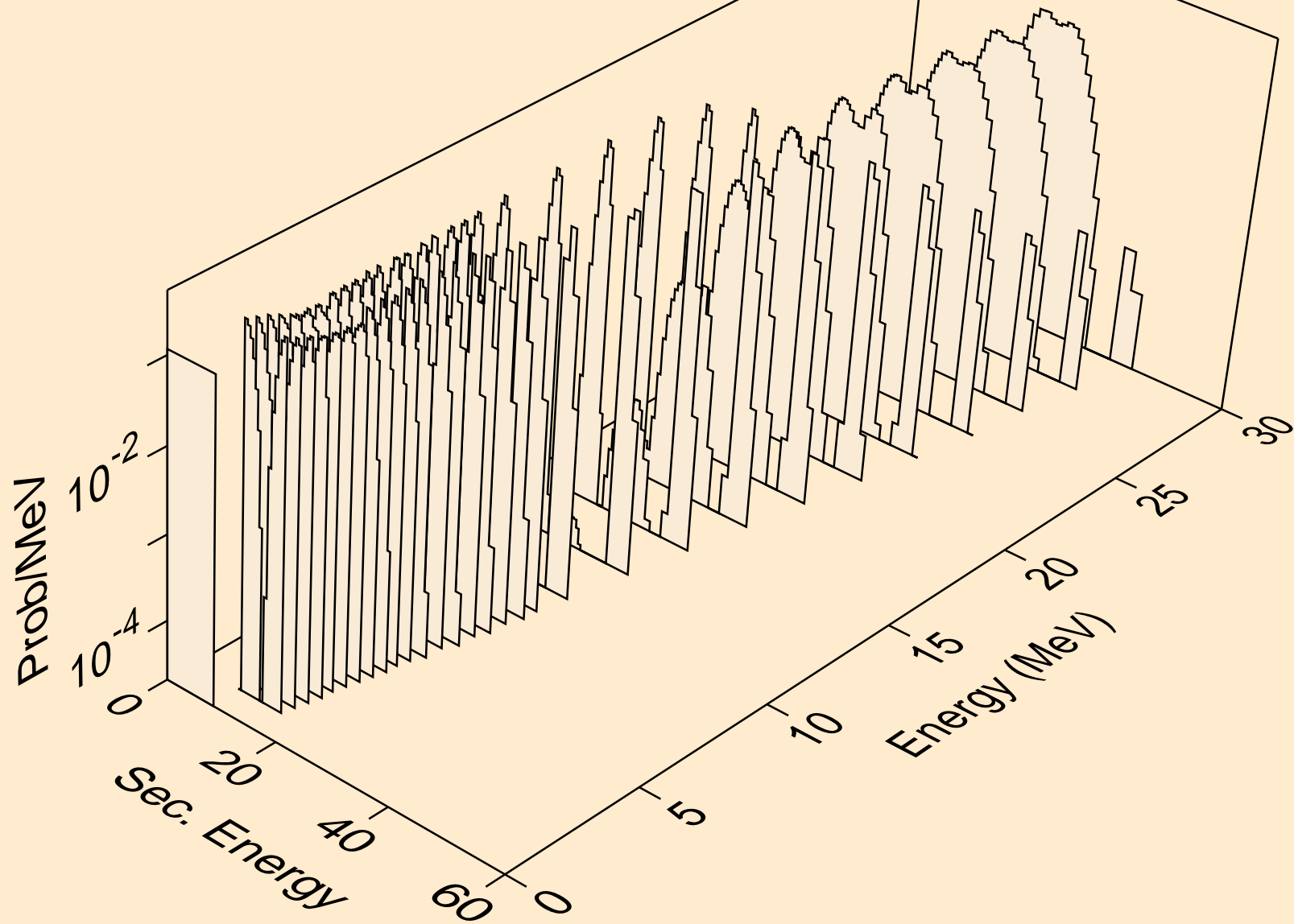

LR253M NEUTRON ACER TENDL-2024 LIBRARY; T=0.K
alphas from (n,pa)

