

# LU174 NEUTRON ACER TENDL-2024 LIBRARY; T=0.K

## Principal cross sections

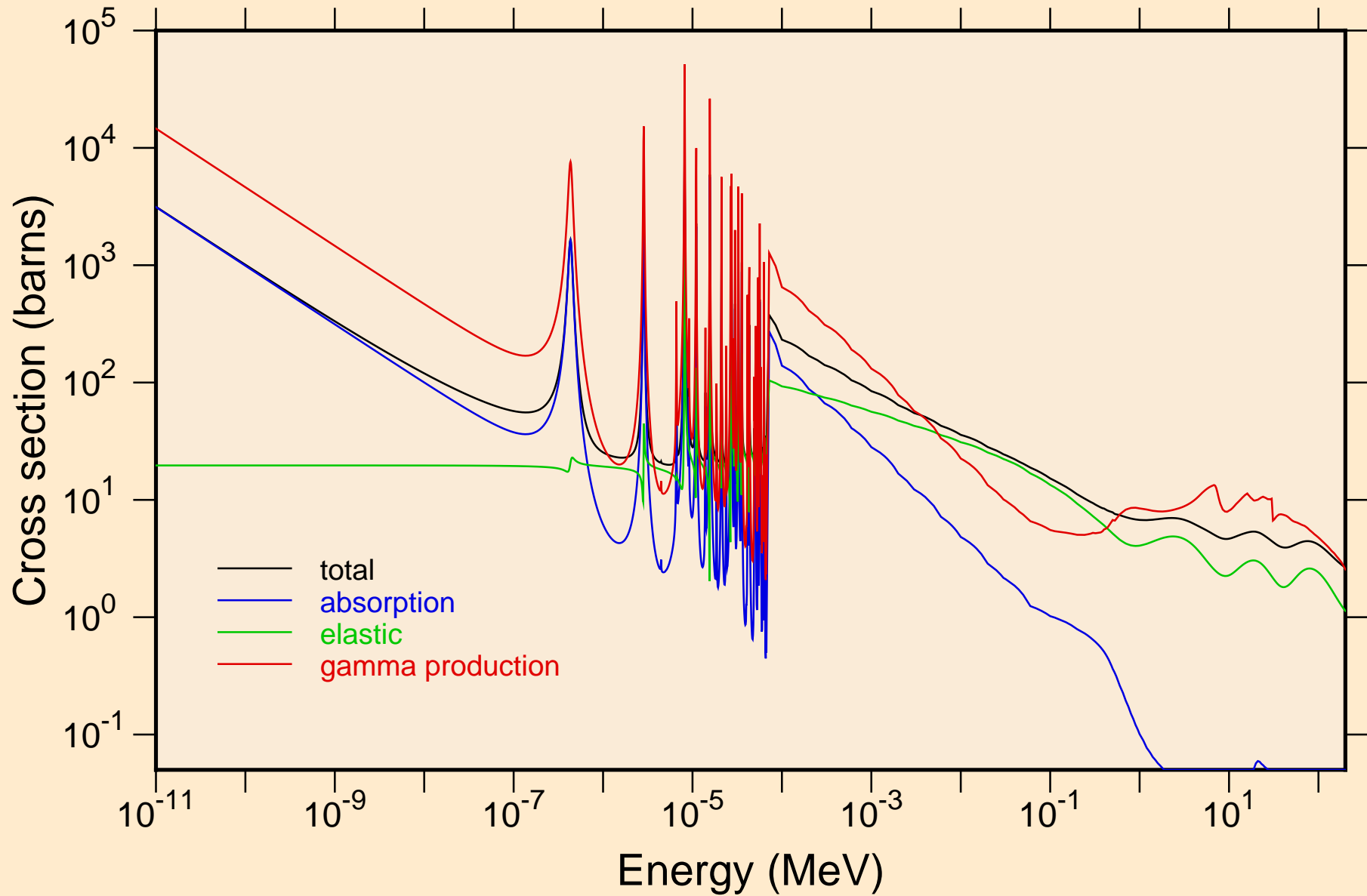

LU174 NEUTRON ACER TENDL-2024 LIBRARY; T=0.K  
resonance total cross section

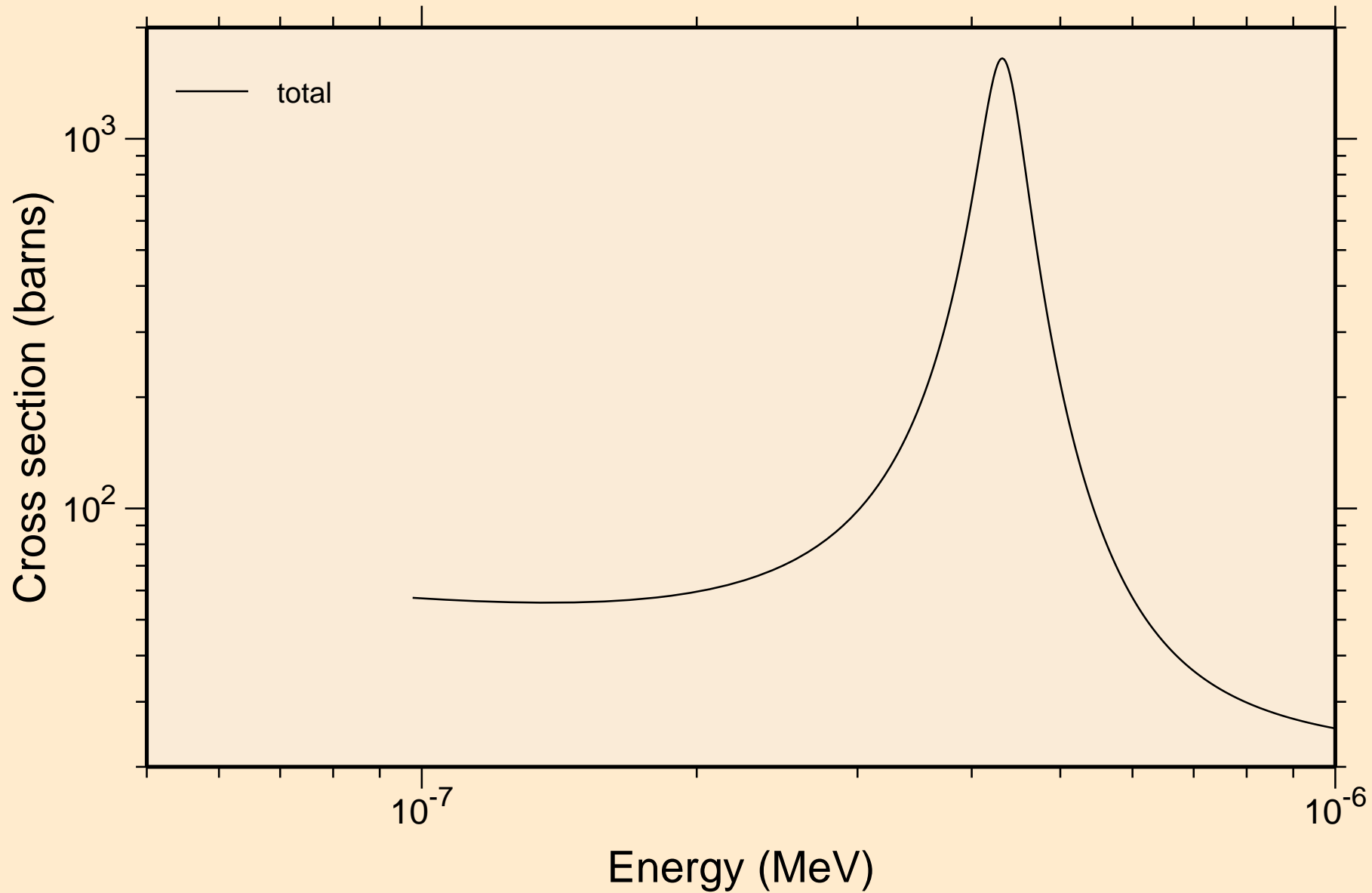

LU174 NEUTRON ACER TENDL-2024 LIBRARY; T=0.K  
resonance total cross section

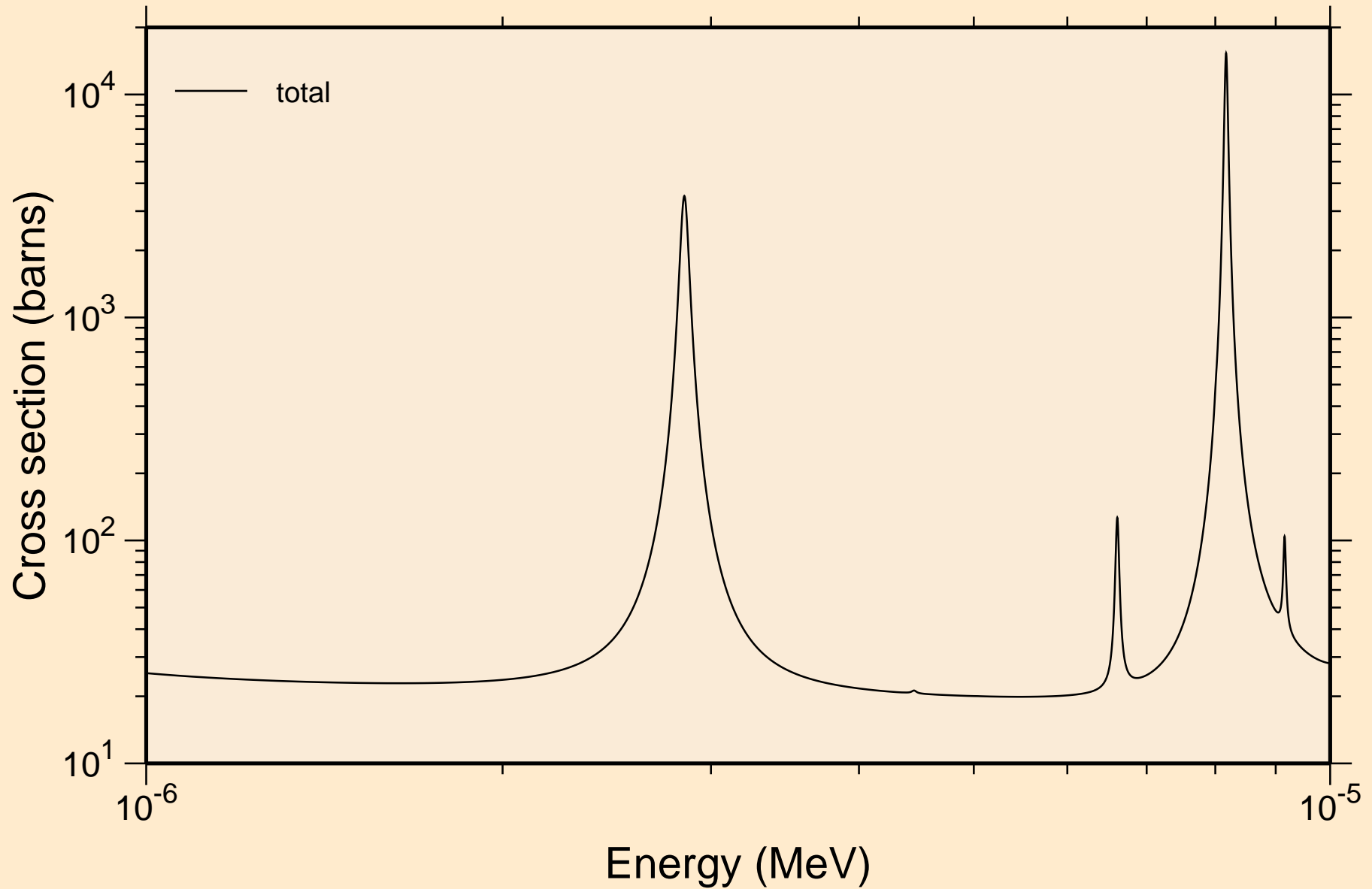

LU174 NEUTRON ACER TENDL-2024 LIBRARY; T=0.K  
resonance total cross section

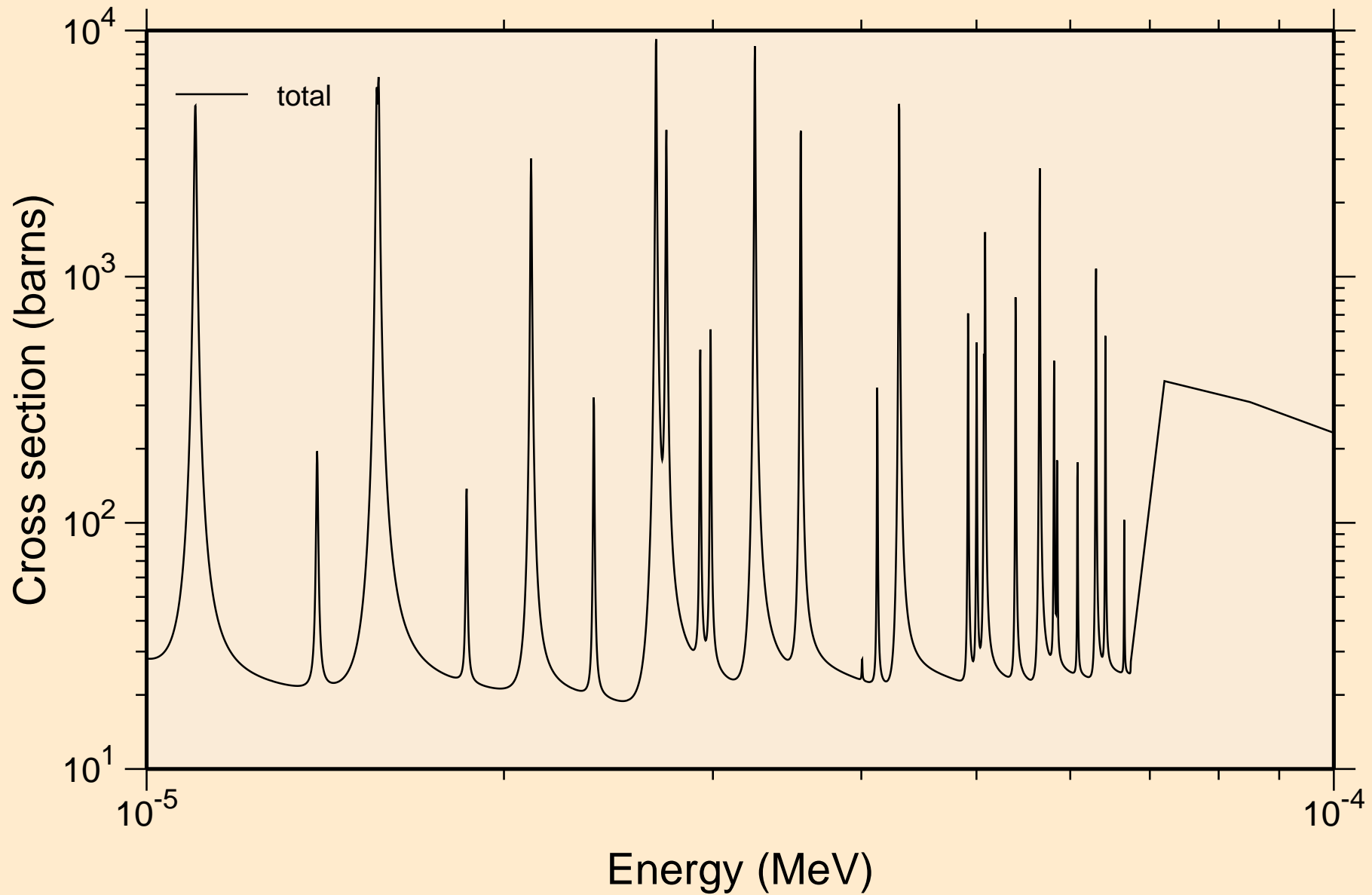

LU174 NEUTRON ACER TENDL-2024 LIBRARY; T=0.K  
resonance total cross section

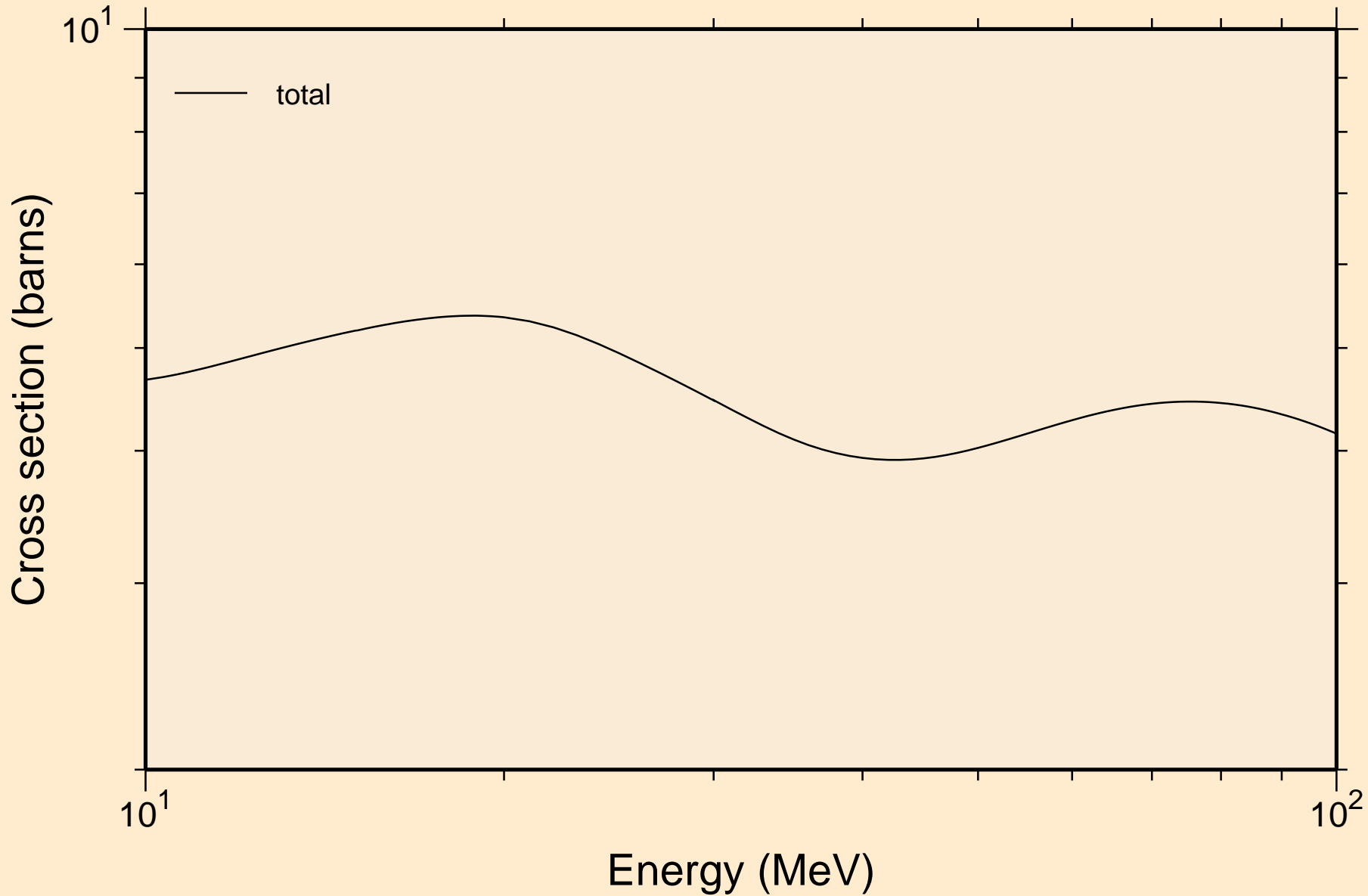

LU174 NEUTRON ACER TENDL-2024 LIBRARY; T=0.K  
resonance absorption cross sections

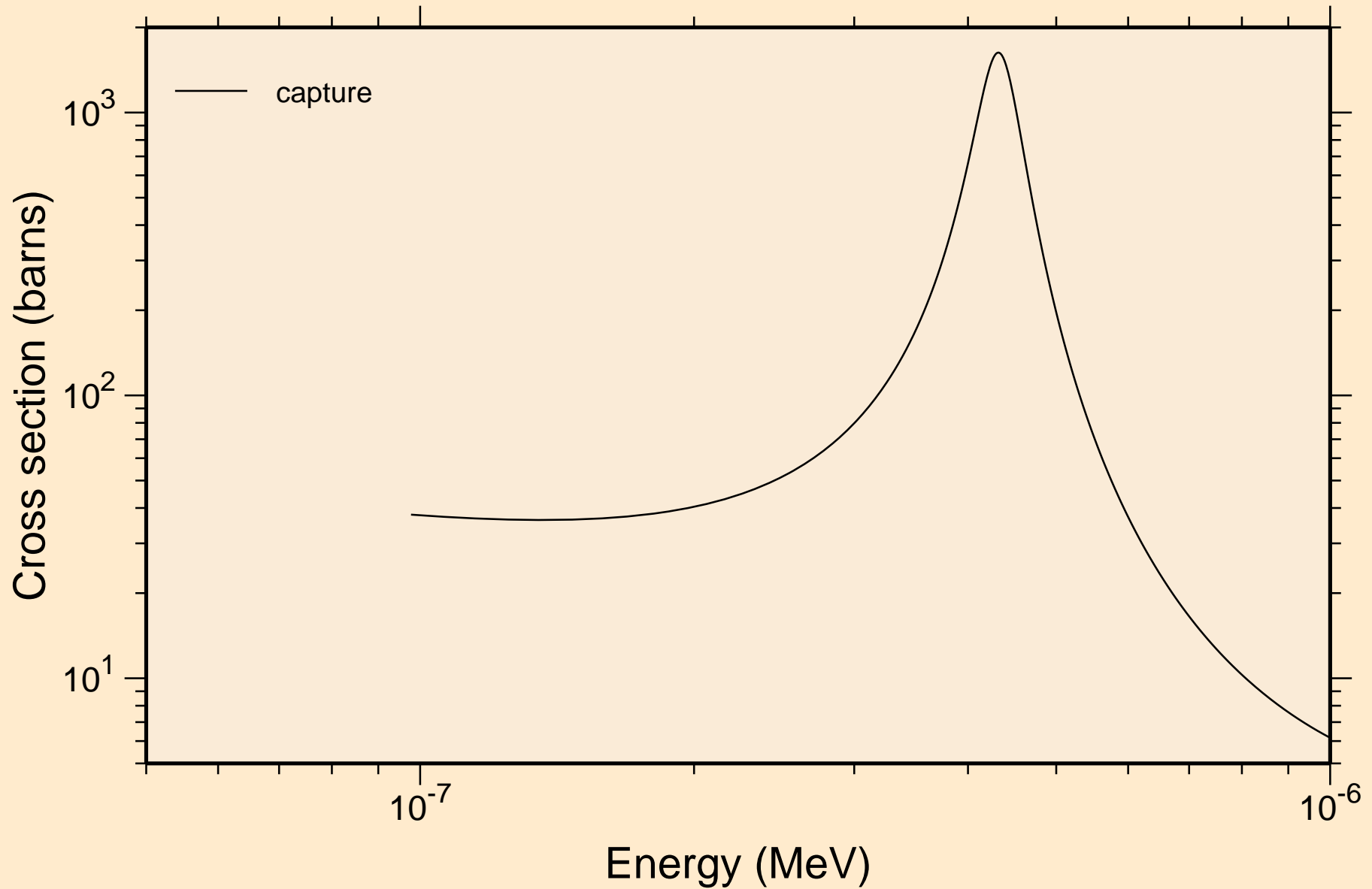

LU174 NEUTRON ACER TENDL-2024 LIBRARY; T=0.K  
resonance absorption cross sections

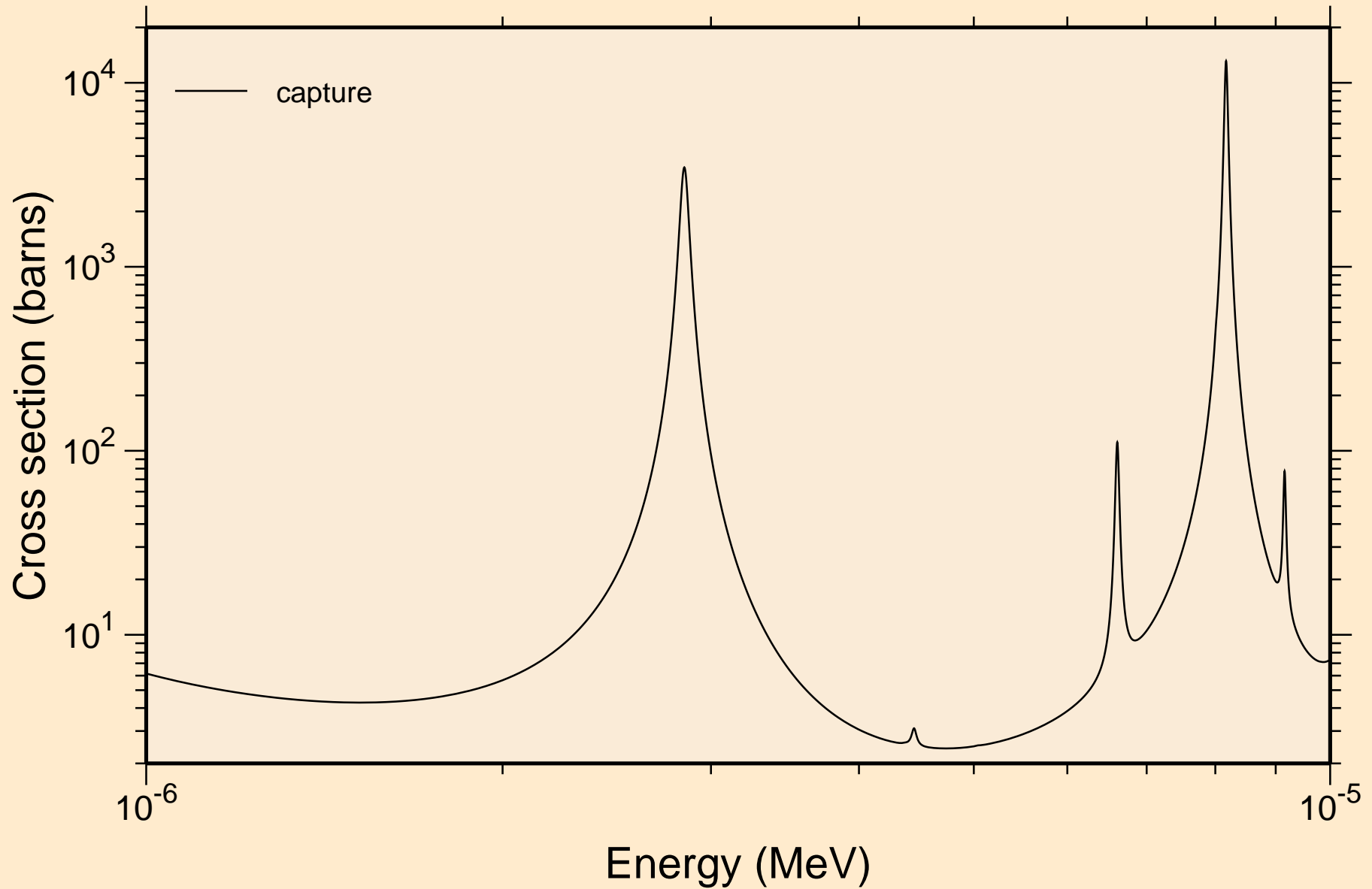

LU174 NEUTRON ACER TENDL-2024 LIBRARY; T=0.K  
resonance absorption cross sections

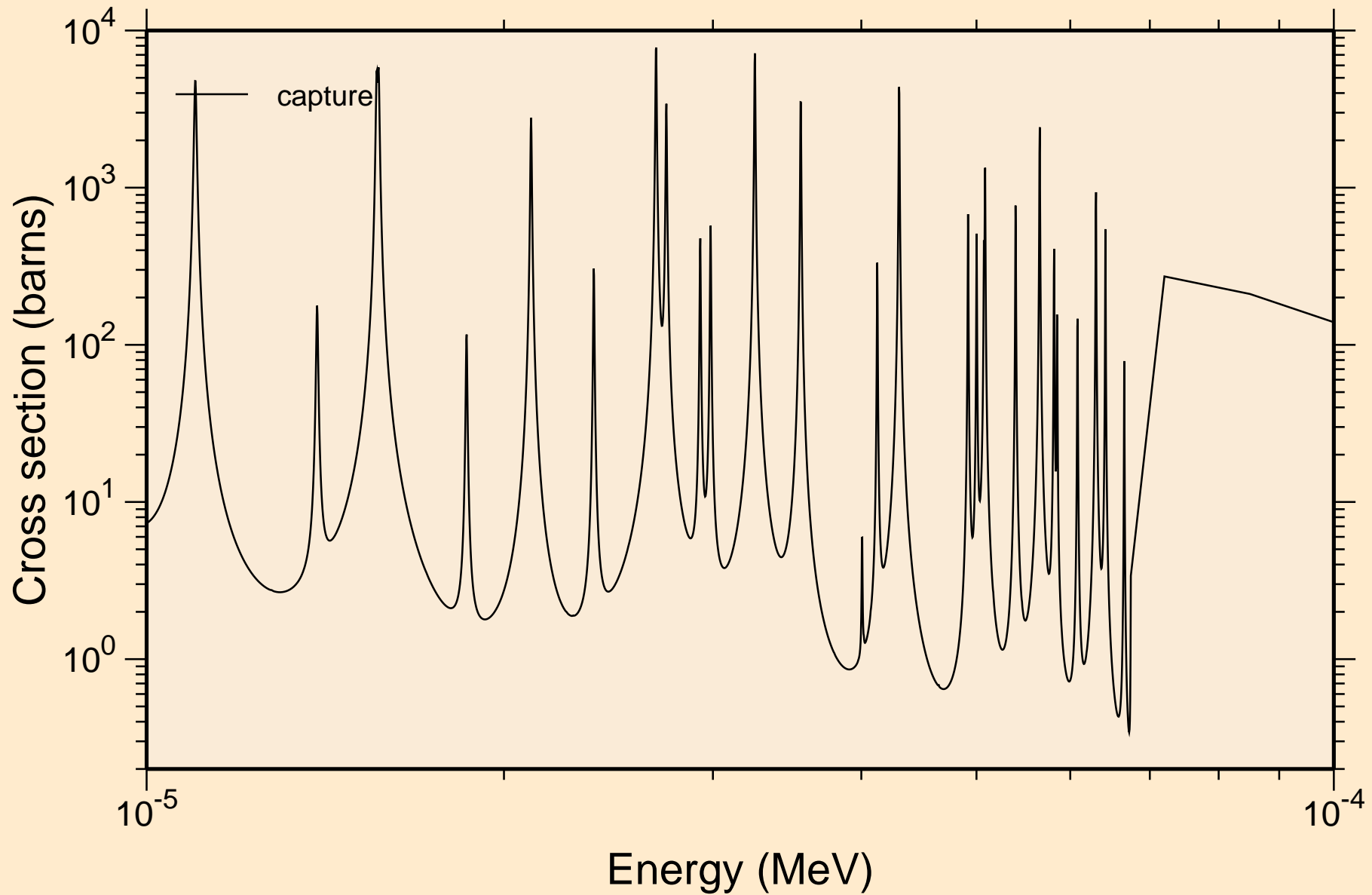



LU174 NEUTRON ACER TENDL-2024 LIBRARY; T=0.K  
resonance absorption cross sections

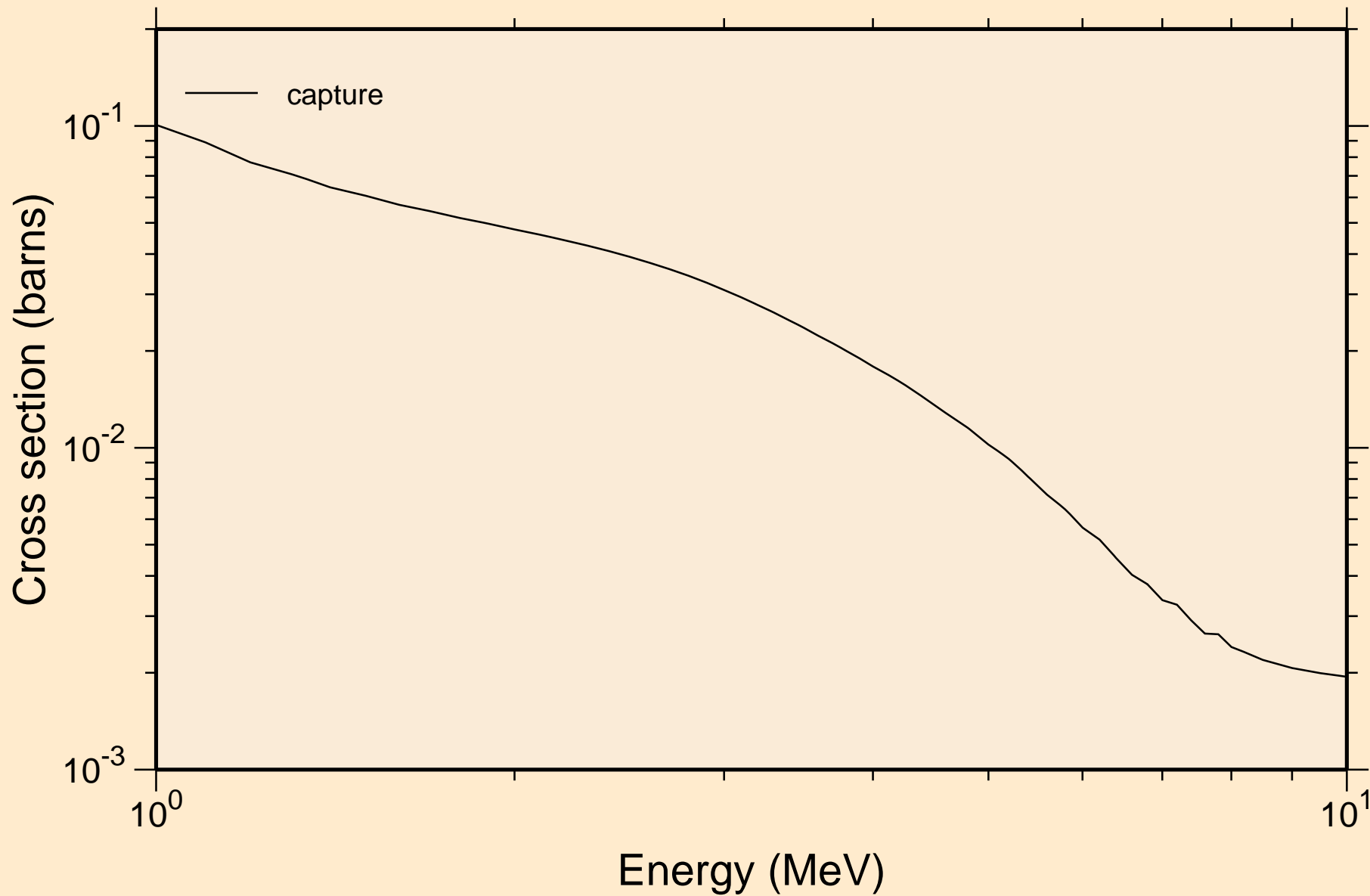

# LU174 NEUTRON ACER TENDL-2024 LIBRARY; T=0.K

## Heating

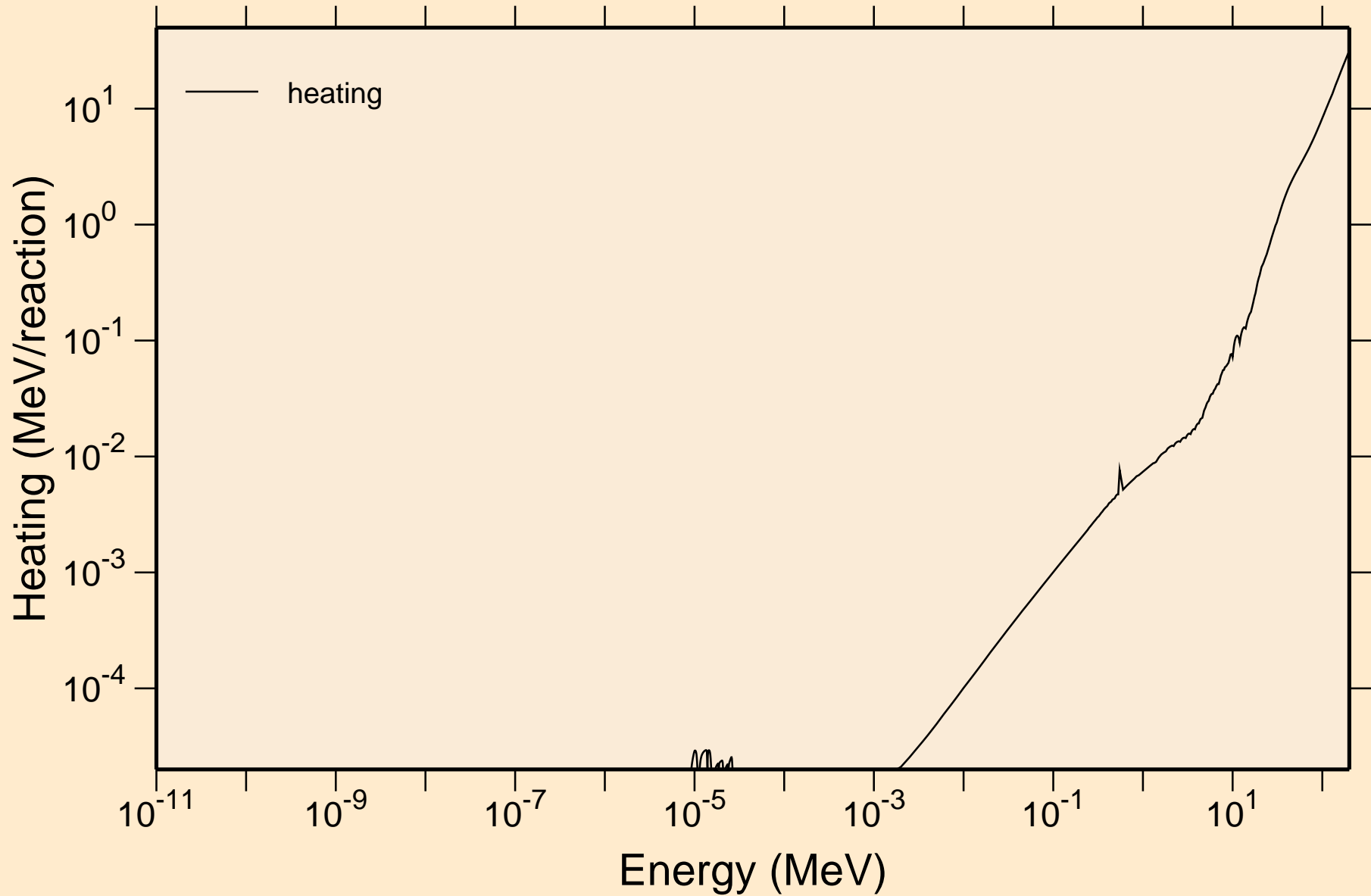

LU174 NEUTRON ACER TENDL-2024 LIBRARY; T=0.K  
Damage

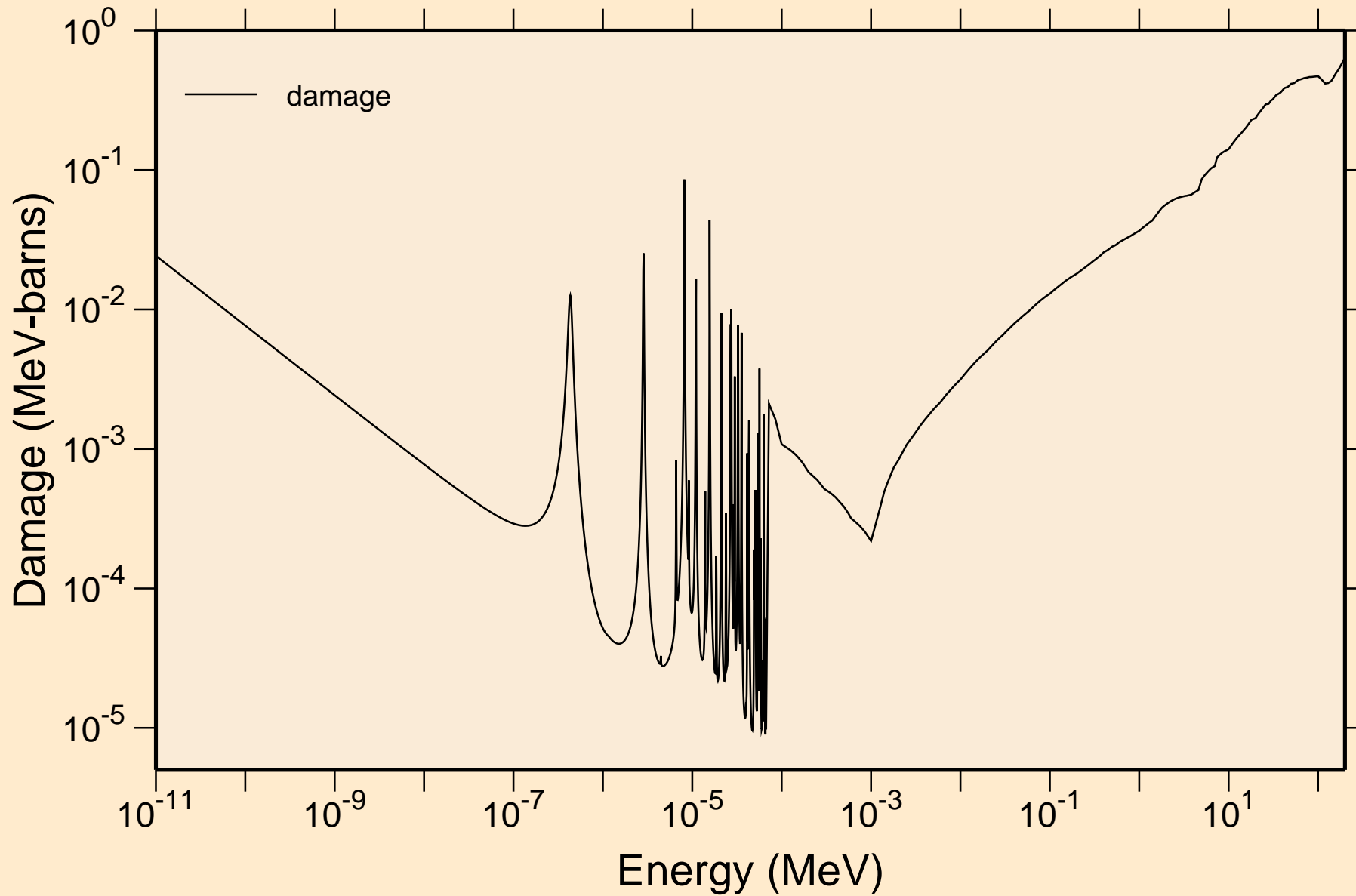

LU174 NEUTRON ACER TENDL-2024 LIBRARY; T=0.K  
Non-threshold reactions

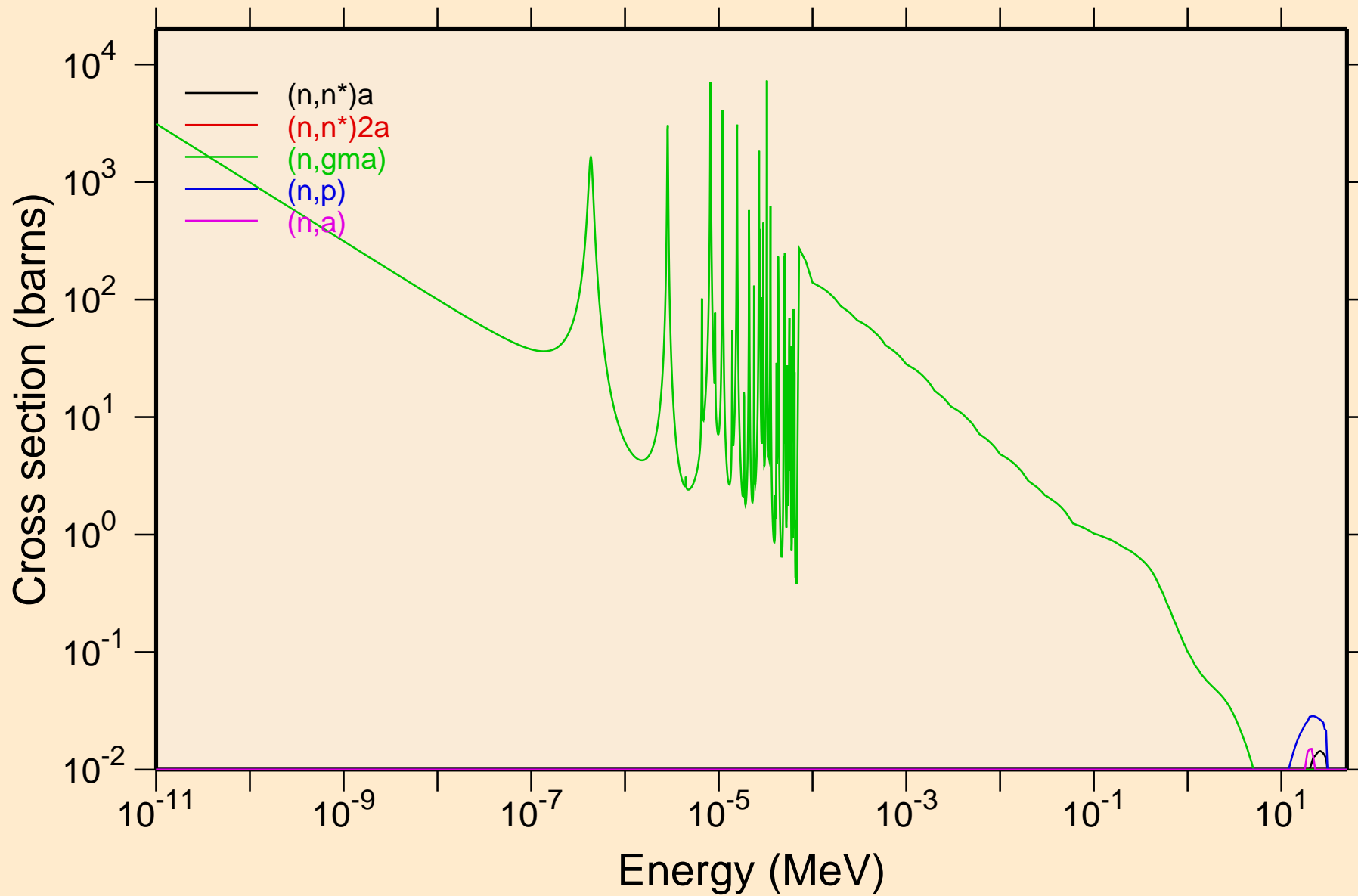

LU174 NEUTRON ACER TENDL-2024 LIBRARY; T=0.K  
Non-threshold reactions

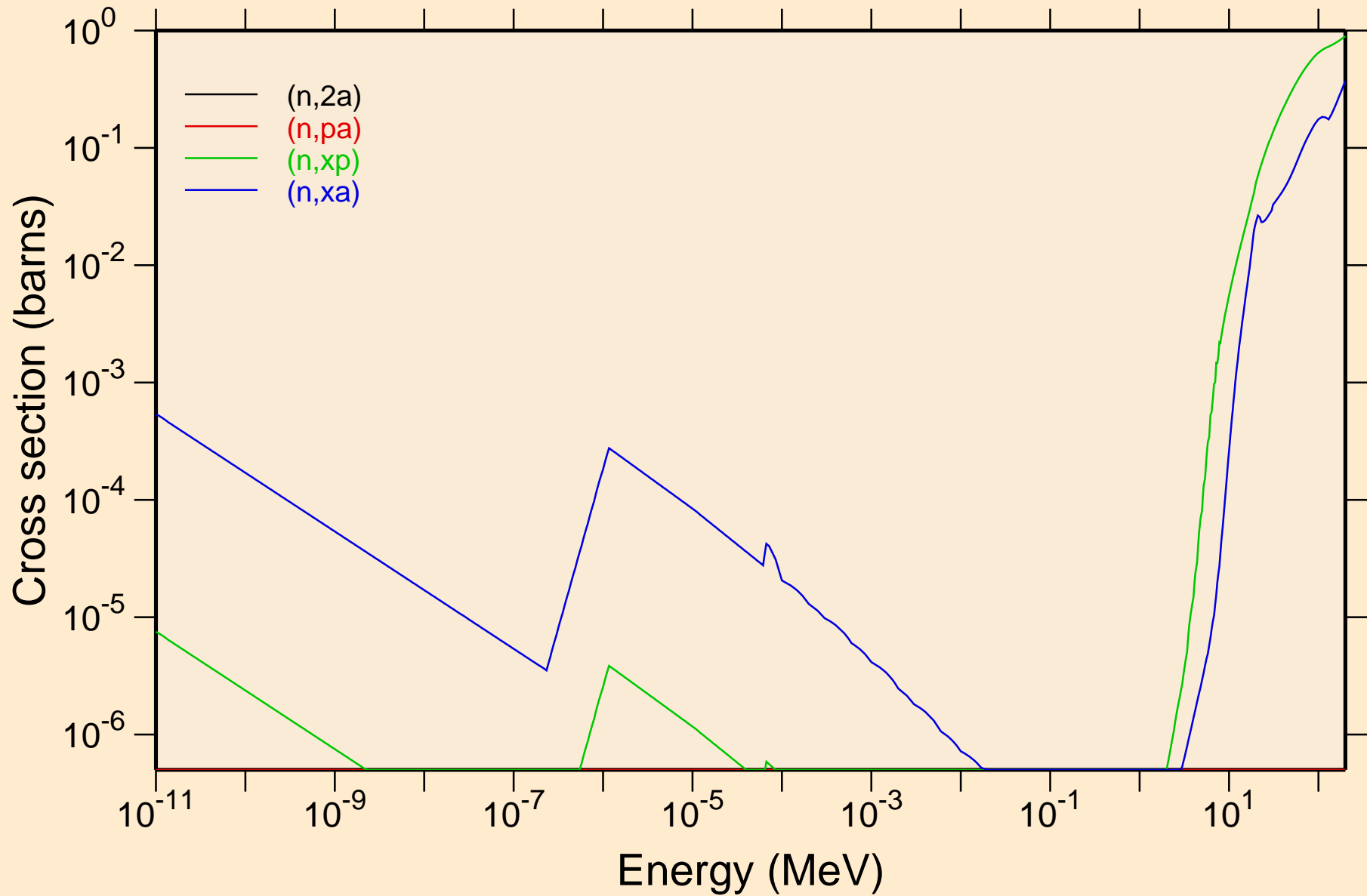

# LU174 NEUTRON ACER TENDL-2024 LIBRARY; T=0.K

## Principal cross sections

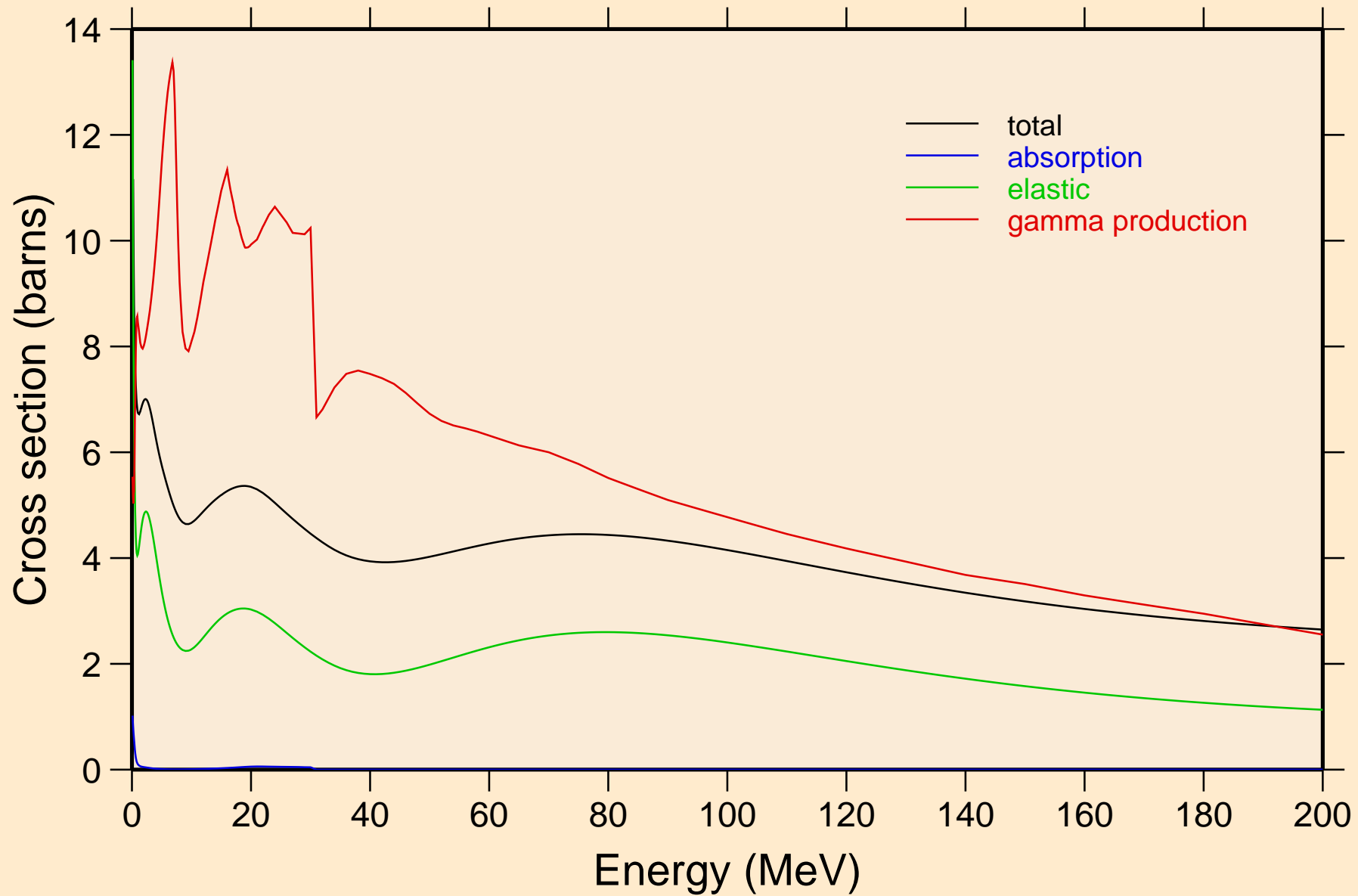

# LU174 NEUTRON ACER TENDL-2024 LIBRARY; T=0.K

## Heating

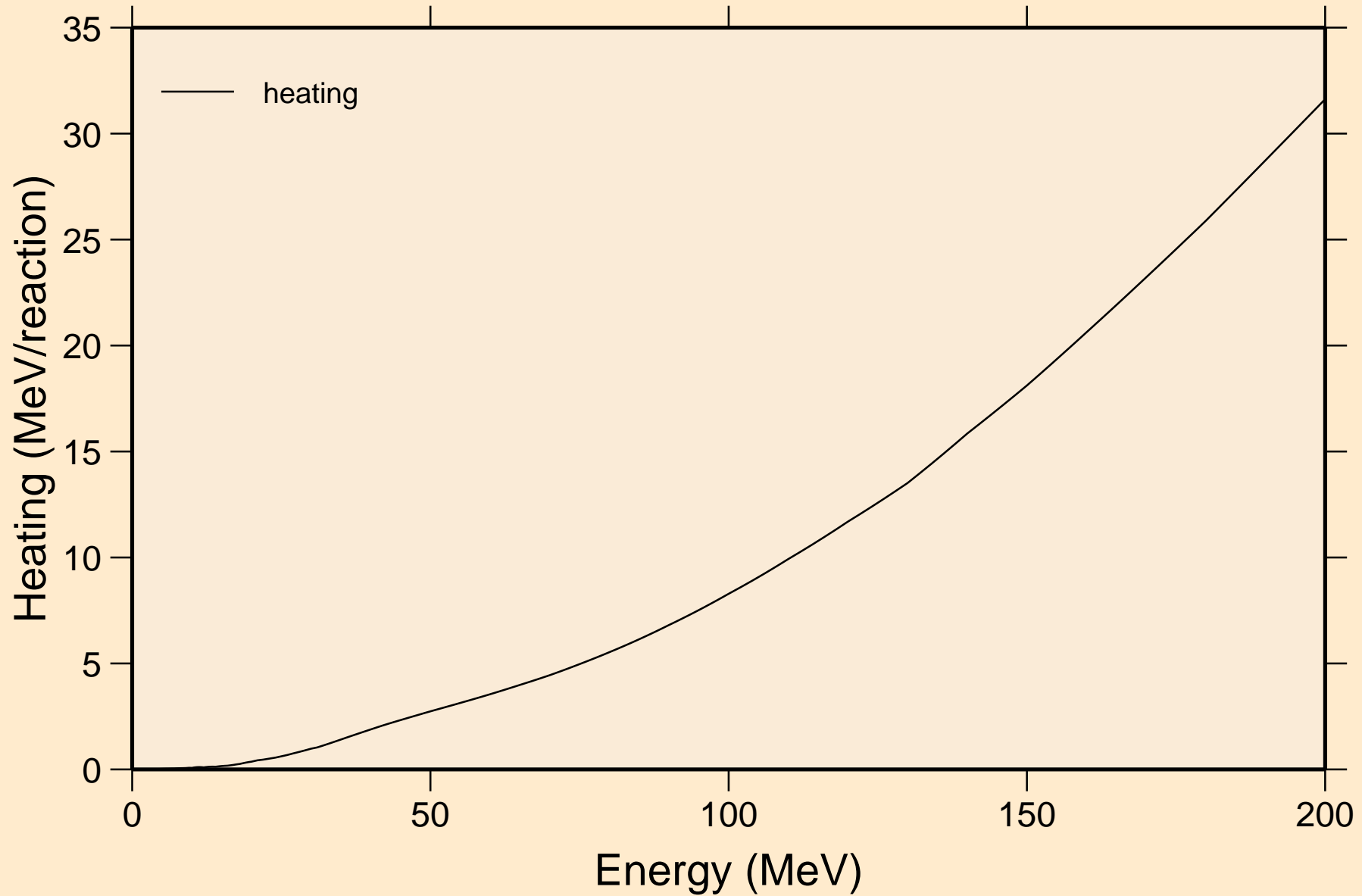

LU174 NEUTRON ACER TENDL-2024 LIBRARY; T=0.K  
Damage

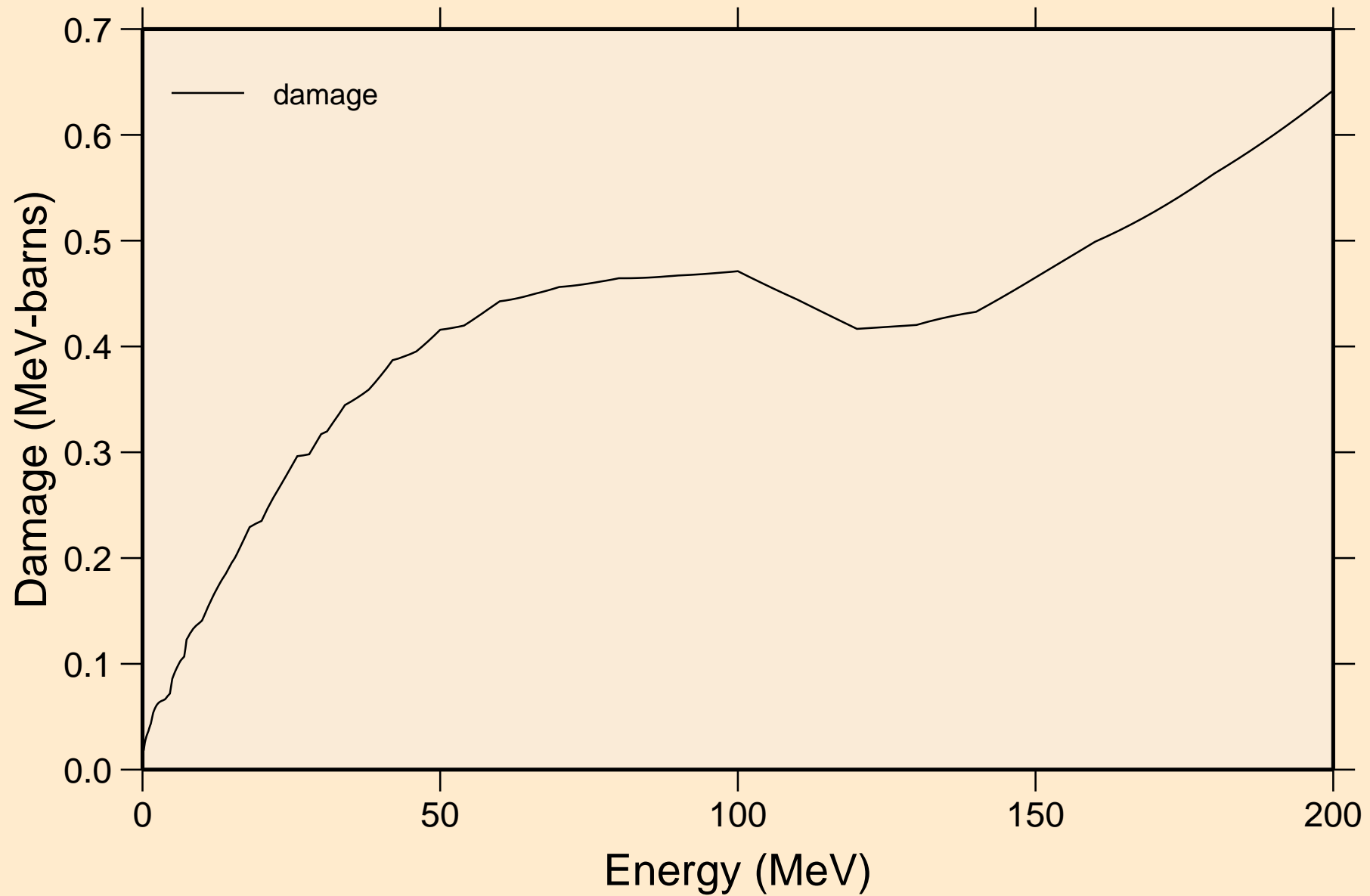



LU174 NEUTRON ACER TENDL-2024 LIBRARY; T=0.K  
Non-threshold reactions

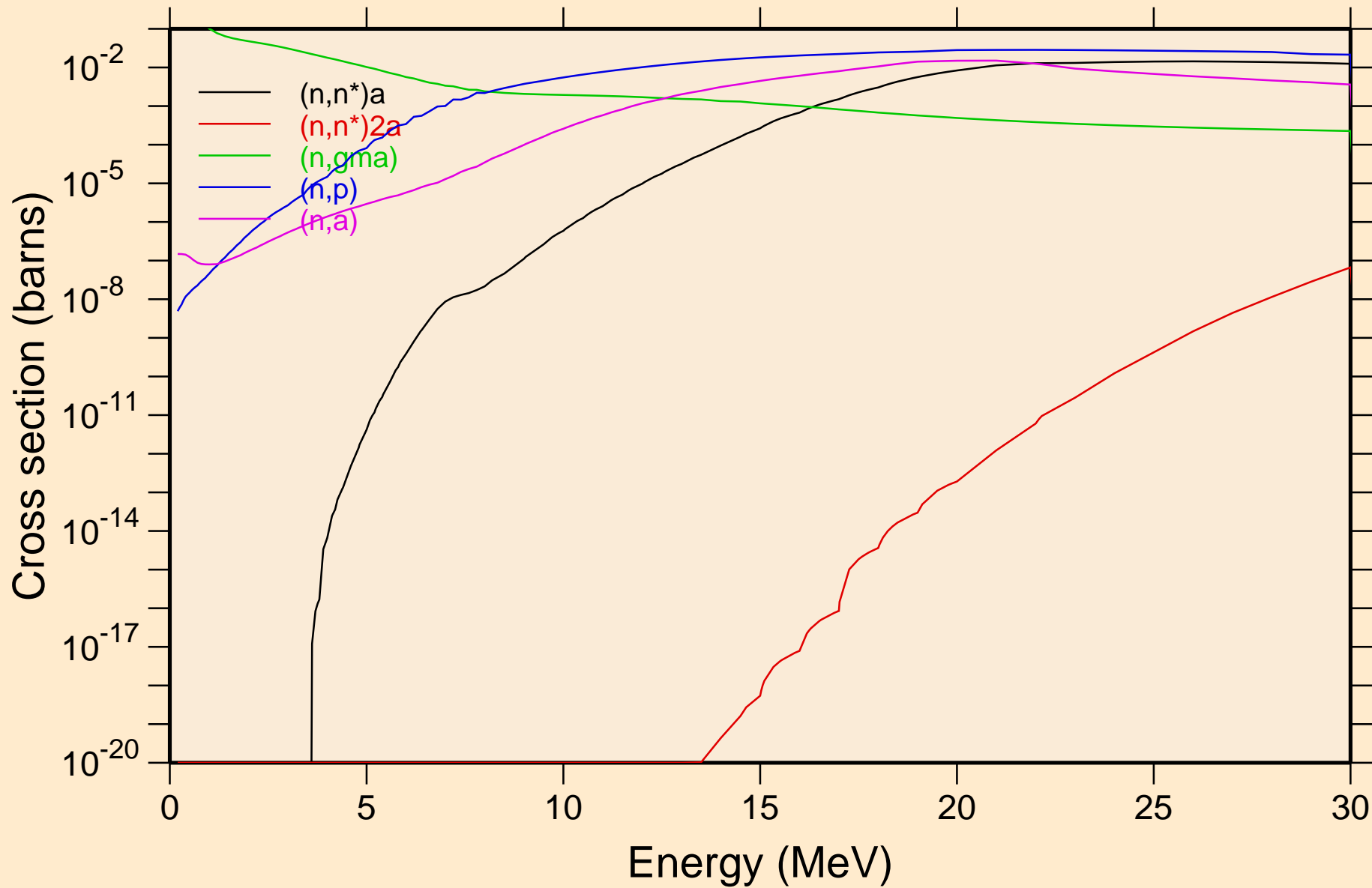

LU174 NEUTRON ACER TENDL-2024 LIBRARY; T=0.K  
Non-threshold reactions

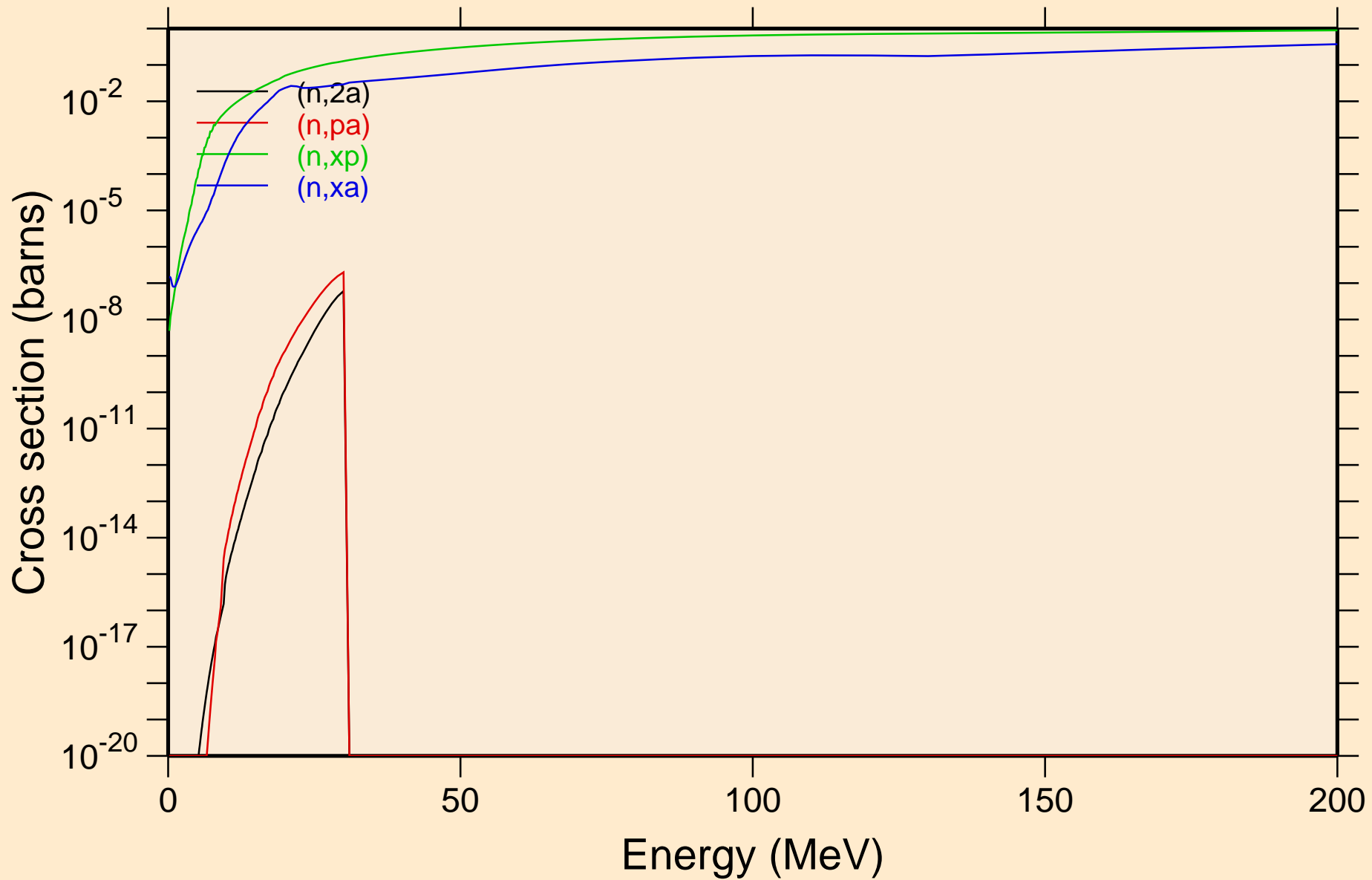

LU174 NEUTRON ACER TENDL-2024 LIBRARY; T=0.K  
Inelastic levels

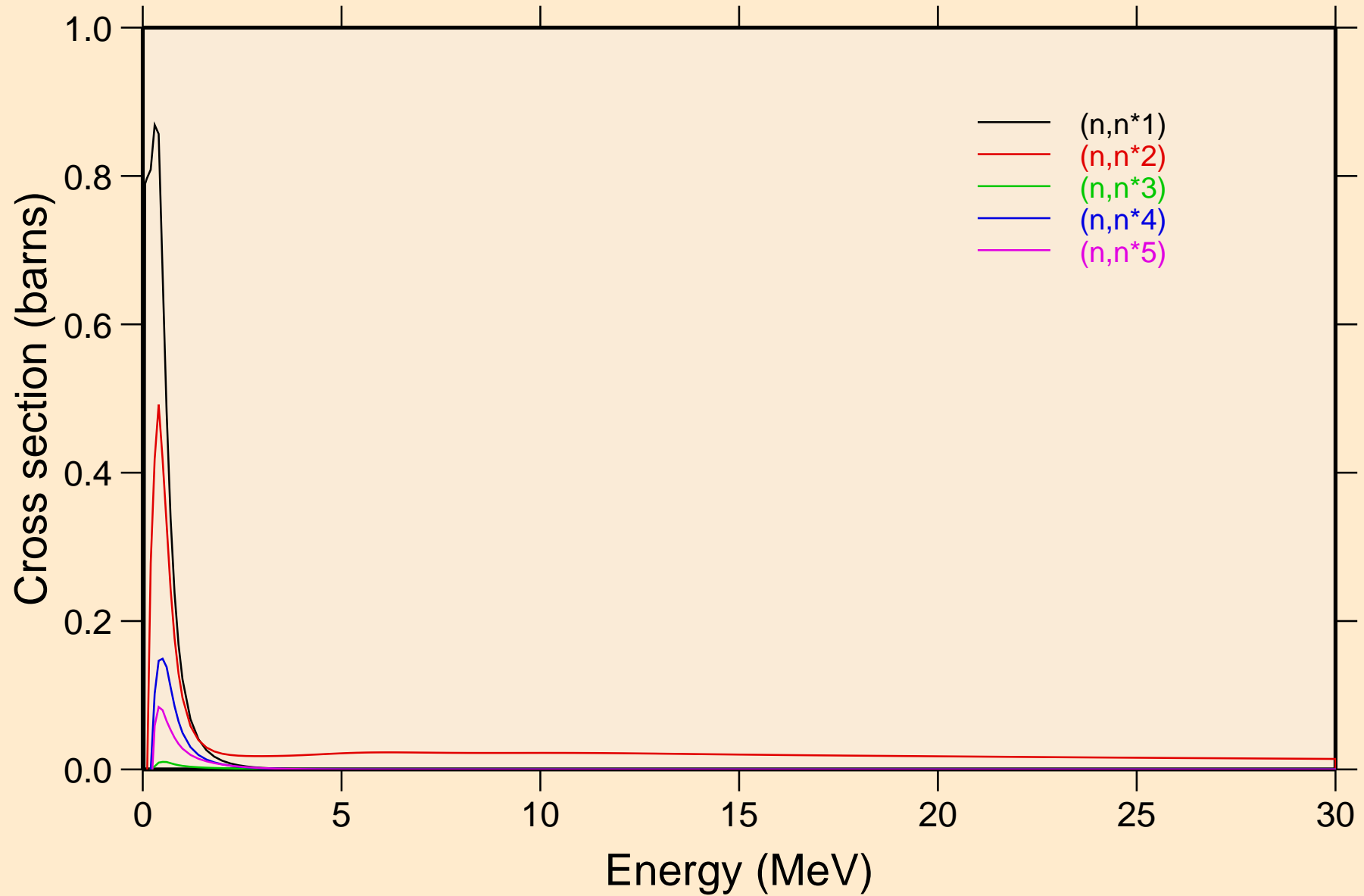

LU174 NEUTRON ACER TENDL-2024 LIBRARY; T=0.K  
Inelastic levels

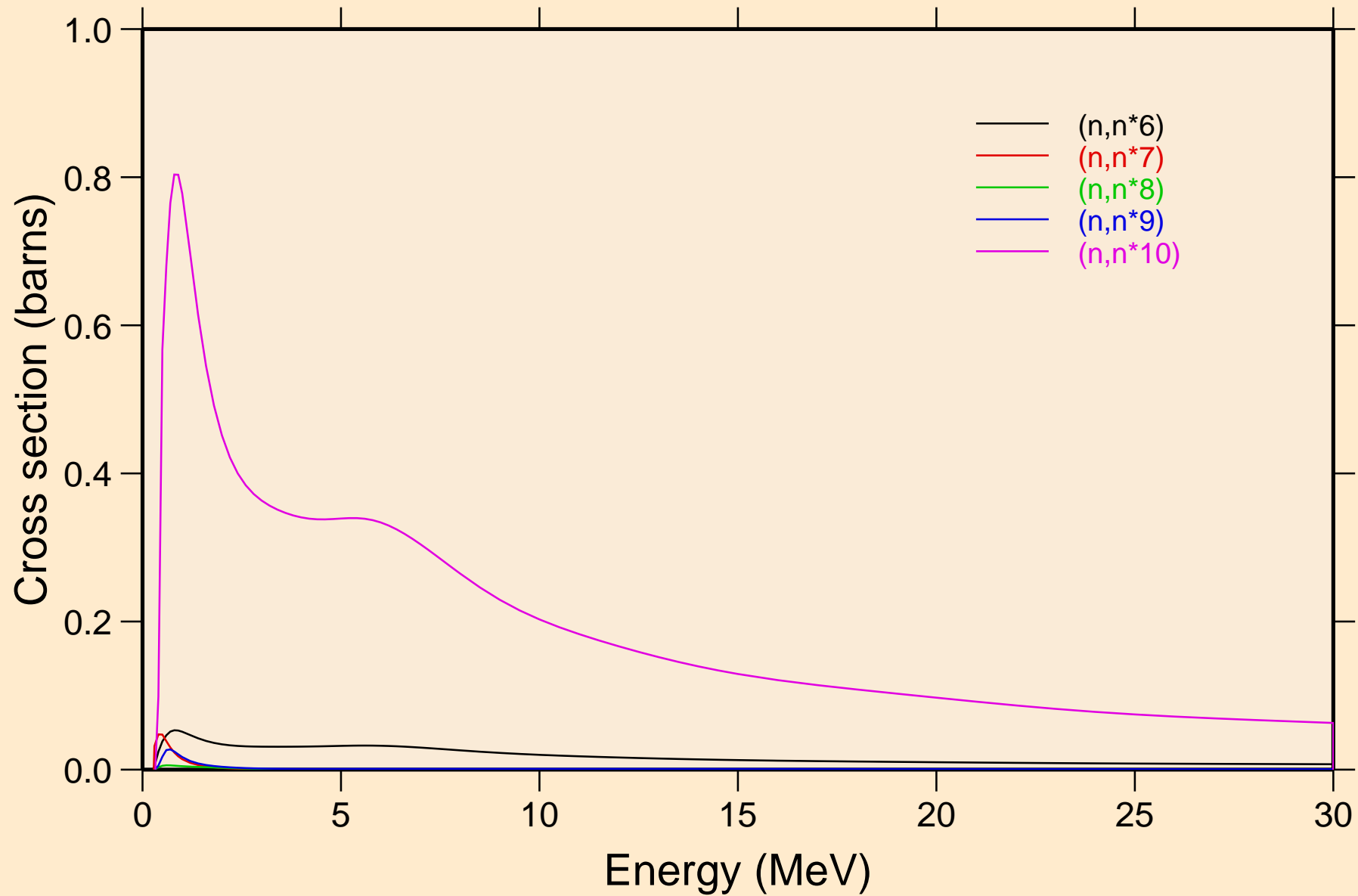

LU174 NEUTRON ACER TENDL-2024 LIBRARY; T=0.K  
Inelastic levels

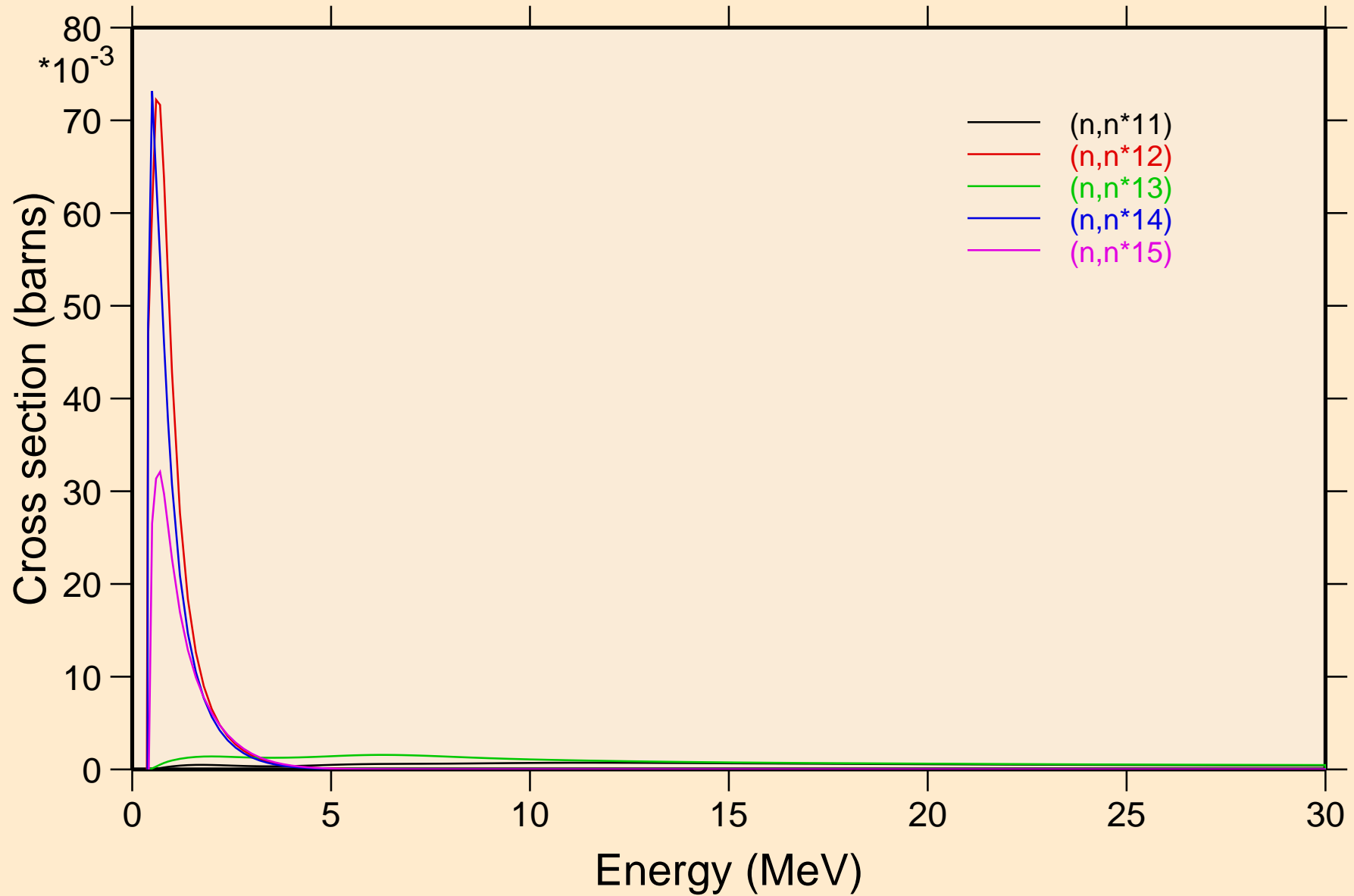

LU174 NEUTRON ACER TENDL-2024 LIBRARY; T=0.K  
Inelastic levels

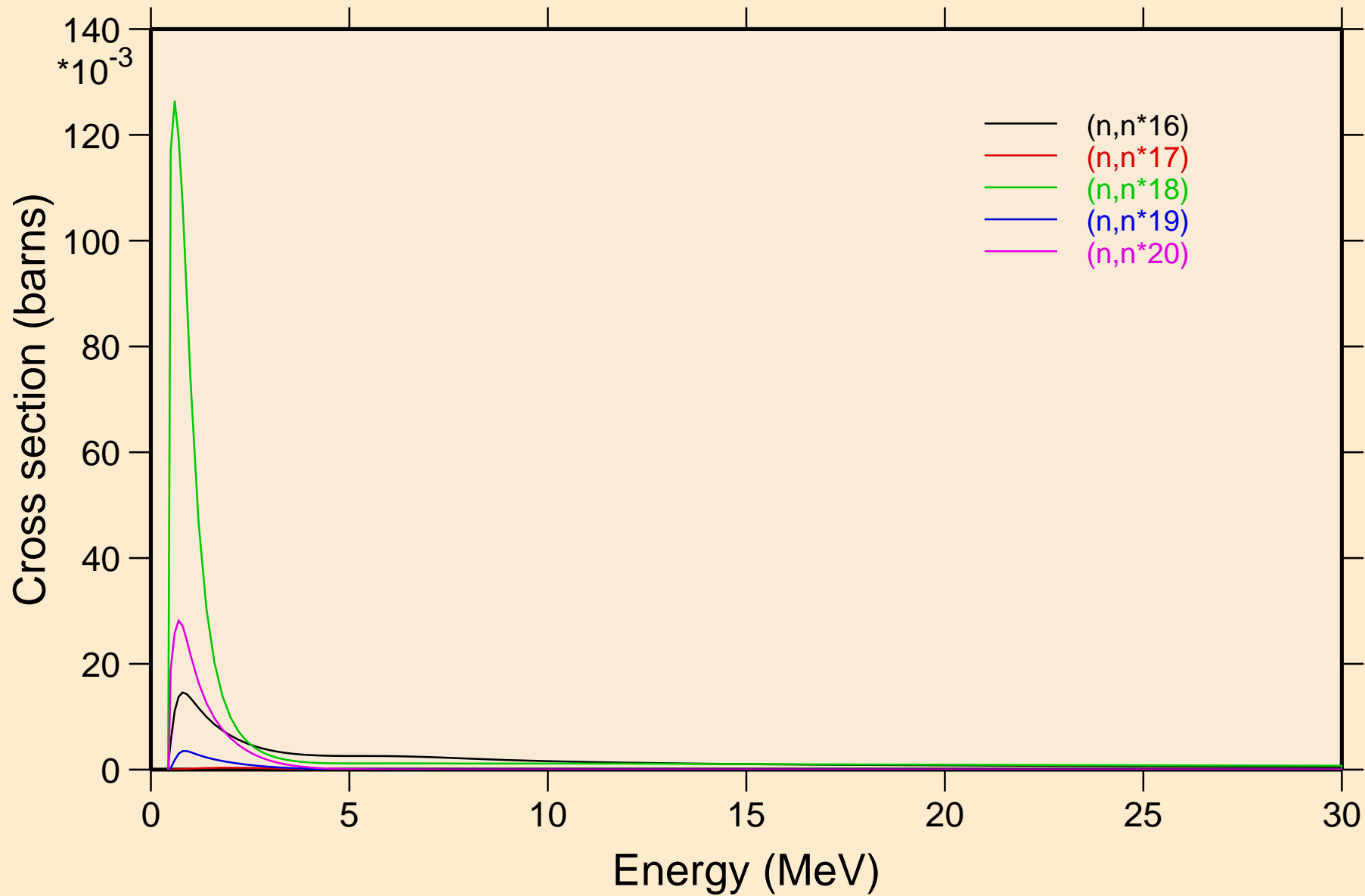

LU174 NEUTRON ACER TENDL-2024 LIBRARY; T=0.K  
Inelastic levels

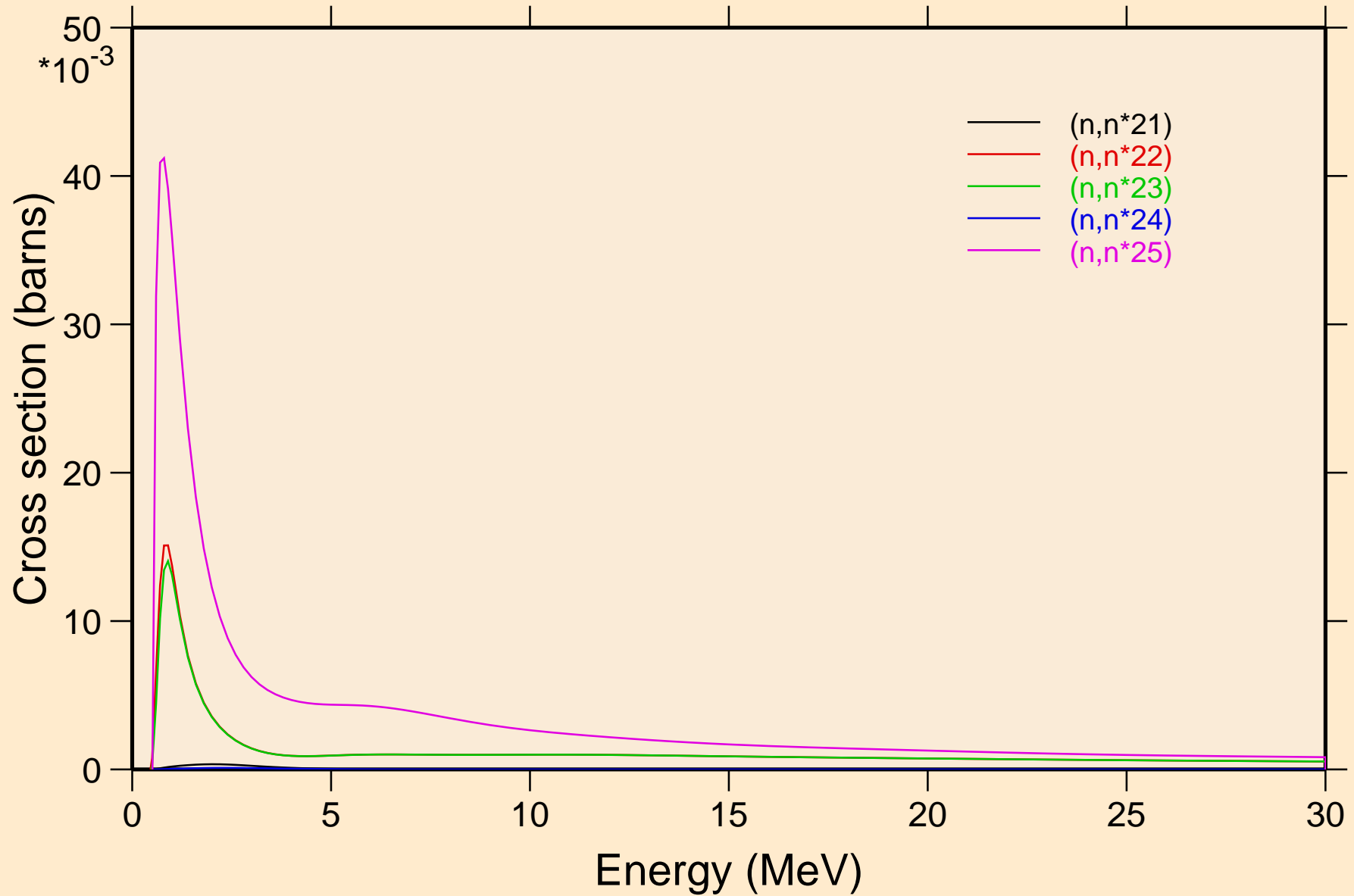

LU174 NEUTRON ACER TENDL-2024 LIBRARY; T=0.K  
Inelastic levels

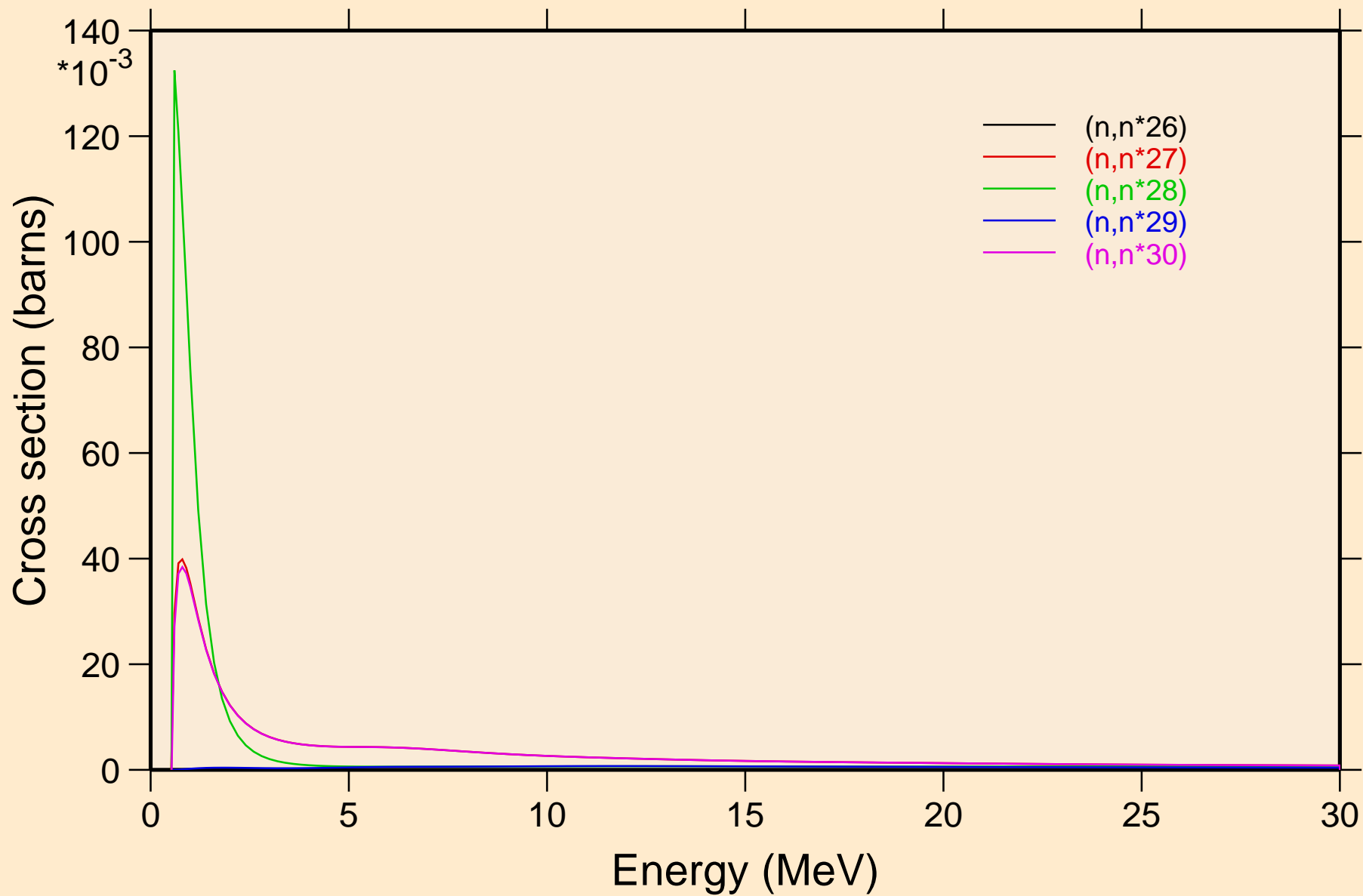



# LU174 NEUTRON ACER TENDL-2024 LIBRARY; T=0.K

## Threshold reactions

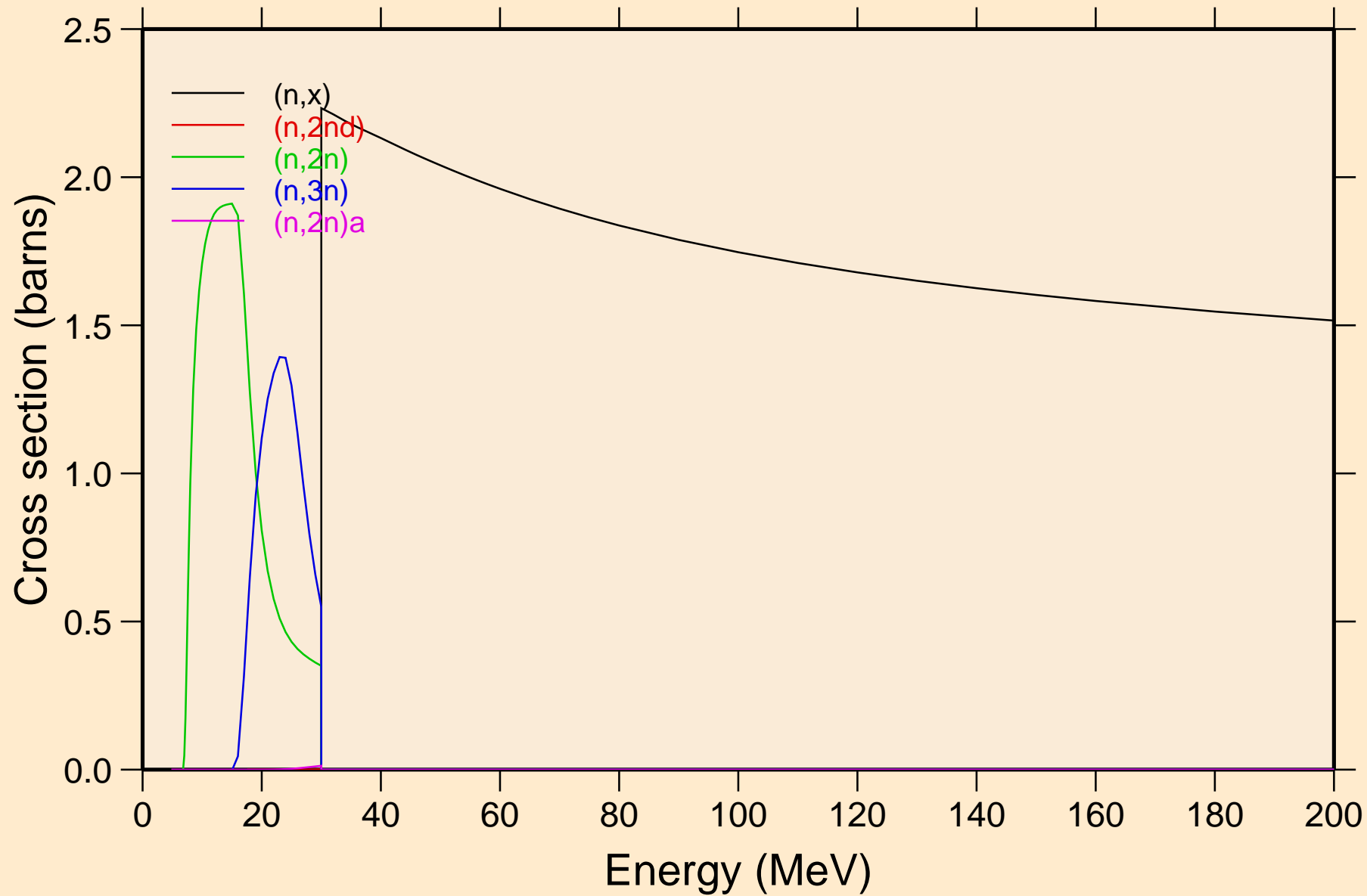

LU174 NEUTRON ACER TENDL-2024 LIBRARY; T=0.K  
Threshold reactions

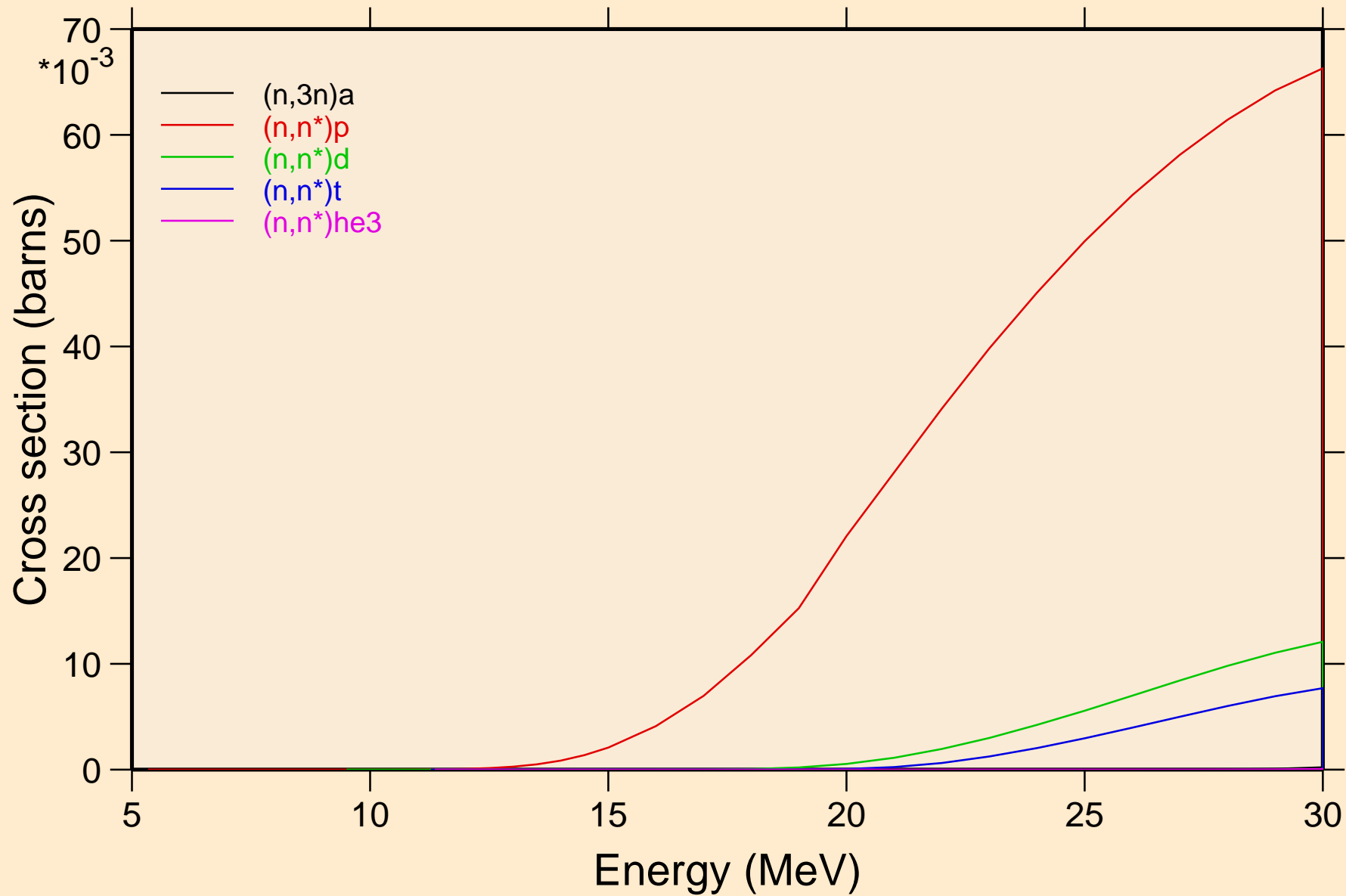

LU174 NEUTRON ACER TENDL-2024 LIBRARY; T=0.K  
Threshold reactions

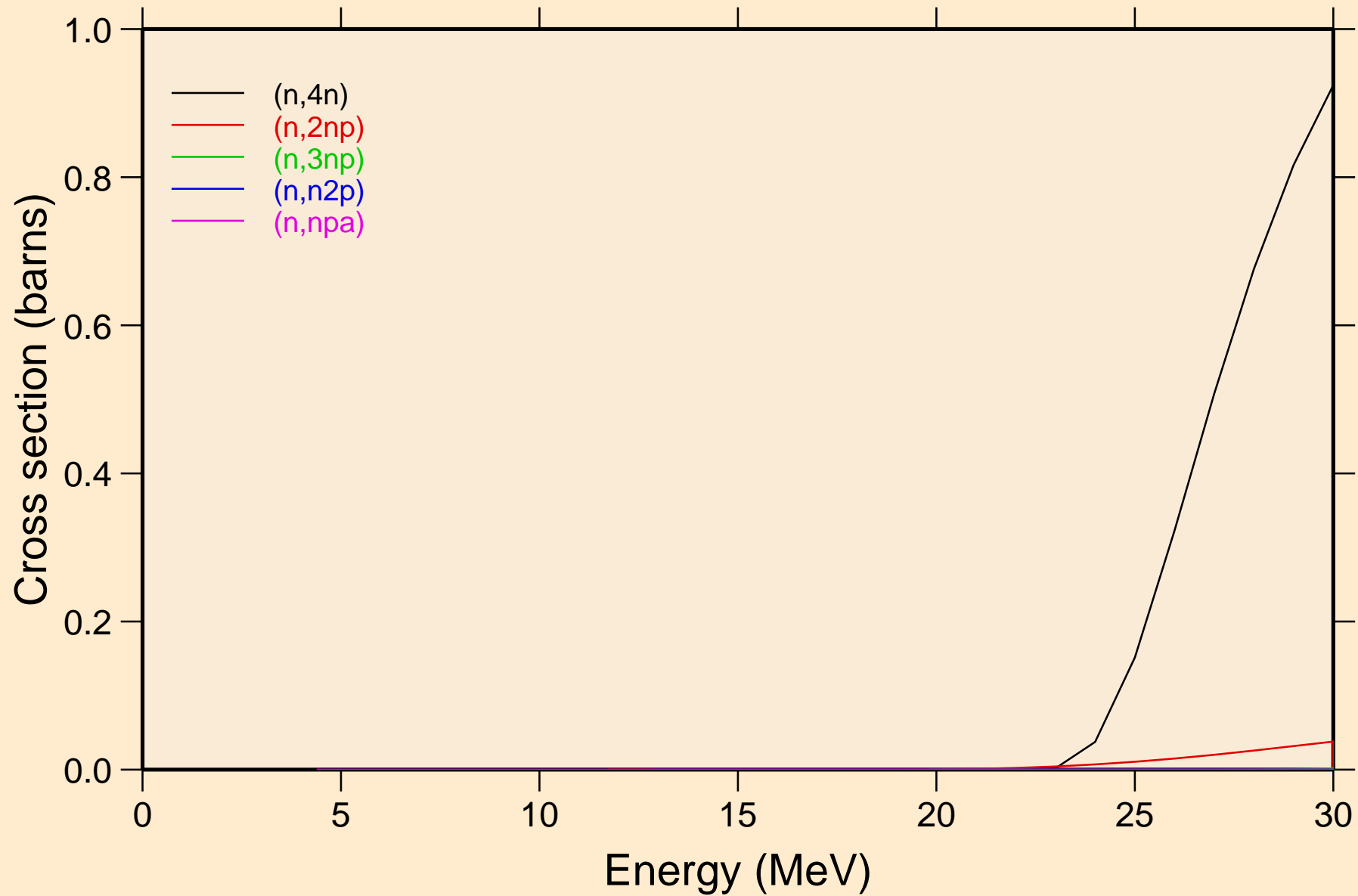

LU174 NEUTRON ACER TENDL-2024 LIBRARY; T=0.K  
Threshold reactions

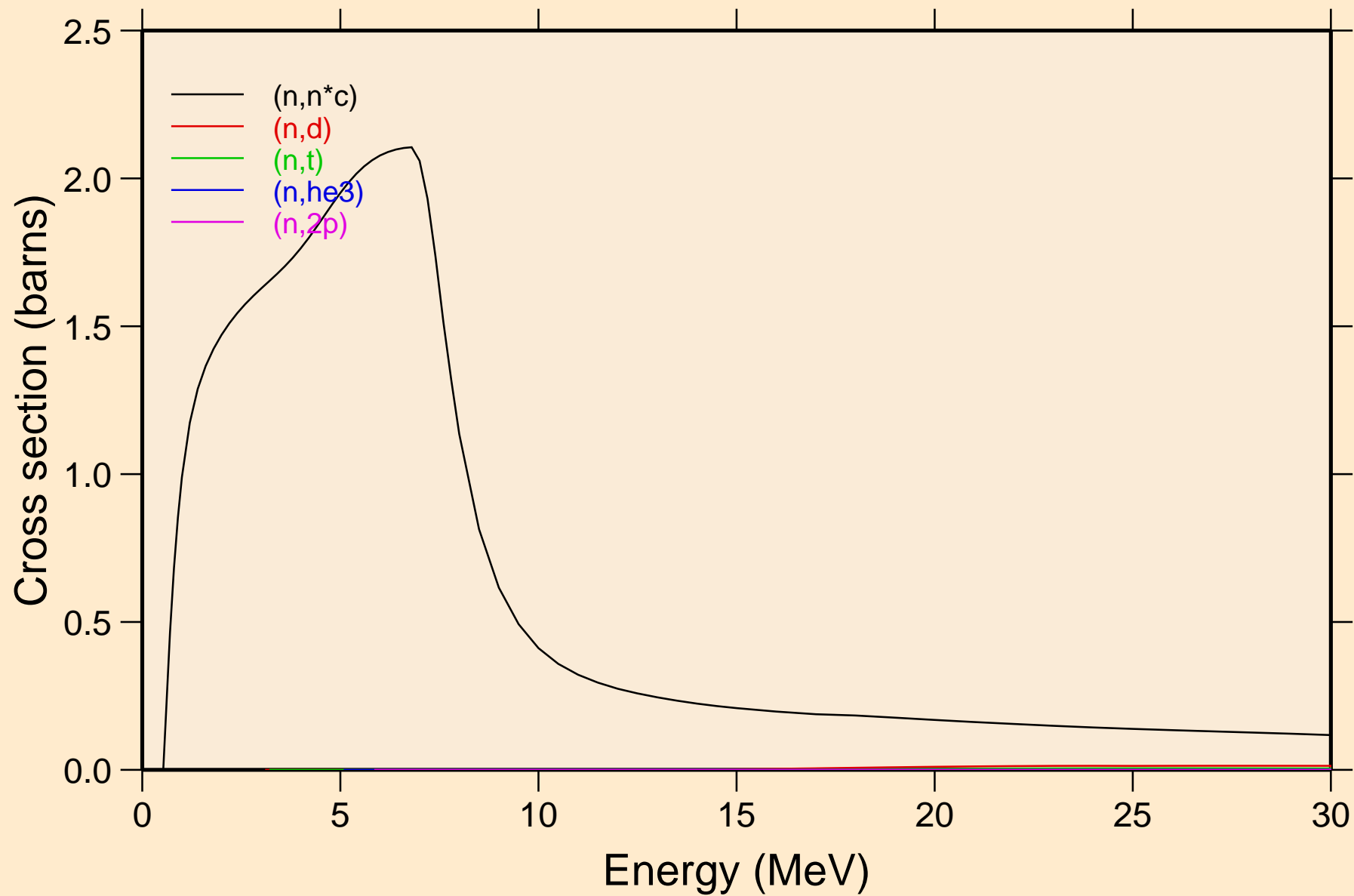

LU174 NEUTRON ACER TENDL-2024 LIBRARY; T=0.K  
Threshold reactions

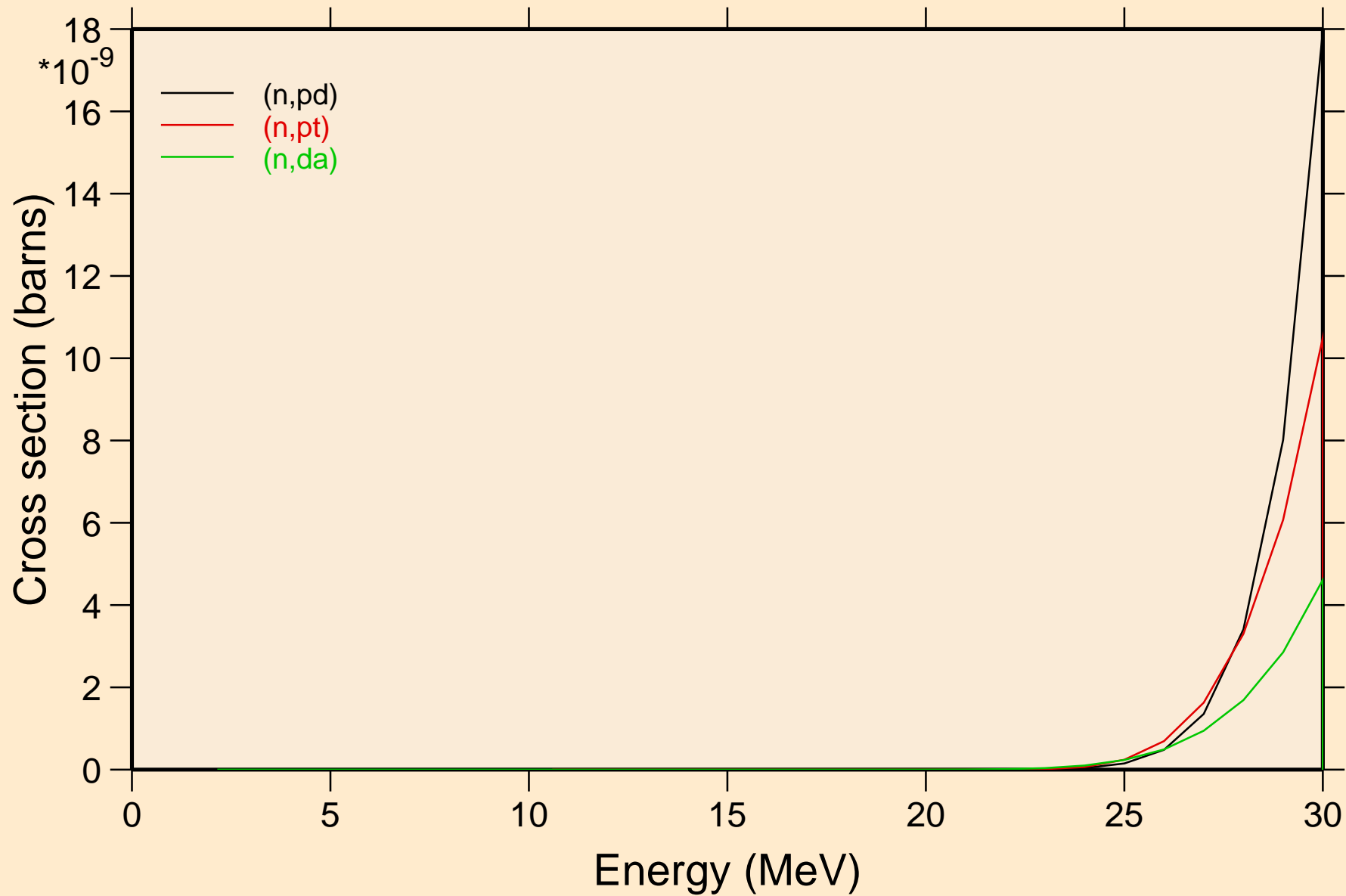

# LU174 NEUTRON ACER TENDL-2024 LIBRARY; T=0.K

## Threshold reactions

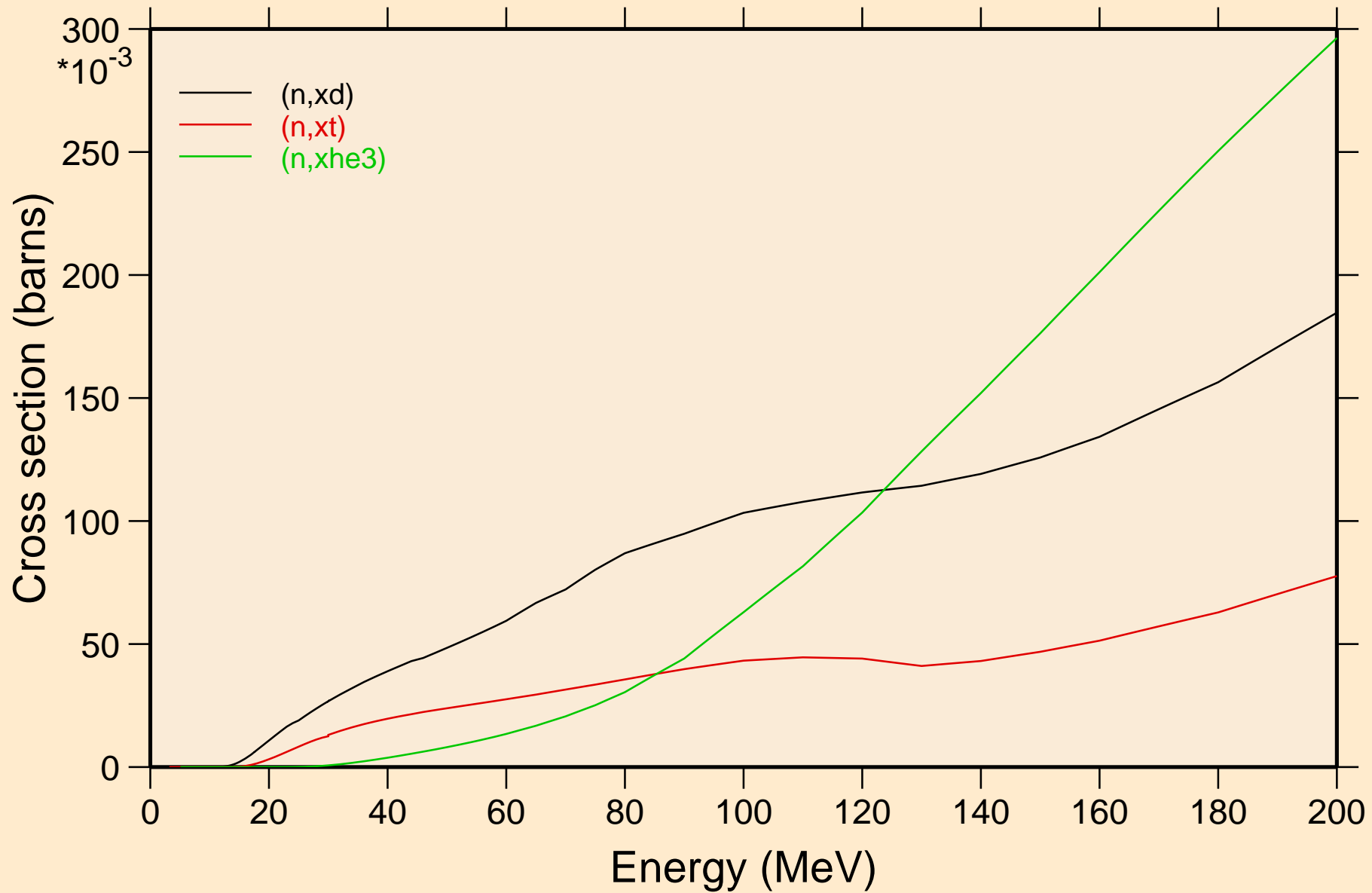

LU174 NEUTRON ACER TENDL-2024 LIBRARY; T=0.K  
angular distribution for elastic

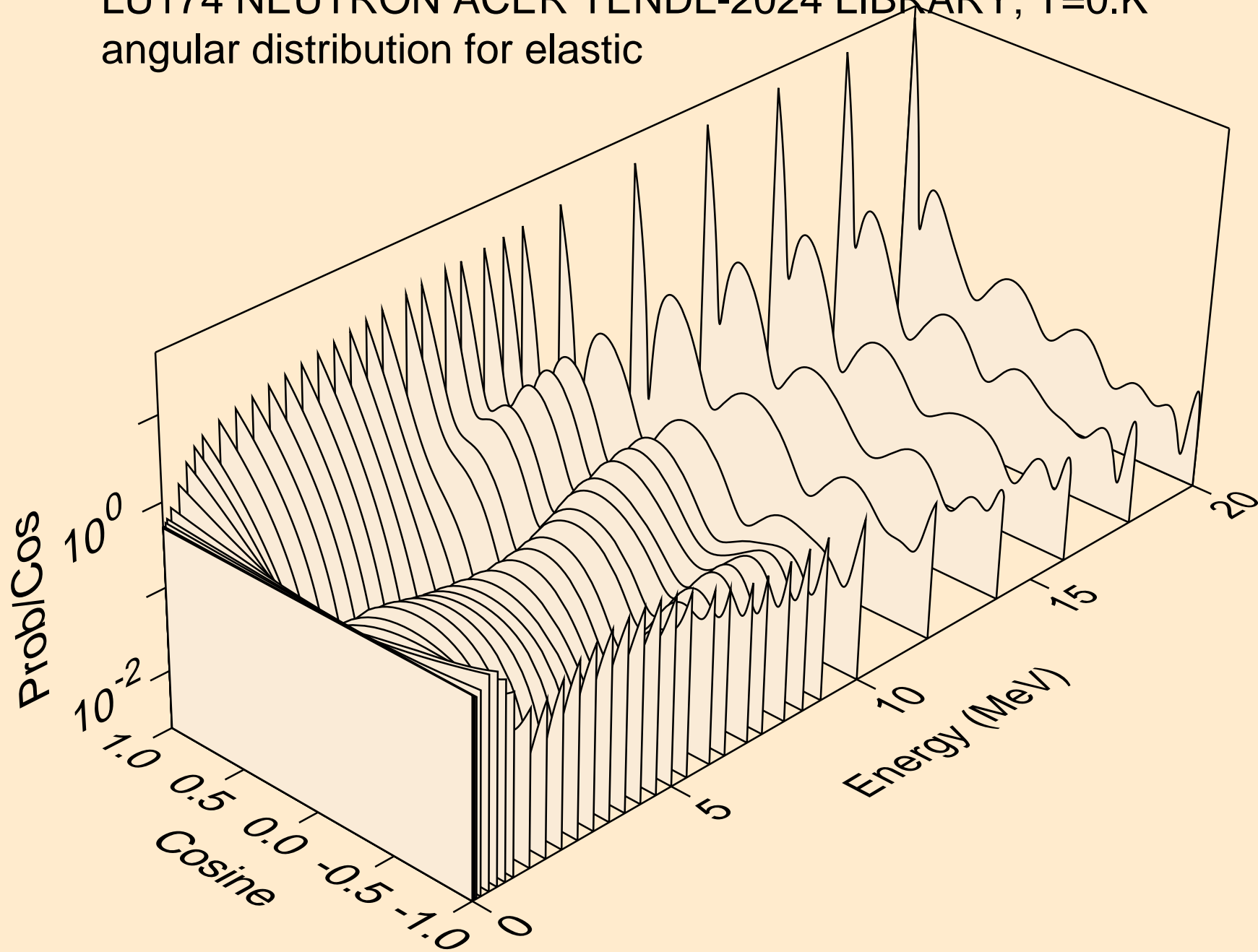

LU174 NEUTRON ACER TENDL-2024 LIBRARY; T=0.K  
angular distribution for elastic

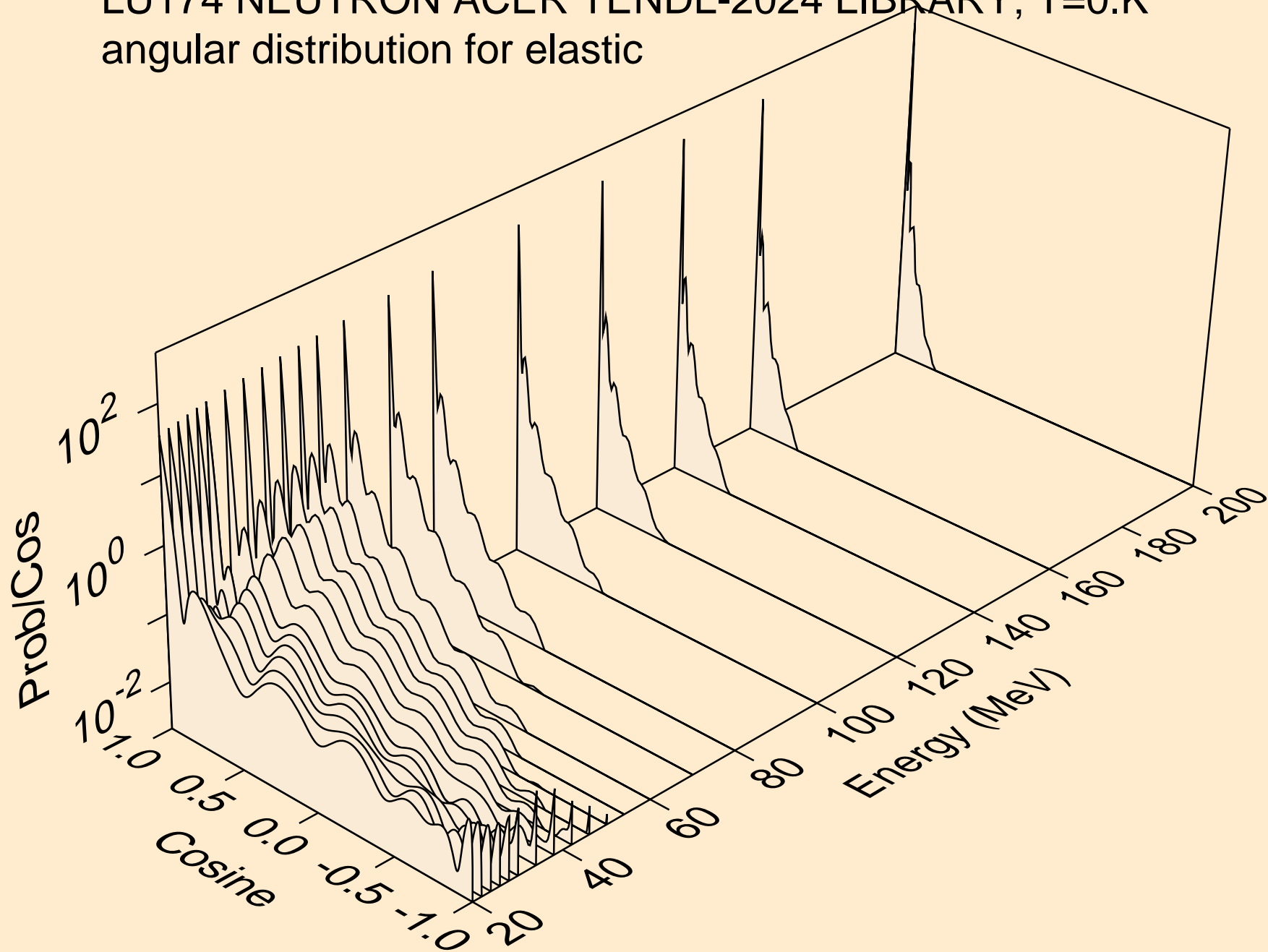



LU174 NEUTRON ACER TENDL-2024 LIBRARY; T=0.K  
angular distribution for (n,n\*1)

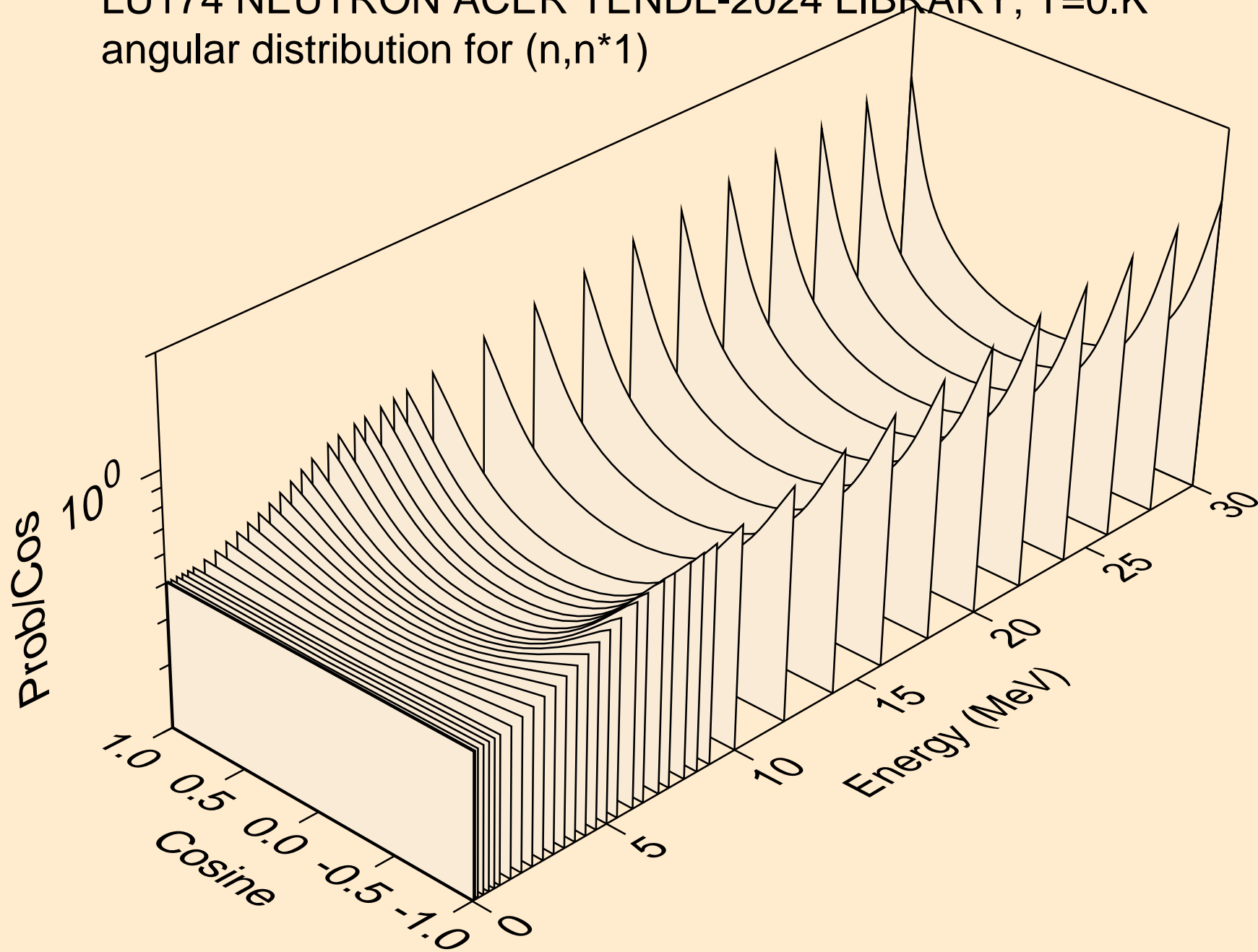

LU174 NEUTRON ACER TENDL-2024 LIBRARY; T=0.K  
angular distribution for (n,n\*2)

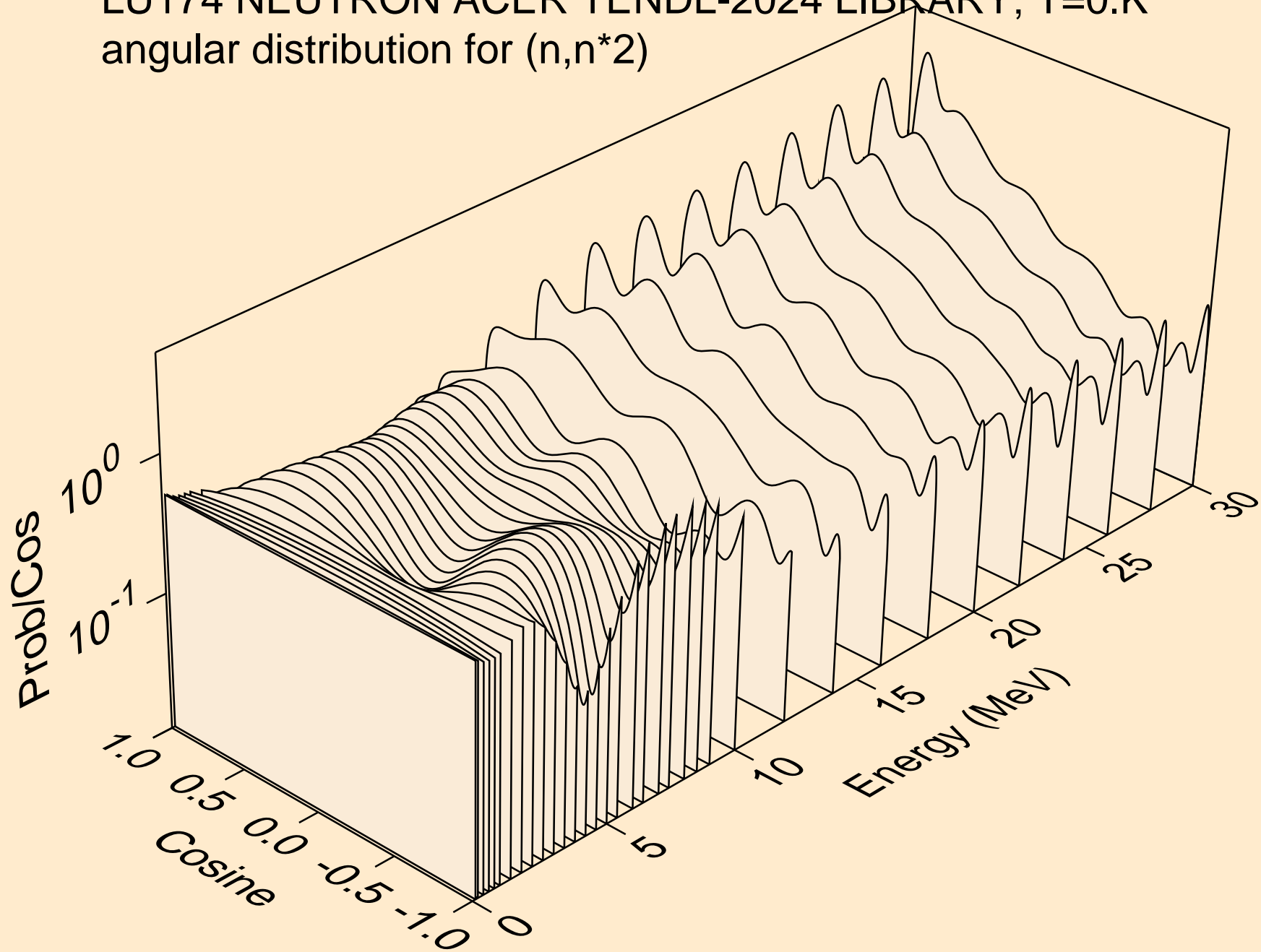

LU174 NEUTRON ACER TENDL-2024 LIBRARY; T=0.K  
angular distribution for (n,n\*3)

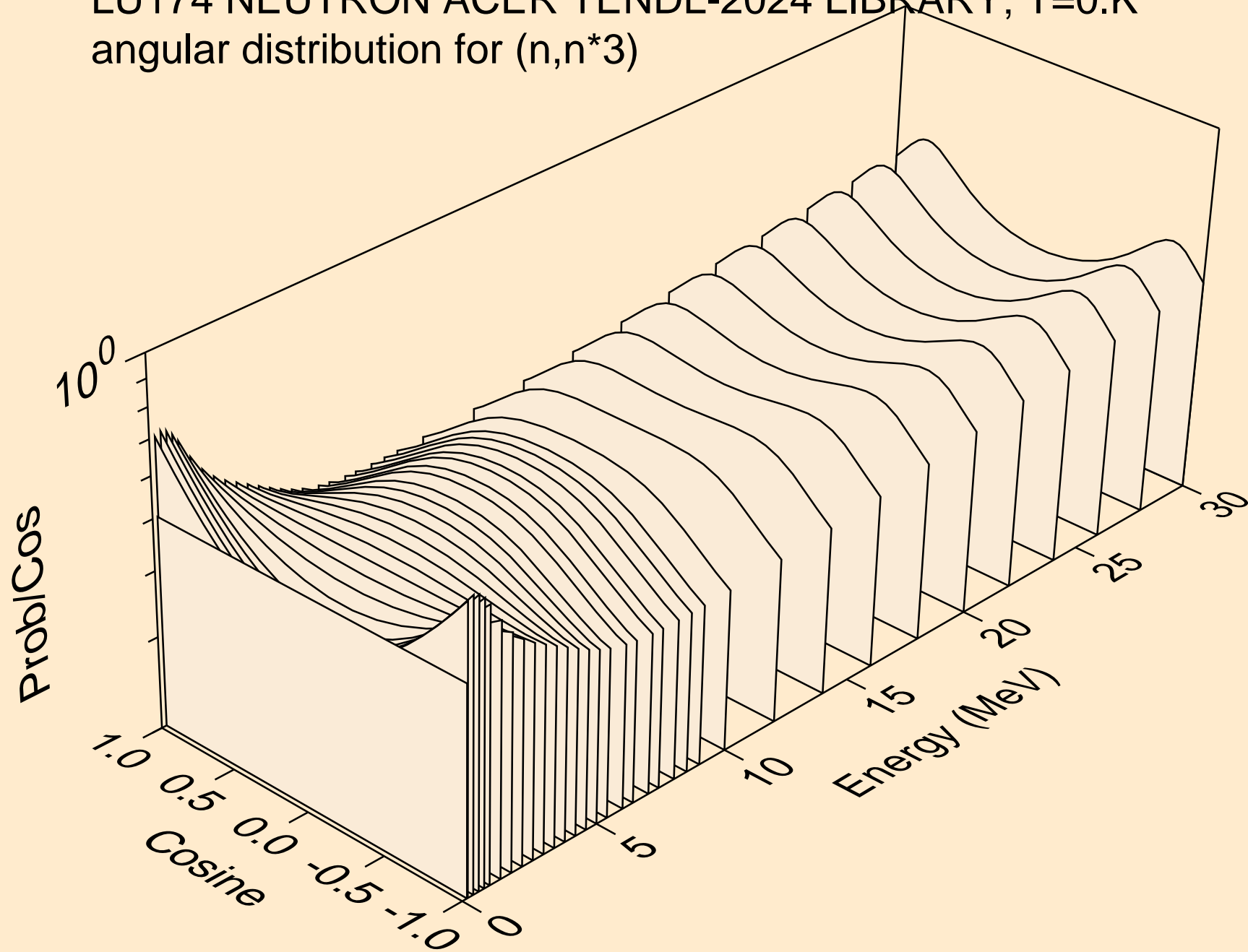

LU174 NEUTRON ACER TENDL-2024 LIBRARY; T=0.K  
angular distribution for (n,n\*4)

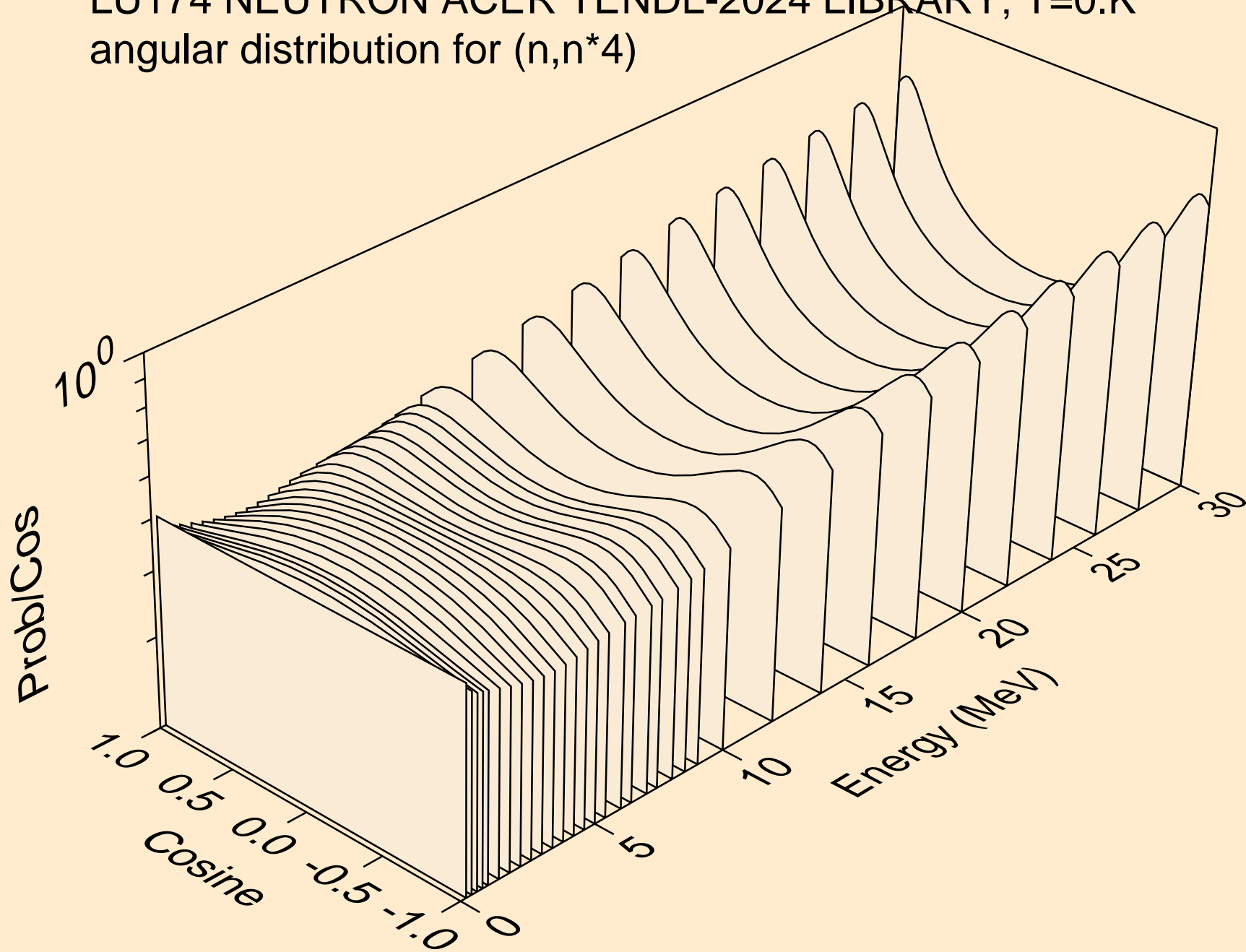

LU174 NEUTRON ACER TENDL-2024 LIBRARY; T=0.K  
angular distribution for (n,n\*5)

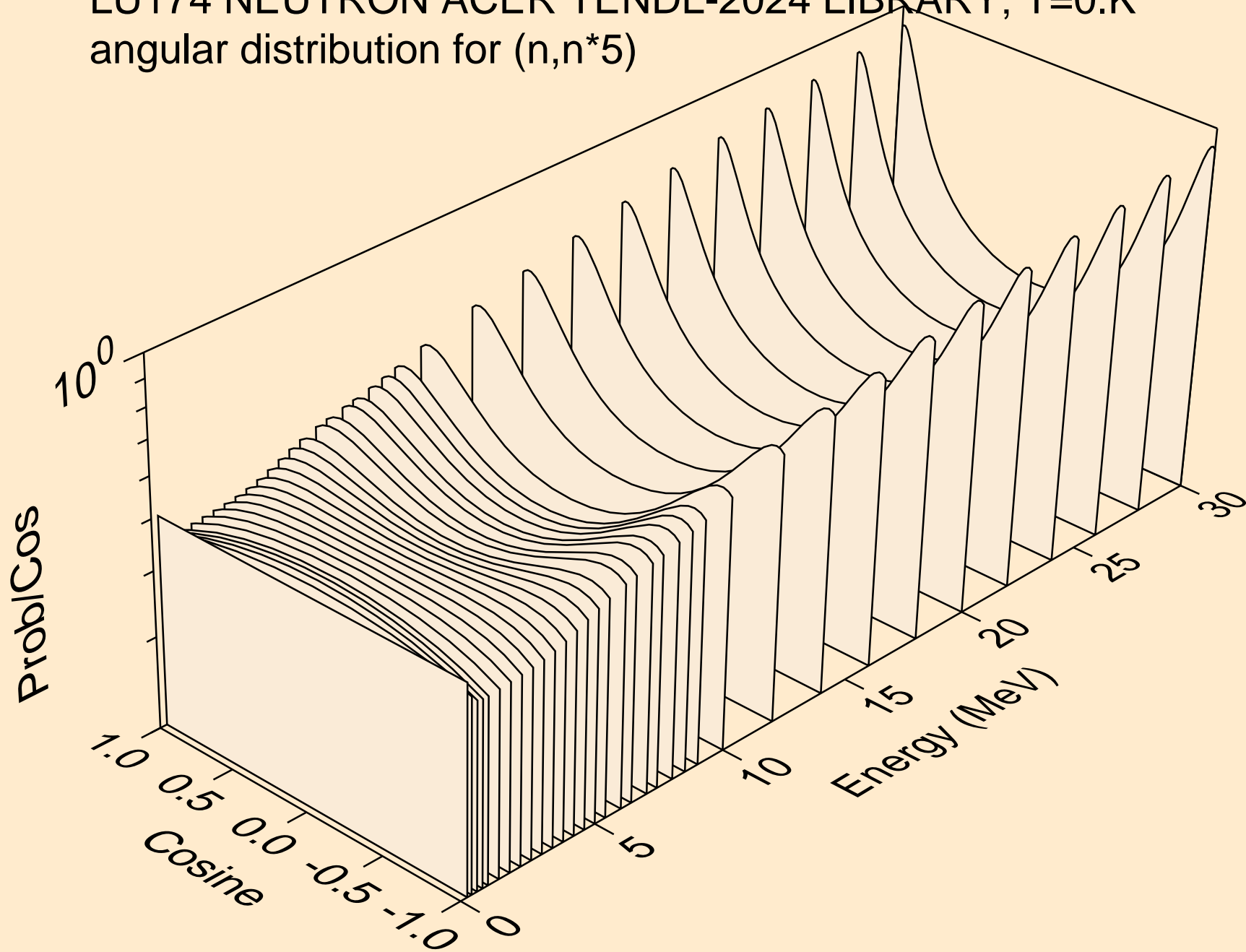

LU174 NEUTRON ACER TENDL-2024 LIBRARY; T=0.K  
angular distribution for (n,n\*6)

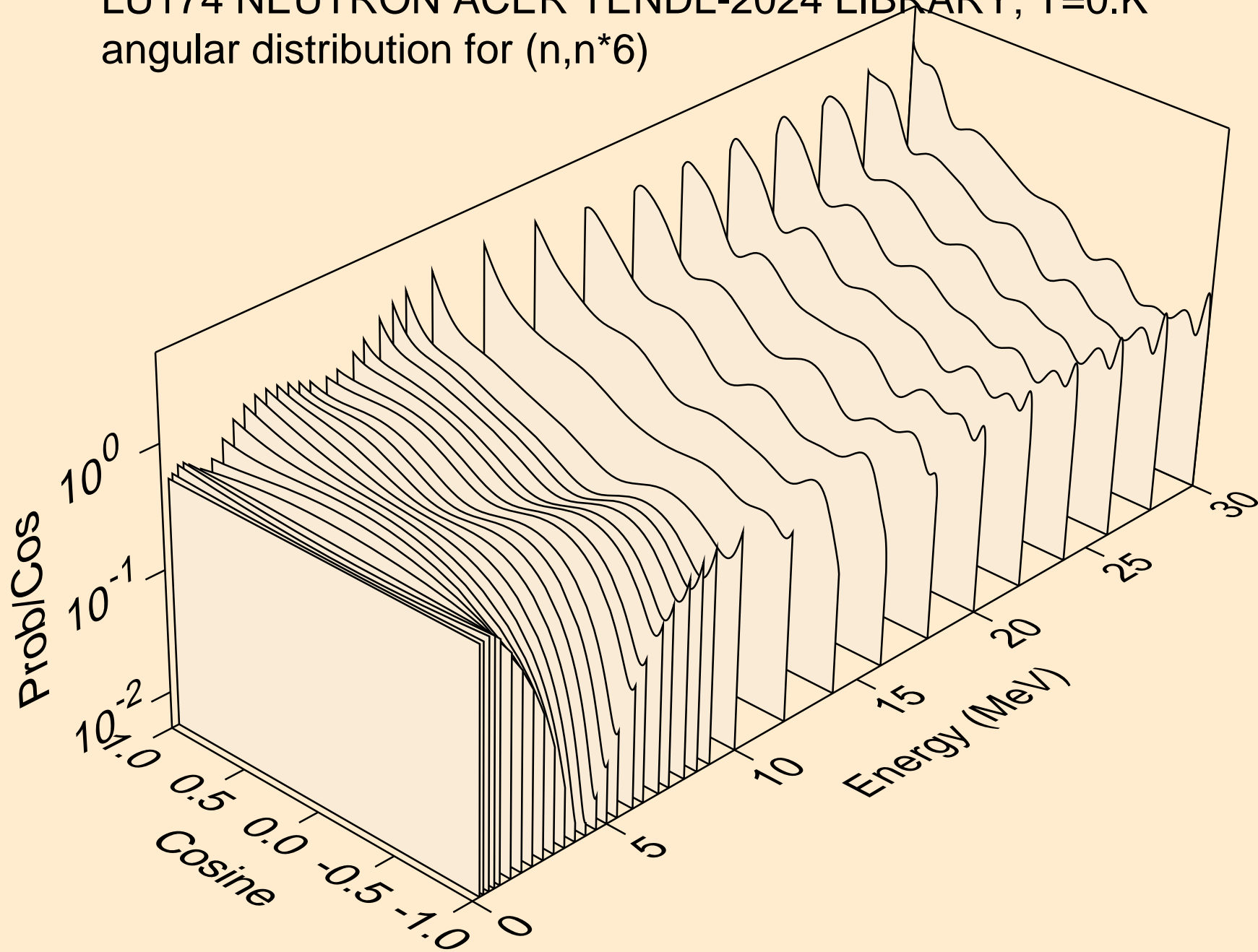

LU174 NEUTRON ACER TENDL-2024 LIBRARY; T=0.K  
angular distribution for (n,n\*7)

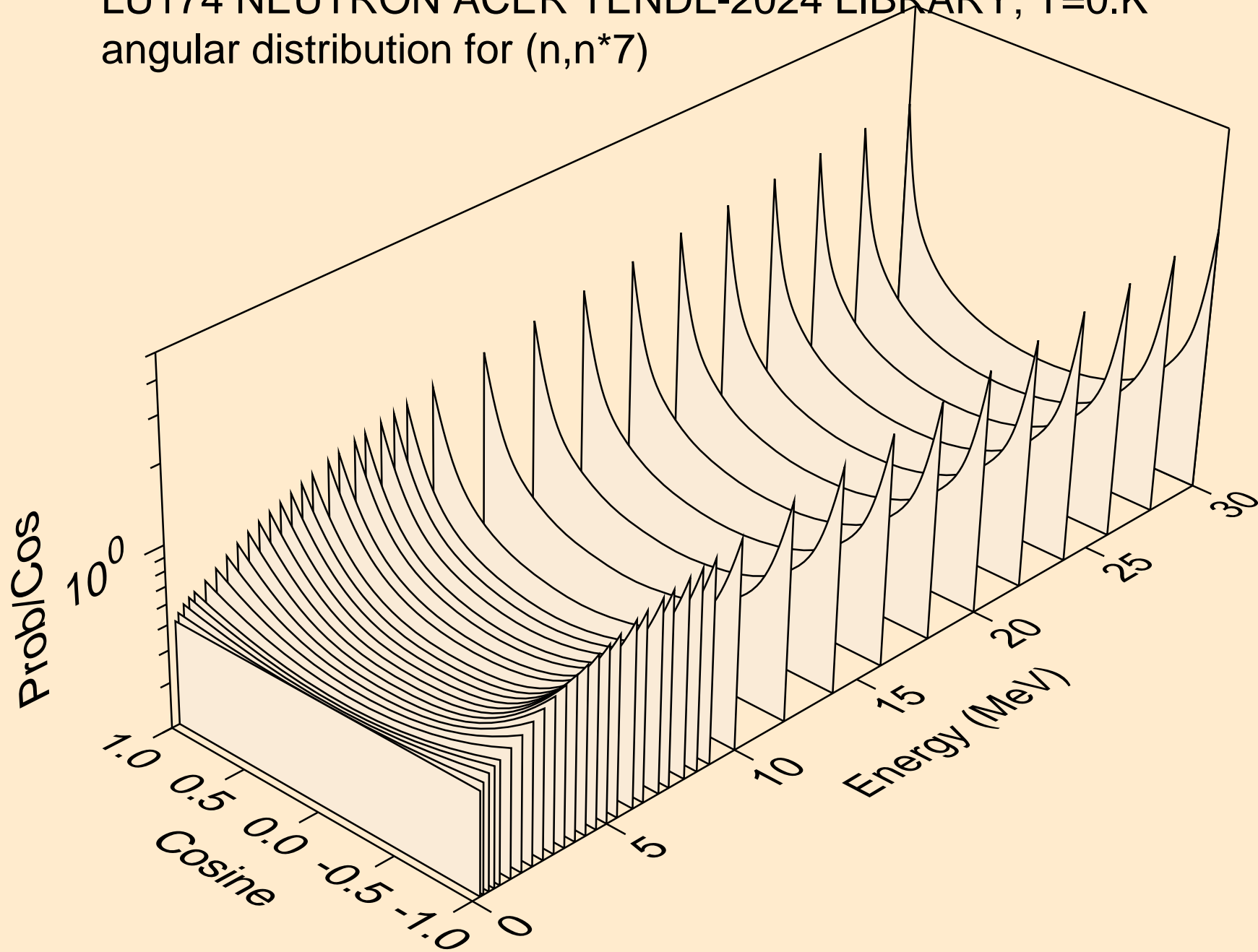

LU174 NEUTRON ACER TENDL-2024 LIBRARY; T=0.K  
angular distribution for (n,n\*8)

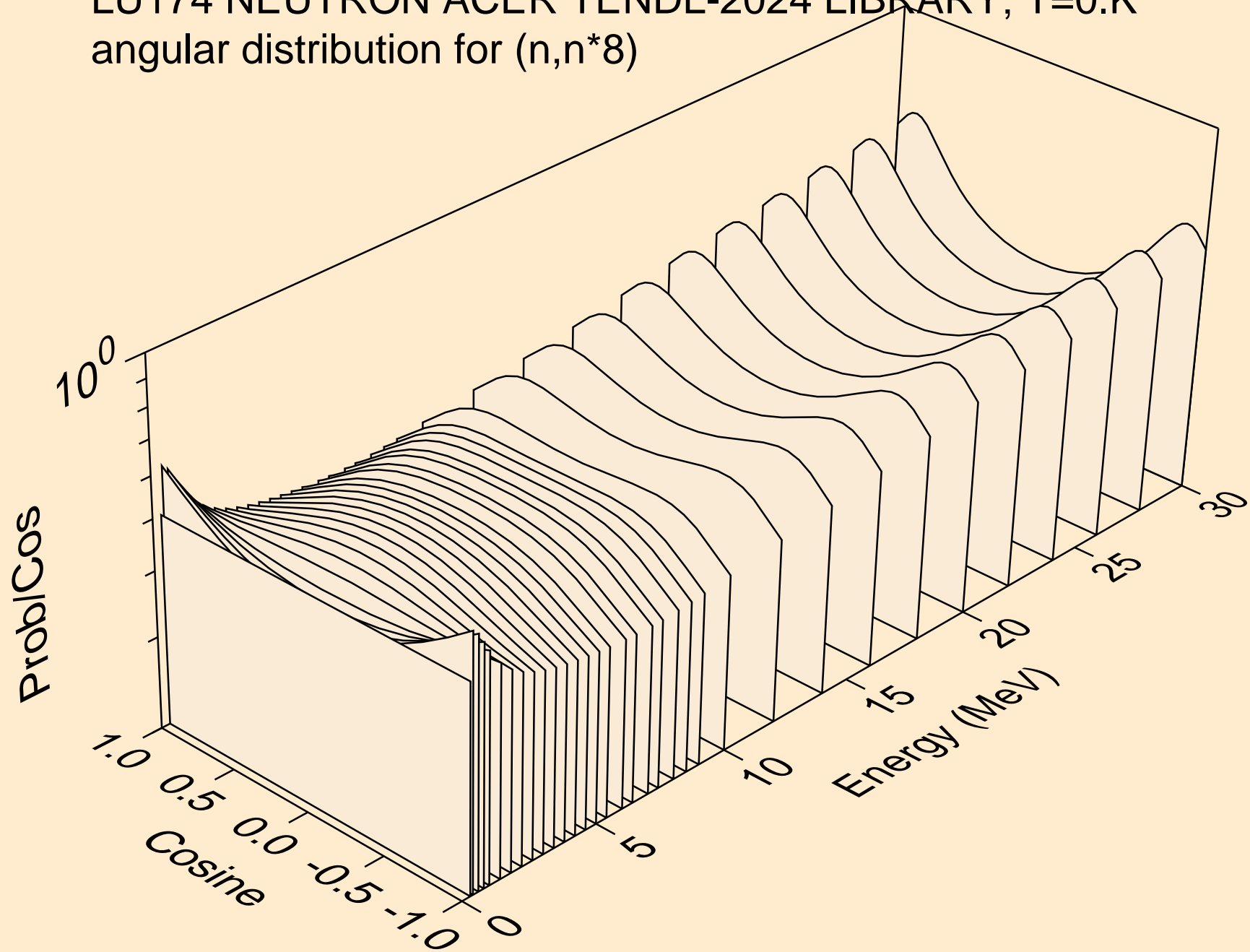



LU174 NEUTRON ACER TENDL-2024 LIBRARY; T=0.K  
angular distribution for (n,n\*9)

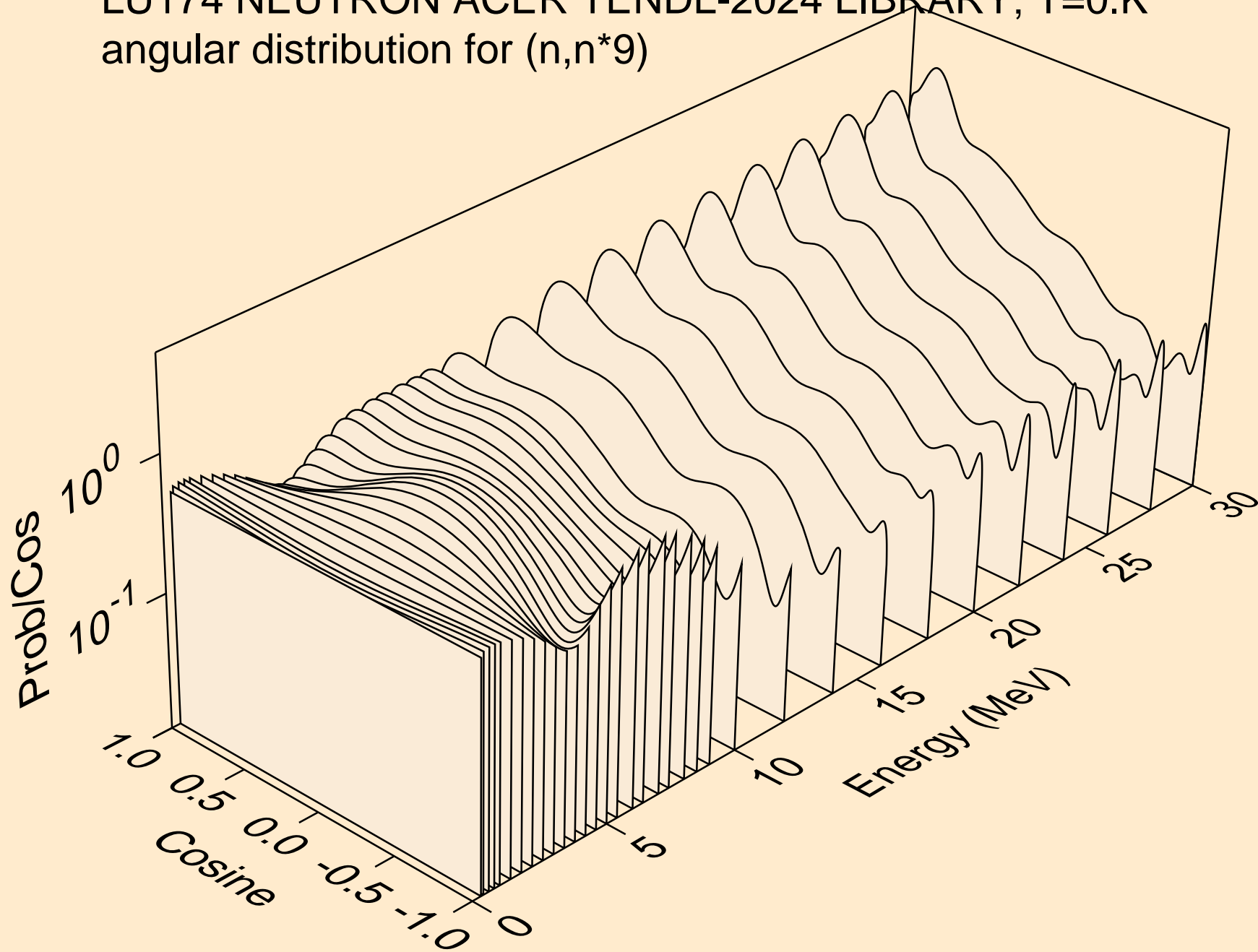

LU174 NEUTRON ACER TENDL-2024 LIBRARY; T=0.K  
angular distribution for (n,n\*10)

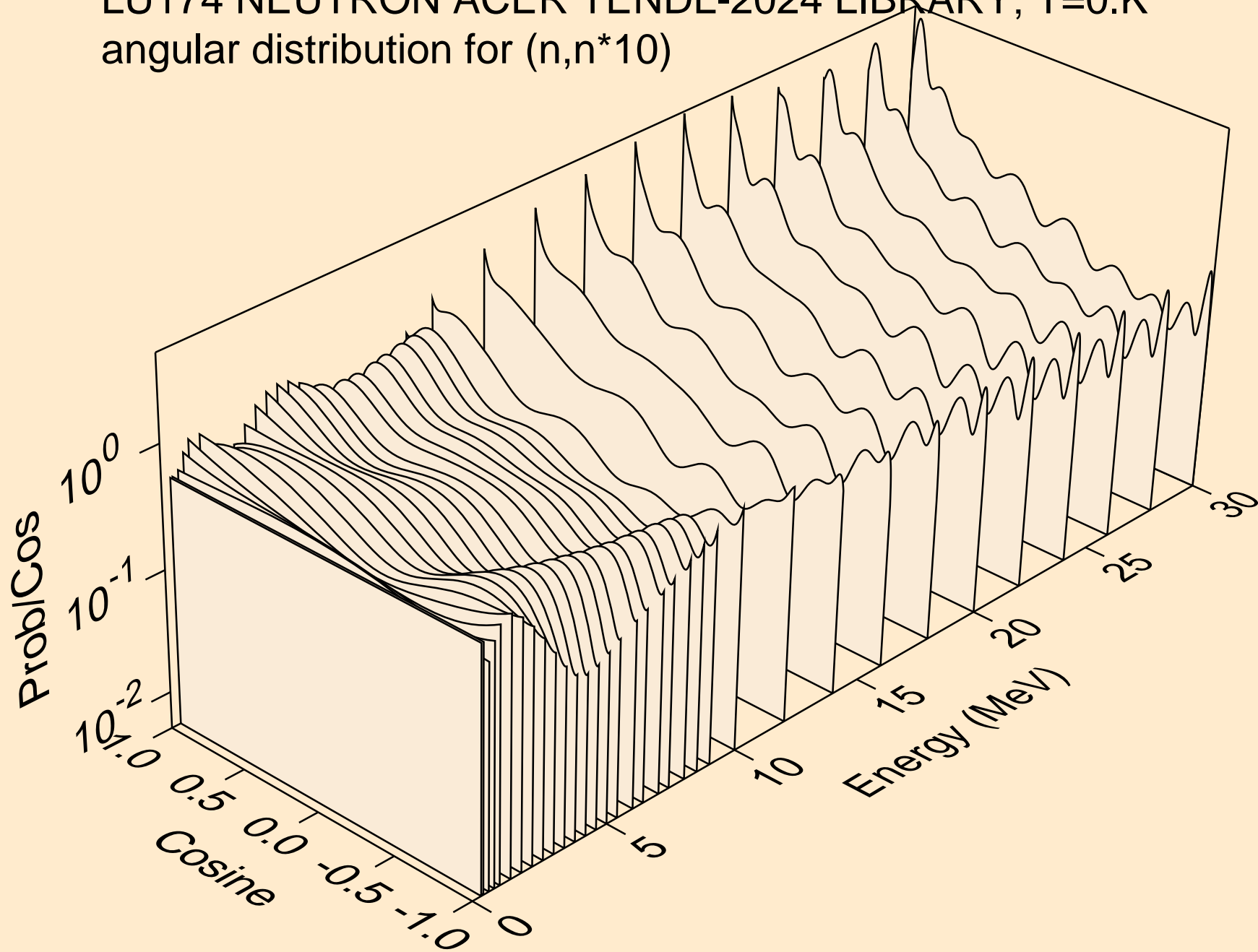

LU174 NEUTRON ACER TENDL-2024 LIBRARY; T=0.K  
angular distribution for (n,n\*11)

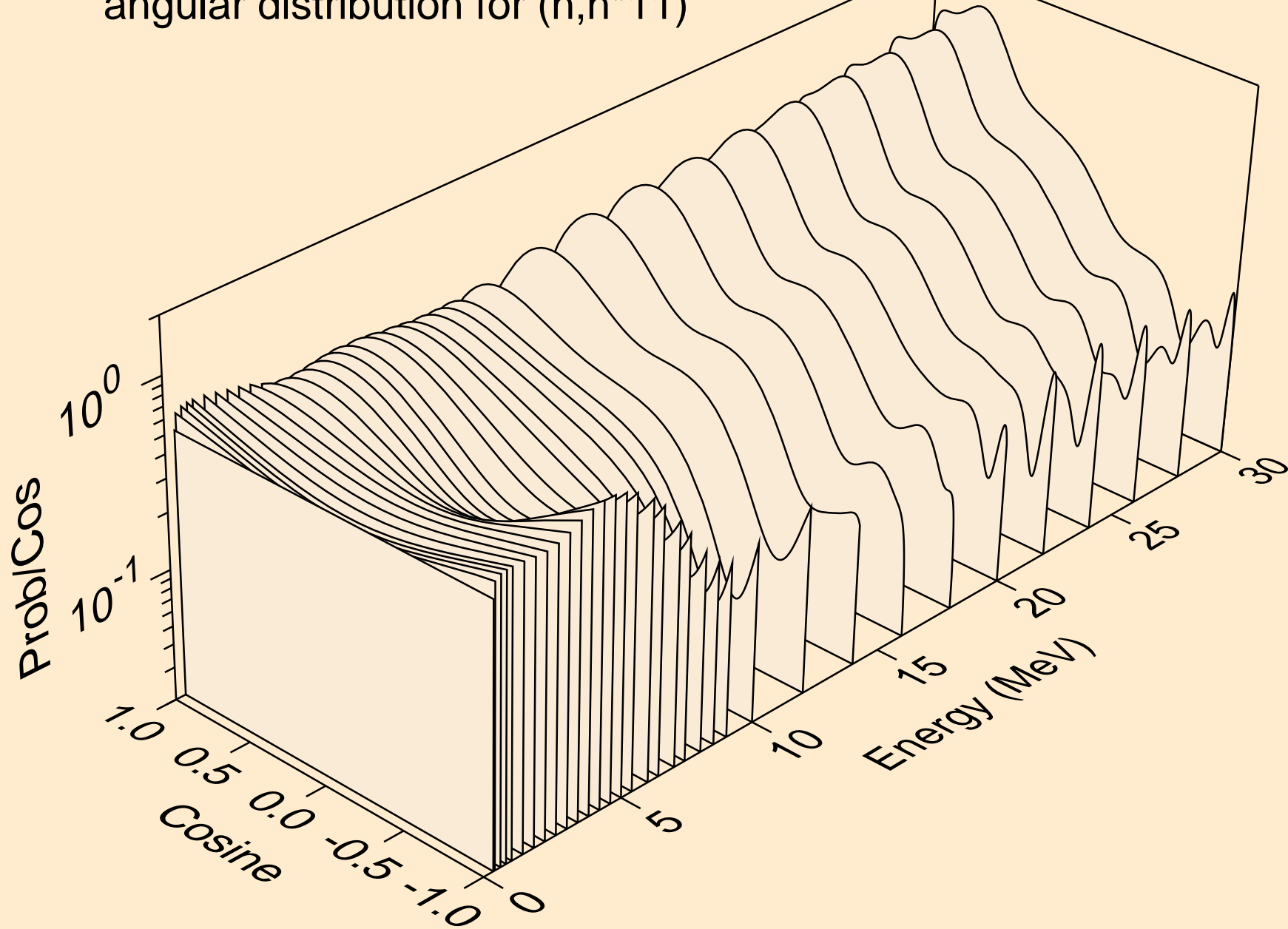

LU174 NEUTRON ACER TENDL-2024 LIBRARY; T=0.K  
angular distribution for (n,n\*12)

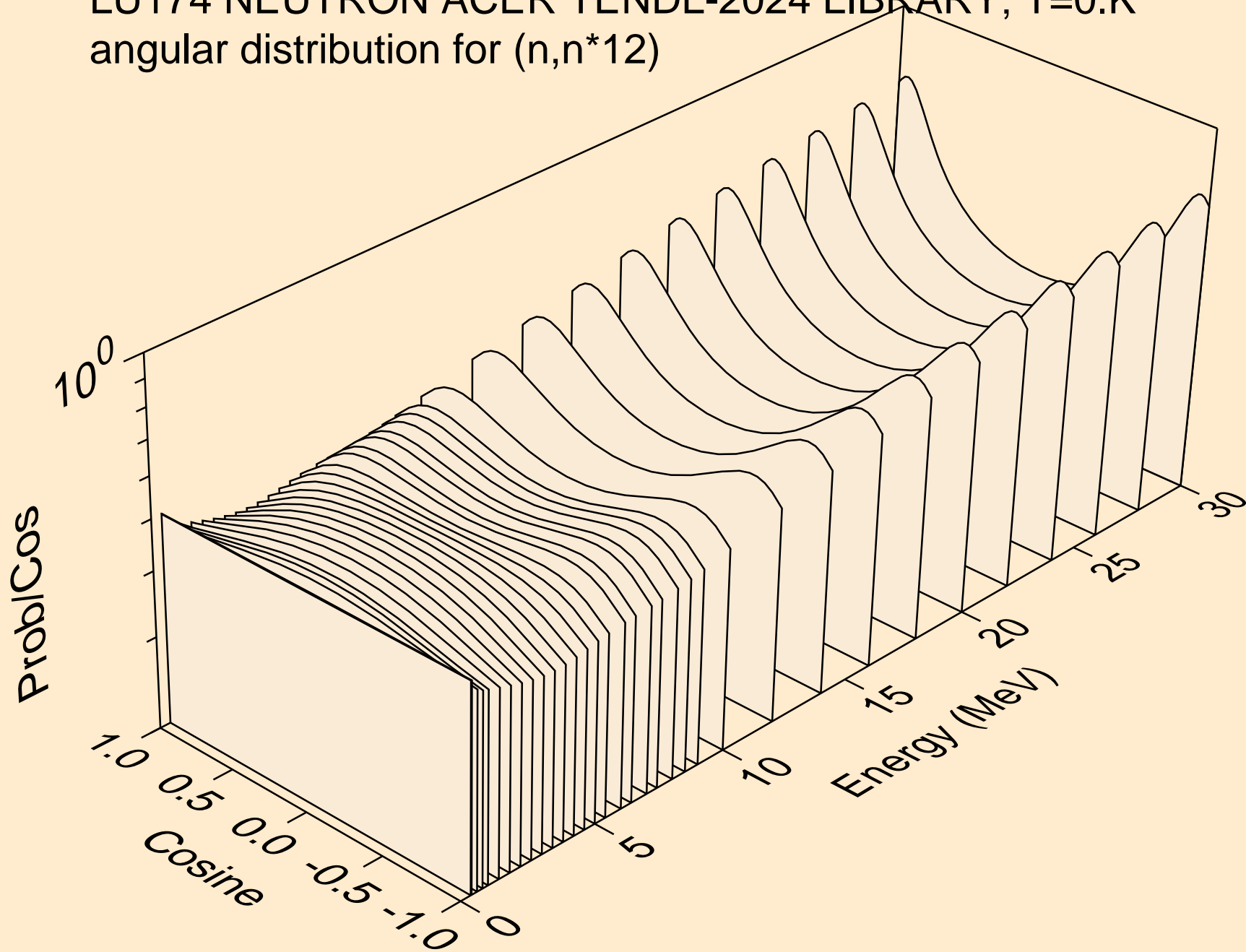

LU174 NEUTRON ACER TENDL-2024 LIBRARY; T=0.K  
angular distribution for (n,n\*13)

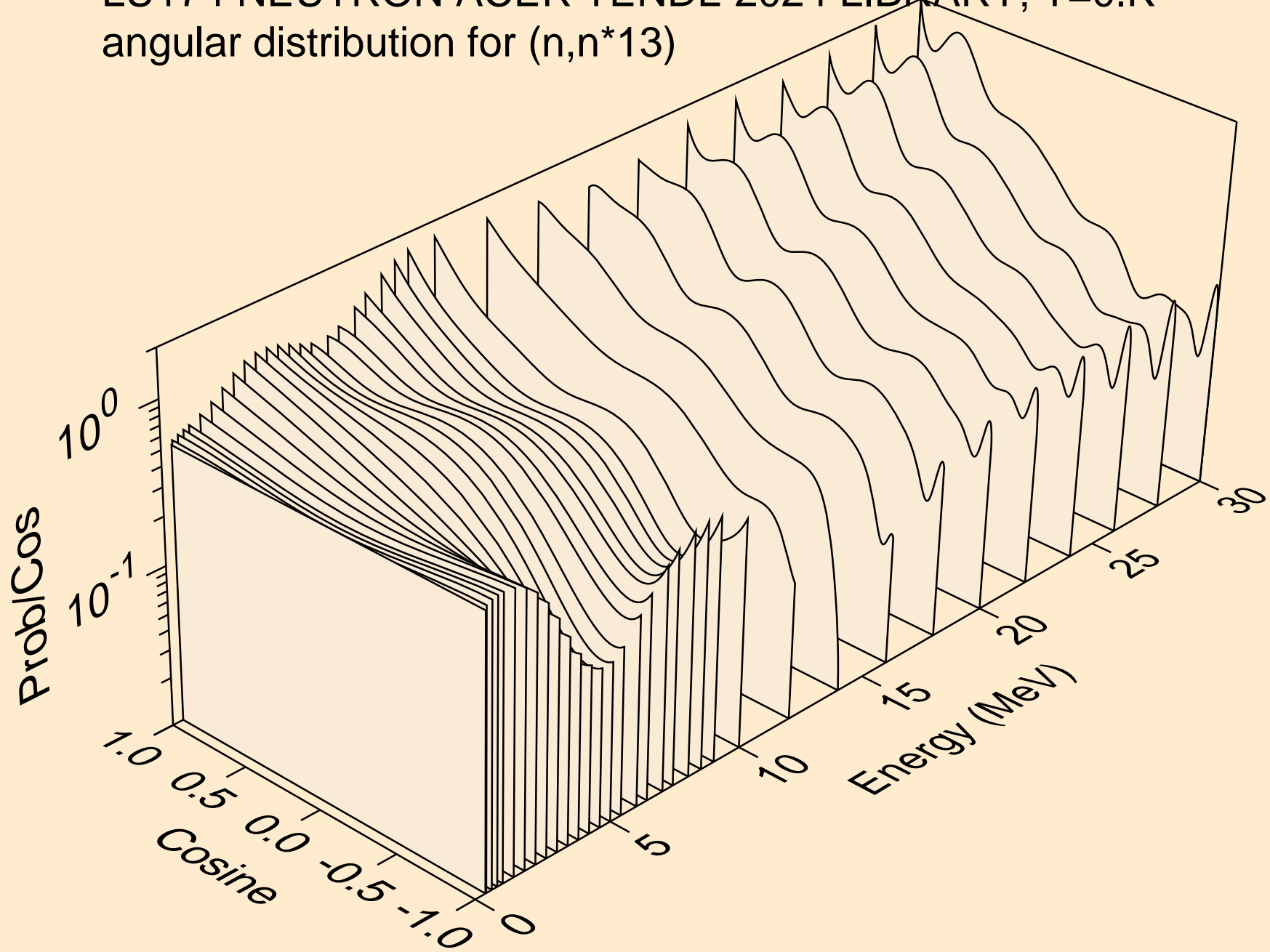

LU174 NEUTRON ACER TENDL-2024 LIBRARY; T=0.K  
angular distribution for (n,n\*14)

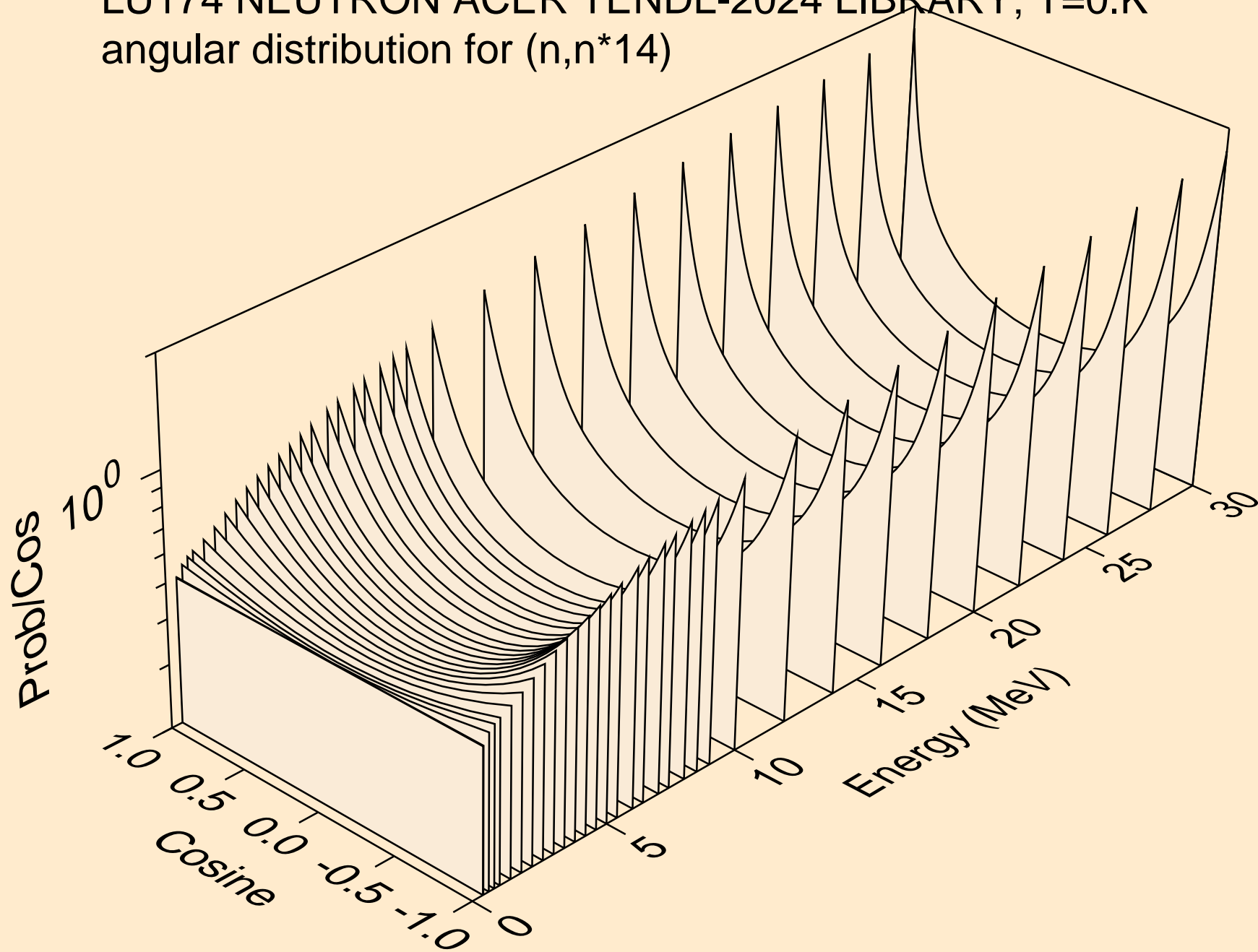

LU174 NEUTRON ACER TENDL-2024 LIBRARY; T=0.K  
angular distribution for (n,n\*15)

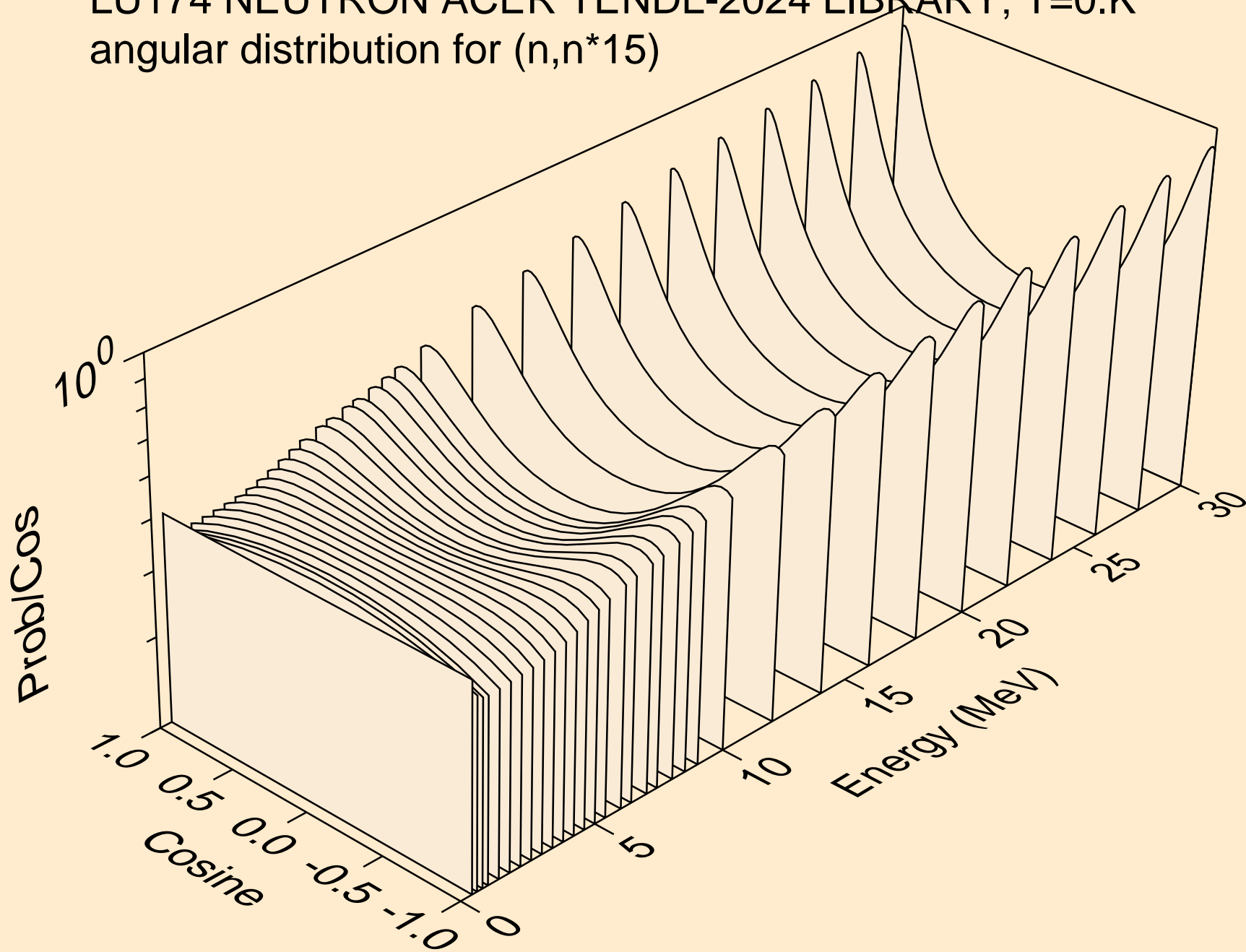

LU174 NEUTRON ACER TENDL-2024 LIBRARY; T=0.K  
angular distribution for (n,n\*16)

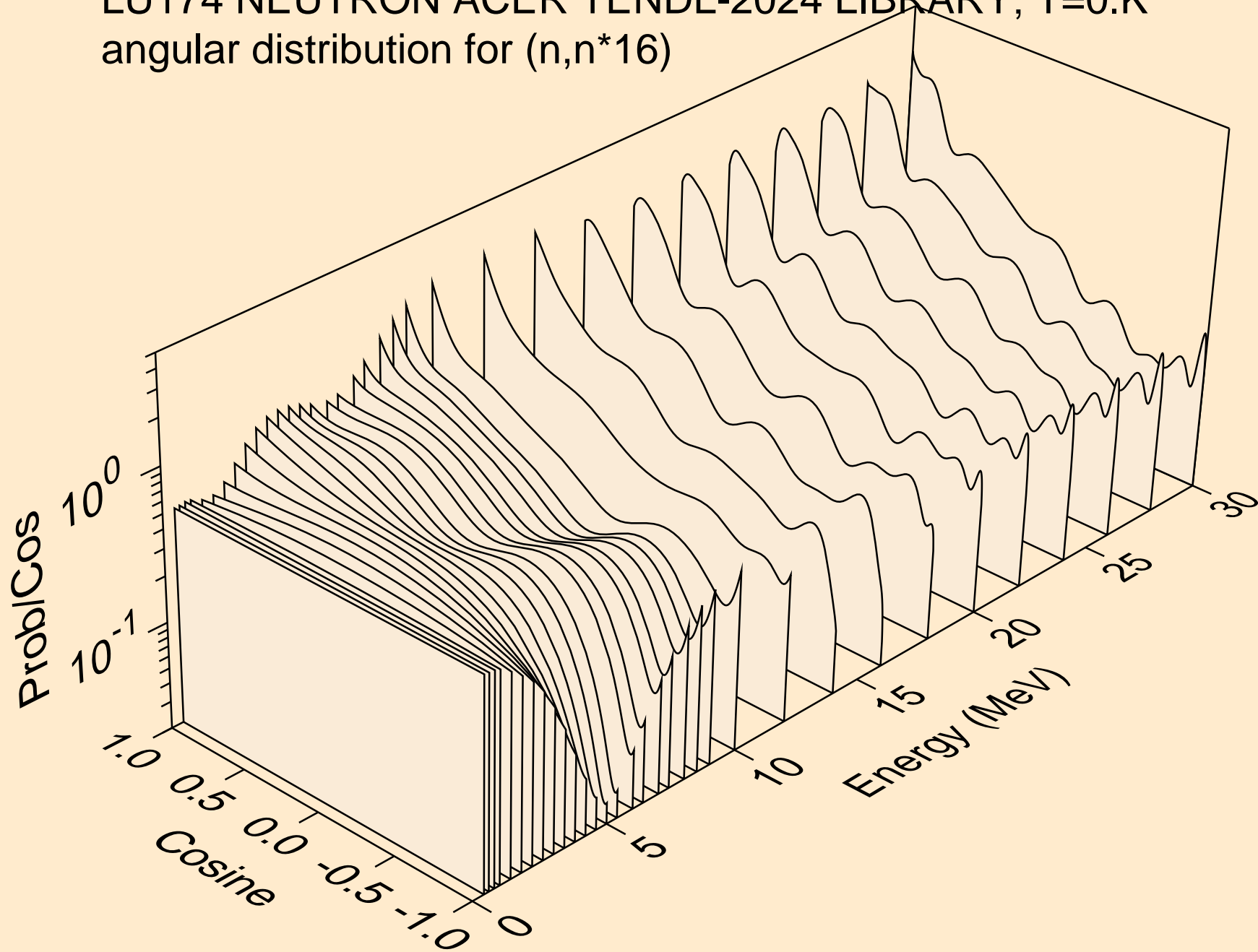



LU174 NEUTRON ACER TENDL-2024 LIBRARY; T=0.K  
angular distribution for (n,n\*17)

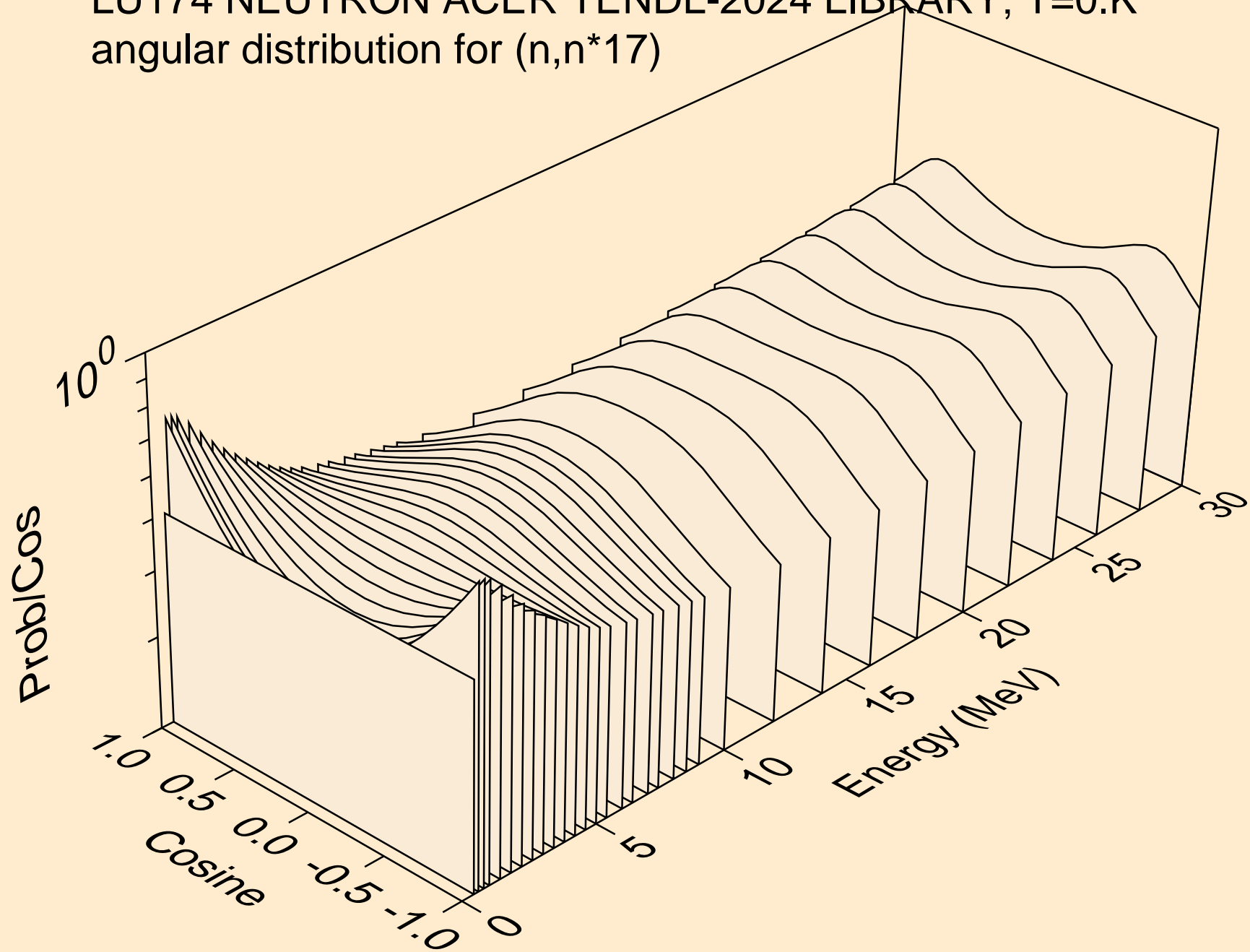

LU174 NEUTRON ACER TENDL-2024 LIBRARY; T=0.K  
angular distribution for (n,n\*18)

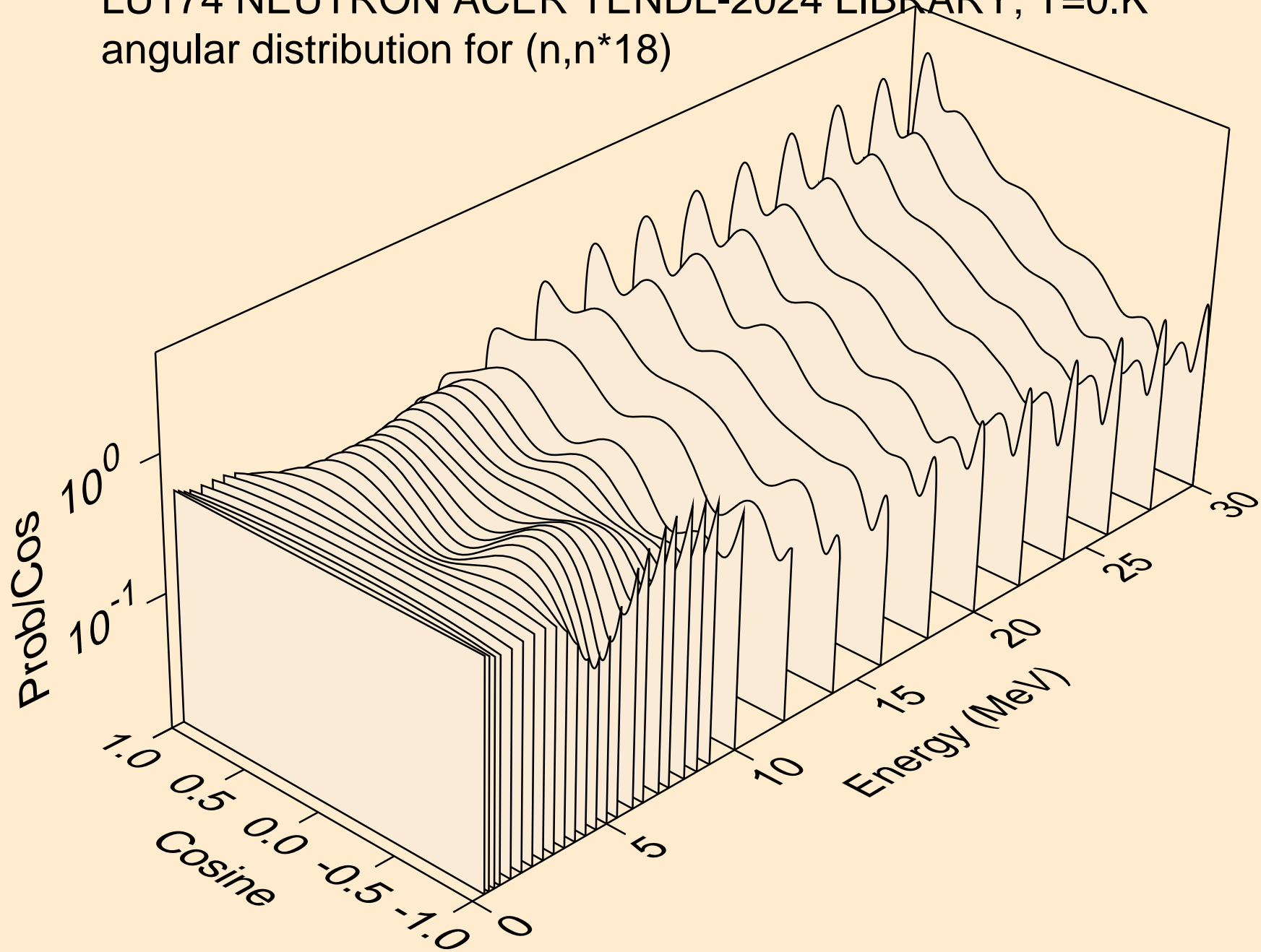

LU174 NEUTRON ACER TENDL-2024 LIBRARY; T=0.K  
angular distribution for (n,n\*19)

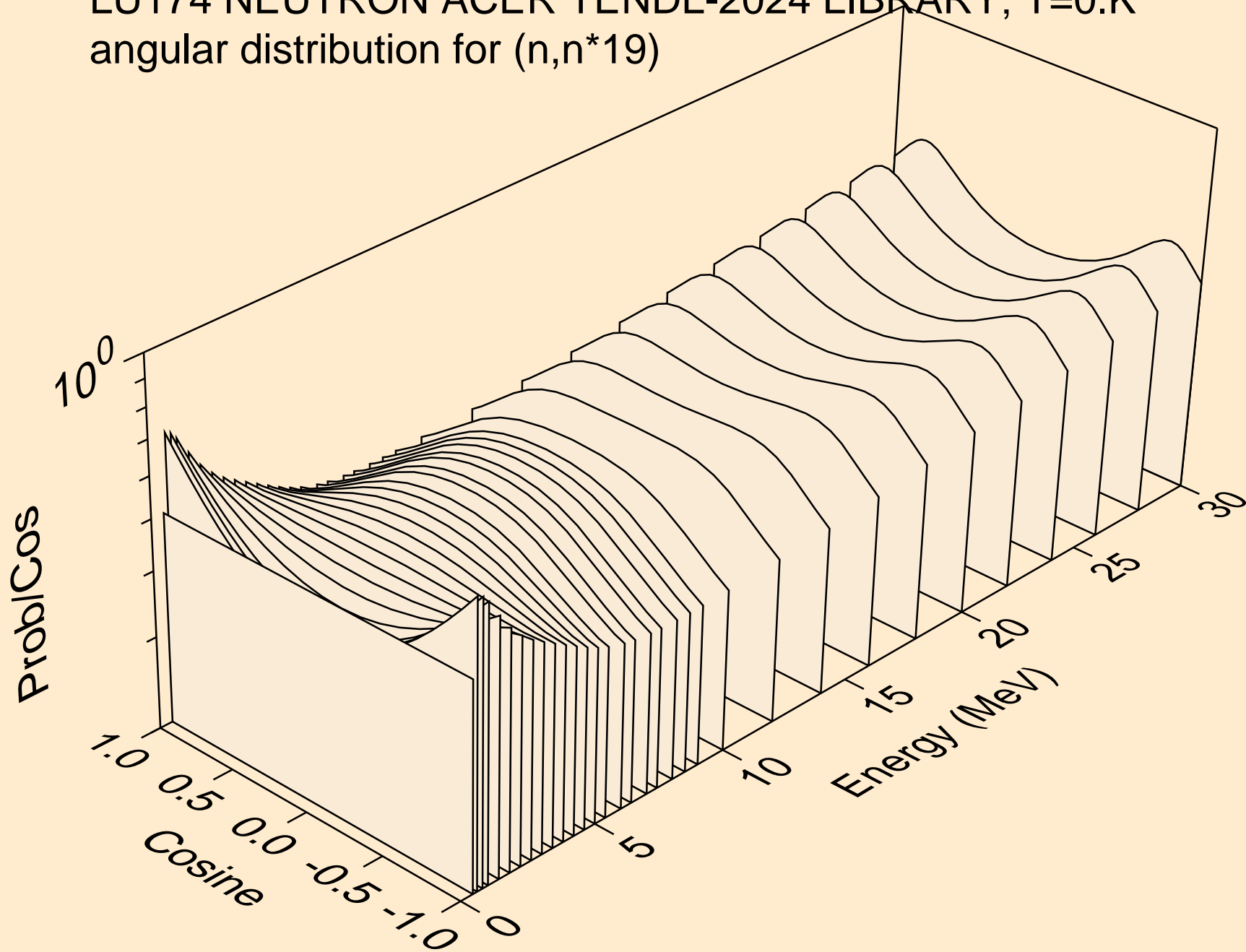

LU174 NEUTRON ACER TENDL-2024 LIBRARY; T=0.K  
angular distribution for (n,n\*20)

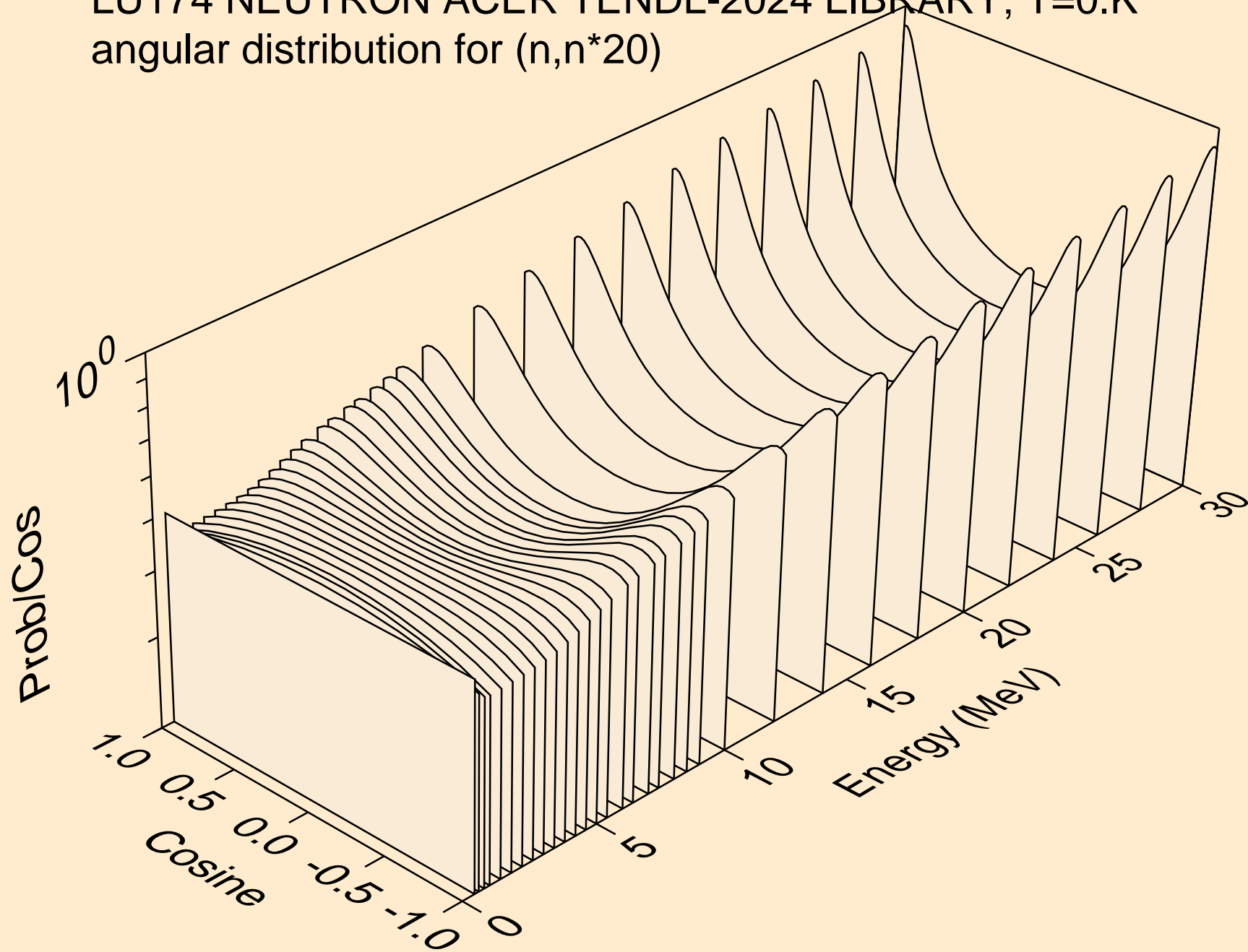

LU174 NEUTRON ACER TENDL-2024 LIBRARY; T=0.K  
angular distribution for (n,n\*21)

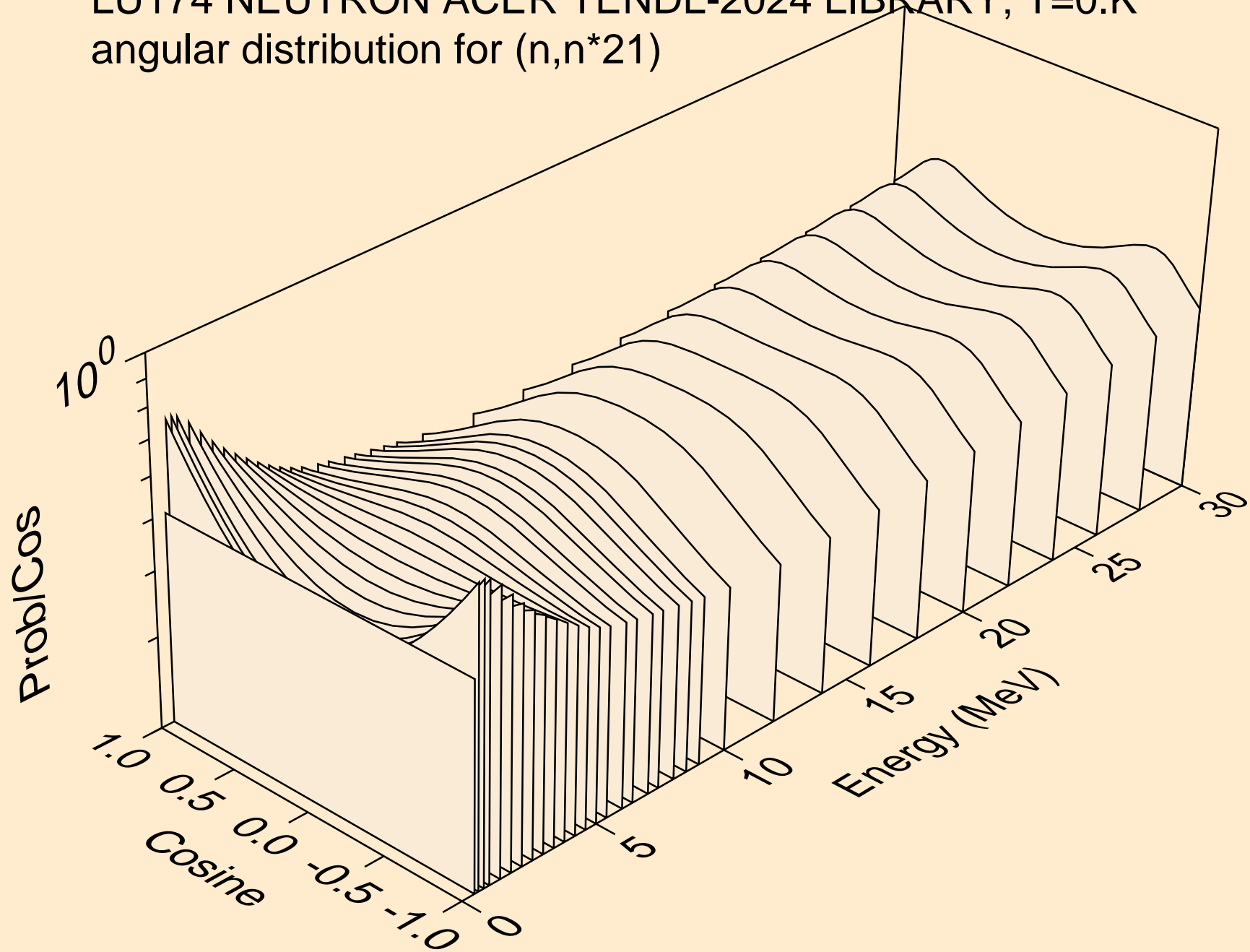

LU174 NEUTRON ACER TENDL-2024 LIBRARY; T=0.K  
angular distribution for (n,n\*22)

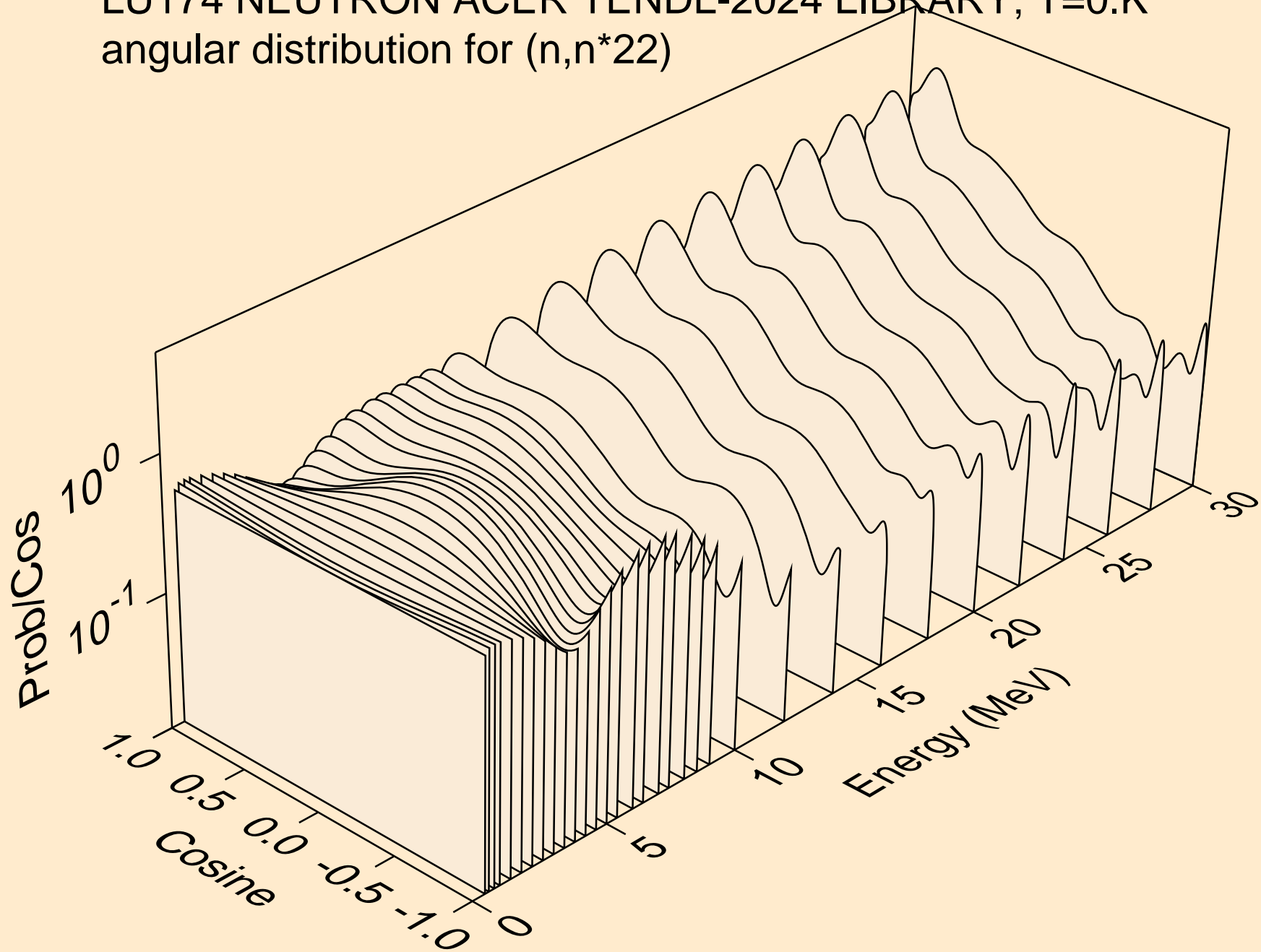

LU174 NEUTRON ACER TENDL-2024 LIBRARY; T=0.K  
angular distribution for (n,n\*23)

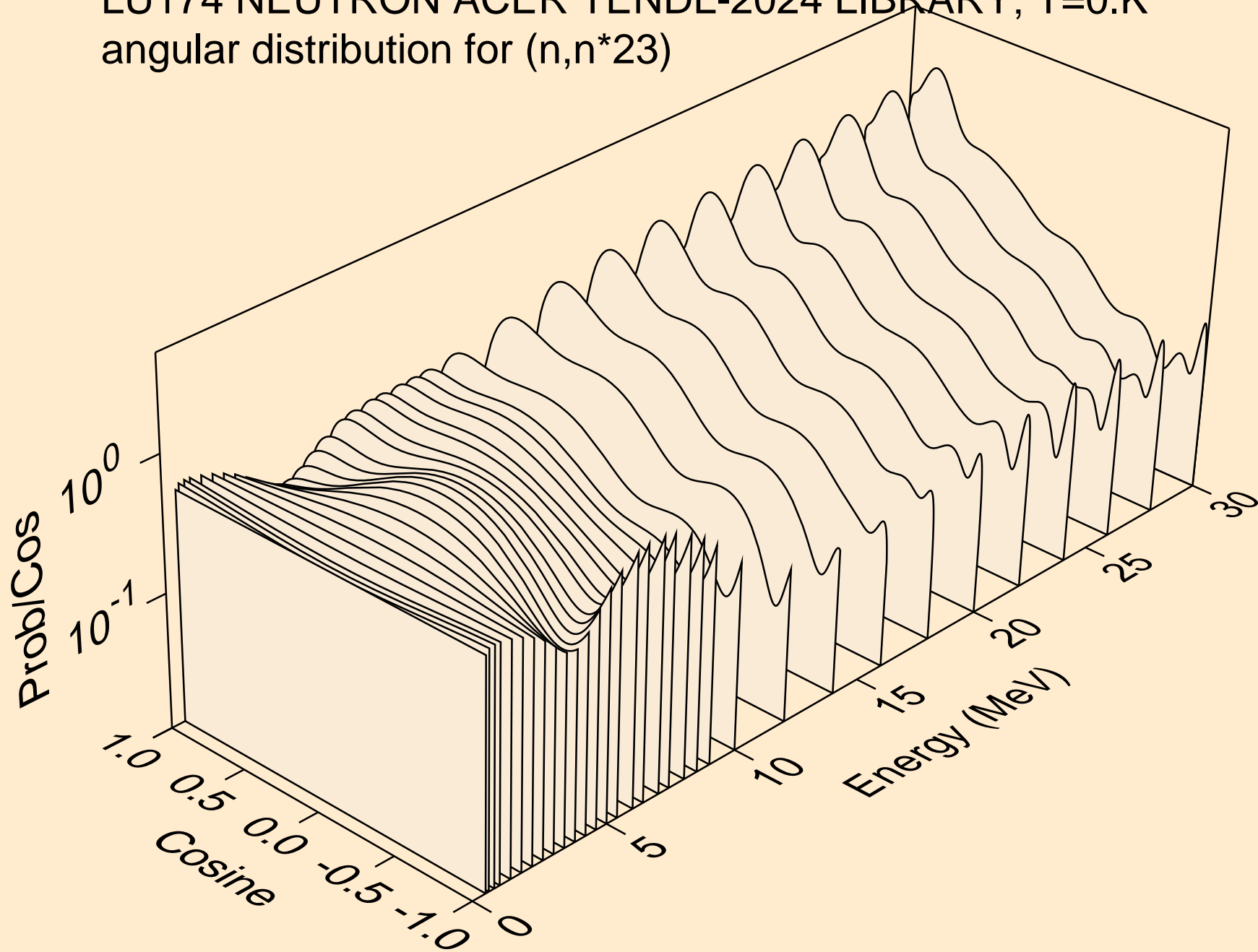

LU174 NEUTRON ACER TENDL-2024 LIBRARY; T=0.K  
angular distribution for (n,n\*24)

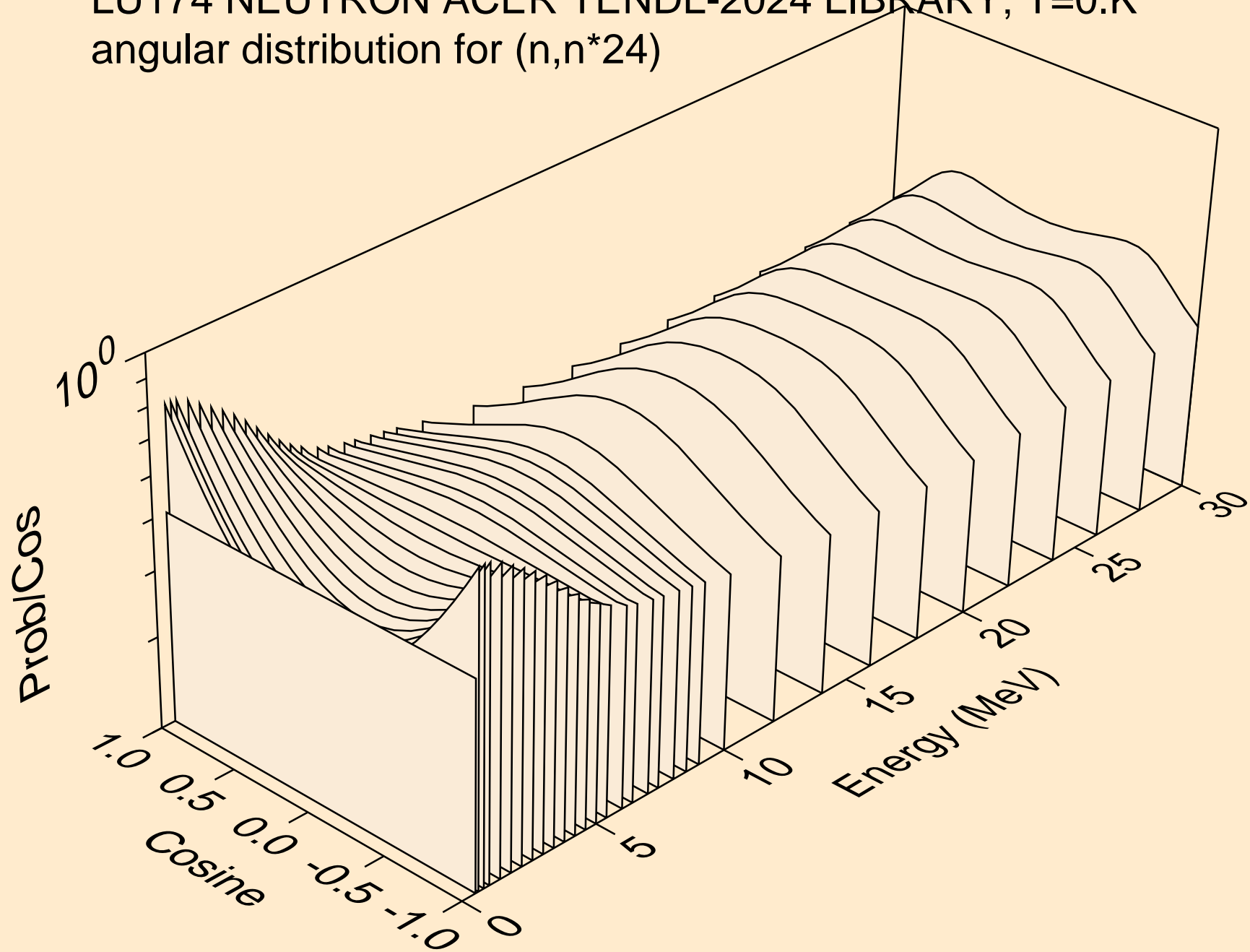



LU174 NEUTRON ACER TENDL-2024 LIBRARY; T=0.K  
angular distribution for (n,n\*25)

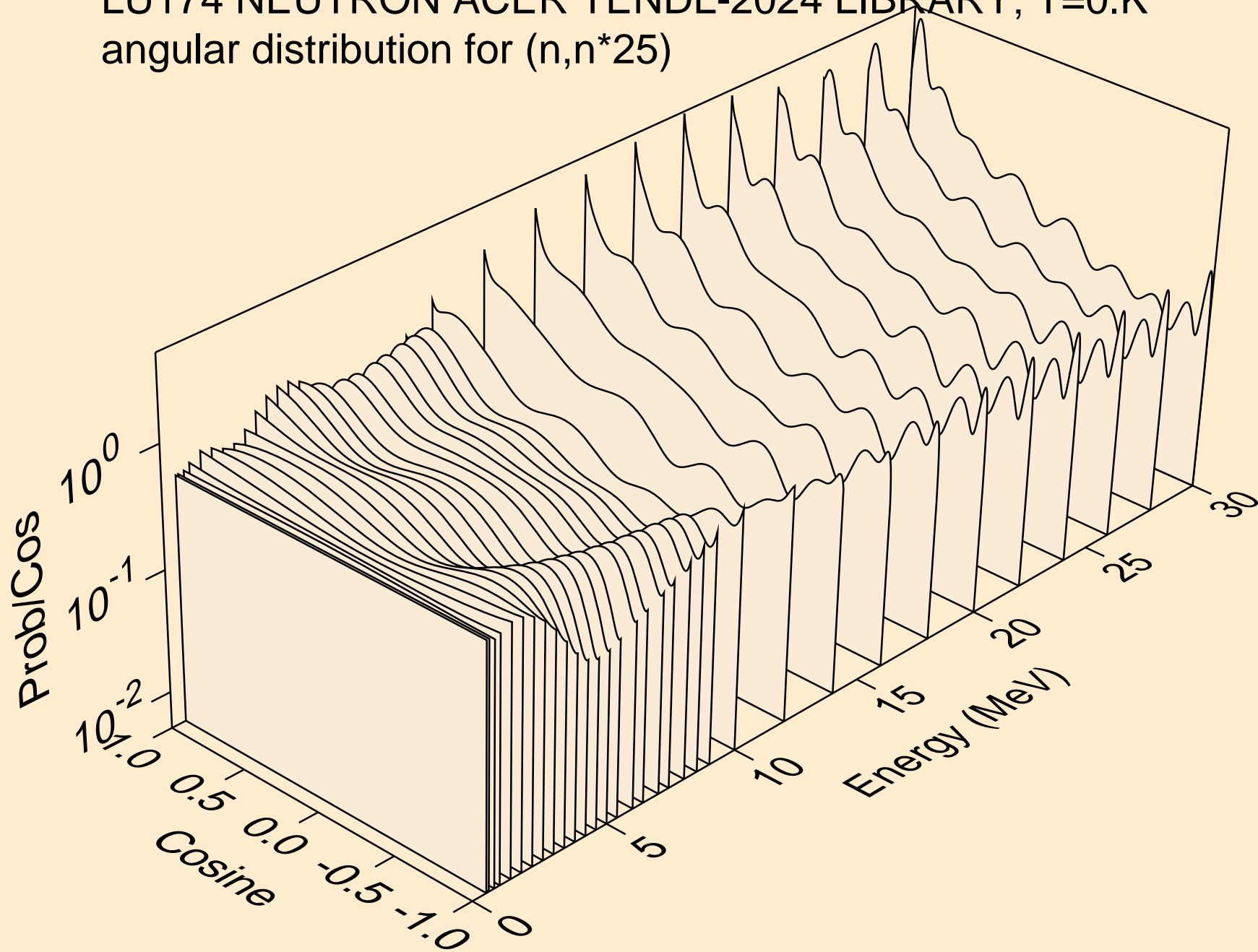

LU174 NEUTRON ACER TENDL-2024 LIBRARY; T=0.K  
angular distribution for (n,n\*26)

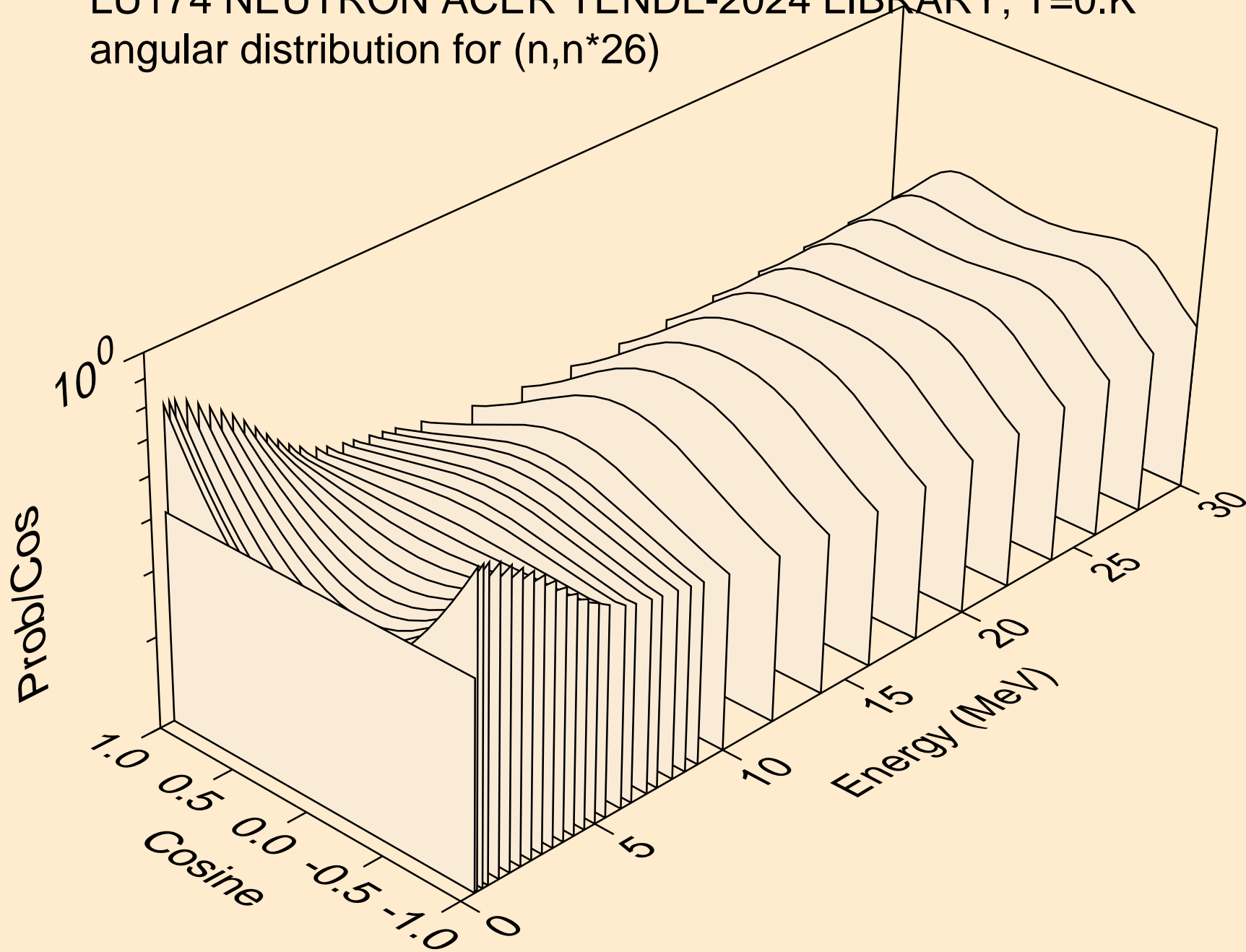

LU174 NEUTRON ACER TENDL-2024 LIBRARY; T=0.K  
angular distribution for (n,n\*27)

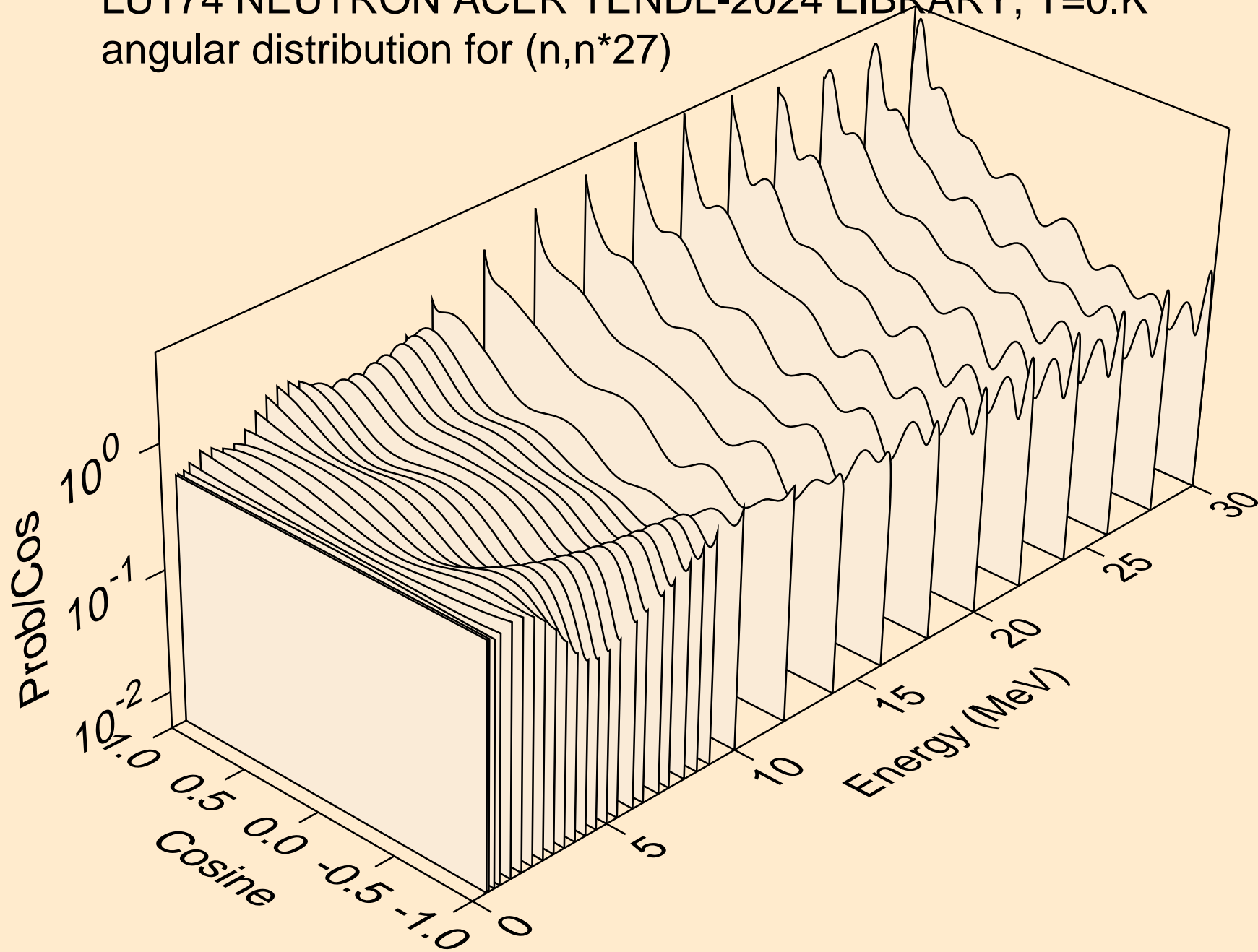

LU174 NEUTRON ACER TENDL-2024 LIBRARY; T=0.K  
angular distribution for (n,n\*28)

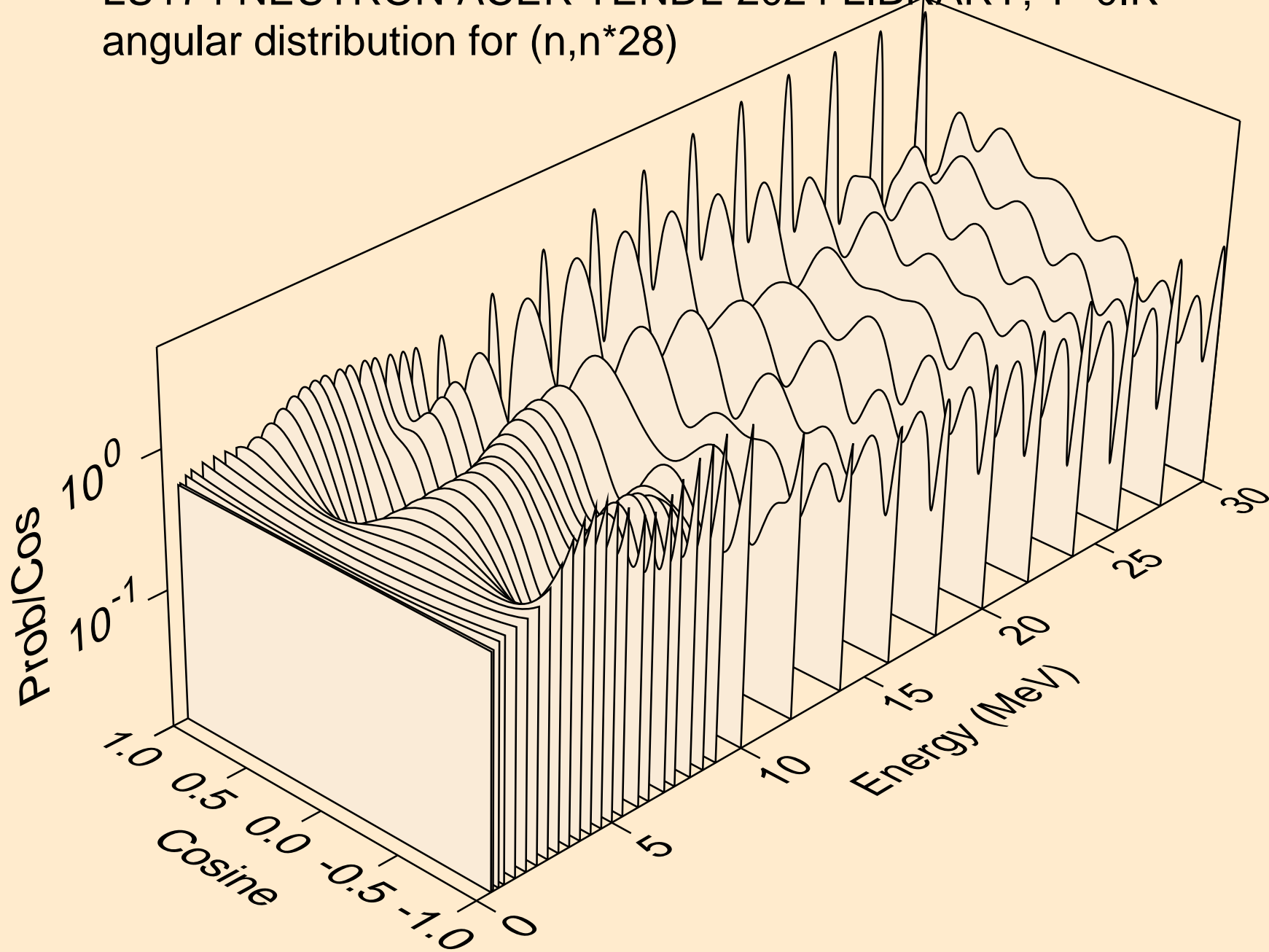

LU174 NEUTRON ACER TENDL-2024 LIBRARY; T=0.K  
angular distribution for (n,n\*29)

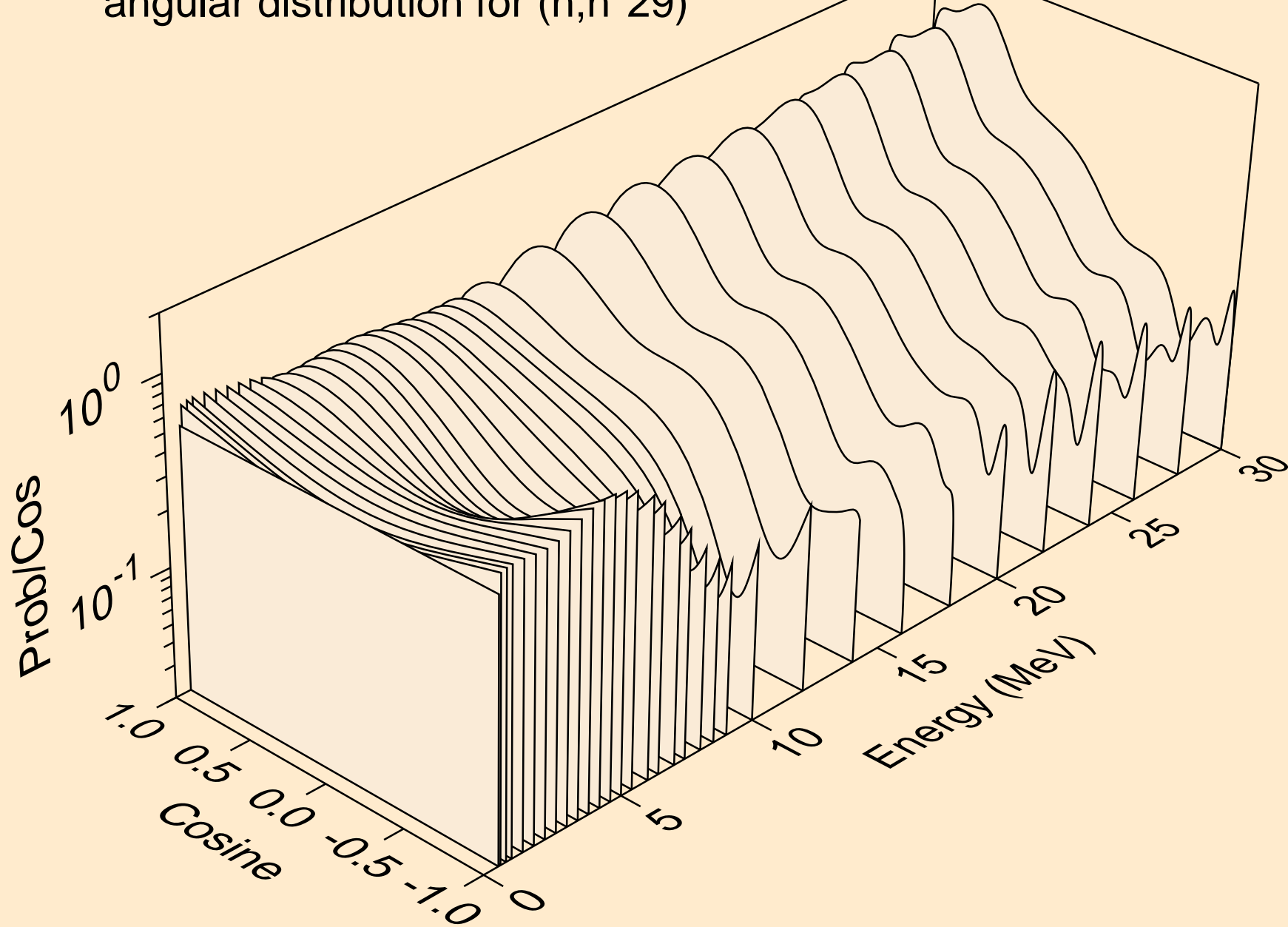

LU174 NEUTRON ACER TENDL-2024 LIBRARY; T=0.K  
angular distribution for (n,n\*30)

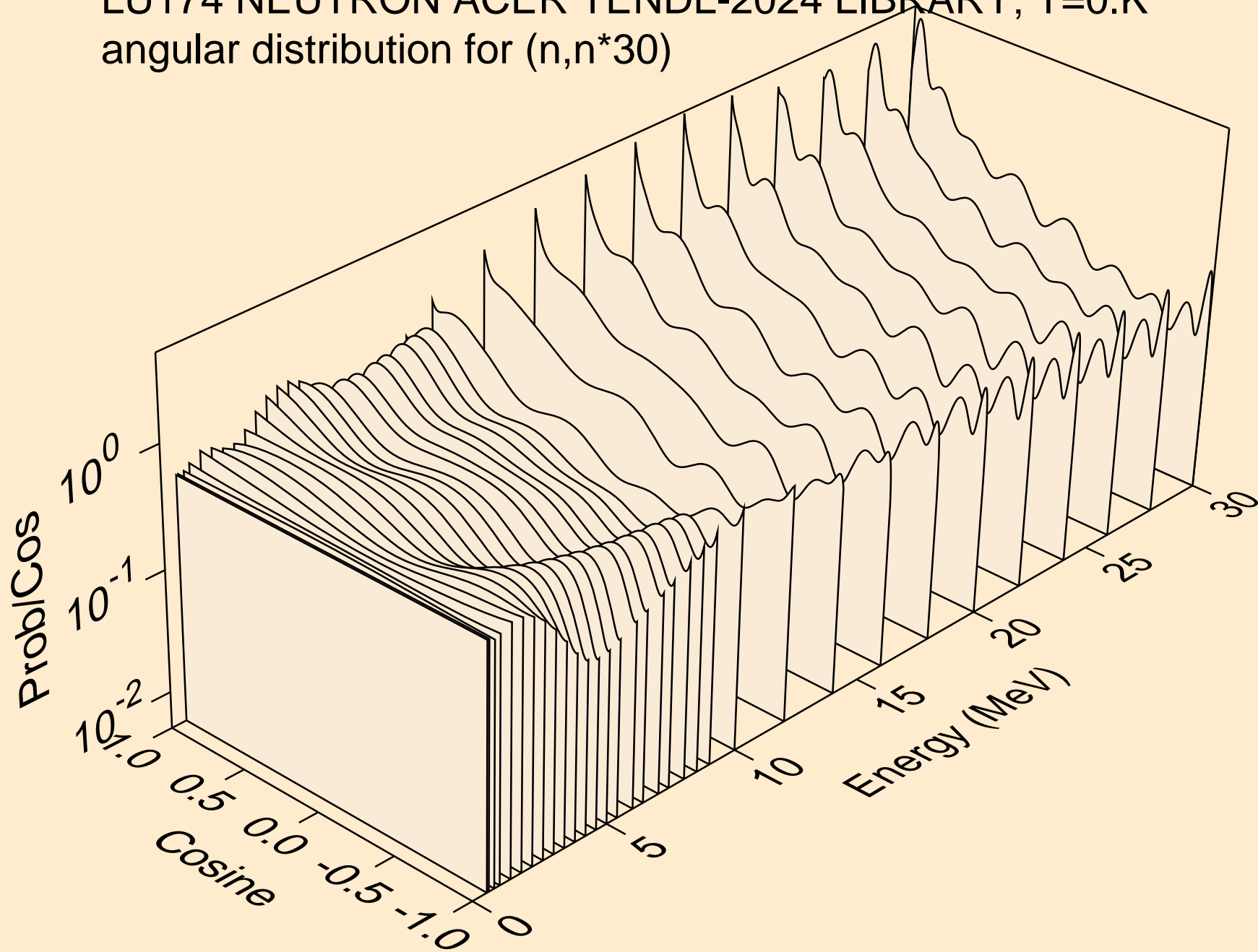

LU174 NEUTRON ACER TENDL-2024 LIBRARY; T=0.K  
Neutron emission for (n,x)

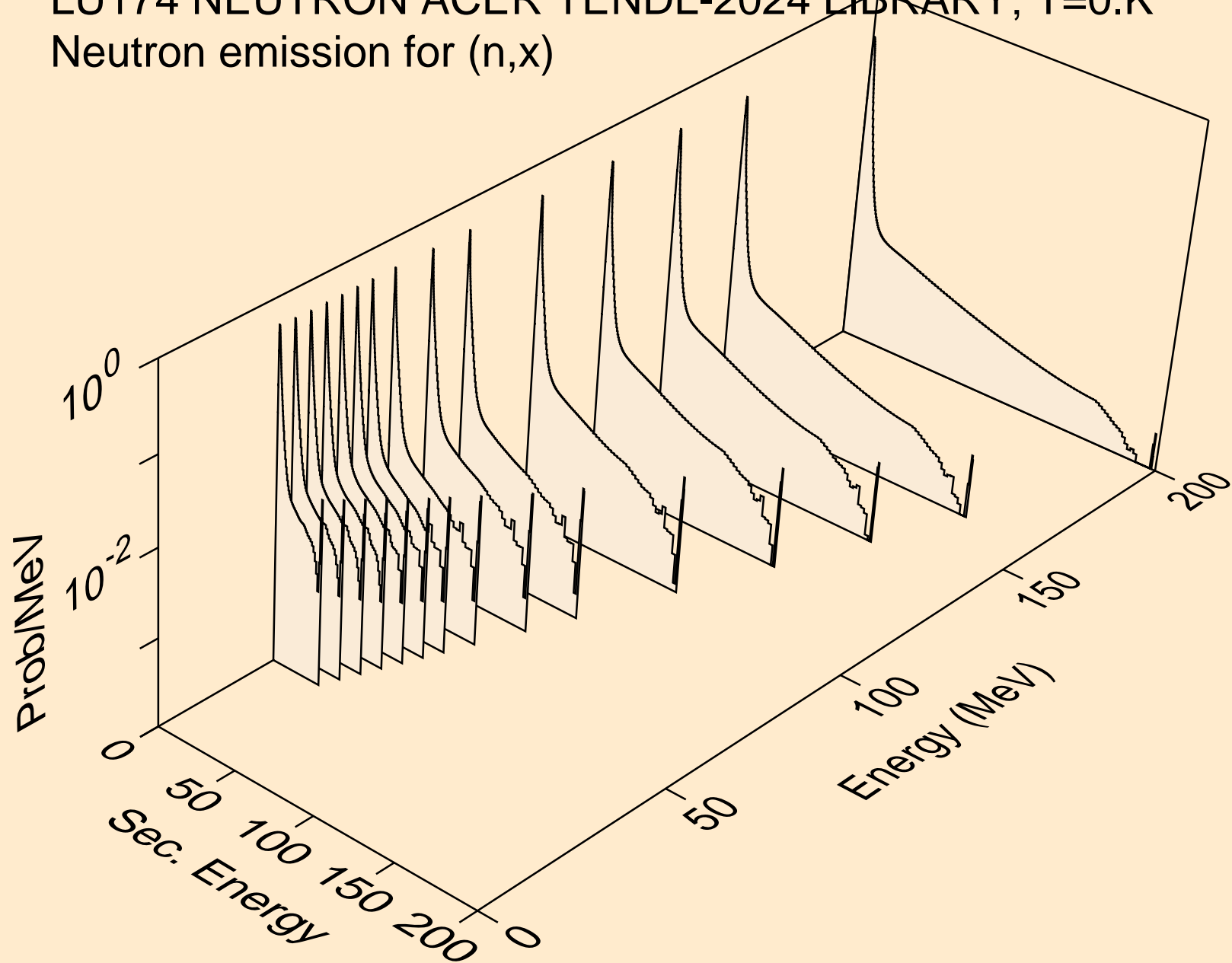

LU174 NEUTRON ACER TENDL-2024 LIBRARY; T=0.K  
Neutron emission for (n,2nd)

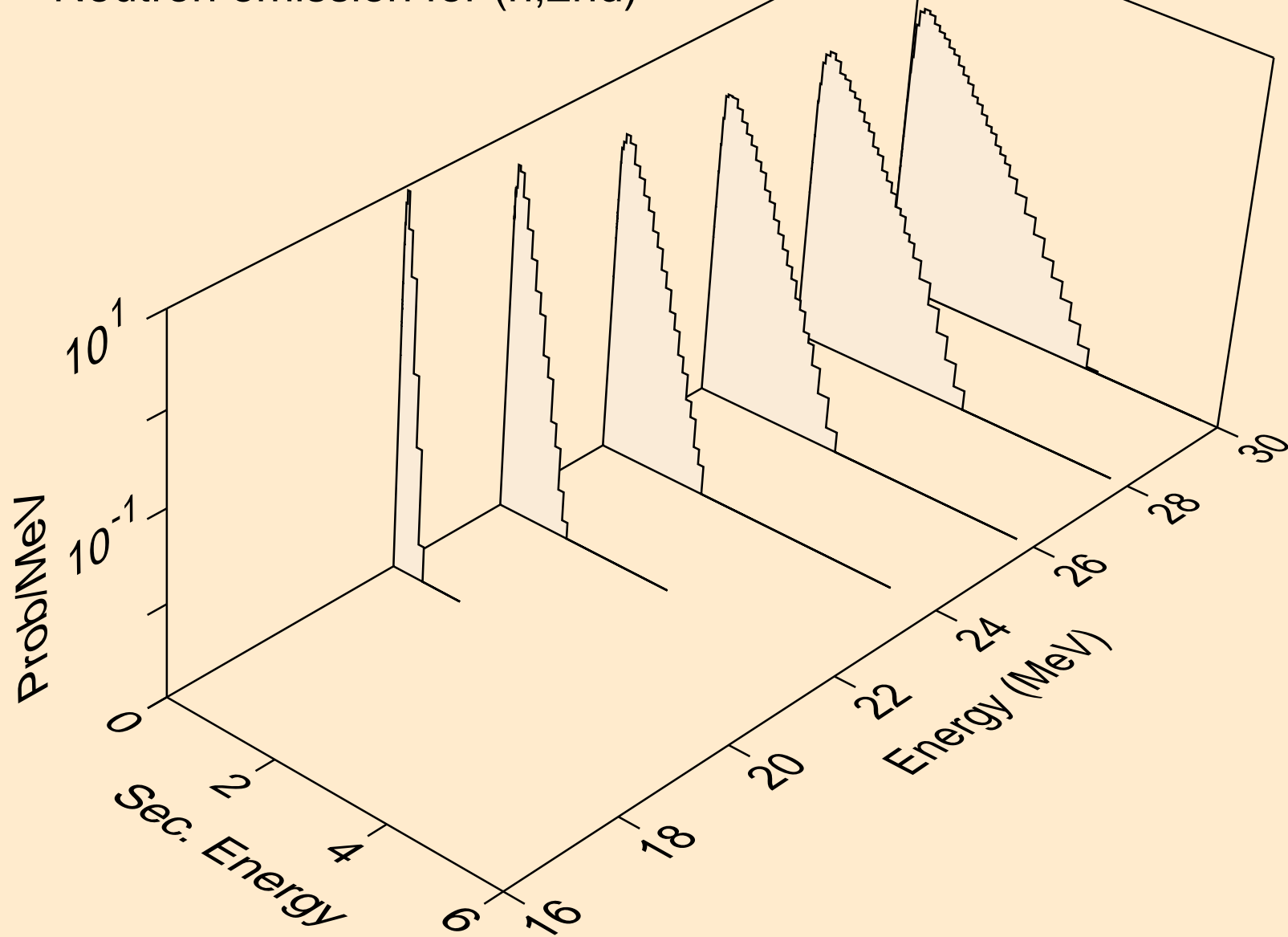



LU174 NEUTRON ACER TENDL-2024 LIBRARY; T=0.K  
Neutron emission for (n,2n)

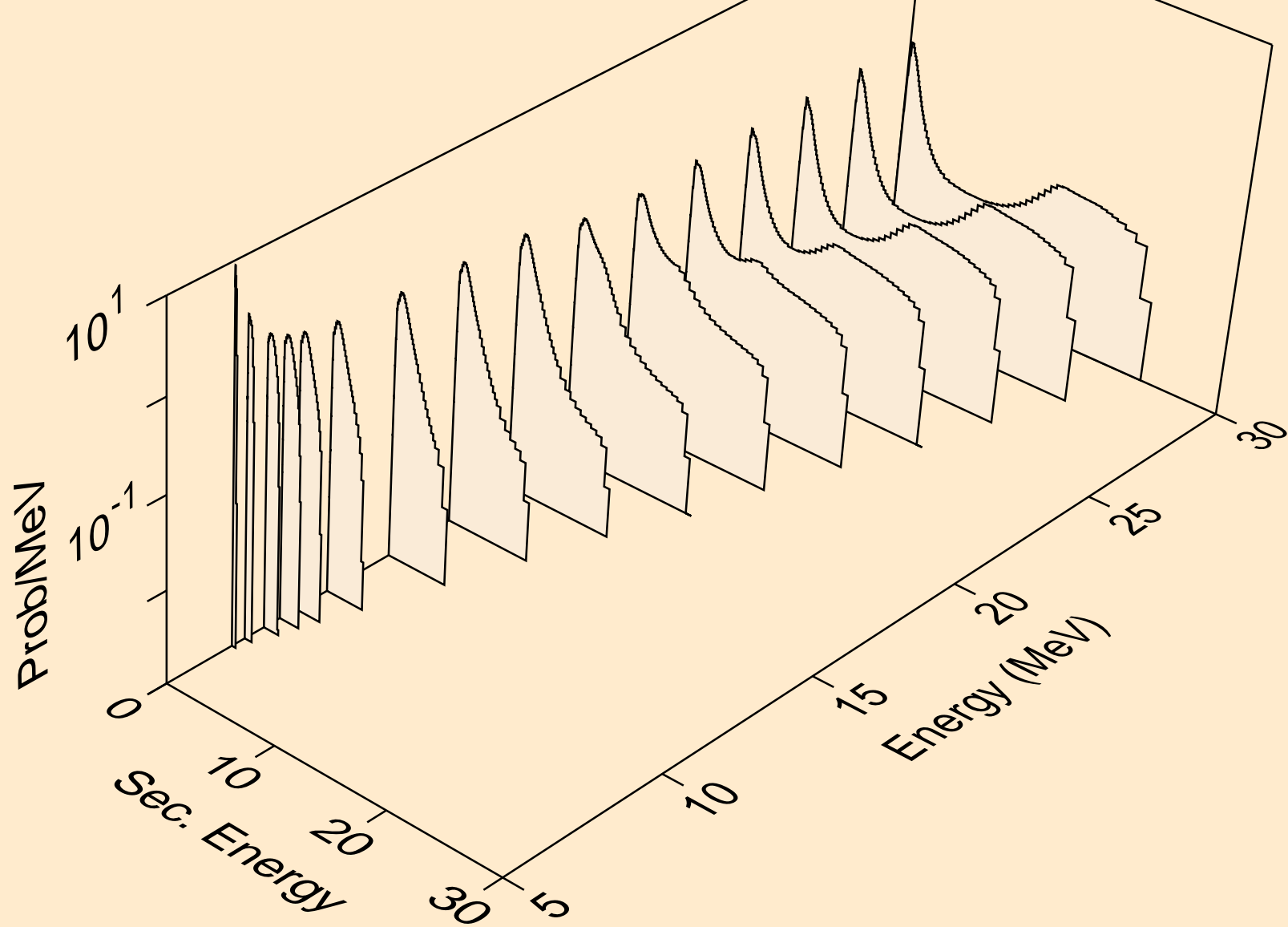

LU174 NEUTRON ACER TENDL-2024 LIBRARY; T=0.K  
Neutron emission for (n,3n)

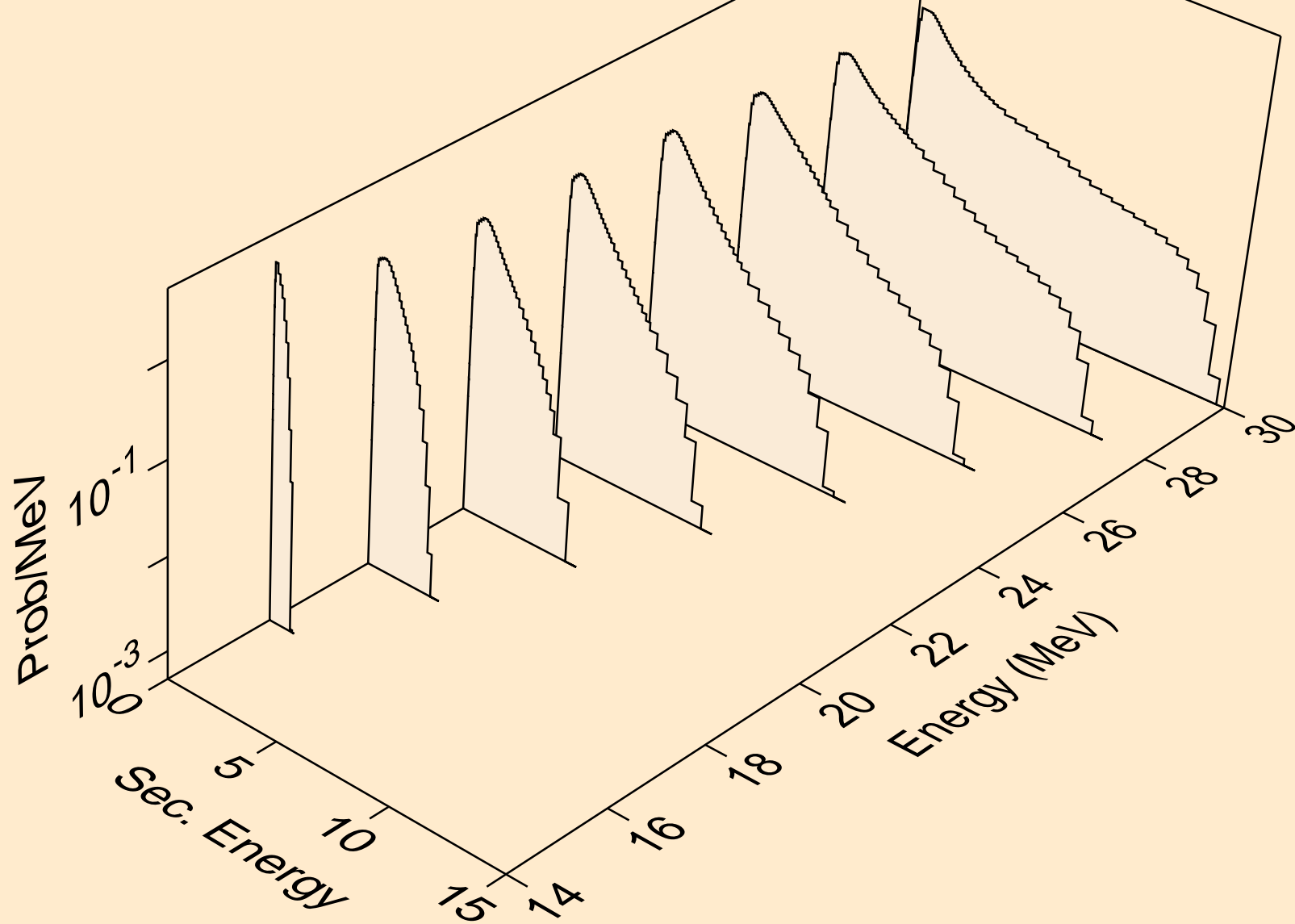

LU174 NEUTRON ACER TENDL-2024 LIBRARY; T=0.K  
Neutron emission for (n,n\*)a

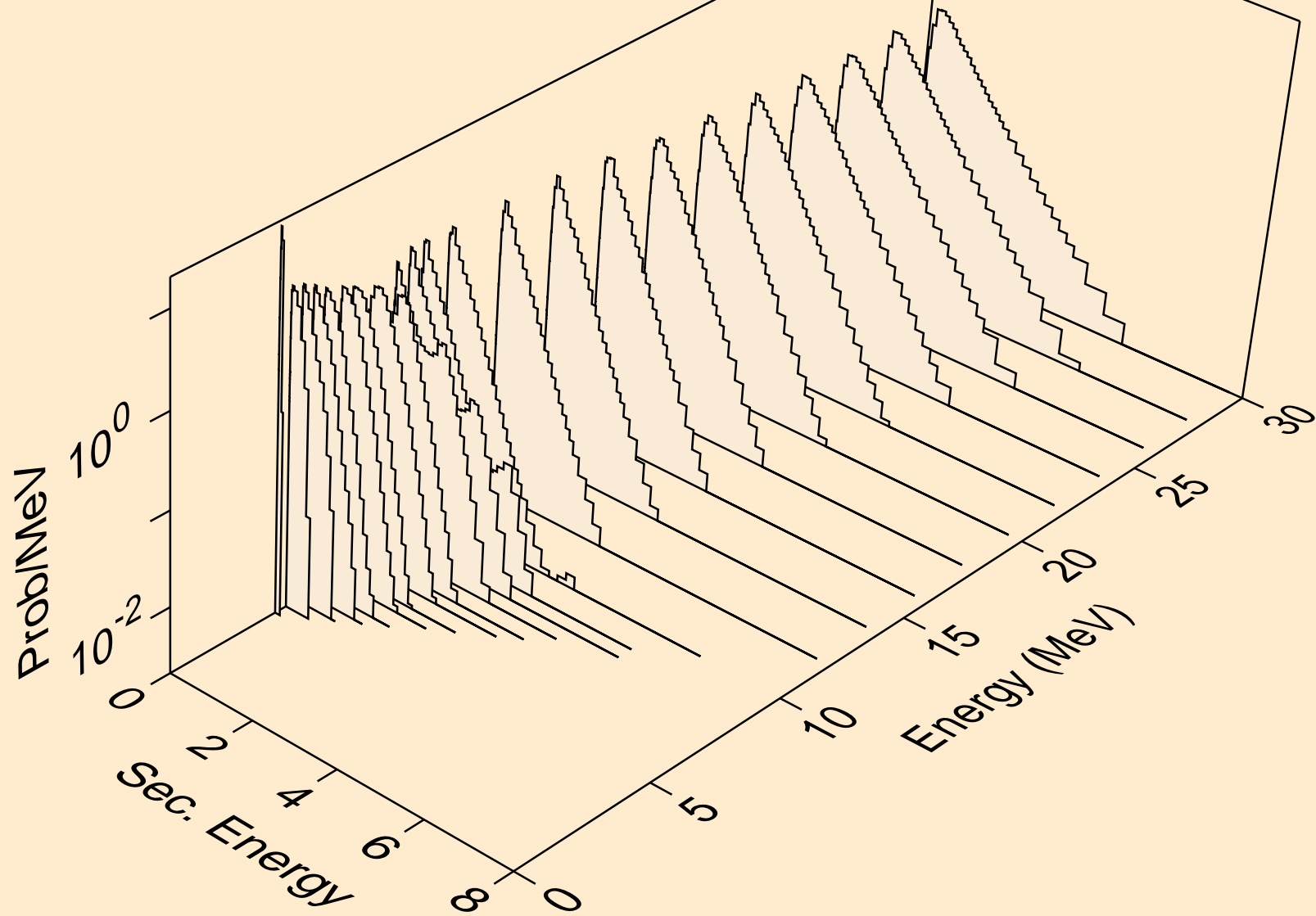

LU174 NEUTRON ACER TENDL-2024 LIBRARY; T=0.K  
Neutron emission for (n,2n)a

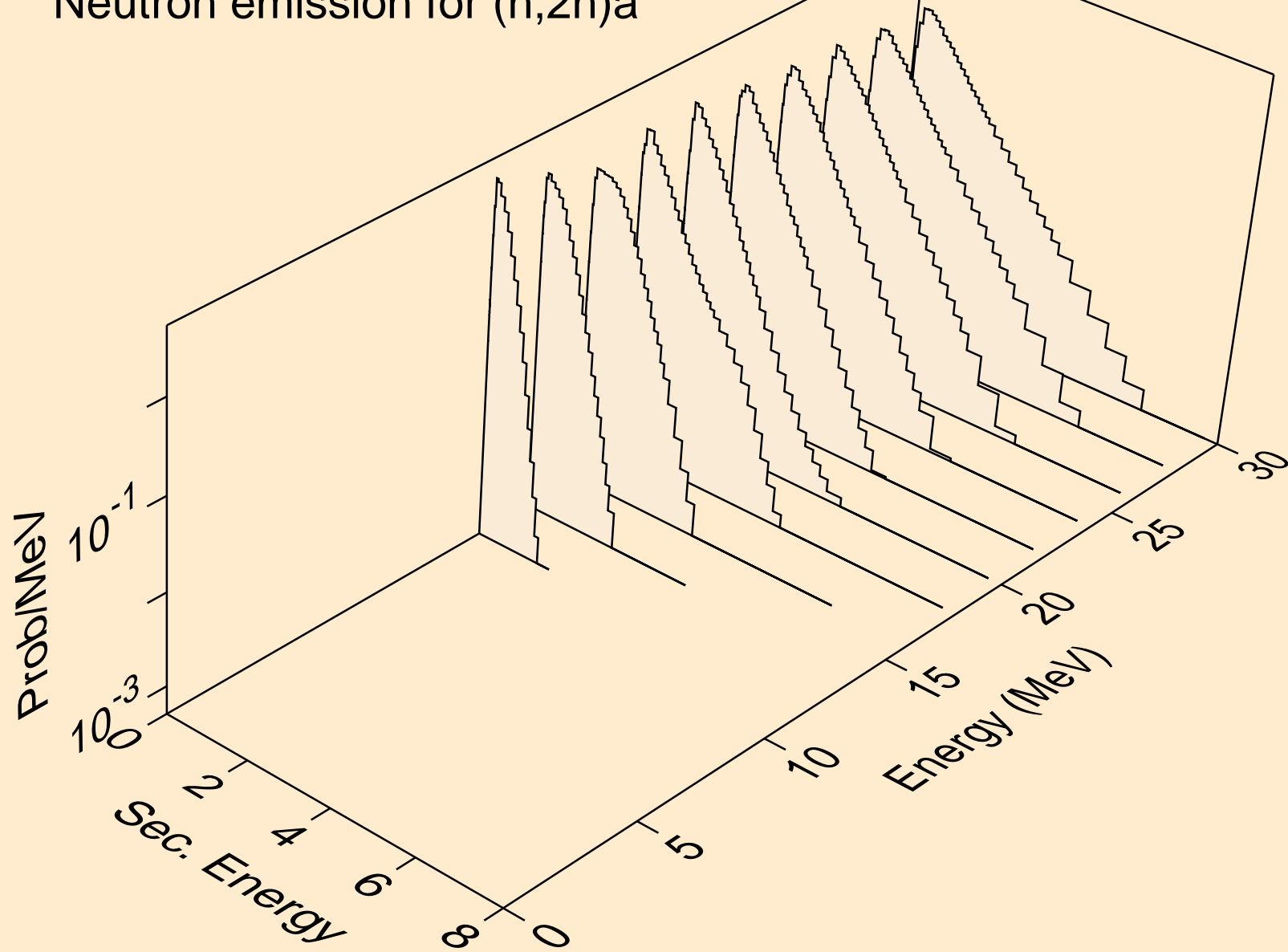

LU174 NEUTRON ACER TENDL-2024 LIBRARY; T=0.K  
Neutron emission for (n,3n)a

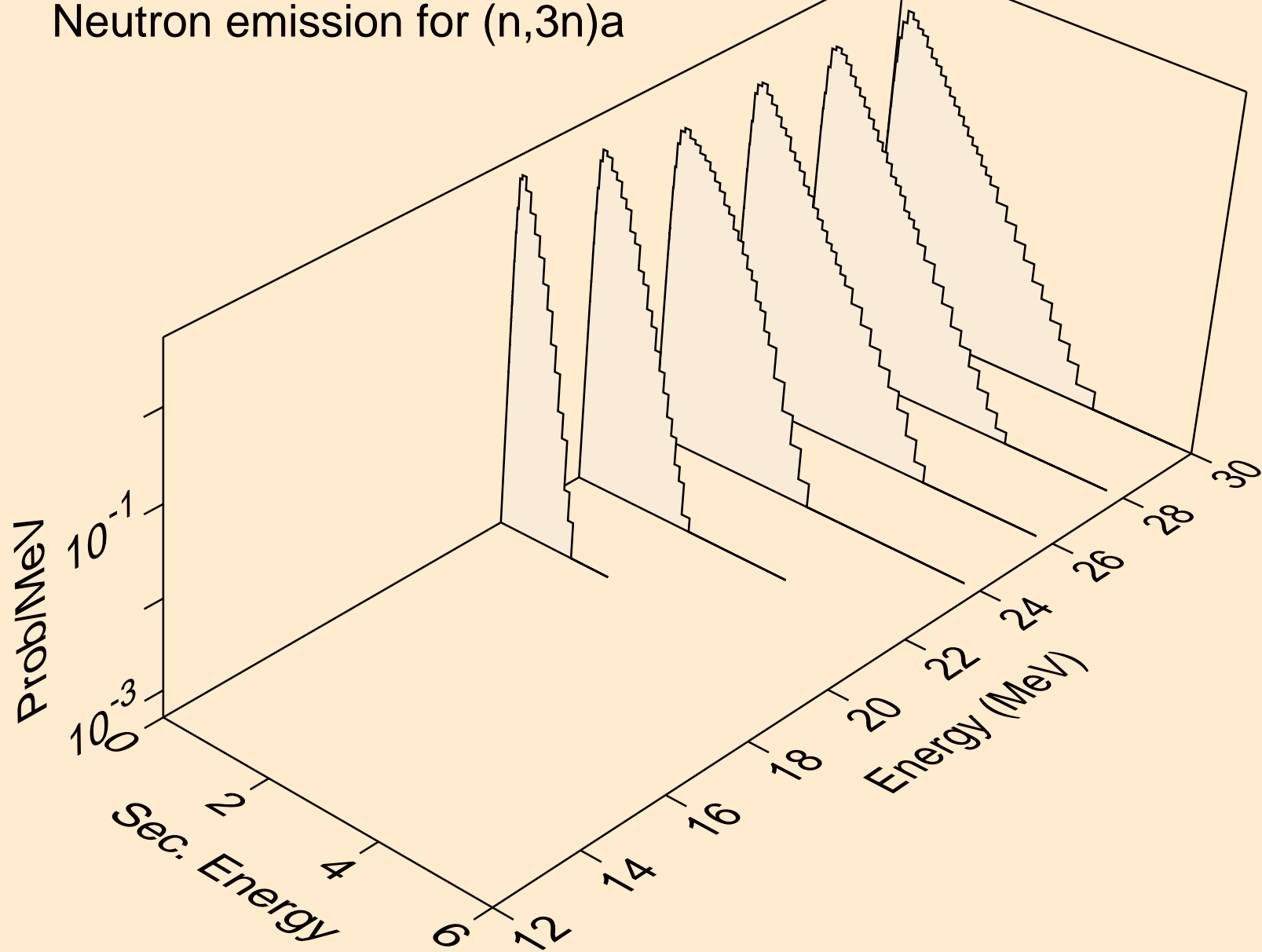

LU174 NEUTRON ACER TENDL-2024 LIBRARY; T=0.K  
Neutron emission for (n,n\*)p

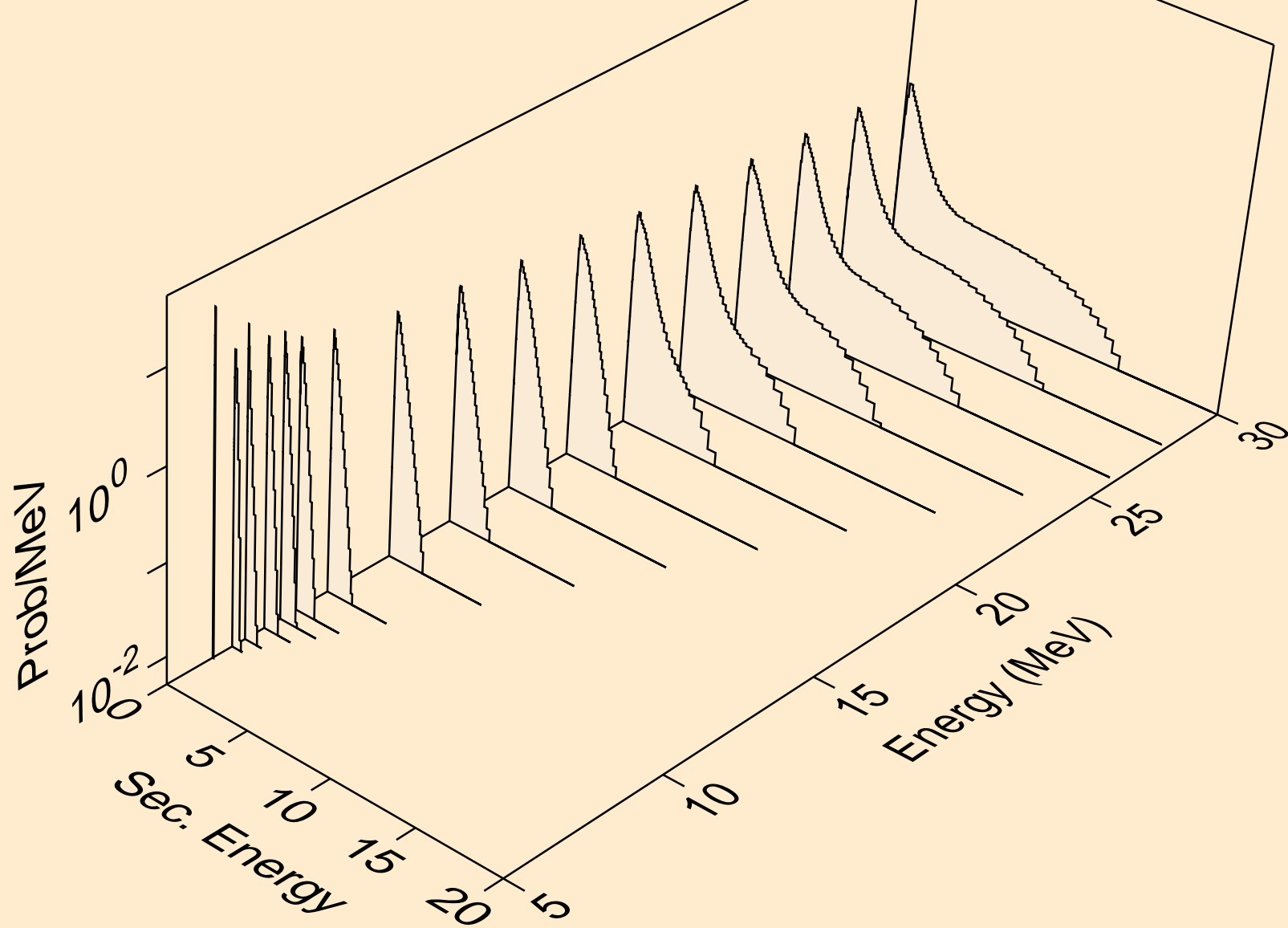

LU174 NEUTRON ACER TENDL-2024 LIBRARY; T=0.K  
Neutron emission for (n,n\*)2a

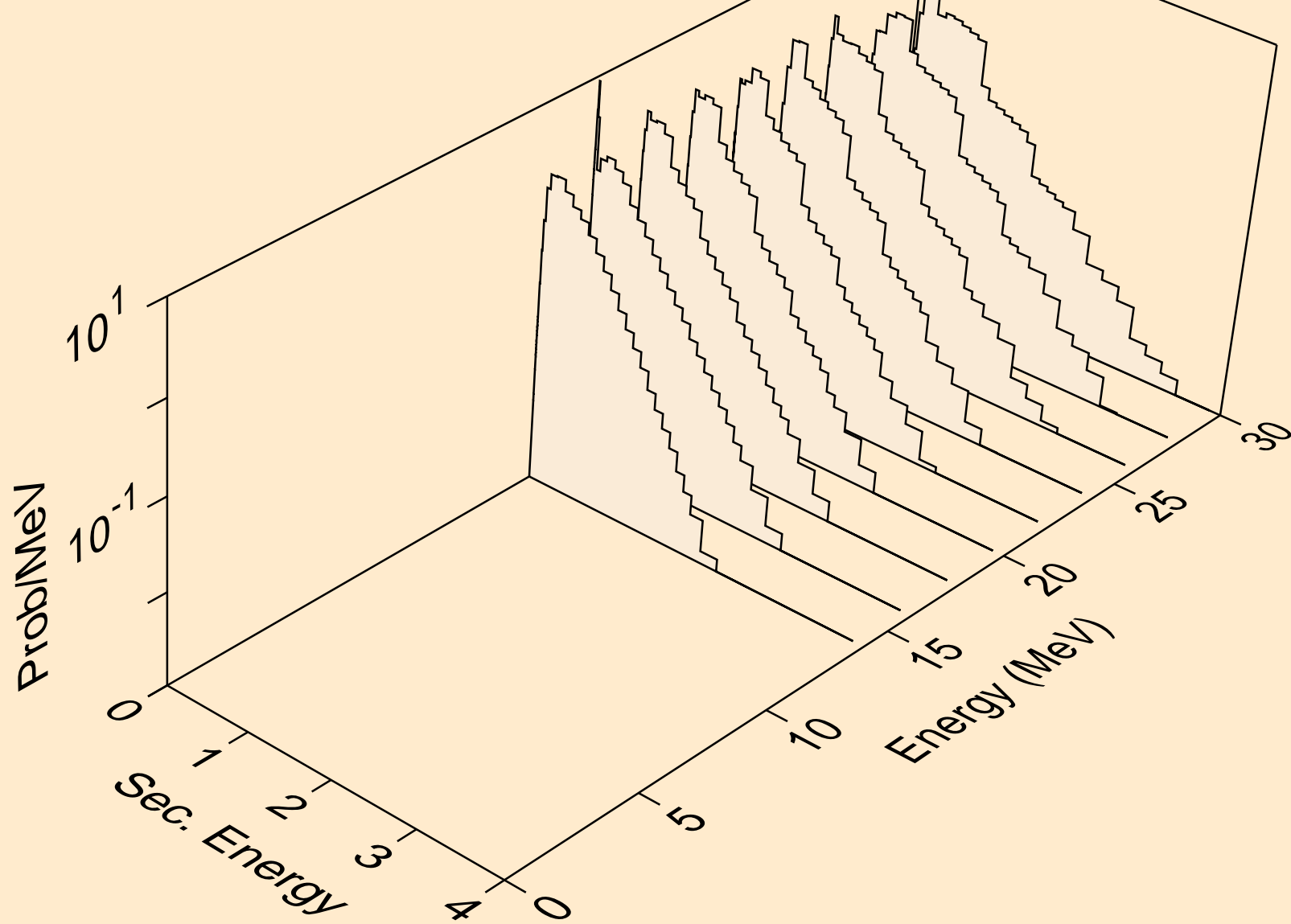

LU174 NEUTRON ACER TENDL-2024 LIBRARY; T=0.K  
Neutron emission for (n,n\*)d

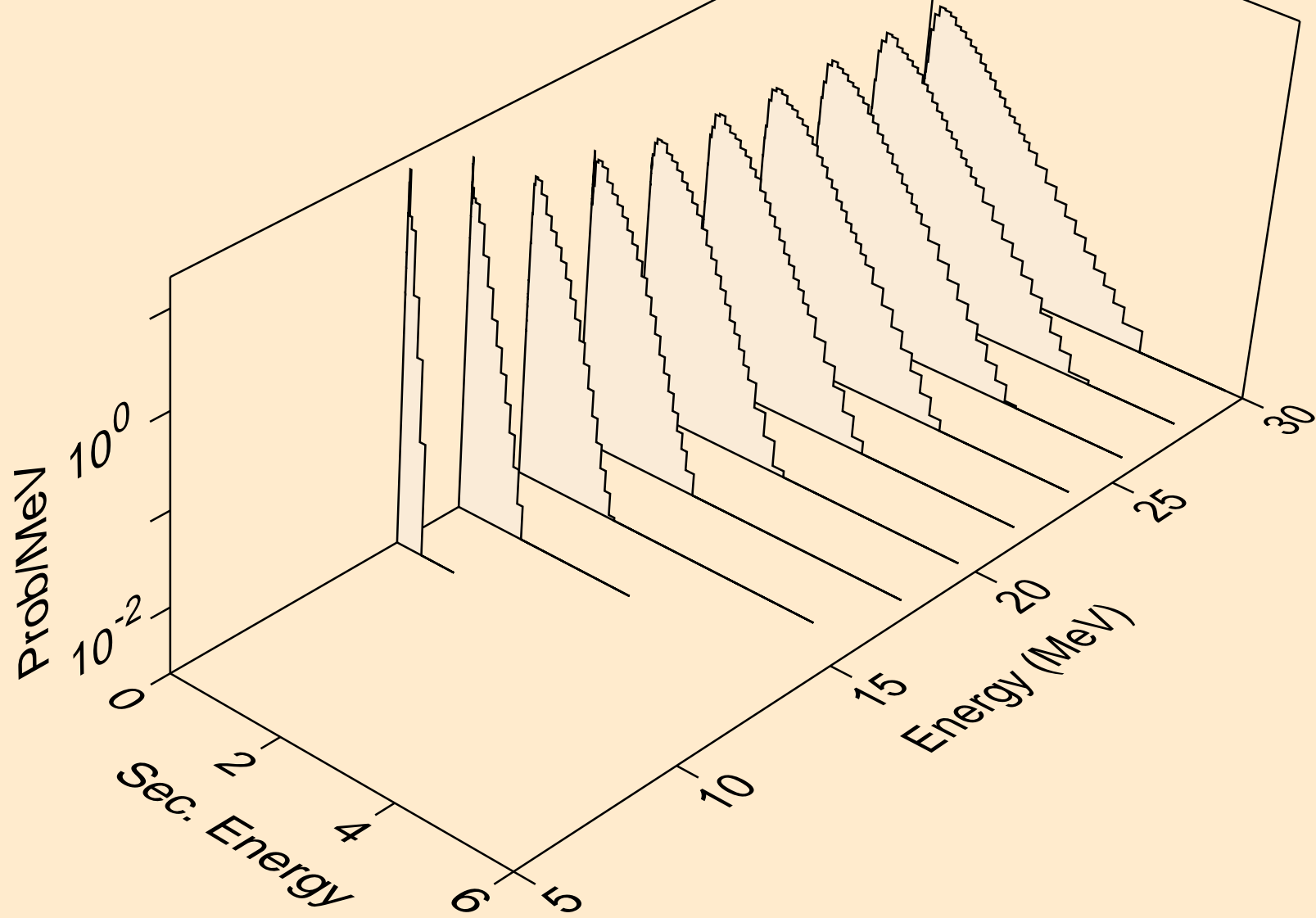



LU174 NEUTRON ACER TENDL-2024 LIBRARY; T=0.K  
Neutron emission for (n,n\*)t

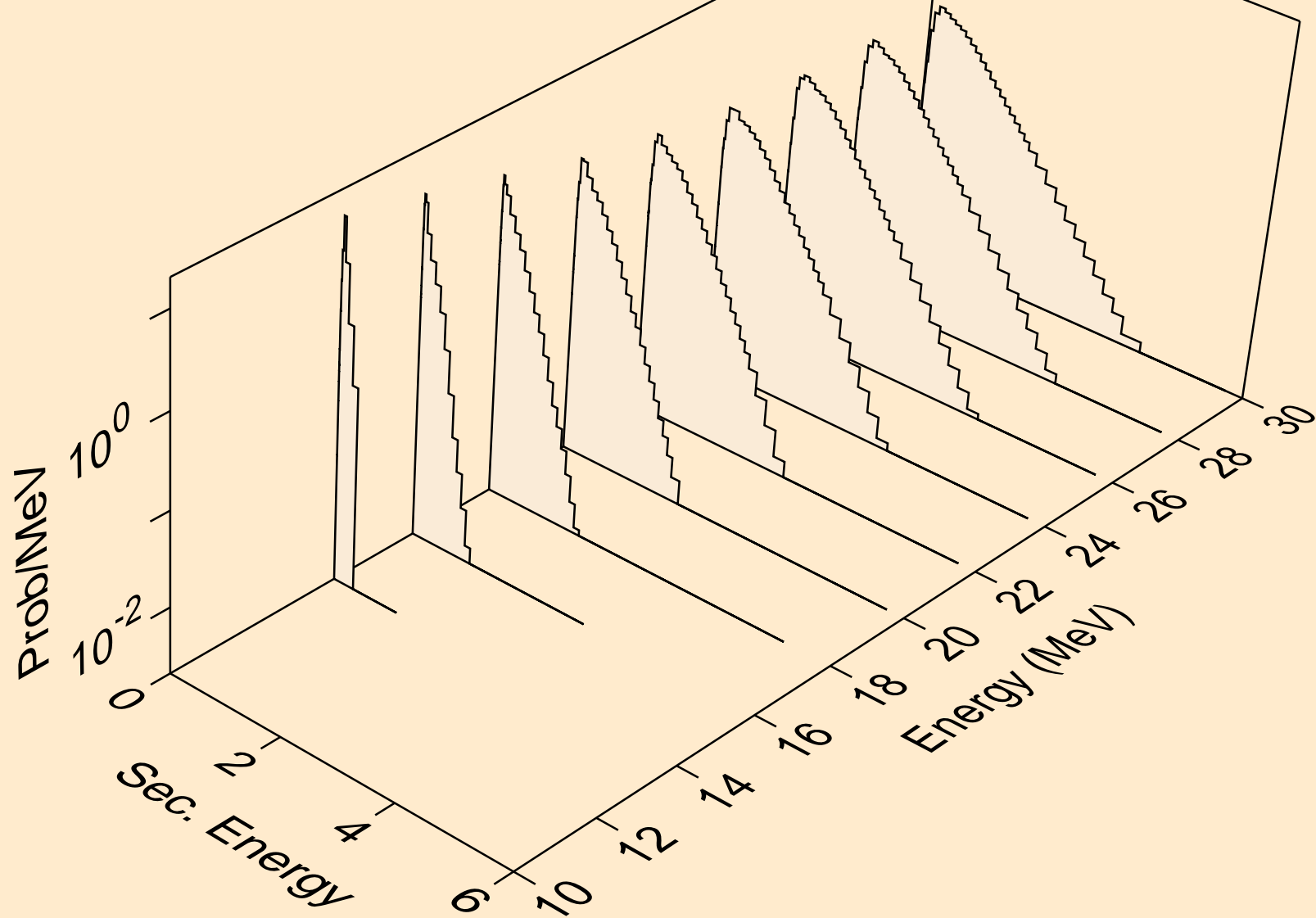

LU174 NEUTRON ACER TENDL-2024 LIBRARY; T=0.K  
Neutron emission for (n,n\*)he3

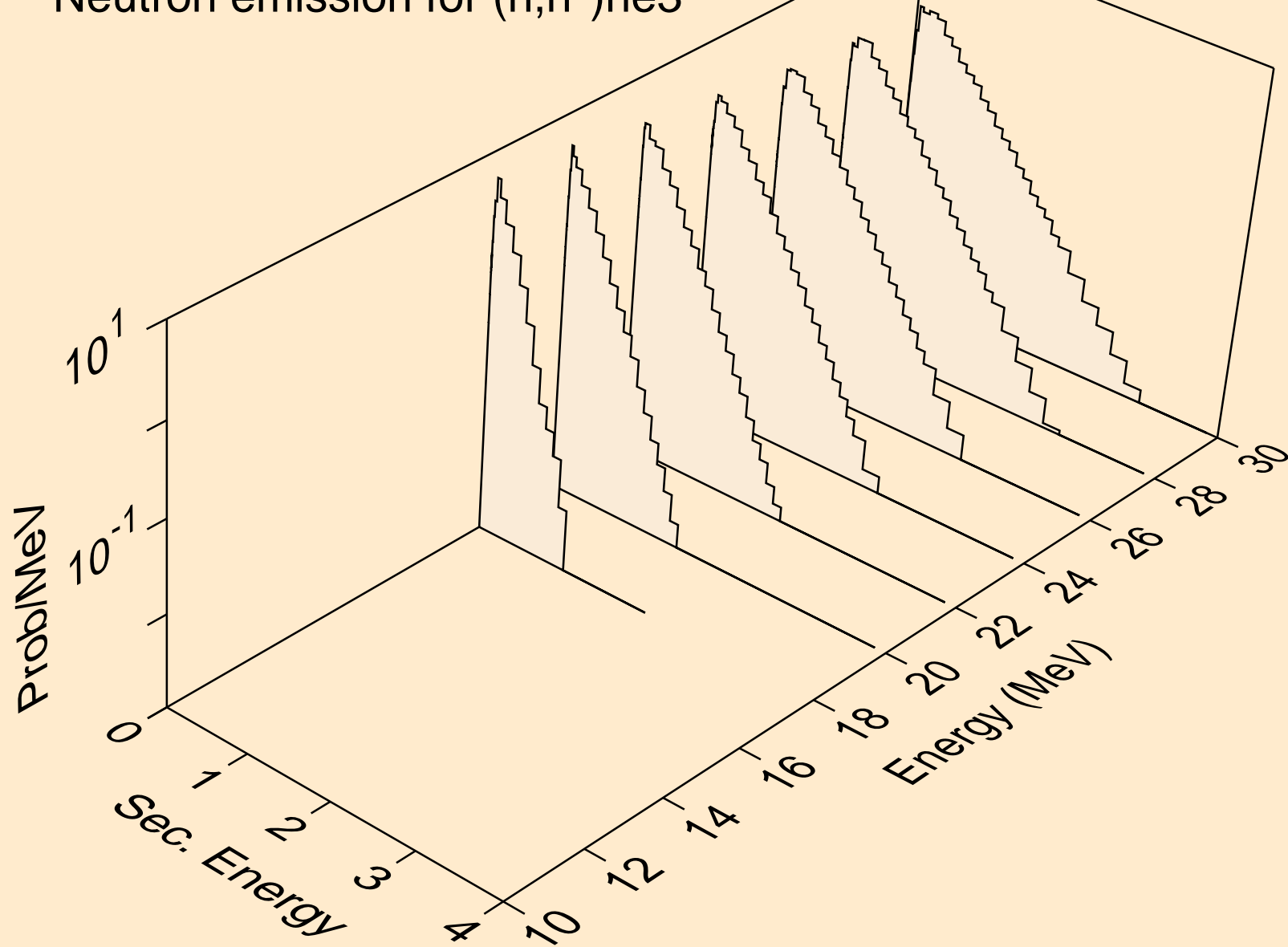

LU174 NEUTRON ACER TENDL-2024 LIBRARY; T=0.K  
Neutron emission for (n,4n)

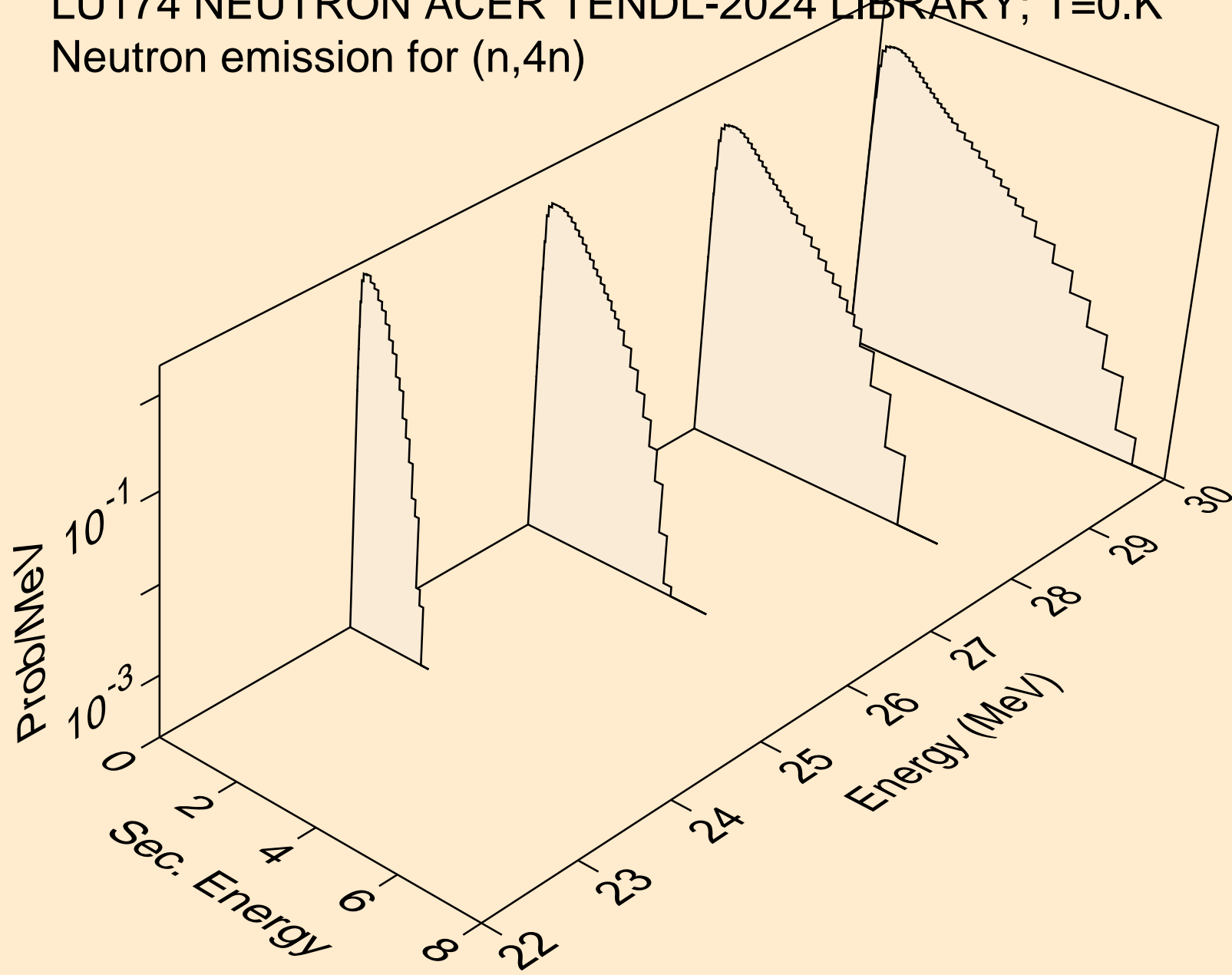

LU174 NEUTRON ACER TENDL-2024 LIBRARY; T=0.K  
Neutron emission for (n,2np)

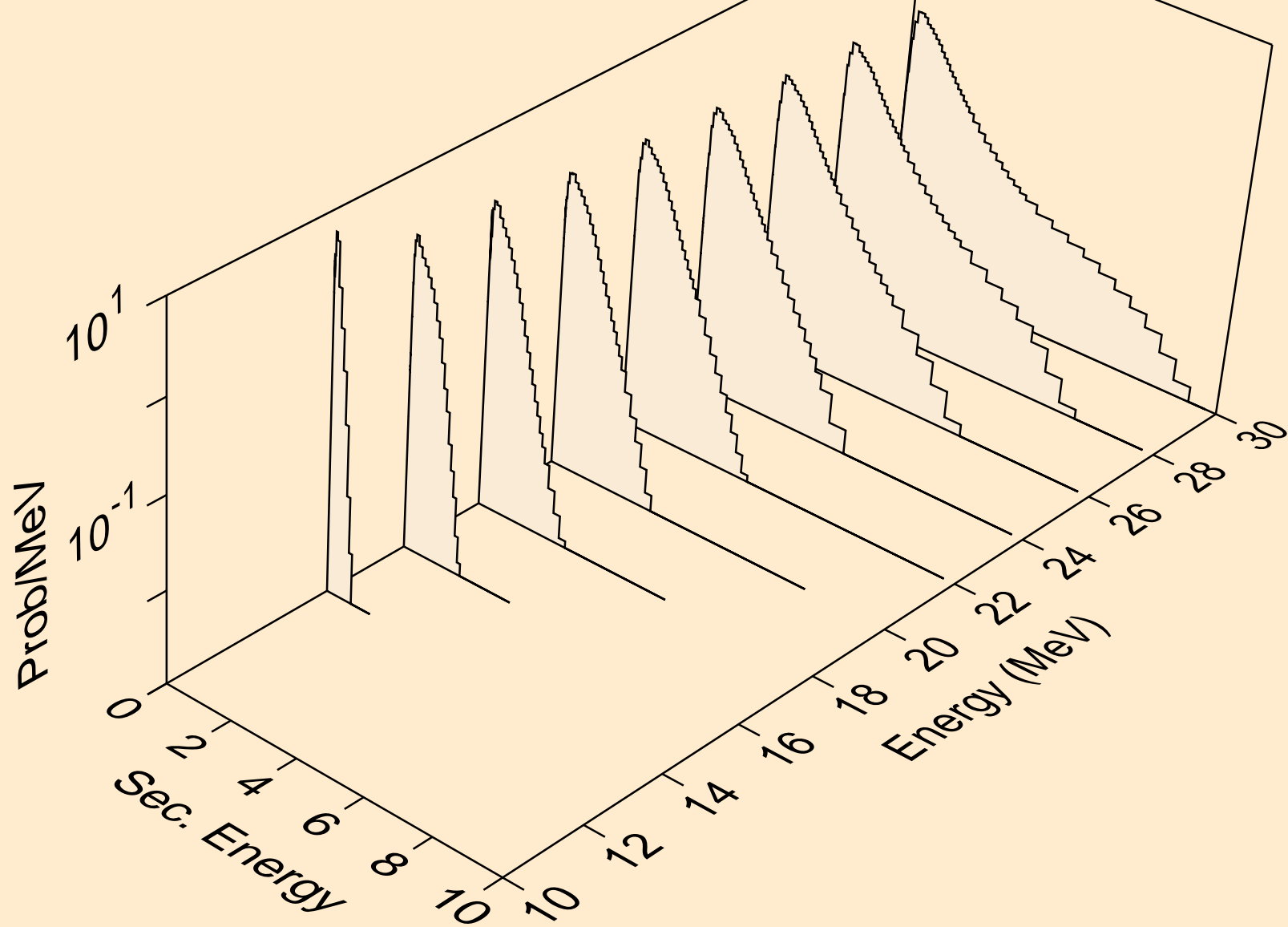

LU174 NEUTRON ACER TENDL-2024 LIBRARY; T=0.K  
Neutron emission for (n,3np)

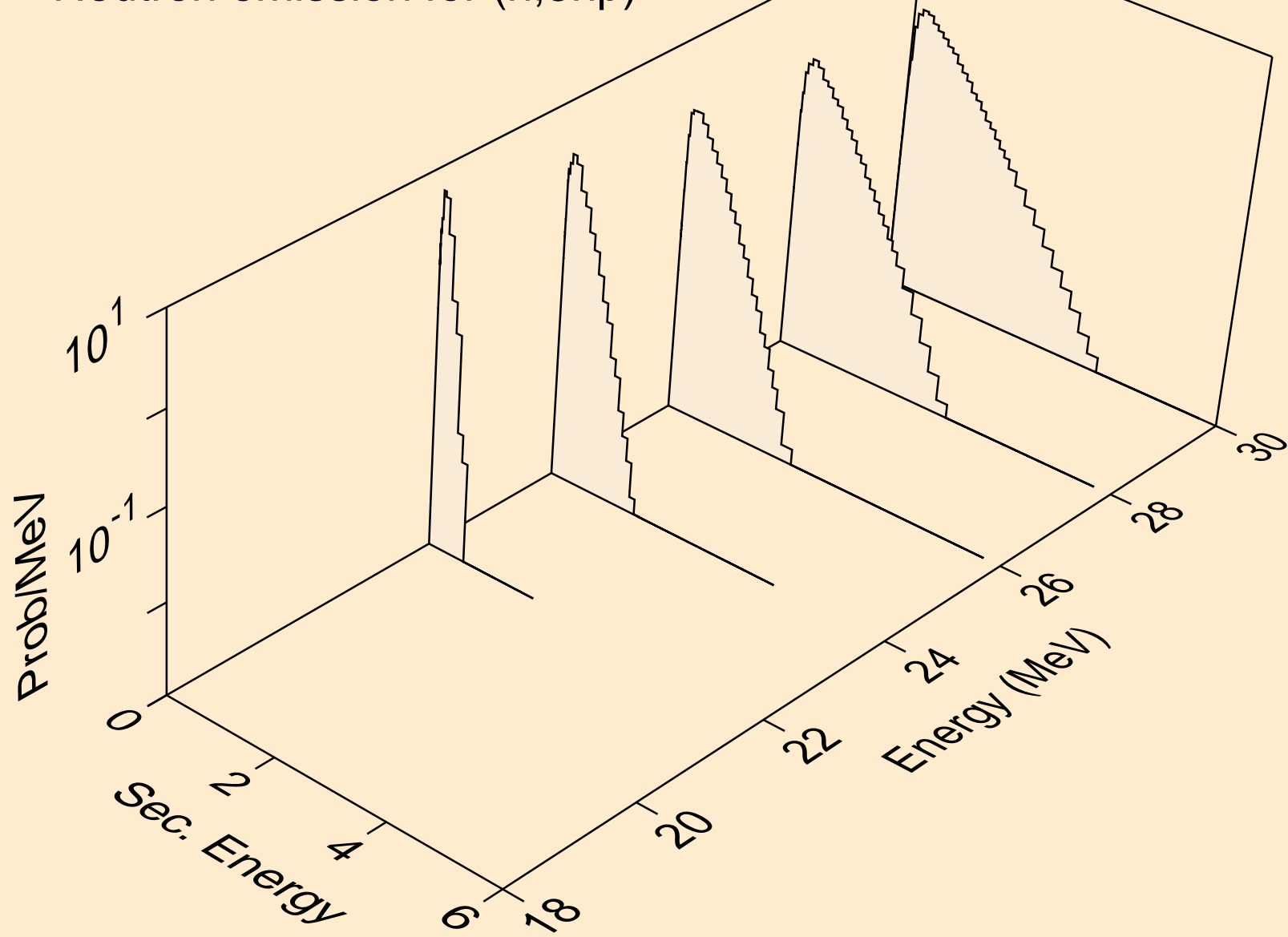

LU174 NEUTRON ACER TENDL-2024 LIBRARY; T=0.K  
Neutron emission for (n,n2p)

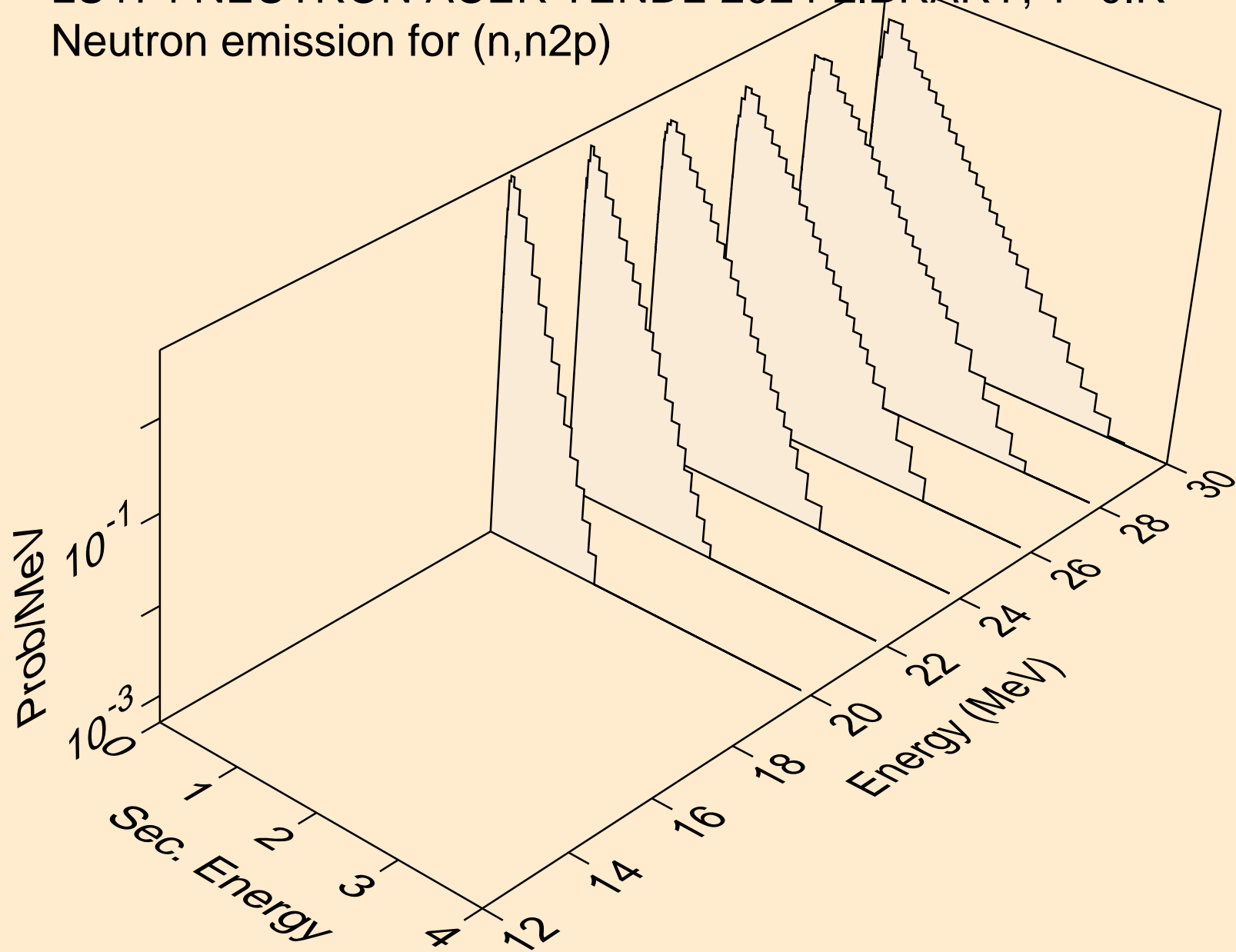

LU174 NEUTRON ACER TENDL-2024 LIBRARY; T=0.K  
Neutron emission for (n,npa)

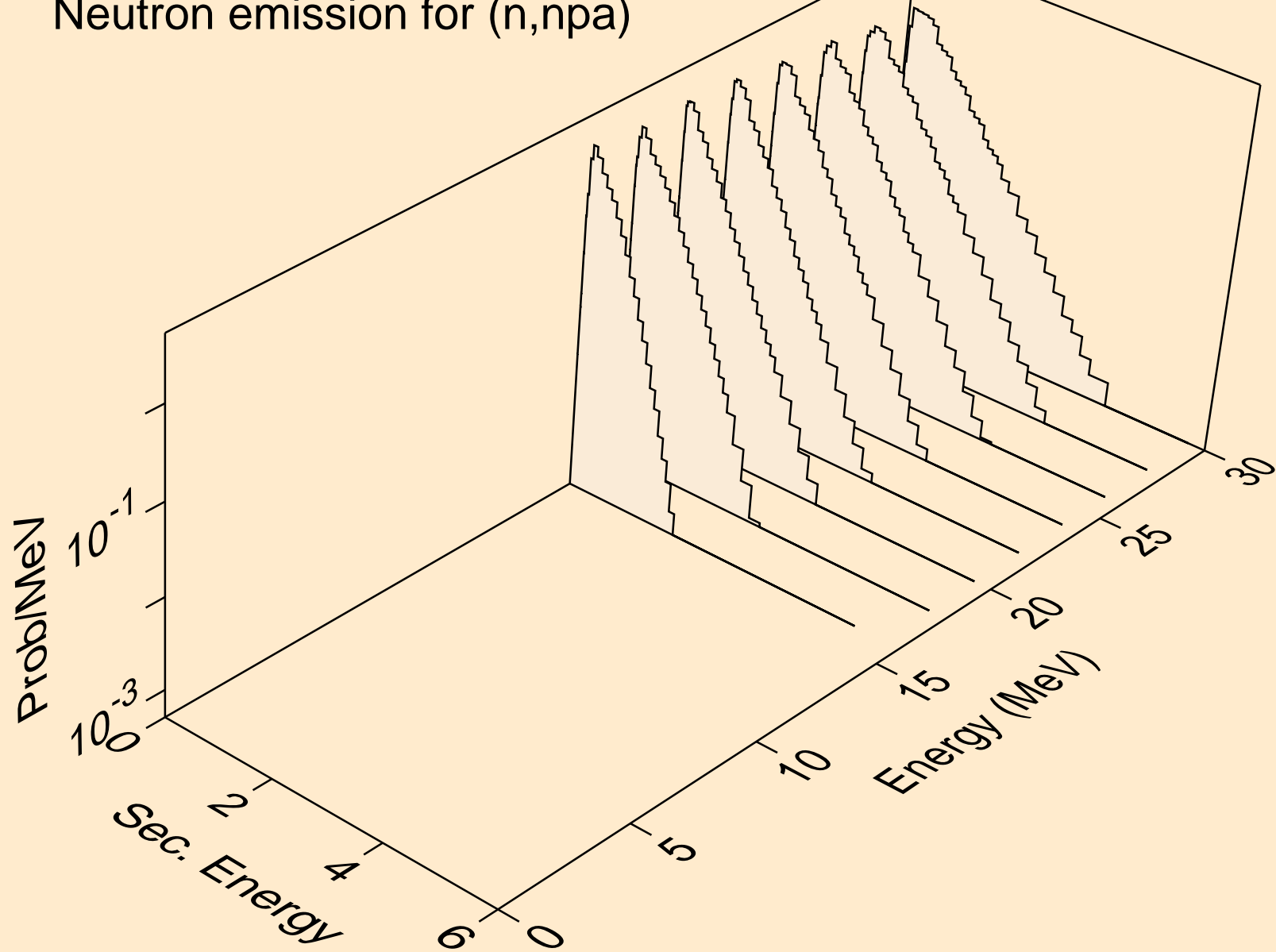

LU174 NEUTRON ACER TENDL-2024 LIBRARY; T=0.K  
Neutron emission for (n,n\*c)

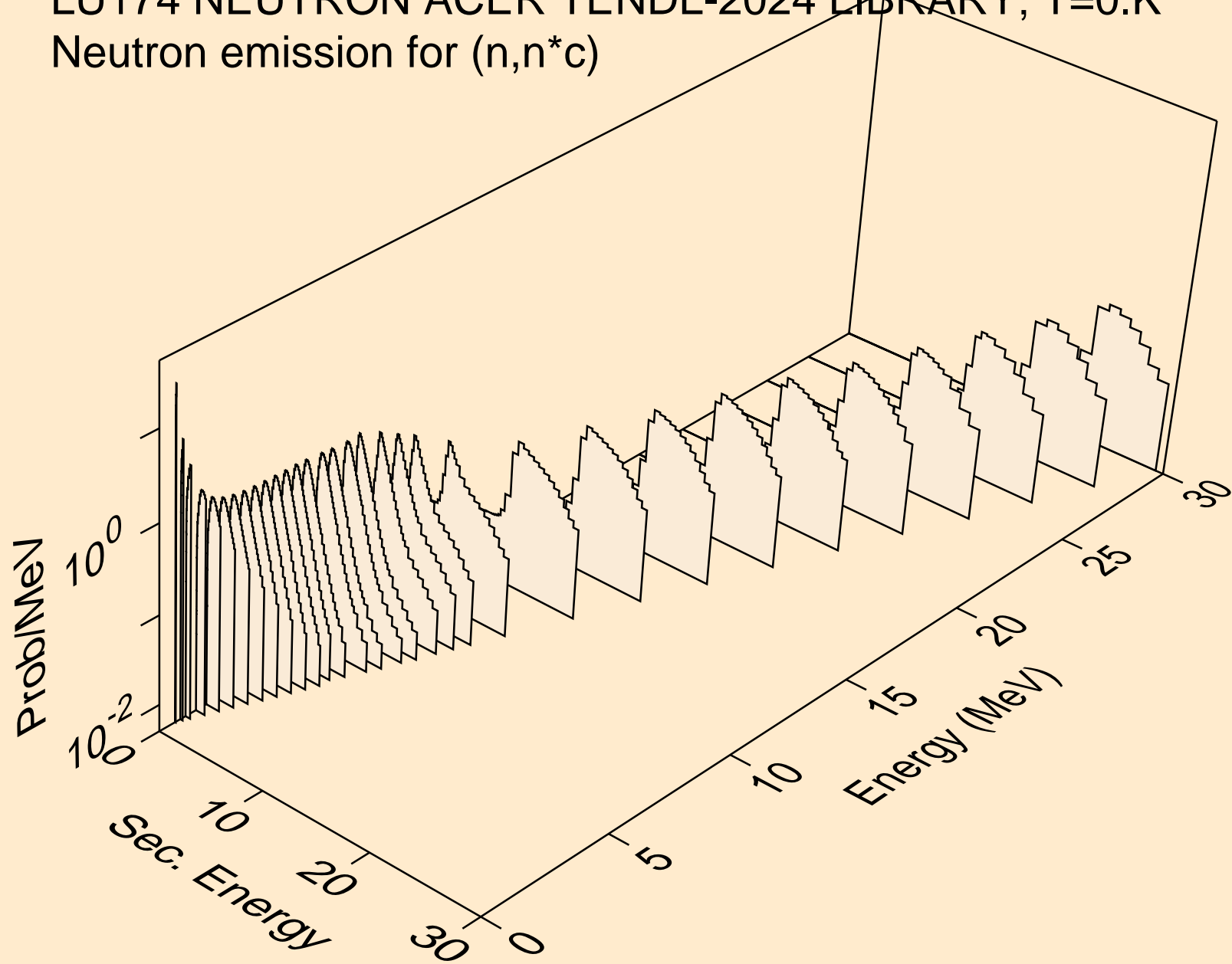



LU174 NEUTRON ACER TENDL-2024 LIBRARY; T=0.K  
Photon emission for (n,x)

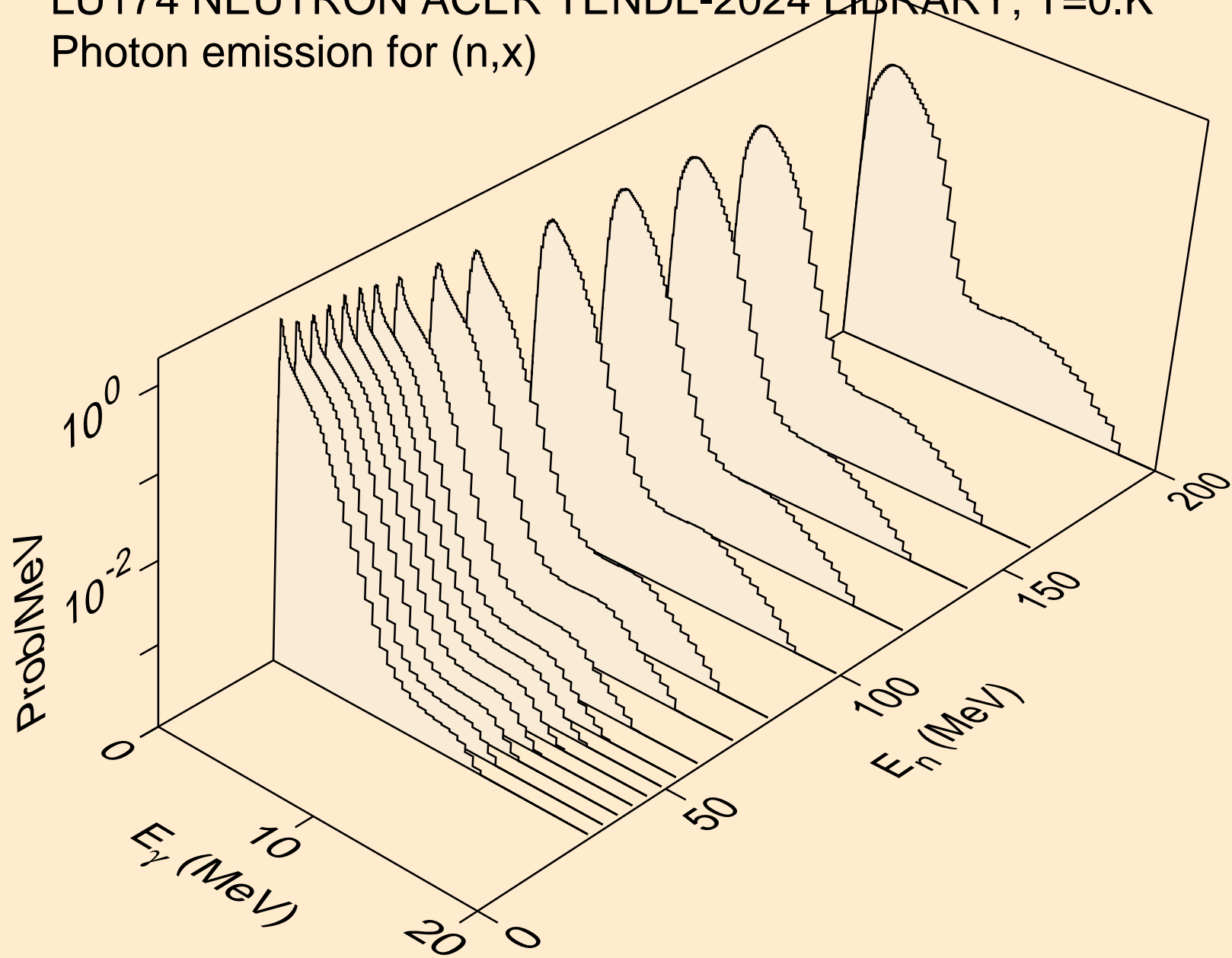

LU174 NEUTRON ACER TENDL-2024 LIBRARY; T=0.K  
Photon emission for (n,2nd)

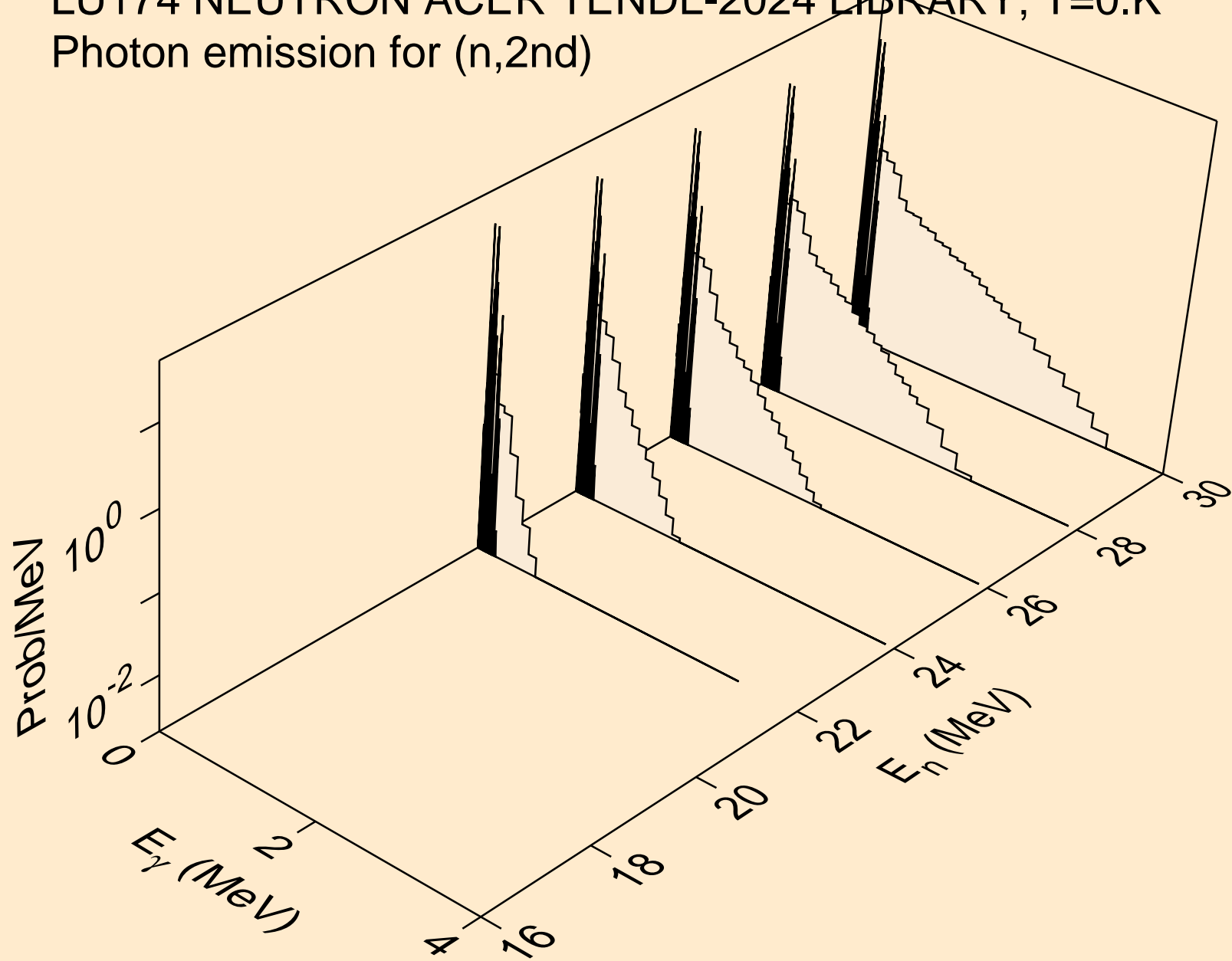

LU174 NEUTRON ACER TENDL-2024 LIBRARY; T=0.K  
Photon emission for (n,2n)

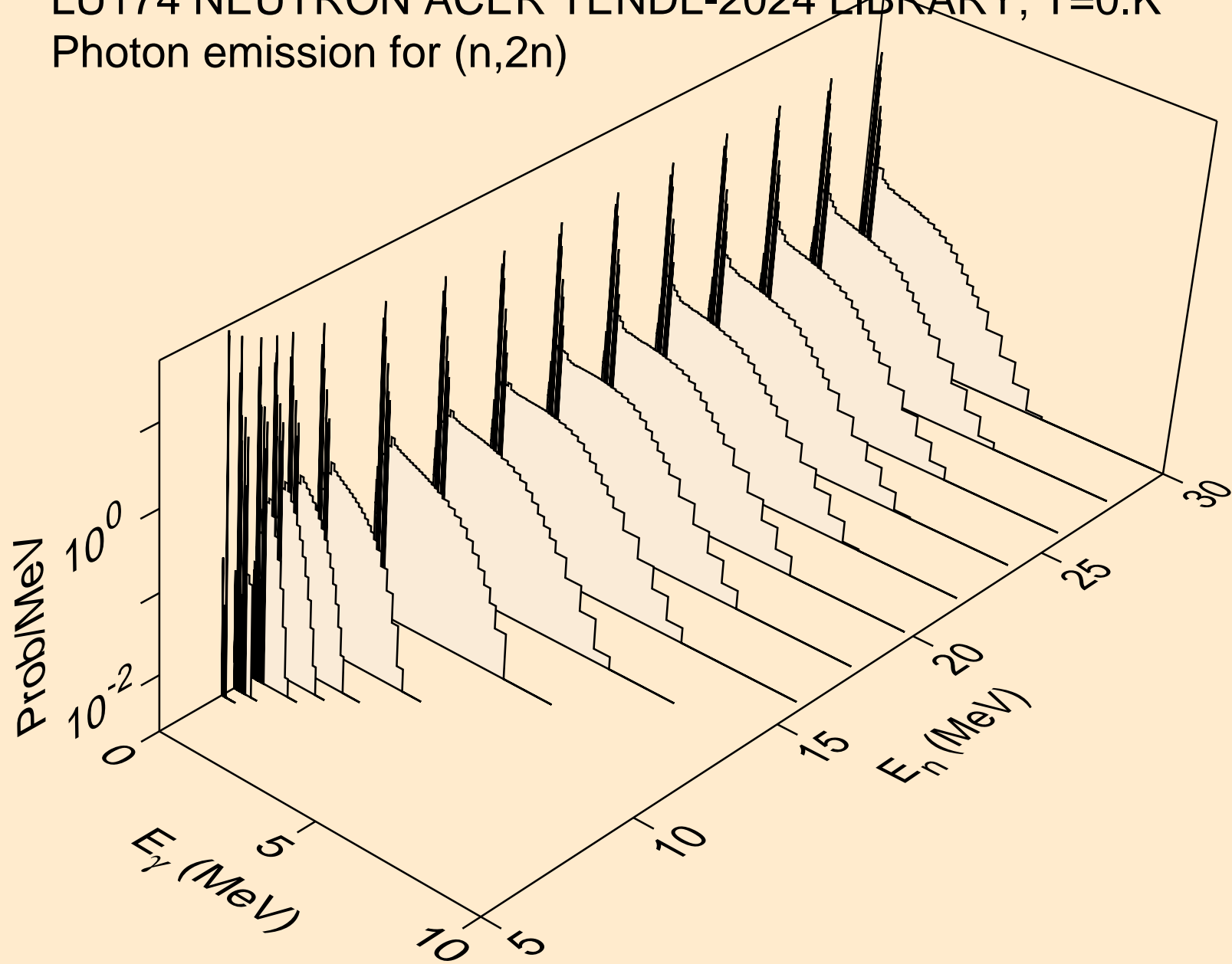

LU174 NEUTRON ACER TENDL-2024 LIBRARY; T=0.K  
Photon emission for (n,3n)

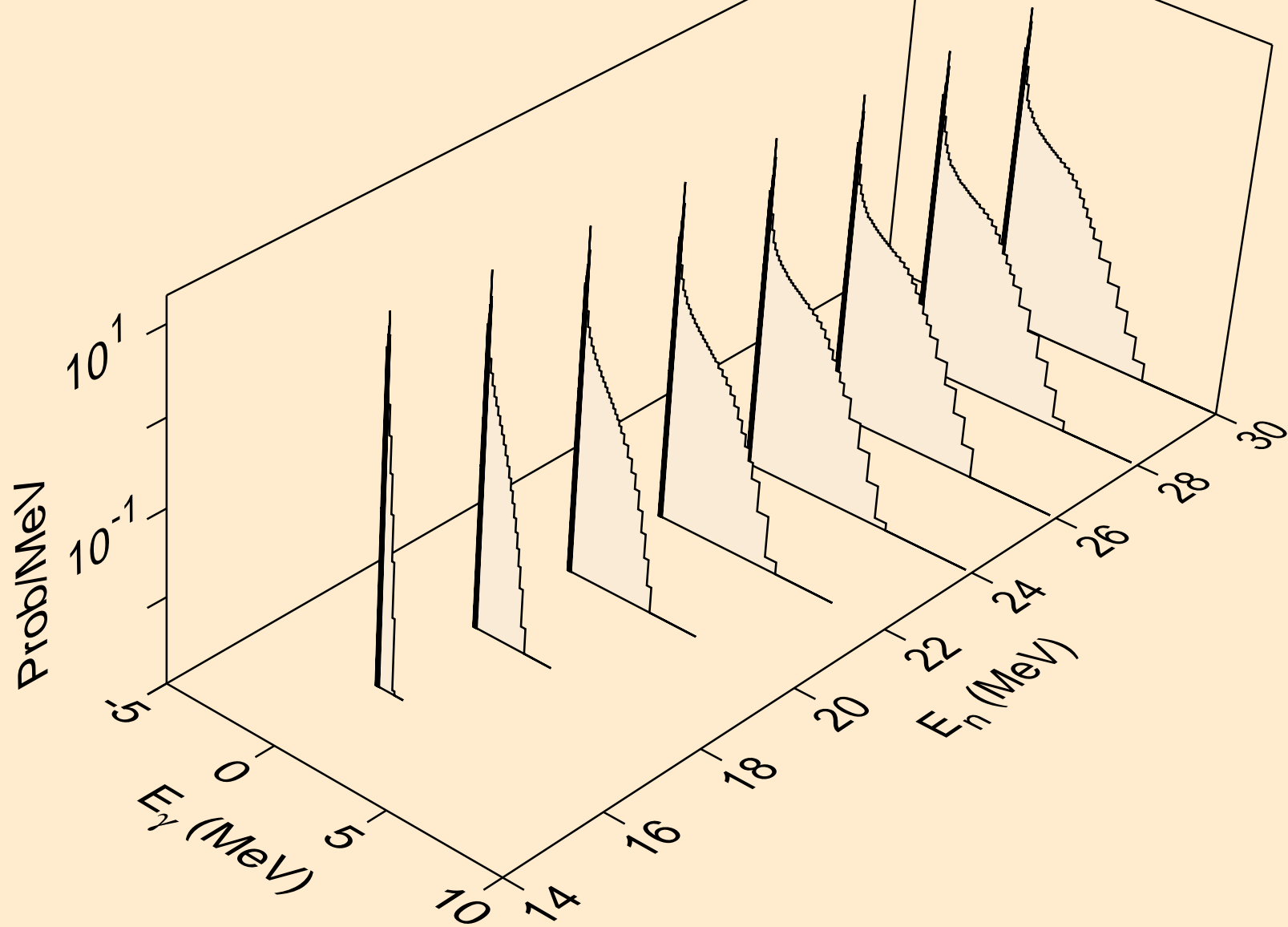

LU174 NEUTRON ACER TENDL-2024 LIBRARY; T=0.K  
Photon emission for (n,n\*)a

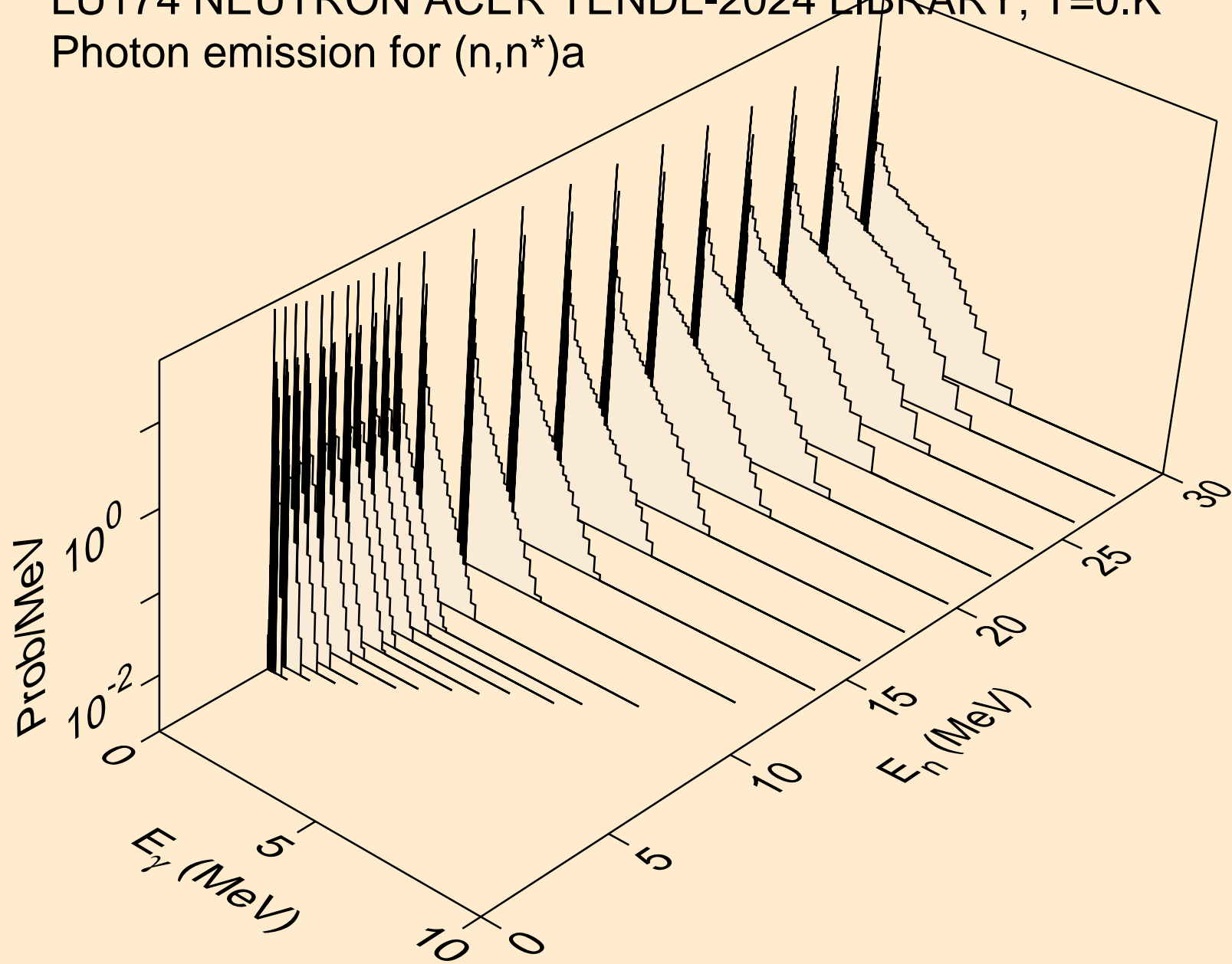

LU174 NEUTRON ACER TENDL-2024 LIBRARY; T=0.K  
Photon emission for (n,2n)a

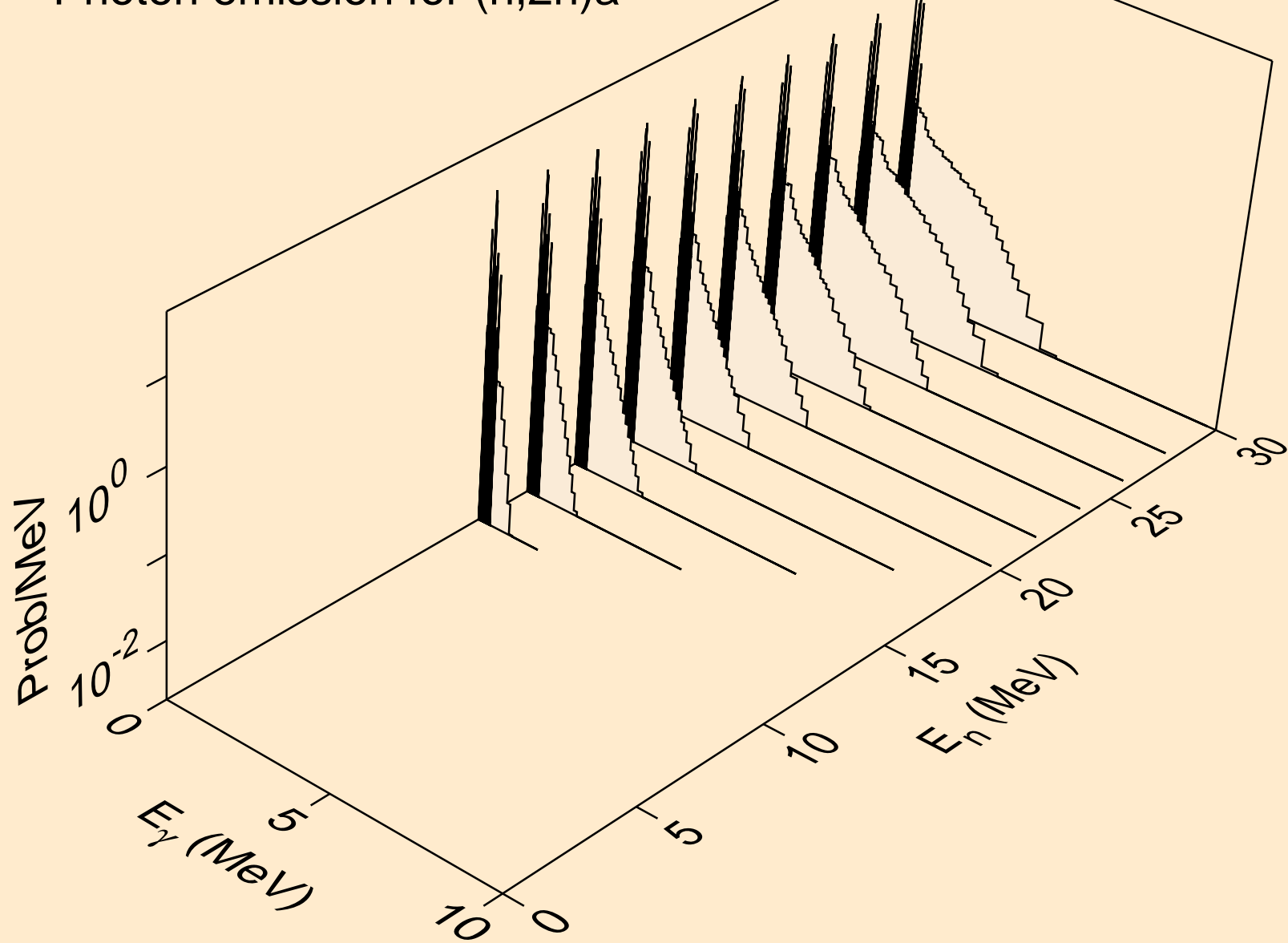

LU174 NEUTRON ACER TENDL-2024 LIBRARY; T=0.K  
Photon emission for (n,3n)a

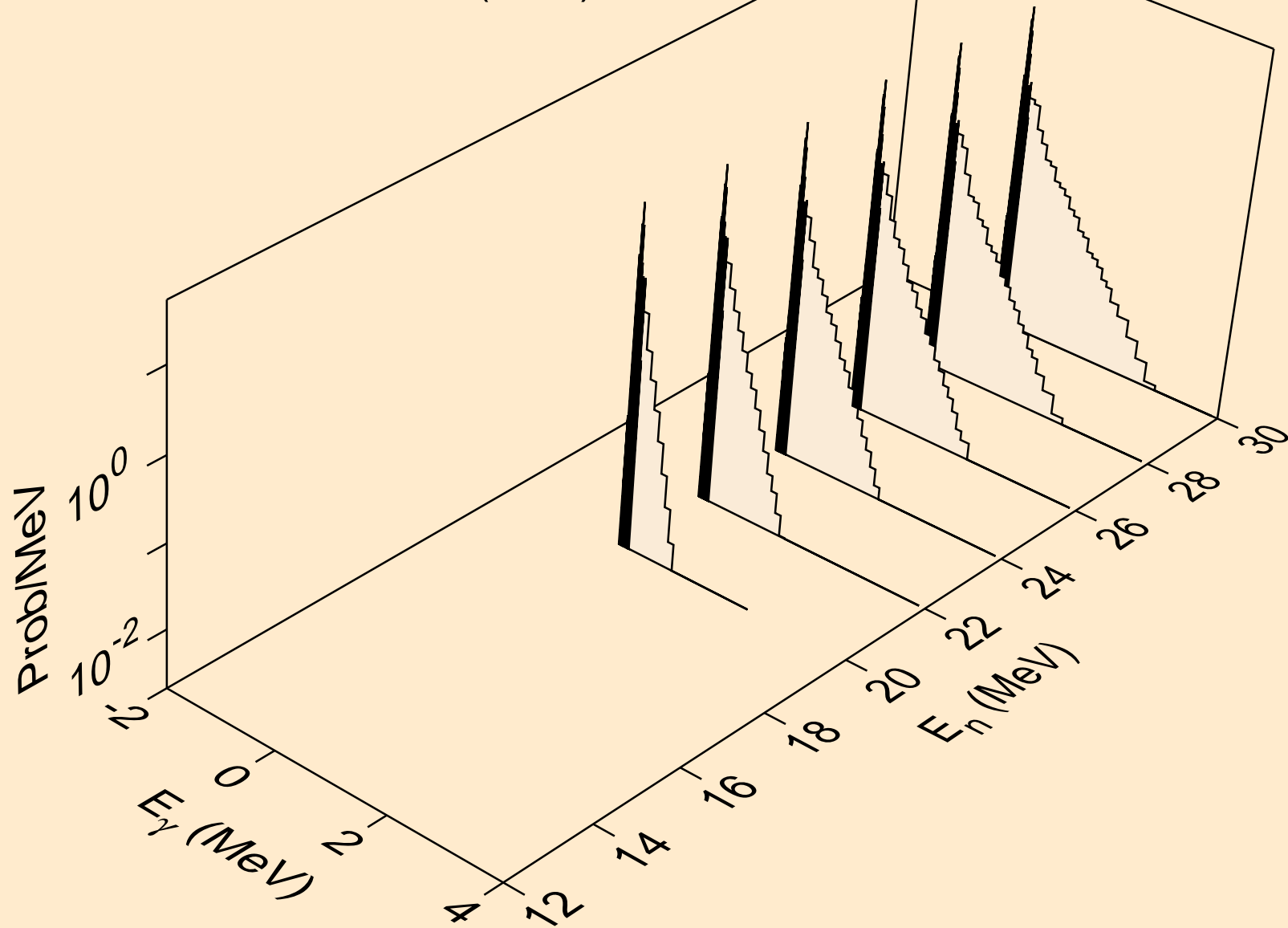

LU174 NEUTRON ACER TENDL-2024 LIBRARY; T=0.K  
Photon emission for (n,n\*)p

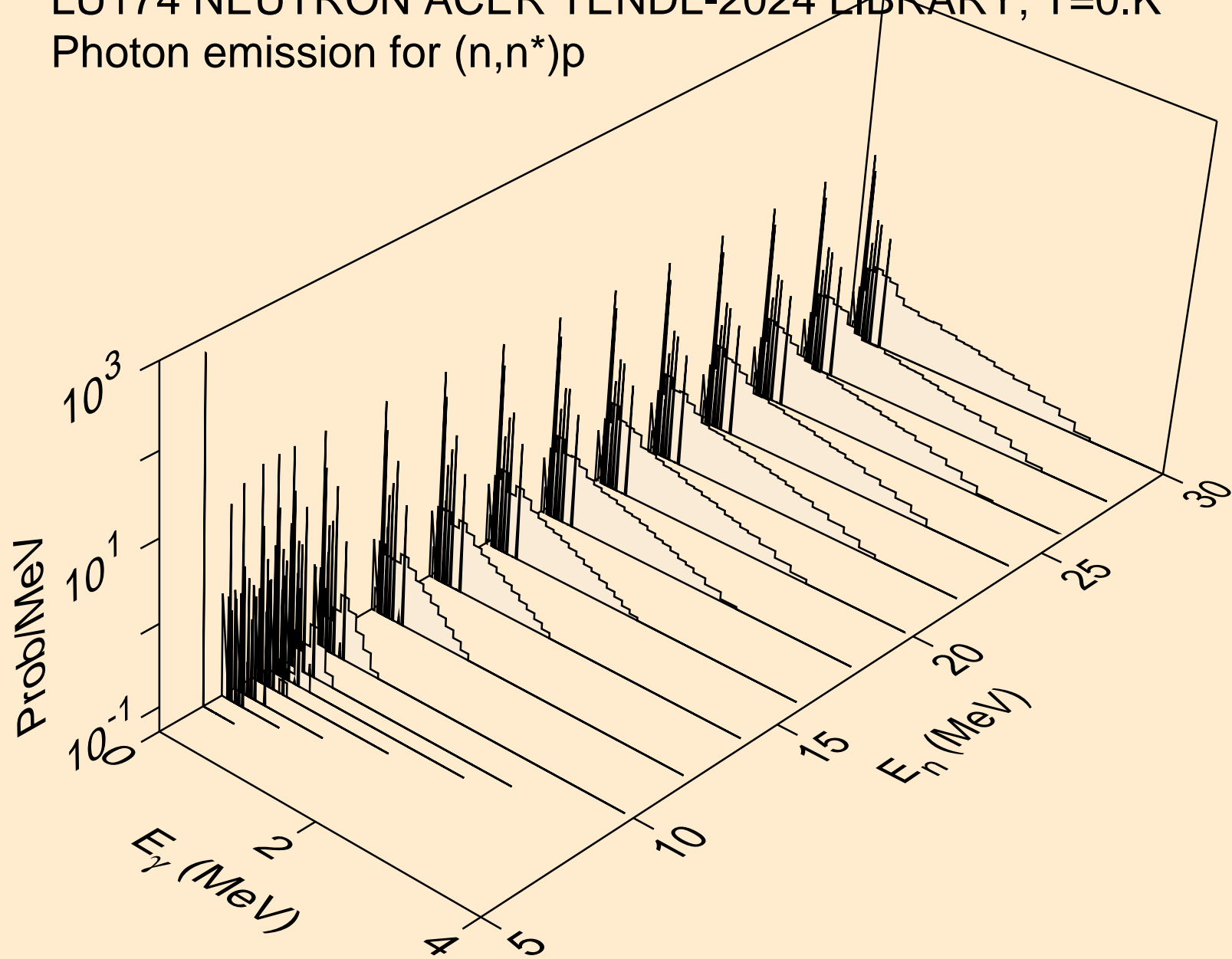



LU174 NEUTRON ACER TENDL-2024 LIBRARY; T=0.K  
Photon emission for (n,n\*)2a

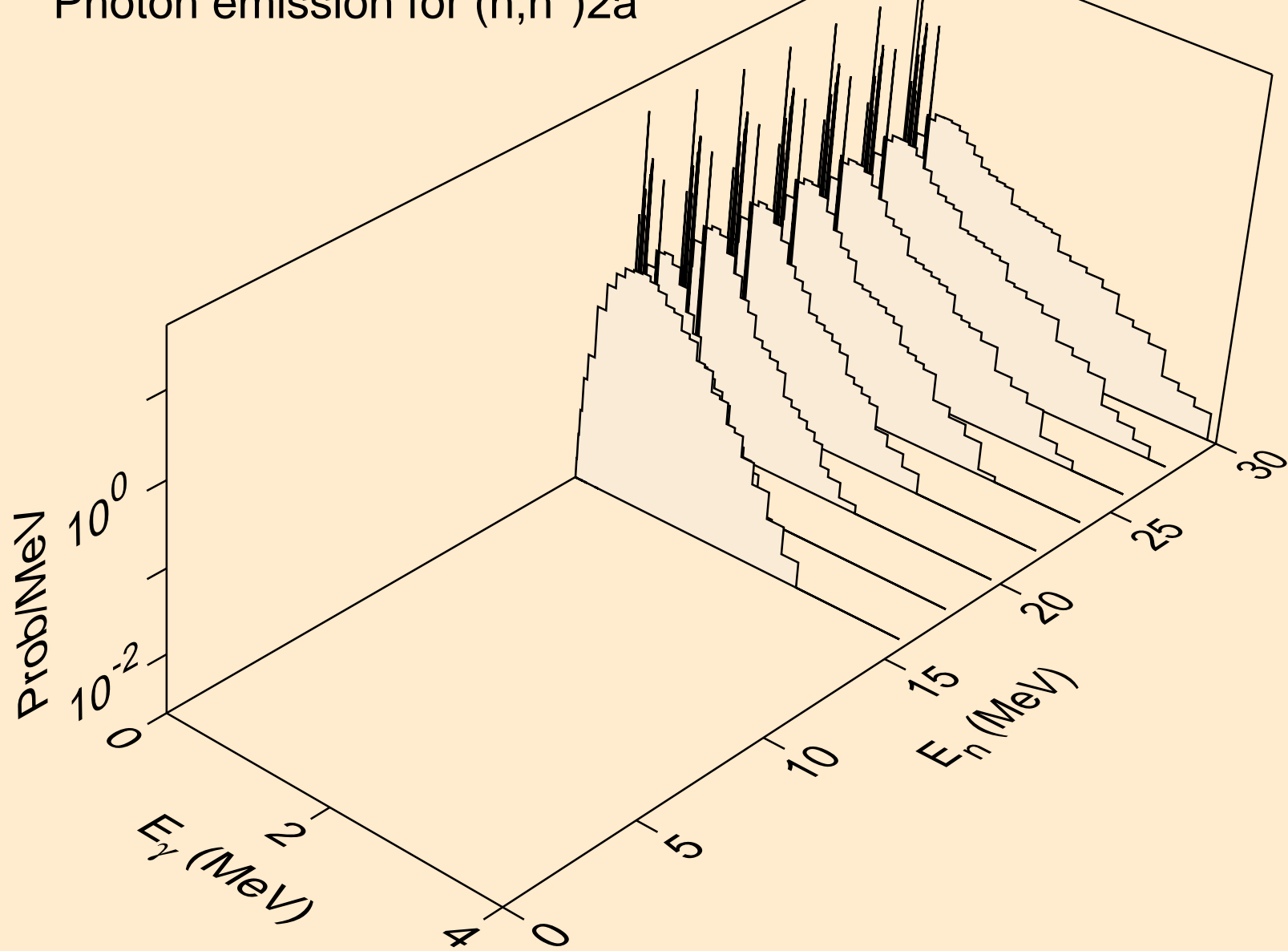

LU174 NEUTRON ACER TENDL-2024 LIBRARY; T=0.K  
Photon emission for (n,n\*)d

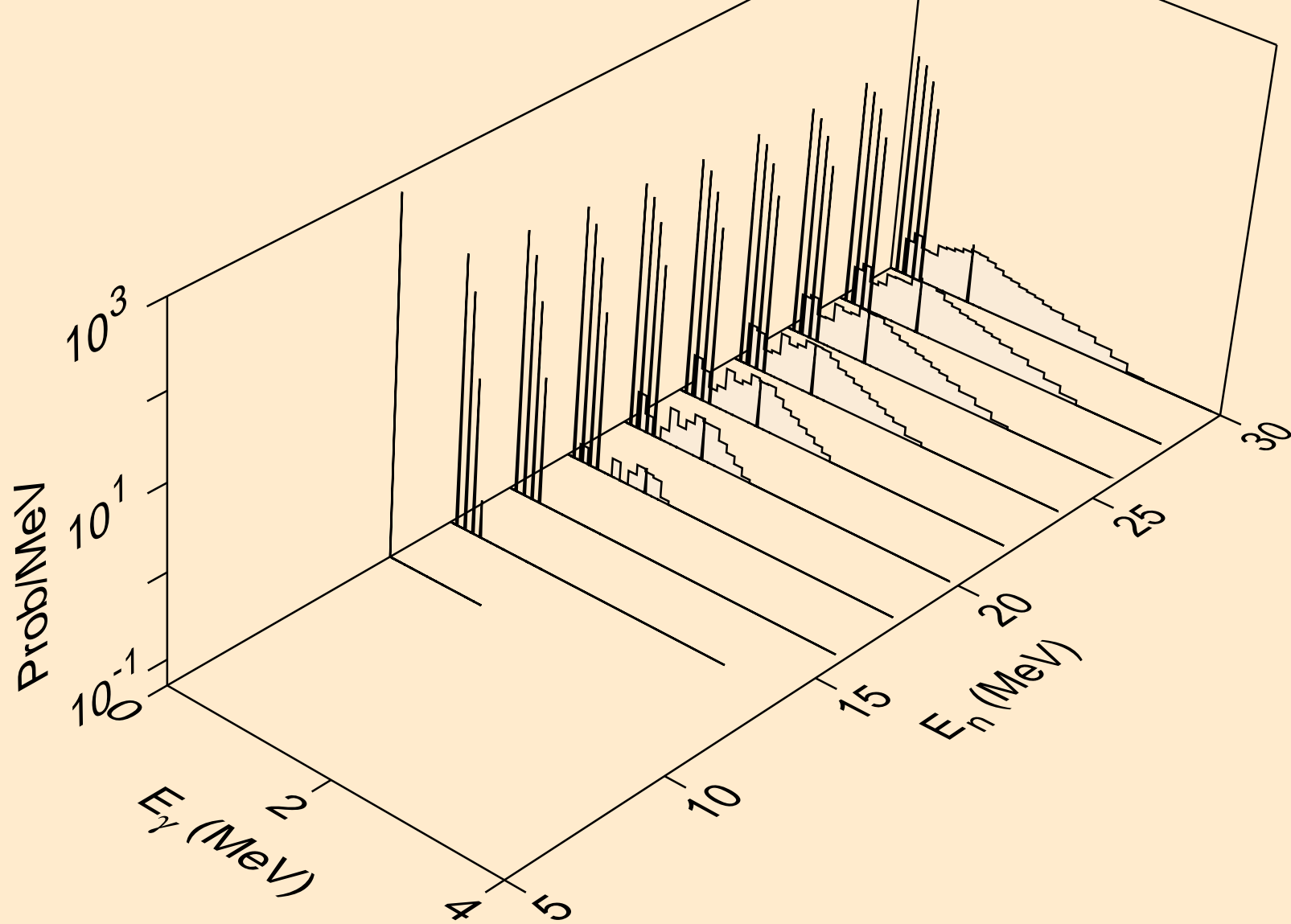

LU174 NEUTRON ACER TENDL-2024 LIBRARY; T=0.K  
Photon emission for (n,n\*)t

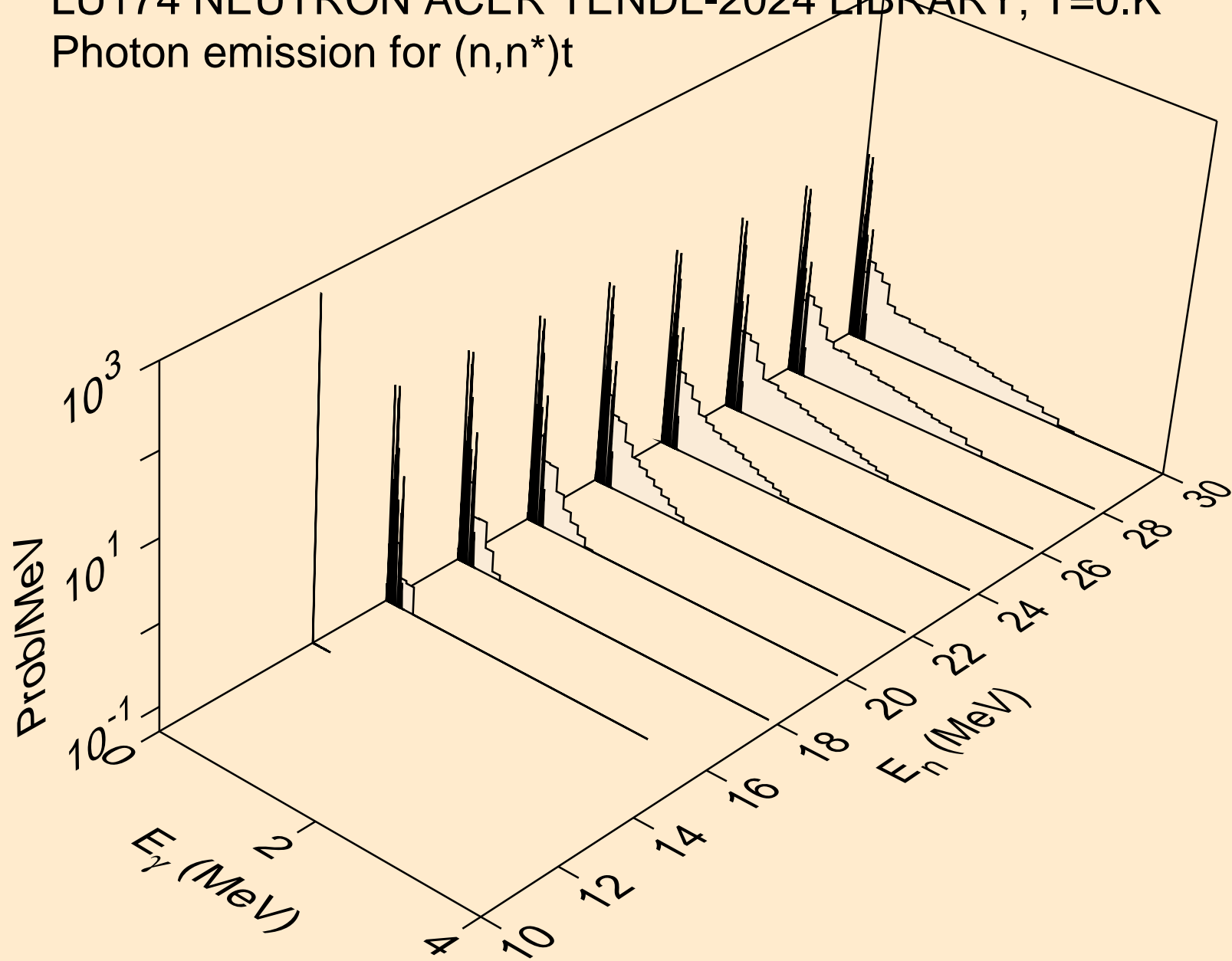

LU174 NEUTRON ACER TENDL-2024 LIBRARY; T=0.K  
Photon emission for (n,n\*)he3

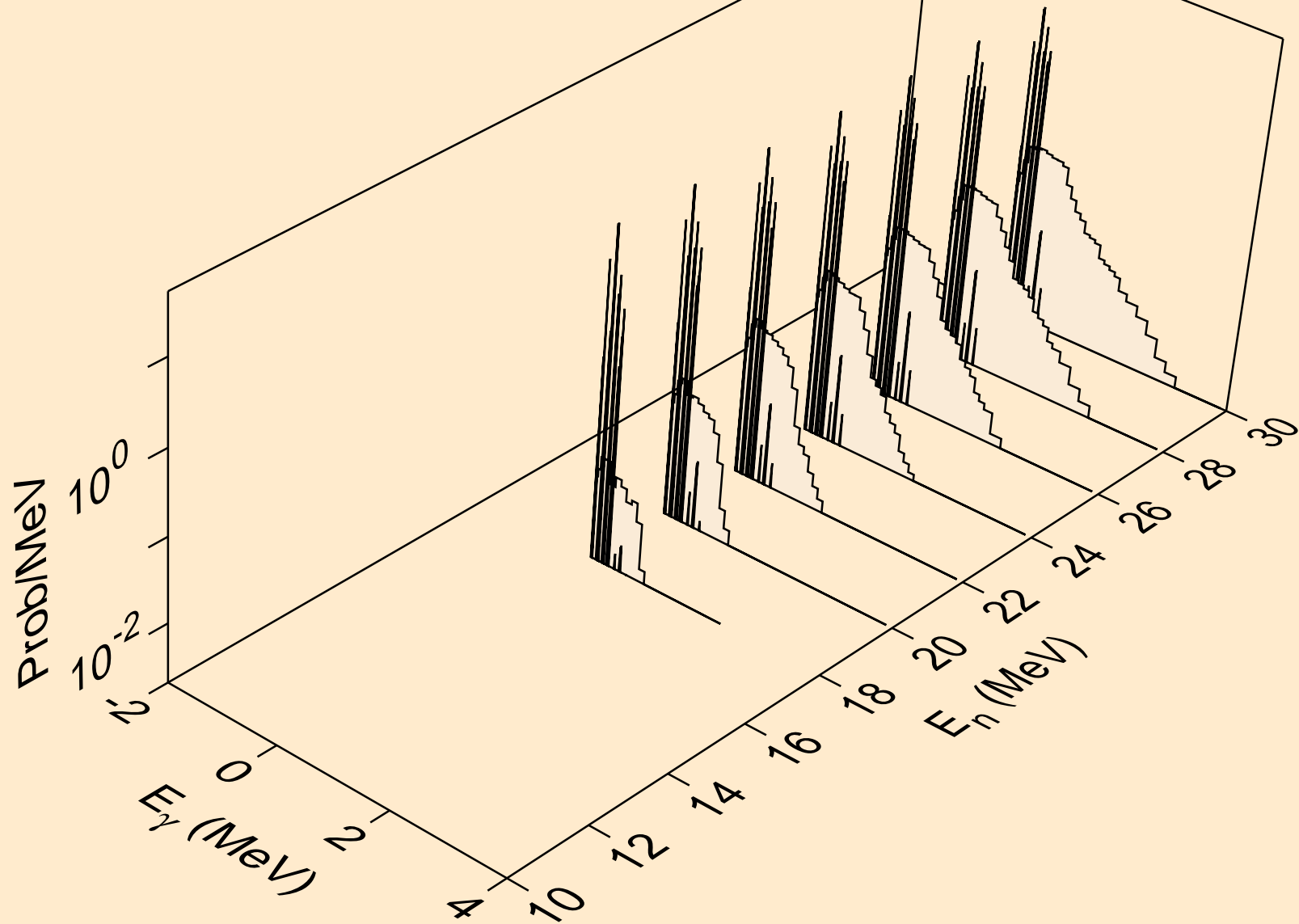

LU174 NEUTRON ACER TENDL-2024 LIBRARY; T=0.K  
Photon emission for (n,4n)

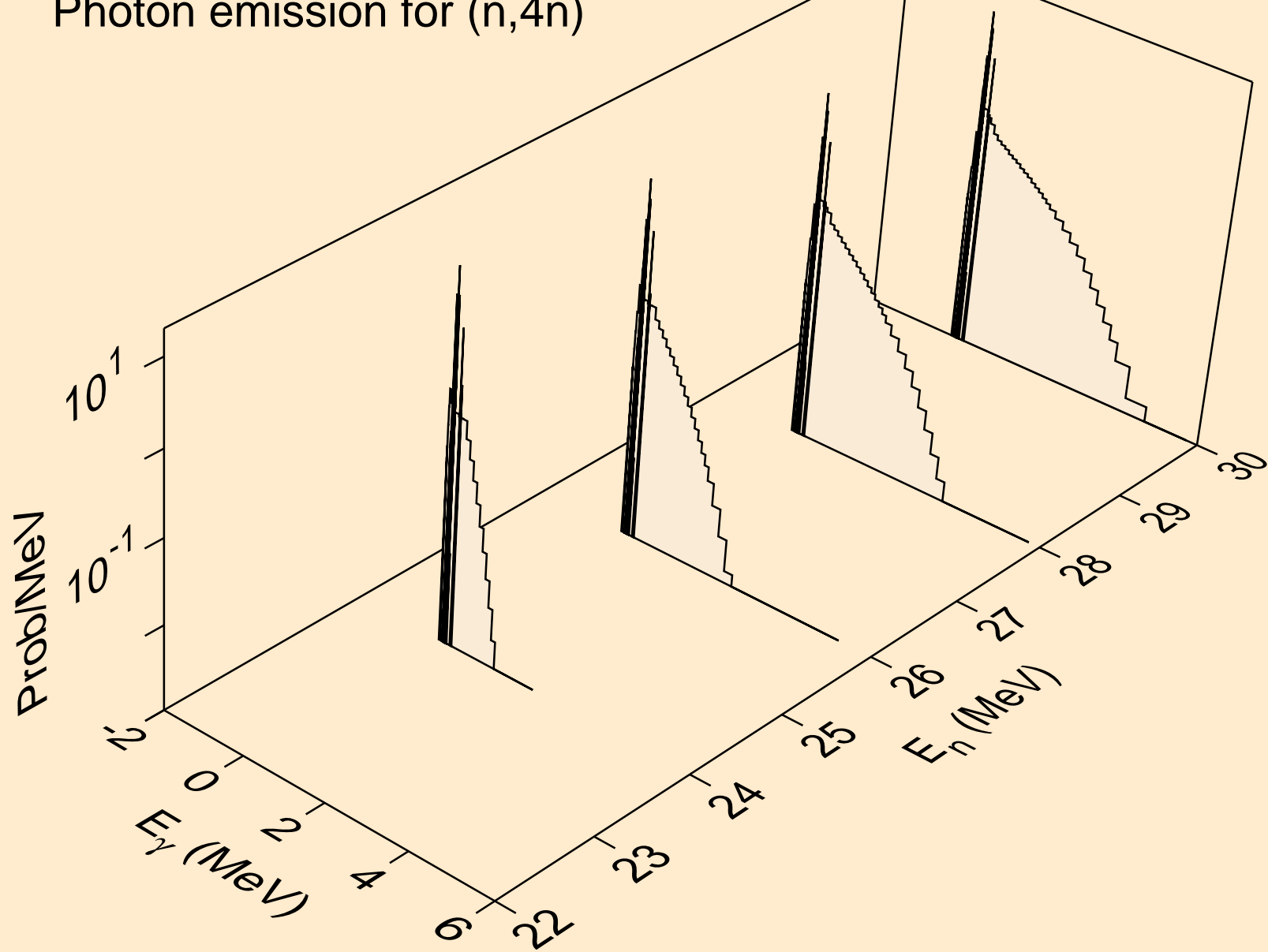

LU174 NEUTRON ACER TENDL-2024 LIBRARY; T=0.K  
Photon emission for (n,2np)

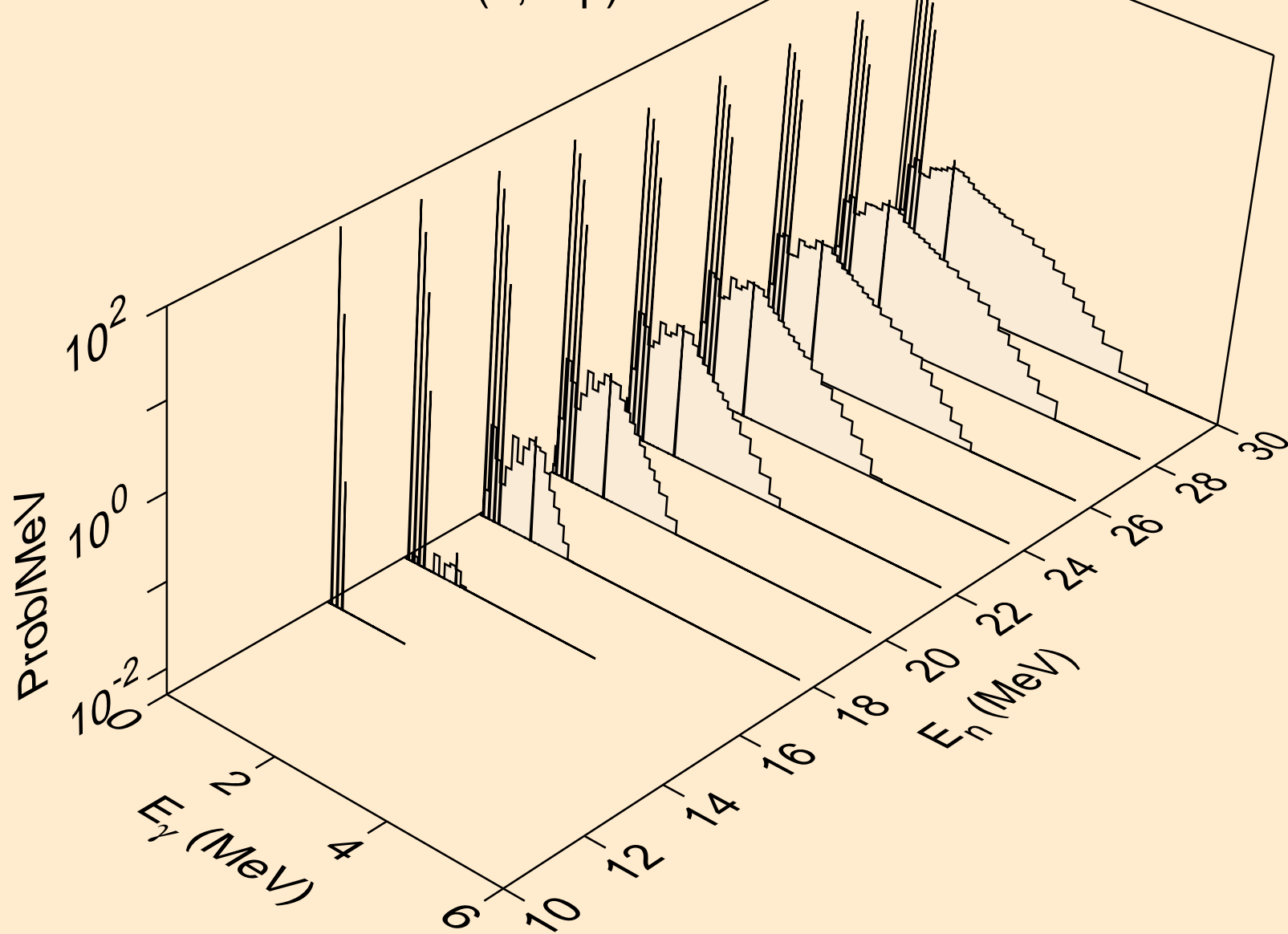

LU174 NEUTRON ACER TENDL-2024 LIBRARY; T=0.K  
Photon emission for (n,3np)

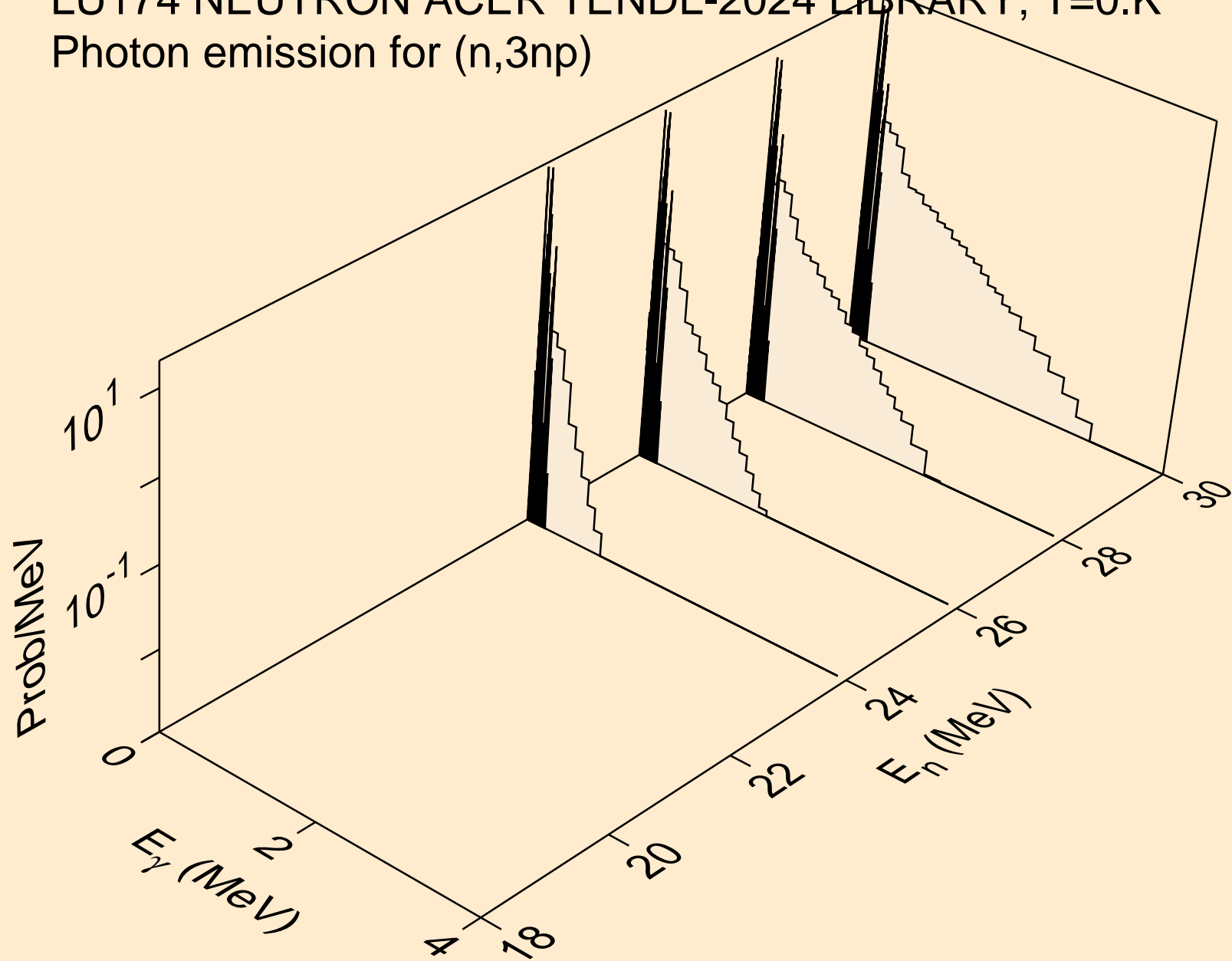

LU174 NEUTRON ACER TENDL-2024 LIBRARY; T=0.K  
Photon emission for (n,n2p)

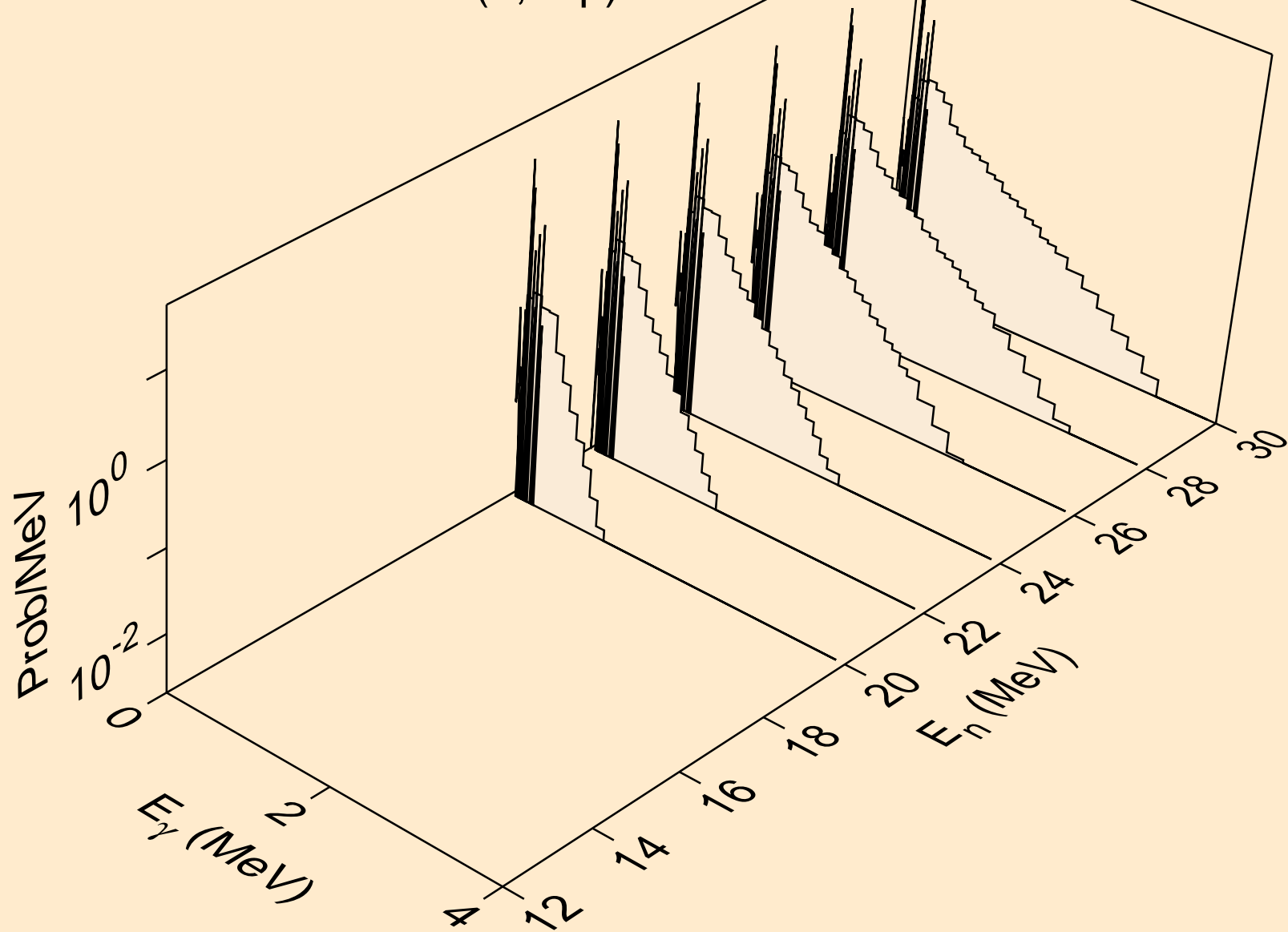



LU174 NEUTRON ACER TENDL-2024 LIBRARY; T=0.K  
Photon emission for (n,npa)

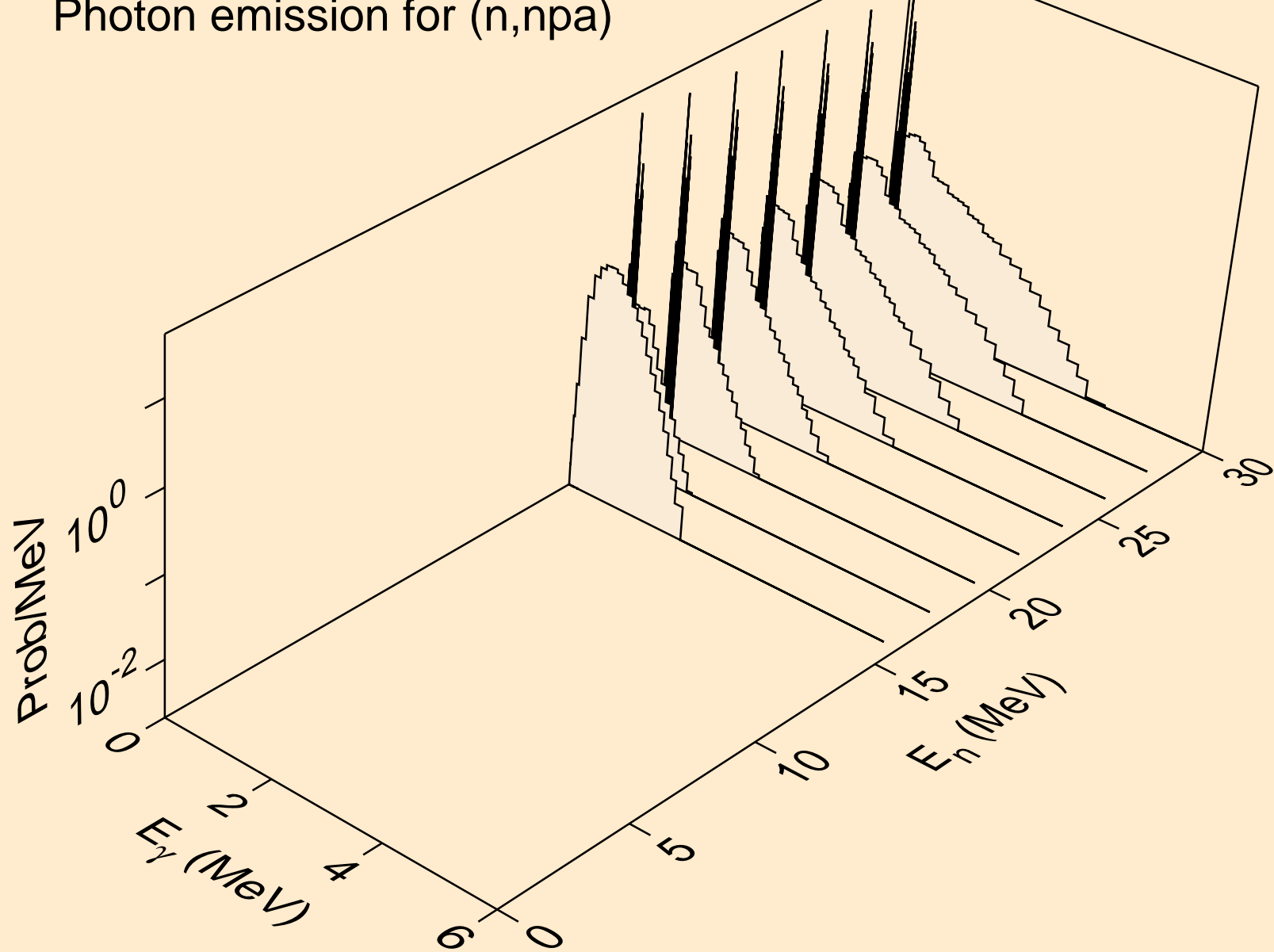

LU174 NEUTRON ACER TENDL-2024 LIBRARY; T=0.K  
Photon emission for (n,n\*c)

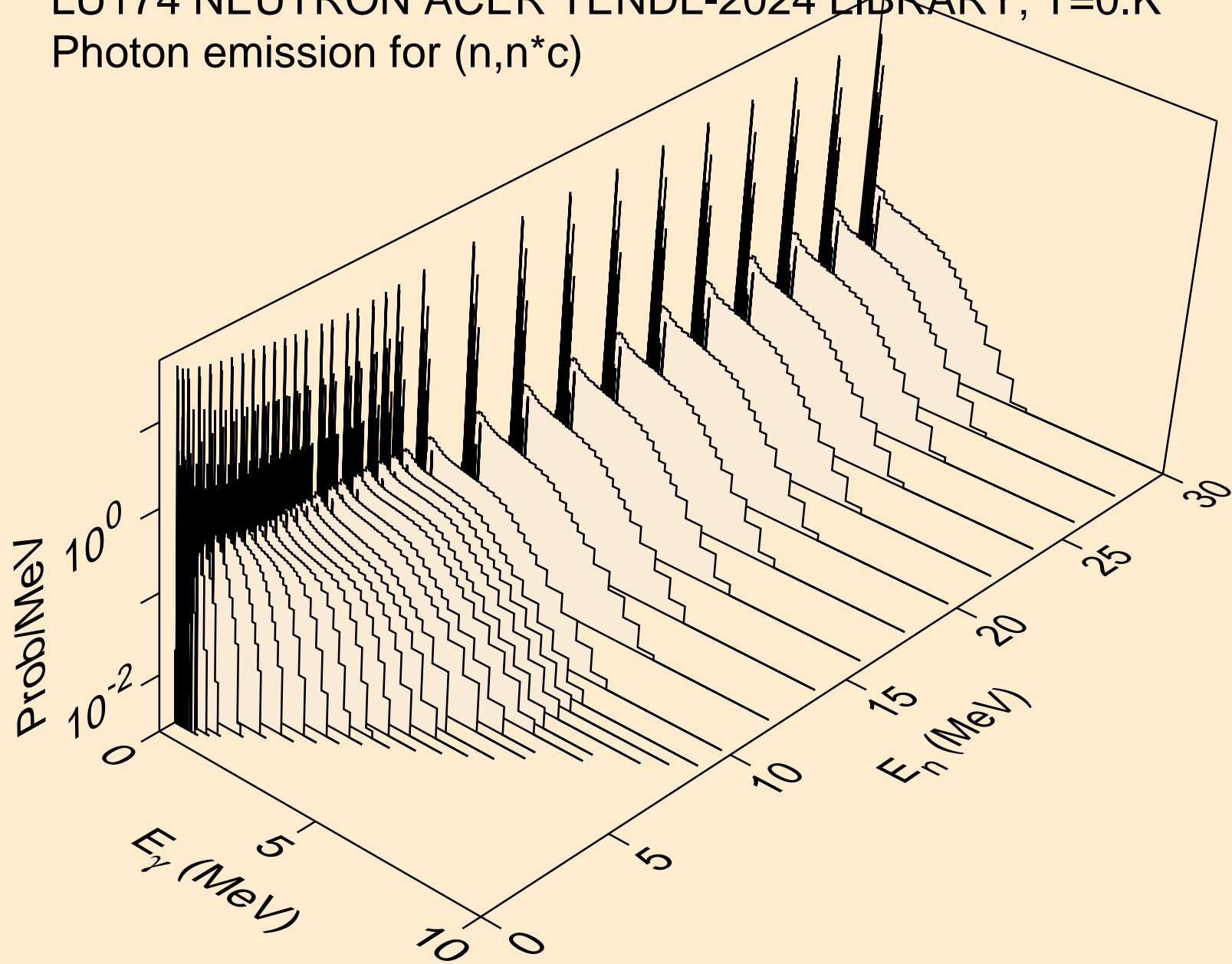

LU174 NEUTRON ACER TENDL-2024 LIBRARY; T=0.K  
Photon emission for (n,gma)

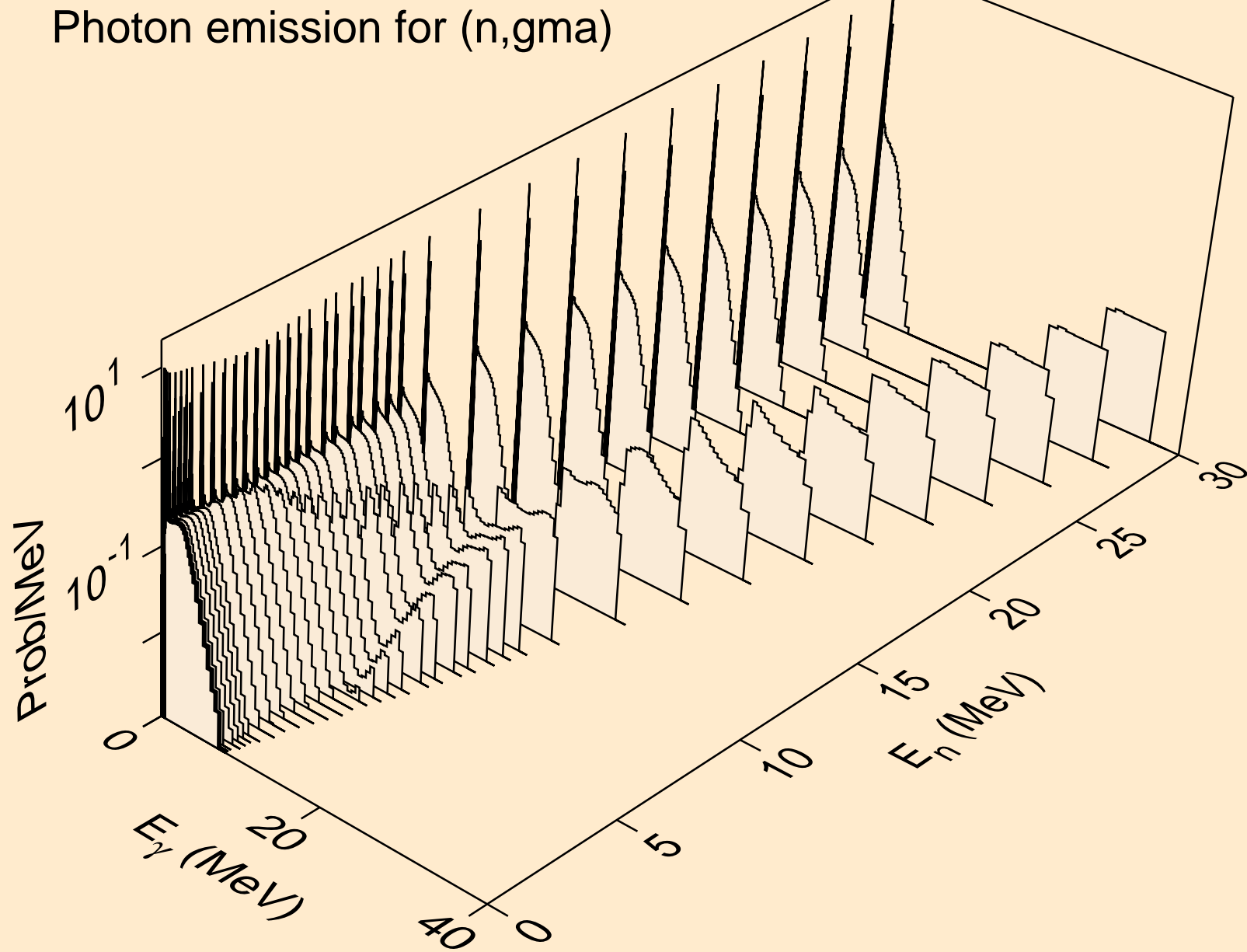

LU174 NEUTRON ACER TENDL-2024 LIBRARY; T=0.K  
Photon emission for (n,p)

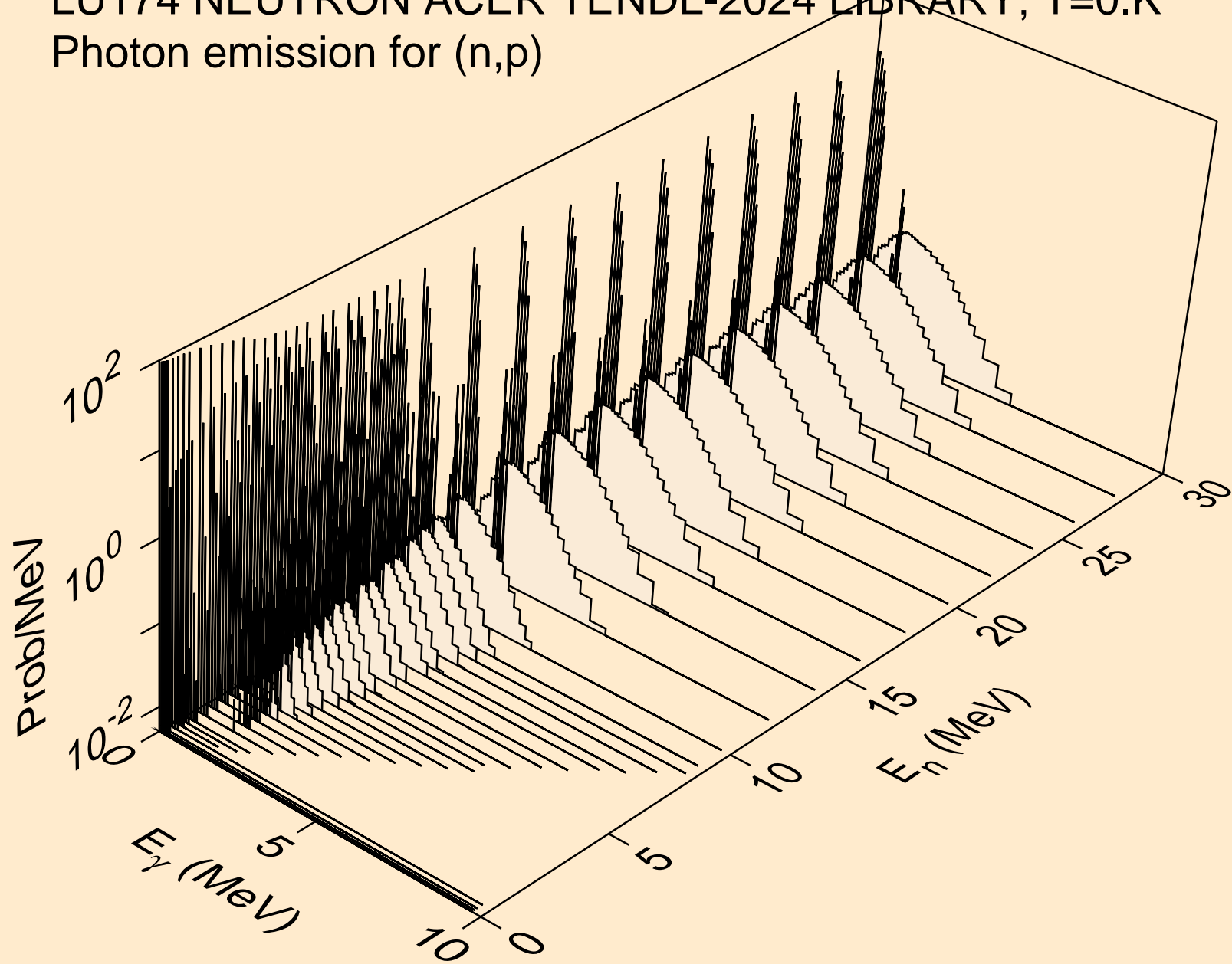

LU174 NEUTRON ACER TENDL-2024 LIBRARY; T=0.K  
Photon emission for (n,d)

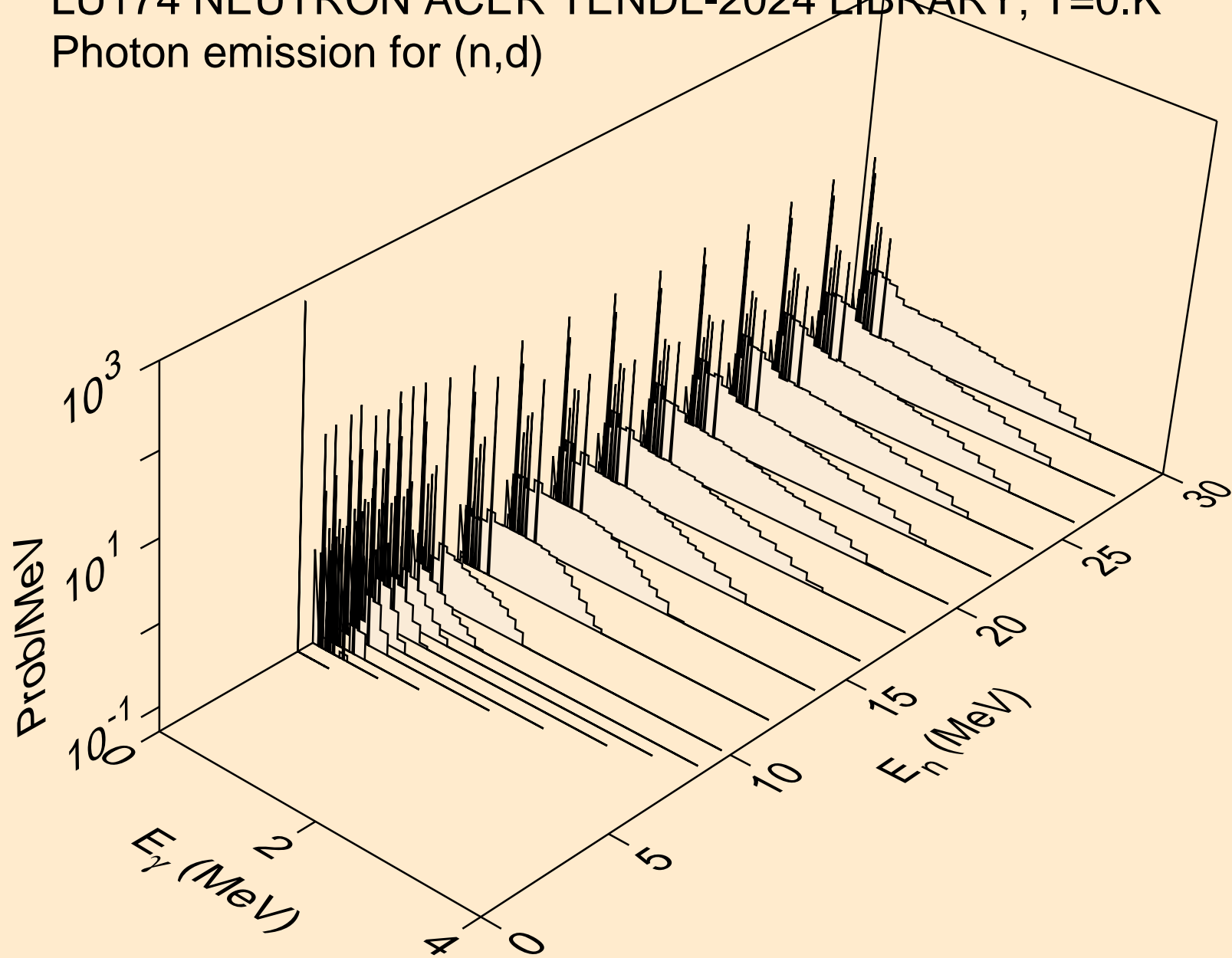

LU174 NEUTRON ACER TENDL-2024 LIBRARY; T=0.K  
Photon emission for (n,t)

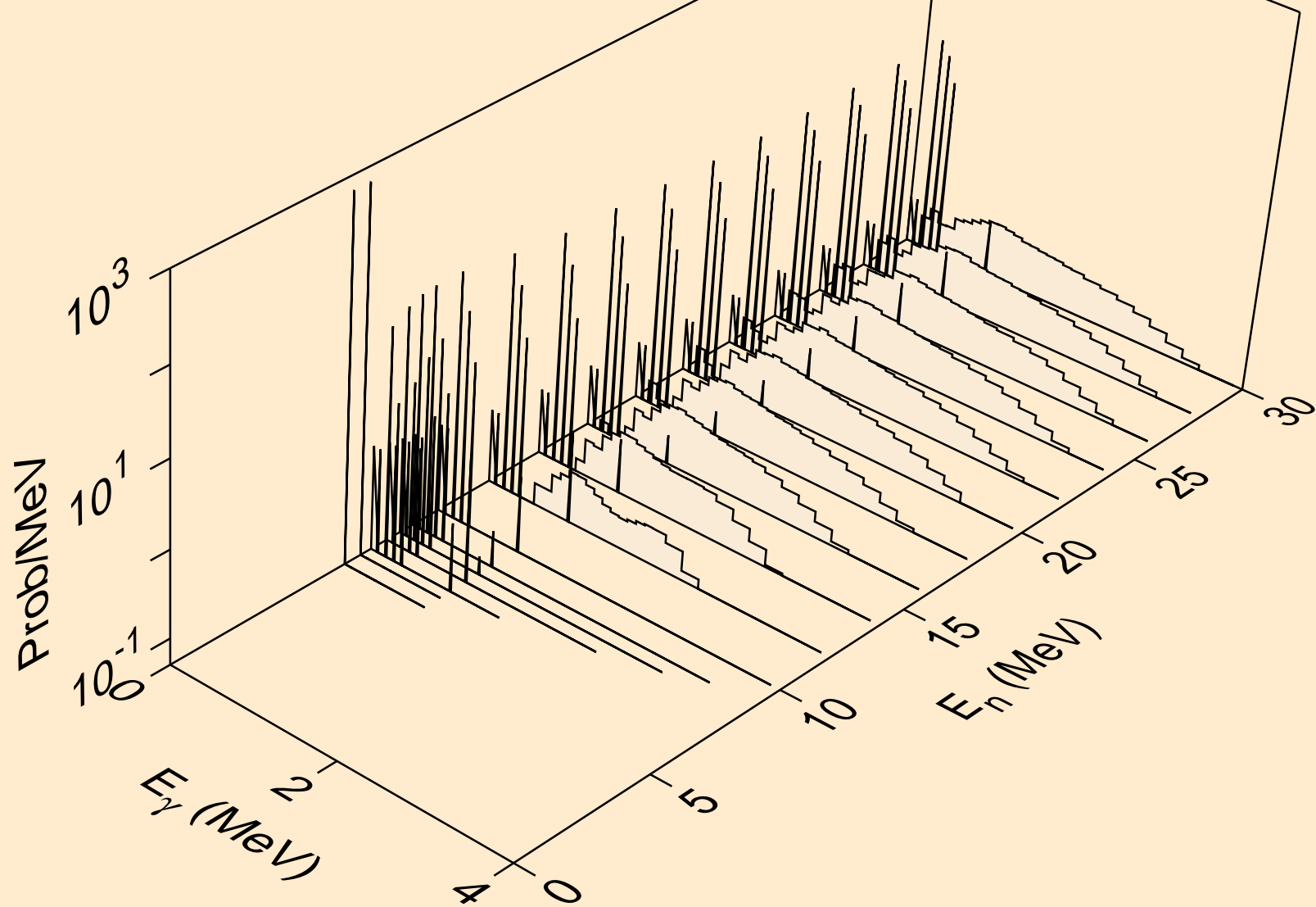

LU174 NEUTRON ACER TENDL-2024 LIBRARY; T=0.K  
Photon emission for (n,he3)

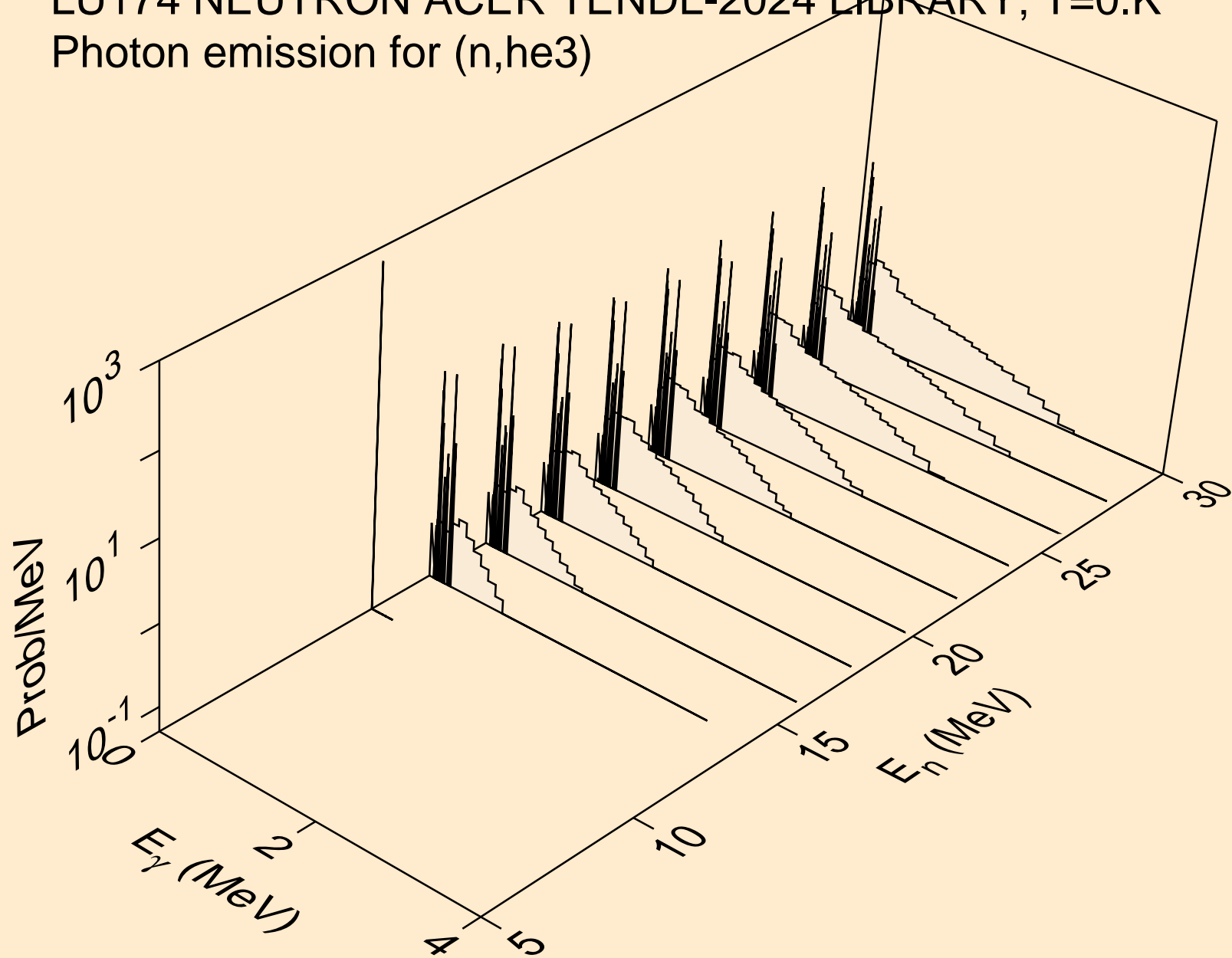

LU174 NEUTRON ACER TENDL-2024 LIBRARY; T=0.K  
Photon emission for (n,a)

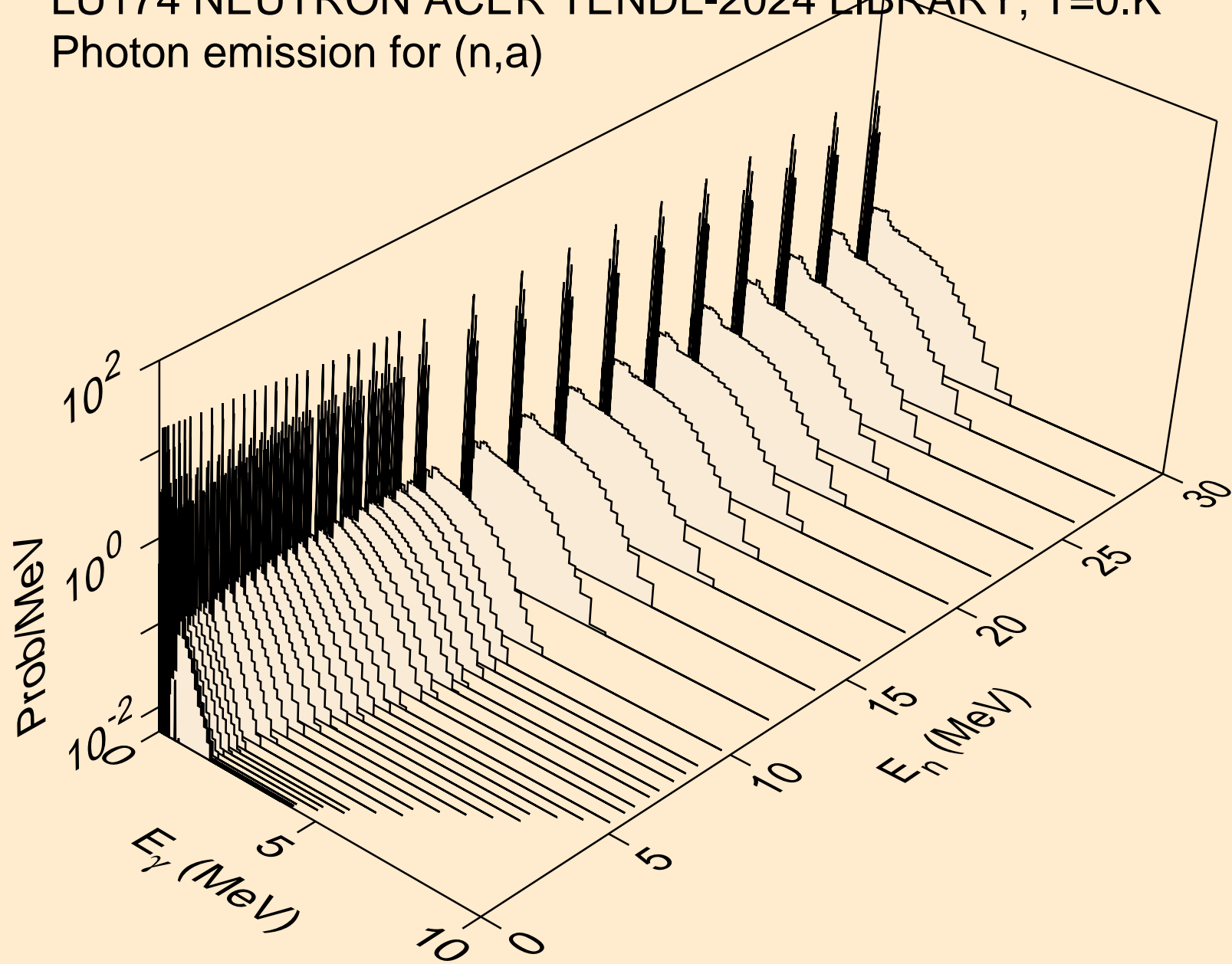



LU174 NEUTRON ACER TENDL-2024 LIBRARY; T=0.K  
Photon emission for (n,2a)

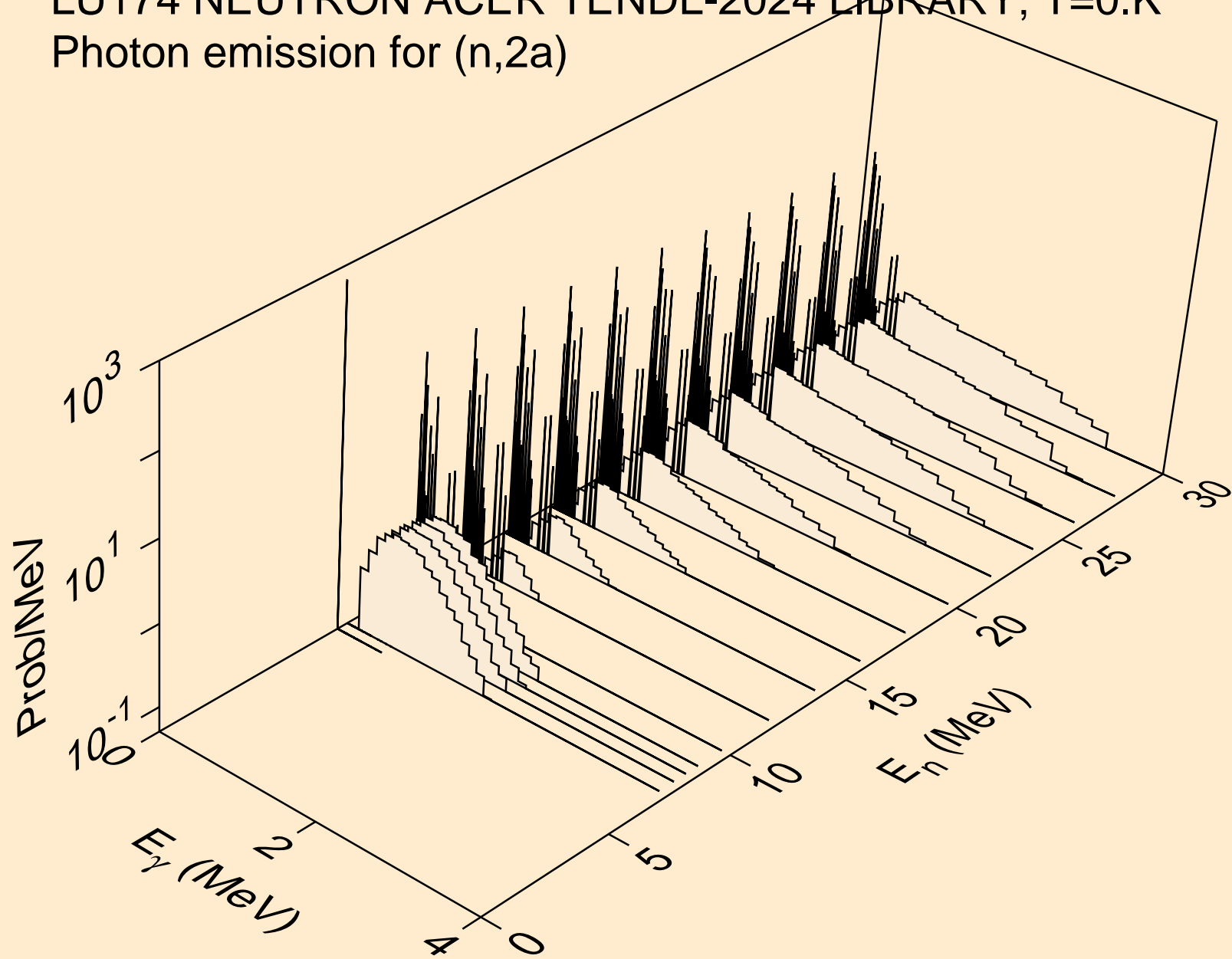

LU174 NEUTRON ACER TENDL-2024 LIBRARY; T=0.K  
Photon emission for (n,2p)

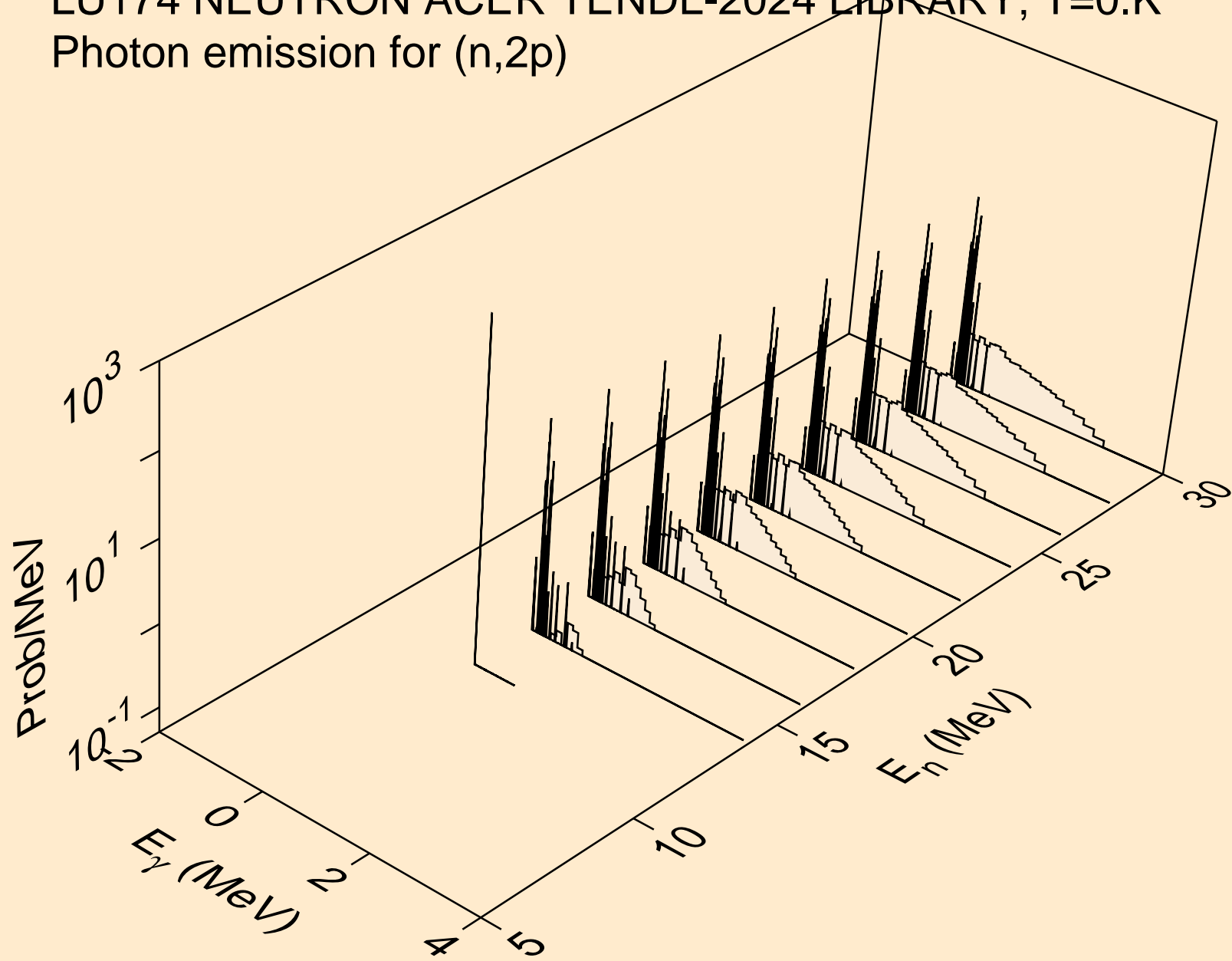

LU174 NEUTRON ACER TENDL-2024 LIBRARY; T=0.K  
Photon emission for (n,p $\alpha$ )

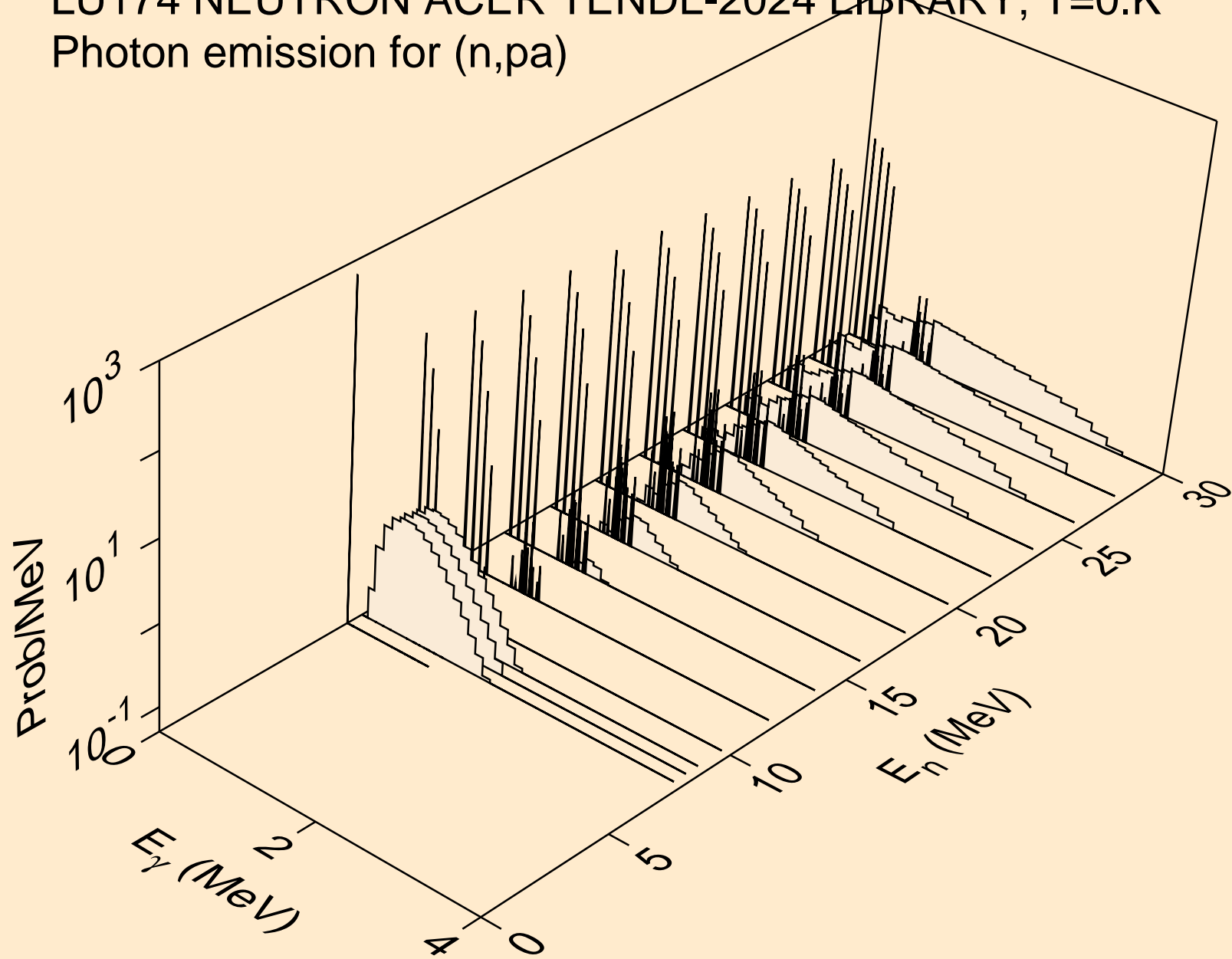

LU174 NEUTRON ACER TENDL-2024 LIBRARY; T=0.K  
Photon emission for (n,pd)

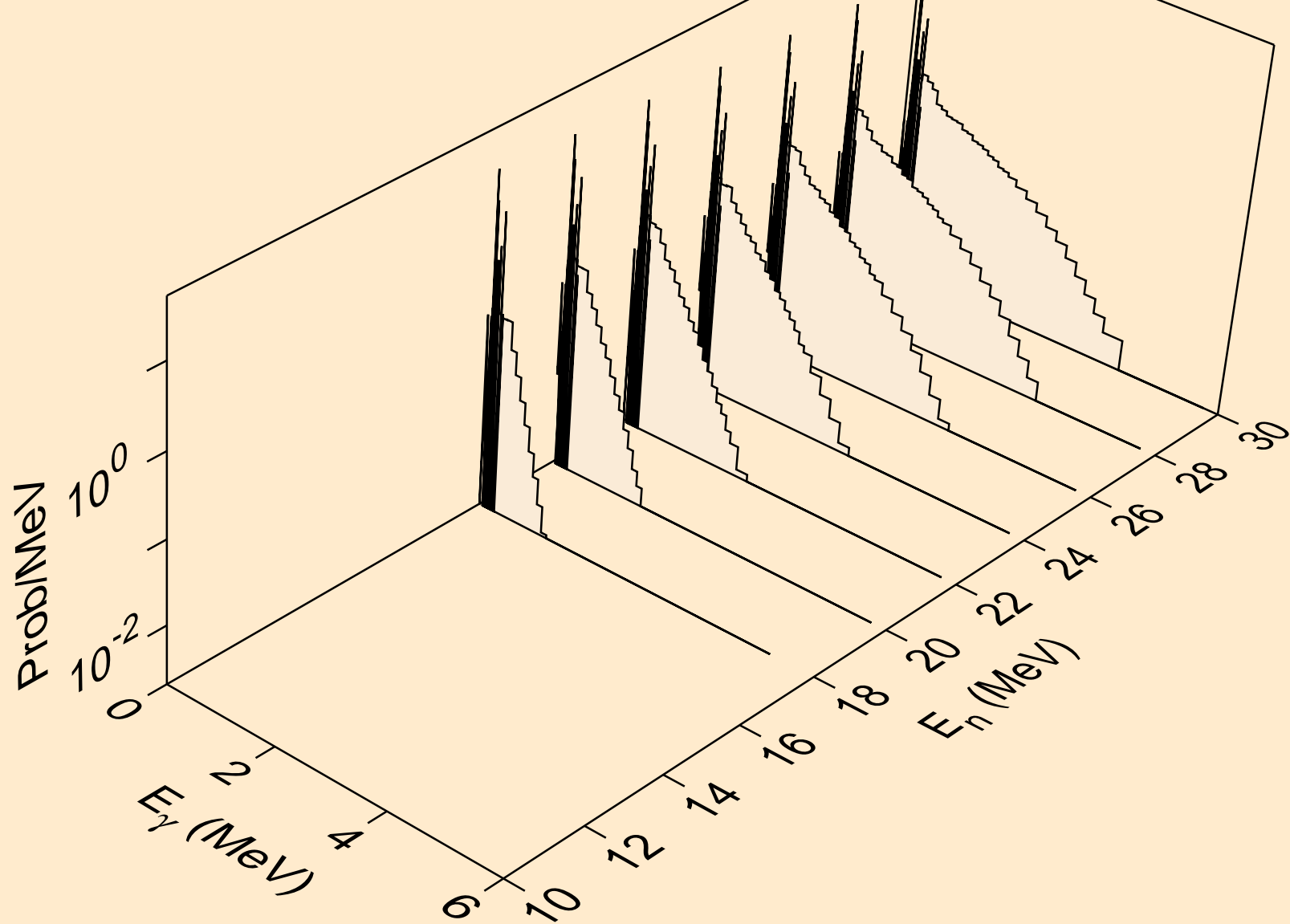

LU174 NEUTRON ACER TENDL-2024 LIBRARY; T=0.K  
Photon emission for (n,pt)

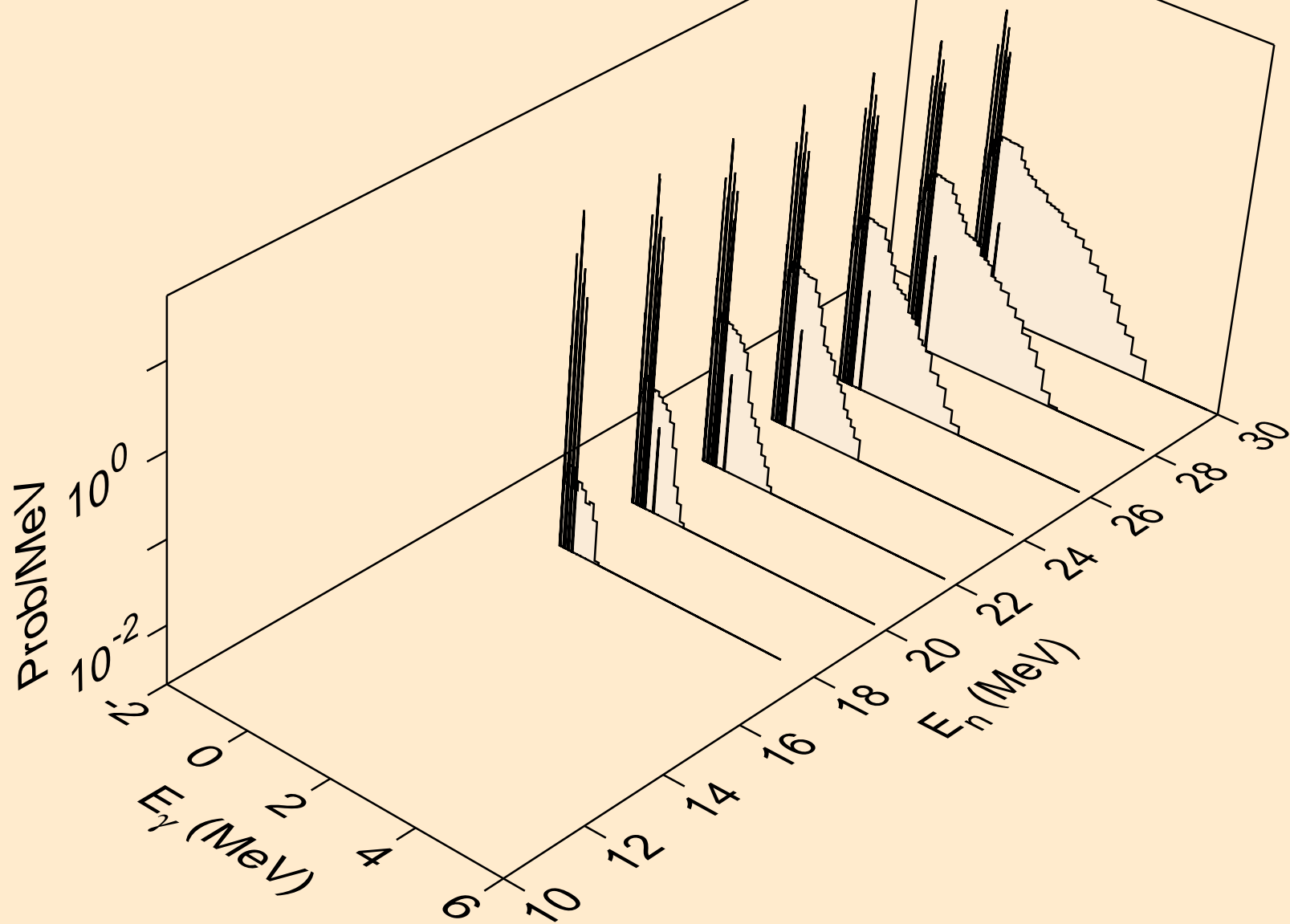

LU174 NEUTRON ACER TENDL-2024 LIBRARY; T=0.K  
Photon emission for (n,da)

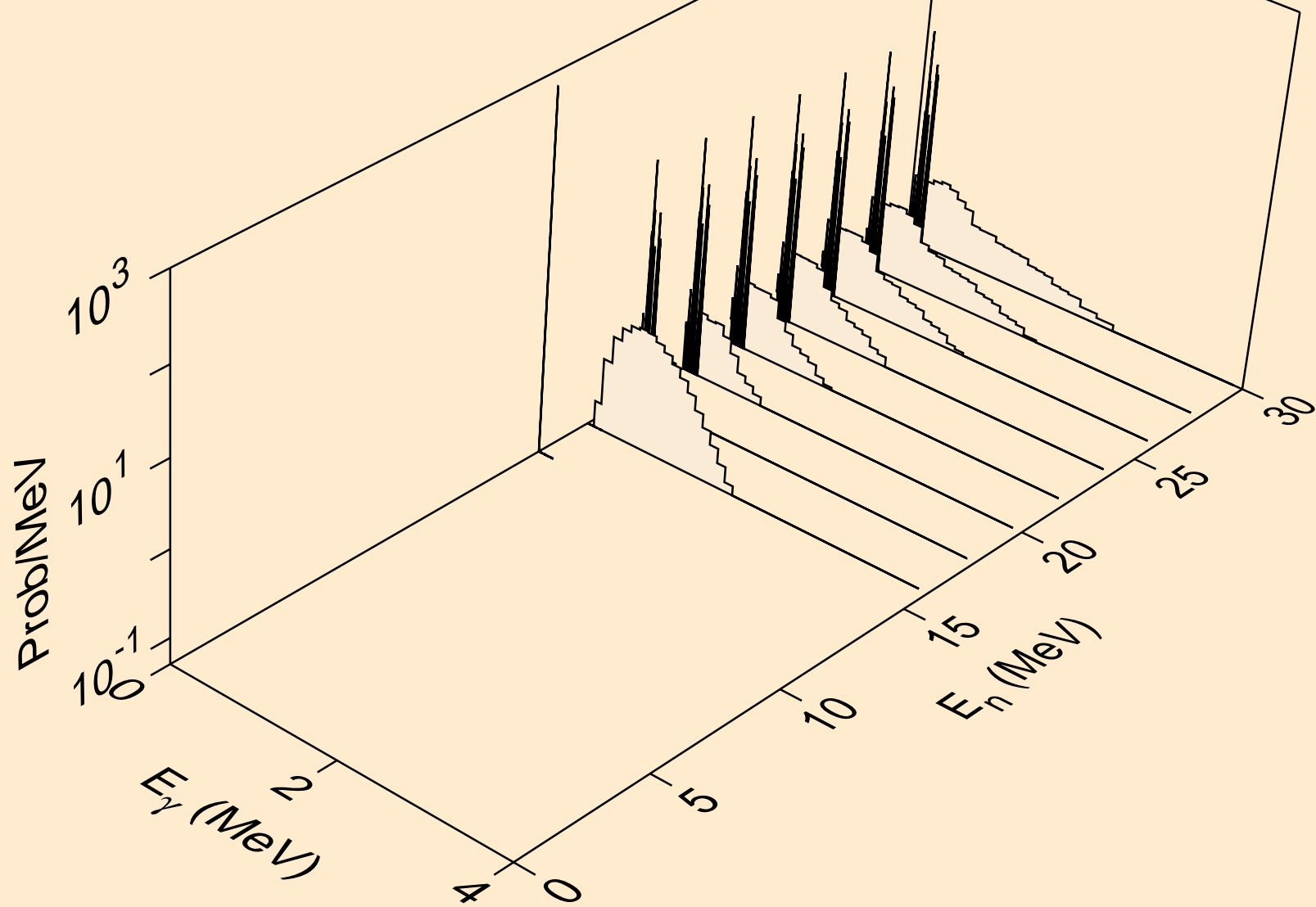

LU174 NEUTRON ACER TENDL-2024 LIBRARY; T=0.K  
thermal capture photon spectrum

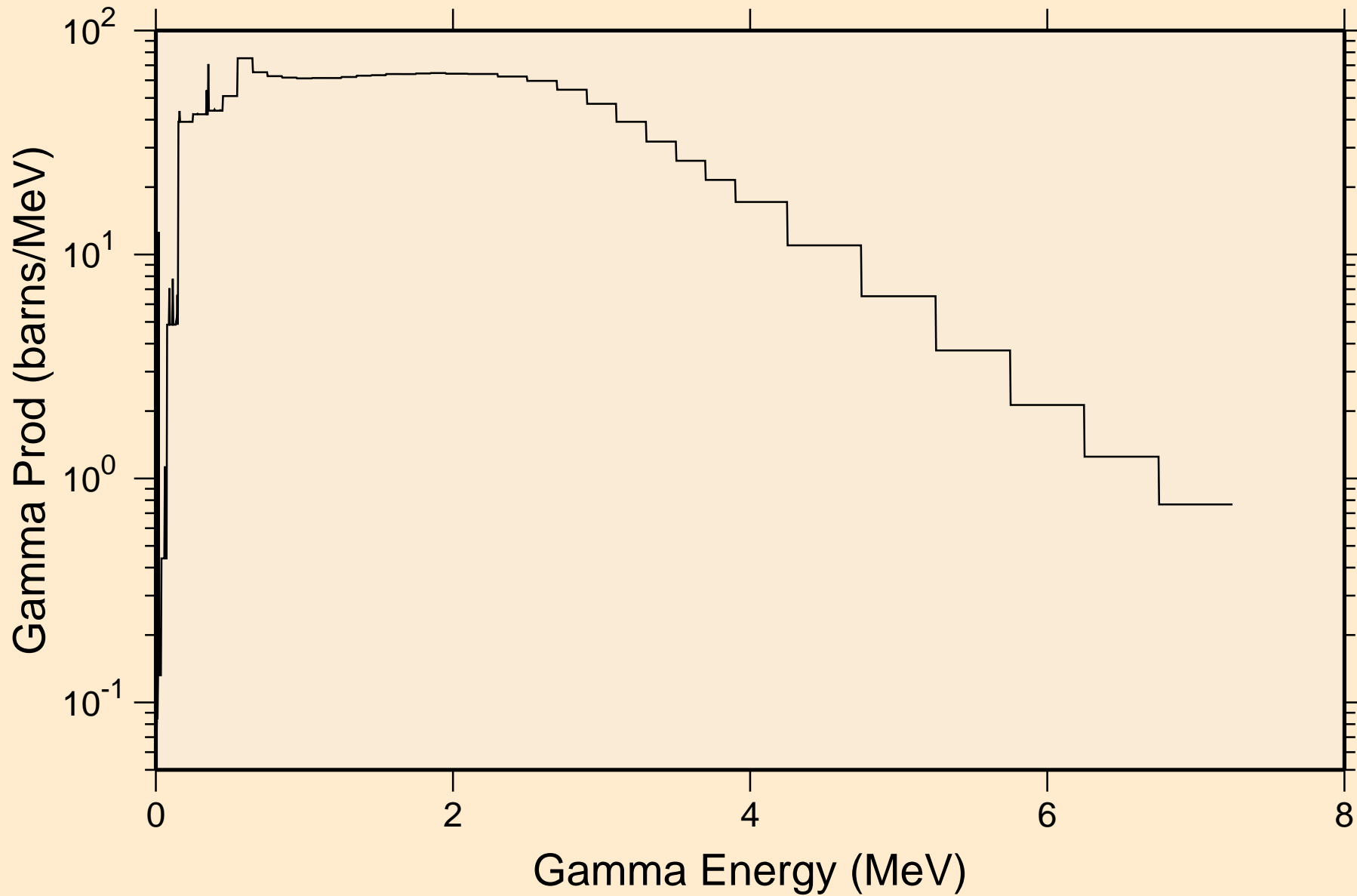

LU174 NEUTRON ACER TENDL-2024 LIBRARY; T=0.K  
14 MeV photon spectrum

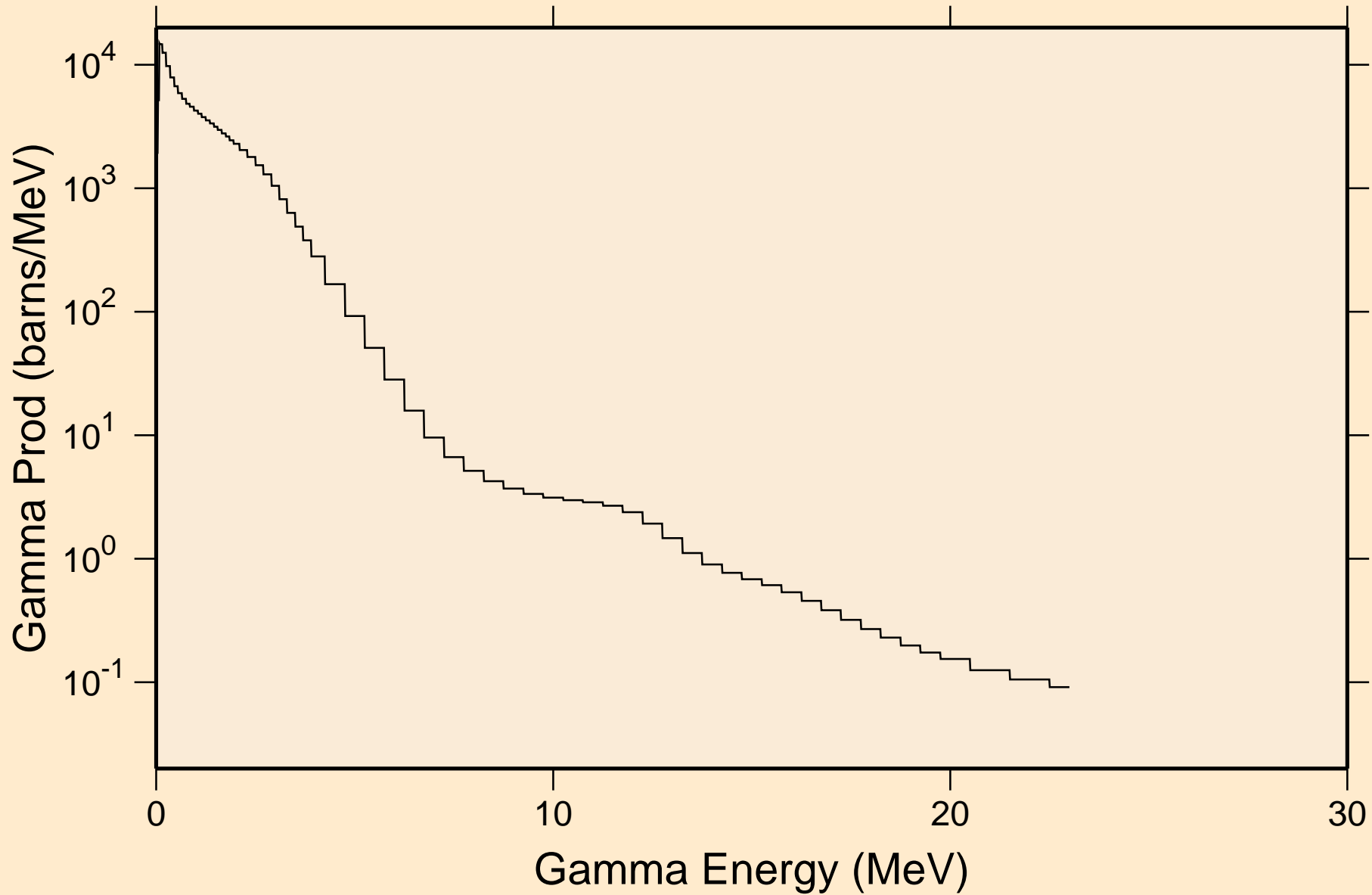



LU174 NEUTRON ACER TENDL-2024 LIBRARY; T=0.K  
Particle heating contributions

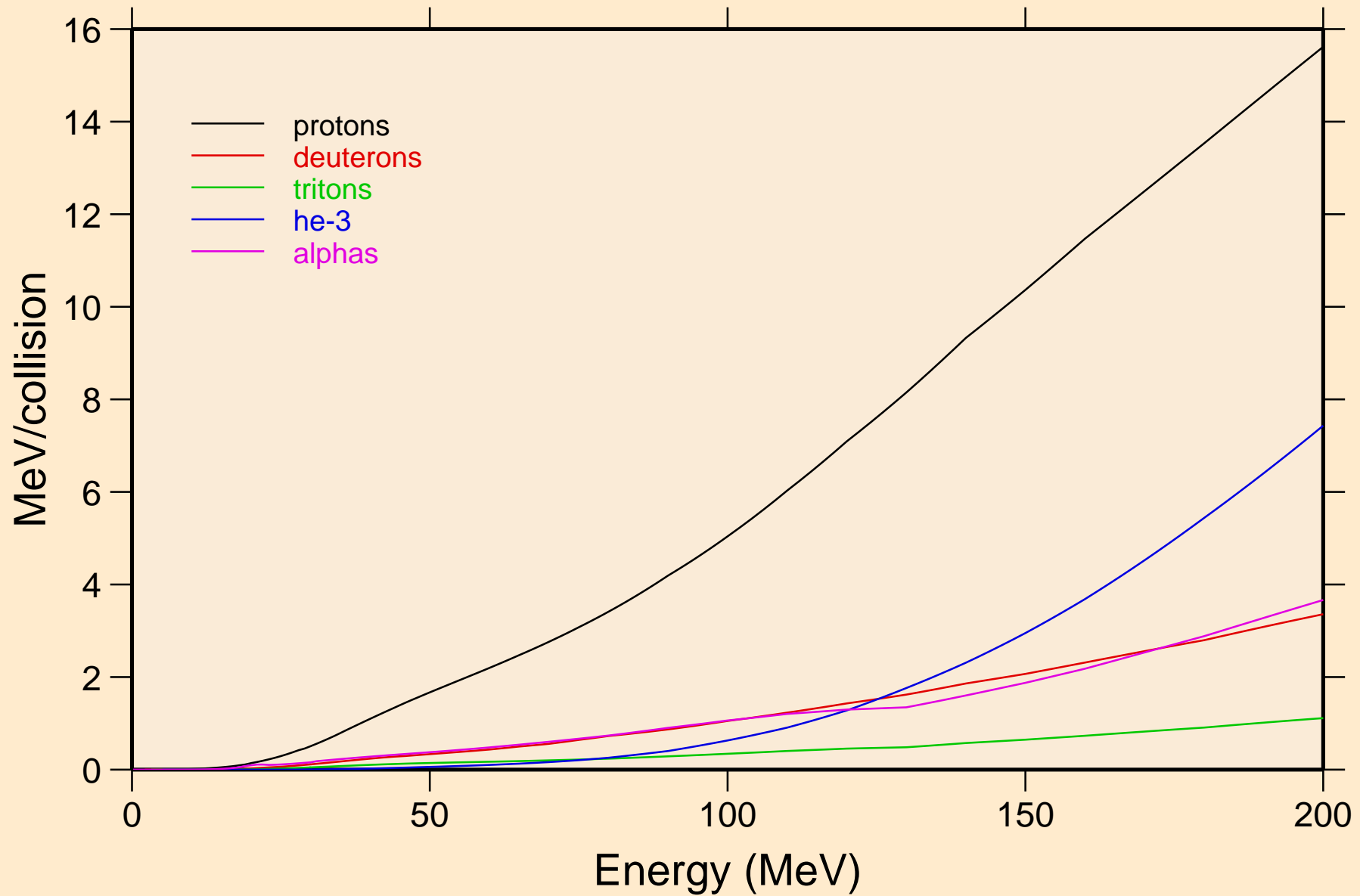

LU174 NEUTRON ACER TENDL-2024 LIBRARY; T=0.K  
Recoil Heating

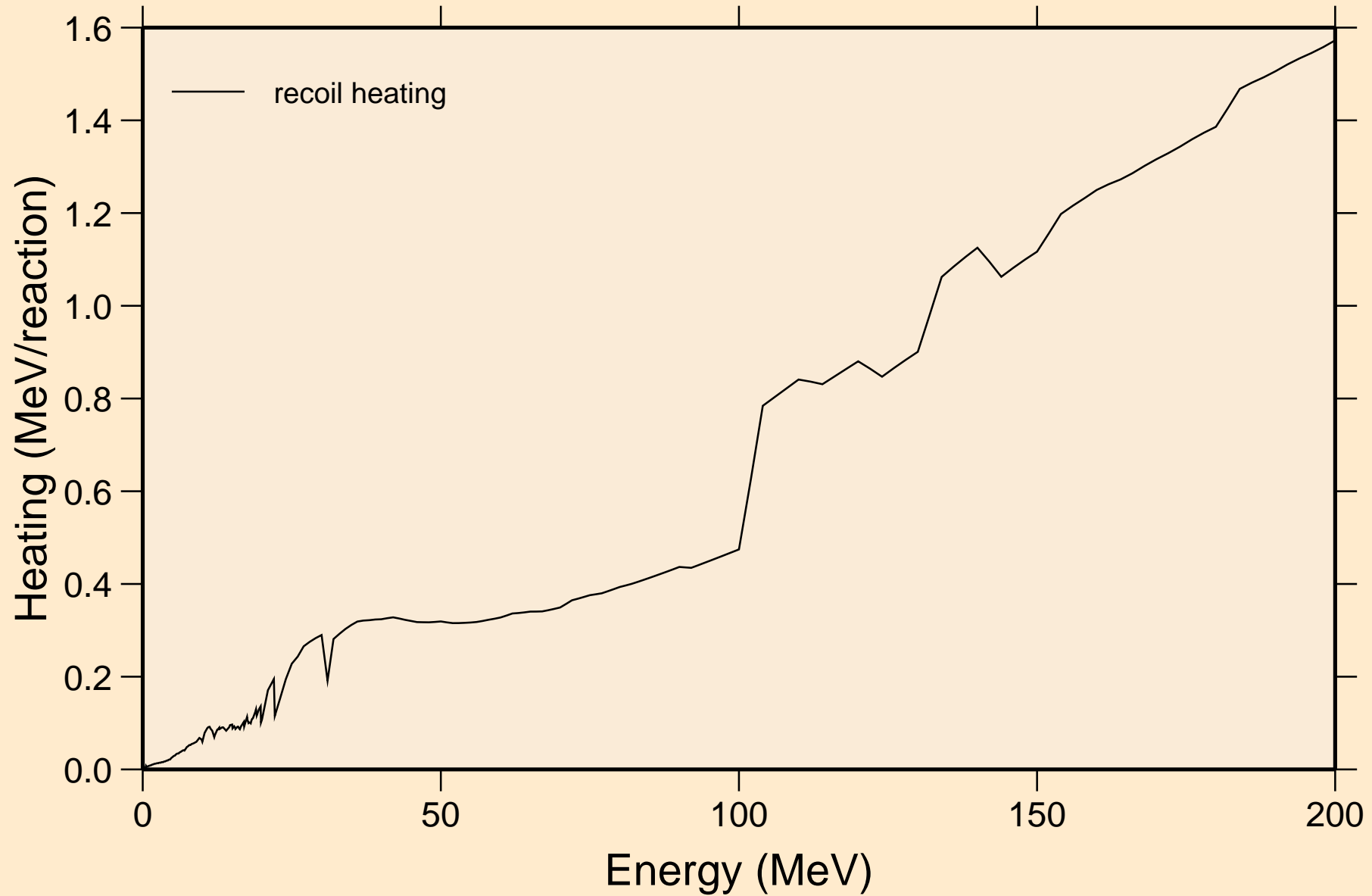

LU174 NEUTRON ACER TENDL-2024 LIBRARY; T=0.K  
Particle production cross sections

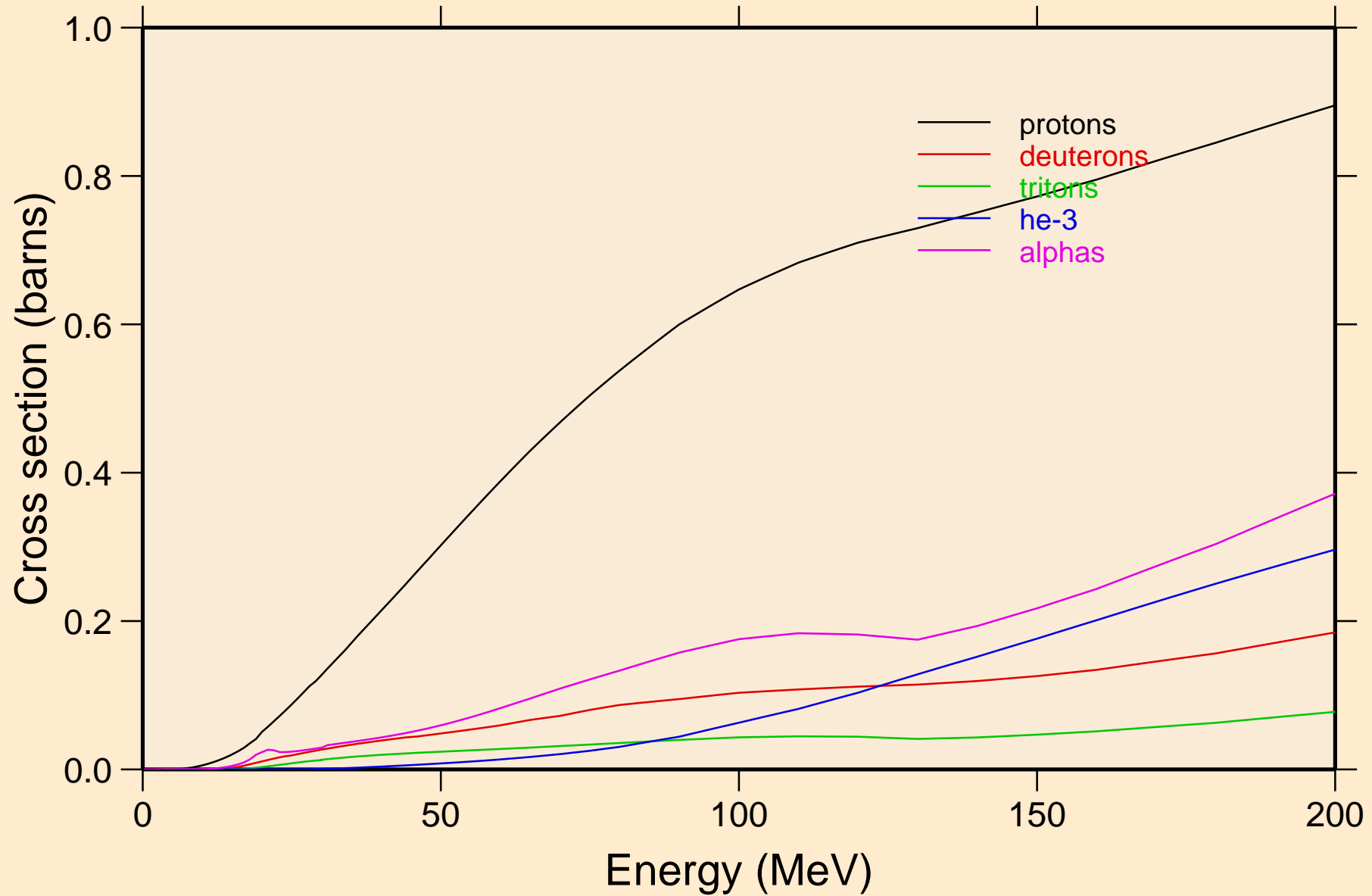

LU174 NEUTRON ACER TENDL-2024 LIBRARY; T=0.K  
protons from (n,x)

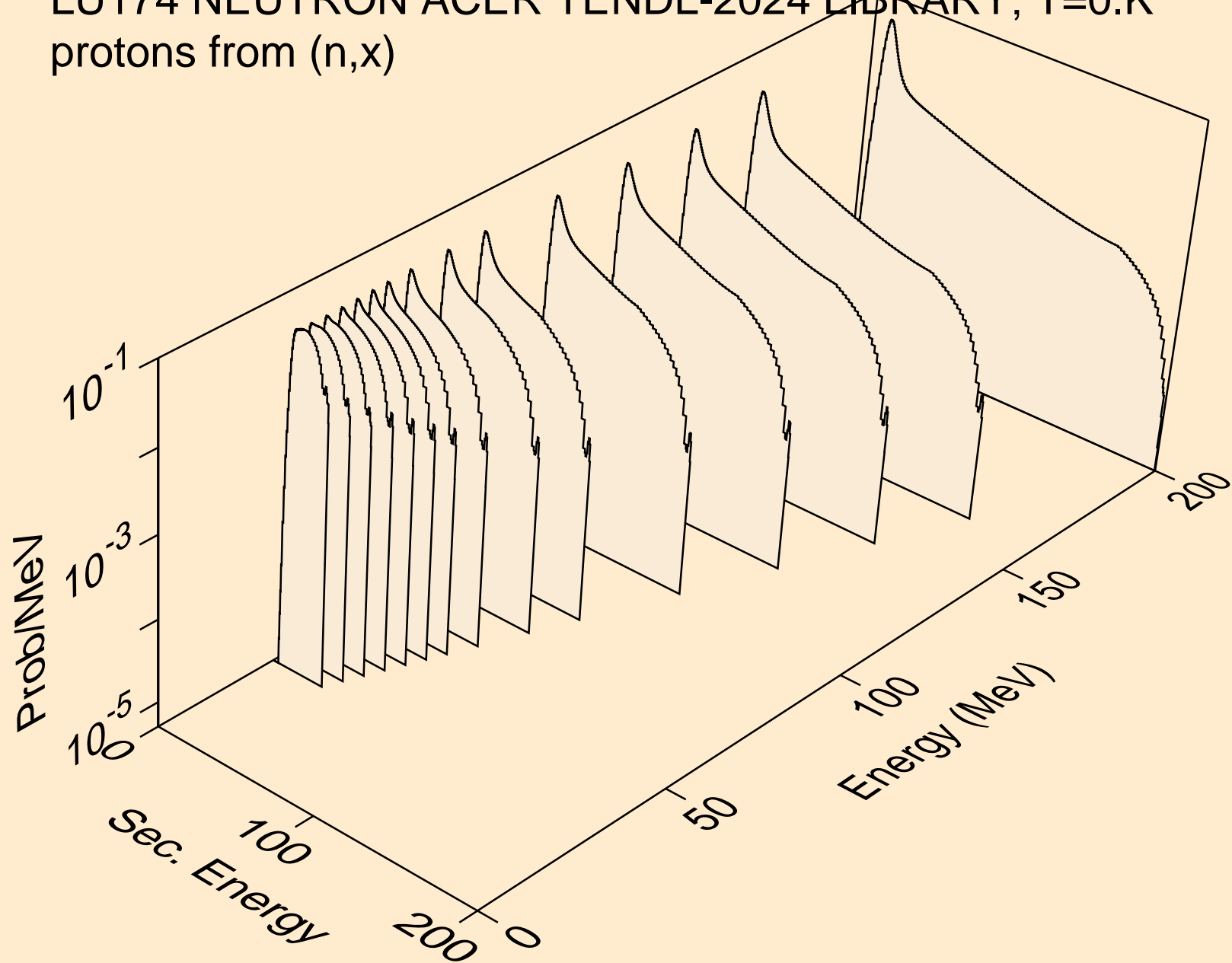

LU174 NEUTRON ACER TENDL-2024 LIBRARY; T=0.K  
protons from (n,n\*)p

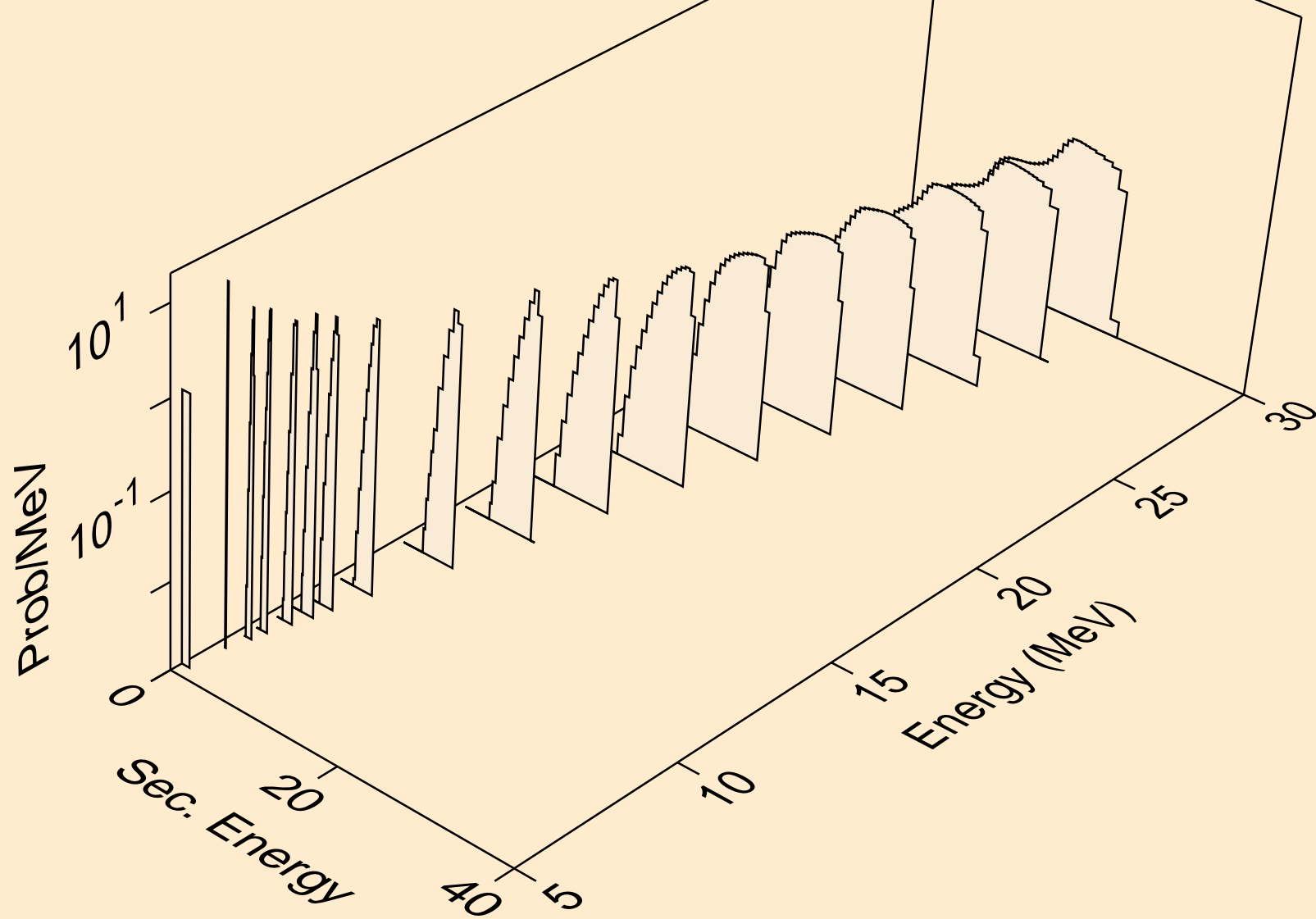

LU174 NEUTRON ACER TENDL-2024 LIBRARY; T=0.K  
protons from (n,2np)

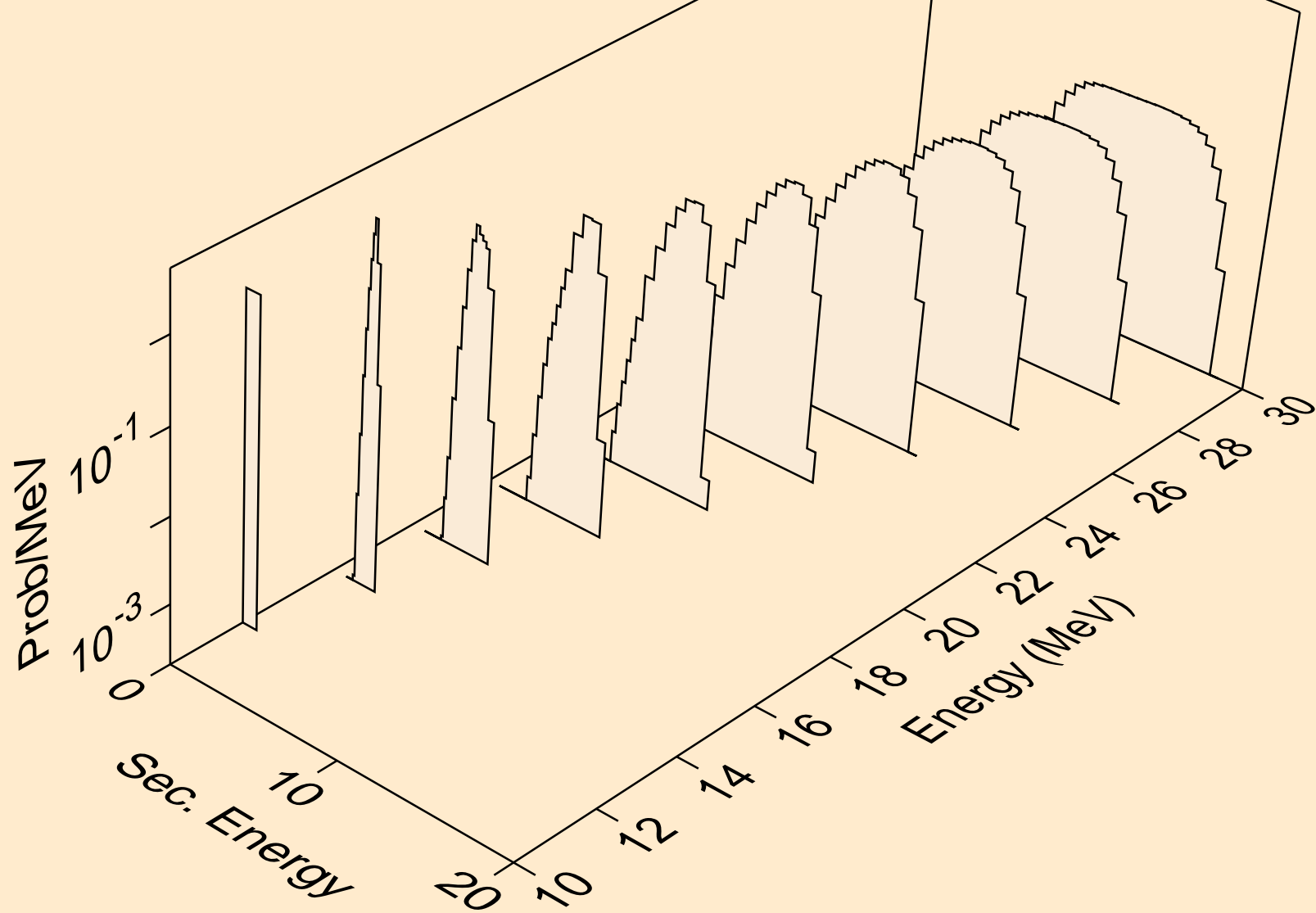

LU174 NEUTRON ACER TENDL-2024 LIBRARY; T=0.K  
protons from (n,3np)

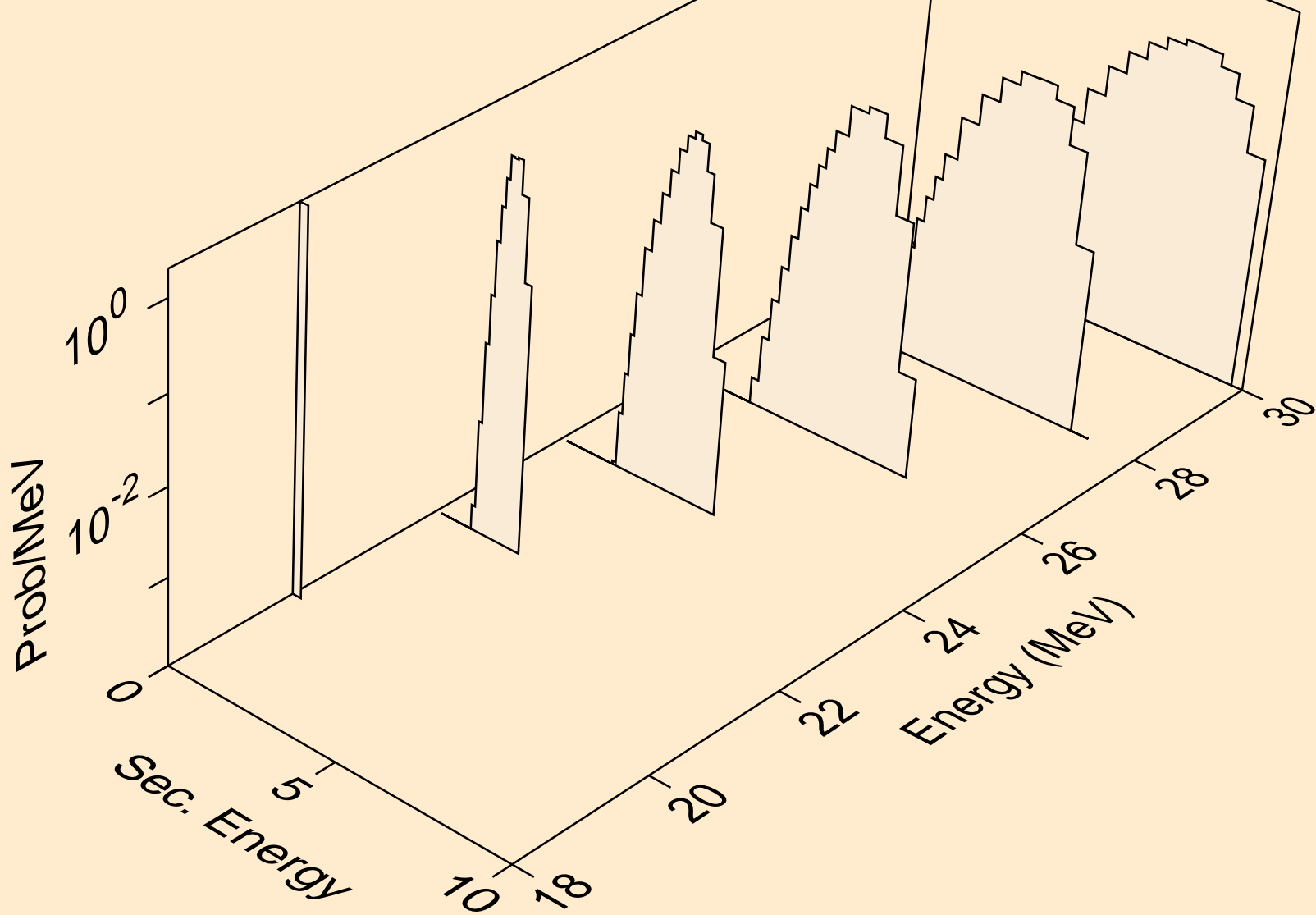

LU174 NEUTRON ACER TENDL-2024 LIBRARY; T=0.K  
protons from (n,n2p)

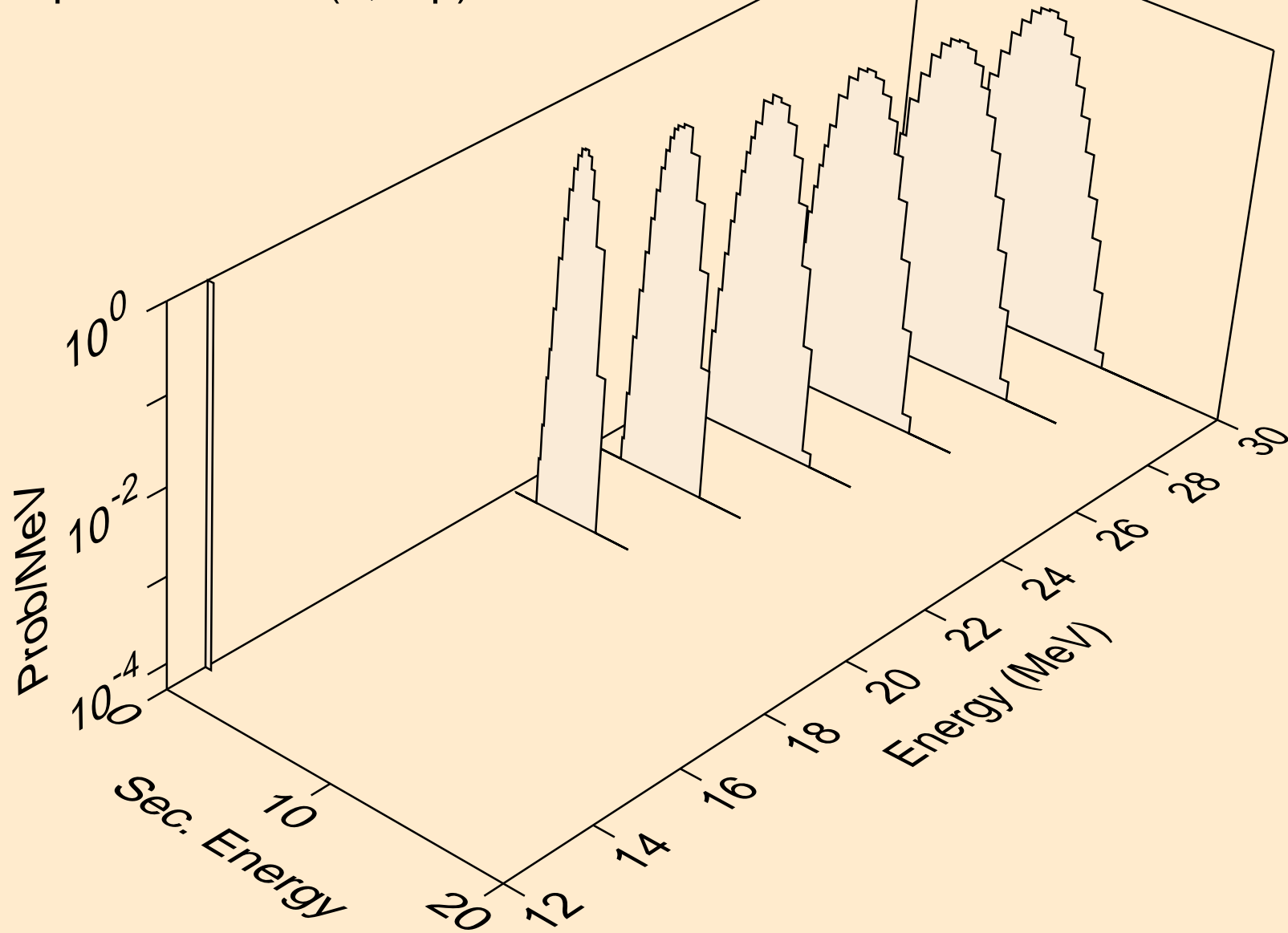



LU174 NEUTRON ACER TENDL-2024 LIBRARY; T=0.K  
protons from (n,npa)

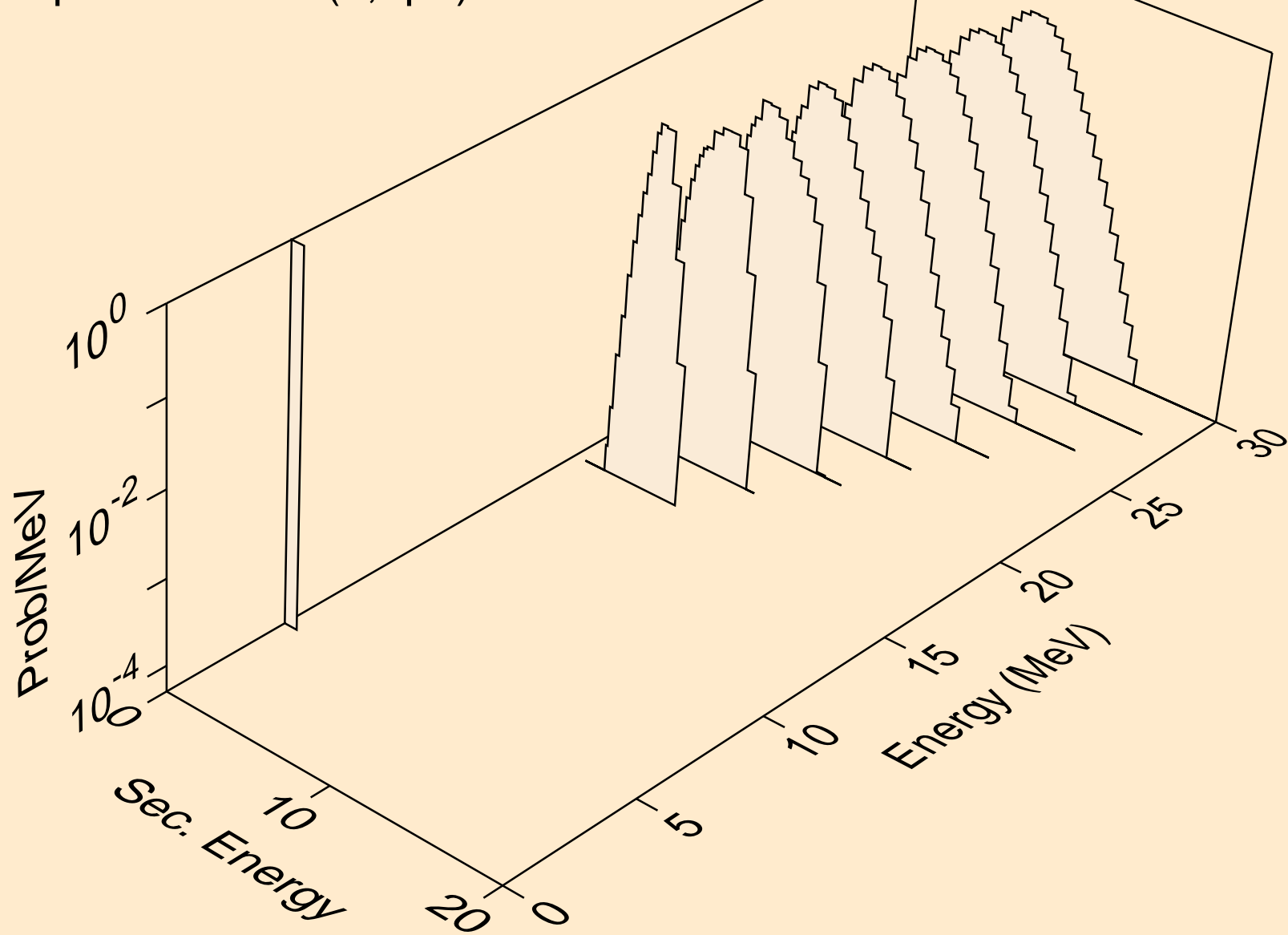

LU174 NEUTRON ACER TENDL-2024 LIBRARY; T=0.K  
protons from (n,p)

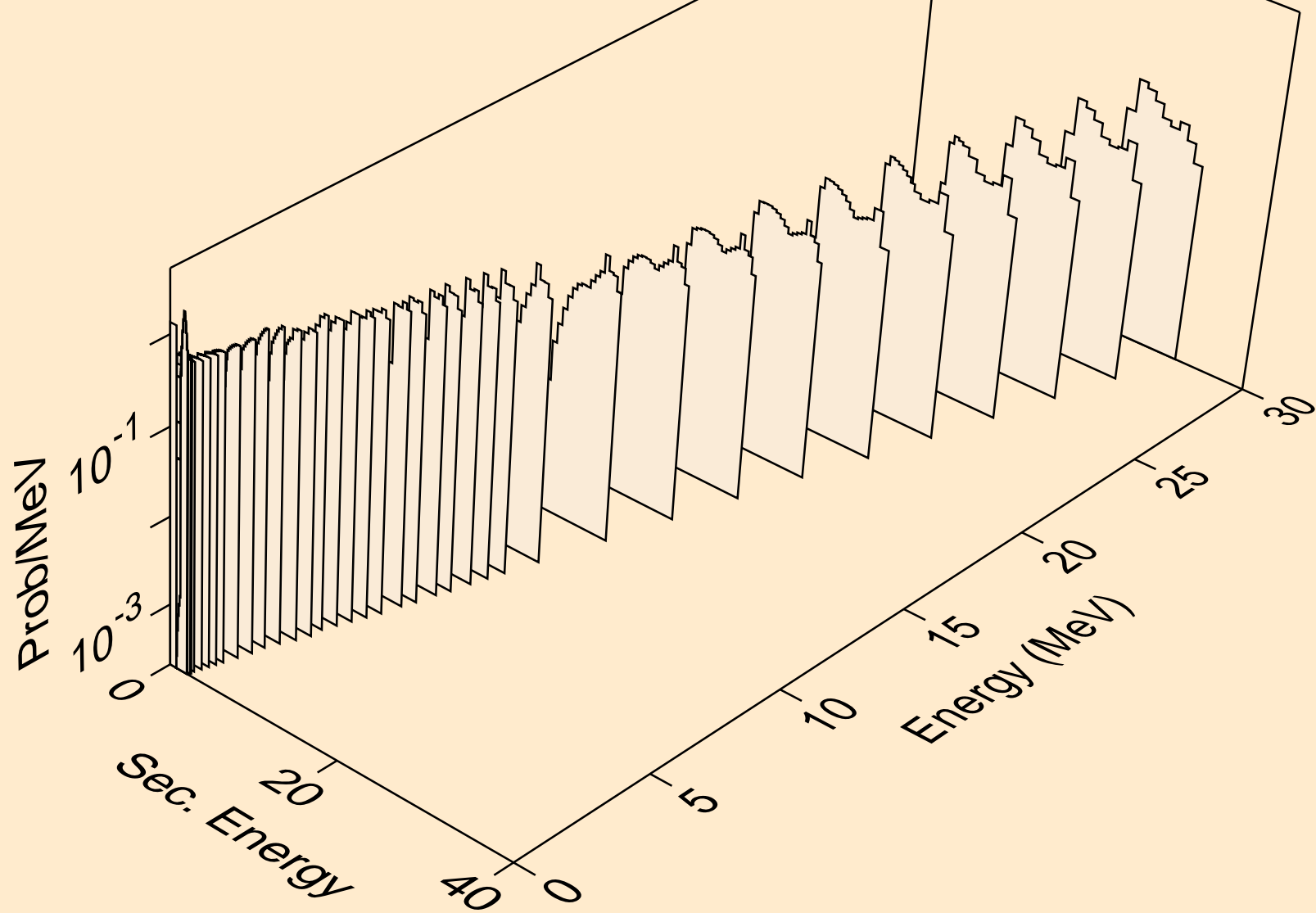

LU174 NEUTRON ACER TENDL-2024 LIBRARY; T=0.K  
protons from (n,2p)

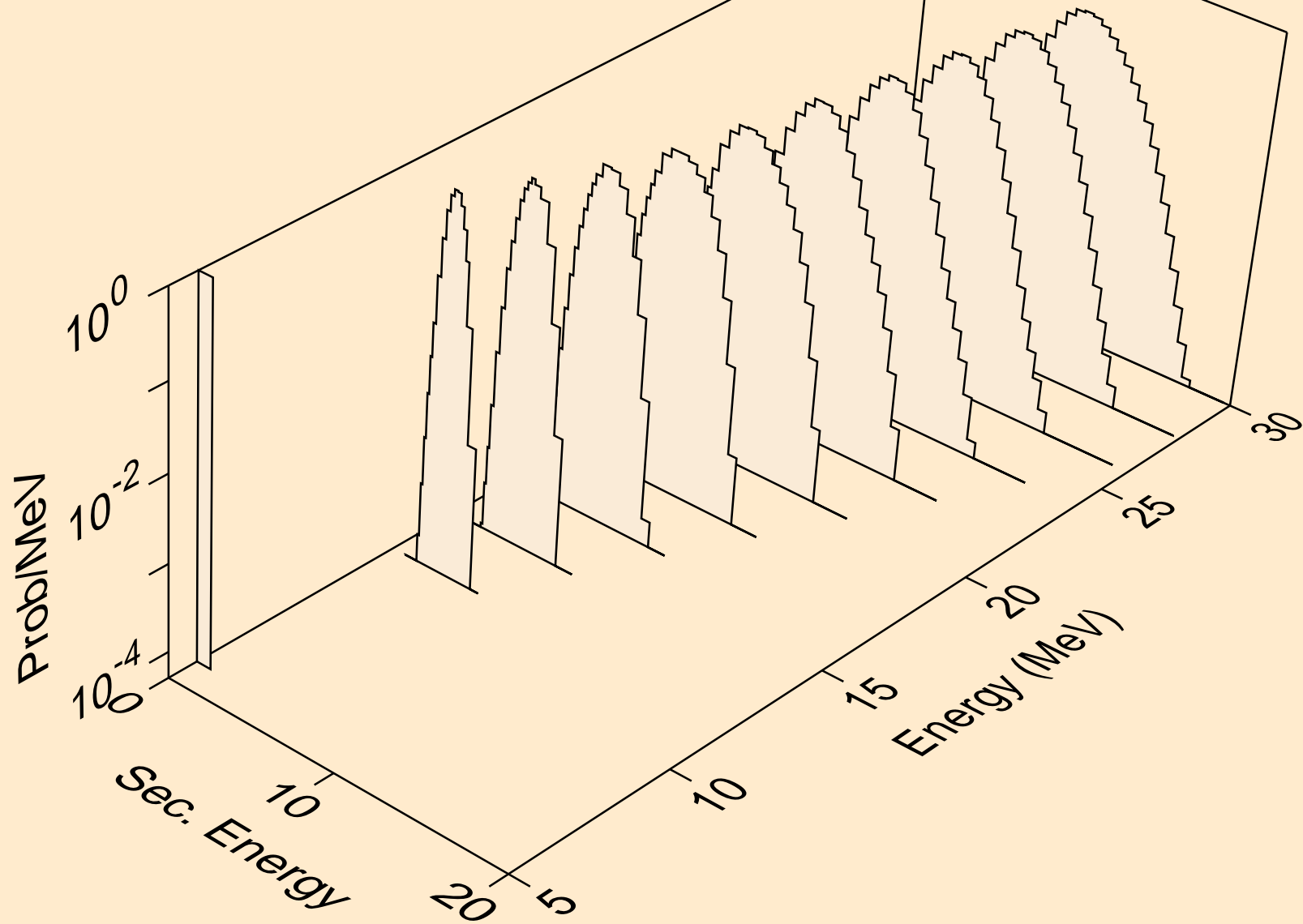

LU174 NEUTRON ACER TENDL-2024 LIBRARY; T=0.K  
protons from (n,p)

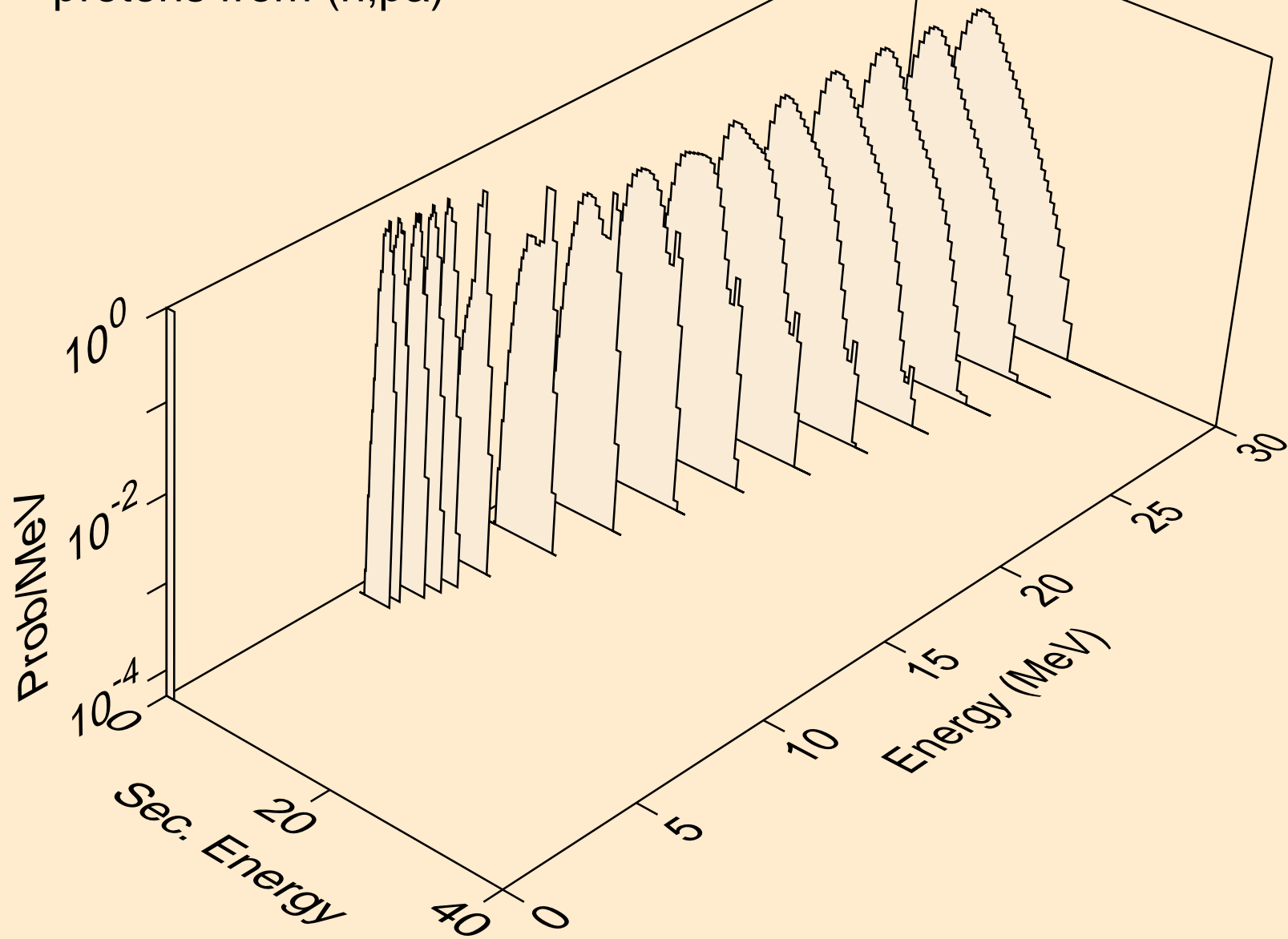

LU174 NEUTRON ACER TENDL-2024 LIBRARY; T=0.K  
protons from (n,pd)

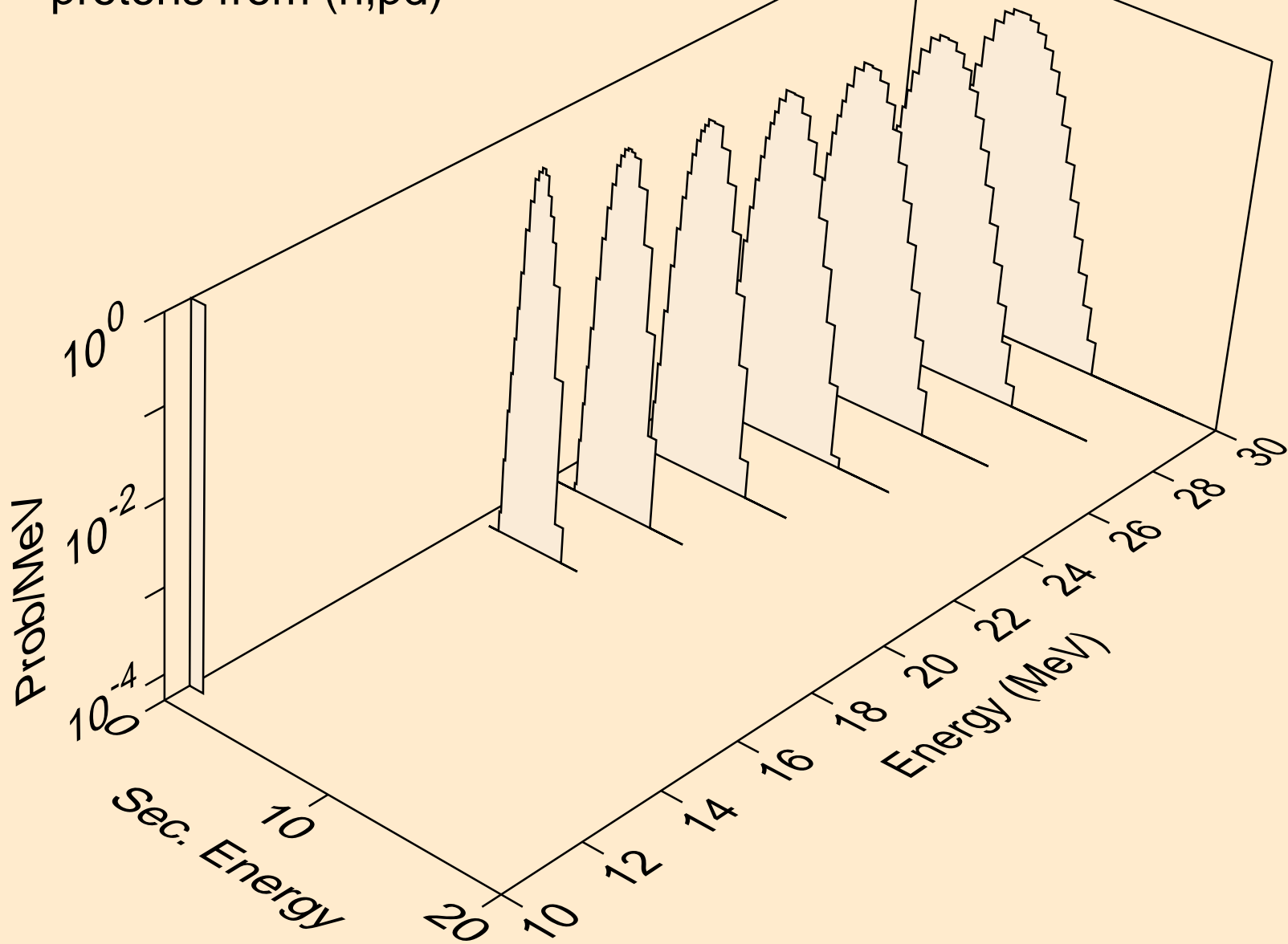

LU174 NEUTRON ACER TENDL-2024 LIBRARY; T=0.K  
protons from (n,pt)

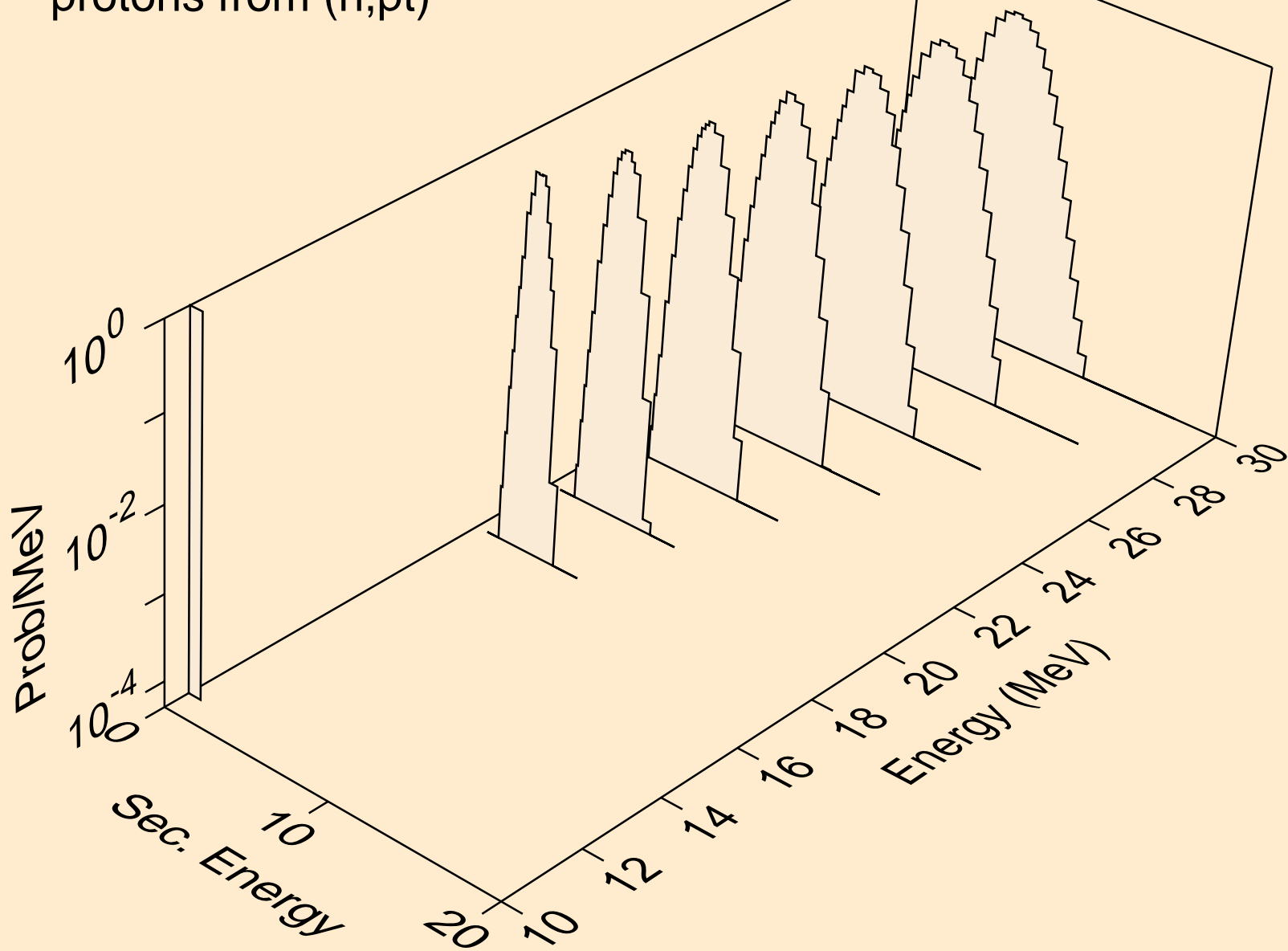

LU174 NEUTRON ACER TENDL-2024 LIBRARY; T=0.K  
deuterons from (n,x)

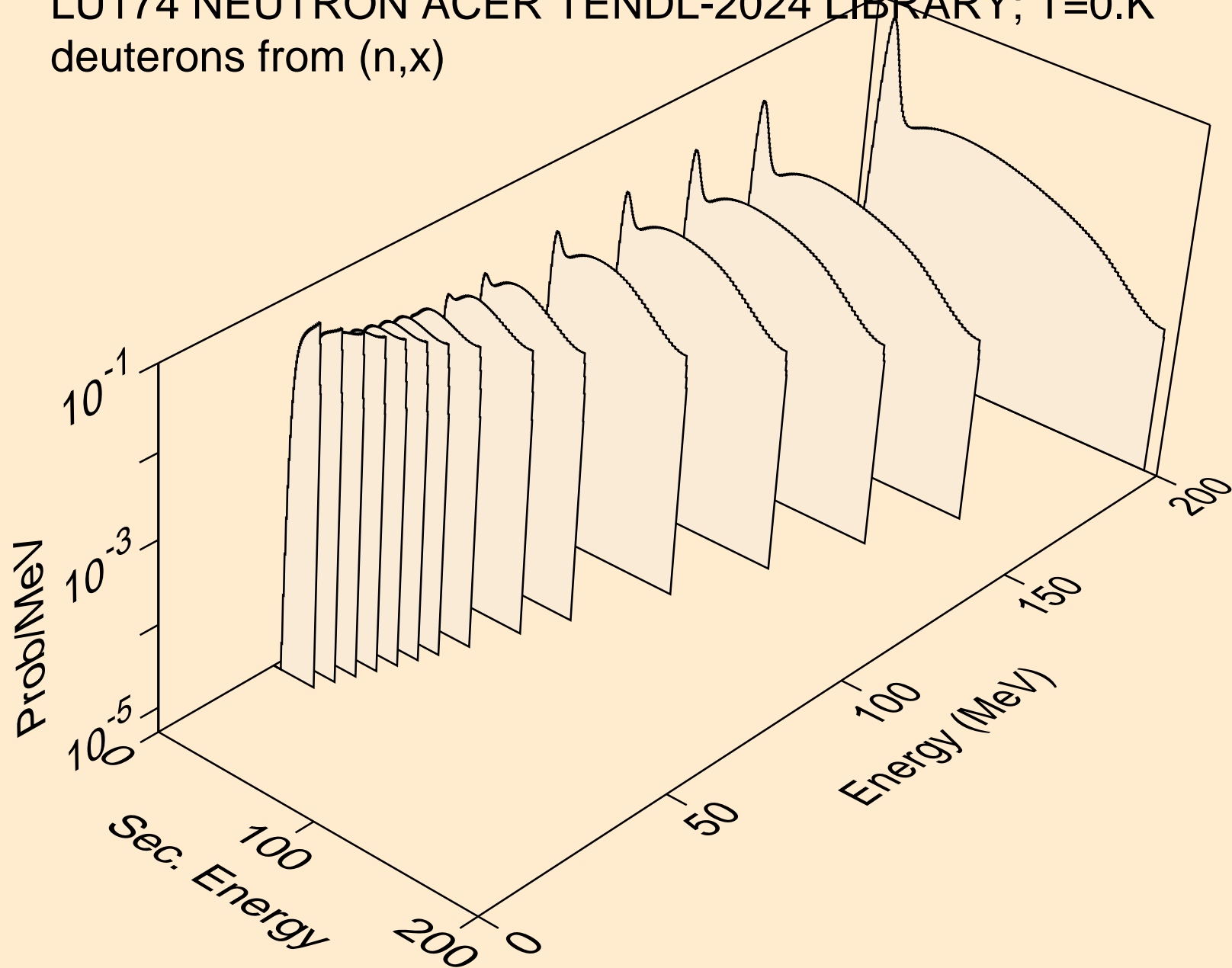

LU174 NEUTRON ACER TENDL-2024 LIBRARY; T=0.K  
deuterons from (n,2nd)

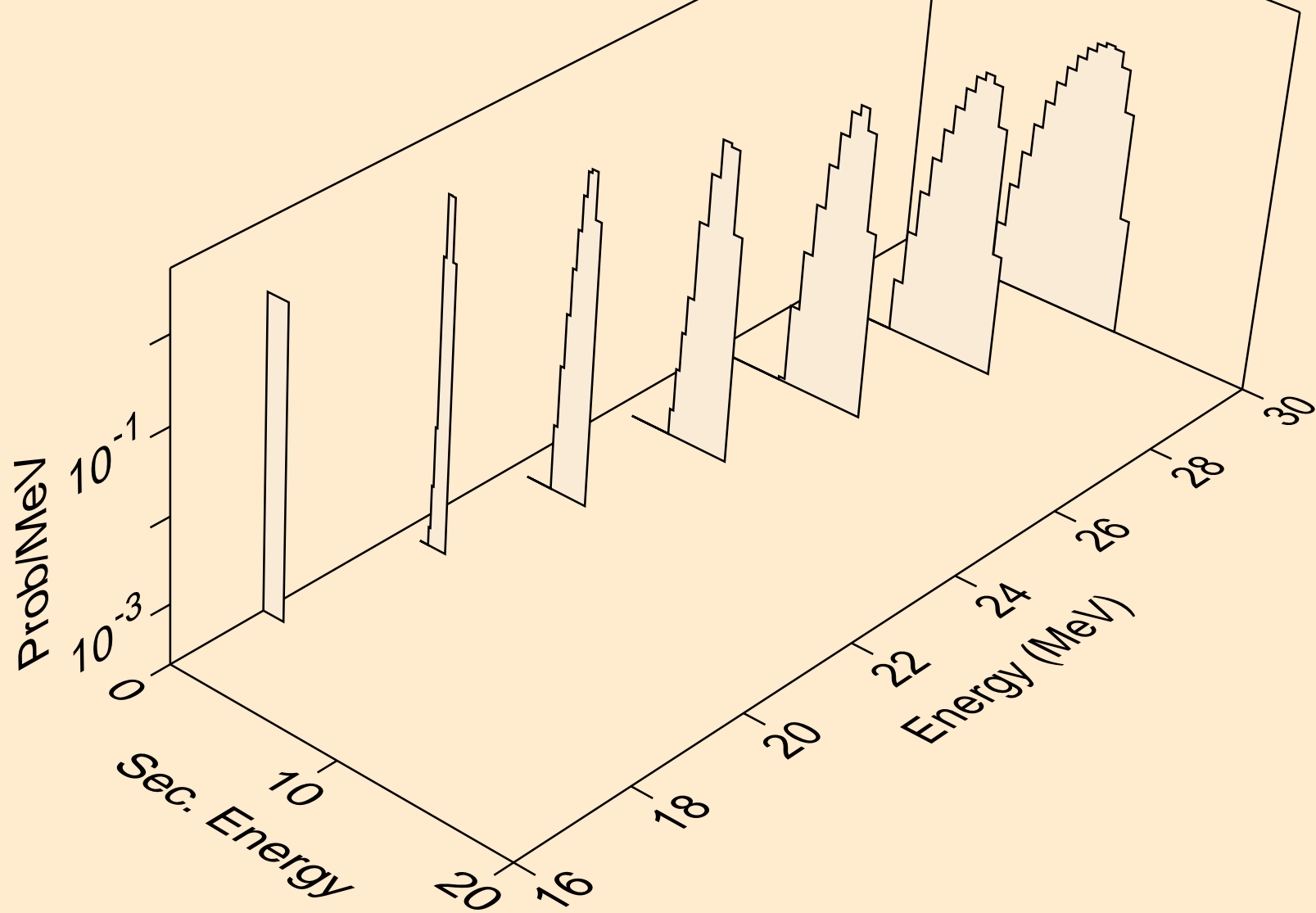



LU174 NEUTRON ACER TENDL-2024 LIBRARY; T=0.K  
deuterons from (n,n\*)d

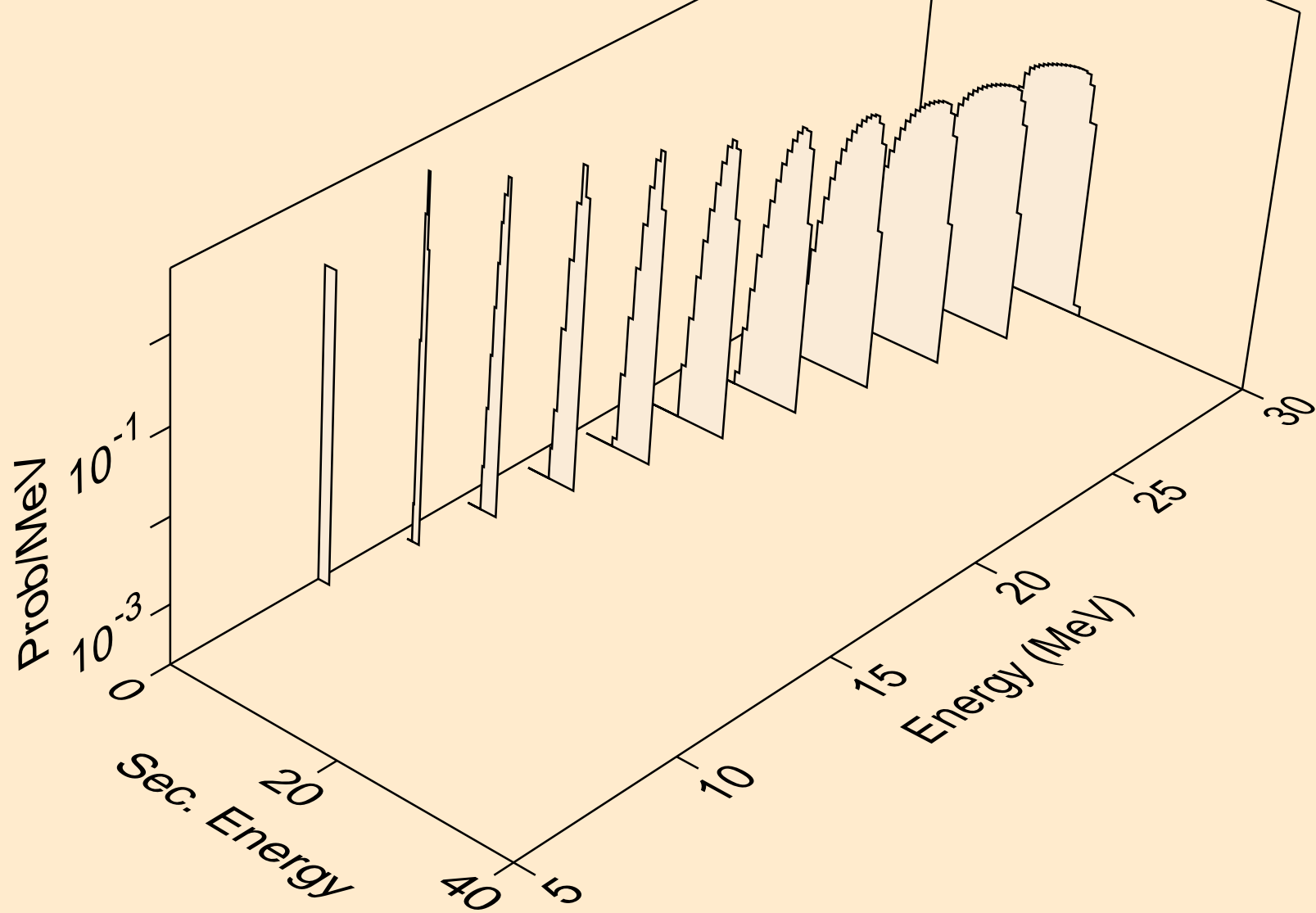

LU174 NEUTRON ACER TENDL-2024 LIBRARY; T=0.K  
deuterons from (n,d)

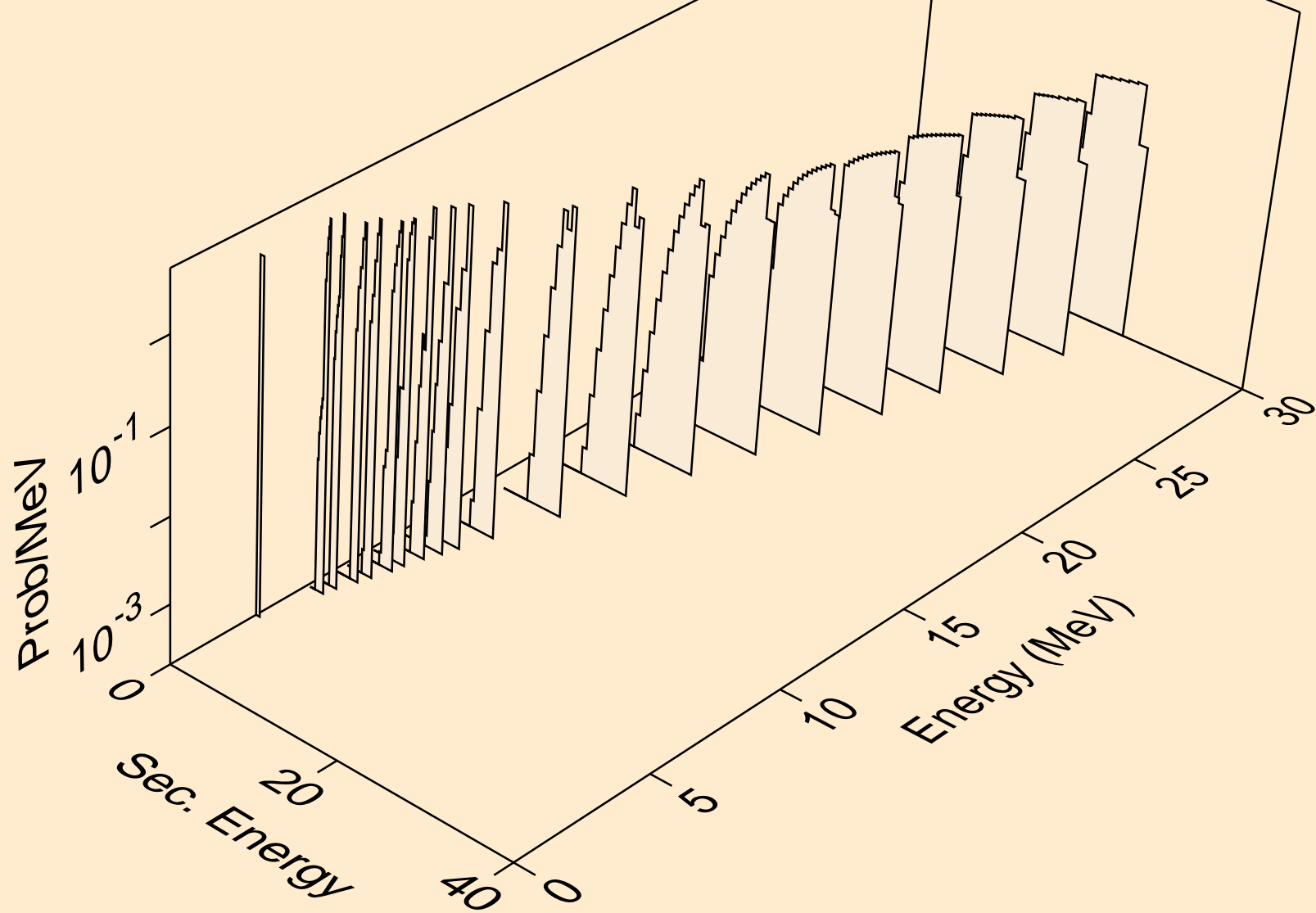

LU174 NEUTRON ACER TENDL-2024 LIBRARY; T=0.K  
deuterons from (n,pd)

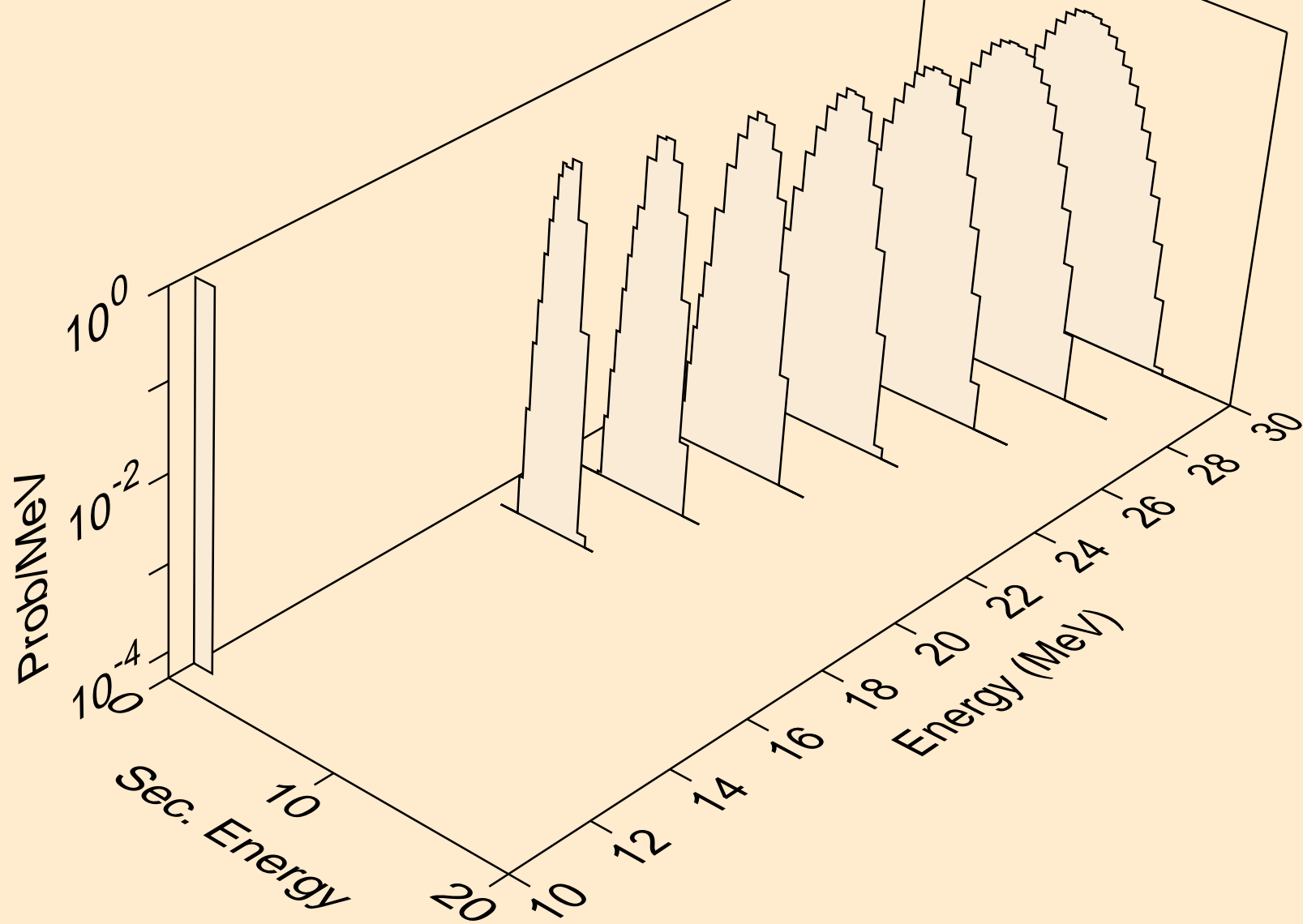

LU174 NEUTRON ACER TENDL-2024 LIBRARY; T=0.K  
deuterons from (n,da)

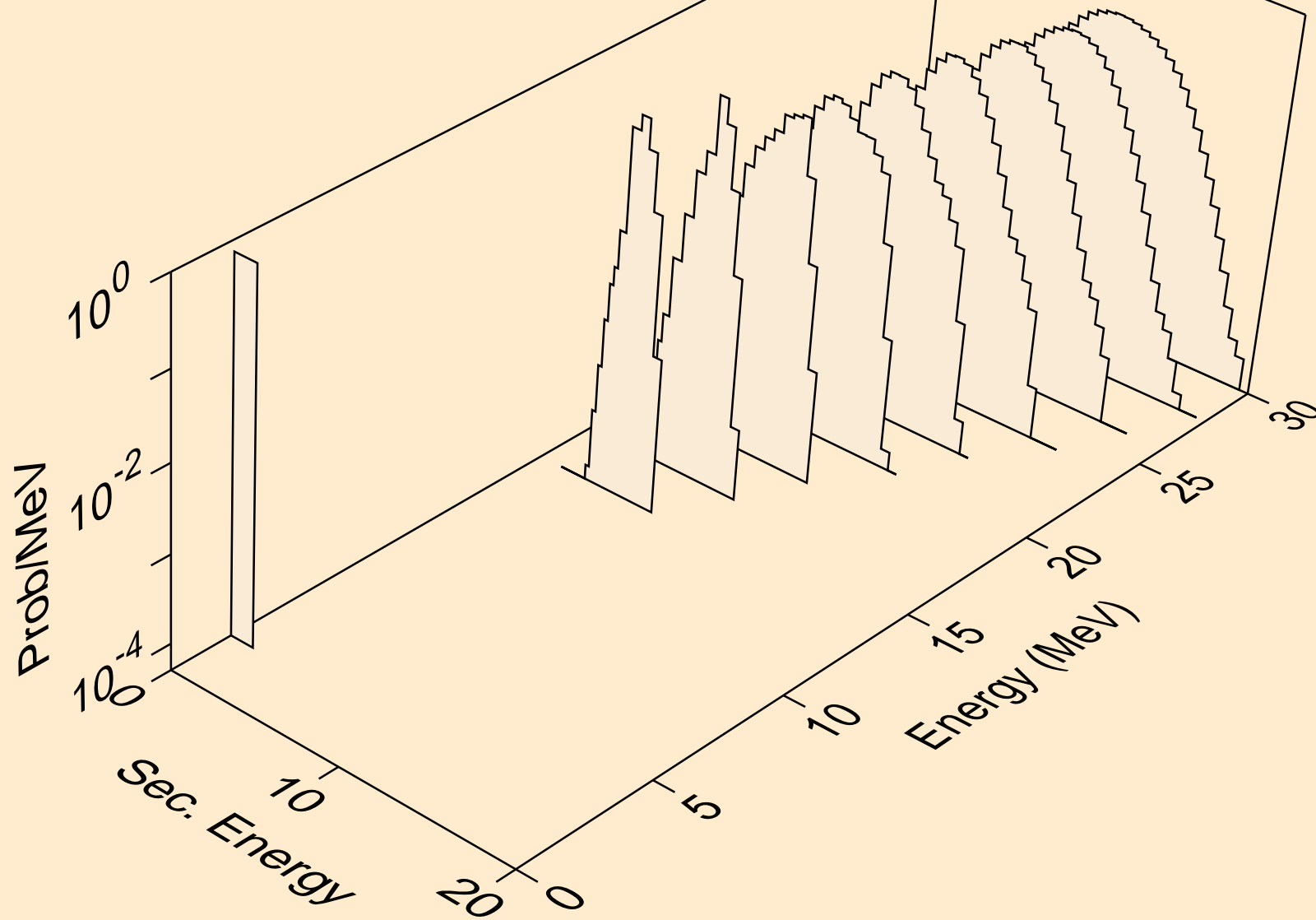

LU174 NEUTRON ACER TENDL-2024 LIBRARY; T=0.K  
tritons from (n,x)

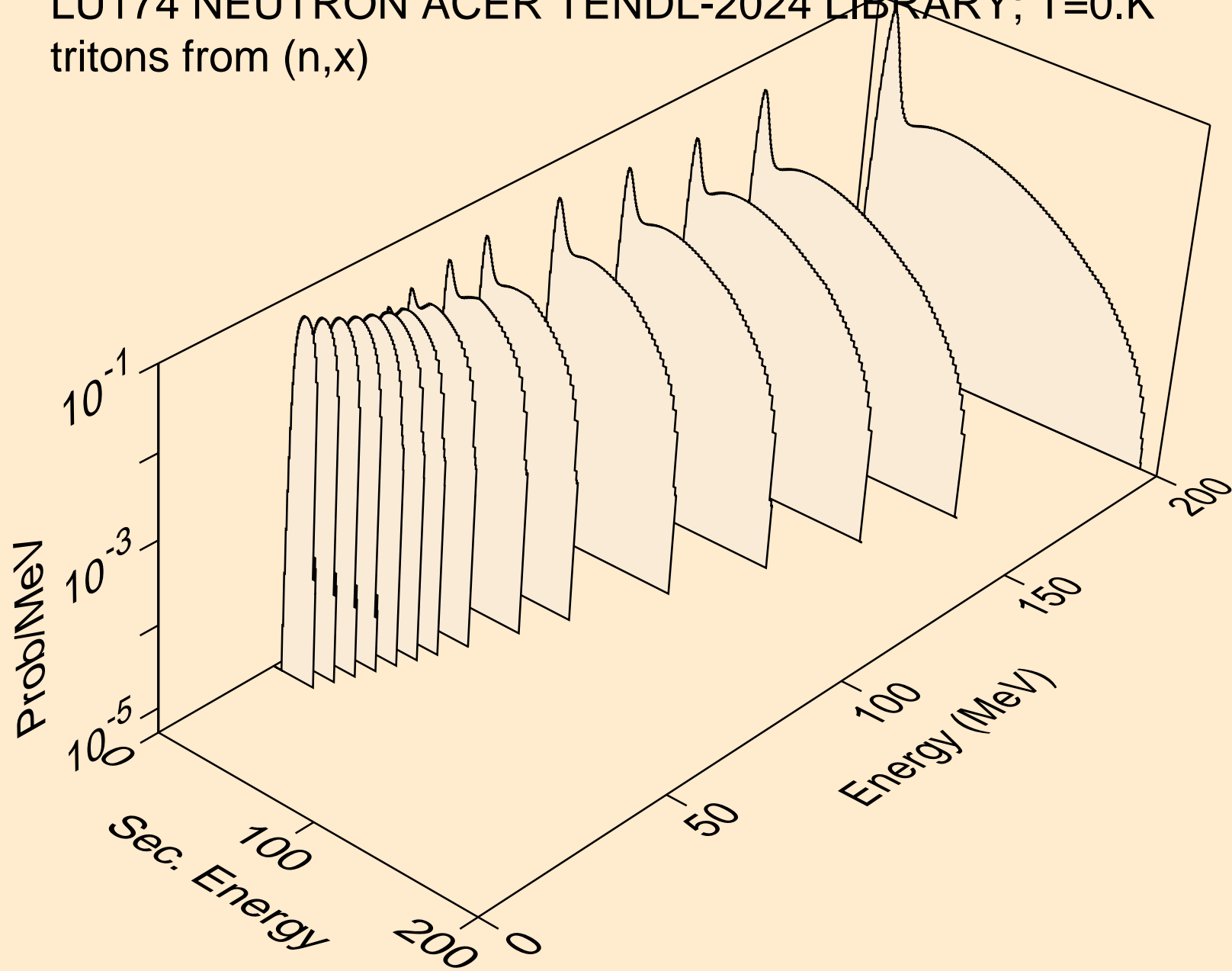

LU174 NEUTRON ACER TENDL-2024 LIBRARY; T=0.K  
tritons from (n,n\*)t

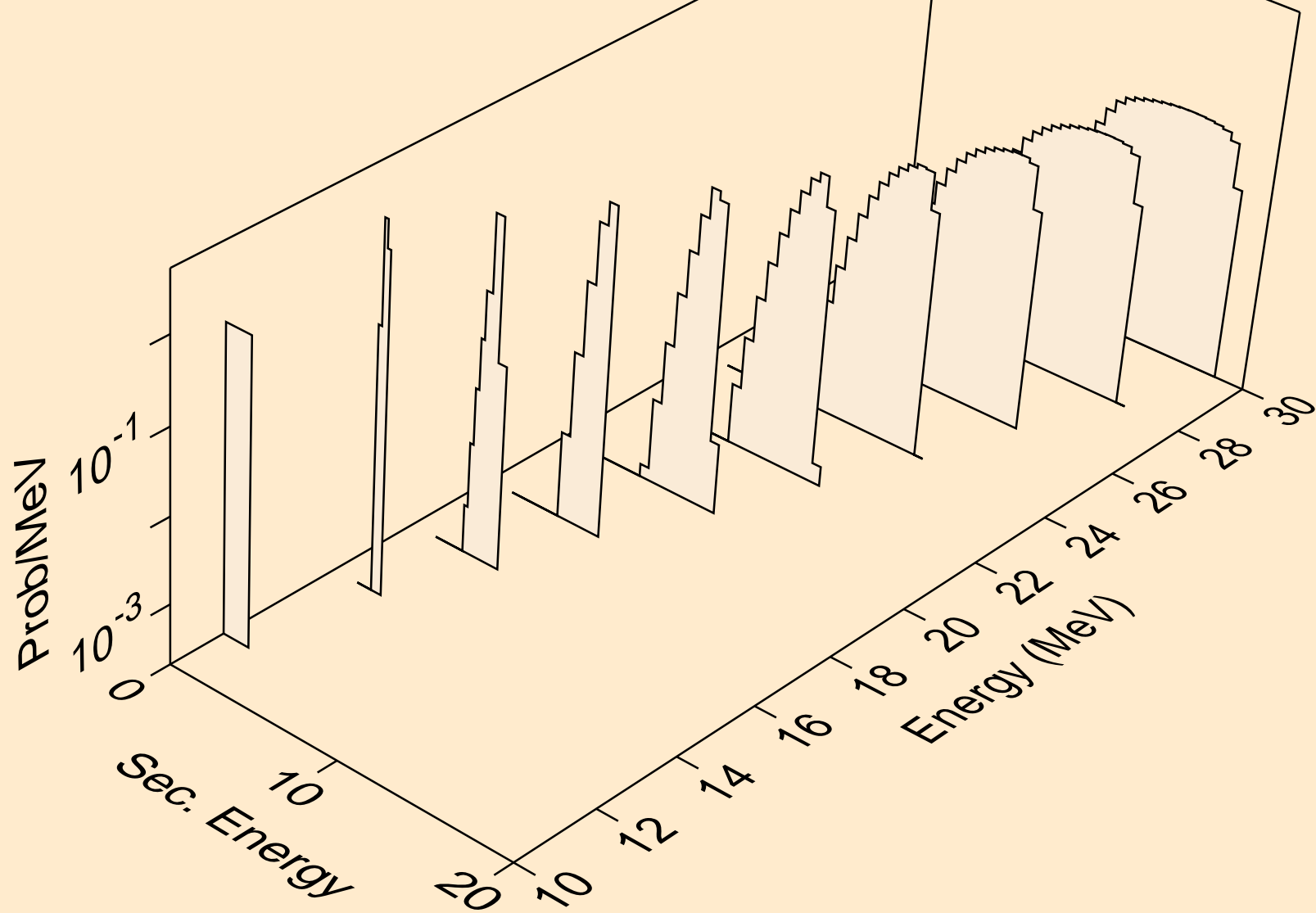

LU174 NEUTRON ACER TENDL-2024 LIBRARY; T=0.K  
tritons from (n,t)

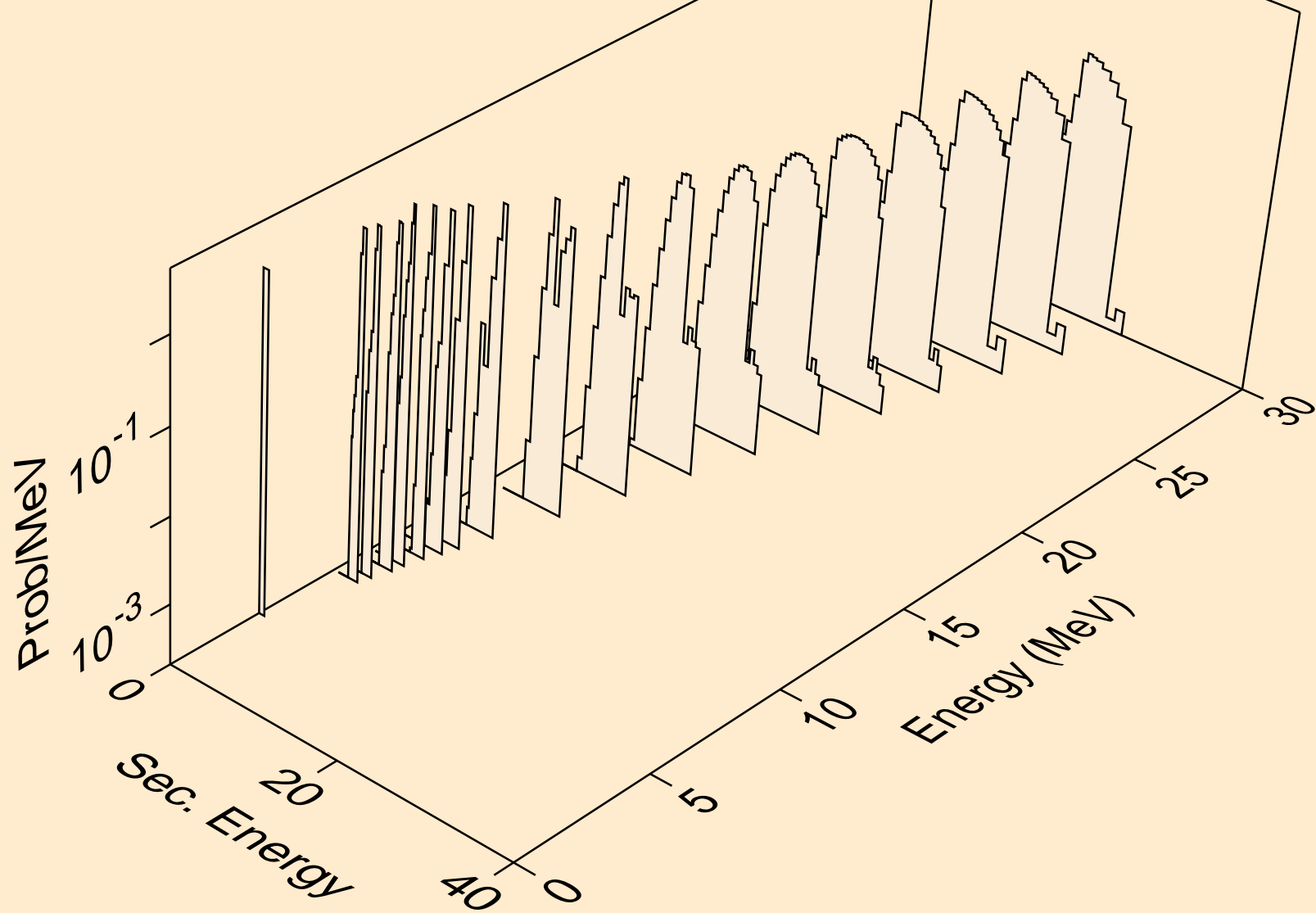

LU174 NEUTRON ACER TENDL-2024 LIBRARY; T=0.K  
tritons from (n,pt)

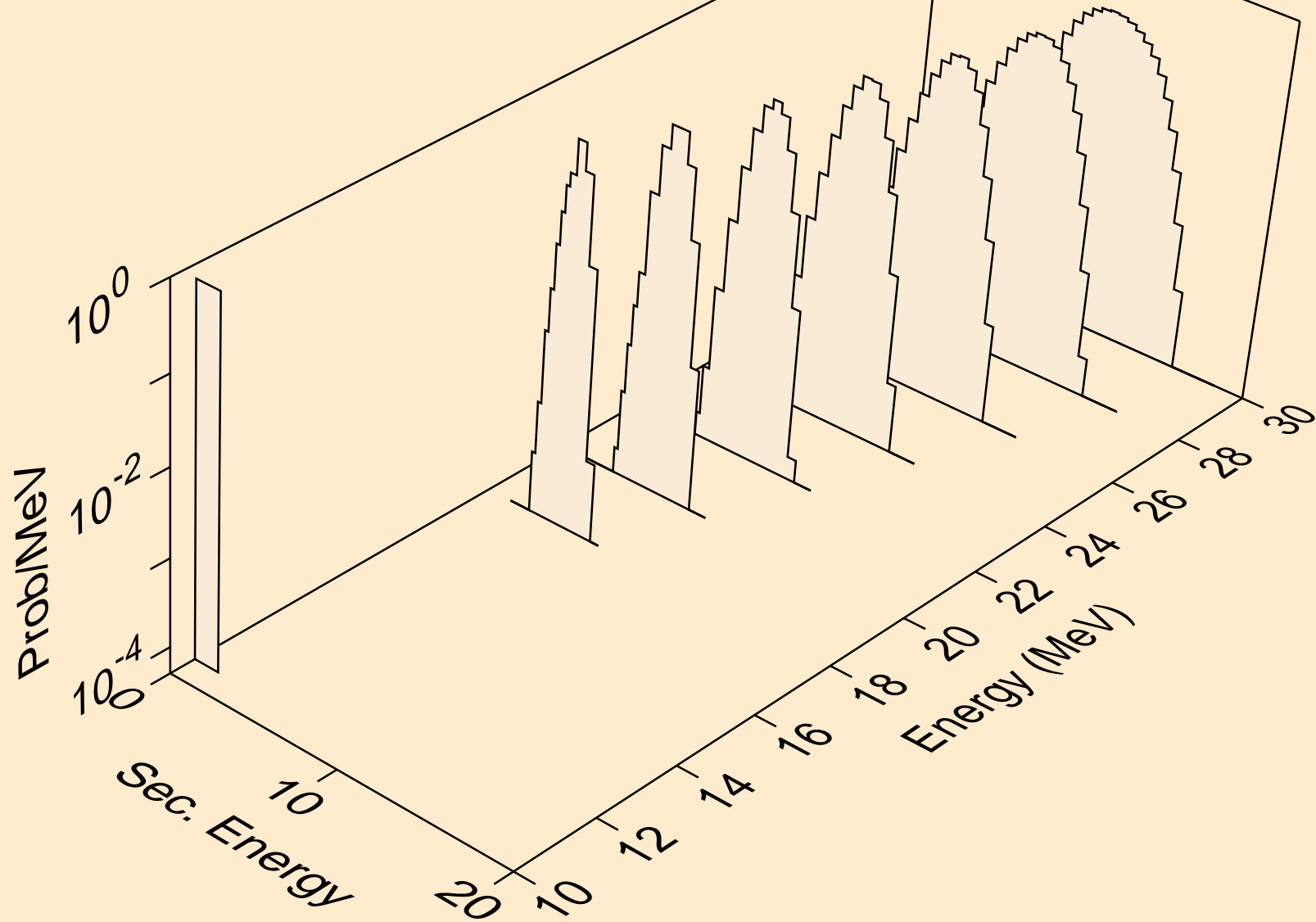



LU174 NEUTRON ACER TENDL-2024 LIBRARY; T=0.K  
he3s from (n,x)

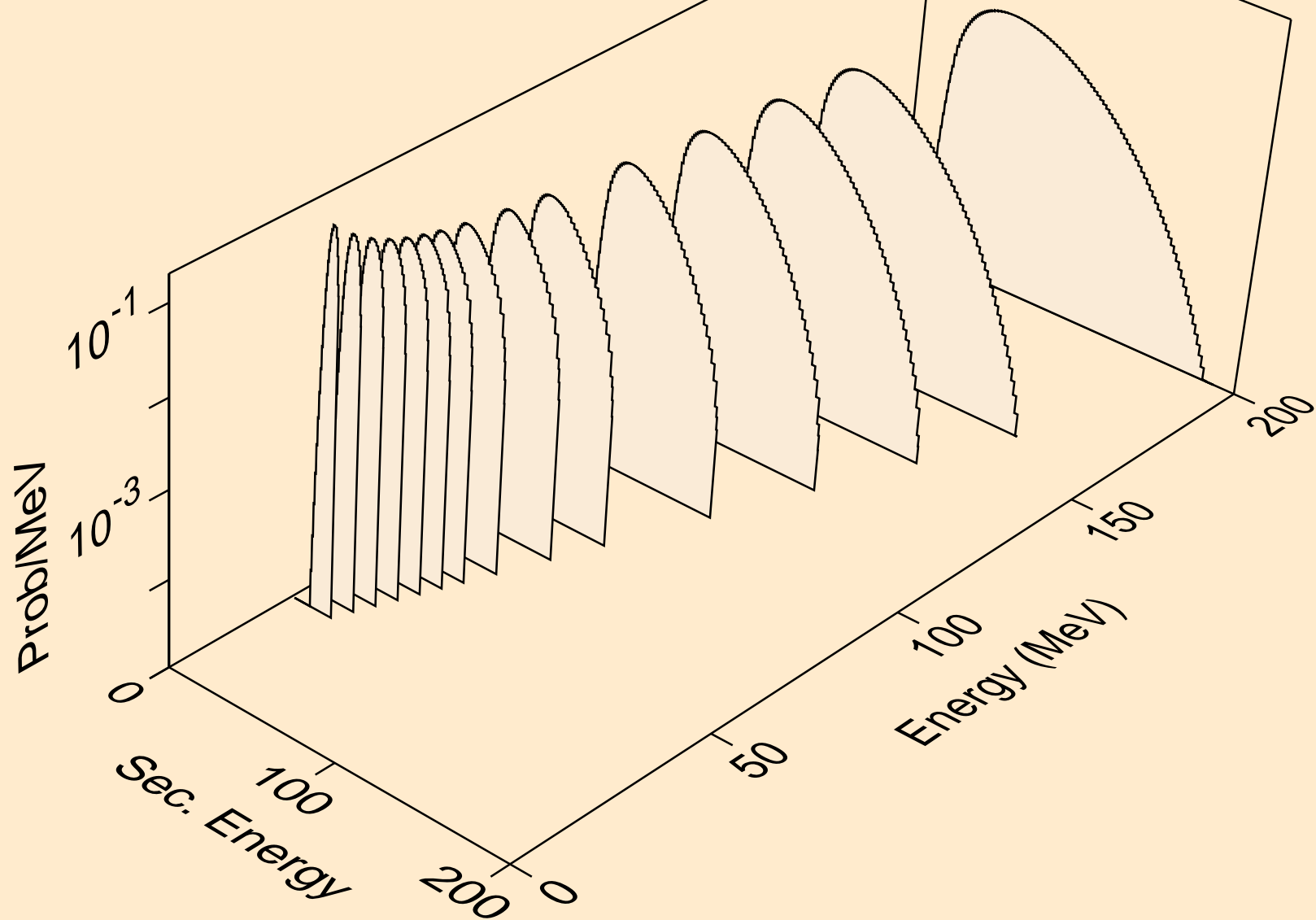

LU174 NEUTRON ACER TENDL-2024 LIBRARY; T=0.K  
he3s from (n,n\*)he3

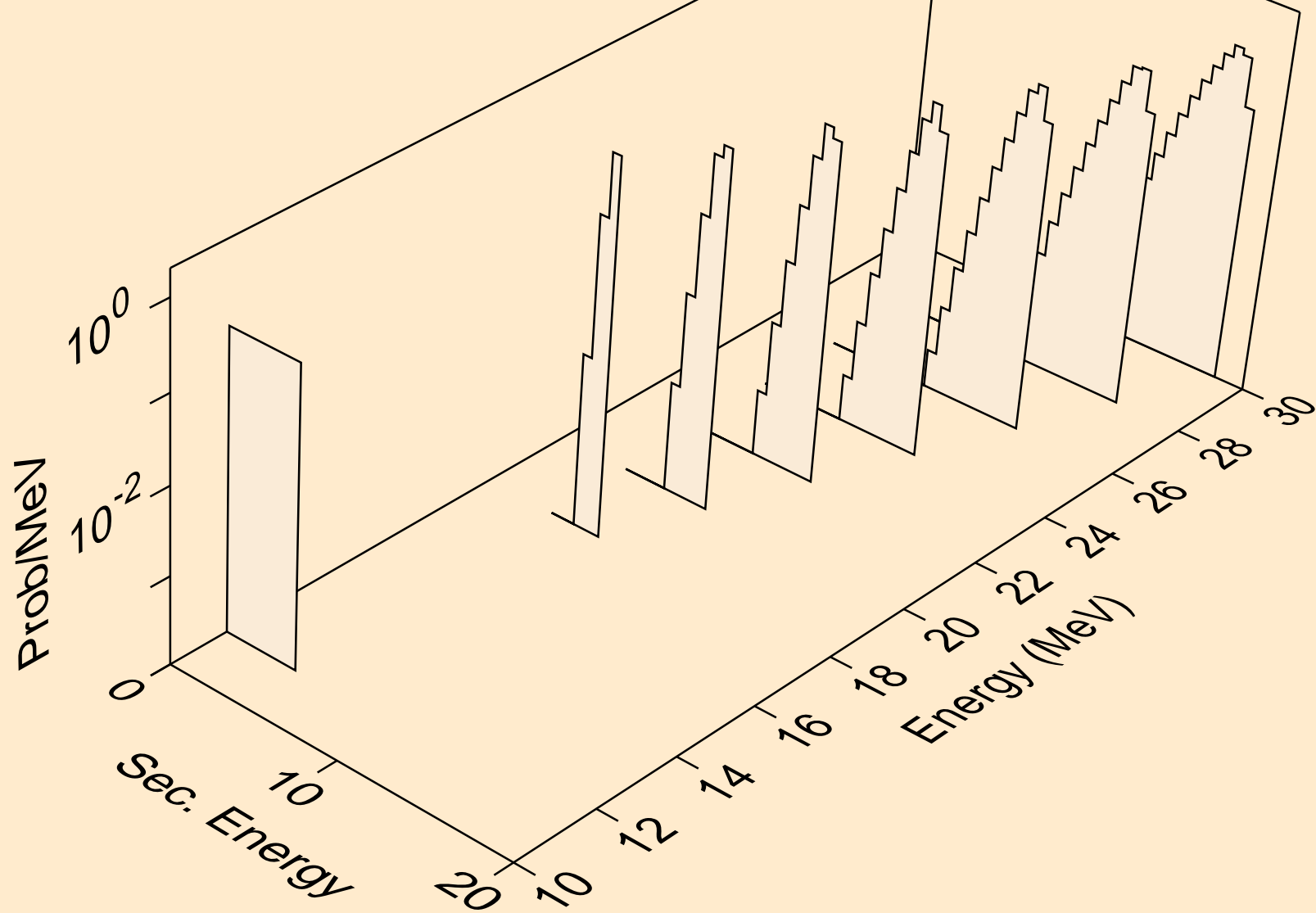

LU174 NEUTRON ACER TENDL-2024 LIBRARY; T=0.K  
he3s from (n,he3)

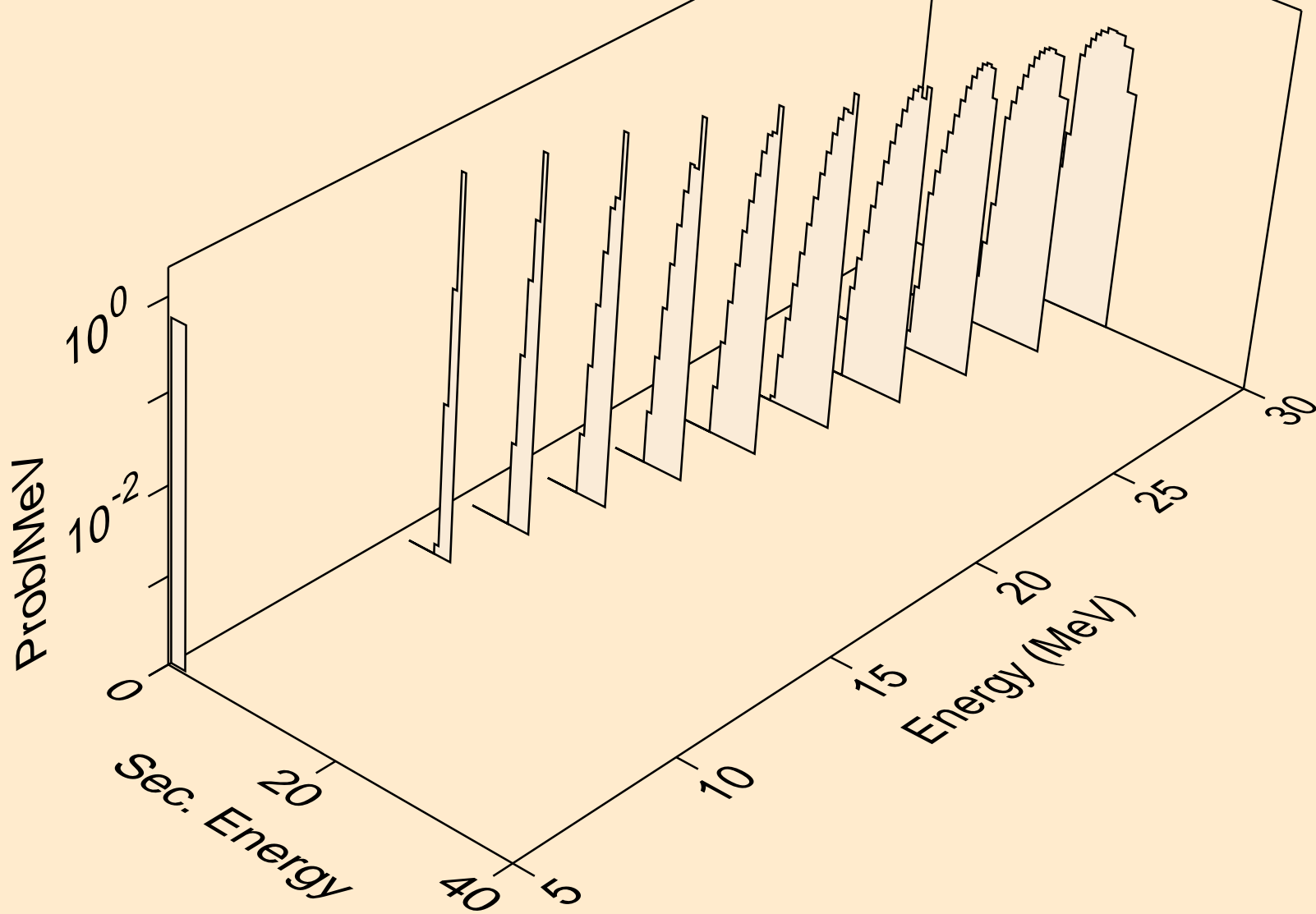

LU174 NEUTRON ACER TENDL-2024 LIBRARY; T=0.K  
alphas from (n,x)

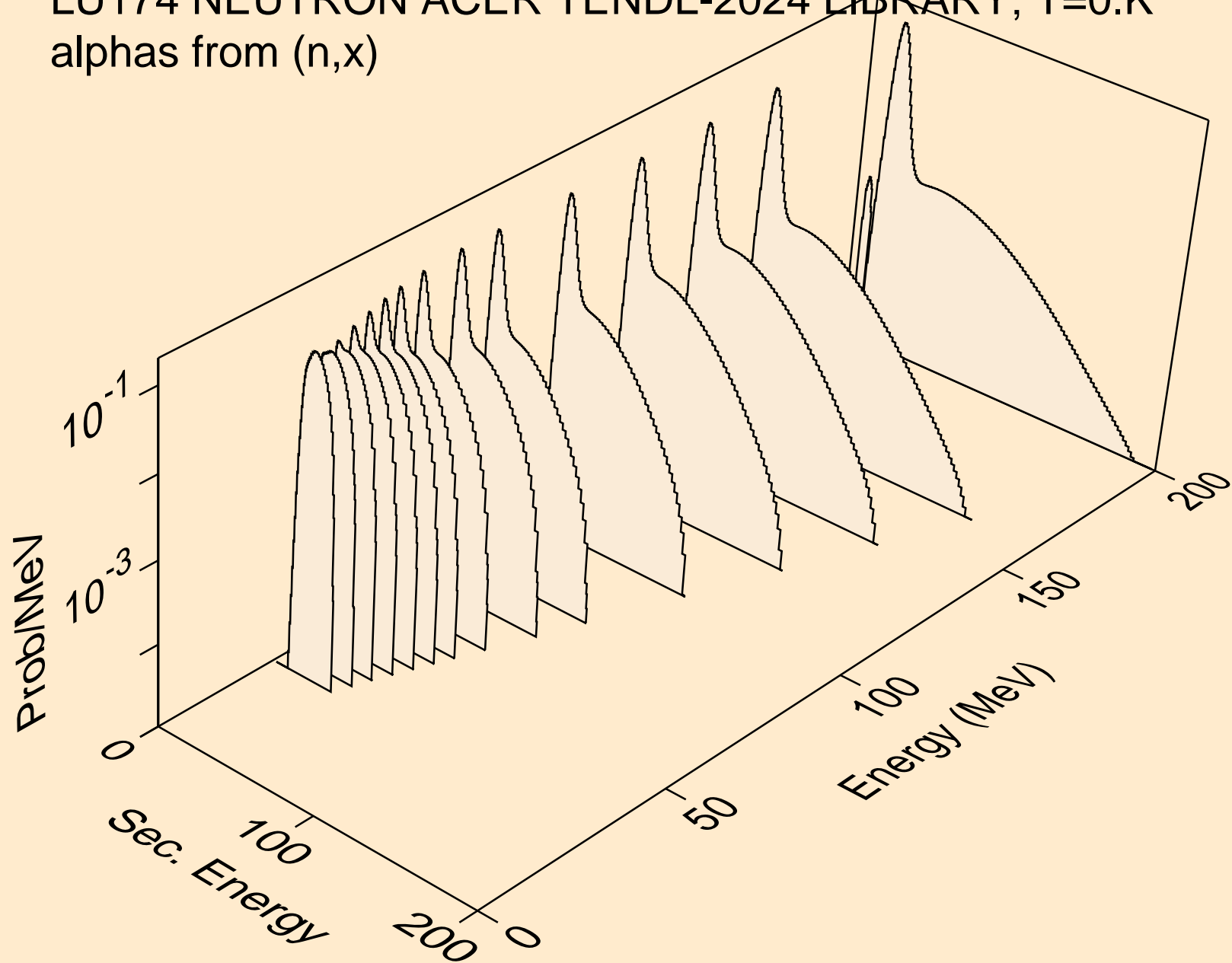

LU174 NEUTRON ACER TENDL-2024 LIBRARY; T=0.K  
alphas from (n,n\*)a

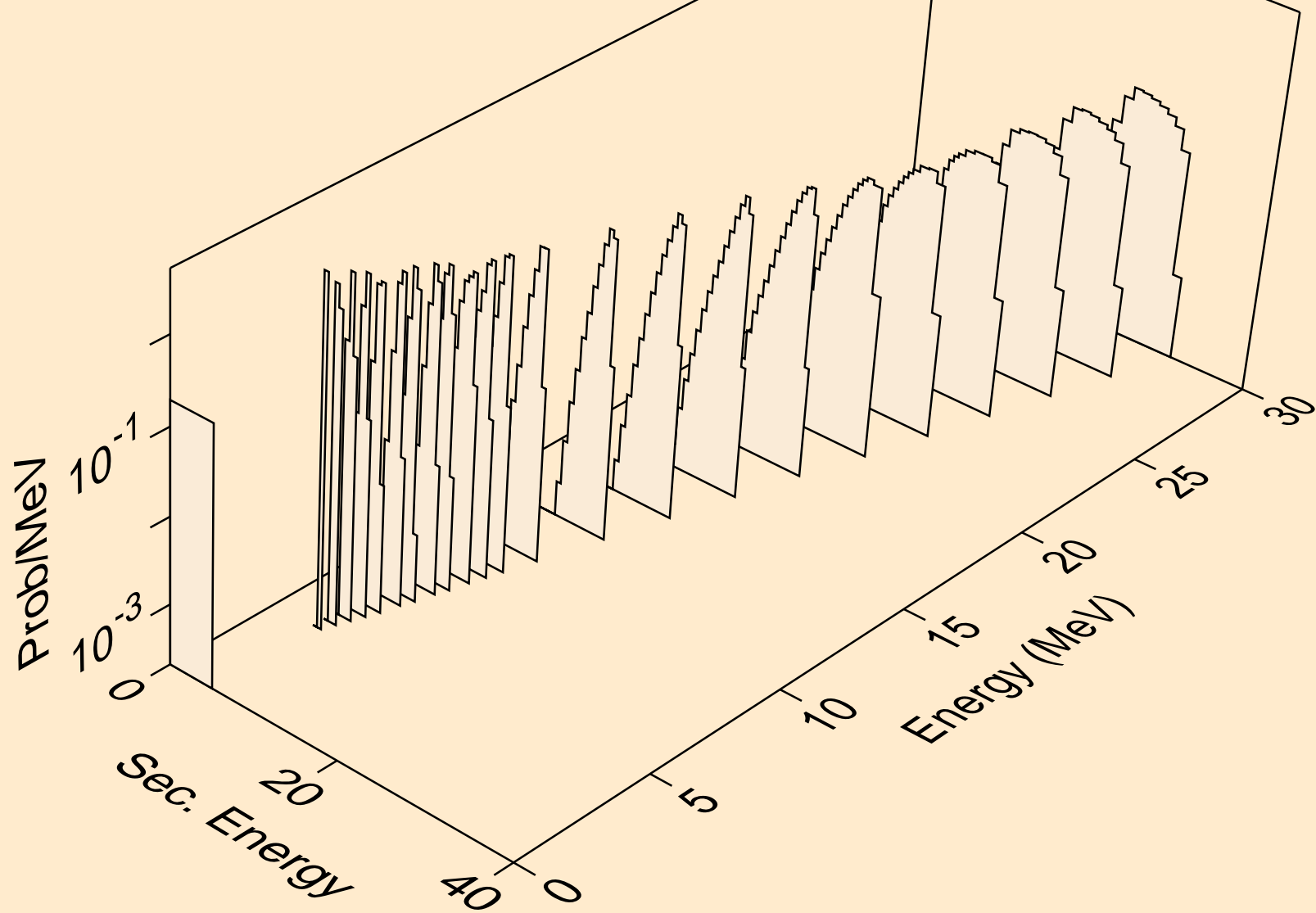

LU174 NEUTRON ACER TENDL-2024 LIBRARY; T=0.K  
alphas from (n,2n)a

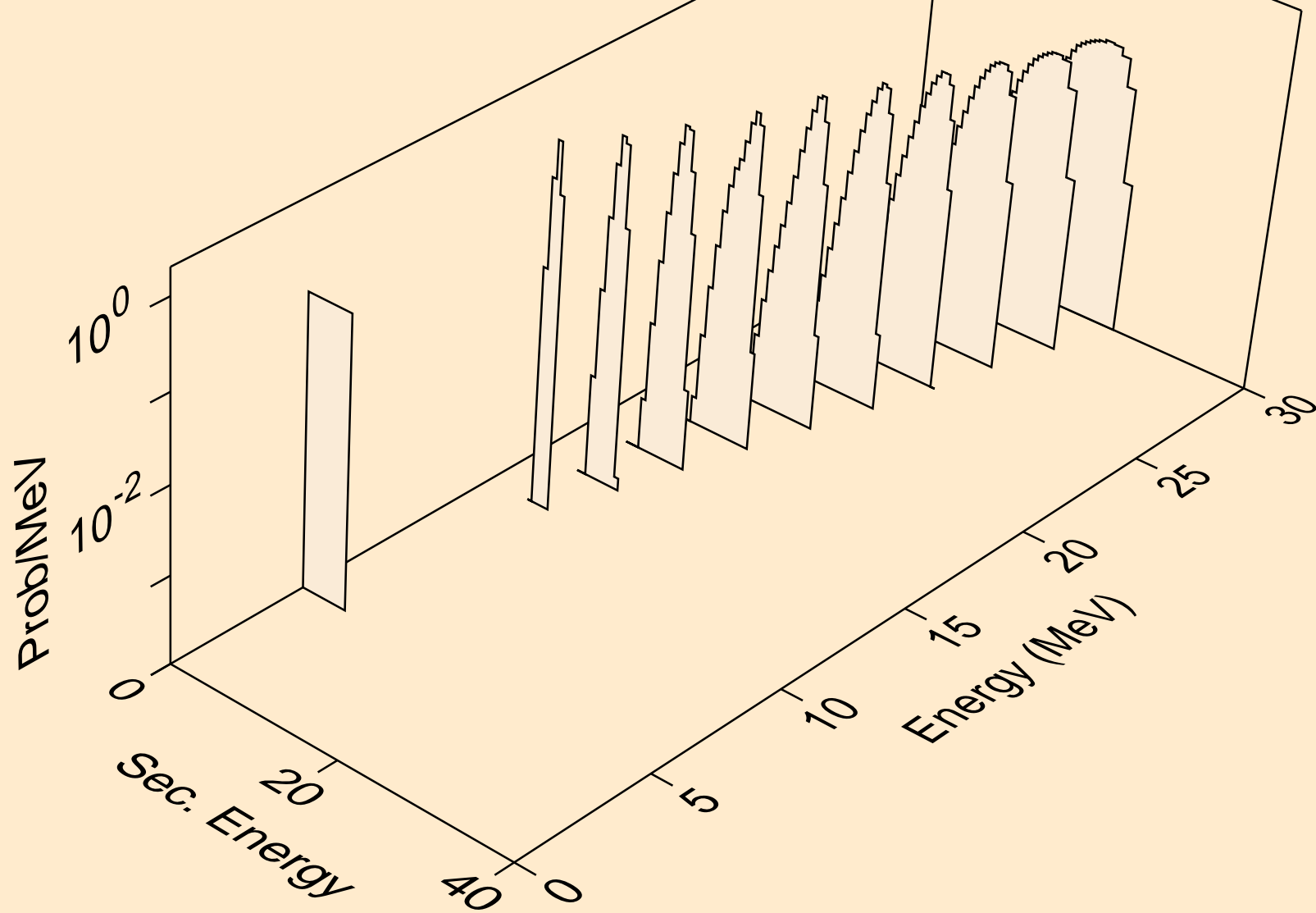

LU174 NEUTRON ACER TENDL-2024 LIBRARY; T=0.K  
alphas from (n,3n)a

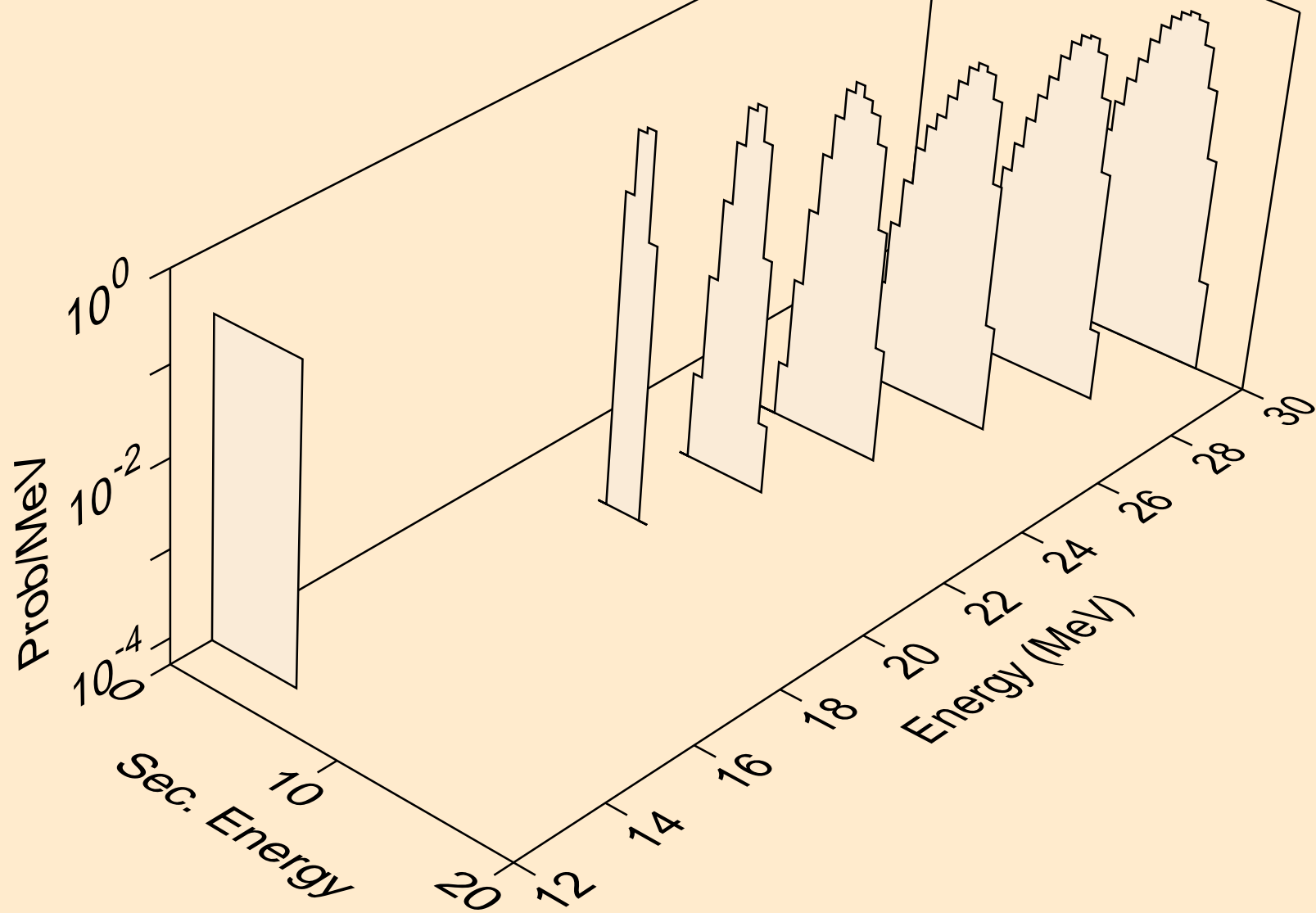

LU174 NEUTRON ACER TENDL-2024 LIBRARY; T=0.K  
alphas from (n,n\*)2a

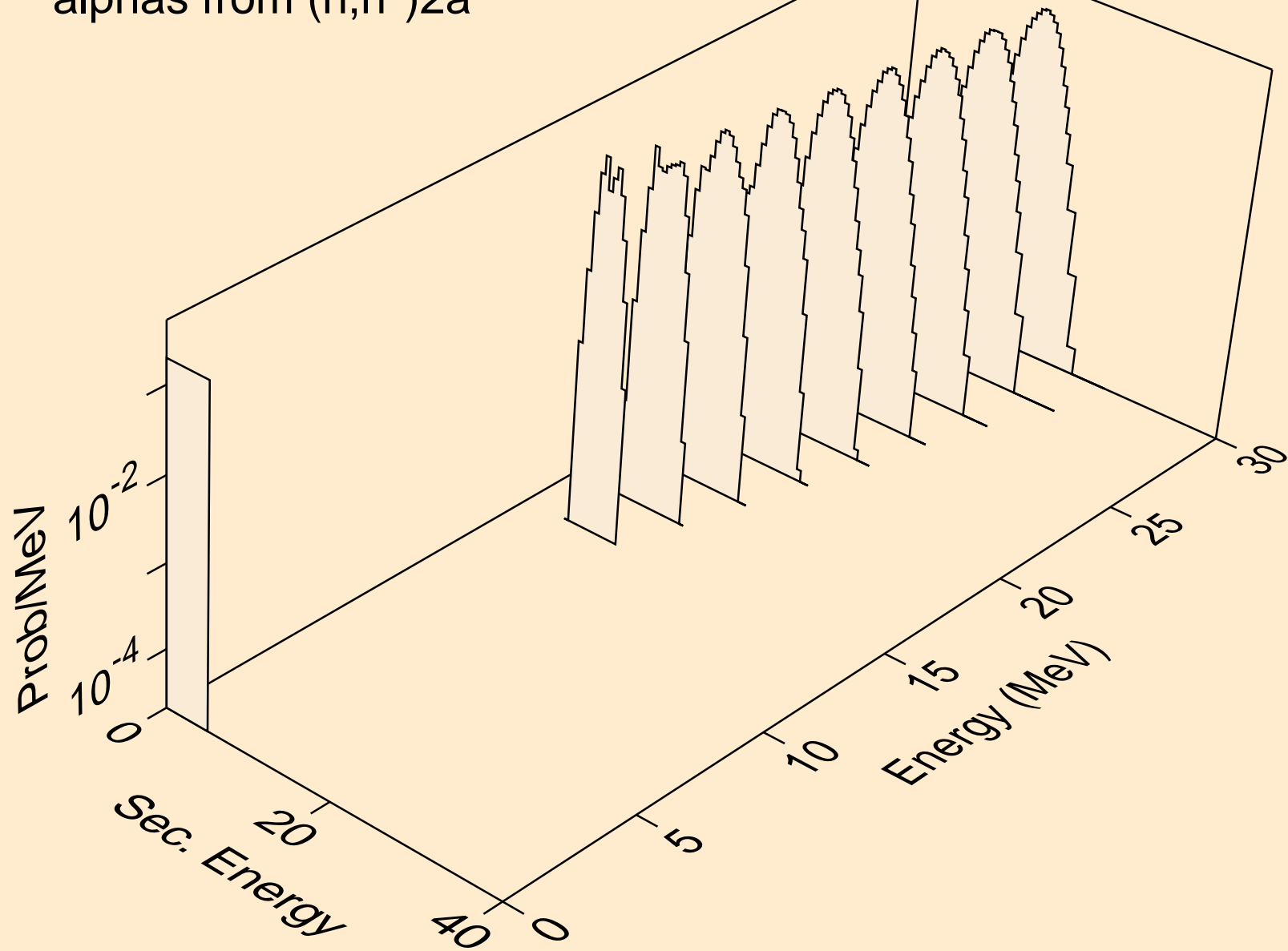



LU174 NEUTRON ACER TENDL-2024 LIBRARY; T=0.K  
alphas from (n,npa)

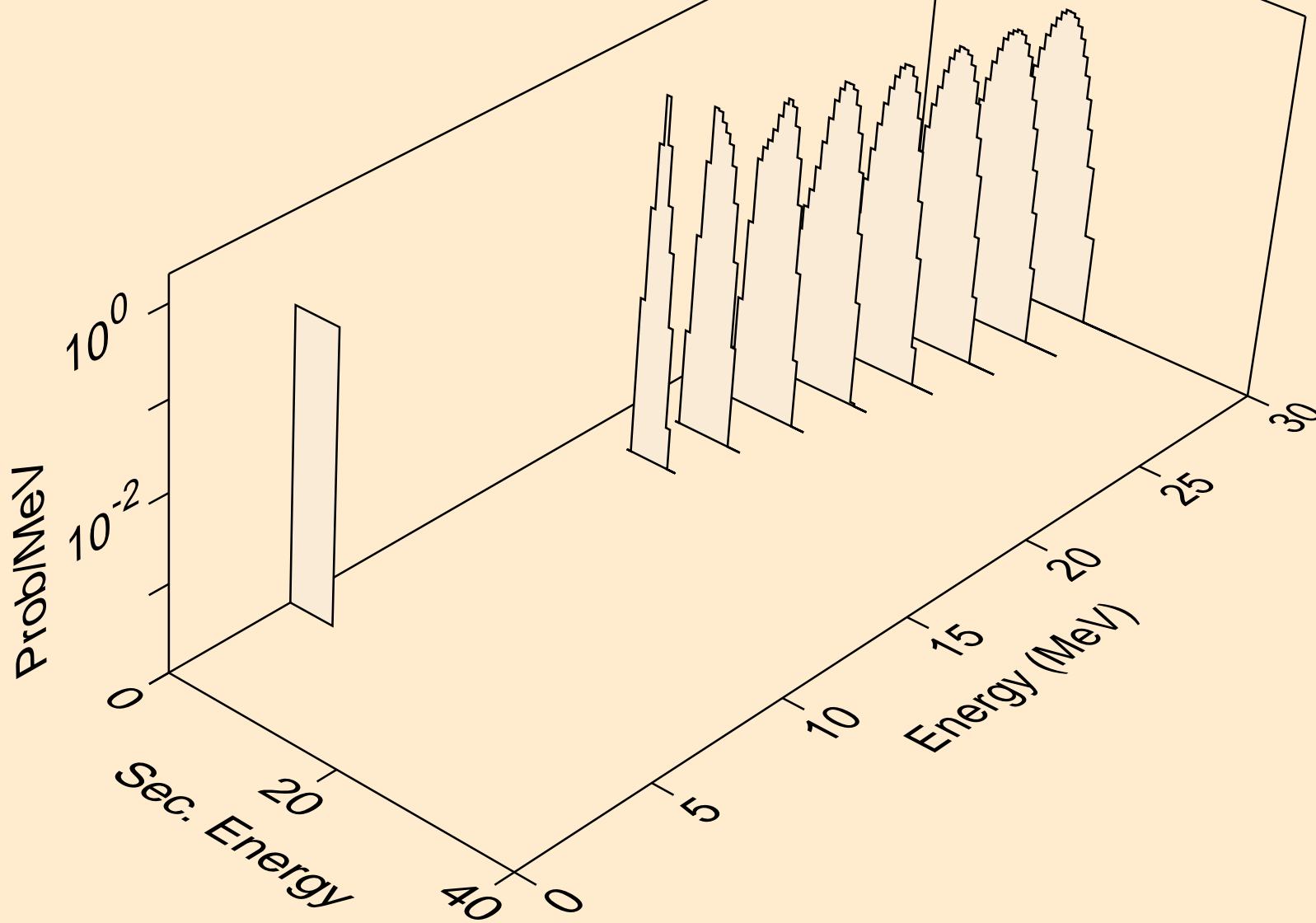

LU174 NEUTRON ACER TENDL-2024 LIBRARY; T=0.K  
alphas from (n,a)

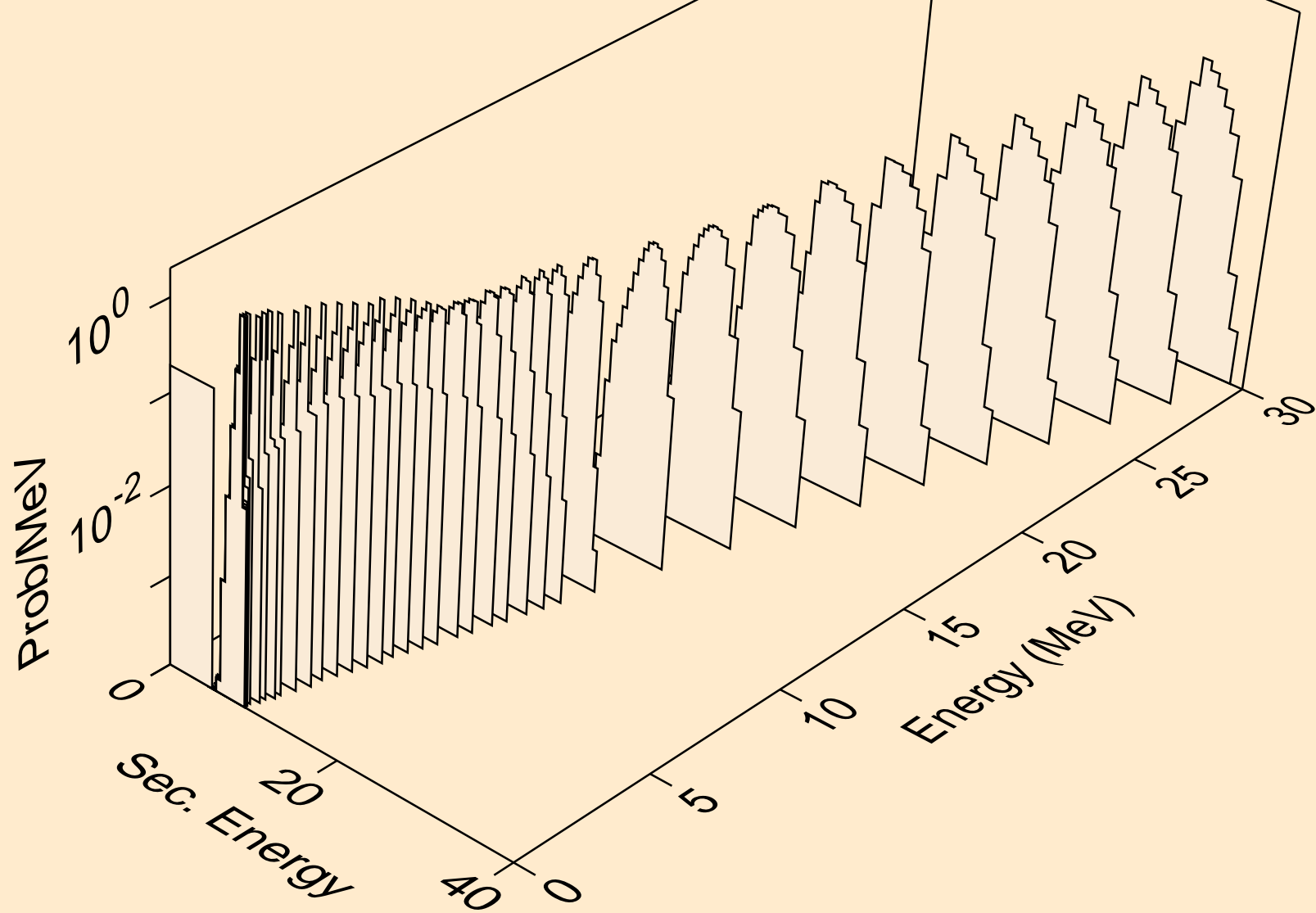

LU174 NEUTRON ACER TENDL-2024 LIBRARY; T=0.K  
alphas from (n,2a)

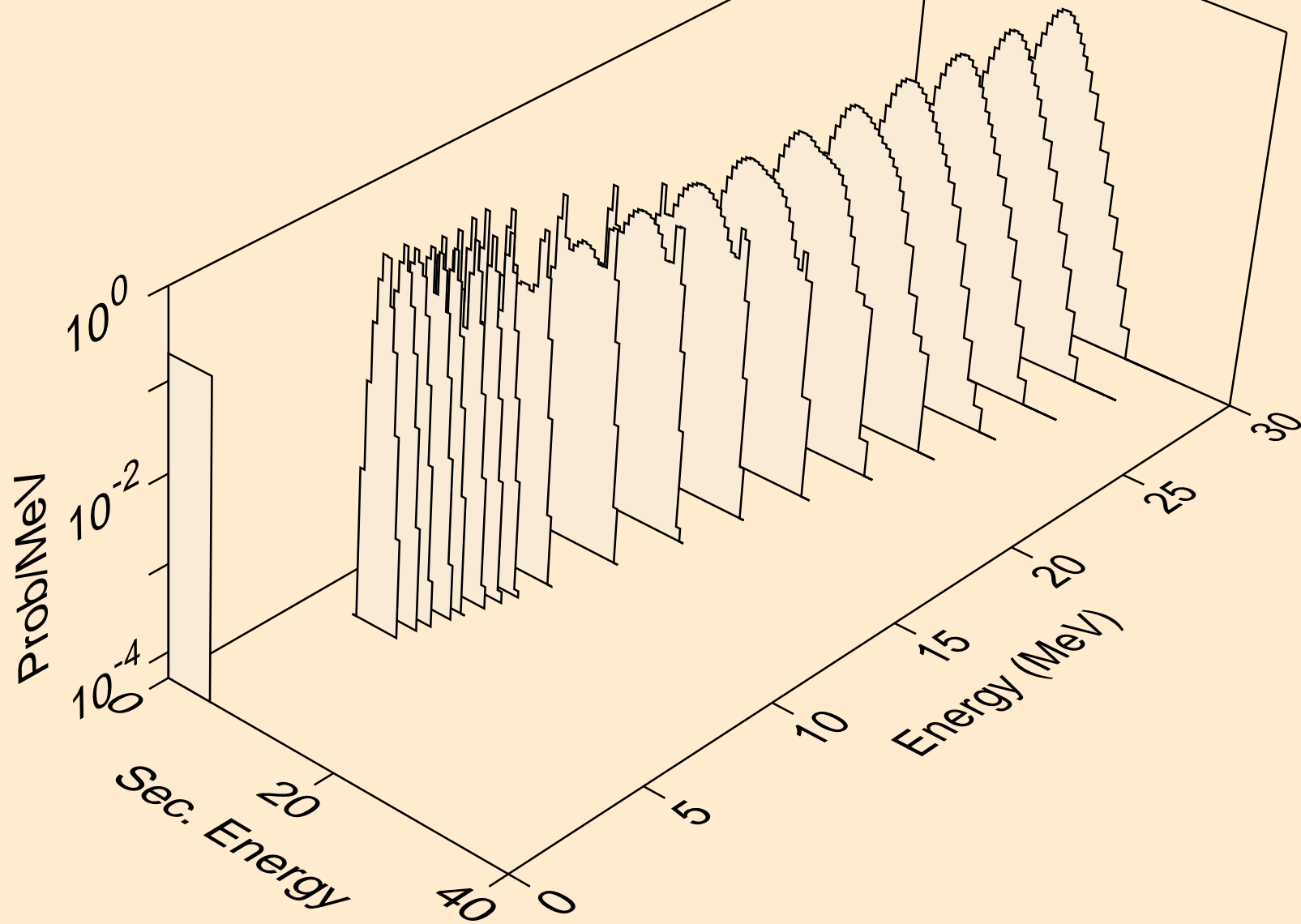

LU174 NEUTRON ACER TENDL-2024 LIBRARY; T=0.K  
alphas from (n,p)

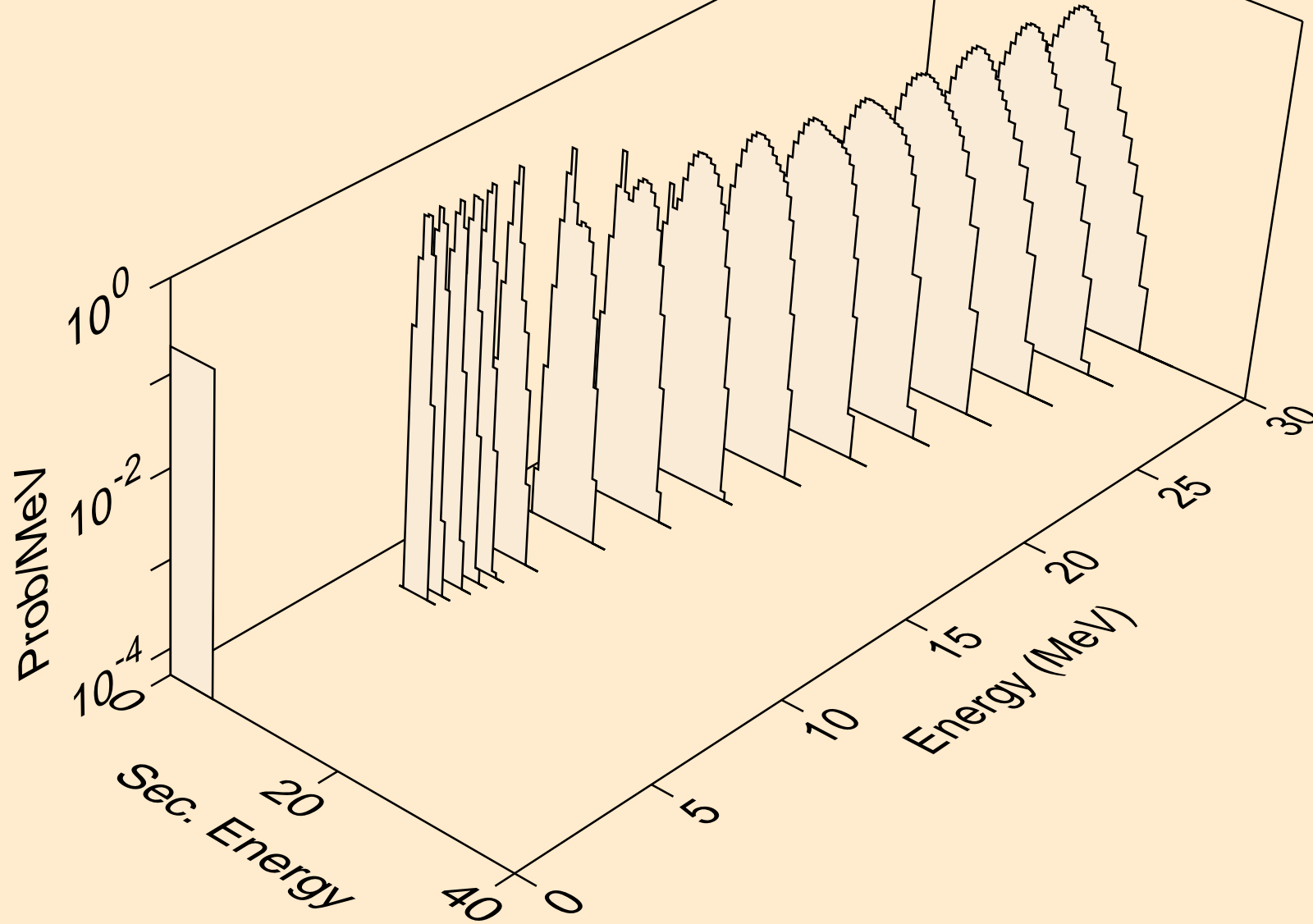

LU174 NEUTRON ACER TENDL-2024 LIBRARY; T=0.K  
alphas from (n,da)

