

LU183 NEUTRON ACER TENDL-2024 LIBRARY; T=0.K

Principal cross sections

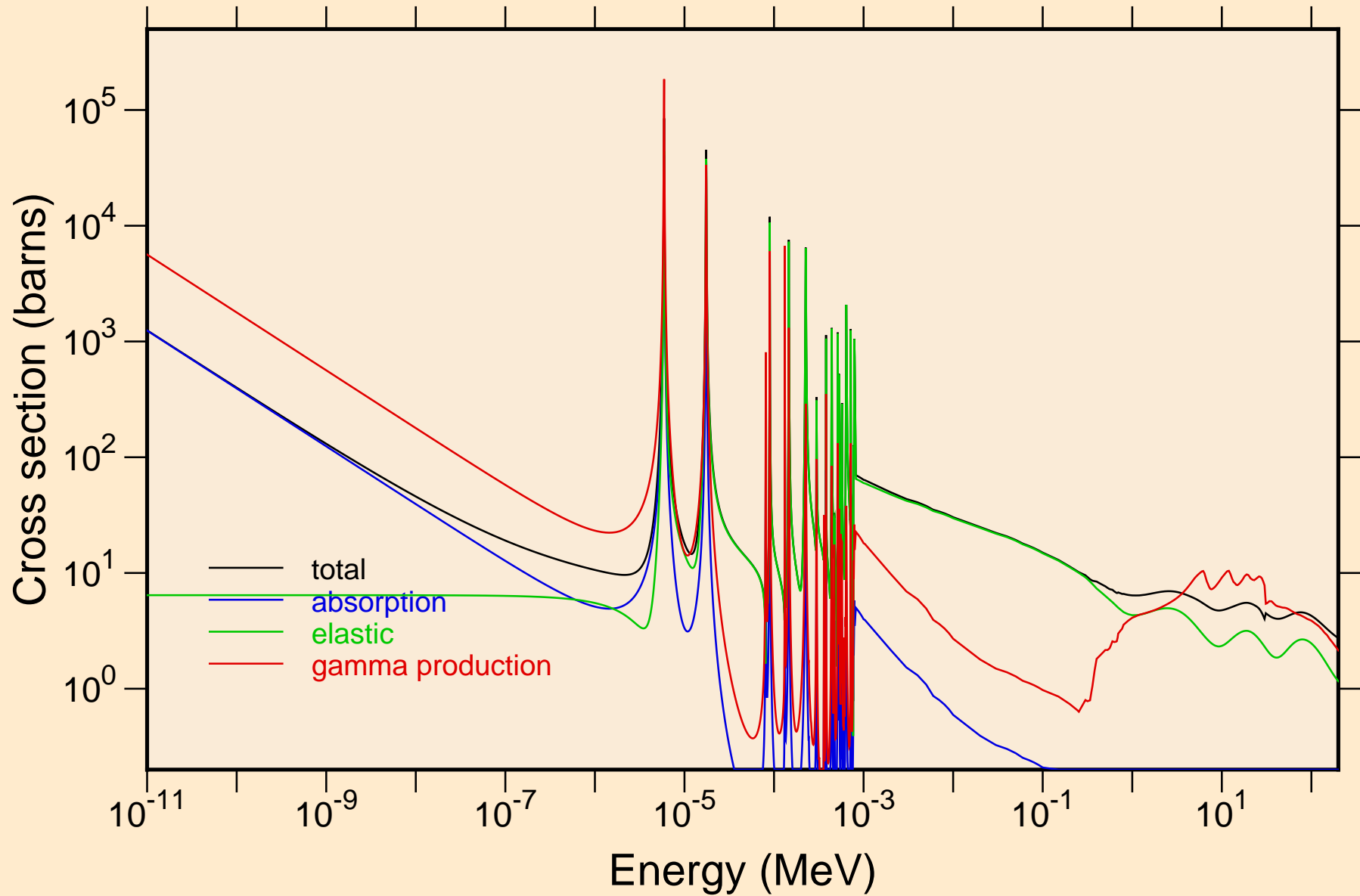

LU183 NEUTRON ACER TENDL-2024 LIBRARY; T=0.K
resonance total cross section

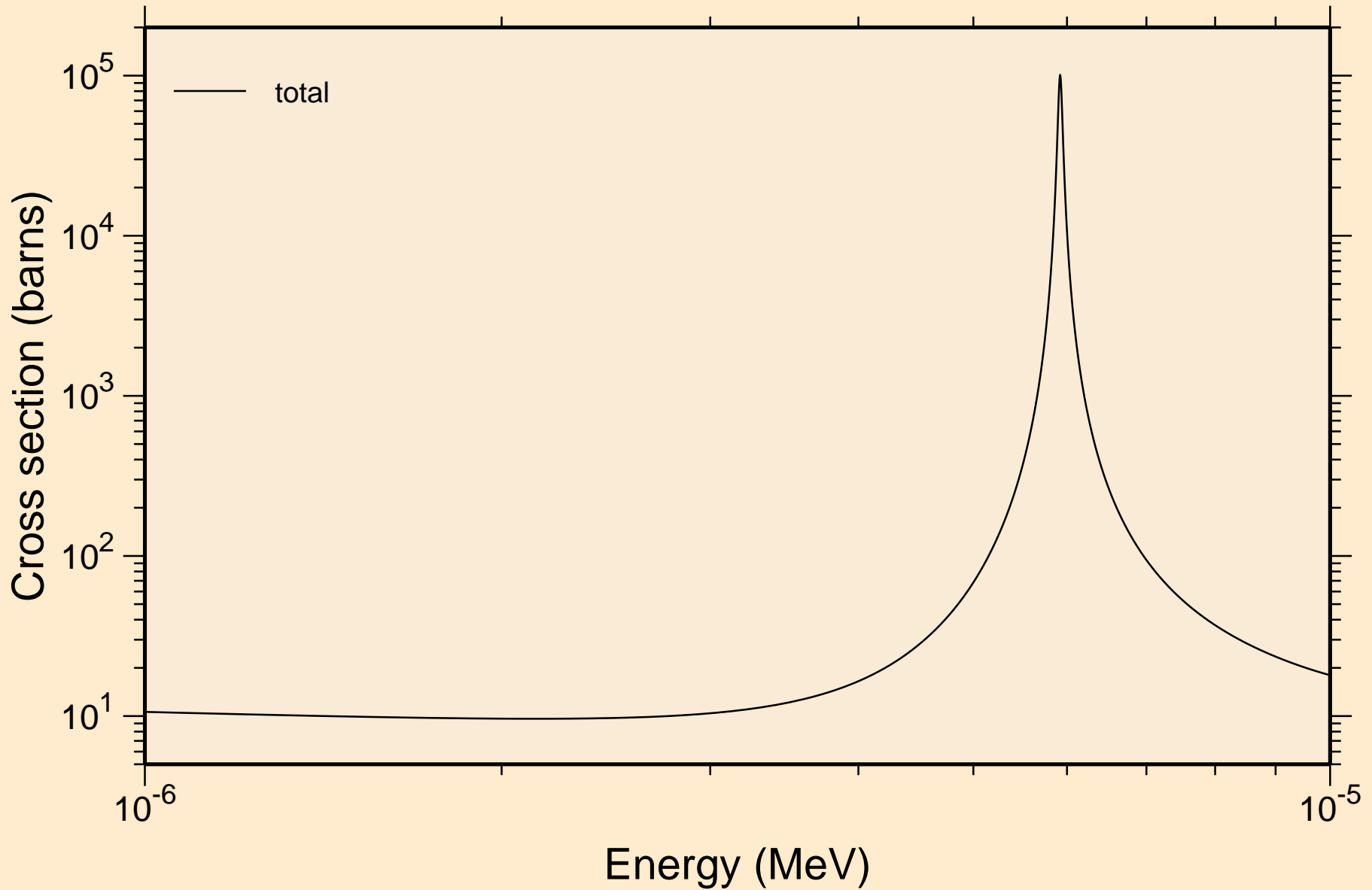

LU183 NEUTRON ACER TENDL-2024 LIBRARY; T=0.K
resonance total cross section

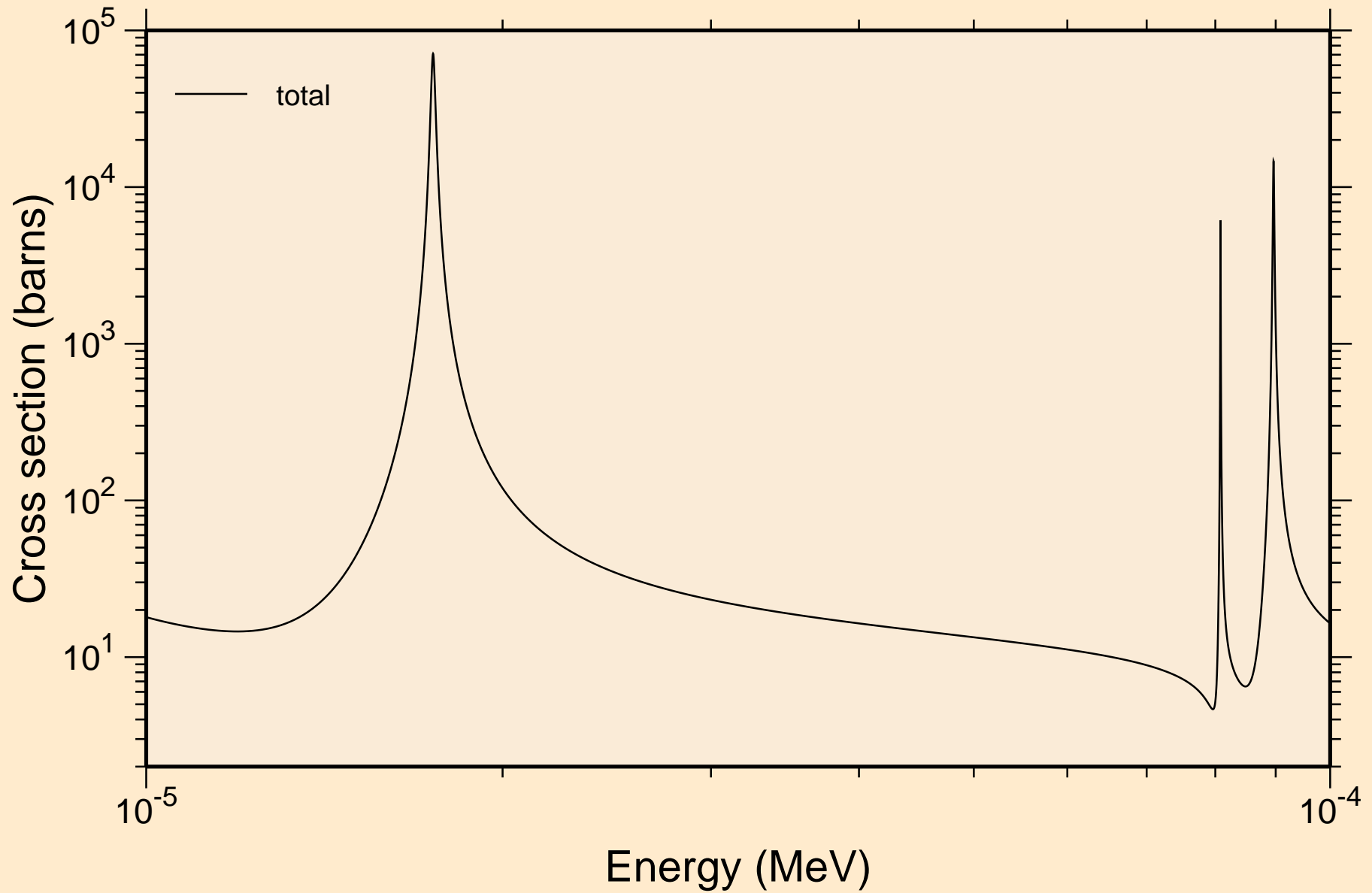

LU183 NEUTRON ACER TENDL-2024 LIBRARY; T=0.K
resonance total cross section

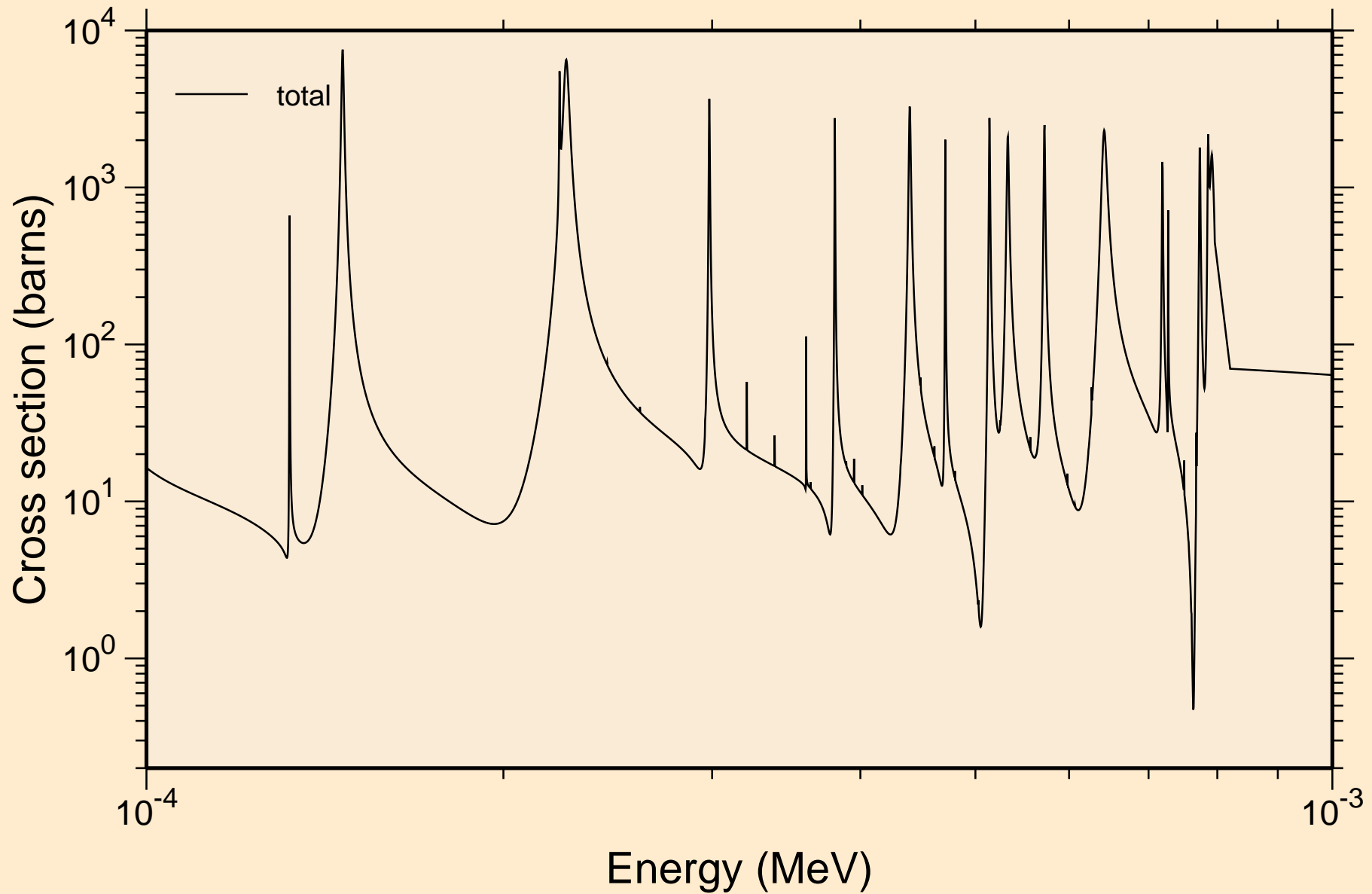

LU183 NEUTRON ACER TENDL-2024 LIBRARY; T=0.K
resonance total cross section

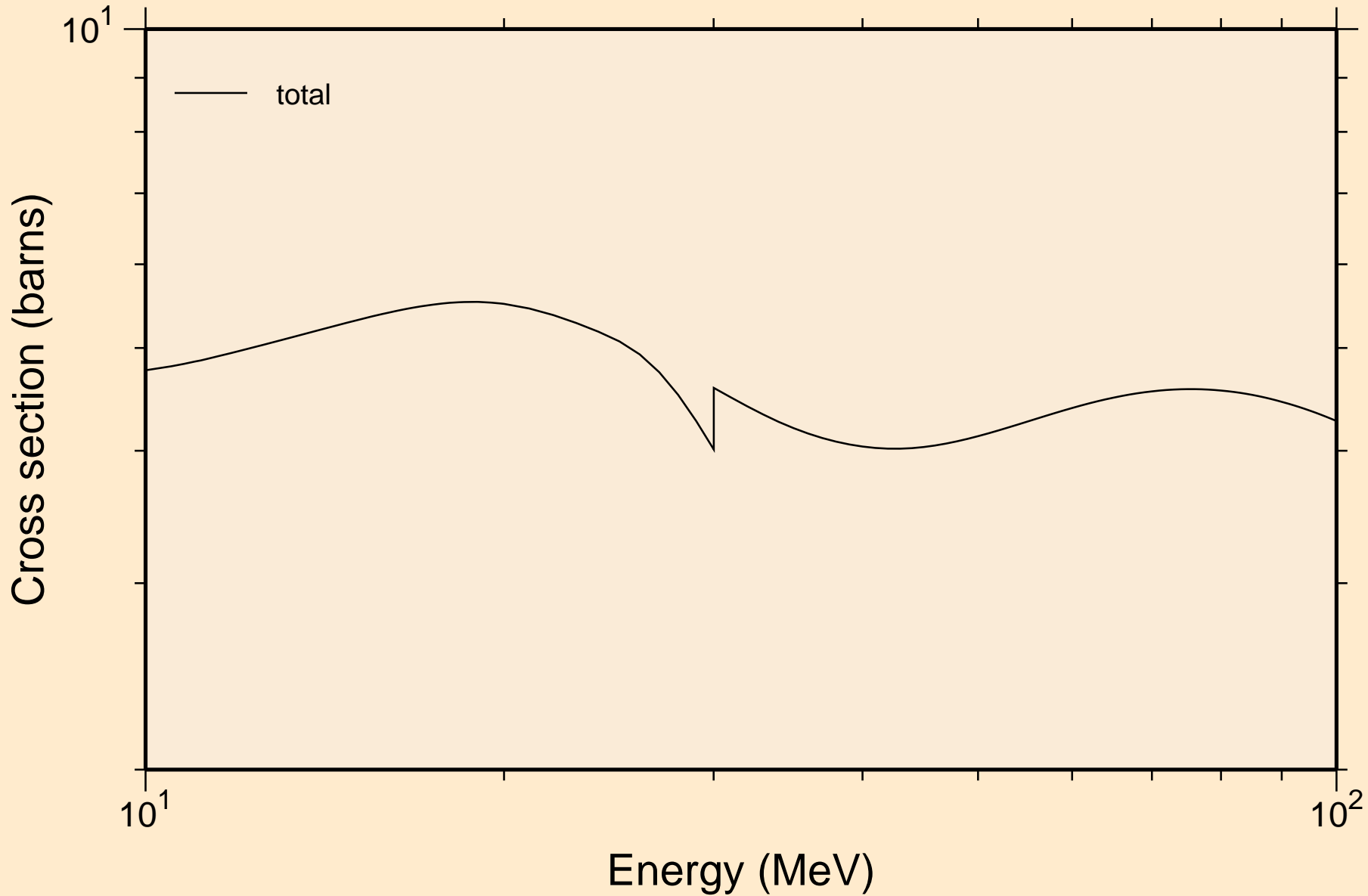

LU183 NEUTRON ACER TENDL-2024 LIBRARY; T=0.K
resonance absorption cross sections

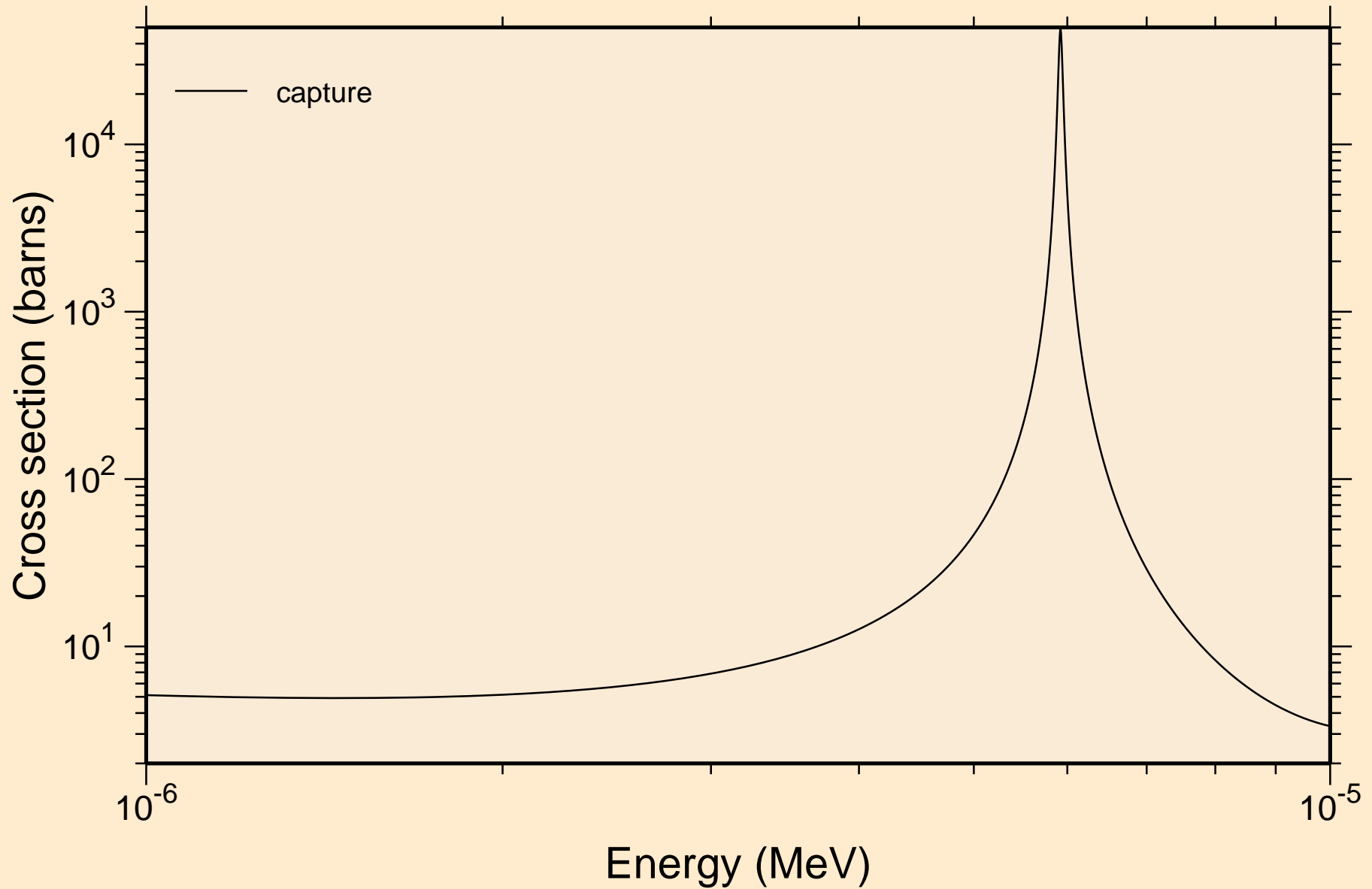

LU183 NEUTRON ACER TENDL-2024 LIBRARY; T=0.K
resonance absorption cross sections

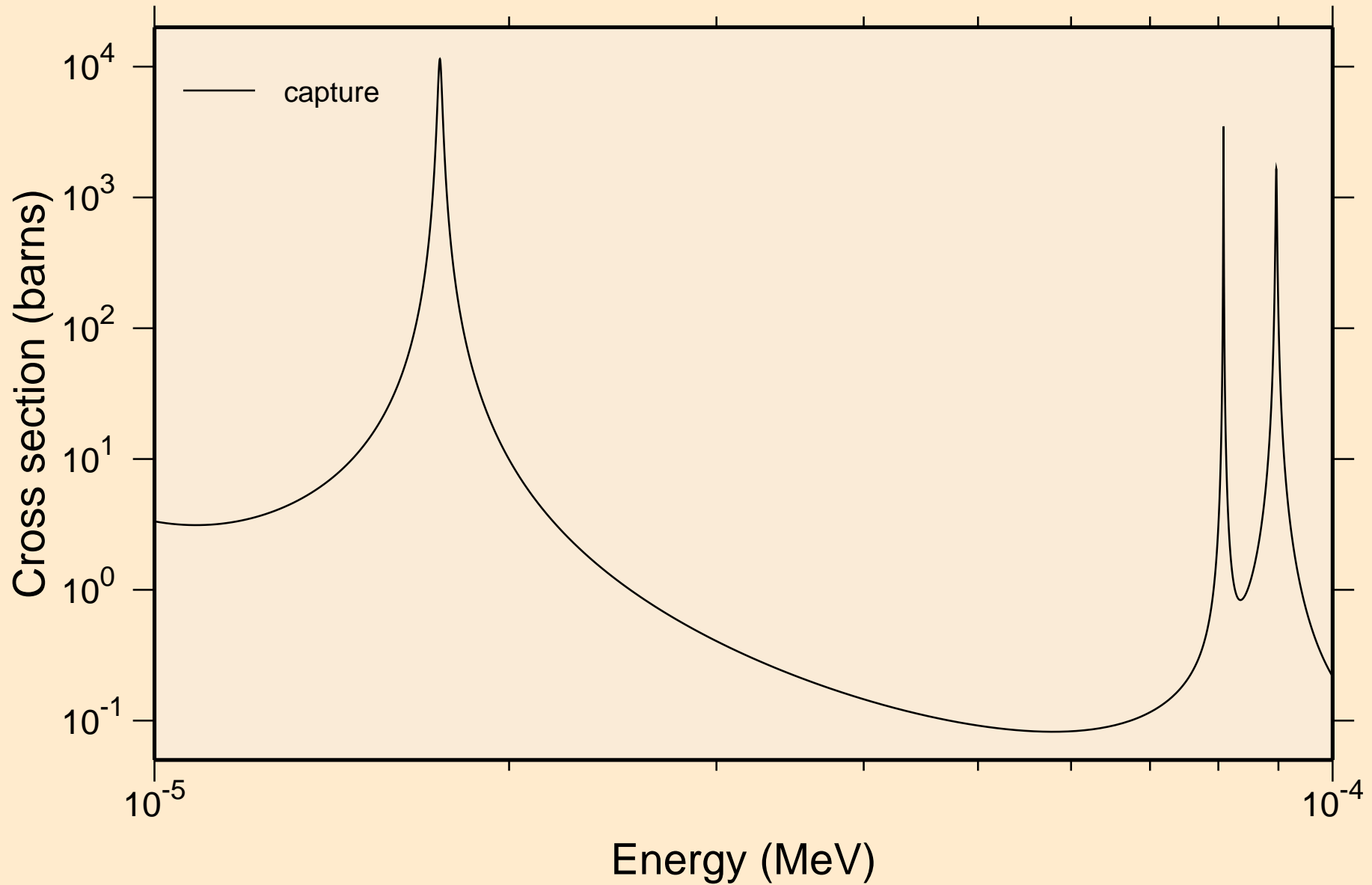

LU183 NEUTRON ACER TENDL-2024 LIBRARY; T=0.K
resonance absorption cross sections

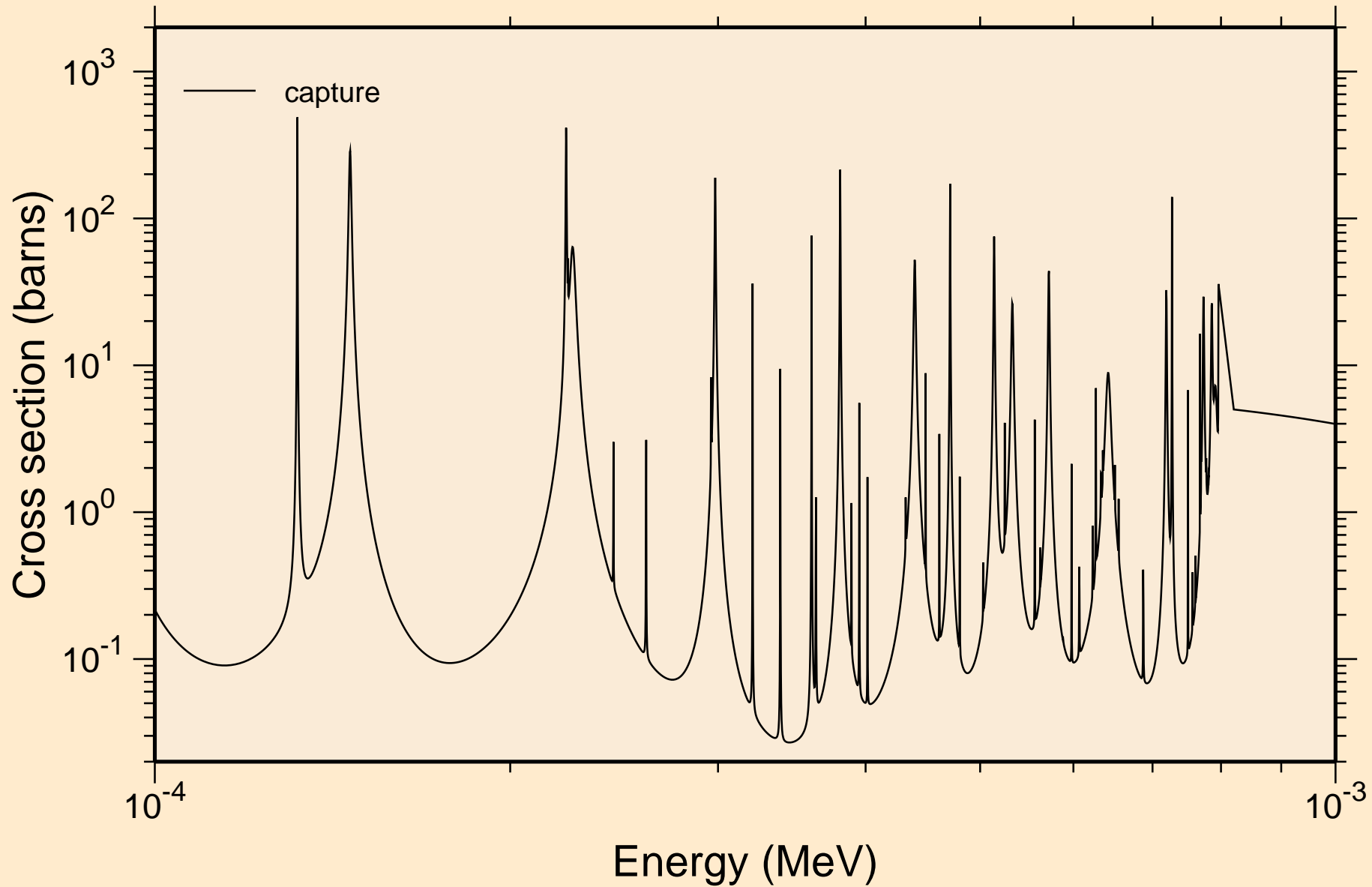

LU183 NEUTRON ACER TENDL-2024 LIBRARY; T=0.K
resonance absorption cross sections

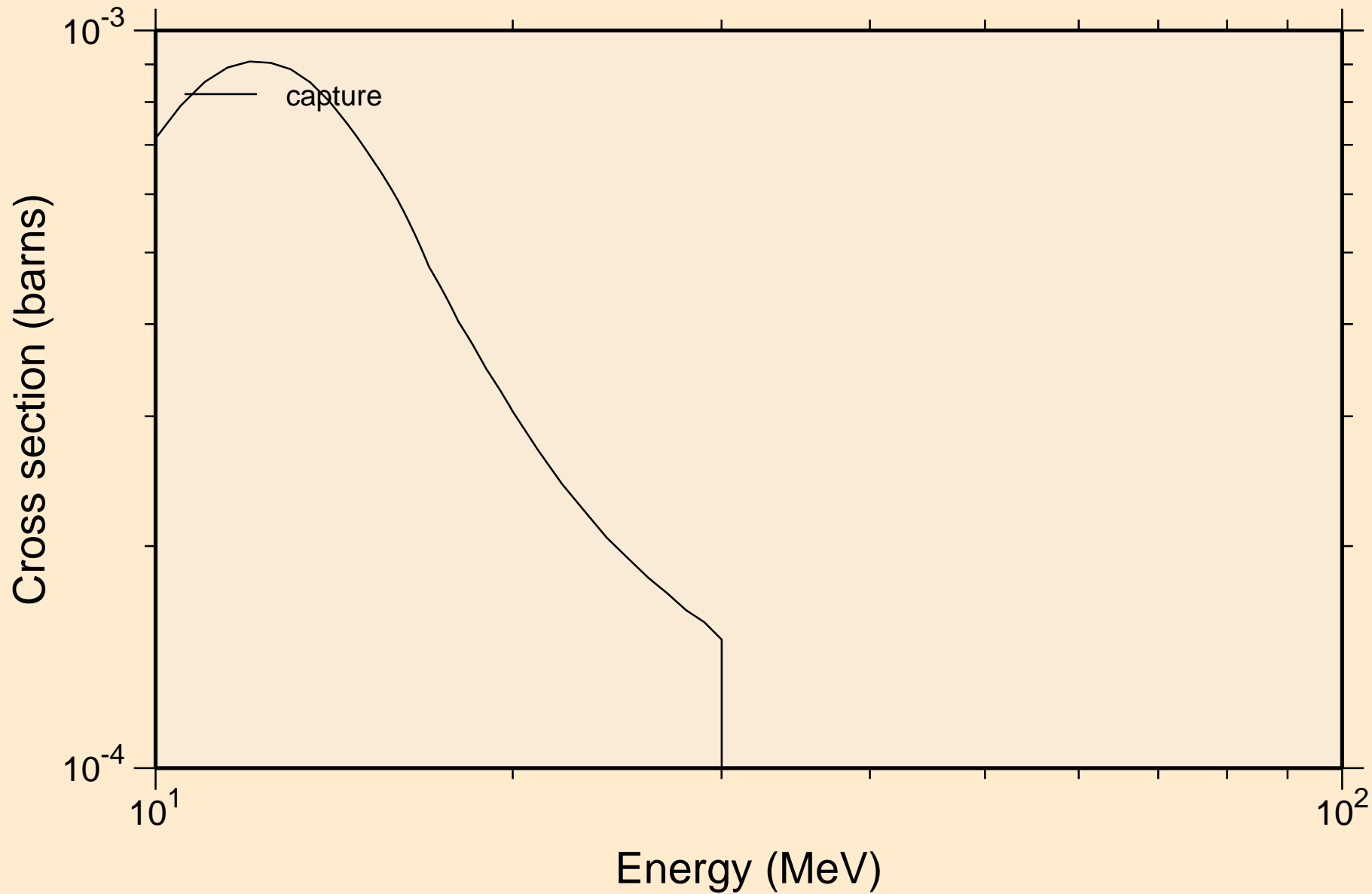

LU183 NEUTRON ACER TENDL-2024 LIBRARY; T=0.K
Heating

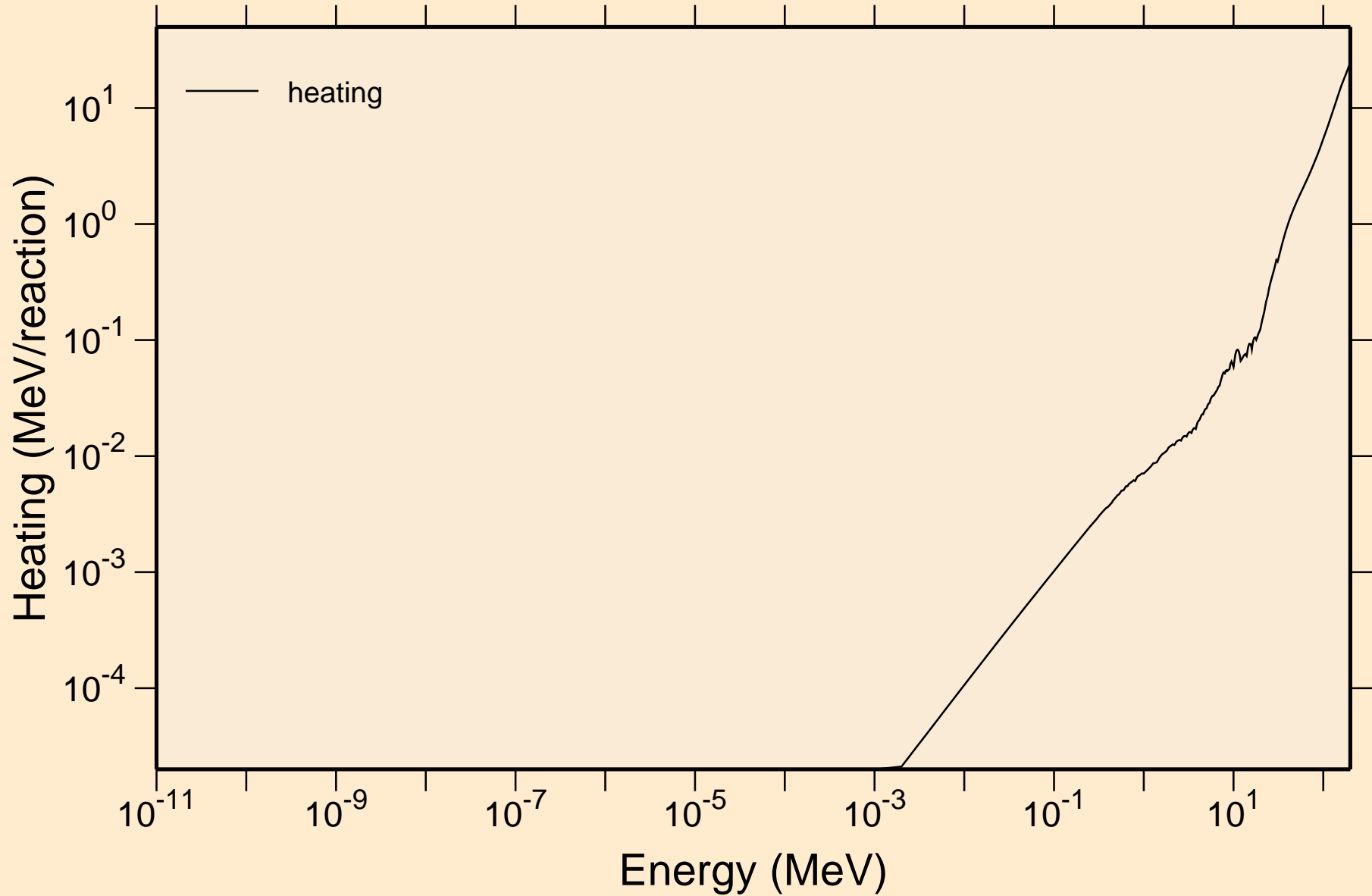

LU183 NEUTRON ACER TENDL-2024 LIBRARY; T=0.K

Damage

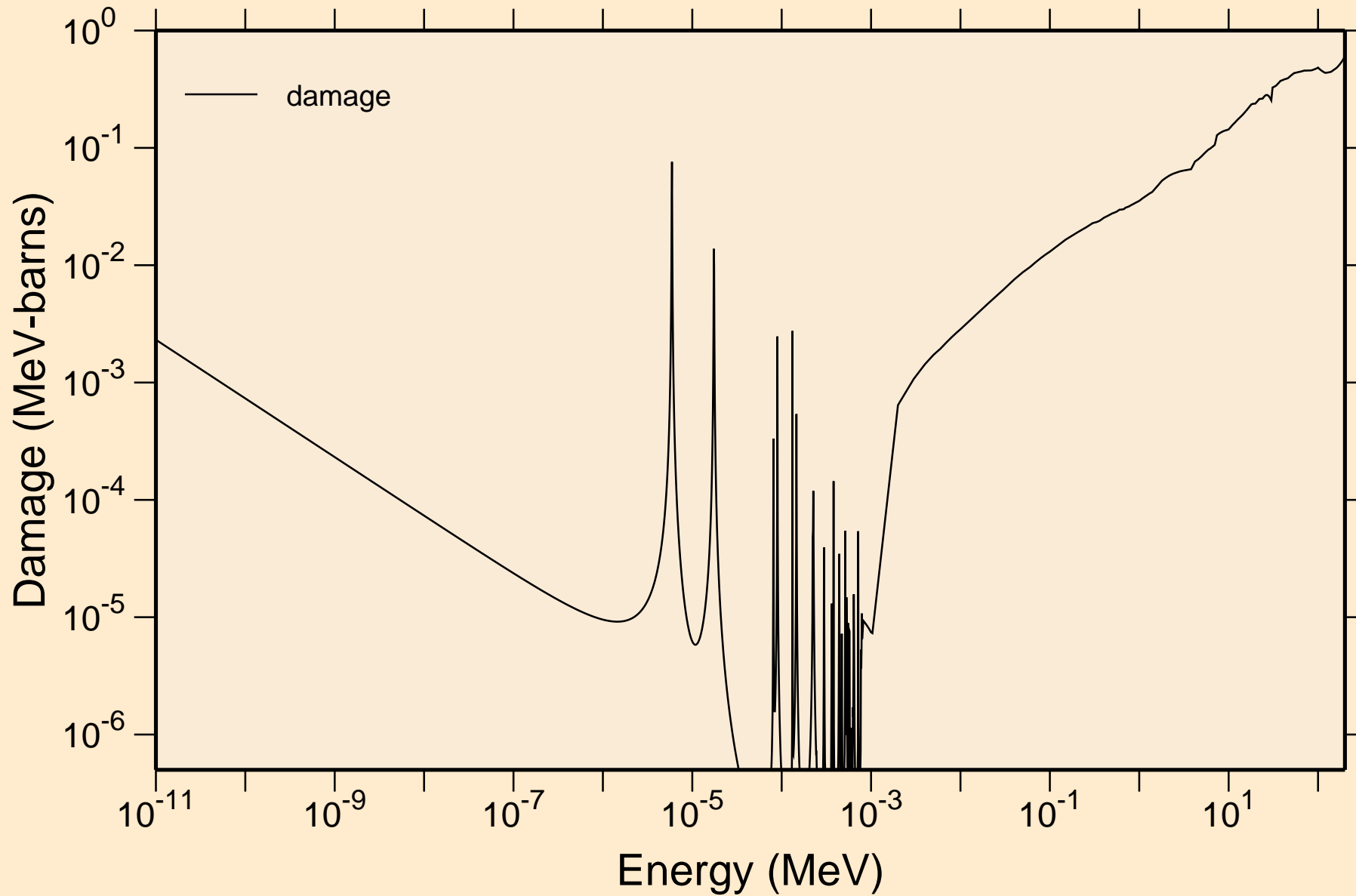

LU183 NEUTRON ACER TENDL-2024 LIBRARY; T=0.K
Non-threshold reactions

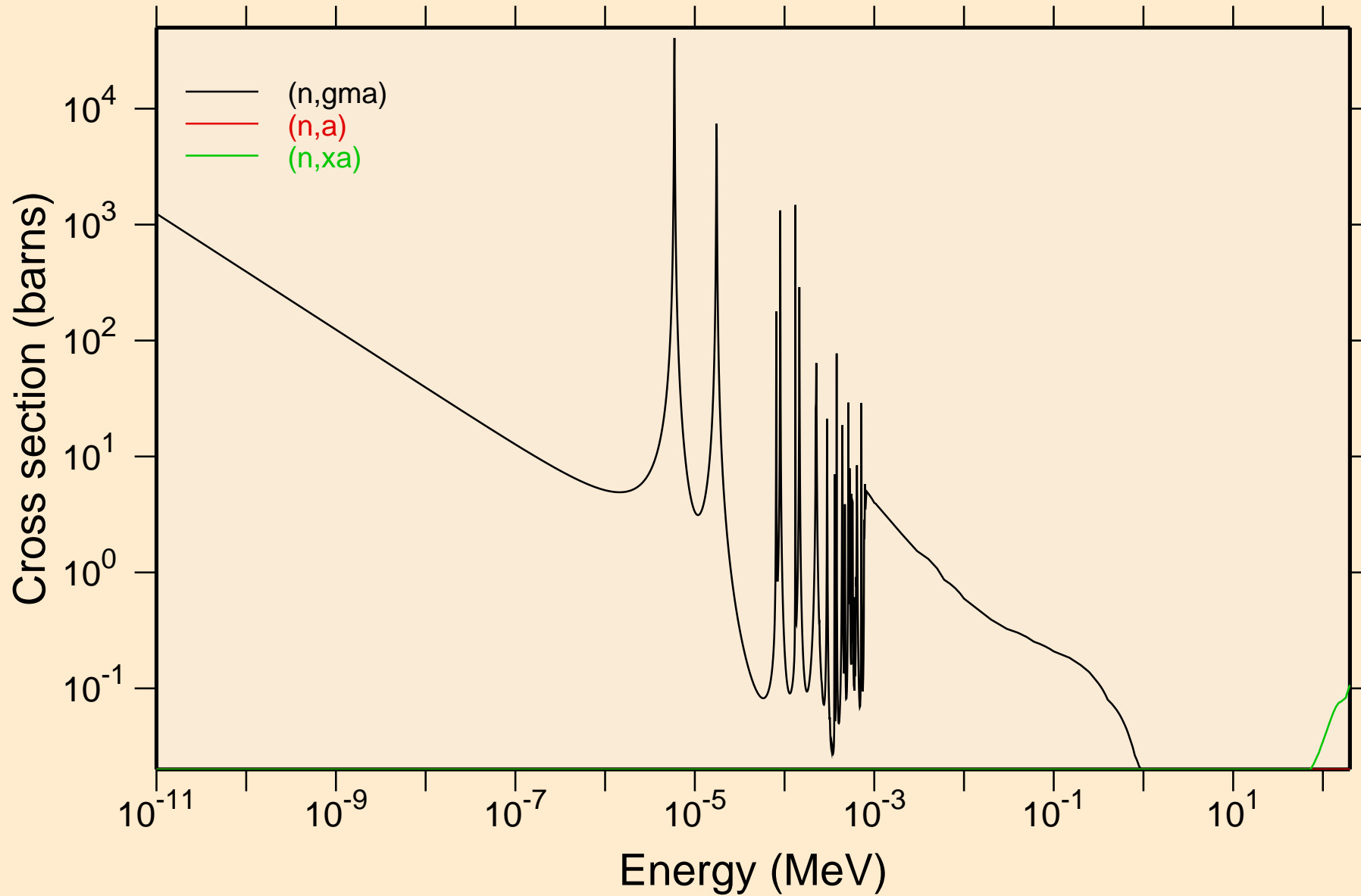

LU183 NEUTRON ACER TENDL-2024 LIBRARY; T=0.K

Principal cross sections

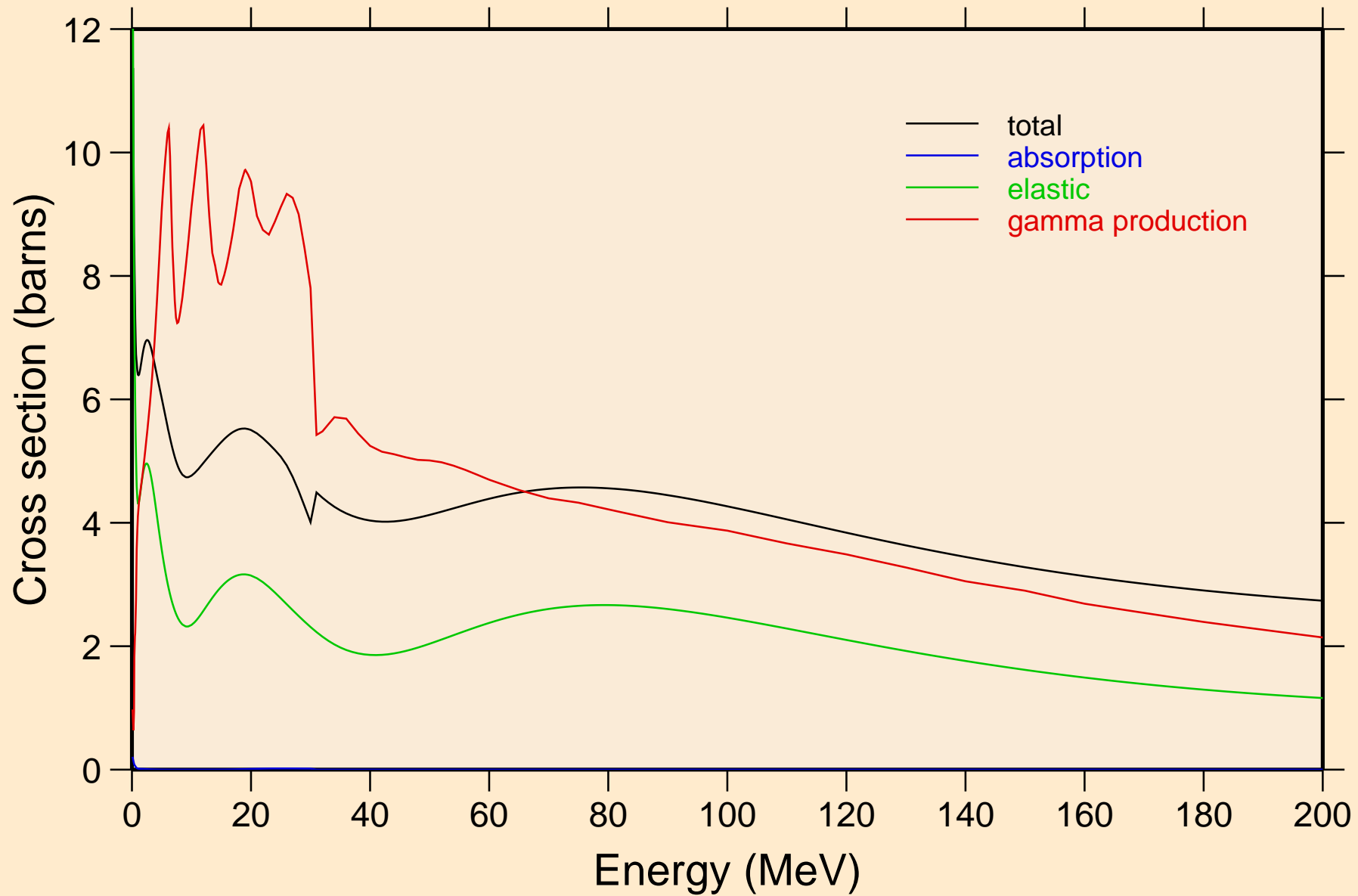

LU183 NEUTRON ACER TENDL-2024 LIBRARY; T=0.K

Heating

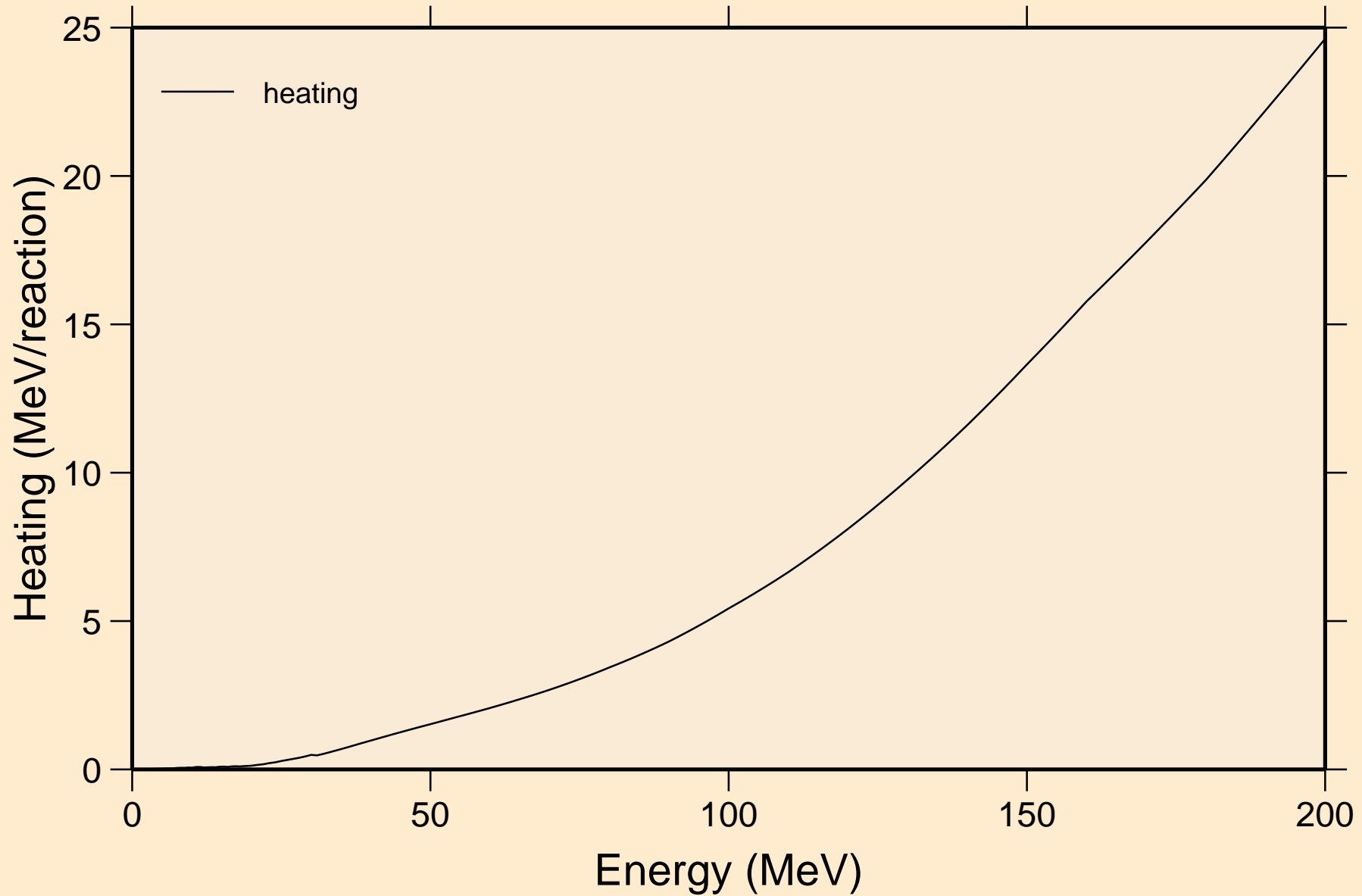

LU183 NEUTRON ACER TENDL-2024 LIBRARY; T=0.K
Damage

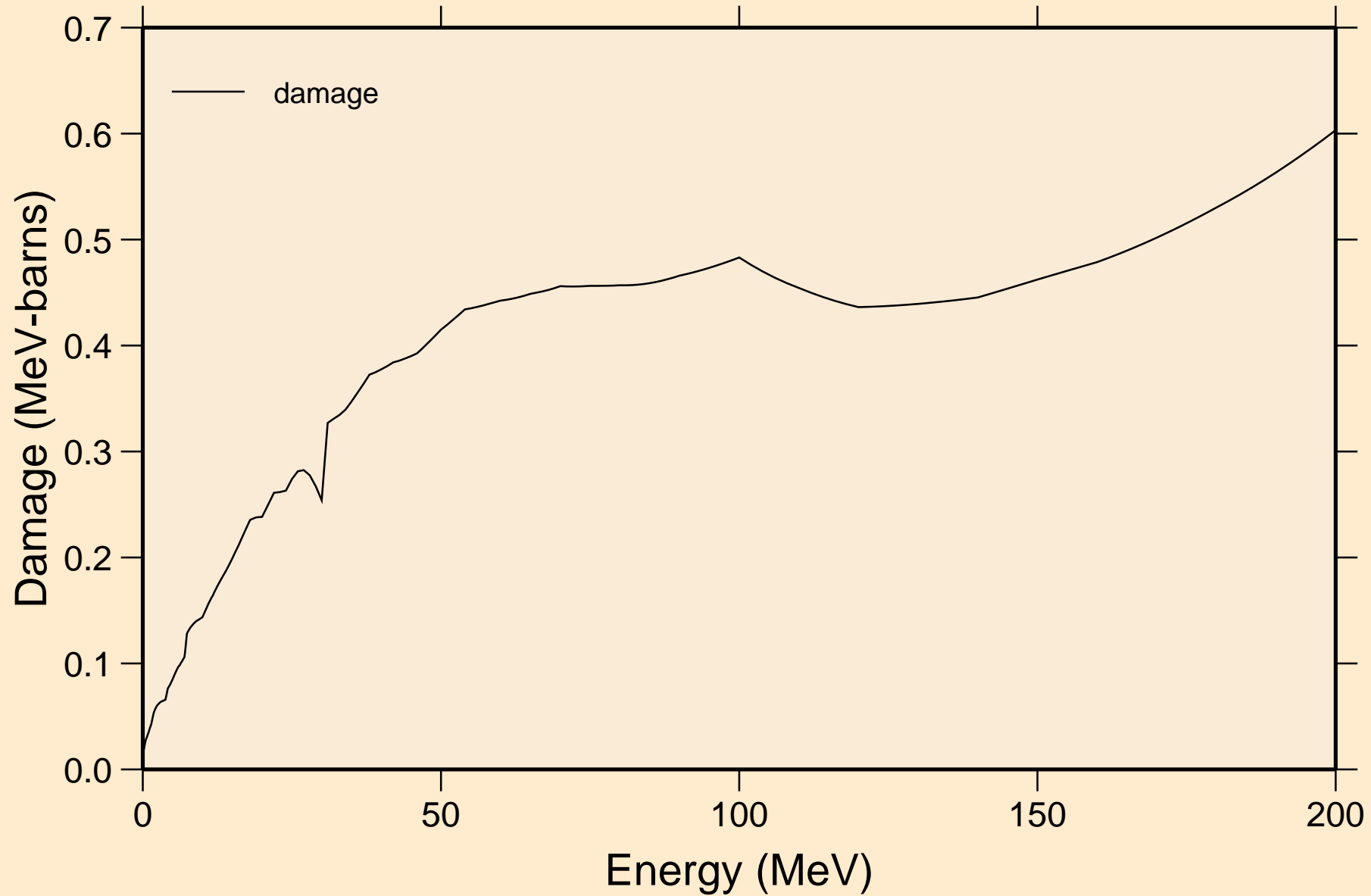

LU183 NEUTRON ACER TENDL-2024 LIBRARY; T=0.K
Non-threshold reactions

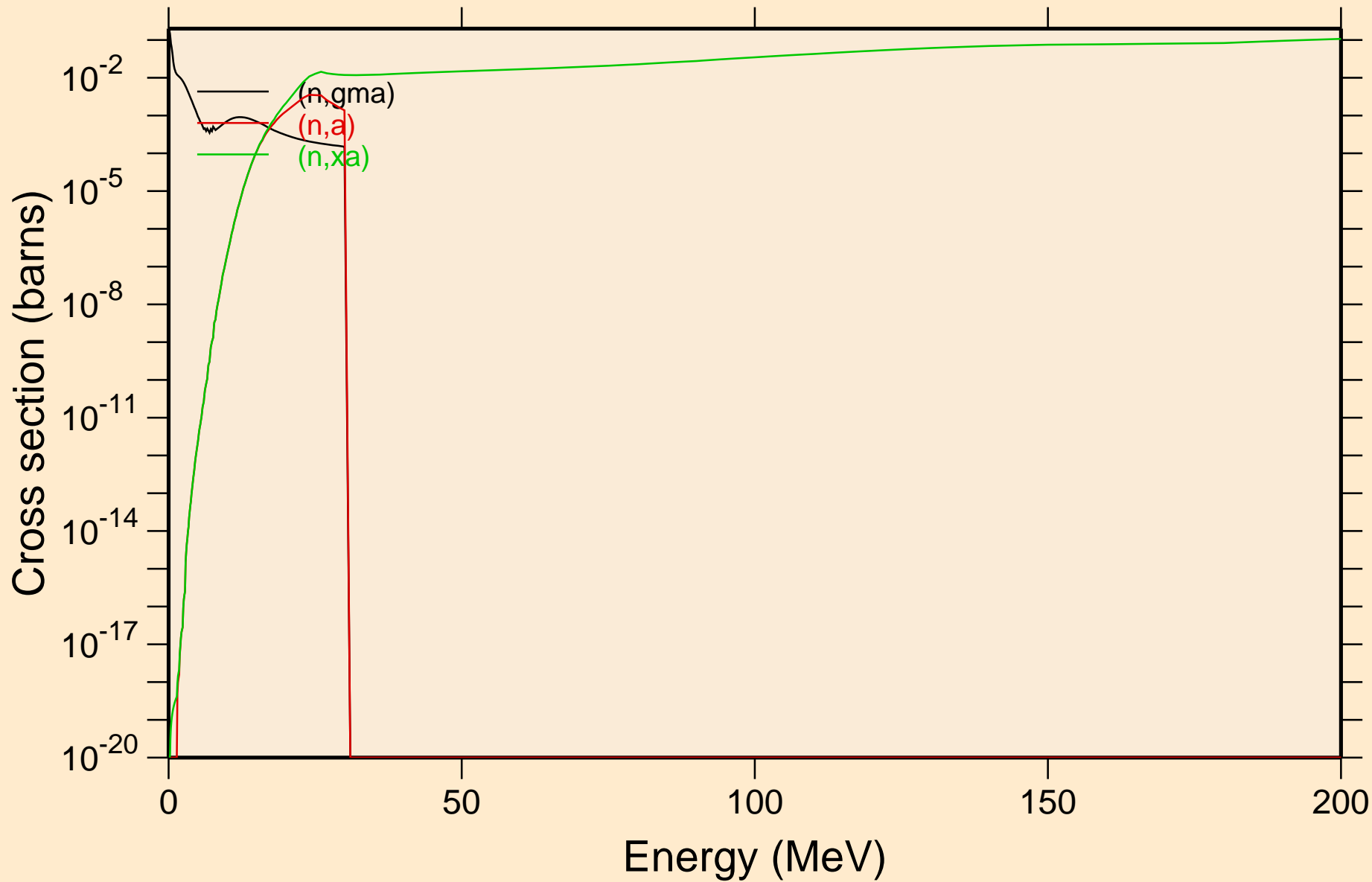

LU183 NEUTRON ACER TENDL-2024 LIBRARY; T=0.K
Inelastic levels

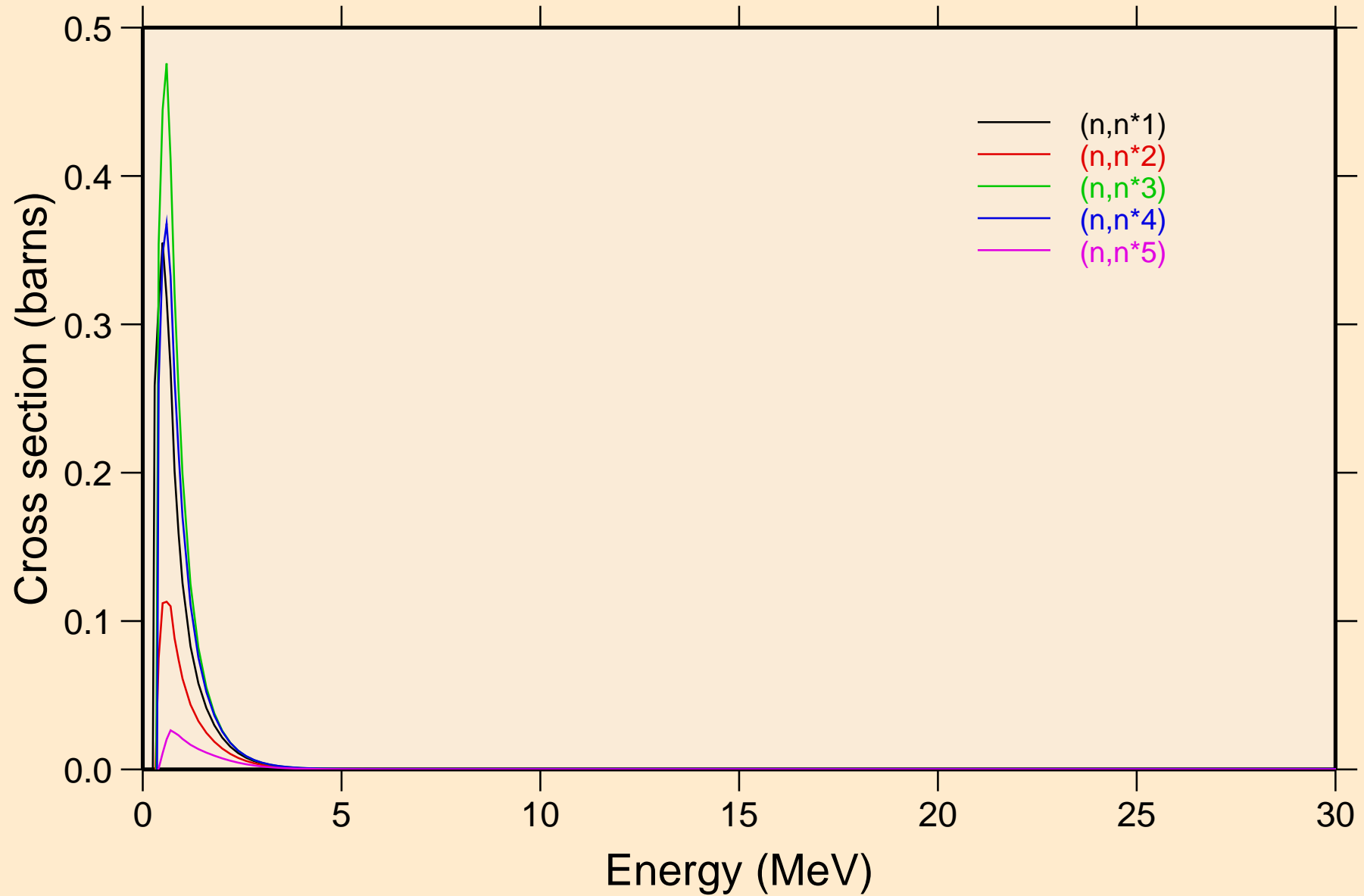

LU183 NEUTRON ACER TENDL-2024 LIBRARY; T=0.K
Inelastic levels

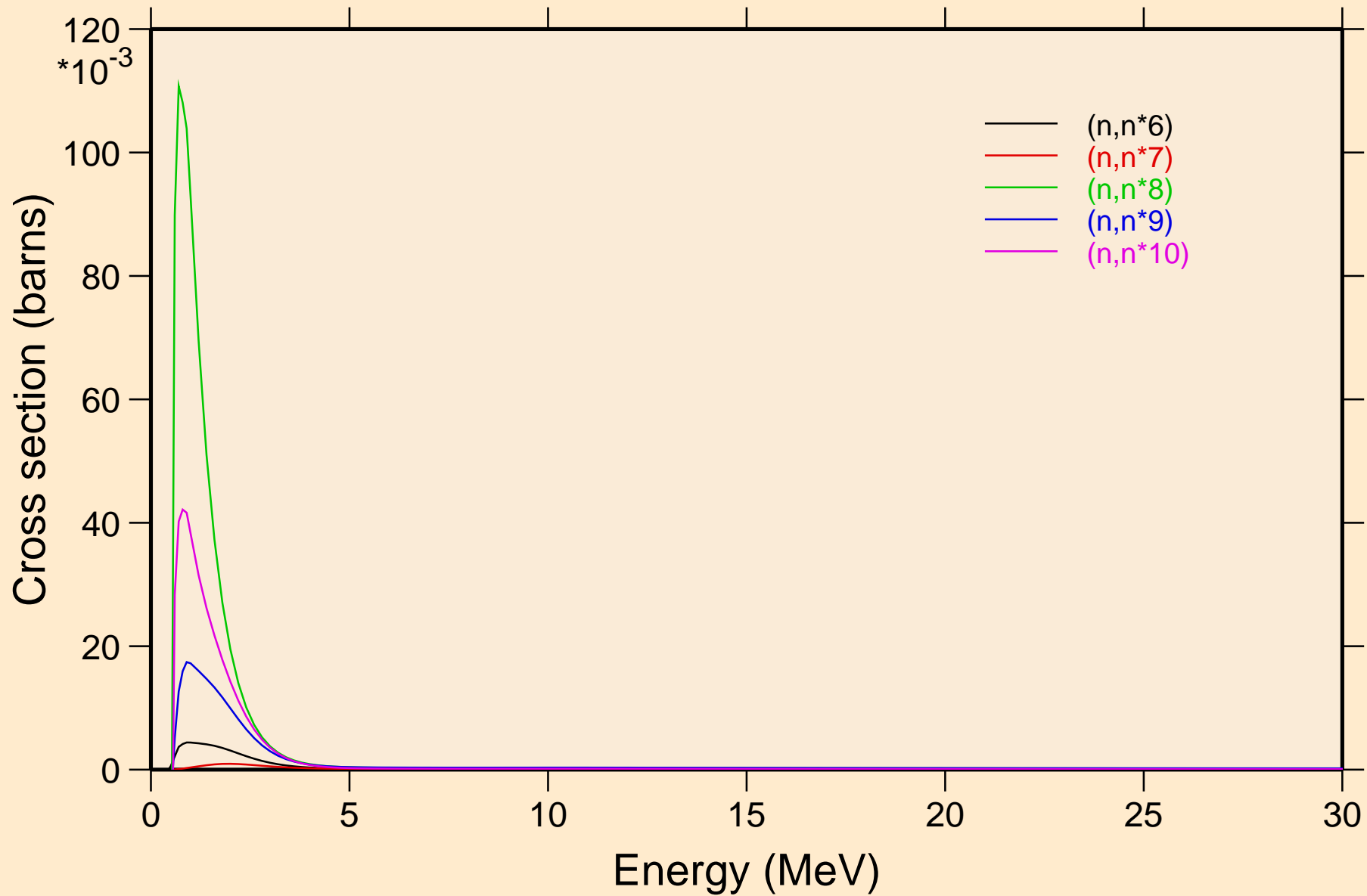

LU183 NEUTRON ACER TENDL-2024 LIBRARY; T=0.K
Inelastic levels

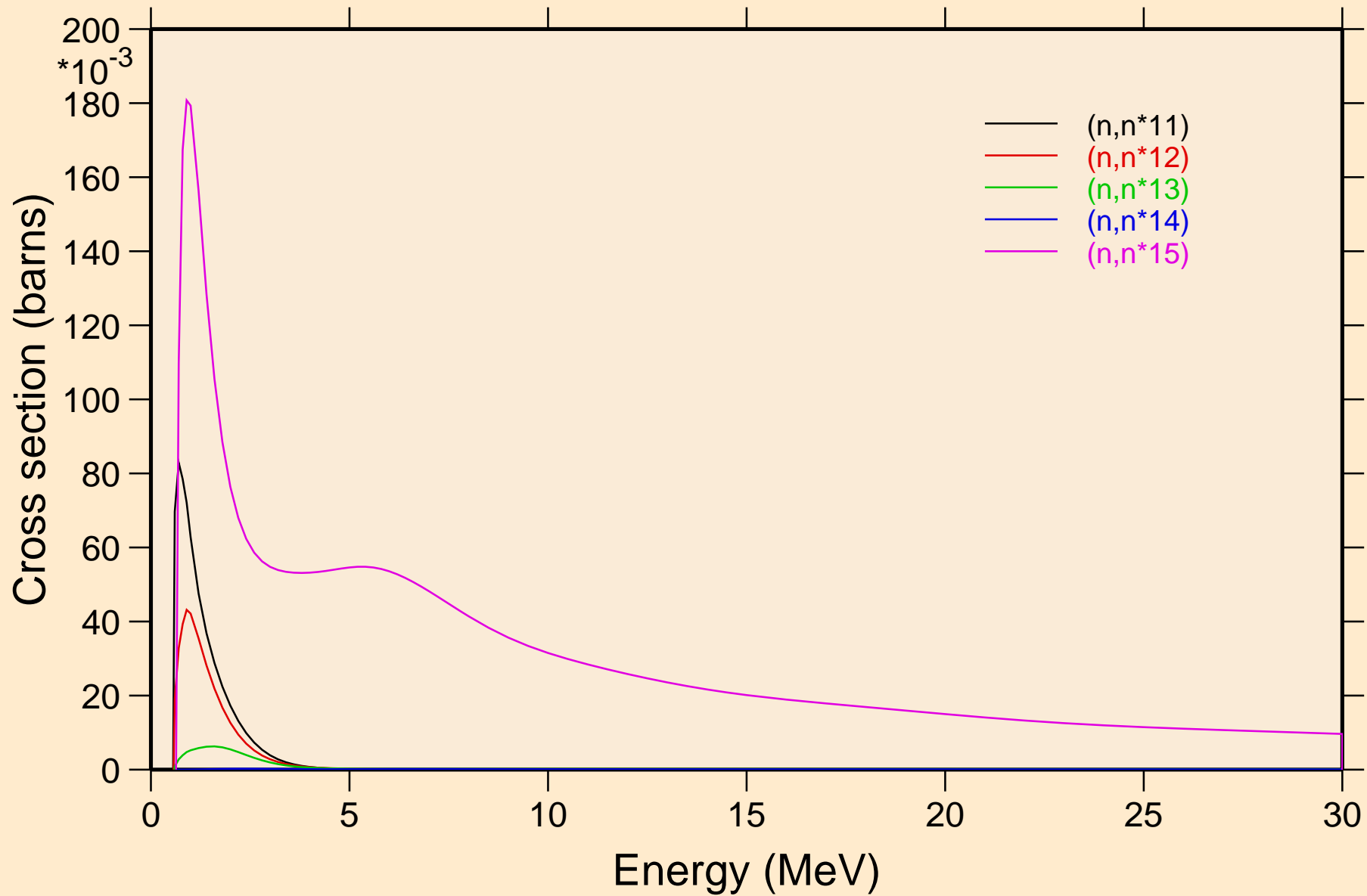

LU183 NEUTRON ACER TENDL-2024 LIBRARY; T=0.K
Inelastic levels

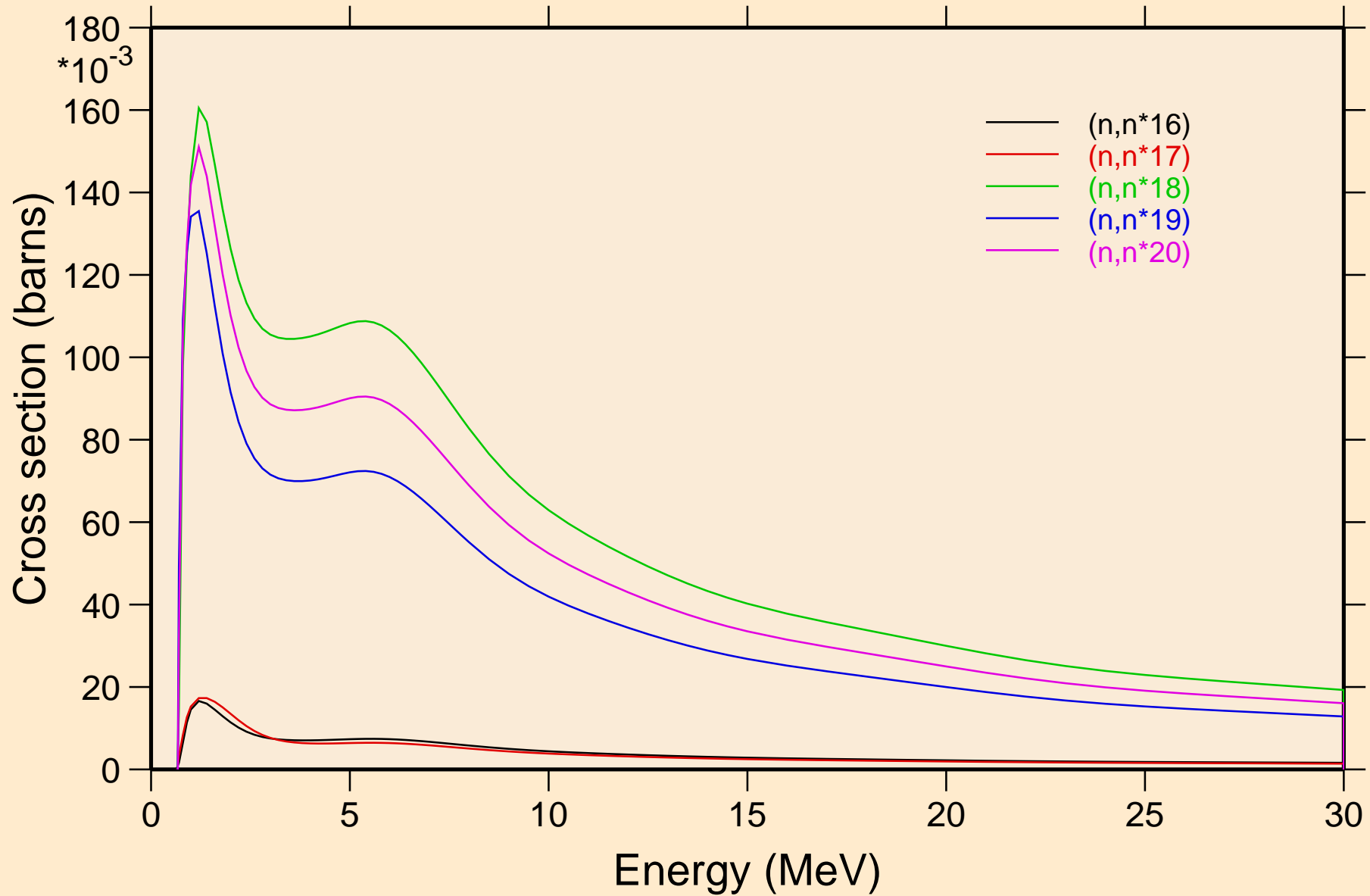

LU183 NEUTRON ACER TENDL-2024 LIBRARY; T=0.K
Inelastic levels

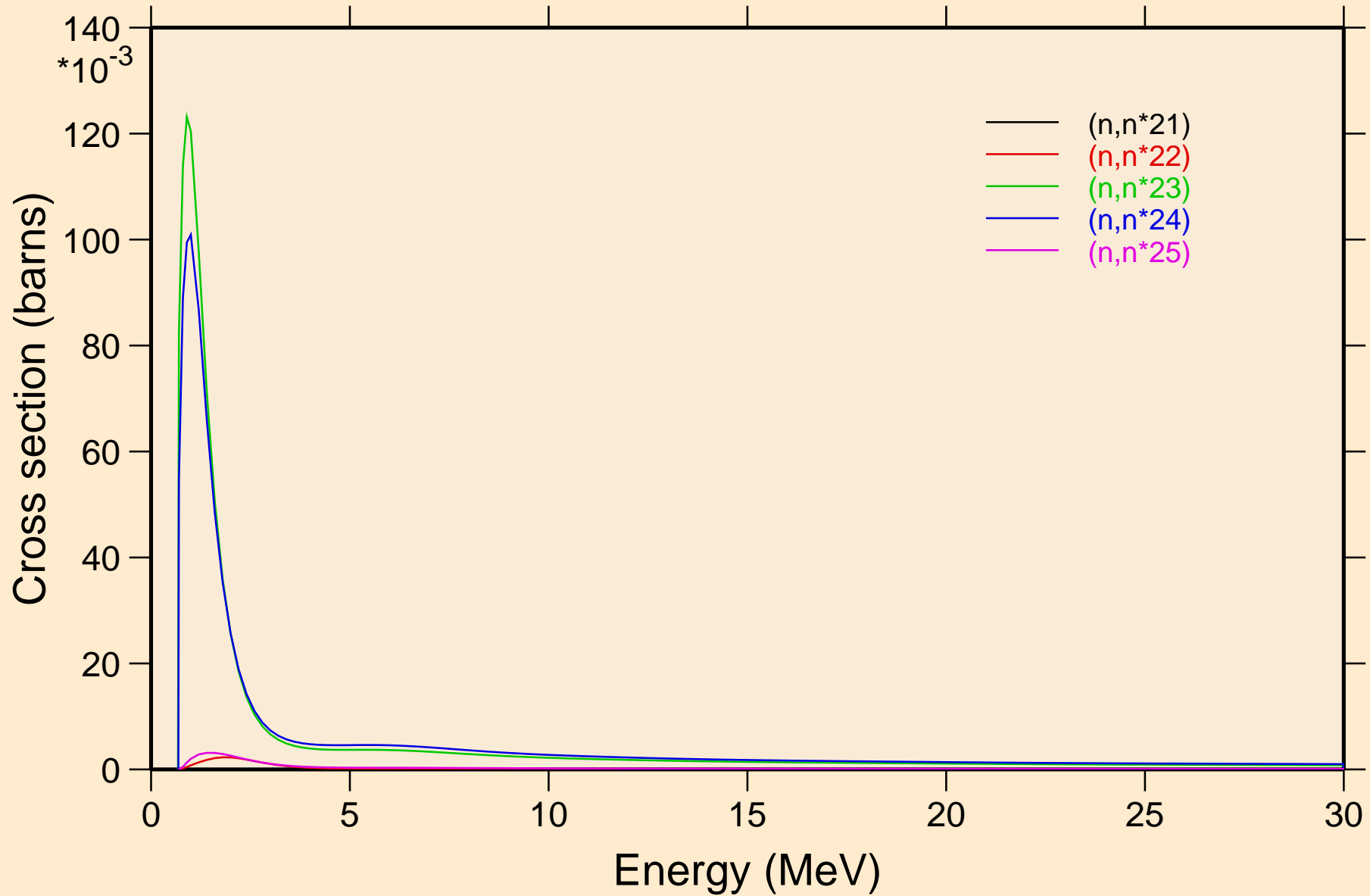

LU183 NEUTRON ACER TENDL-2024 LIBRARY; T=0.K
Inelastic levels

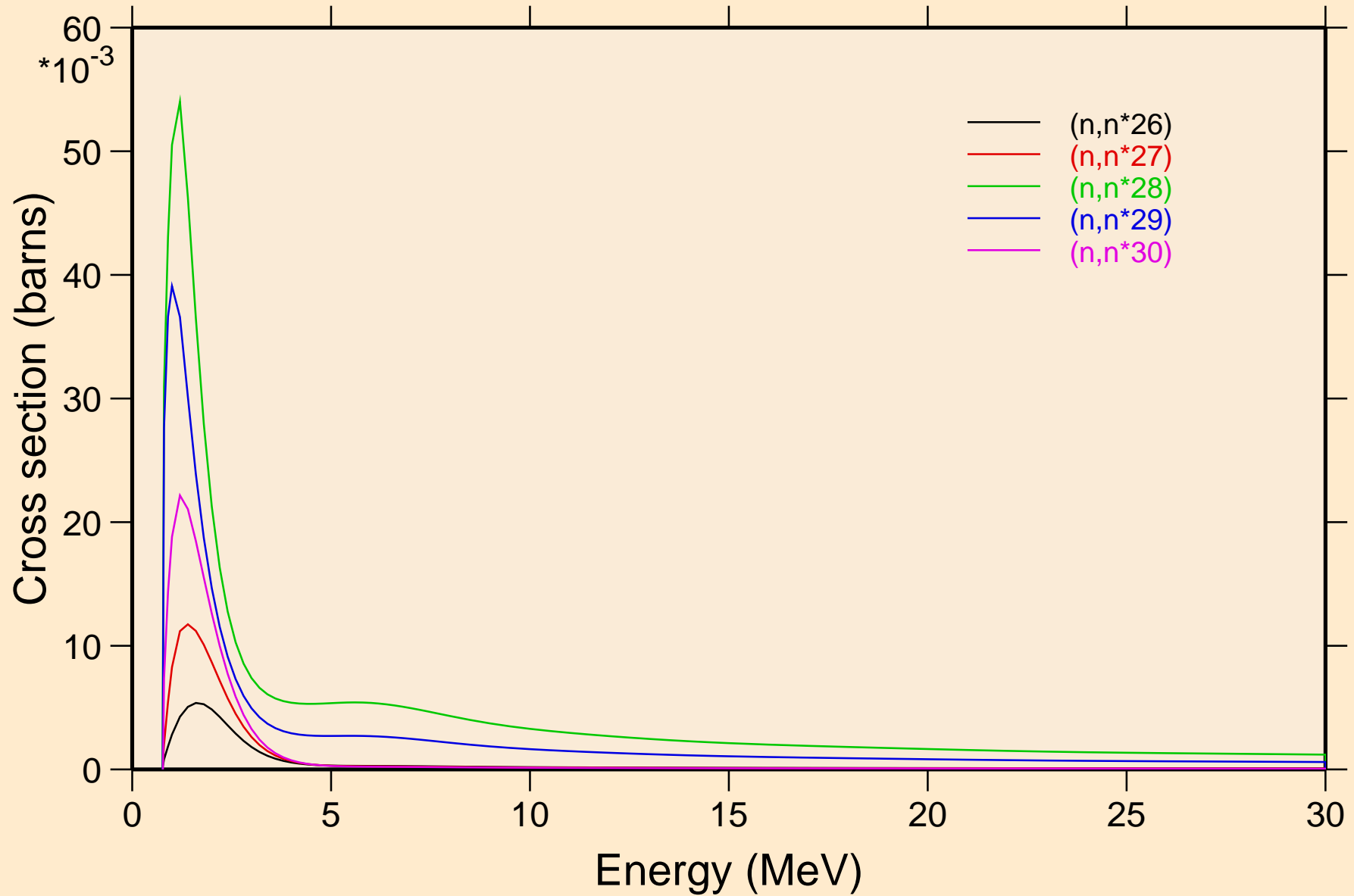

LU183 NEUTRON ACER TENDL-2024 LIBRARY; T=0.K

Threshold reactions

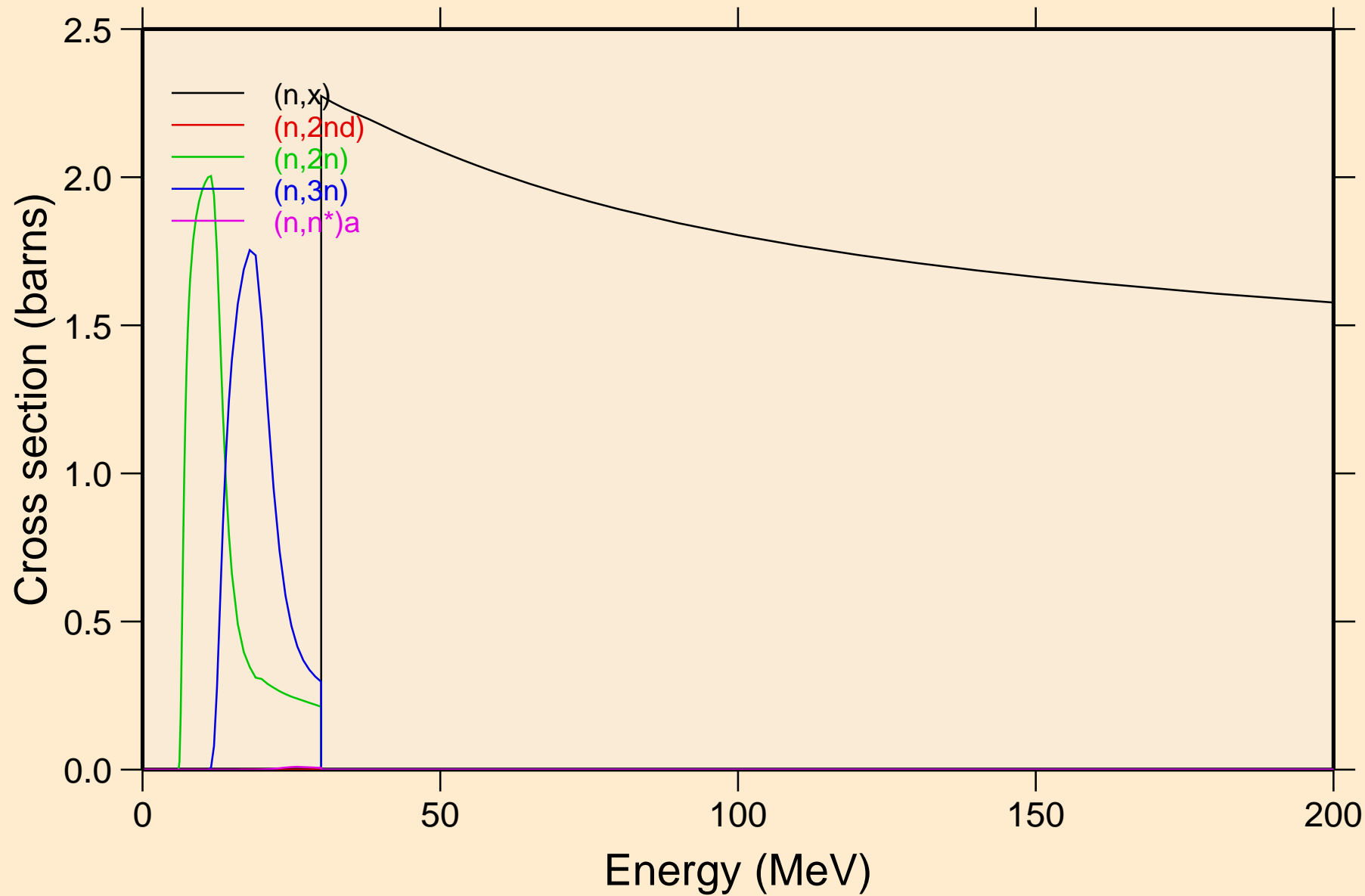

LU183 NEUTRON ACER TENDL-2024 LIBRARY; T=0.K

Threshold reactions

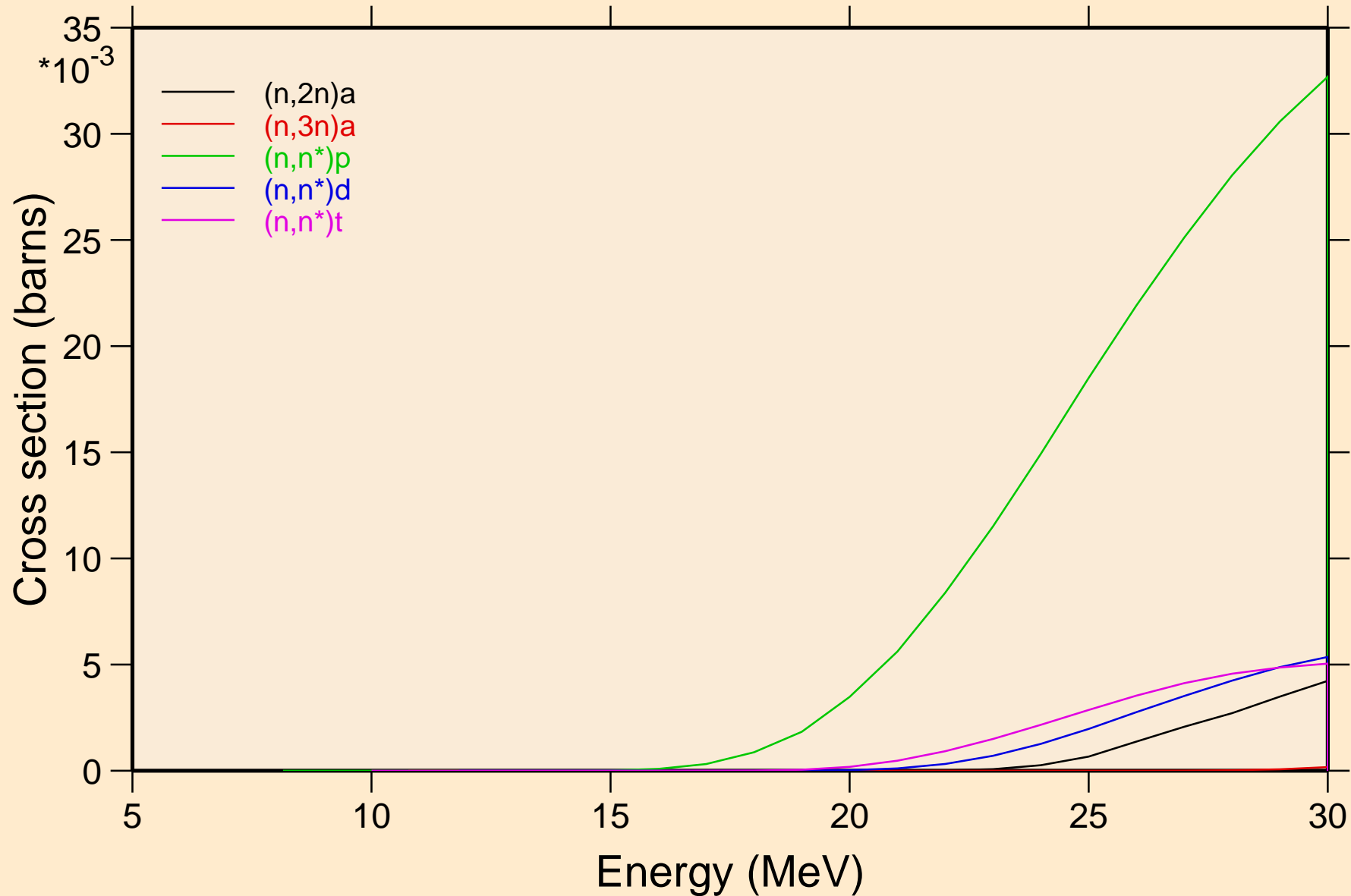

LU183 NEUTRON ACER TENDL-2024 LIBRARY; T=0.K
Threshold reactions

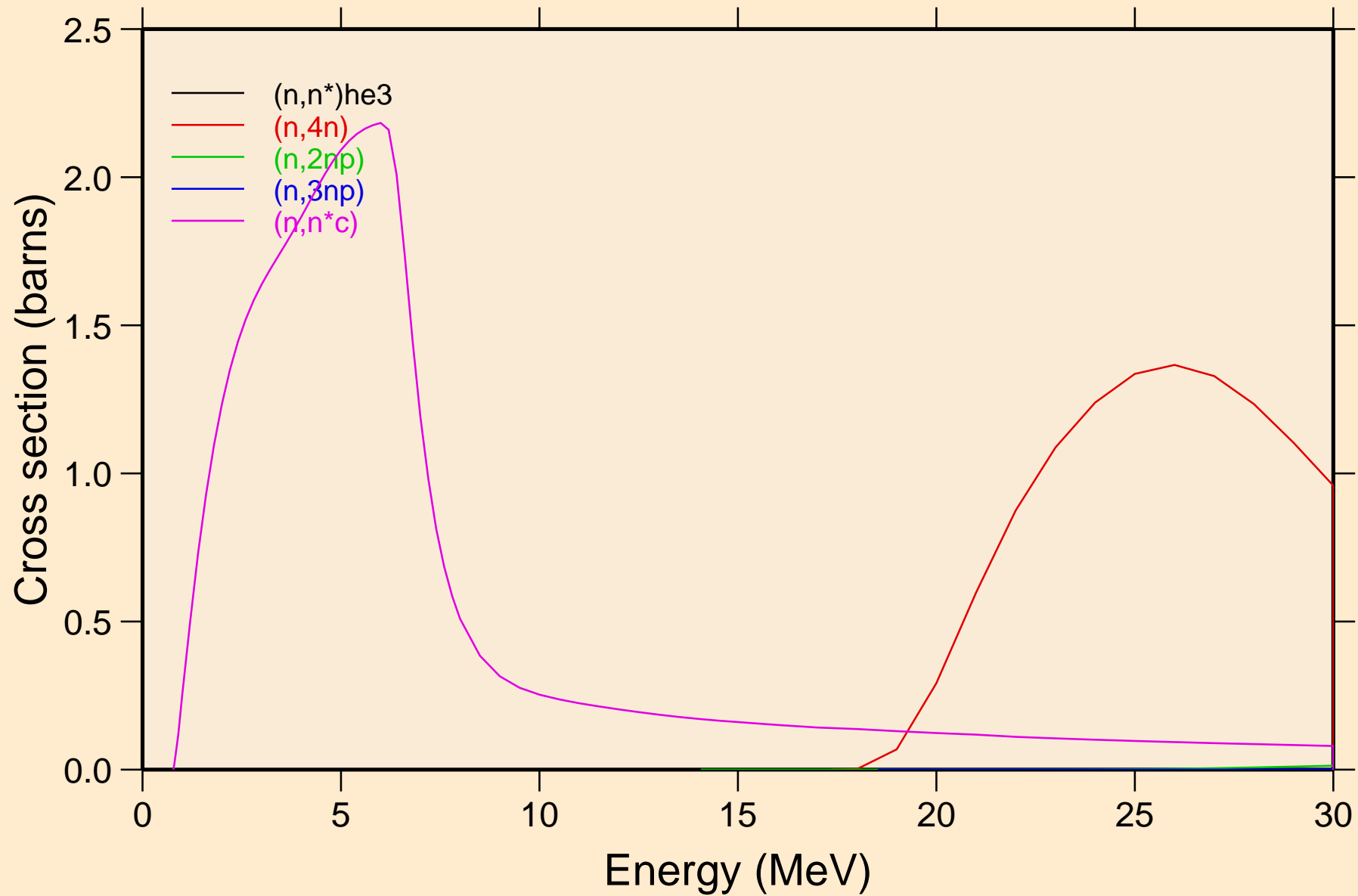

LU183 NEUTRON ACER TENDL-2024 LIBRARY; T=0.K
Threshold reactions

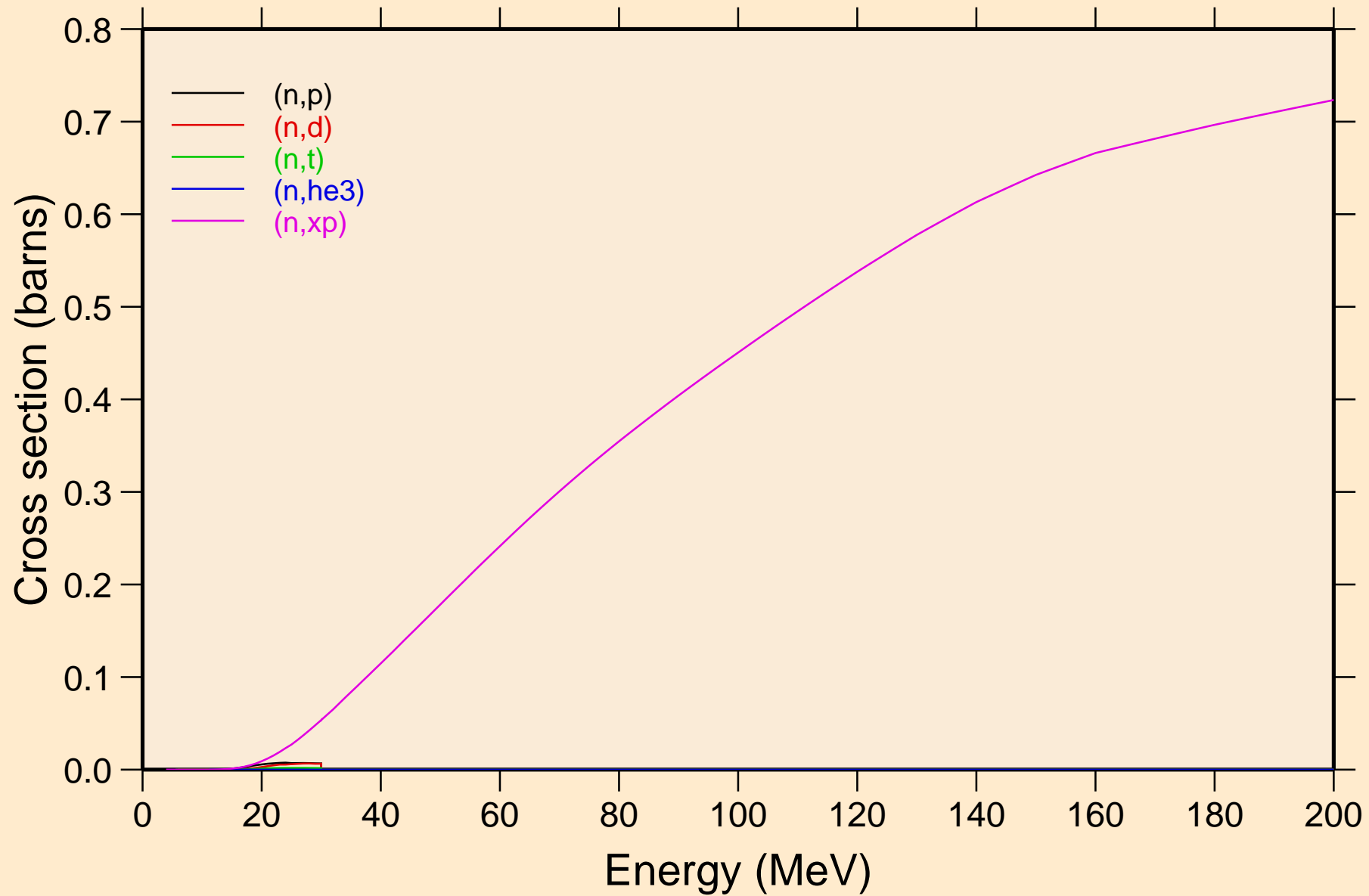

LU183 NEUTRON ACER TENDL-2024 LIBRARY; T=0.K

Threshold reactions

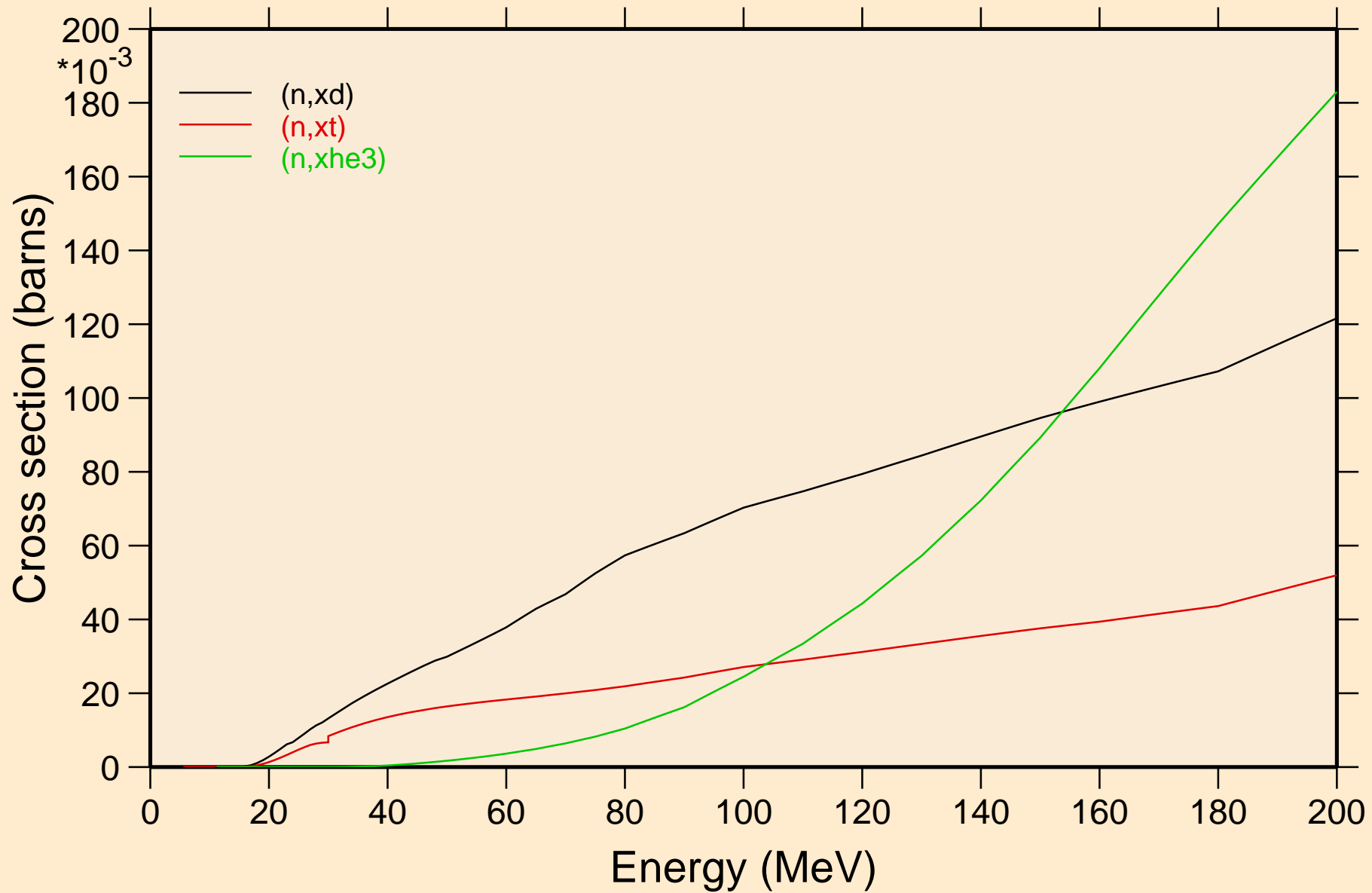

LU183 NEUTRON ACER TENDL-2024 LIBRARY; T=0.K
angular distribution for elastic

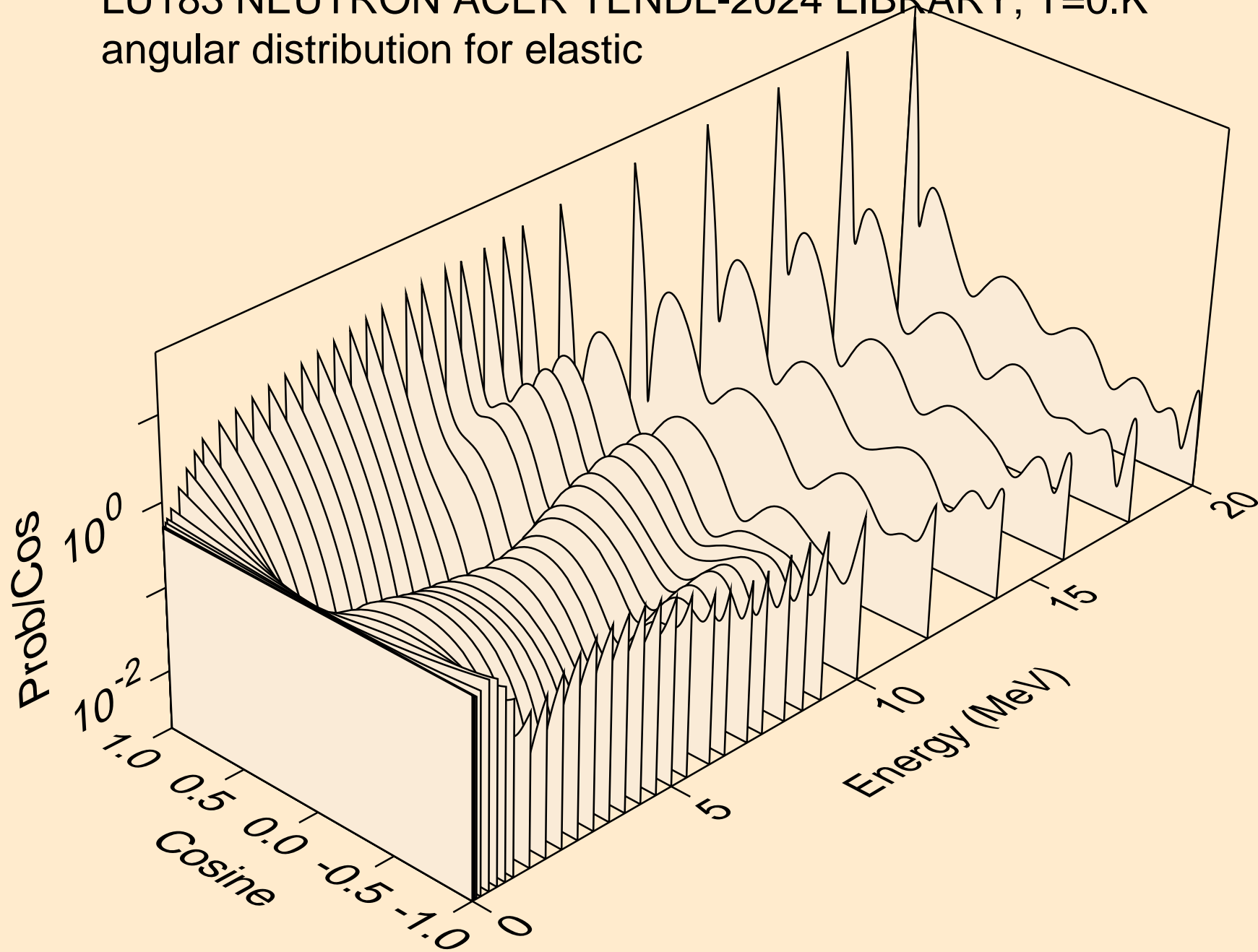

LU183 NEUTRON ACER TENDL-2024 LIBRARY; T=0.K
angular distribution for elastic

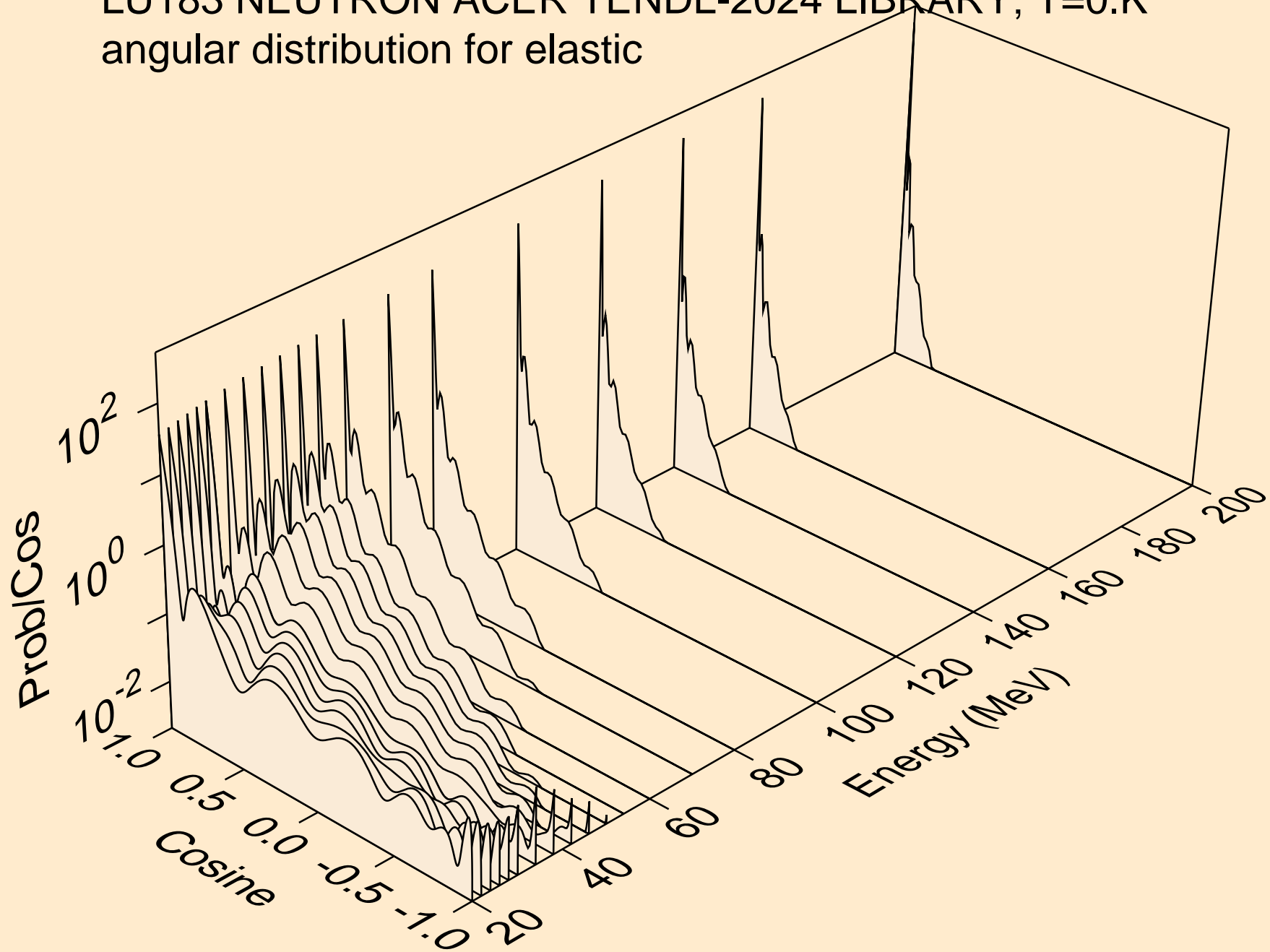

LU183 NEUTRON ACER TENDL-2024 LIBRARY; T=0.K
angular distribution for (n,n*1)

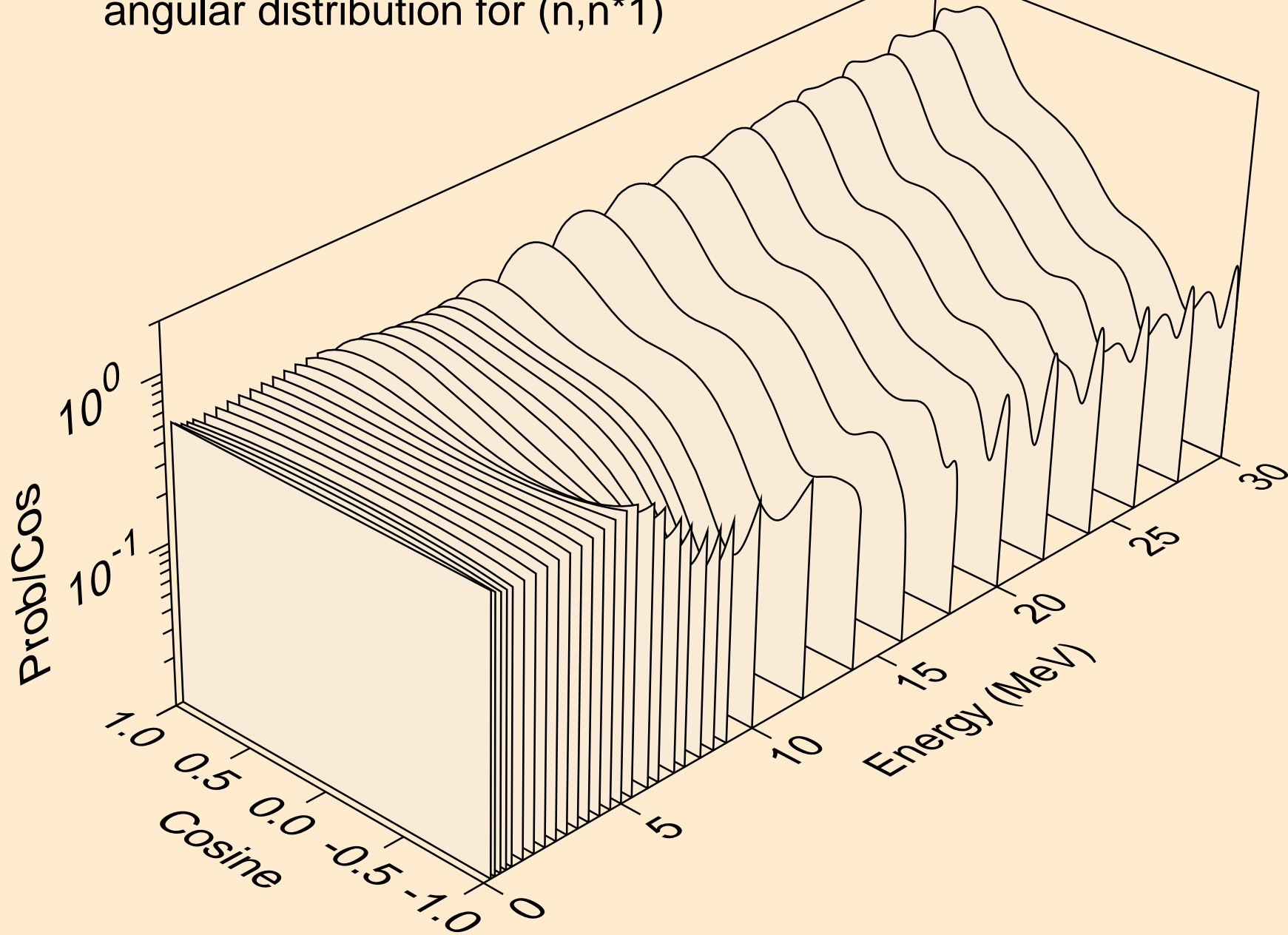

LU183 NEUTRON ACER TENDL-2024 LIBRARY; T=0.K
angular distribution for (n,n*2)

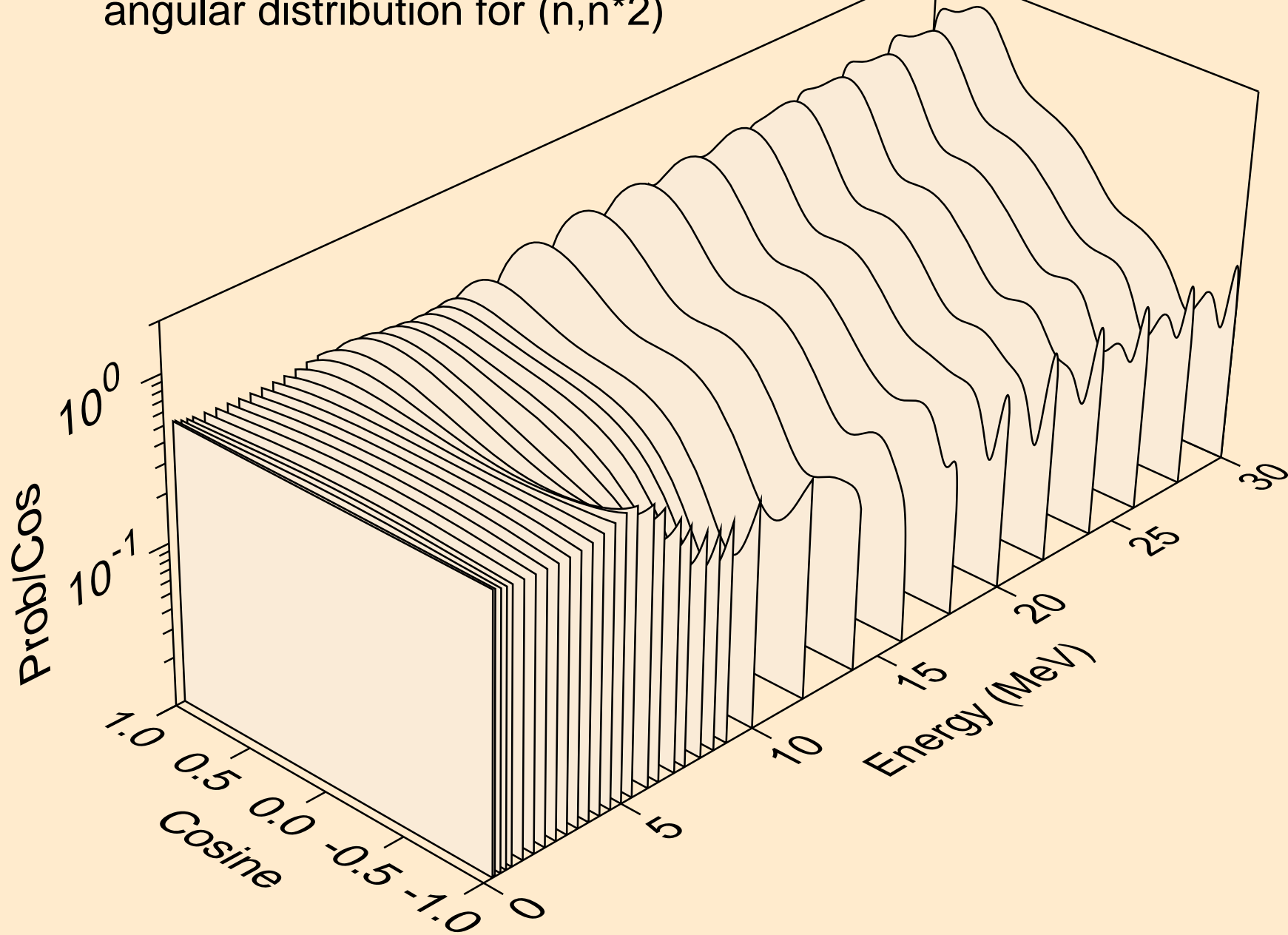

LU183 NEUTRON ACER TENDL-2024 LIBRARY; T=0.K
angular distribution for (n,n*3)

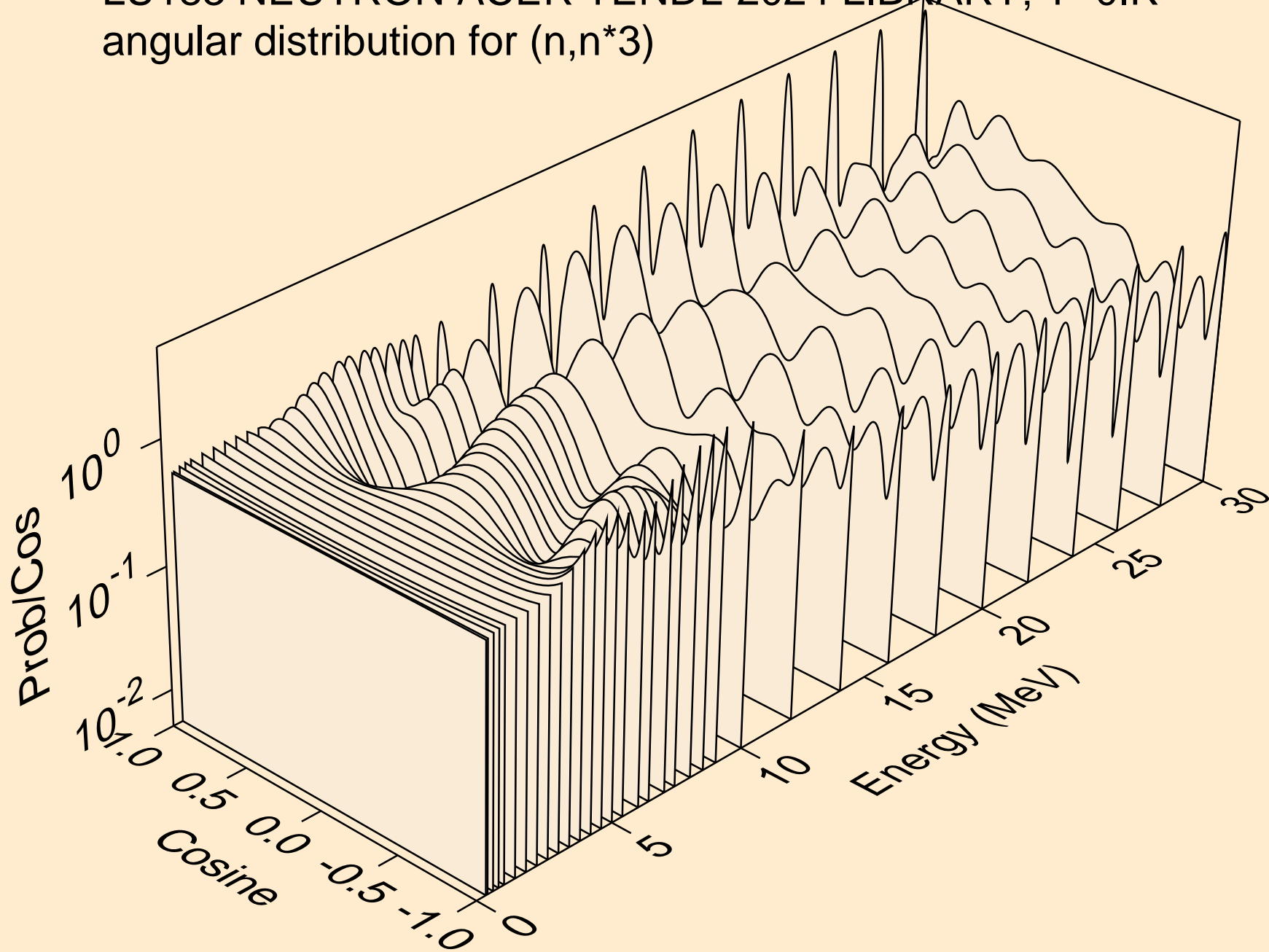

LU183 NEUTRON ACER TENDL-2024 LIBRARY; T=0.K
angular distribution for (n,n*4)

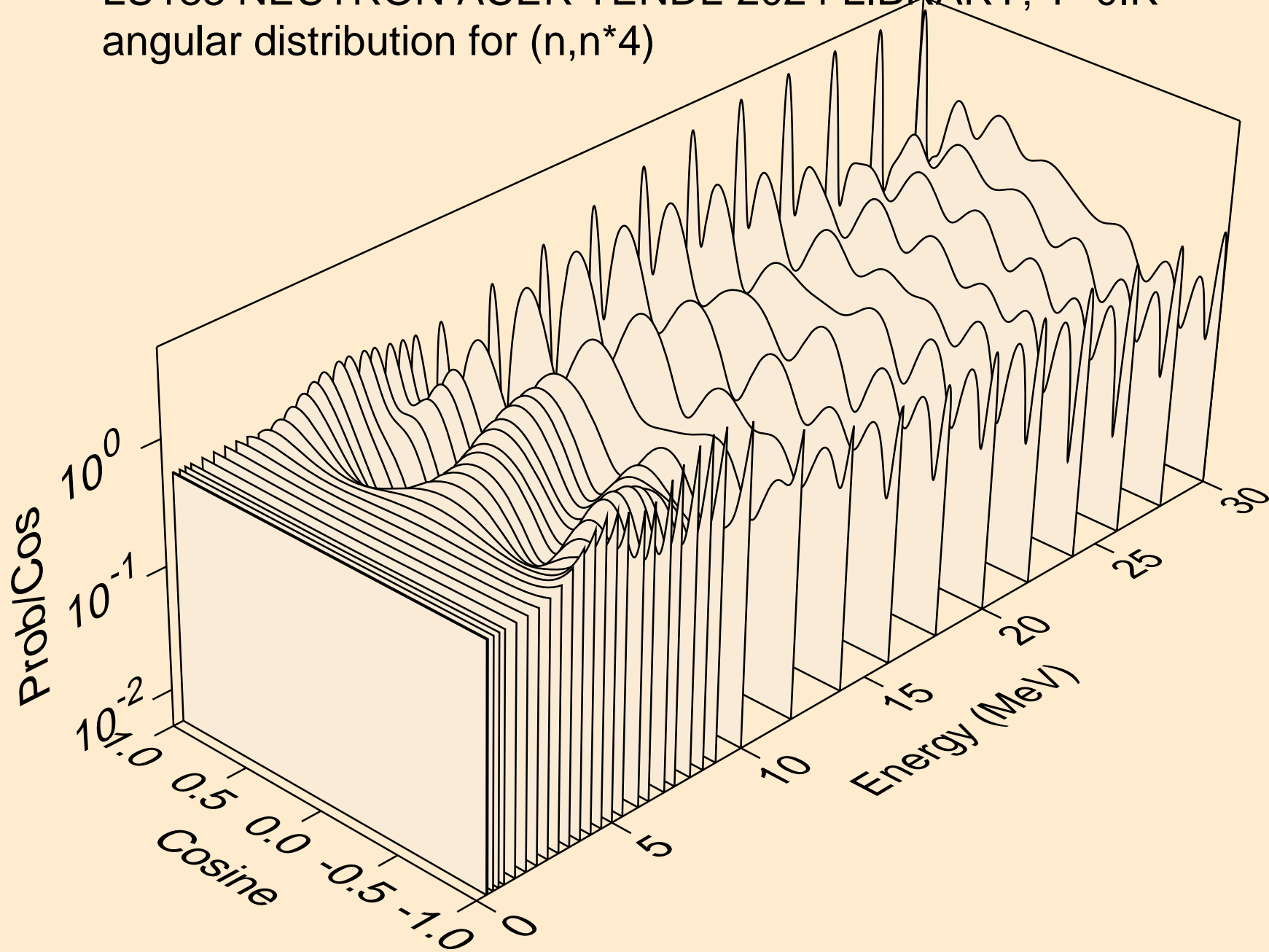

LU183 NEUTRON ACER TENDL-2024 LIBRARY; T=0.K
angular distribution for (n,n*5)

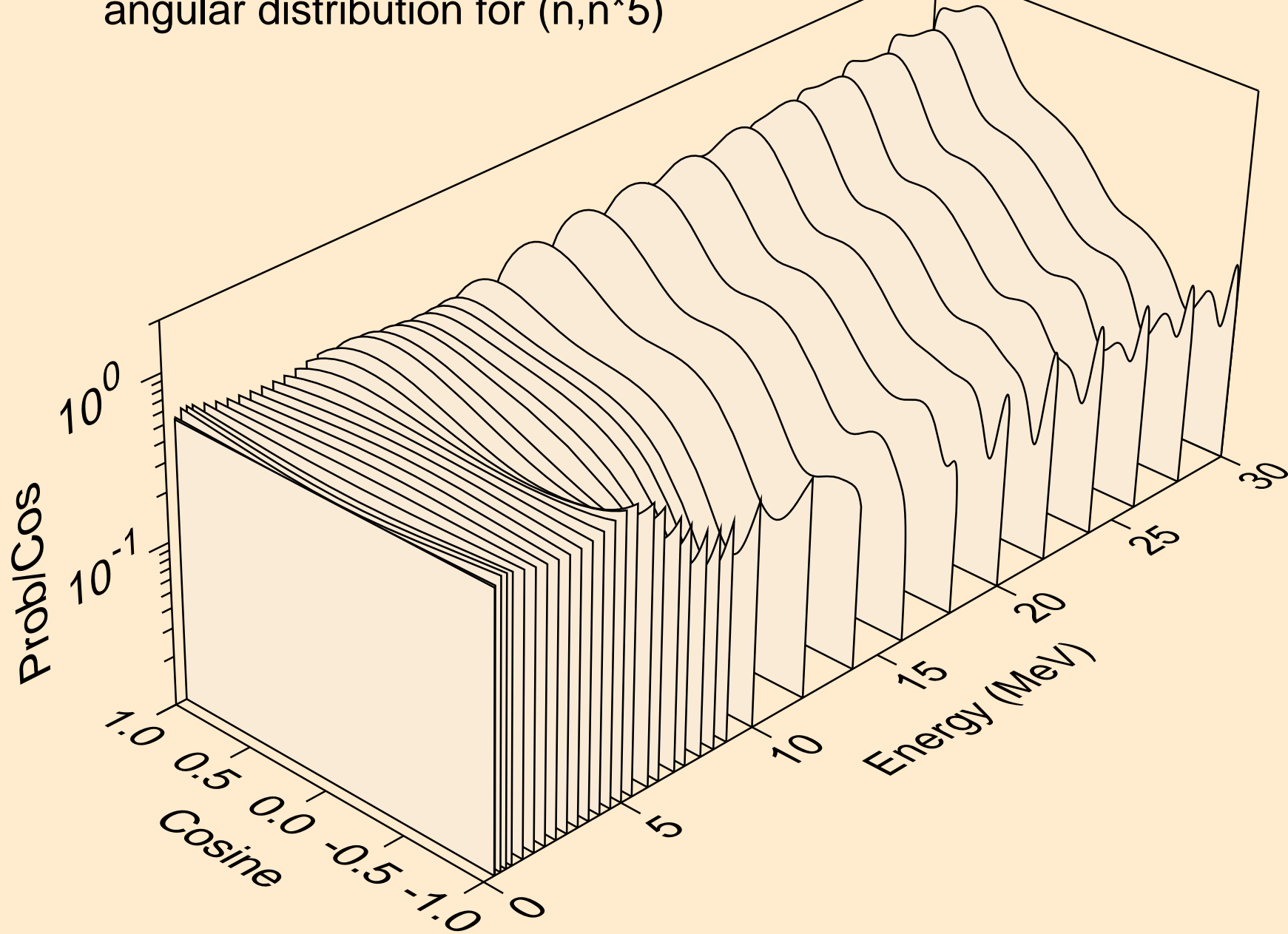

LU183 NEUTRON ACER TENDL-2024 LIBRARY; T=0.K
angular distribution for (n,n*6)

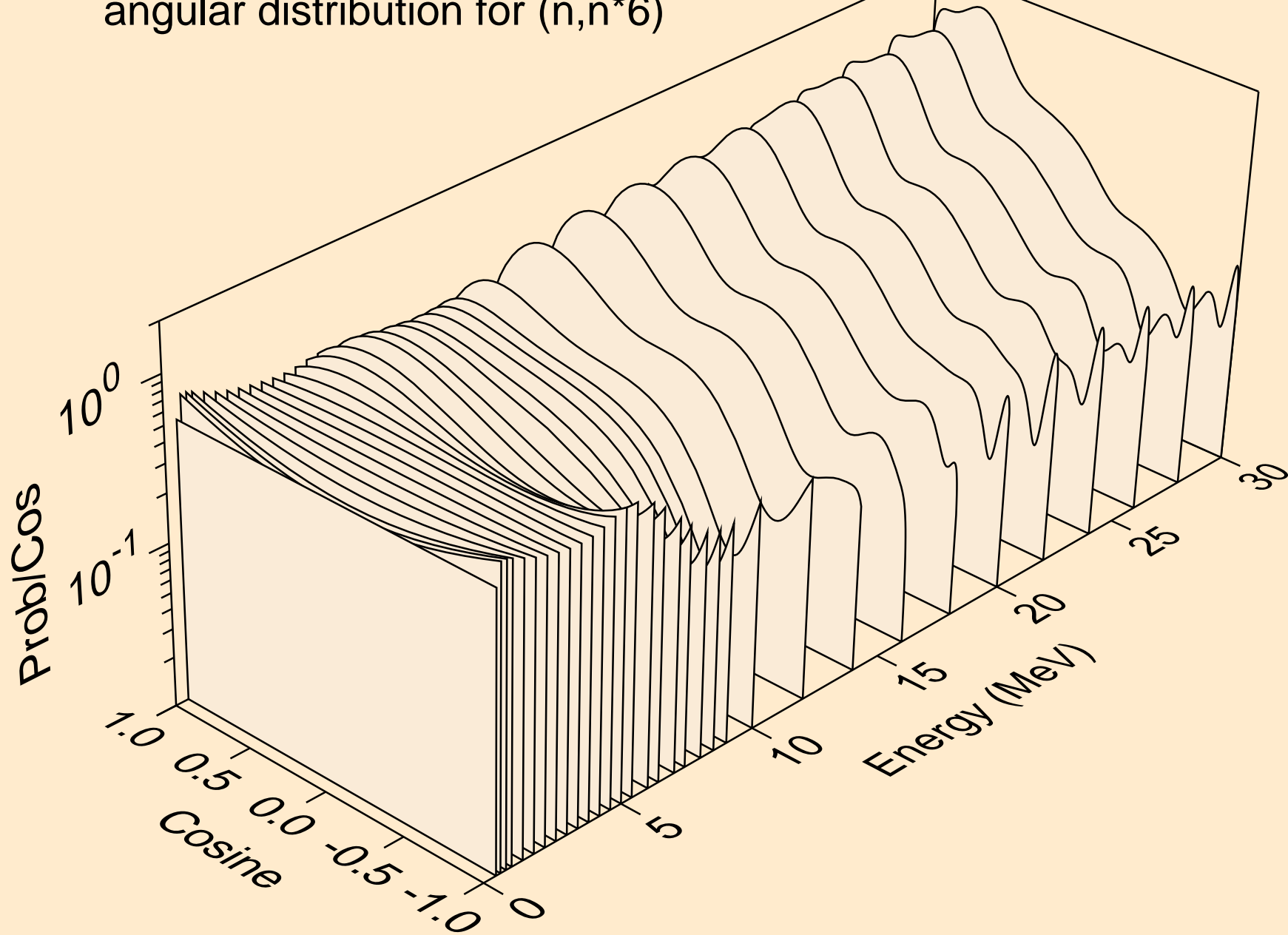

LU183 NEUTRON ACER TENDL-2024 LIBRARY; T=0.K
angular distribution for (n,n*7)

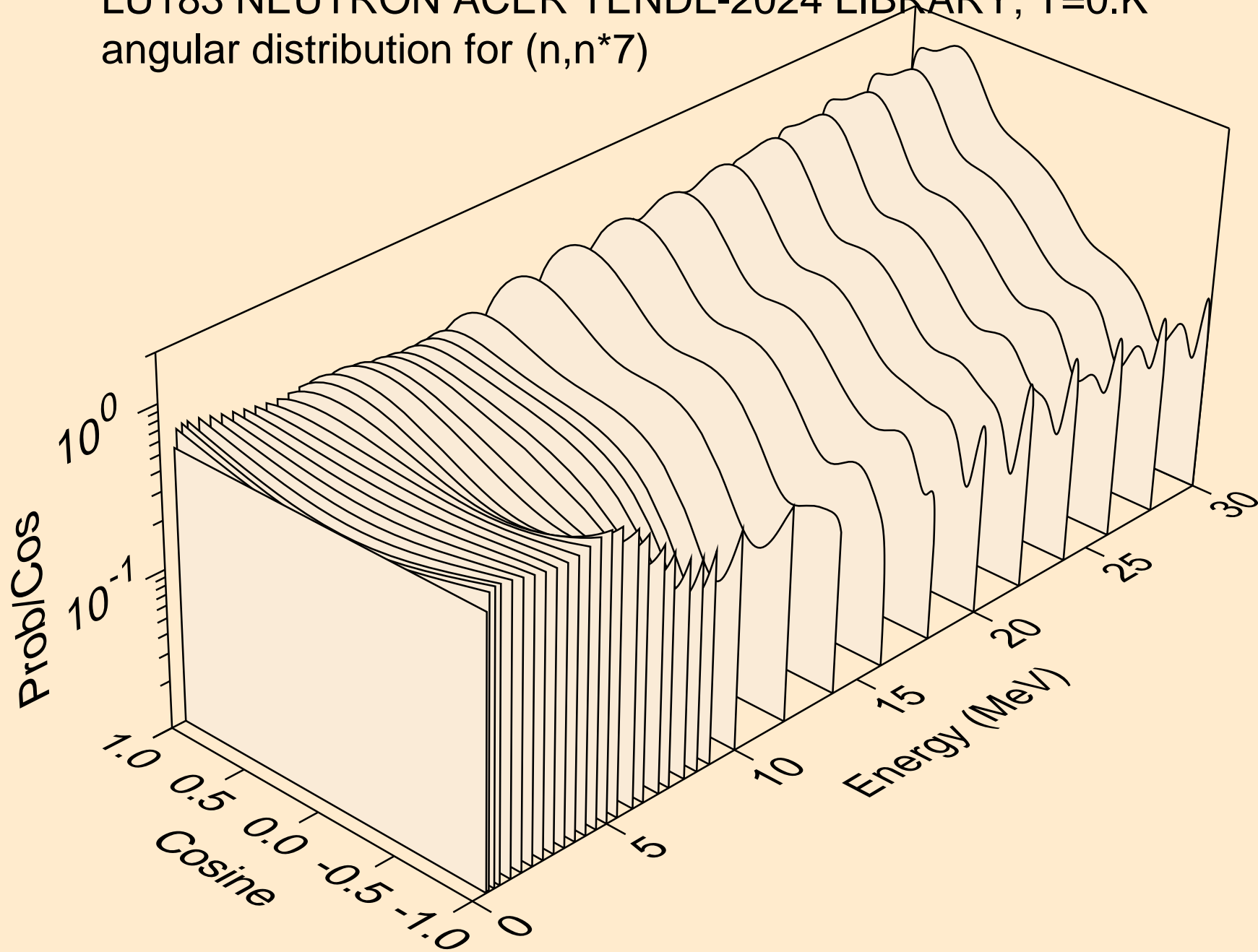

LU183 NEUTRON ACER TENDL-2024 LIBRARY; T=0.K
angular distribution for (n,n*8)

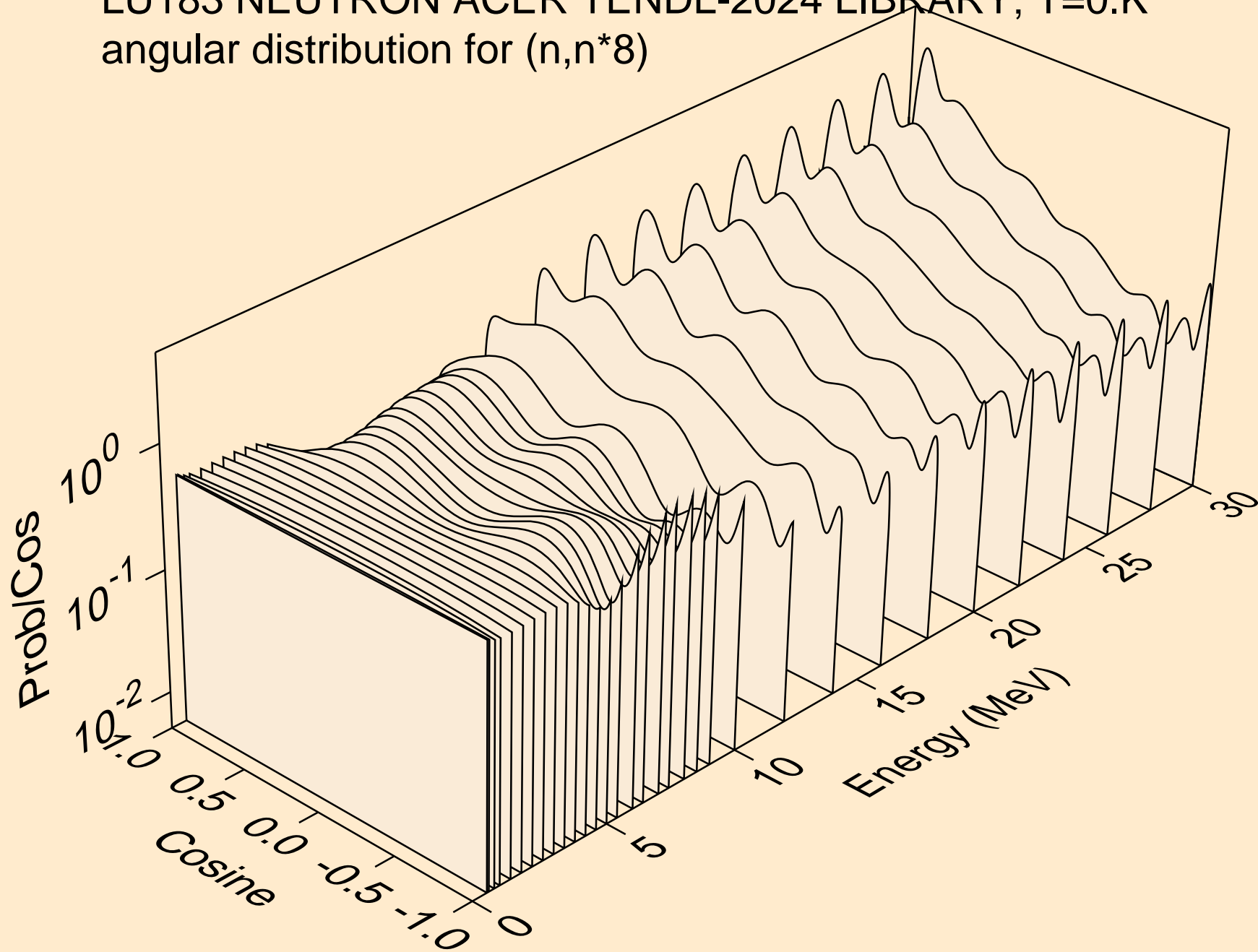

LU183 NEUTRON ACER TENDL-2024 LIBRARY; T=0.K
angular distribution for (n,n*9)

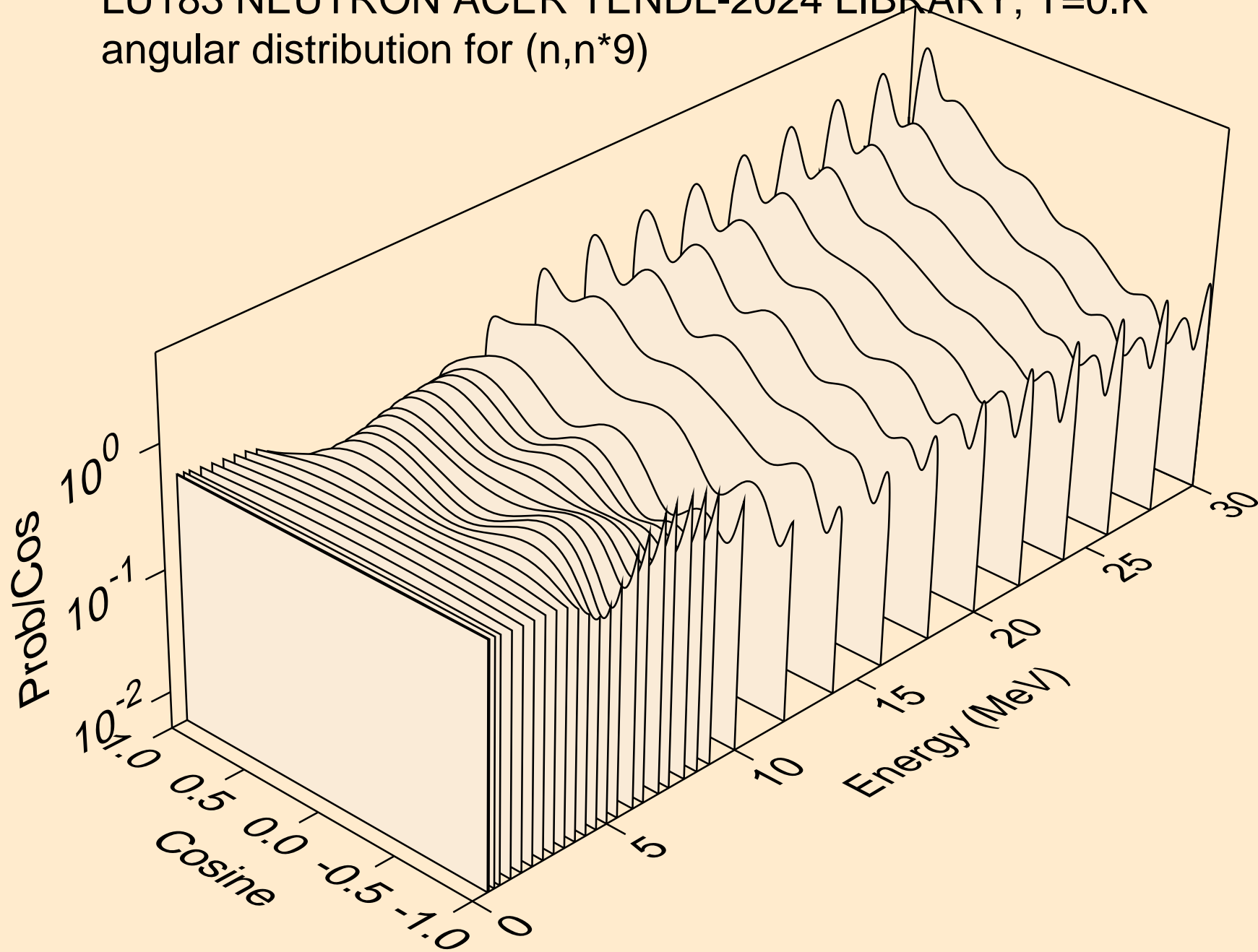

LU183 NEUTRON ACER TENDL-2024 LIBRARY; T=0.K
angular distribution for (n,n*10)

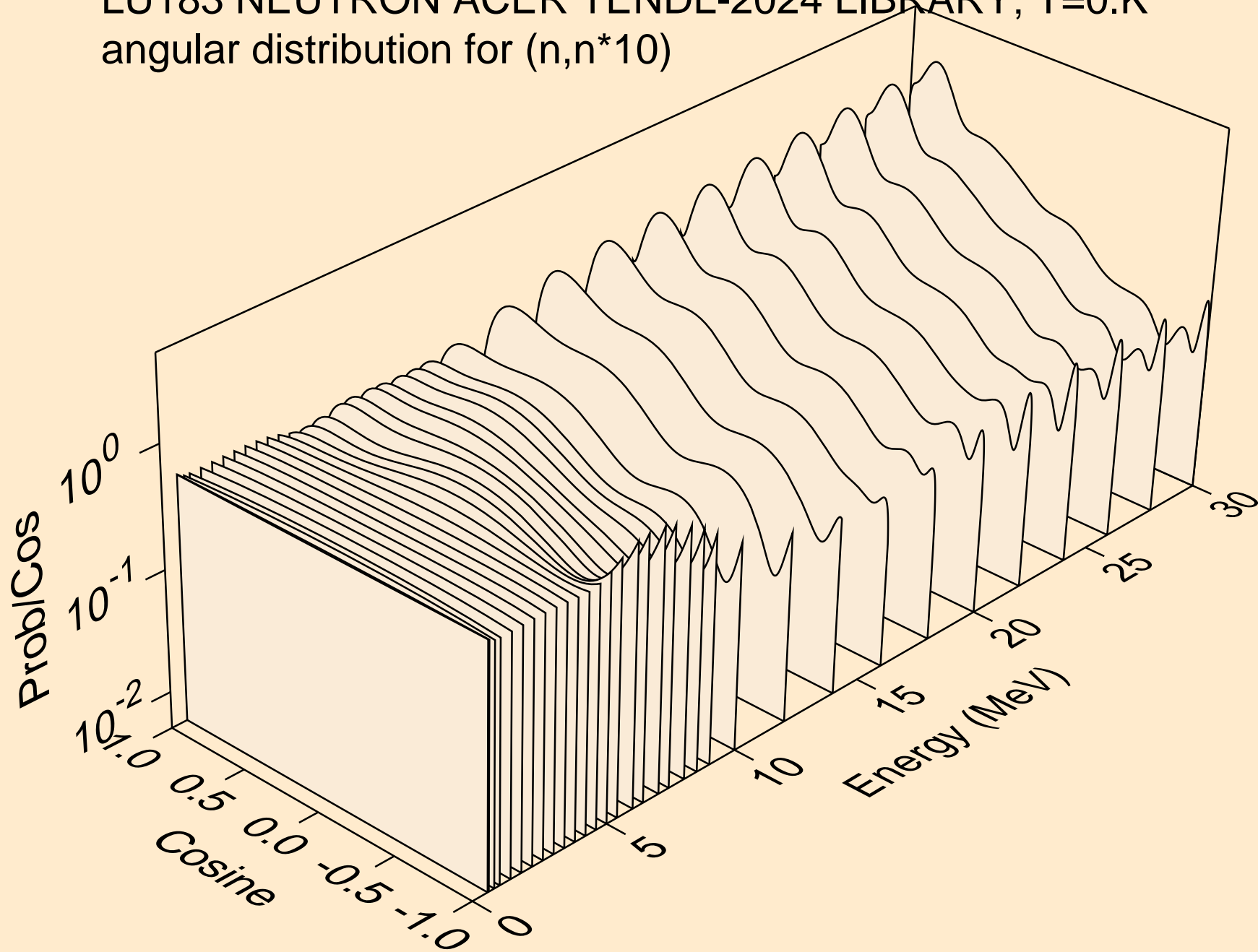

LU183 NEUTRON ACER TENDL-2024 LIBRARY; T=0.K
angular distribution for (n,n*11)

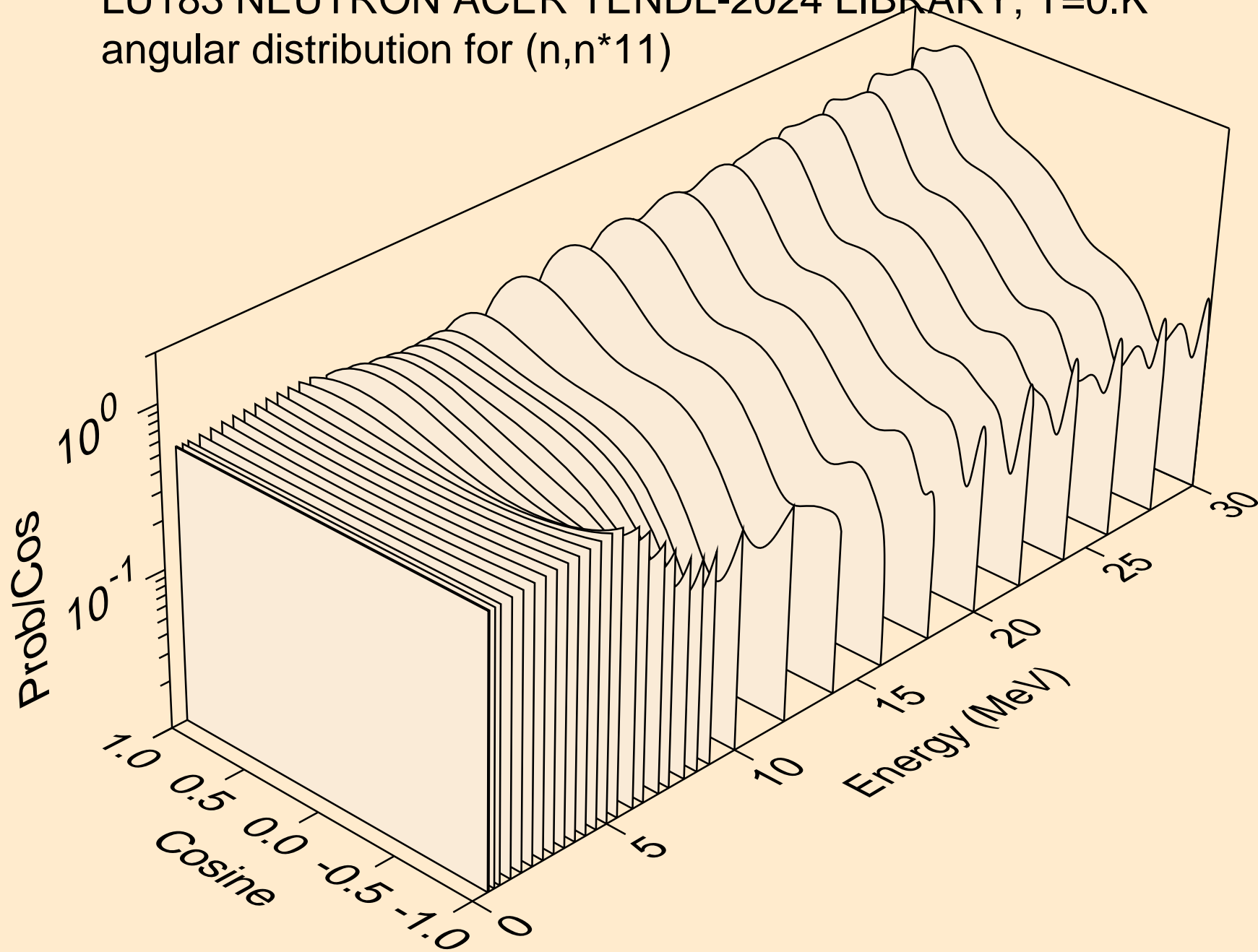

LU183 NEUTRON ACER TENDL-2024 LIBRARY; T=0.K
angular distribution for (n,n*12)

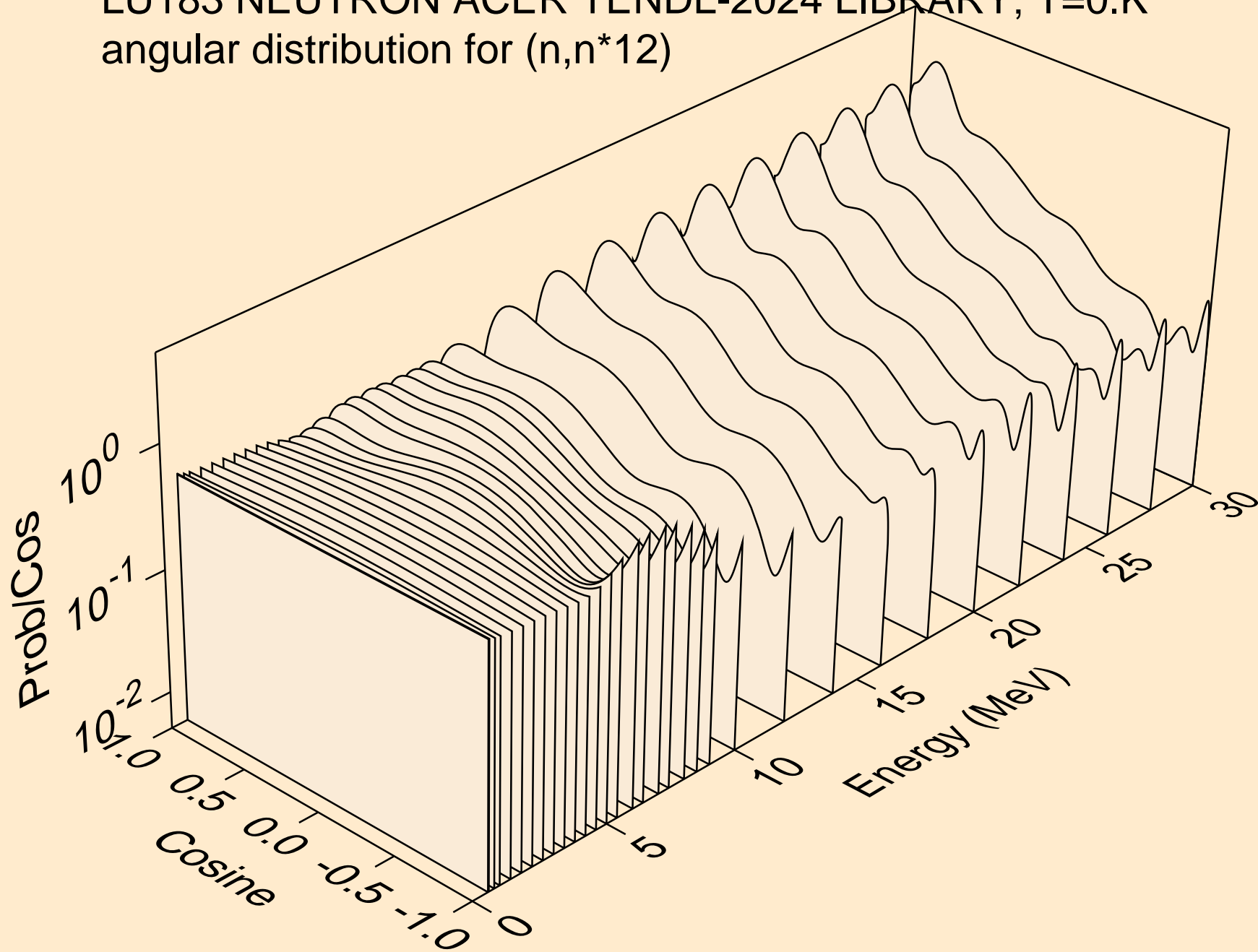

LU183 NEUTRON ACER TENDL-2024 LIBRARY; T=0.K
angular distribution for (n,n*13)

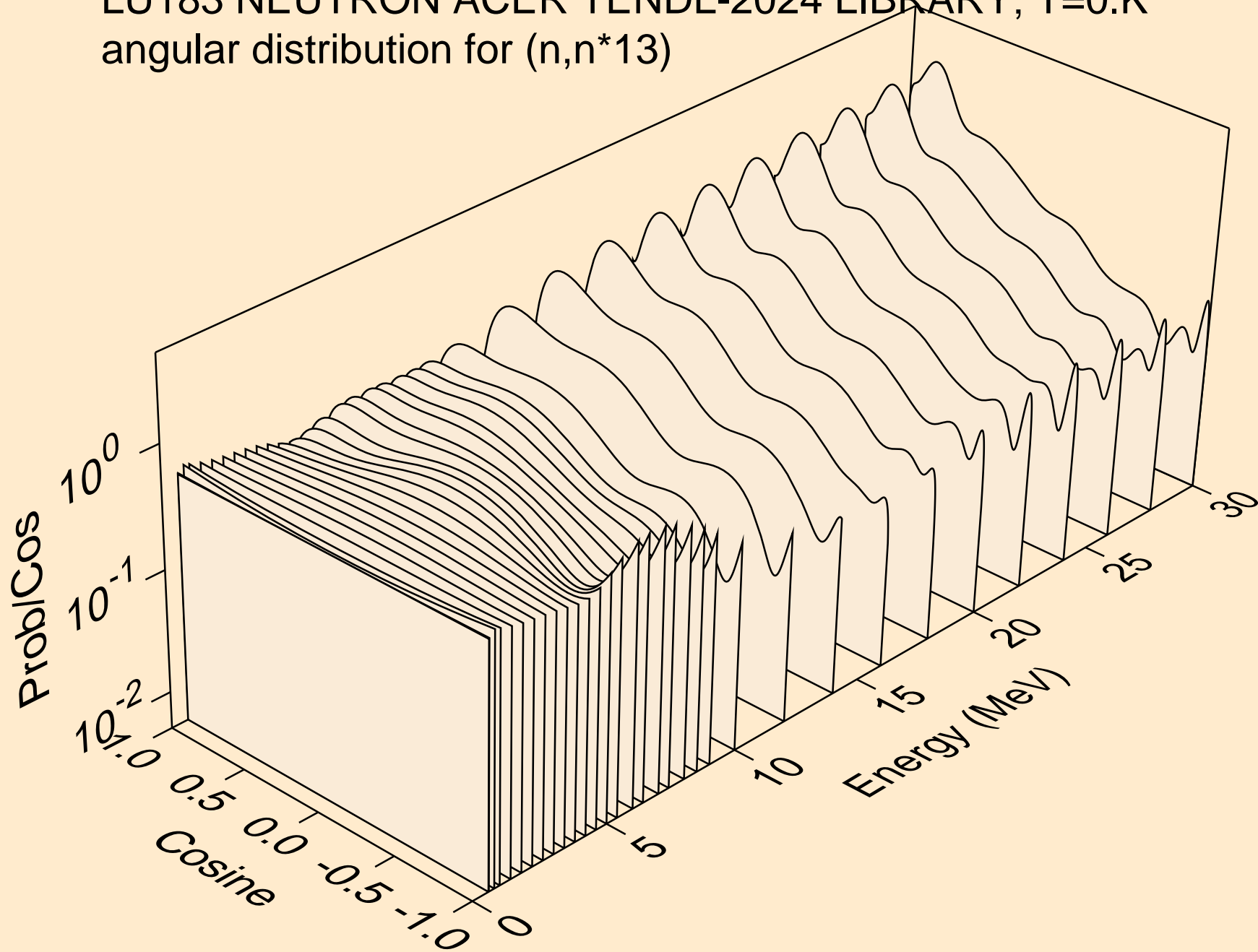

LU183 NEUTRON ACER TENDL-2024 LIBRARY; T=0.K
angular distribution for (n,n*14)

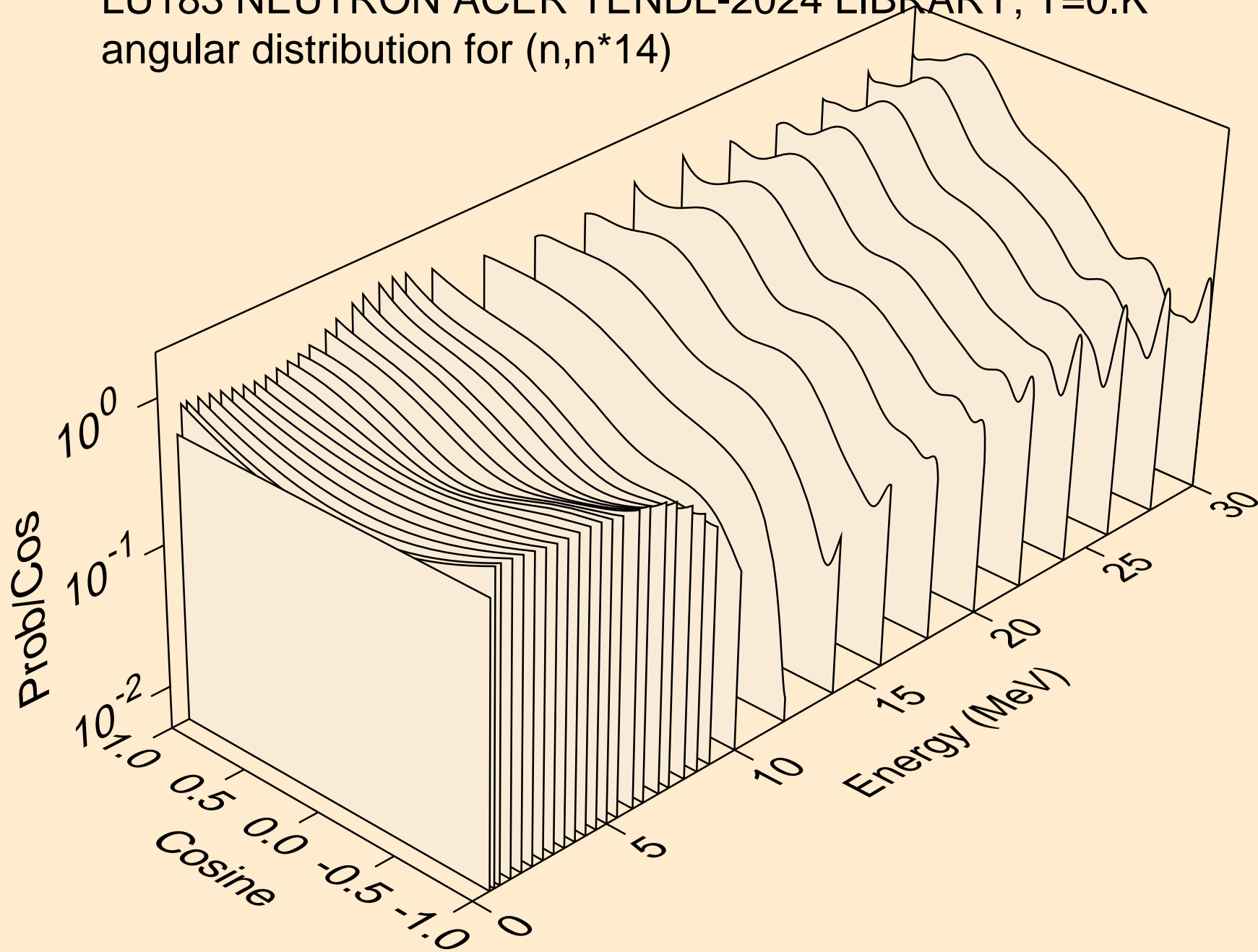

LU183 NEUTRON ACER TENDL-2024 LIBRARY; T=0.K
angular distribution for (n,n*15)

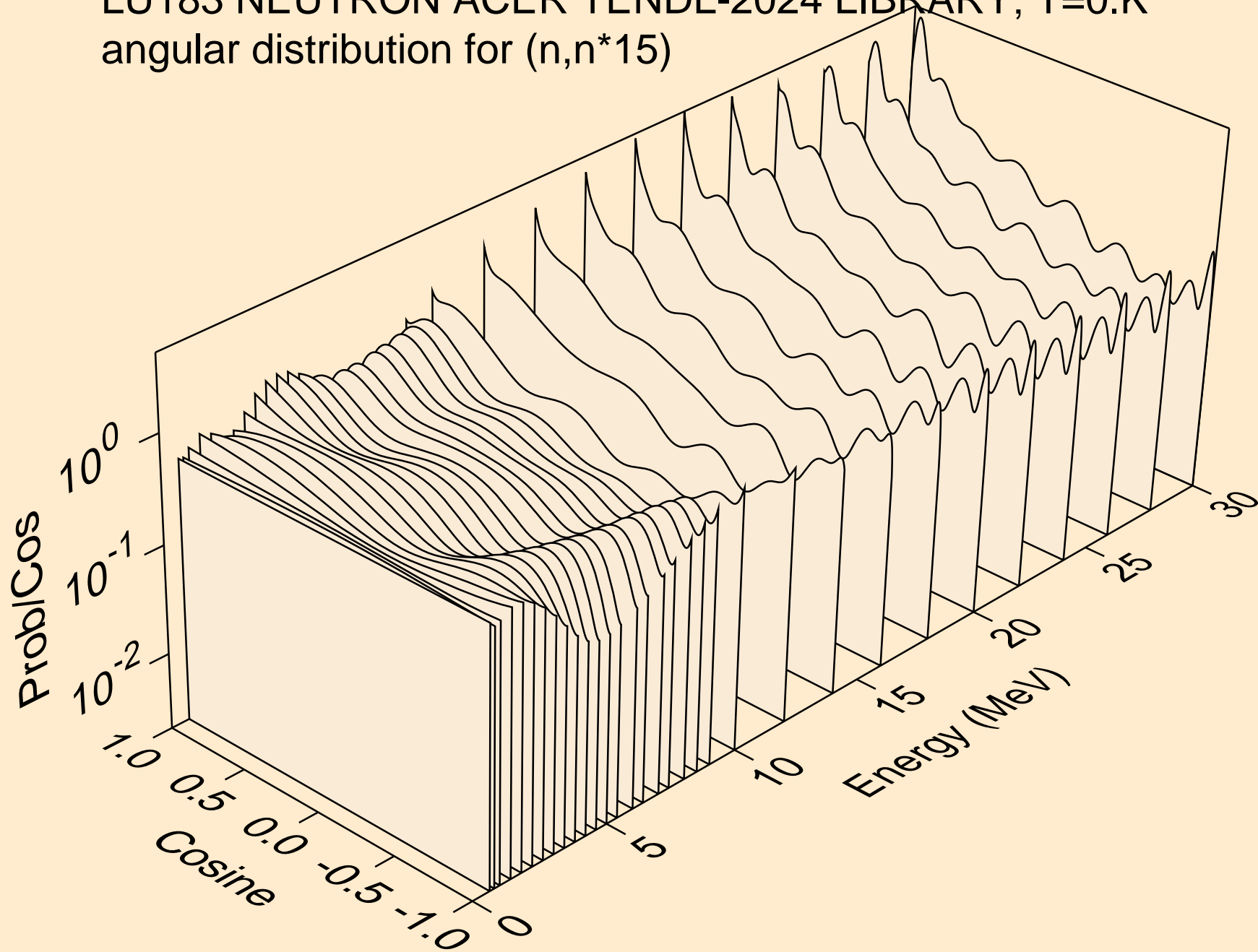

LU183 NEUTRON ACER TENDL-2024 LIBRARY; T=0.K
angular distribution for (n,n*16)

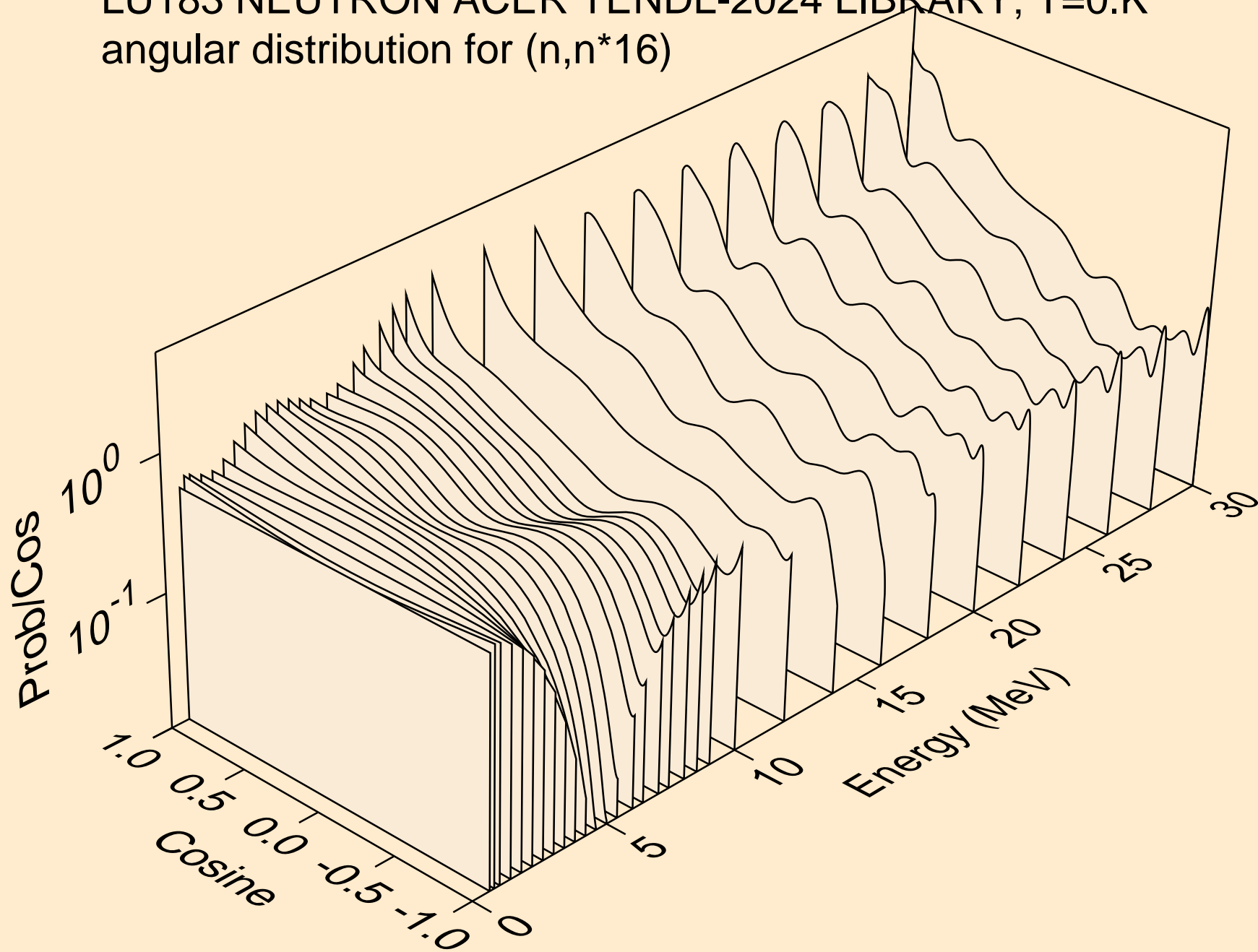

LU183 NEUTRON ACER TENDL-2024 LIBRARY; T=0.K
angular distribution for (n,n*17)

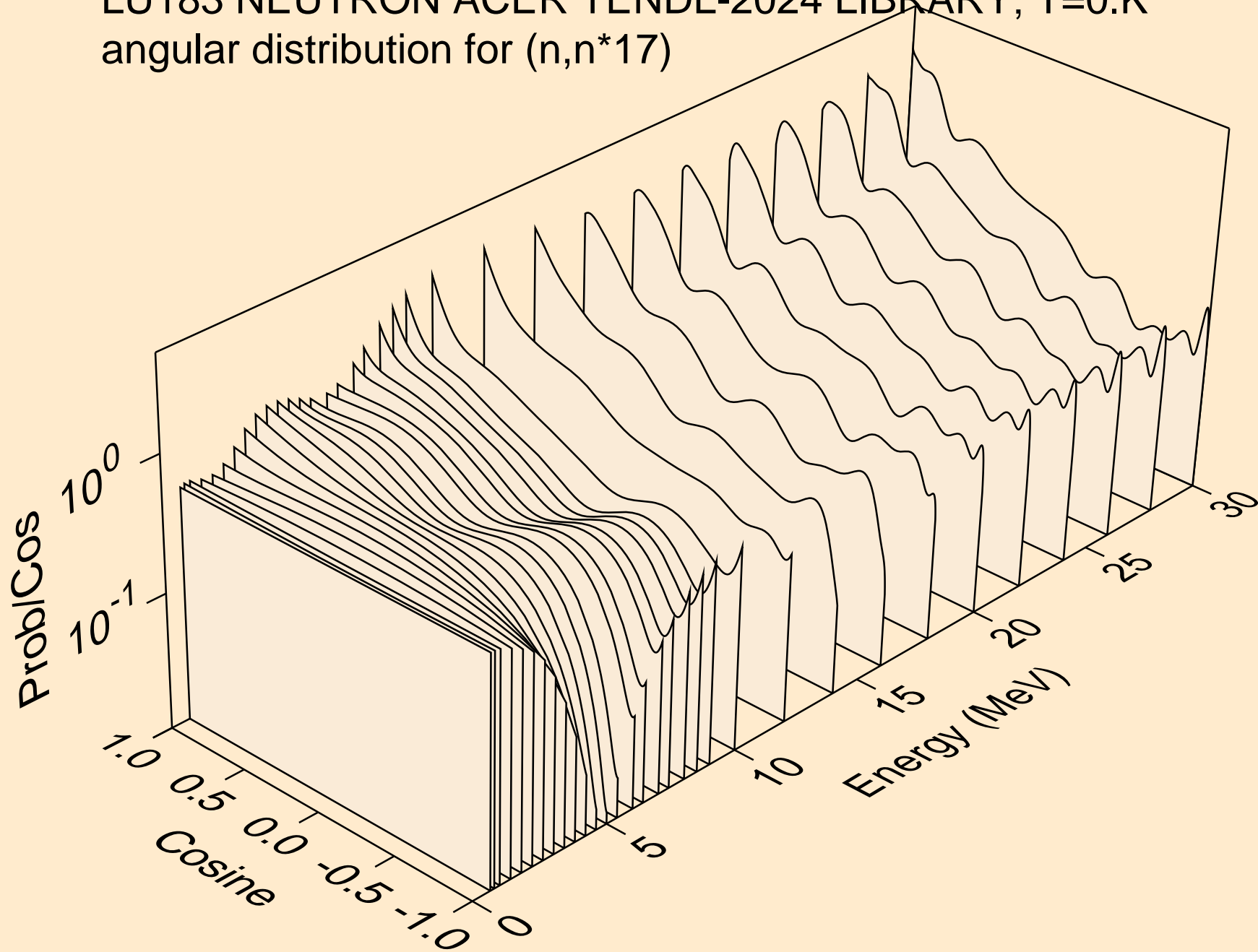

LU183 NEUTRON ACER TENDL-2024 LIBRARY; T=0.K
angular distribution for (n,n*18)

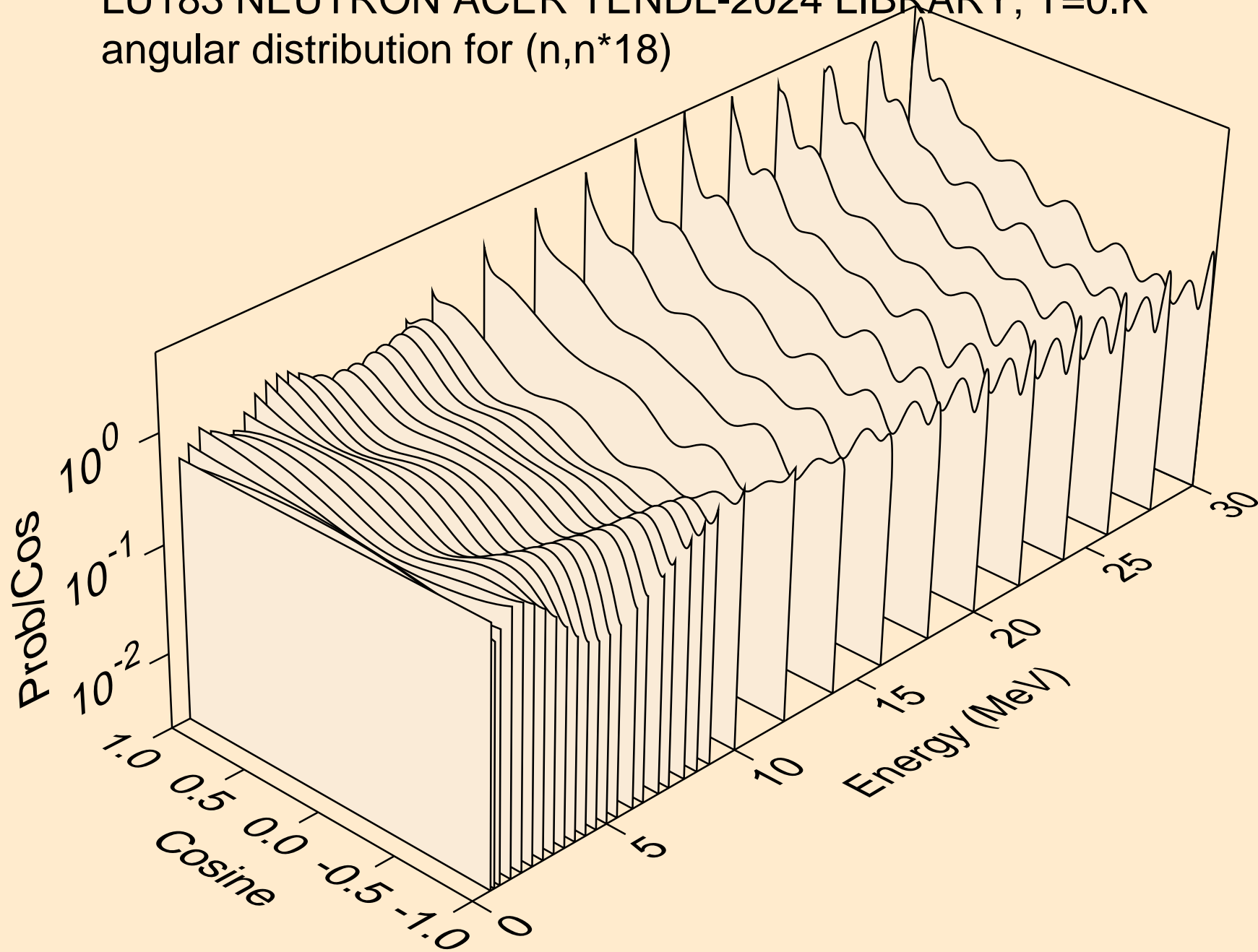

LU183 NEUTRON ACER TENDL-2024 LIBRARY; T=0.K
angular distribution for (n,n*19)

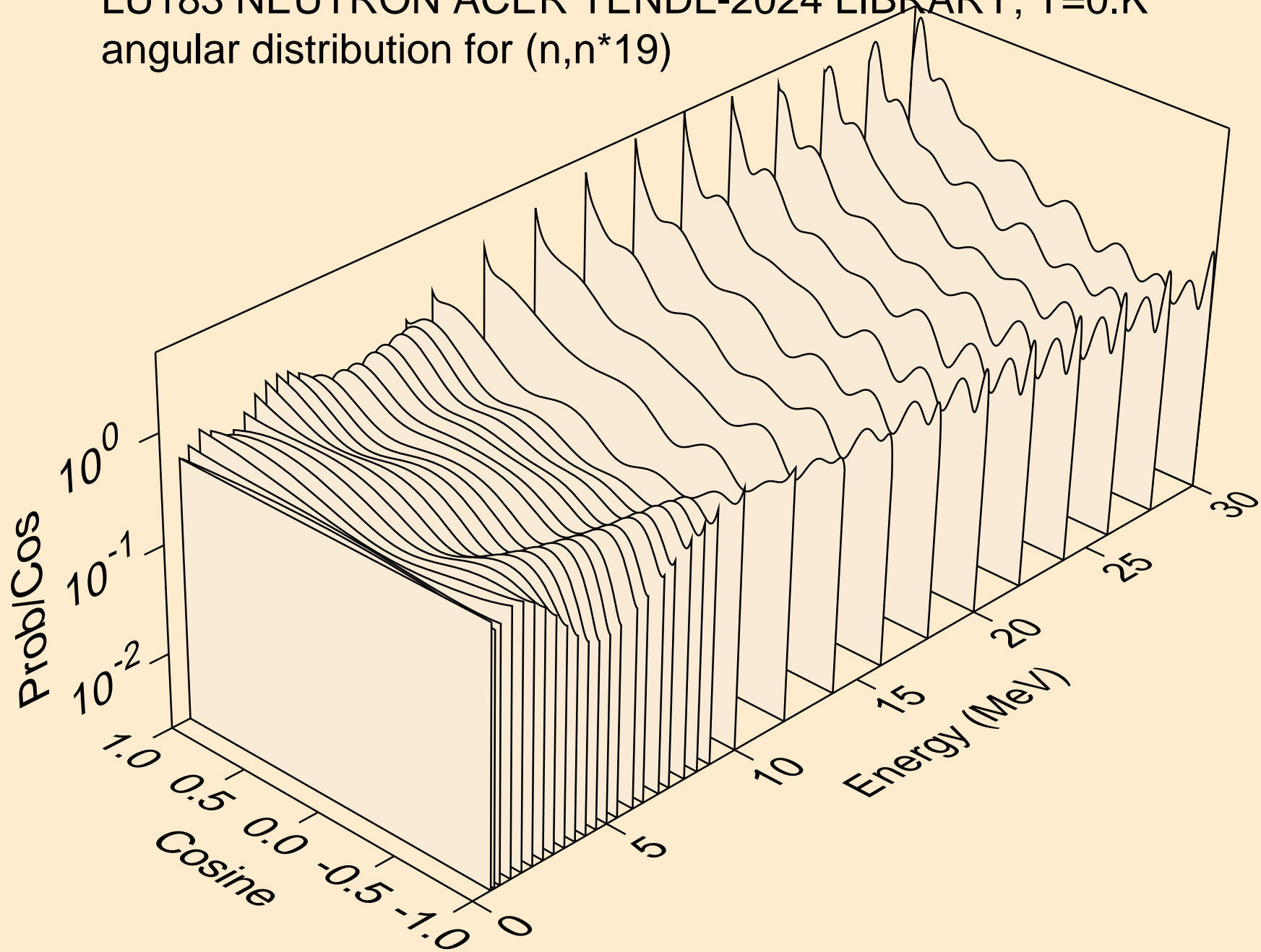

LU183 NEUTRON ACER TENDL-2024 LIBRARY; T=0.K
angular distribution for (n,n*20)

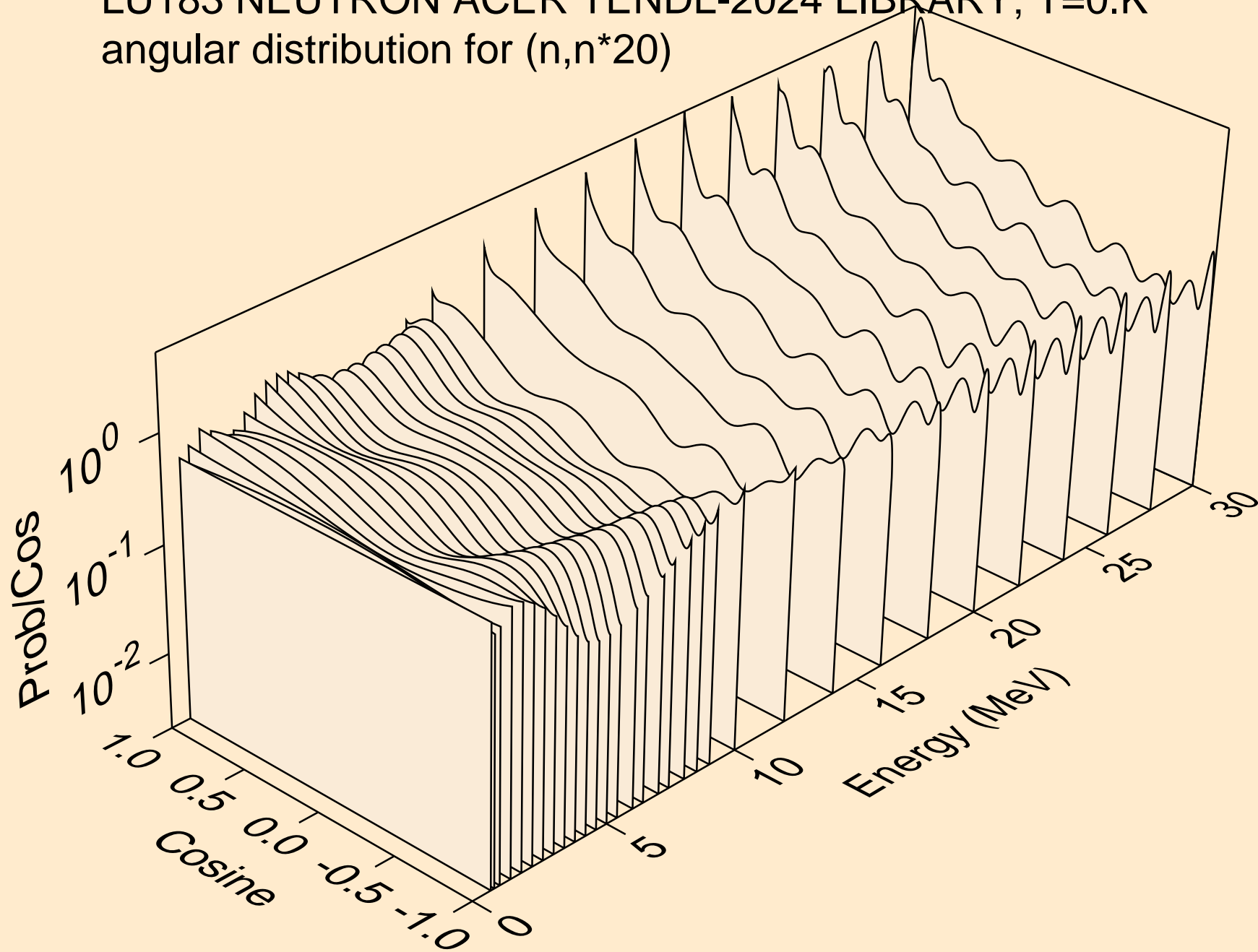

LU183 NEUTRON ACER TENDL-2024 LIBRARY; T=0.K
angular distribution for (n,n*21)

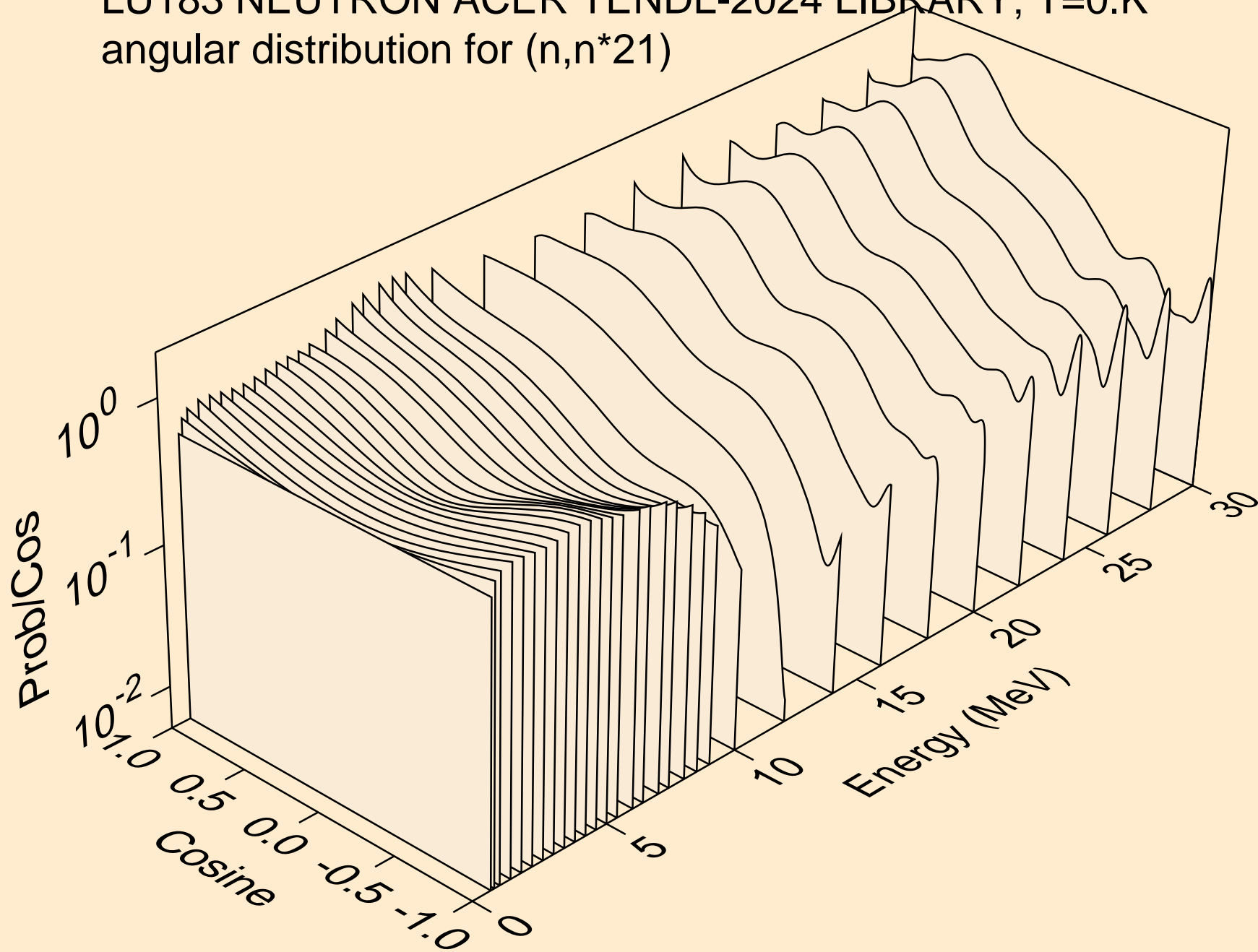

LU183 NEUTRON ACER TENDL-2024 LIBRARY; T=0.K
angular distribution for (n,n*22)

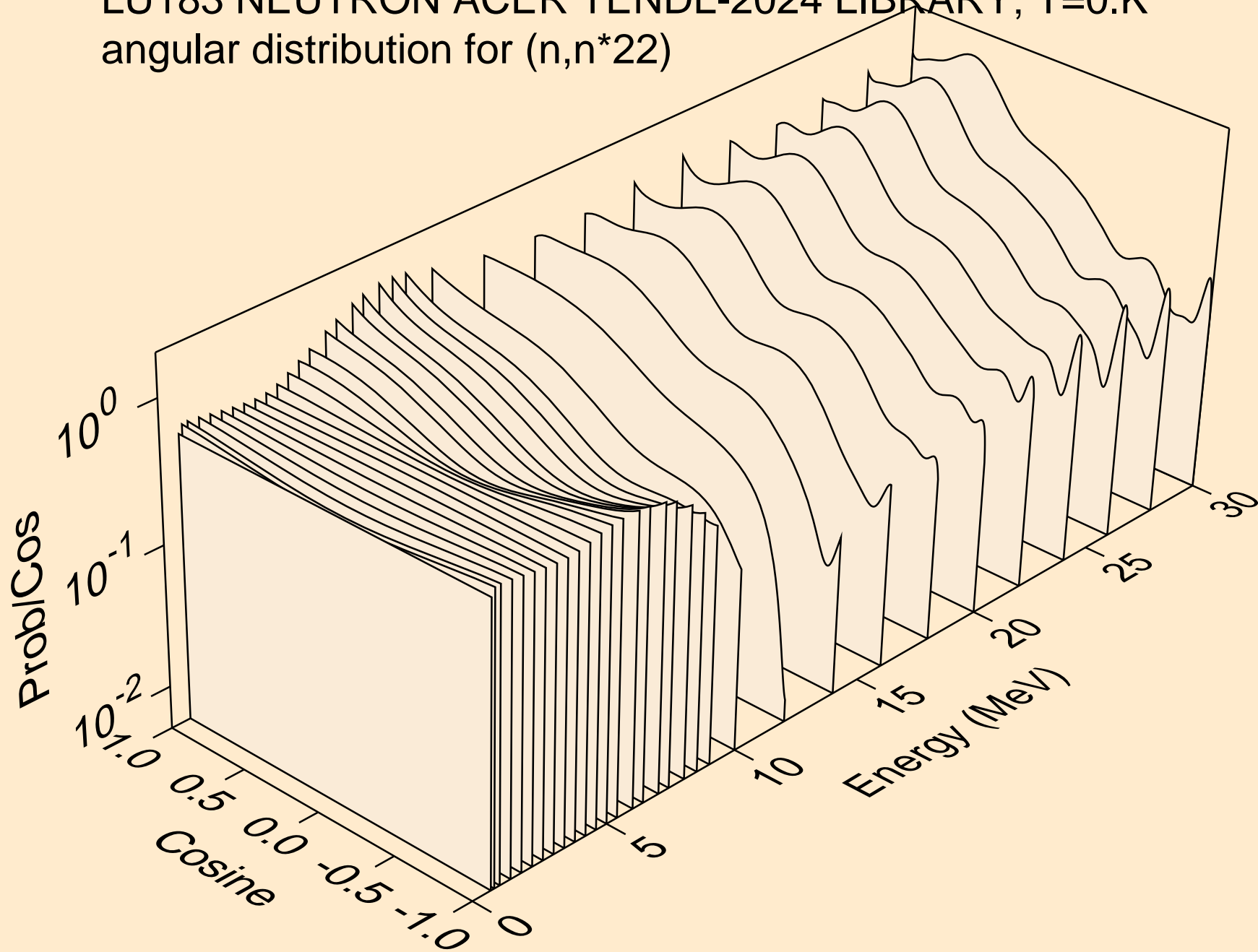

LU183 NEUTRON ACER TENDL-2024 LIBRARY; T=0.K
angular distribution for (n,n*23)

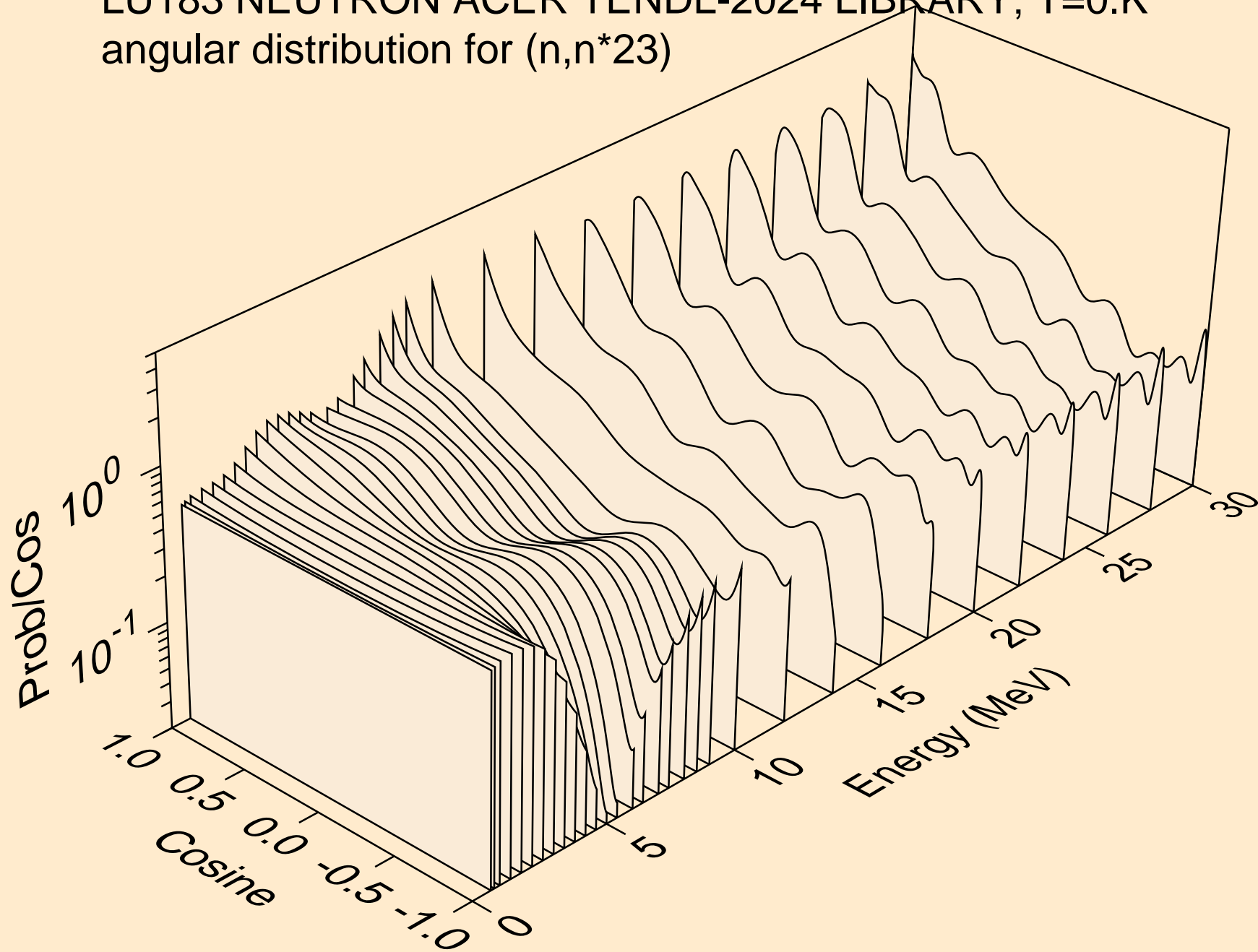

LU183 NEUTRON ACER TENDL-2024 LIBRARY; T=0.K
angular distribution for (n,n*24)

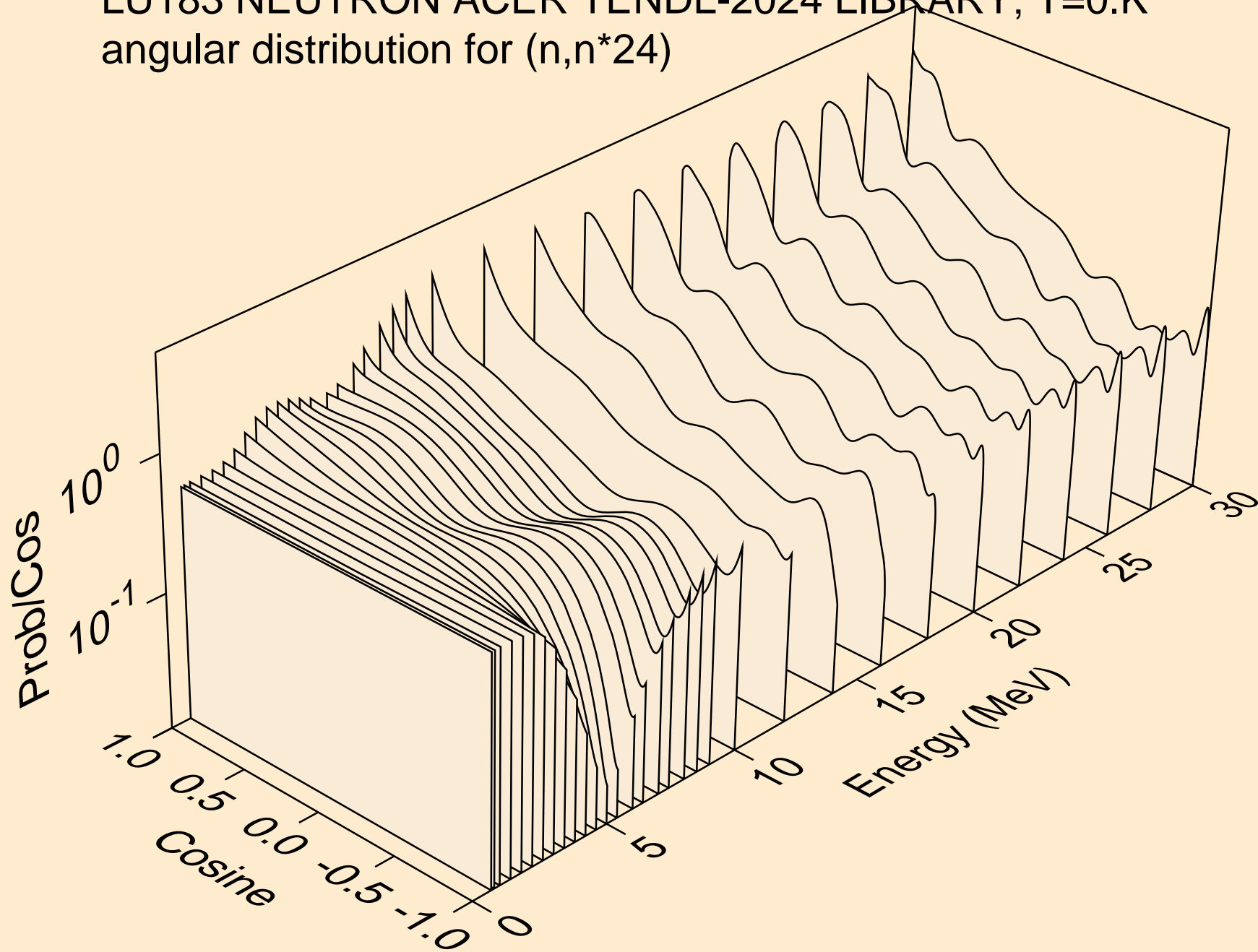

LU183 NEUTRON ACER TENDL-2024 LIBRARY; T=0.K
angular distribution for (n,n*25)

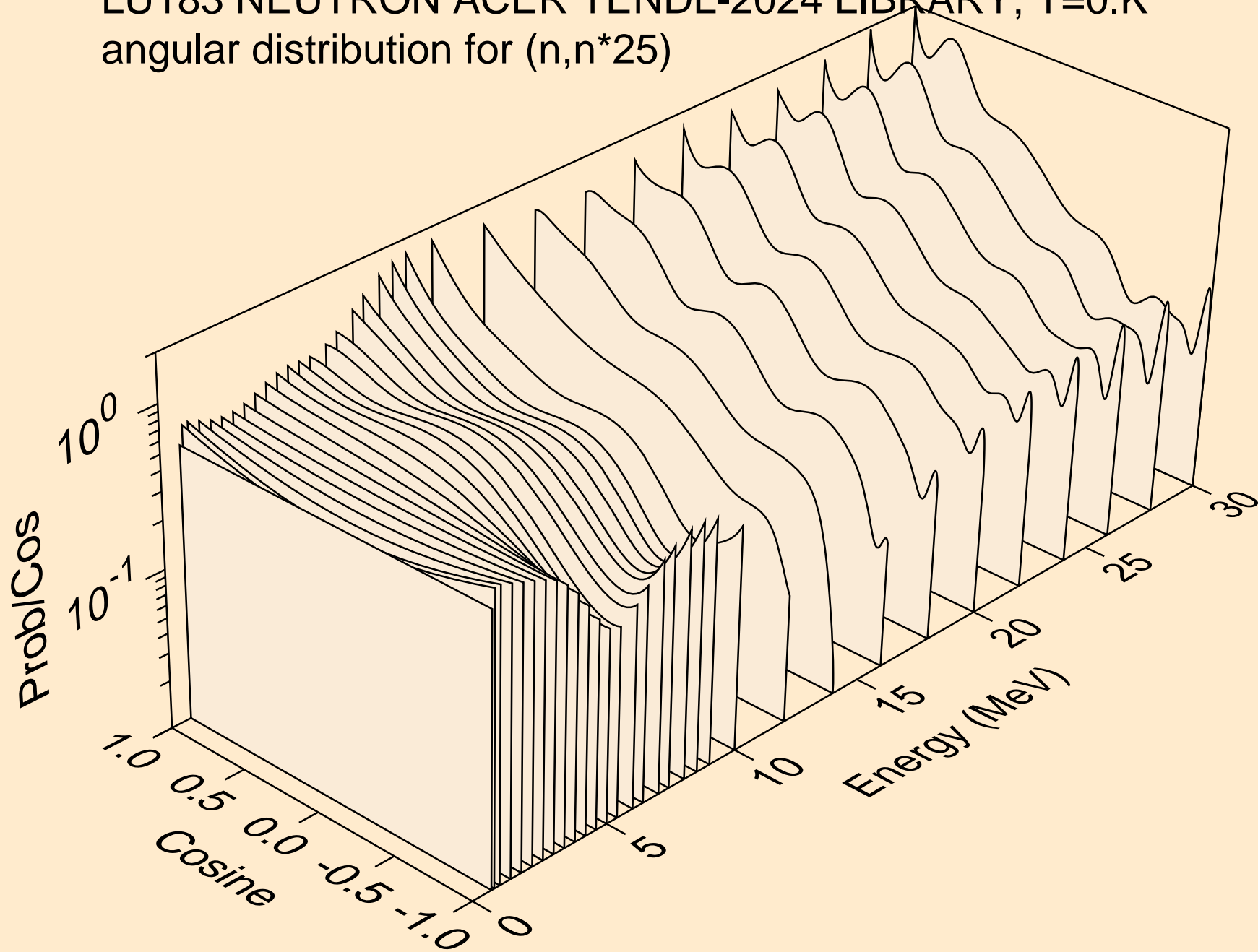

LU183 NEUTRON ACER TENDL-2024 LIBRARY; T=0.K
angular distribution for (n,n*26)

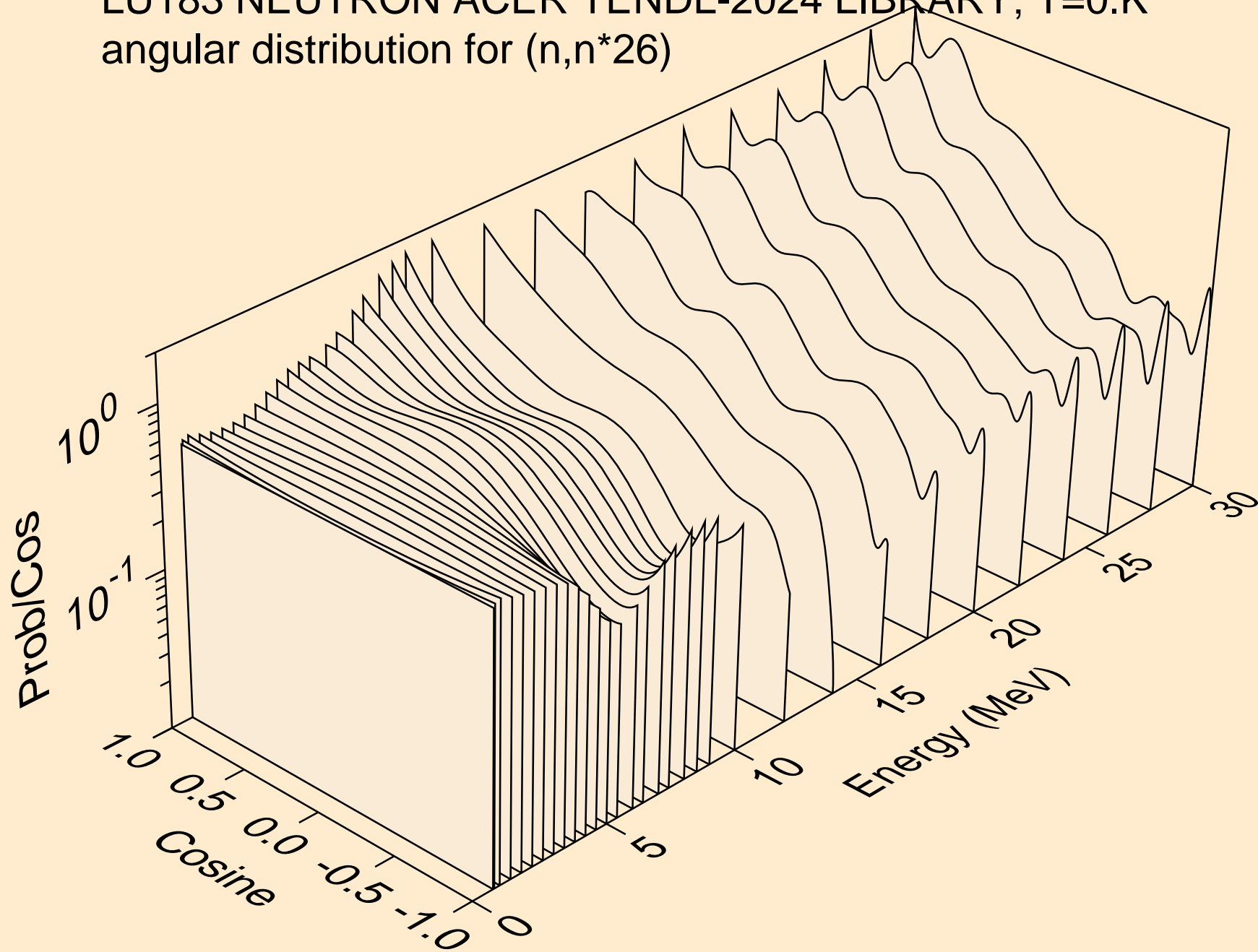

LU183 NEUTRON ACER TENDL-2024 LIBRARY; T=0.K
angular distribution for (n,n*27)

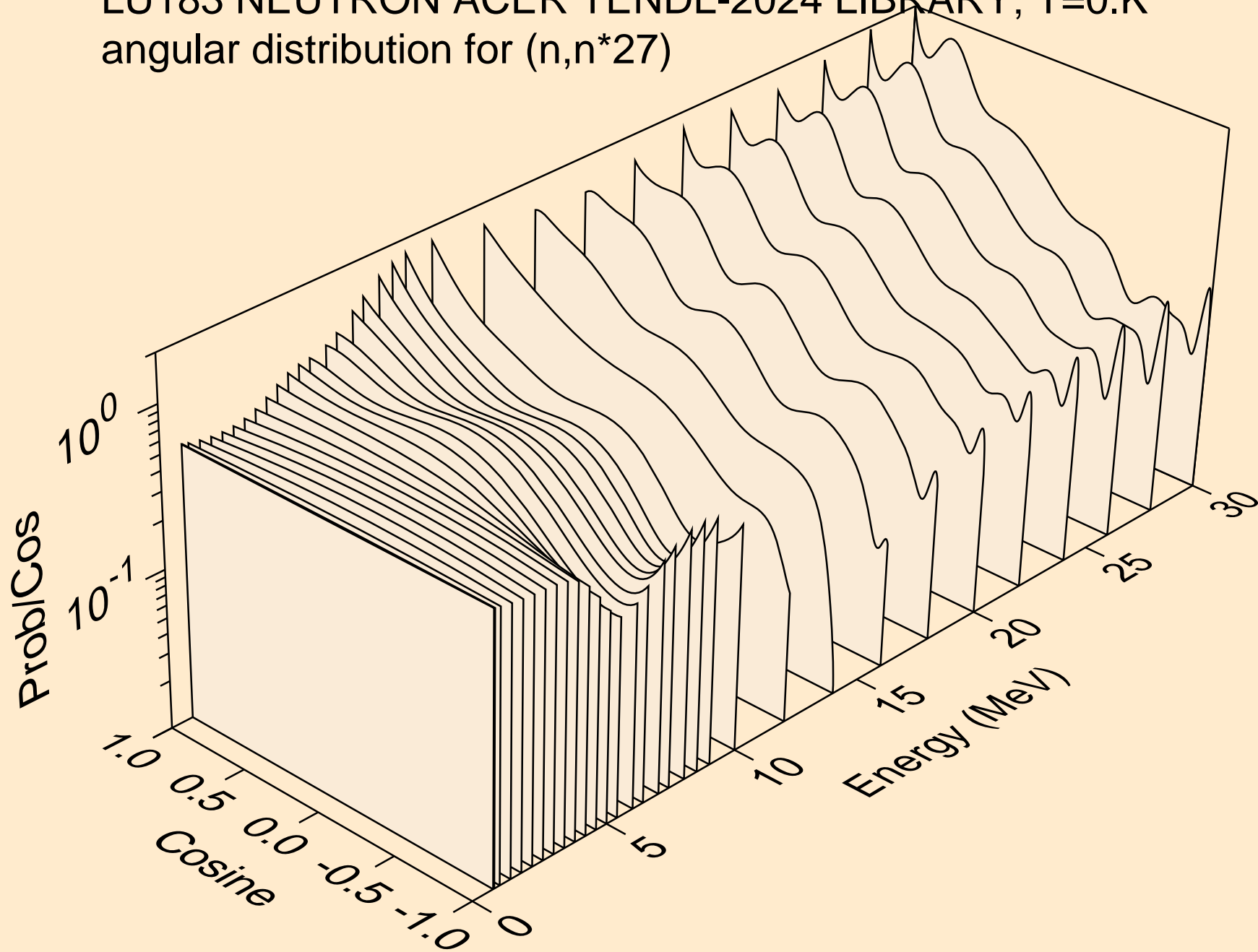

LU183 NEUTRON ACER TENDL-2024 LIBRARY; T=0.K
angular distribution for (n,n*28)

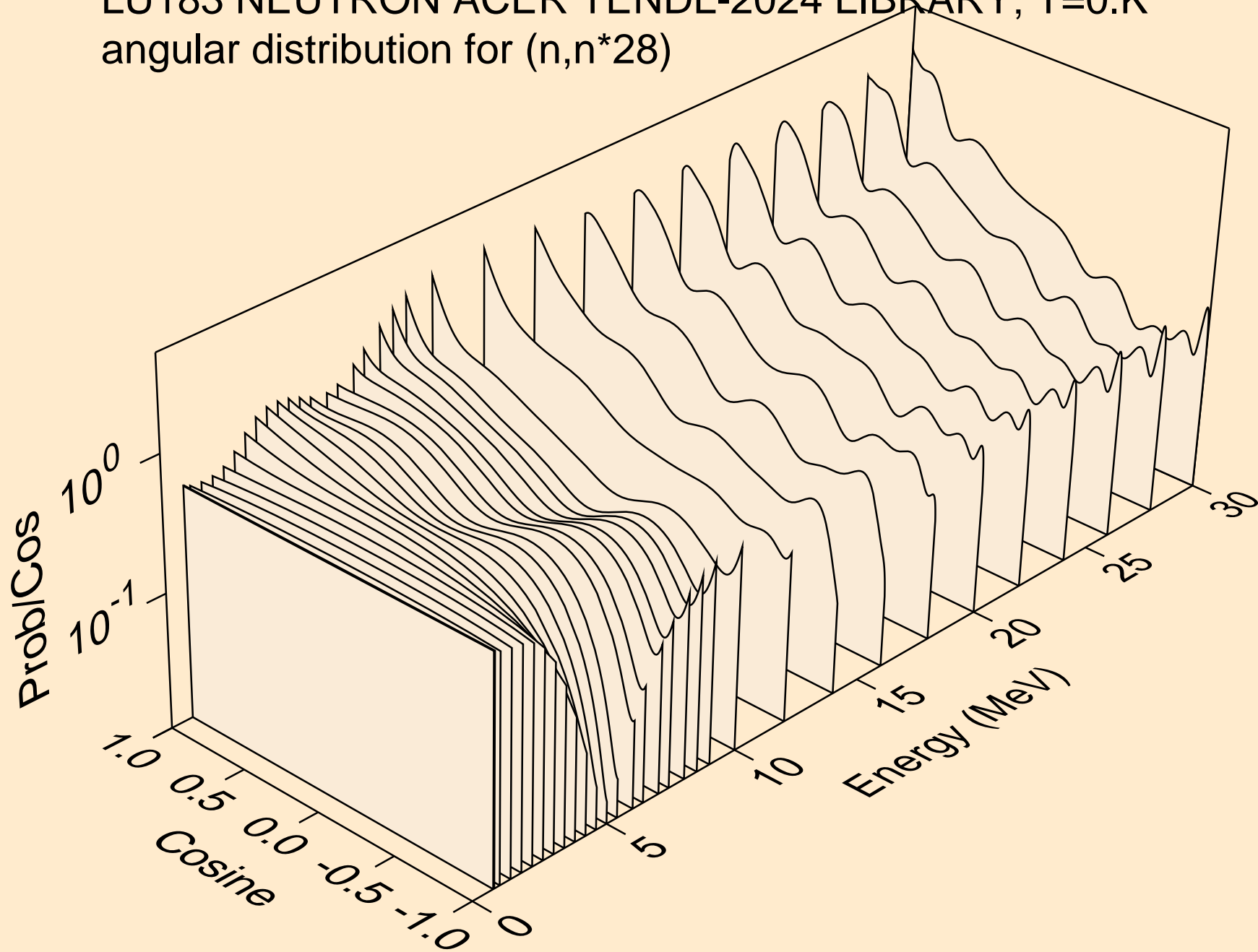

LU183 NEUTRON ACER TENDL-2024 LIBRARY; T=0.K
angular distribution for (n,n*29)

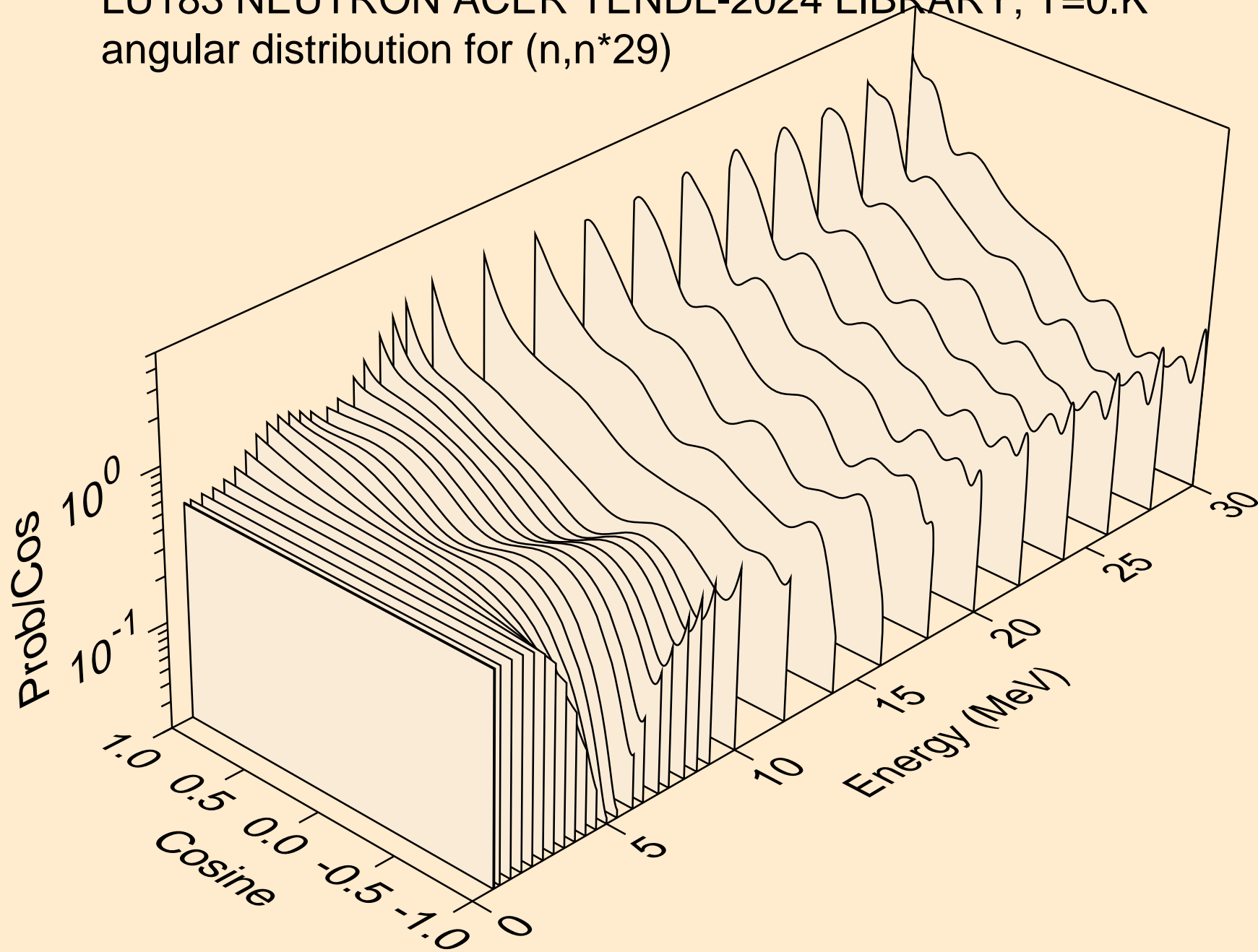

LU183 NEUTRON ACER TENDL-2024 LIBRARY; T=0.K
angular distribution for (n,n*30)

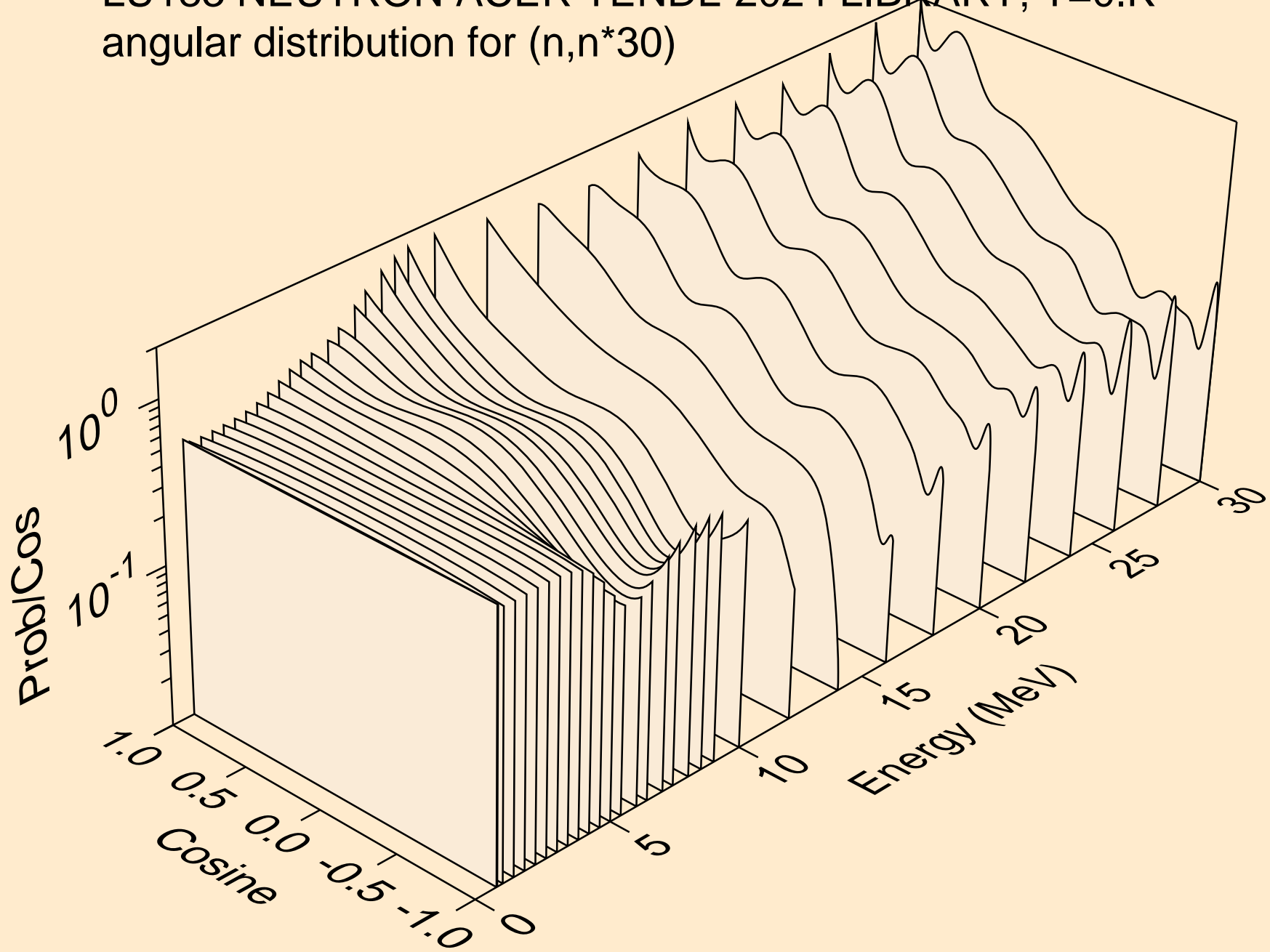

LU183 NEUTRON ACER TENDL-2024 LIBRARY; T=0.K
Neutron emission for (n,x)

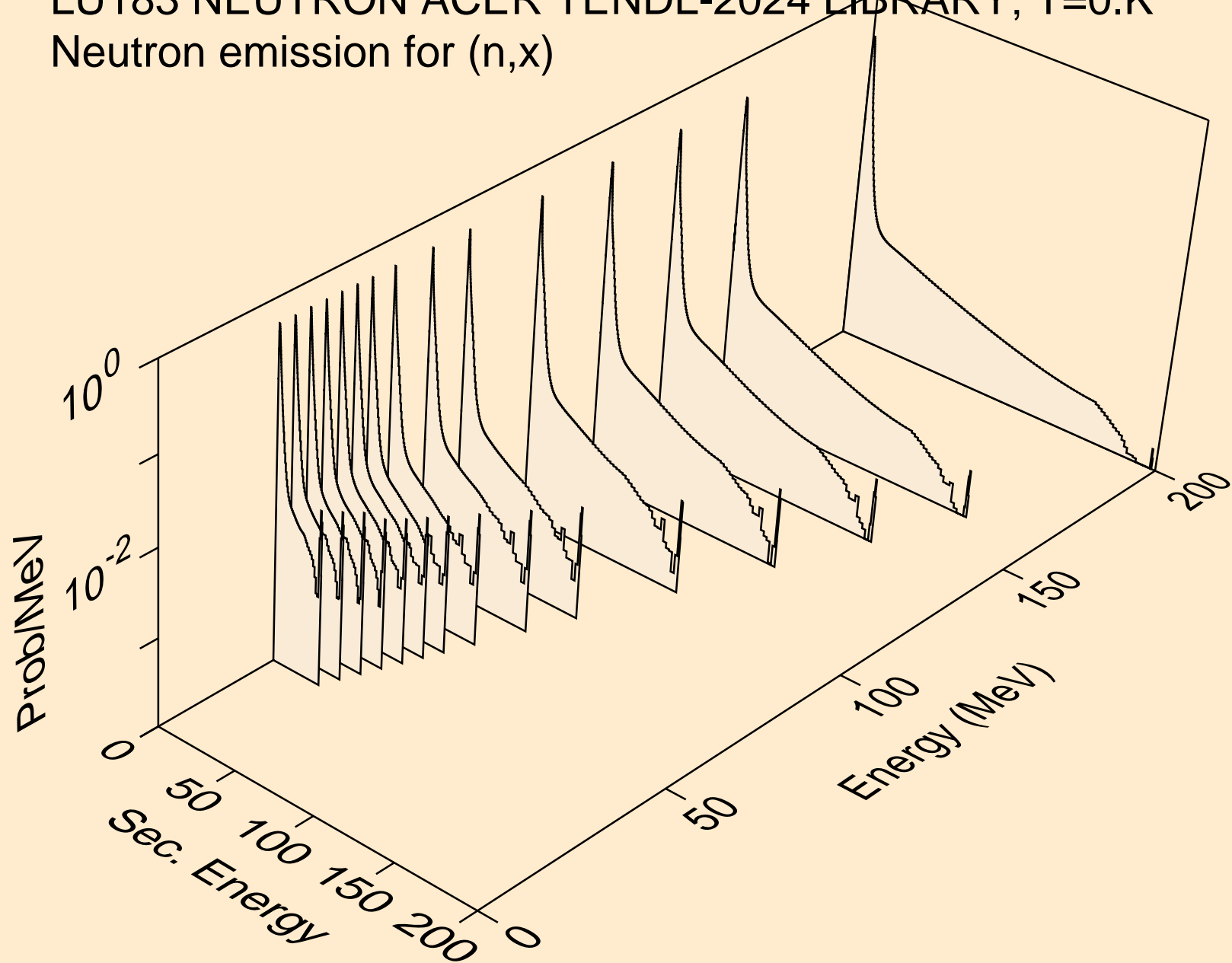

LU183 NEUTRON ACER TENDL-2024 LIBRARY; T=0.K
Neutron emission for (n,2nd)

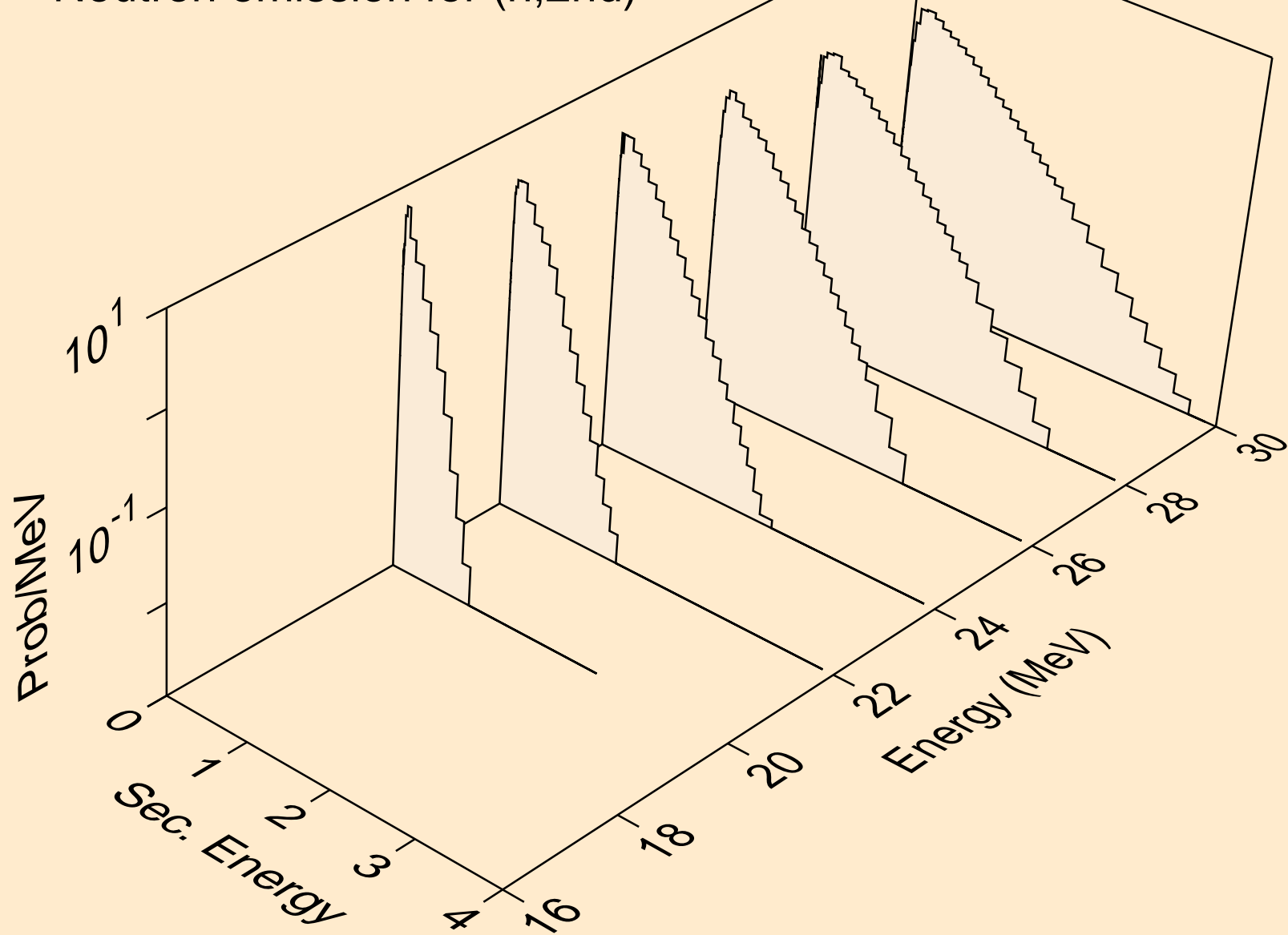

LU183 NEUTRON ACER TENDL-2024 LIBRARY; T=0.K
Neutron emission for (n,2n)

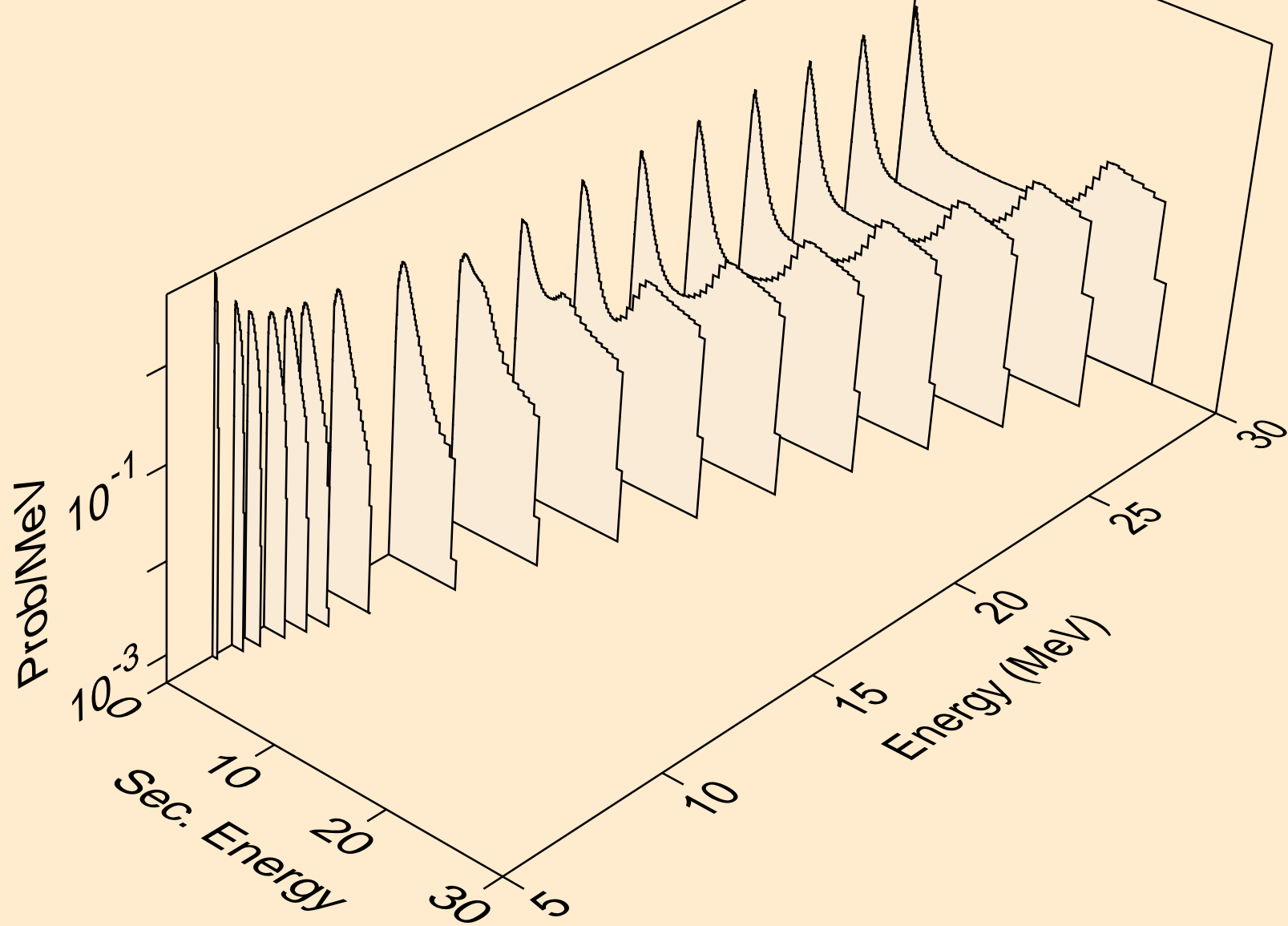

LU183 NEUTRON ACER TENDL-2024 LIBRARY; T=0.K
Neutron emission for (n,3n)

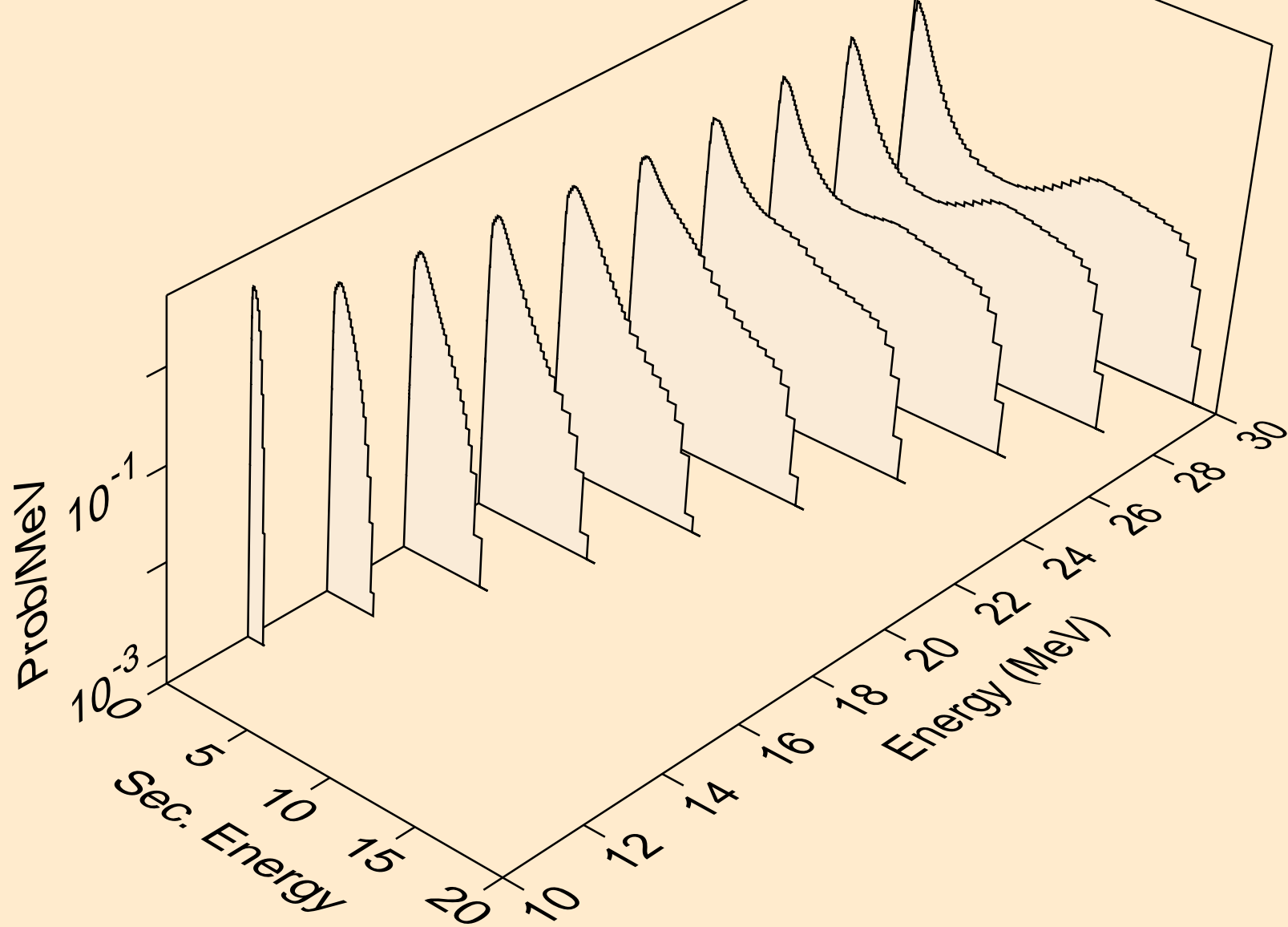

LU183 NEUTRON ACER TENDL-2024 LIBRARY; T=0.K
Neutron emission for (n,n*)a

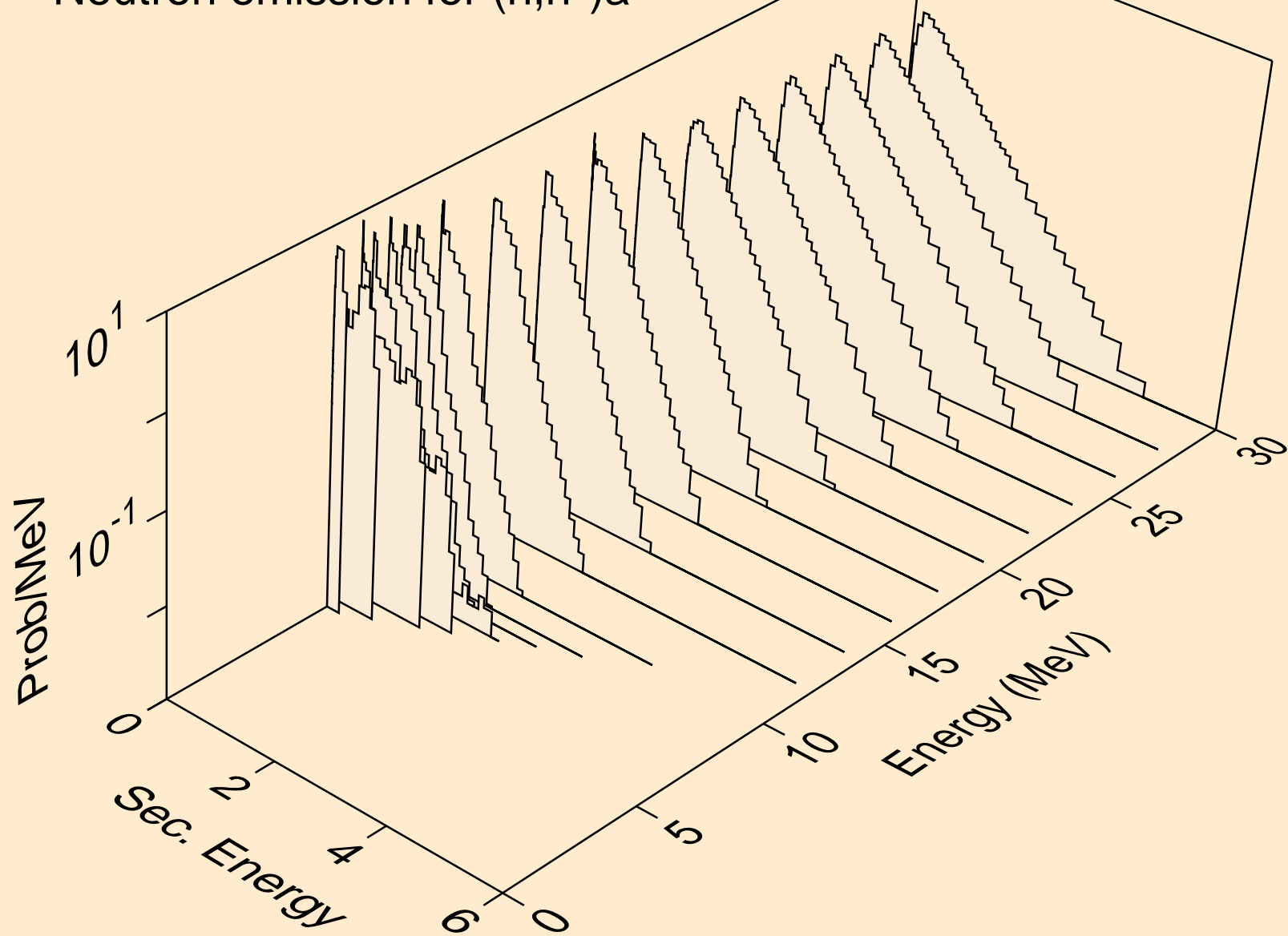

LU183 NEUTRON ACER TENDL-2024 LIBRARY; T=0.K
Neutron emission for (n,2n)_a

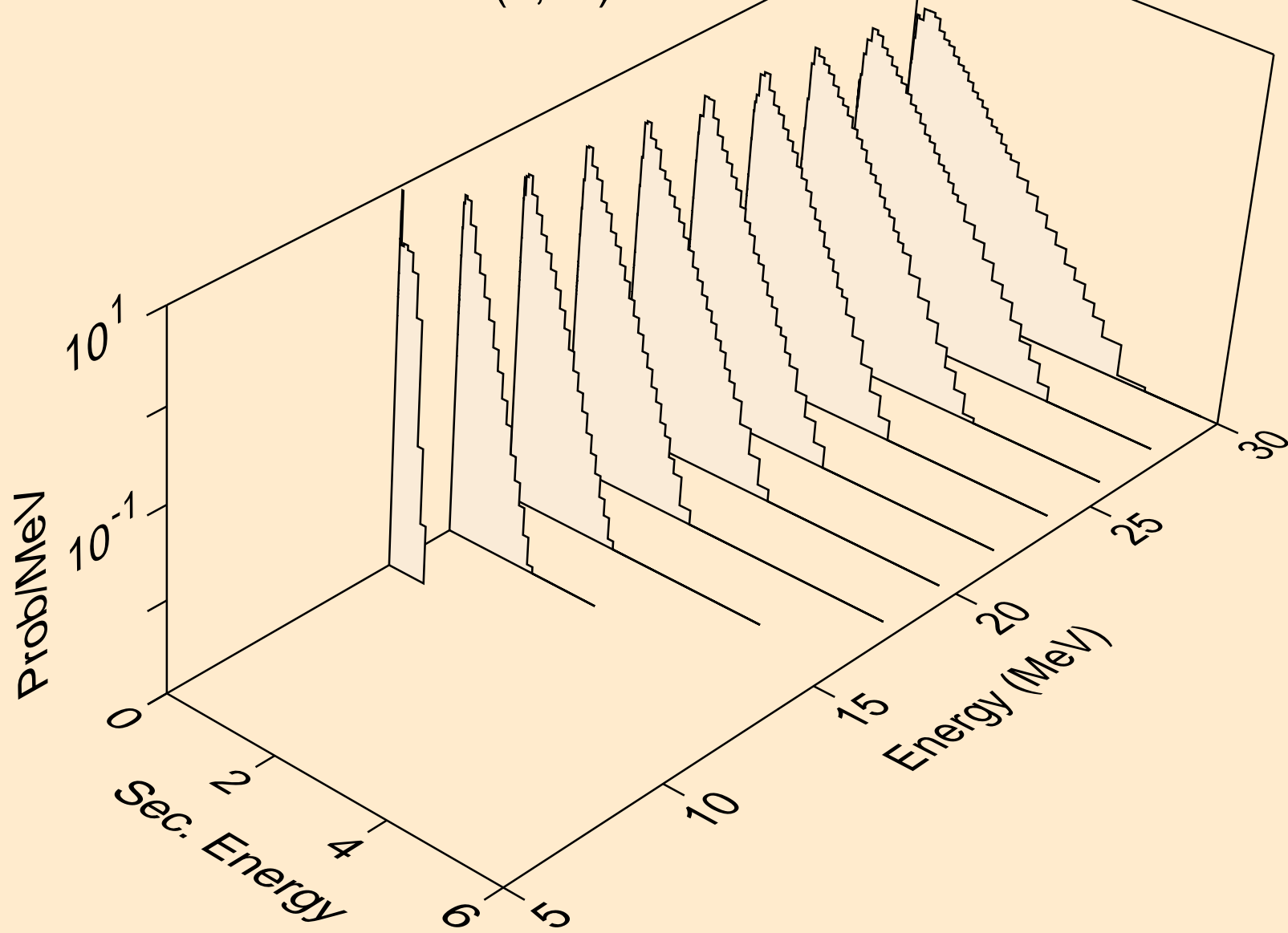

LU183 NEUTRON ACER TENDL-2024 LIBRARY; T=0.K
Neutron emission for (n,3n)a

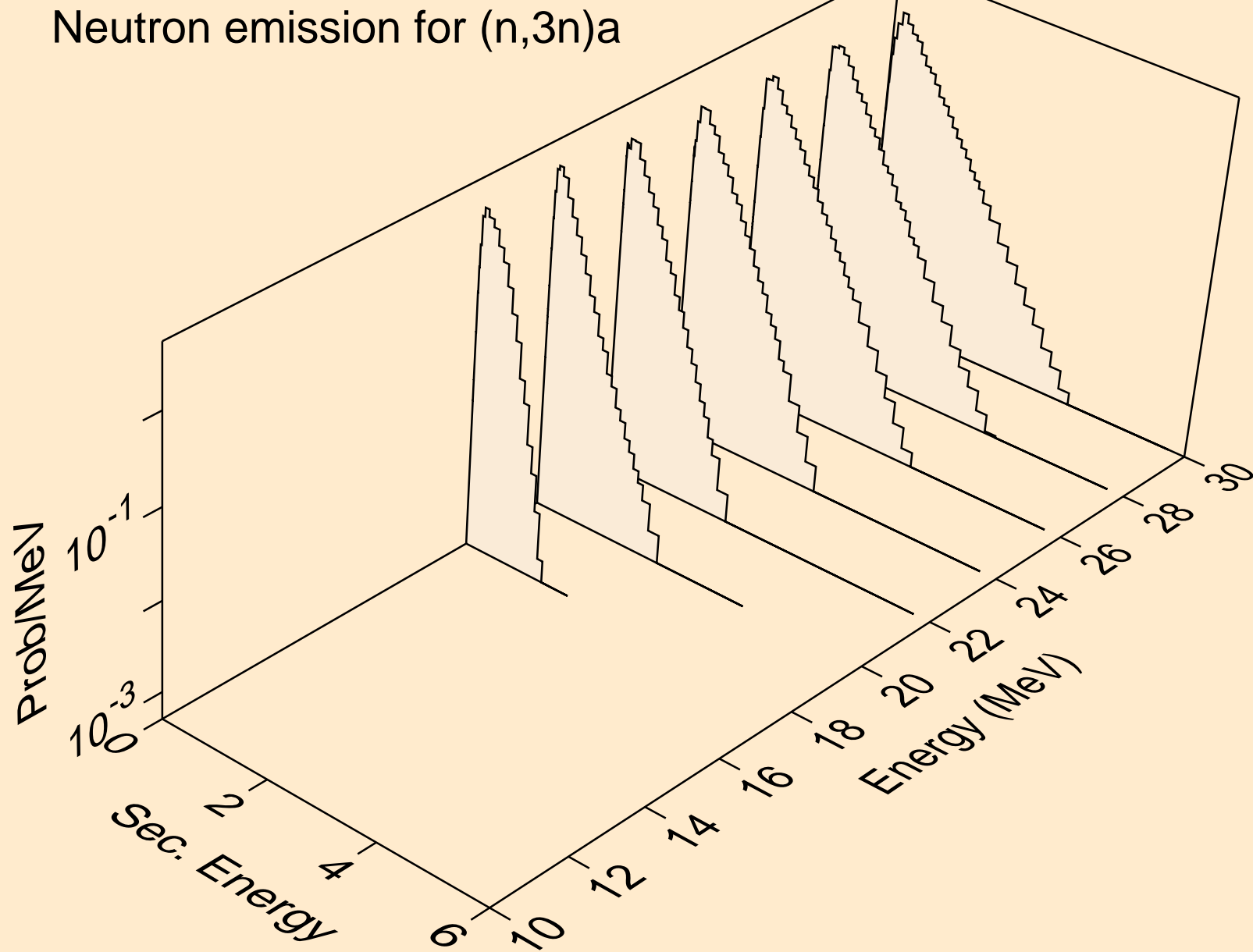

LU183 NEUTRON ACER TENDL-2024 LIBRARY; T=0.K
Neutron emission for (n,n*)p

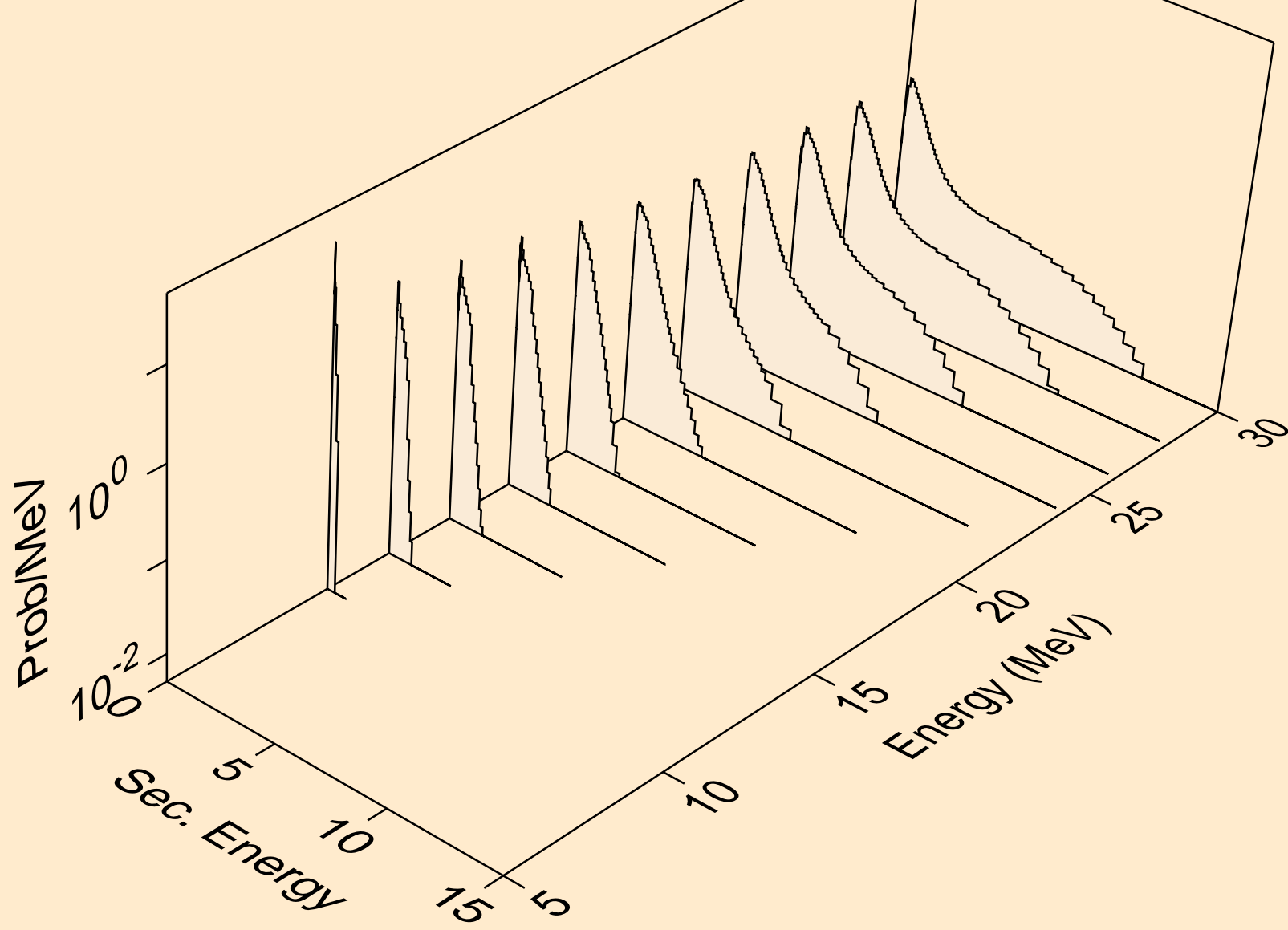

LU183 NEUTRON ACER TENDL-2024 LIBRARY; T=0.K
Neutron emission for (n,n*)d

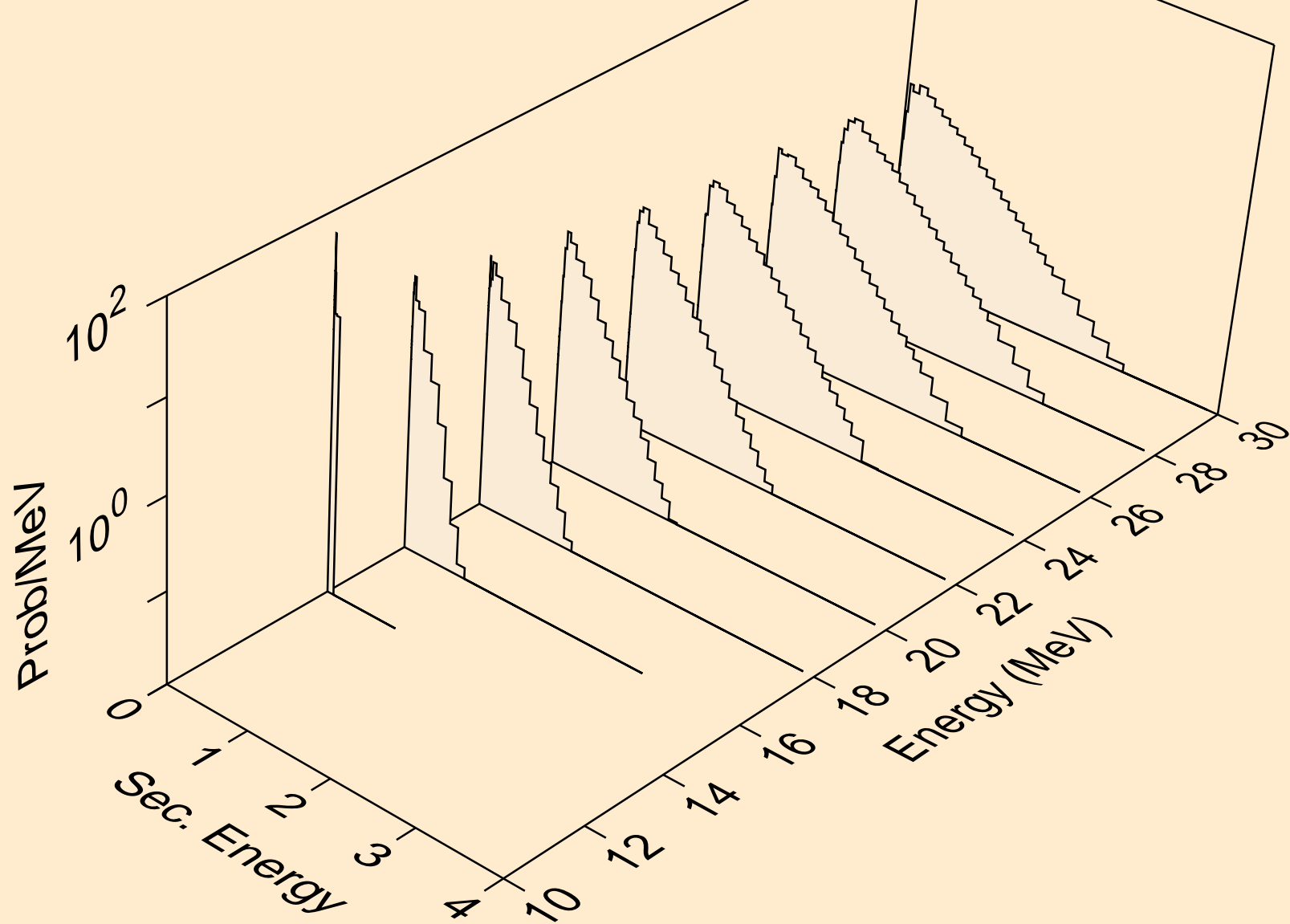

LU183 NEUTRON ACER TENDL-2024 LIBRARY; T=0.K
Neutron emission for (n,n*)t

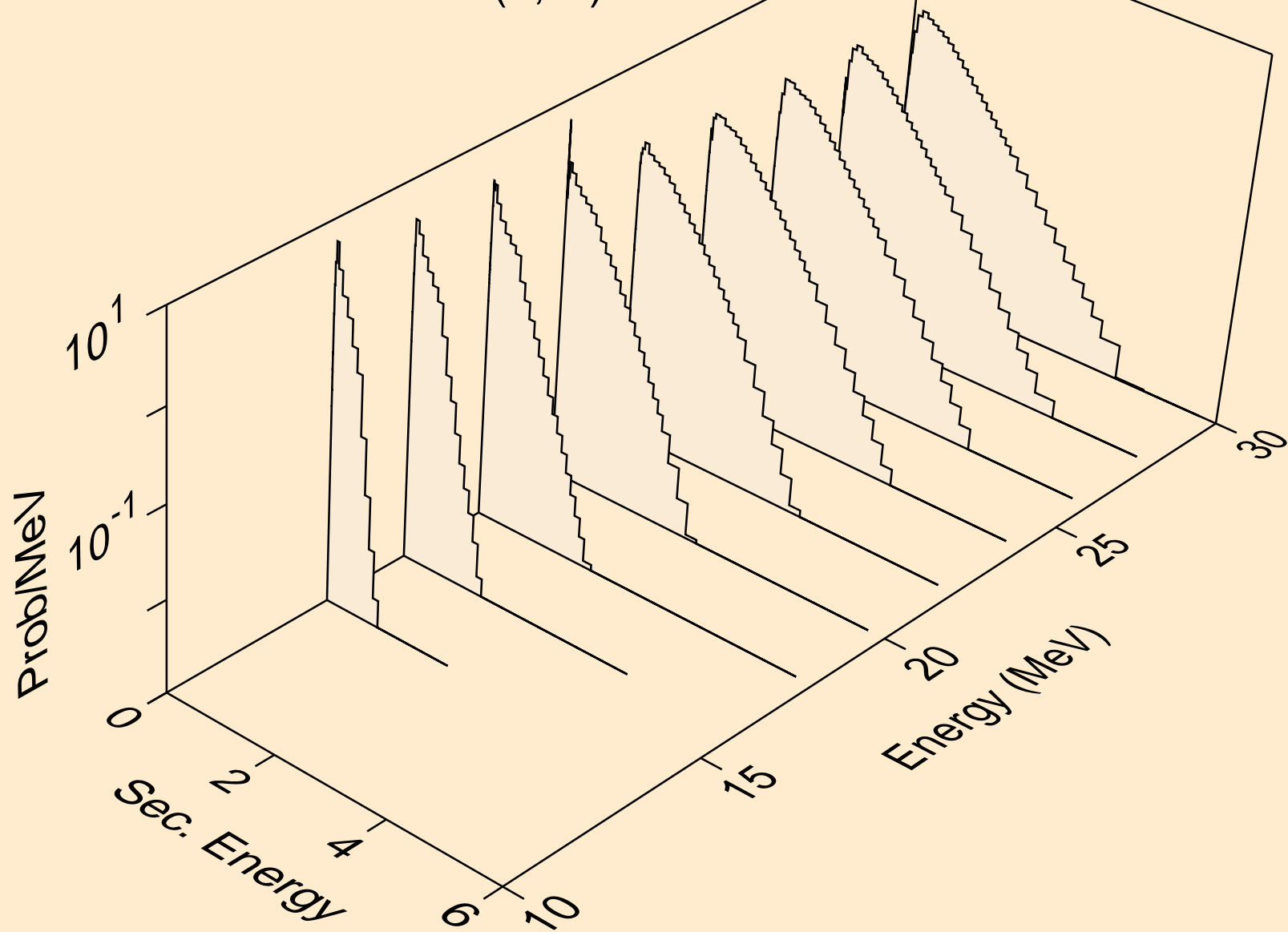

LU183 NEUTRON ACER TENDL-2024 LIBRARY; T=0.K
Neutron emission for (n,n*)he3

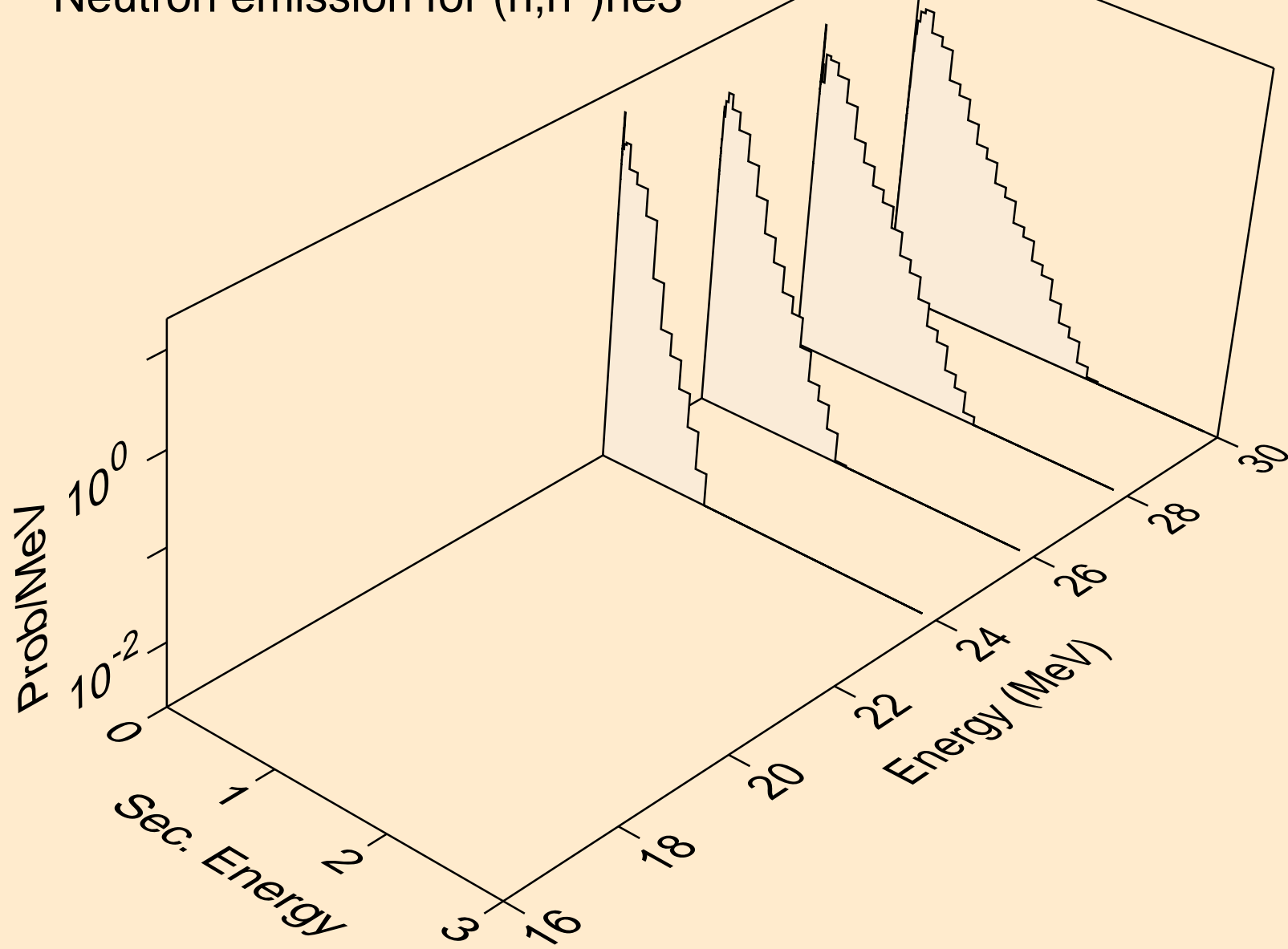

LU183 NEUTRON ACER TENDL-2024 LIBRARY; T=0.K
Neutron emission for (n,4n)

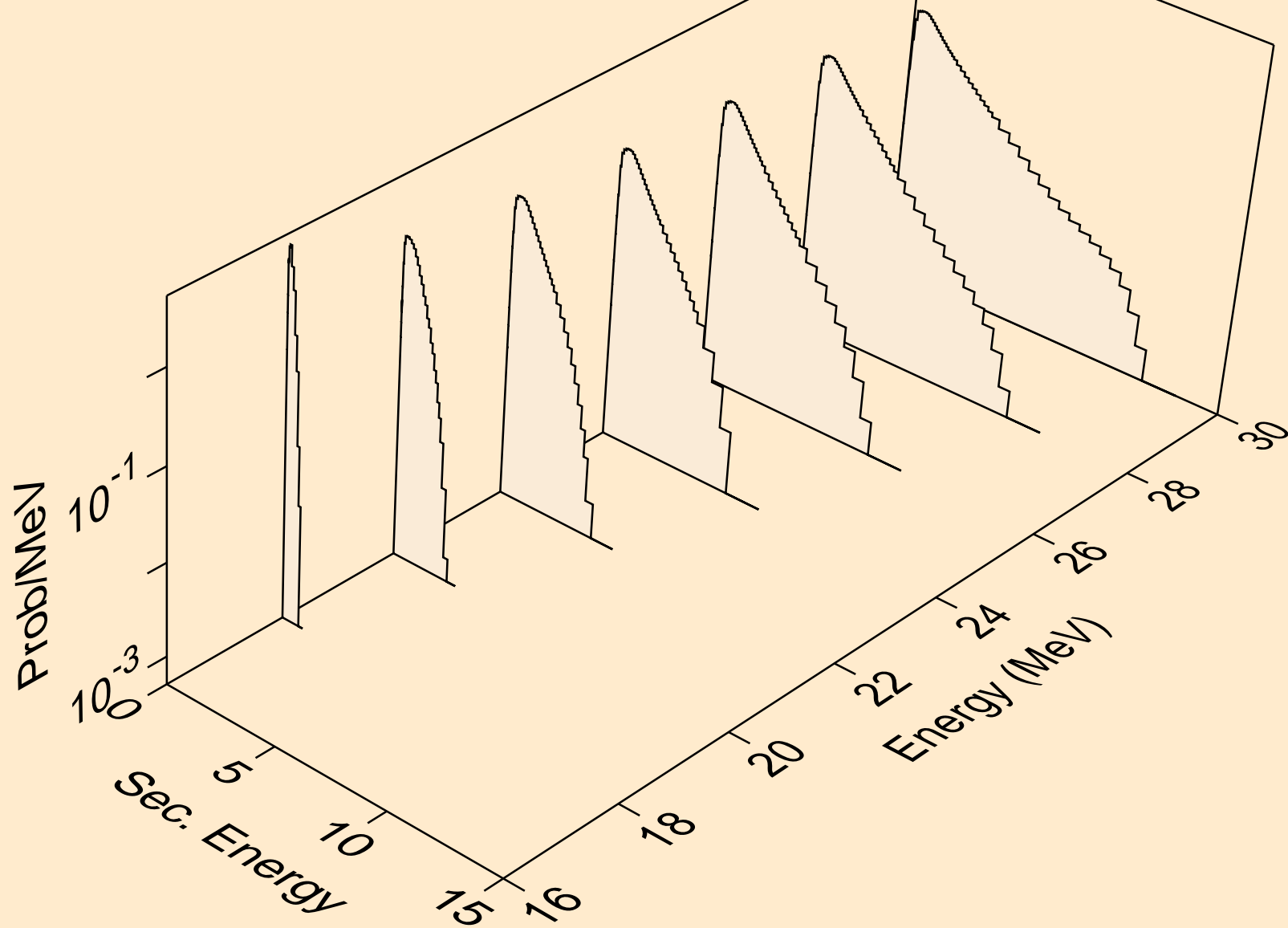

LU183 NEUTRON ACER TENDL-2024 LIBRARY; T=0.K
Neutron emission for (n,2np)

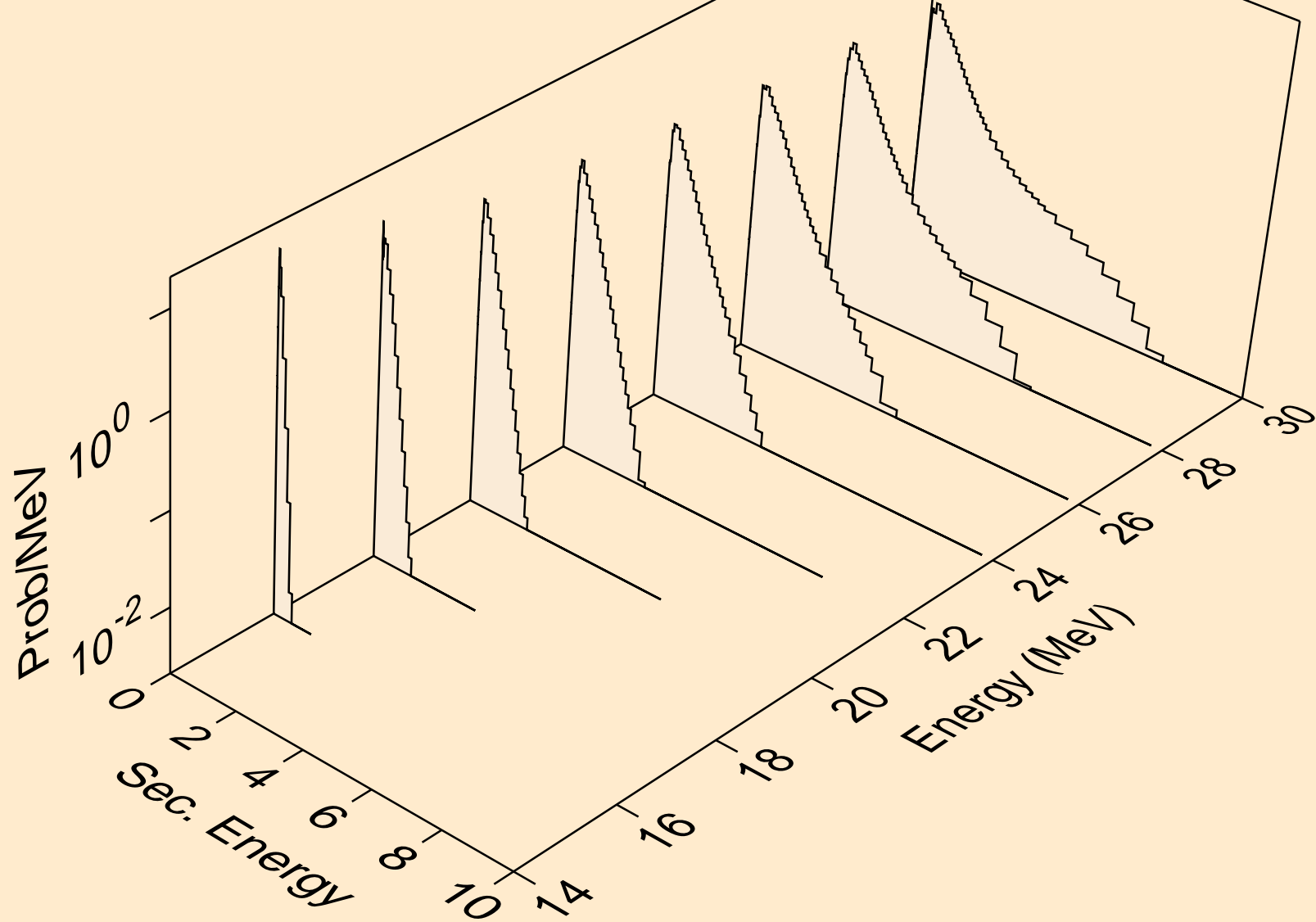

LU183 NEUTRON ACER TENDL-2024 LIBRARY; T=0.K
Neutron emission for (n,3np)

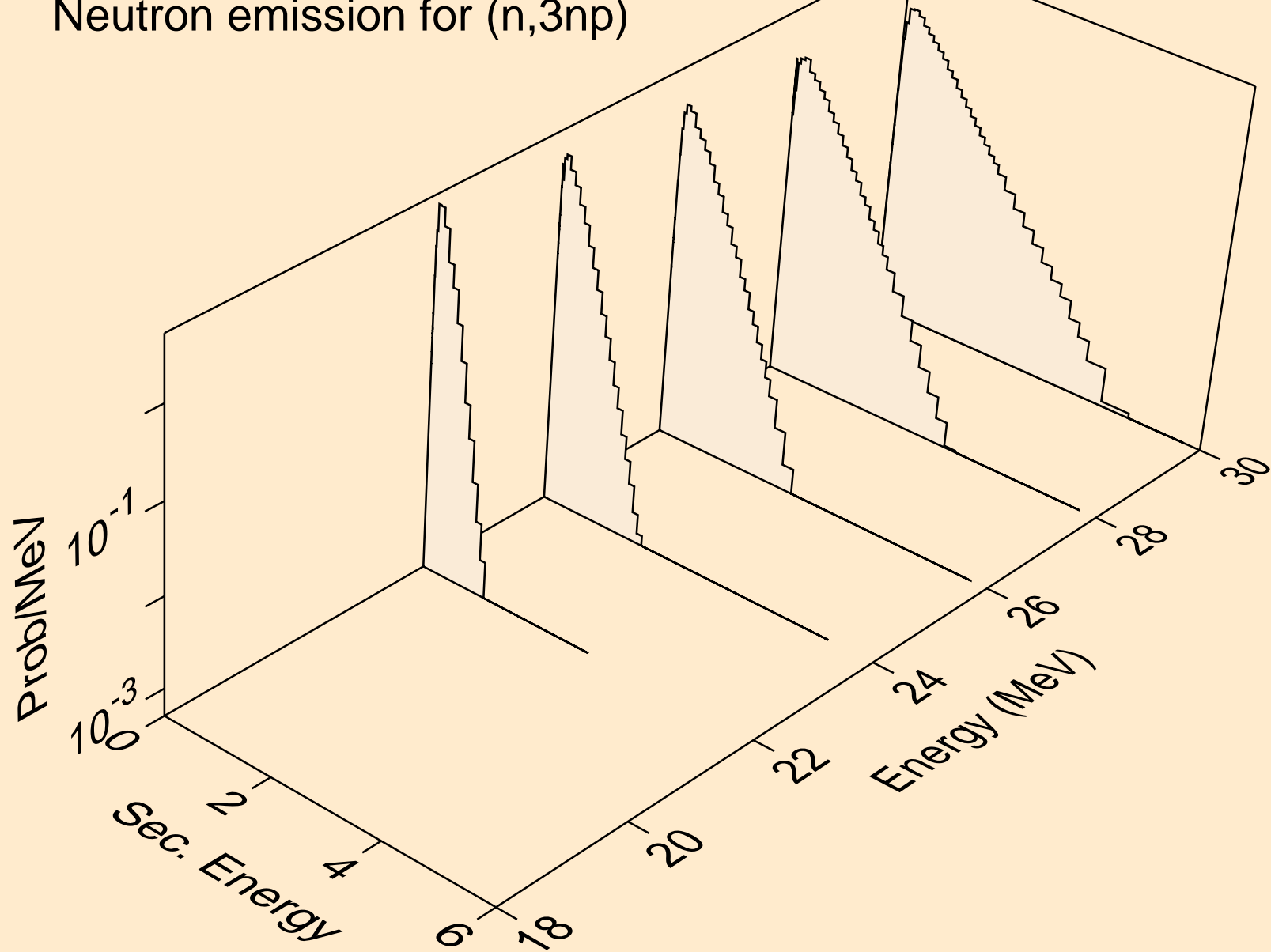

LU183 NEUTRON ACER TENDL-2024 LIBRARY; T=0.K
Neutron emission for (n,n*c)

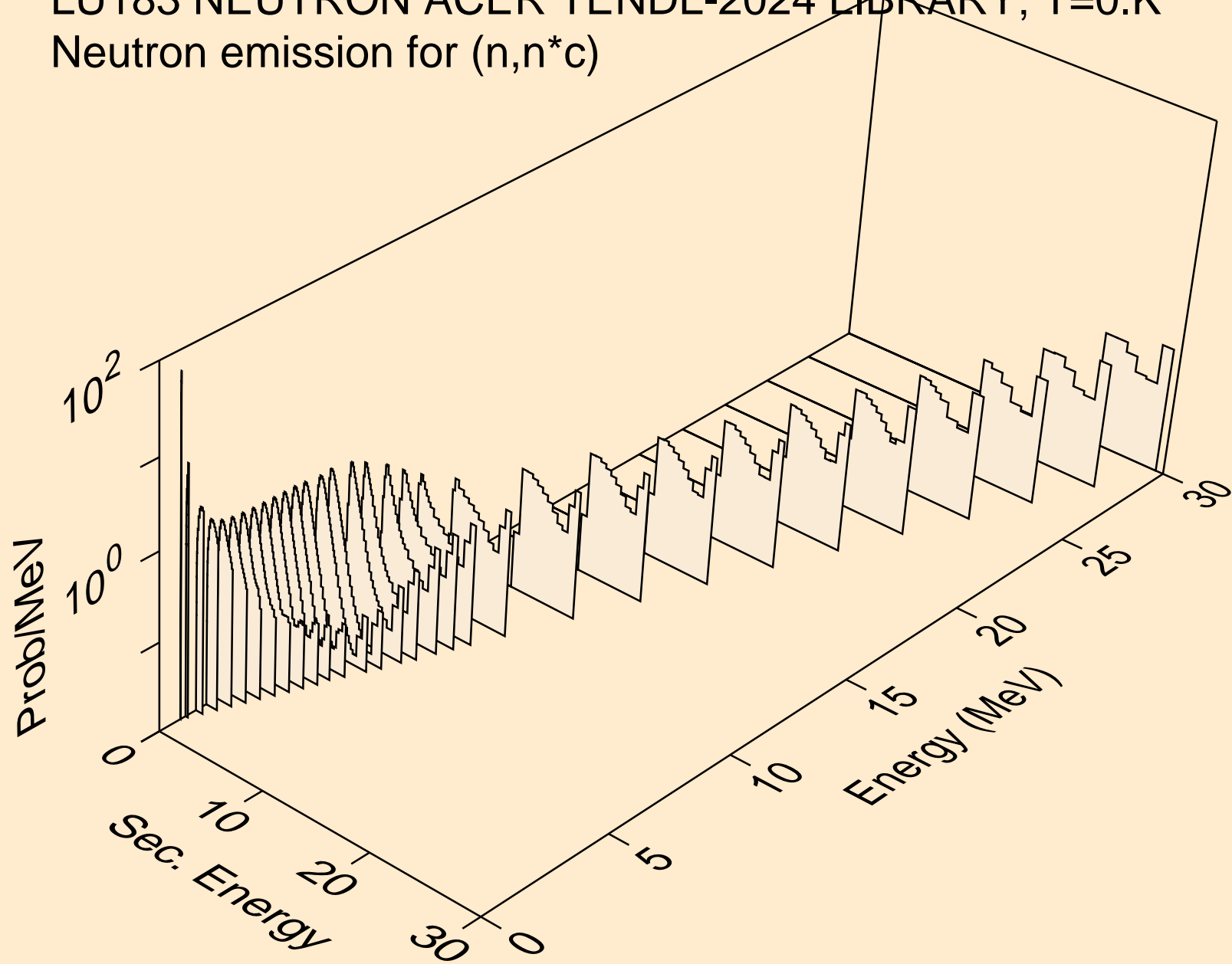

LU183 NEUTRON ACER TENDL-2024 LIBRARY; T=0.K
Photon emission for (n,x)

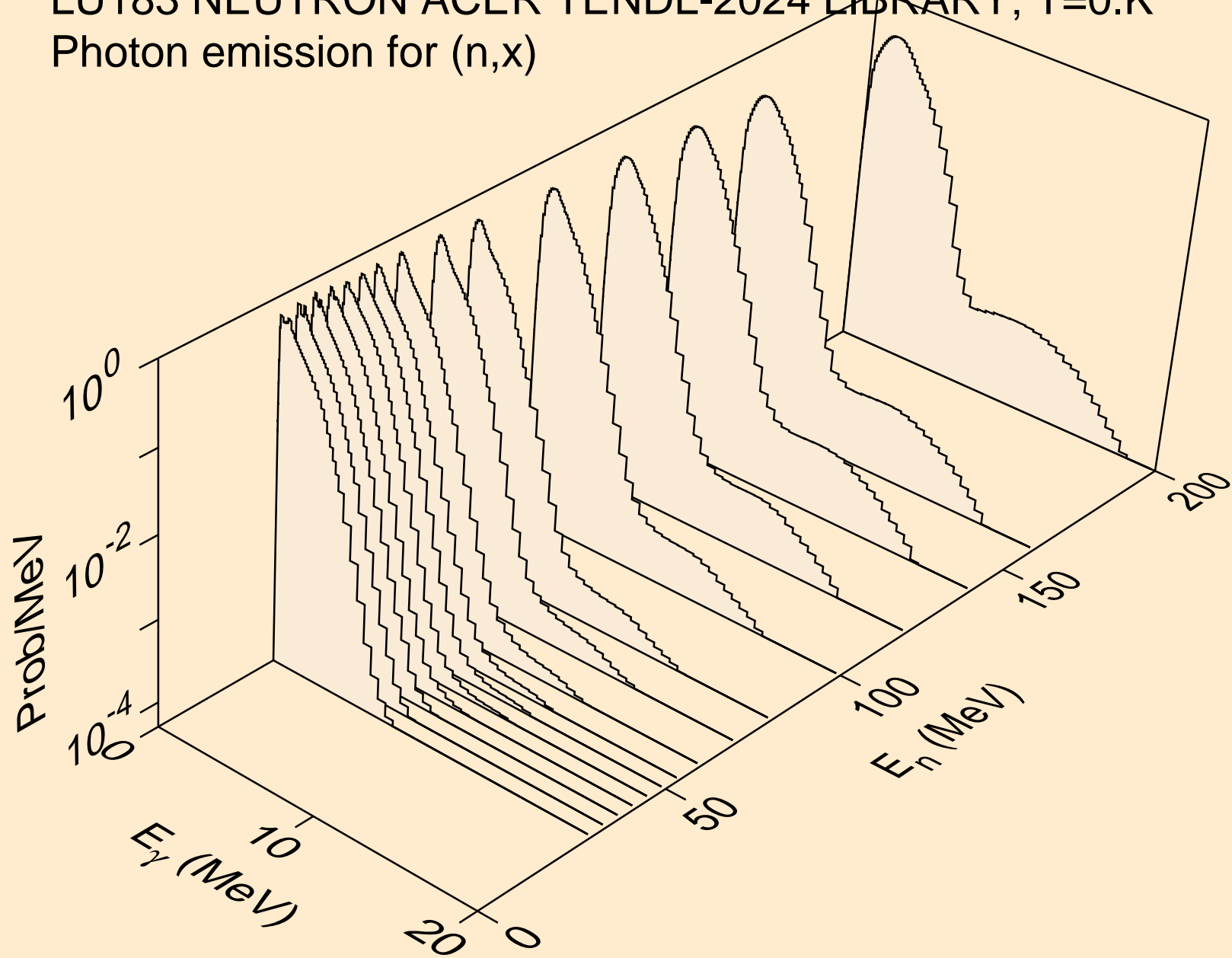

LU183 NEUTRON ACER TENDL-2024 LIBRARY; T=0.K
Photon emission for (n,2nd)

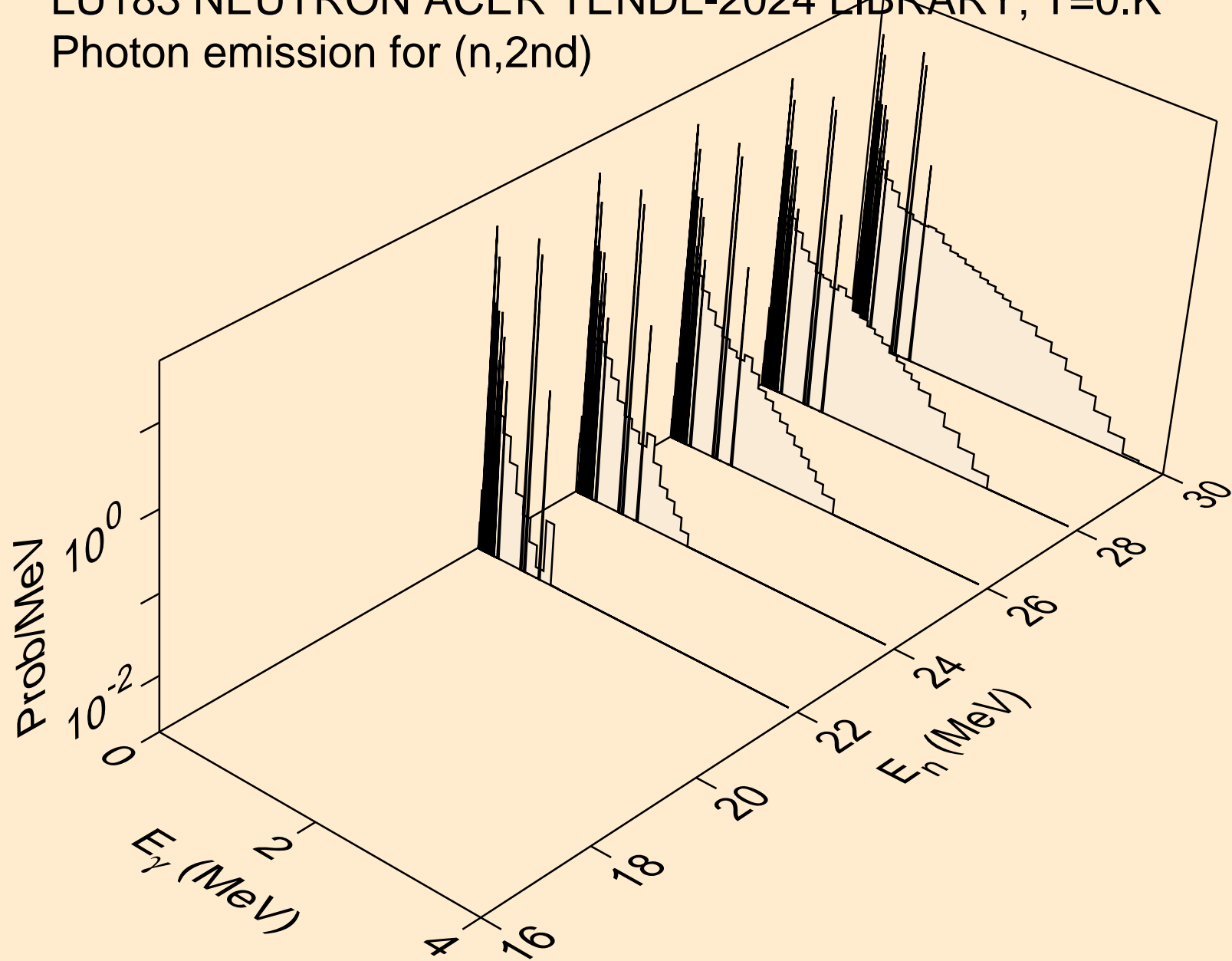

LU183 NEUTRON ACER TENDL-2024 LIBRARY; T=0.K
Photon emission for (n,2n)

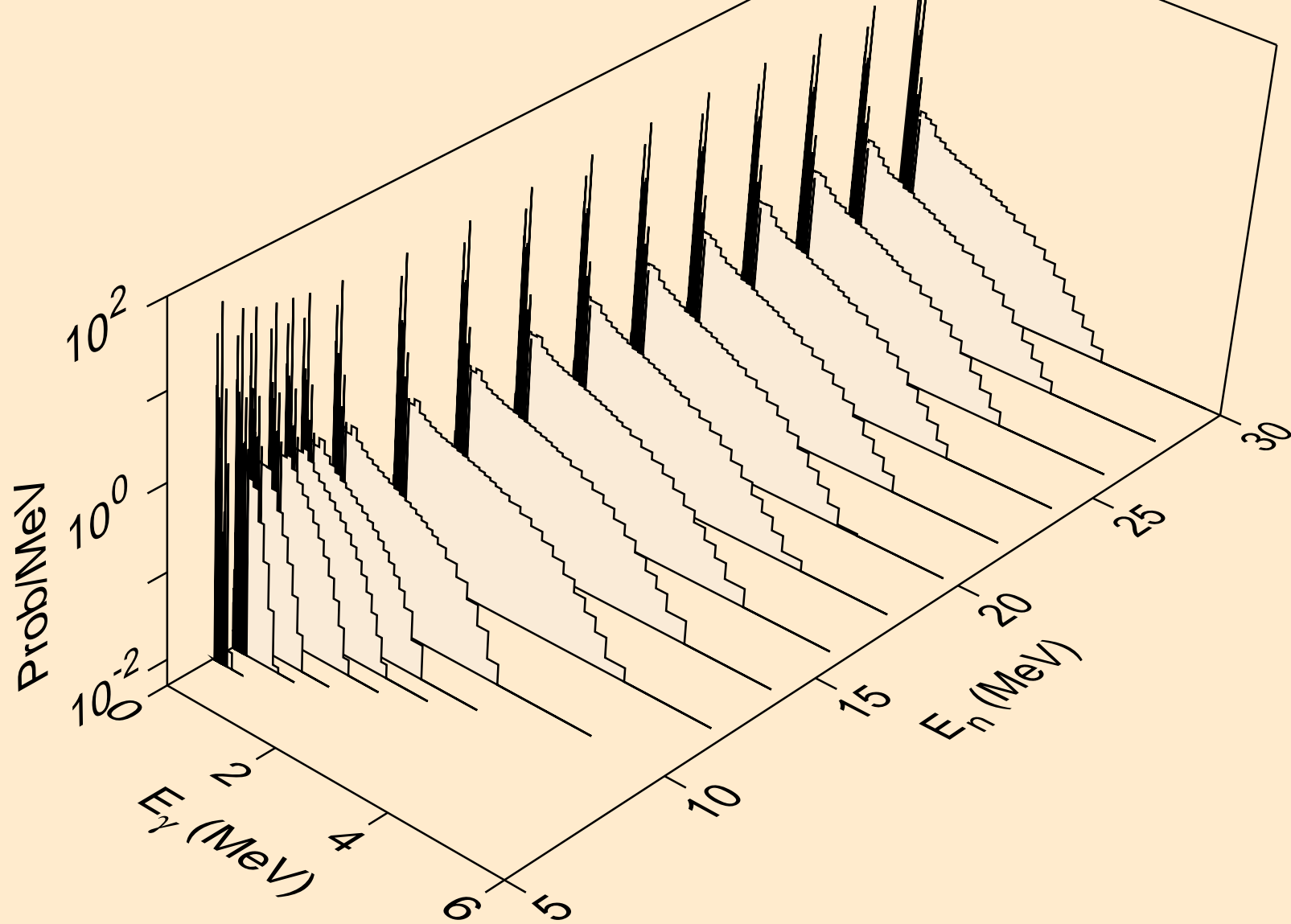

LU183 NEUTRON ACER TENDL-2024 LIBRARY; T=0.K
Photon emission for (n,3n)

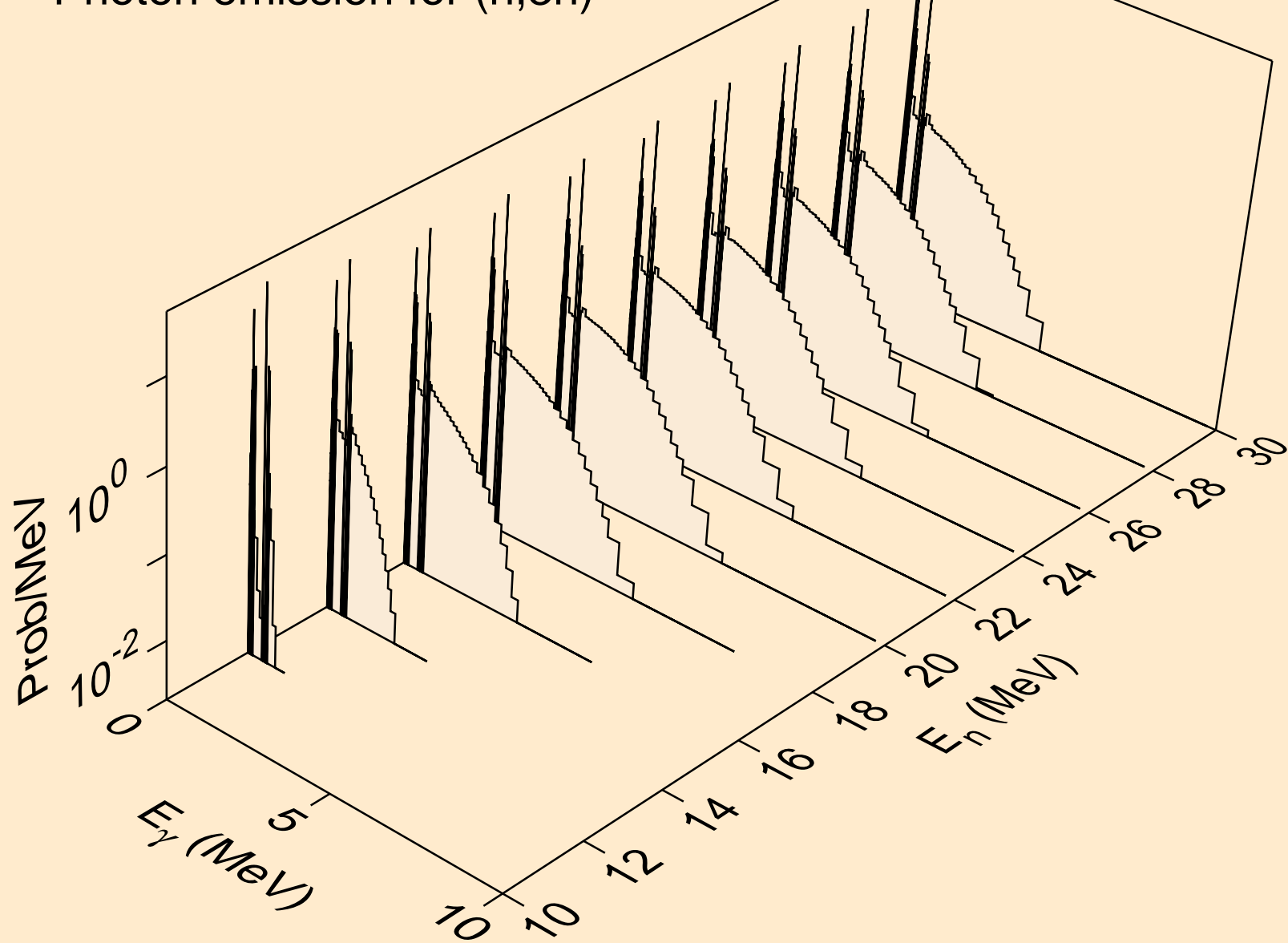

LU183 NEUTRON ACER TENDL-2024 LIBRARY; T=0.K
Photon emission for (n,n*)a

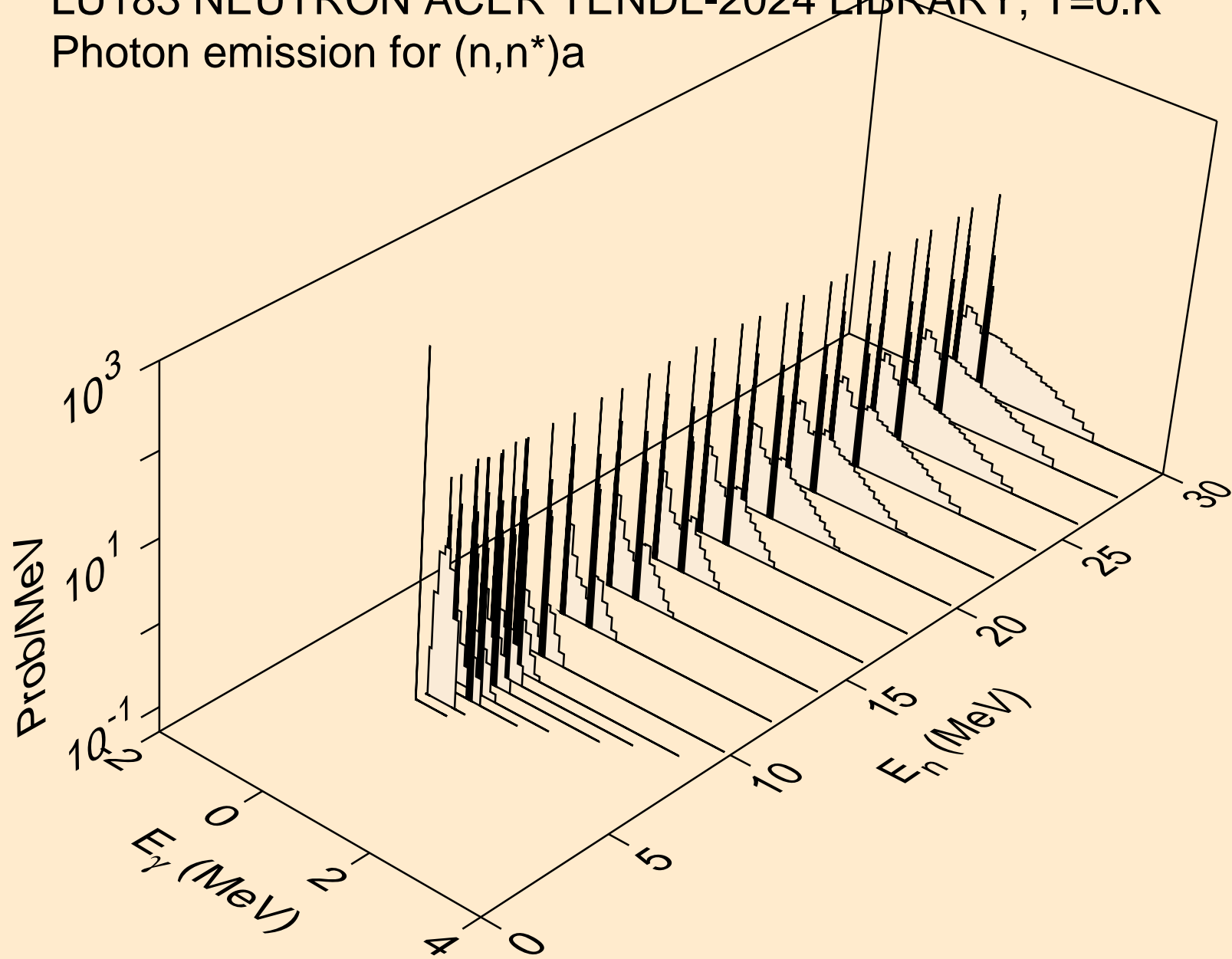

LU183 NEUTRON ACER TENDL-2024 LIBRARY; T=0.K
Photon emission for (n,2n)a

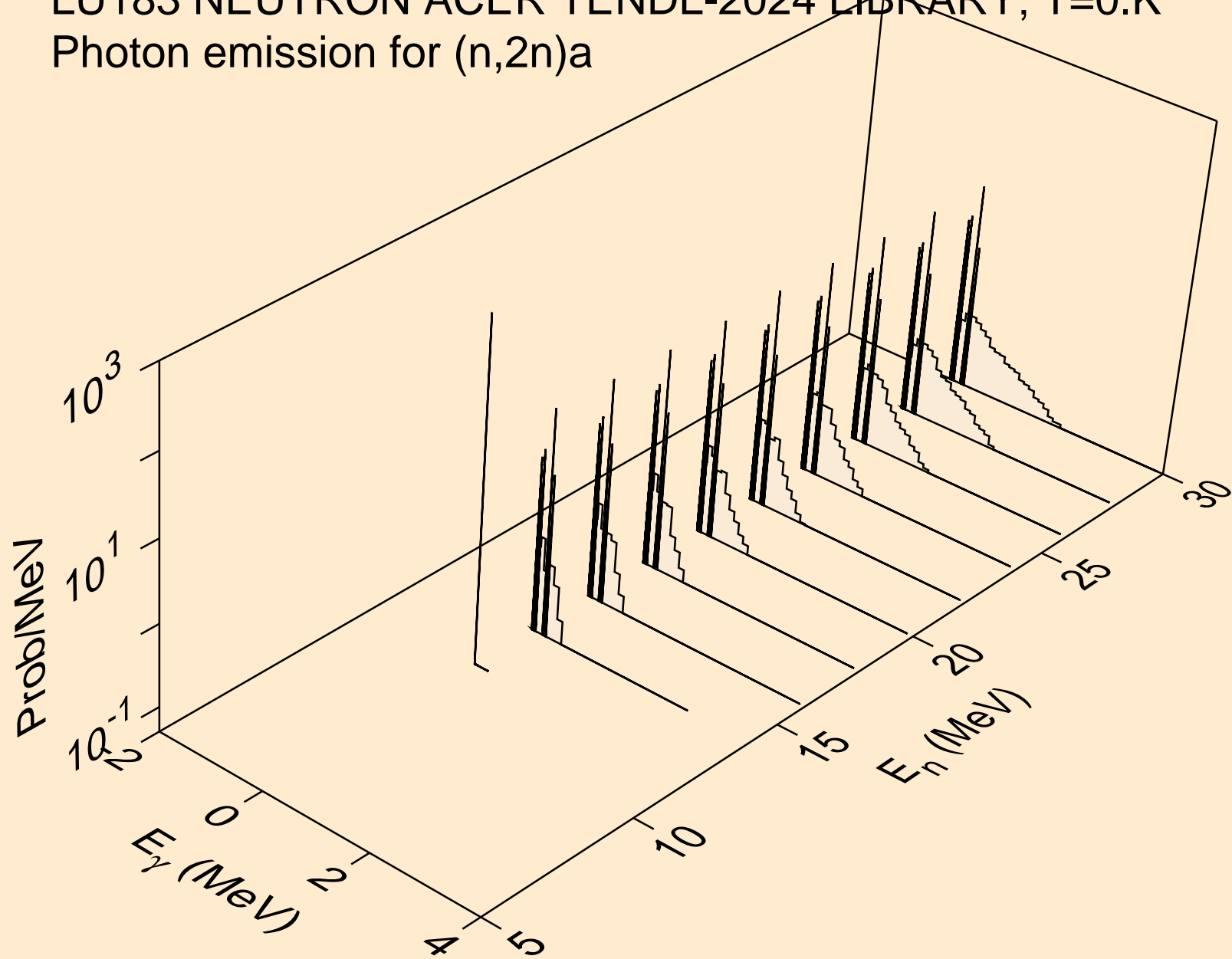

LU183 NEUTRON ACER TENDL-2024 LIBRARY; T=0.K
Photon emission for (n,3n)a

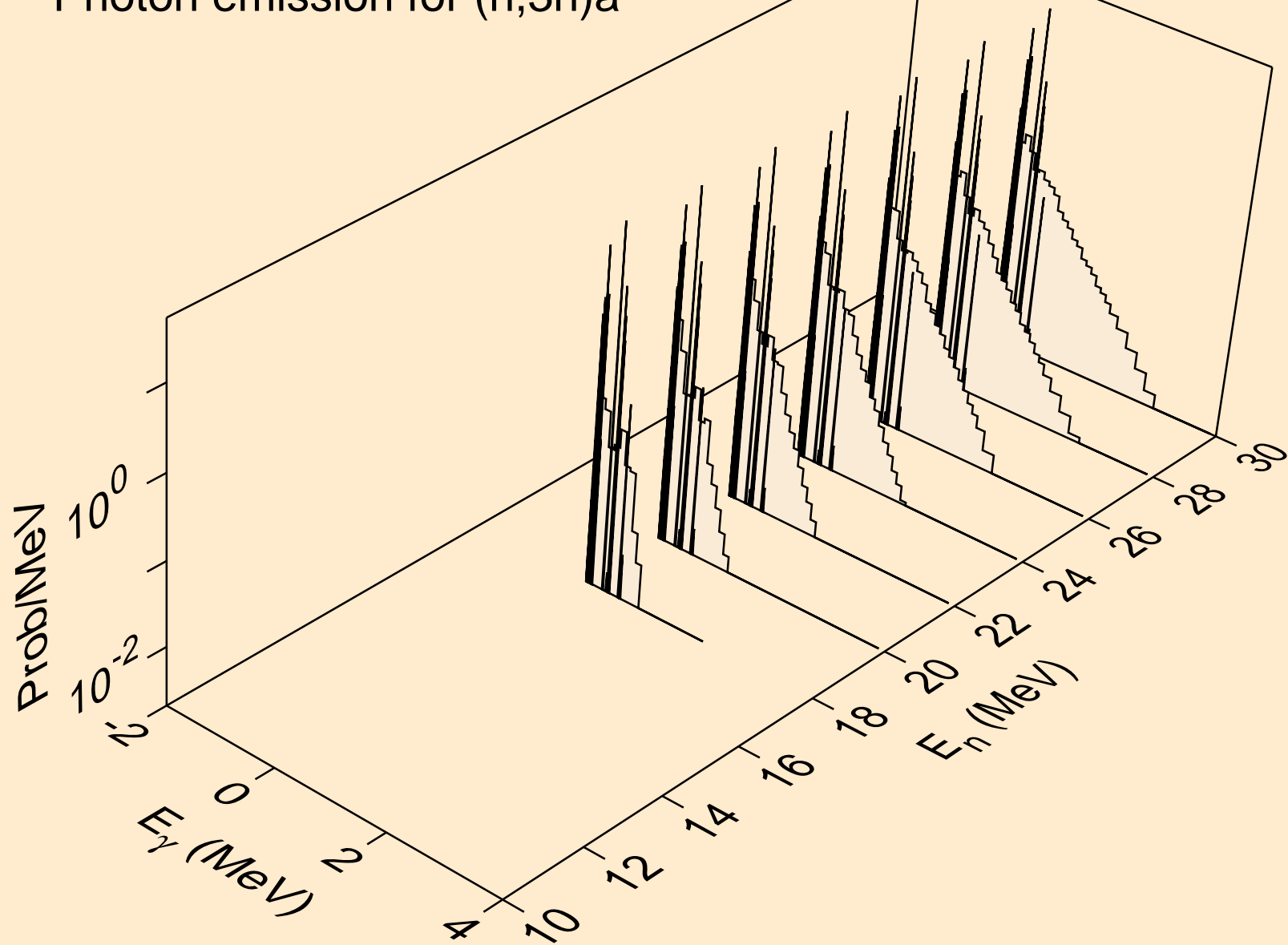

LU183 NEUTRON ACER TENDL-2024 LIBRARY; T=0.K
Photon emission for (n,n*)p

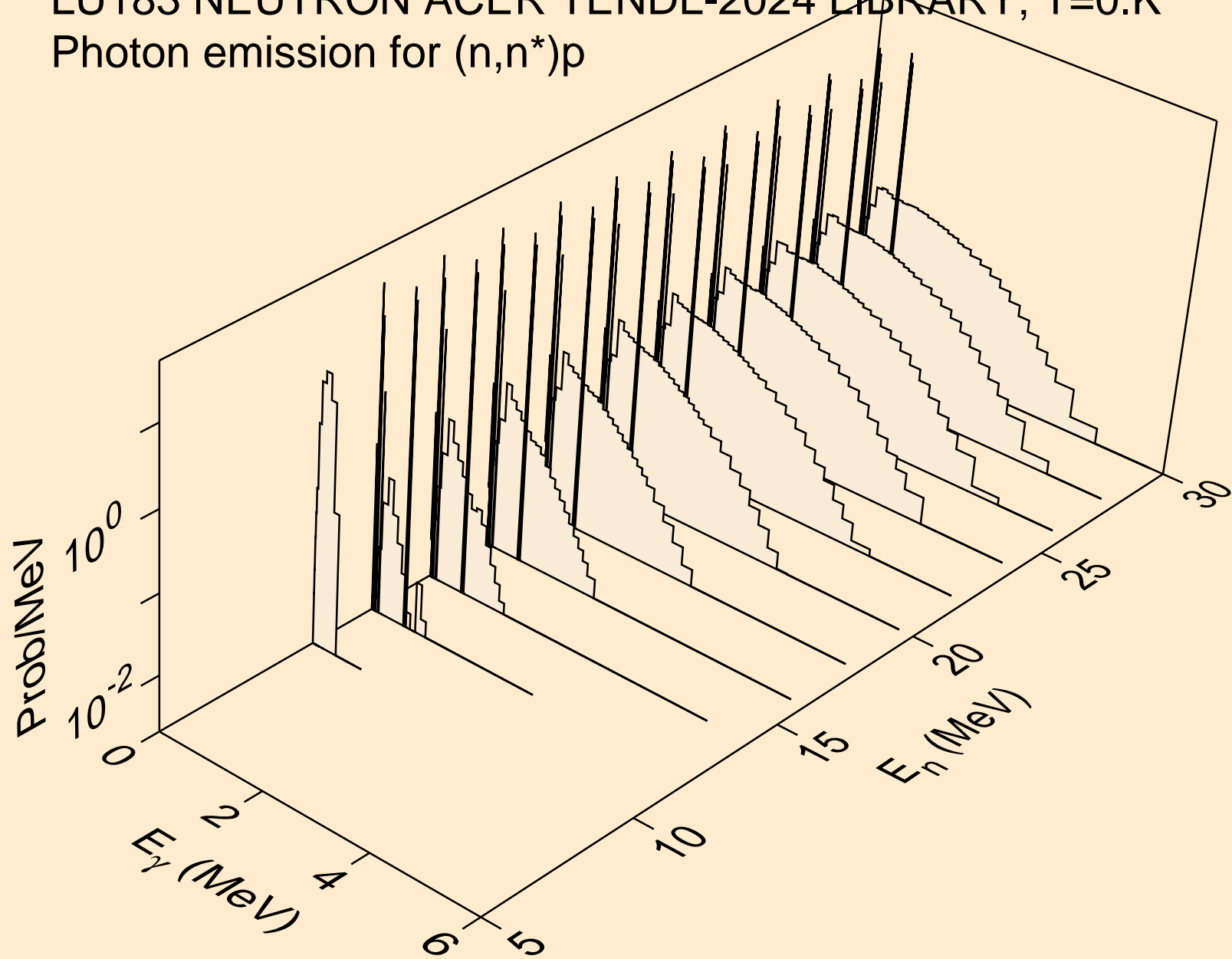

LU183 NEUTRON ACER TENDL-2024 LIBRARY; T=0.K
Photon emission for (n,n*)d

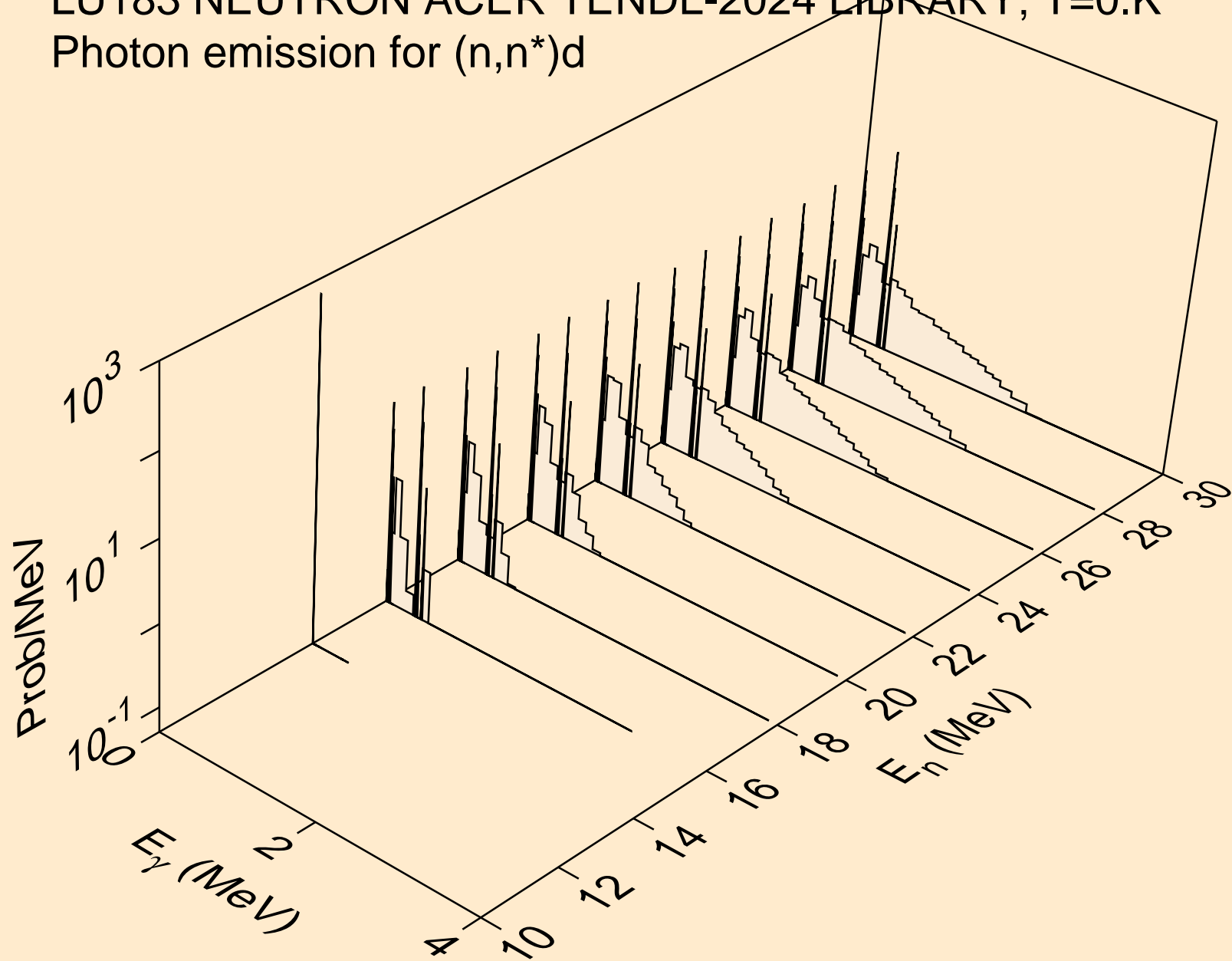

LU183 NEUTRON ACER TENDL-2024 LIBRARY; T=0.K
Photon emission for (n,n*)t

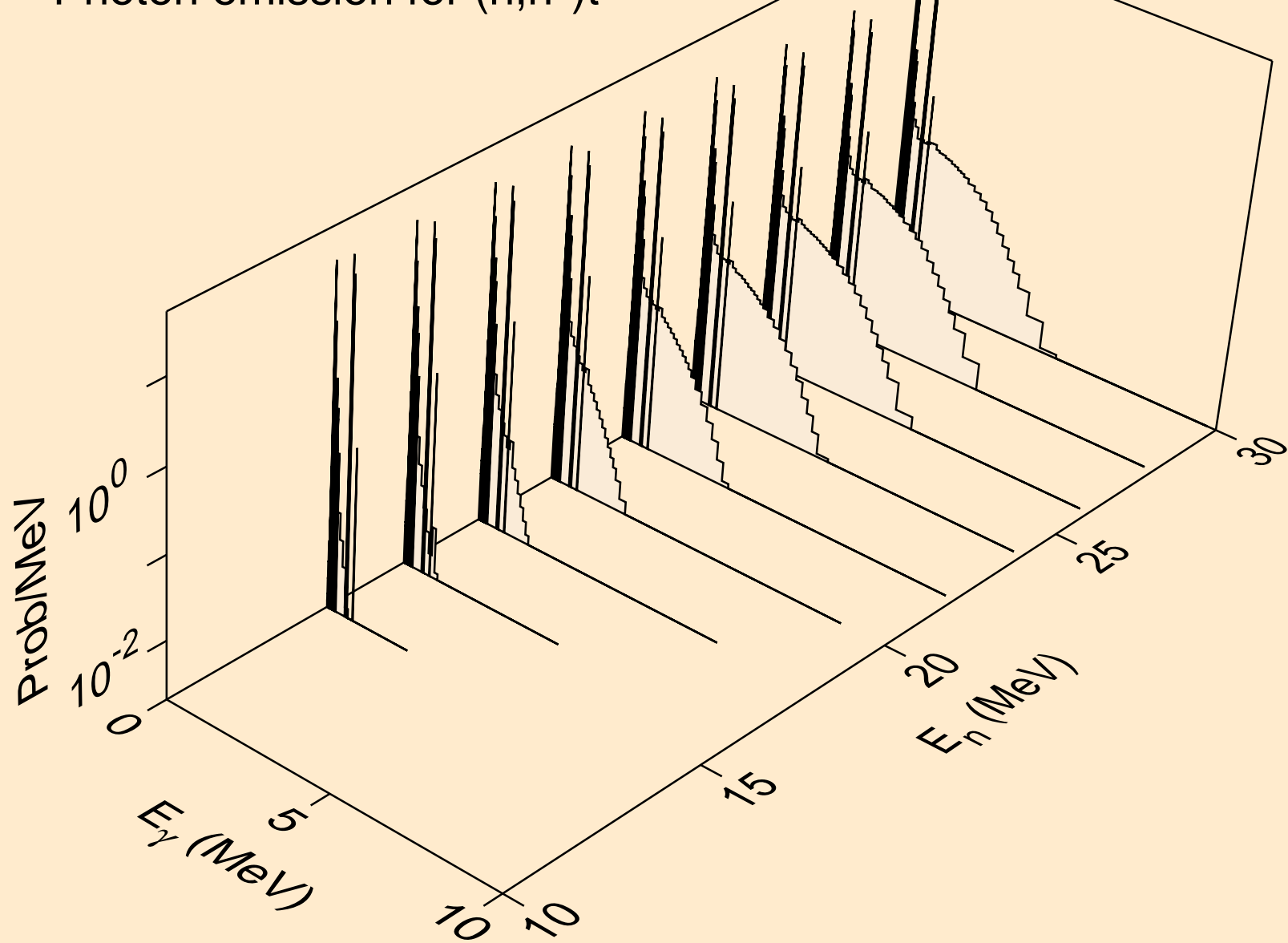

LU183 NEUTRON ACER TENDL-2024 LIBRARY; T=0.K
Photon emission for (n,n*)he3

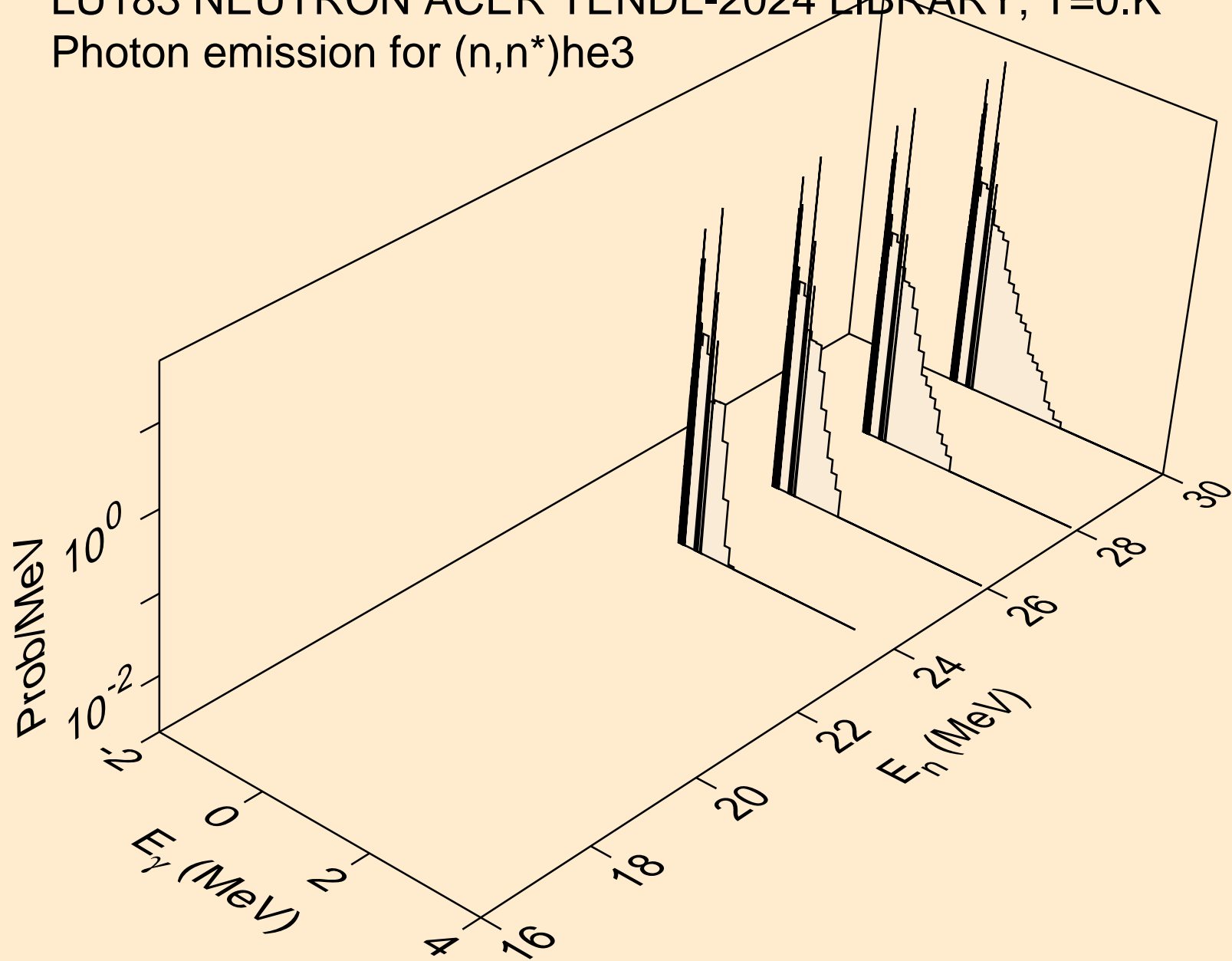

LU183 NEUTRON ACER TENDL-2024 LIBRARY; T=0.K
Photon emission for (n,4n)

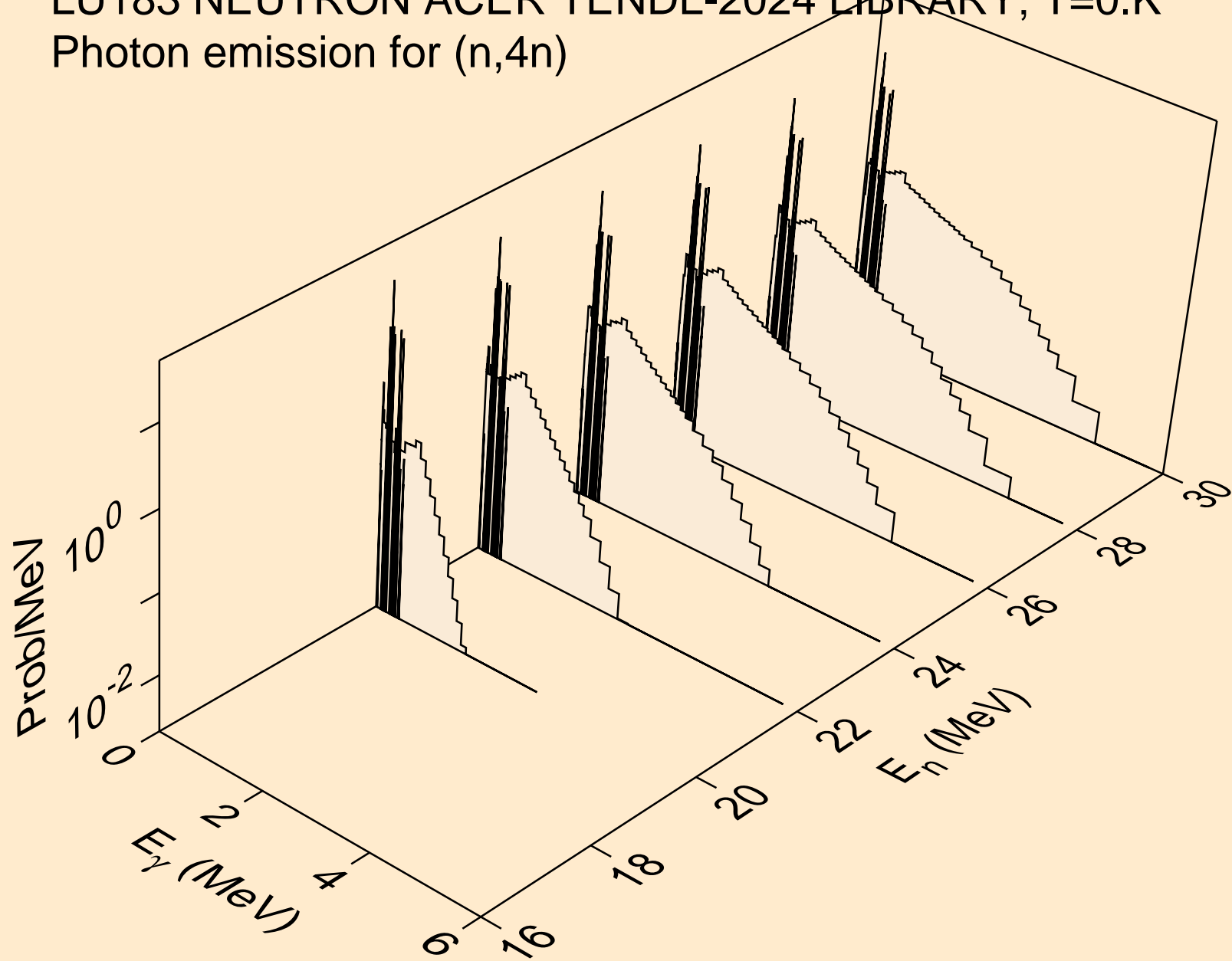

LU183 NEUTRON ACER TENDL-2024 LIBRARY; T=0.K
Photon emission for (n,2np)

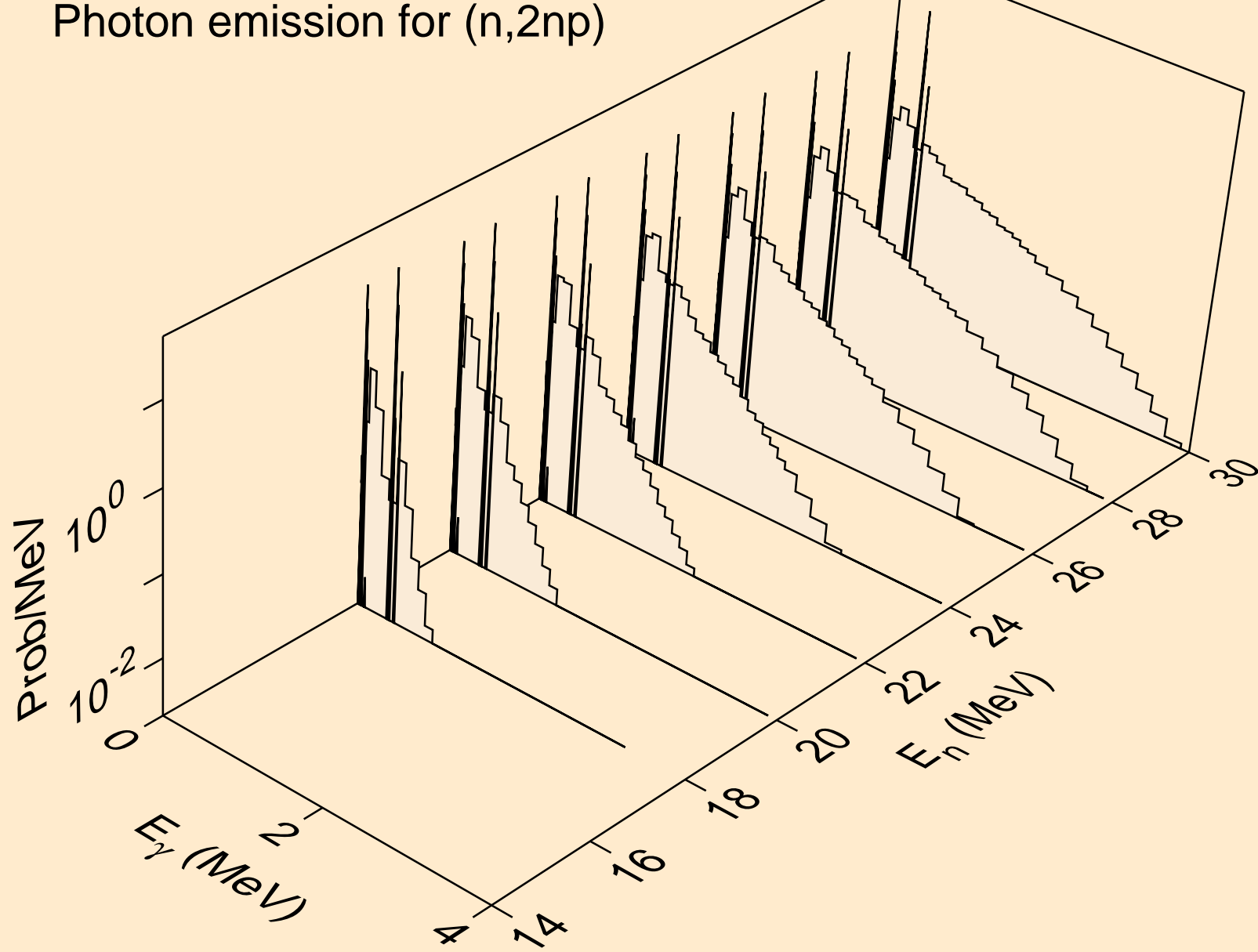

LU183 NEUTRON ACER TENDL-2024 LIBRARY; T=0.K
Photon emission for (n,3np)

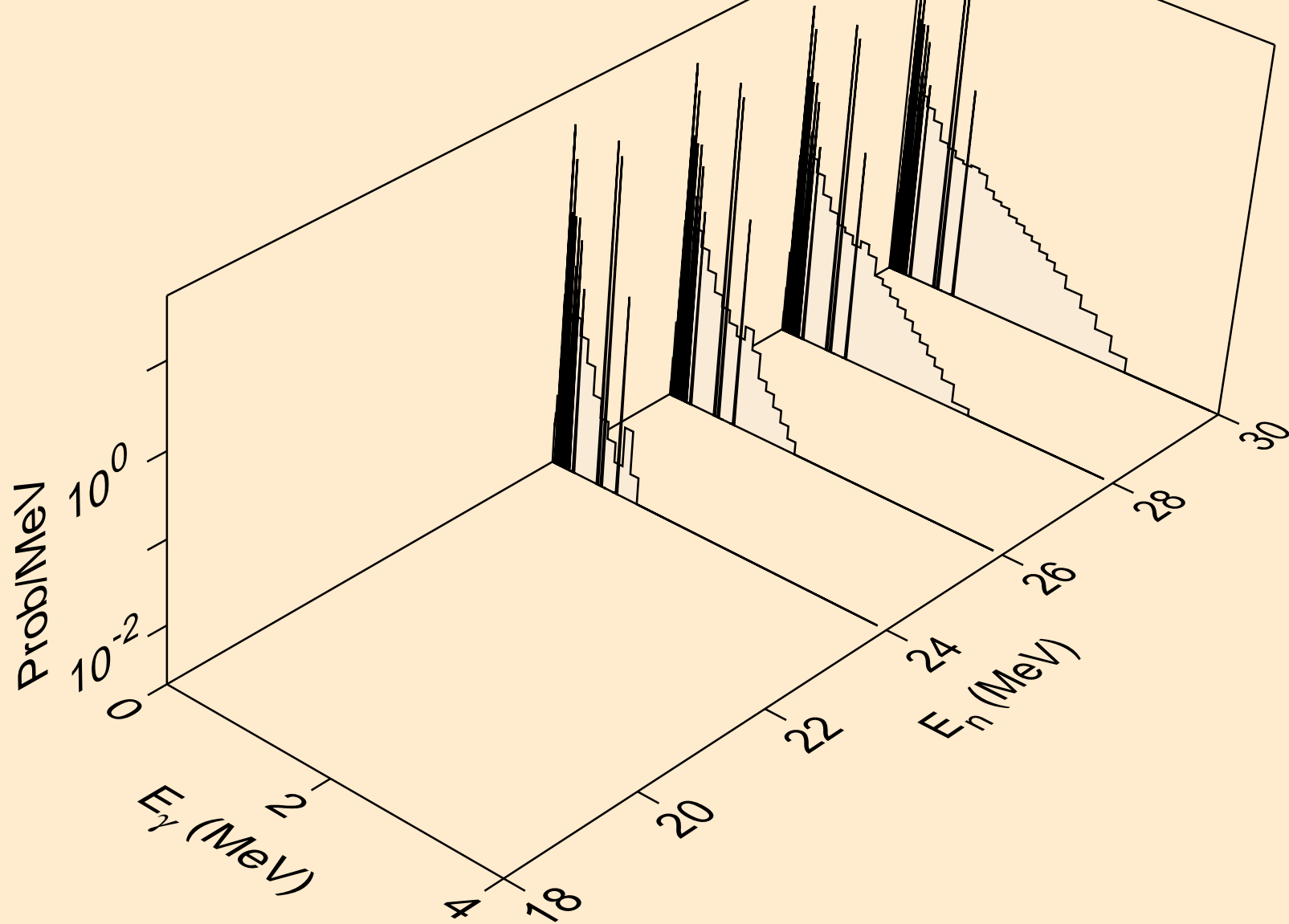

LU183 NEUTRON ACER TENDL-2024 LIBRARY; T=0.K
Photon emission for (n,n*c)

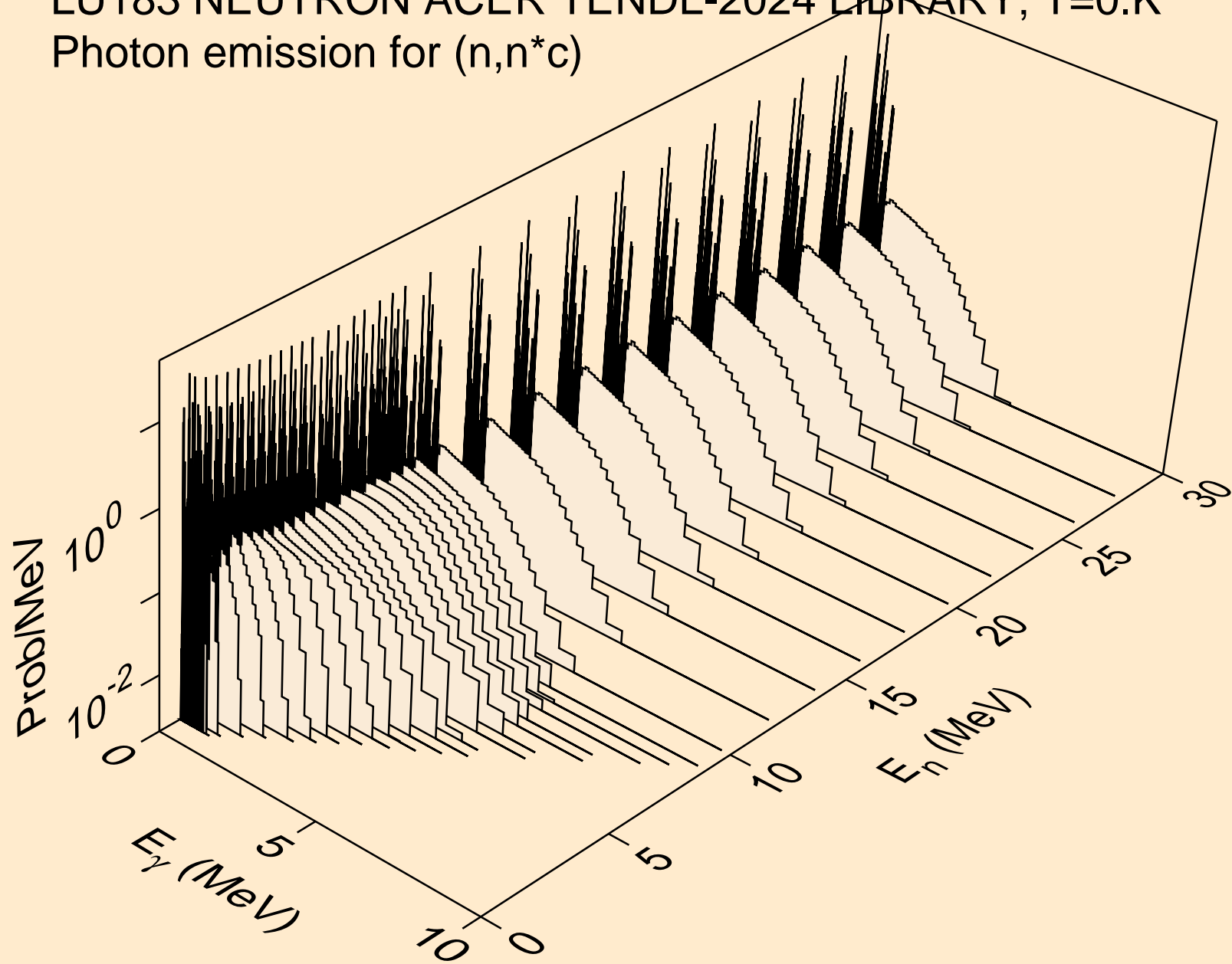

LU183 NEUTRON ACER TENDL-2024 LIBRARY; T=0.K
Photon emission for (n,gma)

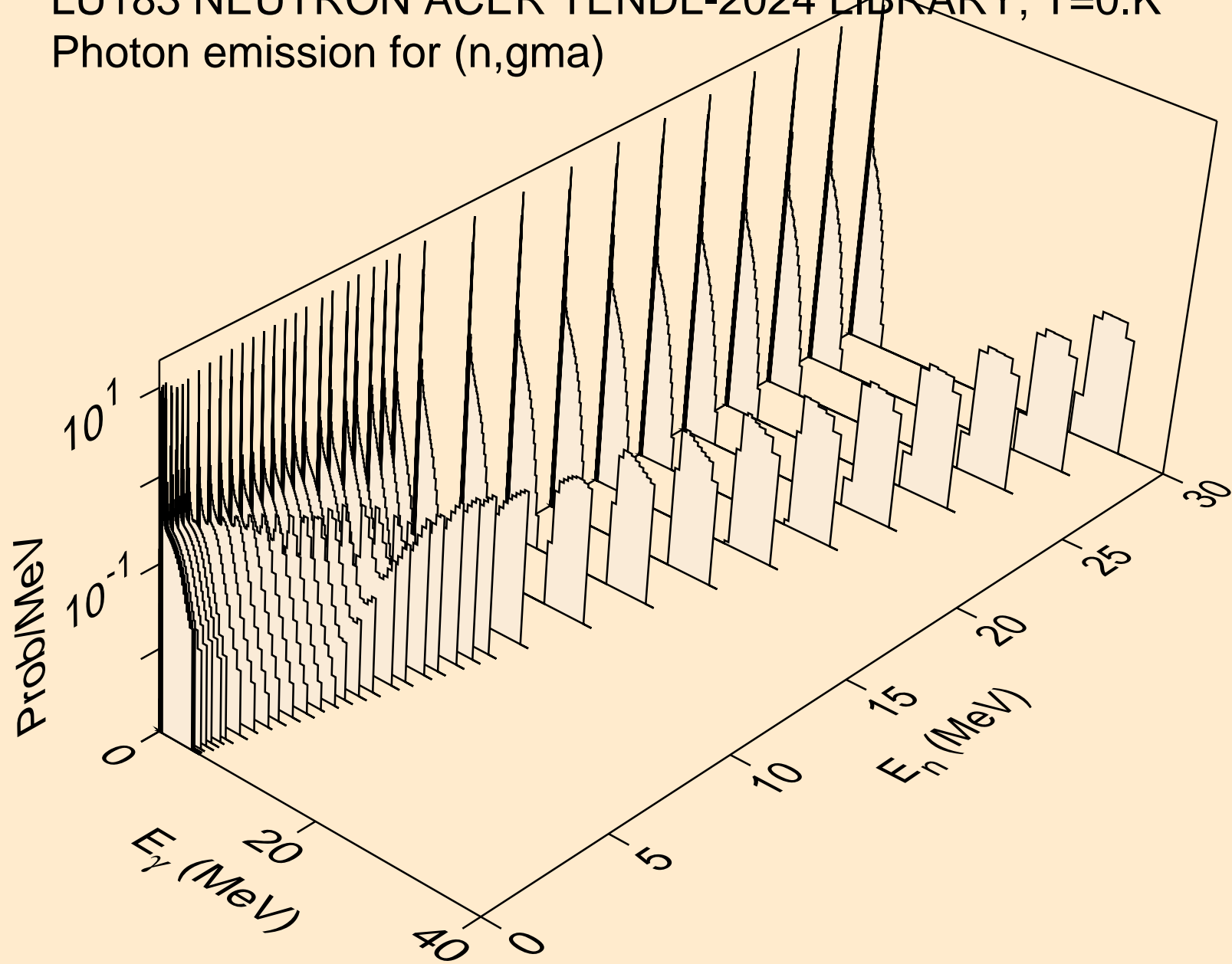

LU183 NEUTRON ACER TENDL-2024 LIBRARY; T=0.K
Photon emission for (n,p)

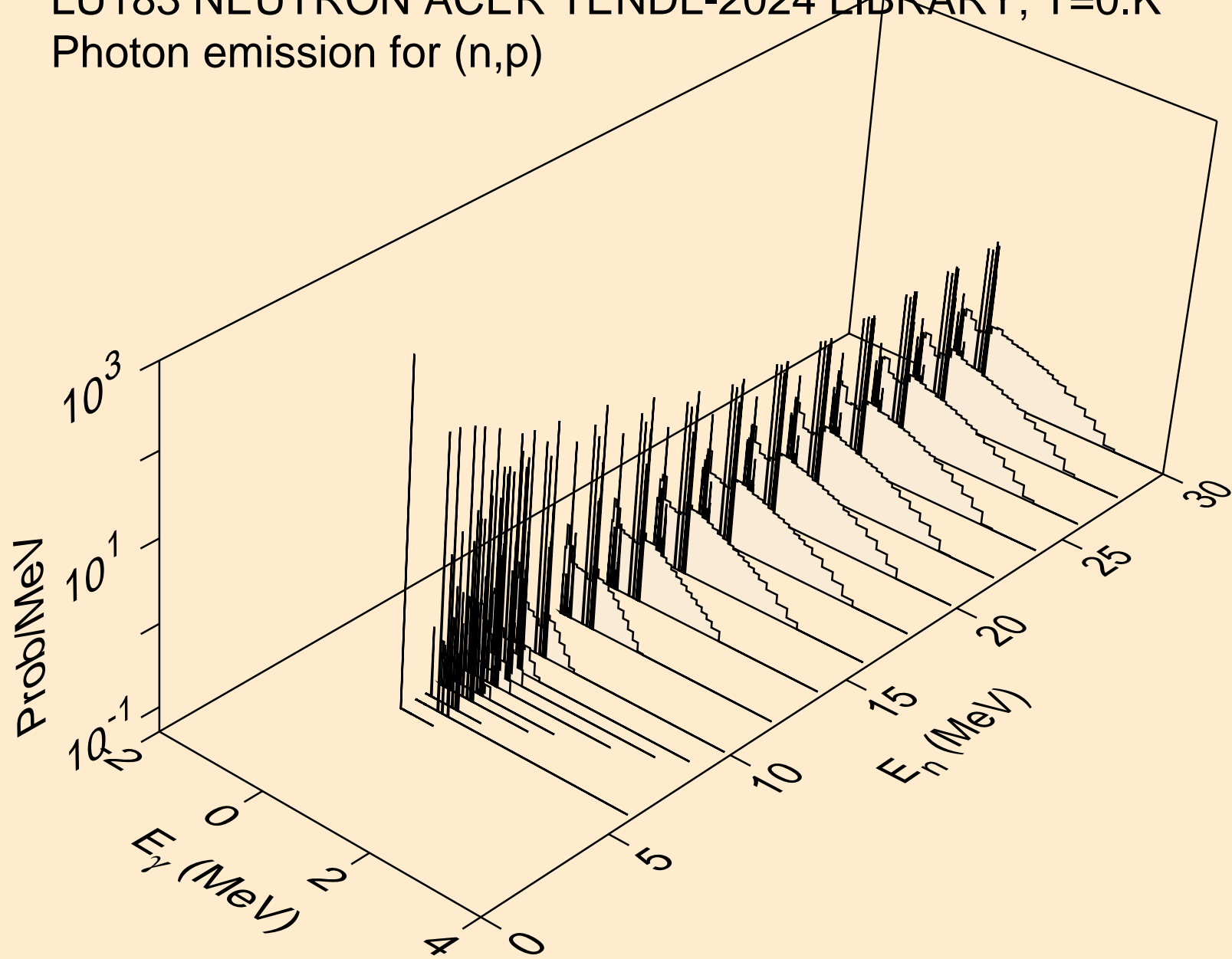

LU183 NEUTRON ACER TENDL-2024 LIBRARY; T=0.K
Photon emission for (n,d)

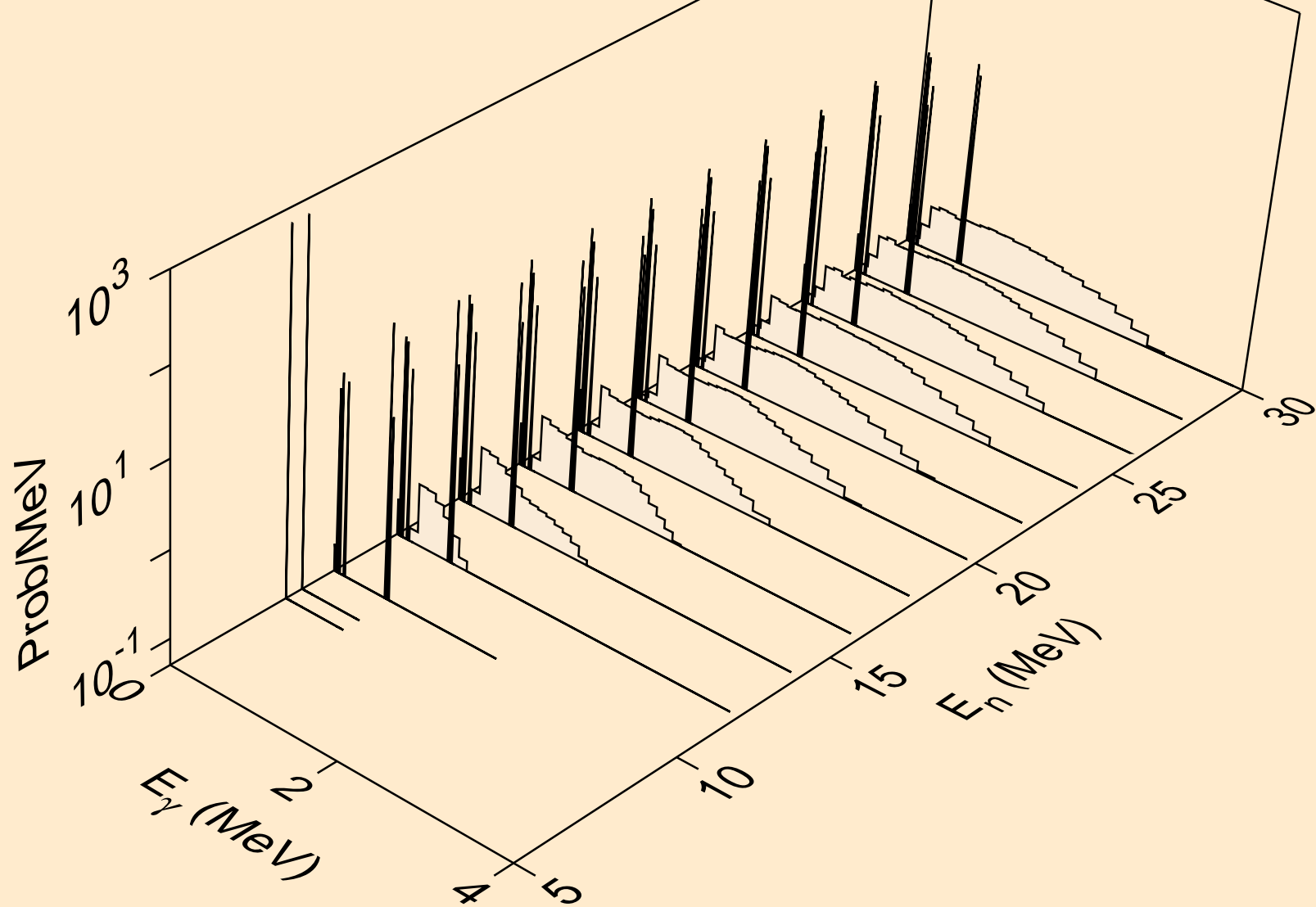

LU183 NEUTRON ACER TENDL-2024 LIBRARY; T=0.K
Photon emission for (n,t)

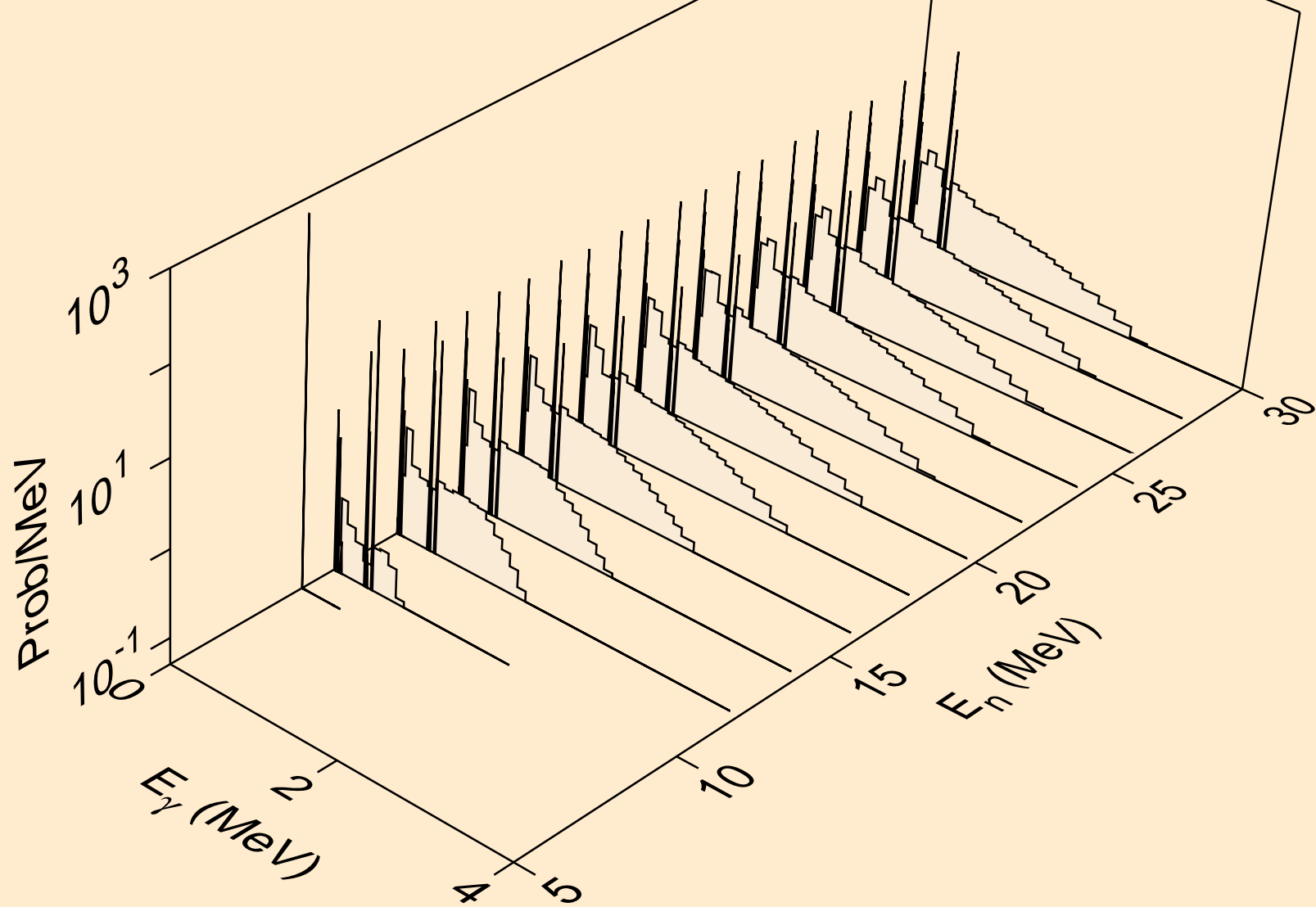

LU183 NEUTRON ACER TENDL-2024 LIBRARY; T=0.K
Photon emission for (n,he3)

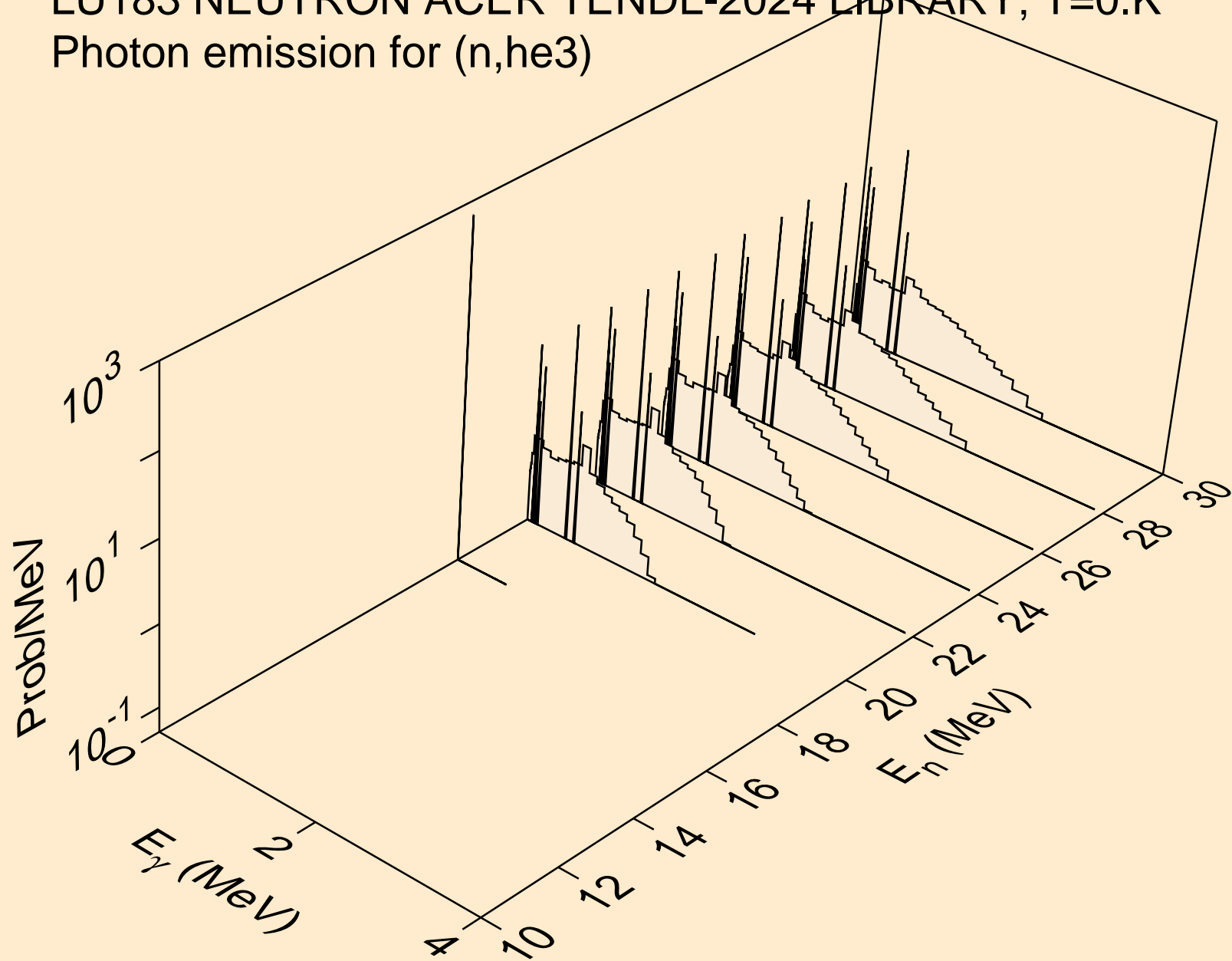

LU183 NEUTRON ACER TENDL-2024 LIBRARY; T=0.K
Photon emission for (n,a)

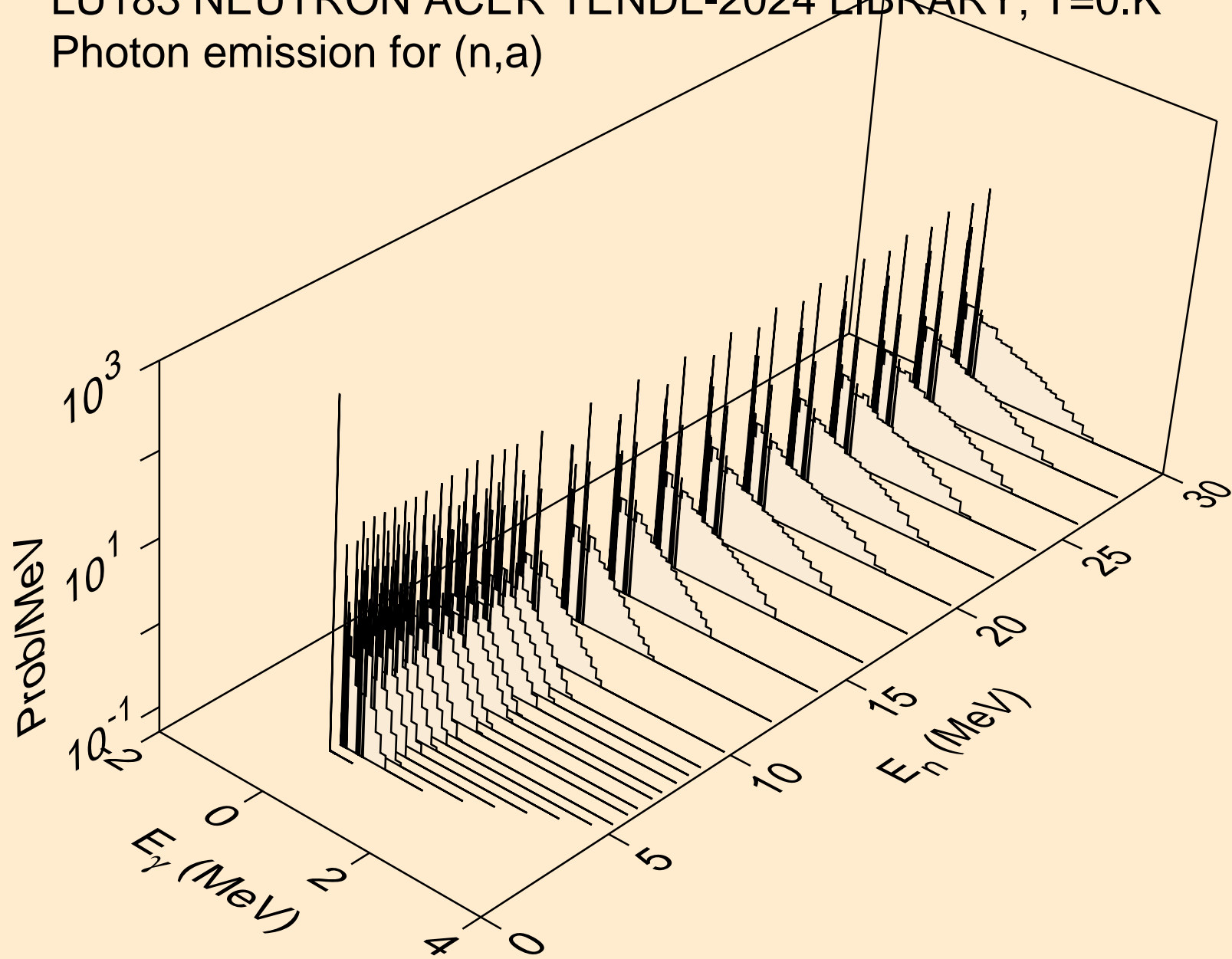

LU183 NEUTRON ACER TENDL-2024 LIBRARY; T=0.K
thermal capture photon spectrum

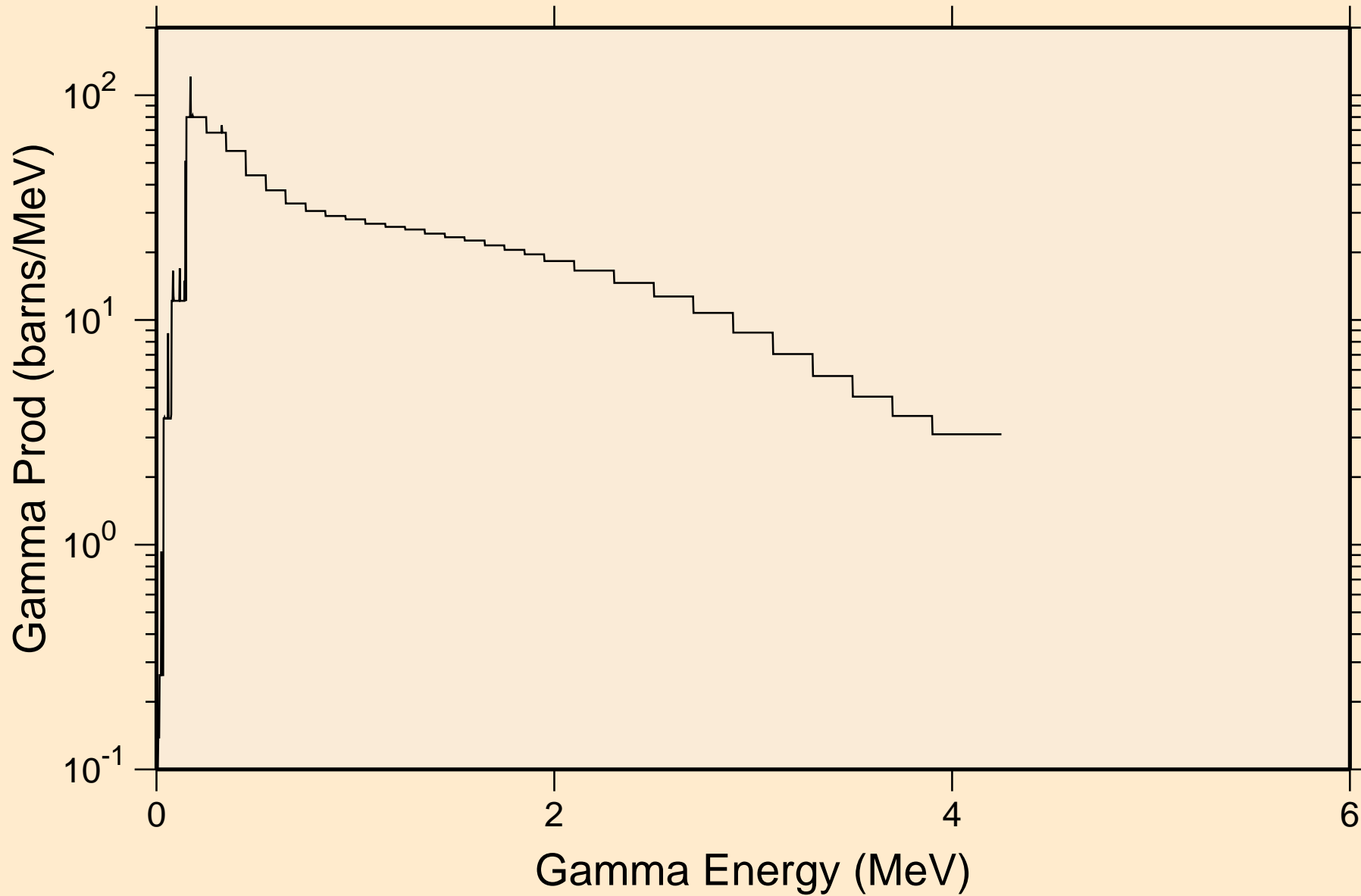

LU183 NEUTRON ACER TENDL-2024 LIBRARY; T=0.K
14 MeV photon spectrum

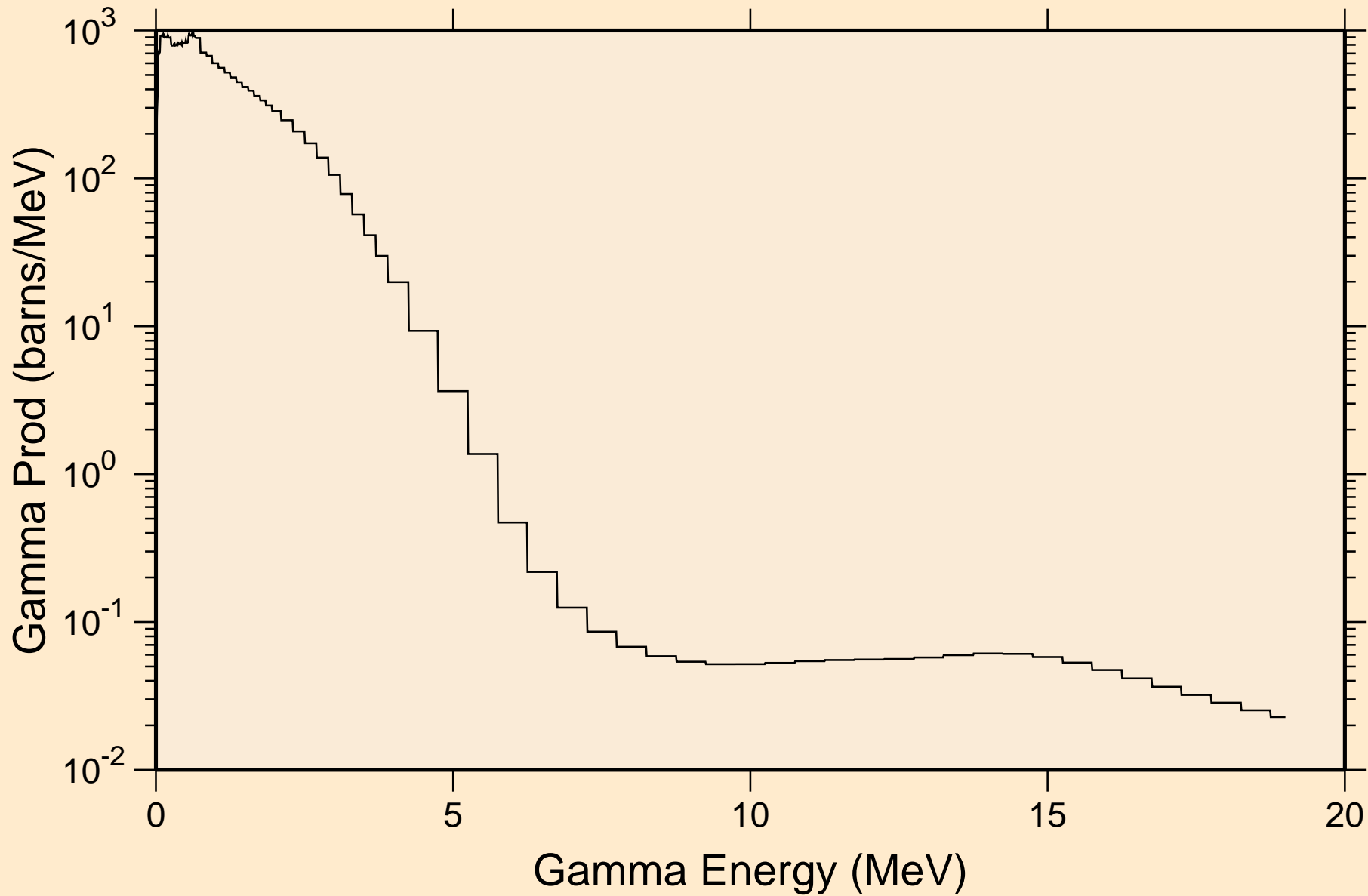

LU183 NEUTRON ACER TENDL-2024 LIBRARY; T=0.K

Particle heating contributions

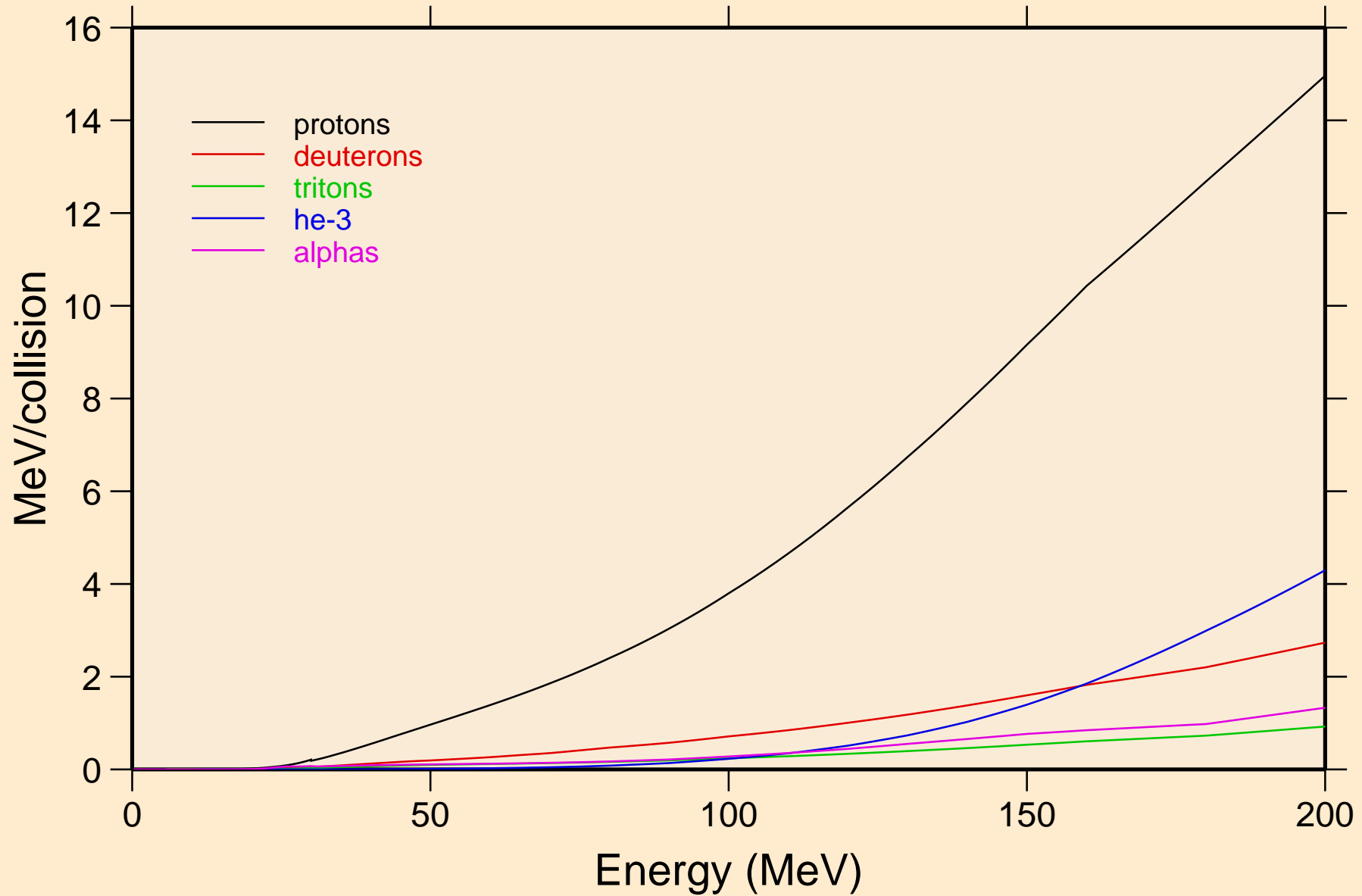

LU183 NEUTRON ACER TENDL-2024 LIBRARY; T=0.K
Recoil Heating

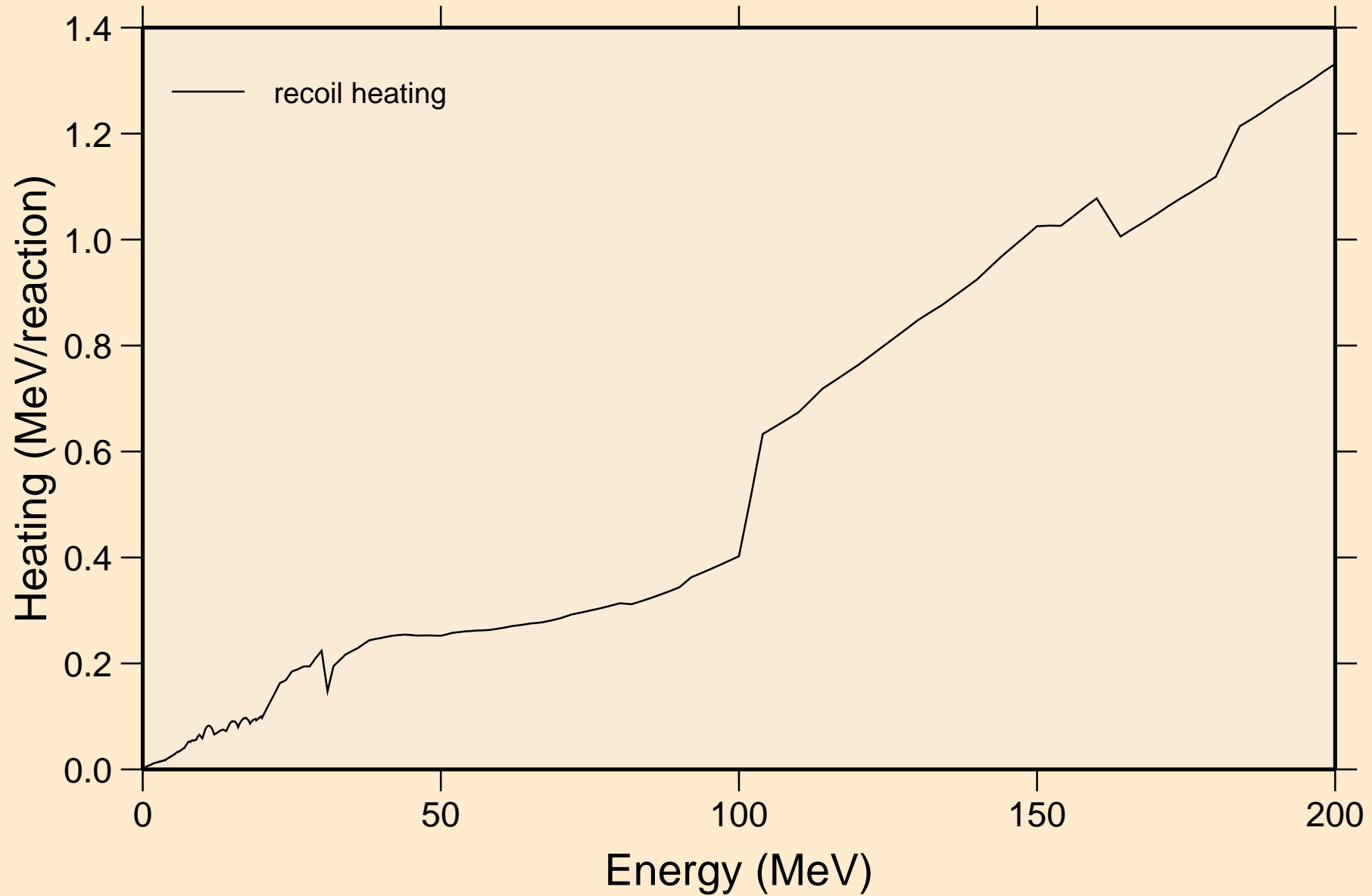

LU183 NEUTRON ACER TENDL-2024 LIBRARY; T=0.K
Particle production cross sections

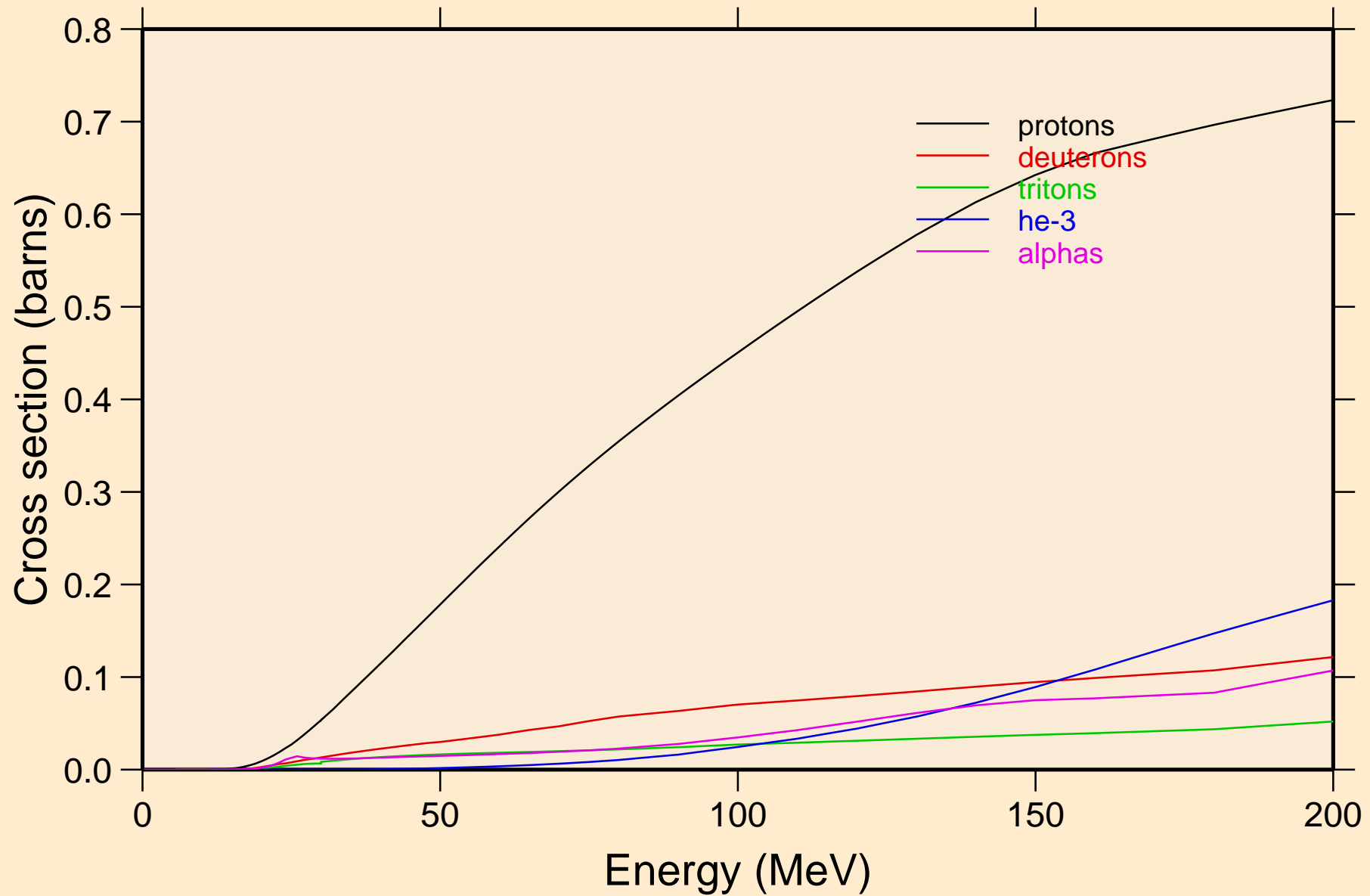

LU183 NEUTRON ACER TENDL-2024 LIBRARY; T=0.K
protons from (n,x)

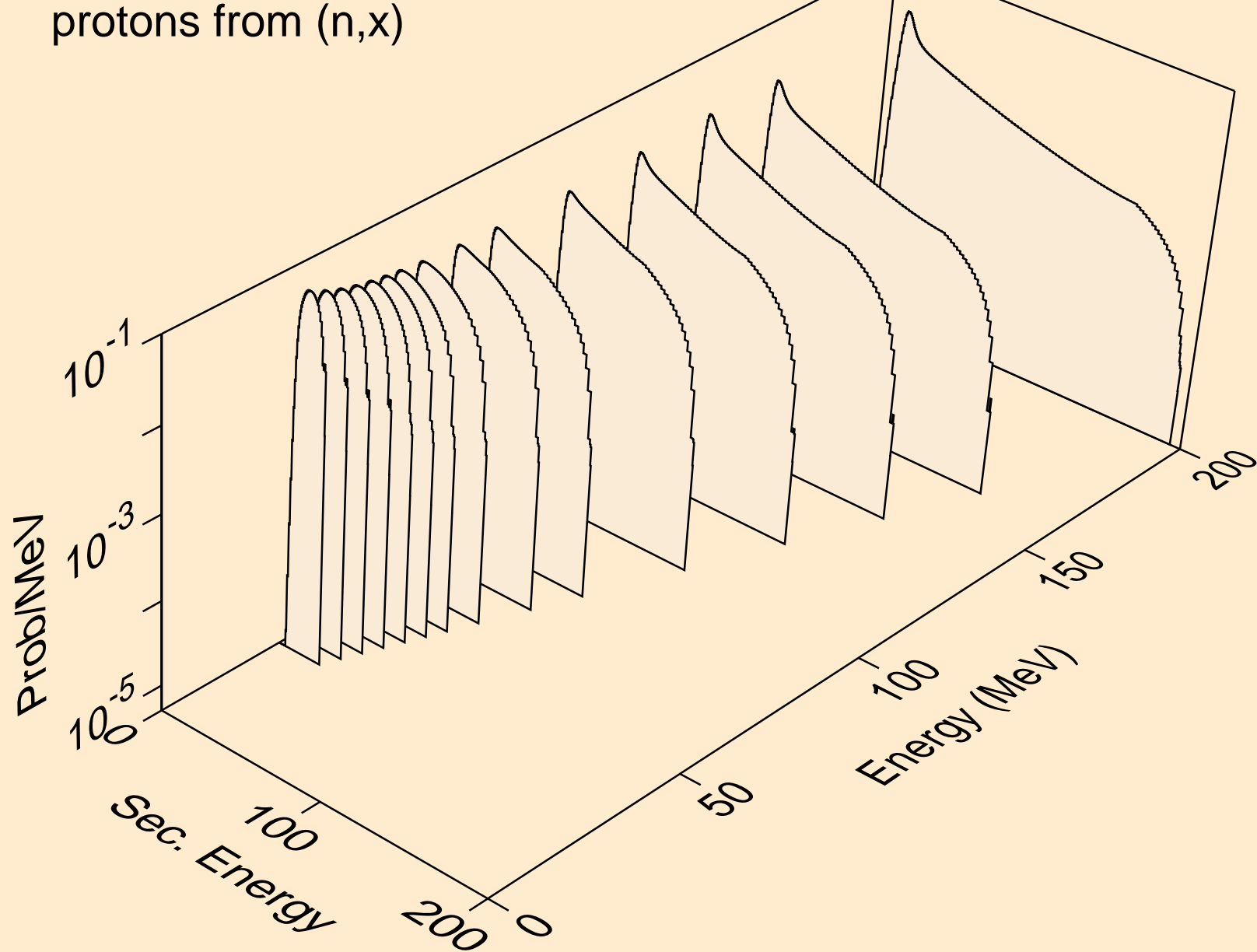

LU183 NEUTRON ACER TENDL-2024 LIBRARY; T=0.K
protons from (n,n*)p

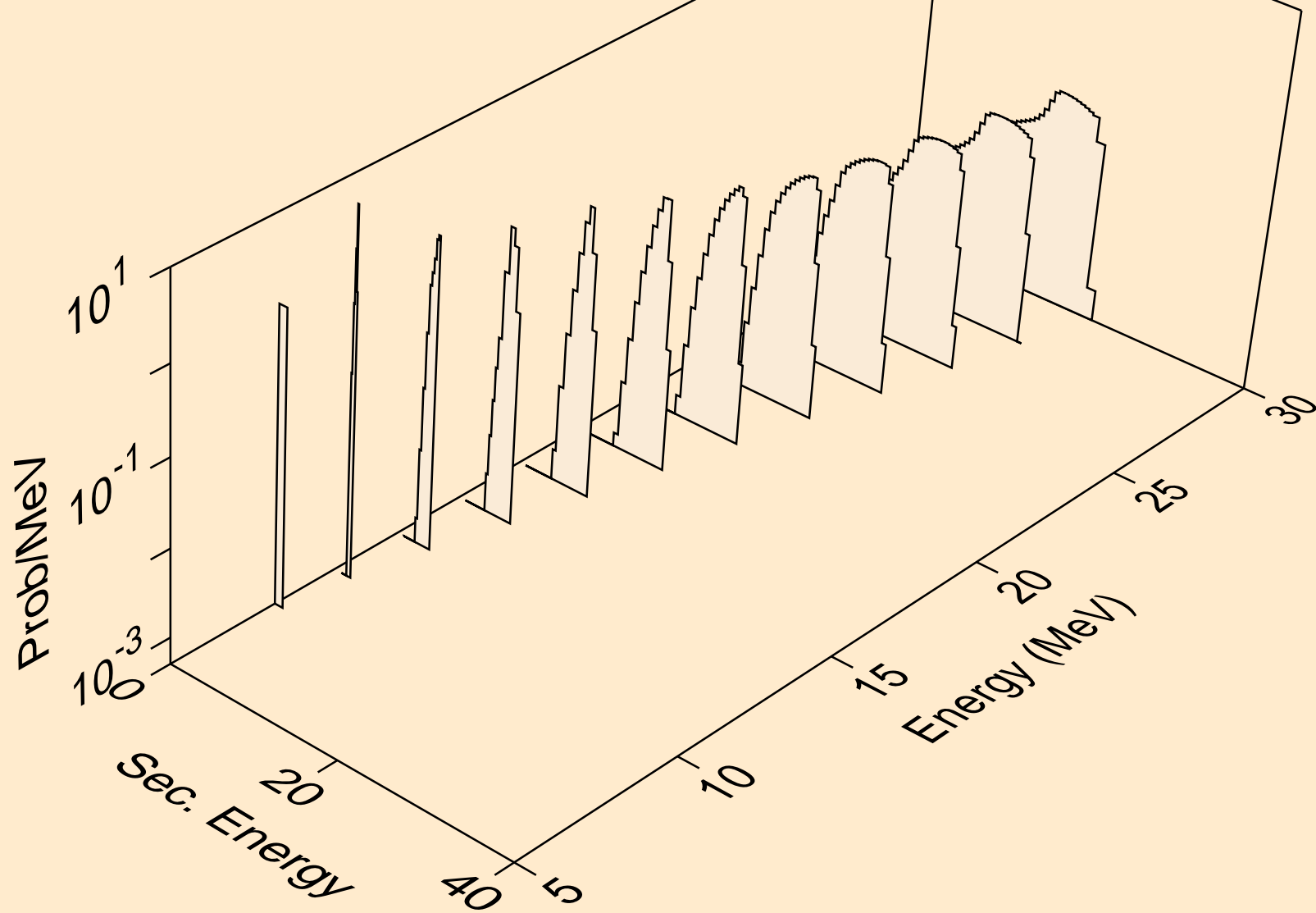

LU183 NEUTRON ACER TENDL-2024 LIBRARY; T=0.K
protons from (n,2np)

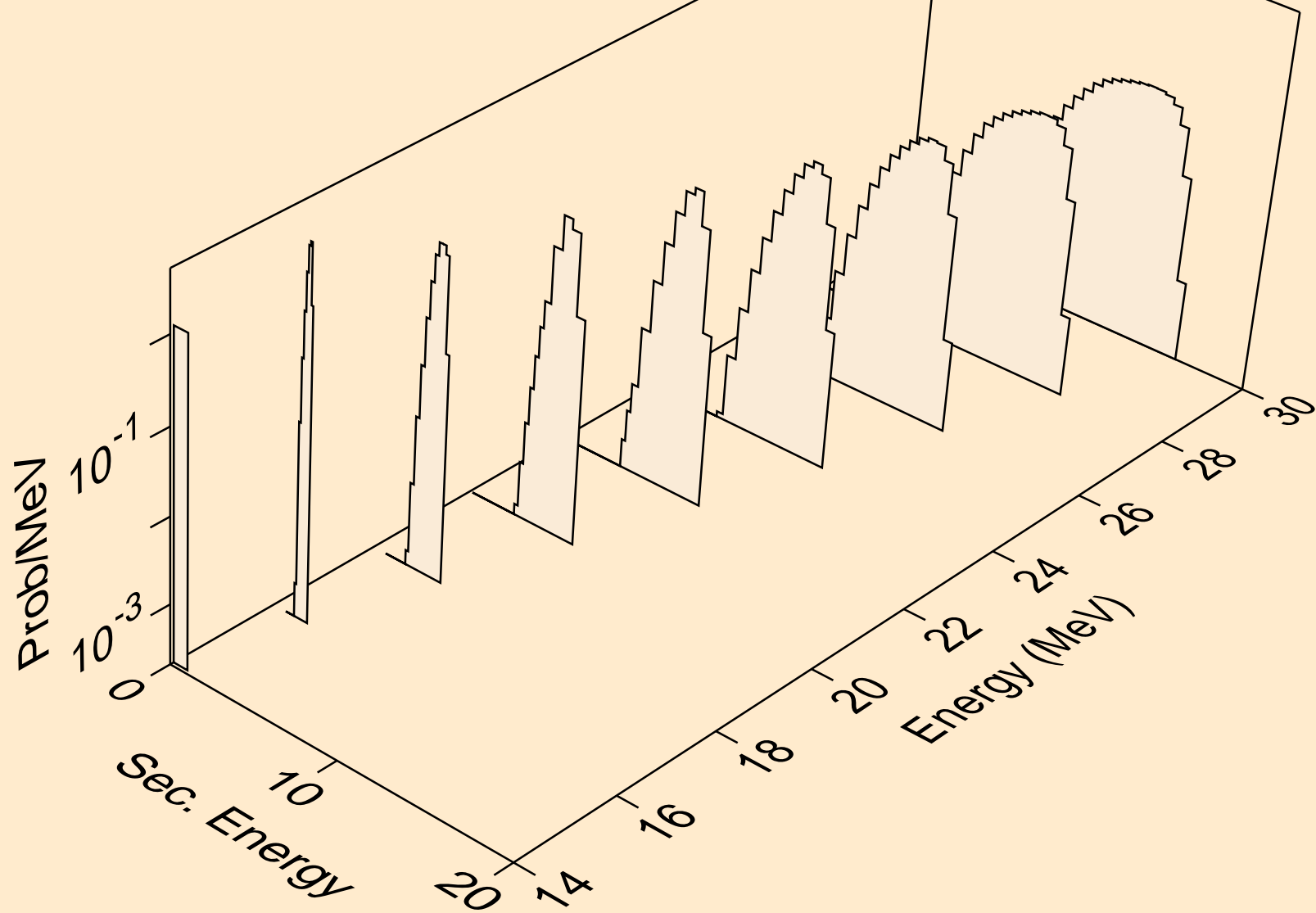

LU183 NEUTRON ACER TENDL-2024 LIBRARY; T=0.K
protons from (n,3np)

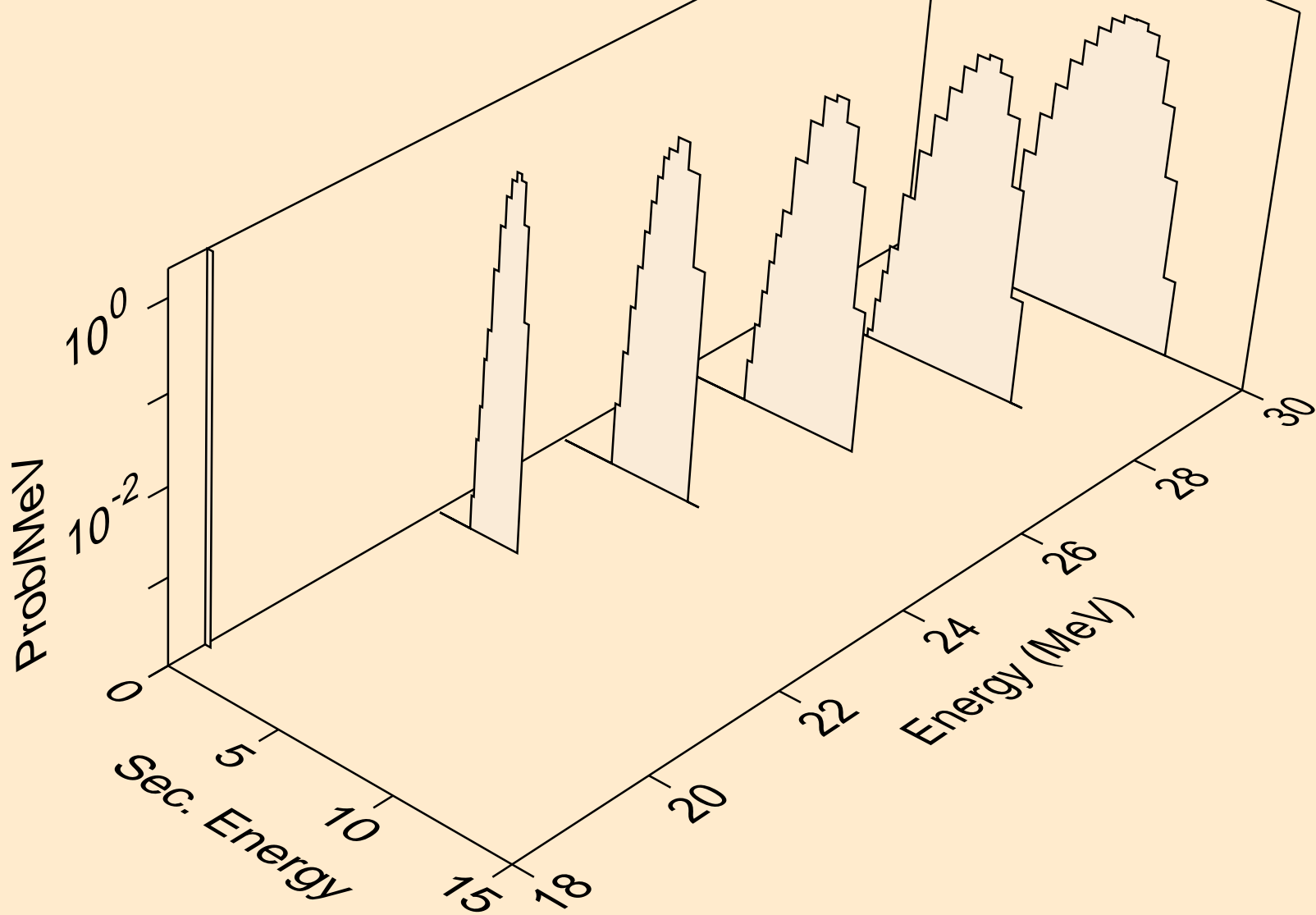

LU183 NEUTRON ACER TENDL-2024 LIBRARY; T=0.K
protons from (n,p)

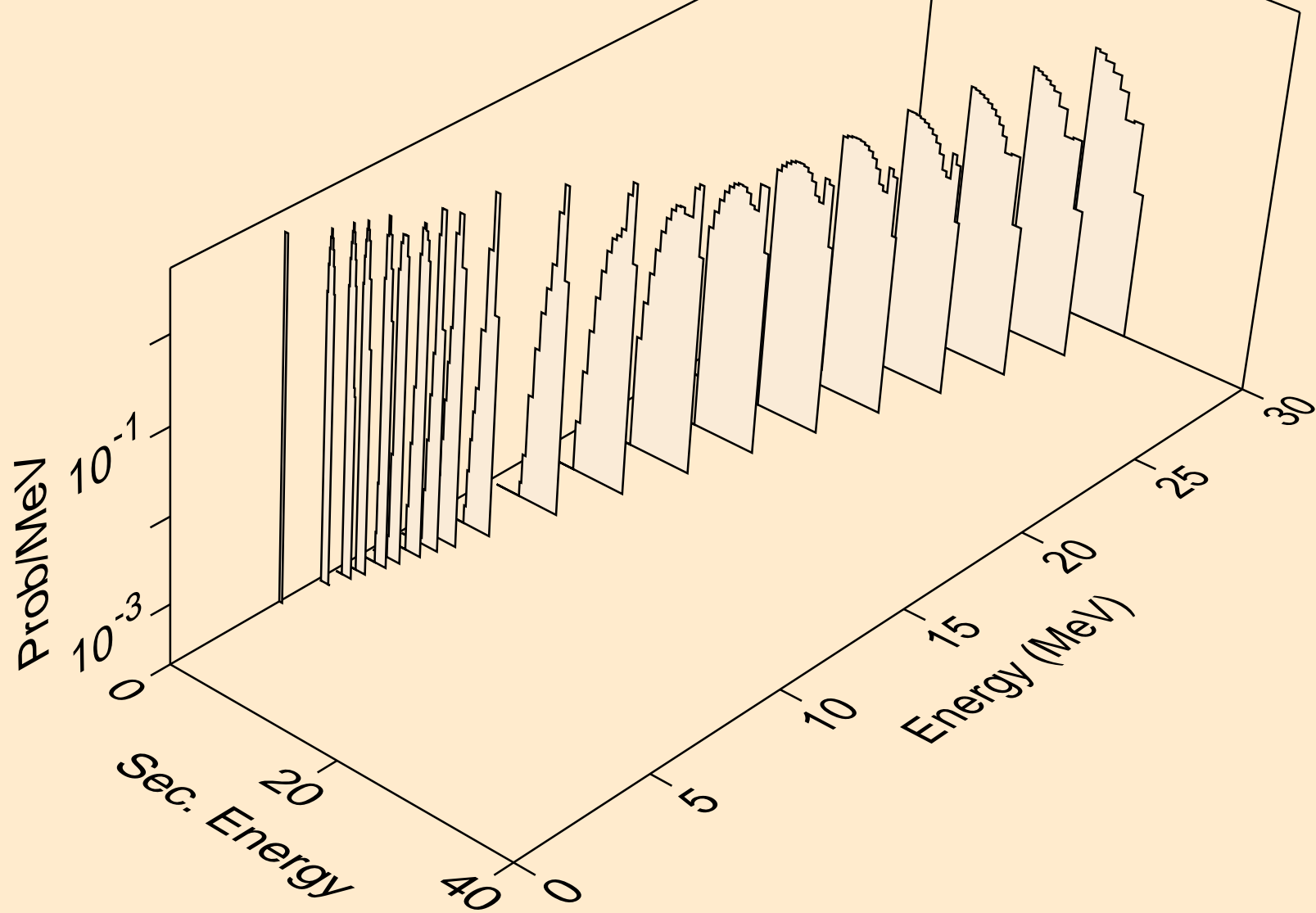

LU183 NEUTRON ACER TENDL-2024 LIBRARY; T=0.K
deuterons from (n,x)

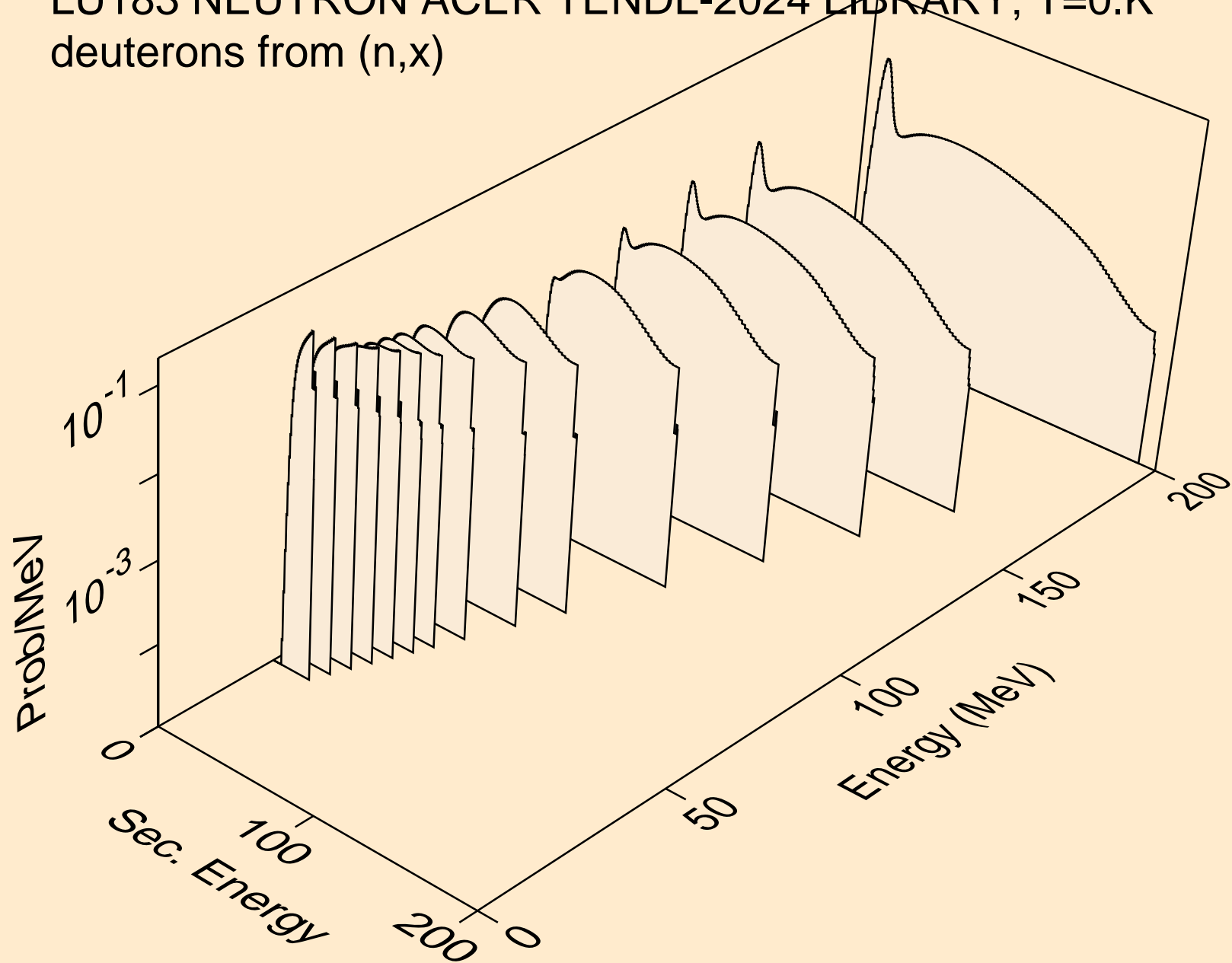

LU183 NEUTRON ACER TENDL-2024 LIBRARY; T=0.K
deuterons from (n,2nd)

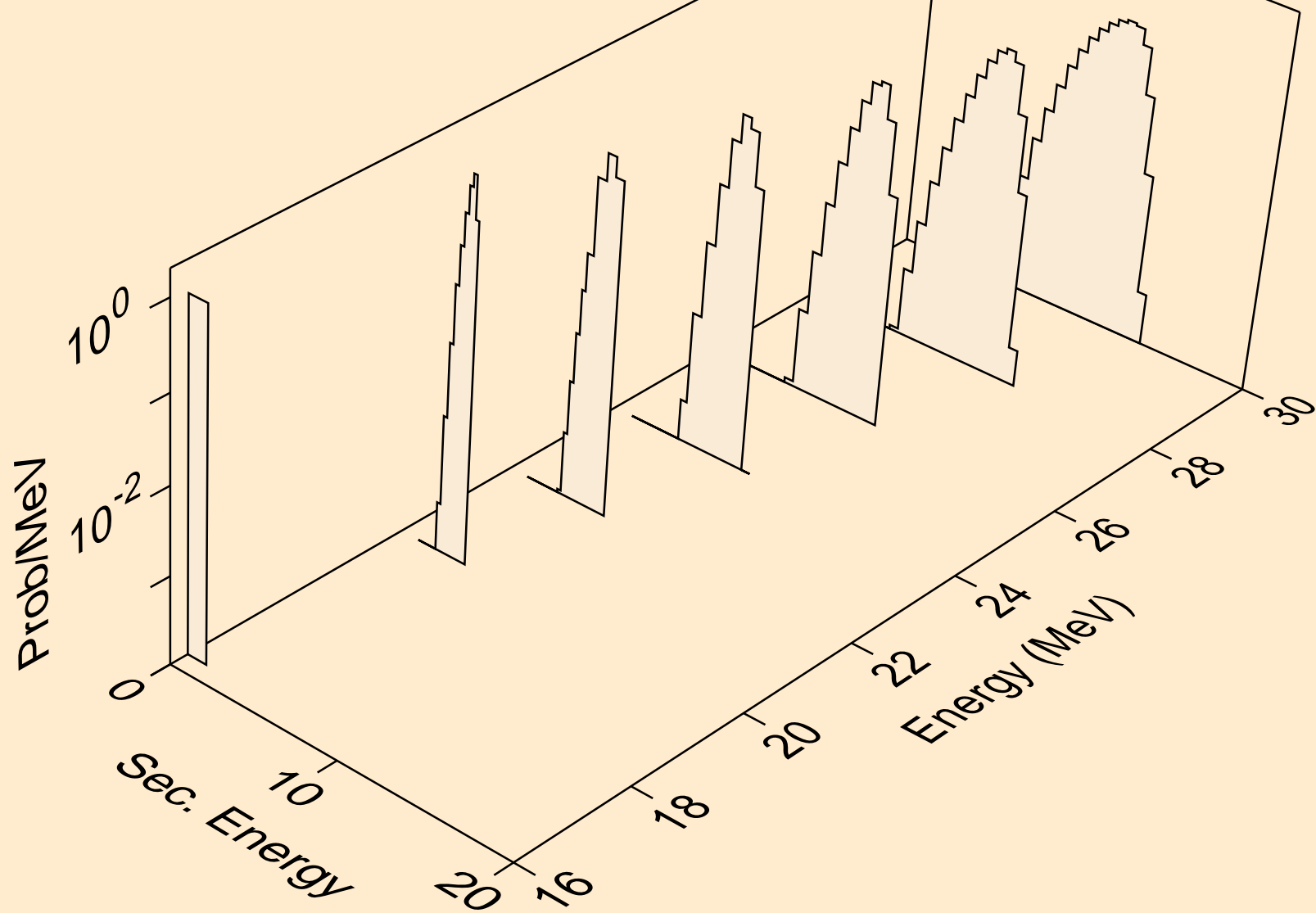

LU183 NEUTRON ACER TENDL-2024 LIBRARY; T=0.K
deuterons from (n,n*)d

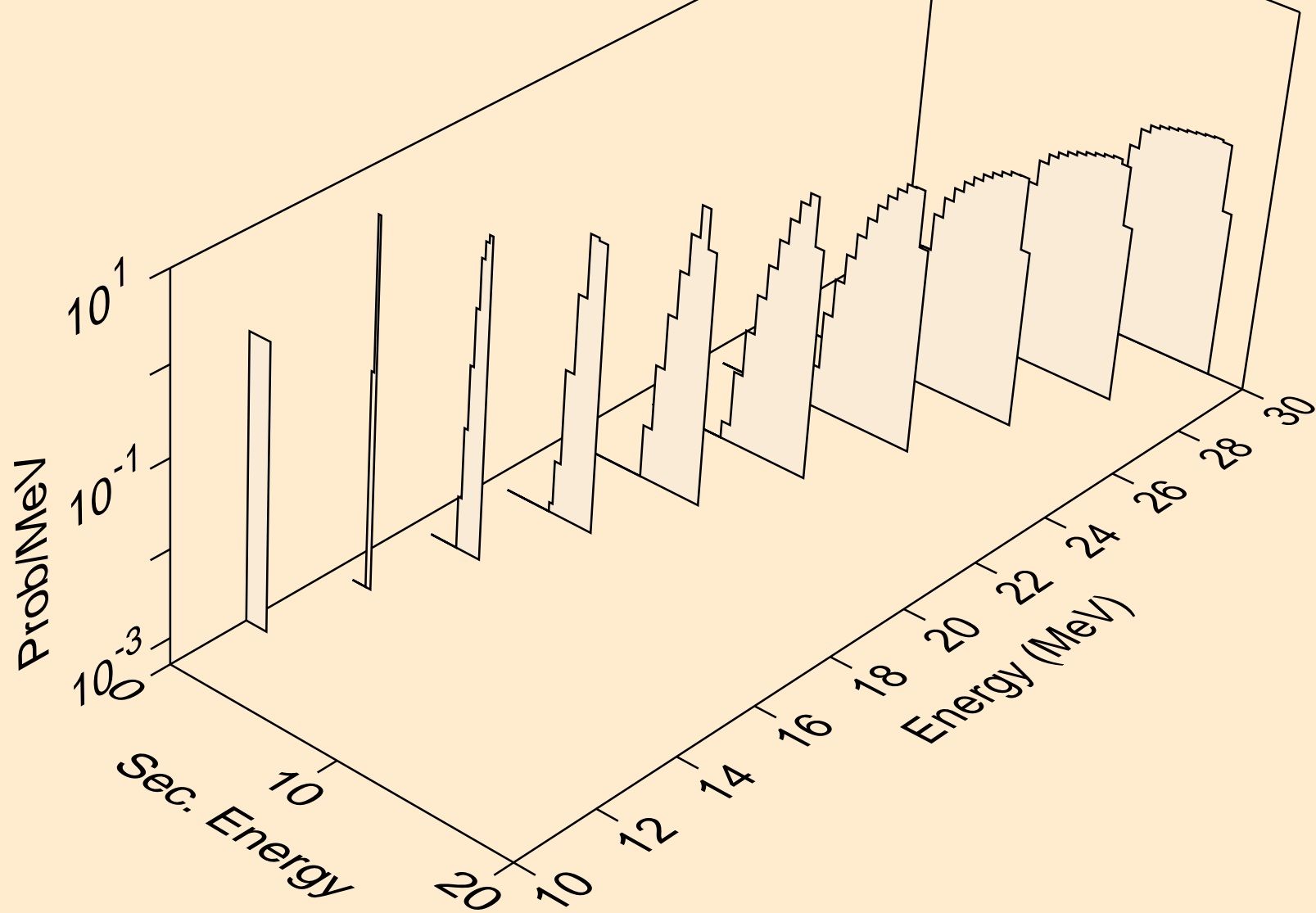

LU183 NEUTRON ACER TENDL-2024 LIBRARY; T=0.K
deuterons from (n,d)

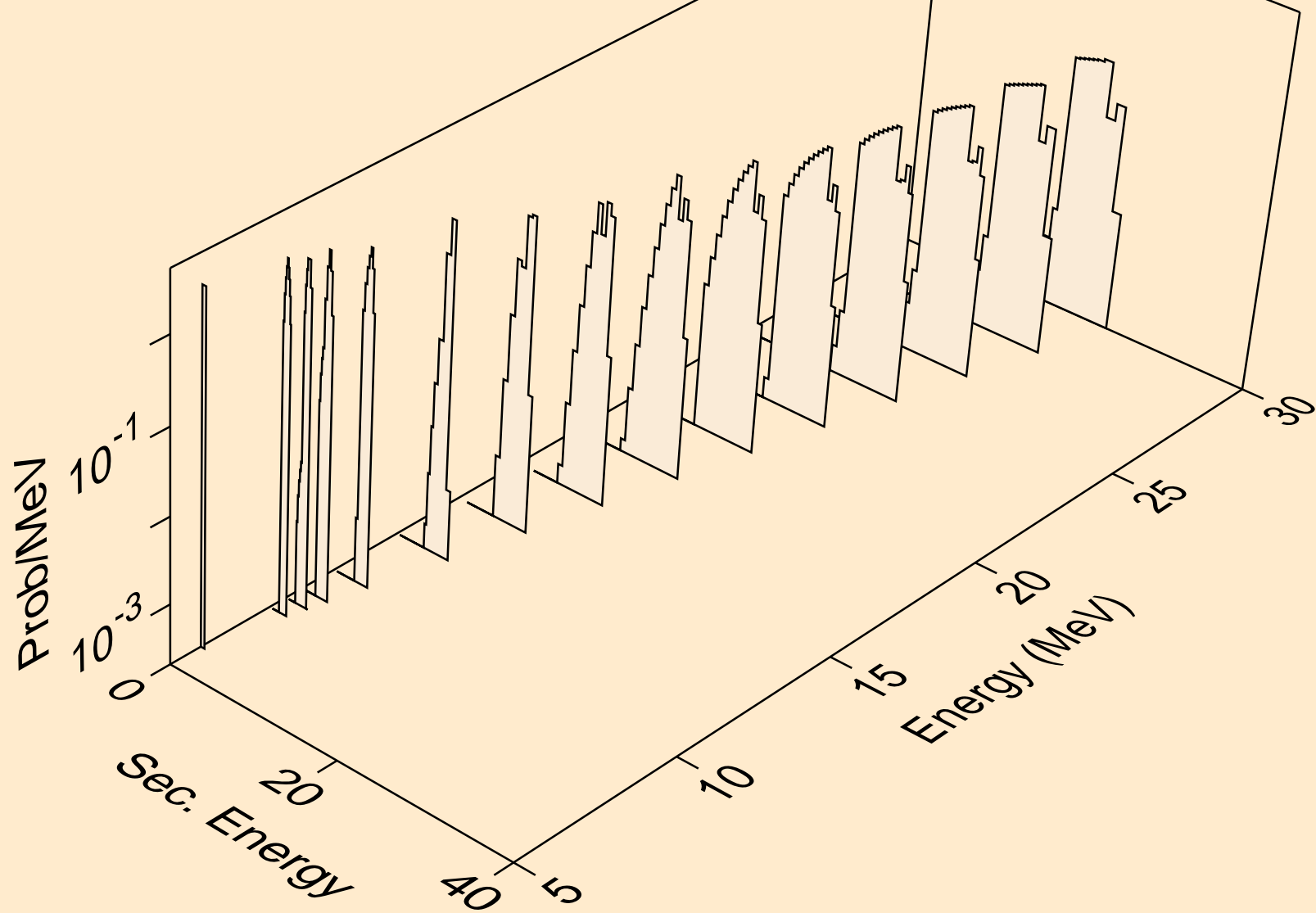

LU183 NEUTRON ACER TENDL-2024 LIBRARY; T=0.K
tritons from (n,x)

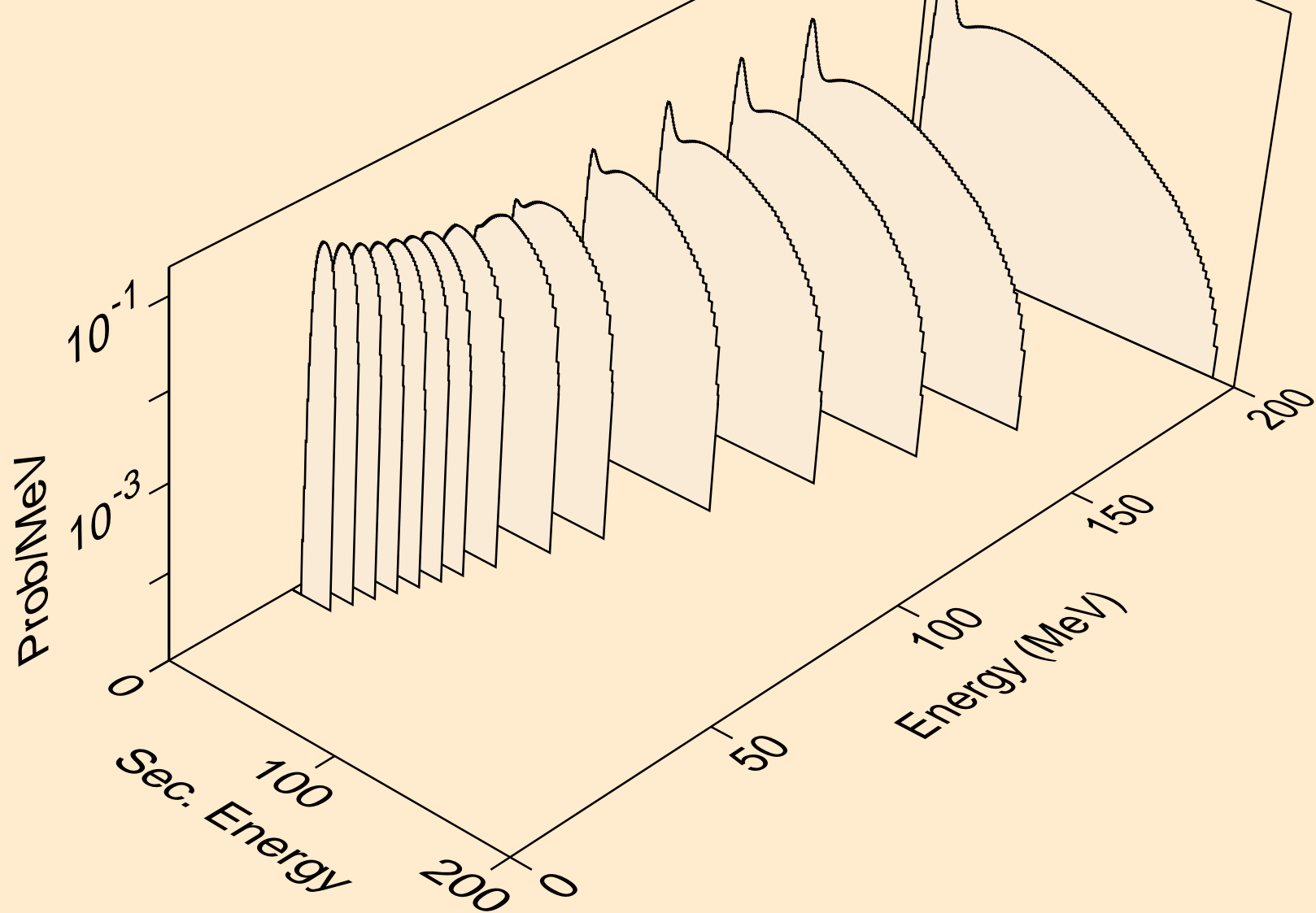

LU183 NEUTRON ACER TENDL-2024 LIBRARY; T=0.K
tritons from (n,n*)t

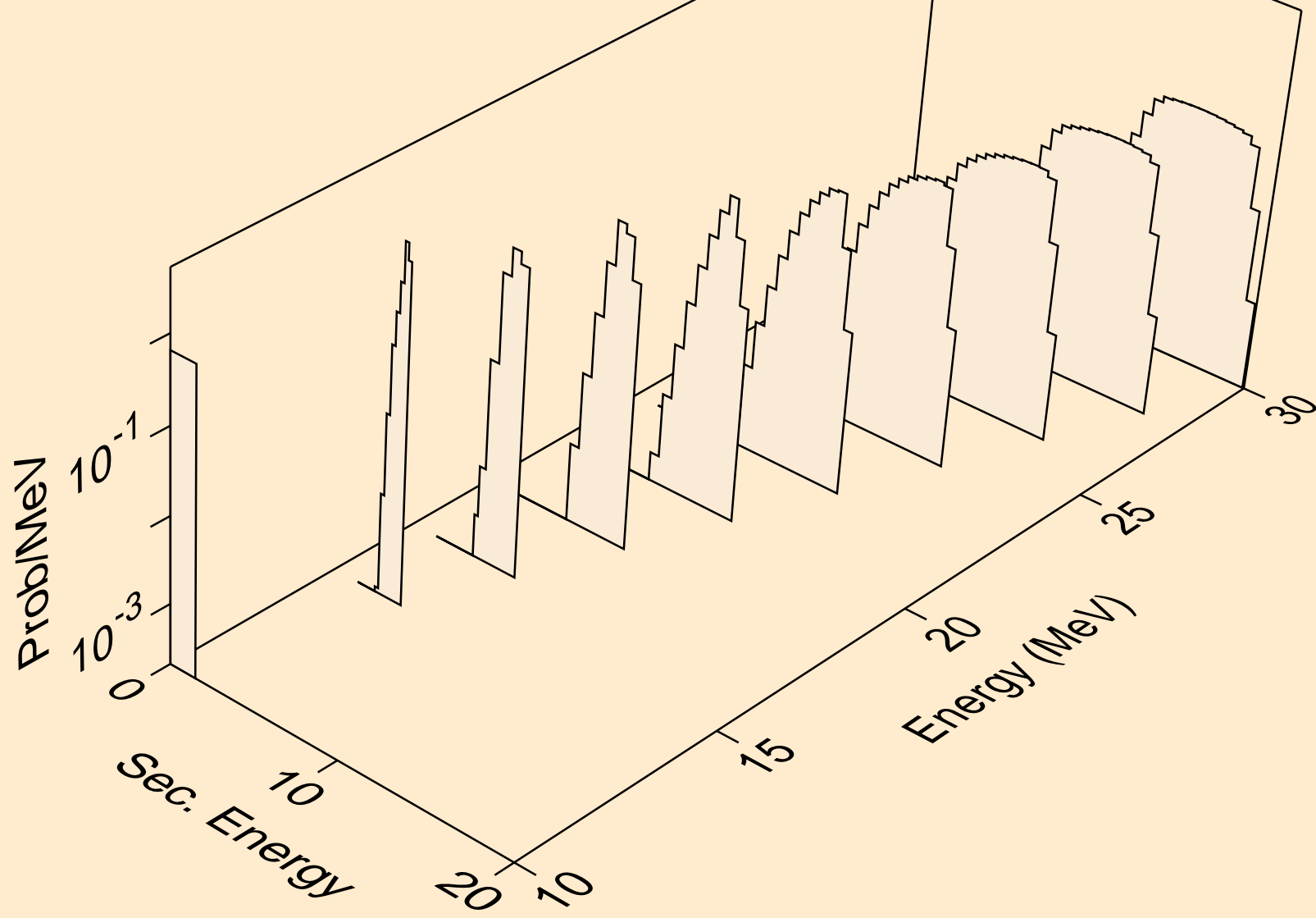

LU183 NEUTRON ACER TENDL-2024 LIBRARY; T=0.K
tritons from (n,t)

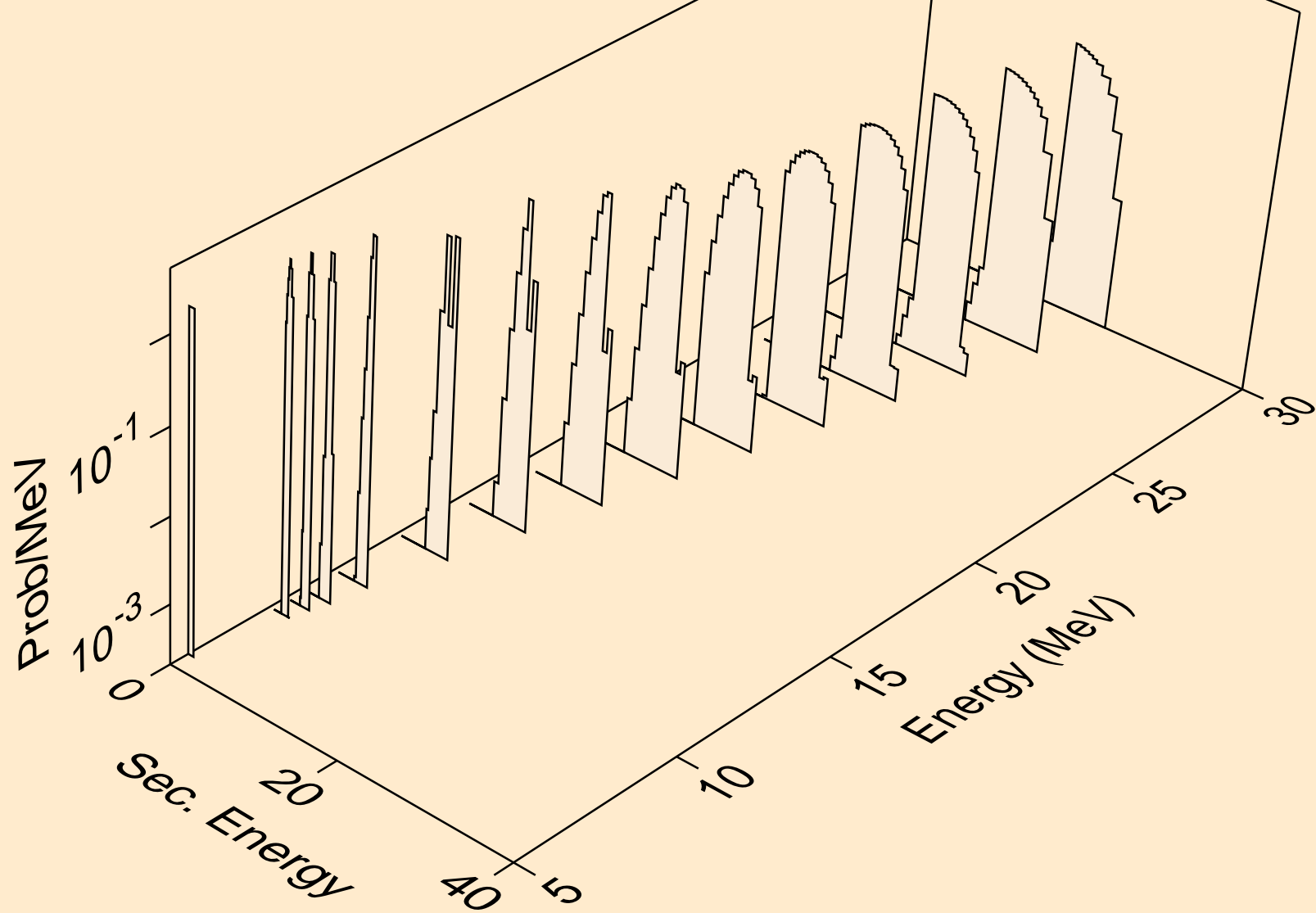

LU183 NEUTRON ACER TENDL-2024 LIBRARY; T=0.K
he3s from (n,x)

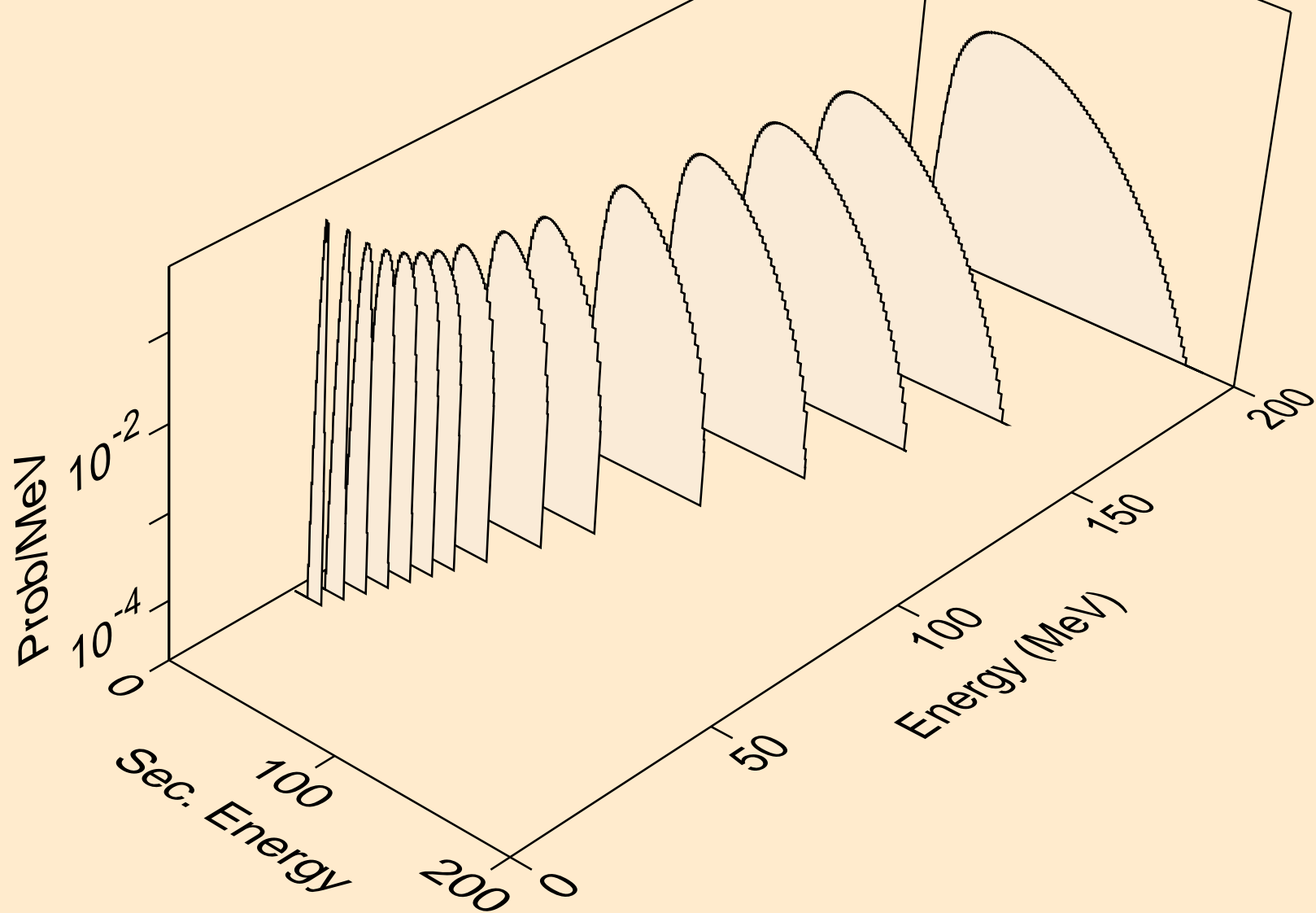

LU183 NEUTRON ACER TENDL-2024 LIBRARY; T=0.K
he3s from (n,n*)he3

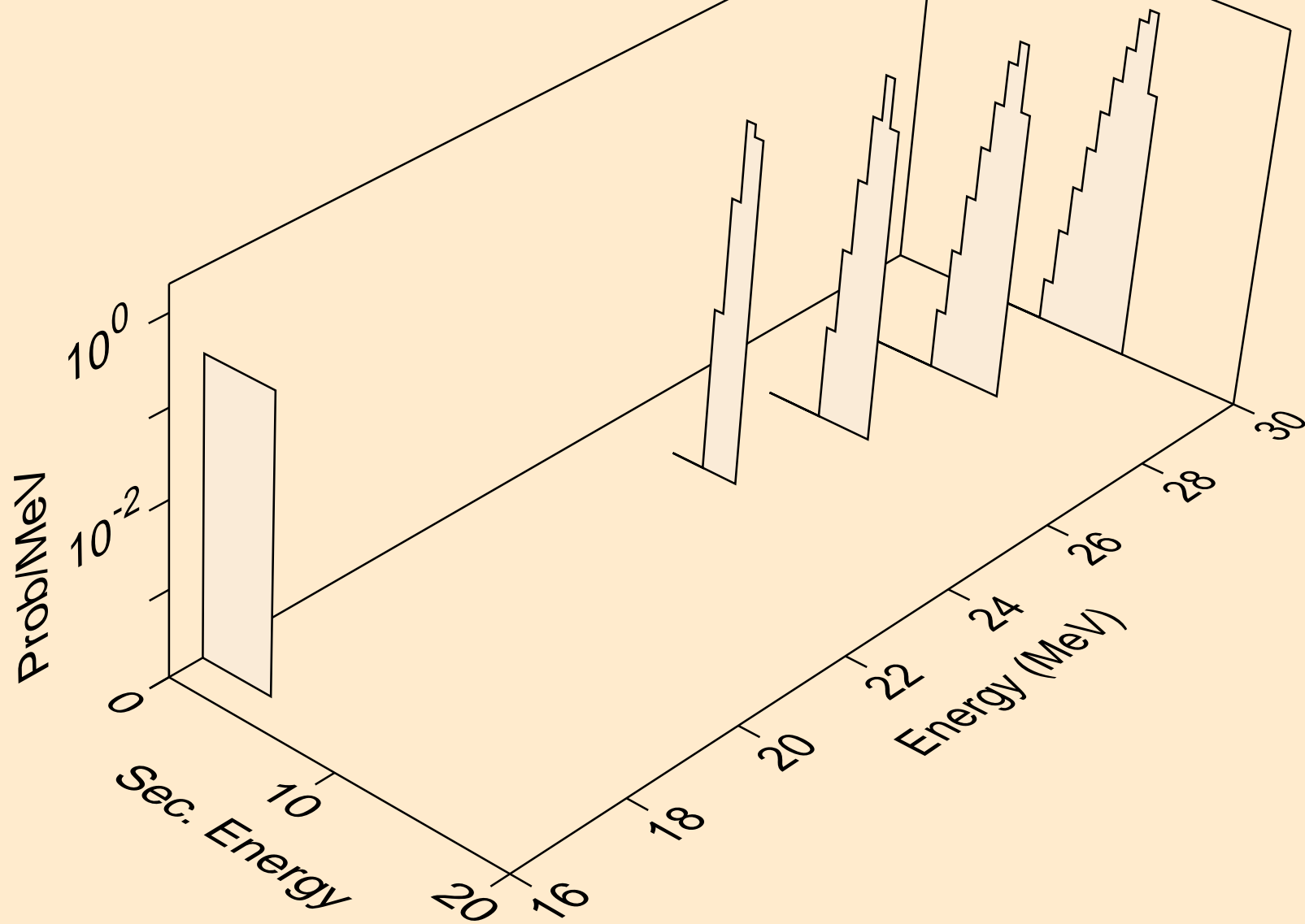

LU183 NEUTRON ACER TENDL-2024 LIBRARY; T=0.K
he3s from (n,he3)

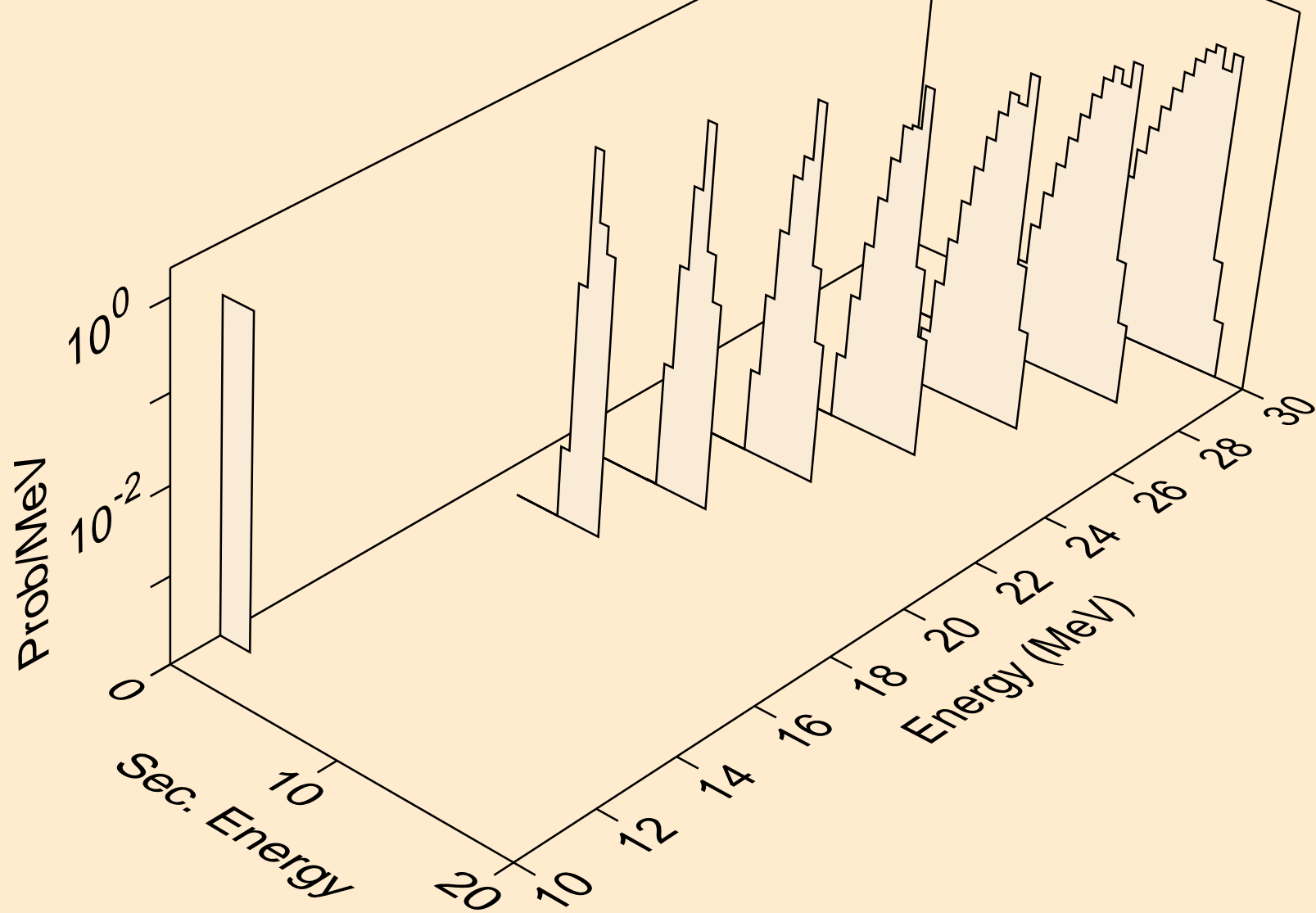

LU183 NEUTRON ACER TENDL-2024 LIBRARY; T=0.K
alphas from (n,x)

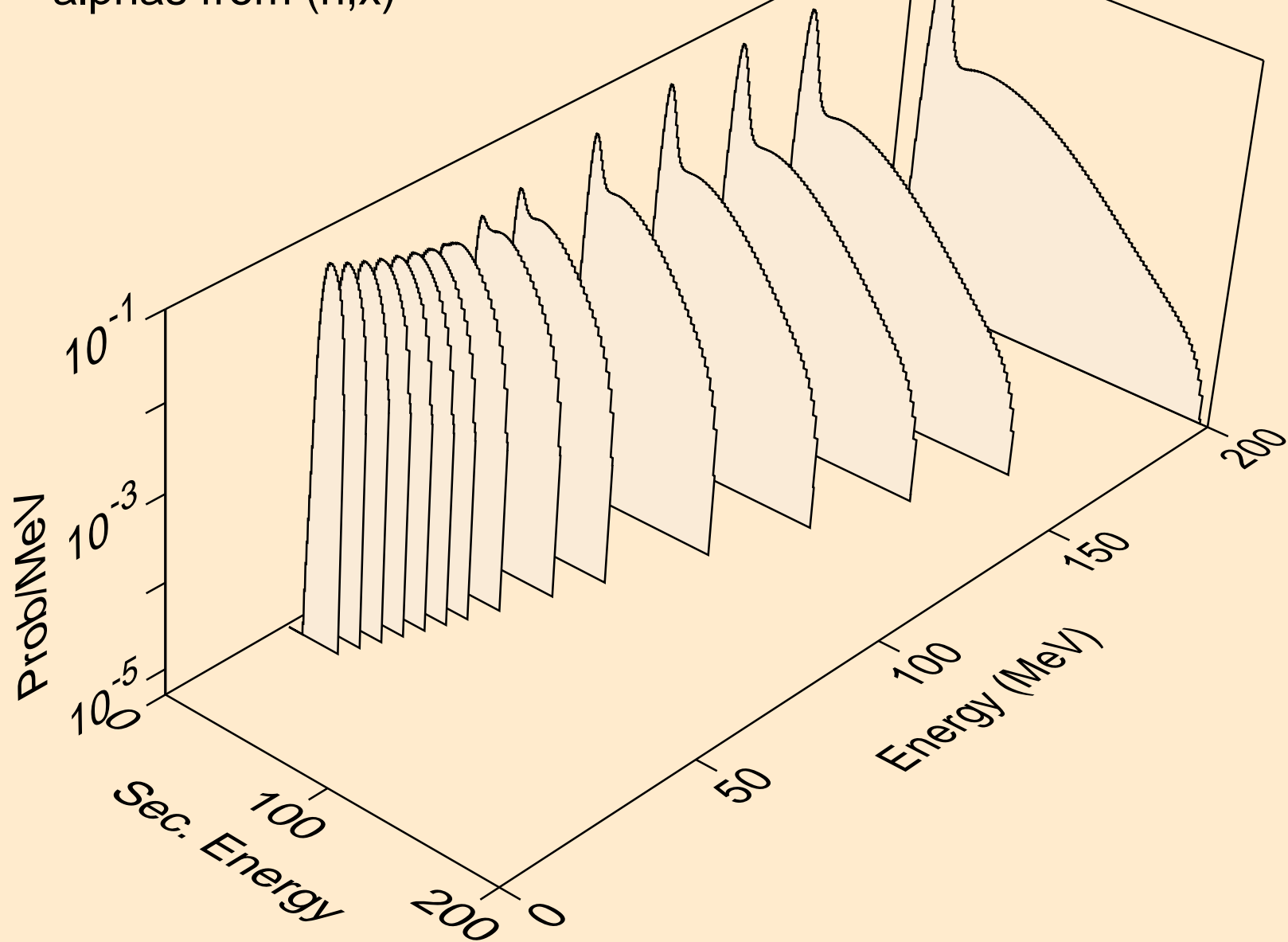

LU183 NEUTRON ACER TENDL-2024 LIBRARY; T=0.K
alphas from (n,n*)a

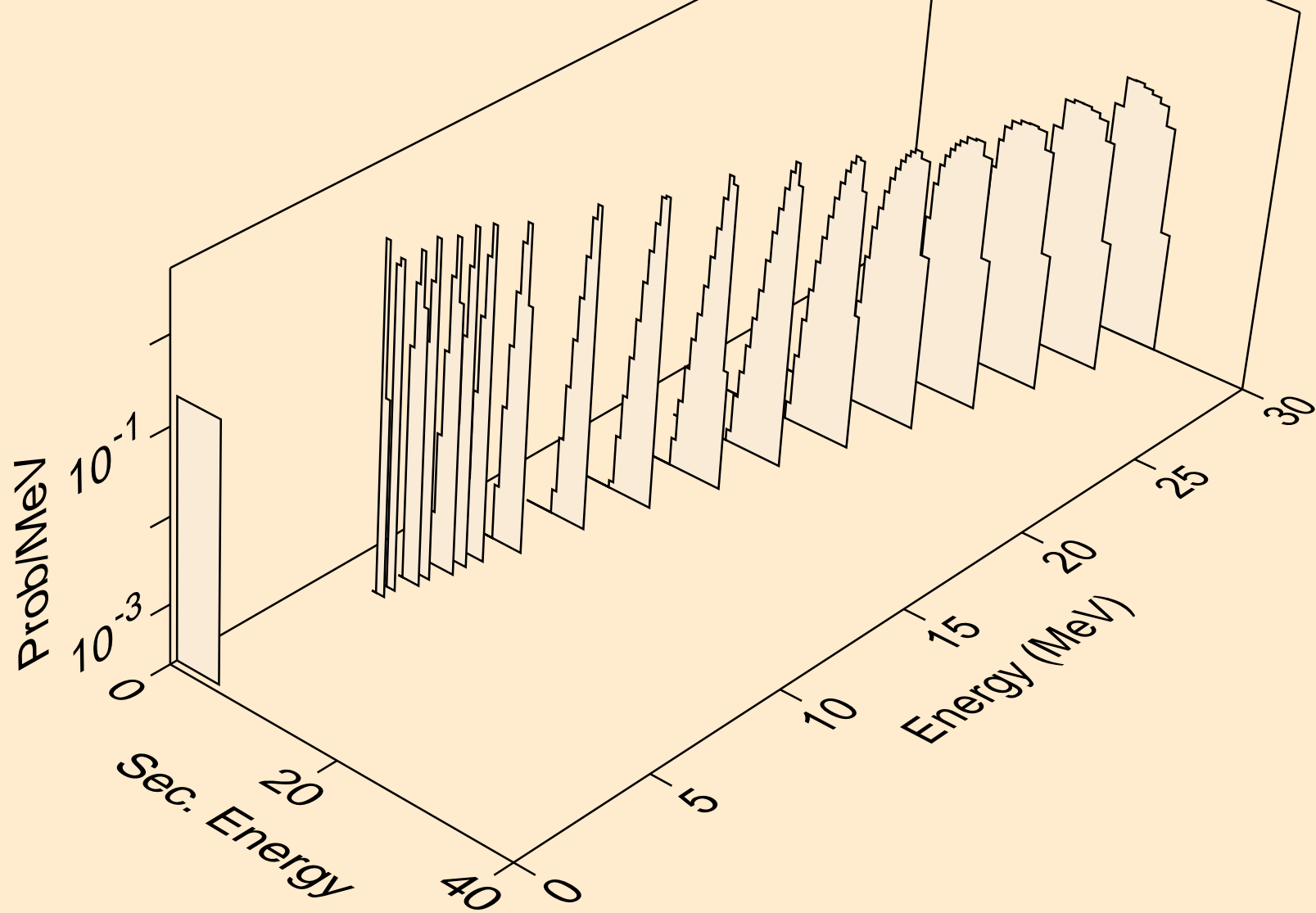

LU183 NEUTRON ACER TENDL-2024 LIBRARY; T=0.K
alphas from (n,2n)a

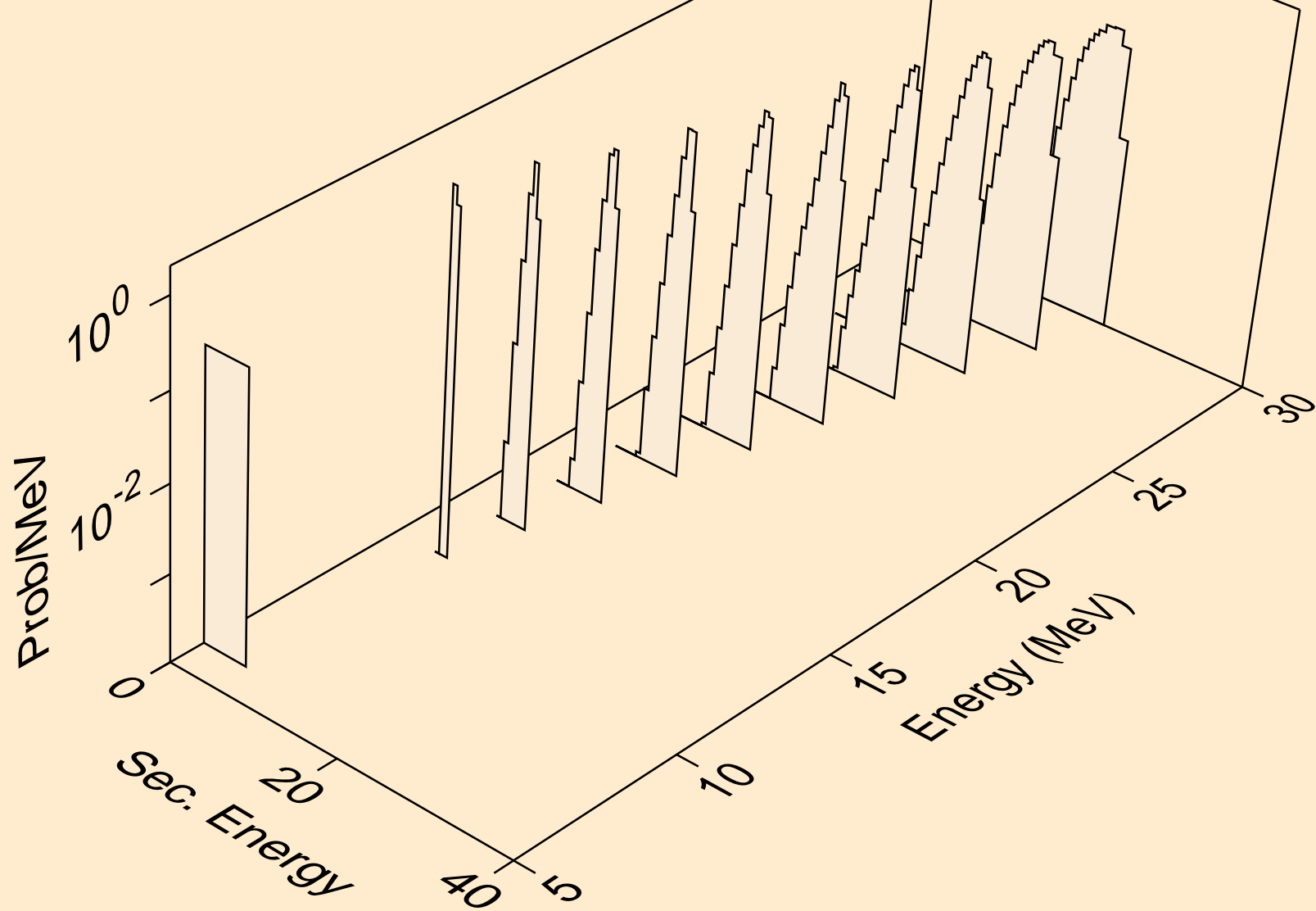

LU183 NEUTRON ACER TENDL-2024 LIBRARY; T=0.K
alphas from (n,3n)a

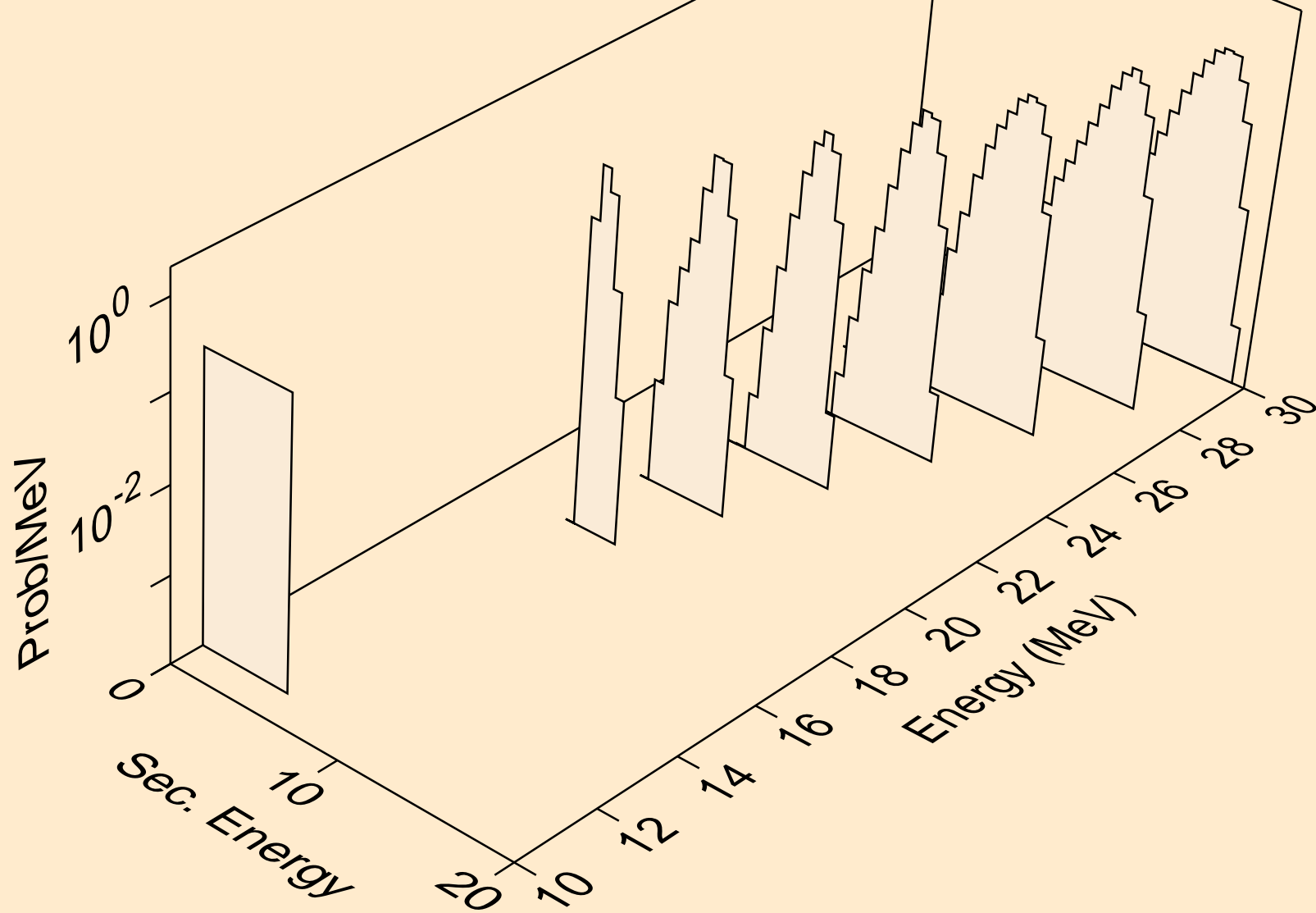

LU183 NEUTRON ACER TENDL-2024 LIBRARY; T=0.K
alphas from (n,a)

