

MO103 NEUTRON ACER TENDL-2024 LIBRARY; T=0.K

Principal cross sections

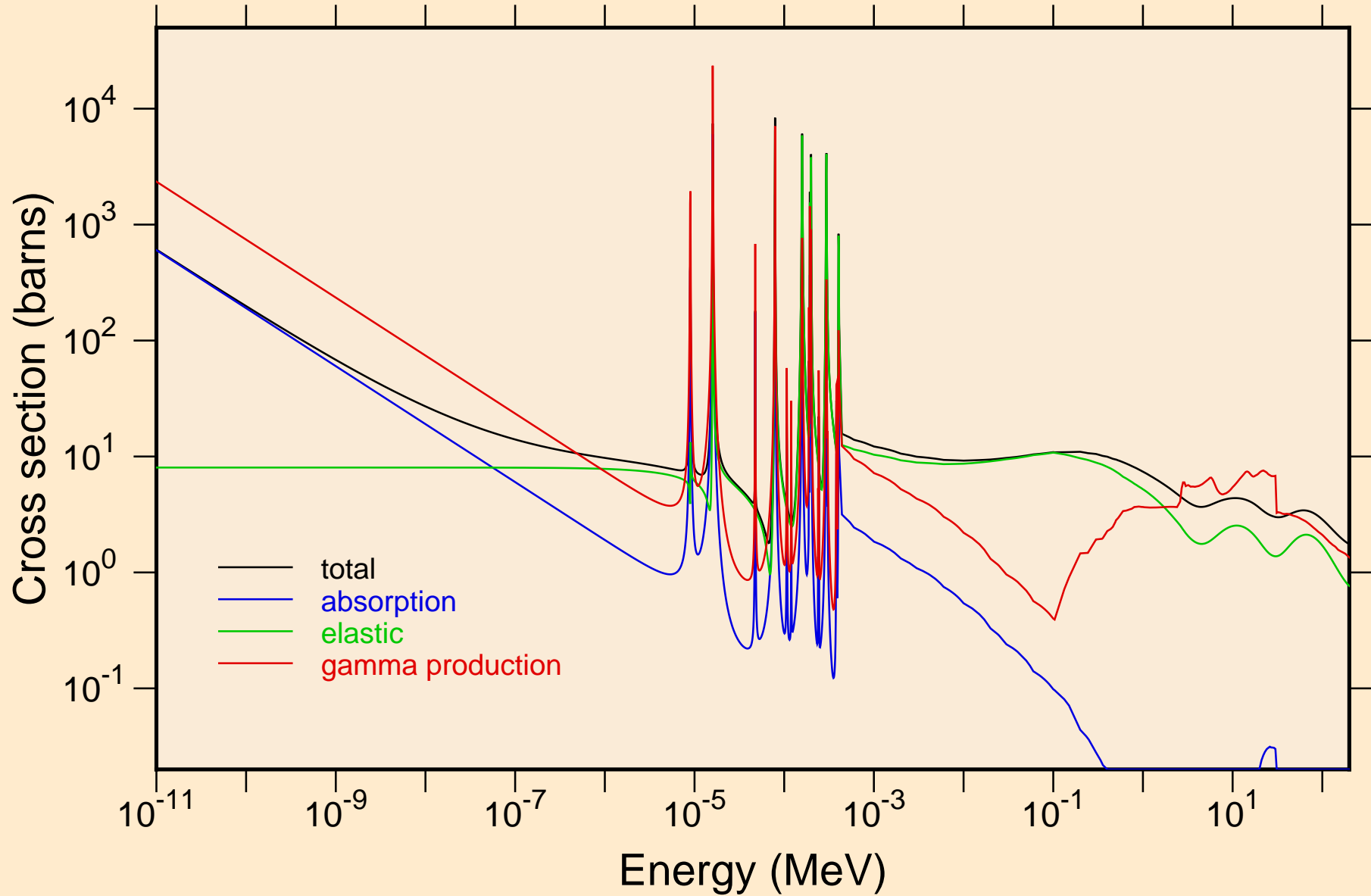

MO103 NEUTRON ACER TENDL-2024 LIBRARY; T=0.K
resonance total cross section

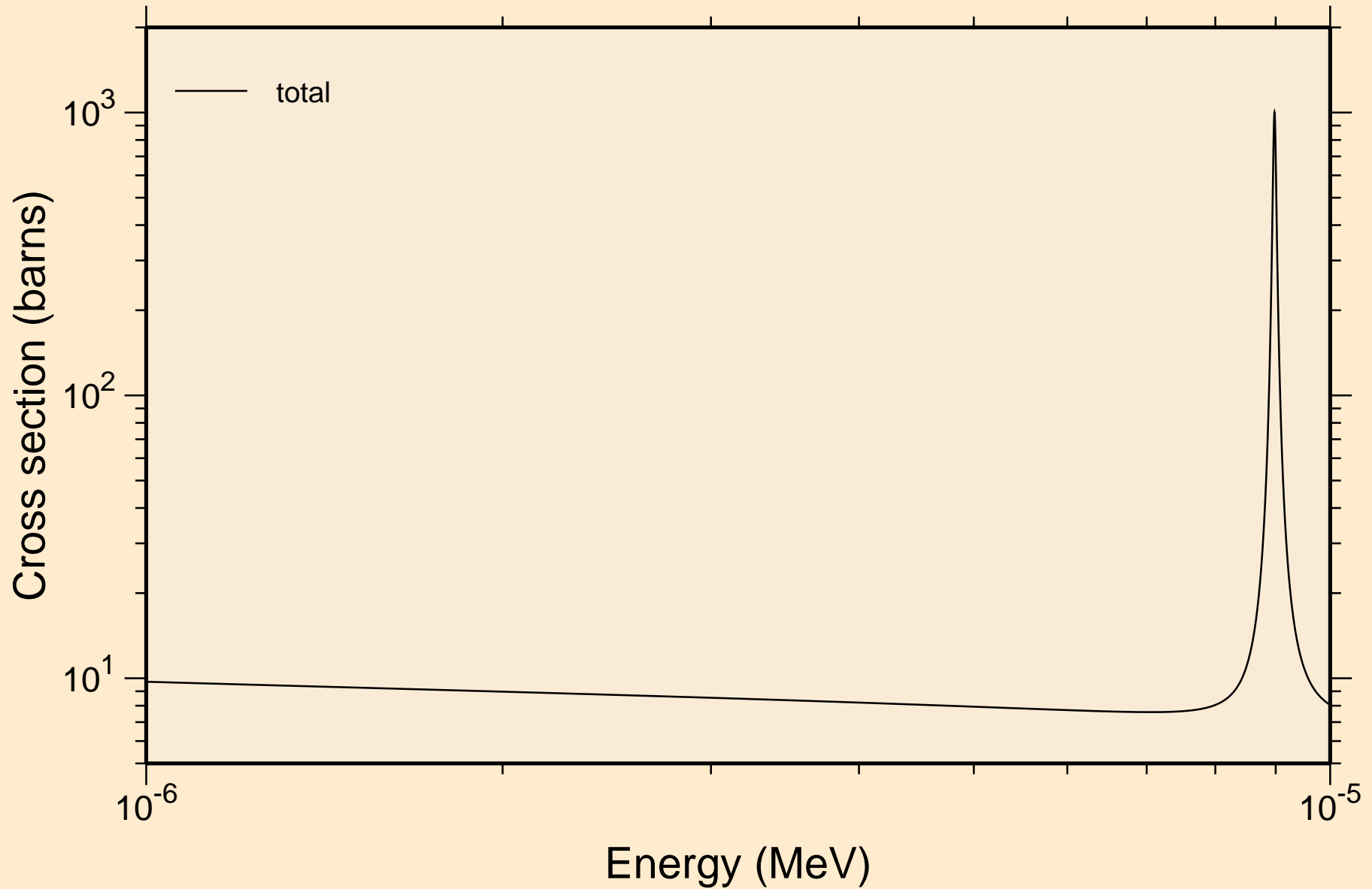

MO103 NEUTRON ACER TENDL-2024 LIBRARY; T=0.K
resonance total cross section

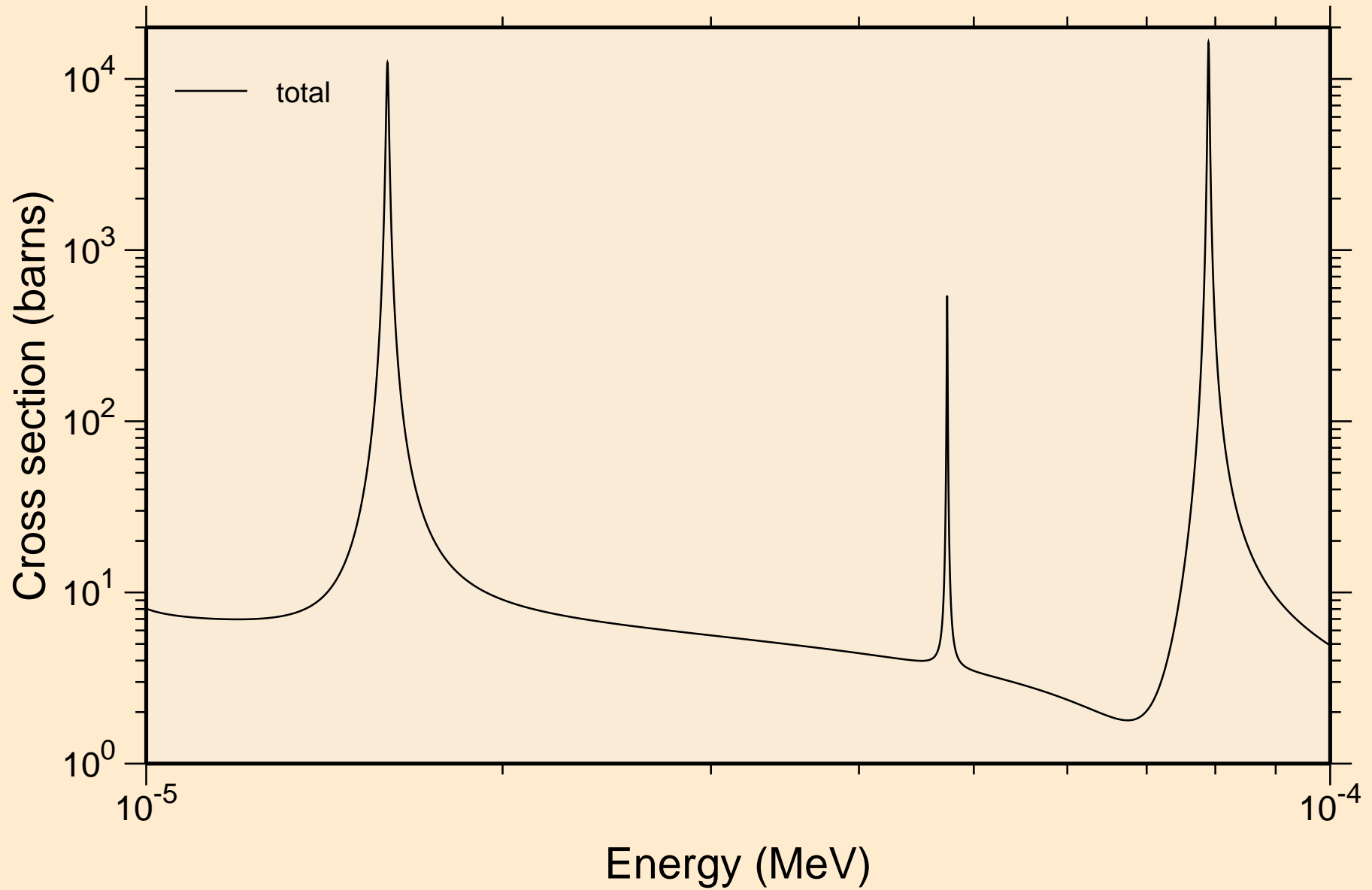

MO103 NEUTRON ACER TENDL-2024 LIBRARY; T=0.K
resonance total cross section

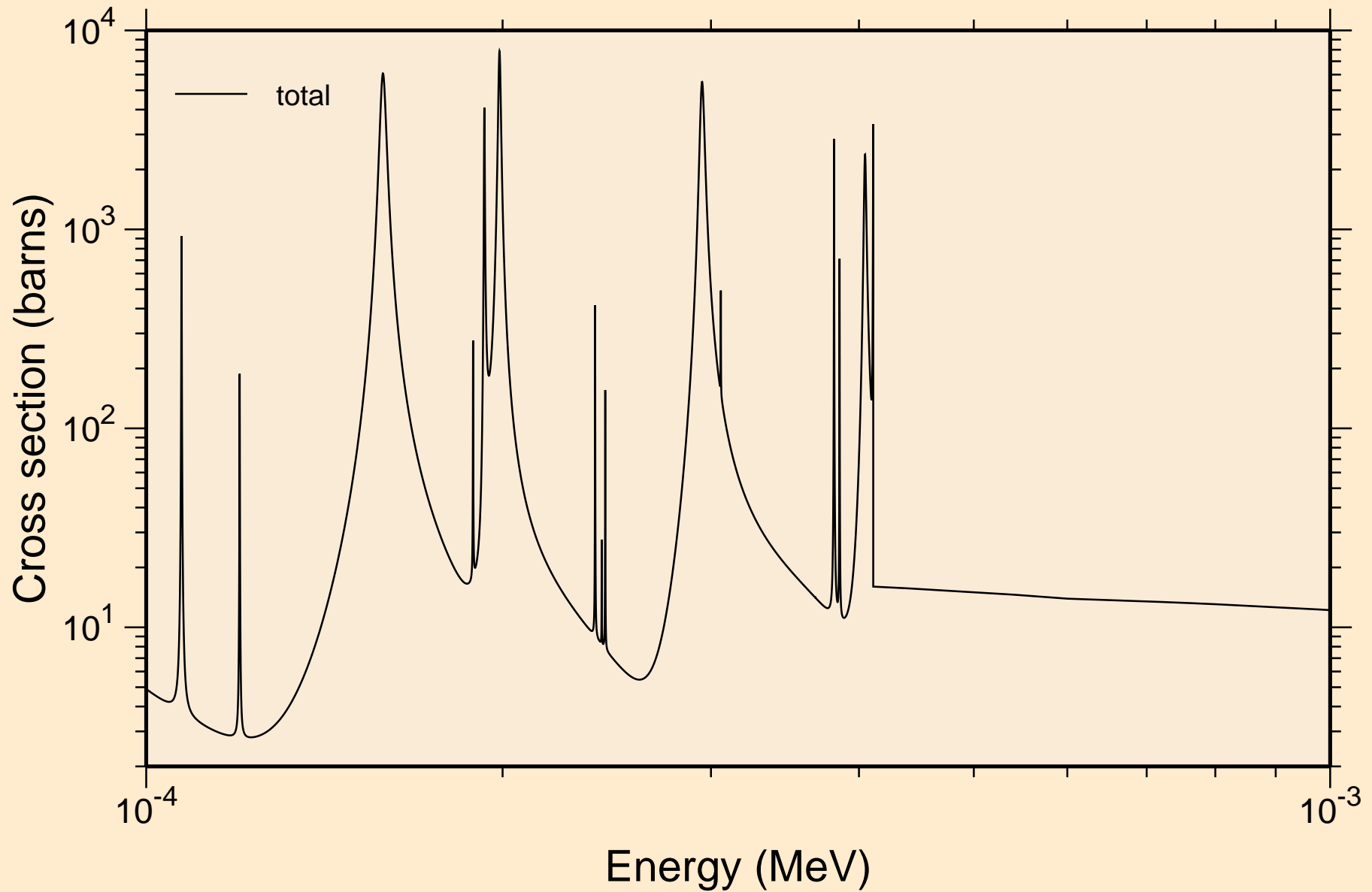

MO103 NEUTRON ACER TENDL-2024 LIBRARY; T=0.K
resonance total cross section

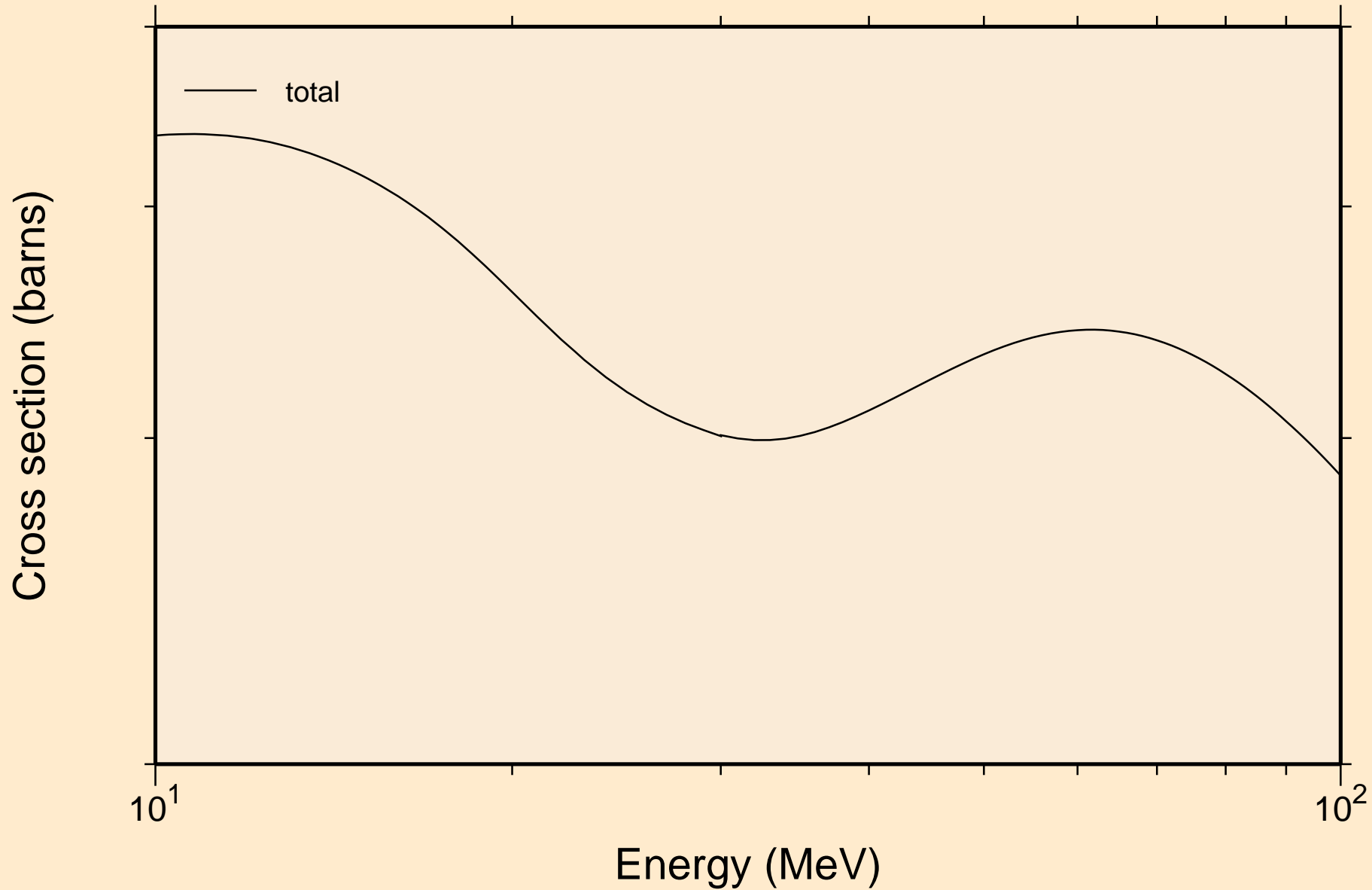

MO103 NEUTRON ACER TENDL-2024 LIBRARY; T=0.K
resonance absorption cross sections

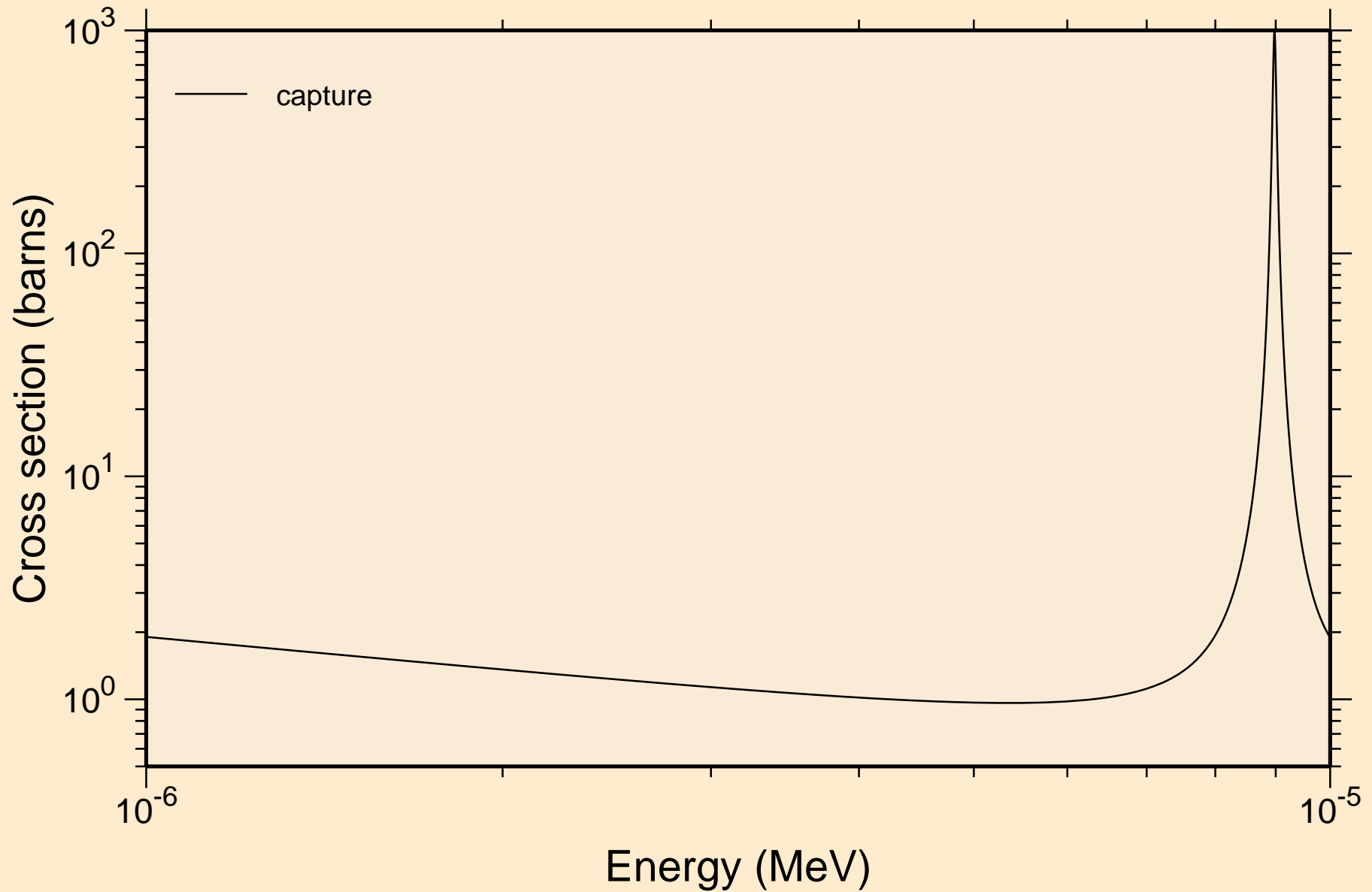

MO103 NEUTRON ACER TENDL-2024 LIBRARY; T=0.K
resonance absorption cross sections

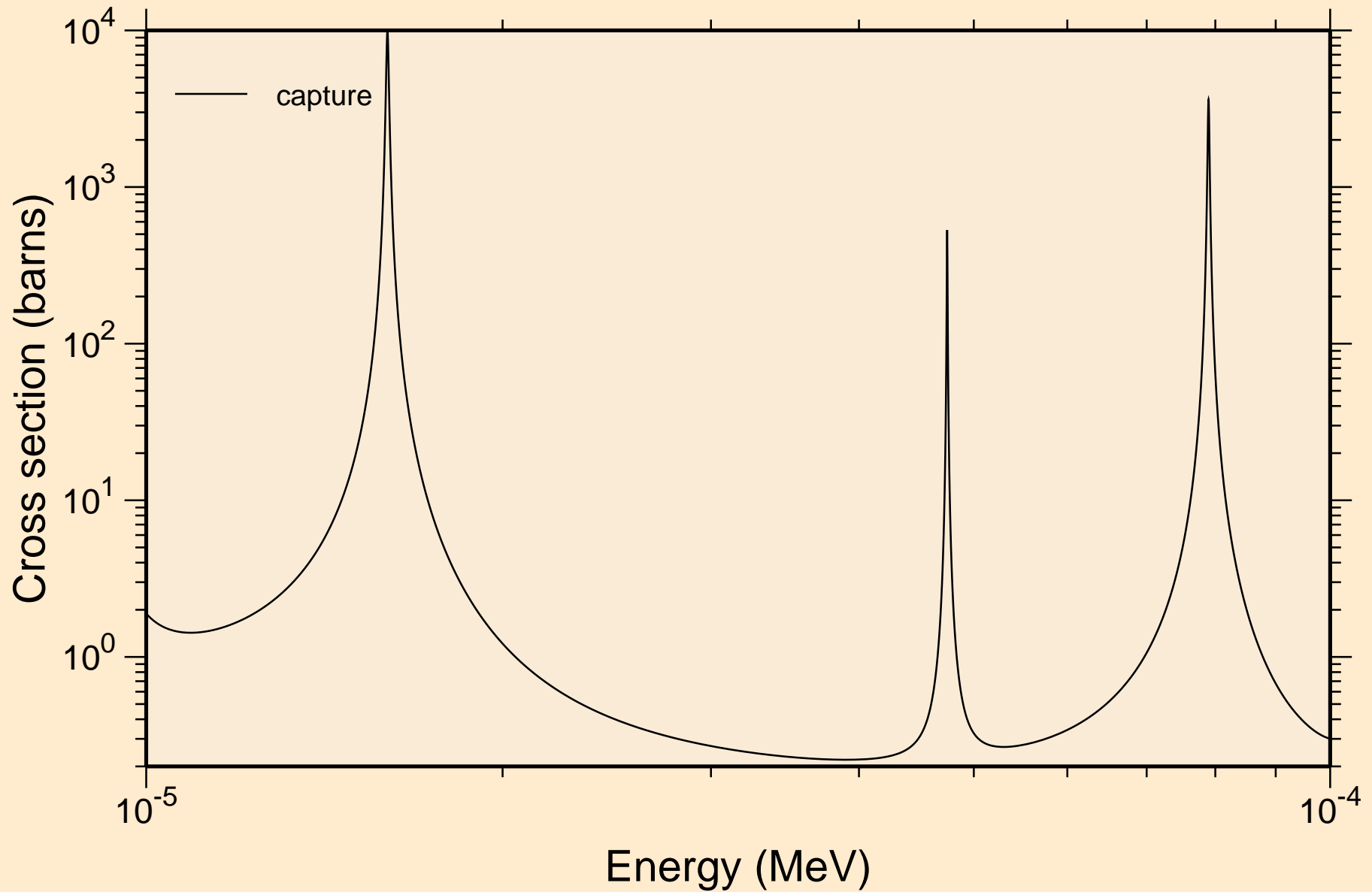

MO103 NEUTRON ACER TENDL-2024 LIBRARY; T=0.K
resonance absorption cross sections

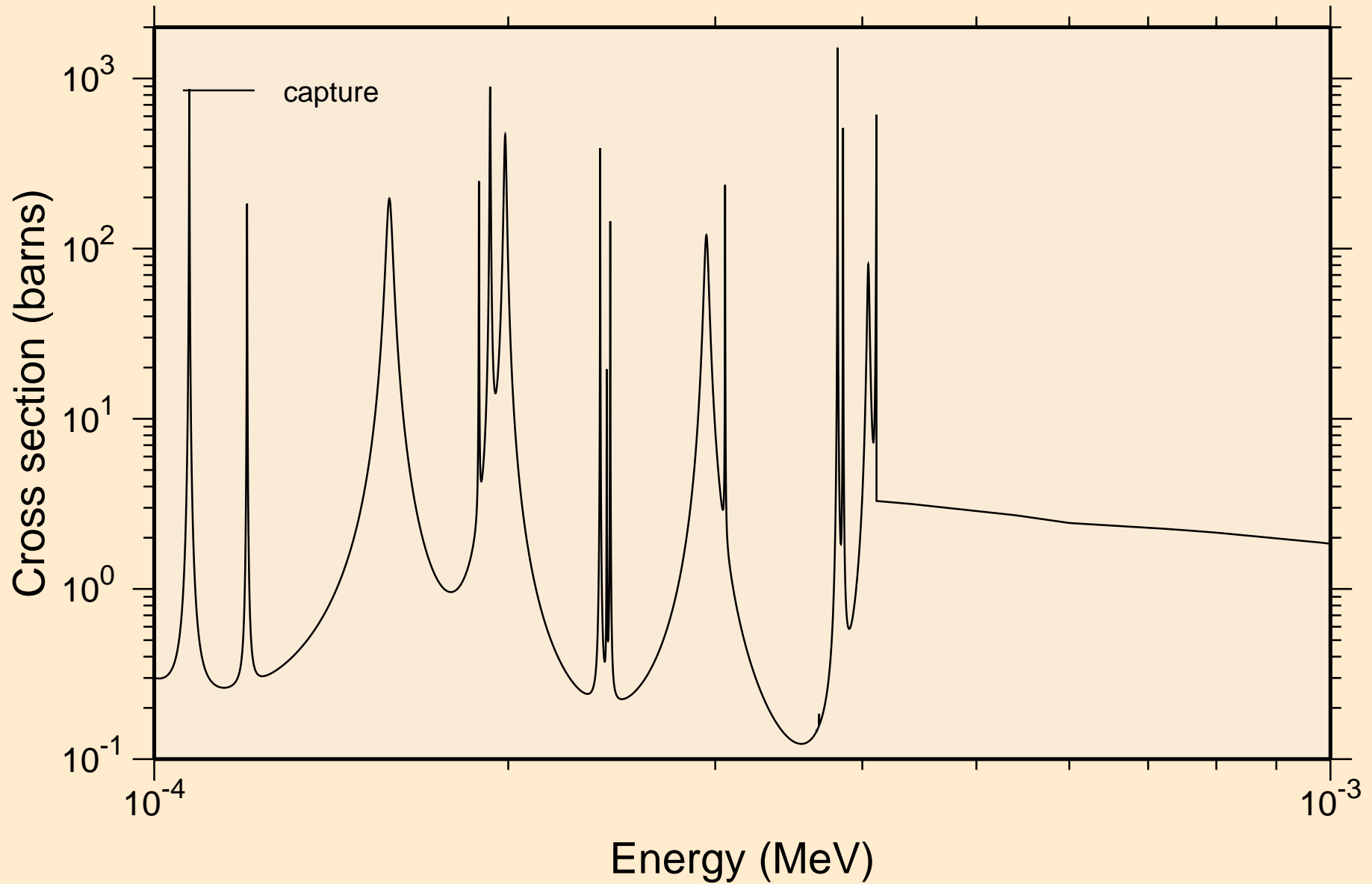

MO103 NEUTRON ACER TENDL-2024 LIBRARY; T=0.K
resonance absorption cross sections

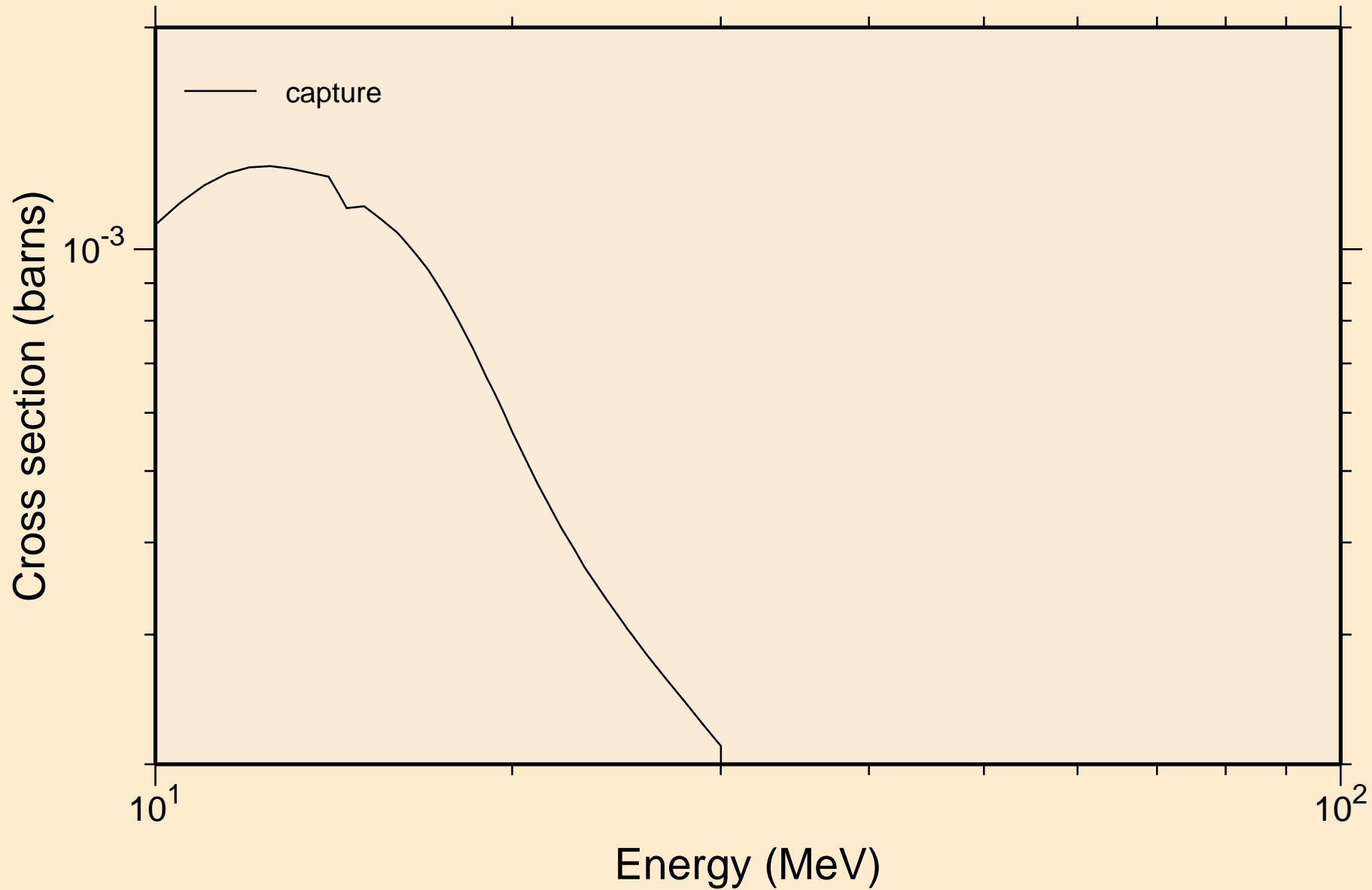

MO103 NEUTRON ACER TENDL-2024 LIBRARY; T=0.K
Heating

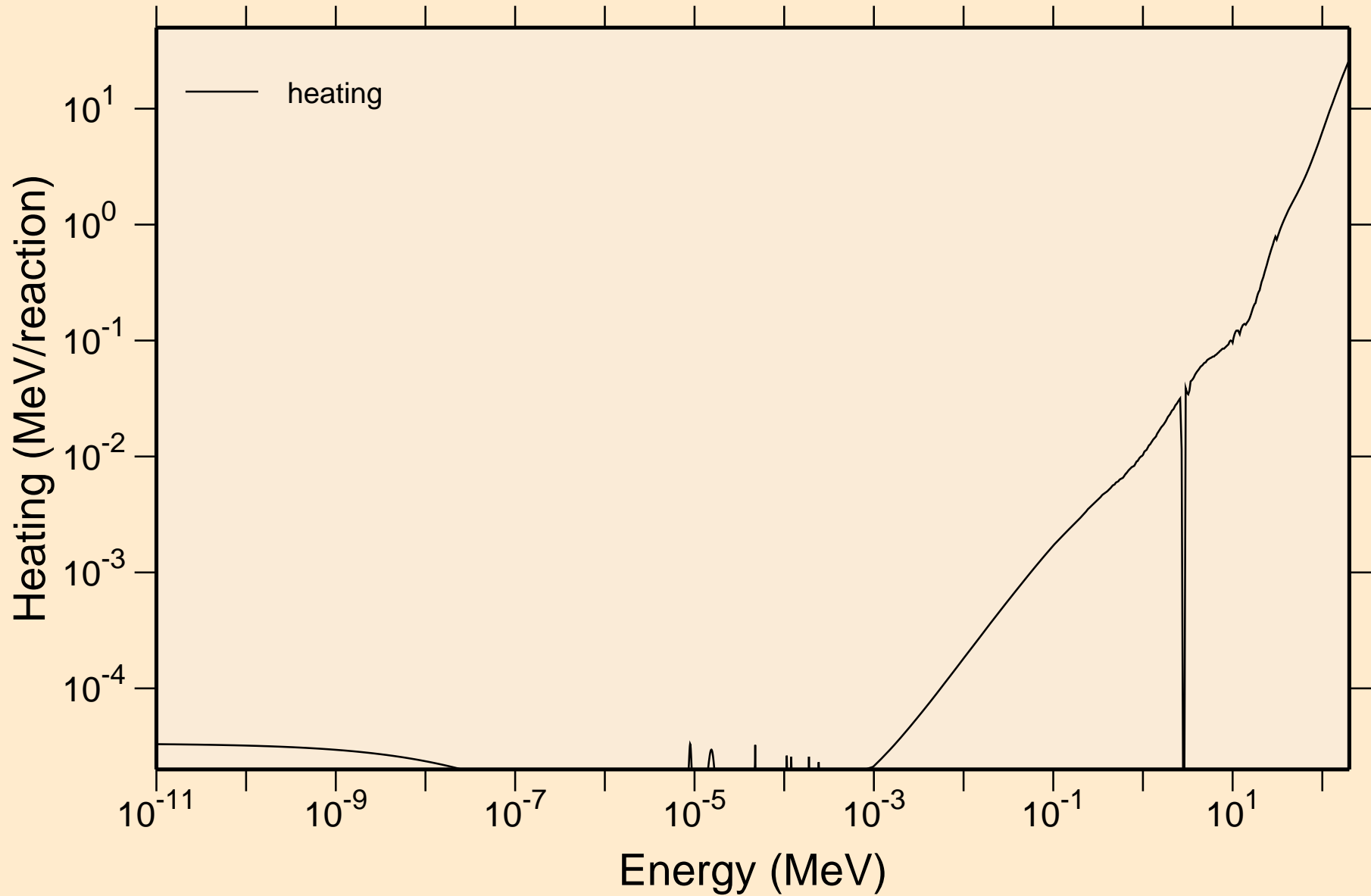

MO103 NEUTRON ACER TENDL-2024 LIBRARY; T=0.K

Damage

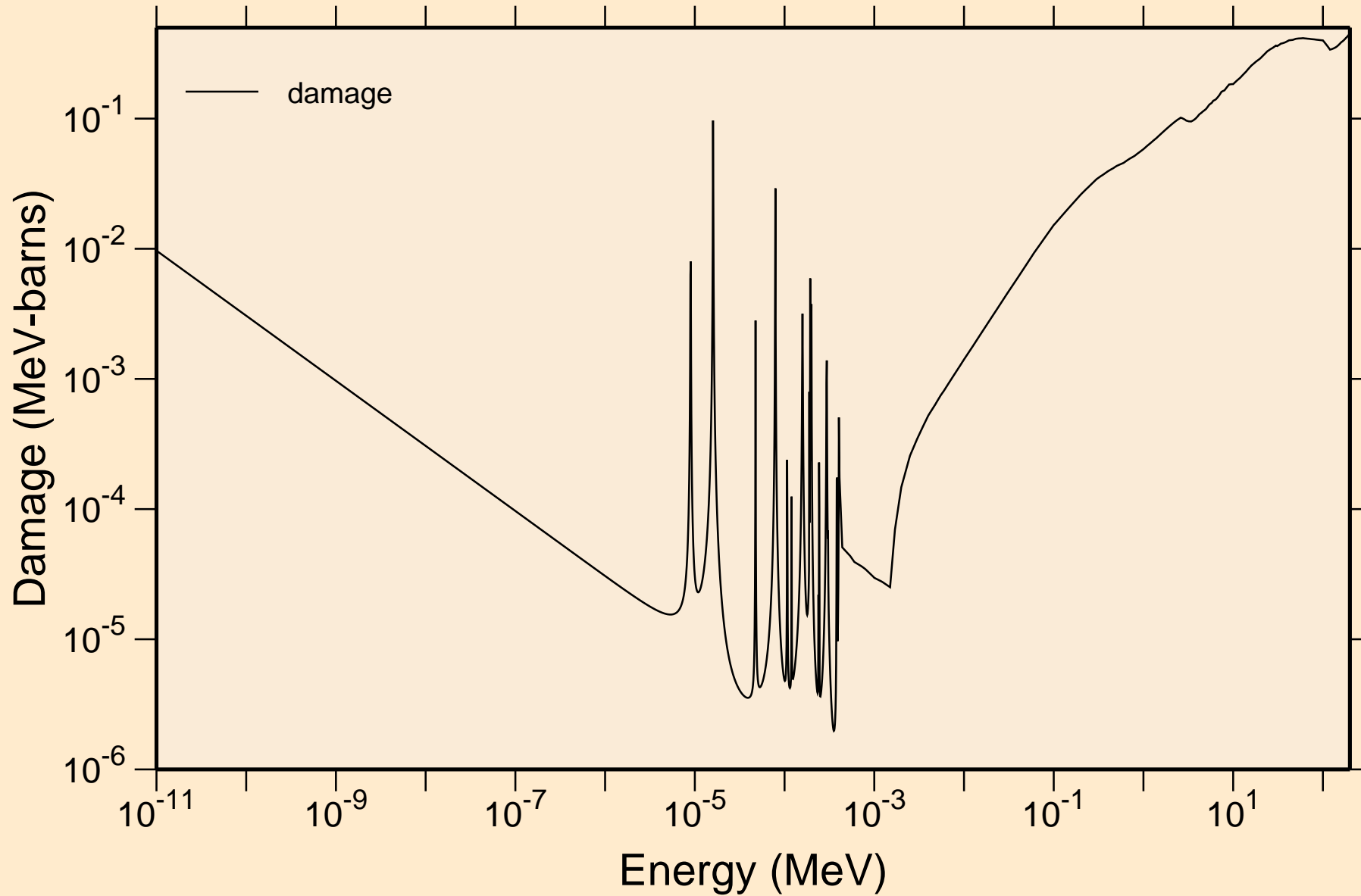

MO103 NEUTRON ACER TENDL-2024 LIBRARY; T=0.K
Non-threshold reactions

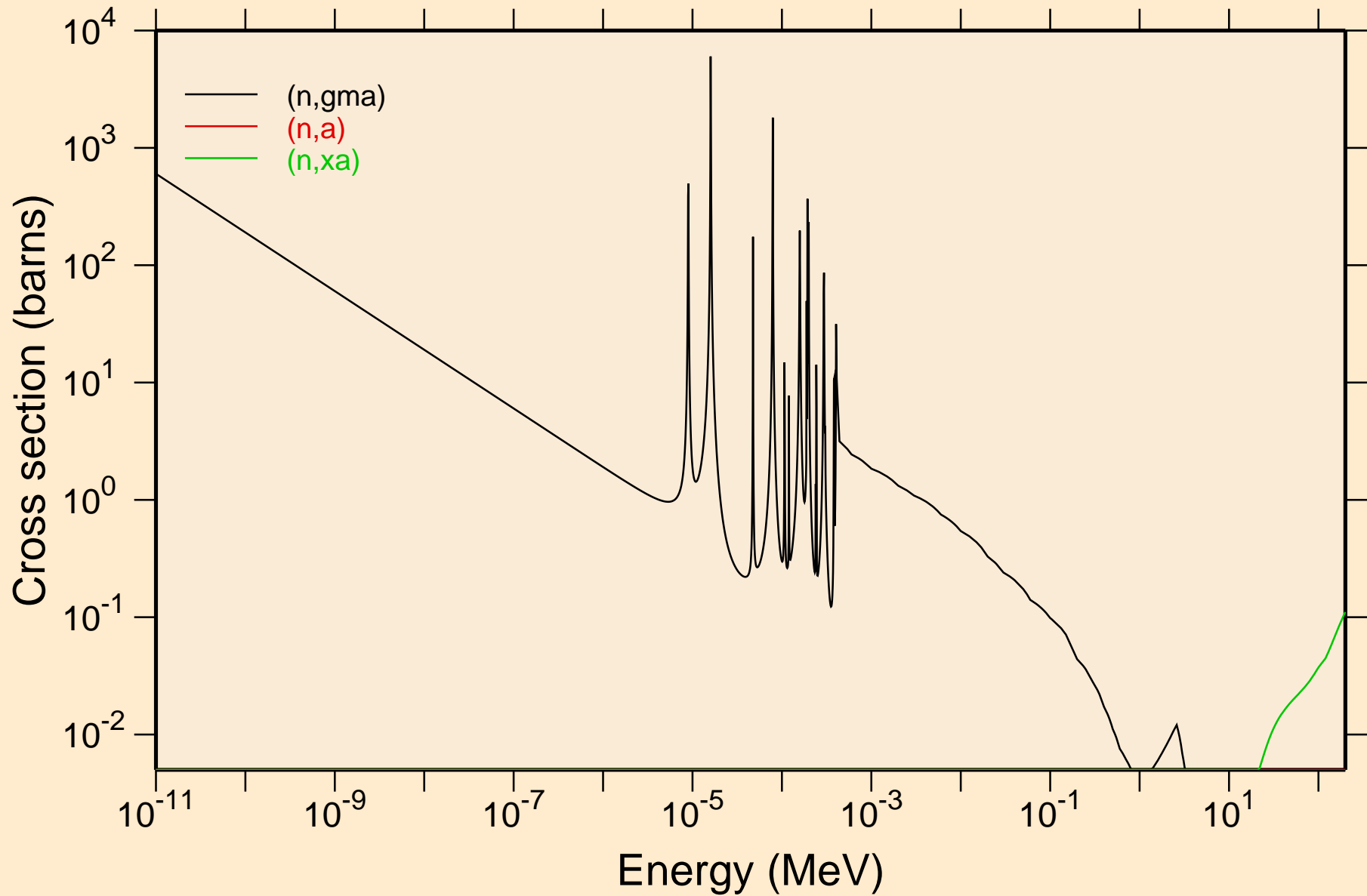

MO103 NEUTRON ACER TENDL-2024 LIBRARY; T=0.K

Principal cross sections

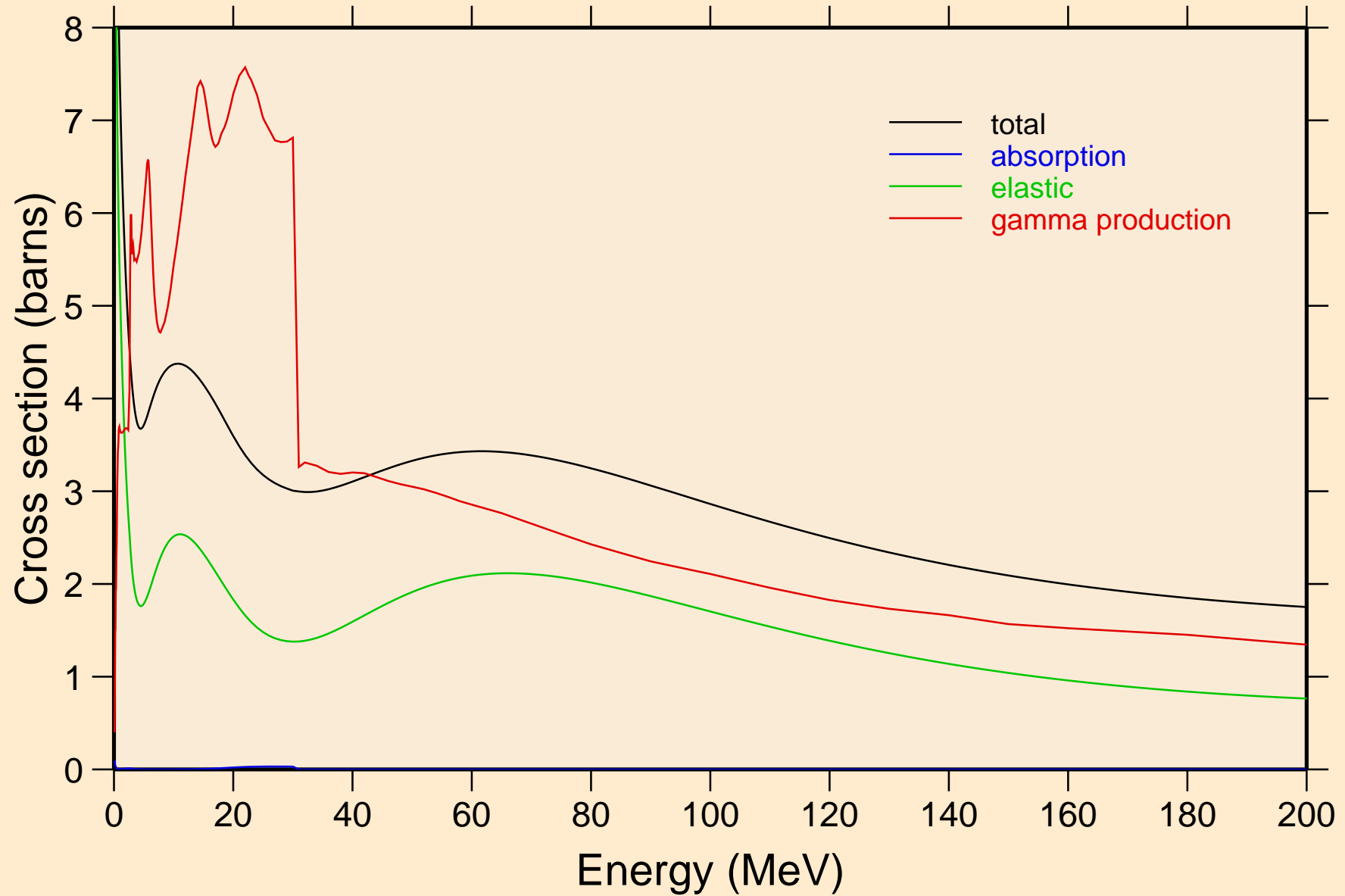

MO103 NEUTRON ACER TENDL-2024 LIBRARY; T=0.K

Heating

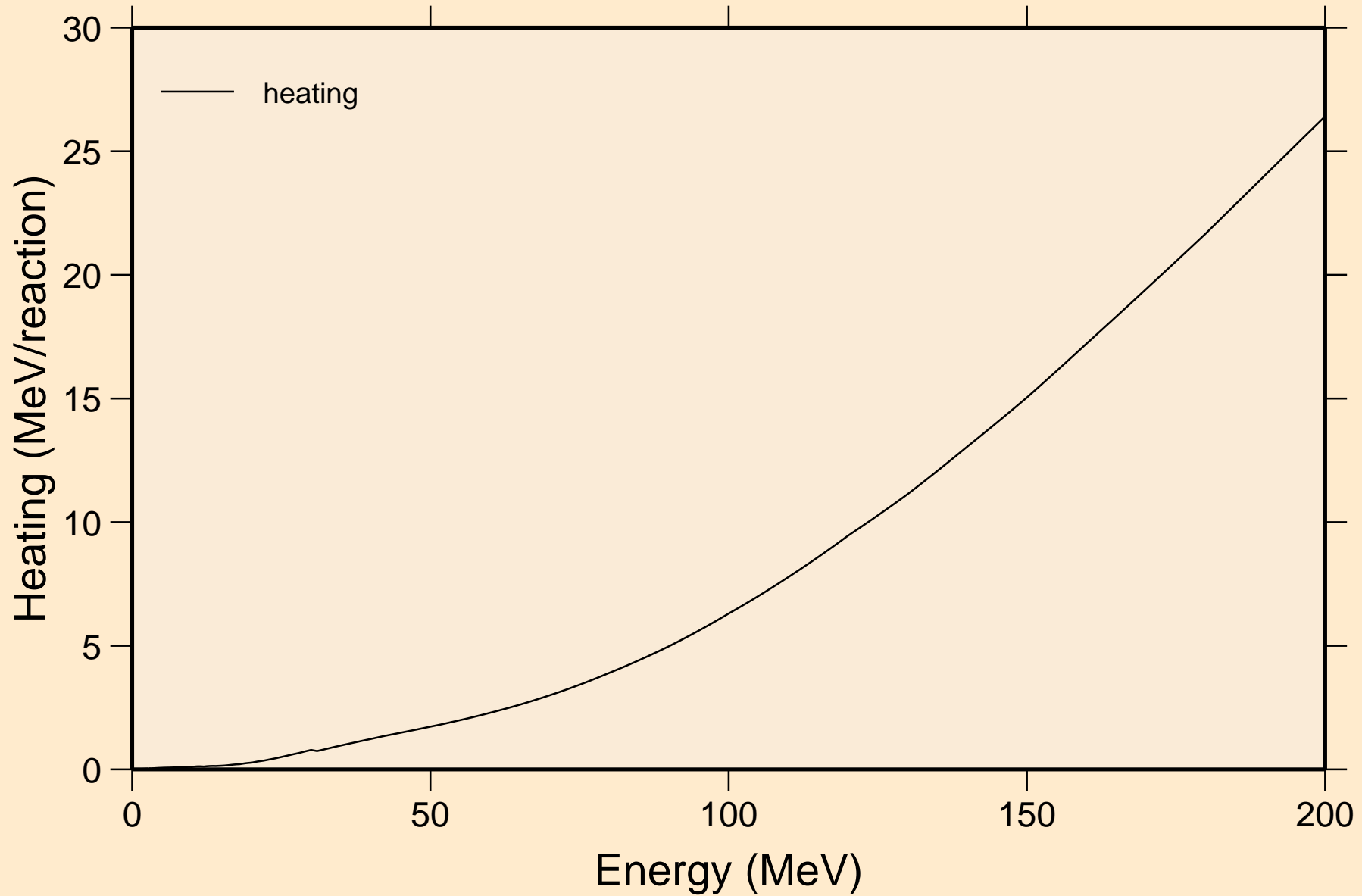

MO103 NEUTRON ACER TENDL-2024 LIBRARY; T=0.K
Damage

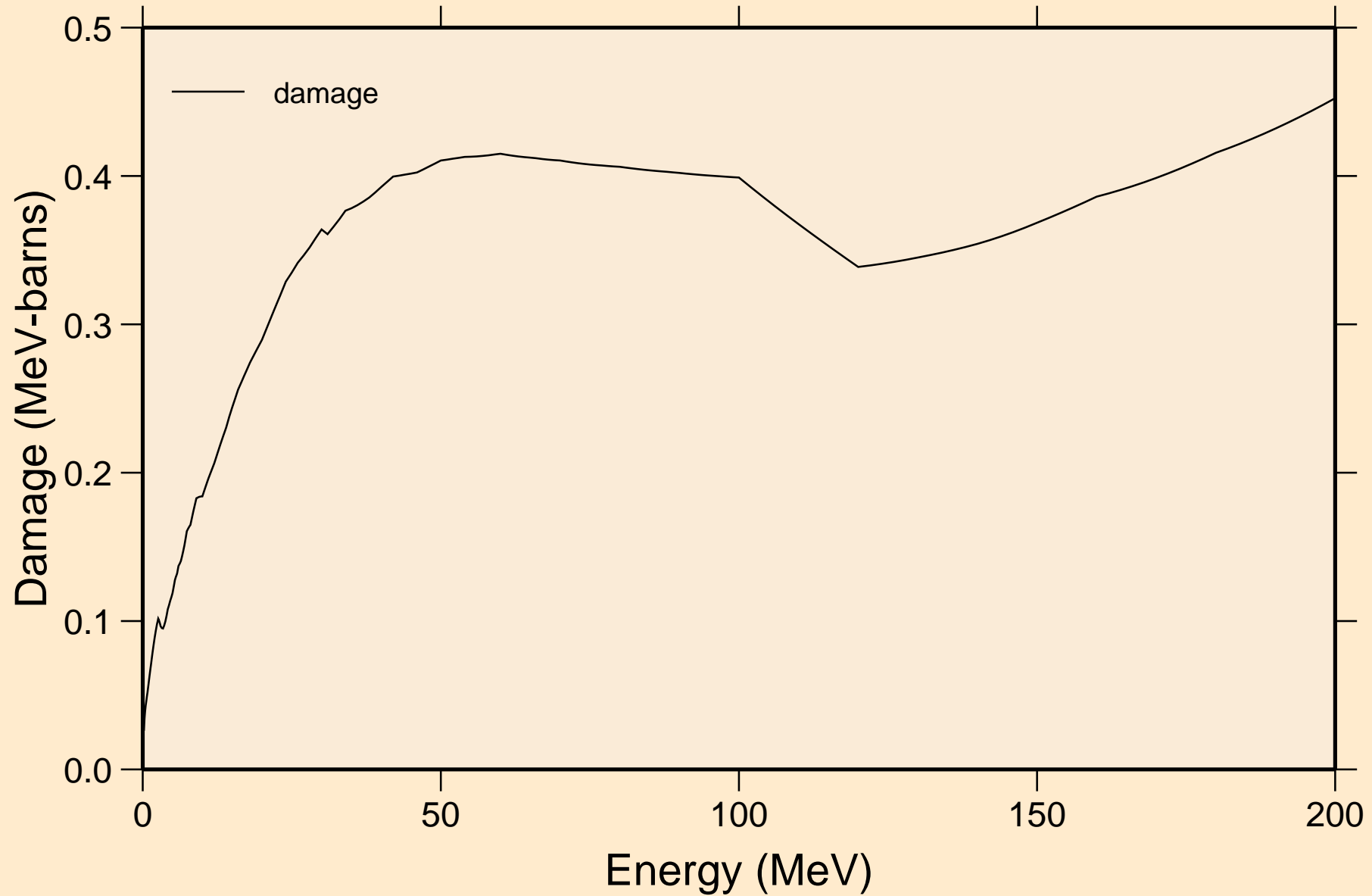

MO103 NEUTRON ACER TENDL-2024 LIBRARY; T=0.K
Non-threshold reactions

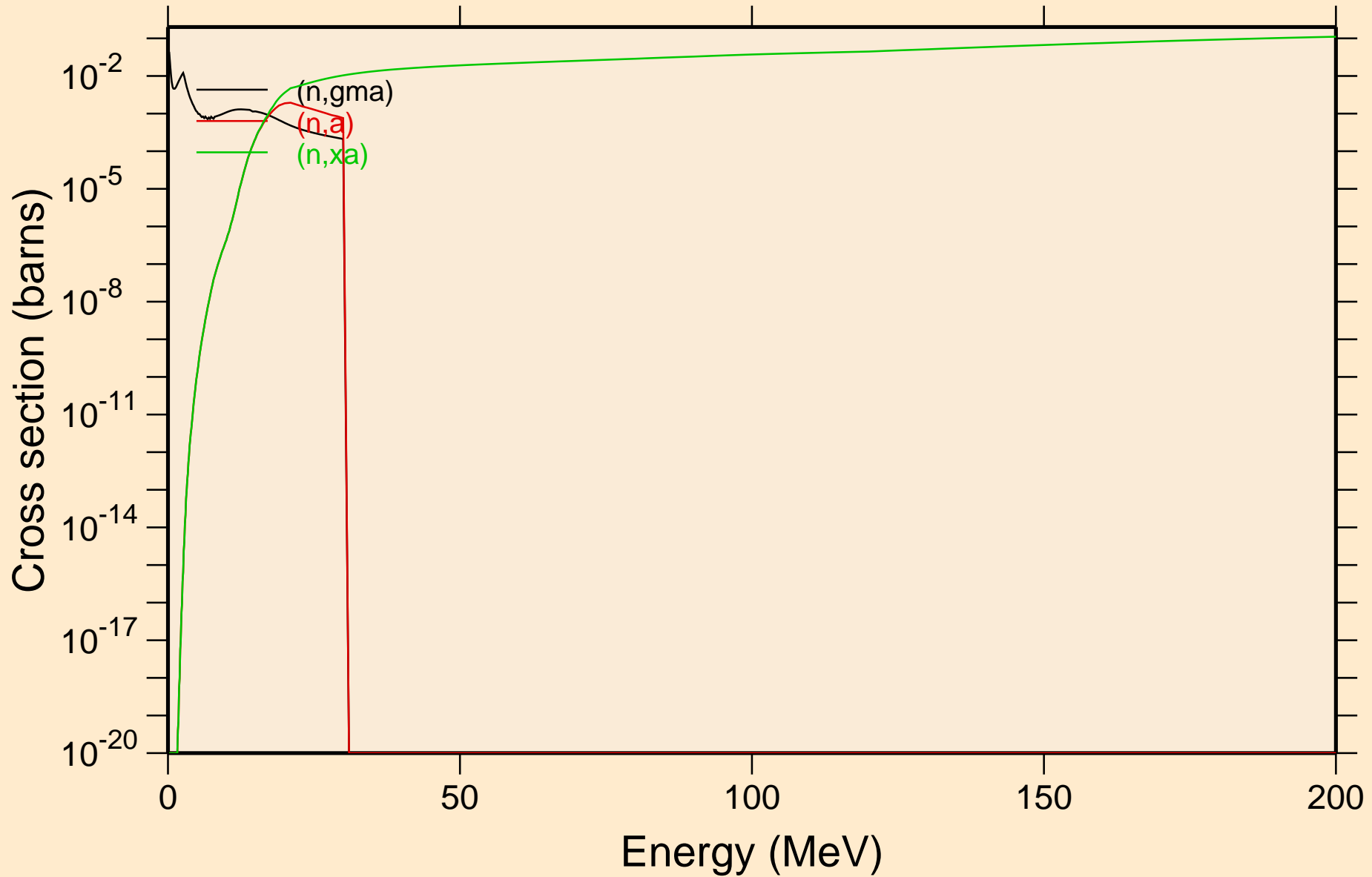

MO103 NEUTRON ACER TENDL-2024 LIBRARY; T=0.K
Inelastic levels

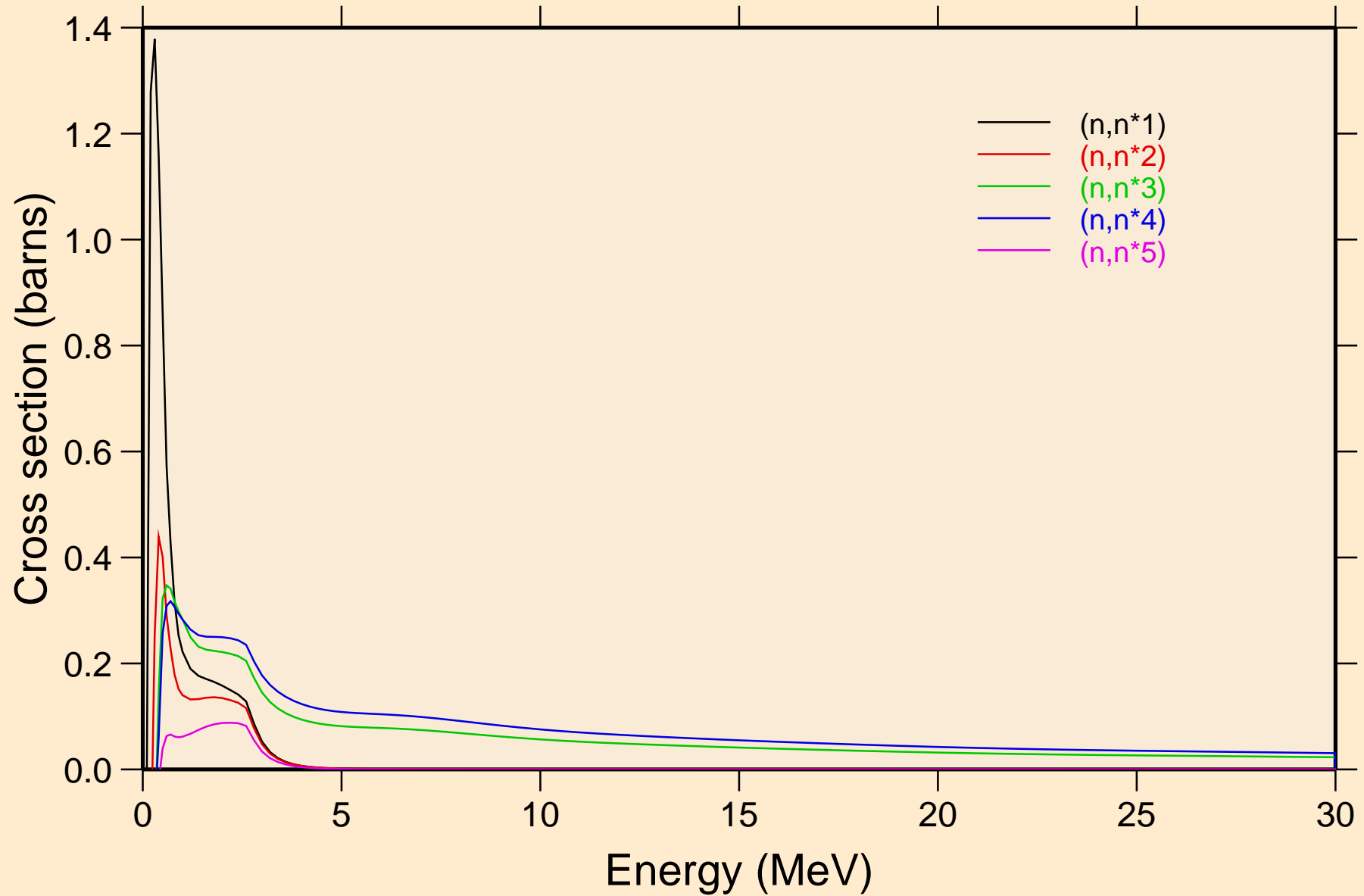

MO103 NEUTRON ACER TENDL-2024 LIBRARY; T=0.K
Inelastic levels

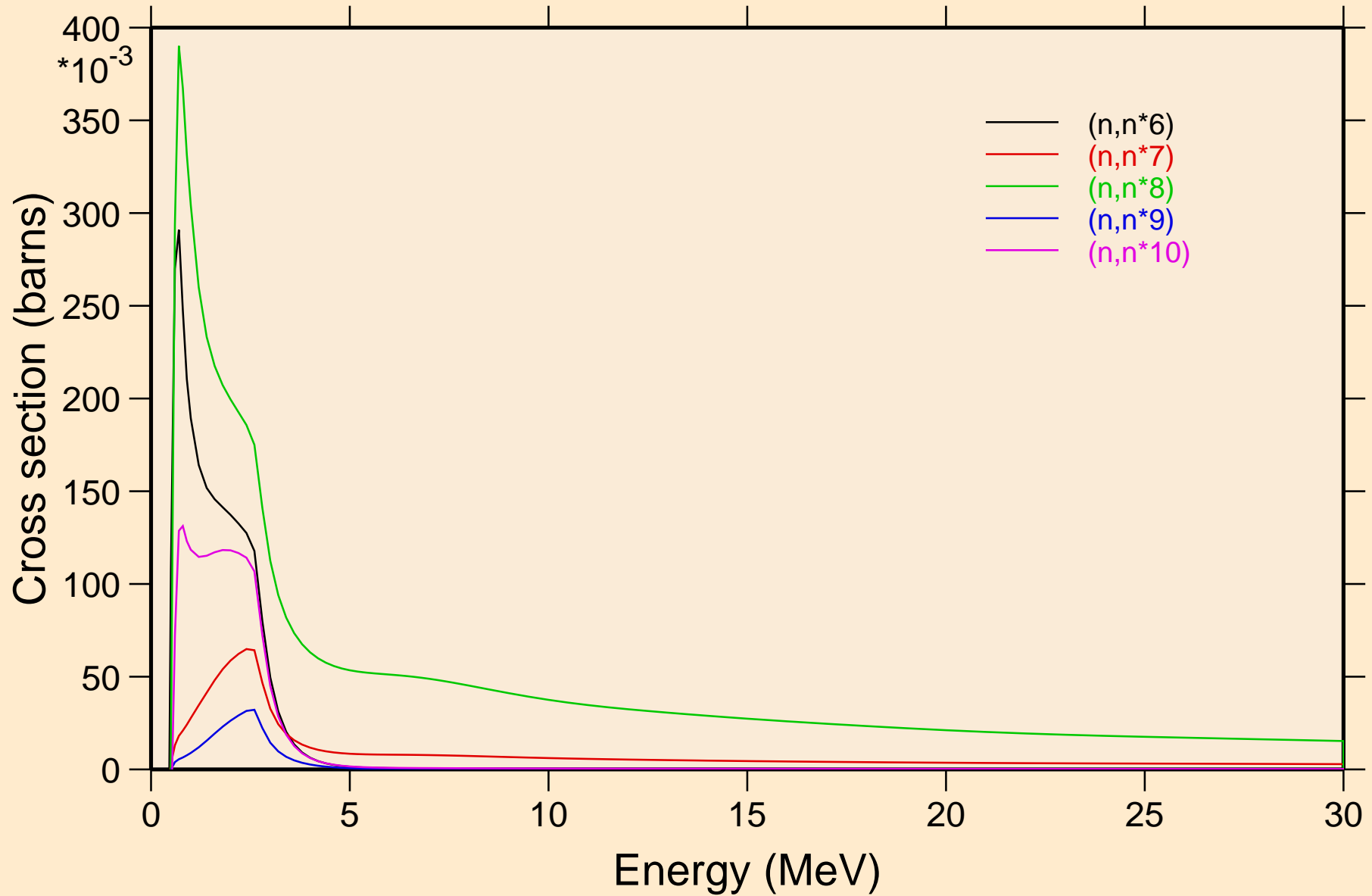

MO103 NEUTRON ACER TENDL-2024 LIBRARY; T=0.K
Inelastic levels

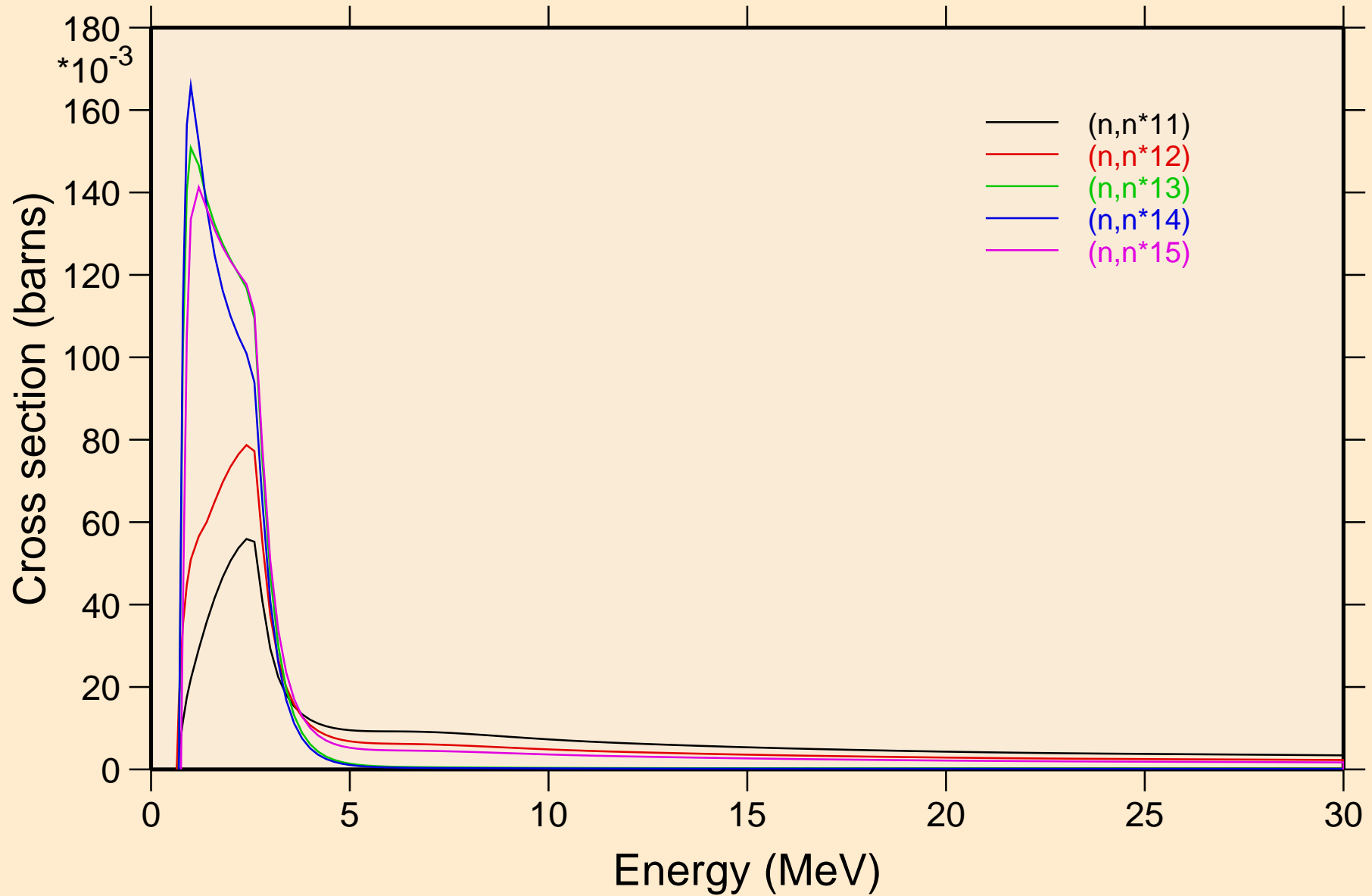

MO103 NEUTRON ACER TENDL-2024 LIBRARY; T=0.K
Inelastic levels

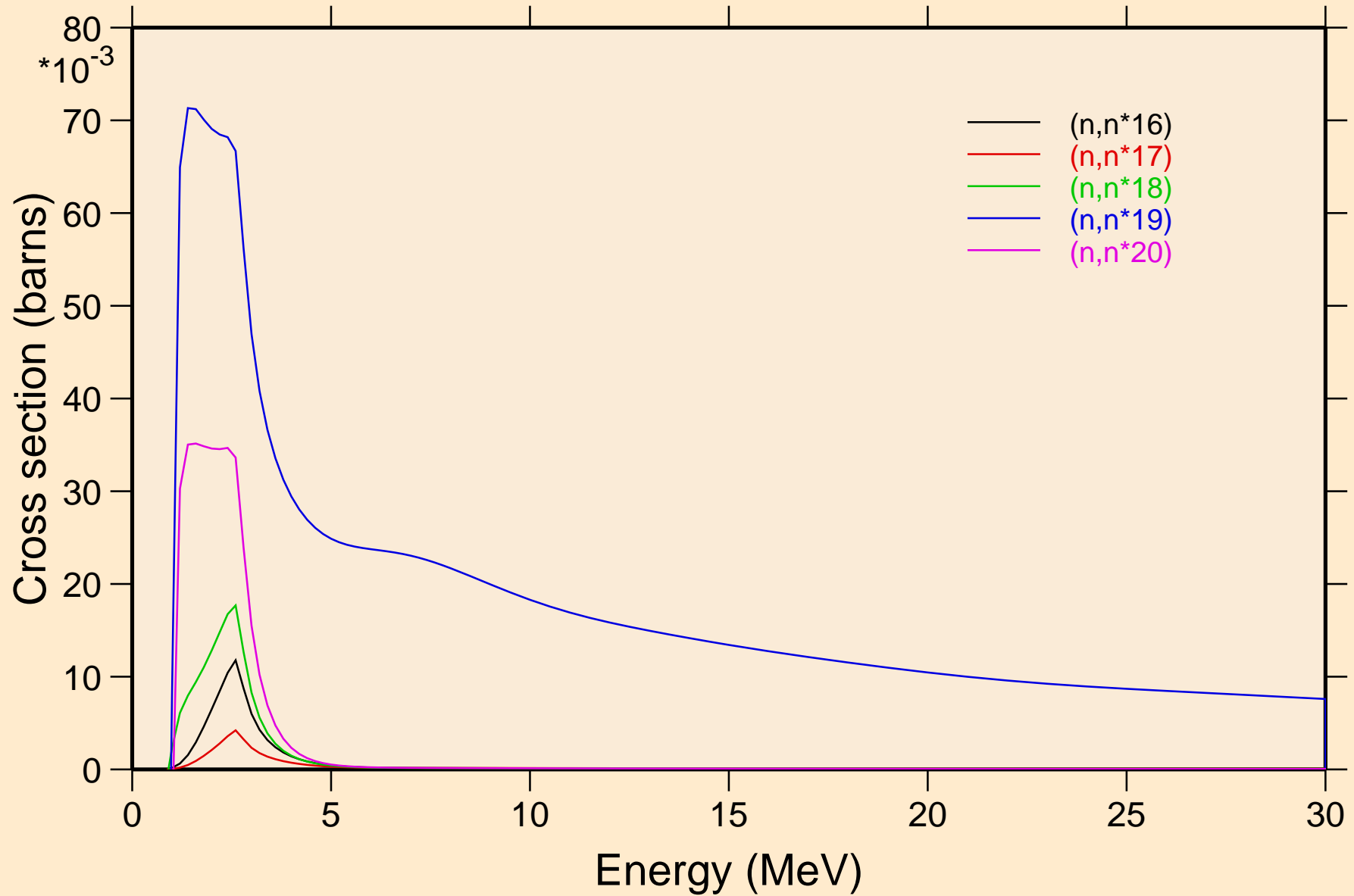

MO103 NEUTRON ACER TENDL-2024 LIBRARY; T=0.K
Inelastic levels

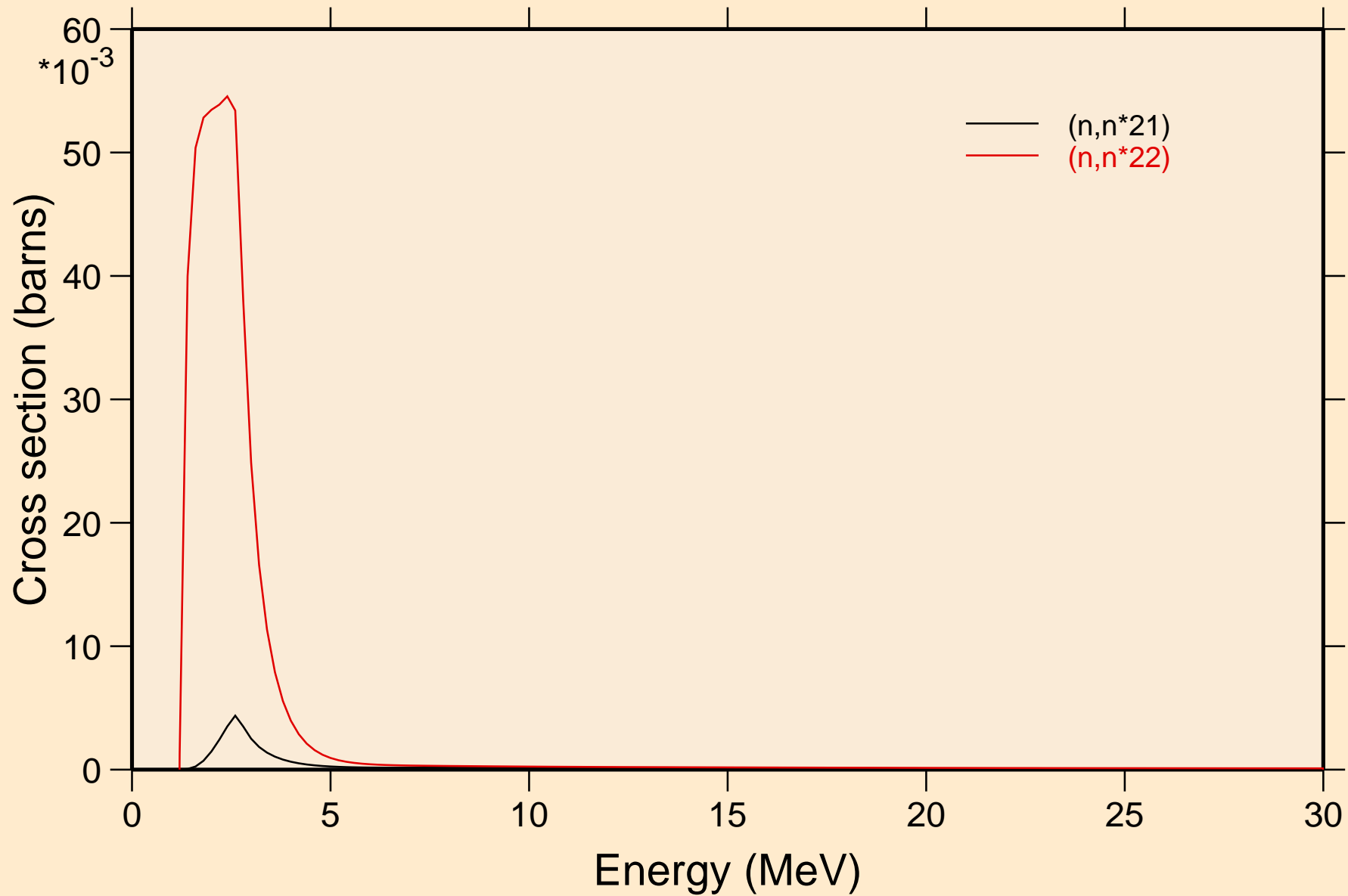

MO103 NEUTRON ACER TENDL-2024 LIBRARY; T=0.K
Threshold reactions

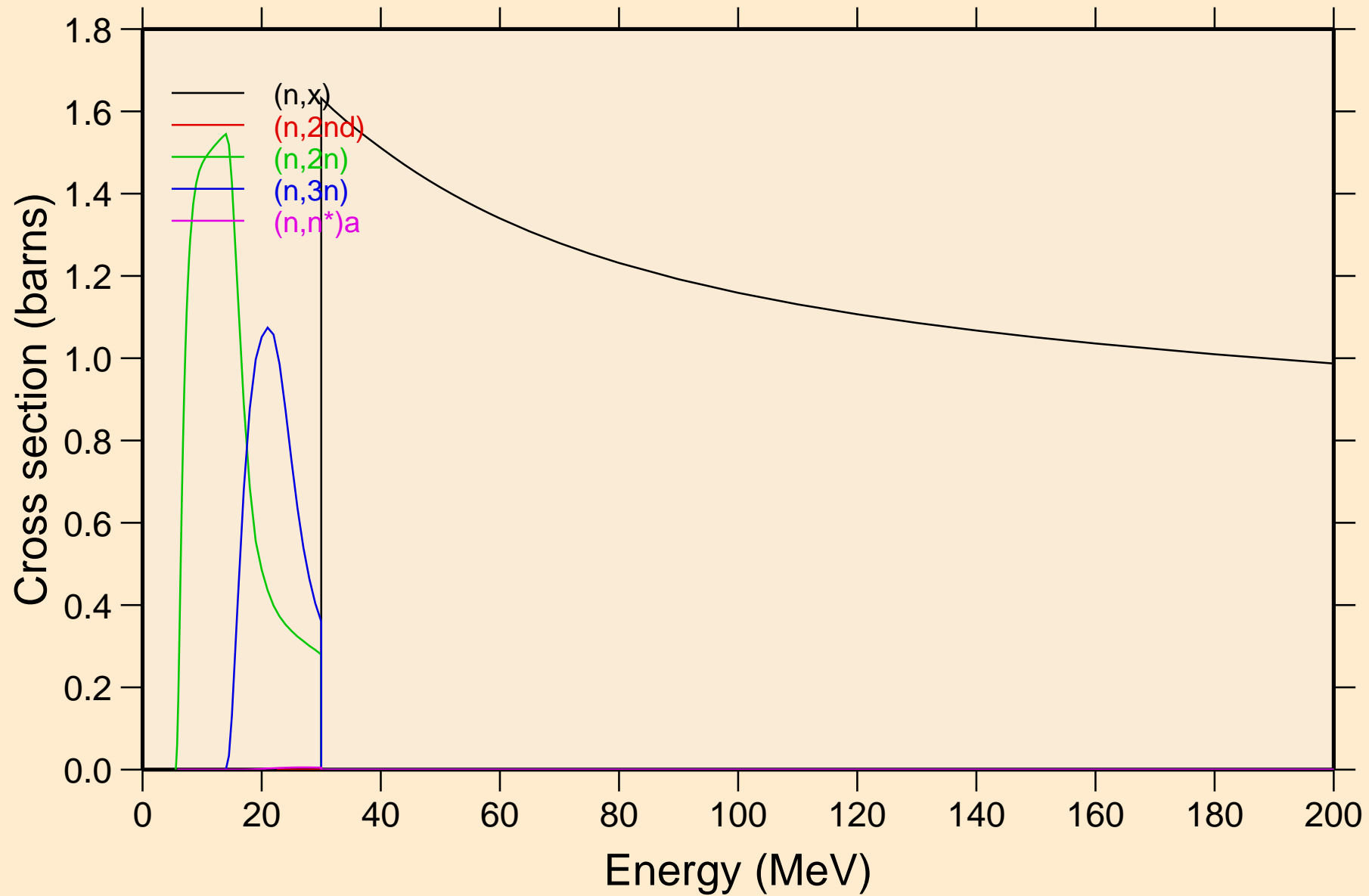

MO103 NEUTRON ACER TENDL-2024 LIBRARY; T=0.K

Threshold reactions

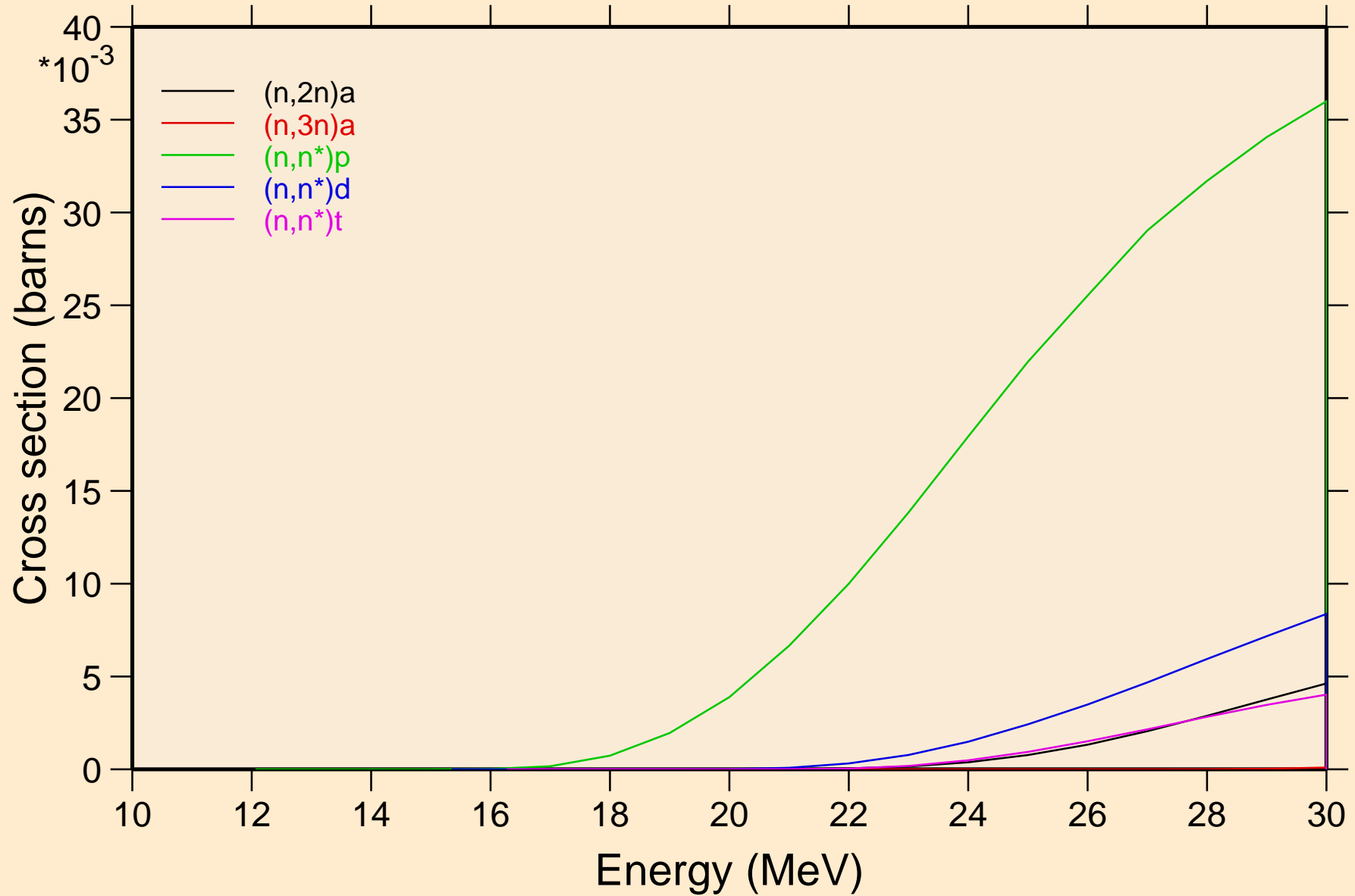

MO103 NEUTRON ACER TENDL-2024 LIBRARY; T=0.K
Threshold reactions

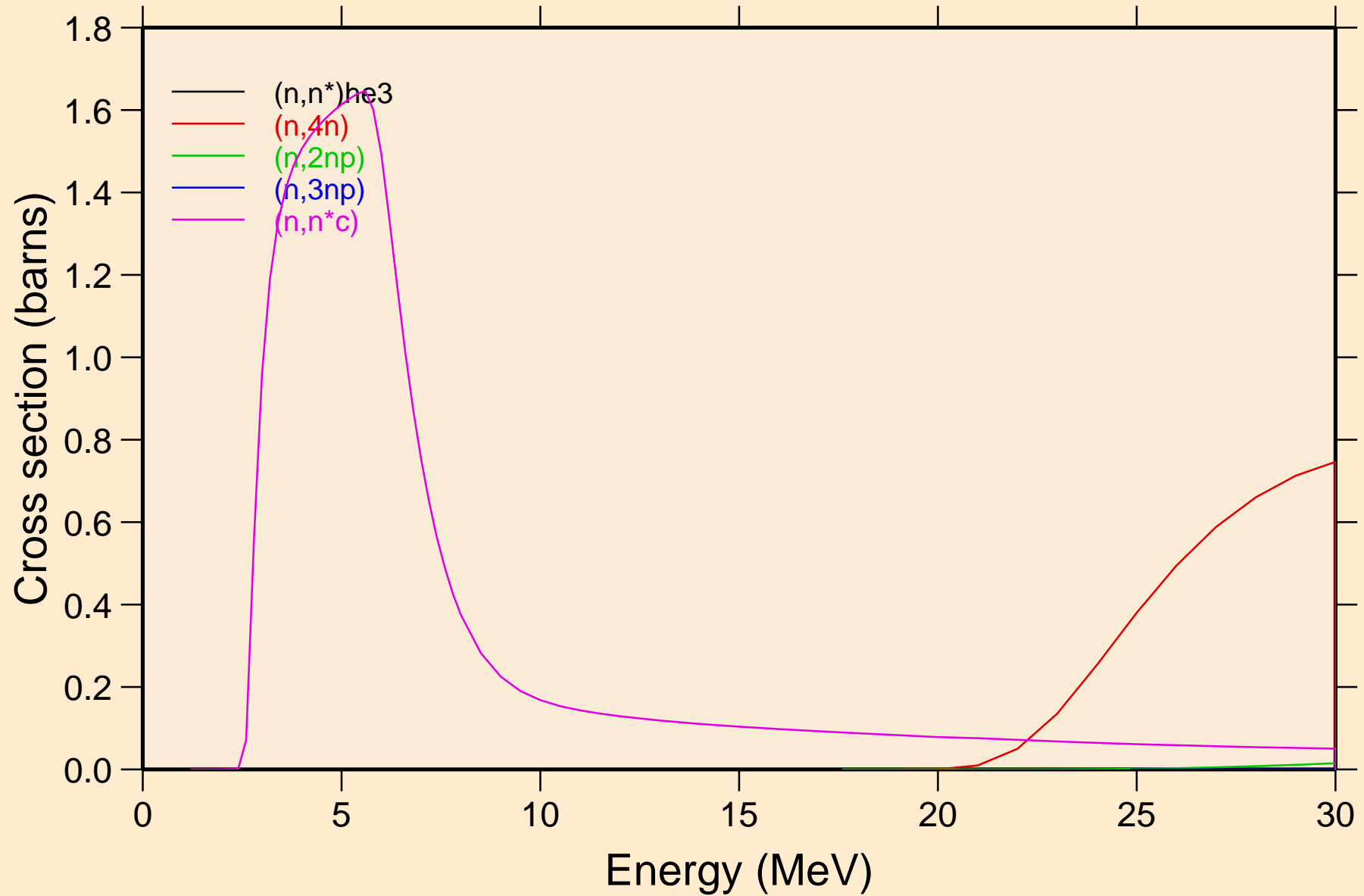

MO103 NEUTRON ACER TENDL-2024 LIBRARY; T=0.K

Threshold reactions

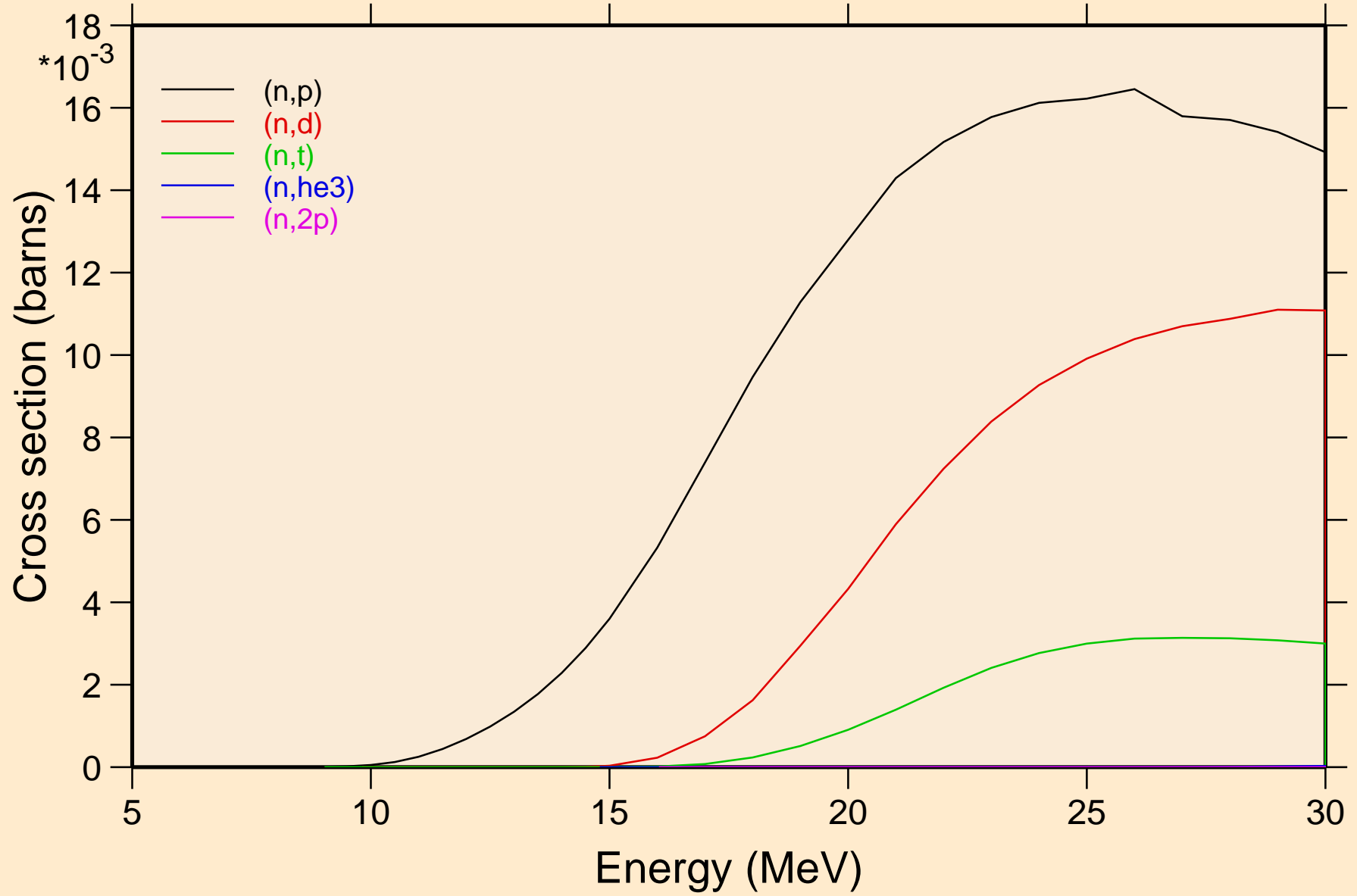

MO103 NEUTRON ACER TENDL-2024 LIBRARY; T=0.K
Threshold reactions

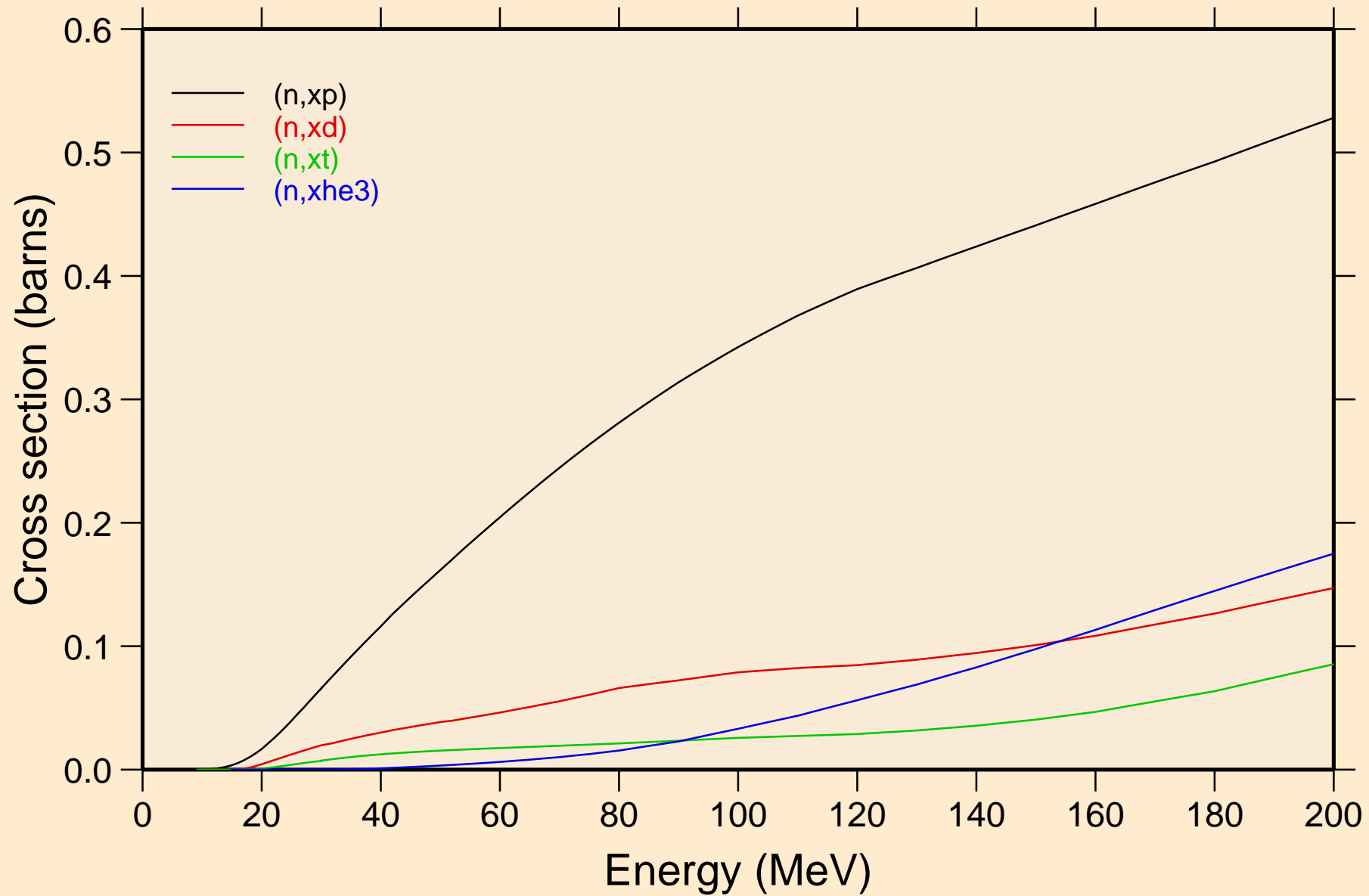

MO103 NEUTRON ACER TENDL-2024 LIBRARY; T=0.K
angular distribution for elastic

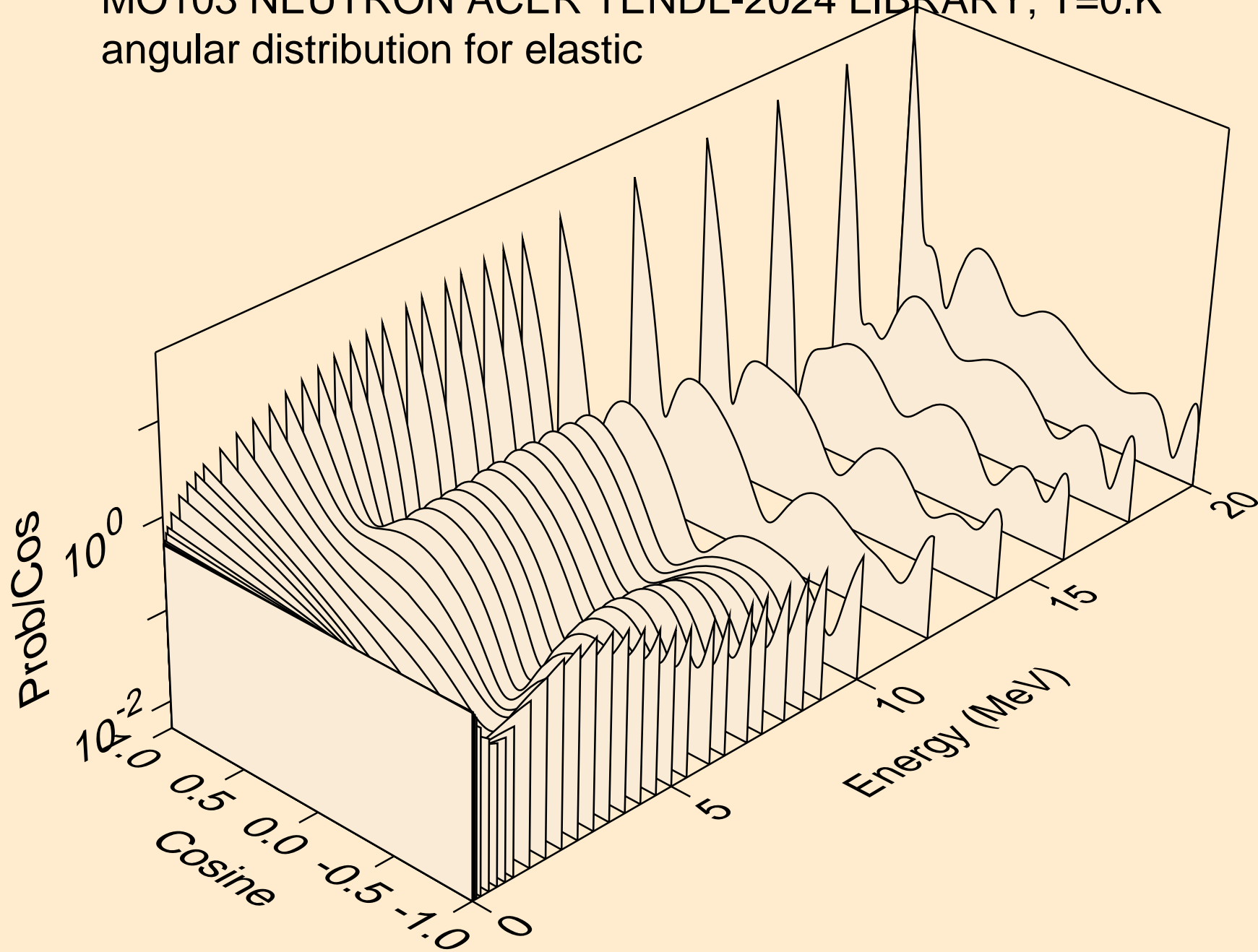

MO103 NEUTRON ACER TENDL-2024 LIBRARY; T=0.K
angular distribution for elastic

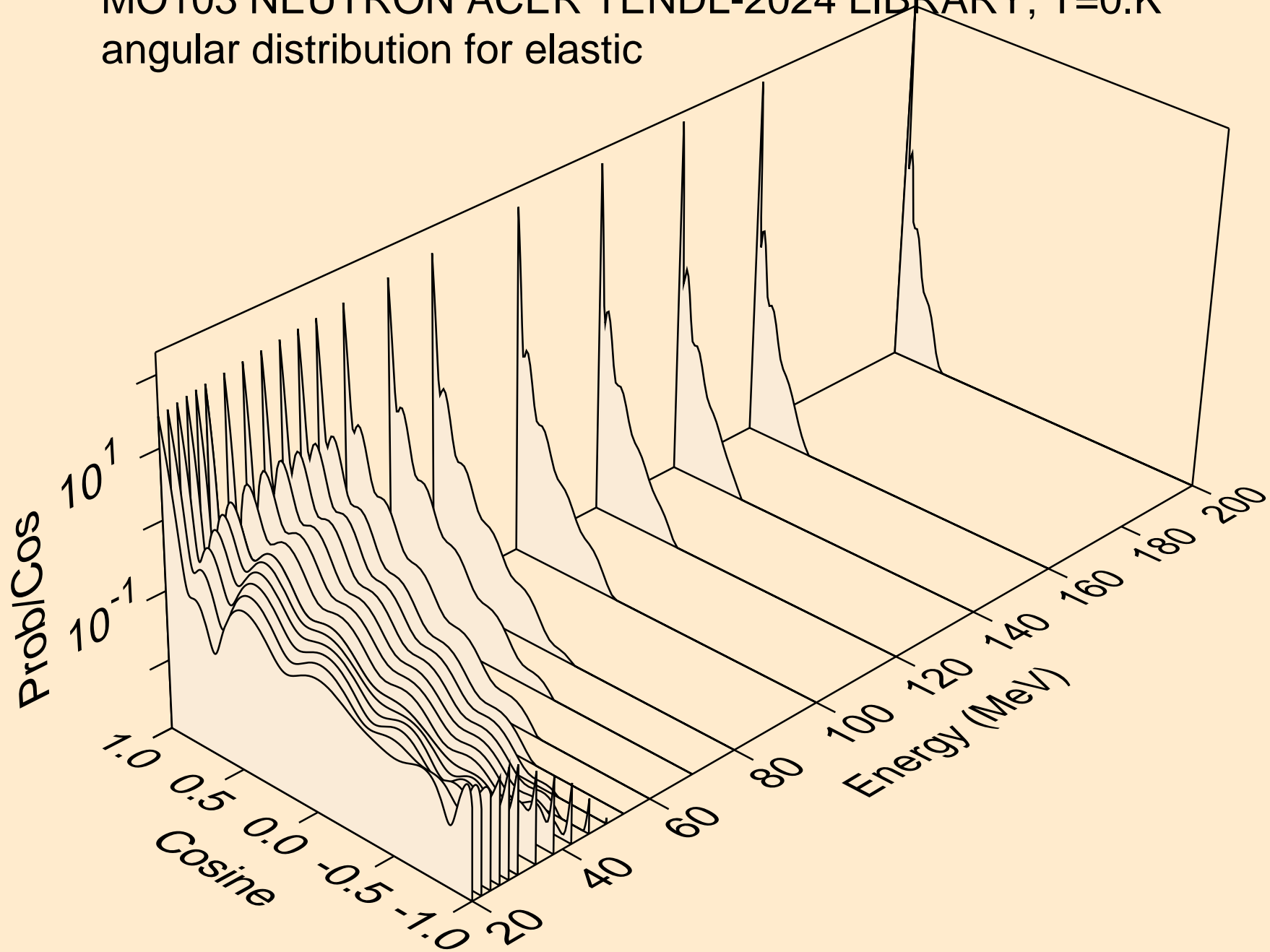

MO103 NEUTRON ACER TENDL-2024 LIBRARY; T=0.K
angular distribution for (n,n*1)

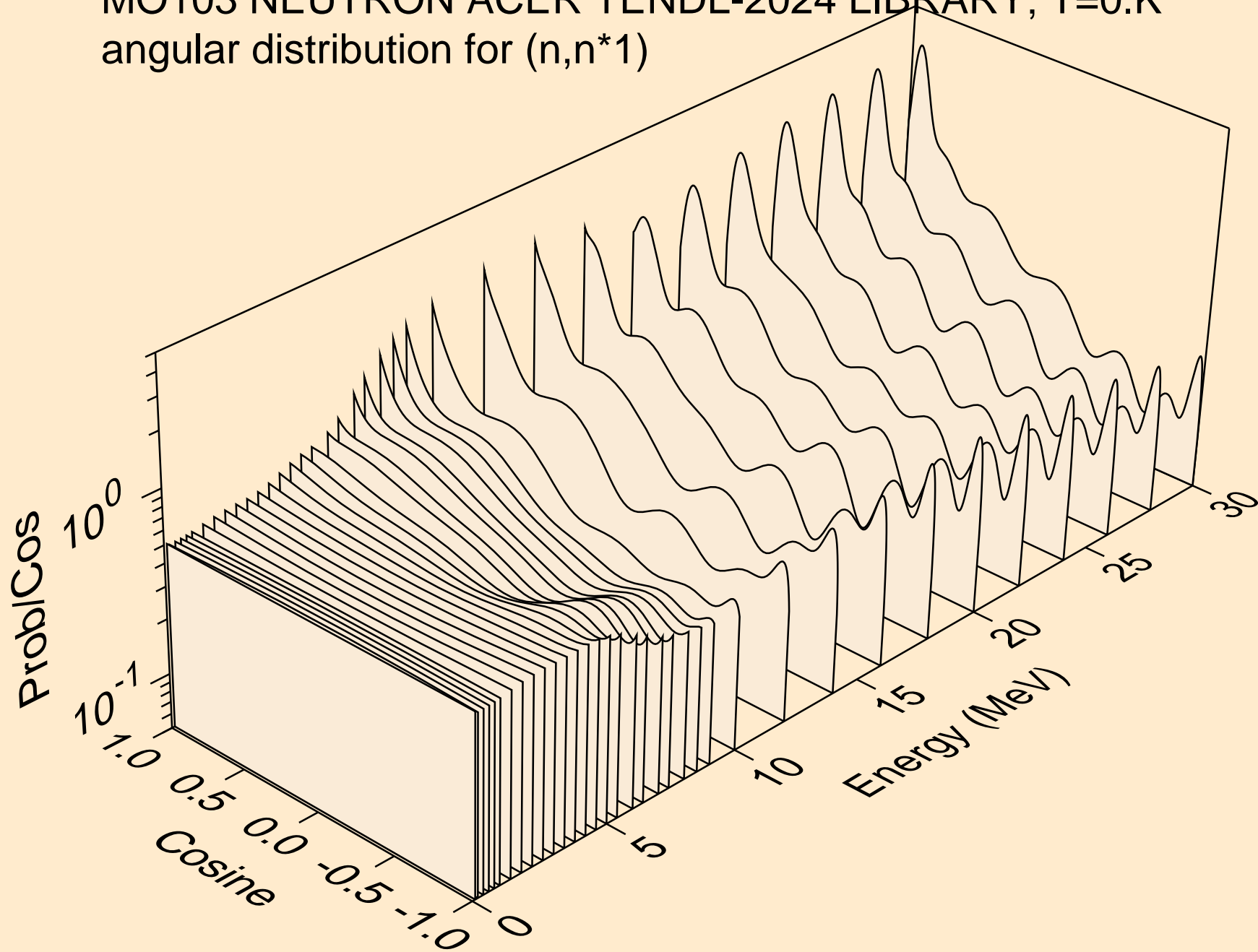

MO103 NEUTRON ACER TENDL-2024 LIBRARY; T=0.K
angular distribution for (n,n*2)

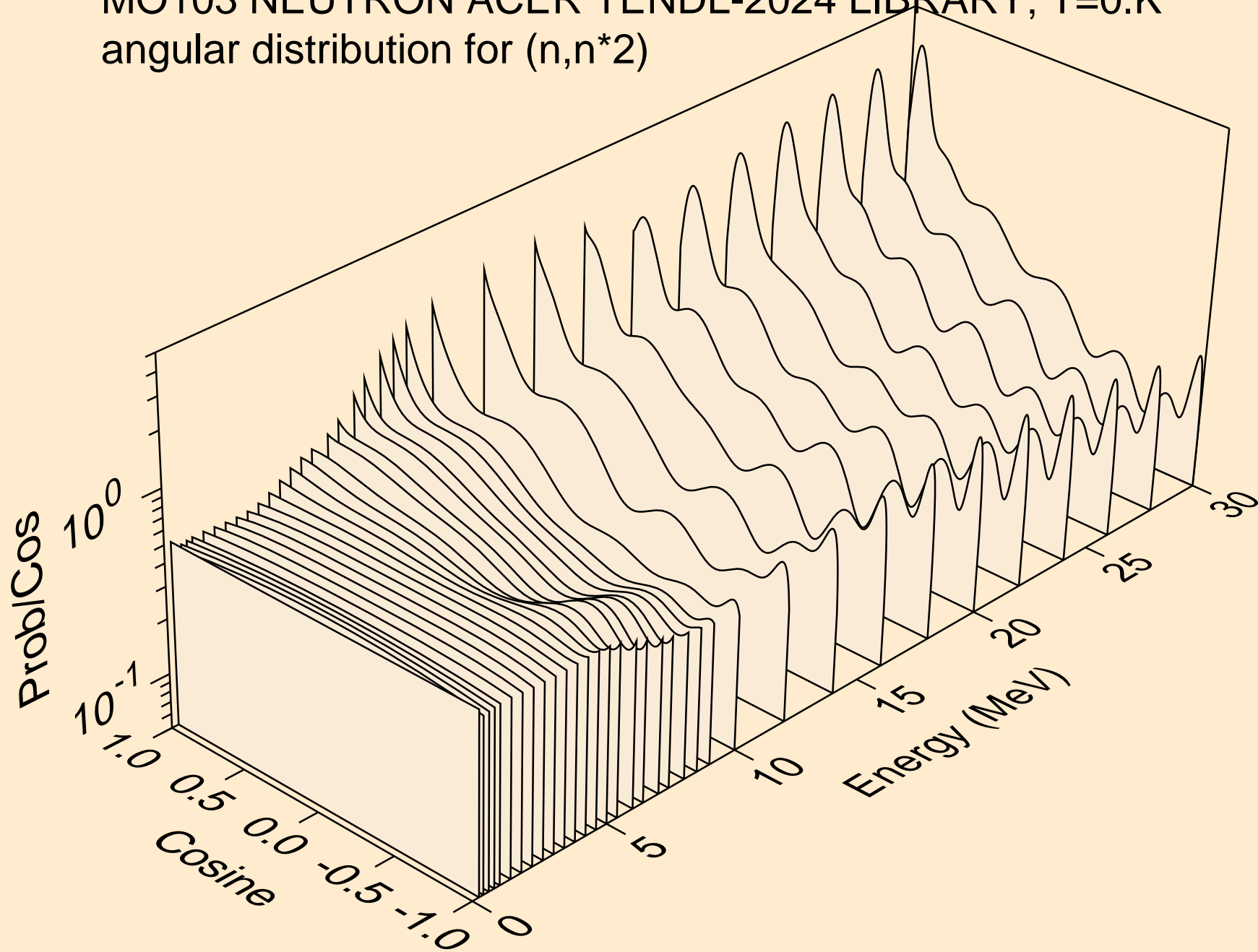

MO103 NEUTRON ACER TENDL-2024 LIBRARY; T=0.K
angular distribution for (n,n*3)

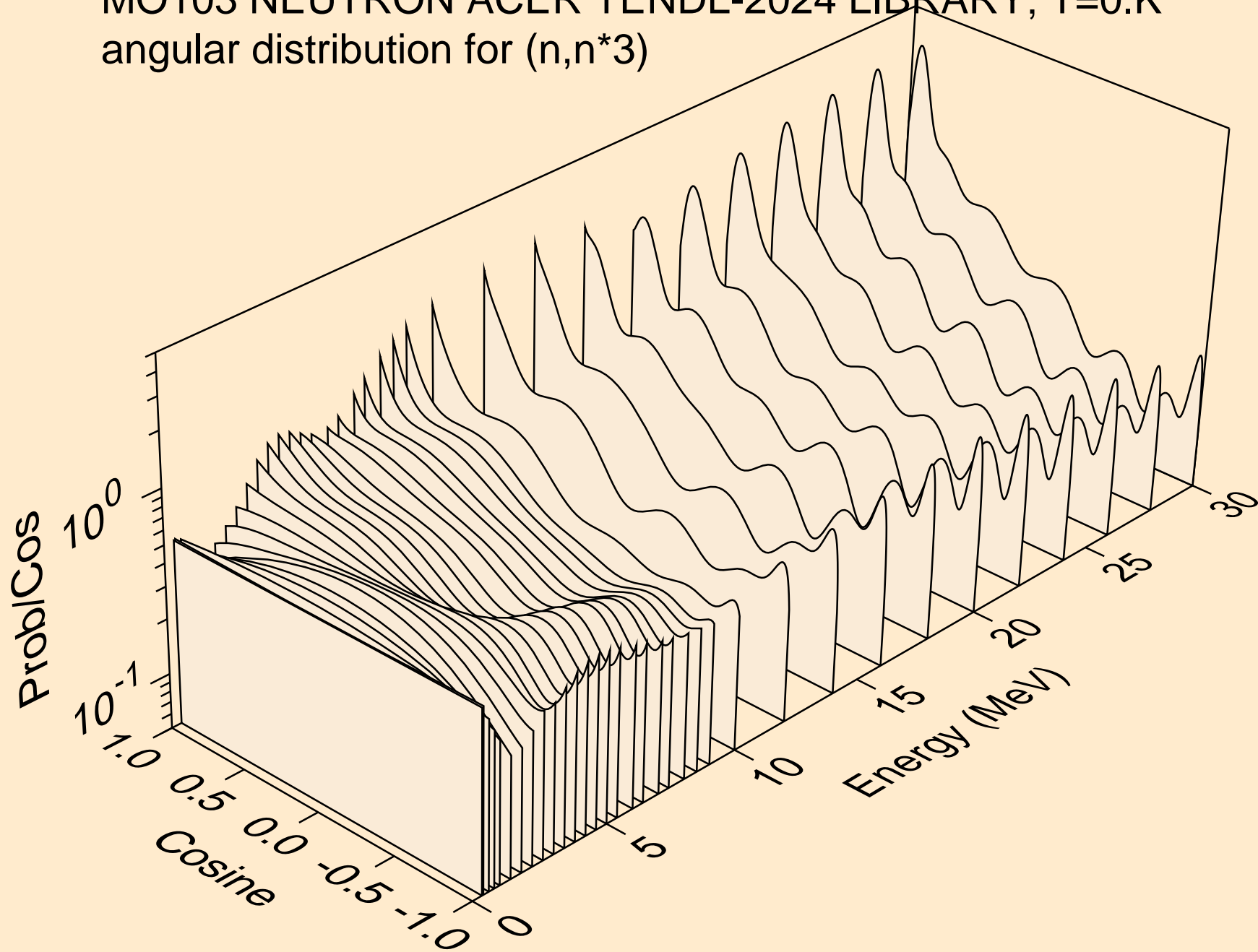

MO103 NEUTRON ACER TENDL-2024 LIBRARY; T=0.K
angular distribution for (n,n*4)

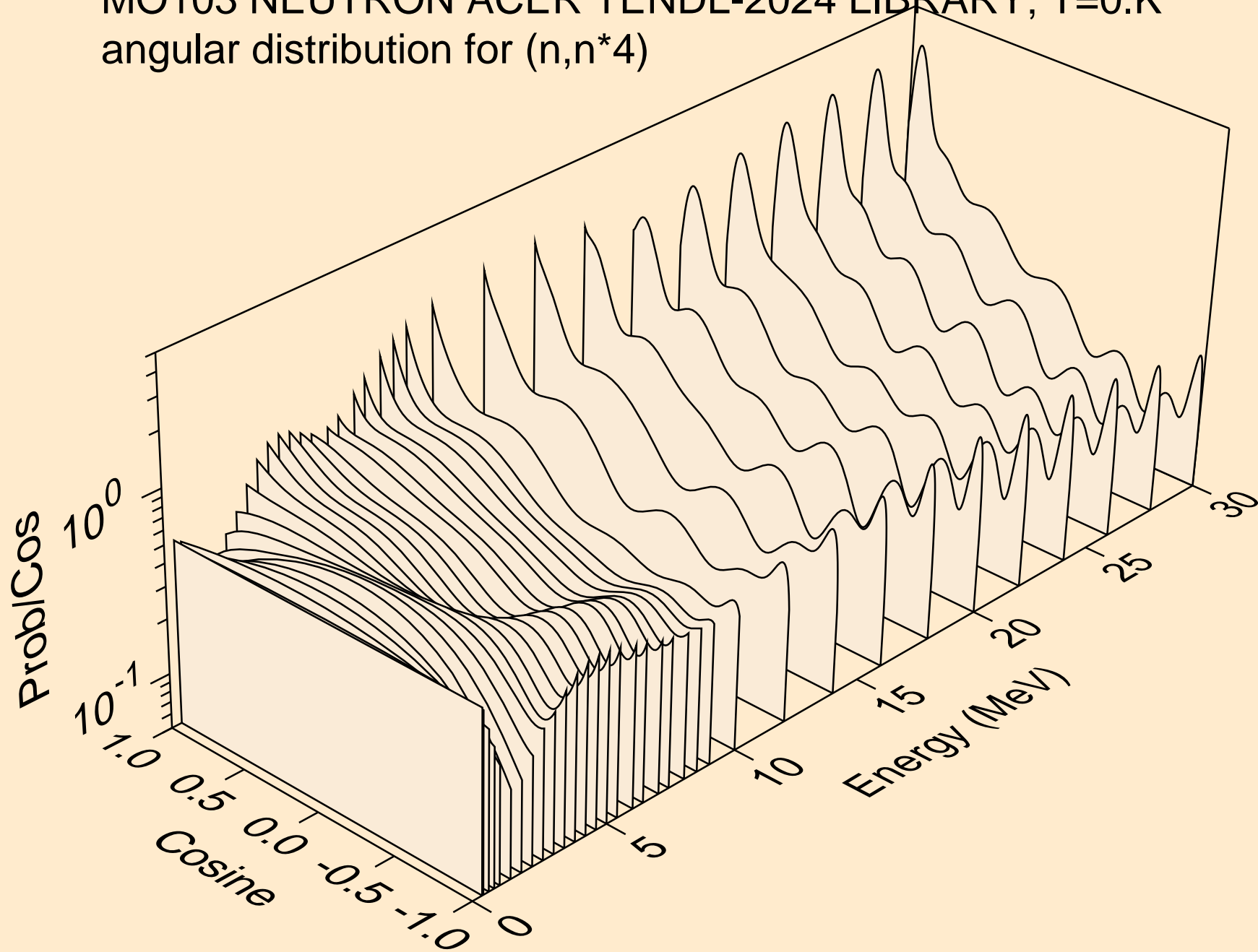

MO103 NEUTRON ACER TENDL-2024 LIBRARY; T=0.K
angular distribution for (n,n*5)

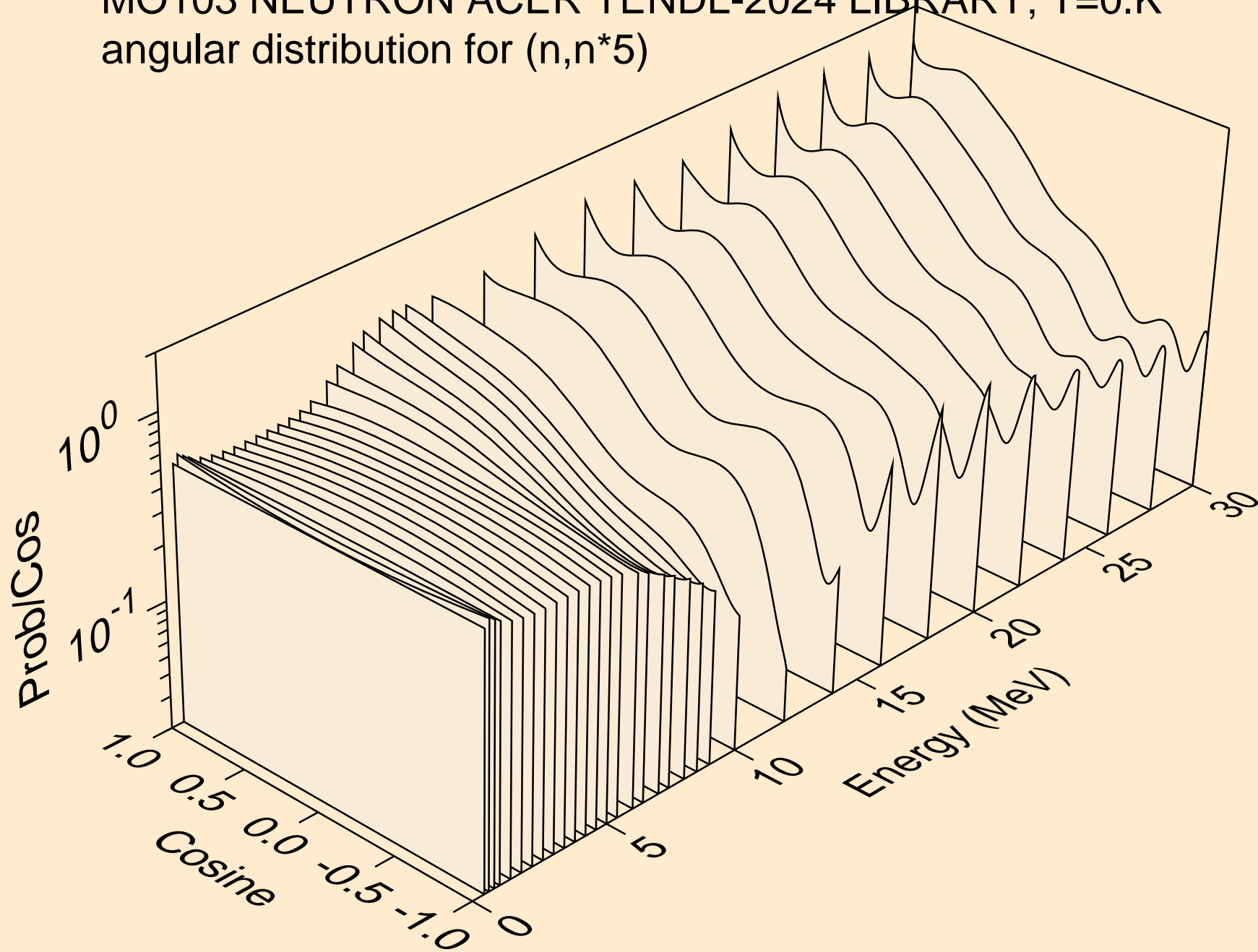

MO103 NEUTRON ACER TENDL-2024 LIBRARY; T=0.K
angular distribution for (n,n*6)

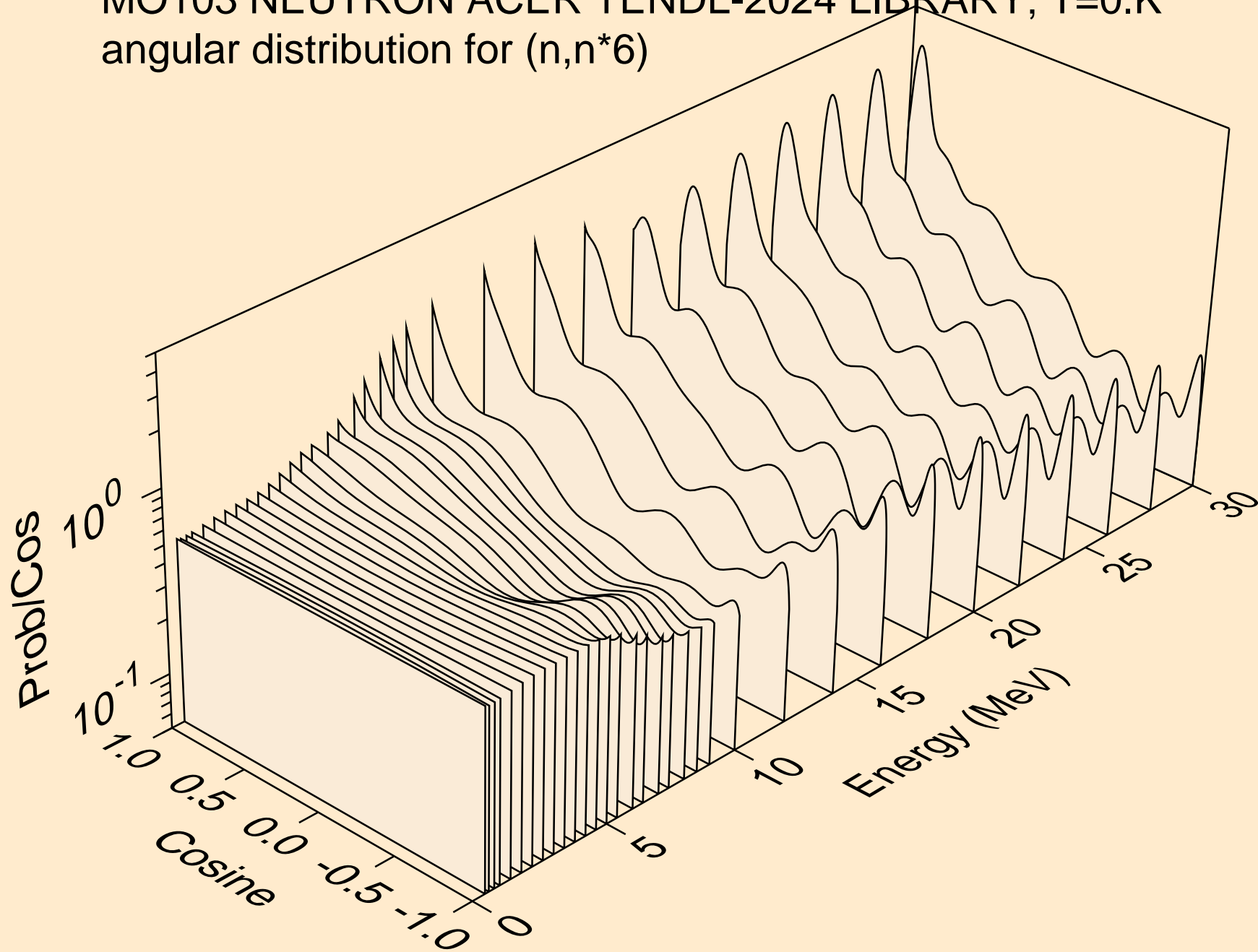

MO103 NEUTRON ACER TENDL-2024 LIBRARY; T=0.K
angular distribution for (n,n*7)

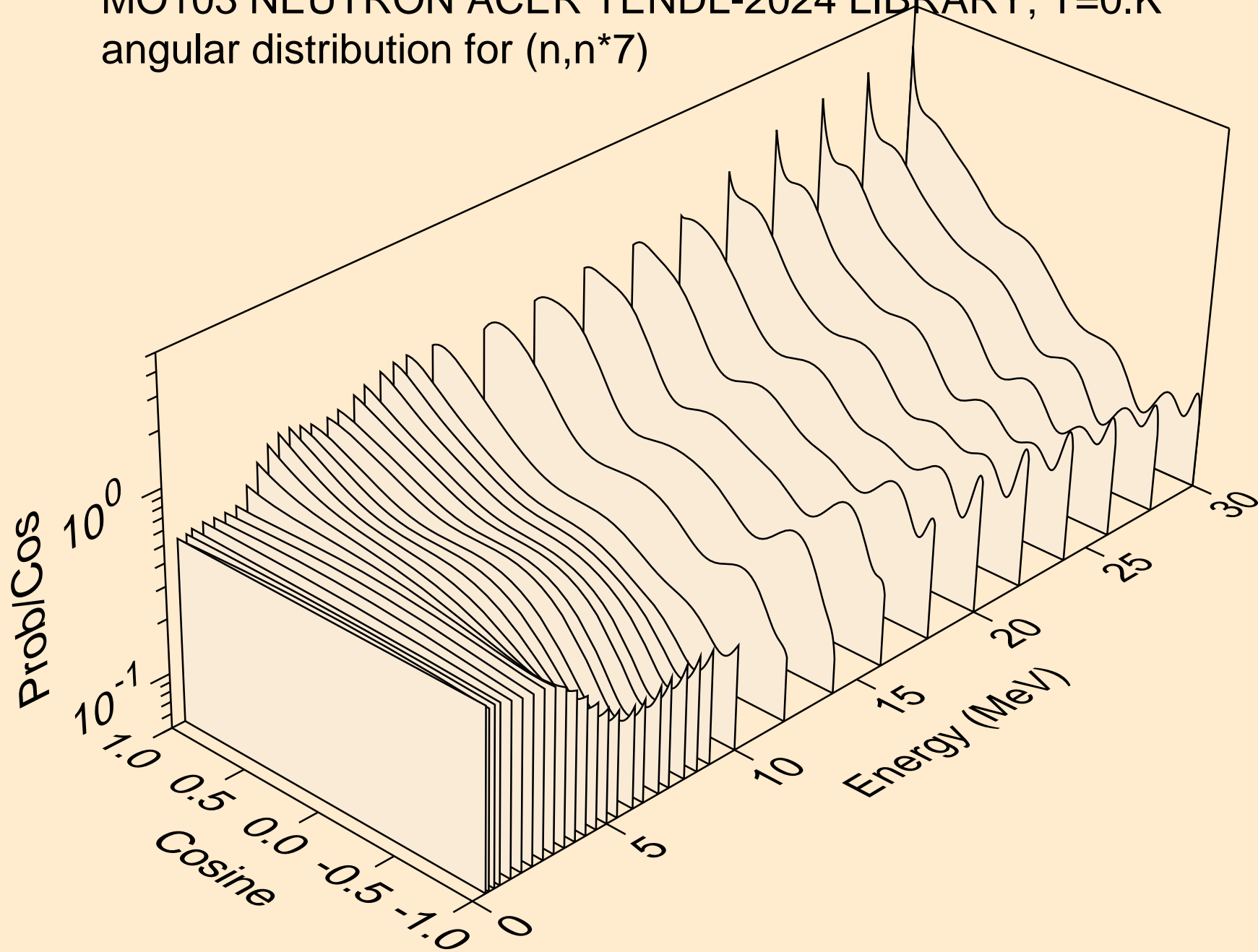

MO103 NEUTRON ACER TENDL-2024 LIBRARY; T=0.K
angular distribution for (n,n*8)

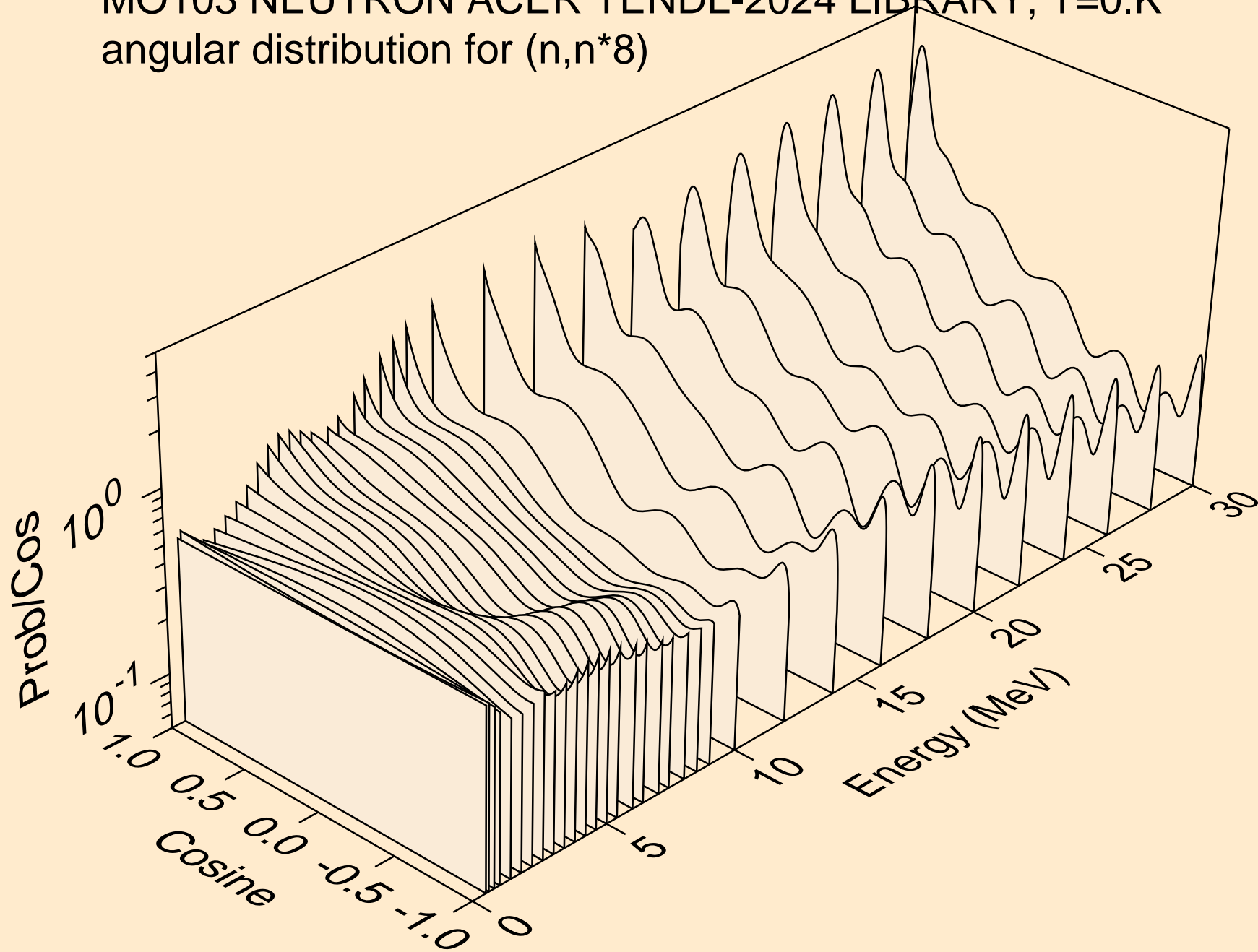

MO103 NEUTRON ACER TENDL-2024 LIBRARY; T=0.K
angular distribution for (n,n*9)

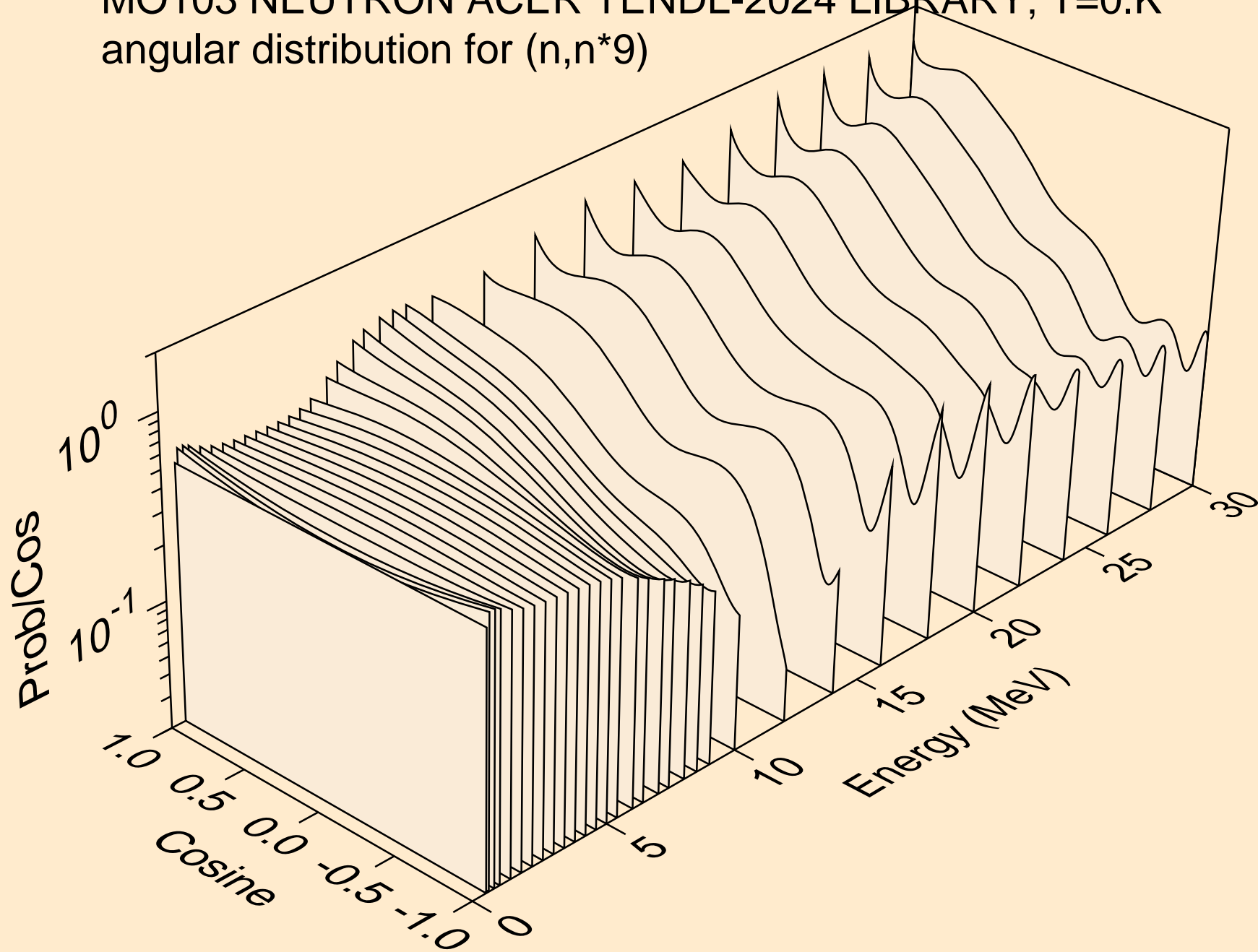

MO103 NEUTRON ACER TENDL-2024 LIBRARY; T=0.K
angular distribution for (n,n*10)

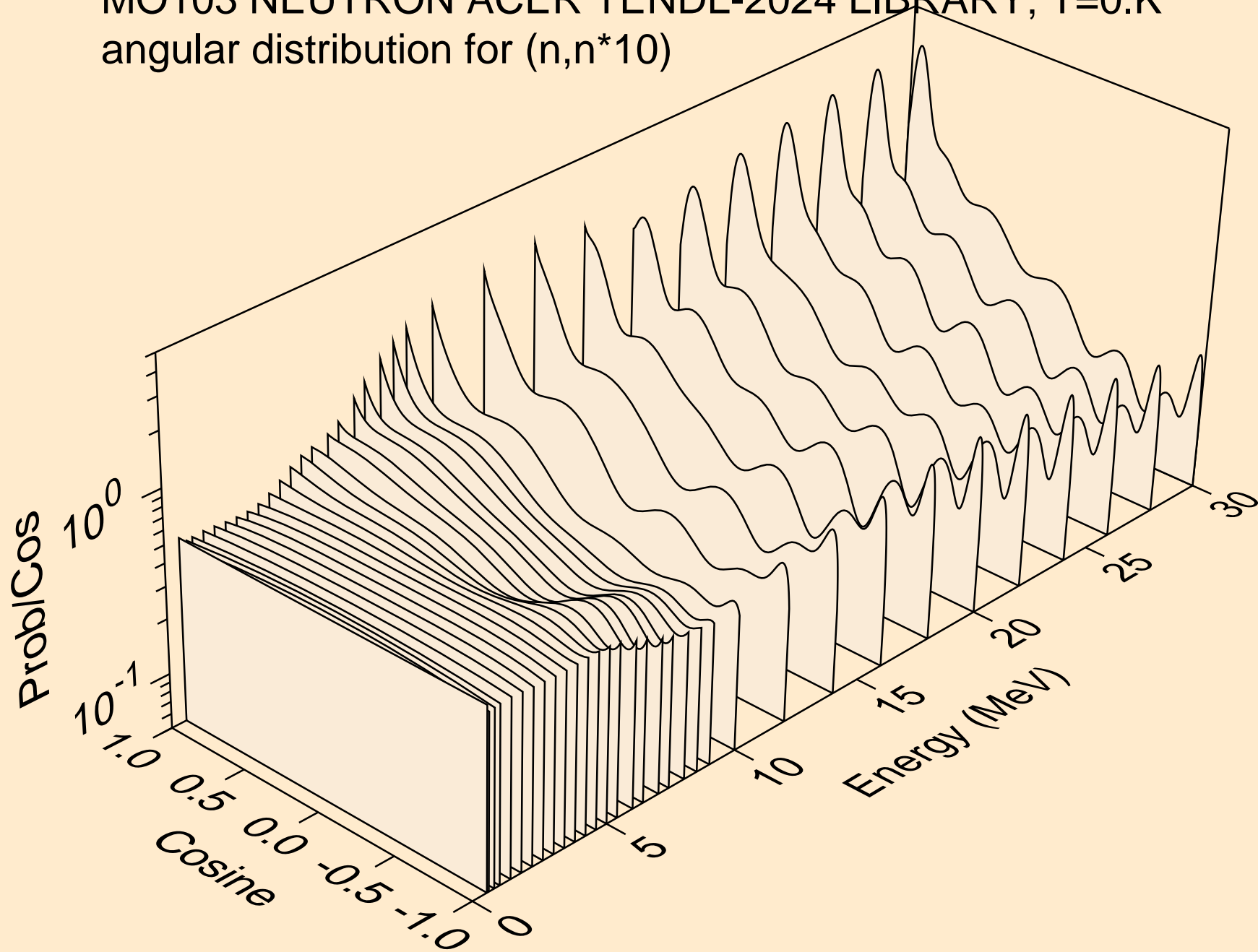

MO103 NEUTRON ACER TENDL-2024 LIBRARY; T=0.K
angular distribution for (n,n*11)

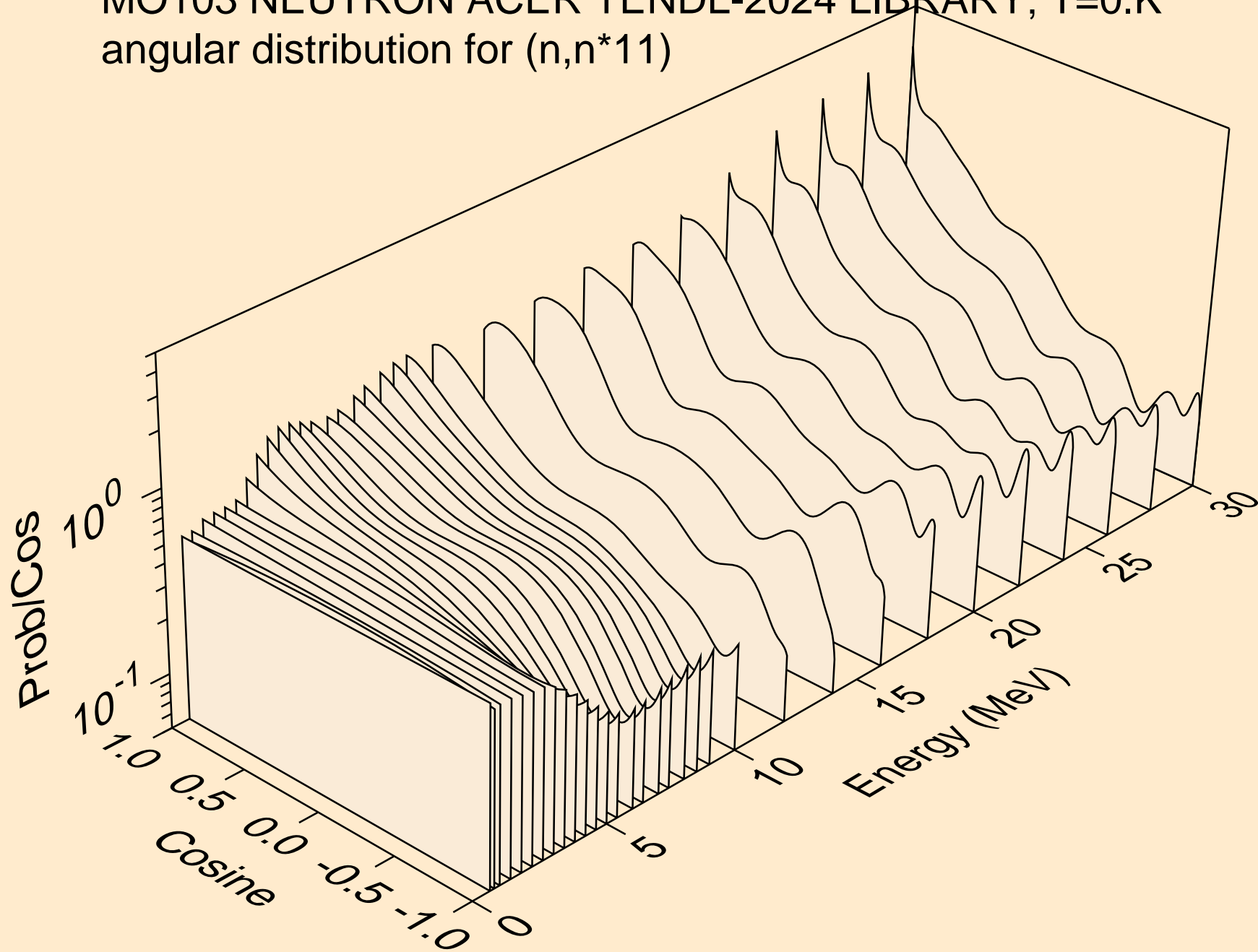

MO103 NEUTRON ACER TENDL-2024 LIBRARY; T=0.K
angular distribution for (n,n*12)

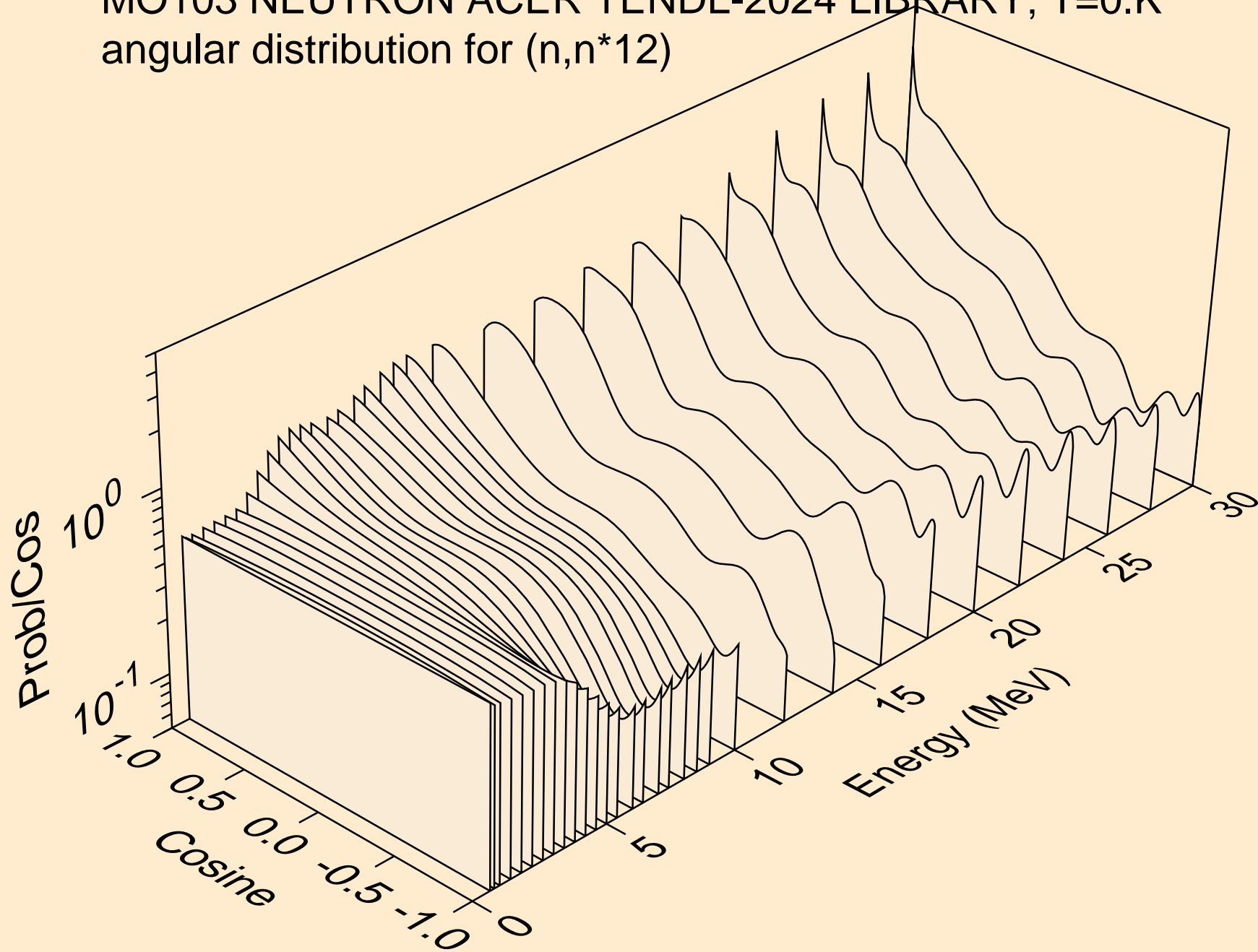

MO103 NEUTRON ACER TENDL-2024 LIBRARY; T=0.K
angular distribution for (n,n*13)

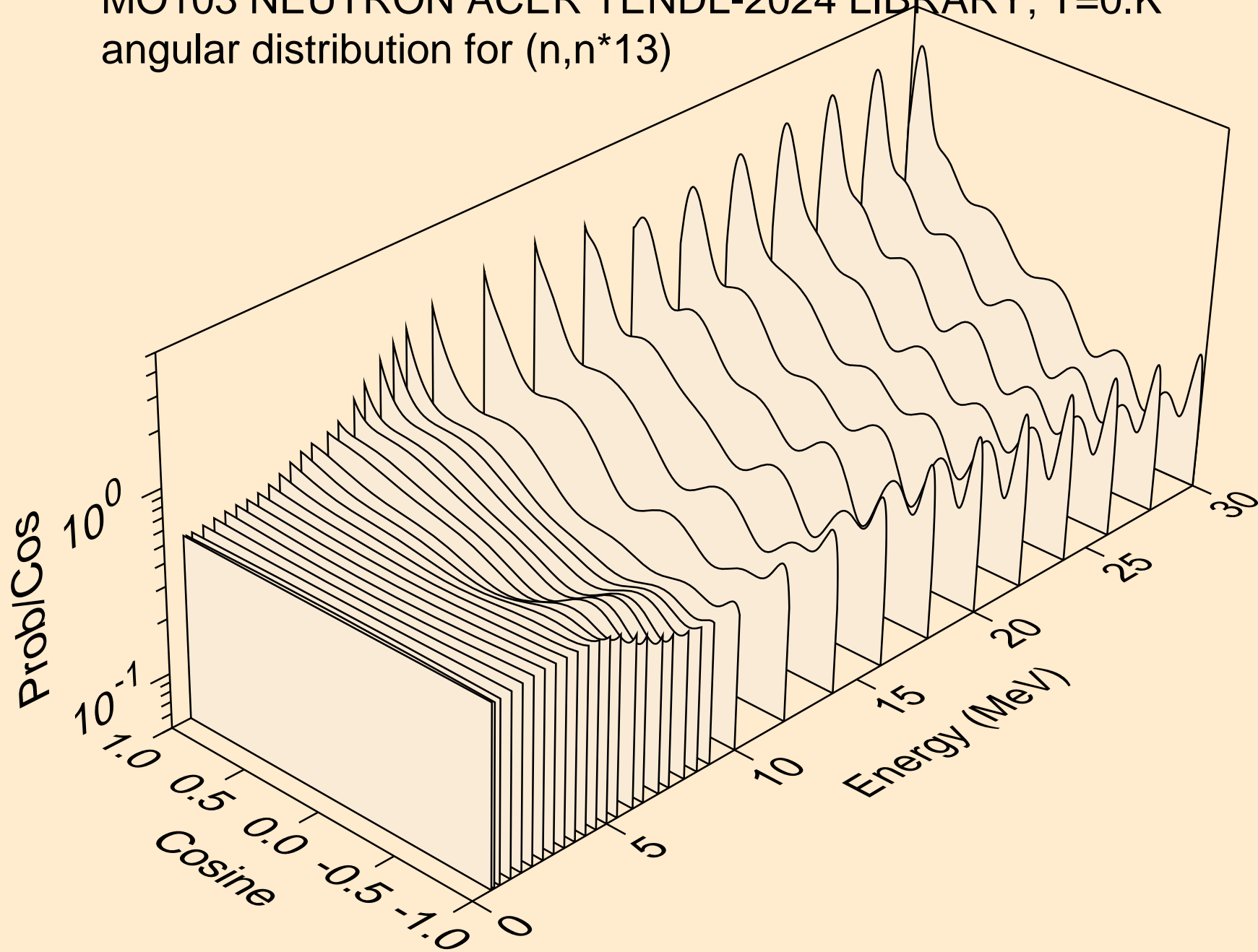

MO103 NEUTRON ACER TENDL-2024 LIBRARY; T=0.K
angular distribution for (n,n*14)

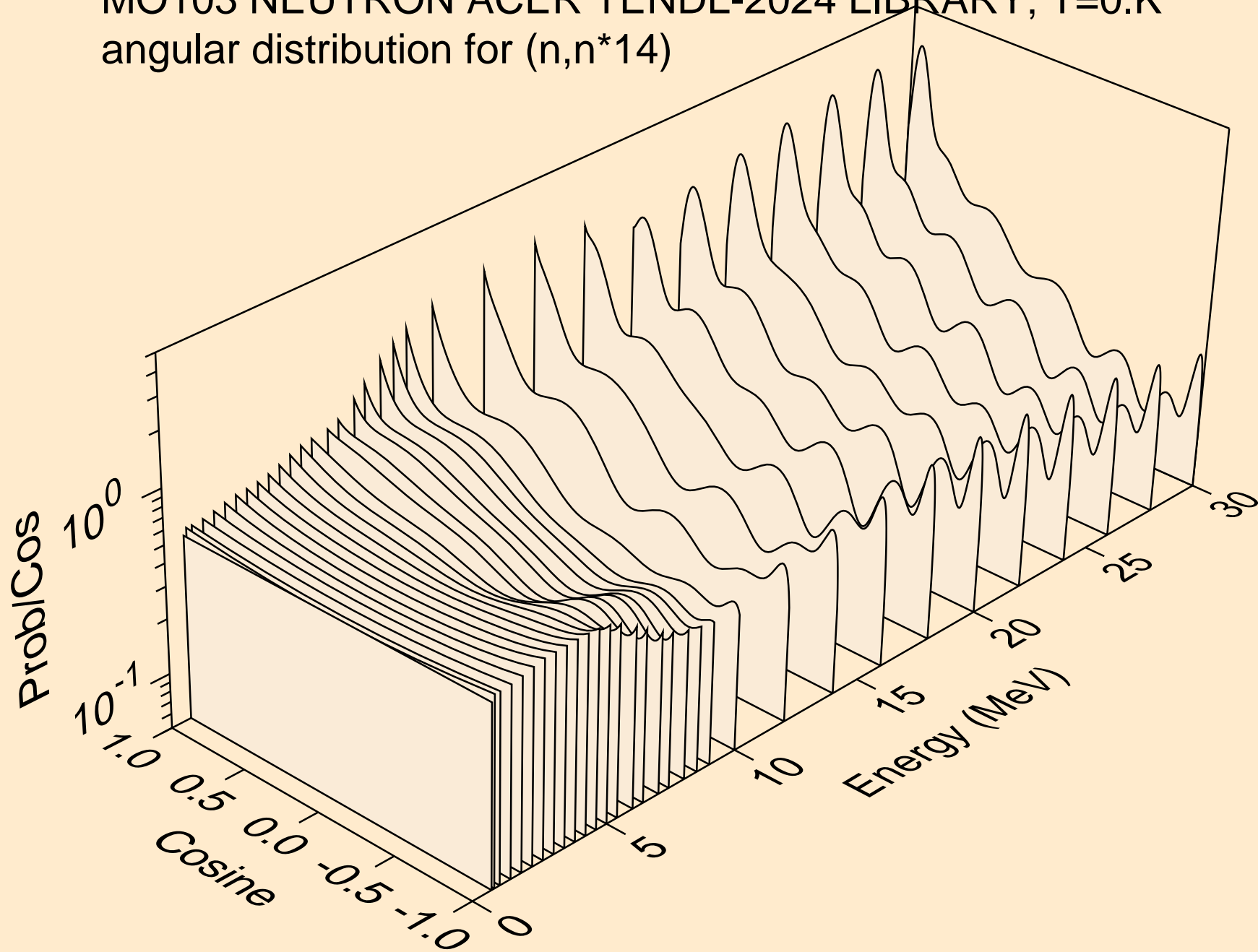

MO103 NEUTRON ACER TENDL-2024 LIBRARY; T=0.K
angular distribution for (n,n*15)

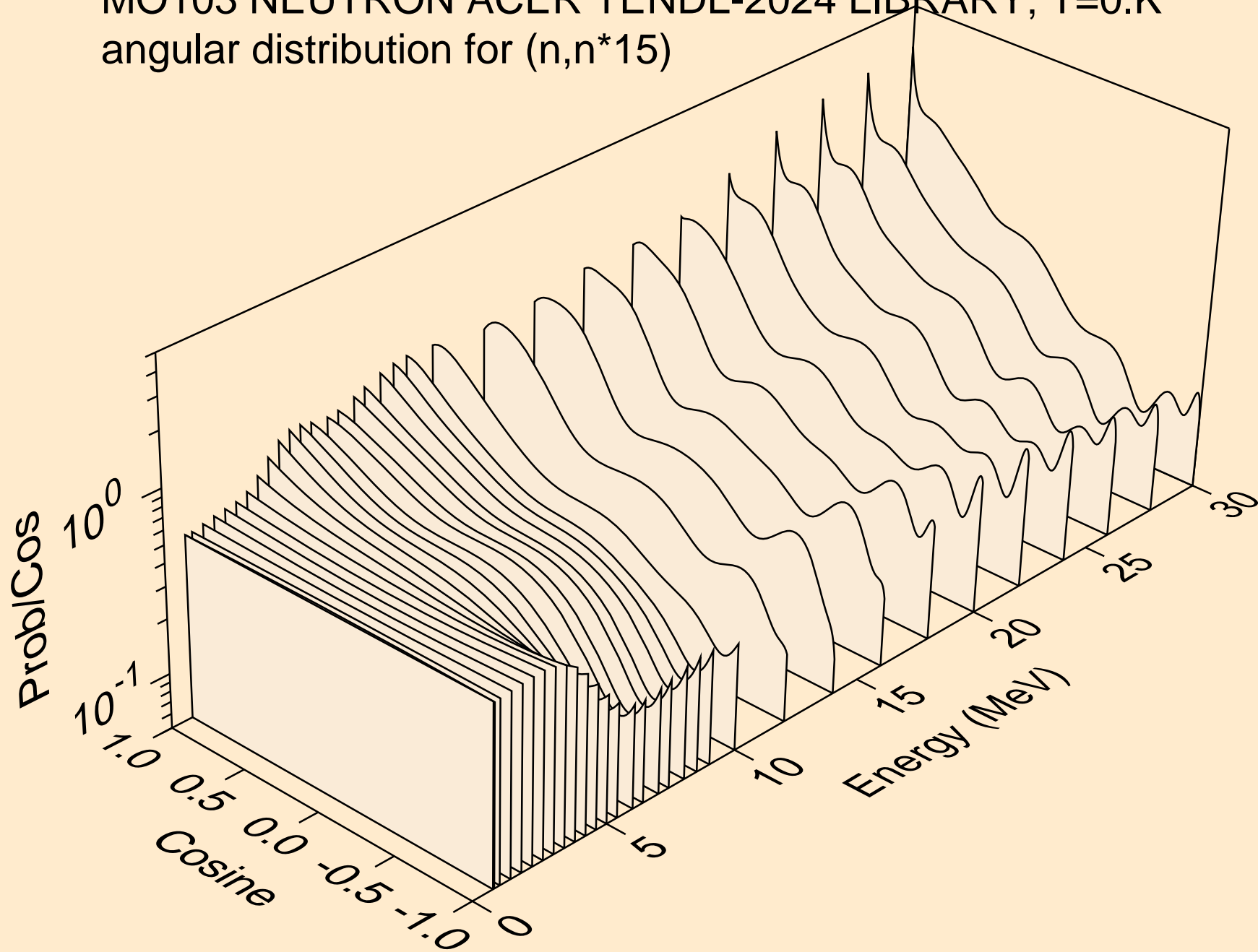

MO103 NEUTRON ACER TENDL-2024 LIBRARY; T=0.K
angular distribution for (n,n*16)

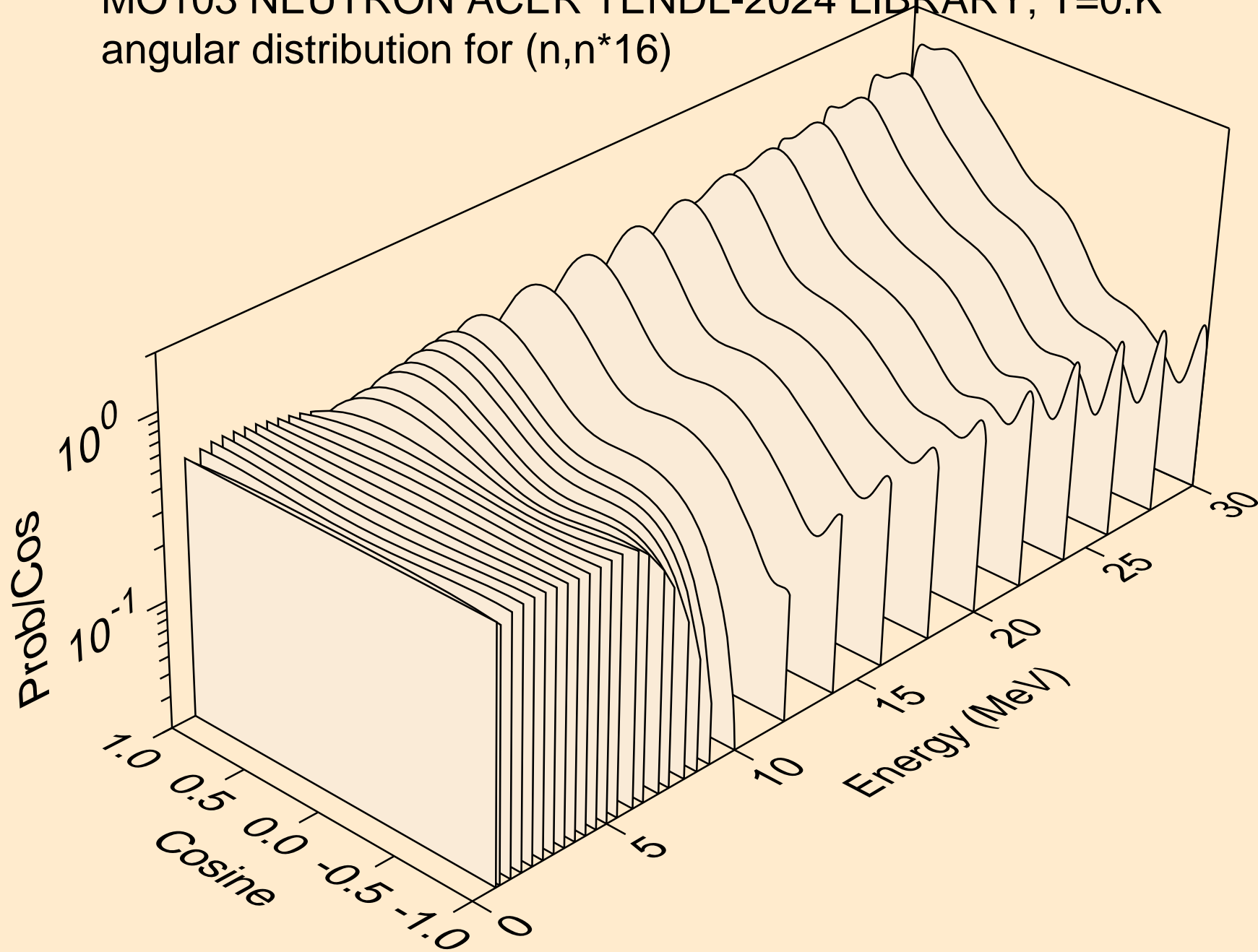

MO103 NEUTRON ACER TENDL-2024 LIBRARY; T=0.K
angular distribution for (n,n*17)

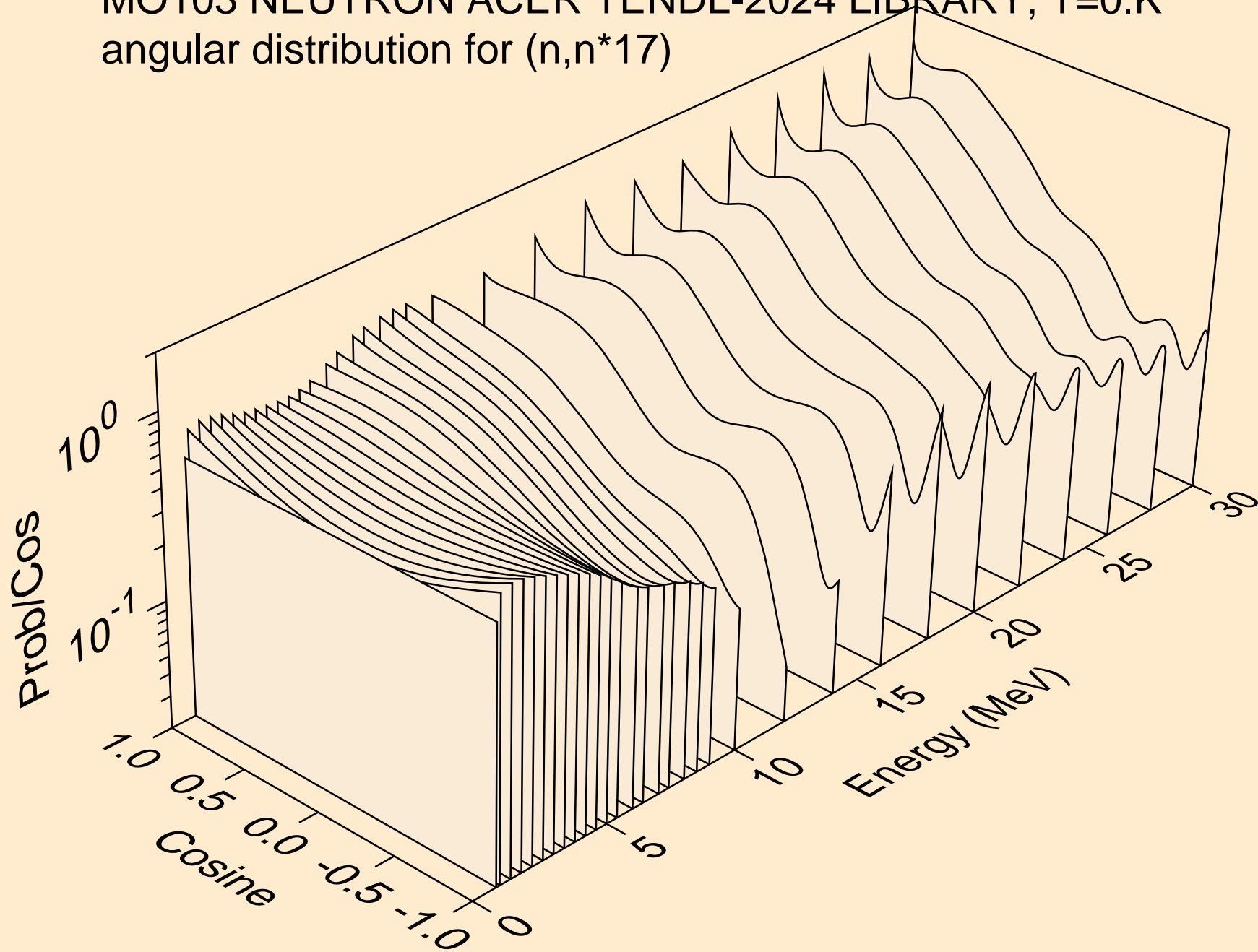

MO103 NEUTRON ACER TENDL-2024 LIBRARY; T=0.K
angular distribution for (n,n*18)

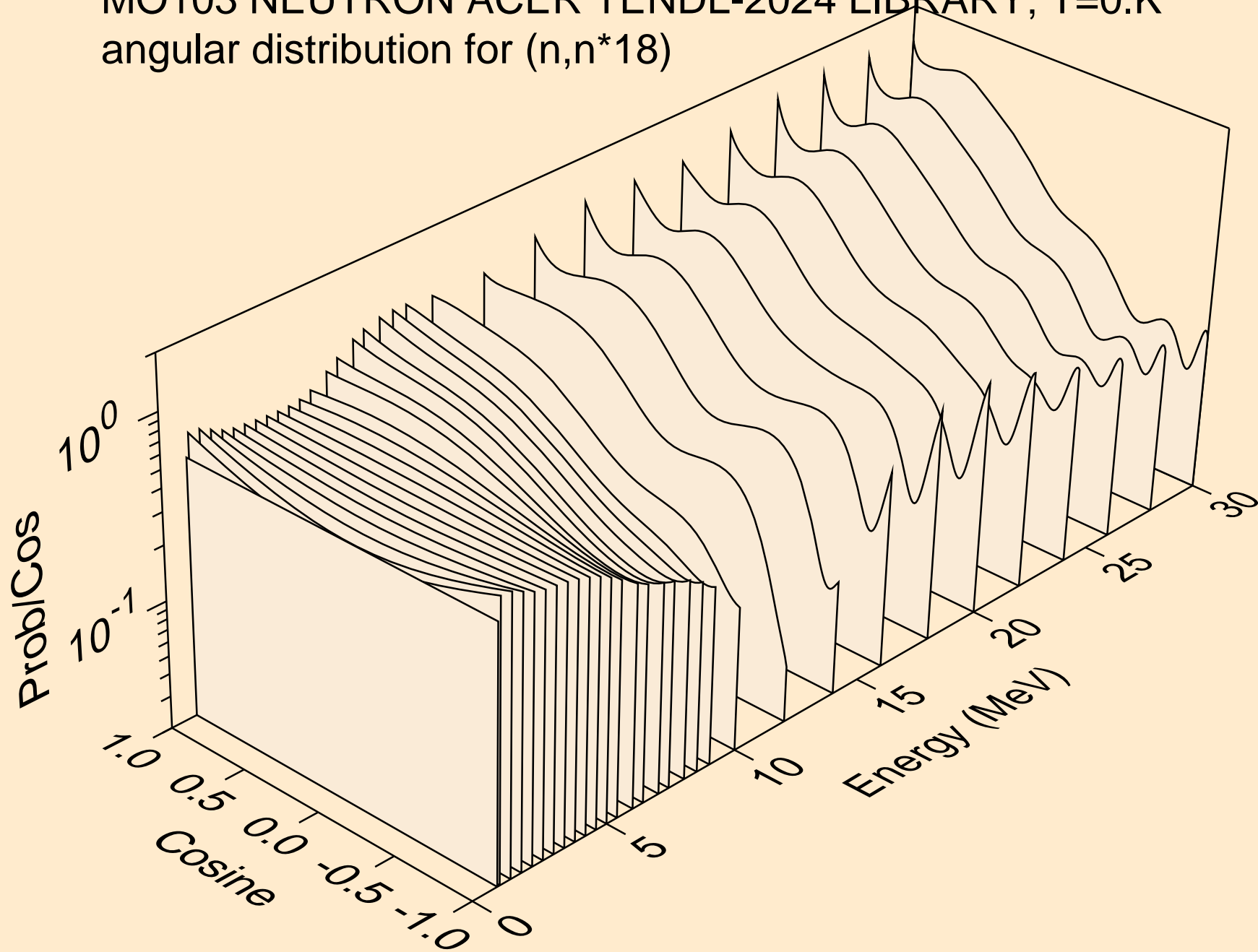

MO103 NEUTRON ACER TENDL-2024 LIBRARY; T=0.K
angular distribution for (n,n*19)

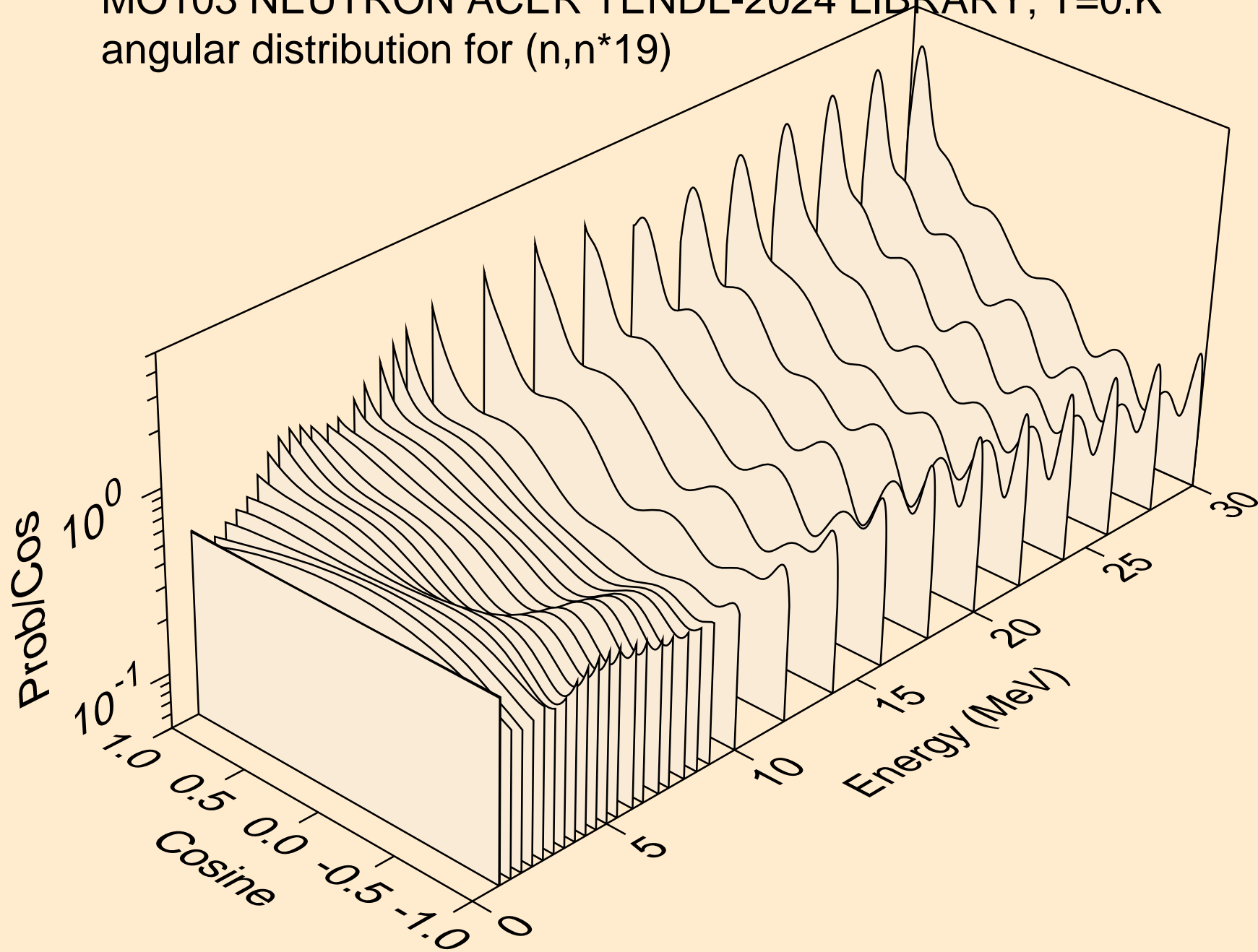

MO103 NEUTRON ACER TENDL-2024 LIBRARY; T=0.K
angular distribution for (n,n*20)

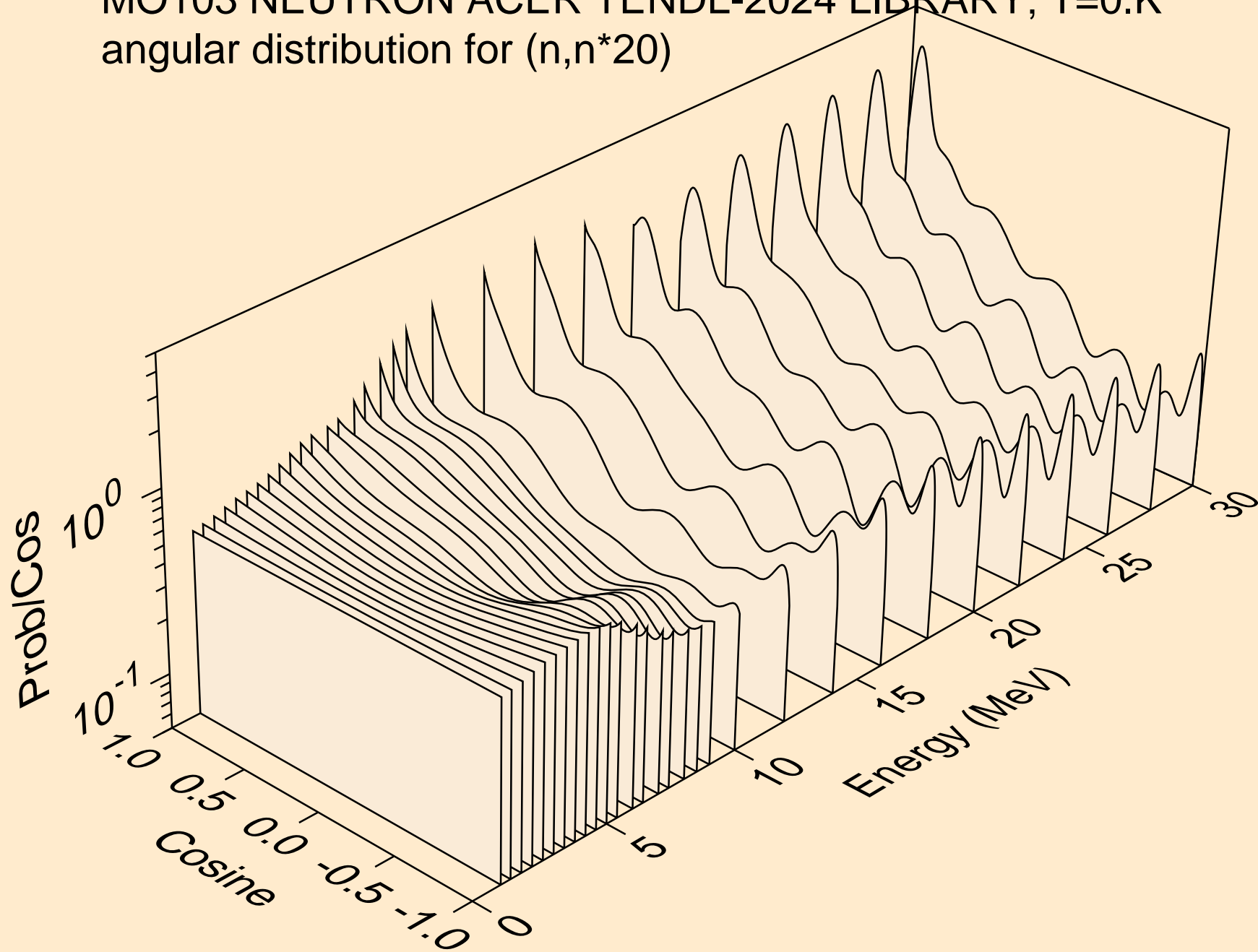

MO103 NEUTRON ACER TENDL-2024 LIBRARY; T=0.K
angular distribution for (n,n*21)

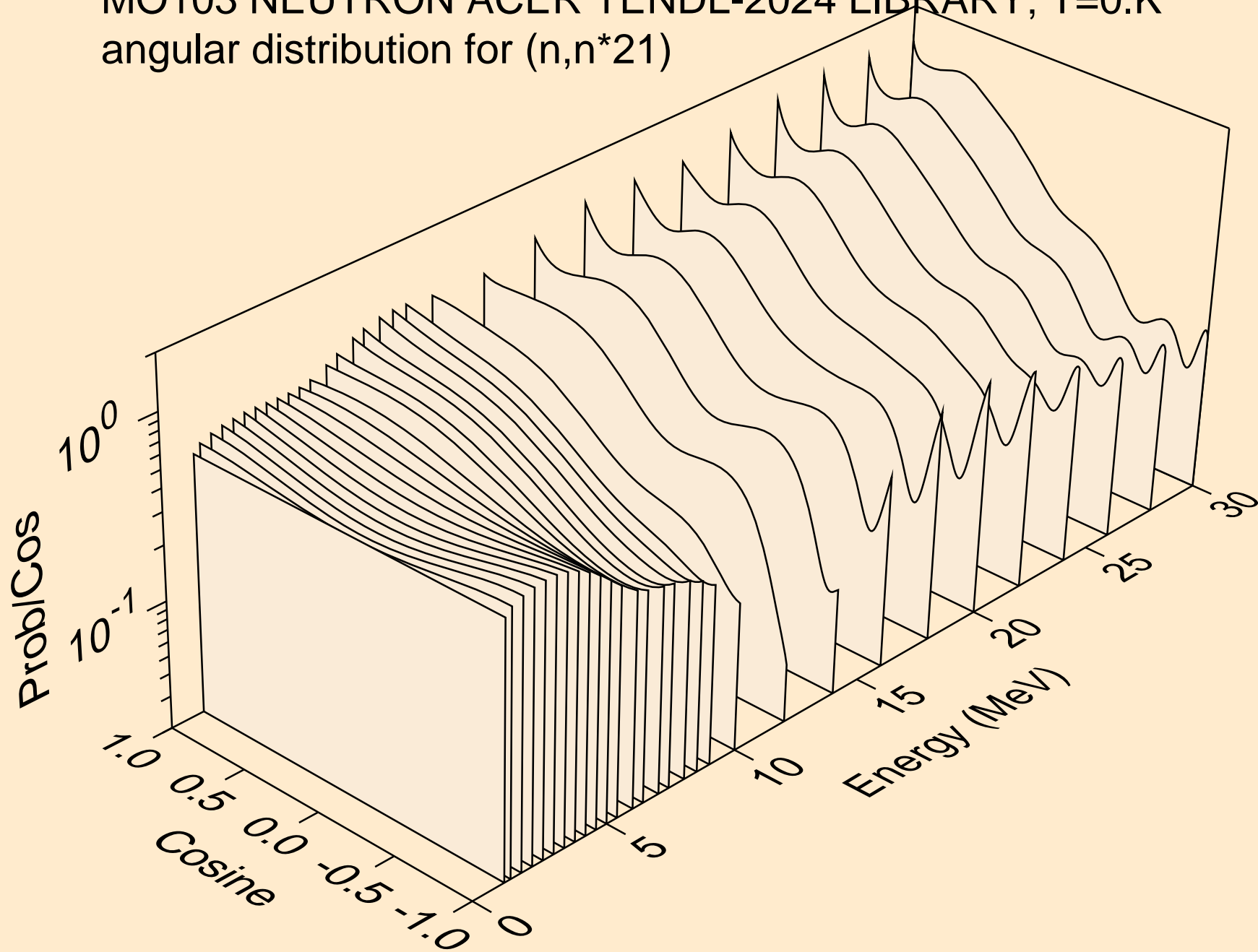

MO103 NEUTRON ACER TENDL-2024 LIBRARY; T=0.K
angular distribution for (n,n*22)

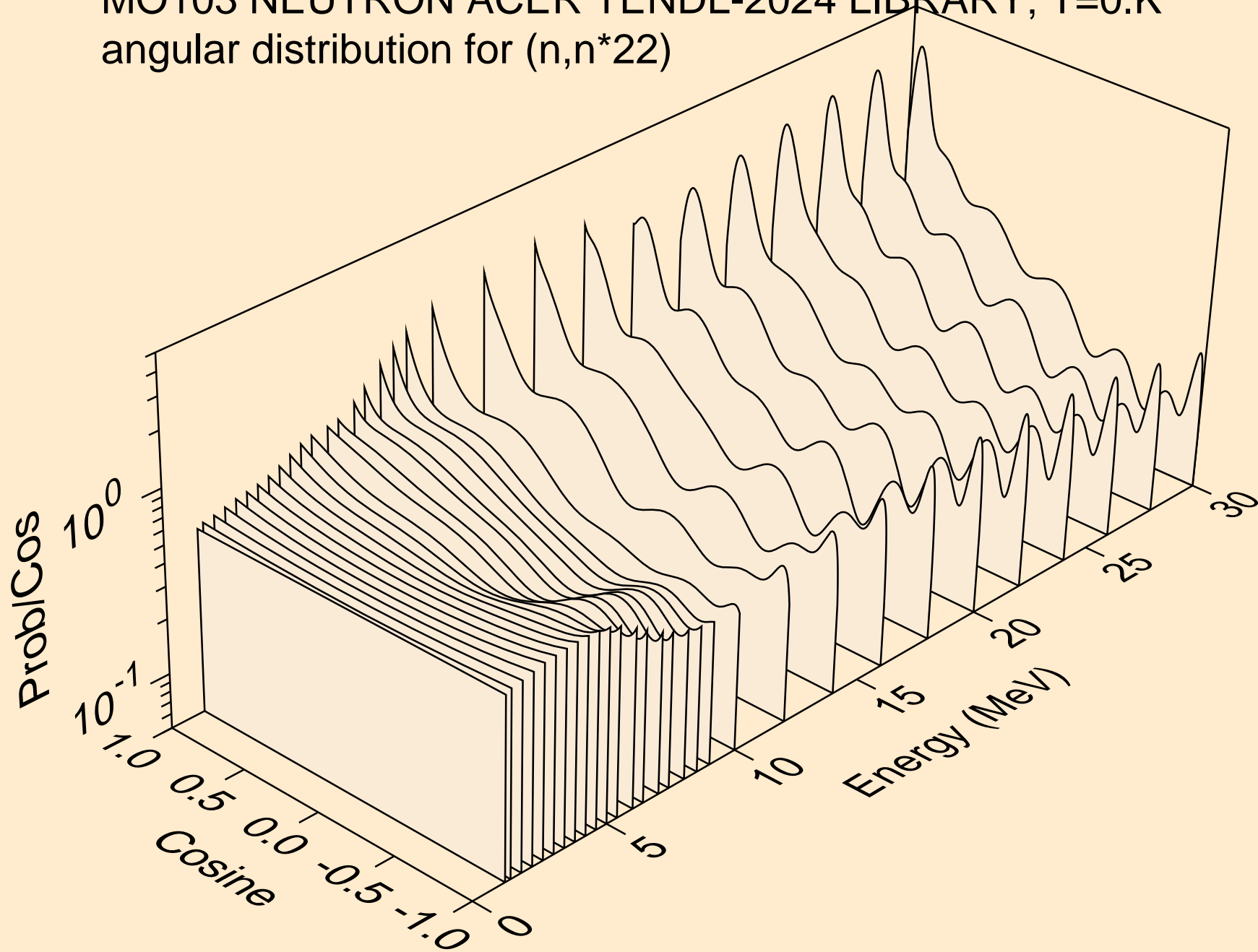

MO103 NEUTRON ACER TENDL-2024 LIBRARY; T=0.K
Neutron emission for (n,x)

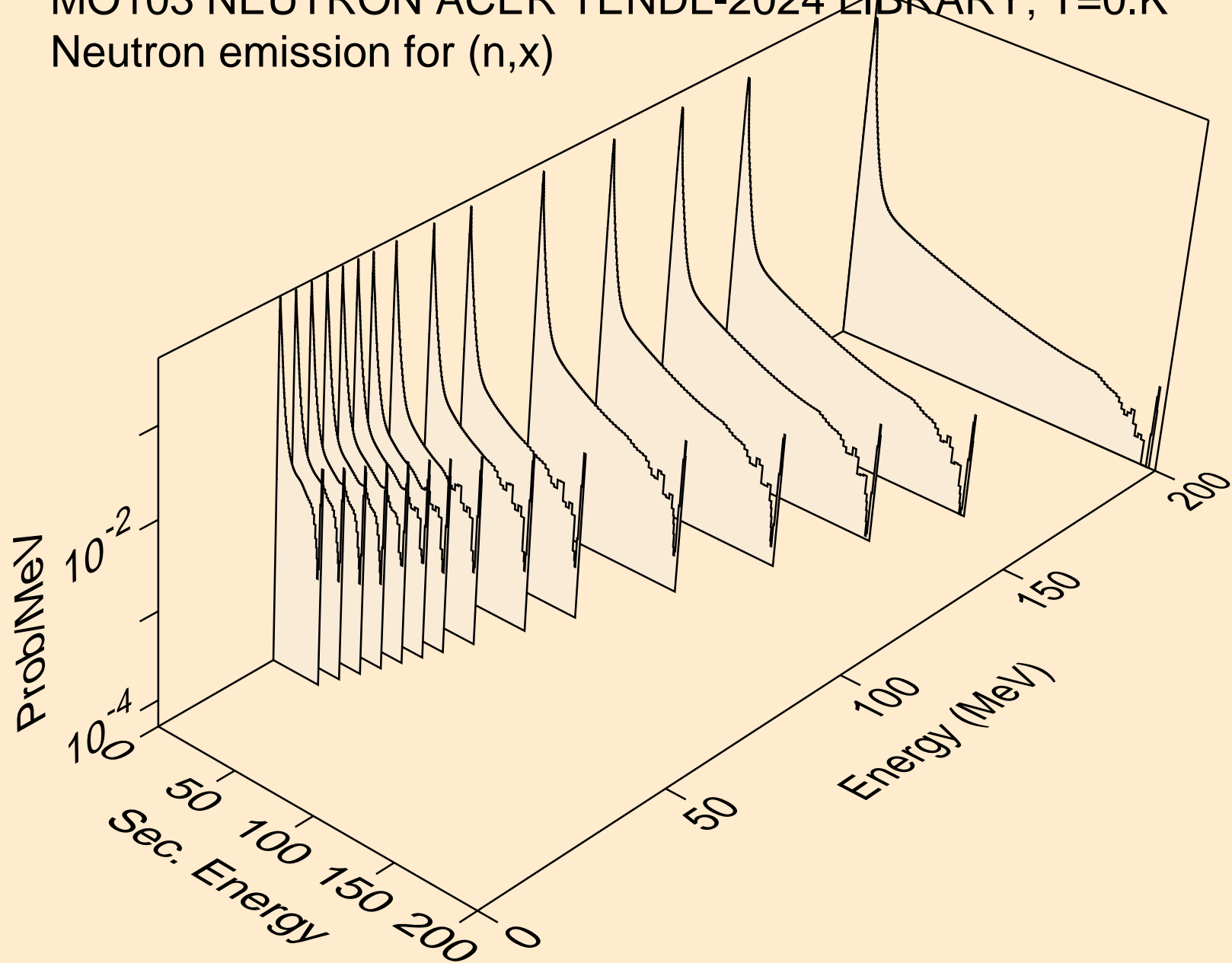

MO103 NEUTRON ACER TENDL-2024 LIBRARY; T=0.K
Neutron emission for (n,2nd)

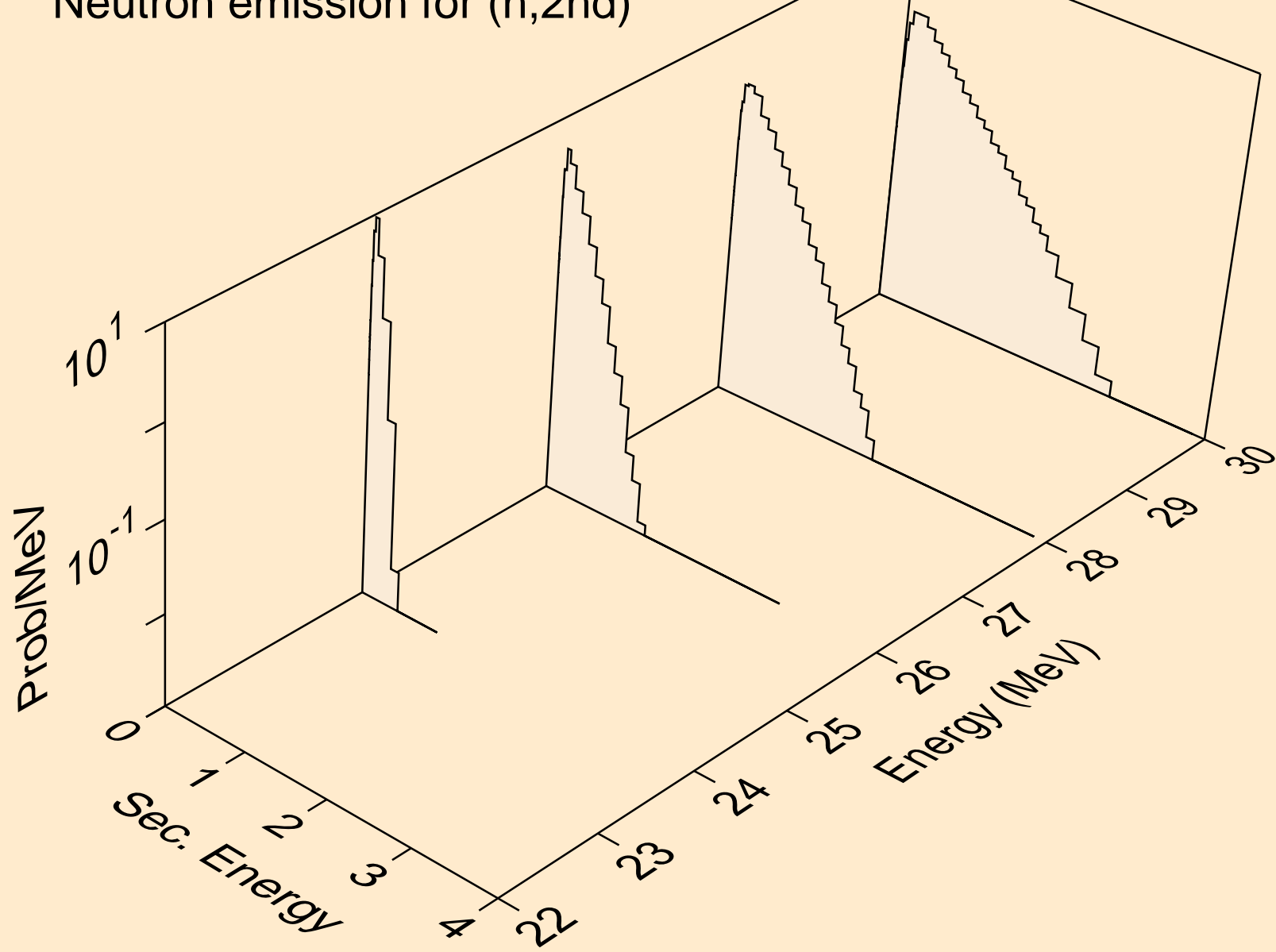

MO103 NEUTRON ACER TENDL-2024 LIBRARY; T=0.K
Neutron emission for (n,2n)

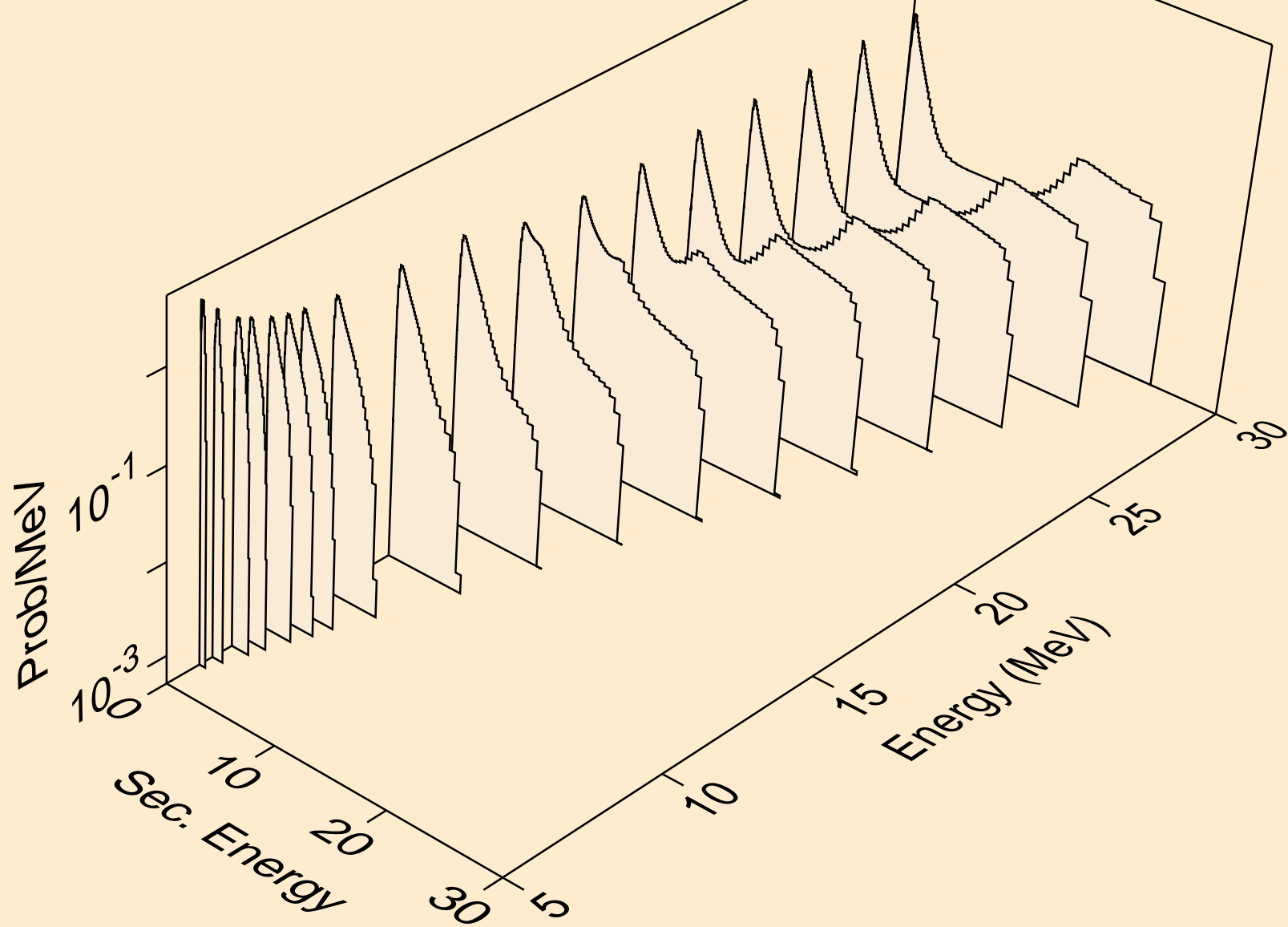

MO103 NEUTRON ACER TENDL-2024 LIBRARY; T=0.K
Neutron emission for (n,3n)

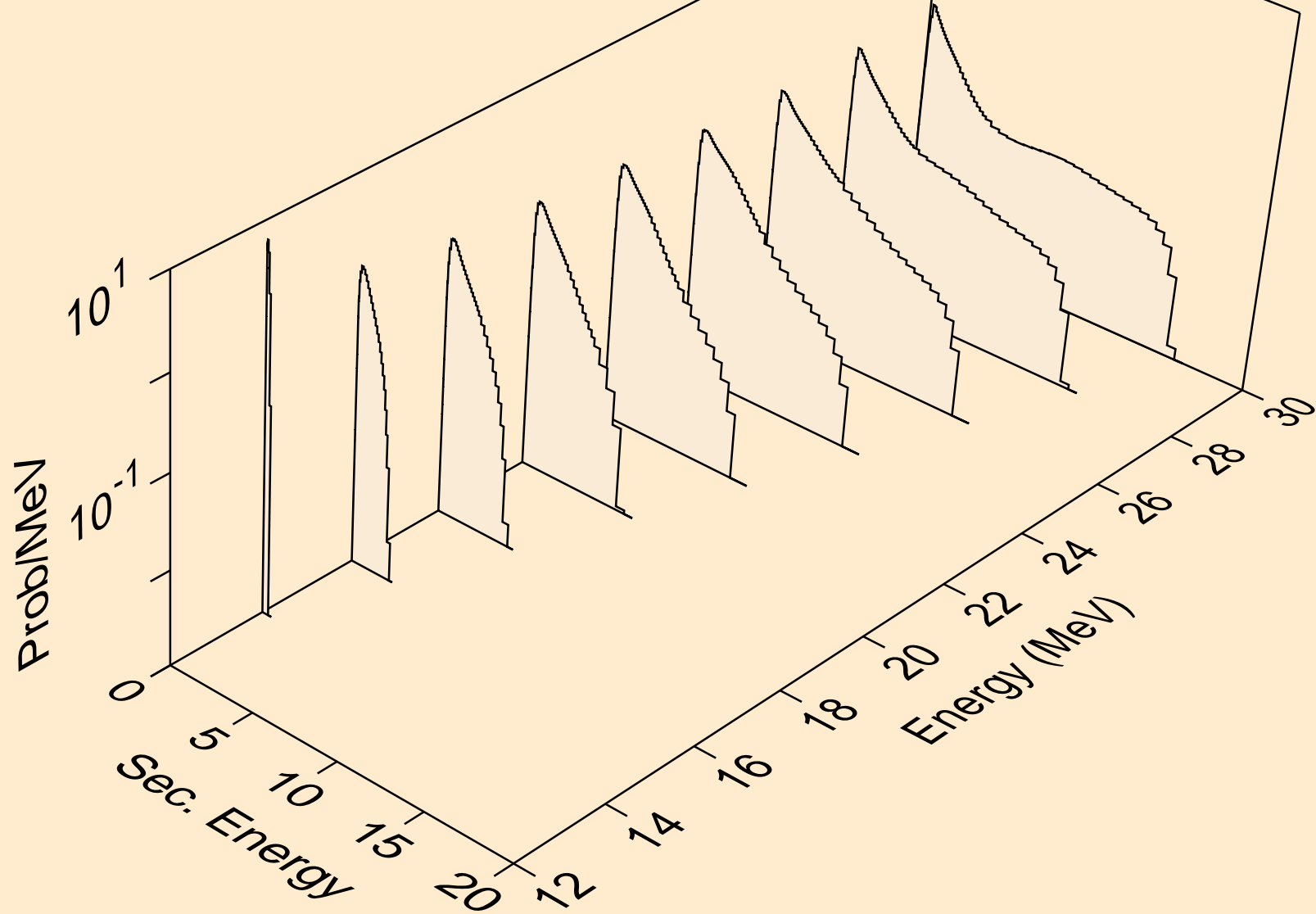

MO103 NEUTRON ACER TENDL-2024 LIBRARY; T=0.K
Neutron emission for (n,n*)a

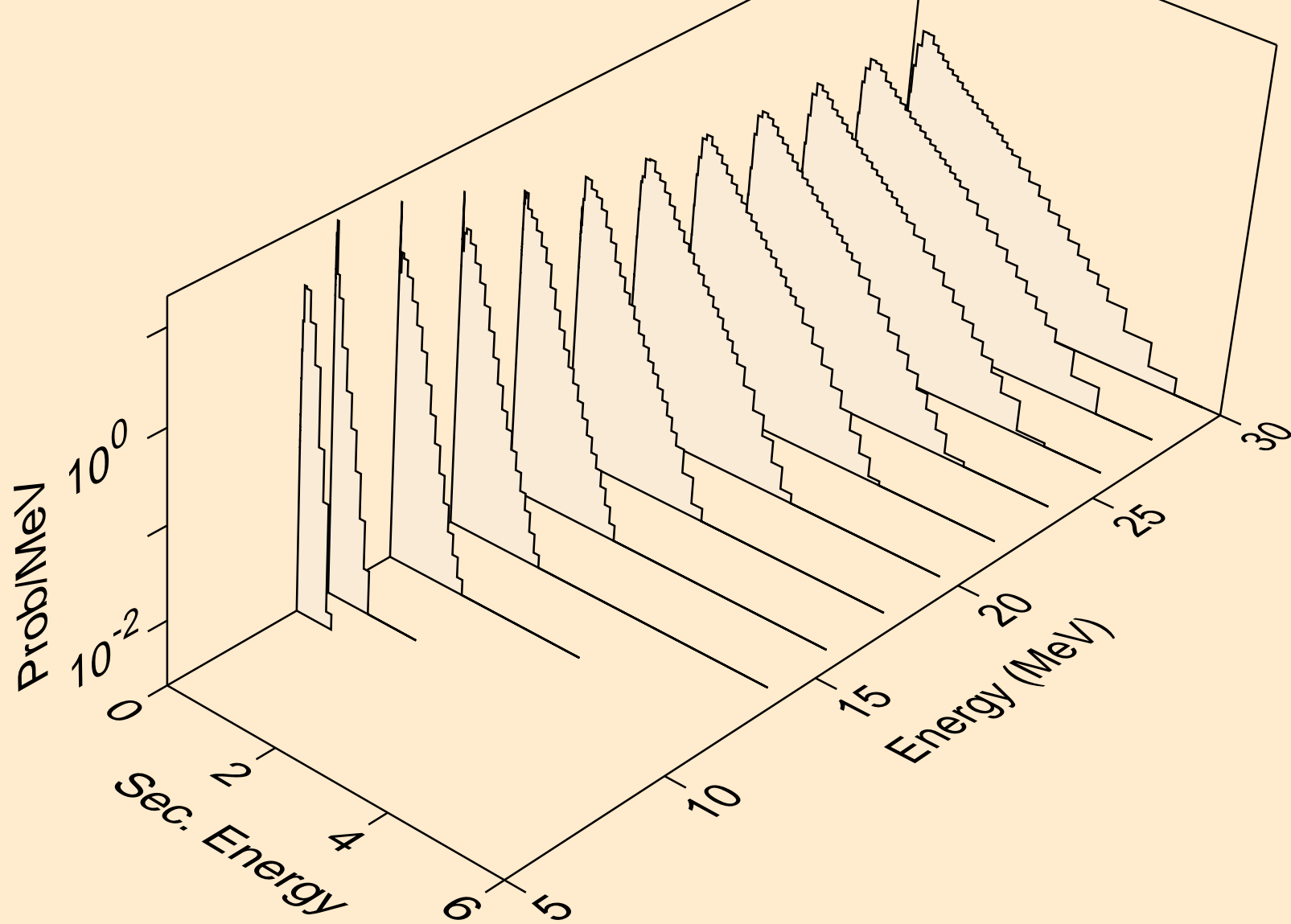

MO103 NEUTRON ACER TENDL-2024 LIBRARY; T=0.K
Neutron emission for (n,2n)a

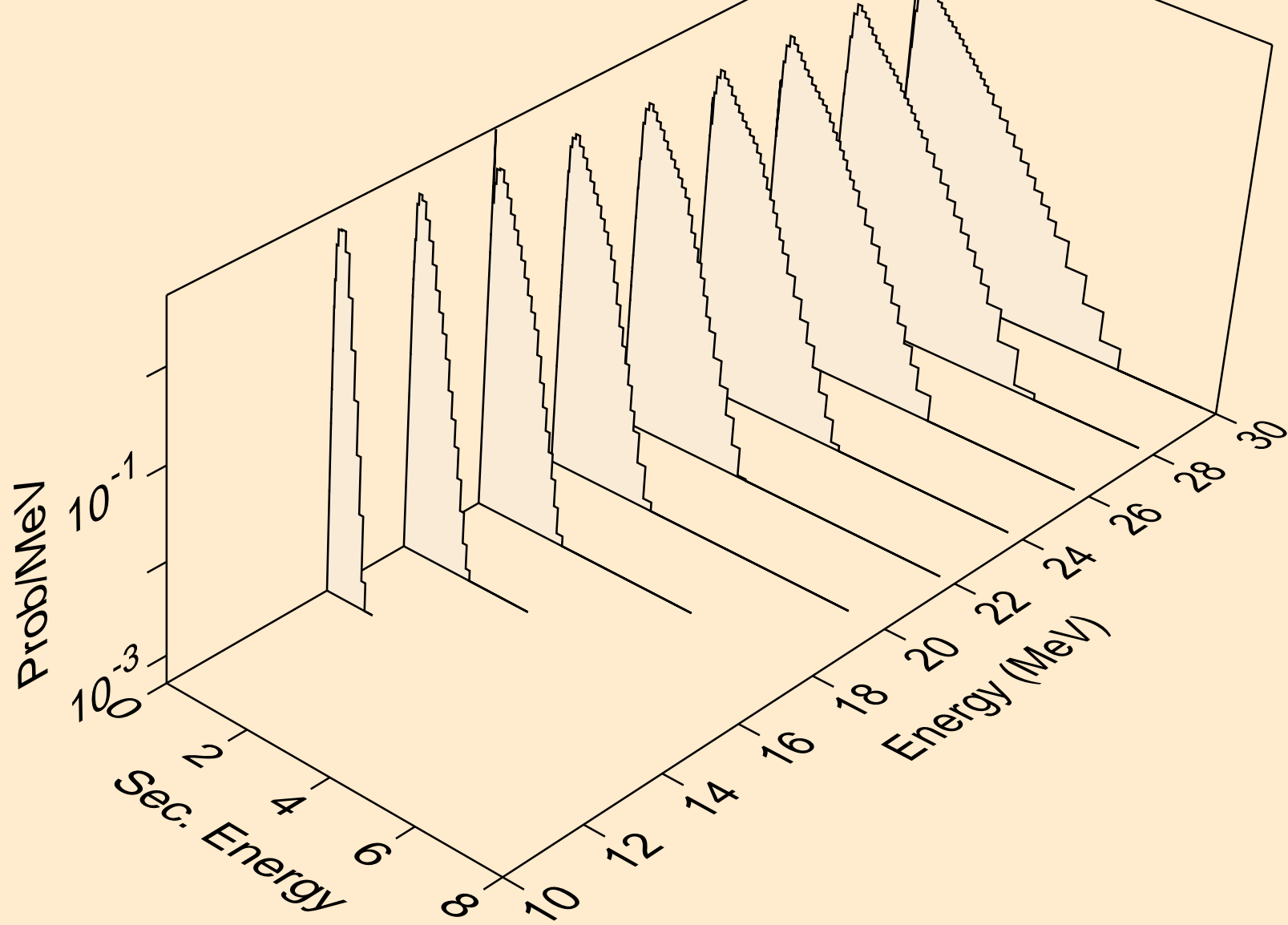

MO103 NEUTRON ACER TENDL-2024 LIBRARY; T=0.K
Neutron emission for (n,3n)a

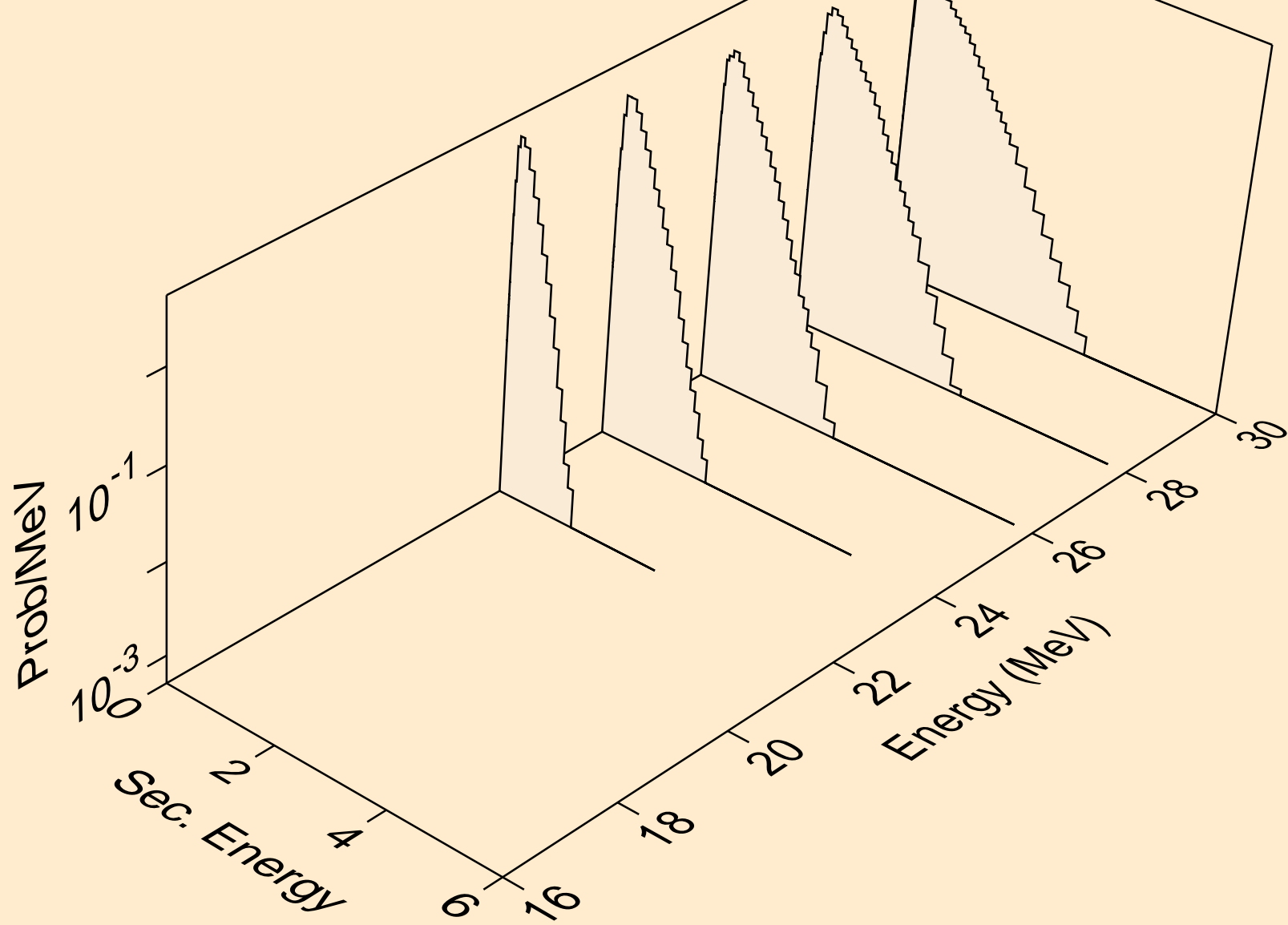

MO103 NEUTRON ACER TENDL-2024 LIBRARY; T=0.K
Neutron emission for (n,n*)p

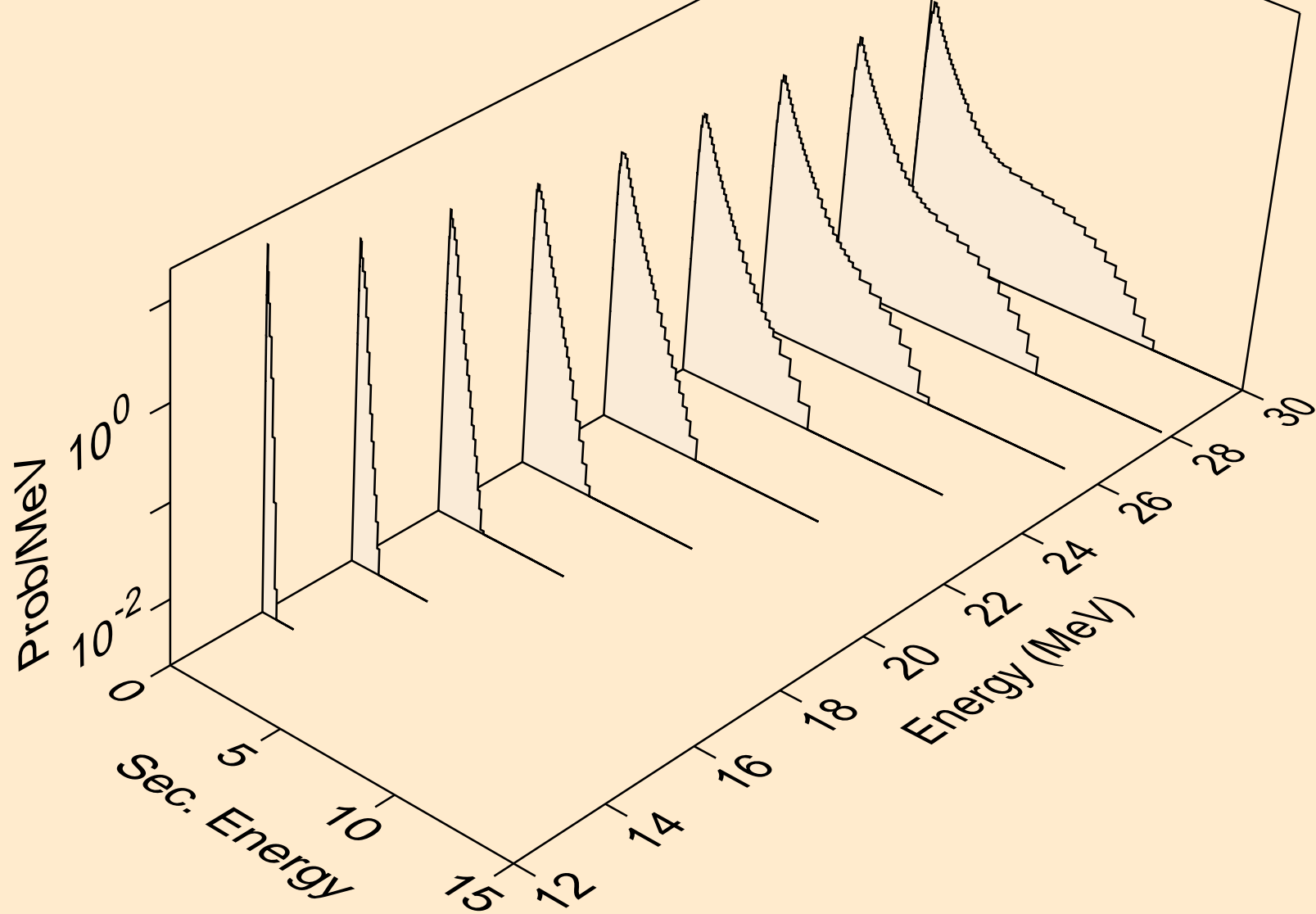

MO103 NEUTRON ACER TENDL-2024 LIBRARY; T=0.K
Neutron emission for (n,n*)d

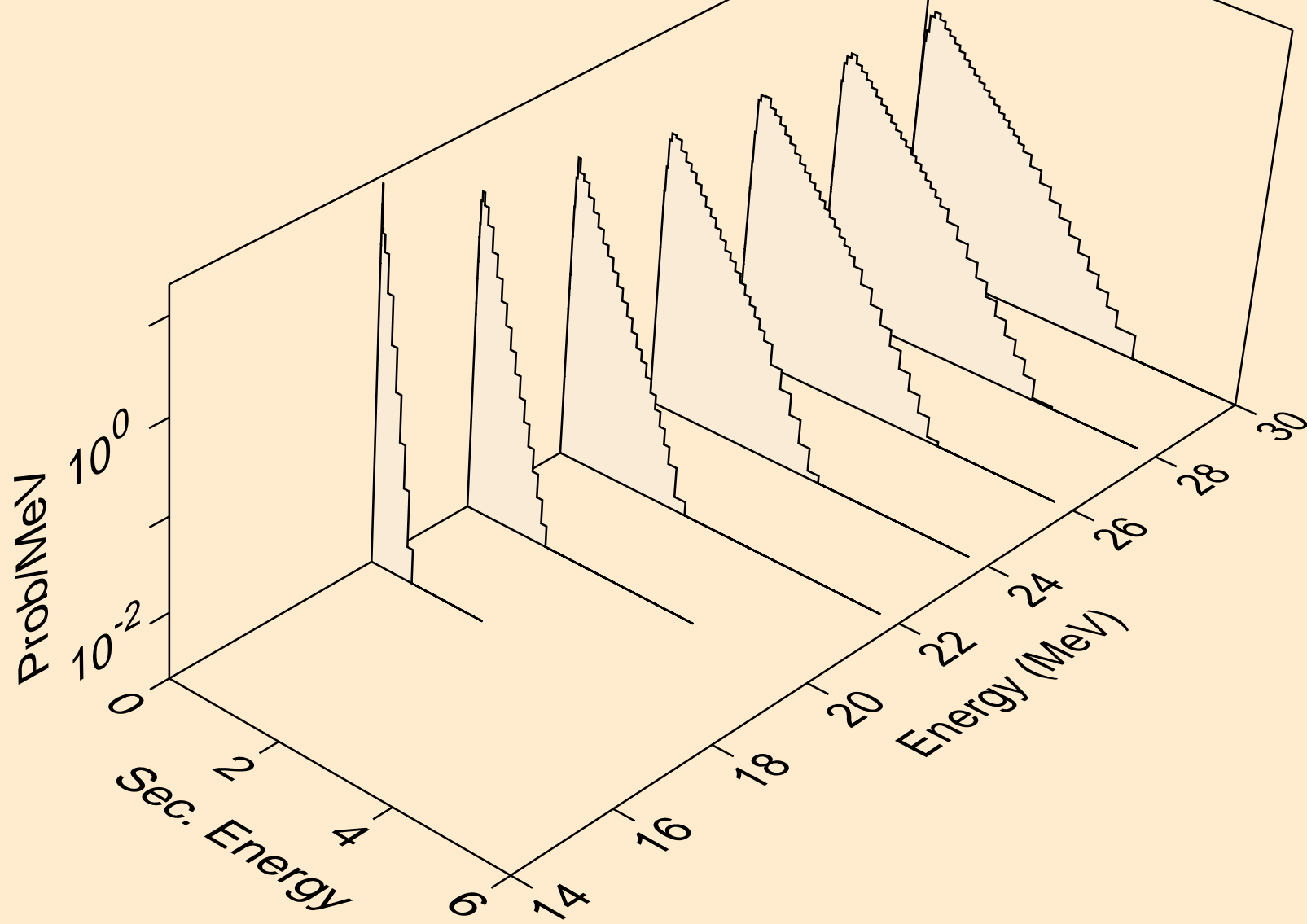

MO103 NEUTRON ACER TENDL-2024 LIBRARY; T=0.K
Neutron emission for (n,n*)t

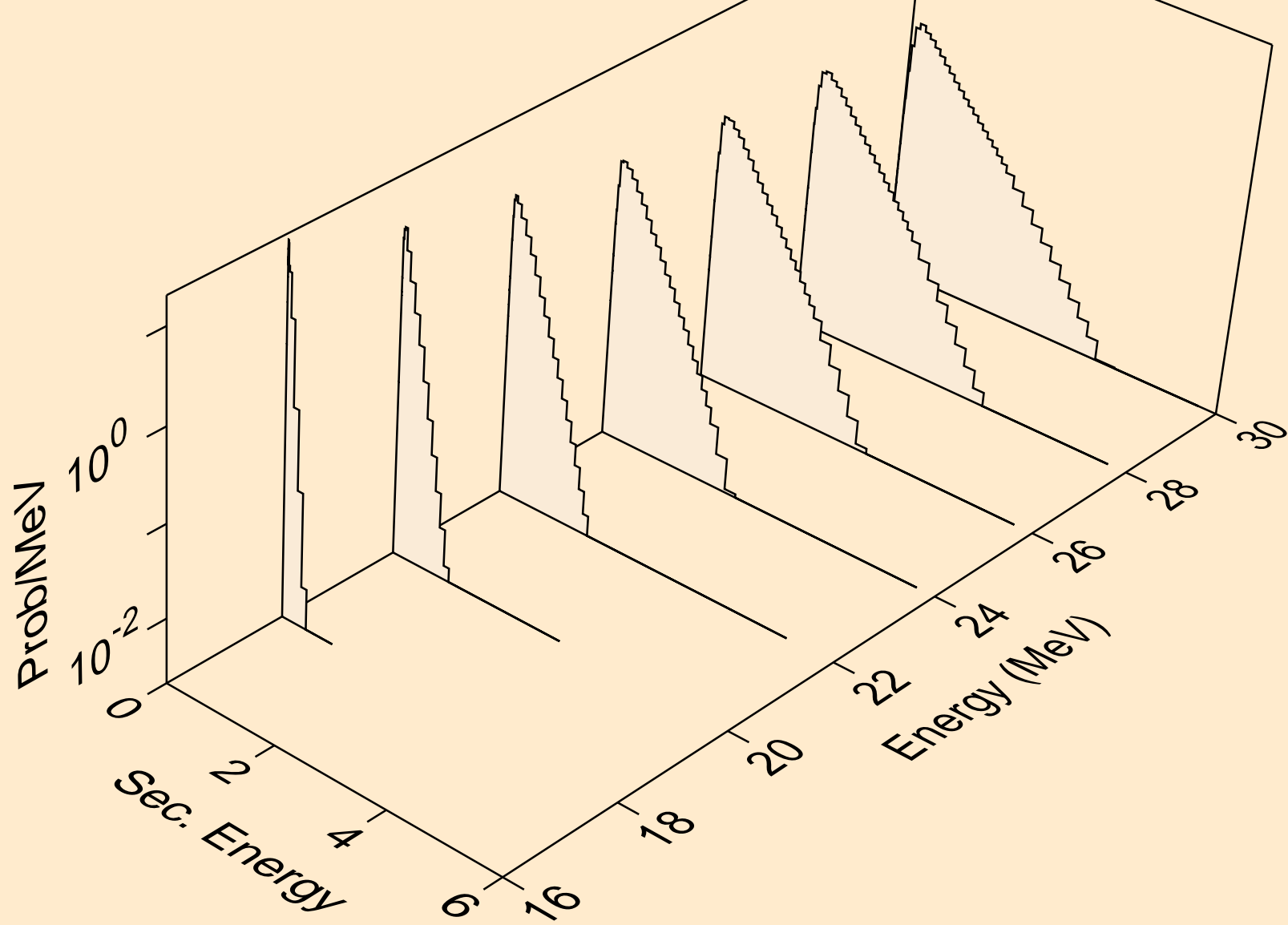

MO103 NEUTRON ACER TENDL-2024 LIBRARY; T=0.K
Neutron emission for (n,n*)he3

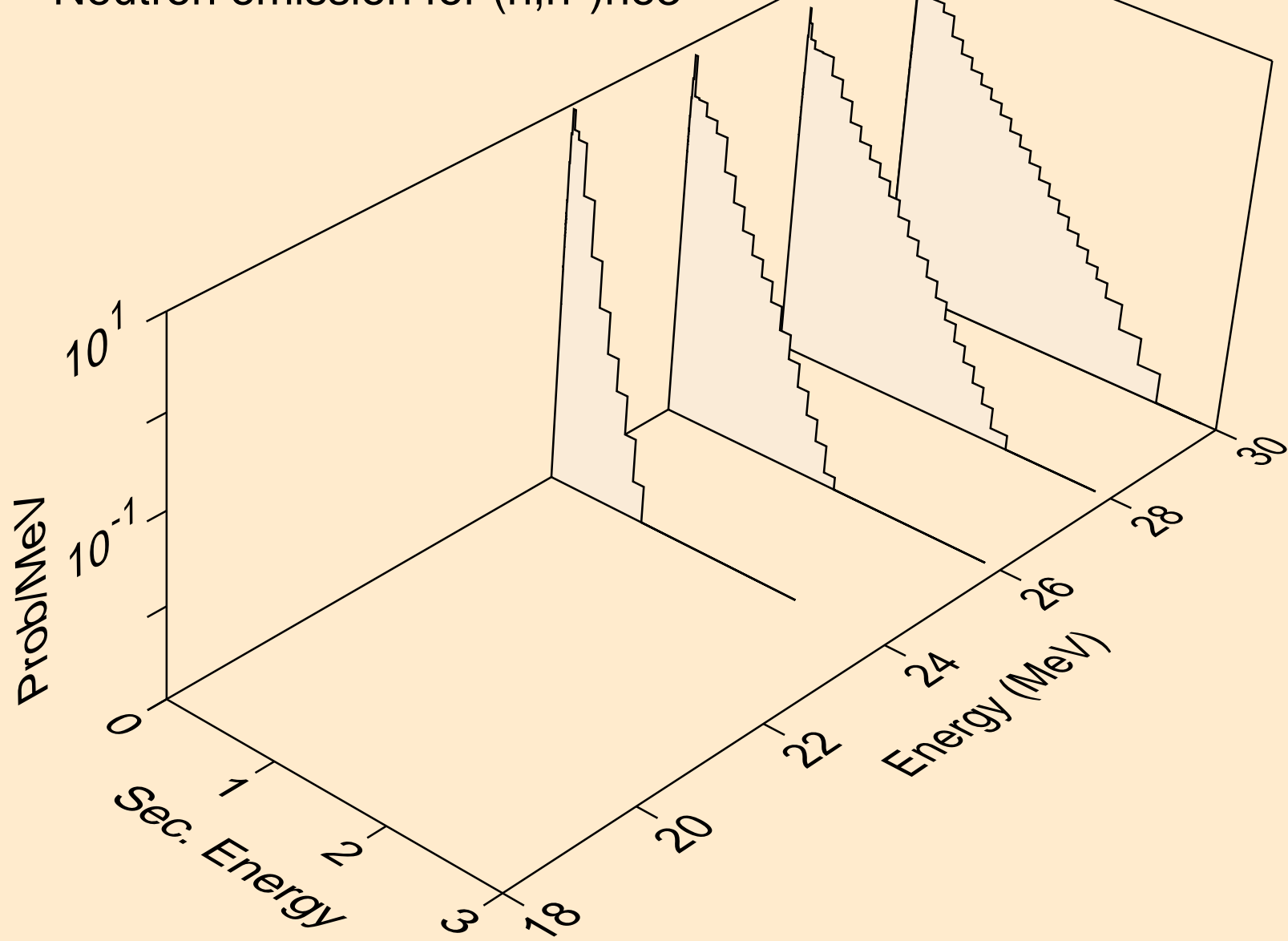

MO103 NEUTRON ACER TENDL-2024 LIBRARY; T=0.K
Neutron emission for (n,4n)

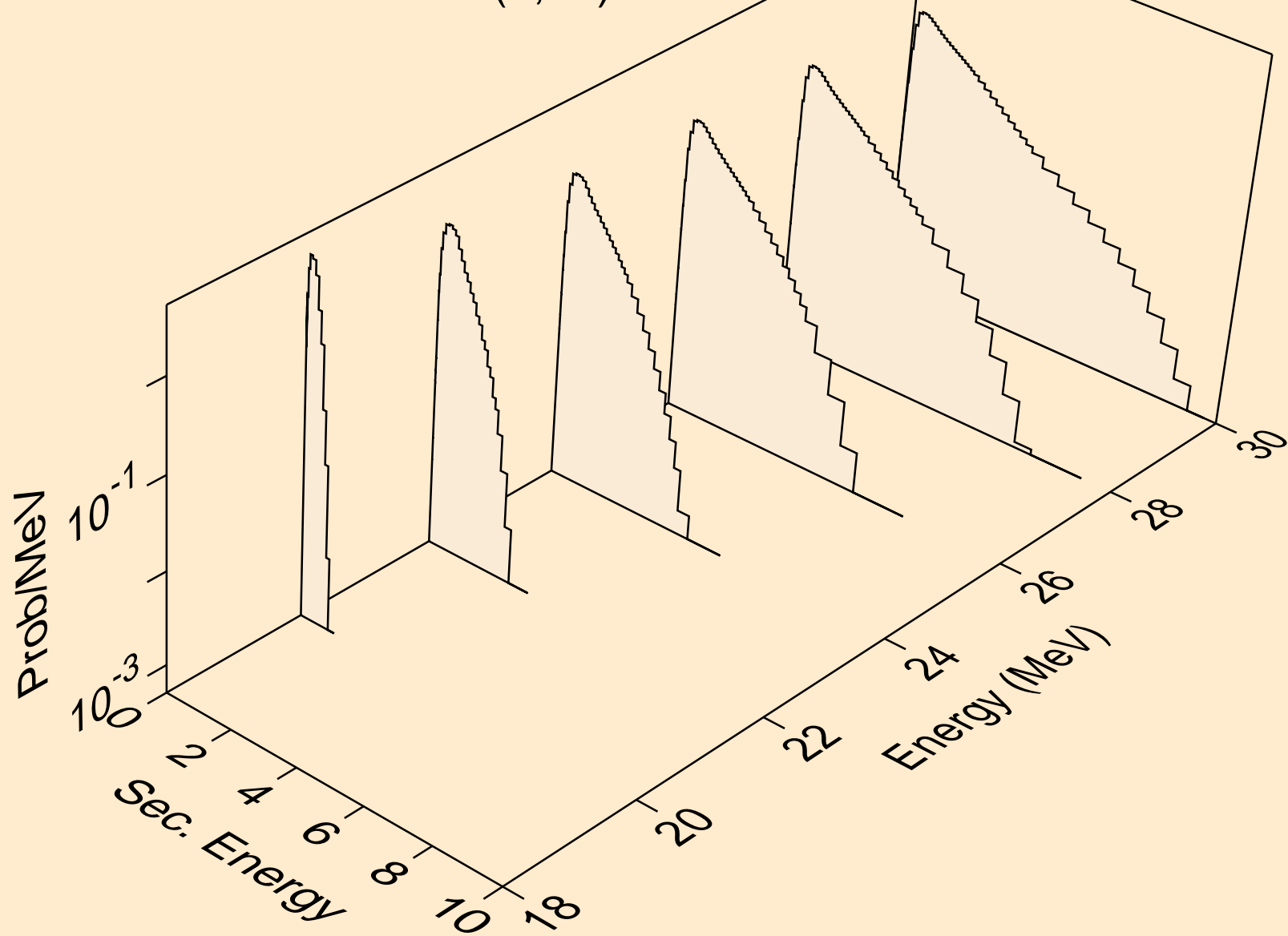

MO103 NEUTRON ACER TENDL-2024 LIBRARY; T=0.K
Neutron emission for (n,2np)

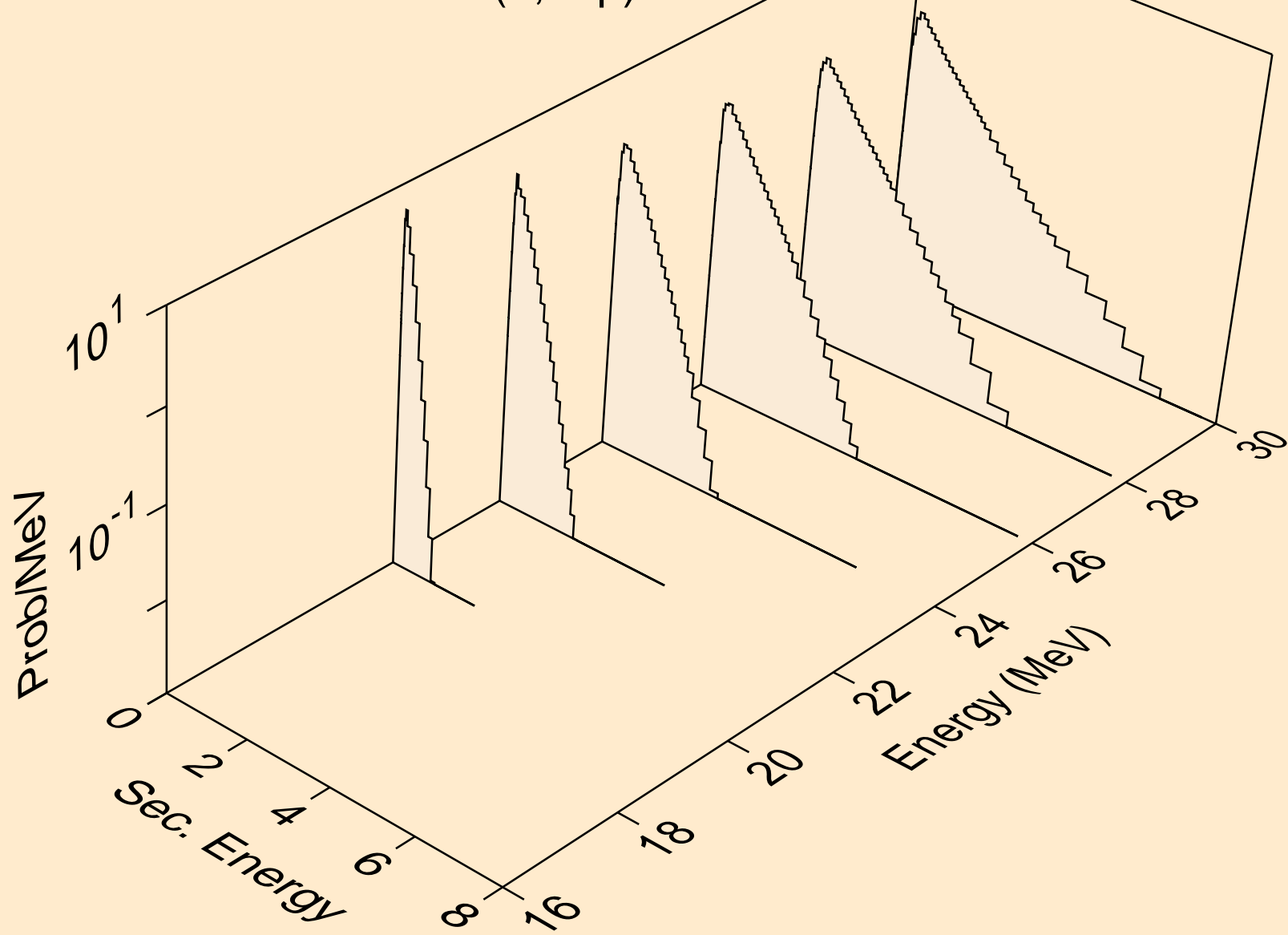

MO103 NEUTRON ACER TENDL-2024 LIBRARY; T=0.K
Neutron emission for (n,3np)

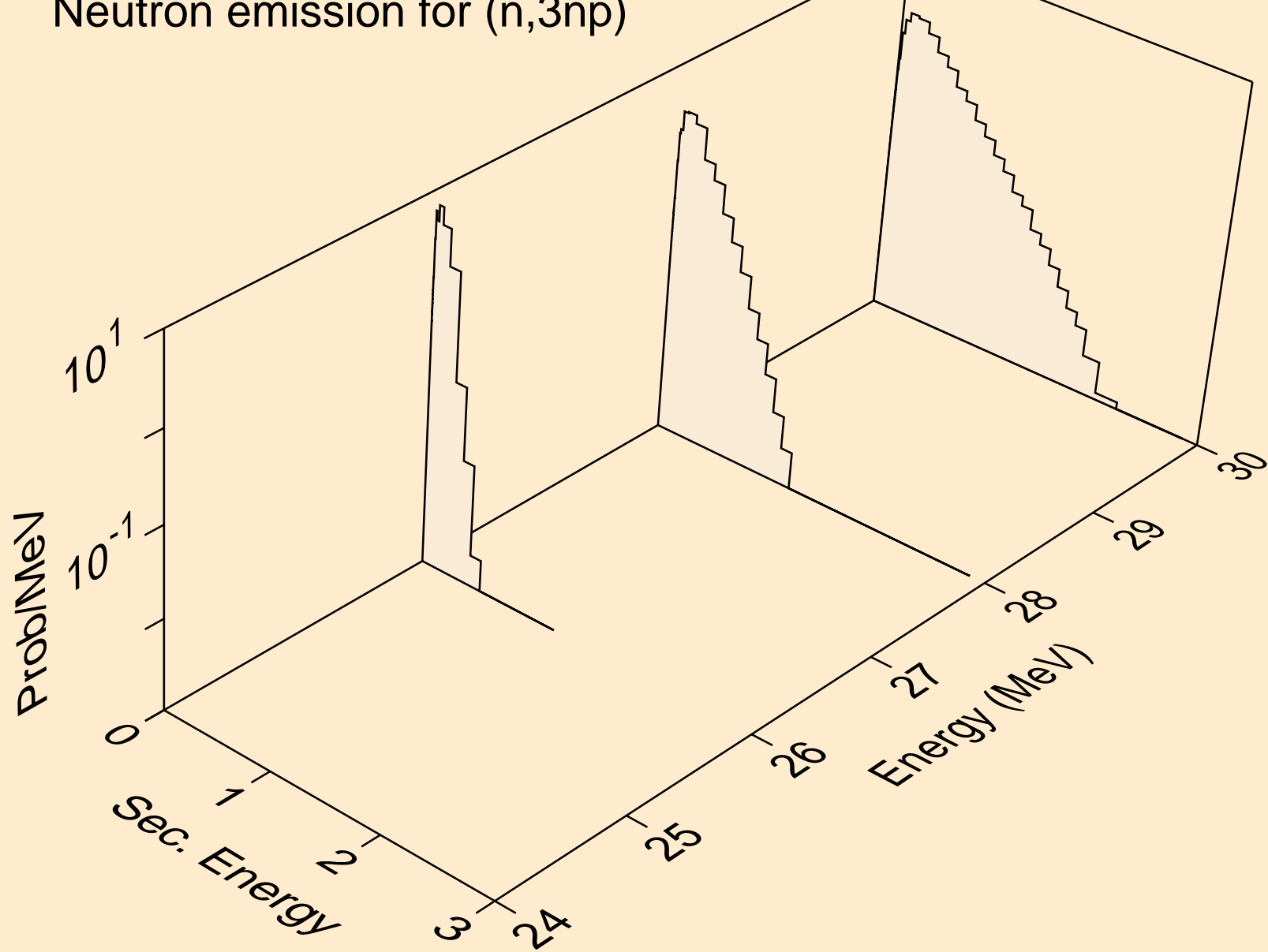

MO103 NEUTRON ACER TENDL-2024 LIBRARY; T=0.K
Neutron emission for (n,n*c)

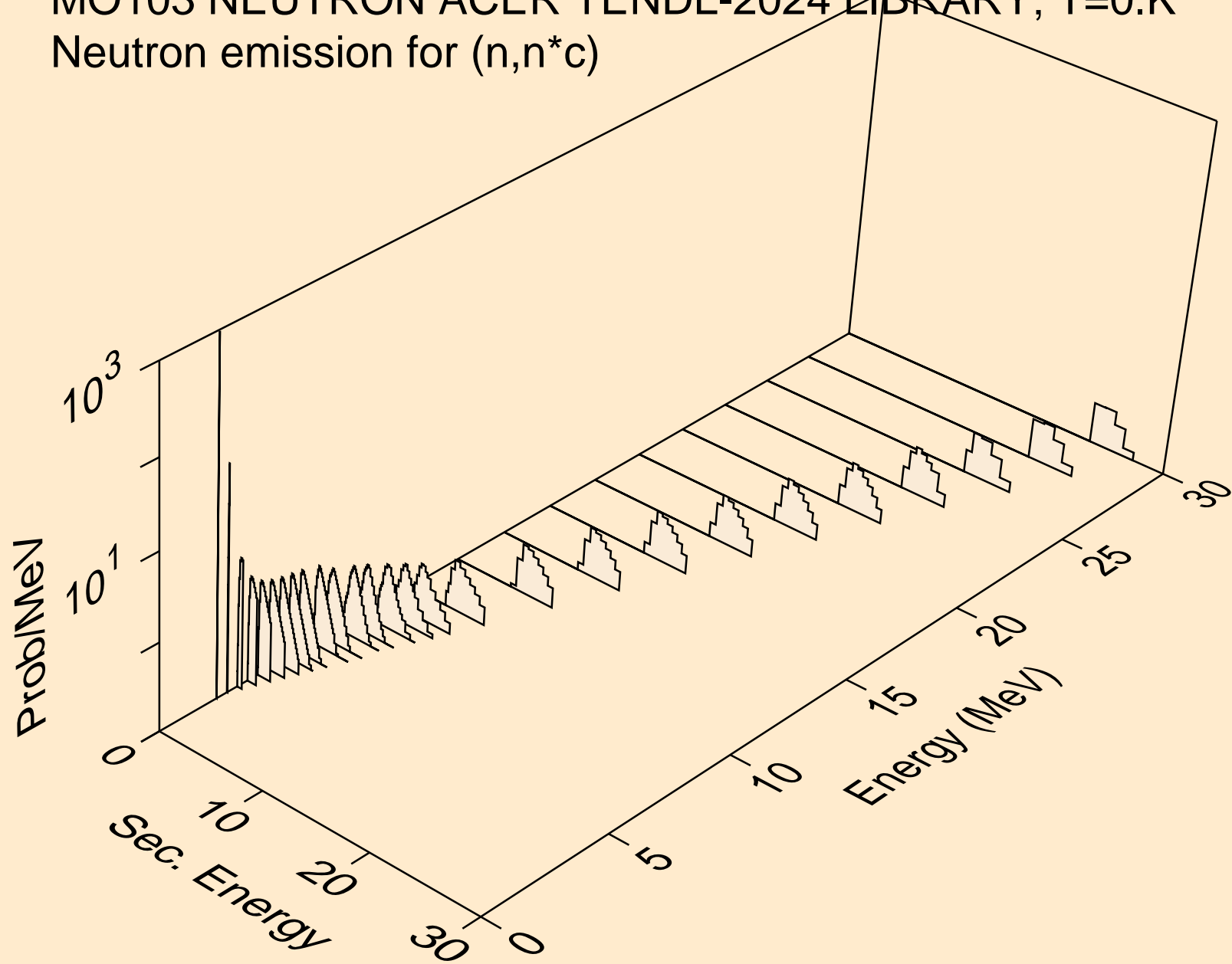

MO103 NEUTRON ACER TENDL-2024 LIBRARY; T=0.K
Photon emission for (n,x)

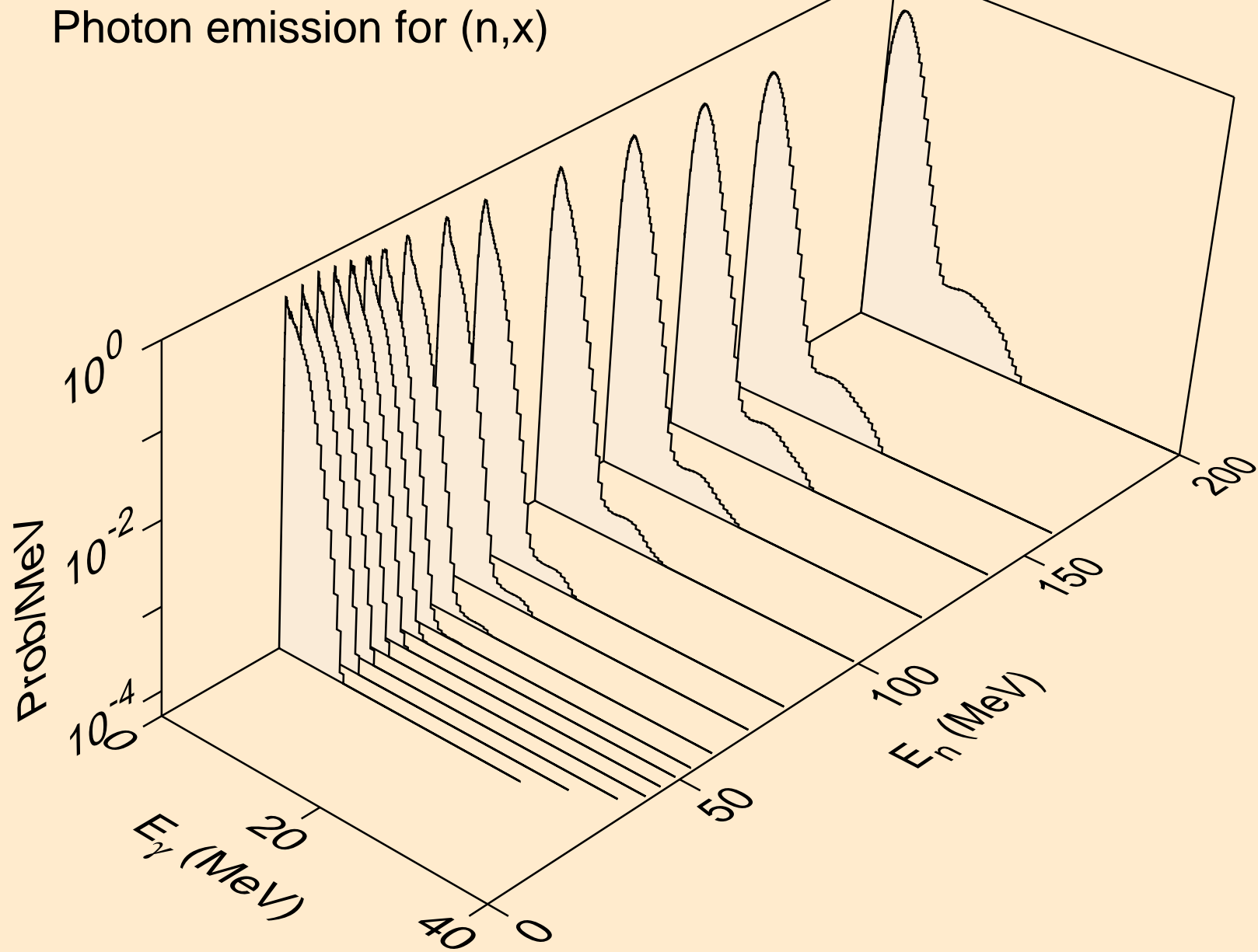

MO103 NEUTRON ACER TENDL-2024 LIBRARY; T=0.K
Photon emission for (n,2nd)

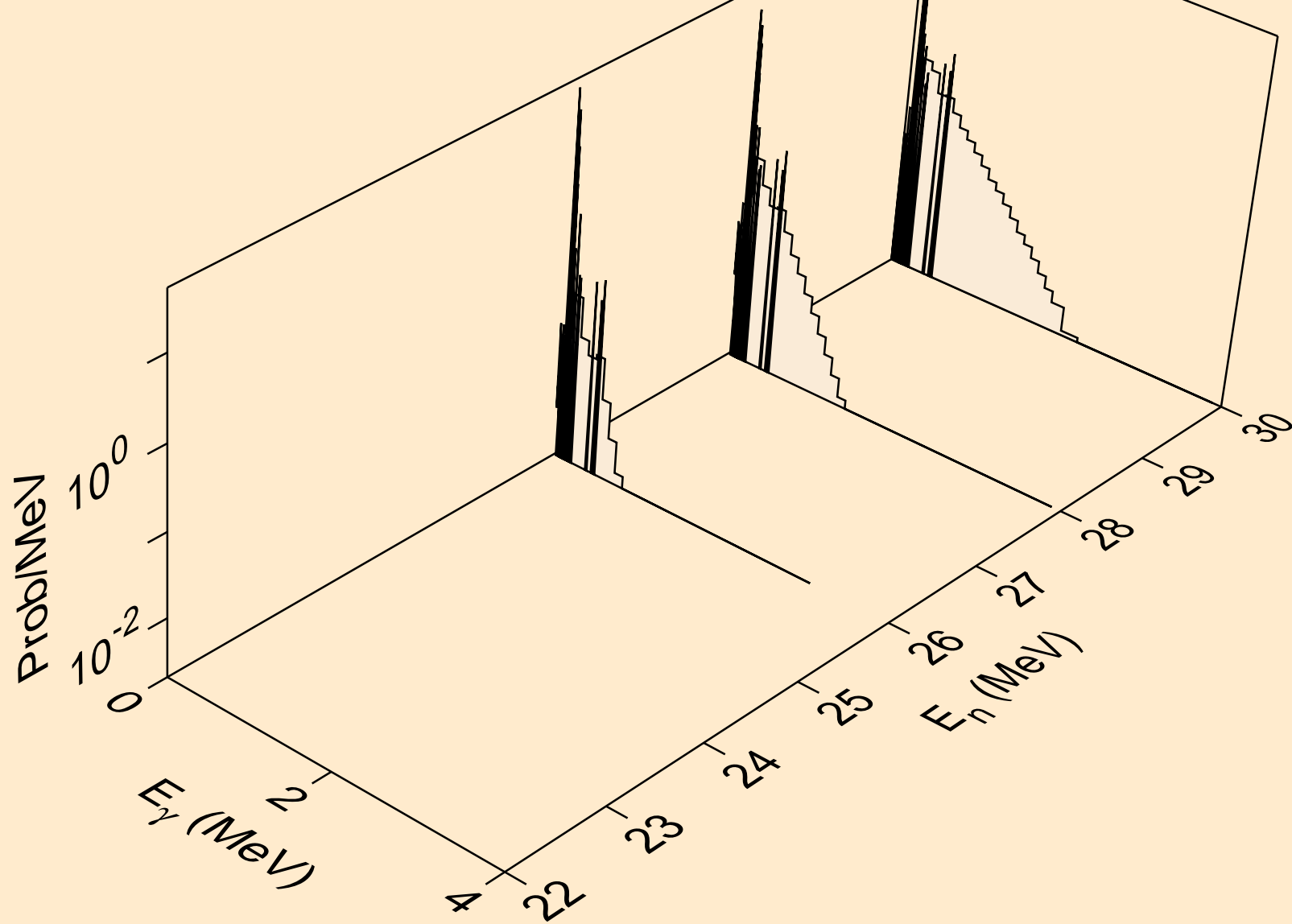

MO103 NEUTRON ACER TENDL-2024 LIBRARY; T=0.K
Photon emission for (n,2n)

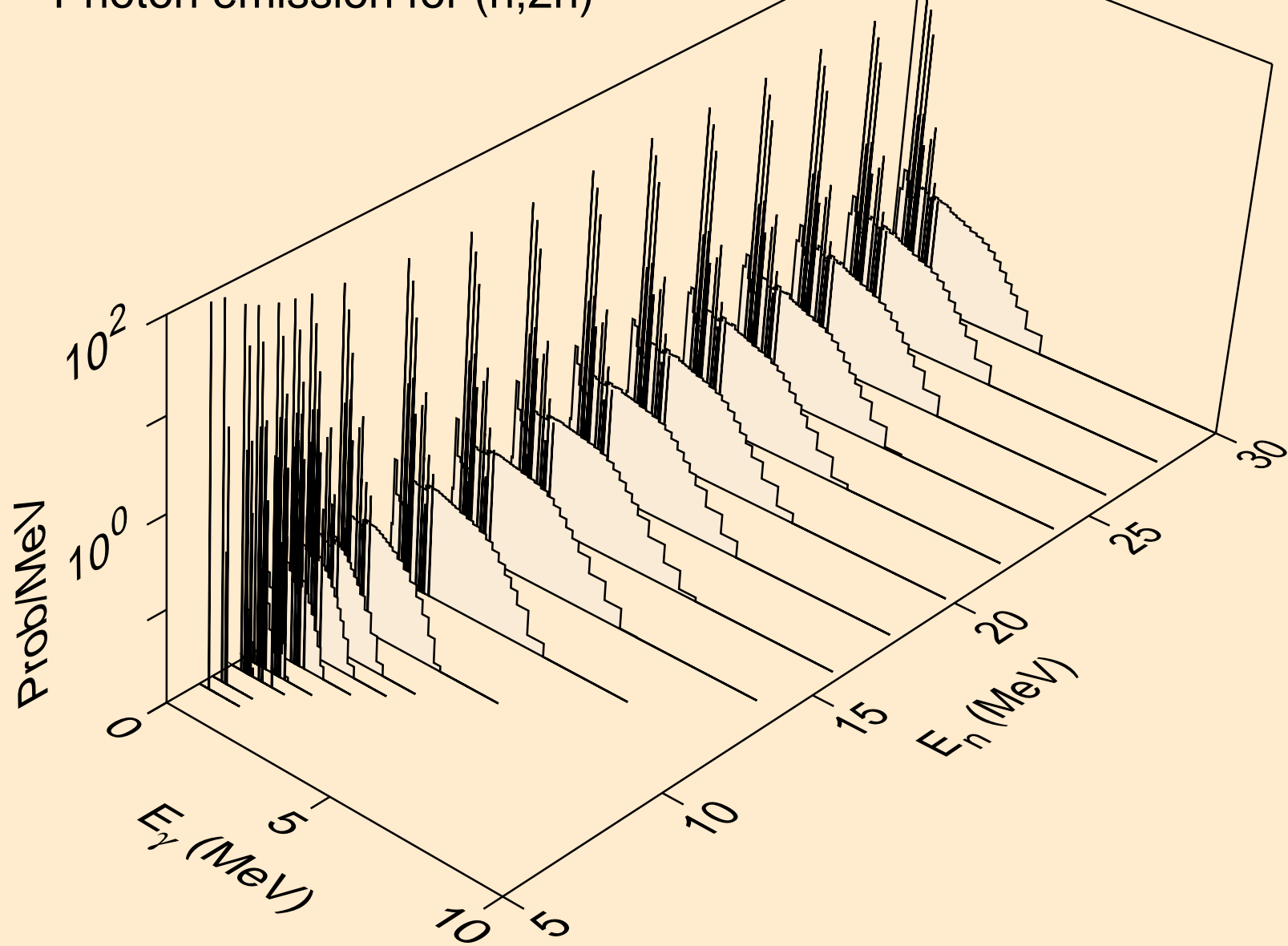

MO103 NEUTRON ACER TENDL-2024 LIBRARY; T=0.K
Photon emission for (n,3n)

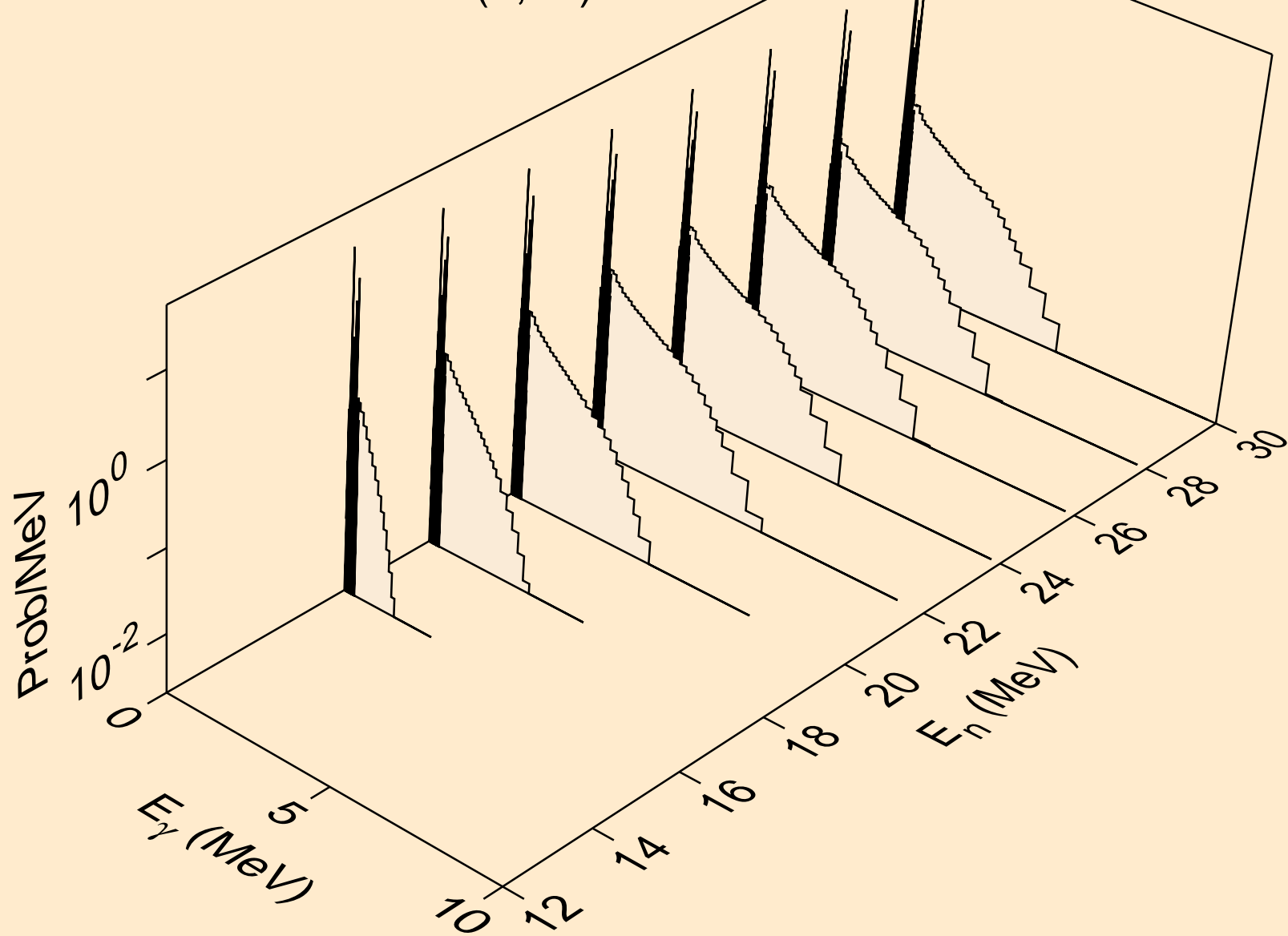

MO103 NEUTRON ACER TENDL-2024 LIBRARY; T=0.K
Photon emission for (n,n*)a

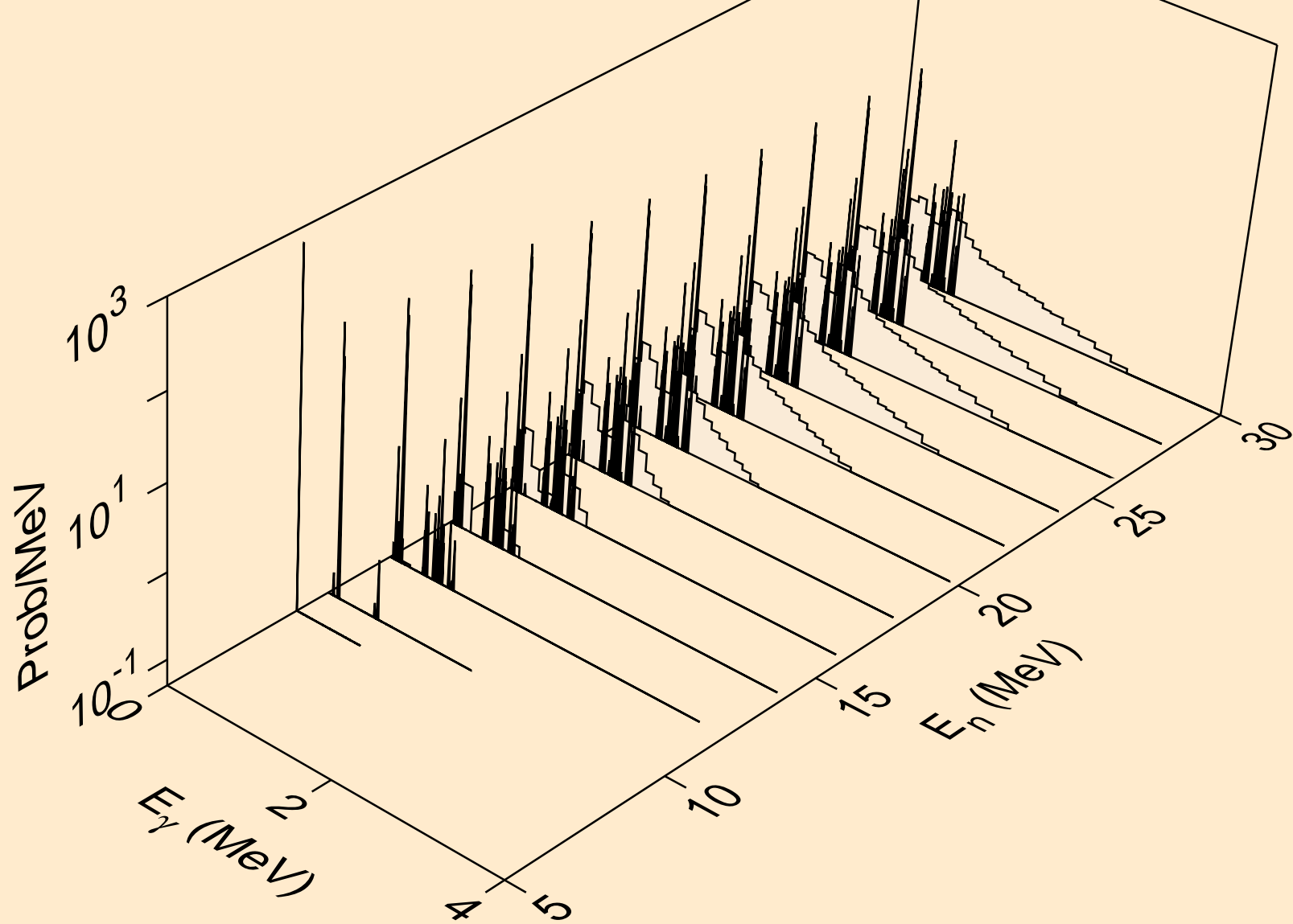

MO103 NEUTRON ACER TENDL-2024 LIBRARY; T=0.K
Photon emission for (n,2n)a

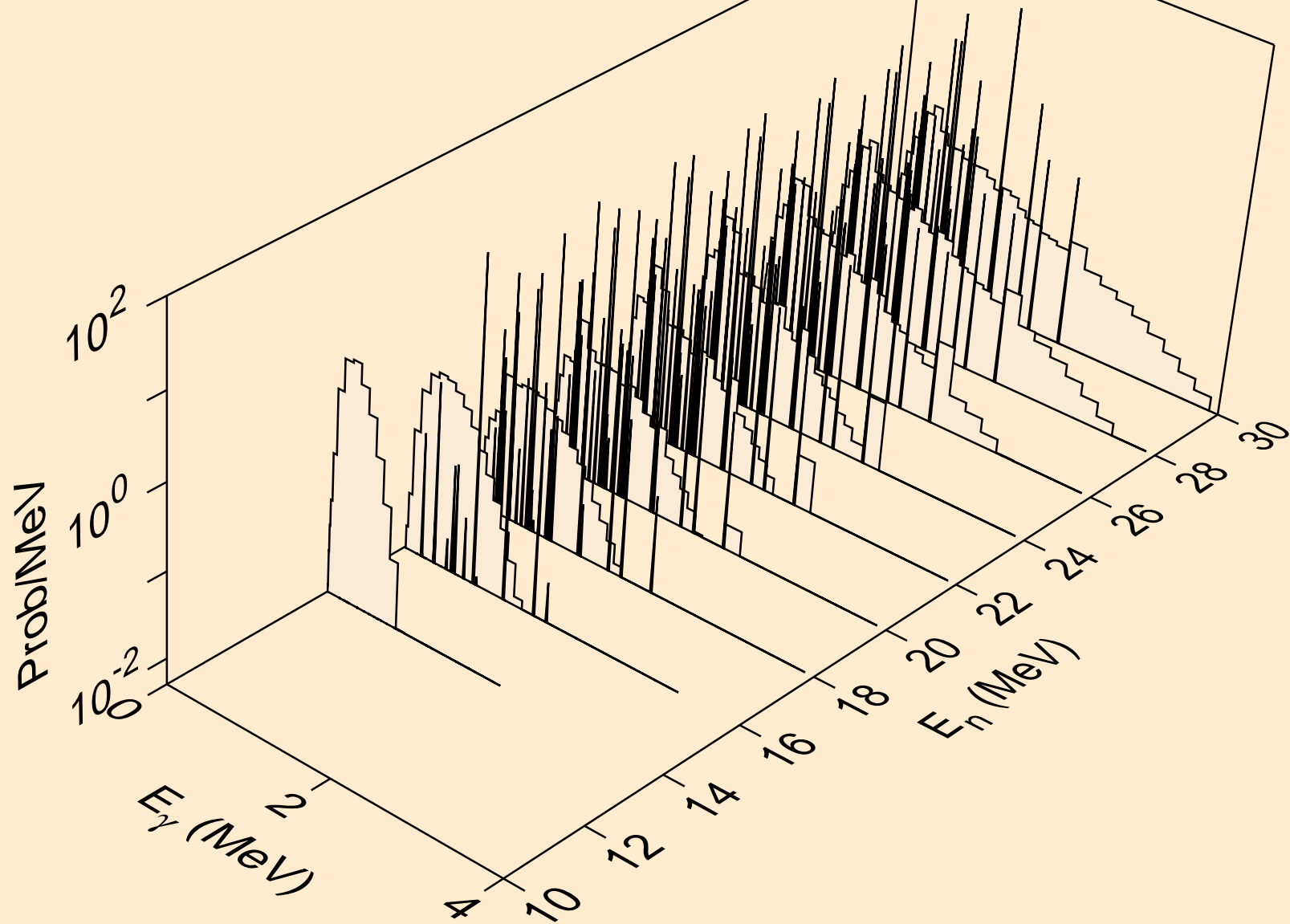

MO103 NEUTRON ACER TENDL-2024 LIBRARY; T=0.K
Photon emission for (n,3n)a

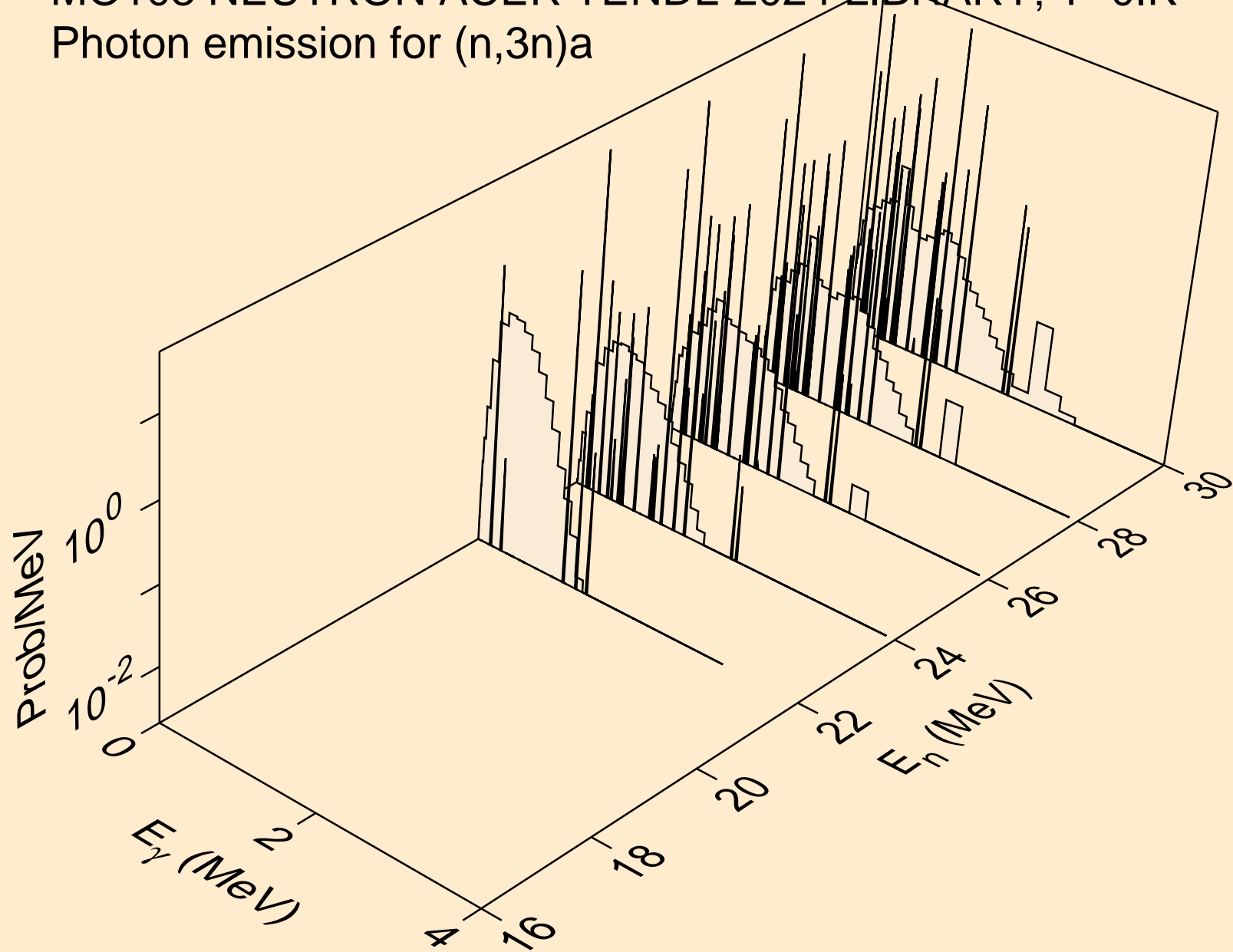

MO103 NEUTRON ACER TENDL-2024 LIBRARY; T=0.K
Photon emission for (n,n*)p

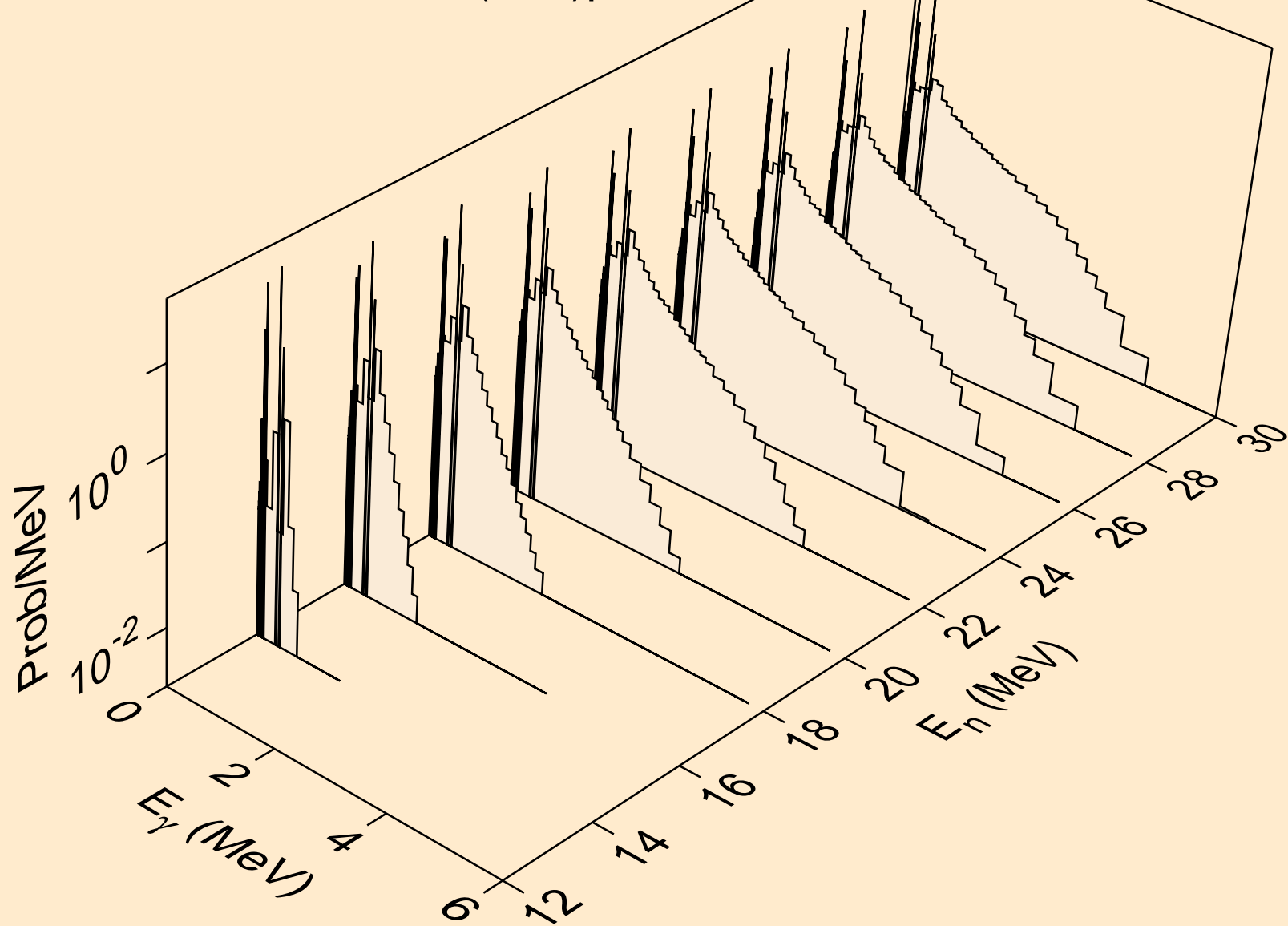

MO103 NEUTRON ACER TENDL-2024 LIBRARY; T=0.K
Photon emission for (n,n*)d

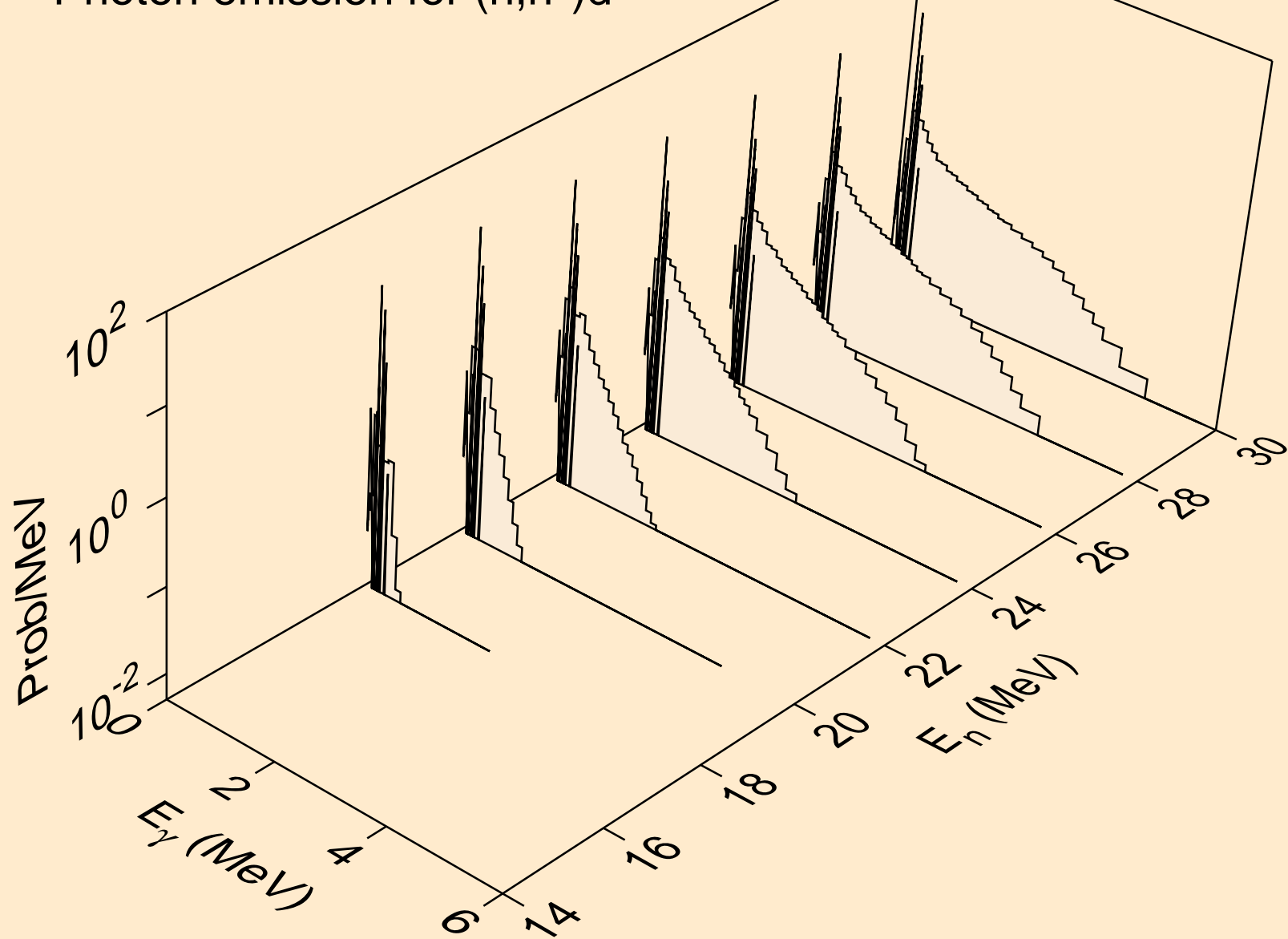

MO103 NEUTRON ACER TENDL-2024 LIBRARY; T=0.K
Photon emission for (n,n*)t

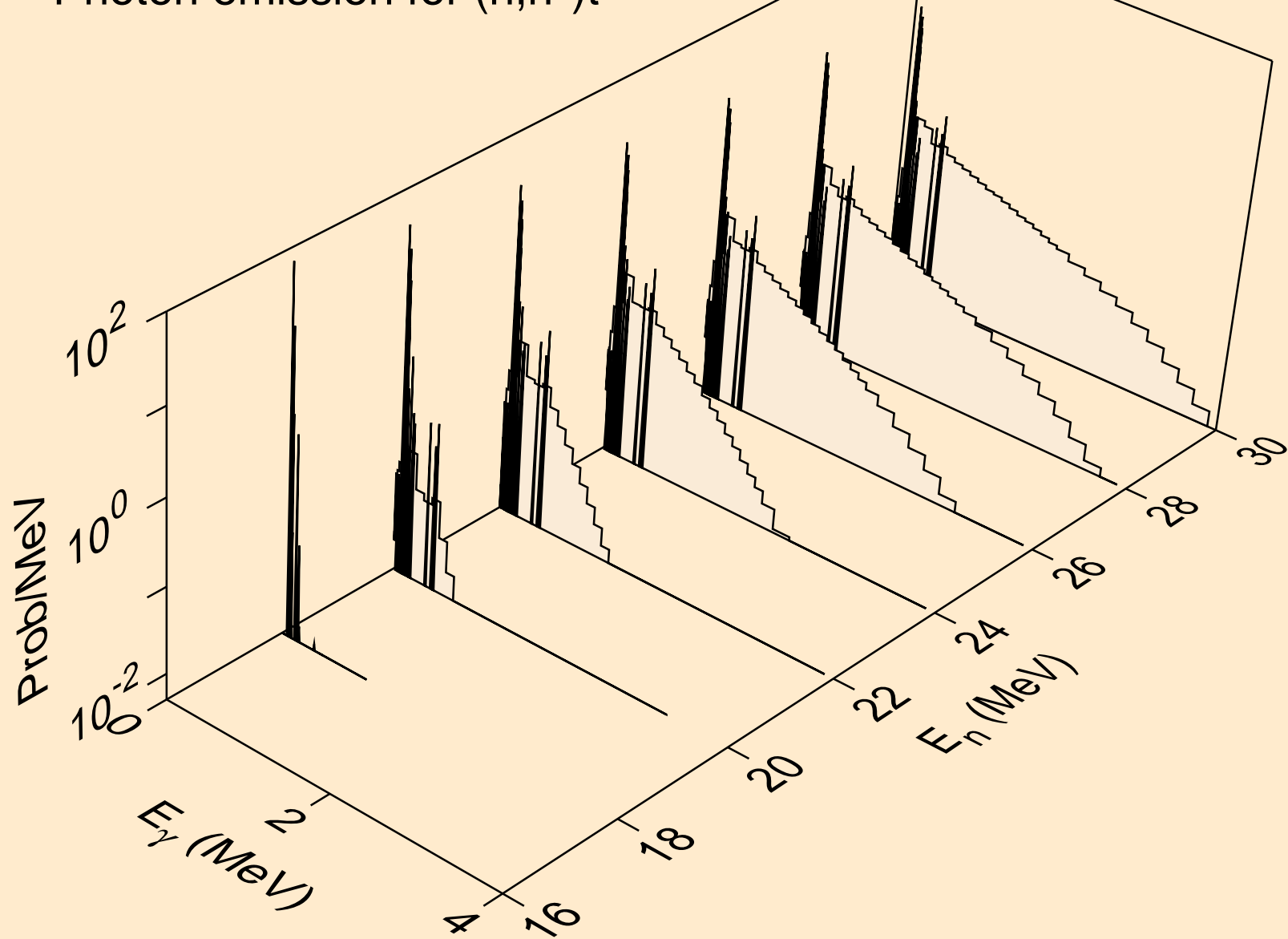

MO103 NEUTRON ACER TENDL-2024 LIBRARY; T=0.K
Photon emission for (n,n*)he3

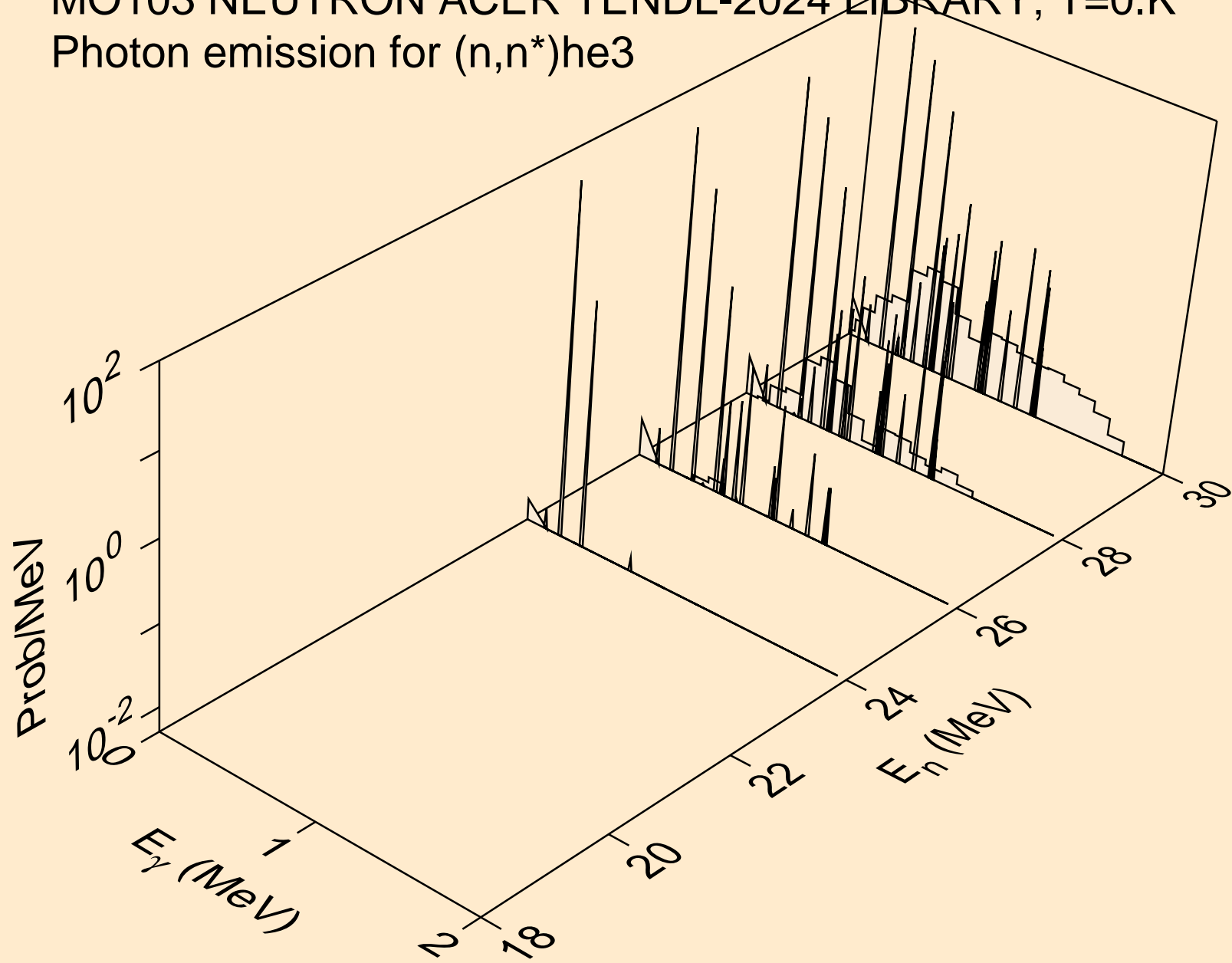

MO103 NEUTRON ACER TENDL-2024 LIBRARY; T=0.K
Photon emission for (n,4n)

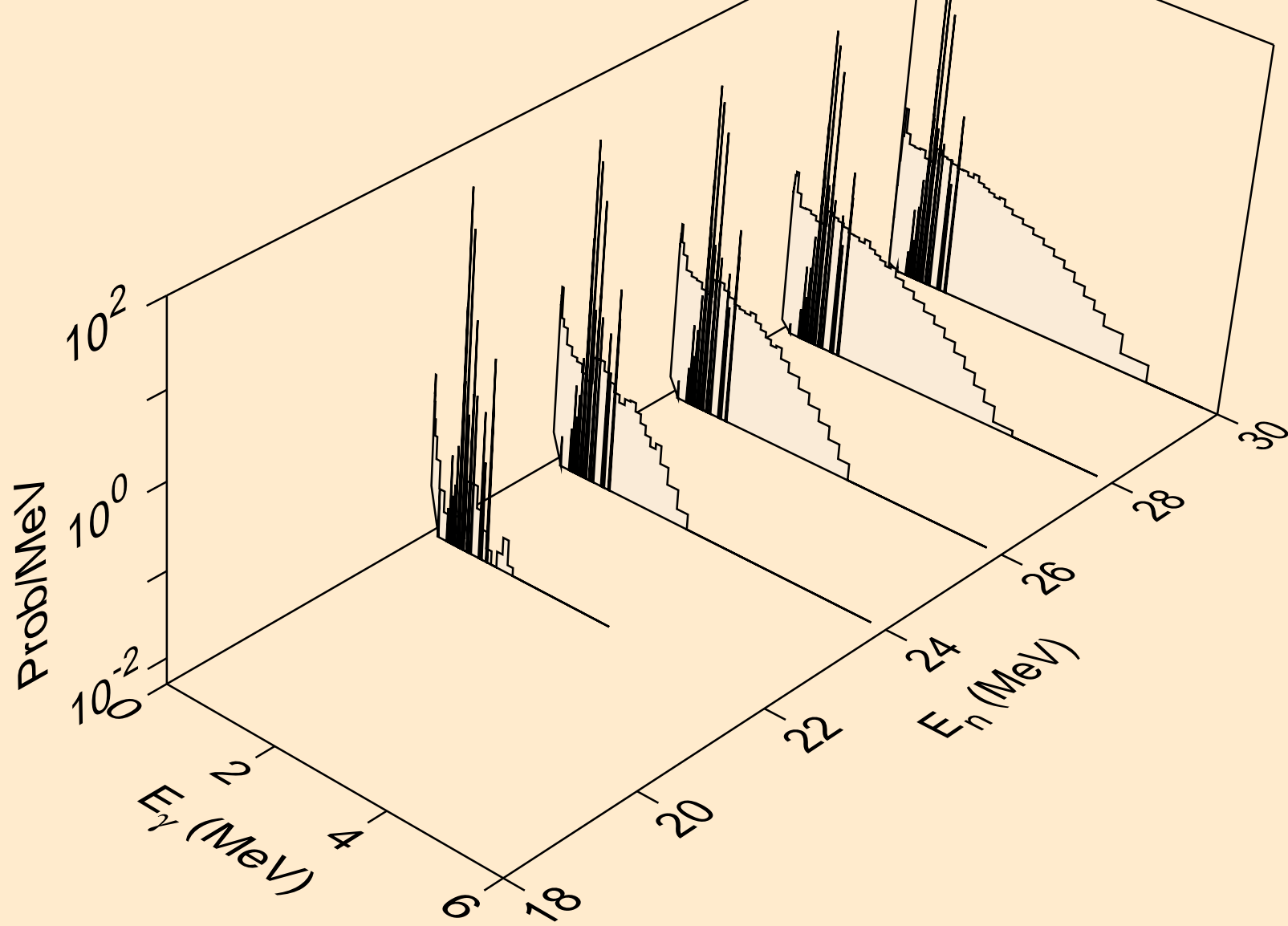

MO103 NEUTRON ACER TENDL-2024 LIBRARY; T=0.K
Photon emission for (n,2np)

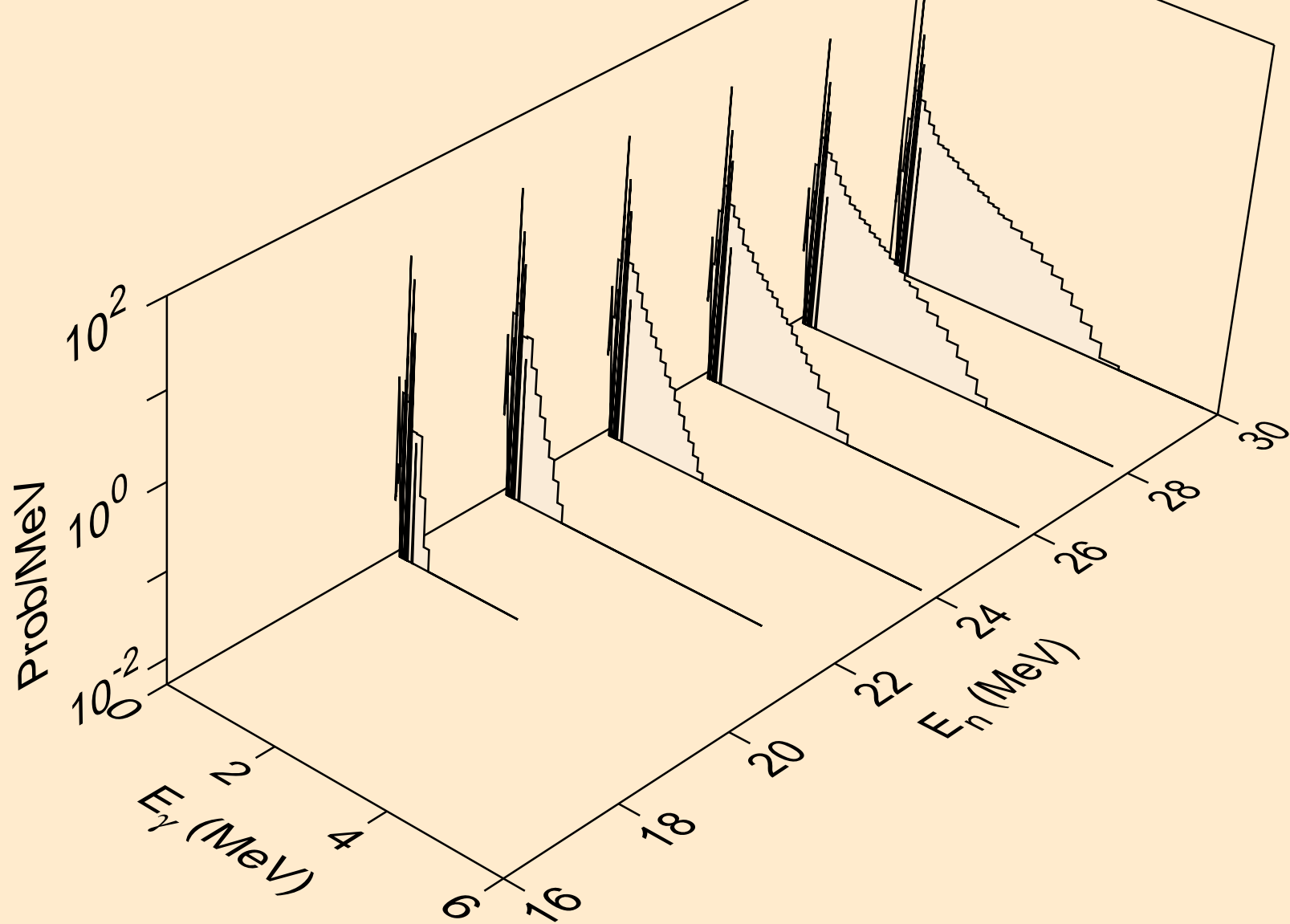

MO103 NEUTRON ACER TENDL-2024 LIBRARY; T=0.K
Photon emission for (n,3np)

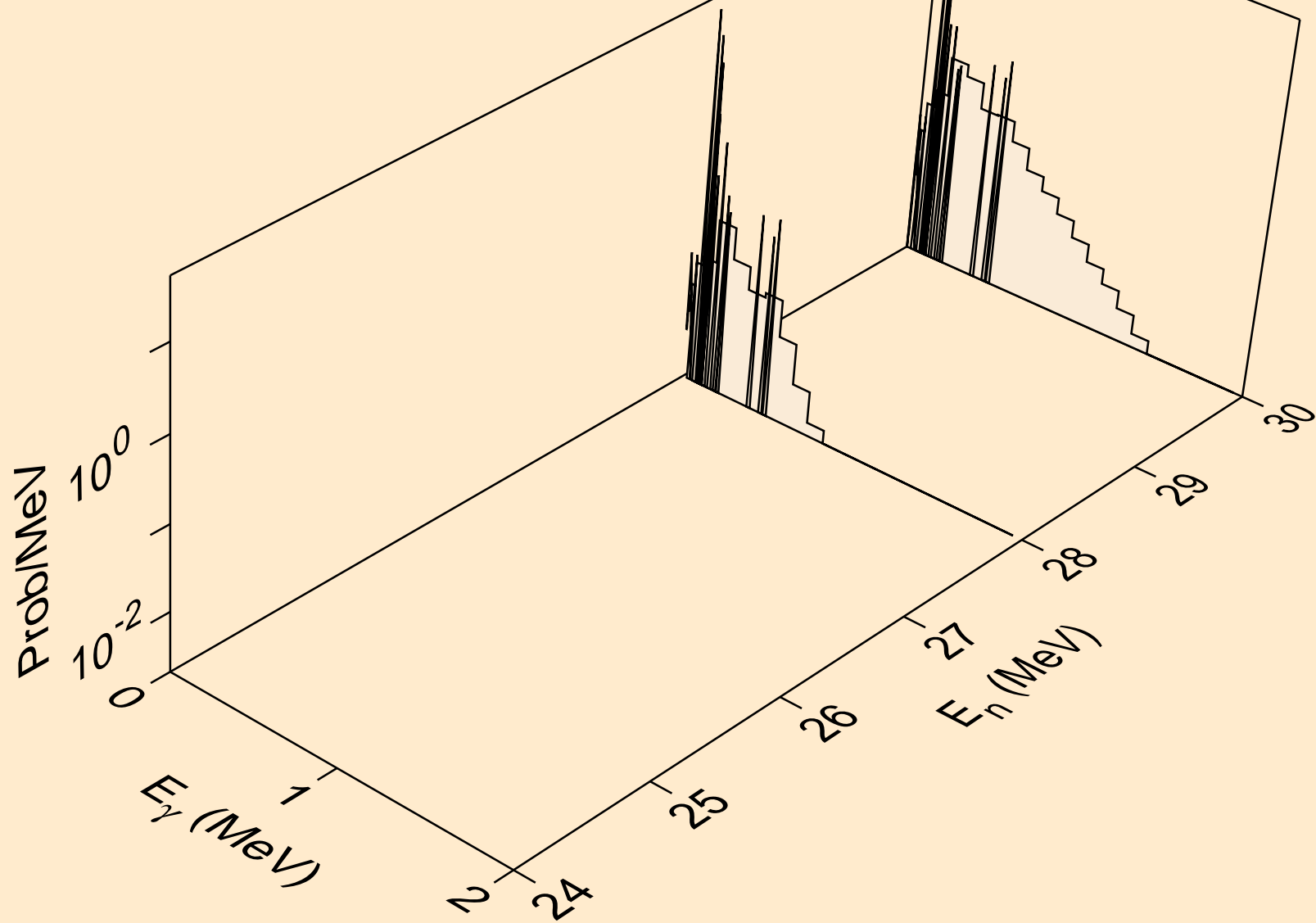

MO103 NEUTRON ACER TENDL-2024 LIBRARY; T=0.K
Photon emission for (n,n*c)

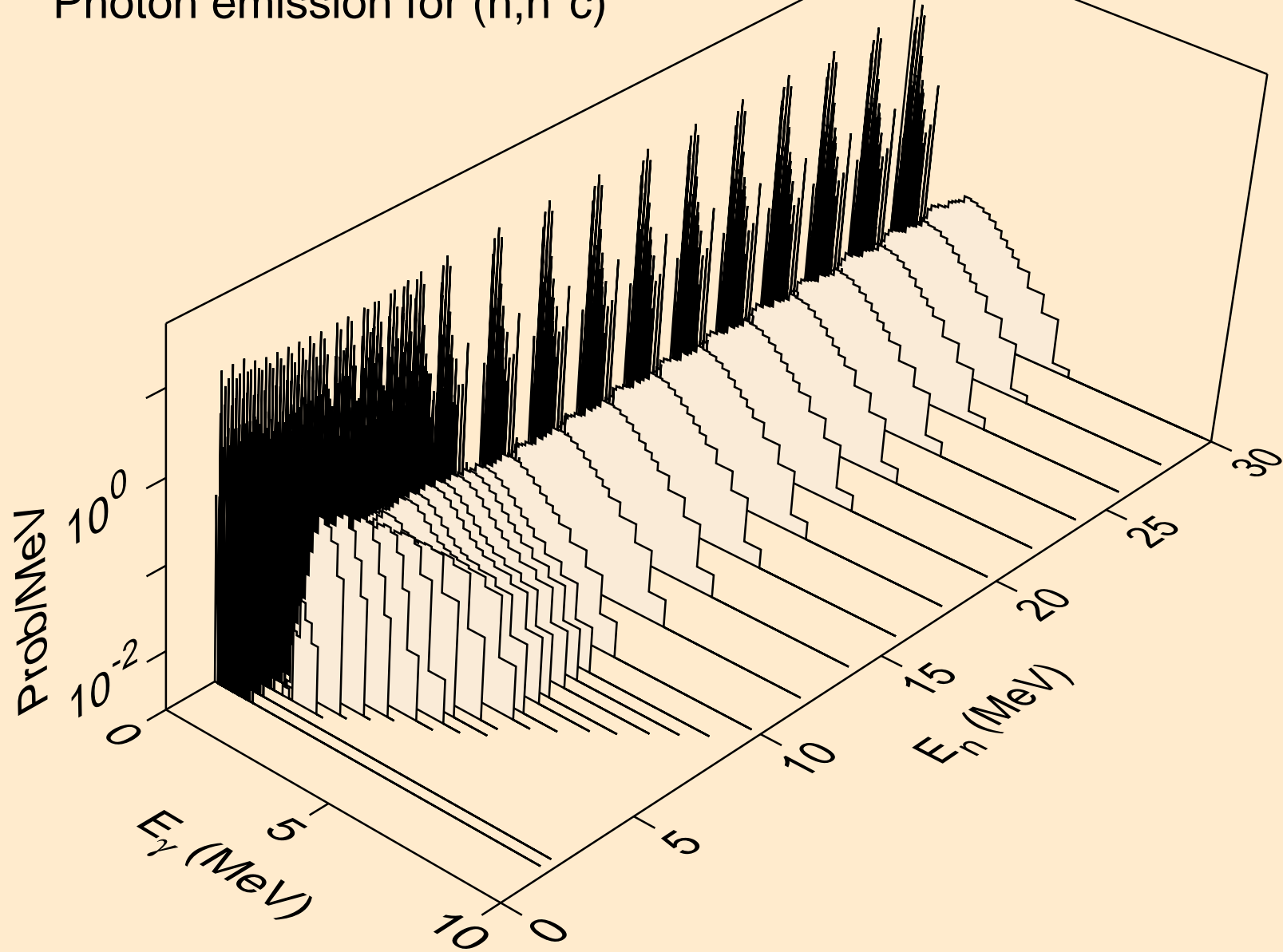

MO103 NEUTRON ACER TENDL-2024 LIBRARY; T=0.K
Photon emission for (n,gma)

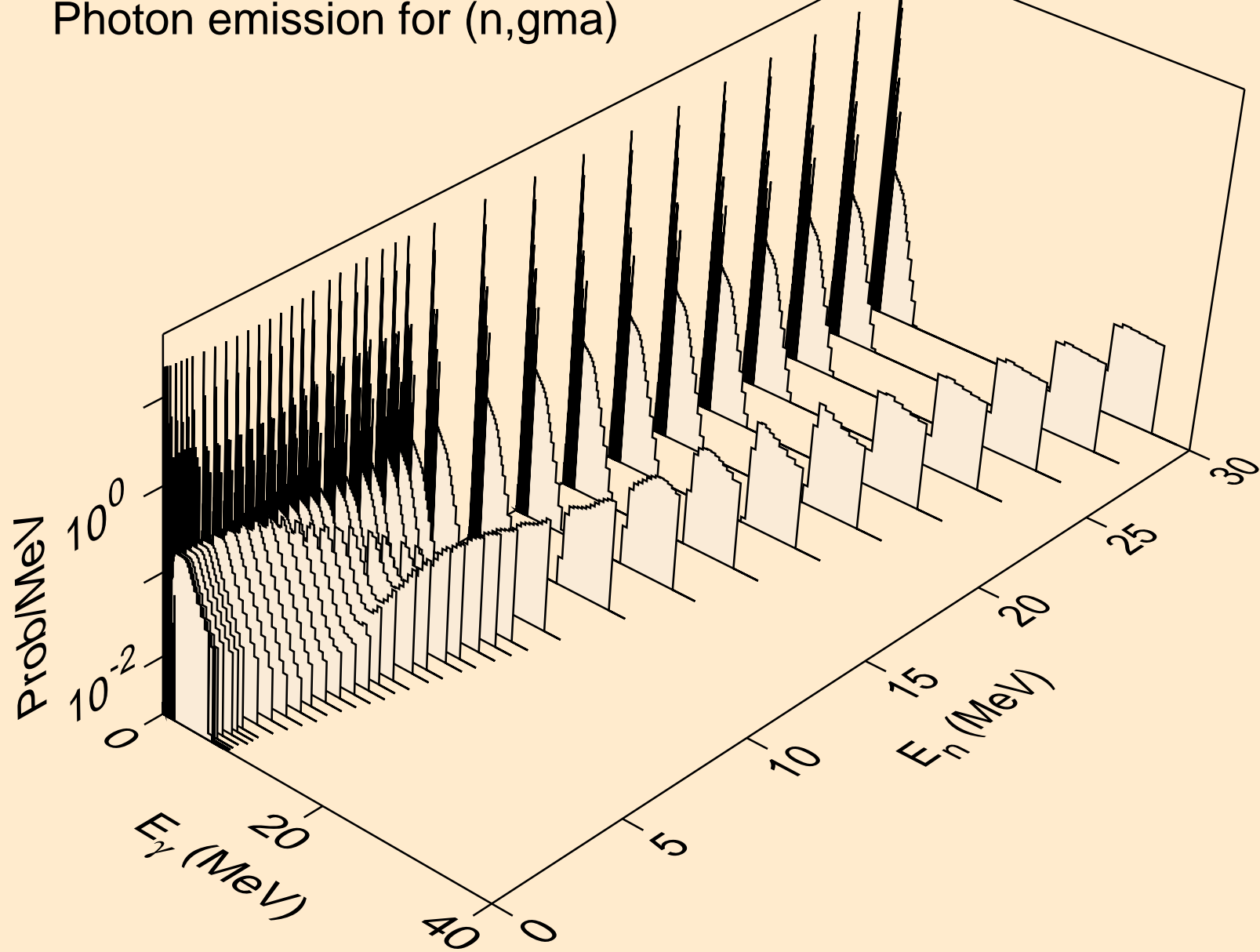

MO103 NEUTRON ACER TENDL-2024 LIBRARY; T=0.K
Photon emission for (n,p)

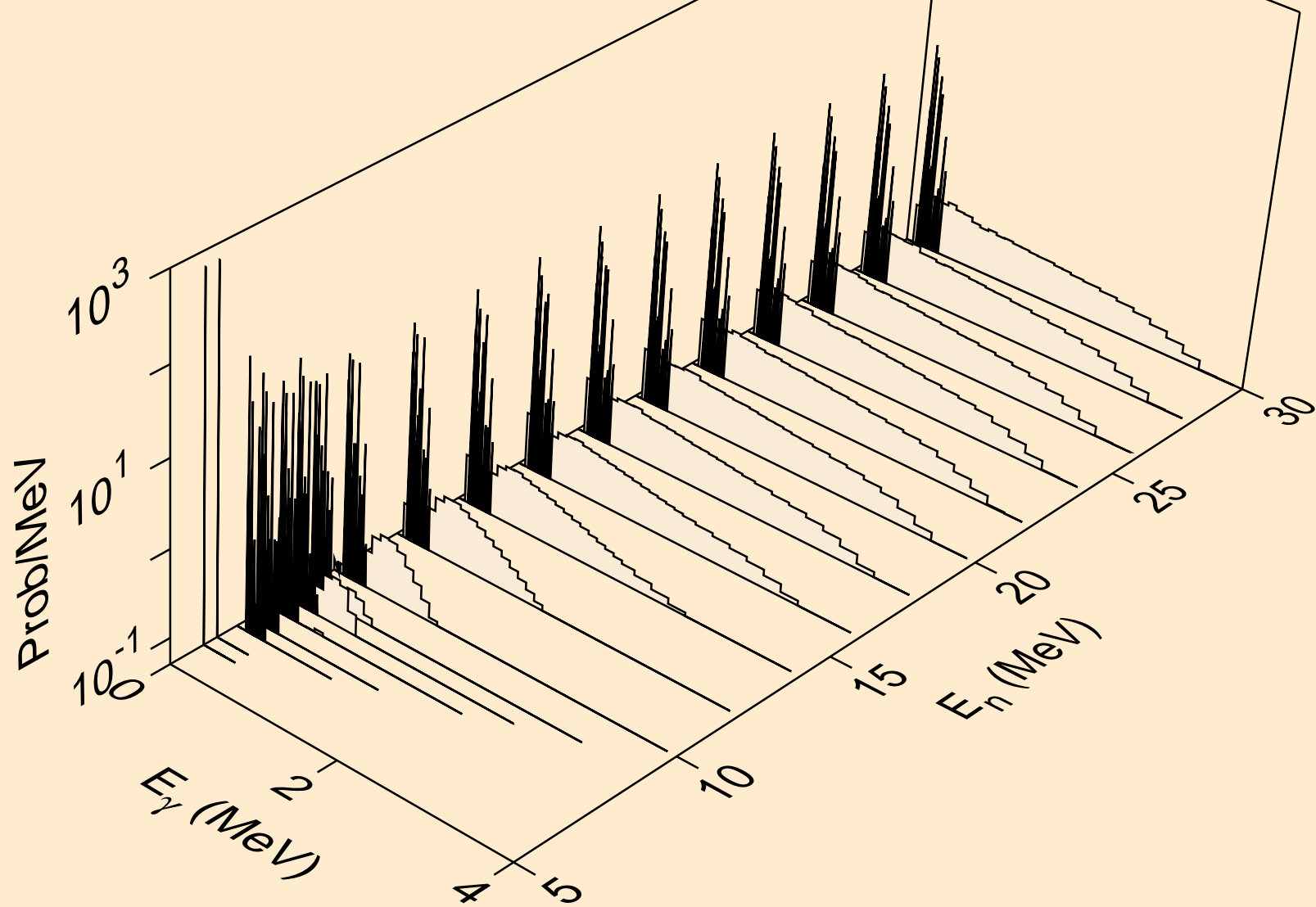

MO103 NEUTRON ACER TENDL-2024 LIBRARY; T=0.K
Photon emission for (n,d)

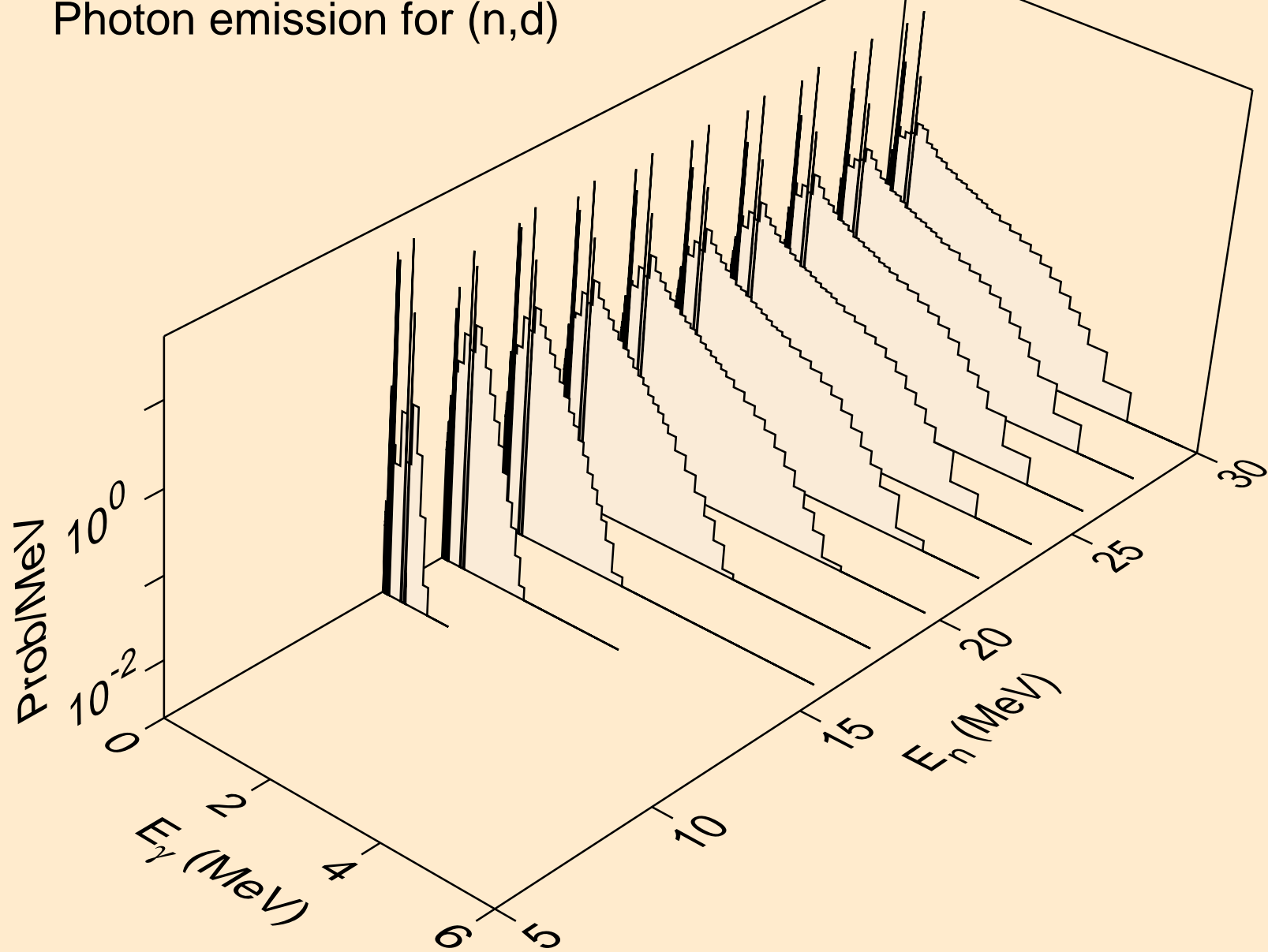

MO103 NEUTRON ACER TENDL-2024 LIBRARY; T=0.K
Photon emission for (n,t)

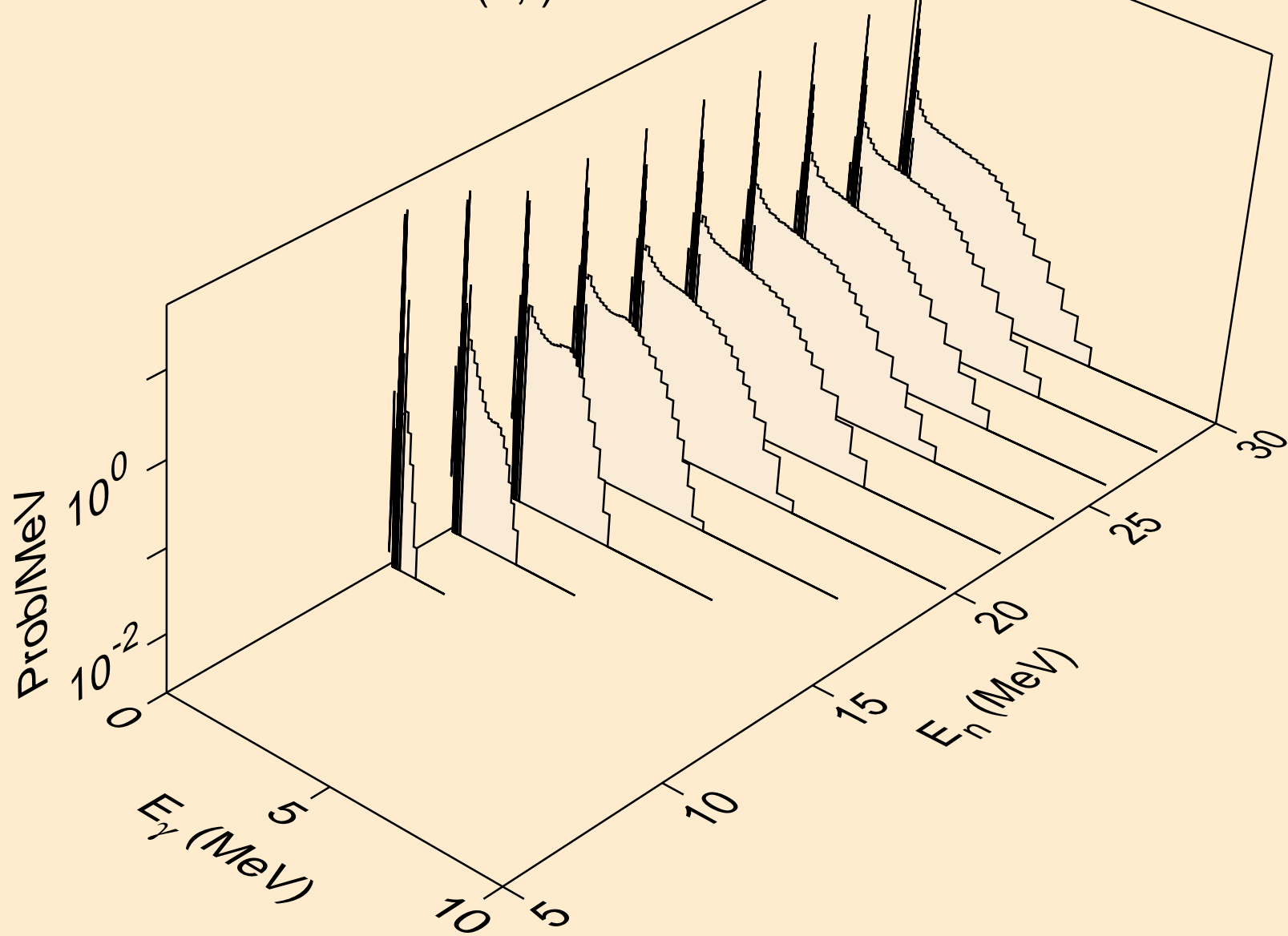

MO103 NEUTRON ACER TENDL-2024 LIBRARY; T=0.K
Photon emission for (n,he3)

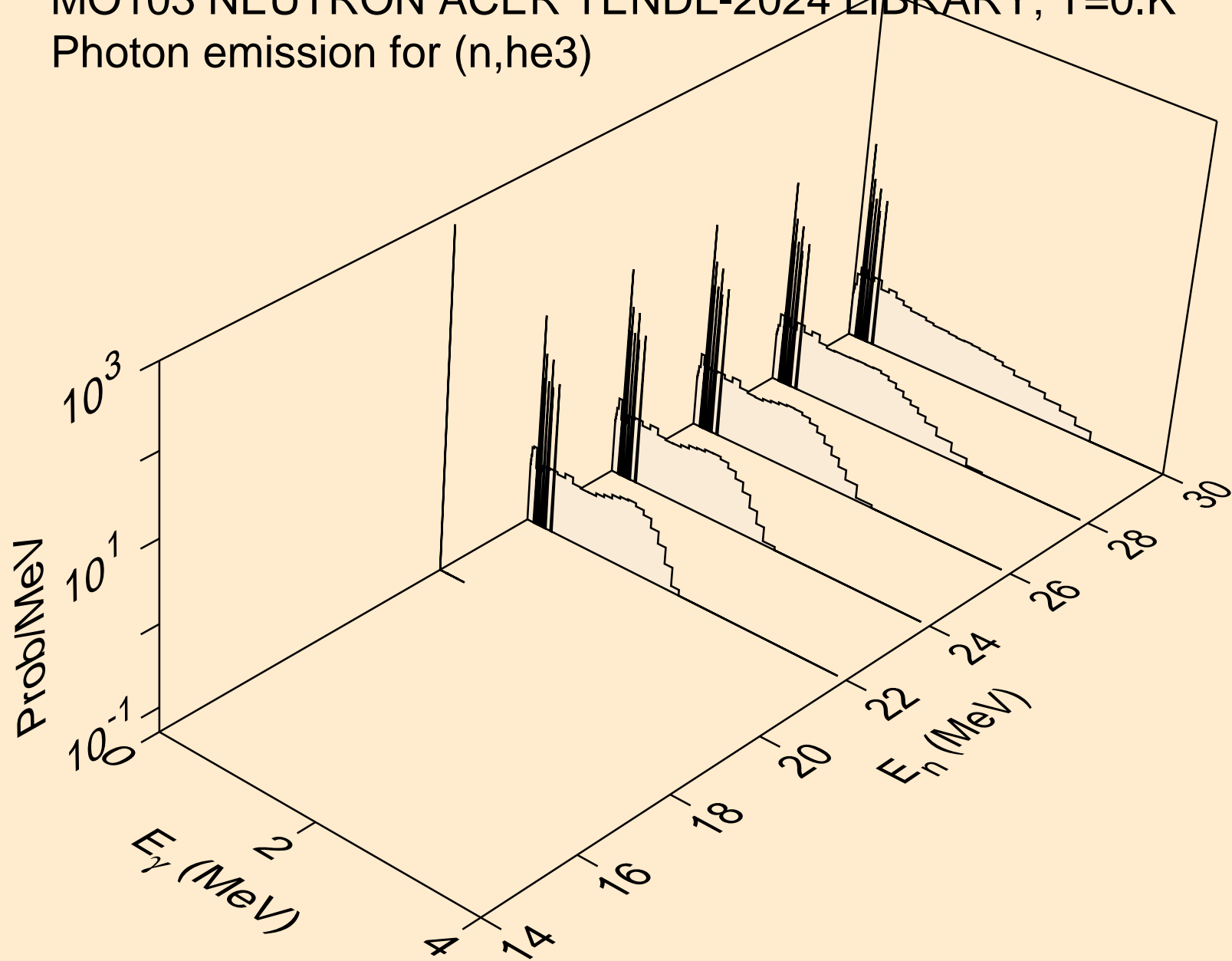

MO103 NEUTRON ACER TENDL-2024 LIBRARY; T=0.K
Photon emission for (n,a)

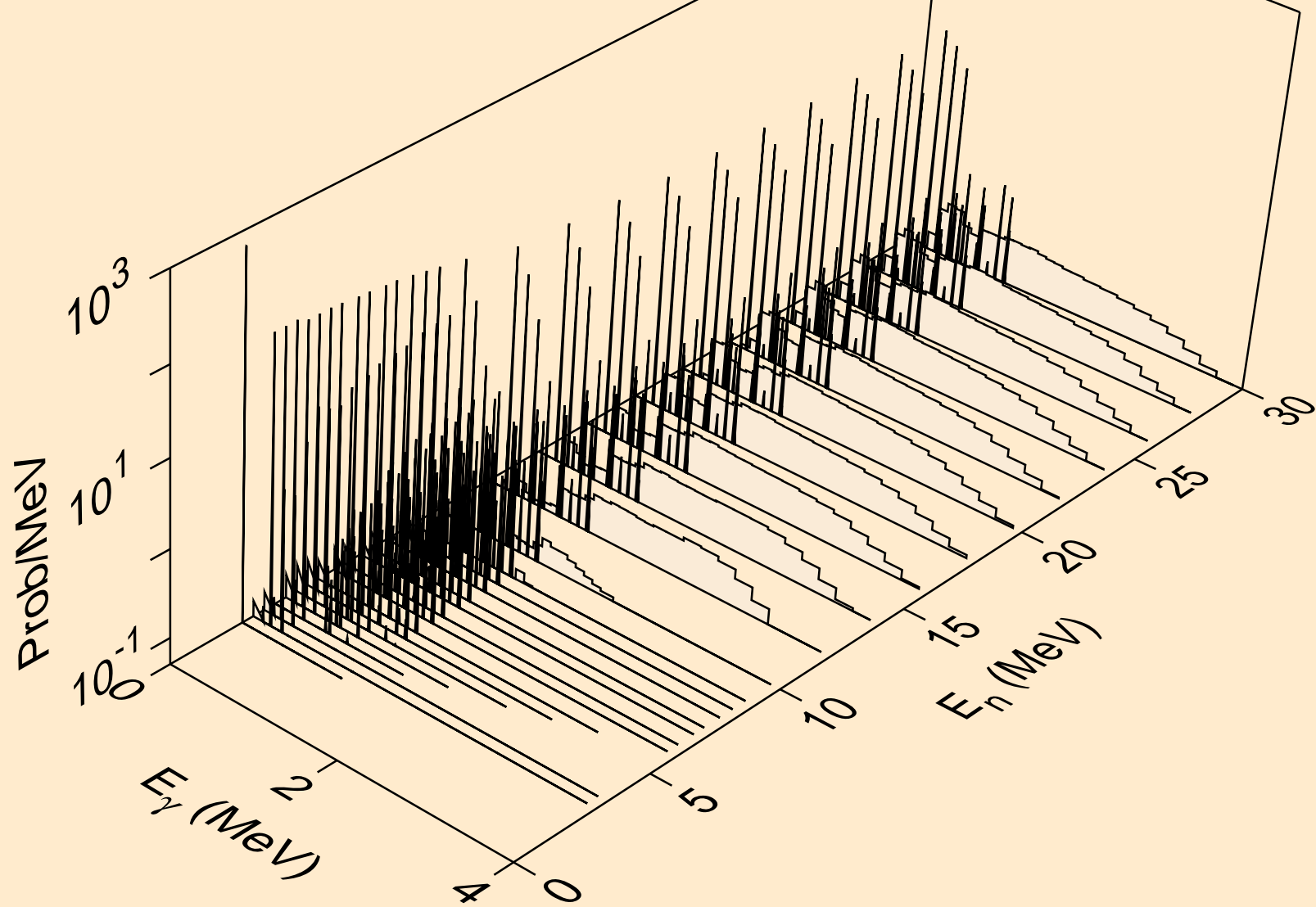

MO103 NEUTRON ACER TENDL-2024 LIBRARY; T=0.K
Photon emission for (n,2p)

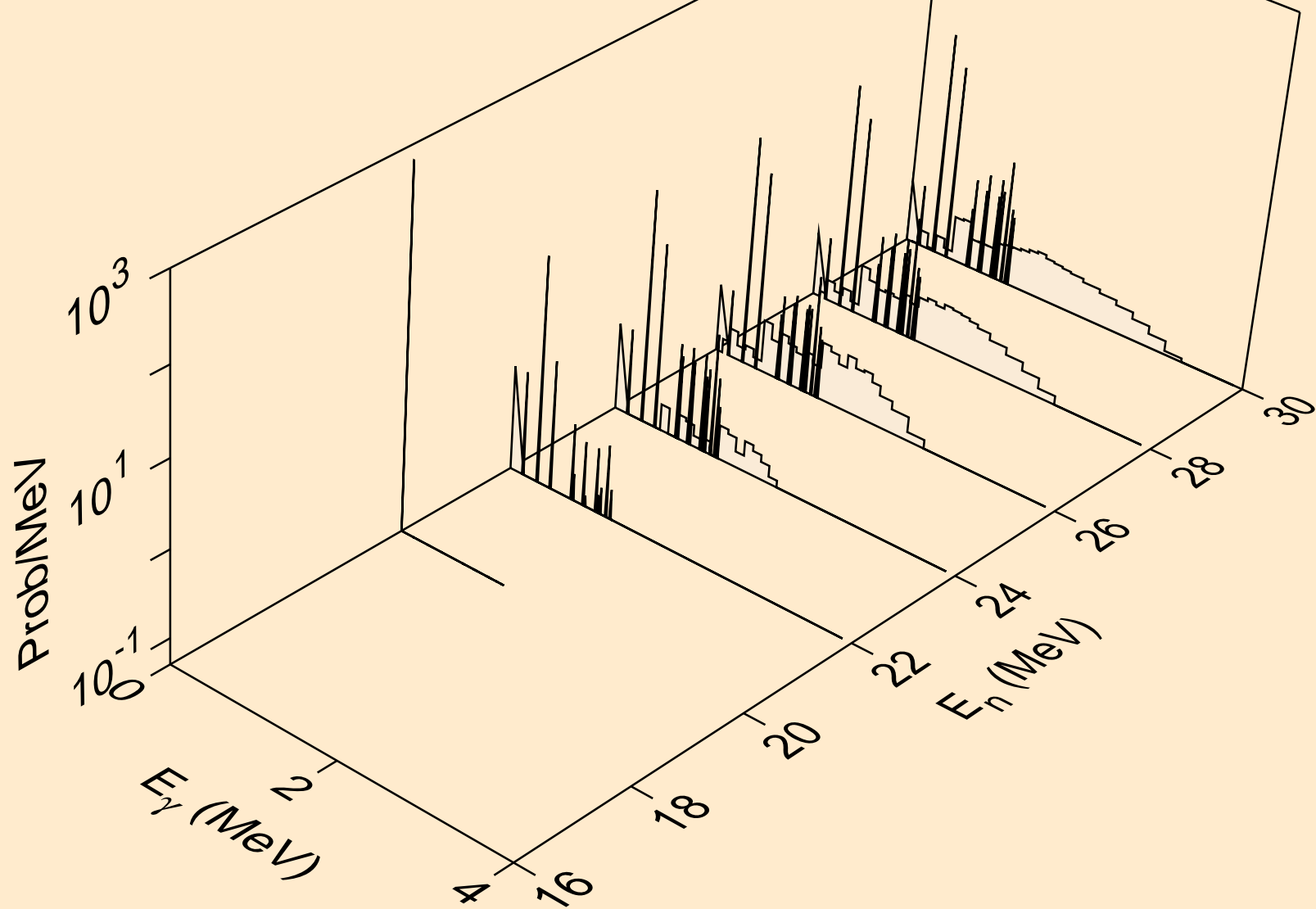

MO103 NEUTRON ACER TENDL-2024 LIBRARY; T=0.K
thermal capture photon spectrum

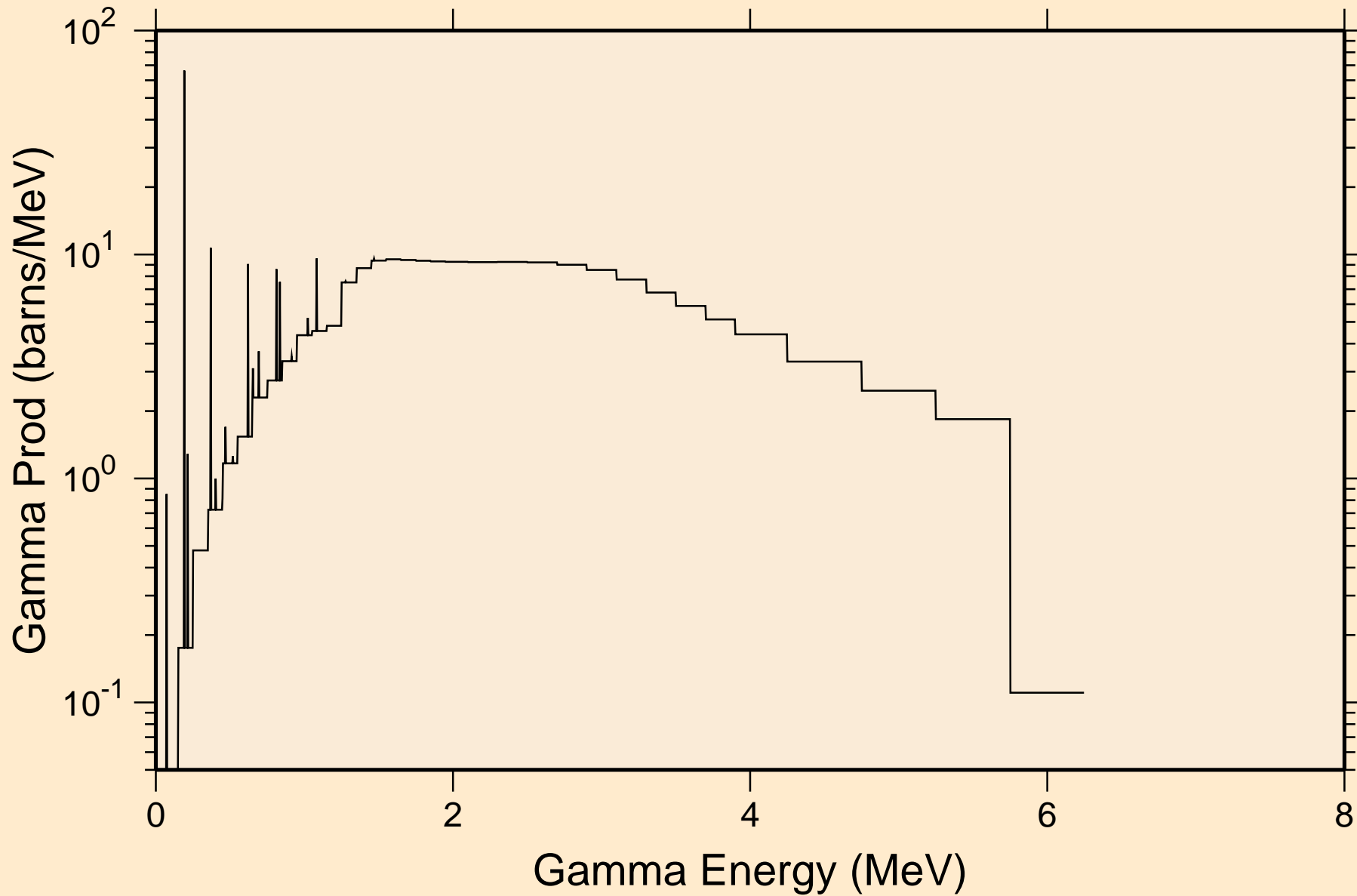

MO103 NEUTRON ACER TENDL-2024 LIBRARY; T=0.K
14 MeV photon spectrum

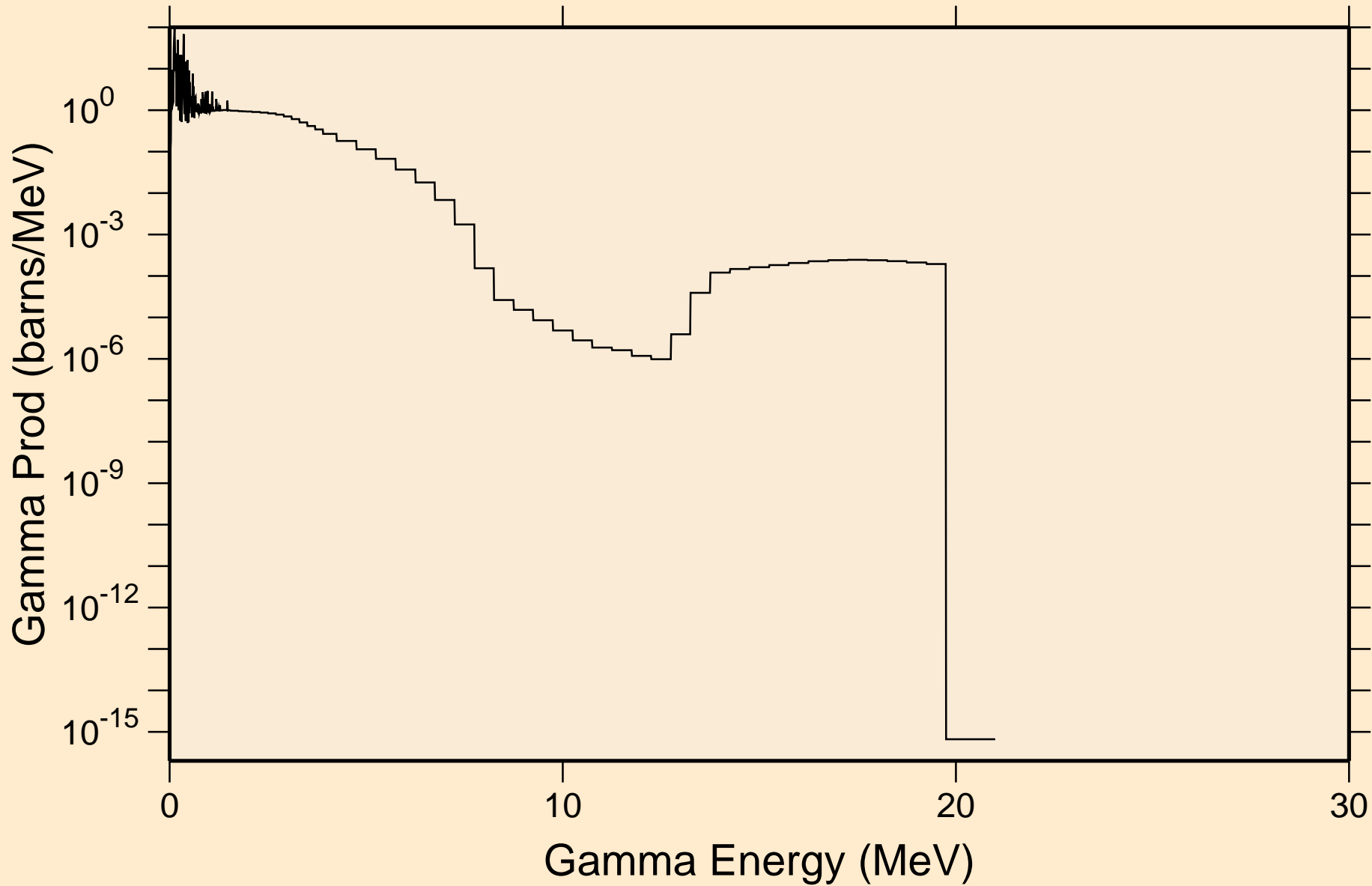

MO103 NEUTRON ACER TENDL-2024 LIBRARY; T=0.K

Particle heating contributions

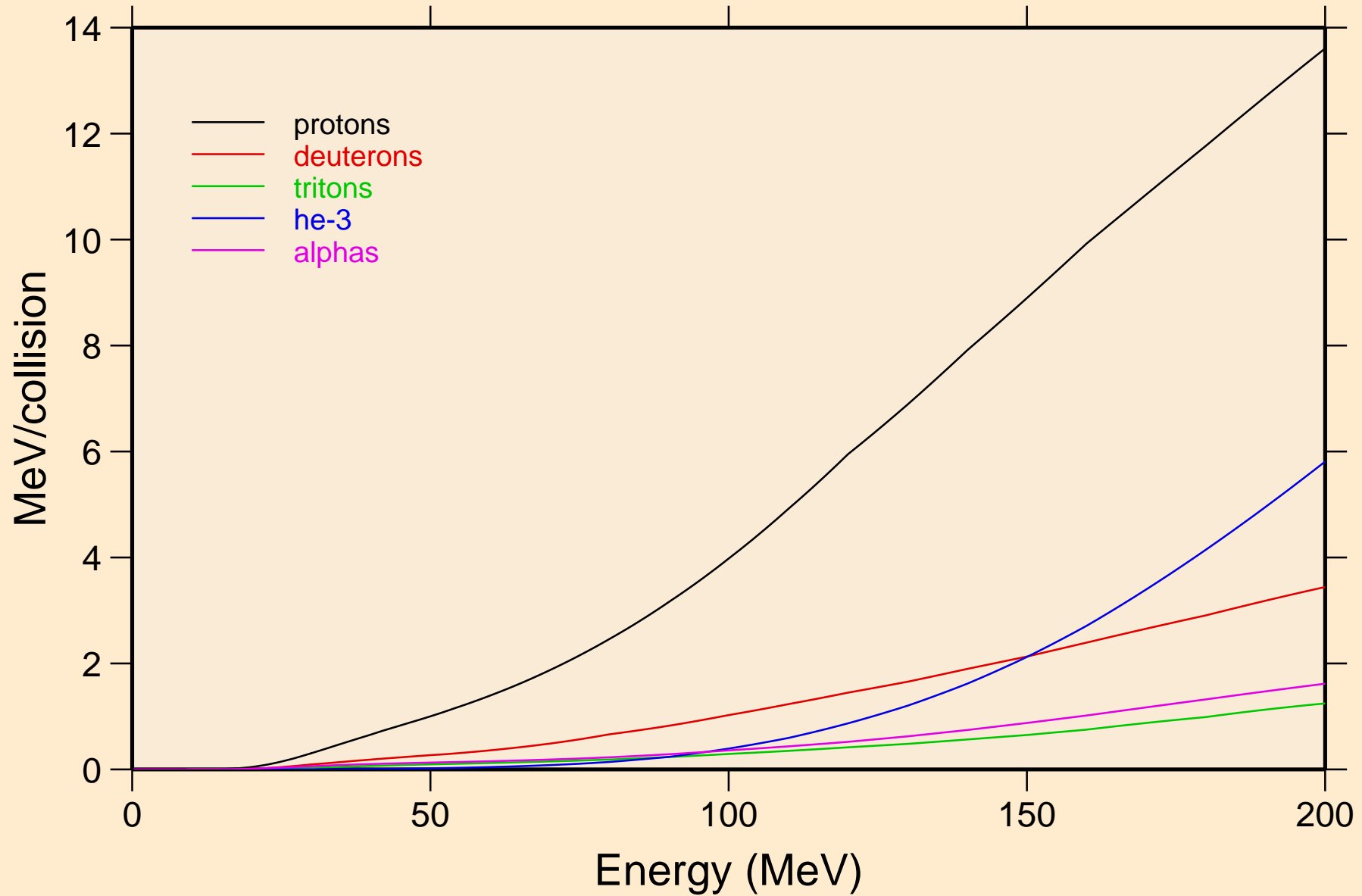

MO103 NEUTRON ACER TENDL-2024 LIBRARY; T=0.K
Recoil Heating

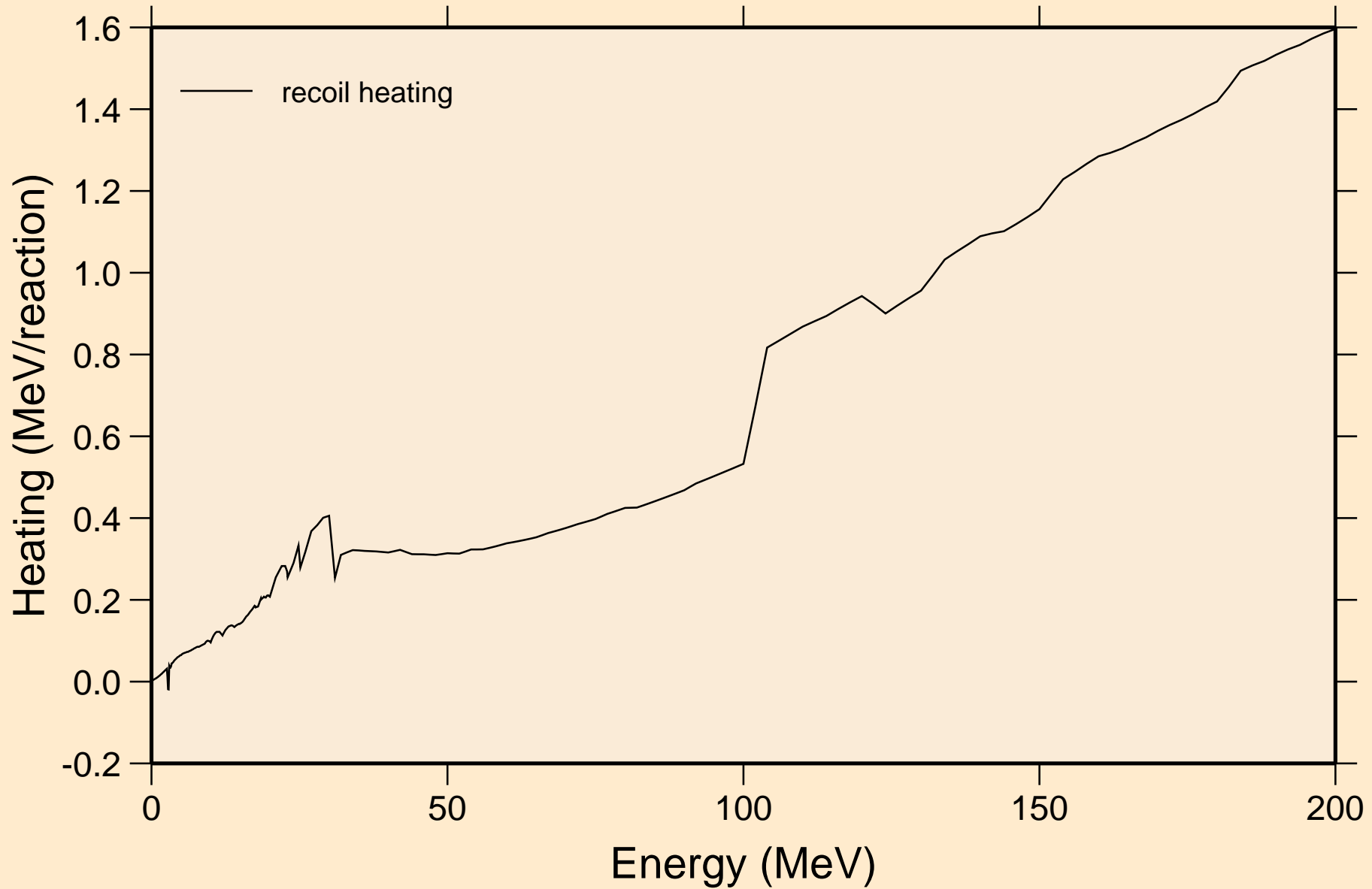

MO103 NEUTRON ACER TENDL-2024 LIBRARY; T=0.K
Particle production cross sections

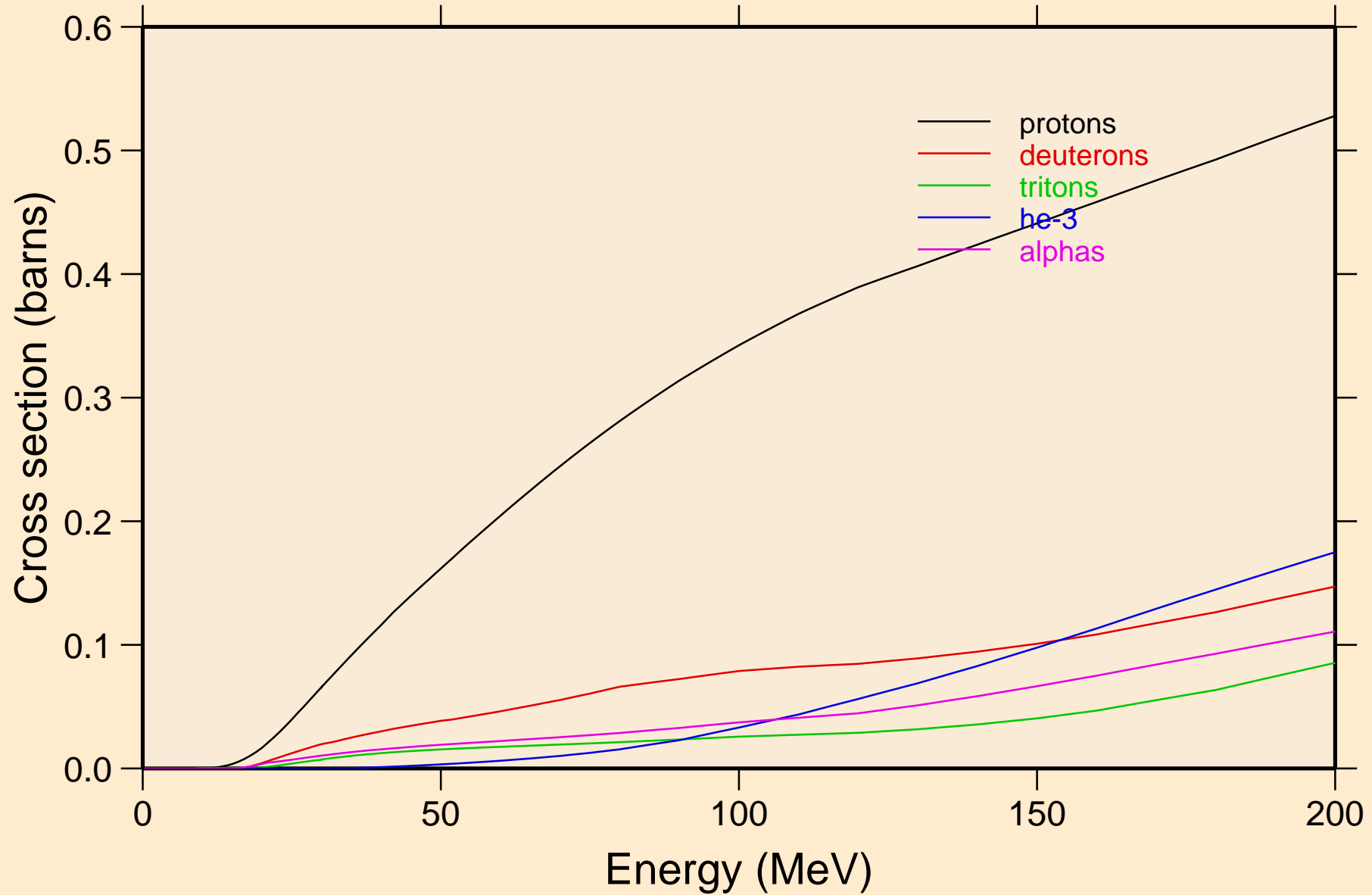

MO103 NEUTRON ACER TENDL-2024 LIBRARY; T=0.K
protons from (n,x)

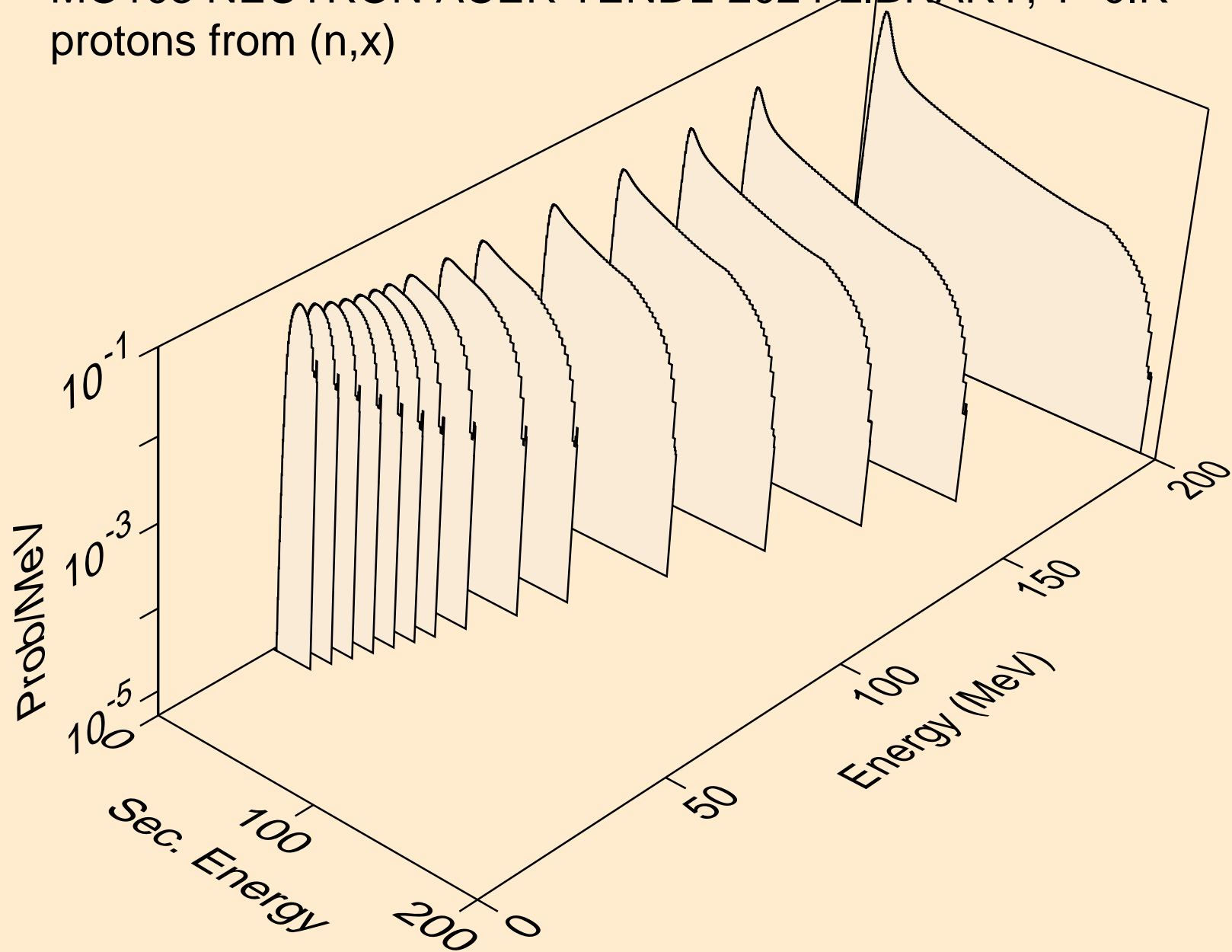

MO103 NEUTRON ACER TENDL-2024 LIBRARY; T=0.K
protons from (n,n*)p

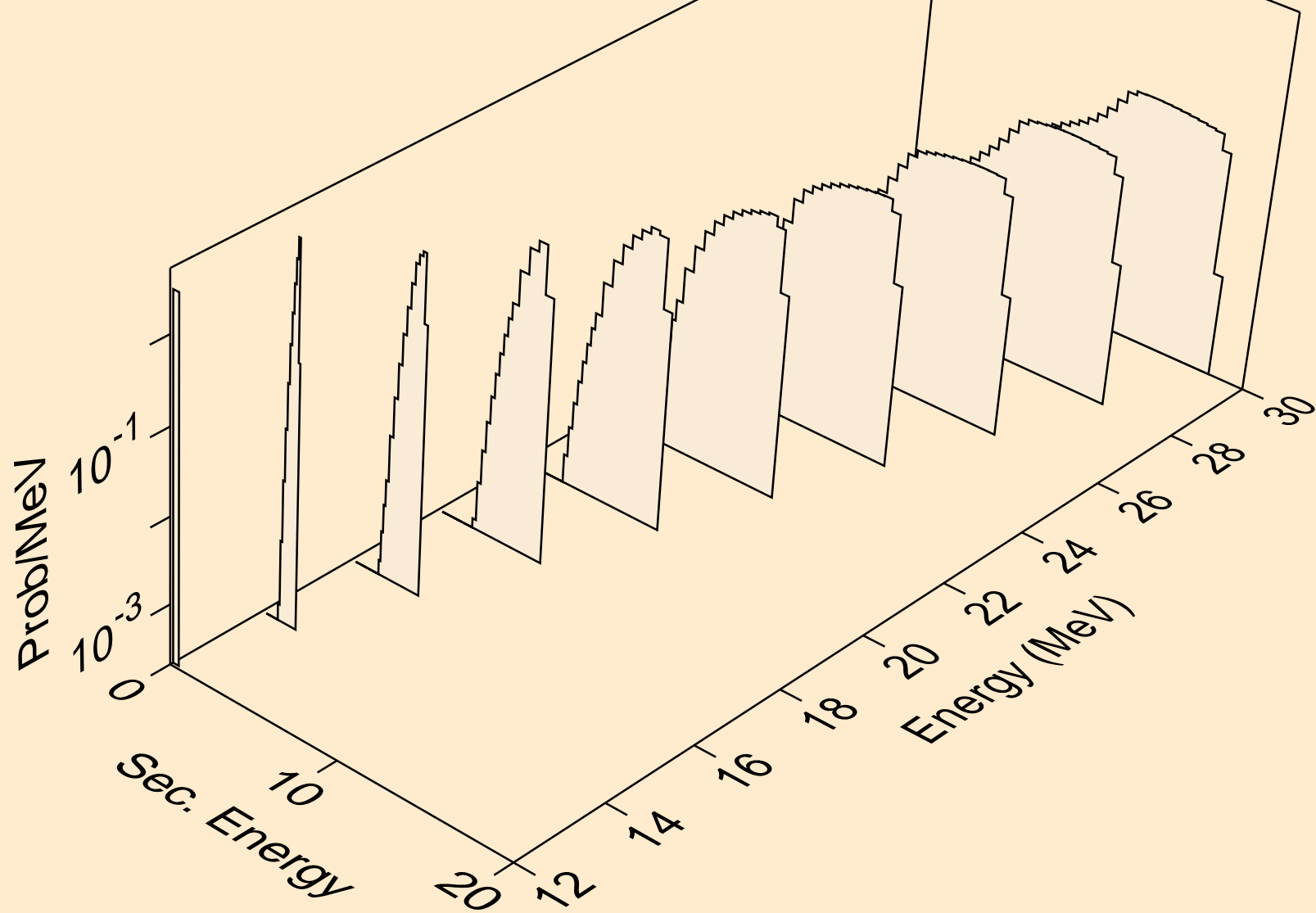

MO103 NEUTRON ACER TENDL-2024 LIBRARY; T=0.K
protons from (n,2np)

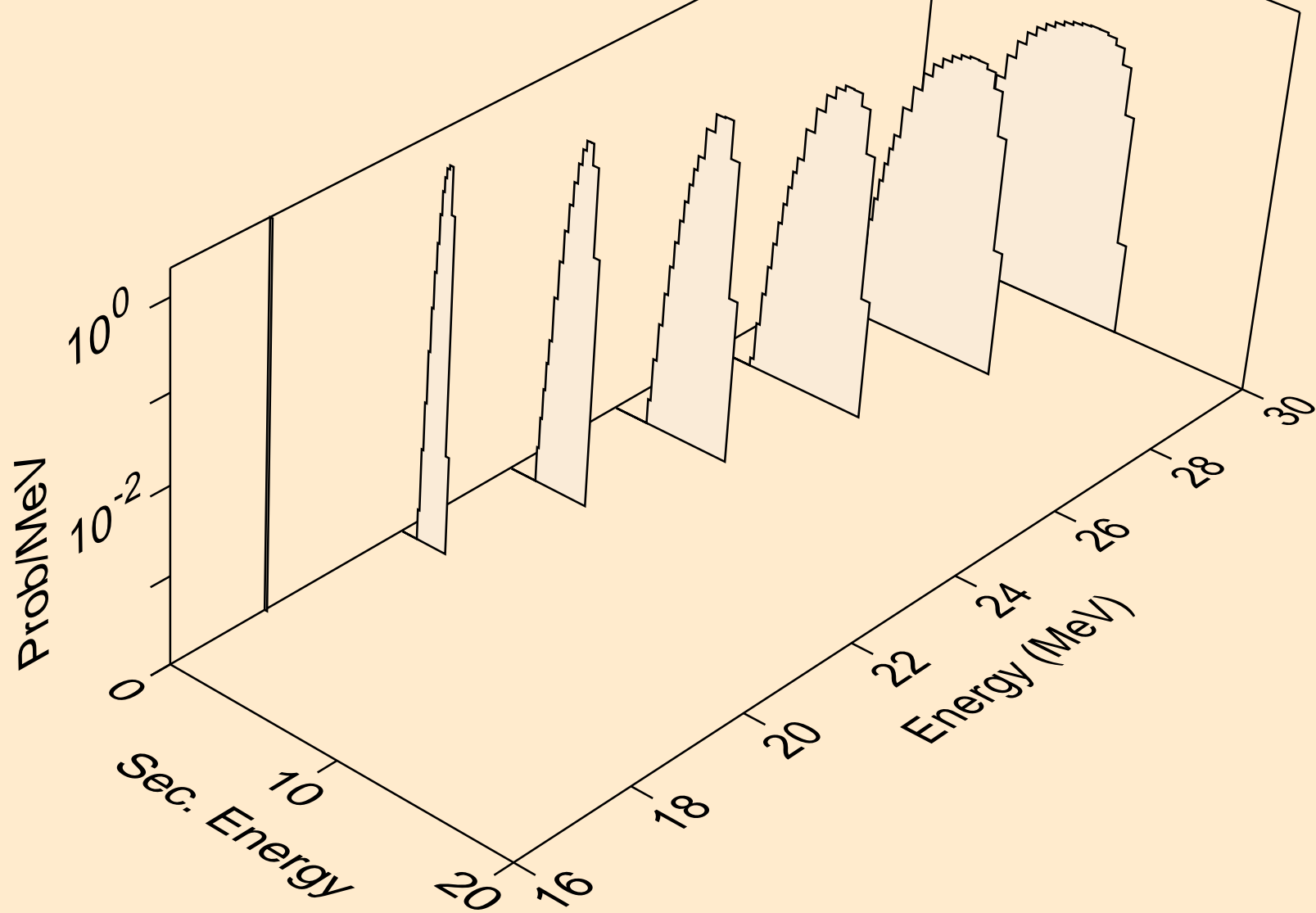

MO103 NEUTRON ACER TENDL-2024 LIBRARY; T=0.K
protons from (n,3np)

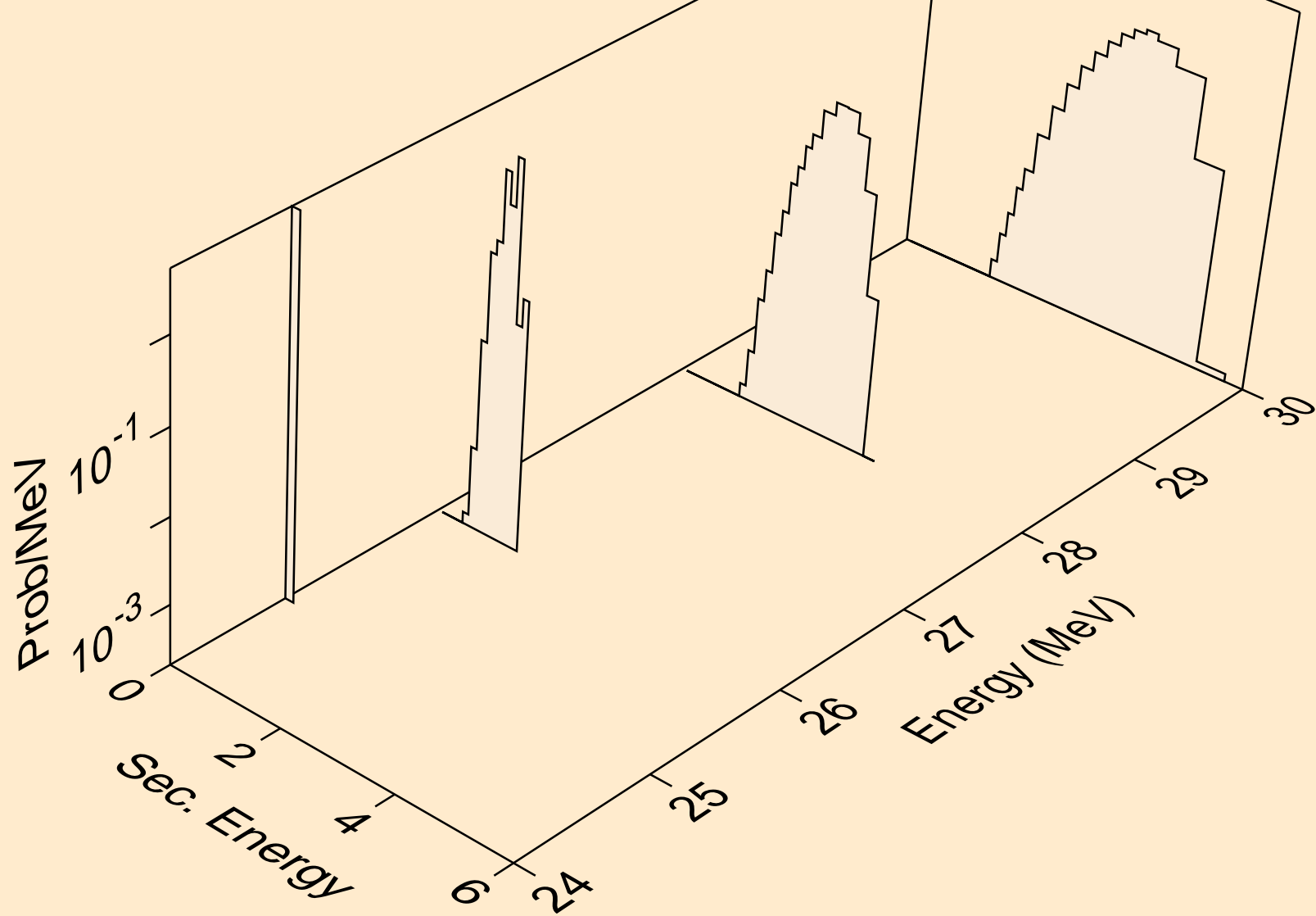

MO103 NEUTRON ACER TENDL-2024 LIBRARY; T=0.K
protons from (n,p)

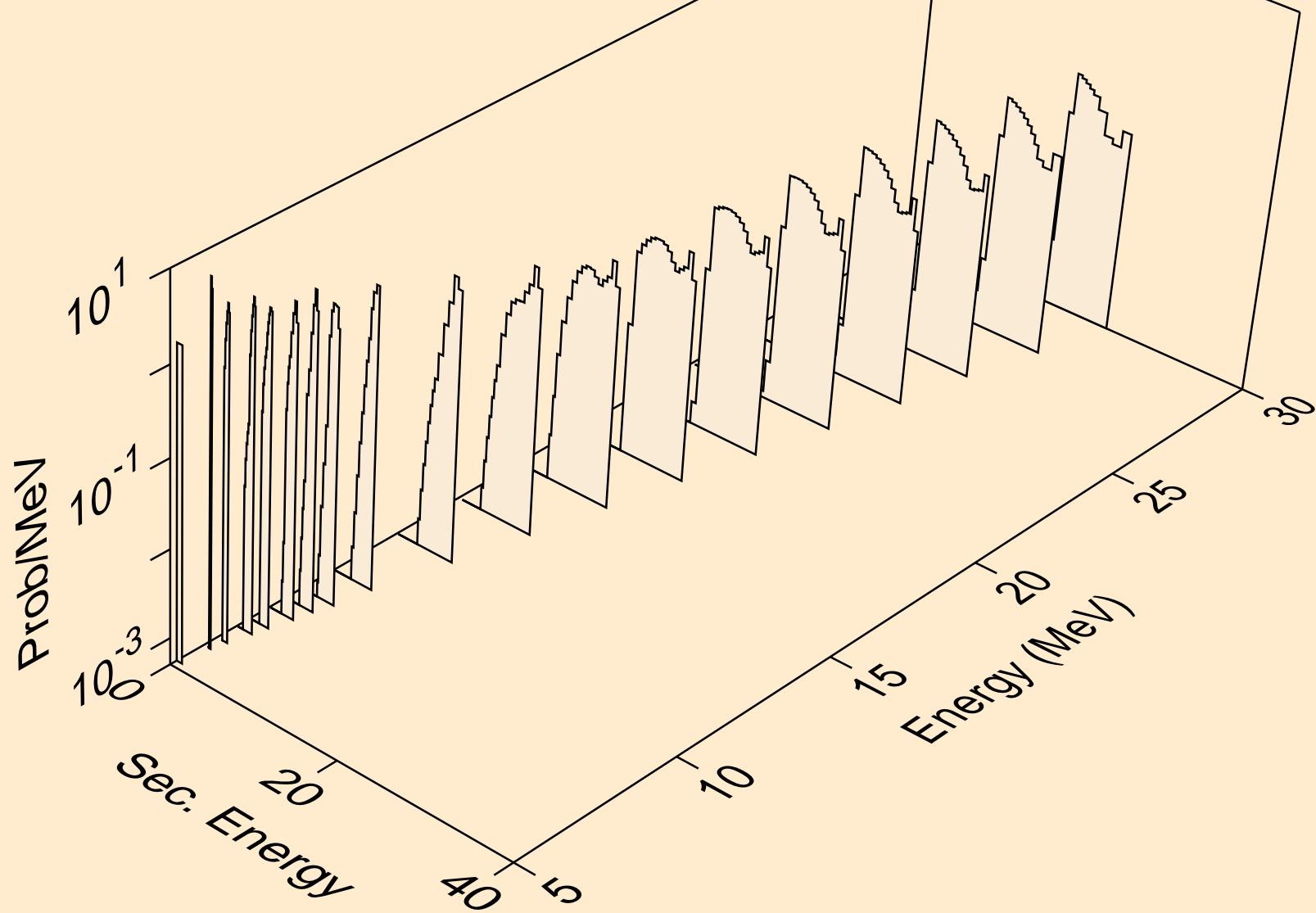

MO103 NEUTRON ACER TENDL-2024 LIBRARY; T=0.K
protons from (n,2p)

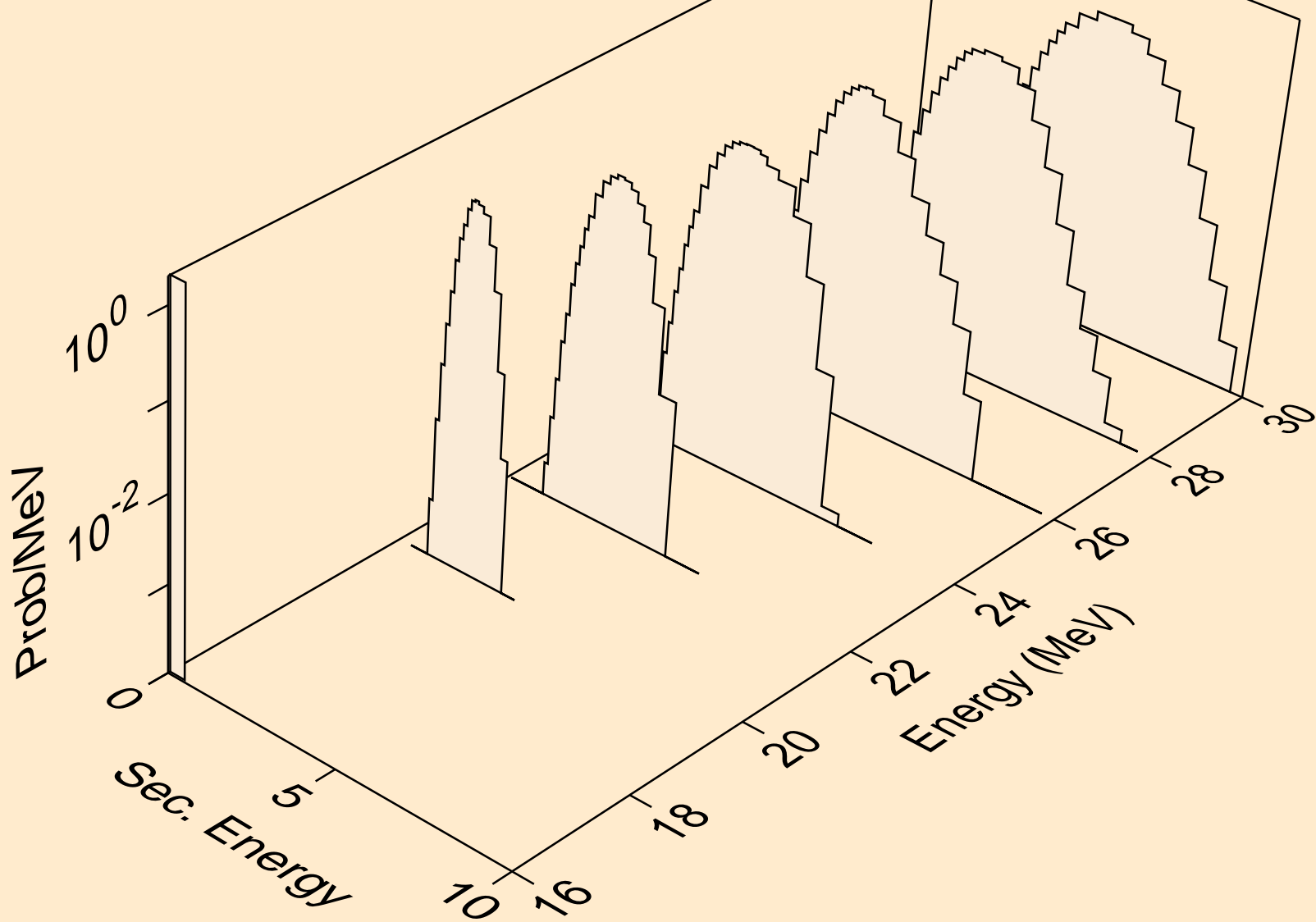

MO103 NEUTRON ACER TENDL-2024 LIBRARY; T=0.K
deuterons from (n,x)

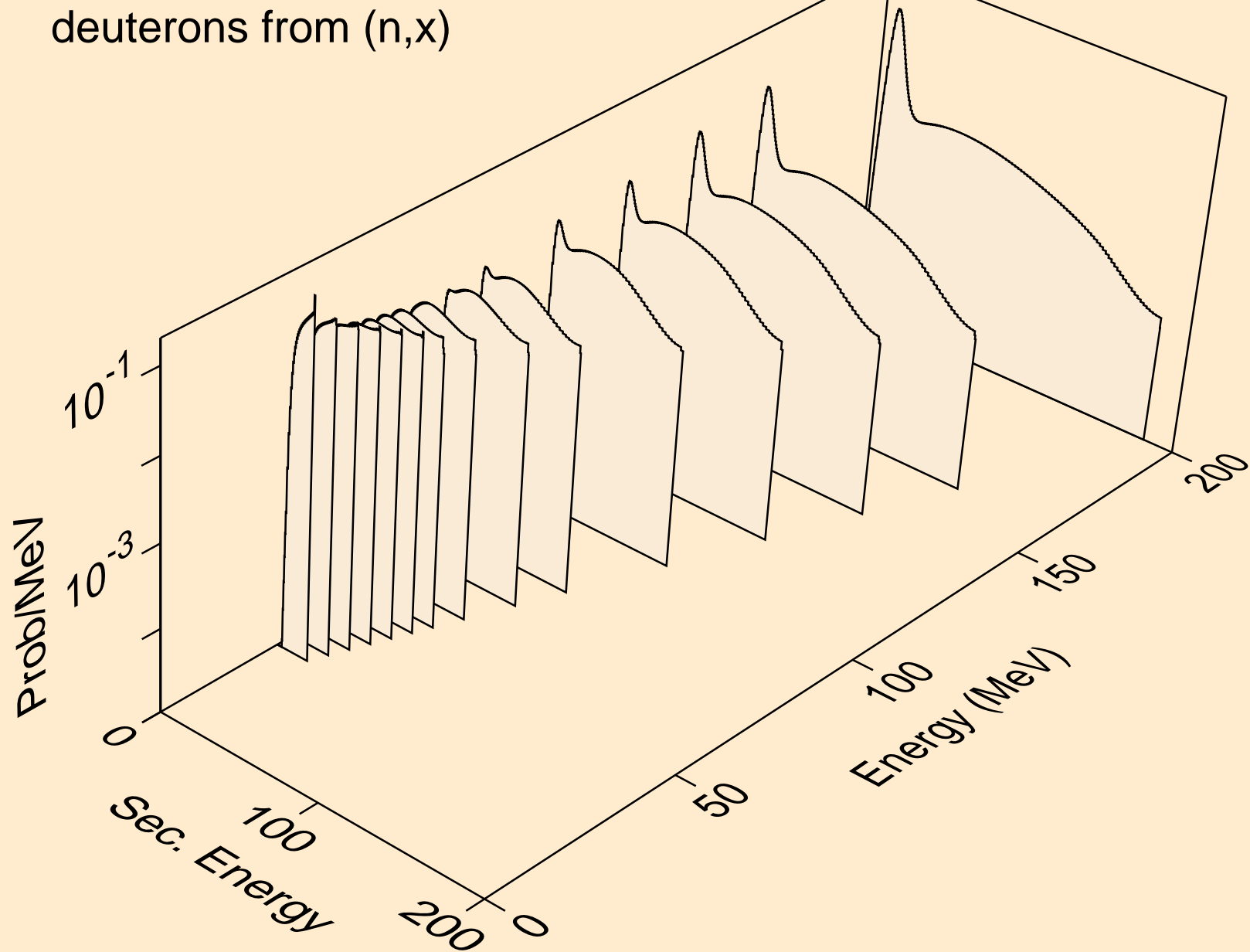

MO103 NEUTRON ACER TENDL-2024 LIBRARY; T=0.K
deuterons from (n,2nd)

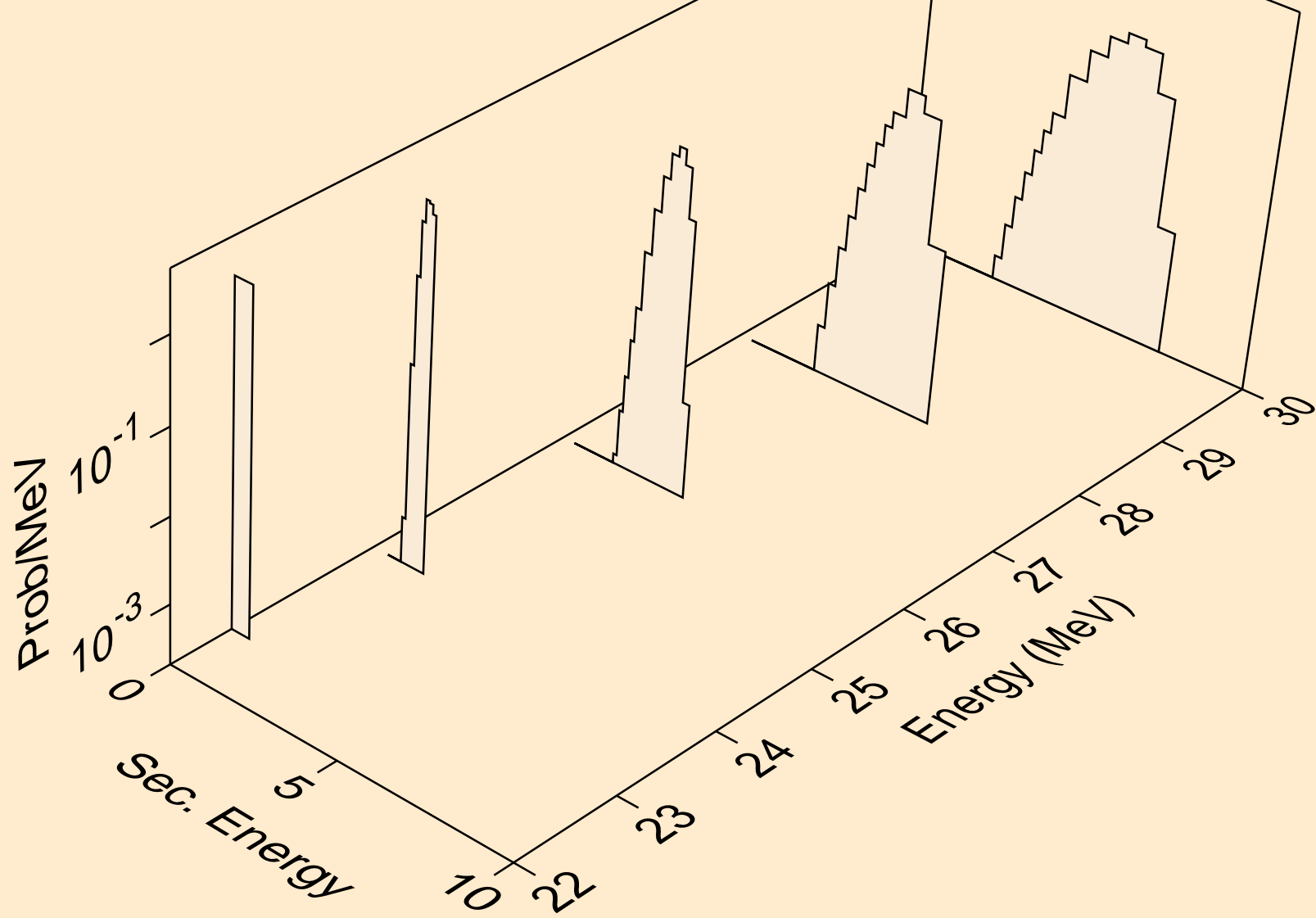

MO103 NEUTRON ACER TENDL-2024 LIBRARY; T=0.K
deuterons from (n,n*)d

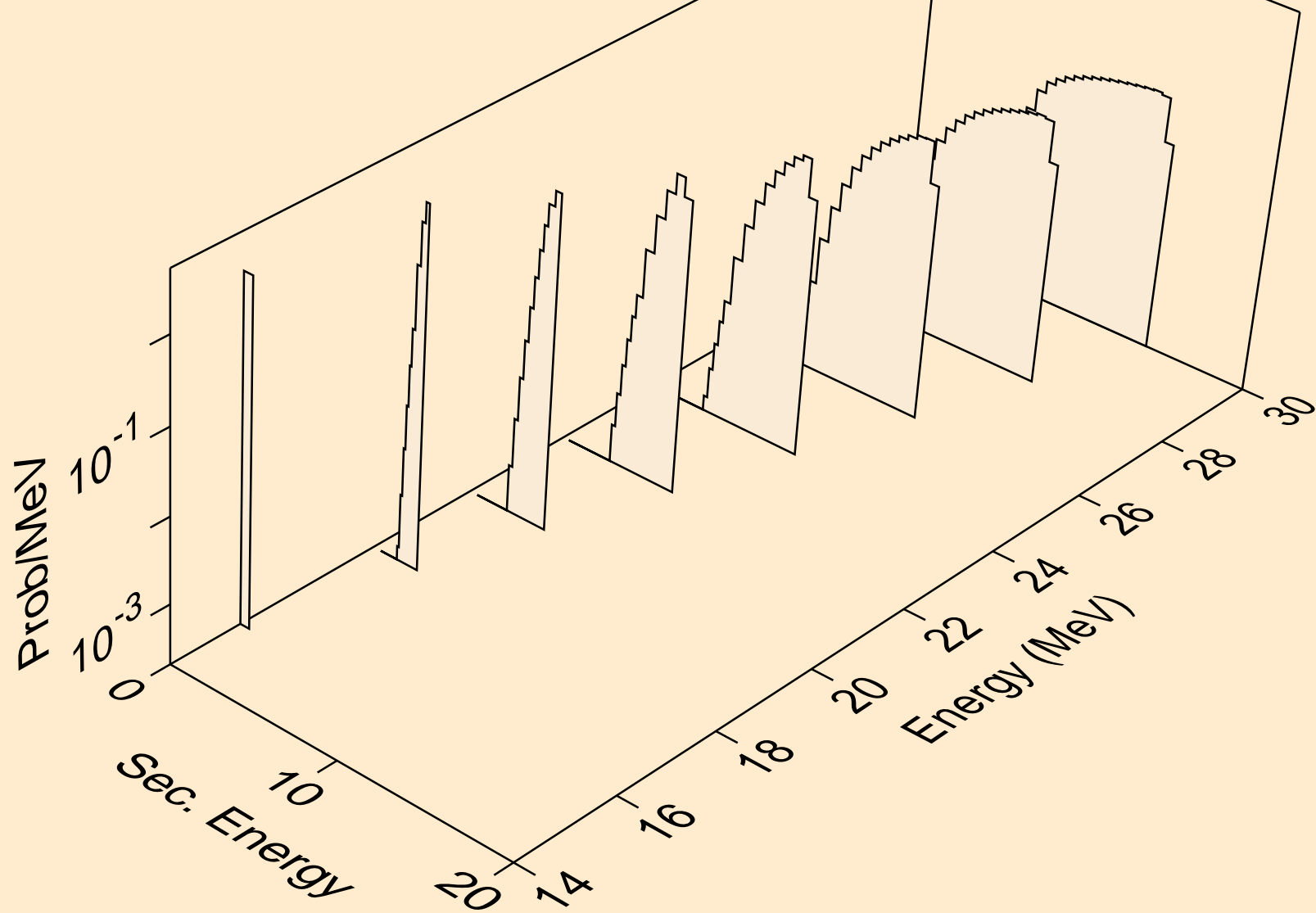

MO103 NEUTRON ACER TENDL-2024 LIBRARY; T=0.K
deuterons from (n,d)

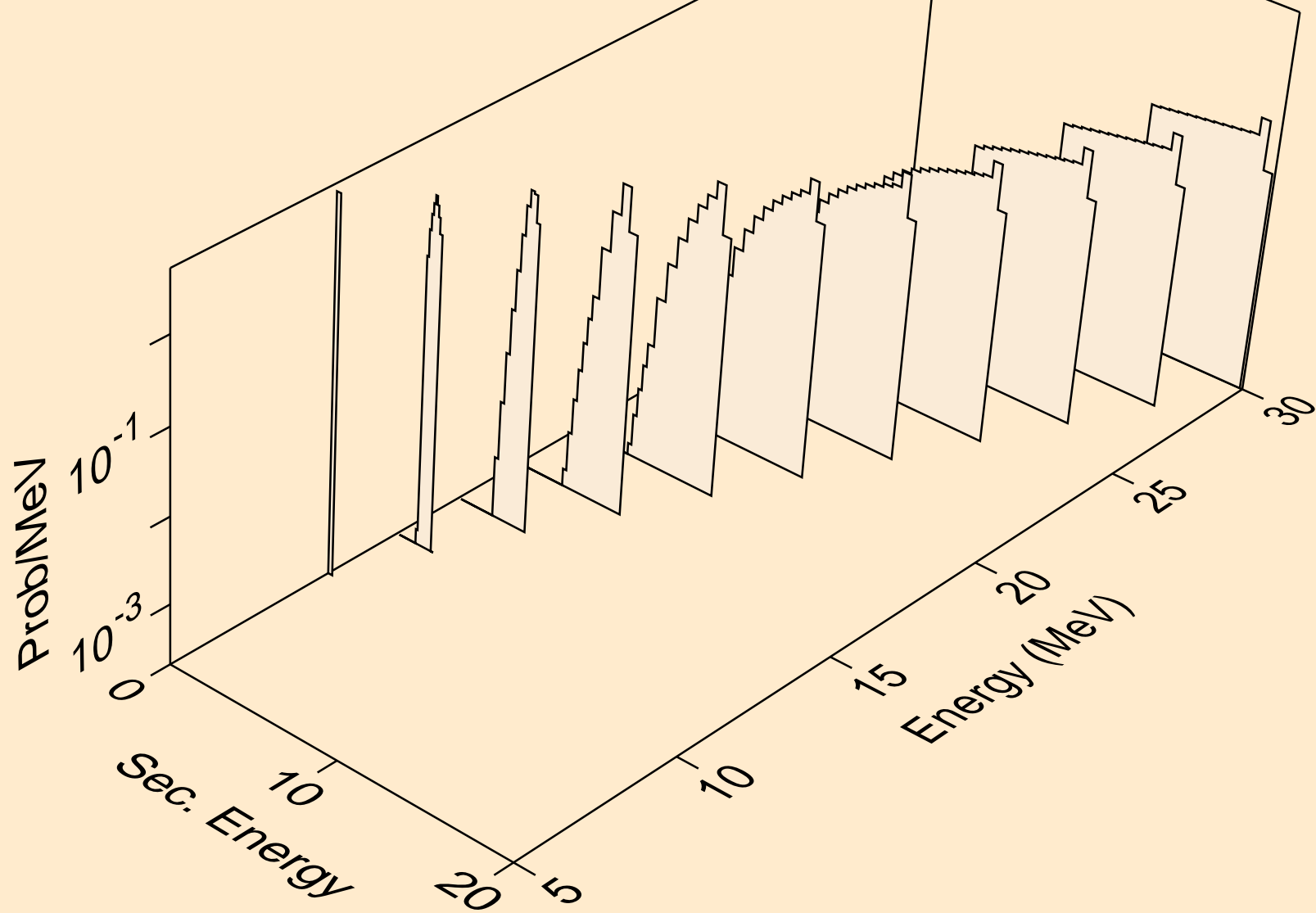

MO103 NEUTRON ACER TENDL-2024 LIBRARY; T=0.K
tritons from (n,x)

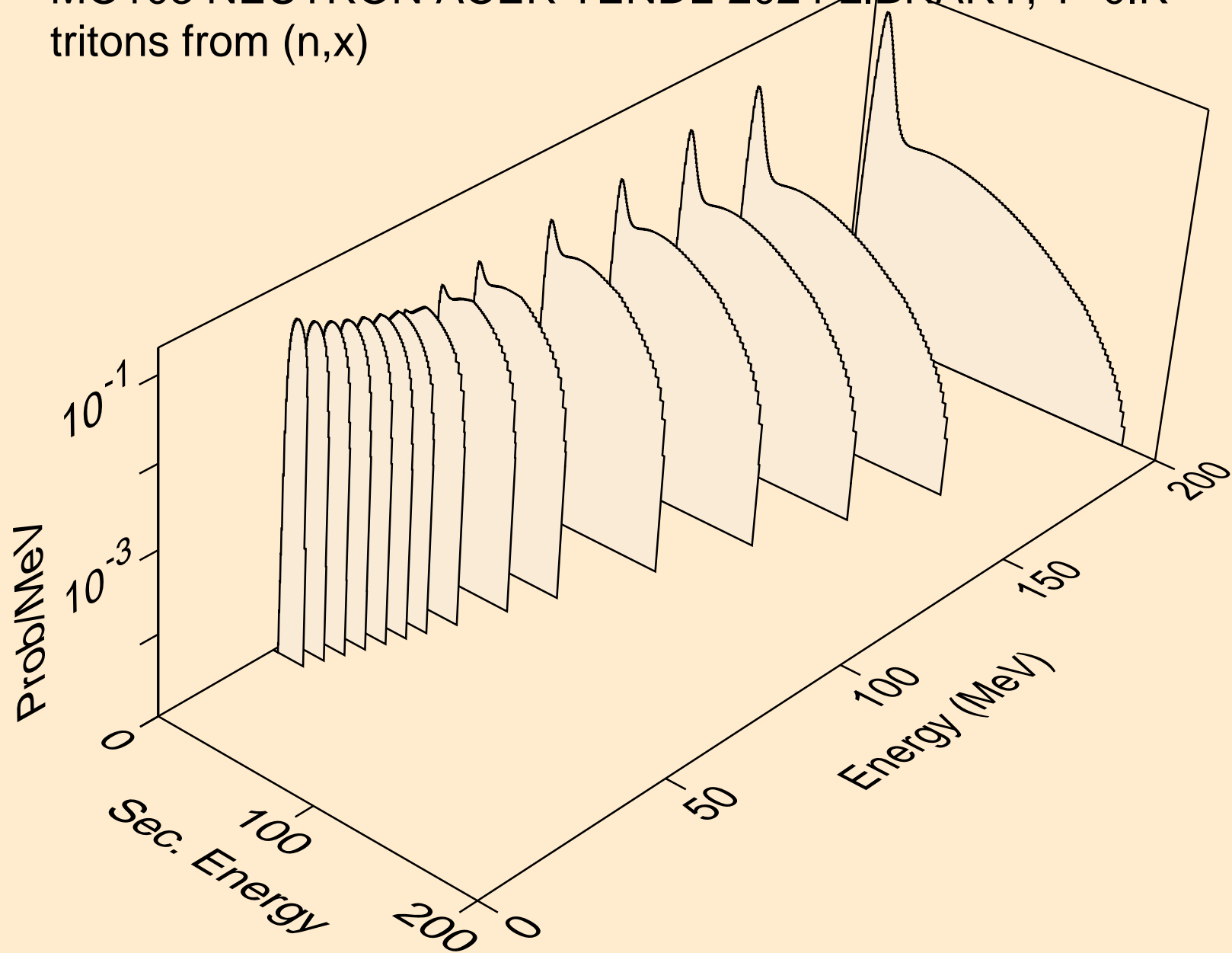

MO103 NEUTRON ACER TENDL-2024 LIBRARY; T=0.K
tritons from (n,n*)t

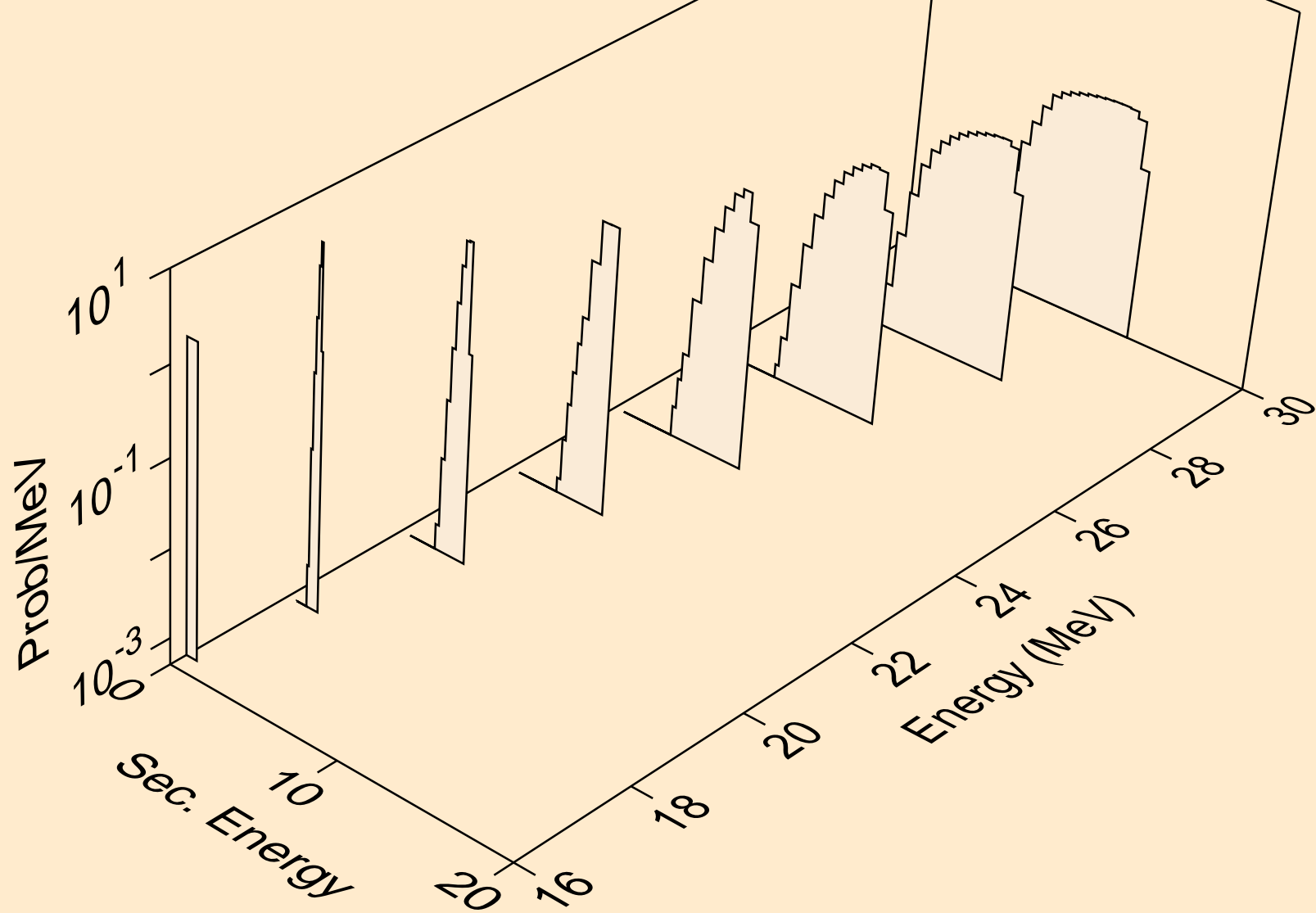

MO103 NEUTRON ACER TENDL-2024 LIBRARY; T=0.K
tritons from (n,t)

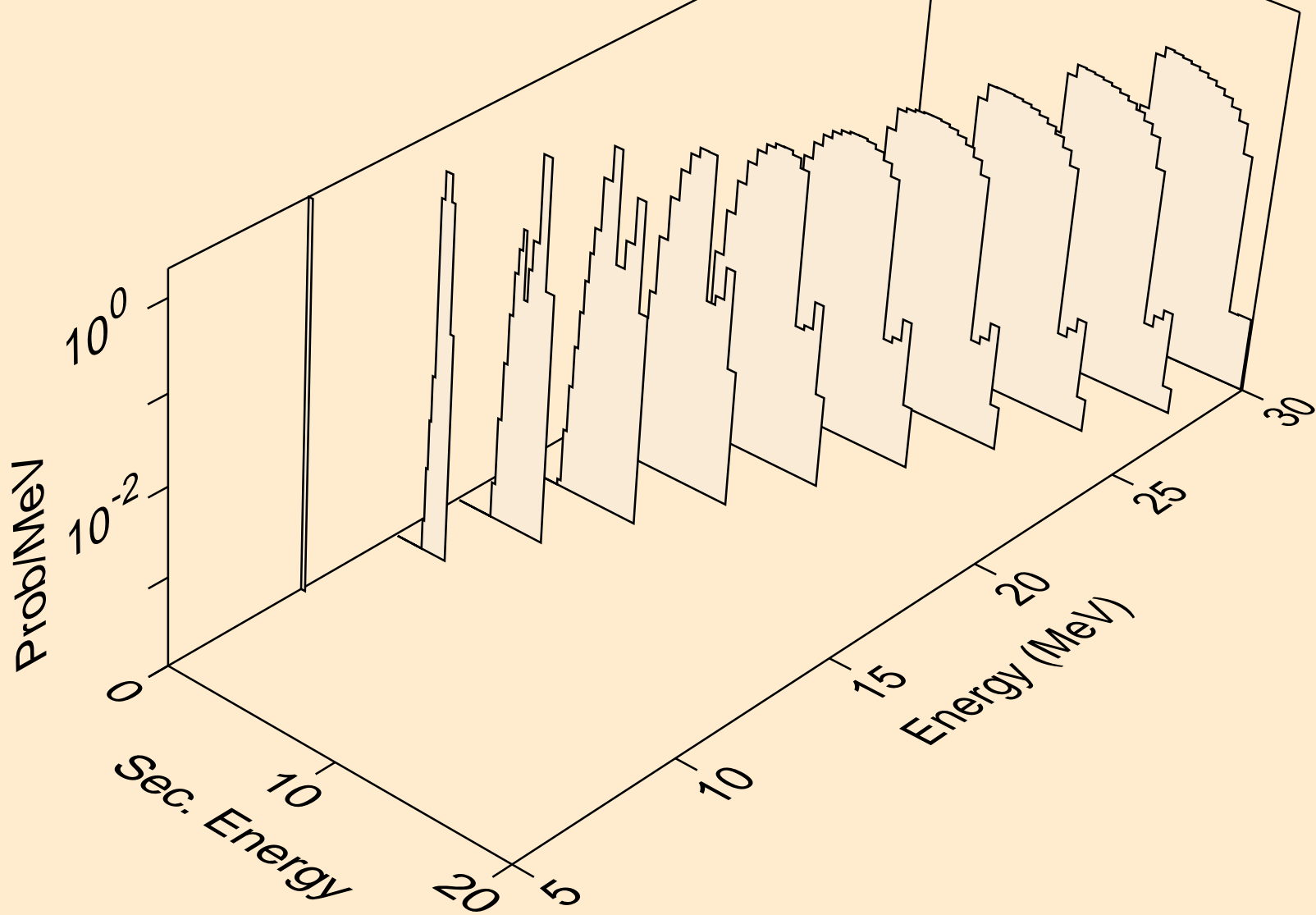

MO103 NEUTRON ACER TENDL-2024 LIBRARY; T=0.K
he3s from (n,x)

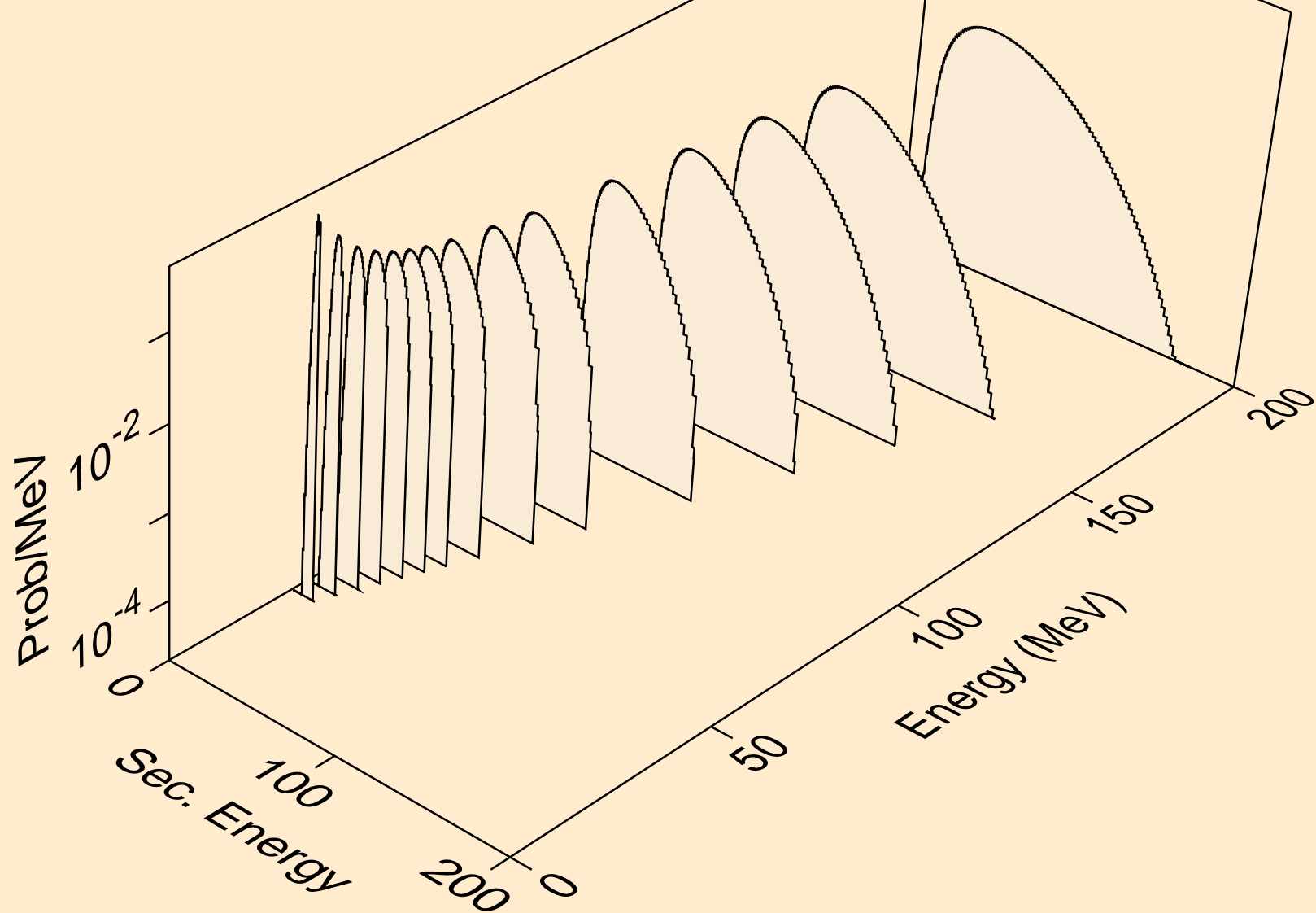

MO103 NEUTRON ACER TENDL-2024 LIBRARY; T=0.K
he3s from (n,n*)he3

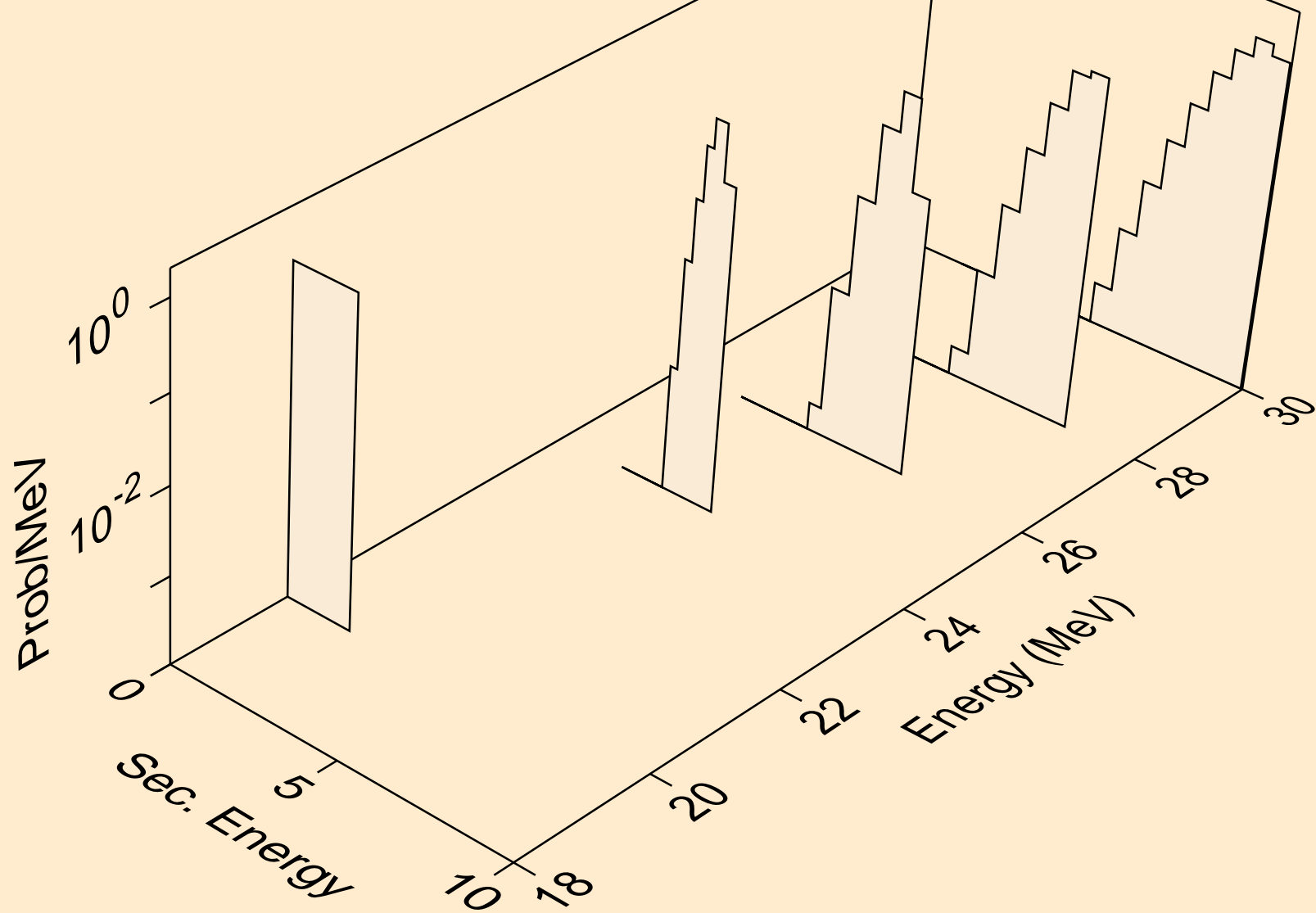

MO103 NEUTRON ACER TENDL-2024 LIBRARY; T=0.K
he3s from (n,he3)

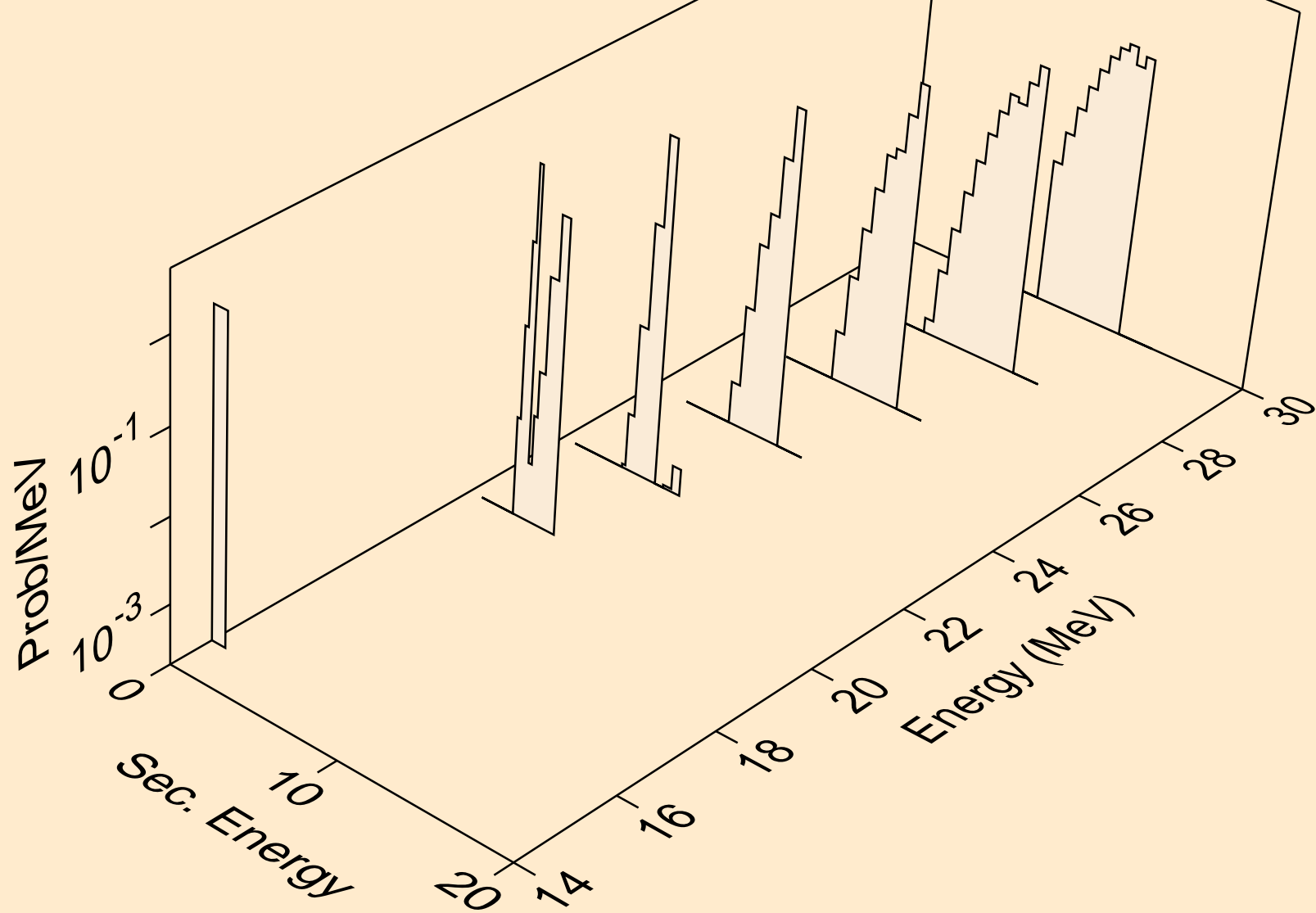

MO103 NEUTRON ACER TENDL-2024 LIBRARY; T=0.K
alphas from (n,x)

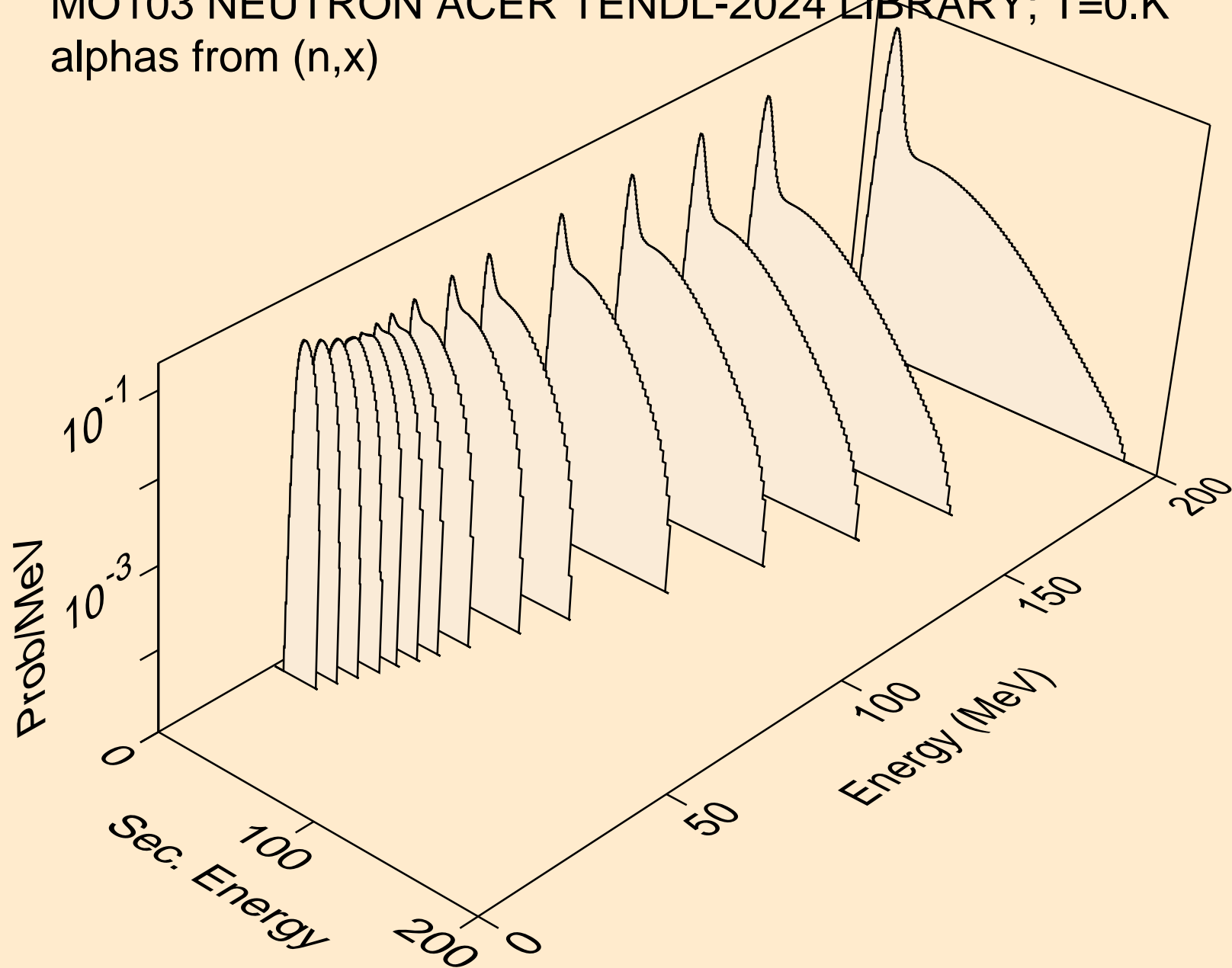

MO103 NEUTRON ACER TENDL-2024 LIBRARY; T=0.K
alphas from (n,n*)a

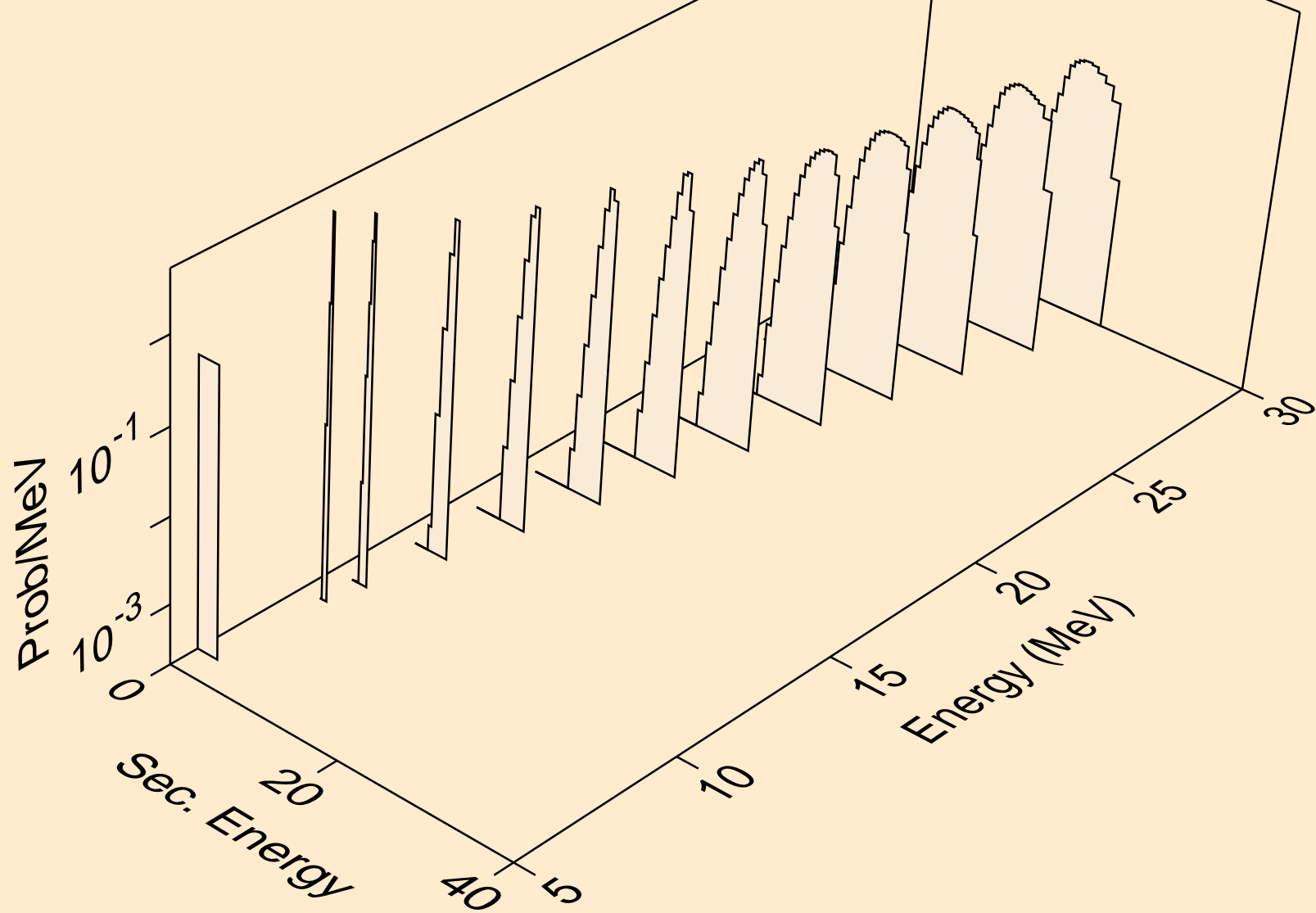

MO103 NEUTRON ACER TENDL-2024 LIBRARY; T=0.K
alphas from (n,2n)a

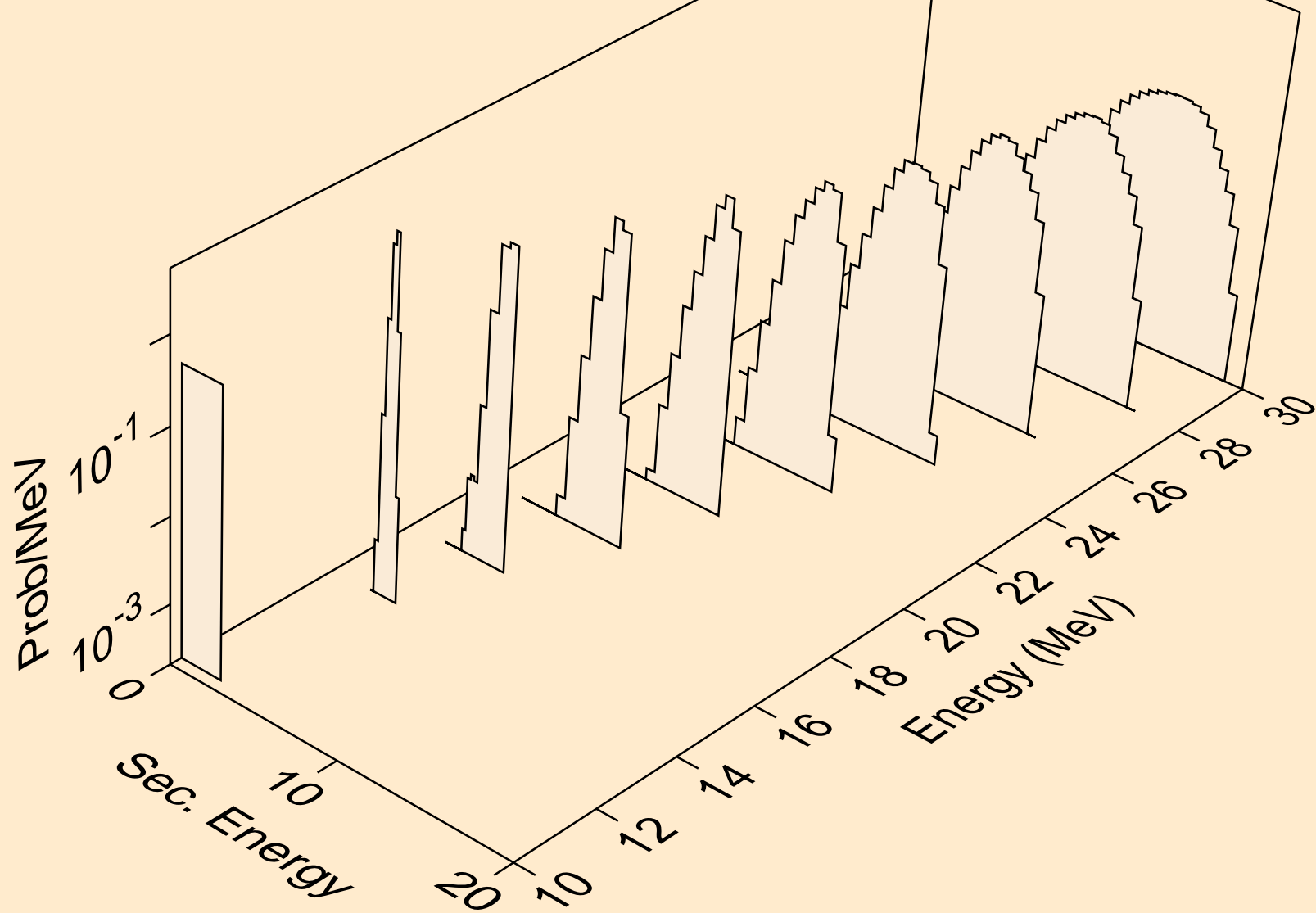

MO103 NEUTRON ACER TENDL-2024 LIBRARY; T=0.K
alphas from (n,3n)a

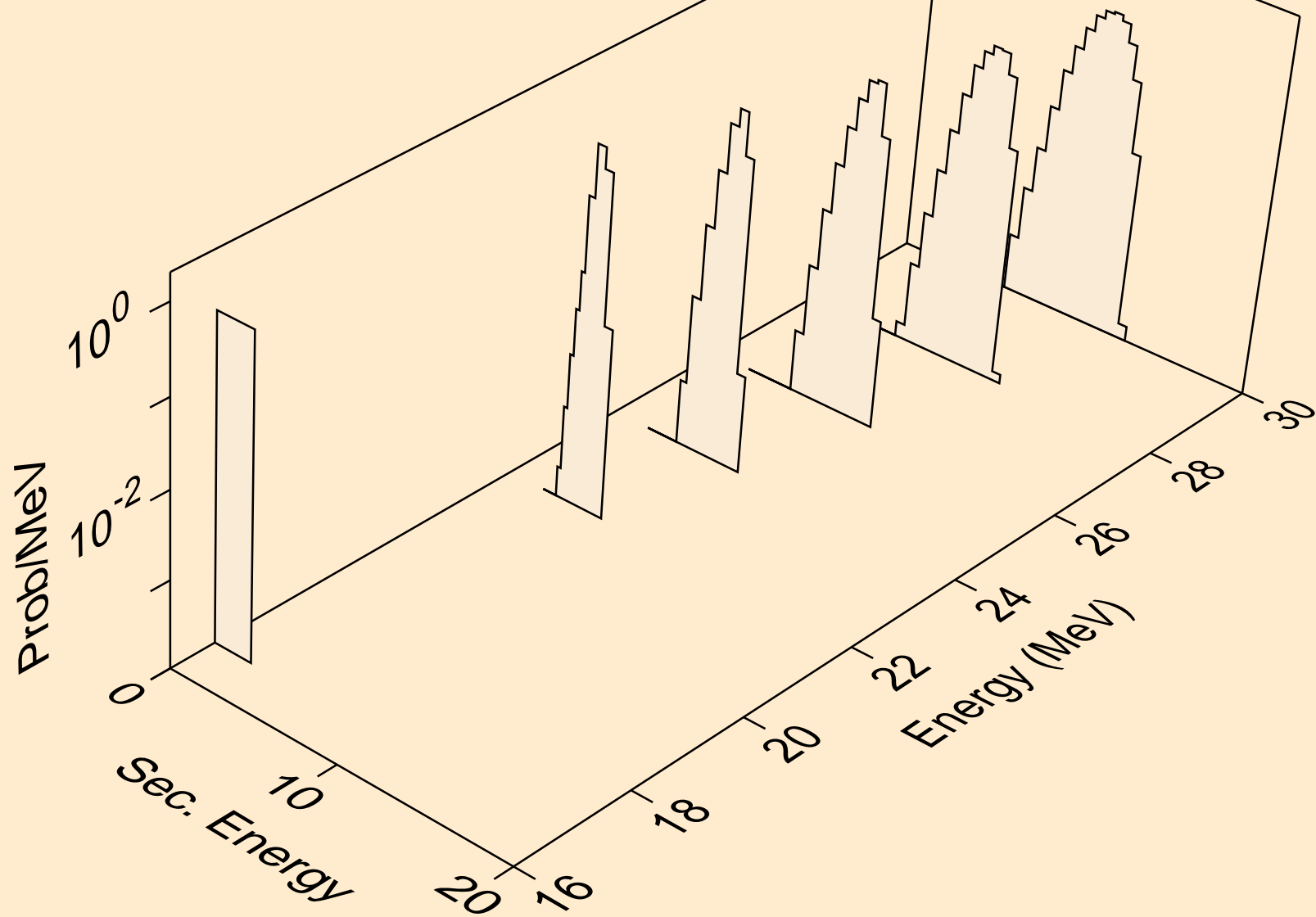

MO103 NEUTRON ACER TENDL-2024 LIBRARY; T=0.K
alphas from (n,a)

