

ND139 NEUTRON ACER TENDL-2024 LIBRARY; T=0.K

Principal cross sections

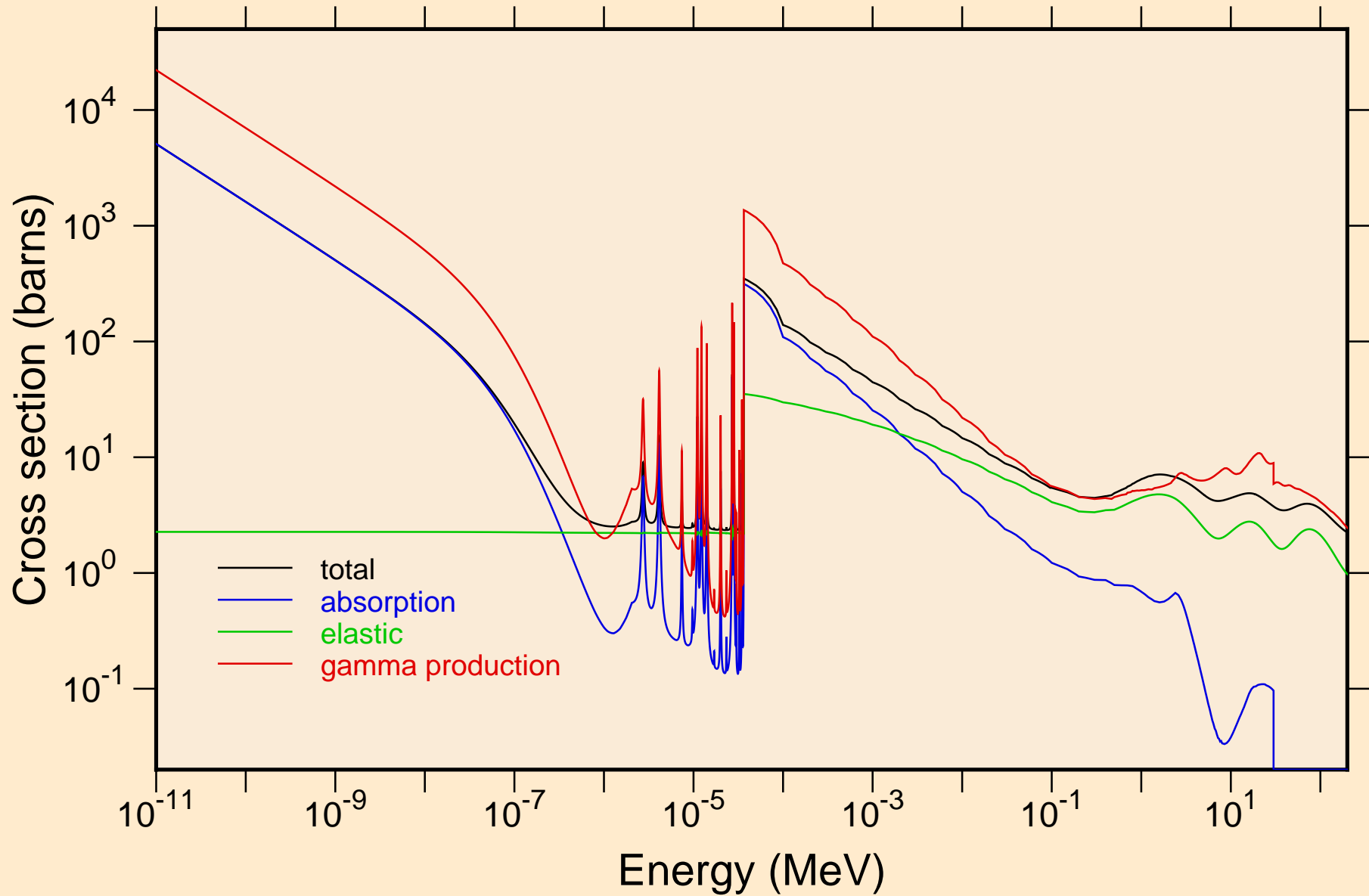

ND139 NEUTRON ACER TENDL-2024 LIBRARY; T=0.K
resonance total cross section

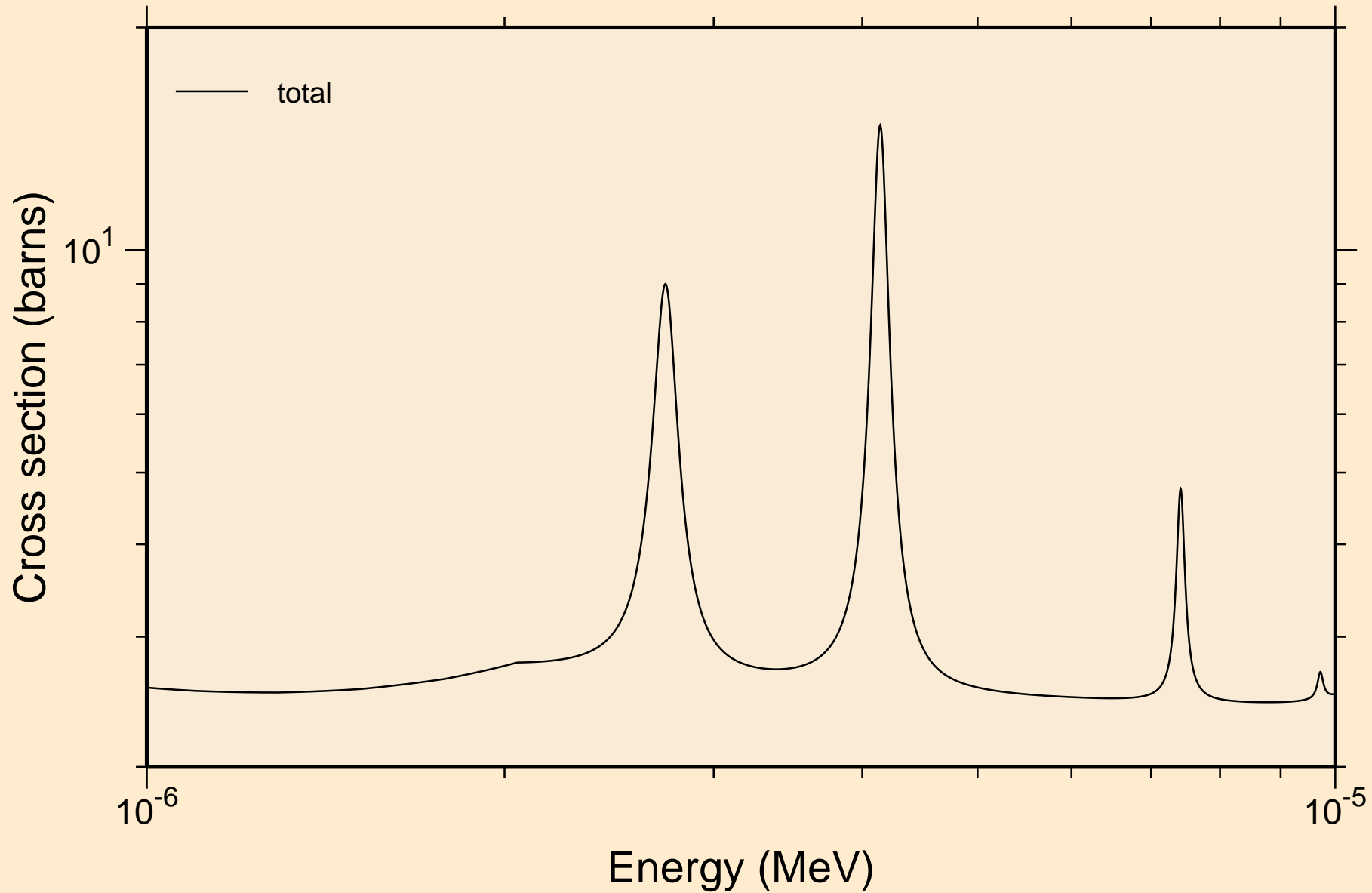

ND139 NEUTRON ACER TENDL-2024 LIBRARY; T=0.K
resonance total cross section

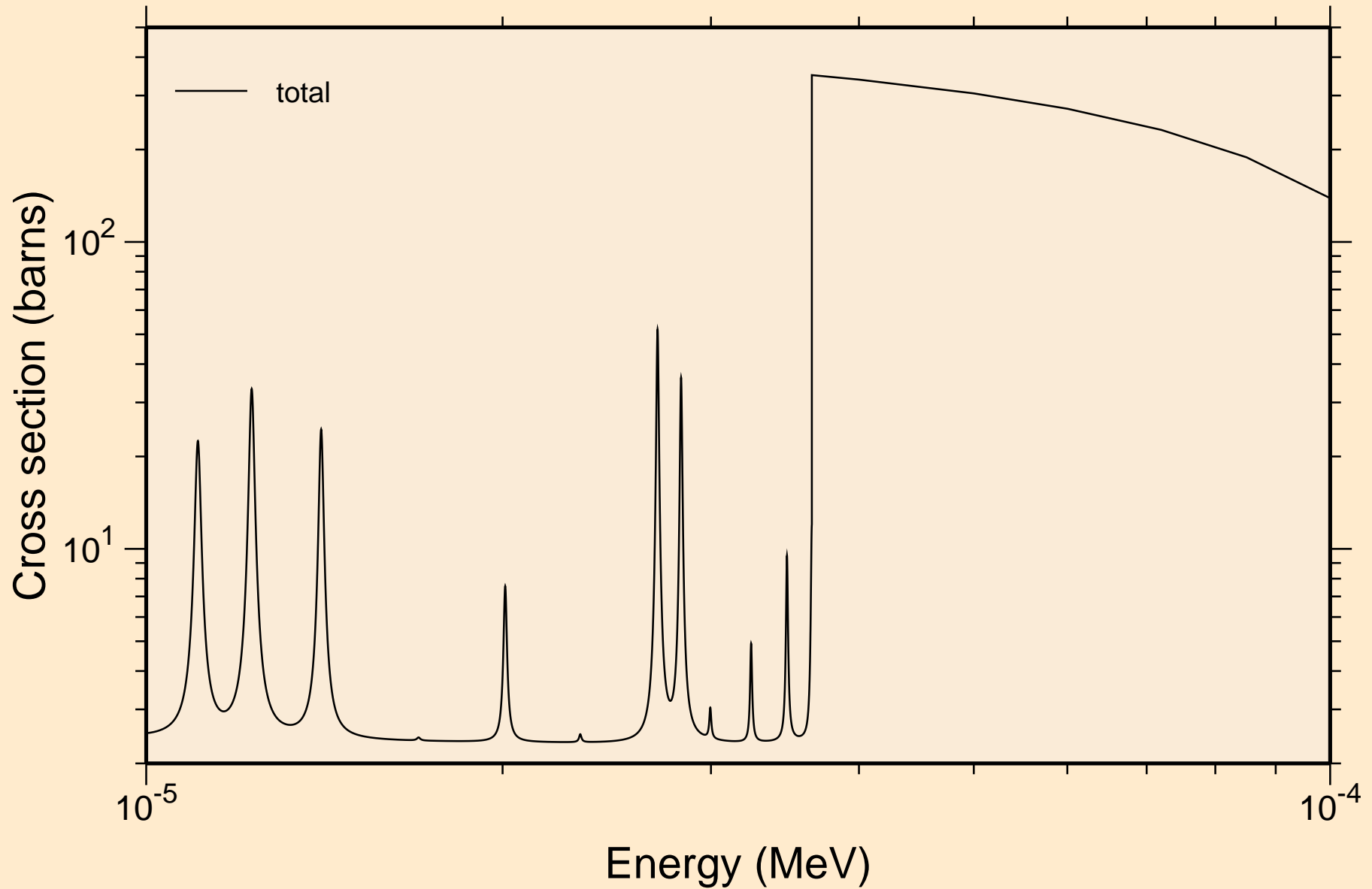

ND139 NEUTRON ACER TENDL-2024 LIBRARY; T=0.K
resonance total cross section

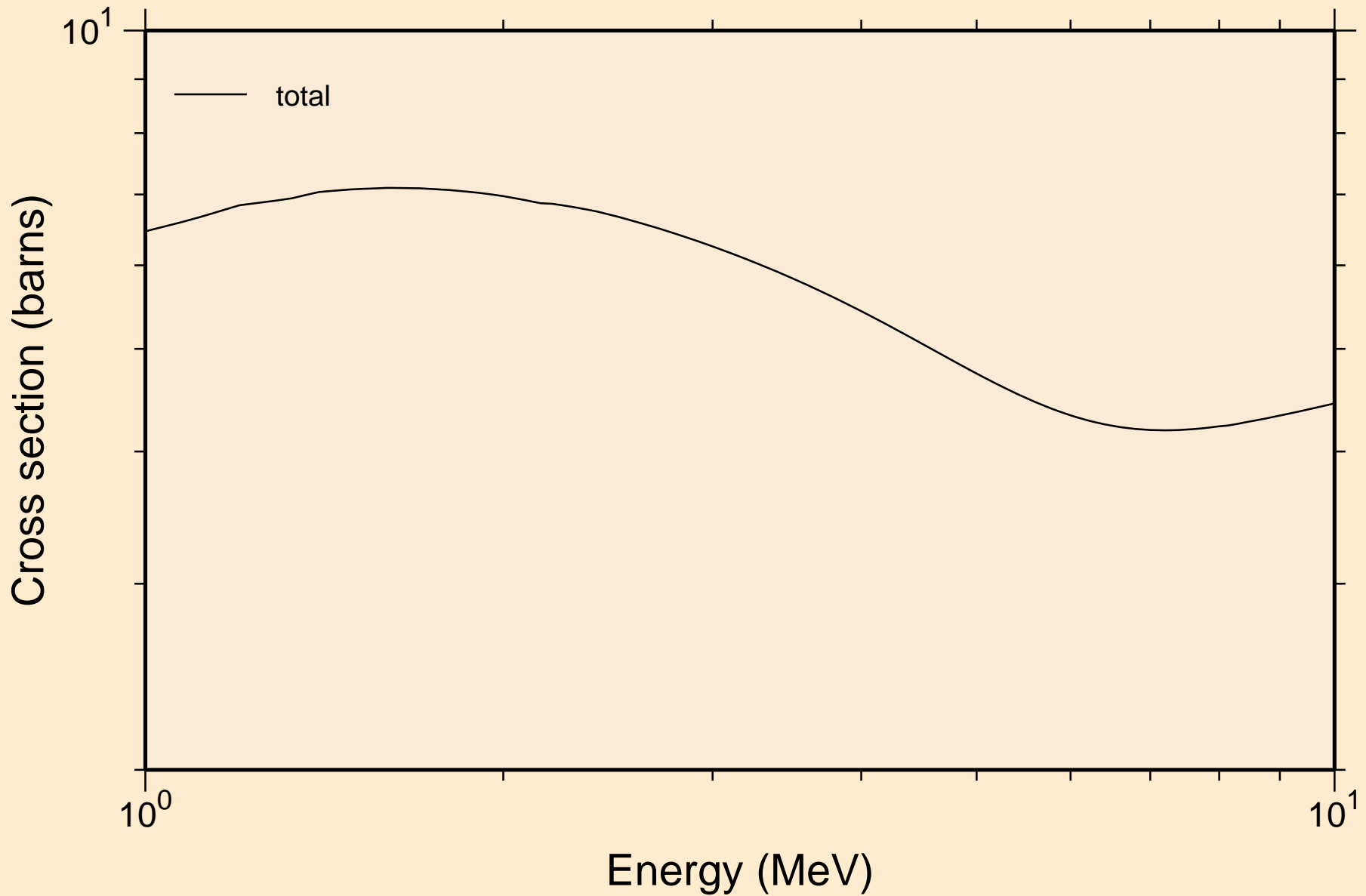

ND139 NEUTRON ACER TENDL-2024 LIBRARY; T=0.K
resonance absorption cross sections

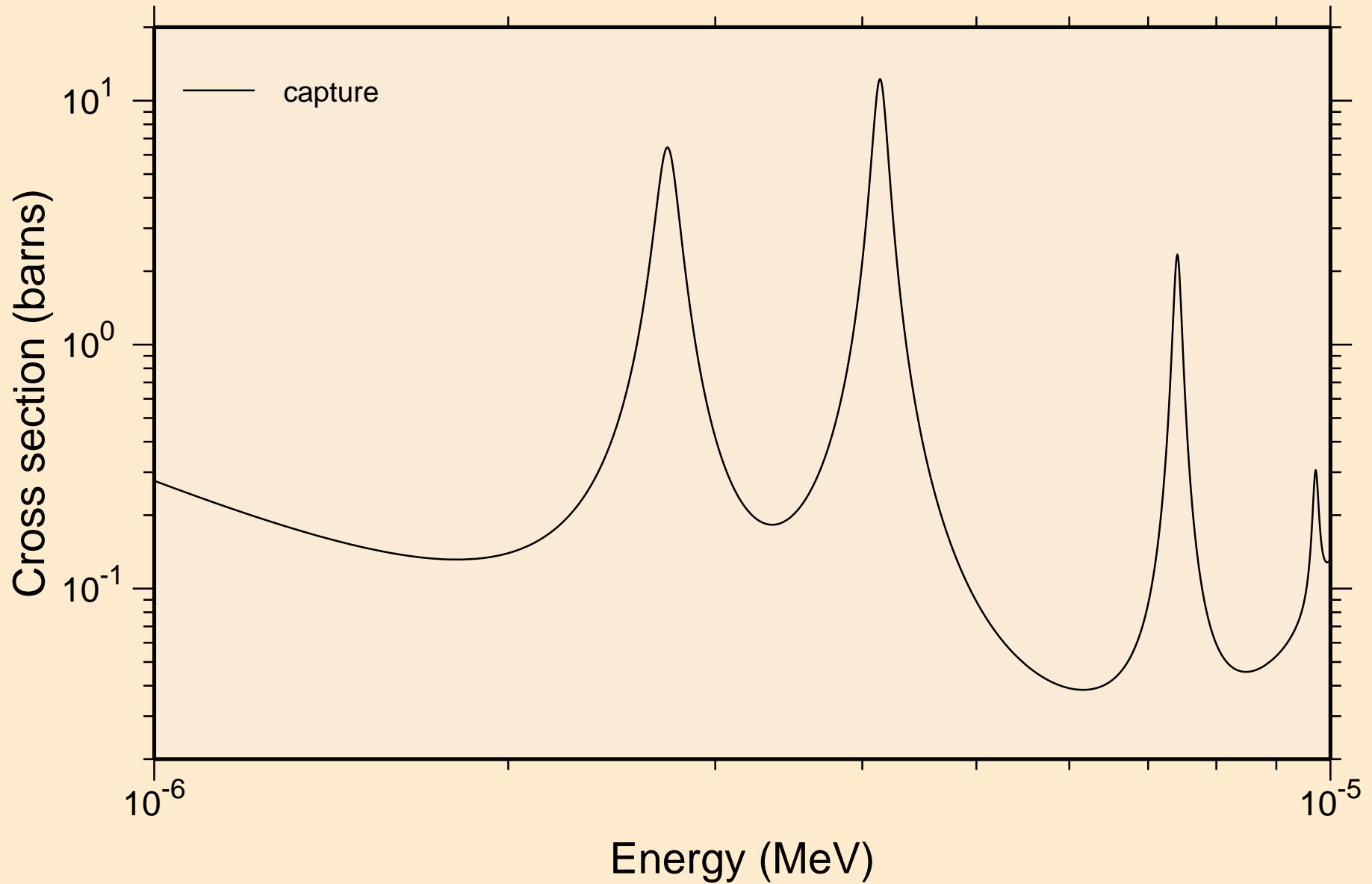

ND139 NEUTRON ACER TENDL-2024 LIBRARY; T=0.K
resonance absorption cross sections

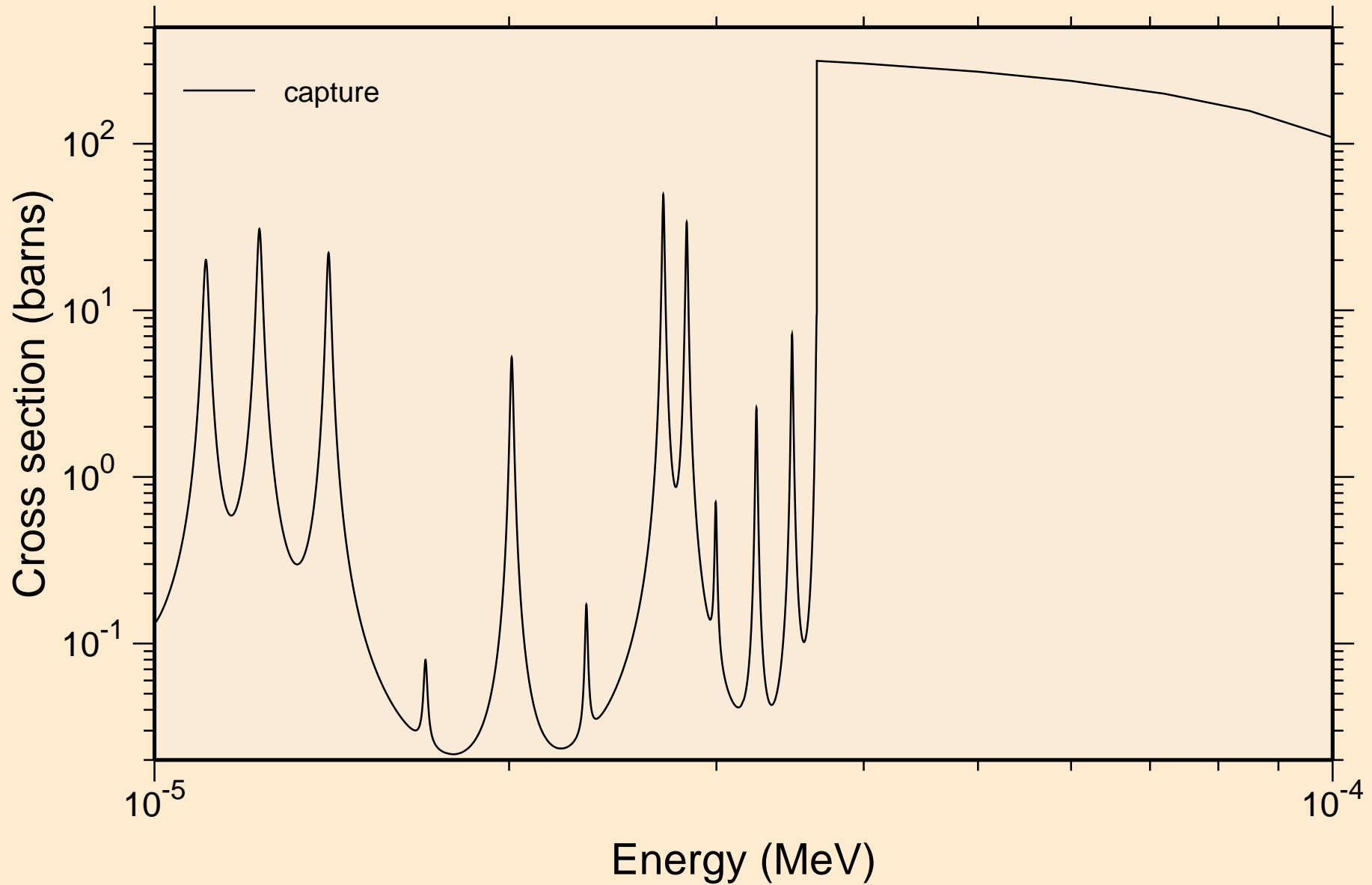

ND139 NEUTRON ACER TENDL-2024 LIBRARY; T=0.K
resonance absorption cross sections

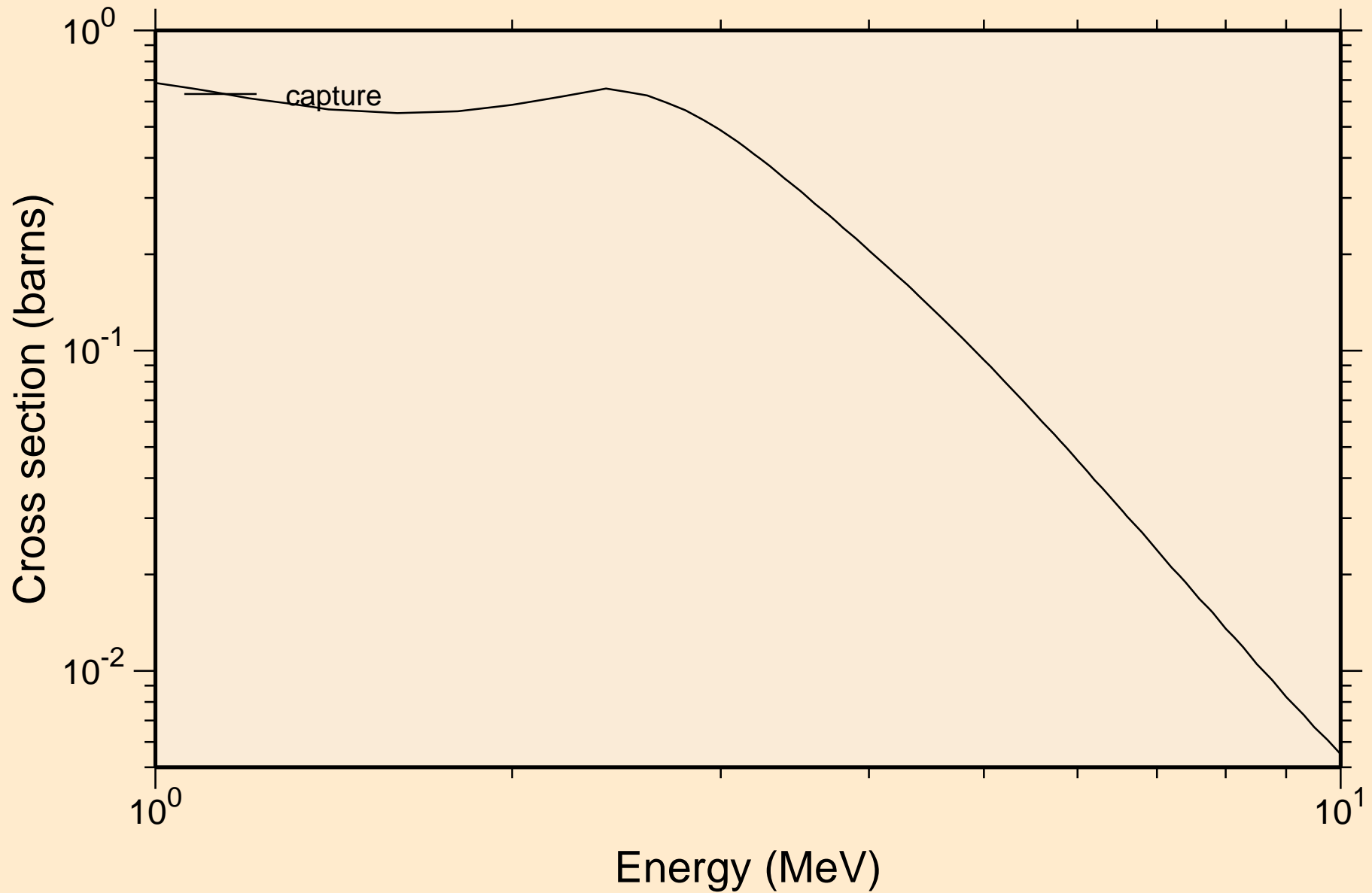

ND139 NEUTRON ACER TENDL-2024 LIBRARY; T=0.K
Heating

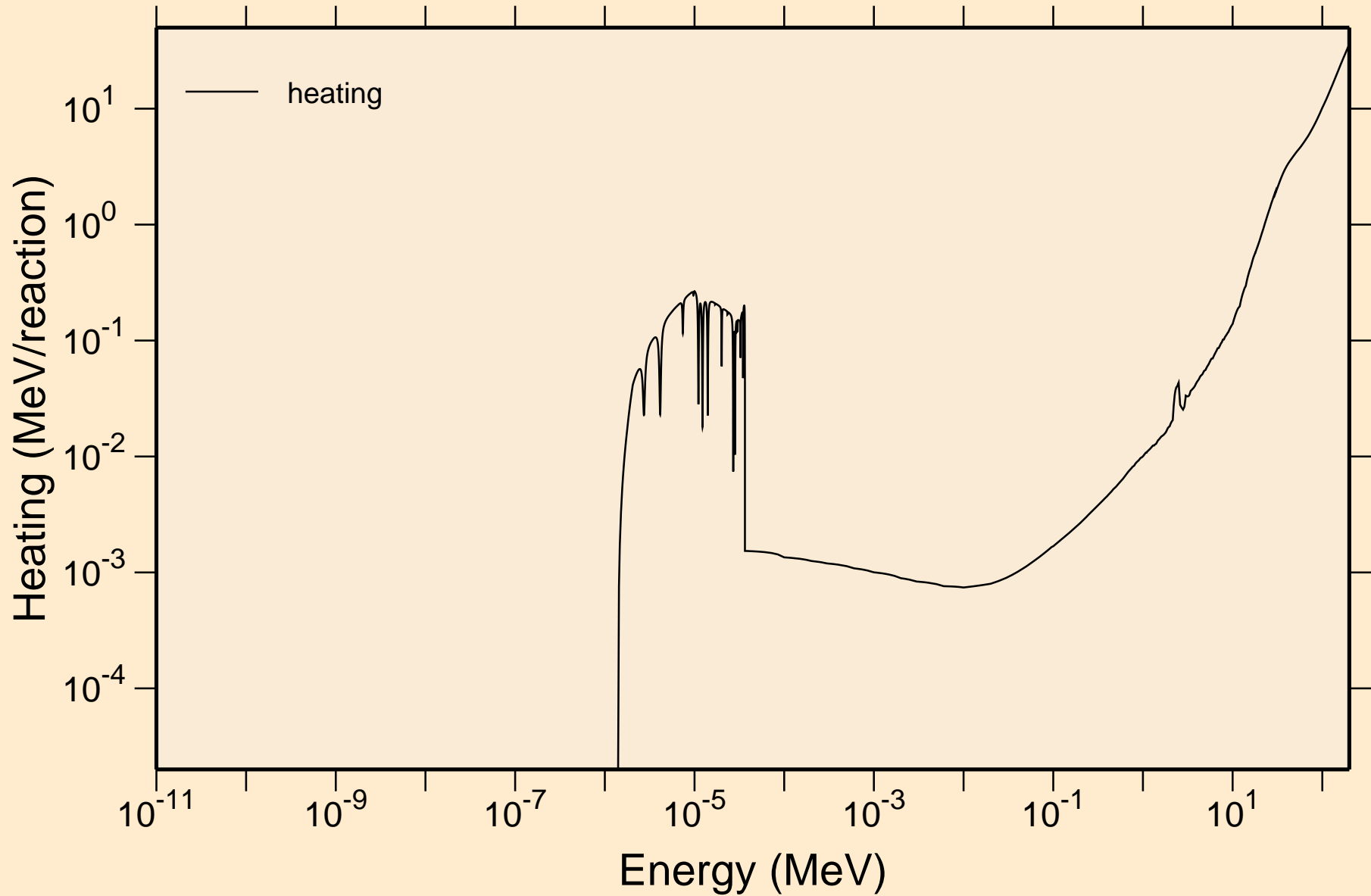

ND139 NEUTRON ACER TENDL-2024 LIBRARY; T=0.K

Damage

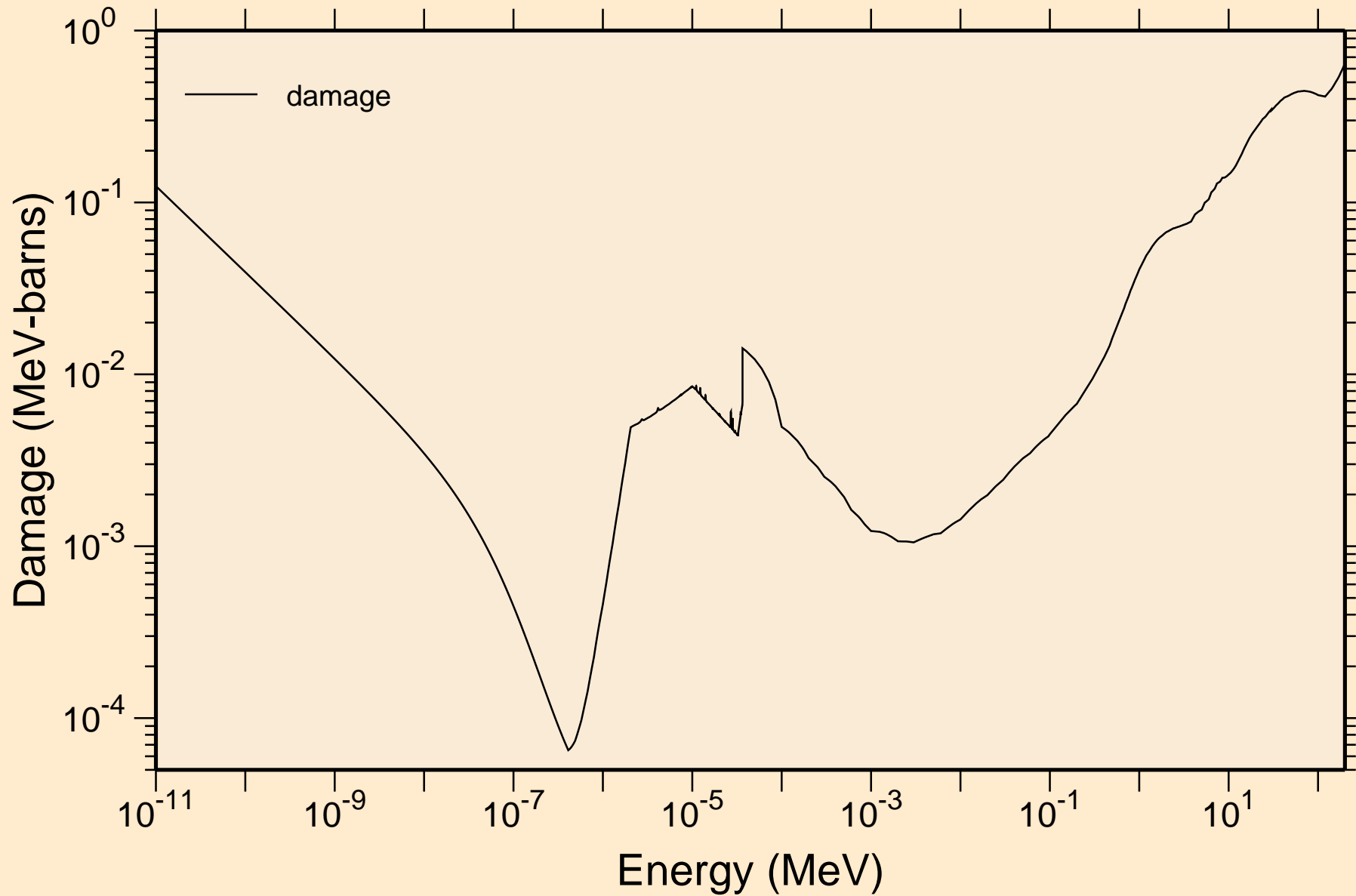

ND139 NEUTRON ACER TENDL-2024 LIBRARY; T=0.K

Non-threshold reactions

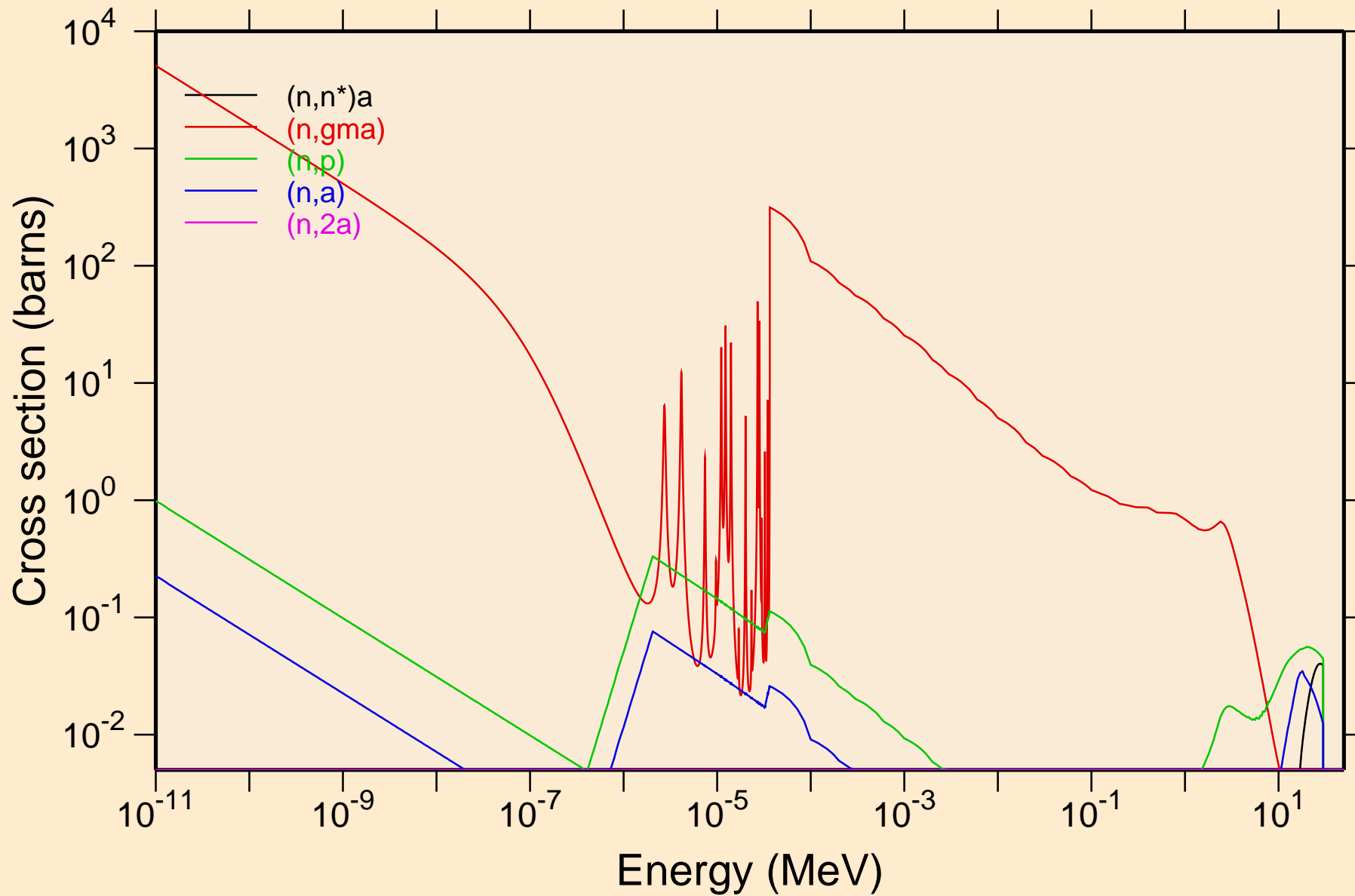

ND139 NEUTRON ACER TENDL-2024 LIBRARY; T=0.K
Non-threshold reactions

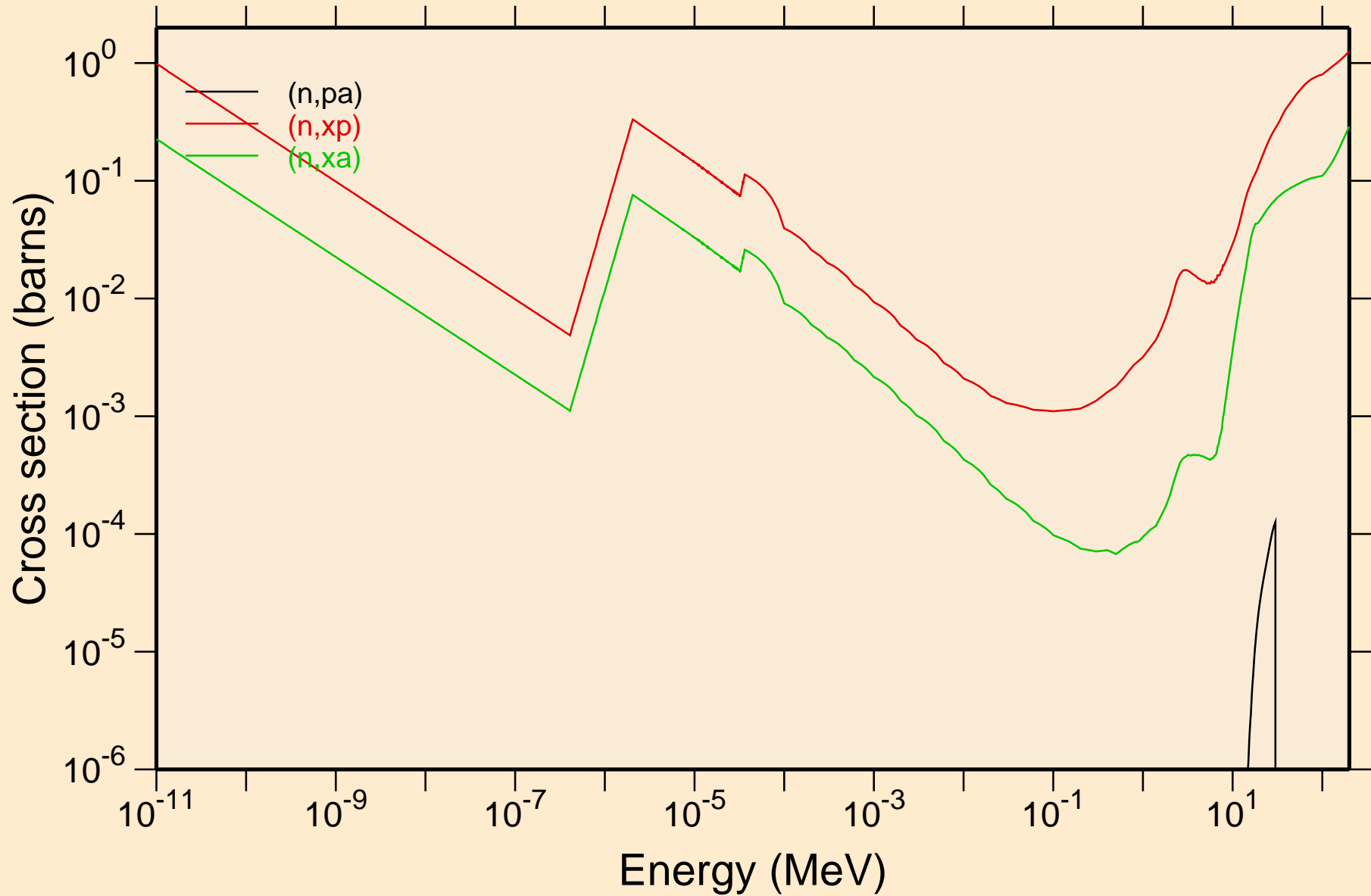

ND139 NEUTRON ACER TENDL-2024 LIBRARY; T=0.K

Principal cross sections

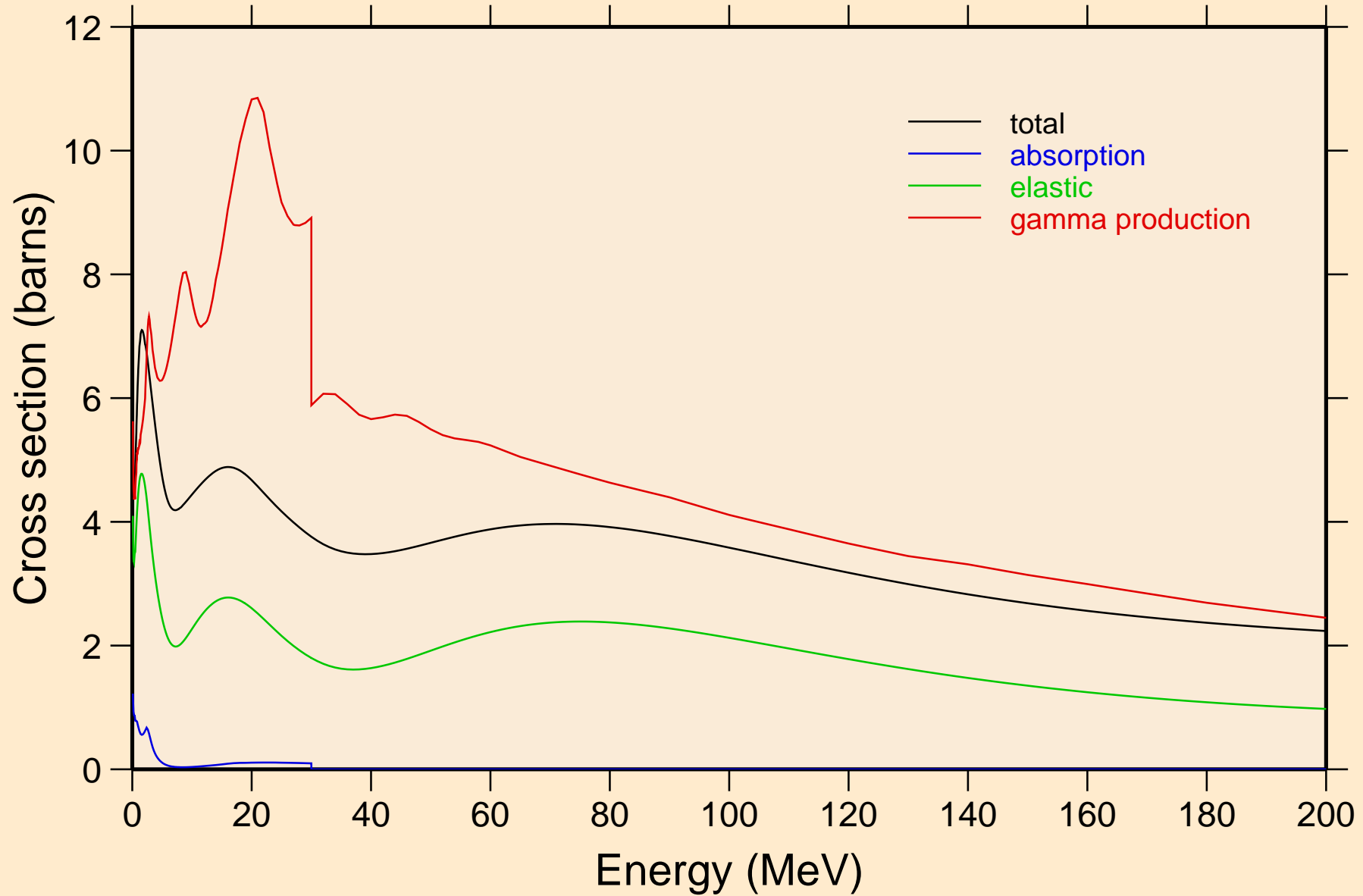

ND139 NEUTRON ACER TENDL-2024 LIBRARY; T=0.K

Heating

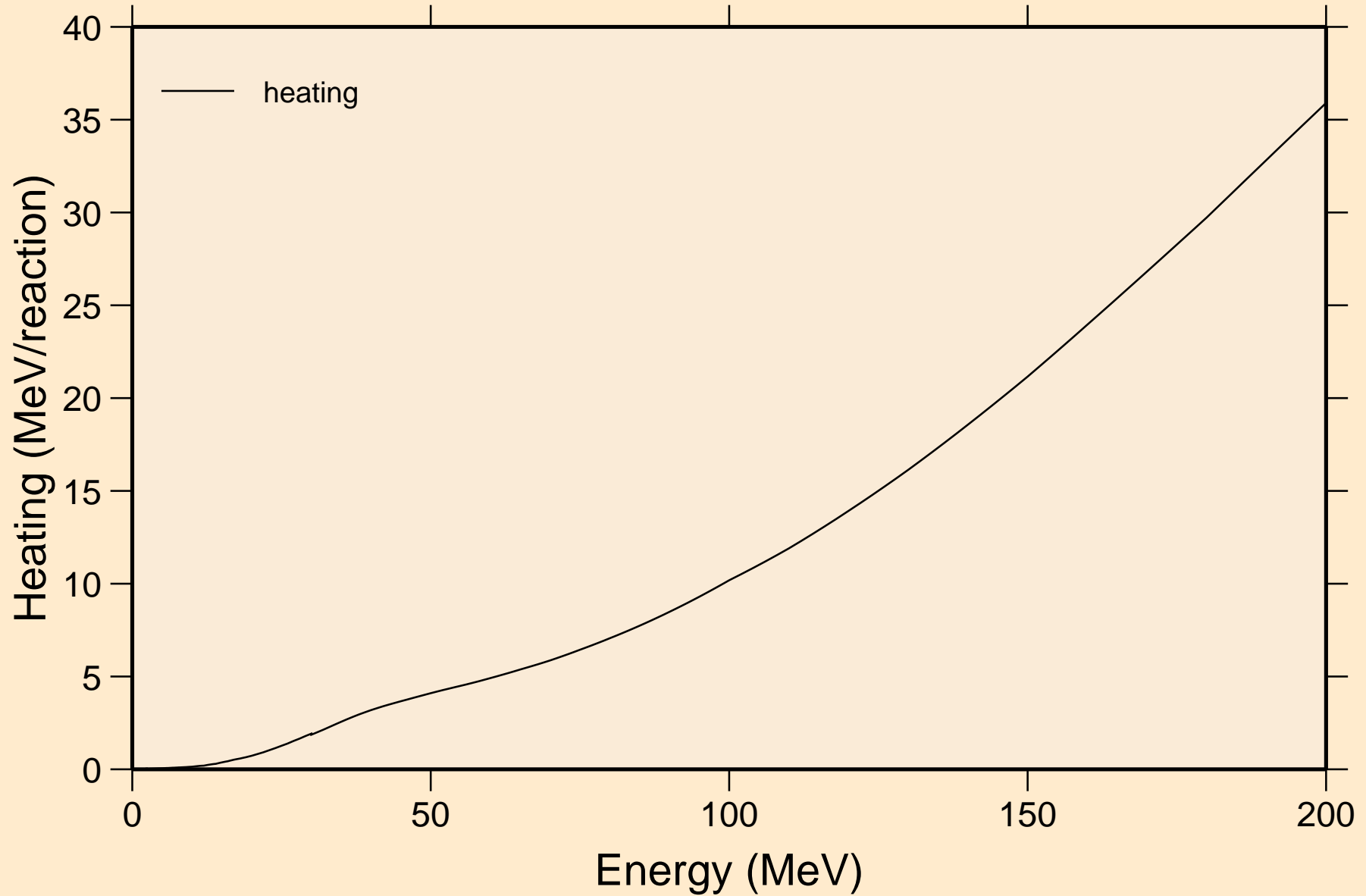

ND139 NEUTRON ACER TENDL-2024 LIBRARY; T=0.K

Damage

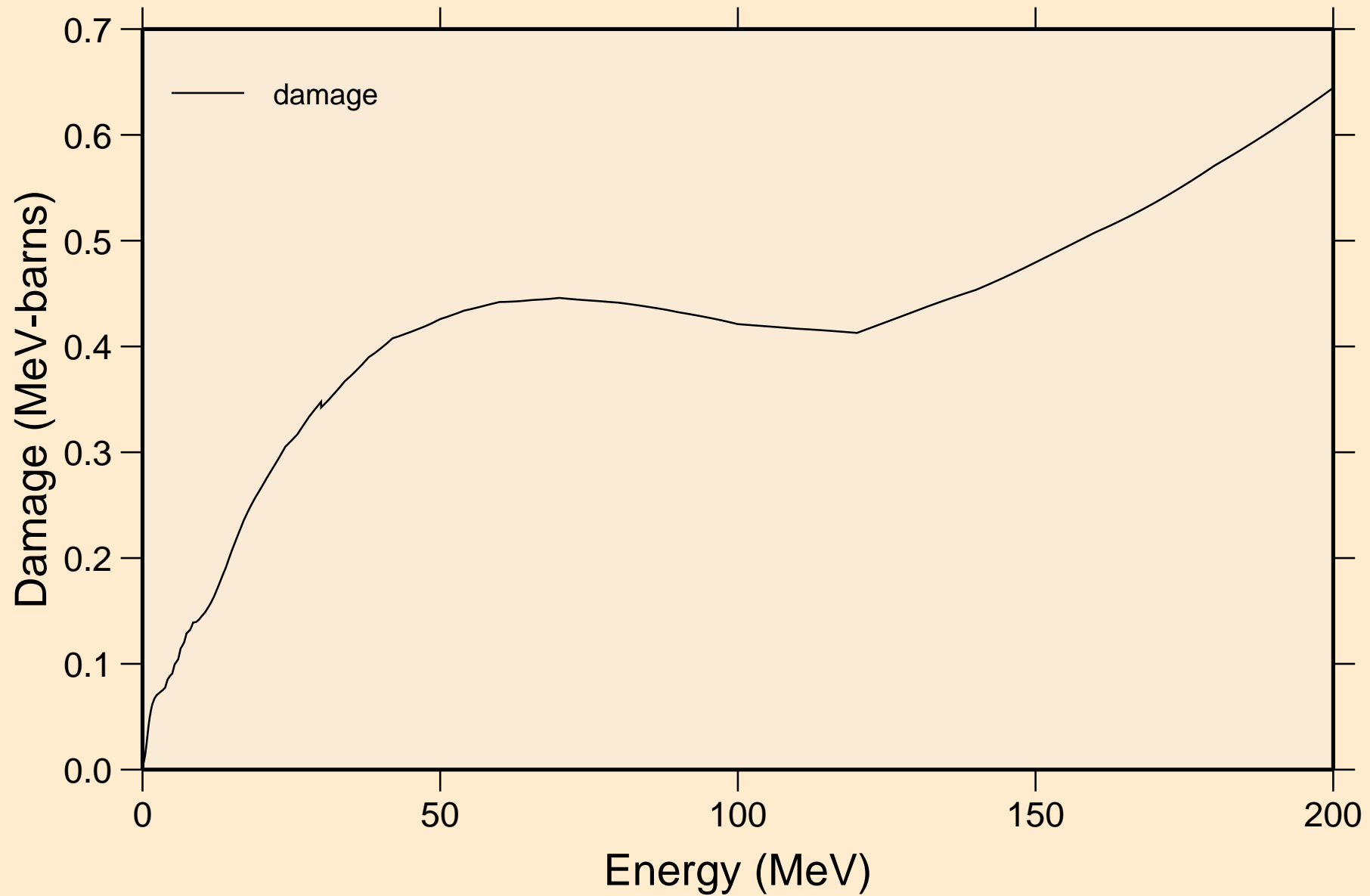

ND139 NEUTRON ACER TENDL-2024 LIBRARY; T=0.K

Non-threshold reactions

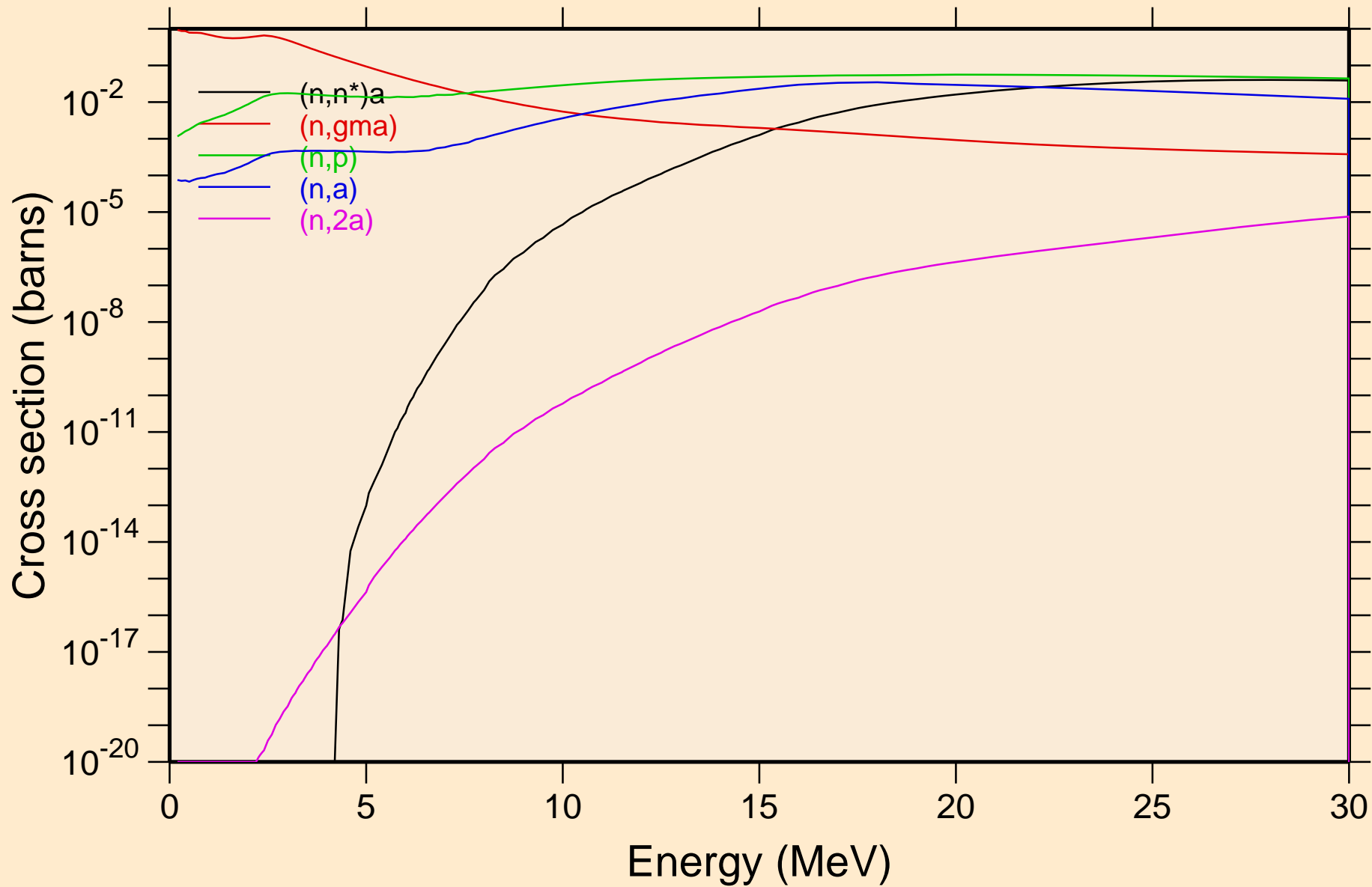

ND139 NEUTRON ACER TENDL-2024 LIBRARY; T=0.K

Non-threshold reactions

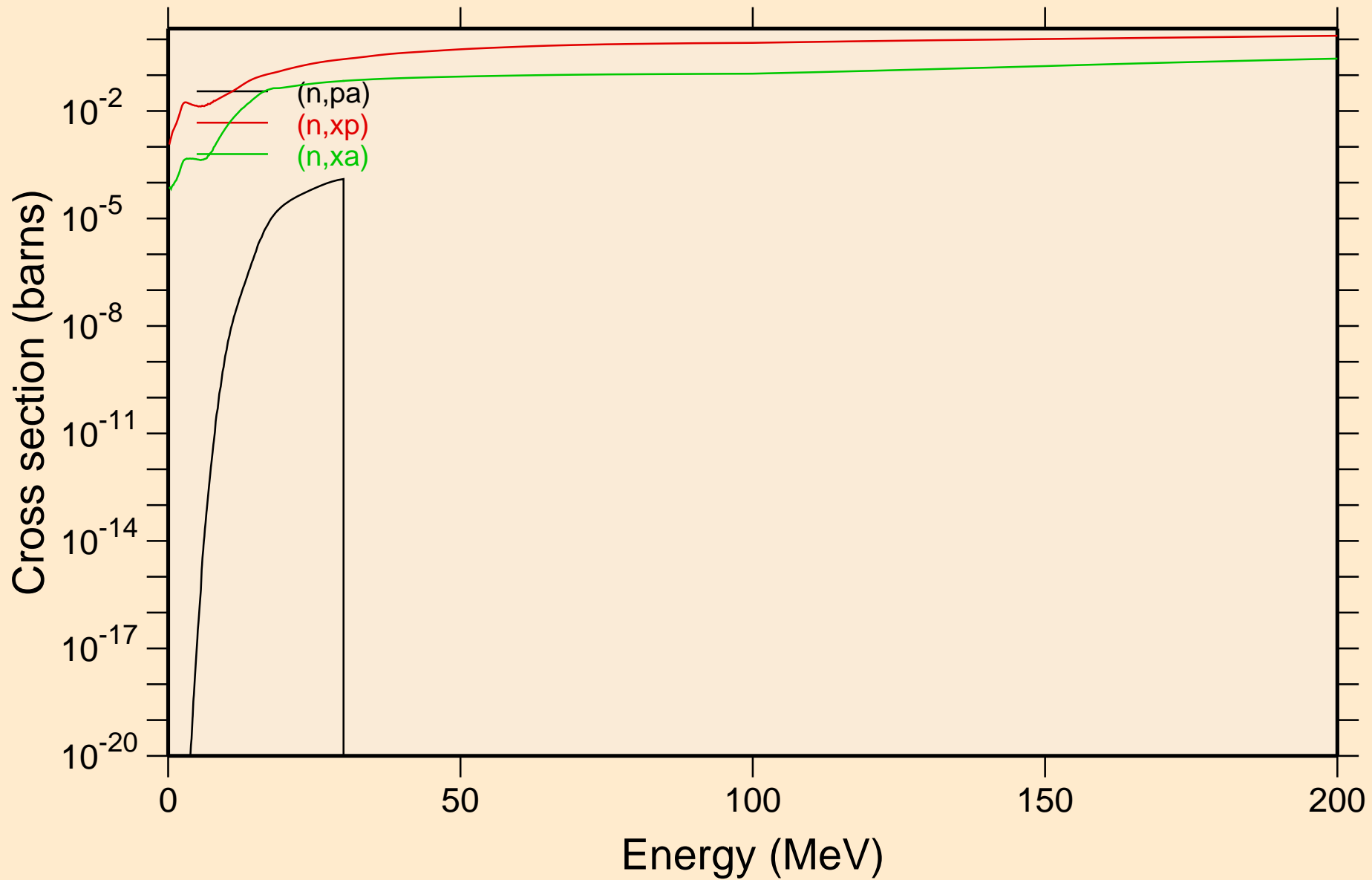

ND139 NEUTRON ACER TENDL-2024 LIBRARY; T=0.K

Inelastic levels

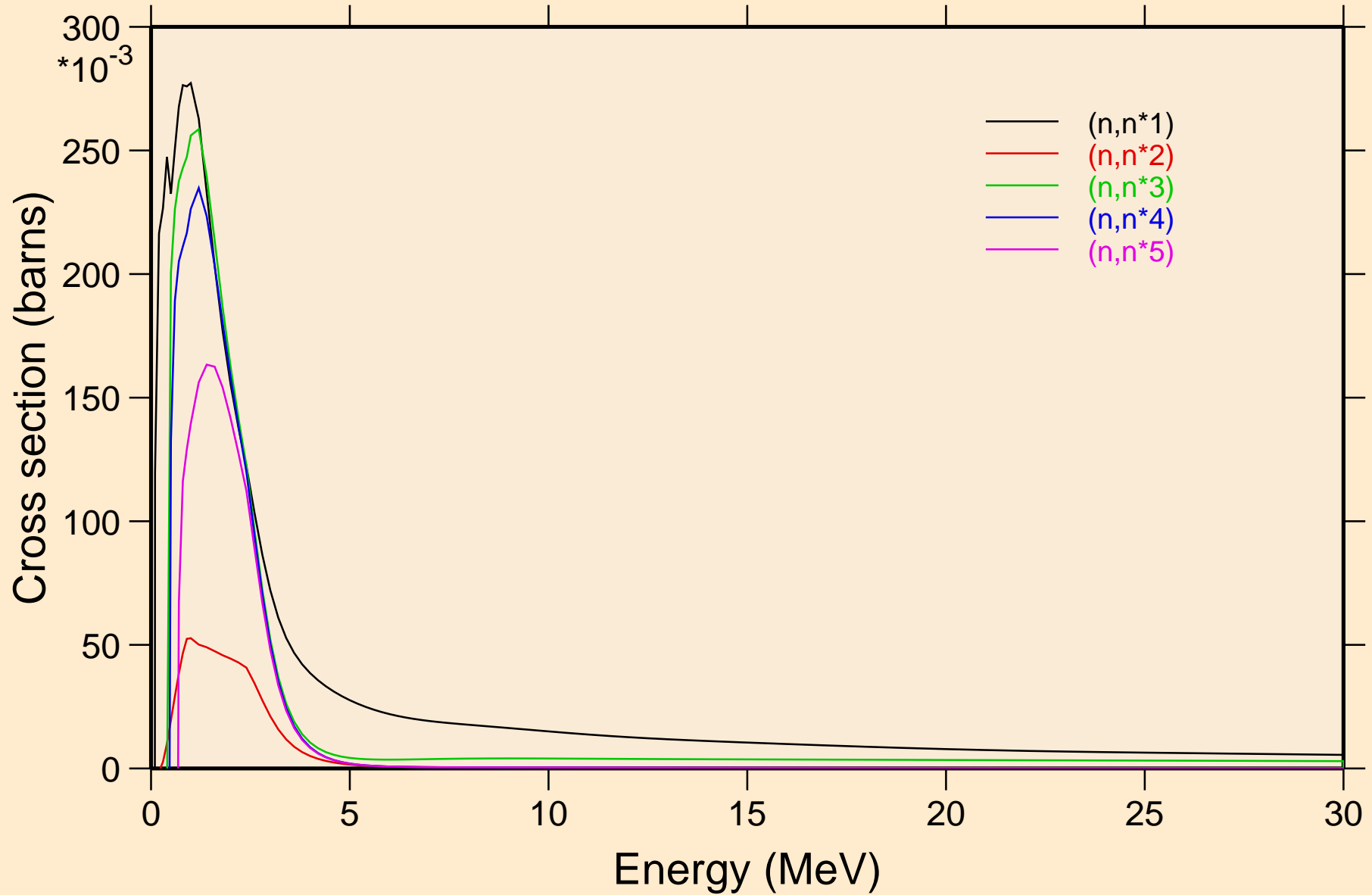

ND139 NEUTRON ACER TENDL-2024 LIBRARY; T=0.K

Inelastic levels

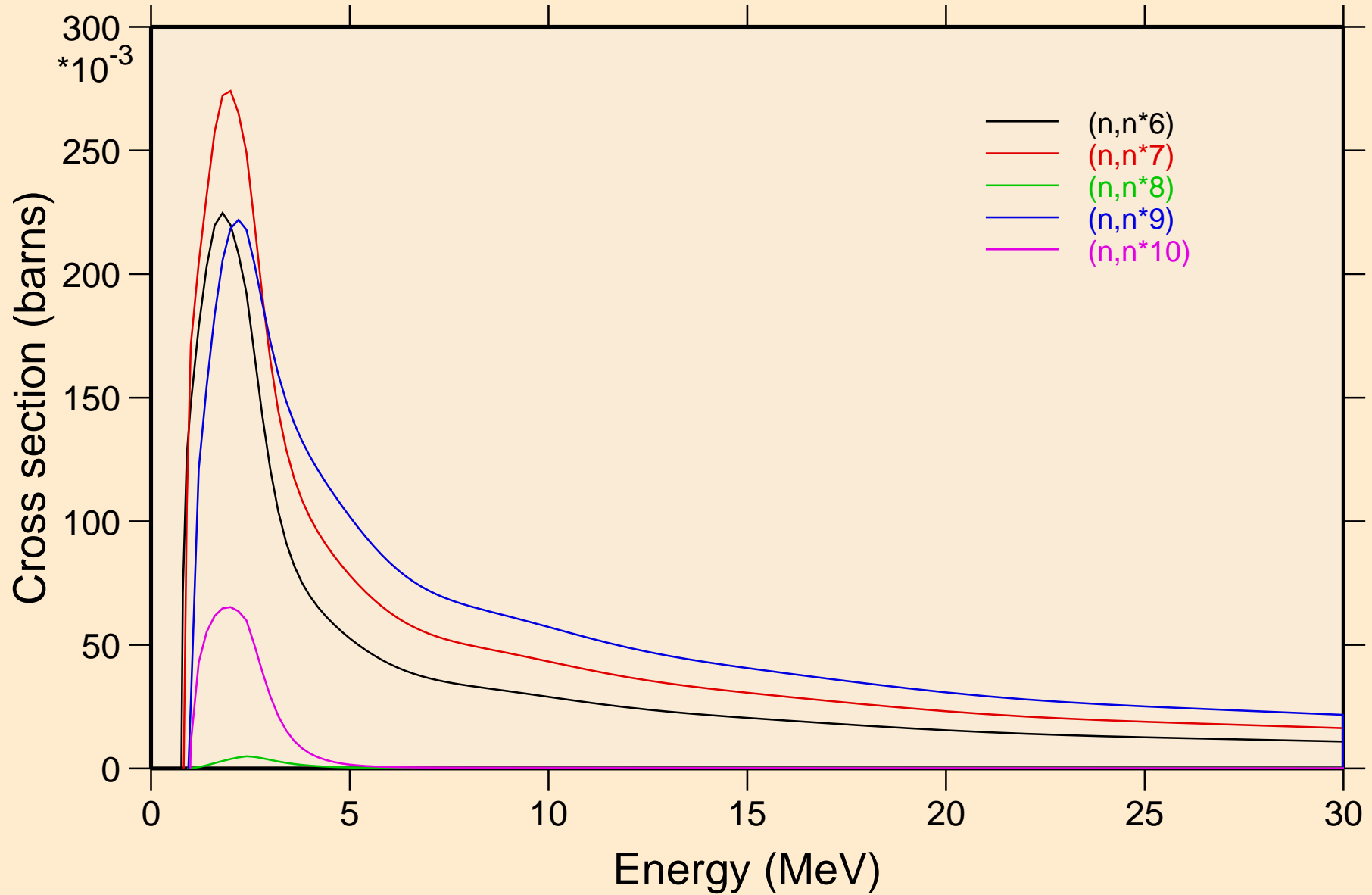

ND139 NEUTRON ACER TENDL-2024 LIBRARY; T=0.K

Inelastic levels

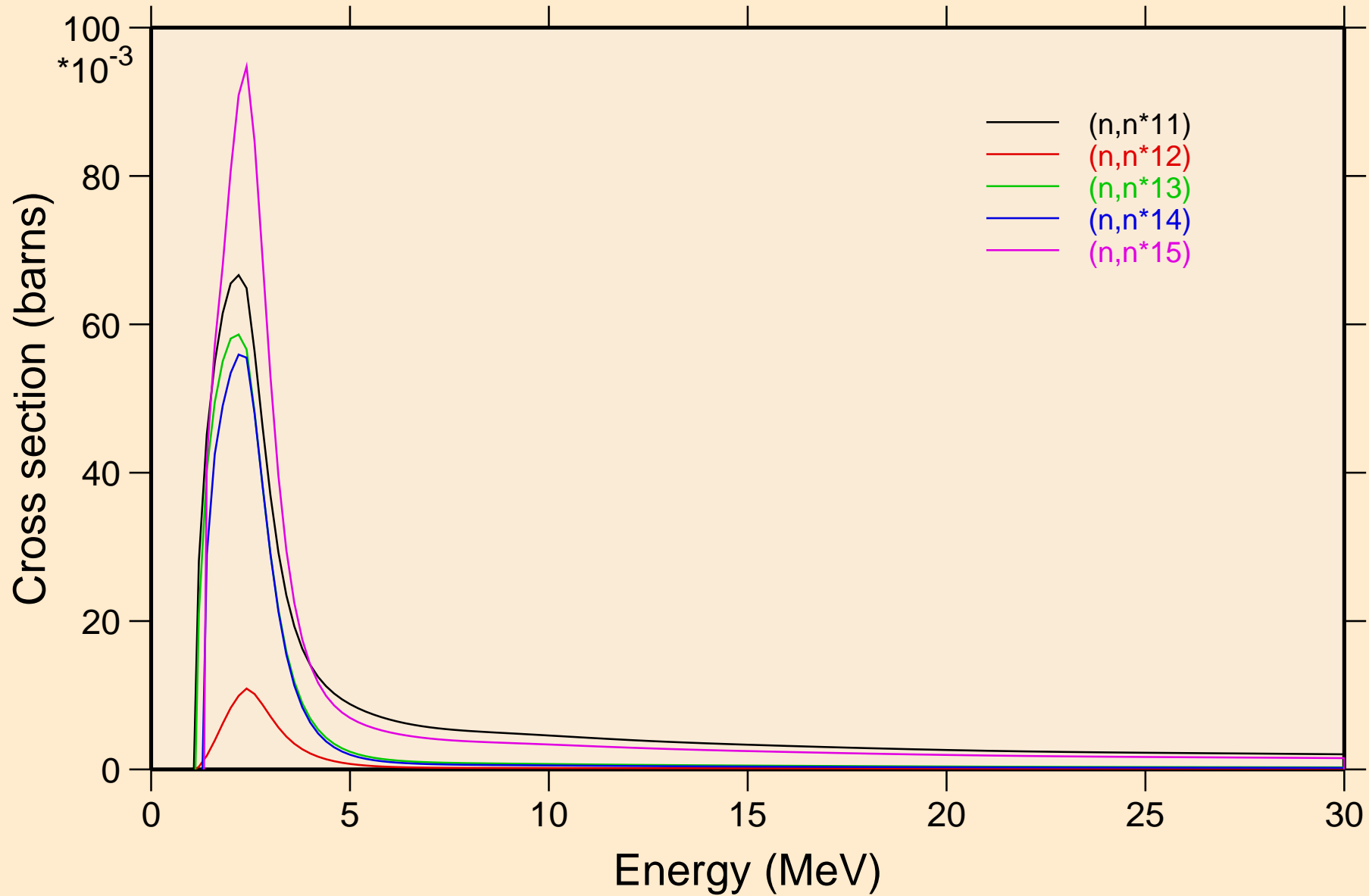

ND139 NEUTRON ACER TENDL-2024 LIBRARY; T=0.K
Inelastic levels

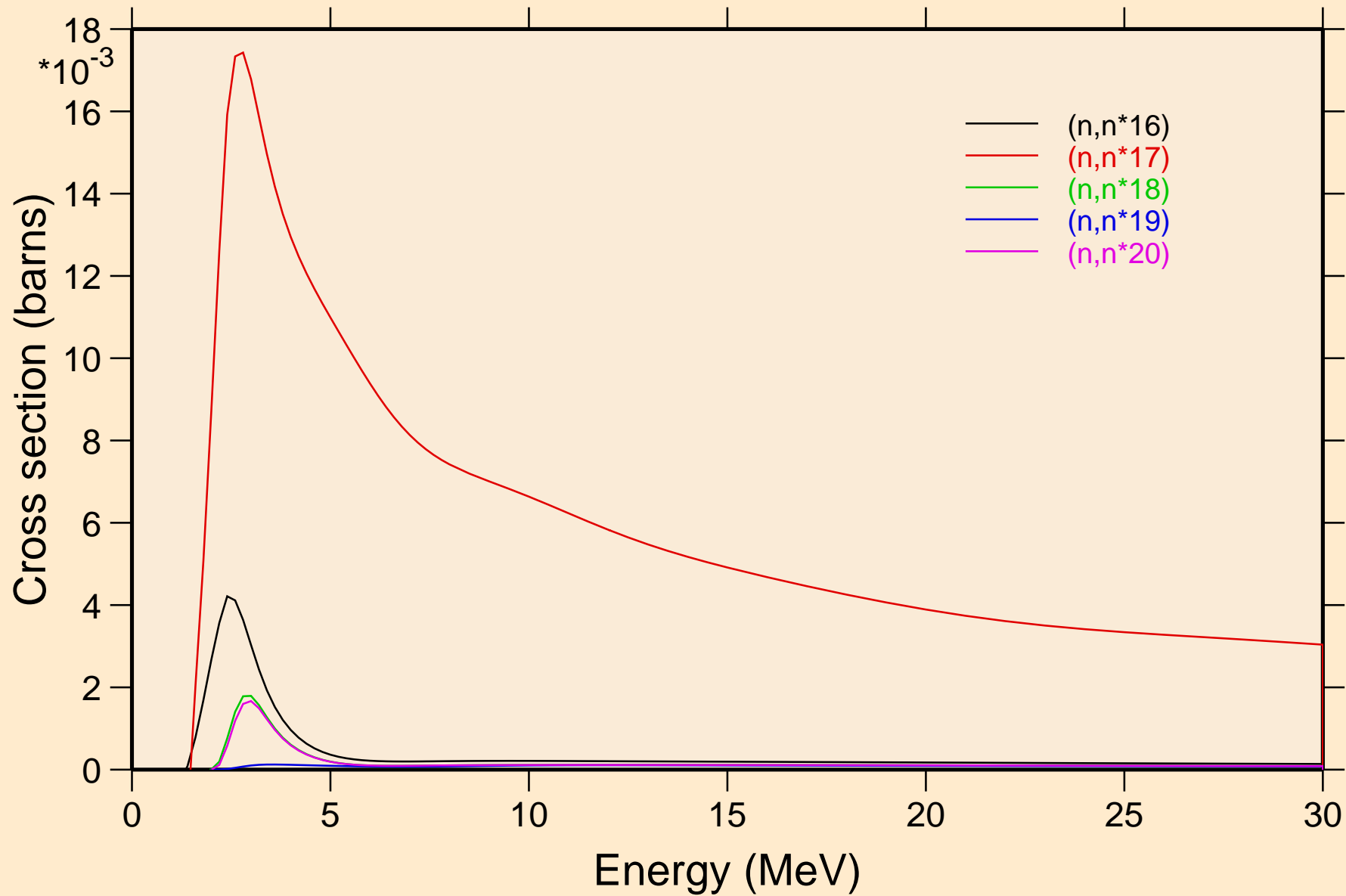

ND139 NEUTRON ACER TENDL-2024 LIBRARY; T=0.K

Inelastic levels

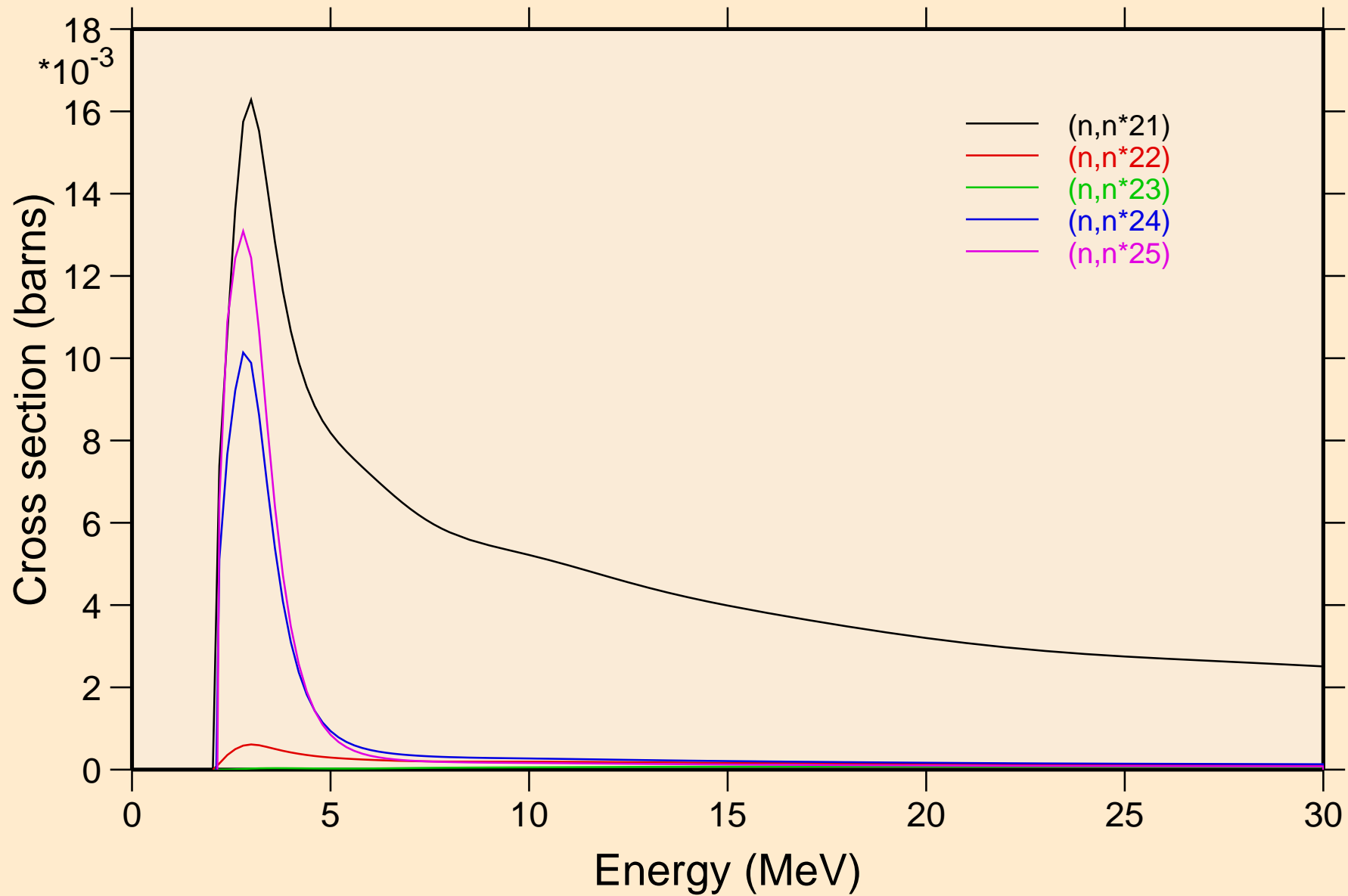

ND139 NEUTRON ACER TENDL-2024 LIBRARY; T=0.K

Threshold reactions

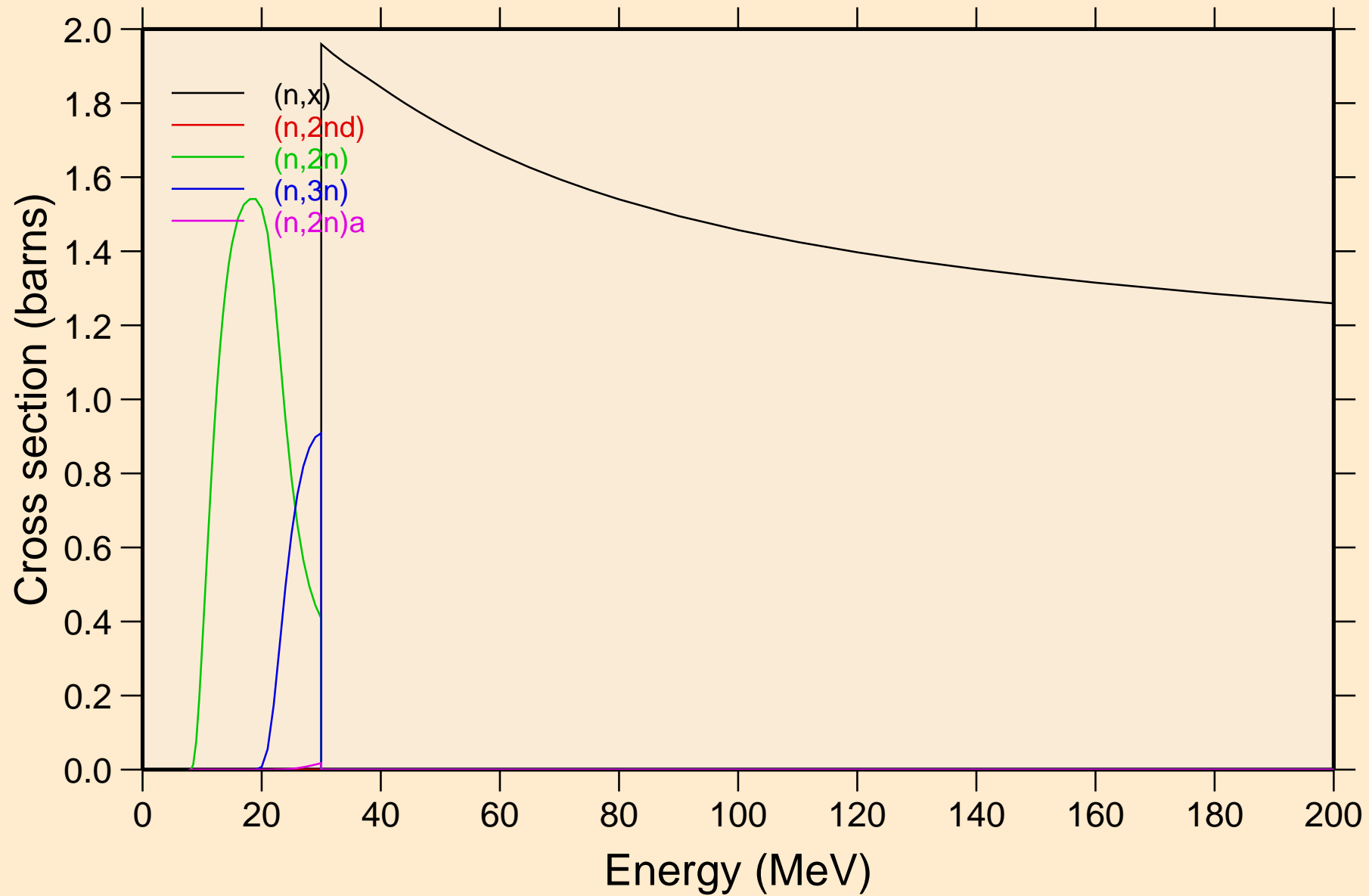

ND139 NEUTRON ACER TENDL-2024 LIBRARY; T=0.K
Threshold reactions

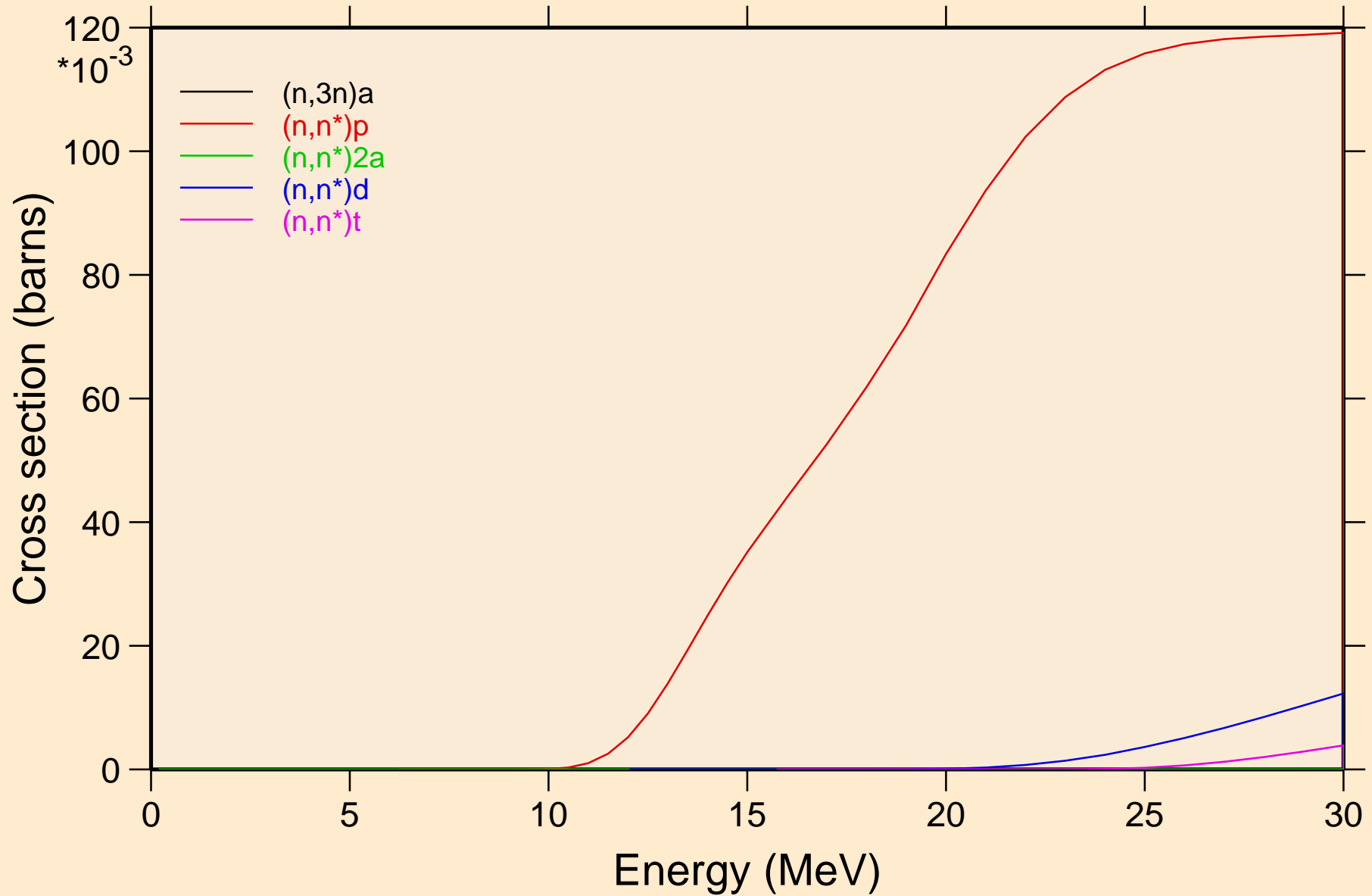

ND139 NEUTRON ACER TENDL-2024 LIBRARY; T=0.K

Threshold reactions

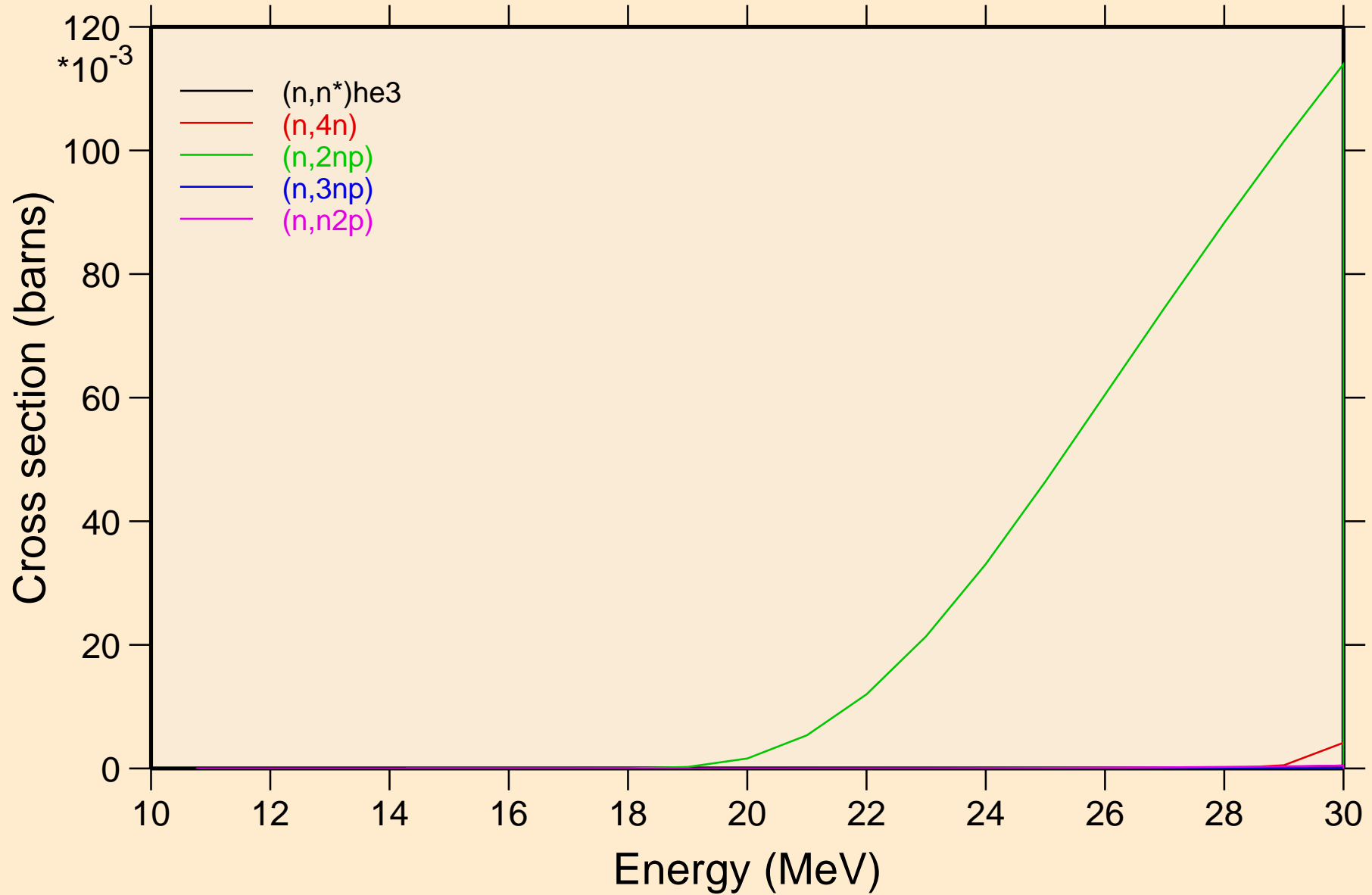

ND139 NEUTRON ACER TENDL-2024 LIBRARY; T=0.K

Threshold reactions

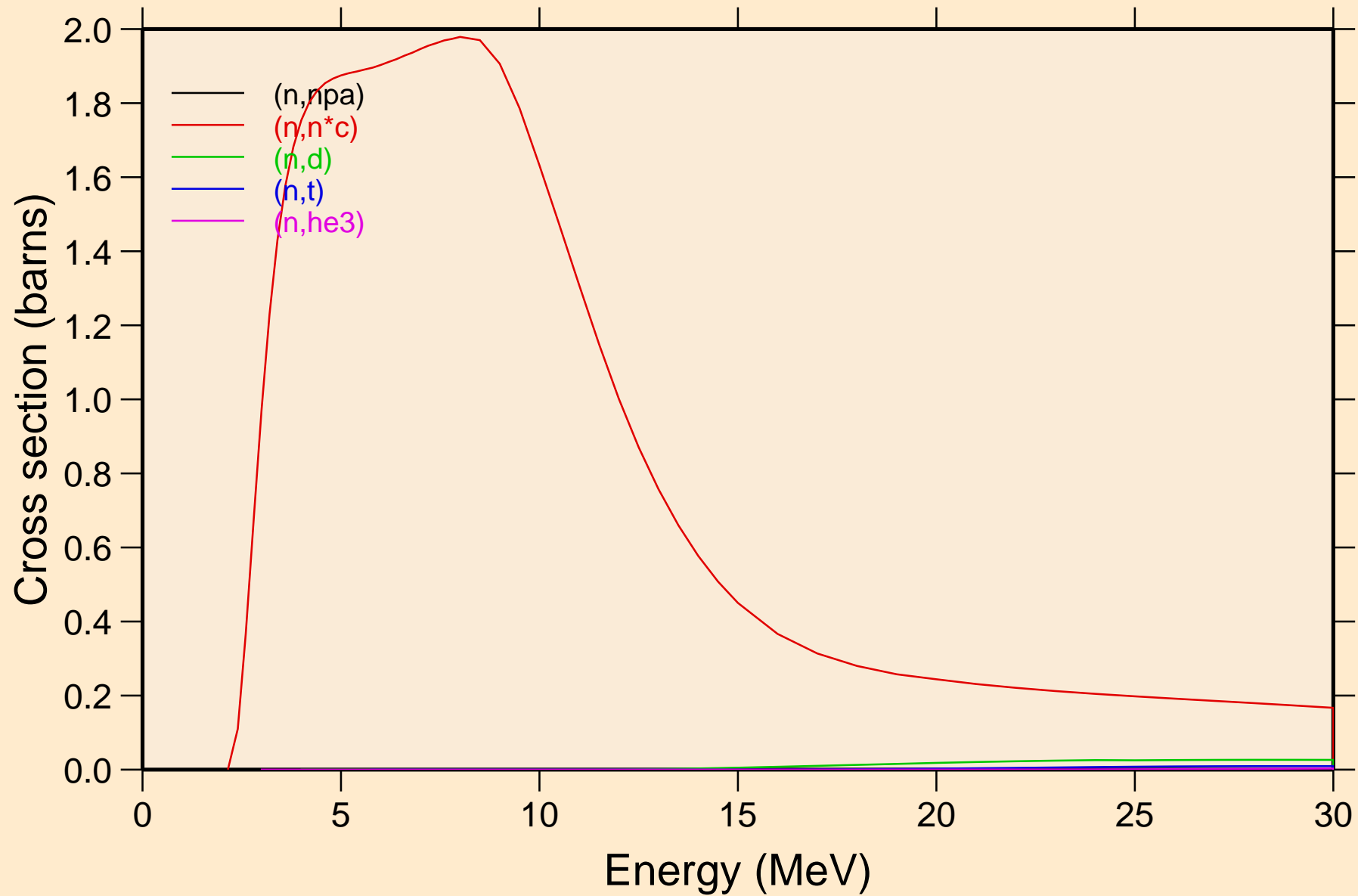

ND139 NEUTRON ACER TENDL-2024 LIBRARY; T=0.K

Threshold reactions

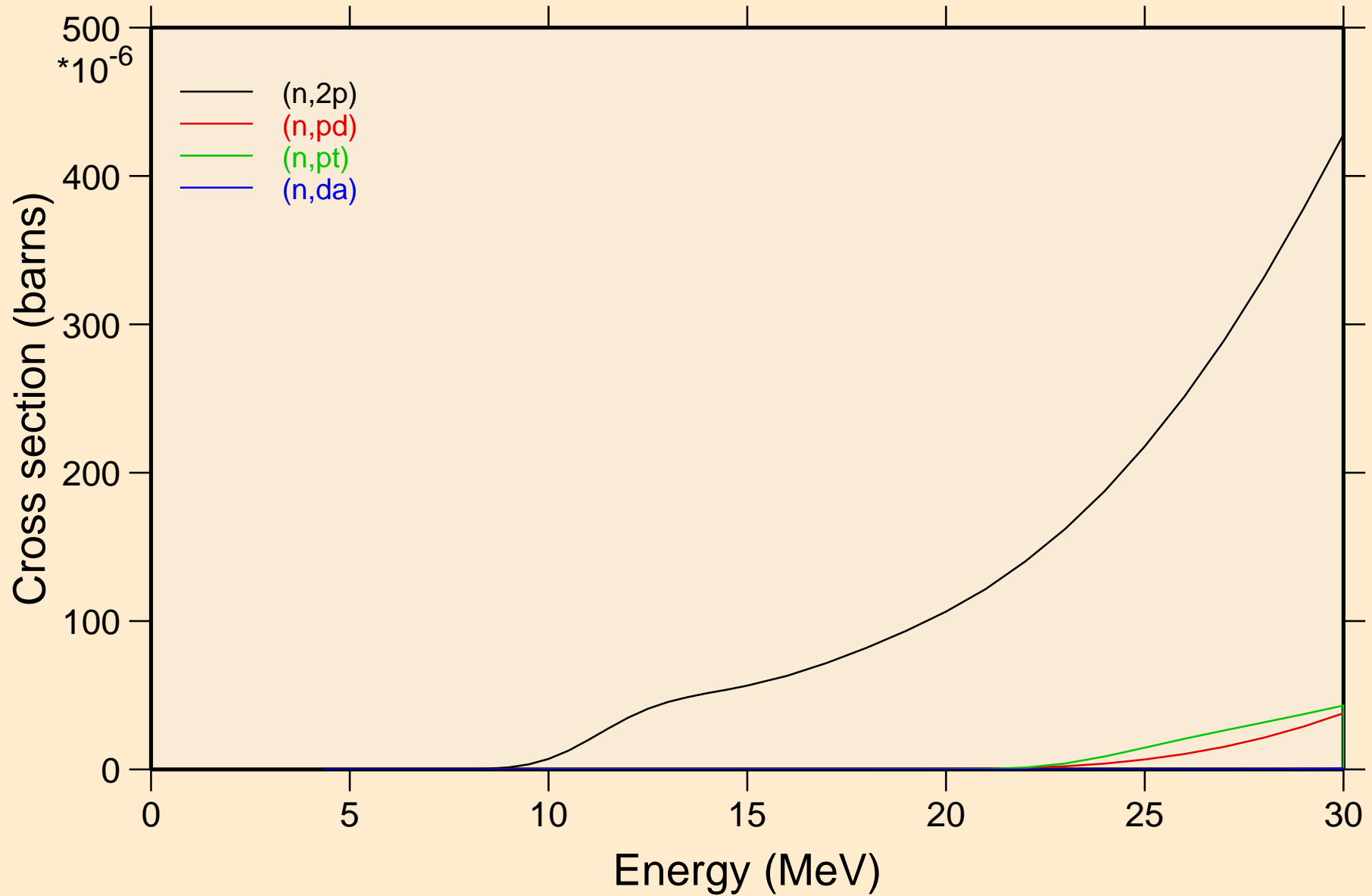

ND139 NEUTRON ACER TENDL-2024 LIBRARY; T=0.K

Threshold reactions

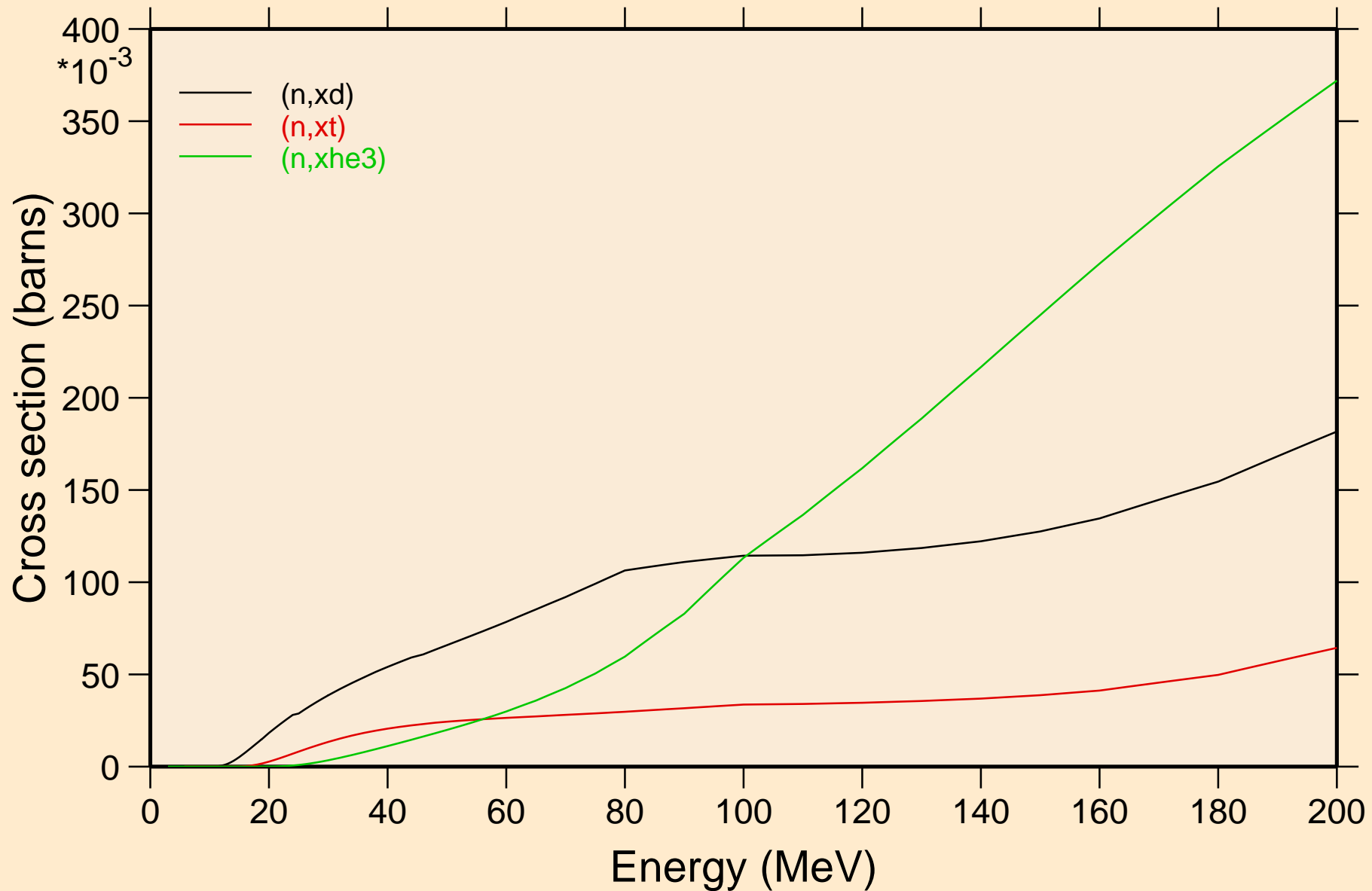

ND139 NEUTRON ACER TENDL-2024 LIBRARY; T=0.K
angular distribution for elastic

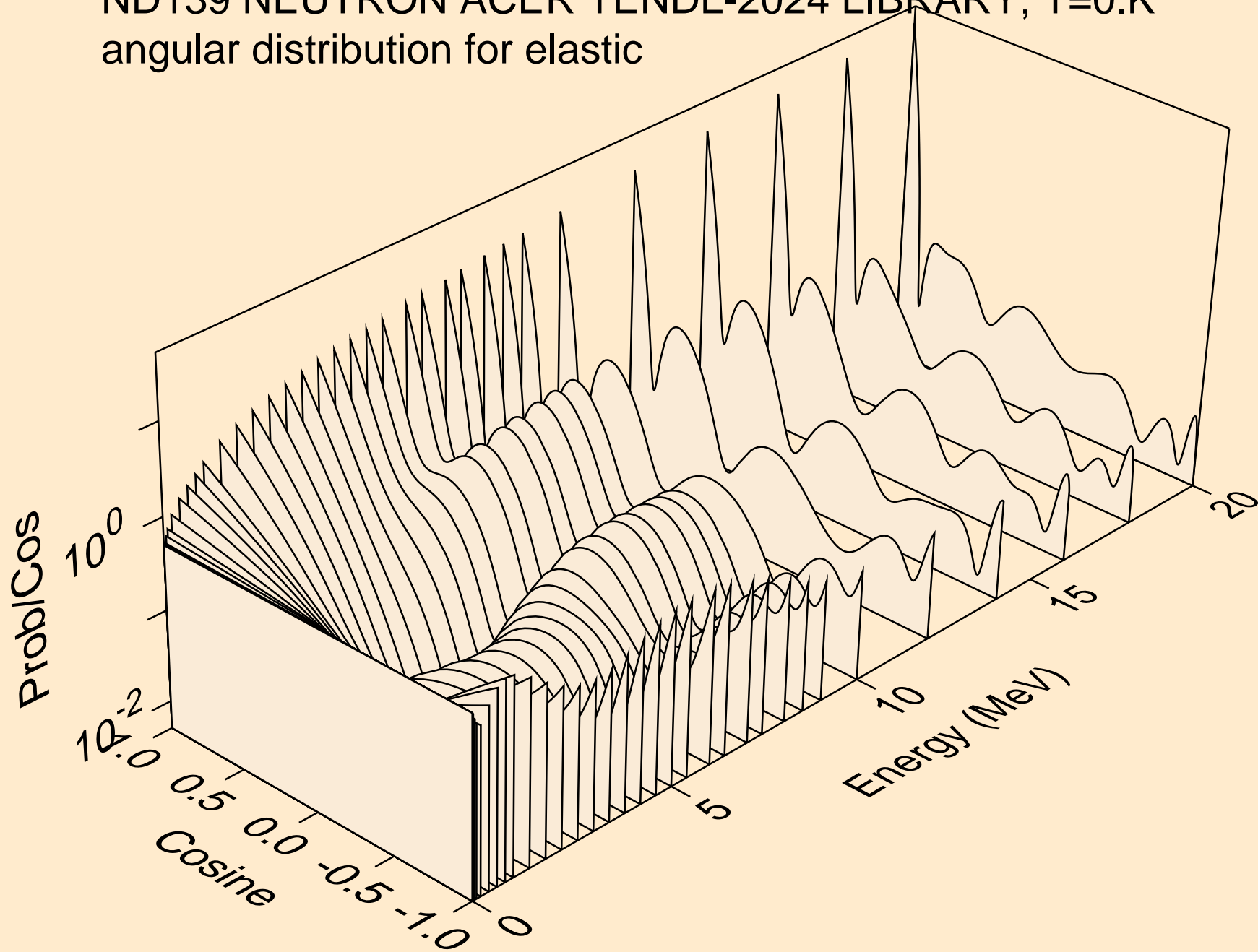

ND139 NEUTRON ACER TENDL-2024 LIBRARY; T=0.K
angular distribution for elastic

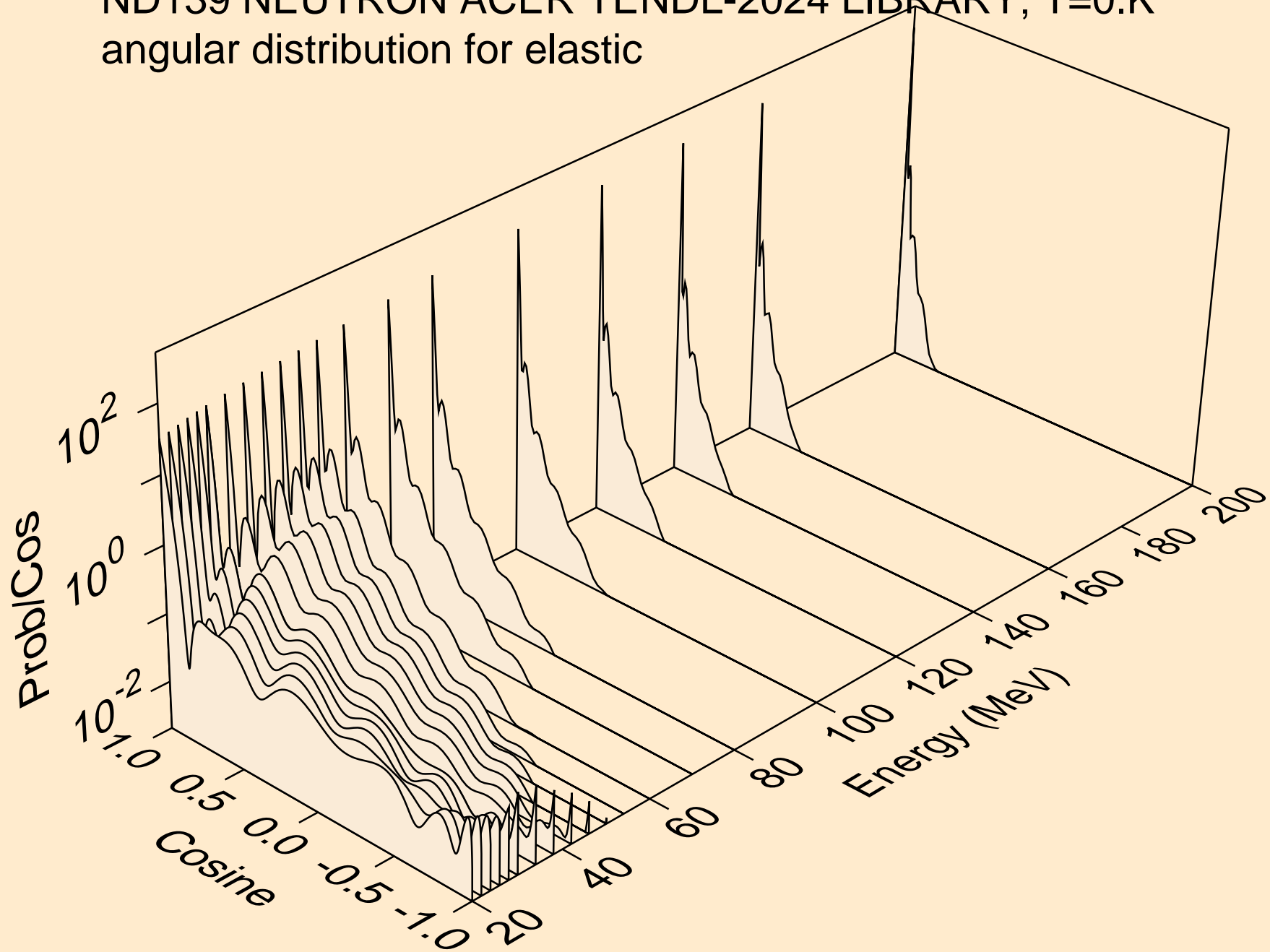

ND139 NEUTRON ACER TENDL-2024 LIBRARY; T=0.K
angular distribution for (n,n*1)

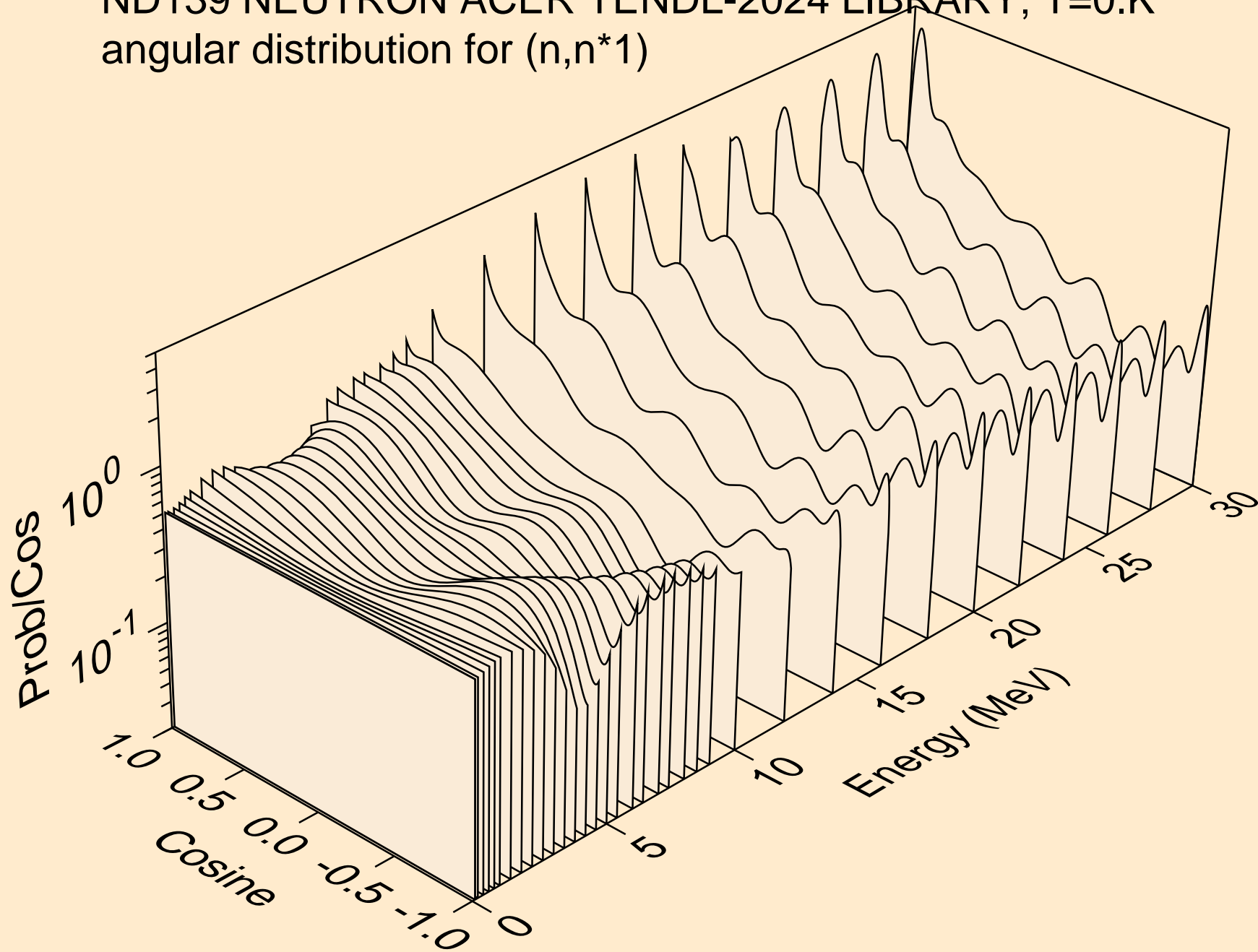

ND139 NEUTRON ACER TENDL-2024 LIBRARY; T=0.K
angular distribution for (n,n*2)

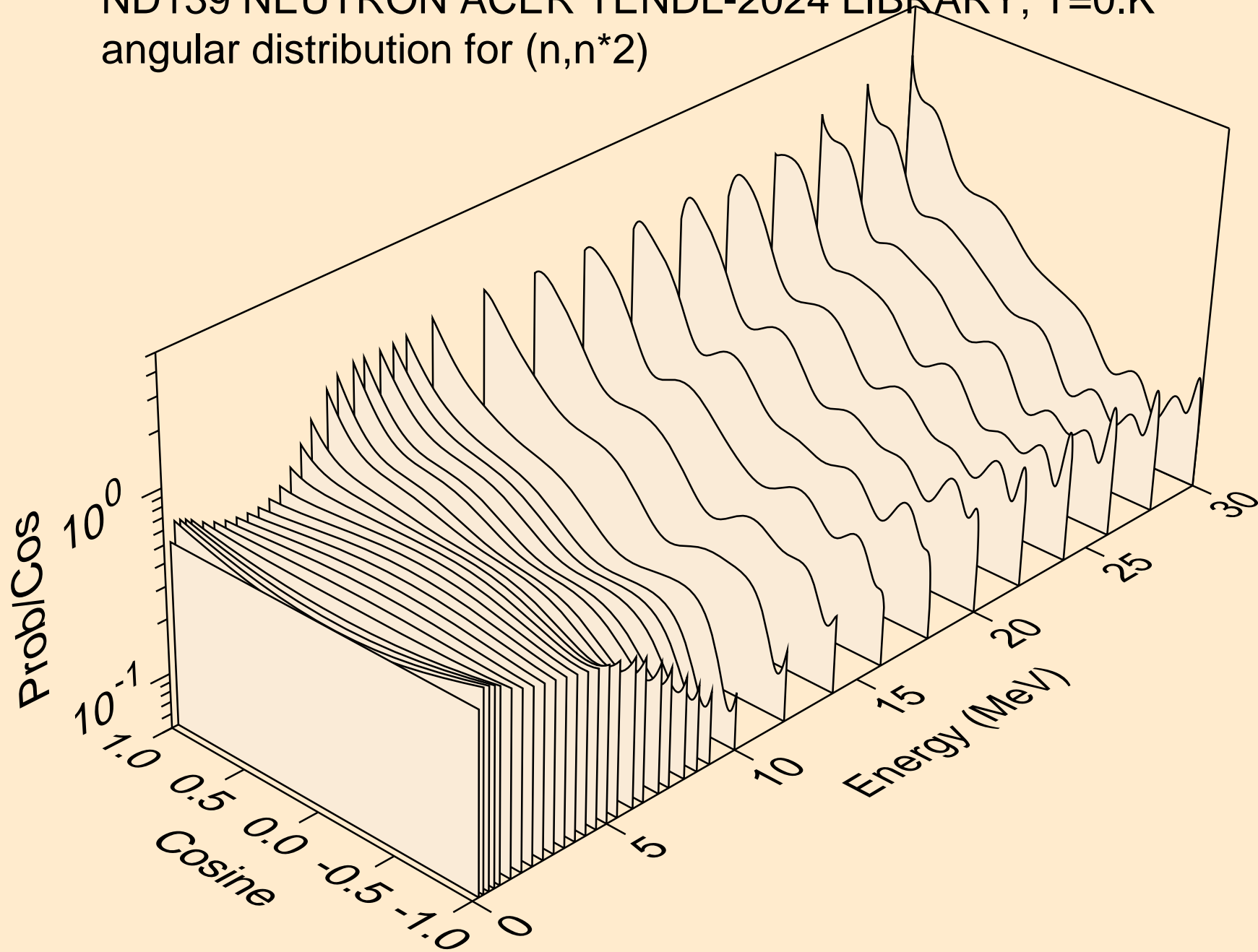

ND139 NEUTRON ACER TENDL-2024 LIBRARY; T=0.K
angular distribution for (n,n*3)

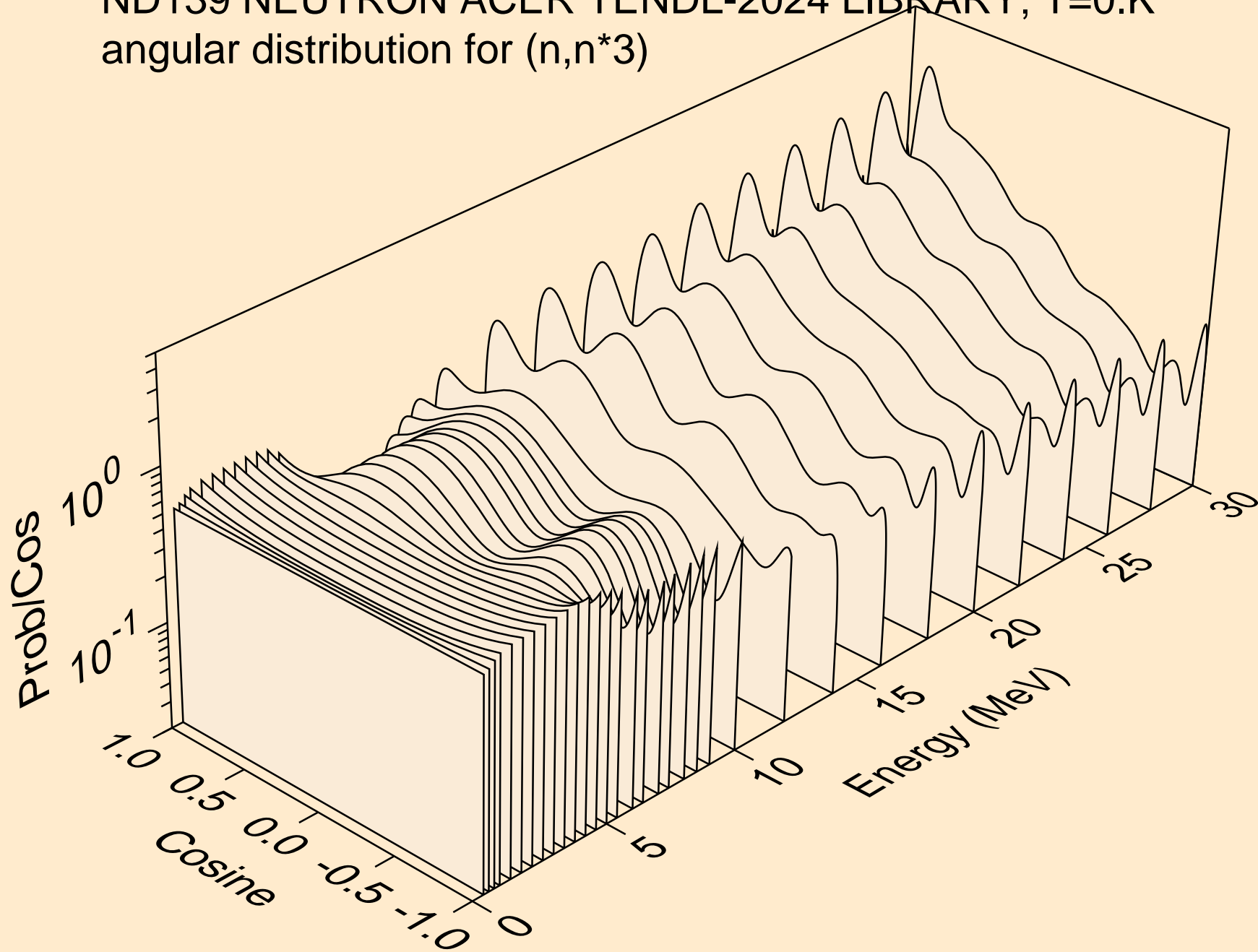

ND139 NEUTRON ACER TENDL-2024 LIBRARY; T=0.K
angular distribution for (n,n*4)

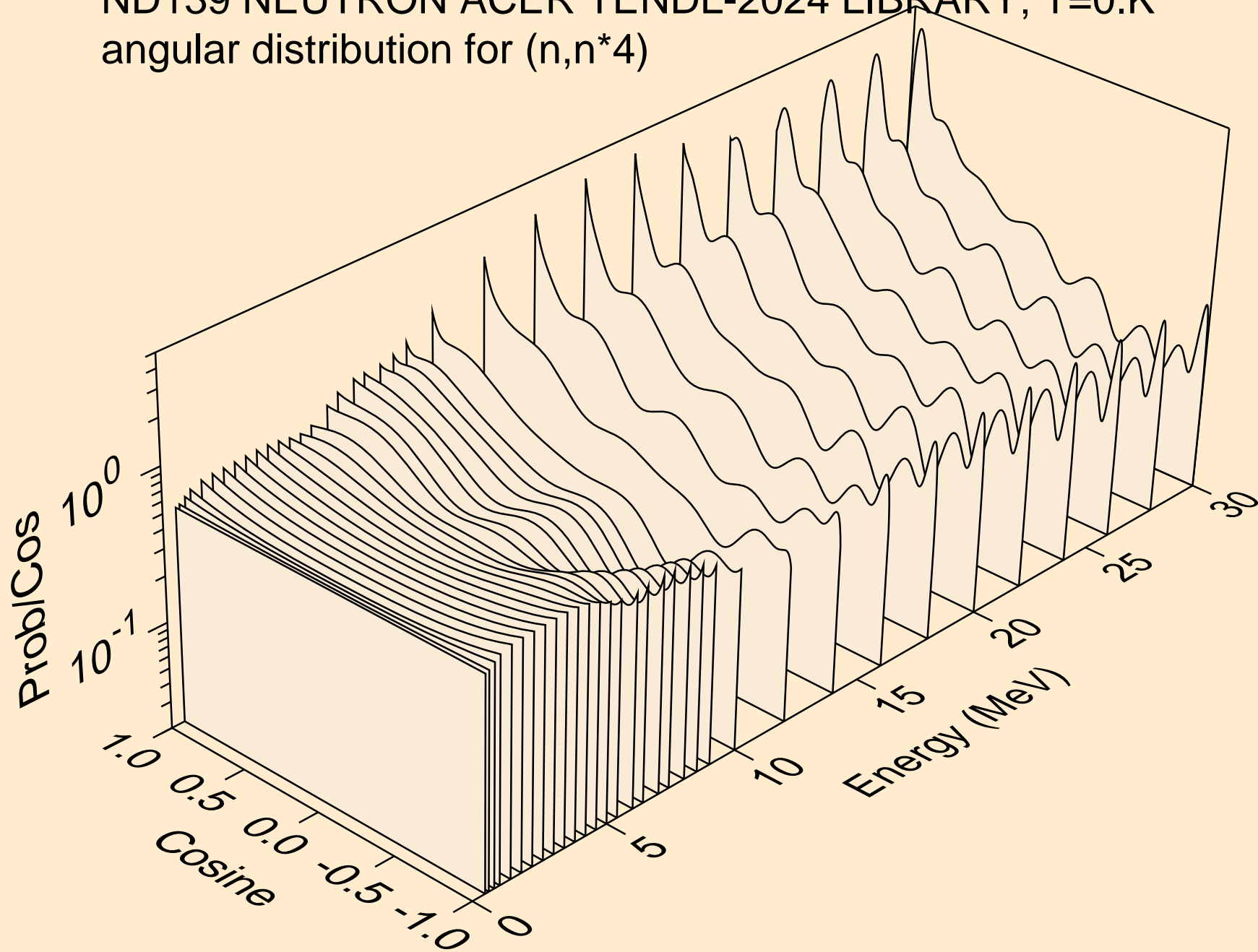

ND139 NEUTRON ACER TENDL-2024 LIBRARY; T=0.K
angular distribution for (n,n*5)

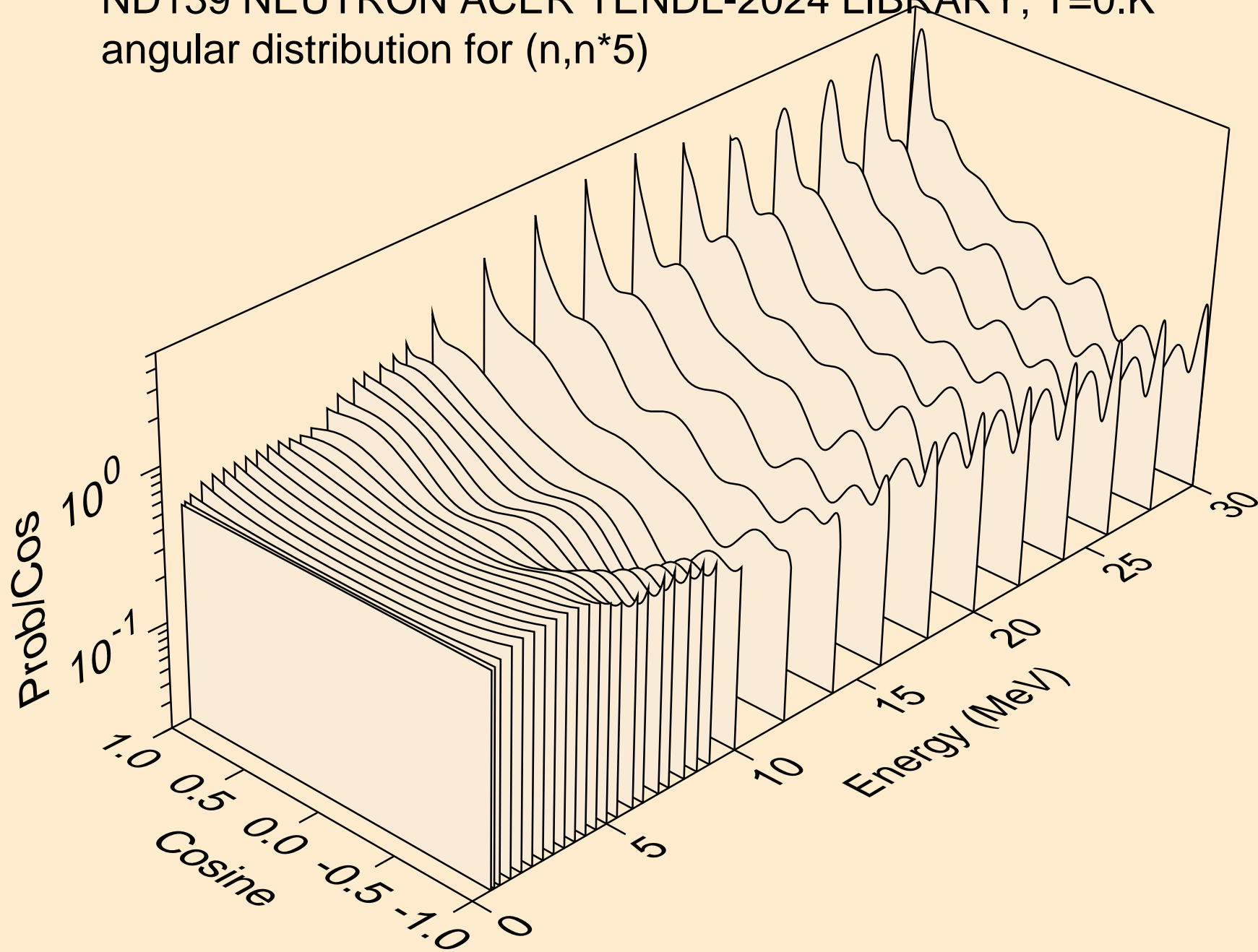

ND139 NEUTRON ACER TENDL-2024 LIBRARY; T=0.K
angular distribution for (n,n*6)

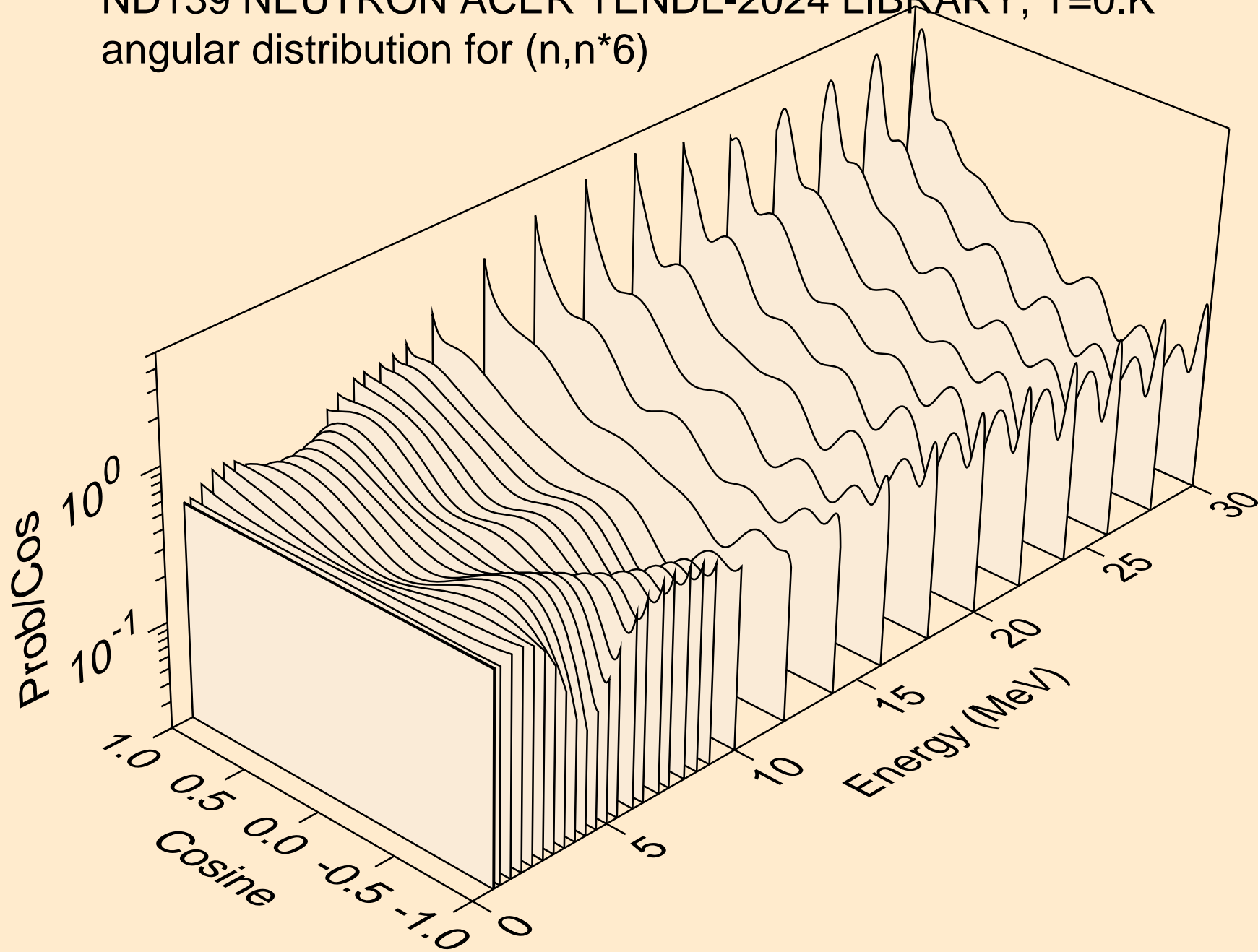

ND139 NEUTRON ACER TENDL-2024 LIBRARY; T=0.K
angular distribution for (n,n*7)

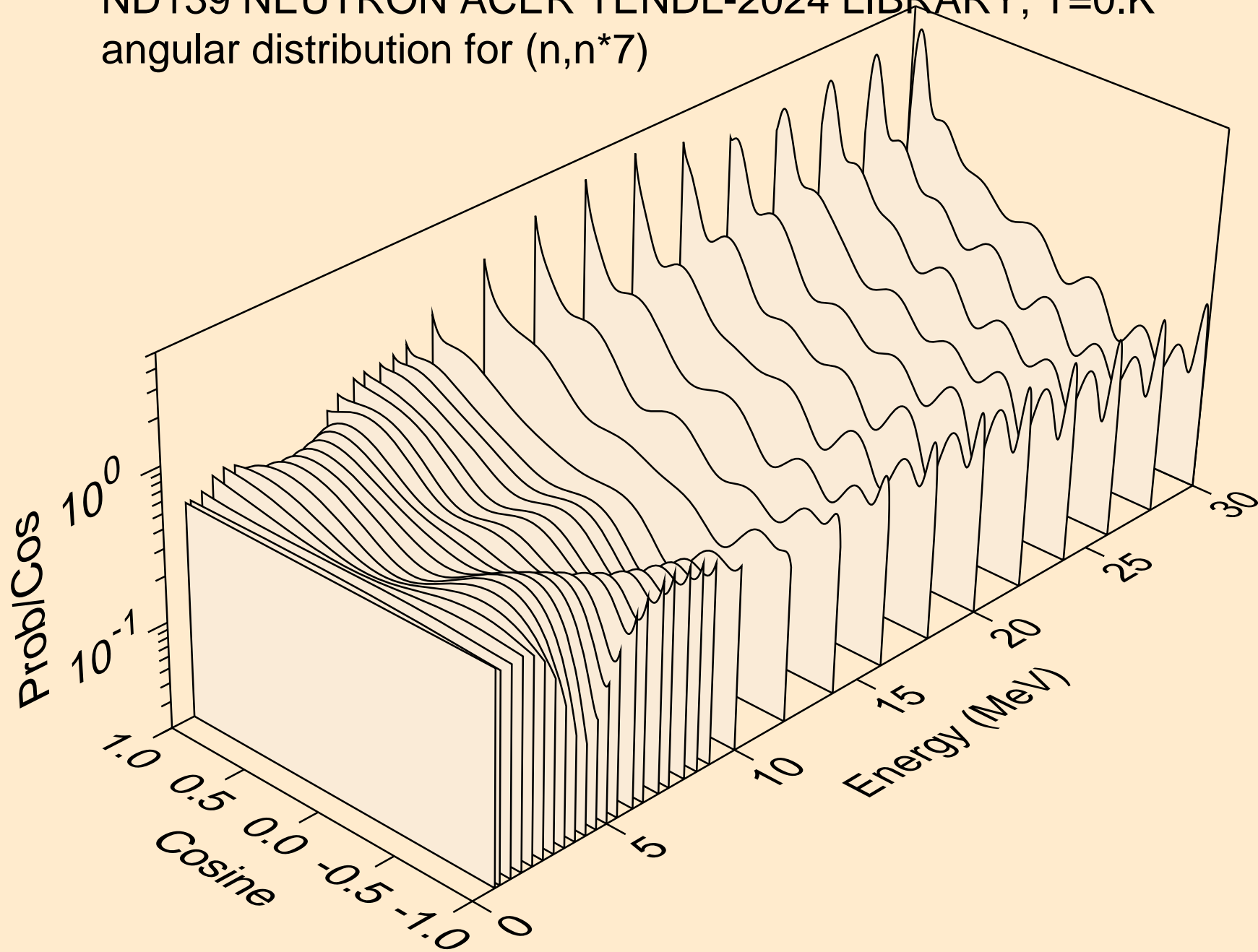

ND139 NEUTRON ACER TENDL-2024 LIBRARY; T=0.K
angular distribution for (n,n*8)

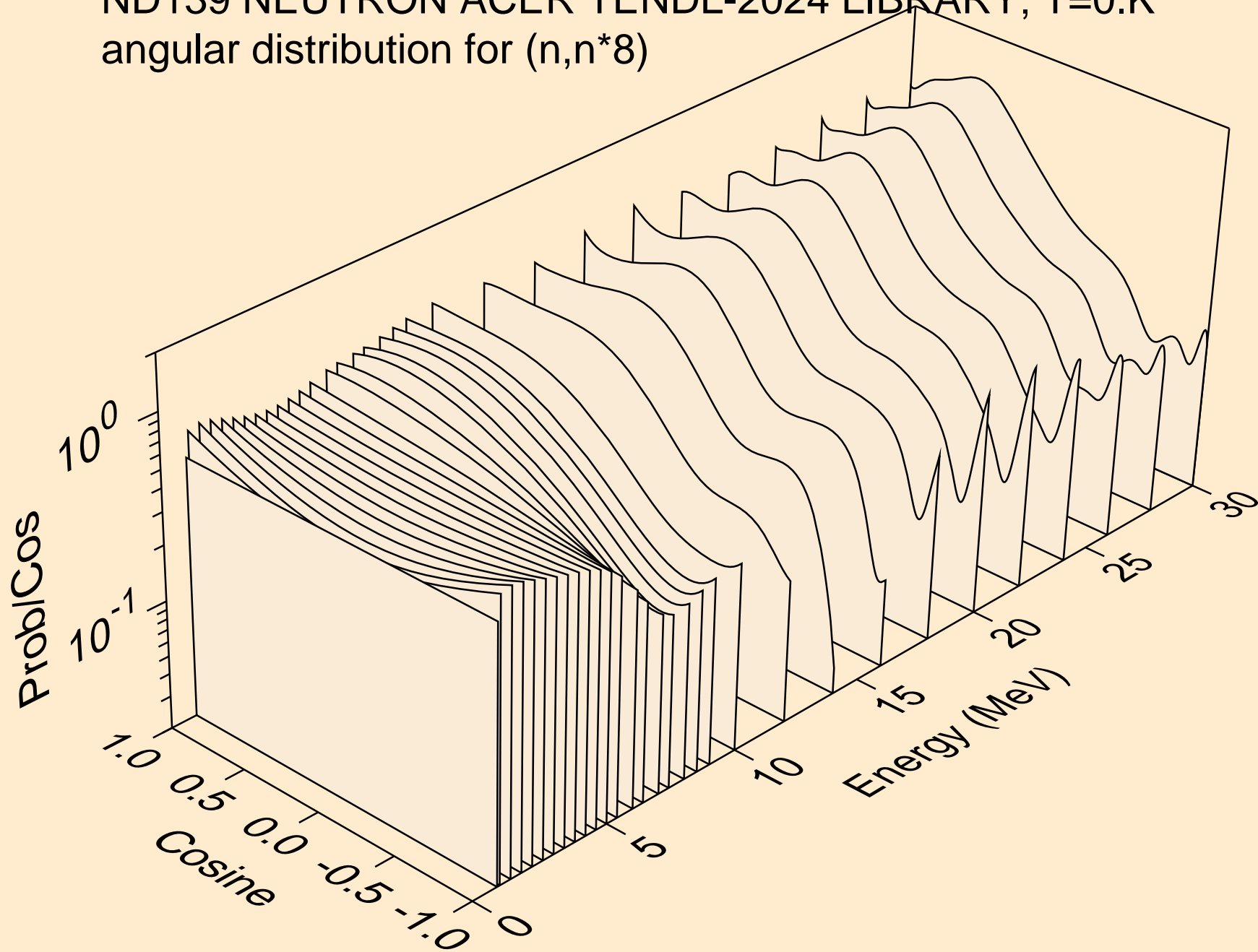

ND139 NEUTRON ACER TENDL-2024 LIBRARY; T=0.K
angular distribution for (n,n*9)

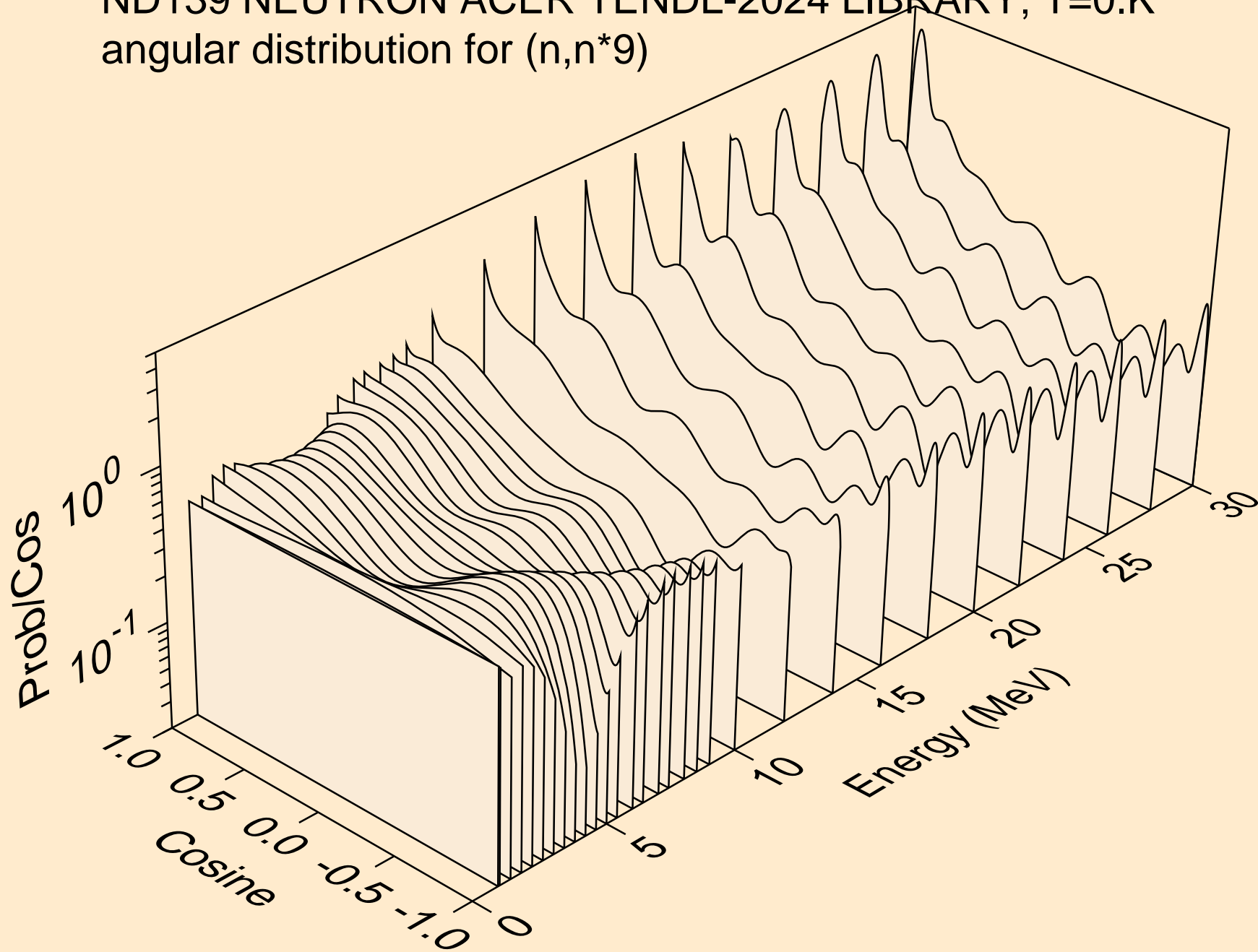

ND139 NEUTRON ACER TENDL-2024 LIBRARY; T=0.K
angular distribution for (n,n*10)

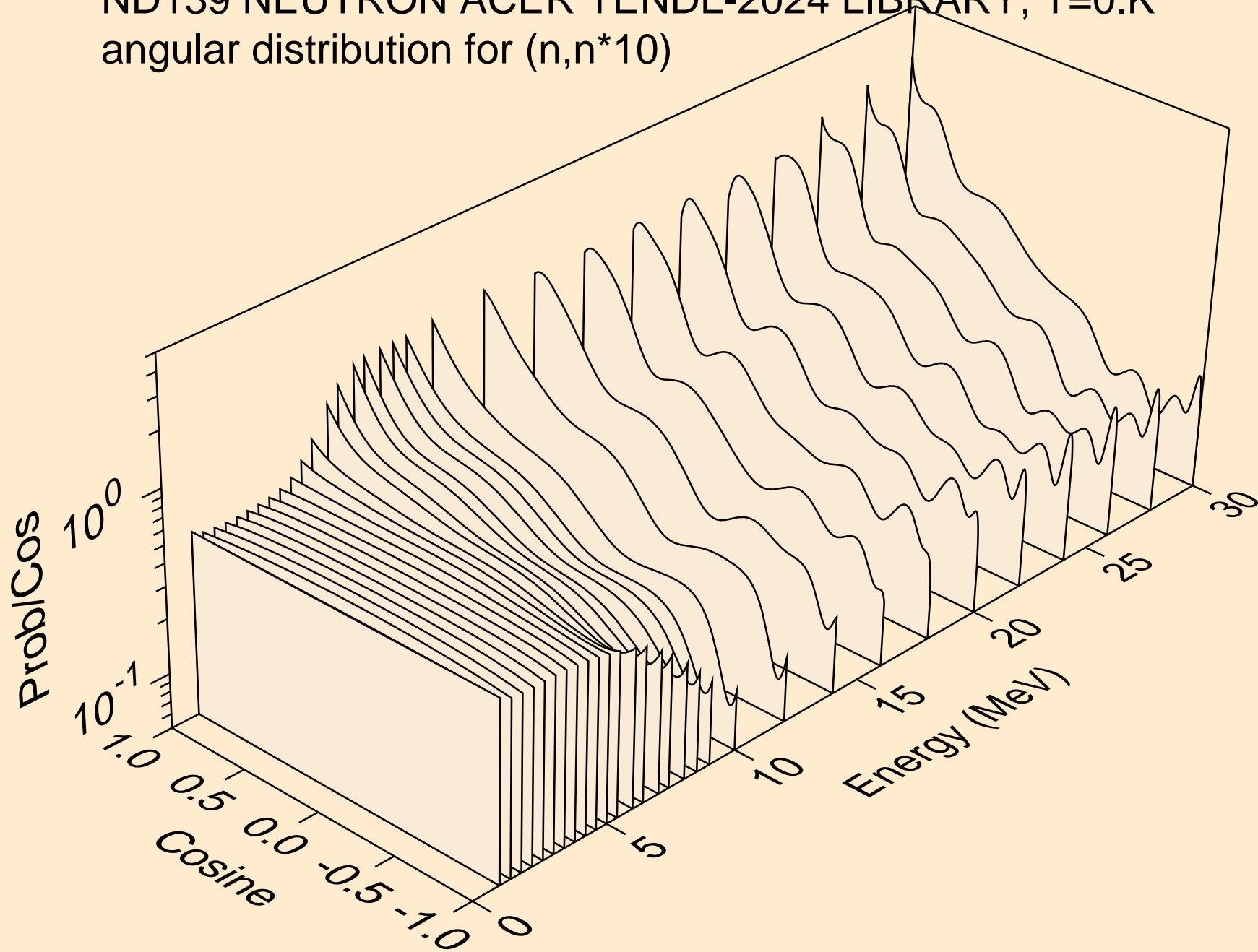

ND139 NEUTRON ACER TENDL-2024 LIBRARY; T=0.K
angular distribution for (n,n*11)

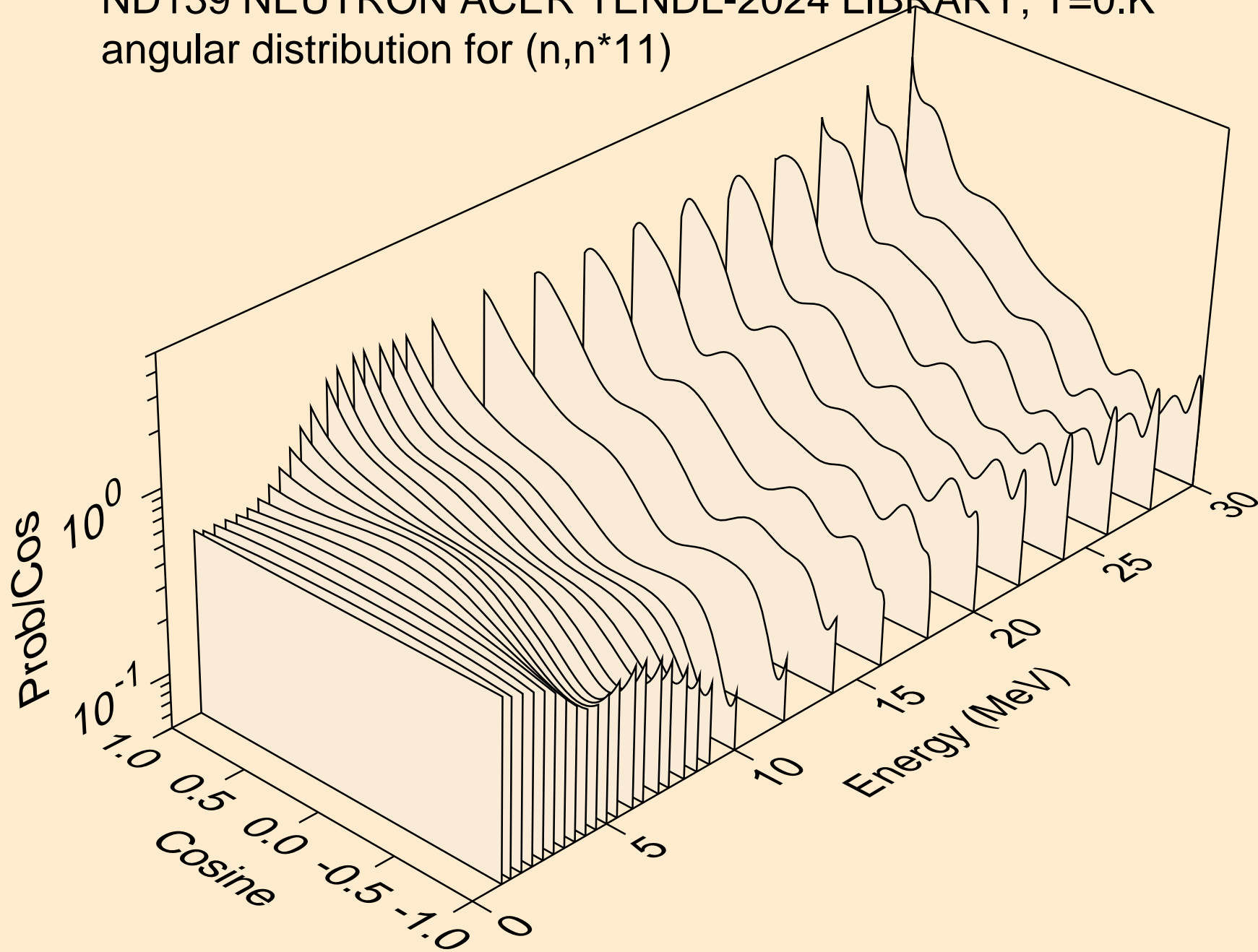

ND139 NEUTRON ACER TENDL-2024 LIBRARY; T=0.K
angular distribution for (n,n*12)

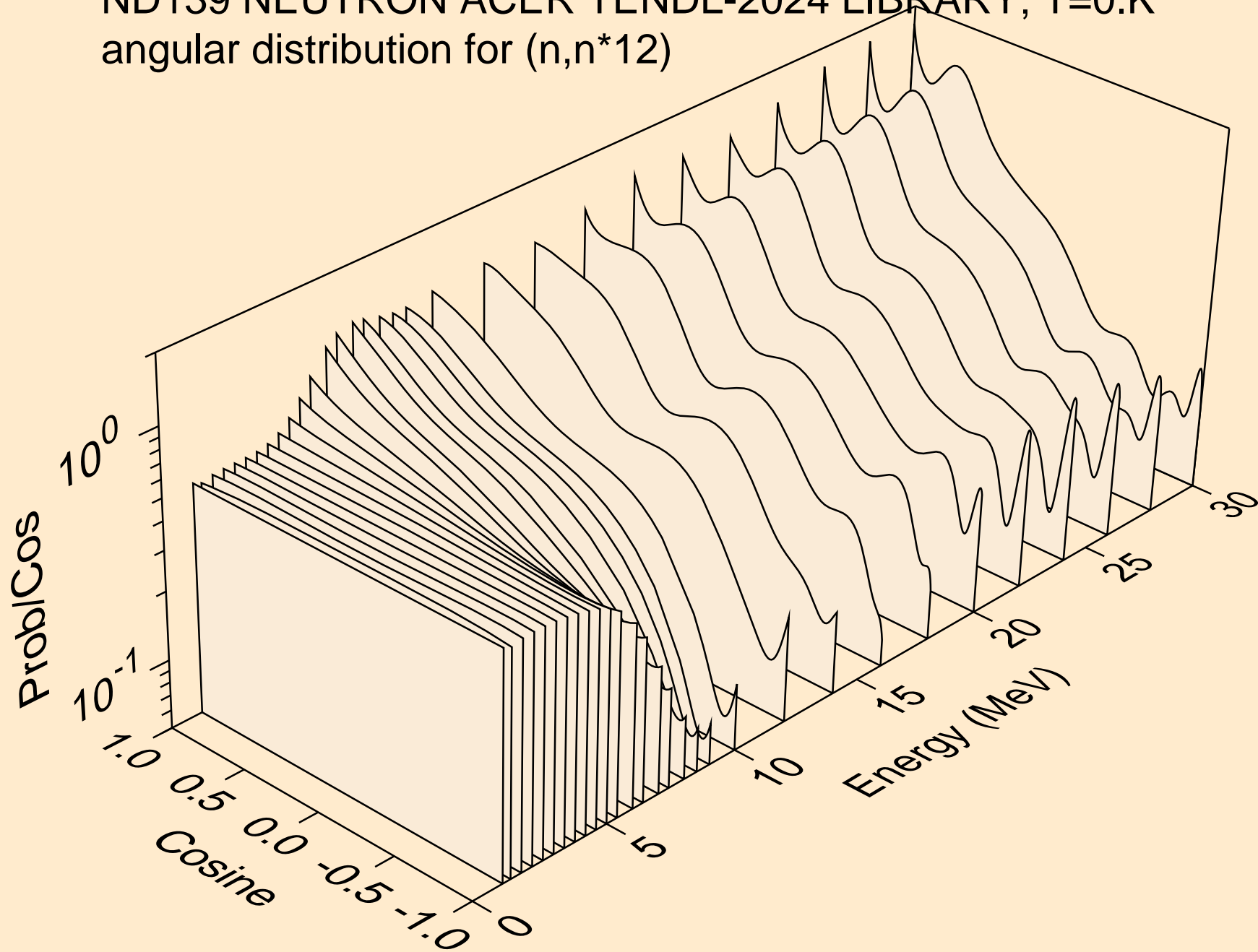

ND139 NEUTRON ACER TENDL-2024 LIBRARY; T=0.K
angular distribution for (n,n*13)

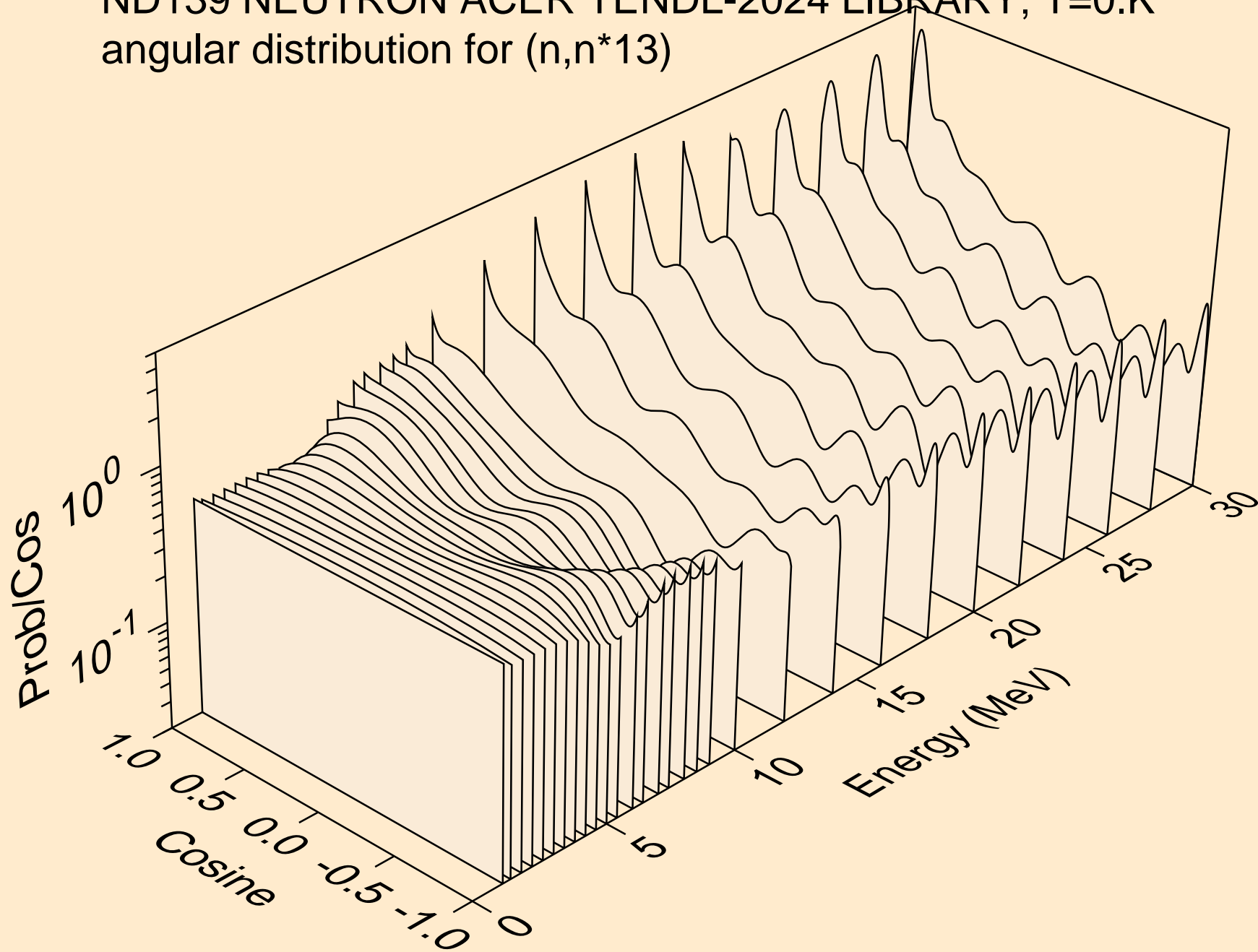

ND139 NEUTRON ACER TENDL-2024 LIBRARY; T=0.K
angular distribution for (n,n*14)

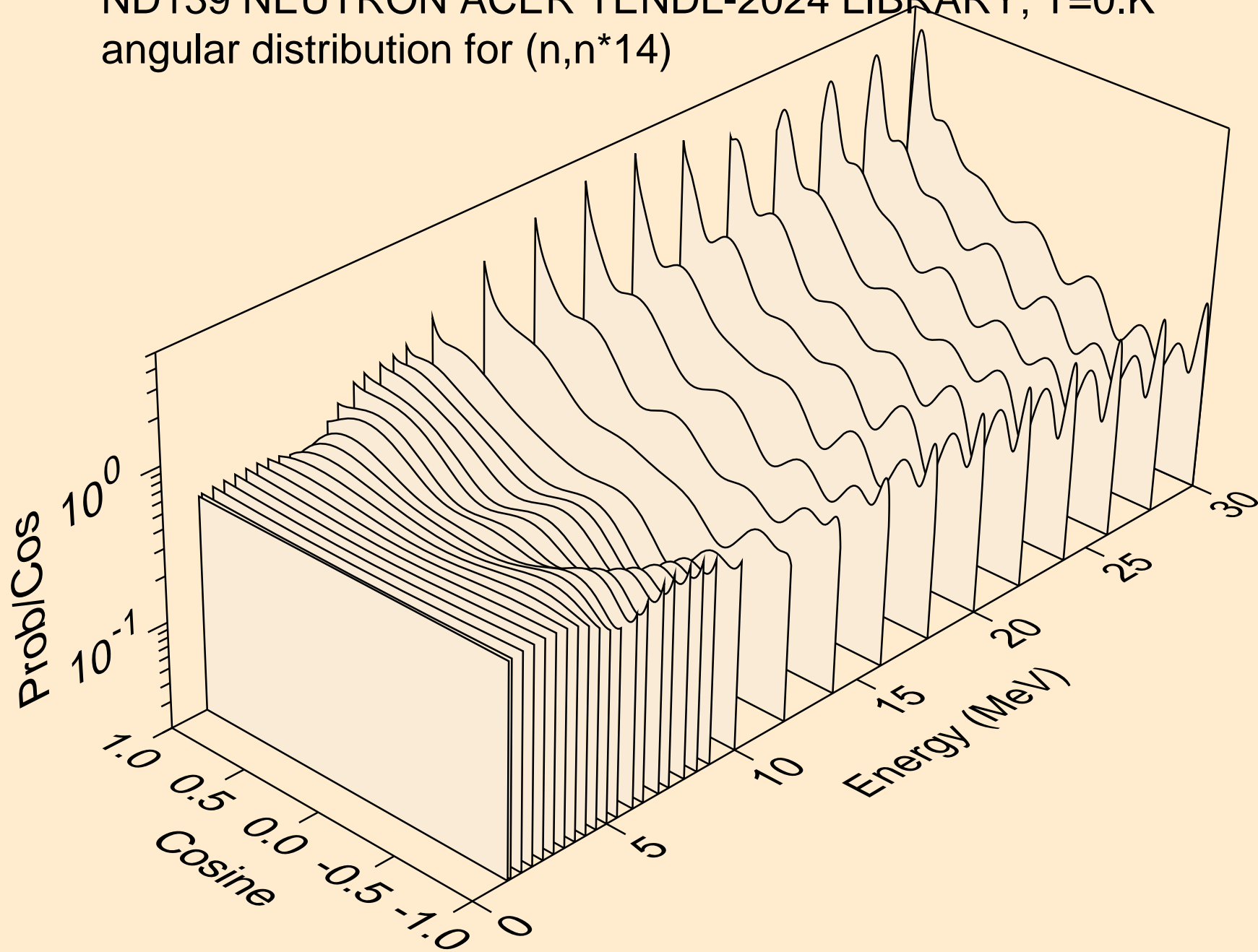

ND139 NEUTRON ACER TENDL-2024 LIBRARY; T=0.K
angular distribution for (n,n*15)

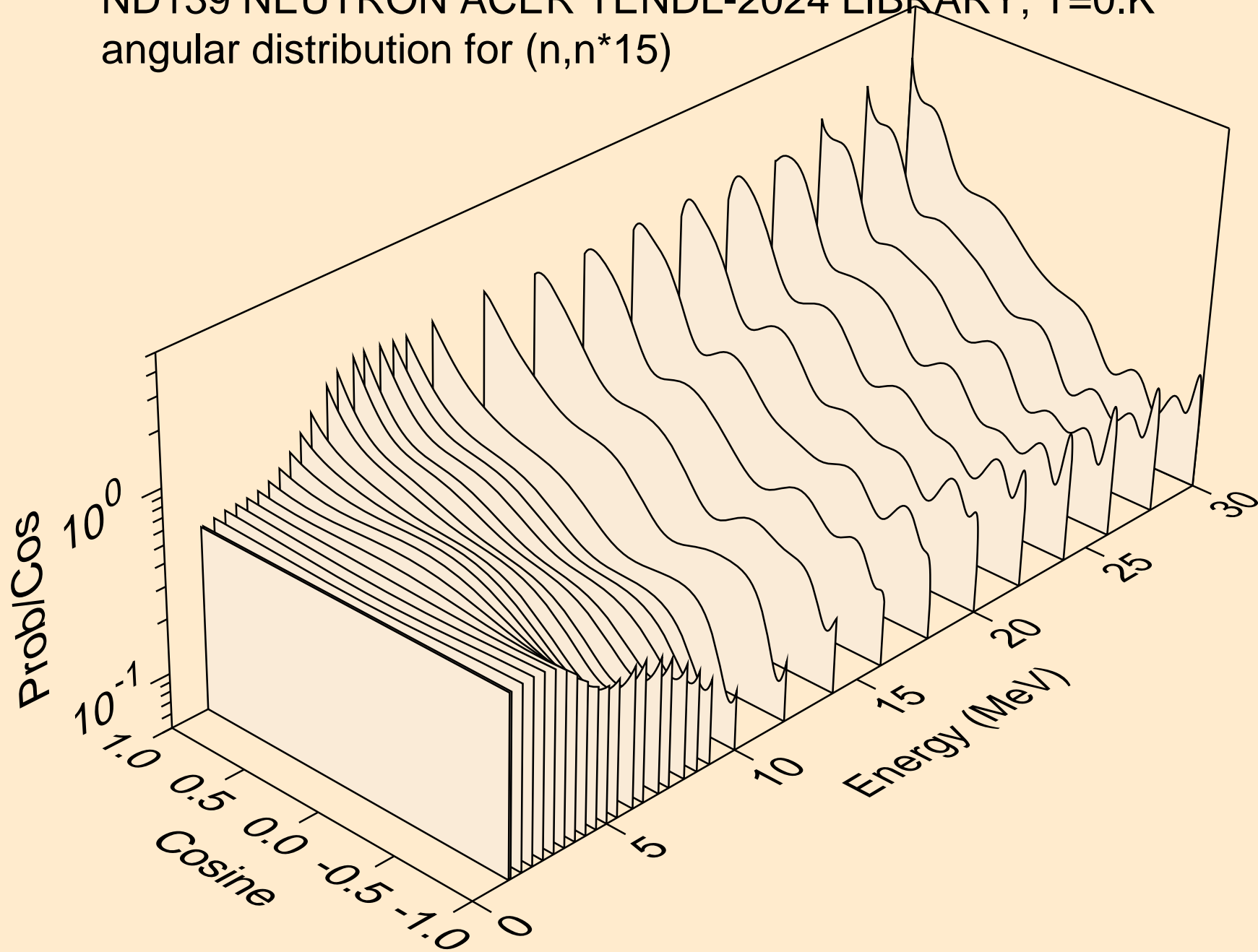

ND139 NEUTRON ACER TENDL-2024 LIBRARY; T=0.K
angular distribution for (n,n*16)

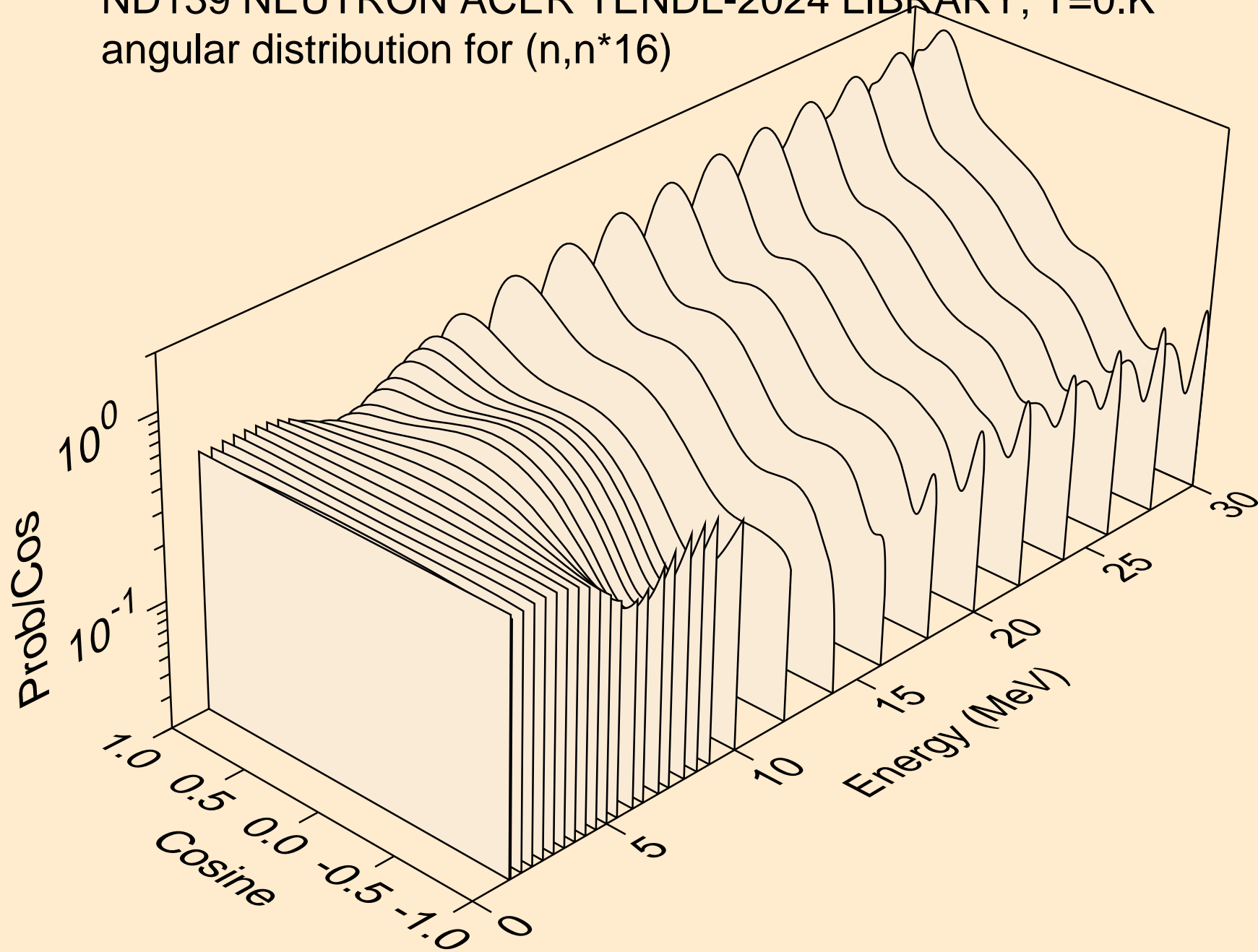

ND139 NEUTRON ACER TENDL-2024 LIBRARY; T=0.K
angular distribution for (n,n*17)

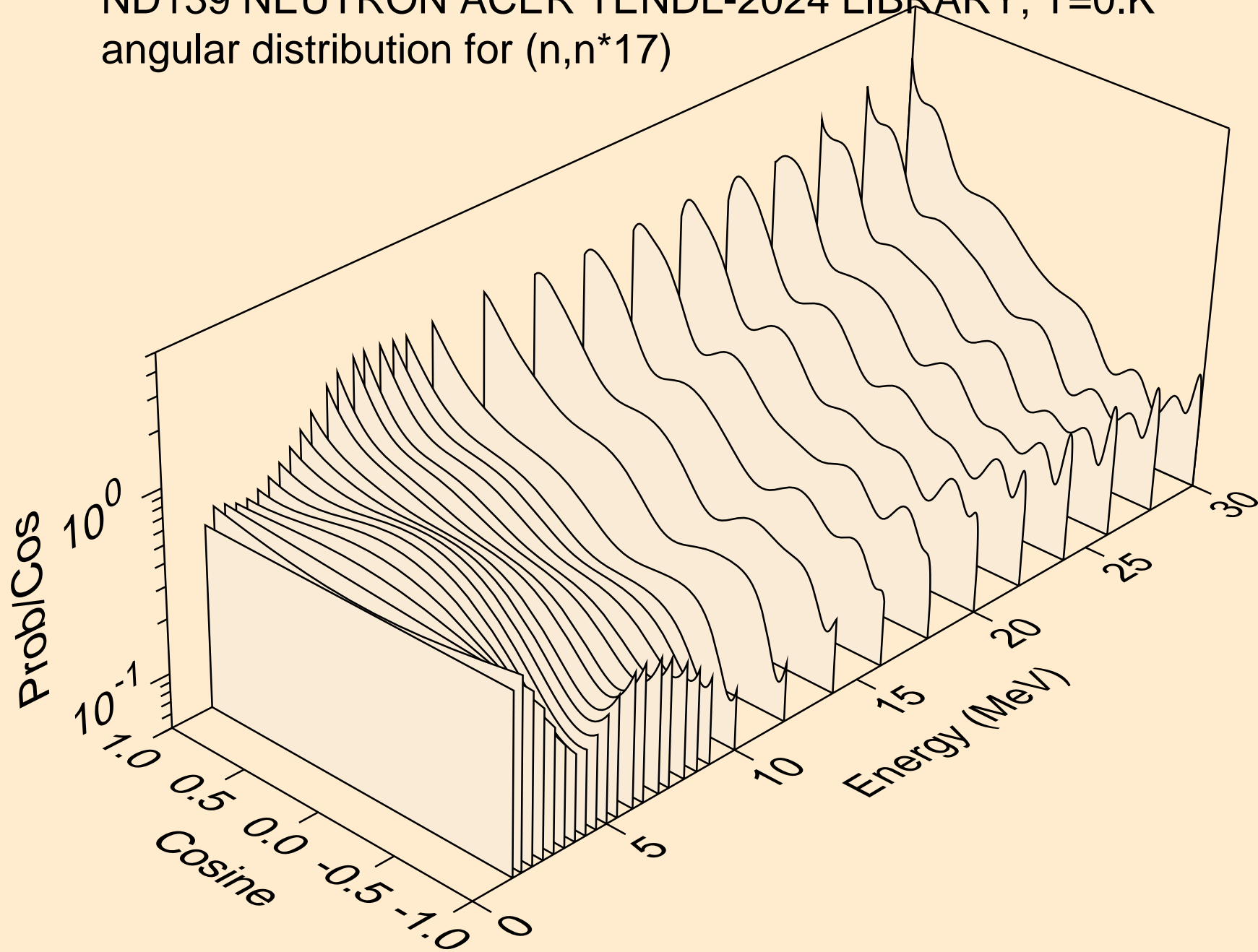

ND139 NEUTRON ACER TENDL-2024 LIBRARY; T=0.K
angular distribution for (n,n*18)

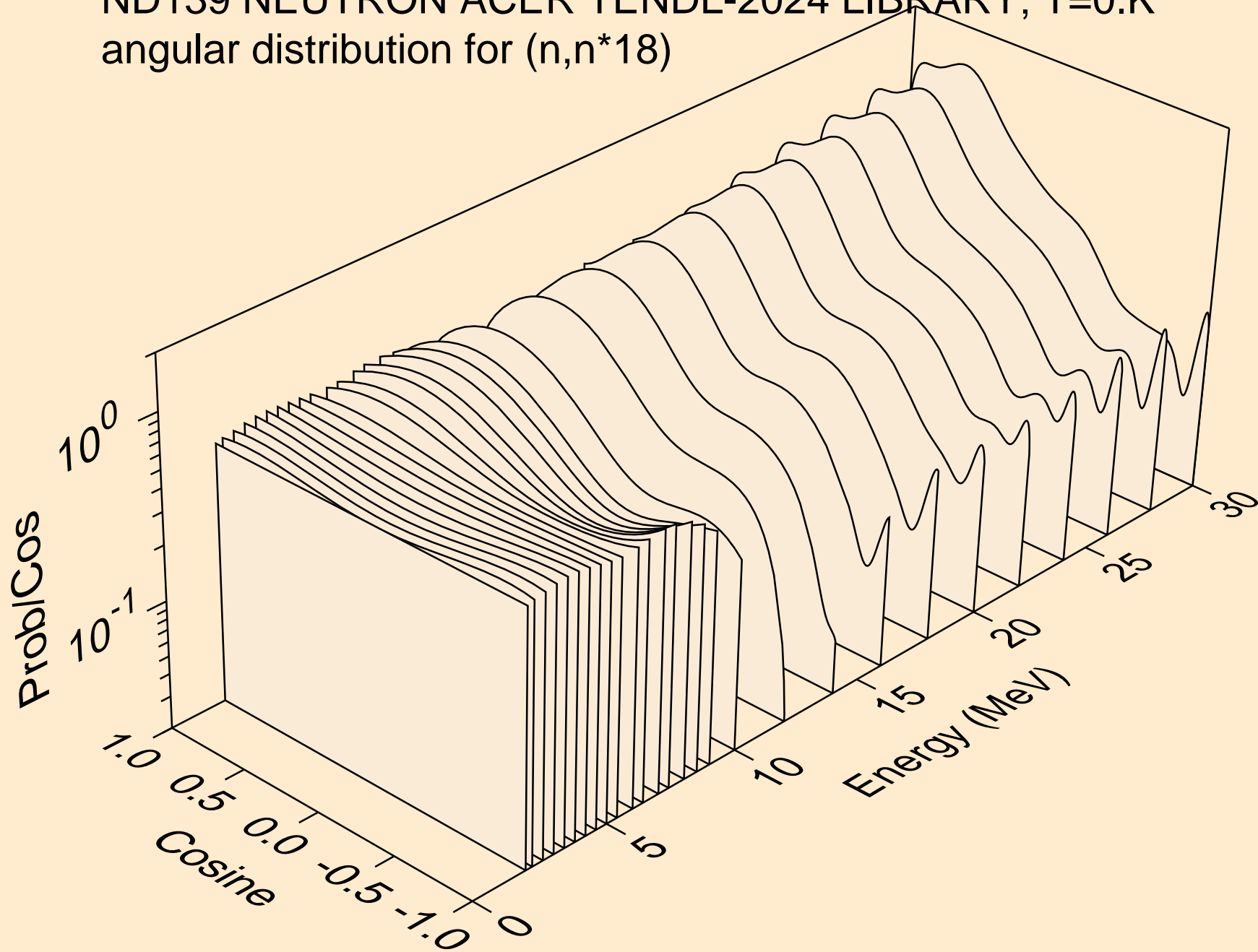

ND139 NEUTRON ACER TENDL-2024 LIBRARY; T=0.K
angular distribution for (n,n*19)

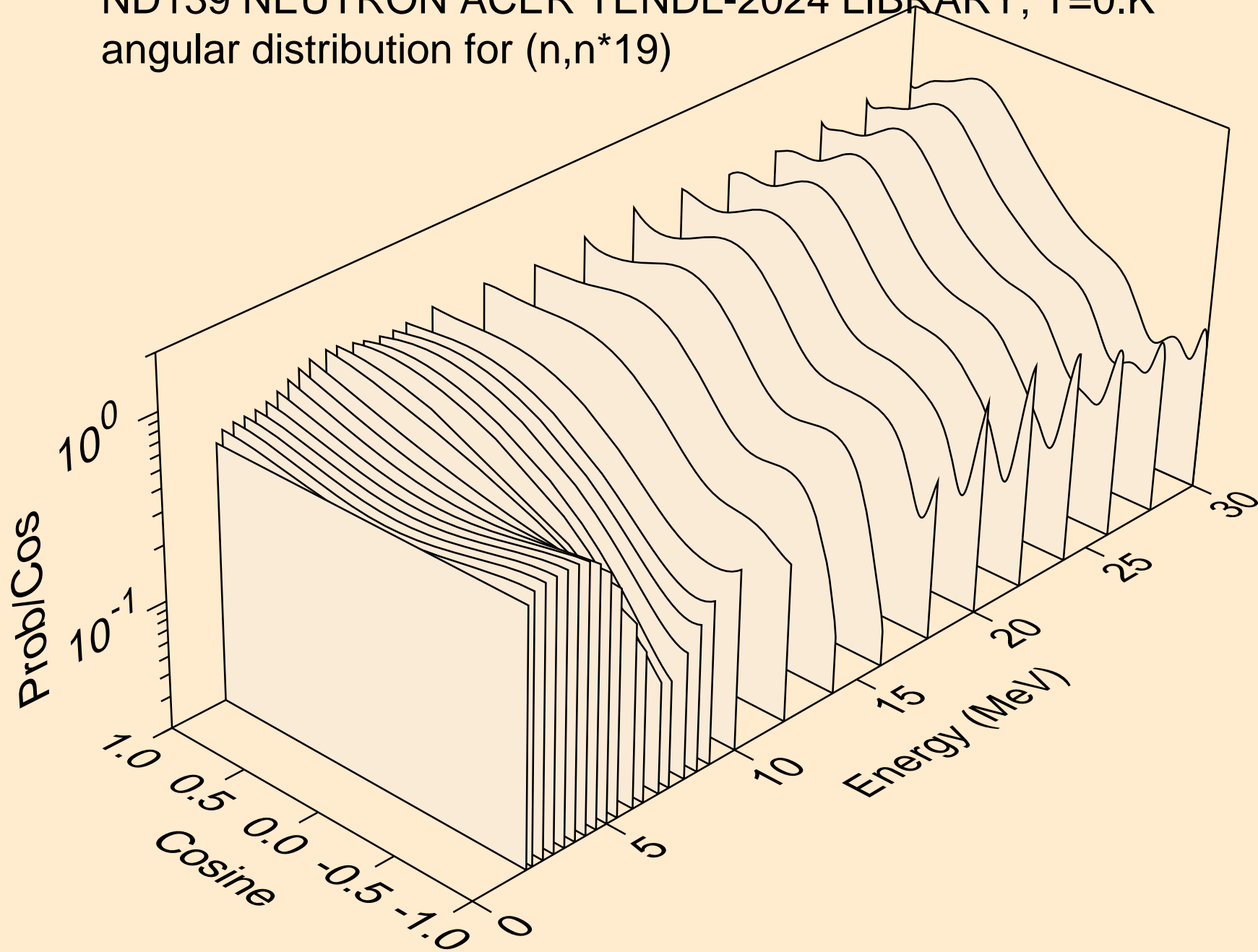

ND139 NEUTRON ACER TENDL-2024 LIBRARY; T=0.K
angular distribution for (n,n*20)

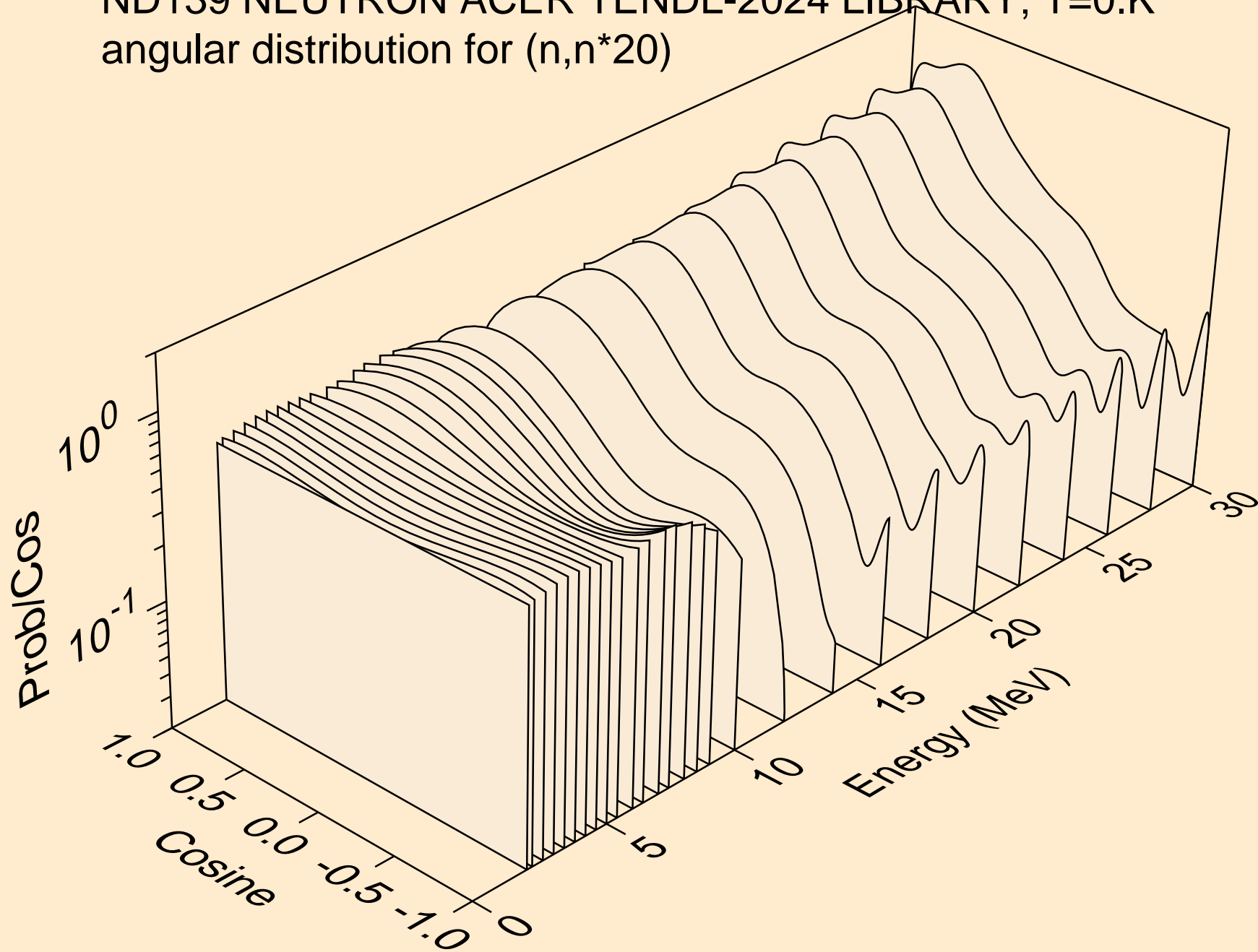

ND139 NEUTRON ACER TENDL-2024 LIBRARY; T=0.K
angular distribution for (n,n*21)

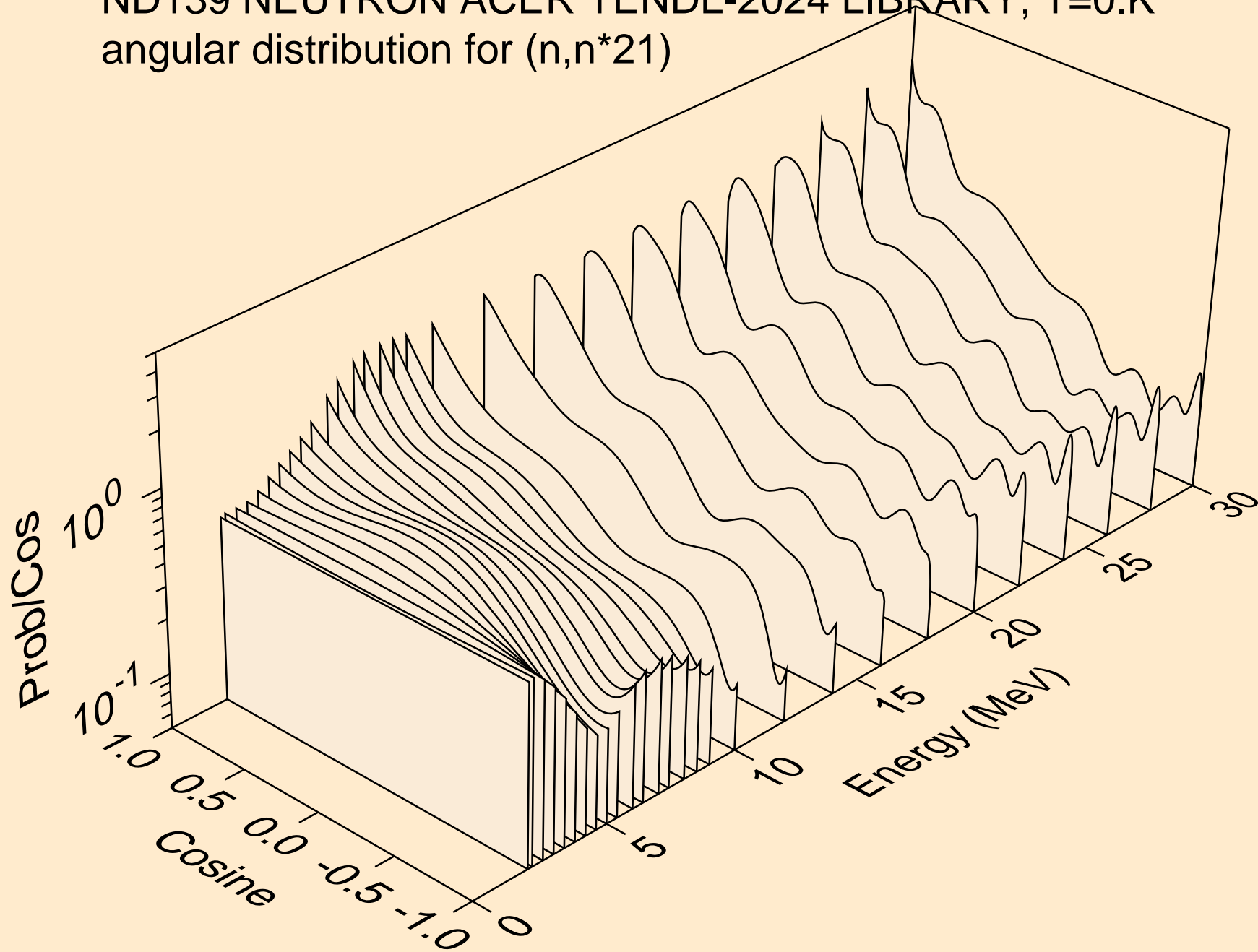

ND139 NEUTRON ACER TENDL-2024 LIBRARY; T=0.K
angular distribution for (n,n*22)

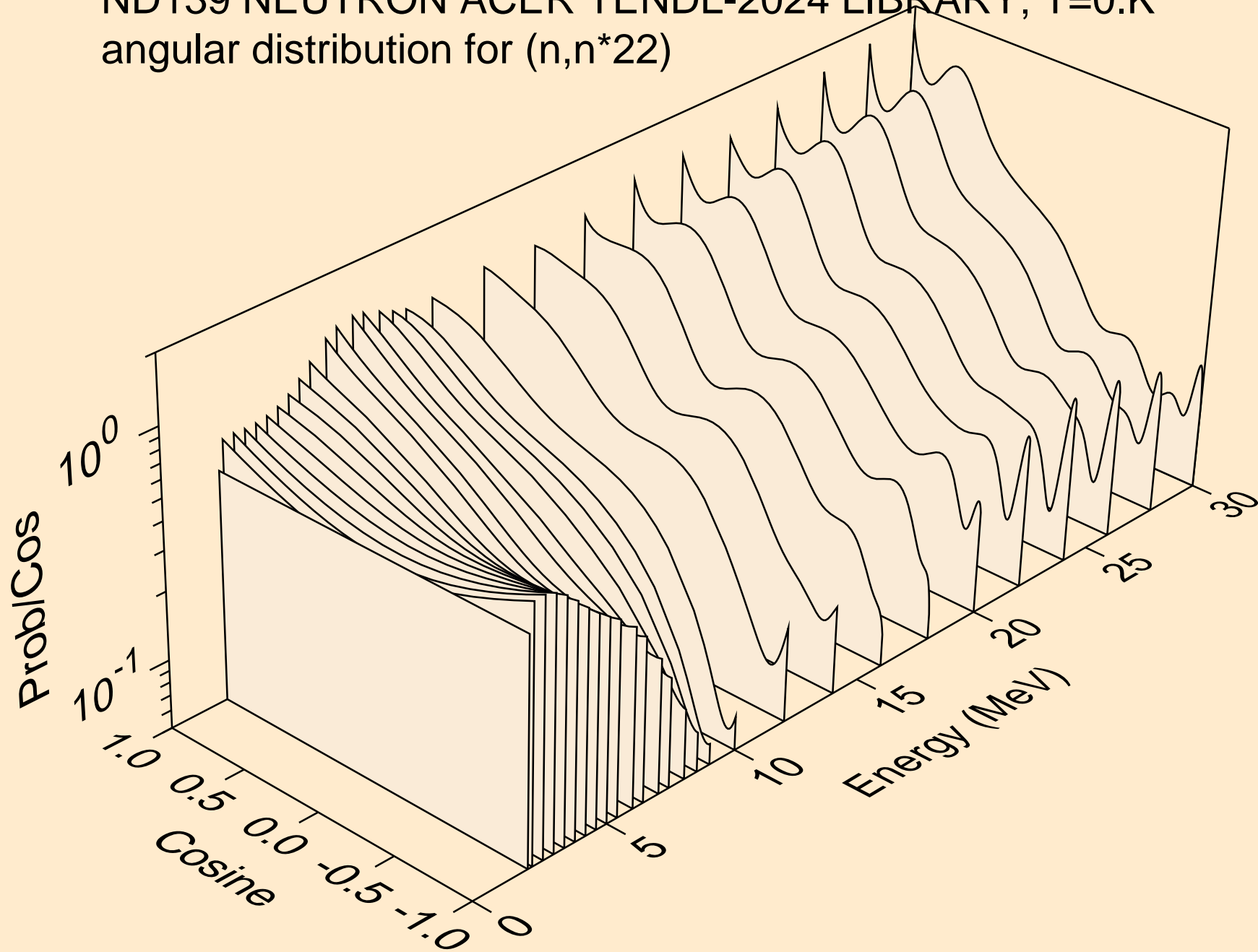

ND139 NEUTRON ACER TENDL-2024 LIBRARY; T=0.K
angular distribution for (n,n*23)

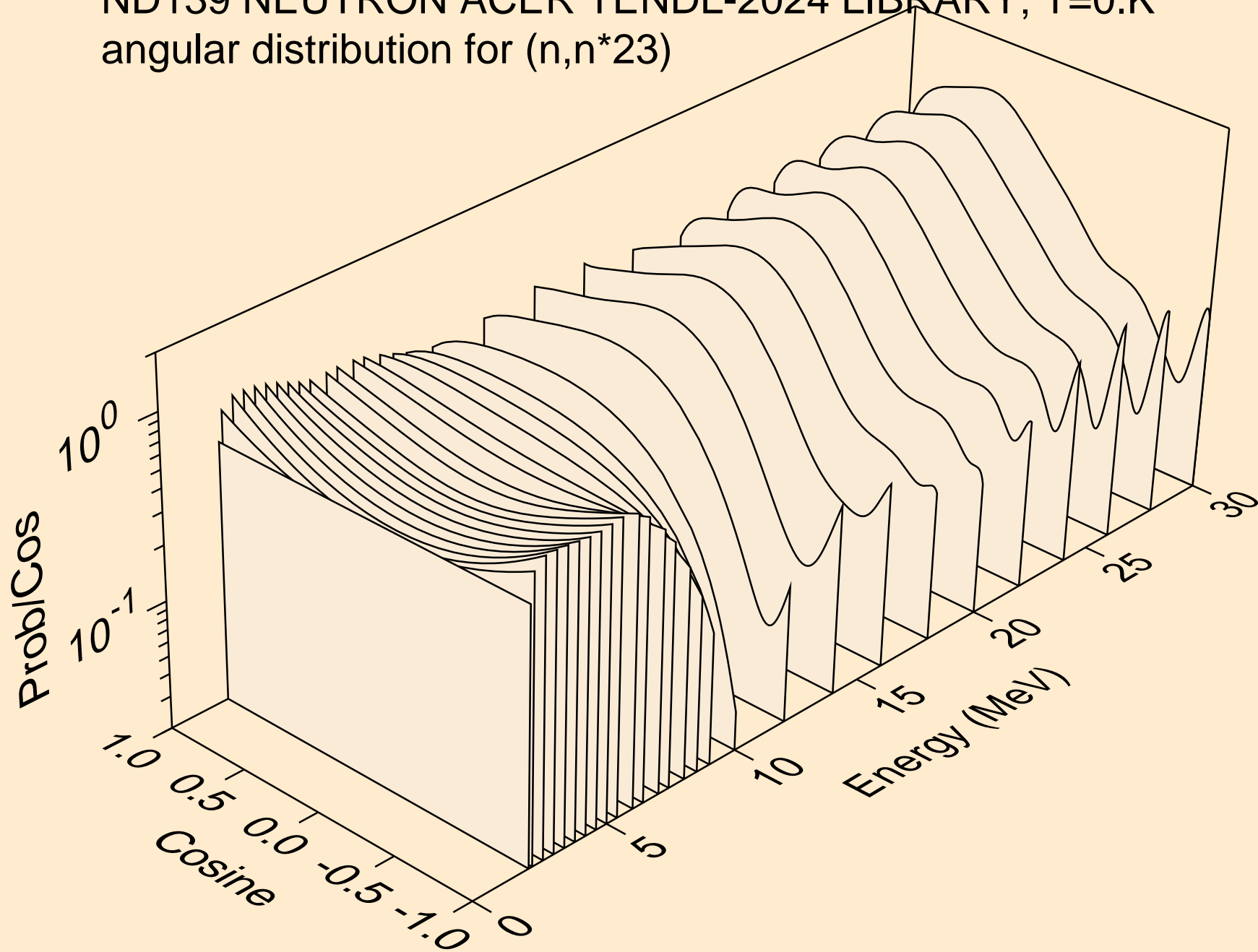

ND139 NEUTRON ACER TENDL-2024 LIBRARY; T=0.K
angular distribution for (n,n*24)

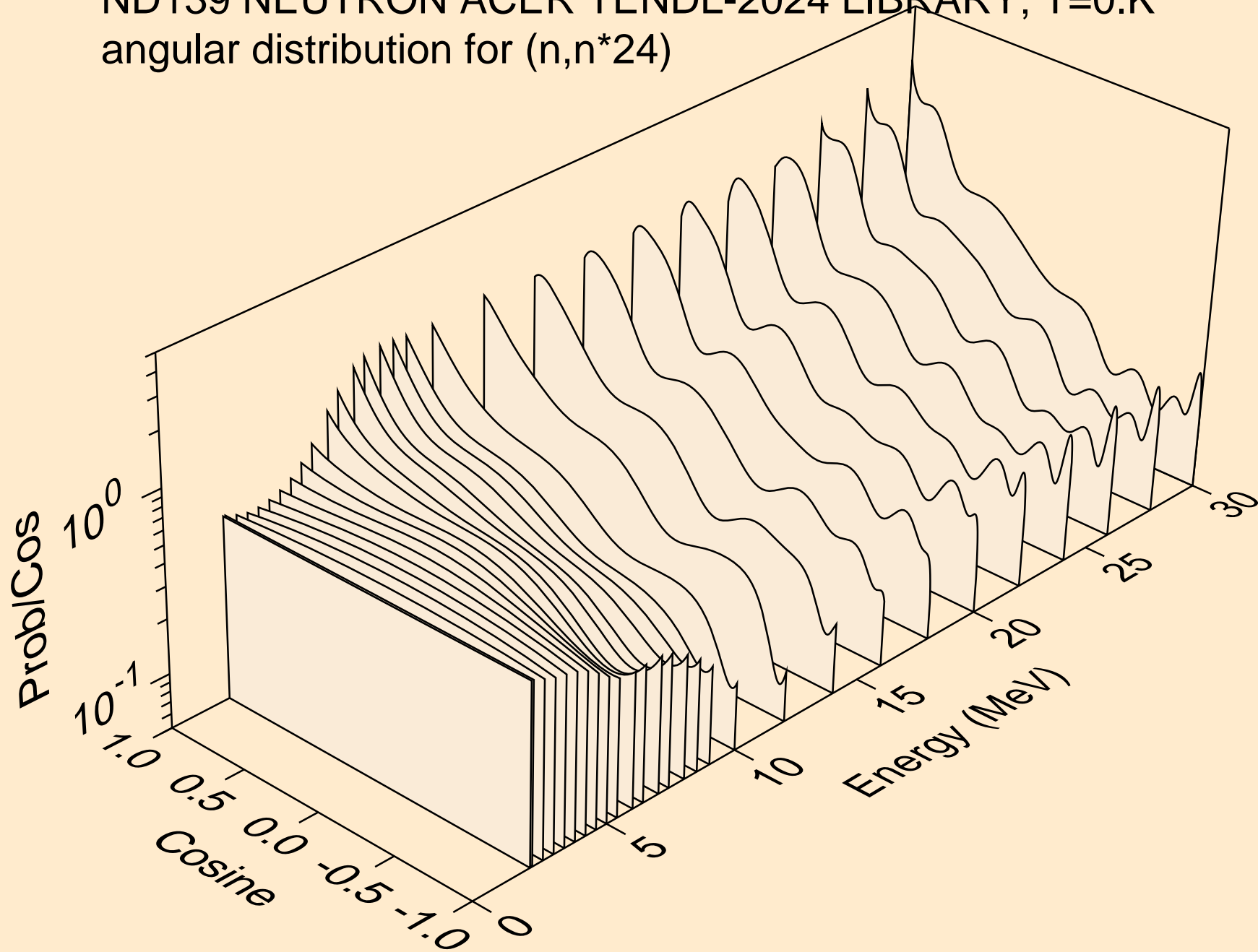

ND139 NEUTRON ACER TENDL-2024 LIBRARY; T=0.K
angular distribution for (n,n*25)

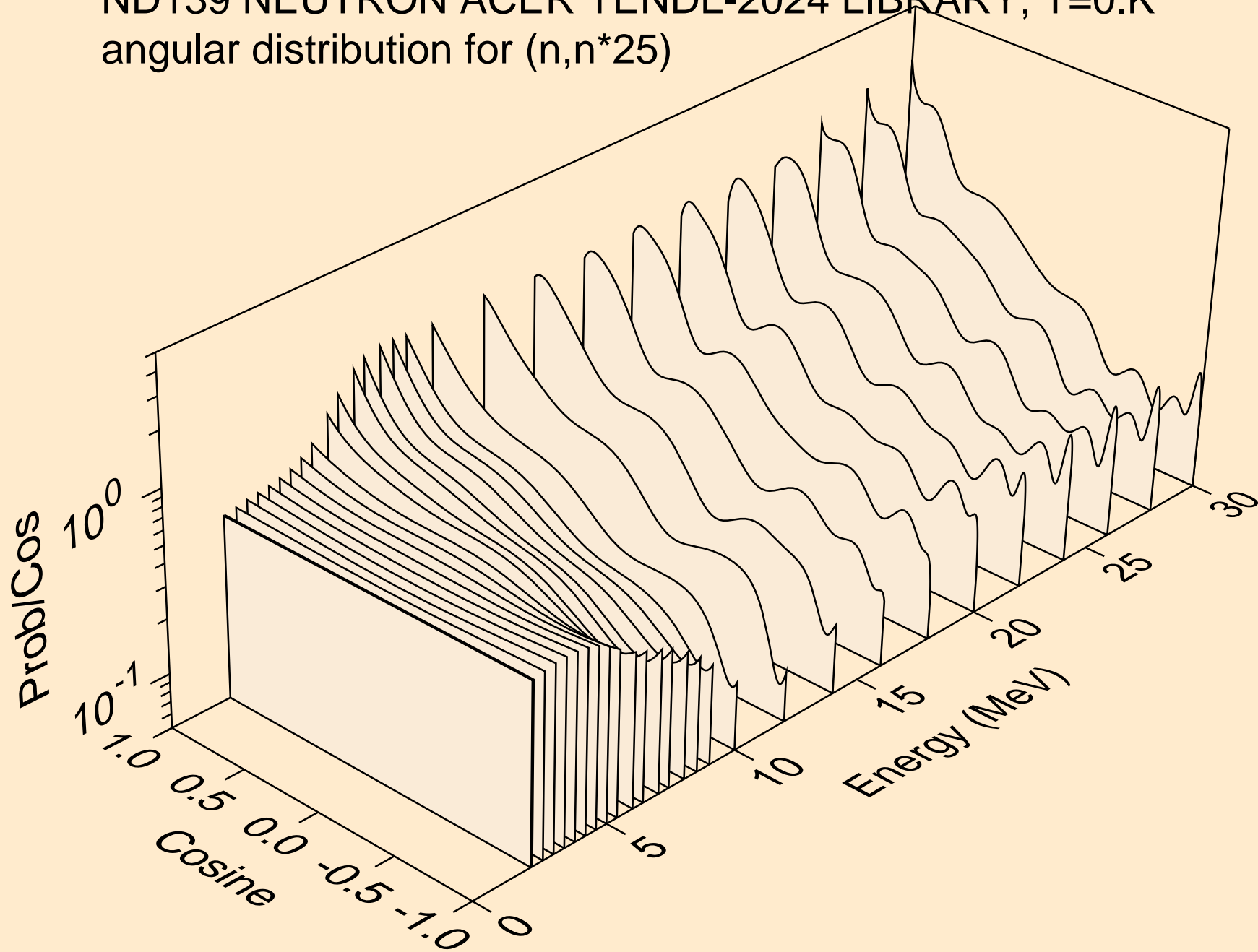

ND139 NEUTRON ACER TENDL-2024 LIBRARY; T=0.K
Neutron emission for (n,x)

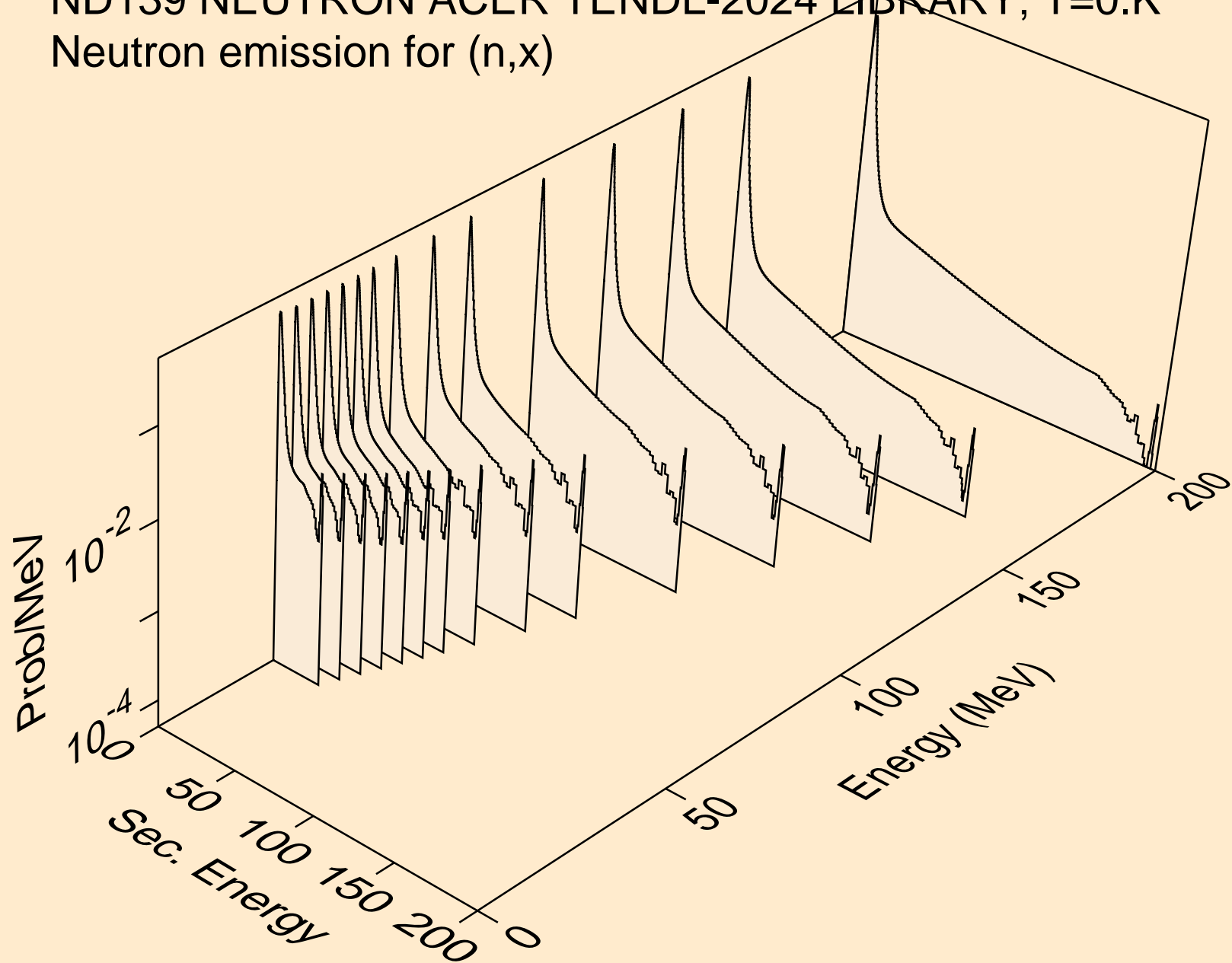

ND139 NEUTRON ACER TENDL-2024 LIBRARY; T=0.K
Neutron emission for (n,2nd)

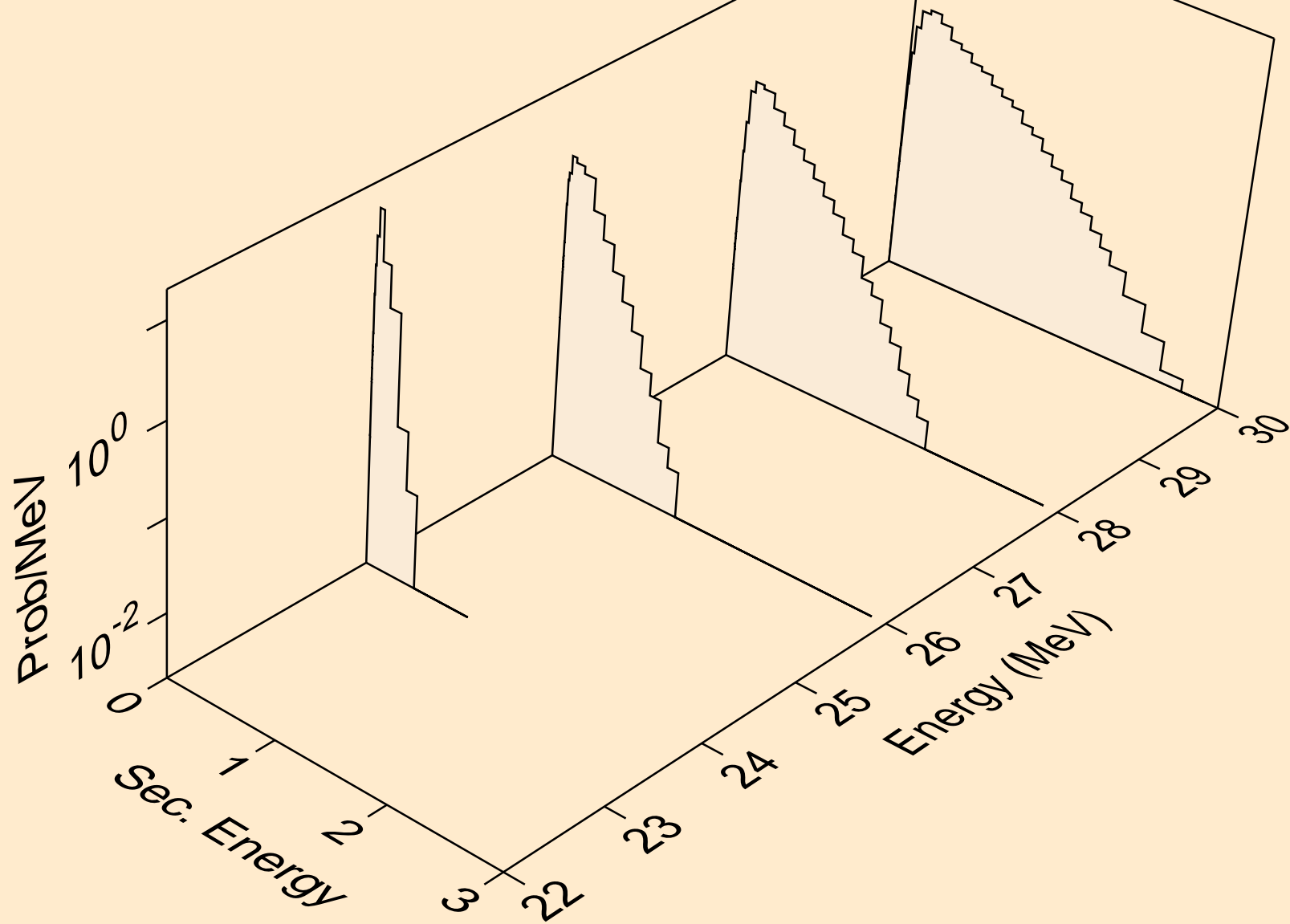

ND139 NEUTRON ACER TENDL-2024 LIBRARY; T=0.K
Neutron emission for (n,2n)

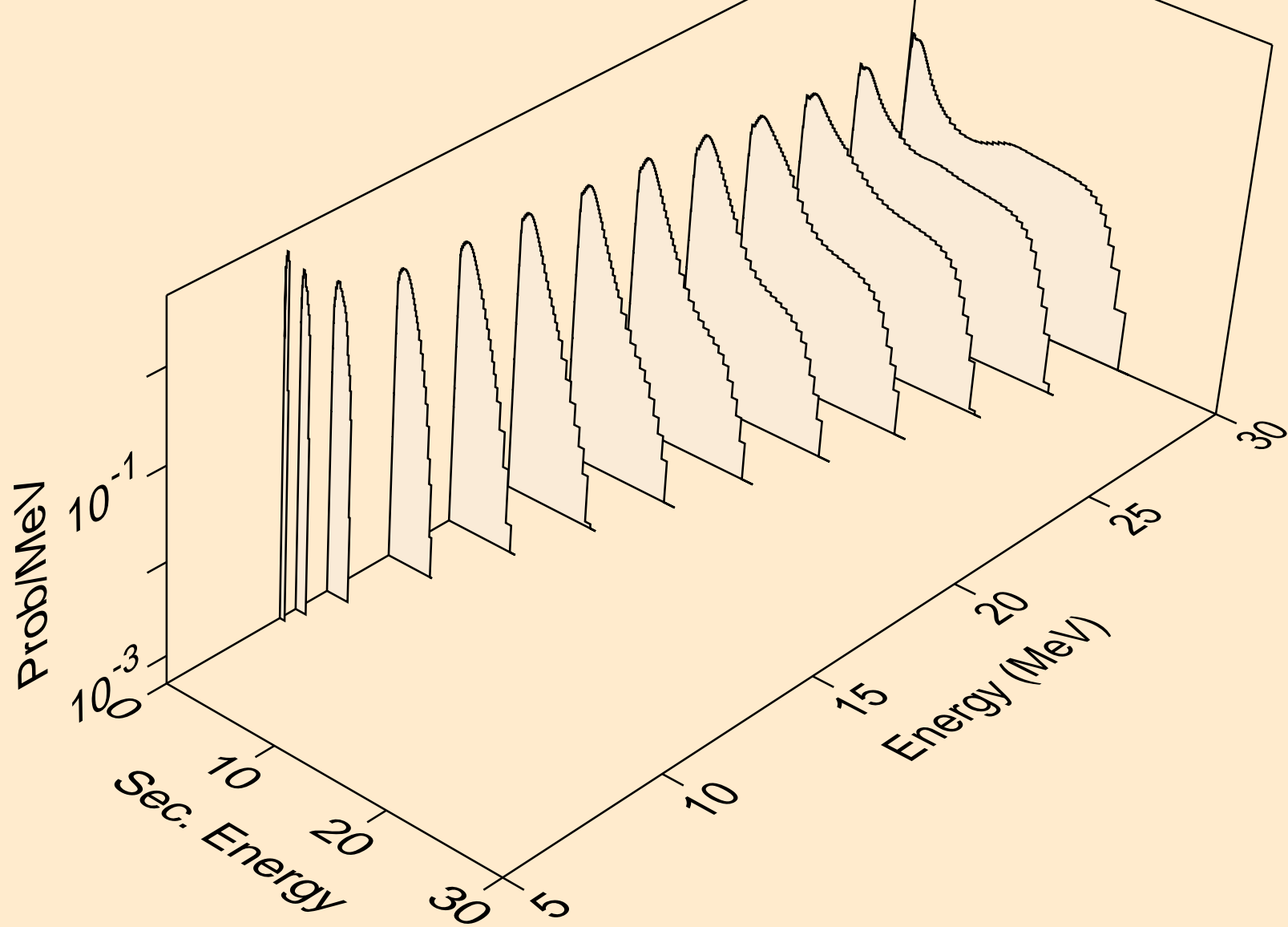

ND139 NEUTRON ACER TENDL-2024 LIBRARY; T=0.K
Neutron emission for (n,3n)

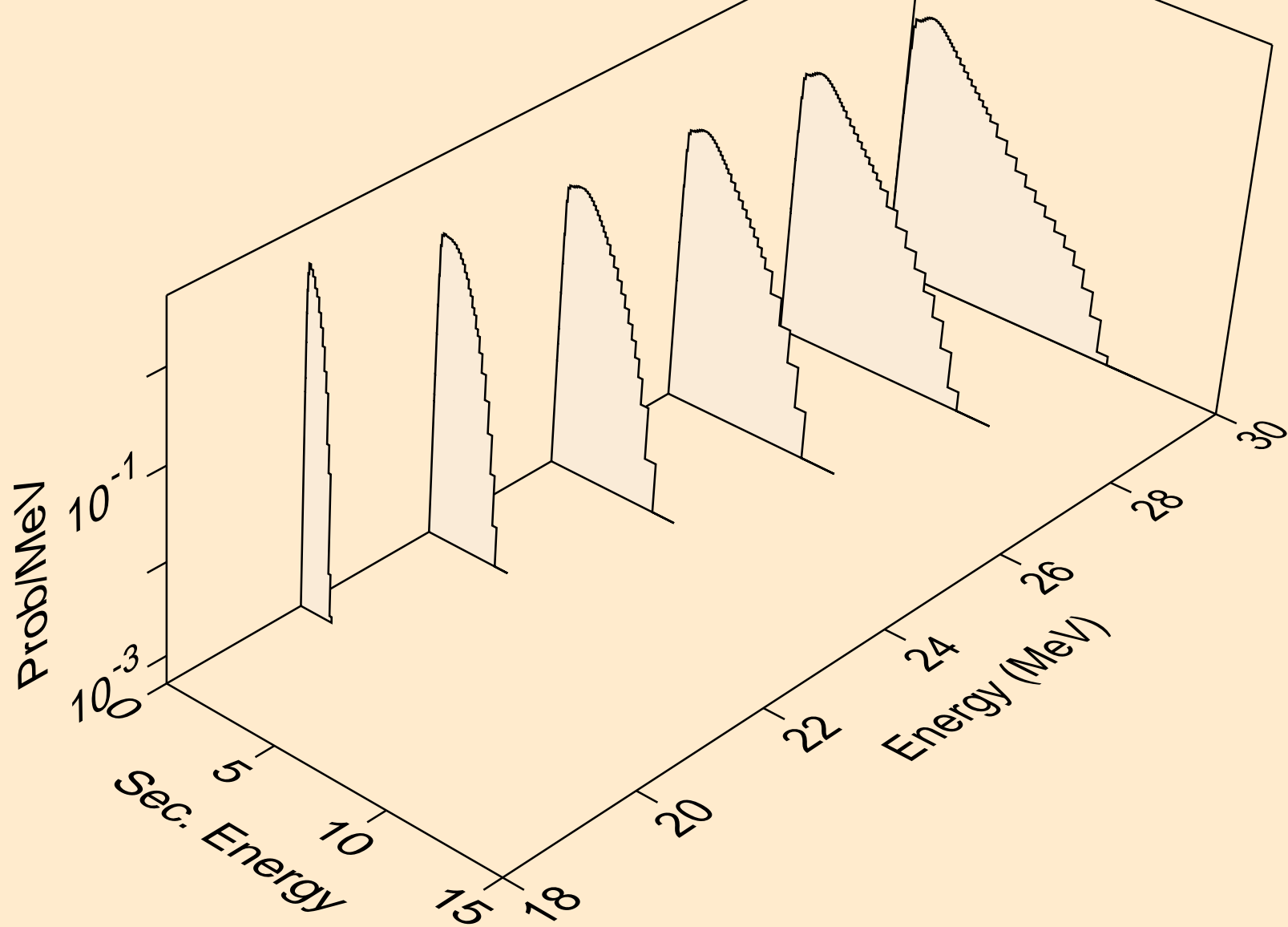

ND139 NEUTRON ACER TENDL-2024 LIBRARY; T=0.K
Neutron emission for (n,n*)a

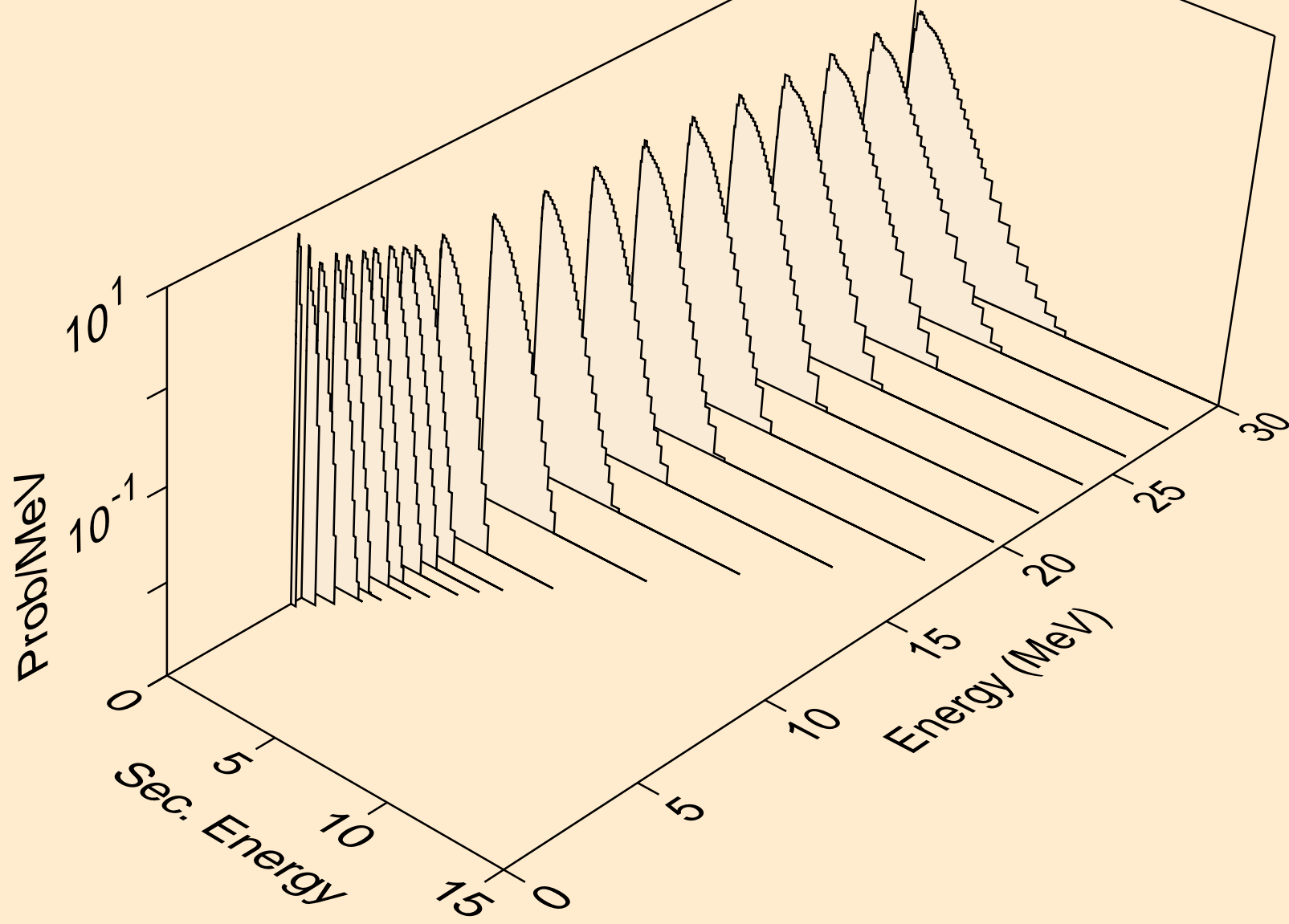

ND139 NEUTRON ACER TENDL-2024 LIBRARY; T=0.K
Neutron emission for (n,2n)a

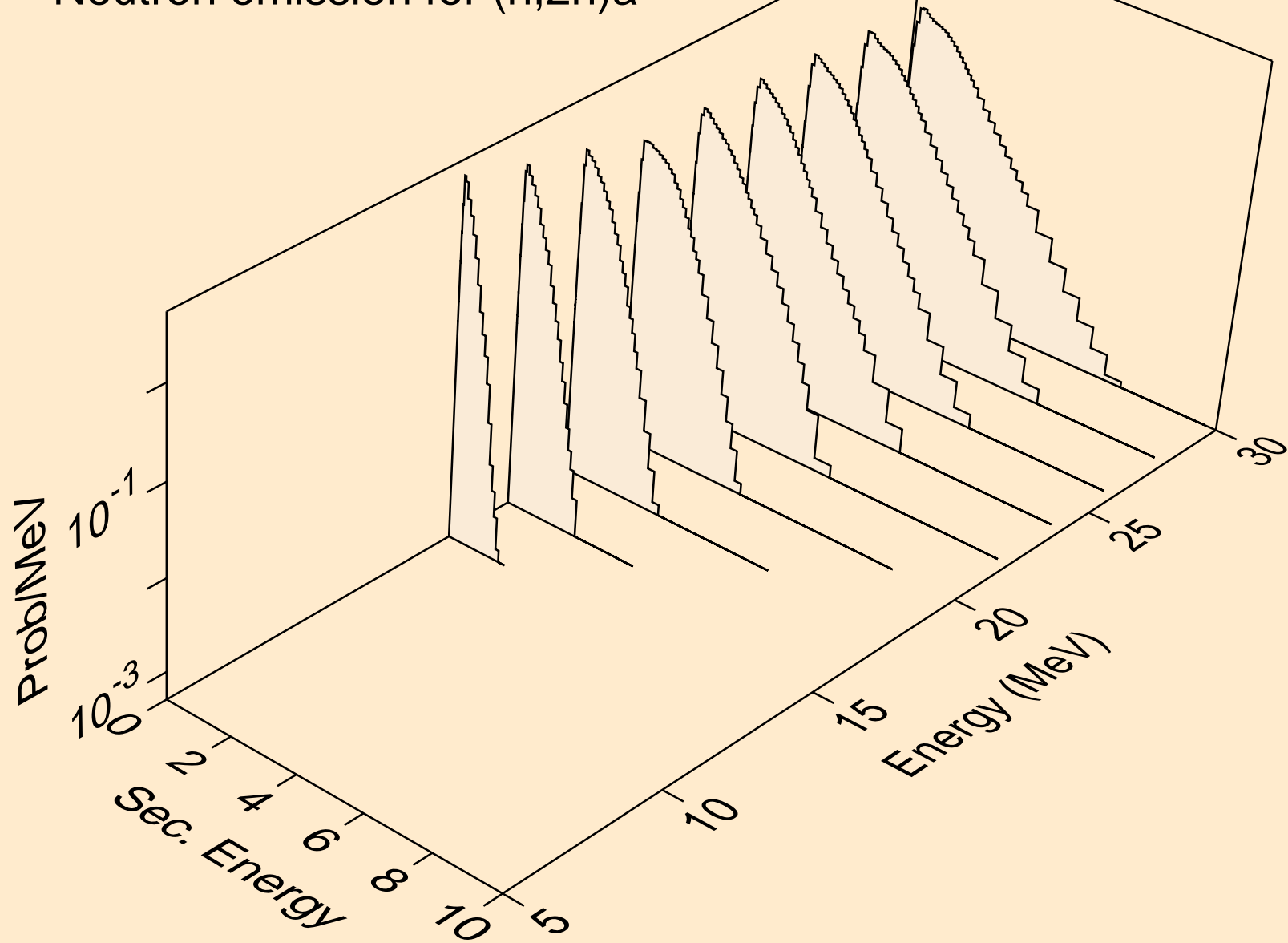

ND139 NEUTRON ACER TENDL-2024 LIBRARY; T=0.K
Neutron emission for (n,3n)a

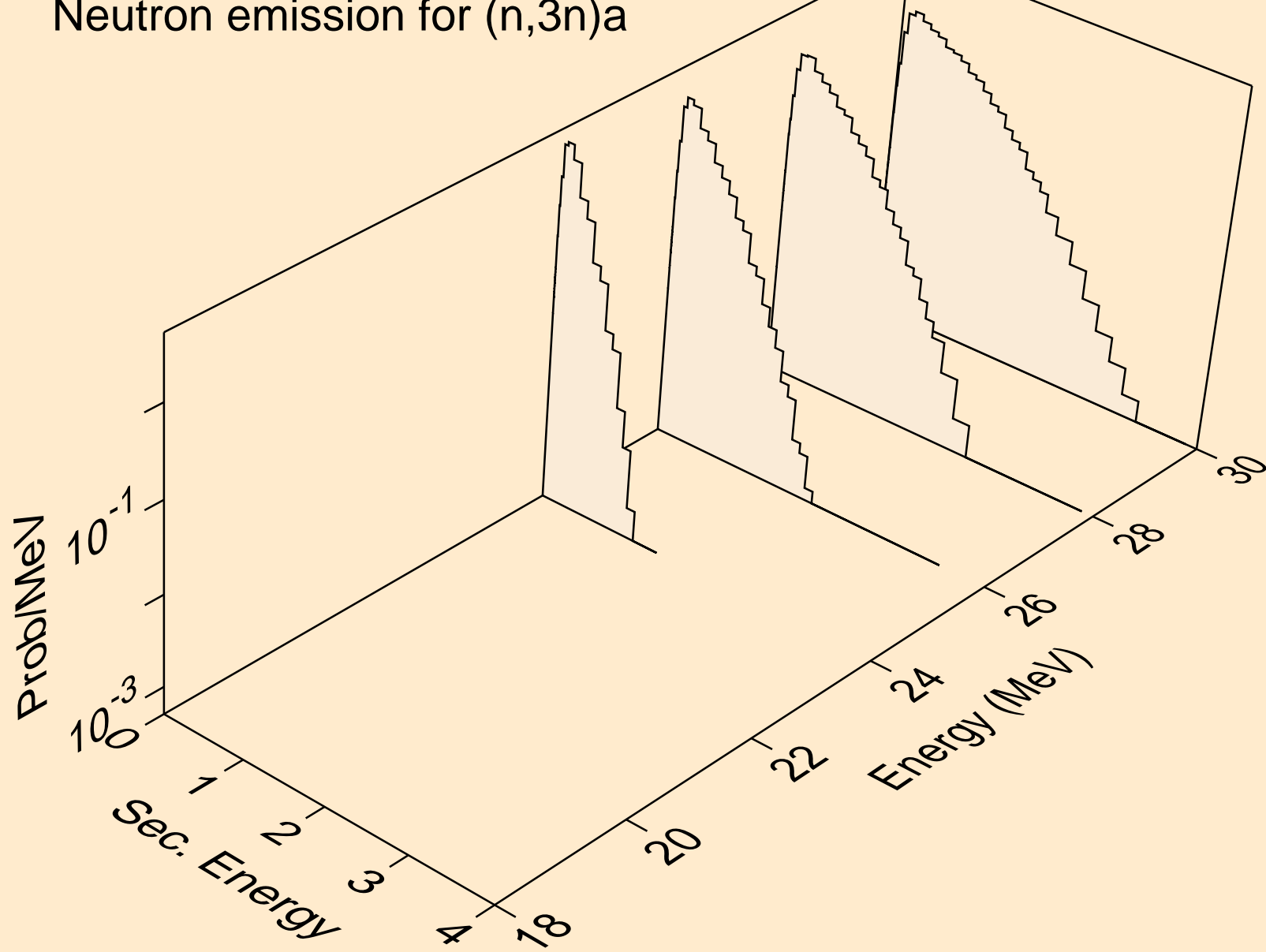

ND139 NEUTRON ACER TENDL-2024 LIBRARY; T=0.K
Neutron emission for (n,n*)p

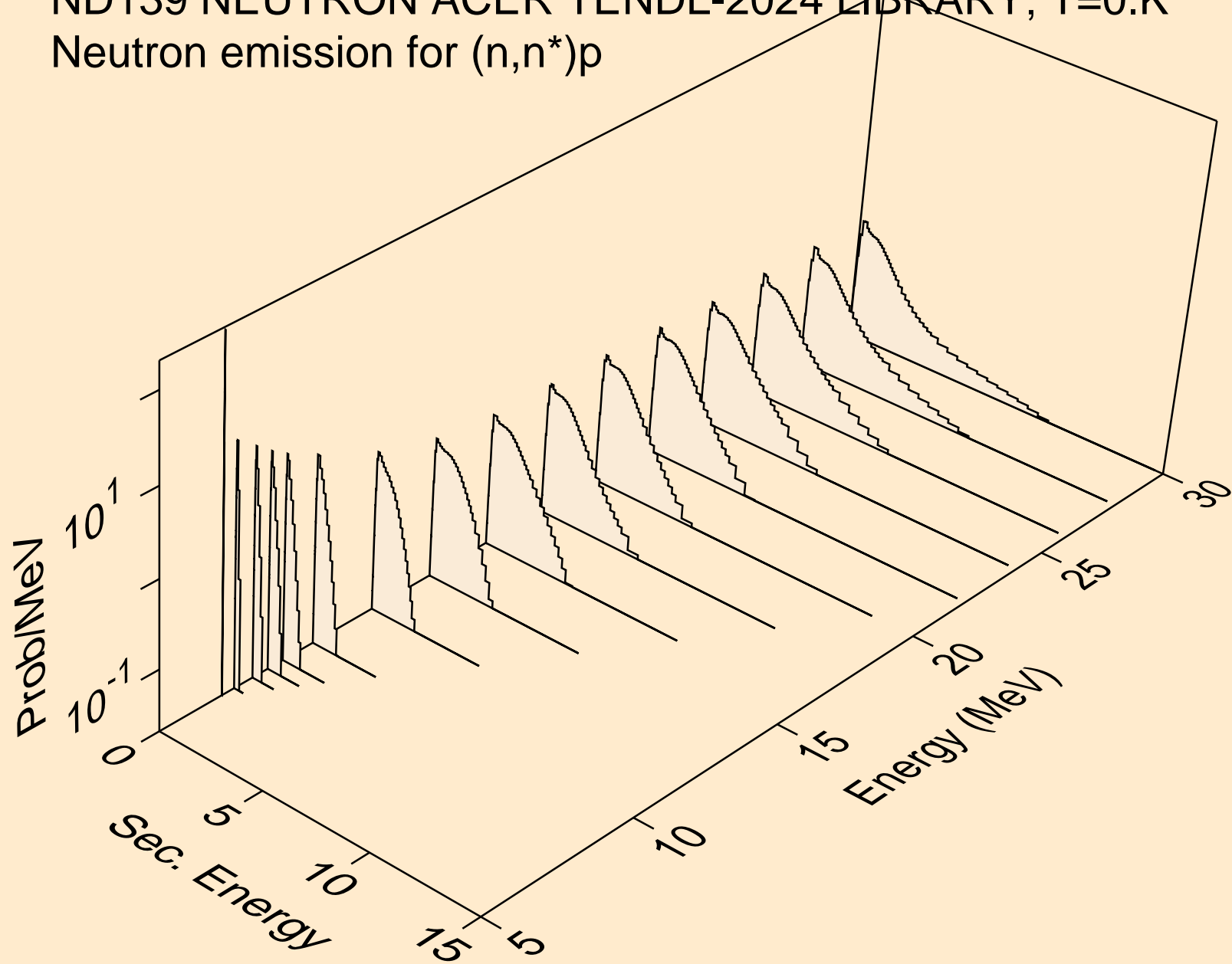

ND139 NEUTRON ACER TENDL-2024 LIBRARY; T=0.K
Neutron emission for (n,n*)2a

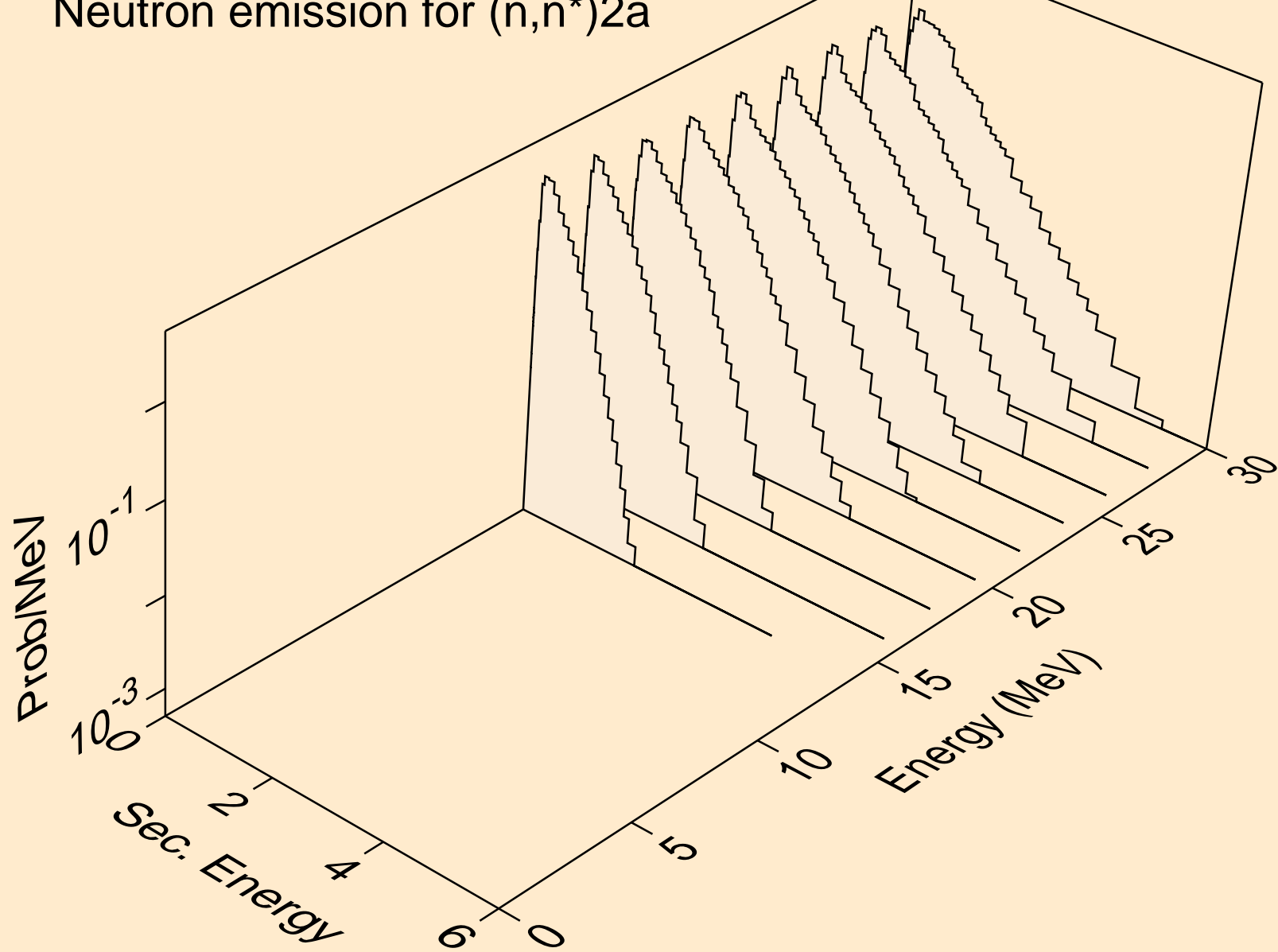

ND139 NEUTRON ACER TENDL-2024 LIBRARY; T=0.K
Neutron emission for (n,n*)d

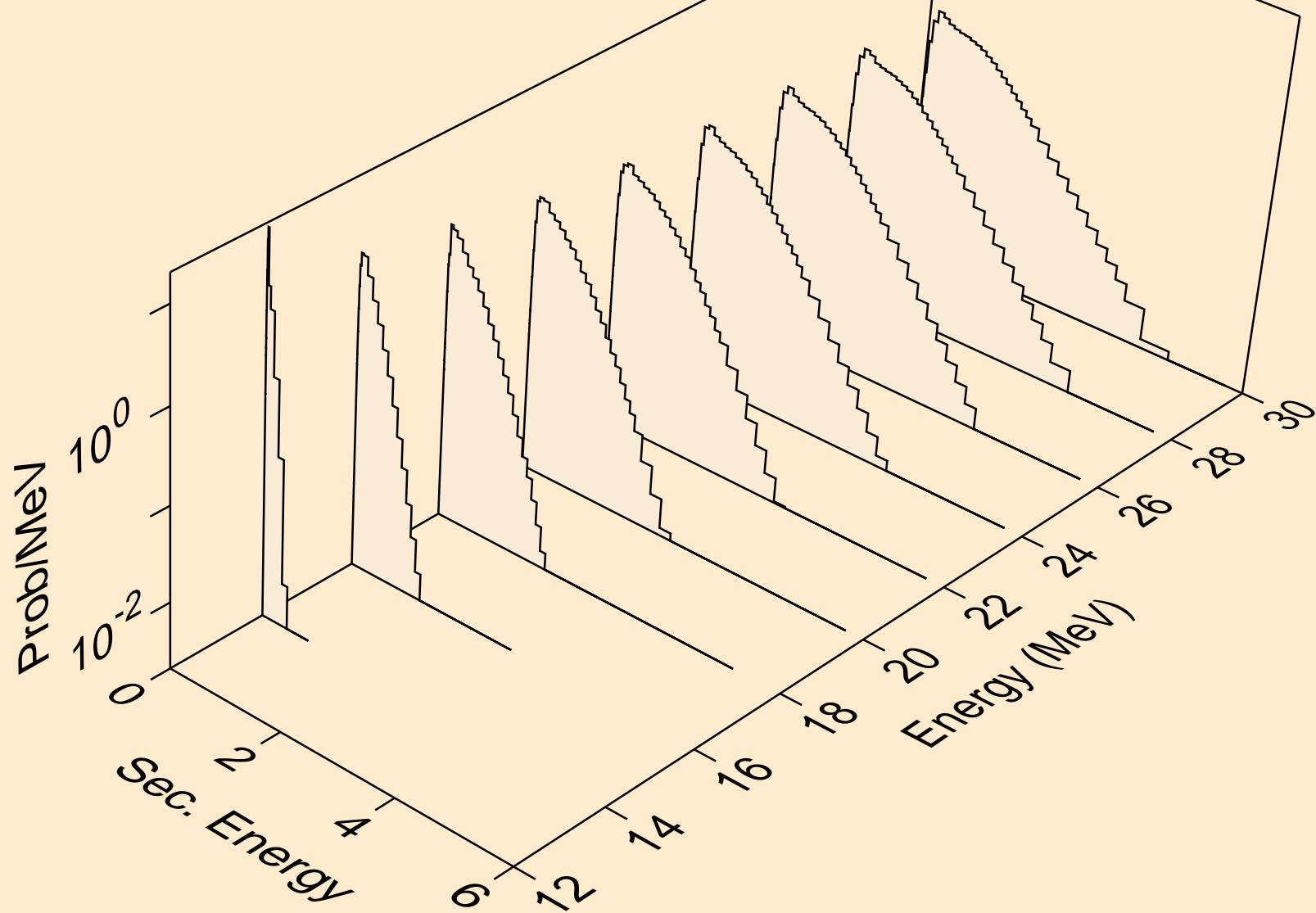

ND139 NEUTRON ACER TENDL-2024 LIBRARY; T=0.K
Neutron emission for (n,n*)t

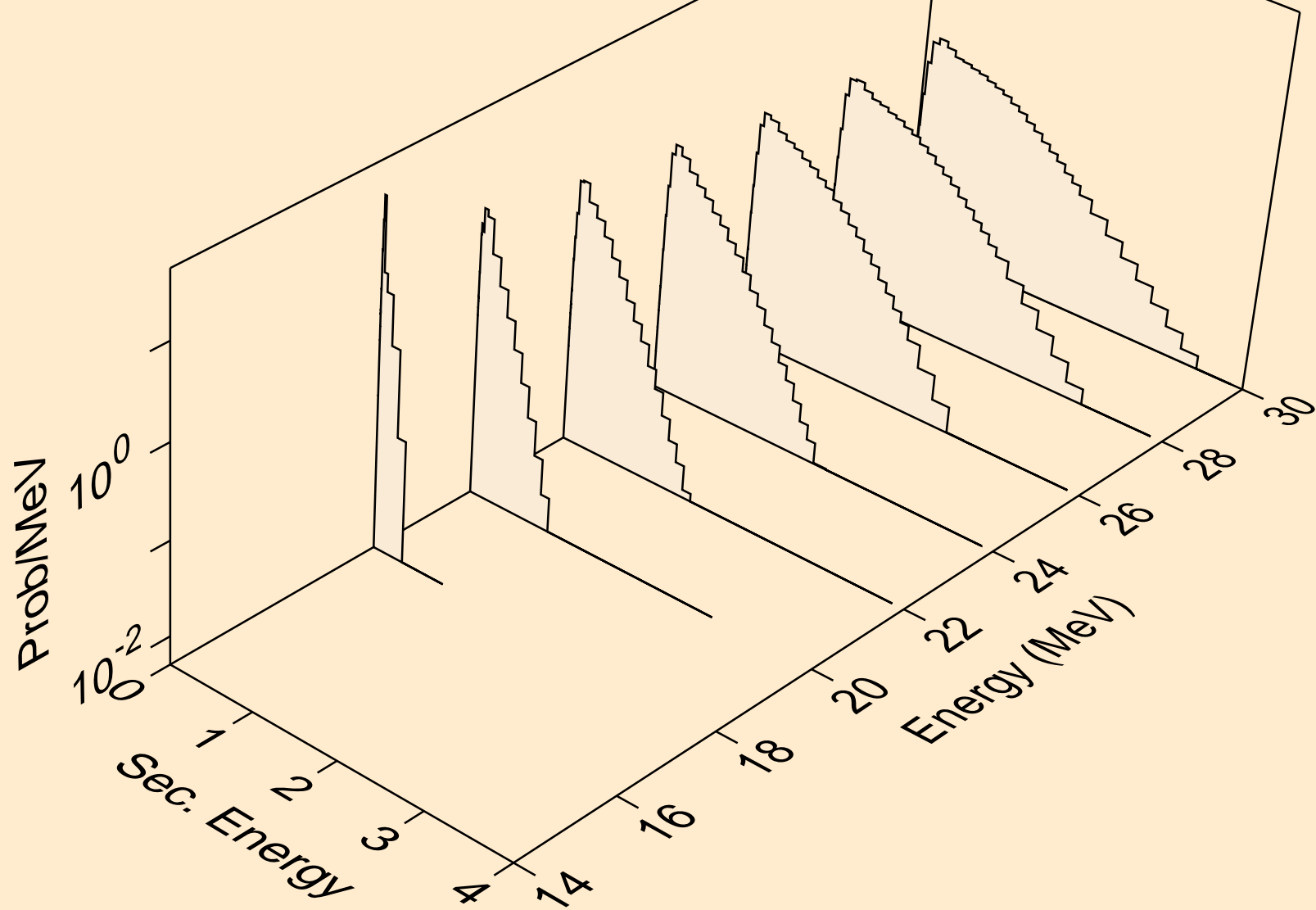

ND139 NEUTRON ACER TENDL-2024 LIBRARY; T=0.K
Neutron emission for (n,n*)he3

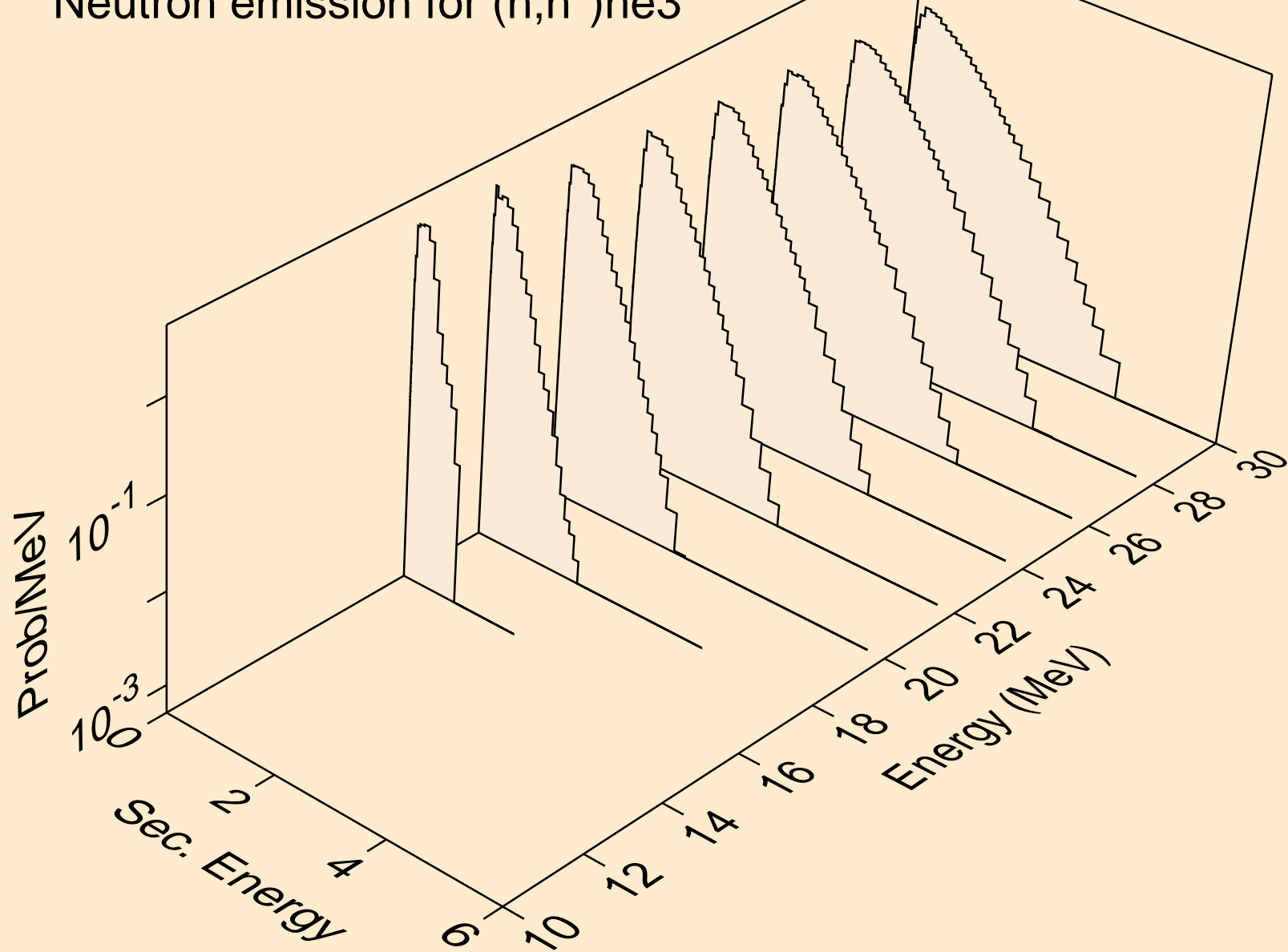

ND139 NEUTRON ACER TENDL-2024 LIBRARY; T=0.K
Neutron emission for (n,4n)

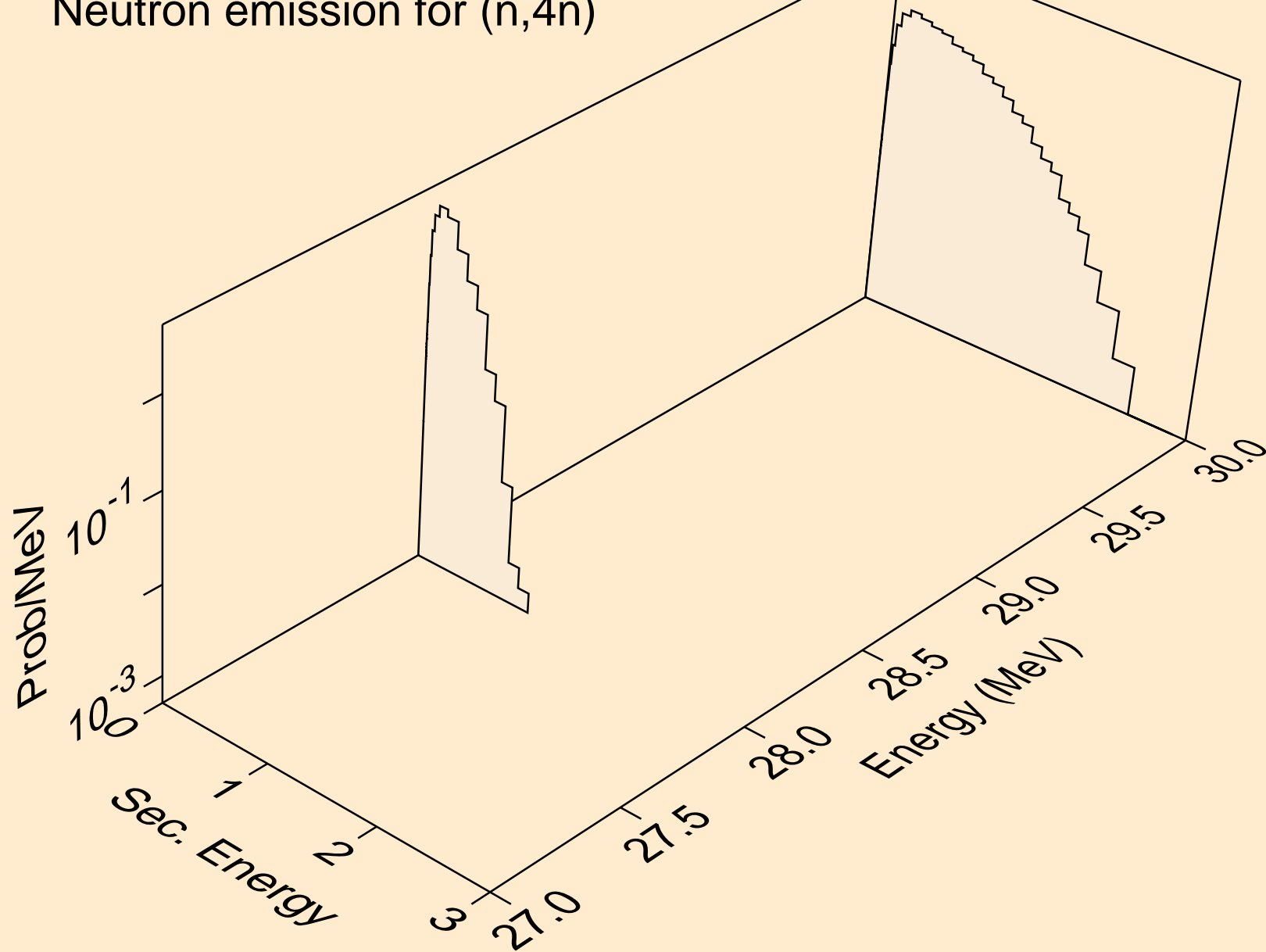

ND139 NEUTRON ACER TENDL-2024 LIBRARY; T=0.K
Neutron emission for (n,2np)

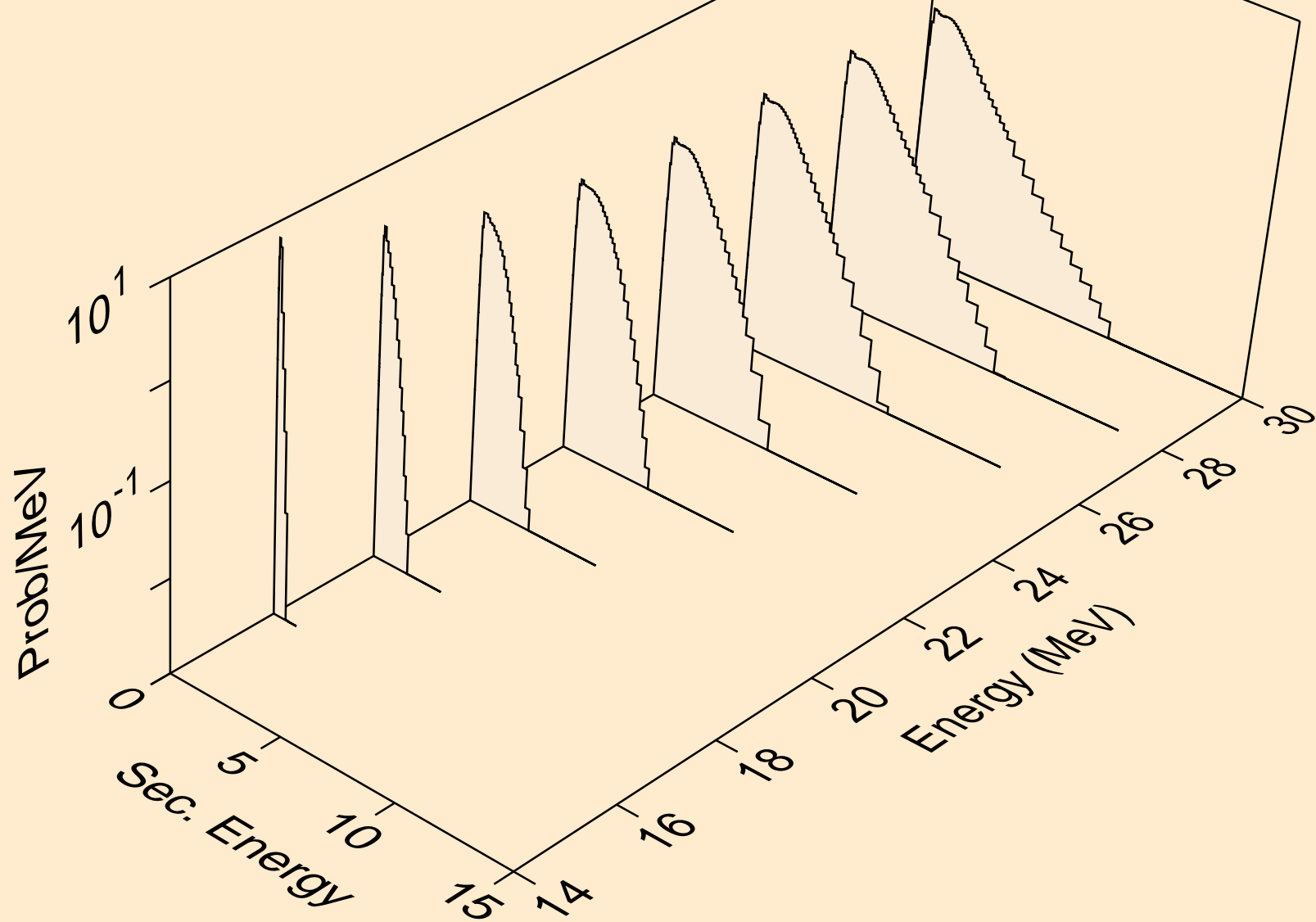

ND139 NEUTRON ACER TENDL-2024 LIBRARY; T=0.K
Neutron emission for (n,3np)

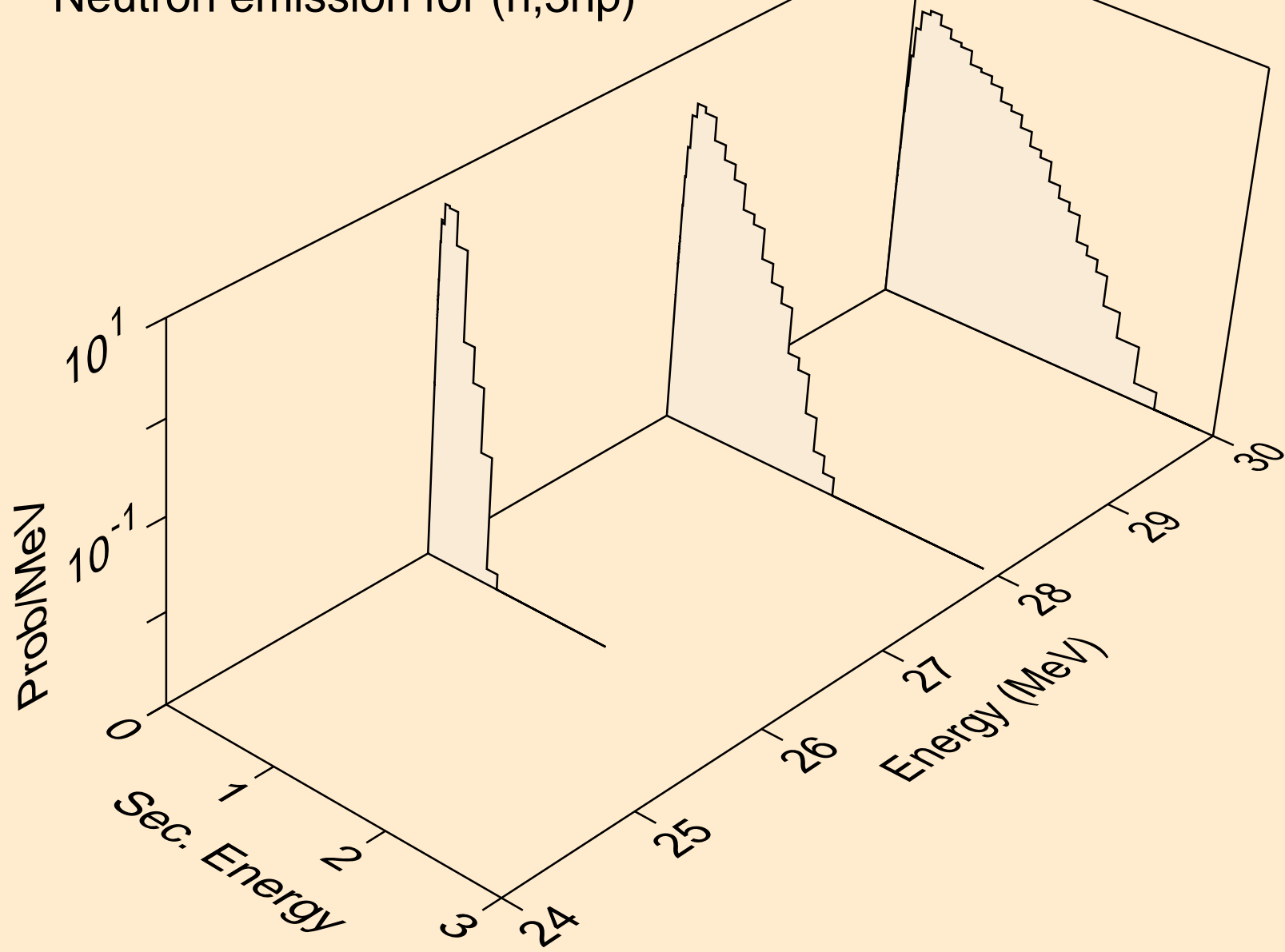

ND139 NEUTRON ACER TENDL-2024 LIBRARY; T=0.K
Neutron emission for (n,n2p)

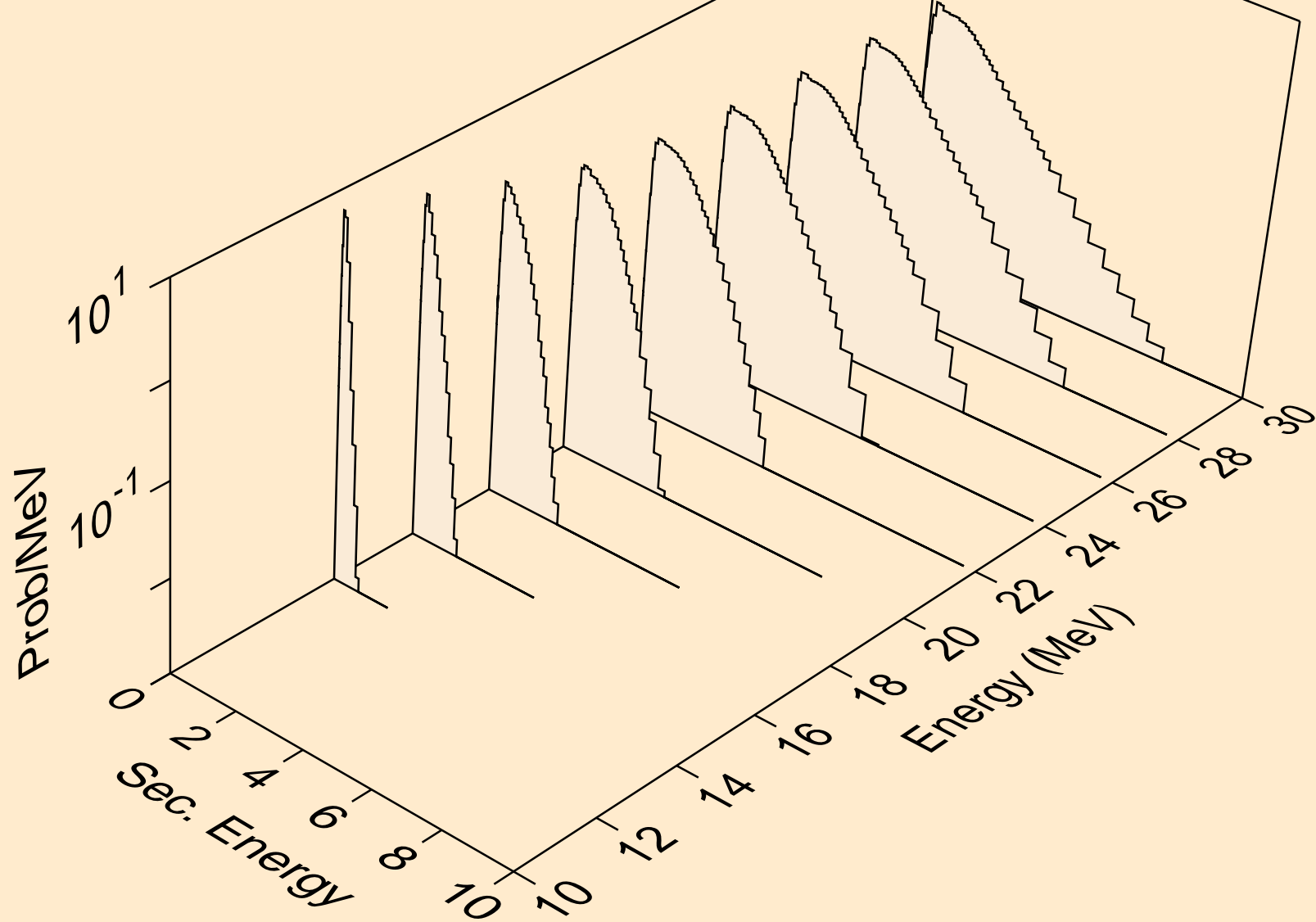

ND139 NEUTRON ACER TENDL-2024 LIBRARY; T=0.K
Neutron emission for (n,npa)

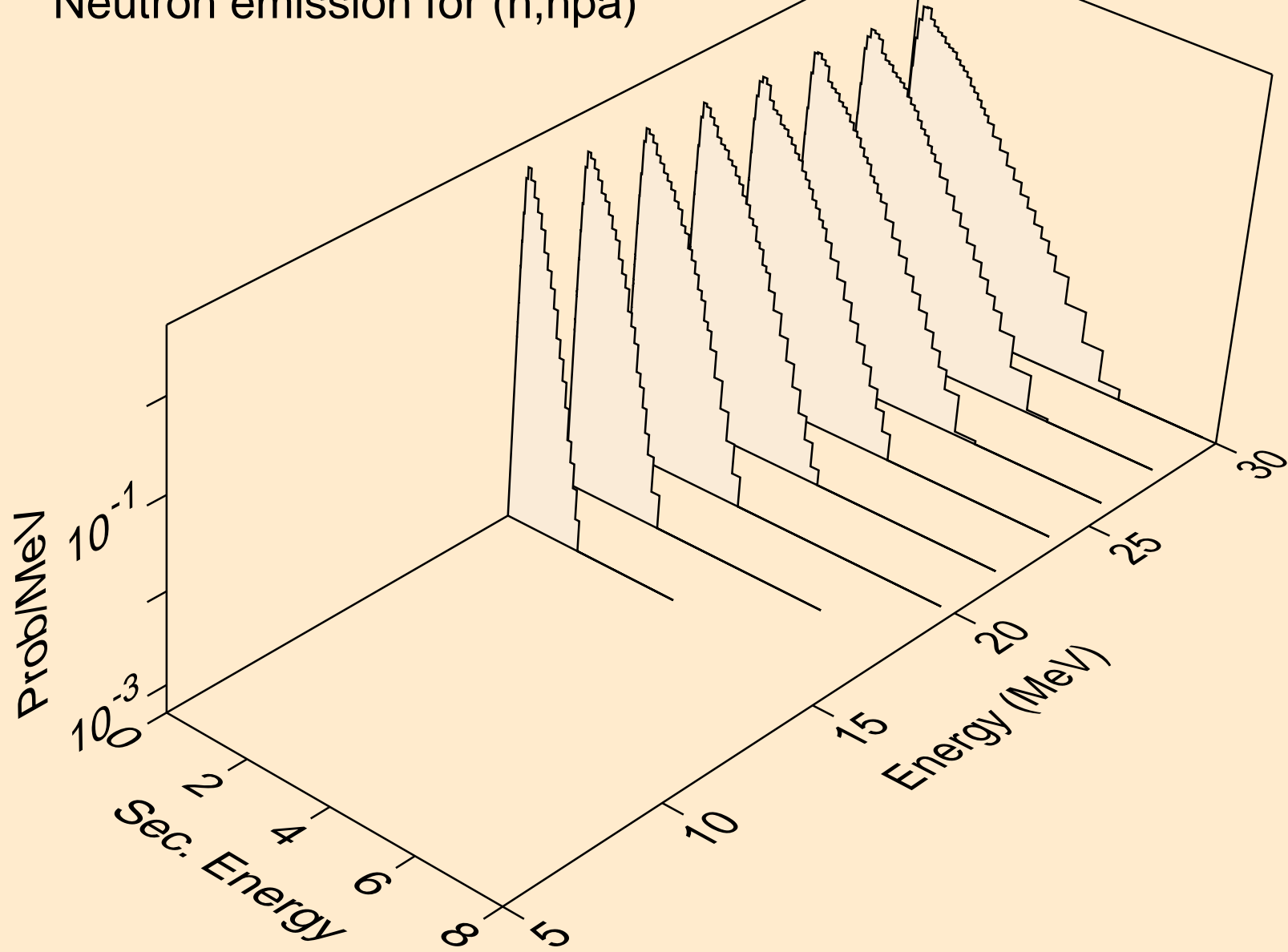

ND139 NEUTRON ACER TENDL-2024 LIBRARY; T=0.K
Neutron emission for (n,n*c)

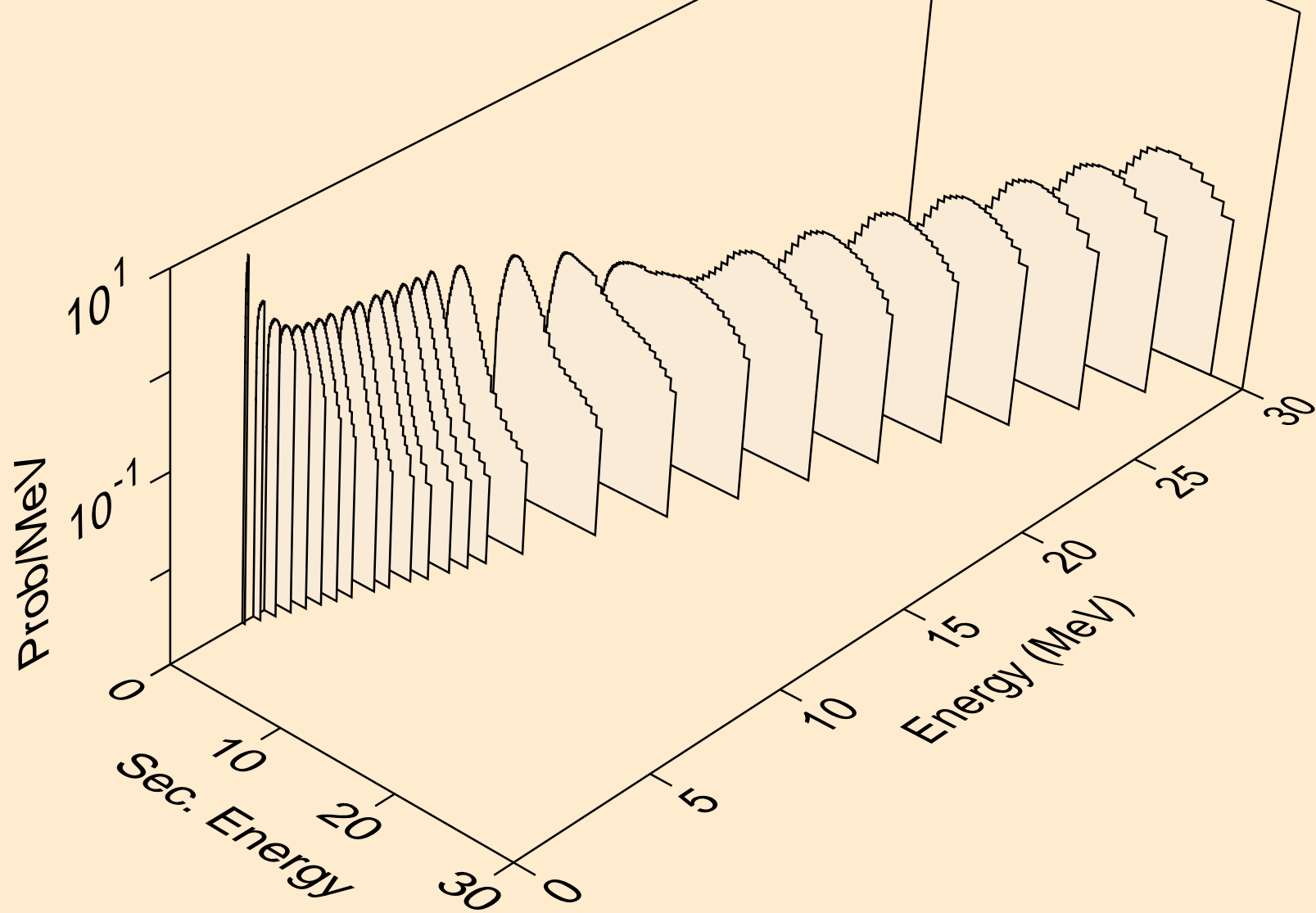

ND139 NEUTRON ACER TENDL-2024 LIBRARY; T=0.K
Photon emission for (n,x)

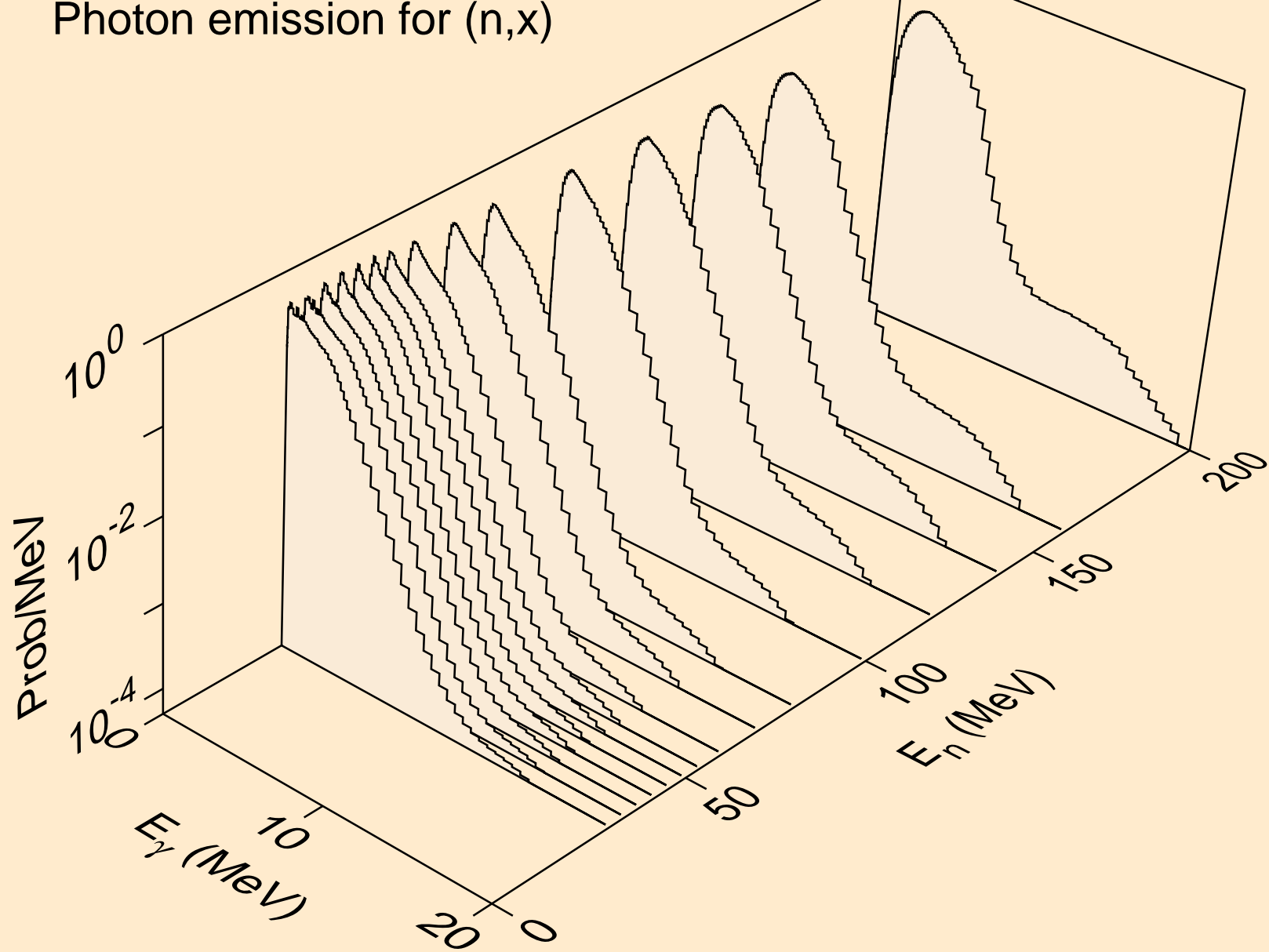

ND139 NEUTRON ACER TENDL-2024 LIBRARY; T=0.K
Photon emission for (n,2nd)

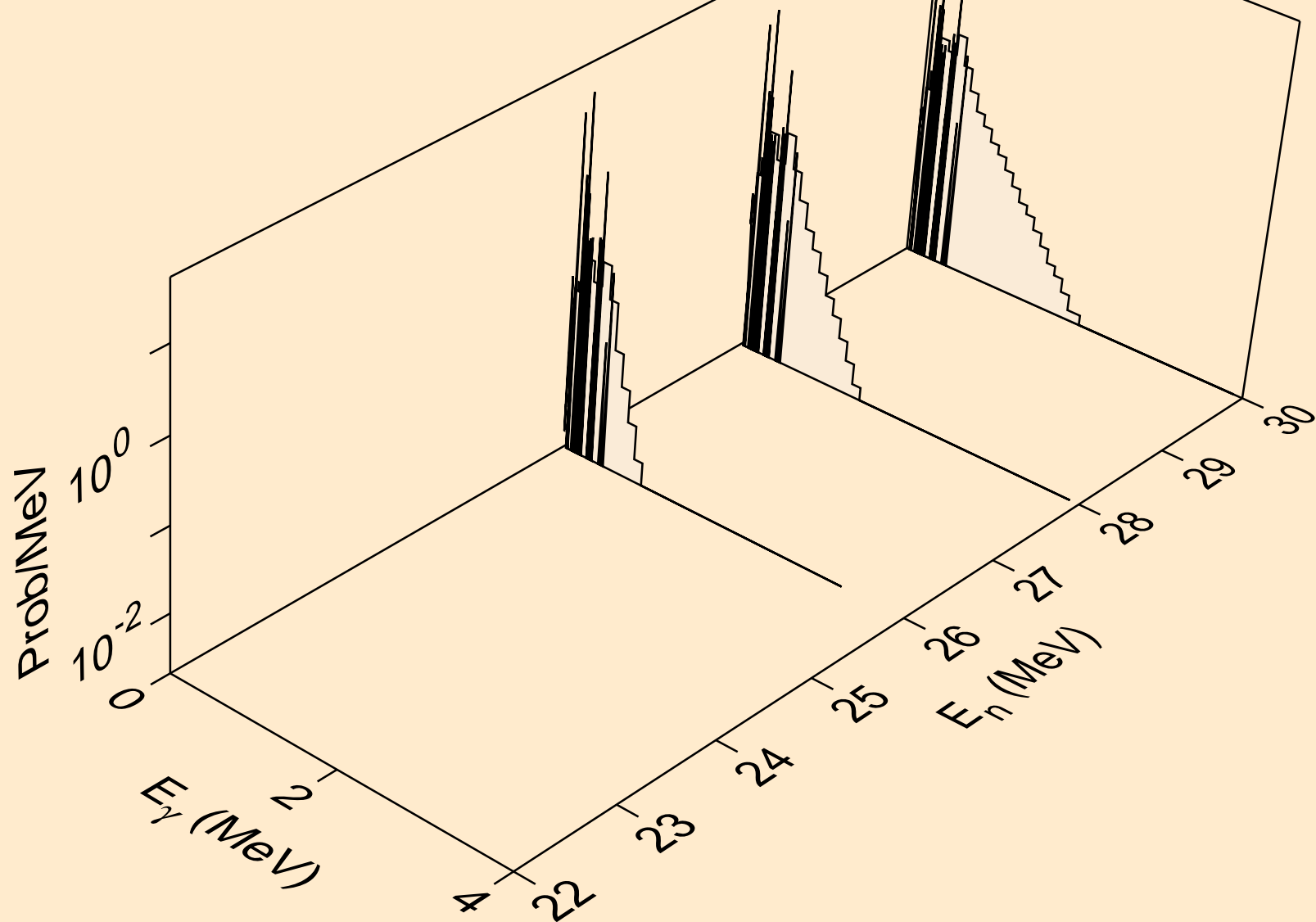

ND139 NEUTRON ACER TENDL-2024 LIBRARY; T=0.K
Photon emission for (n,2n)

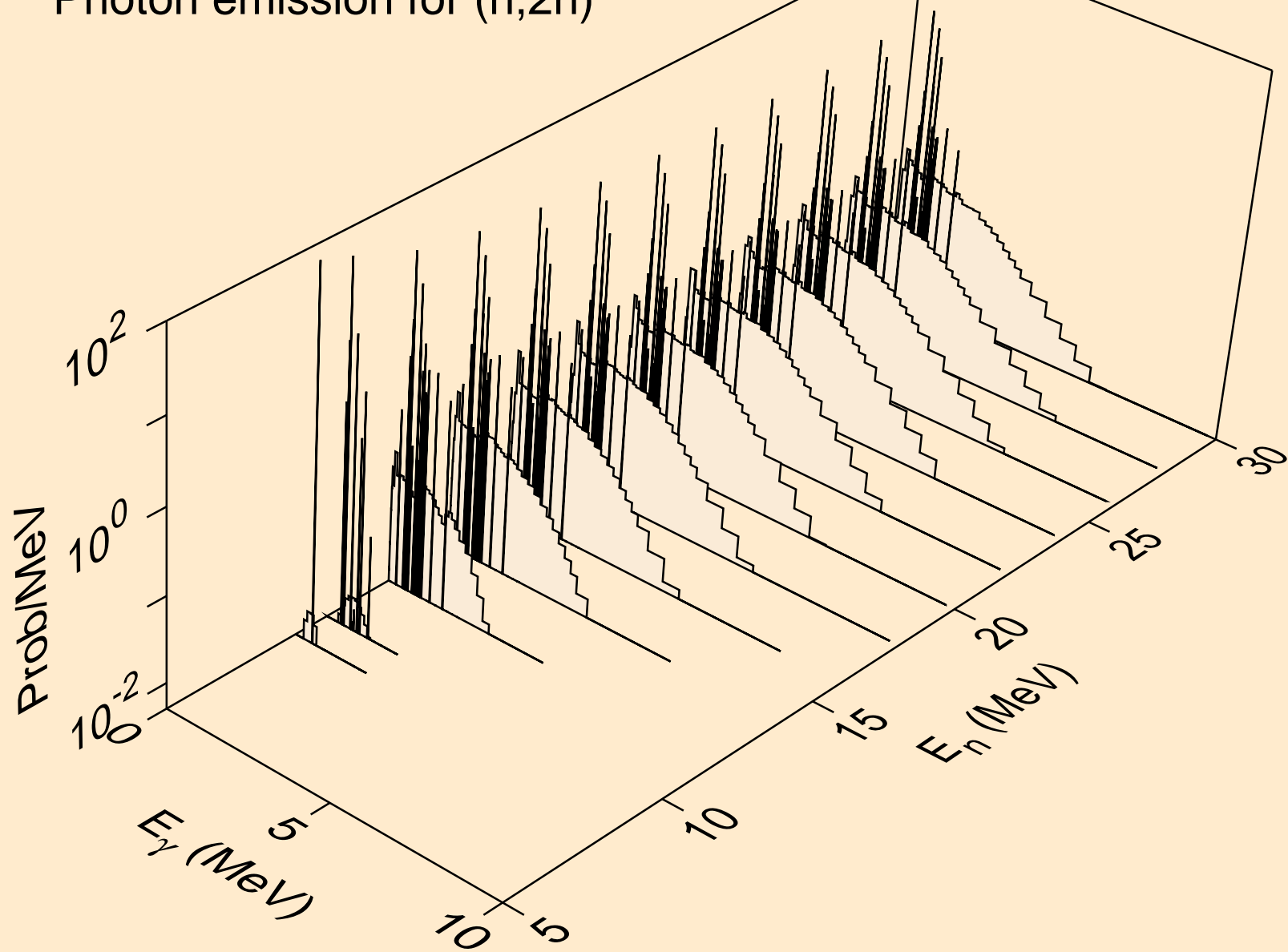

ND139 NEUTRON ACER TENDL-2024 LIBRARY; T=0.K
Photon emission for (n,3n)

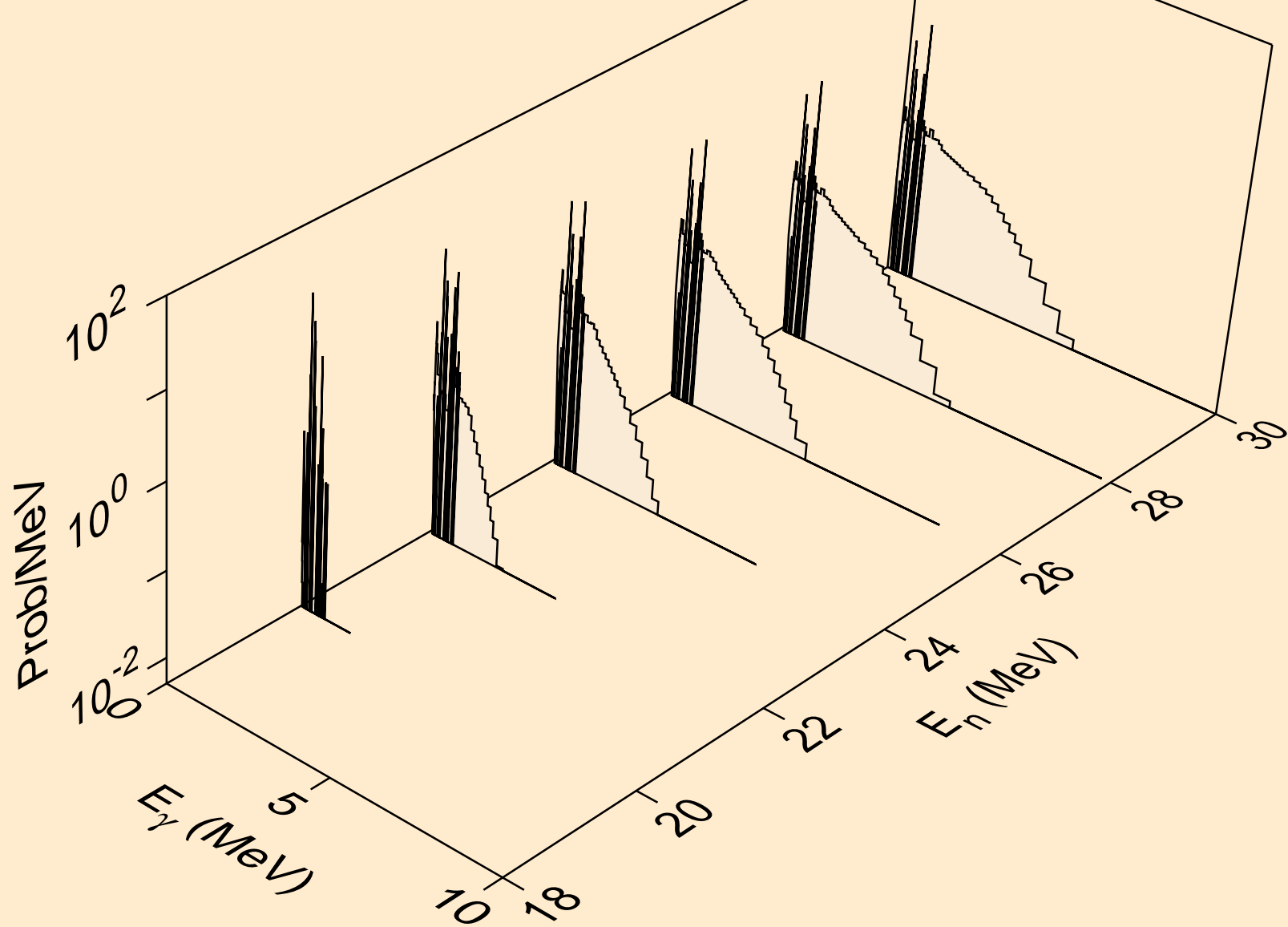

ND139 NEUTRON ACER TENDL-2024 LIBRARY; T=0.K
Photon emission for (n,n*)a

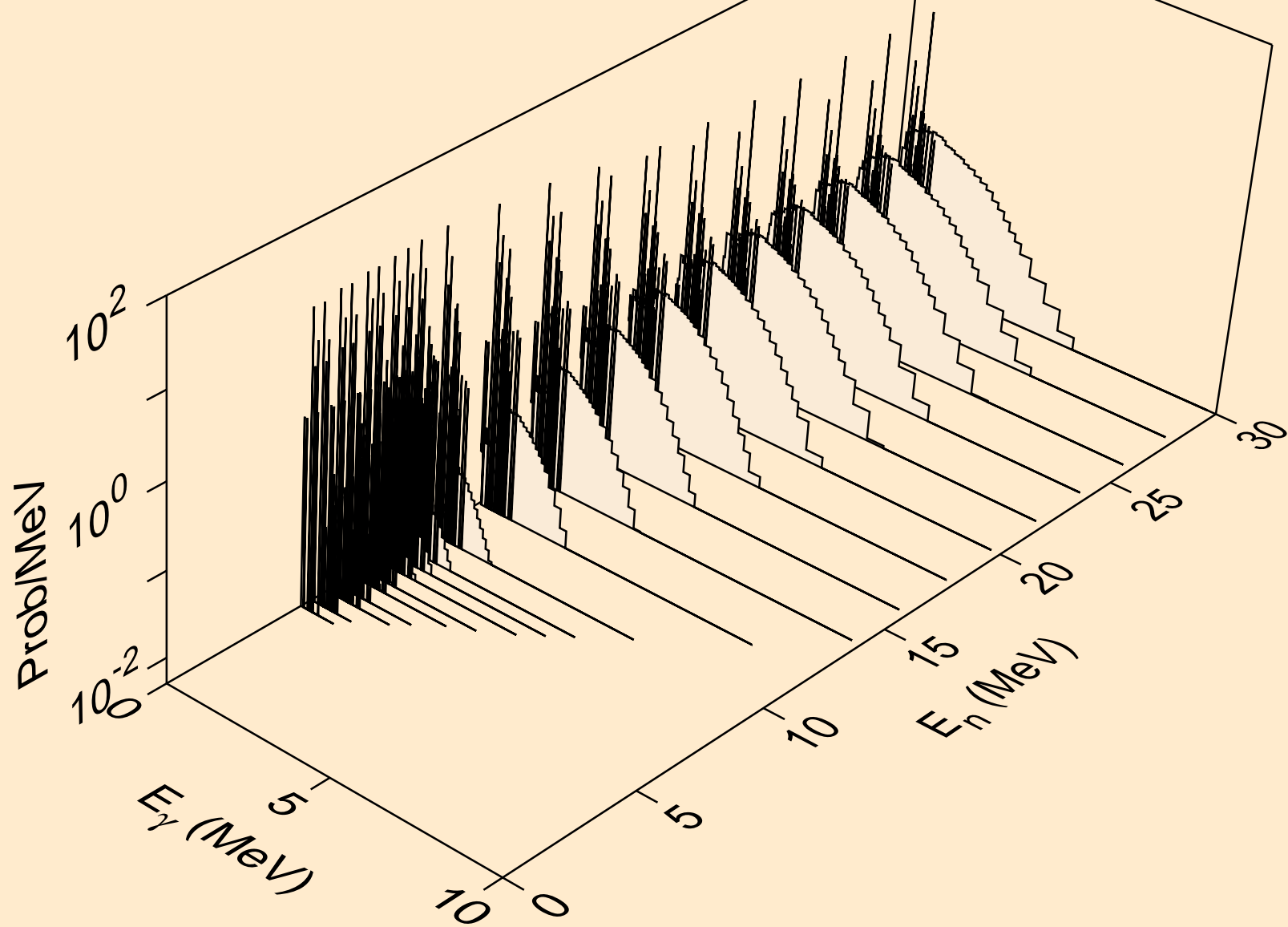

ND139 NEUTRON ACER TENDL-2024 LIBRARY; T=0.K
Photon emission for (n,2n)a

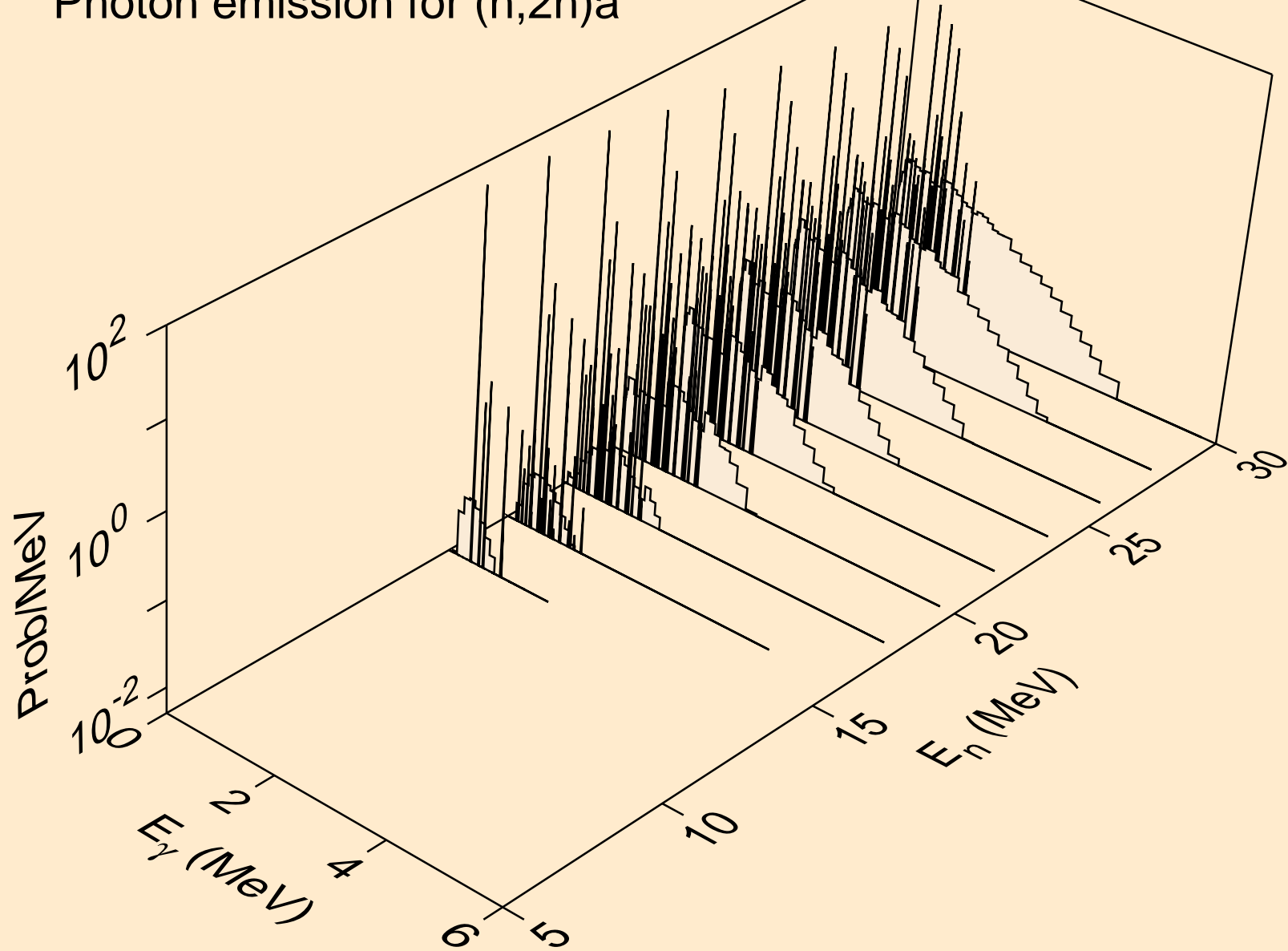

ND139 NEUTRON ACER TENDL-2024 LIBRARY; T=0.K
Photon emission for (n,3n)a

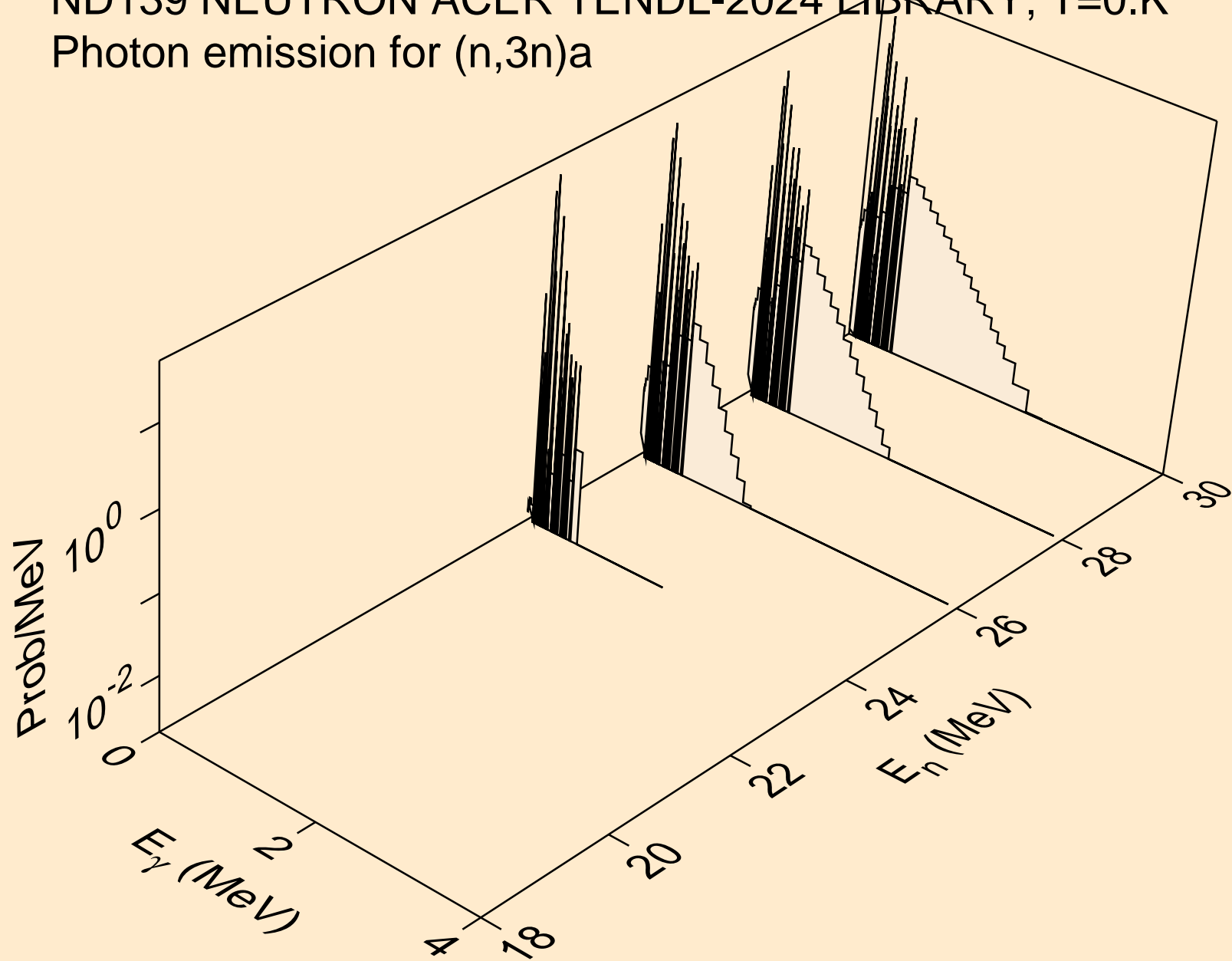

ND139 NEUTRON ACER TENDL-2024 LIBRARY; T=0.K
Photon emission for (n,n*)p

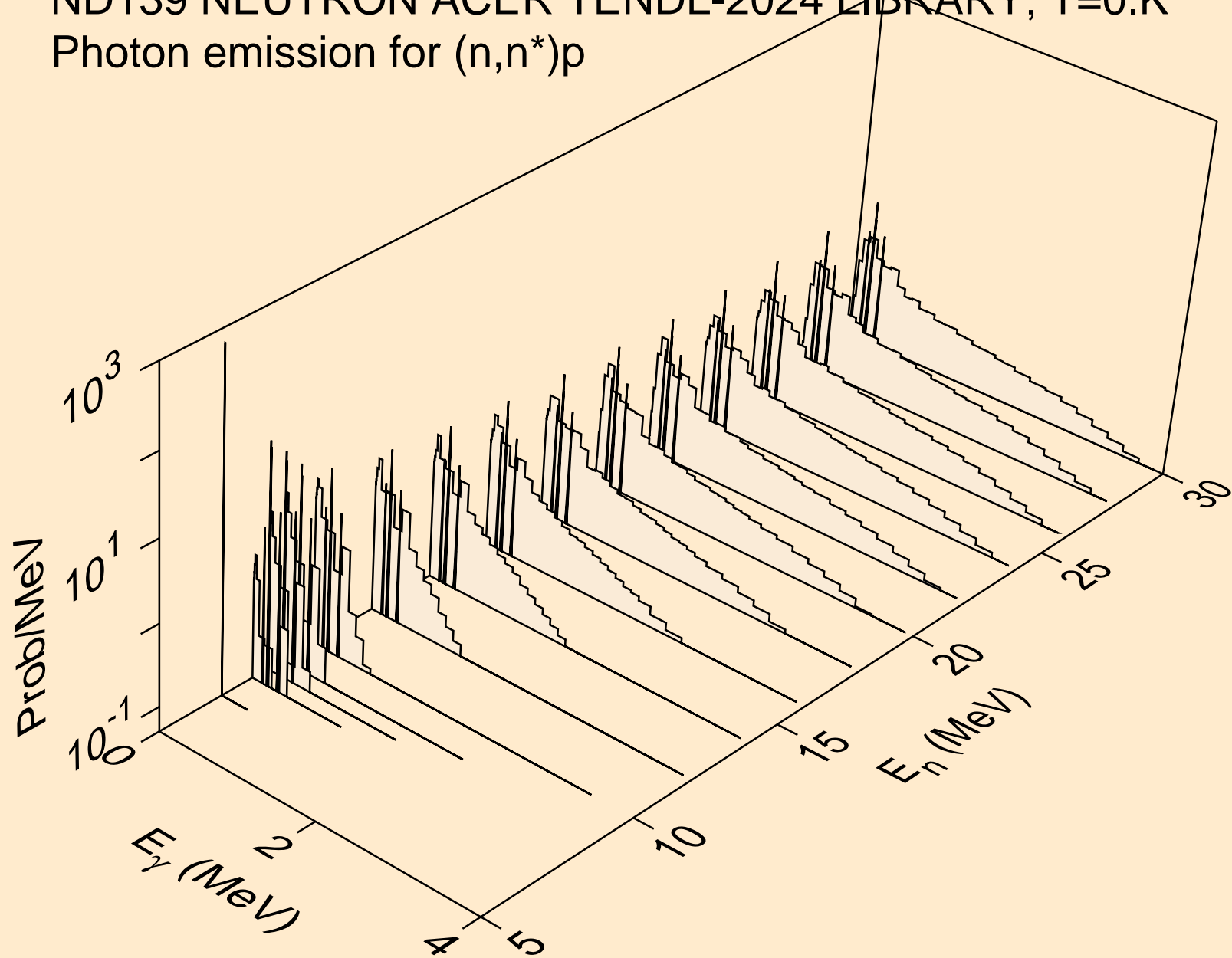

ND139 NEUTRON ACER TENDL-2024 LIBRARY; T=0.K
Photon emission for (n,n*)2a

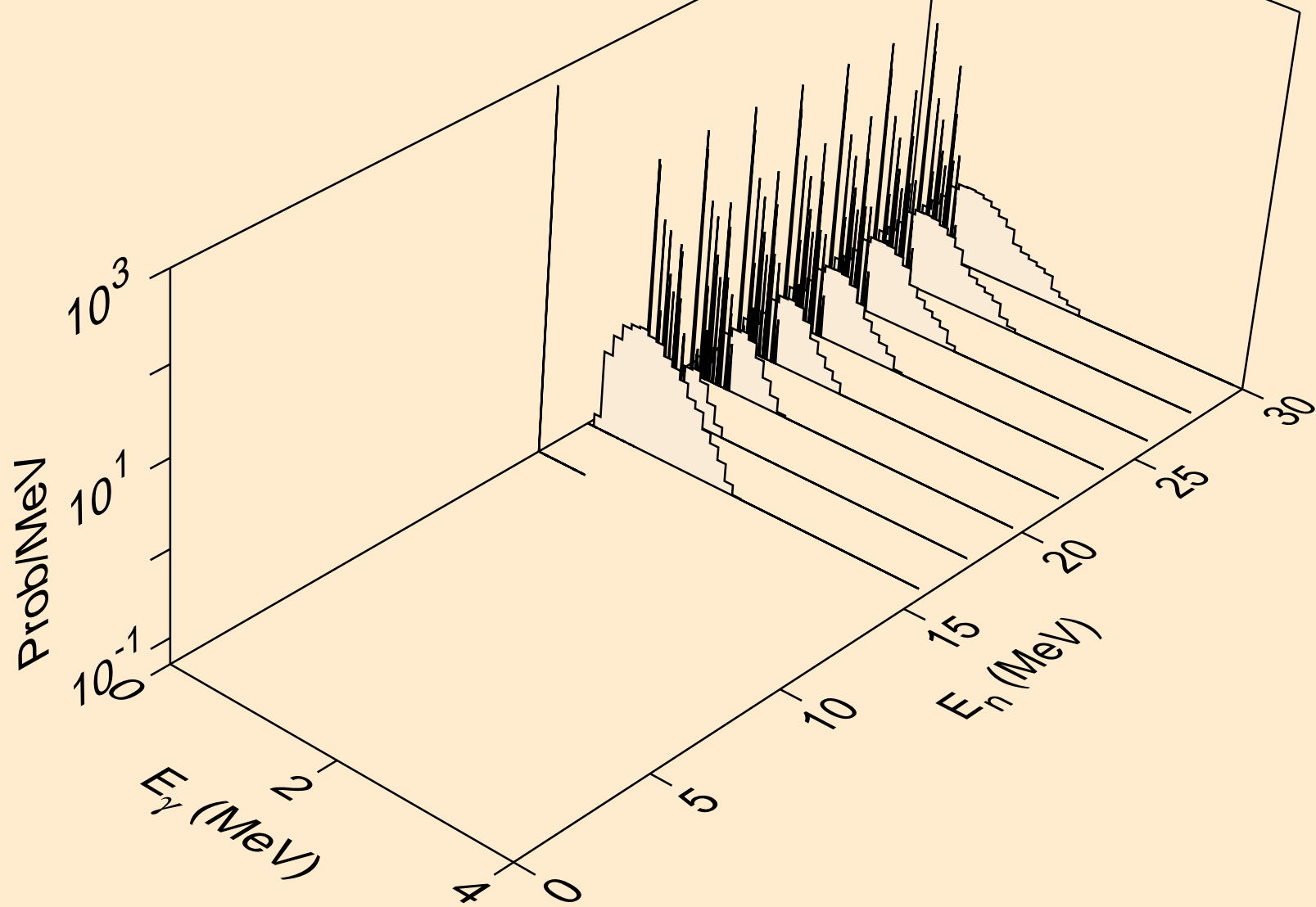

ND139 NEUTRON ACER TENDL-2024 LIBRARY; T=0.K
Photon emission for (n,n*)d

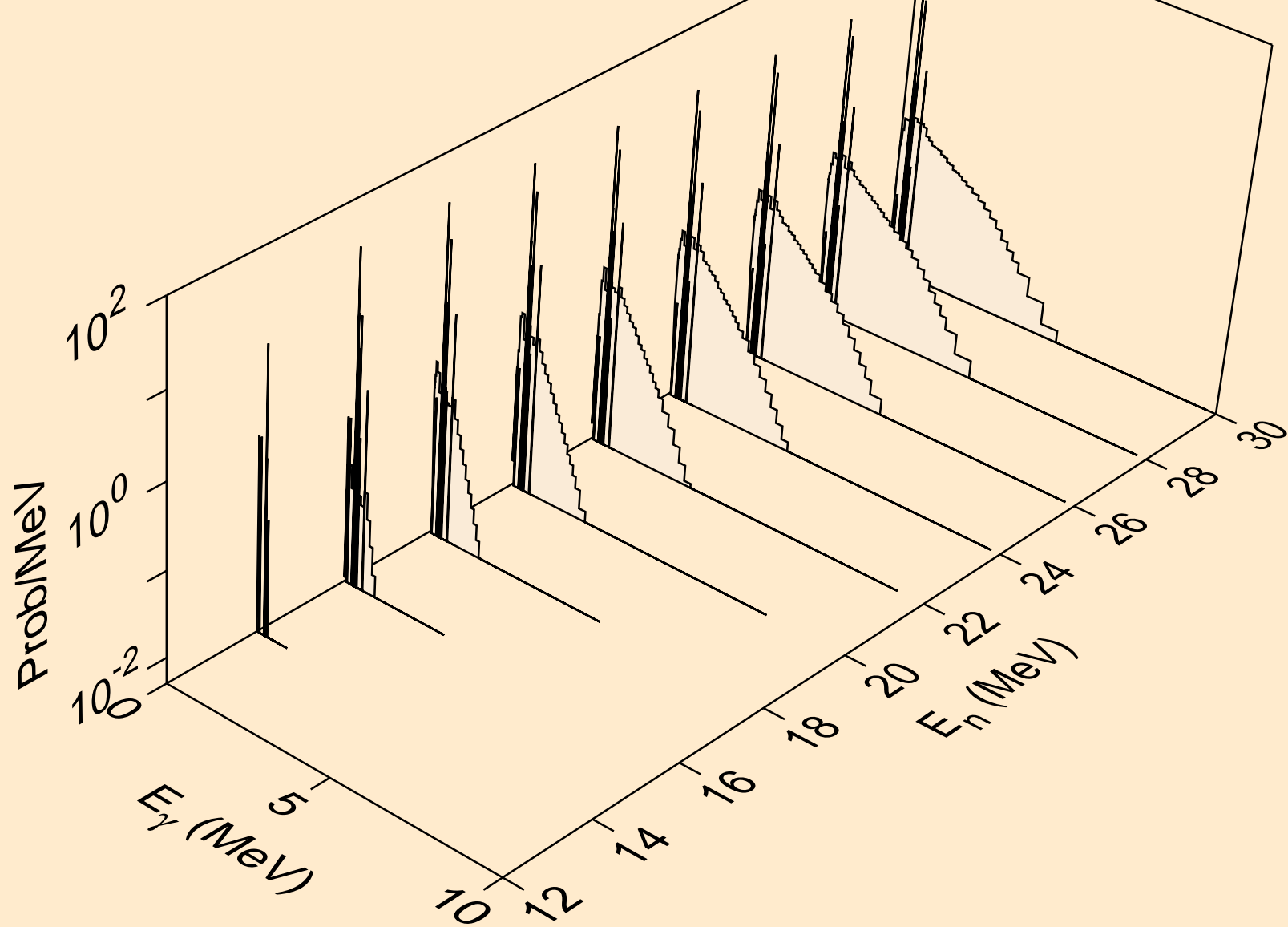

ND139 NEUTRON ACER TENDL-2024 LIBRARY; T=0.K
Photon emission for (n,n*)t

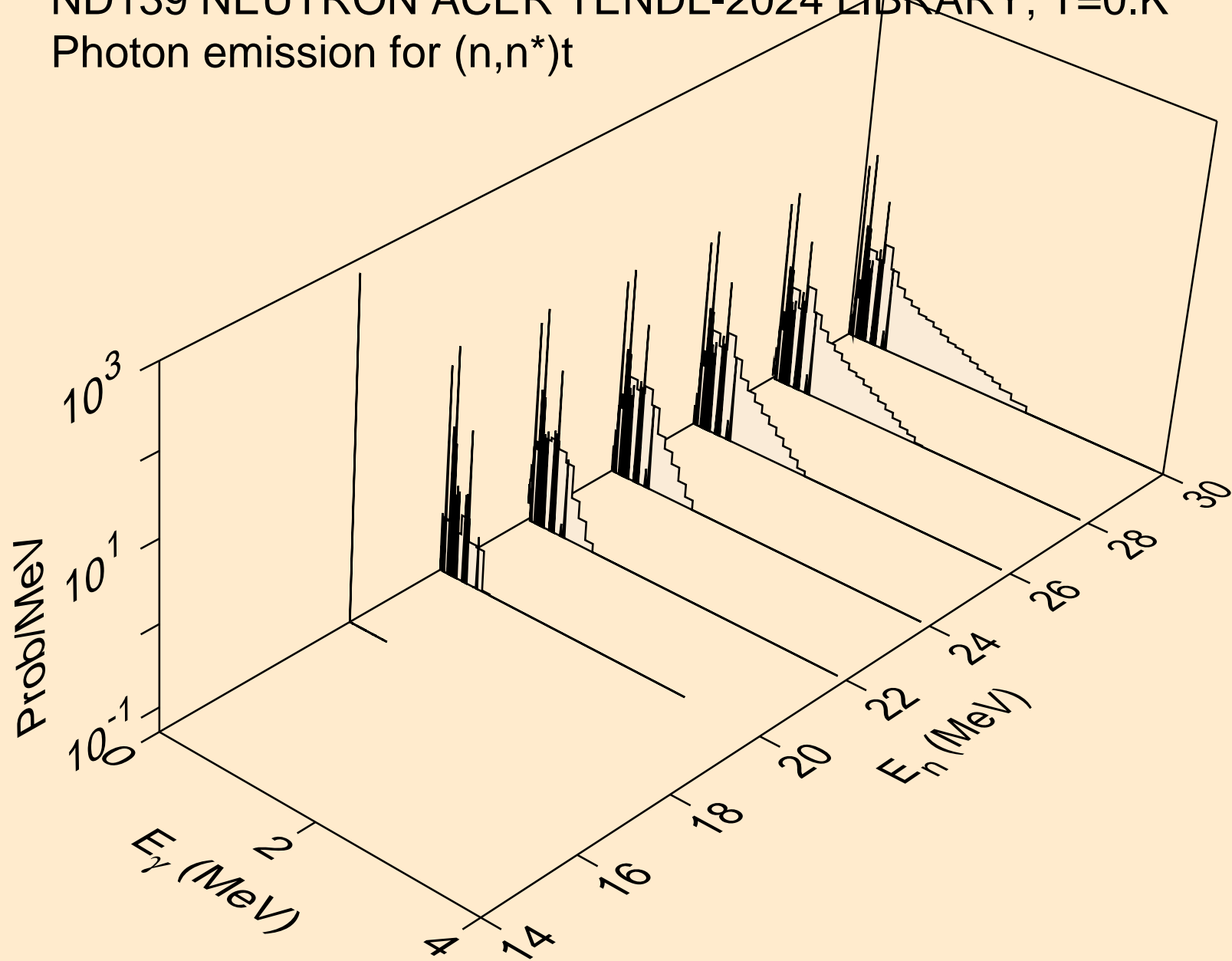

ND139 NEUTRON ACER TENDL-2024 LIBRARY; T=0.K
Photon emission for (n,n*)he3

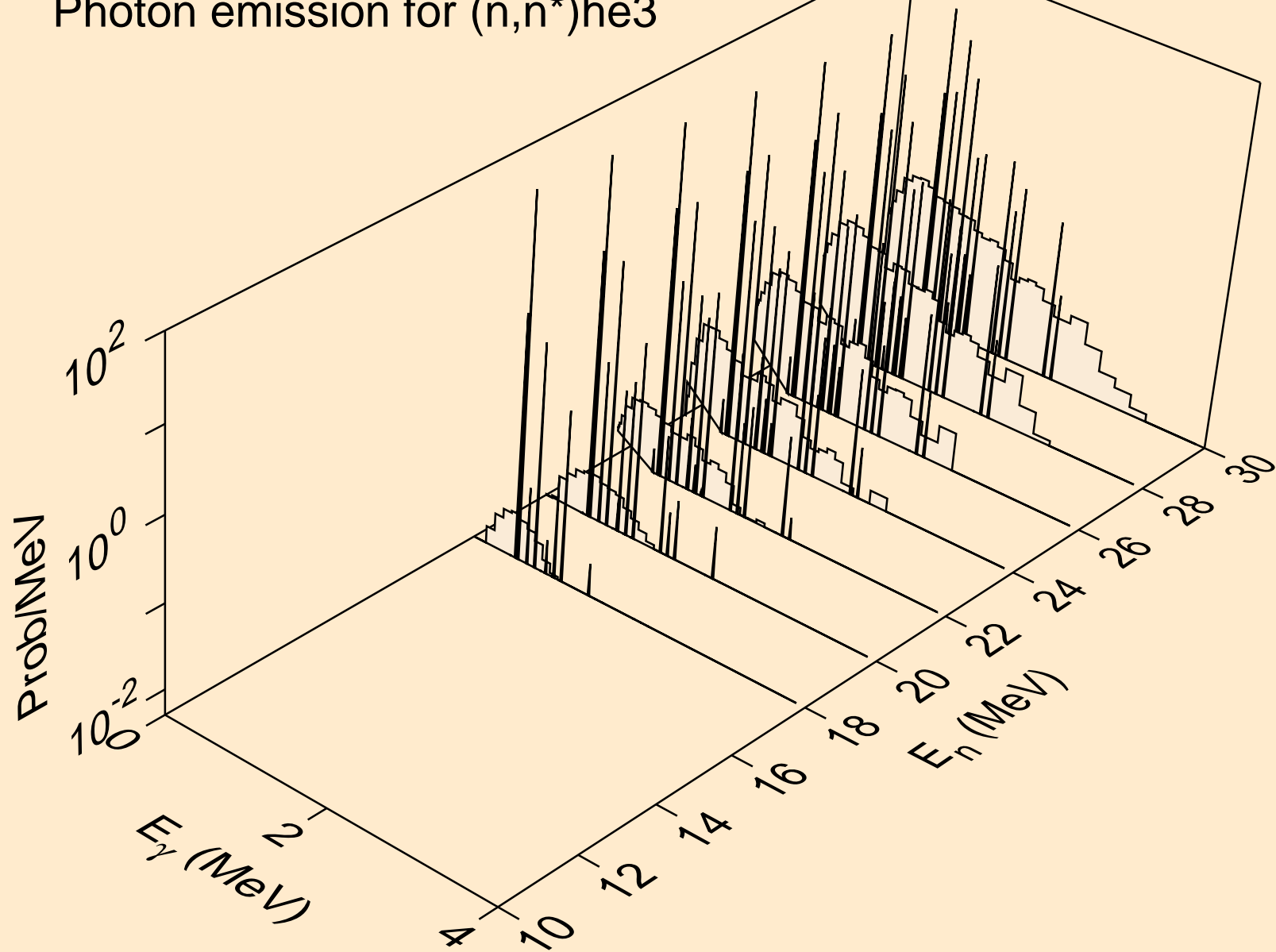

ND139 NEUTRON ACER TENDL-2024 LIBRARY; T=0.K
Photon emission for (n,4n)

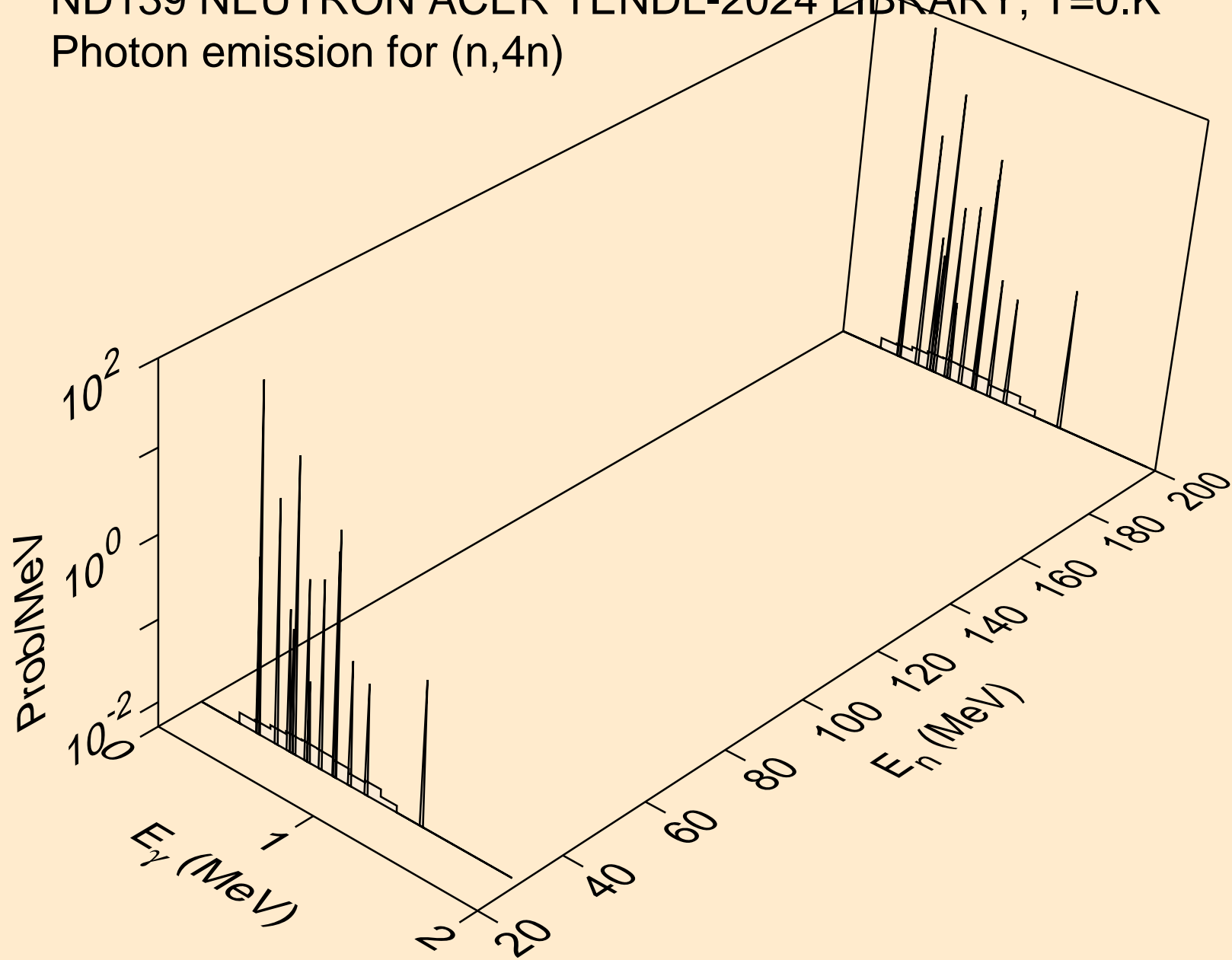

ND139 NEUTRON ACER TENDL-2024 LIBRARY; T=0.K
Photon emission for (n,2np)

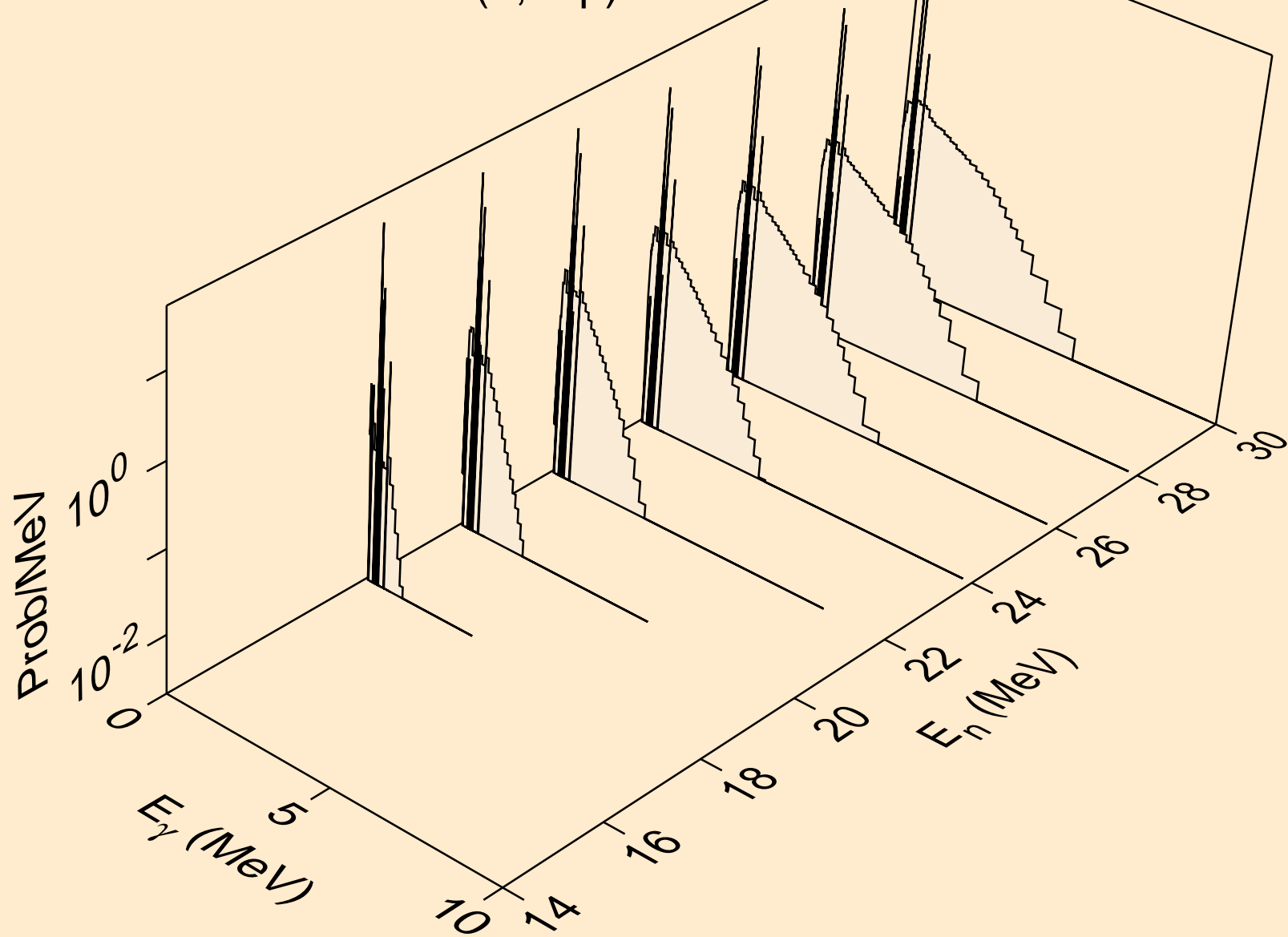

ND139 NEUTRON ACER TENDL-2024 LIBRARY; T=0.K
Photon emission for (n,3np)

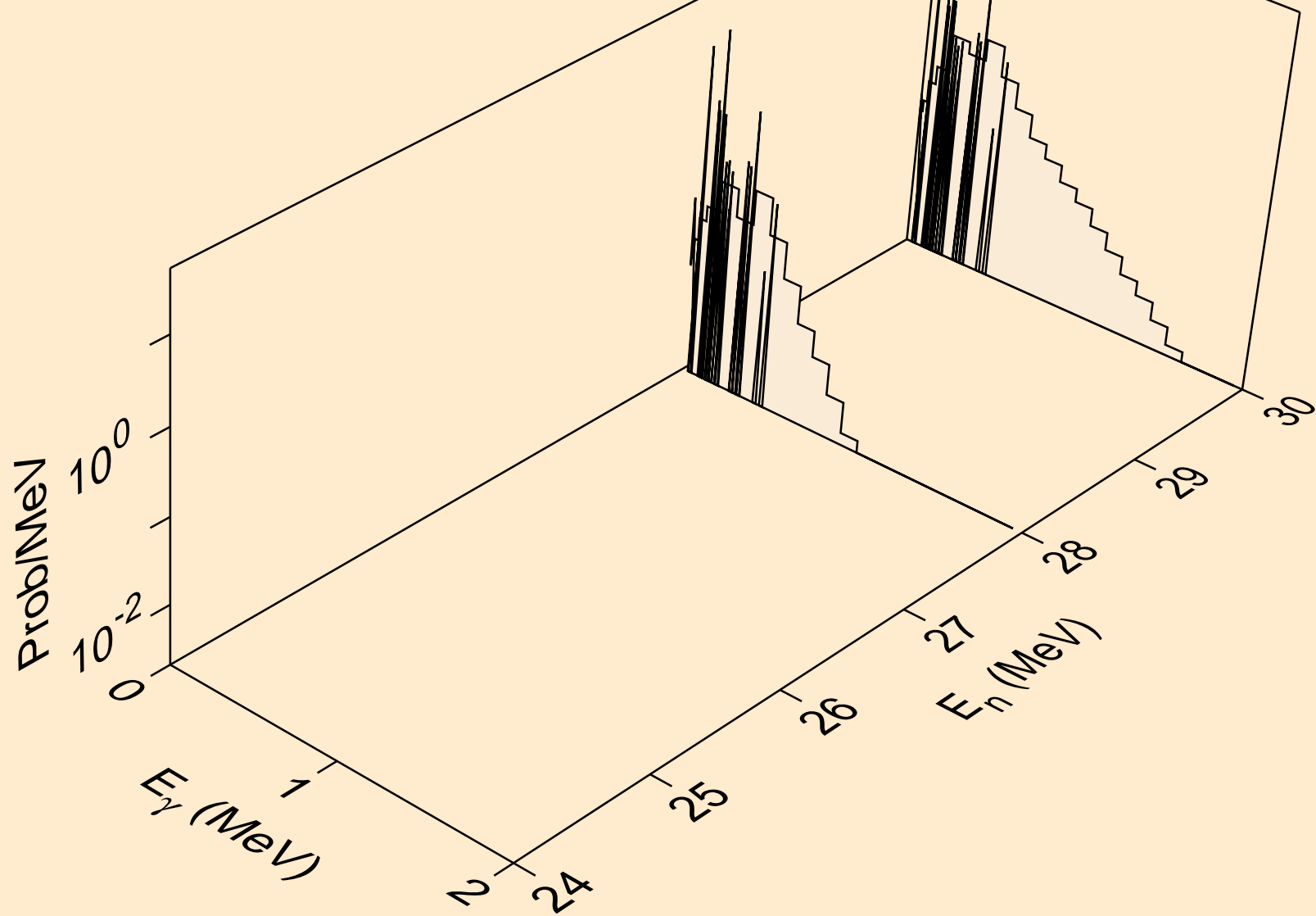

ND139 NEUTRON ACER TENDL-2024 LIBRARY; T=0.K
Photon emission for (n,n2p)

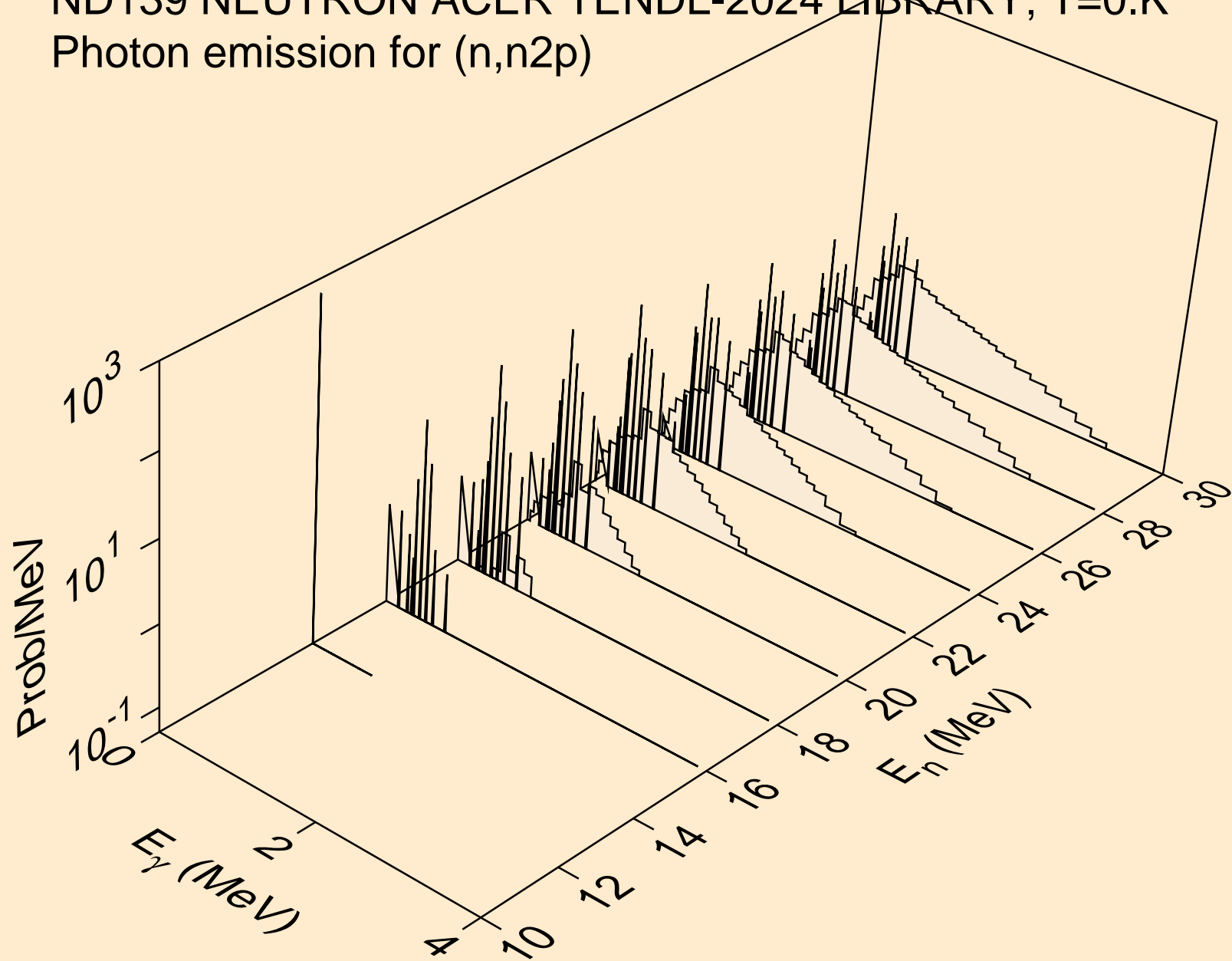

ND139 NEUTRON ACER TENDL-2024 LIBRARY; T=0.K
Photon emission for (n,npa)

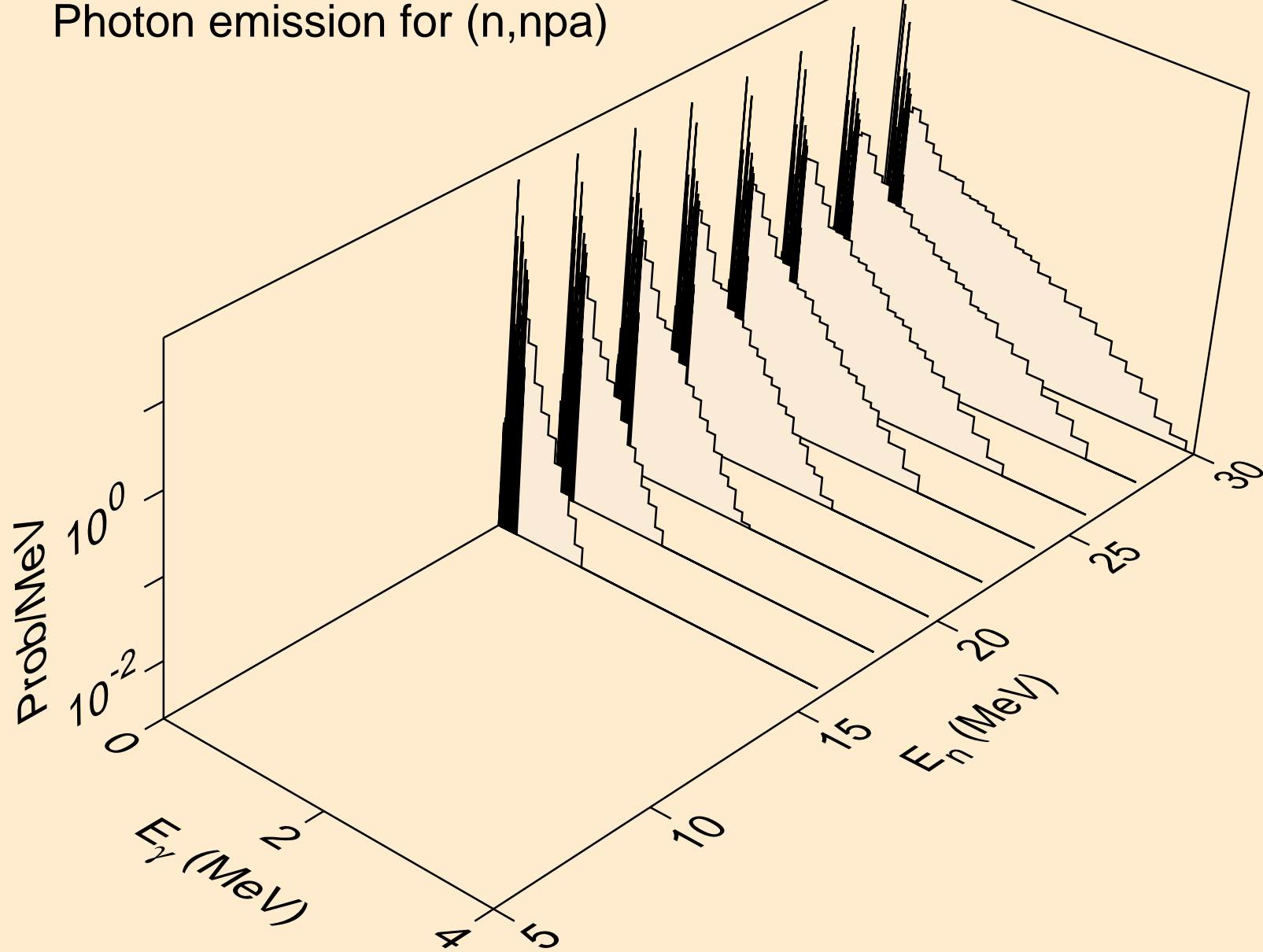

ND139 NEUTRON ACER TENDL-2024 LIBRARY; T=0.K
Photon emission for (n,n*c)

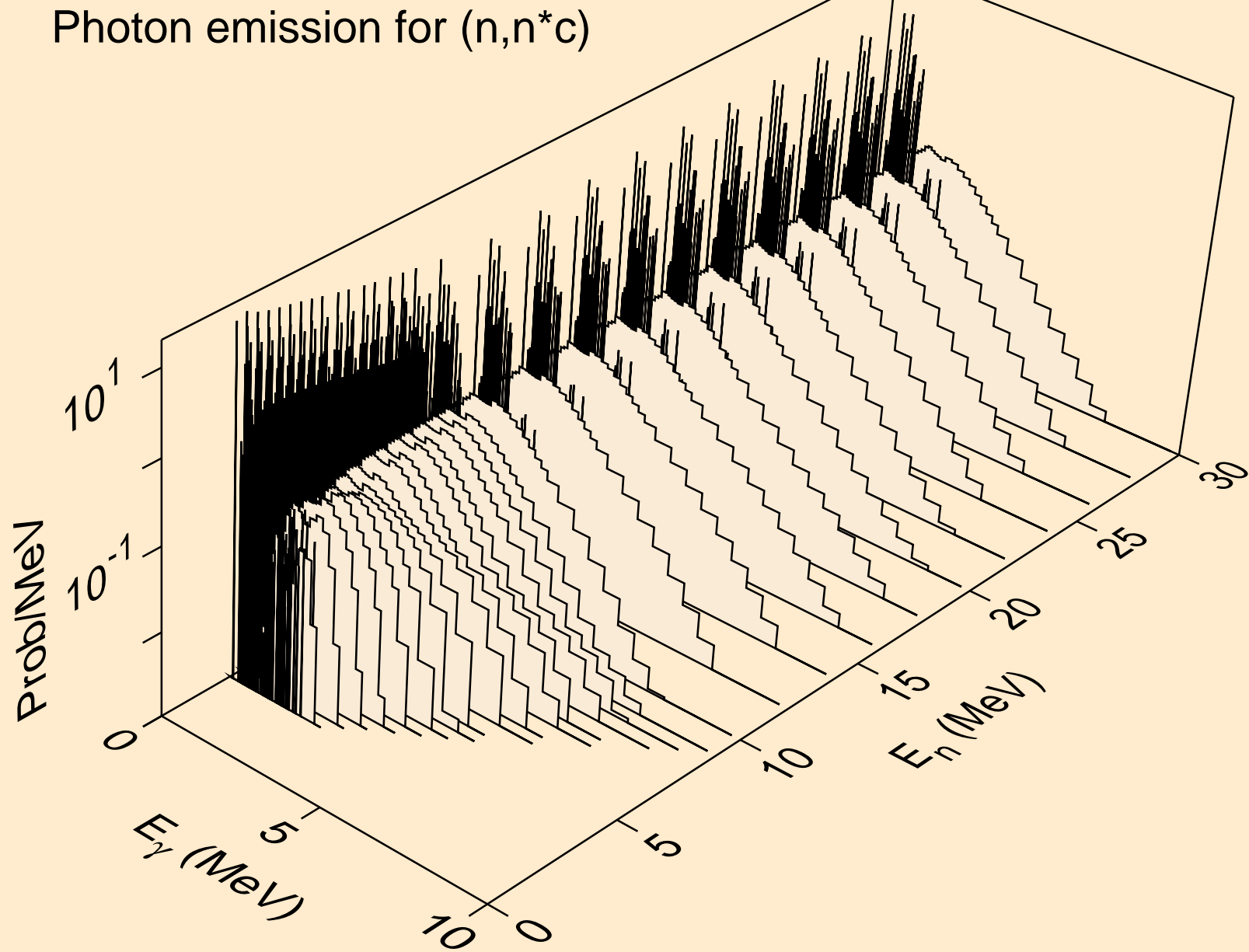

ND139 NEUTRON ACER TENDL-2024 LIBRARY; T=0.K
Photon emission for (n,gma)

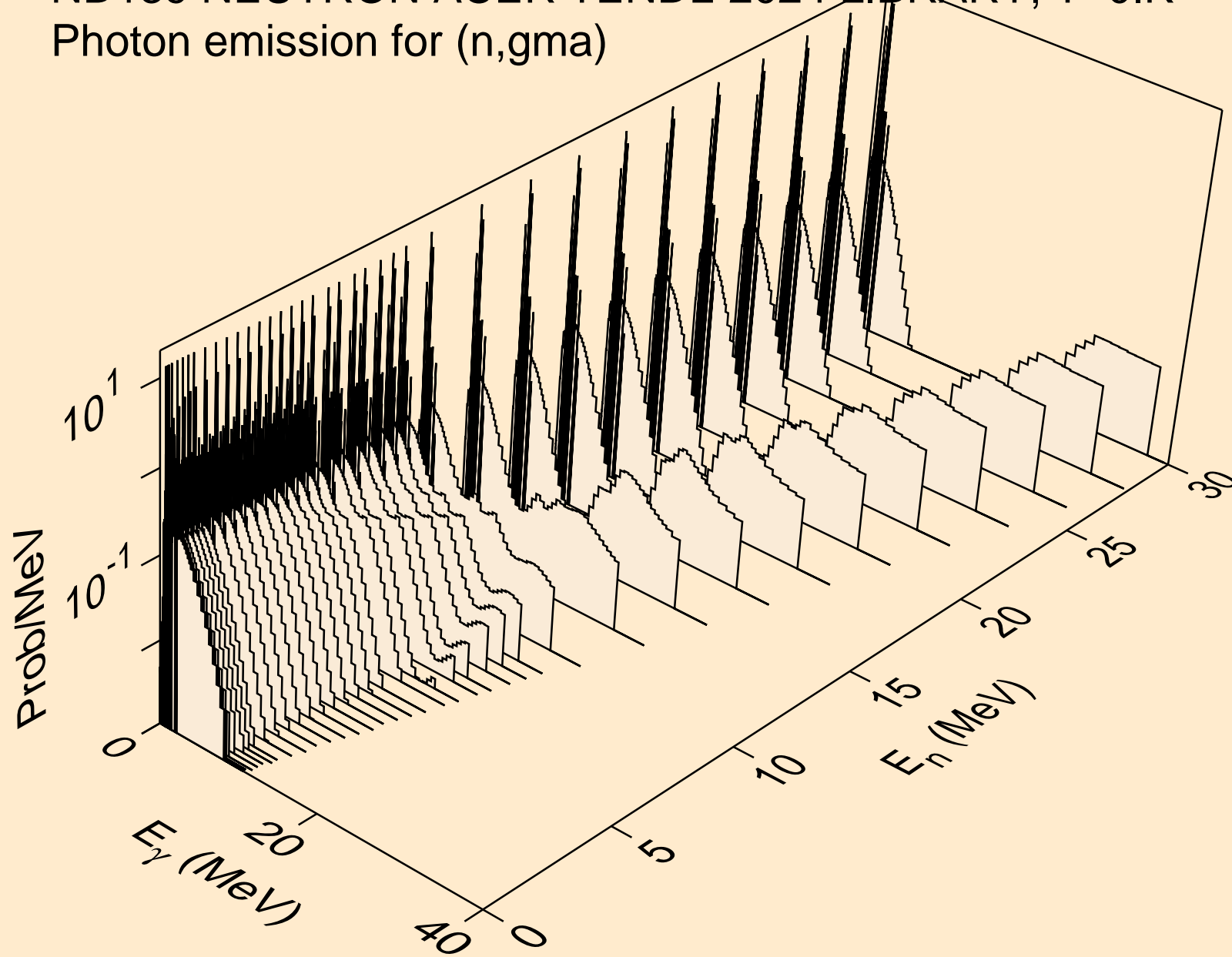

ND139 NEUTRON ACER TENDL-2024 LIBRARY; T=0.K
Photon emission for (n,p)

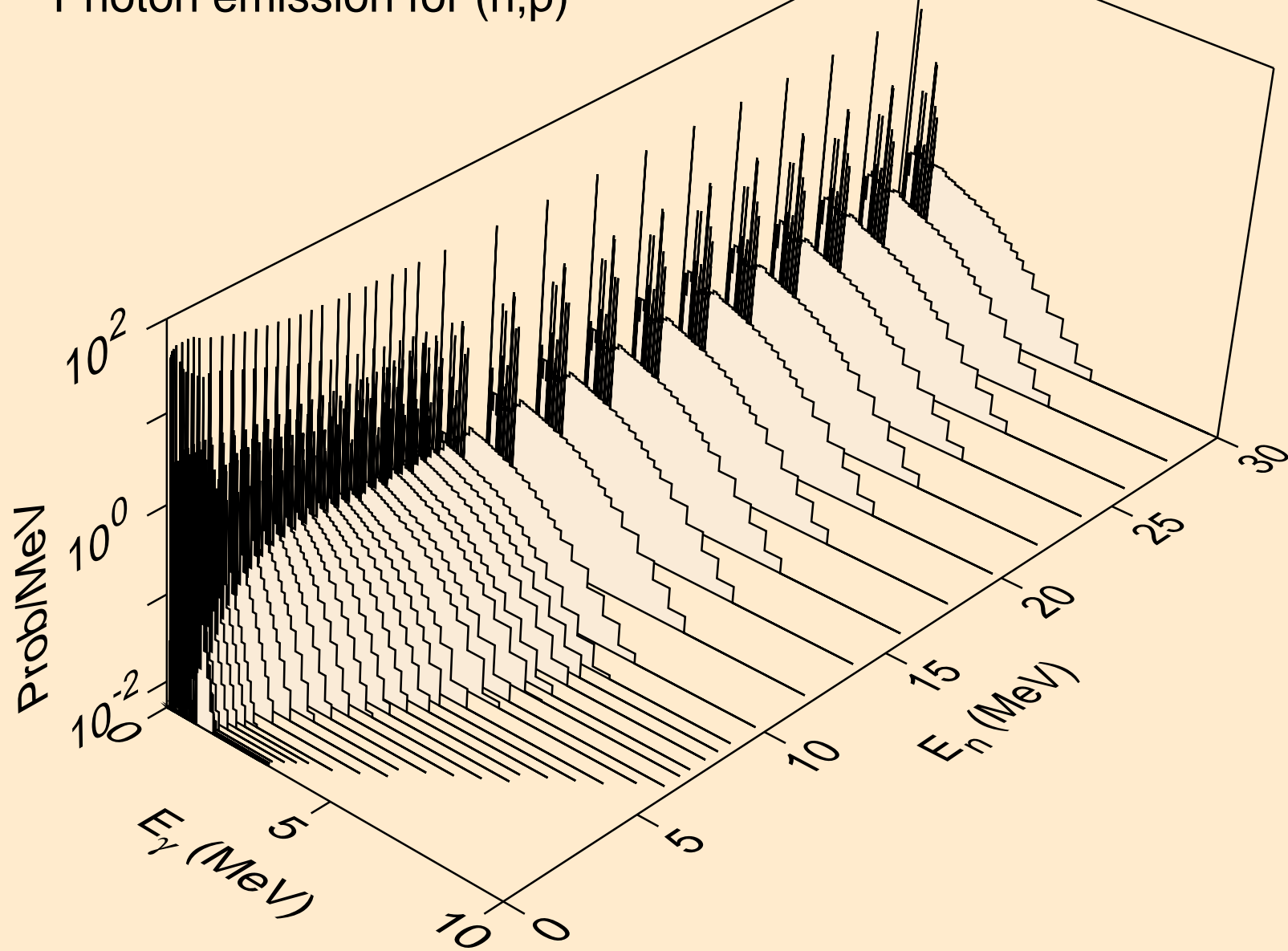

ND139 NEUTRON ACER TENDL-2024 LIBRARY; T=0.K
Photon emission for (n,d)

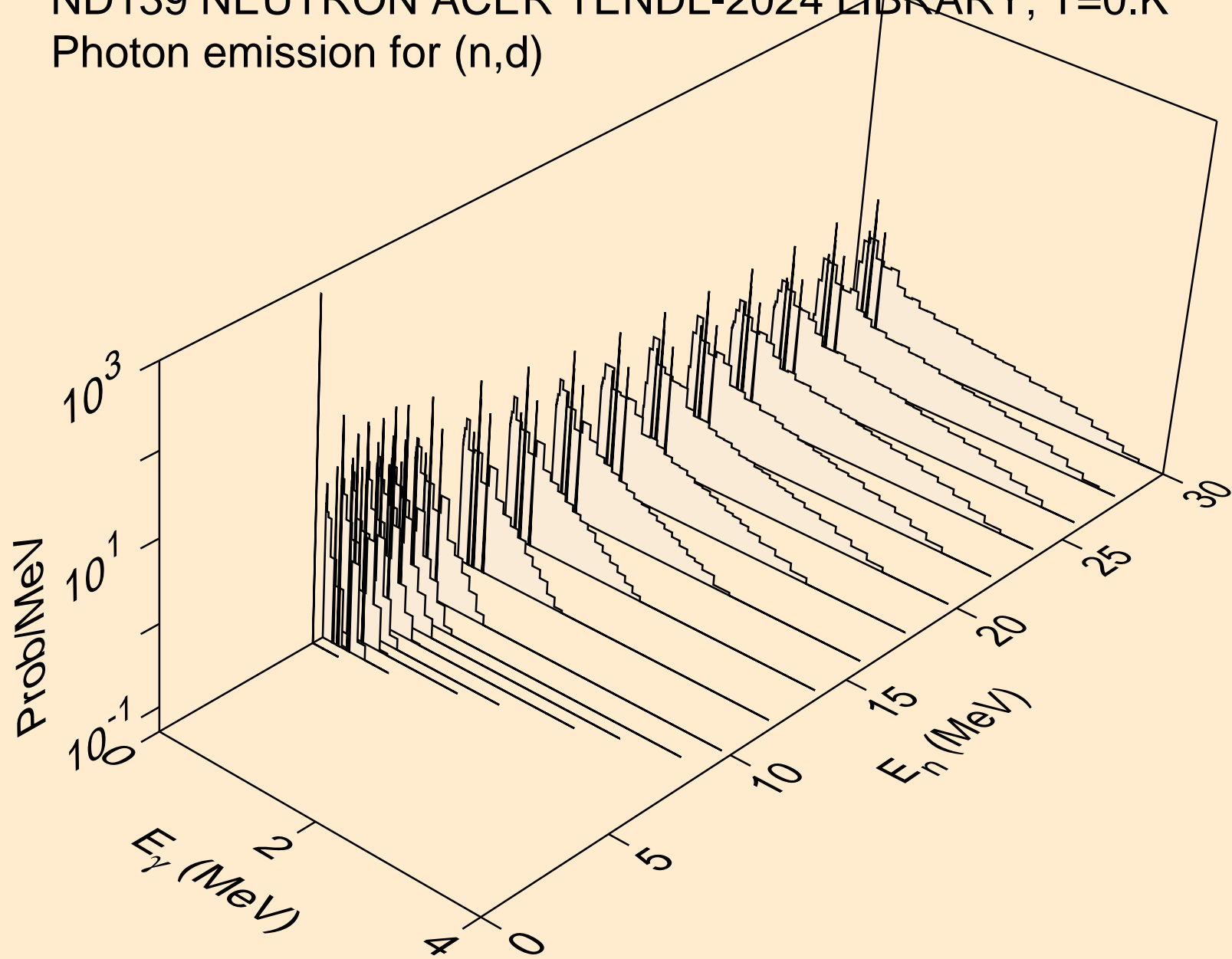

ND139 NEUTRON ACER TENDL-2024 LIBRARY; T=0.K
Photon emission for (n,t)

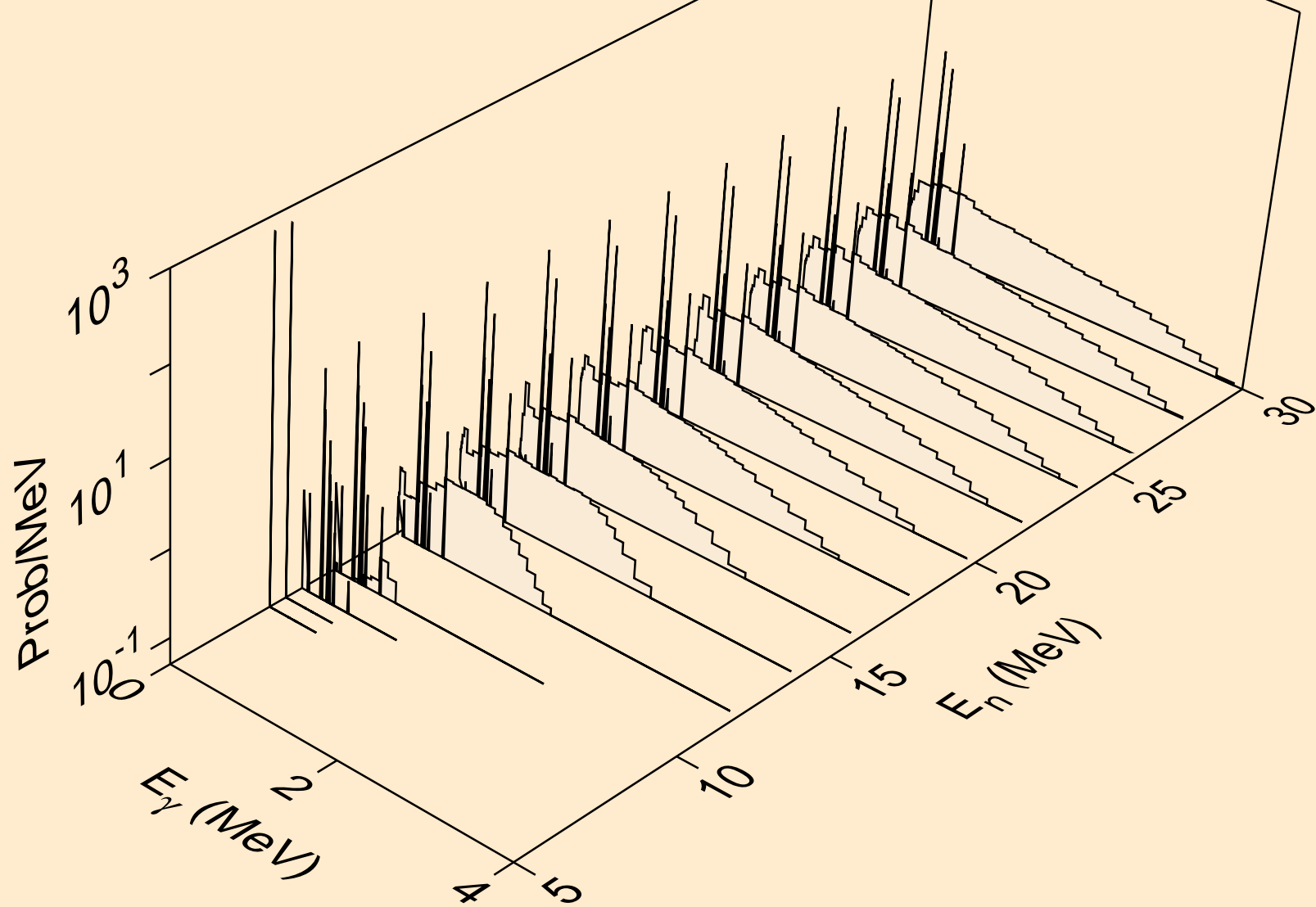

ND139 NEUTRON ACER TENDL-2024 LIBRARY; T=0.K
Photon emission for (n,he3)

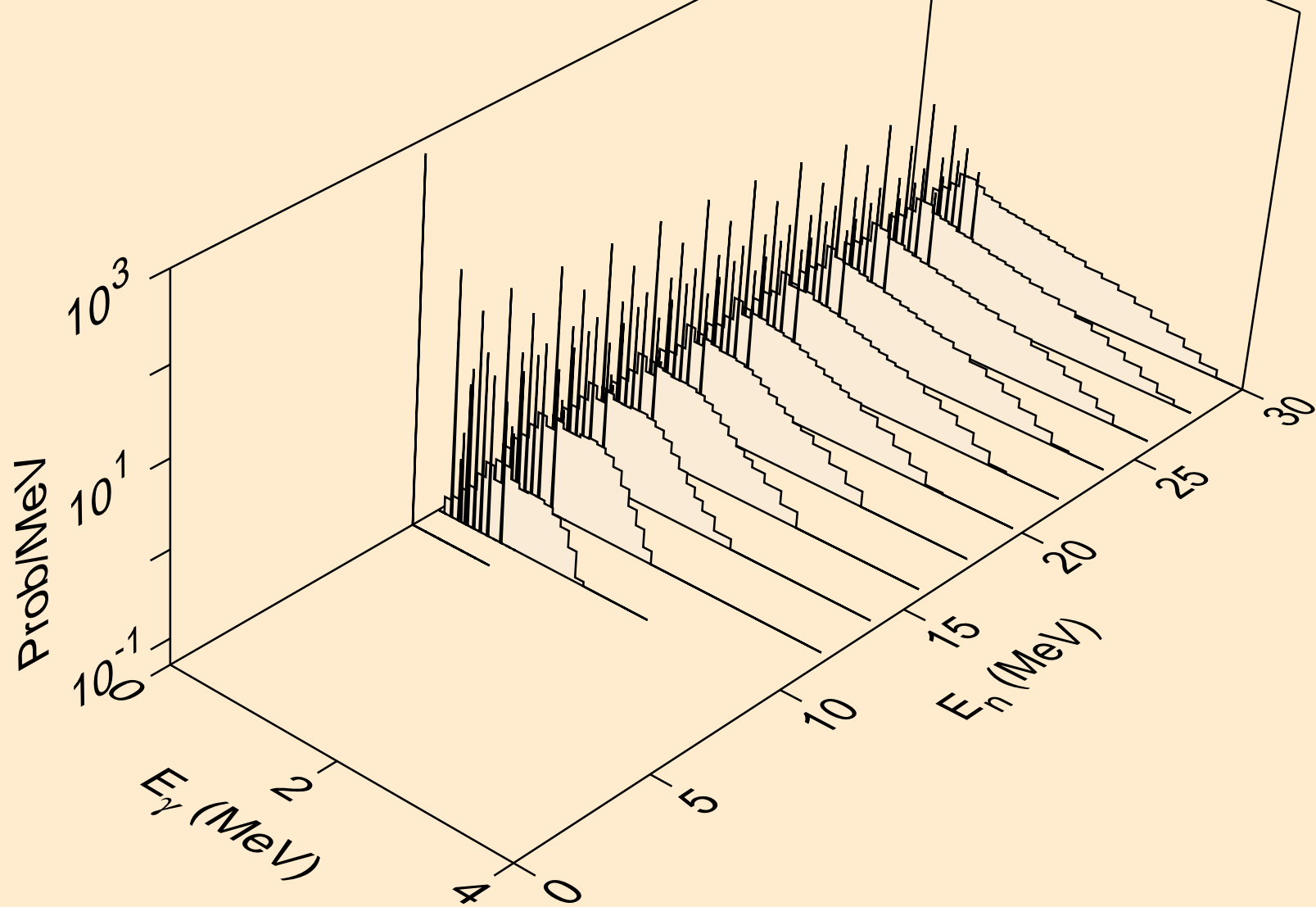

ND139 NEUTRON ACER TENDL-2024 LIBRARY; T=0.K
Photon emission for (n,a)

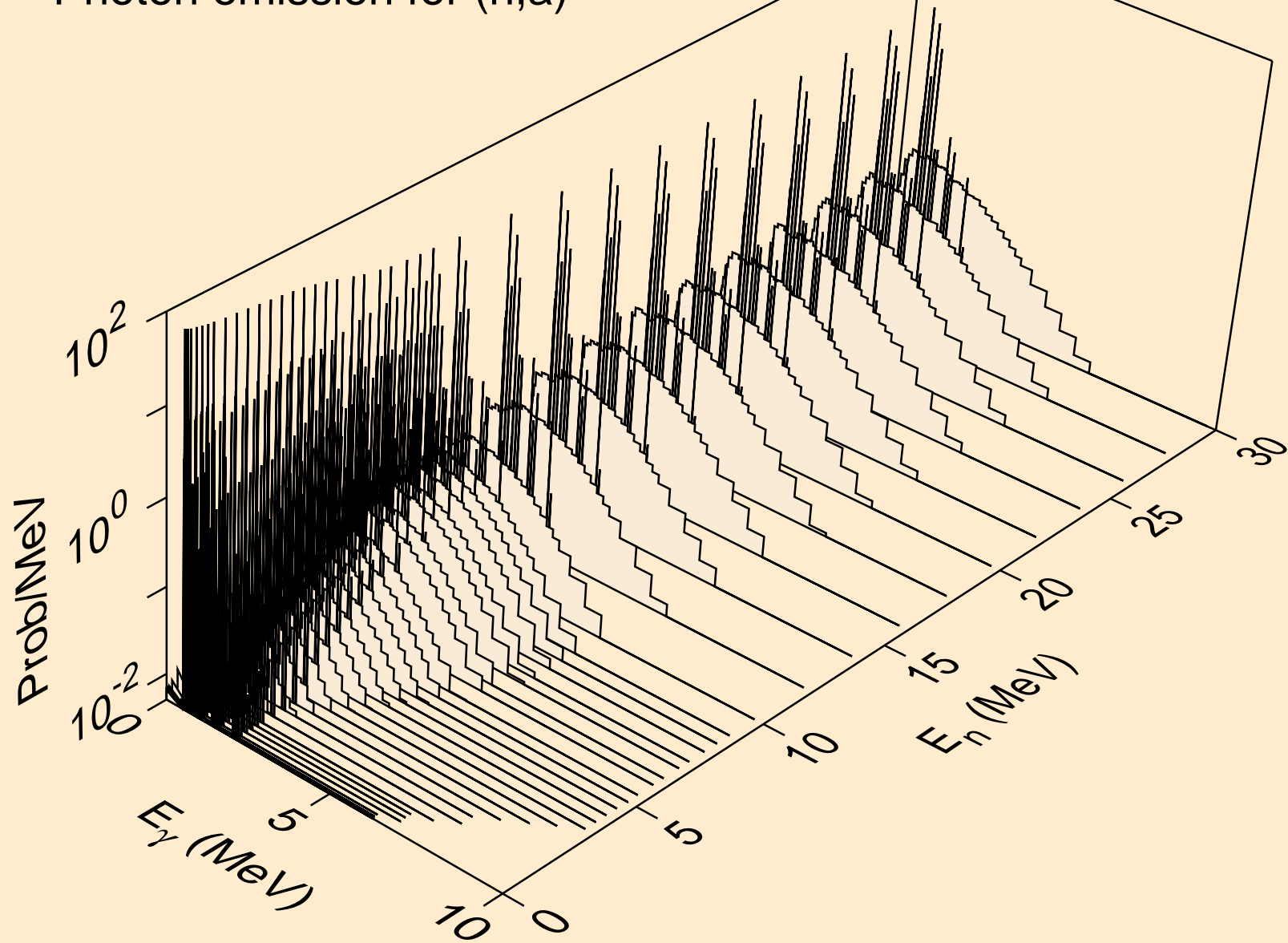

ND139 NEUTRON ACER TENDL-2024 LIBRARY; T=0.K
Photon emission for (n,2a)

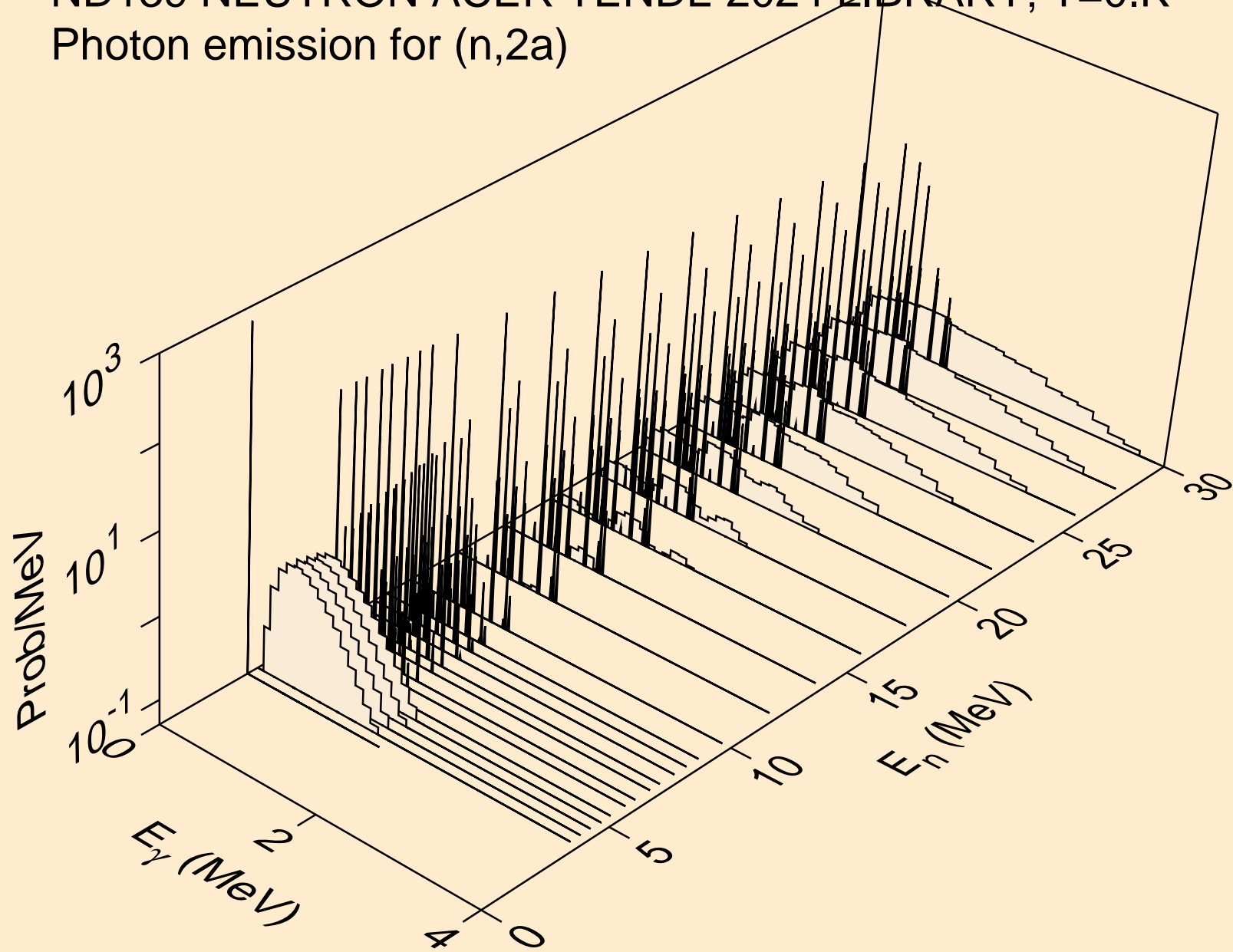

ND139 NEUTRON ACER TENDL-2024 LIBRARY; T=0.K
Photon emission for (n,2p)

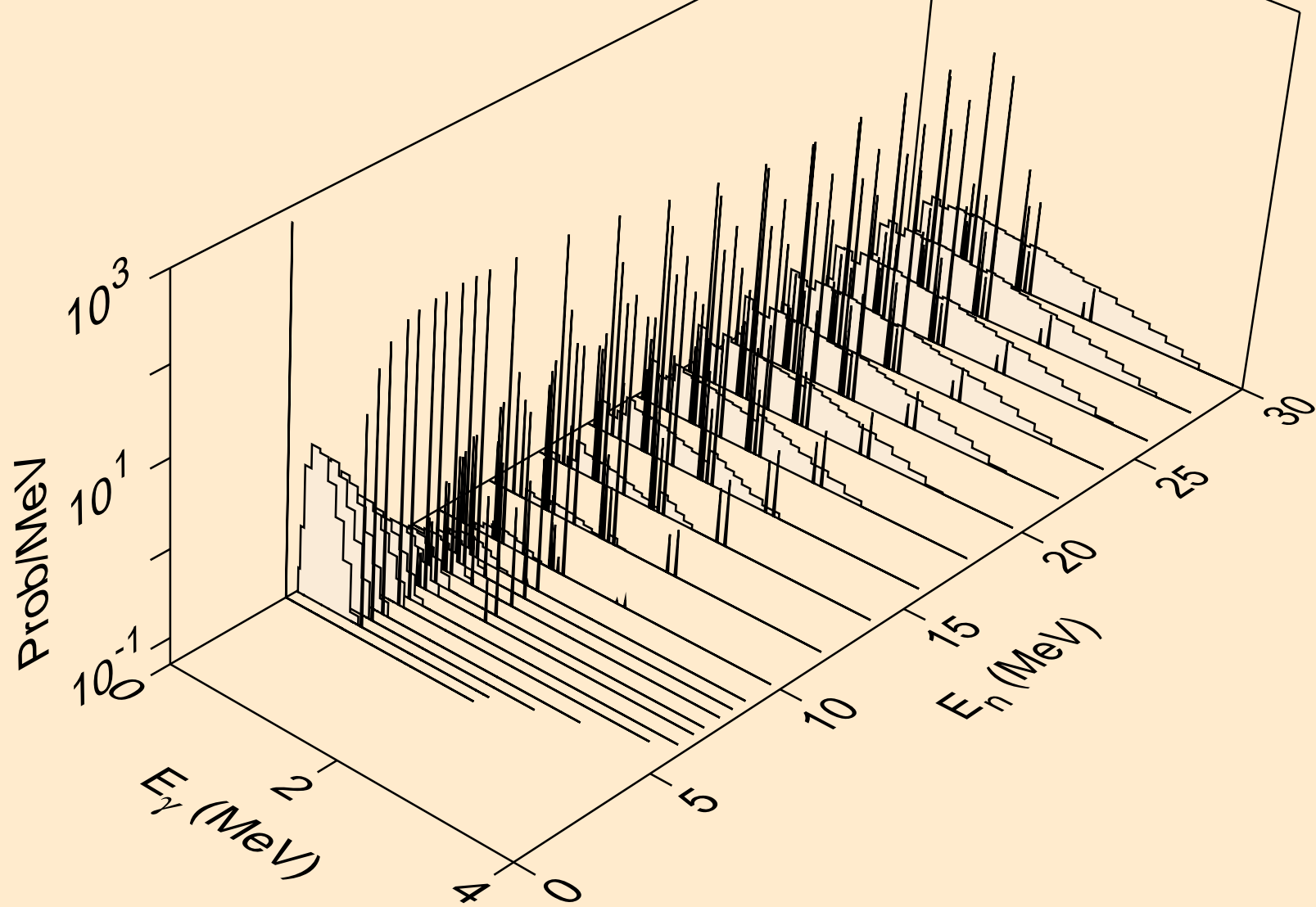

ND139 NEUTRON ACER TENDL-2024 LIBRARY; T=0.K
Photon emission for (n,p α)

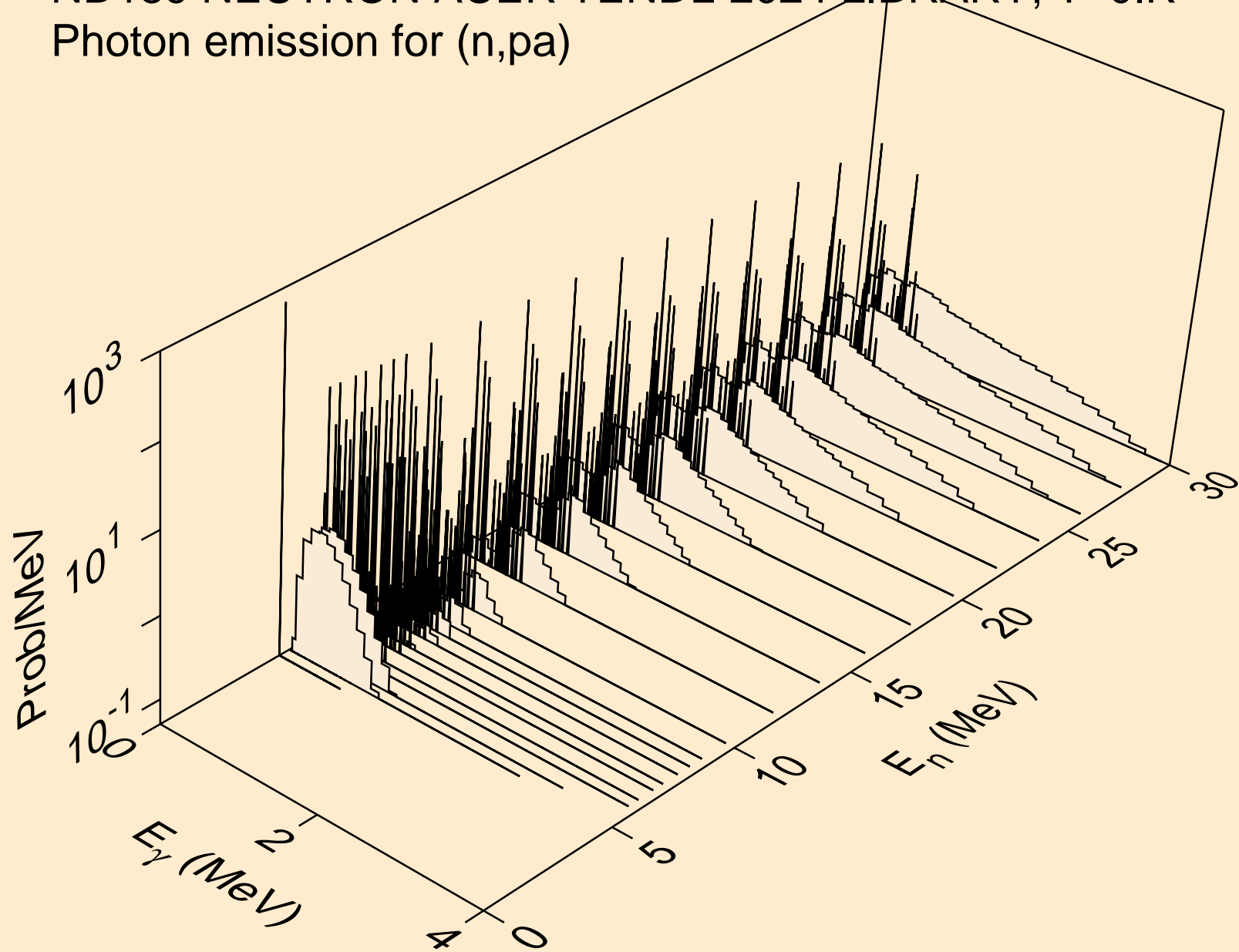

ND139 NEUTRON ACER TENDL-2024 LIBRARY; T=0.K
Photon emission for (n,pd)

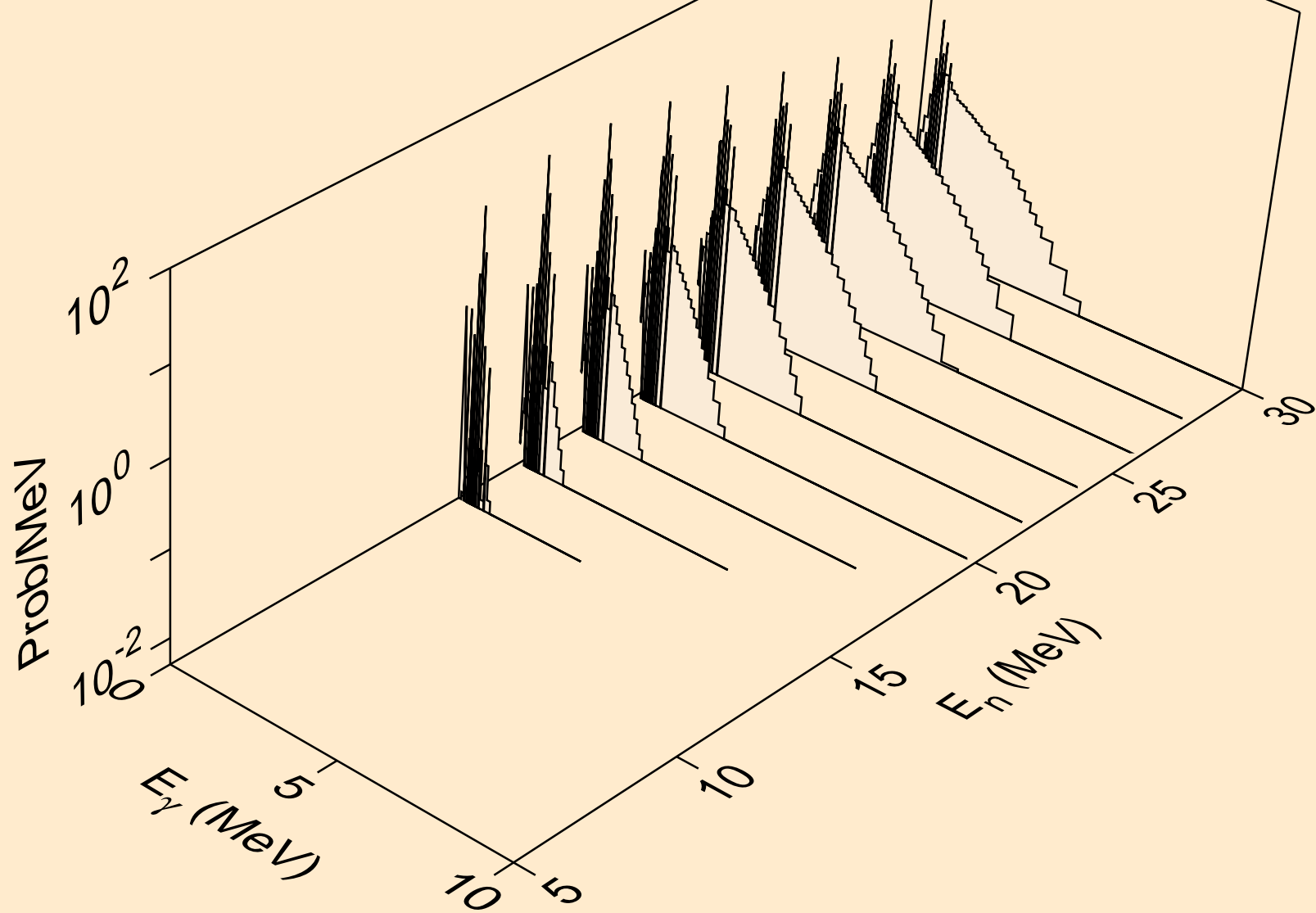

ND139 NEUTRON ACER TENDL-2024 LIBRARY; T=0.K
Photon emission for (n,pt)

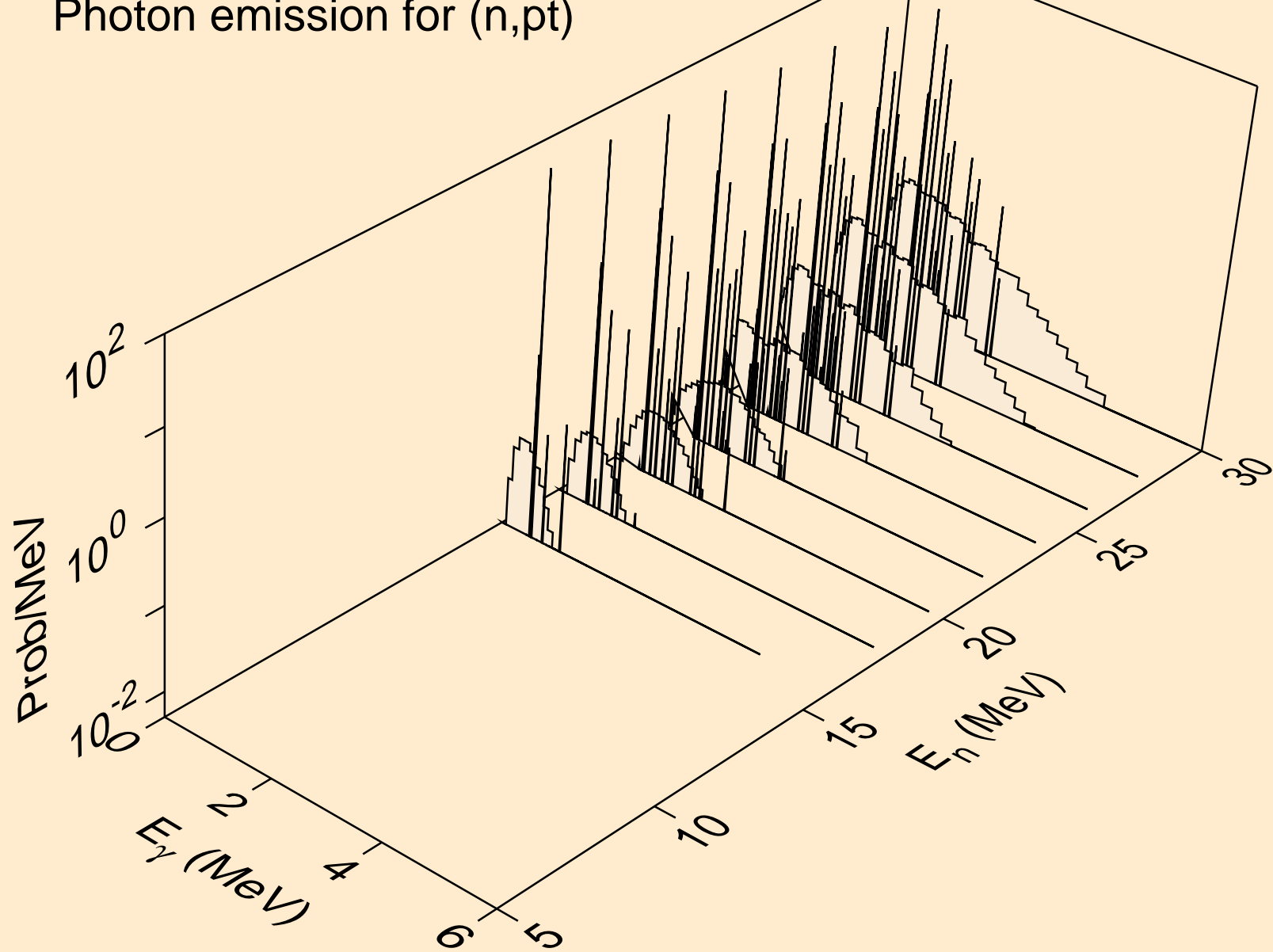

ND139 NEUTRON ACER TENDL-2024 LIBRARY; T=0.K
Photon emission for (n,da)

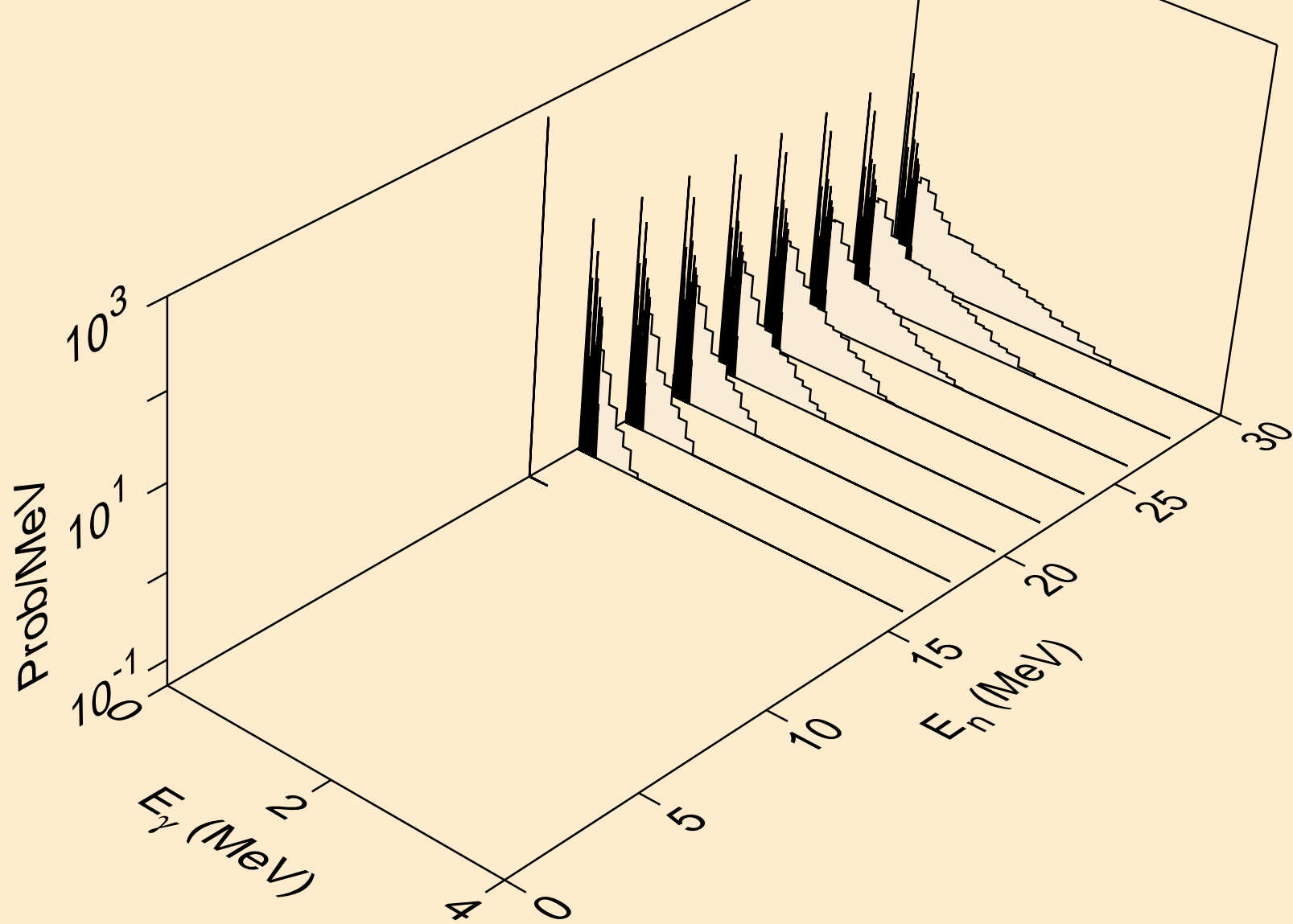

ND139 NEUTRON ACER TENDL-2024 LIBRARY; T=0.K
thermal capture photon spectrum

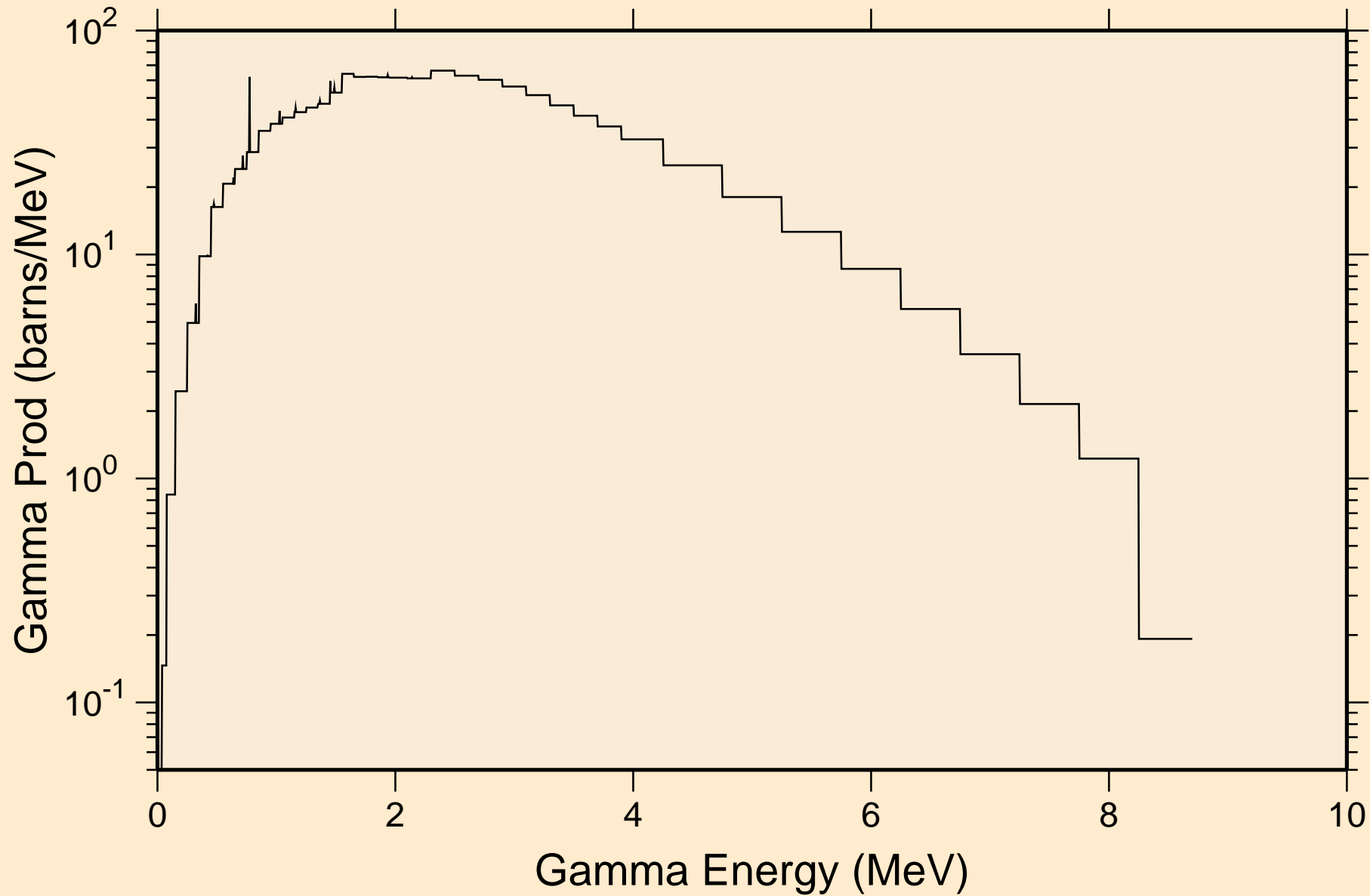

ND139 NEUTRON ACER TENDL-2024 LIBRARY; T=0.K
14 MeV photon spectrum

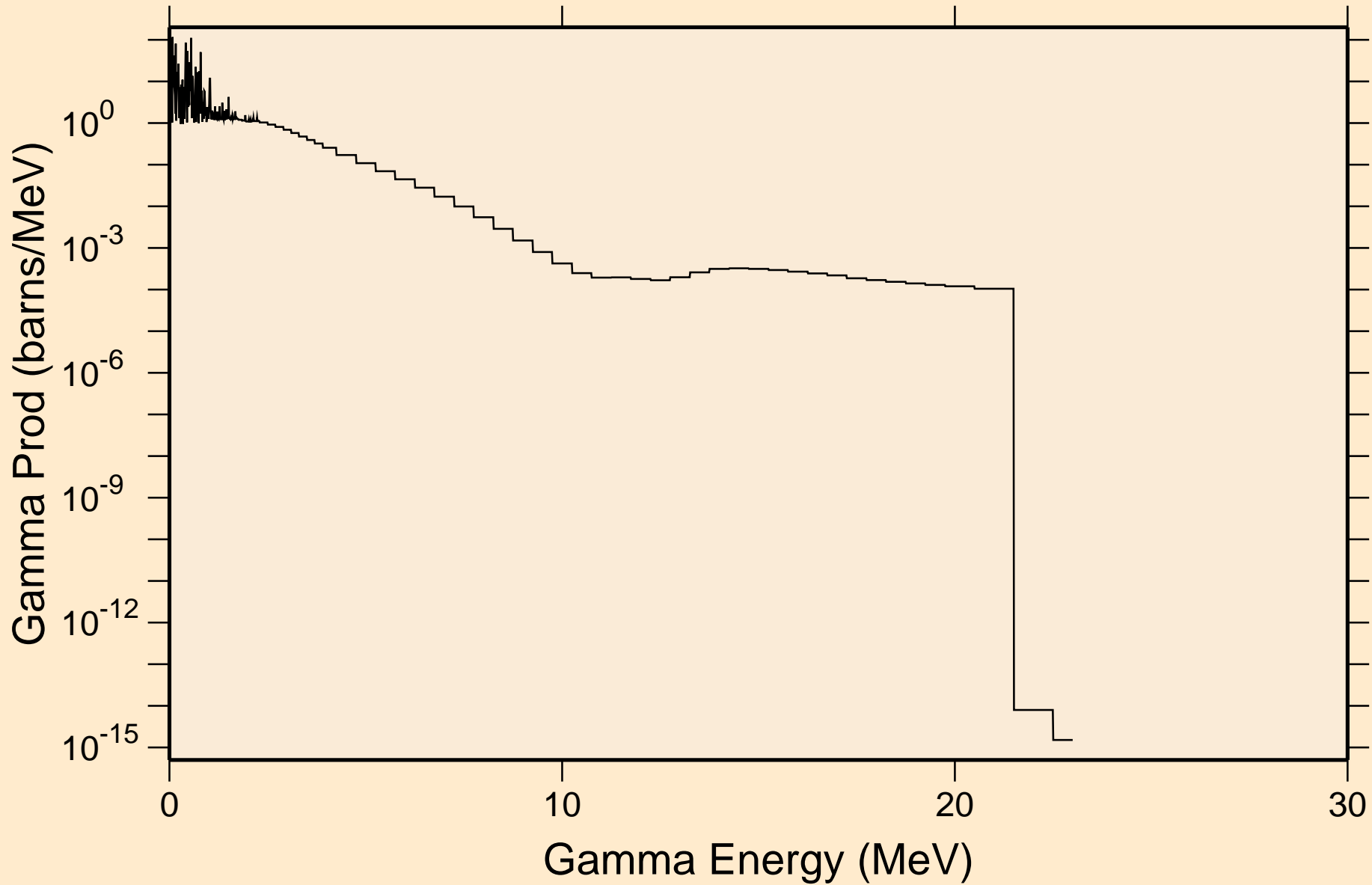

ND139 NEUTRON ACER TENDL-2024 LIBRARY; T=0.K

Particle heating contributions

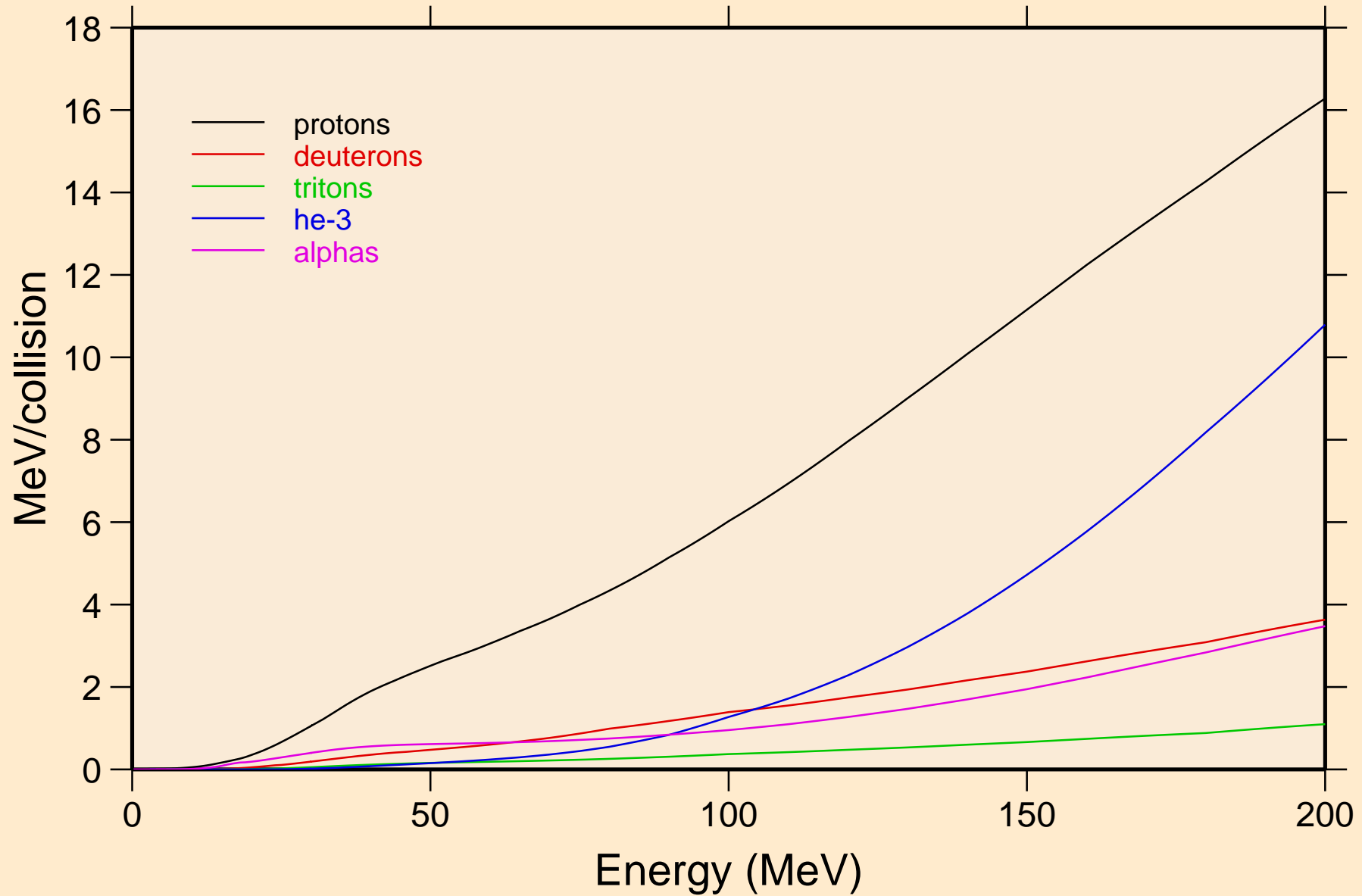

ND139 NEUTRON ACER TENDL-2024 LIBRARY; T=0.K

Recoil Heating

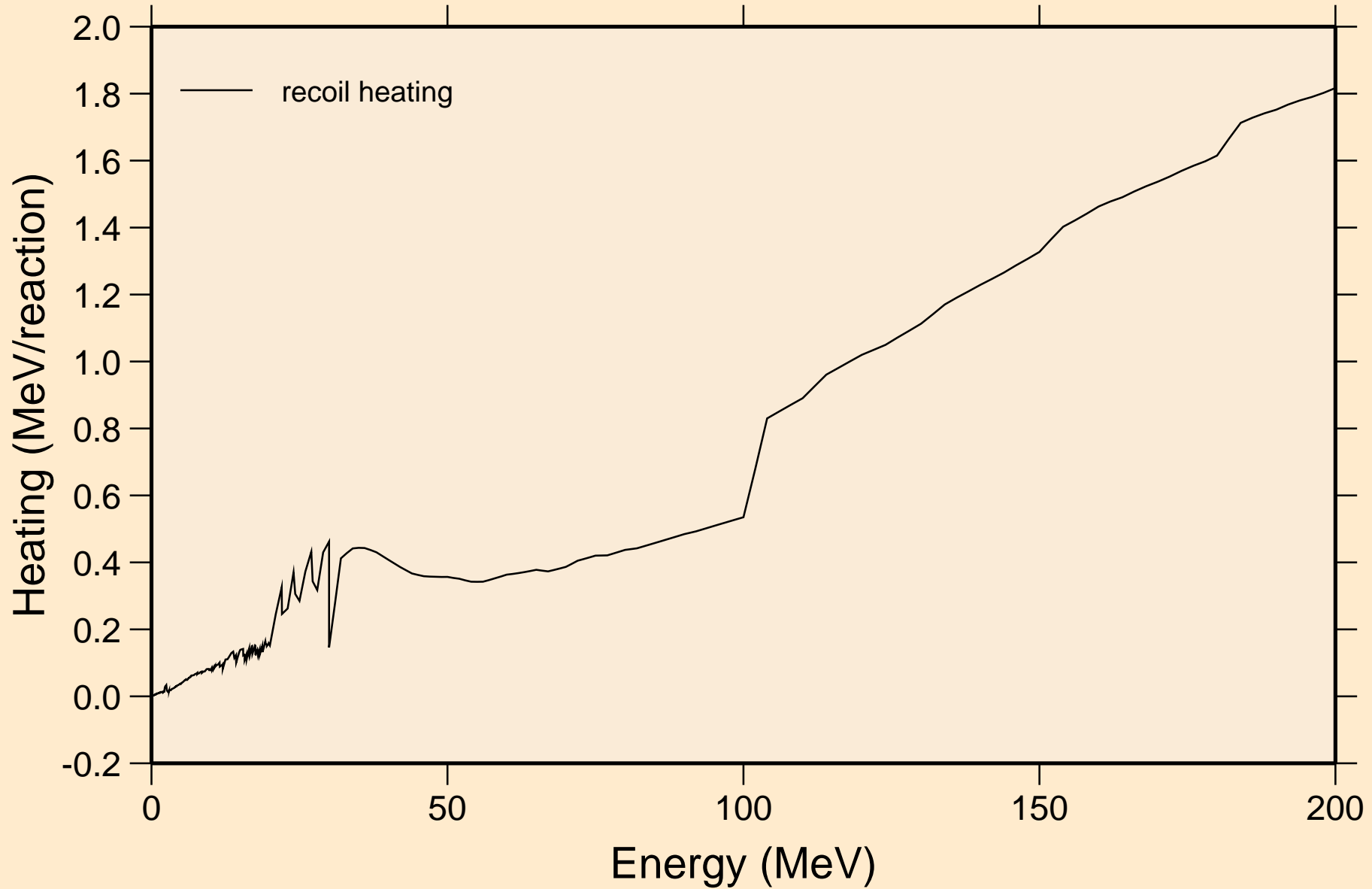

ND139 NEUTRON ACER TENDL-2024 LIBRARY; T=0.K

Particle production cross sections

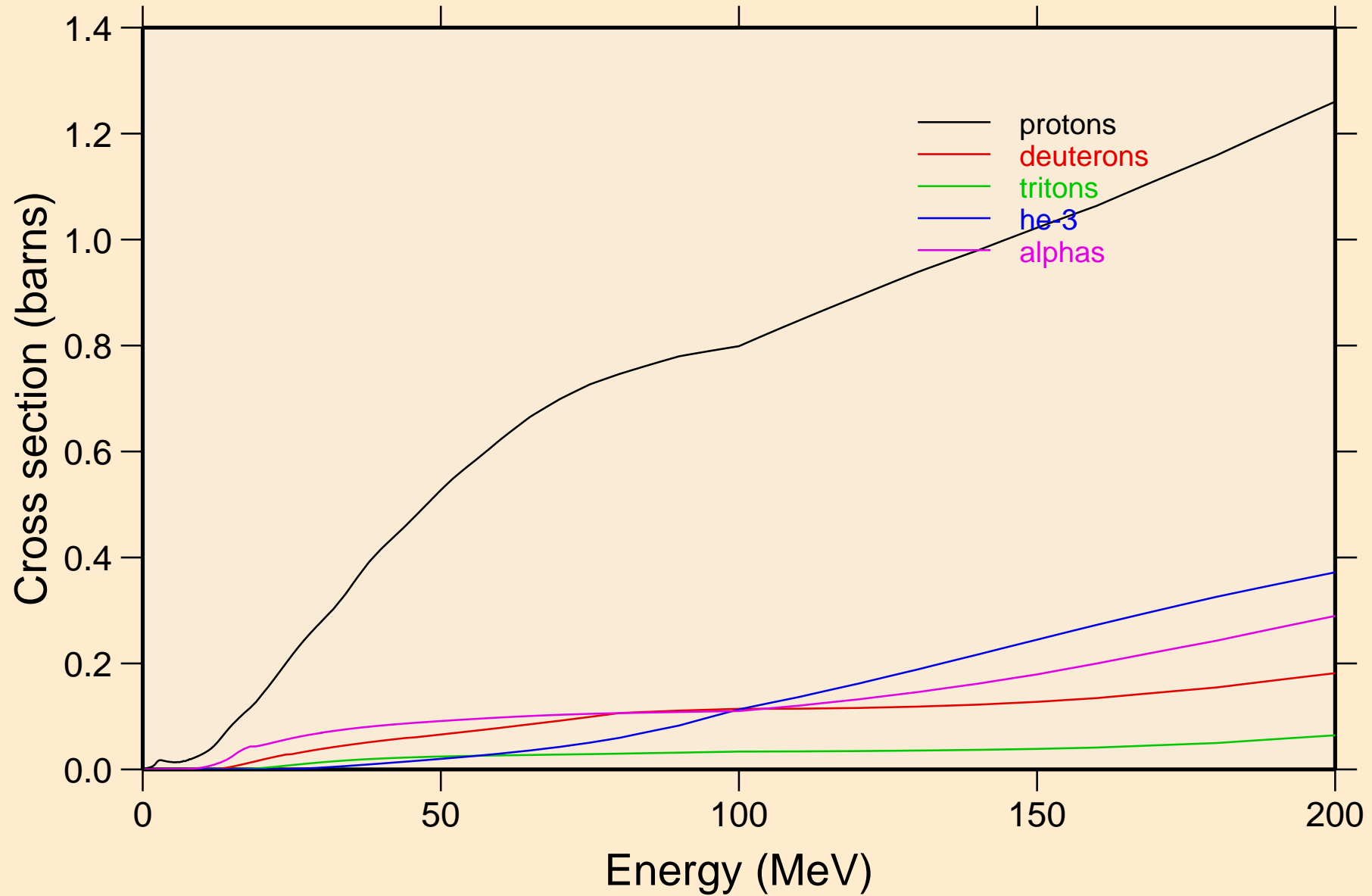

ND139 NEUTRON ACER TENDL-2024 LIBRARY; T=0.K
protons from (n,x)

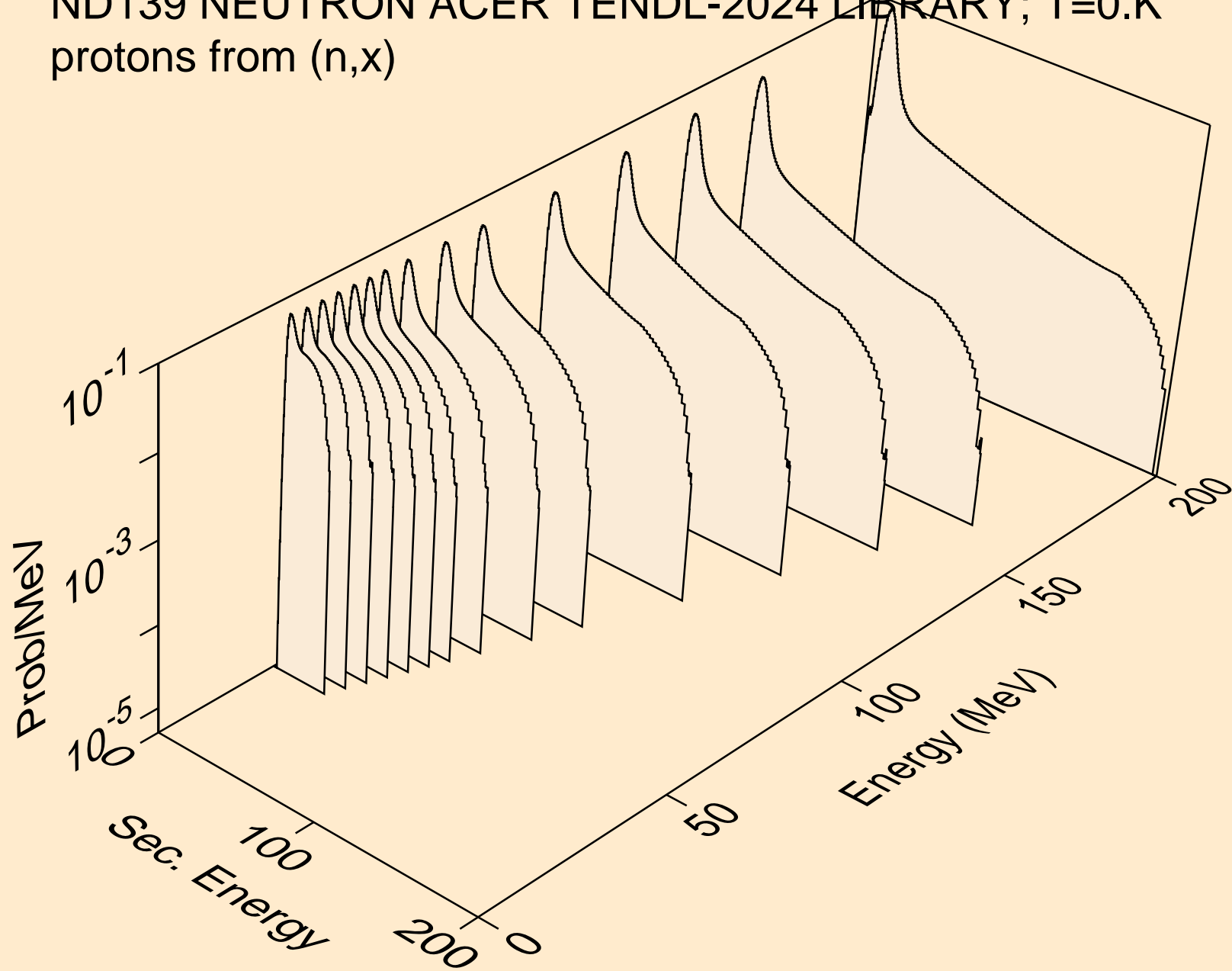

ND139 NEUTRON ACER TENDL-2024 LIBRARY; T=0.K
protons from (n,n*)p

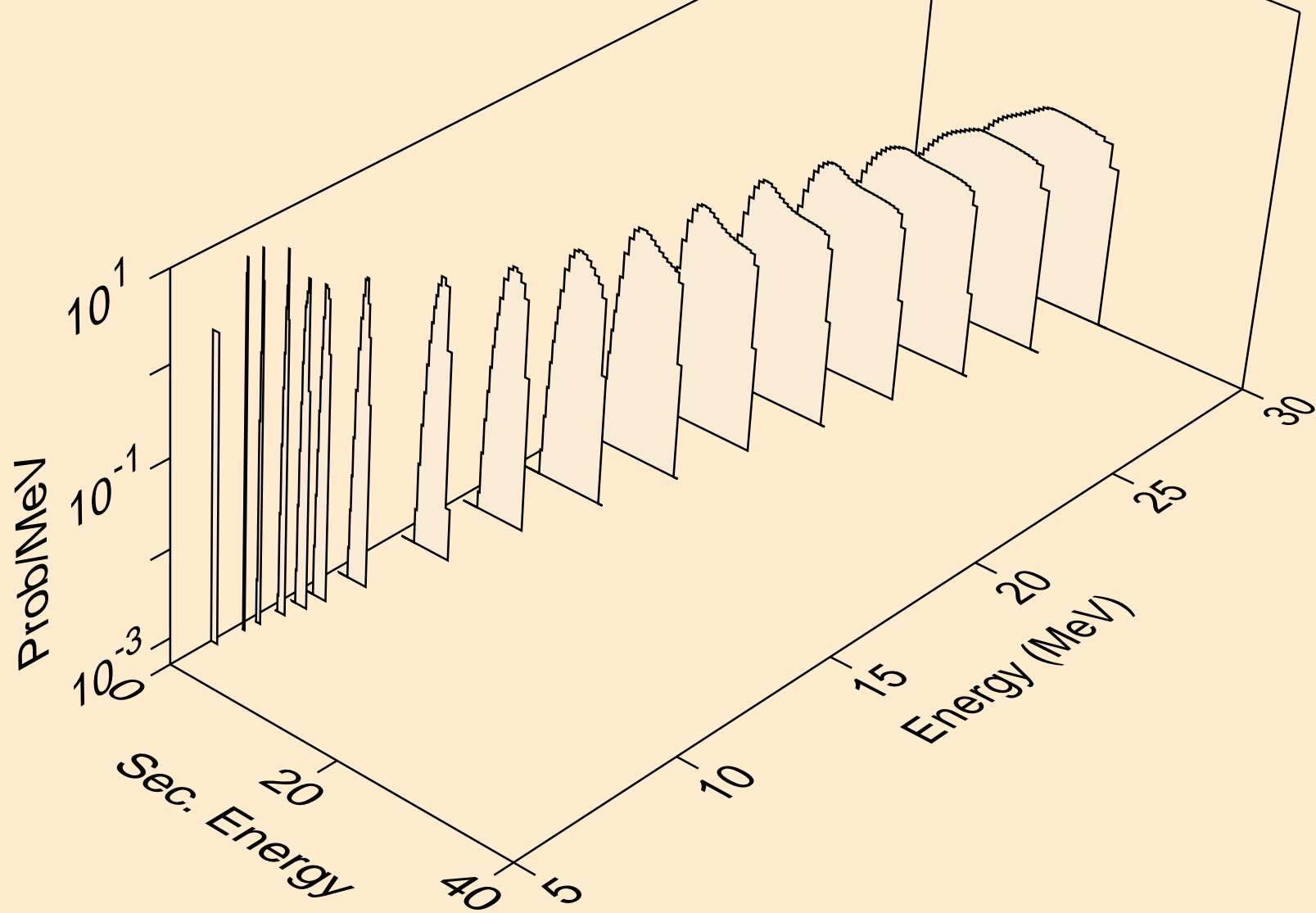

ND139 NEUTRON ACER TENDL-2024 LIBRARY; T=0.K
protons from (n,2np)

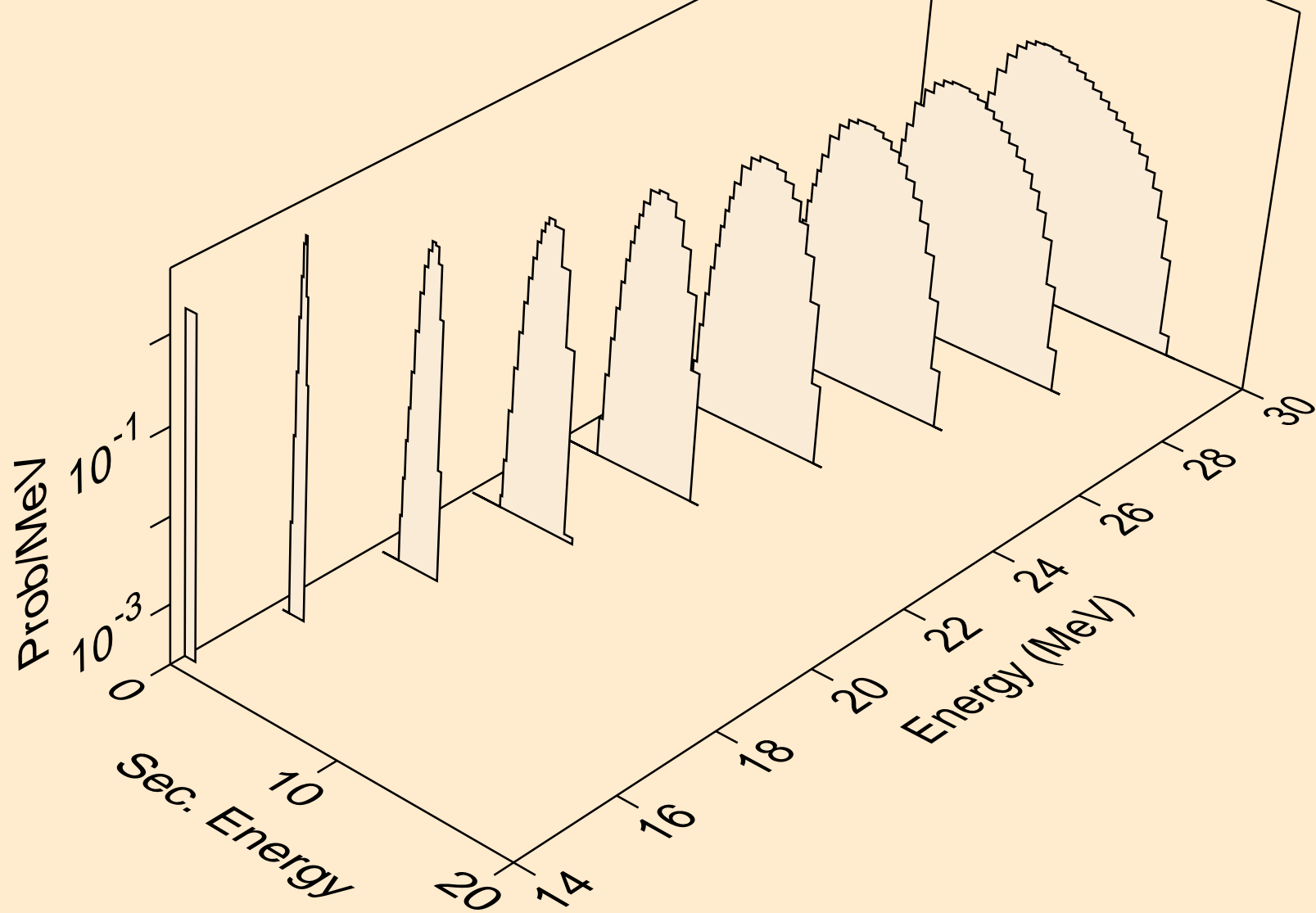

ND139 NEUTRON ACER TENDL-2024 LIBRARY; T=0.K
protons from (n,3np)

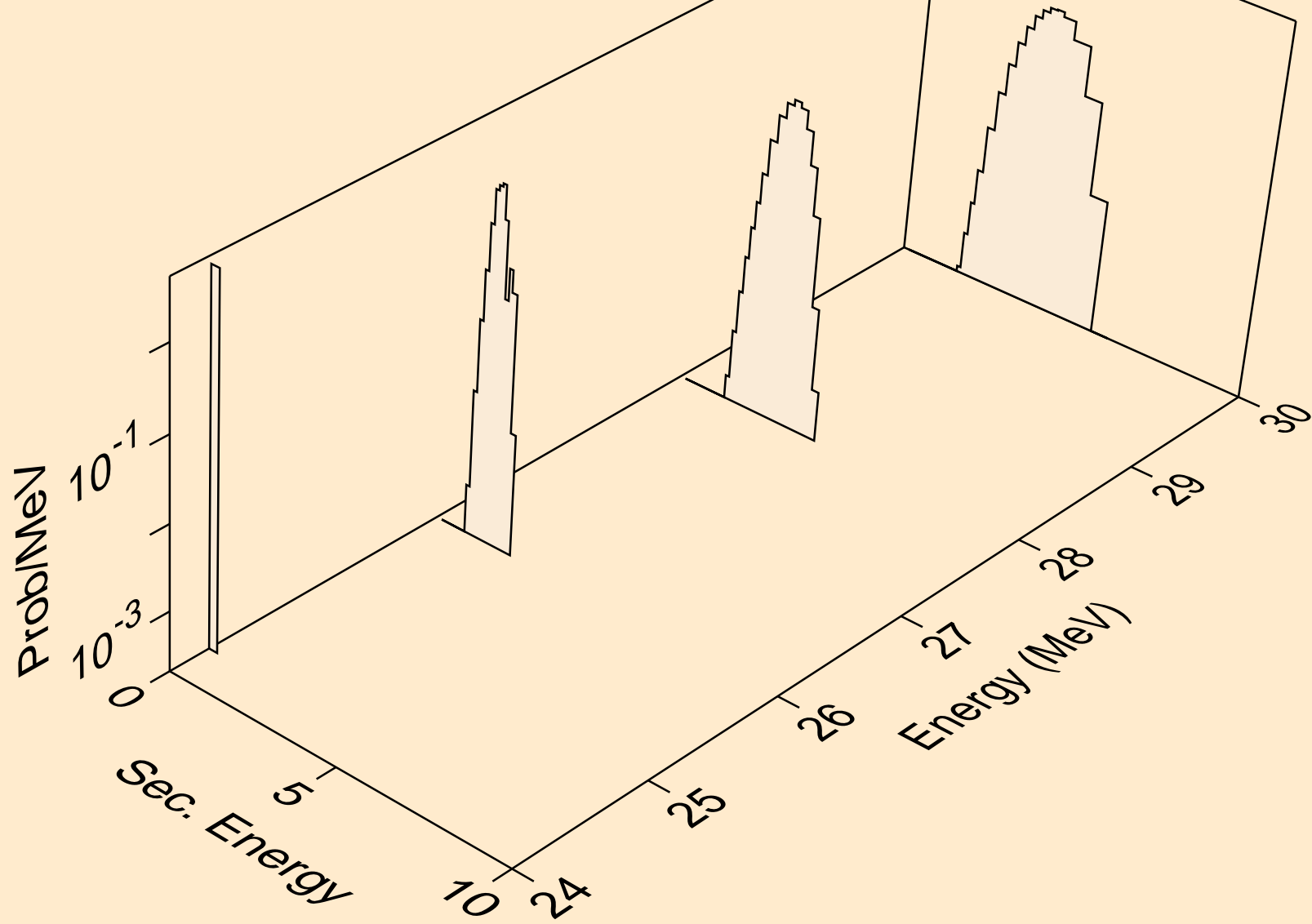

ND139 NEUTRON ACER TENDL-2024 LIBRARY; T=0.K
protons from (n,n2p)

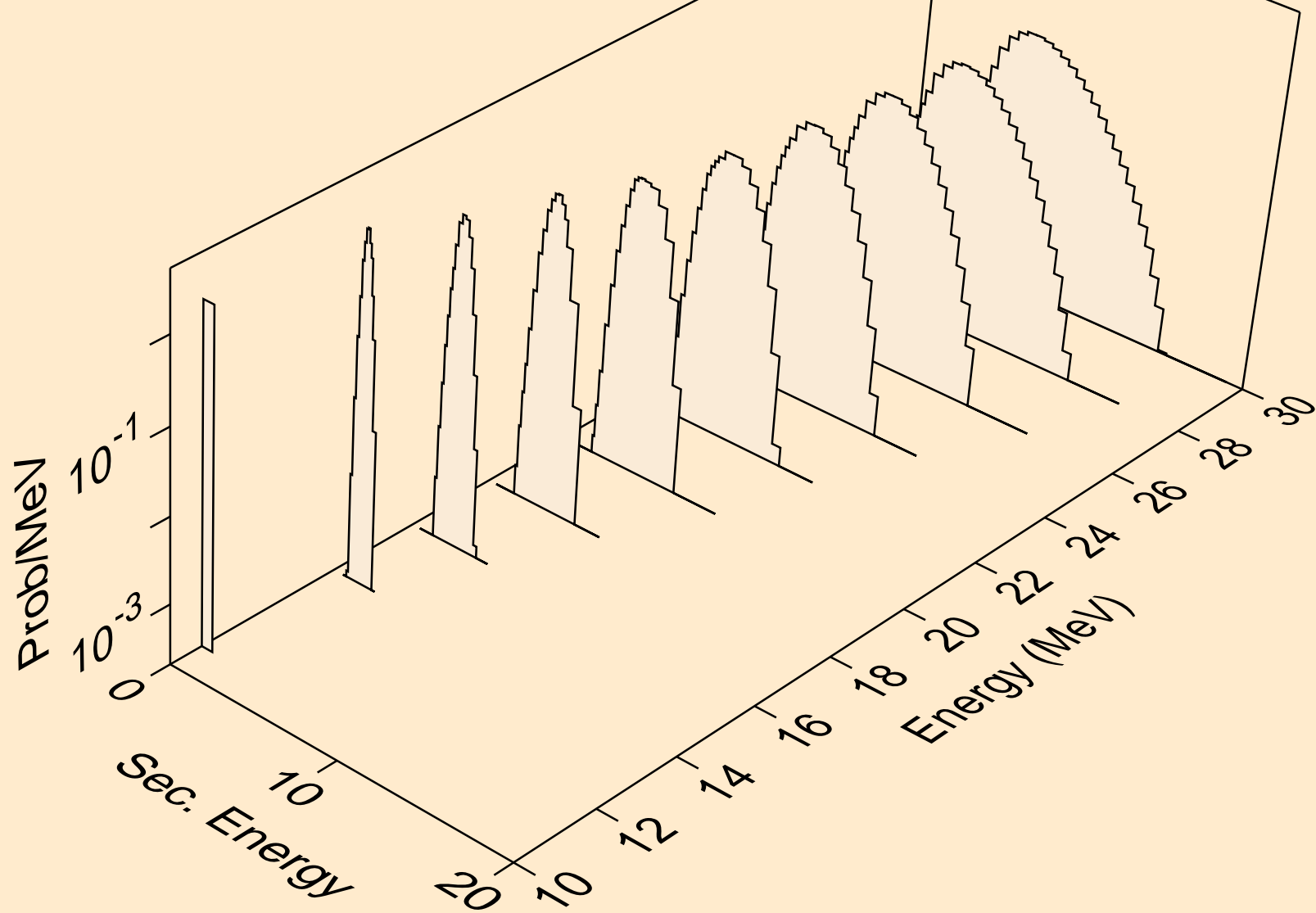

ND139 NEUTRON ACER TENDL-2024 LIBRARY; T=0.K
protons from (n,npa)

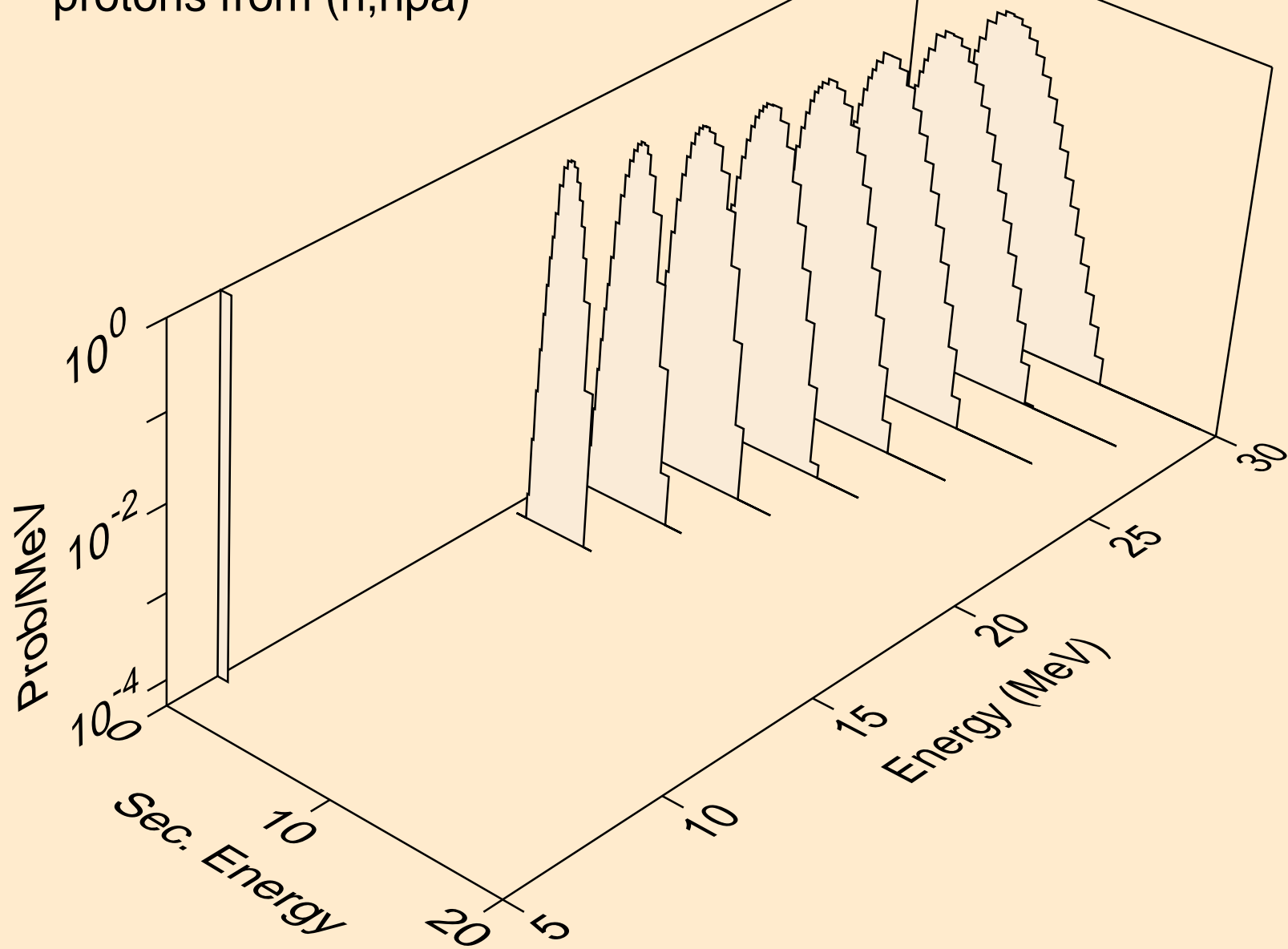

ND139 NEUTRON ACER TENDL-2024 LIBRARY; T=0.K
protons from (n,p)

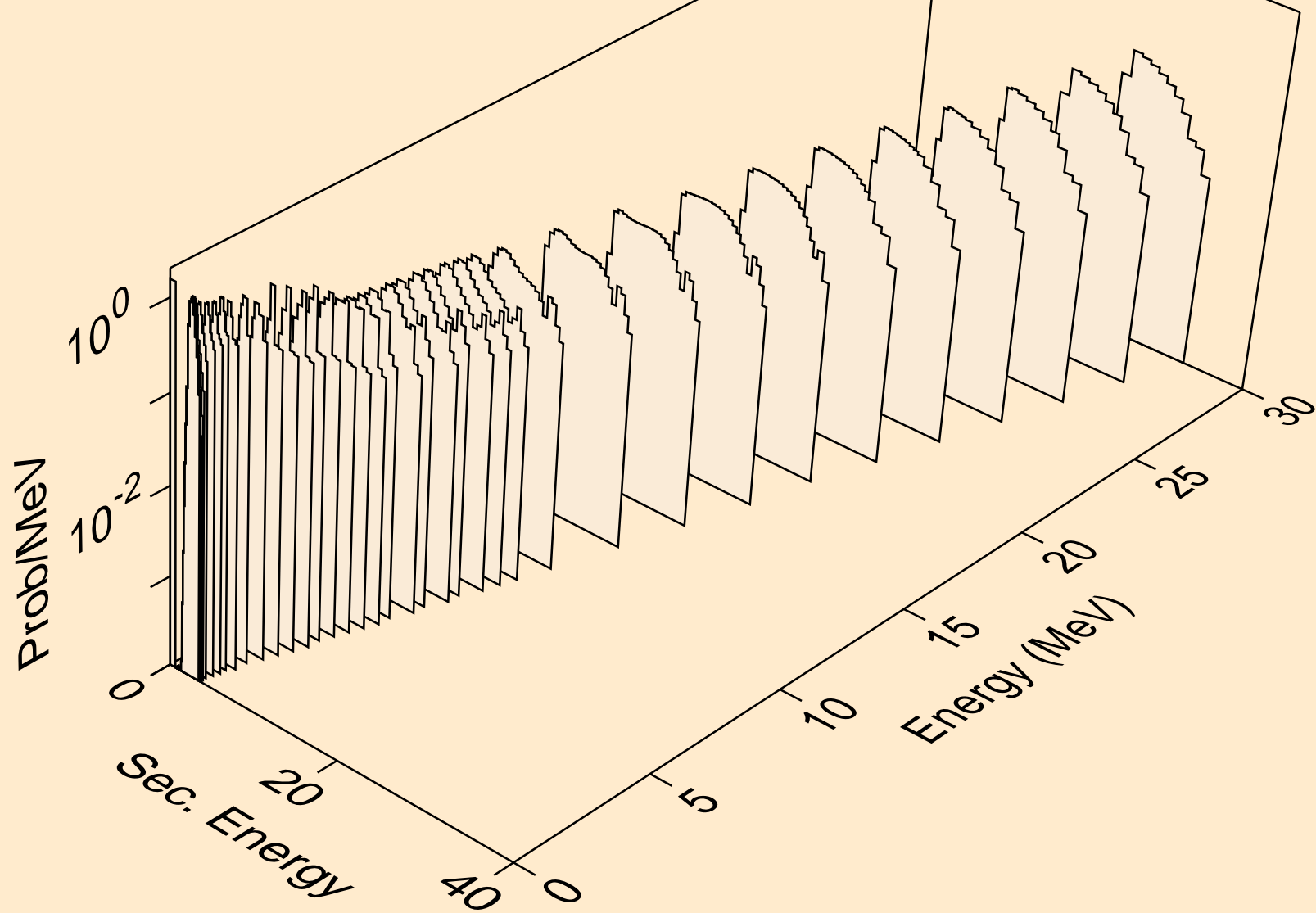

ND139 NEUTRON ACER TENDL-2024 LIBRARY; T=0.K
protons from (n,2p)

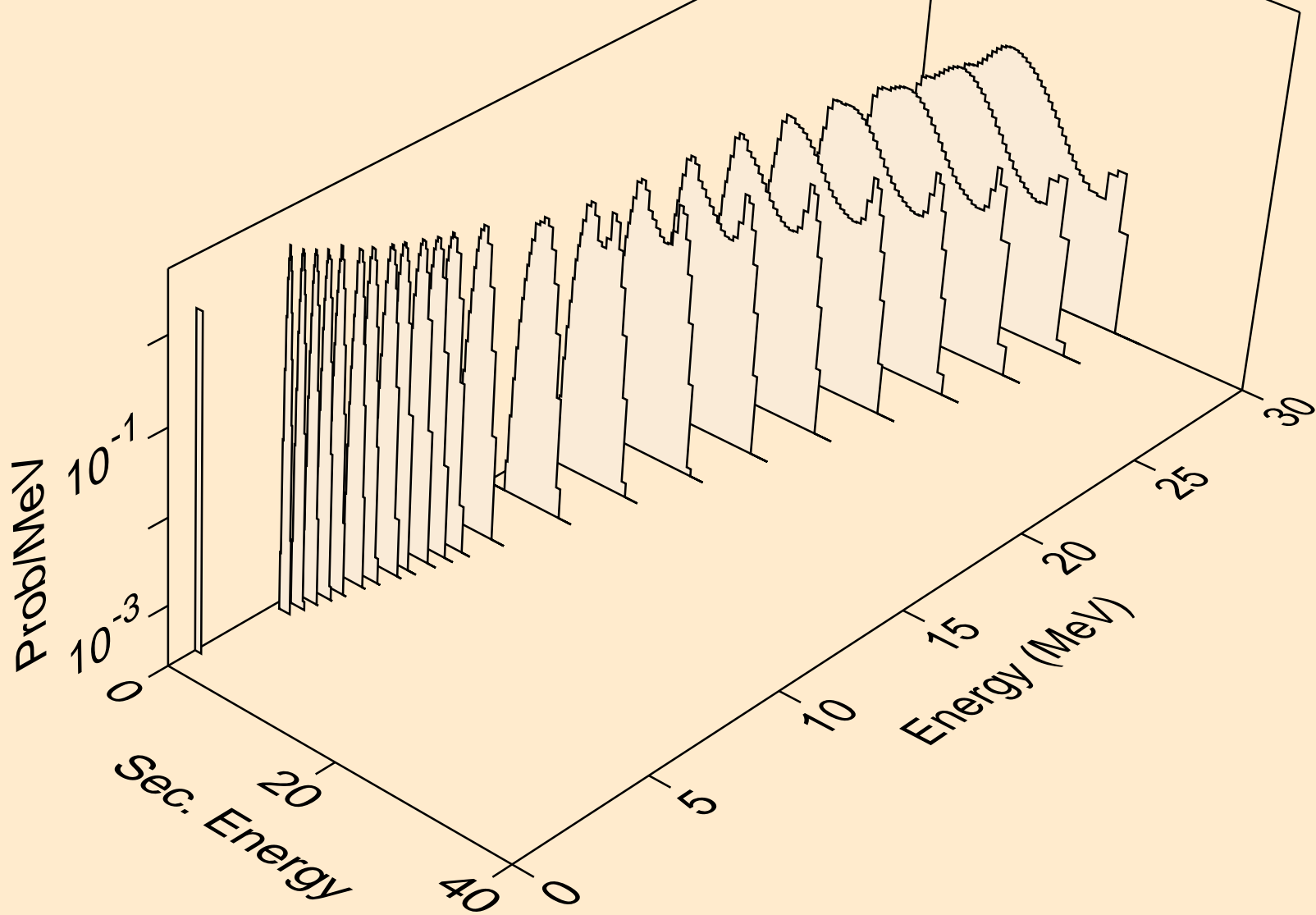

ND139 NEUTRON ACER TENDL-2024 LIBRARY; T=0.K
protons from (n,p)

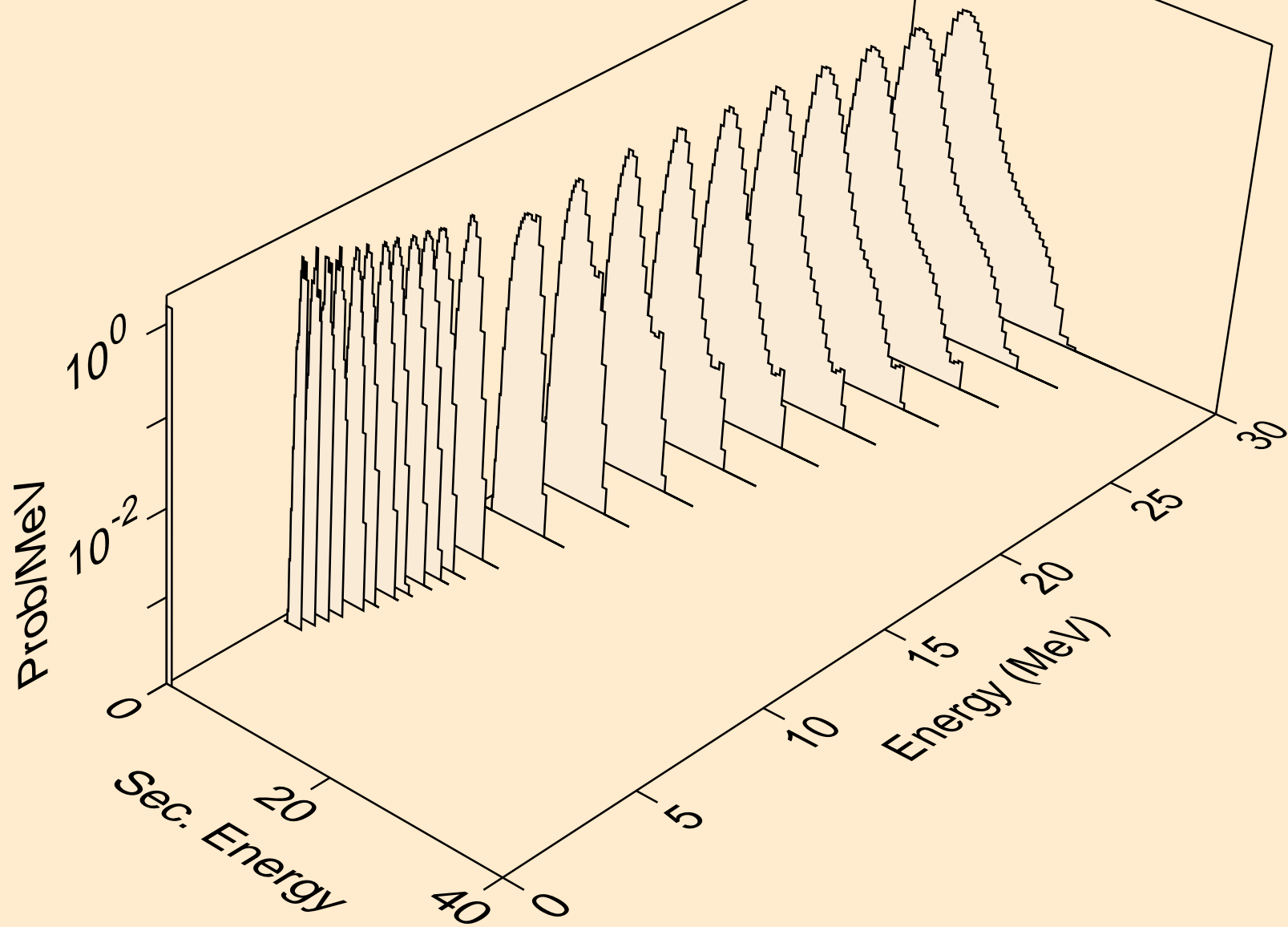

ND139 NEUTRON ACER TENDL-2024 LIBRARY; T=0.K
protons from (n,pd)

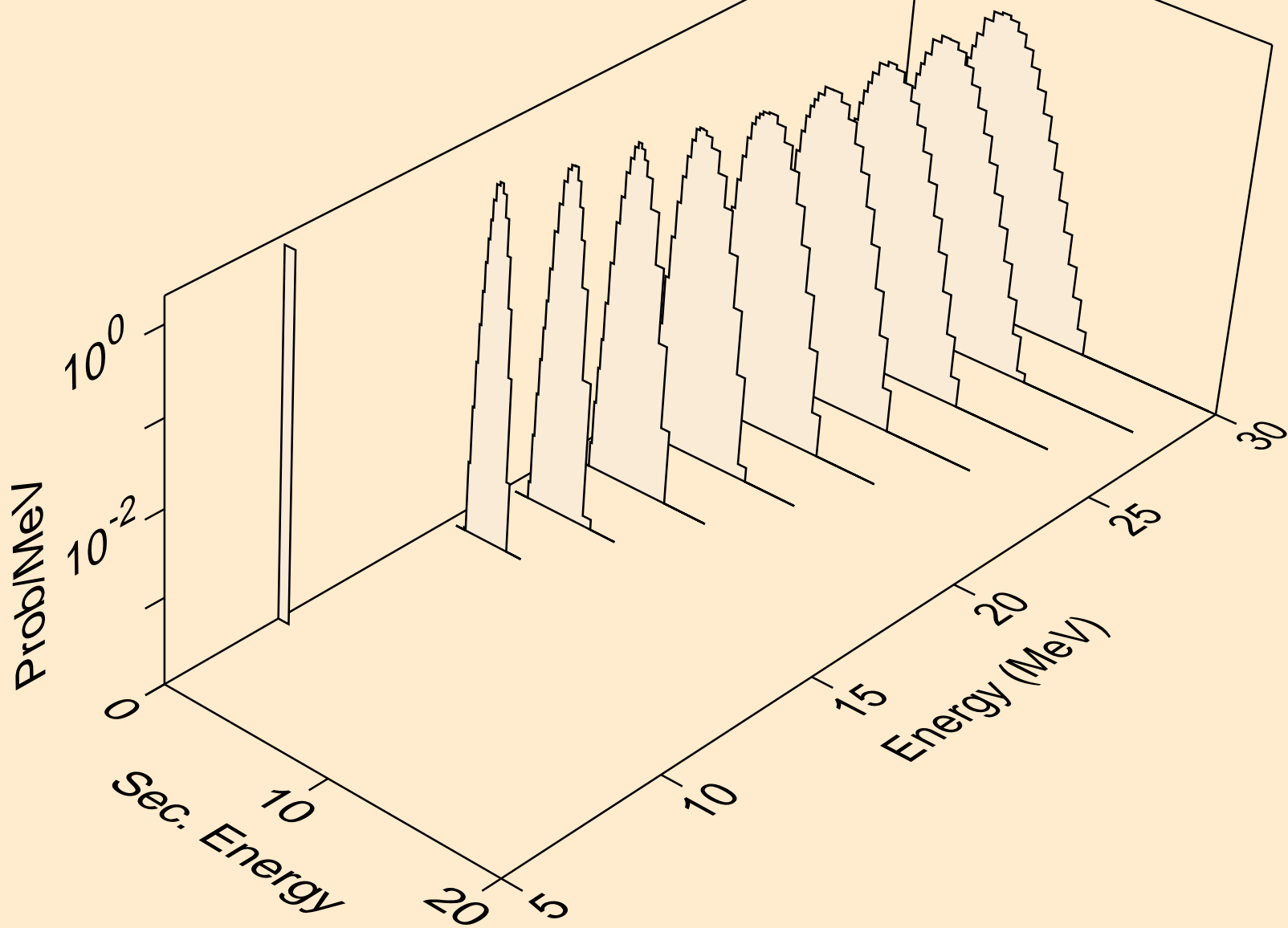

ND139 NEUTRON ACER TENDL-2024 LIBRARY; T=0.K
protons from (n,pt)

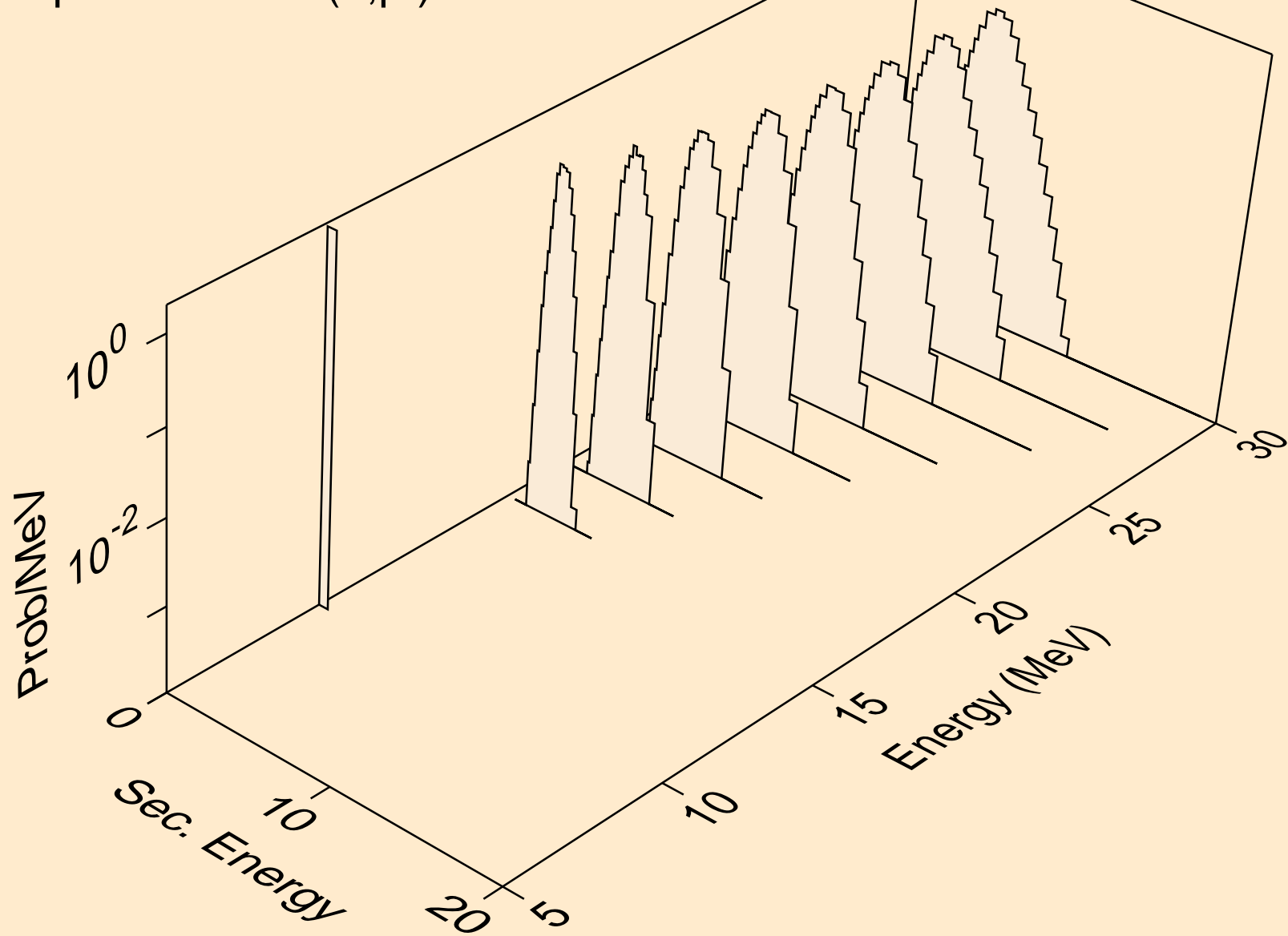

ND139 NEUTRON ACER TENDL-2024 LIBRARY; T=0.K
deuterons from (n,x)

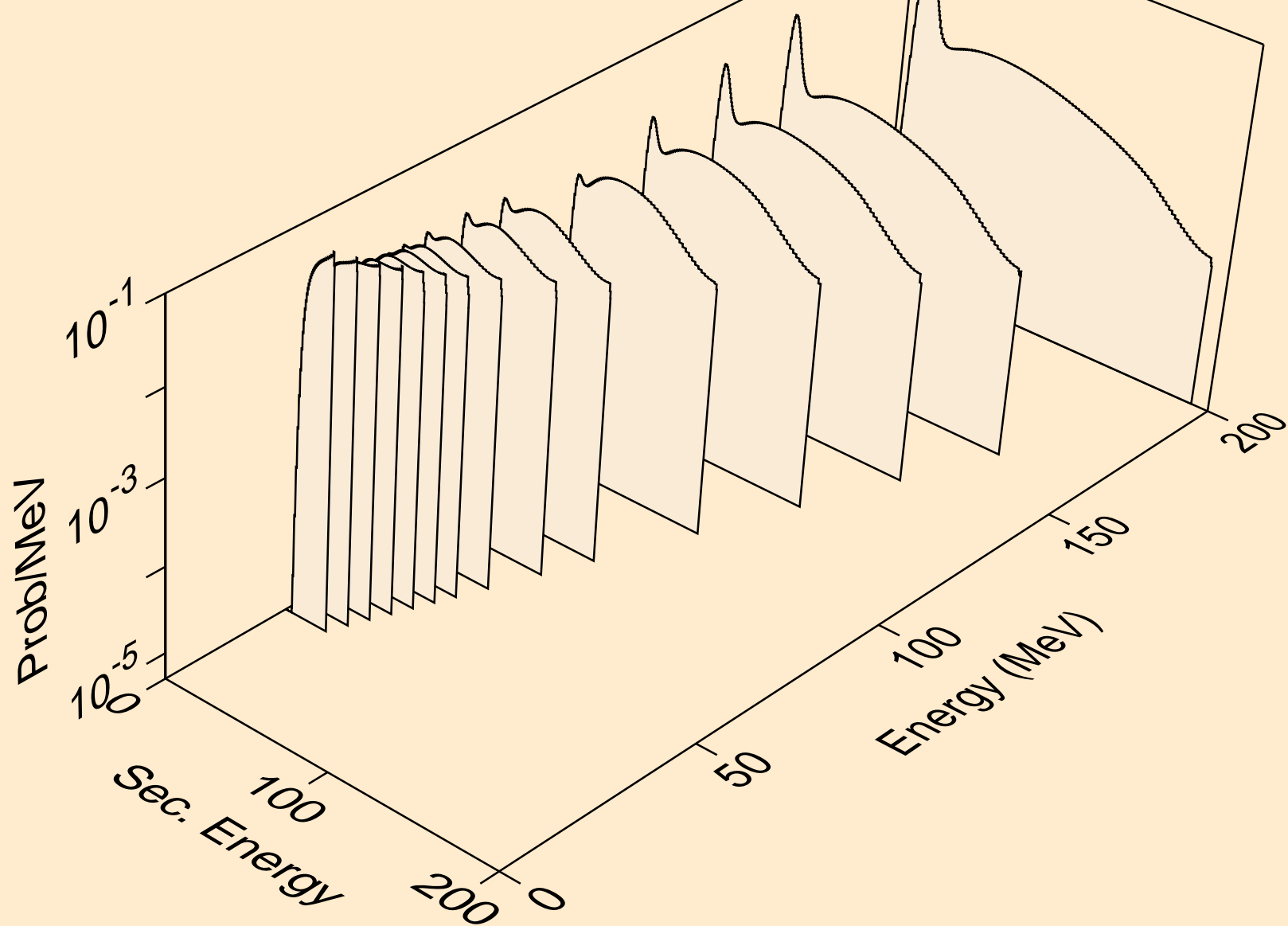

ND139 NEUTRON ACER TENDL-2024 LIBRARY; T=0.K
deuterons from (n,2nd)

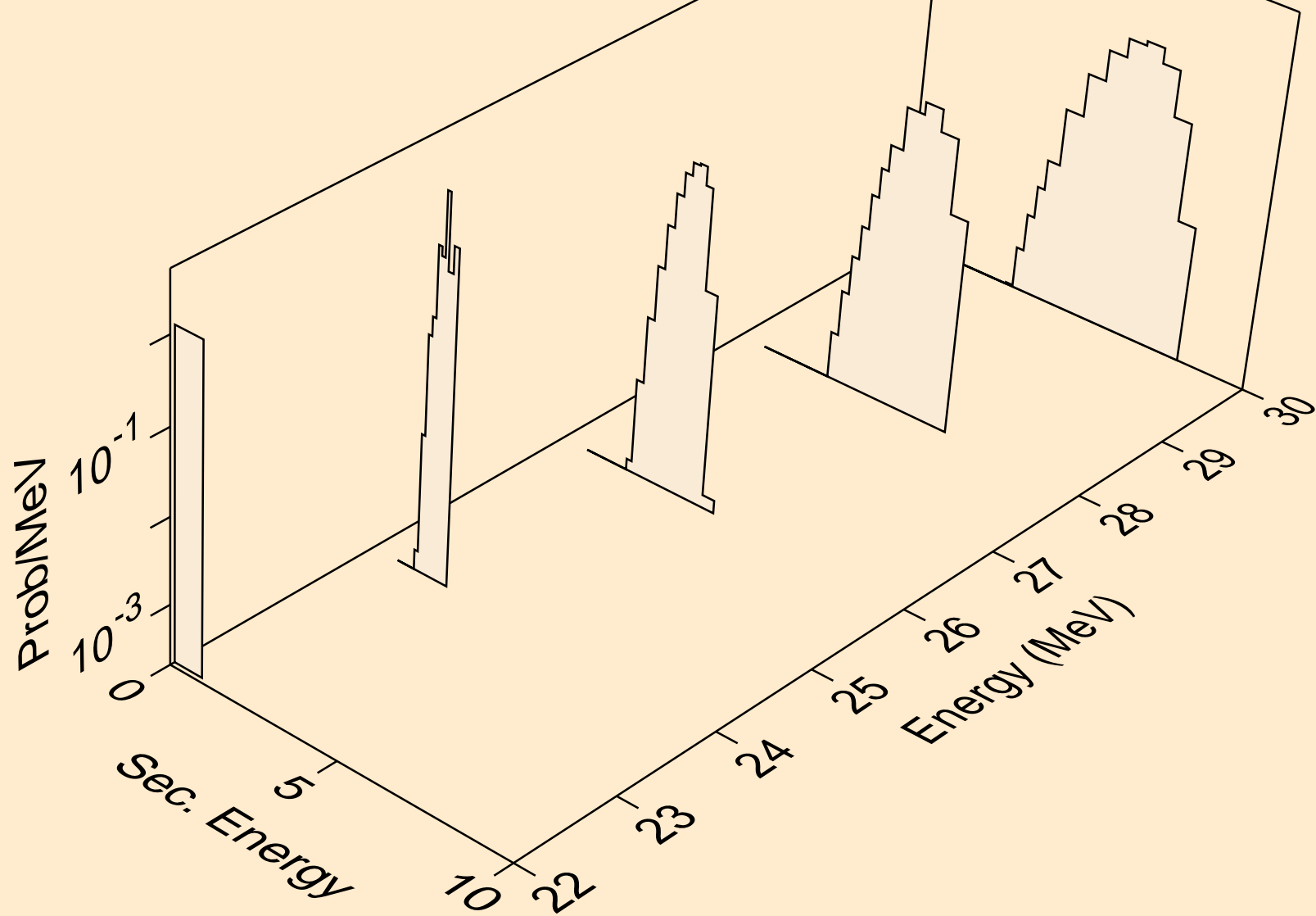

ND139 NEUTRON ACER TENDL-2024 LIBRARY; T=0.K
deuterons from (n,n*)d

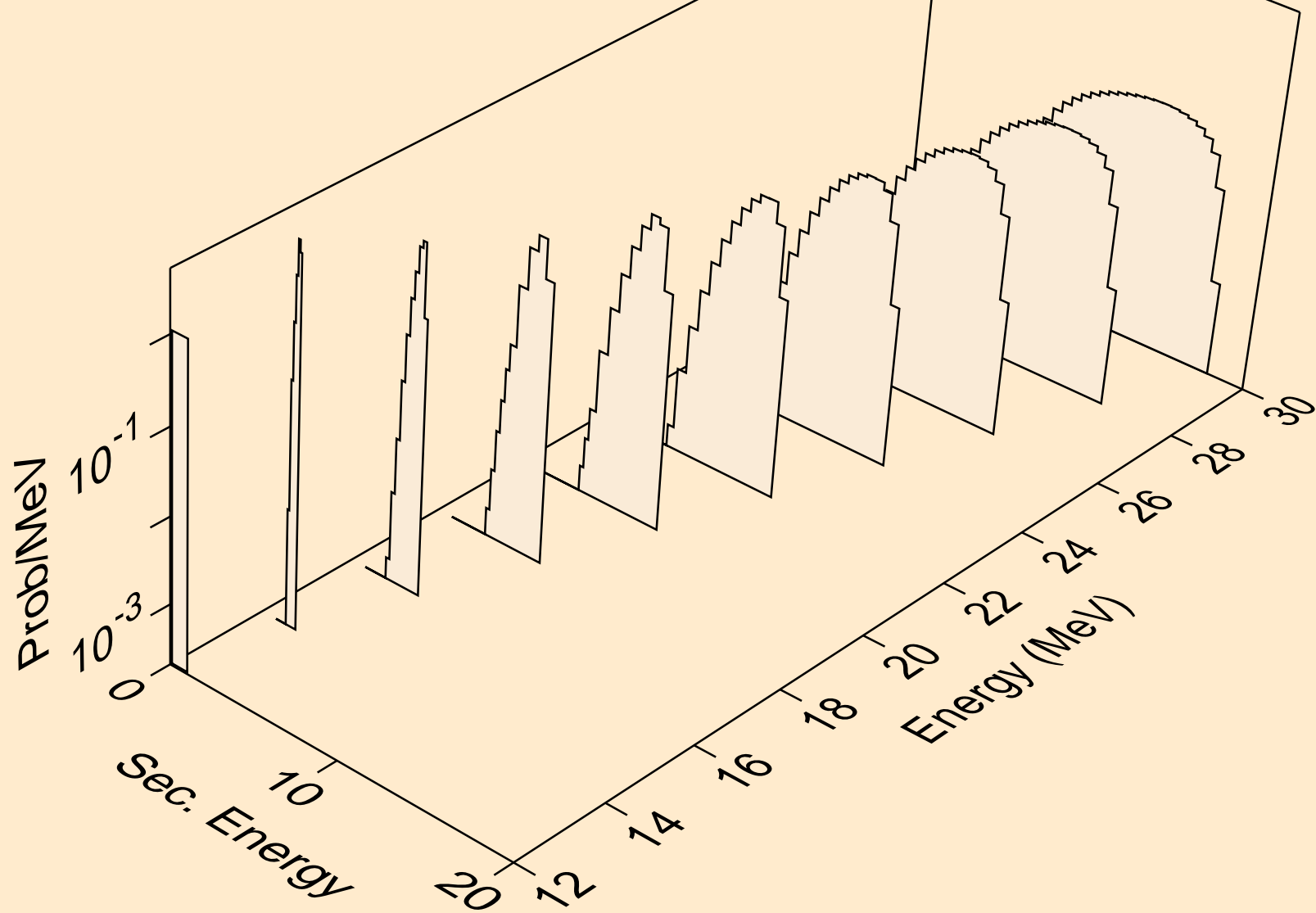

ND139 NEUTRON ACER TENDL-2024 LIBRARY; T=0.K
deuterons from (n,d)

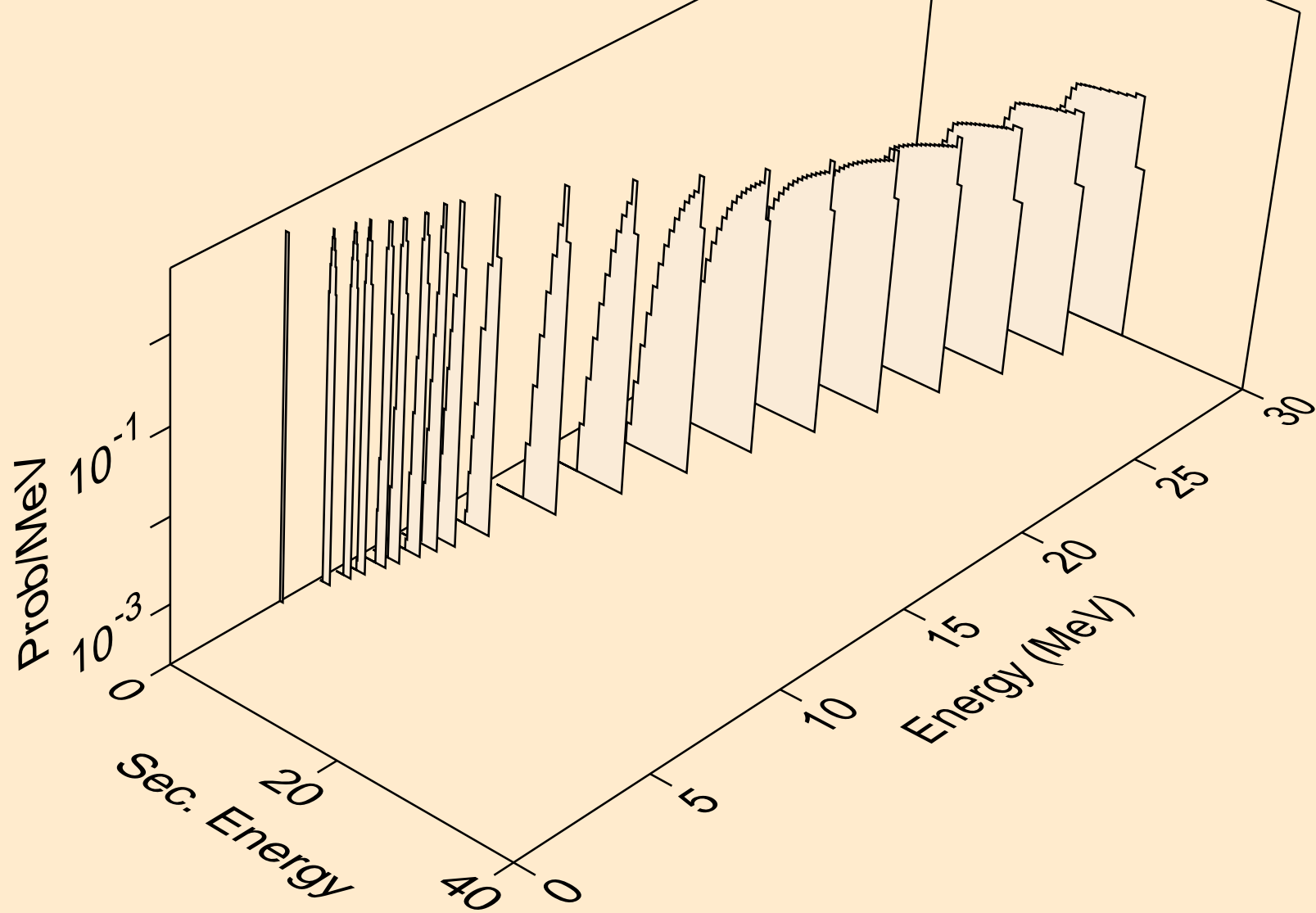

ND139 NEUTRON ACER TENDL-2024 LIBRARY; T=0.K
deuterons from (n,pd)

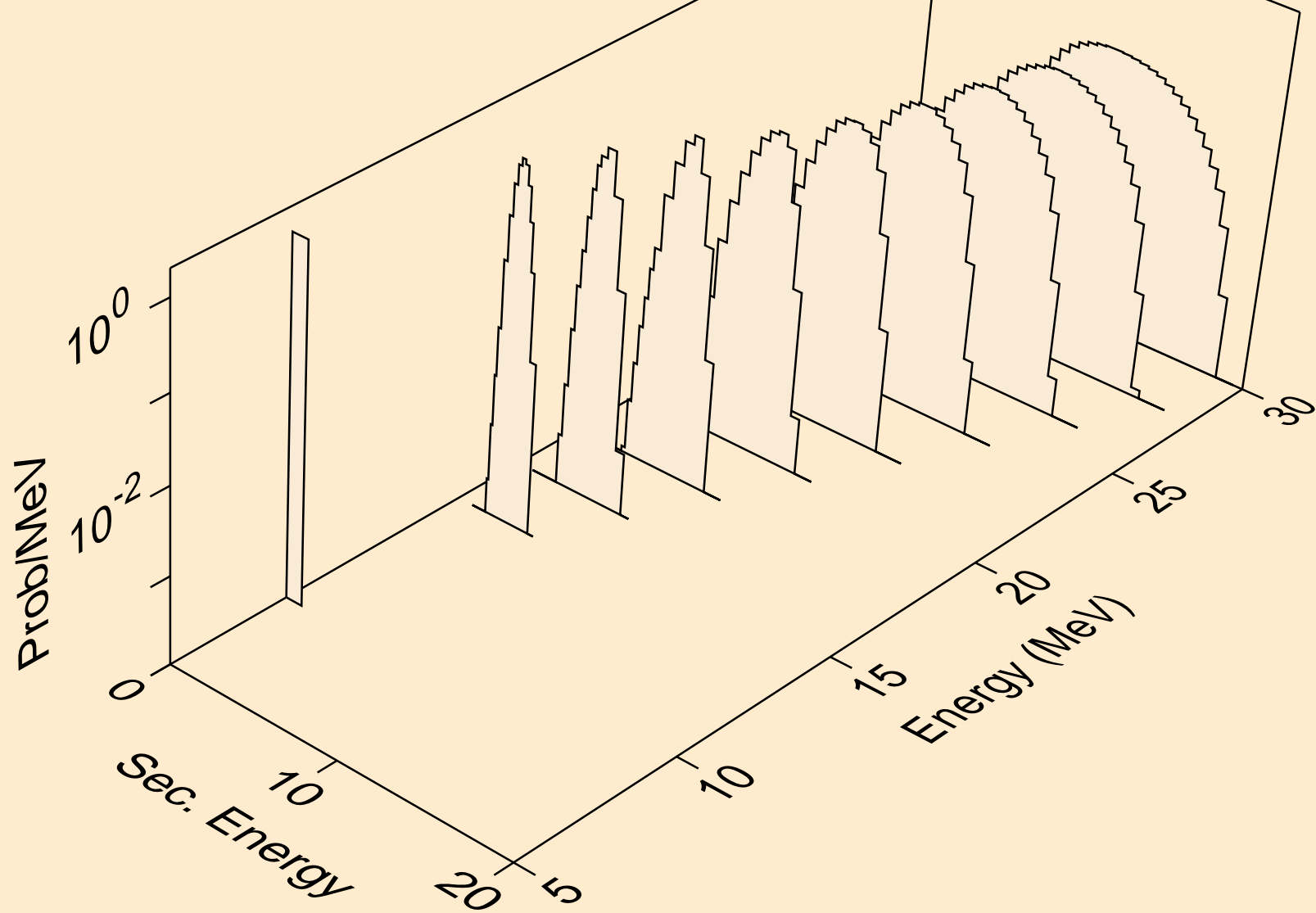

ND139 NEUTRON ACER TENDL-2024 LIBRARY; T=0.K
deuterons from (n,da)

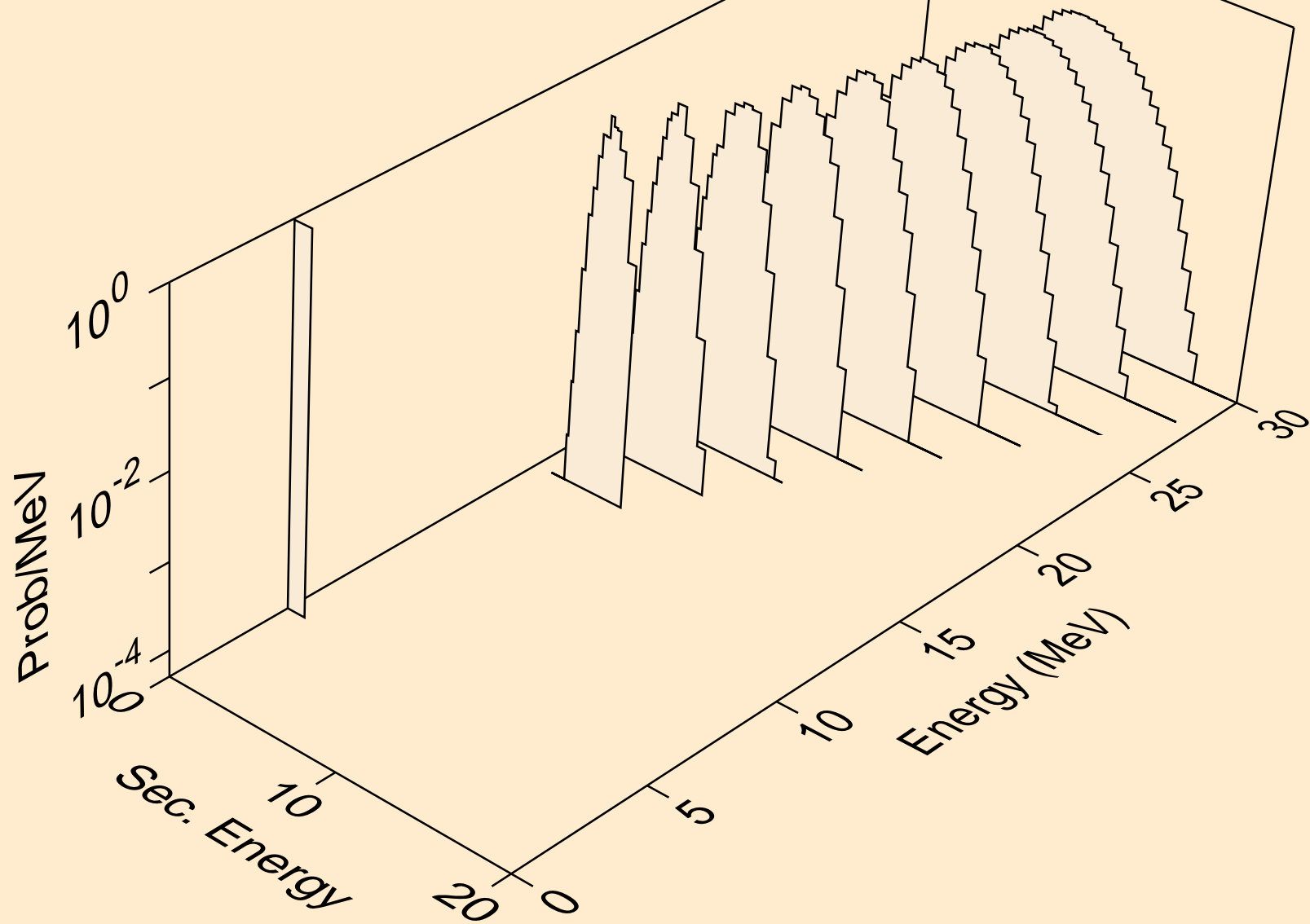

ND139 NEUTRON ACER TENDL-2024 LIBRARY; T=0.K
tritons from (n,x)

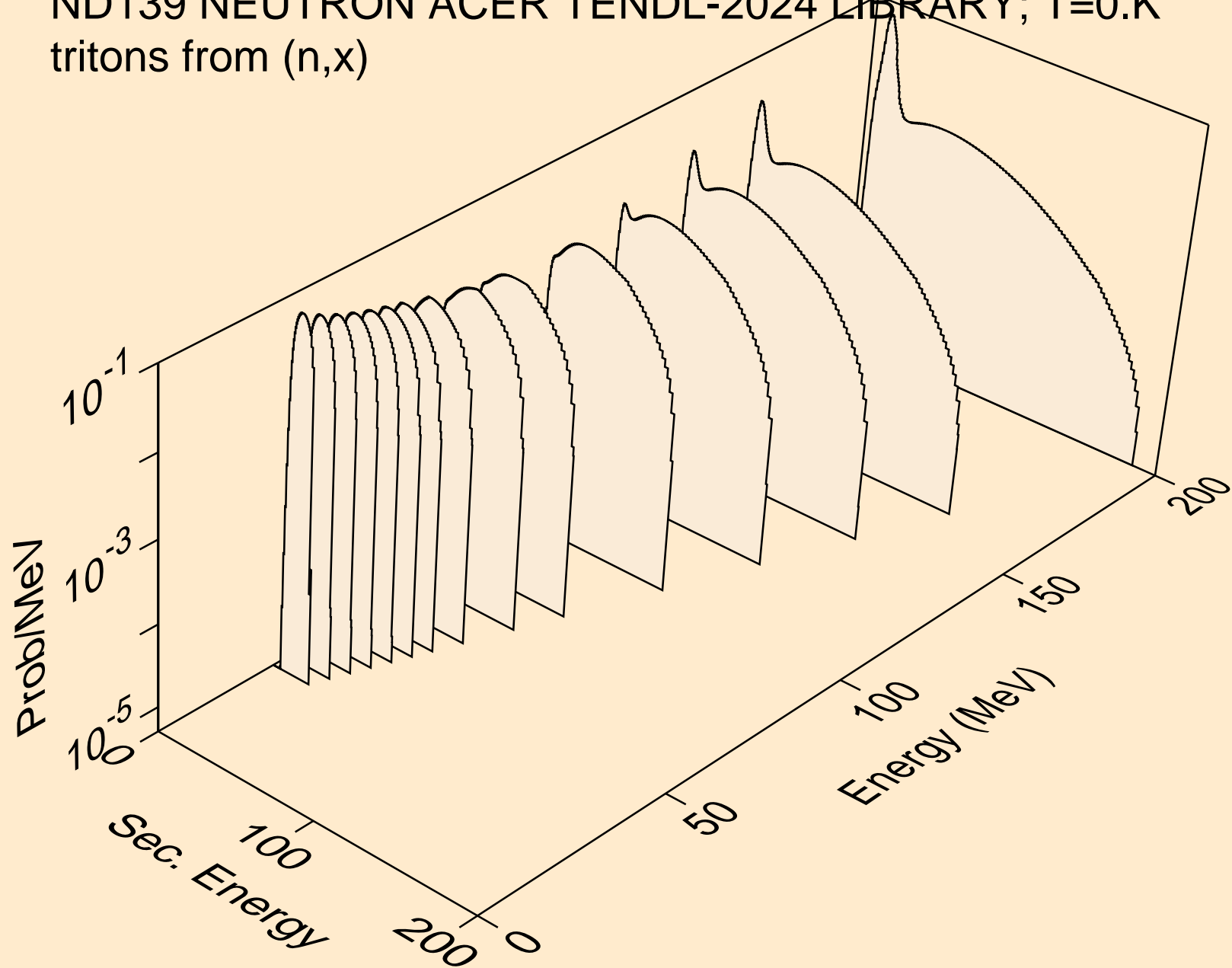

ND139 NEUTRON ACER TENDL-2024 LIBRARY; T=0.K
tritons from (n,n*)t

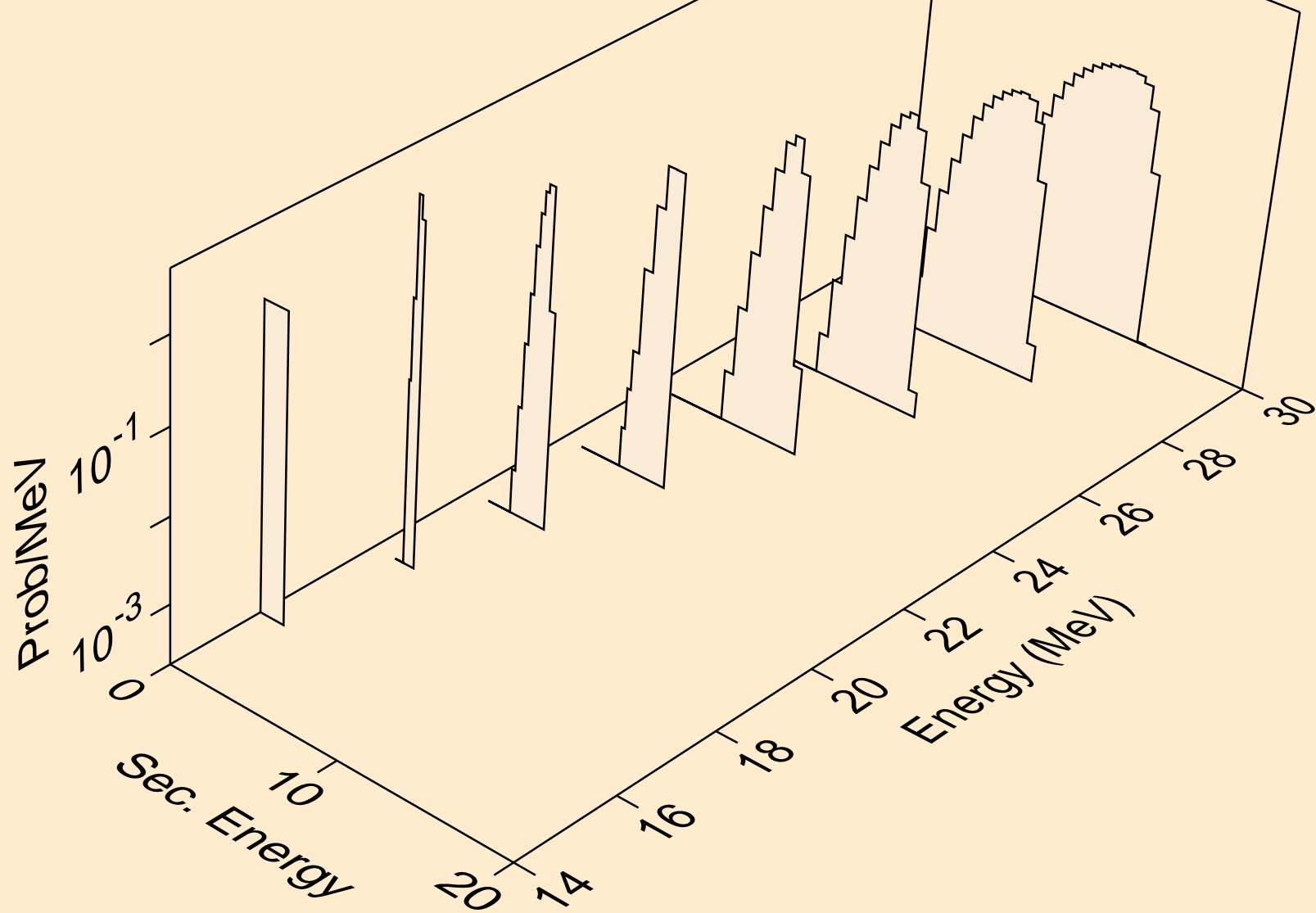

ND139 NEUTRON ACER TENDL-2024 LIBRARY; T=0.K
tritons from (n,t)

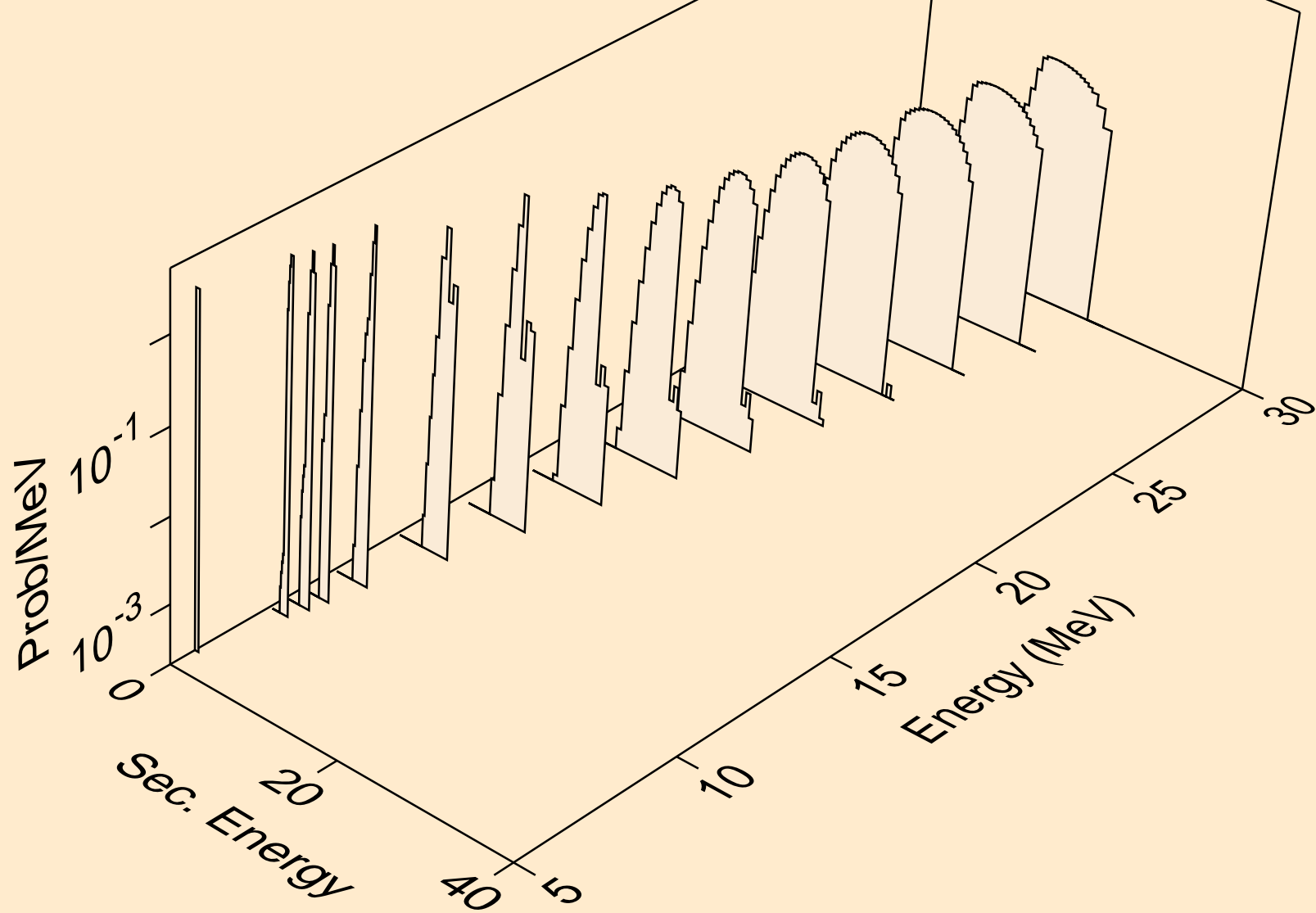

ND139 NEUTRON ACER TENDL-2024 LIBRARY; T=0.K
tritons from (n,pt)

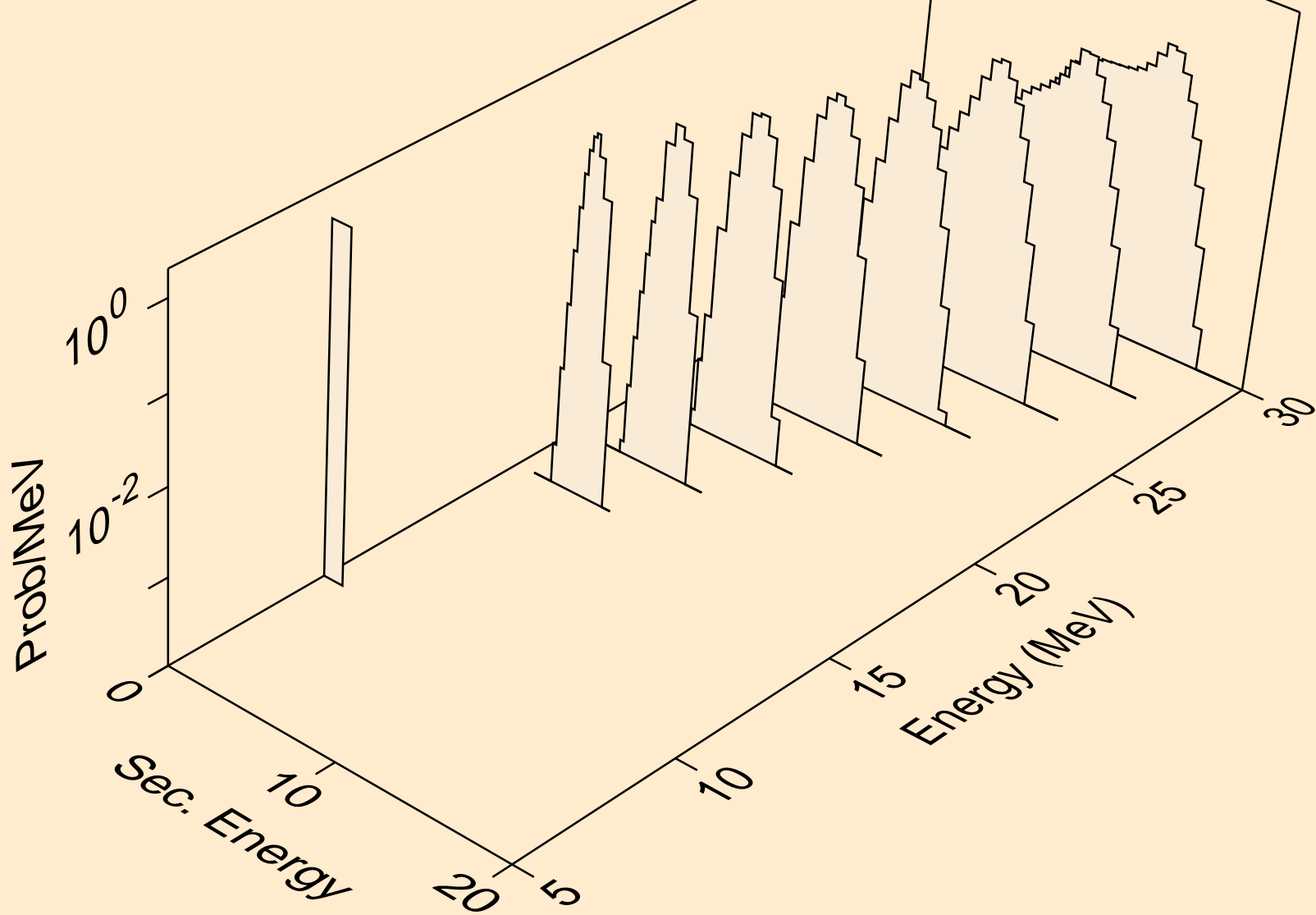

ND139 NEUTRON ACER TENDL-2024 LIBRARY; T=0.K
he3s from (n,x)

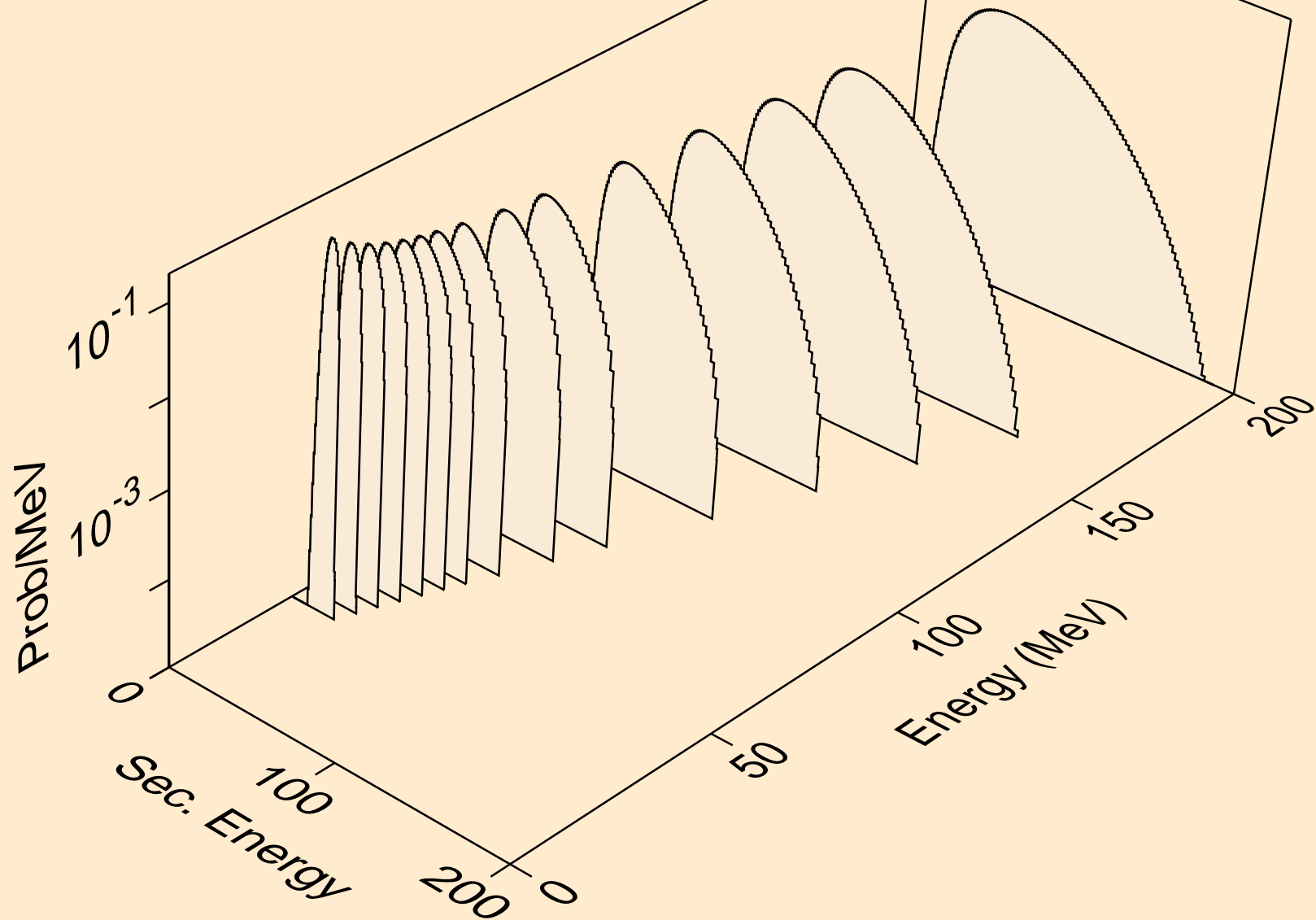

ND139 NEUTRON ACER TENDL-2024 LIBRARY; T=0.K
he3s from (n,n*)he3

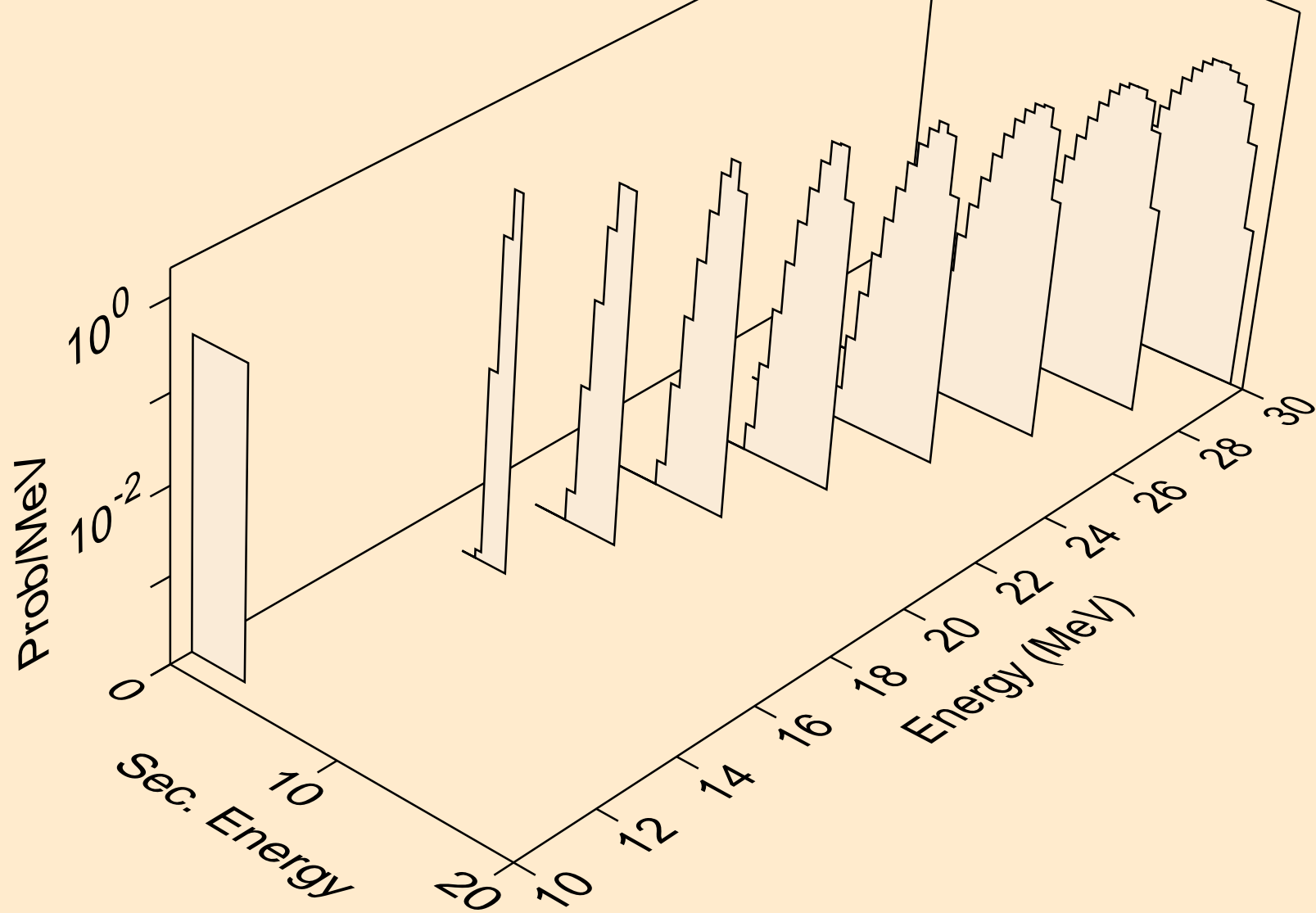

ND139 NEUTRON ACER TENDL-2024 LIBRARY; T=0.K
he3s from (n,he3)

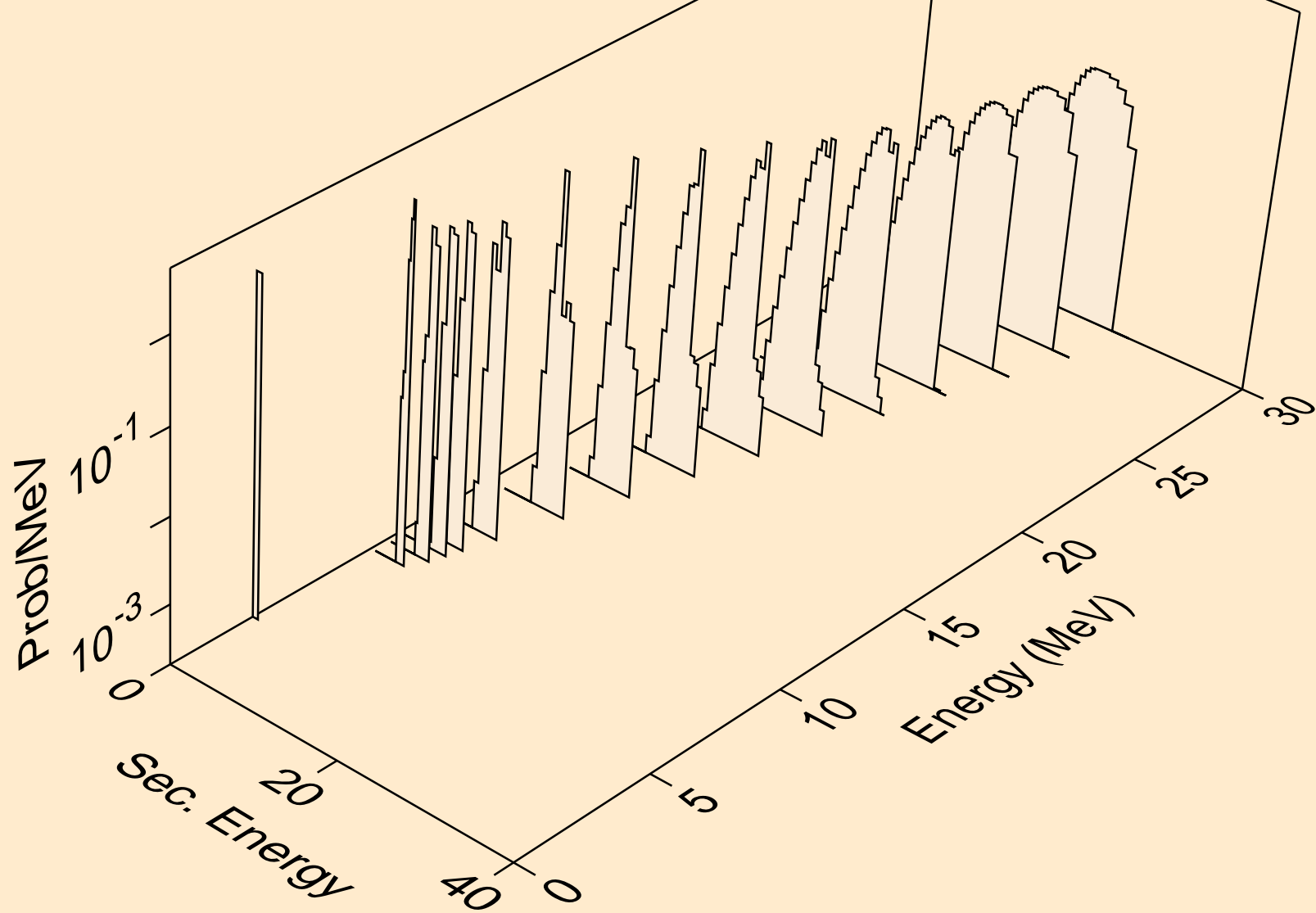

ND139 NEUTRON ACER TENDL-2024 LIBRARY; T=0.K
alphas from (n,x)

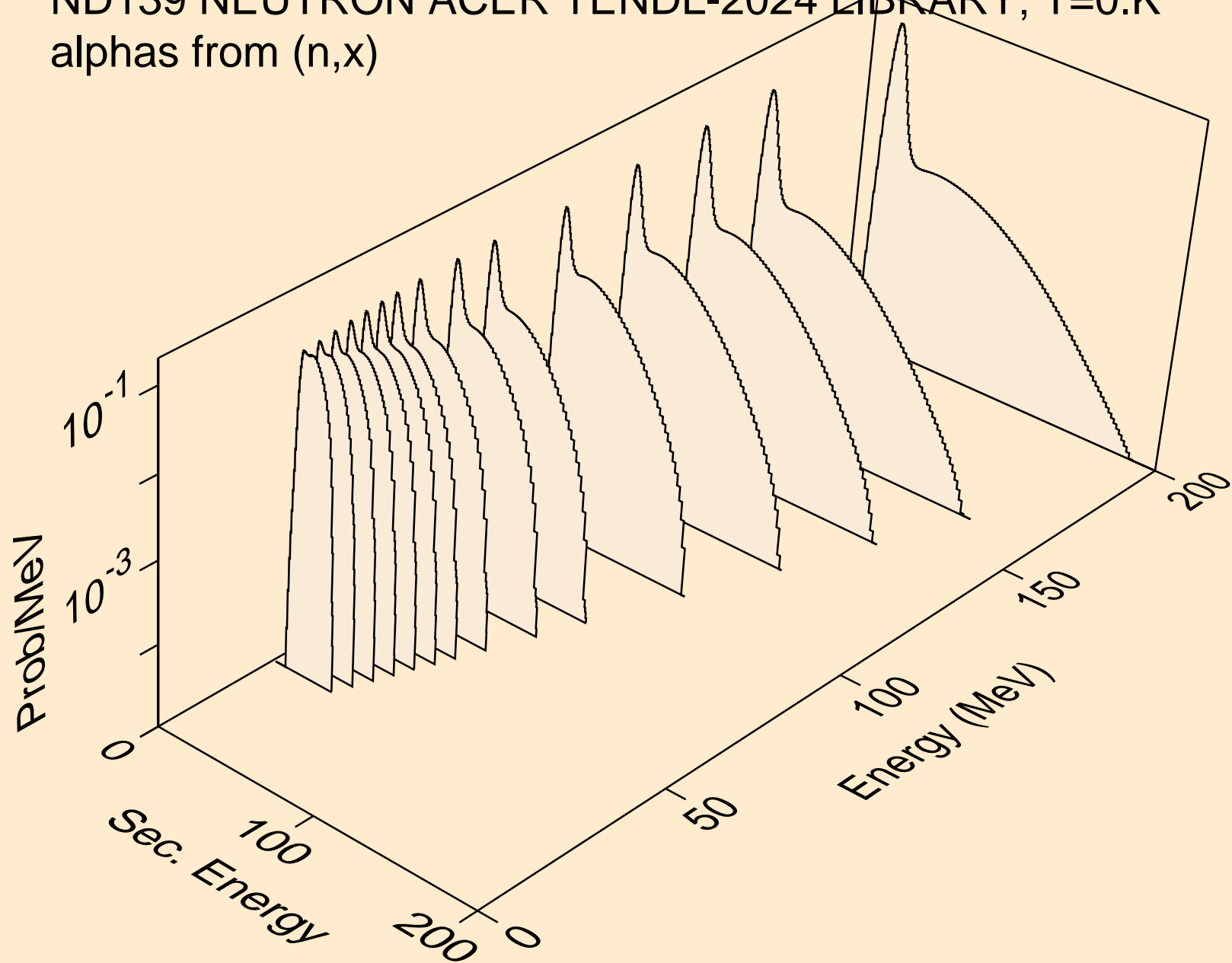

ND139 NEUTRON ACER TENDL-2024 LIBRARY; T=0.K
alphas from (n,n*)a

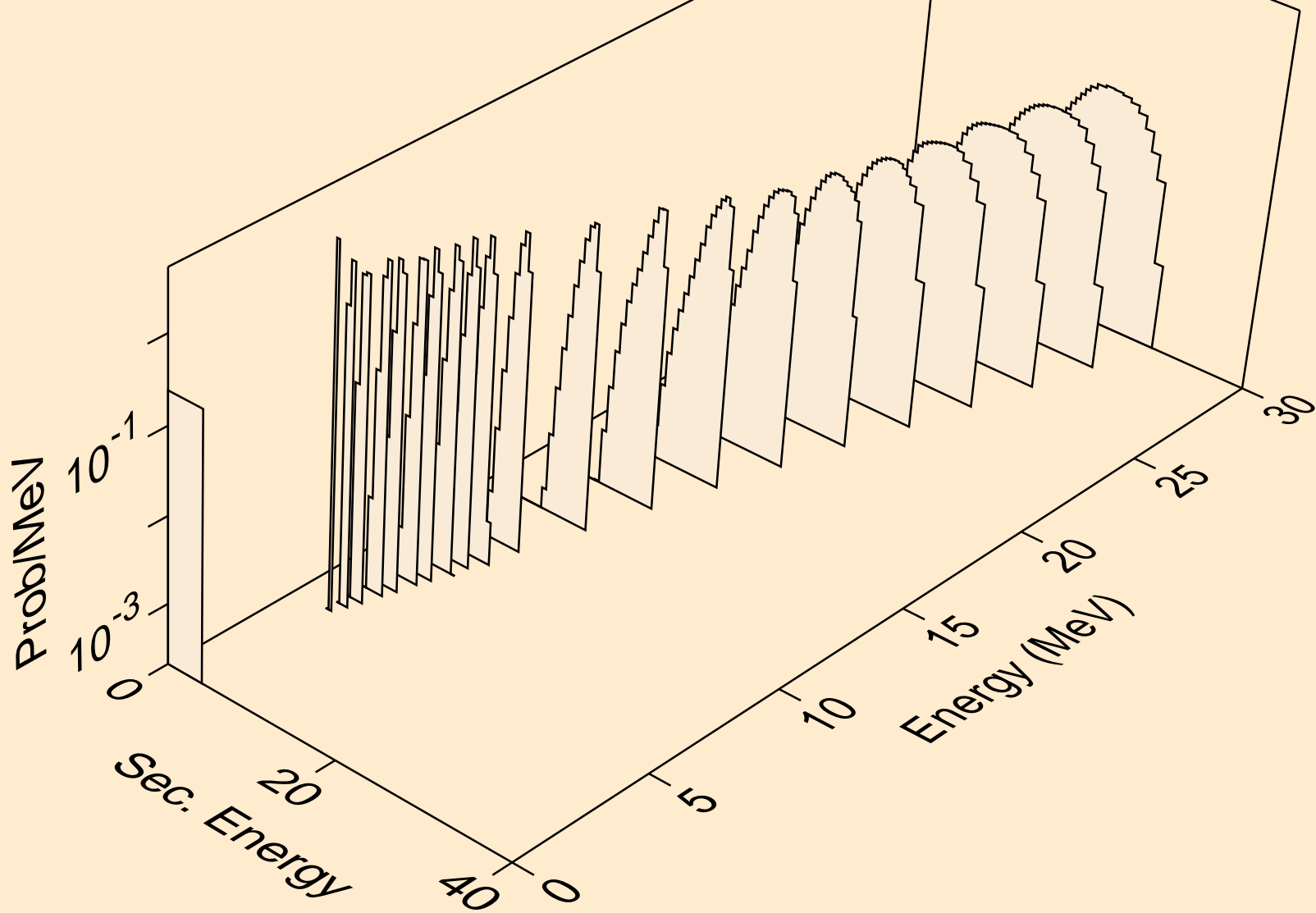

ND139 NEUTRON ACER TENDL-2024 LIBRARY; T=0.K
alphas from (n,2n)a

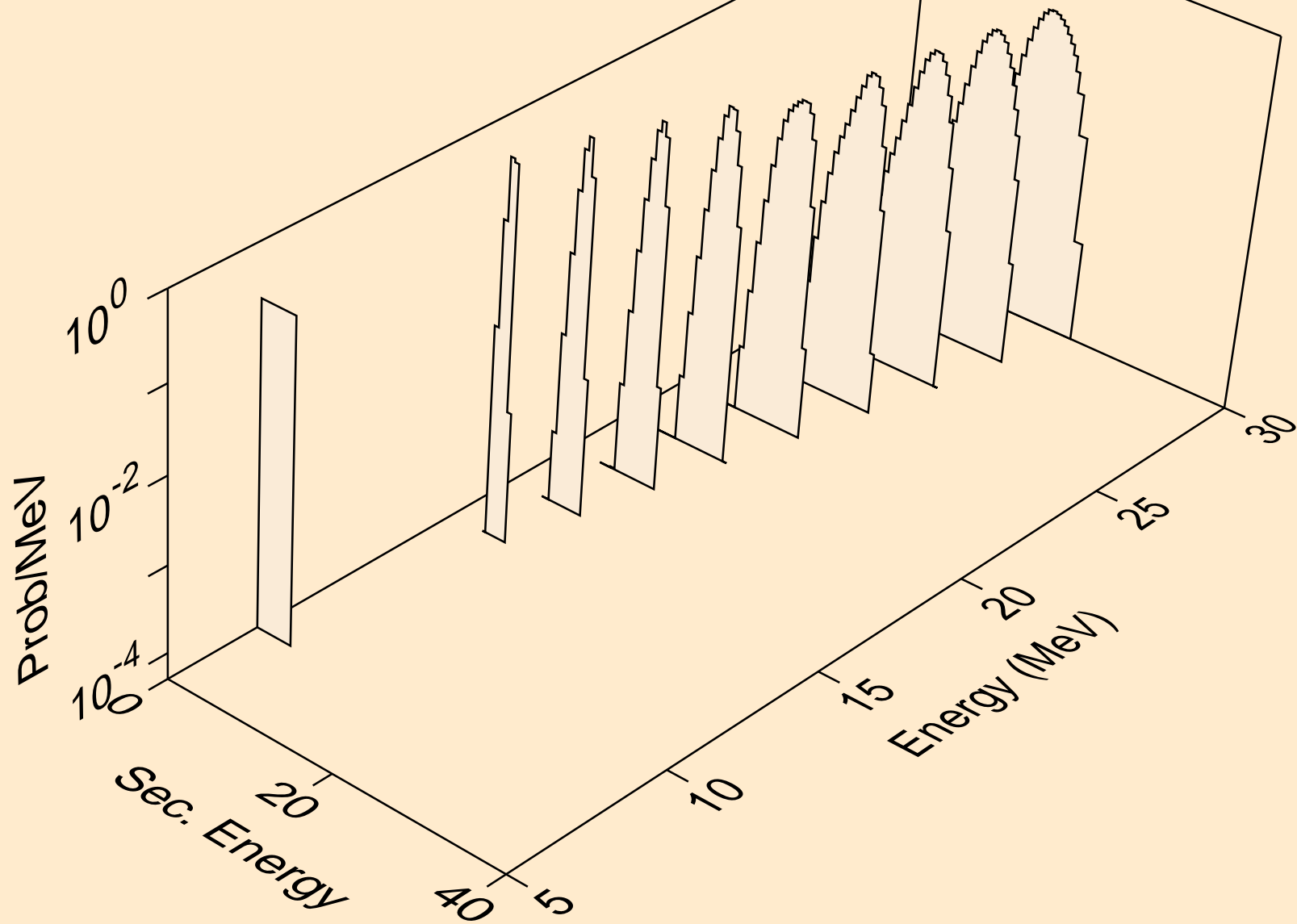

ND139 NEUTRON ACER TENDL-2024 LIBRARY; T=0.K
alphas from (n,3n)a

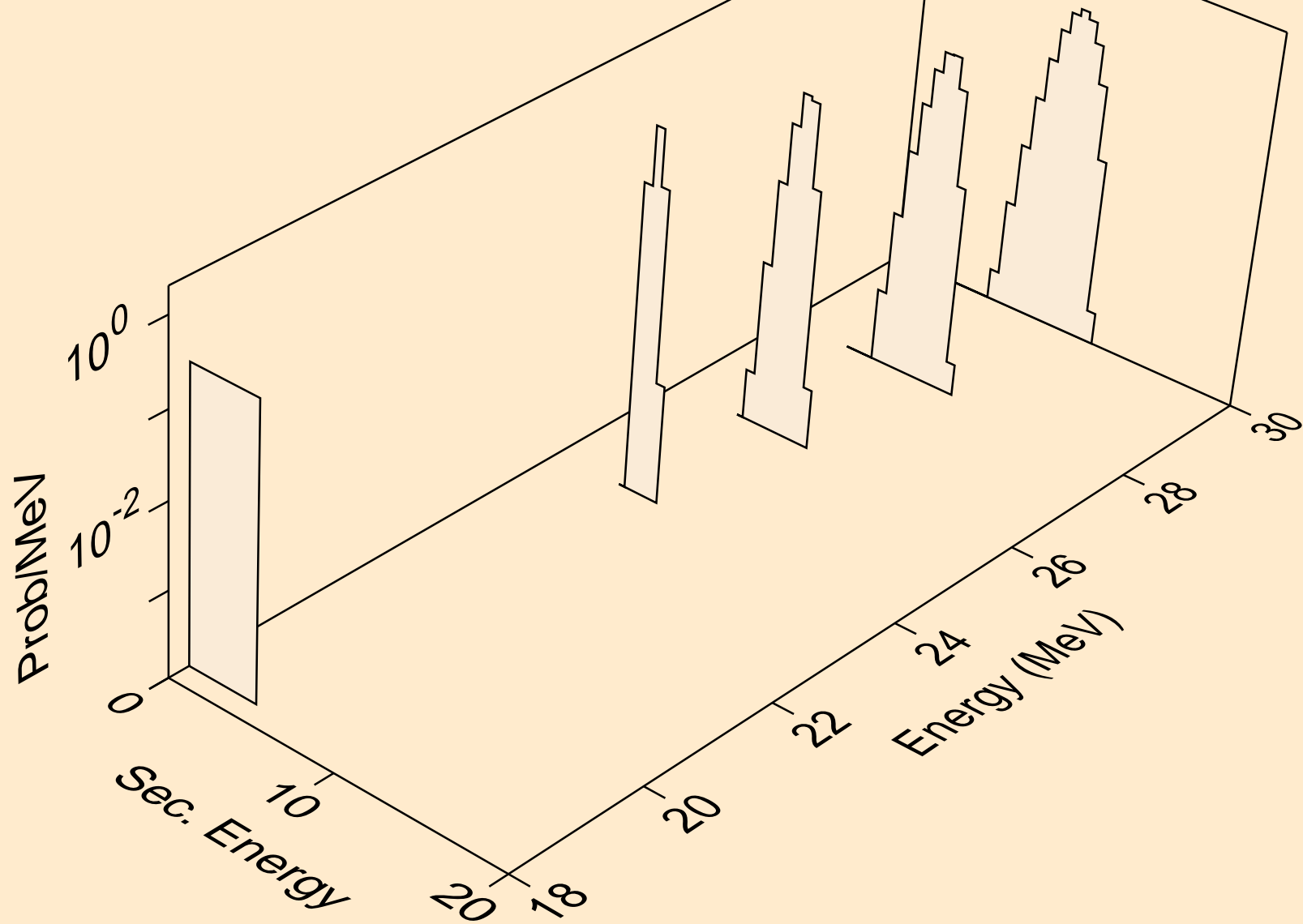

ND139 NEUTRON ACER TENDL-2024 LIBRARY; T=0.K
alphas from (n,n*)2a

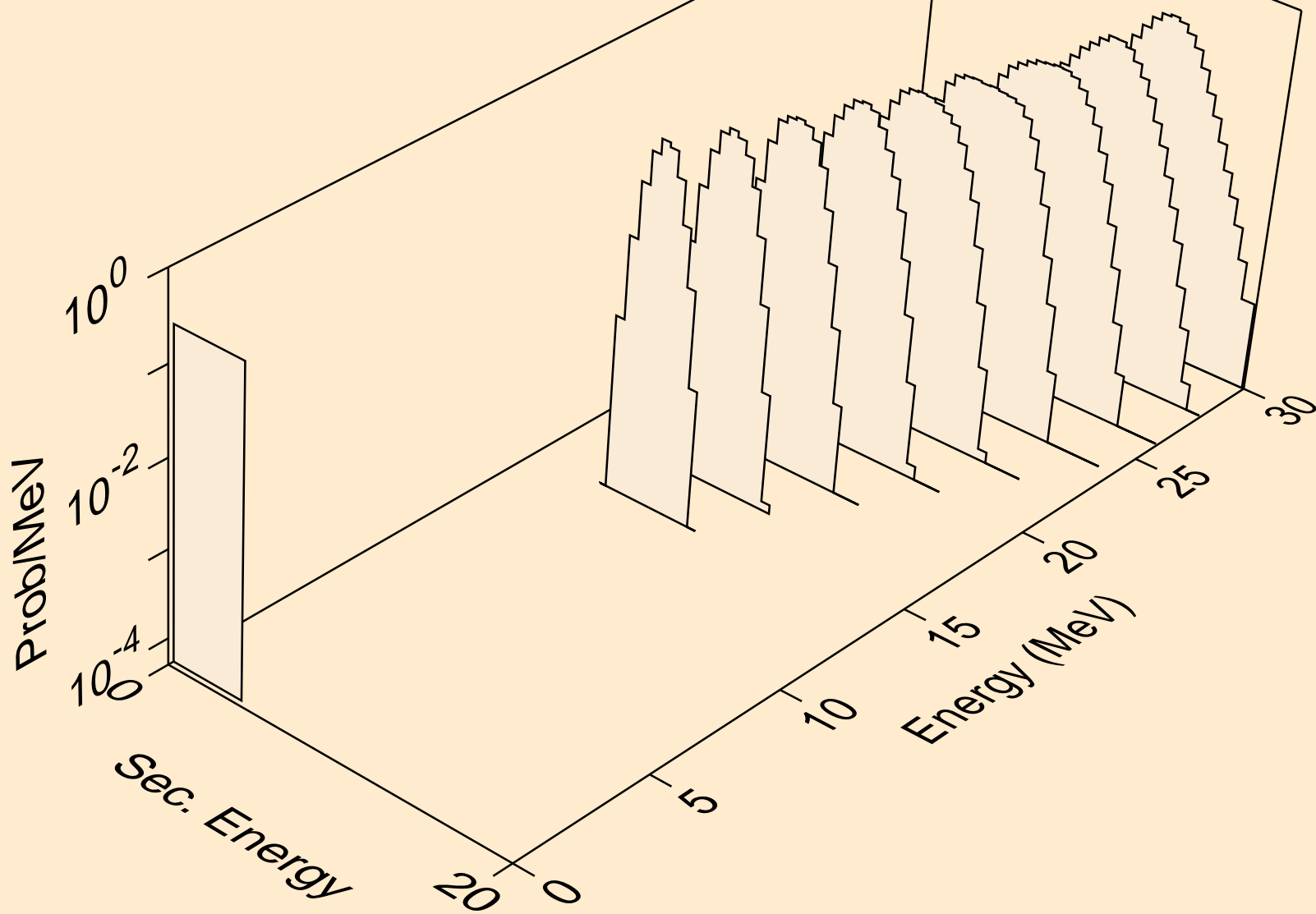

ND139 NEUTRON ACER TENDL-2024 LIBRARY; T=0.K
alphas from (n,npa)

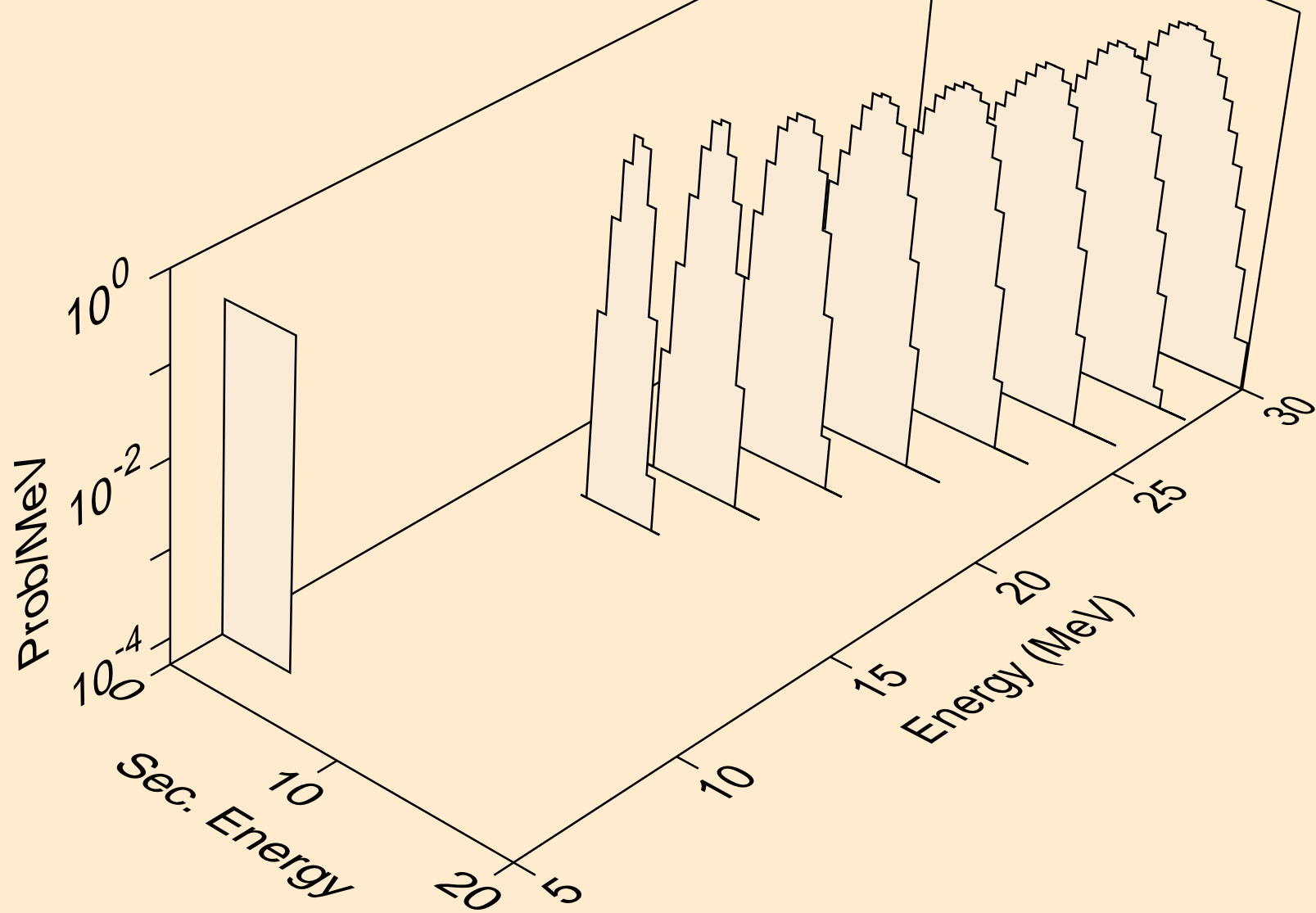

ND139 NEUTRON ACER TENDL-2024 LIBRARY; T=0.K
alphas from (n,a)

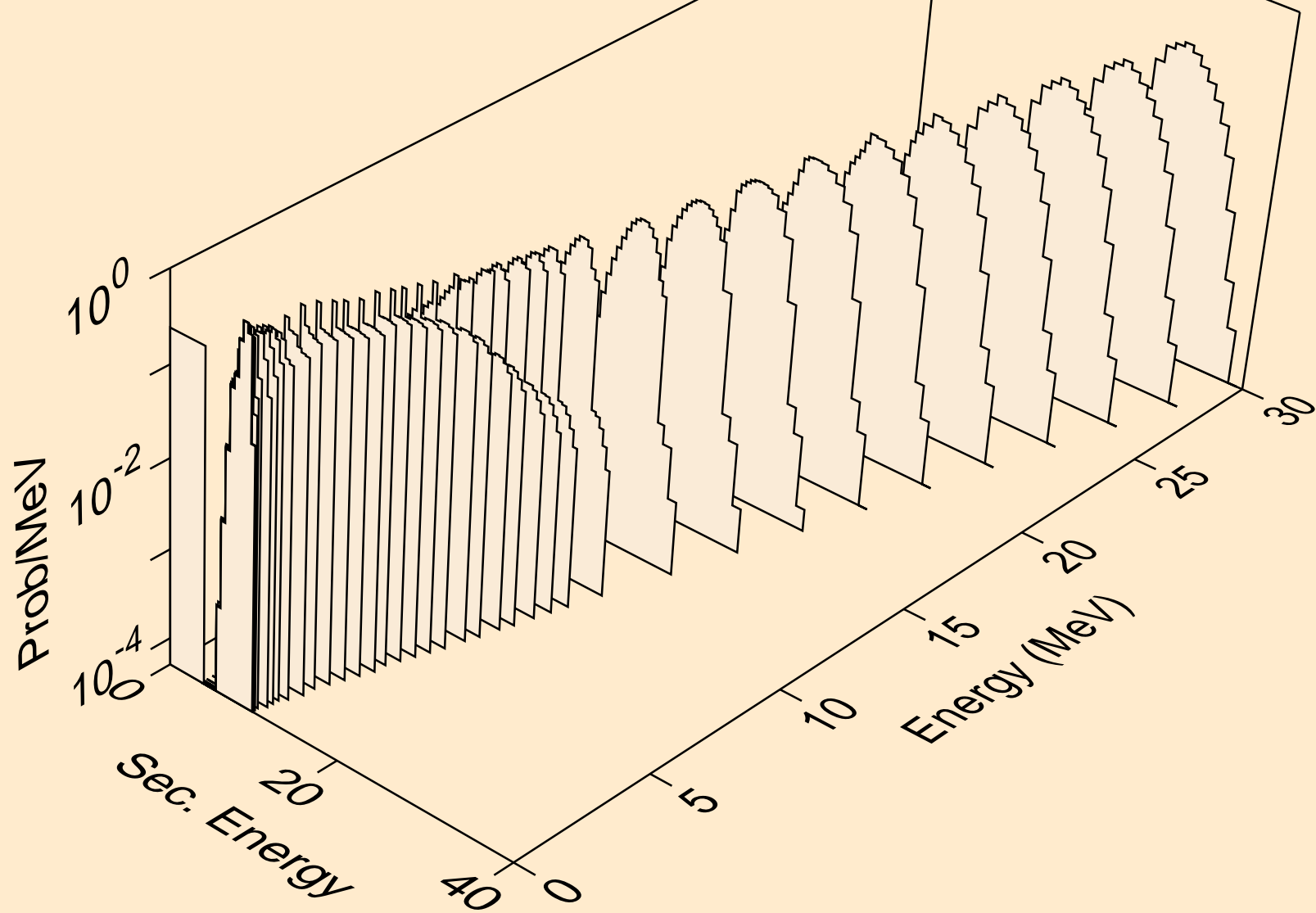

ND139 NEUTRON ACER TENDL-2024 LIBRARY; T=0.K
alphas from (n,2a)

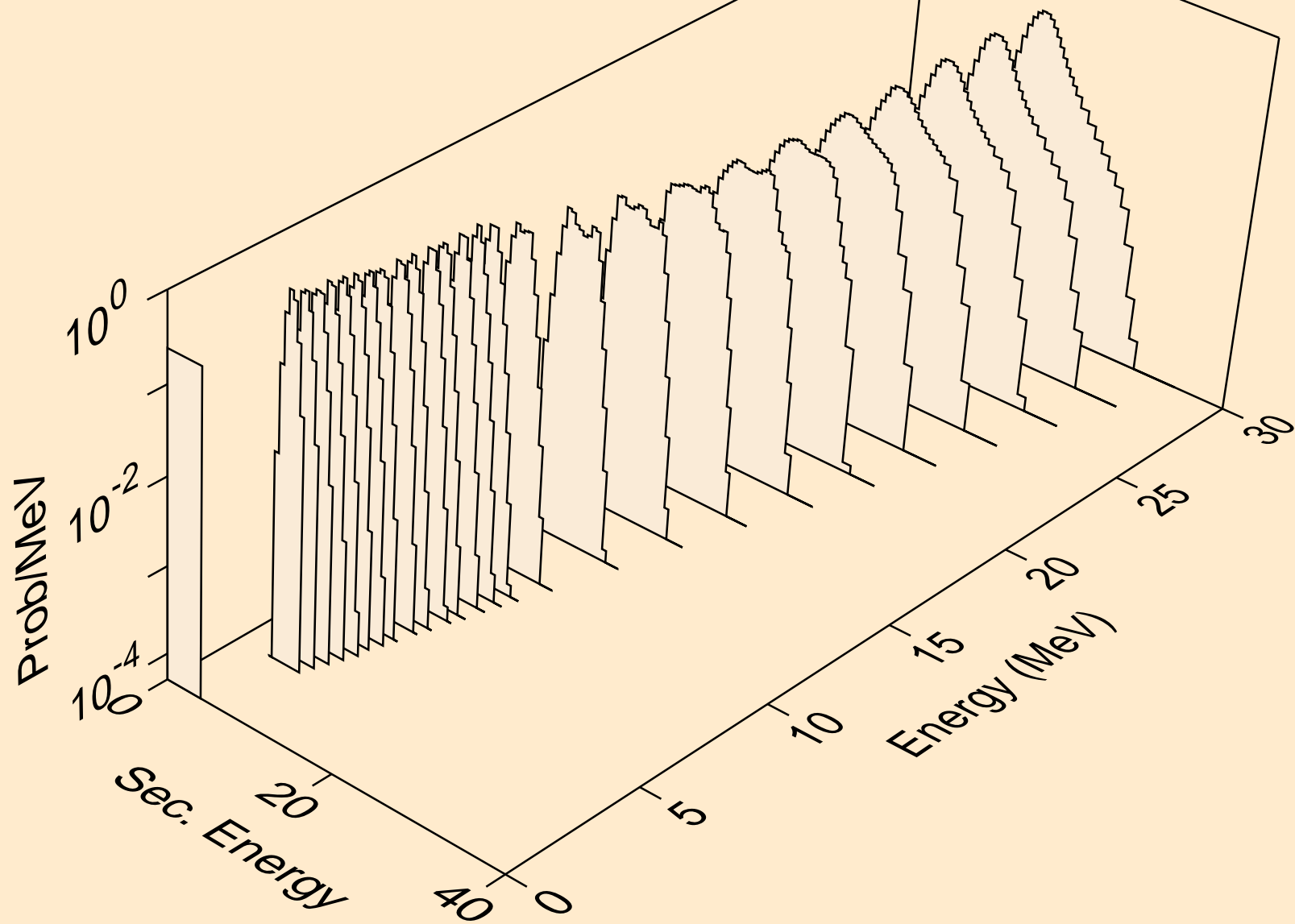

ND139 NEUTRON ACER TENDL-2024 LIBRARY; T=0.K
alphas from (n,pa)

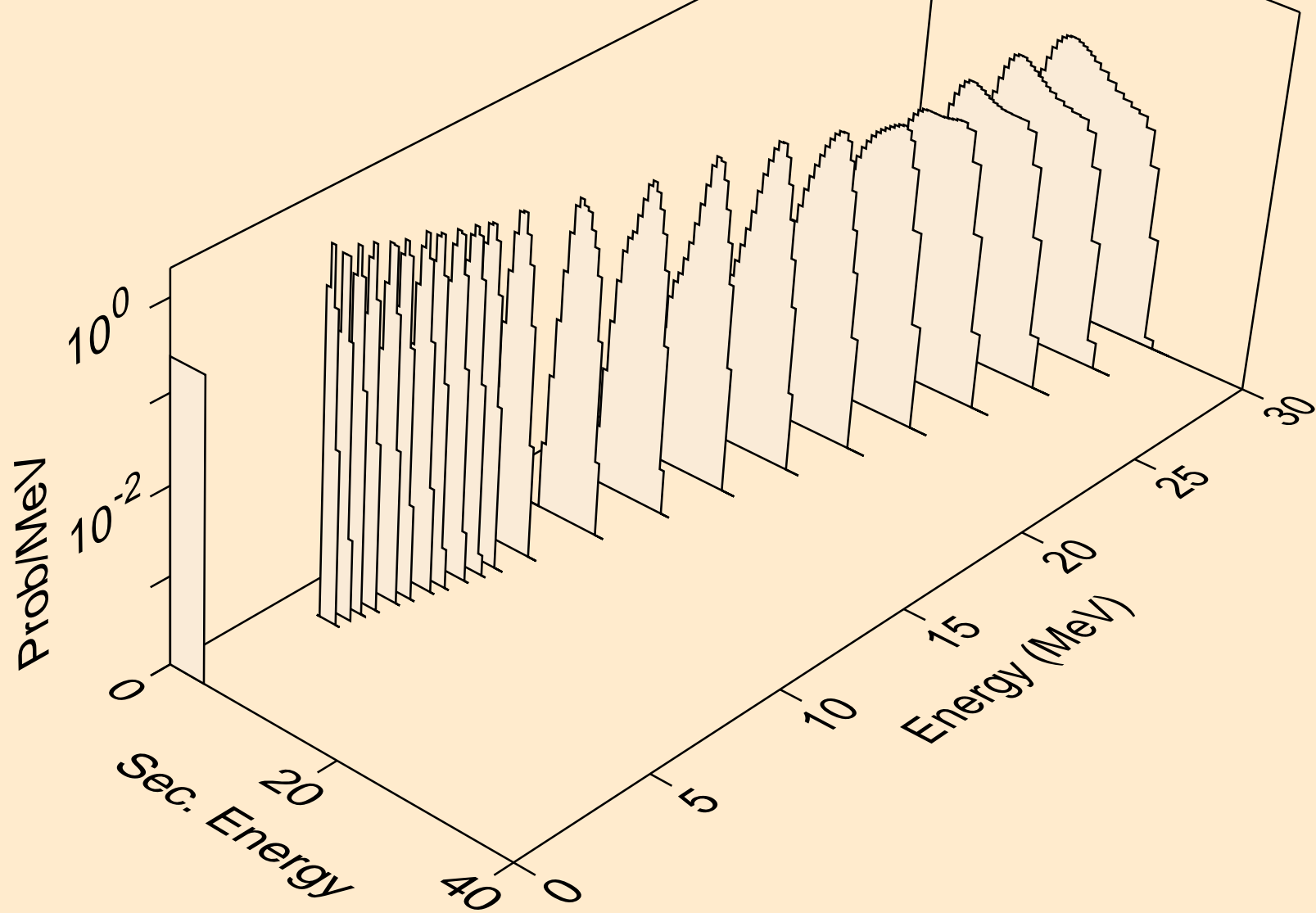

ND139 NEUTRON ACER TENDL-2024 LIBRARY; T=0.K
alphas from (n,da)

