

NP245 NEUTRON ACER TENDL-2024 LIBRARY; T=0.K

Principal cross sections

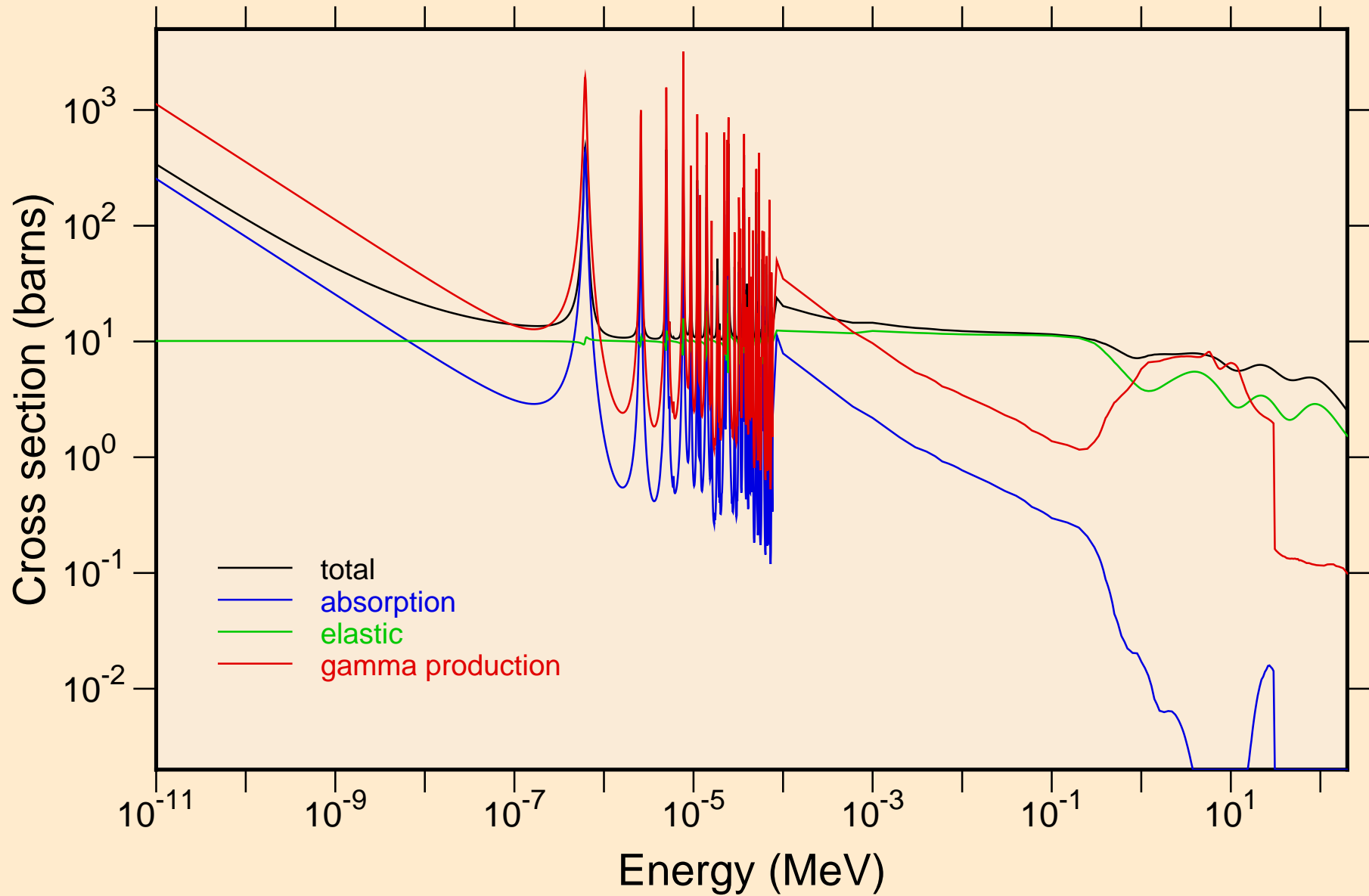

NP245 NEUTRON ACER TENDL-2024 LIBRARY; T=0.K
resonance total cross section

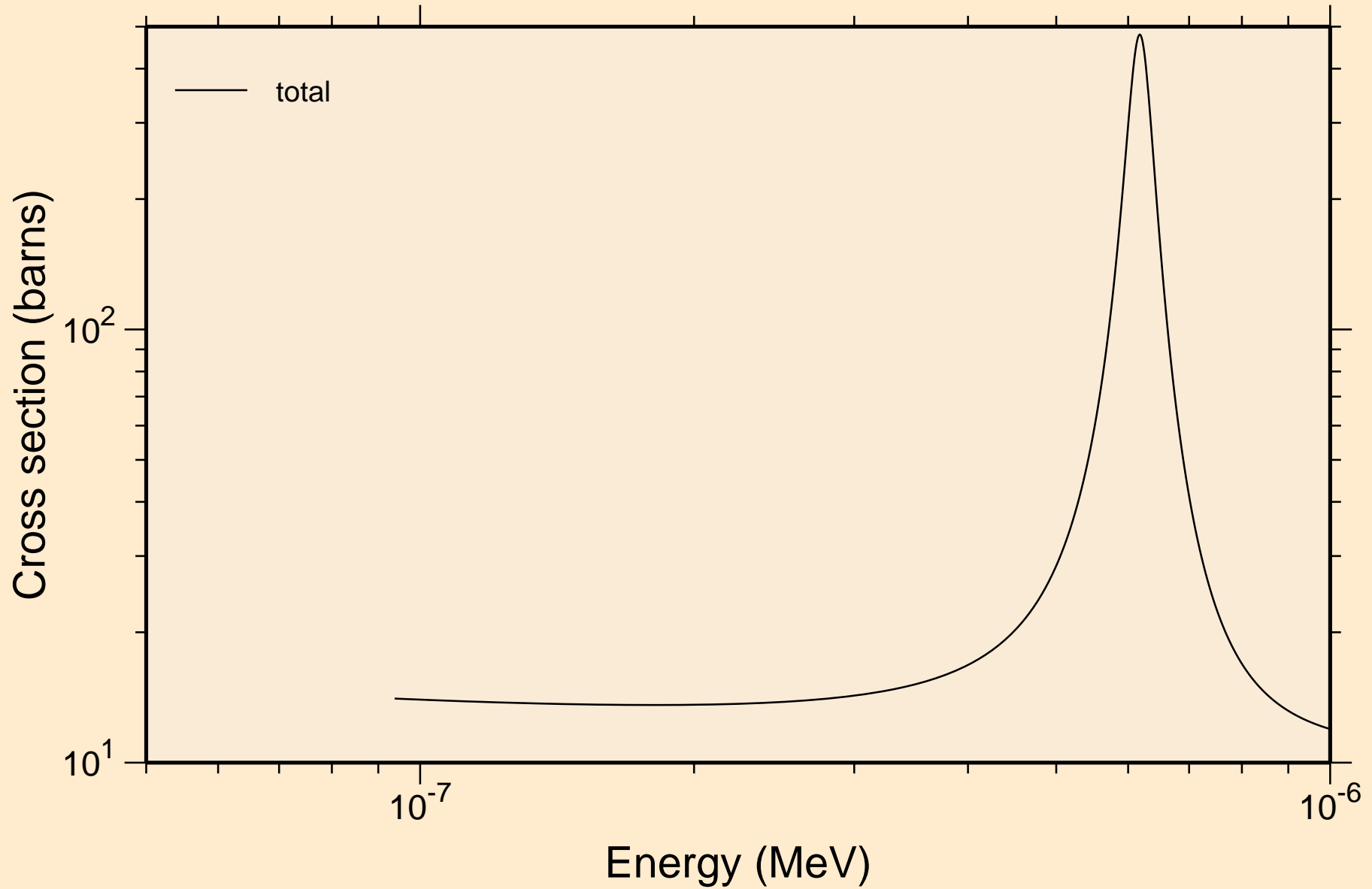

NP245 NEUTRON ACER TENDL-2024 LIBRARY; T=0.K
resonance total cross section

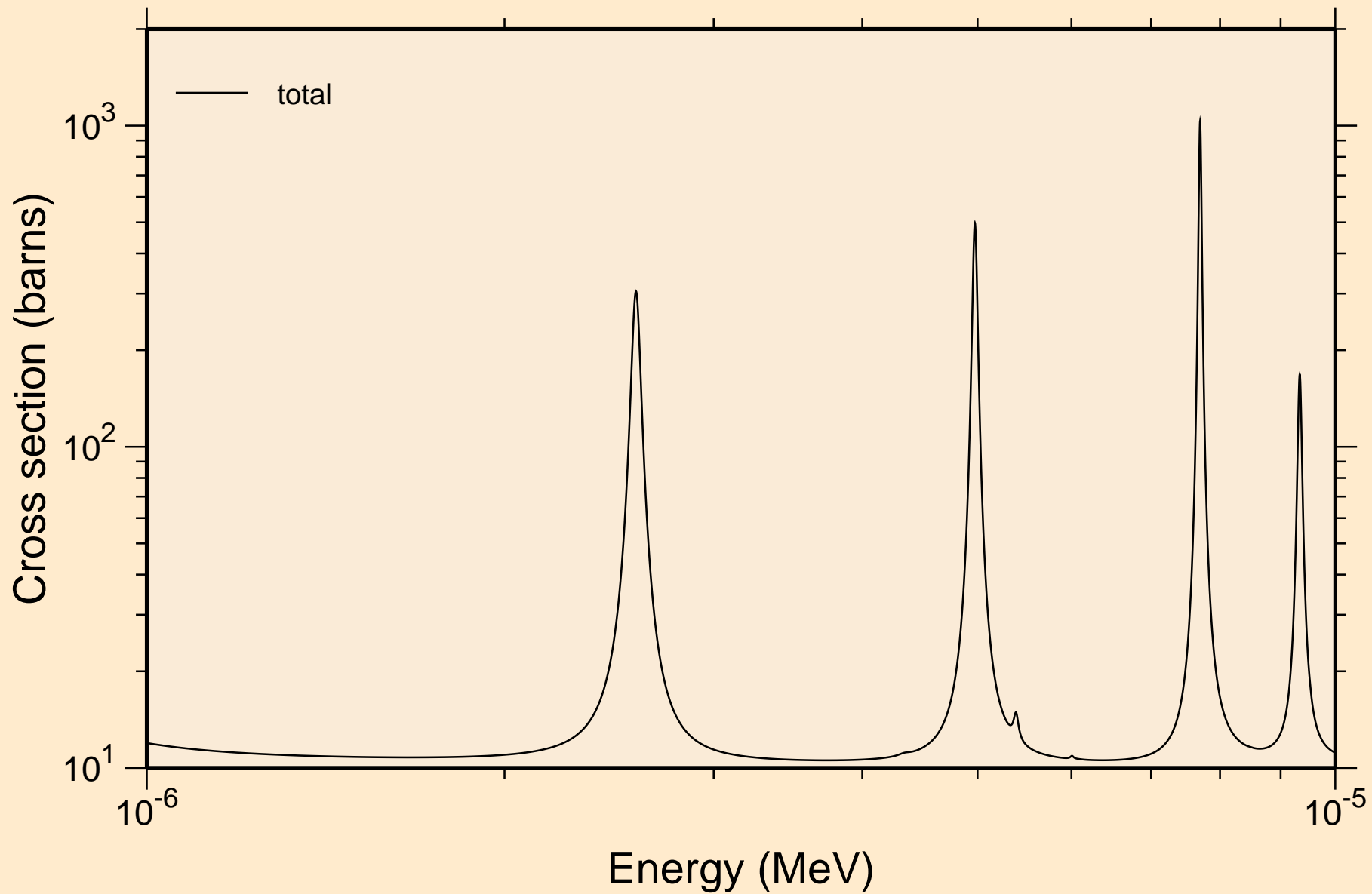

NP245 NEUTRON ACER TENDL-2024 LIBRARY; T=0.K
resonance total cross section

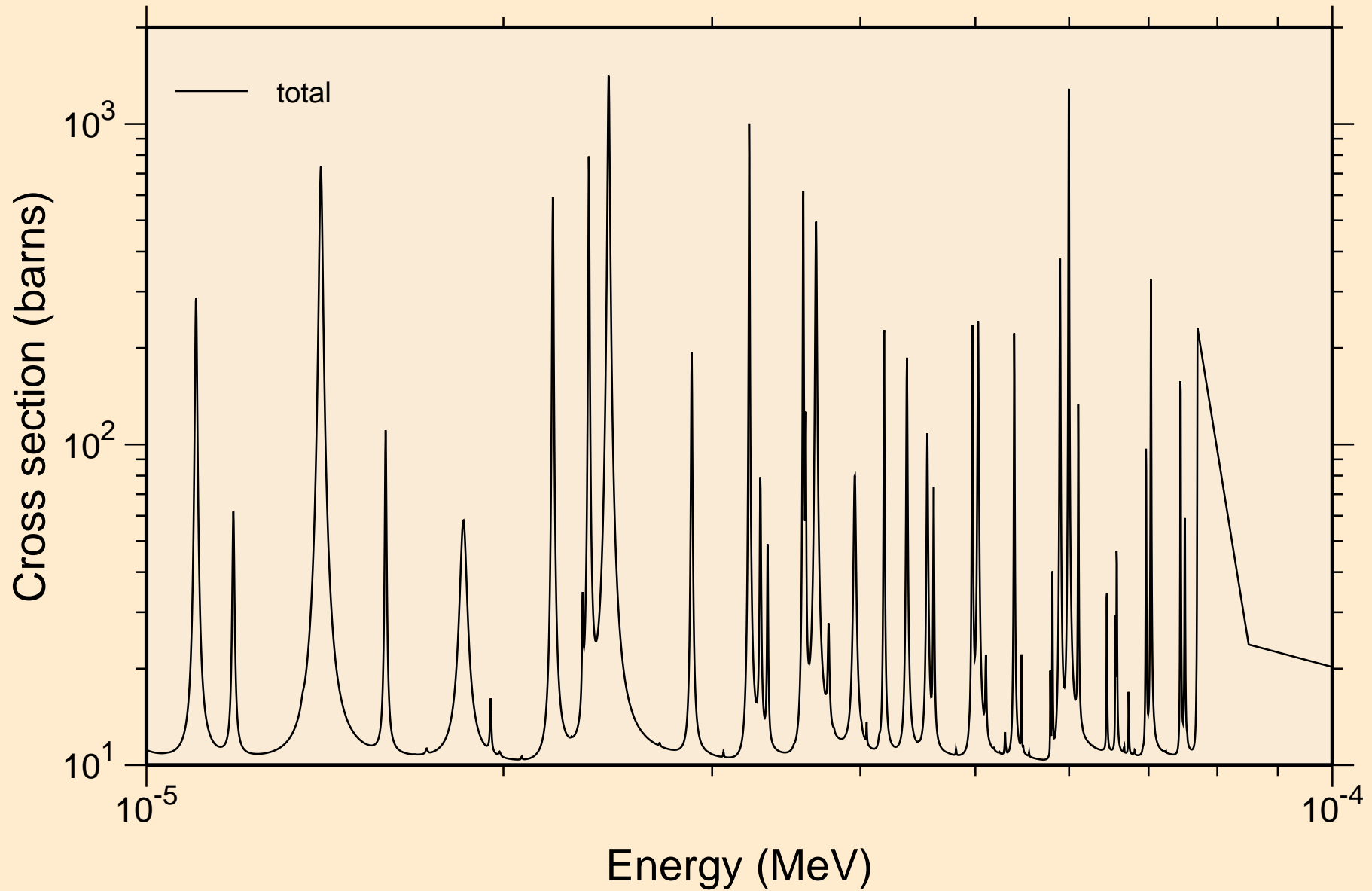

NP245 NEUTRON ACER TENDL-2024 LIBRARY; T=0.K
resonance total cross section

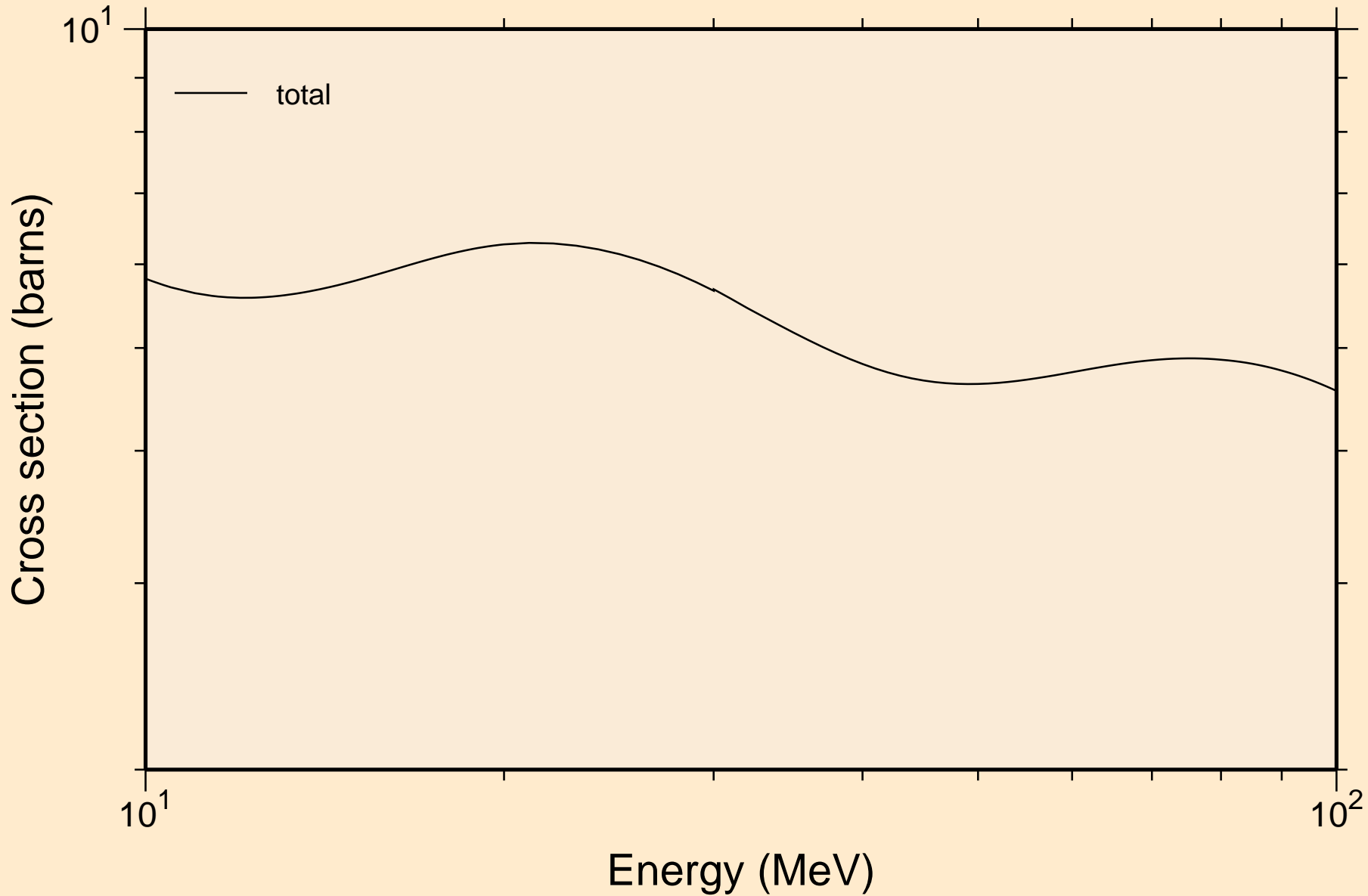

NP245 NEUTRON ACER TENDL-2024 LIBRARY; T=0.K
resonance absorption cross sections

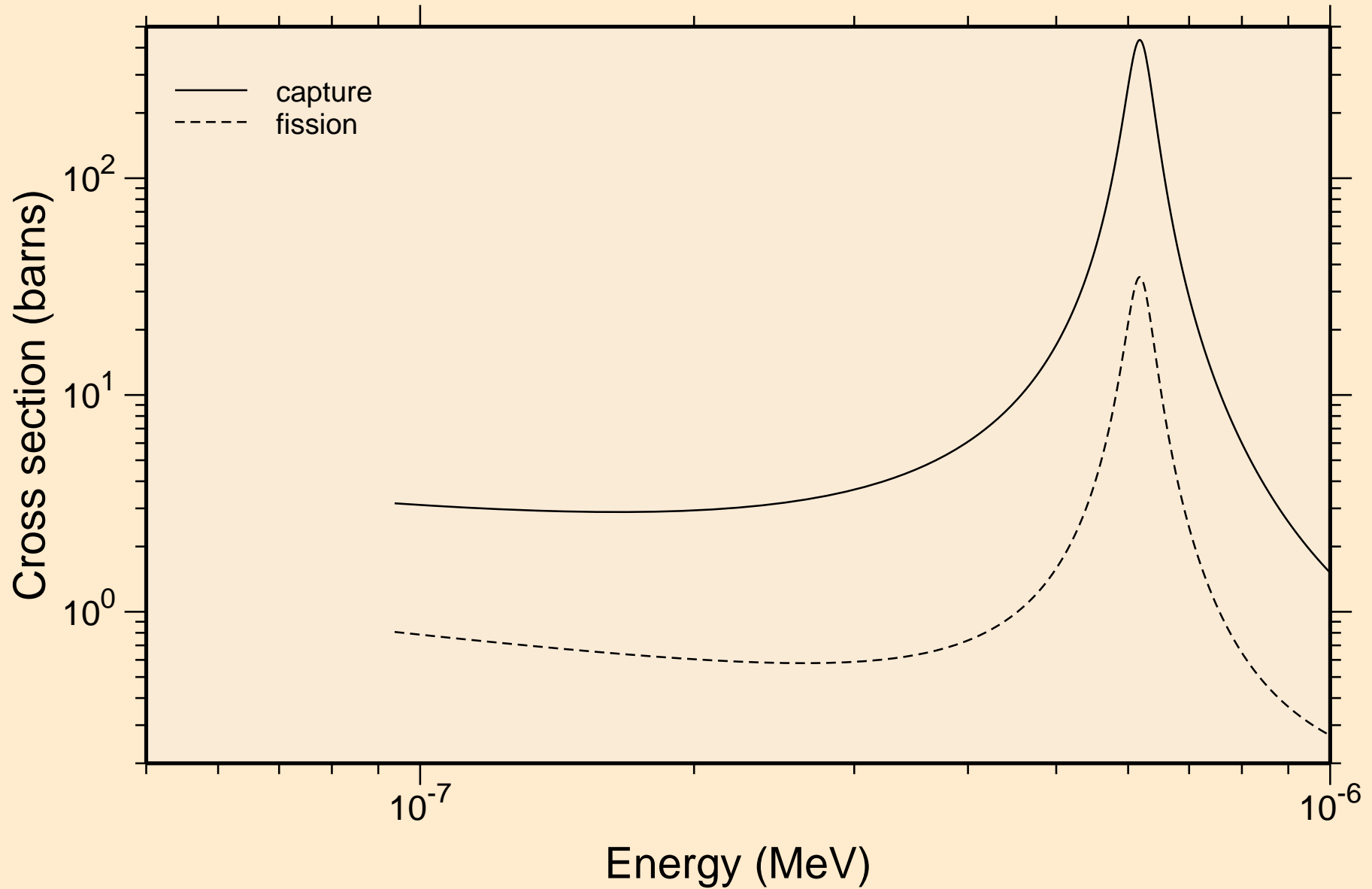

NP245 NEUTRON ACER TENDL-2024 LIBRARY; T=0.K
resonance absorption cross sections

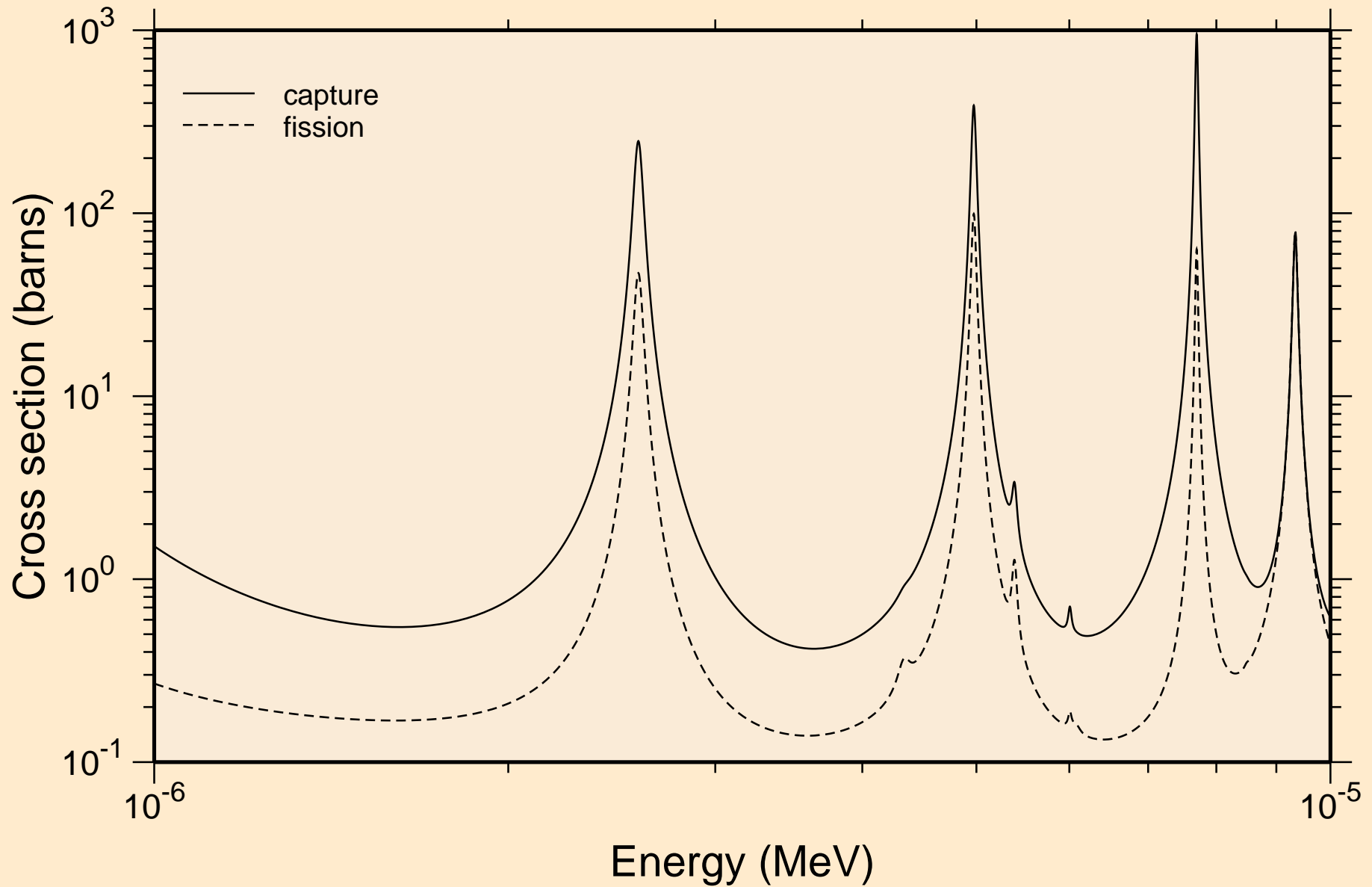

NP245 NEUTRON ACER TENDL-2024 LIBRARY; T=0.K
resonance absorption cross sections

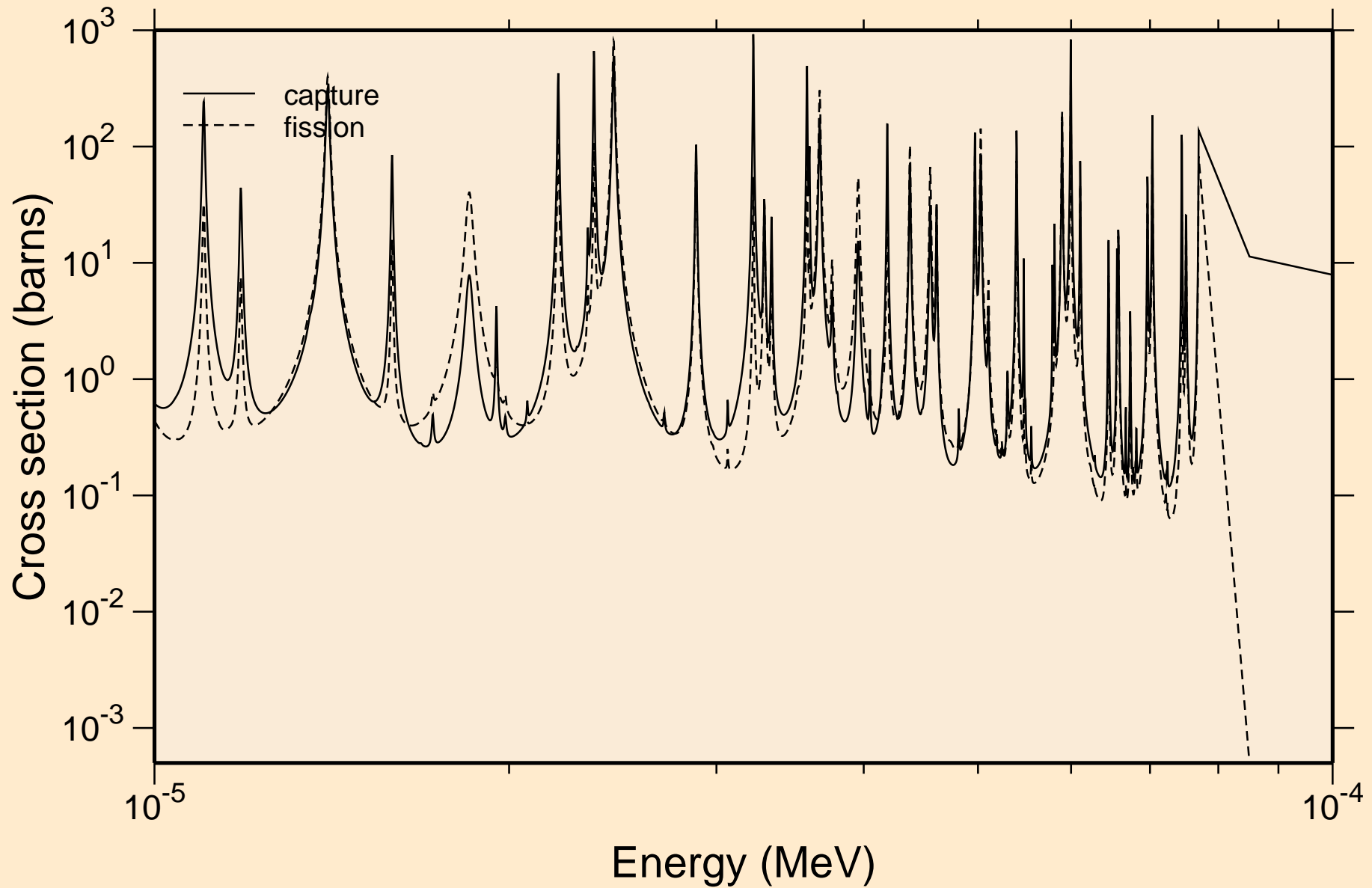

NP245 NEUTRON ACER TENDL-2024 LIBRARY; T=0.K
resonance absorption cross sections

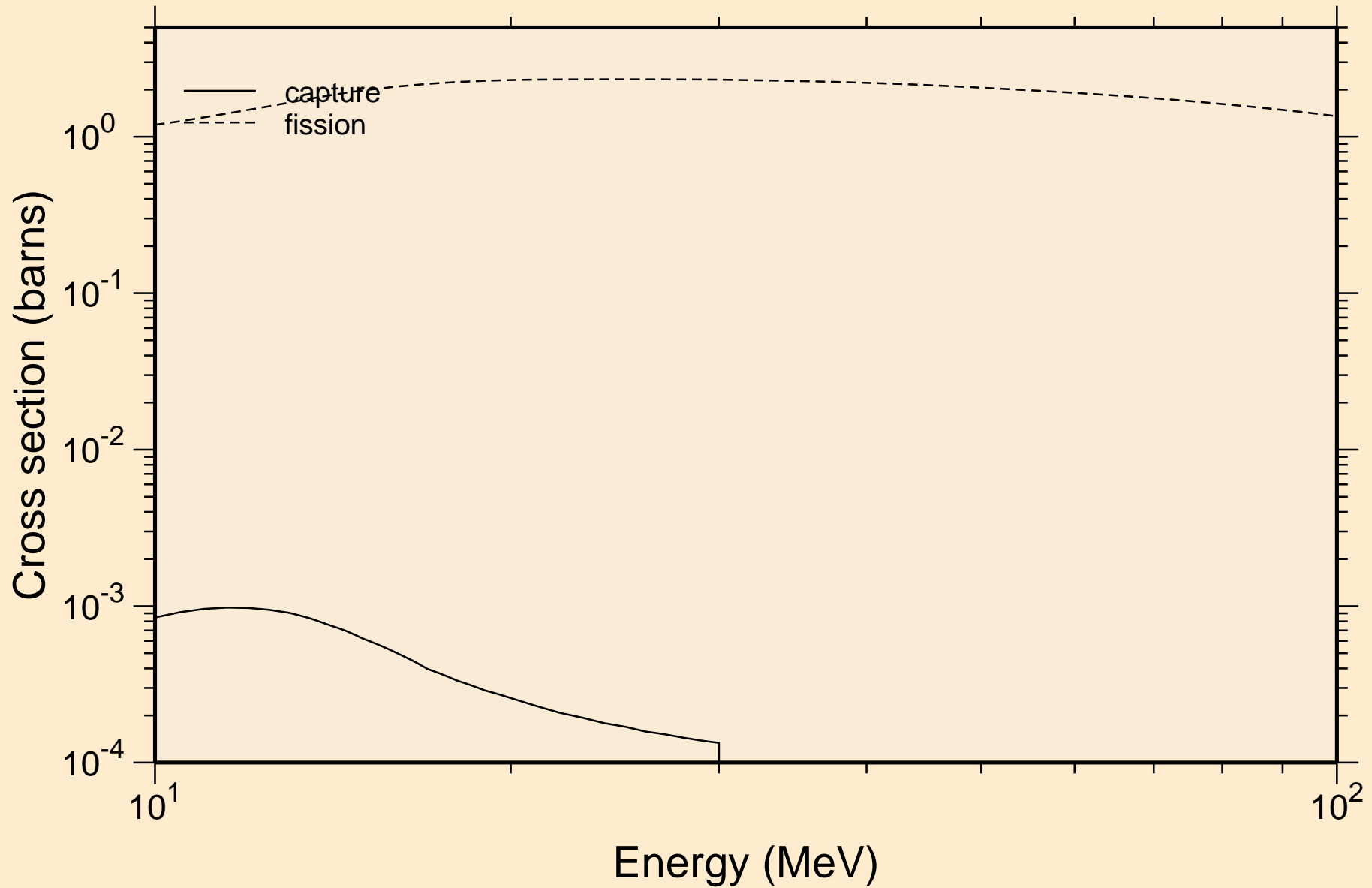

NP245 NEUTRON ACER TENDL-2024 LIBRARY; T=0.K
Heating

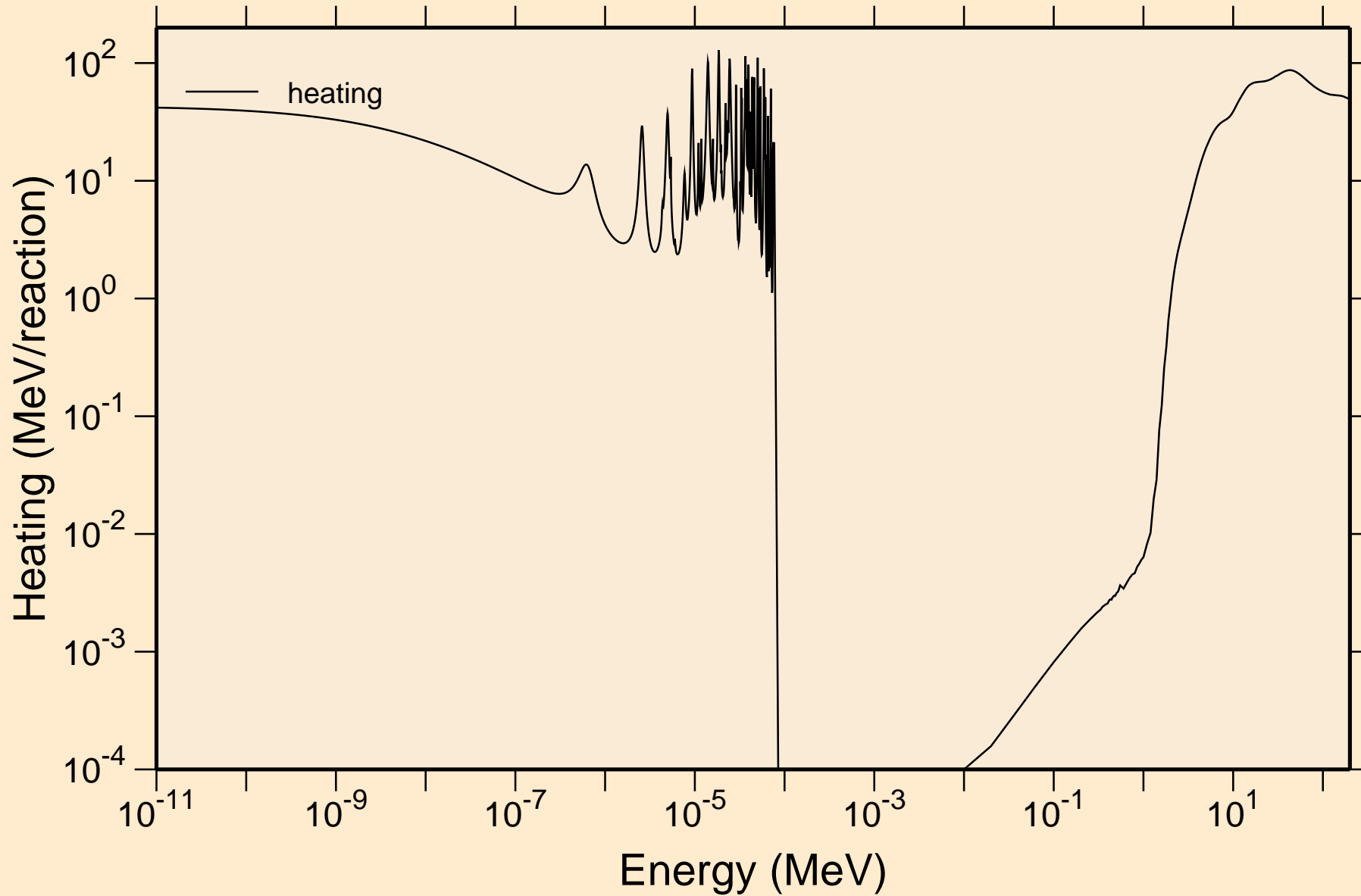

NP245 NEUTRON ACER TENDL-2024 LIBRARY; T=0.K
Damage

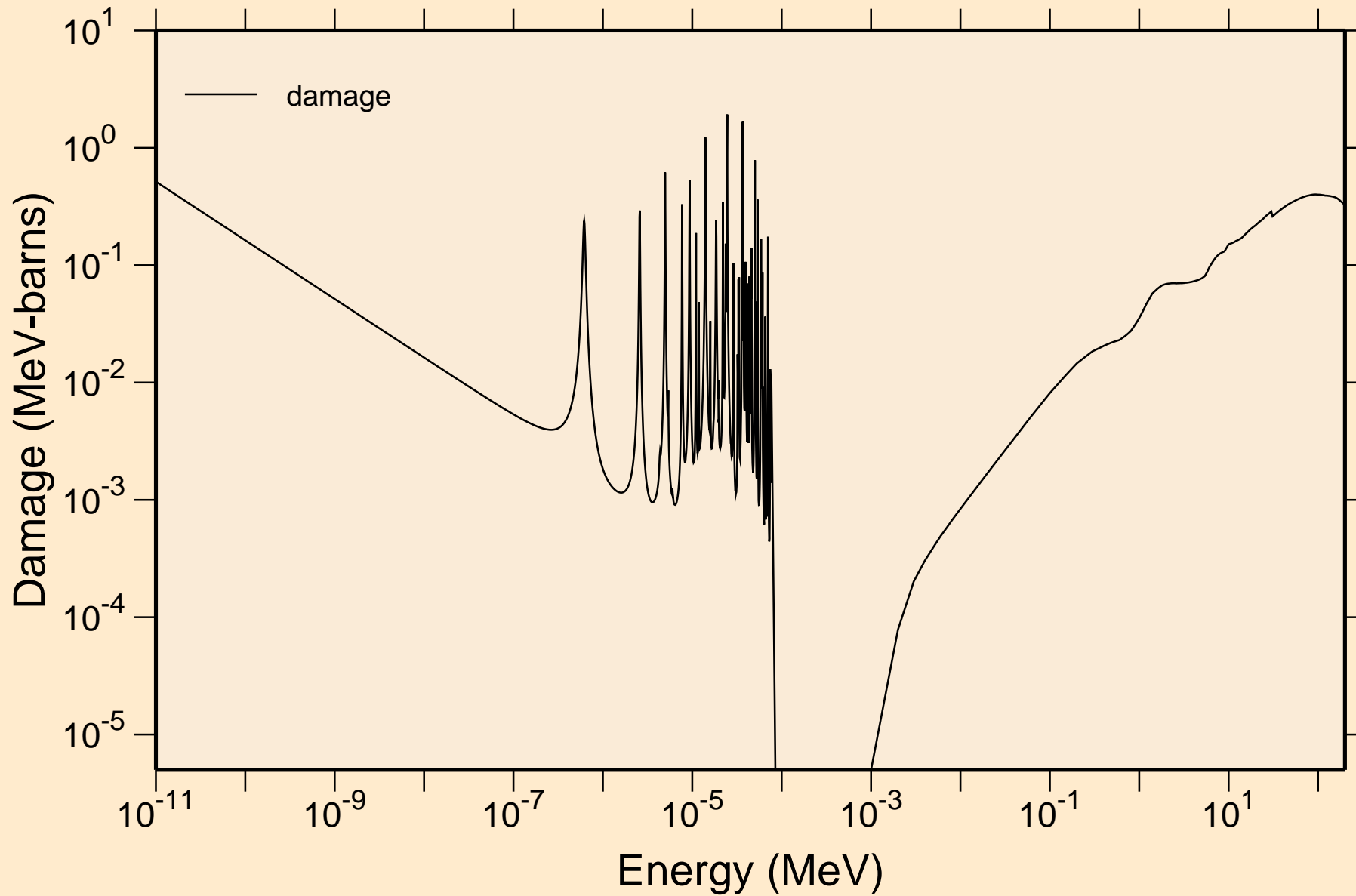

NP245 NEUTRON ACER TENDL-2024 LIBRARY; T=0.K

Non-threshold reactions

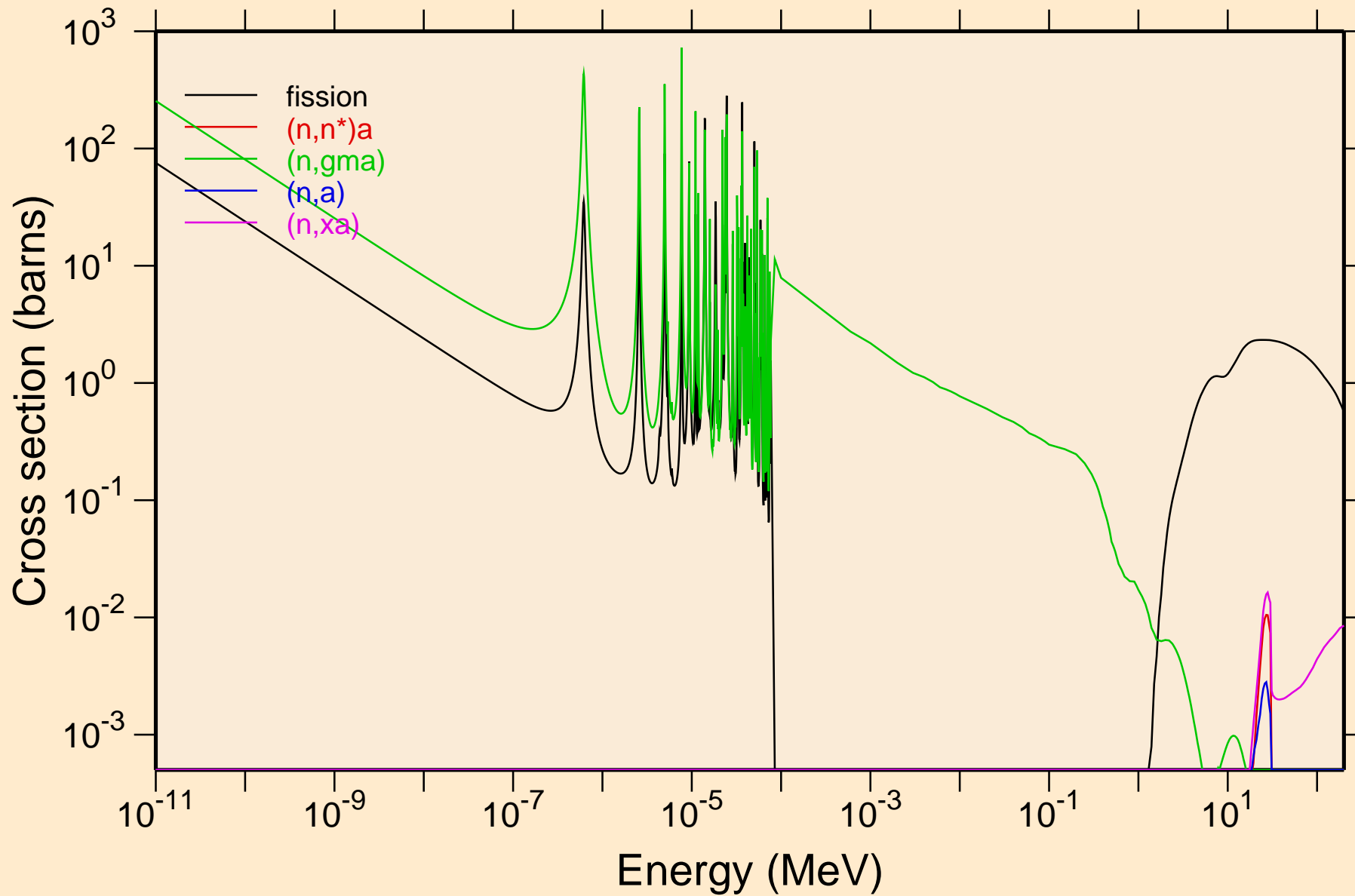

NP245 NEUTRON ACER TENDL-2024 LIBRARY; T=0.K

Principal cross sections

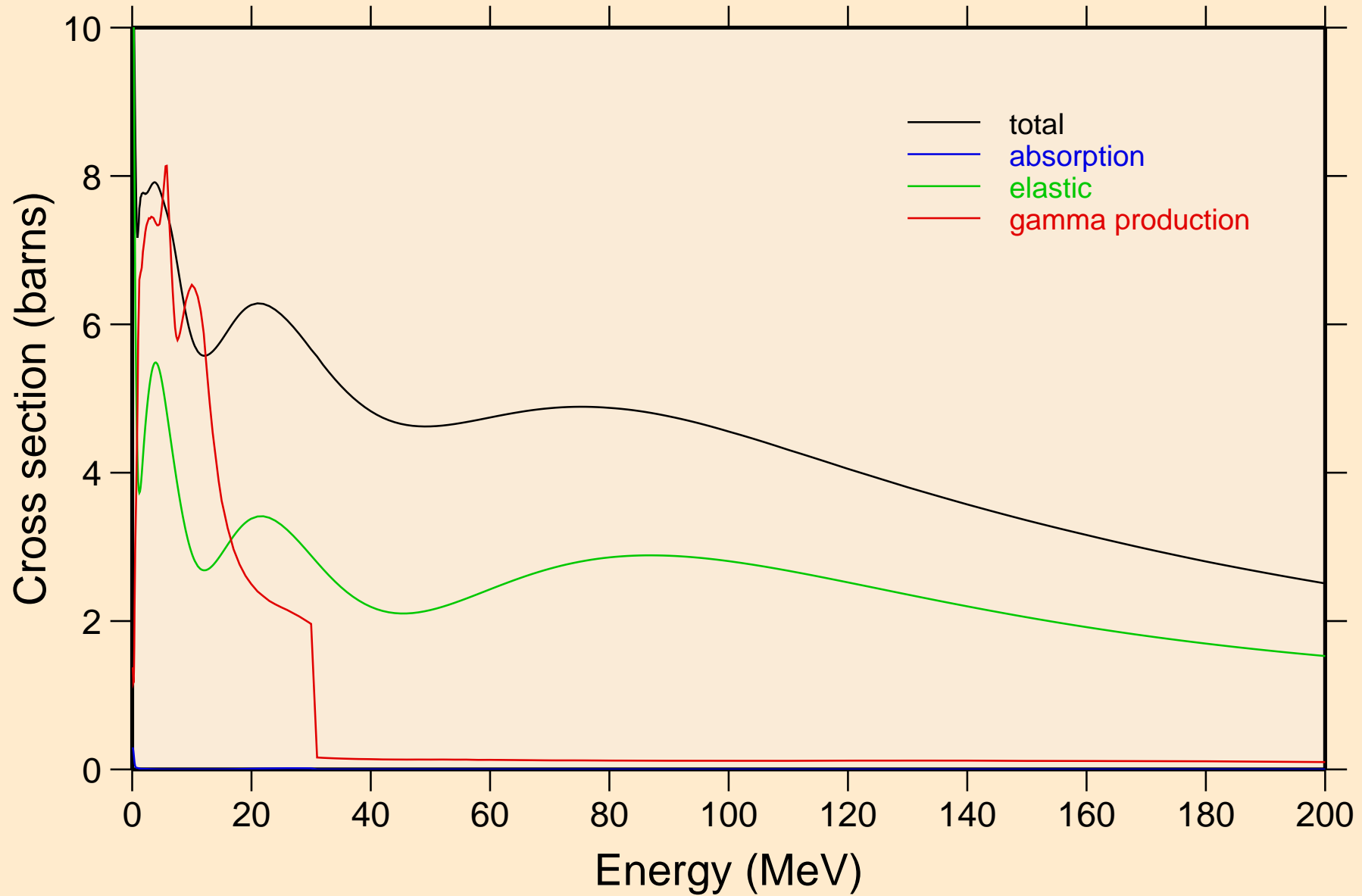

NP245 NEUTRON ACER TENDL-2024 LIBRARY; T=0.K
Heating

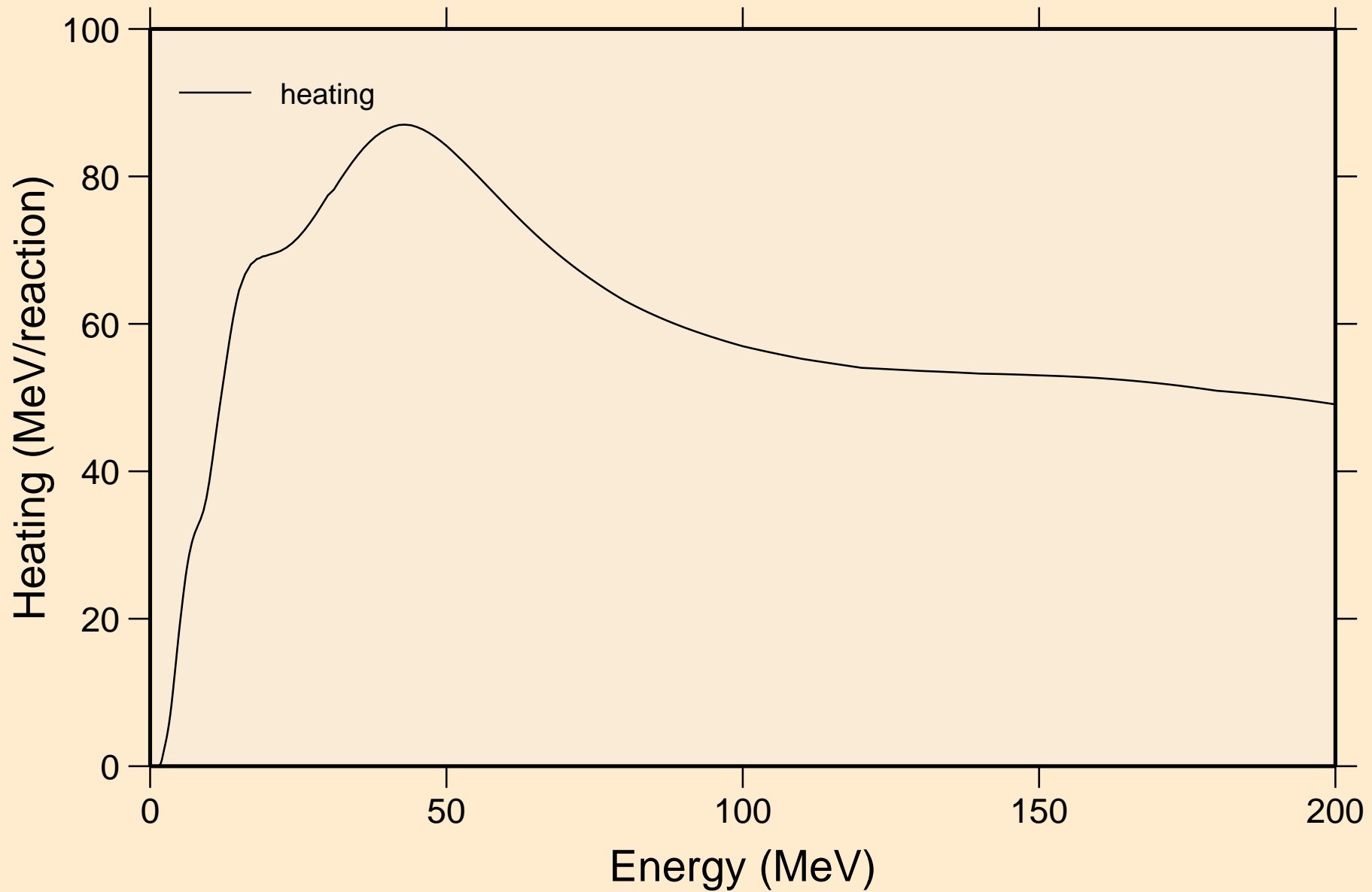

NP245 NEUTRON ACER TENDL-2024 LIBRARY; T=0.K

Damage

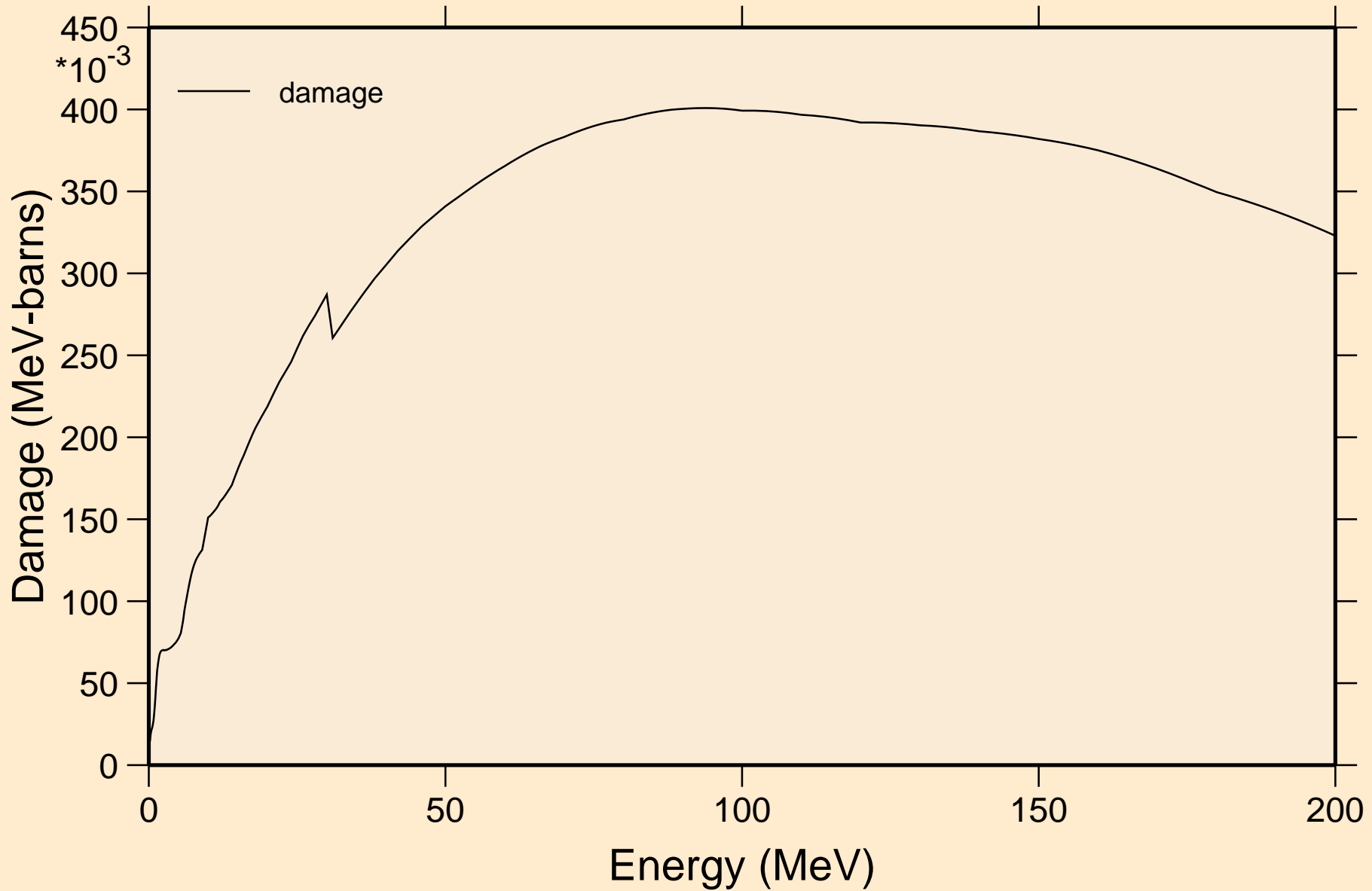

NP245 NEUTRON ACER TENDL-2024 LIBRARY; T=0.K

Non-threshold reactions

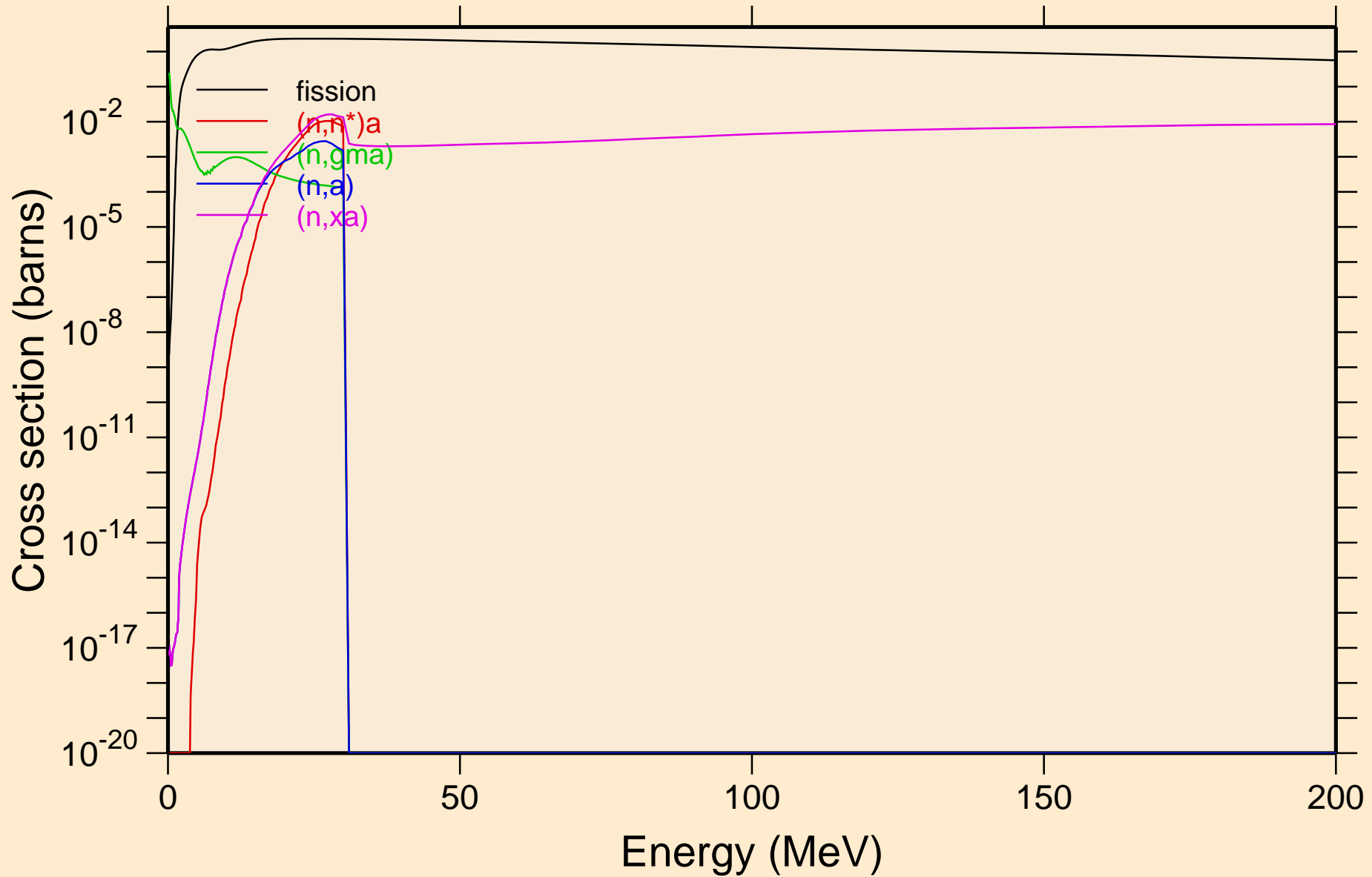

NP245 NEUTRON ACER TENDL-2024 LIBRARY; T=0.K
Inelastic levels

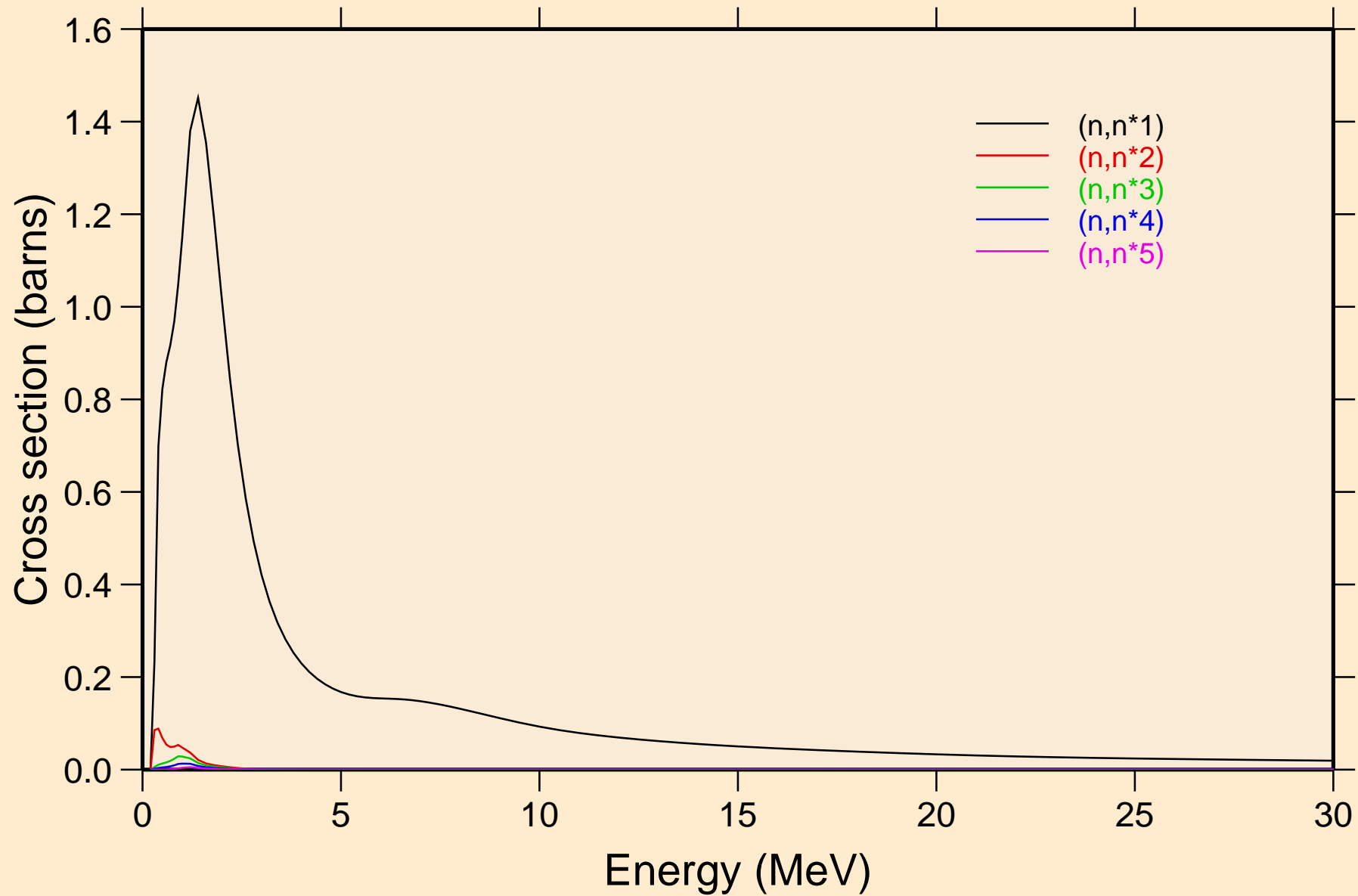

NP245 NEUTRON ACER TENDL-2024 LIBRARY; T=0.K
Inelastic levels

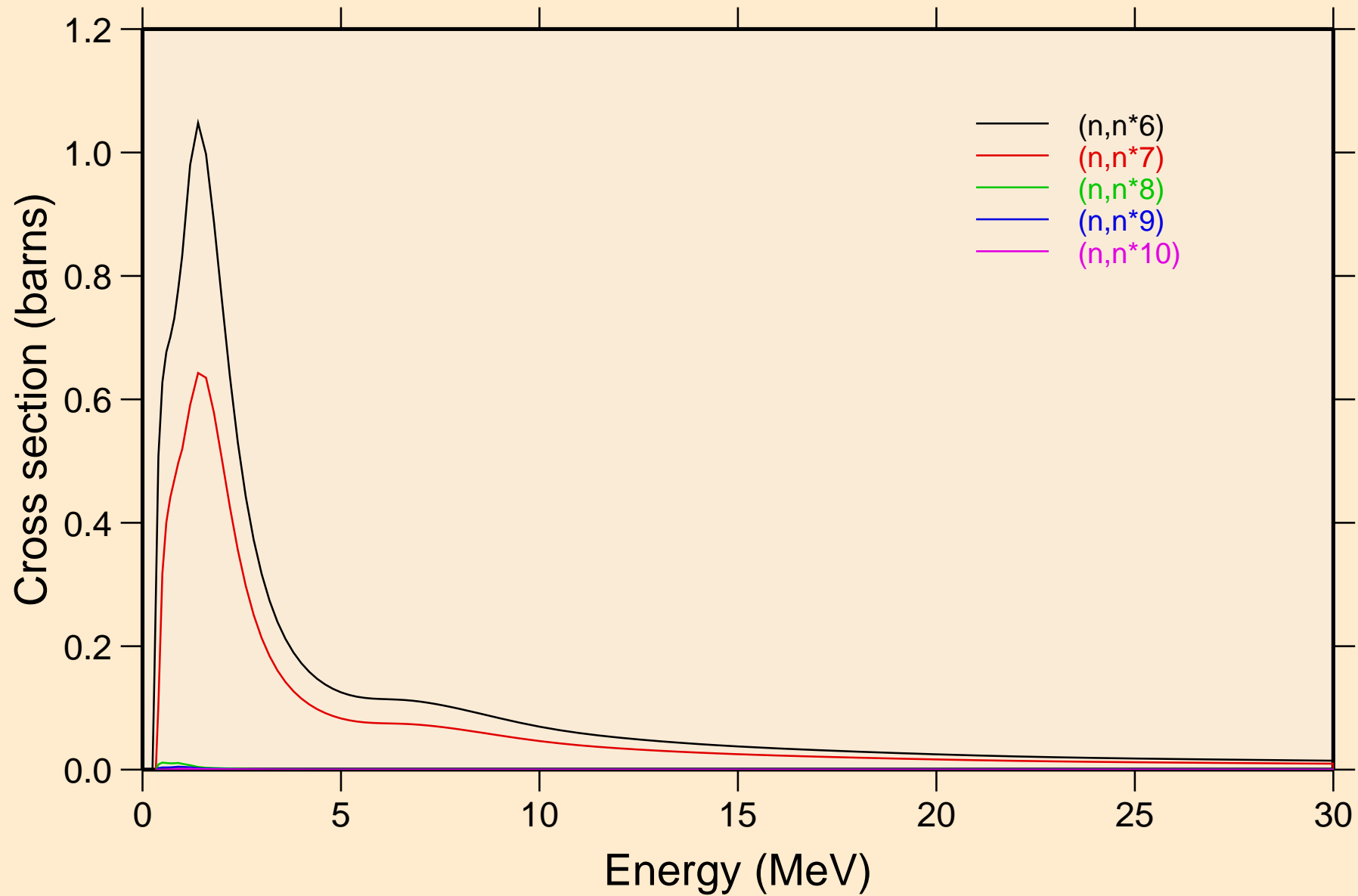

NP245 NEUTRON ACER TENDL-2024 LIBRARY; T=0.K
Inelastic levels

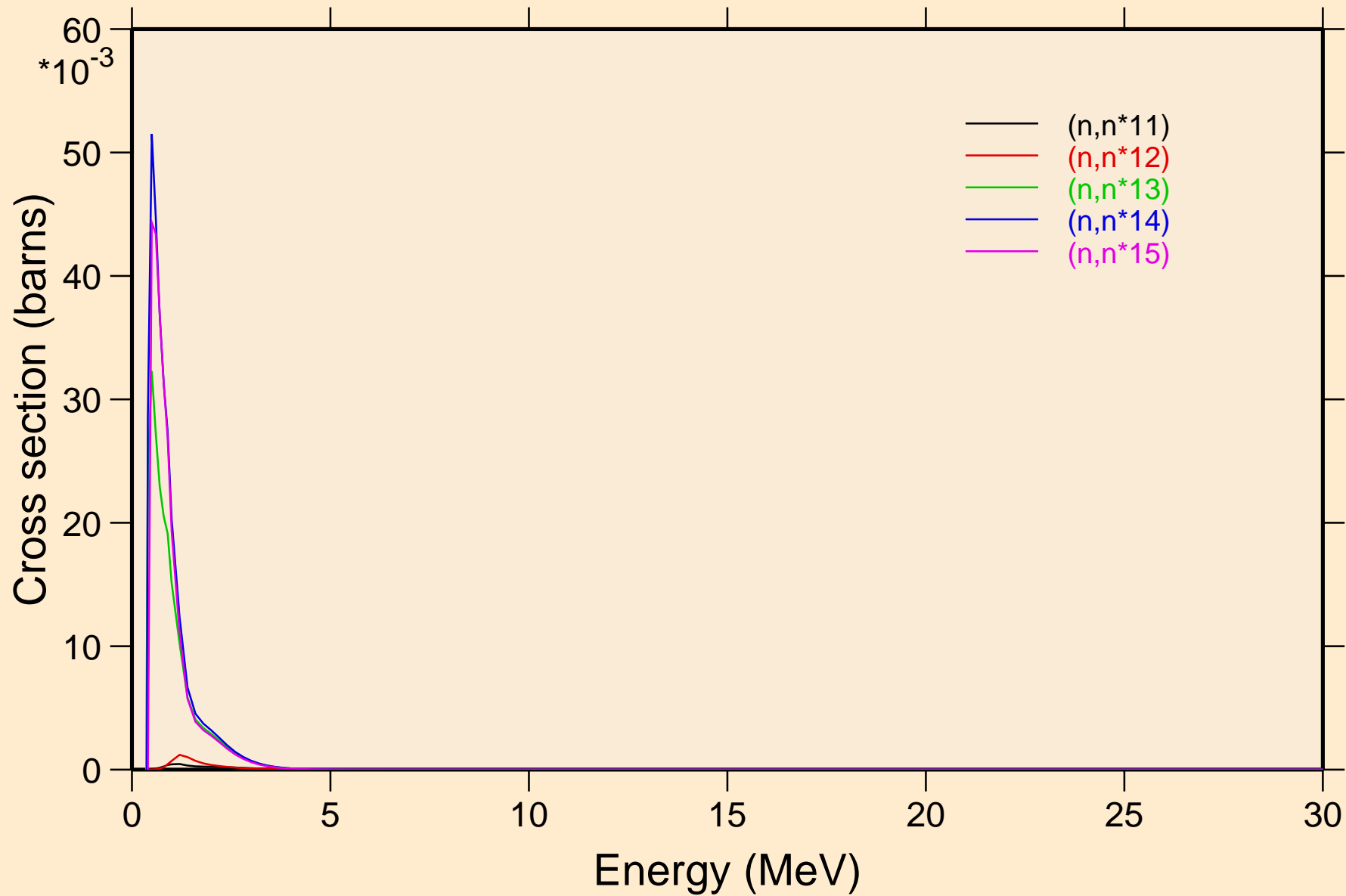

NP245 NEUTRON ACER TENDL-2024 LIBRARY; T=0.K

Inelastic levels

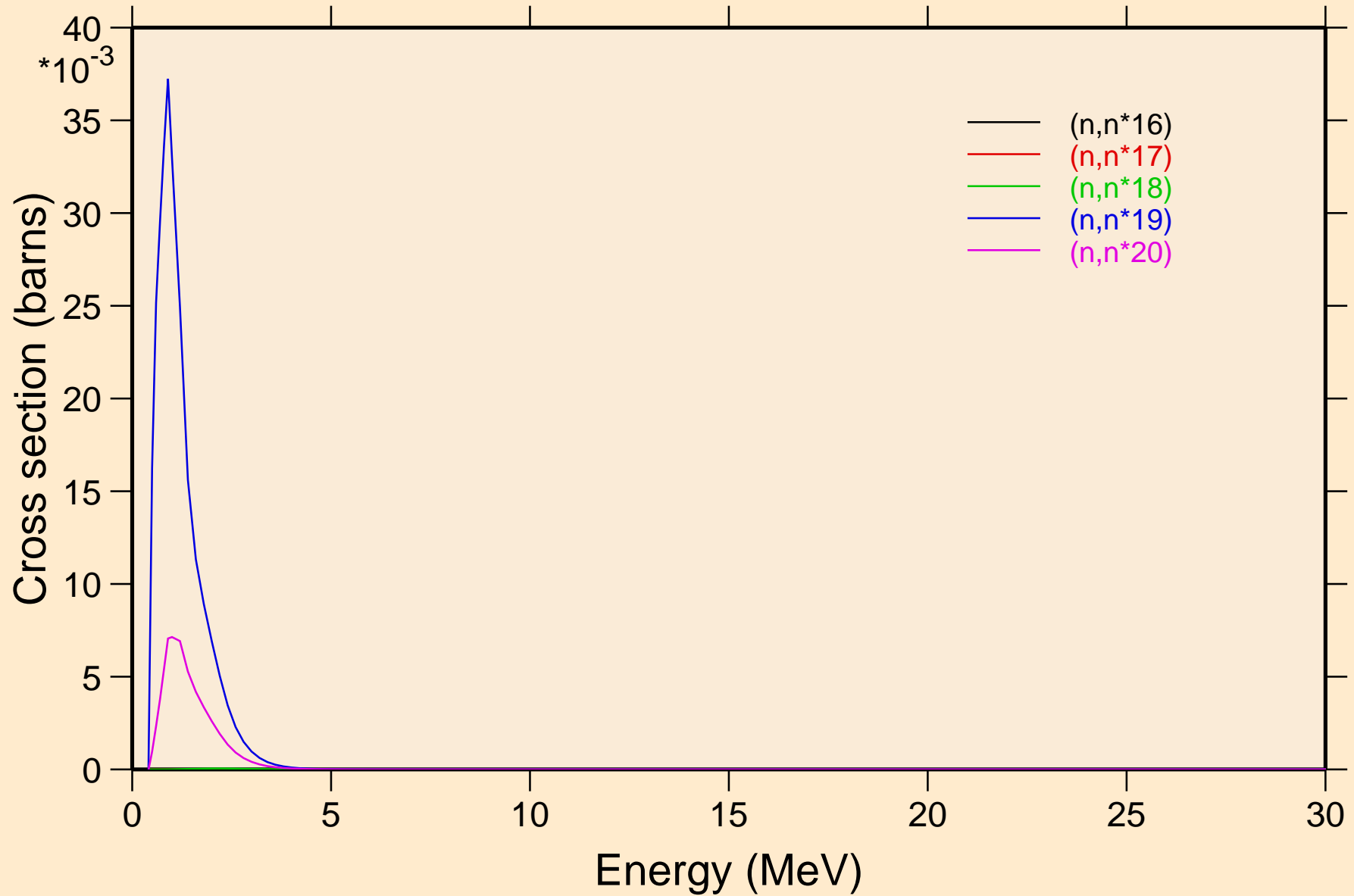

NP245 NEUTRON ACER TENDL-2024 LIBRARY; T=0.K

Inelastic levels

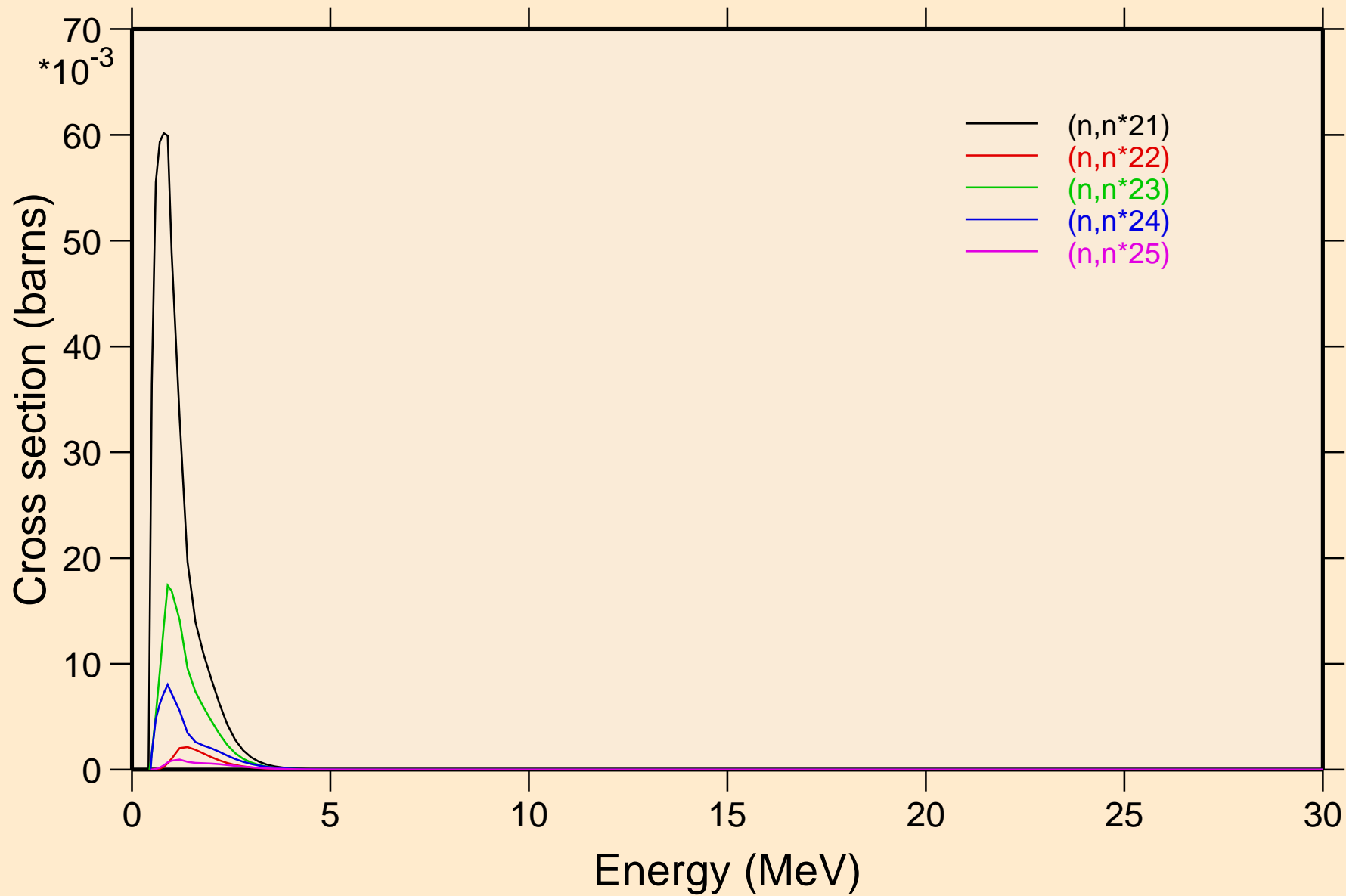

NP245 NEUTRON ACER TENDL-2024 LIBRARY; T=0.K
Inelastic levels

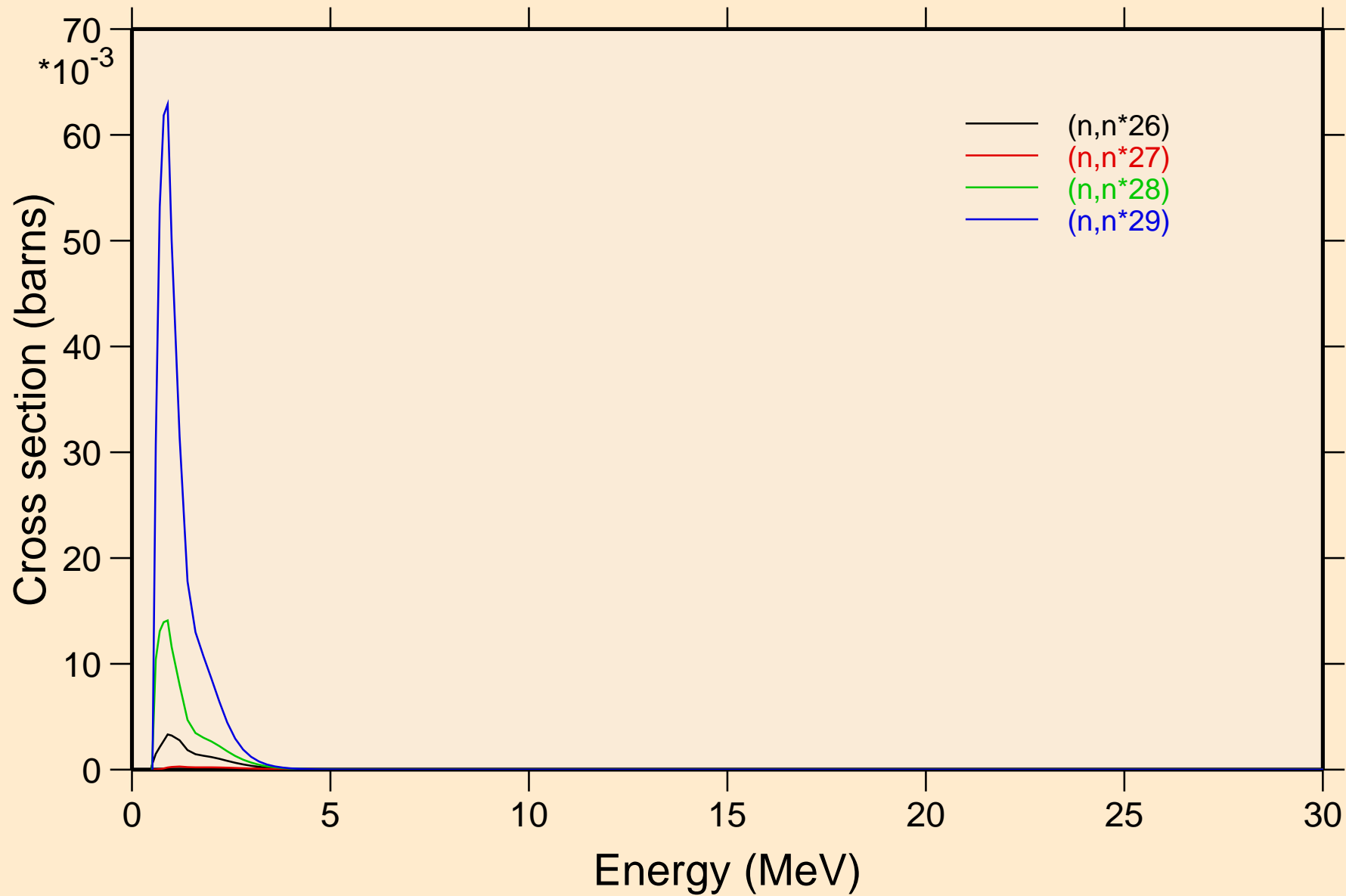

NP245 NEUTRON ACER TENDL-2024 LIBRARY; T=0.K

Threshold reactions

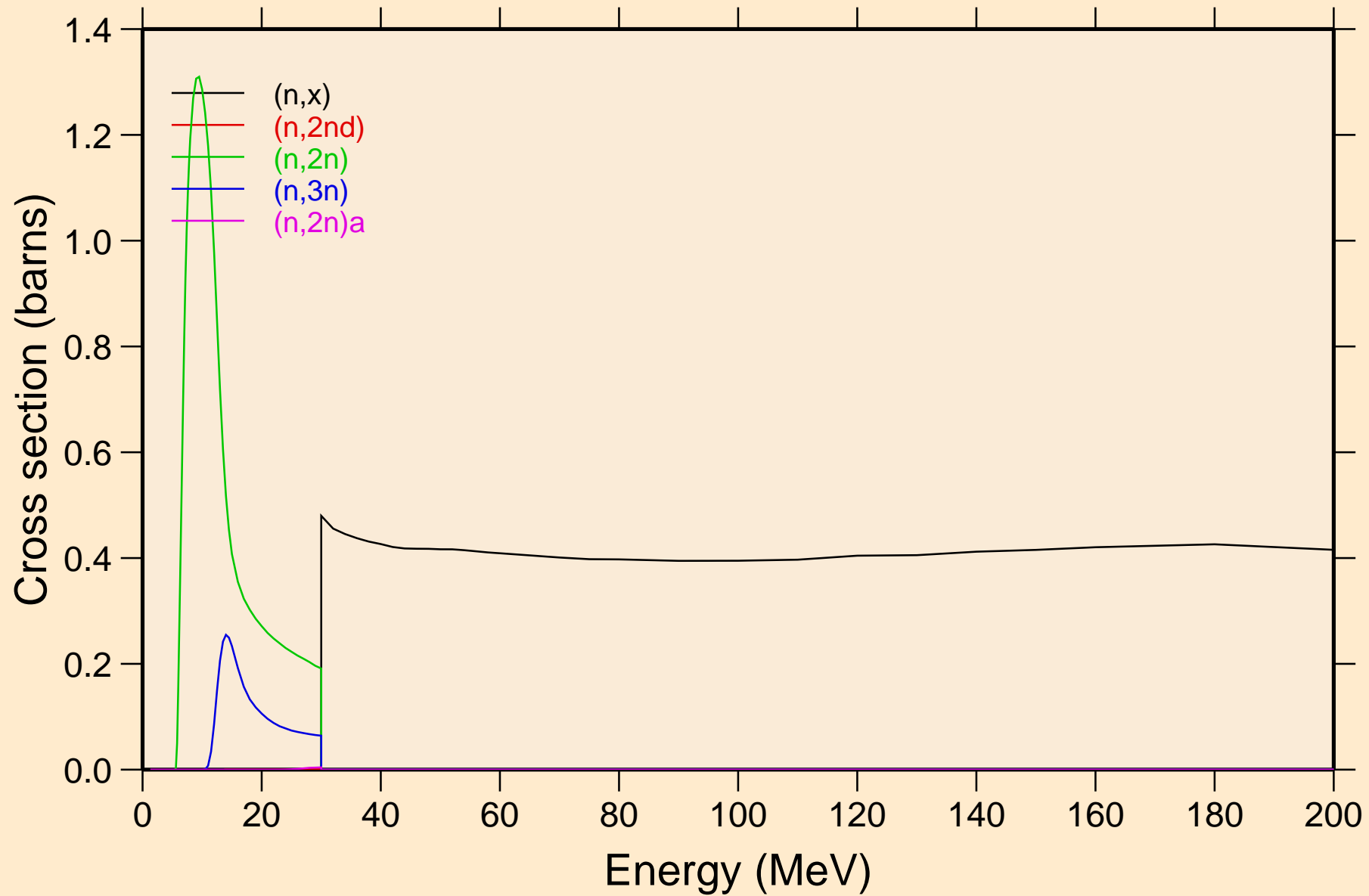

NP245 NEUTRON ACER TENDL-2024 LIBRARY; T=0.K

Threshold reactions

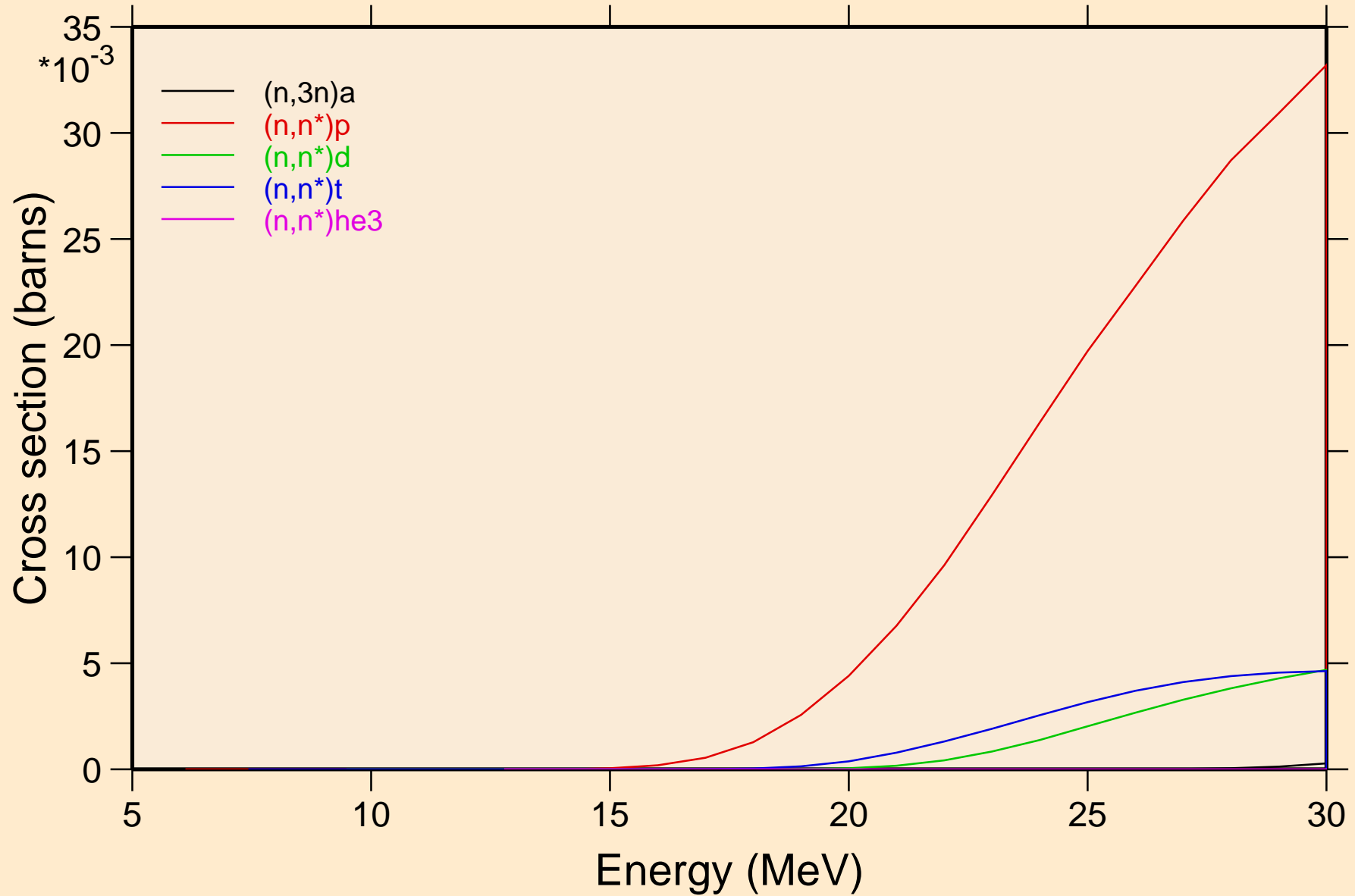

NP245 NEUTRON ACER TENDL-2024 LIBRARY; T=0.K
Threshold reactions

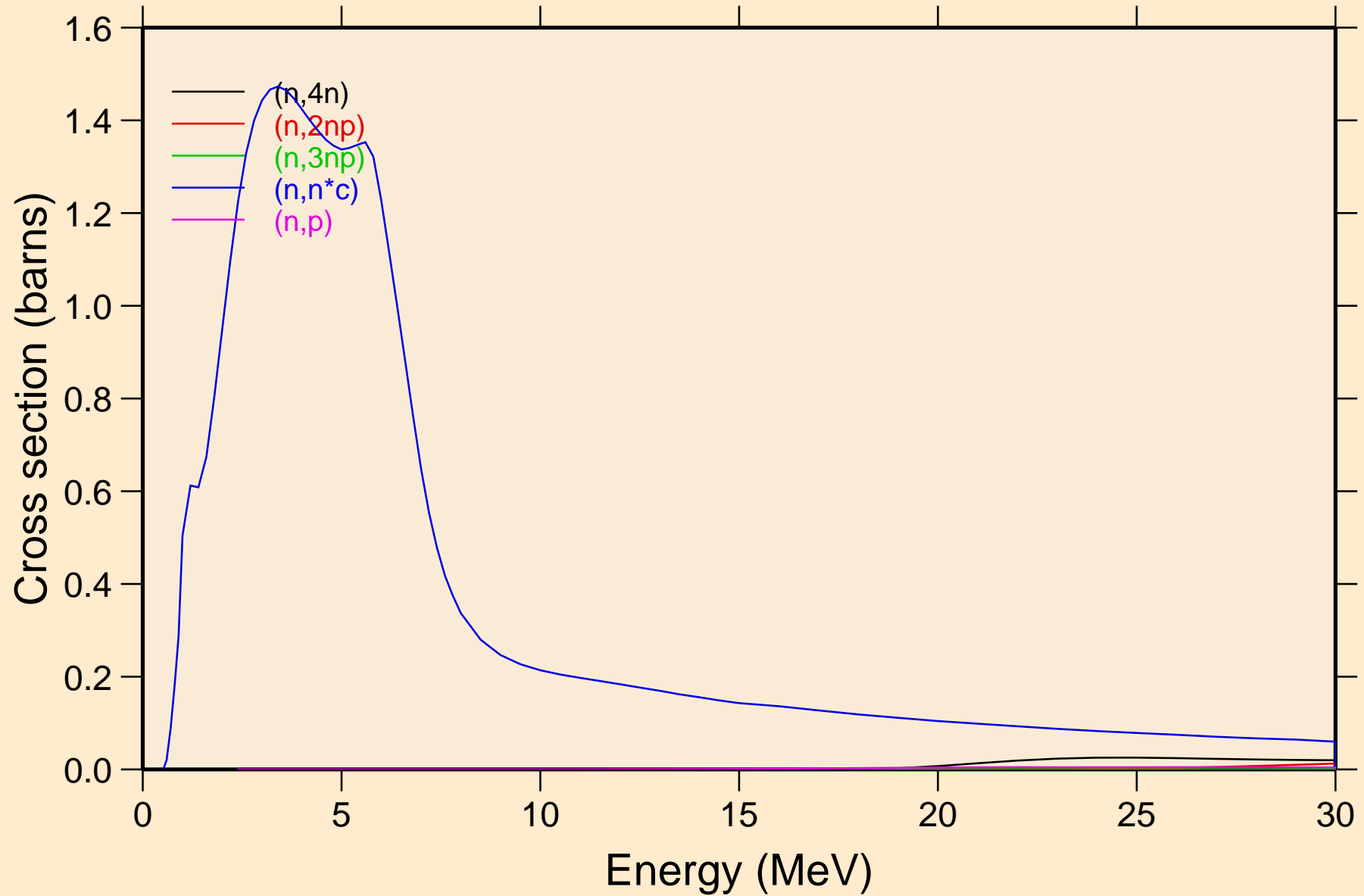

NP245 NEUTRON ACER TENDL-2024 LIBRARY; T=0.K

Threshold reactions

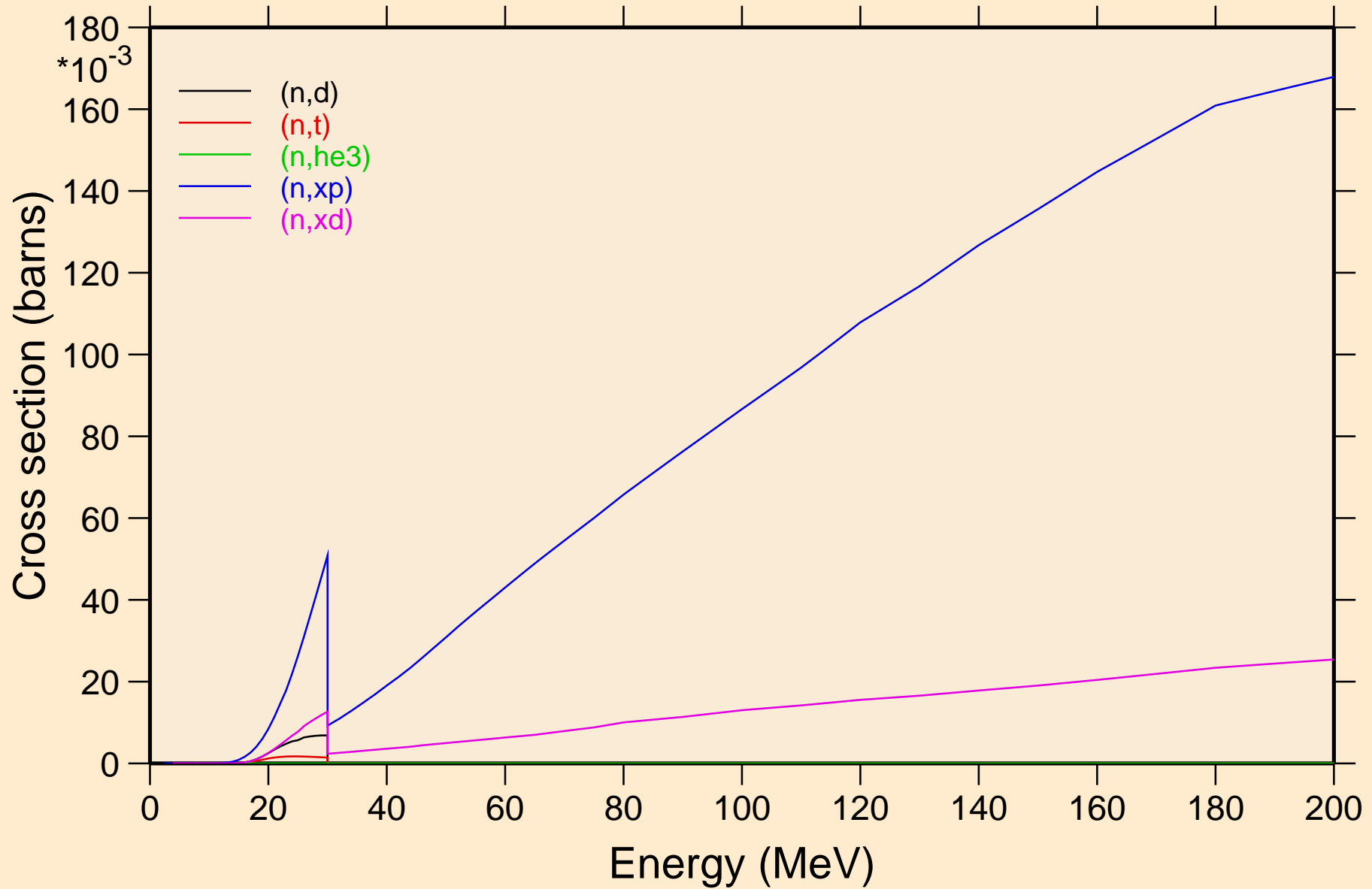

NP245 NEUTRON ACER TENDL-2024 LIBRARY; T=0.K

Threshold reactions

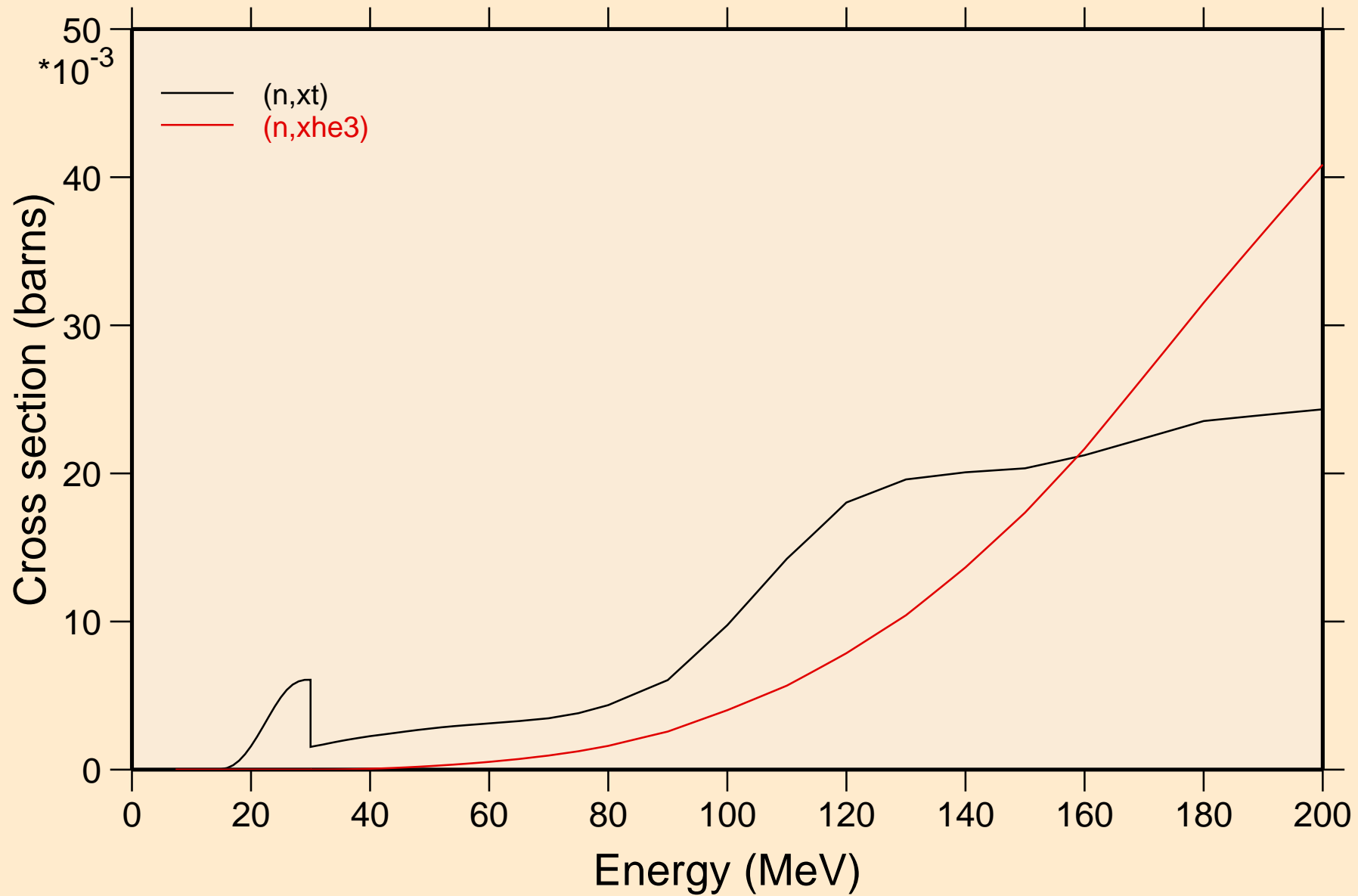

NP245 NEUTRON ACER TENDL-2024 LIBRARY; T=0.K
angular distribution for elastic

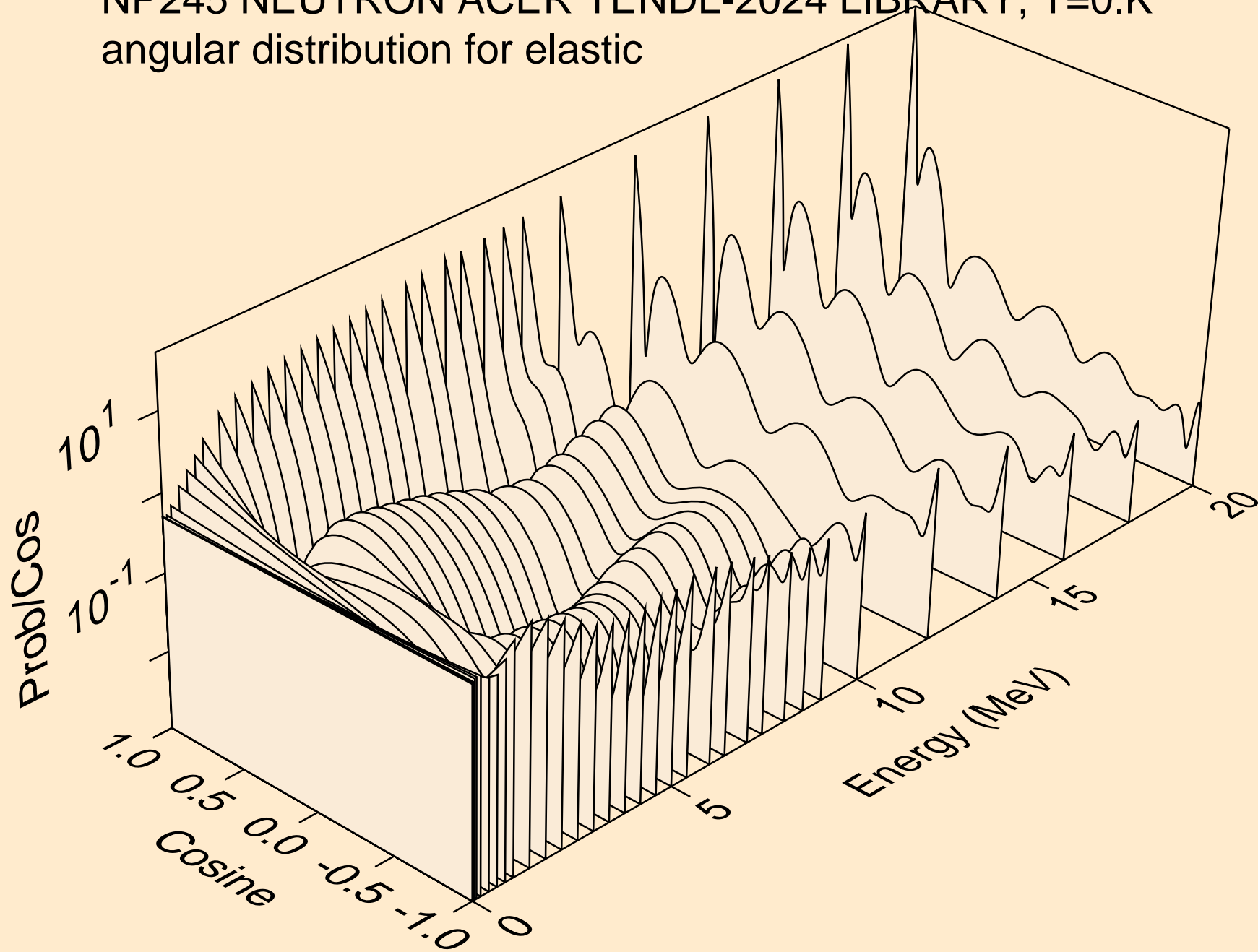

NP245 NEUTRON ACER TENDL-2024 LIBRARY; T=0.K
angular distribution for elastic

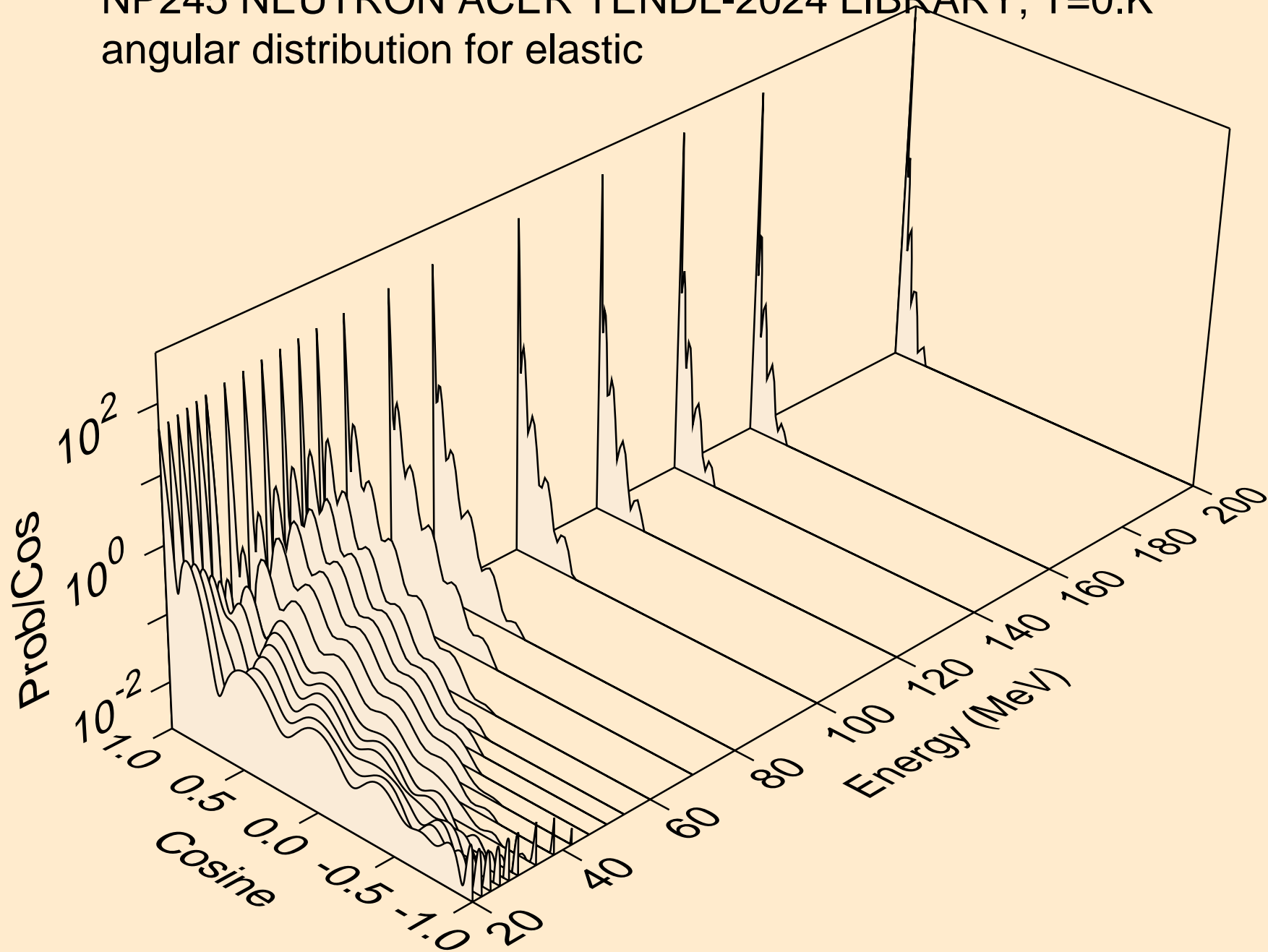

NP245 NEUTRON ACER TENDL-2024 LIBRARY; T=0.K
angular distribution for (n,n*1)

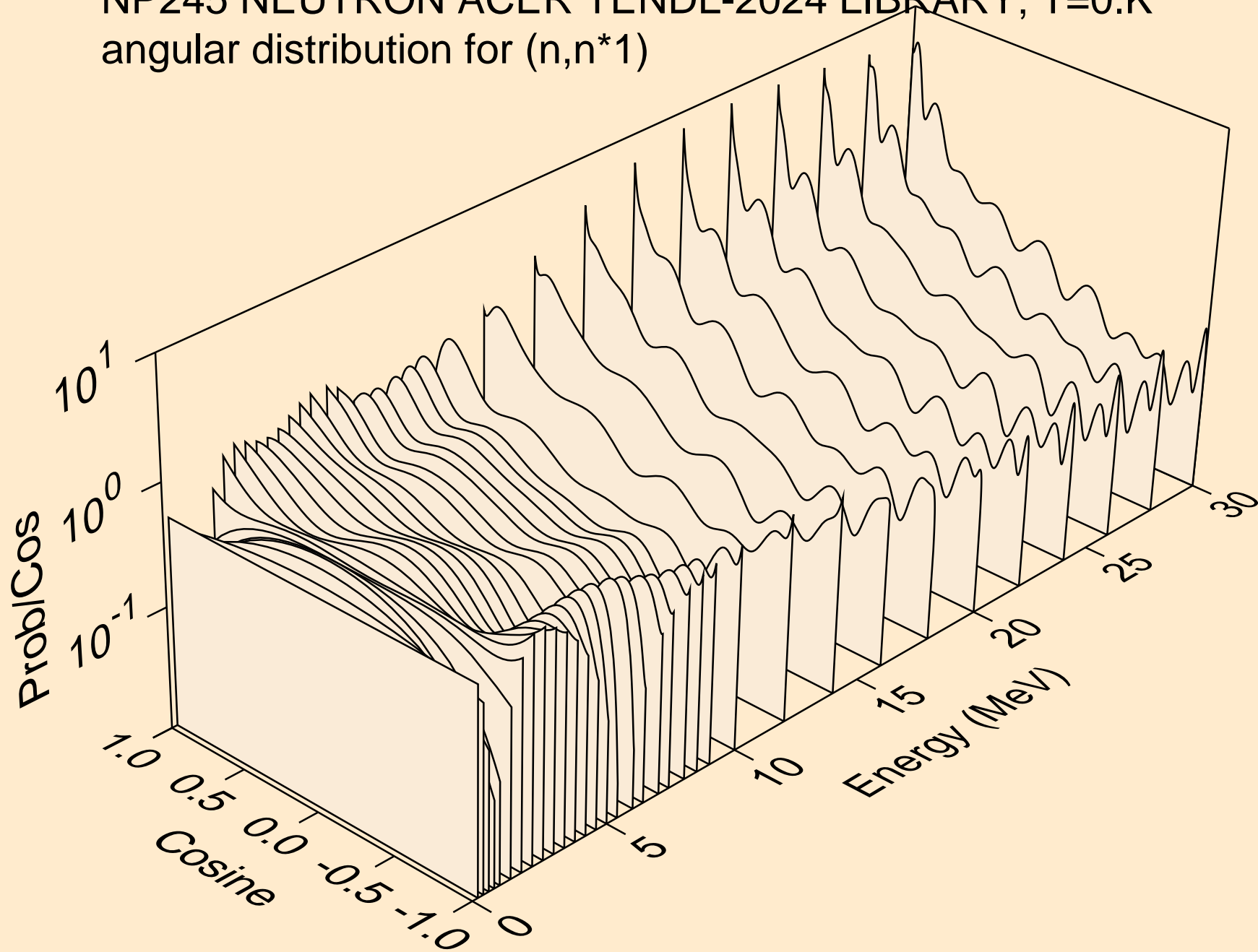

NP245 NEUTRON ACER TENDL-2024 LIBRARY; T=0.K
angular distribution for (n,n*2)

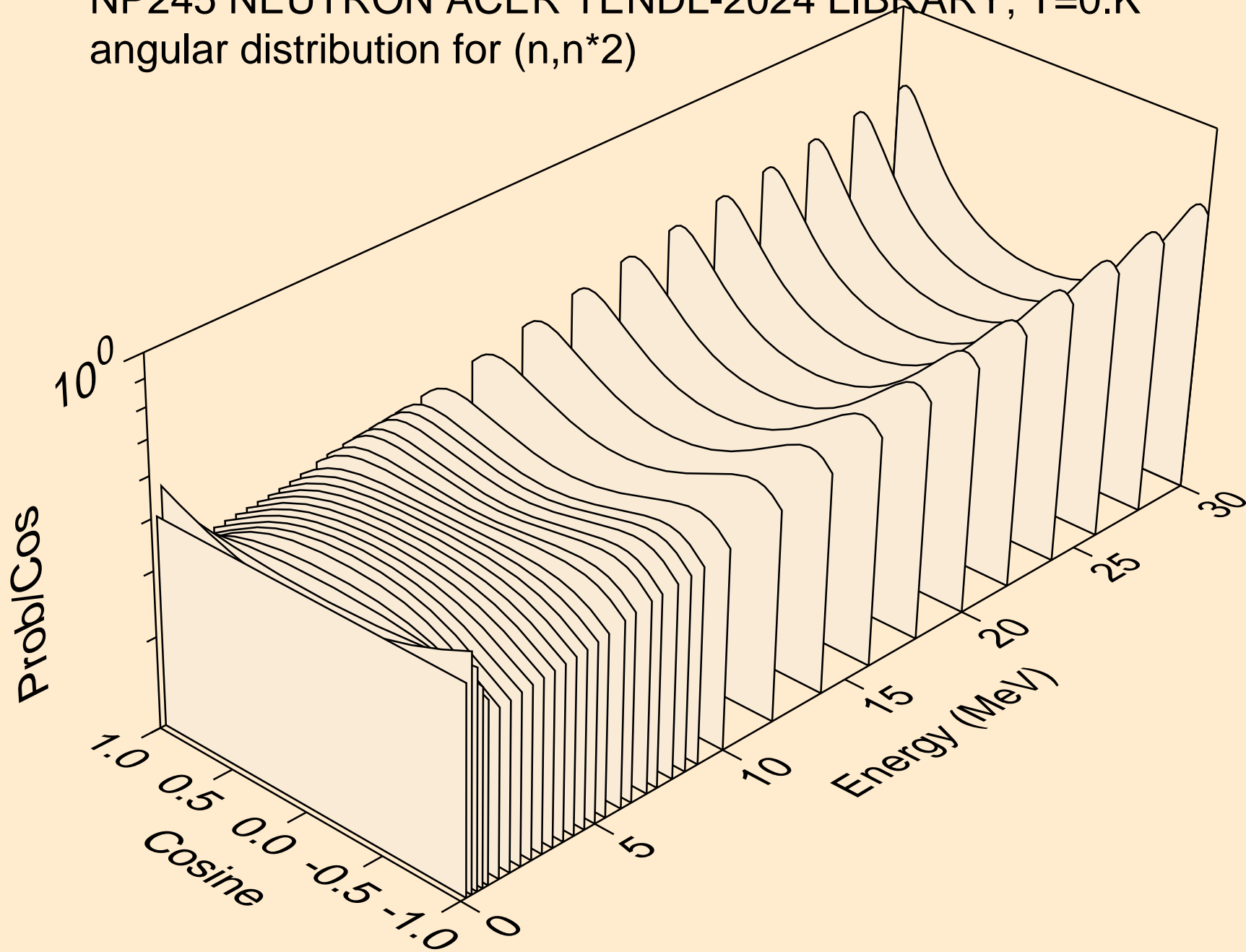

NP245 NEUTRON ACER TENDL-2024 LIBRARY; T=0.K
angular distribution for (n,n*3)

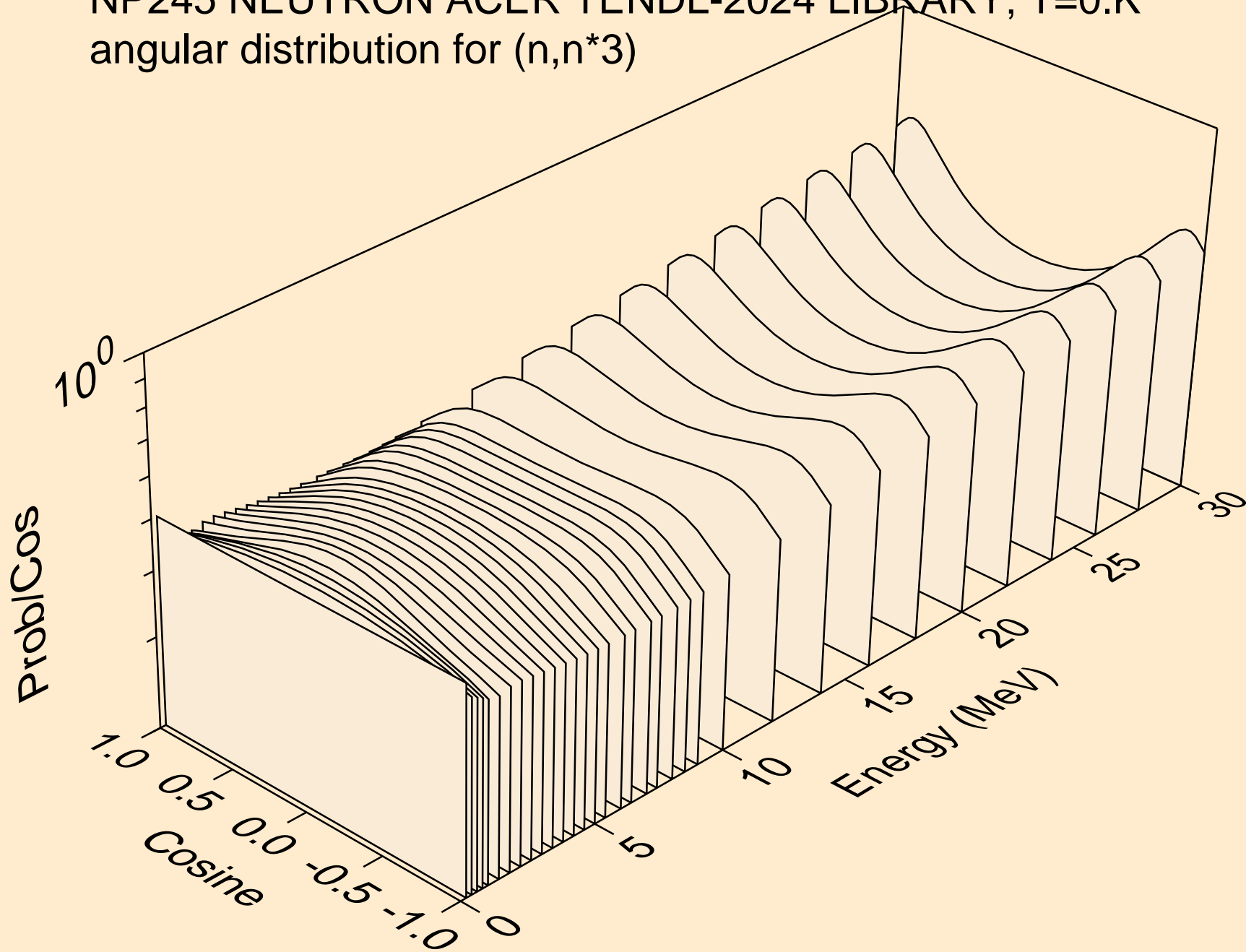

NP245 NEUTRON ACER TENDL-2024 LIBRARY; T=0.K
angular distribution for (n,n*4)

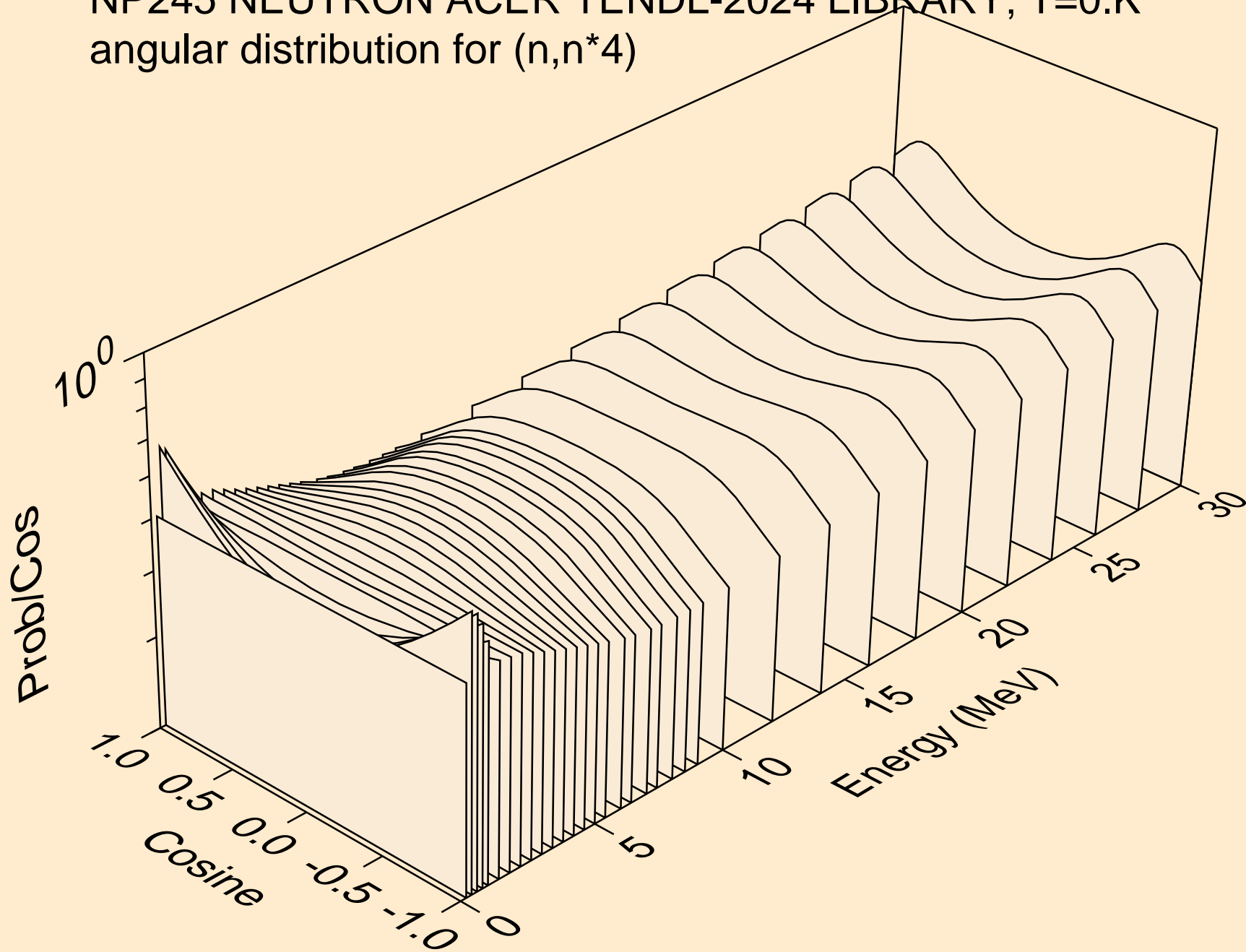

NP245 NEUTRON ACER TENDL-2024 LIBRARY; T=0.K
angular distribution for (n,n*5)

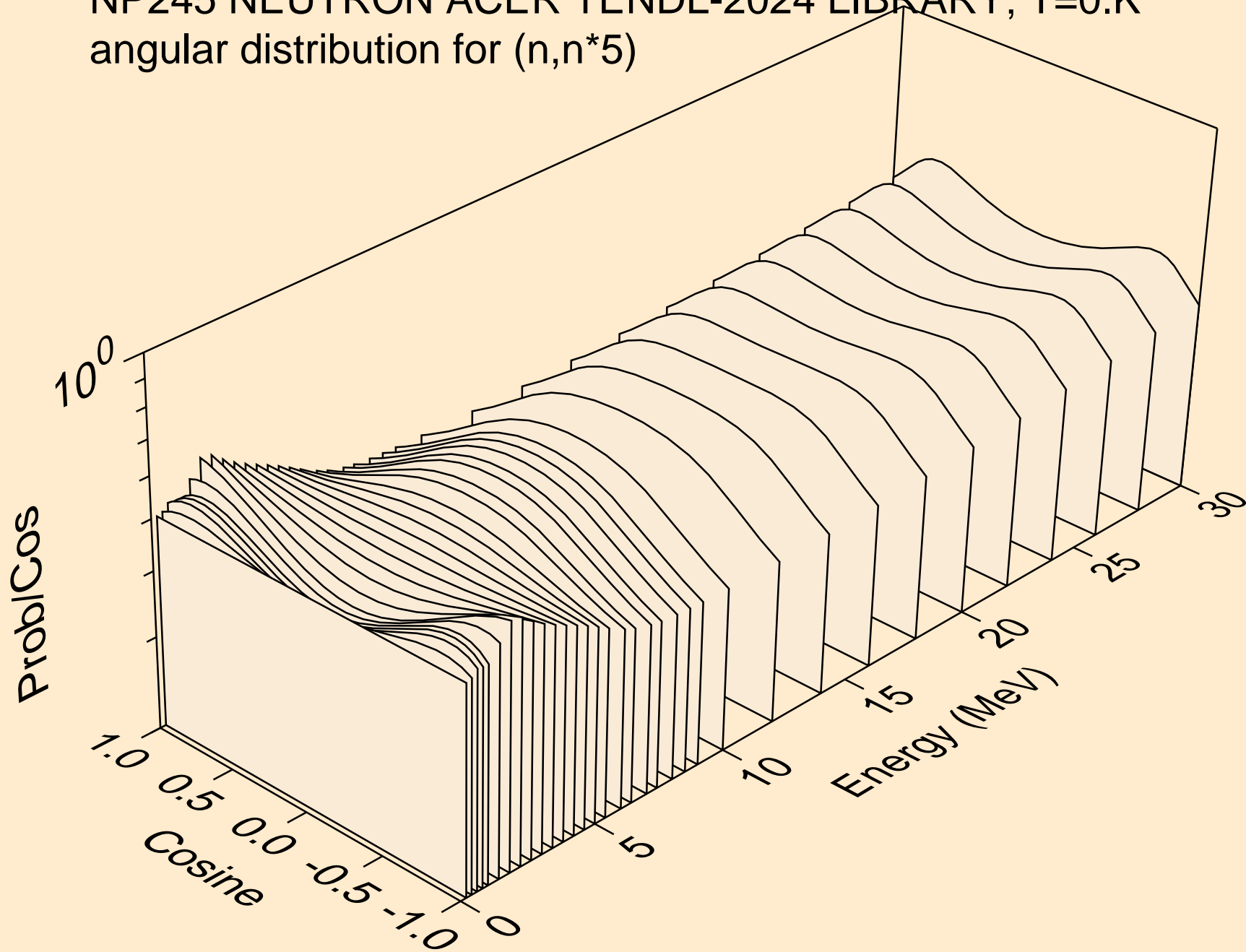

NP245 NEUTRON ACER TENDL-2024 LIBRARY; T=0.K
angular distribution for (n,n*6)

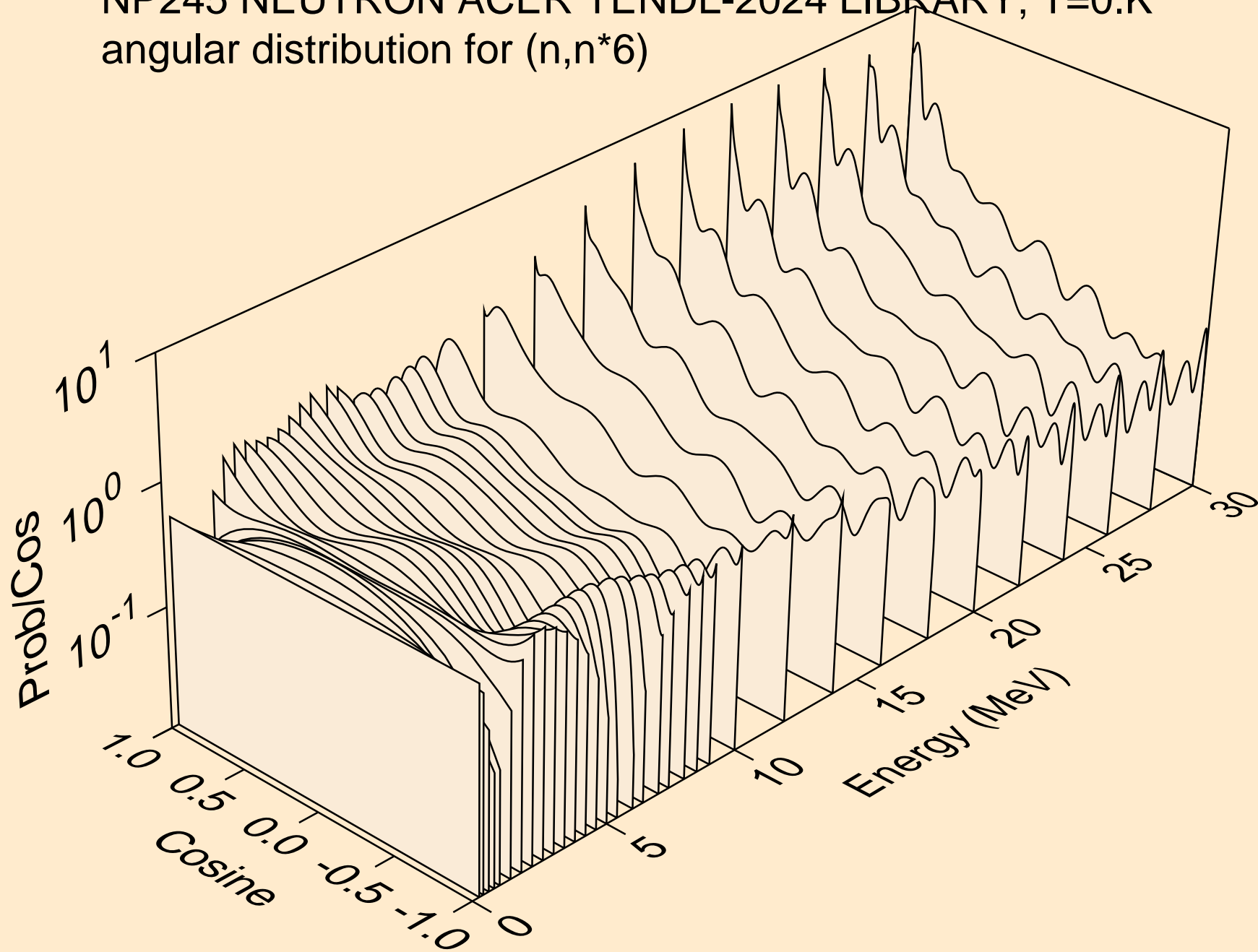

NP245 NEUTRON ACER TENDL-2024 LIBRARY; T=0.K
angular distribution for (n,n*7)

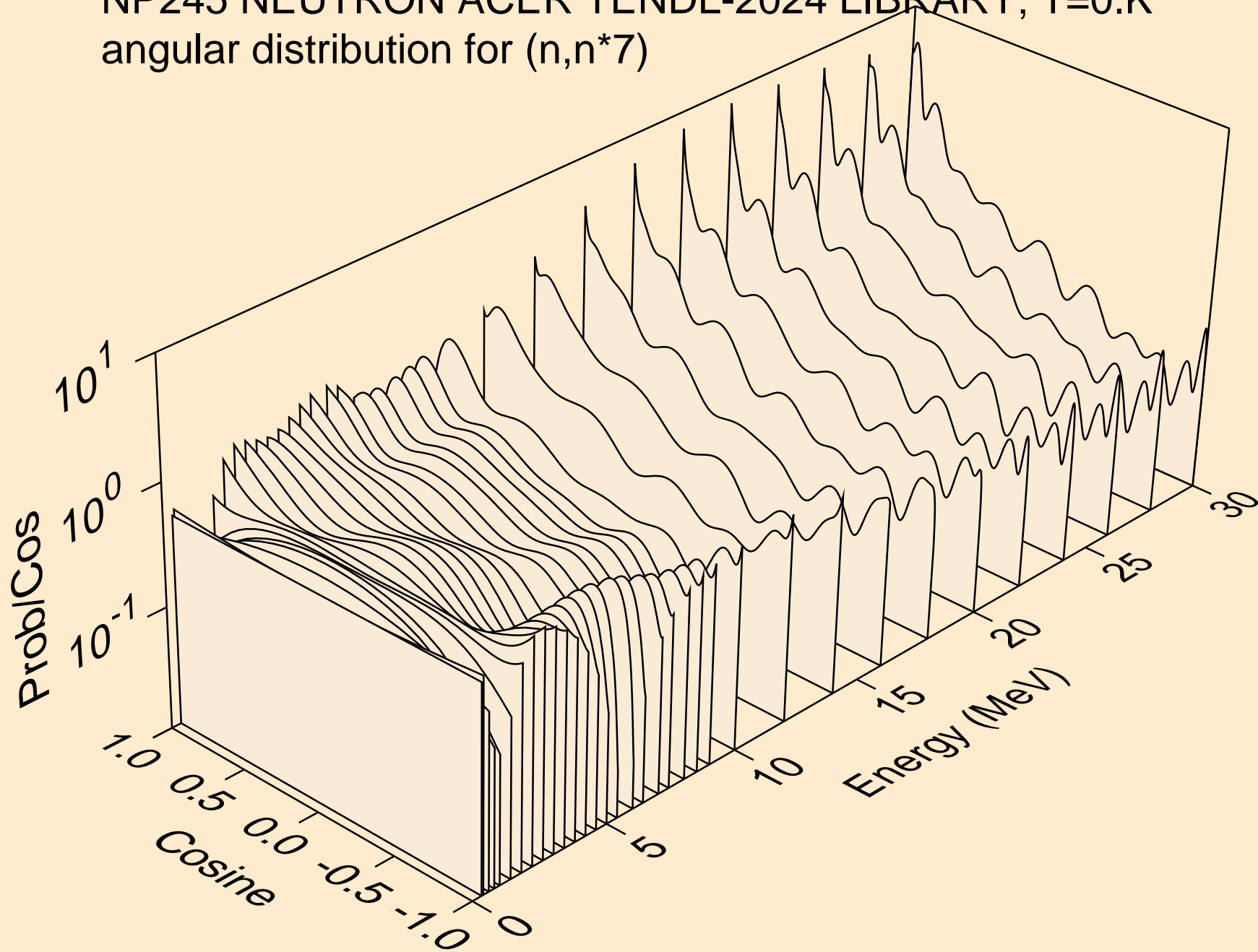

NP245 NEUTRON ACER TENDL-2024 LIBRARY; T=0.K
angular distribution for (n,n*8)

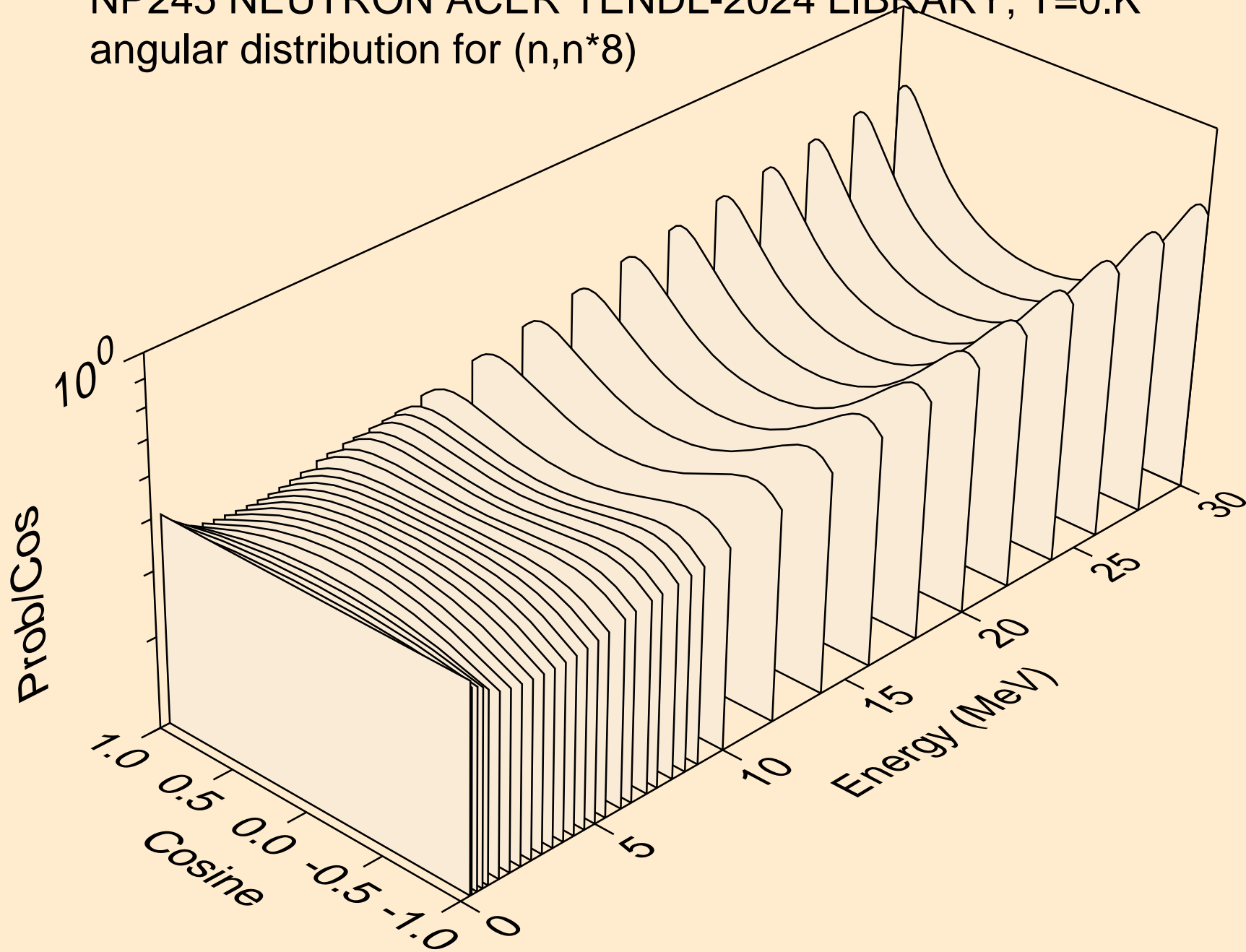

NP245 NEUTRON ACER TENDL-2024 LIBRARY; T=0.K
angular distribution for (n,n*9)

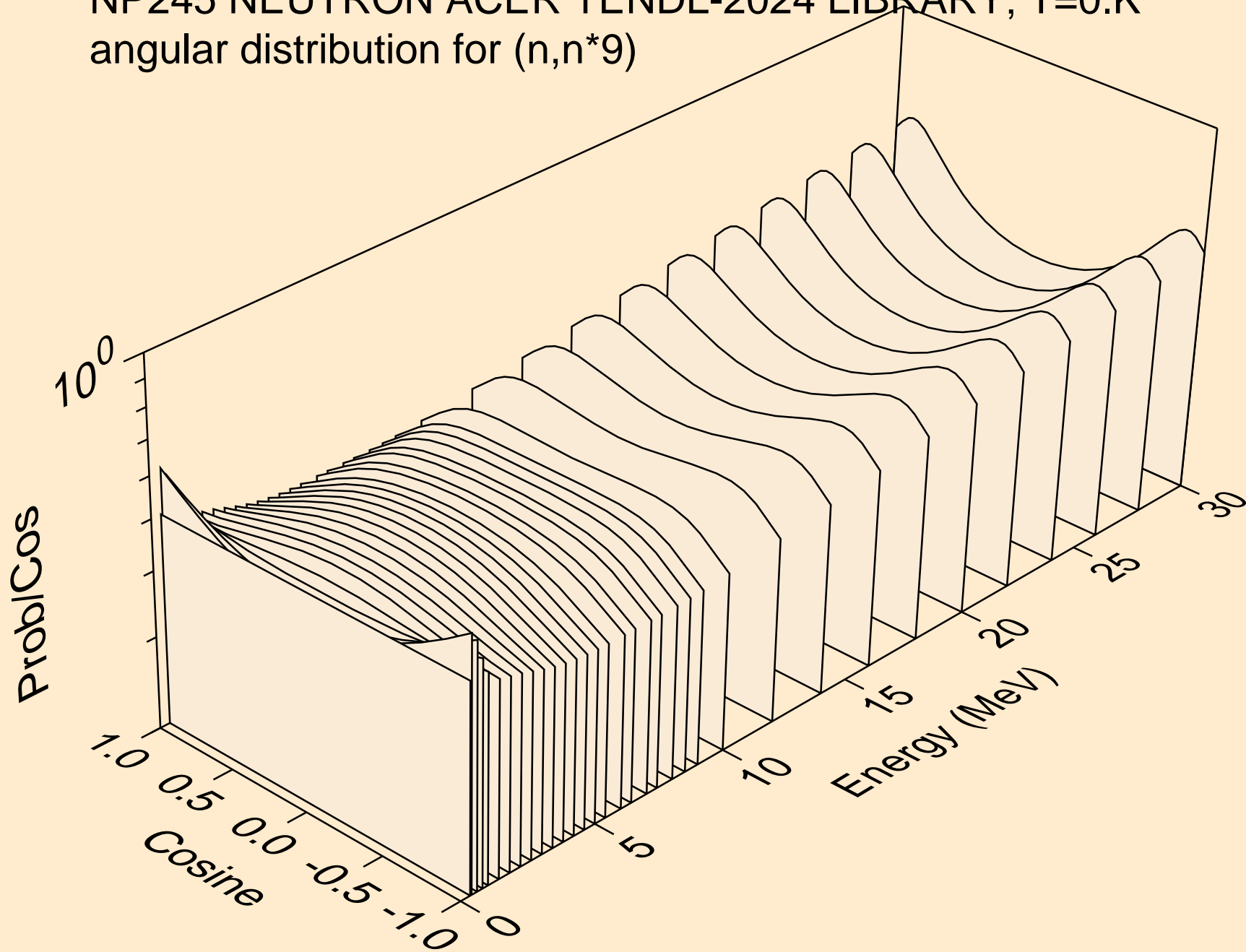

NP245 NEUTRON ACER TENDL-2024 LIBRARY; T=0.K
angular distribution for (n,n*10)

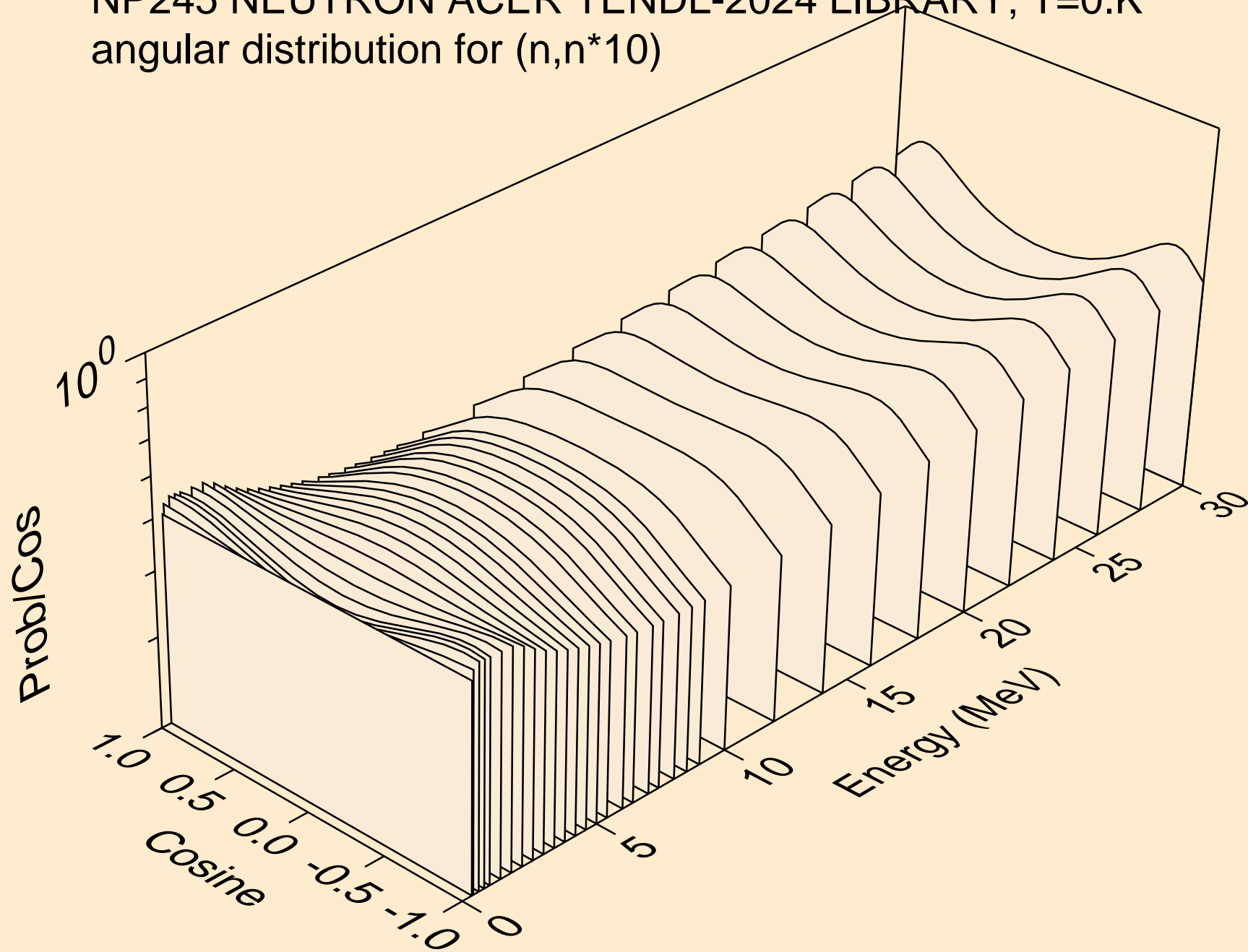

NP245 NEUTRON ACER TENDL-2024 LIBRARY; T=0.K
angular distribution for (n,n*11)

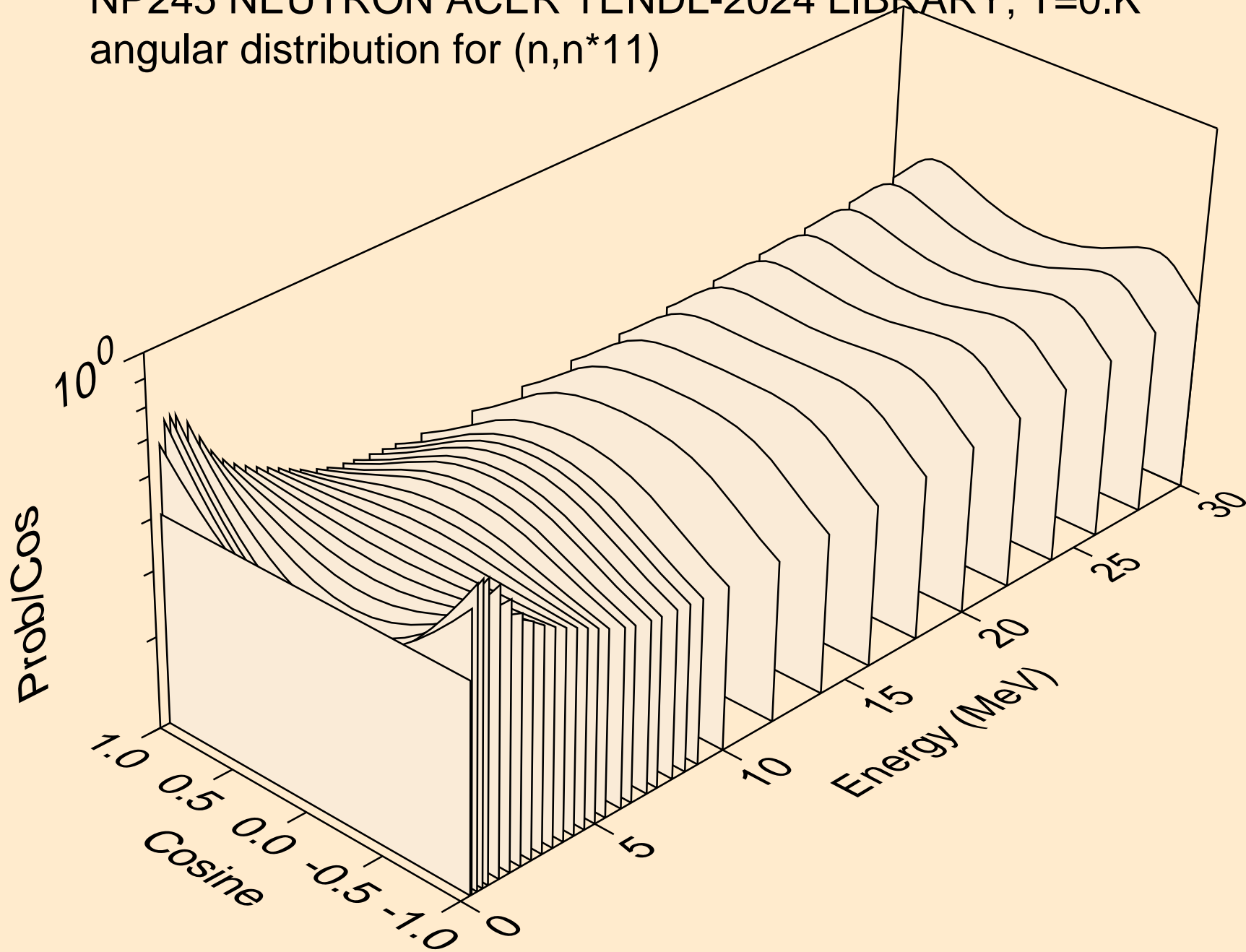

NP245 NEUTRON ACER TENDL-2024 LIBRARY; T=0.K
angular distribution for (n,n*12)

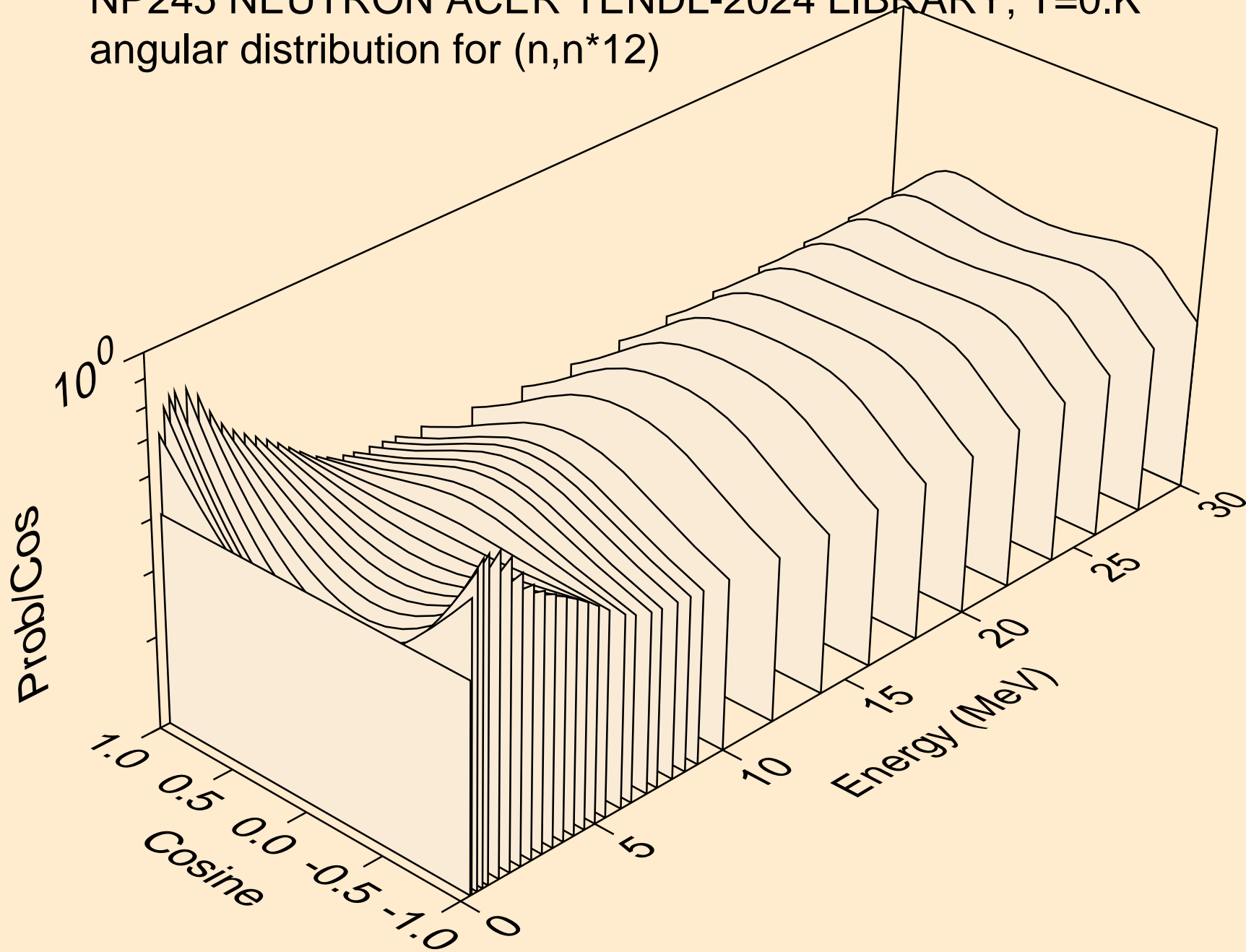

NP245 NEUTRON ACER TENDL-2024 LIBRARY; T=0.K
angular distribution for (n,n*13)

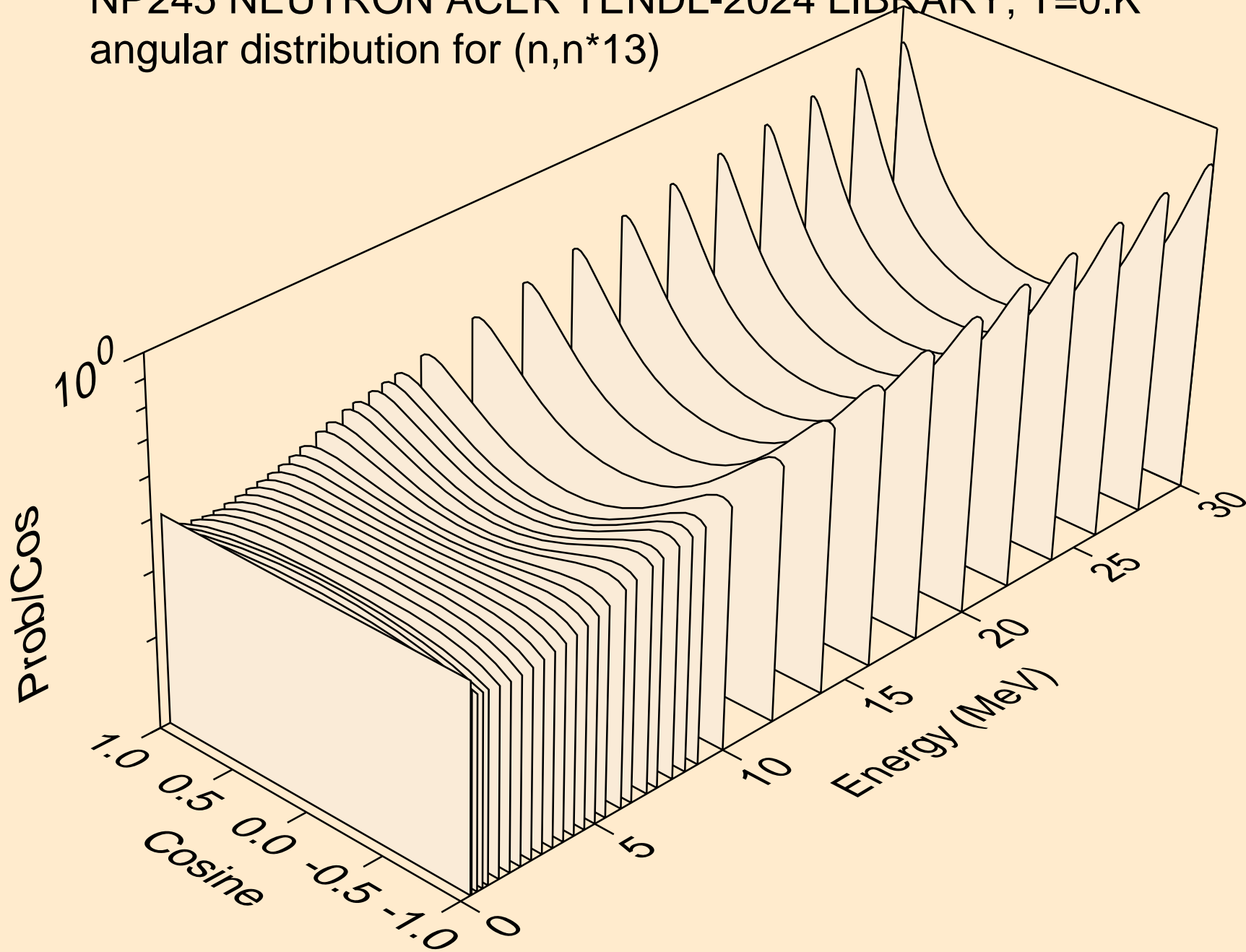

NP245 NEUTRON ACER TENDL-2024 LIBRARY; T=0.K
angular distribution for (n,n*14)

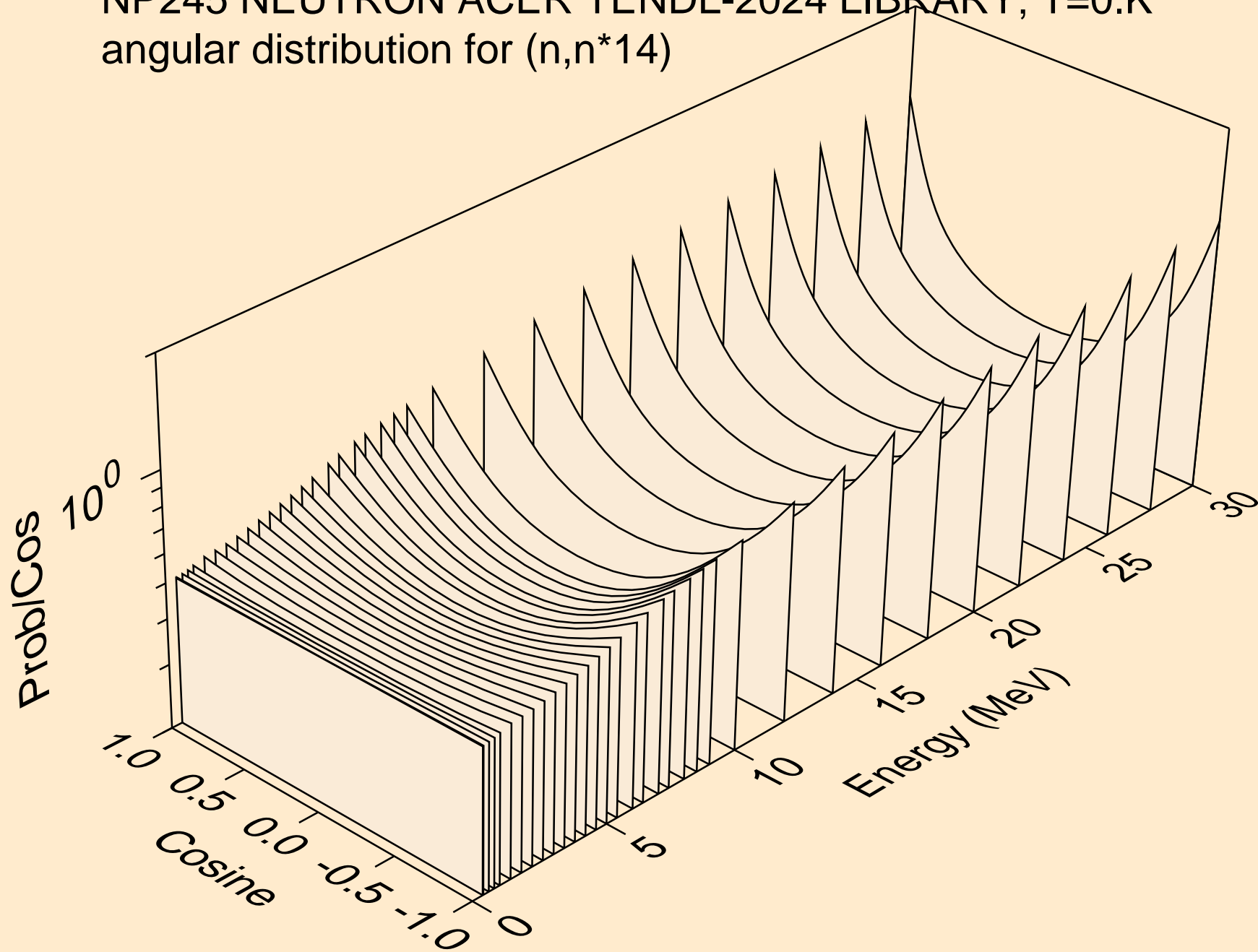

NP245 NEUTRON ACER TENDL-2024 LIBRARY; T=0.K
angular distribution for (n,n*15)

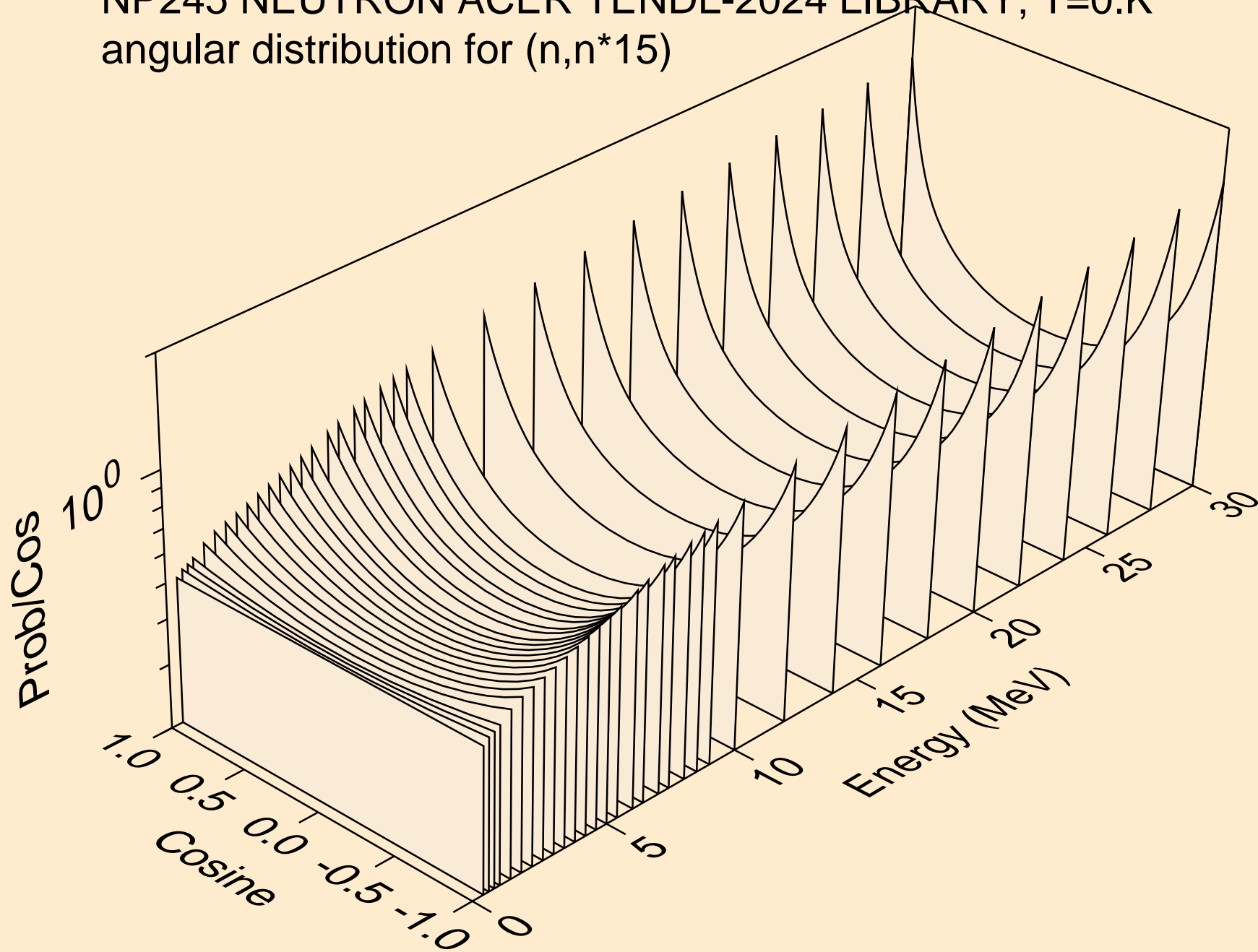

NP245 NEUTRON ACER TENDL-2024 LIBRARY; T=0.K
angular distribution for (n,n*16)

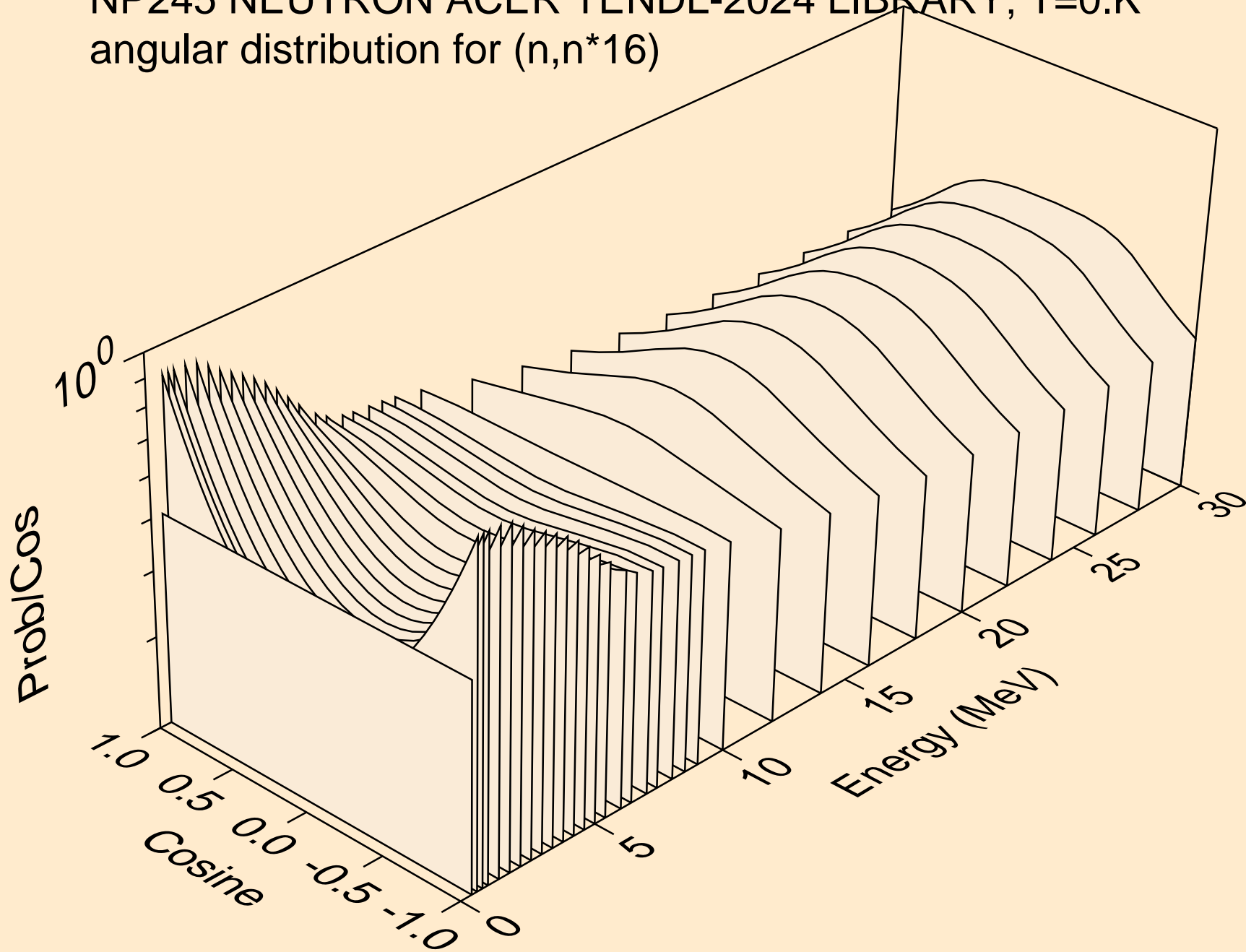

NP245 NEUTRON ACER TENDL-2024 LIBRARY; T=0.K
angular distribution for (n,n*17)

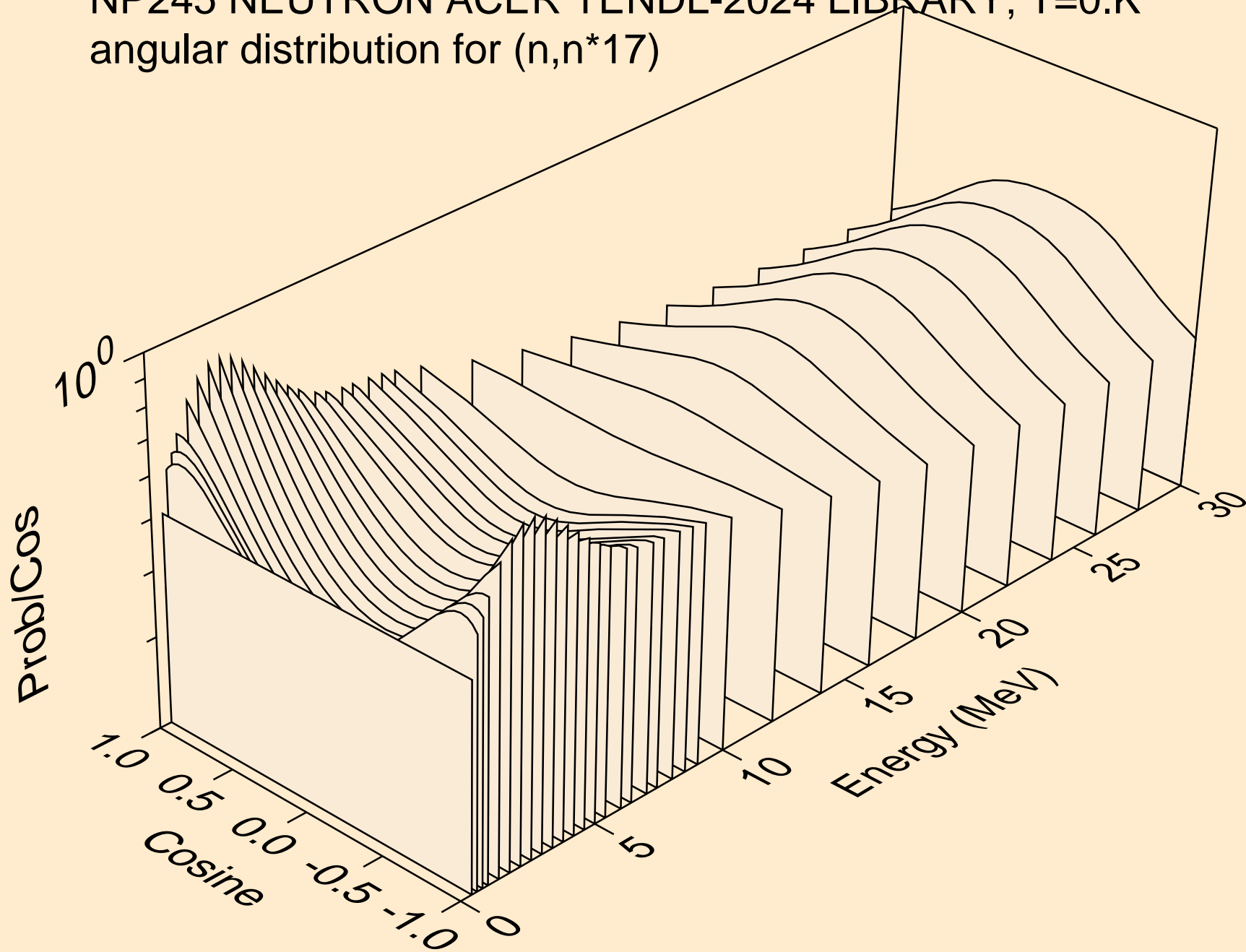

NP245 NEUTRON ACER TENDL-2024 LIBRARY; T=0.K
angular distribution for (n,n*18)

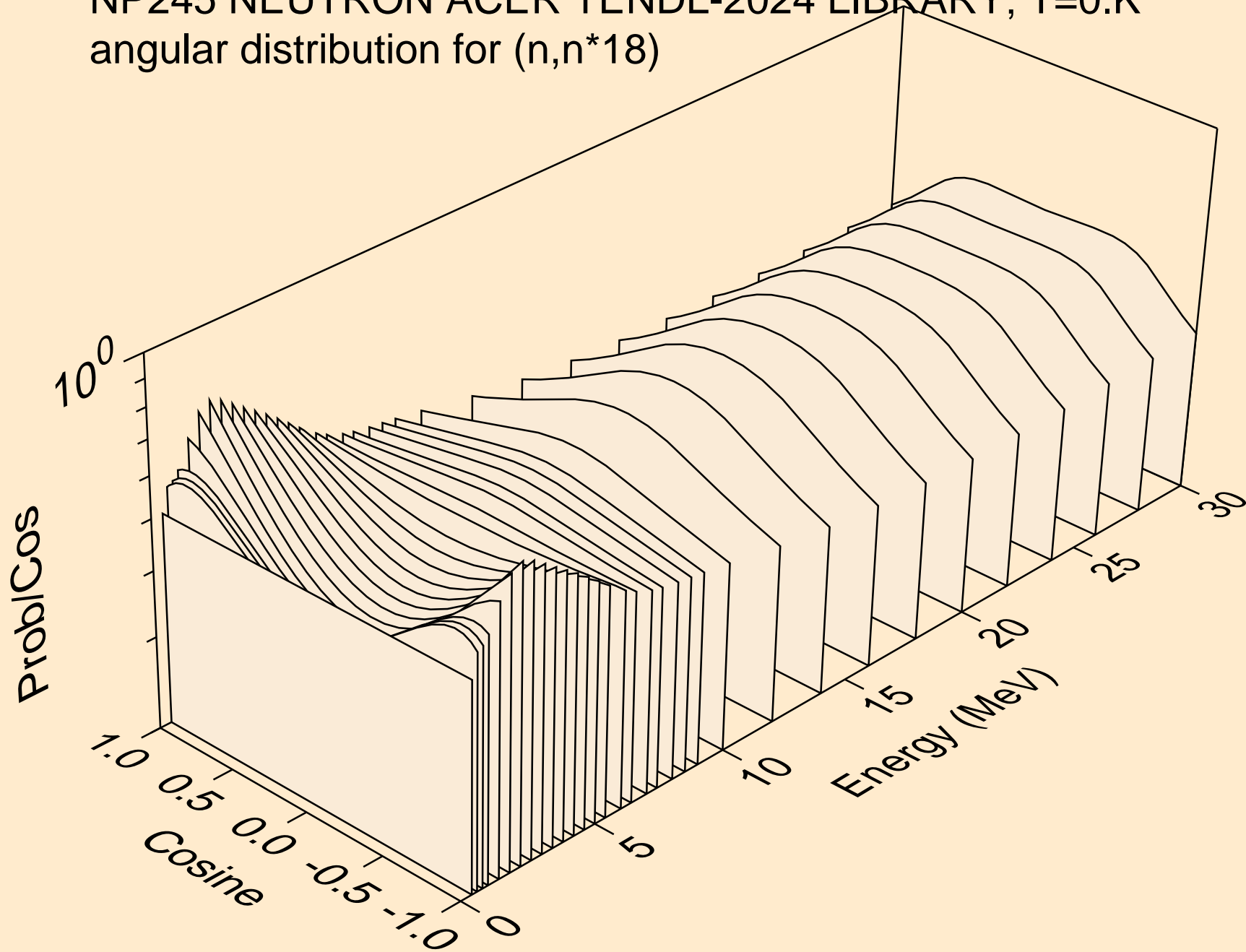

NP245 NEUTRON ACER TENDL-2024 LIBRARY; T=0.K
angular distribution for (n,n*19)

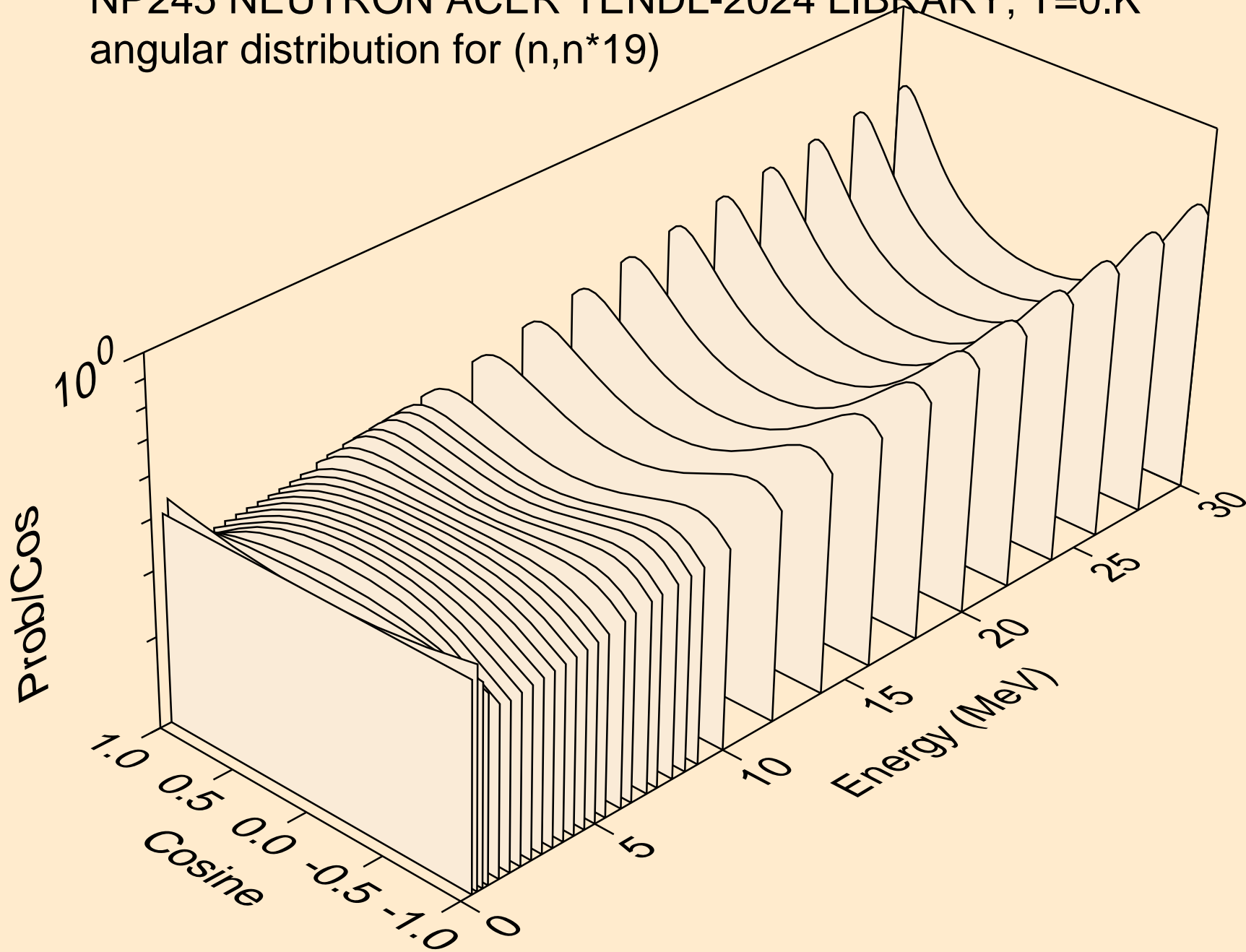

NP245 NEUTRON ACER TENDL-2024 LIBRARY; T=0.K
angular distribution for (n,n*20)

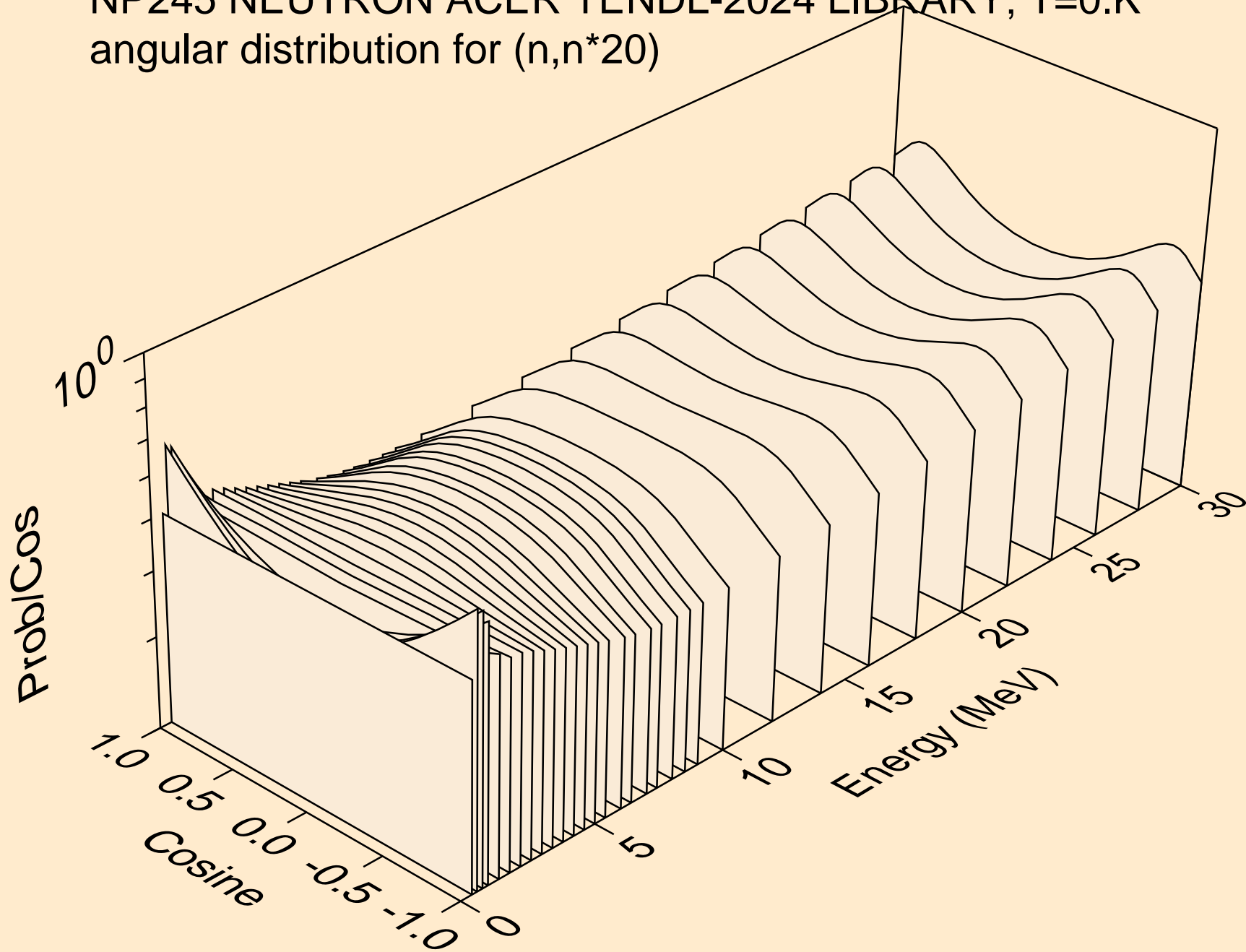

NP245 NEUTRON ACER TENDL-2024 LIBRARY; T=0.K
angular distribution for (n,n*21)

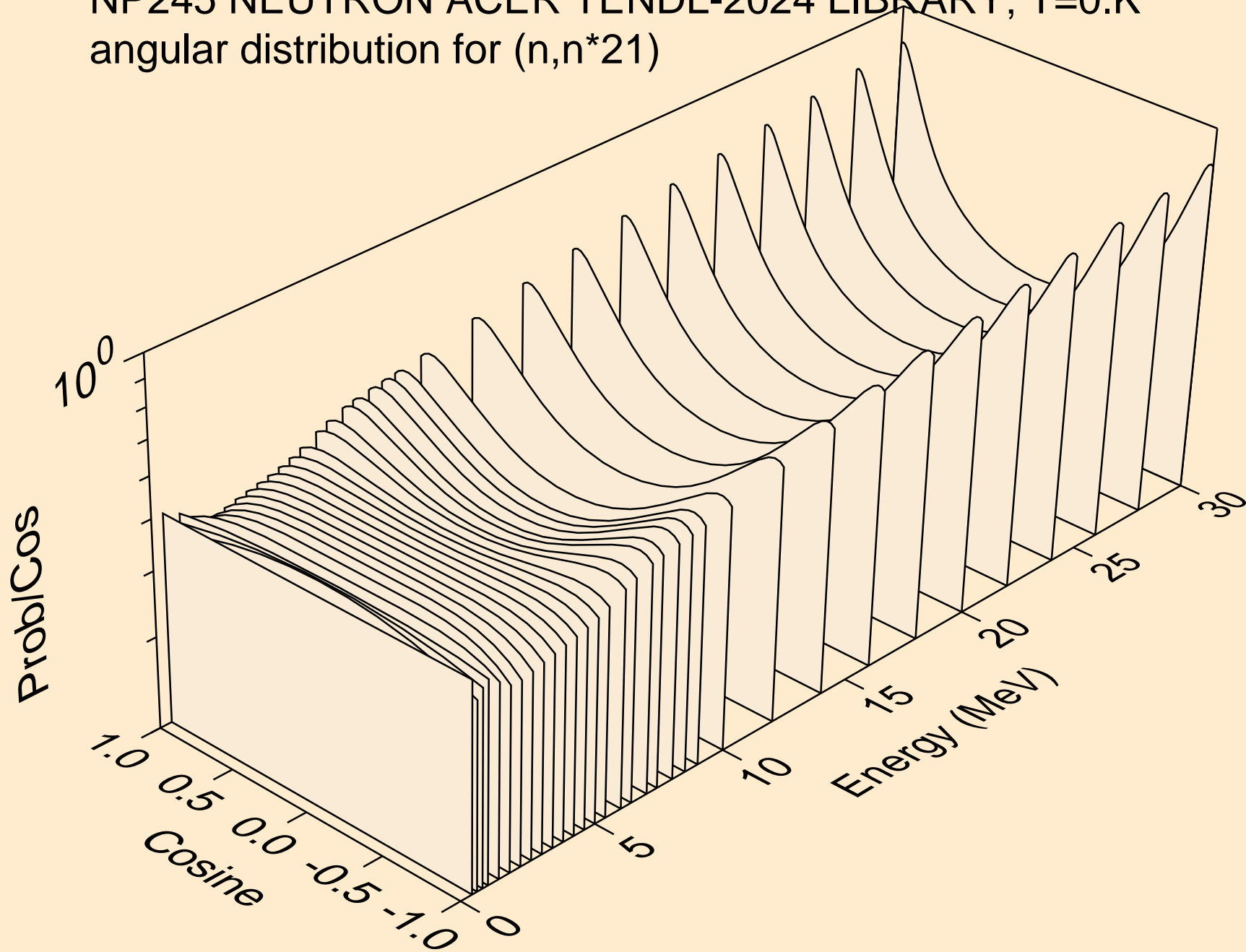

NP245 NEUTRON ACER TENDL-2024 LIBRARY; T=0.K
angular distribution for (n,n*22)

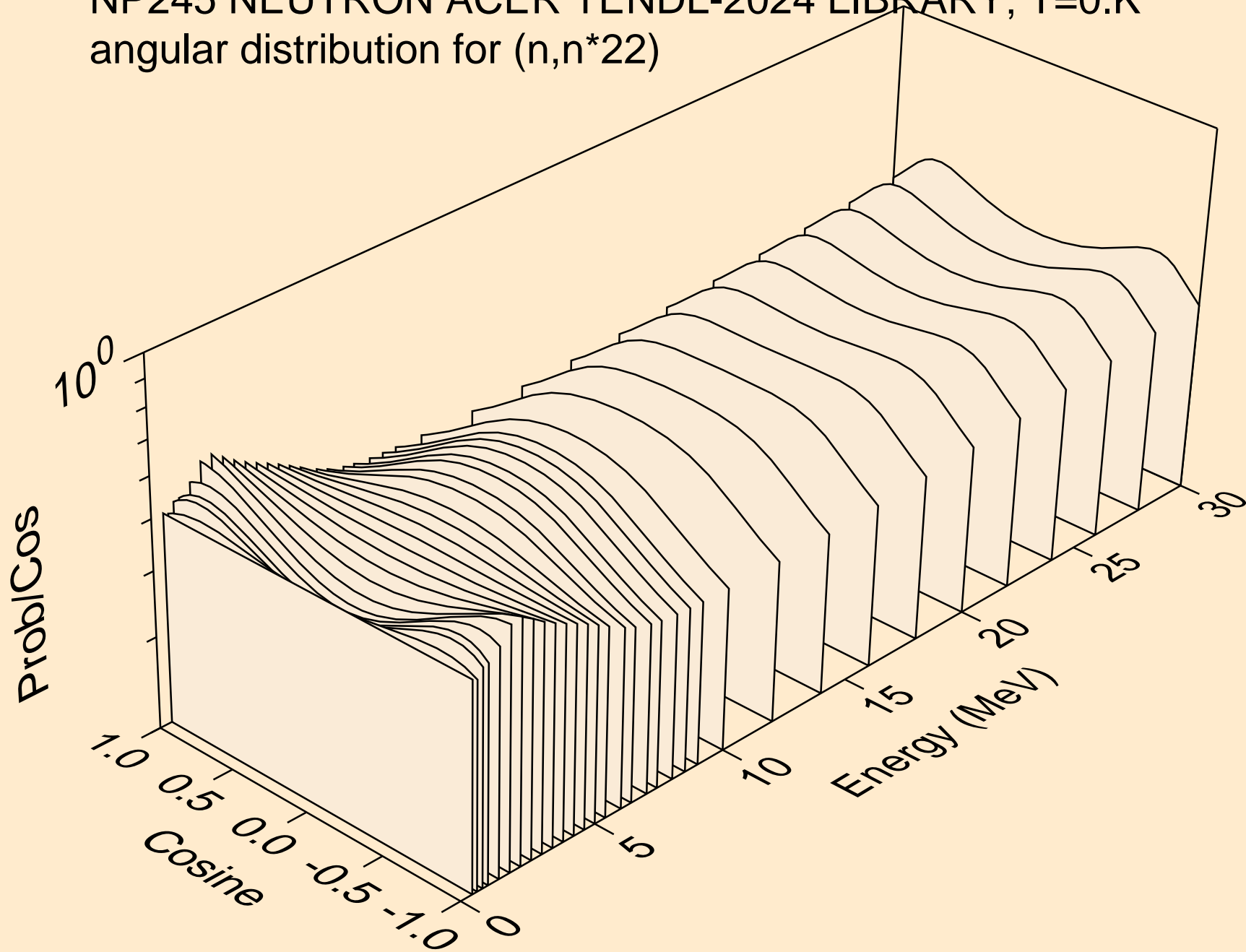

NP245 NEUTRON ACER TENDL-2024 LIBRARY; T=0.K
angular distribution for (n,n*23)

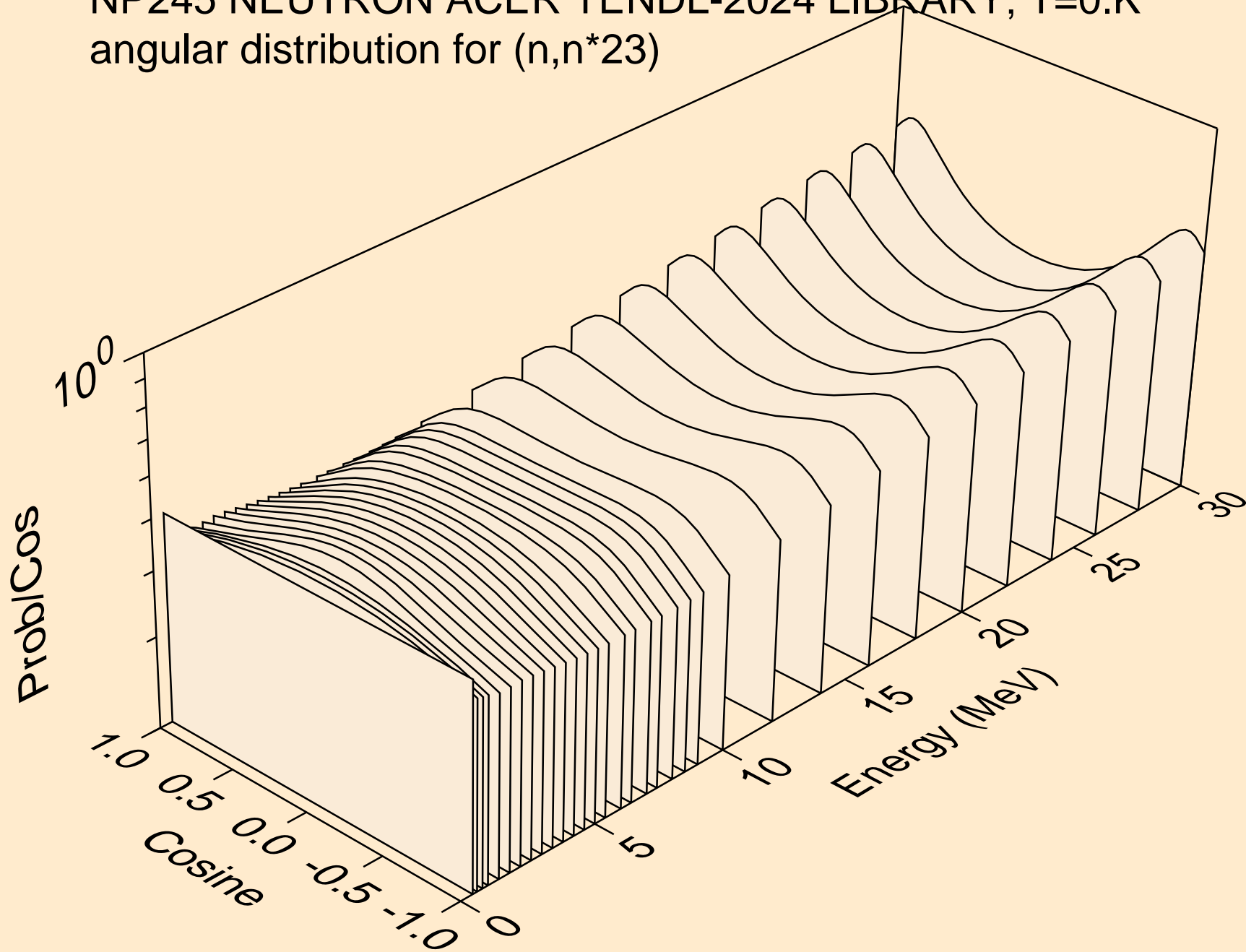

NP245 NEUTRON ACER TENDL-2024 LIBRARY; T=0.K
angular distribution for (n,n*24)

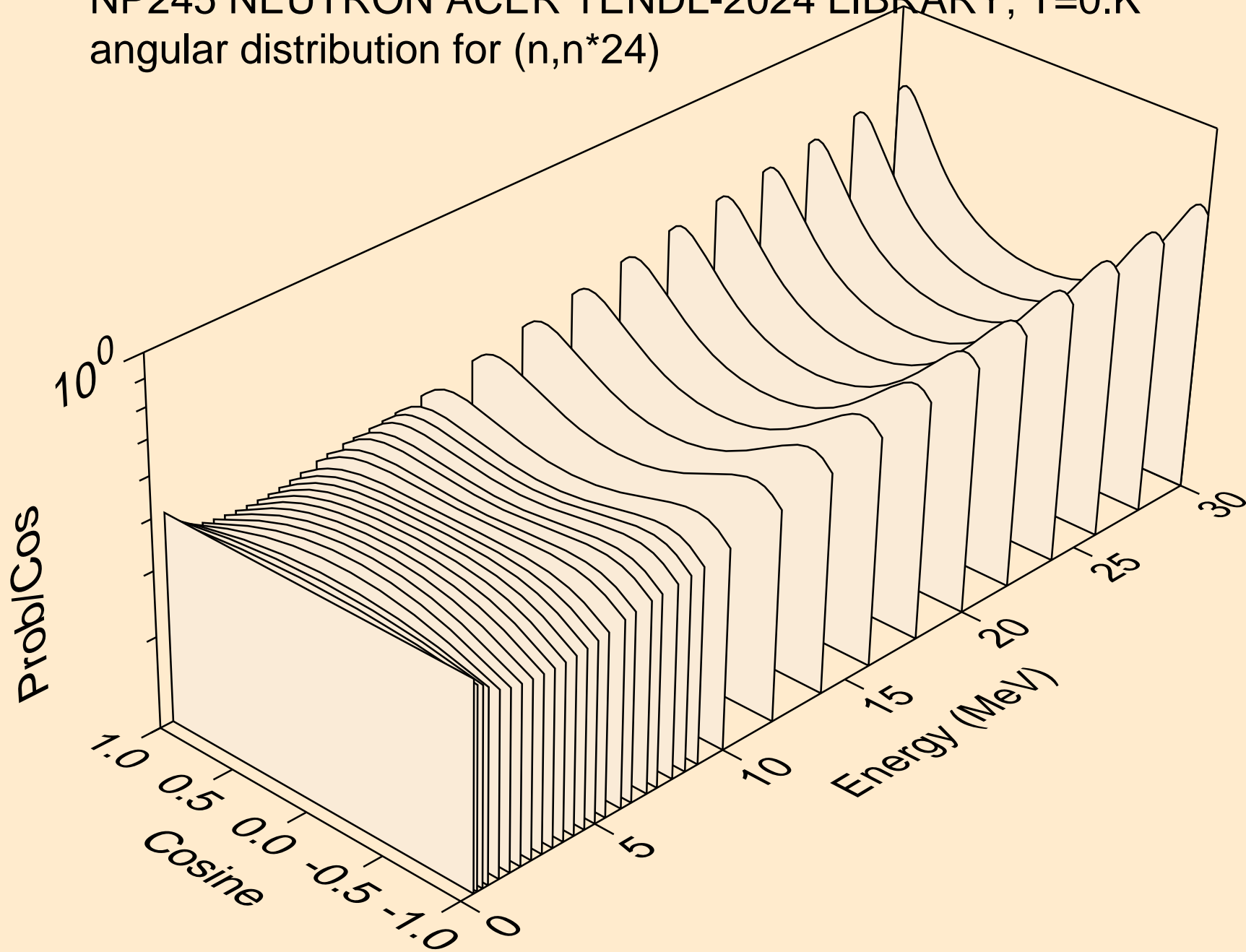

NP245 NEUTRON ACER TENDL-2024 LIBRARY; T=0.K
angular distribution for (n,n*25)

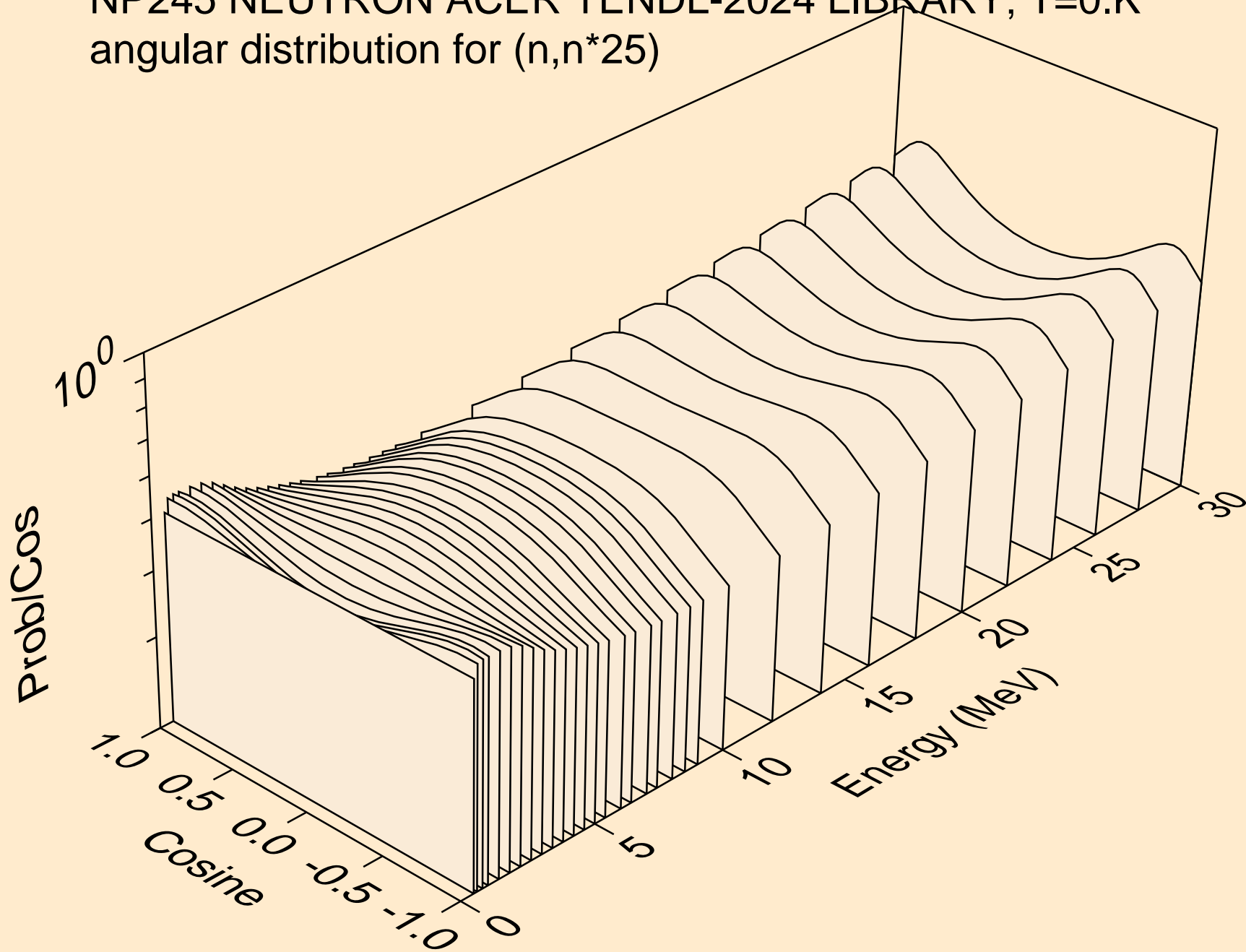

NP245 NEUTRON ACER TENDL-2024 LIBRARY; T=0.K
angular distribution for (n,n*26)

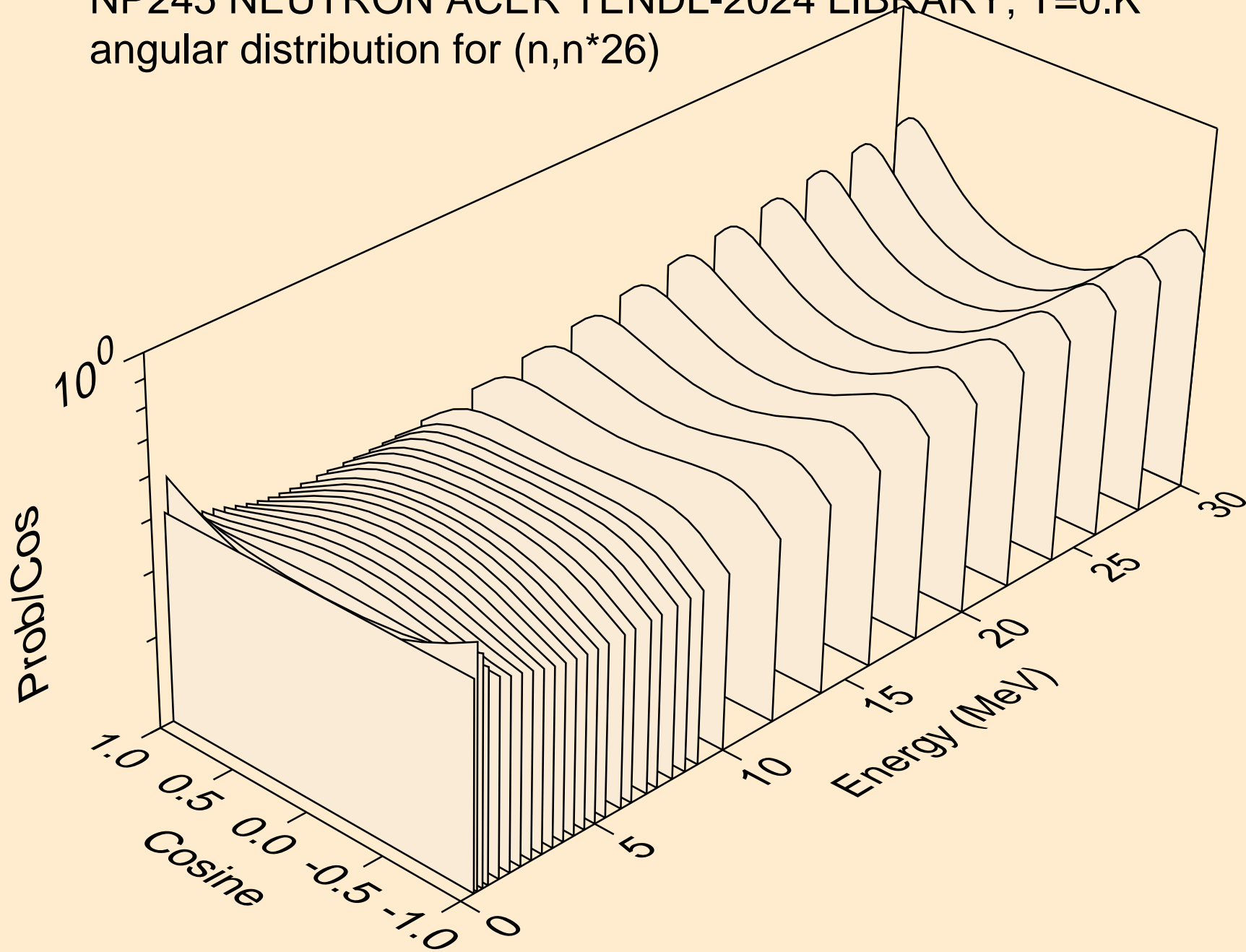

NP245 NEUTRON ACER TENDL-2024 LIBRARY; T=0.K
angular distribution for (n,n*27)

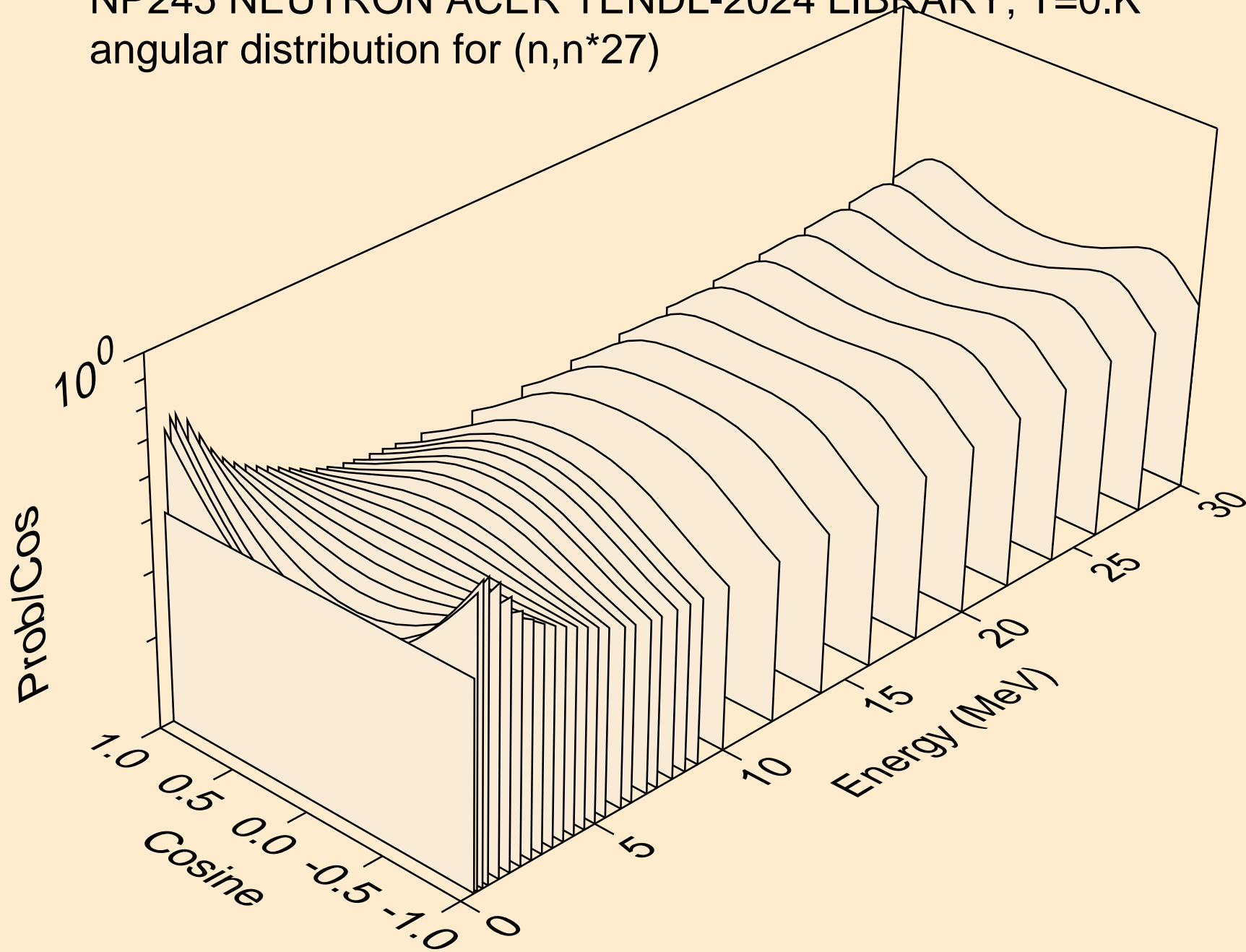

NP245 NEUTRON ACER TENDL-2024 LIBRARY; T=0.K
angular distribution for (n,n*28)

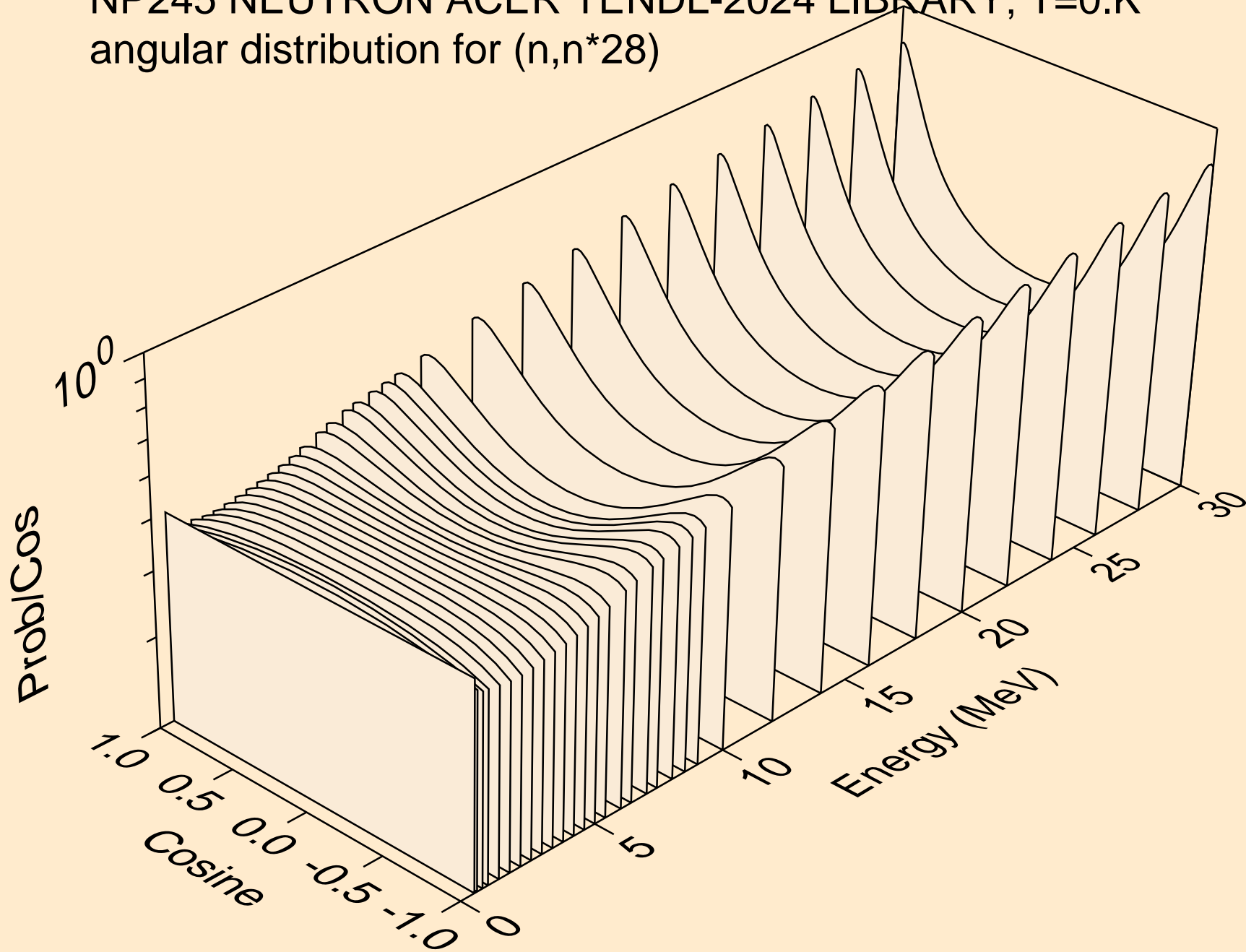

NP245 NEUTRON ACER TENDL-2024 LIBRARY; T=0.K
angular distribution for (n,n*29)

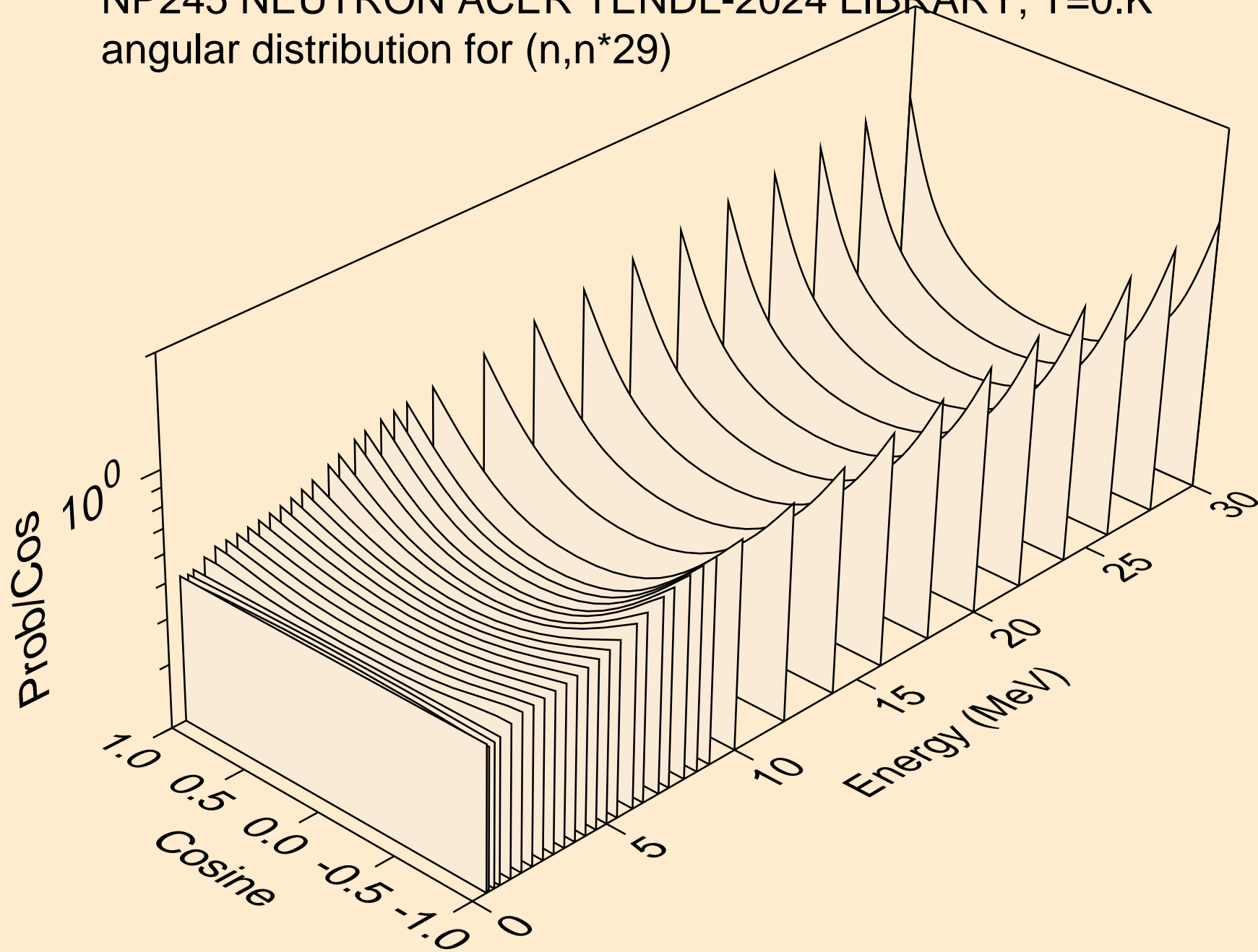

NP245 NEUTRON ACER TENDL-2024 LIBRARY; T=0.K

Total fission nubar

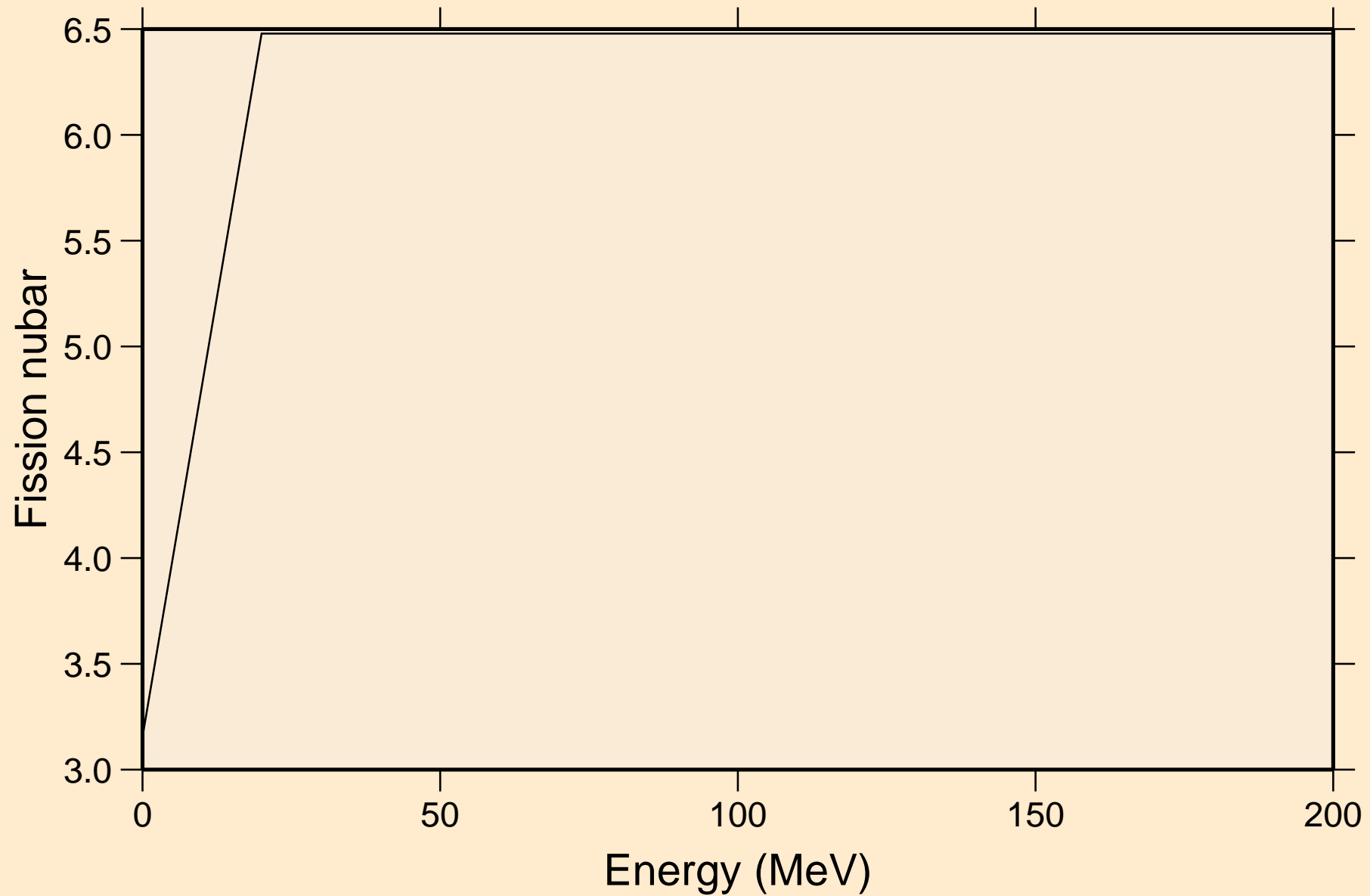

NP245 NEUTRON ACER TENDL-2024 LIBRARY; T=0.K
Neutron emission for (n,x)

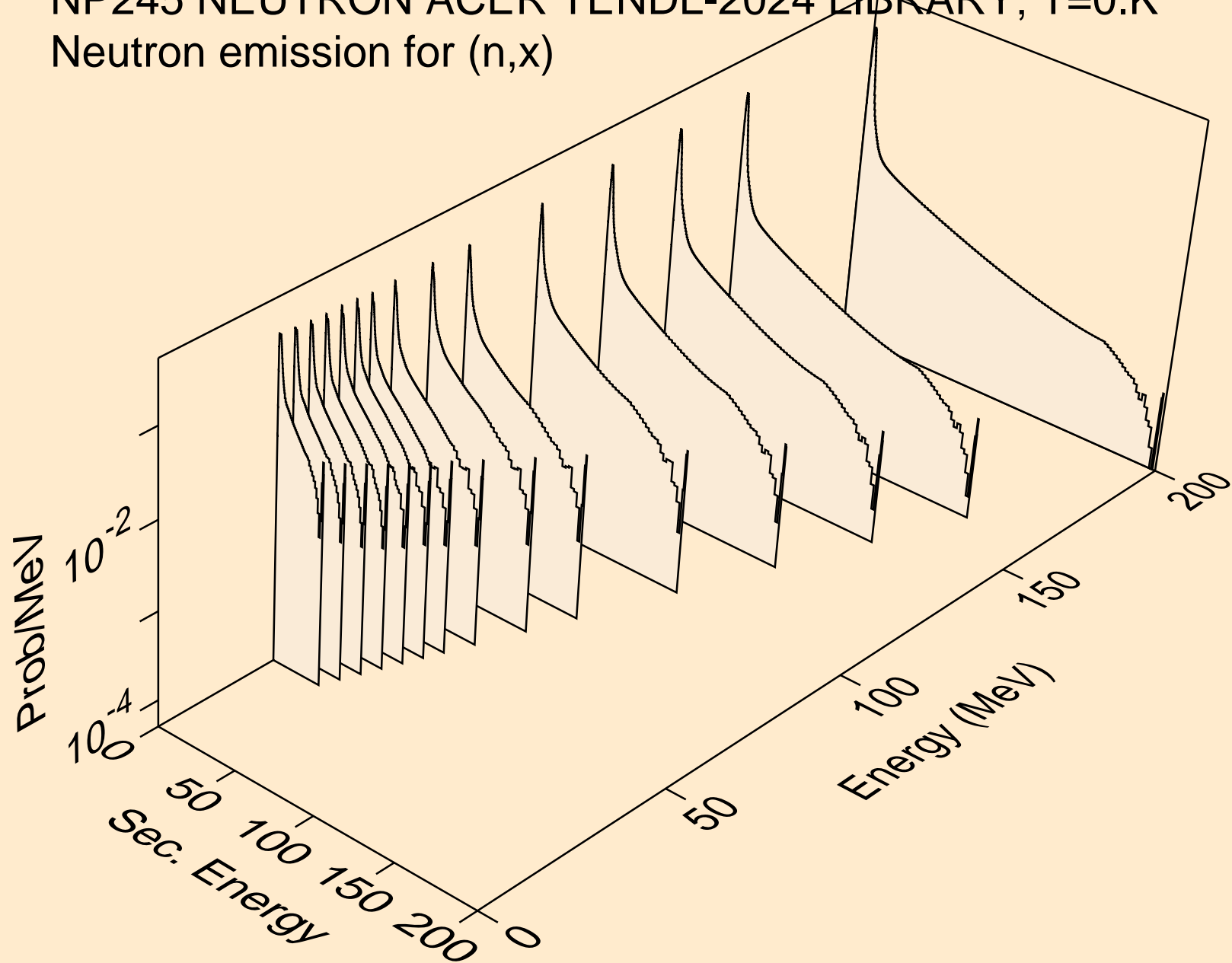

NP245 NEUTRON ACER TENDL-2024 LIBRARY; T=0.K
Neutron emission for (n,2nd)

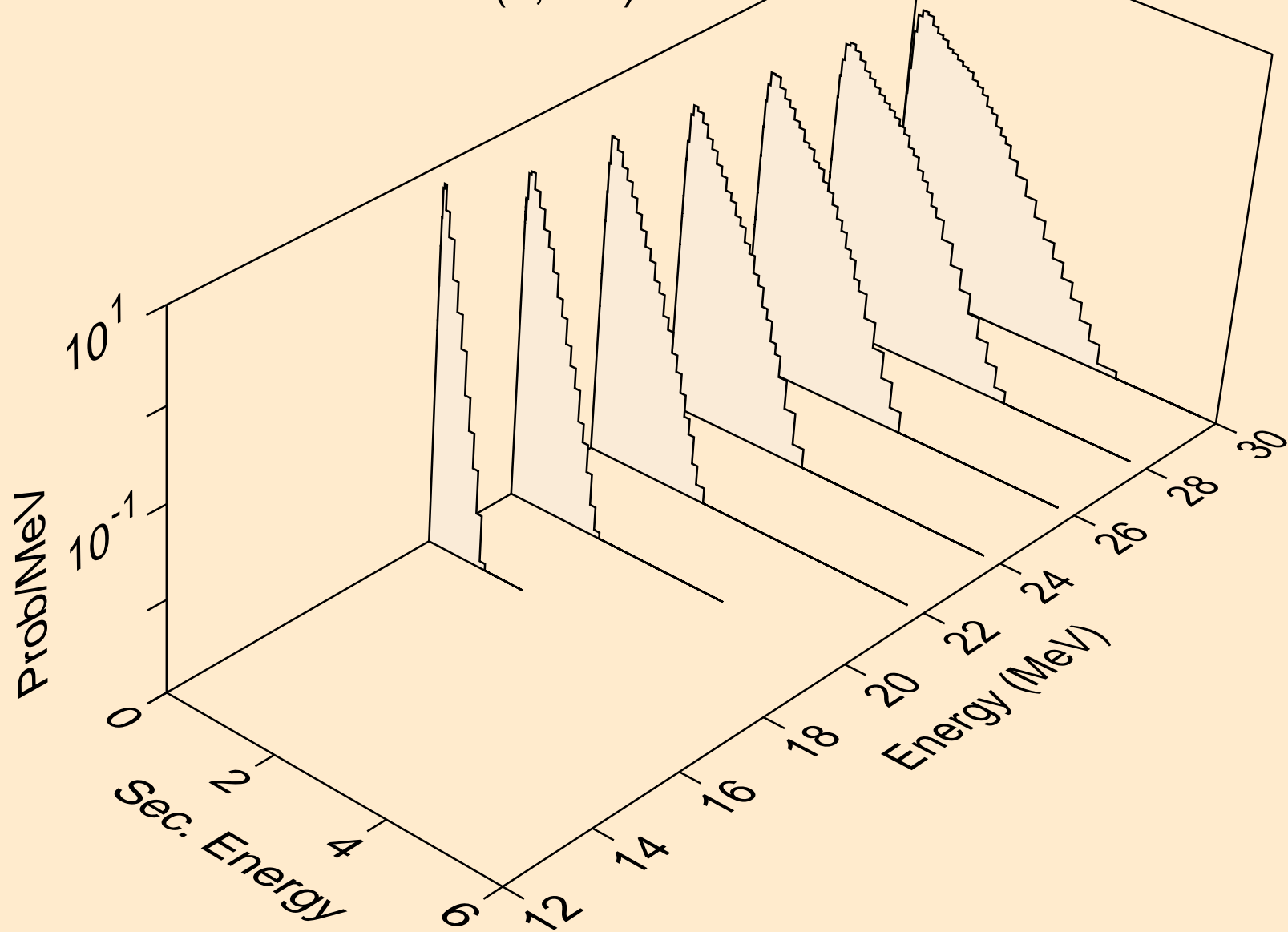

NP245 NEUTRON ACER TENDL-2024 LIBRARY; T=0.K
Neutron emission for (n,2n)

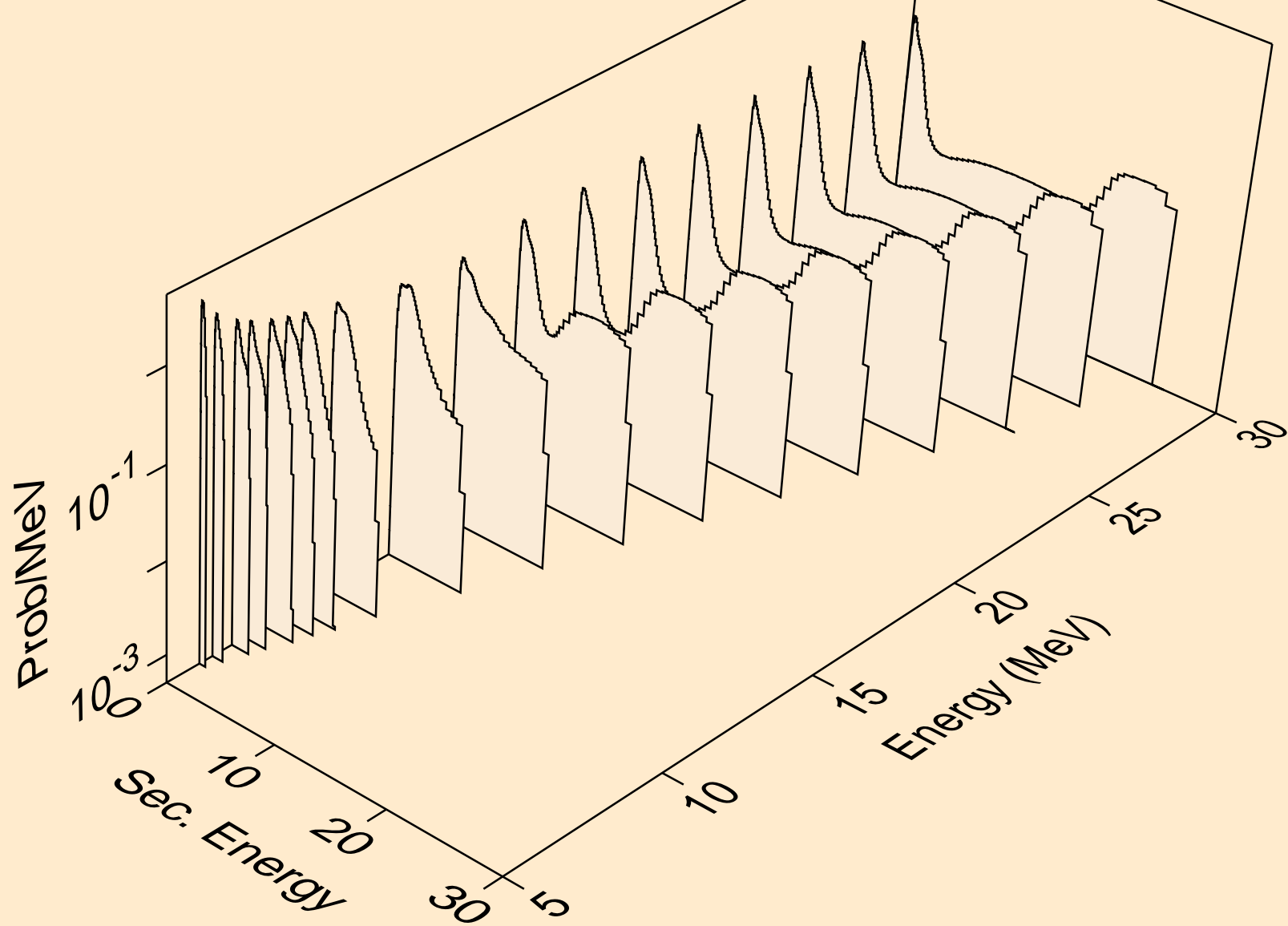

NP245 NEUTRON ACER TENDL-2024 LIBRARY; T=0.K
Neutron emission for (n,3n)

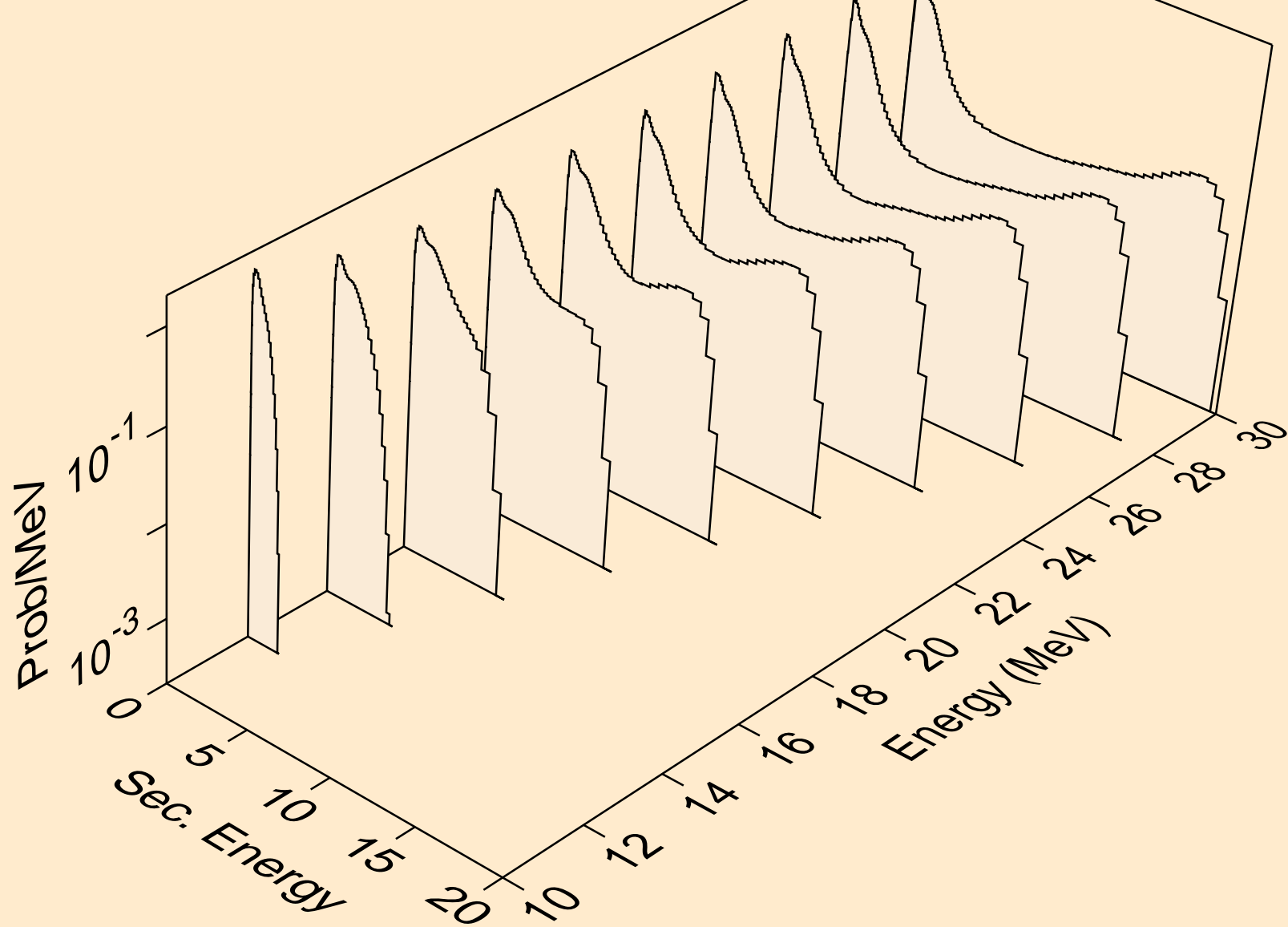

NP245 NEUTRON ACER TENDL-2024 LIBRARY; T=0.K
Neutron emission for fission

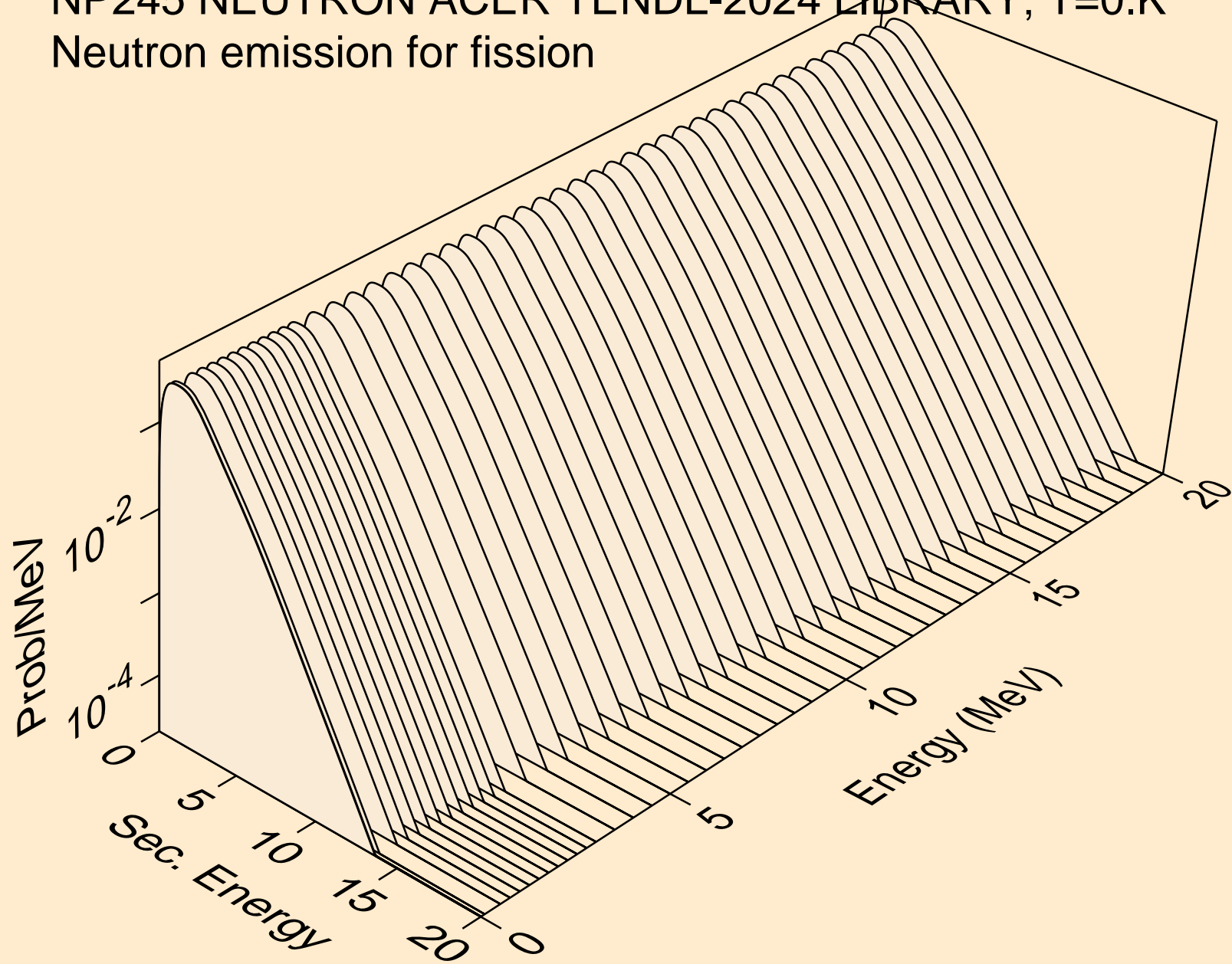

NP245 NEUTRON ACER TENDL-2024 LIBRARY; T=0.K
Neutron emission for (n,n*)a

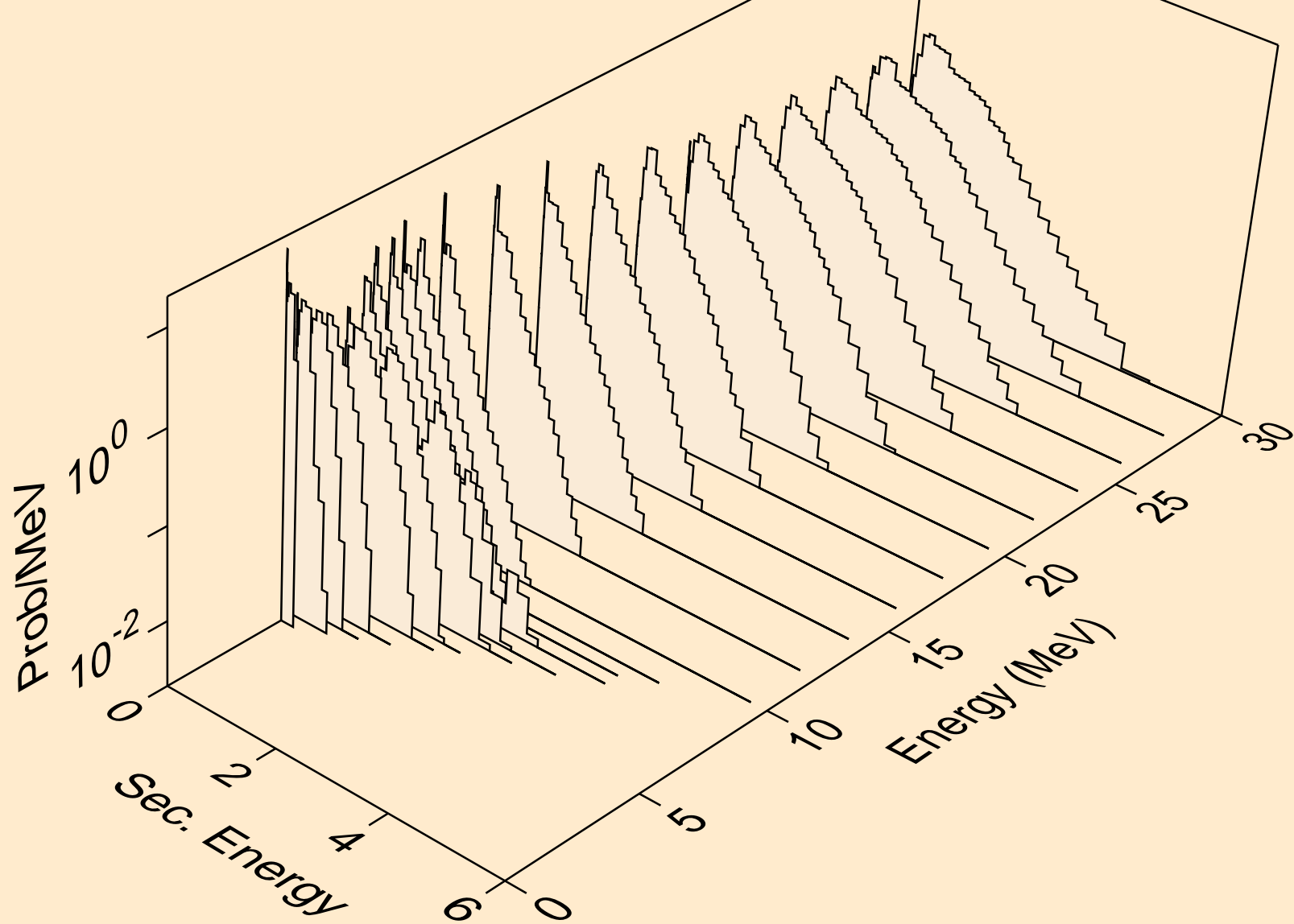

NP245 NEUTRON ACER TENDL-2024 LIBRARY; T=0.K
Neutron emission for (n,2n)a

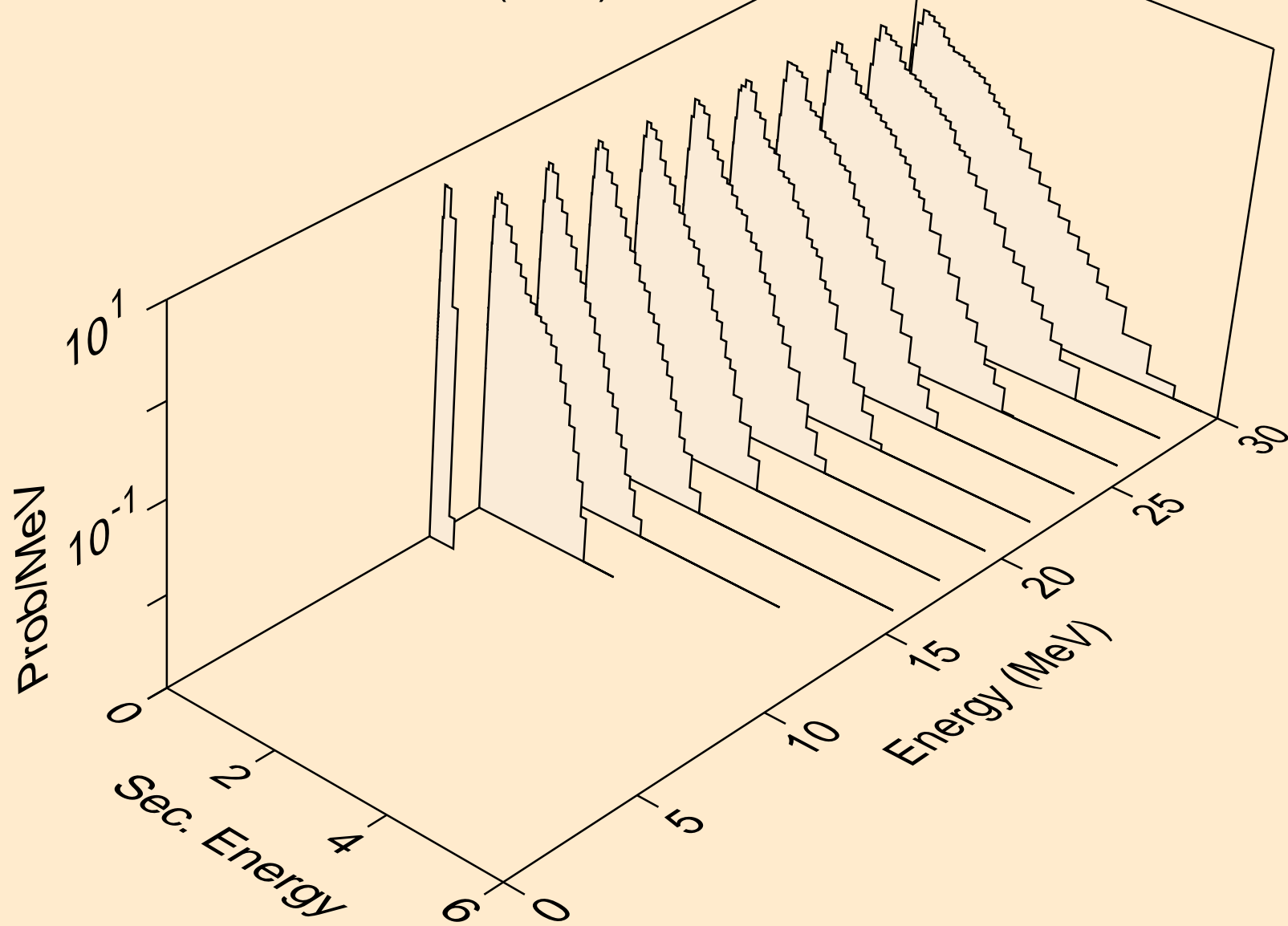

NP245 NEUTRON ACER TENDL-2024 LIBRARY; T=0.K
Neutron emission for (n,3n)a

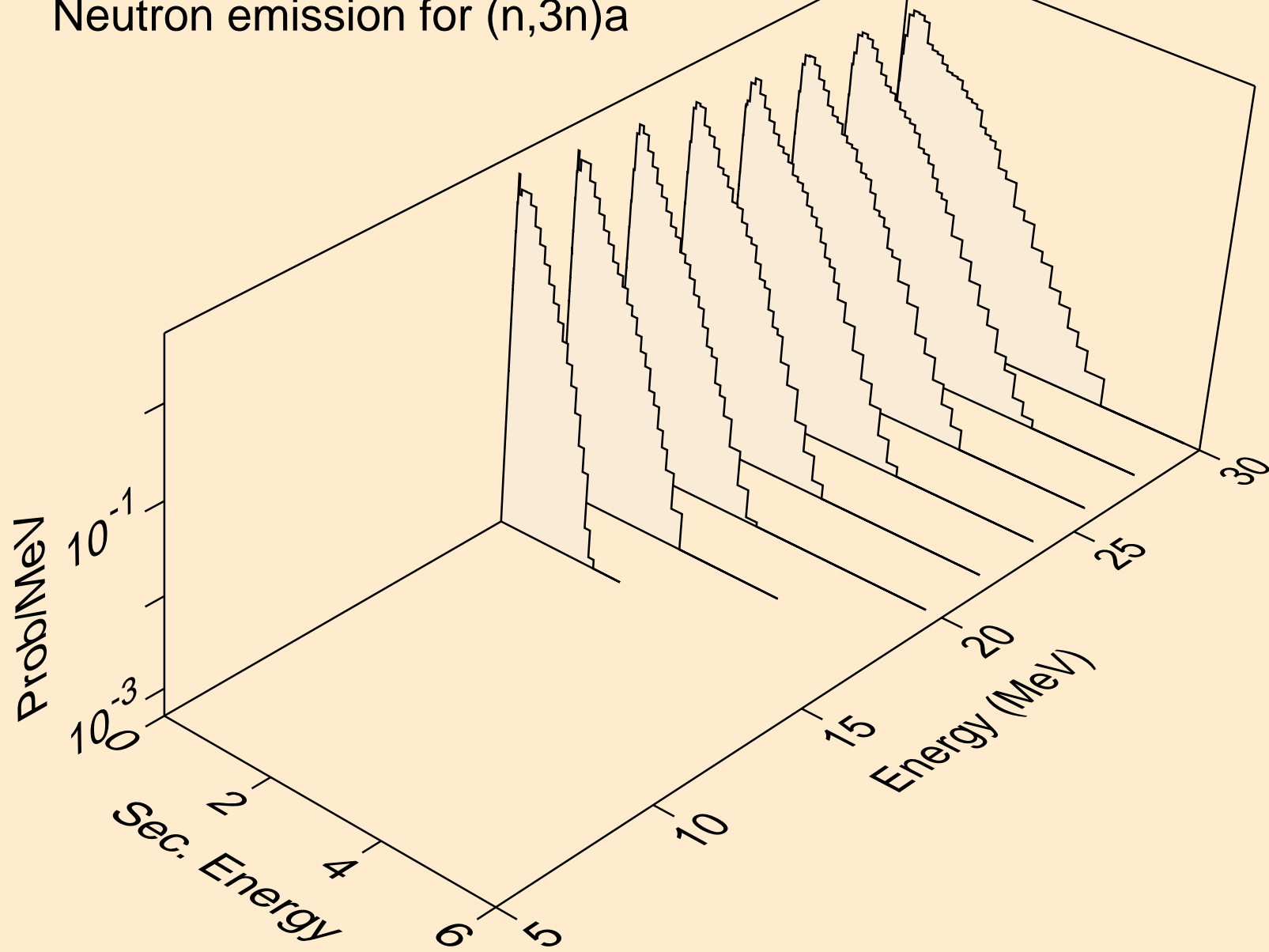

NP245 NEUTRON ACER TENDL-2024 LIBRARY; T=0.K
Neutron emission for (n,n*)p

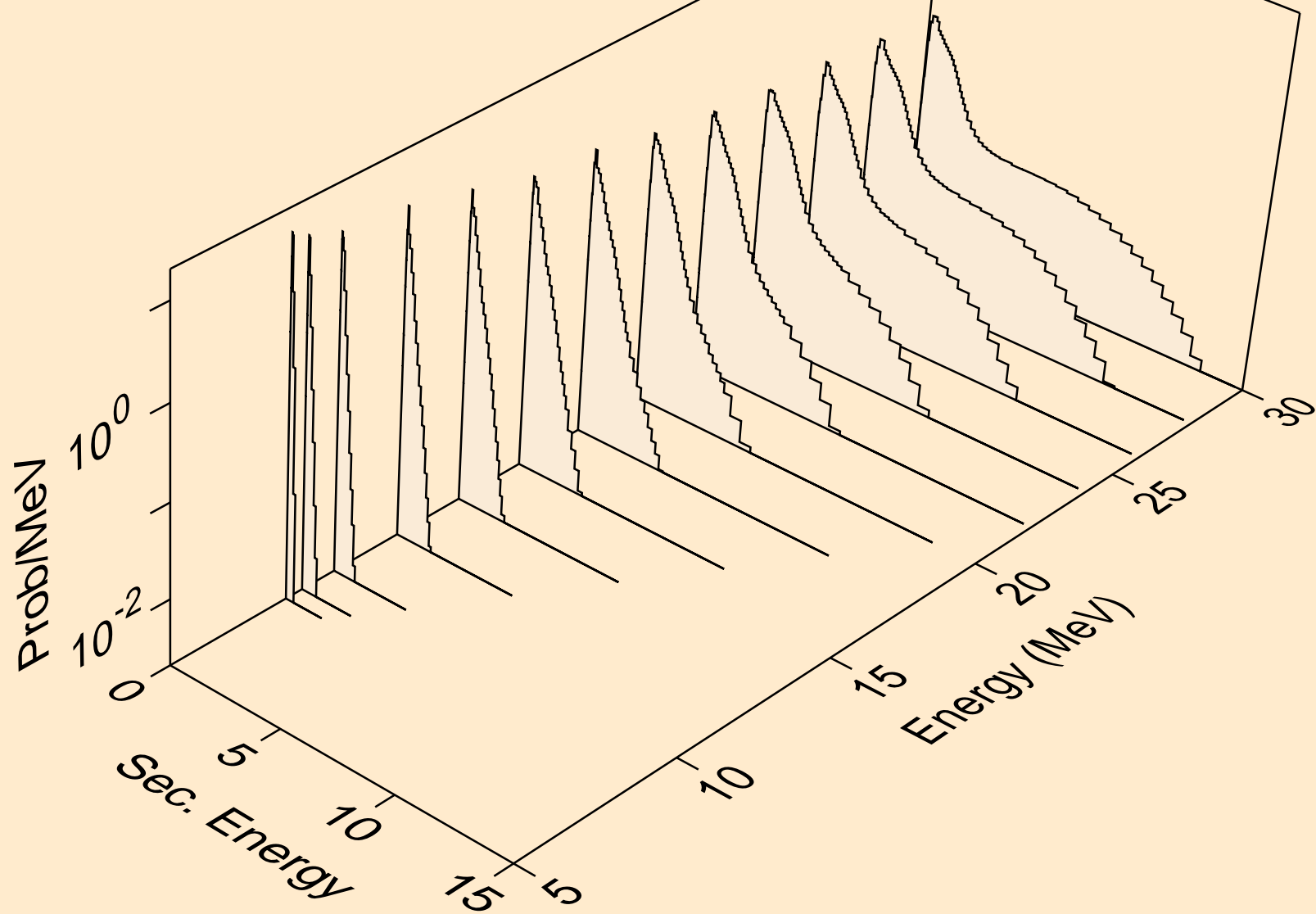

NP245 NEUTRON ACER TENDL-2024 LIBRARY; T=0.K
Neutron emission for (n,n*)d

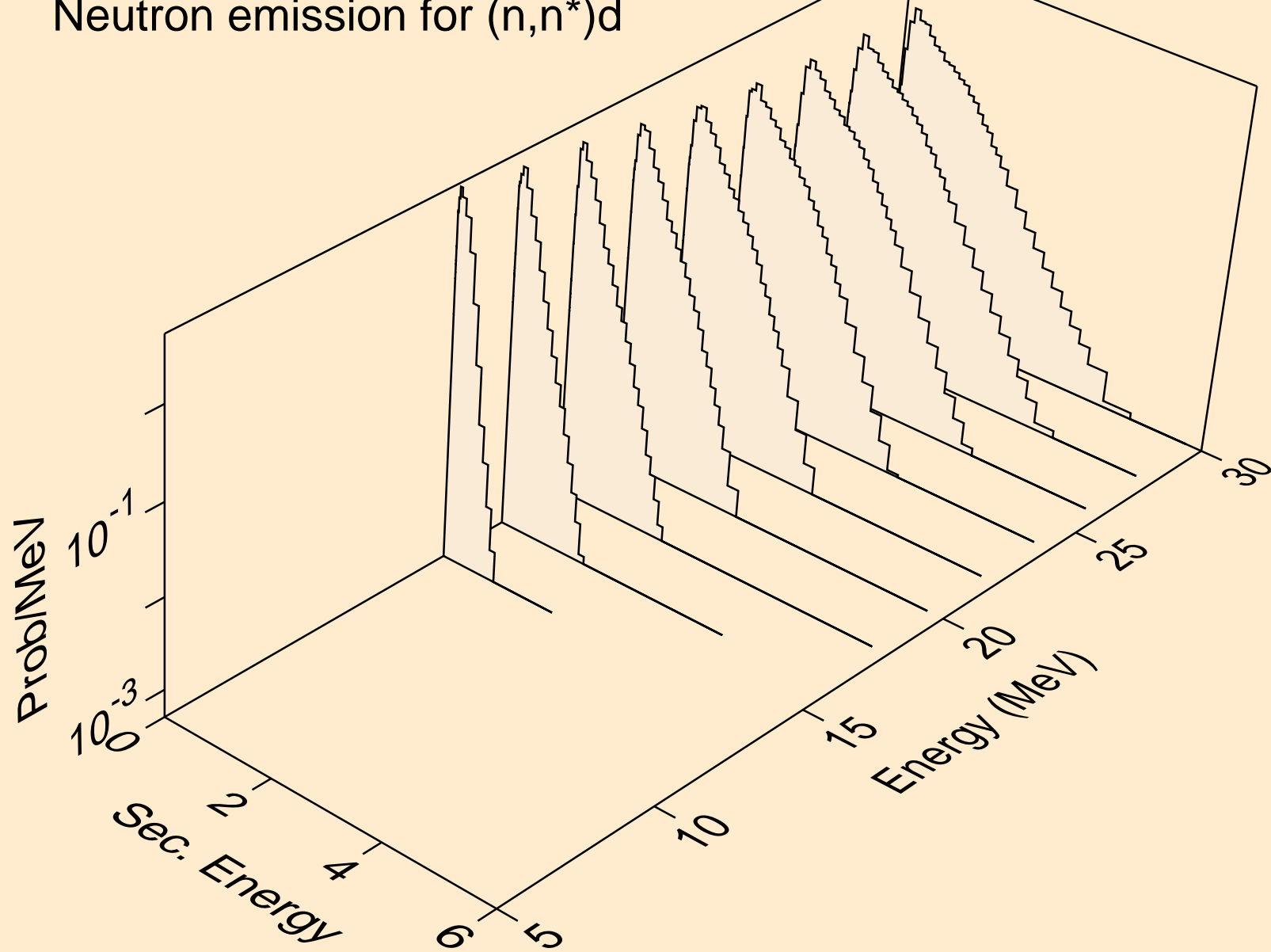

NP245 NEUTRON ACER TENDL-2024 LIBRARY; T=0.K
Neutron emission for (n,n*)t

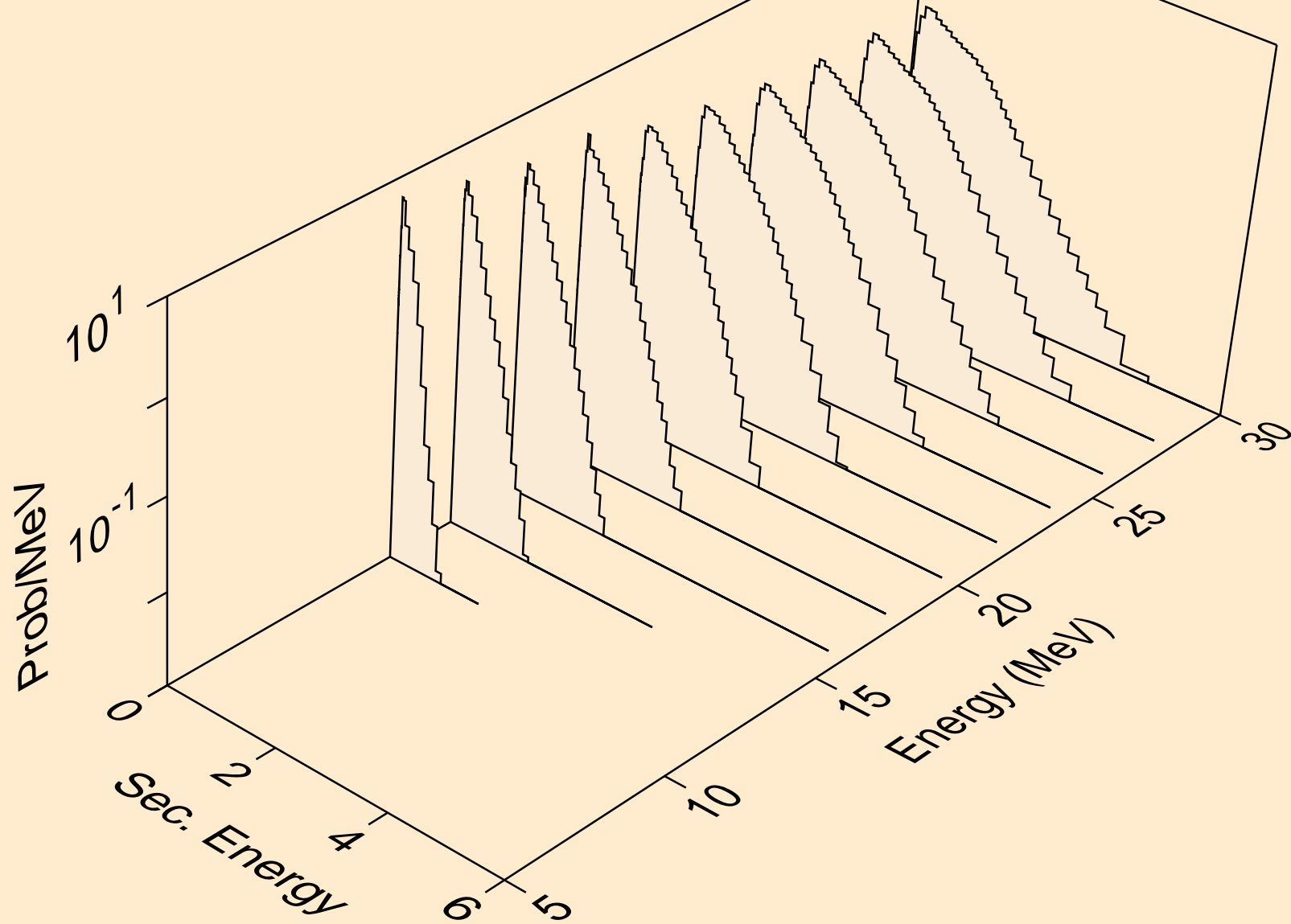

NP245 NEUTRON ACER TENDL-2024 LIBRARY; T=0.K
Neutron emission for (n,n*)he3

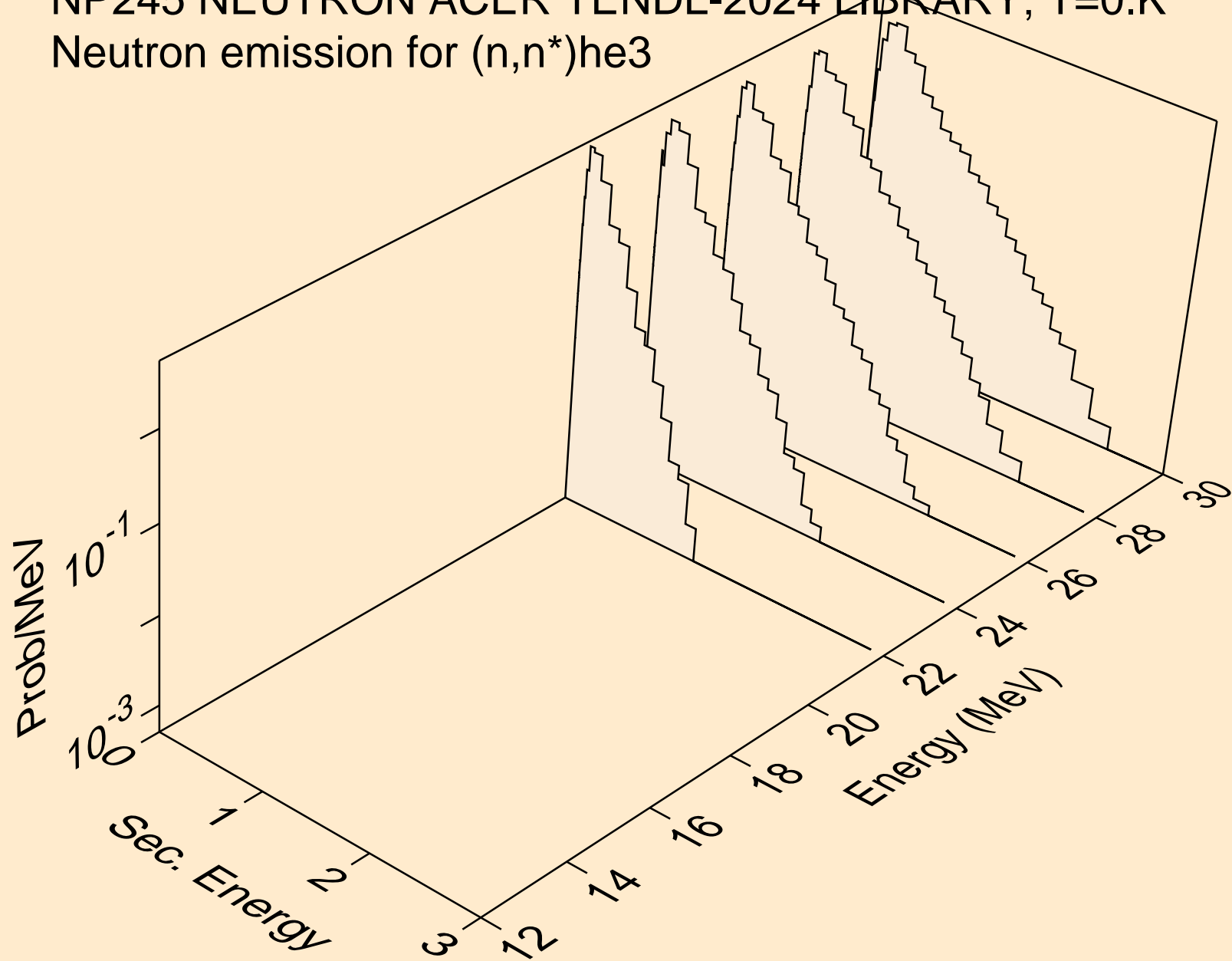

NP245 NEUTRON ACER TENDL-2024 LIBRARY; T=0.K
Neutron emission for (n,4n)

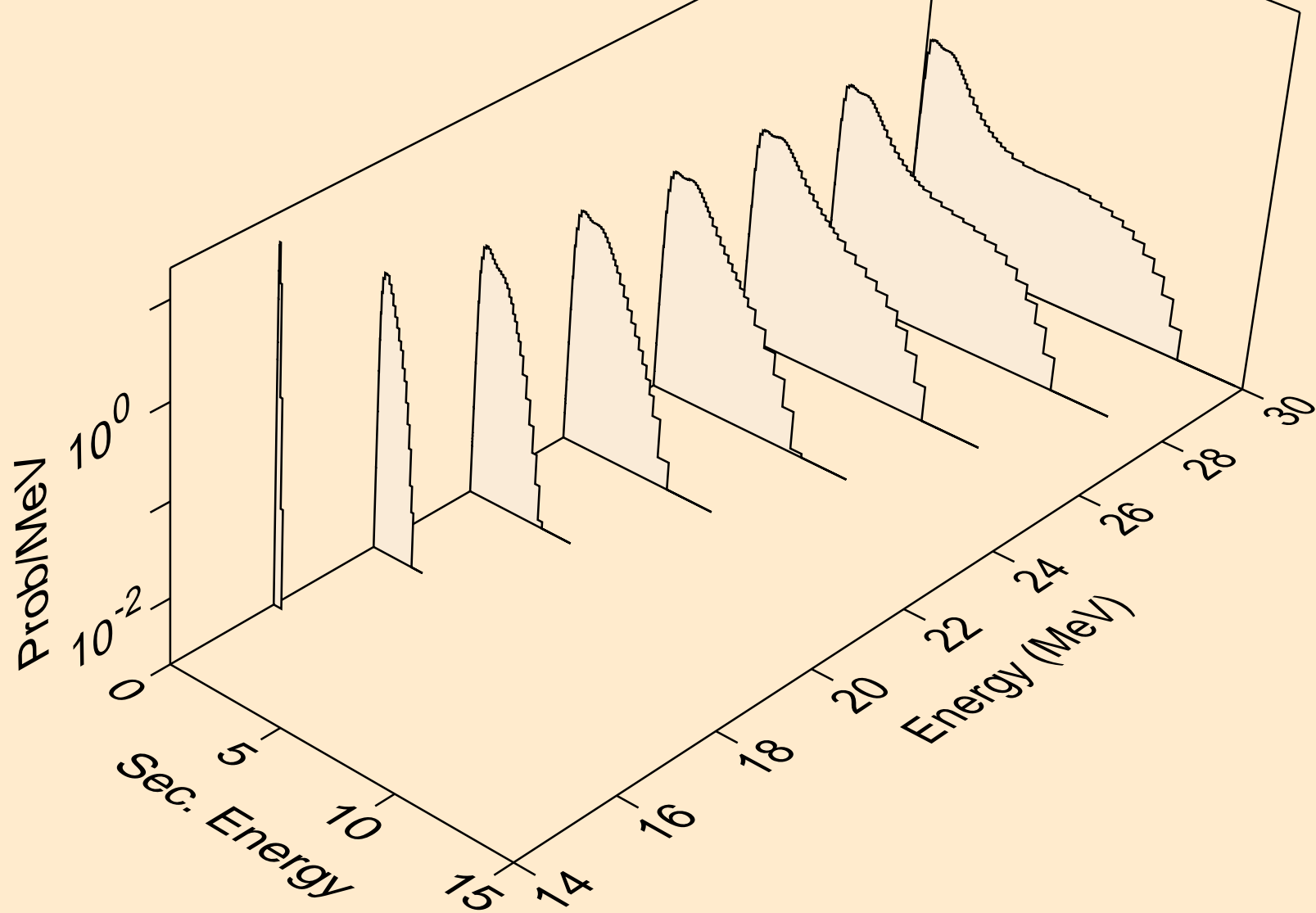

NP245 NEUTRON ACER TENDL-2024 LIBRARY; T=0.K
Neutron emission for (n,2np)

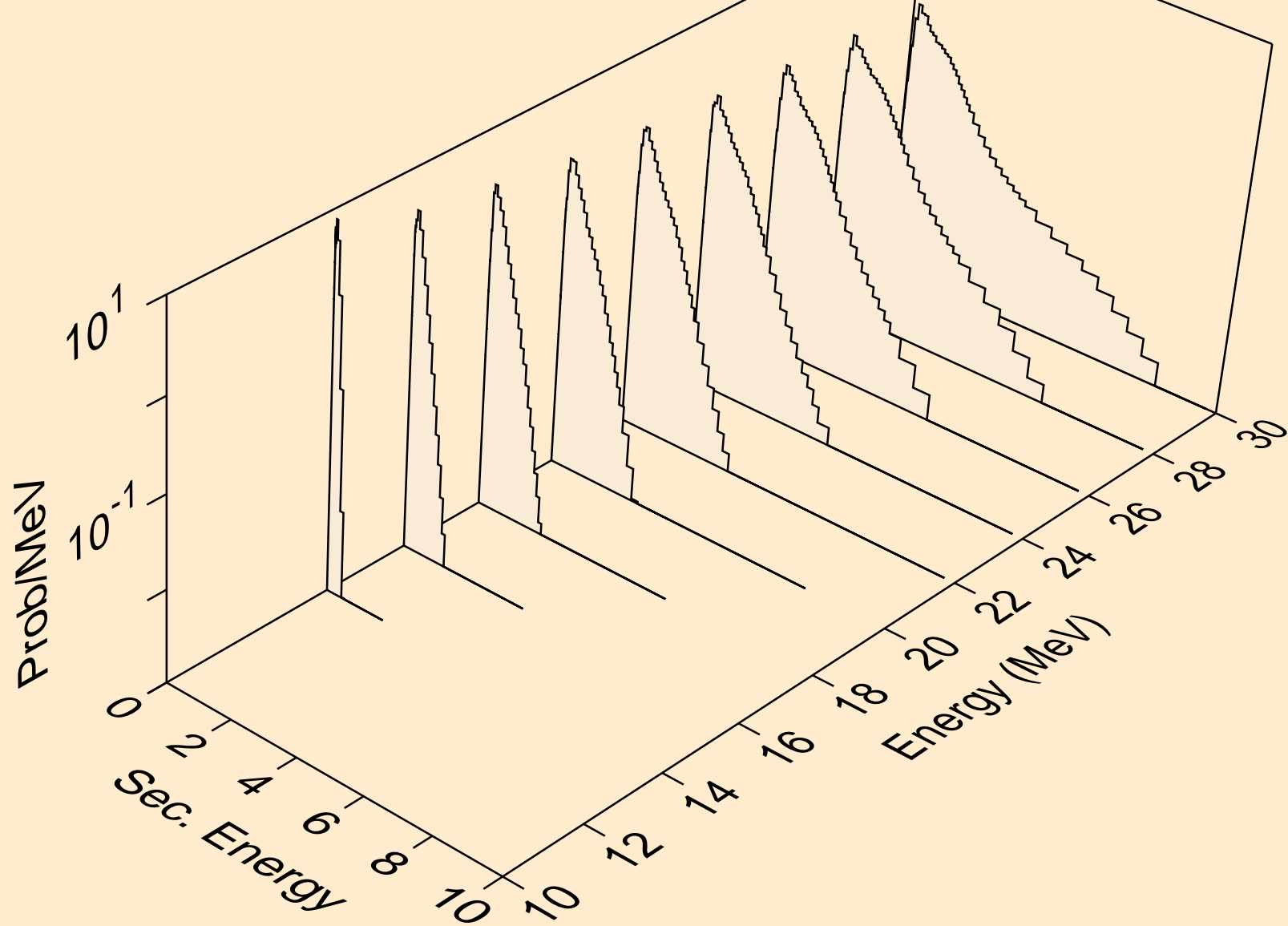

NP245 NEUTRON ACER TENDL-2024 LIBRARY; T=0.K
Neutron emission for (n,3np)

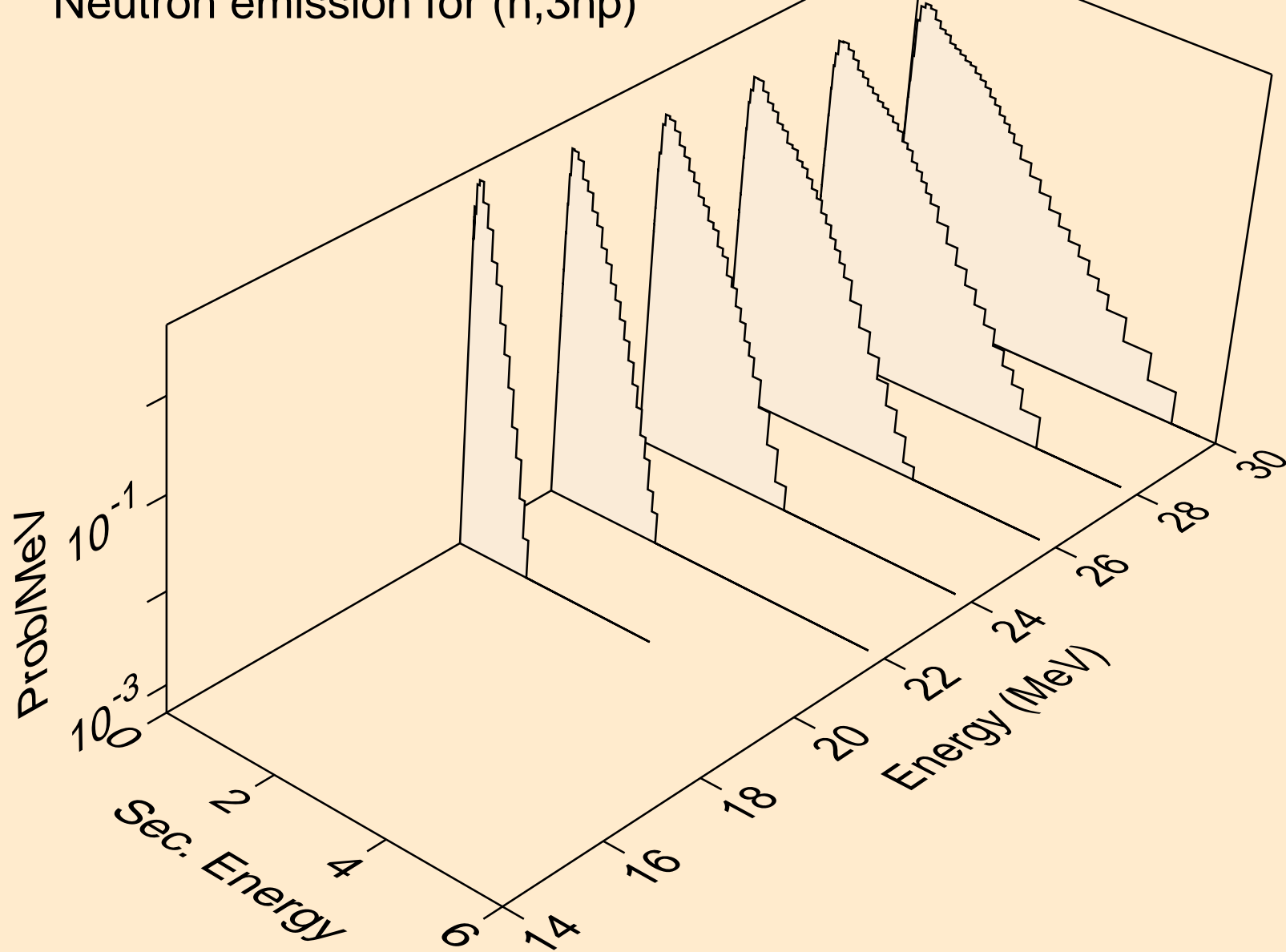

NP245 NEUTRON ACER TENDL-2024 LIBRARY; T=0.K
Neutron emission for (n,n*c)

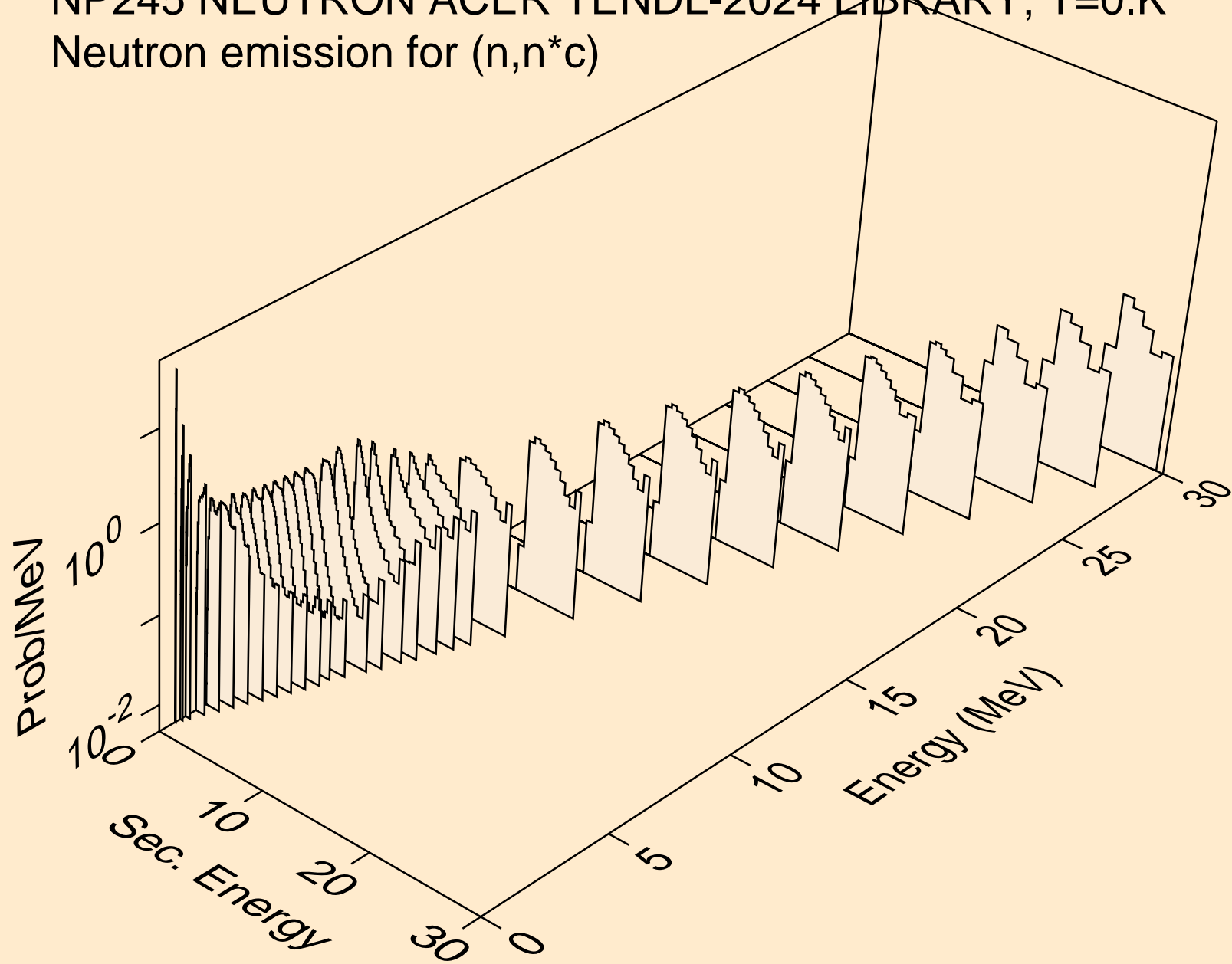

NP245 NEUTRON ACER TENDL-2024 LIBRARY; T=0.K

Delayed nubar

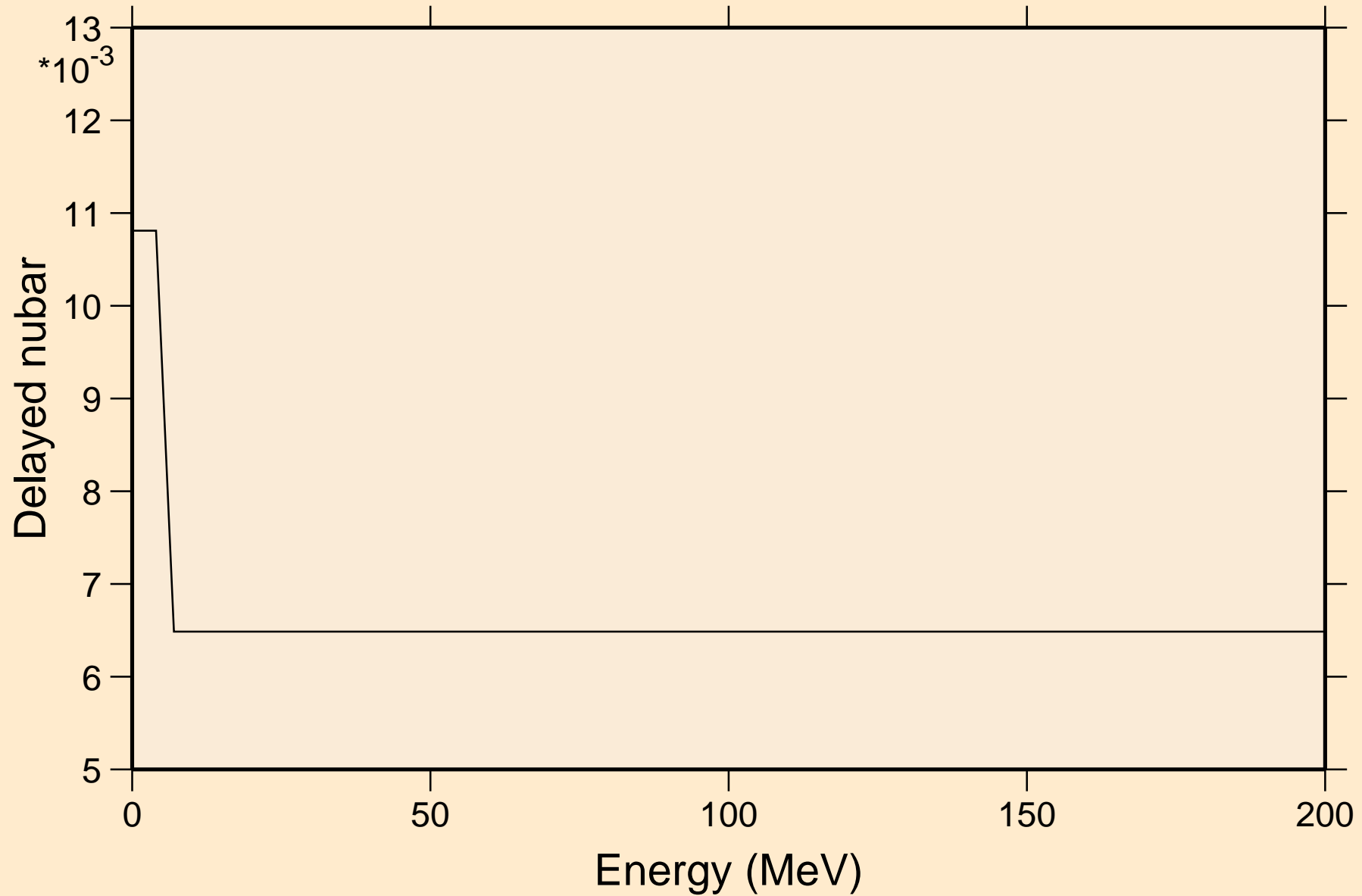

NP245 NEUTRON ACER TENDL-2024 LIBRARY; T=0.K

Delayed neutron spectra

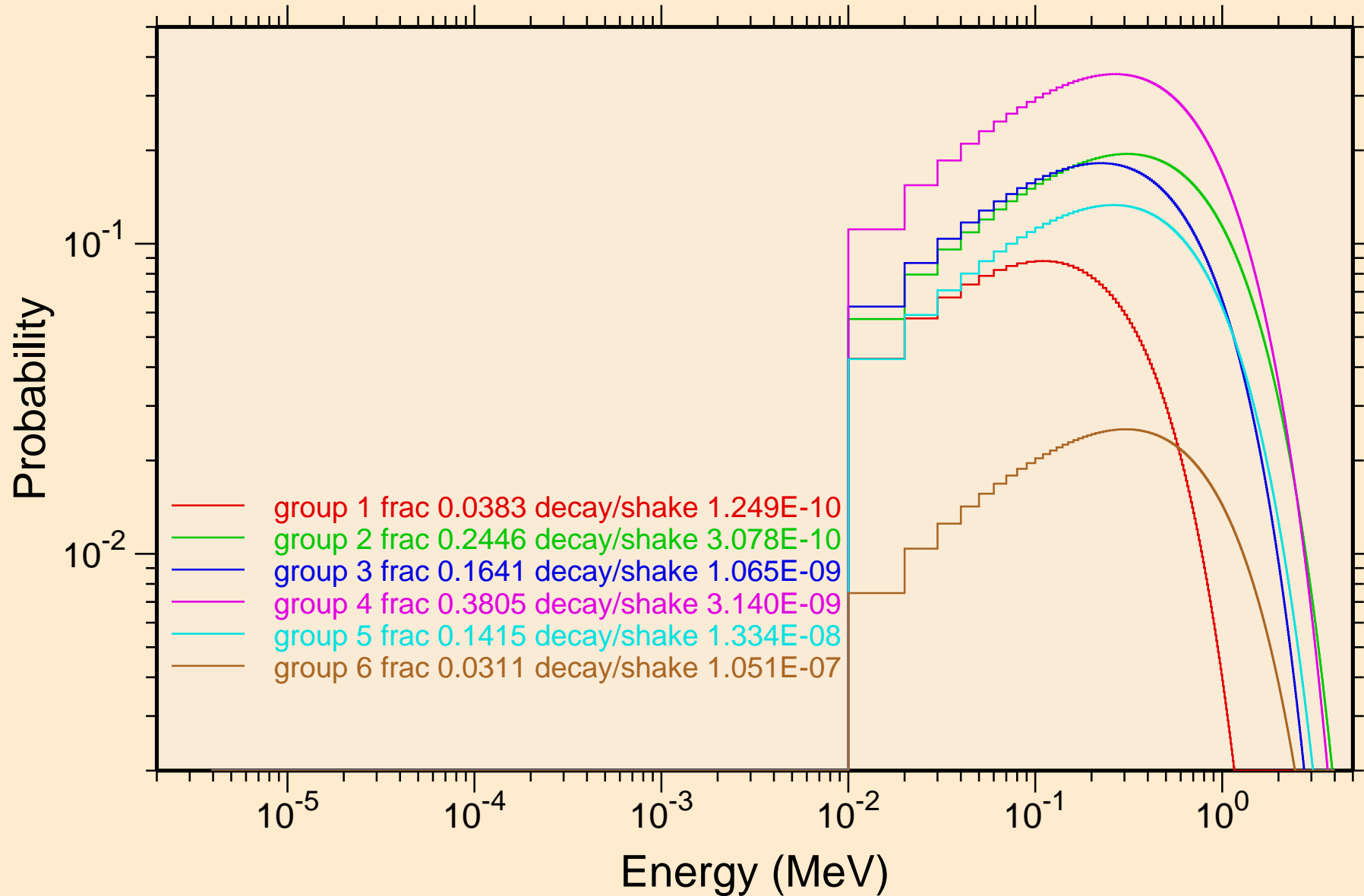

NP245 NEUTRON ACER TENDL-2024 LIBRARY; T=0.K
Photon emission for (n,x)

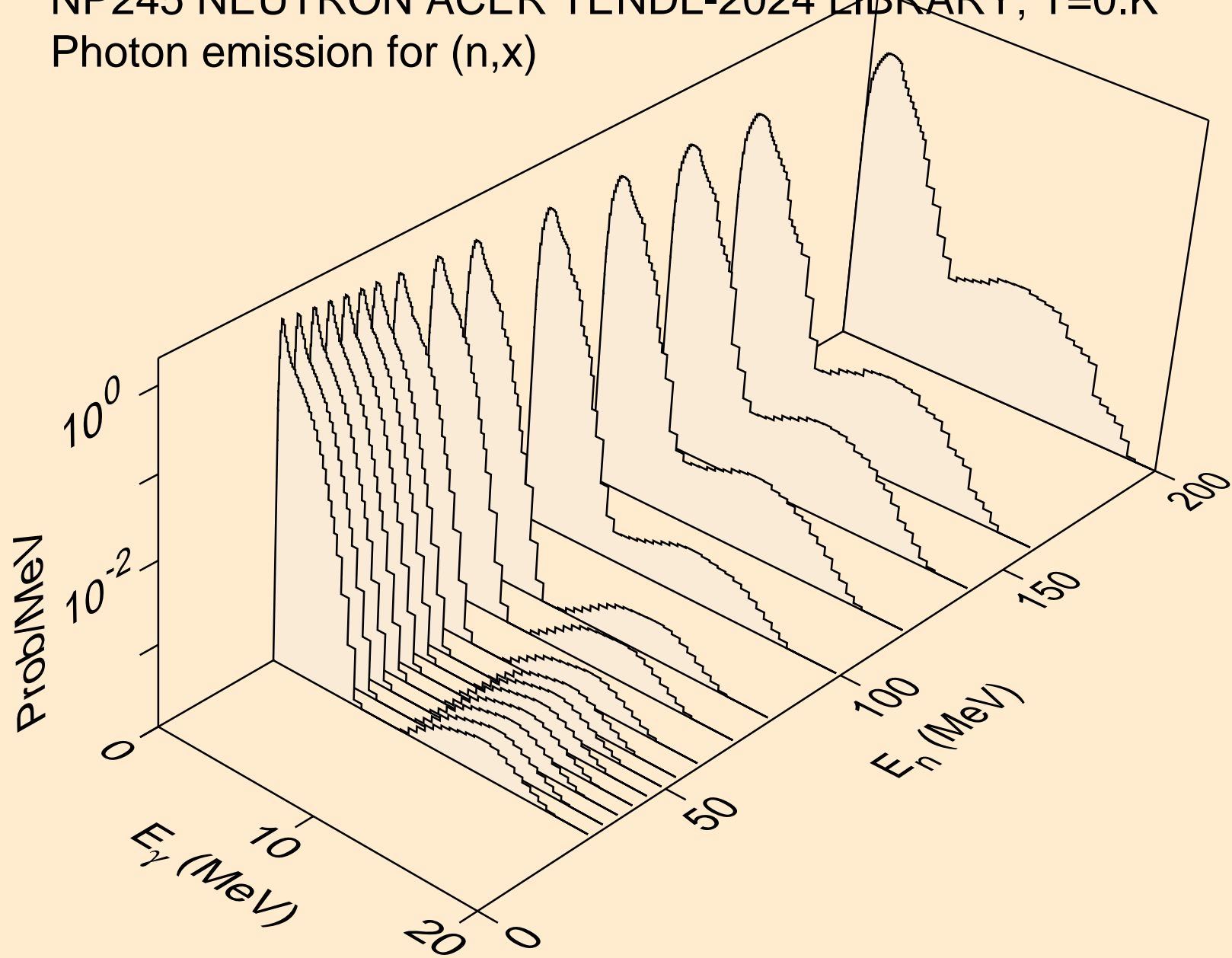

NP245 NEUTRON ACER TENDL-2024 LIBRARY; T=0.K
Photon emission for (n,2nd)

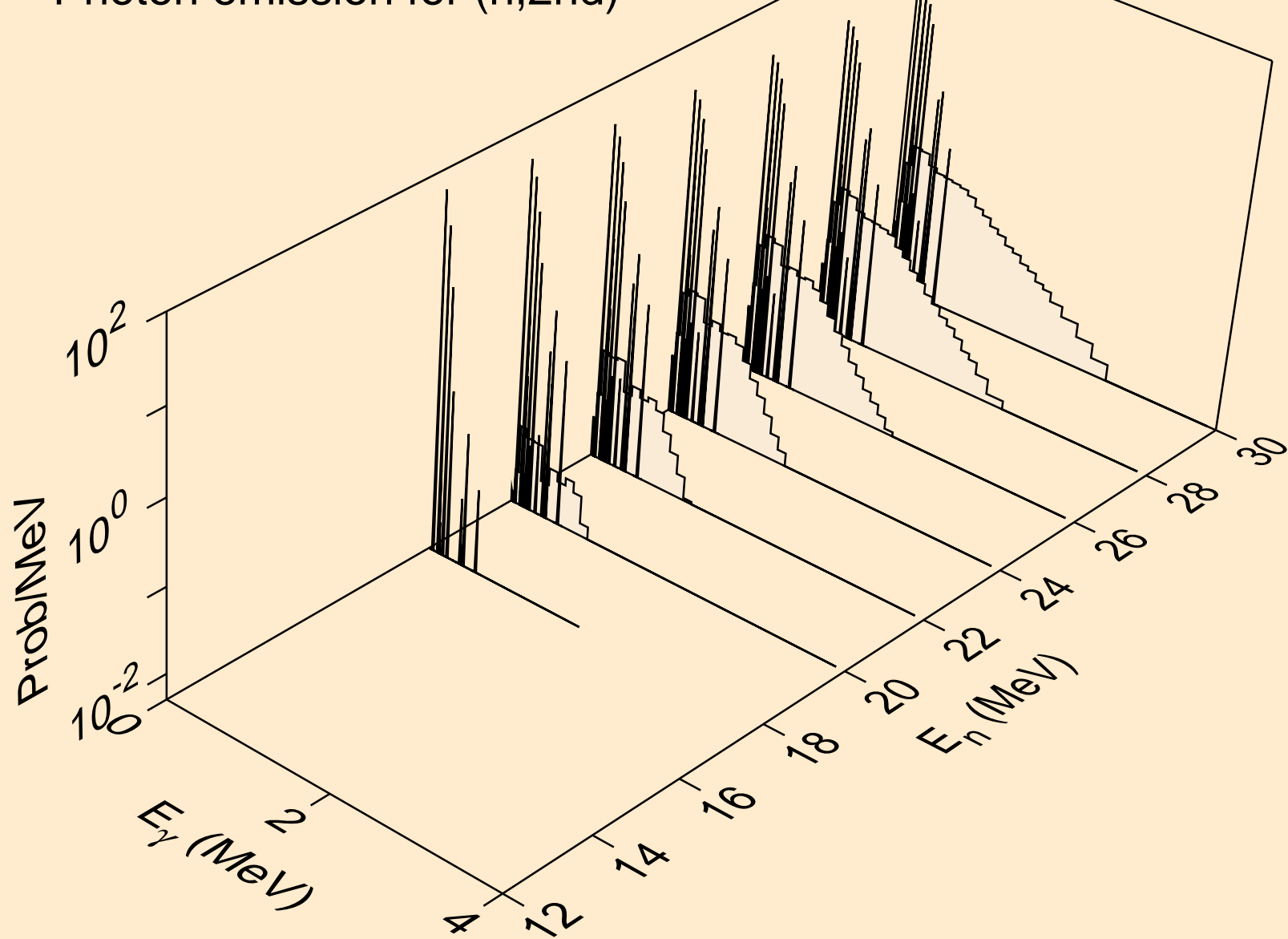

NP245 NEUTRON ACER TENDL-2024 LIBRARY; T=0.K
Photon emission for (n,2n)

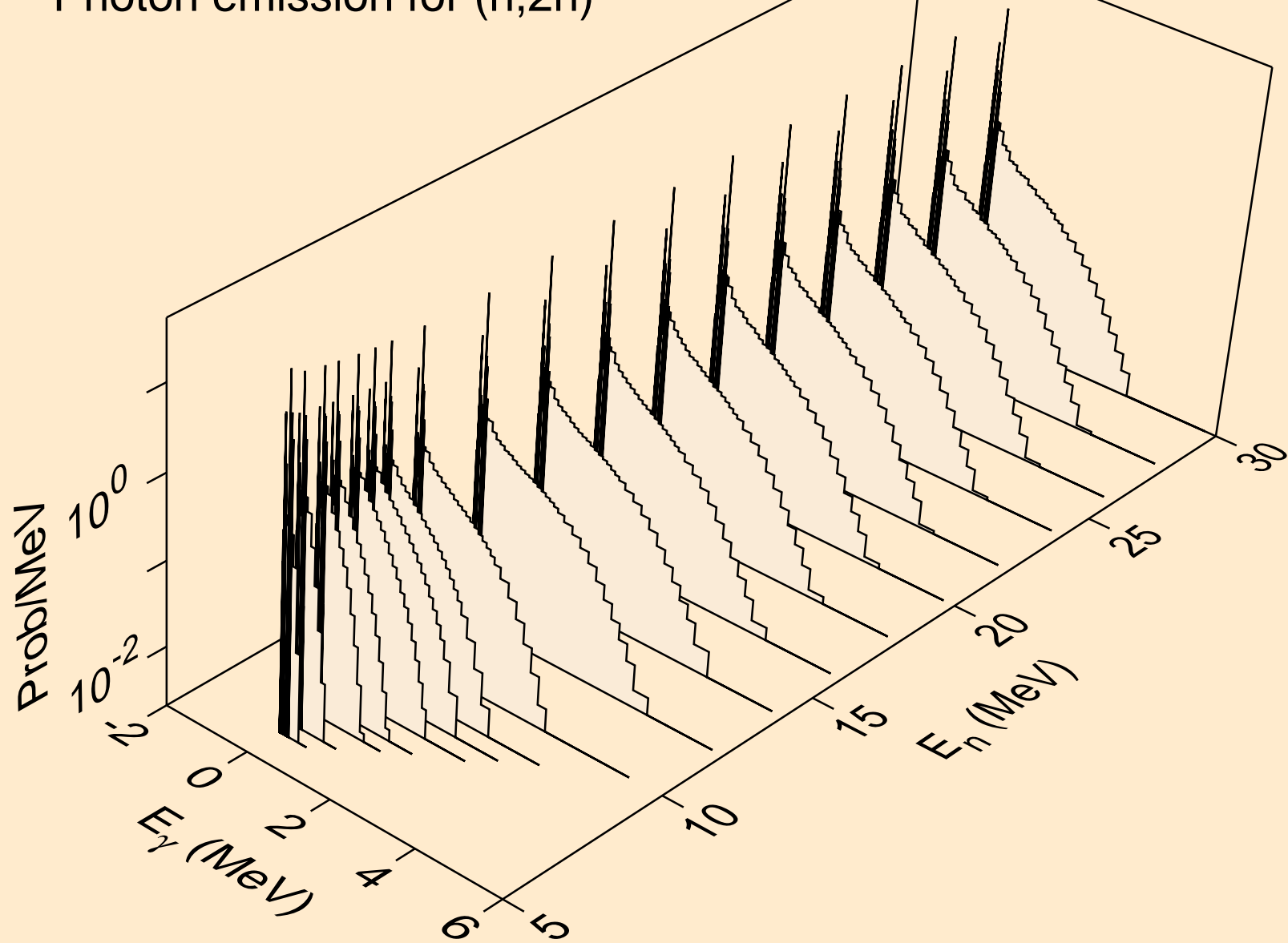

NP245 NEUTRON ACER TENDL-2024 LIBRARY; T=0.K
Photon emission for (n,3n)

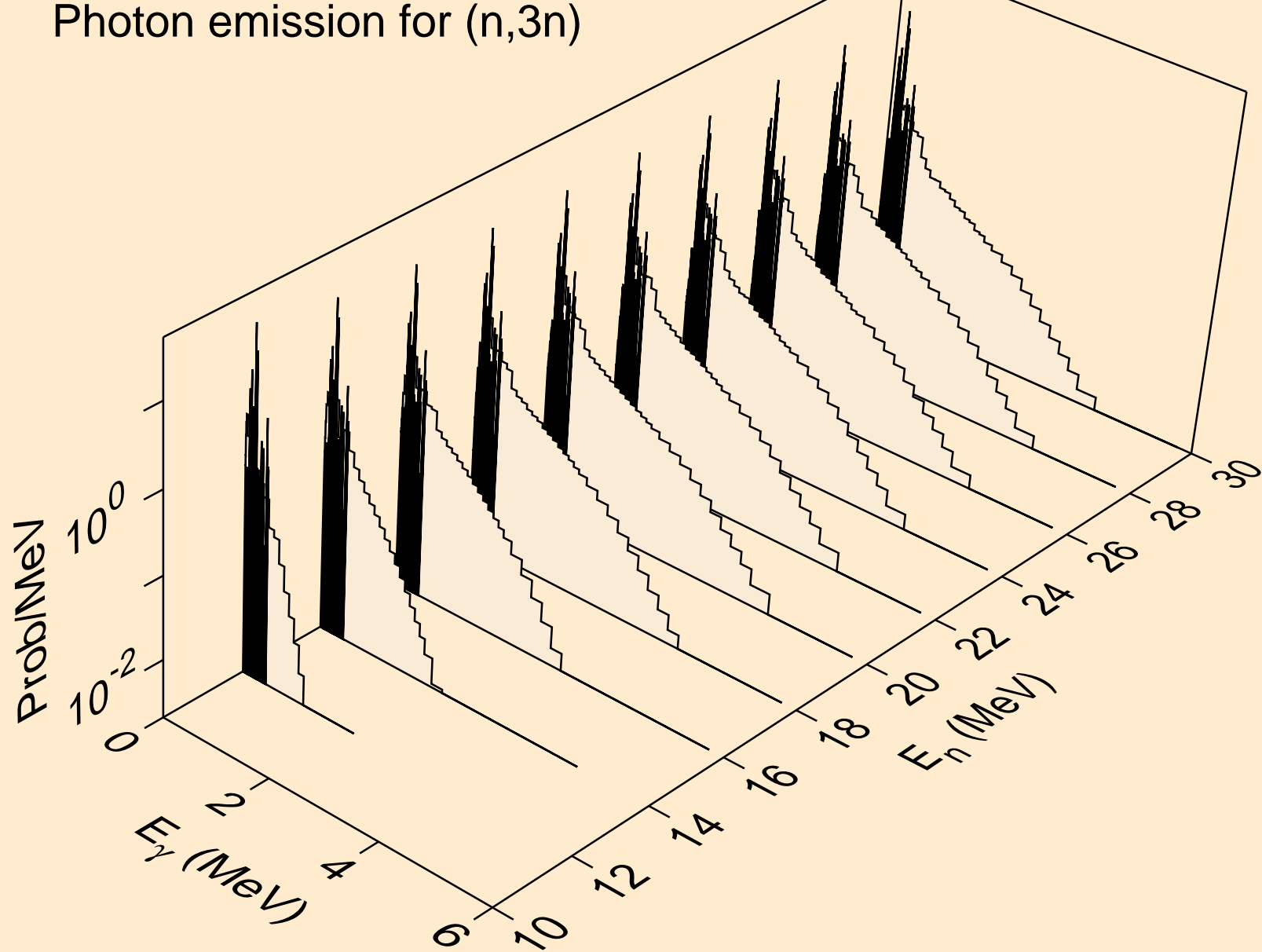

NP245 NEUTRON ACER TENDL-2024 LIBRARY; T=0.K
Photon emission for (n,n*)a

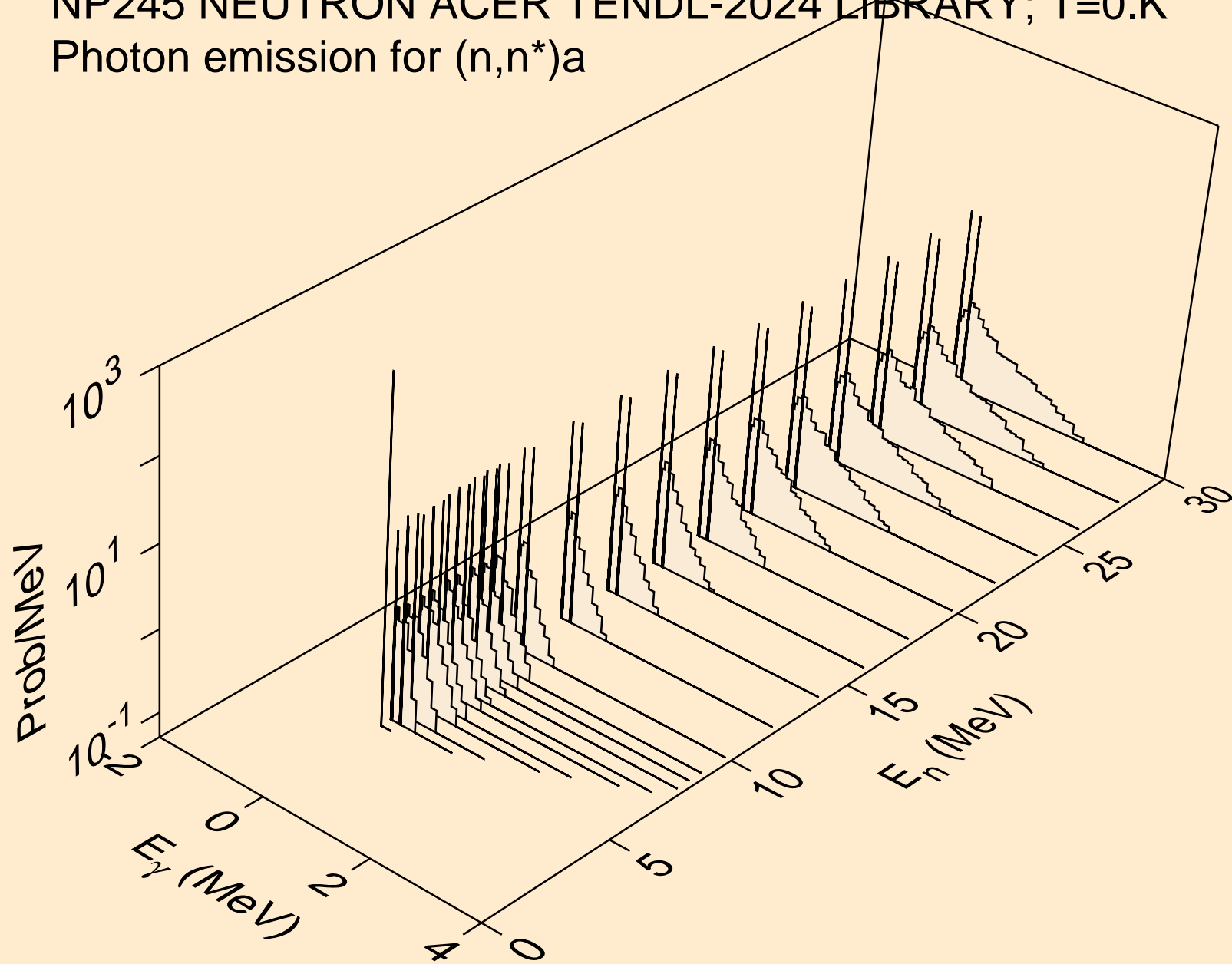

NP245 NEUTRON ACER TENDL-2024 LIBRARY; T=0.K
Photon emission for (n,2n)a

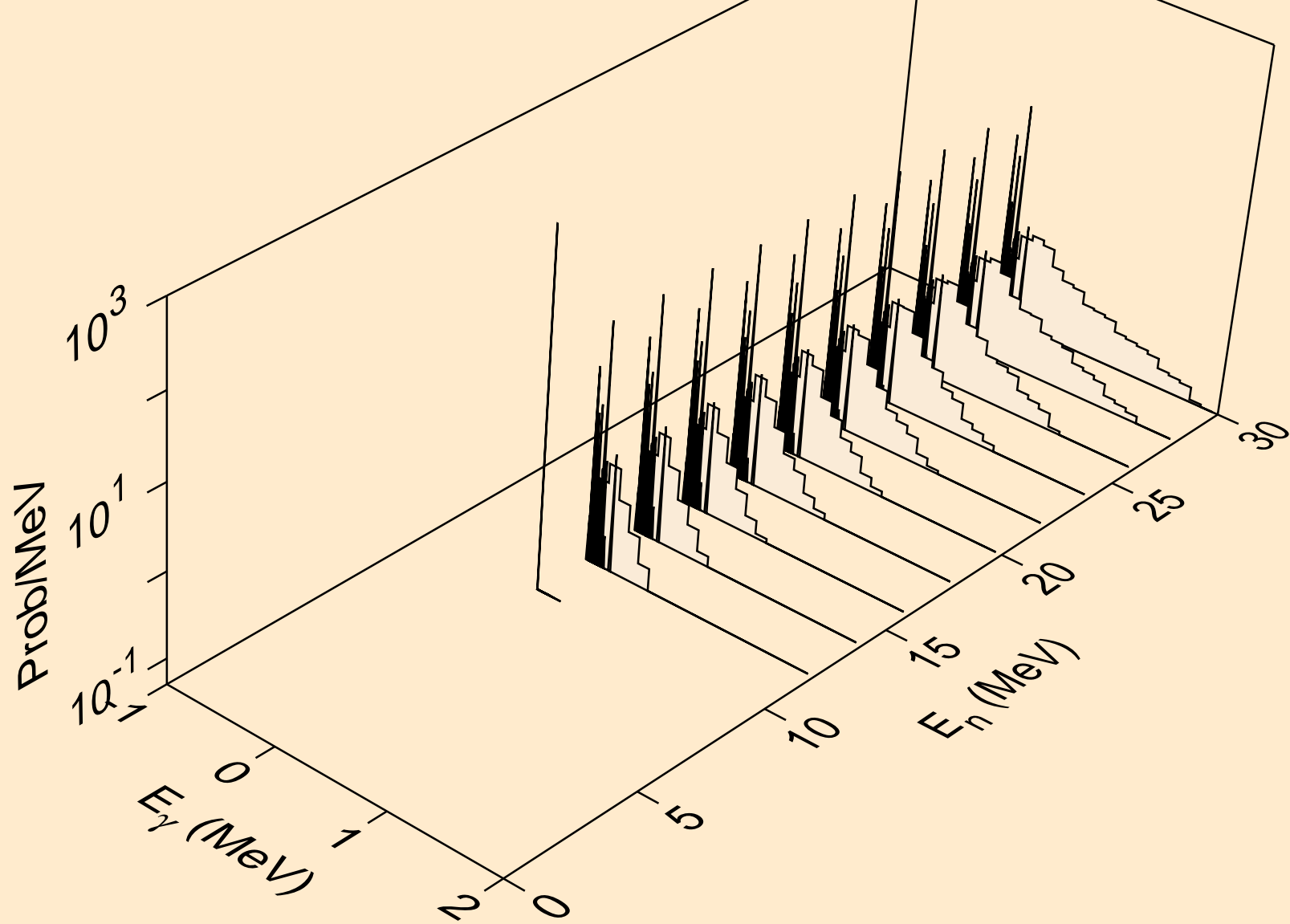

NP245 NEUTRON ACER TENDL-2024 LIBRARY; T=0.K
Photon emission for (n,3n)a

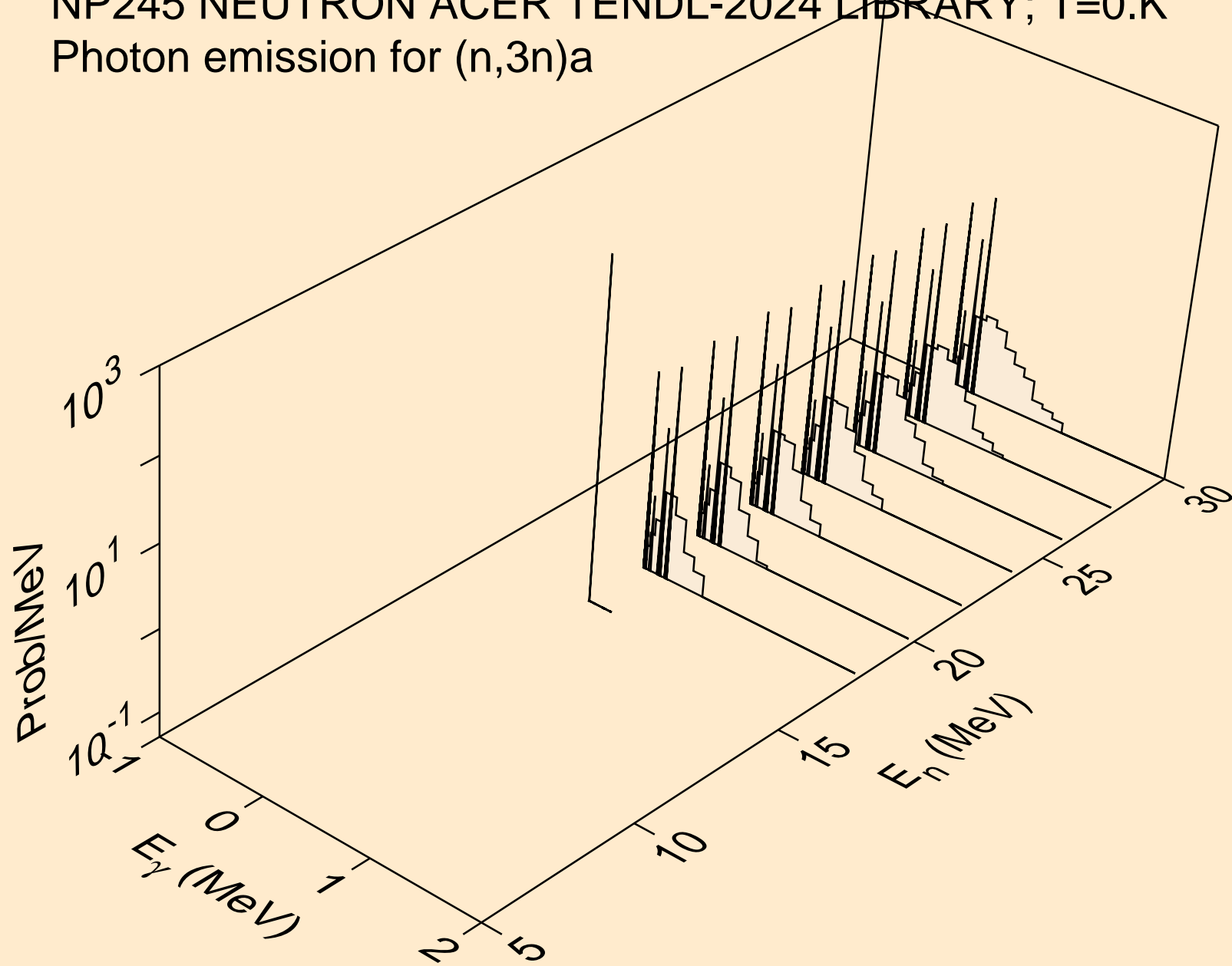

NP245 NEUTRON ACER TENDL-2024 LIBRARY; T=0.K
Photon emission for (n,n*)p

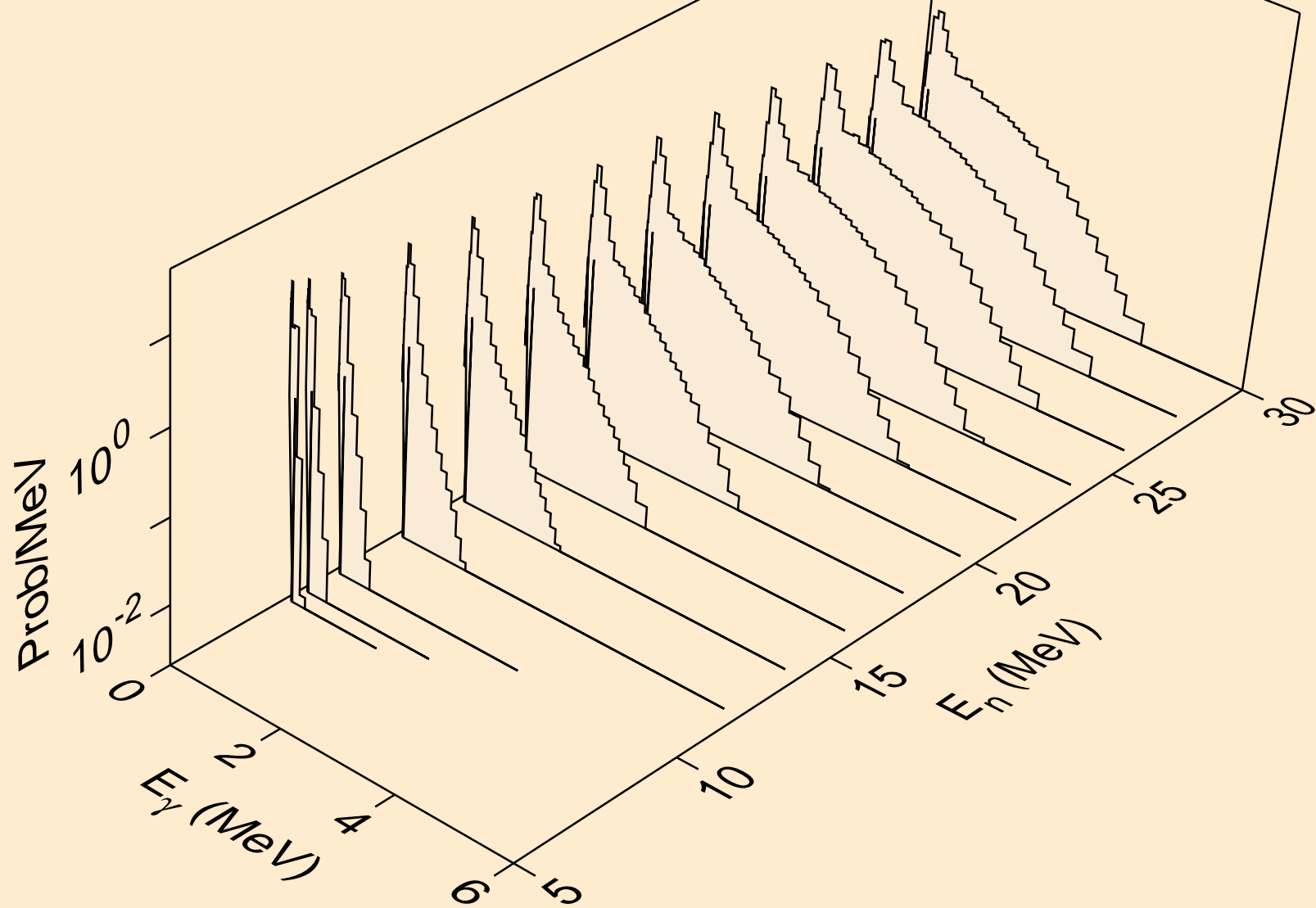

NP245 NEUTRON ACER TENDL-2024 LIBRARY; T=0.K
Photon emission for (n,n*)d

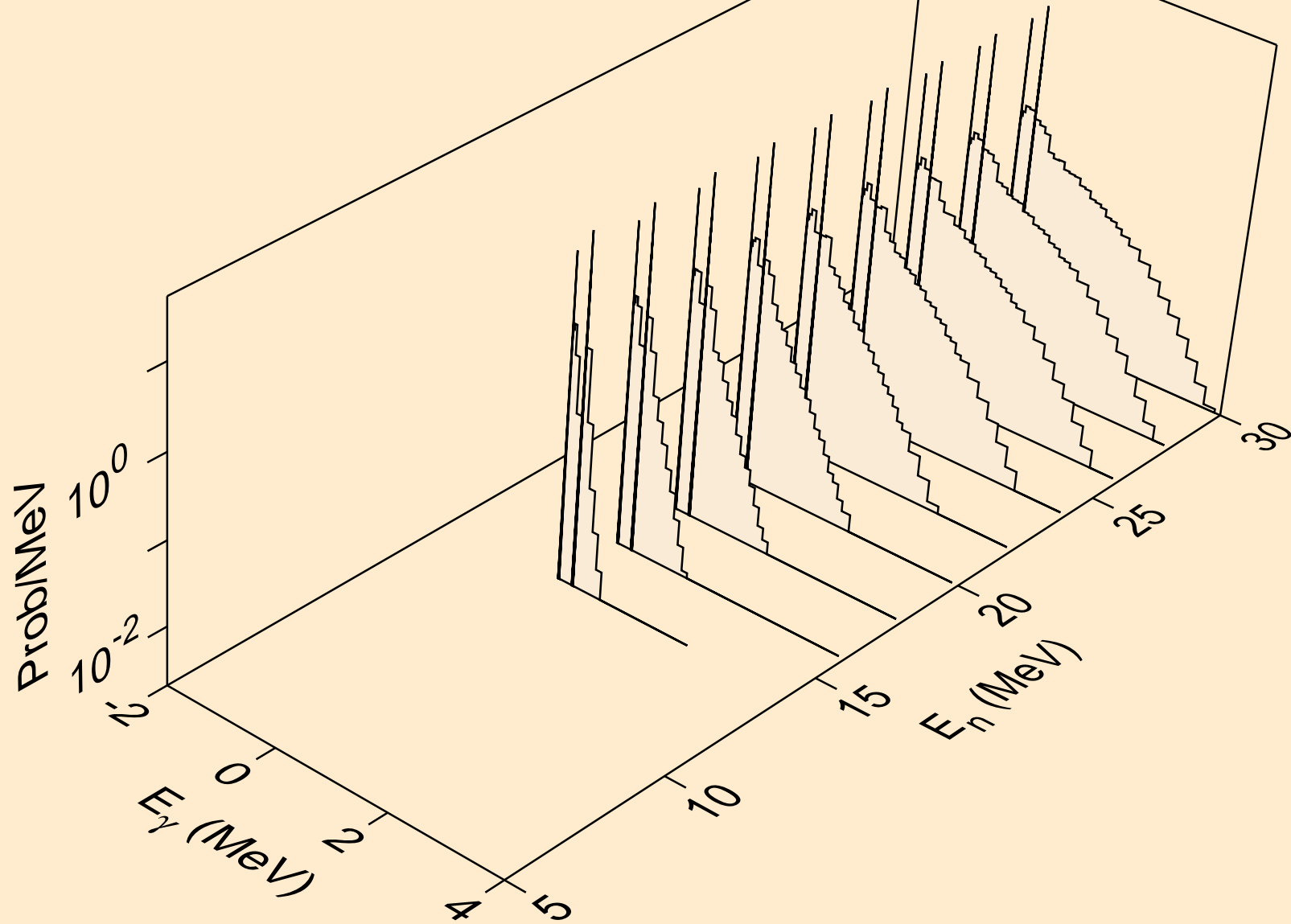

NP245 NEUTRON ACER TENDL-2024 LIBRARY; T=0.K
Photon emission for (n,n*)t

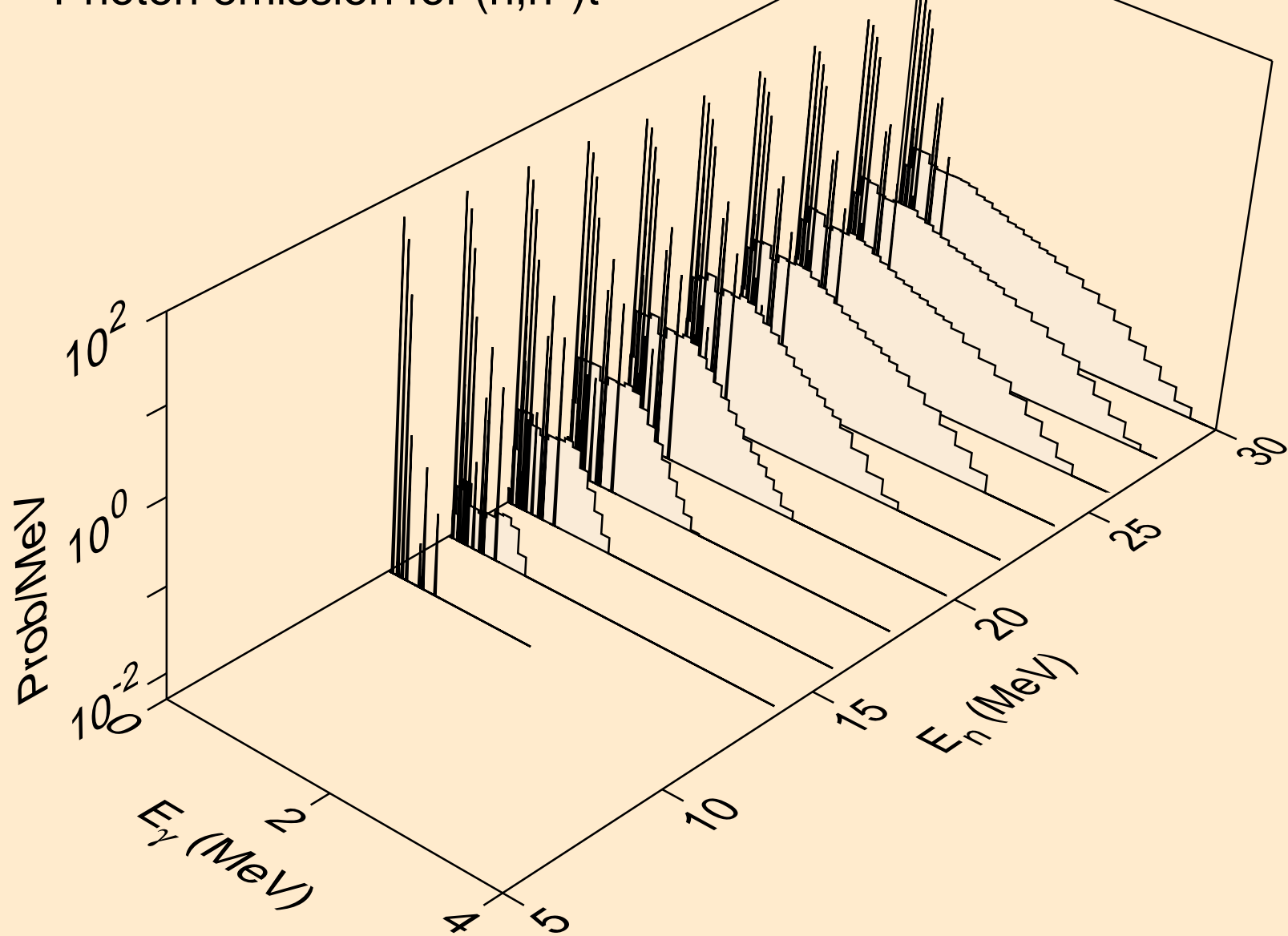

NP245 NEUTRON ACER TENDL-2024 LIBRARY; T=0.K
Photon emission for (n,n*)he3

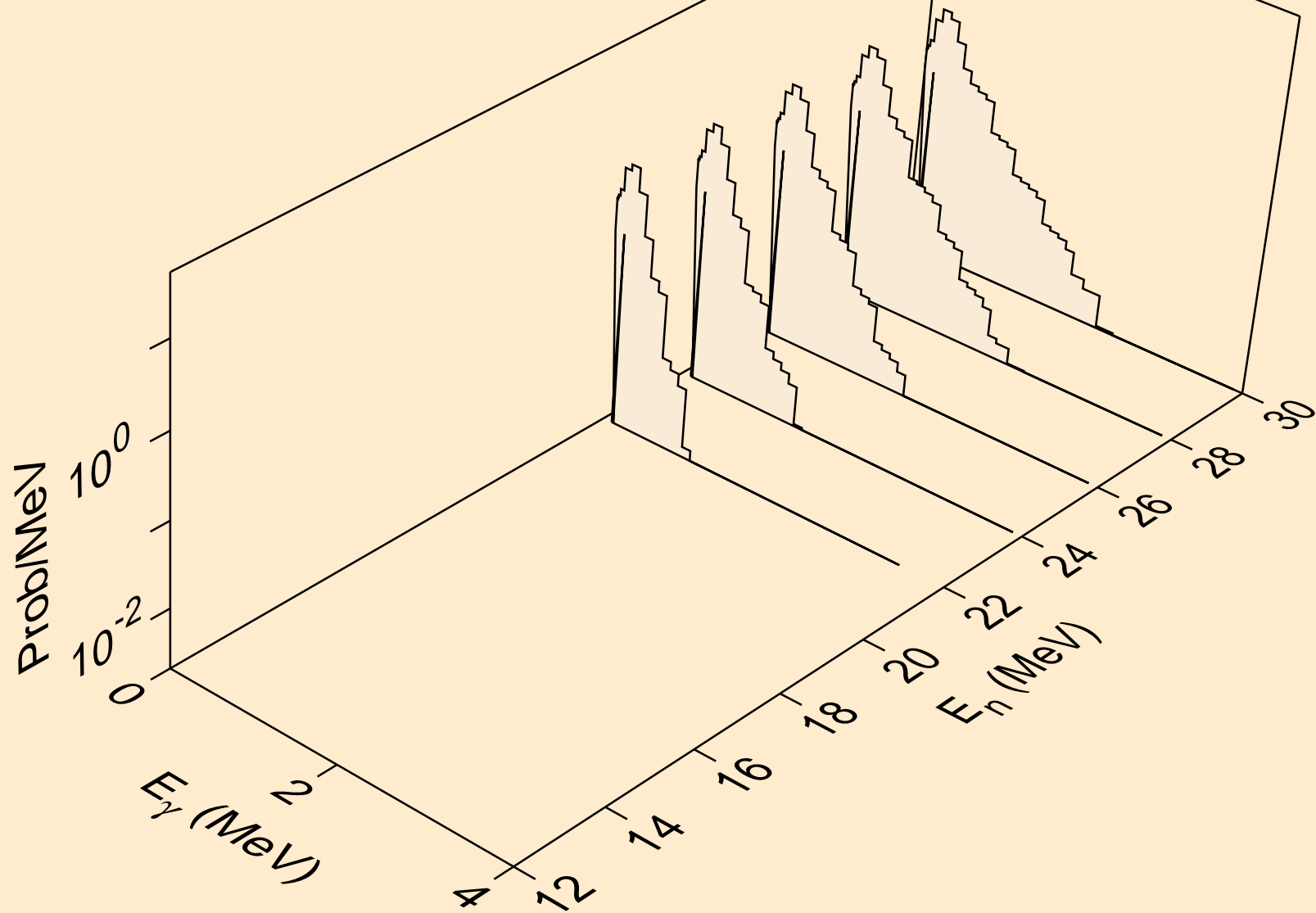

NP245 NEUTRON ACER TENDL-2024 LIBRARY; T=0.K
Photon emission for (n,4n)

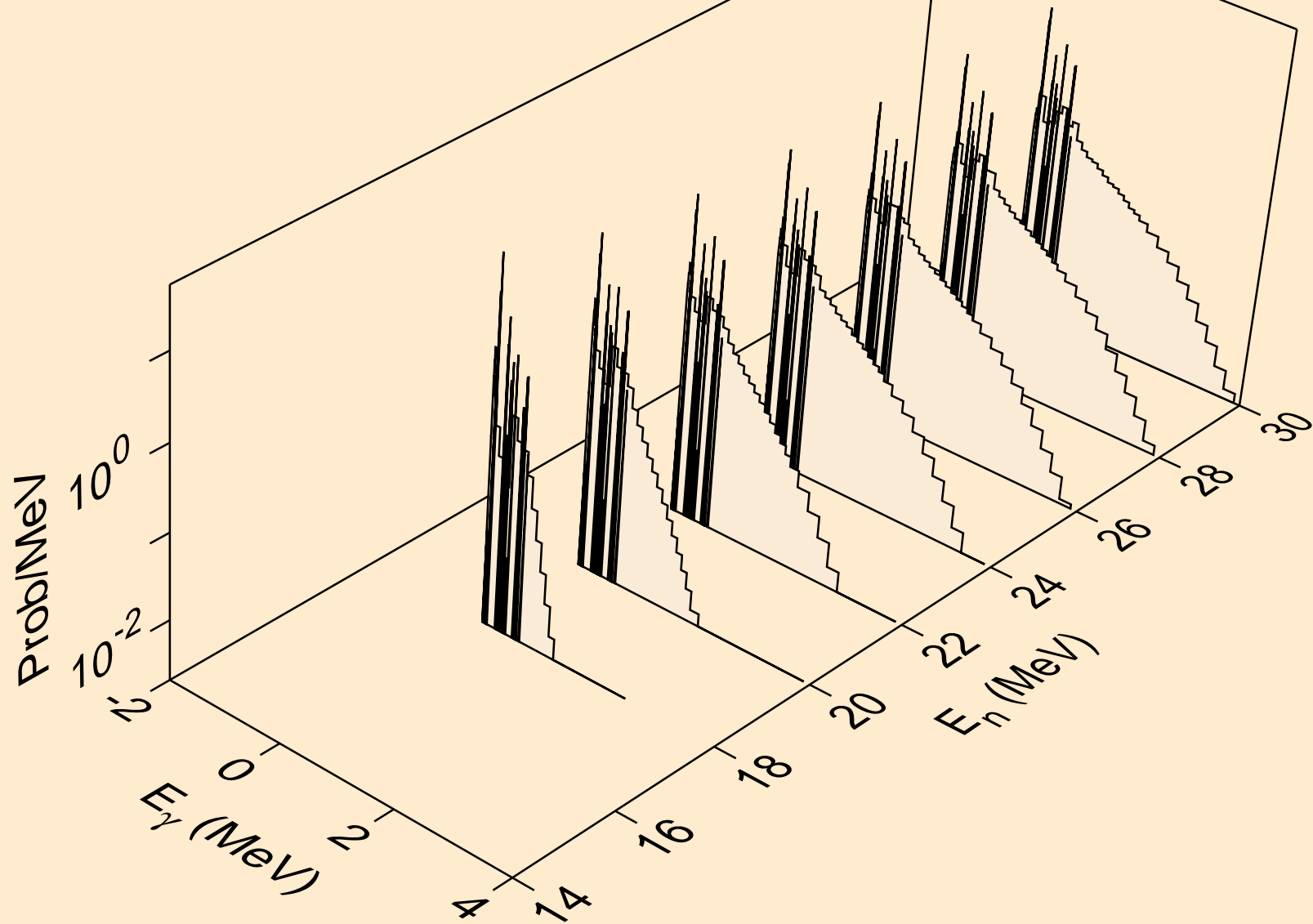

NP245 NEUTRON ACER TENDL-2024 LIBRARY; T=0.K
Photon emission for (n,2np)

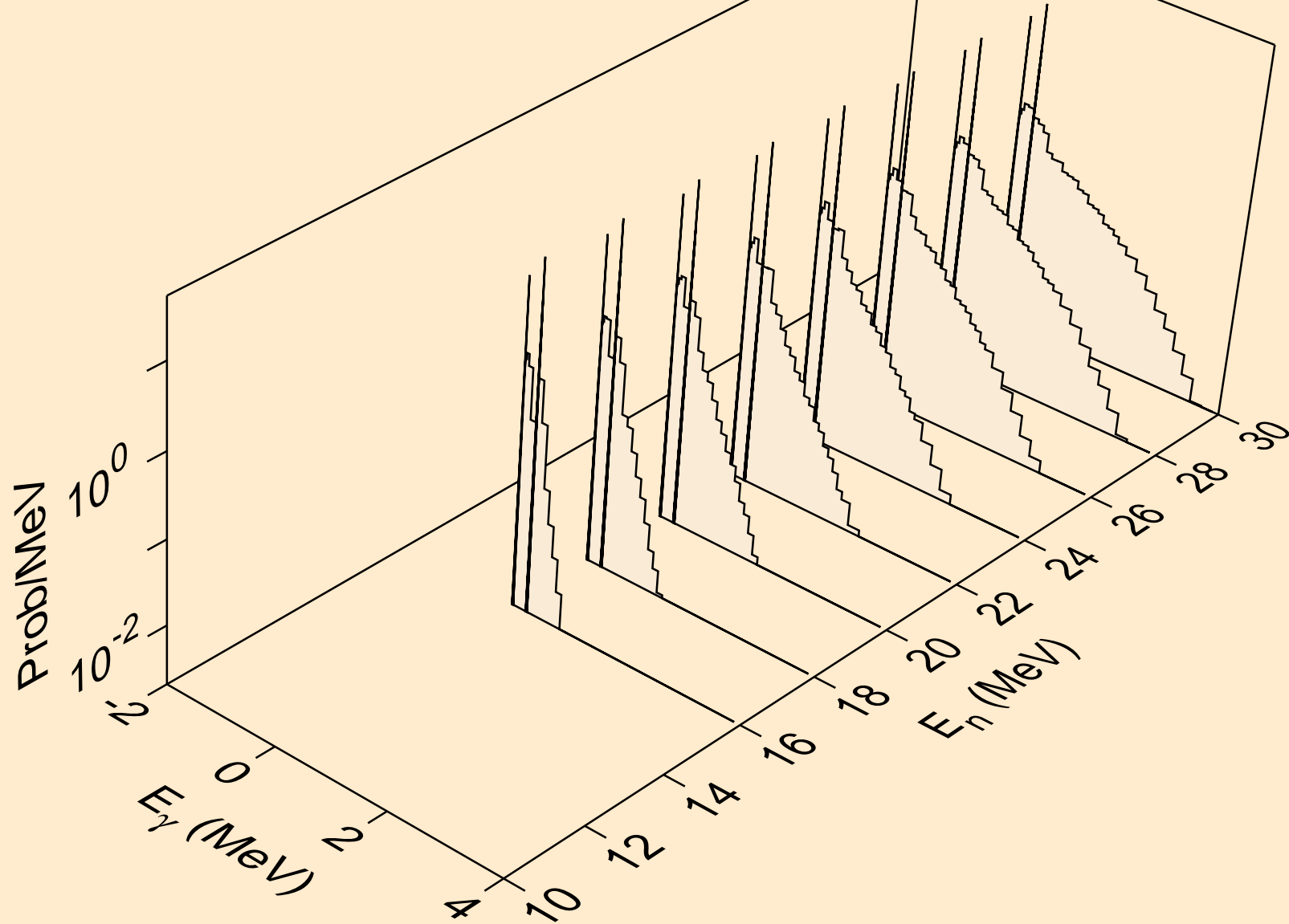

NP245 NEUTRON ACER TENDL-2024 LIBRARY; T=0.K
Photon emission for (n,3np)

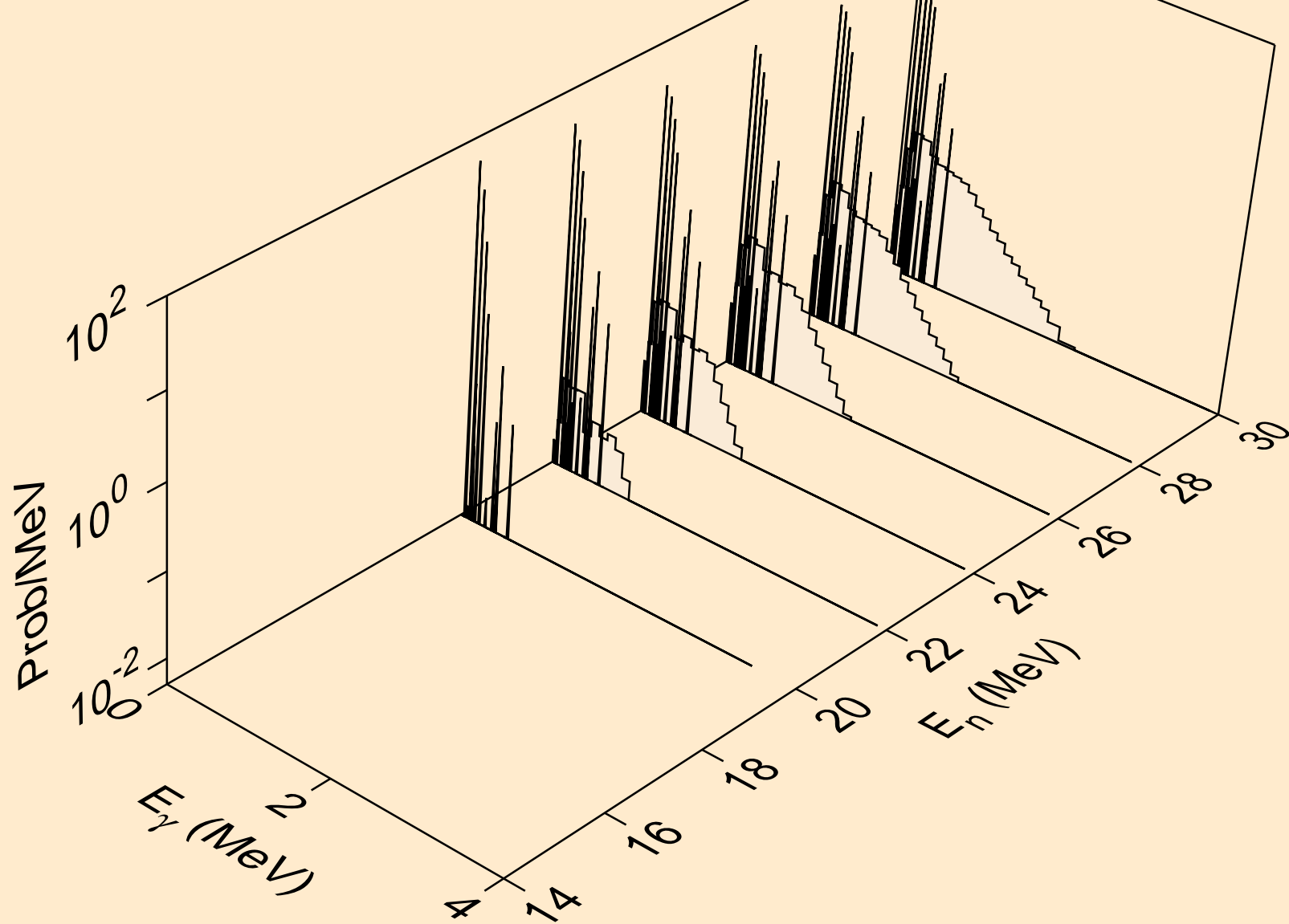

NP245 NEUTRON ACER TENDL-2024 LIBRARY; T=0.K
Photon emission for (n,n*c)

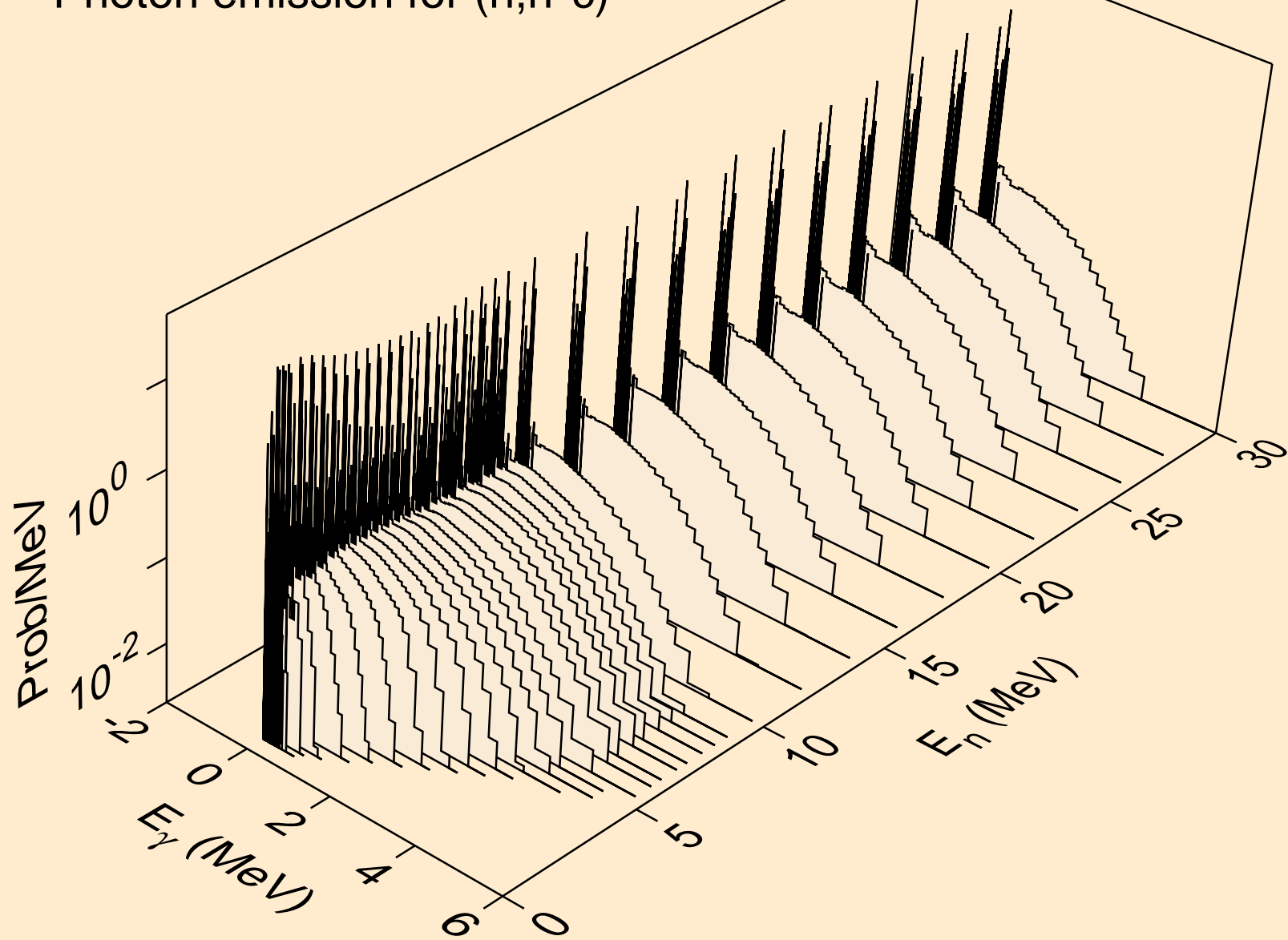

NP245 NEUTRON ACER TENDL-2024 LIBRARY; T=0.K
Photon emission for (n,gma)

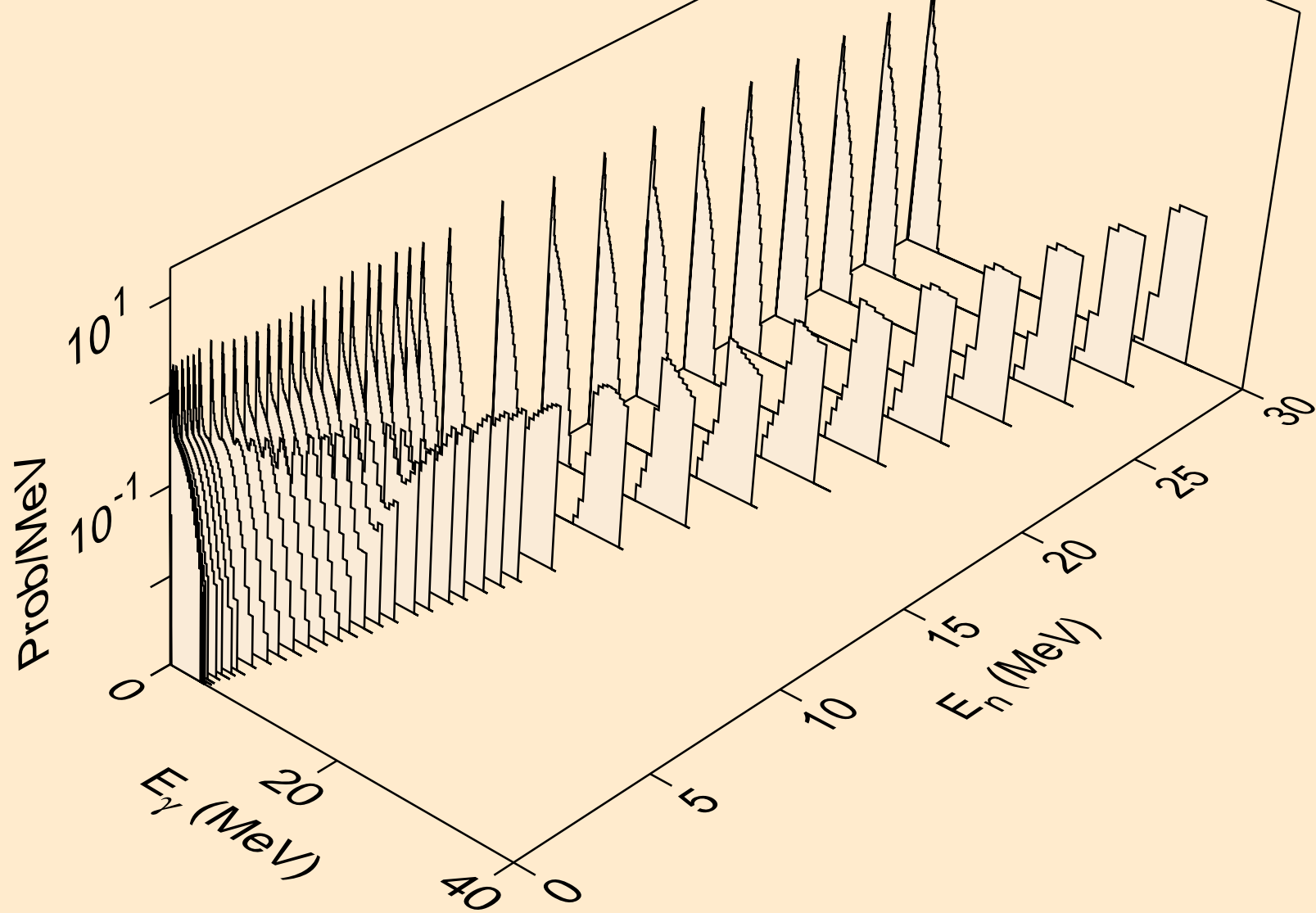

NP245 NEUTRON ACER TENDL-2024 LIBRARY; T=0.K
Photon emission for (n,p)

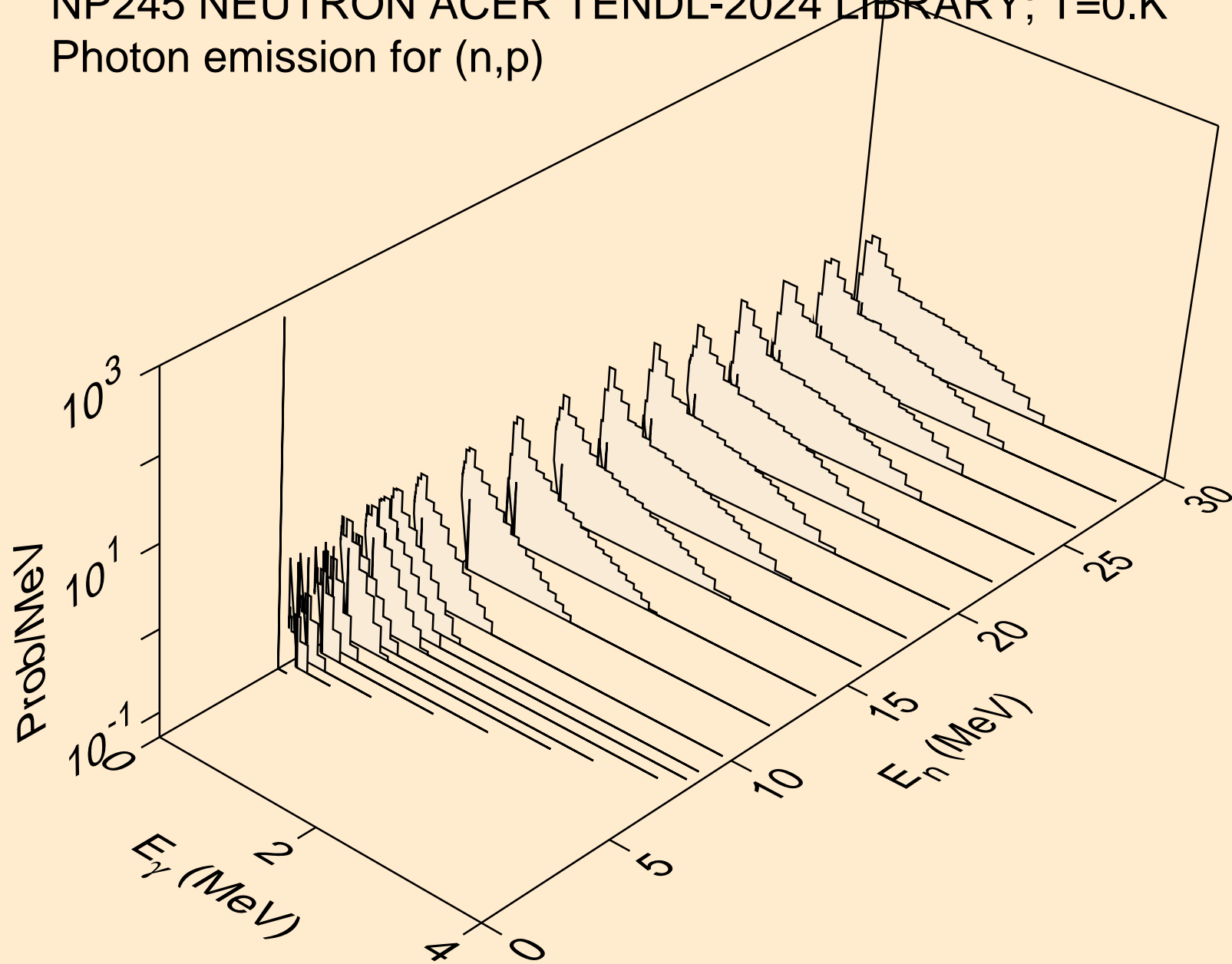

NP245 NEUTRON ACER TENDL-2024 LIBRARY; T=0.K
Photon emission for (n,d)

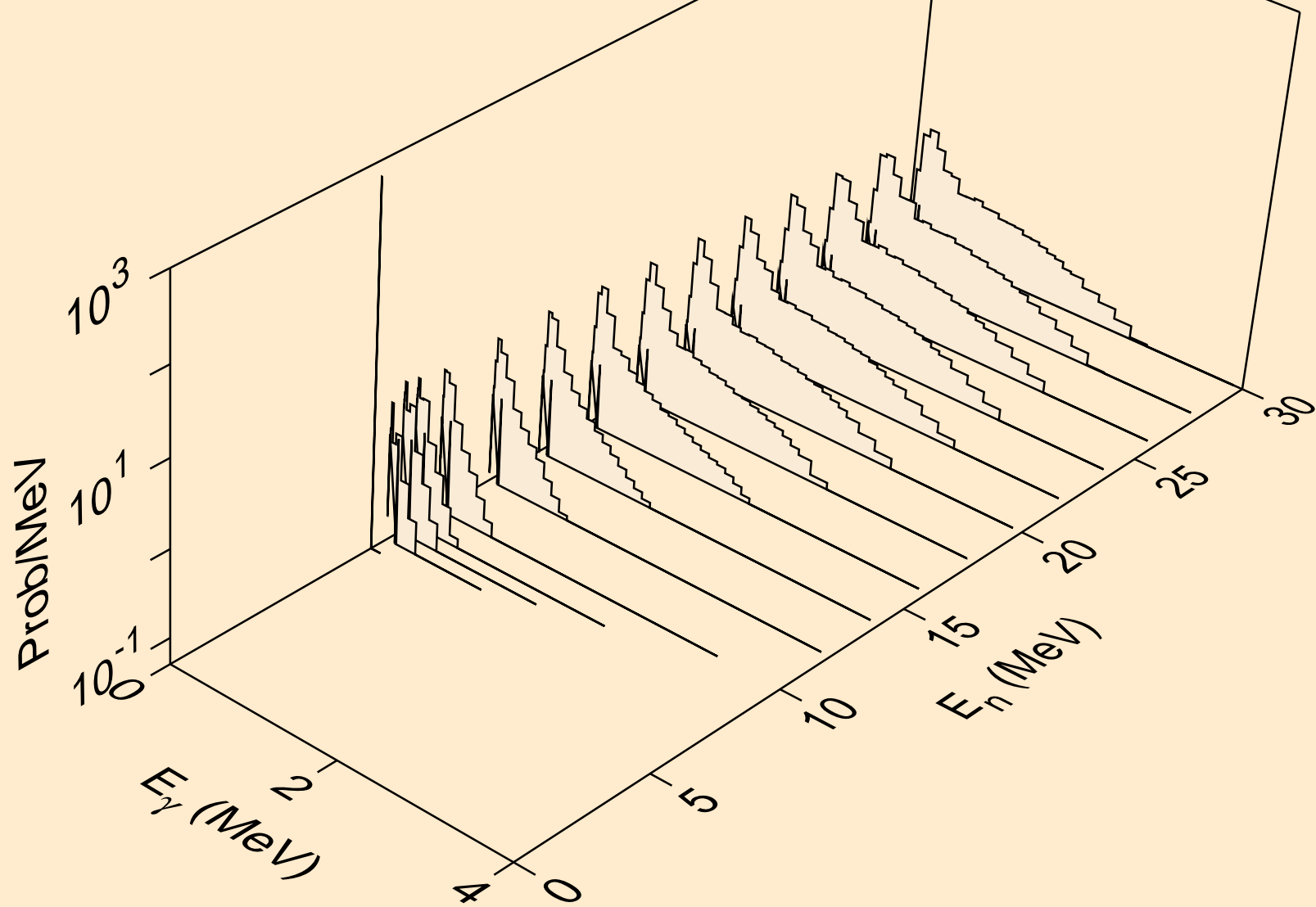

NP245 NEUTRON ACER TENDL-2024 LIBRARY; T=0.K
Photon emission for (n,t)

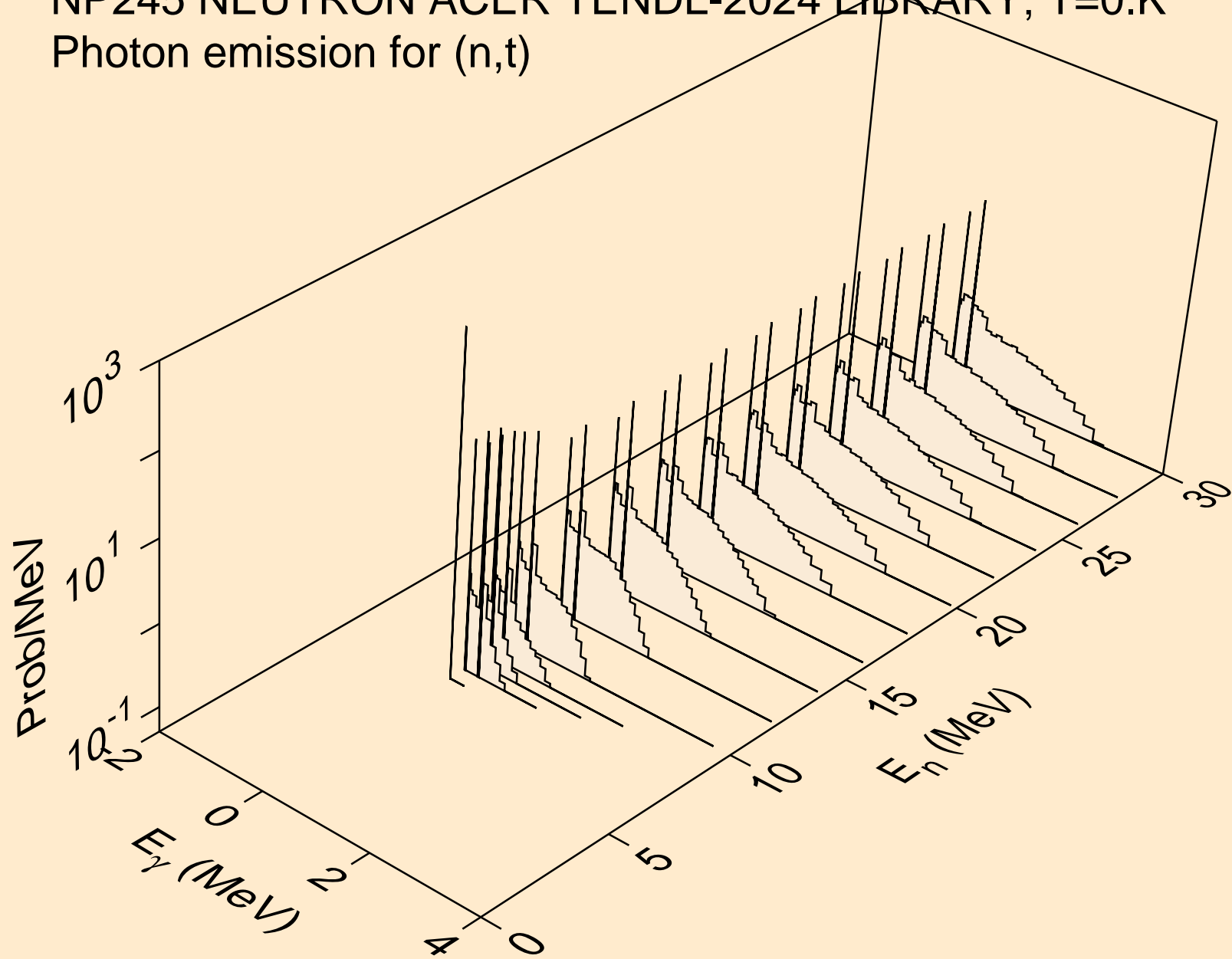

NP245 NEUTRON ACER TENDL-2024 LIBRARY; T=0.K
Photon emission for (n,he3)

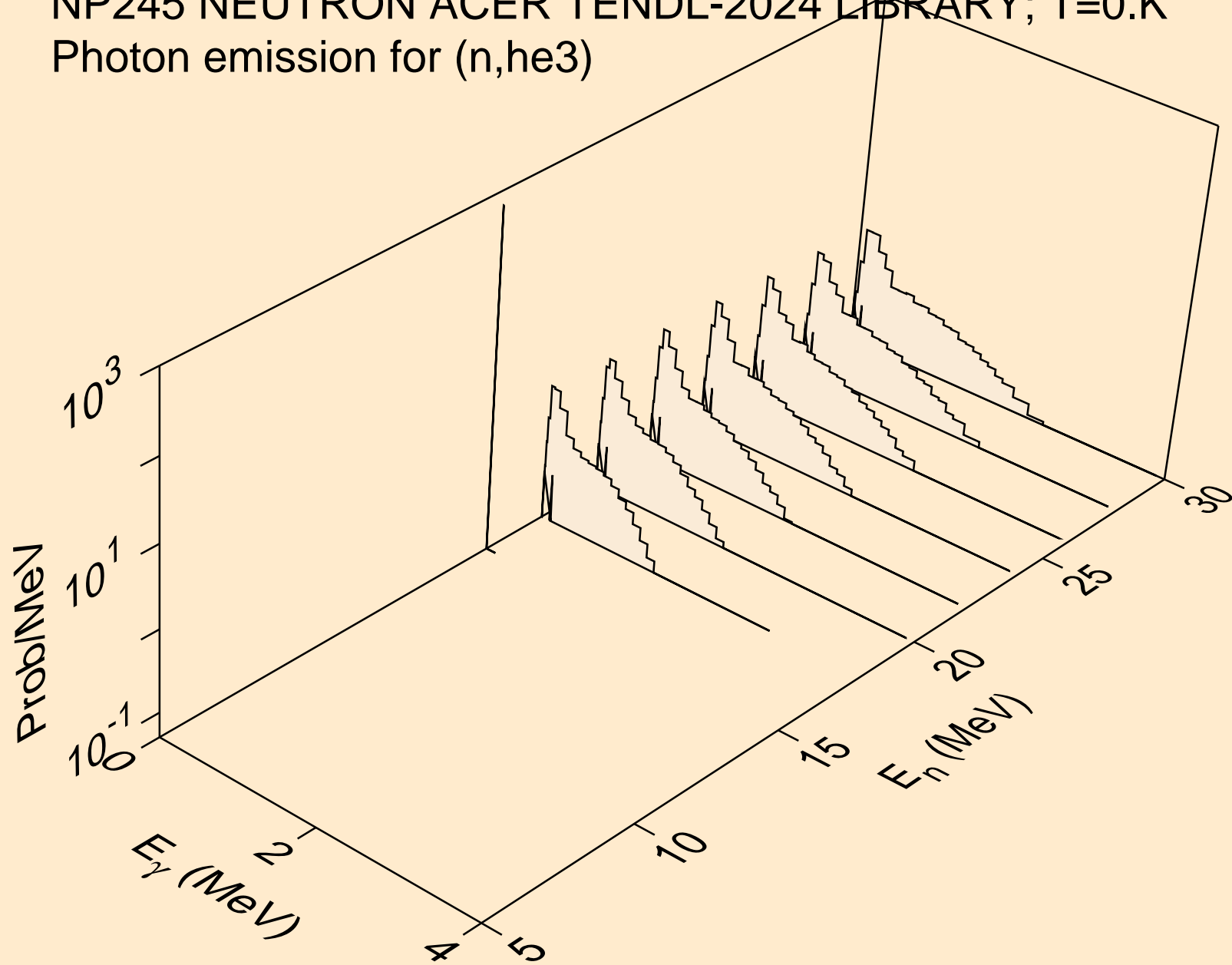

NP245 NEUTRON ACER TENDL-2024 LIBRARY; T=0.K
Photon emission for (n,a)

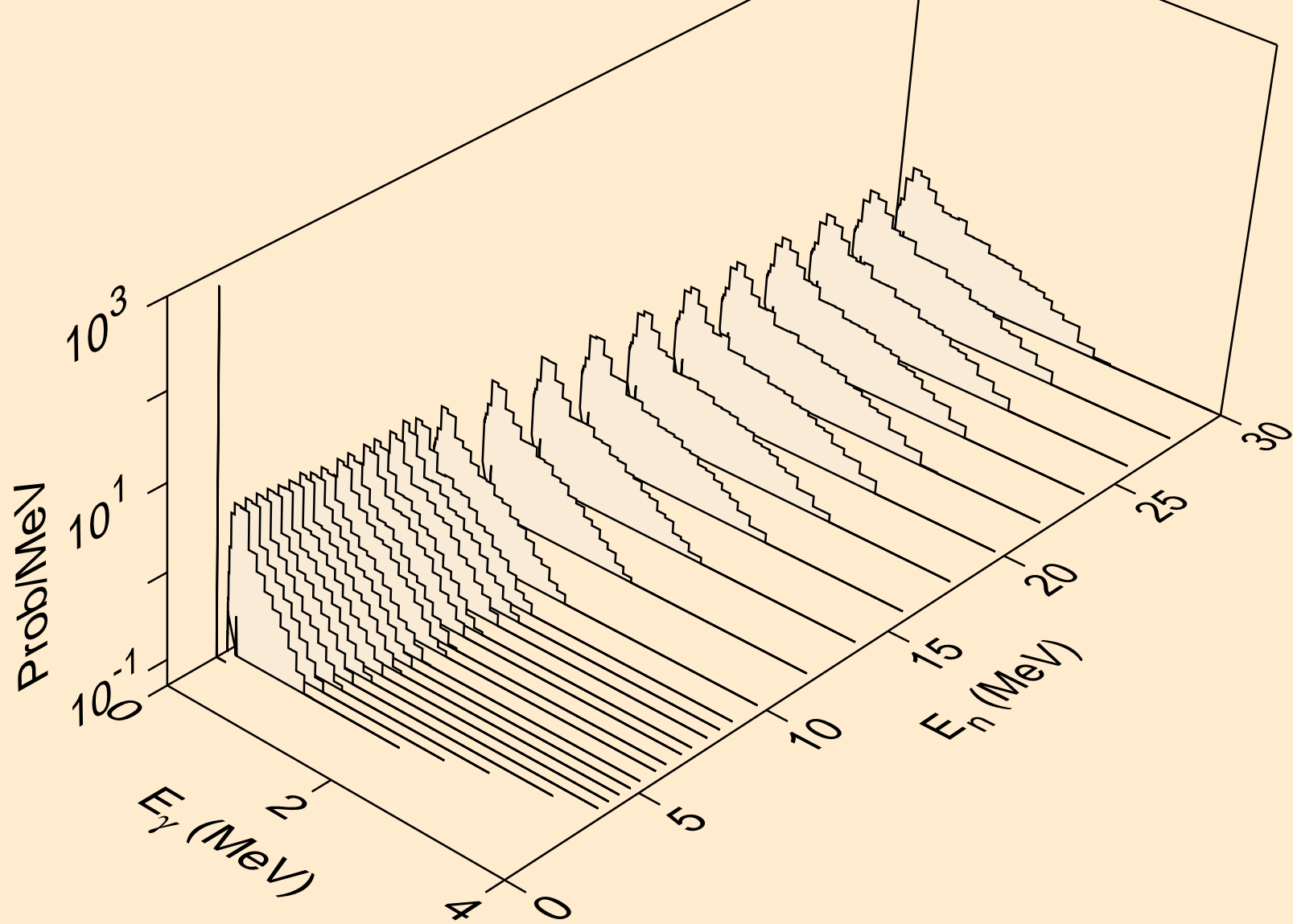

NP245 NEUTRON ACER TENDL-2024 LIBRARY; T=0.K
thermal capture photon spectrum

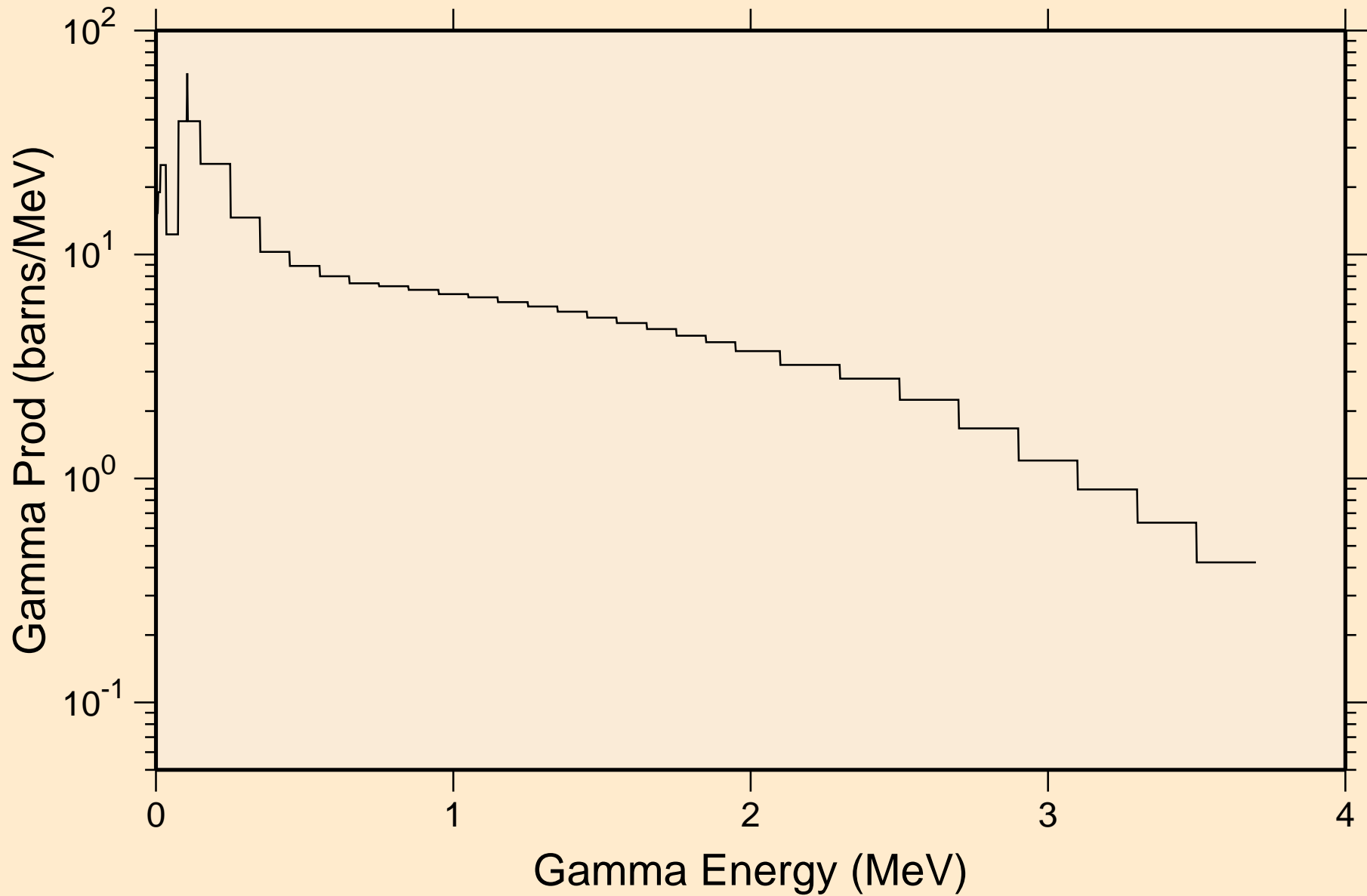

NP245 NEUTRON ACER TENDL-2024 LIBRARY; T=0.K
14 MeV photon spectrum

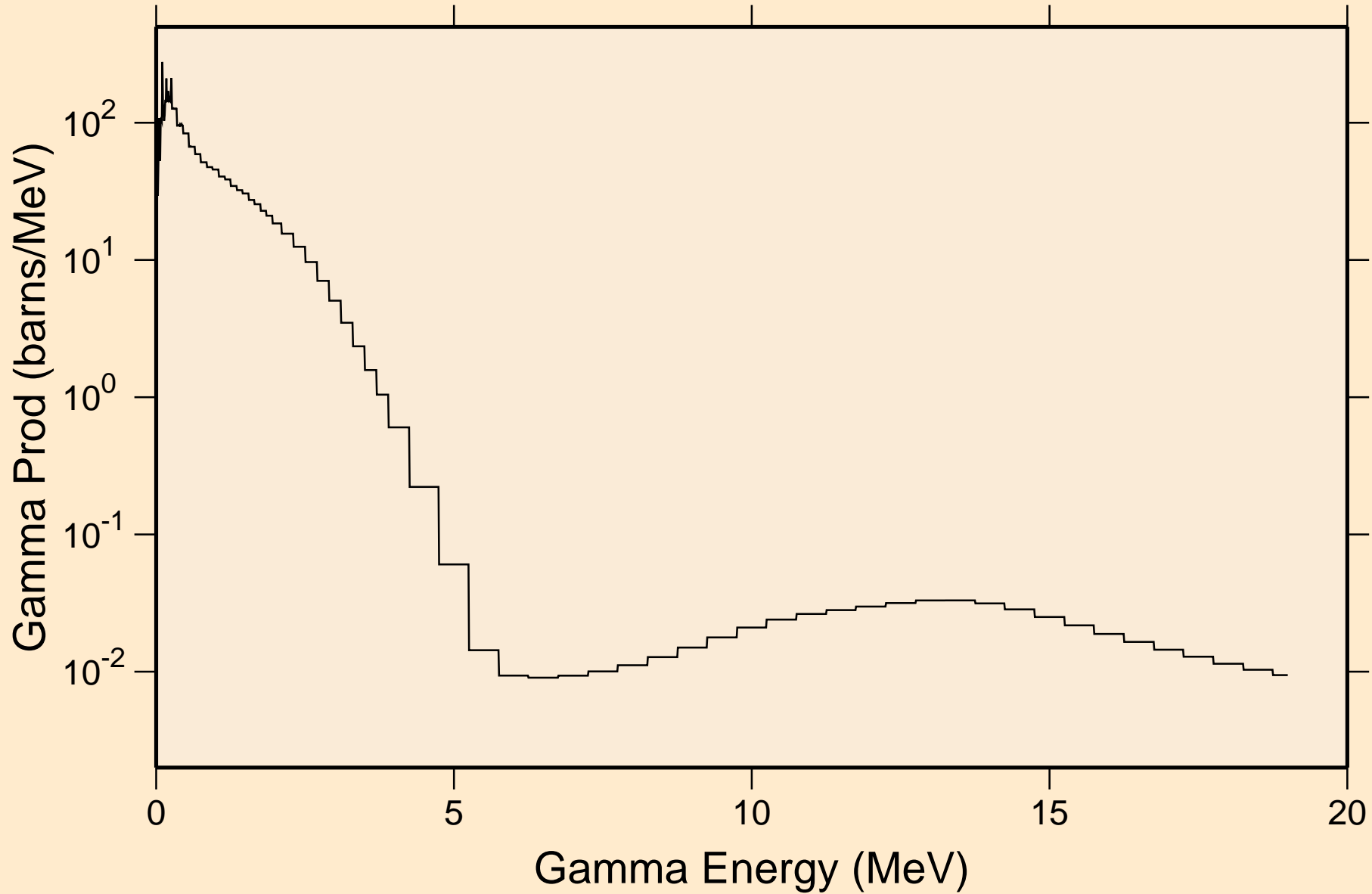

NP245 NEUTRON ACER TENDL-2024 LIBRARY; T=0.K

Particle heating contributions

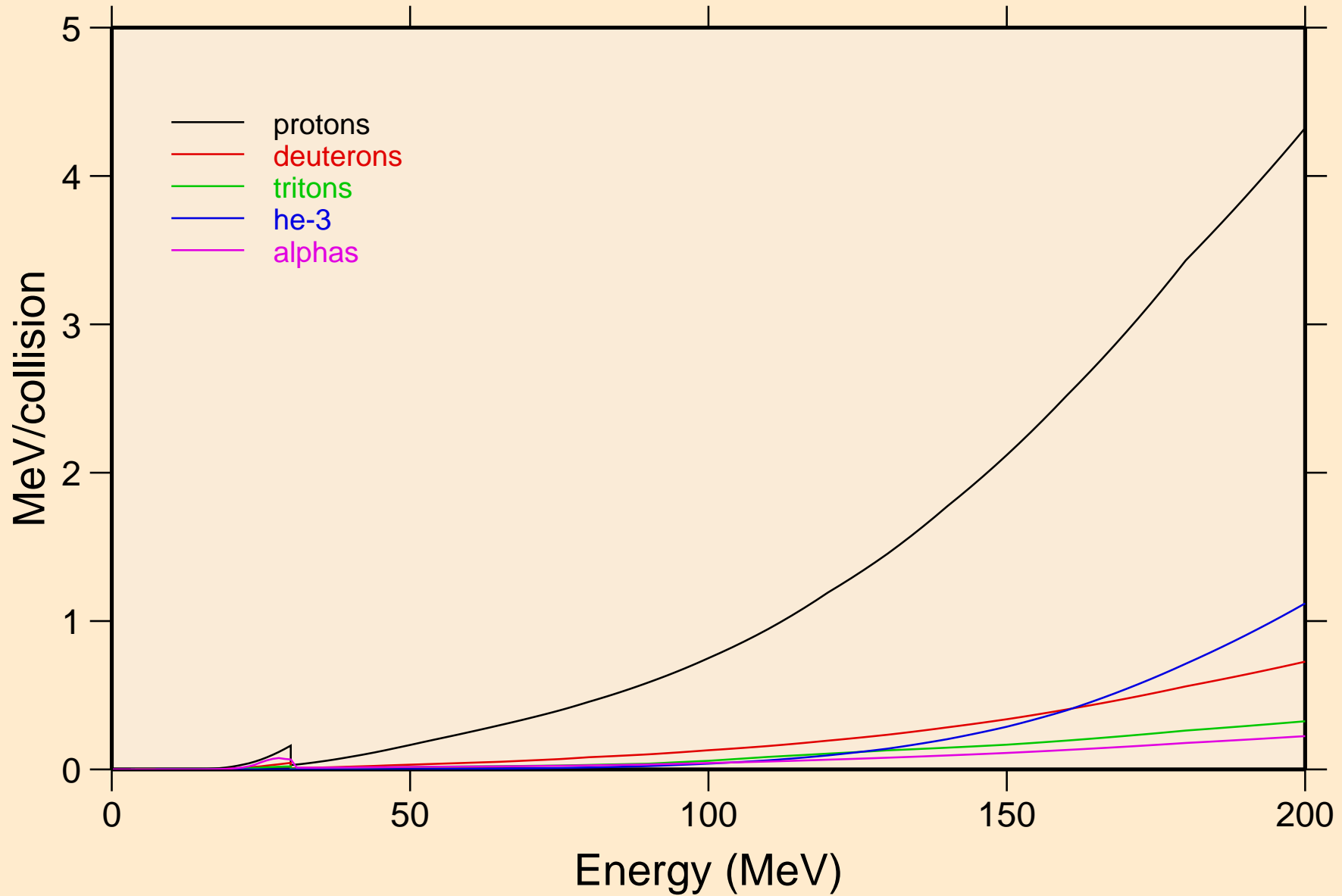

NP245 NEUTRON ACER TENDL-2024 LIBRARY; T=0.K
Recoil Heating

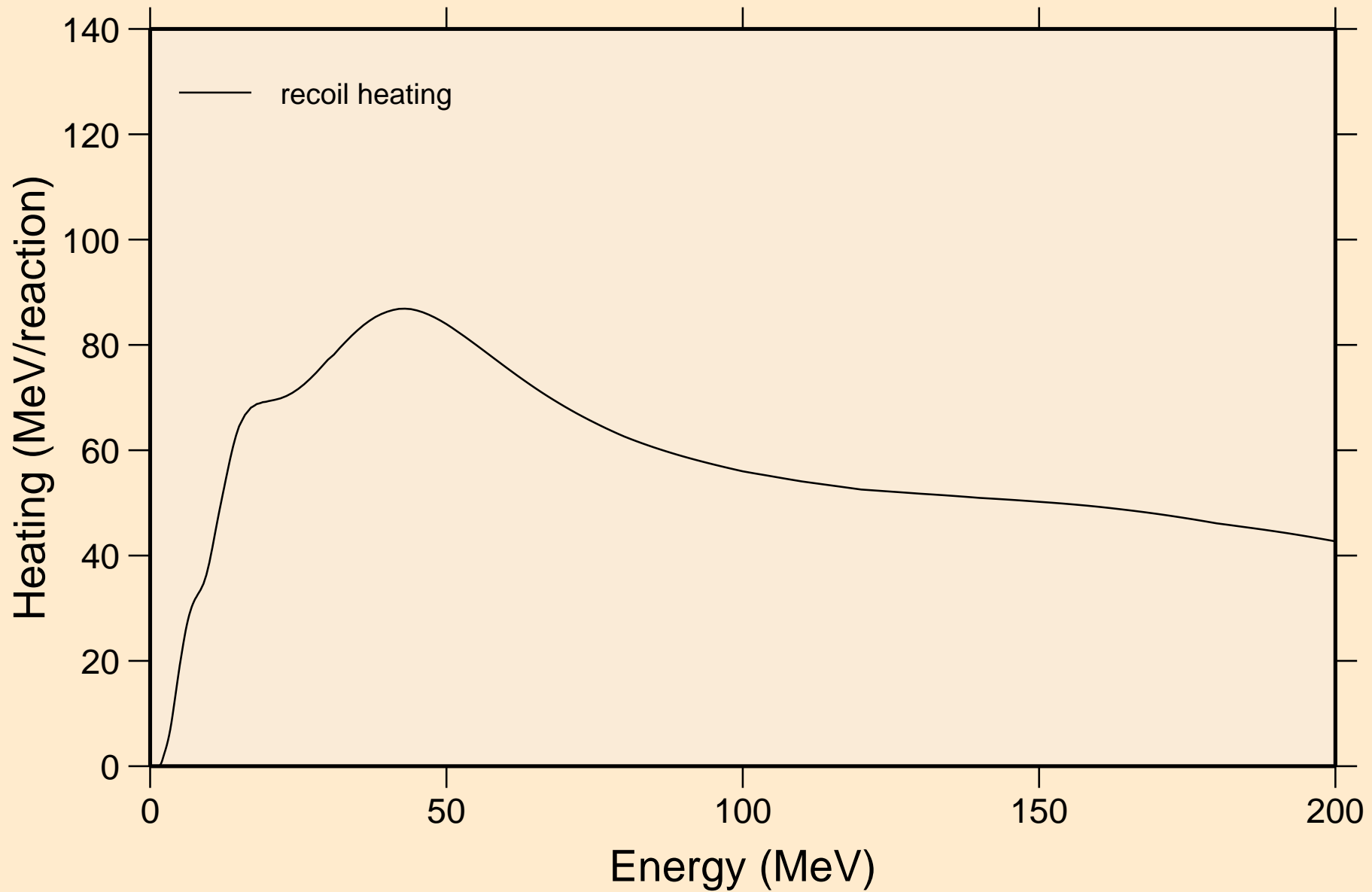

NP245 NEUTRON ACER TENDL-2024 LIBRARY; T=0.K

Particle production cross sections

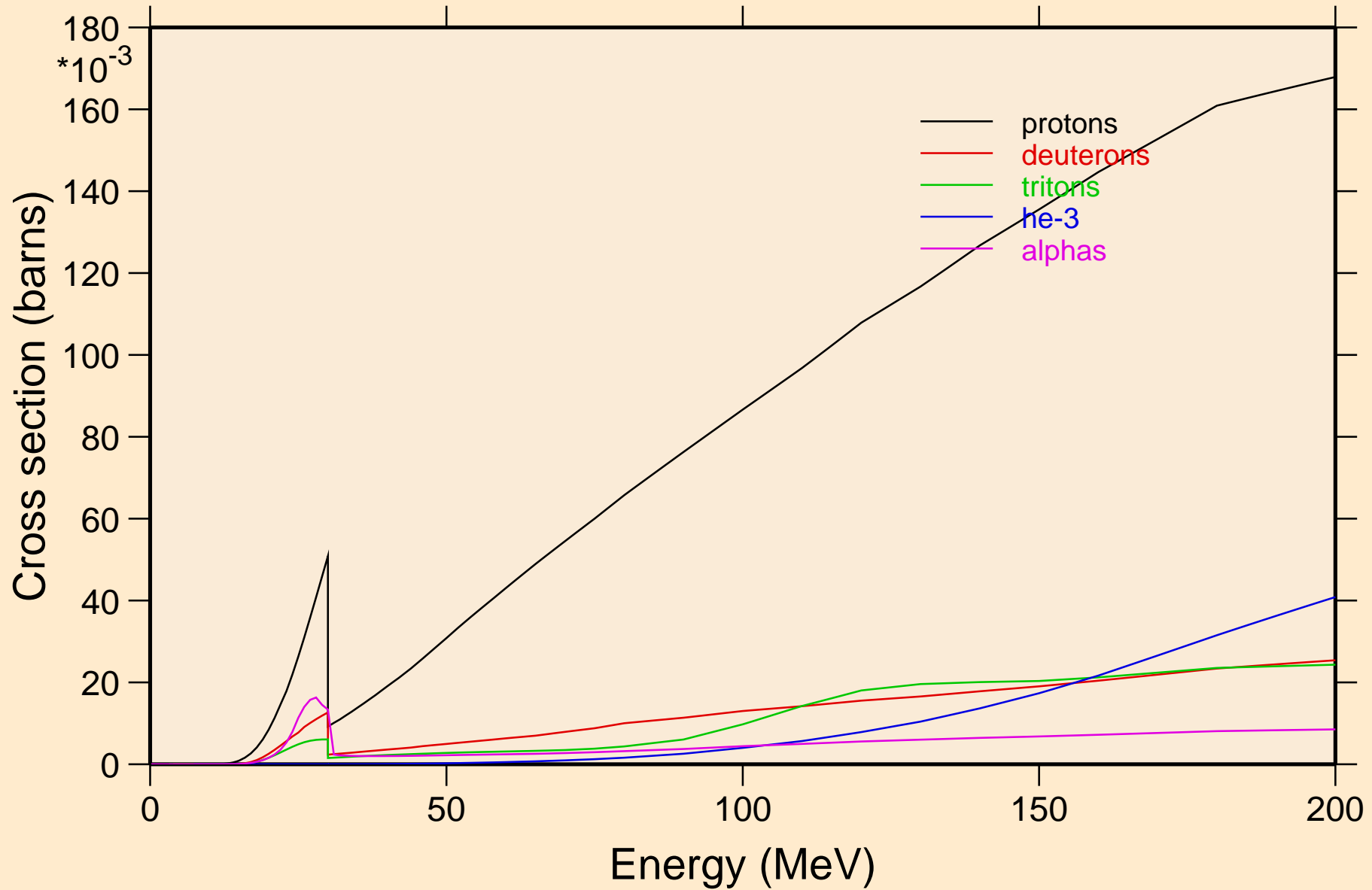

NP245 NEUTRON ACER TENDL-2024 LIBRARY; T=0.K
protons from (n,x)

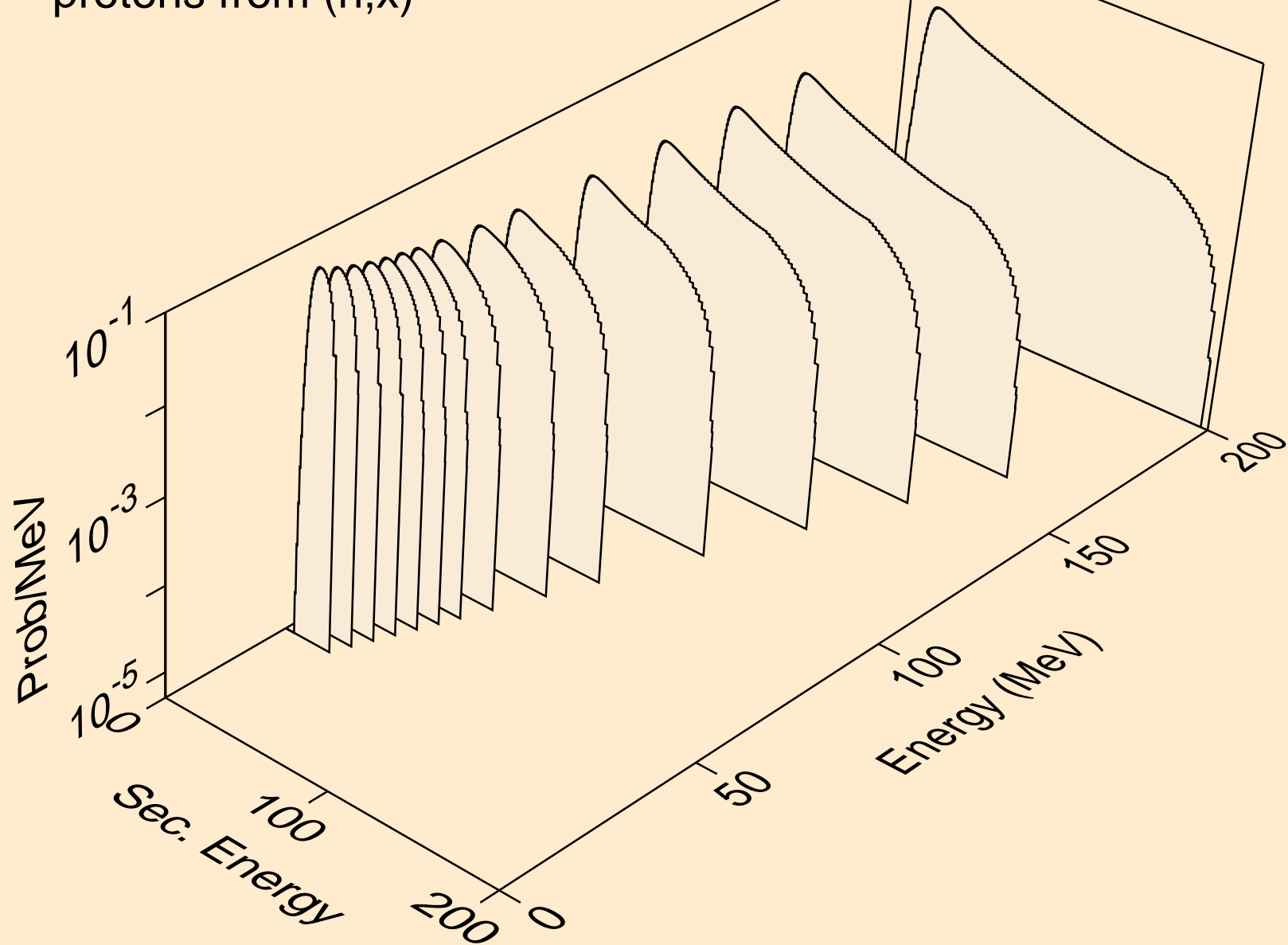

NP245 NEUTRON ACER TENDL-2024 LIBRARY; T=0.K
protons from (n,n*)p

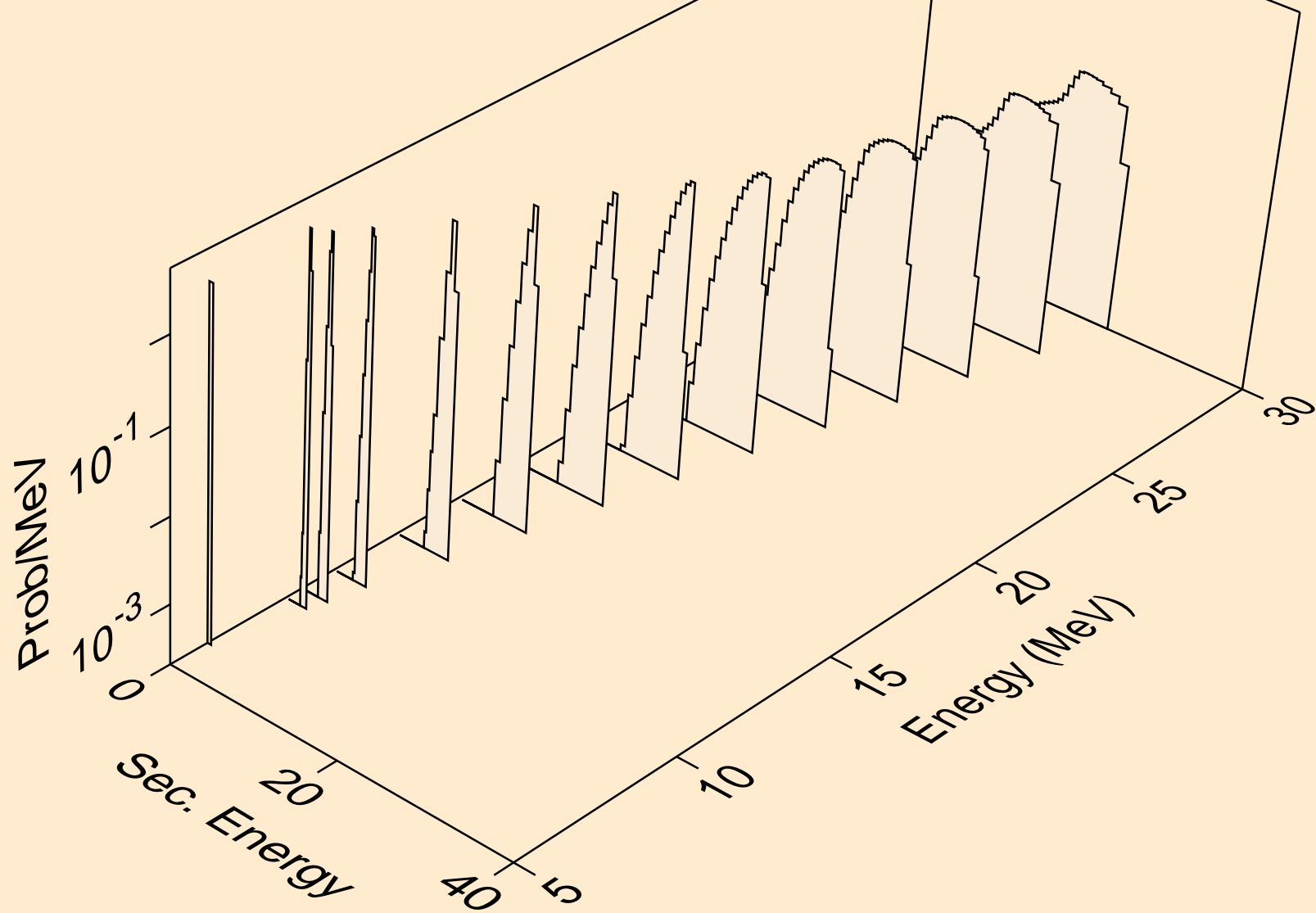

NP245 NEUTRON ACER TENDL-2024 LIBRARY; T=0.K
protons from (n,2np)

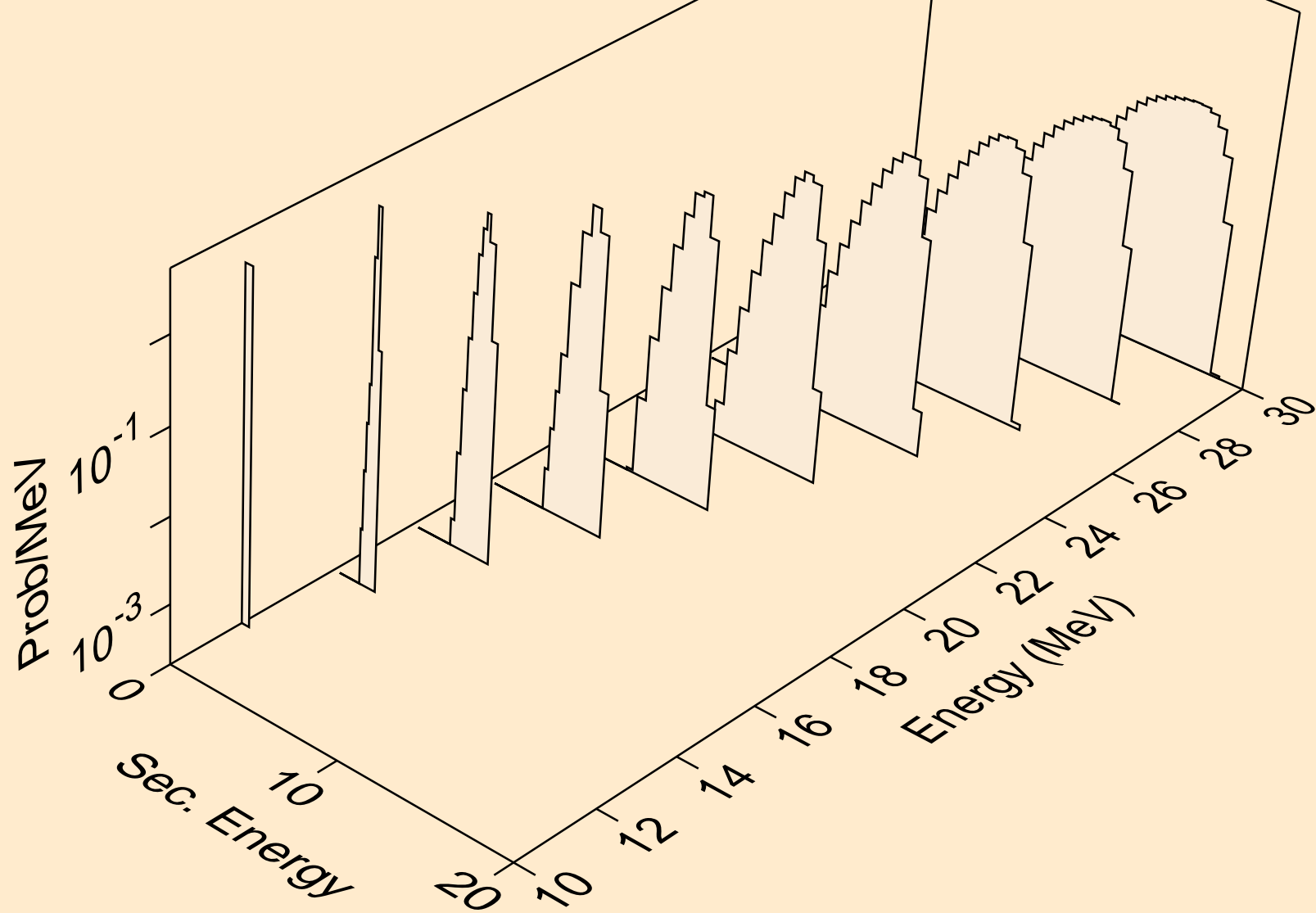

NP245 NEUTRON ACER TENDL-2024 LIBRARY; T=0.K
protons from (n,3np)

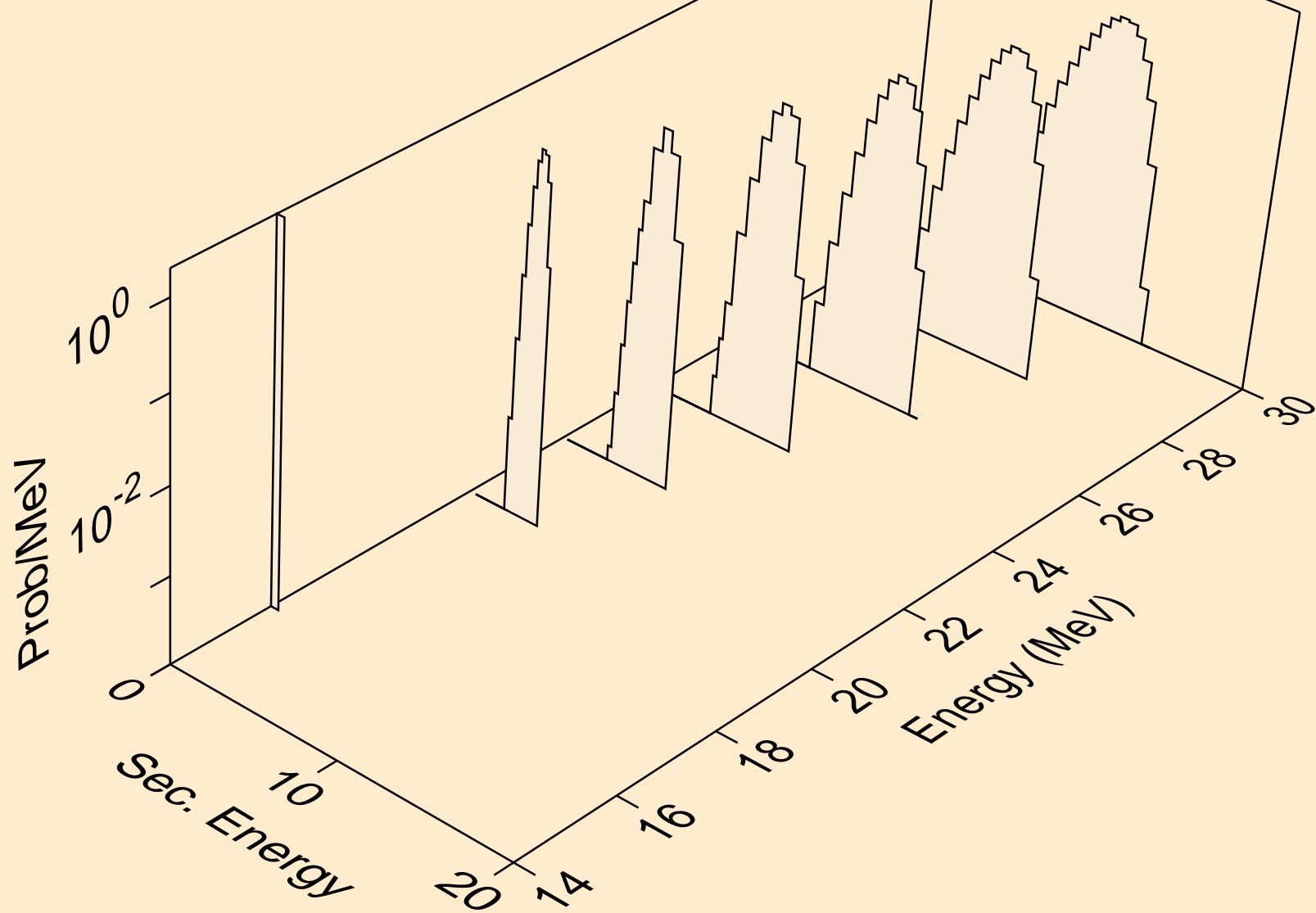

NP245 NEUTRON ACER TENDL-2024 LIBRARY; T=0.K
protons from (n,p)

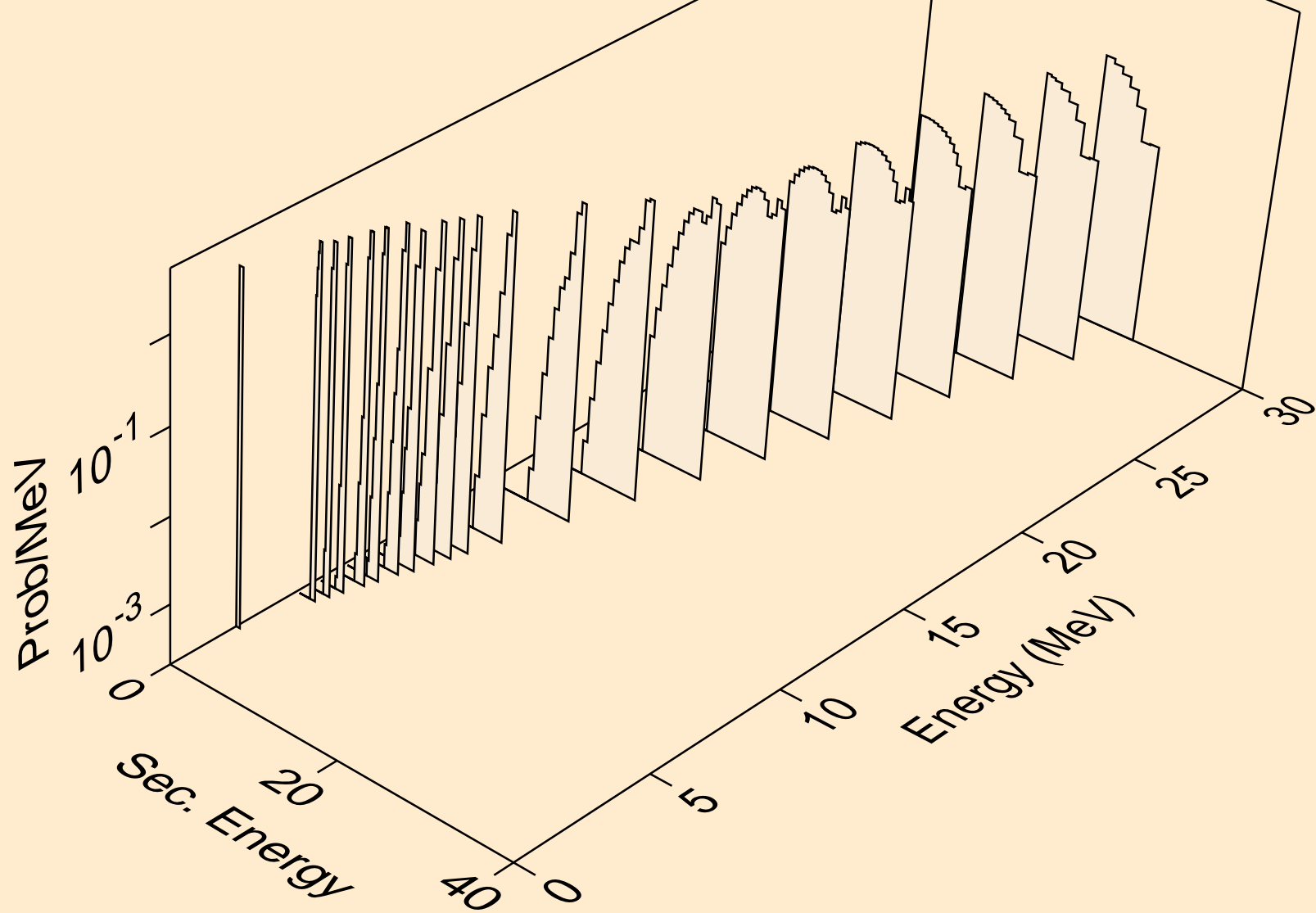

NP245 NEUTRON ACER TENDL-2024 LIBRARY; T=0.K
deuterons from (n,x)

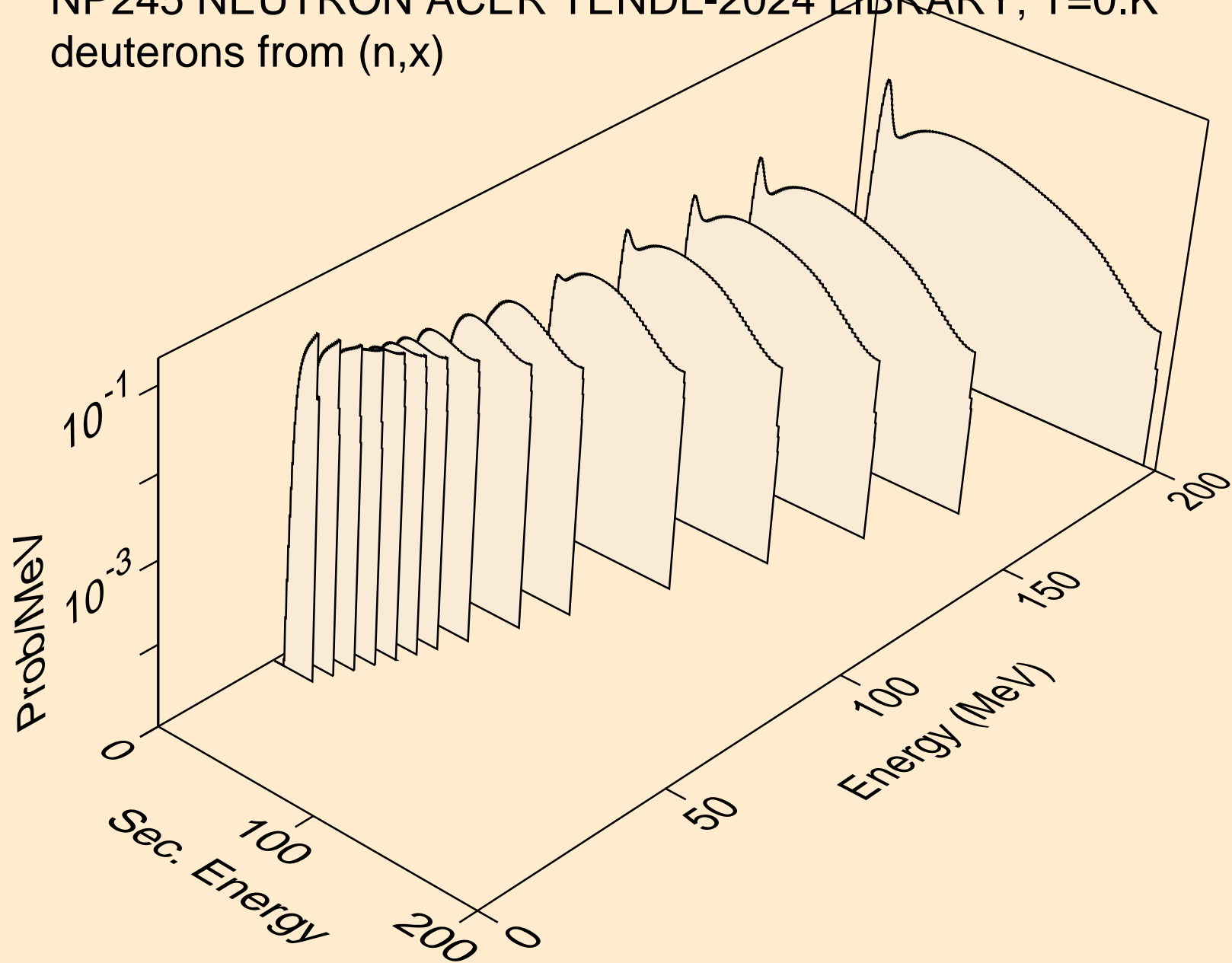

NP245 NEUTRON ACER TENDL-2024 LIBRARY; T=0.K
deuterons from (n,2nd)

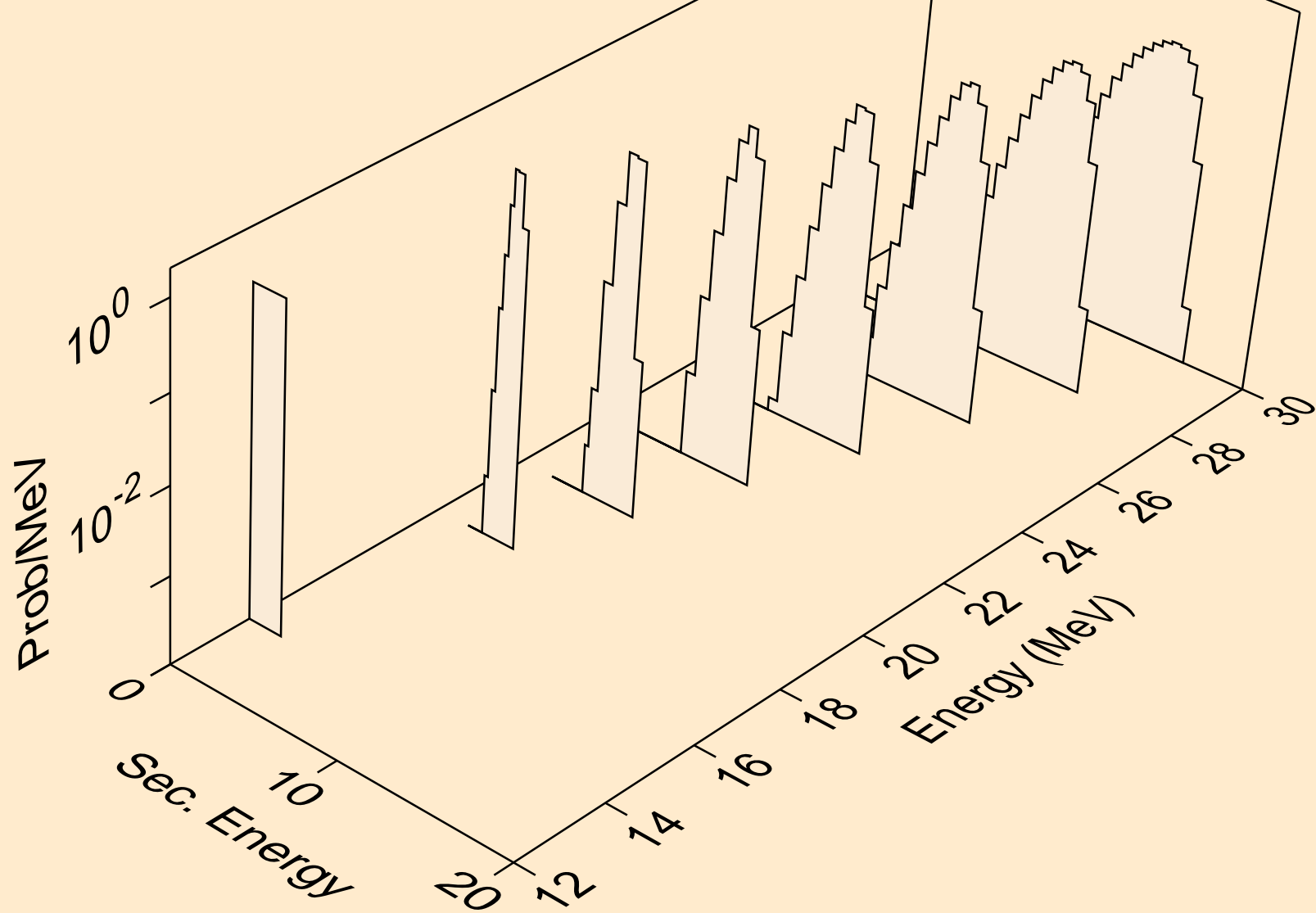

NP245 NEUTRON ACER TENDL-2024 LIBRARY; T=0.K
deuterons from (n,n*)d

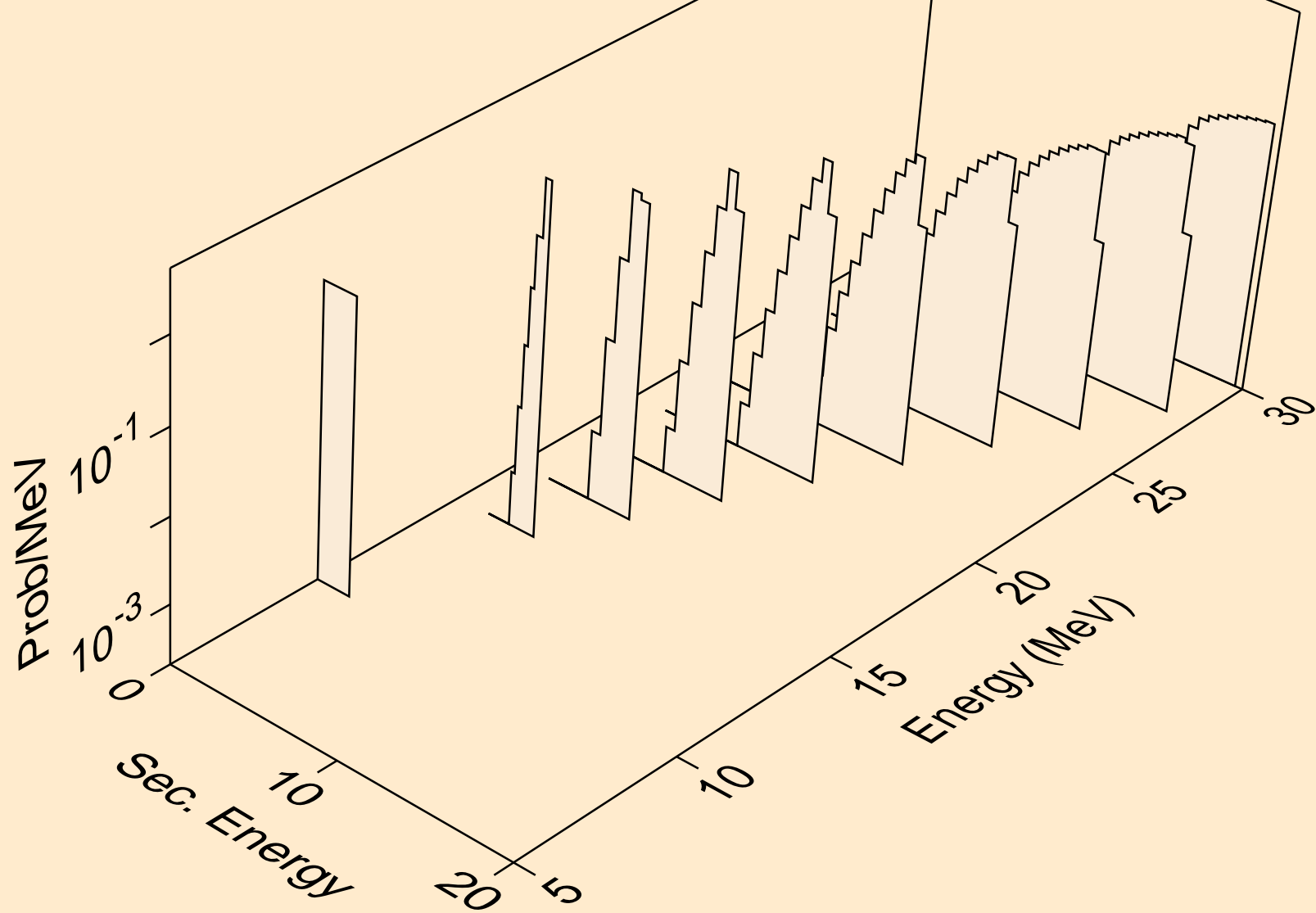

NP245 NEUTRON ACER TENDL-2024 LIBRARY; T=0.K
deuterons from (n,d)

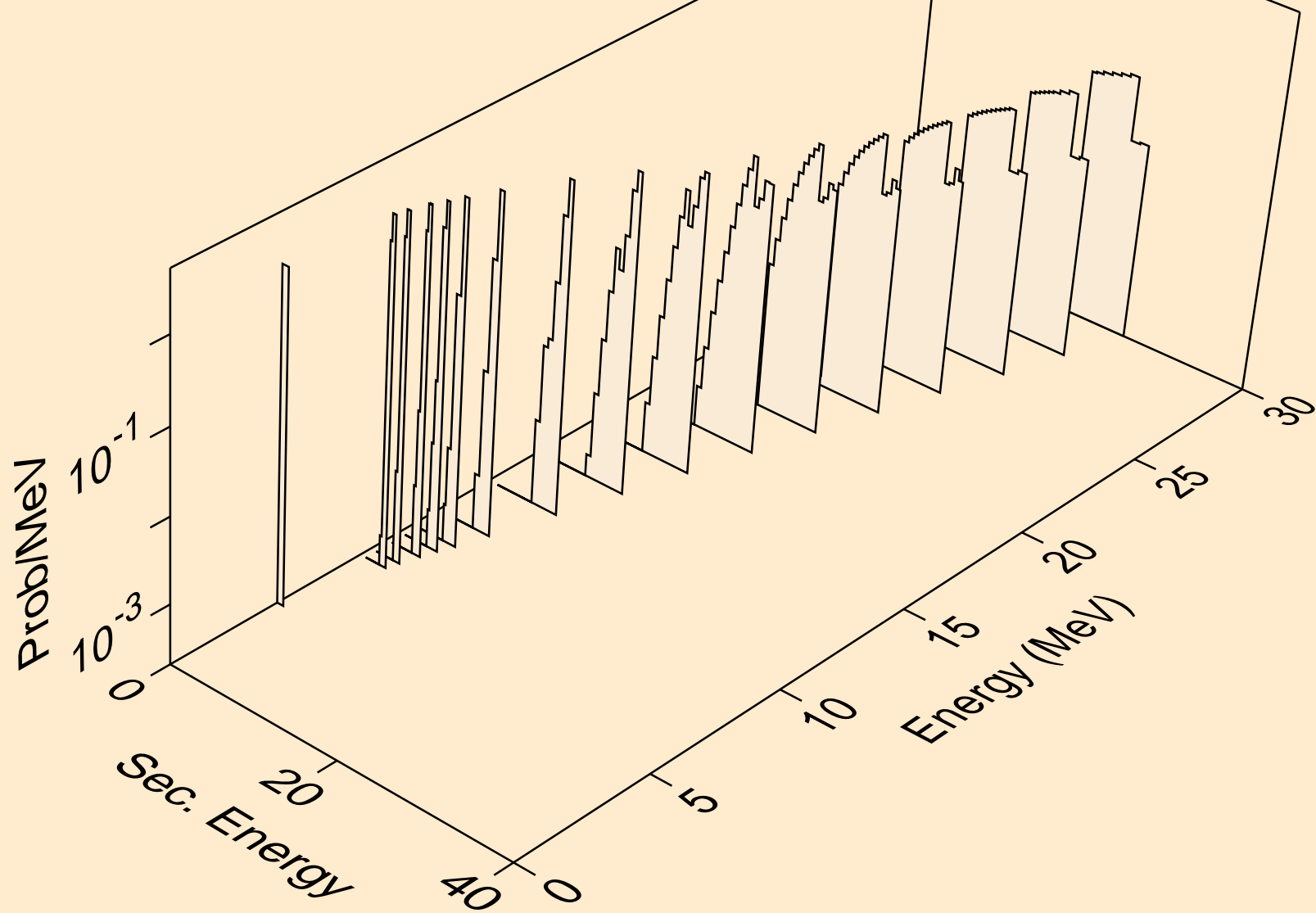

NP245 NEUTRON ACER TENDL-2024 LIBRARY; T=0.K
tritons from (n,x)

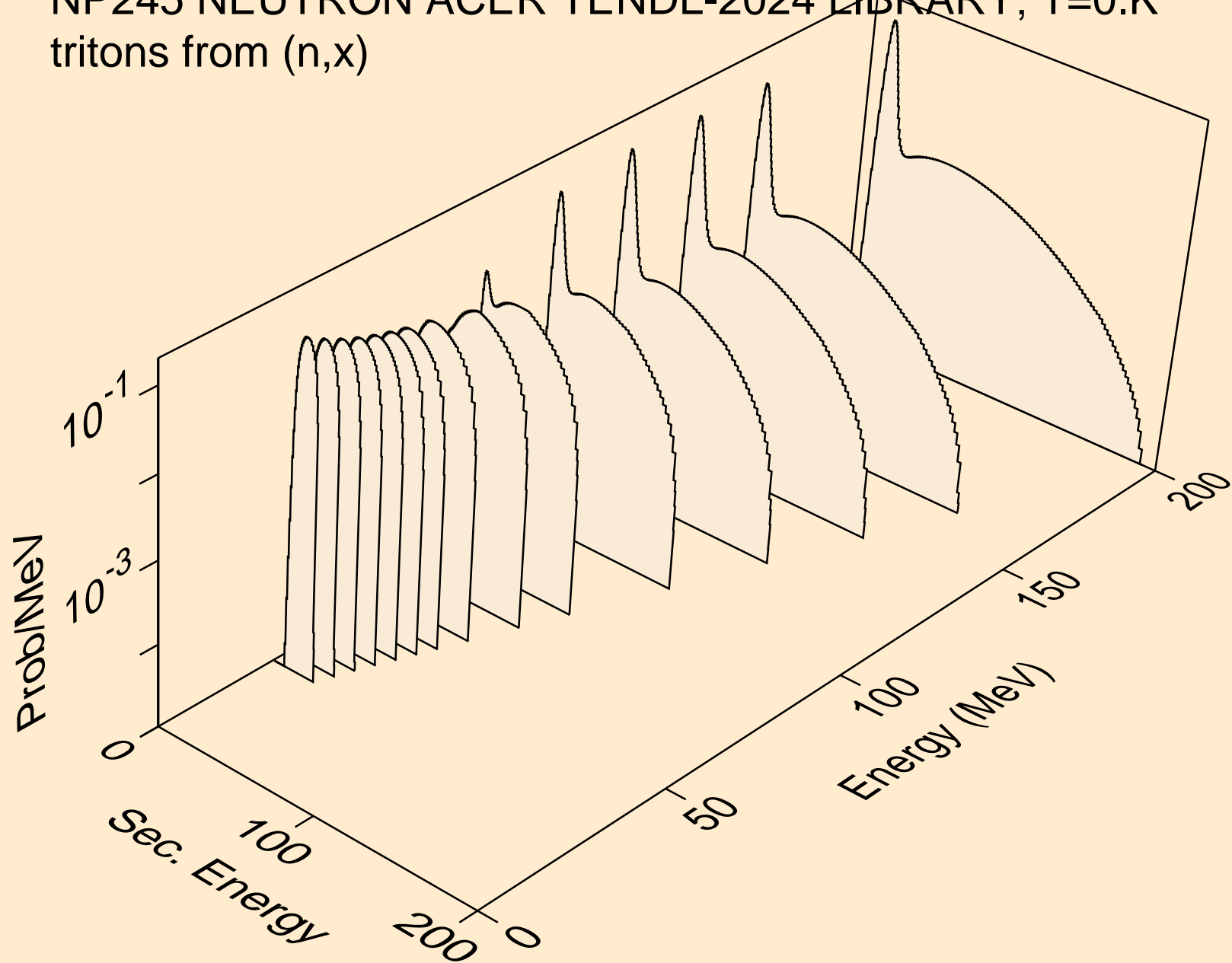

NP245 NEUTRON ACER TENDL-2024 LIBRARY; T=0.K
tritons from (n,n*)t

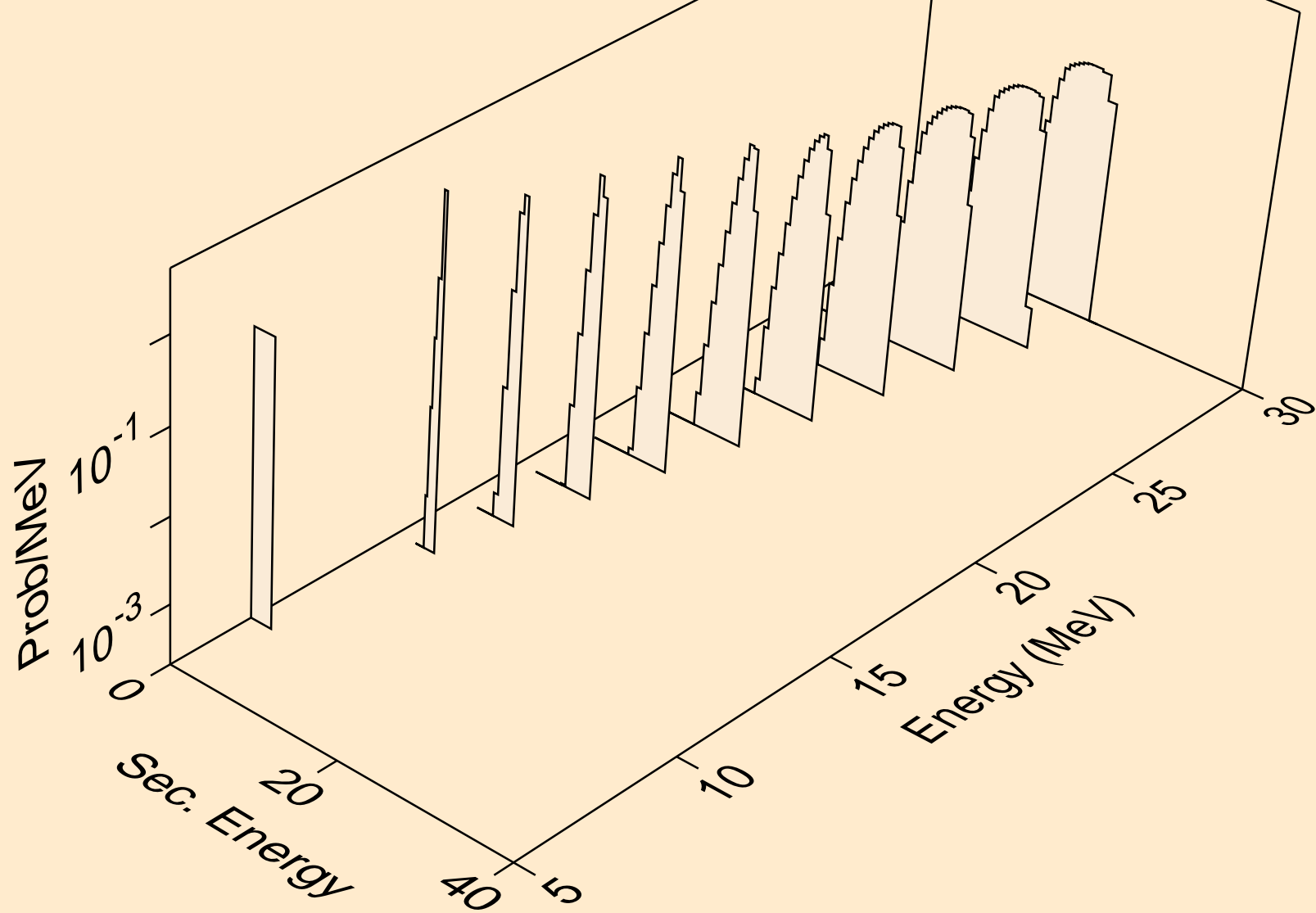

NP245 NEUTRON ACER TENDL-2024 LIBRARY; T=0.K
tritons from (n,t)

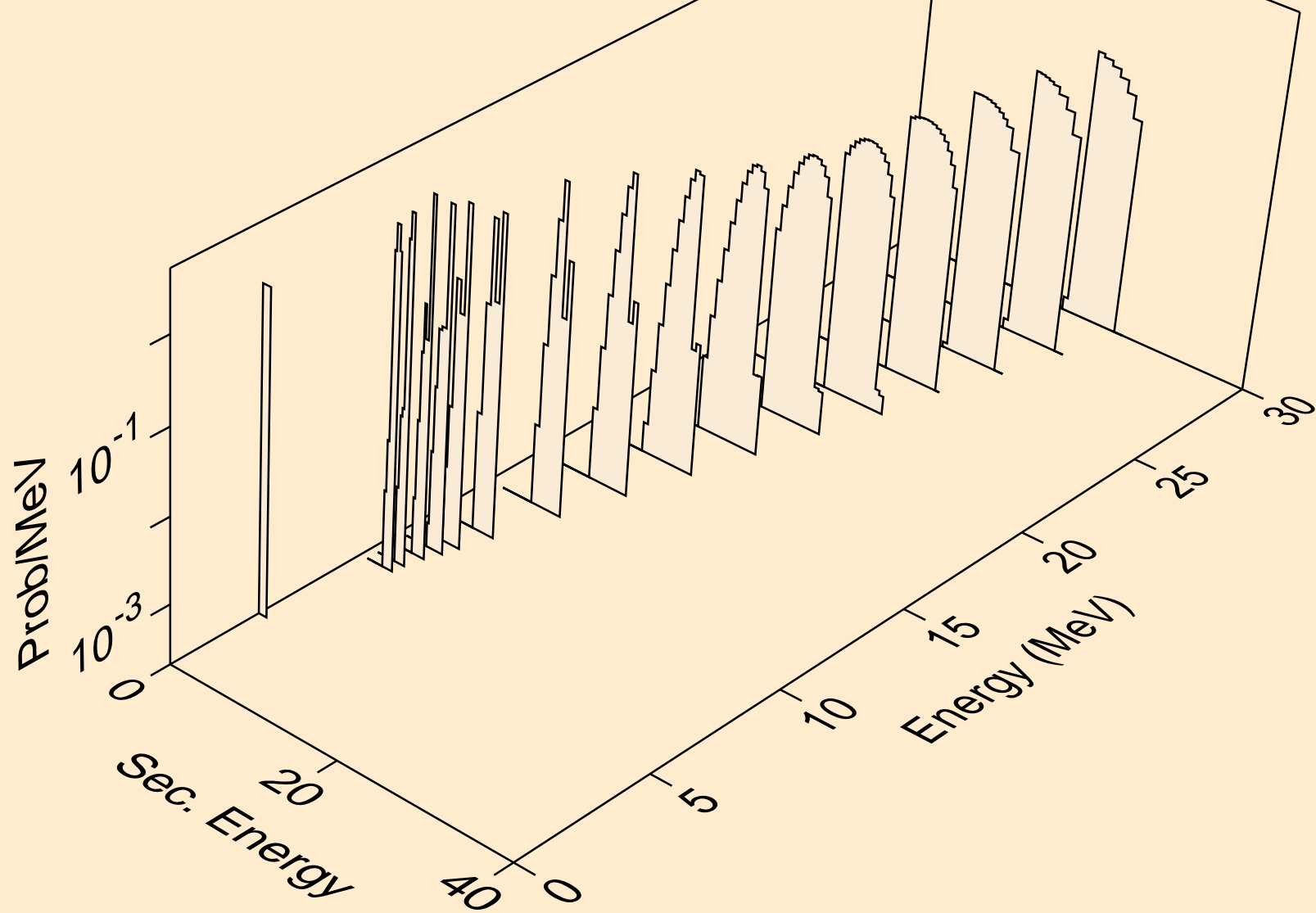

NP245 NEUTRON ACER TENDL-2024 LIBRARY; T=0.K
he3s from (n,x)

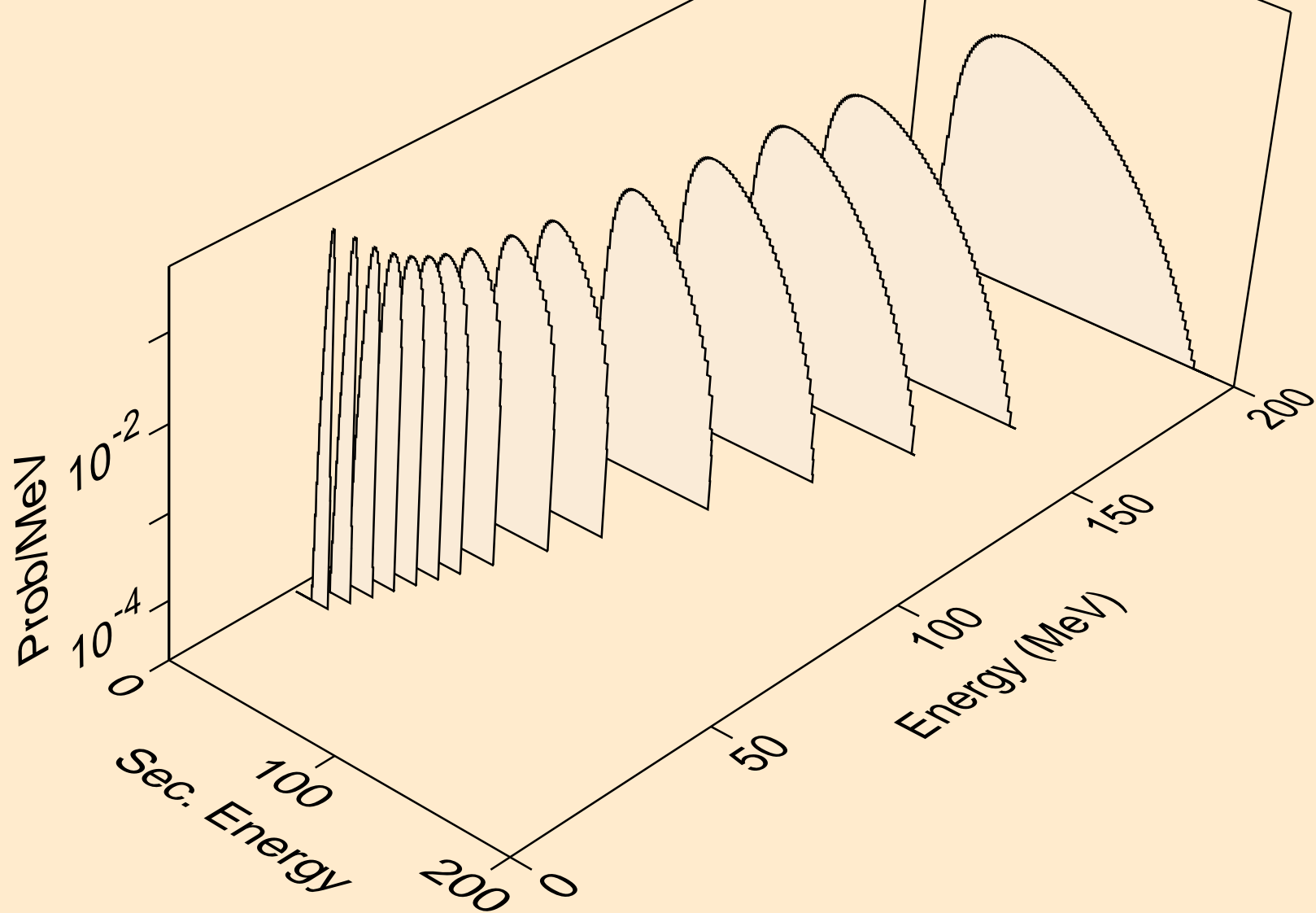

NP245 NEUTRON ACER TENDL-2024 LIBRARY; T=0.K
he3s from (n,n*)he3

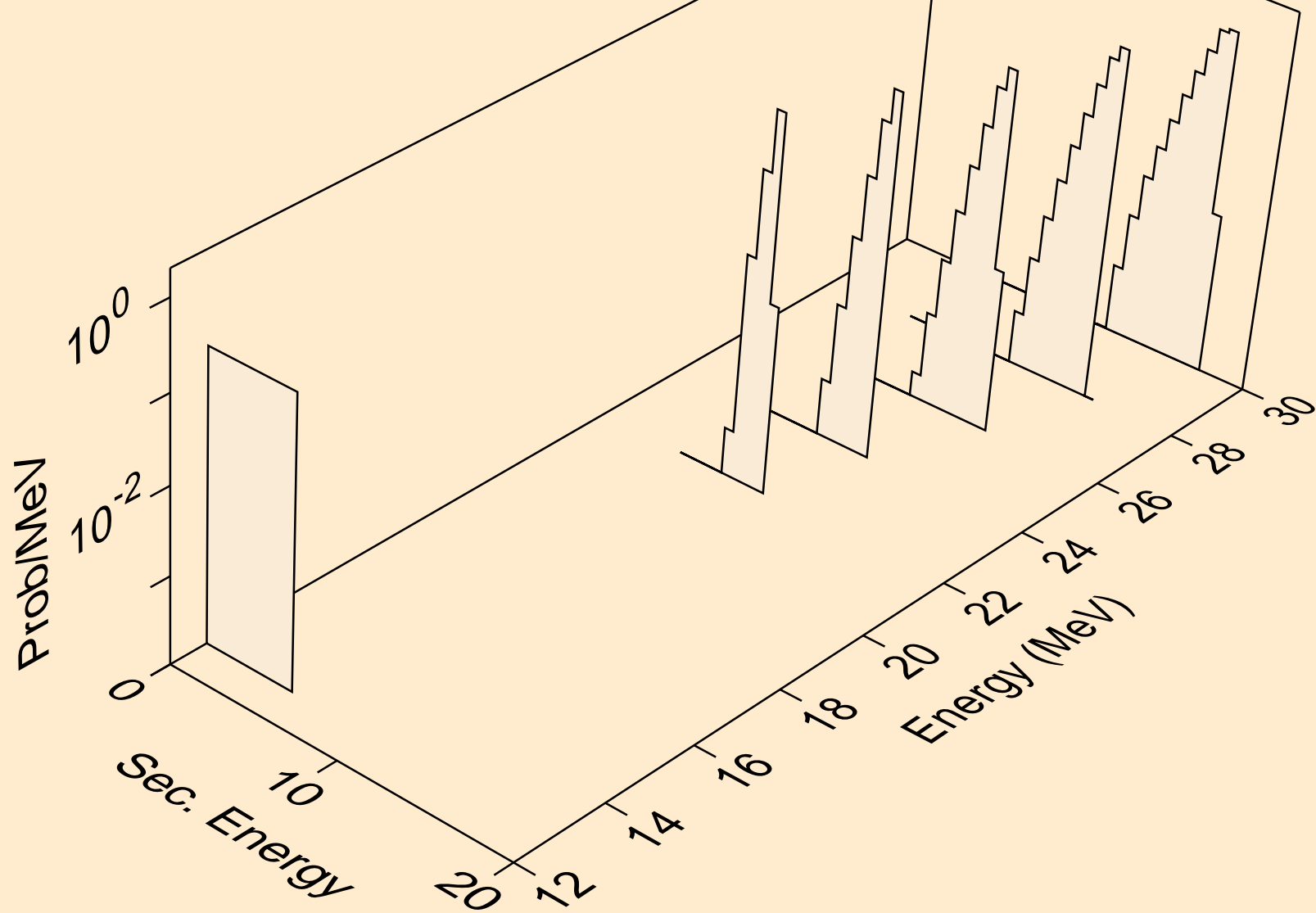

NP245 NEUTRON ACER TENDL-2024 LIBRARY; T=0.K
he3s from (n,he3)

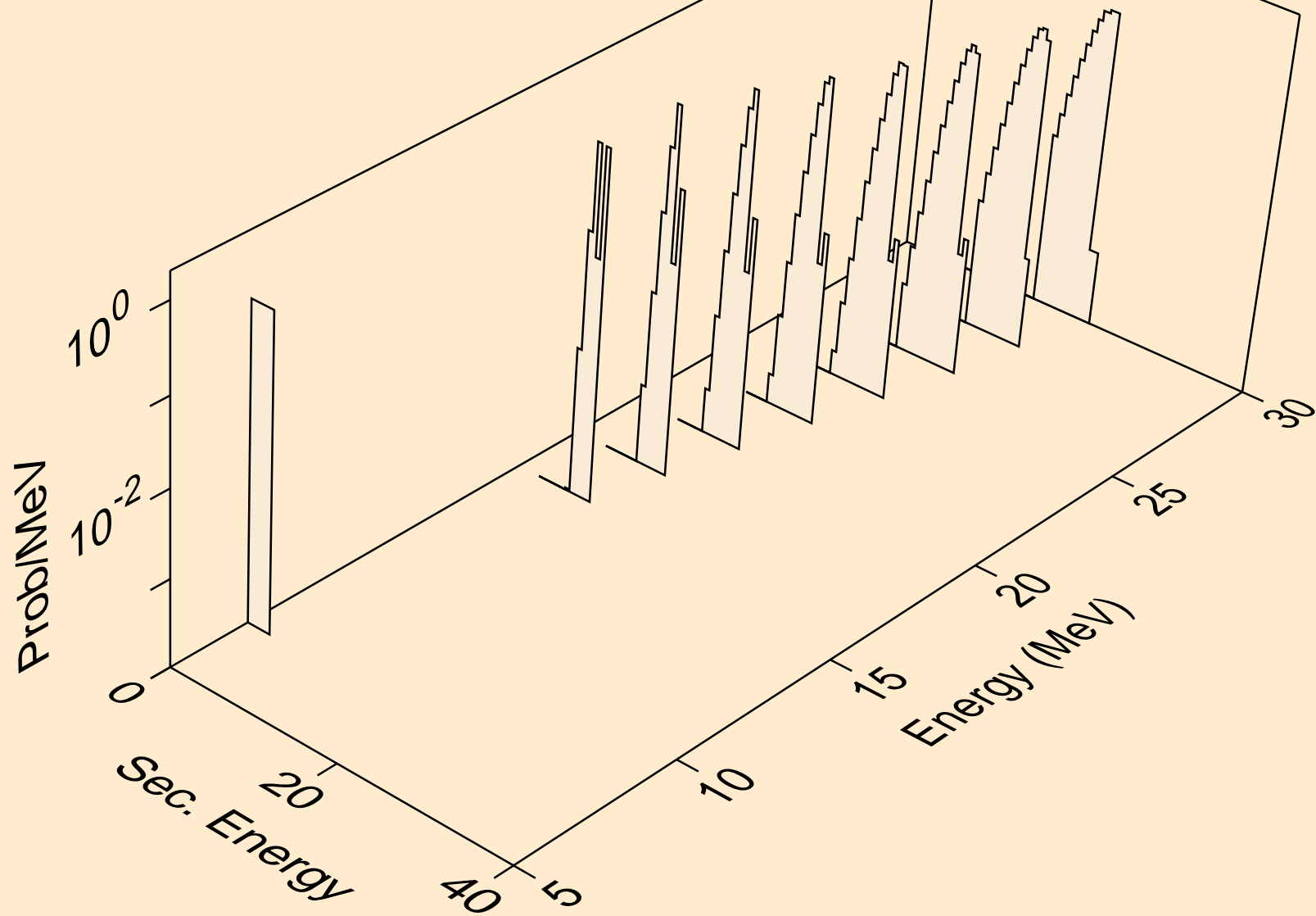

NP245 NEUTRON ACER TENDL-2024 LIBRARY; T=0.K
alphas from (n,x)

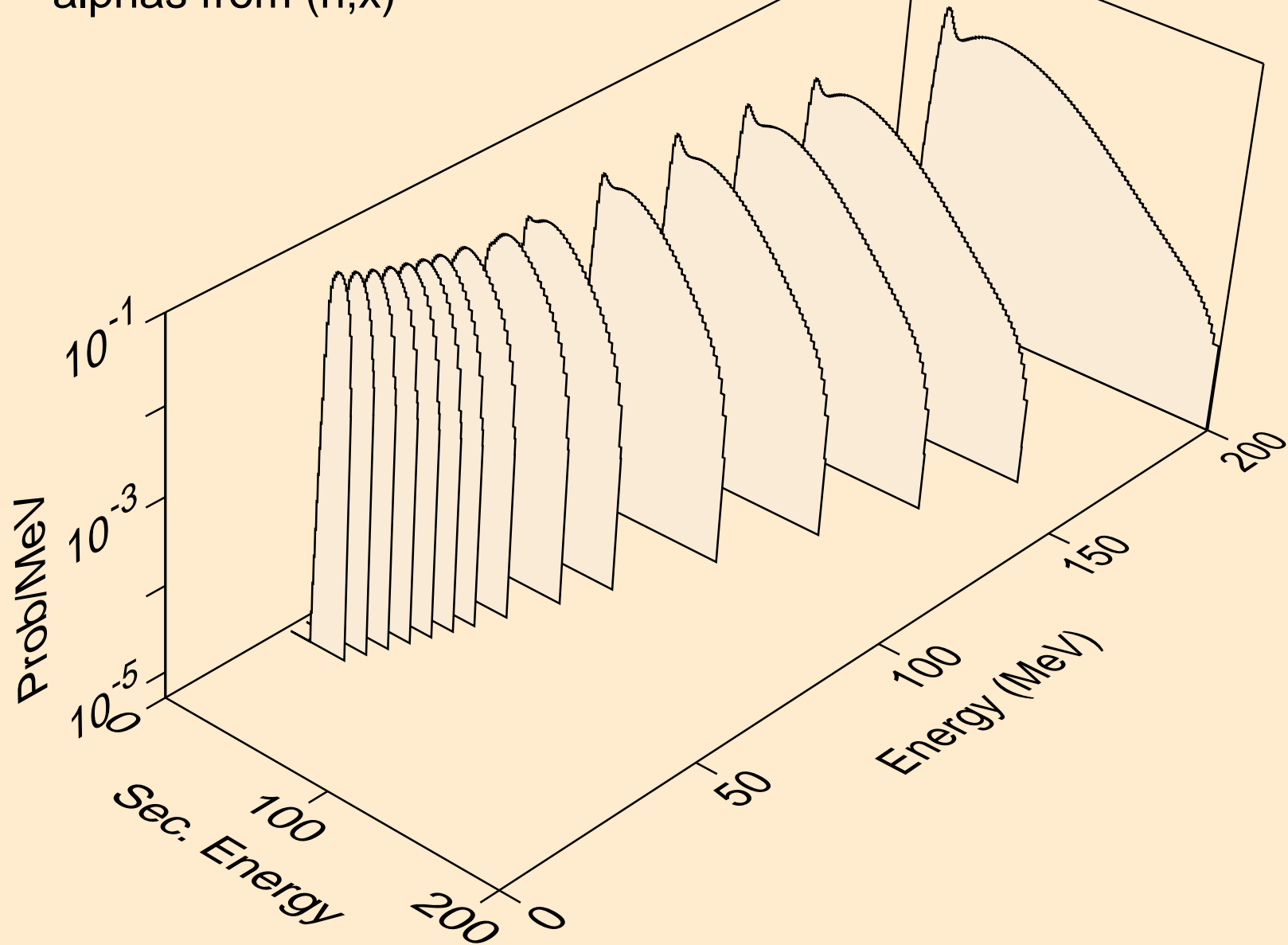

NP245 NEUTRON ACER TENDL-2024 LIBRARY; T=0.K
alphas from (n,n*)a

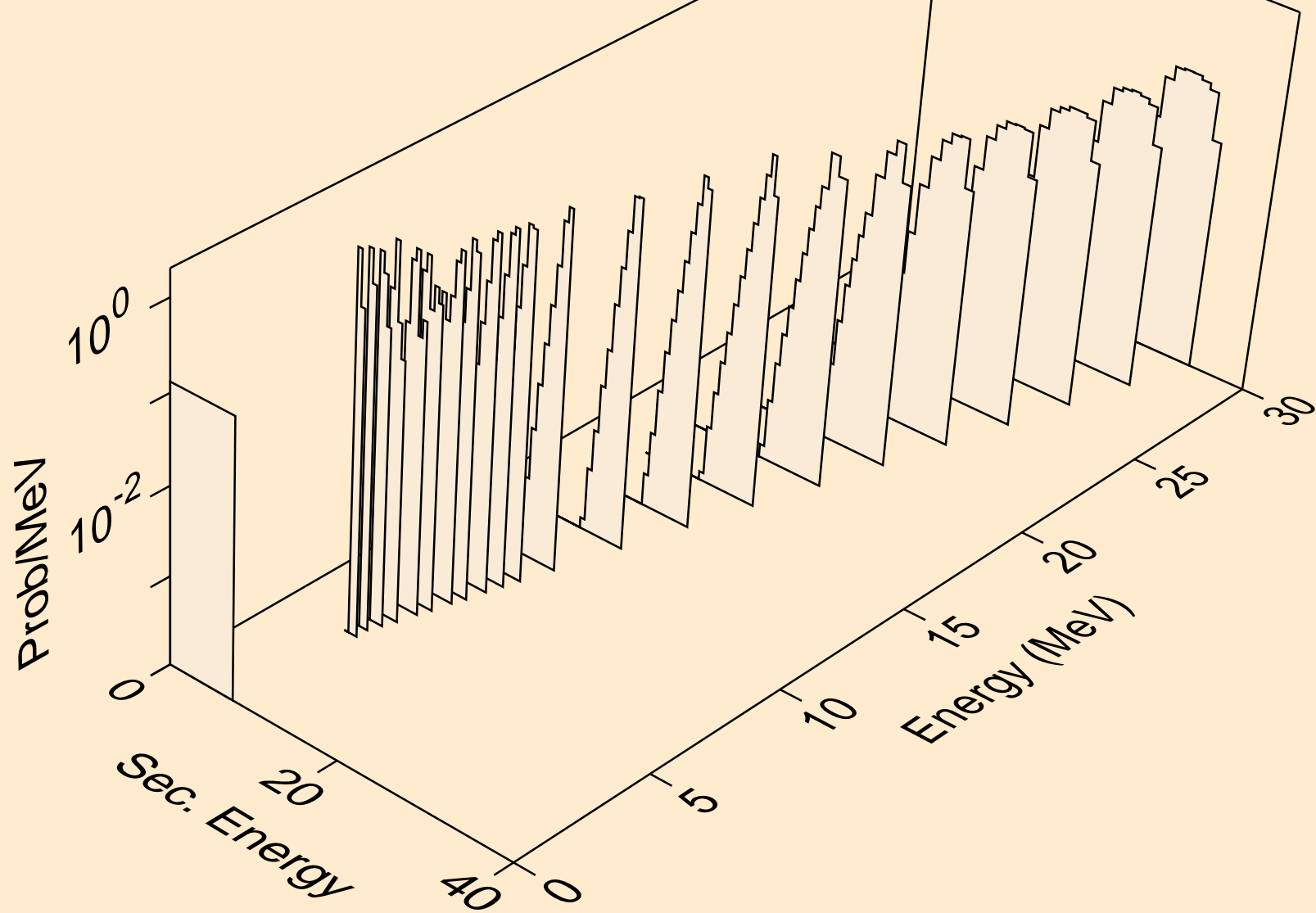

NP245 NEUTRON ACER TENDL-2024 LIBRARY; T=0.K
alphas from (n,2n)a

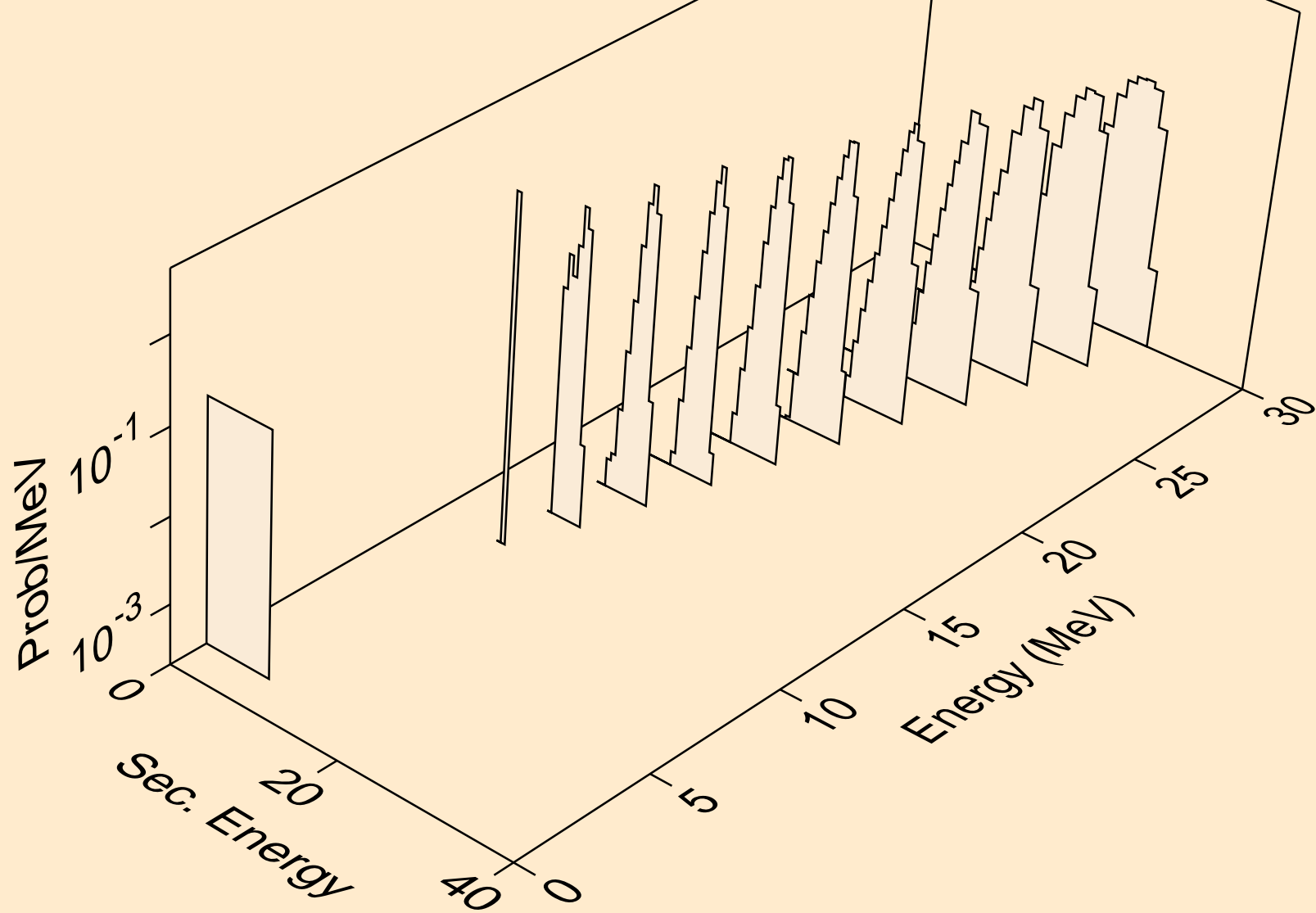

NP245 NEUTRON ACER TENDL-2024 LIBRARY; T=0.K
alphas from (n,3n)a

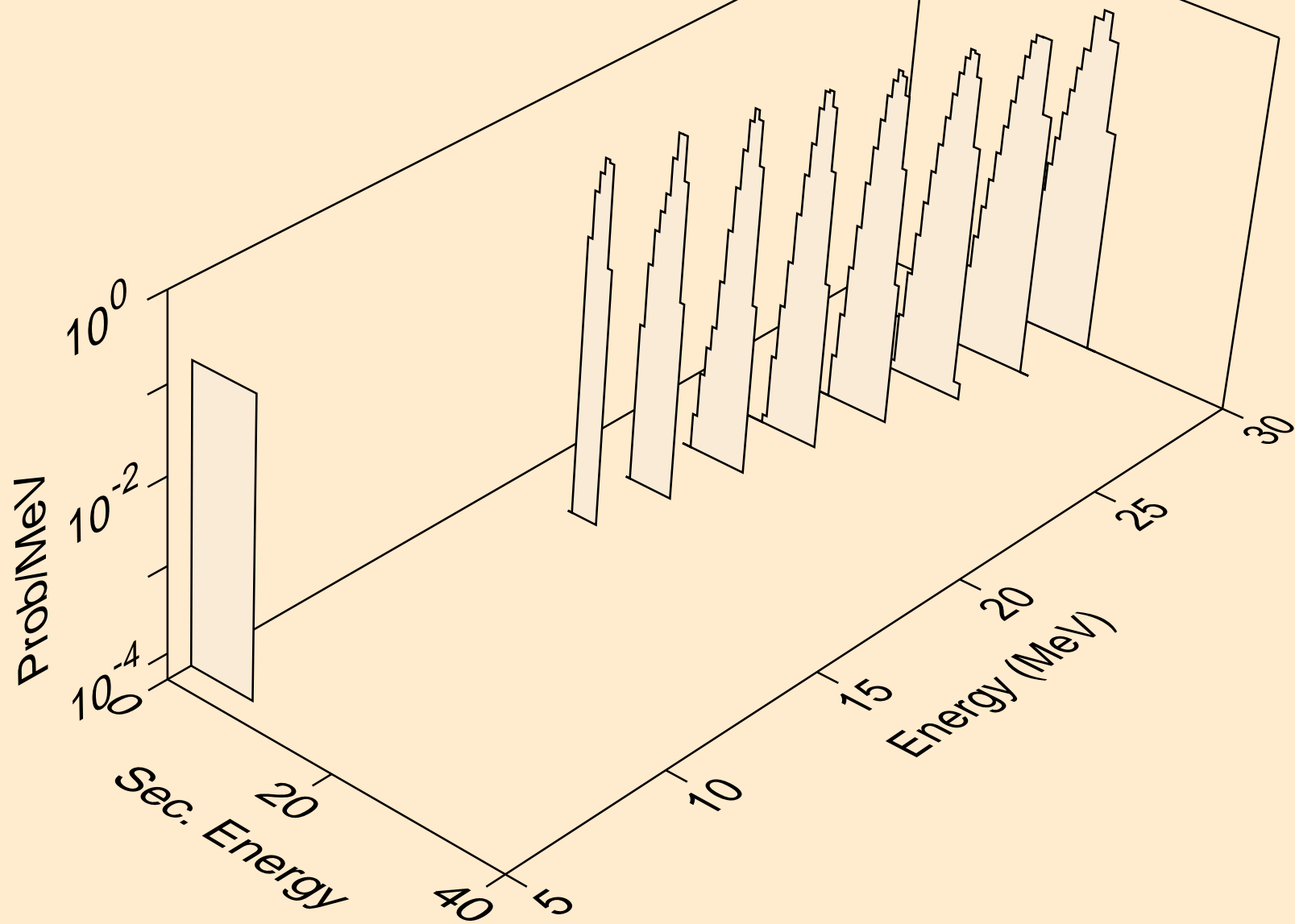

NP245 NEUTRON ACER TENDL-2024 LIBRARY; T=0.K
alphas from (n,a)

