

O015 NEUTRON ACER TENDL-2024 LIBRARY; T=0.K
Principal cross sections

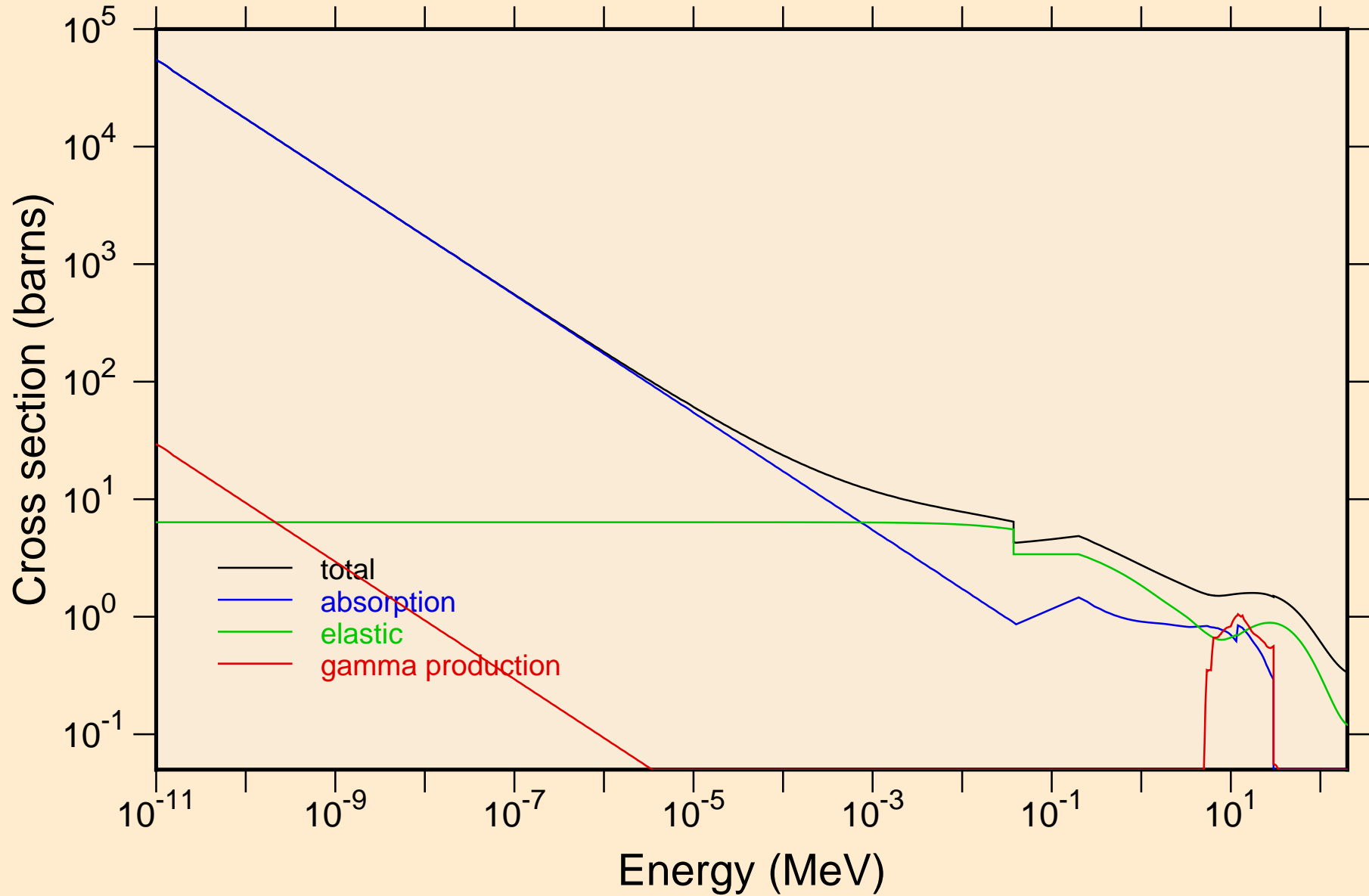

O015 NEUTRON ACER TENDL-2024 LIBRARY; T=0.K

Heating

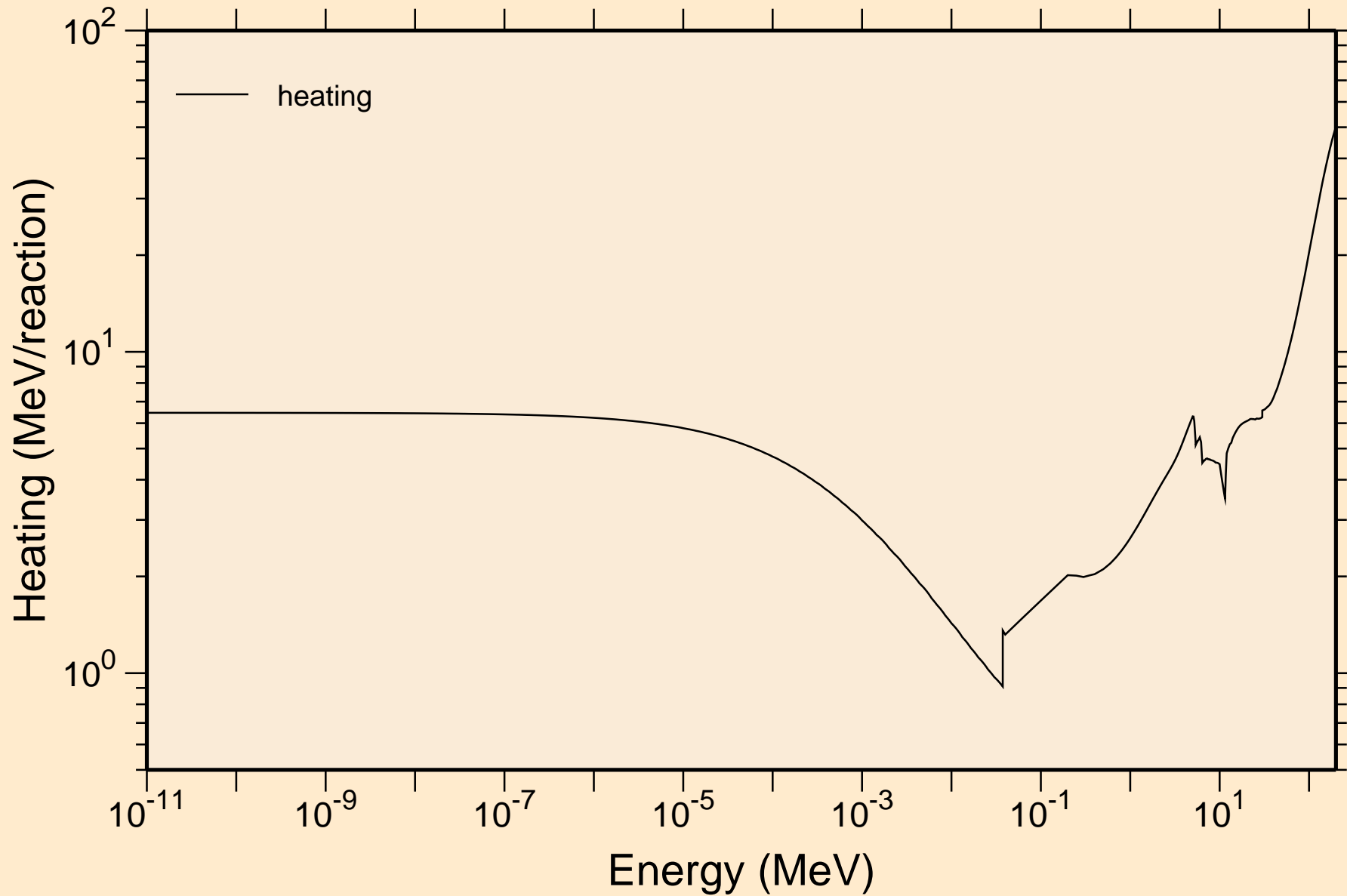

O015 NEUTRON ACER TENDL-2024 LIBRARY; T=0.K
Damage

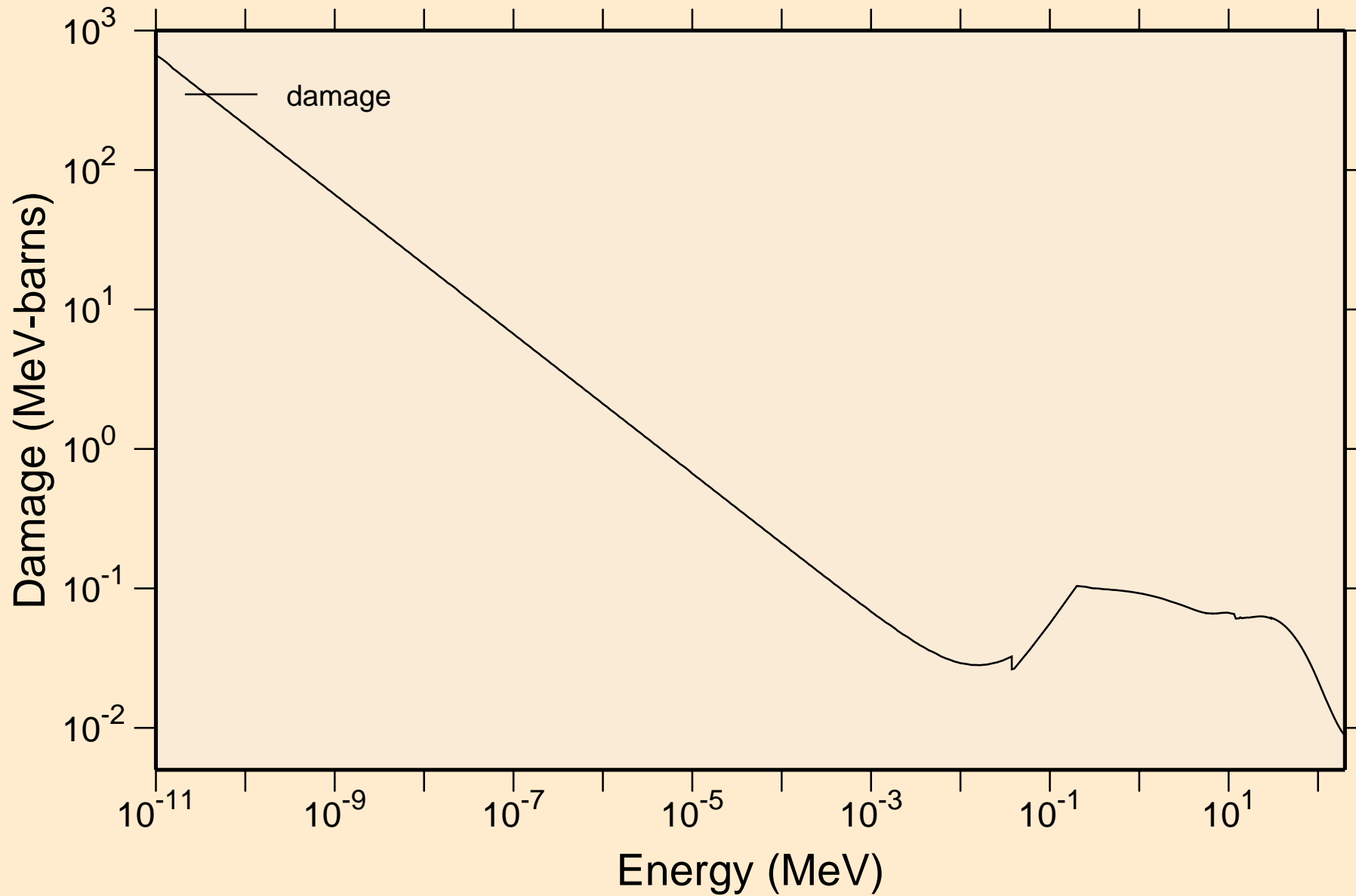

O015 NEUTRON ACER TENDL-2024 LIBRARY; T=0.K

Non-threshold reactions

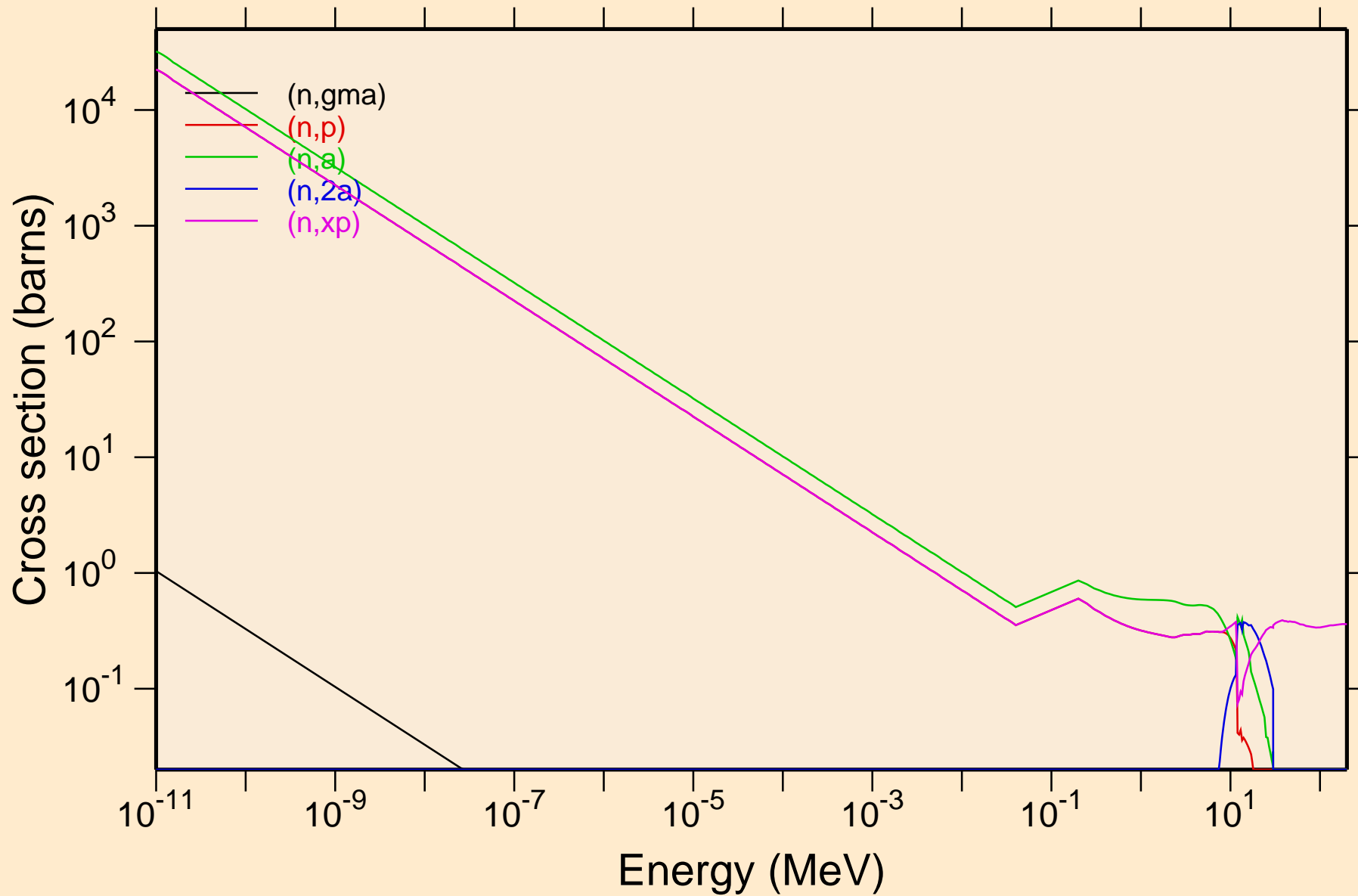

O015 NEUTRON ACER TENDL-2024 LIBRARY; T=0.K
Non-threshold reactions

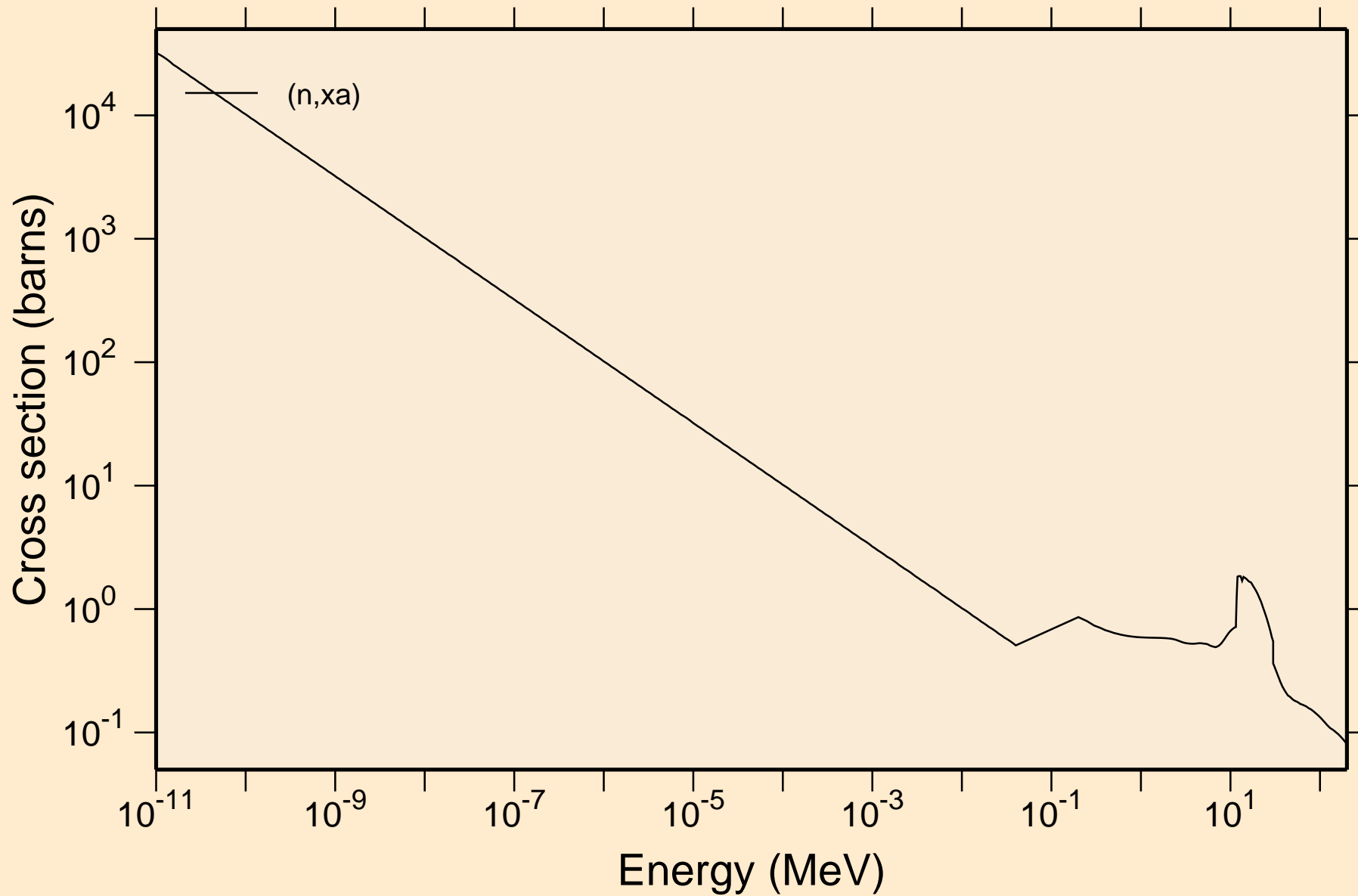

O015 NEUTRON ACER TENDL-2024 LIBRARY; T=0.K

Principal cross sections

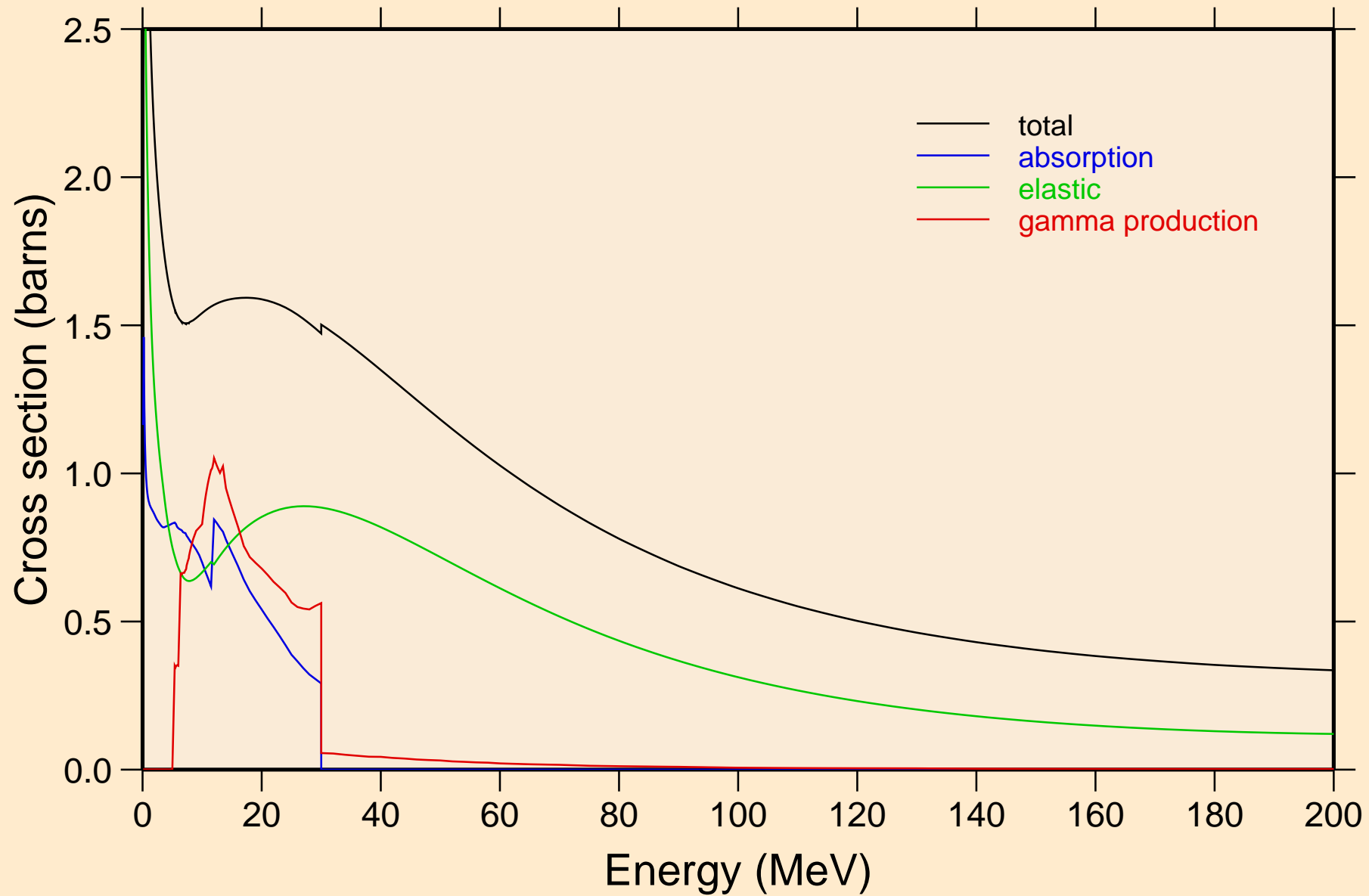

O015 NEUTRON ACER TENDL-2024 LIBRARY; T=0.K

Heating

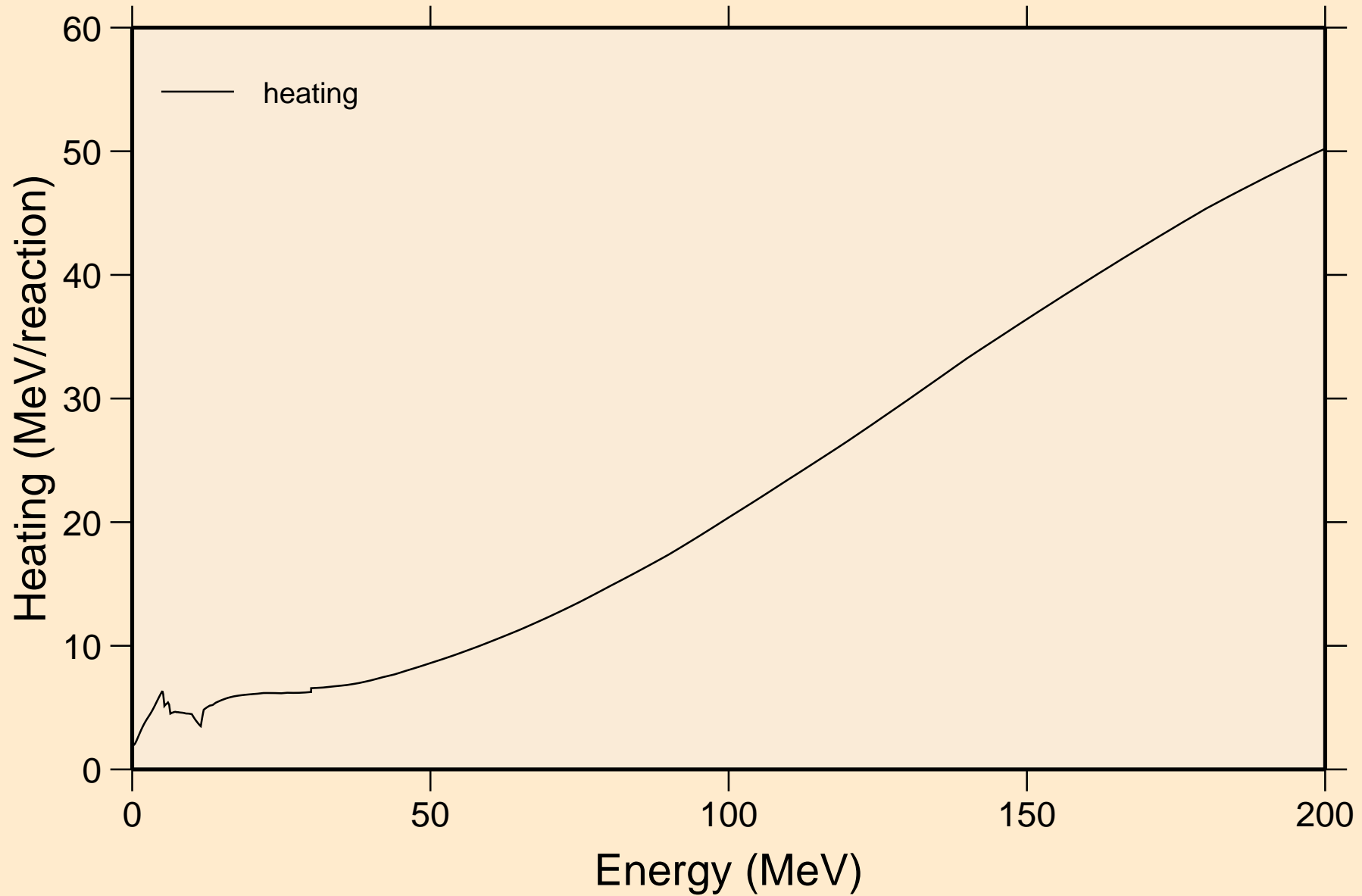

O015 NEUTRON ACER TENDL-2024 LIBRARY; T=0.K
Damage

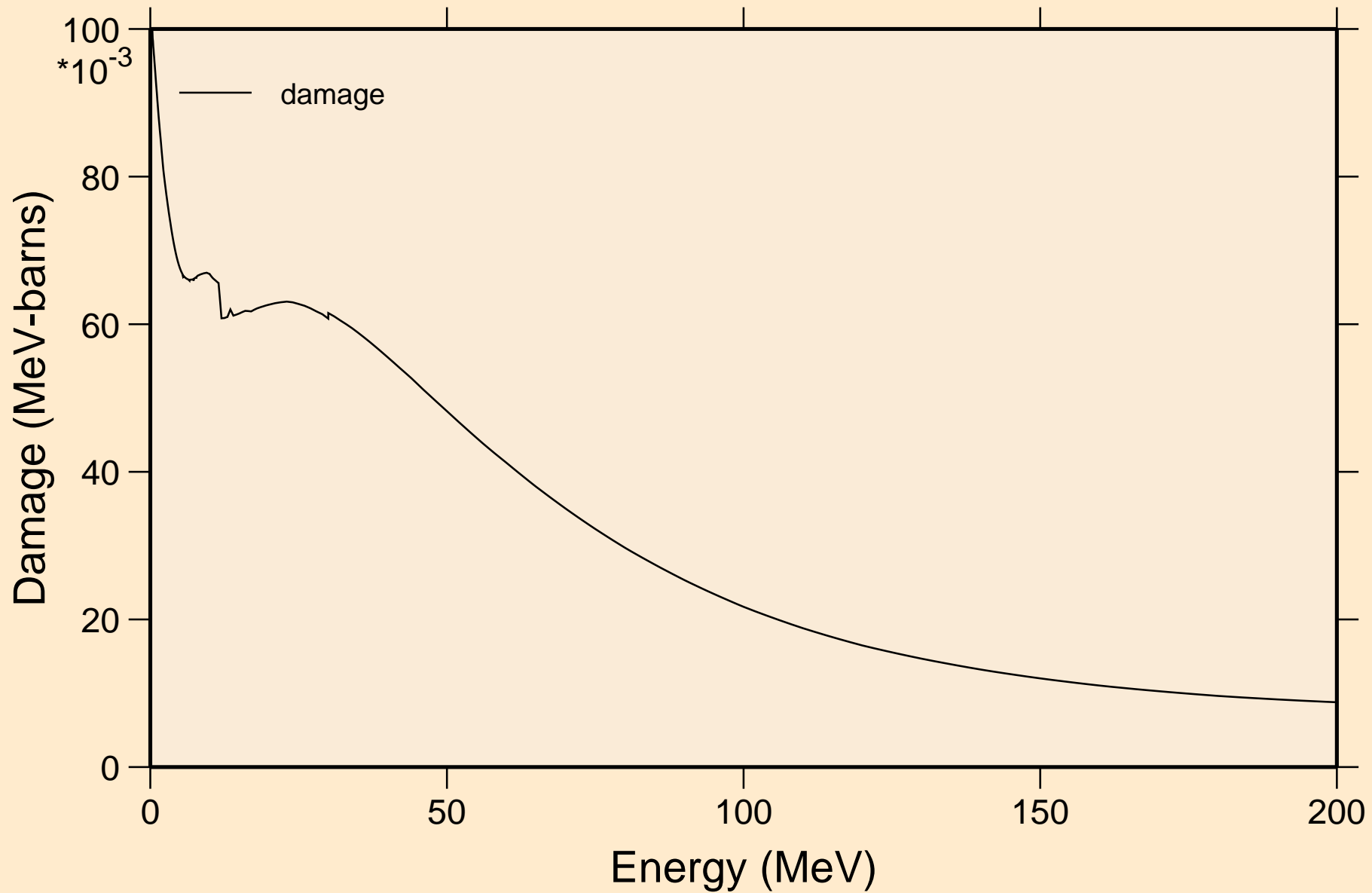

O015 NEUTRON ACER TENDL-2024 LIBRARY; T=0.K

Non-threshold reactions

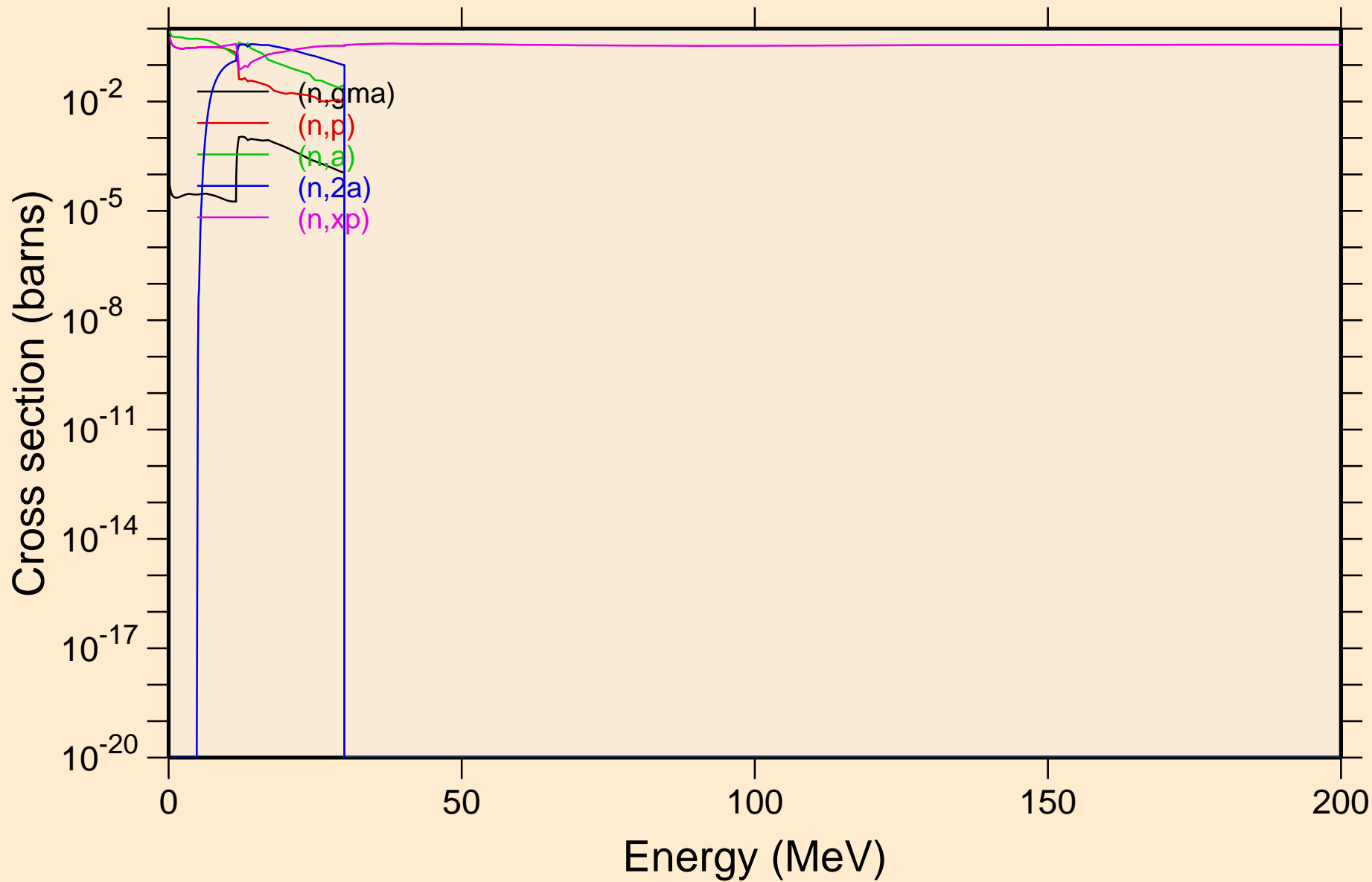

O015 NEUTRON ACER TENDL-2024 LIBRARY; T=0.K
Non-threshold reactions

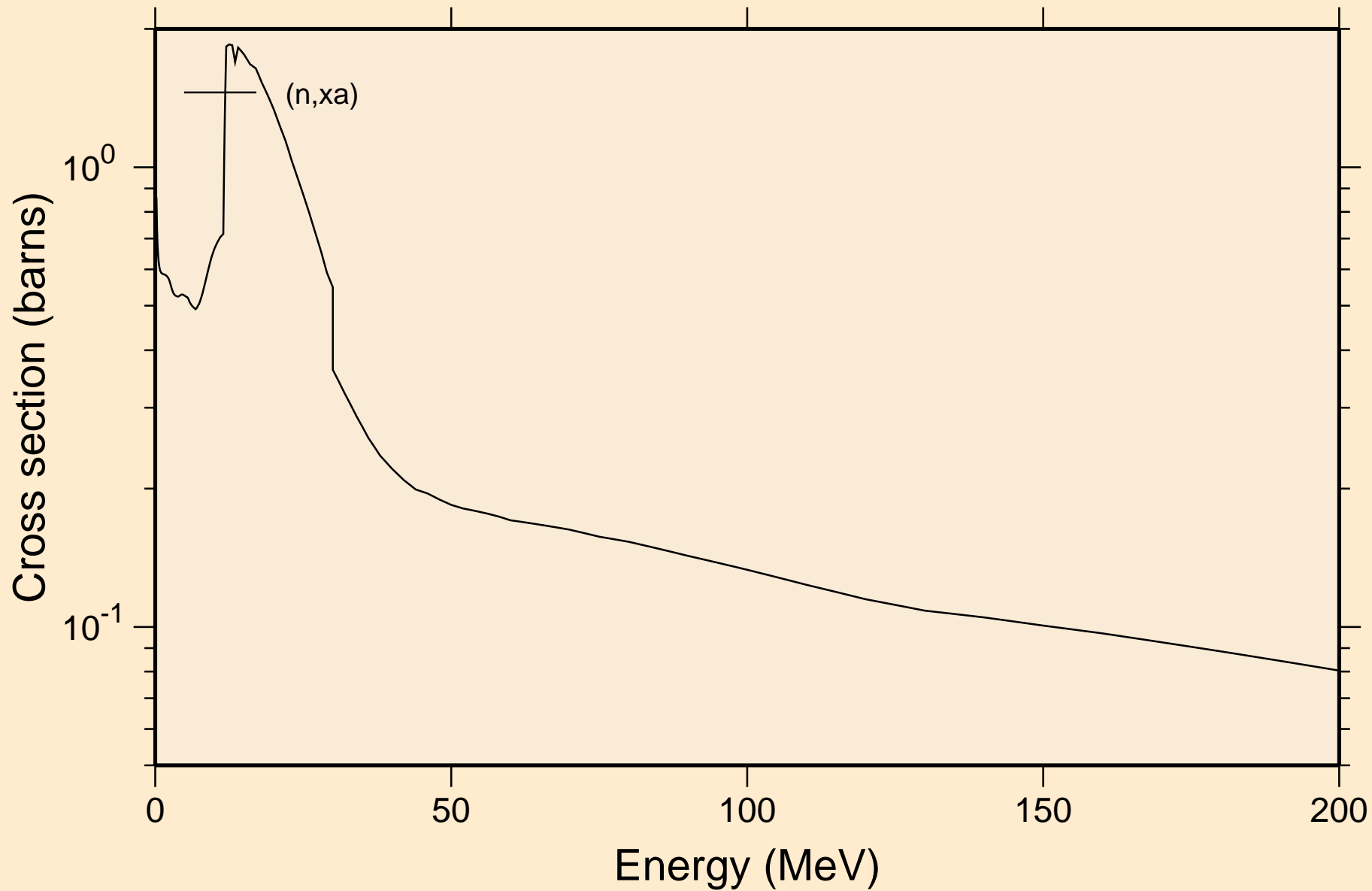

O015 NEUTRON ACER TENDL-2024 LIBRARY; T=0.K
Inelastic levels

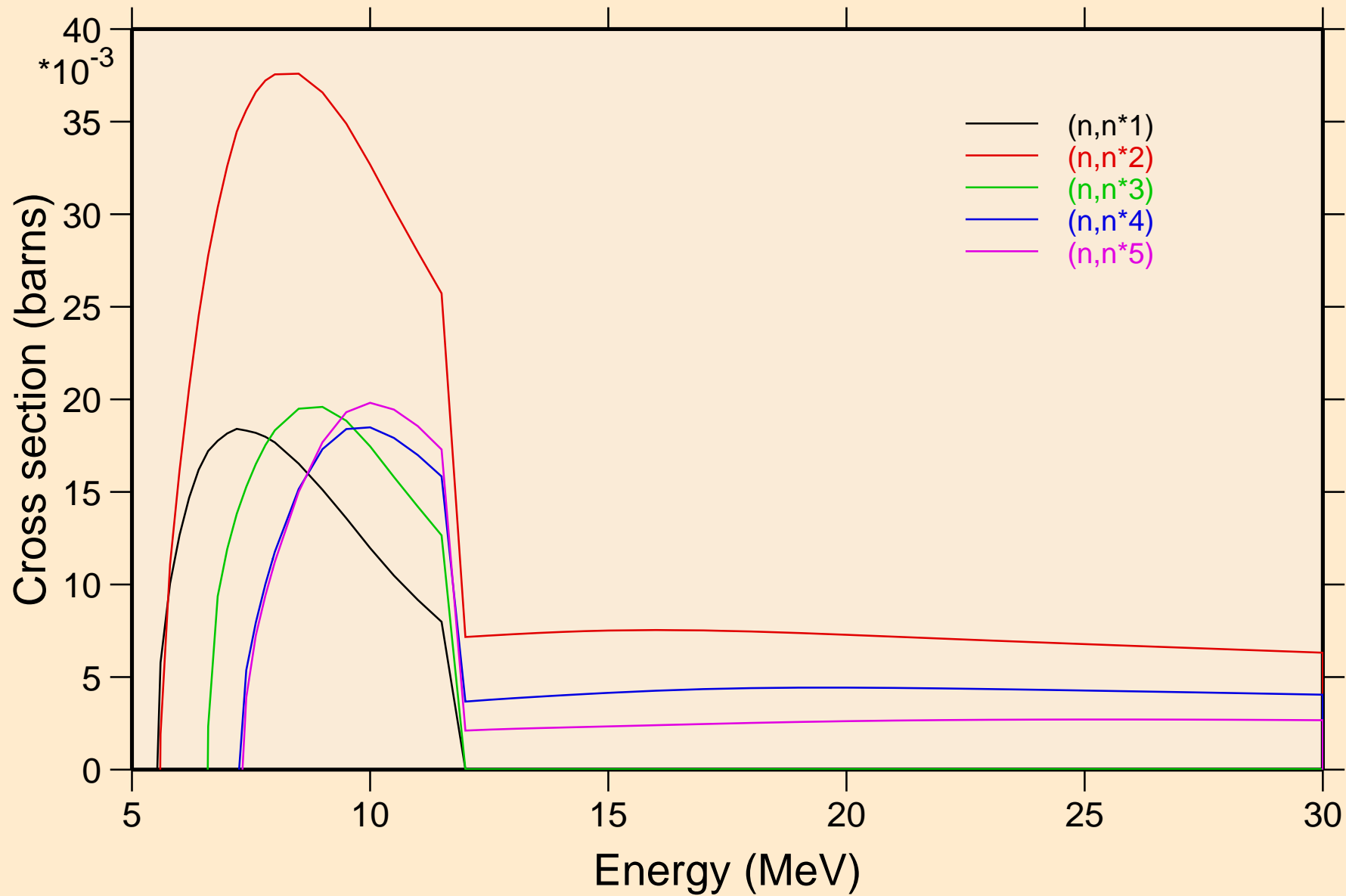

O015 NEUTRON ACER TENDL-2024 LIBRARY; T=0.K
Inelastic levels

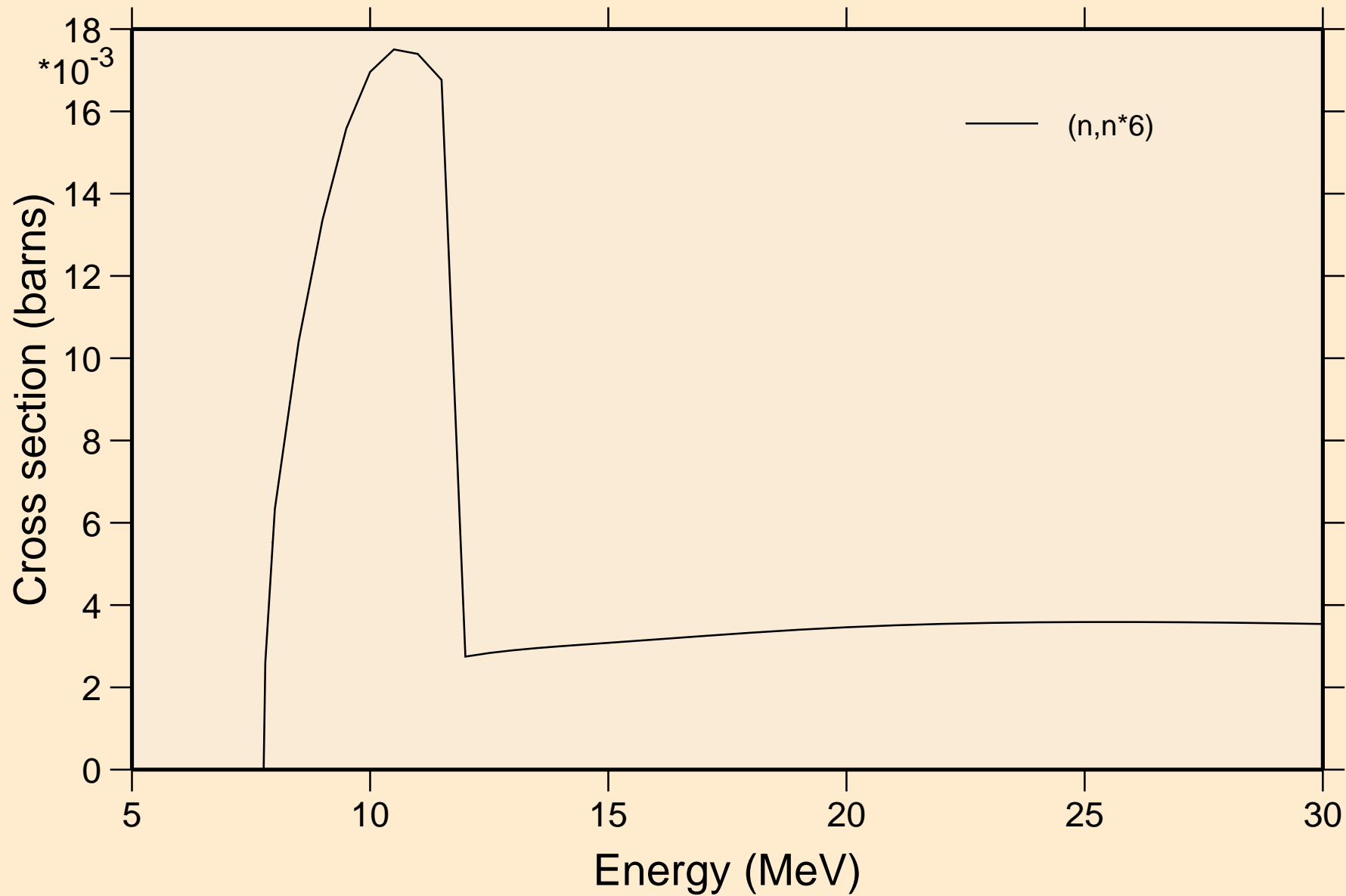

O015 NEUTRON ACER TENDL-2024 LIBRARY; T=0.K
Threshold reactions

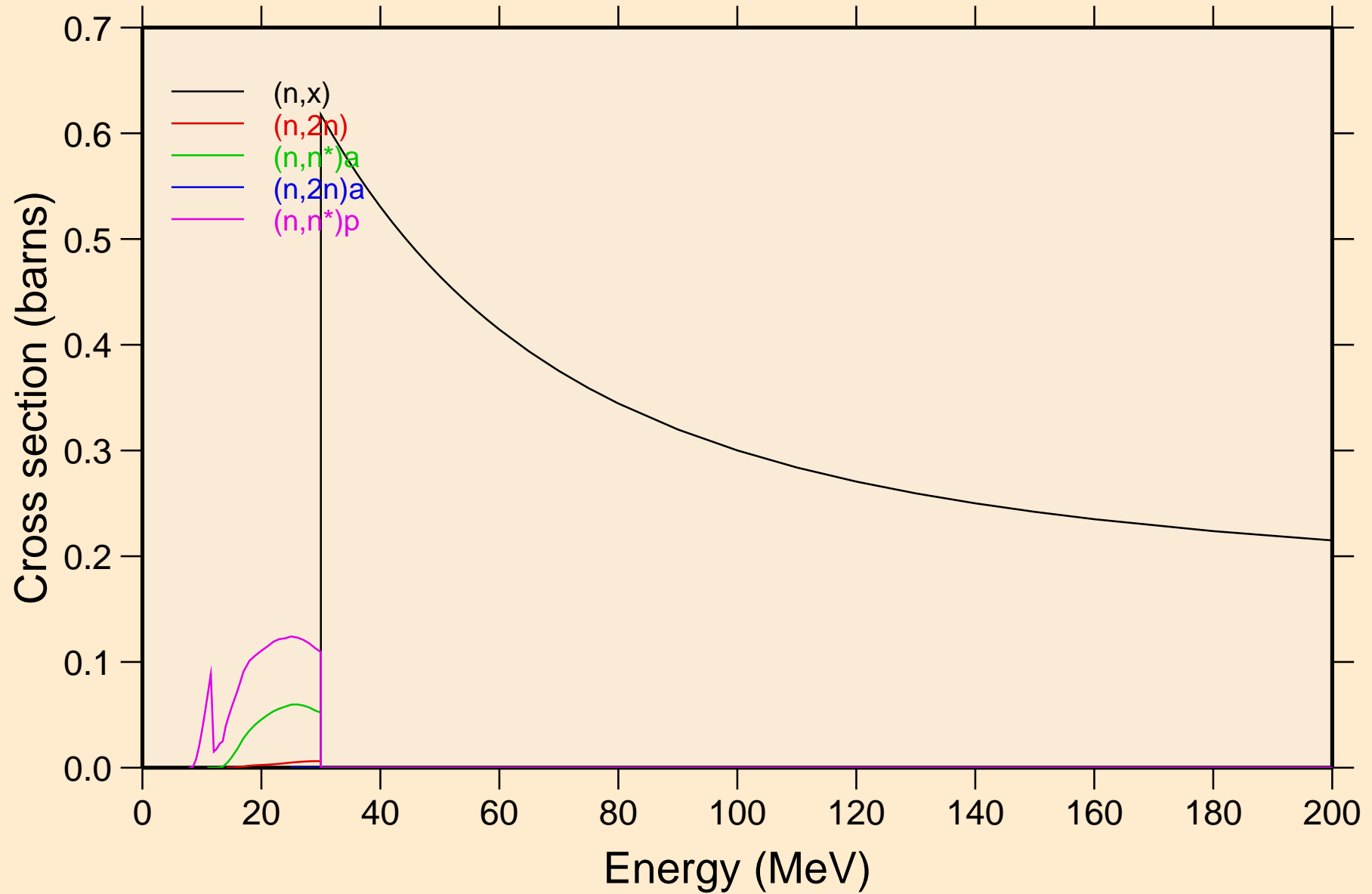

O015 NEUTRON ACER TENDL-2024 LIBRARY; T=0.K
Threshold reactions

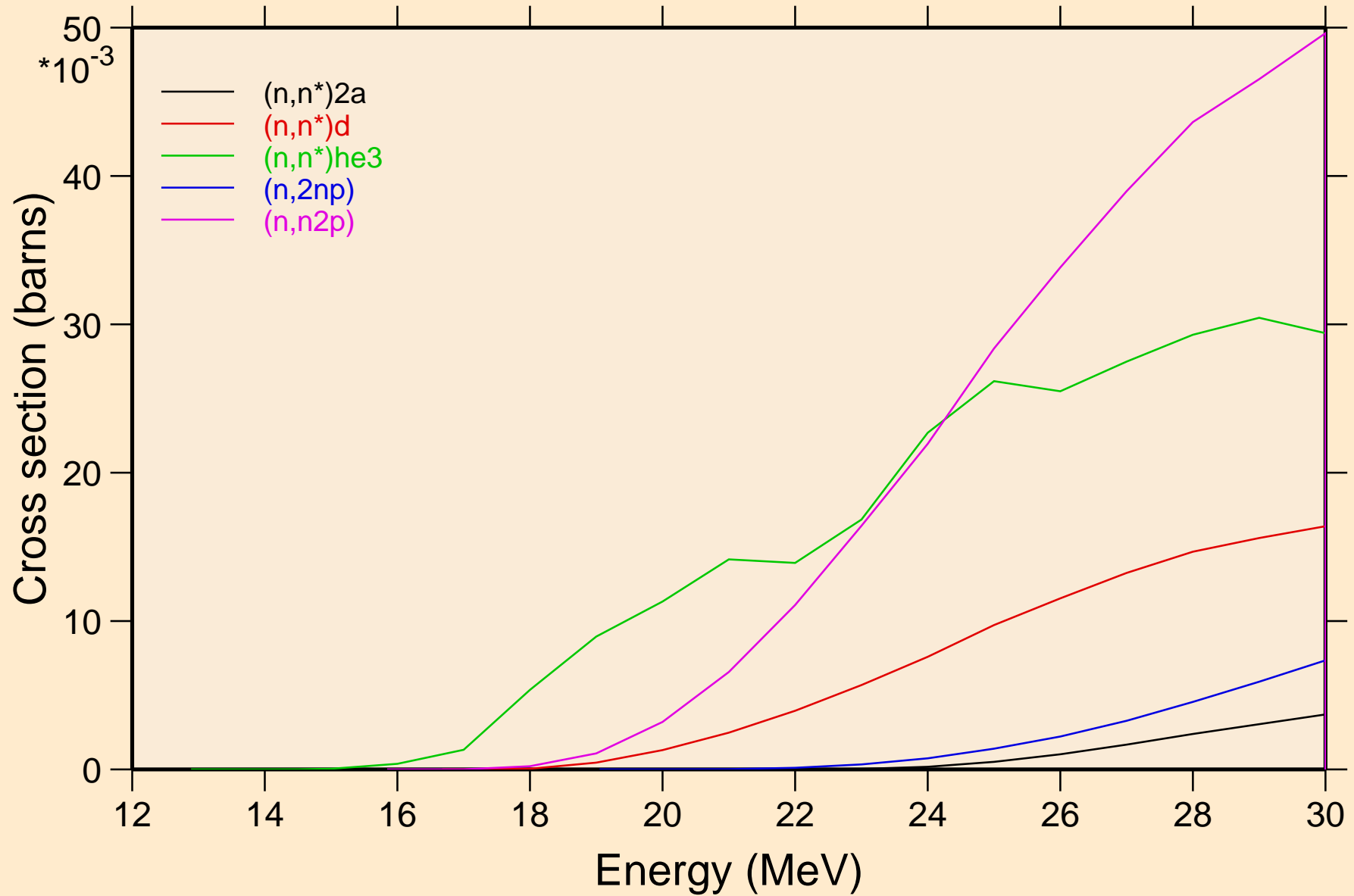

O015 NEUTRON ACER TENDL-2024 LIBRARY; T=0.K

Threshold reactions

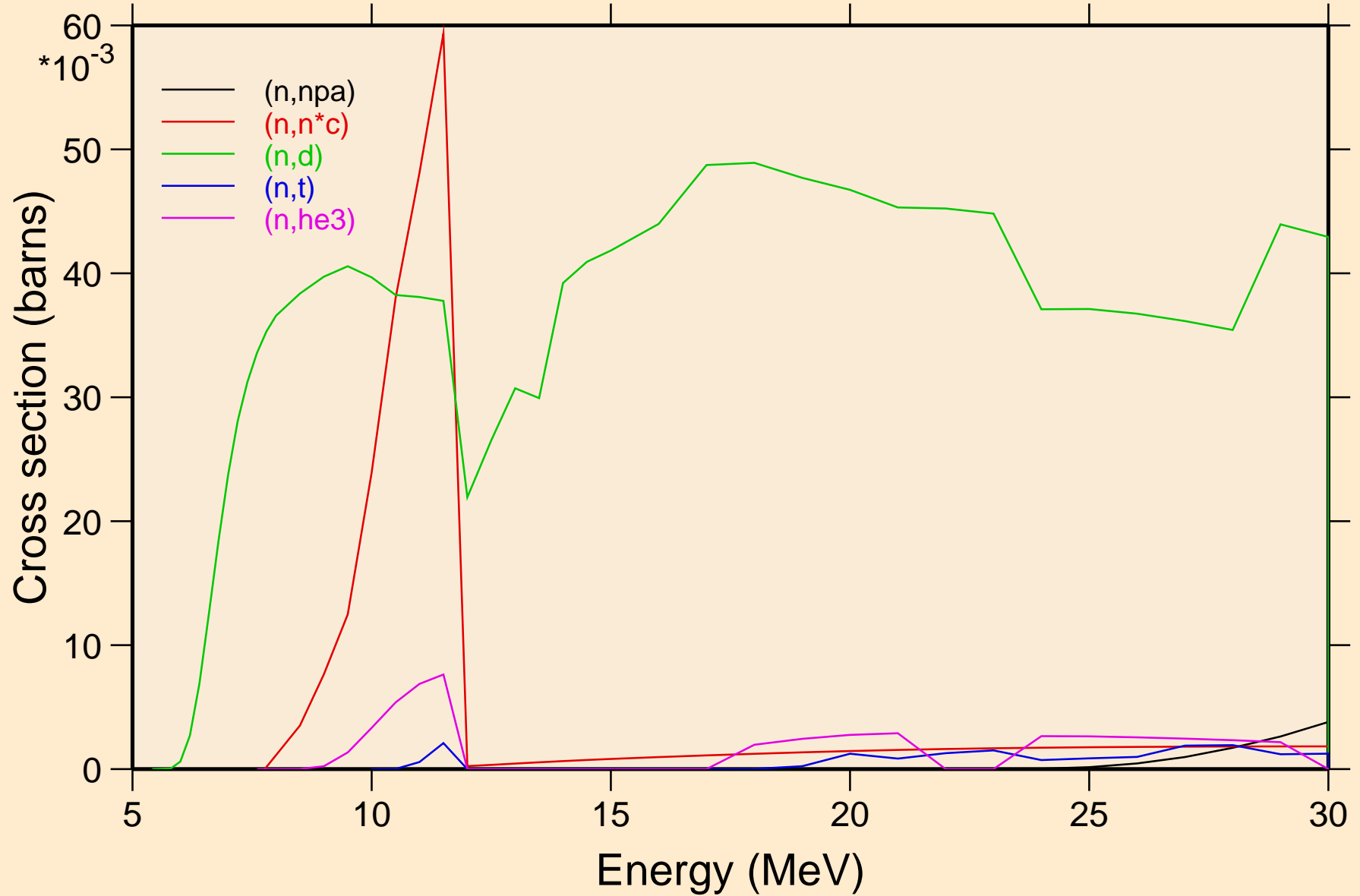

O015 NEUTRON ACER TENDL-2024 LIBRARY; T=0.K
Threshold reactions

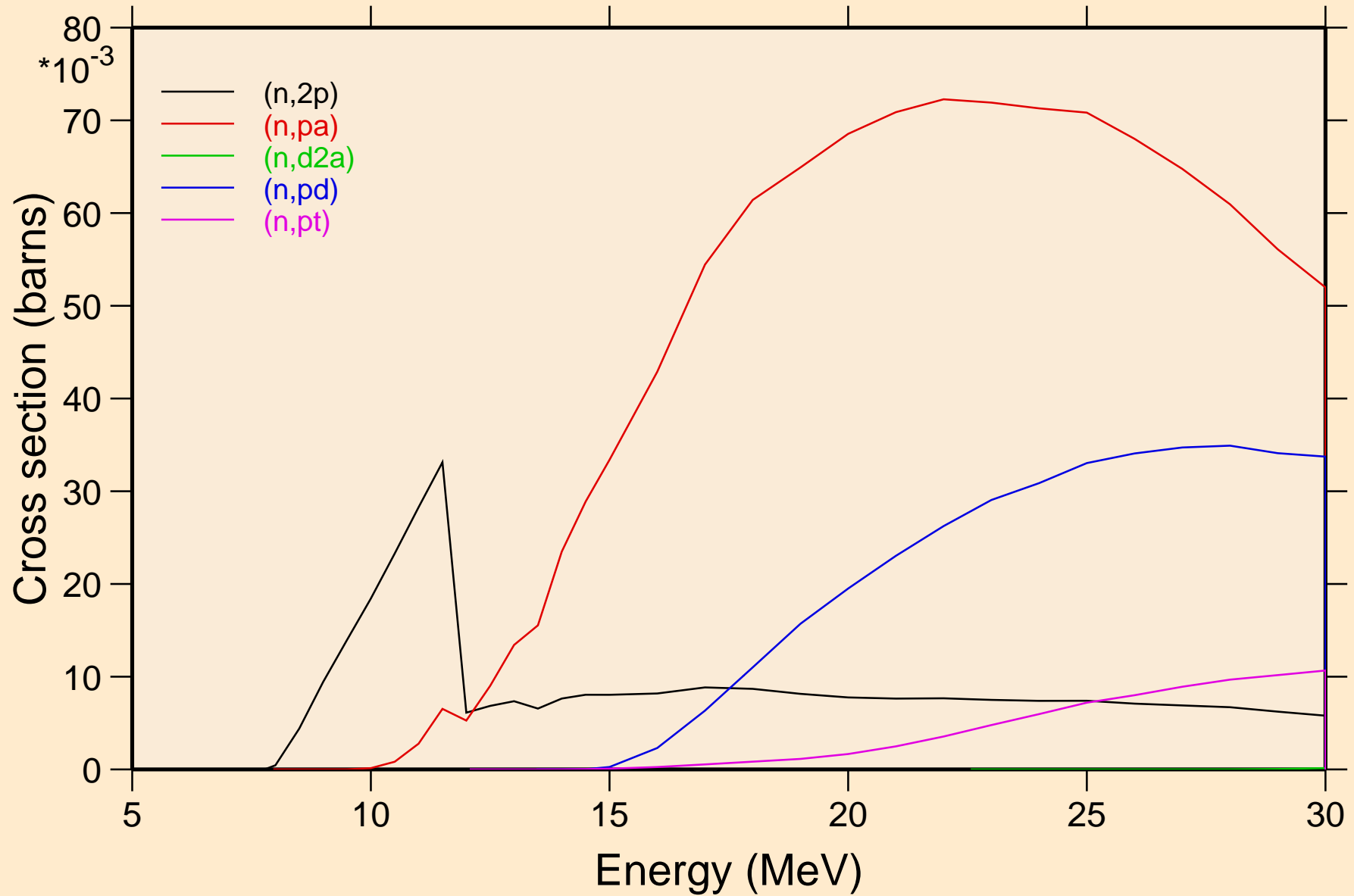

O015 NEUTRON ACER TENDL-2024 LIBRARY; T=0.K
Threshold reactions

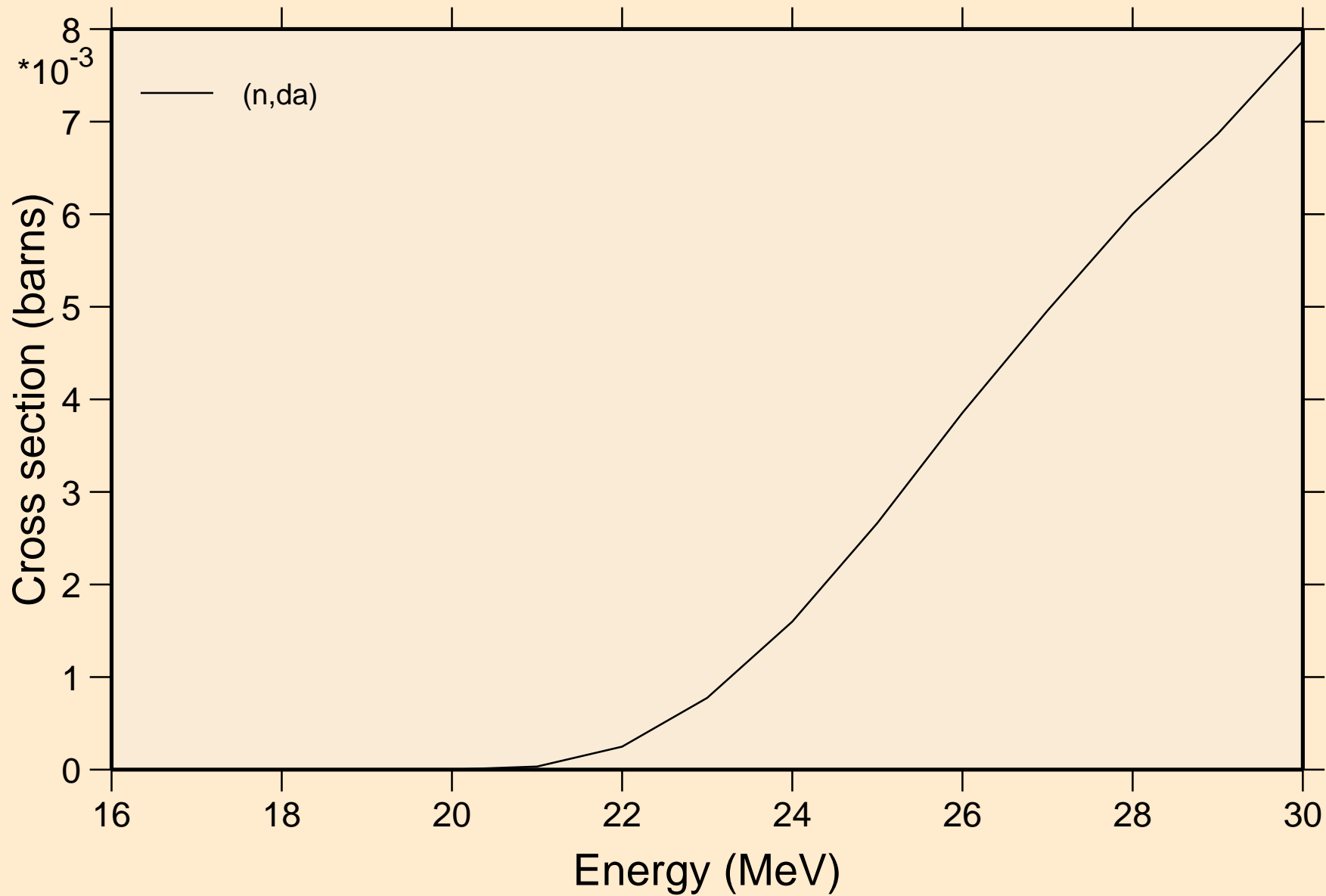

O015 NEUTRON ACER TENDL-2024 LIBRARY; T=0.K

Threshold reactions

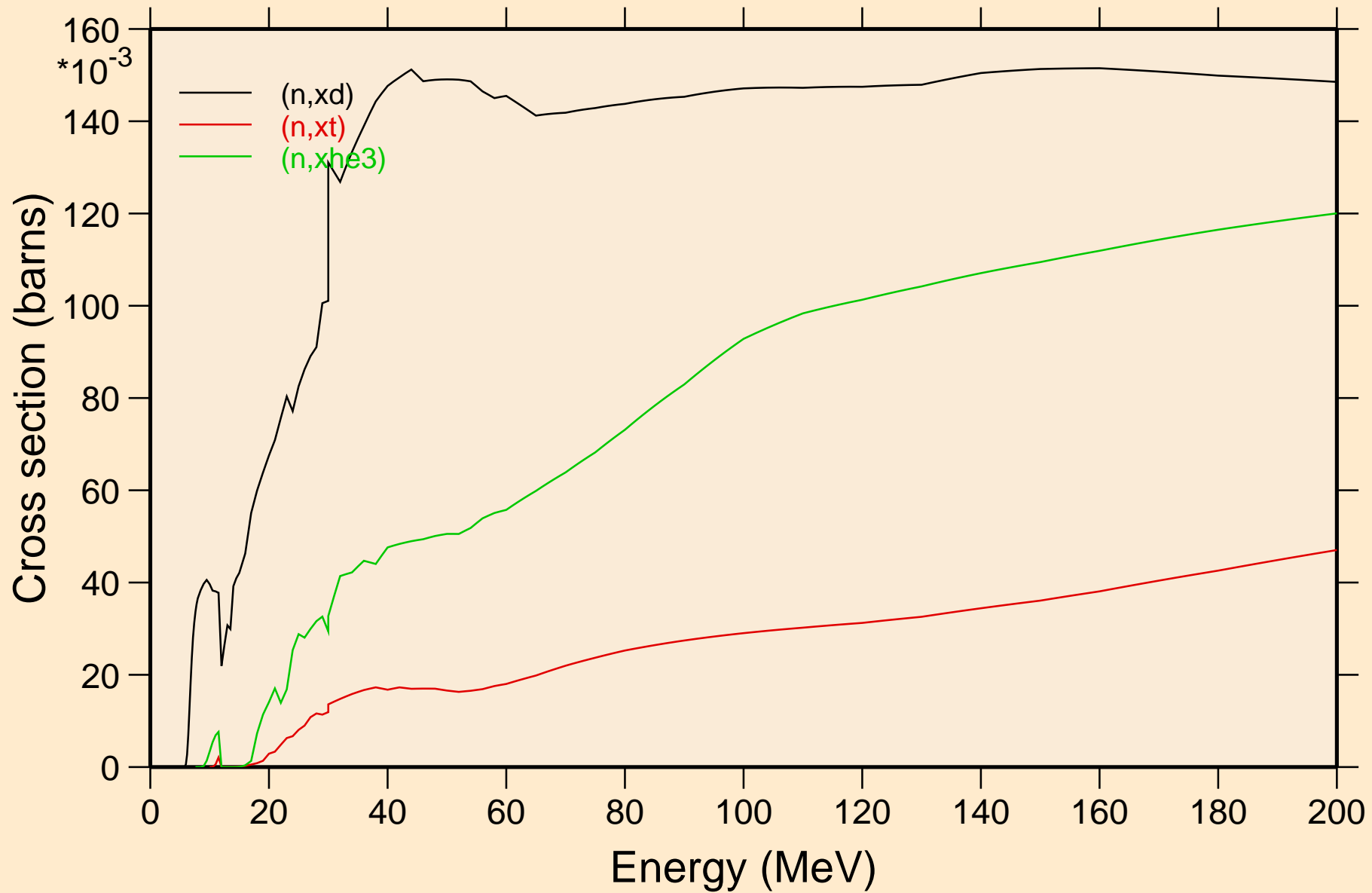

O015 NEUTRON ACER TENDL-2024 LIBRARY; T=0.K
angular distribution for elastic

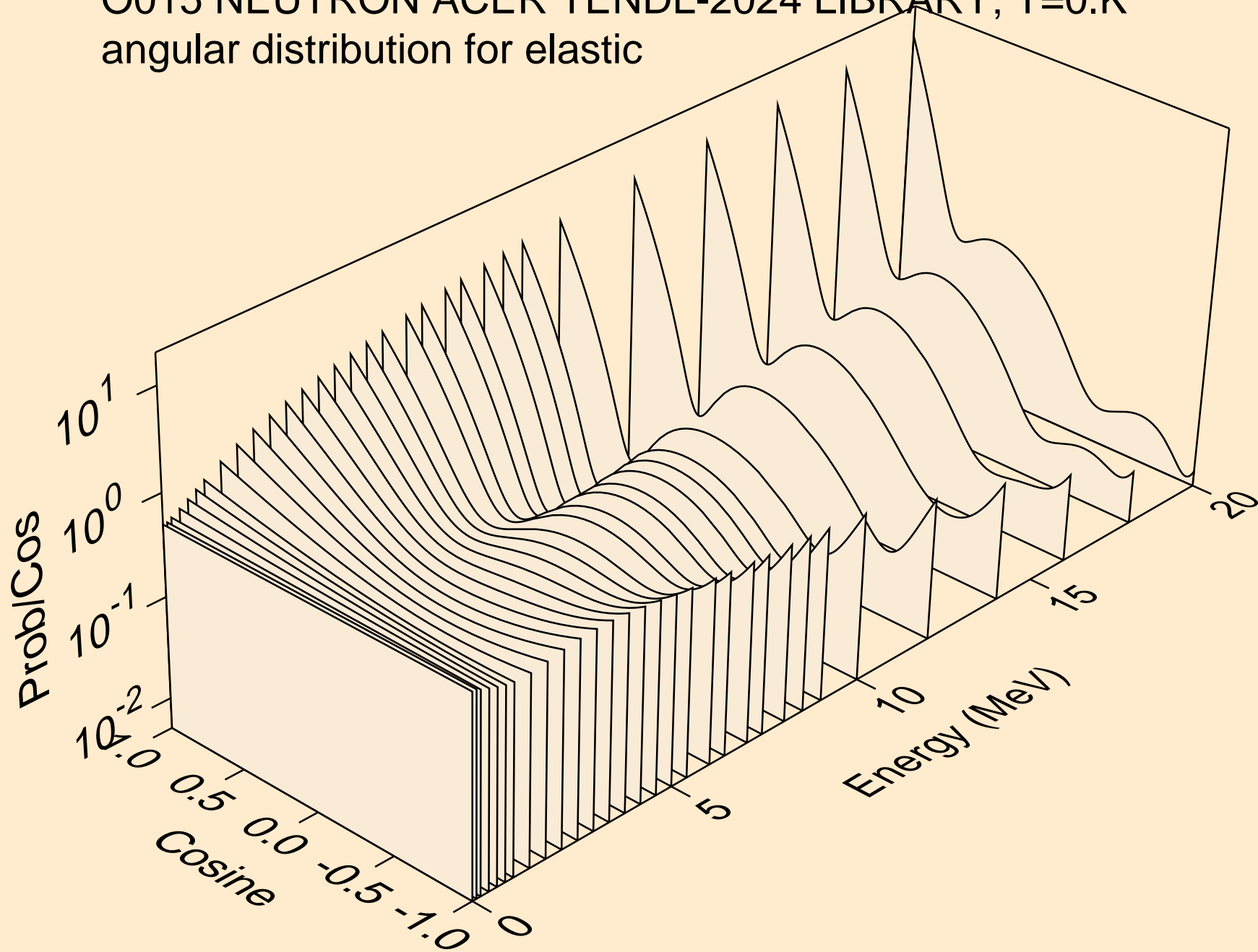

O015 NEUTRON ACER TENDL-2024 LIBRARY; T=0.K
angular distribution for elastic

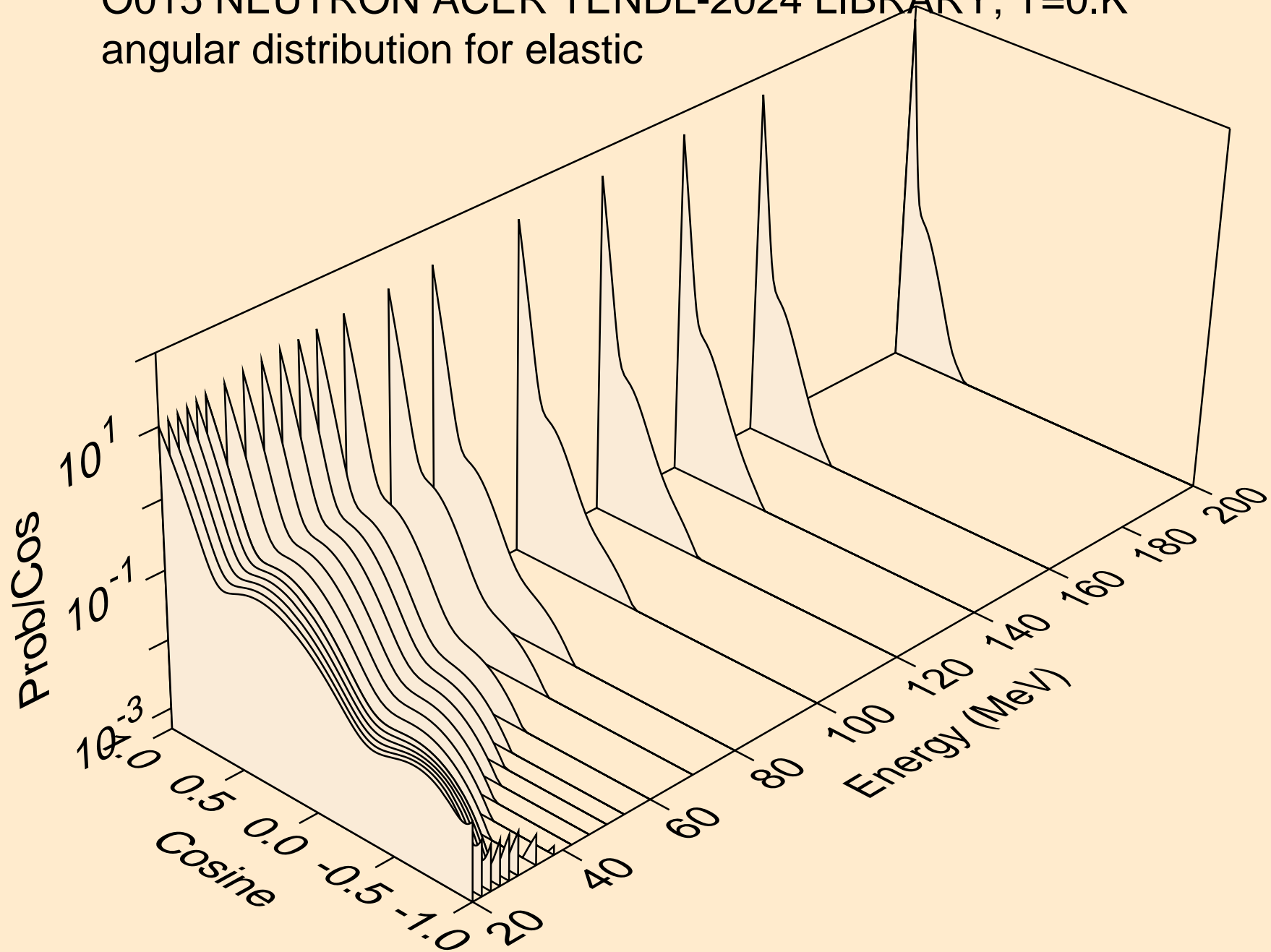

O015 NEUTRON ACER TENDL-2024 LIBRARY; T=0.K
angular distribution for (n,n*1)

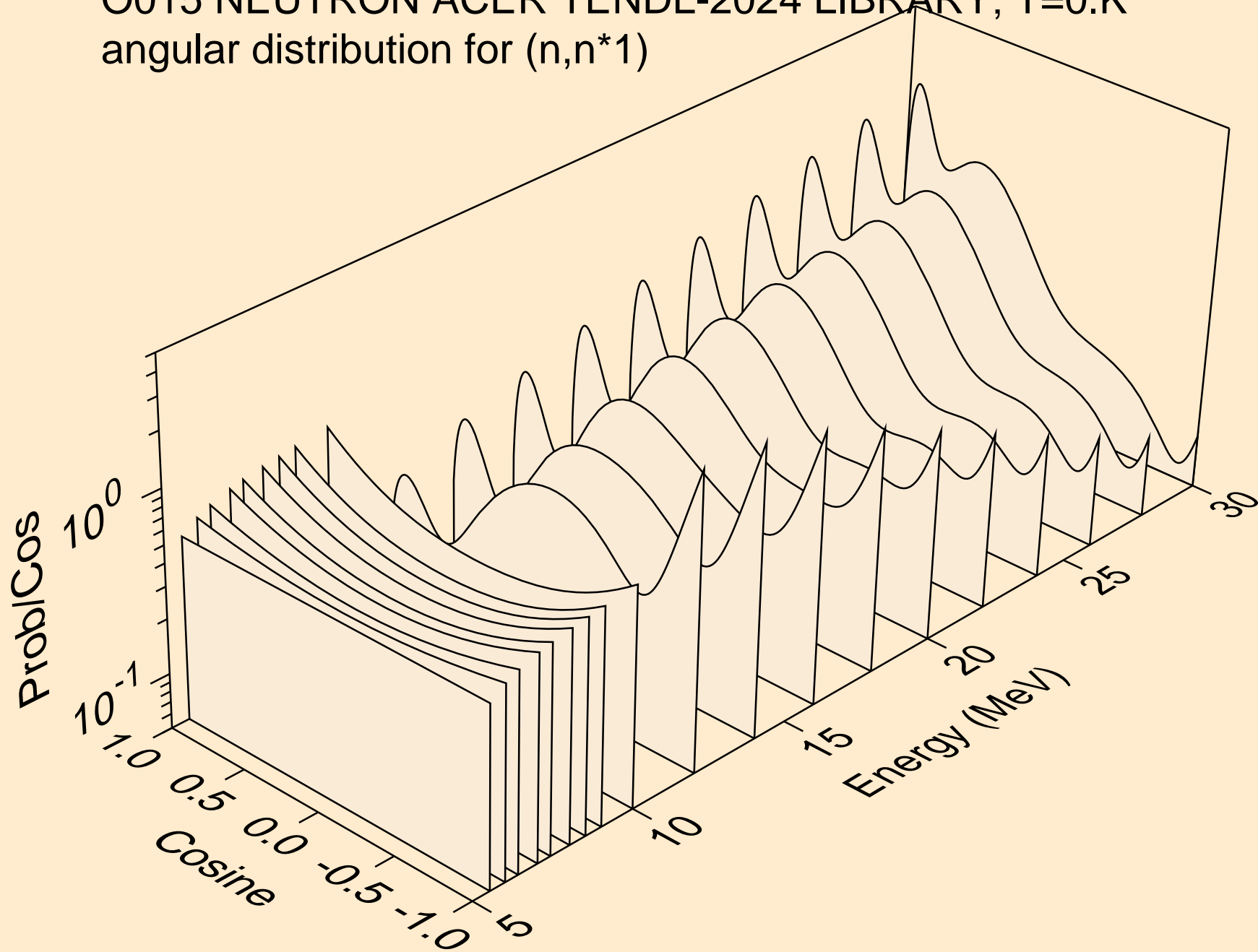

O015 NEUTRON ACER TENDL-2024 LIBRARY; T=0.K
angular distribution for (n,n*2)

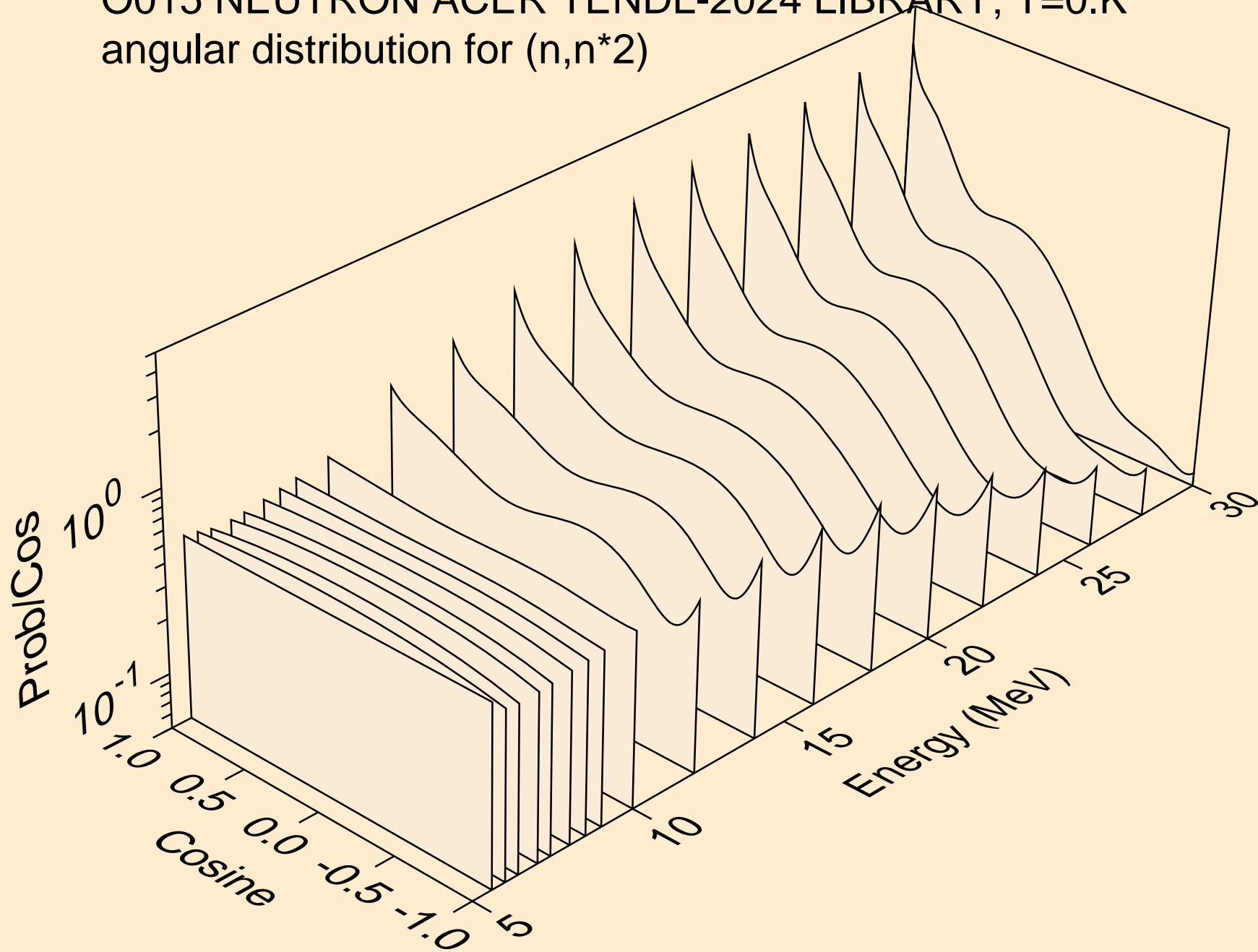

O015 NEUTRON ACER TENDL-2024 LIBRARY; T=0.K
angular distribution for (n,n*3)

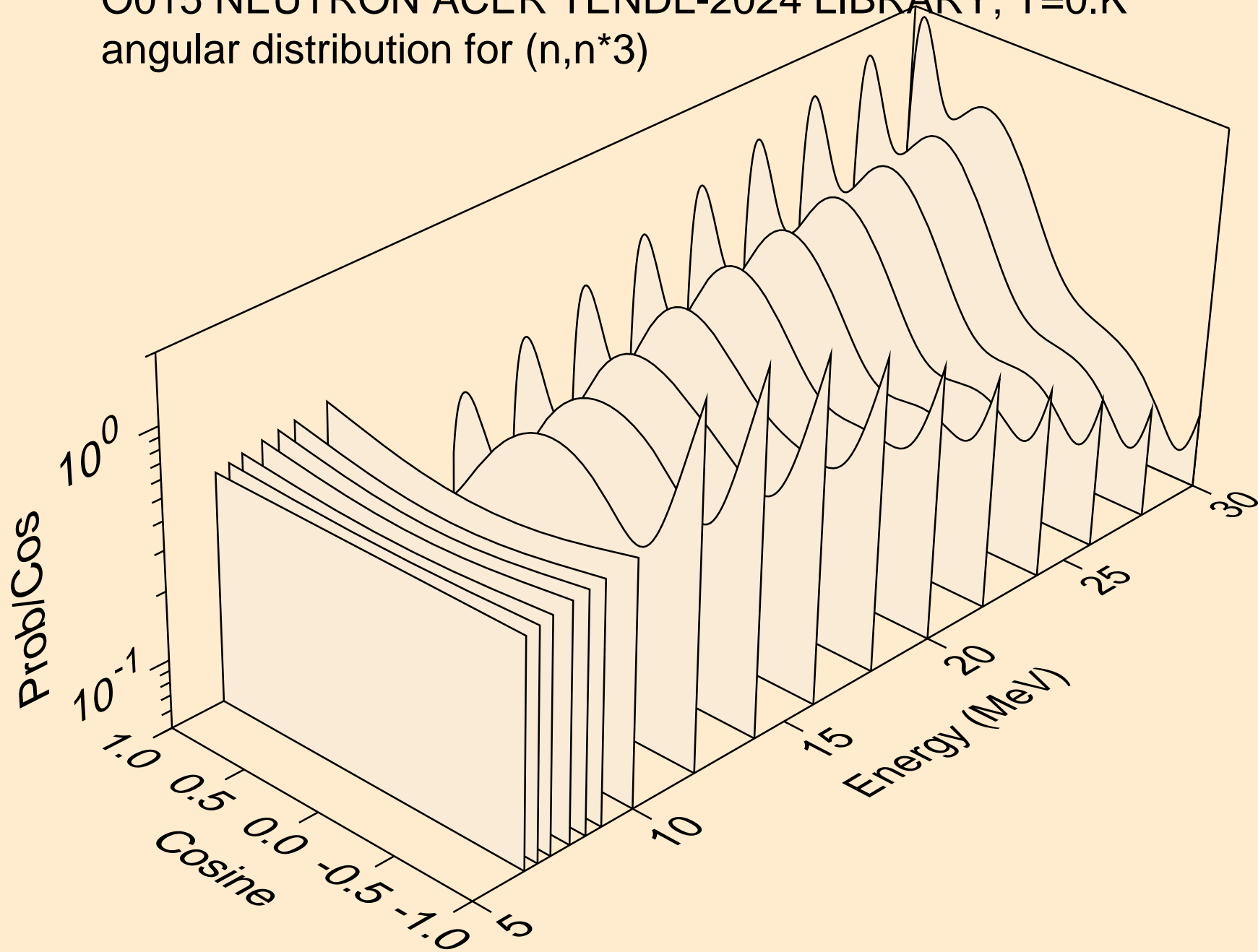

O015 NEUTRON ACER TENDL-2024 LIBRARY; T=0.K
angular distribution for (n,n*4)

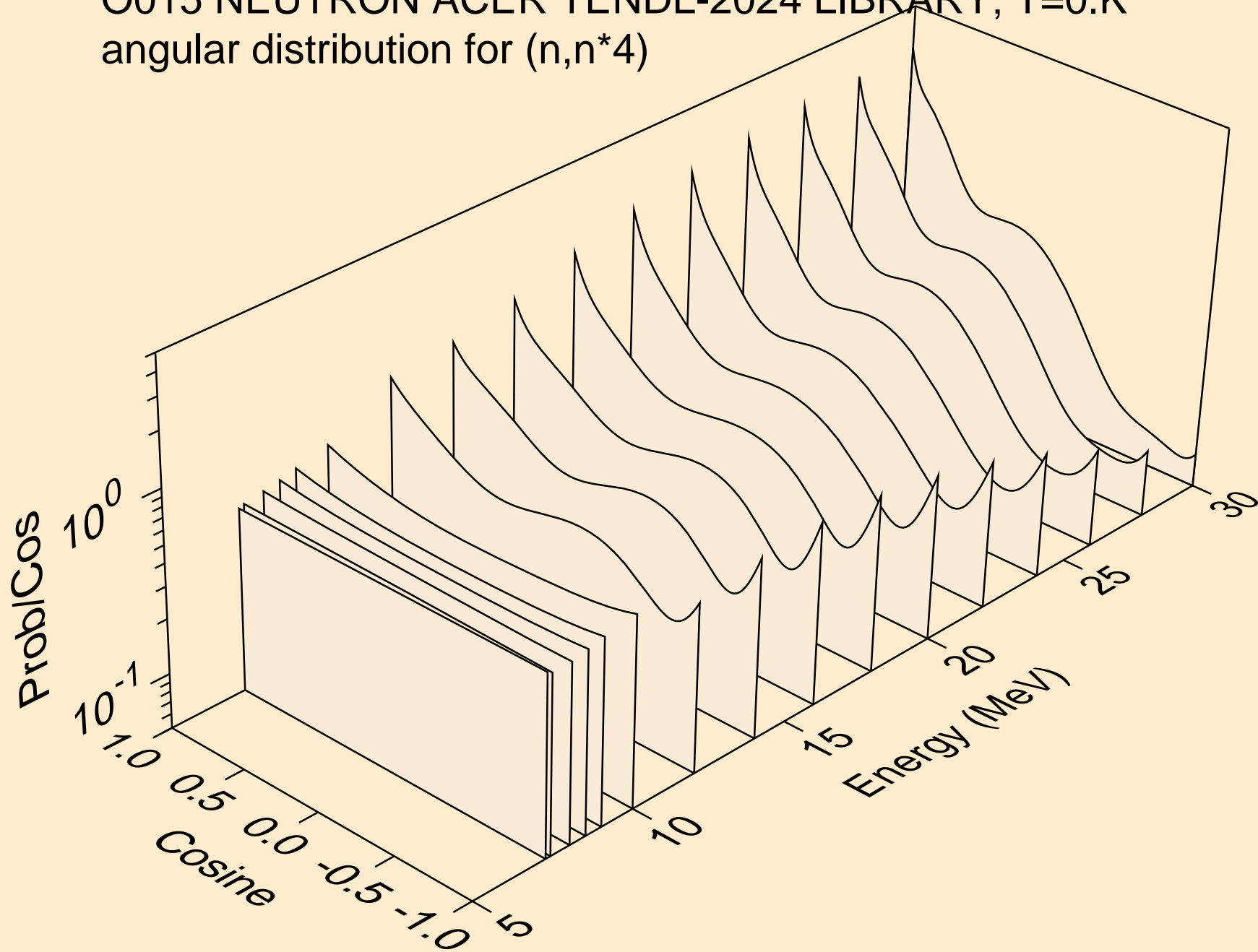

O015 NEUTRON ACER TENDL-2024 LIBRARY; T=0.K
angular distribution for (n,n*5)

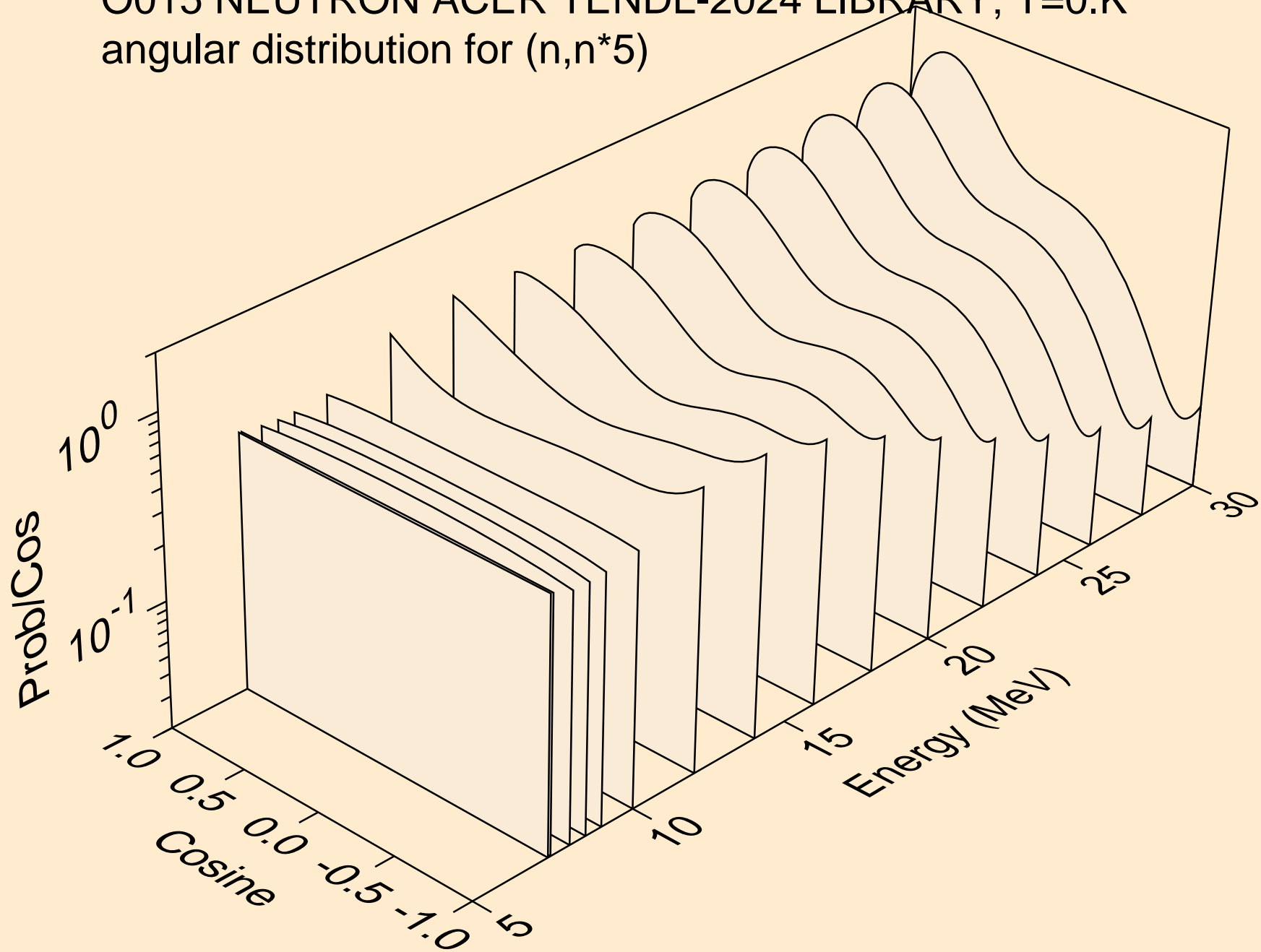

O015 NEUTRON ACER TENDL-2024 LIBRARY; T=0.K
angular distribution for (n,n*6)

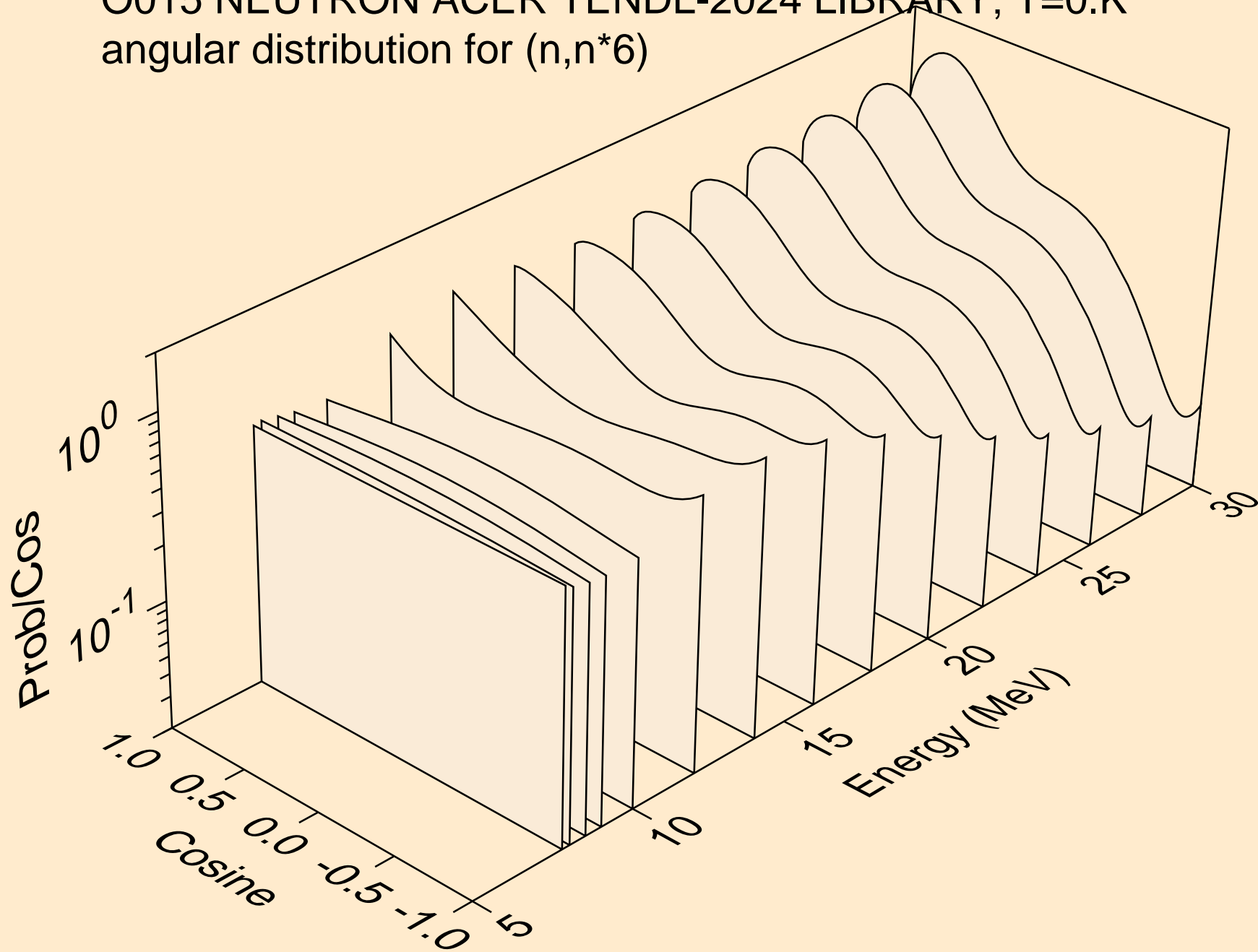

O015 NEUTRON ACER TENDL-2024 LIBRARY; T=0.K
Neutron emission for (n,x)

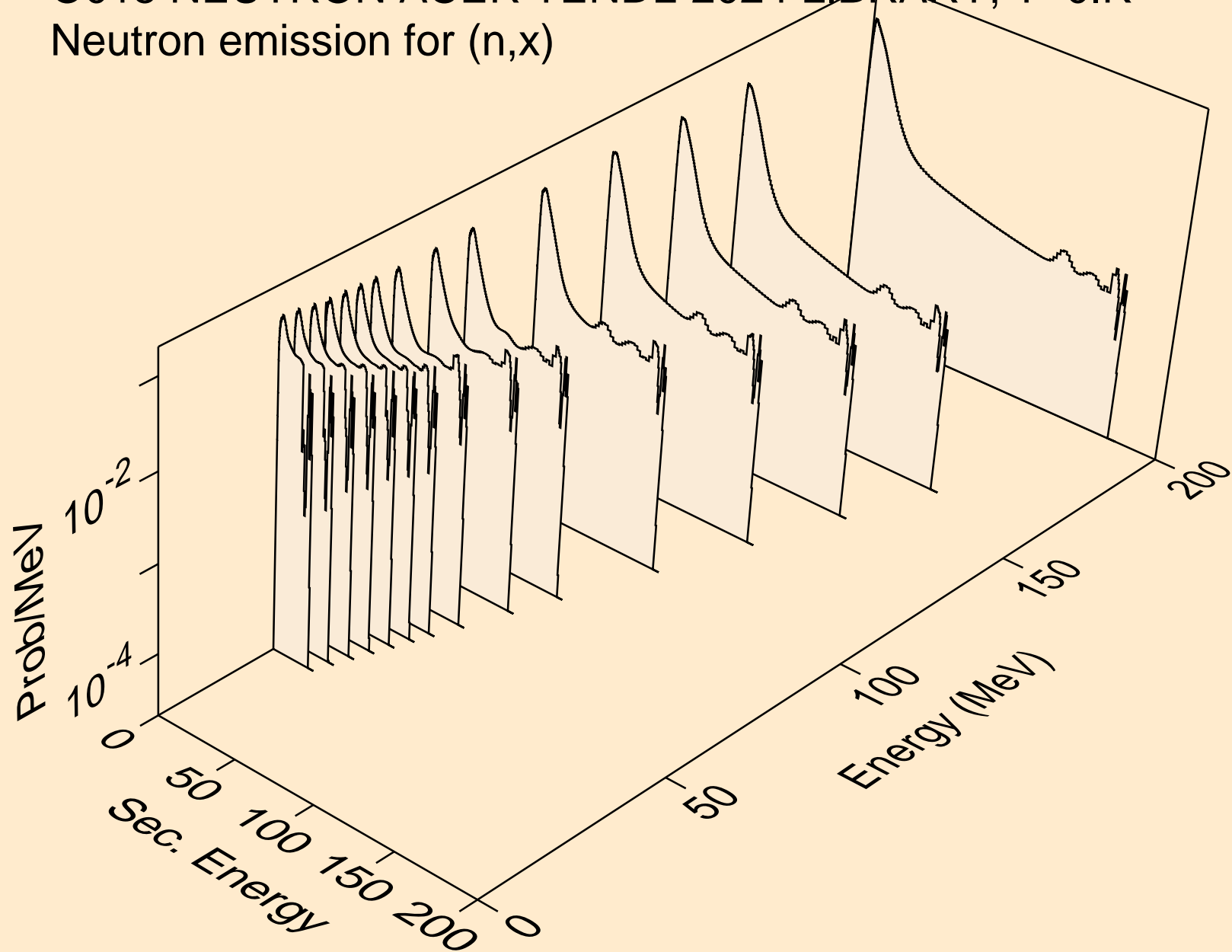

O015 NEUTRON ACER TENDL-2024 LIBRARY; T=0.K
Neutron emission for (n,2n)

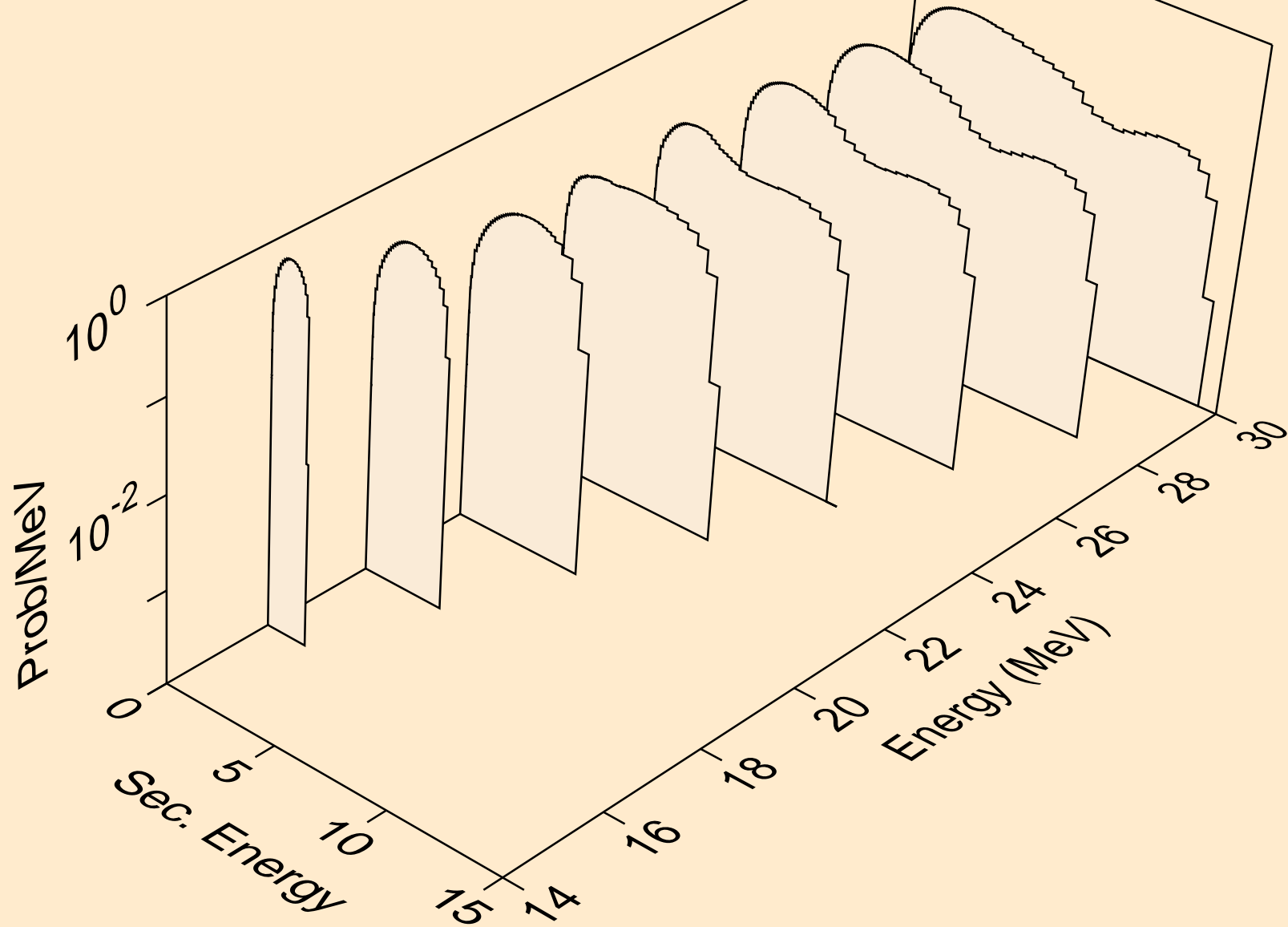

O015 NEUTRON ACER TENDL-2024 LIBRARY; T=0.K
Neutron emission for (n,n*)a

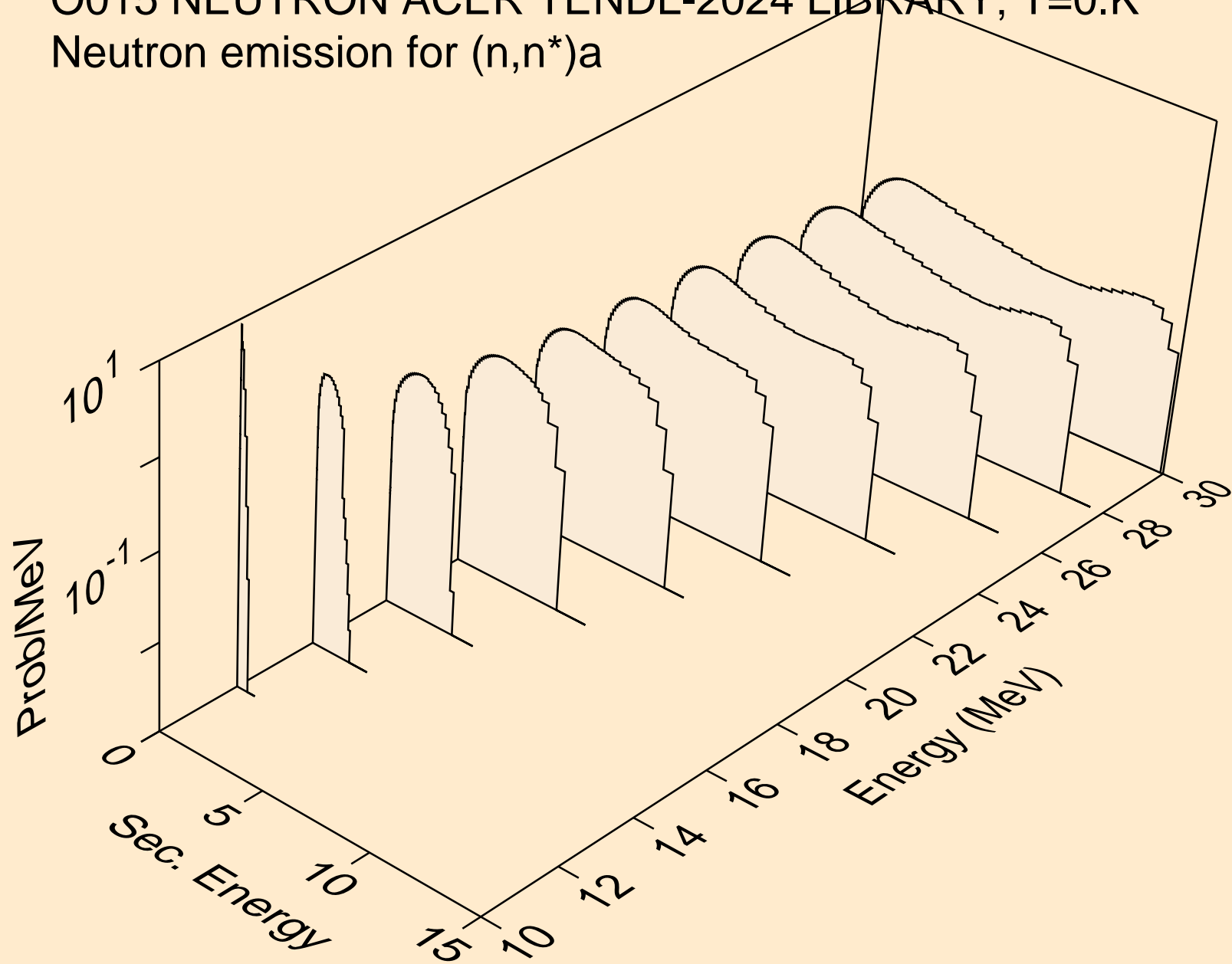

O015 NEUTRON ACER TENDL-2024 LIBRARY; T=0.K
Neutron emission for (n,2n)a

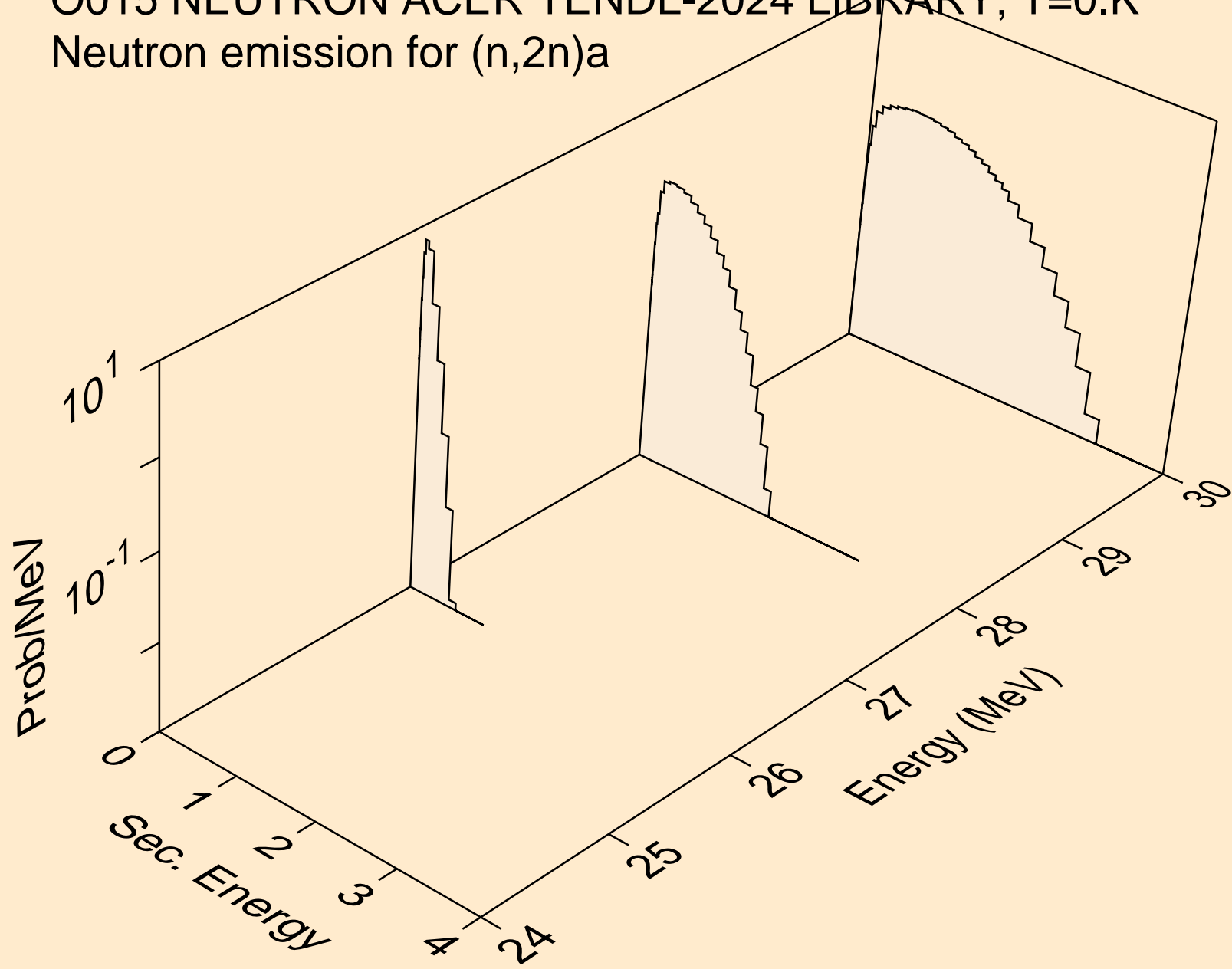

O015 NEUTRON ACER TENDL-2024 LIBRARY; T=0.K
Neutron emission for (n,n*)p

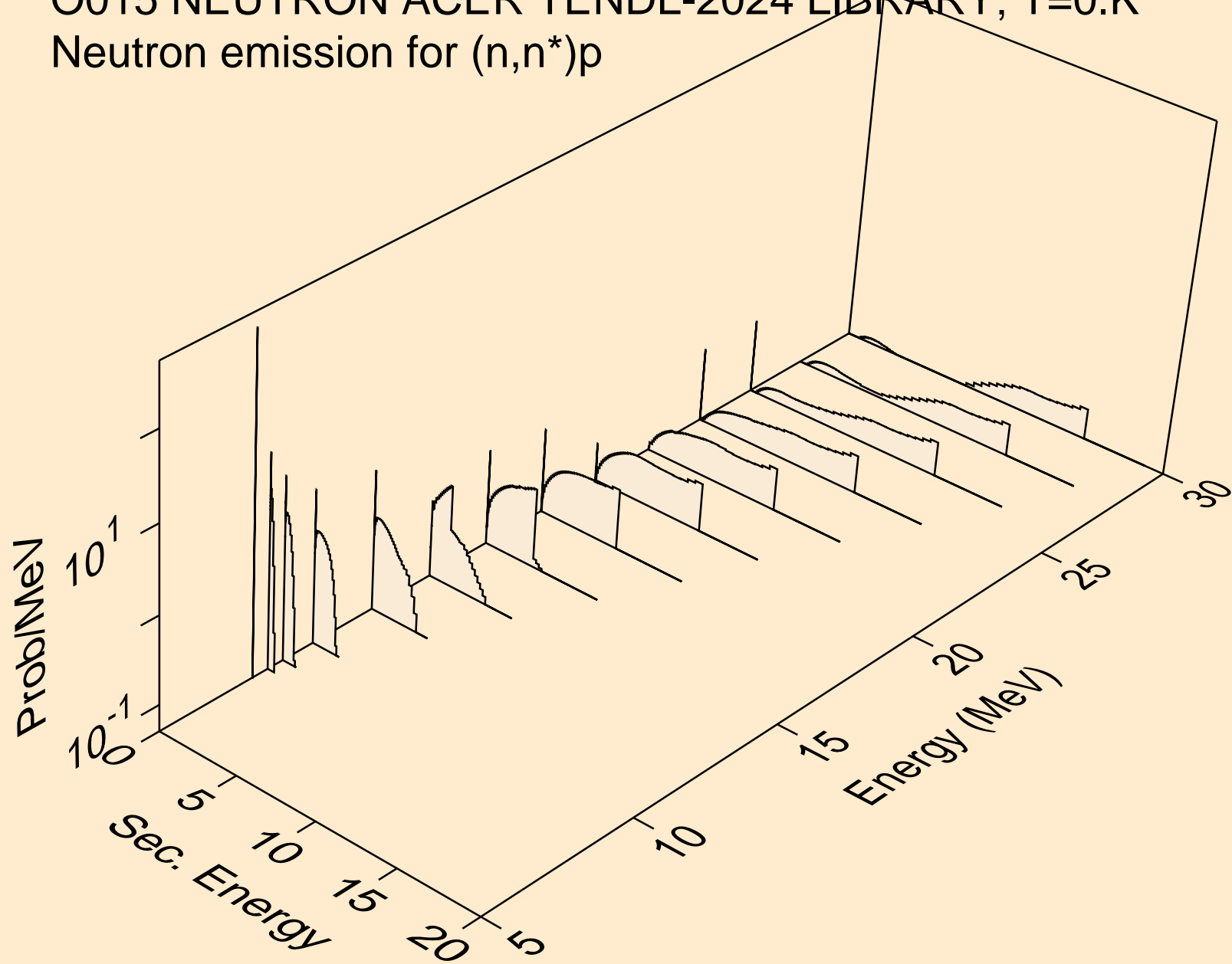

O015 NEUTRON ACER TENDL-2024 LIBRARY; T=0.K
Neutron emission for (n,n*)2a

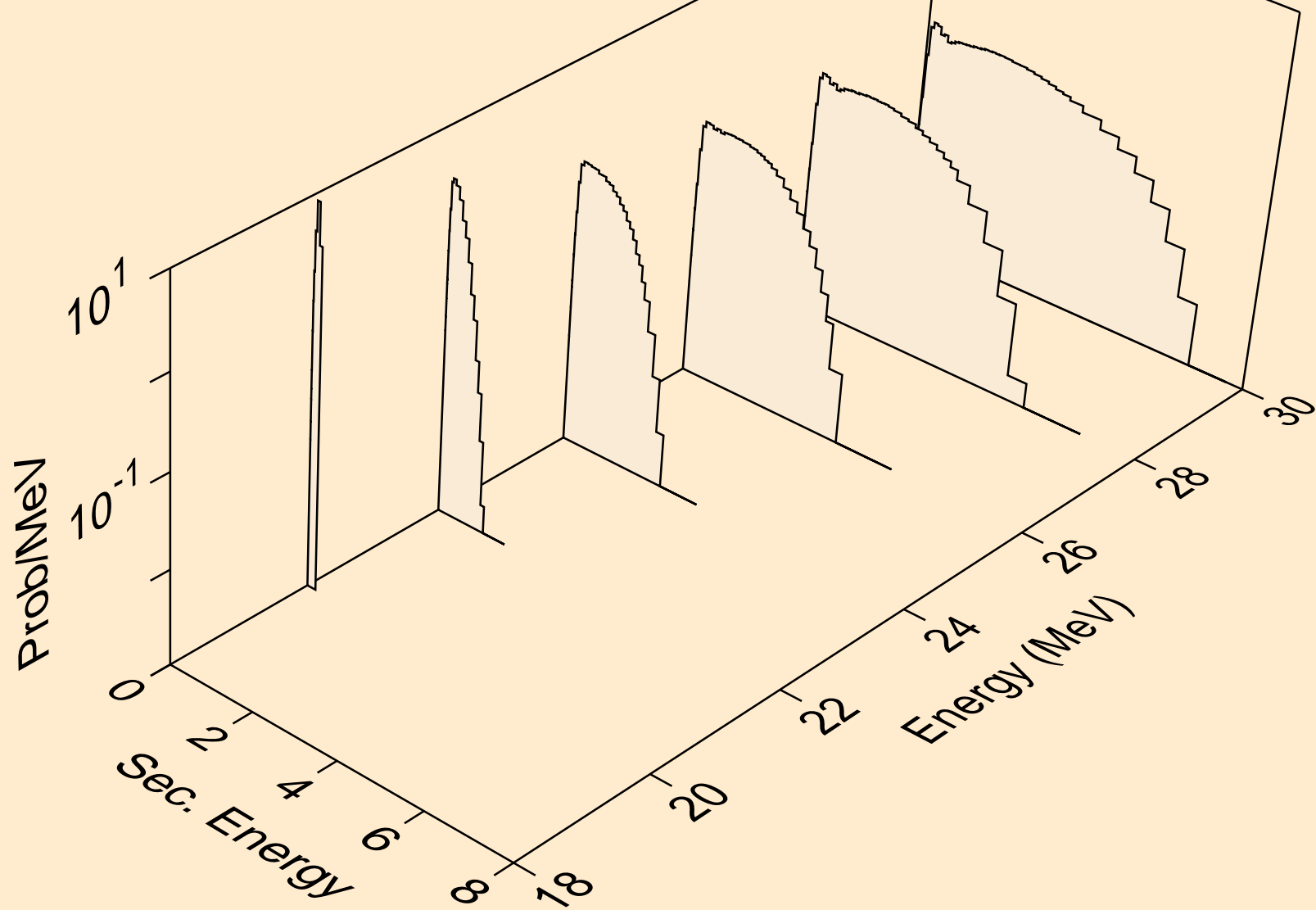

O015 NEUTRON ACER TENDL-2024 LIBRARY; T=0.K
Neutron emission for (n,n*)d

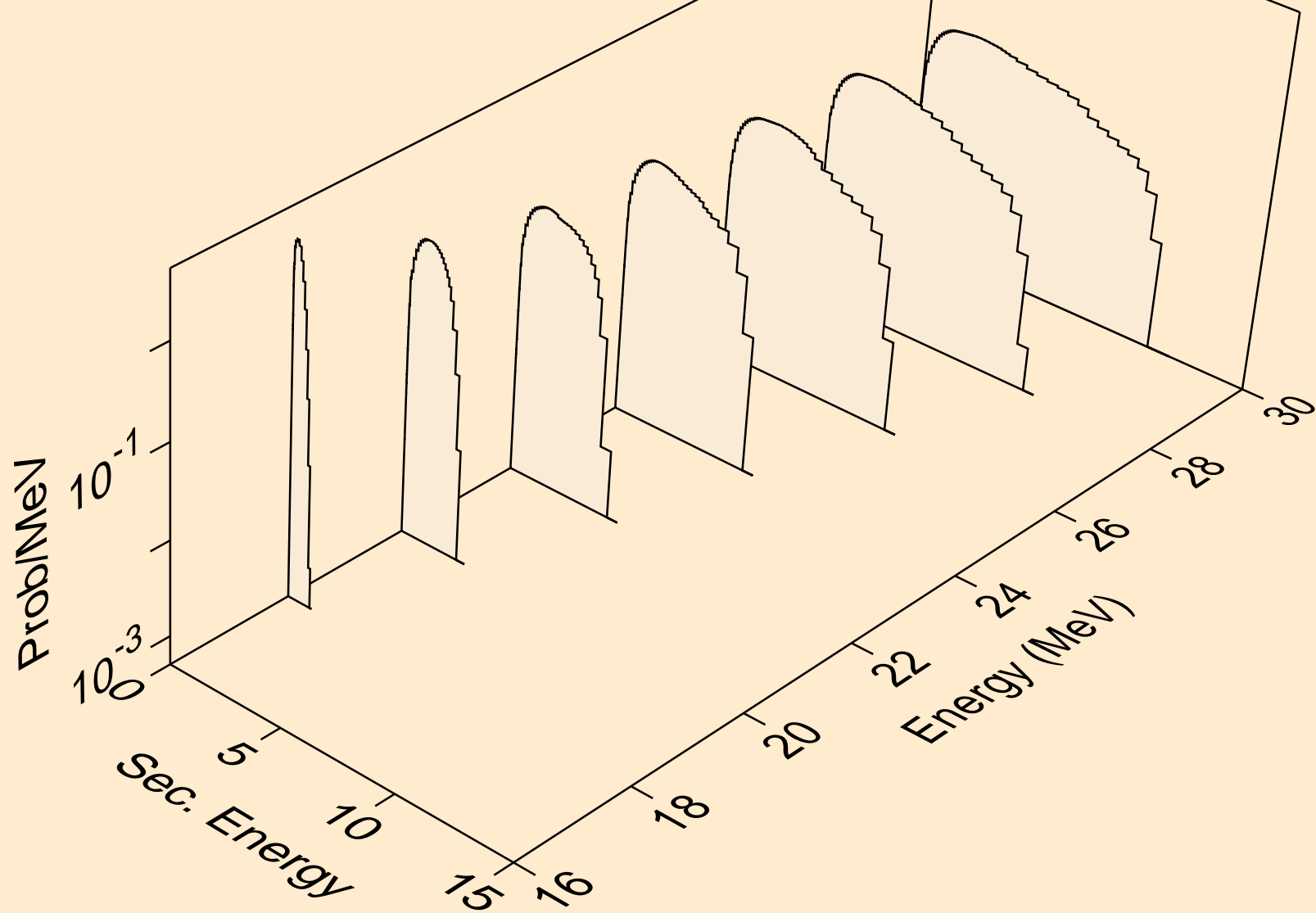

O015 NEUTRON ACER TENDL-2024 LIBRARY; T=0.K
Neutron emission for (n,n*)he3

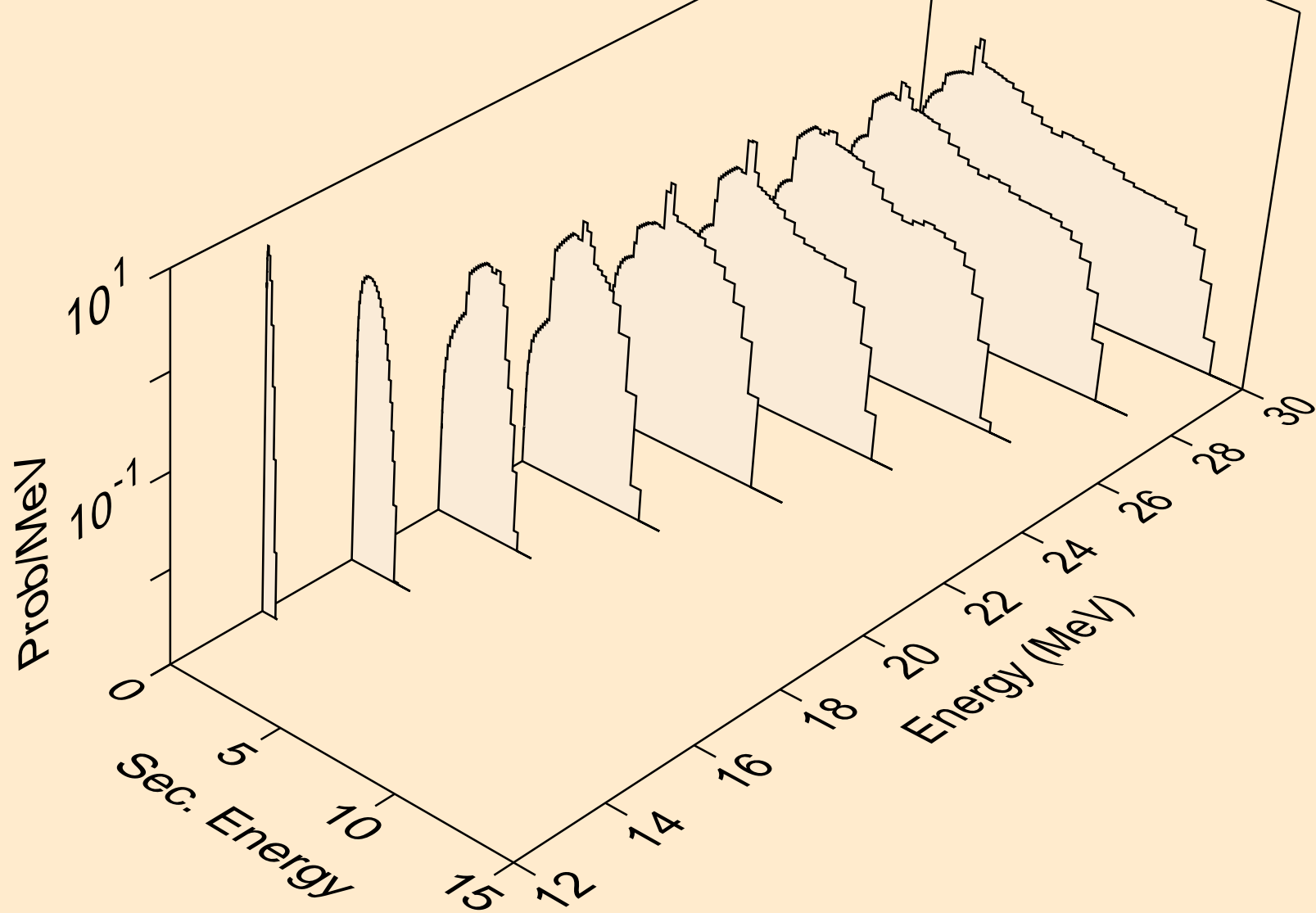

O015 NEUTRON ACER TENDL-2024 LIBRARY; T=0.K
Neutron emission for (n,2np)

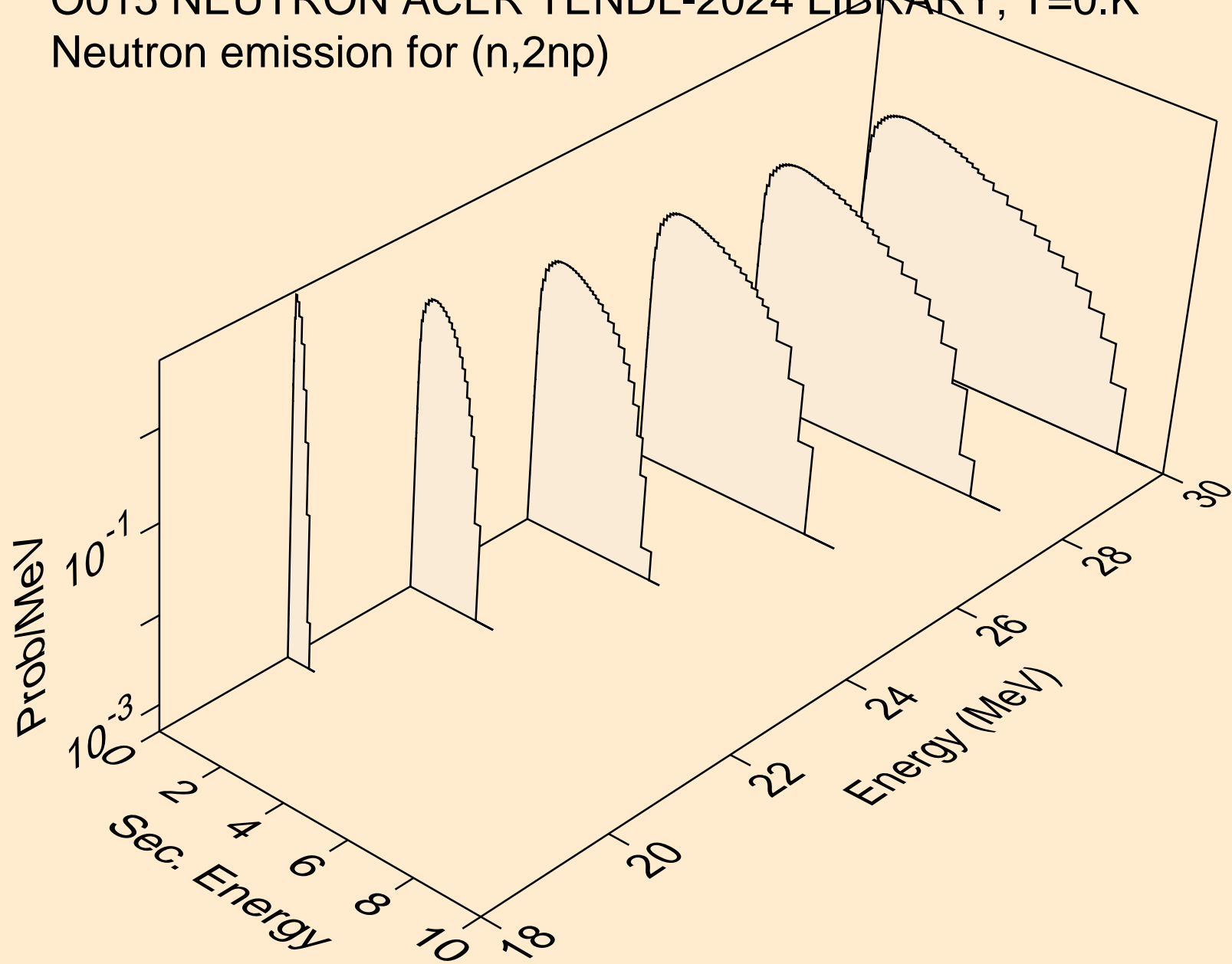

O015 NEUTRON ACER TENDL-2024 LIBRARY; T=0.K
Neutron emission for (n,n2p)

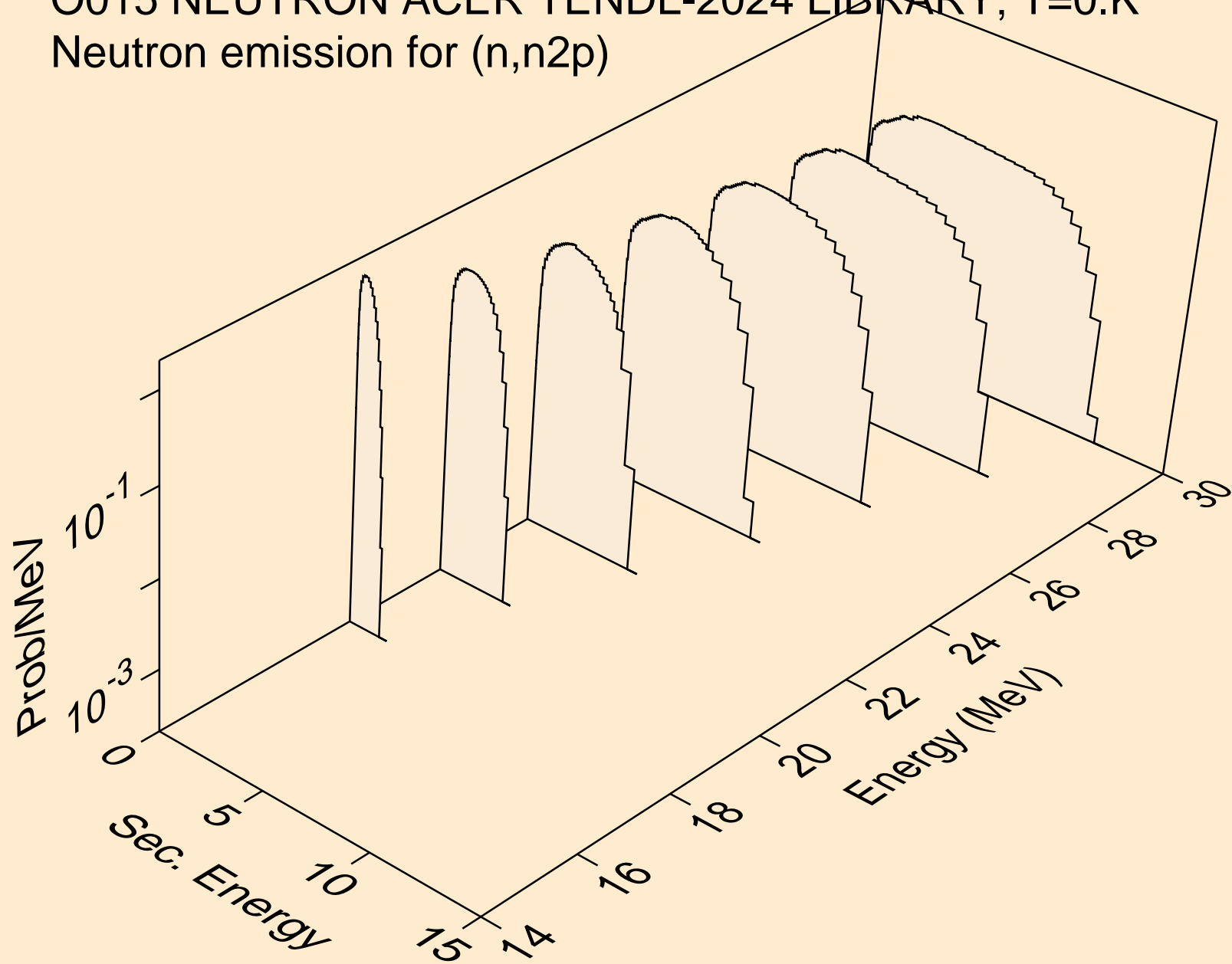

O015 NEUTRON ACER TENDL-2024 LIBRARY; T=0.K
Neutron emission for (n,npa)

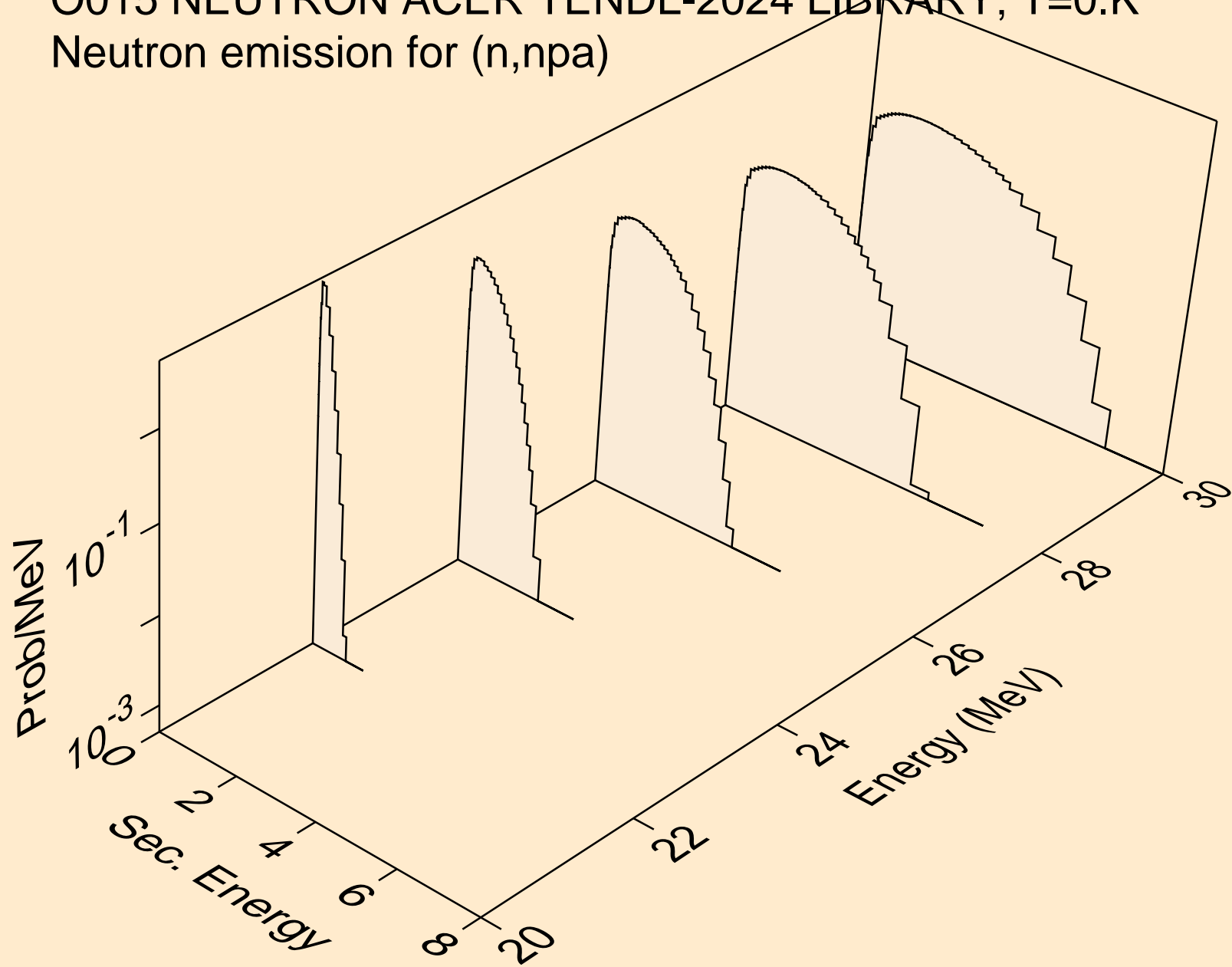

O015 NEUTRON ACER TENDL-2024 LIBRARY; T=0.K
Neutron emission for (n,n*c)

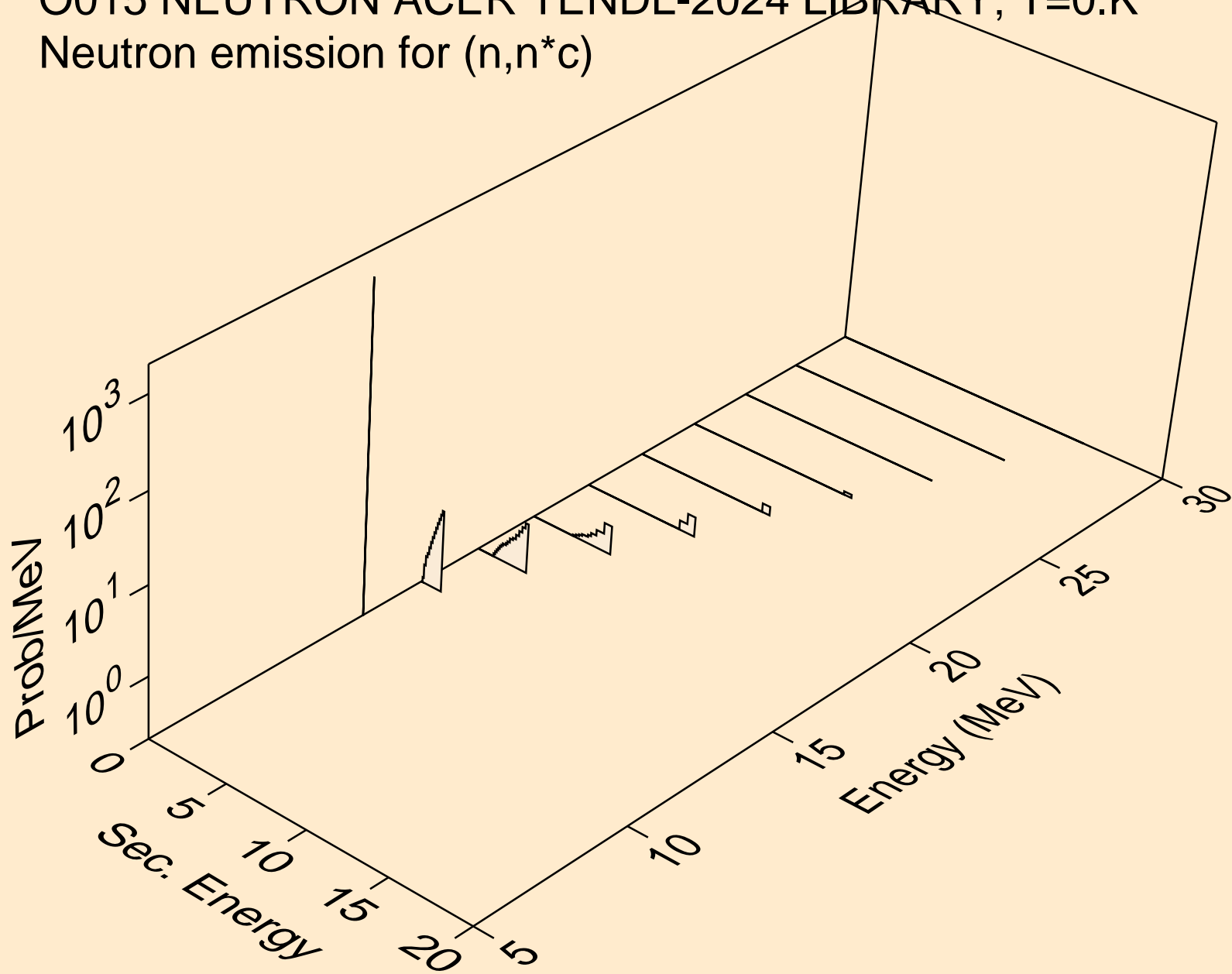

O015 NEUTRON ACER TENDL-2024 LIBRARY; T=0.K
Photon emission for (n,x)

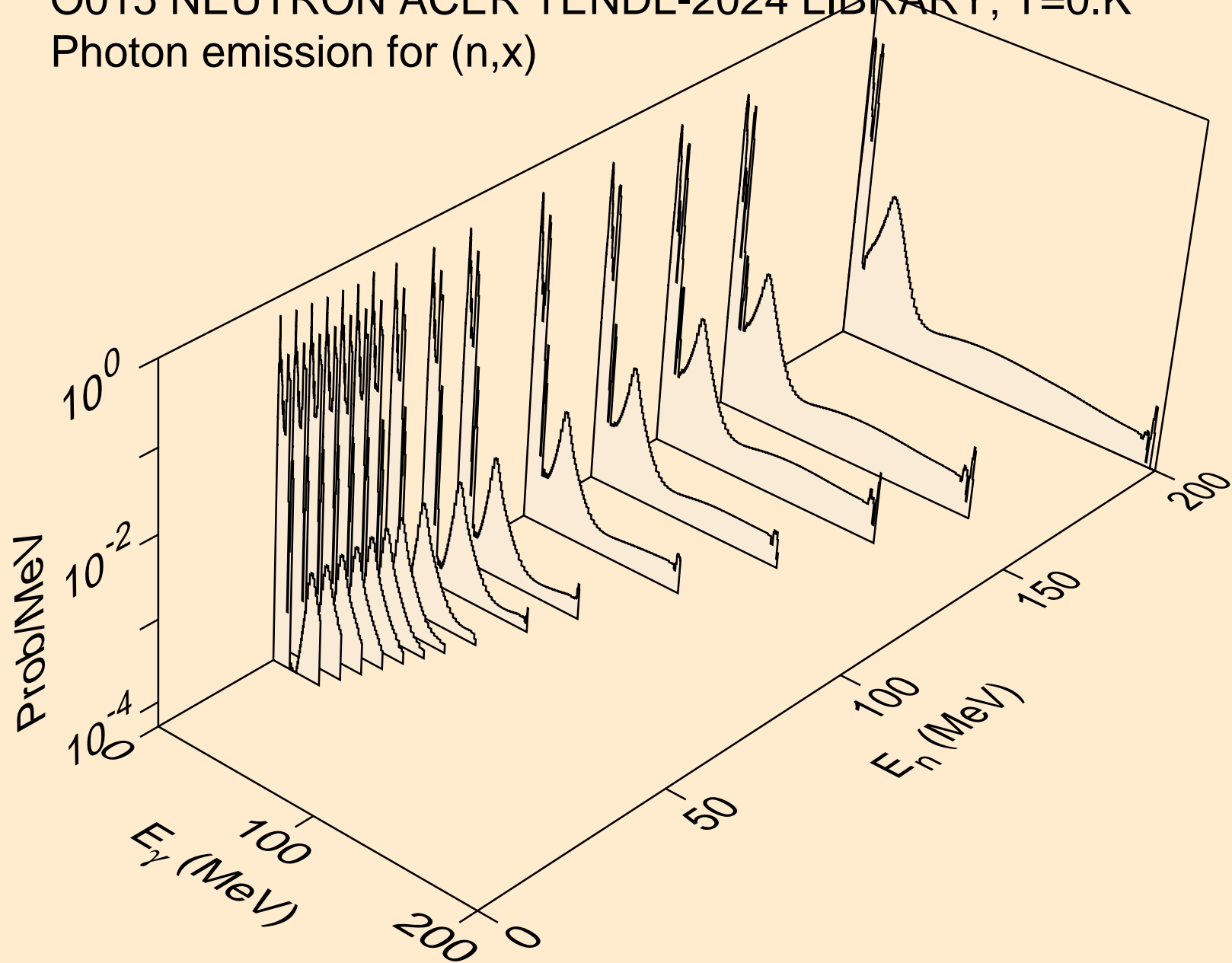

O015 NEUTRON ACER TENDL-2024 LIBRARY; T=0.K
Photon emission for (n,2n)

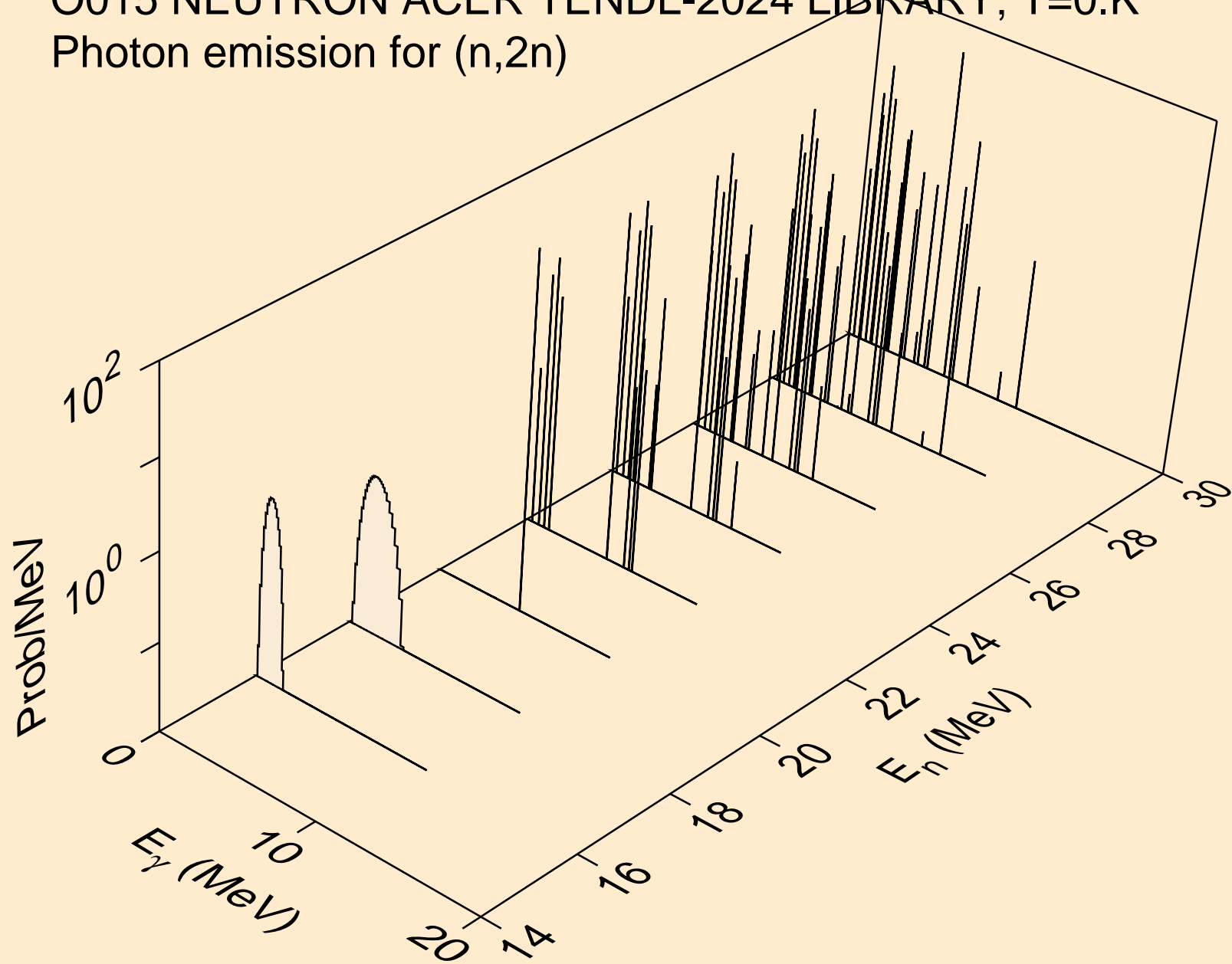

O015 NEUTRON ACER TENDL-2024 LIBRARY; T=0.K
Photon emission for (n,n*)a

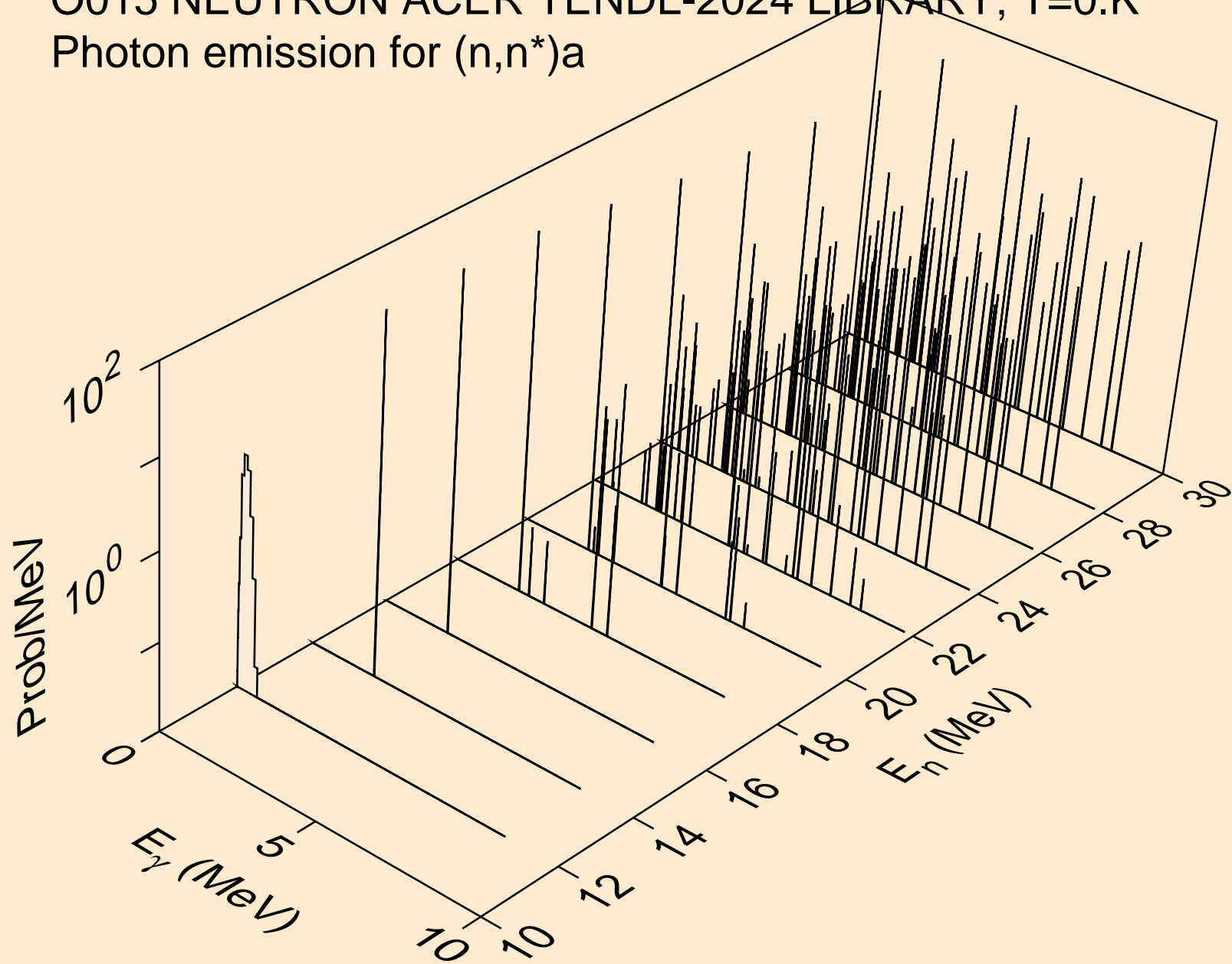

O015 NEUTRON ACER TENDL-2024 LIBRARY; T=0.K
Photon emission for (n,2n)a

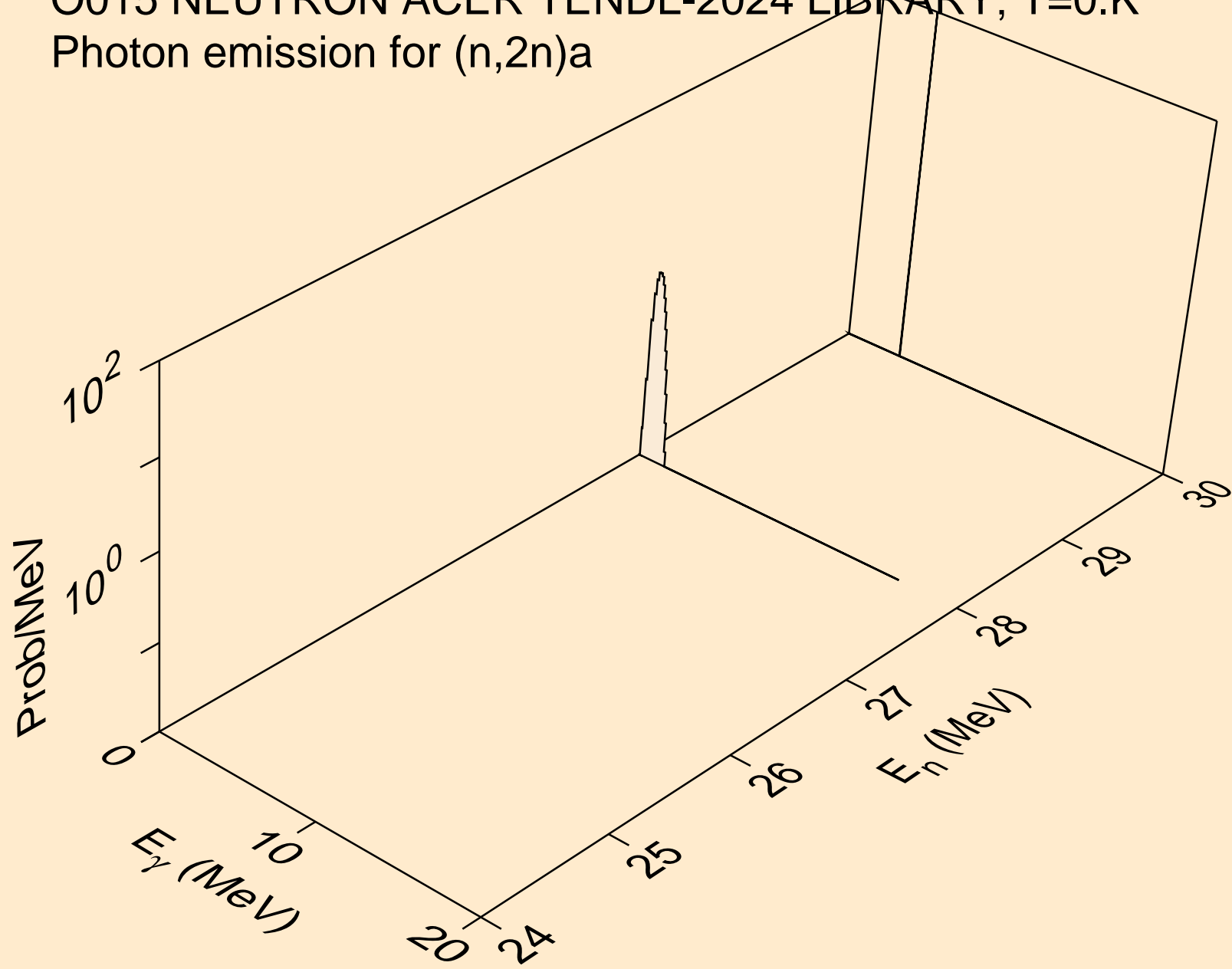

O015 NEUTRON ACER TENDL-2024 LIBRARY; T=0.K
Photon emission for (n,n*)p

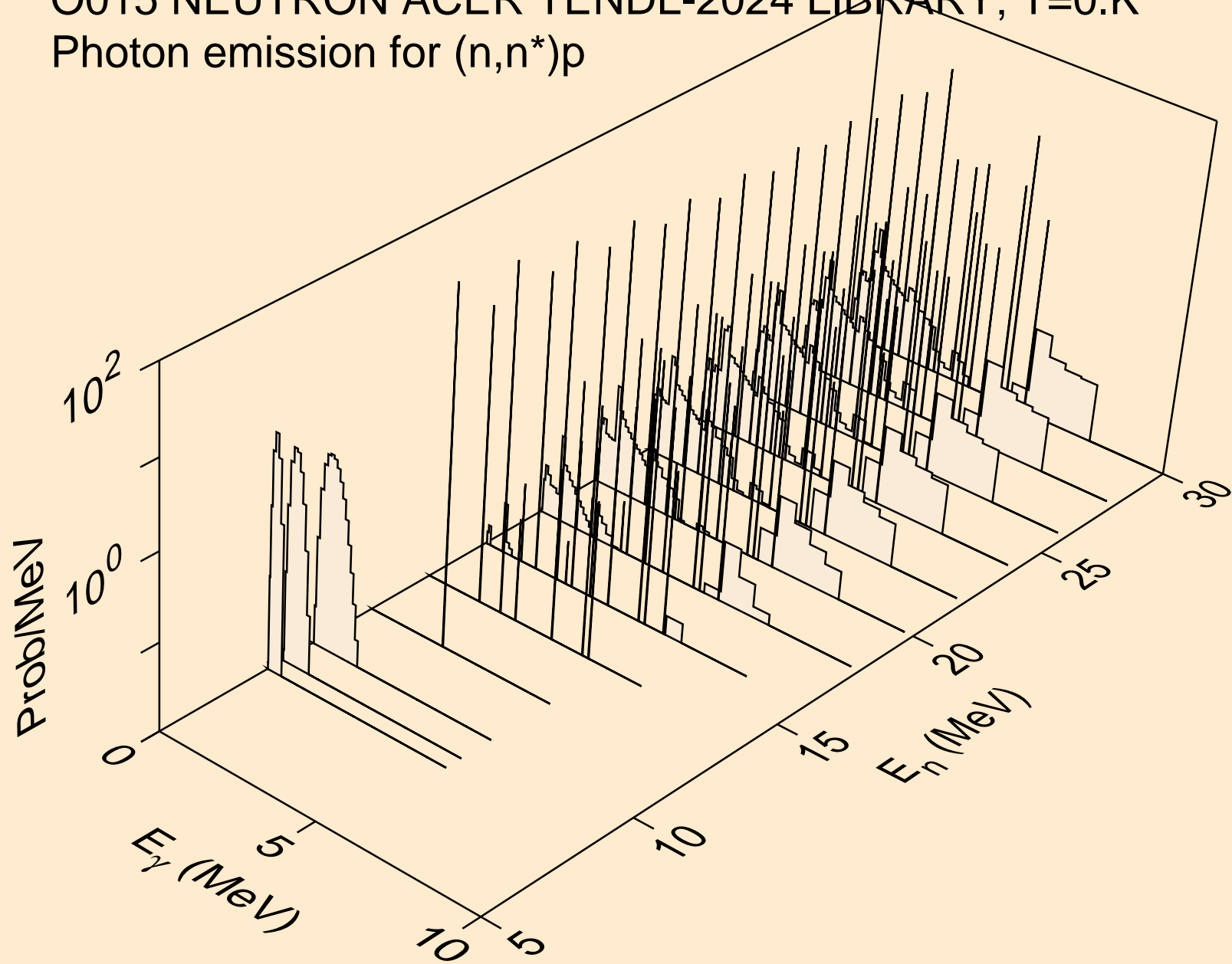

O015 NEUTRON ACER TENDL-2024 LIBRARY; T=0.K
Photon emission for (n,n*)2a

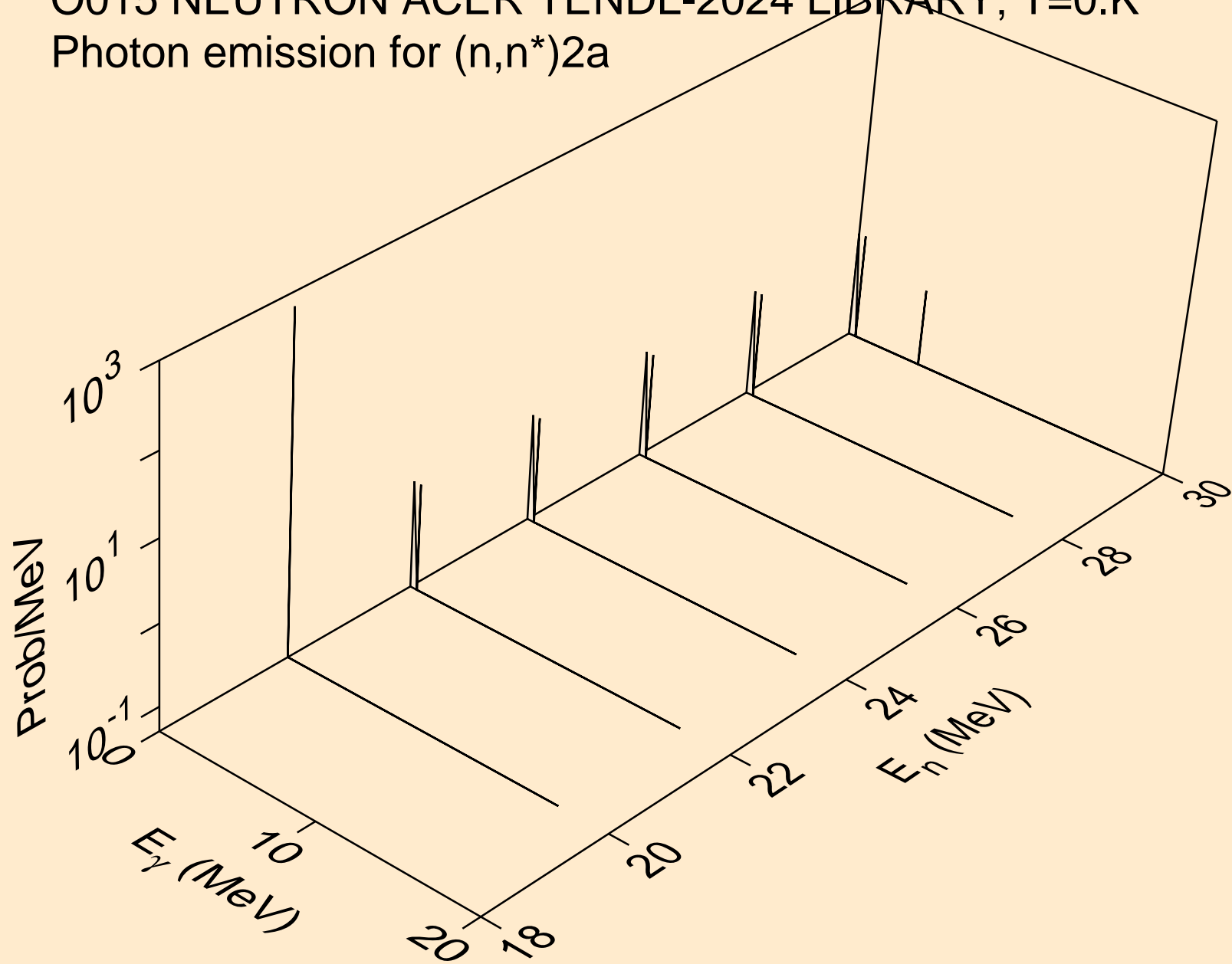

O015 NEUTRON ACER TENDL-2024 LIBRARY; T=0.K
Photon emission for (n,n*)d

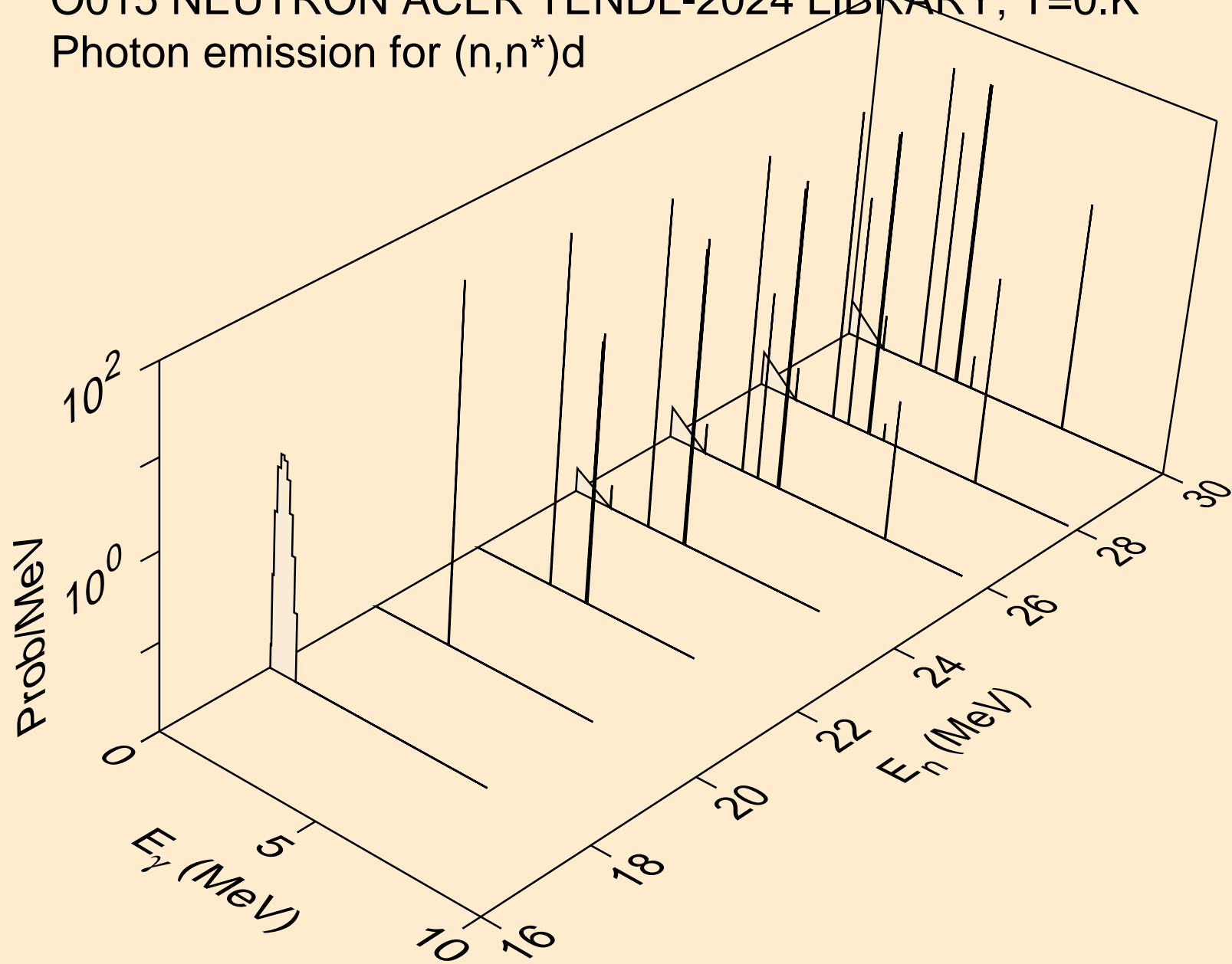

O015 NEUTRON ACER TENDL-2024 LIBRARY; T=0.K
Photon emission for (n,n*)he3

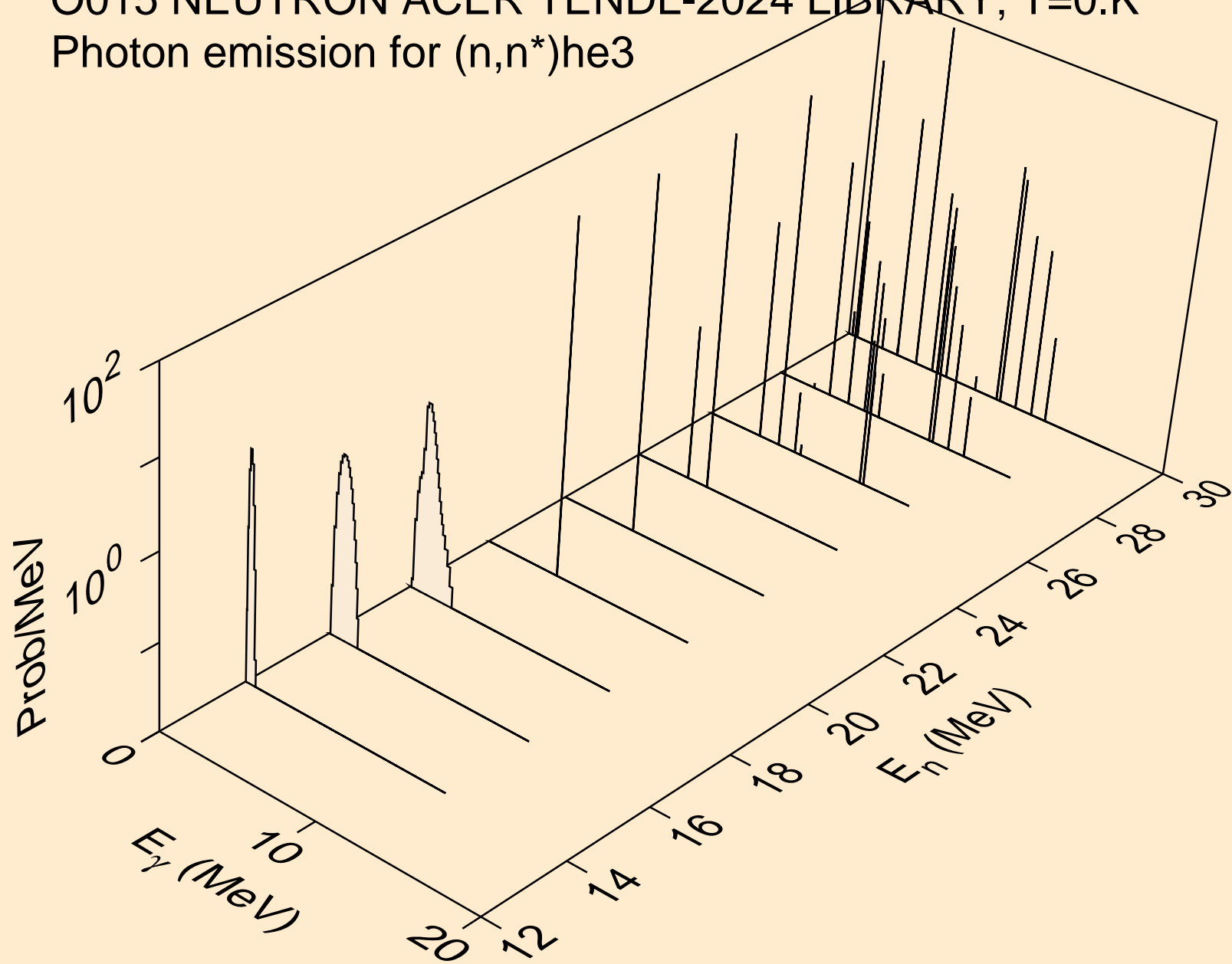

O015 NEUTRON ACER TENDL-2024 LIBRARY; T=0.K
Photon emission for (n,2np)

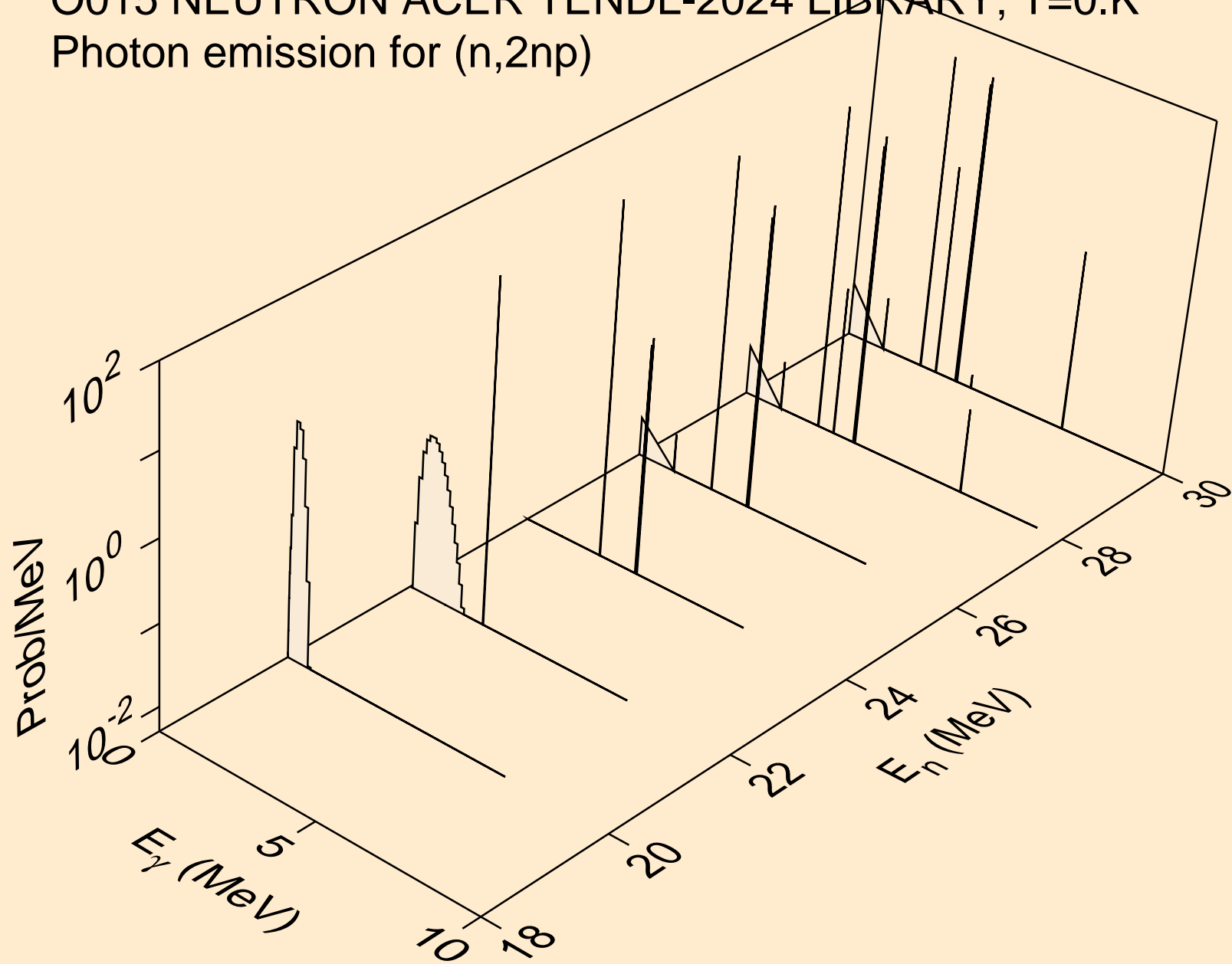

O015 NEUTRON ACER TENDL-2024 LIBRARY; T=0.K
Photon emission for (n,n2p)

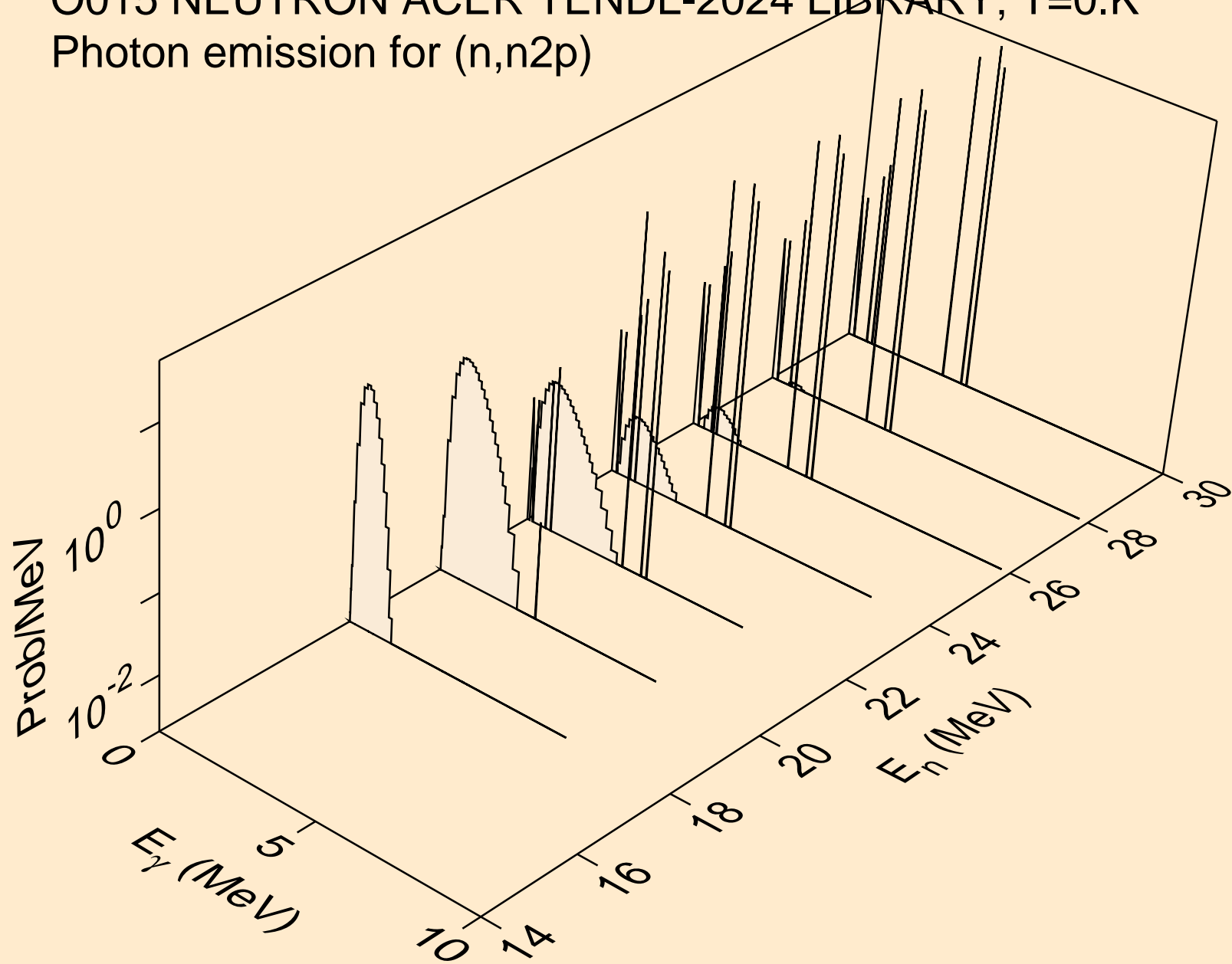

O015 NEUTRON ACER TENDL-2024 LIBRARY; T=0.K
Photon emission for (n,npa)

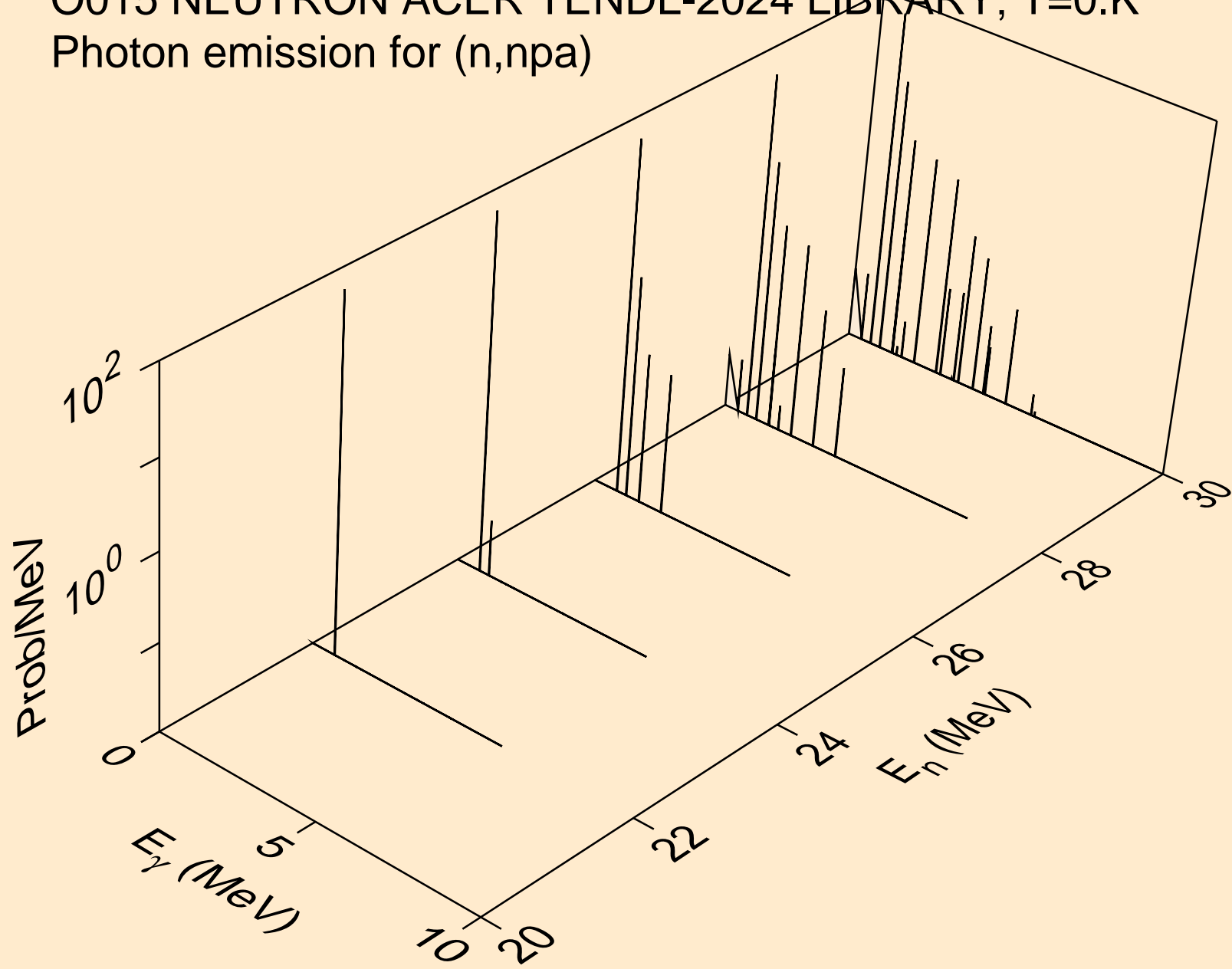

O015 NEUTRON ACER TENDL-2024 LIBRARY; T=0.K
Photon emission for (n,n*c)

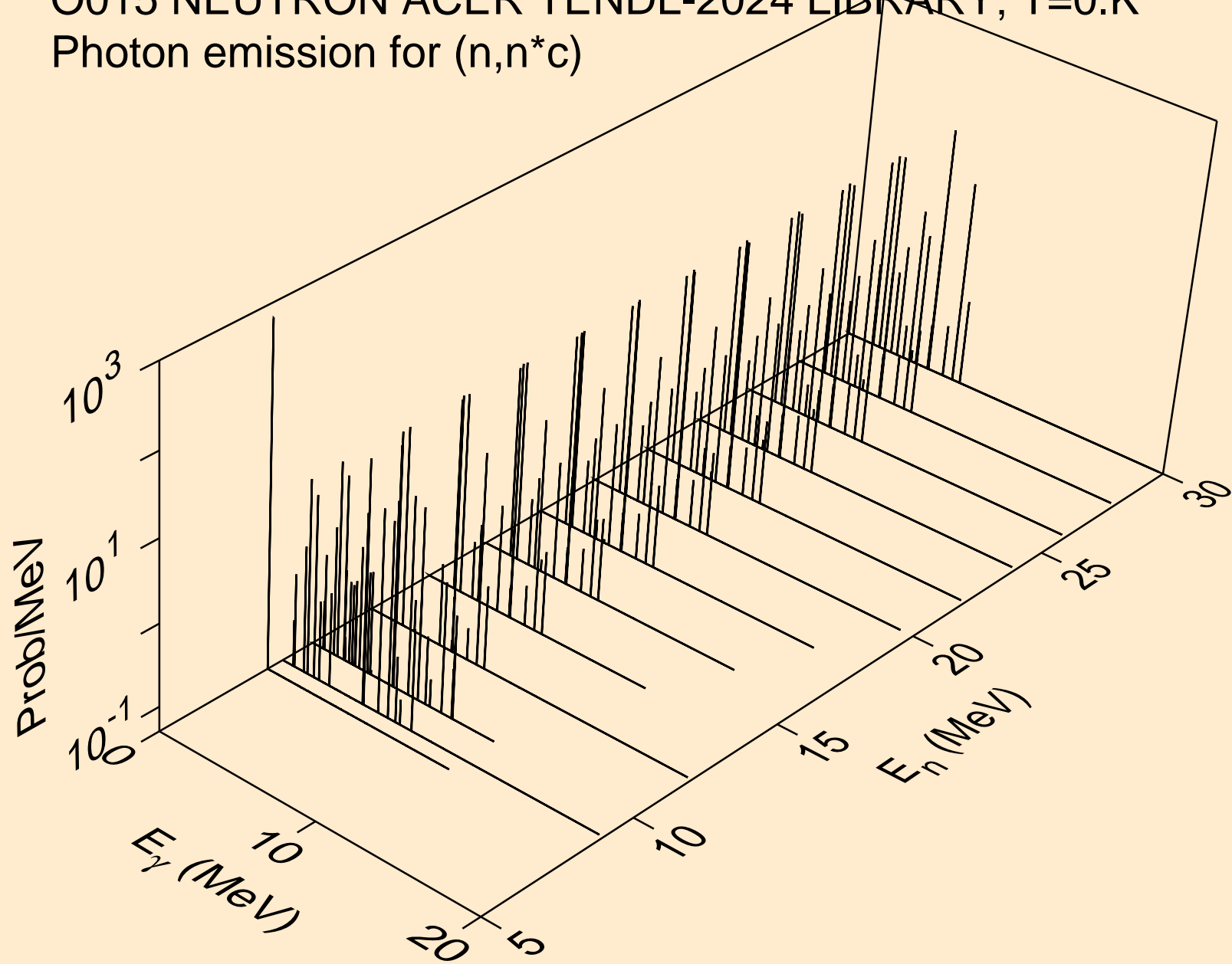

O015 NEUTRON ACER TENDL-2024 LIBRARY; T=0.K
Photon emission for (n,gma)

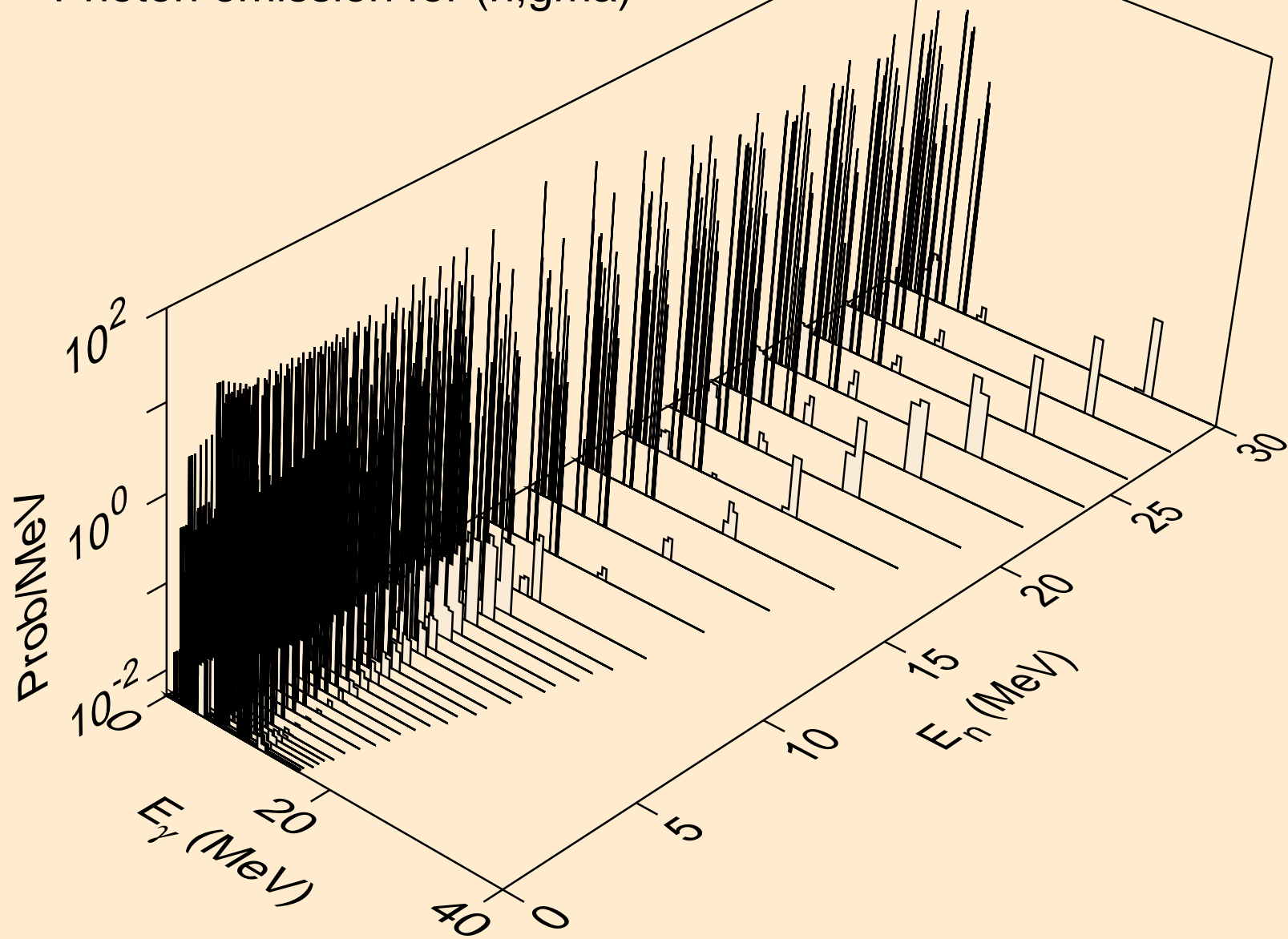

O015 NEUTRON ACER TENDL-2024 LIBRARY; T=0.K
Photon emission for (n,p)

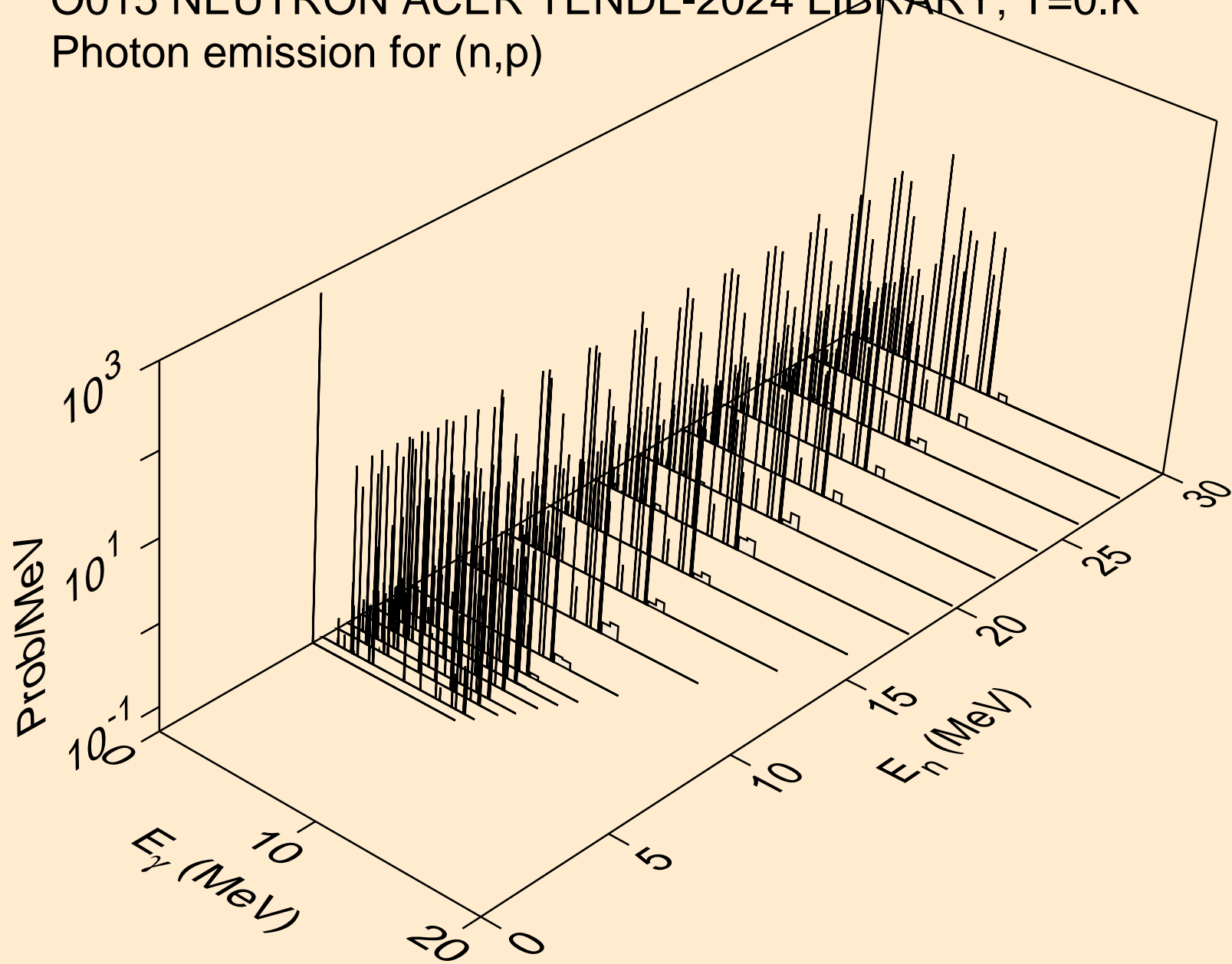

O015 NEUTRON ACER TENDL-2024 LIBRARY; T=0.K
Photon emission for (n,d)

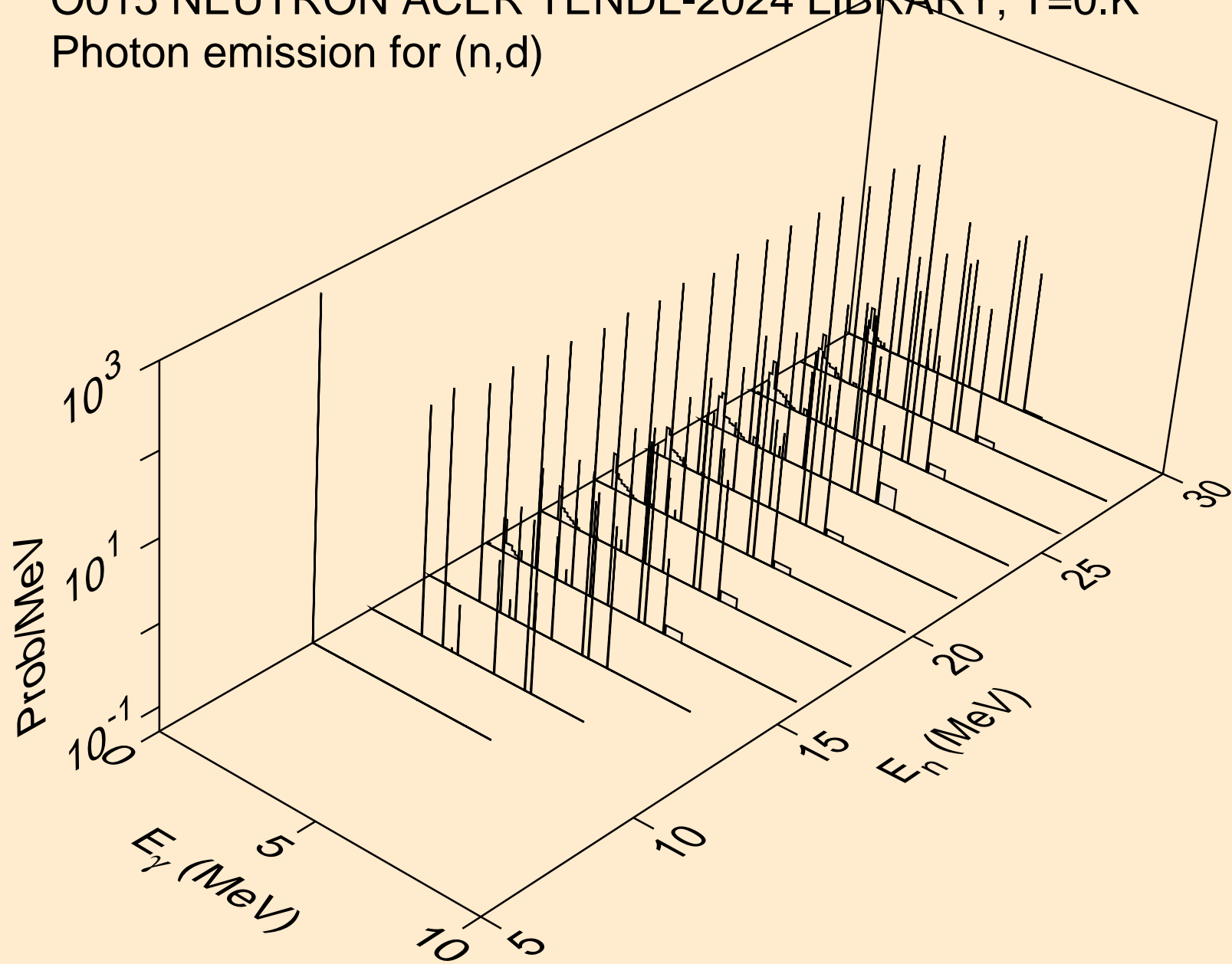

O015 NEUTRON ACER TENDL-2024 LIBRARY; T=0.K
Photon emission for (n,t)

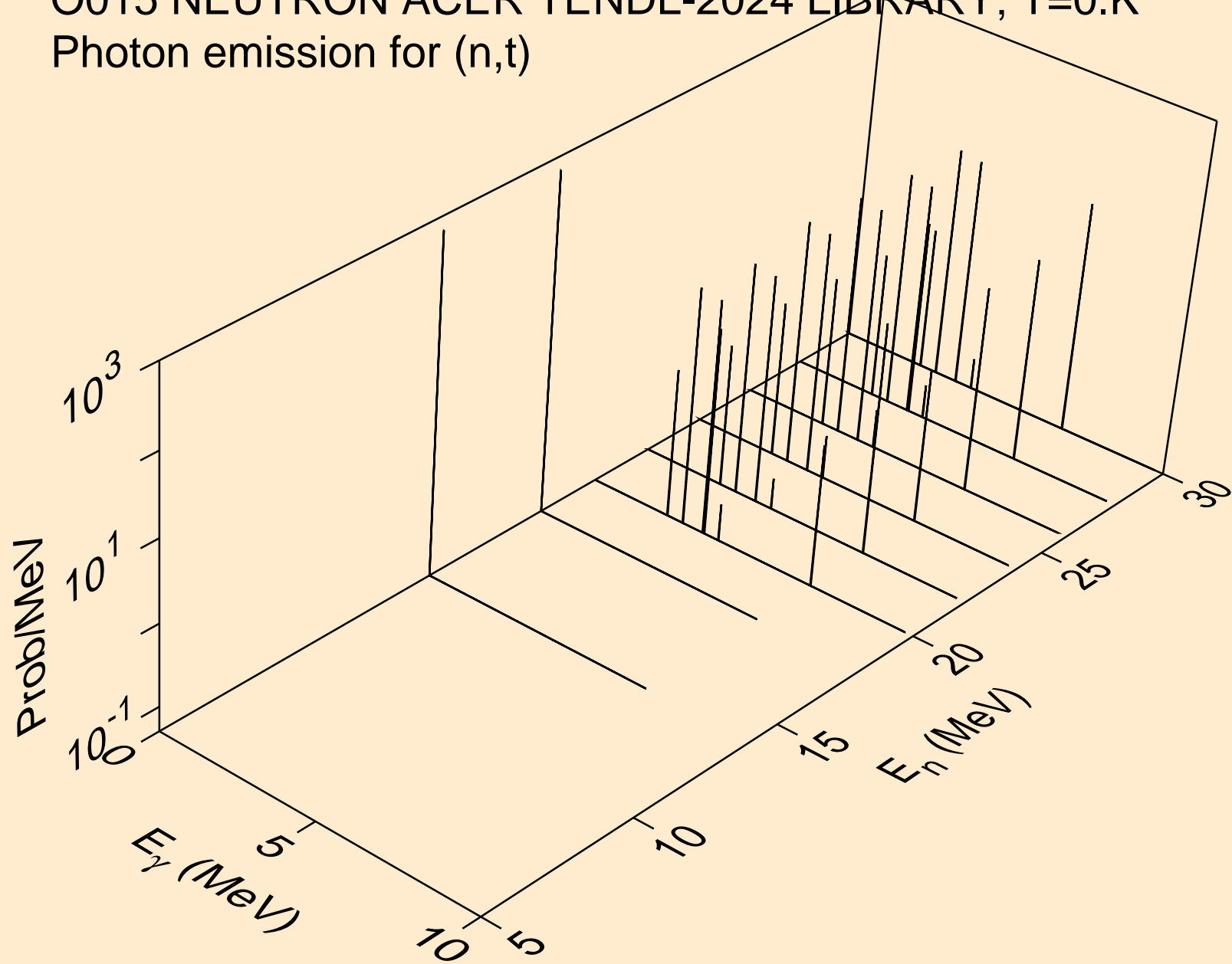

O015 NEUTRON ACER TENDL-2024 LIBRARY; T=0.K
Photon emission for (n,he3)

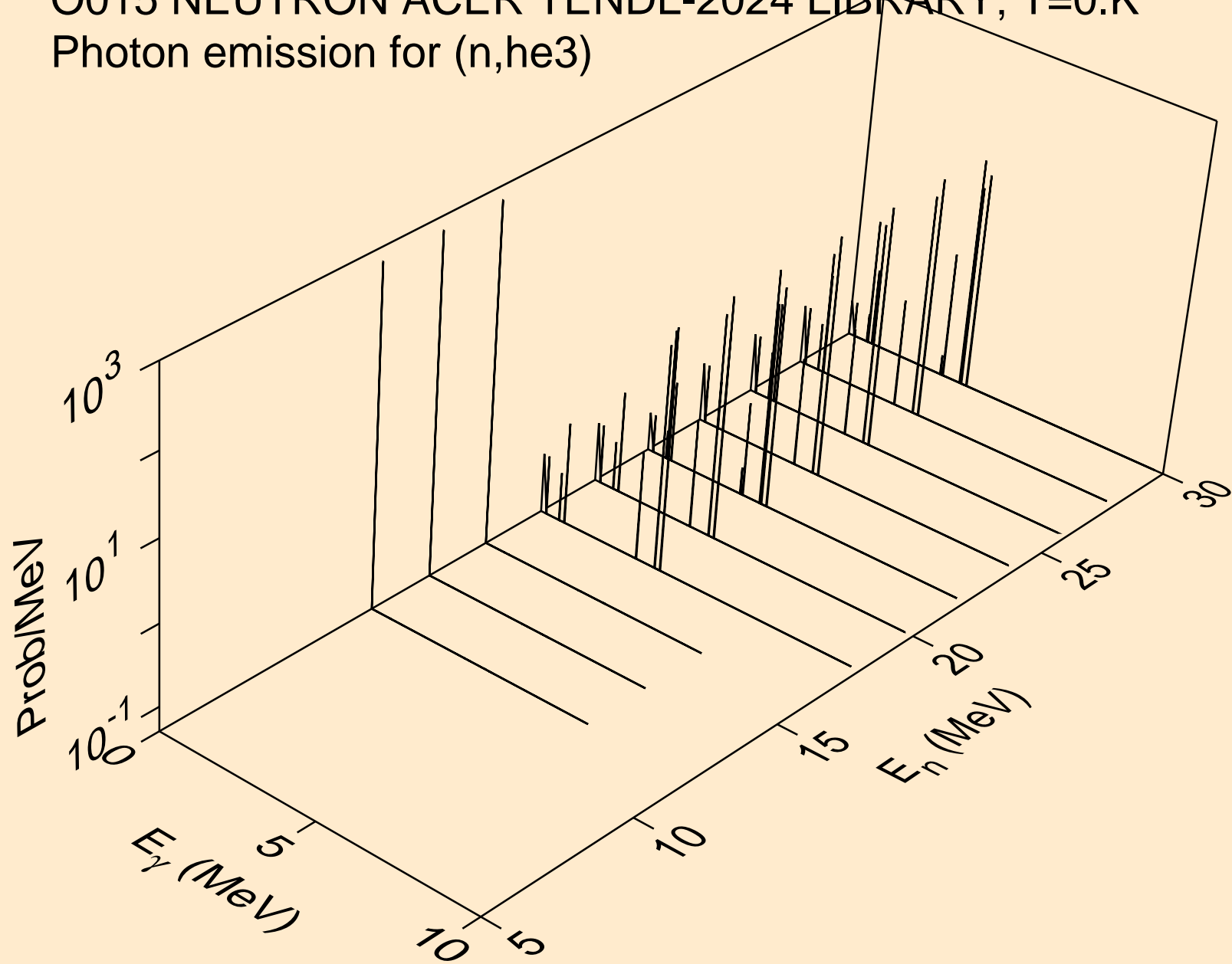

O015 NEUTRON ACER TENDL-2024 LIBRARY; T=0.K
Photon emission for (n,a)

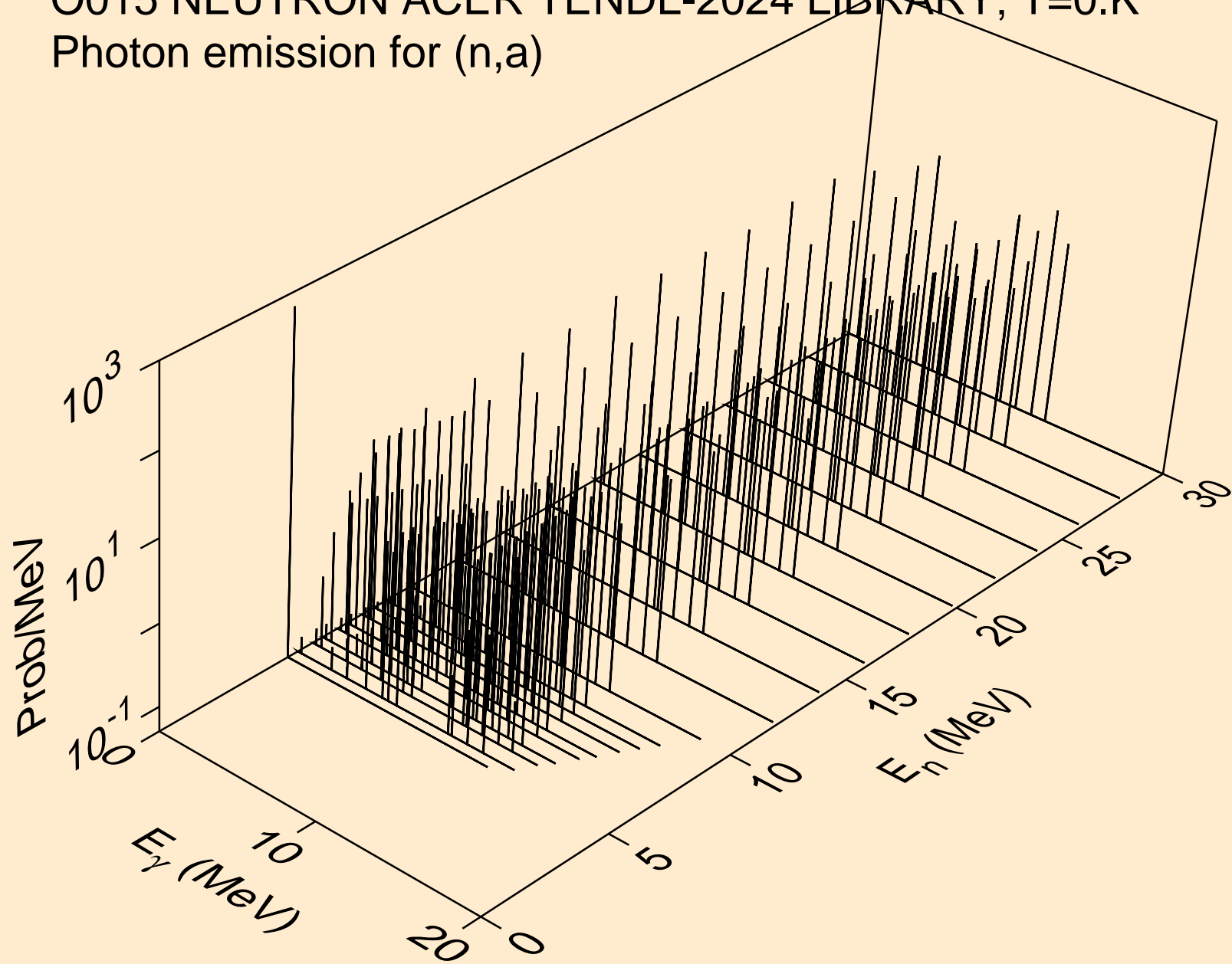

O015 NEUTRON ACER TENDL-2024 LIBRARY; T=0.K
Photon emission for (n,2a)

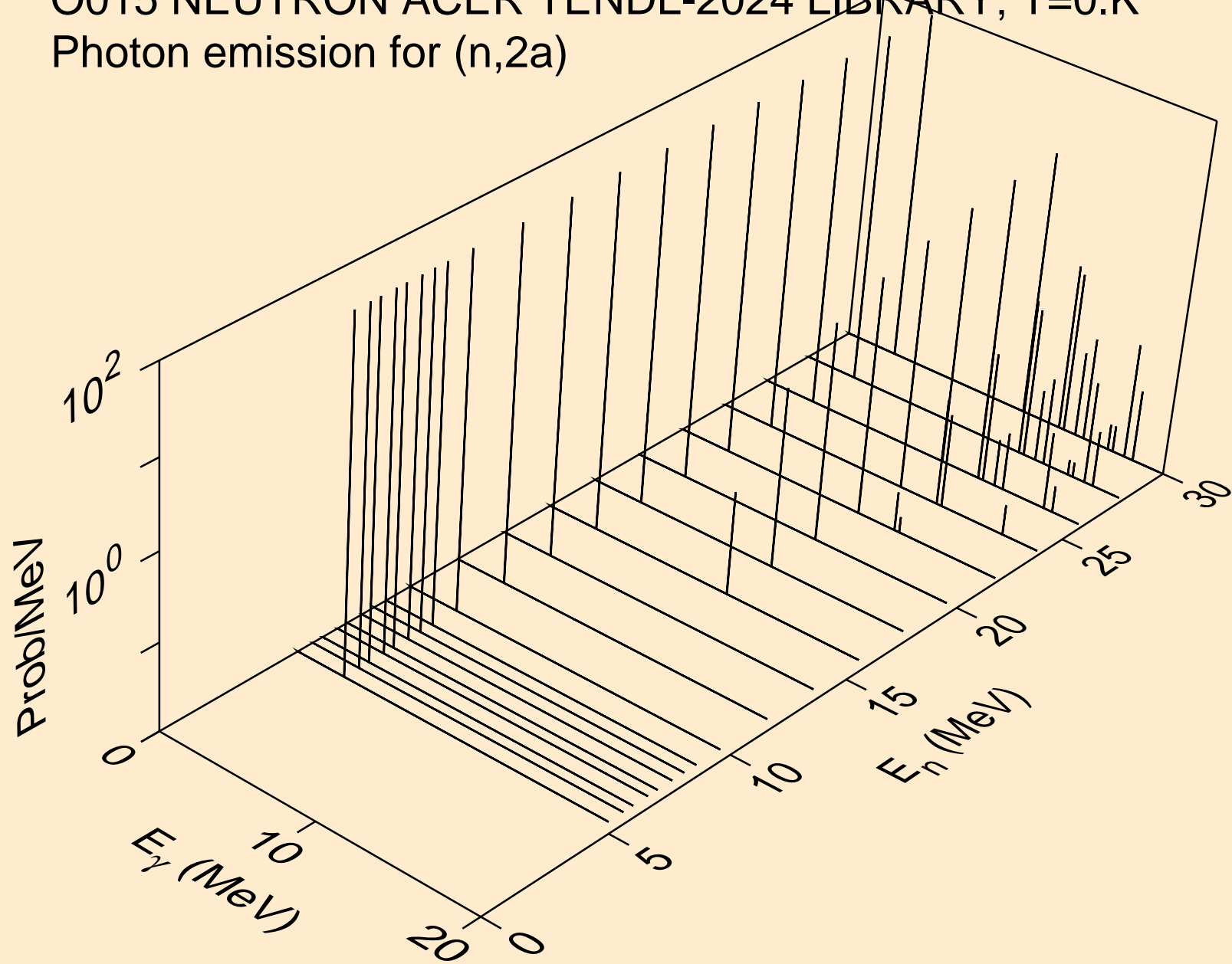

O015 NEUTRON ACER TENDL-2024 LIBRARY; T=0.K
Photon emission for (n,2p)

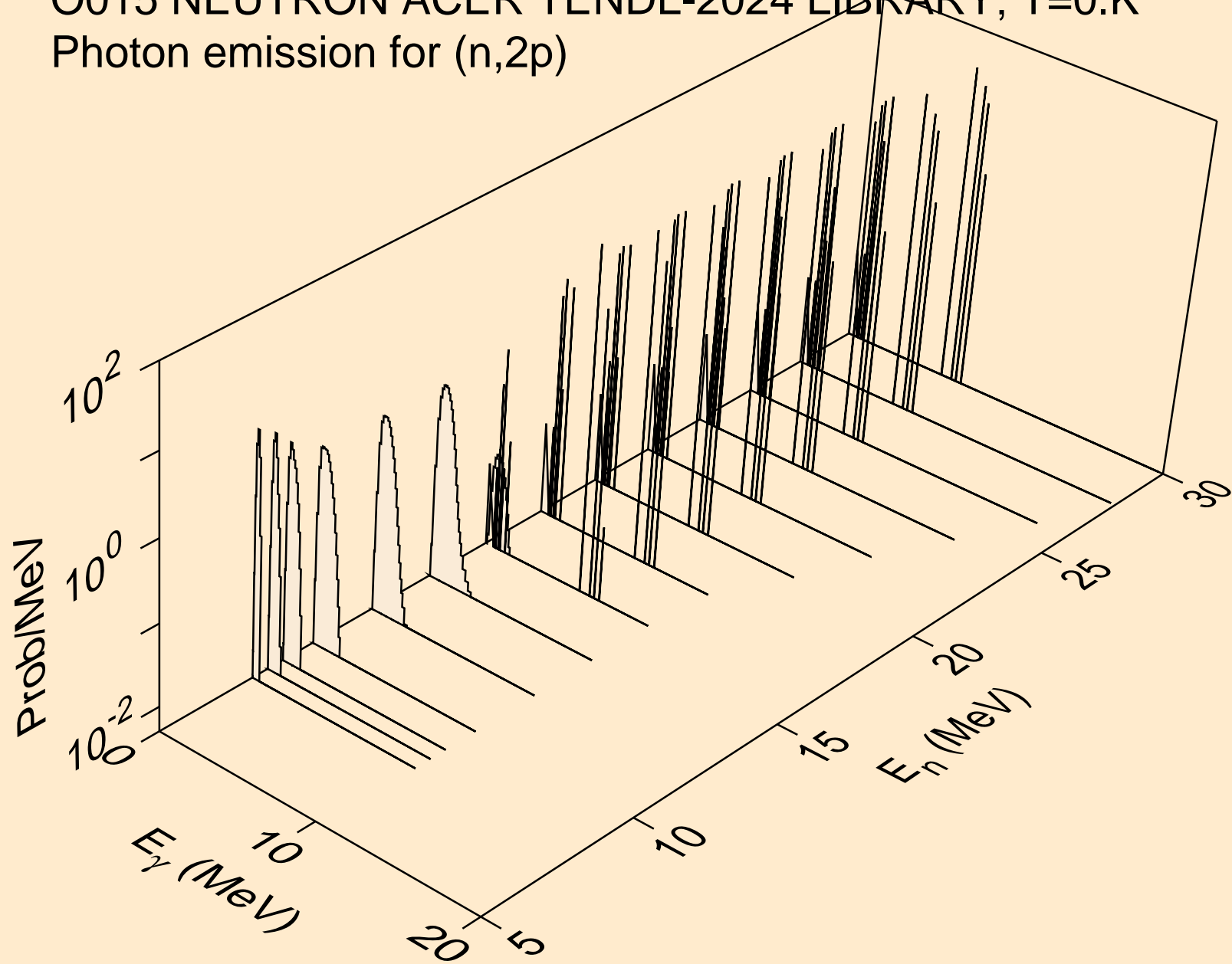

O015 NEUTRON ACER TENDL-2024 LIBRARY; T=0.K
Photon emission for (n,p)

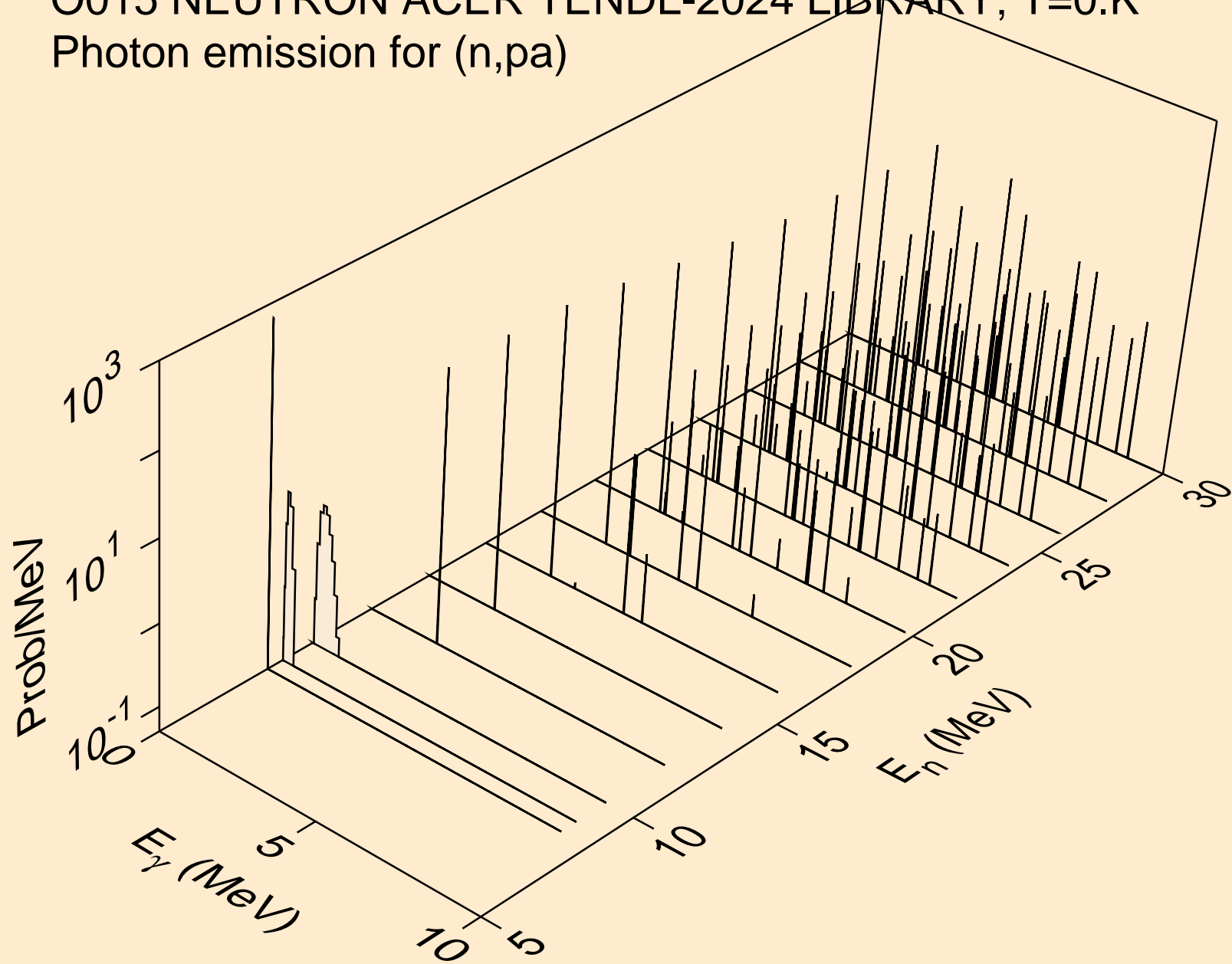

O015 NEUTRON ACER TENDL-2024 LIBRARY; T=0.K
Photon emission for (n,d2a)

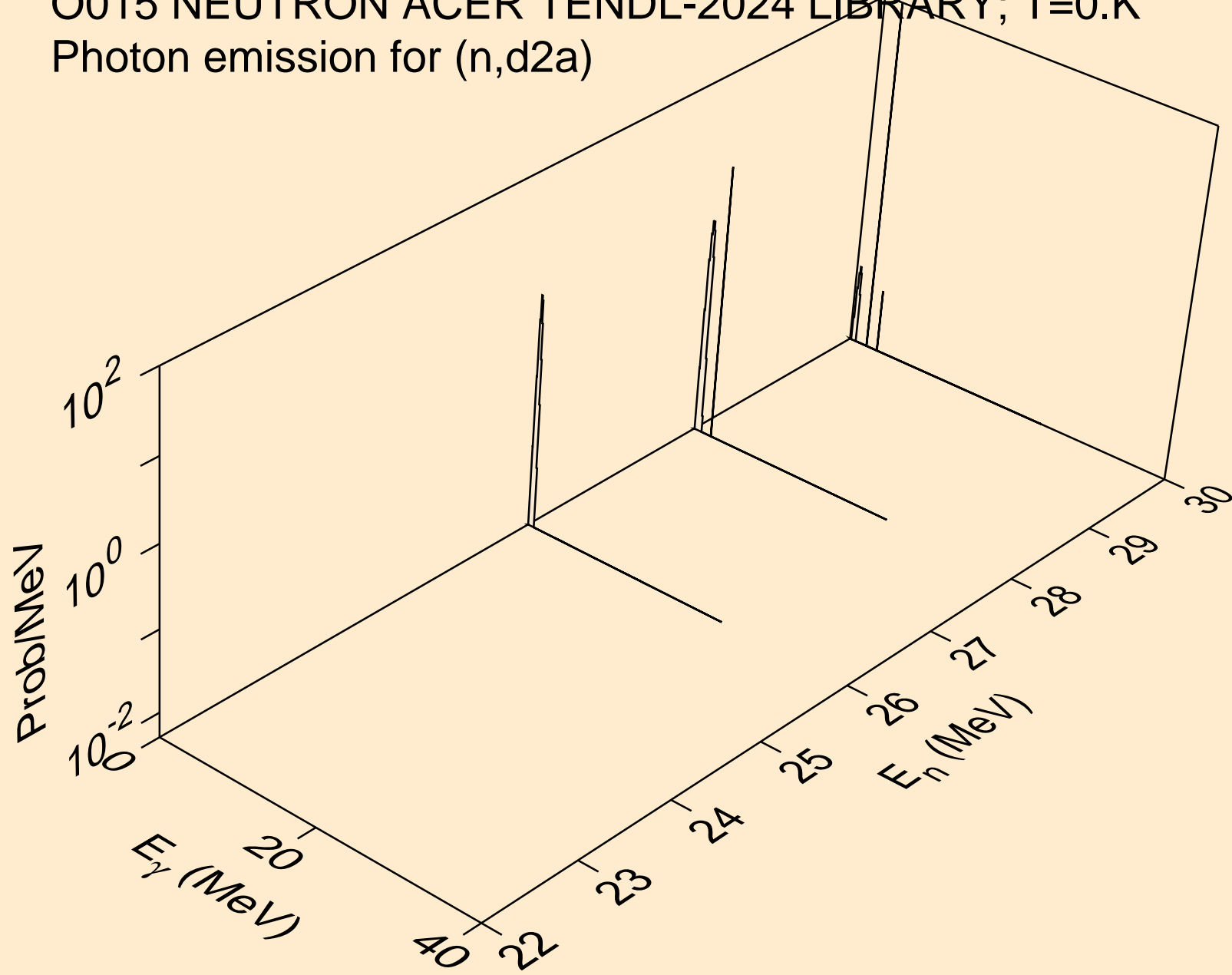

O015 NEUTRON ACER TENDL-2024 LIBRARY; T=0.K
Photon emission for (n,pd)

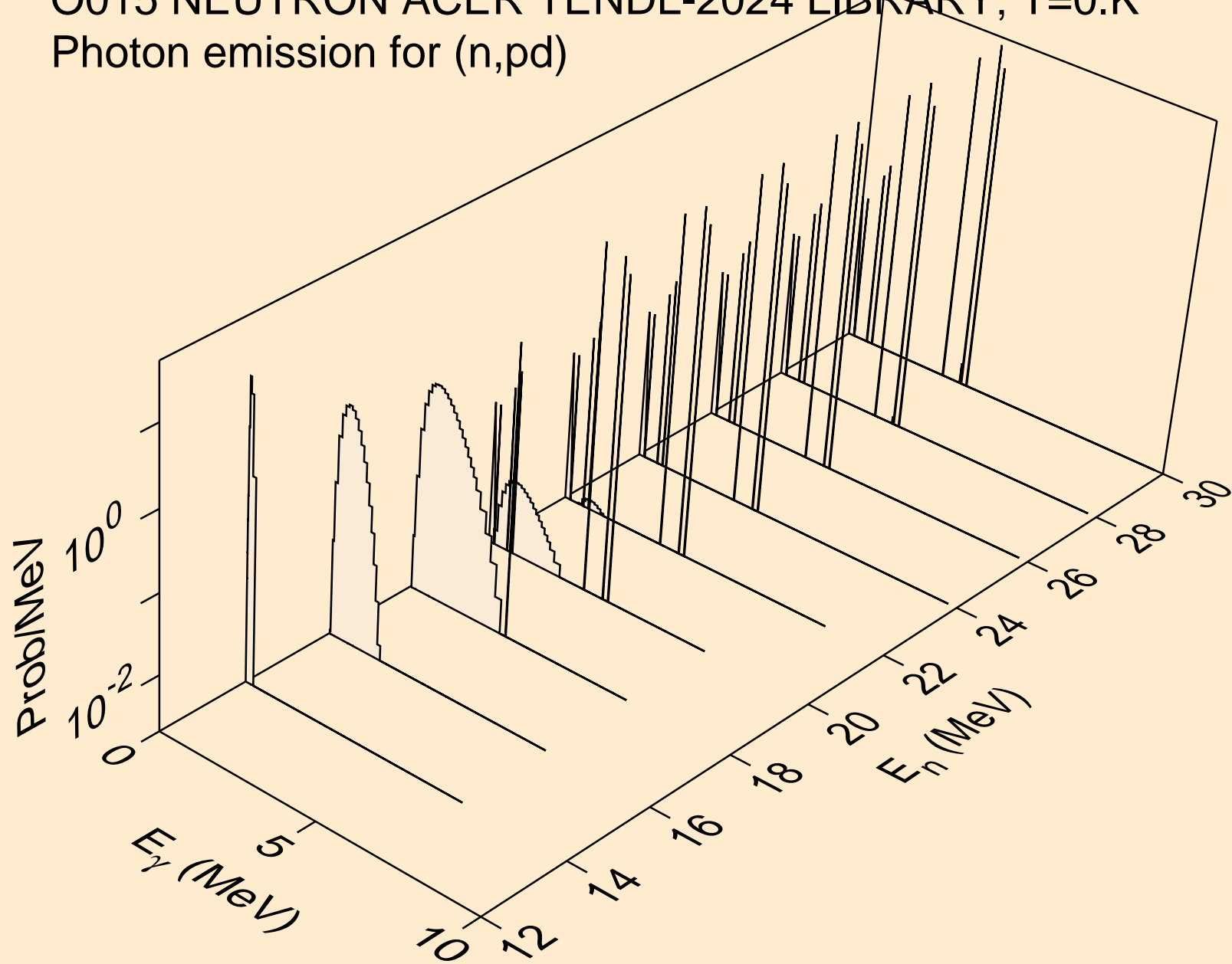

O015 NEUTRON ACER TENDL-2024 LIBRARY; T=0.K
Photon emission for (n,pt)

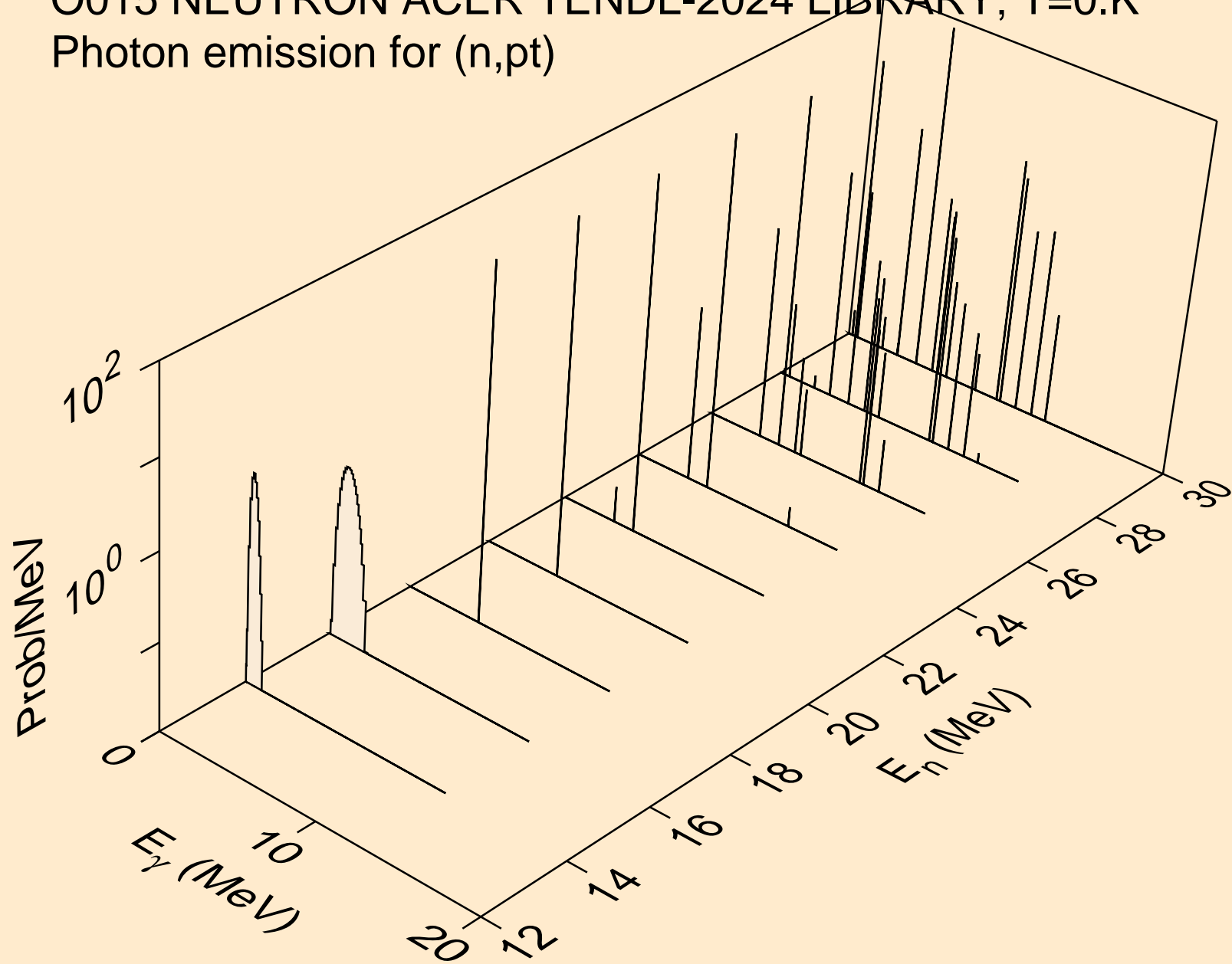

O015 NEUTRON ACER TENDL-2024 LIBRARY; T=0.K
Photon emission for (n,da)

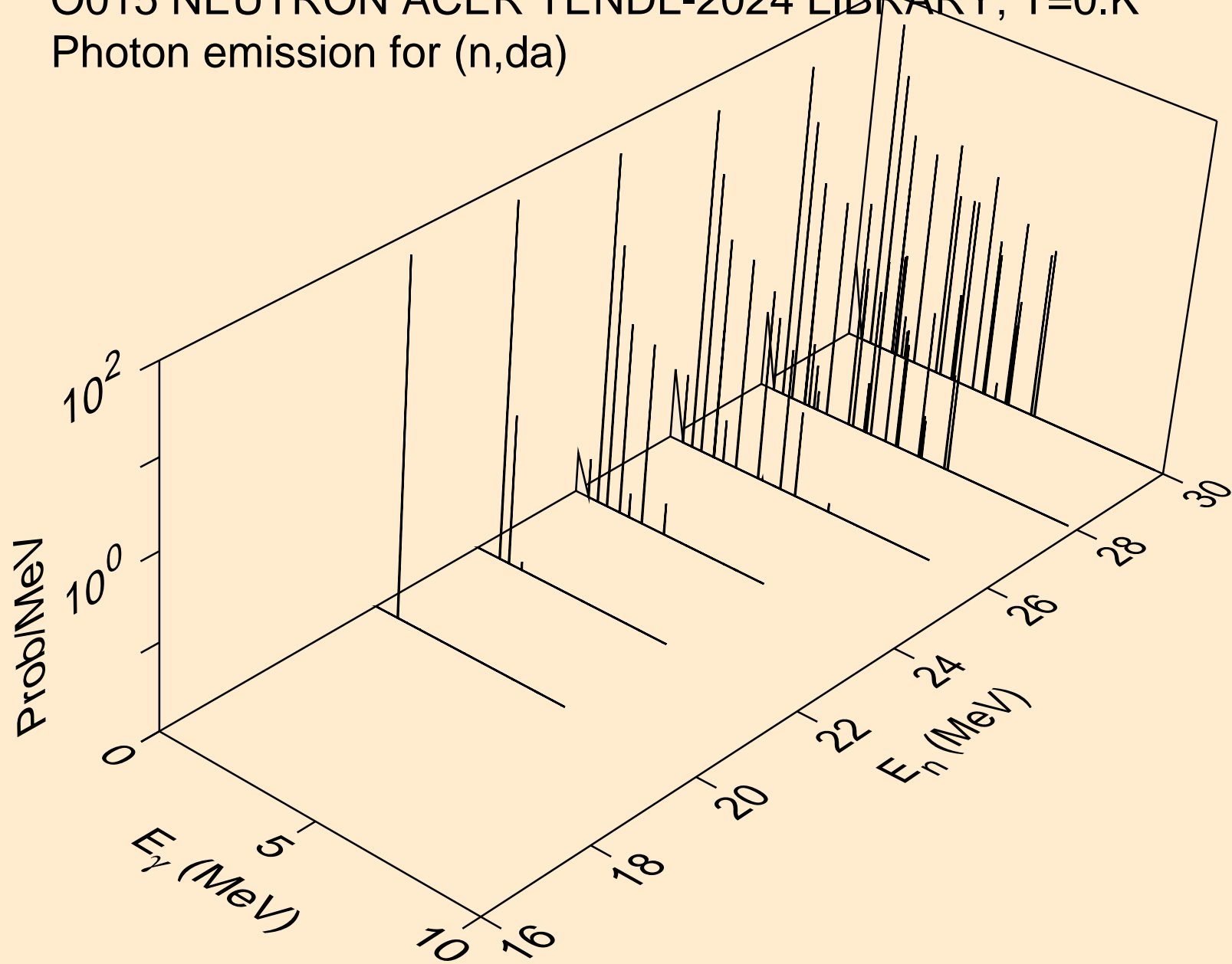

O015 NEUTRON ACER TENDL-2024 LIBRARY; T=0.K
thermal capture photon spectrum

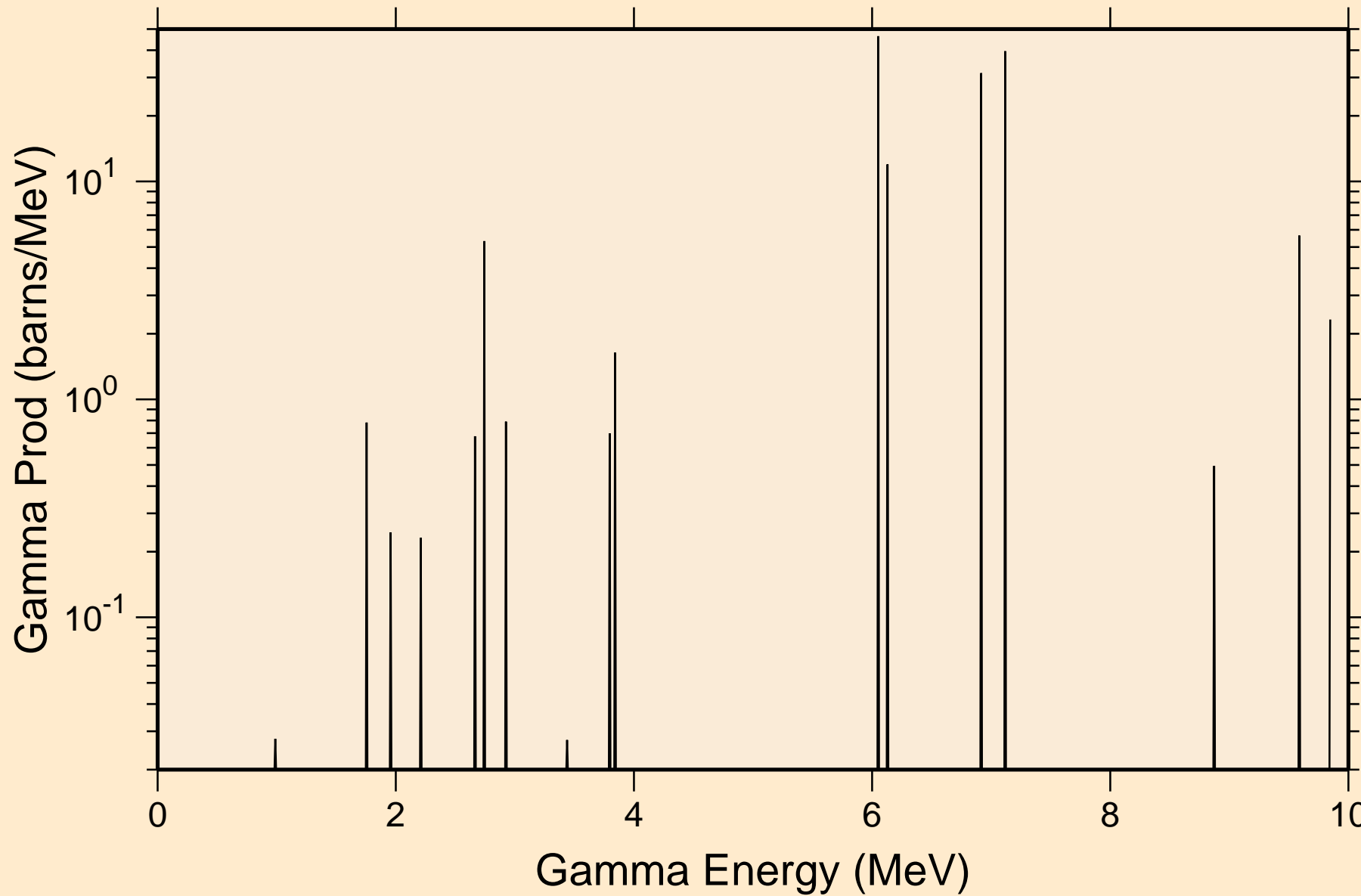

O015 NEUTRON ACER TENDL-2024 LIBRARY; T=0.K
14 MeV photon spectrum

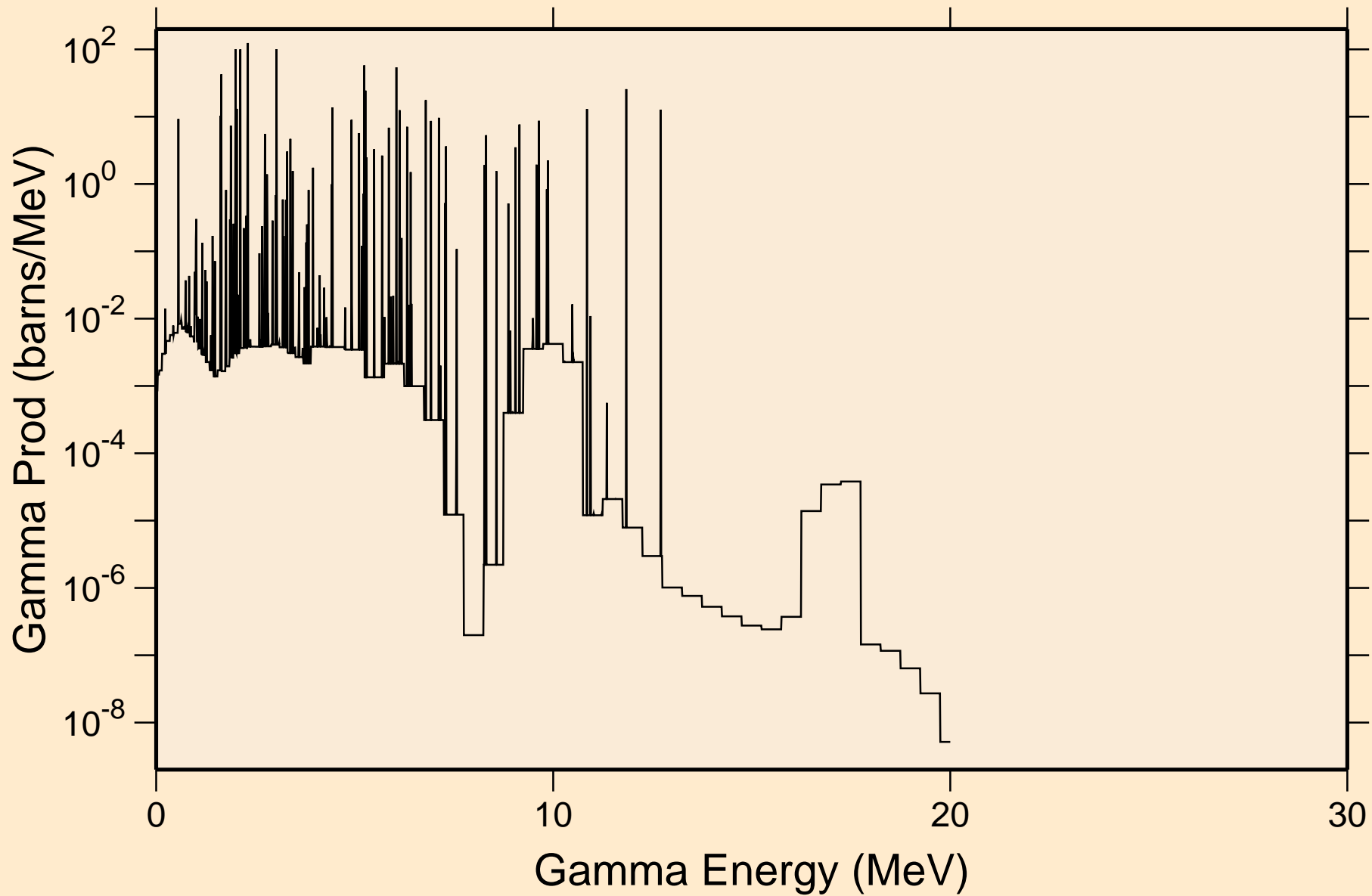

O015 NEUTRON ACER TENDL-2024 LIBRARY; T=0.K

Particle heating contributions

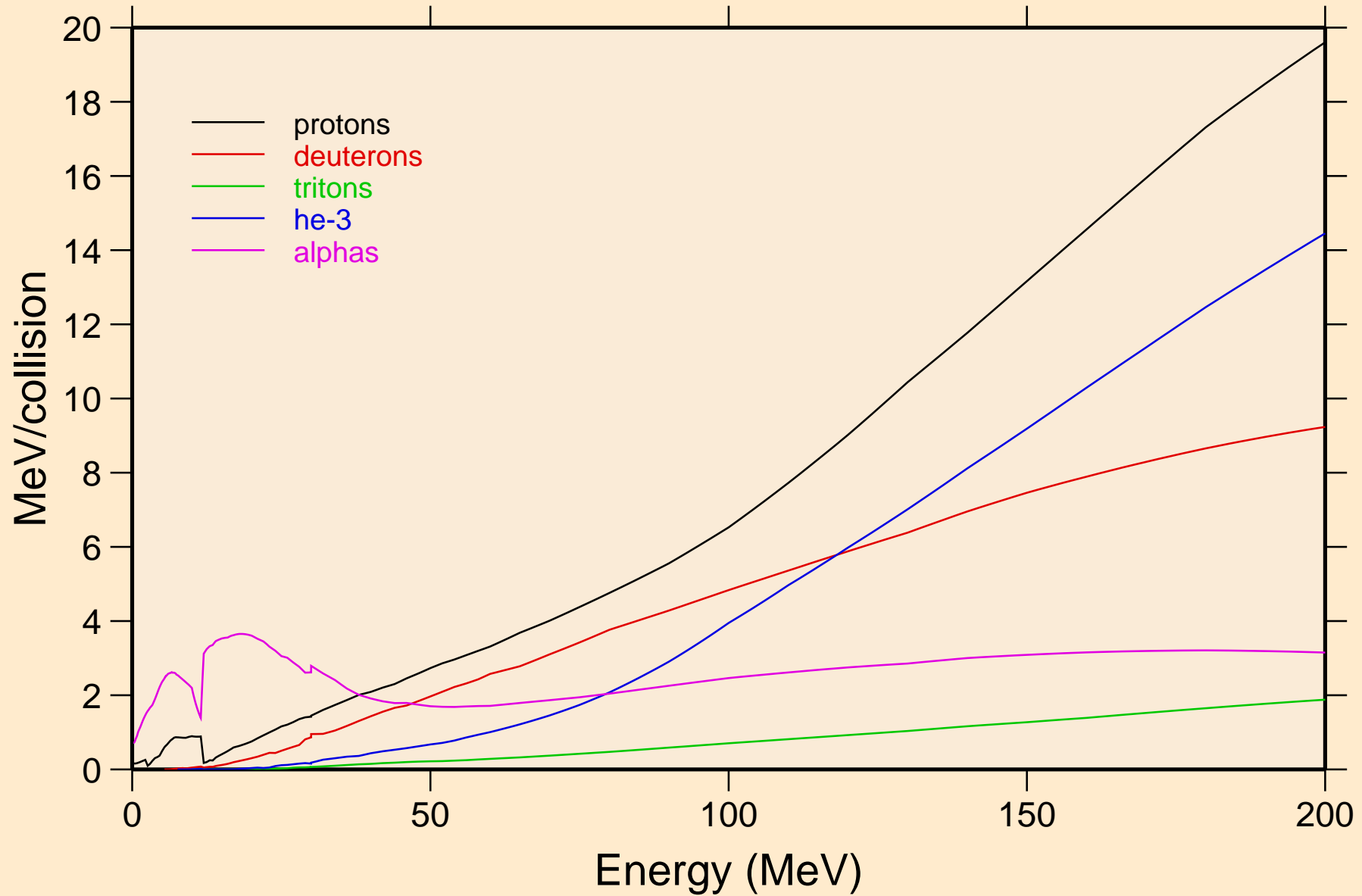

O015 NEUTRON ACER TENDL-2024 LIBRARY; T=0.K
Recoil Heating

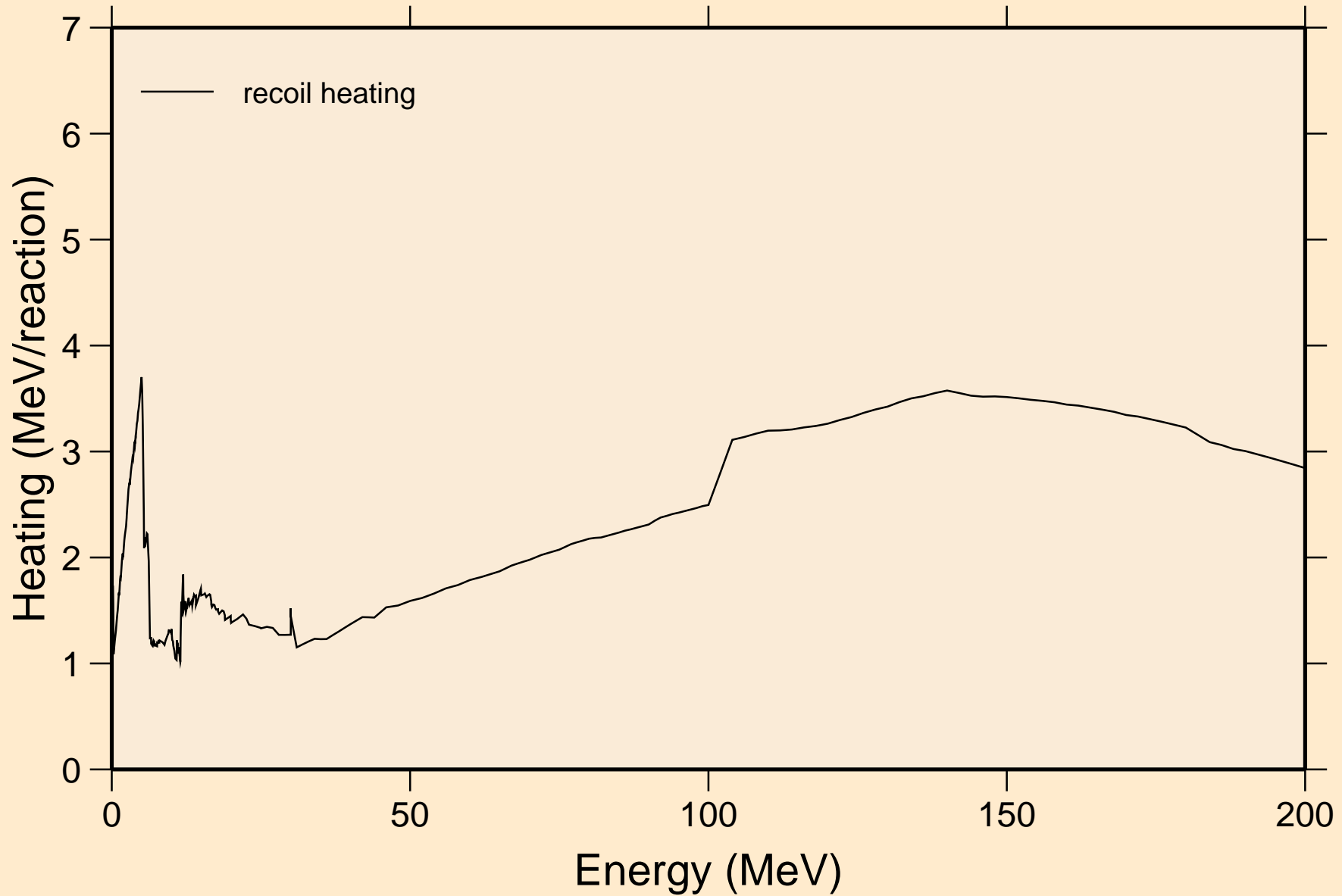

O015 NEUTRON ACER TENDL-2024 LIBRARY; T=0.K
Particle production cross sections

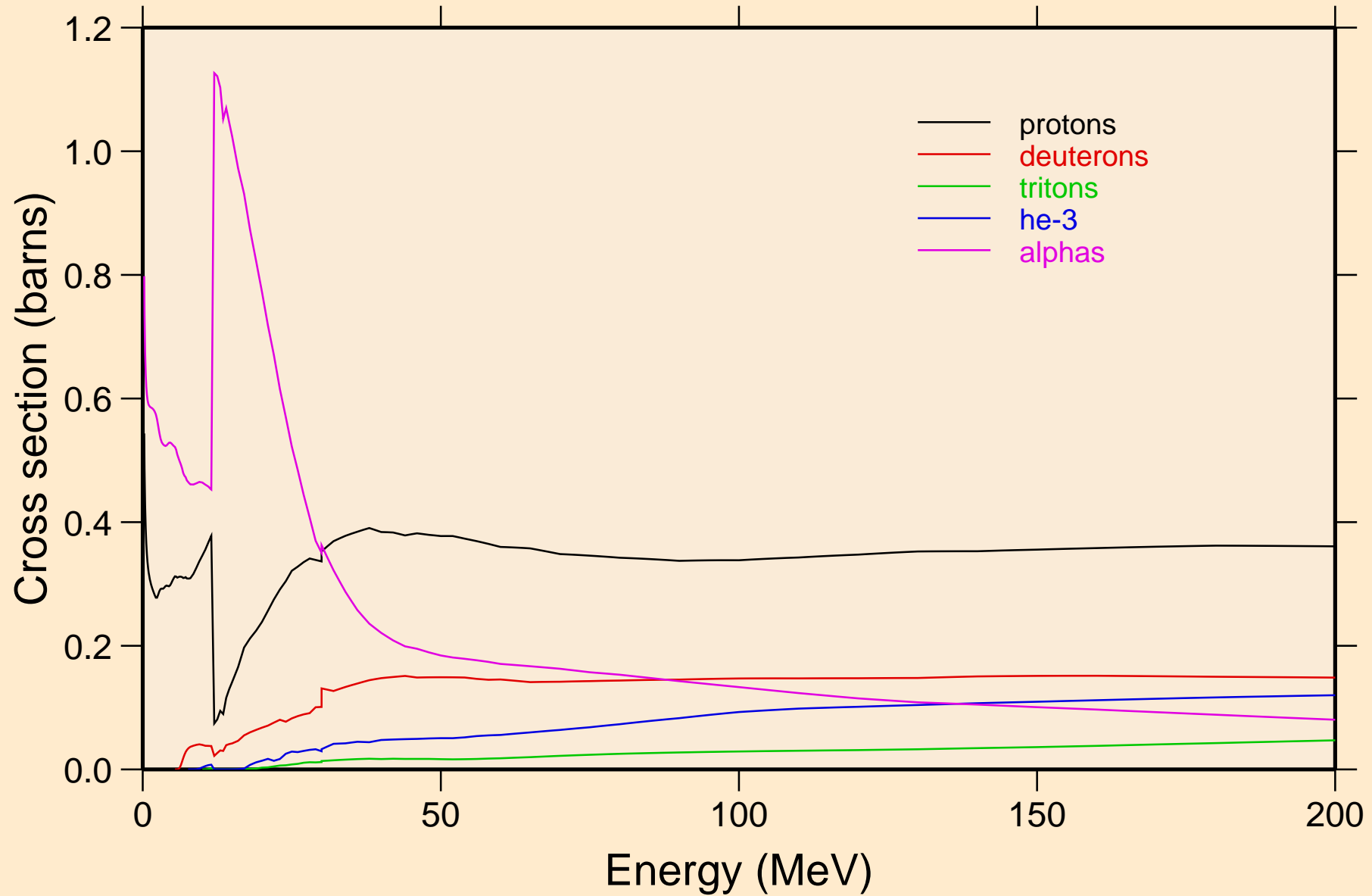

O015 NEUTRON ACER TENDL-2024 LIBRARY; T=0.K
protons from (n,x)

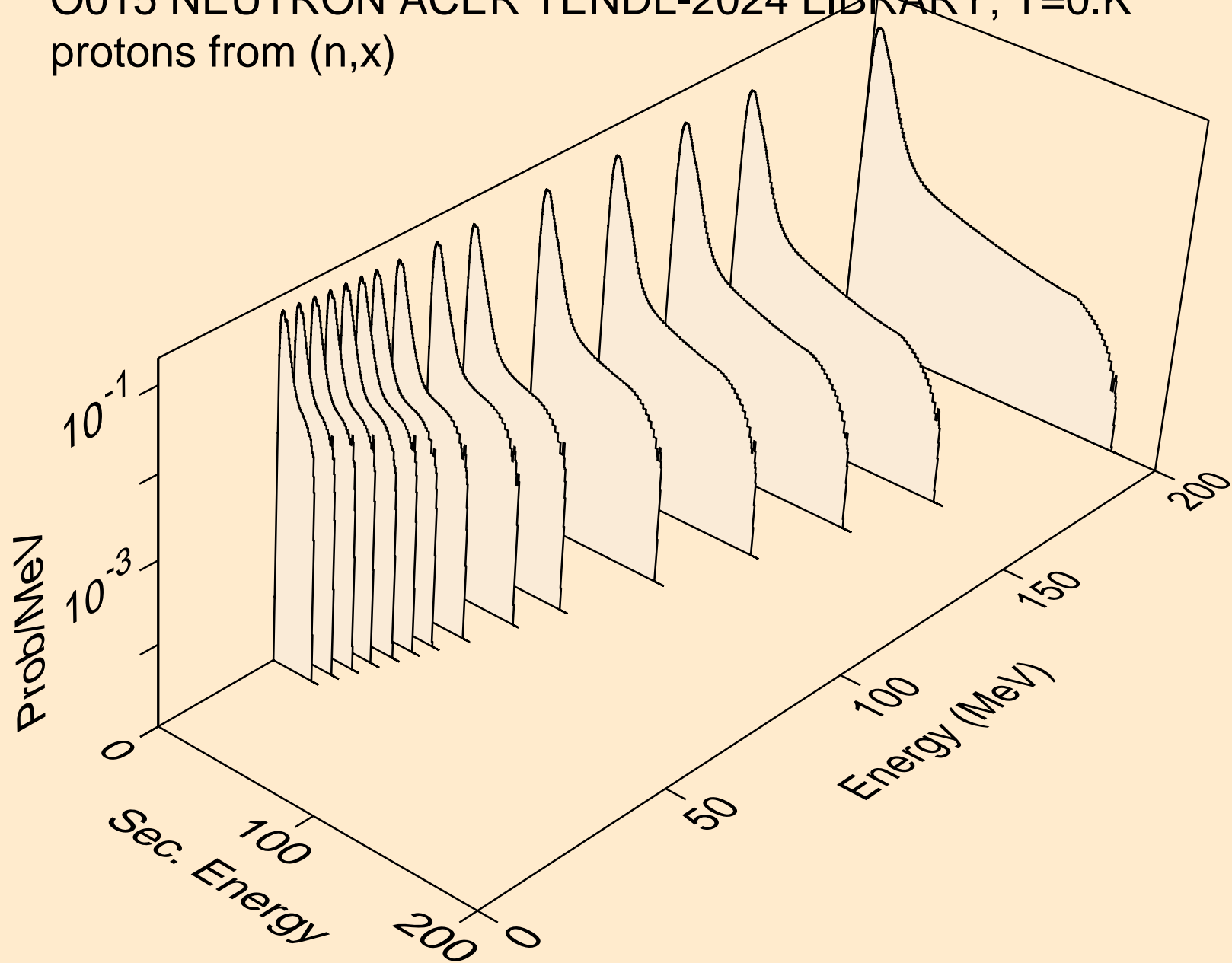

O015 NEUTRON ACER TENDL-2024 LIBRARY; T=0.K
protons from (n,n*)p

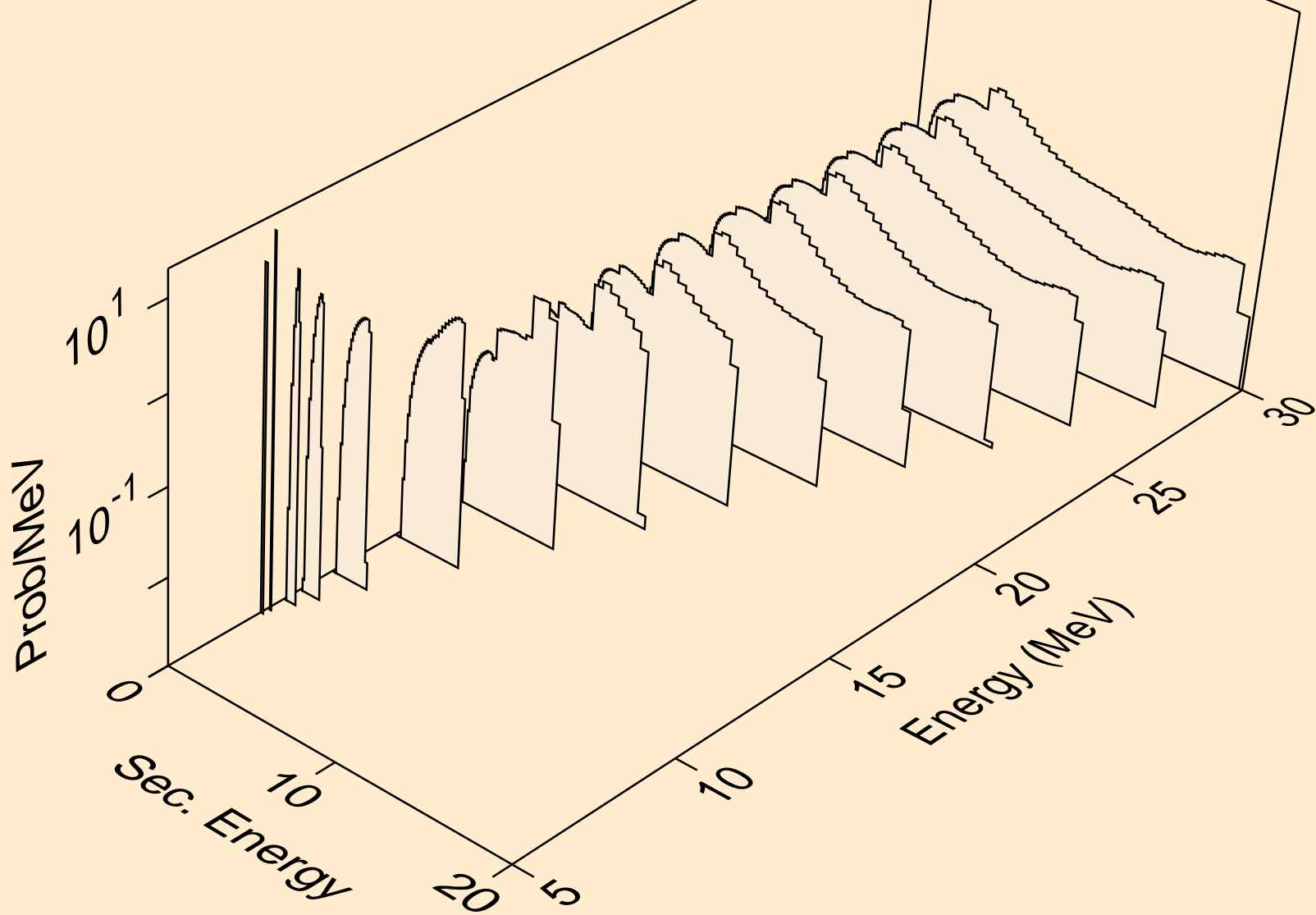

O015 NEUTRON ACER TENDL-2024 LIBRARY; T=0.K
protons from (n,2np)

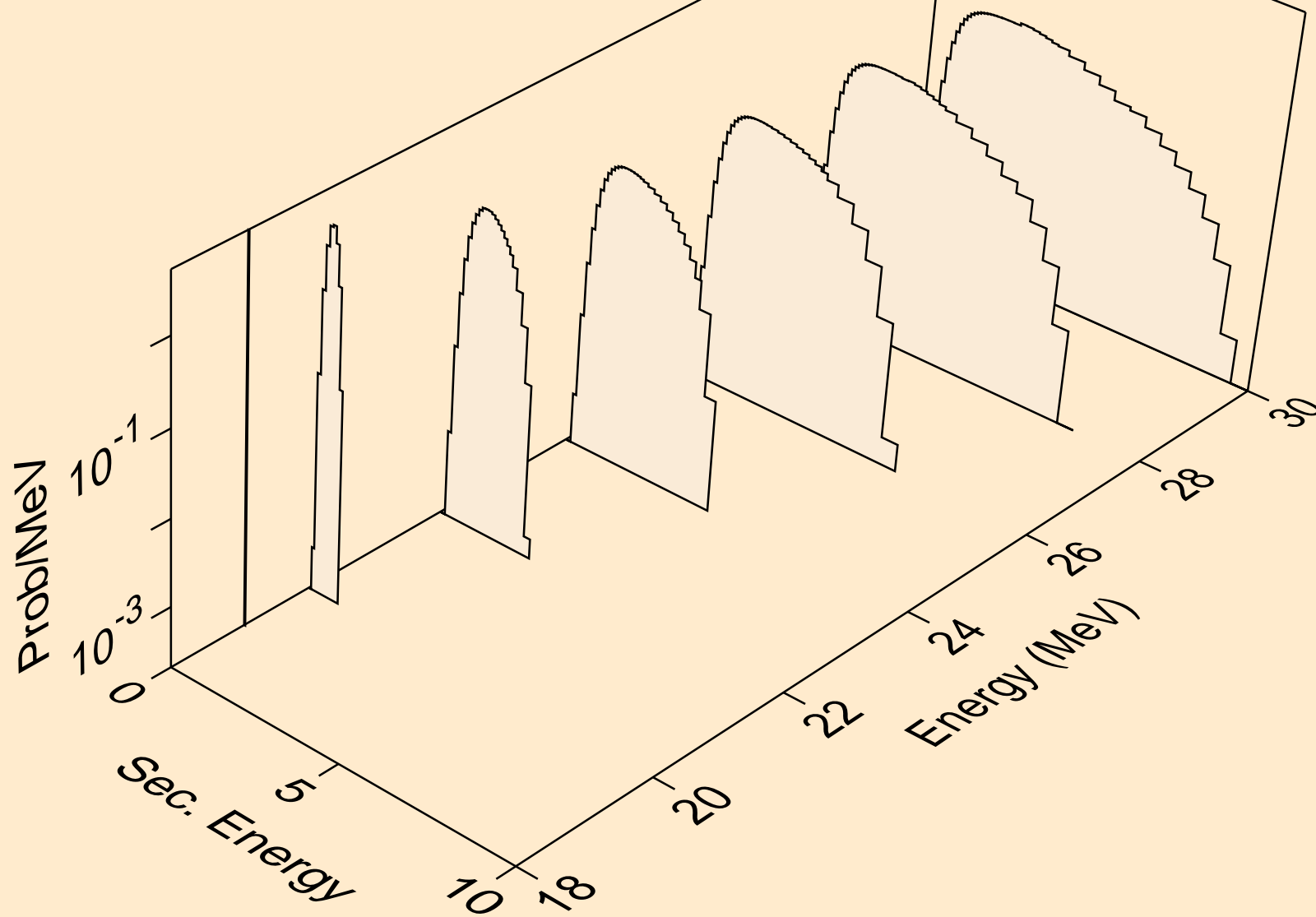

O015 NEUTRON ACER TENDL-2024 LIBRARY; T=0.K
protons from (n,n2p)

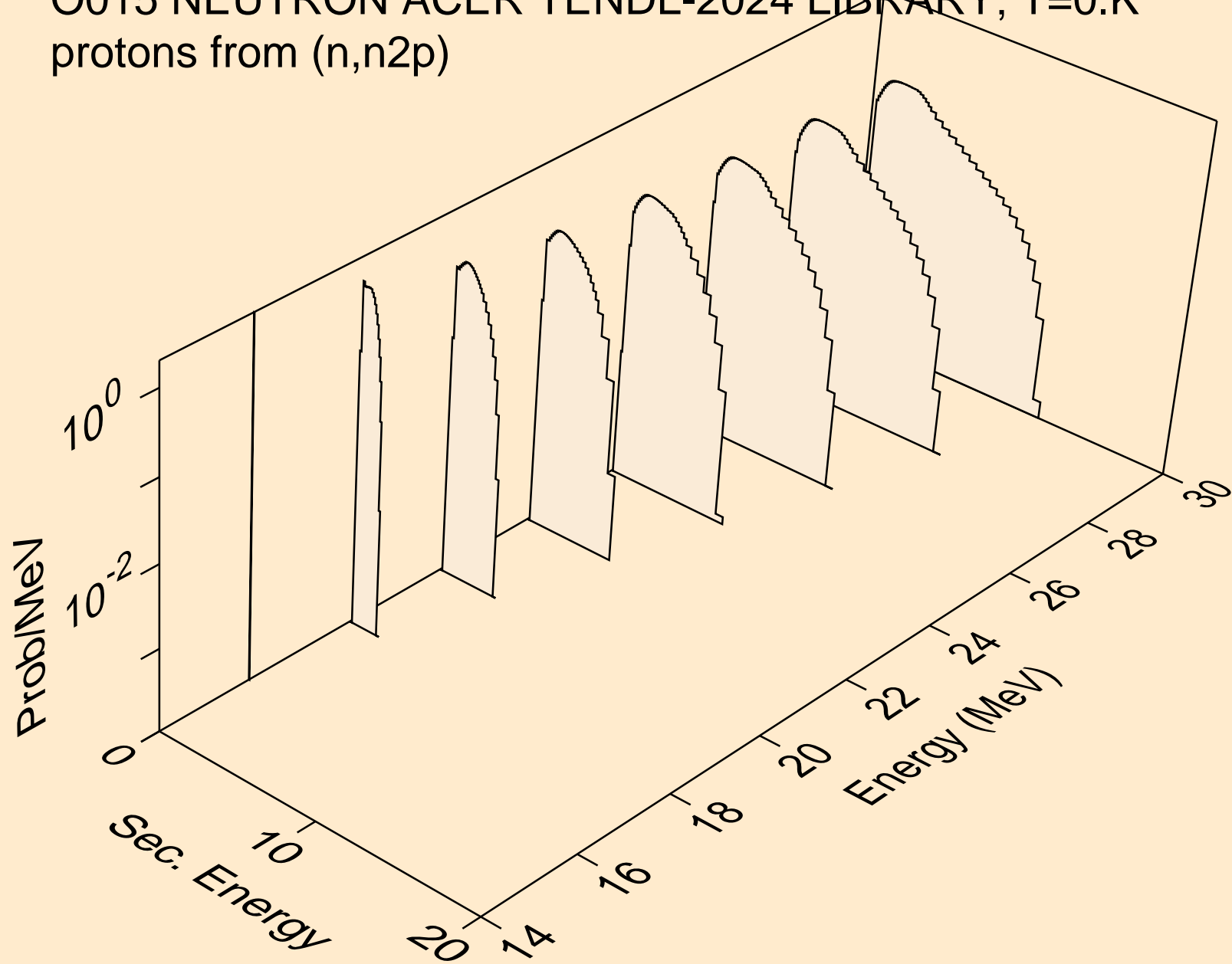

O015 NEUTRON ACER TENDL-2024 LIBRARY; T=0.K
protons from (n,npa)

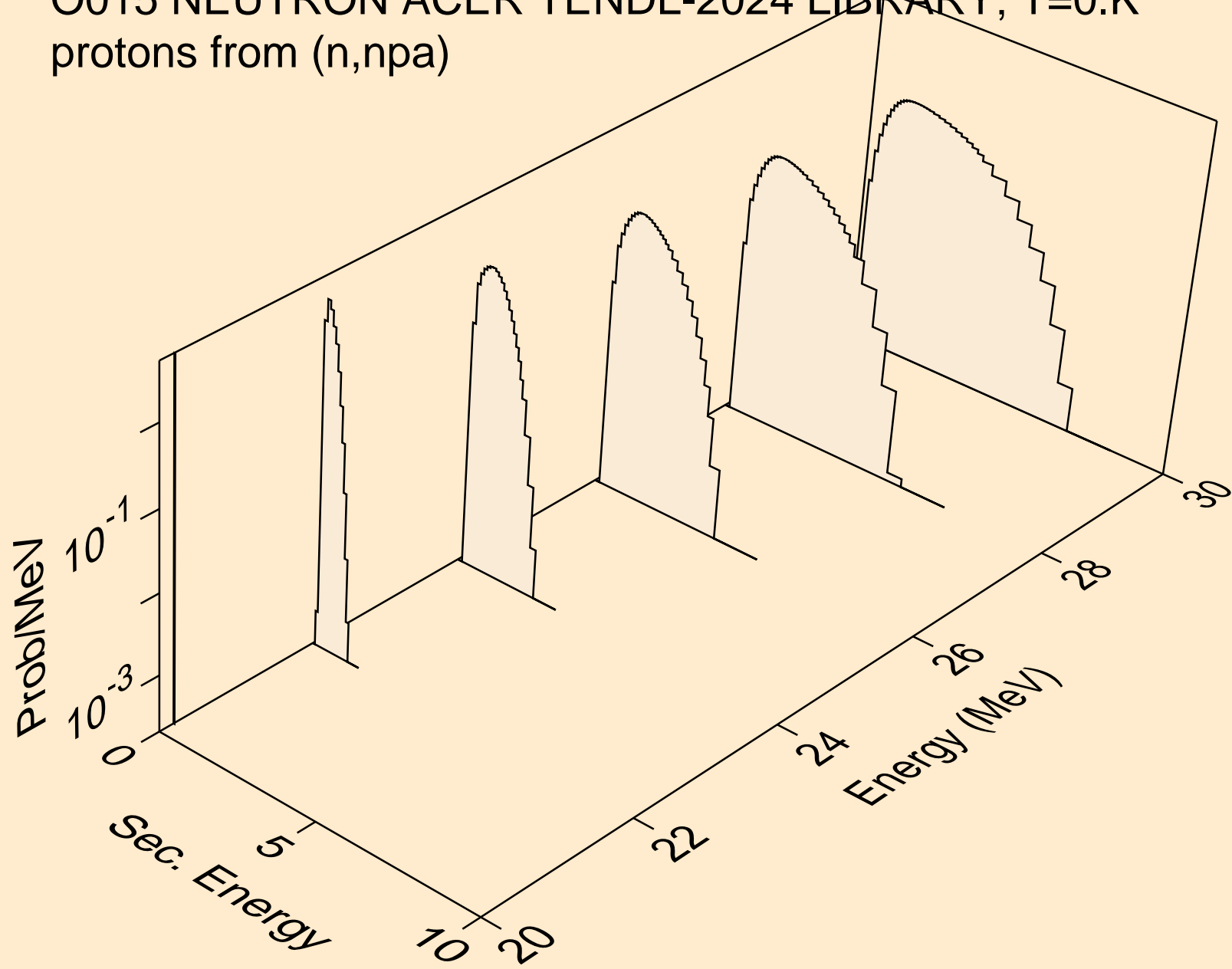

O015 NEUTRON ACER TENDL-2024 LIBRARY; T=0.K
protons from (n,p)

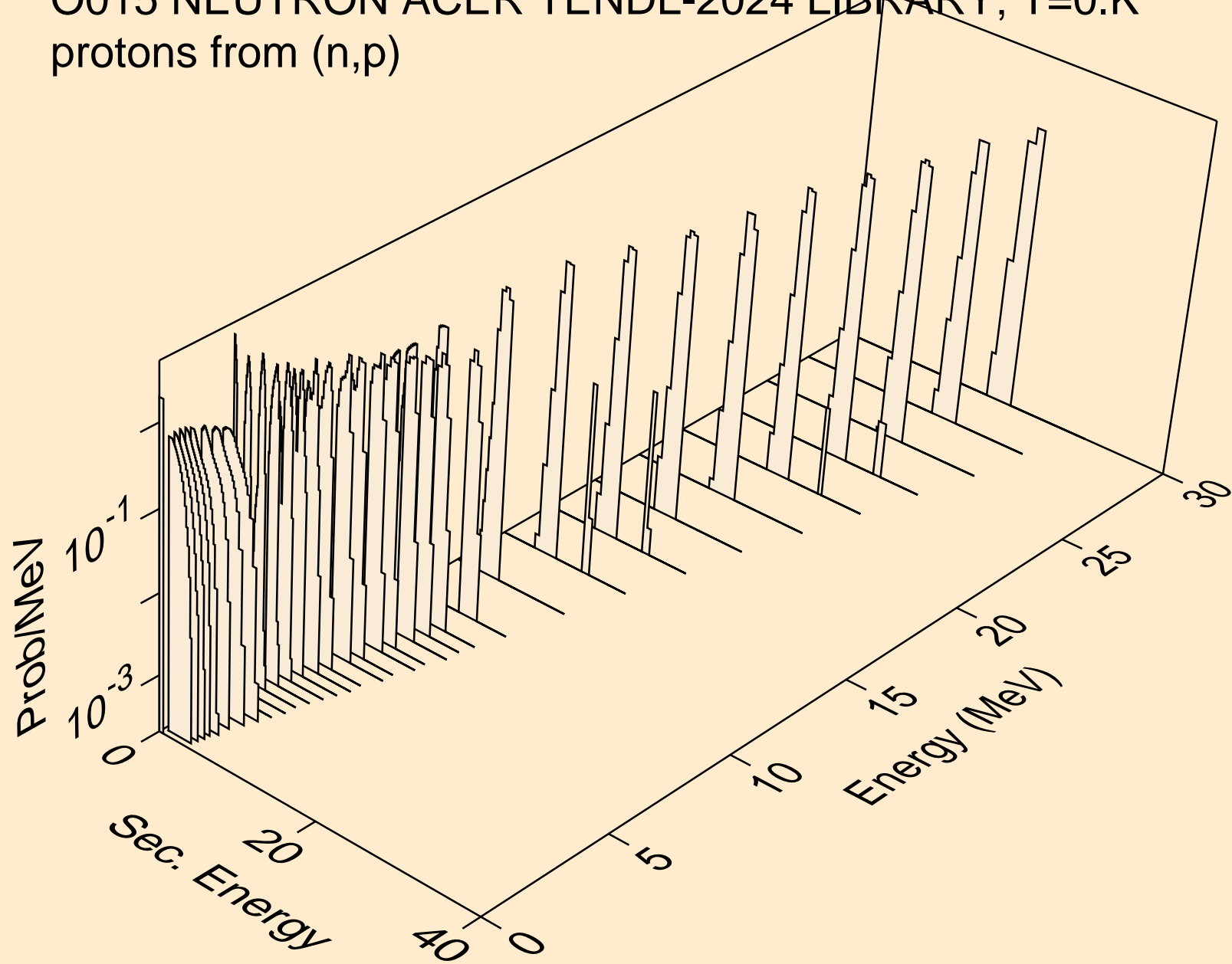

O015 NEUTRON ACER TENDL-2024 LIBRARY; T=0.K
protons from (n,2p)

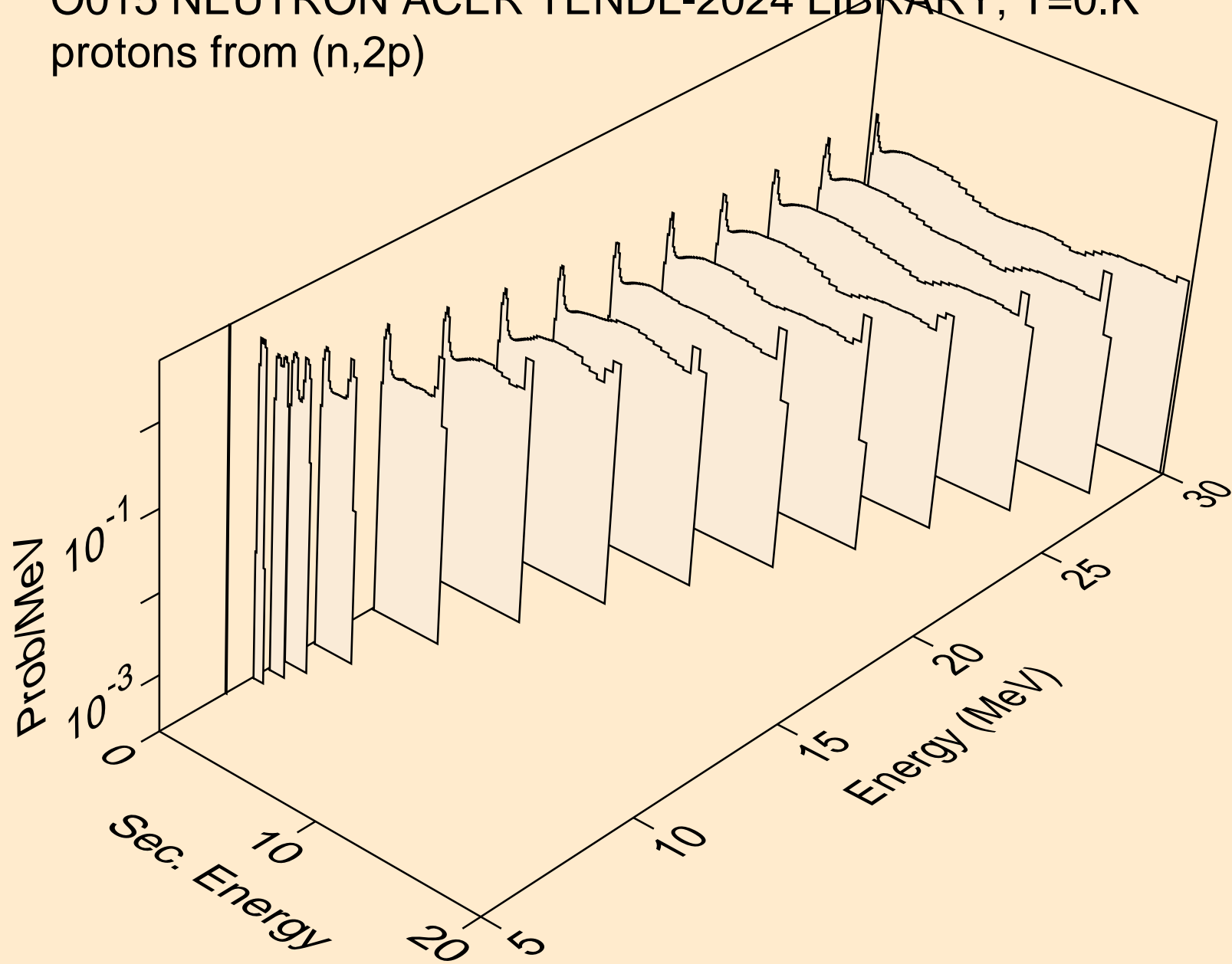

O015 NEUTRON ACER TENDL-2024 LIBRARY; T=0.K
protons from (n,p)

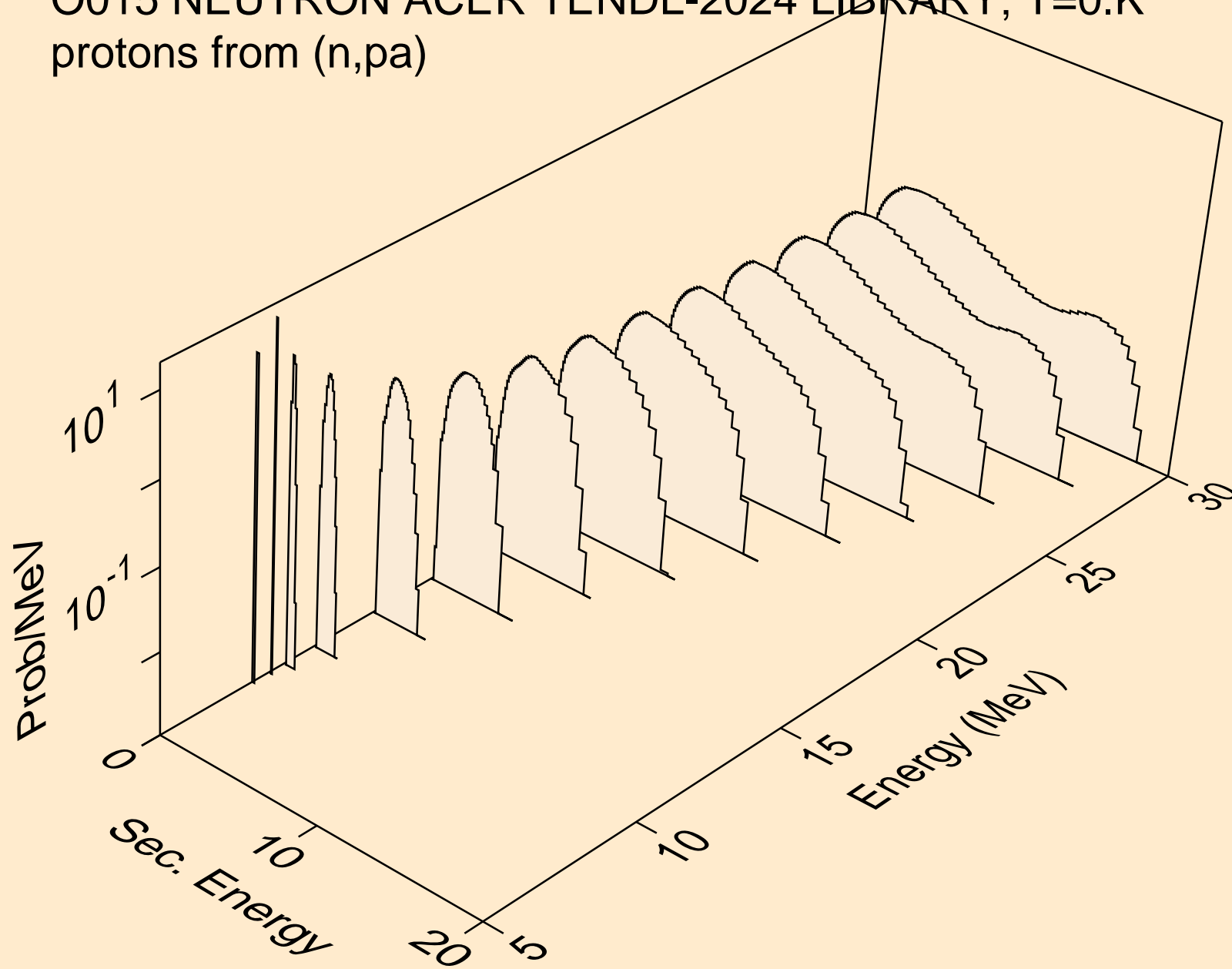

O015 NEUTRON ACER TENDL-2024 LIBRARY; T=0.K
protons from (n,pd)

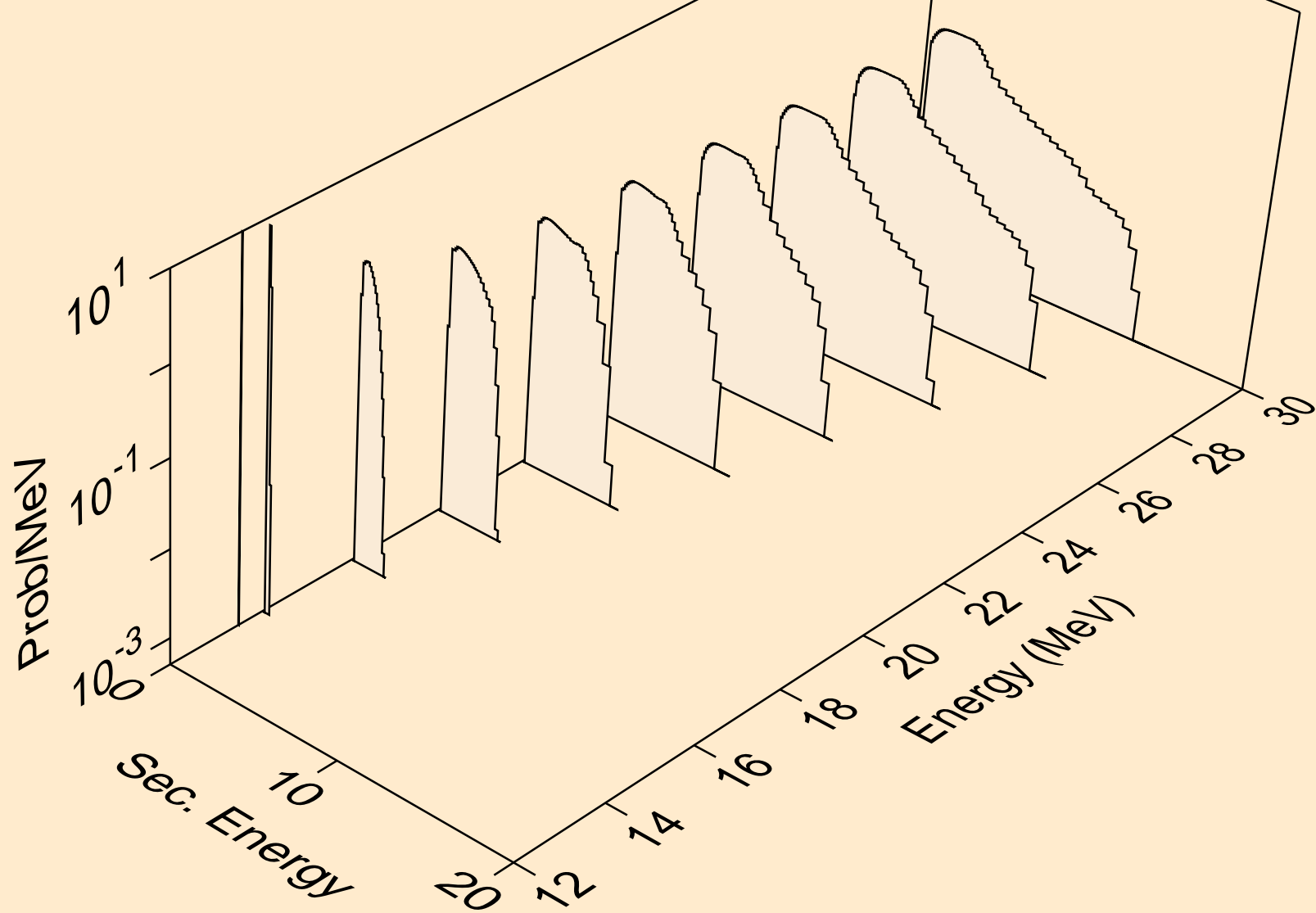

O015 NEUTRON ACER TENDL-2024 LIBRARY; T=0.K
protons from (n,pt)

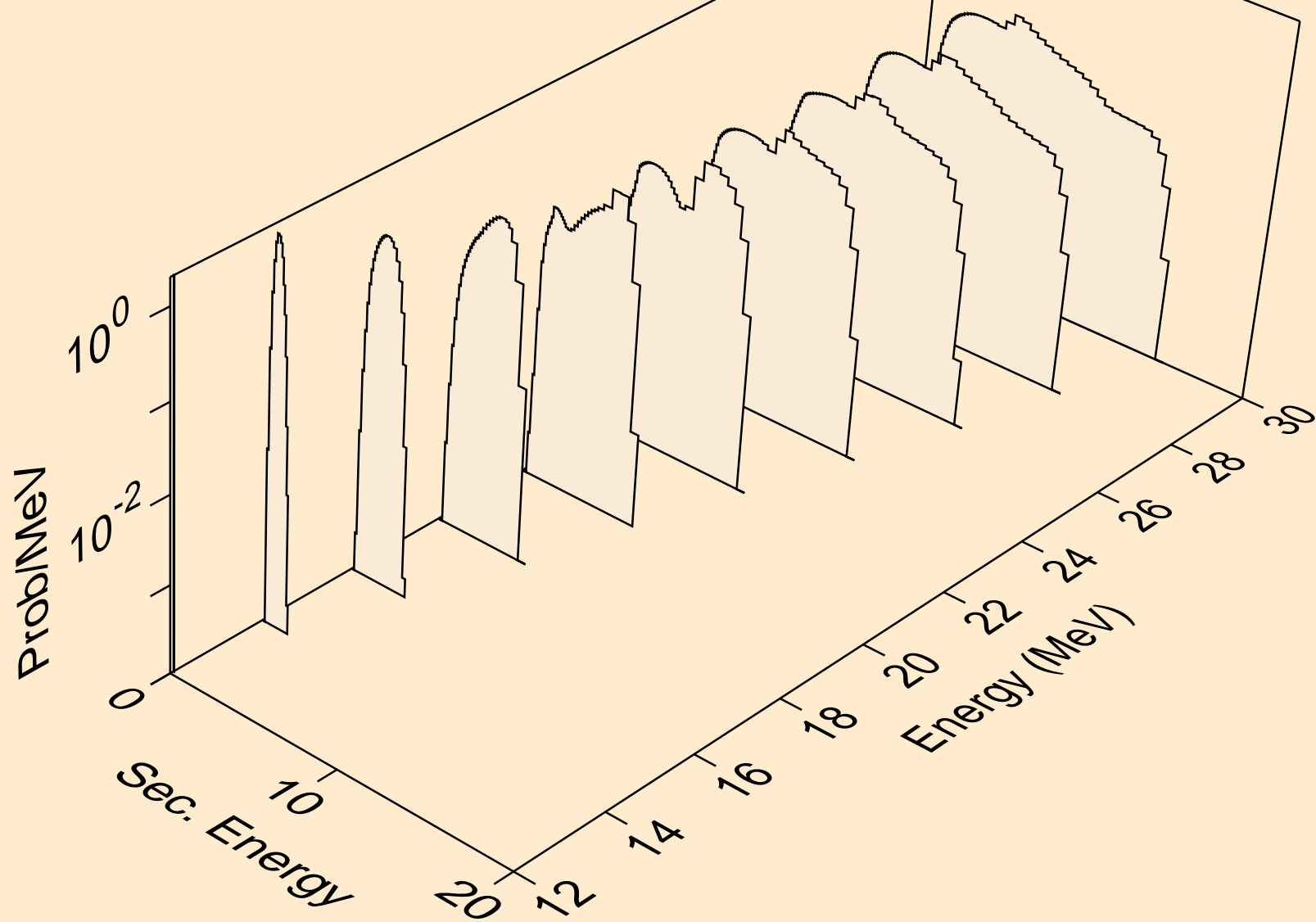

O015 NEUTRON ACER TENDL-2024 LIBRARY; T=0.K
deuterons from (n,x)

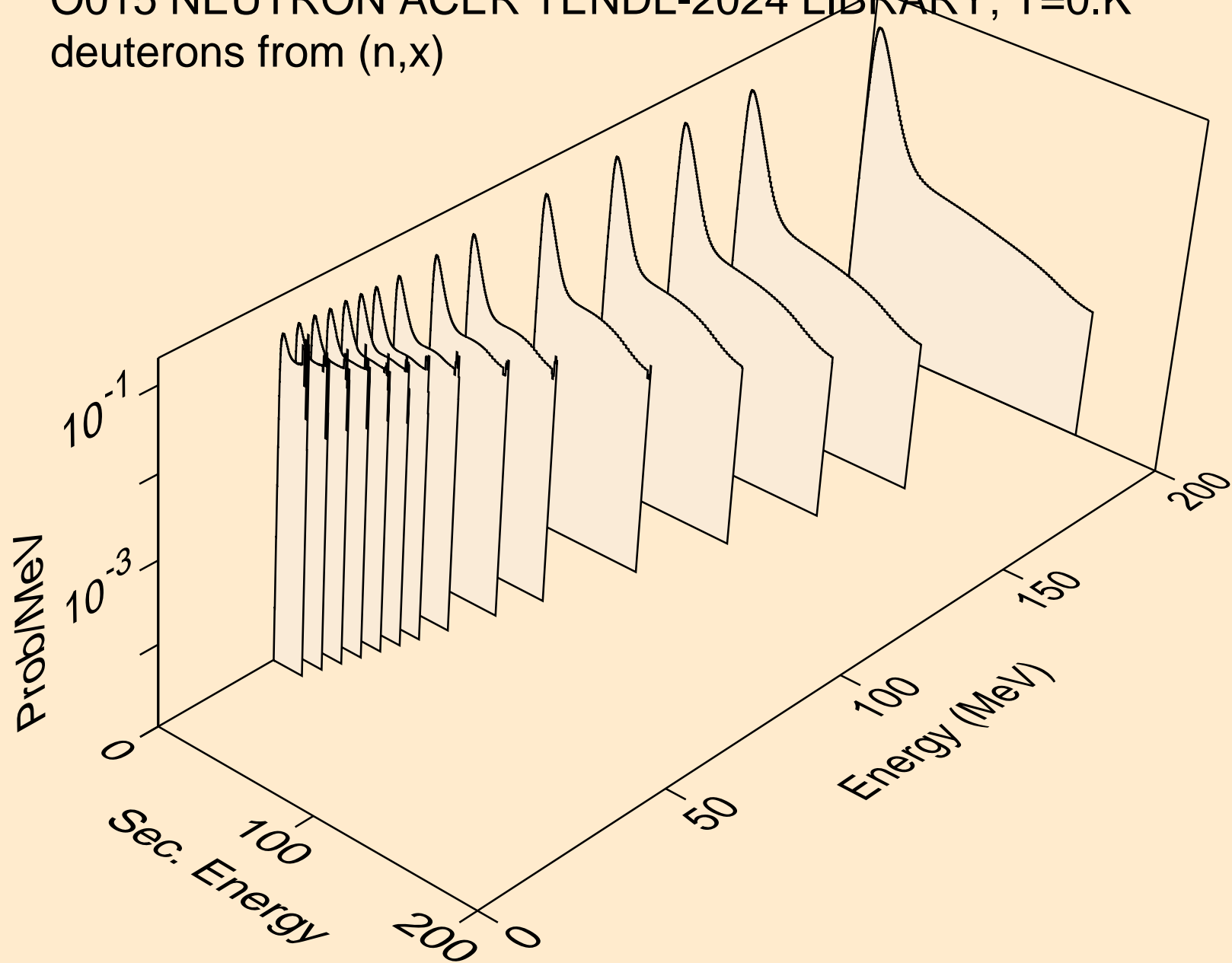

O015 NEUTRON ACER TENDL-2024 LIBRARY; T=0.K
deuterons from (n,n*)d

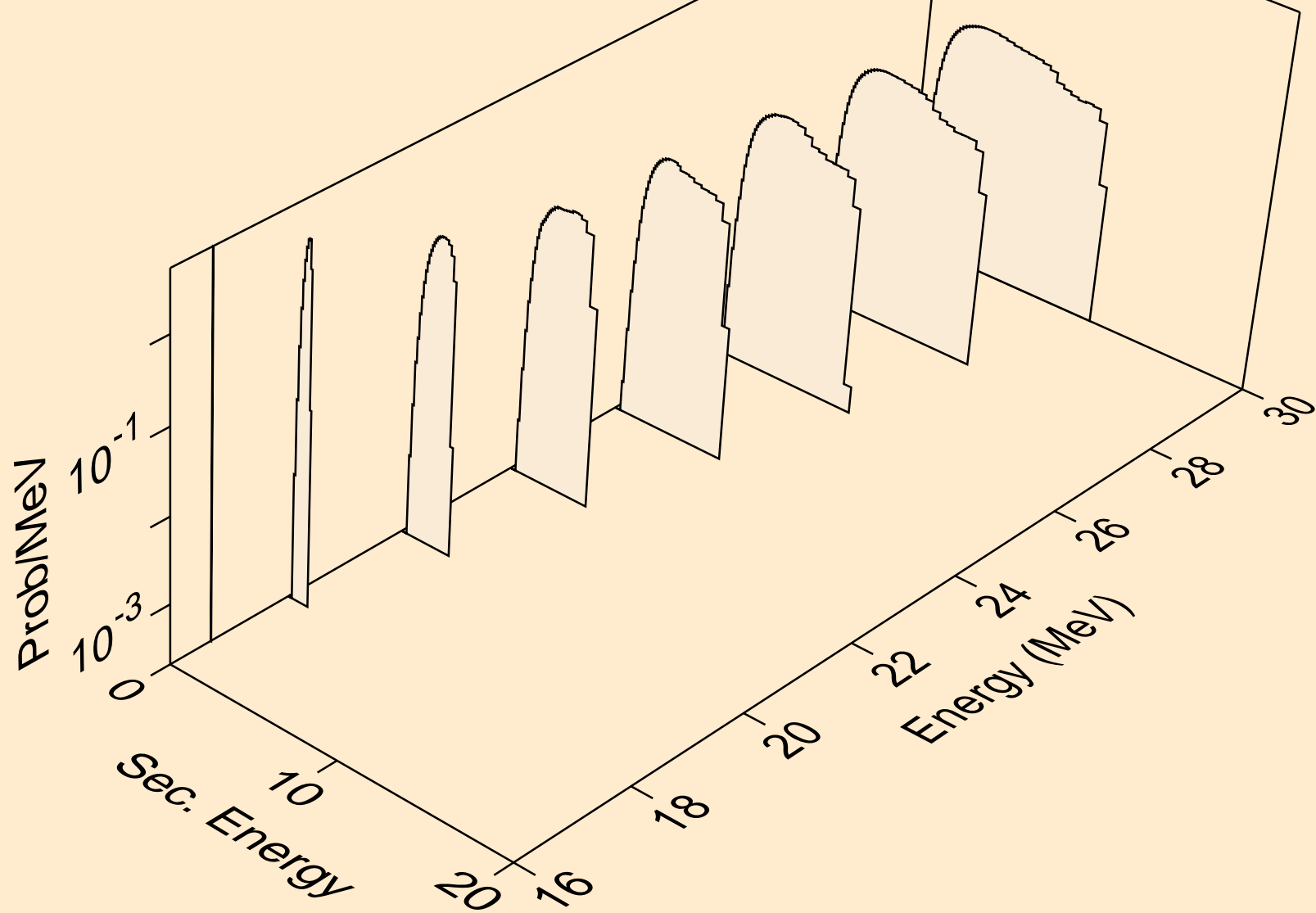

O015 NEUTRON ACER TENDL-2024 LIBRARY; T=0.K
deuterons from (n,d)

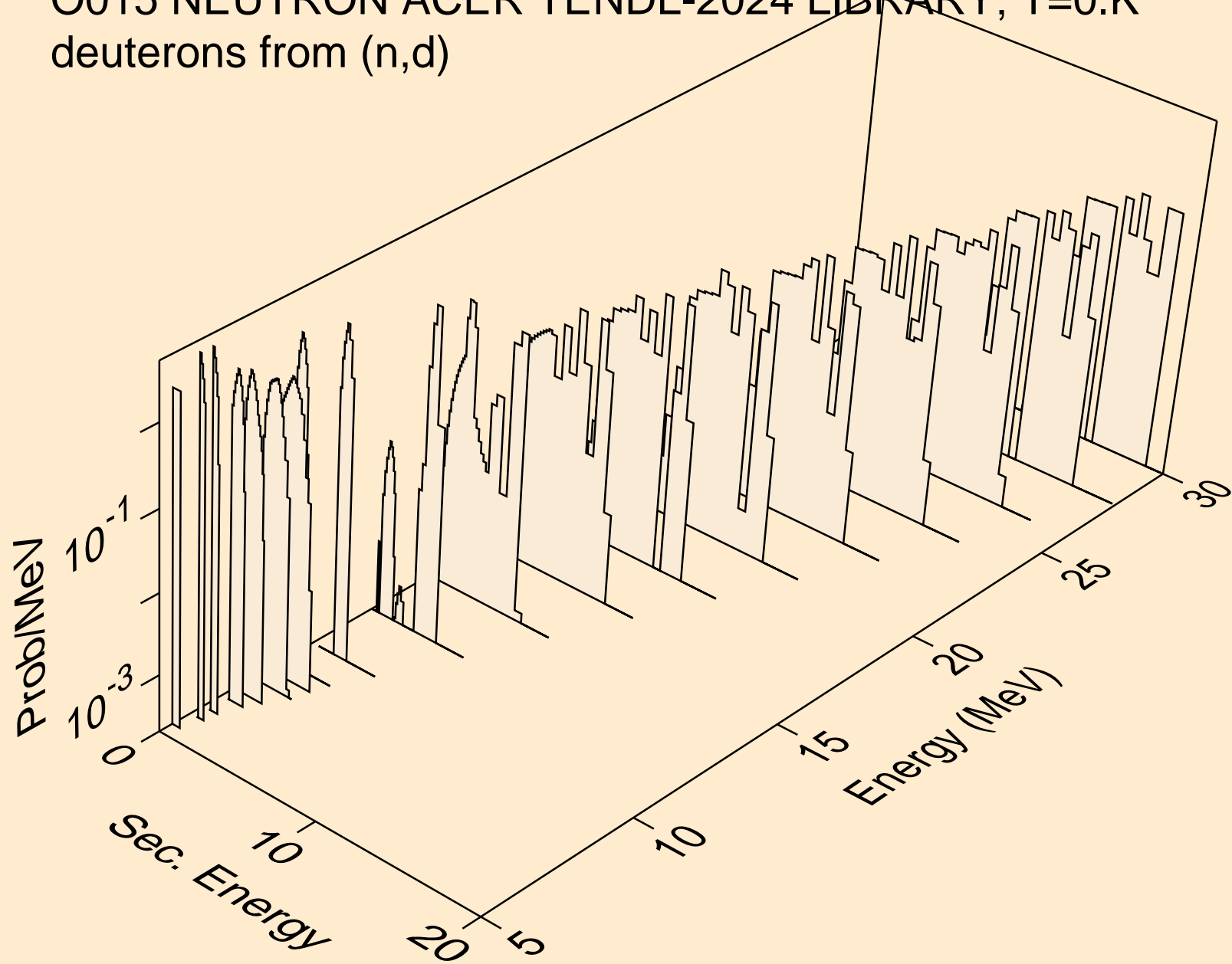

O015 NEUTRON ACER TENDL-2024 LIBRARY; T=0.K
deuterons from (n,d2a)

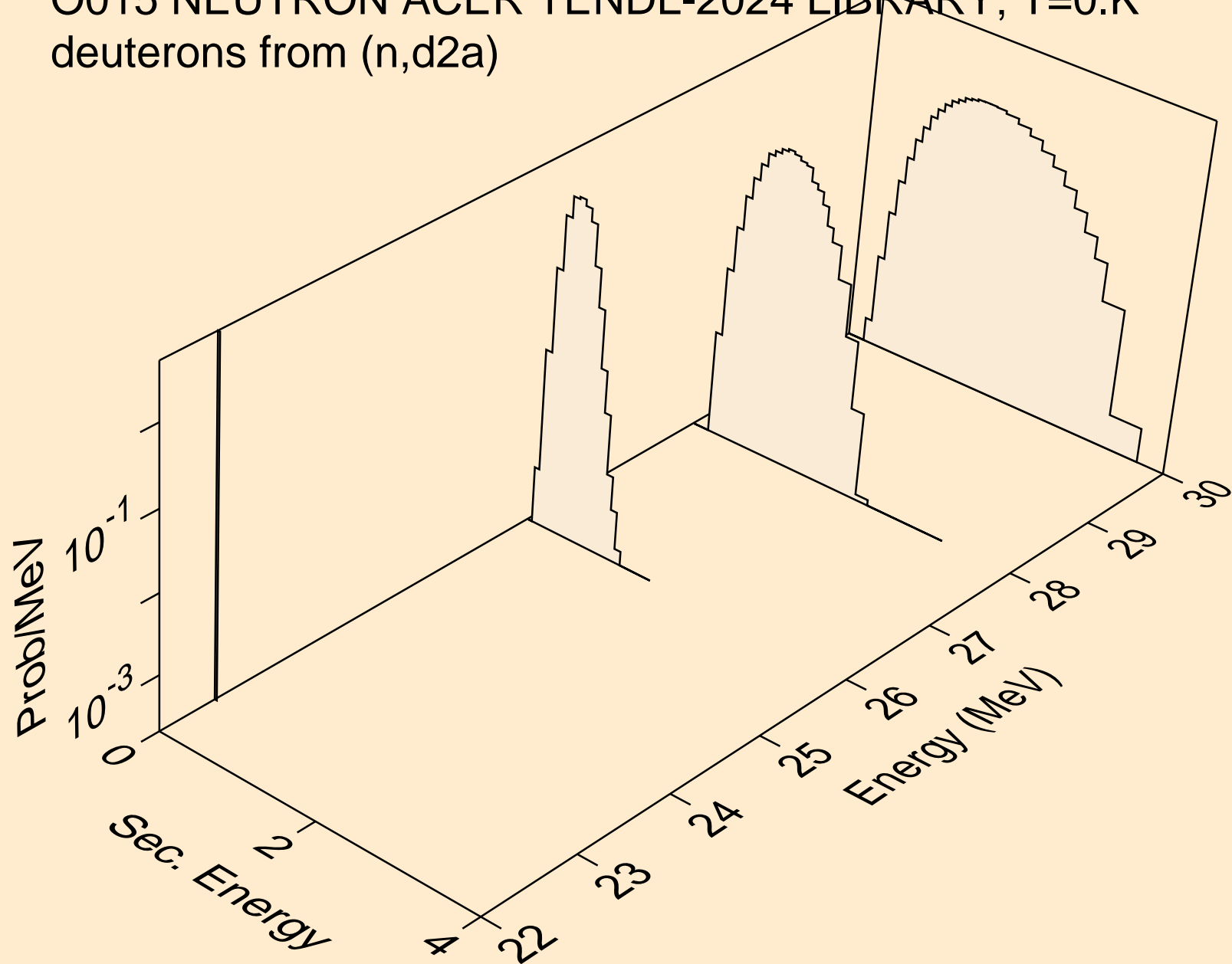

O015 NEUTRON ACER TENDL-2024 LIBRARY; T=0.K
deuterons from (n,pd)

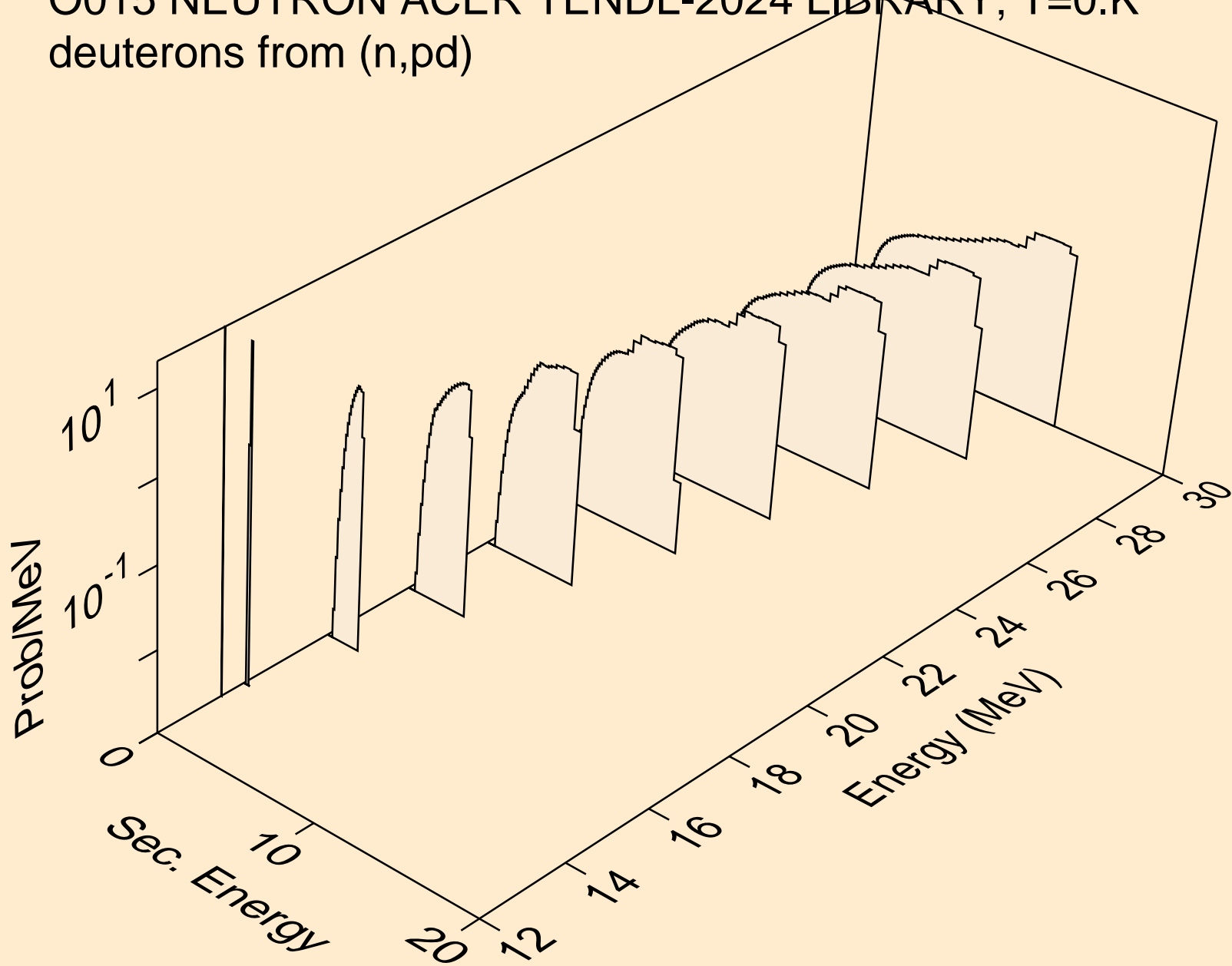

O015 NEUTRON ACER TENDL-2024 LIBRARY; T=0.K
deuterons from (n,da)

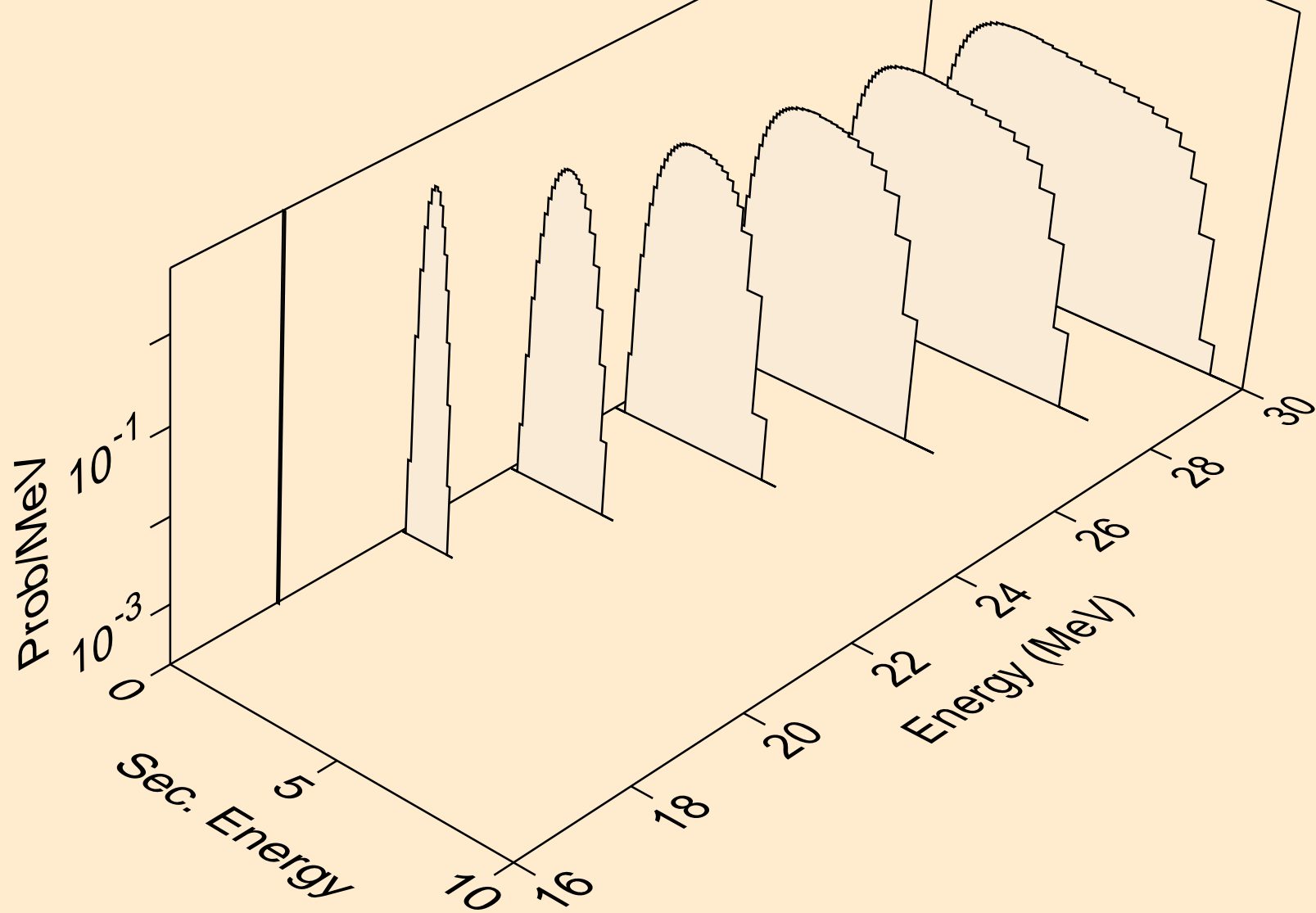

O015 NEUTRON ACER TENDL-2024 LIBRARY; T=0.K
tritons from (n,x)

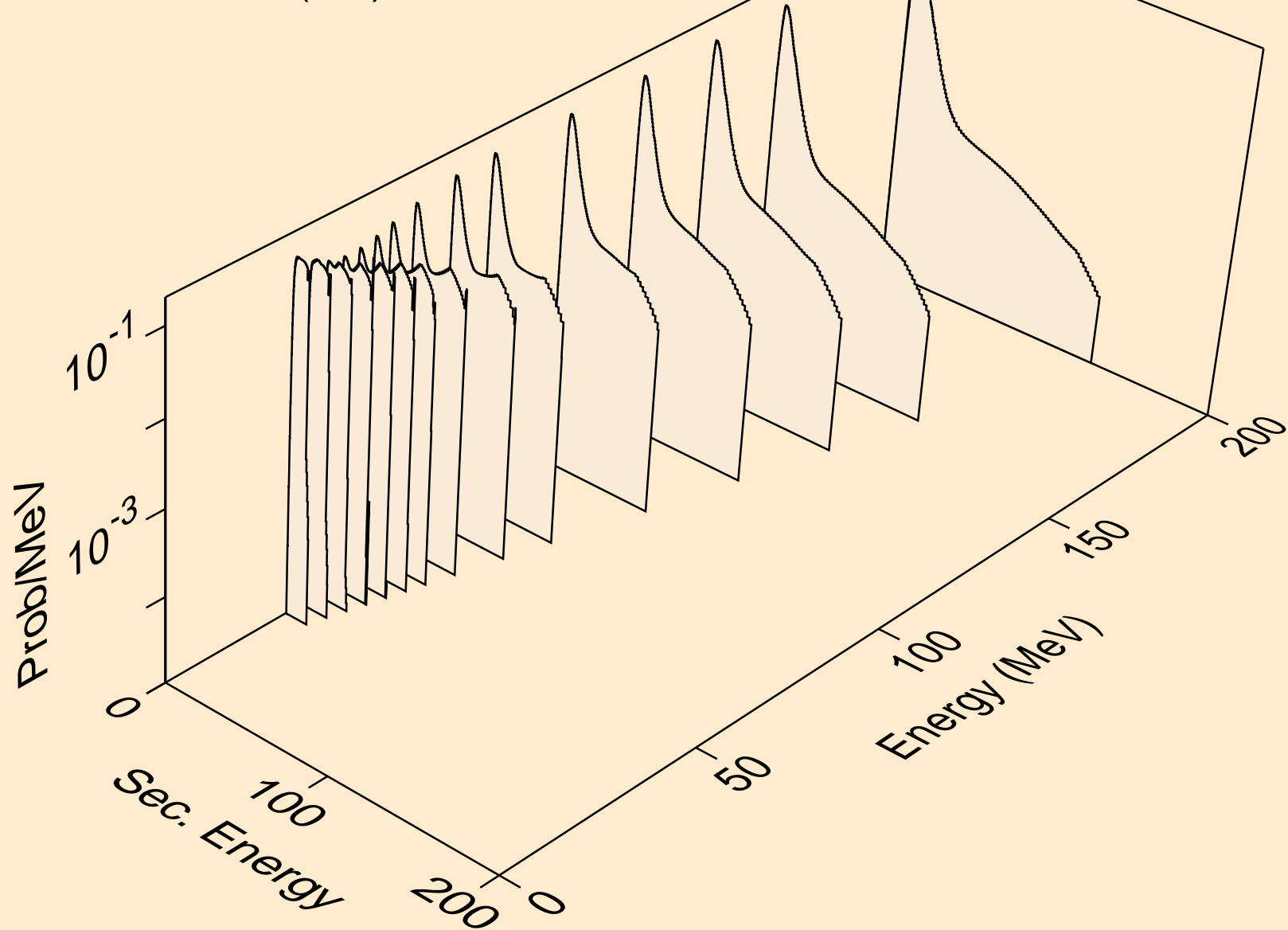

O015 NEUTRON ACER TENDL-2024 LIBRARY; T=0.K
tritons from (n,t)

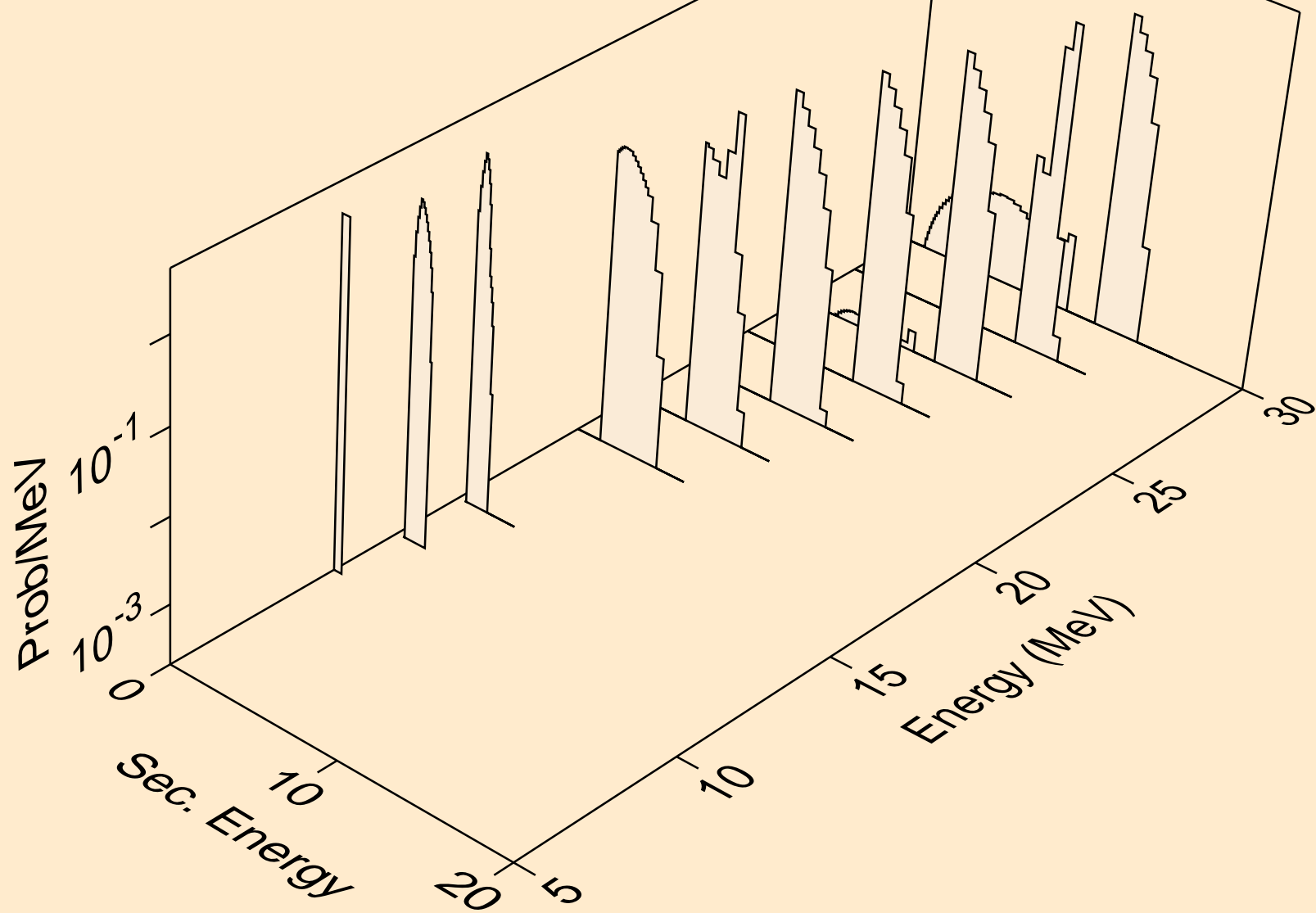

O015 NEUTRON ACER TENDL-2024 LIBRARY; T=0.K
tritons from (n,pt)

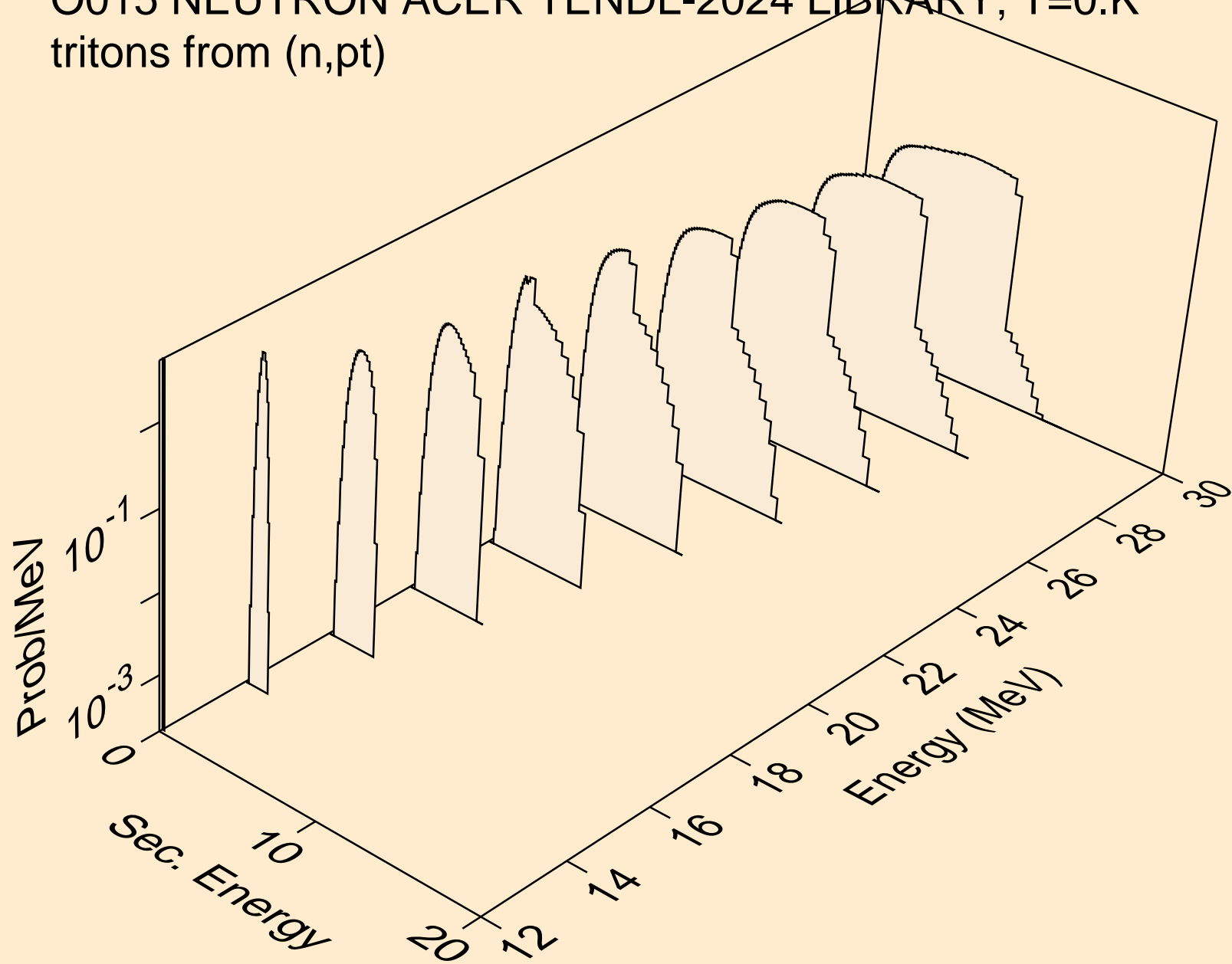

O015 NEUTRON ACER TENDL-2024 LIBRARY; T=0.K
he3s from (n,x)

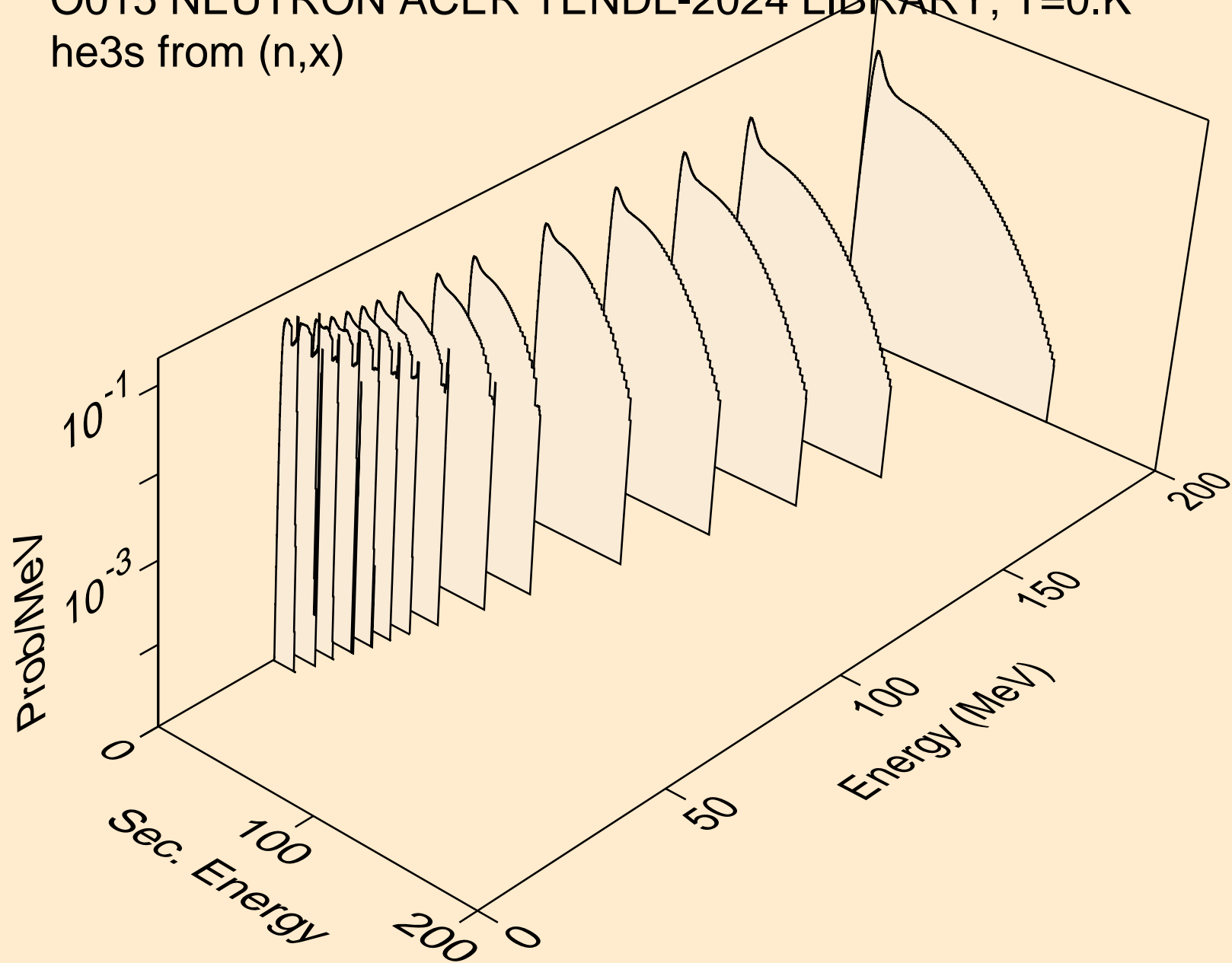

O015 NEUTRON ACER TENDL-2024 LIBRARY; T=0.K
he3s from (n,n*)he3

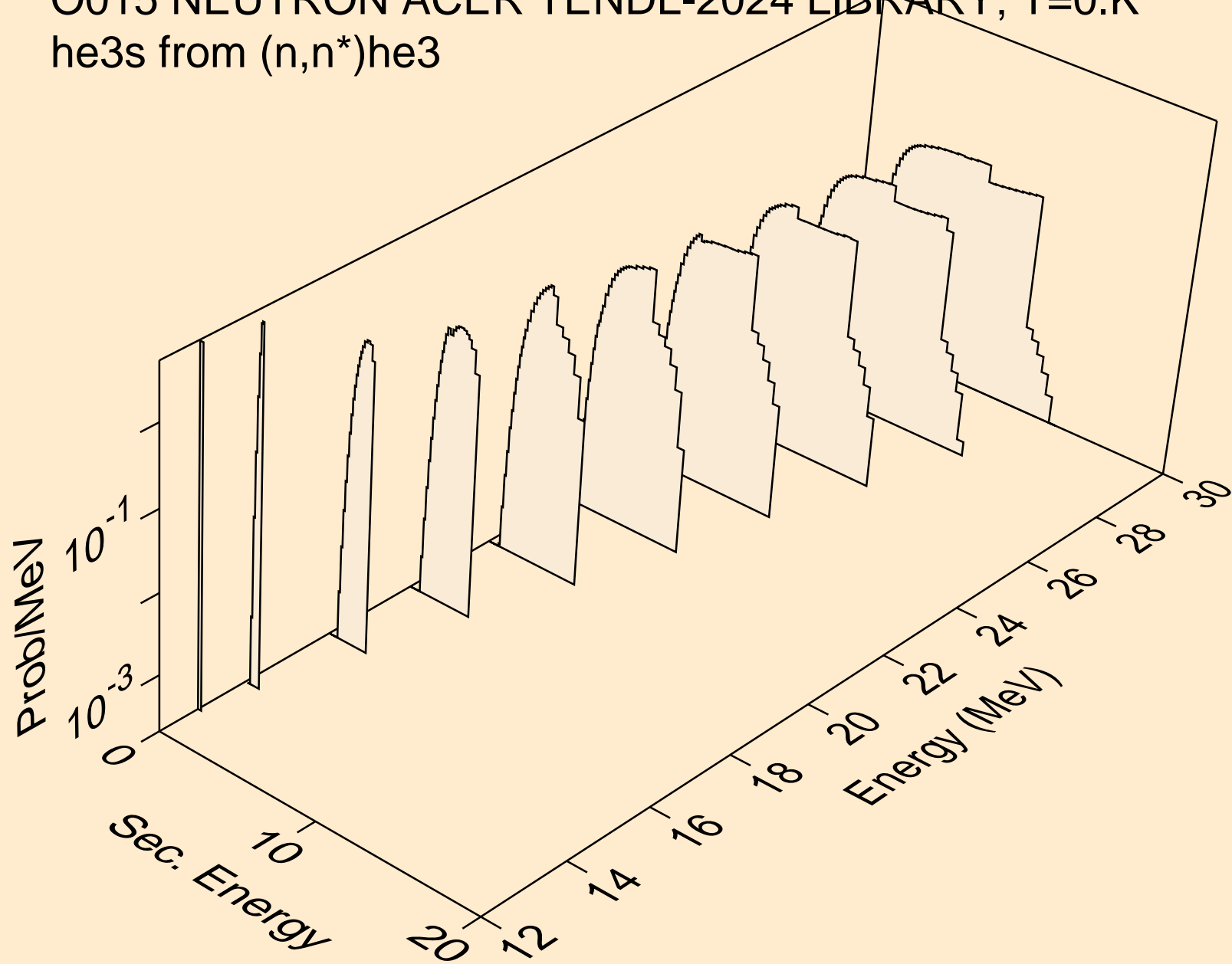

O015 NEUTRON ACER TENDL-2024 LIBRARY; T=0.K
he3s from (n,he3)

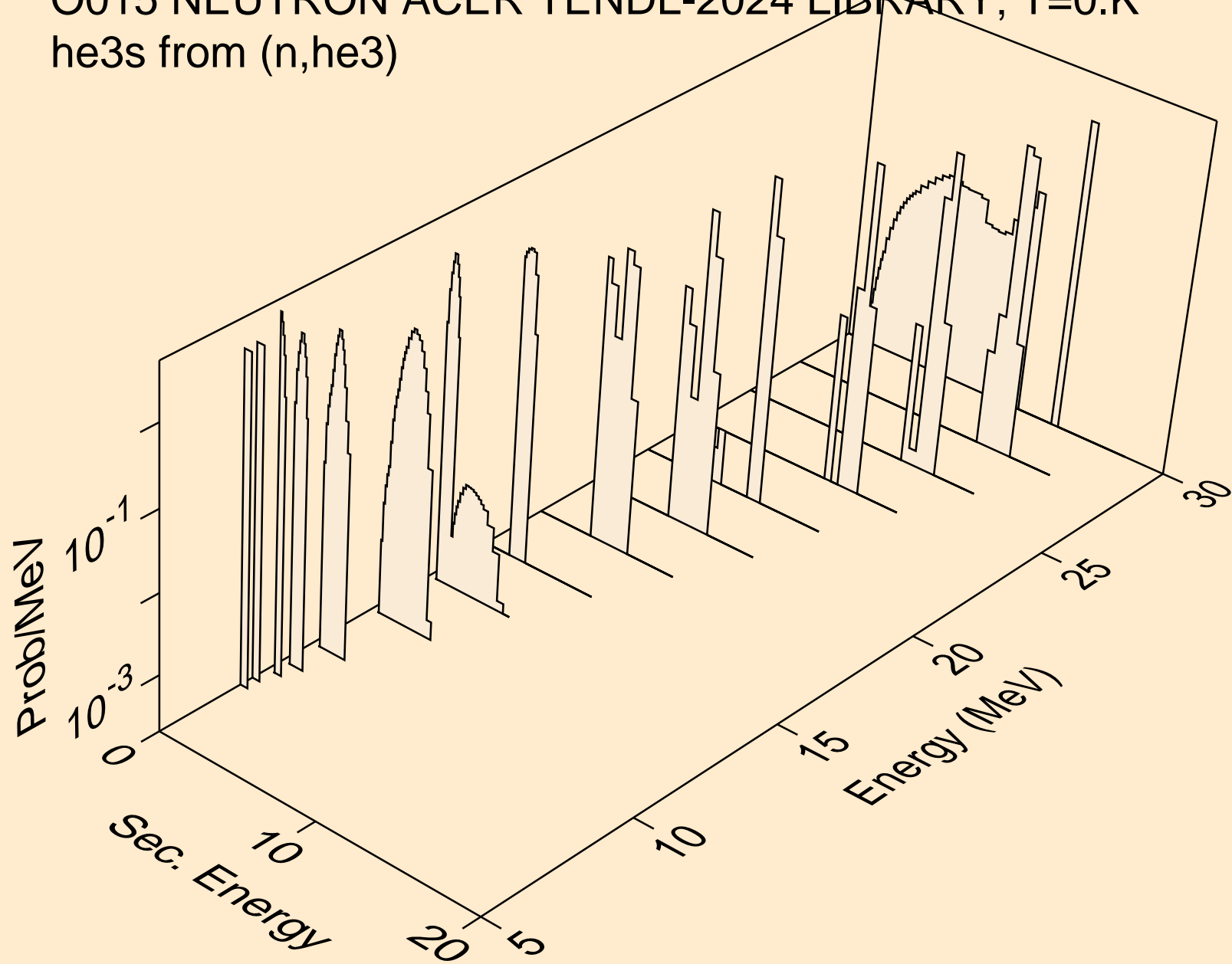

O015 NEUTRON ACER TENDL-2024 LIBRARY; T=0.K
alphas from (n,x)

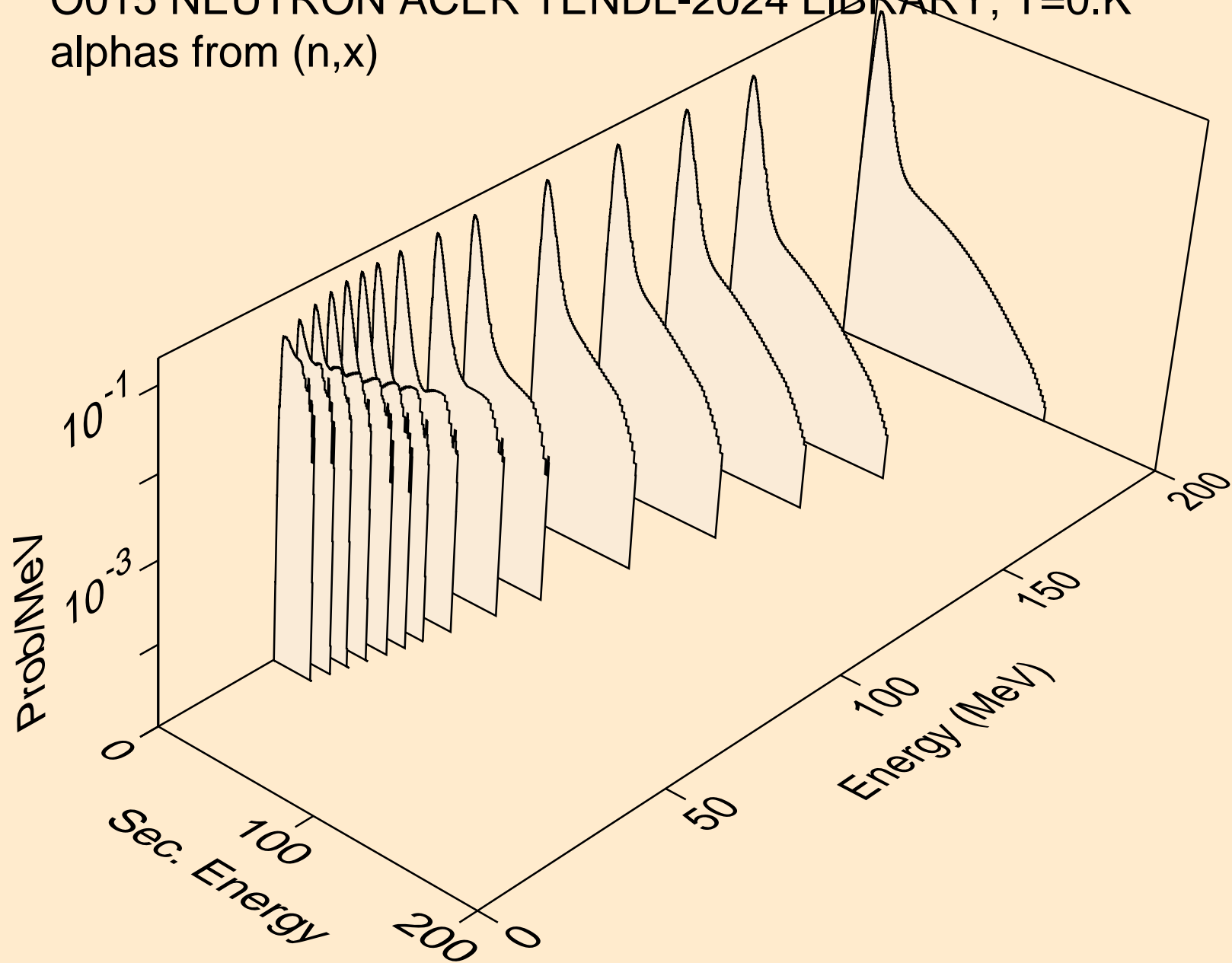

O015 NEUTRON ACER TENDL-2024 LIBRARY; T=0.K
alphas from (n,n*)a

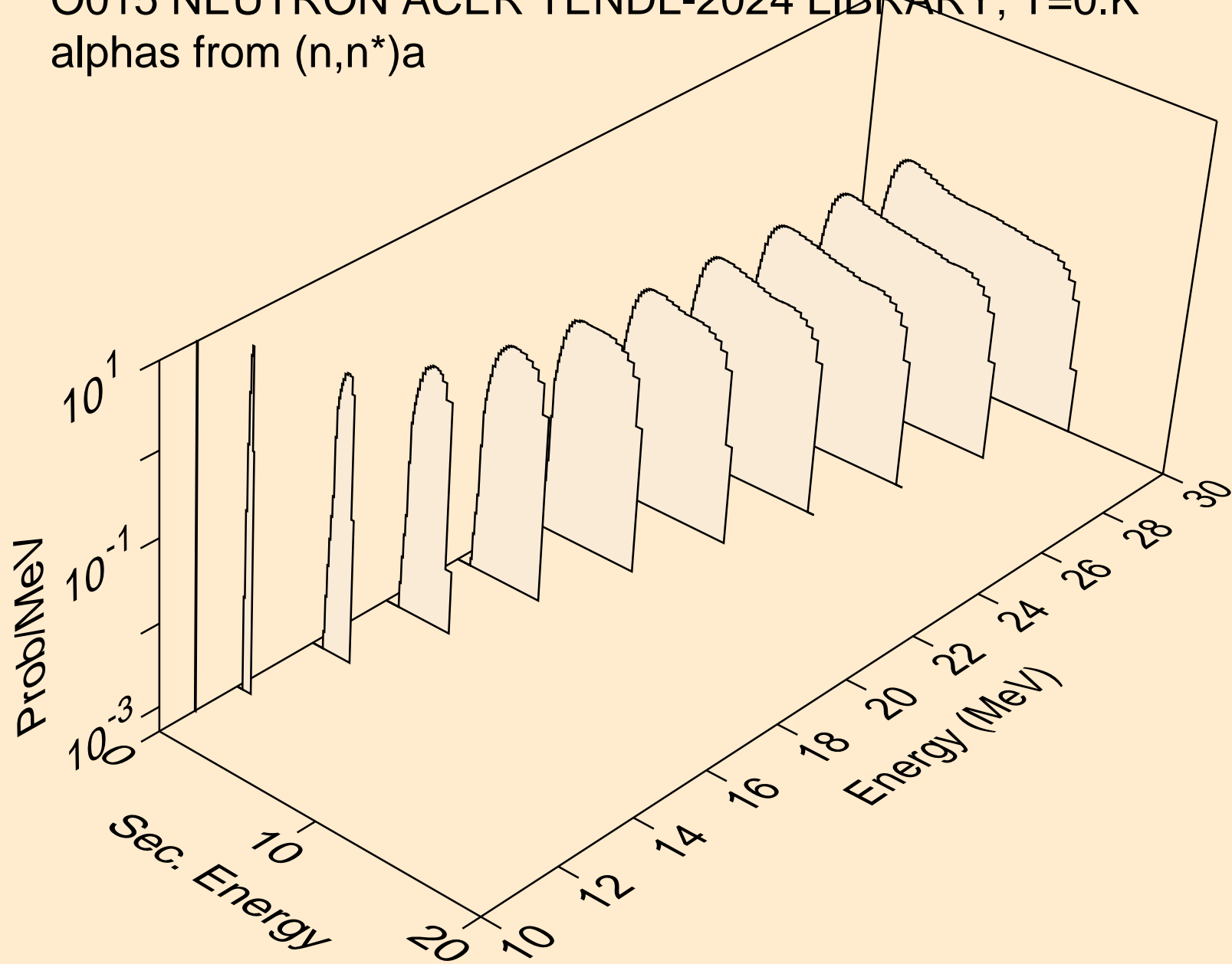

O015 NEUTRON ACER TENDL-2024 LIBRARY; T=0.K
alphas from (n,2n)a

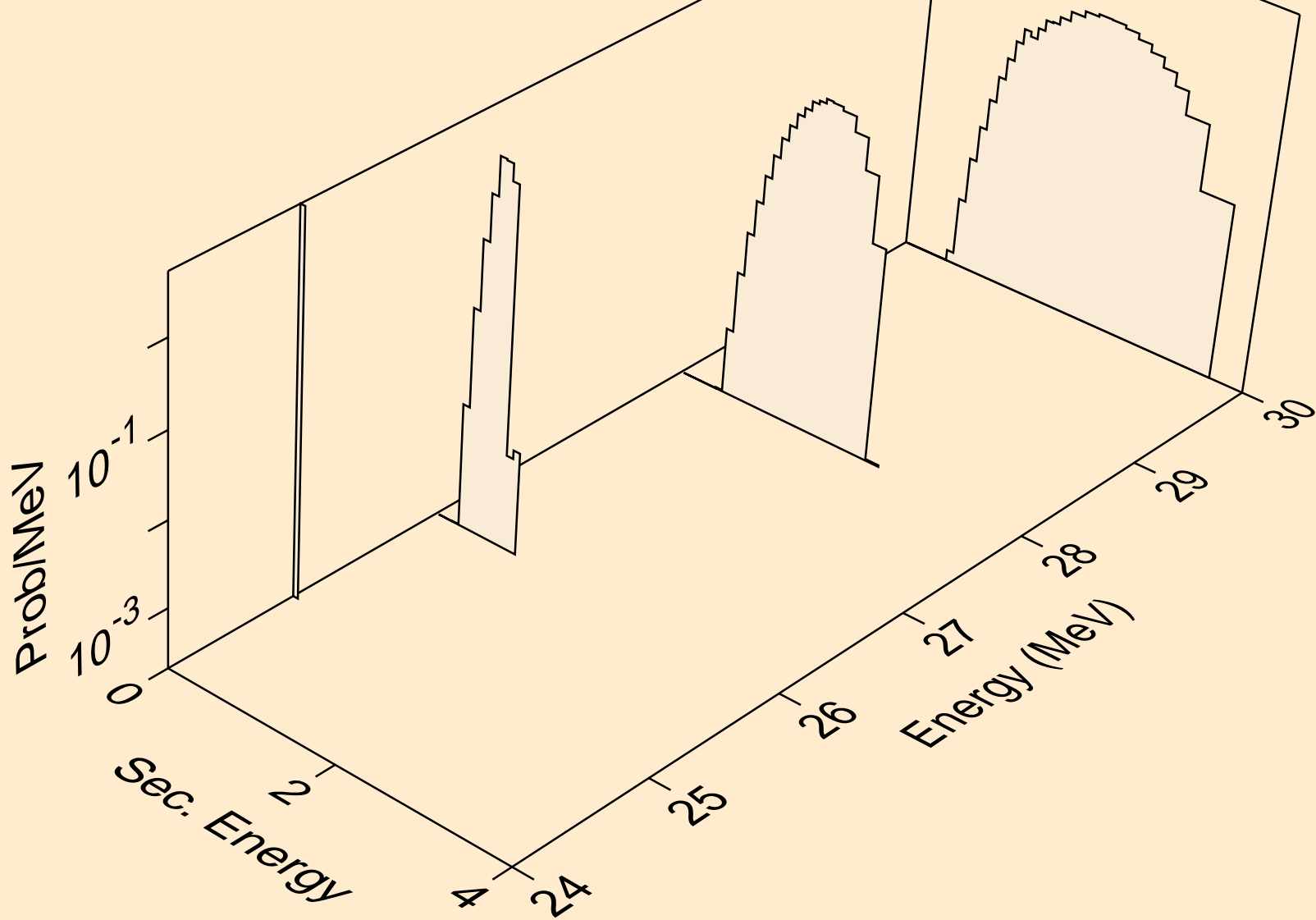

O015 NEUTRON ACER TENDL-2024 LIBRARY; T=0.K
alphas from (n,n*)2a

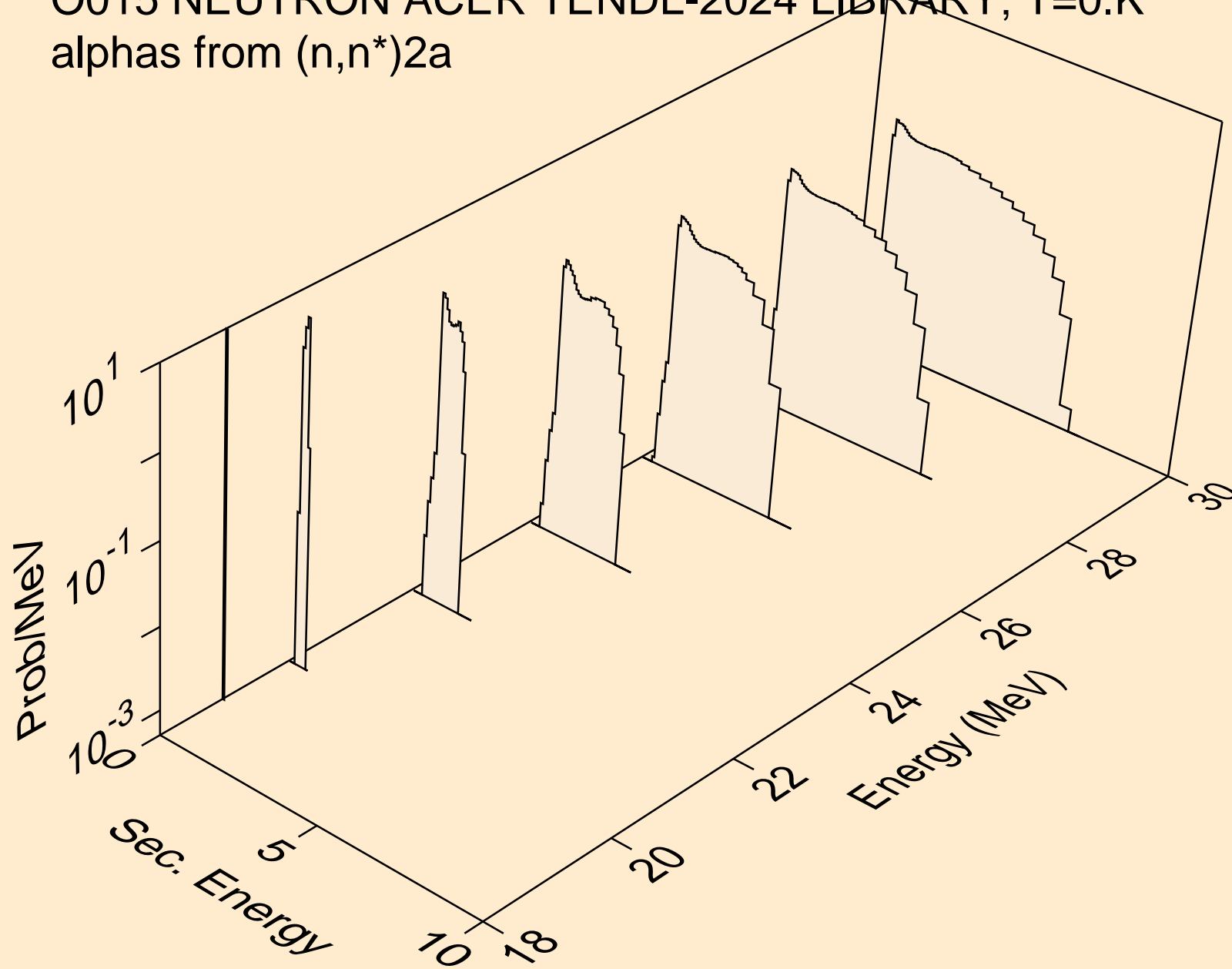

O015 NEUTRON ACER TENDL-2024 LIBRARY; T=0.K
alphas from (n,npa)

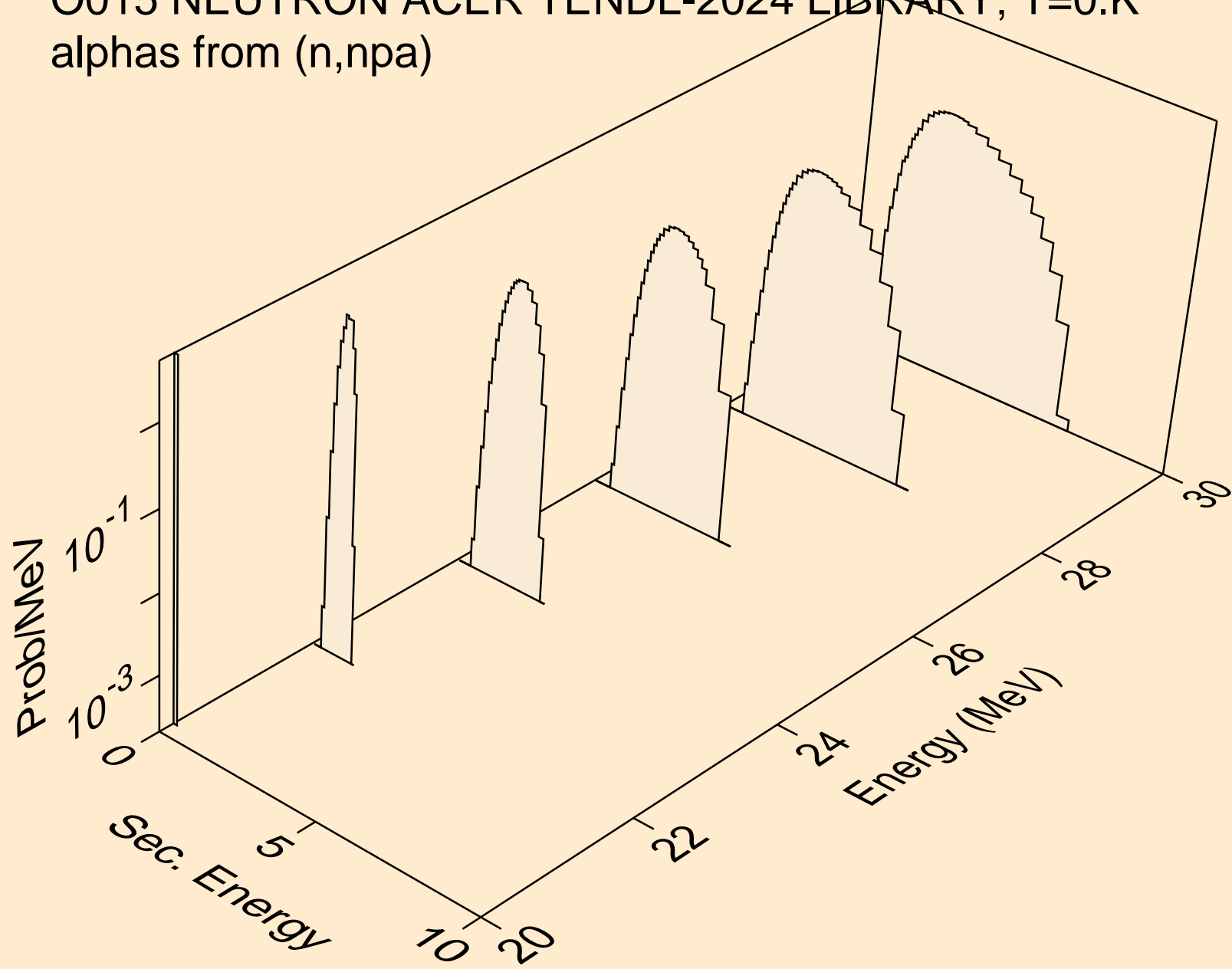

O015 NEUTRON ACER TENDL-2024 LIBRARY; T=0.K
alphas from (n,a)

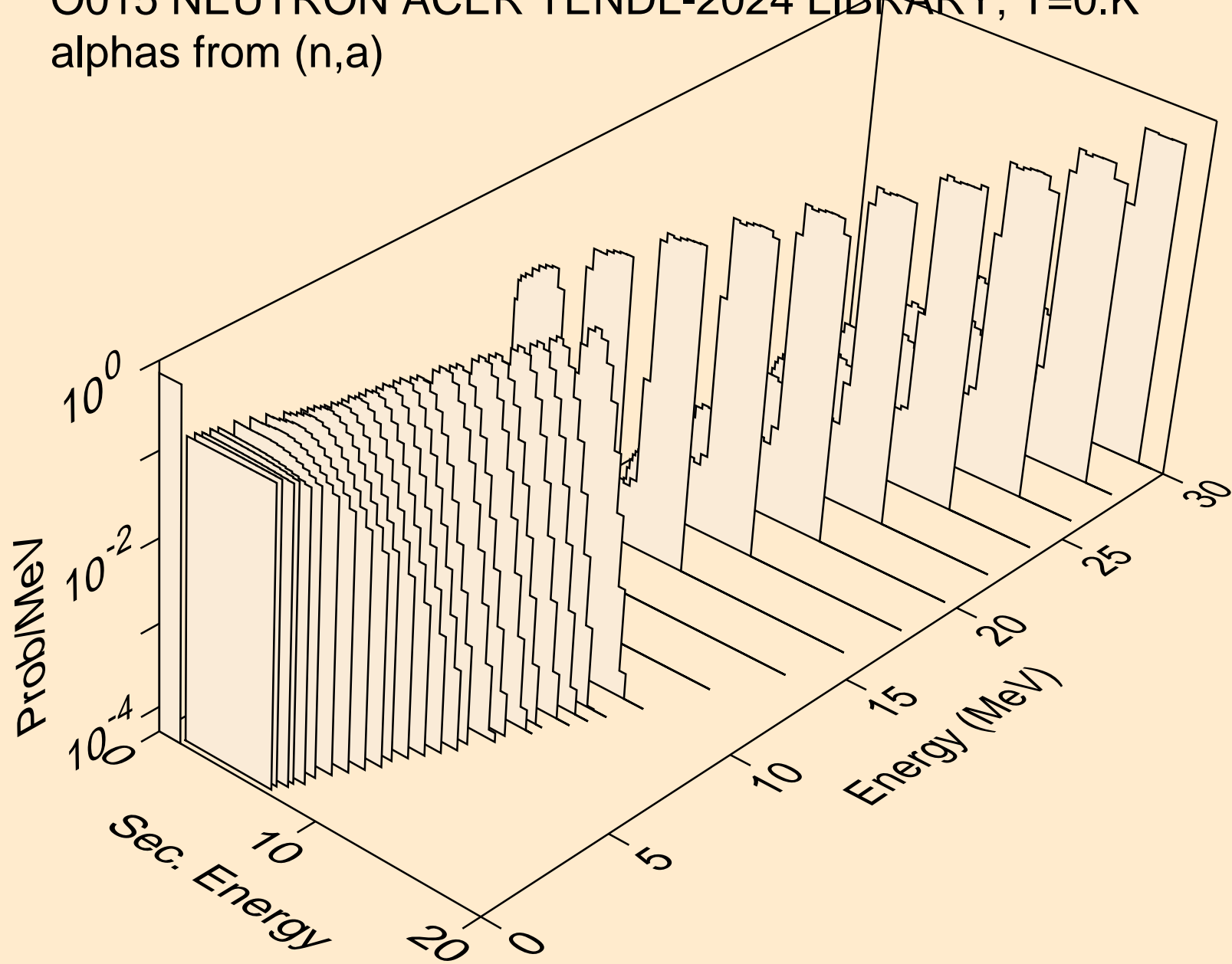

O015 NEUTRON ACER TENDL-2024 LIBRARY; T=0.K
alphas from (n,2a)

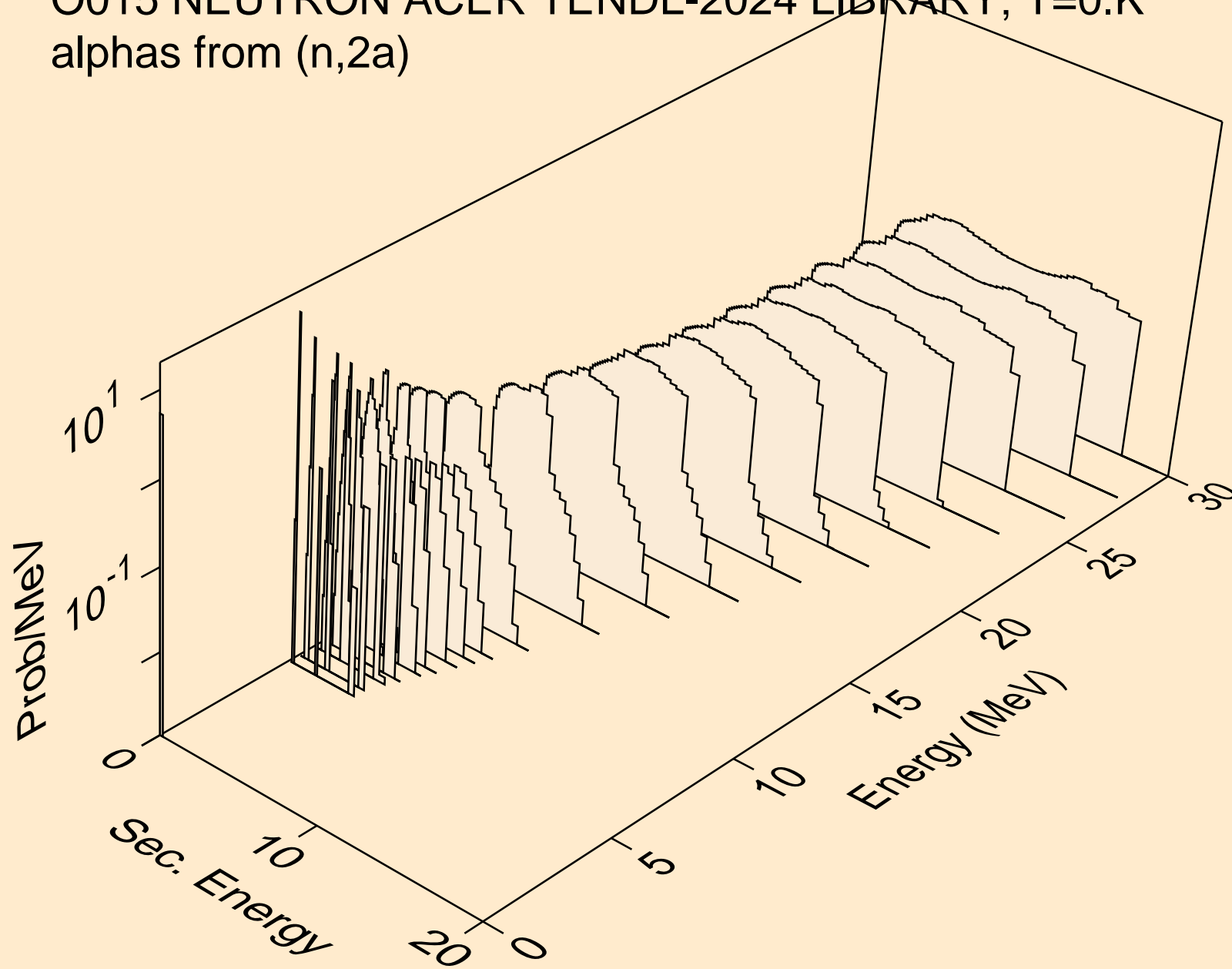

O015 NEUTRON ACER TENDL-2024 LIBRARY; T=0.K
alphas from (n,pa)

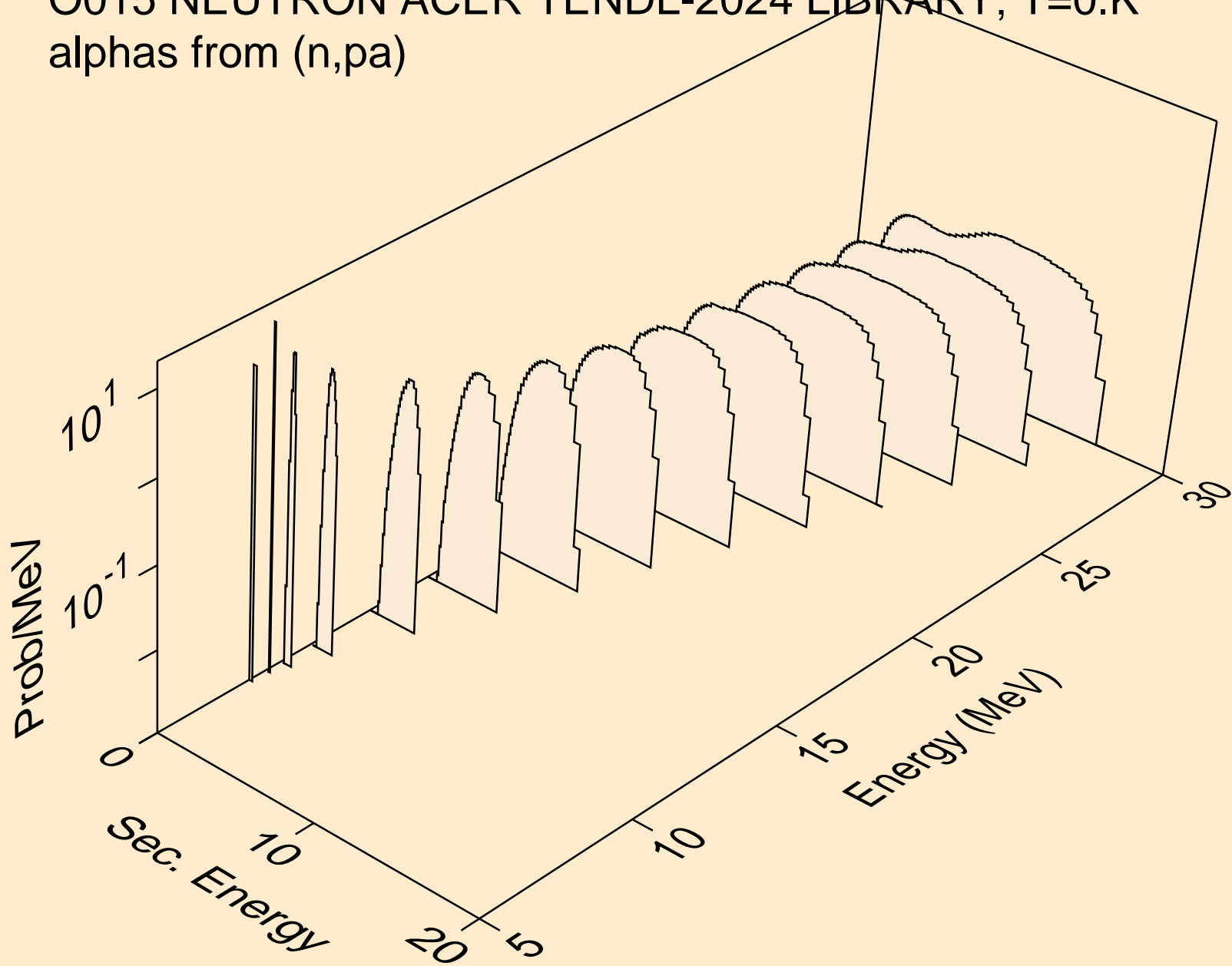

O015 NEUTRON ACER TENDL-2024 LIBRARY; T=0.K
alphas from (n,d2a)

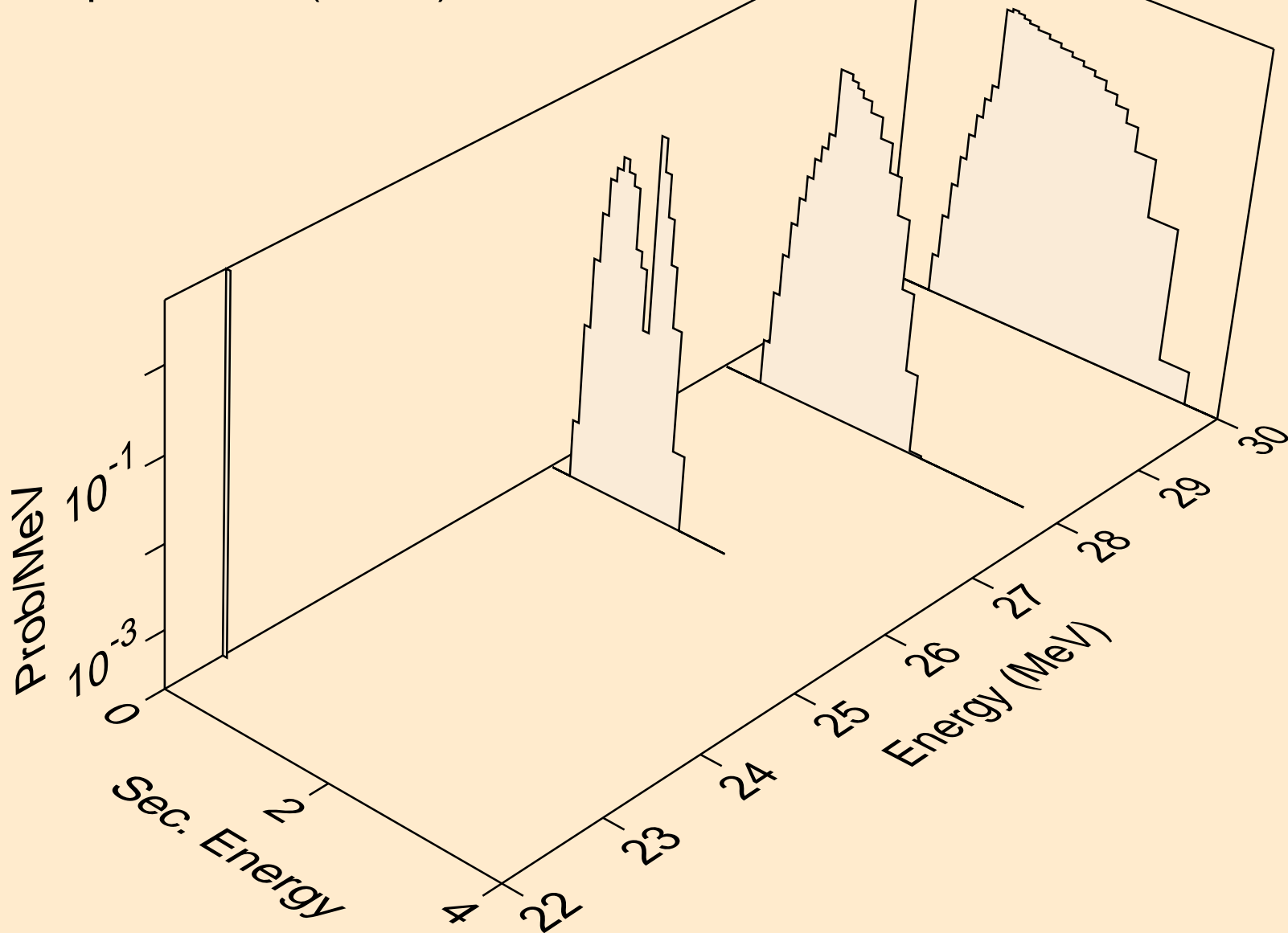

O015 NEUTRON ACER TENDL-2024 LIBRARY; T=0.K
alphas from (n,da)

