

PB192 NEUTRON ACER TENDL-2024 LIBRARY; T=0.K

Principal cross sections

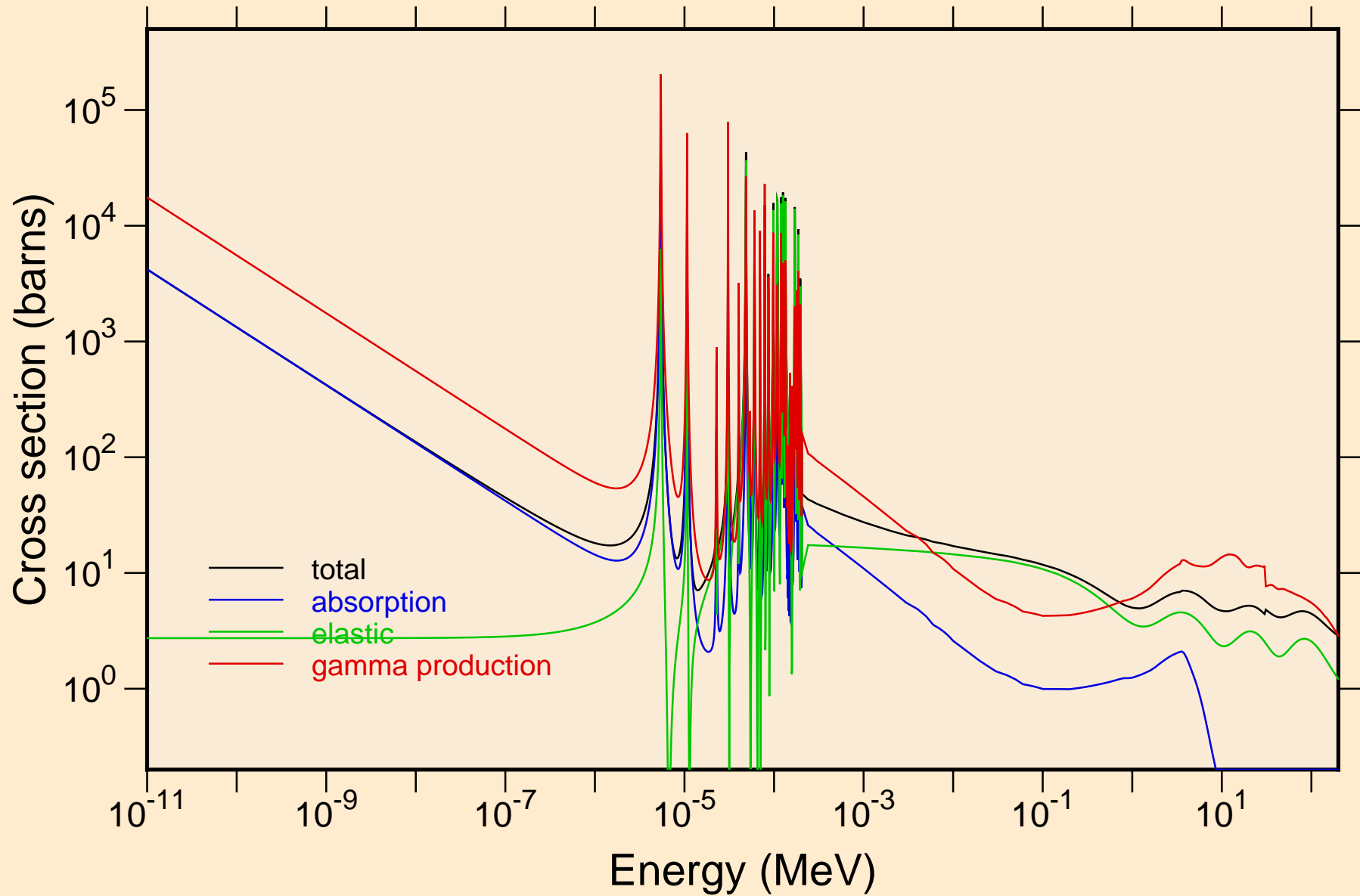

PB192 NEUTRON ACER TENDL-2024 LIBRARY; T=0.K
resonance total cross section

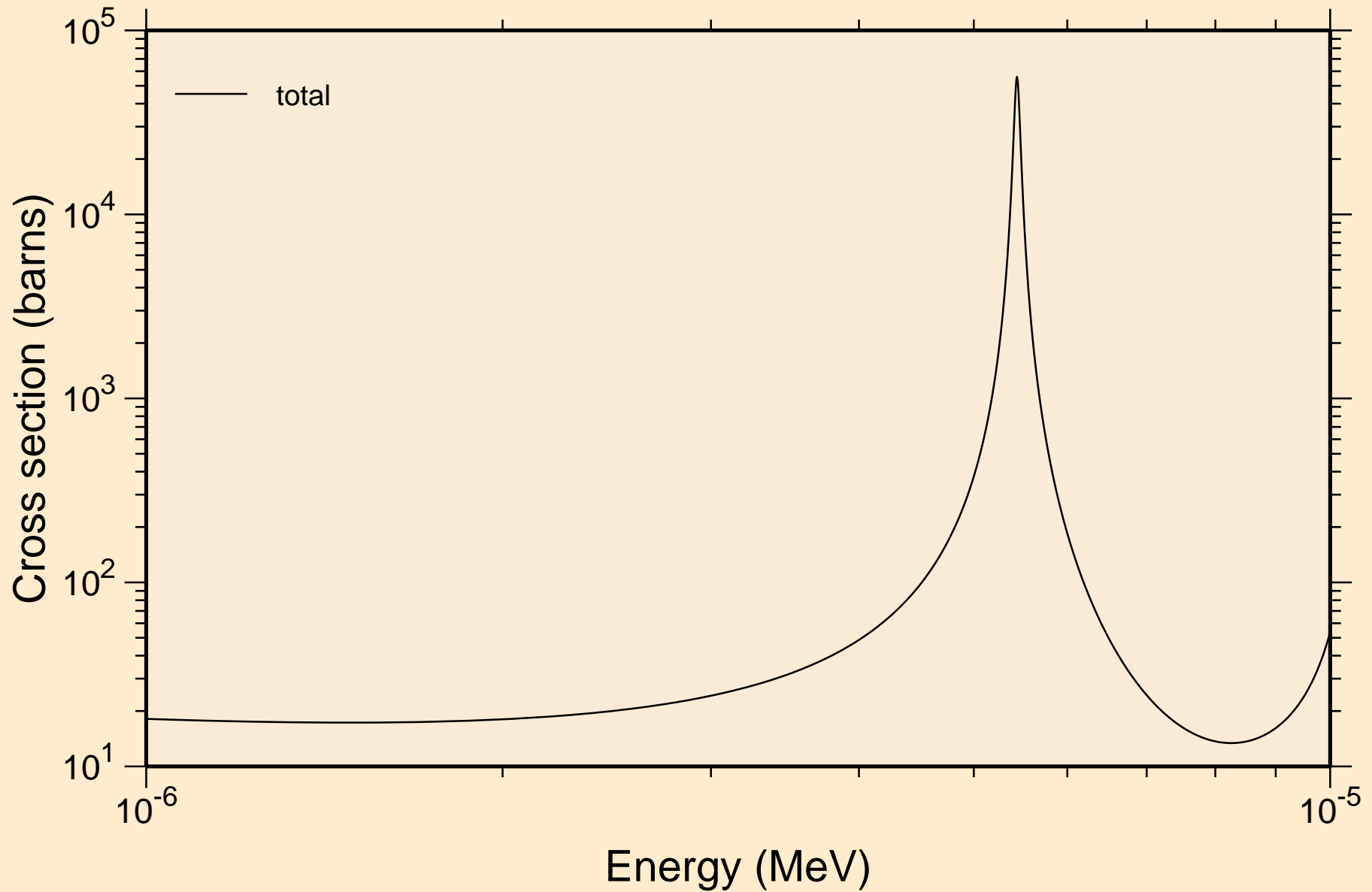

PB192 NEUTRON ACER TENDL-2024 LIBRARY; T=0.K
resonance total cross section

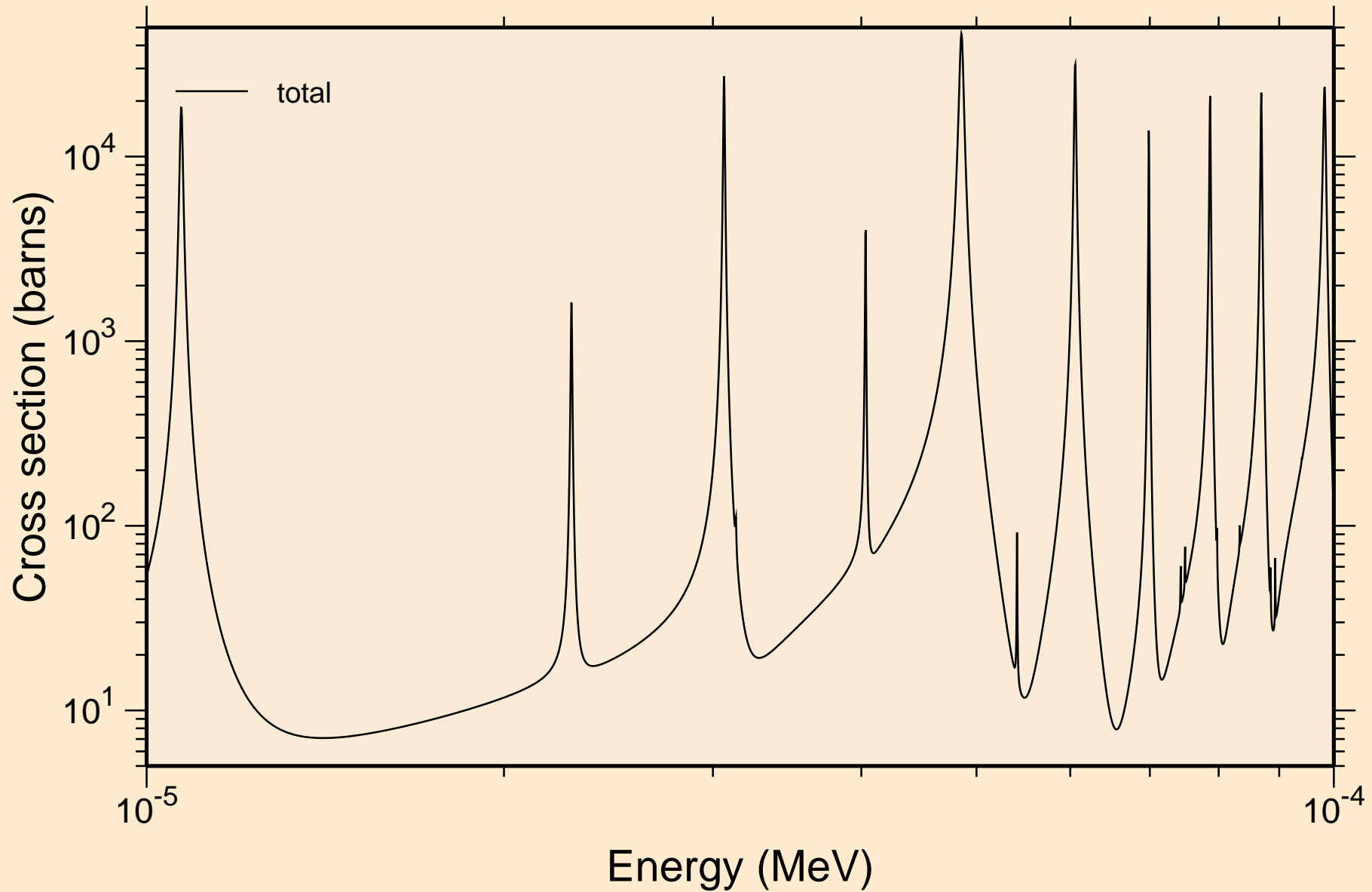

PB192 NEUTRON ACER TENDL-2024 LIBRARY; T=0.K
resonance total cross section

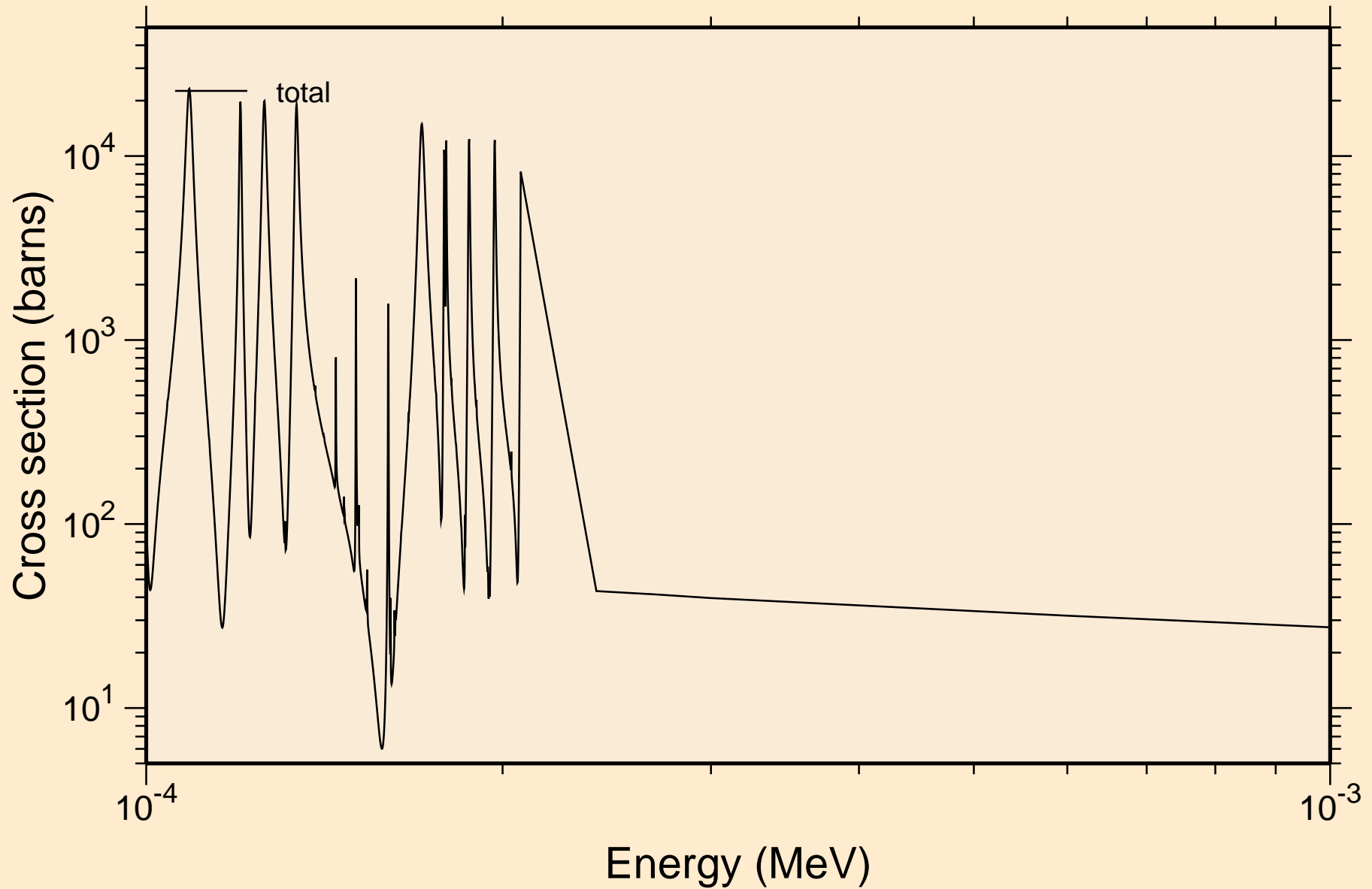

PB192 NEUTRON ACER TENDL-2024 LIBRARY; T=0.K
resonance total cross section

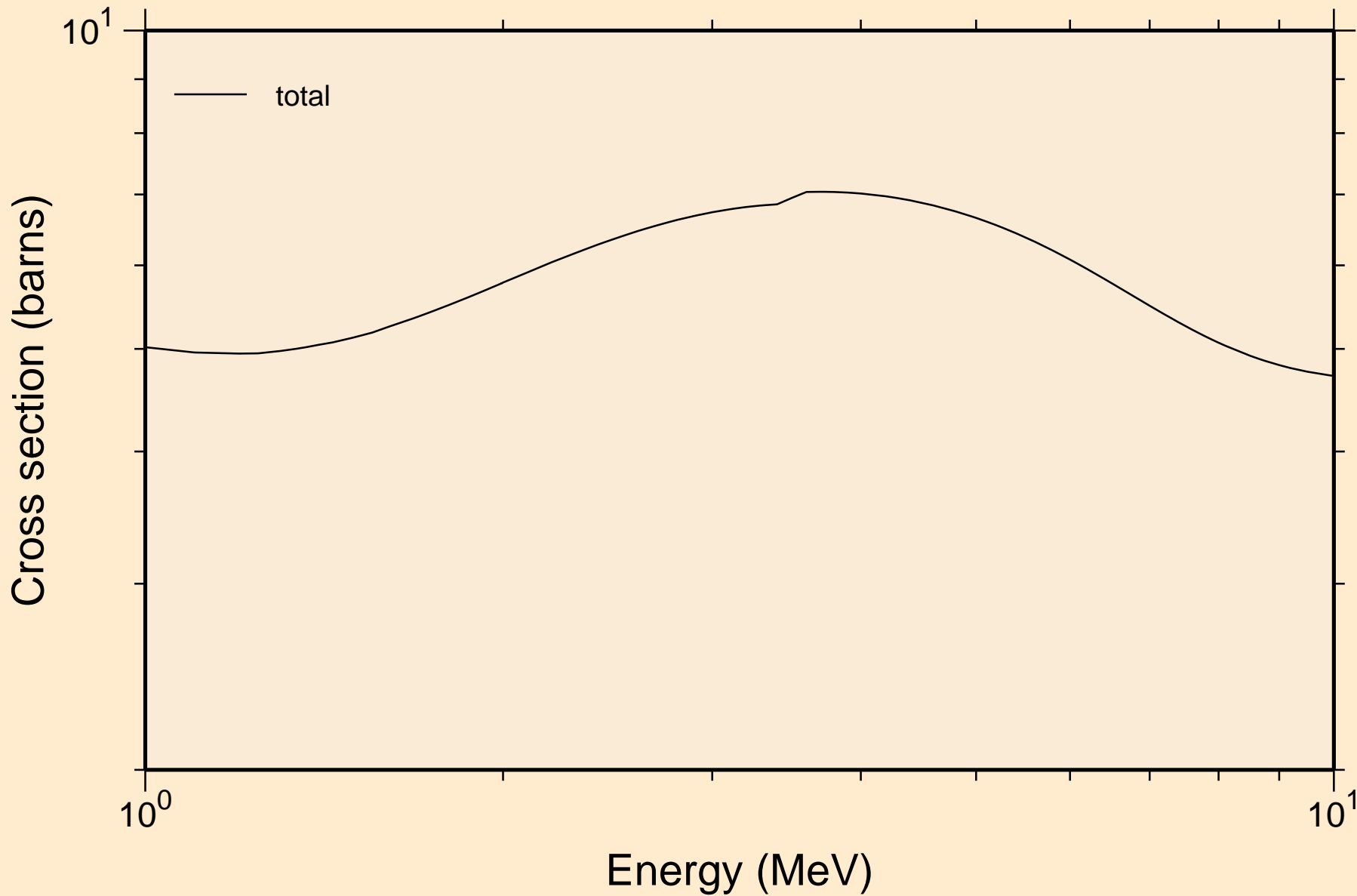

PB192 NEUTRON ACER TENDL-2024 LIBRARY; T=0.K
resonance absorption cross sections

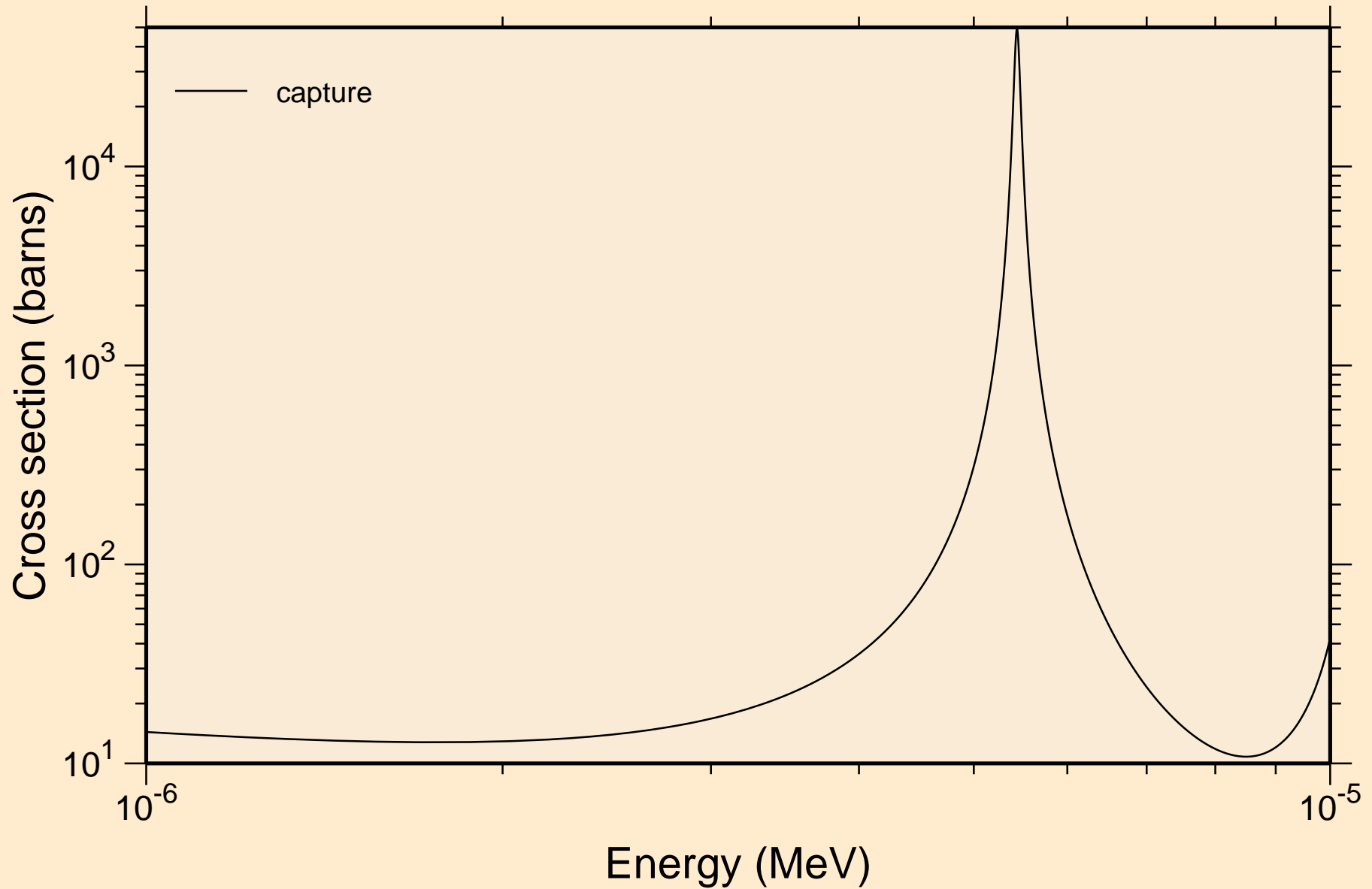

PB192 NEUTRON ACER TENDL-2024 LIBRARY; T=0.K
resonance absorption cross sections

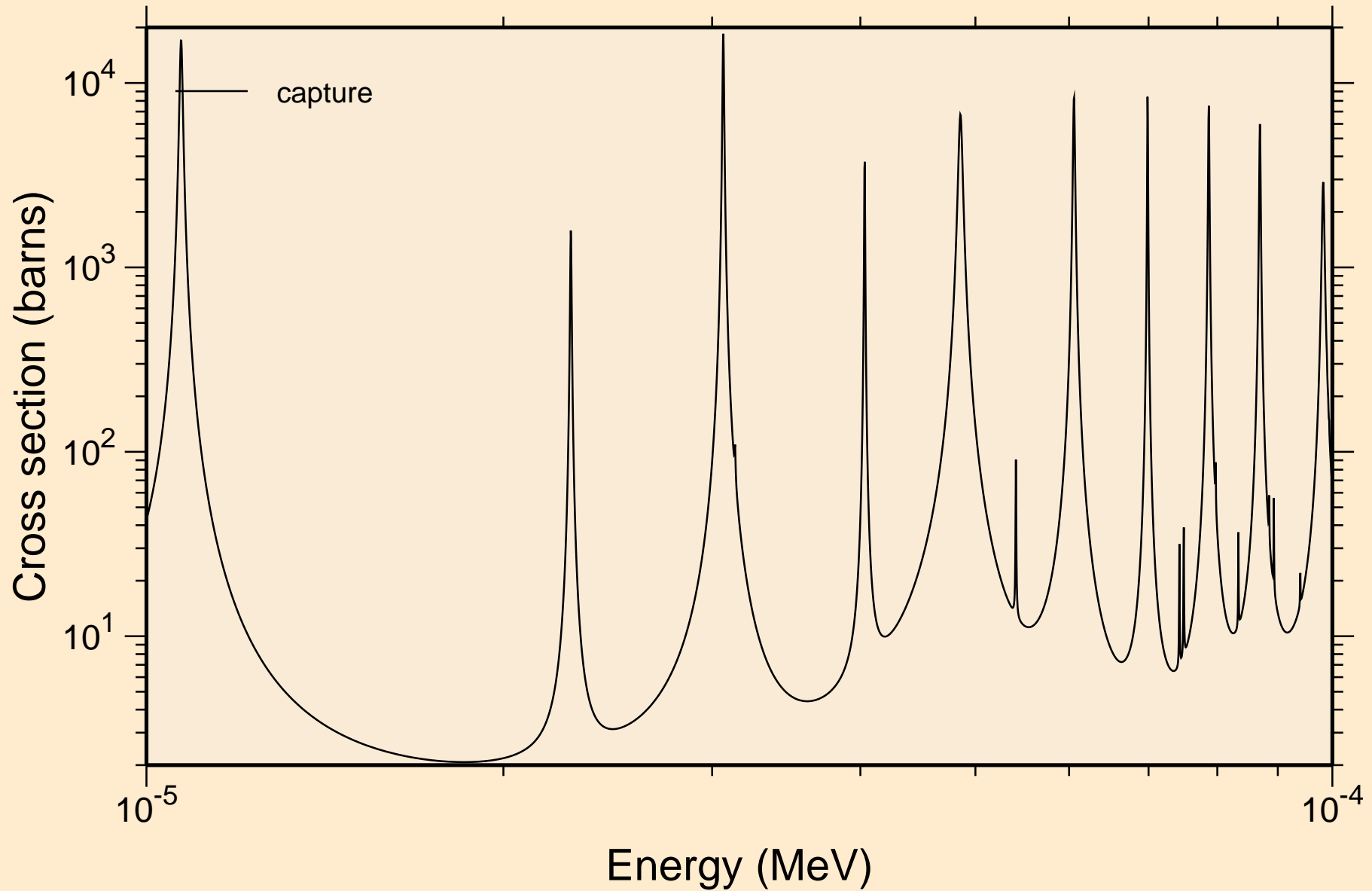

PB192 NEUTRON ACER TENDL-2024 LIBRARY; T=0.K
resonance absorption cross sections

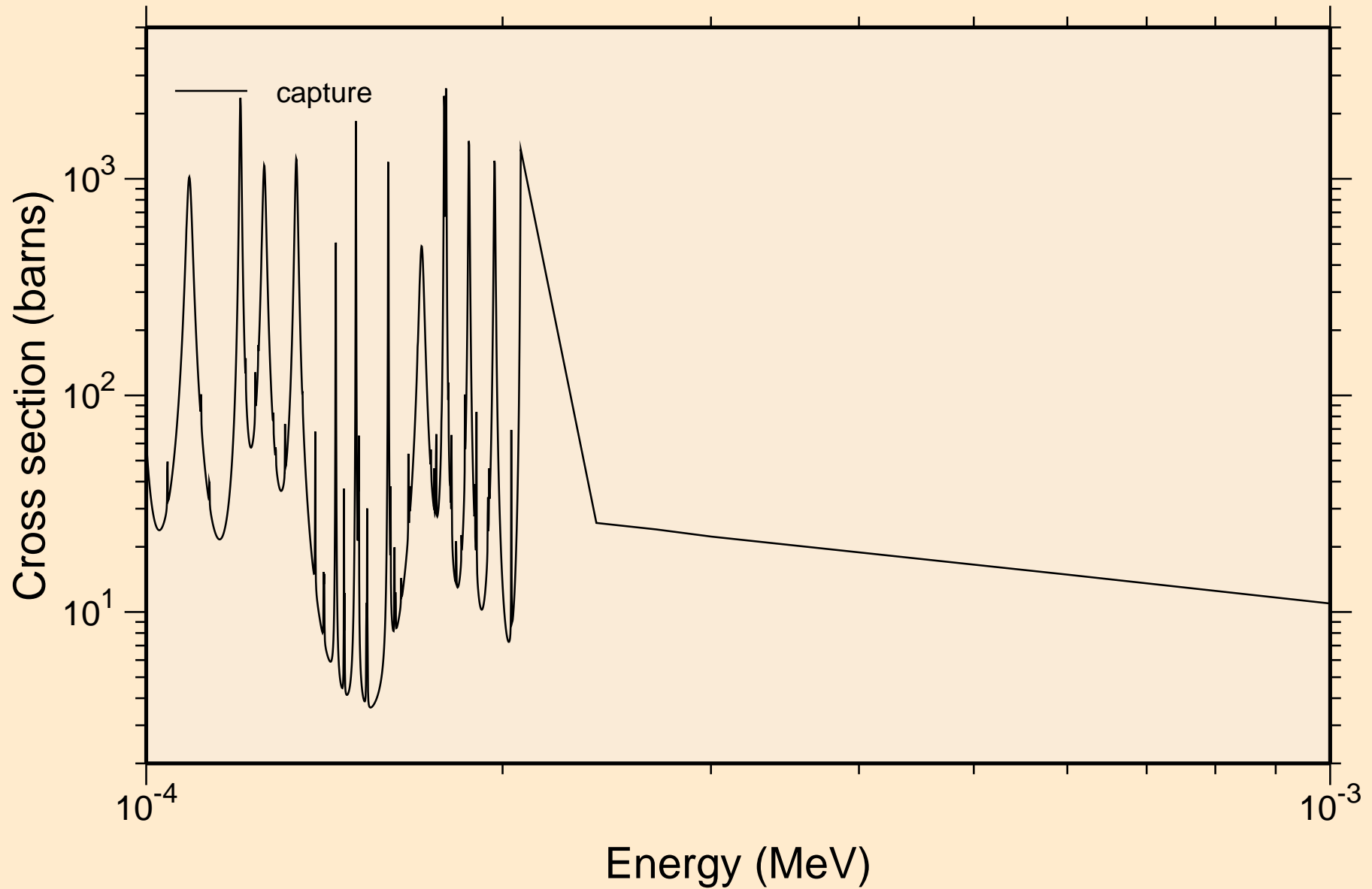

PB192 NEUTRON ACER TENDL-2024 LIBRARY; T=0.K
resonance absorption cross sections

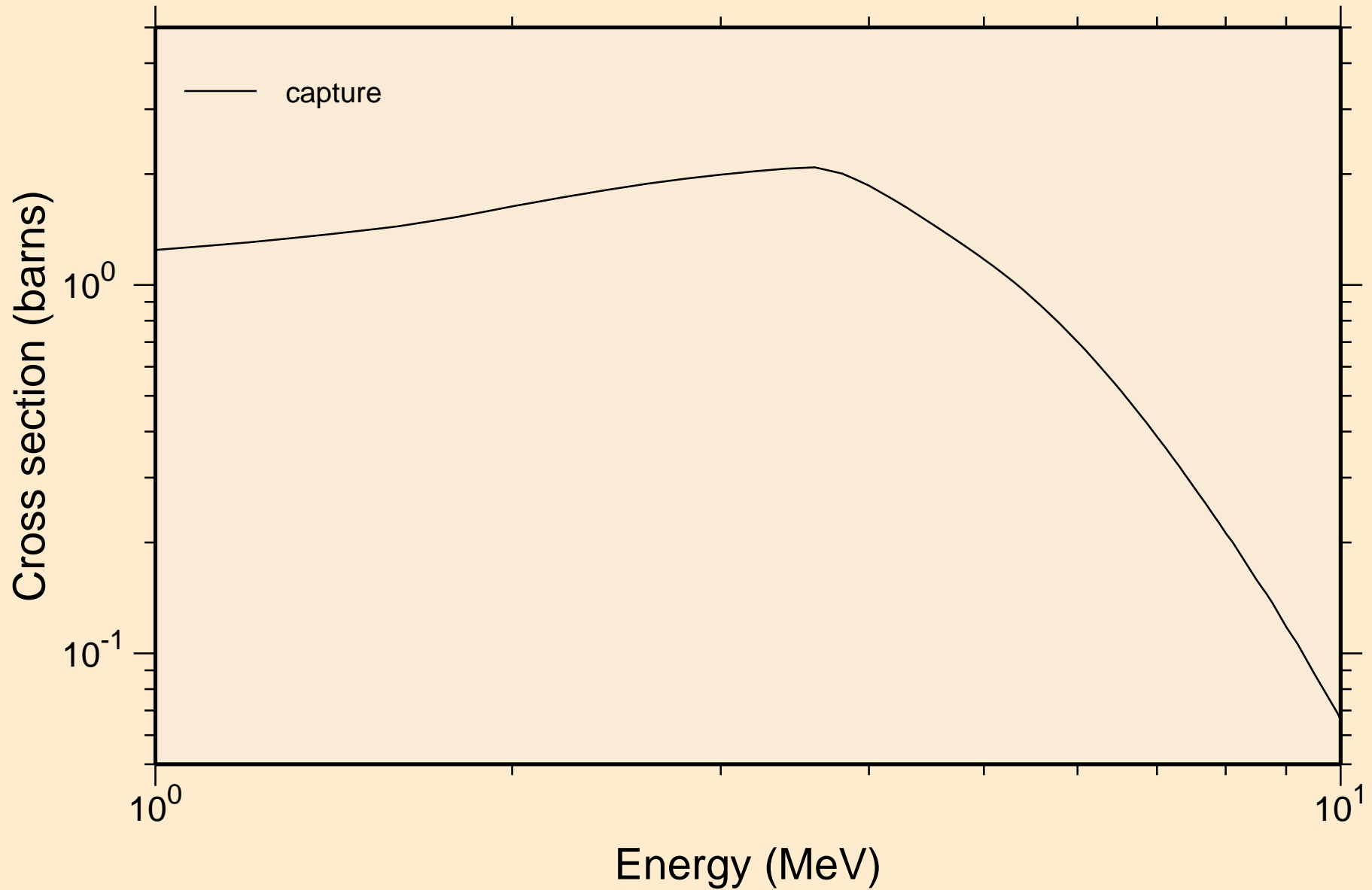

PB192 NEUTRON ACER TENDL-2024 LIBRARY; T=0.K
Heating

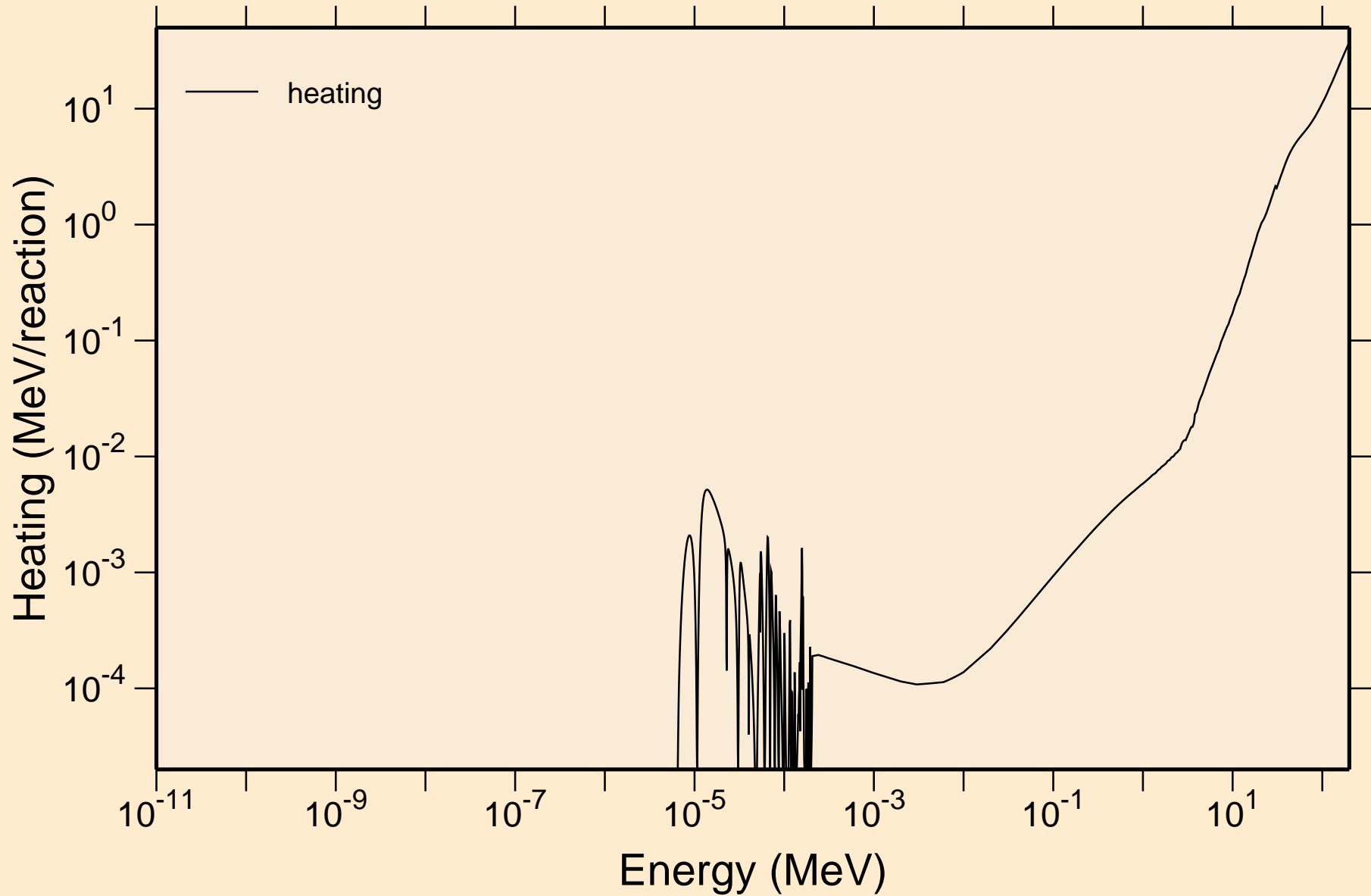

PB192 NEUTRON ACER TENDL-2024 LIBRARY; T=0.K

Damage

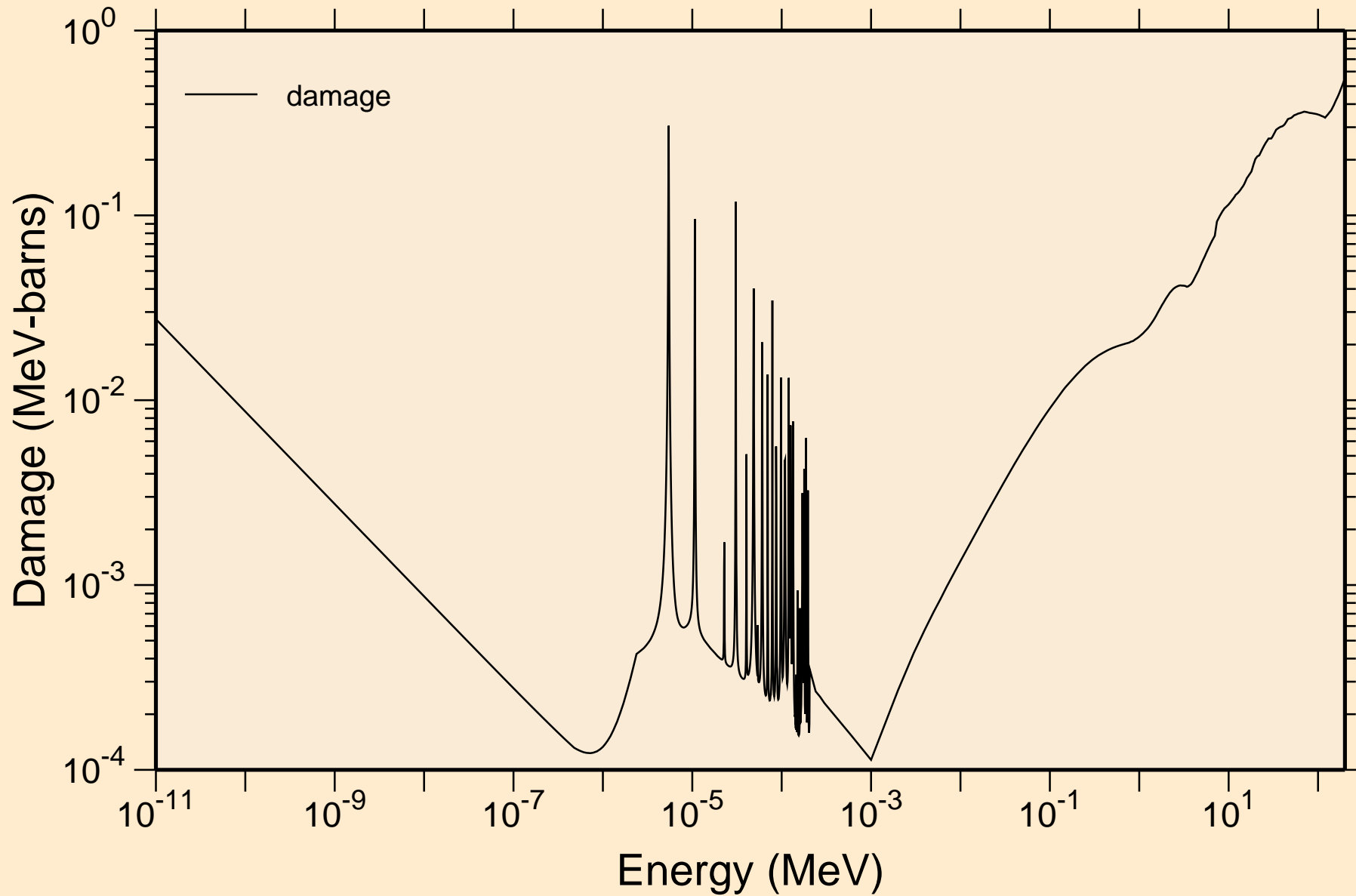

PB192 NEUTRON ACER TENDL-2024 LIBRARY; T=0.K
Non-threshold reactions

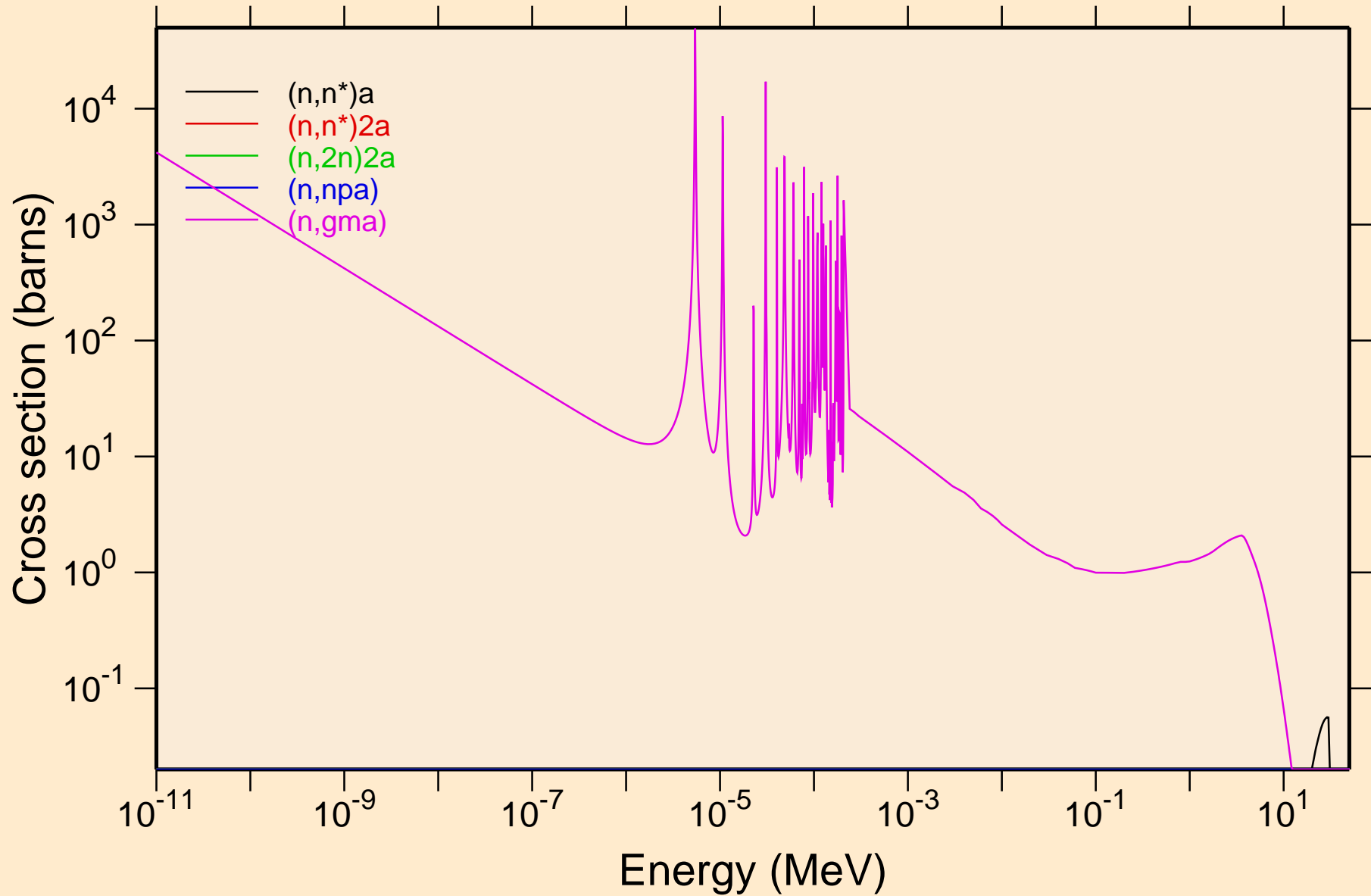

PB192 NEUTRON ACER TENDL-2024 LIBRARY; T=0.K
Non-threshold reactions

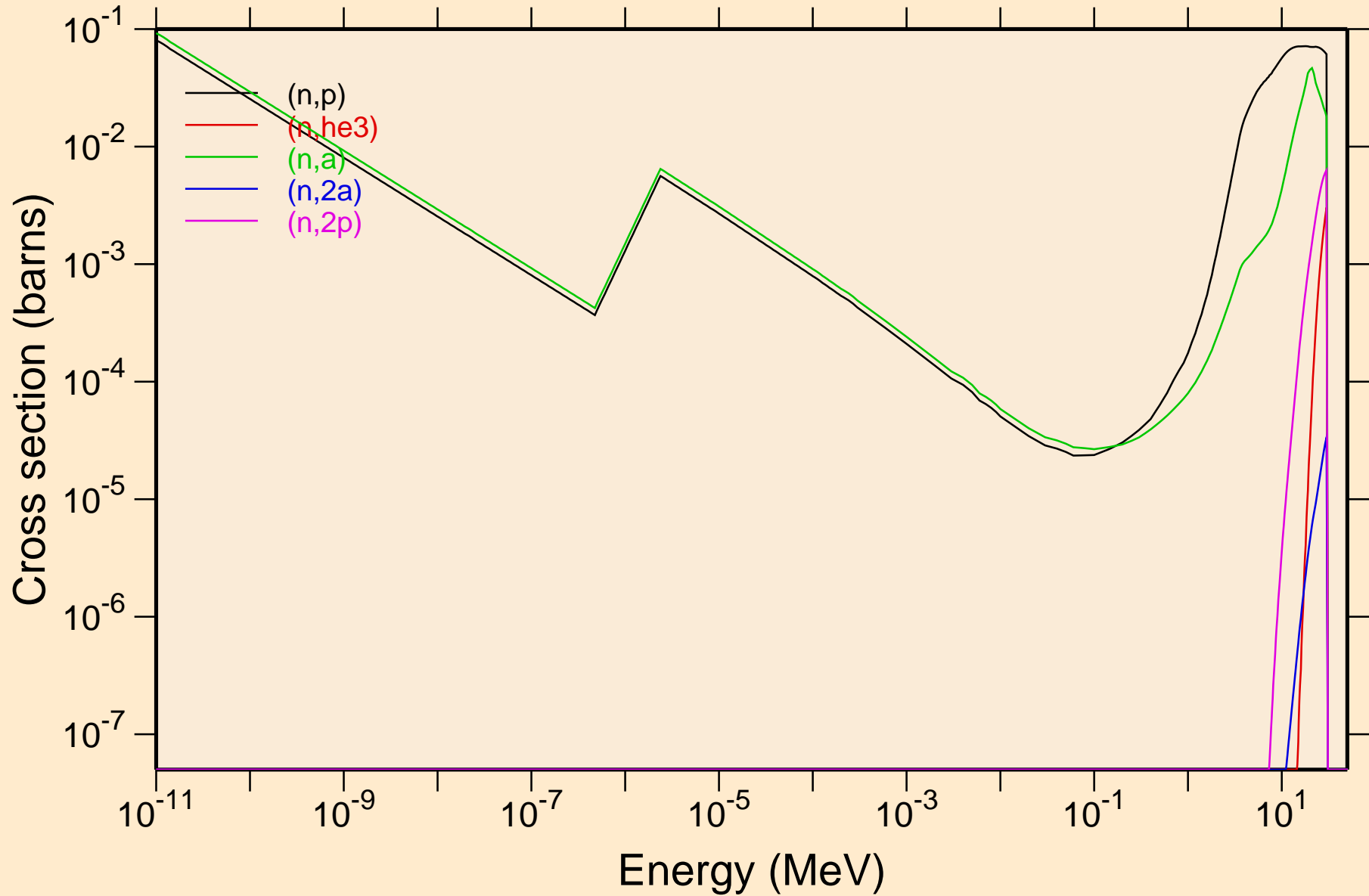

PB192 NEUTRON ACER TENDL-2024 LIBRARY; T=0.K
Non-threshold reactions

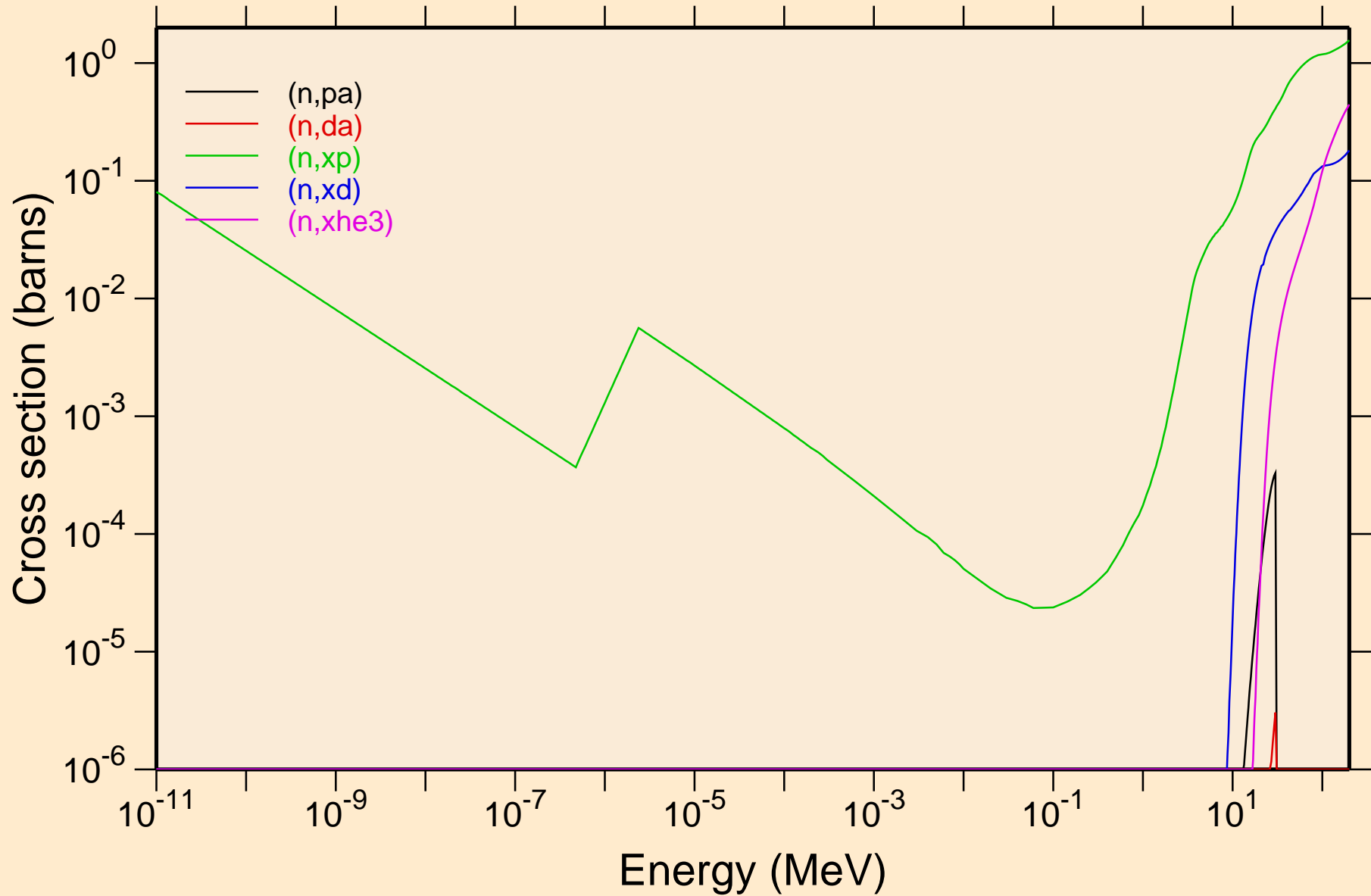

PB192 NEUTRON ACER TENDL-2024 LIBRARY; T=0.K
Non-threshold reactions

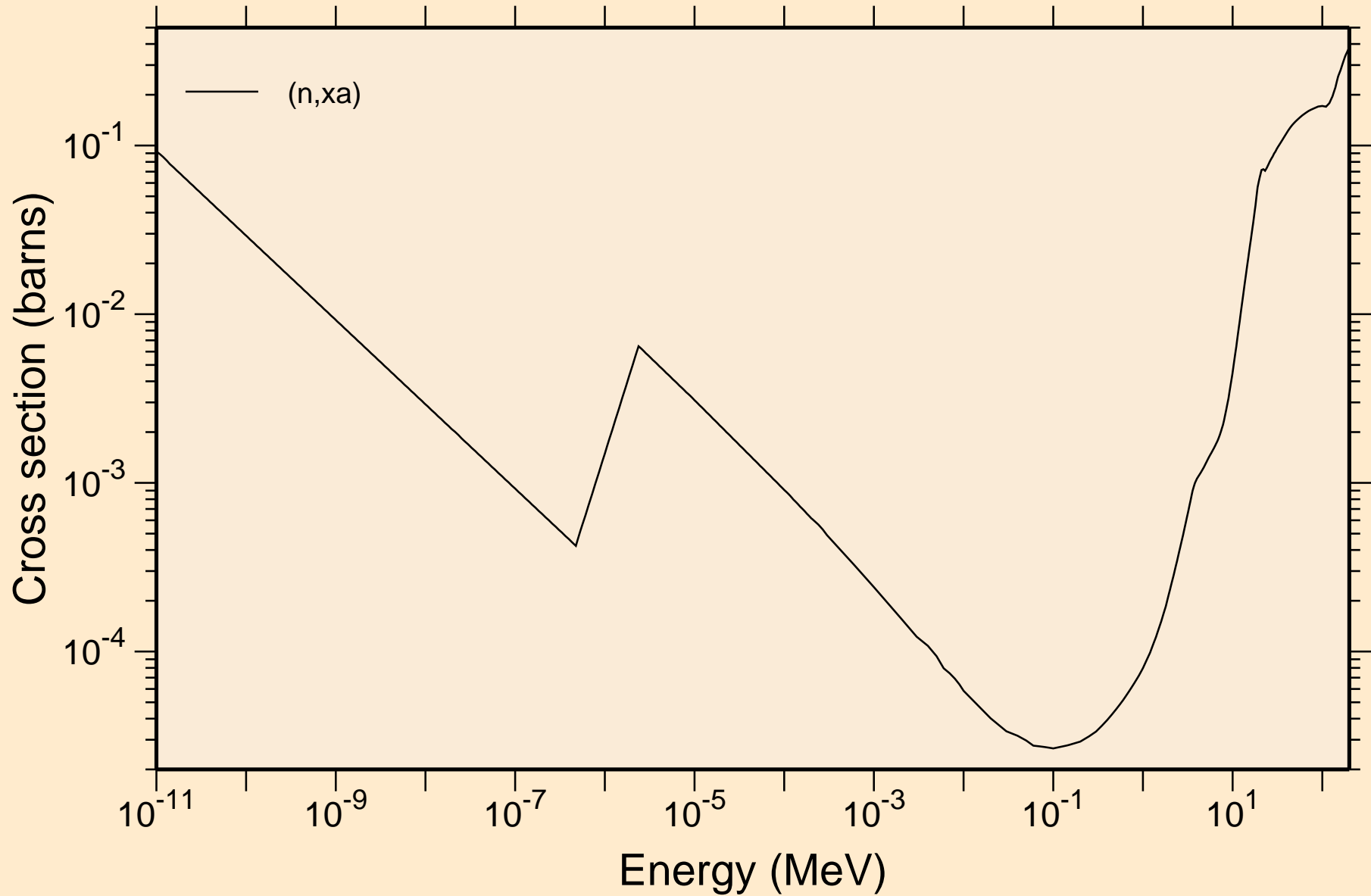

PB192 NEUTRON ACER TENDL-2024 LIBRARY; T=0.K
Principal cross sections

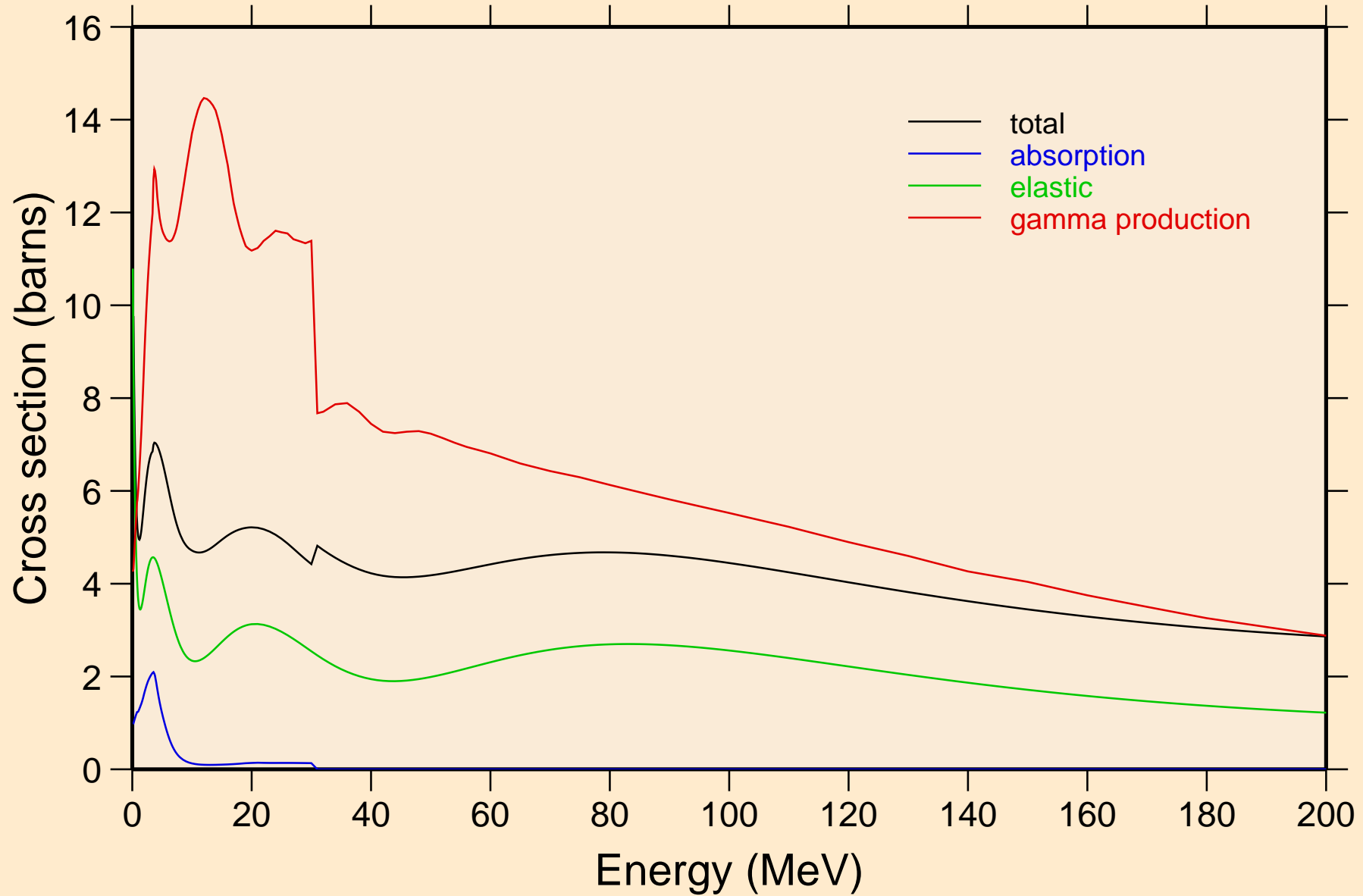

PB192 NEUTRON ACER TENDL-2024 LIBRARY; T=0.K

Heating

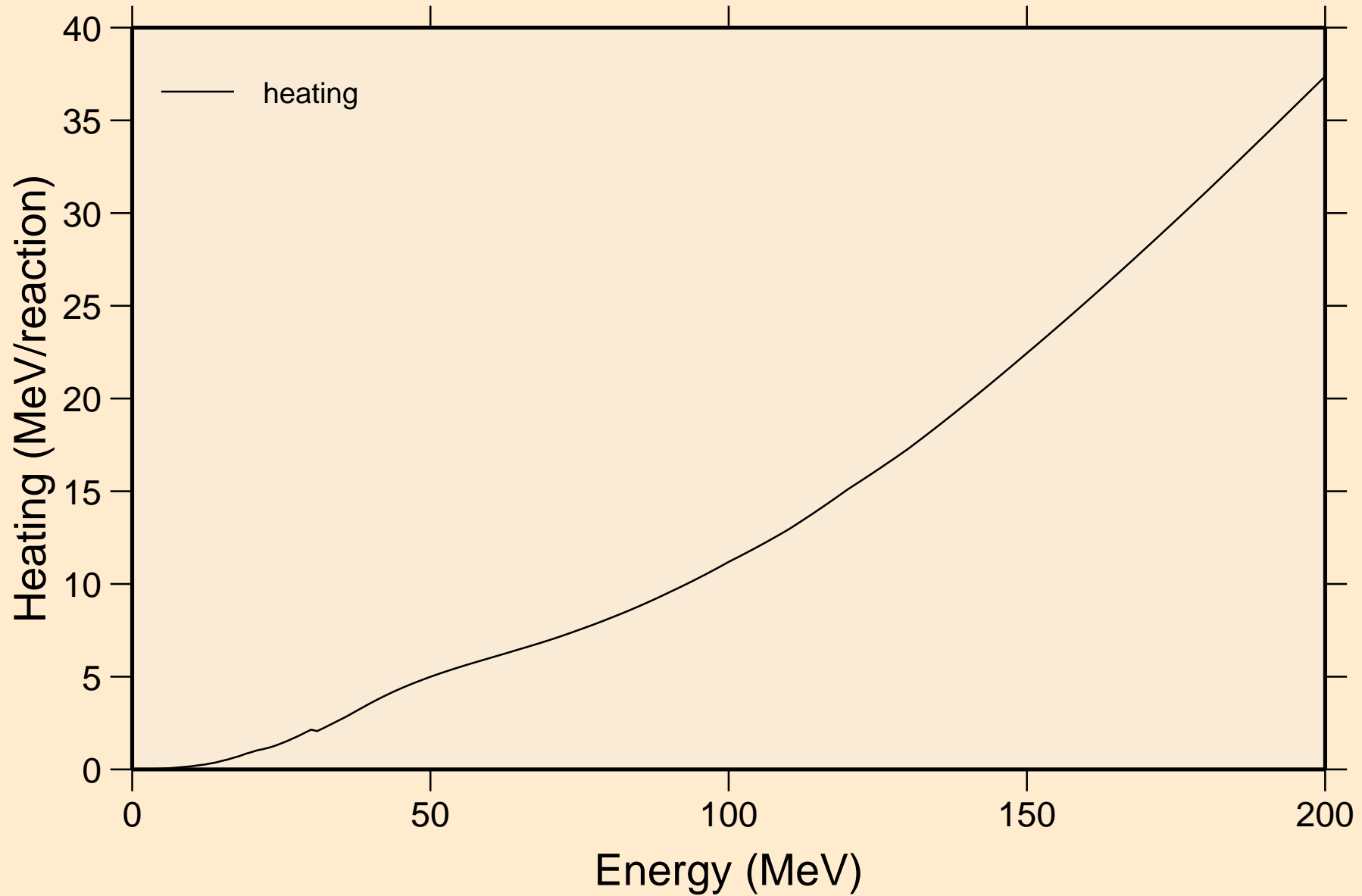

PB192 NEUTRON ACER TENDL-2024 LIBRARY; T=0.K
Damage

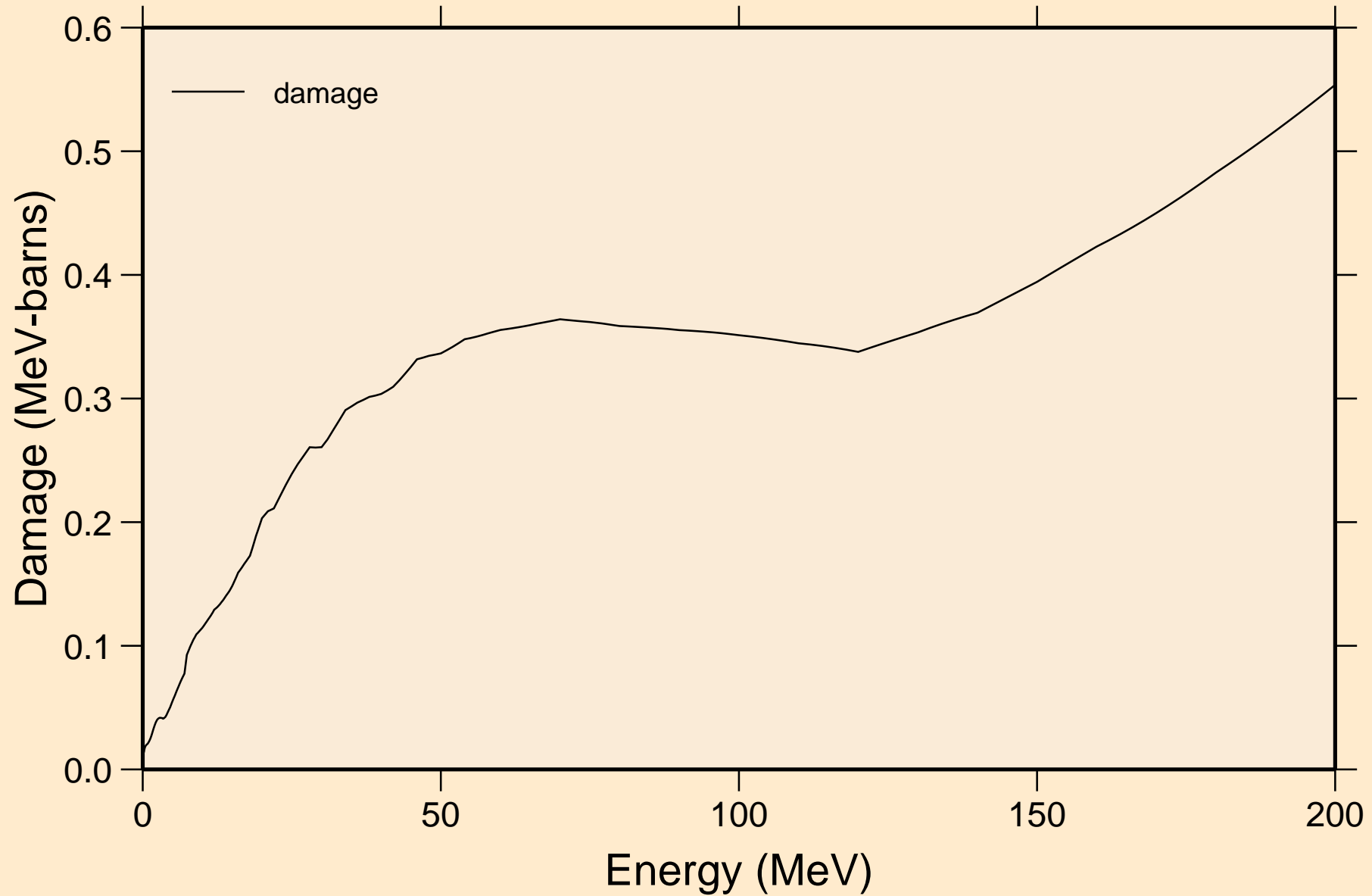

PB192 NEUTRON ACER TENDL-2024 LIBRARY; T=0.K
Non-threshold reactions

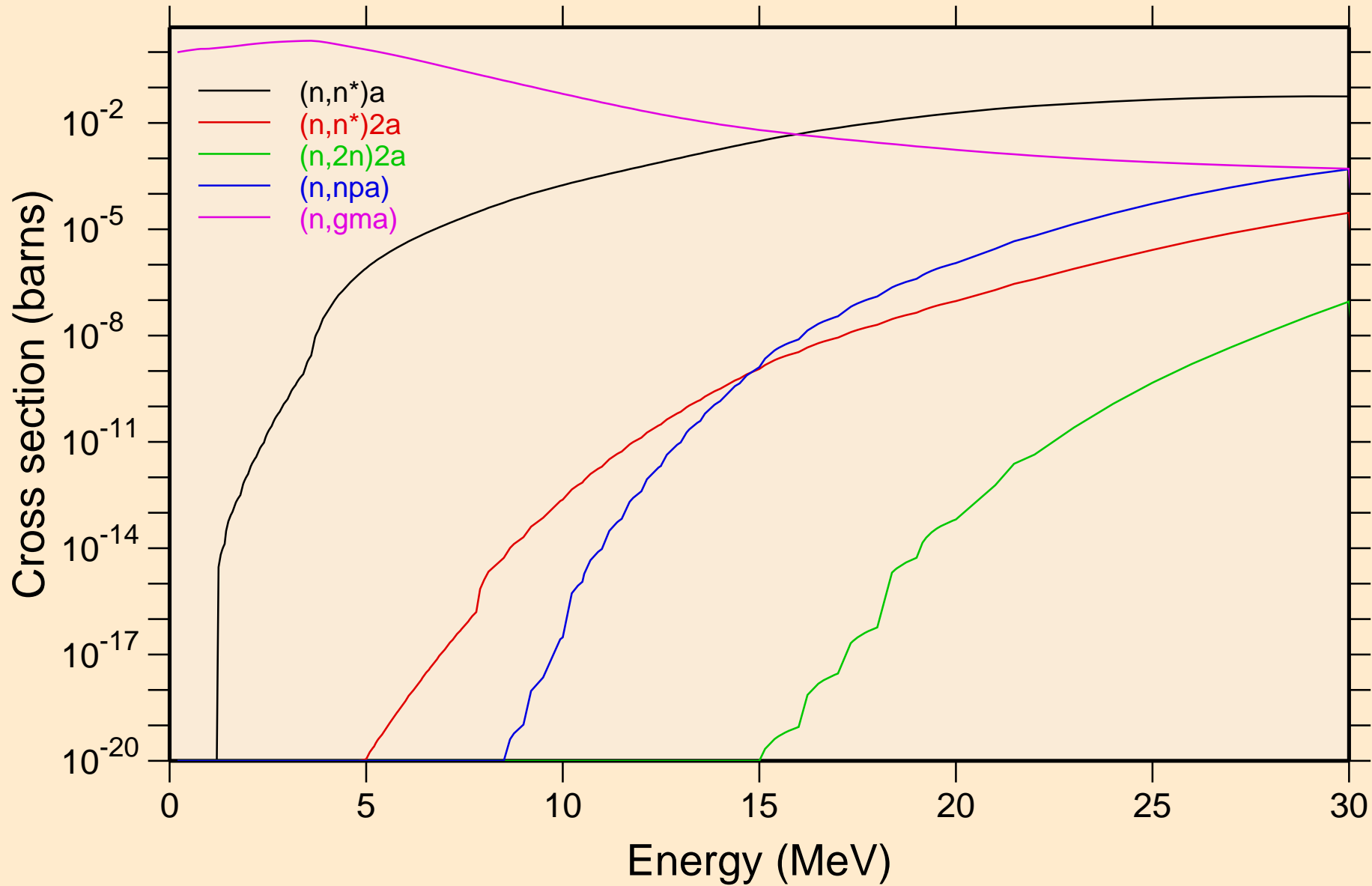

PB192 NEUTRON ACER TENDL-2024 LIBRARY; T=0.K
Non-threshold reactions

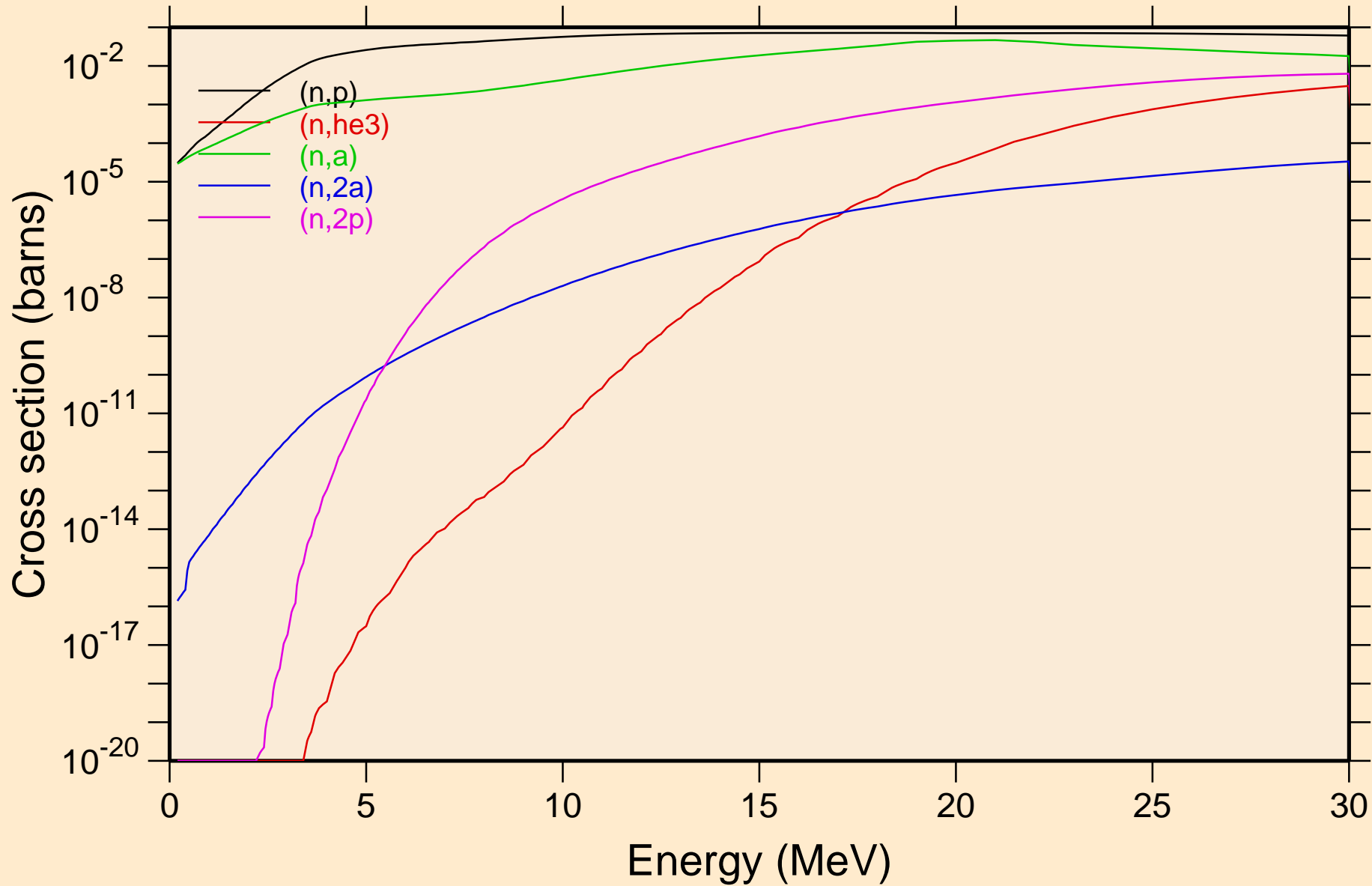

PB192 NEUTRON ACER TENDL-2024 LIBRARY; T=0.K

Non-threshold reactions

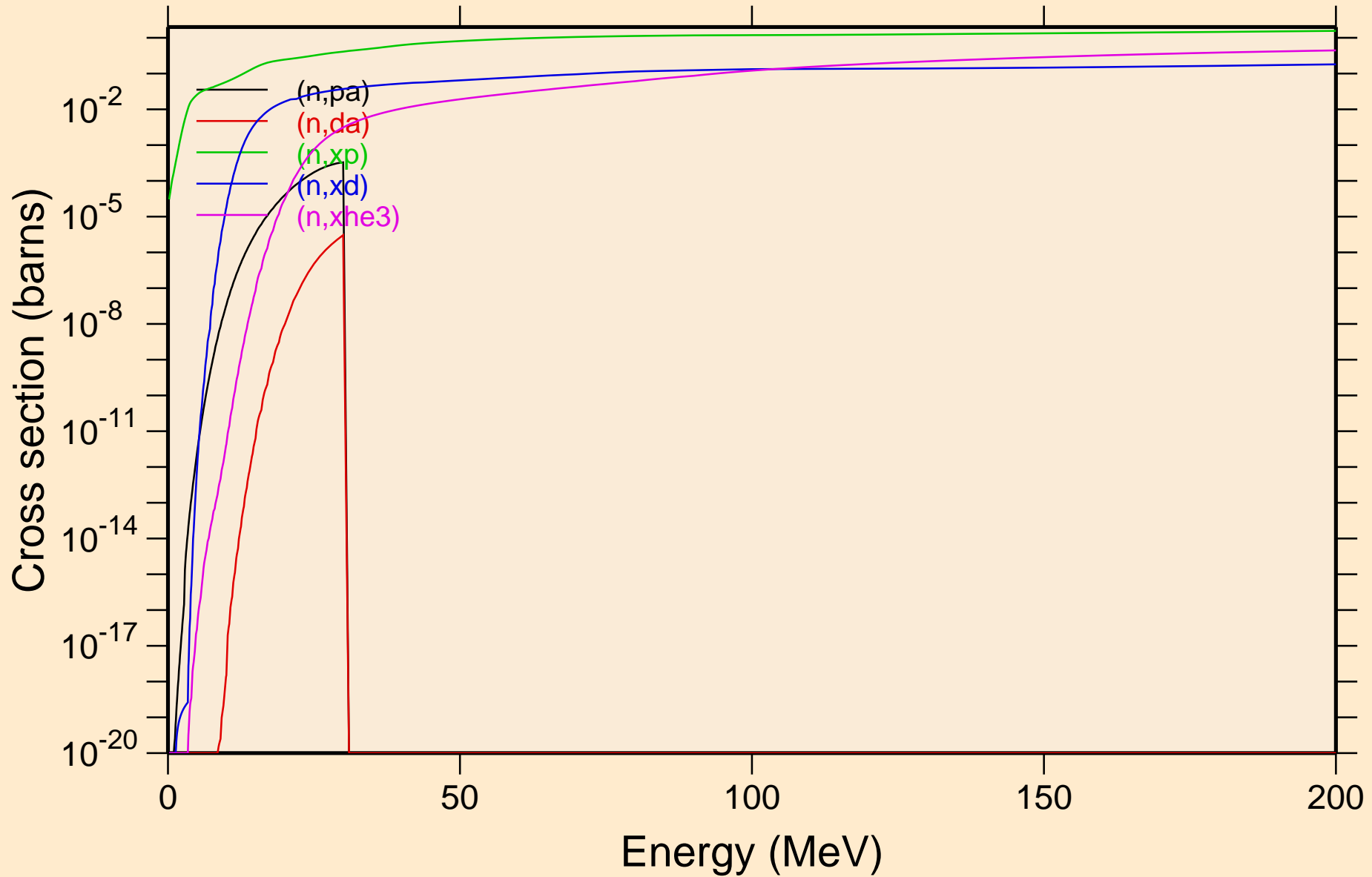

PB192 NEUTRON ACER TENDL-2024 LIBRARY; T=0.K
Non-threshold reactions

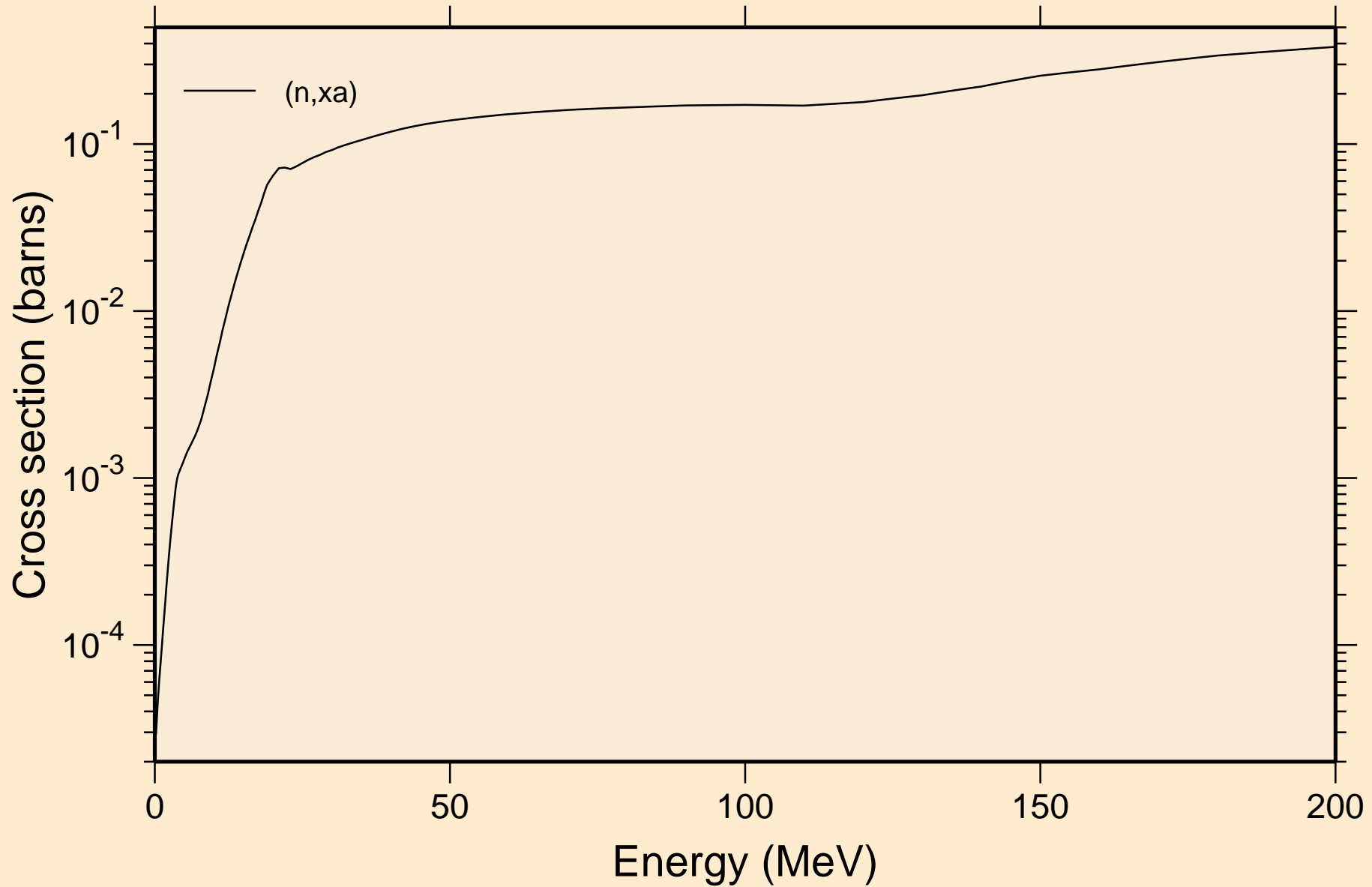

PB192 NEUTRON ACER TENDL-2024 LIBRARY; T=0.K
Inelastic levels

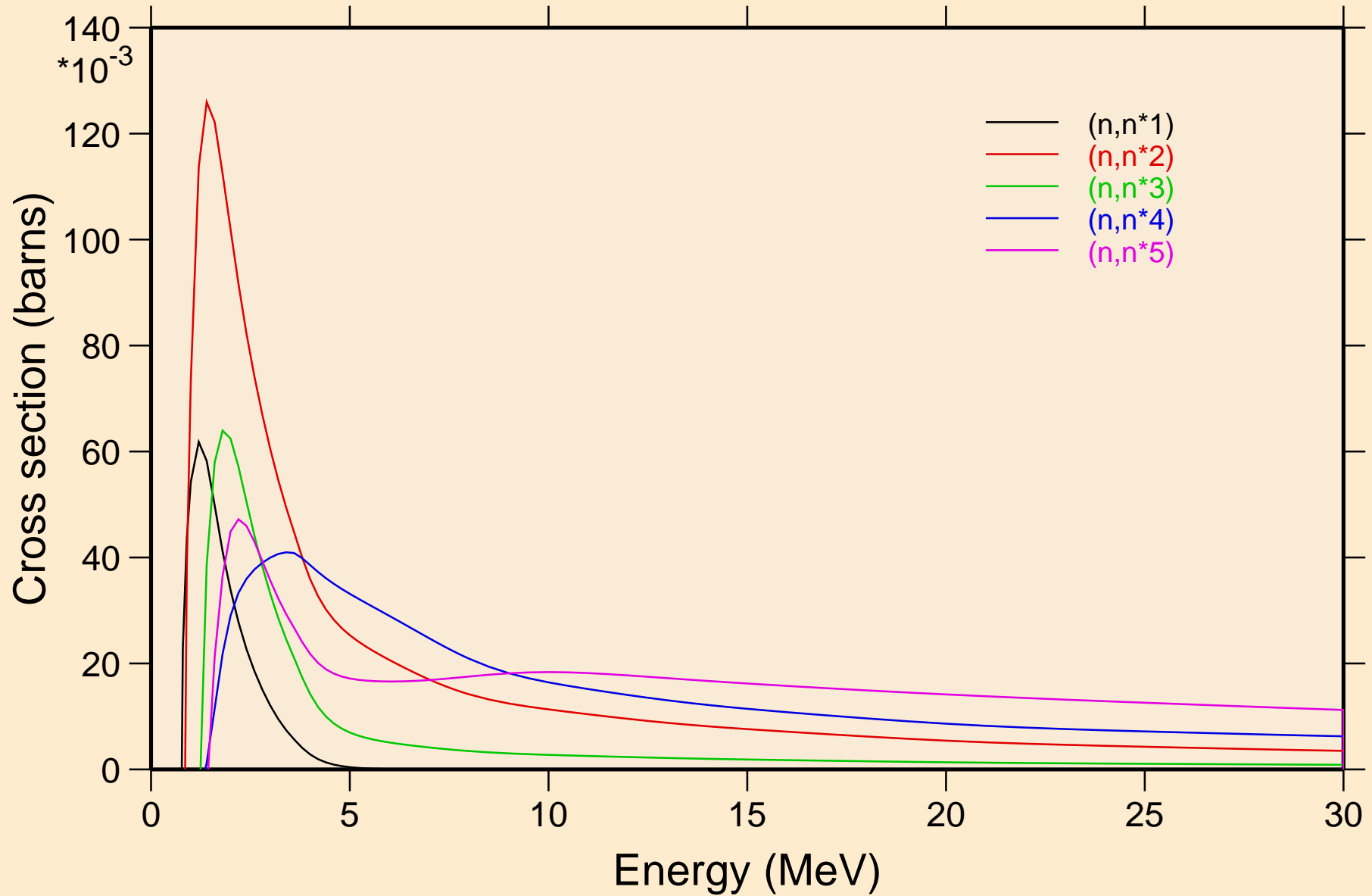

PB192 NEUTRON ACER TENDL-2024 LIBRARY; T=0.K
Inelastic levels

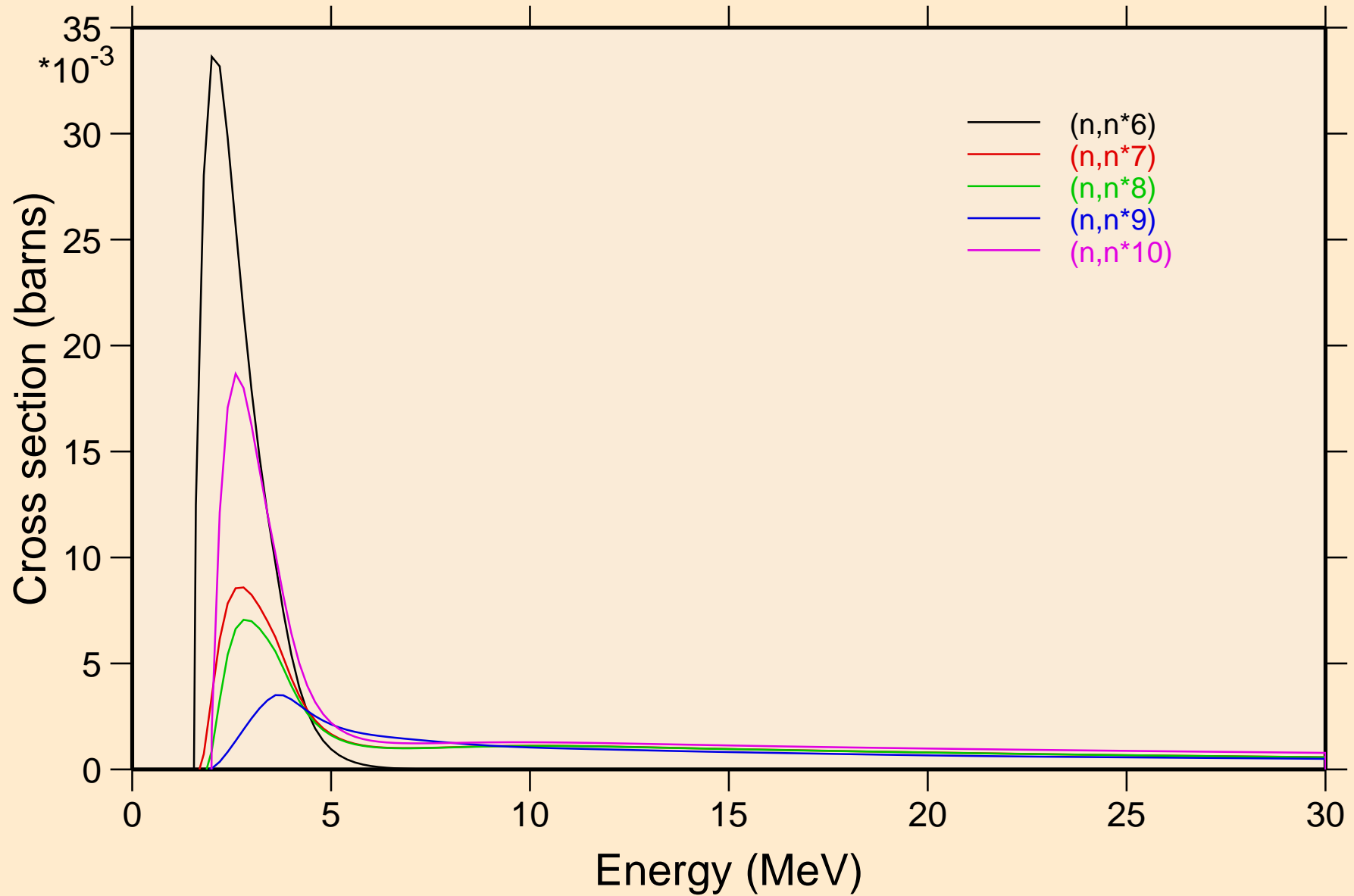

PB192 NEUTRON ACER TENDL-2024 LIBRARY; T=0.K
Threshold reactions

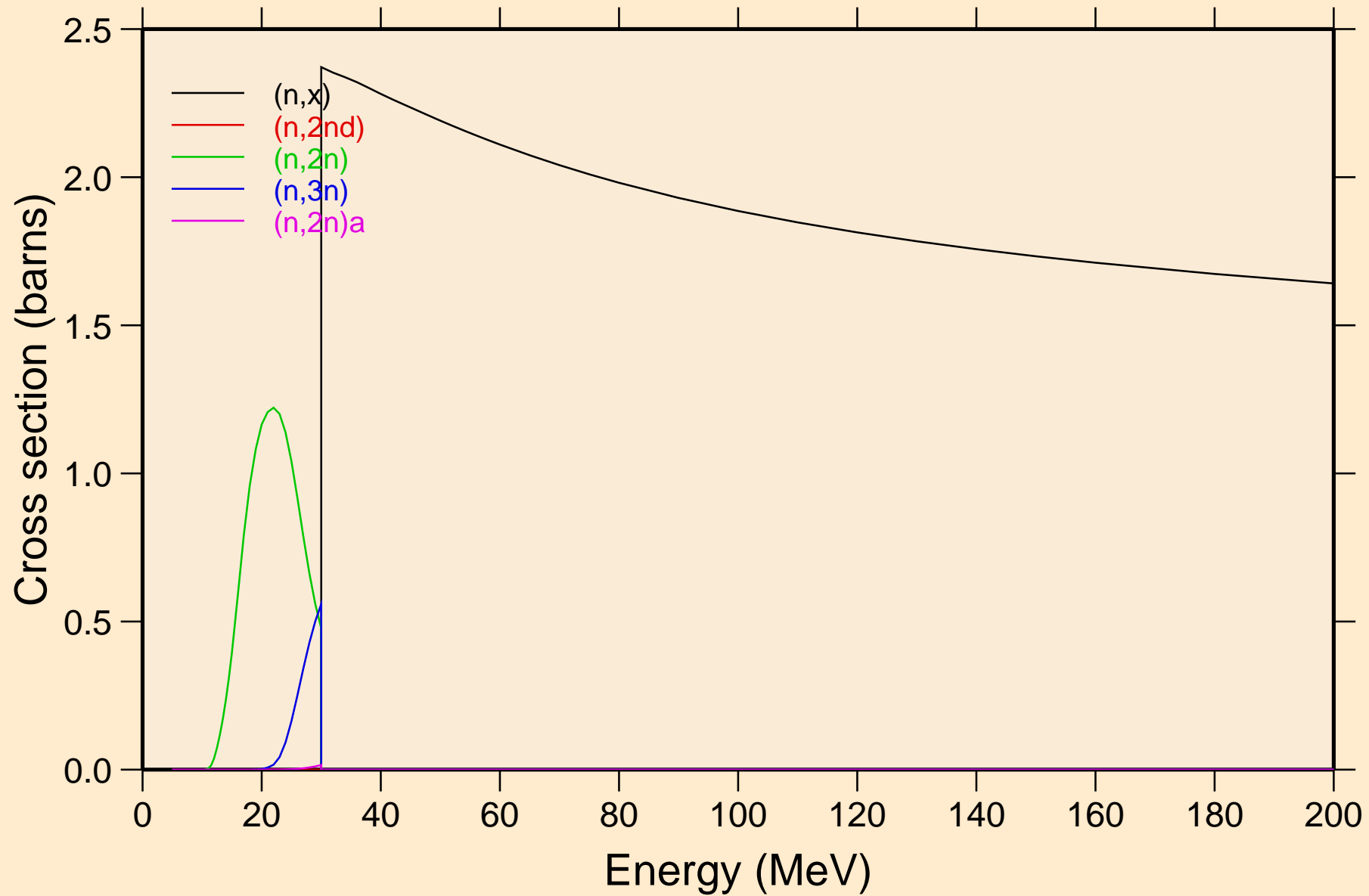

PB192 NEUTRON ACER TENDL-2024 LIBRARY; T=0.K
Threshold reactions

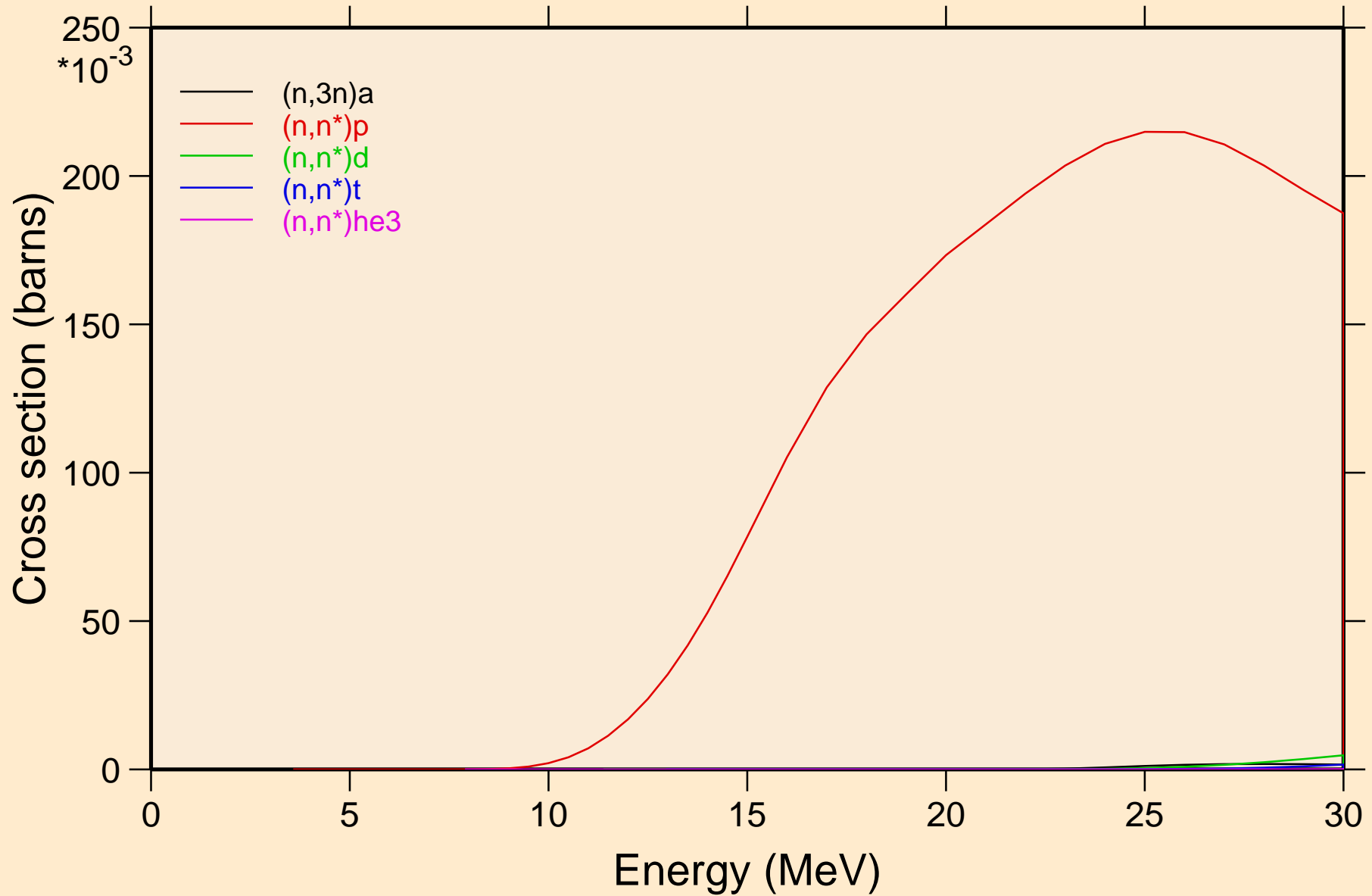

PB192 NEUTRON ACER TENDL-2024 LIBRARY; T=0.K
Threshold reactions

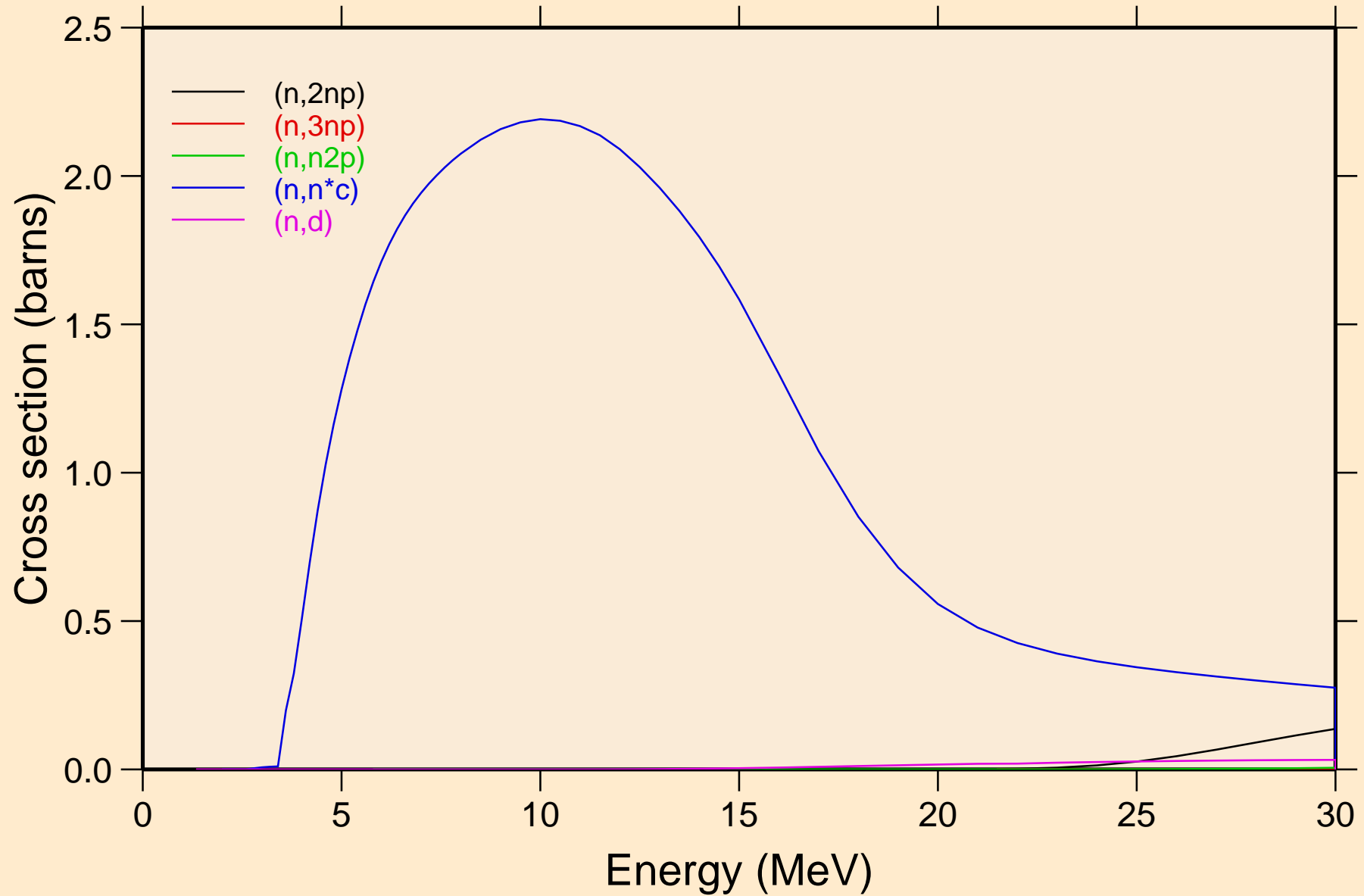

PB192 NEUTRON ACER TENDL-2024 LIBRARY; T=0.K
Threshold reactions

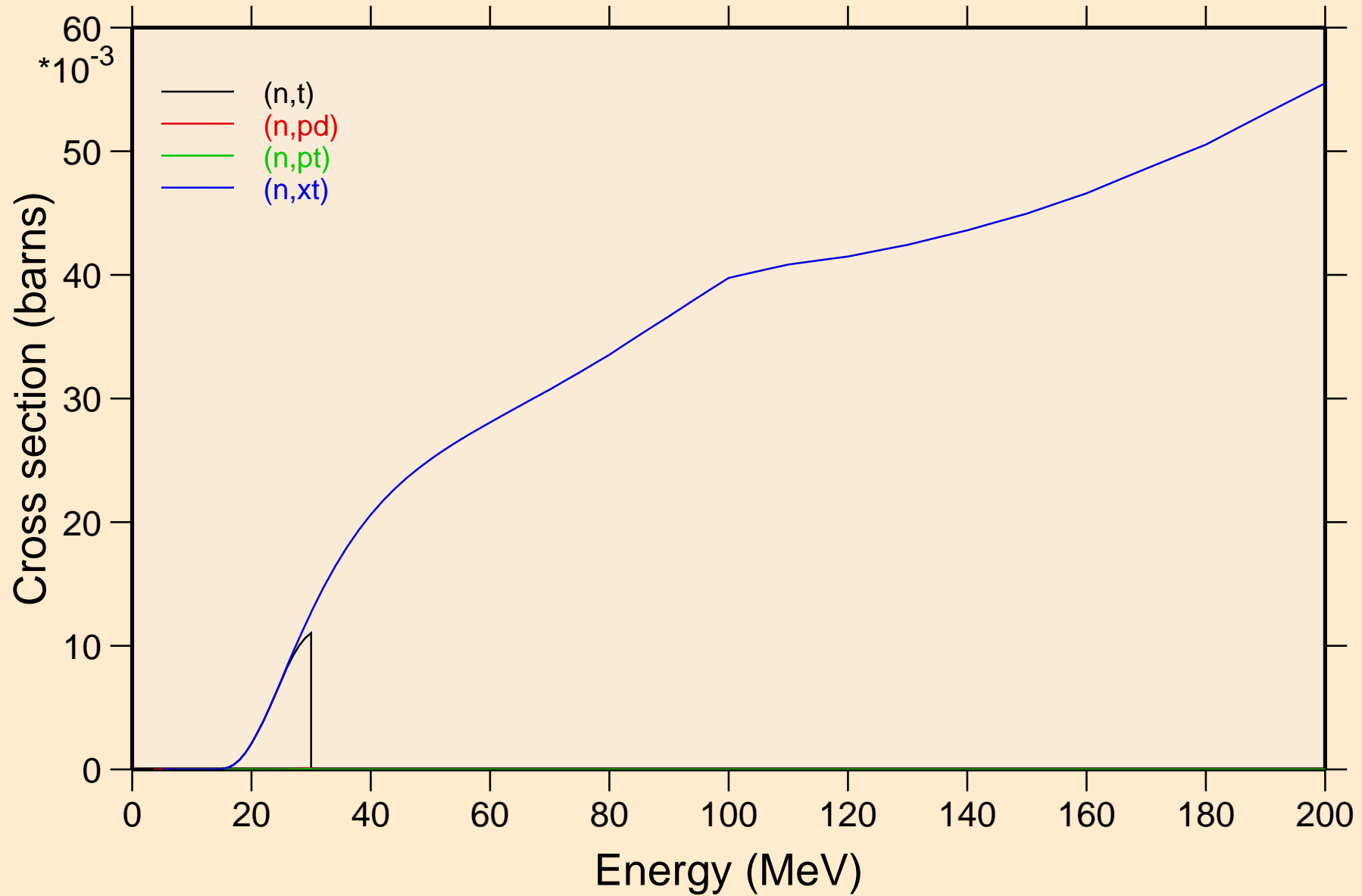

PB192 NEUTRON ACER TENDL-2024 LIBRARY; T=0.K
angular distribution for elastic

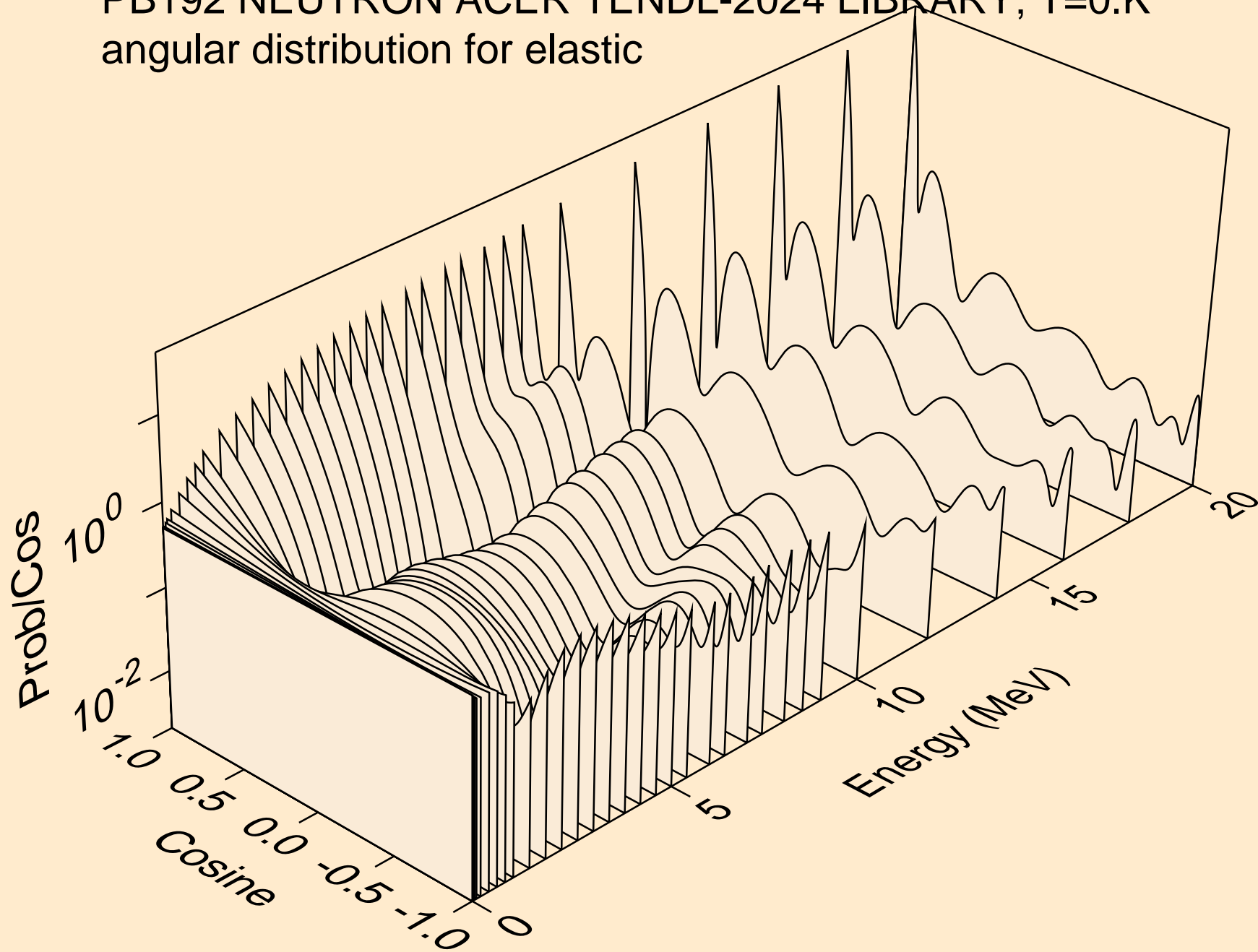

PB192 NEUTRON ACER TENDL-2024 LIBRARY; T=0.K
angular distribution for elastic

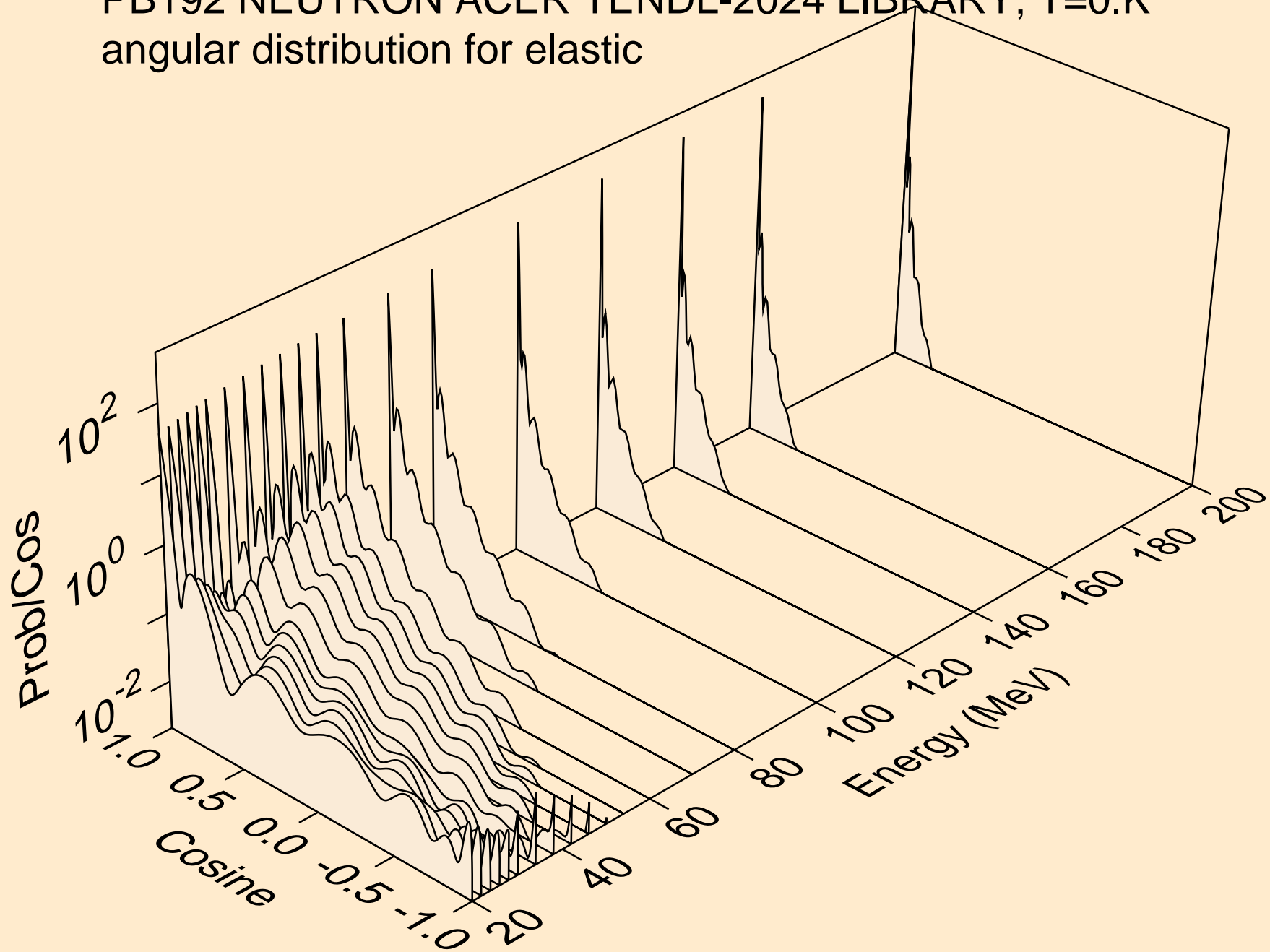

PB192 NEUTRON ACER TENDL-2024 LIBRARY; T=0.K
angular distribution for (n,n*1)

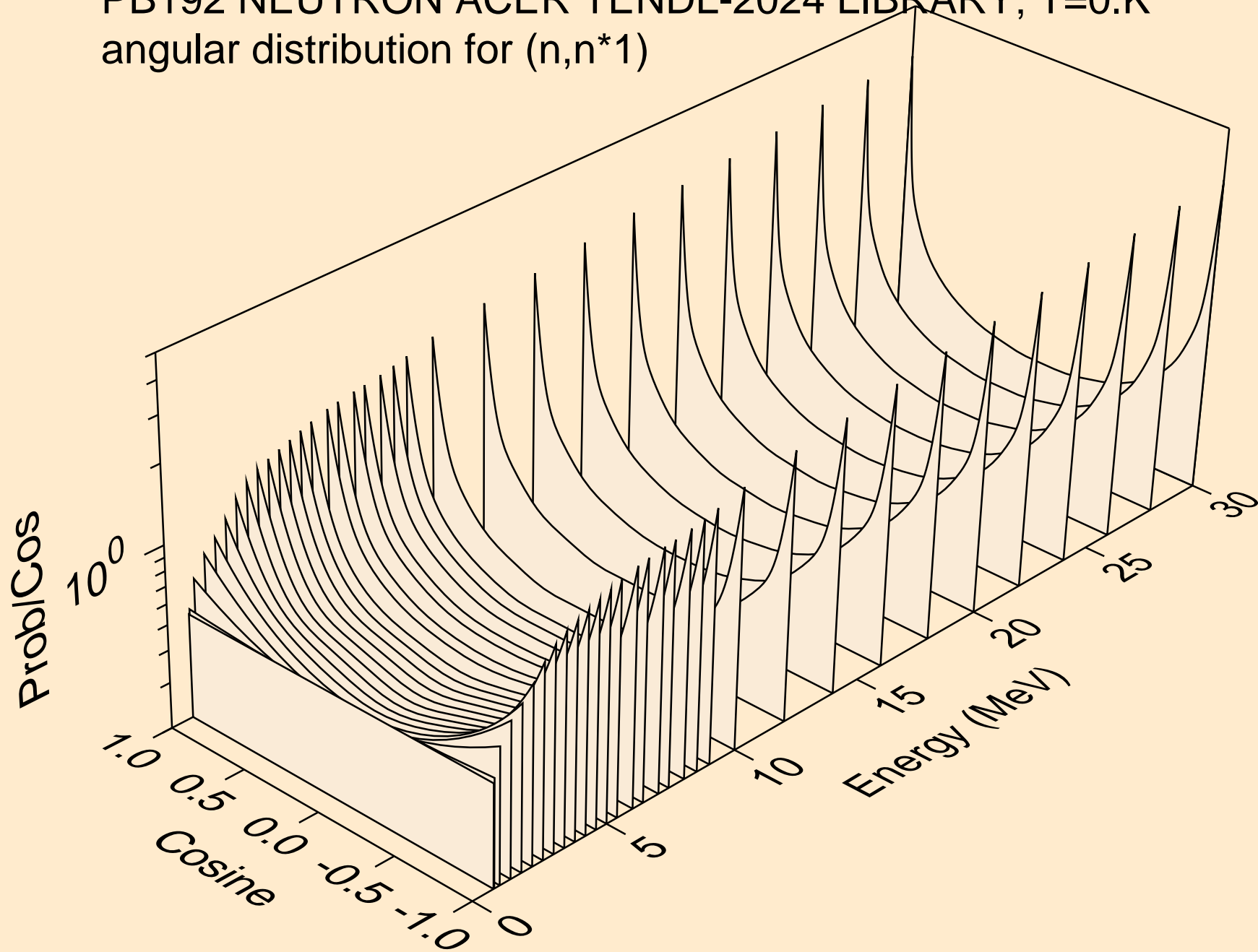

PB192 NEUTRON ACER TENDL-2024 LIBRARY; T=0.K
angular distribution for (n,n*2)

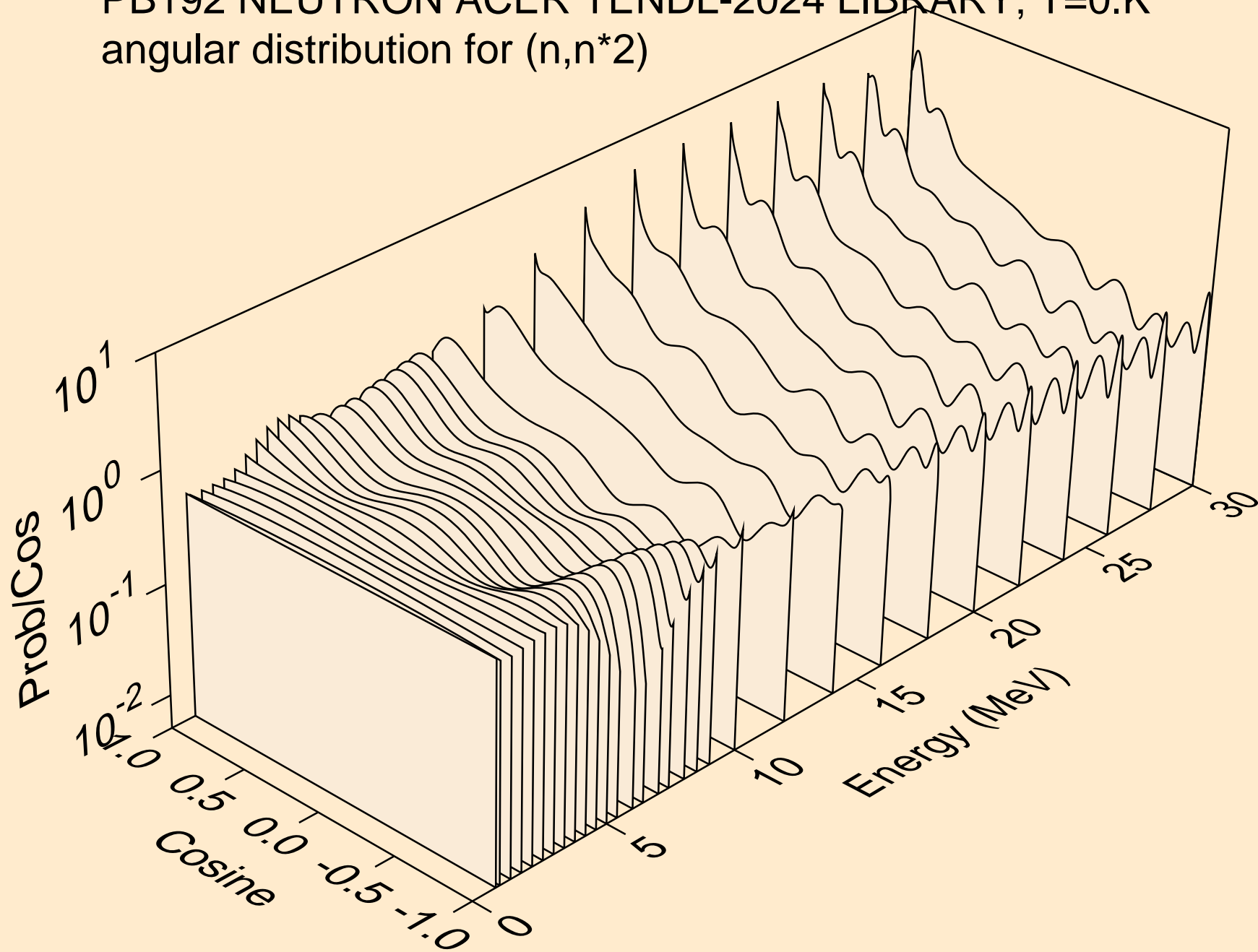

PB192 NEUTRON ACER TENDL-2024 LIBRARY; T=0.K
angular distribution for (n,n*3)

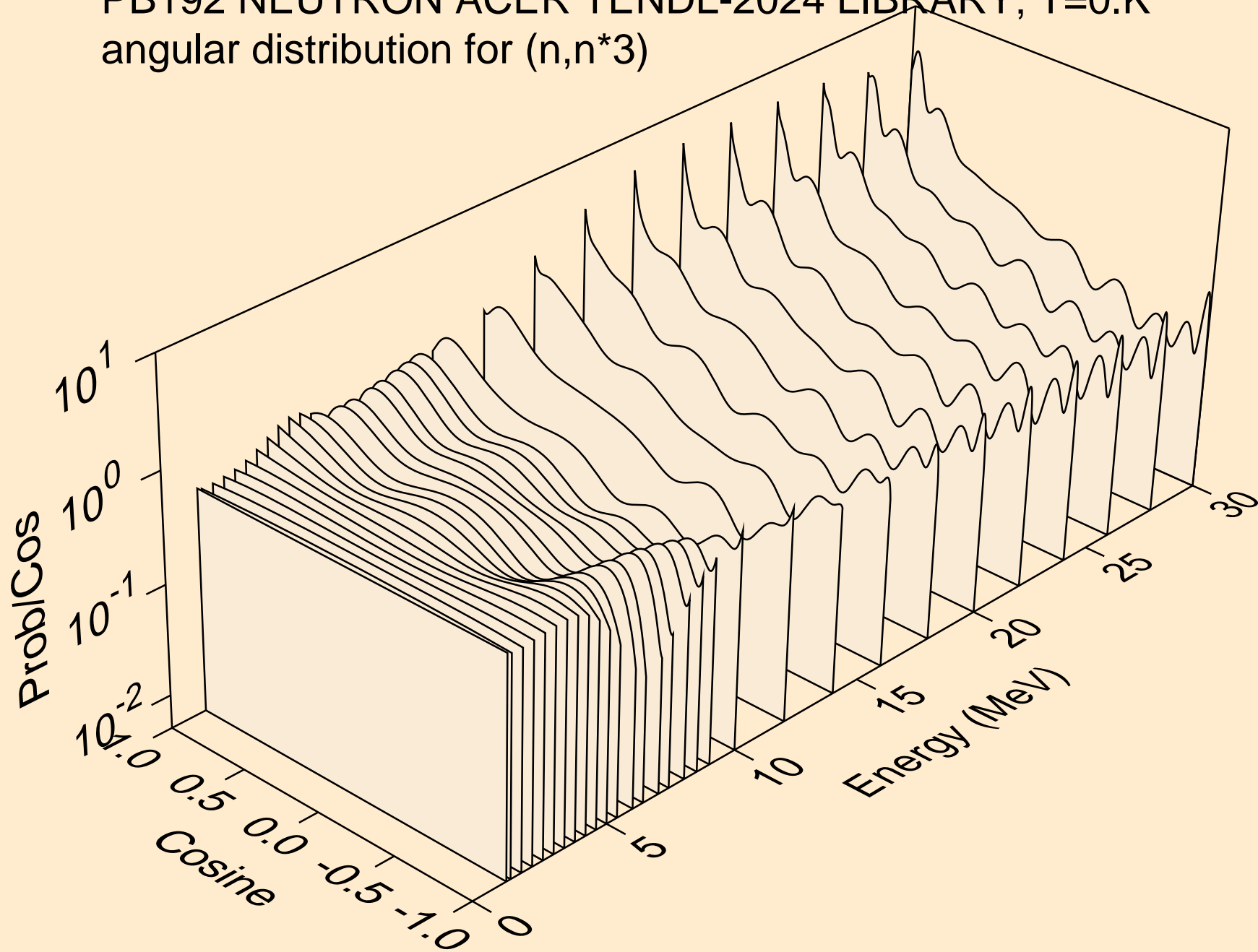

PB192 NEUTRON ACER TENDL-2024 LIBRARY; T=0.K
angular distribution for (n,n*4)

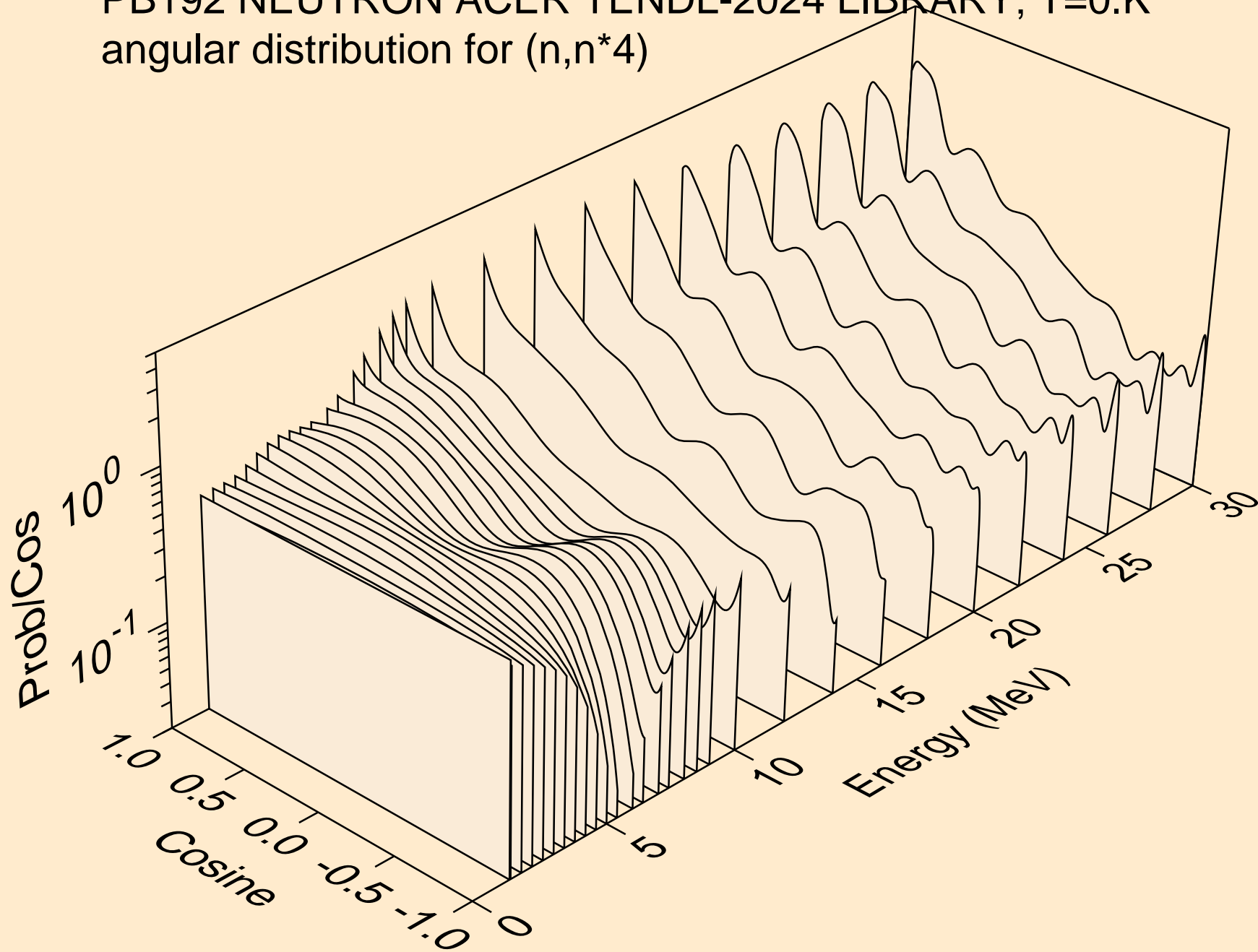

PB192 NEUTRON ACER TENDL-2024 LIBRARY; T=0.K
angular distribution for (n,n*5)

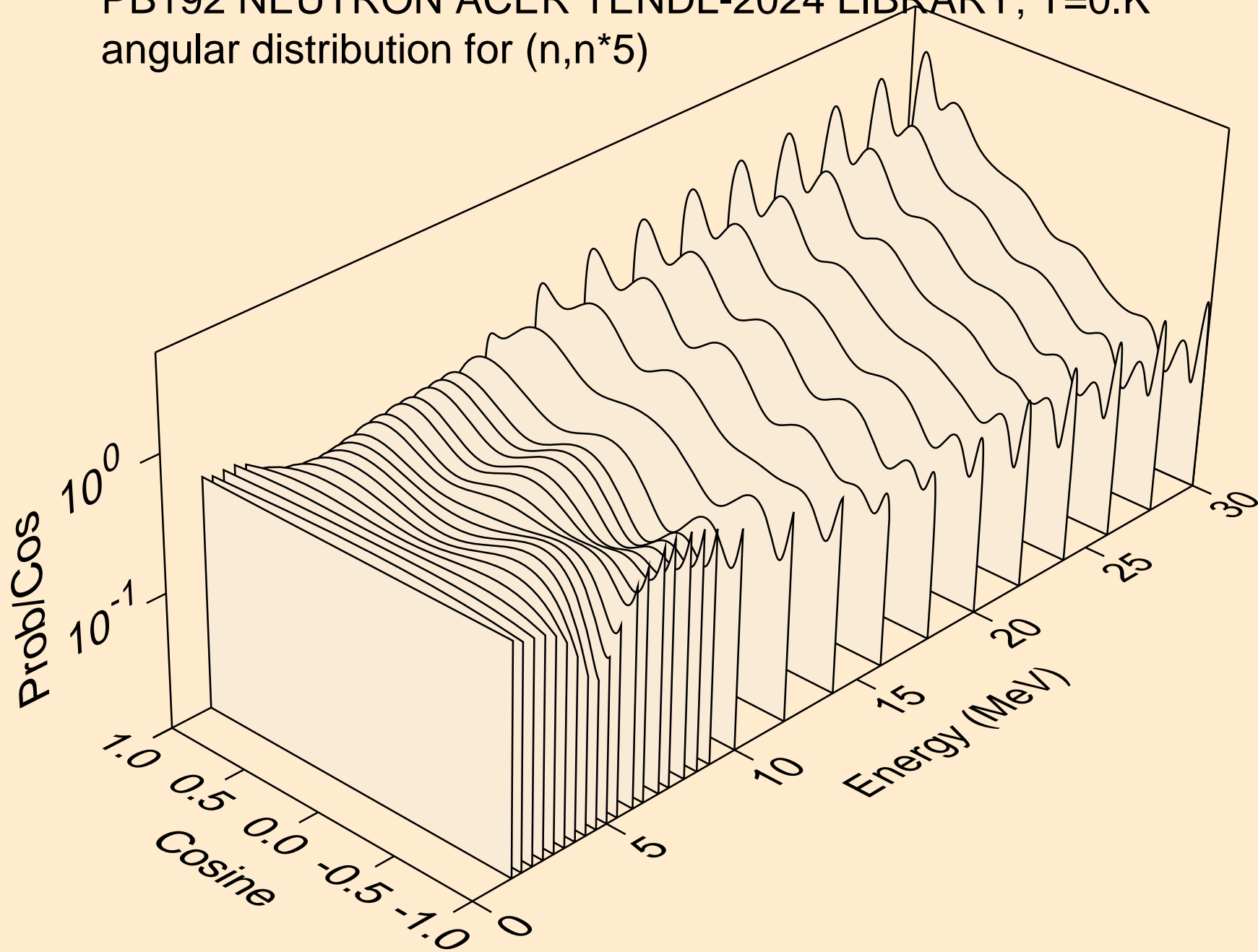

PB192 NEUTRON ACER TENDL-2024 LIBRARY; T=0.K
angular distribution for (n,n*6)

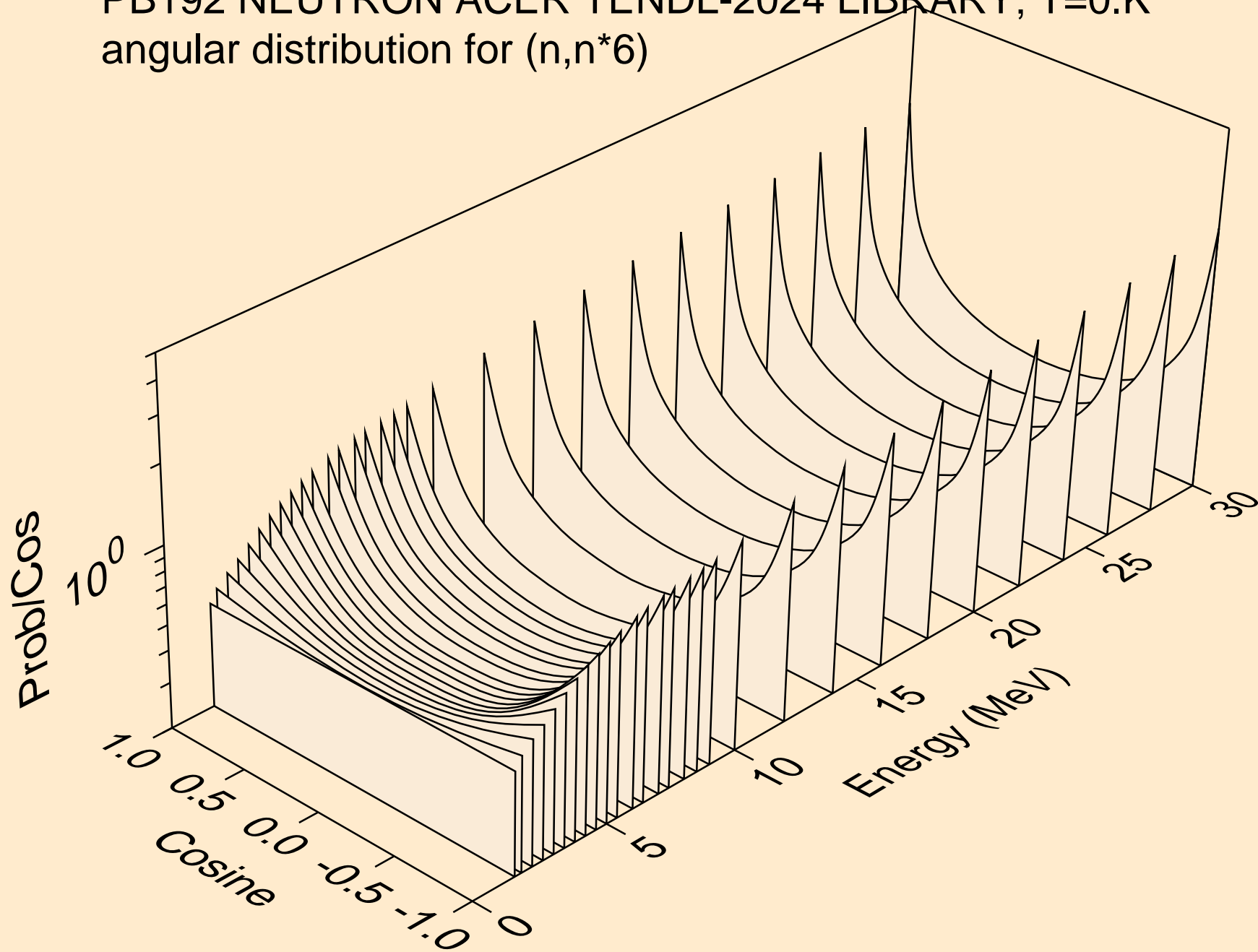

PB192 NEUTRON ACER TENDL-2024 LIBRARY; T=0.K
angular distribution for (n,n*7)

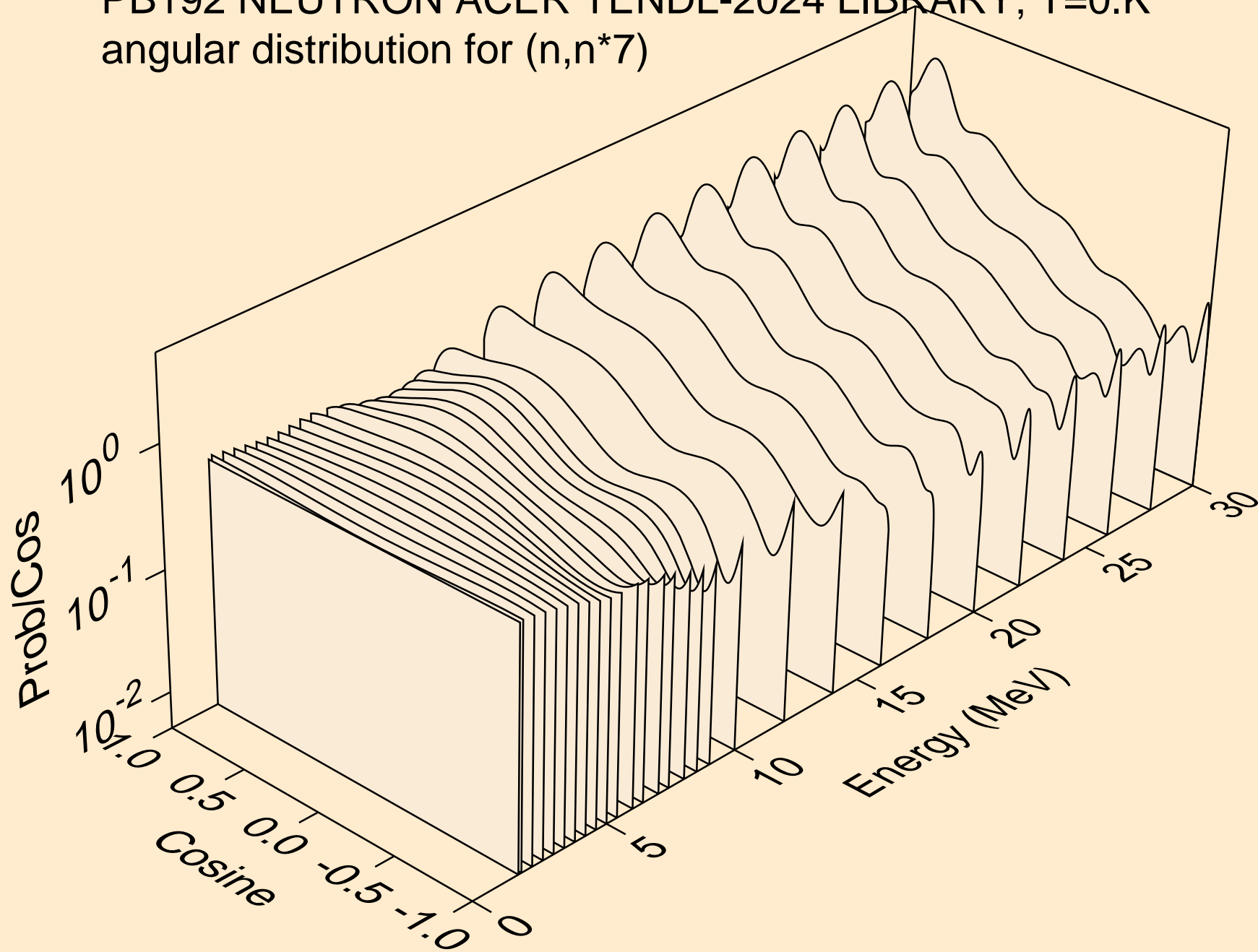

PB192 NEUTRON ACER TENDL-2024 LIBRARY; T=0.K
angular distribution for (n,n*8)

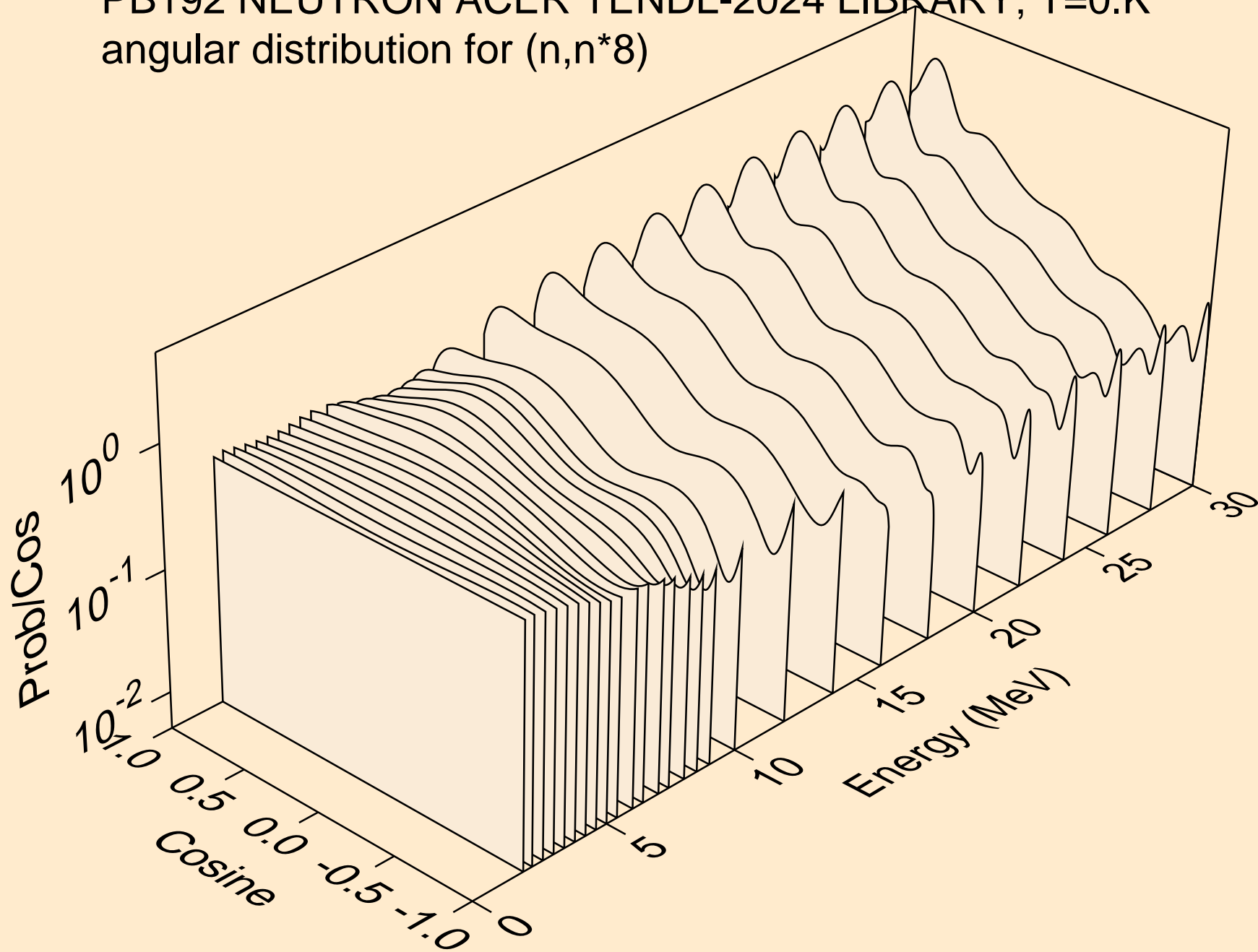

PB192 NEUTRON ACER TENDL-2024 LIBRARY; T=0.K
angular distribution for (n,n*9)

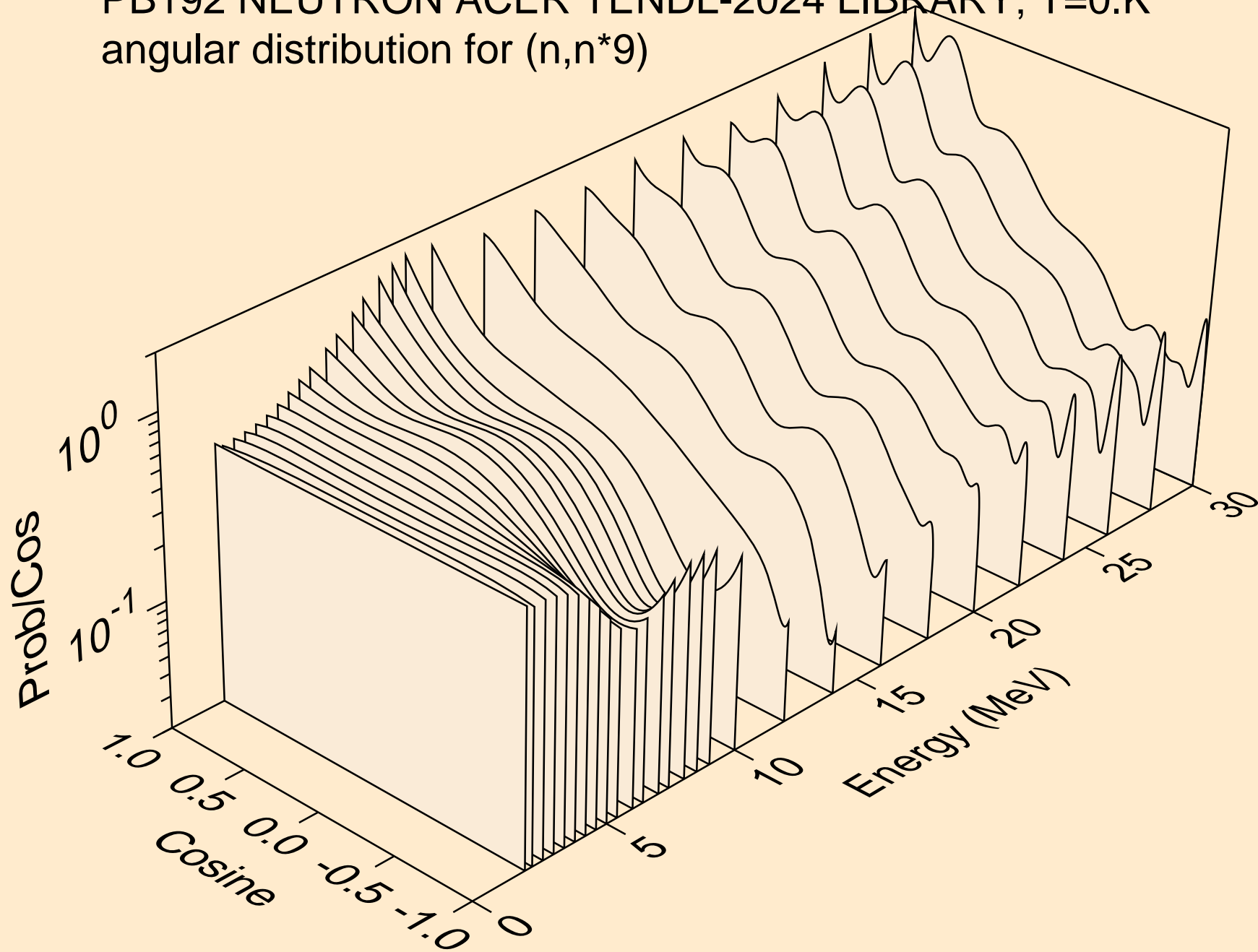

PB192 NEUTRON ACER TENDL-2024 LIBRARY; T=0.K
angular distribution for (n,n*10)

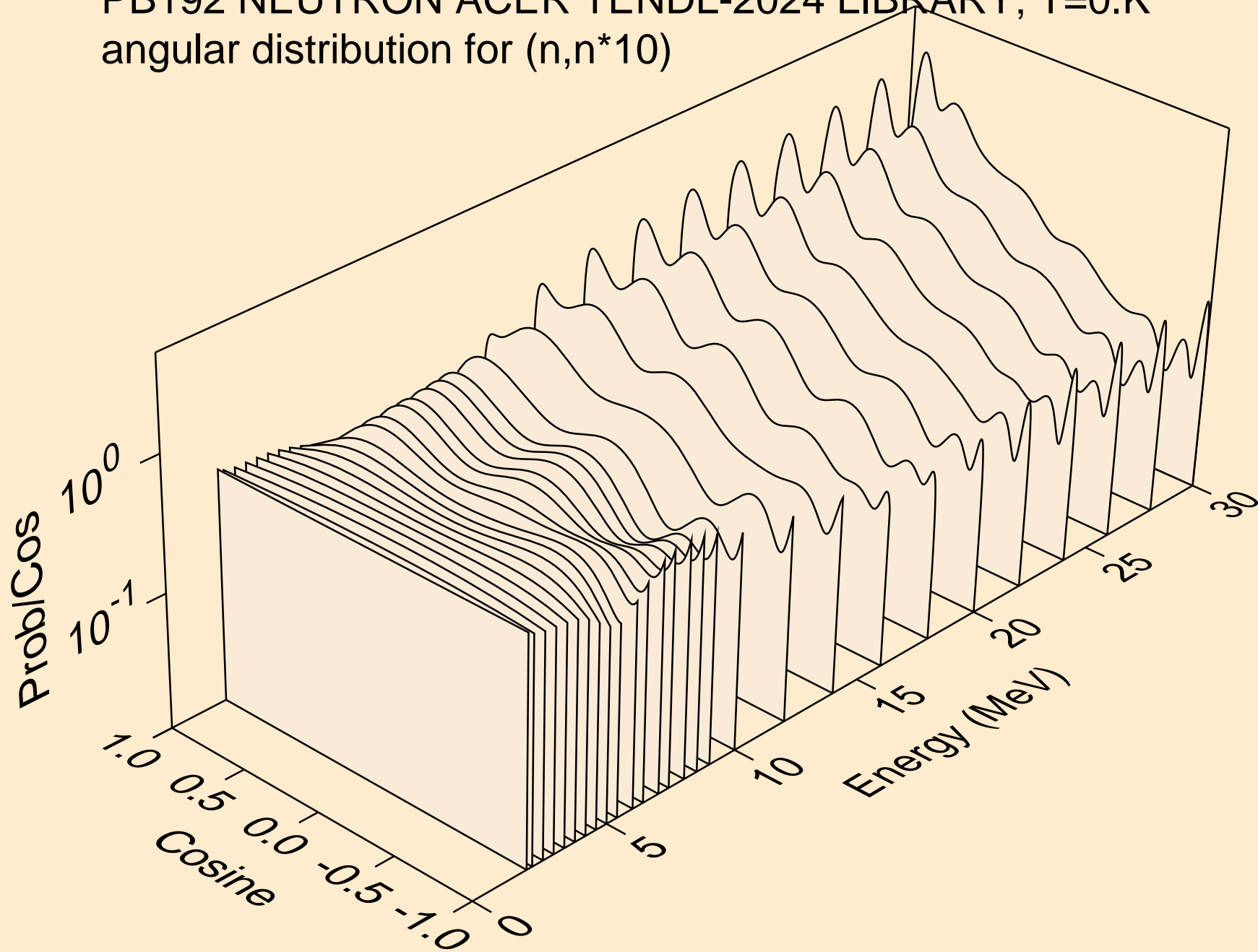

PB192 NEUTRON ACER TENDL-2024 LIBRARY; T=0.K
Neutron emission for (n,x)

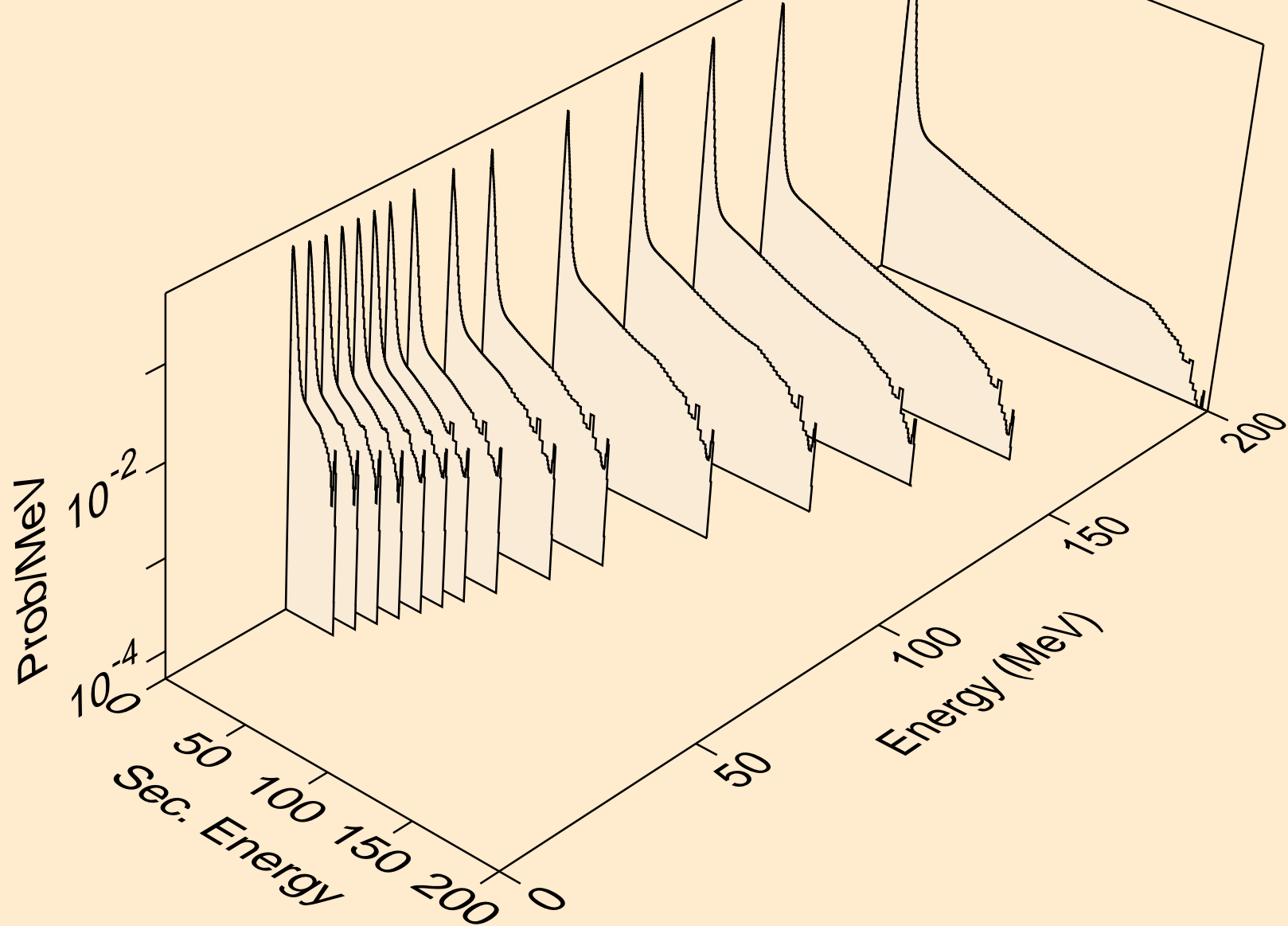

PB192 NEUTRON ACER TENDL-2024 LIBRARY; T=0.K
Neutron emission for (n,2nd)

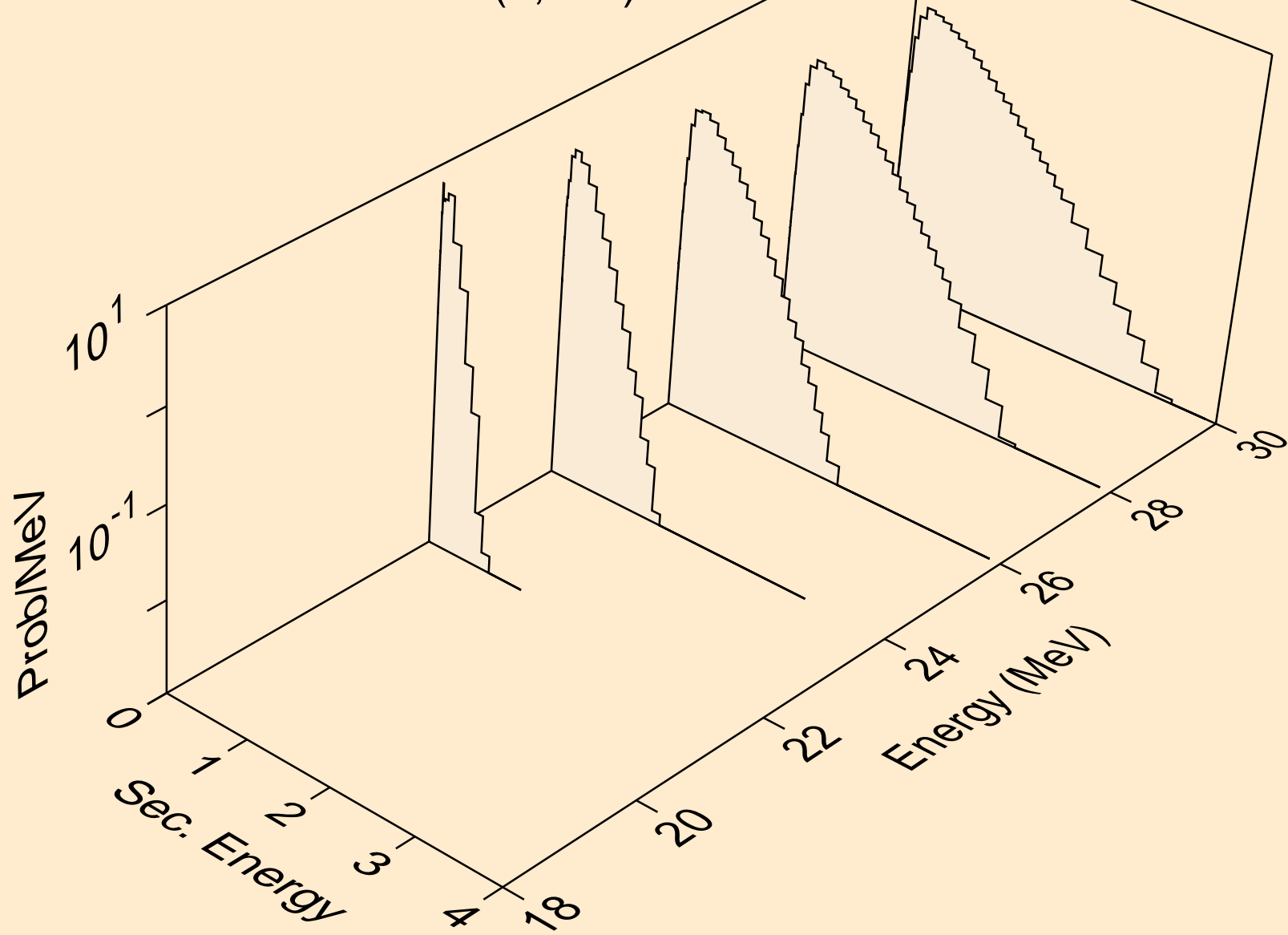

PB192 NEUTRON ACER TENDL-2024 LIBRARY; T=0.K
Neutron emission for (n,2n)

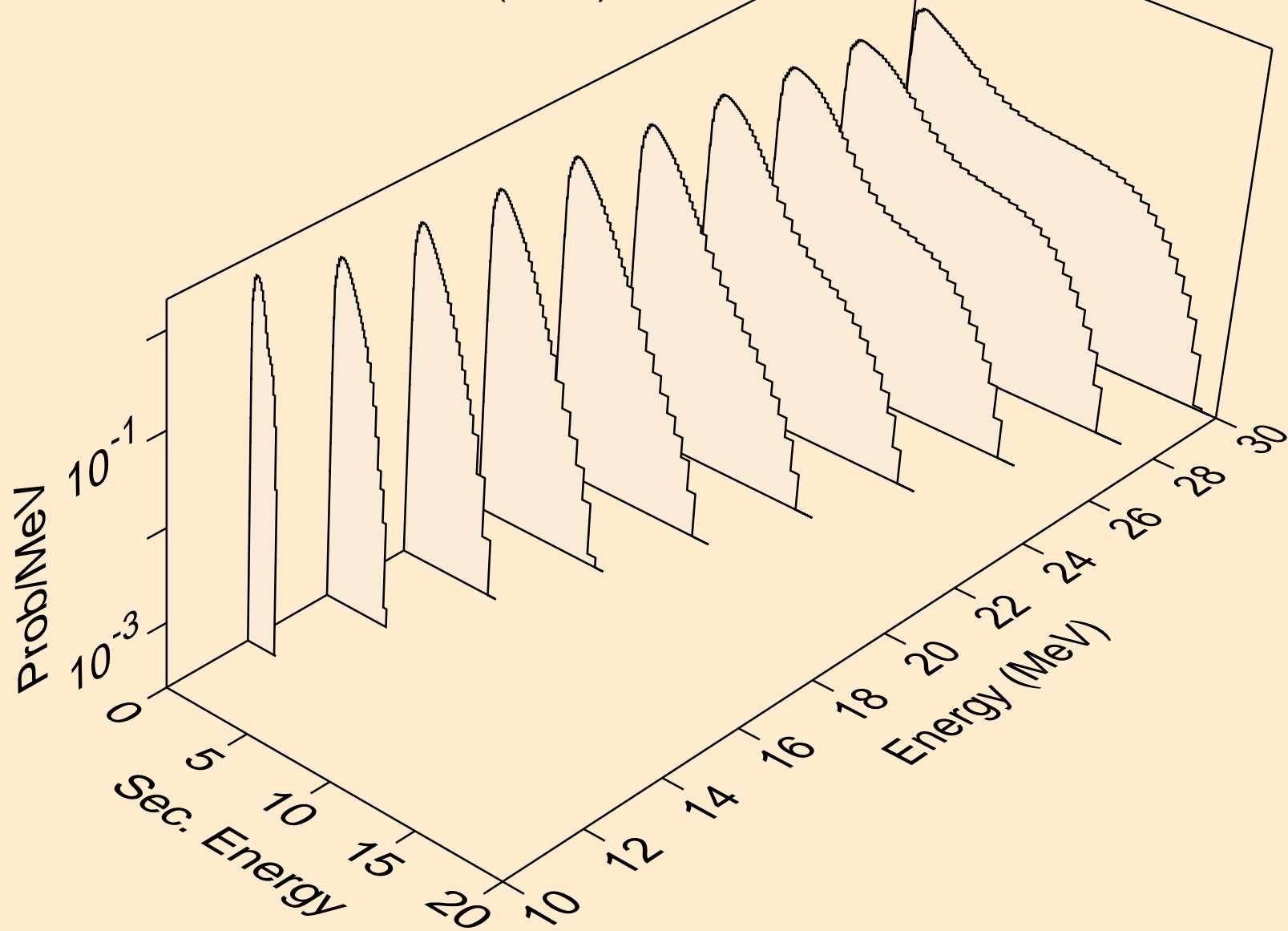

PB192 NEUTRON ACER TENDL-2024 LIBRARY; T=0.K
Neutron emission for (n,3n)

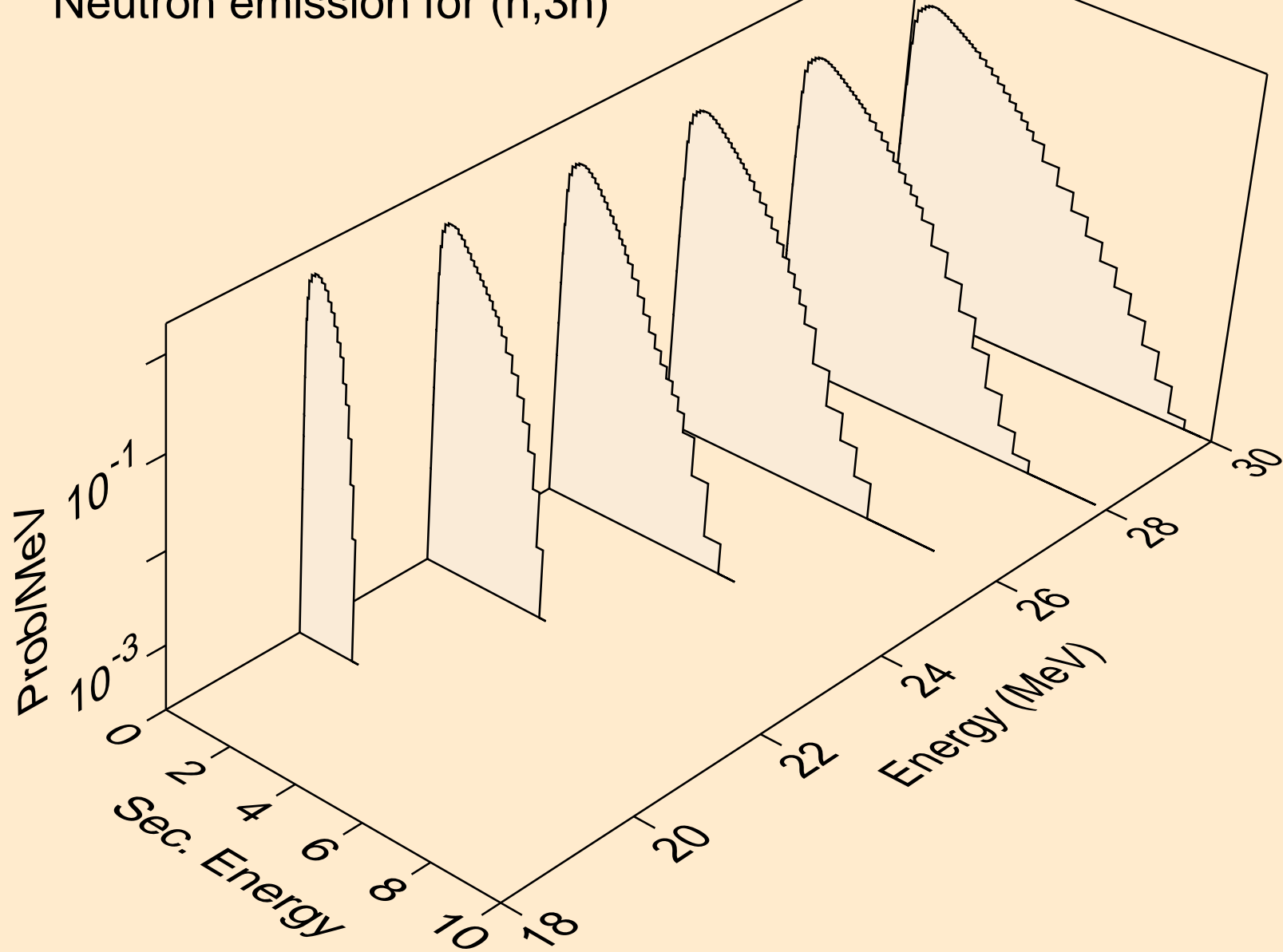

PB192 NEUTRON ACER TENDL-2024 LIBRARY; T=0.K
Neutron emission for (n,n*)a

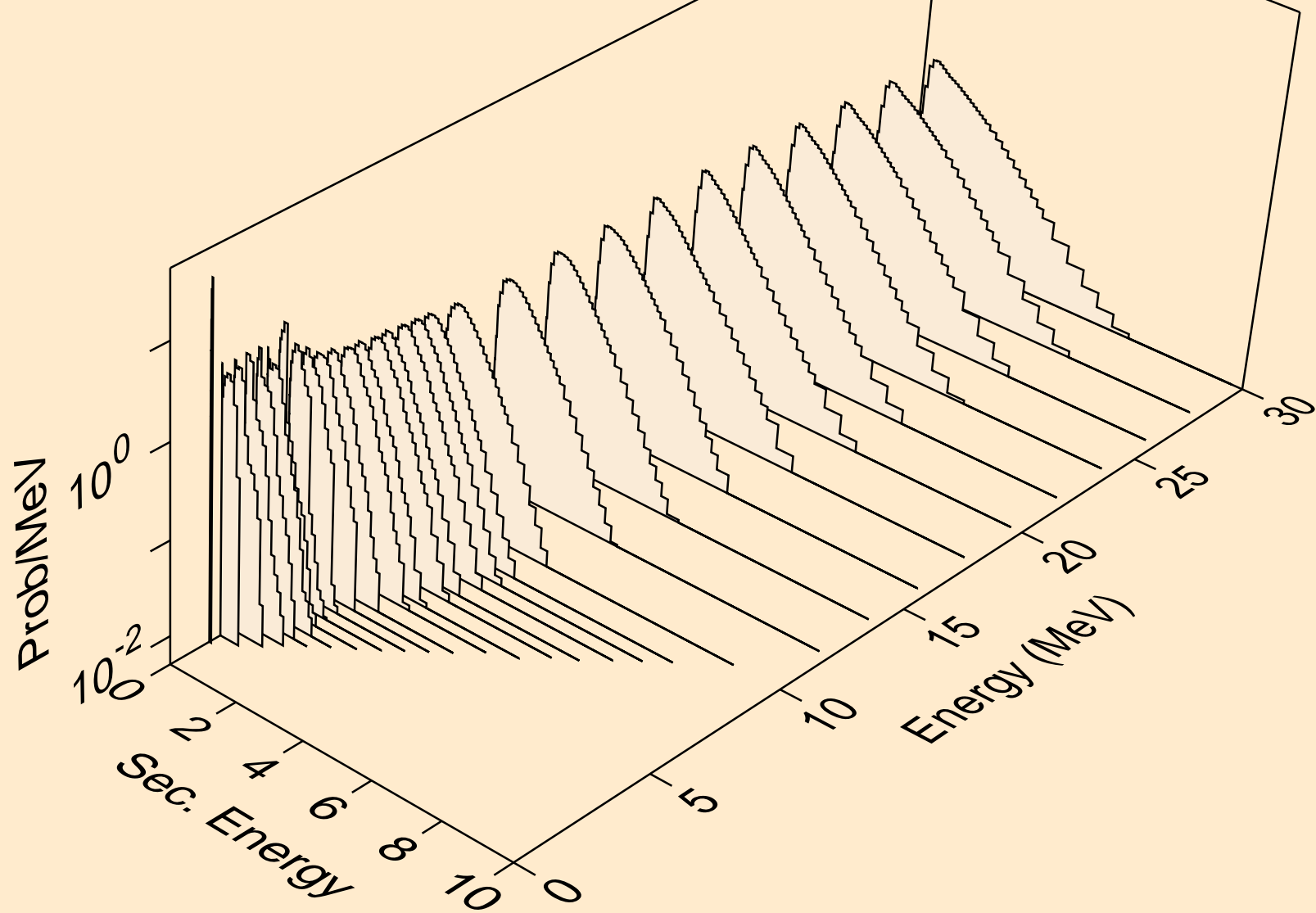

PB192 NEUTRON ACER TENDL-2024 LIBRARY; T=0.K
Neutron emission for (n,2n)_a

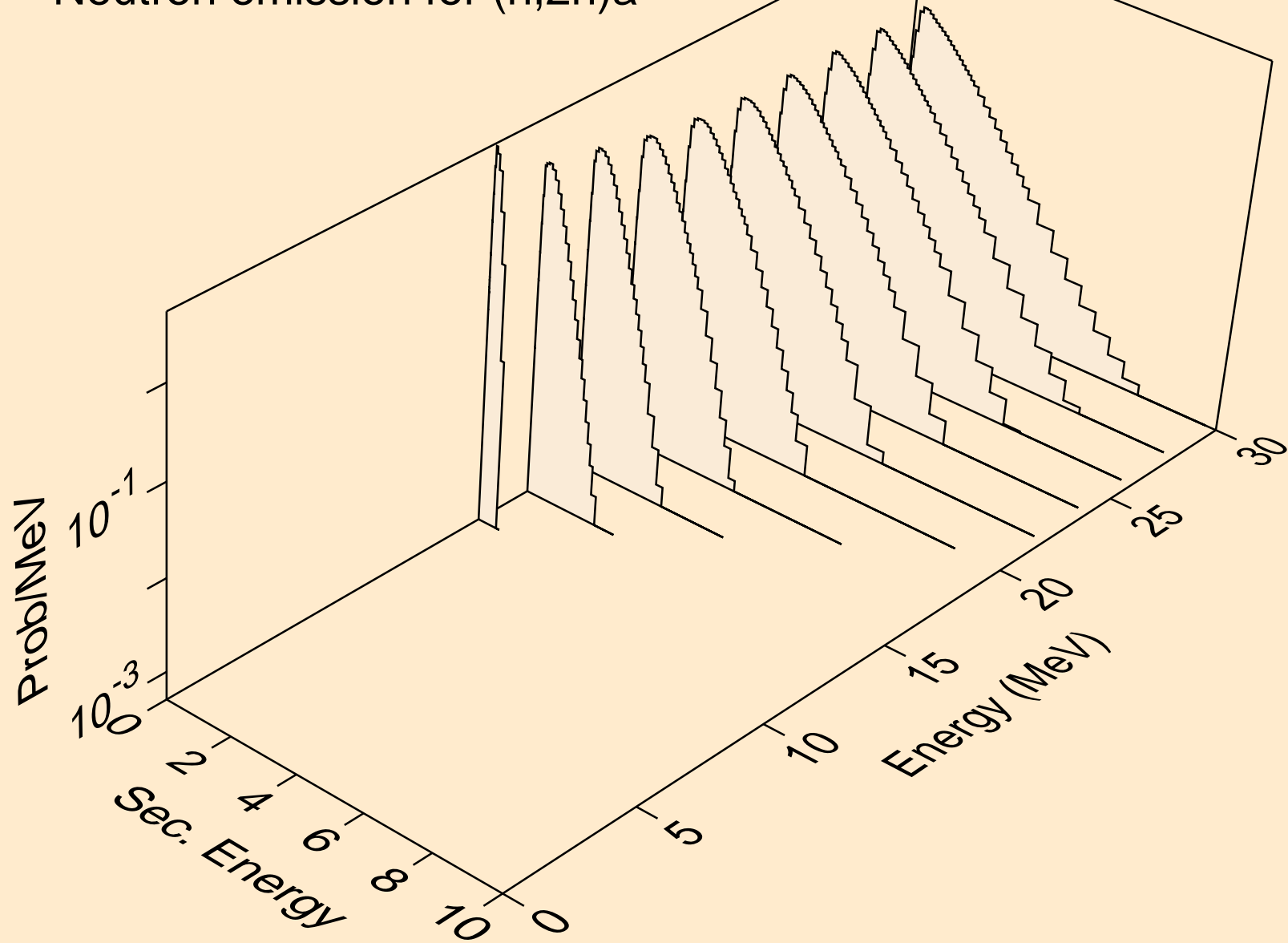

PB192 NEUTRON ACER TENDL-2024 LIBRARY; T=0.K
Neutron emission for (n,3n)a

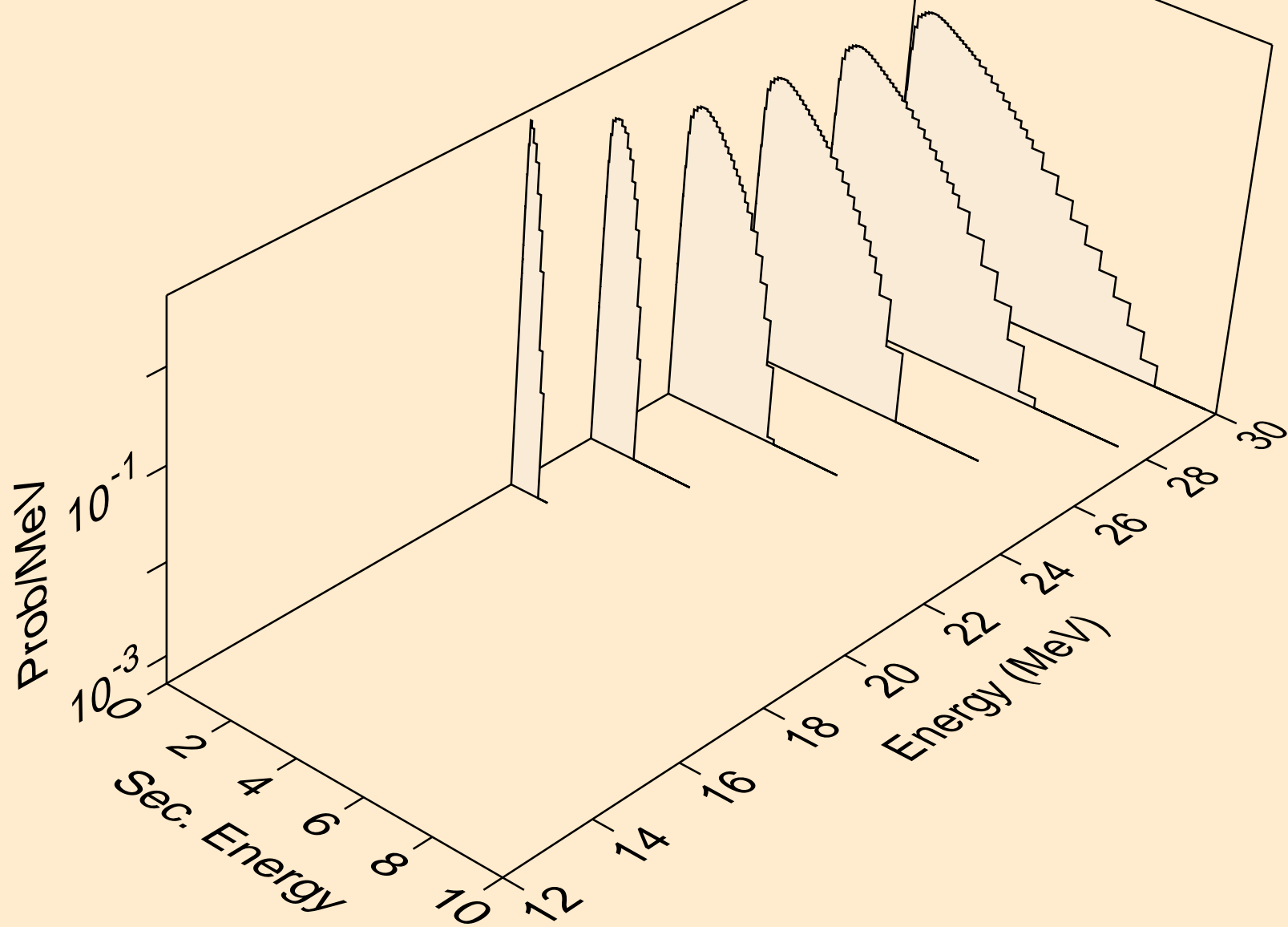

PB192 NEUTRON ACER TENDL-2024 LIBRARY; T=0.K
Neutron emission for (n,n*)p

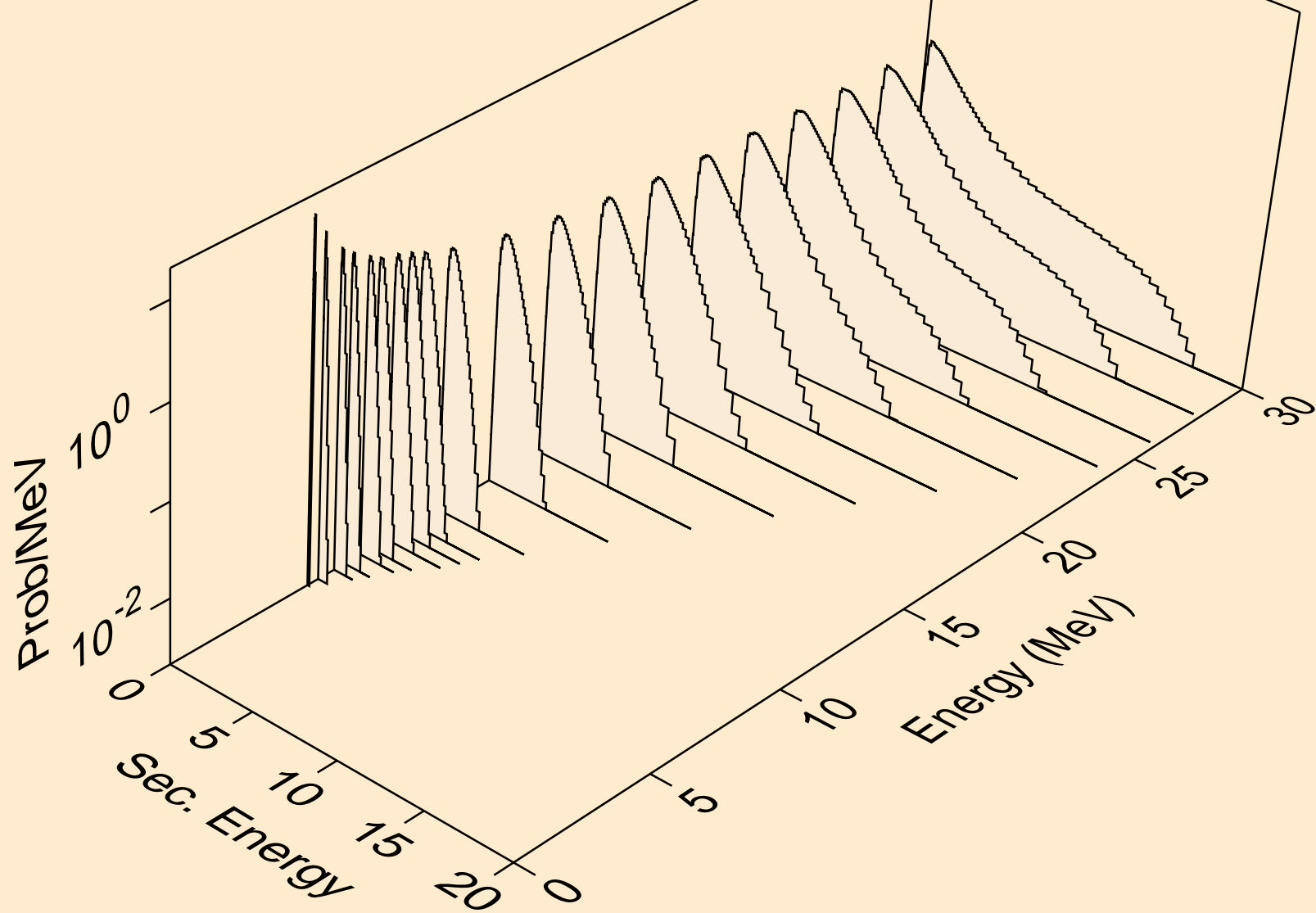

PB192 NEUTRON ACER TENDL-2024 LIBRARY; T=0.K
Neutron emission for (n,n*)2a

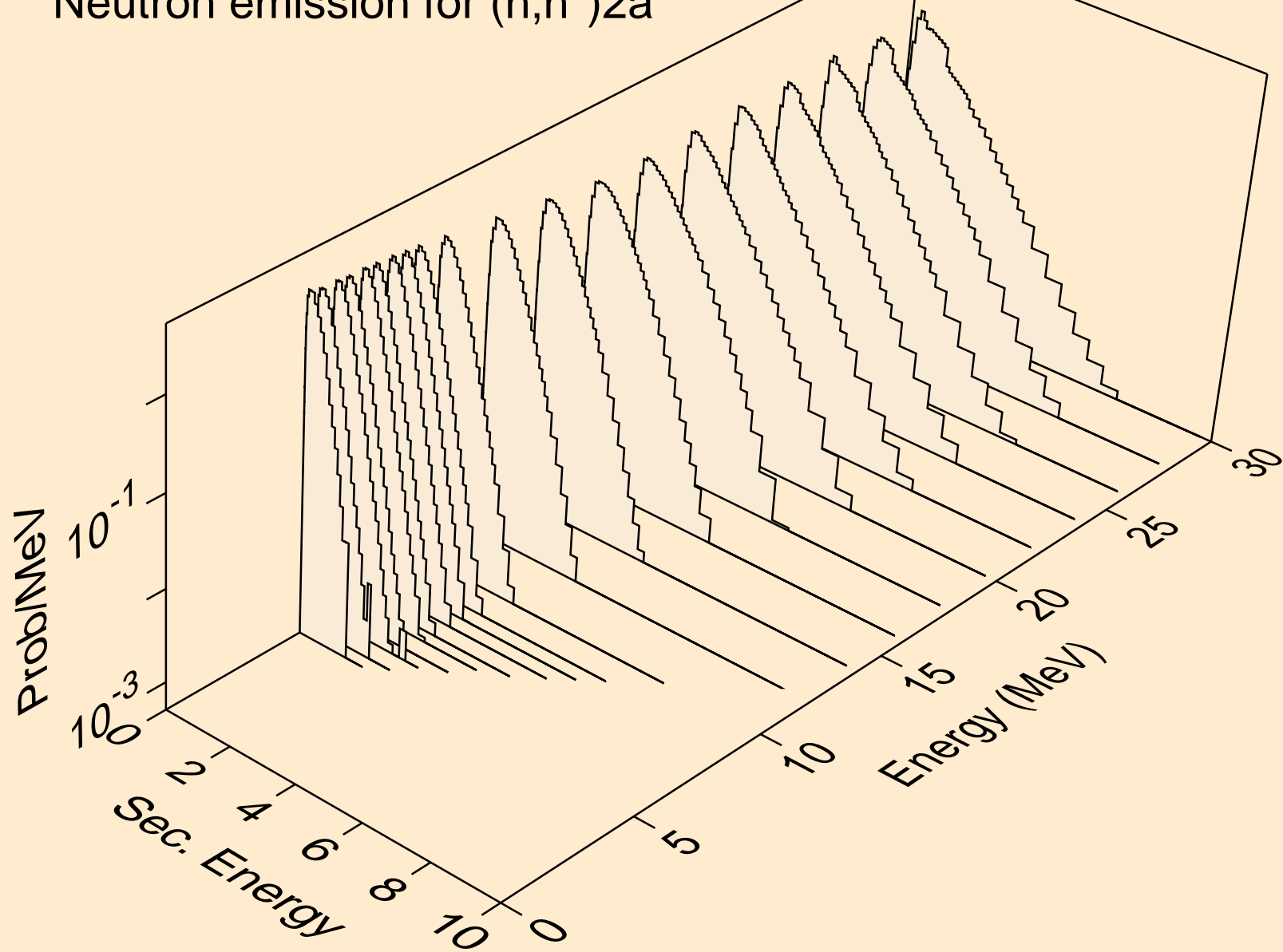

PB192 NEUTRON ACER TENDL-2024 LIBRARY; T=0.K
Neutron emission for (n,2n)2a

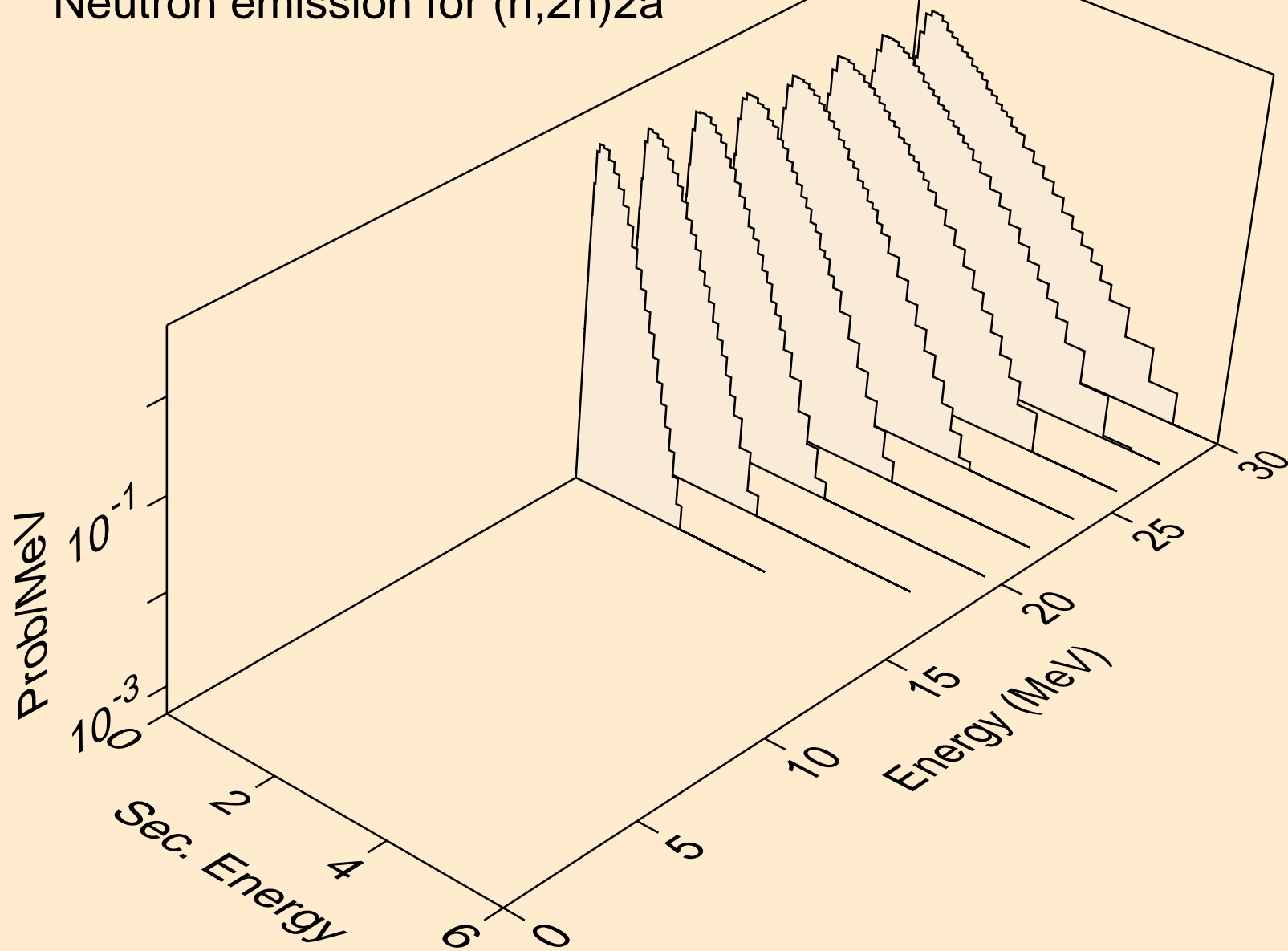

PB192 NEUTRON ACER TENDL-2024 LIBRARY; T=0.K
Neutron emission for (n,n*)d

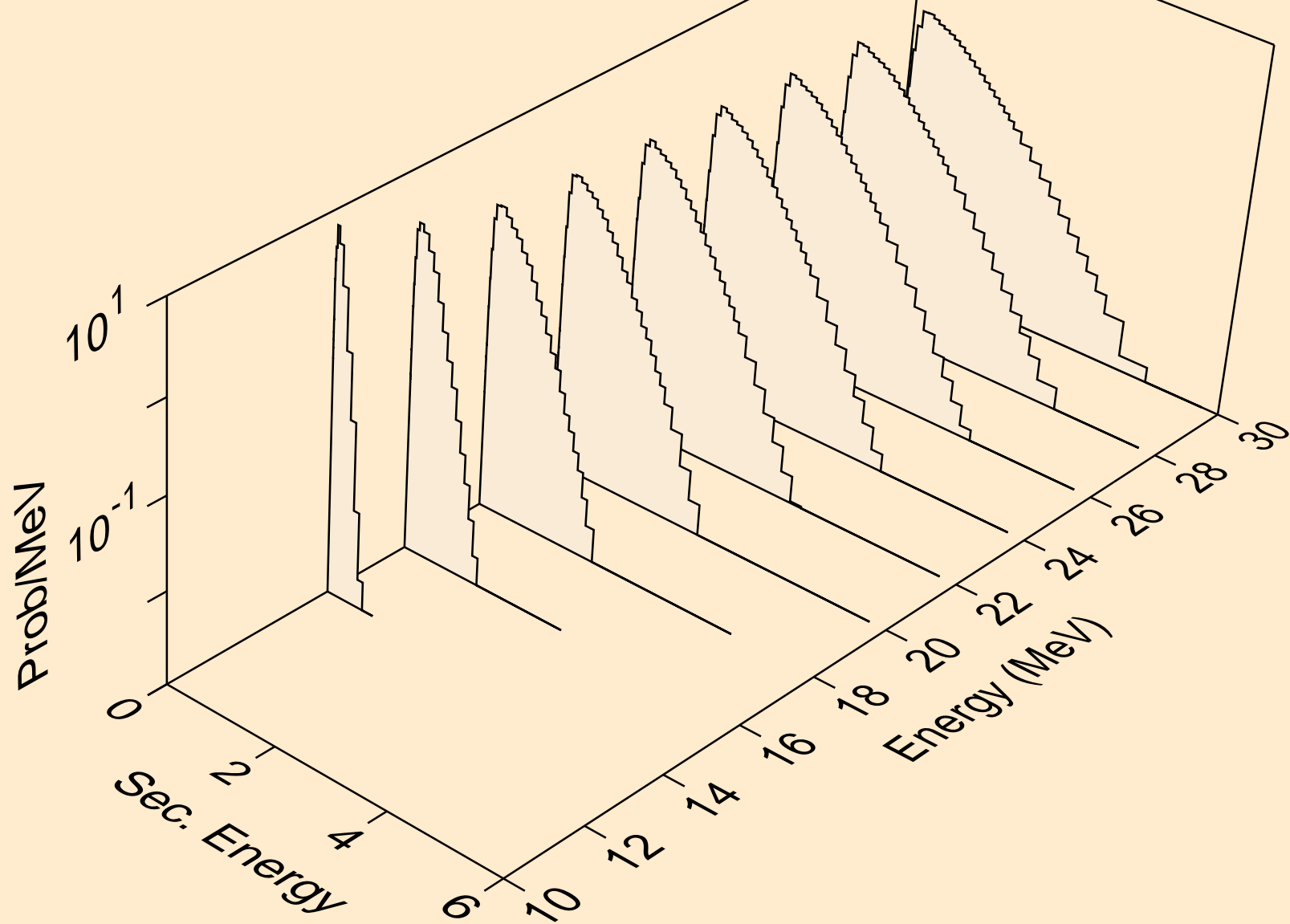

PB192 NEUTRON ACER TENDL-2024 LIBRARY; T=0.K
Neutron emission for (n,n*)t

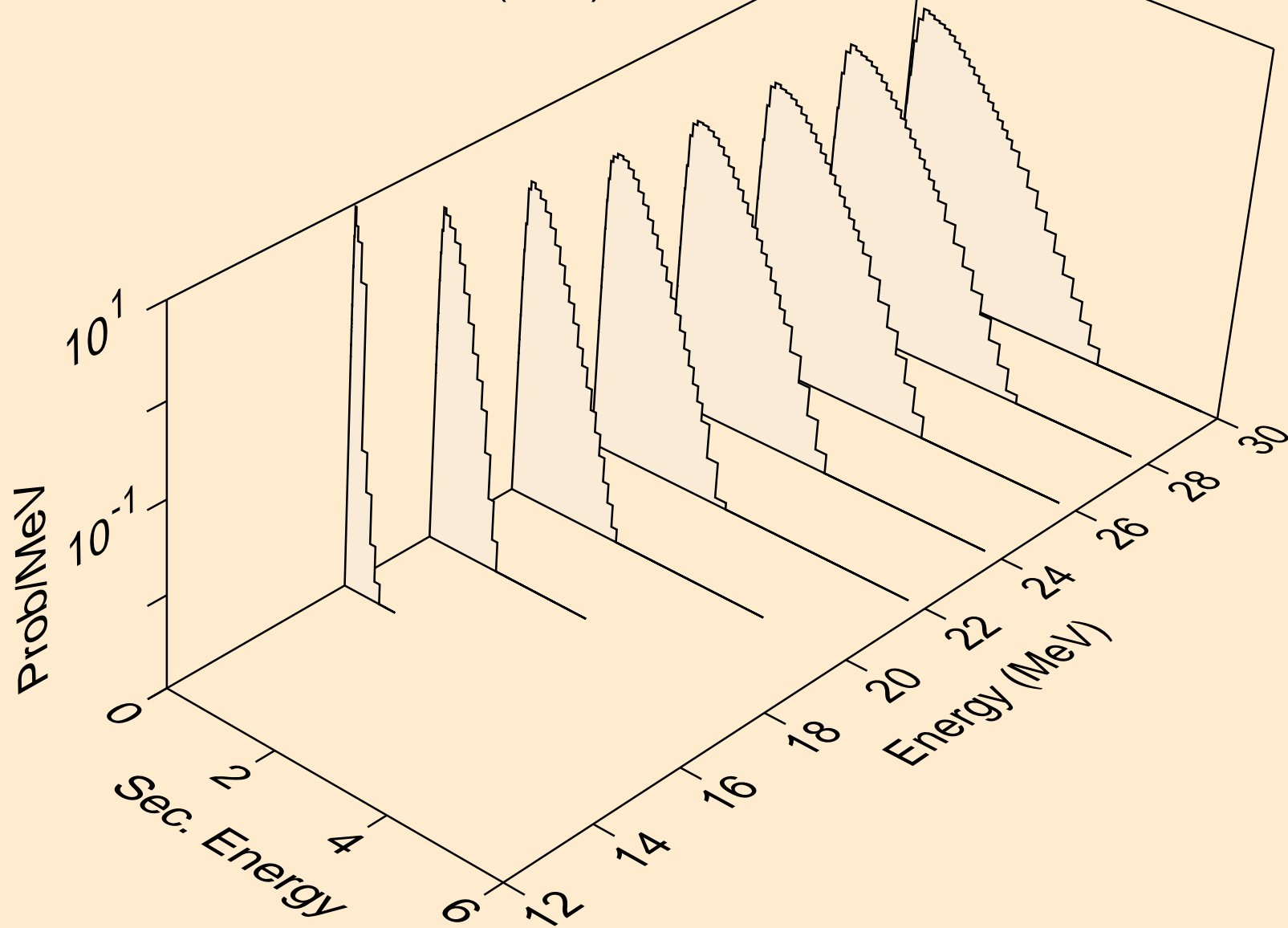

PB192 NEUTRON ACER TENDL-2024 LIBRARY; T=0.K
Neutron emission for (n,n*)he3

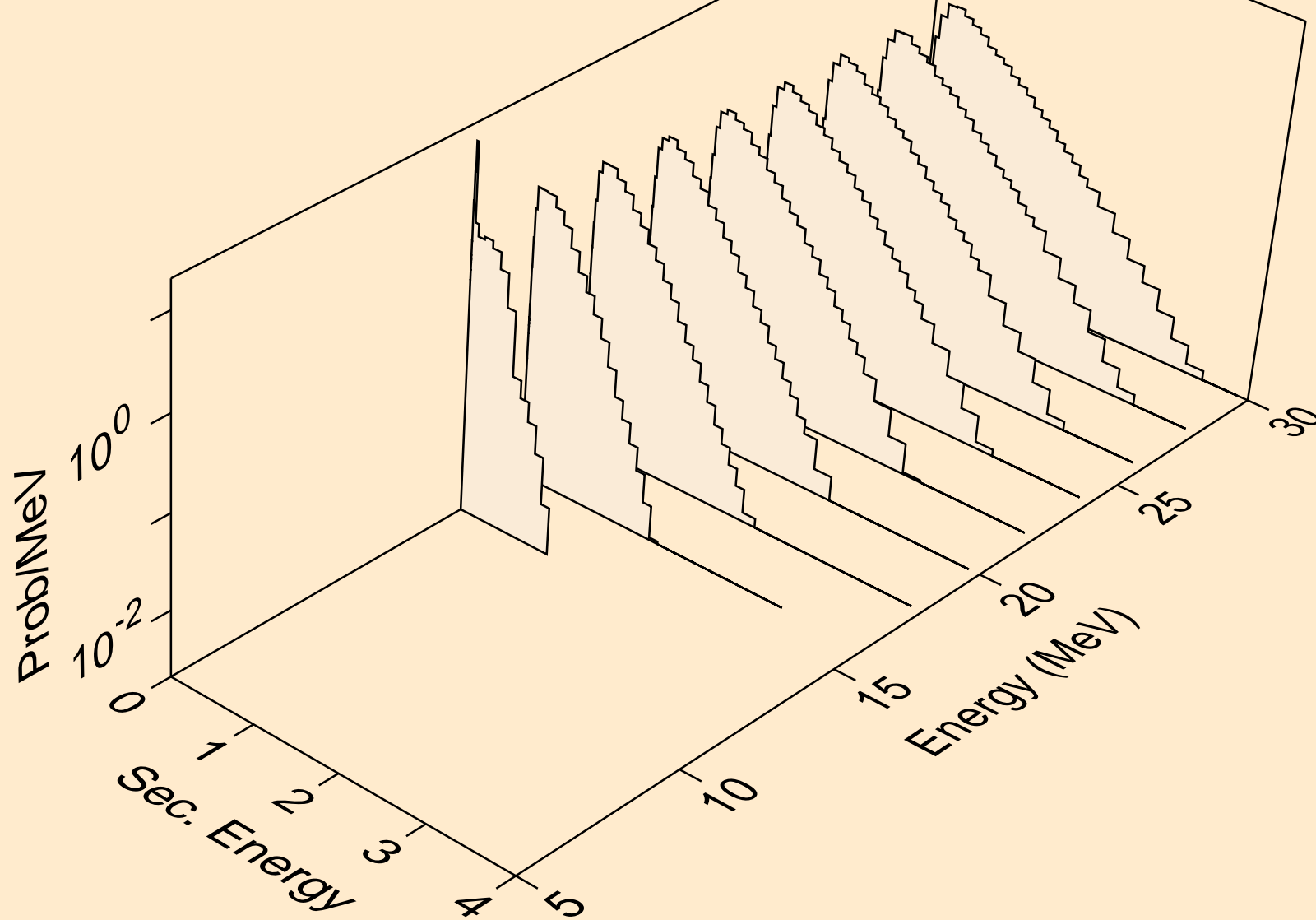

PB192 NEUTRON ACER TENDL-2024 LIBRARY; T=0.K
Neutron emission for (n,2np)

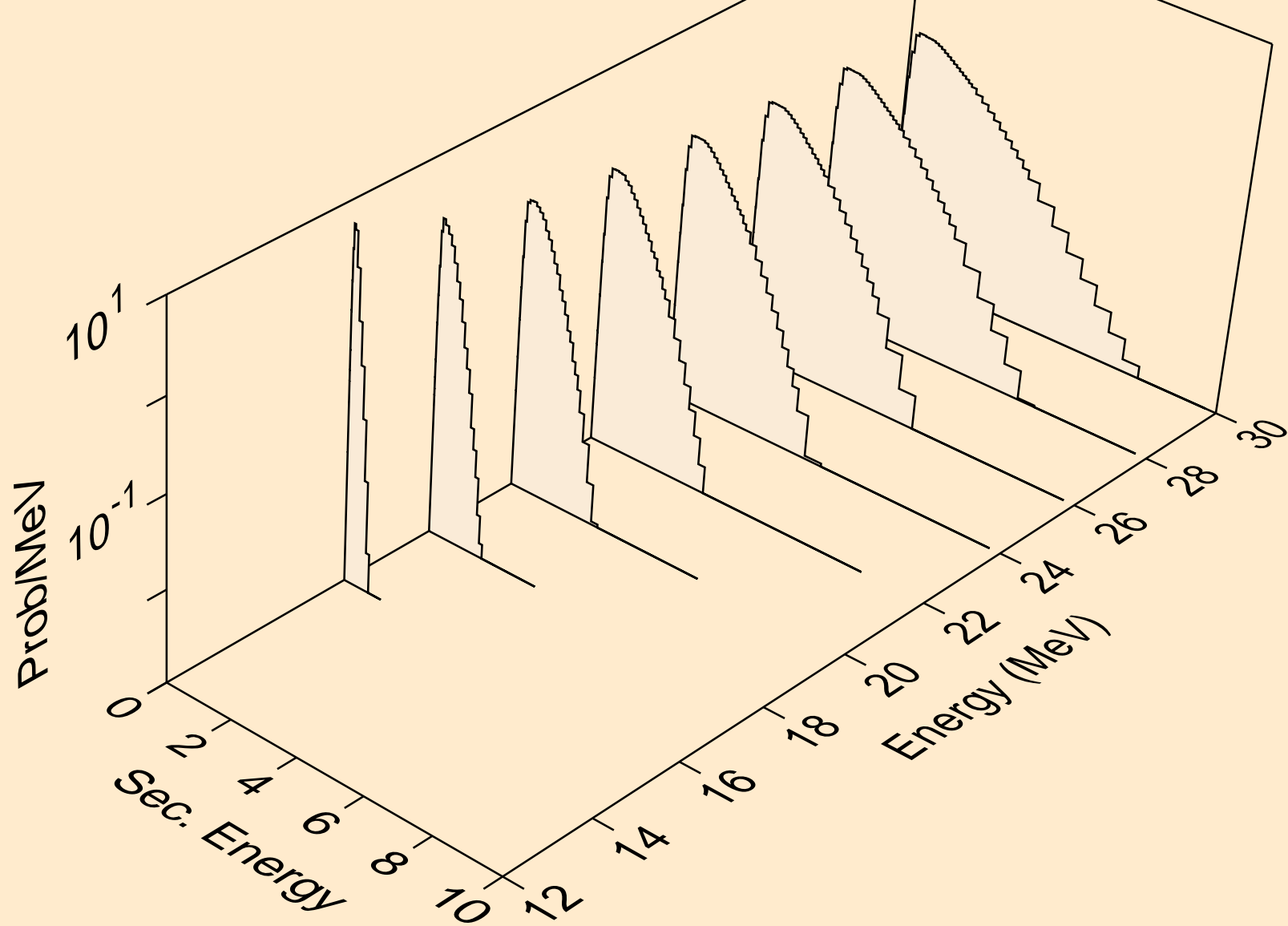

PB192 NEUTRON ACER TENDL-2024 LIBRARY; T=0.K
Neutron emission for (n,3np)

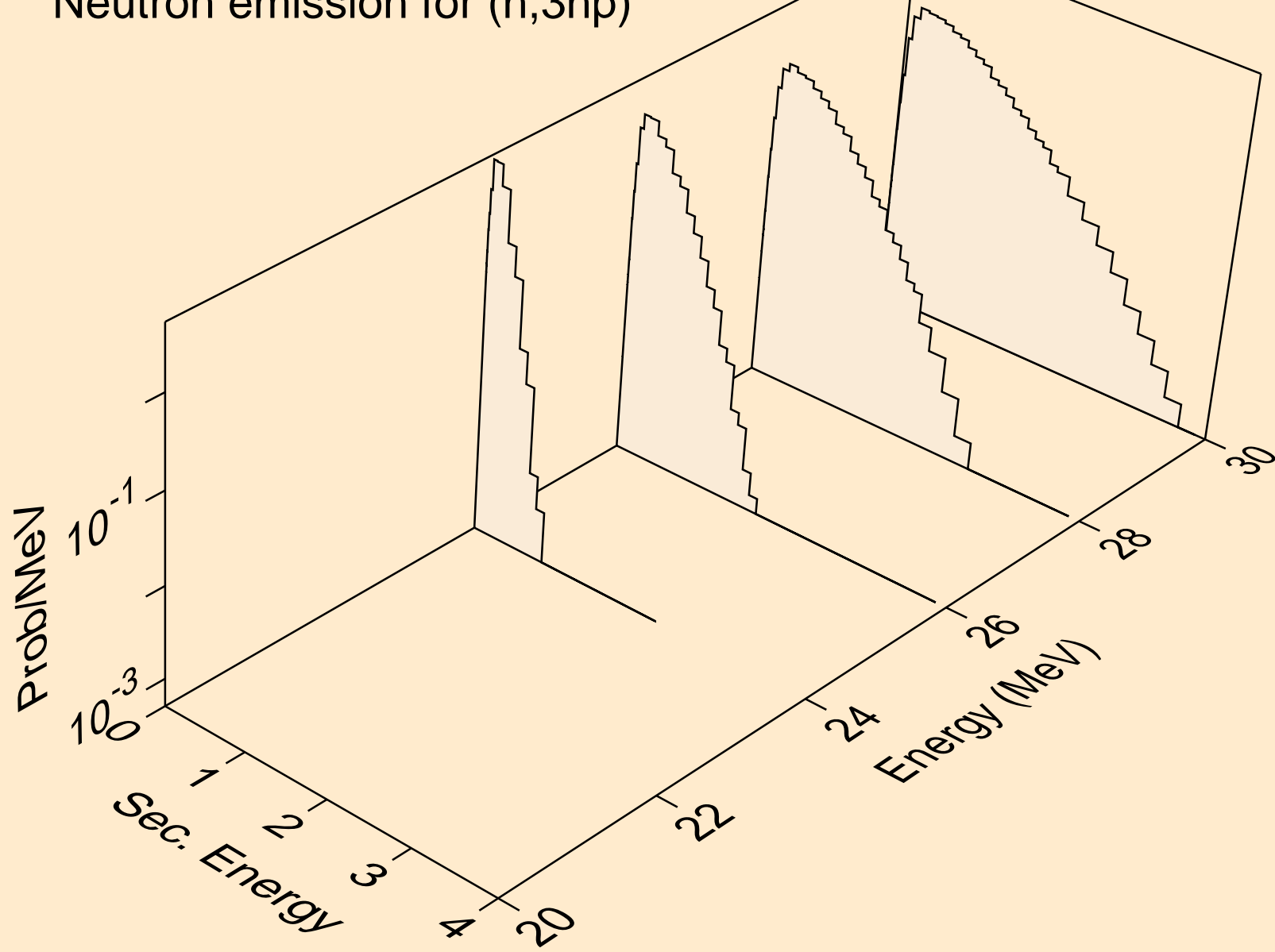

PB192 NEUTRON ACER TENDL-2024 LIBRARY; T=0.K
Neutron emission for (n,n2p)

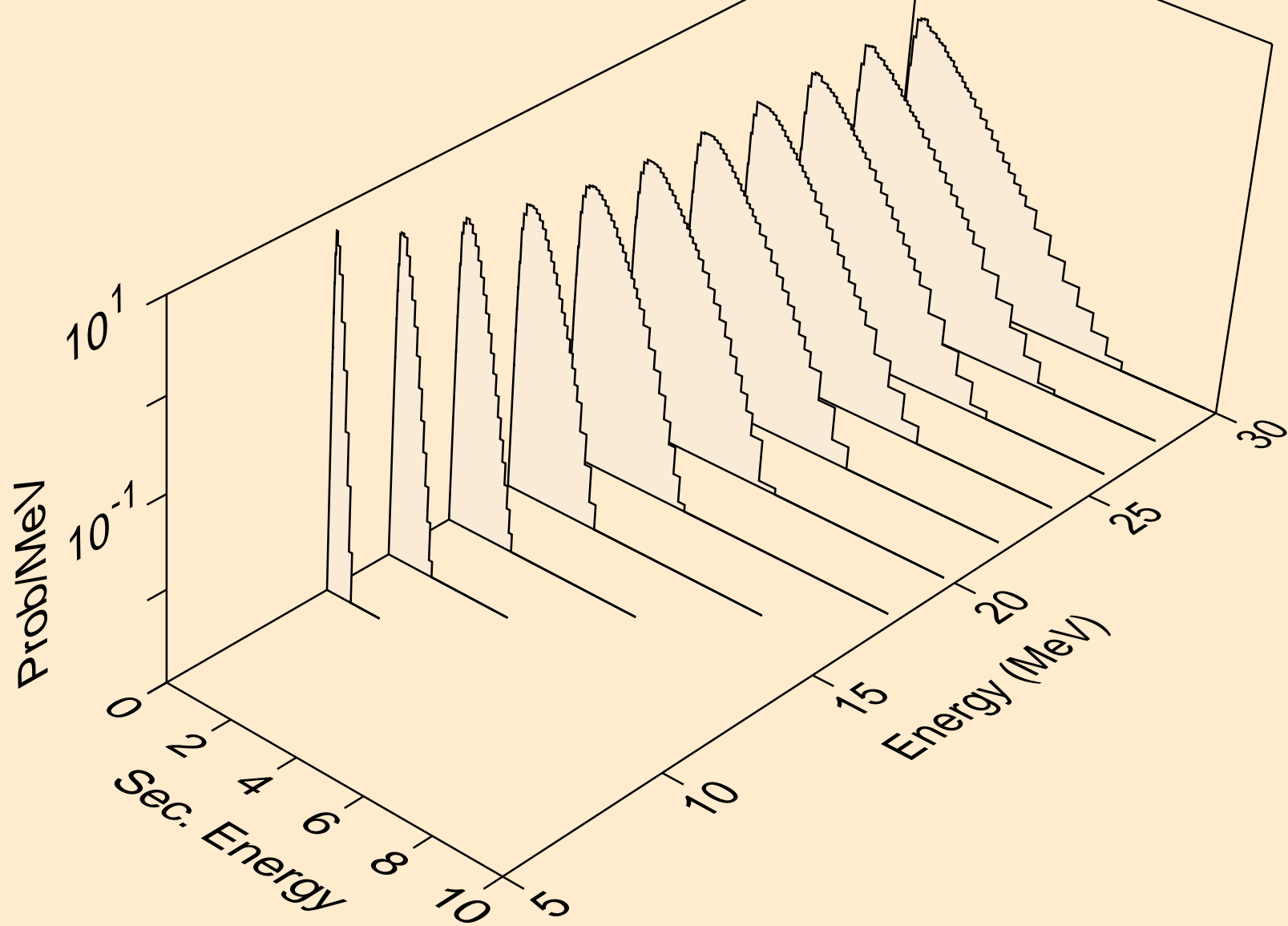

PB192 NEUTRON ACER TENDL-2024 LIBRARY; T=0.K
Neutron emission for (n,npa)

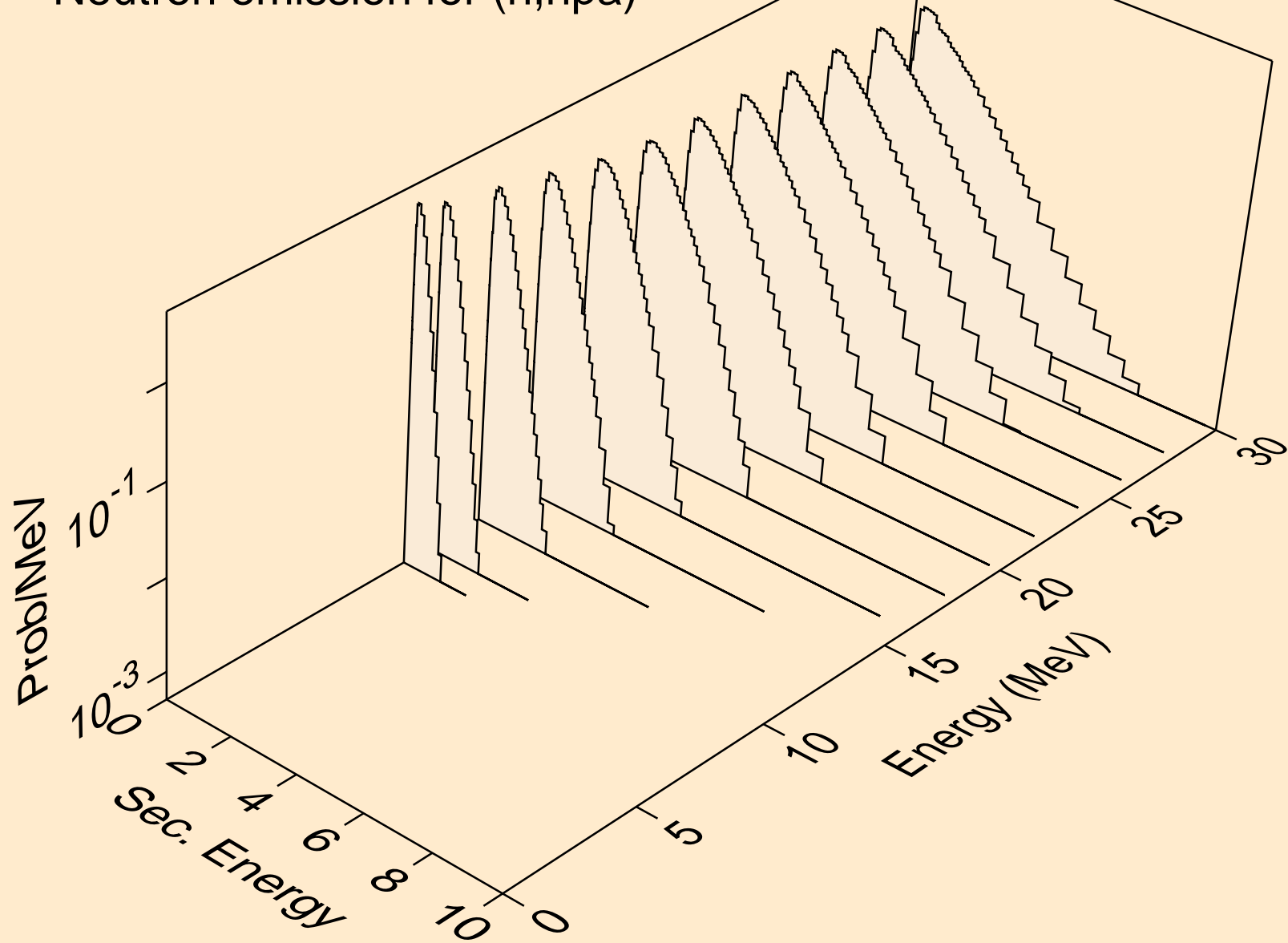

PB192 NEUTRON ACER TENDL-2024 LIBRARY; T=0.K
Neutron emission for (n,n*c)

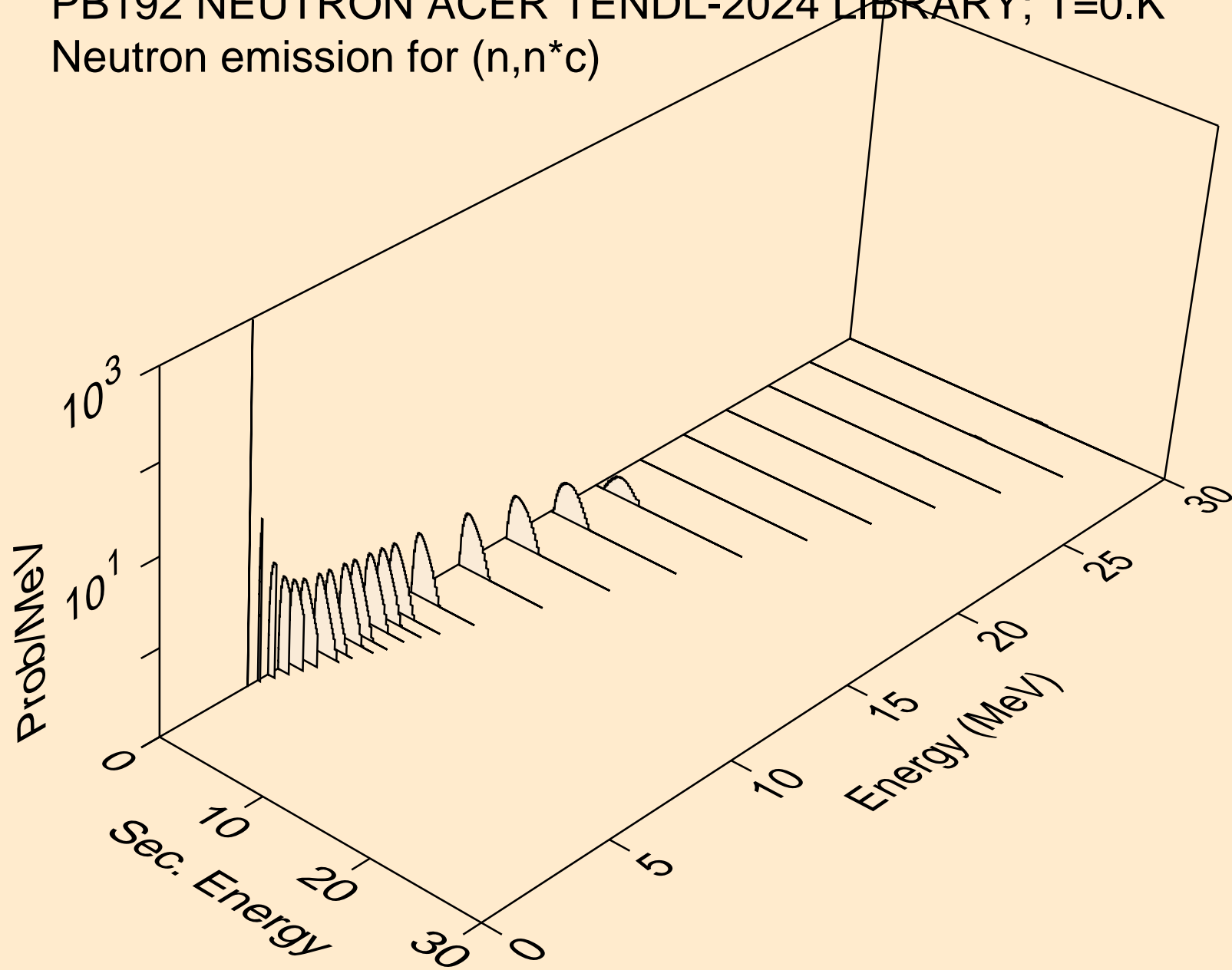

PB192 NEUTRON ACER TENDL-2024 LIBRARY; T=0.K
Photon emission for (n,x)

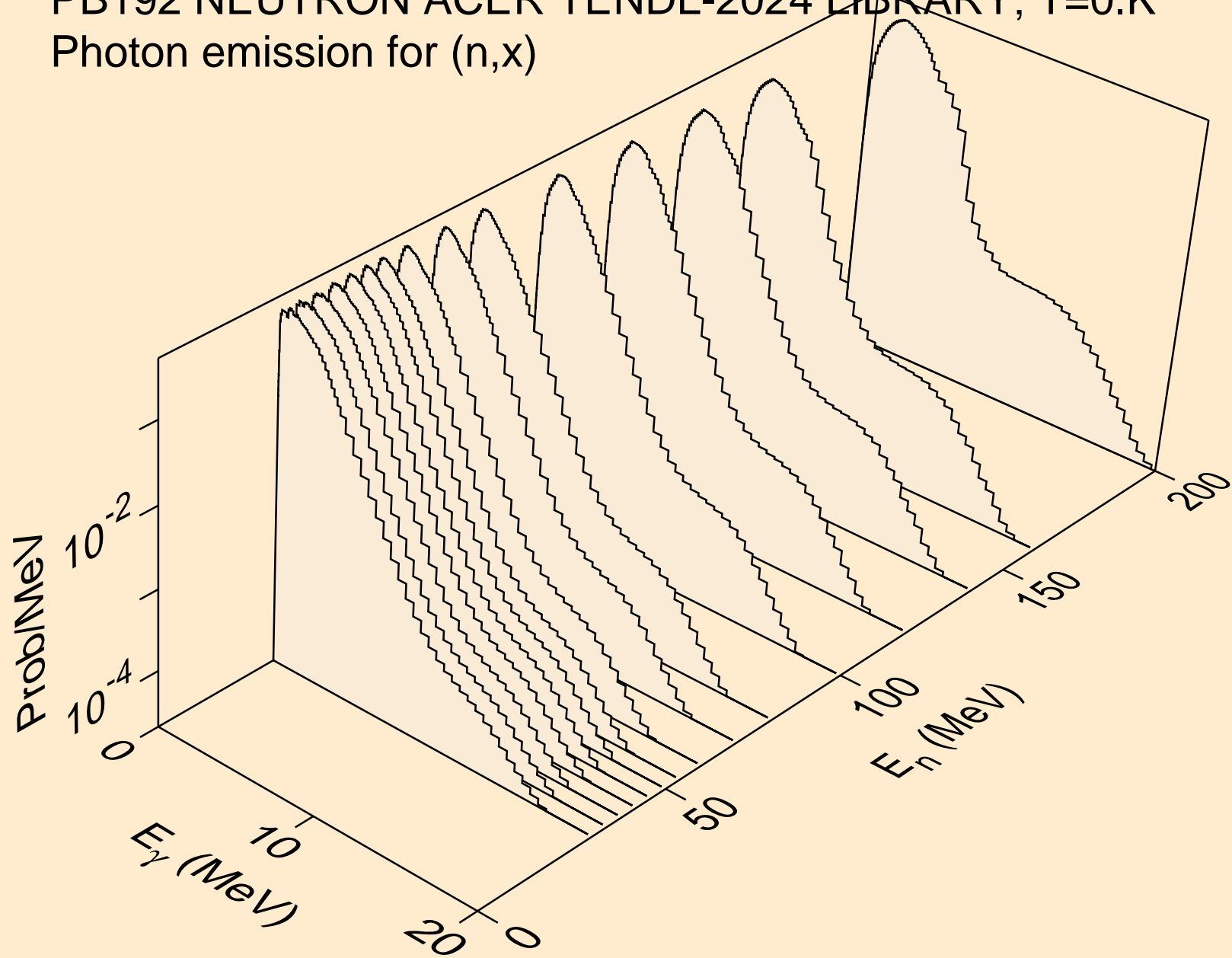

PB192 NEUTRON ACER TENDL-2024 LIBRARY; T=0.K
Photon emission for (n,2nd)

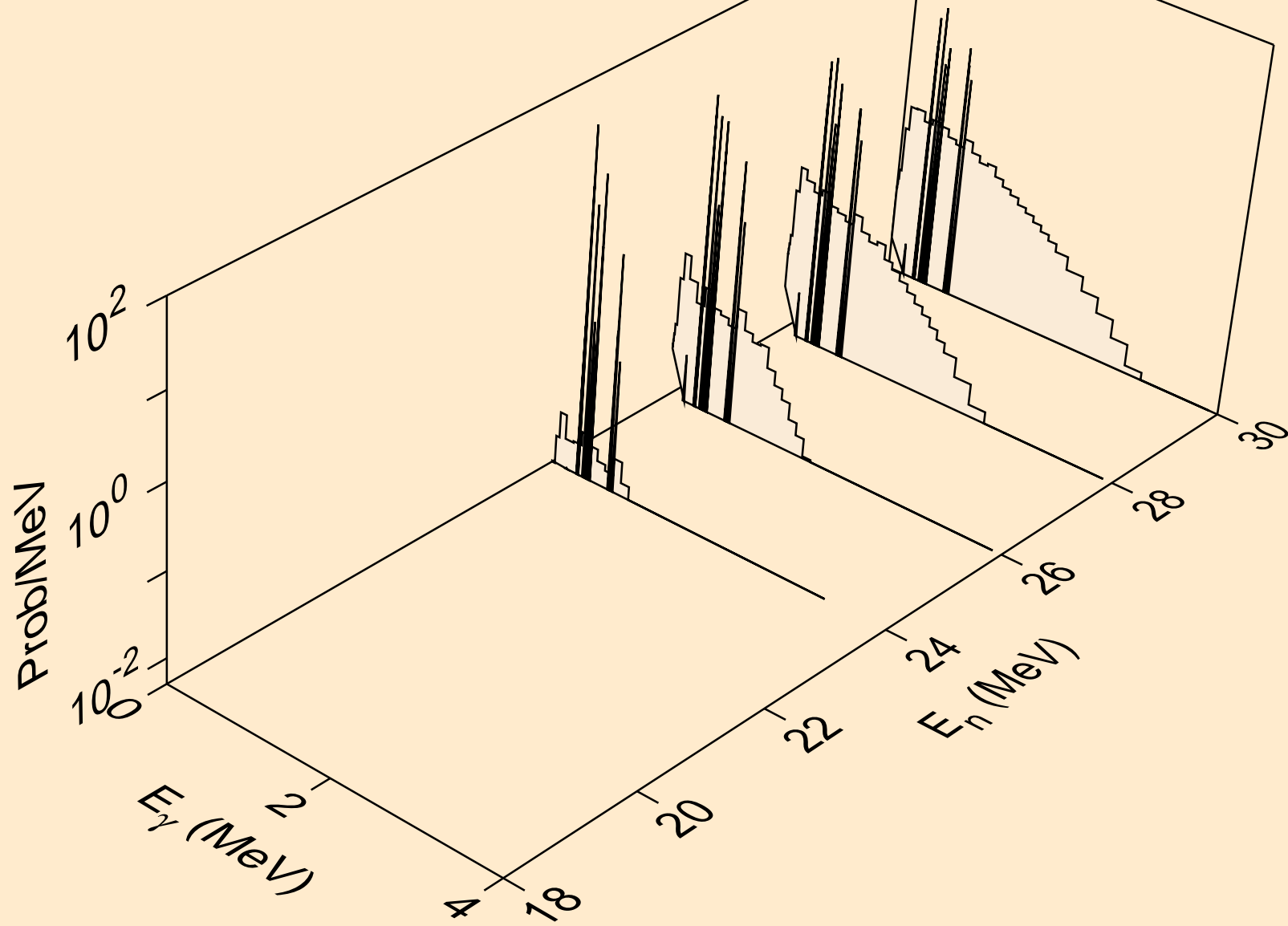

PB192 NEUTRON ACER TENDL-2024 LIBRARY; T=0.K
Photon emission for (n,2n)

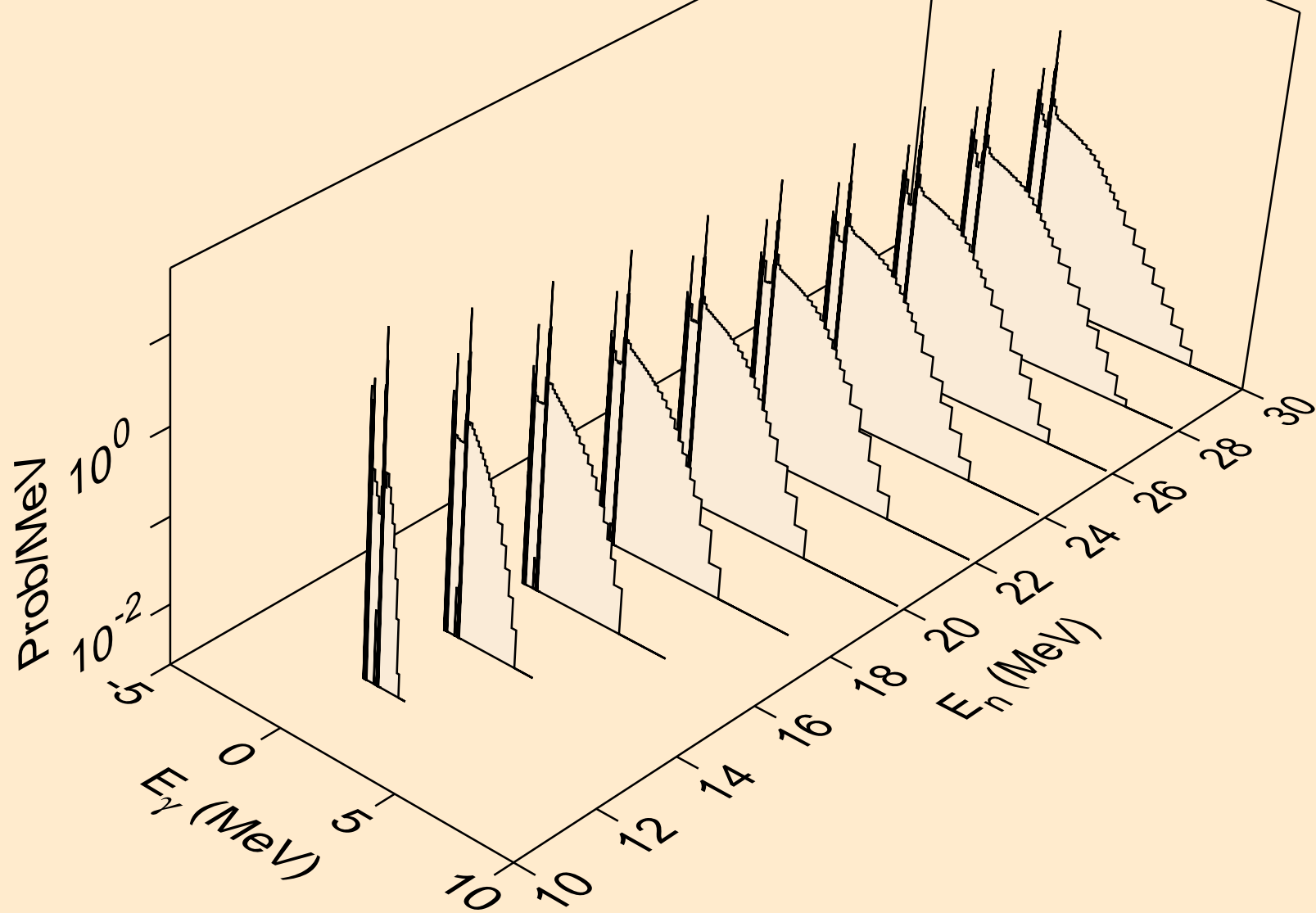

PB192 NEUTRON ACER TENDL-2024 LIBRARY; T=0.K
Photon emission for (n,3n)

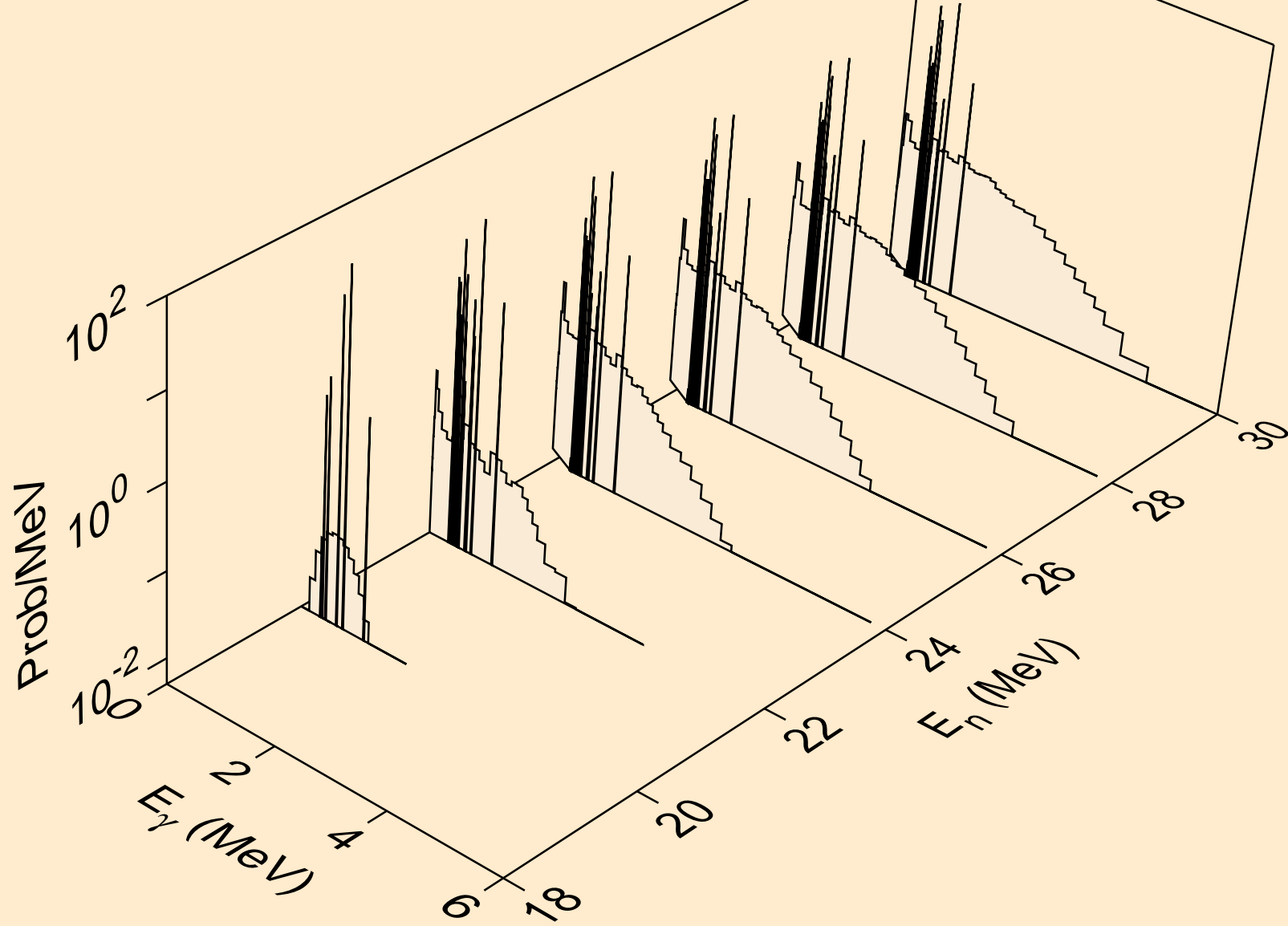

PB192 NEUTRON ACER TENDL-2024 LIBRARY; T=0.K
Photon emission for (n,n*)a

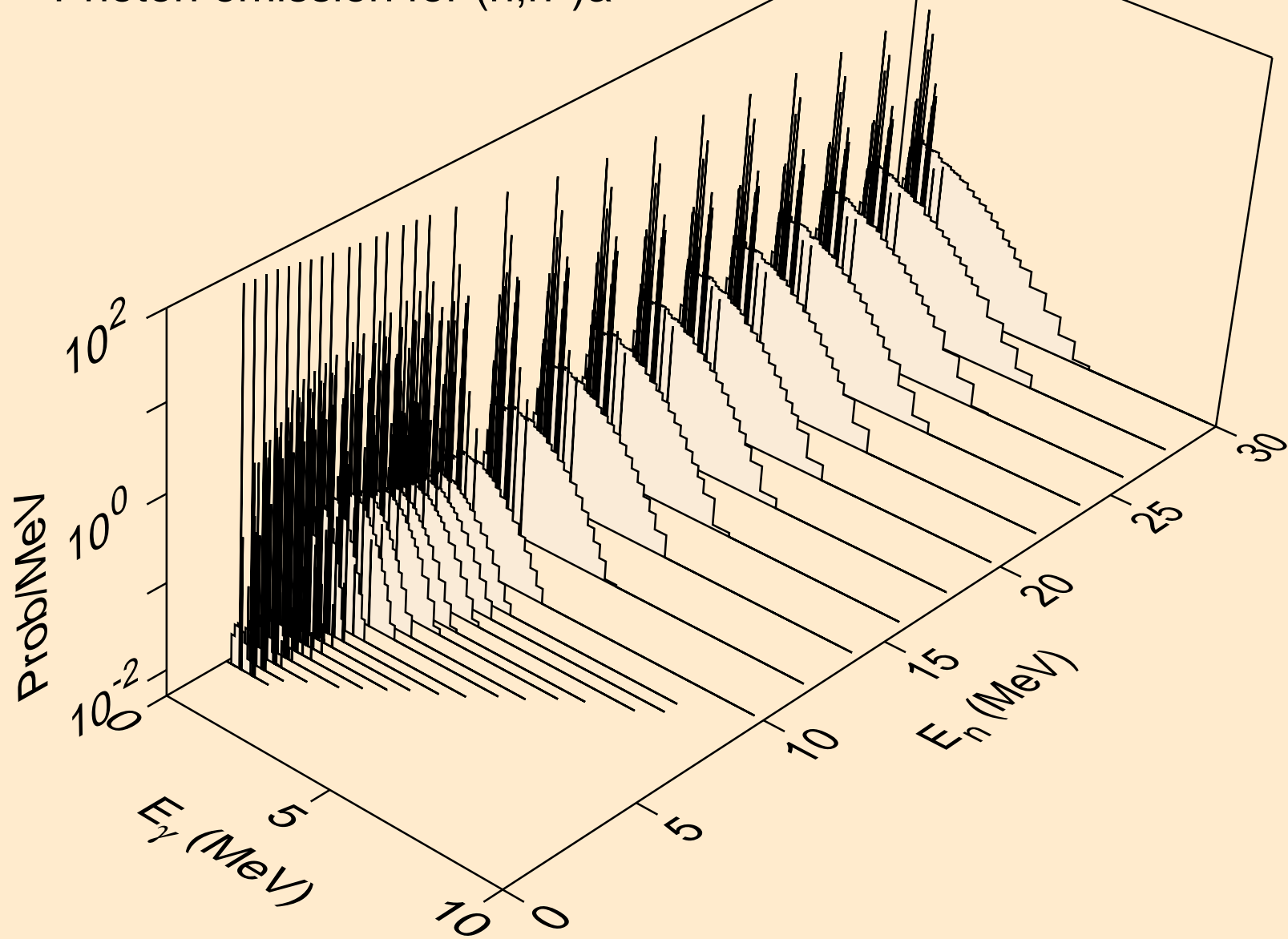

PB192 NEUTRON ACER TENDL-2024 LIBRARY; T=0.K
Photon emission for (n,2n)a

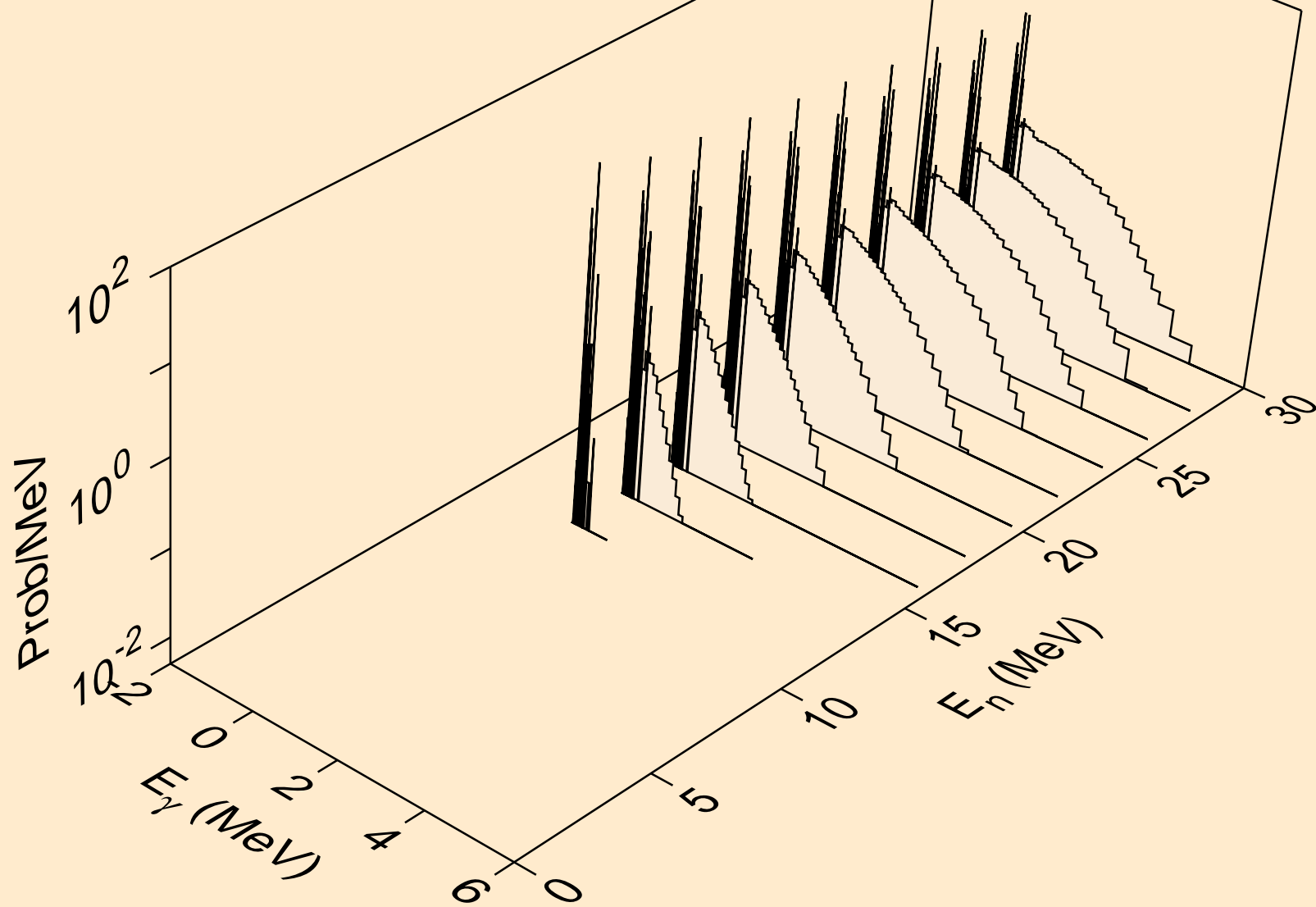

PB192 NEUTRON ACER TENDL-2024 LIBRARY; T=0.K
Photon emission for (n,3n)a

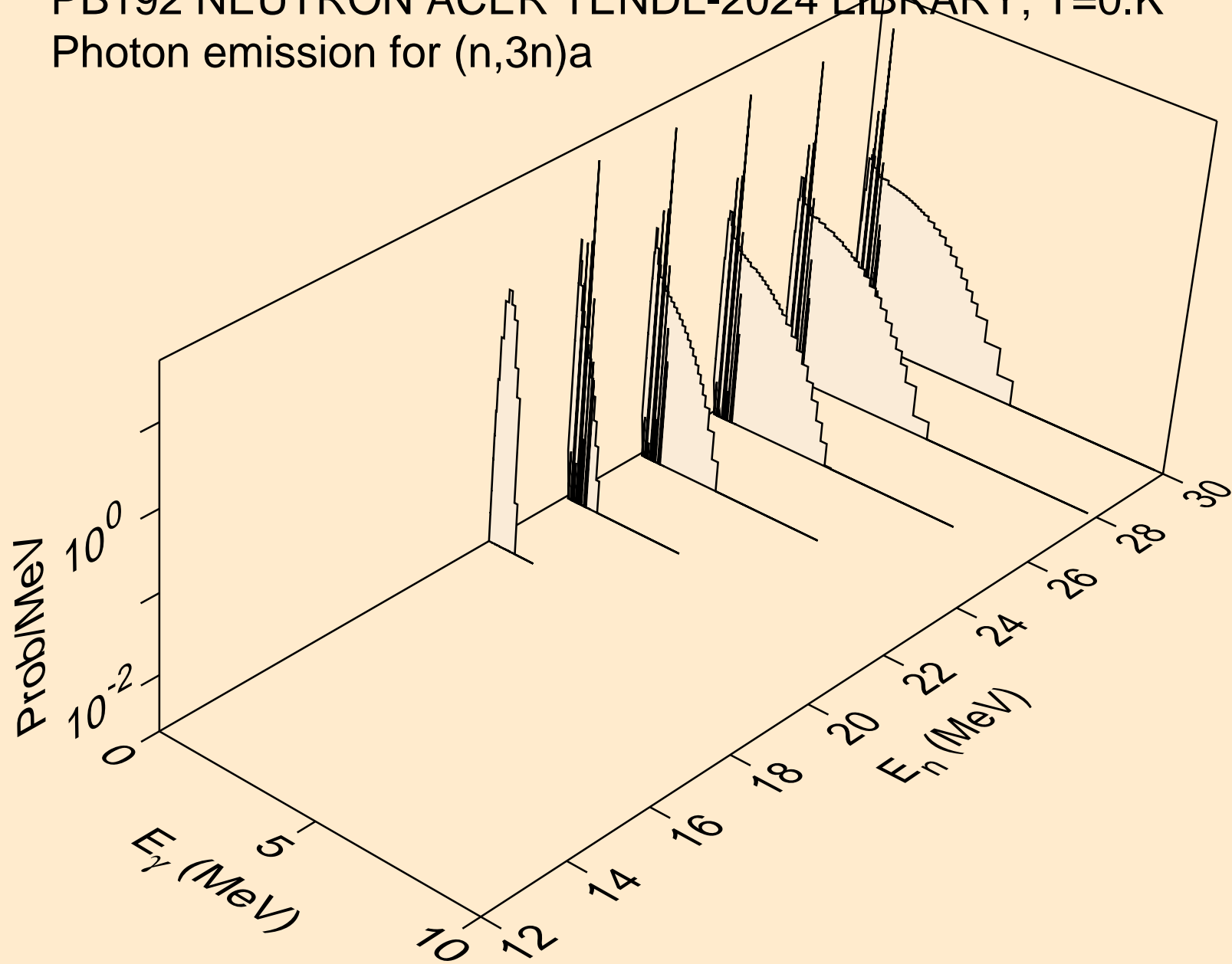

PB192 NEUTRON ACER TENDL-2024 LIBRARY; T=0.K
Photon emission for (n,n*)p

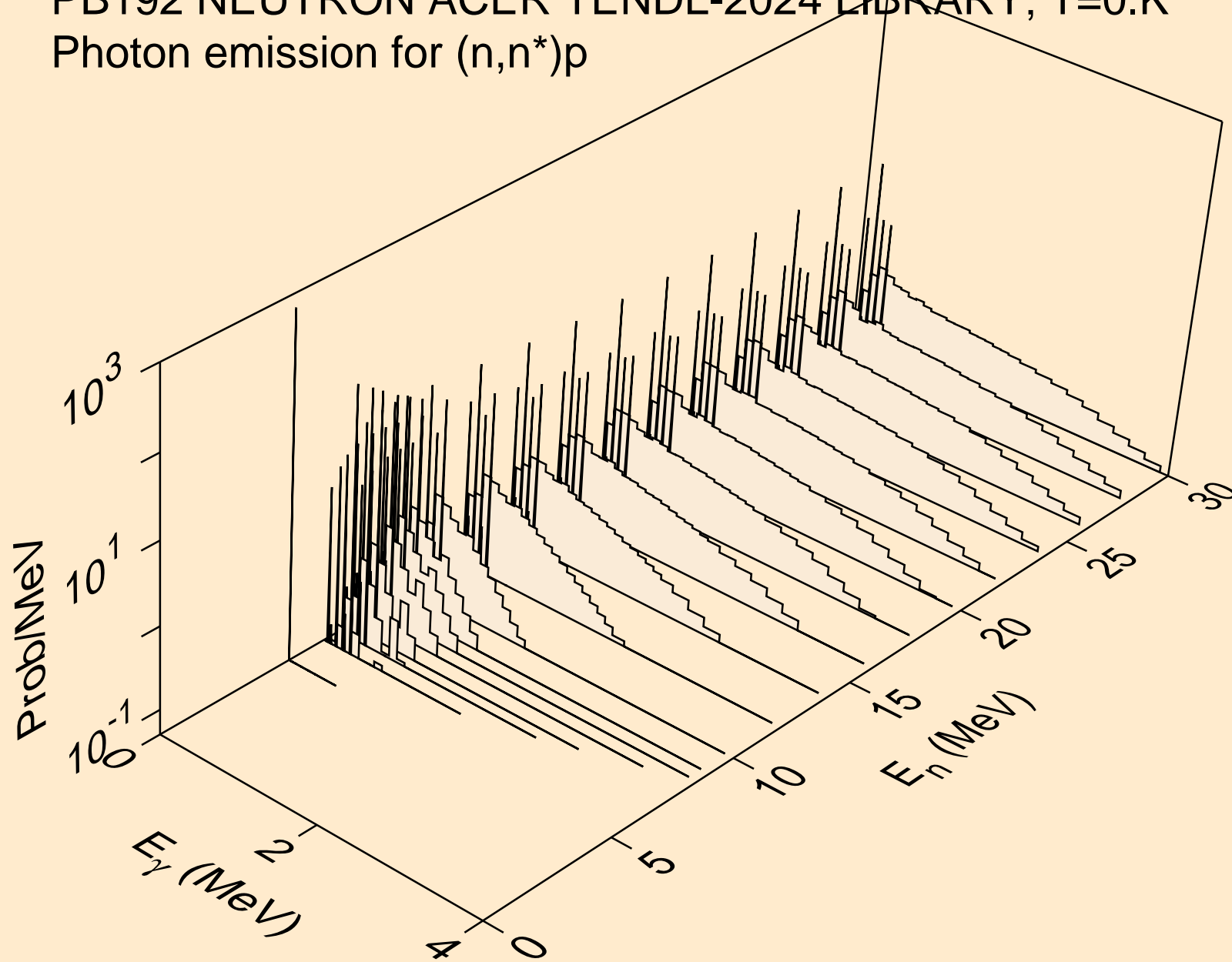

PB192 NEUTRON ACER TENDL-2024 LIBRARY; T=0.K
Photon emission for (n,n*)2a

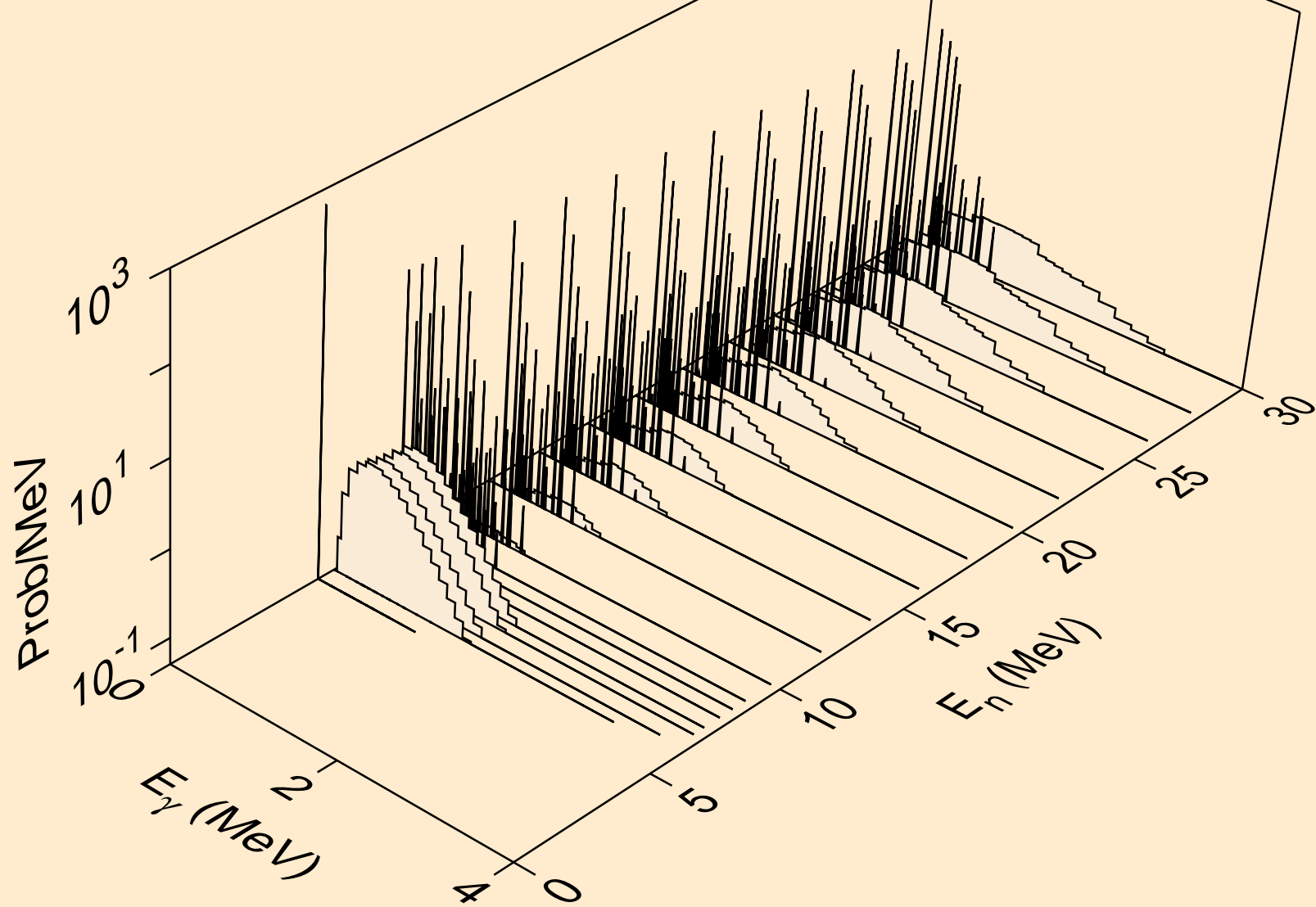

PB192 NEUTRON ACER TENDL-2024 LIBRARY; T=0.K
Photon emission for (n,2n)2a

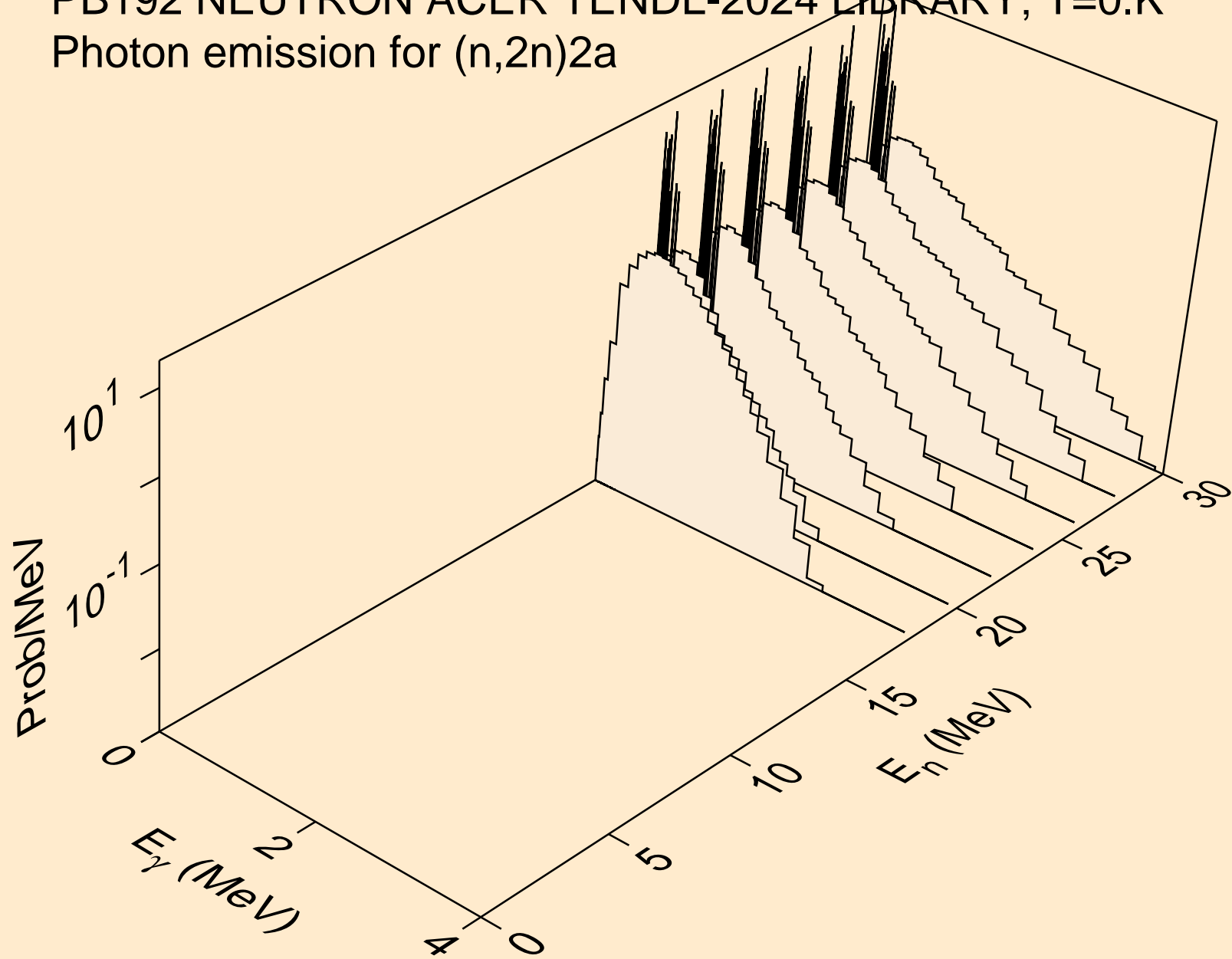

PB192 NEUTRON ACER TENDL-2024 LIBRARY; T=0.K
Photon emission for (n,n*)d

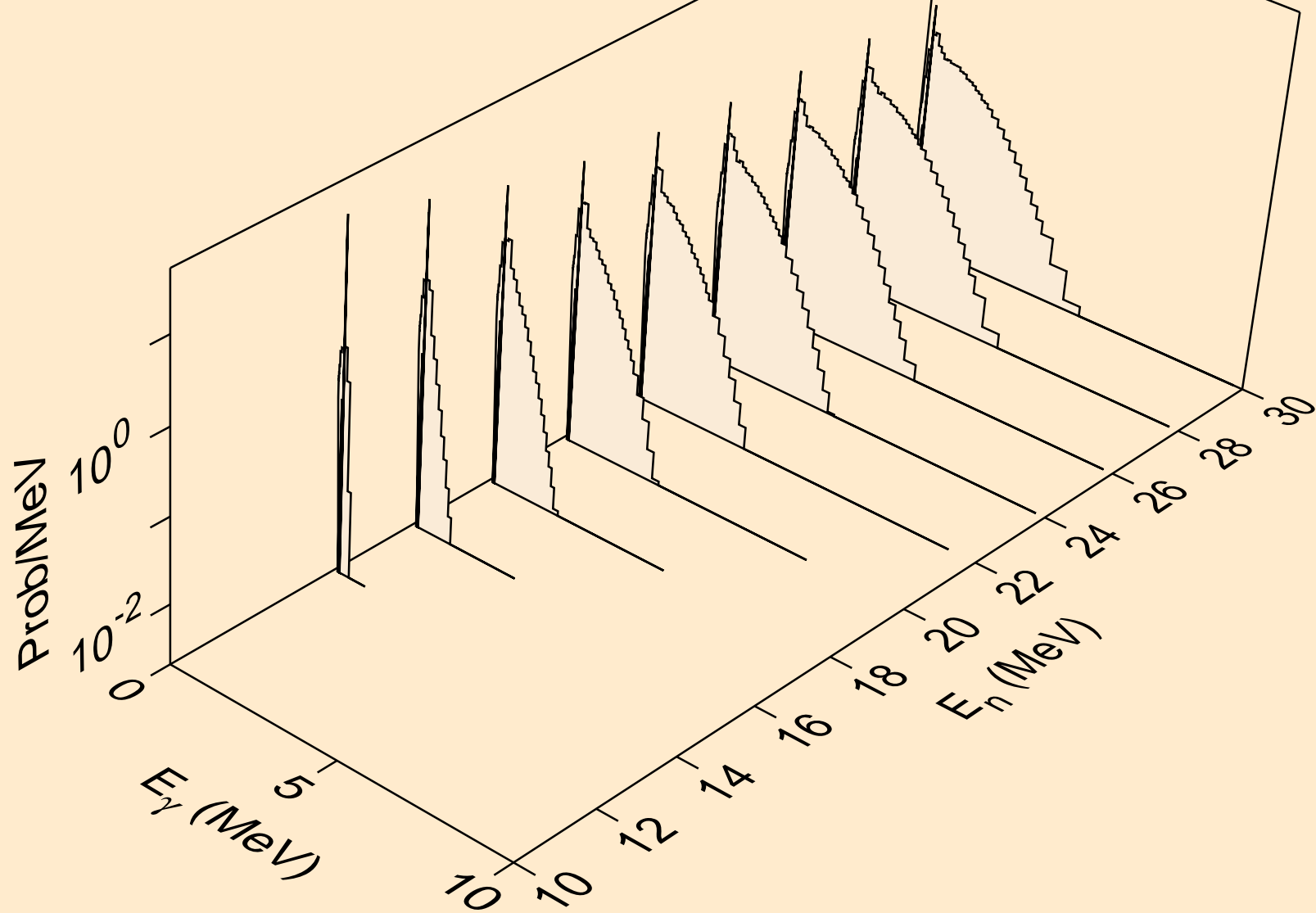

PB192 NEUTRON ACER TENDL-2024 LIBRARY; T=0.K
Photon emission for (n,n*)t

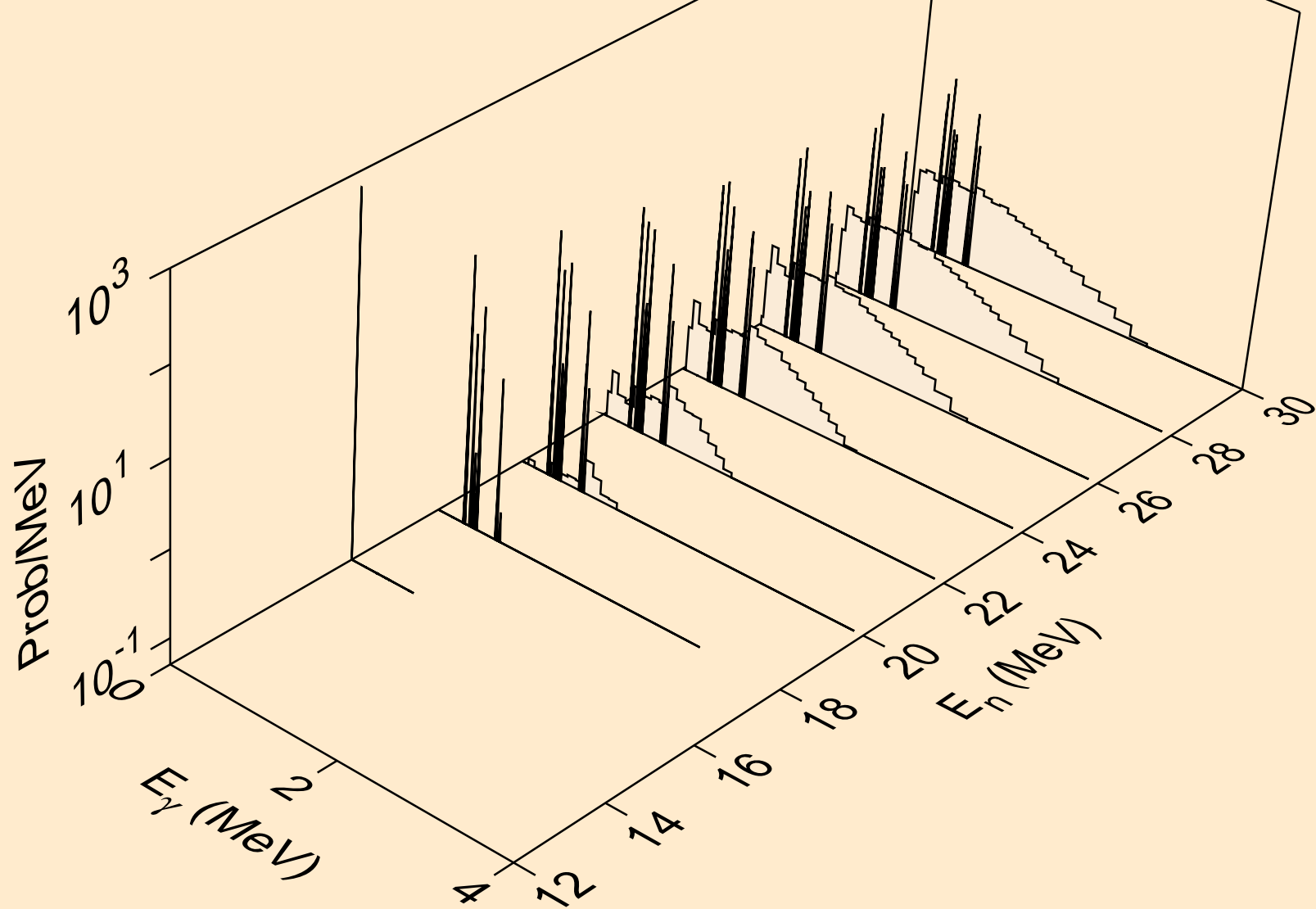

PB192 NEUTRON ACER TENDL-2024 LIBRARY; T=0.K
Photon emission for (n,n*)he3

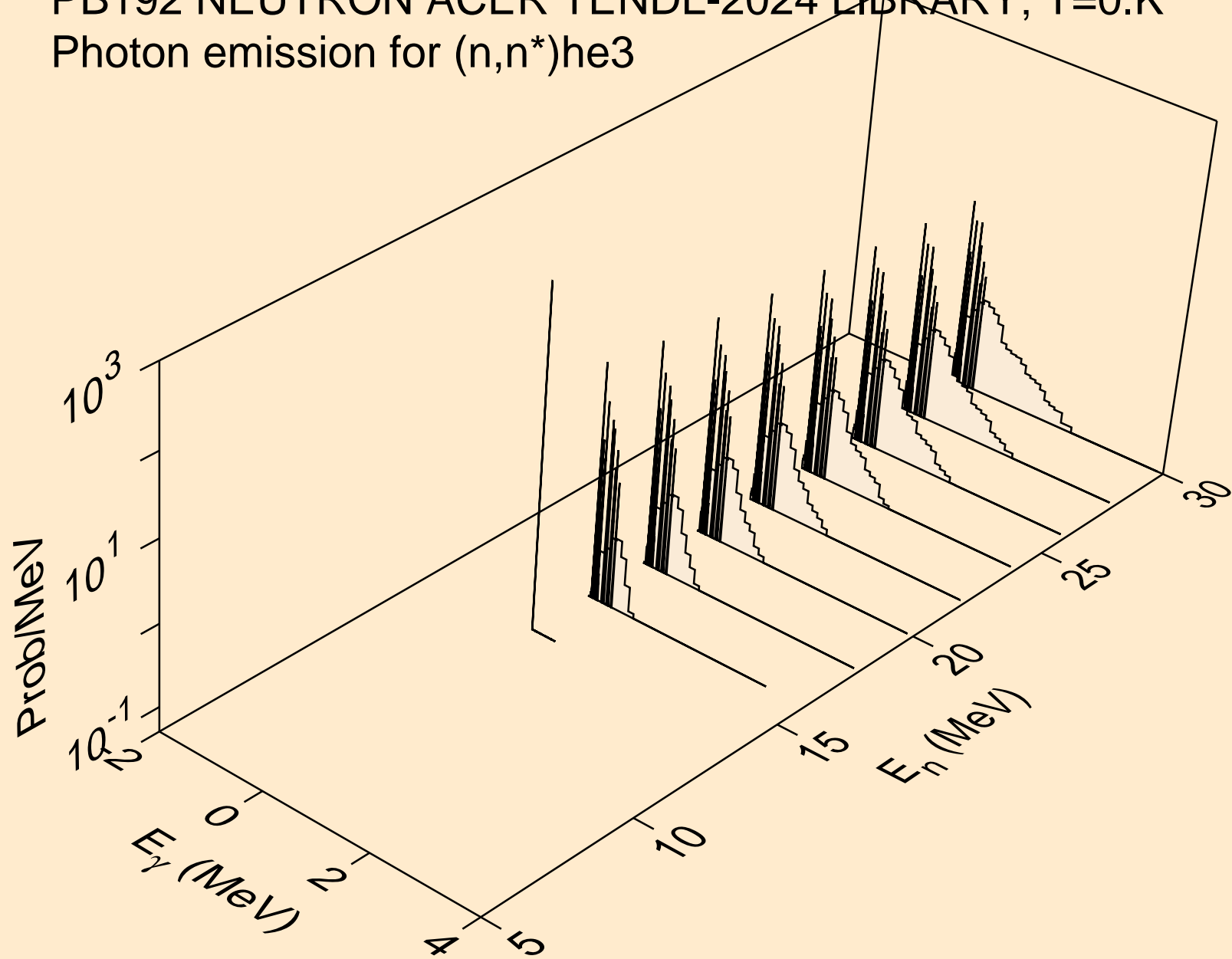

PB192 NEUTRON ACER TENDL-2024 LIBRARY; T=0.K
Photon emission for (n,2np)

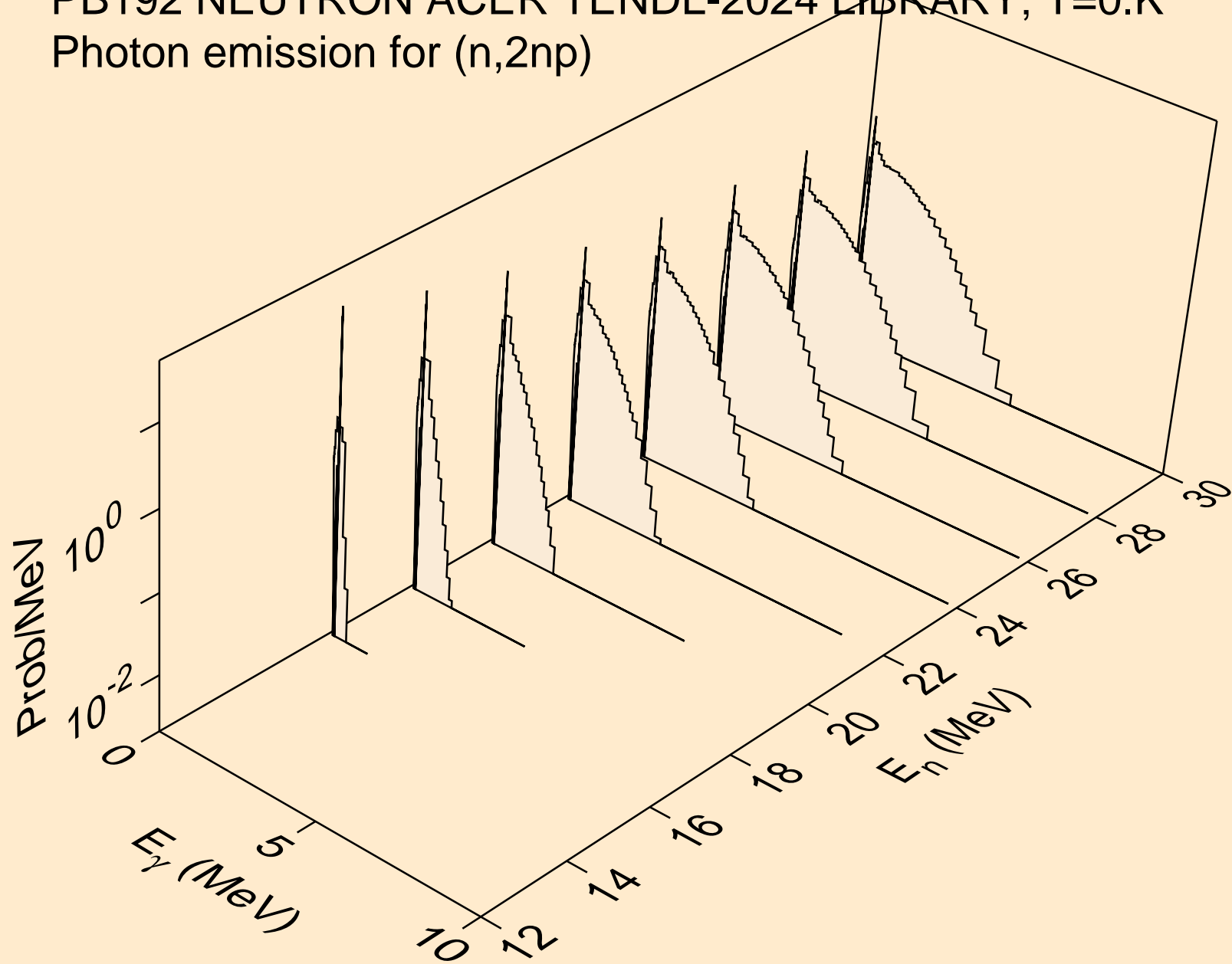

PB192 NEUTRON ACER TENDL-2024 LIBRARY; T=0.K
Photon emission for (n,3np)

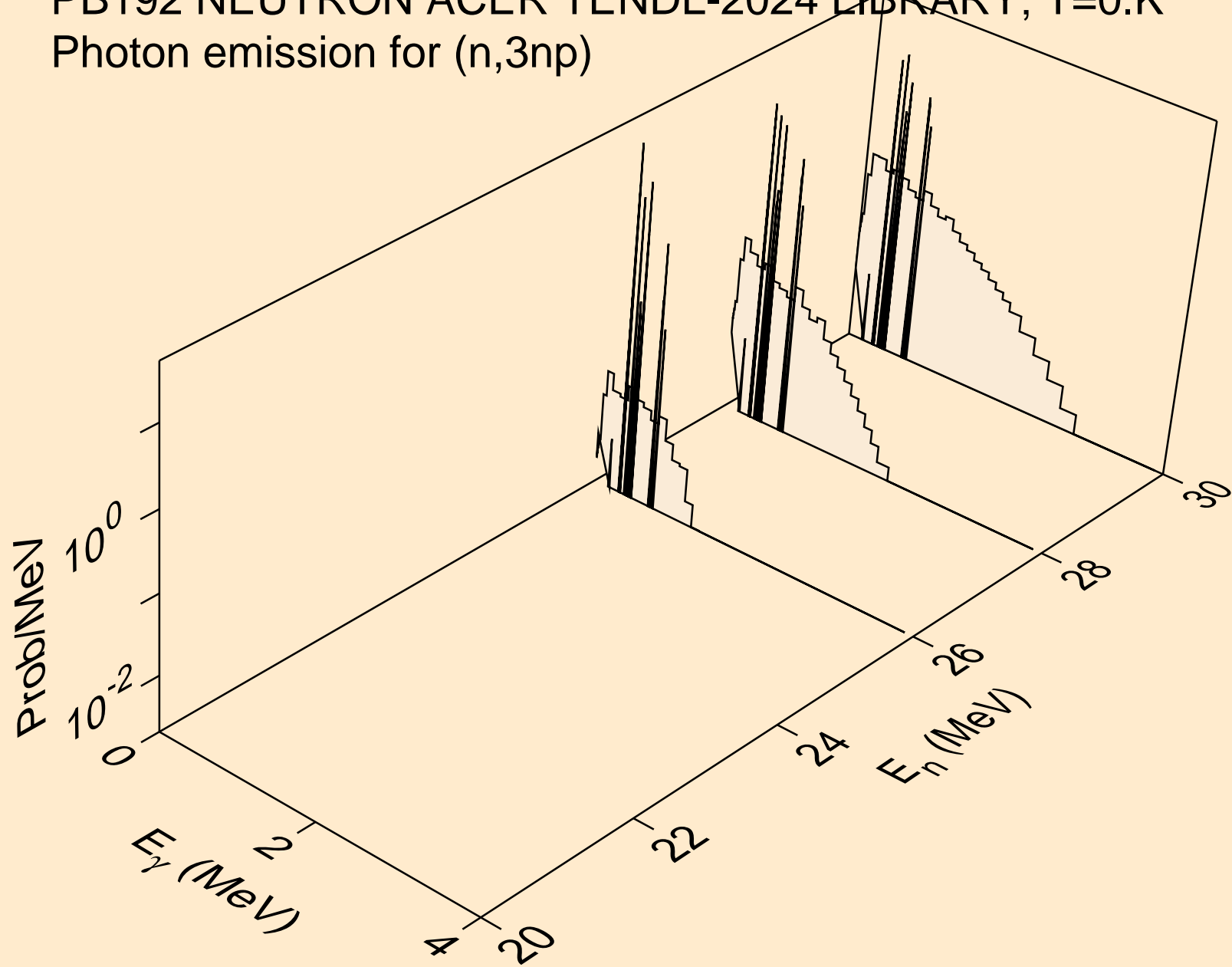

PB192 NEUTRON ACER TENDL-2024 LIBRARY; T=0.K
Photon emission for (n,n2p)

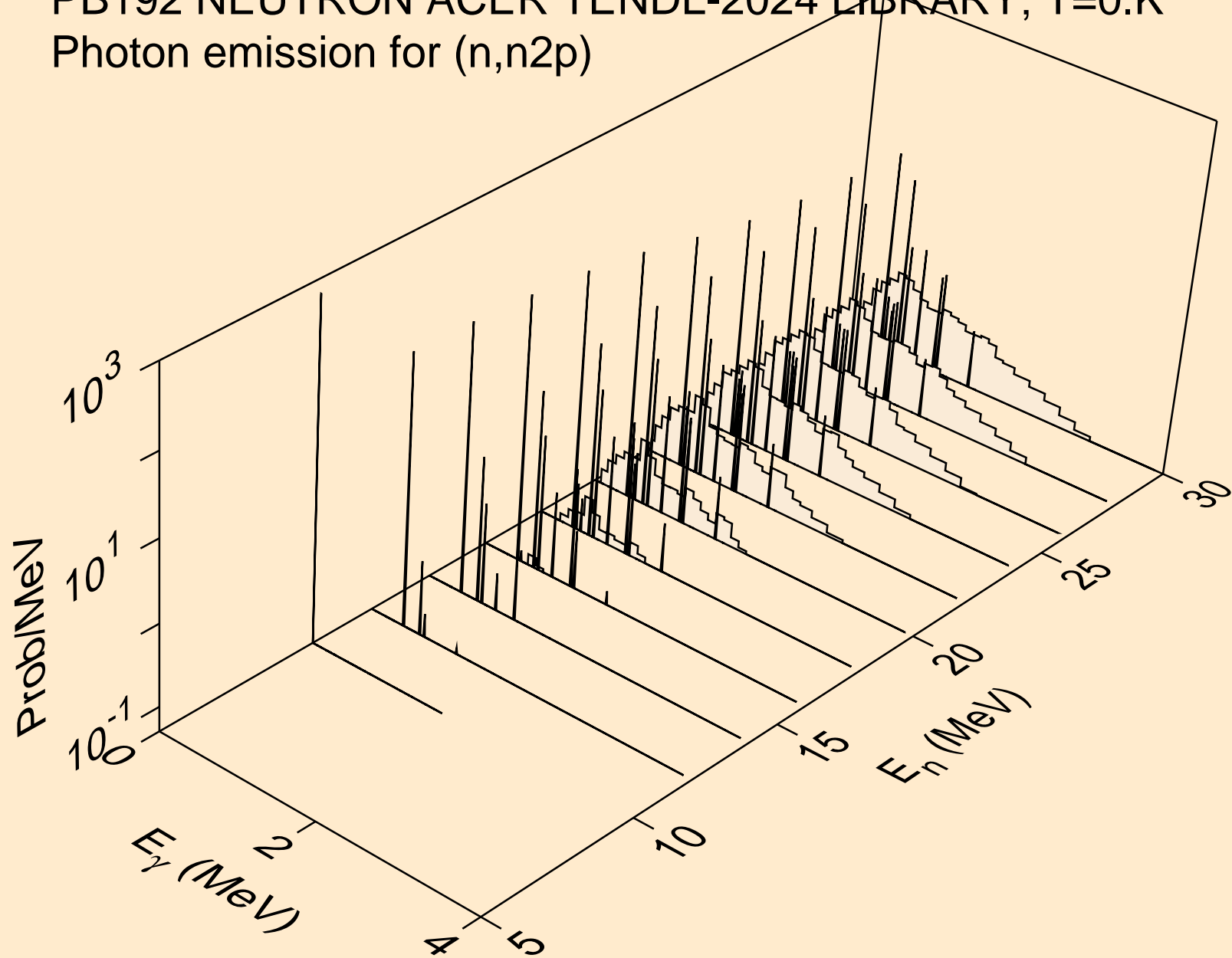

PB192 NEUTRON ACER TENDL-2024 LIBRARY; T=0.K
Photon emission for (n,npa)

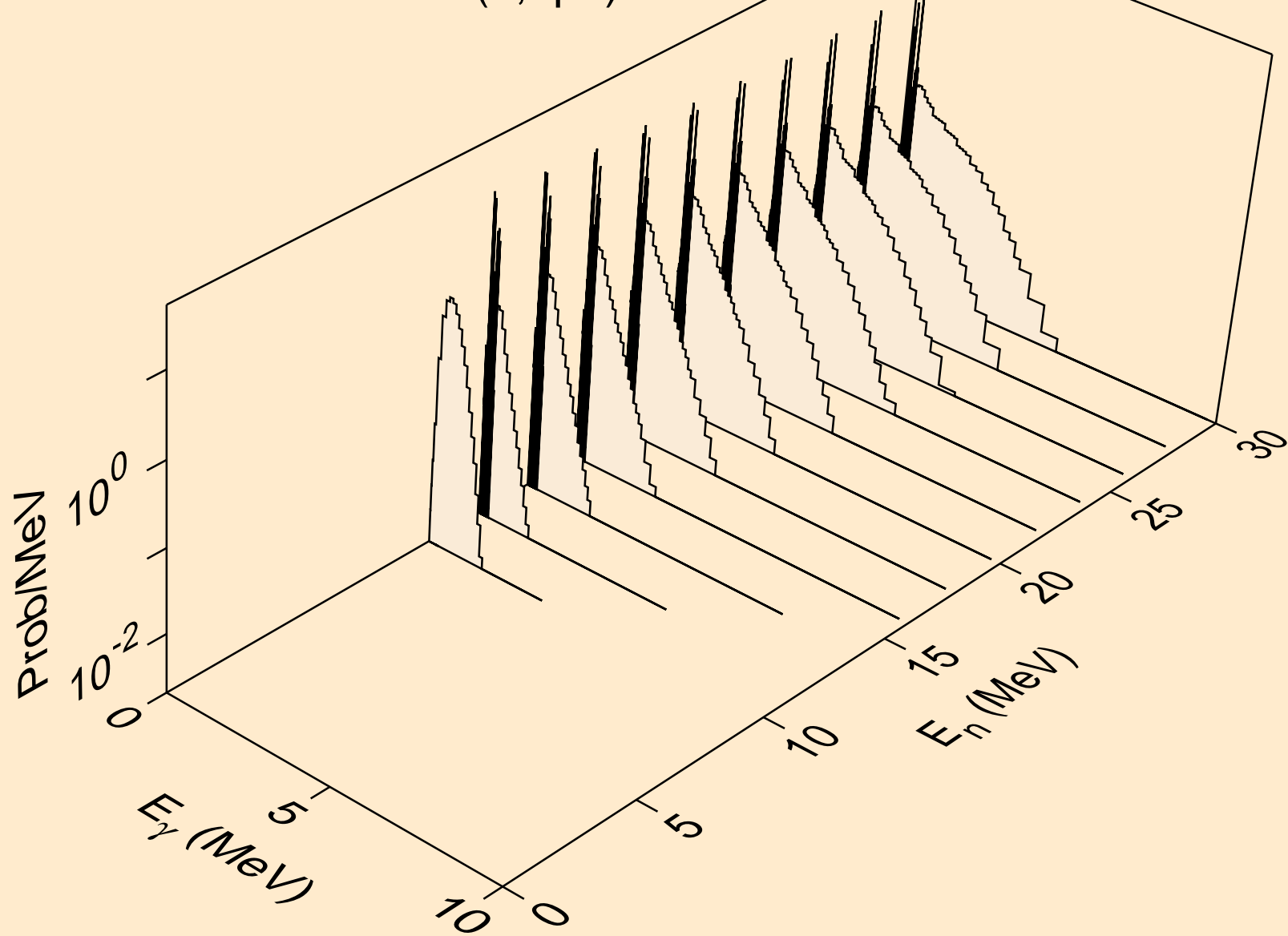

PB192 NEUTRON ACER TENDL-2024 LIBRARY; T=0.K
Photon emission for (n,n*c)

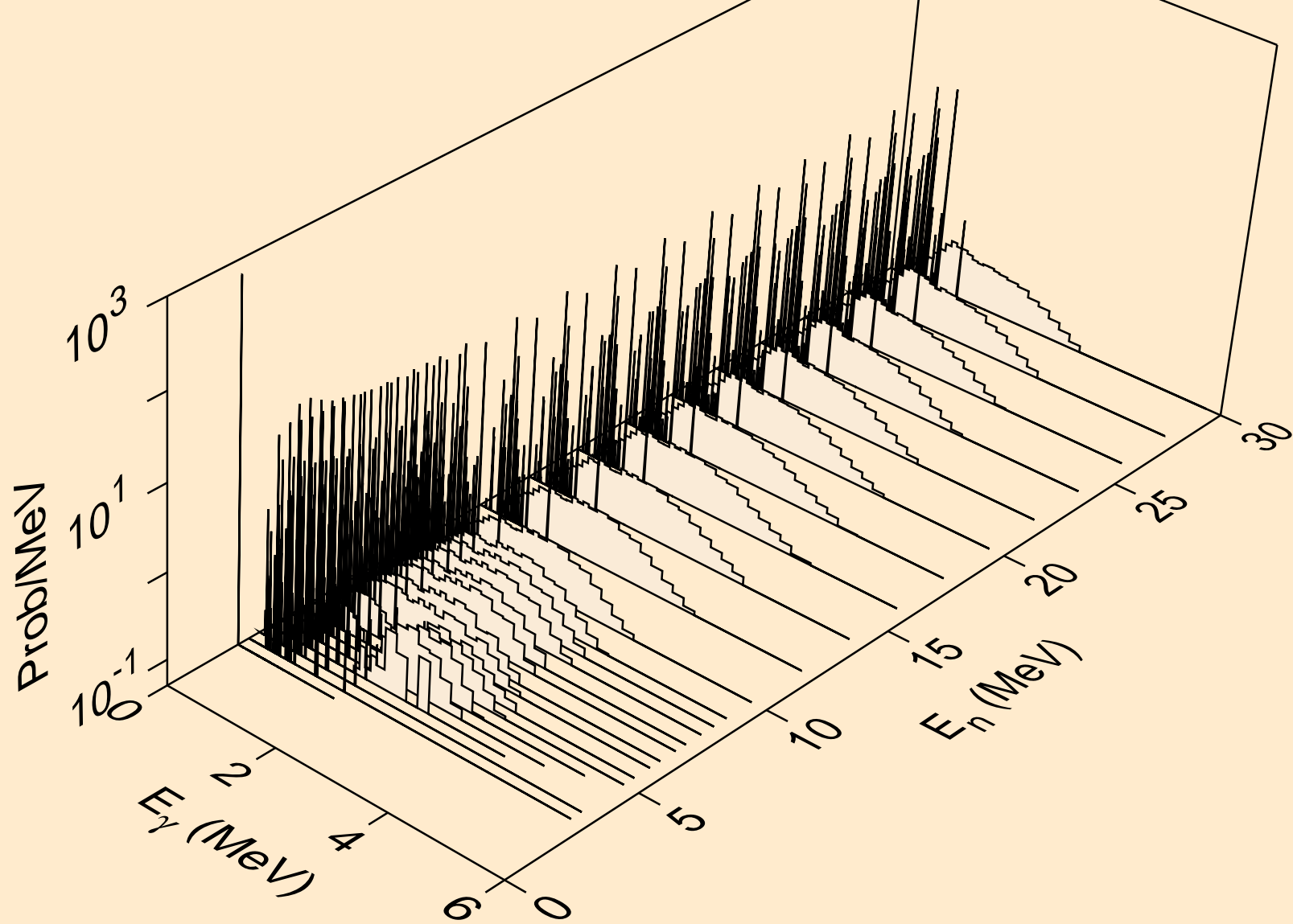

PB192 NEUTRON ACER TENDL-2024 LIBRARY; T=0.K
Photon emission for (n,gma)

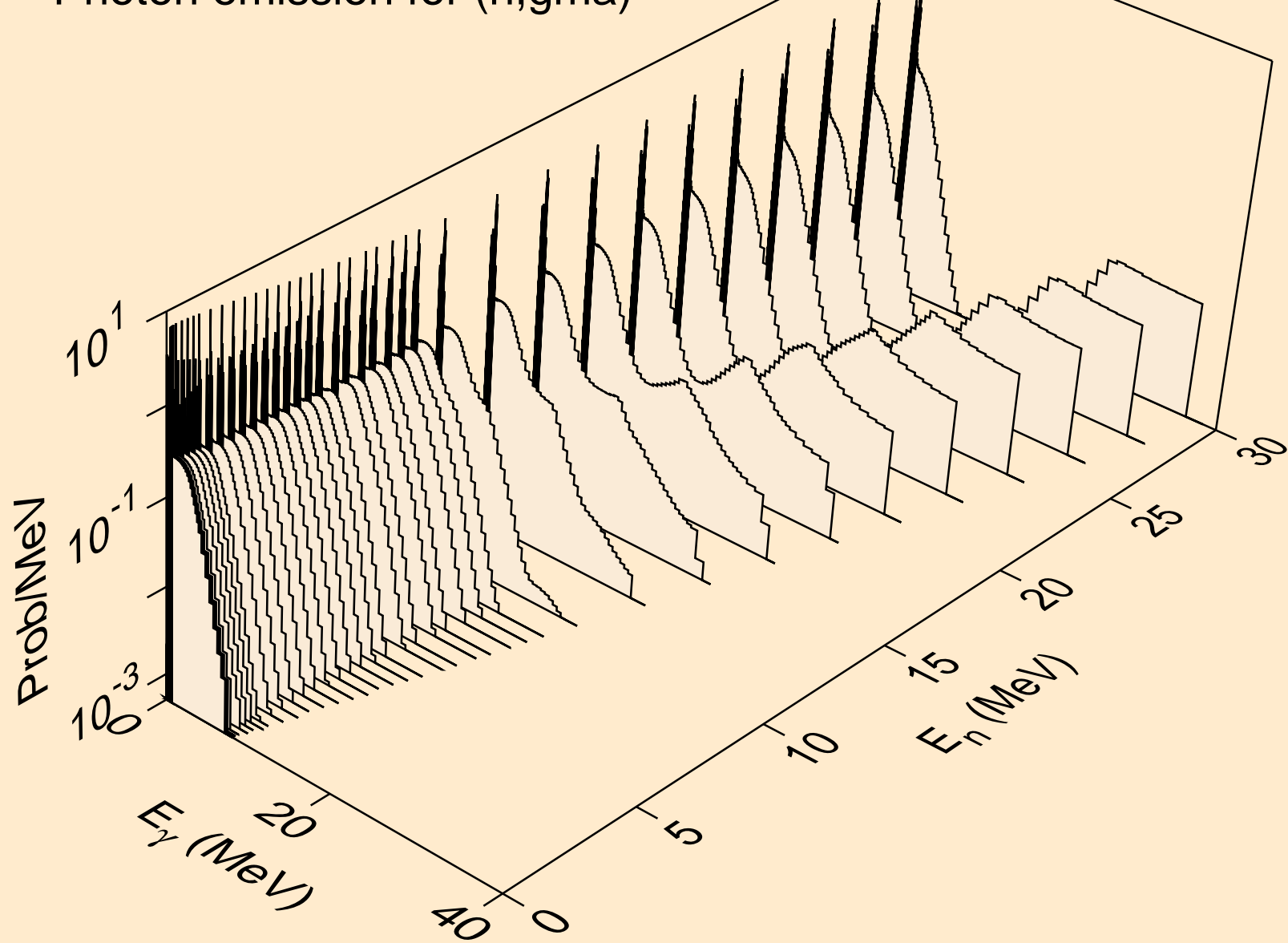

PB192 NEUTRON ACER TENDL-2024 LIBRARY; T=0.K
Photon emission for (n,p)

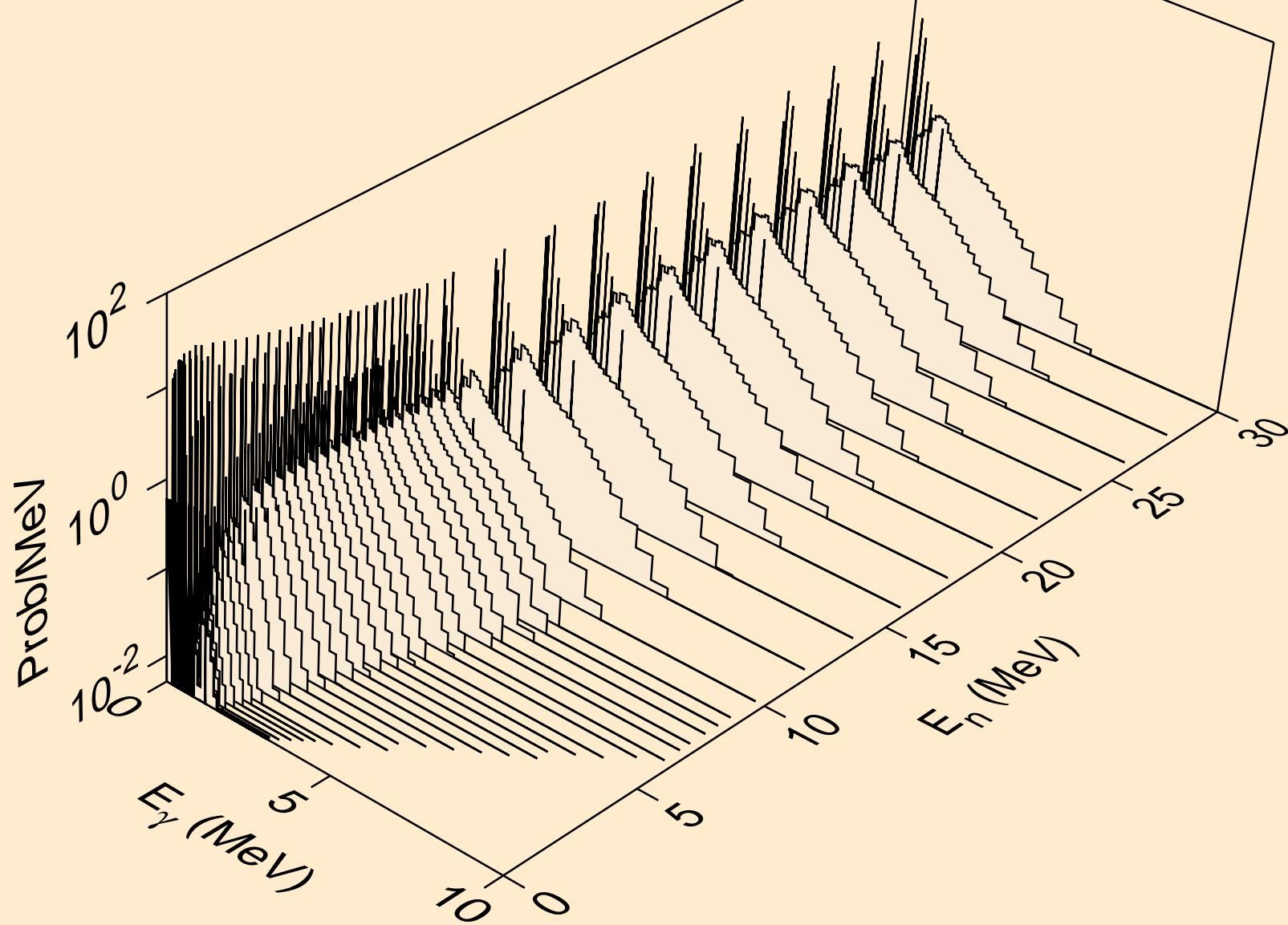

PB192 NEUTRON ACER TENDL-2024 LIBRARY; T=0.K
Photon emission for (n,d)

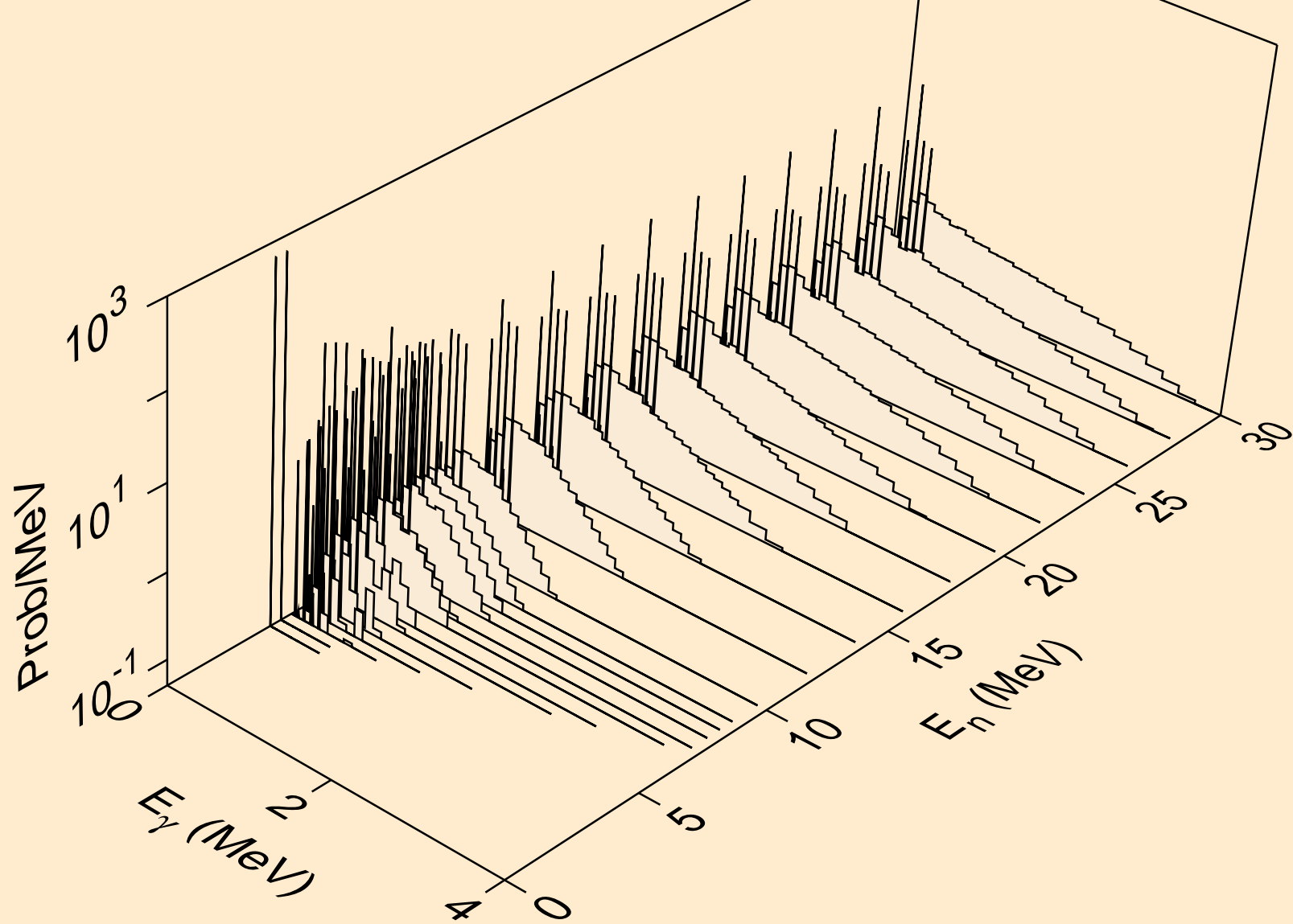

PB192 NEUTRON ACER TENDL-2024 LIBRARY; T=0.K
Photon emission for (n,t)

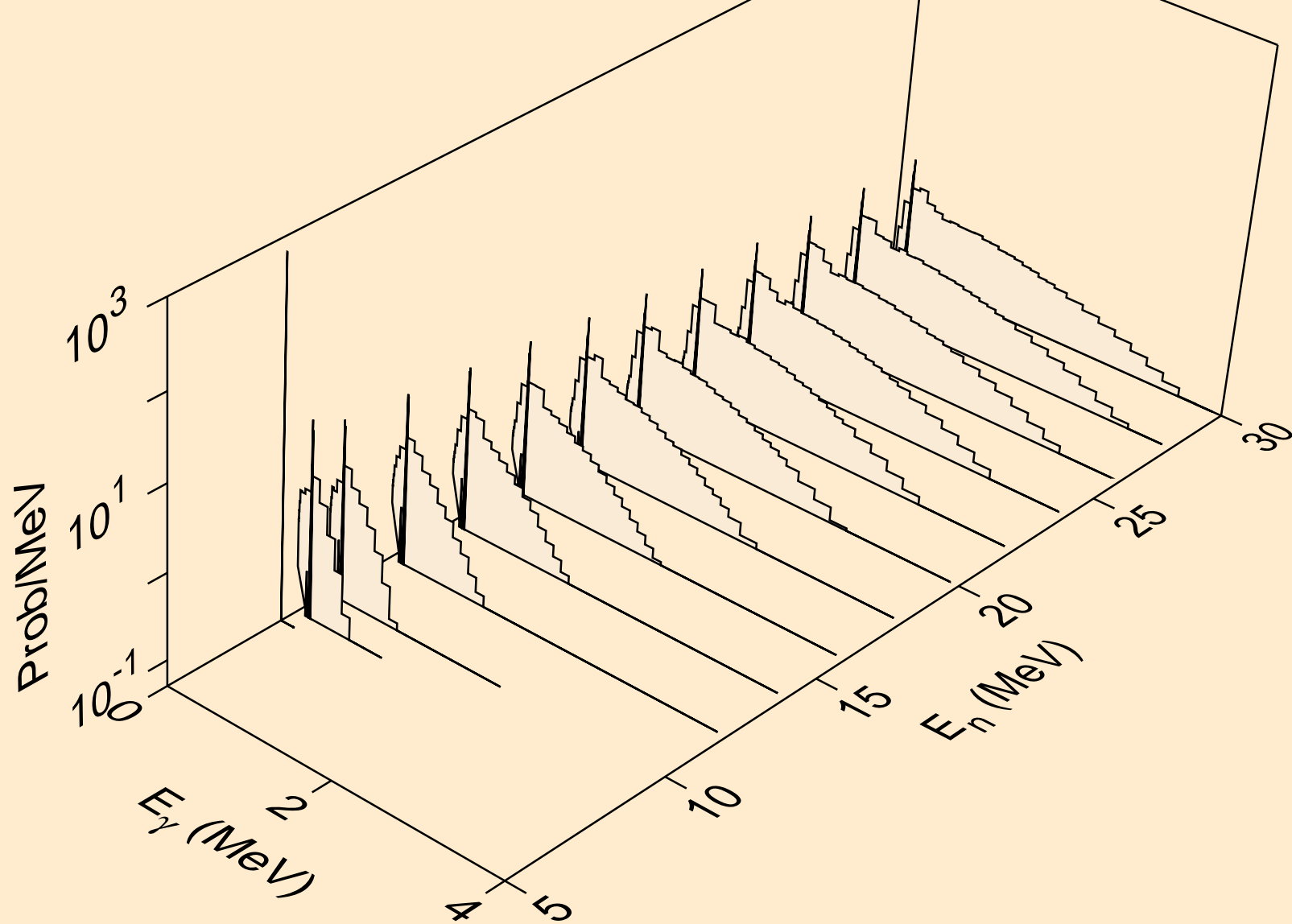

PB192 NEUTRON ACER TENDL-2024 LIBRARY; T=0.K
Photon emission for (n,he3)

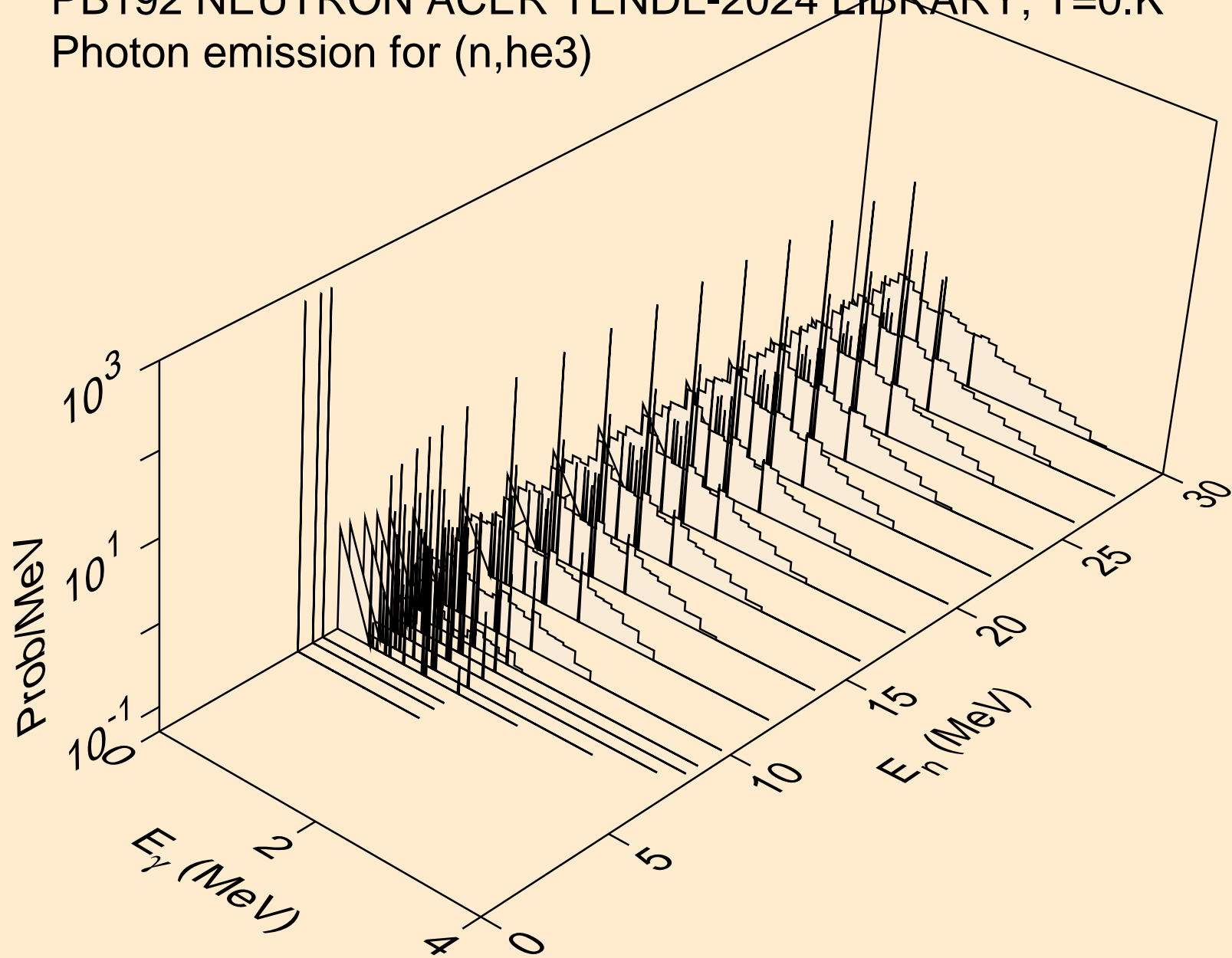

PB192 NEUTRON ACER TENDL-2024 LIBRARY; T=0.K
Photon emission for (n,a)

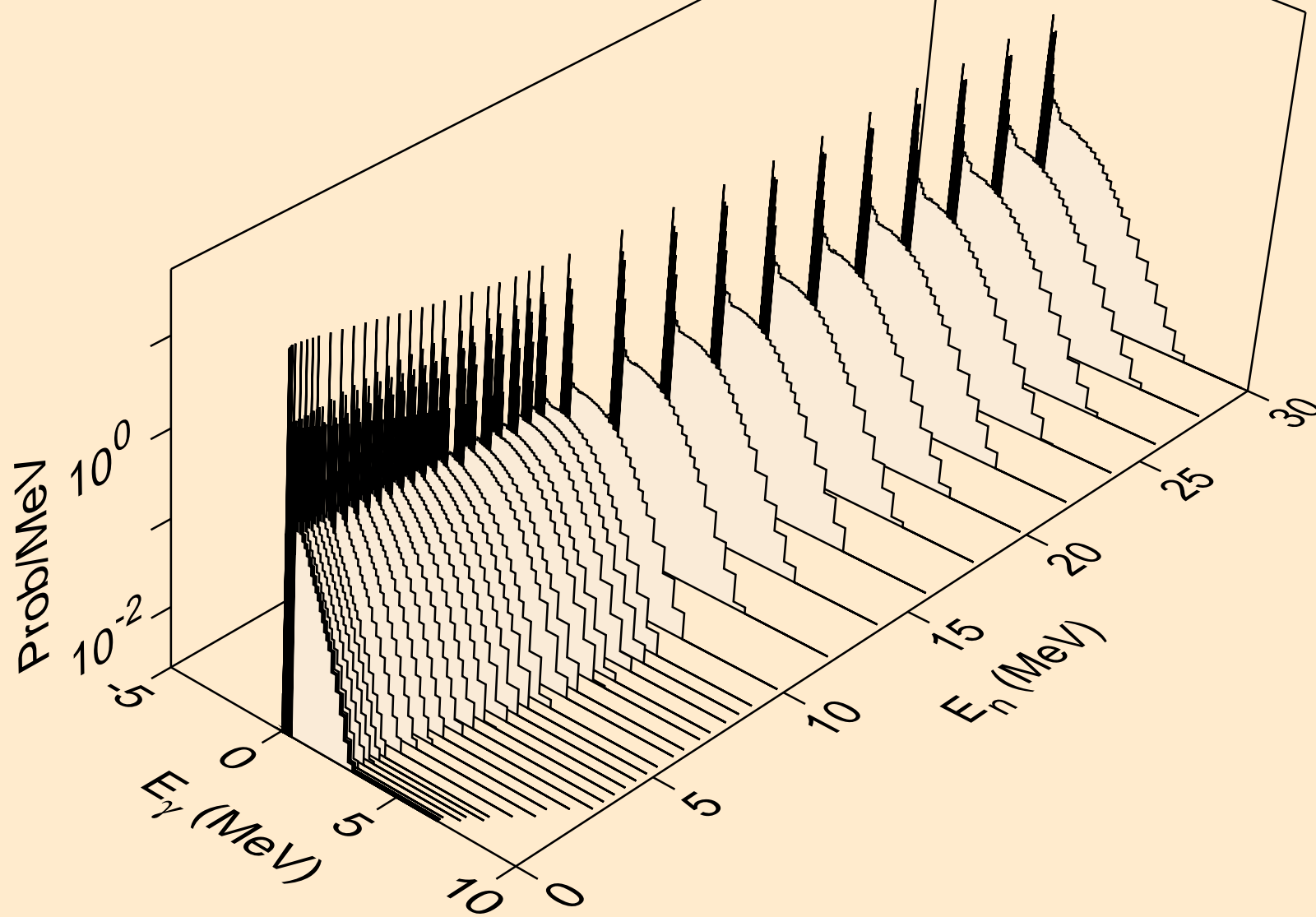

PB192 NEUTRON ACER TENDL-2024 LIBRARY; T=0.K
Photon emission for (n,2a)

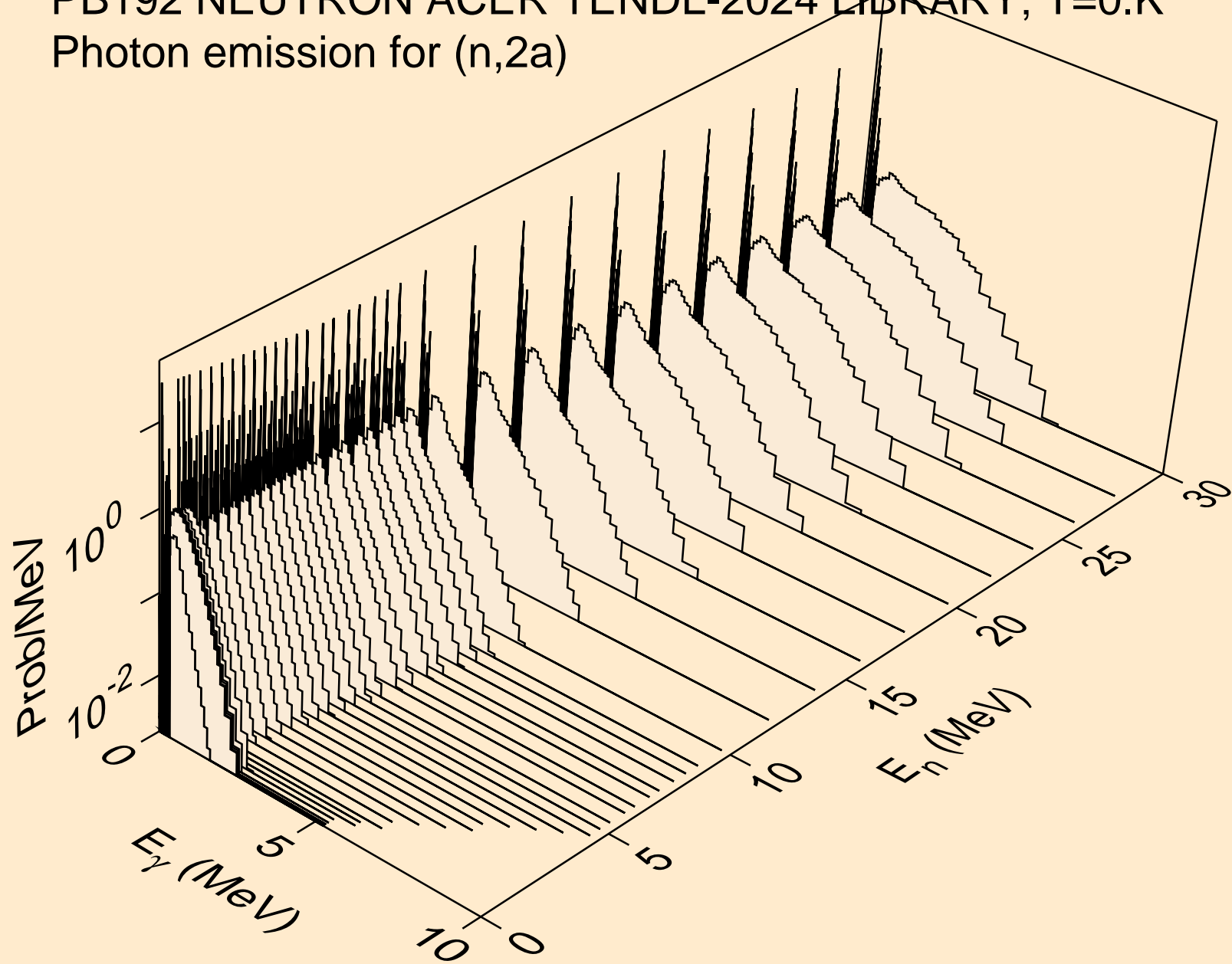

PB192 NEUTRON ACER TENDL-2024 LIBRARY; T=0.K
Photon emission for (n,2p)

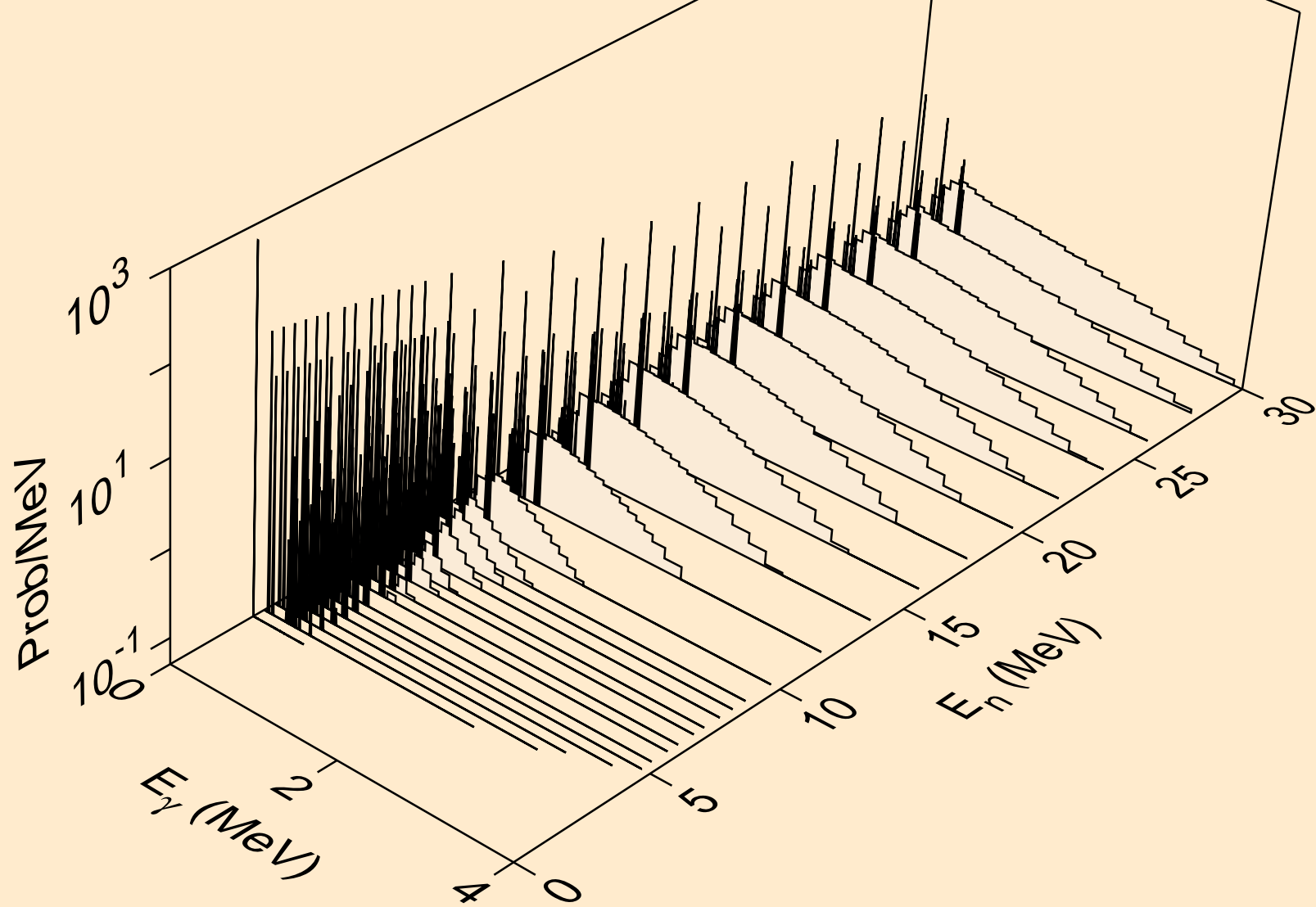

PB192 NEUTRON ACER TENDL-2024 LIBRARY; T=0.K
Photon emission for (n,p α)

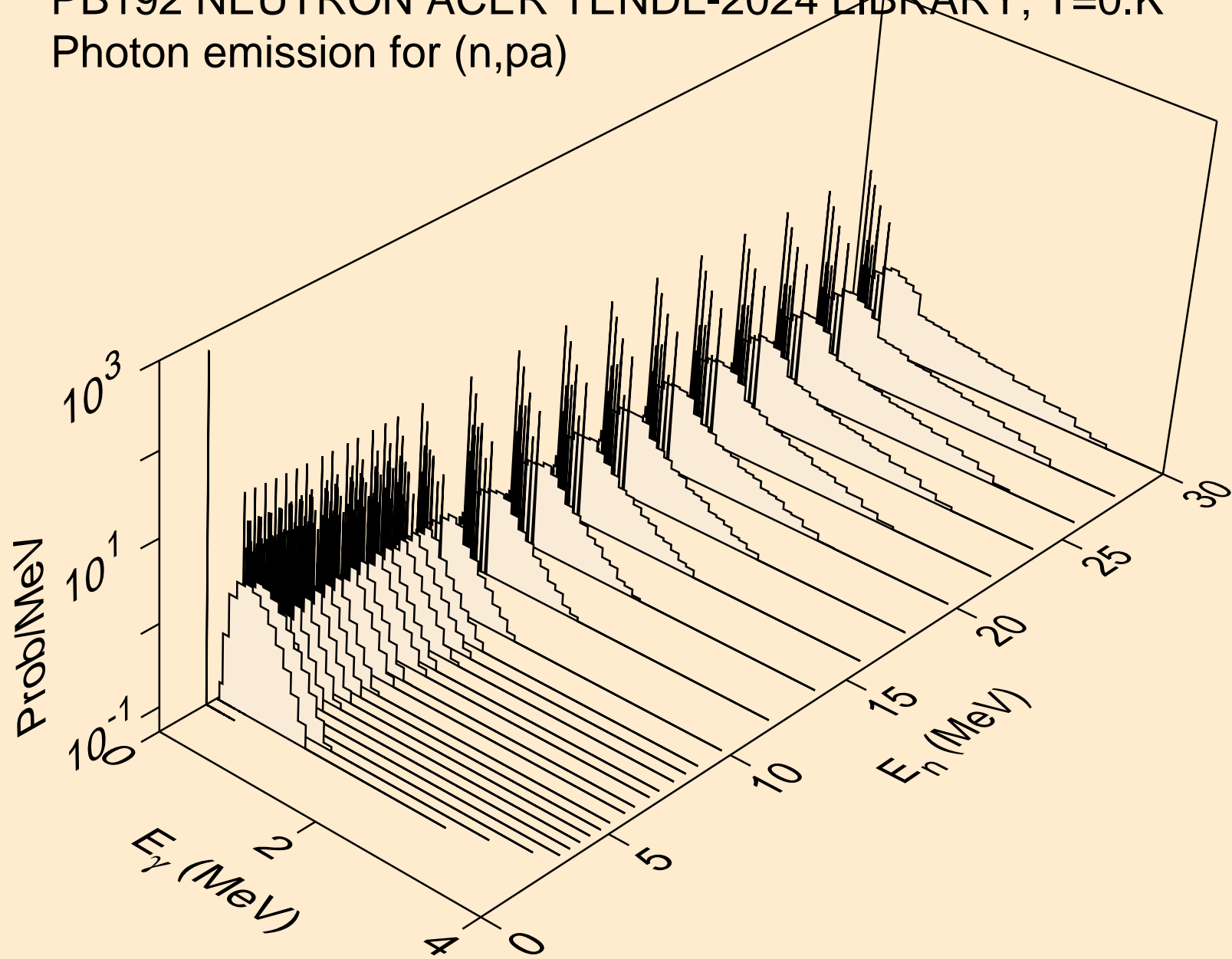

PB192 NEUTRON ACER TENDL-2024 LIBRARY; T=0.K
Photon emission for (n,pd)

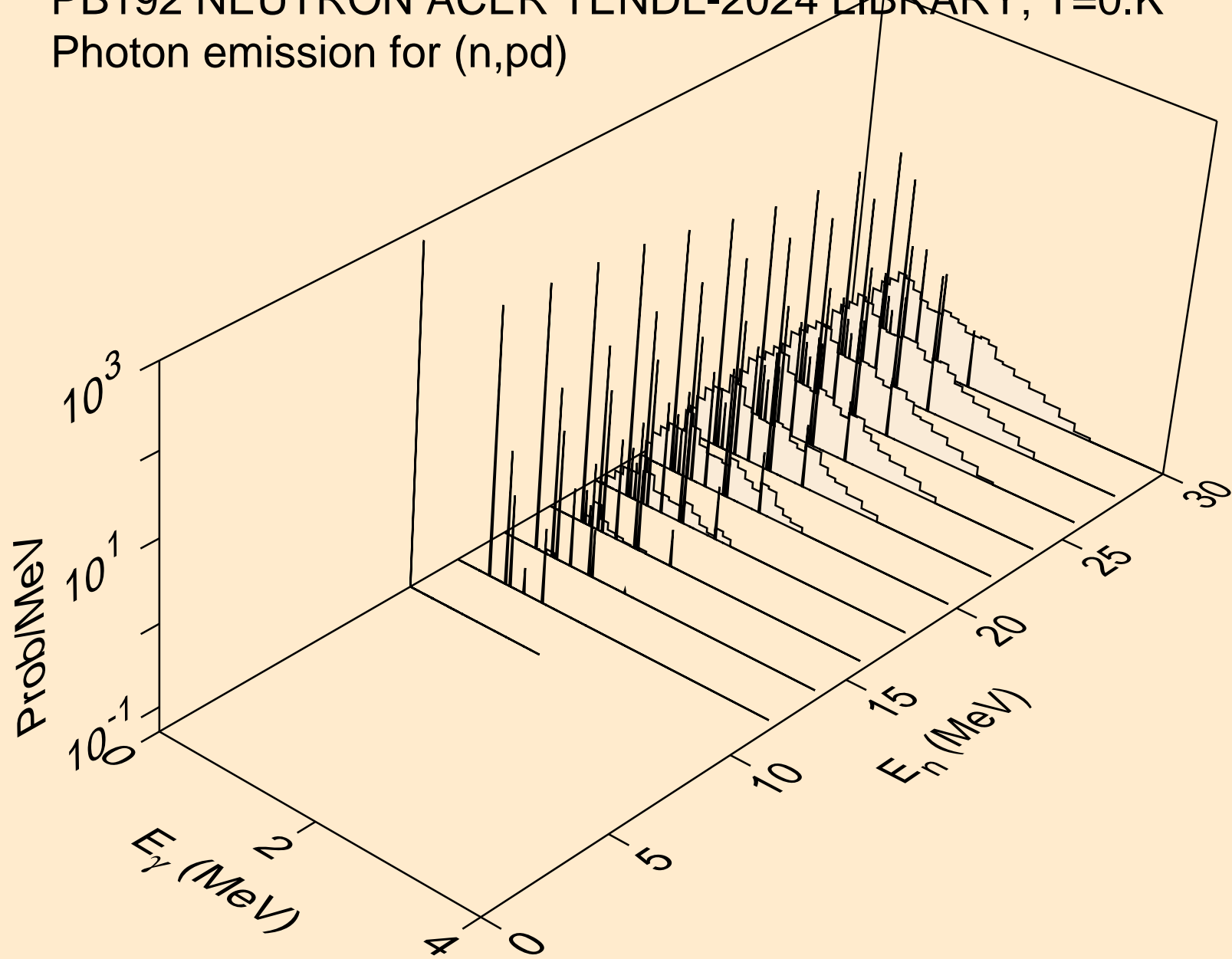

PB192 NEUTRON ACER TENDL-2024 LIBRARY; T=0.K
Photon emission for (n,pt)

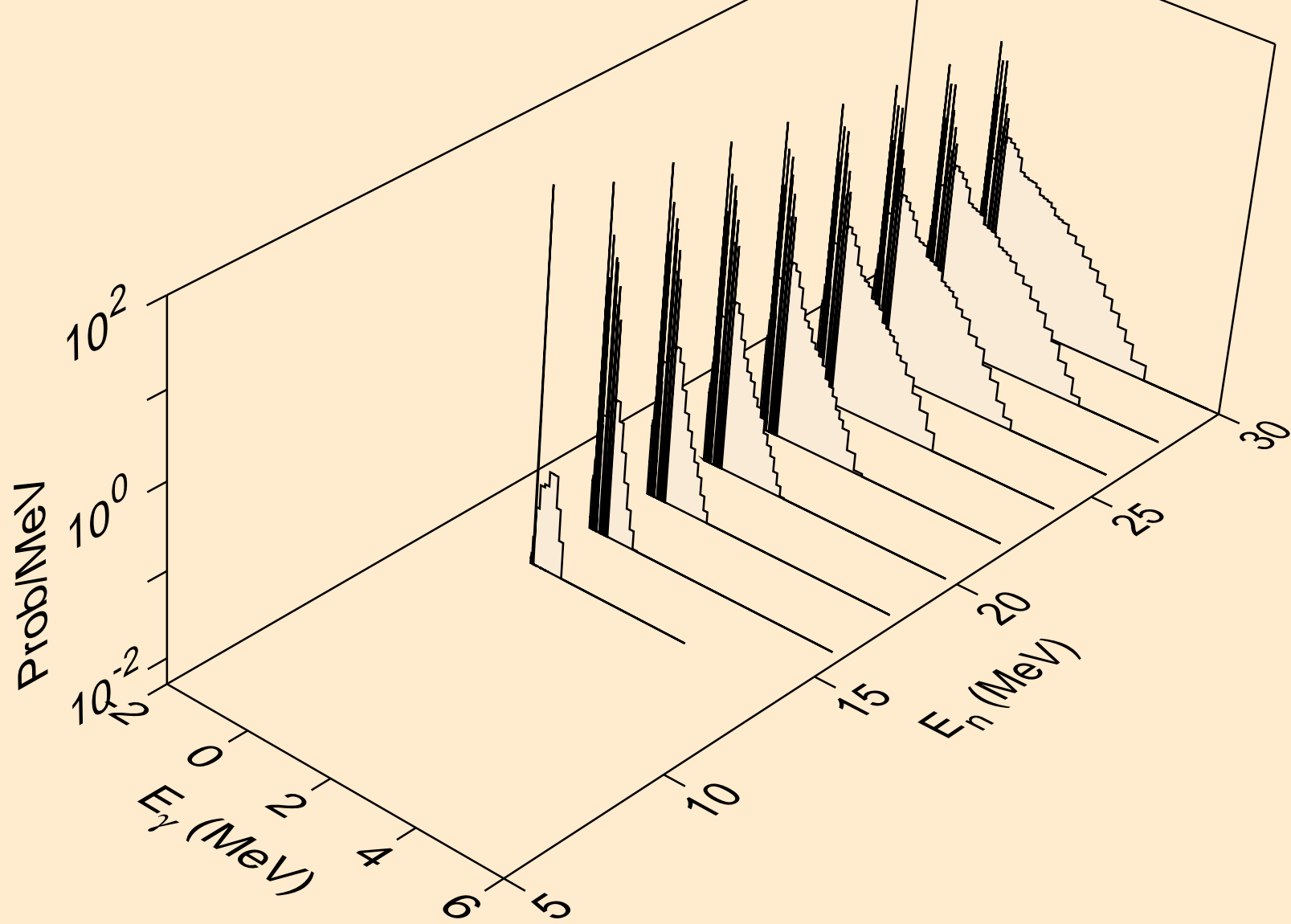

PB192 NEUTRON ACER TENDL-2024 LIBRARY; T=0.K
Photon emission for (n,da)

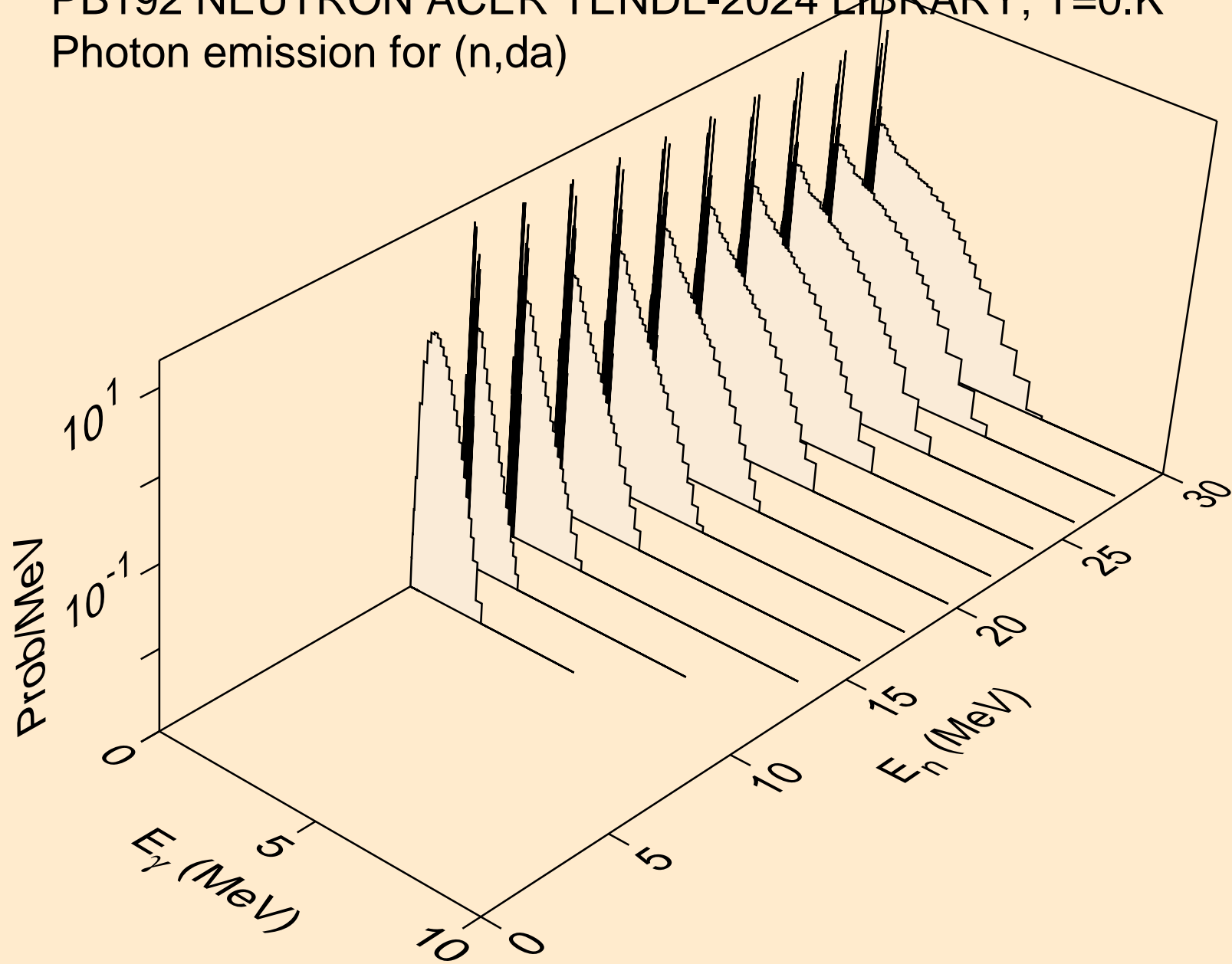

PB192 NEUTRON ACER TENDL-2024 LIBRARY; T=0.K
thermal capture photon spectrum

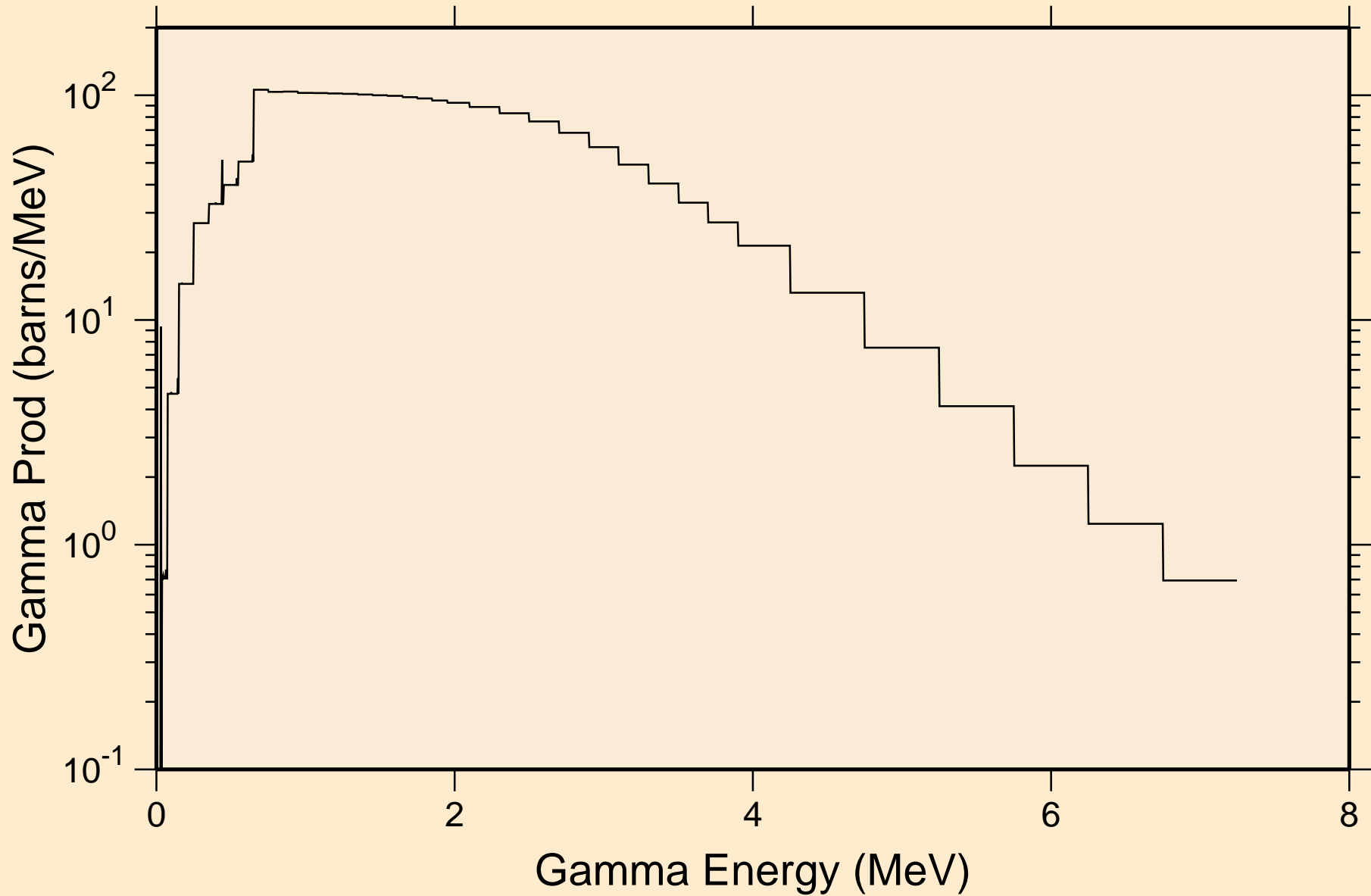

PB192 NEUTRON ACER TENDL-2024 LIBRARY; T=0.K
14 MeV photon spectrum

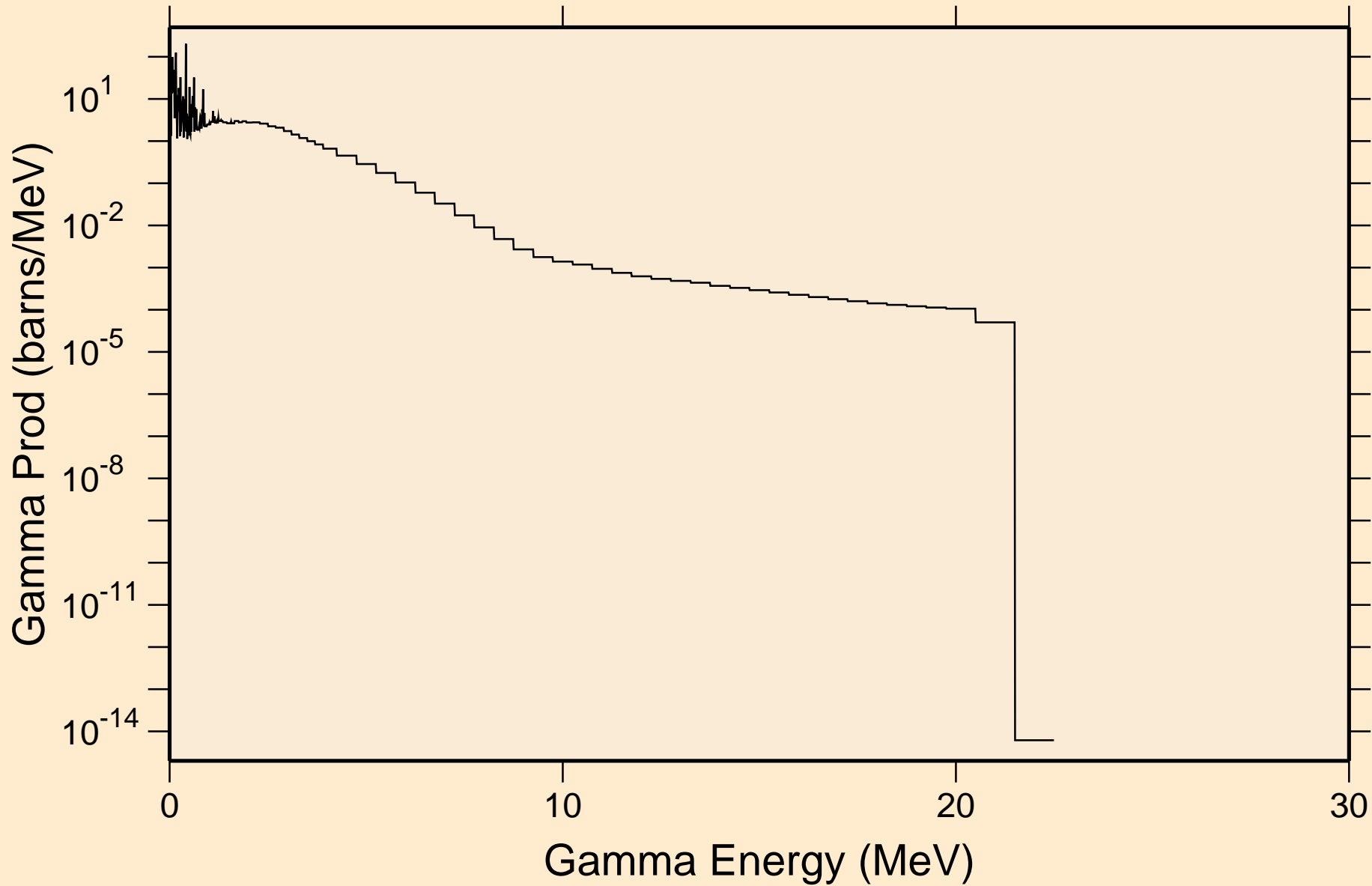

PB192 NEUTRON ACER TENDL-2024 LIBRARY; T=0.K

Particle heating contributions

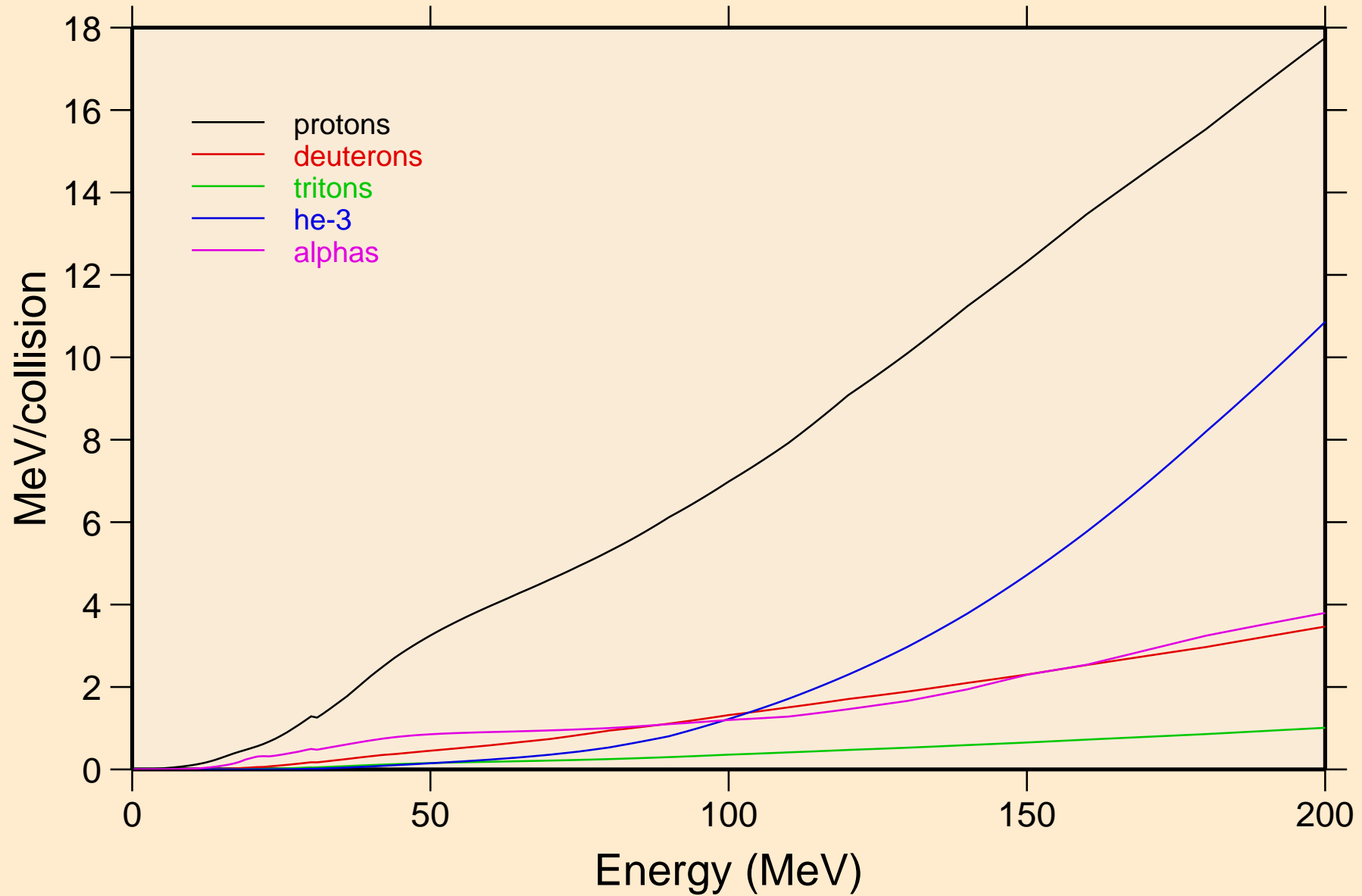

PB192 NEUTRON ACER TENDL-2024 LIBRARY; T=0.K
Recoil Heating

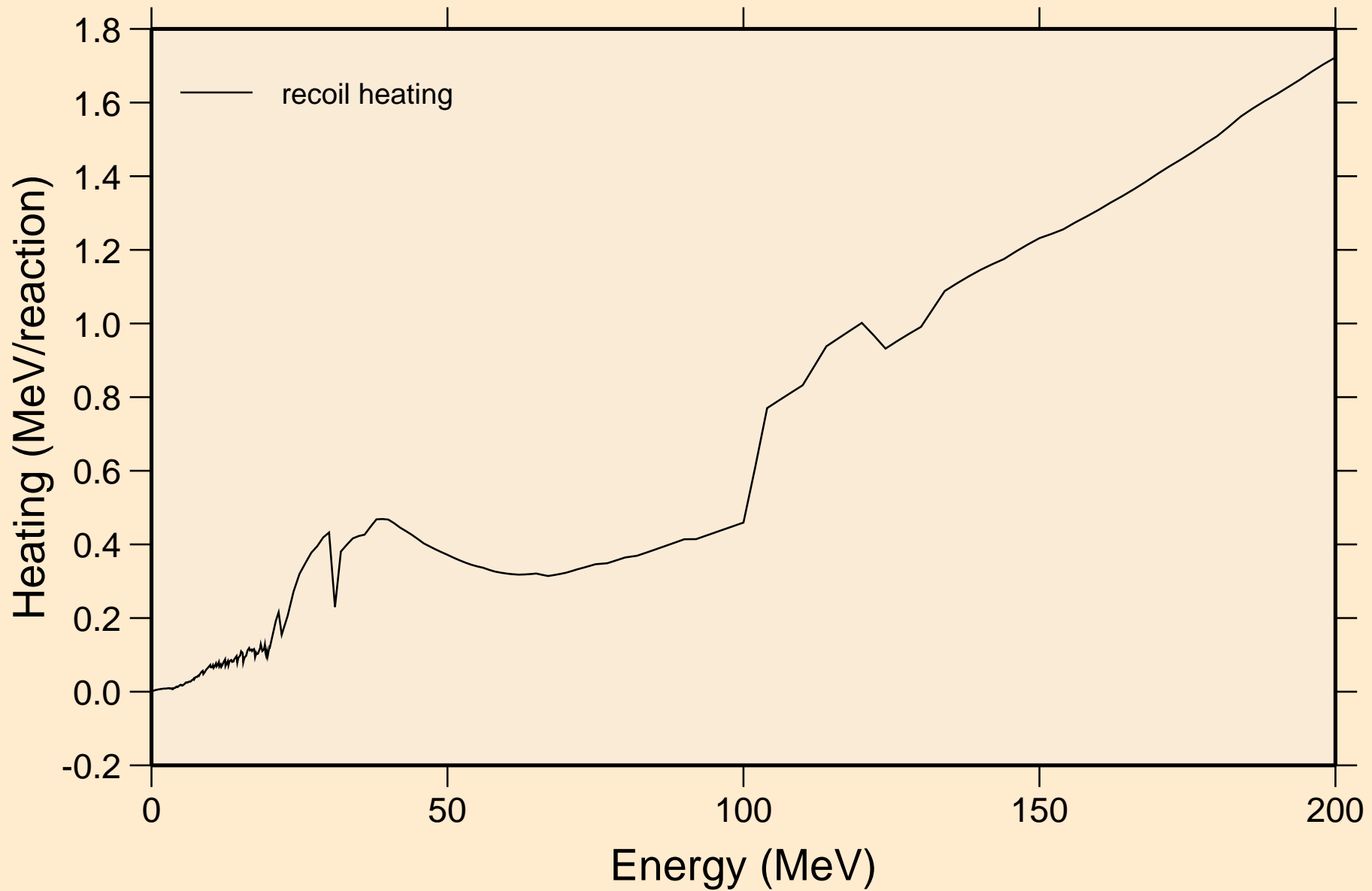

PB192 NEUTRON ACER TENDL-2024 LIBRARY; T=0.K
Particle production cross sections

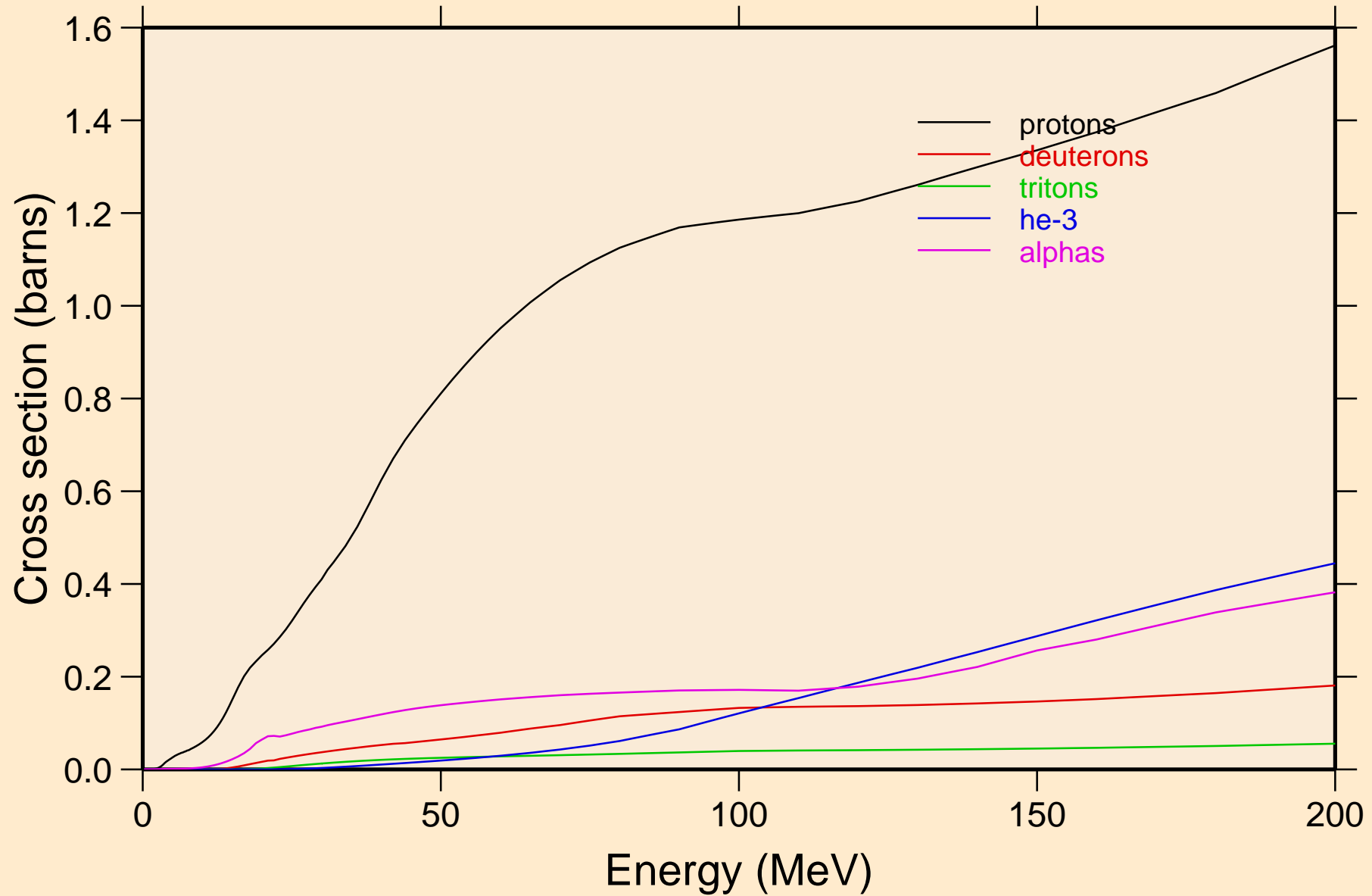

PB192 NEUTRON ACER TENDL-2024 LIBRARY; T=0.K
protons from (n,x)

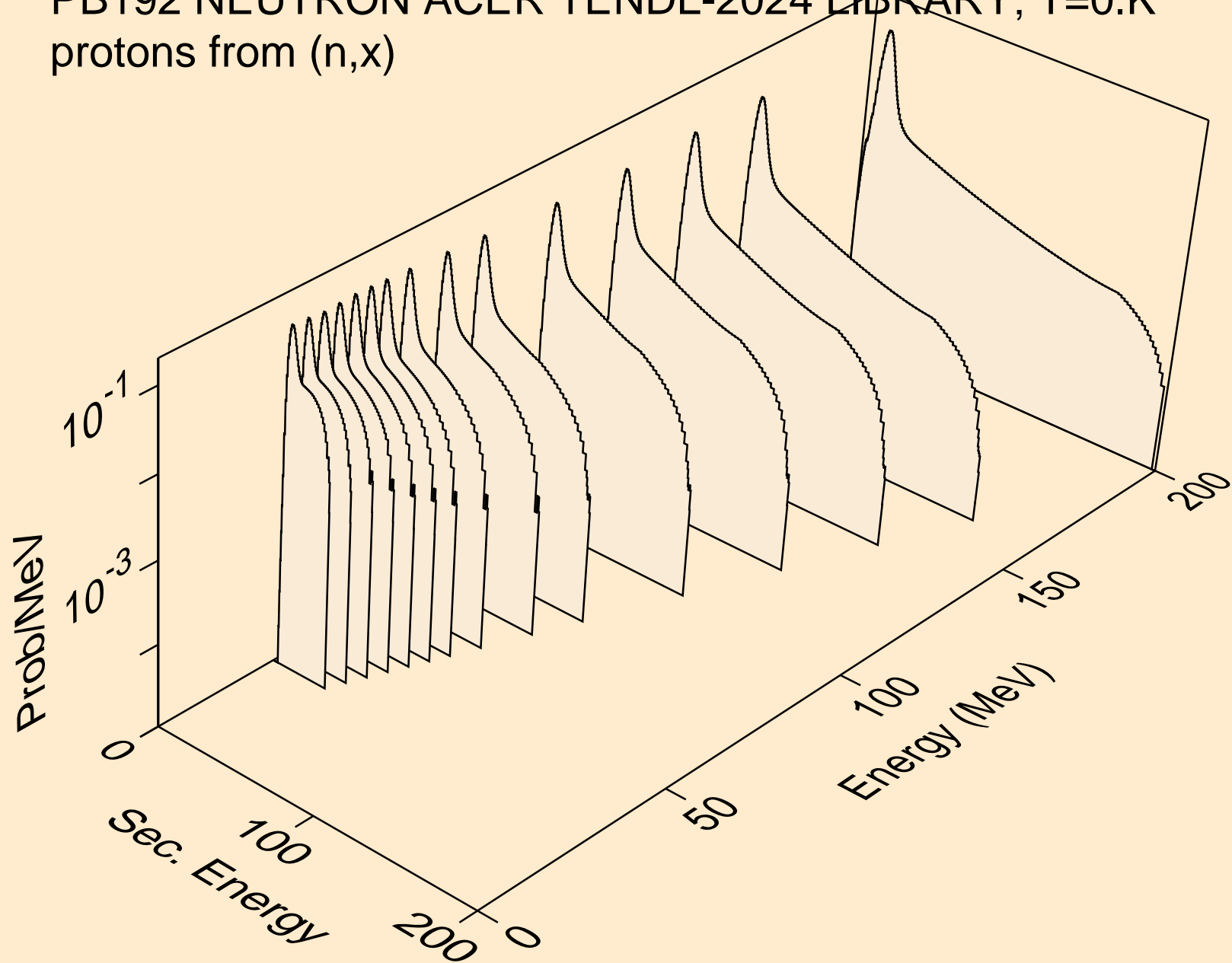

PB192 NEUTRON ACER TENDL-2024 LIBRARY; T=0.K
protons from (n,n*)p

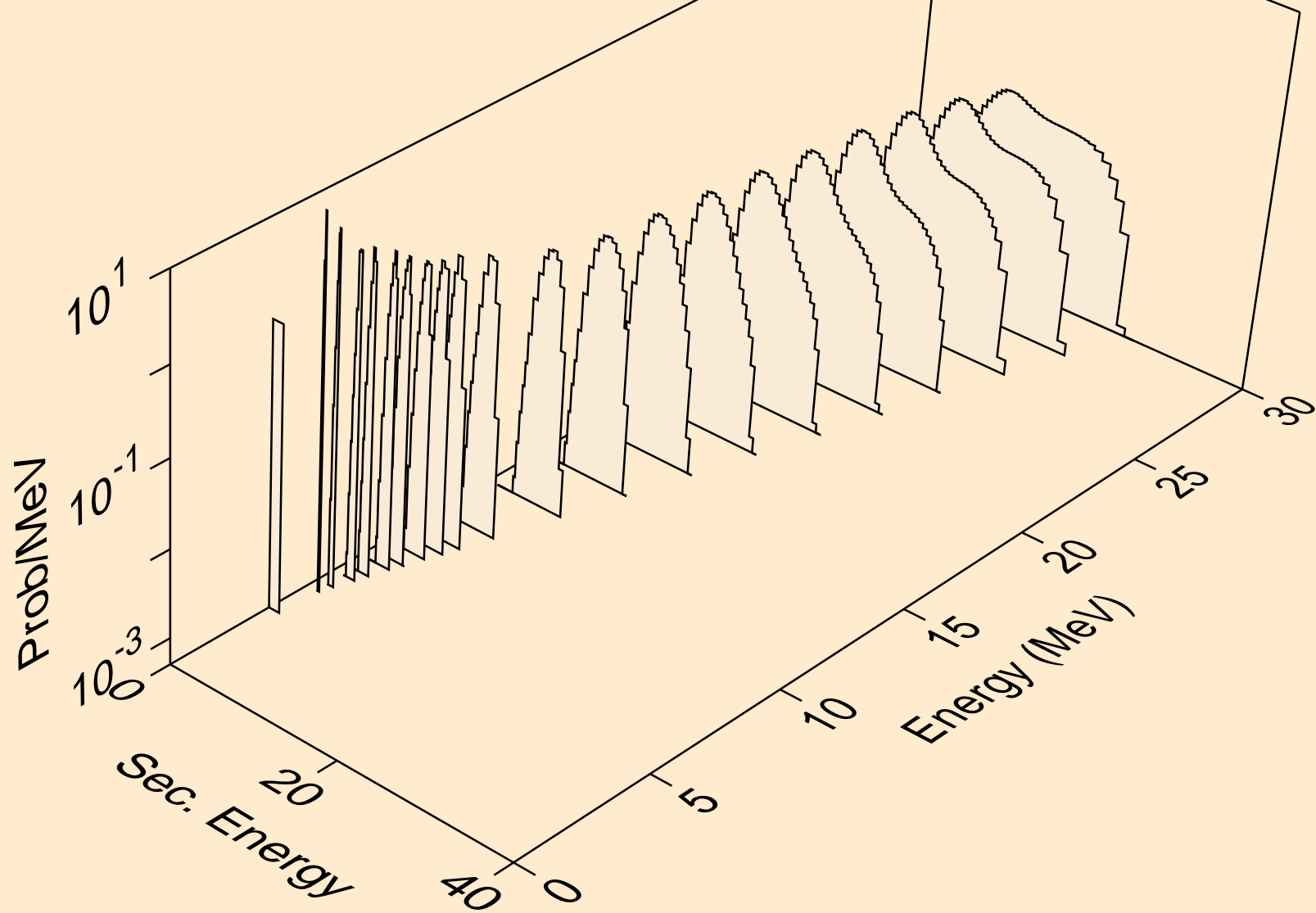

PB192 NEUTRON ACER TENDL-2024 LIBRARY; T=0.K
protons from (n,2np)

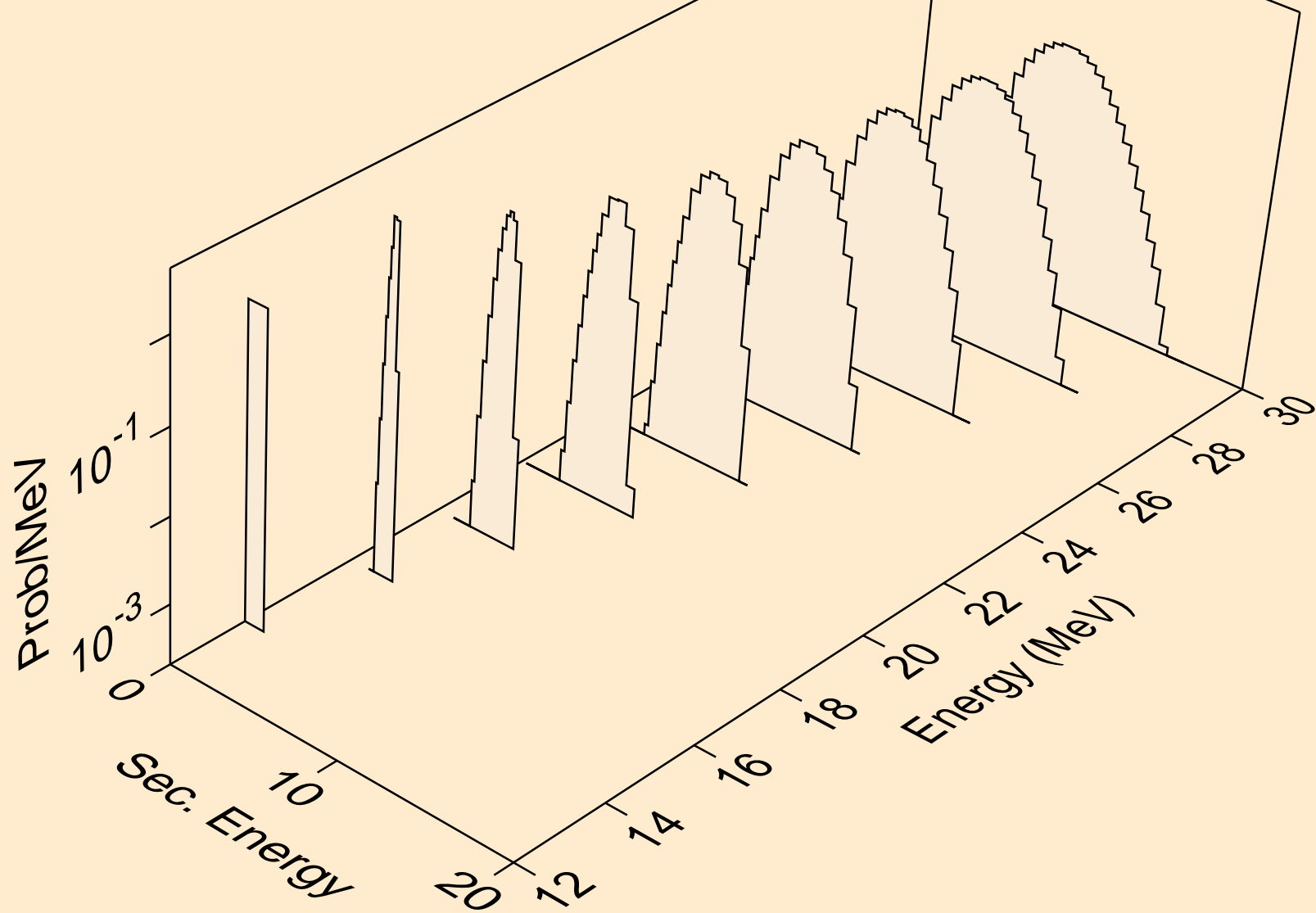

PB192 NEUTRON ACER TENDL-2024 LIBRARY; T=0.K
protons from (n,3np)

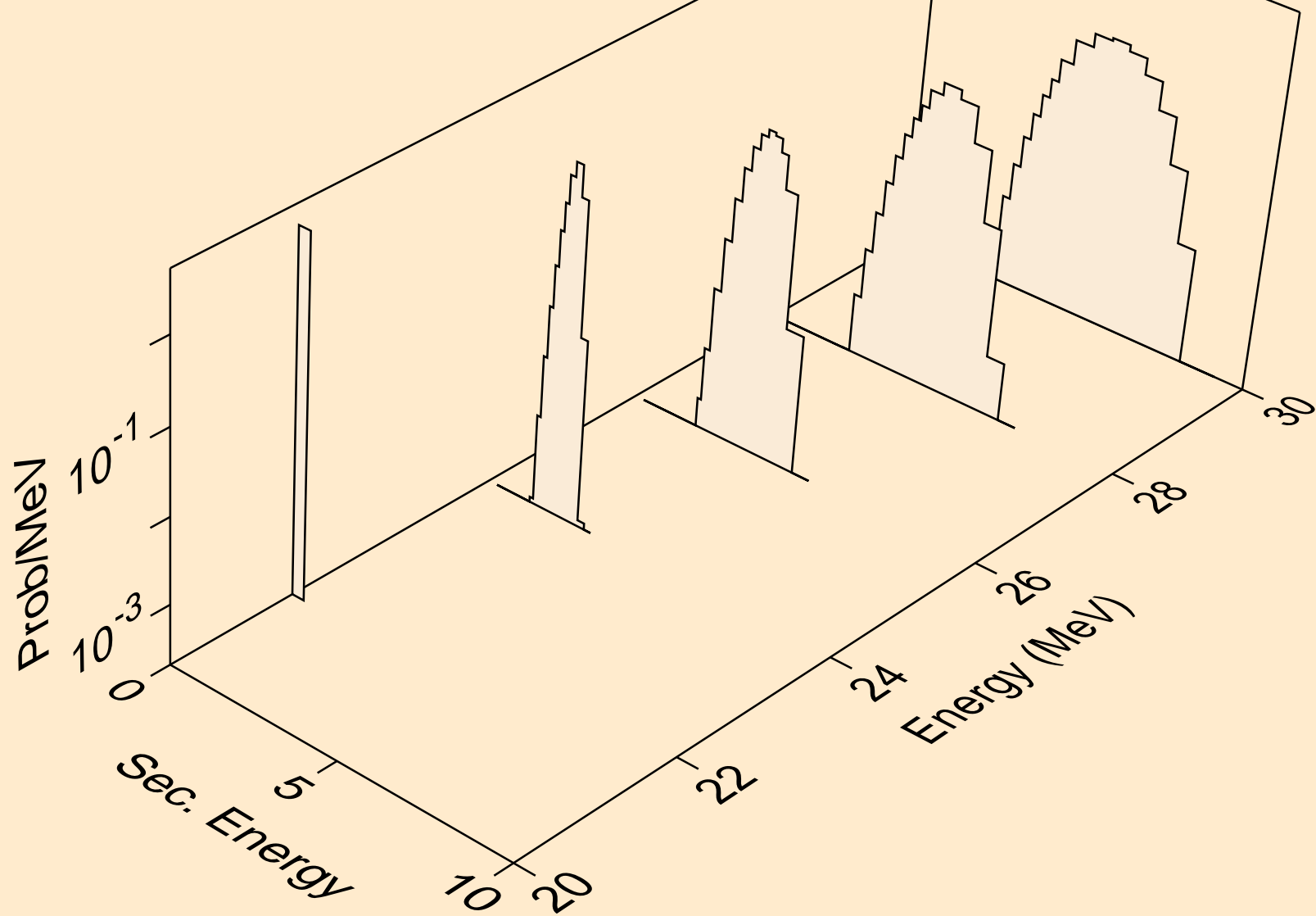

PB192 NEUTRON ACER TENDL-2024 LIBRARY; T=0.K
protons from (n,n2p)

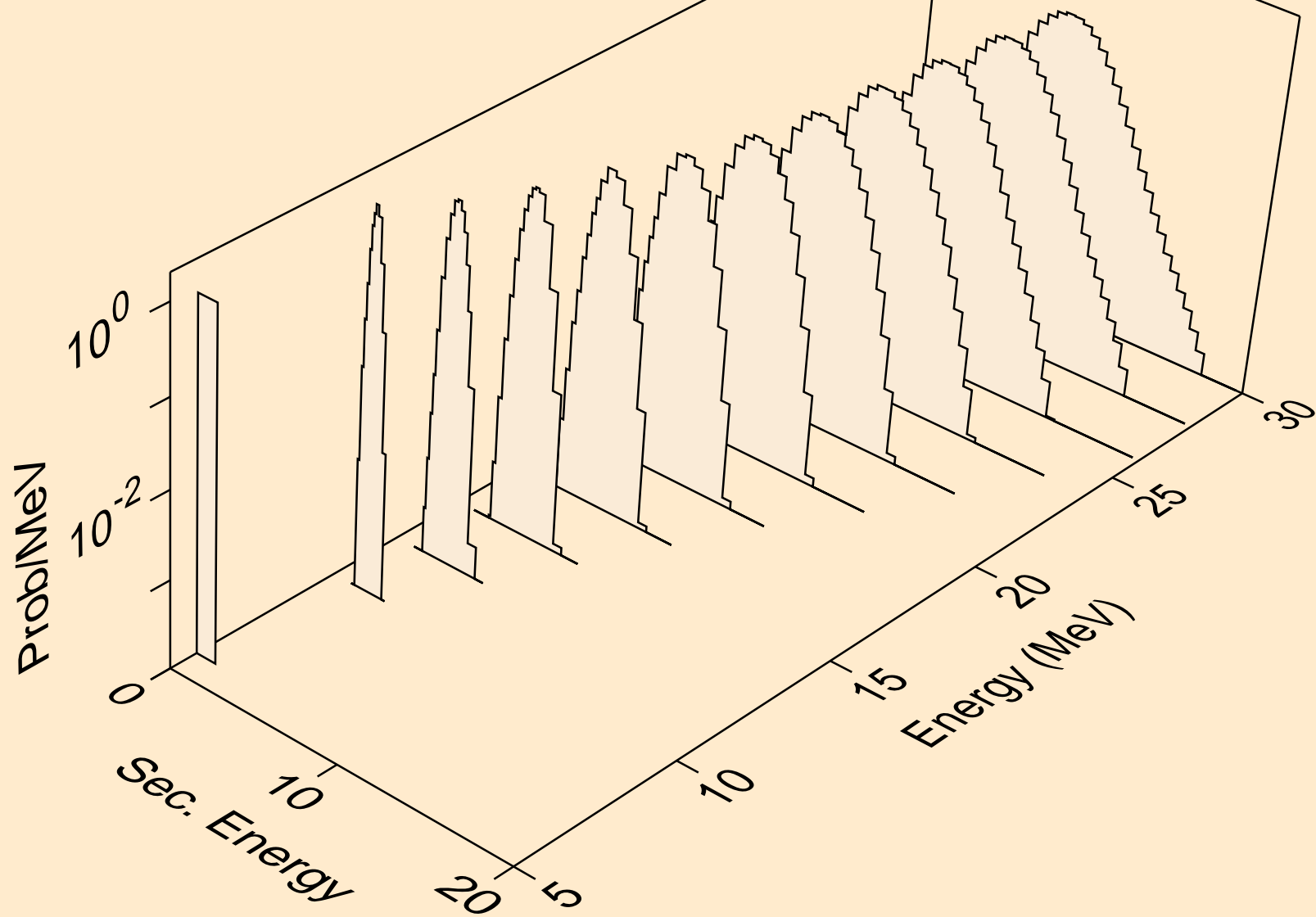

PB192 NEUTRON ACER TENDL-2024 LIBRARY; T=0.K
protons from (n,npa)

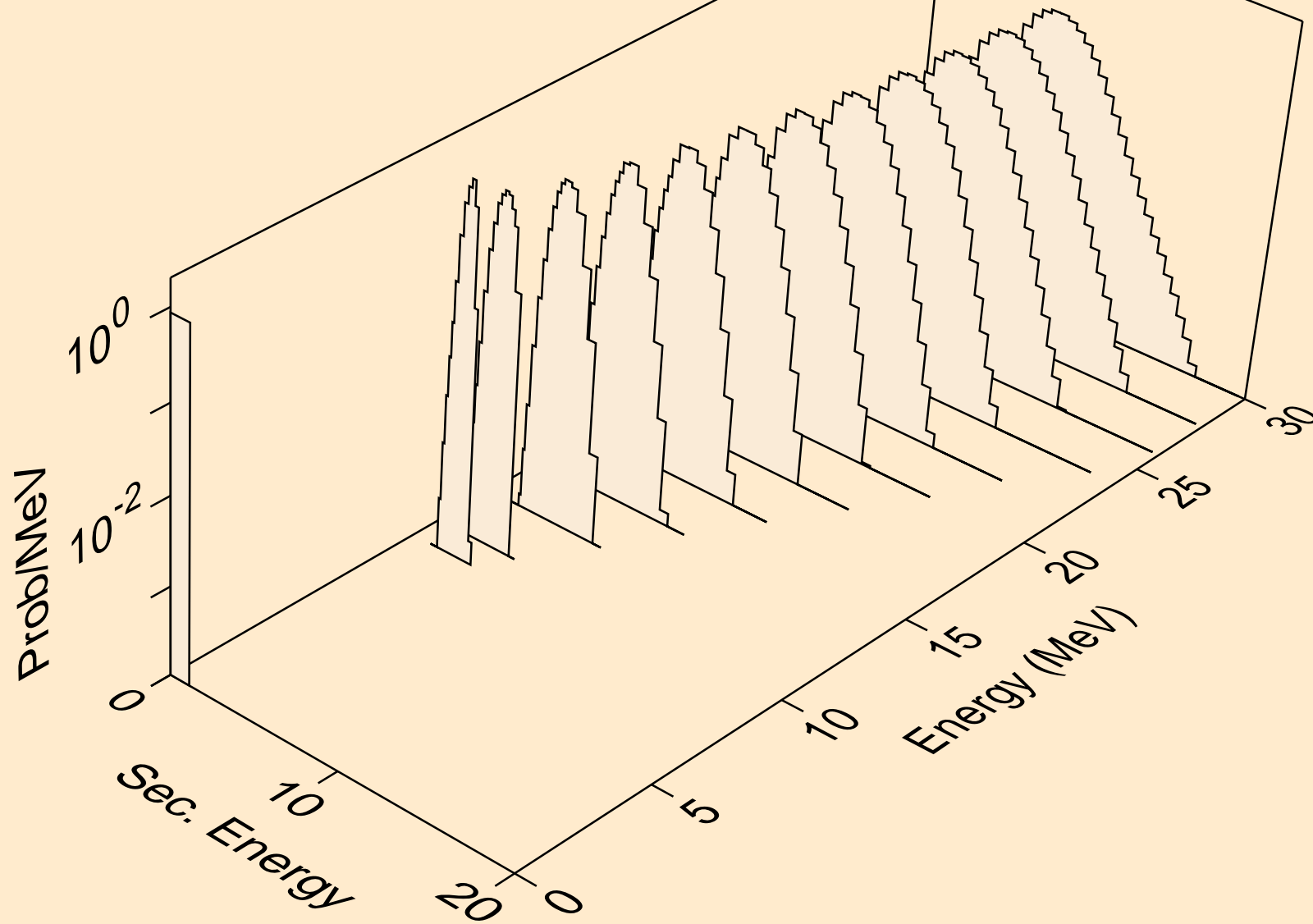

PB192 NEUTRON ACER TENDL-2024 LIBRARY; T=0.K
protons from (n,p)

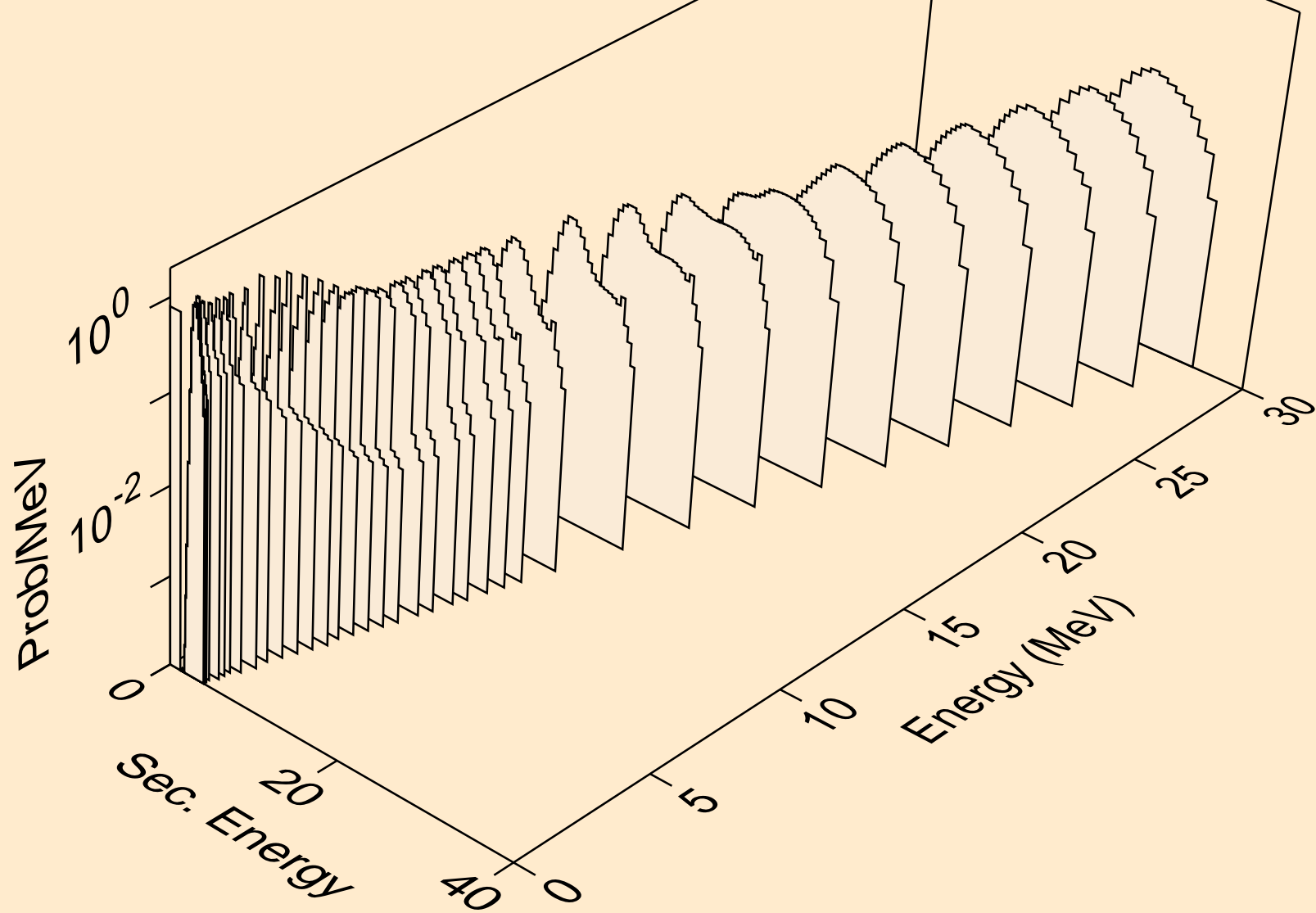

PB192 NEUTRON ACER TENDL-2024 LIBRARY; T=0.K
protons from (n,2p)

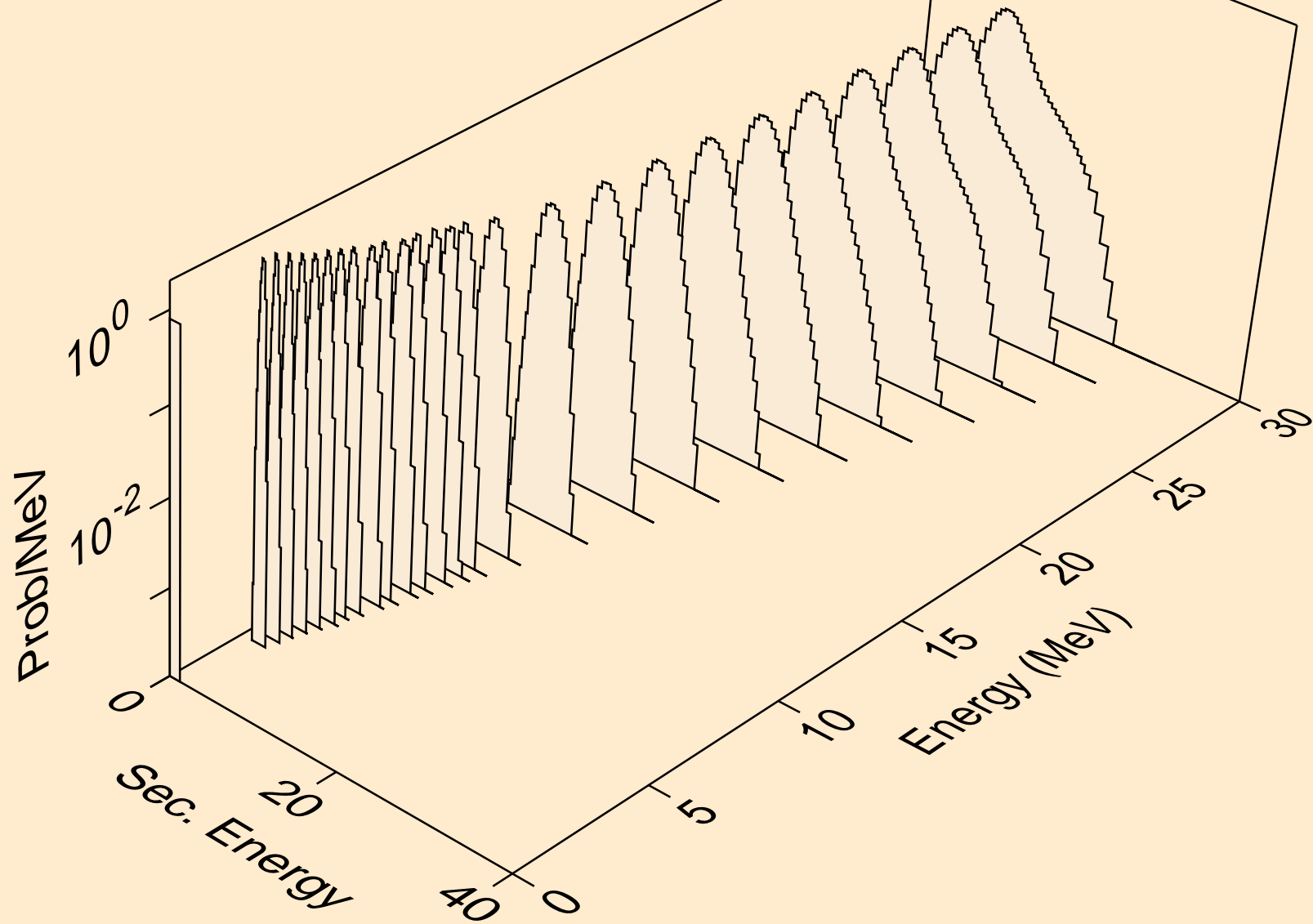

PB192 NEUTRON ACER TENDL-2024 LIBRARY; T=0.K
protons from (n,p)

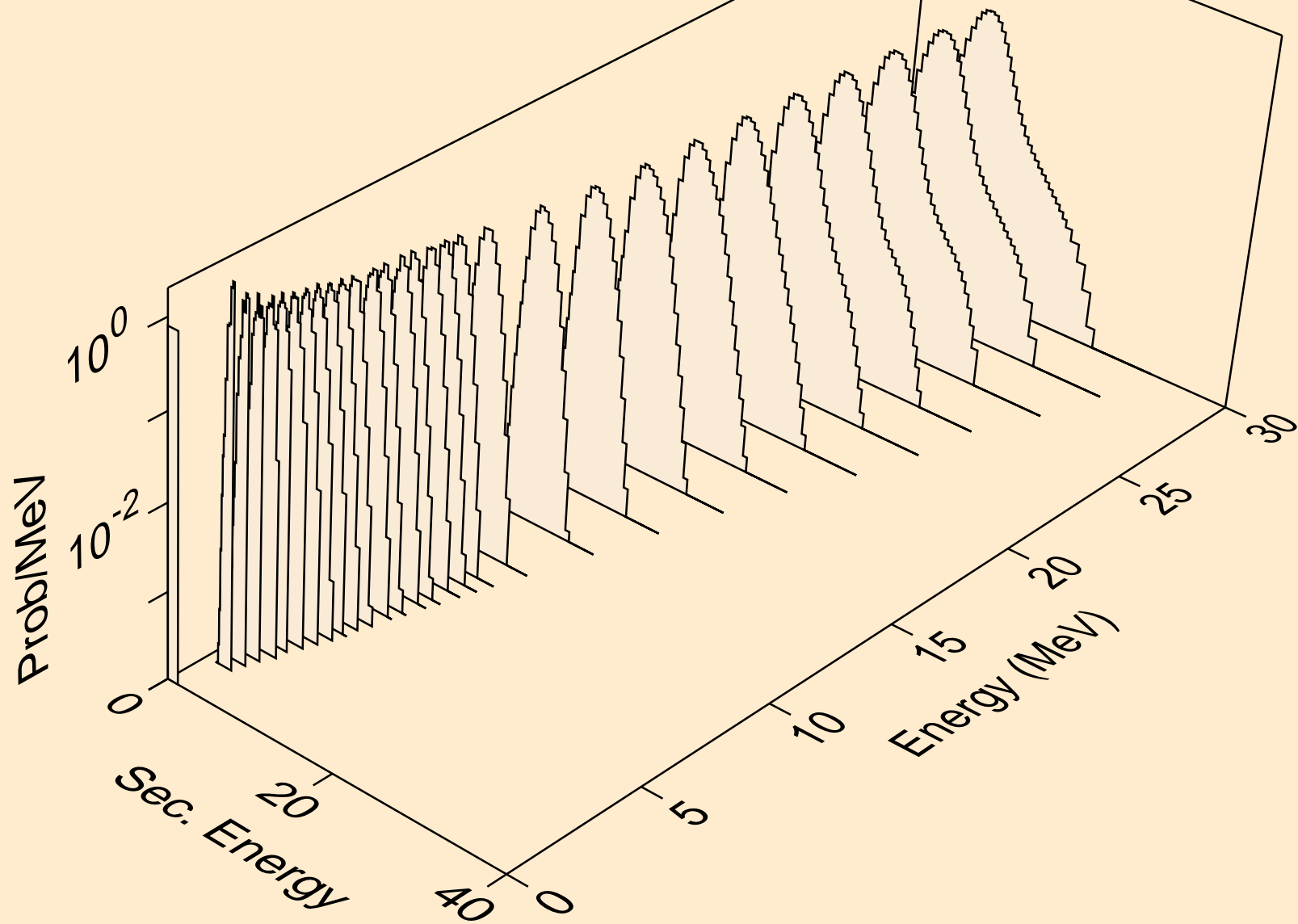

PB192 NEUTRON ACER TENDL-2024 LIBRARY; T=0.K
protons from (n,pd)

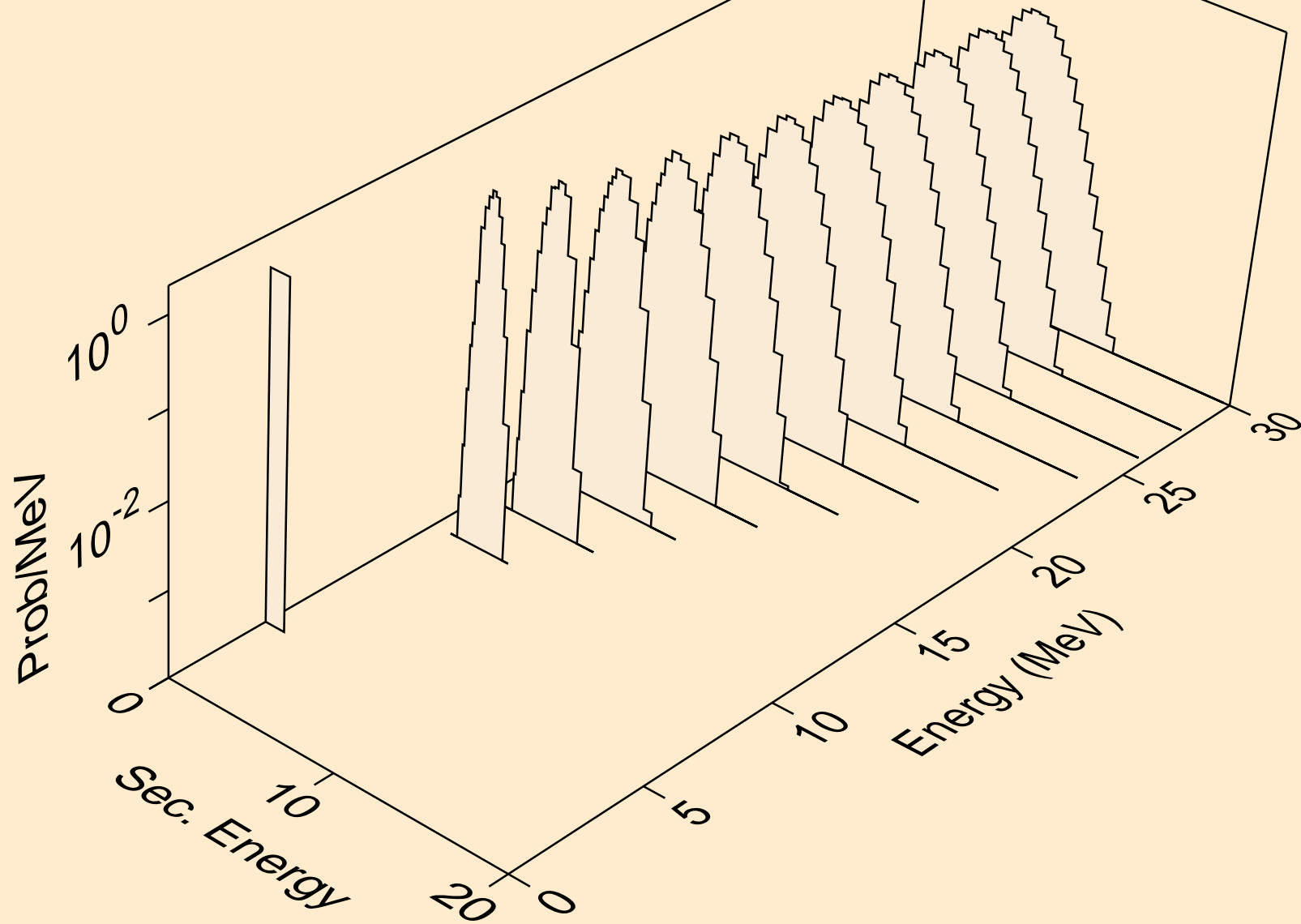

PB192 NEUTRON ACER TENDL-2024 LIBRARY; T=0.K
protons from (n,pt)

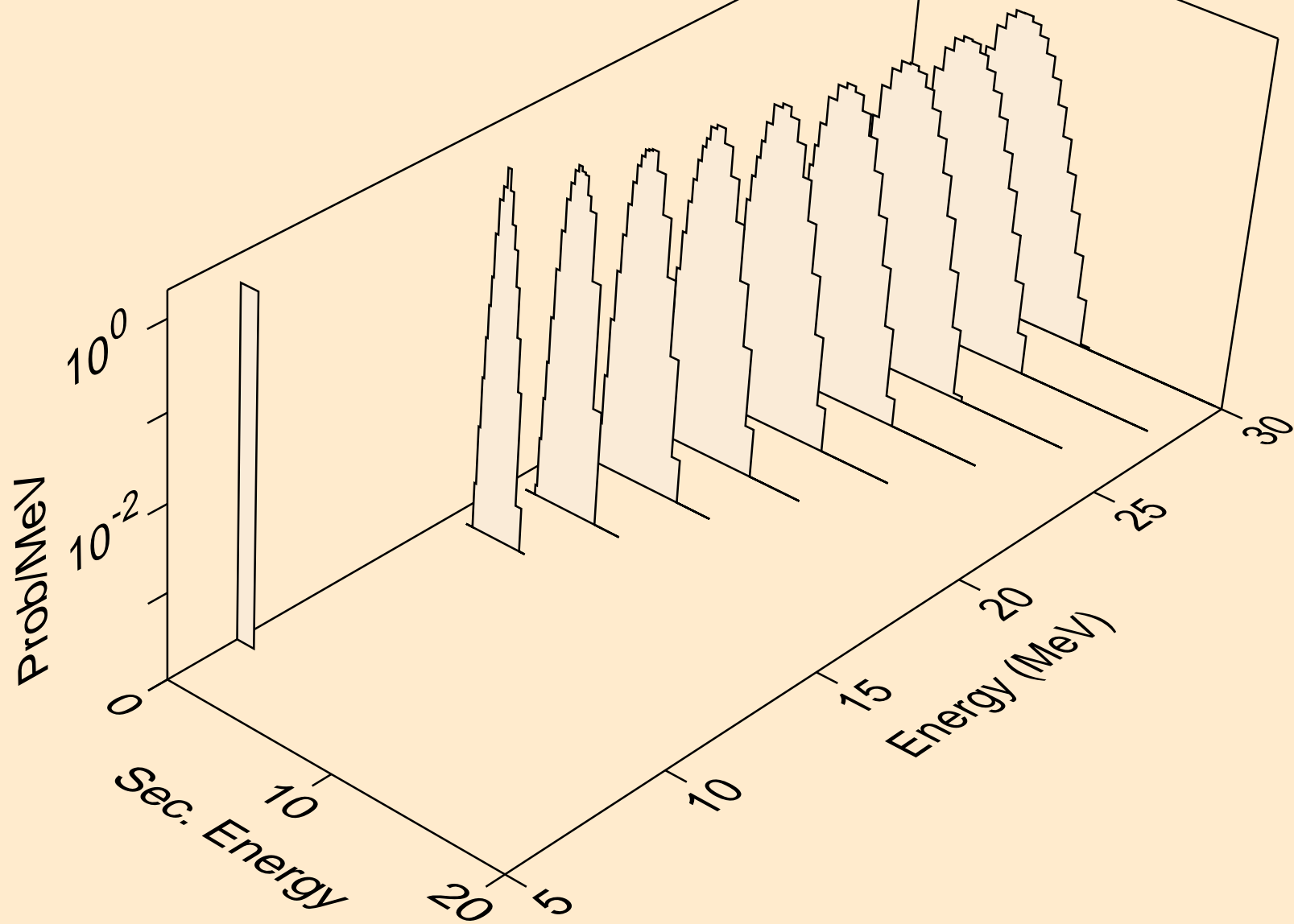

PB192 NEUTRON ACER TENDL-2024 LIBRARY; T=0.K
deuterons from (n,x)

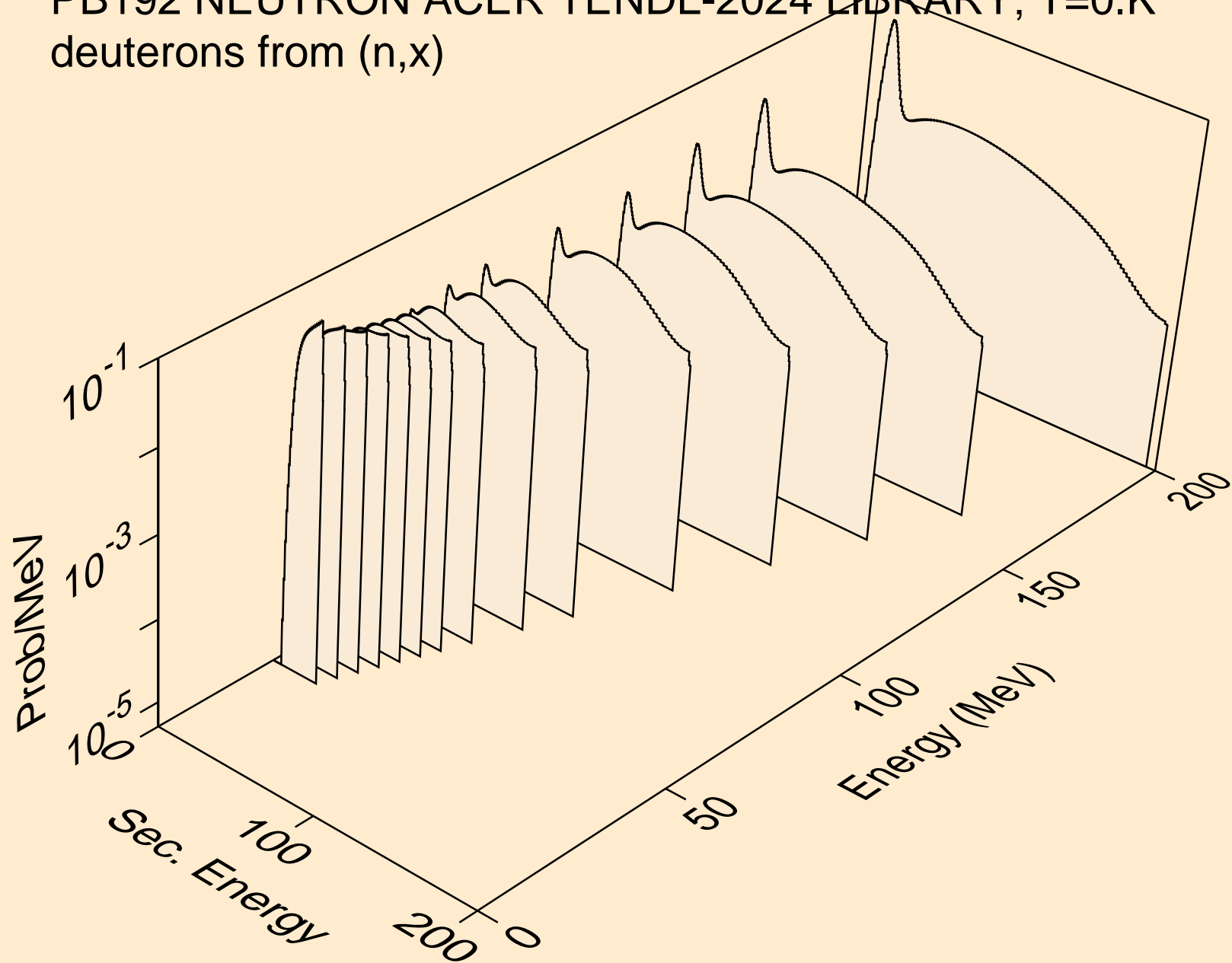

PB192 NEUTRON ACER TENDL-2024 LIBRARY; T=0.K
deuterons from (n,2nd)

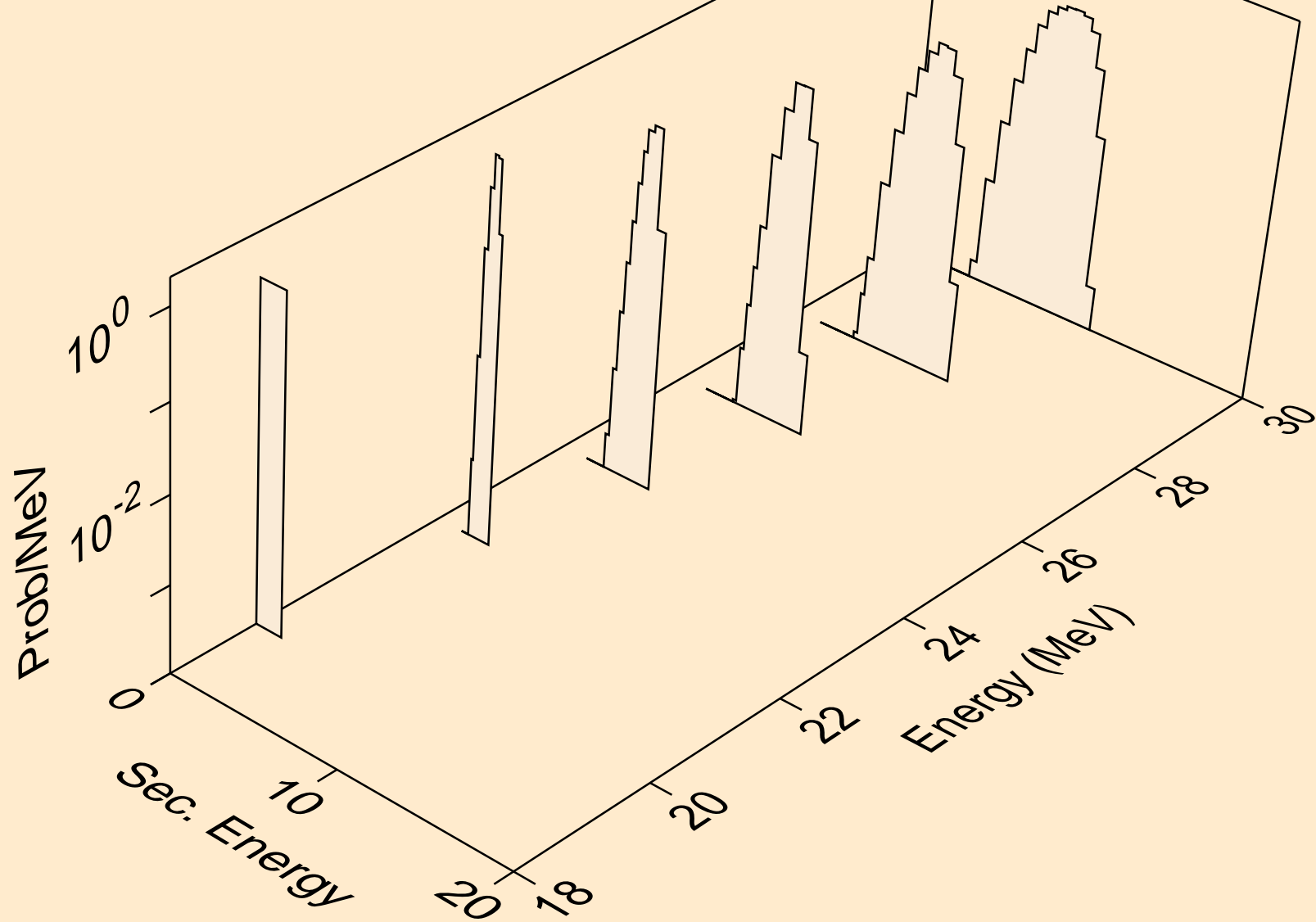

PB192 NEUTRON ACER TENDL-2024 LIBRARY; T=0.K
deuterons from (n,n*)d

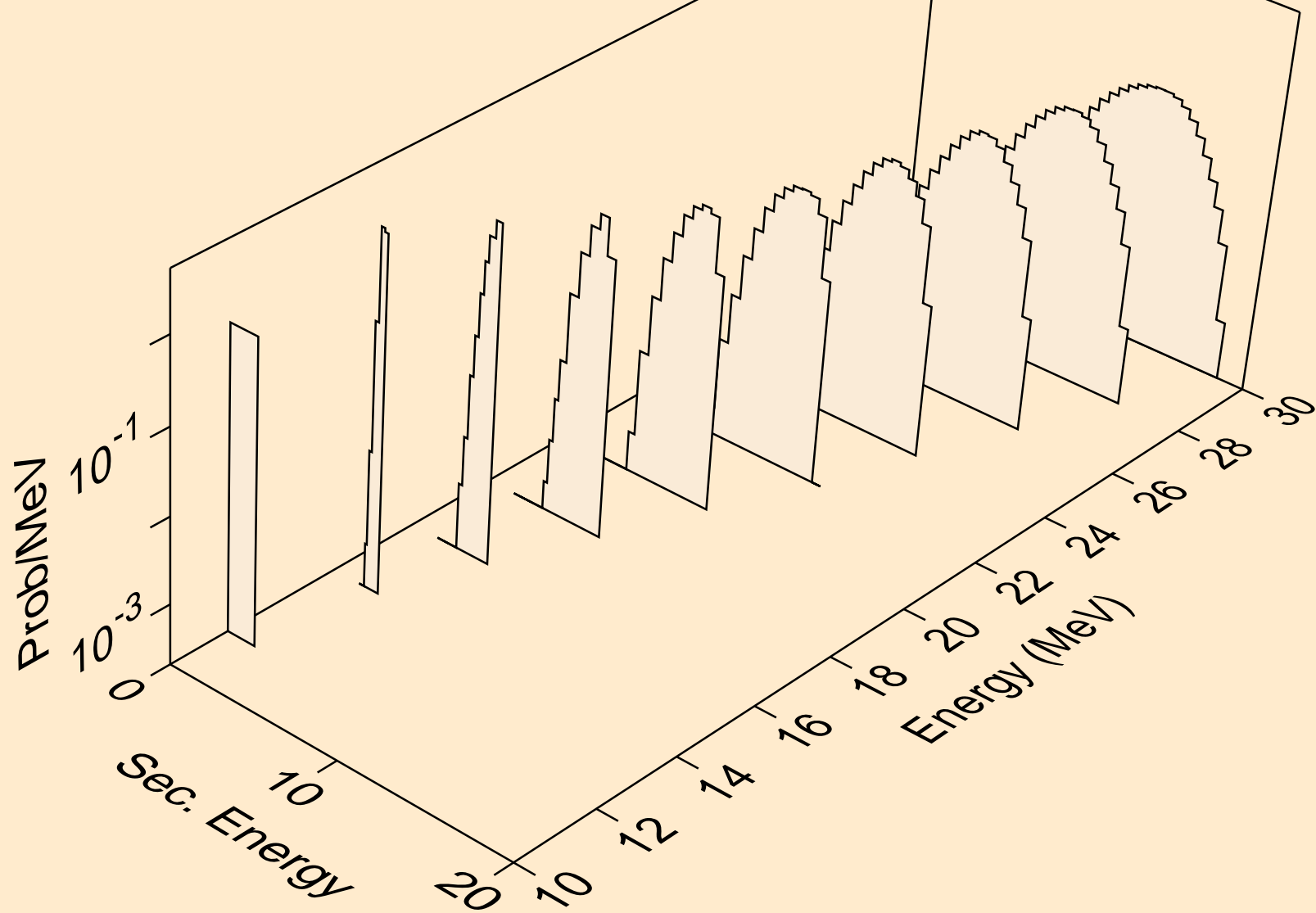

PB192 NEUTRON ACER TENDL-2024 LIBRARY; T=0.K
deuterons from (n,d)

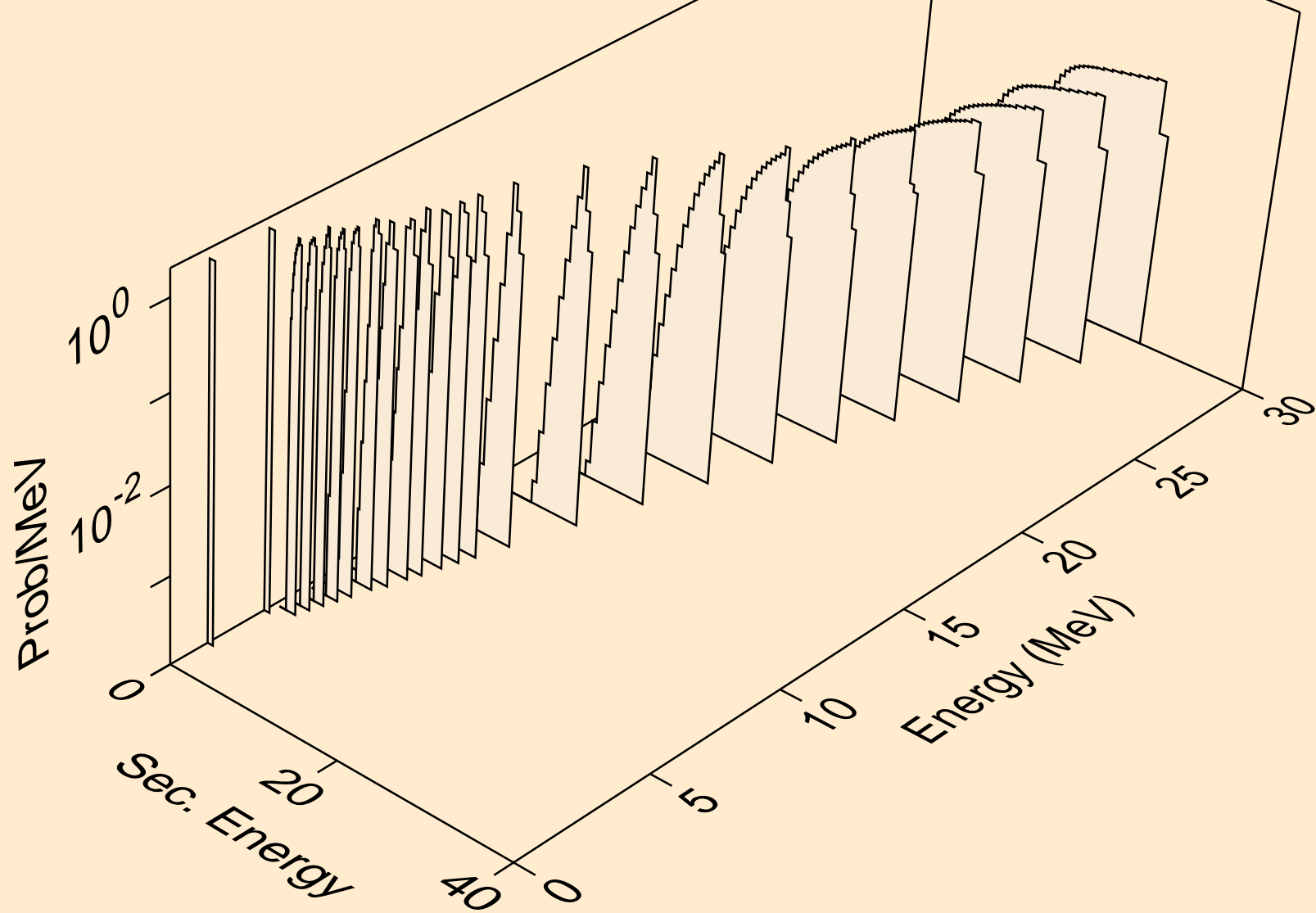

PB192 NEUTRON ACER TENDL-2024 LIBRARY; T=0.K
deuterons from (n,pd)

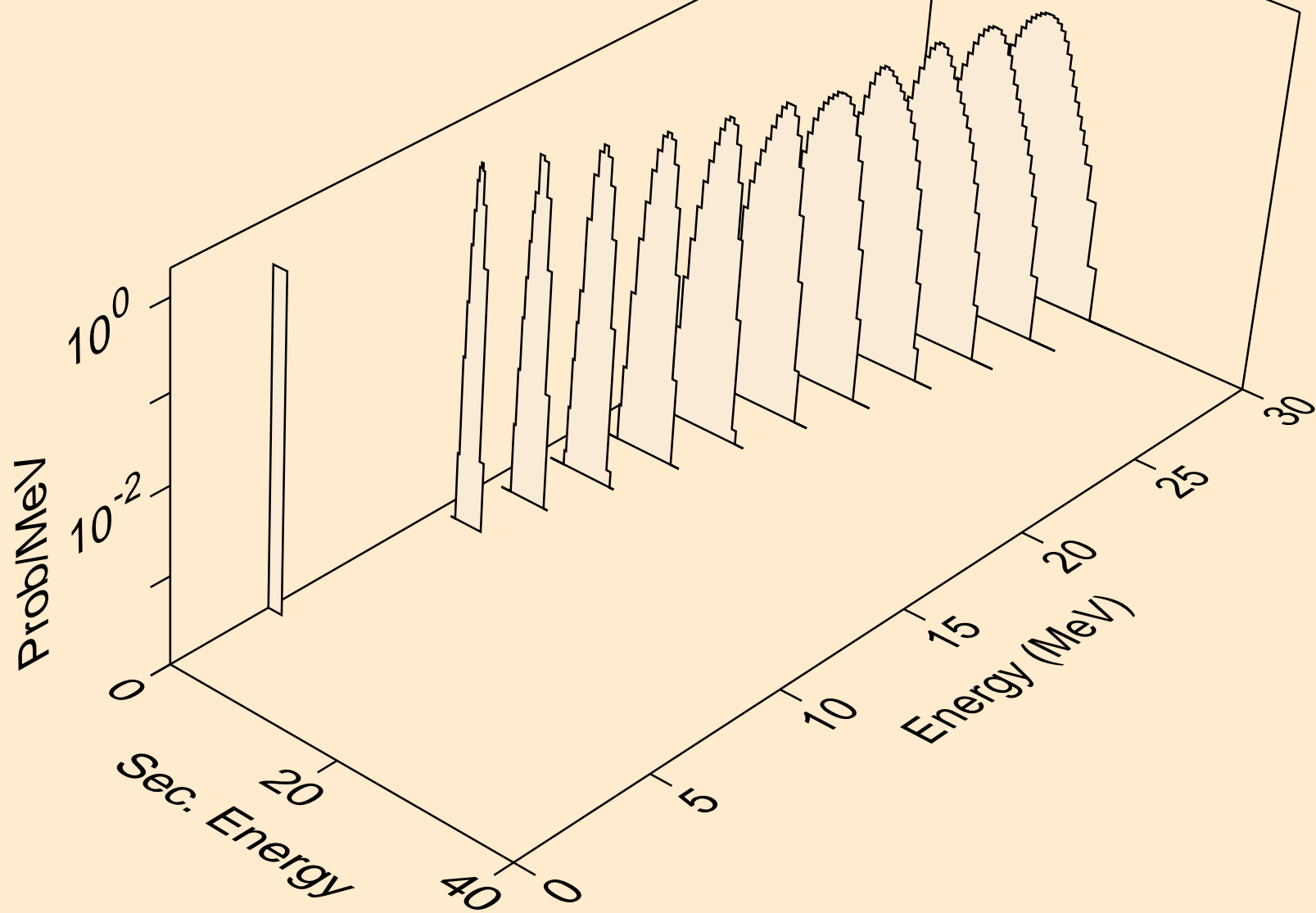

PB192 NEUTRON ACER TENDL-2024 LIBRARY; T=0.K
deuterons from (n,da)

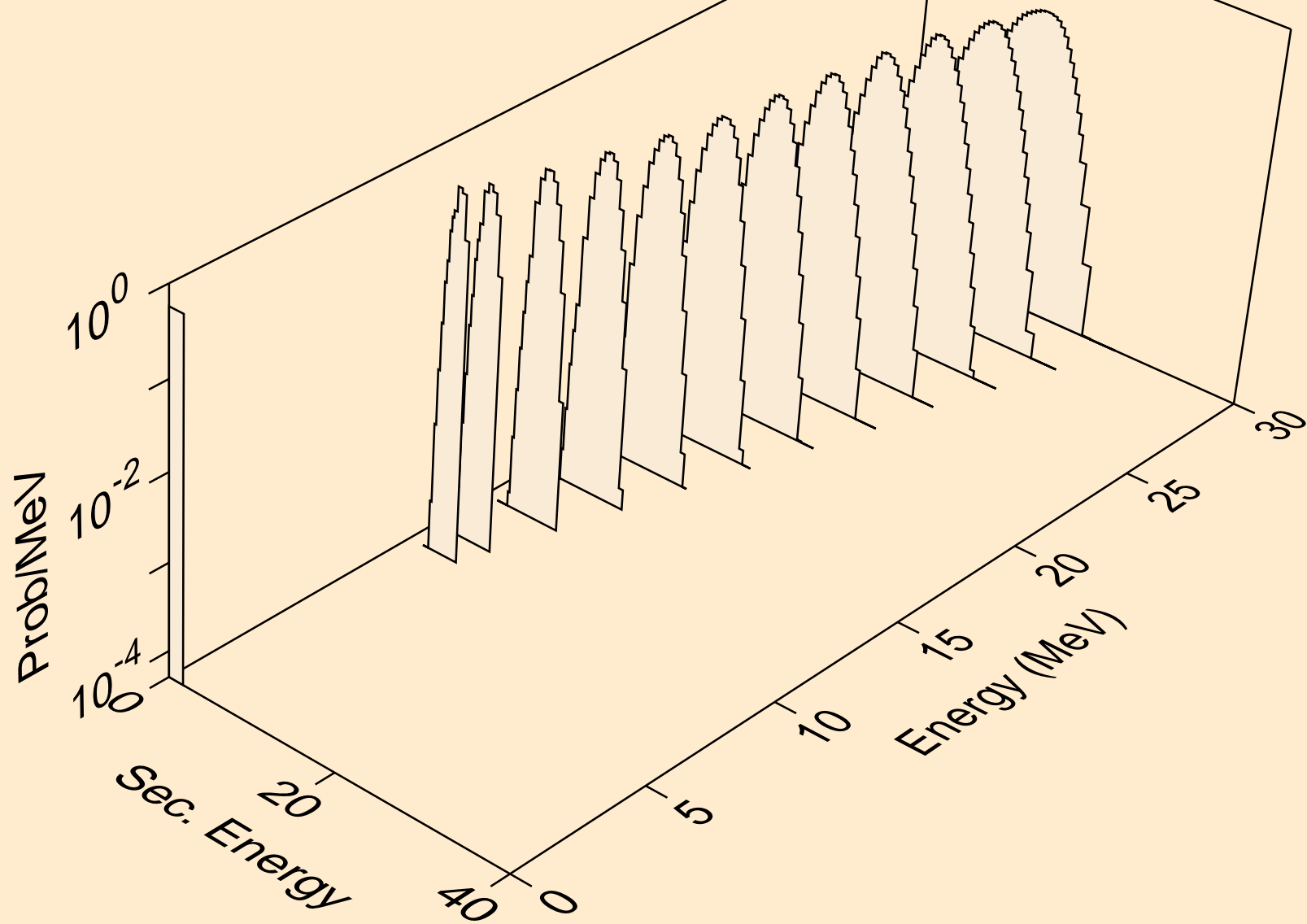

PB192 NEUTRON ACER TENDL-2024 LIBRARY; T=0.K
tritons from (n,x)

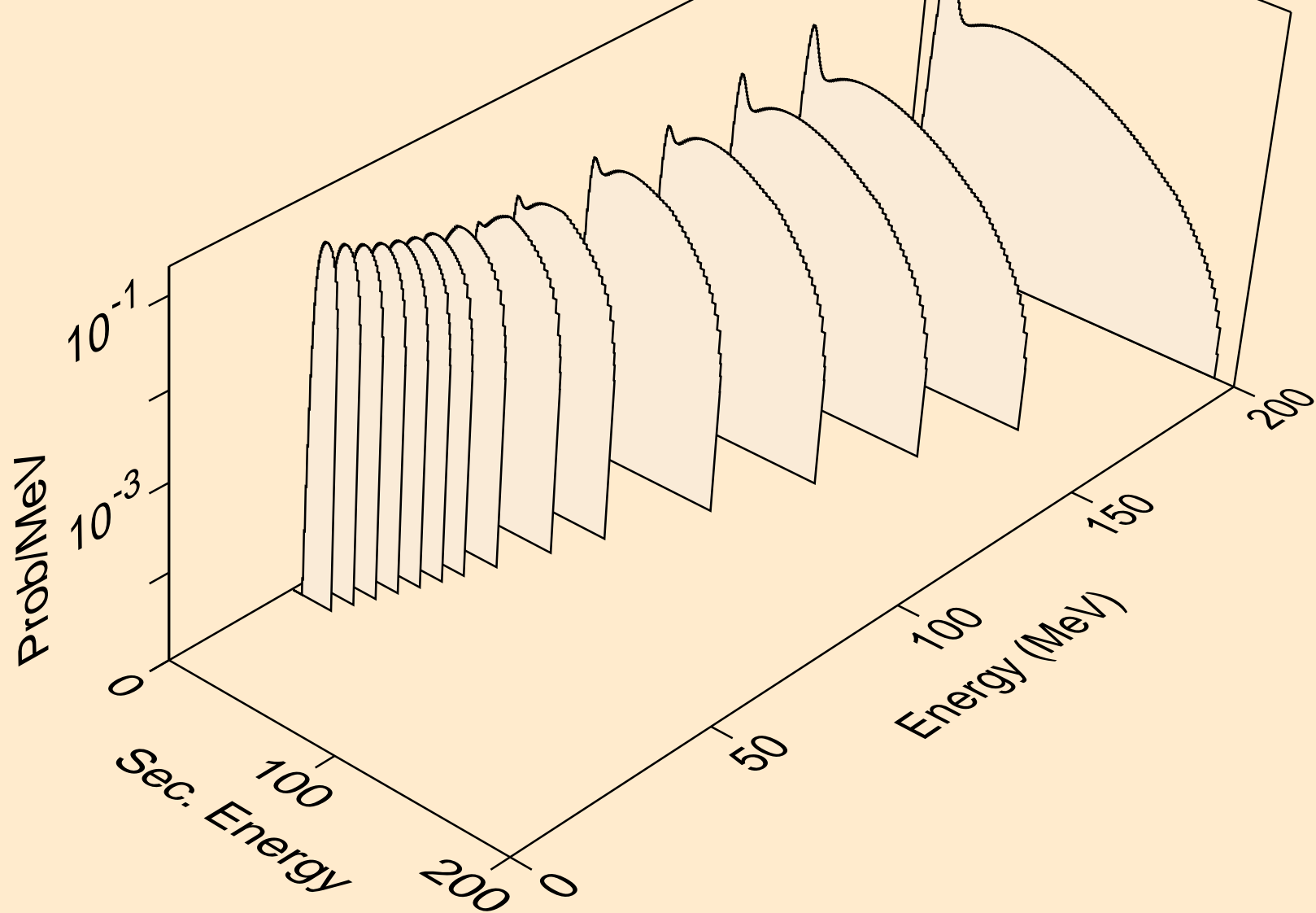

PB192 NEUTRON ACER TENDL-2024 LIBRARY; T=0.K
tritons from (n,n*)t

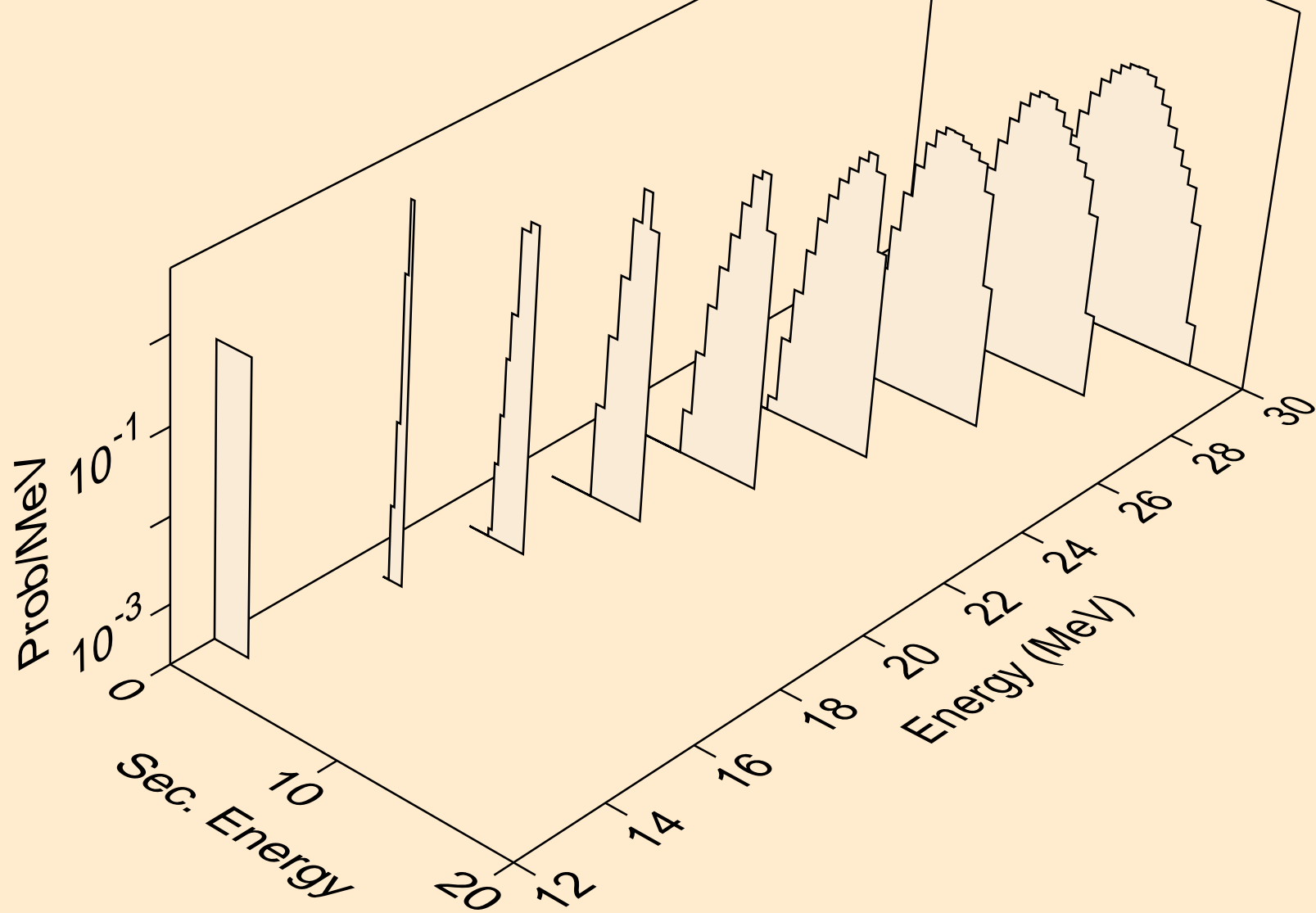

PB192 NEUTRON ACER TENDL-2024 LIBRARY; T=0.K
tritons from (n,t)

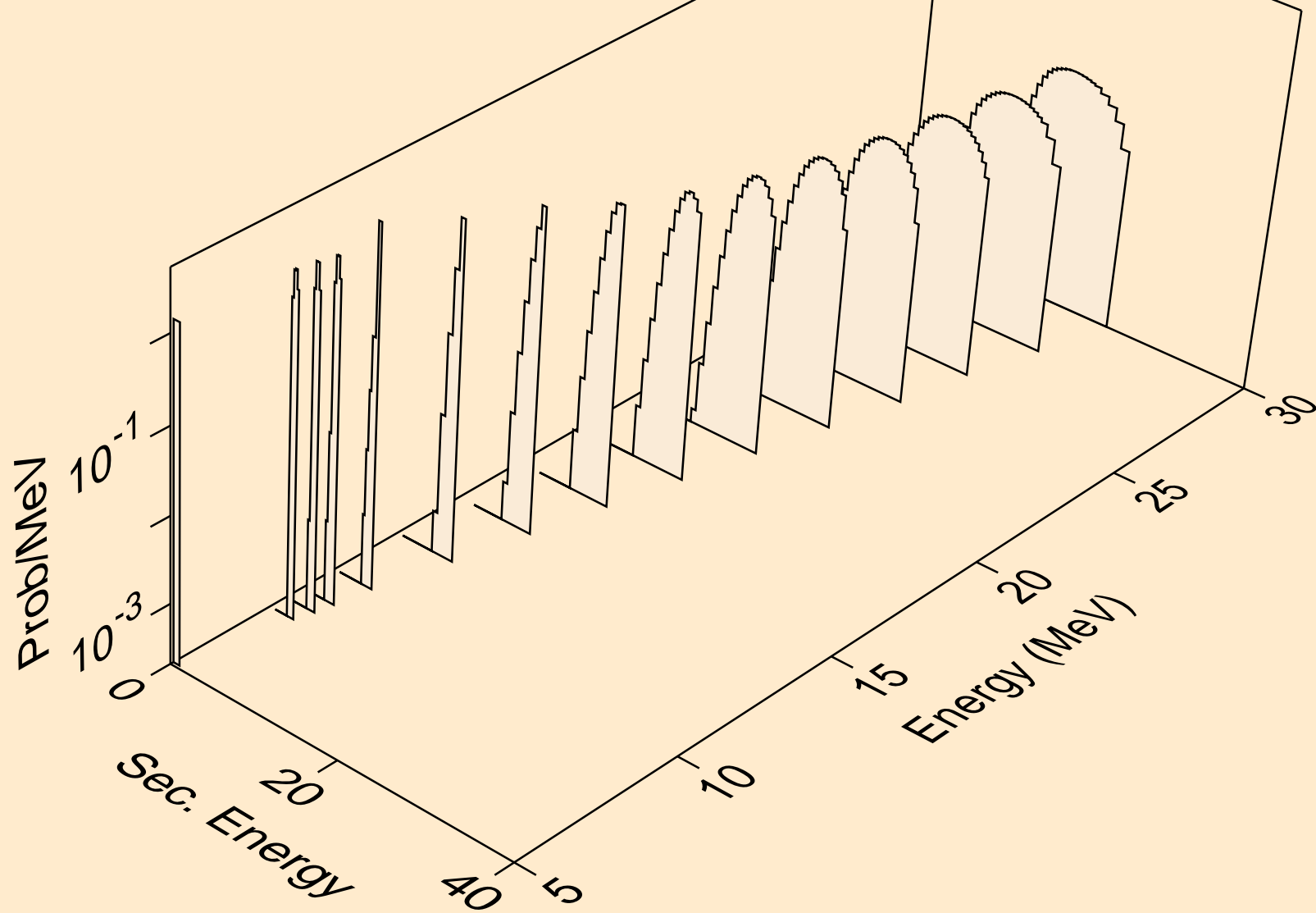

PB192 NEUTRON ACER TENDL-2024 LIBRARY; T=0.K
tritons from (n,pt)

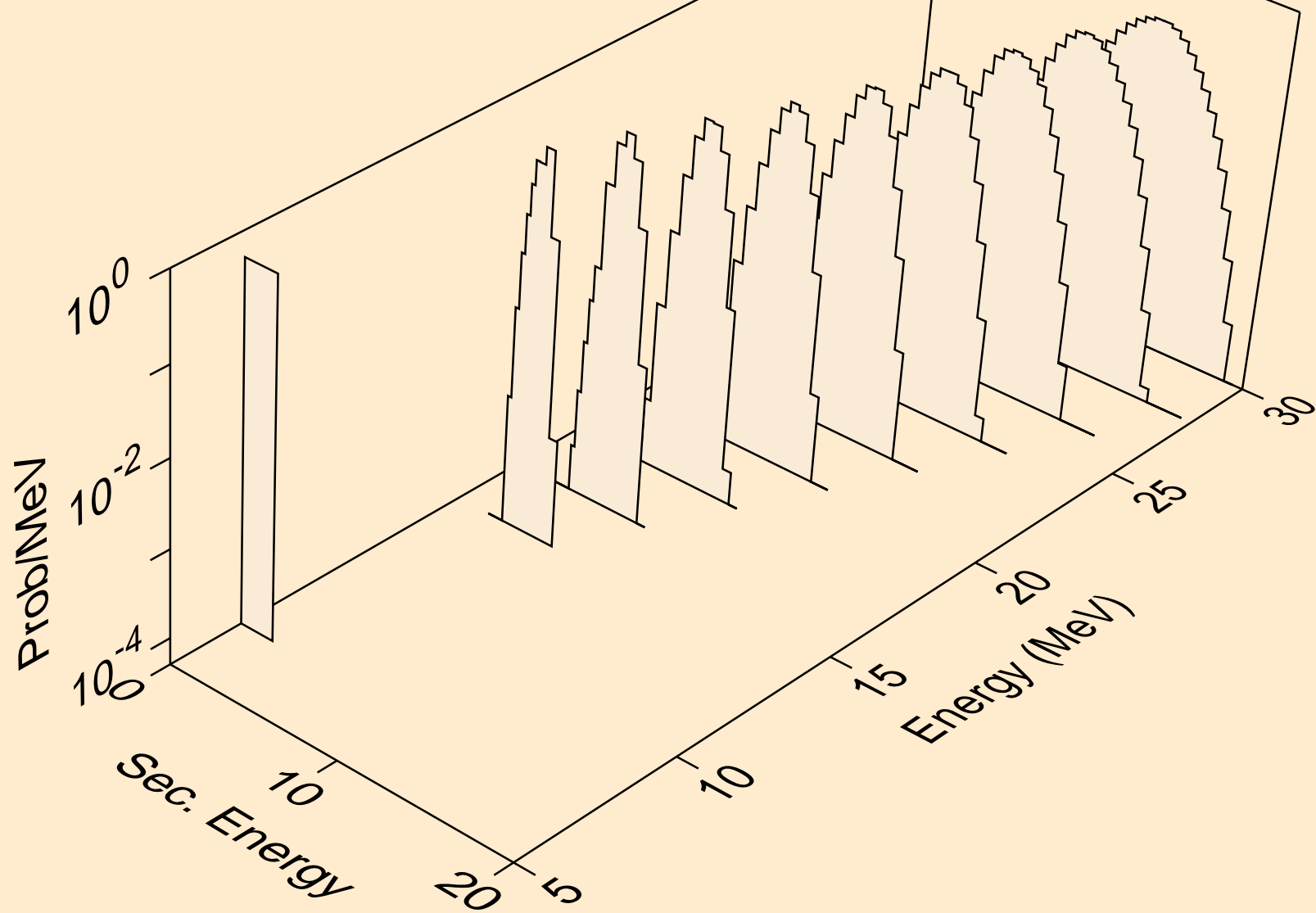

PB192 NEUTRON ACER TENDL-2024 LIBRARY; T=0.K
he3s from (n,x)

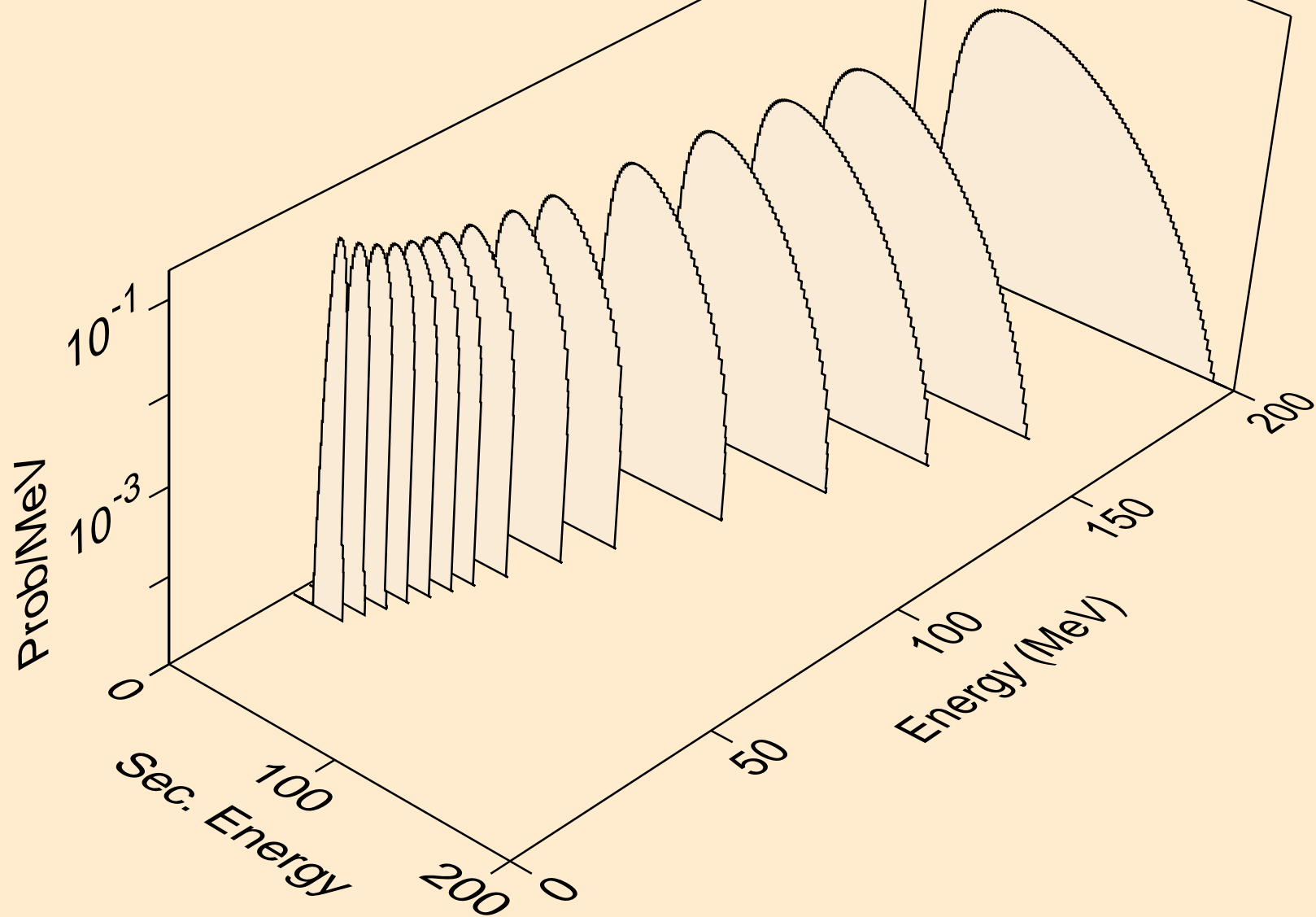

PB192 NEUTRON ACER TENDL-2024 LIBRARY; T=0.K
he3s from (n,n*)he3

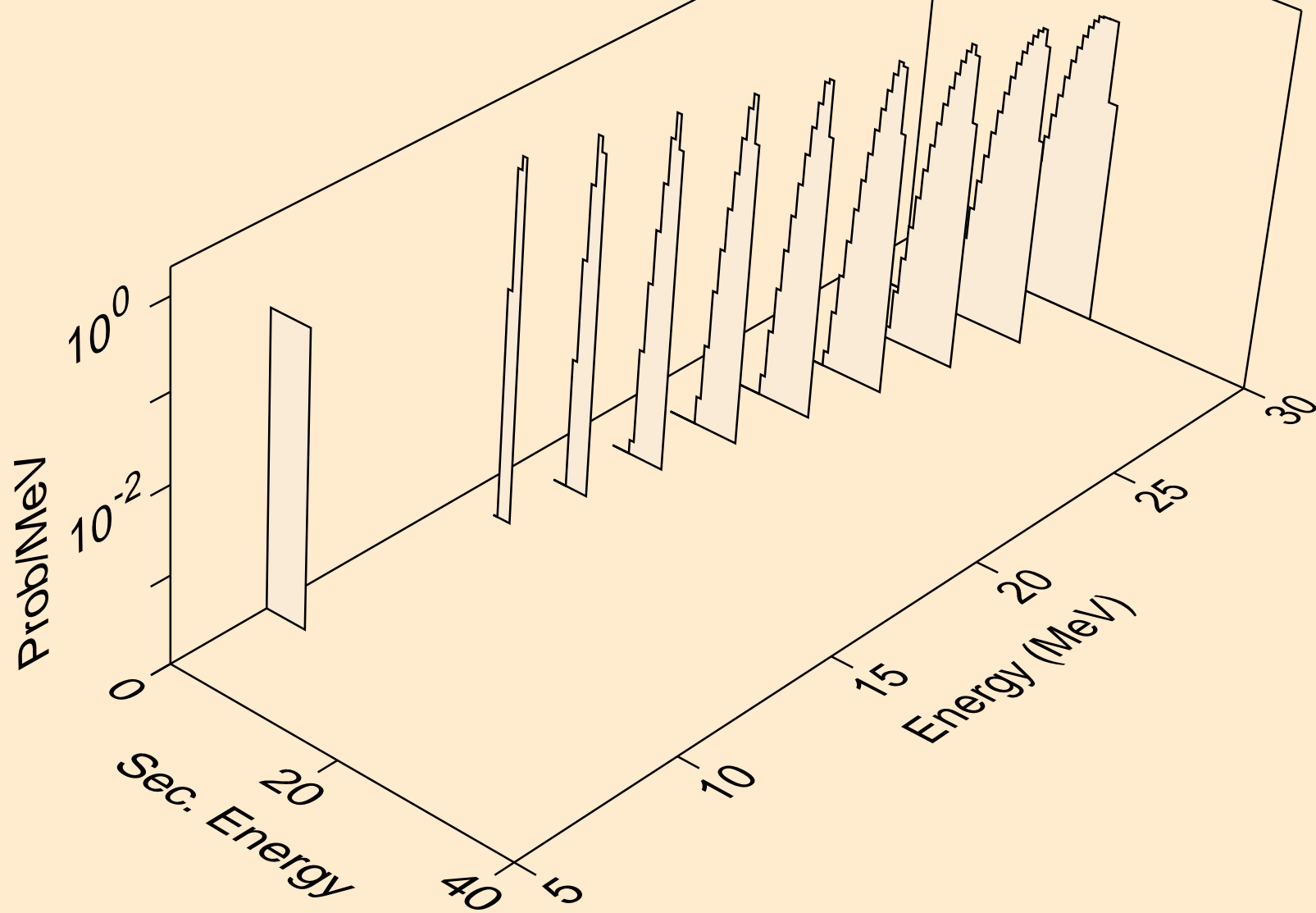

PB192 NEUTRON ACER TENDL-2024 LIBRARY; T=0.K
he3s from (n,he3)

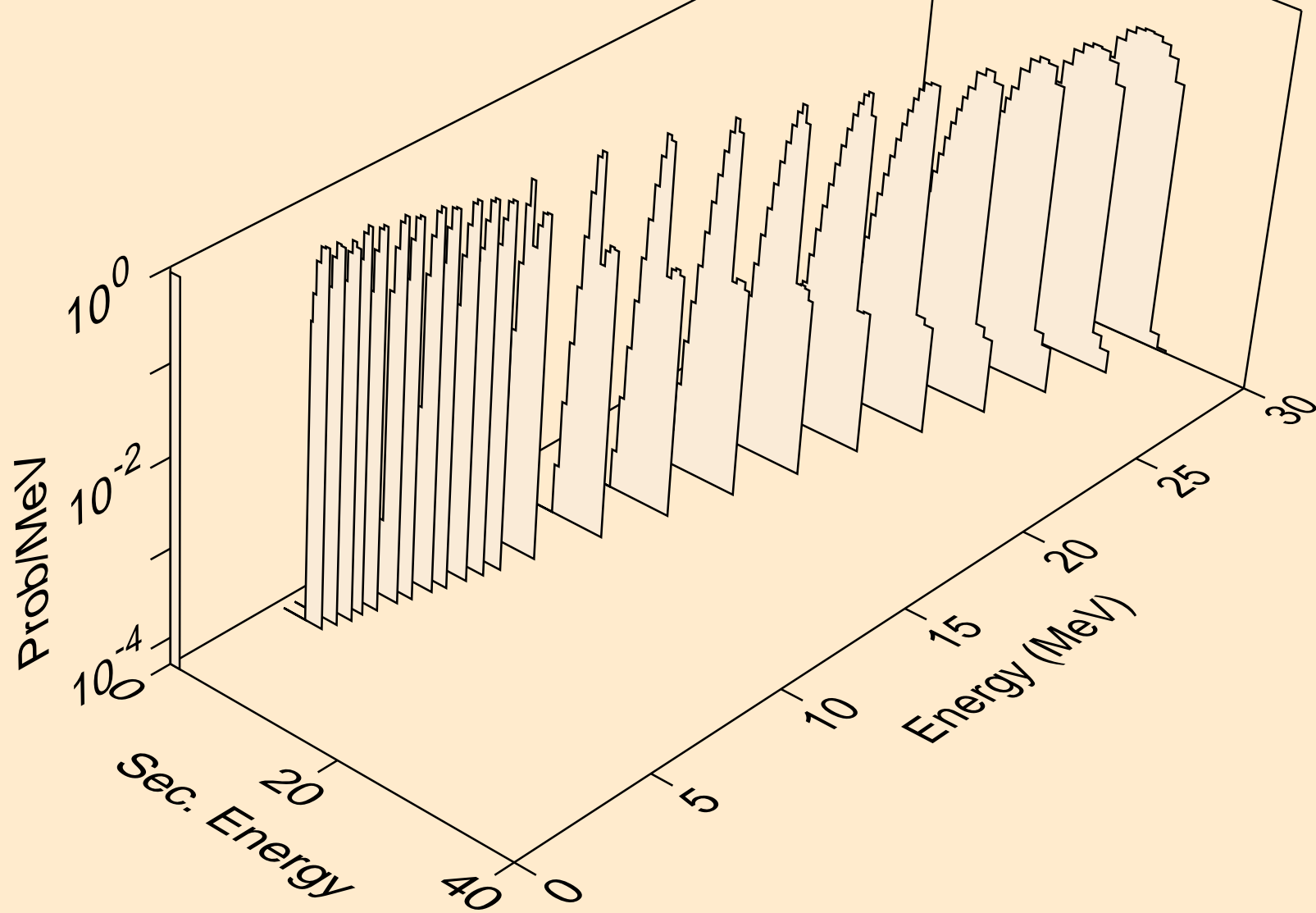

PB192 NEUTRON ACER TENDL-2024 LIBRARY; T=0.K
alphas from (n,x)

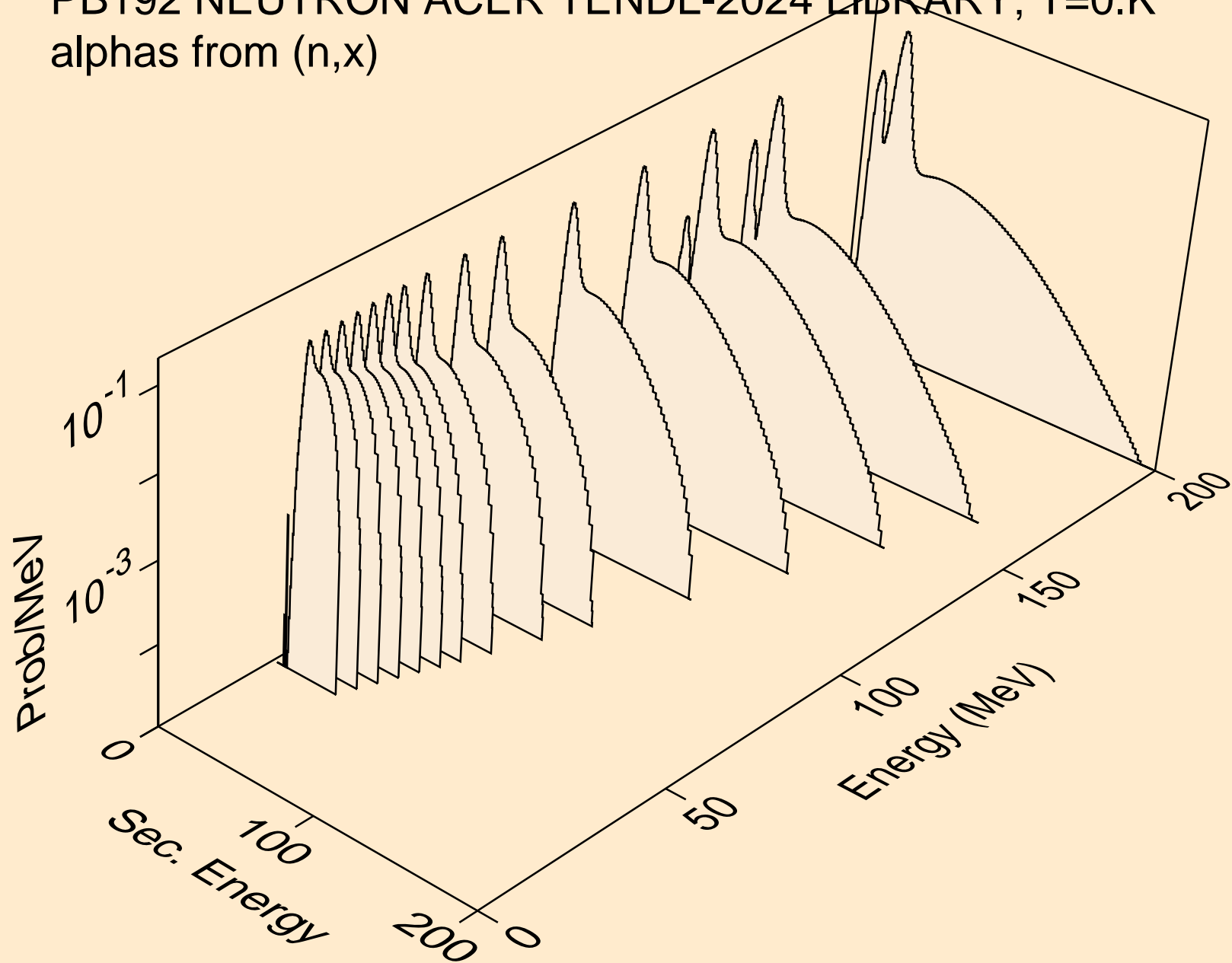

PB192 NEUTRON ACER TENDL-2024 LIBRARY; T=0.K
alphas from (n,n*)a

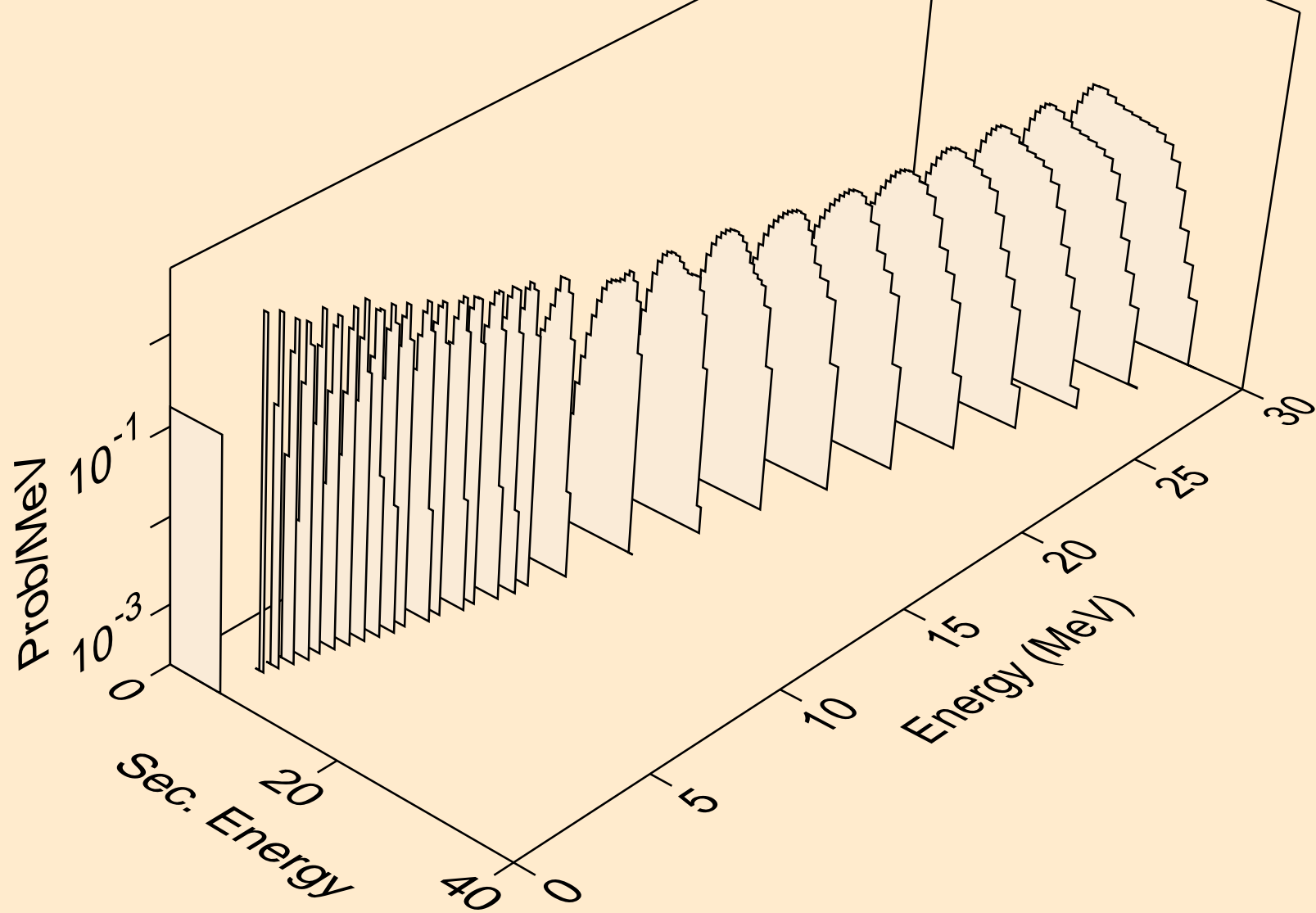

PB192 NEUTRON ACER TENDL-2024 LIBRARY; T=0.K
alphas from (n,2n)a

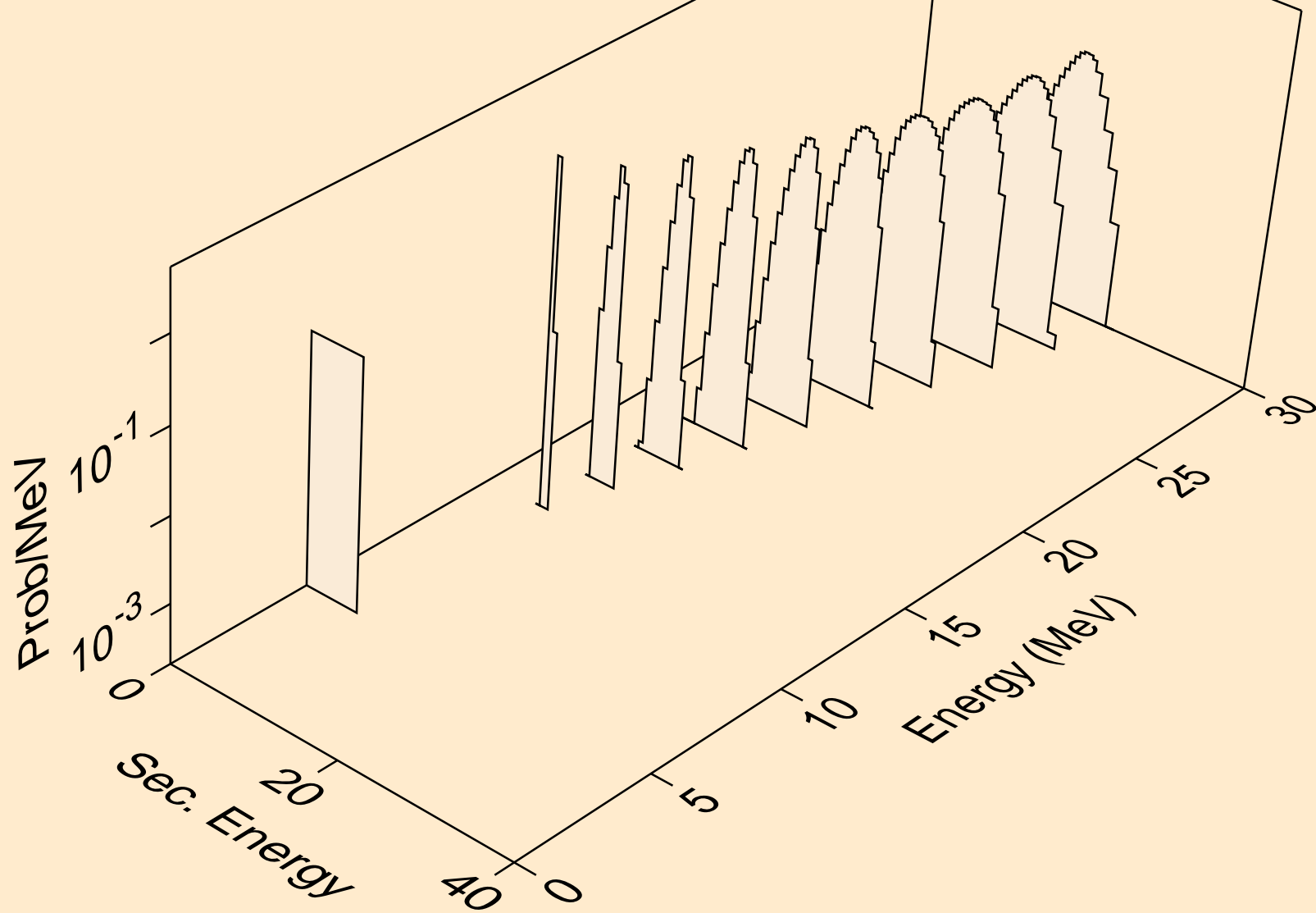

PB192 NEUTRON ACER TENDL-2024 LIBRARY; T=0.K
alphas from (n,3n)a

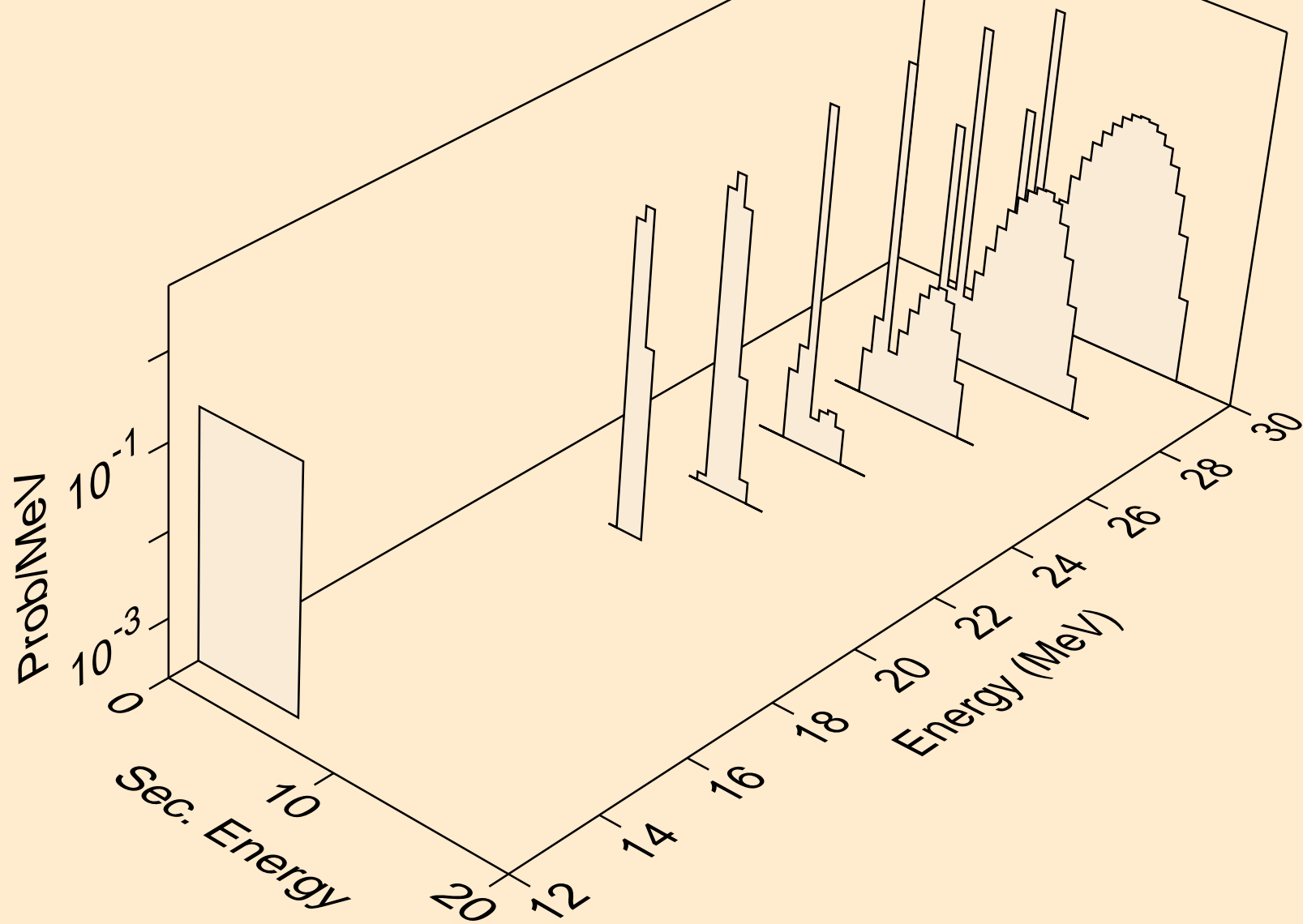

PB192 NEUTRON ACER TENDL-2024 LIBRARY; T=0.K
alphas from (n,n*)2a

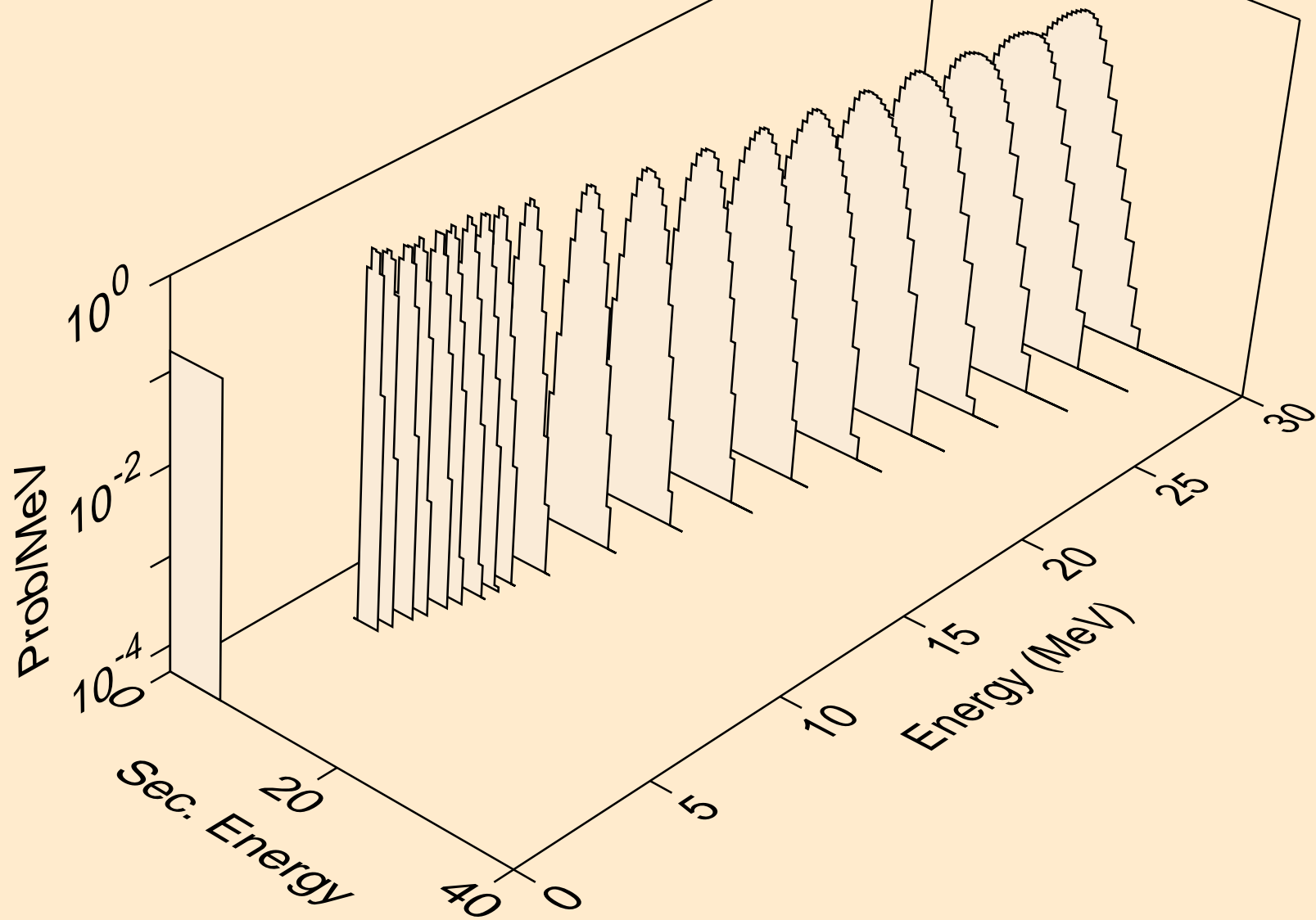

PB192 NEUTRON ACER TENDL-2024 LIBRARY; T=0.K
alphas from (n,2n)2a

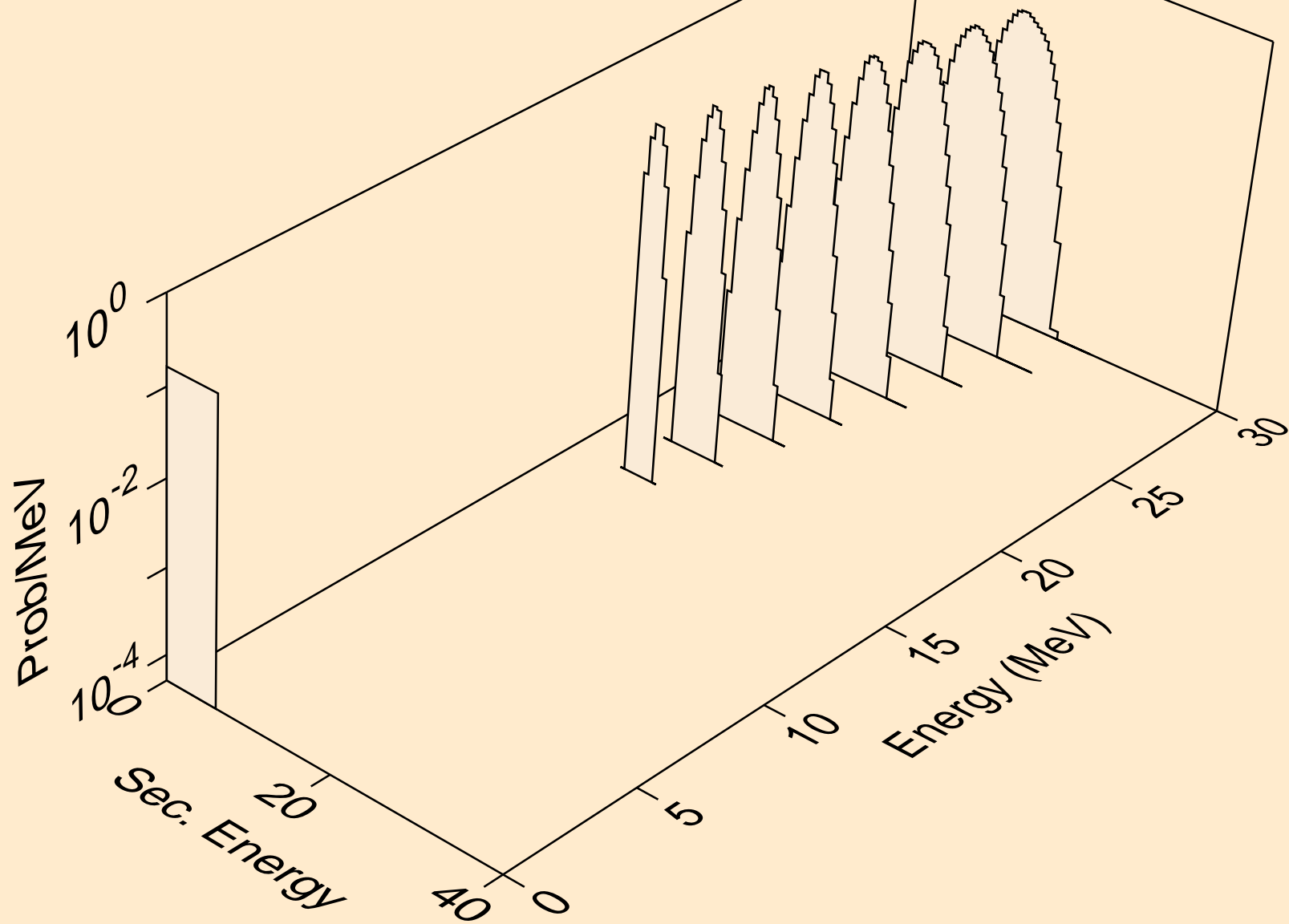

PB192 NEUTRON ACER TENDL-2024 LIBRARY; T=0.K
alphas from (n,npa)

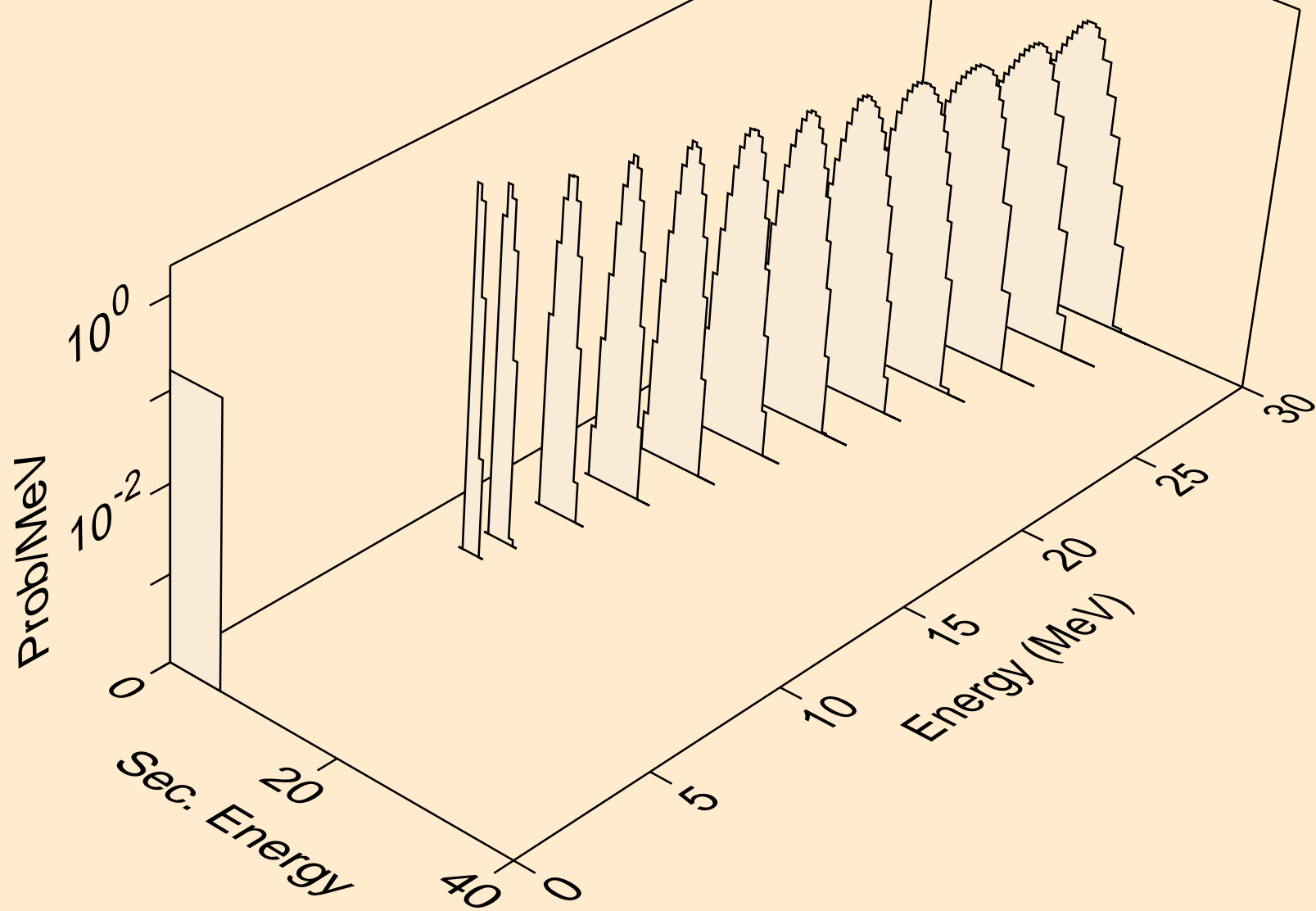

PB192 NEUTRON ACER TENDL-2024 LIBRARY; T=0.K
alphas from (n,a)

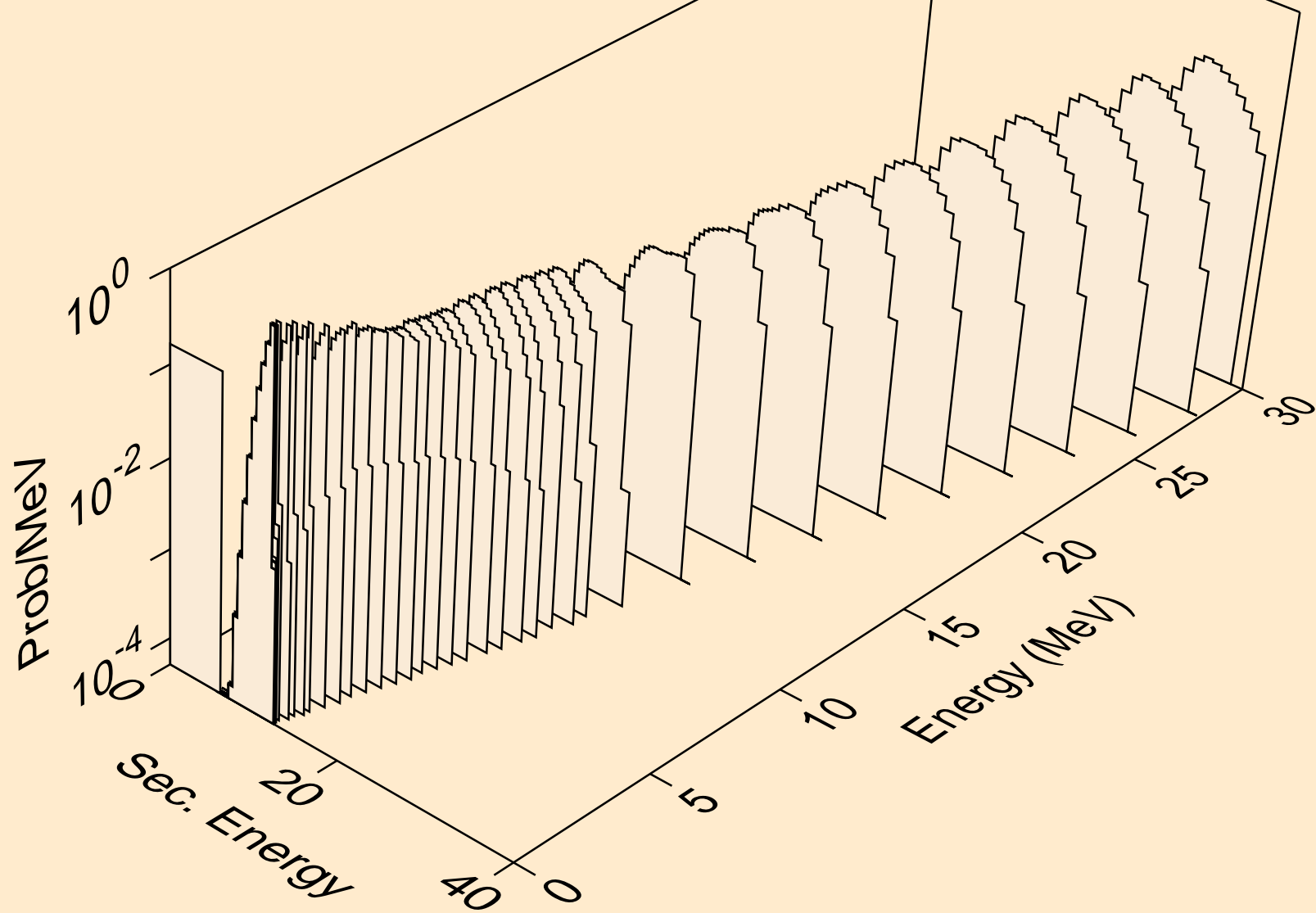

PB192 NEUTRON ACER TENDL-2024 LIBRARY; T=0.K
alphas from (n,2a)

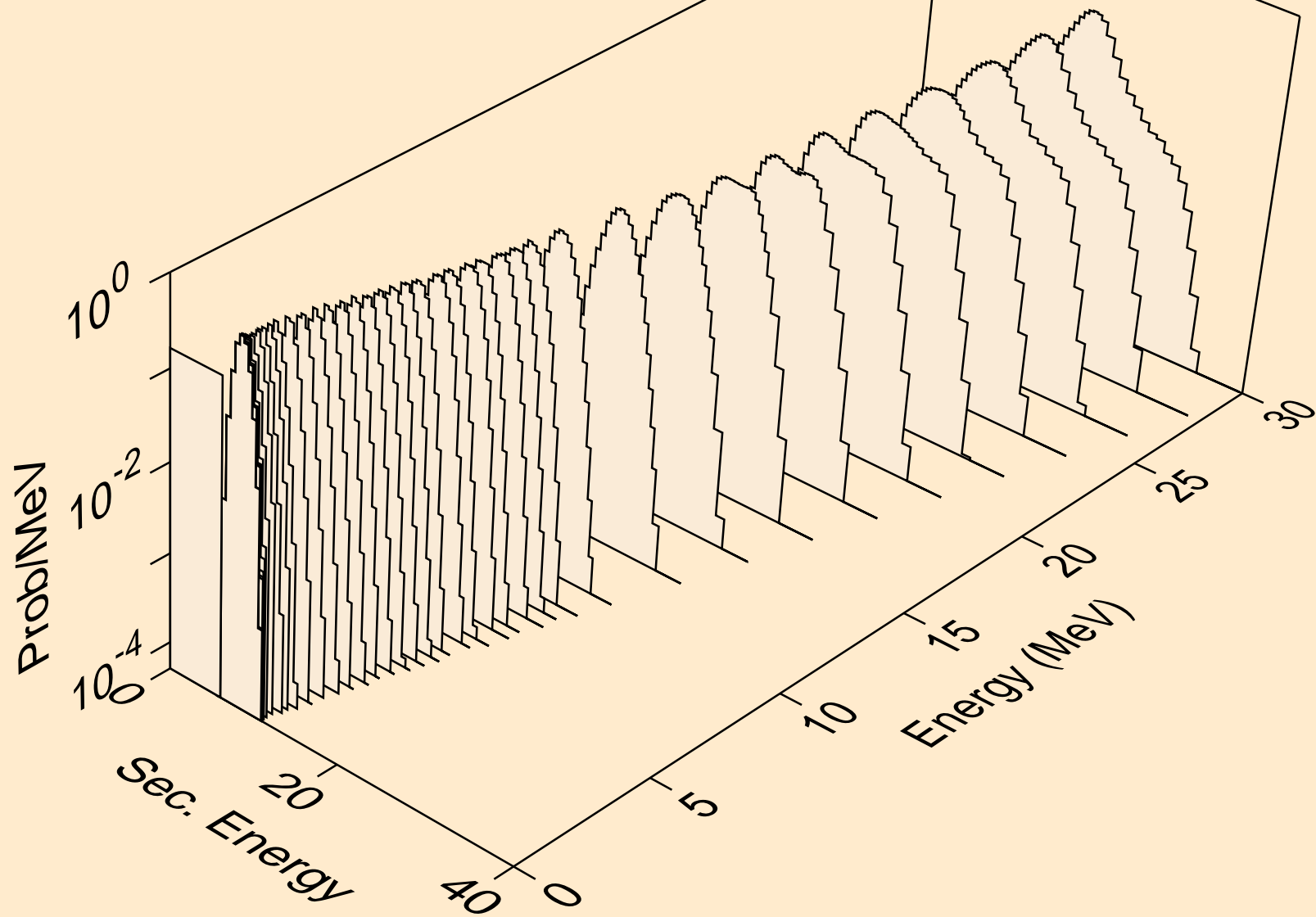

PB192 NEUTRON ACER TENDL-2024 LIBRARY; T=0.K
alphas from (n,pa)

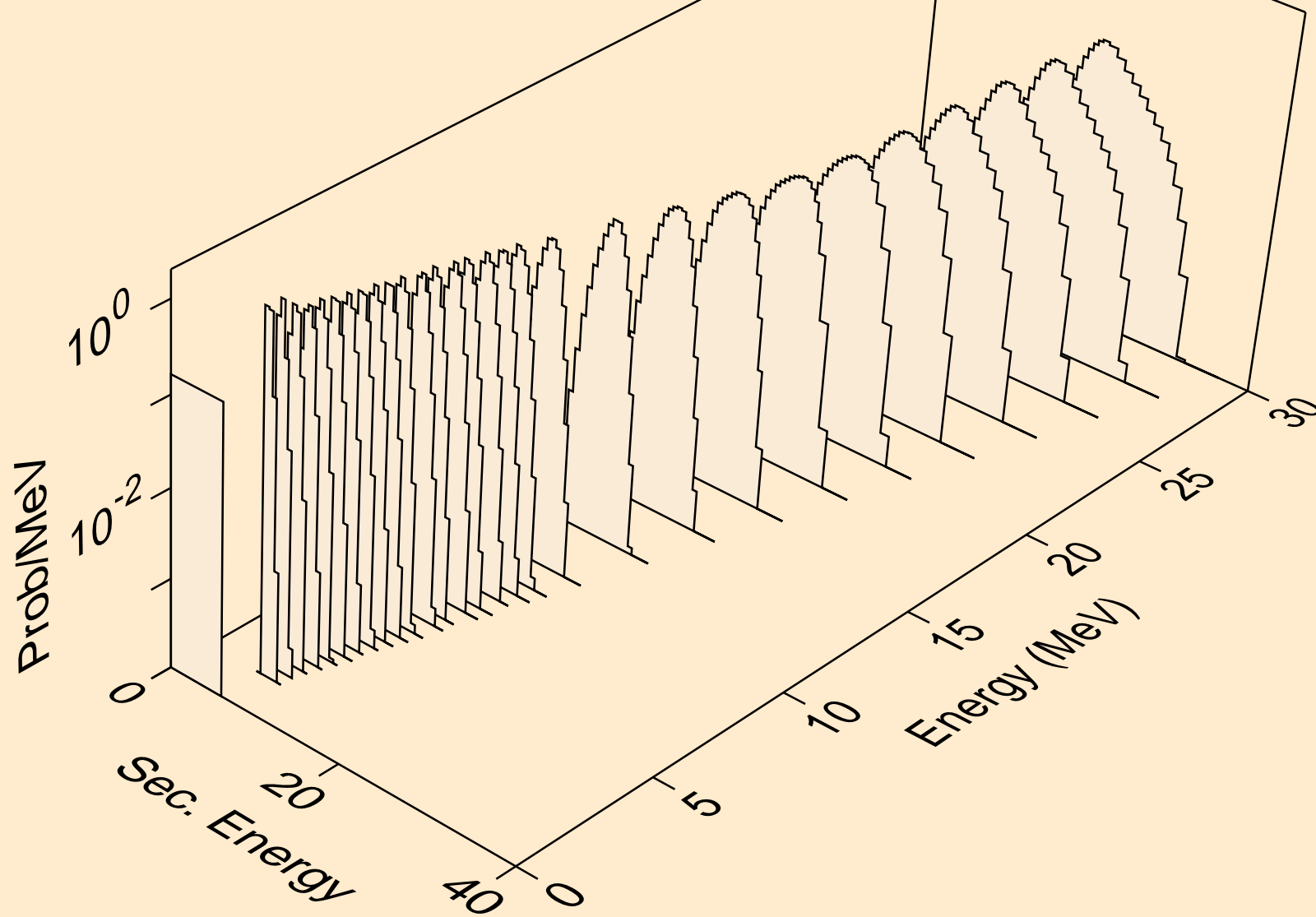

PB192 NEUTRON ACER TENDL-2024 LIBRARY; T=0.K
alphas from (n,da)

