

PD095M NEUTRON ACER TENDL-2024 LIBRARY; T=0.K

Principal cross sections

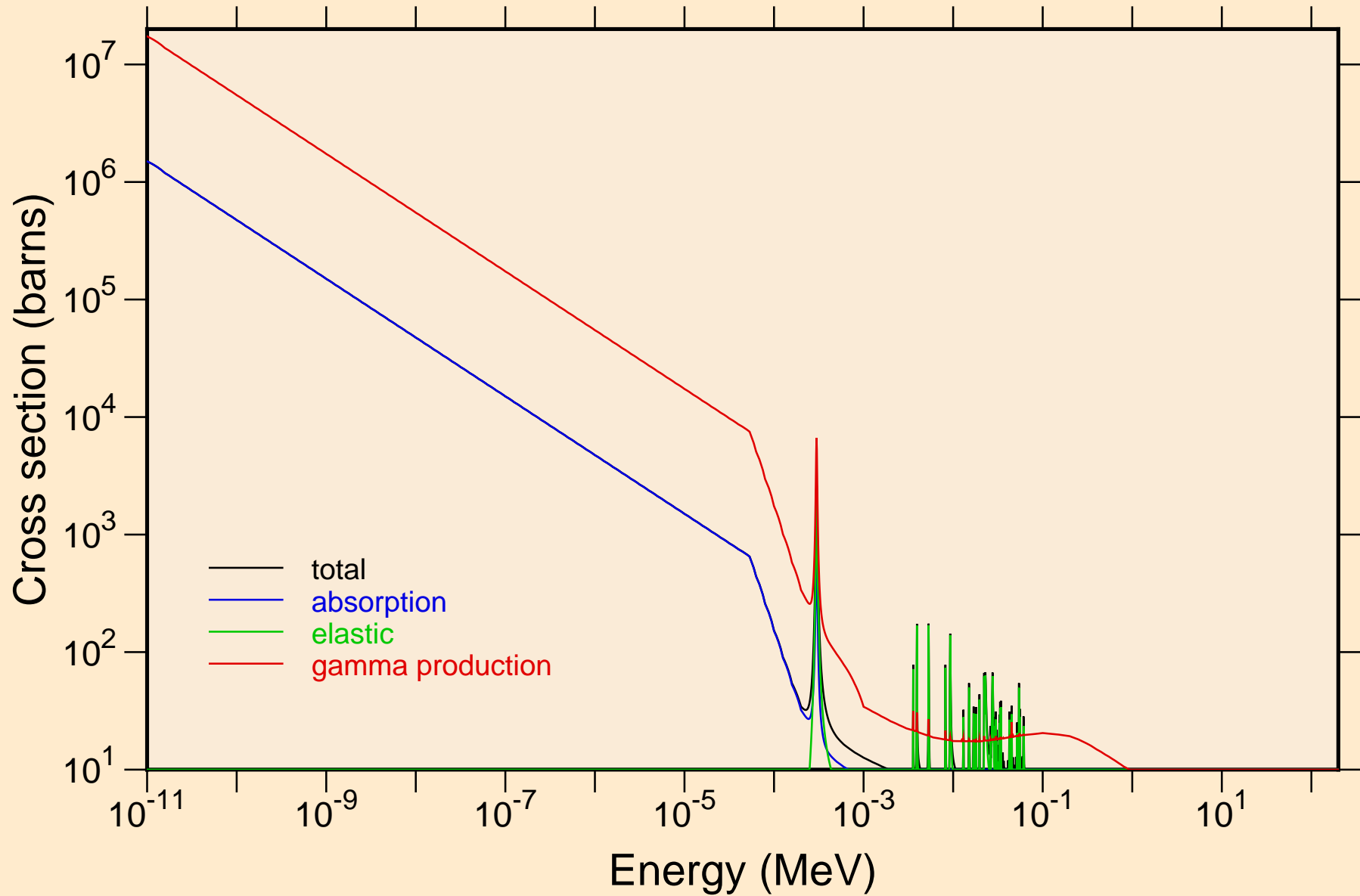

PD095M NEUTRON ACER TENDL-2024 LIBRARY; T=0.K
resonance total cross section

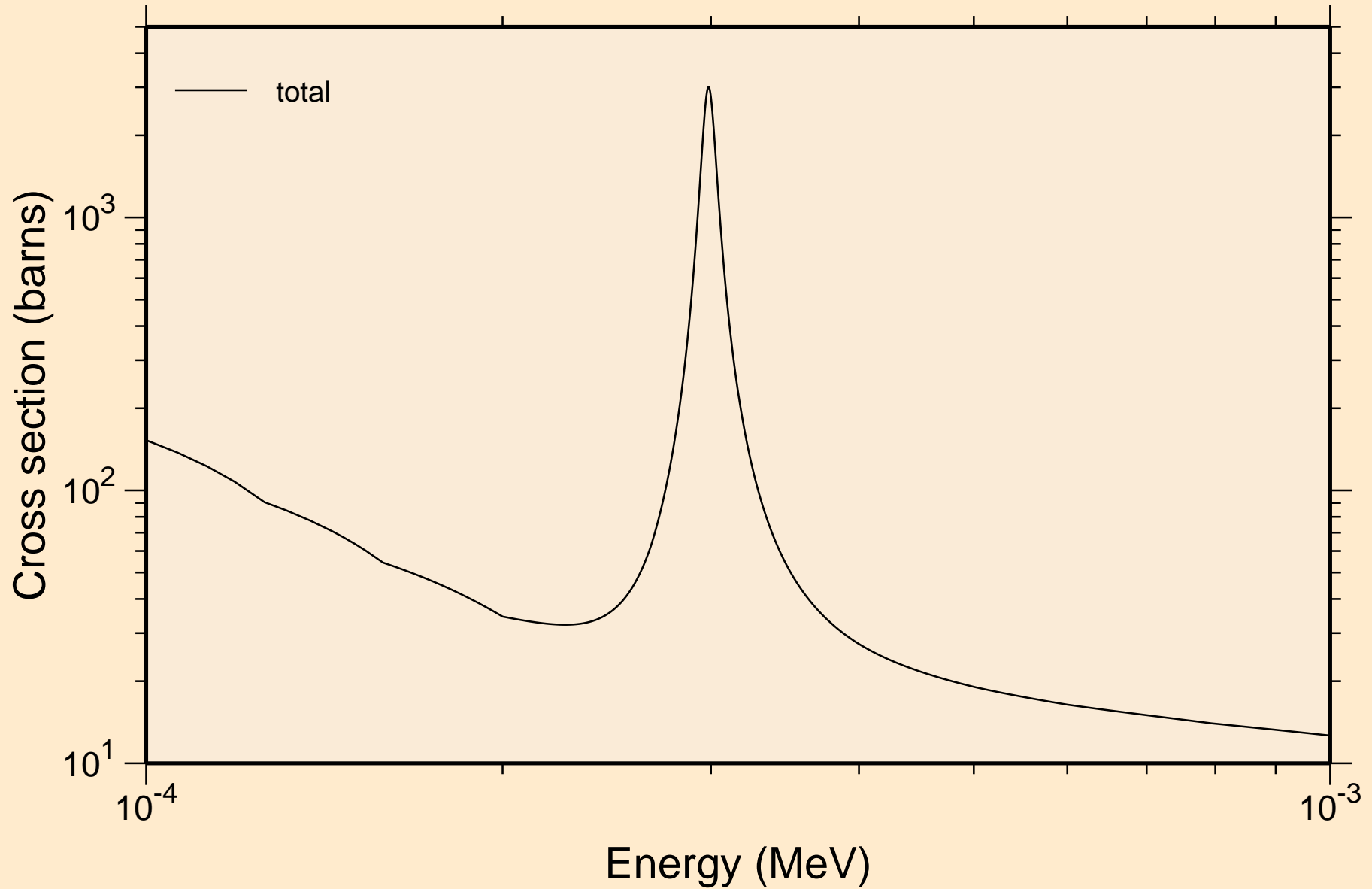

PD095M NEUTRON ACER TENDL-2024 LIBRARY; T=0.K
resonance total cross section

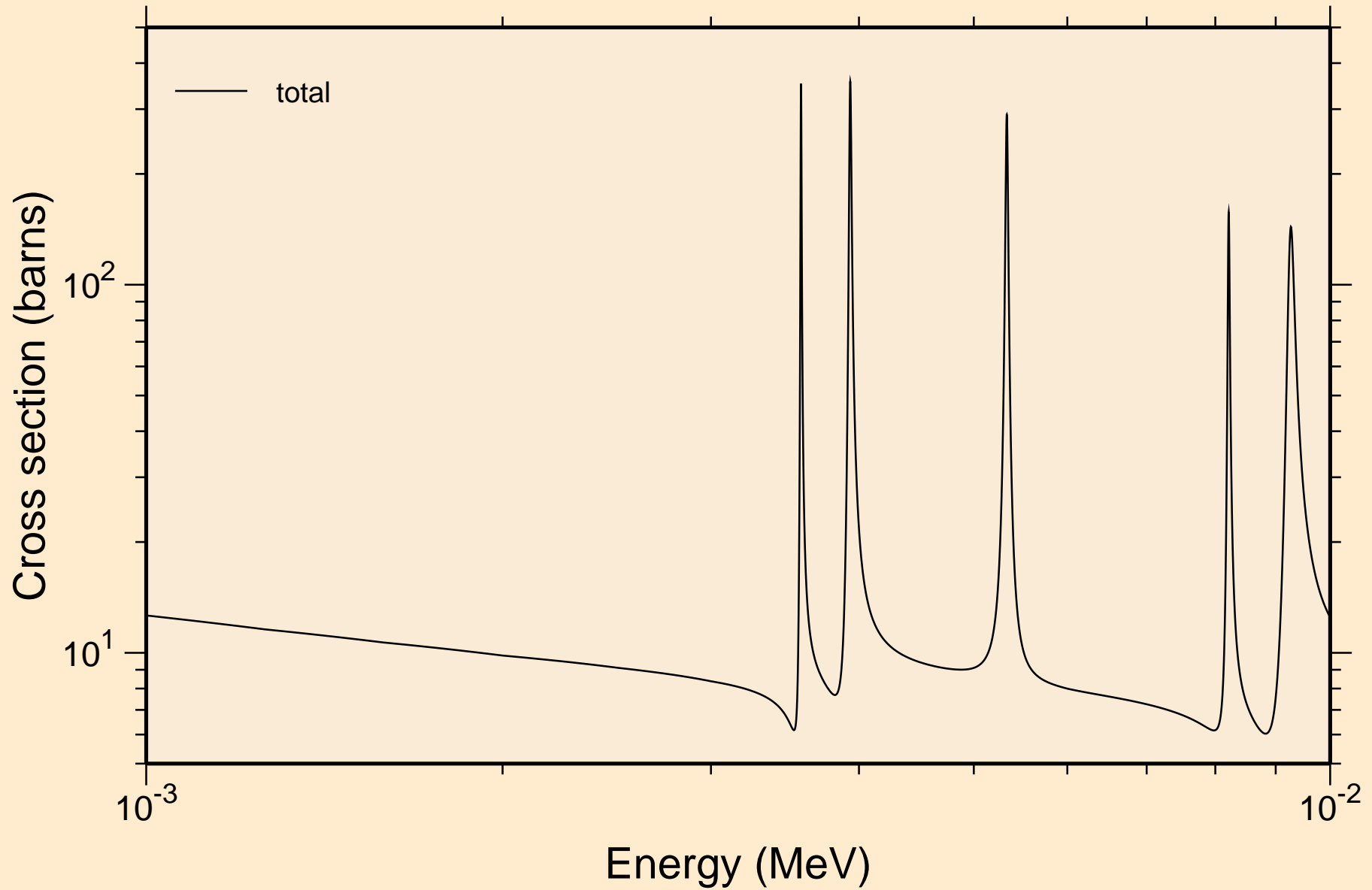

PD095M NEUTRON ACER TENDL-2024 LIBRARY; T=0.K
resonance total cross section

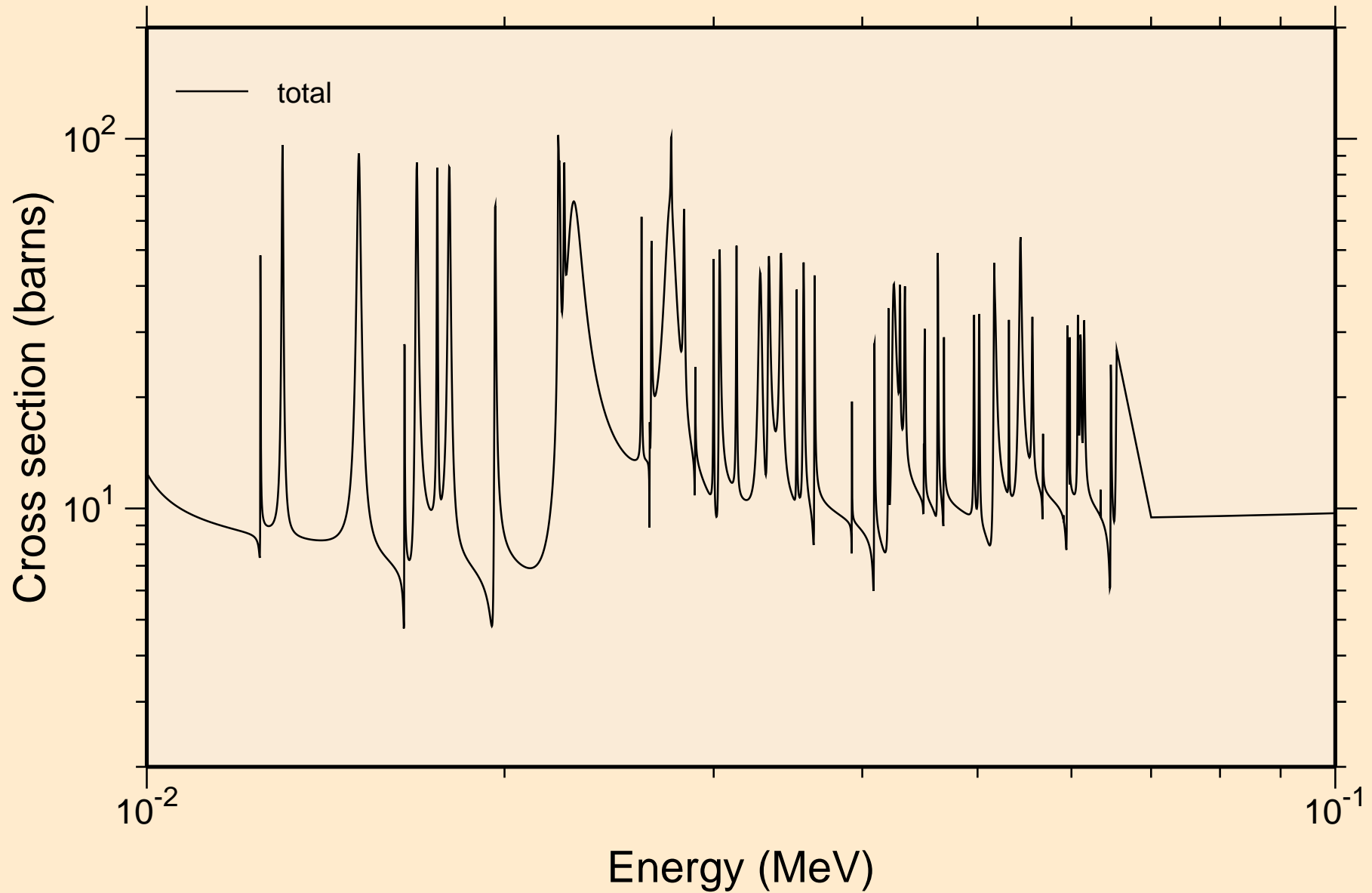

P̄095M NEUTRON ACER TENDL-2024 LIBRARY; T=0.K
resonance total cross section

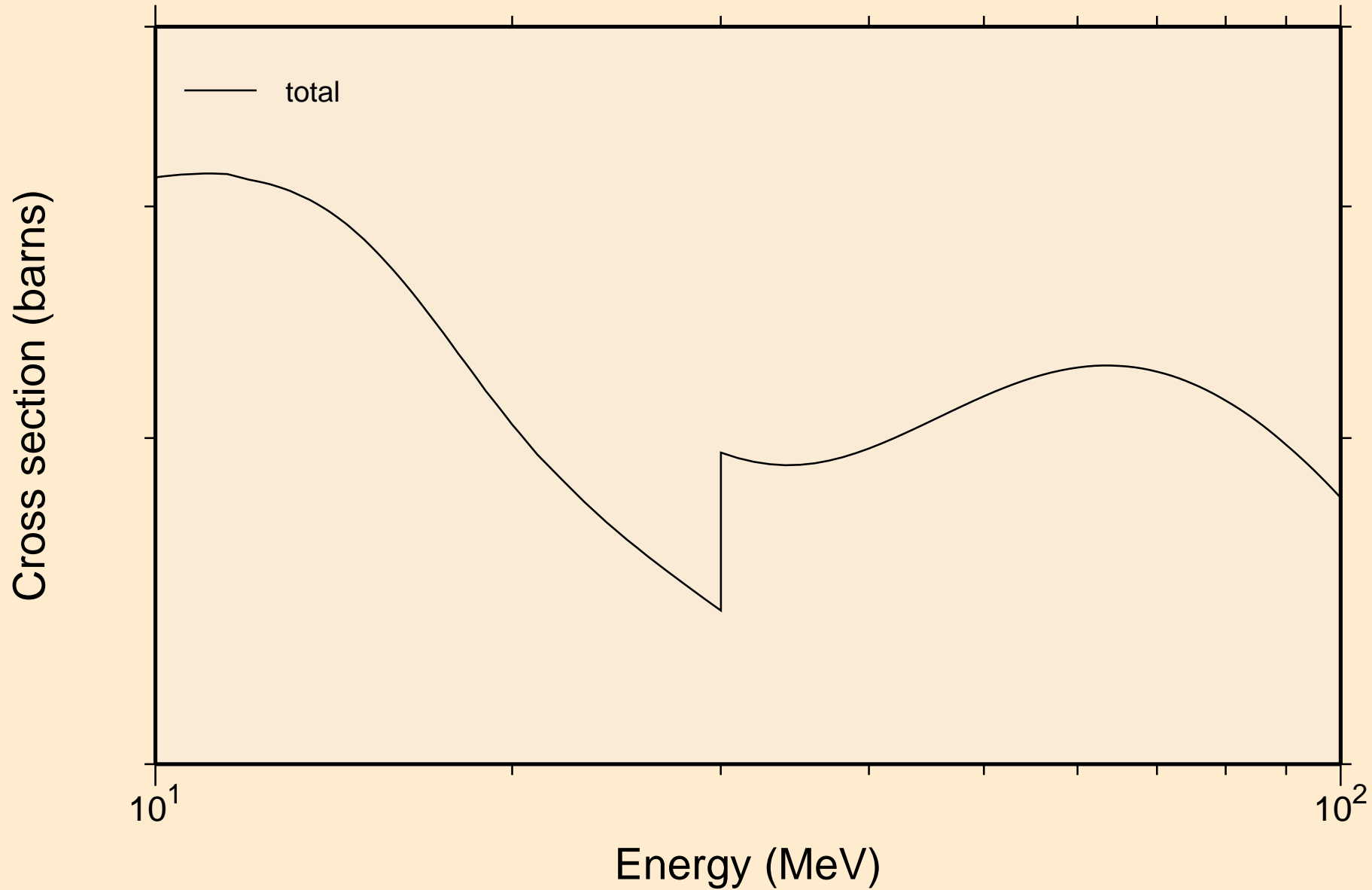

PD095M NEUTRON ACER TENDL-2024 LIBRARY; T=0.K
resonance absorption cross sections

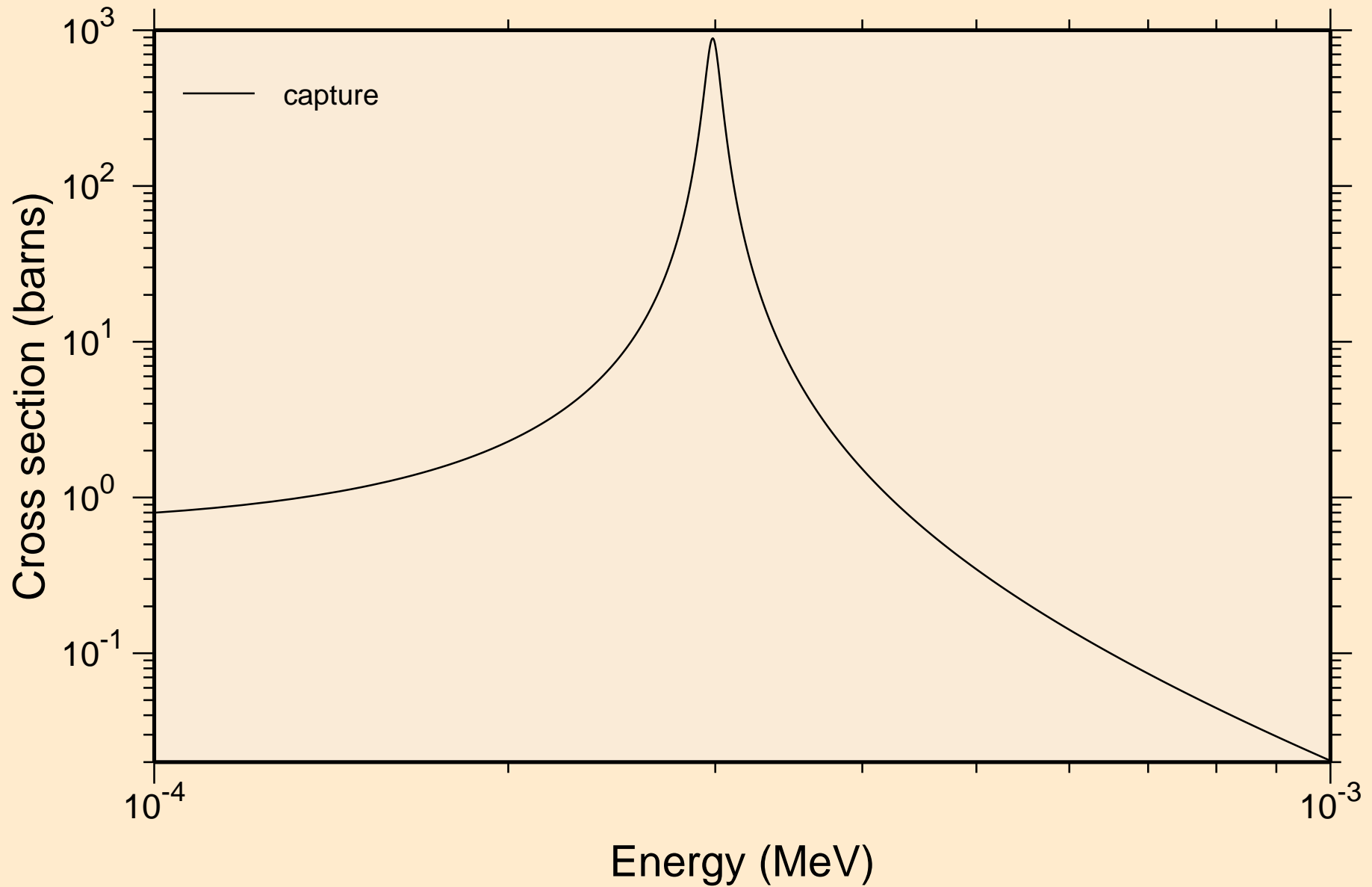

PD095M NEUTRON ACER TENDL-2024 LIBRARY; T=0.K
resonance absorption cross sections

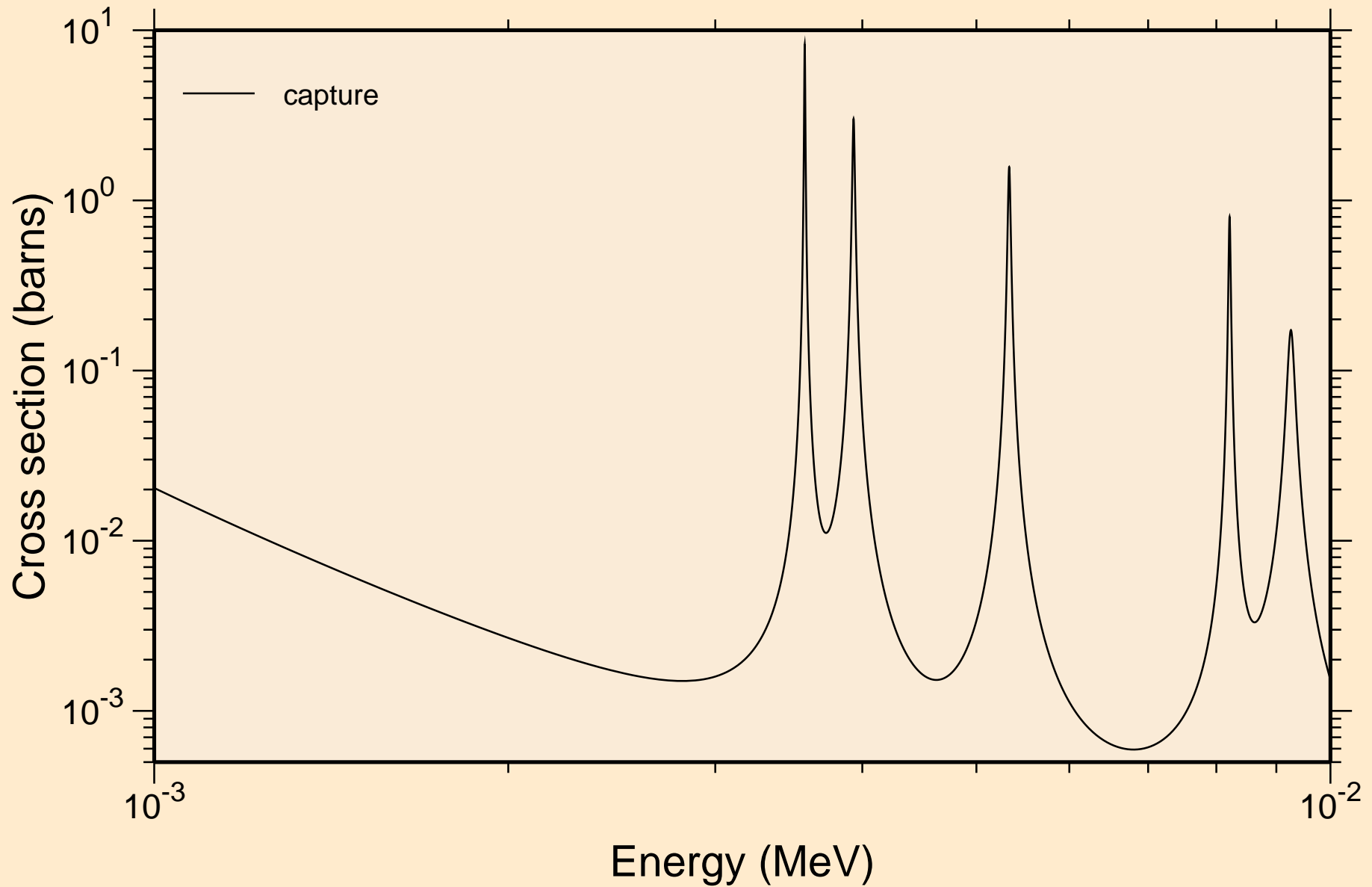

PD095M NEUTRON ACER TENDL-2024 LIBRARY; T=0.K
resonance absorption cross sections

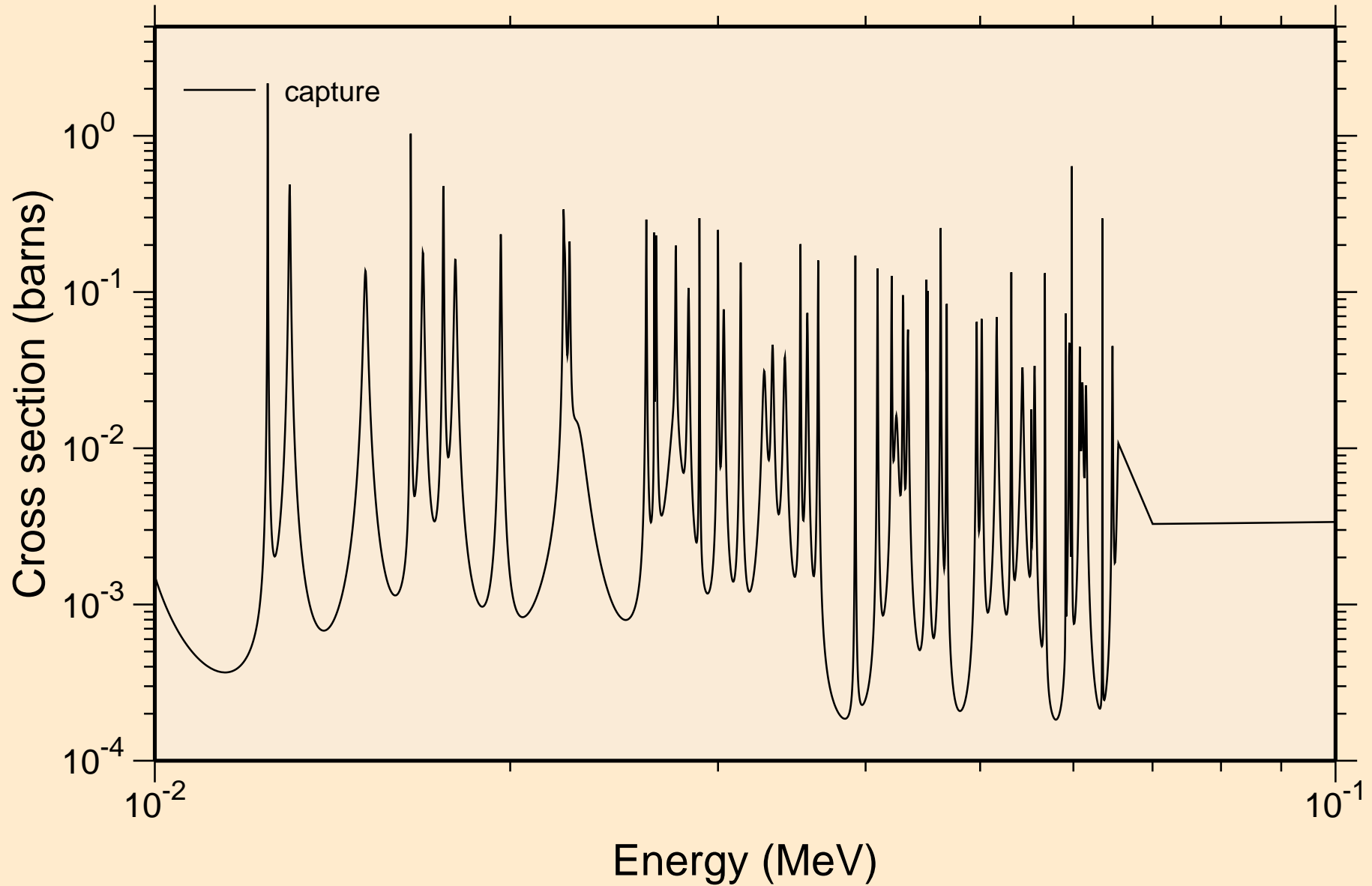

PD095M NEUTRON ACER TENDL-2024 LIBRARY; T=0.K
resonance absorption cross sections

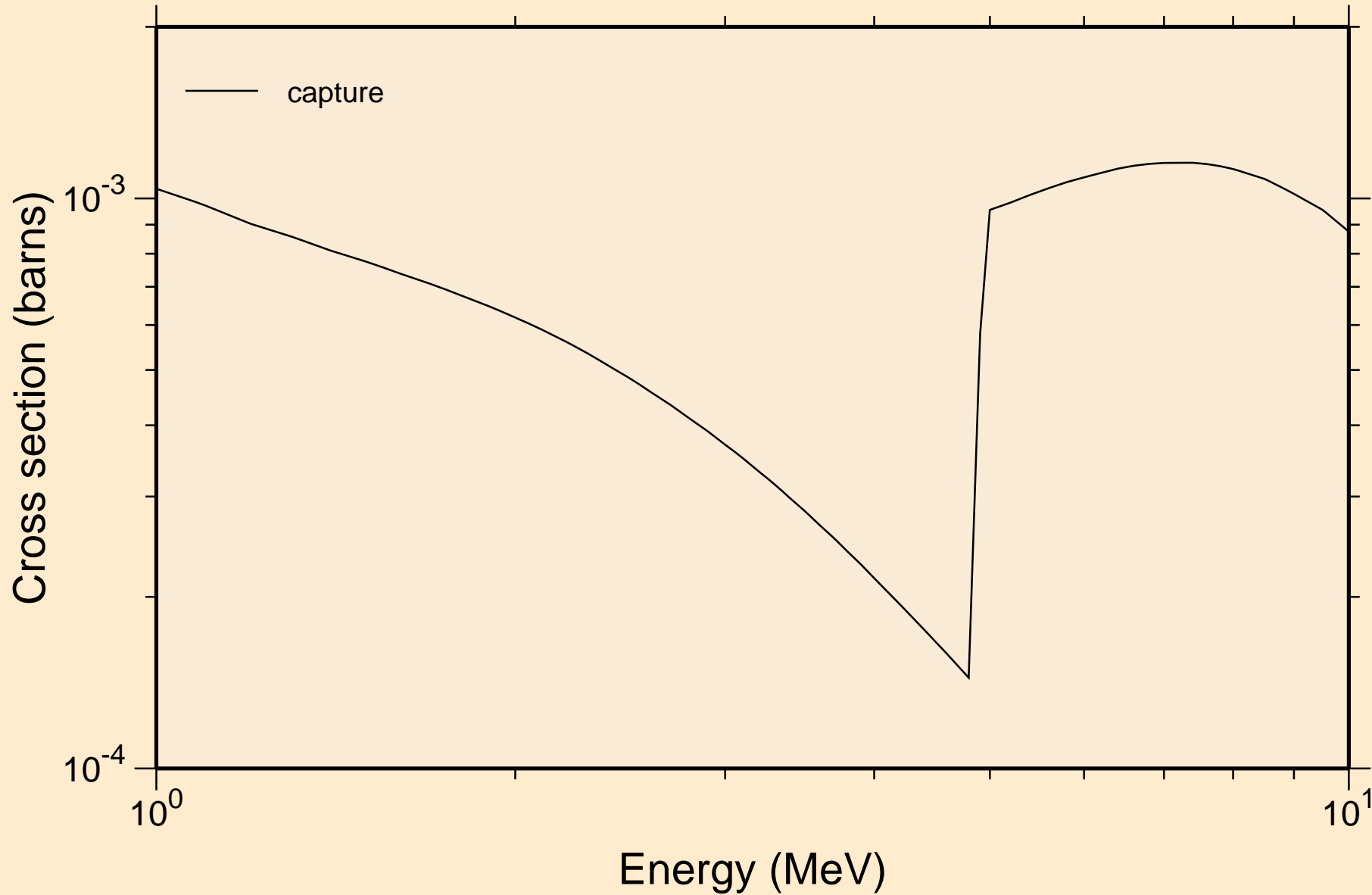

PD095M NEUTRON ACER TENDL-2024 LIBRARY; T=0.K
Heating

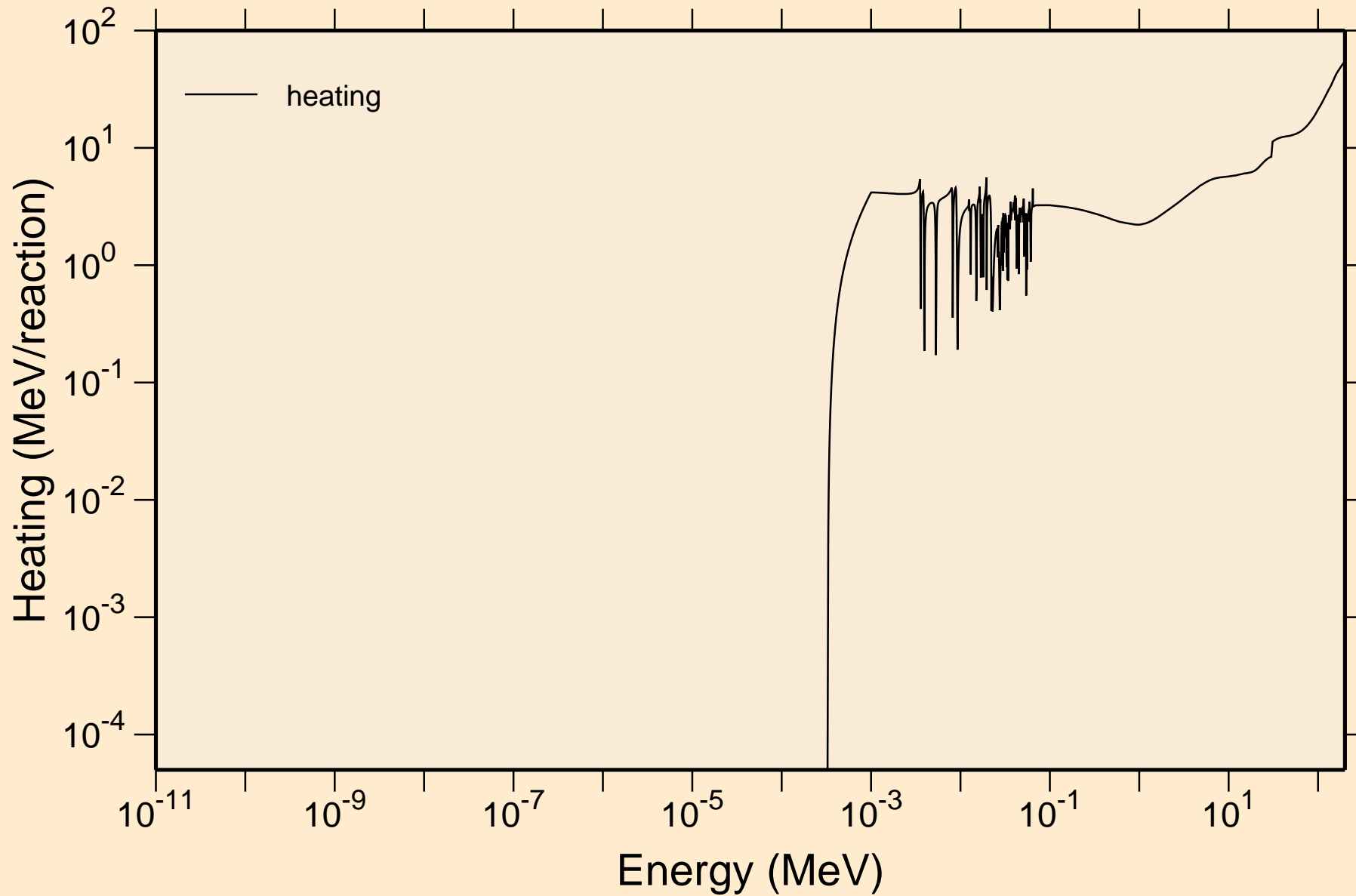

PD095M NEUTRON ACER TENDL-2024 LIBRARY; T=0.K
Damage

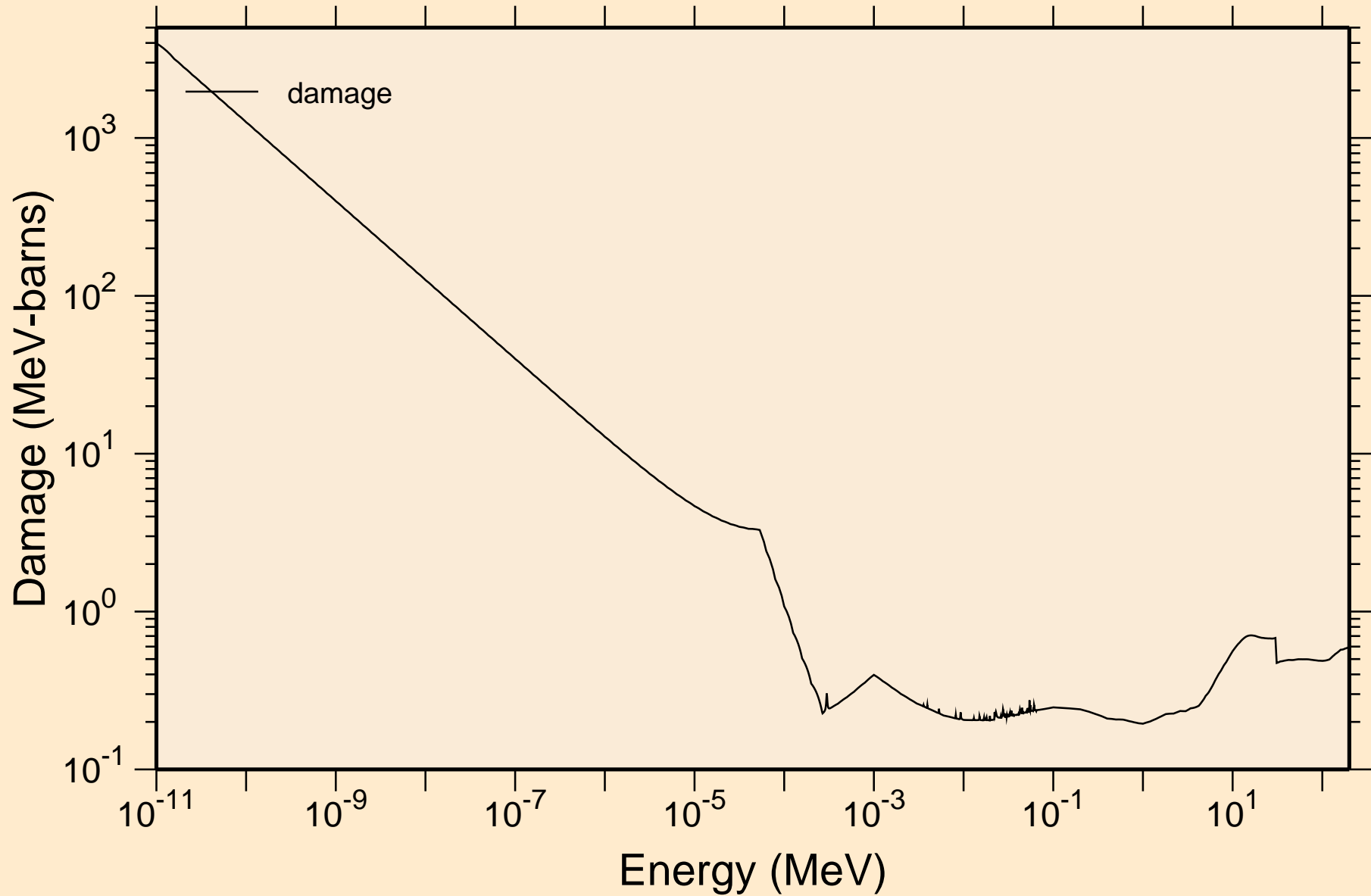

PD095M NEUTRON ACER TENDL-2024 LIBRARY; T=0.K
Non-threshold reactions

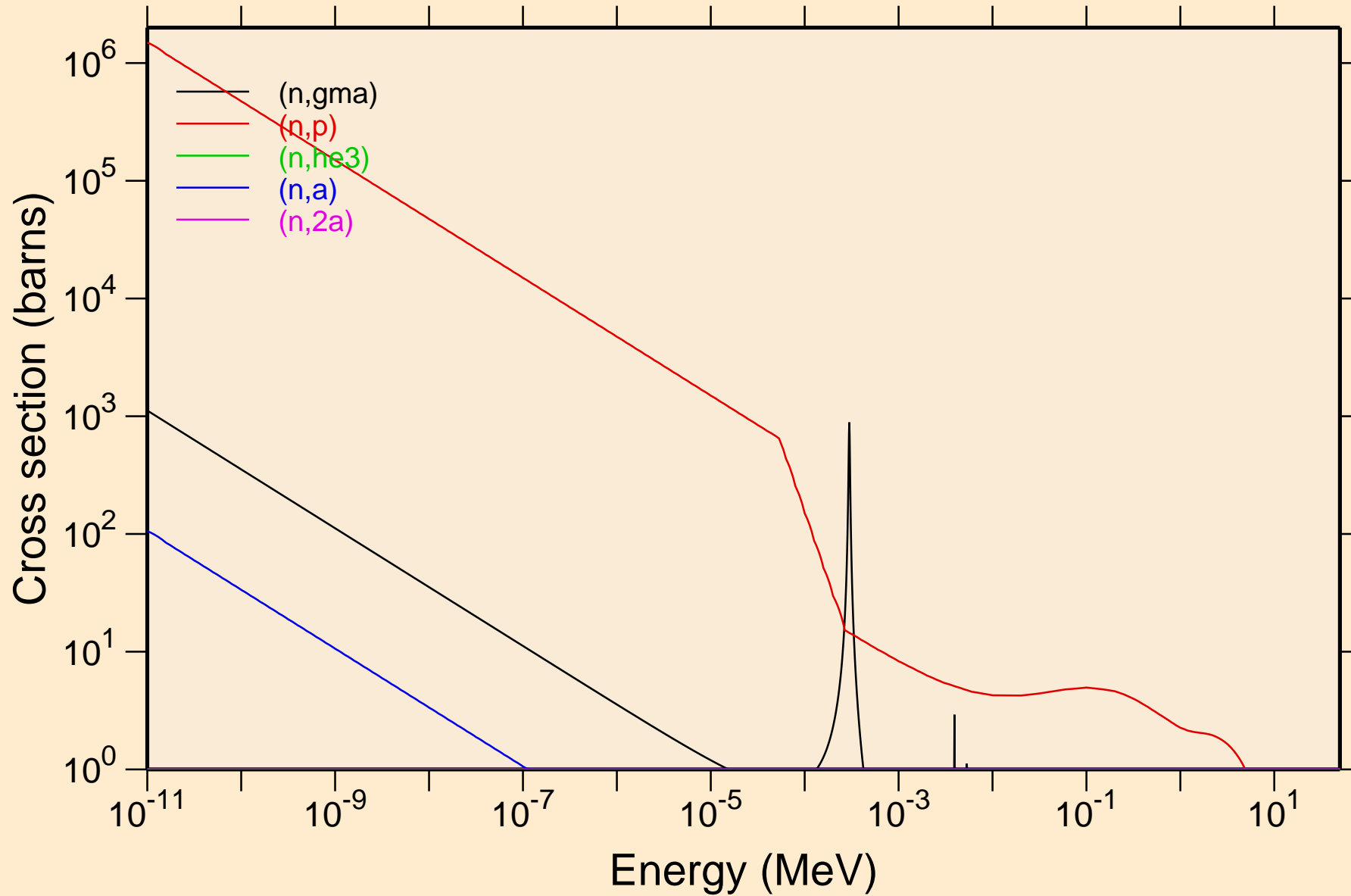

PD095M NEUTRON ACER TENDL-2024 LIBRARY; T=0.K
Non-threshold reactions

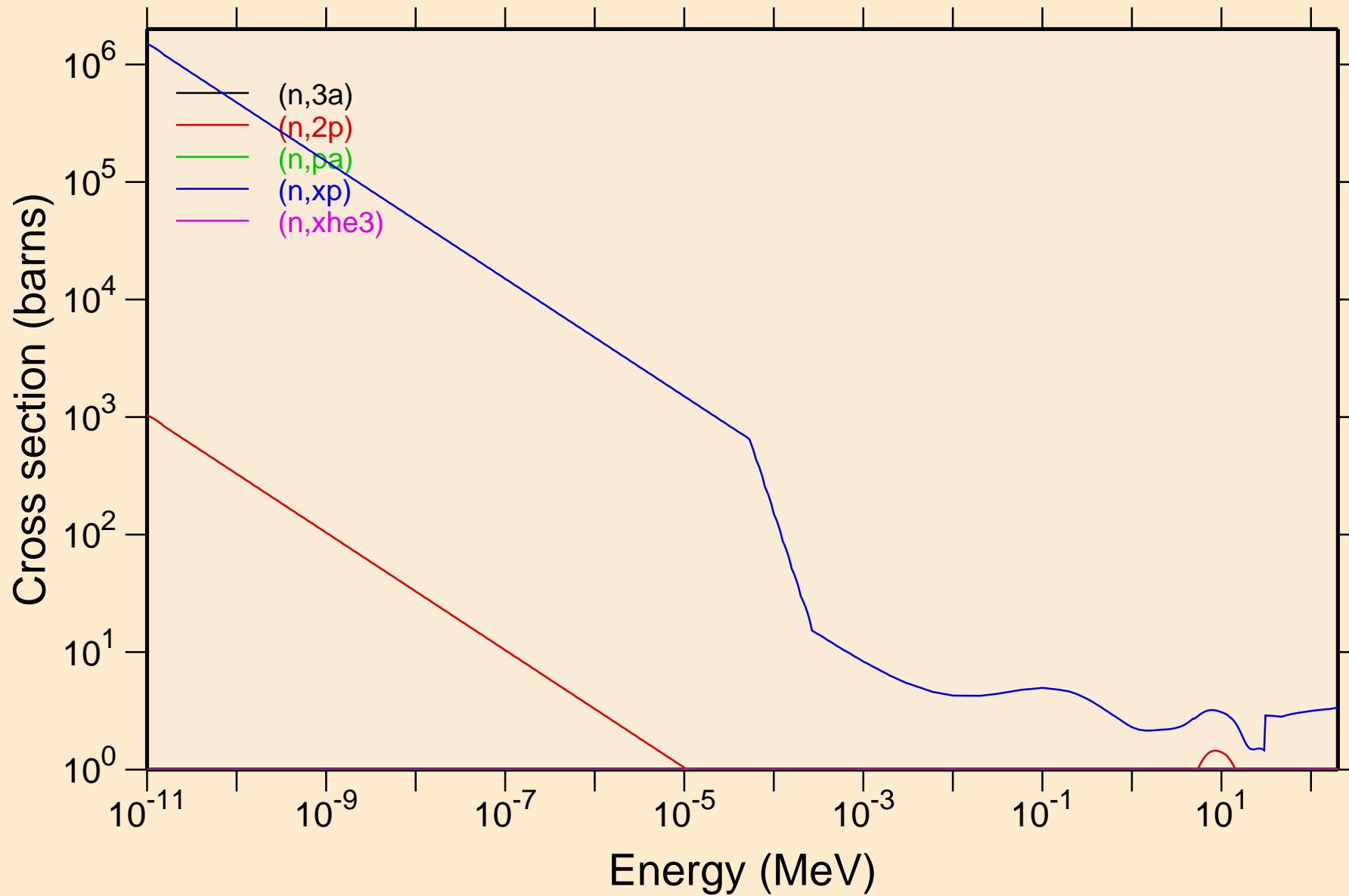

PD095M NEUTRON ACER TENDL-2024 LIBRARY; T=0.K
Non-threshold reactions

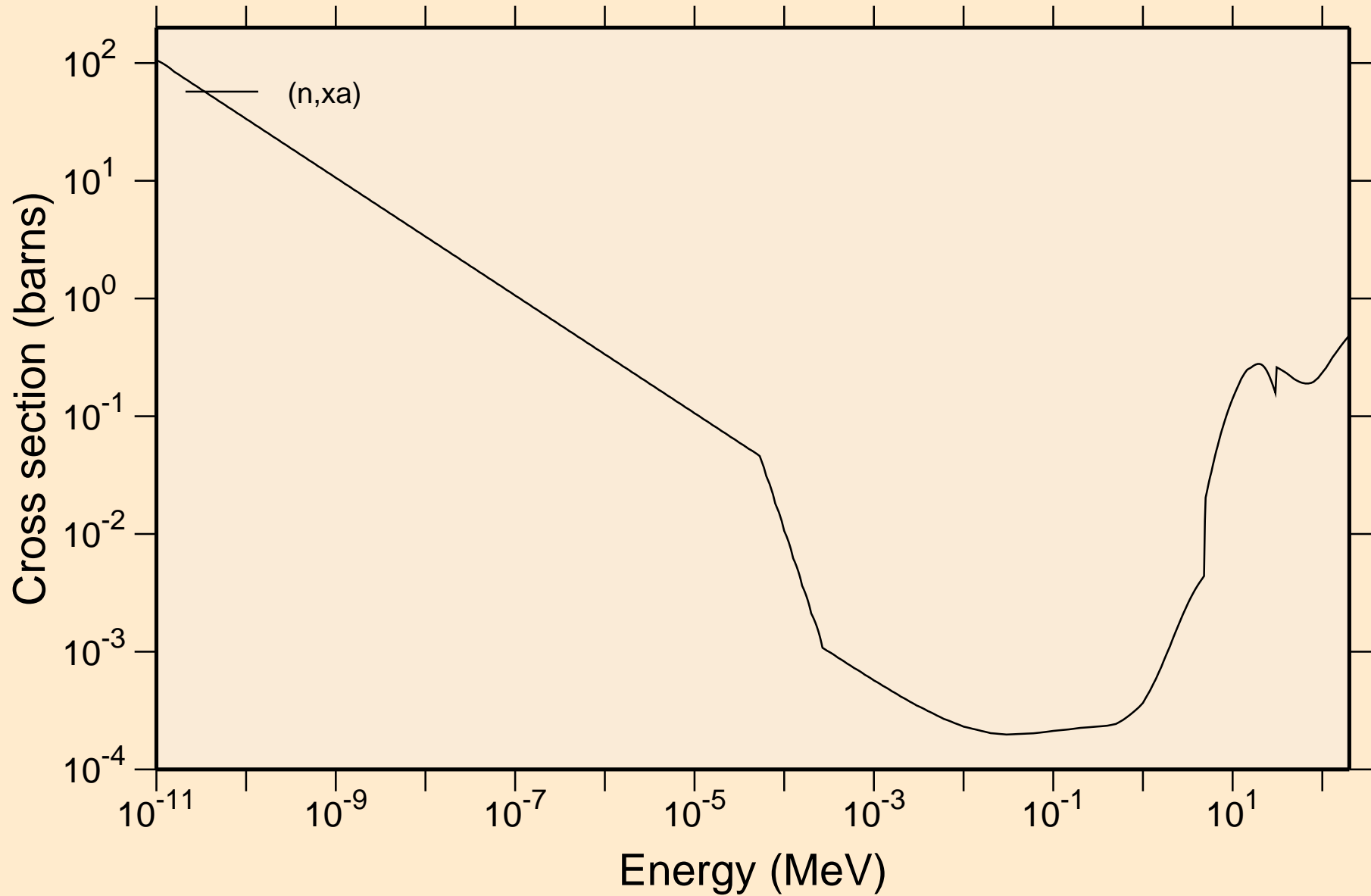

PD095M NEUTRON ACER TENDL-2024 LIBRARY; T=0.K
Principal cross sections

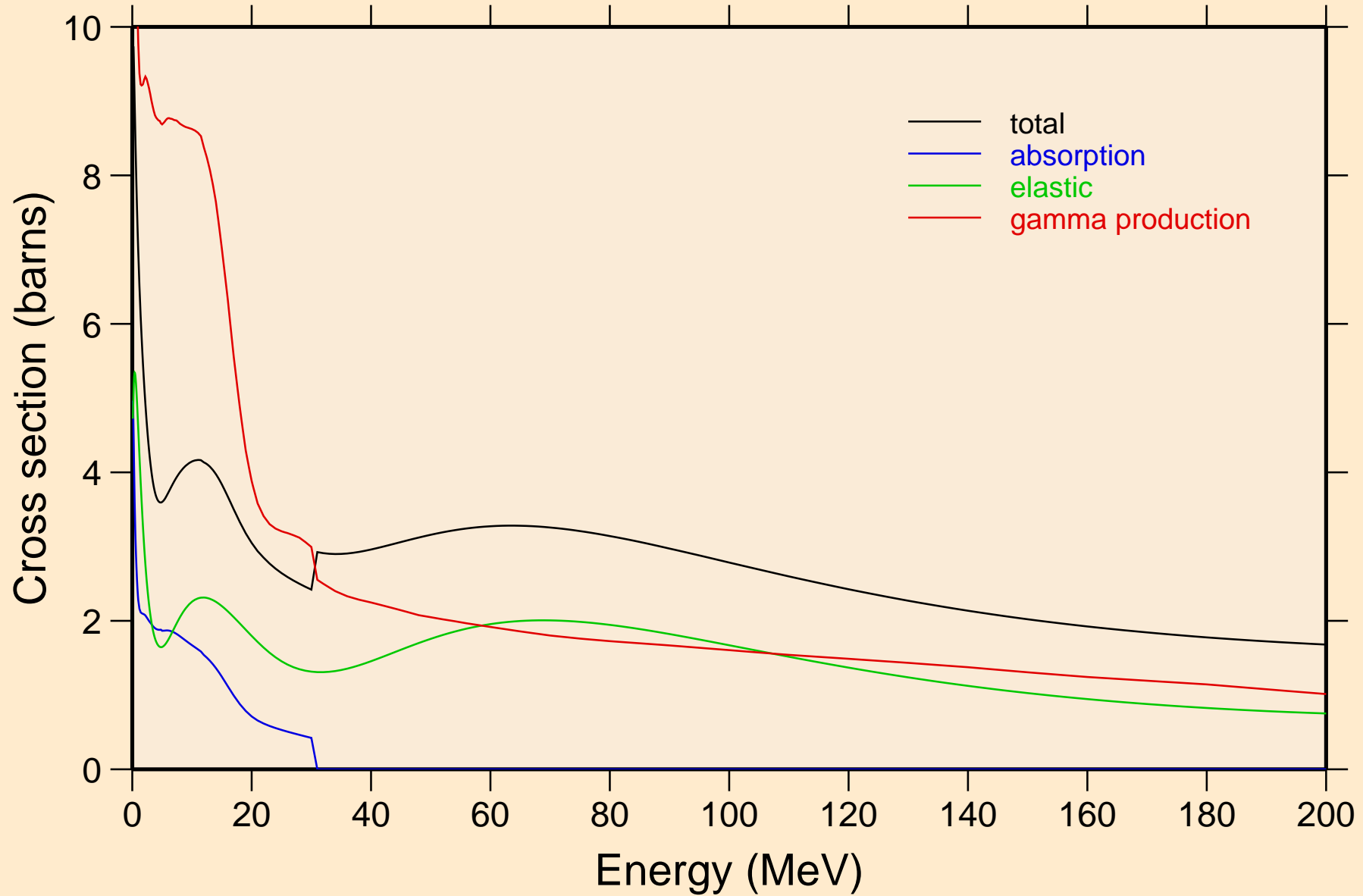

PD095M NEUTRON ACER TENDL-2024 LIBRARY; T=0.K

Heating

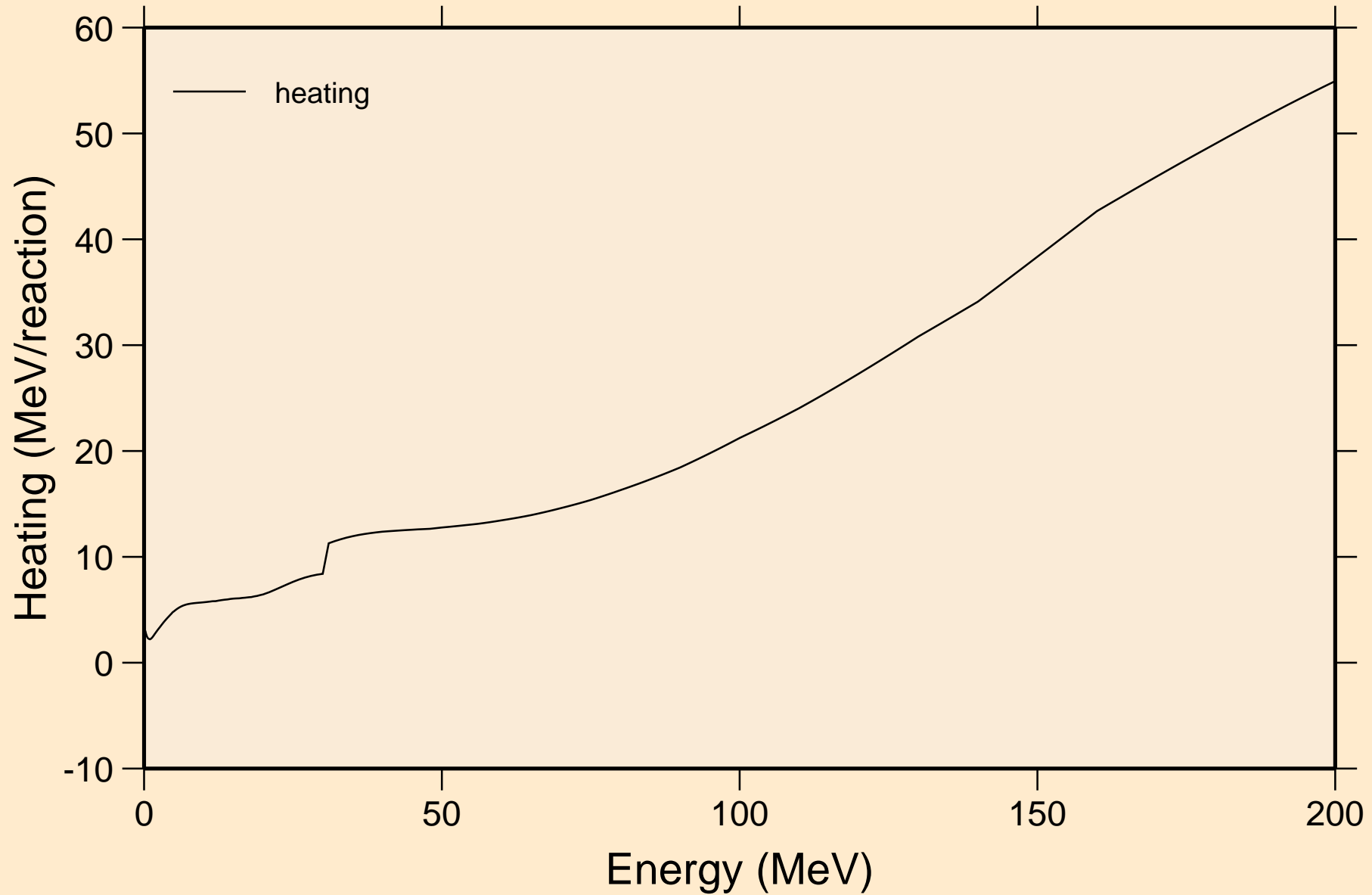

PD095M NEUTRON ACER TENDL-2024 LIBRARY; T=0.K
Damage

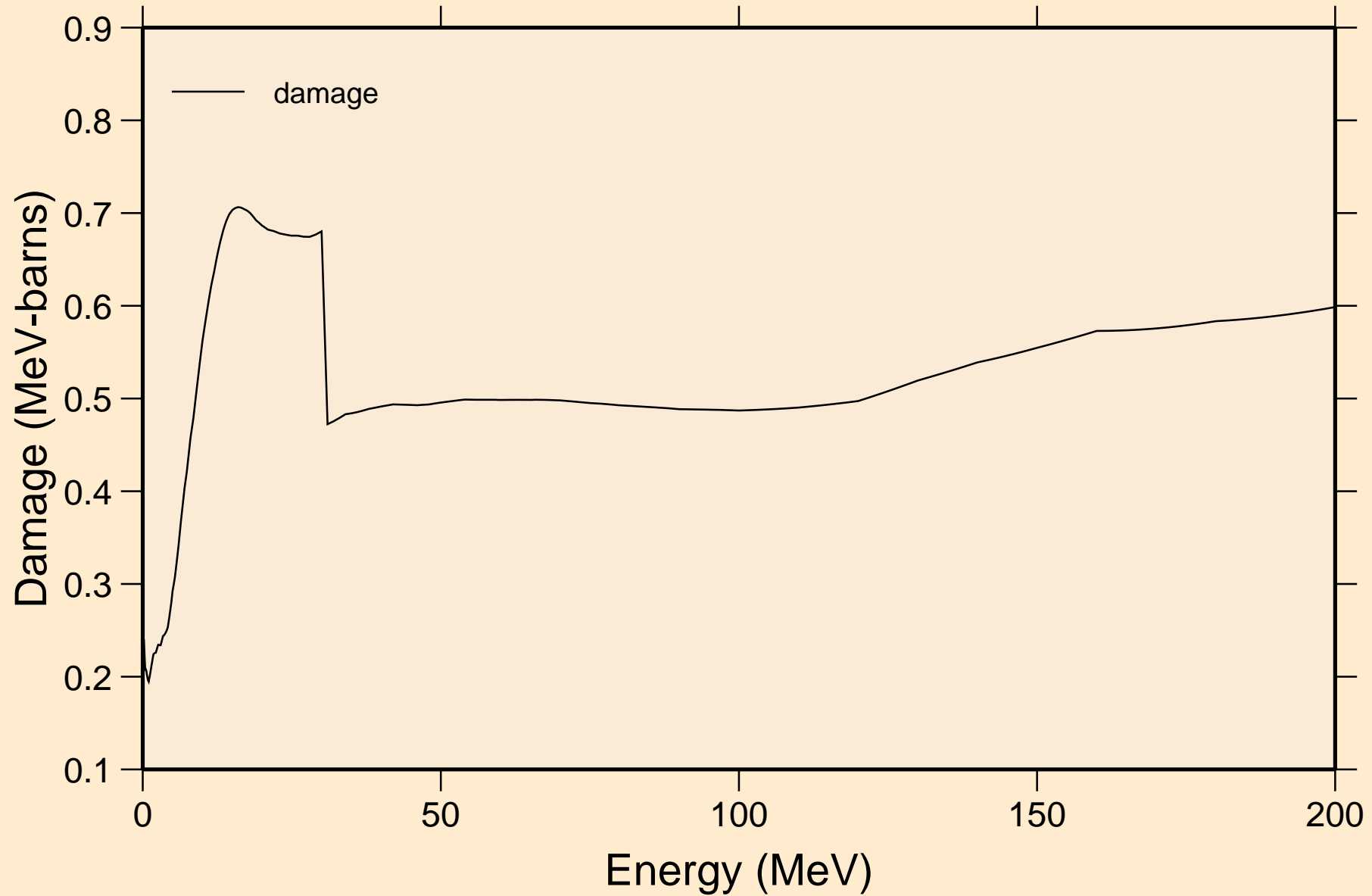

PD095M NEUTRON ACER TENDL-2024 LIBRARY; T=0.K
Non-threshold reactions

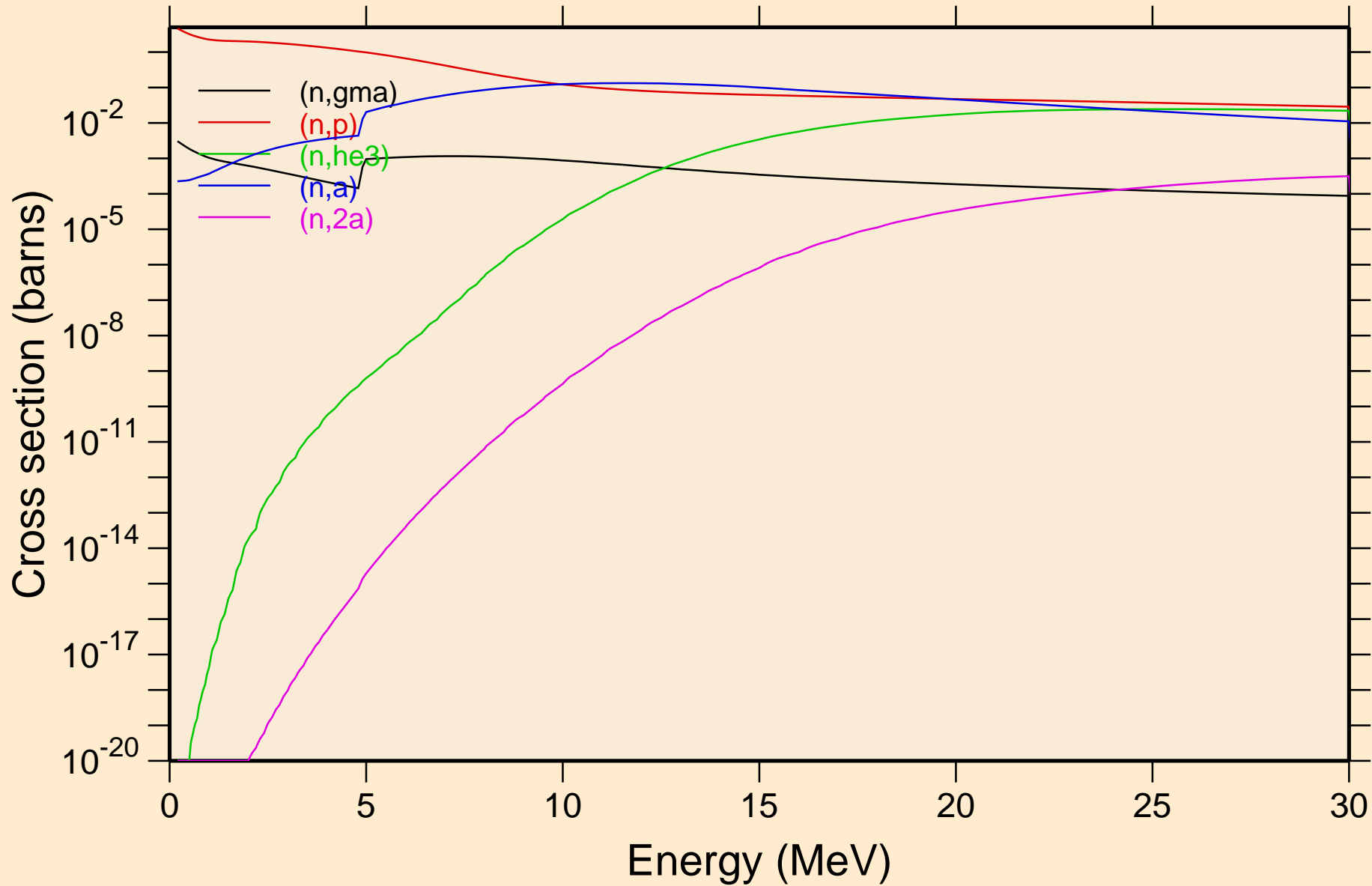

PD095M NEUTRON ACER TENDL-2024 LIBRARY; T=0.K
Non-threshold reactions

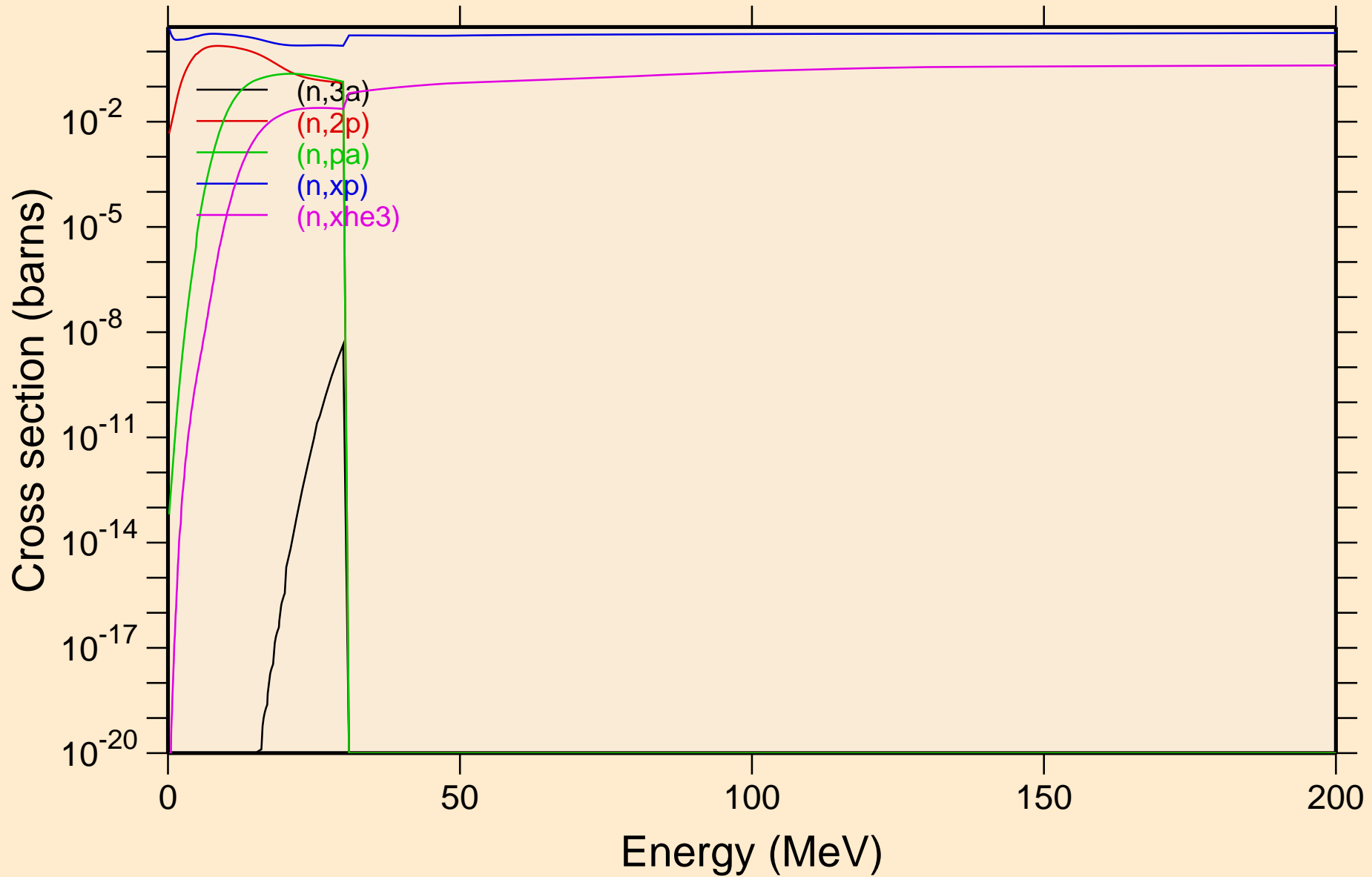

PD095M NEUTRON ACER TENDL-2024 LIBRARY; T=0.K
Non-threshold reactions

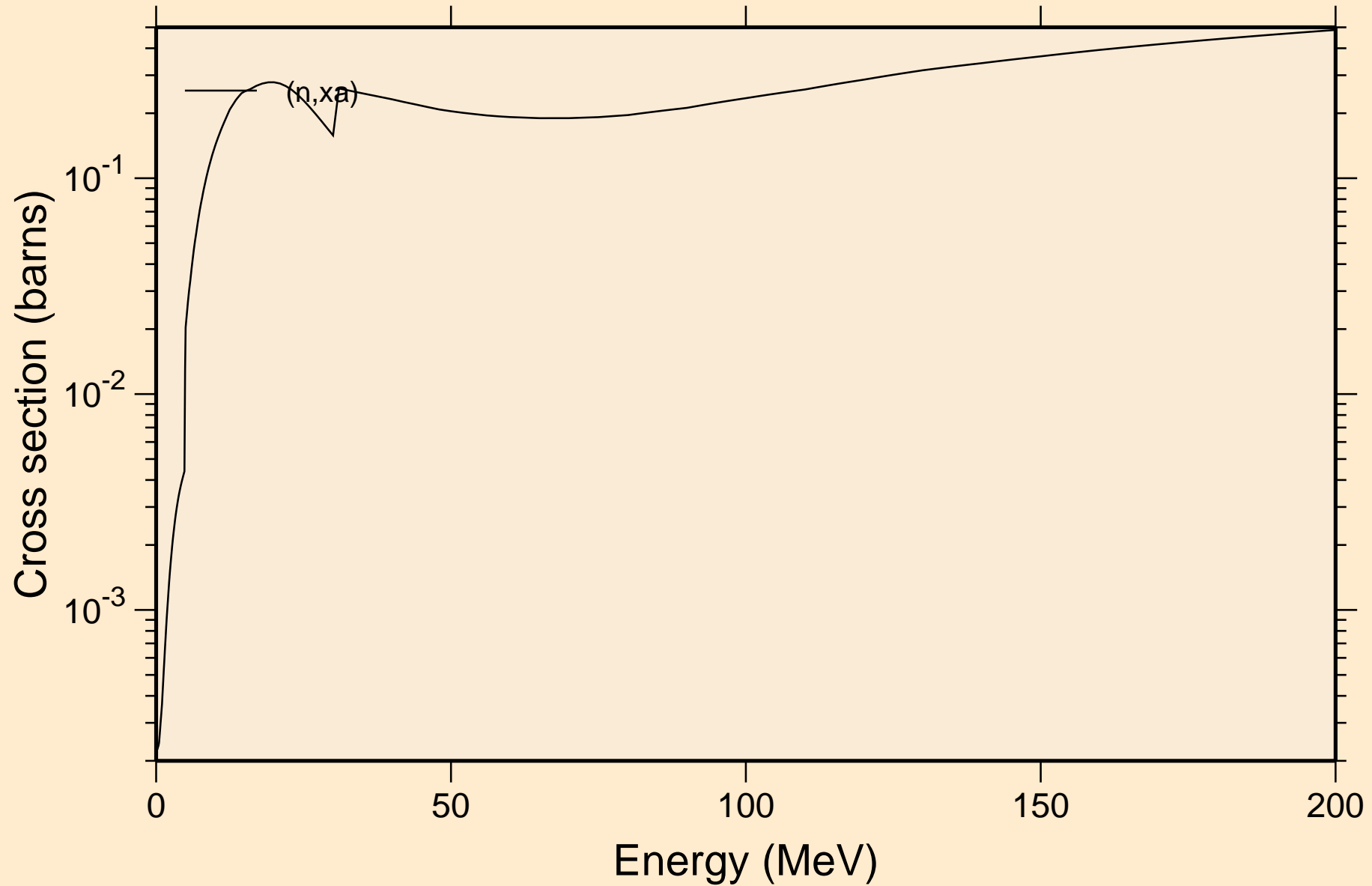

PD095M NEUTRON ACER TENDL-2024 LIBRARY; T=0.K
Inelastic levels

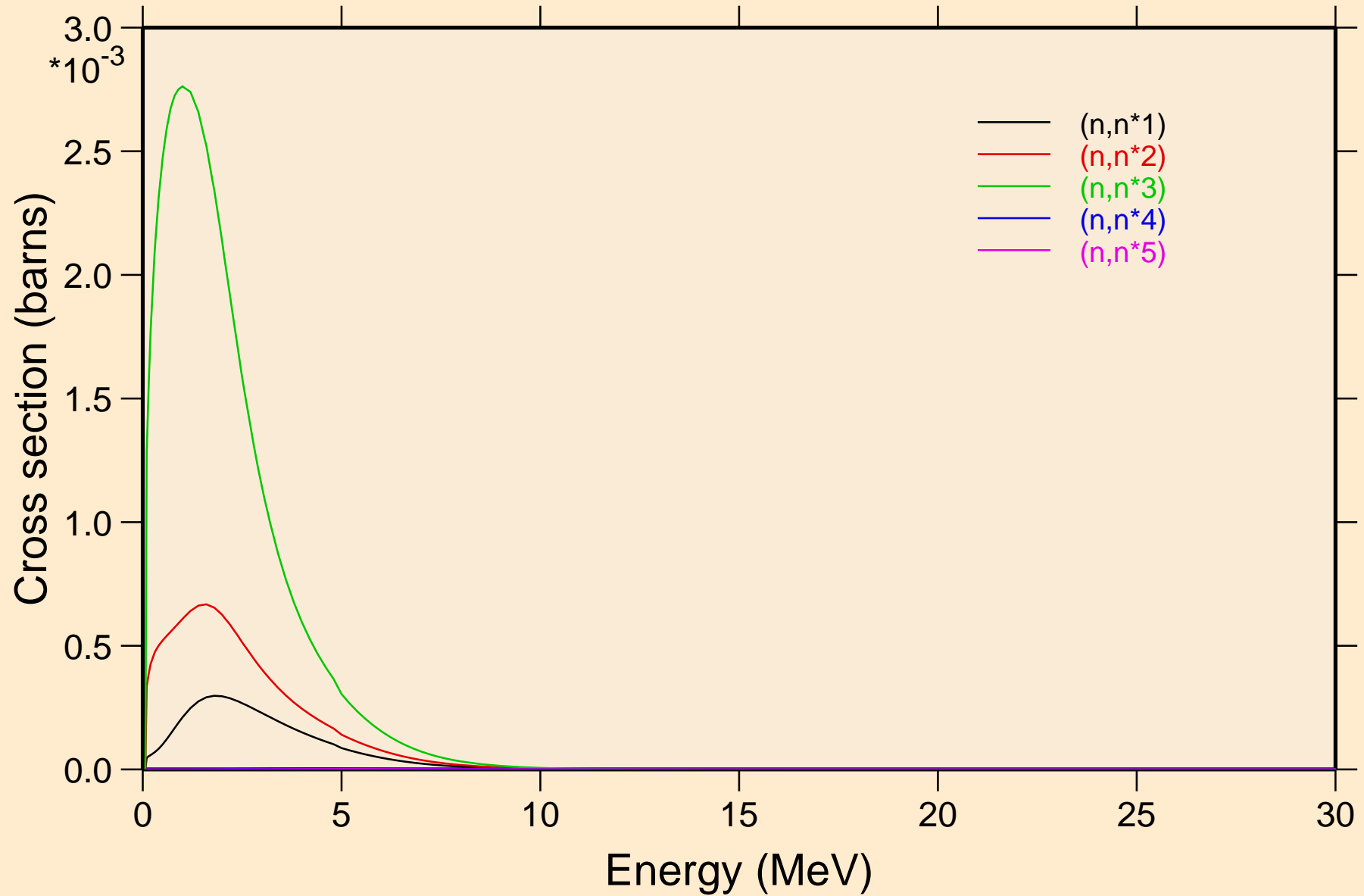

PD095M NEUTRON ACER TENDL-2024 LIBRARY; T=0.K
Inelastic levels

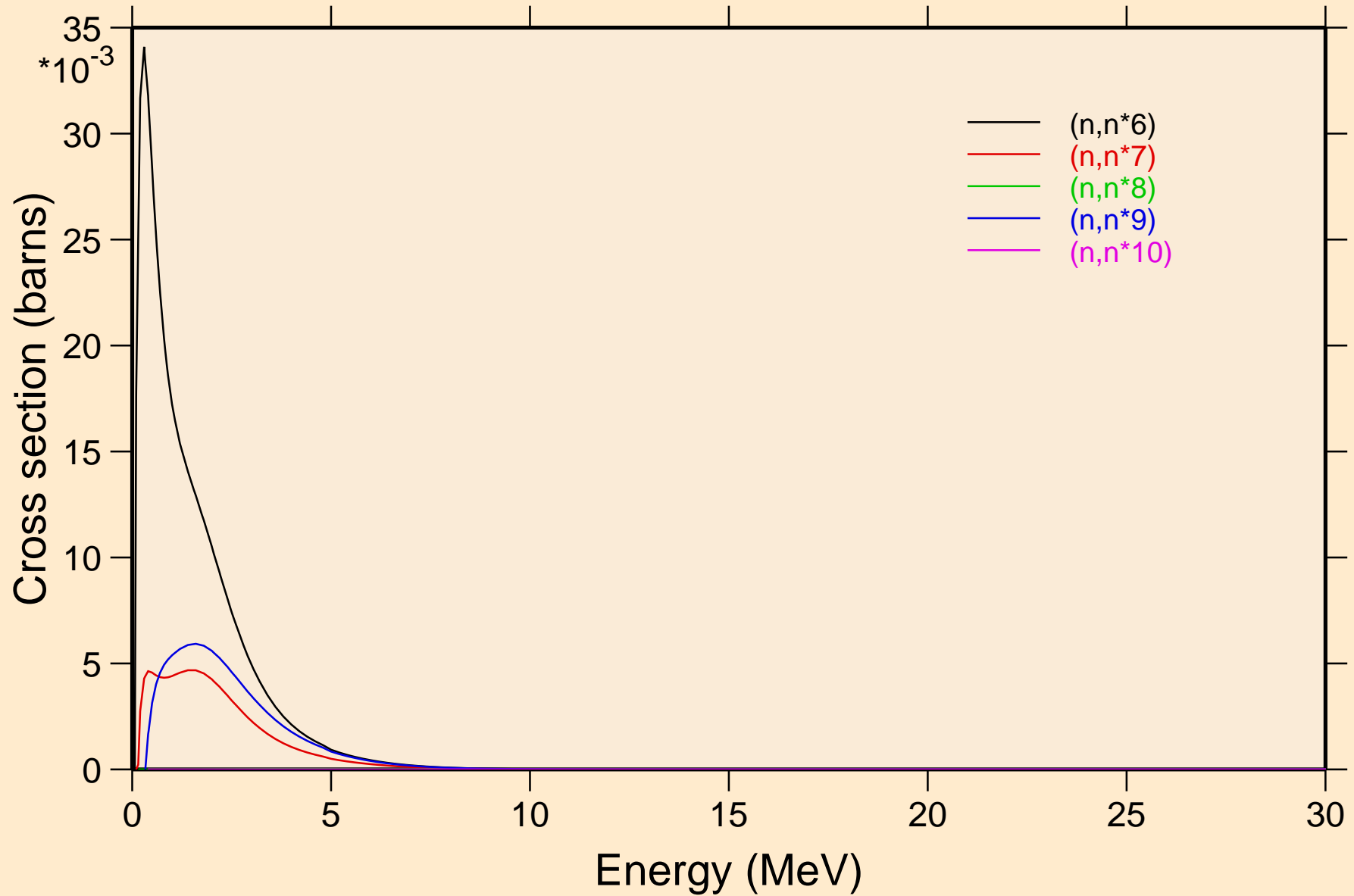

PD095M NEUTRON ACER TENDL-2024 LIBRARY; T=0.K
Inelastic levels

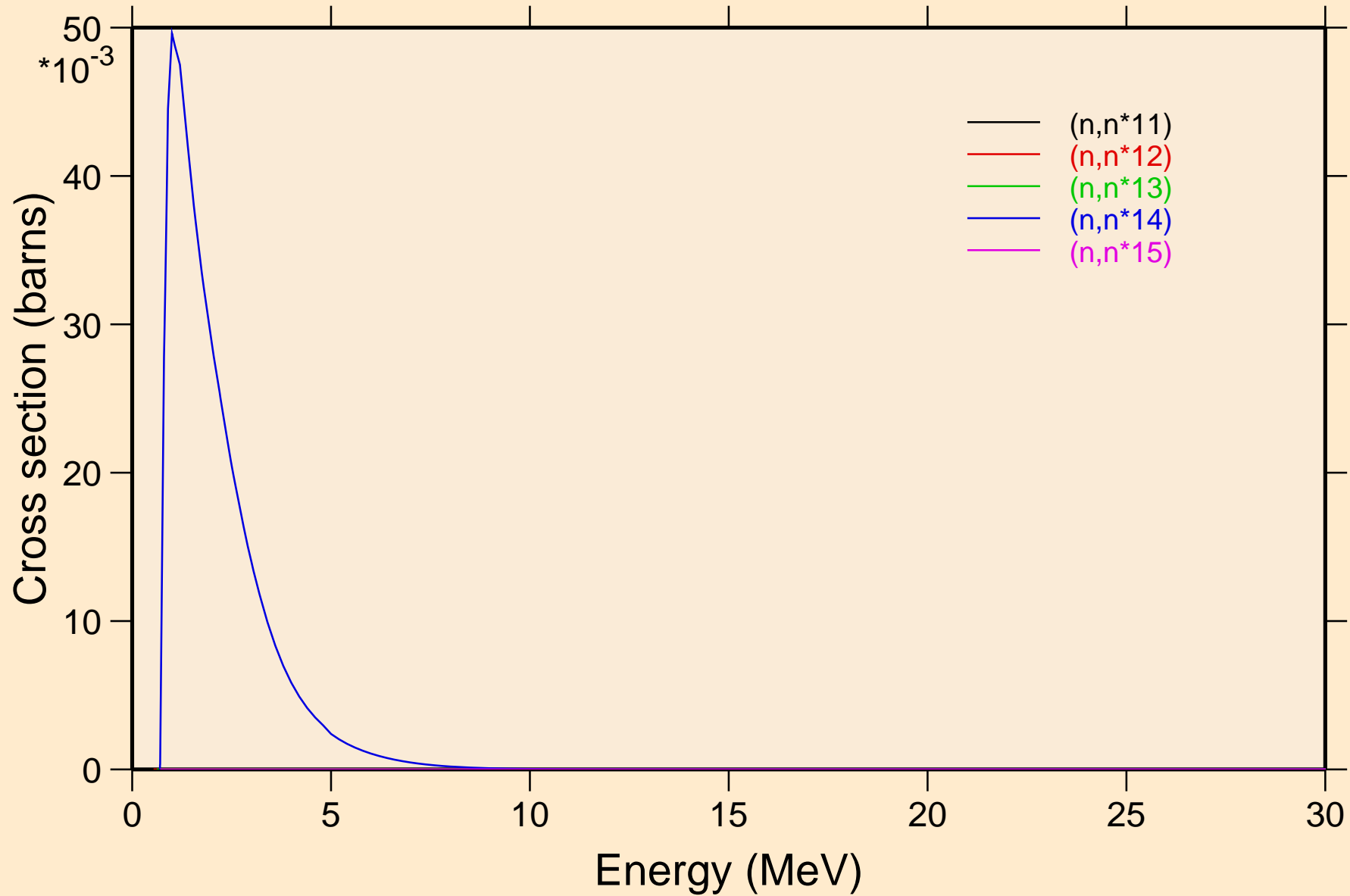

PD095M NEUTRON ACER TENDL-2024 LIBRARY; T=0.K
Inelastic levels

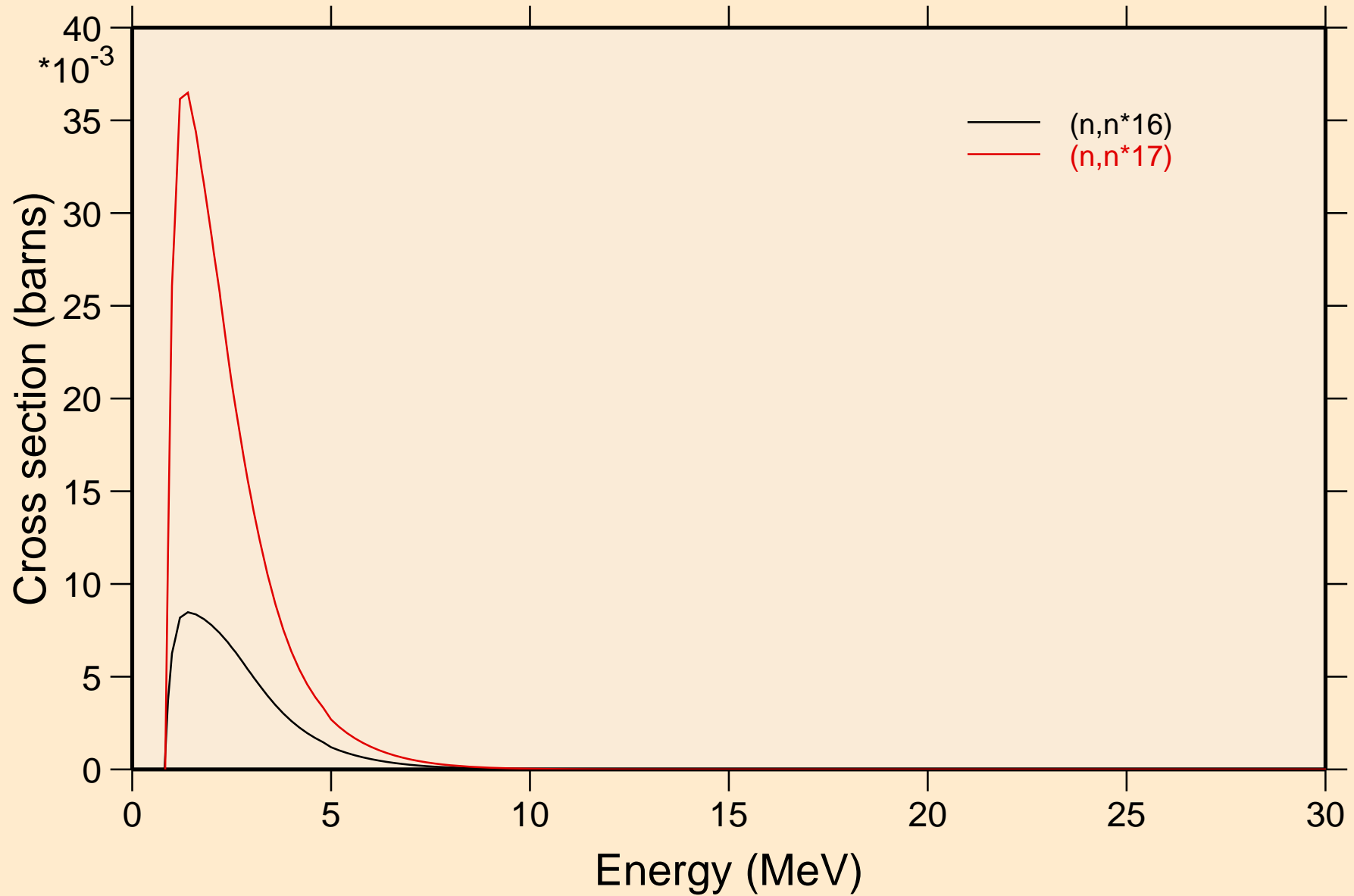

PD095M NEUTRON ACER TENDL-2024 LIBRARY; T=0.K
Threshold reactions

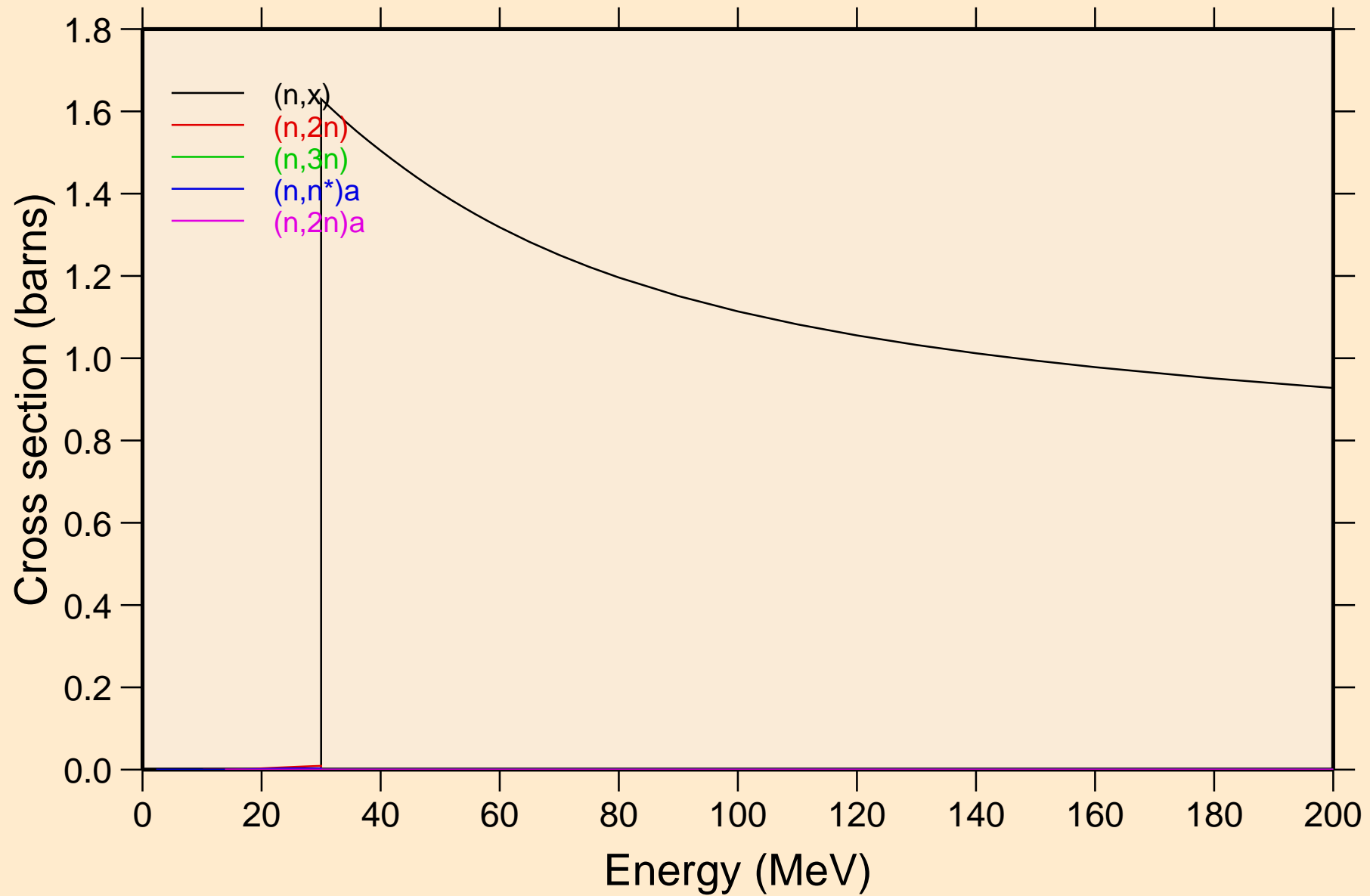

PD095M NEUTRON ACER TENDL-2024 LIBRARY; T=0.K
Threshold reactions

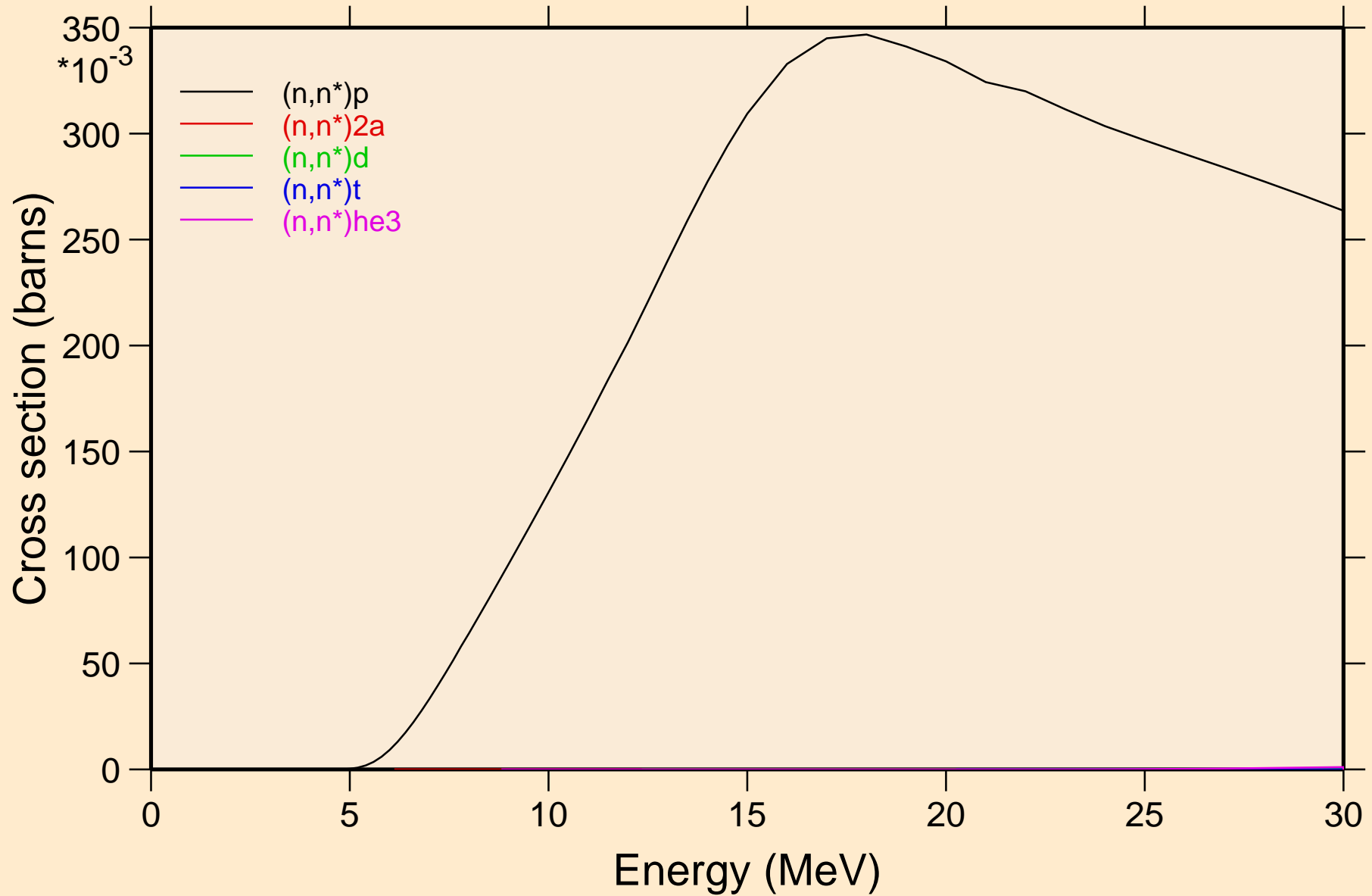

PD095M NEUTRON ACER TENDL-2024 LIBRARY; T=0.K
Threshold reactions

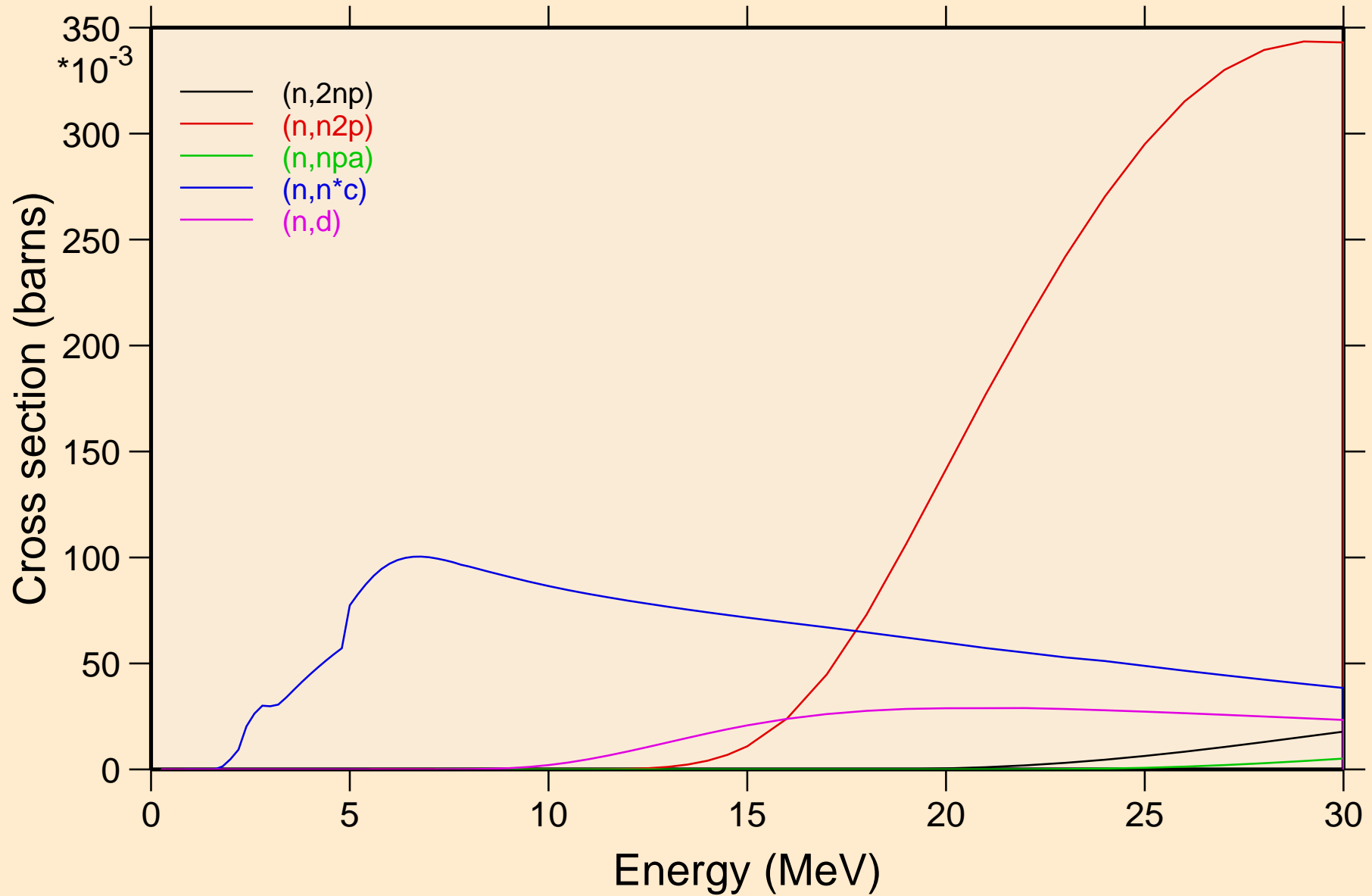

PD095M NEUTRON ACER TENDL-2024 LIBRARY; T=0.K
Threshold reactions

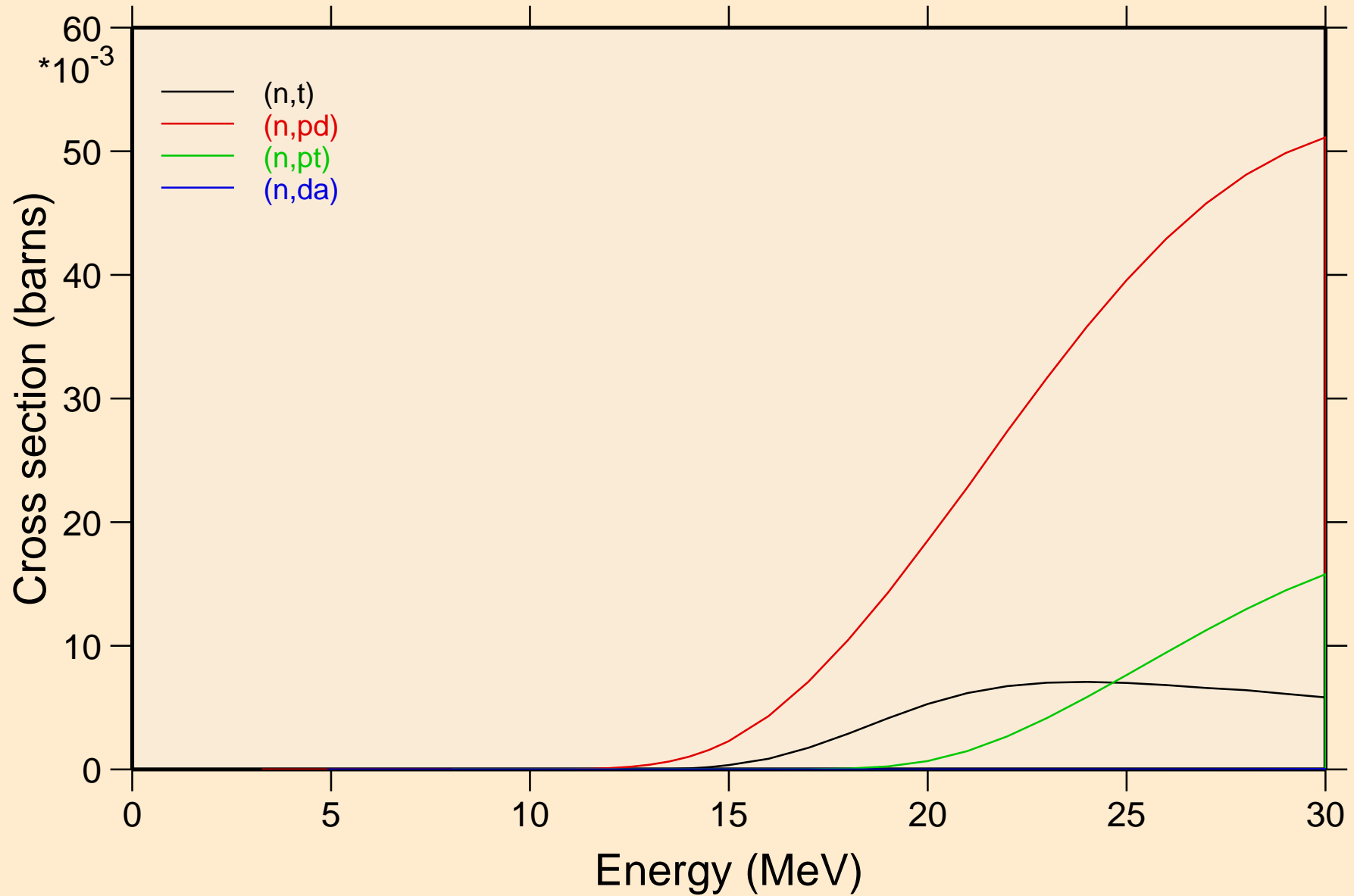

PD095M NEUTRON ACER TENDL-2024 LIBRARY; T=0.K
Threshold reactions

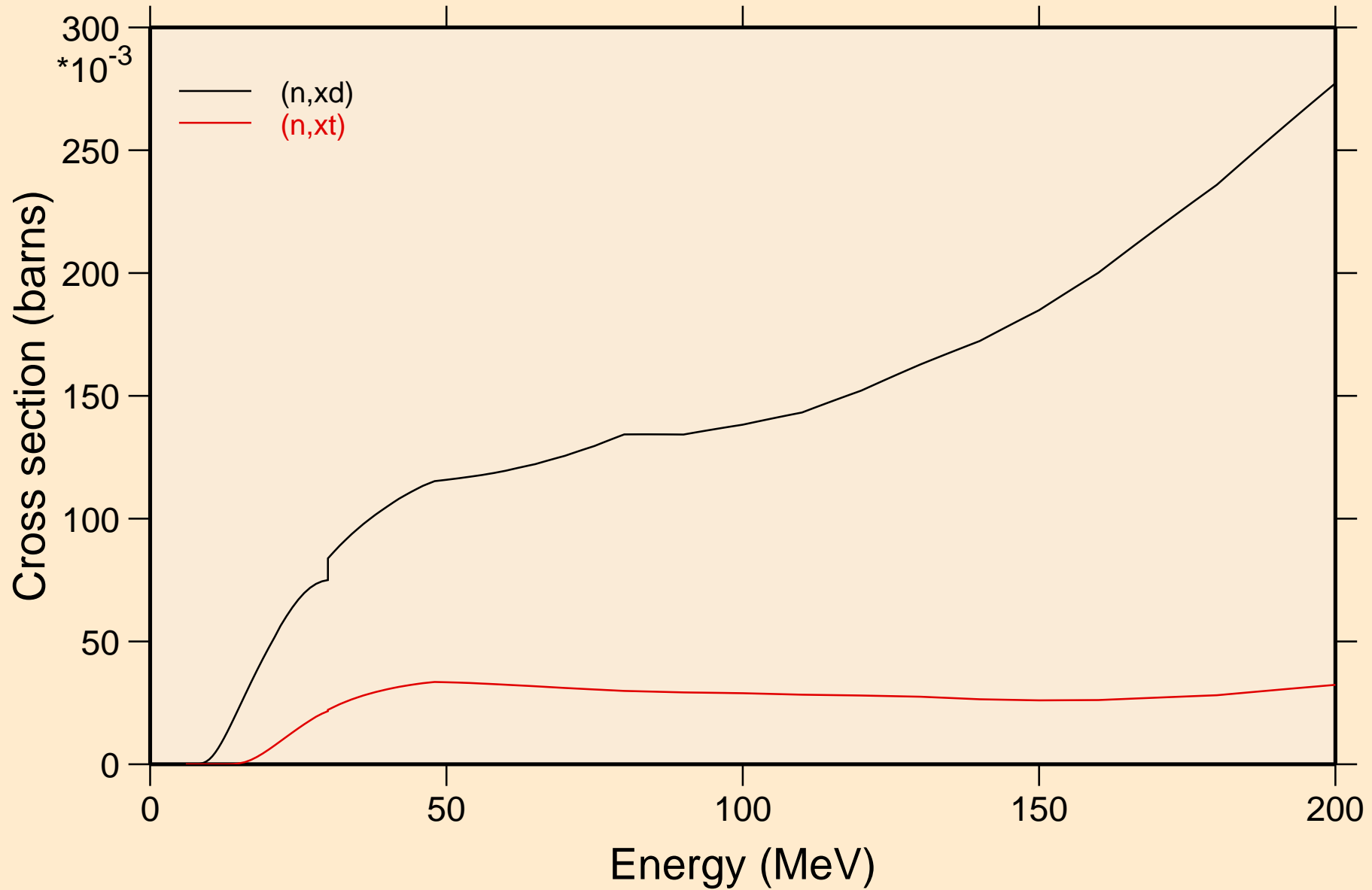

PD095M NEUTRON ACER TENDL-2024 LIBRARY; T=0.K
angular distribution for elastic

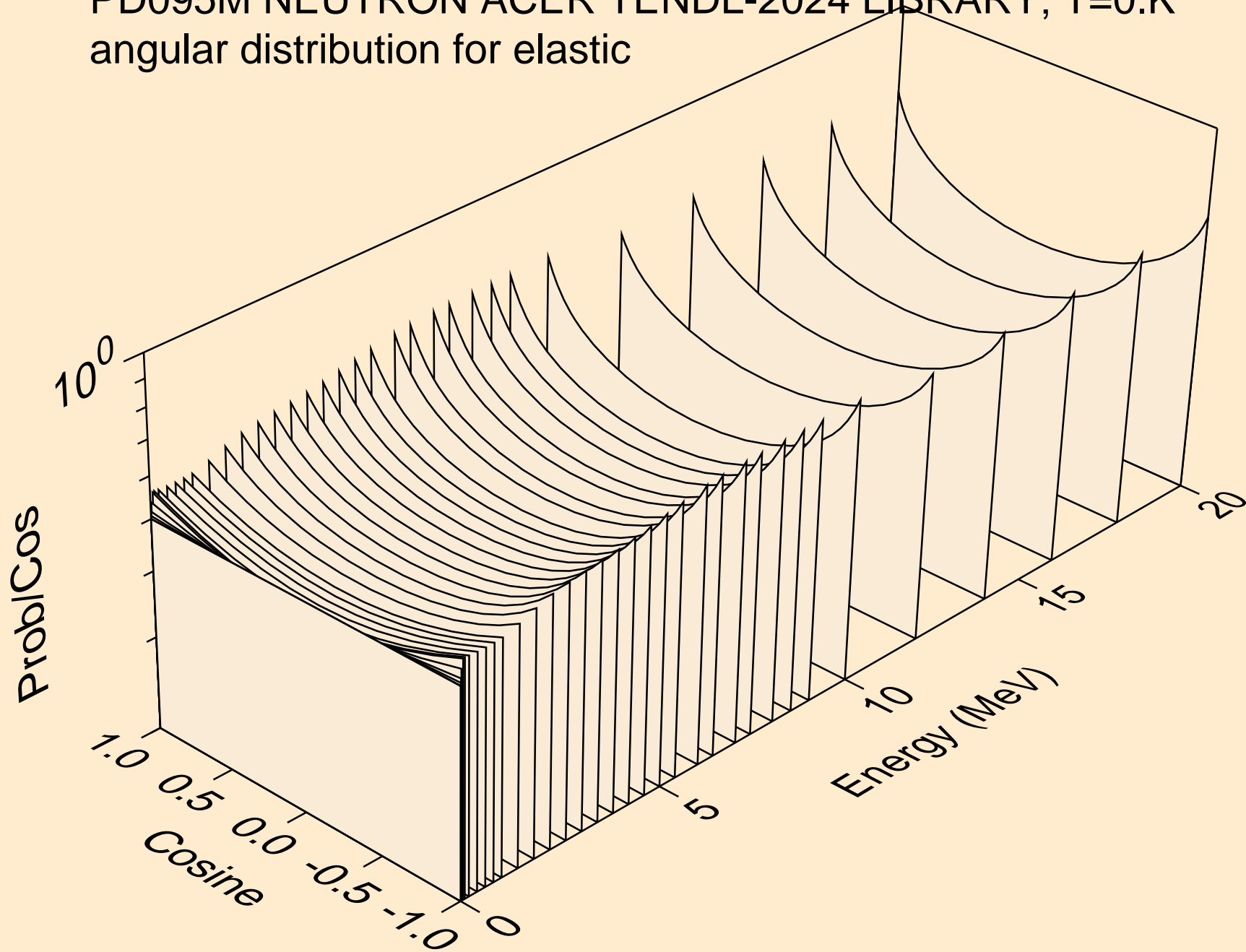

PD095M NEUTRON ACER TENDL-2024 LIBRARY; T=0.K
angular distribution for elastic

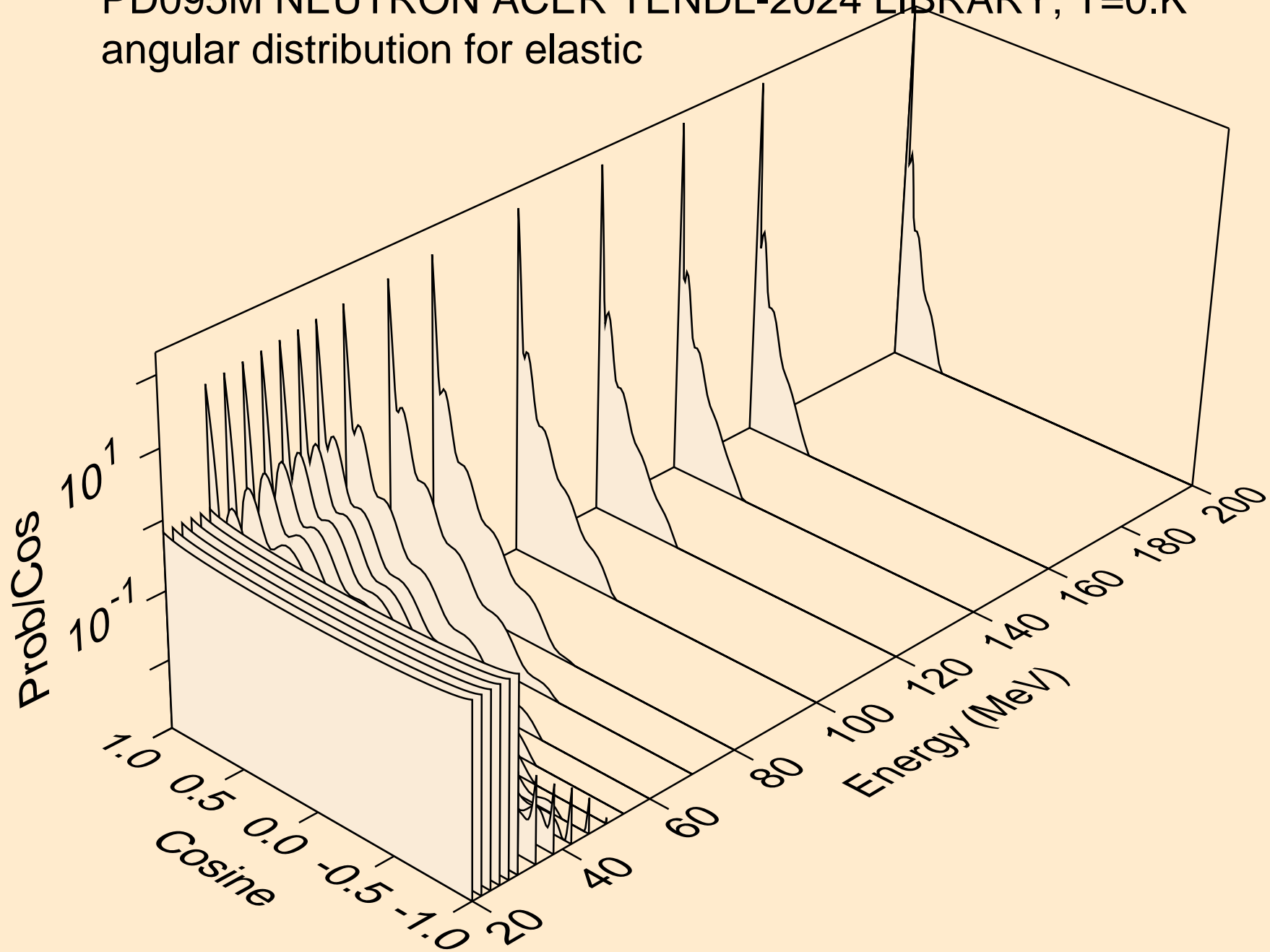

PD095M NEUTRON ACER TENDL-2024 LIBRARY; T=0.K
angular distribution for (n,n*1)

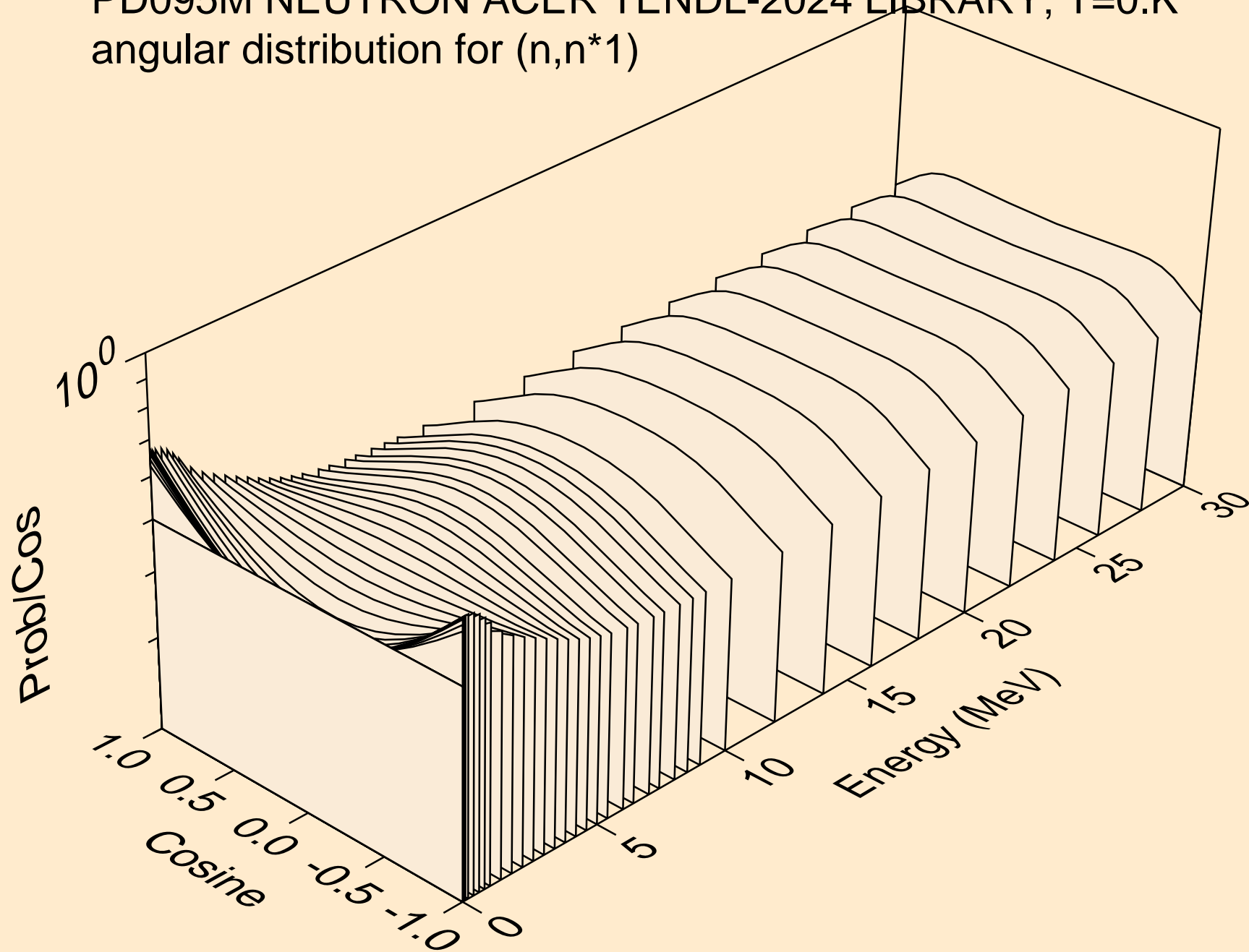

PD095M NEUTRON ACER TENDL-2024 LIBRARY; T=0.K
angular distribution for (n,n*2)

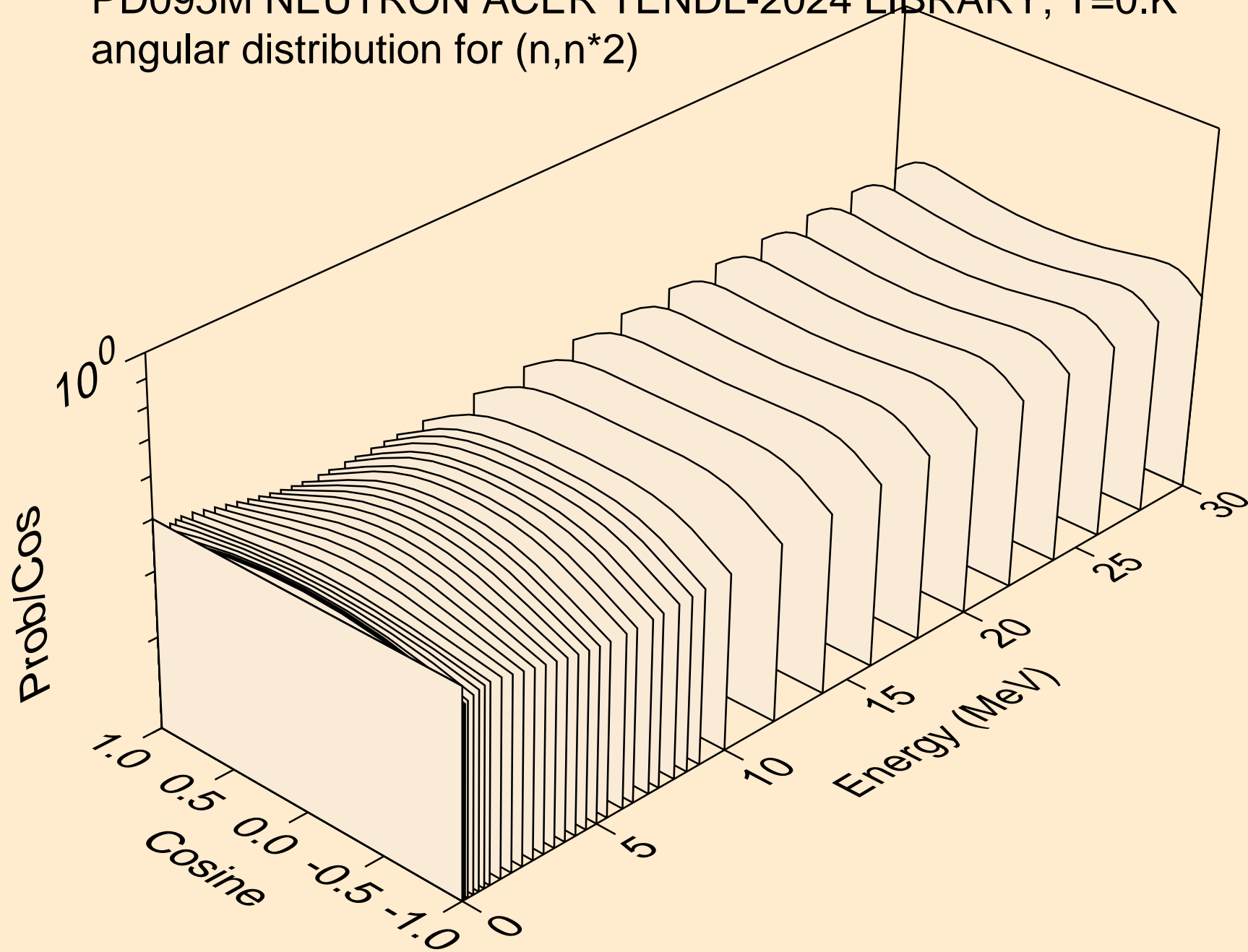

PD095M NEUTRON ACER TENDL-2024 LIBRARY; T=0.K
angular distribution for (n,n*3)

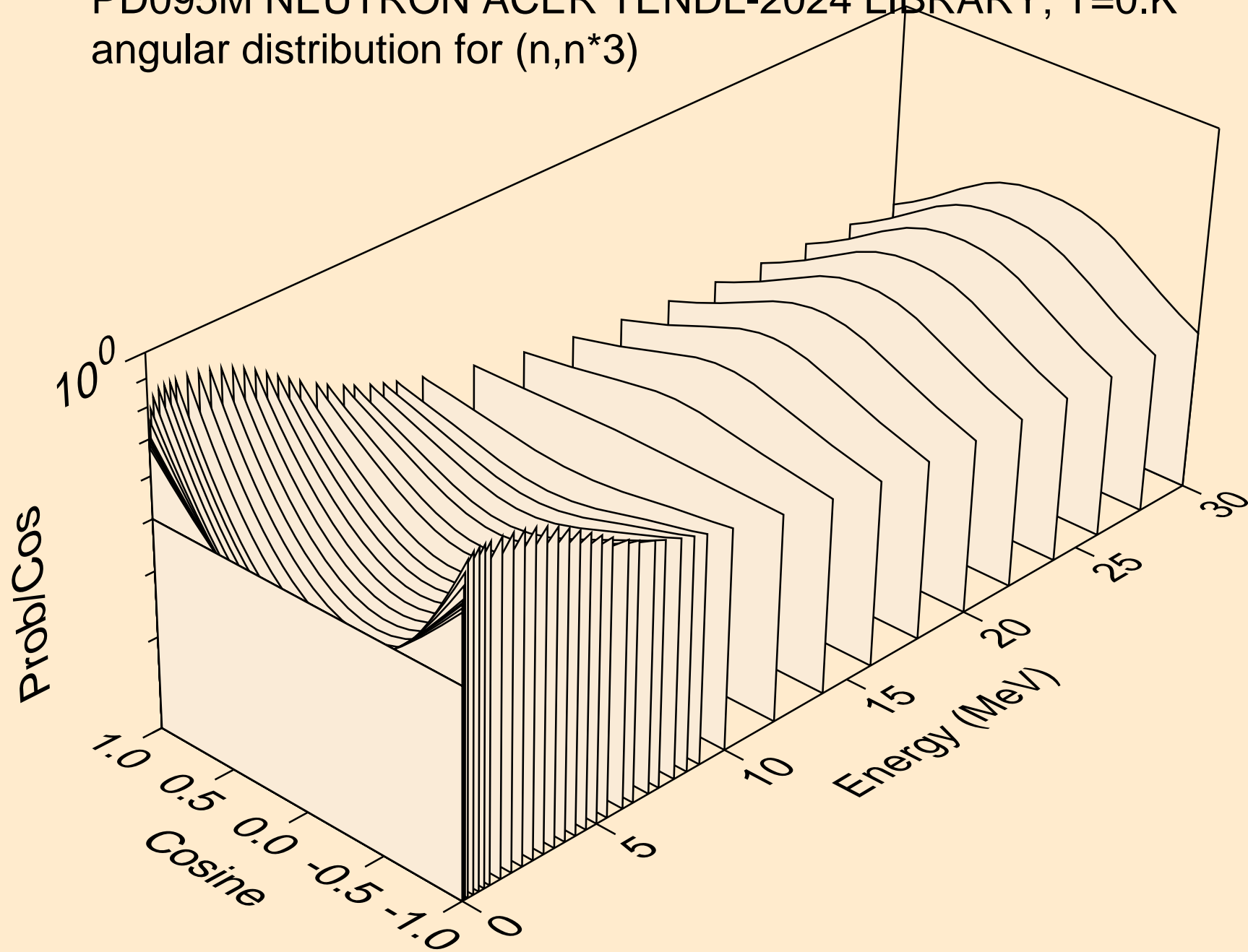

PD095M NEUTRON ACER TENDL-2024 LIBRARY; T=0.K
angular distribution for (n,n*4)

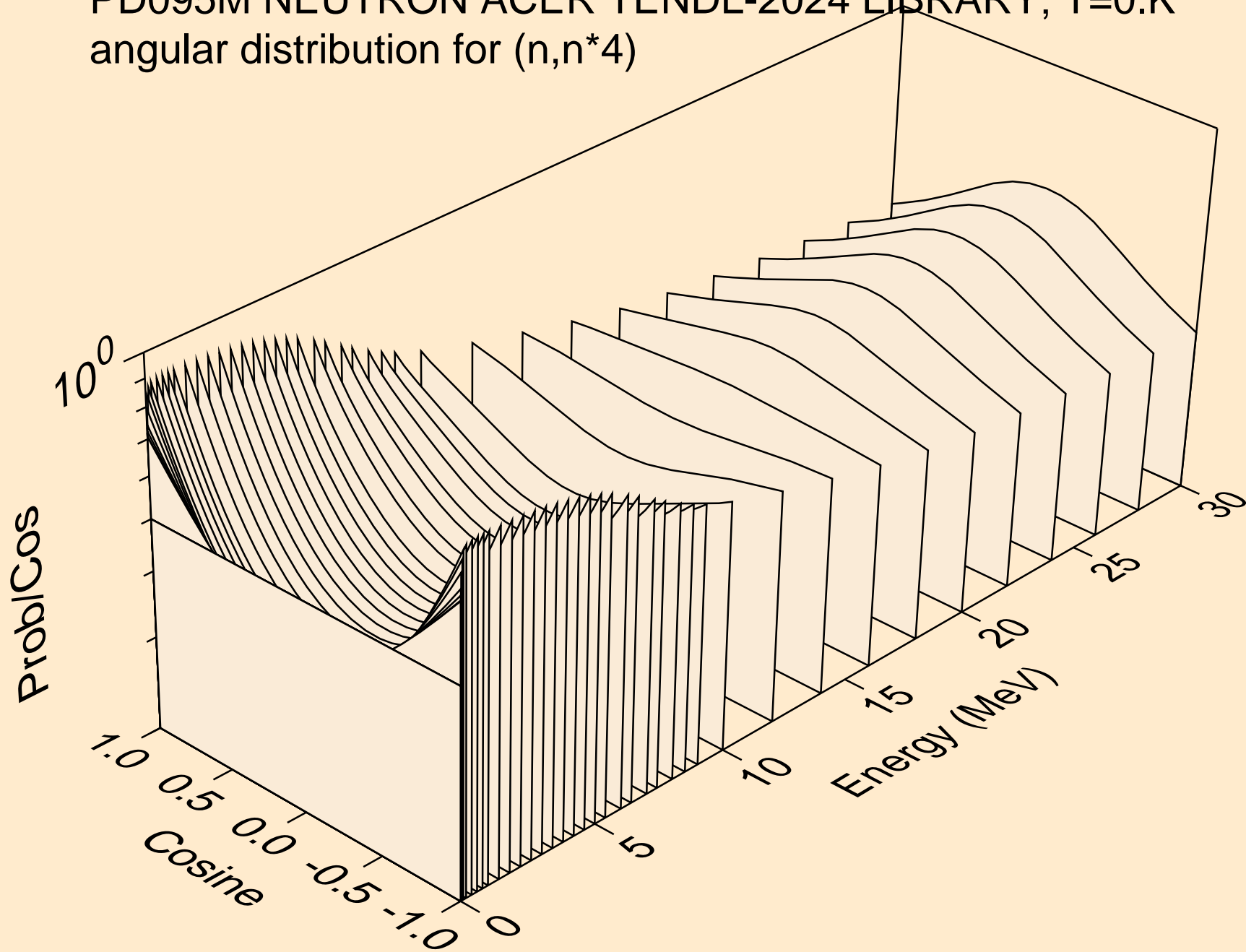

PD095M NEUTRON ACER TENDL-2024 LIBRARY; T=0.K
angular distribution for (n,n*5)

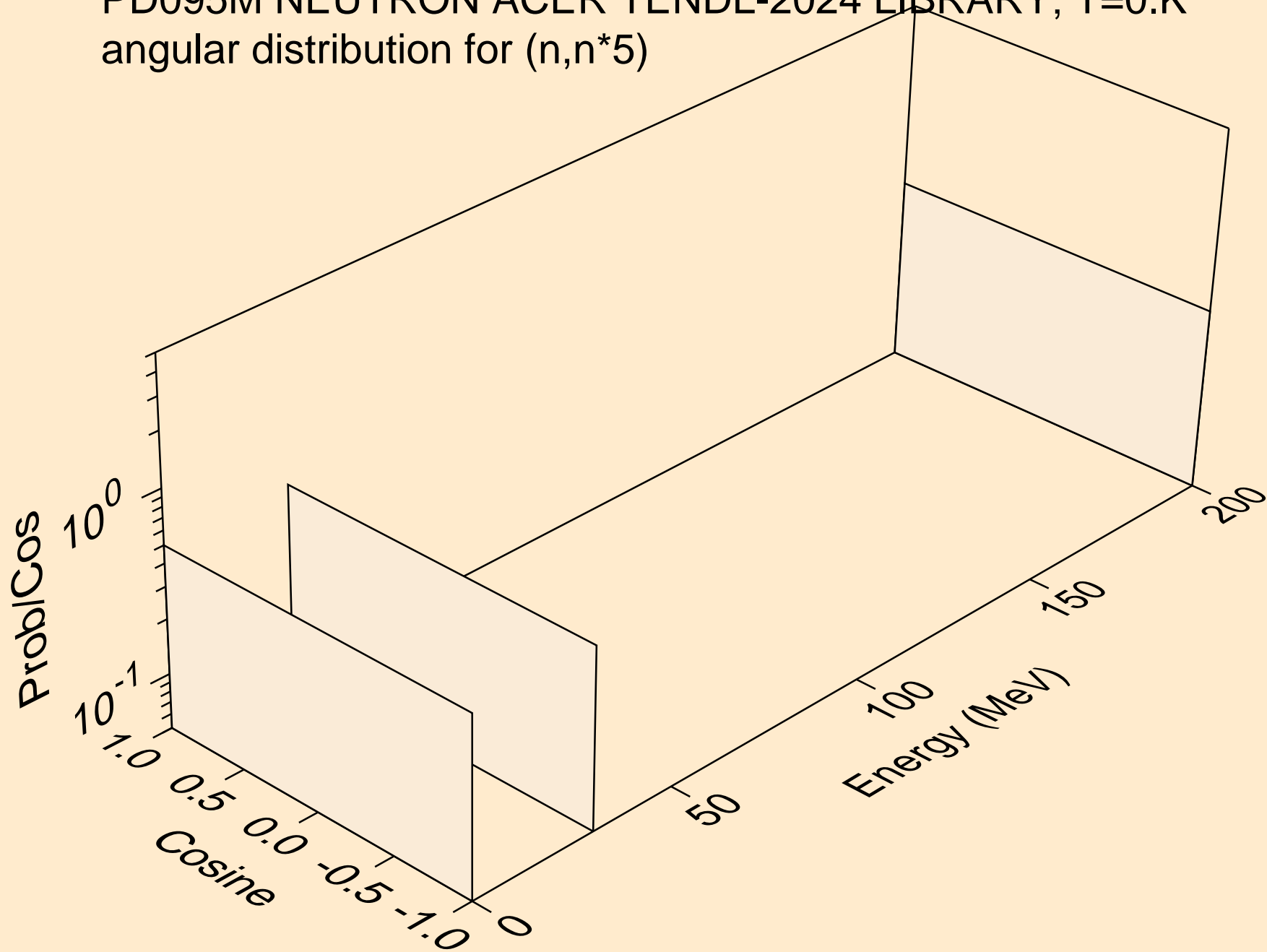

PD095M NEUTRON ACER TENDL-2024 LIBRARY; T=0.K
angular distribution for (n,n*6)

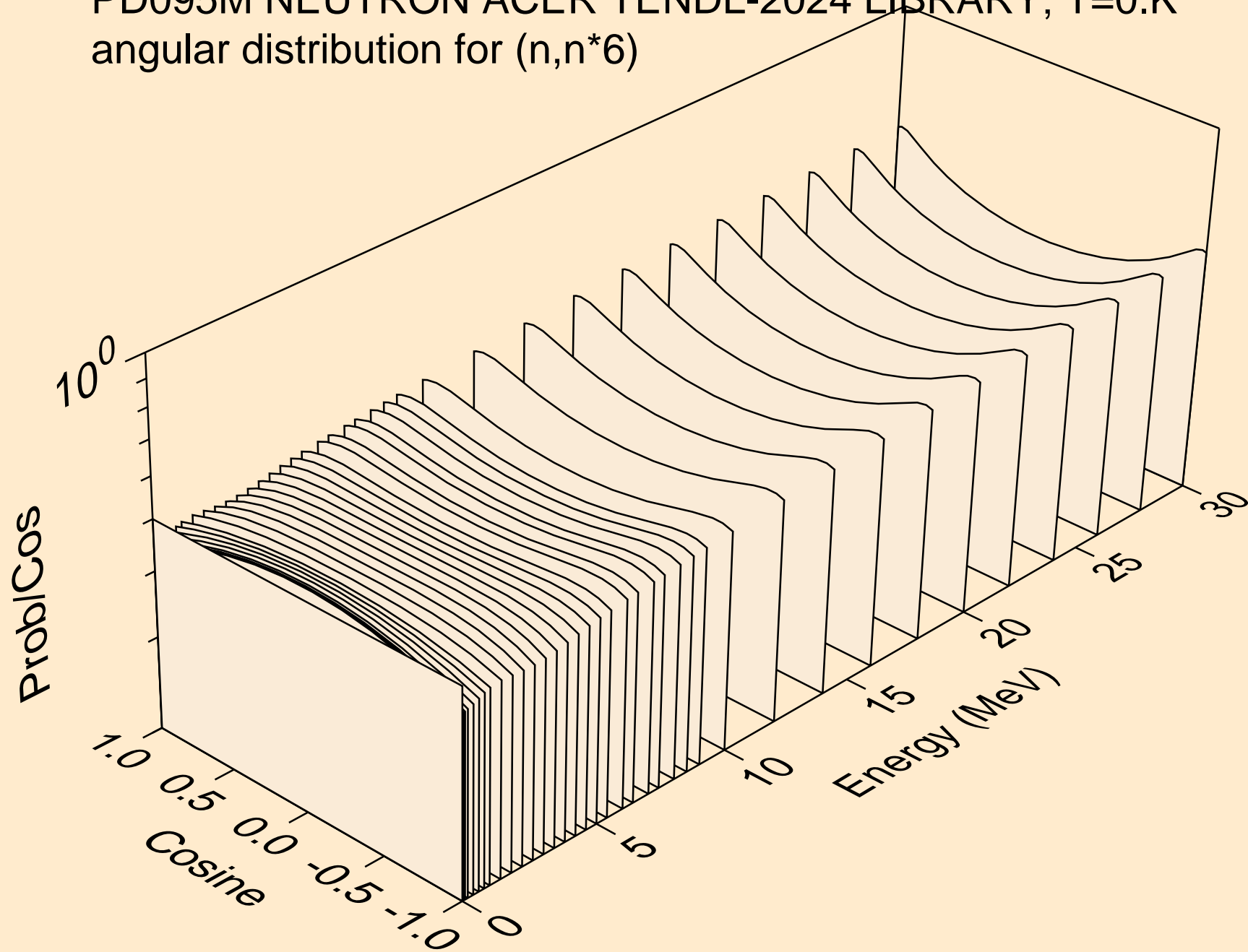

PD095M NEUTRON ACER TENDL-2024 LIBRARY; T=0.K
angular distribution for (n,n*7)

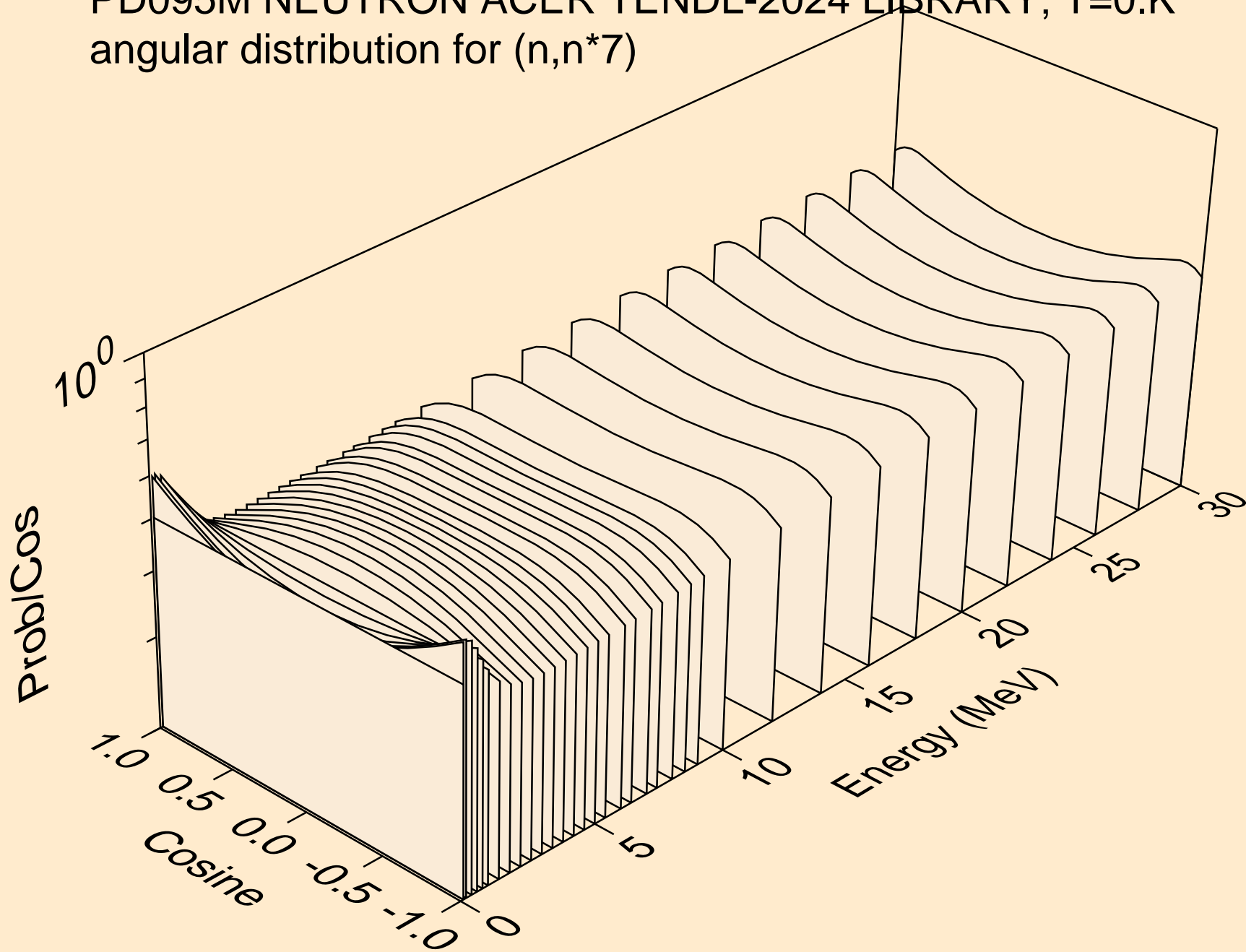

PD095M NEUTRON ACER TENDL-2024 LIBRARY; T=0.K
angular distribution for (n,n*8)

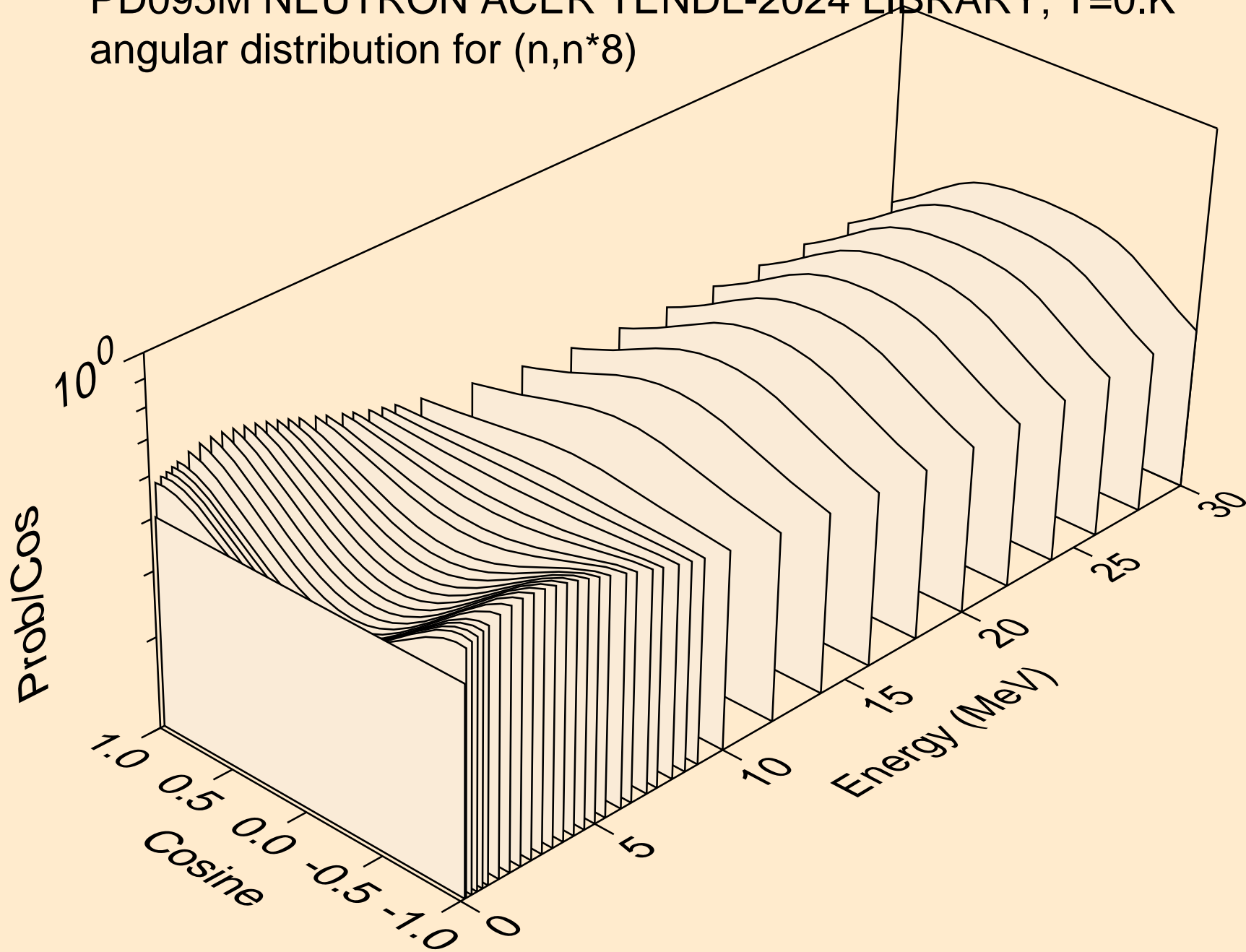

PD095M NEUTRON ACER TENDL-2024 LIBRARY; T=0.K
angular distribution for (n,n*9)

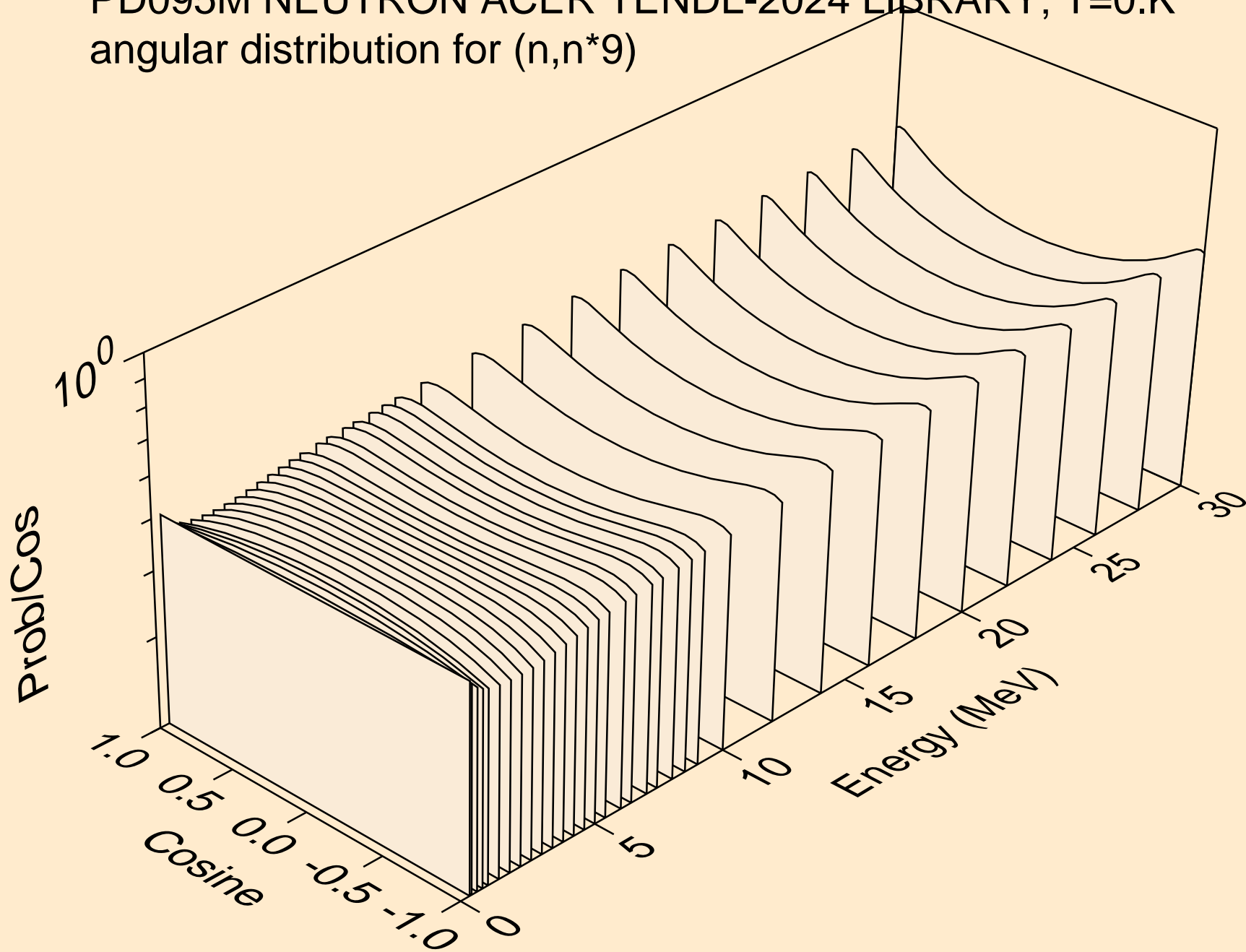

PD095M NEUTRON ACER TENDL-2024 LIBRARY; T=0.K
angular distribution for (n,n*10)

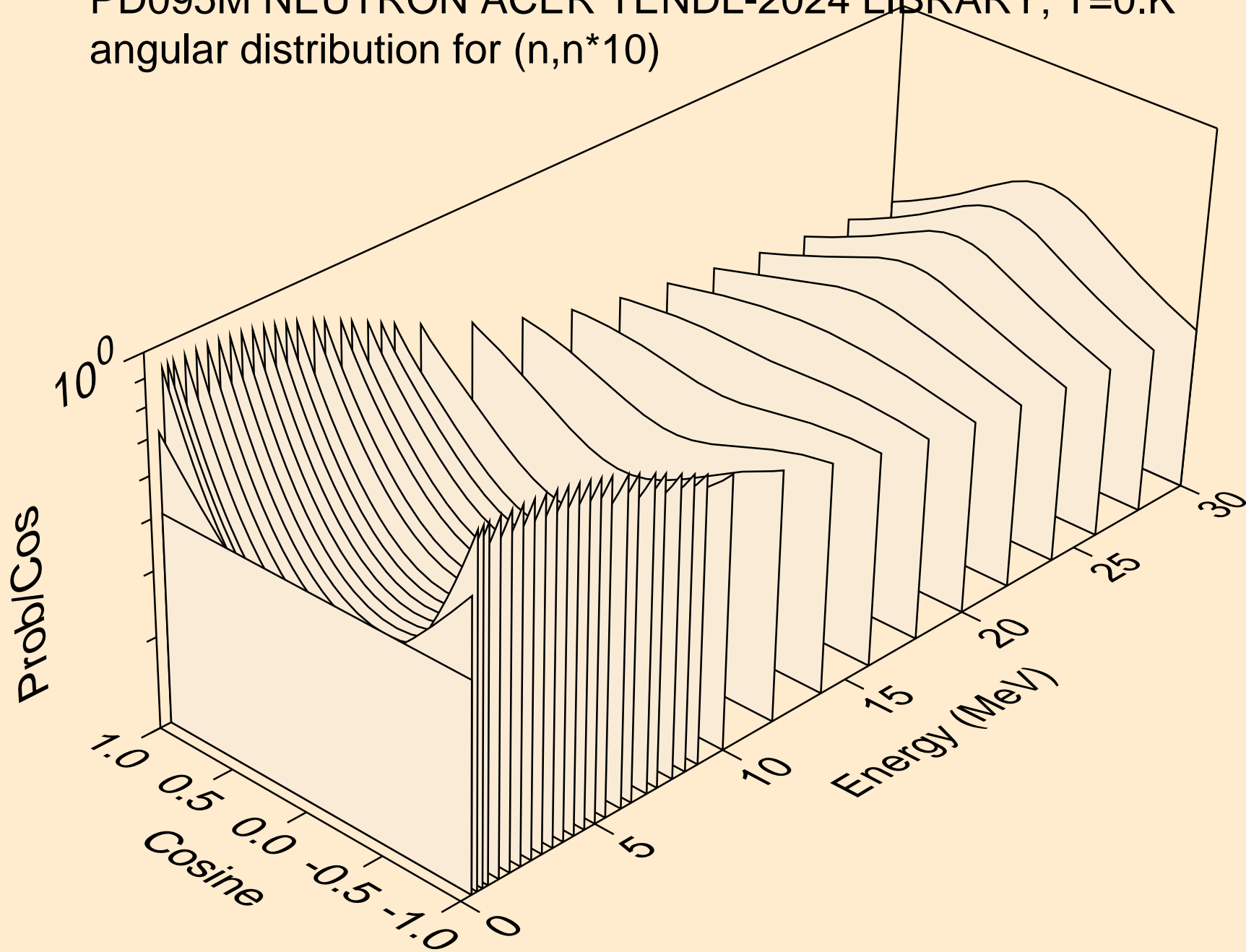

PD095M NEUTRON ACER TENDL-2024 LIBRARY; T=0.K
angular distribution for (n,n*11)

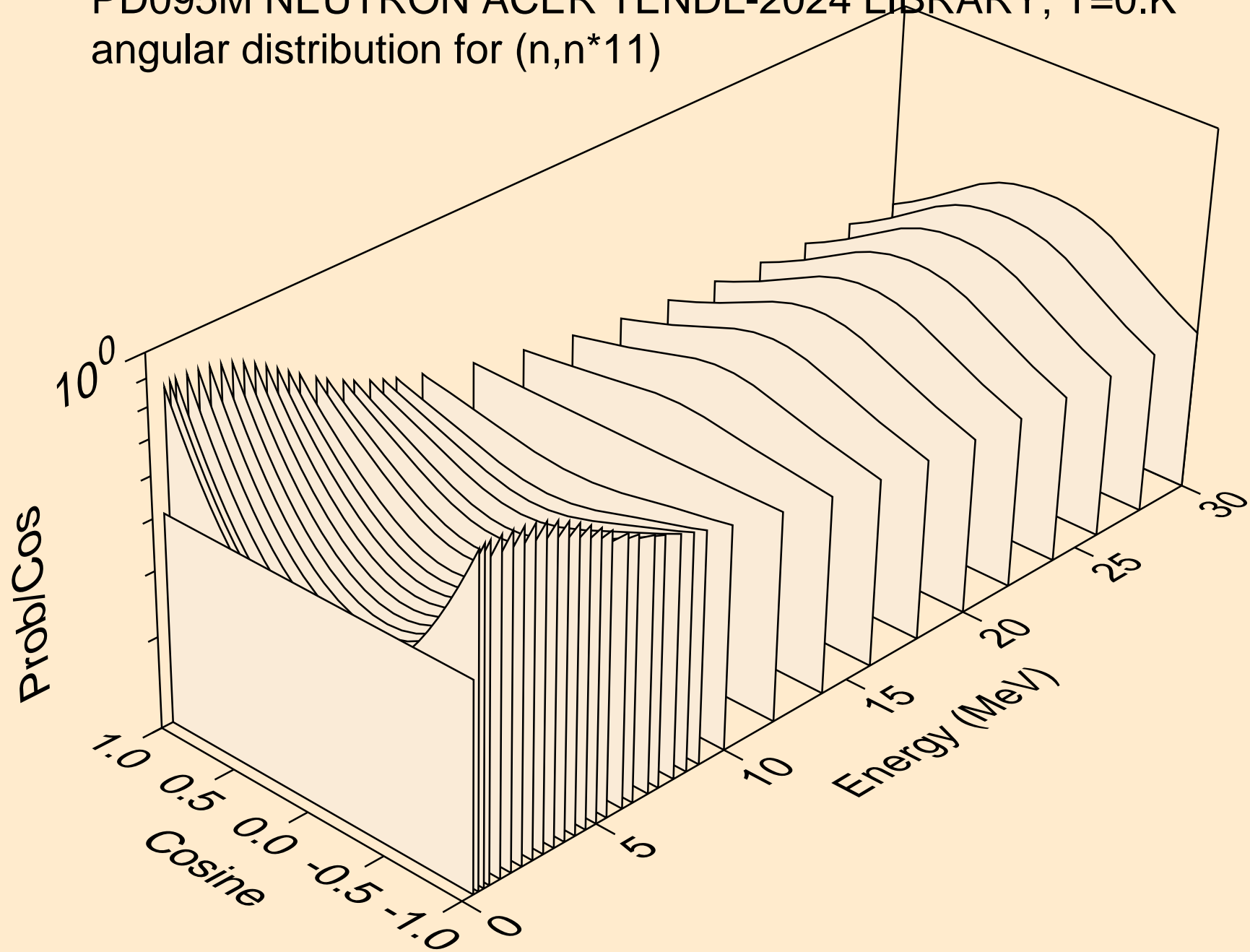

PD095M NEUTRON ACER TENDL-2024 LIBRARY; T=0.K
angular distribution for (n,n*12)

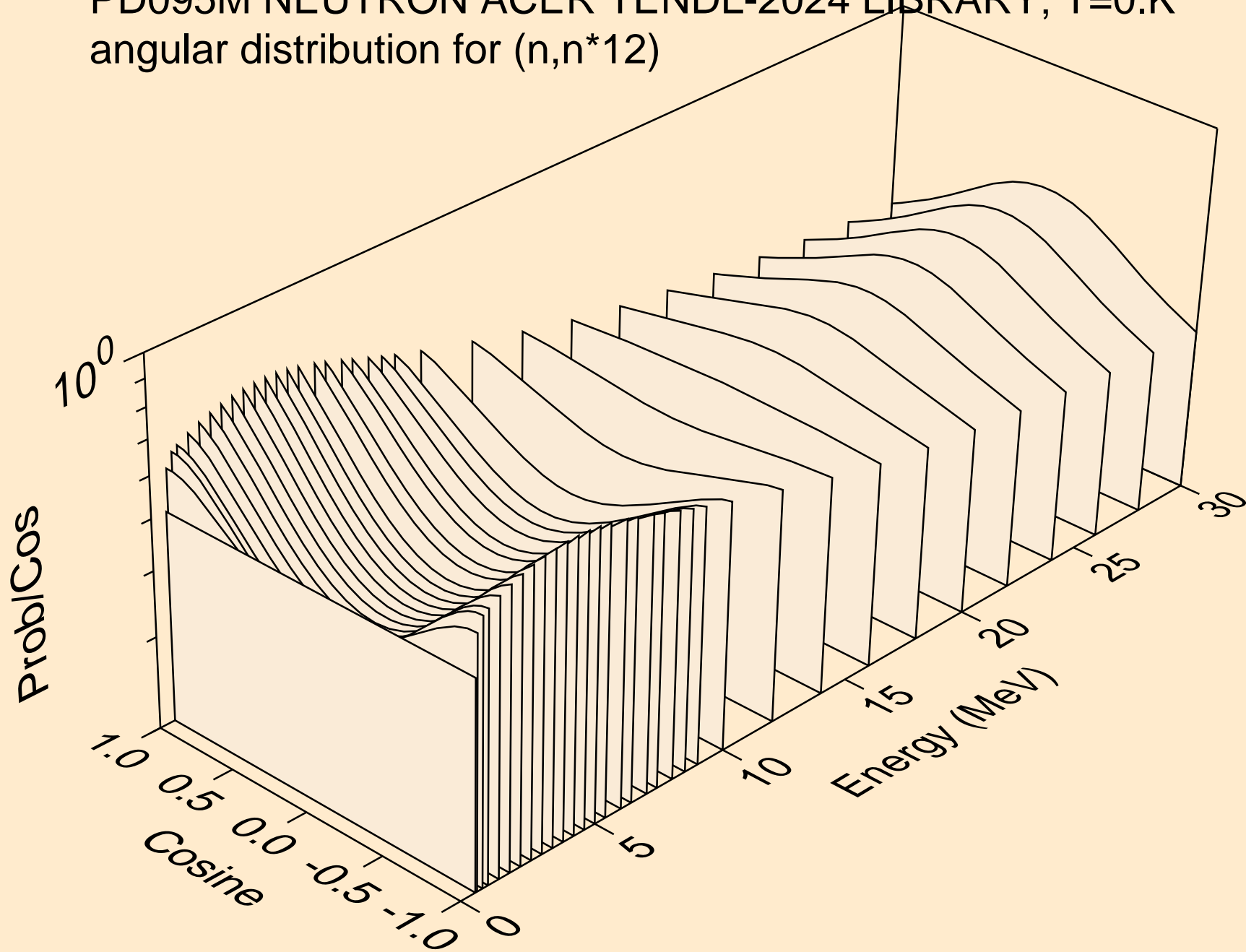

PD095M NEUTRON ACER TENDL-2024 LIBRARY; T=0.K
angular distribution for (n,n*13)

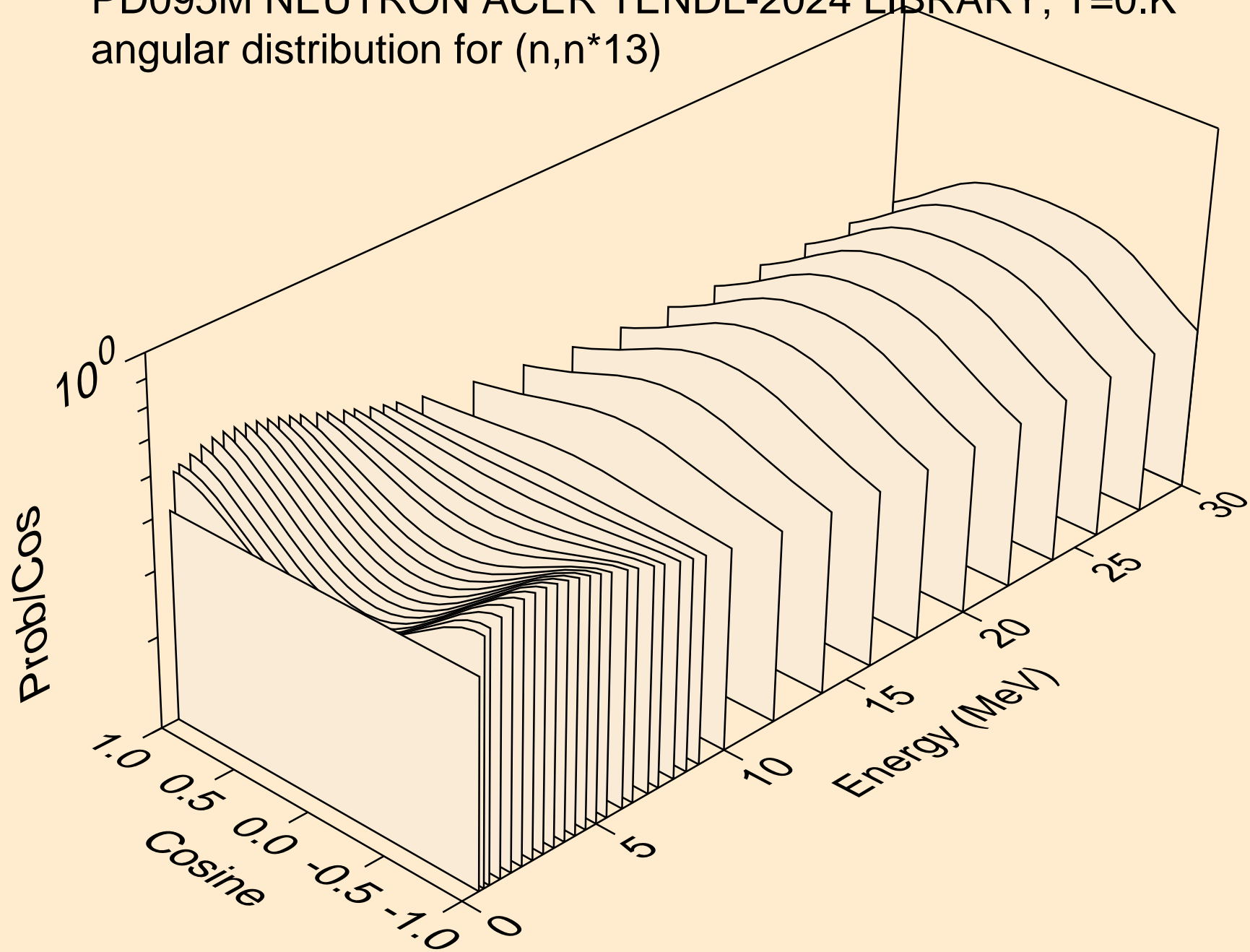

PD095M NEUTRON ACER TENDL-2024 LIBRARY; T=0.K
angular distribution for (n,n*14)

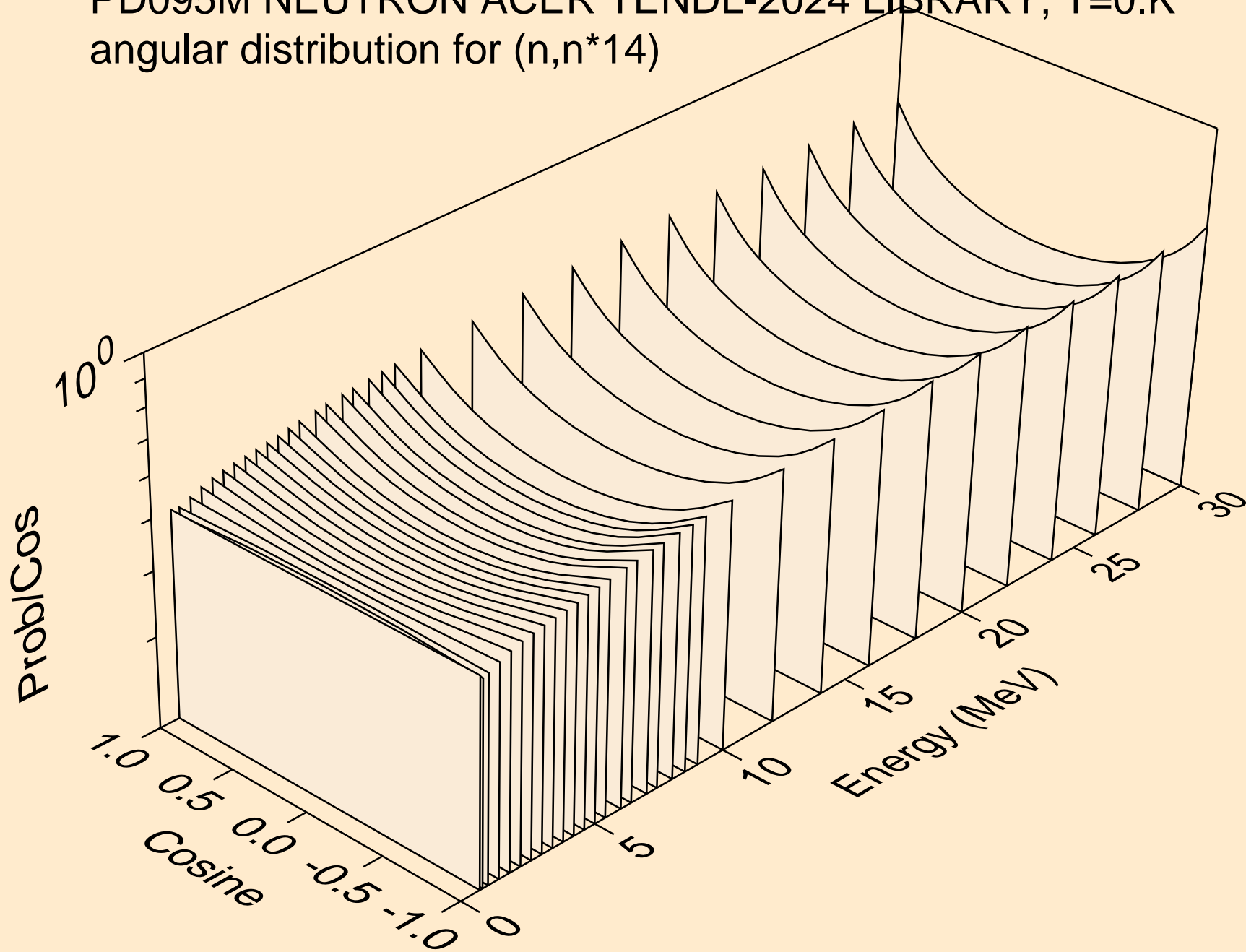

PD095M NEUTRON ACER TENDL-2024 LIBRARY; T=0.K
angular distribution for (n,n*15)

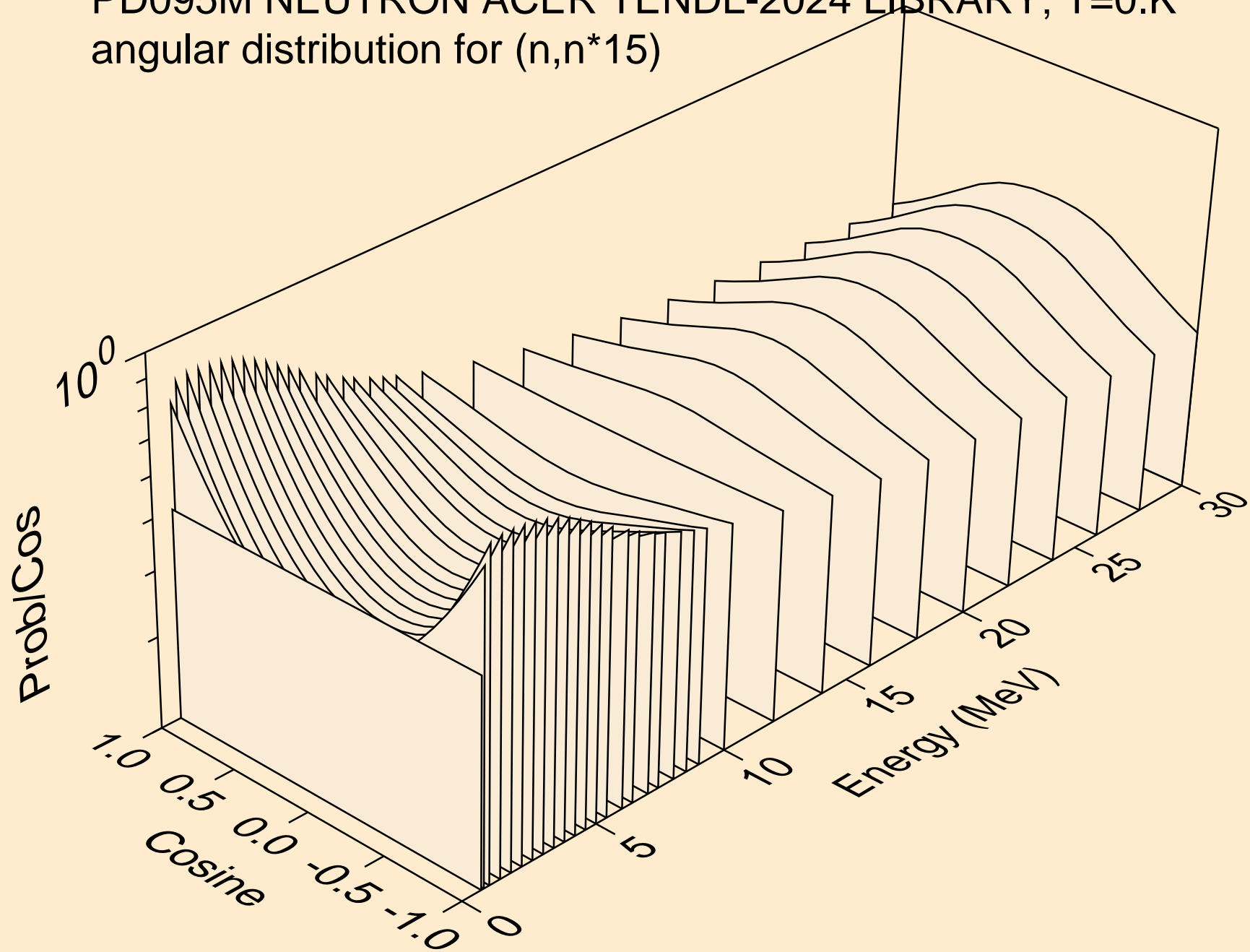

PD095M NEUTRON ACER TENDL-2024 LIBRARY; T=0.K
angular distribution for (n,n*16)

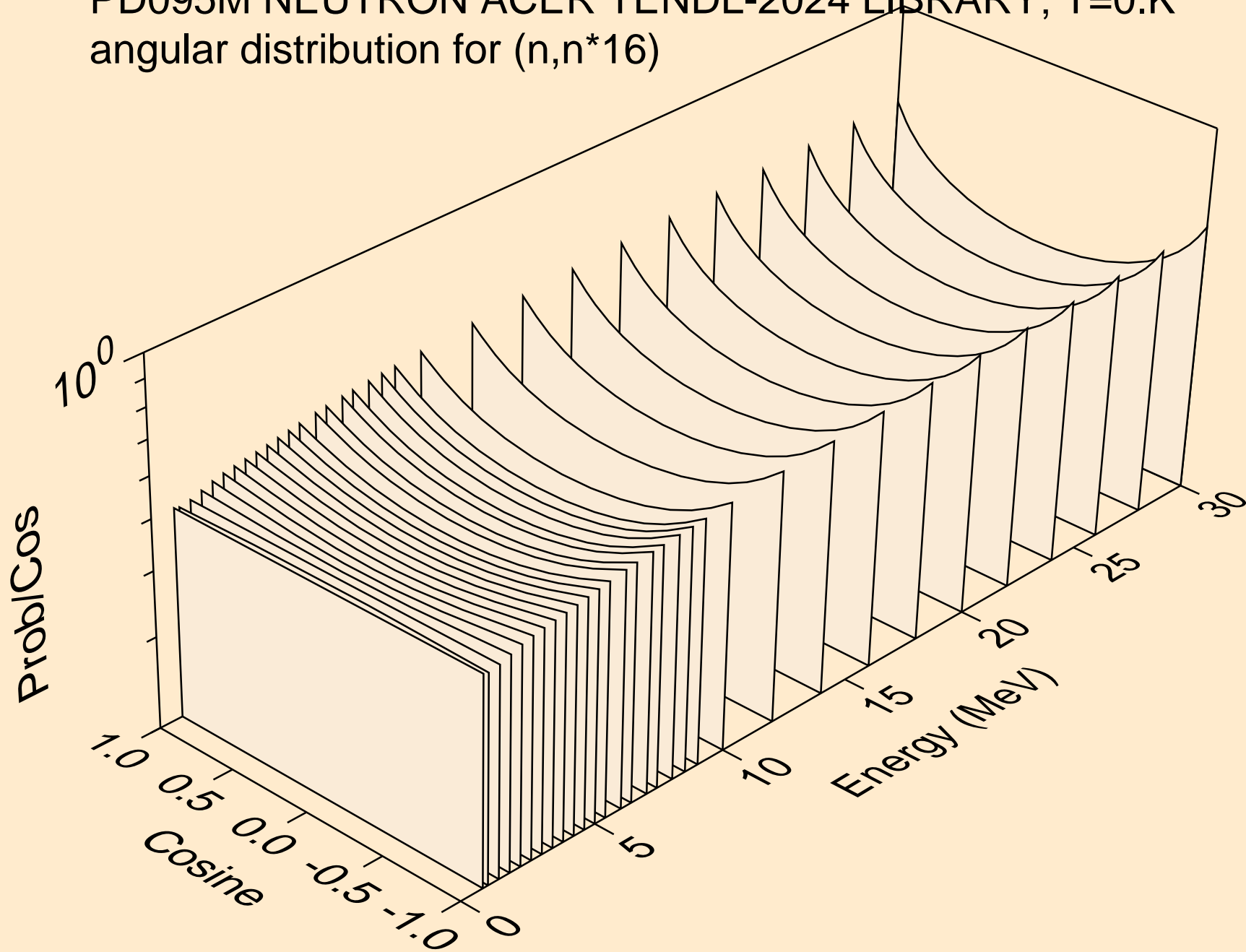

PD095M NEUTRON ACER TENDL-2024 LIBRARY; T=0.K
angular distribution for (n,n*17)

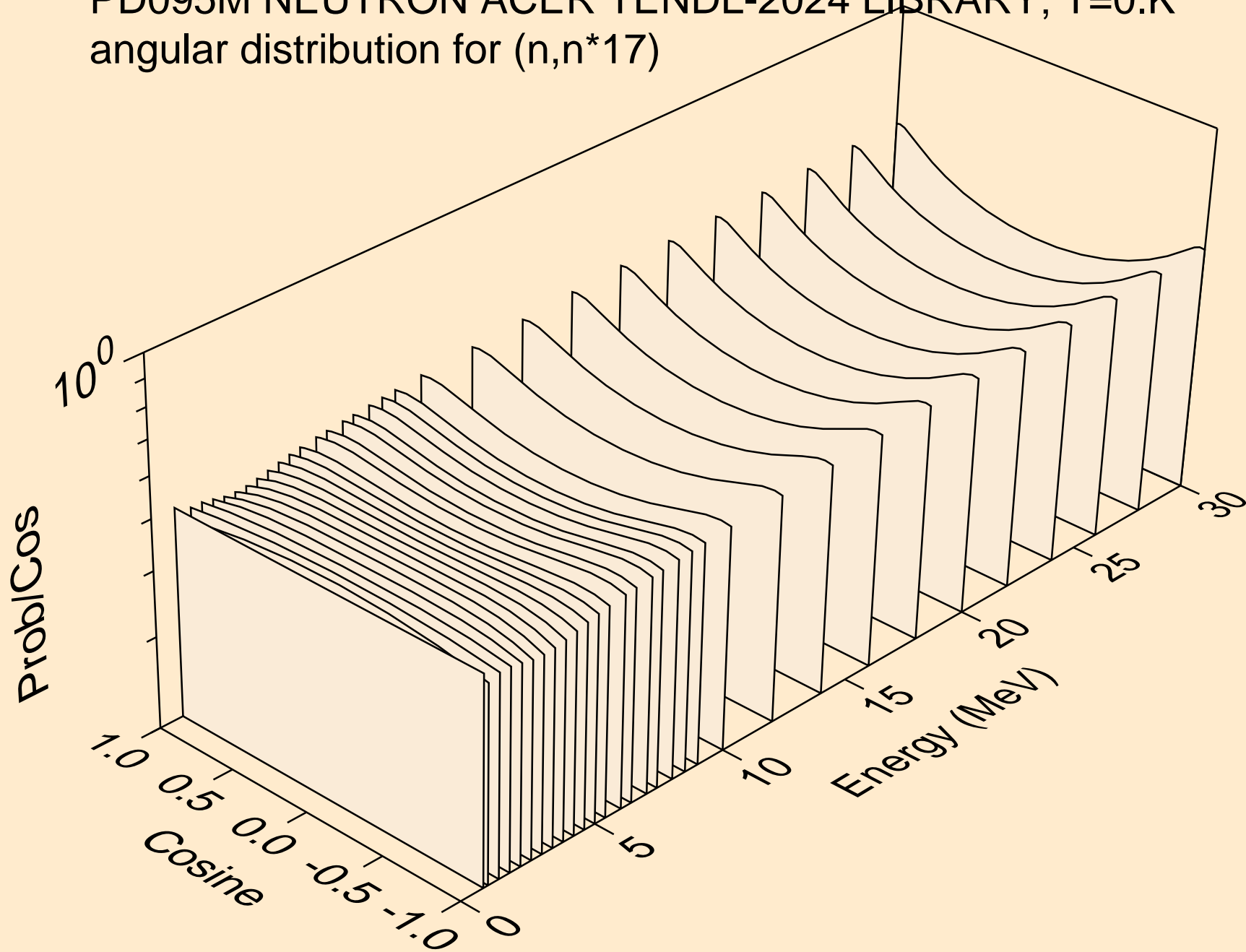

PD095M NEUTRON ACER TENDL-2024 LIBRARY; T=0.K
Neutron emission for (n,x)

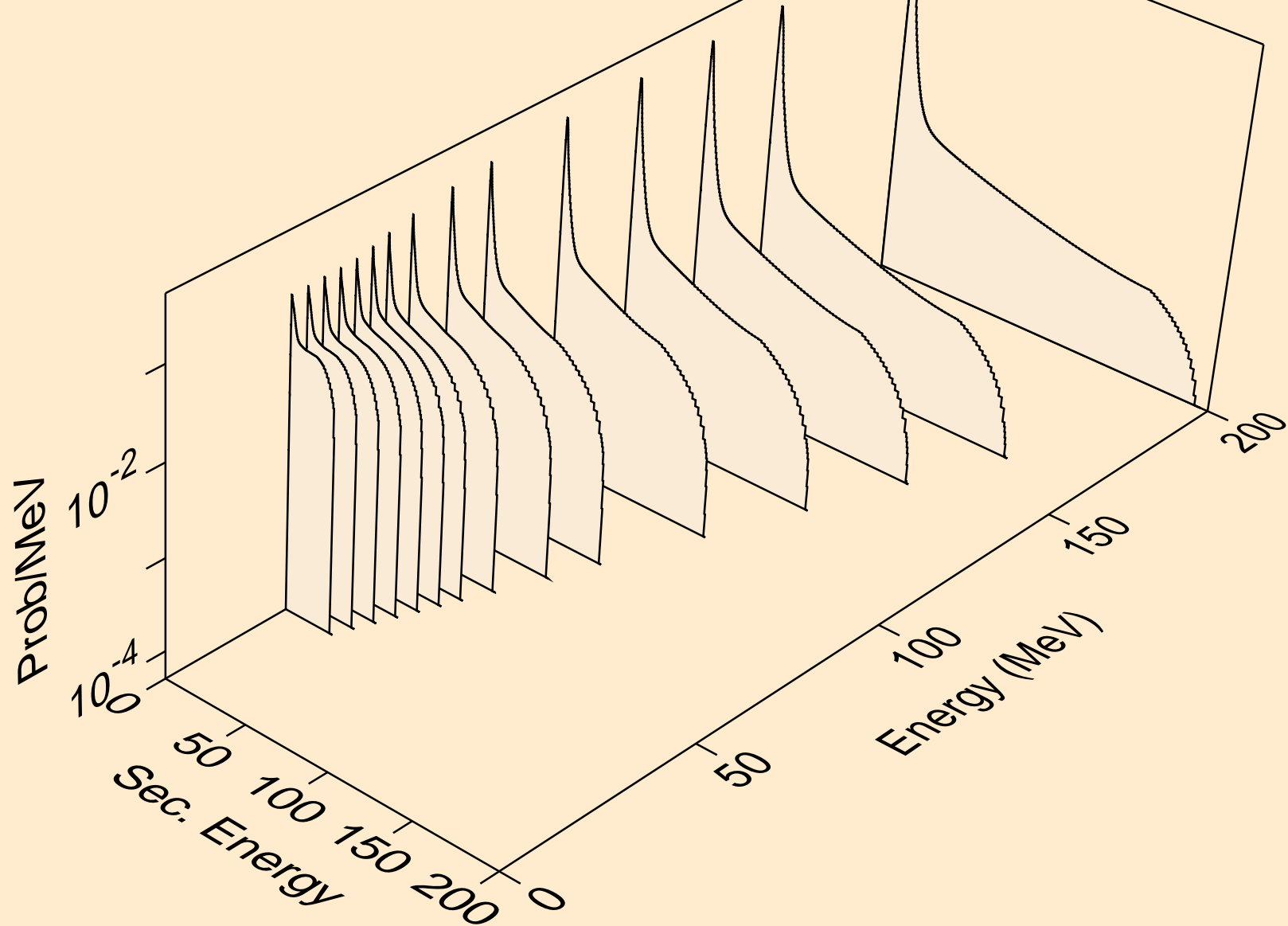

PD095M NEUTRON ACER TENDL-2024 LIBRARY; T=0.K
Neutron emission for (n,2n)

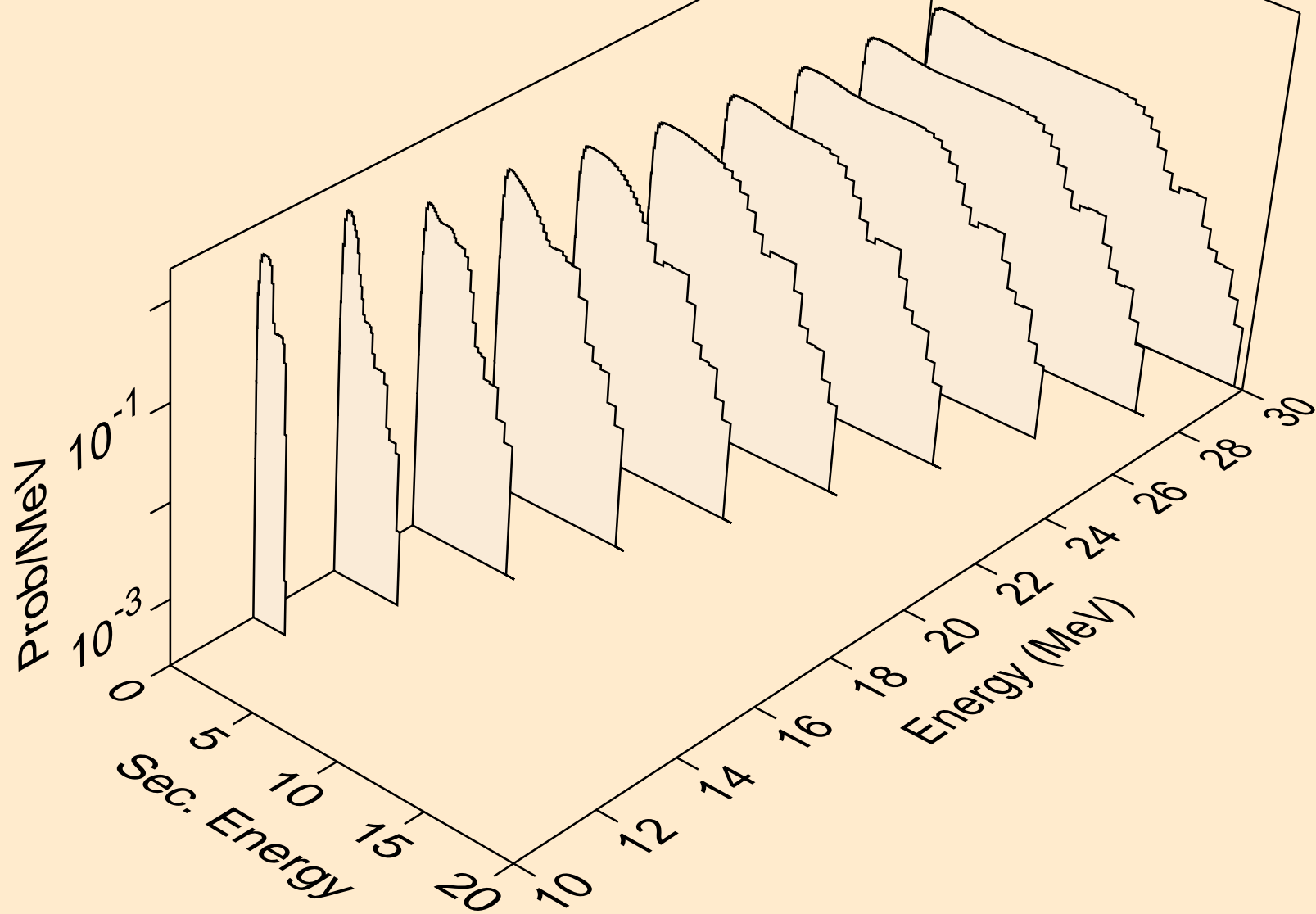

PD095M NEUTRON ACER TENDL-2024 LIBRARY; T=0.K
Neutron emission for (n,3n)

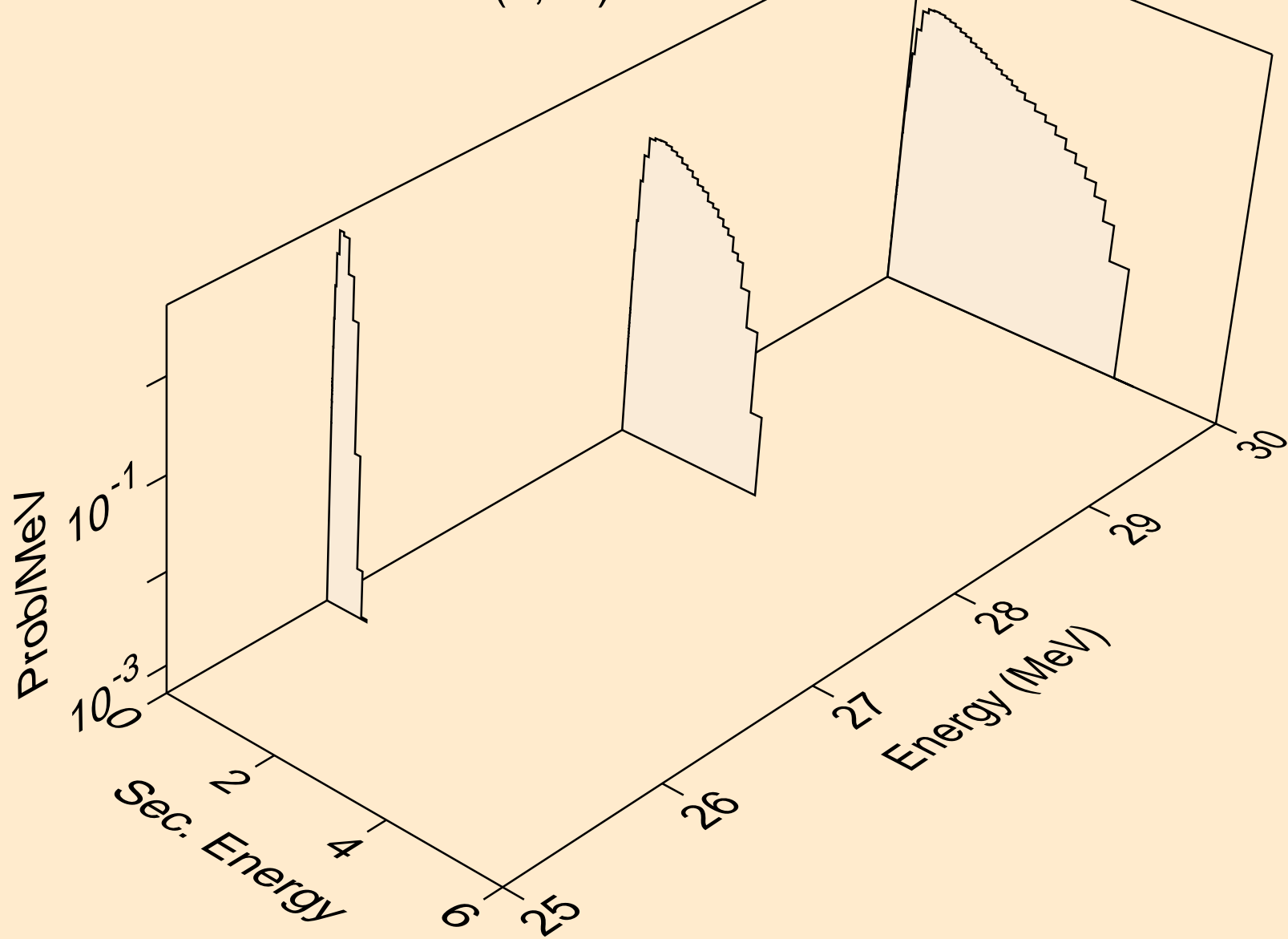

PD095M NEUTRON ACER TENDL-2024 LIBRARY; T=0.K
Neutron emission for (n,n*)a

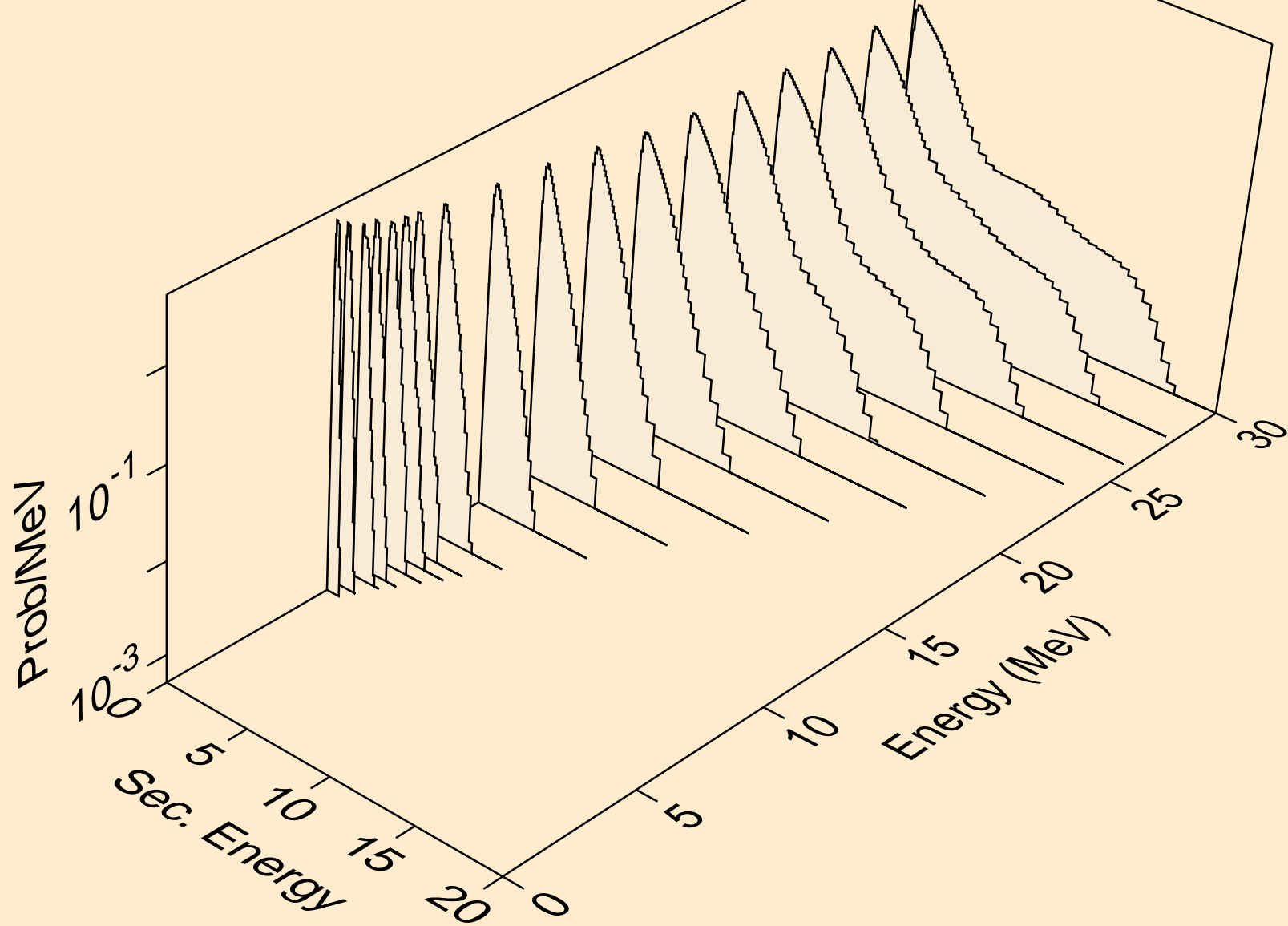

PD095M NEUTRON ACER TENDL-2024 LIBRARY; T=0.K
Neutron emission for (n,2n)a

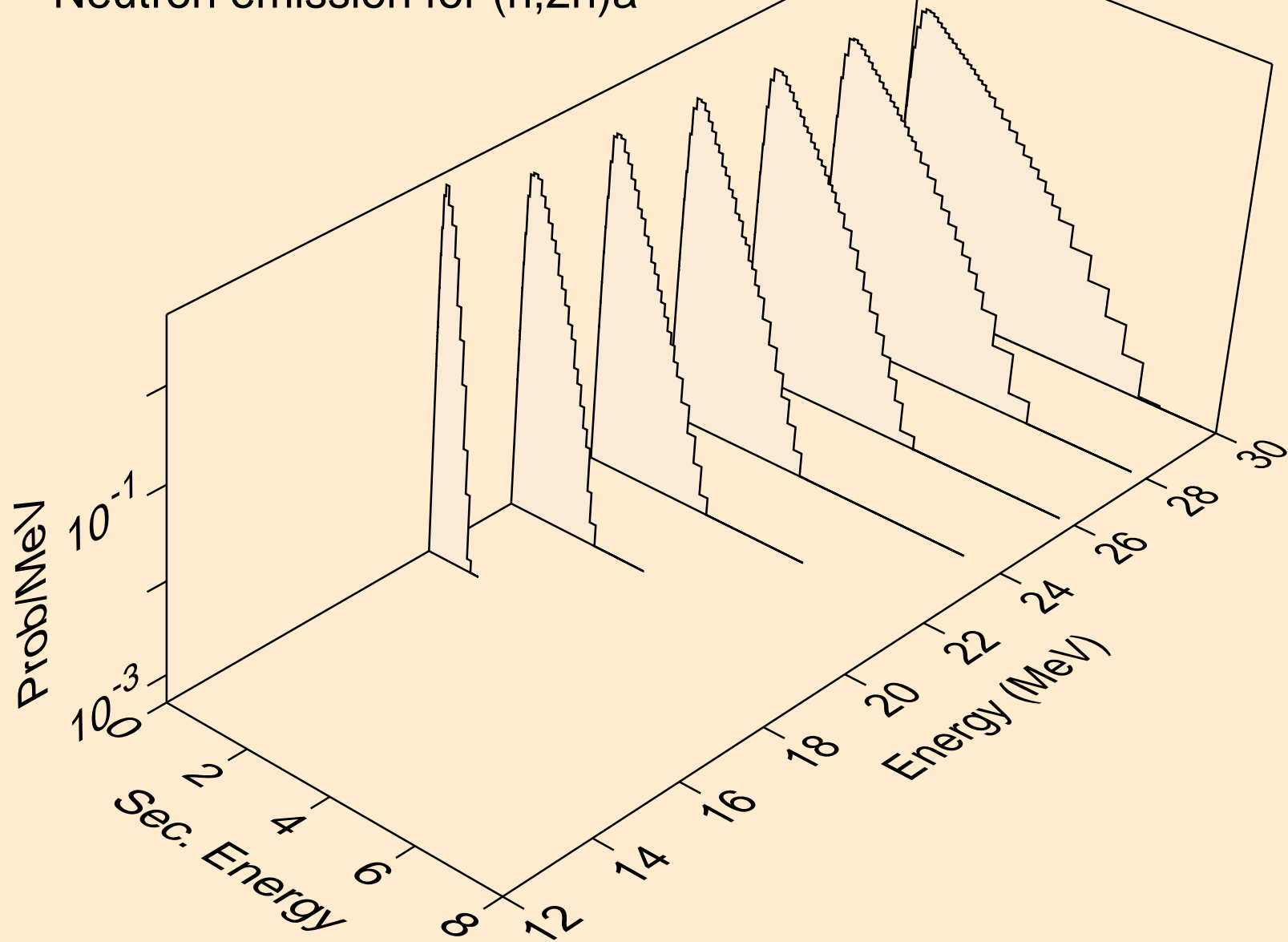

PD095M NEUTRON ACER TENDL-2024 LIBRARY; T=0.K
Neutron emission for (n,n*)p

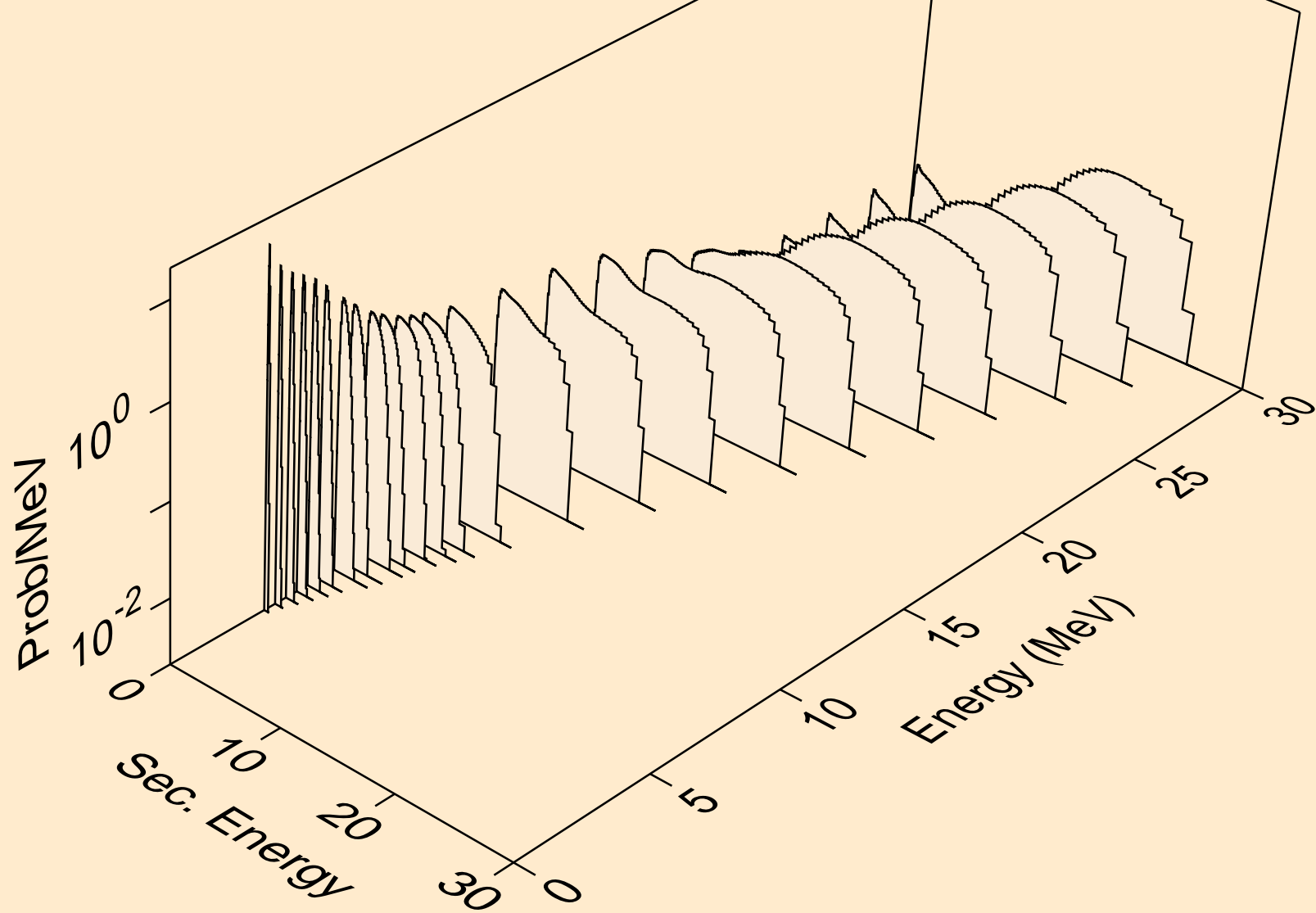

PD095M NEUTRON ACER TENDL-2024 LIBRARY; T=0.K
Neutron emission for (n,n*)2a

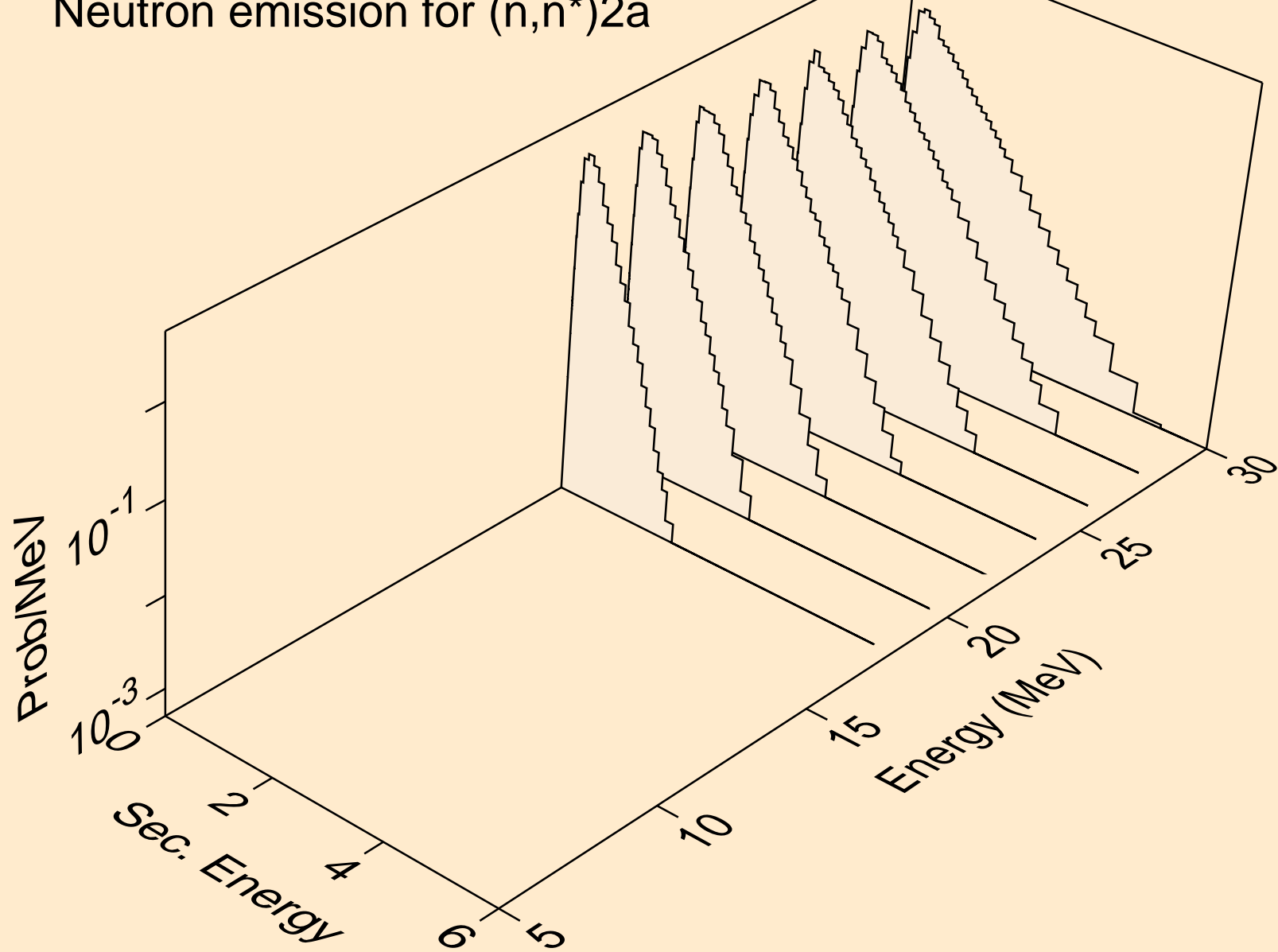

PD095M NEUTRON ACER TENDL-2024 LIBRARY; T=0.K
Neutron emission for (n,n*)d

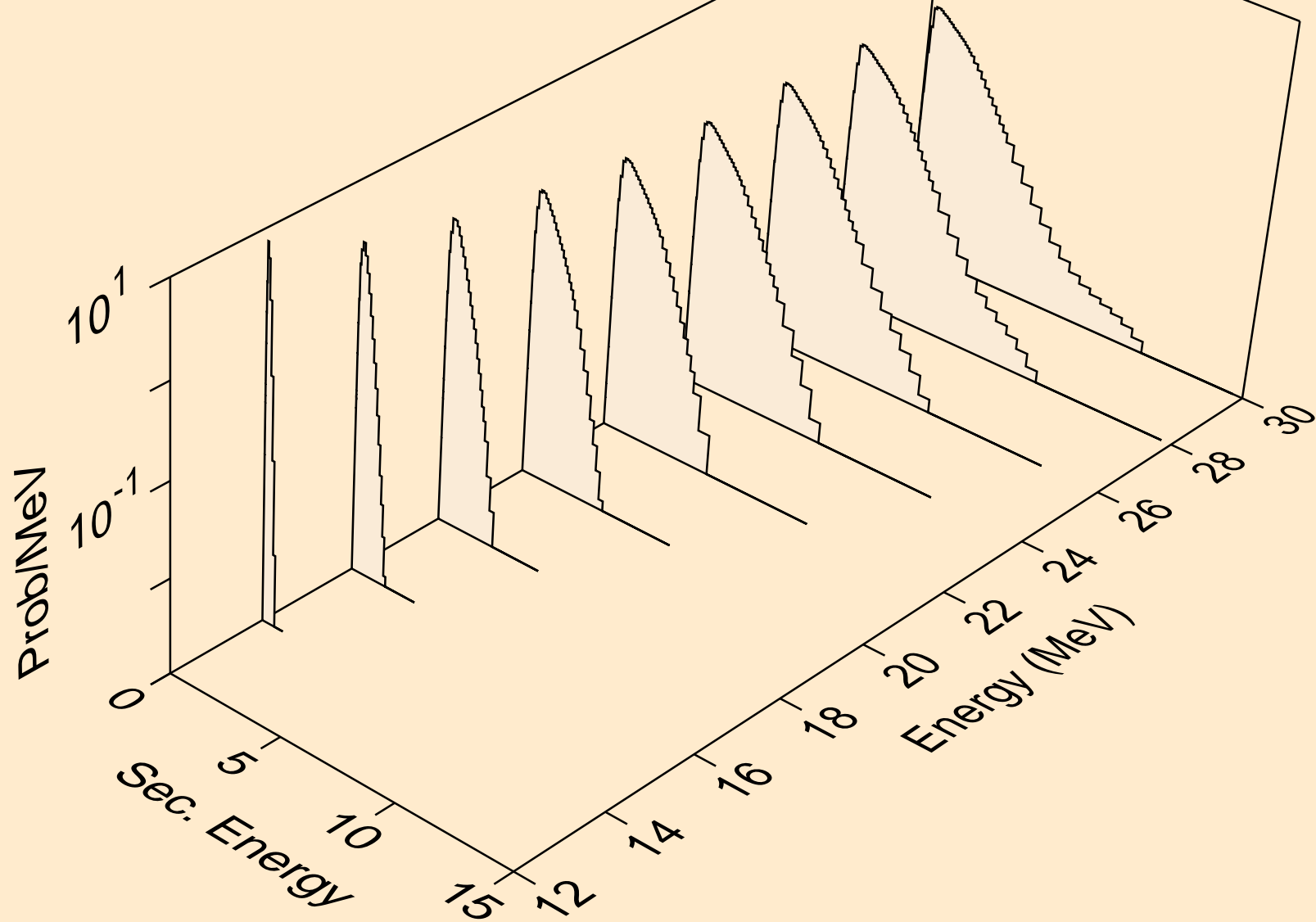

PD095M NEUTRON ACER TENDL-2024 LIBRARY; T=0.K
Neutron emission for (n,n*)t

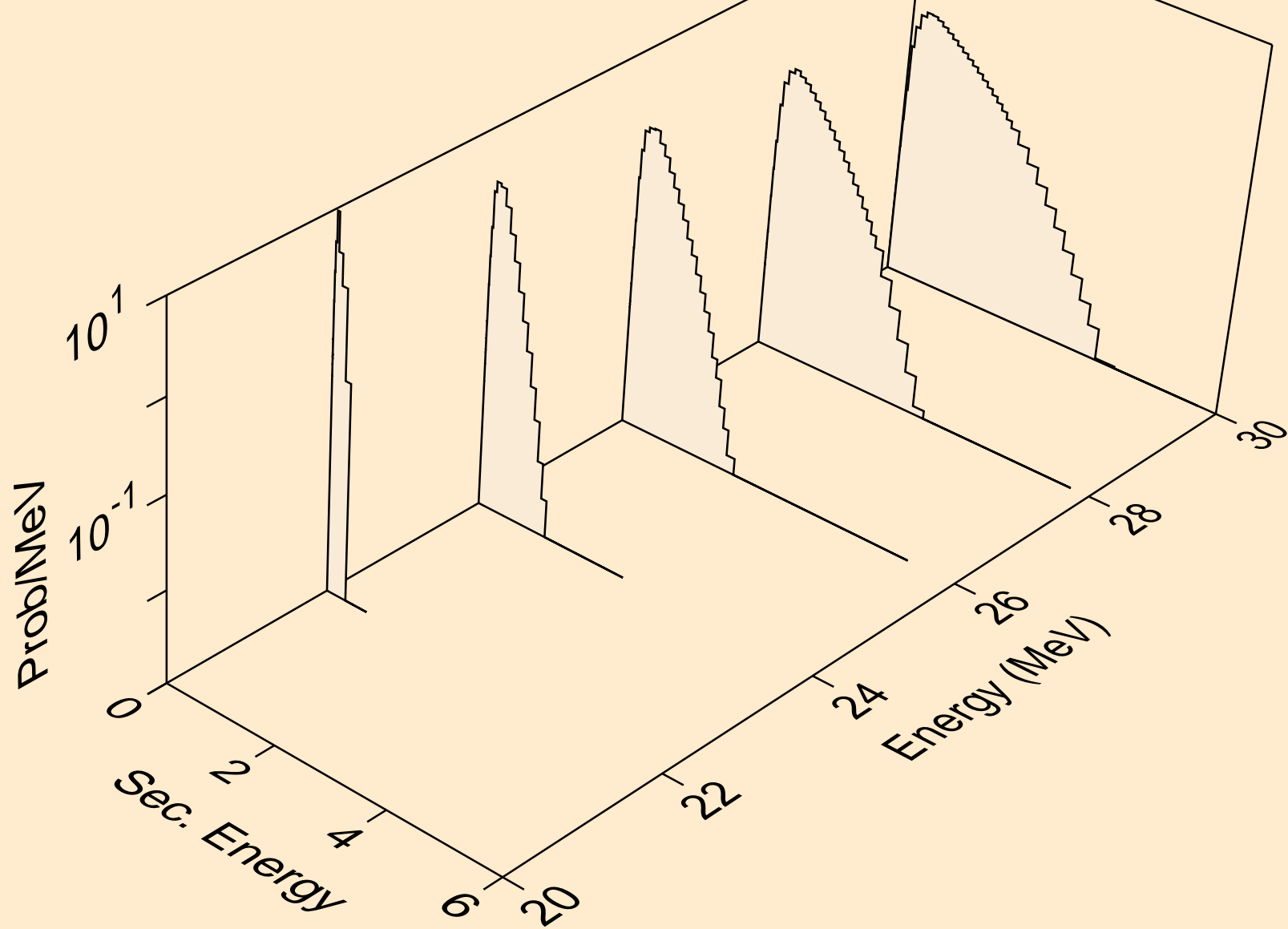

PD095M NEUTRON ACER TENDL-2024 LIBRARY; T=0.K
Neutron emission for (n,n*)he3

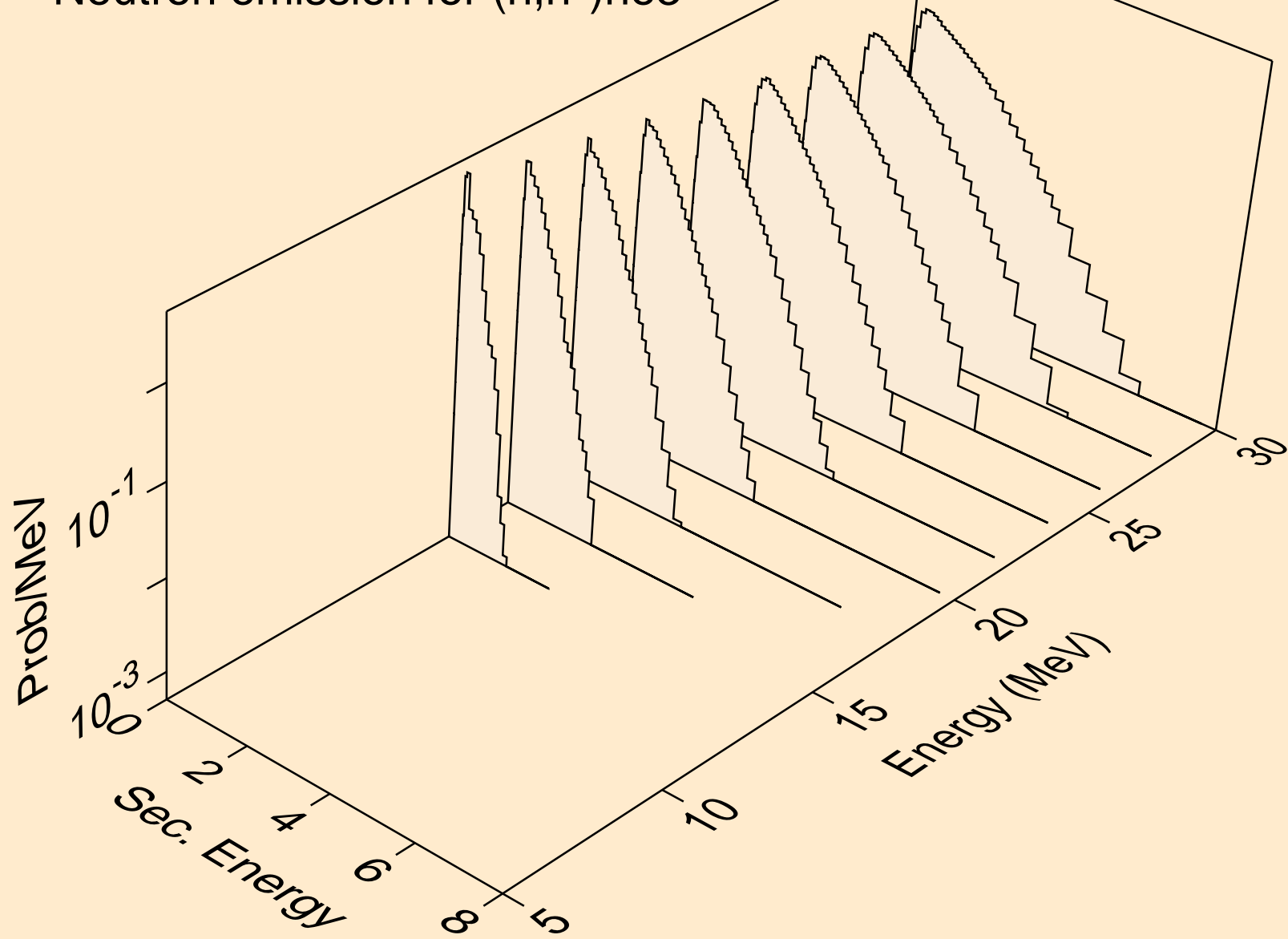

PD095M NEUTRON ACER TENDL-2024 LIBRARY; T=0.K
Neutron emission for (n,2np)

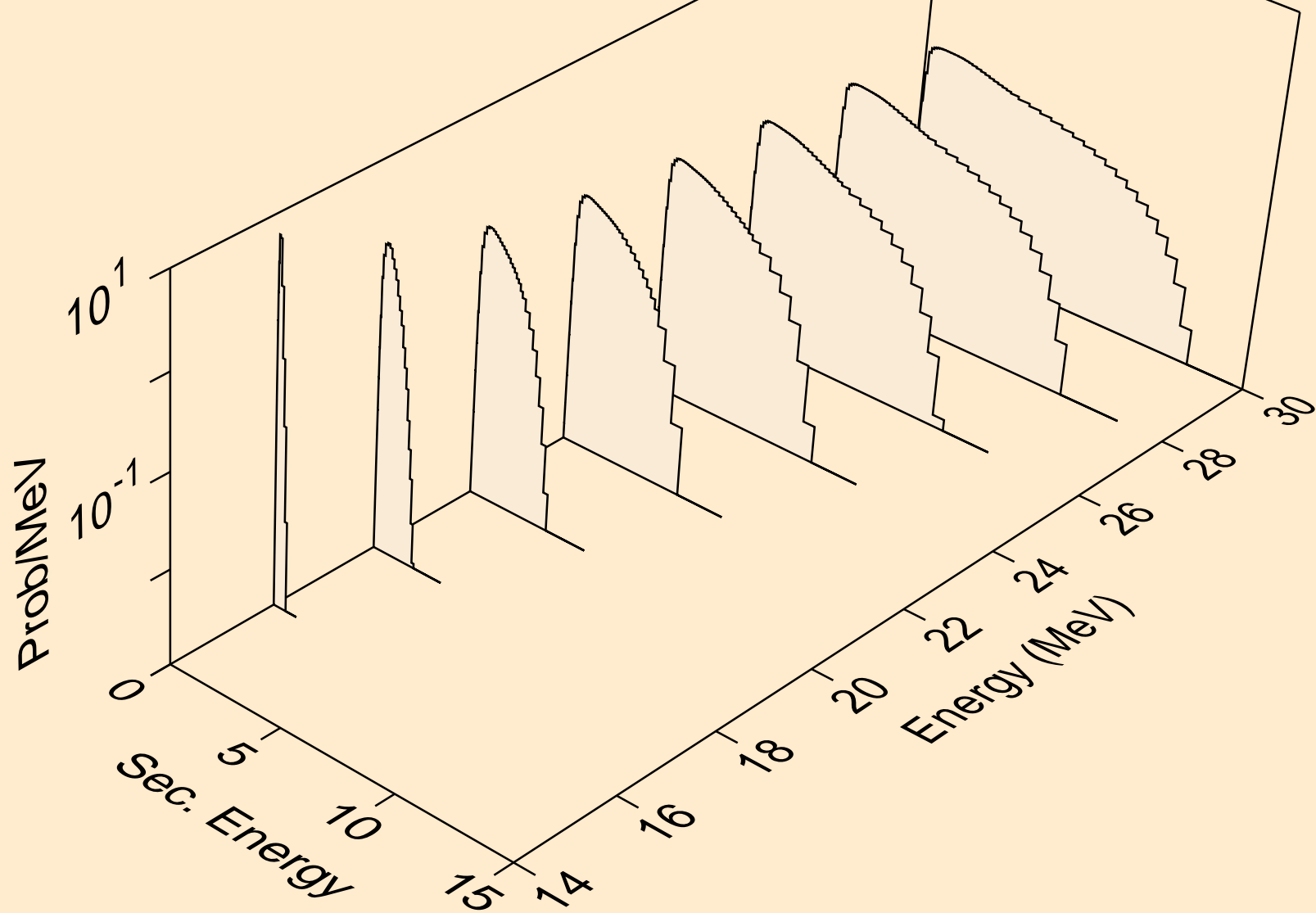

PD095M NEUTRON ACER TENDL-2024 LIBRARY; T=0.K
Neutron emission for (n,n2p)

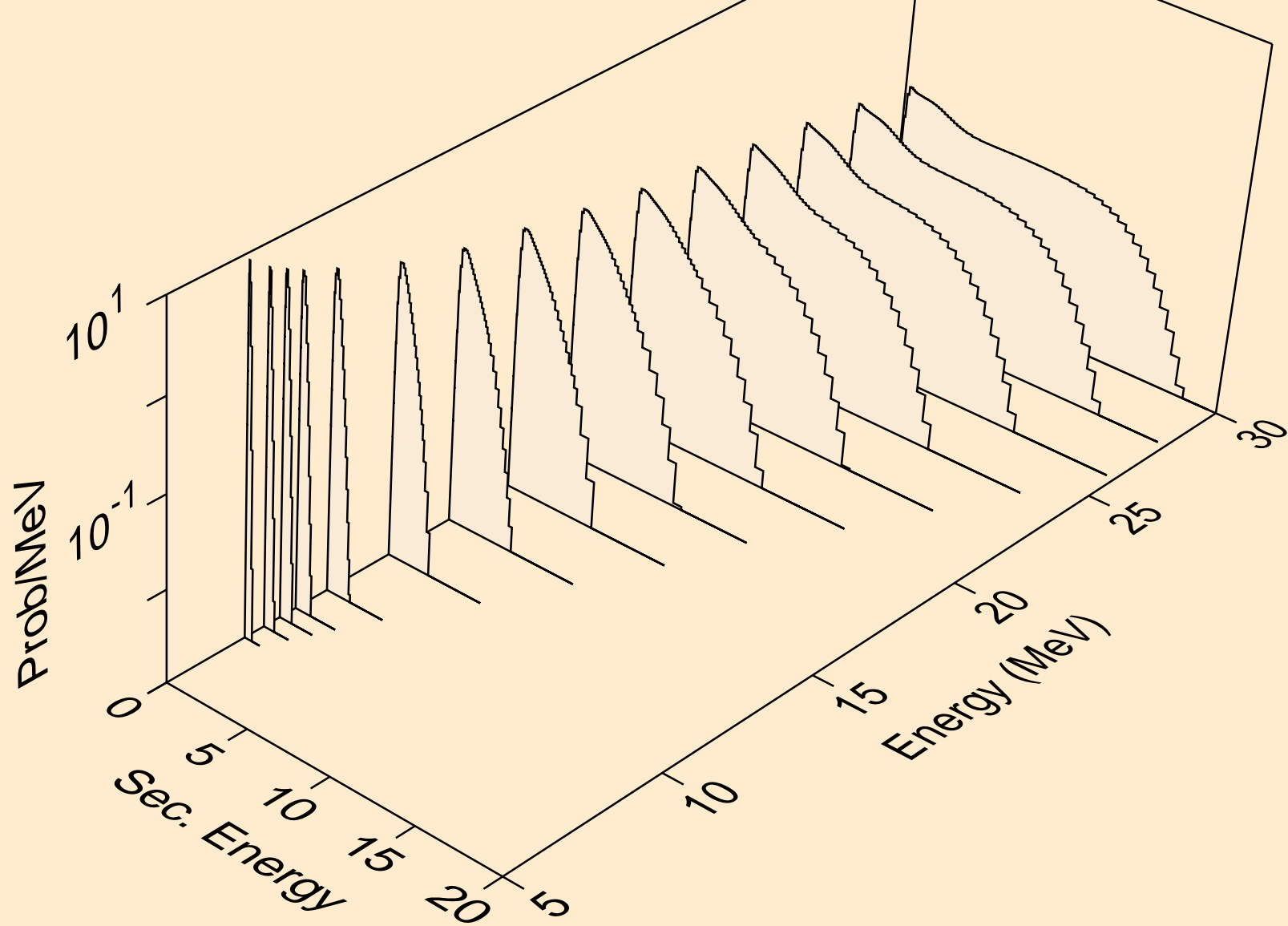

PD095M NEUTRON ACER TENDL-2024 LIBRARY; T=0.K
Neutron emission for (n,npa)

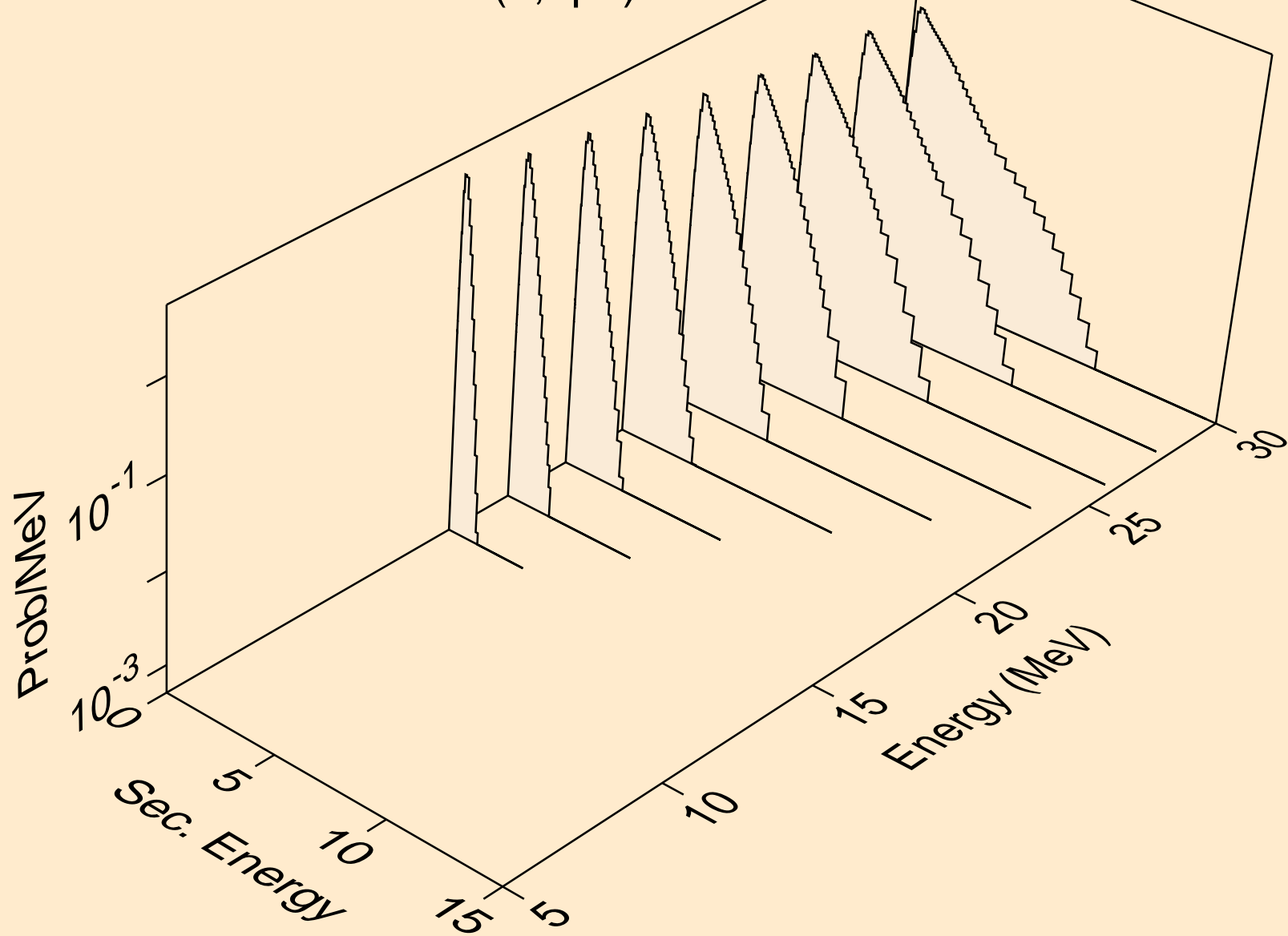

PD095M NEUTRON ACER TENDL-2024 LIBRARY; T=0.K
Neutron emission for (n,n*c)

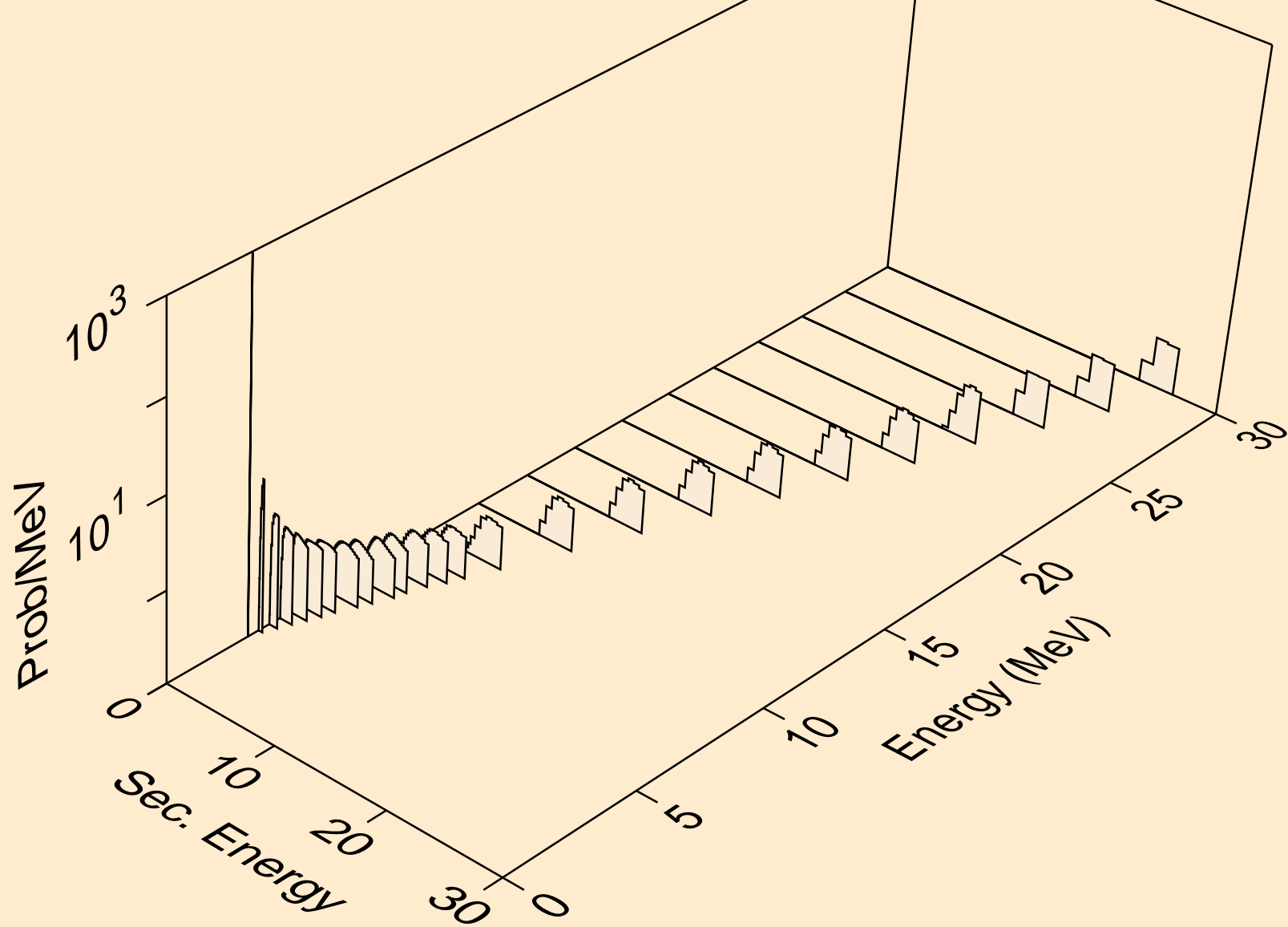

PD095M NEUTRON ACER TENDL-2024 LIBRARY; T=0.K
Photon emission for (n,x)

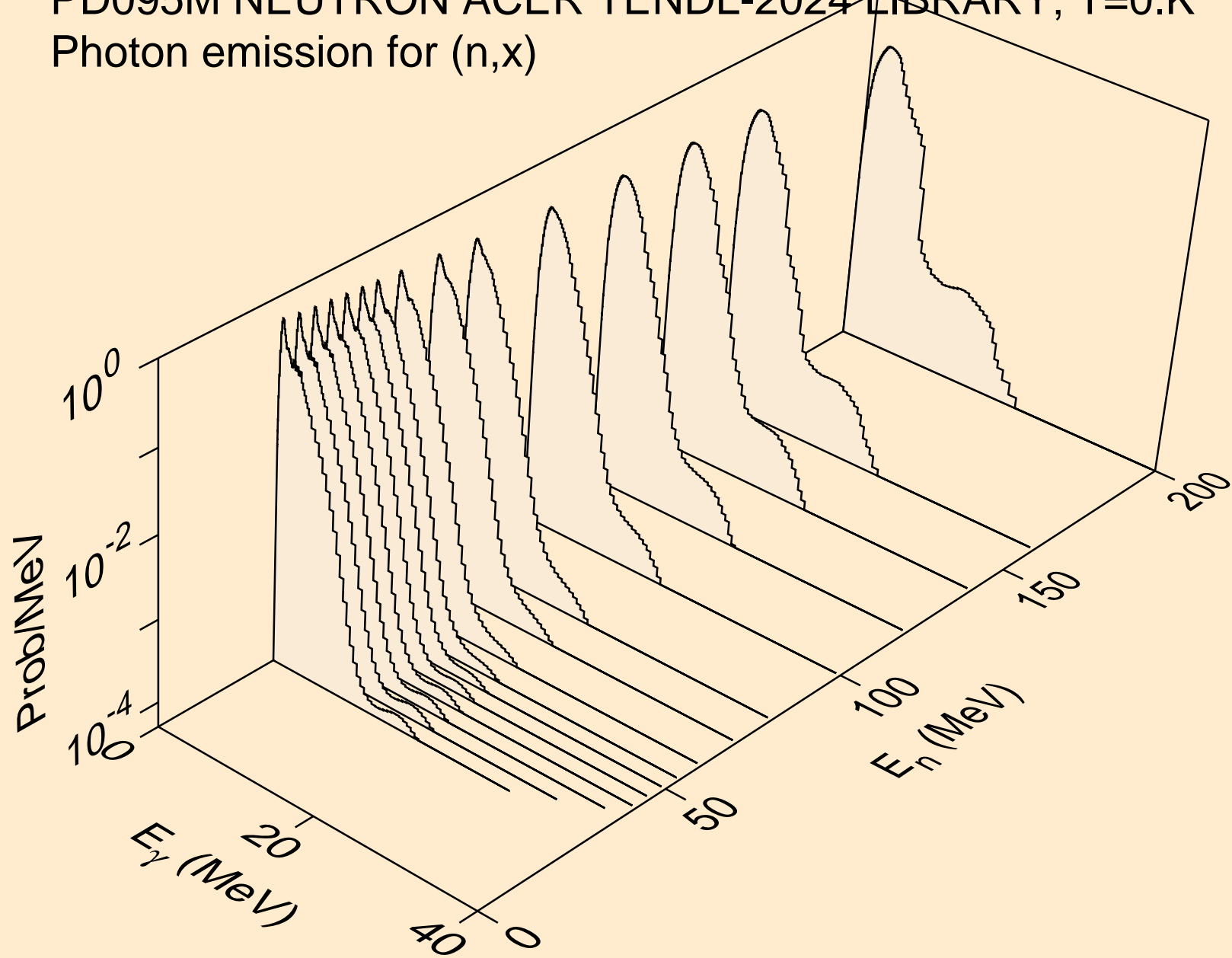

PD095M NEUTRON ACER TENDL-2024 LIBRARY; T=0.K
Photon emission for (n,2n)

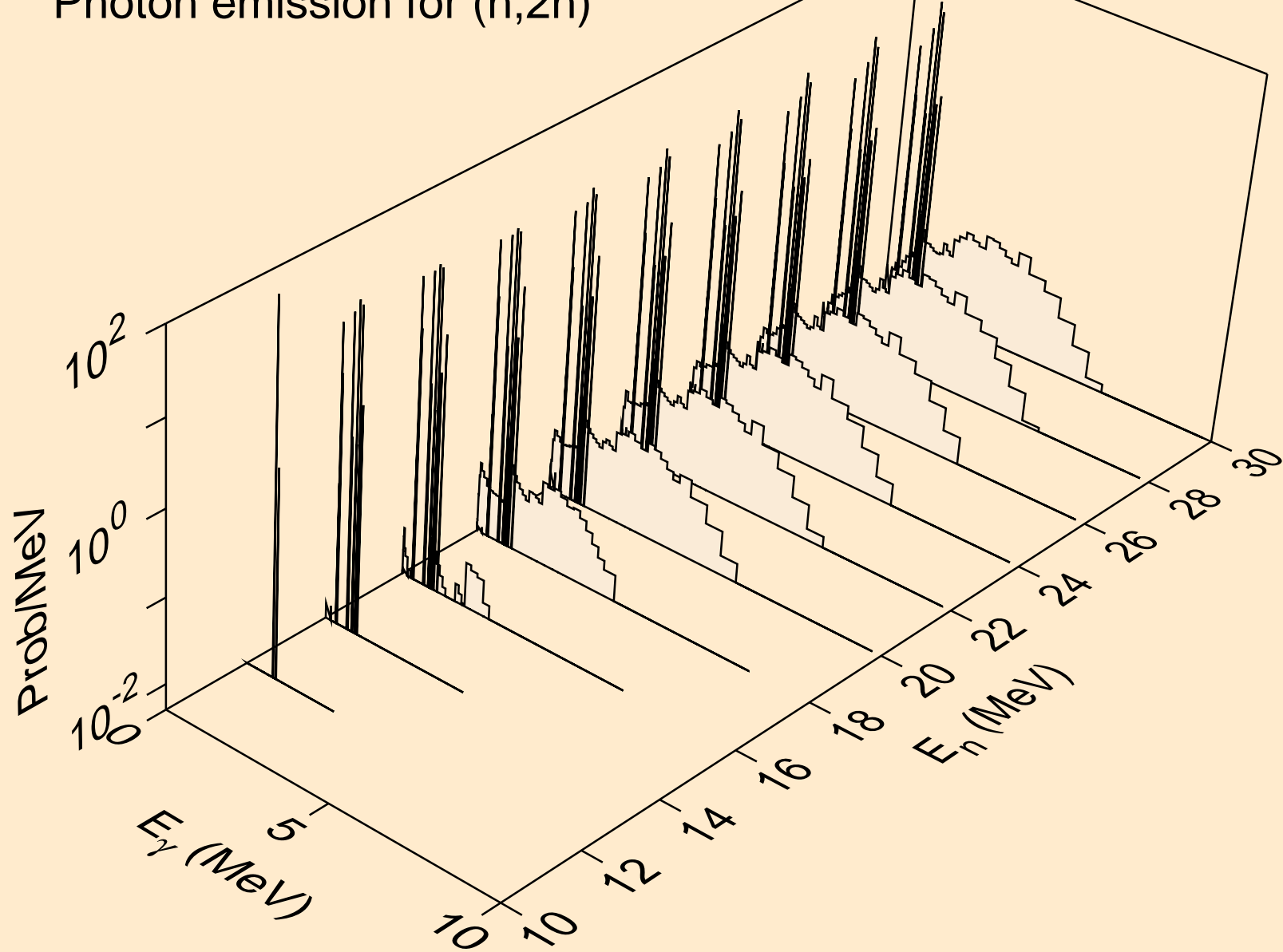

PD095M NEUTRON ACER TENDL-2024 LIBRARY; T=0.K
Photon emission for (n,3n)

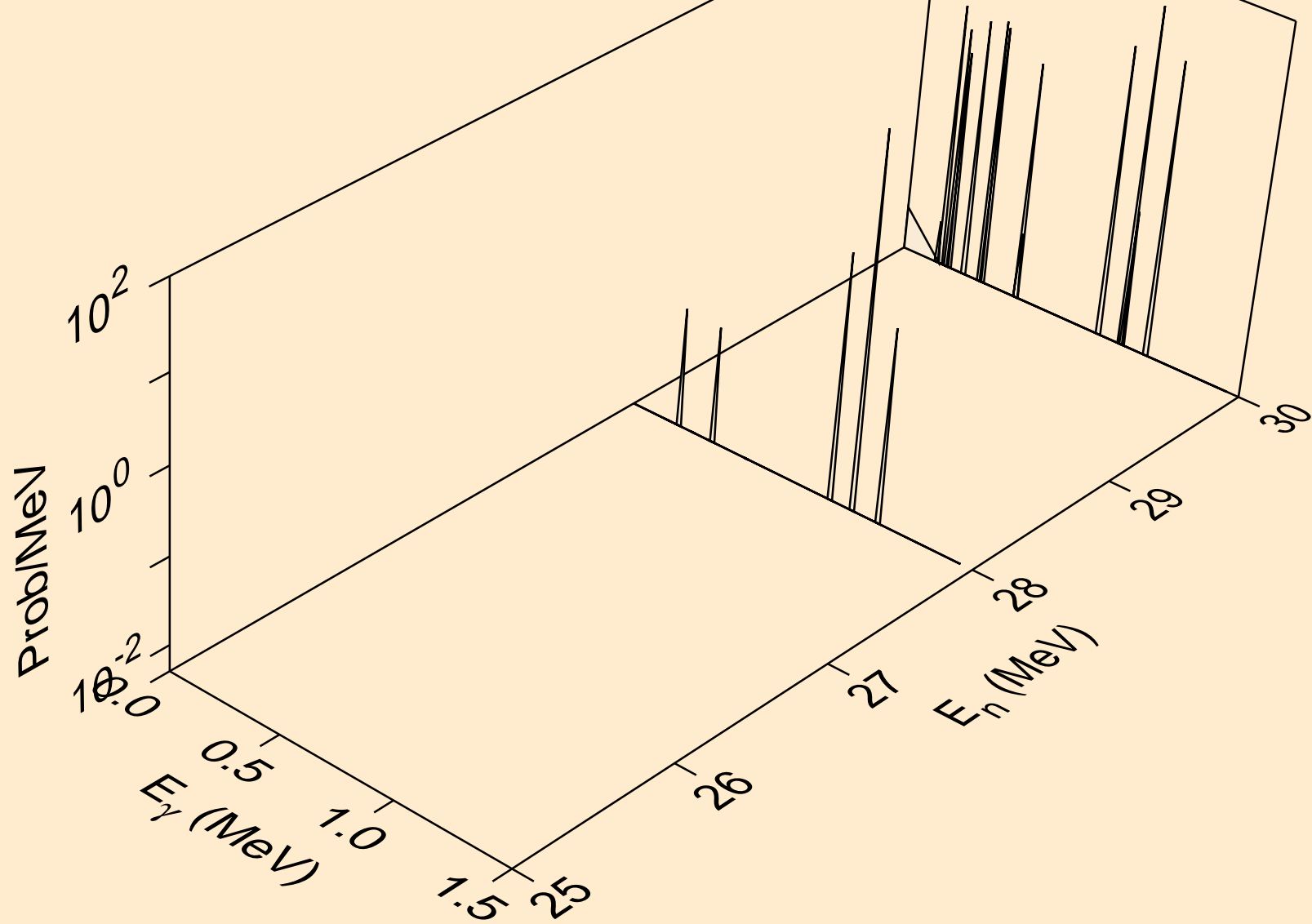

PD095M NEUTRON ACER TENDL-2024 LIBRARY; T=0.K
Photon emission for (n,n*)a

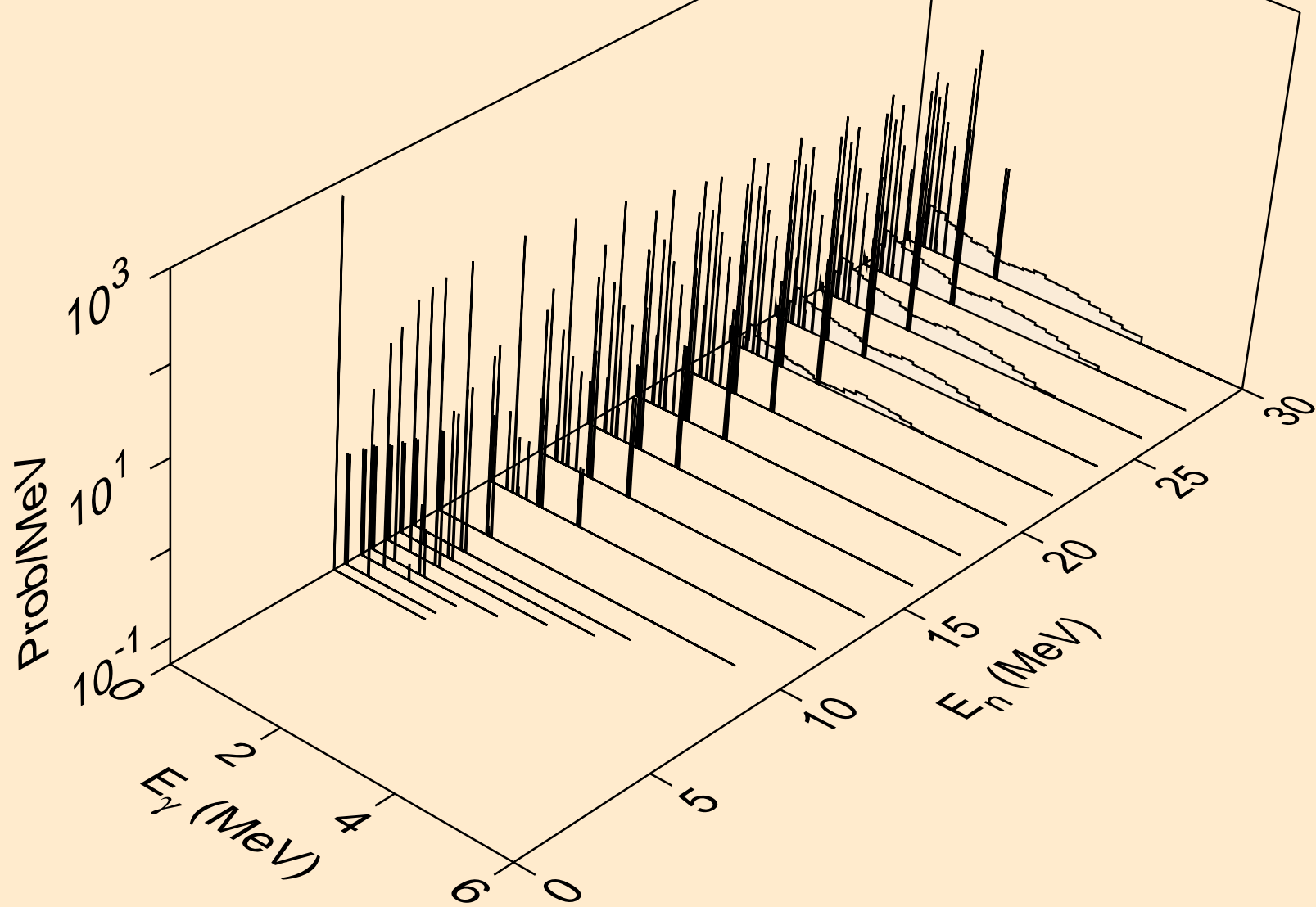

PD095M NEUTRON ACER TENDL-2024 LIBRARY; T=0.K
Photon emission for (n,2n)a

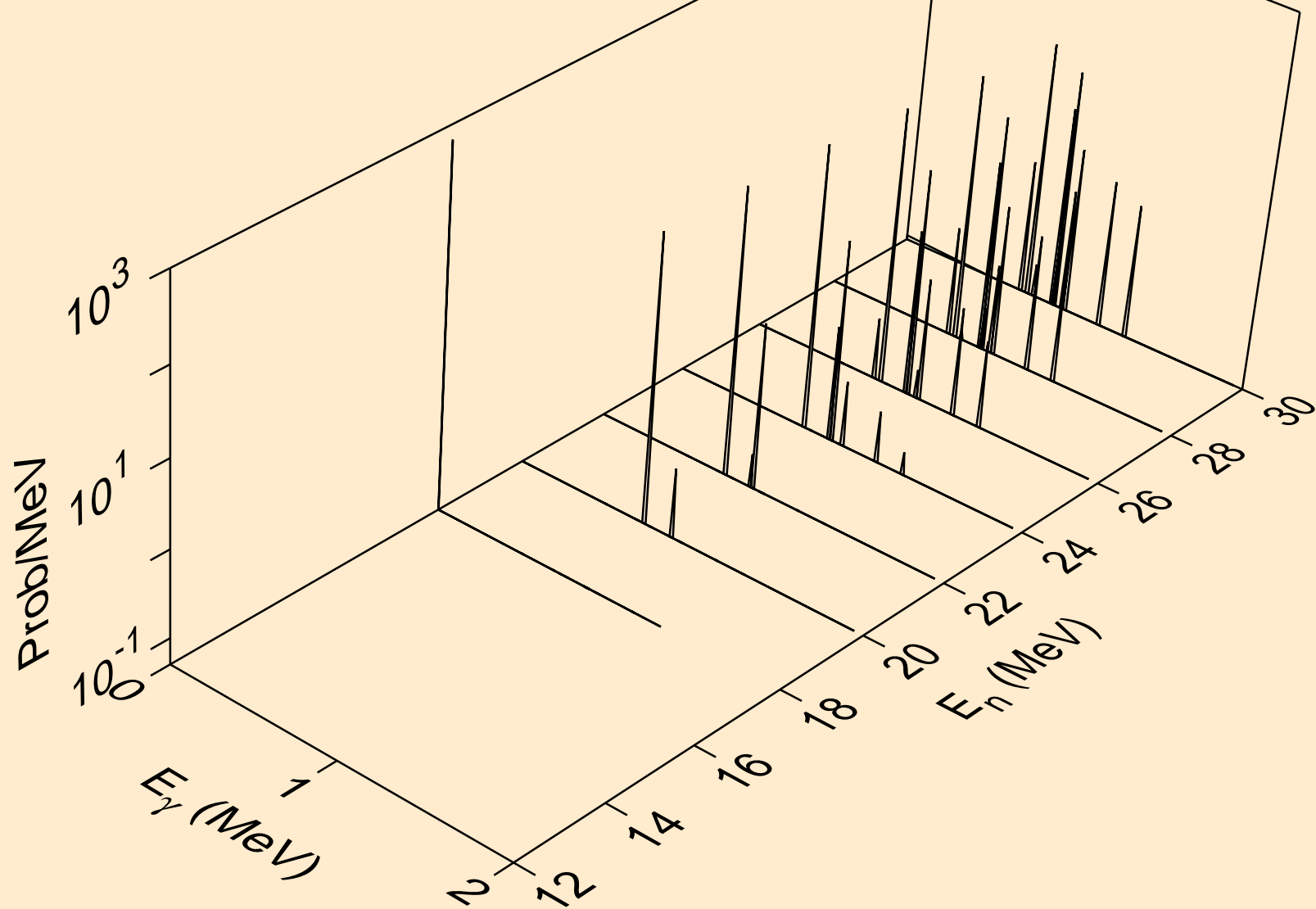

PD095M NEUTRON ACER TENDL-2024 LIBRARY; T=0.K
Photon emission for (n,n*)p

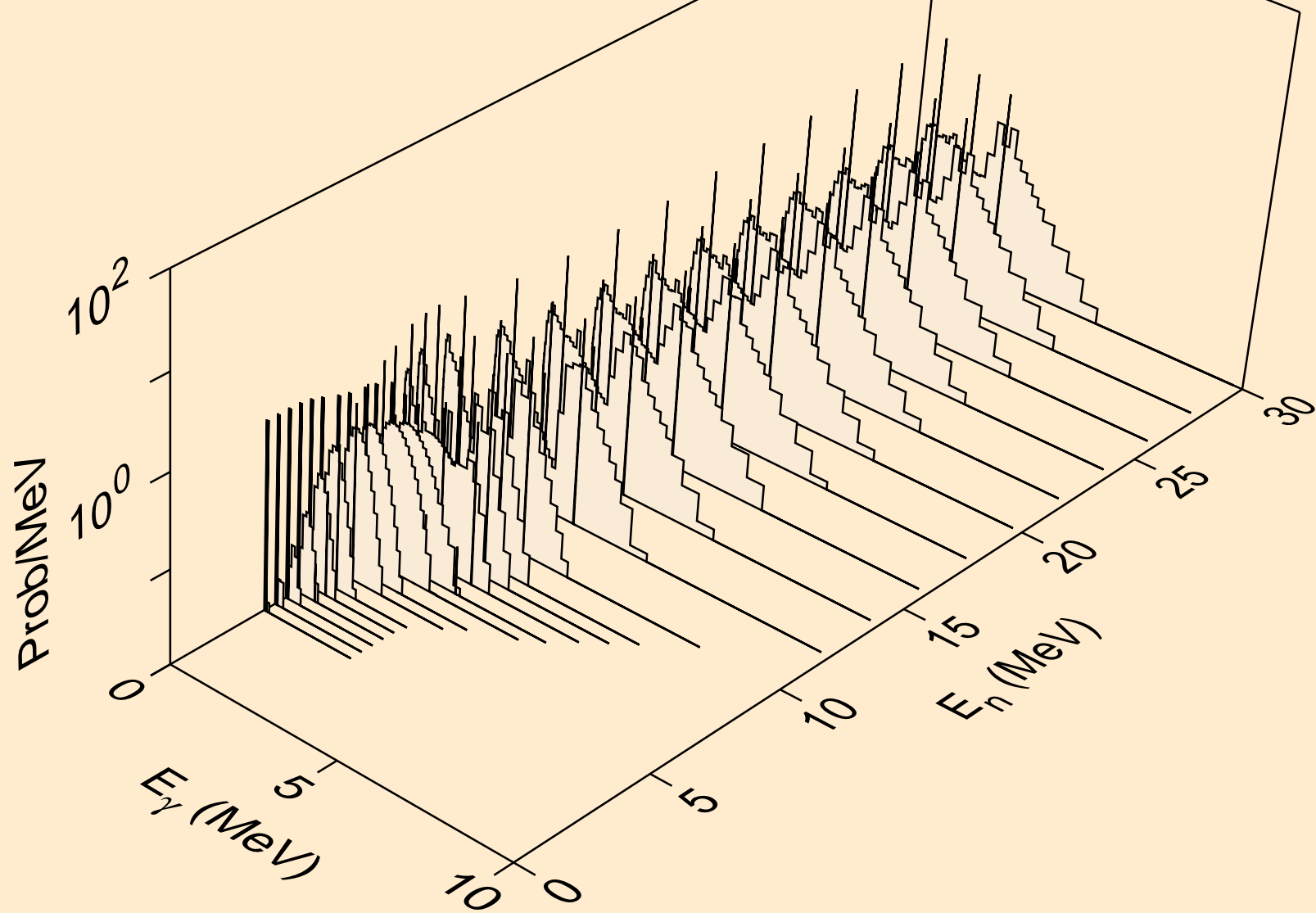

PD095M NEUTRON ACER TENDL-2024 LIBRARY; T=0.K
Photon emission for (n,n*)2a

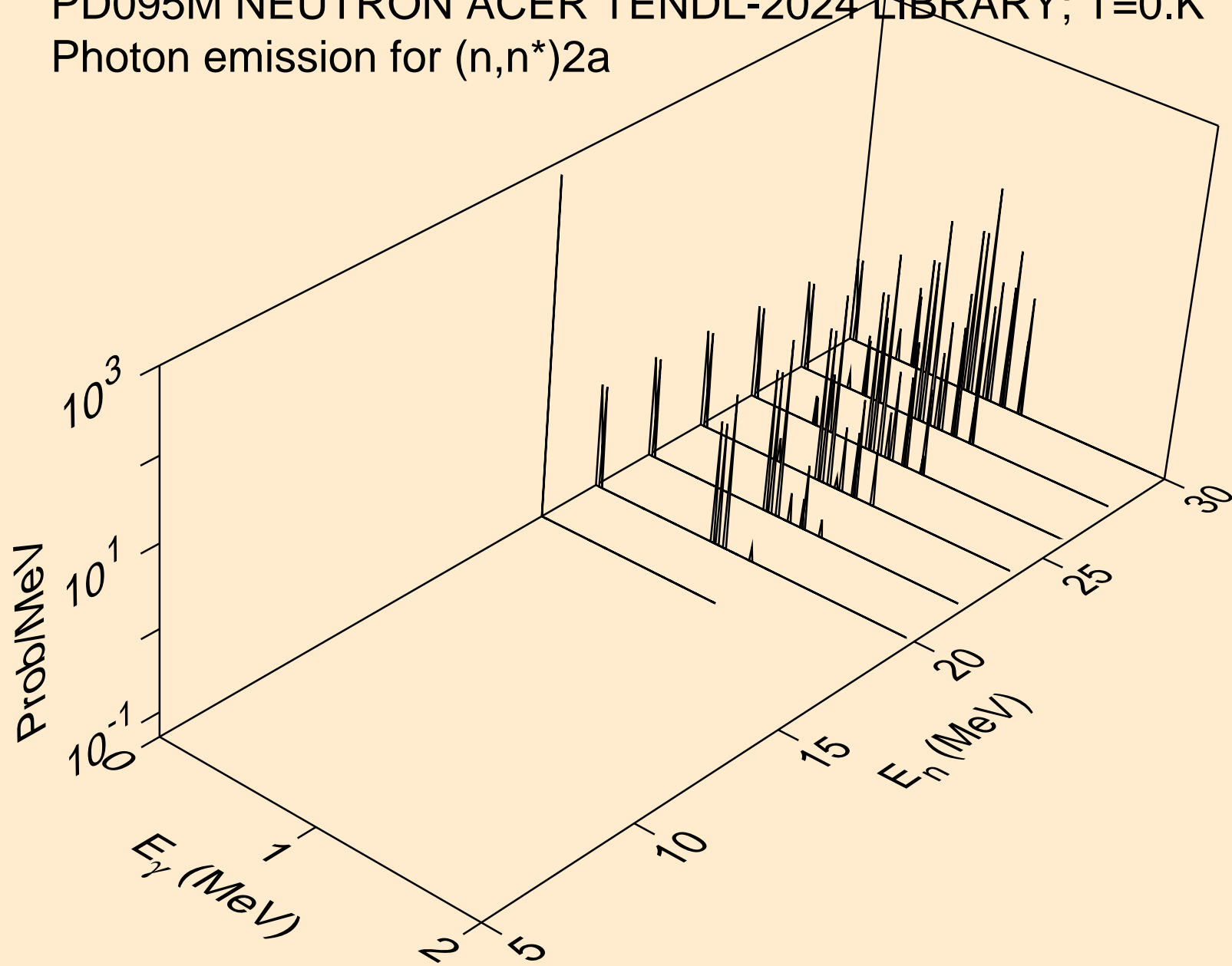

PD095M NEUTRON ACER TENDL-2024 LIBRARY; T=0.K
Photon emission for (n,n*)d

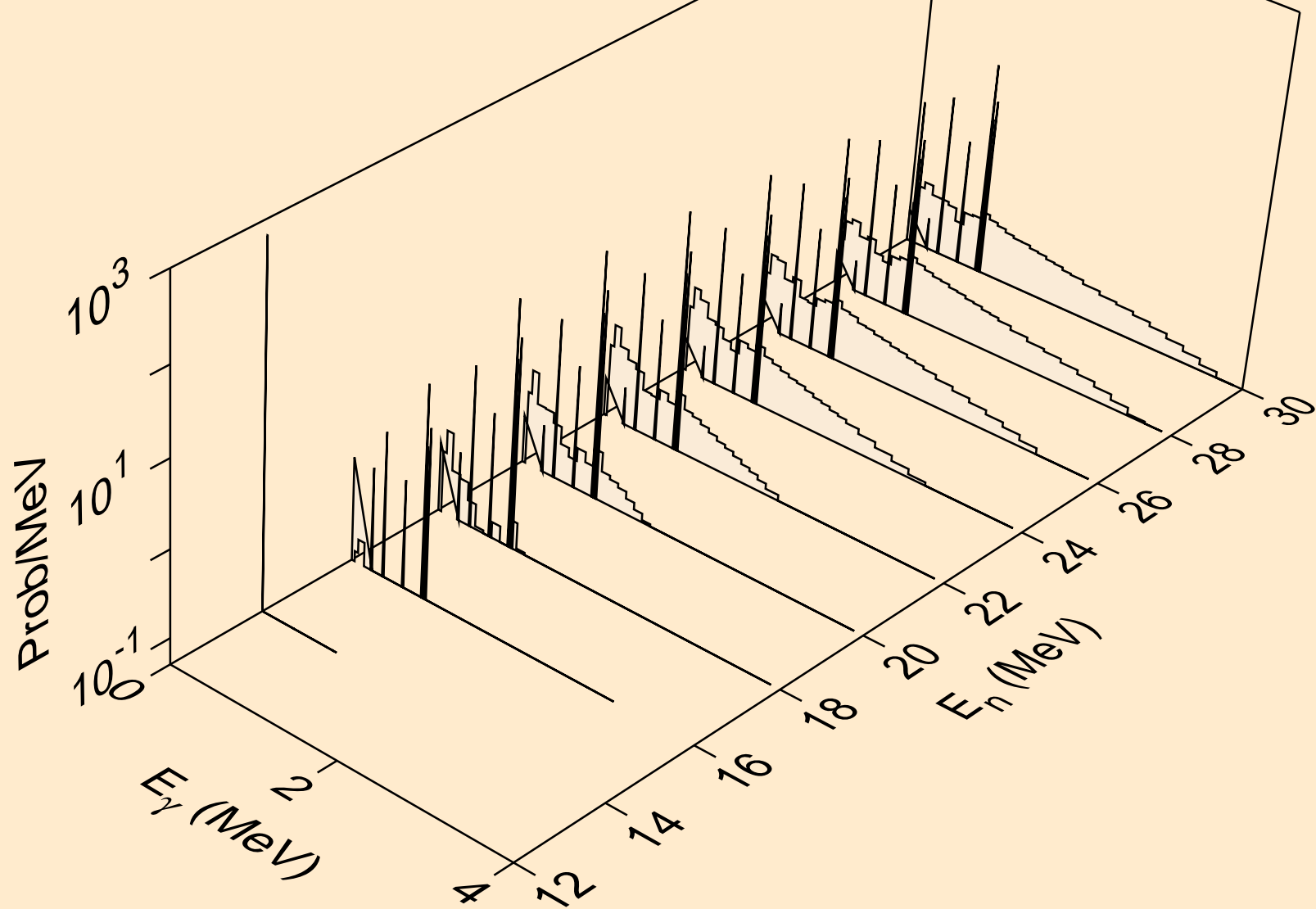

PD095M NEUTRON ACER TENDL-2024 LIBRARY; T=0.K
Photon emission for (n,n*)t

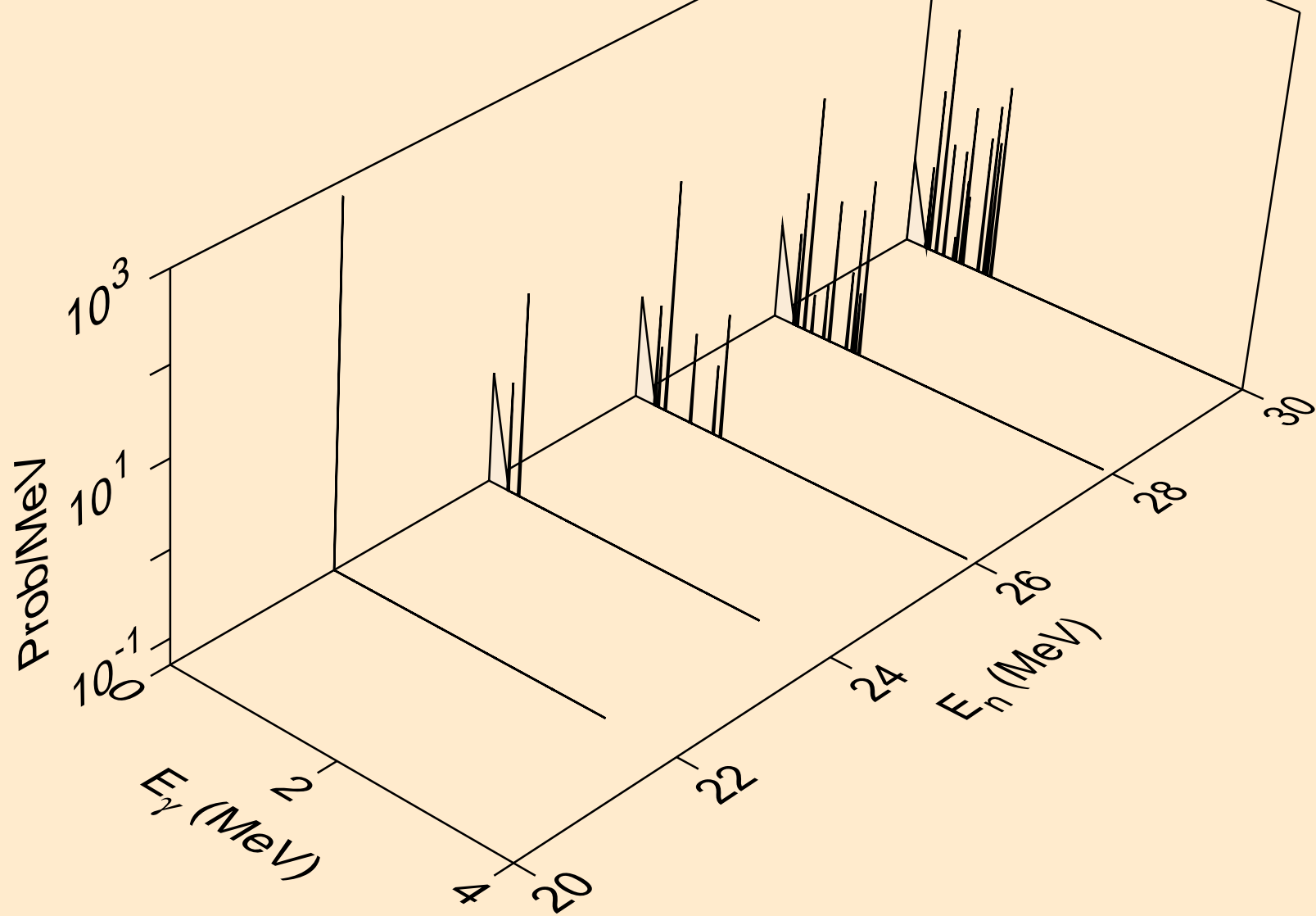

PD095M NEUTRON ACER TENDL-2024 LIBRARY; T=0.K
Photon emission for (n,n*)he3

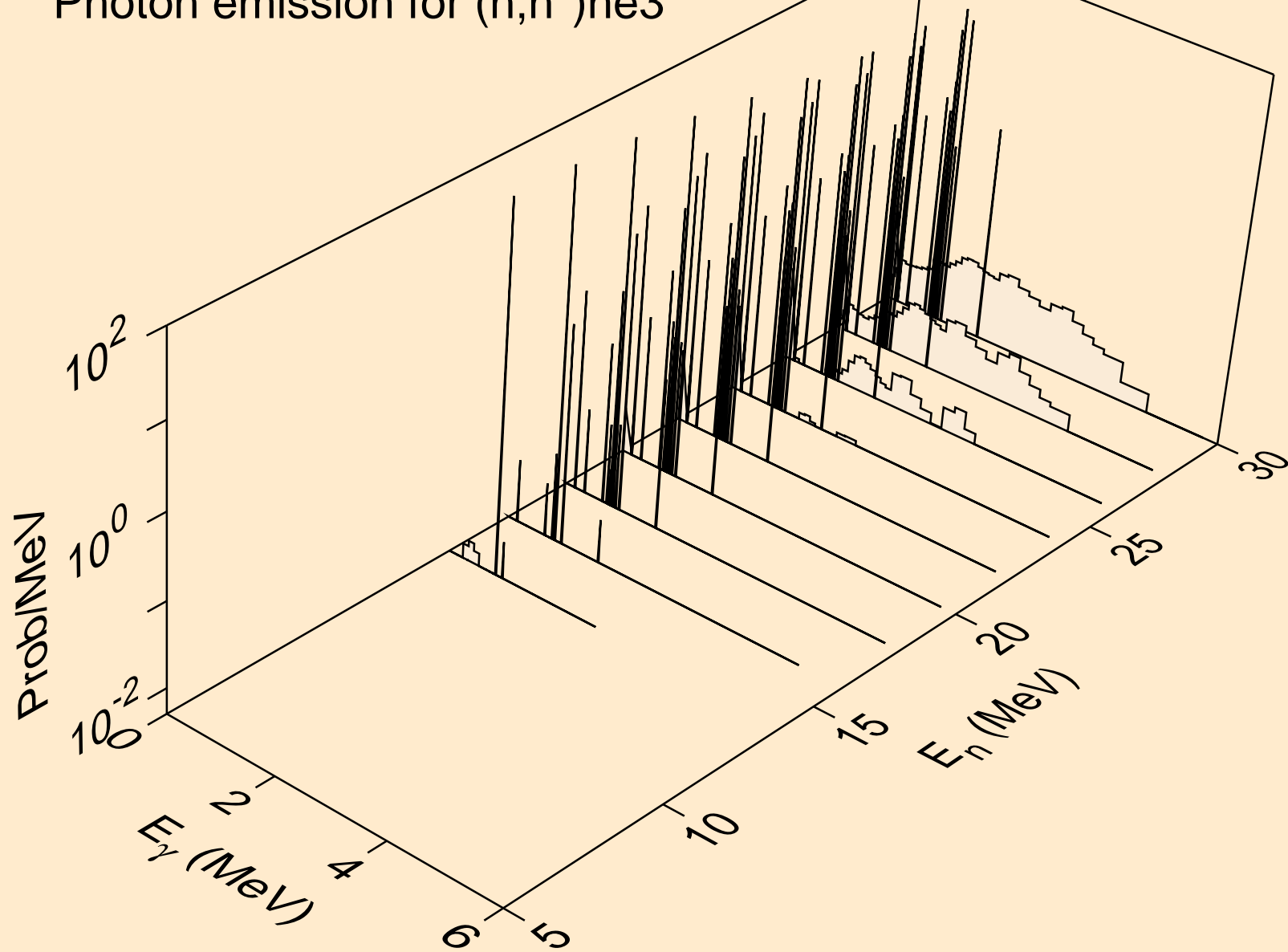

PD095M NEUTRON ACER TENDL-2024 LIBRARY; T=0.K
Photon emission for (n,2np)

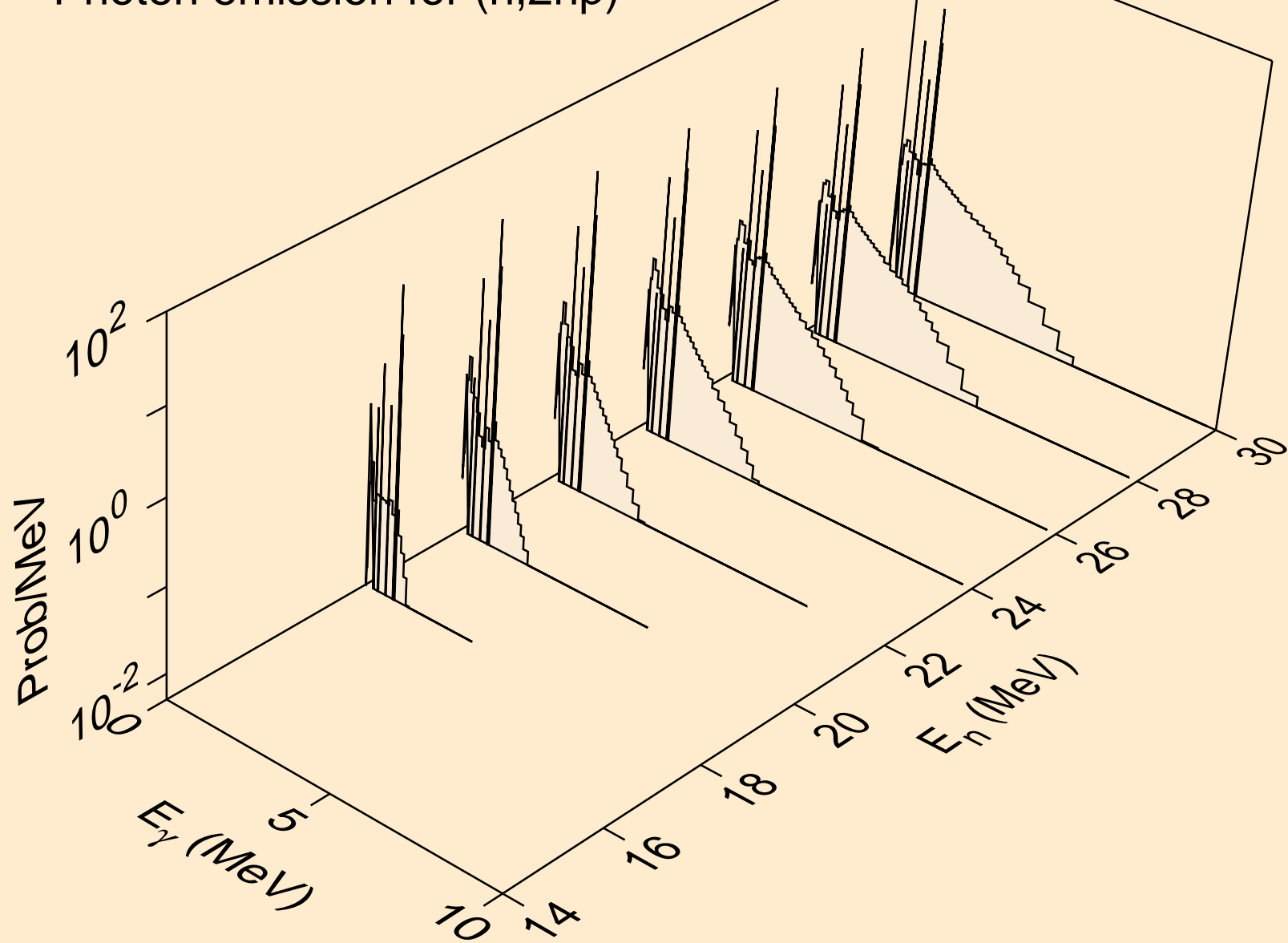

PD095M NEUTRON ACER TENDL-2024 LIBRARY; T=0.K
Photon emission for (n,n2p)

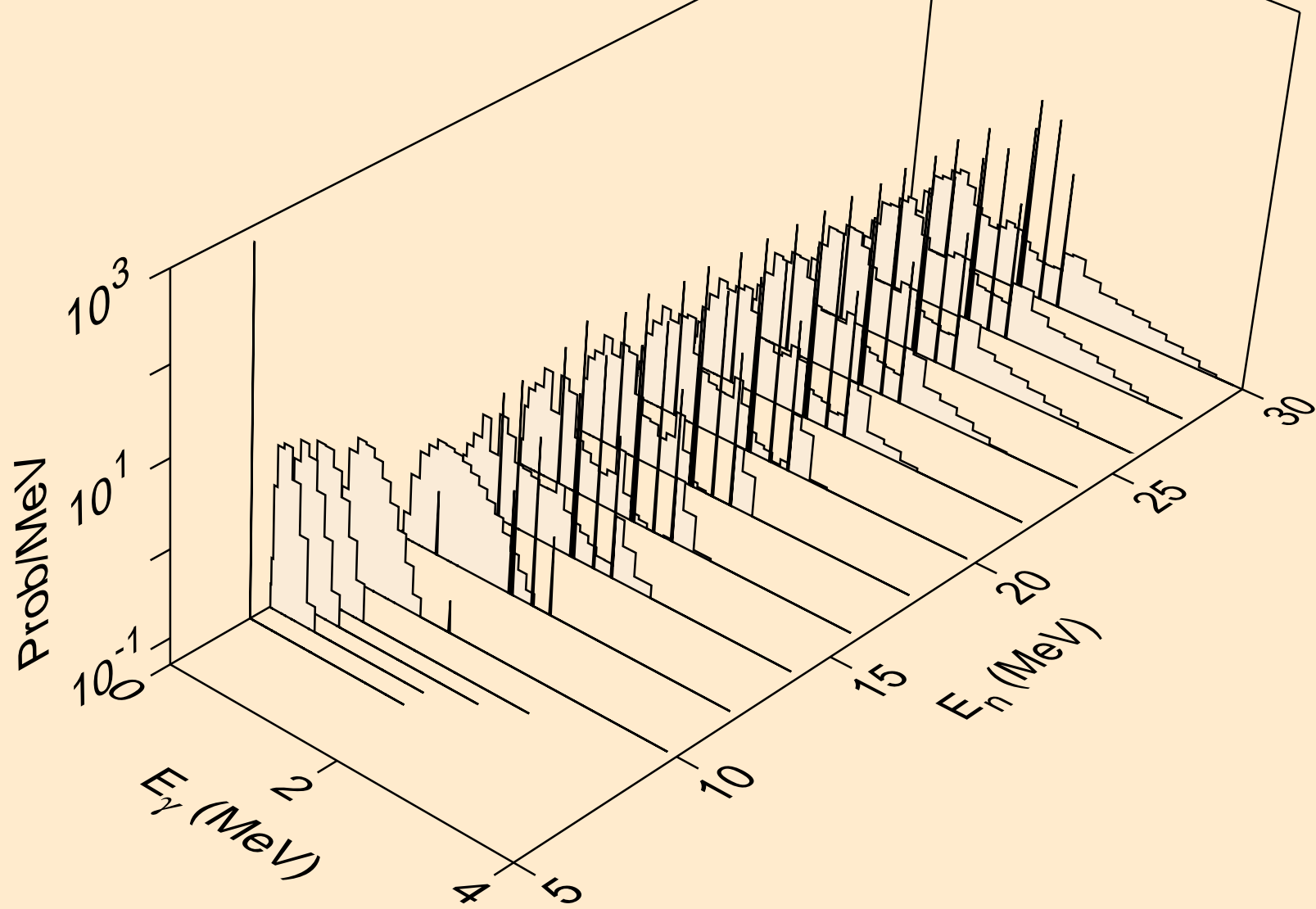

PD095M NEUTRON ACER TENDL-2024 LIBRARY; T=0.K
Photon emission for (n,npa)

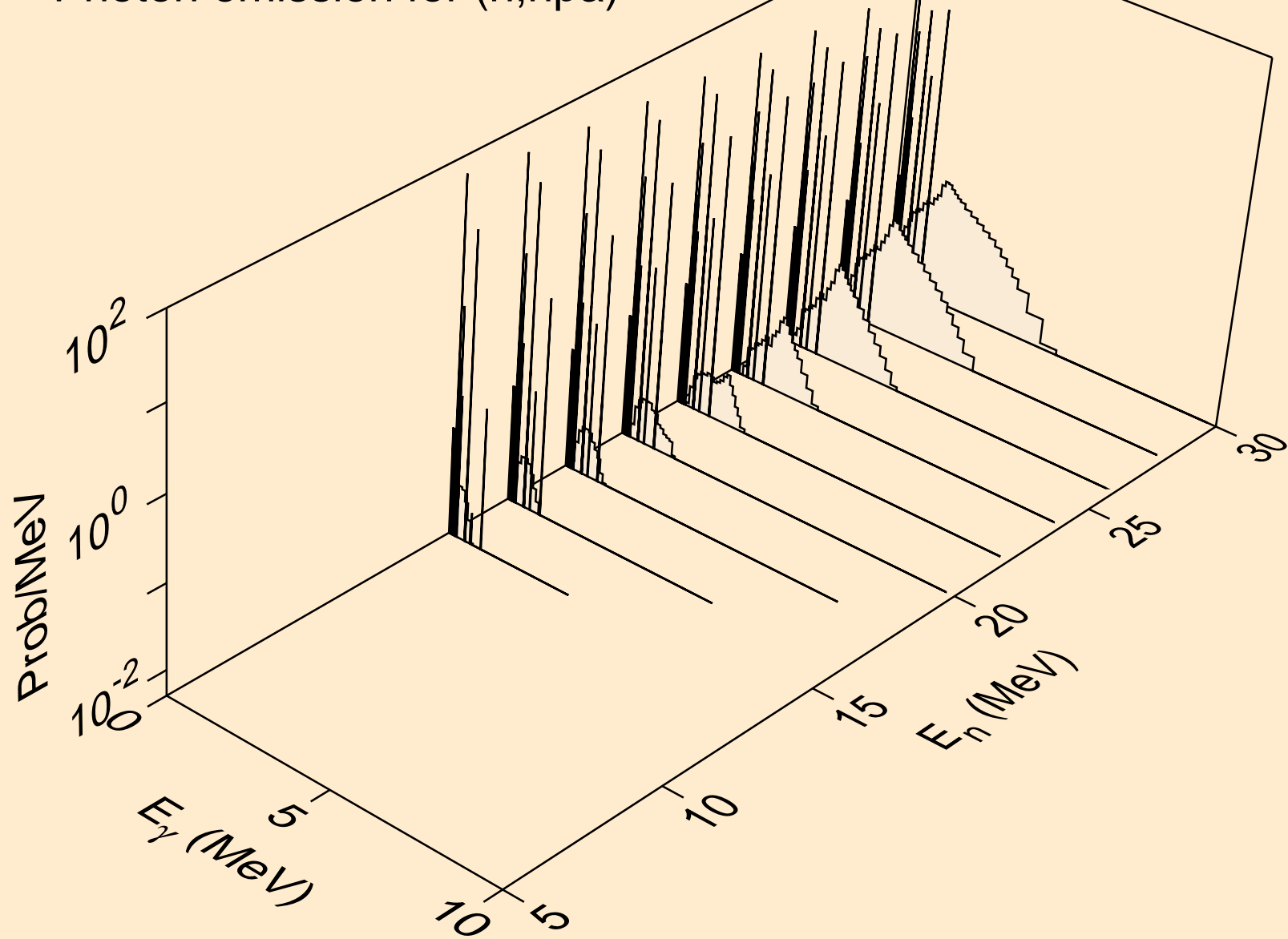

PD095M NEUTRON ACER TENDL-2024 LIBRARY; T=0.K
Photon emission for (n,n*1)

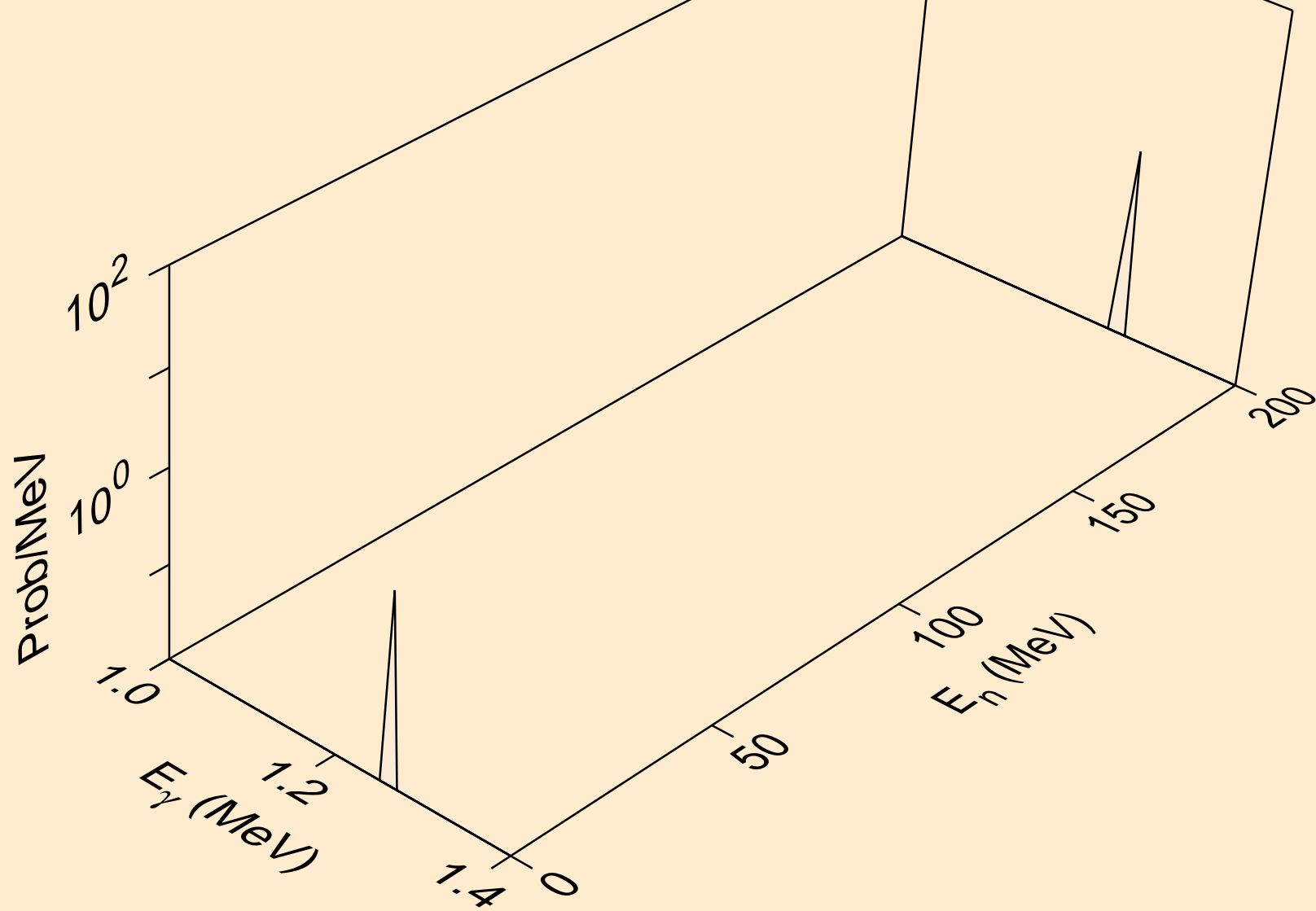

PD095M NEUTRON ACER TENDL-2024 LIBRARY; T=0.K
Photon emission for (n,n*2)

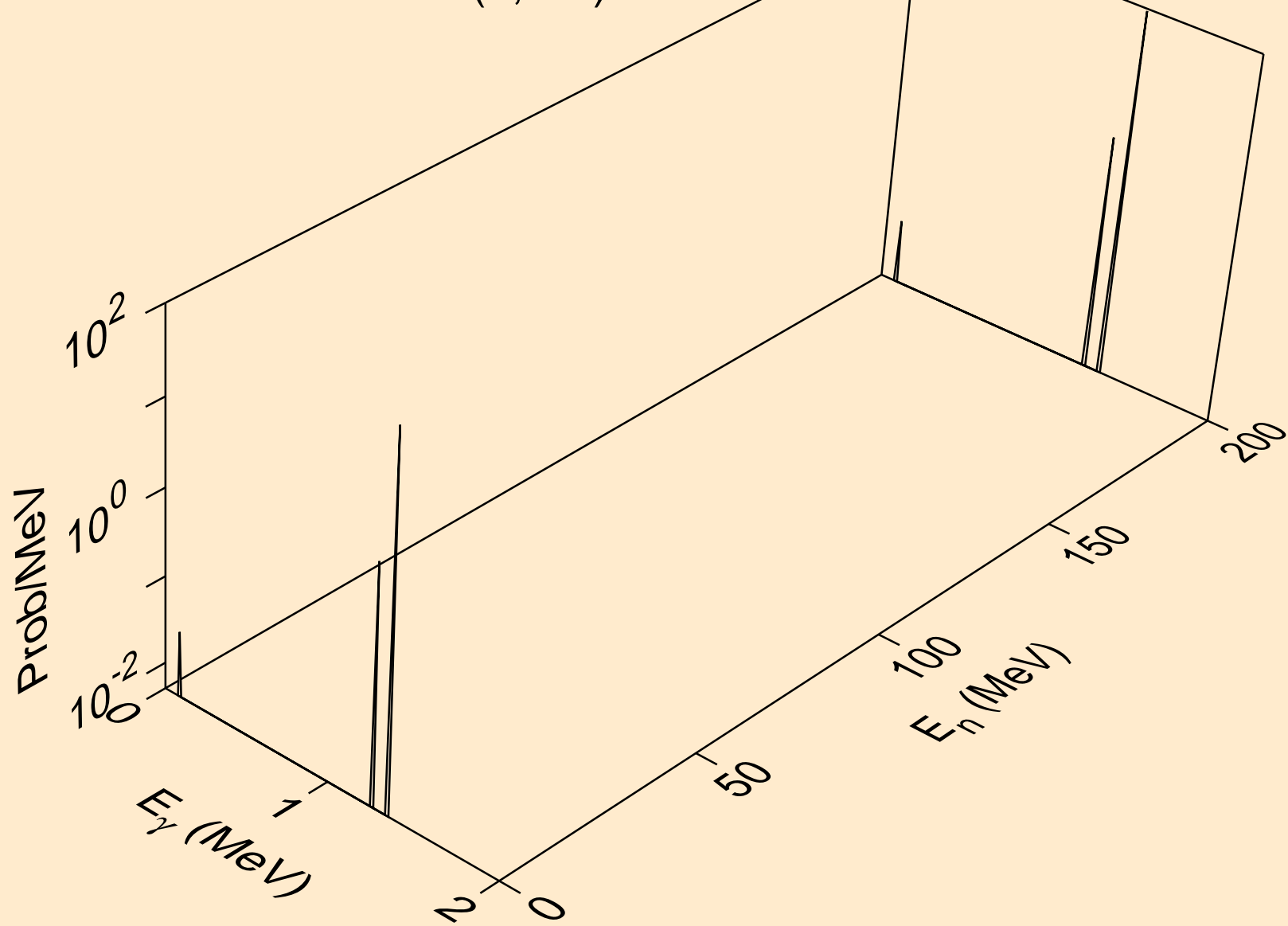

PD095M NEUTRON ACER TENDL-2024 LIBRARY; T=0.K
Photon emission for (n,n*3)

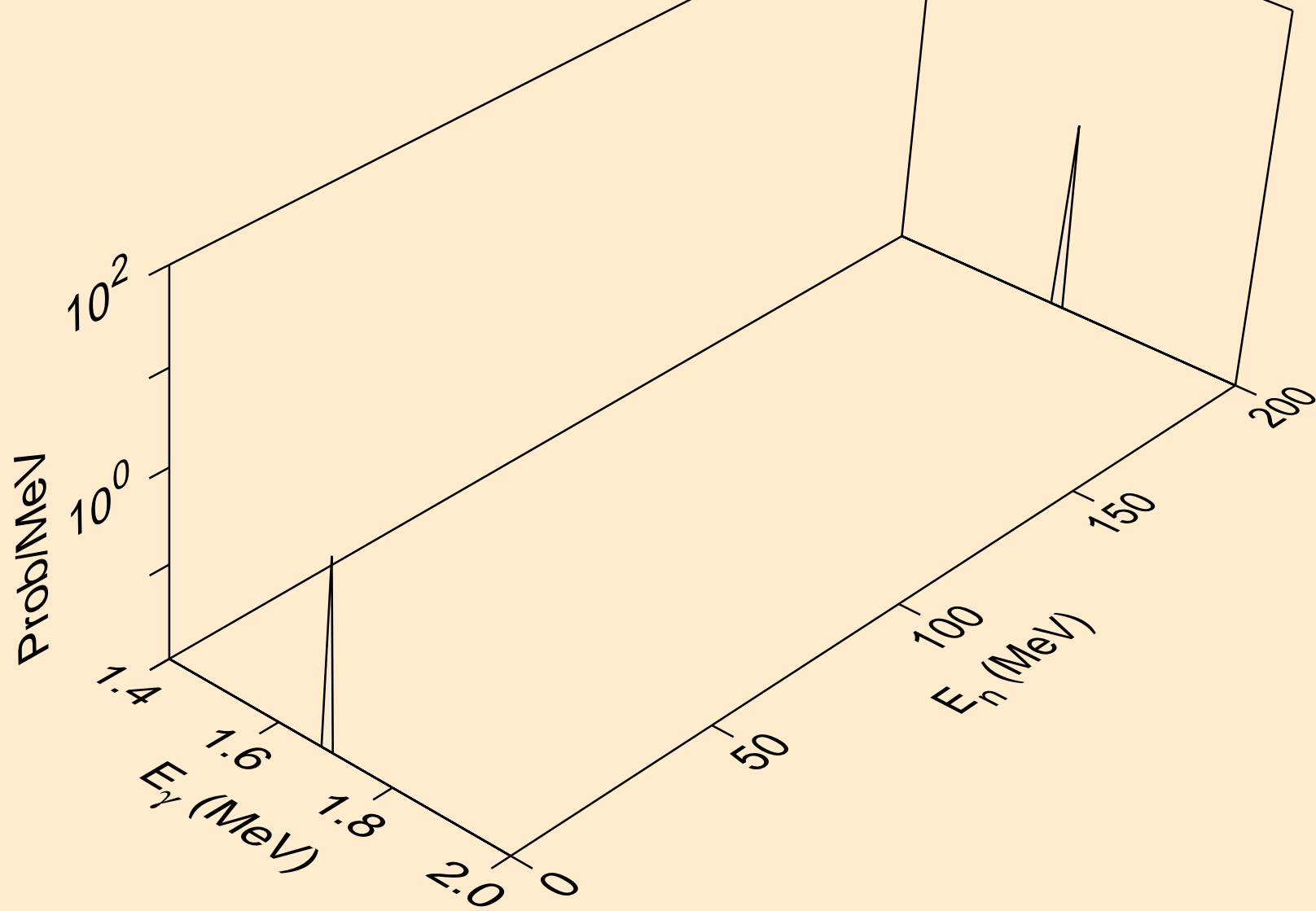

PD095M NEUTRON ACER TENDL-2024 LIBRARY; T=0.K
Photon emission for (n,n*4)

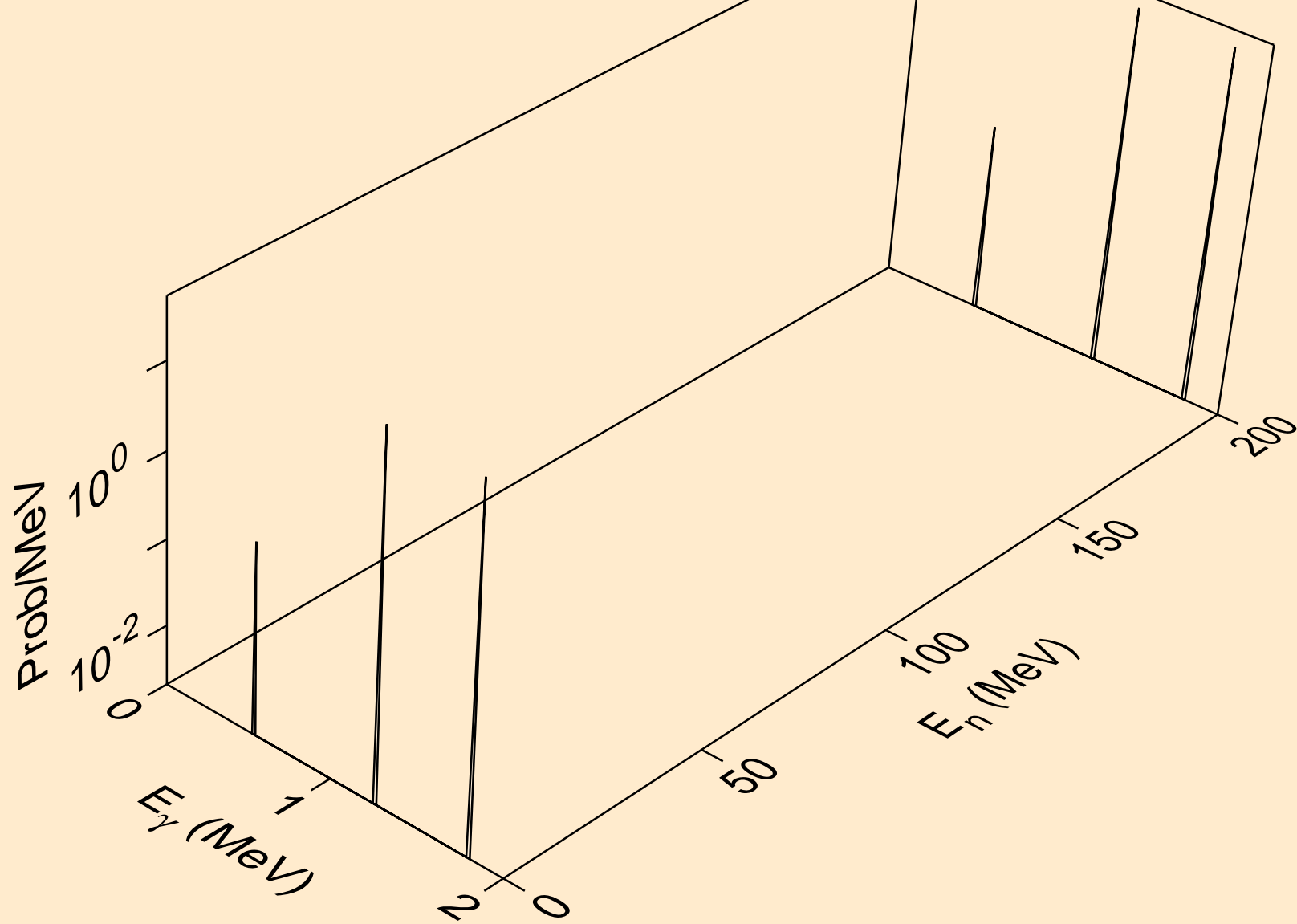

PD095M NEUTRON ACER TENDL-2024 LIBRARY; T=0.K
Photon emission for (n,n*6)

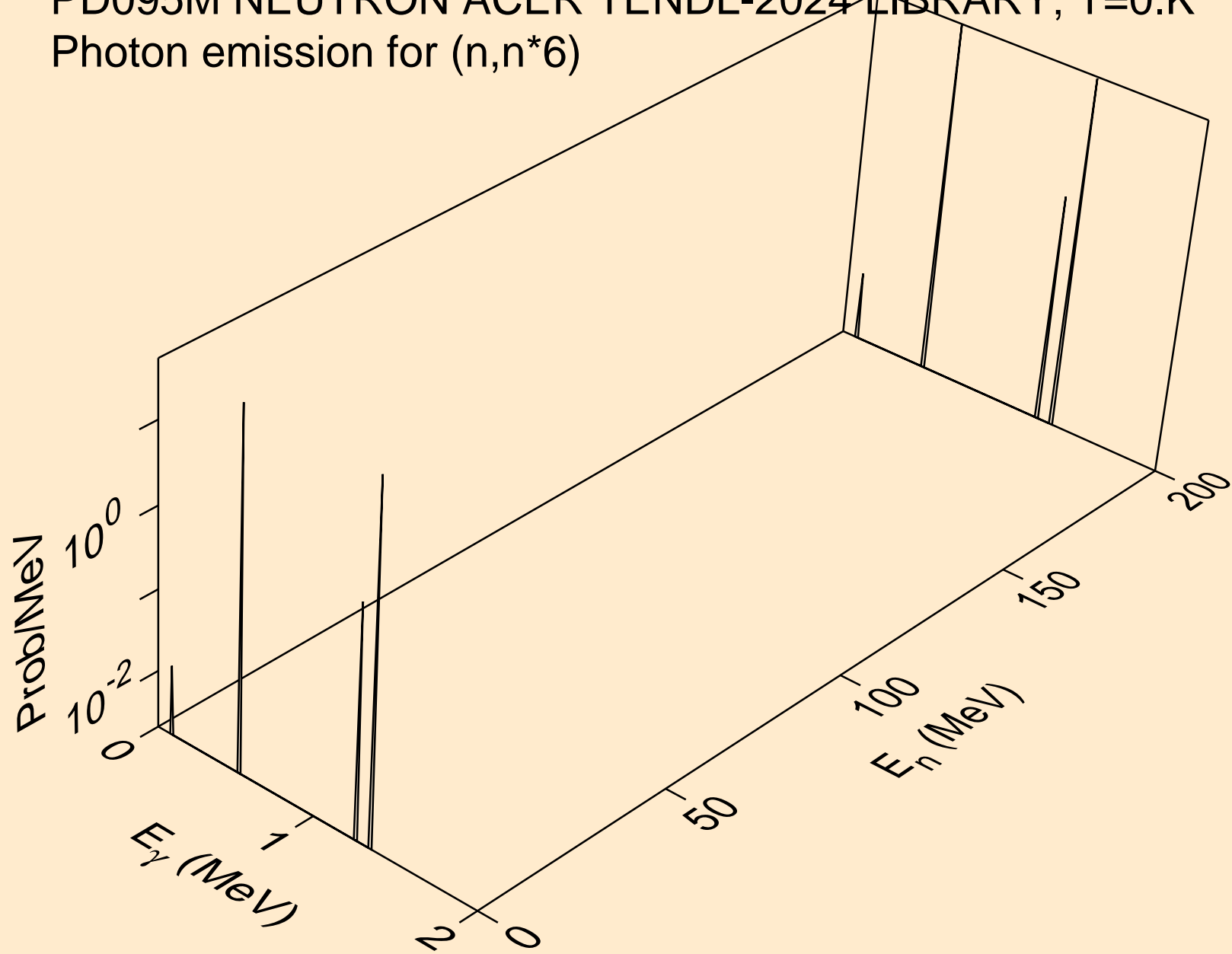

PD095M NEUTRON ACER TENDL-2024 LIBRARY; T=0.K
Photon emission for (n,n*7)

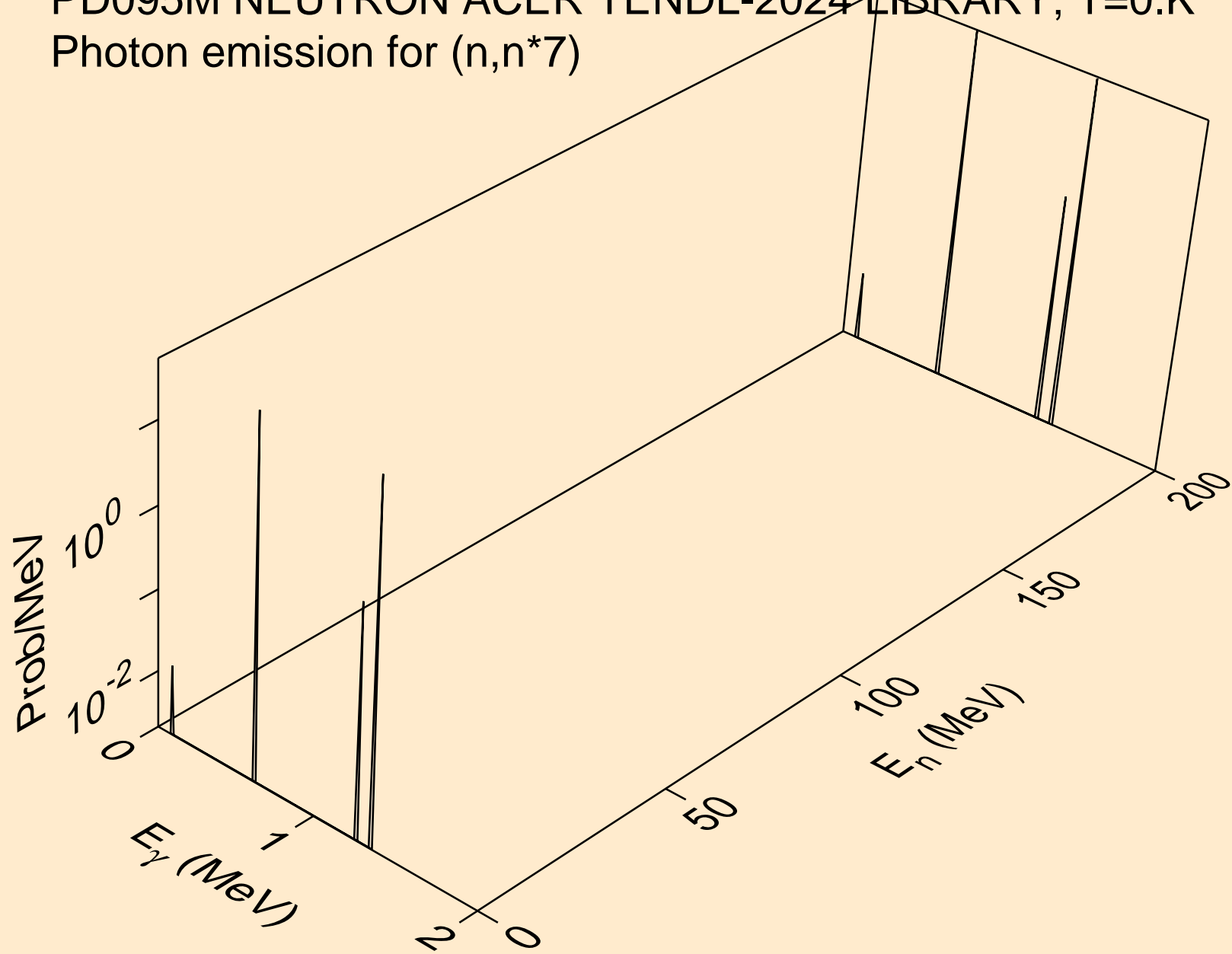

PD095M NEUTRON ACER TENDL-2024 LIBRARY; T=0.K
Photon emission for (n,n*8)

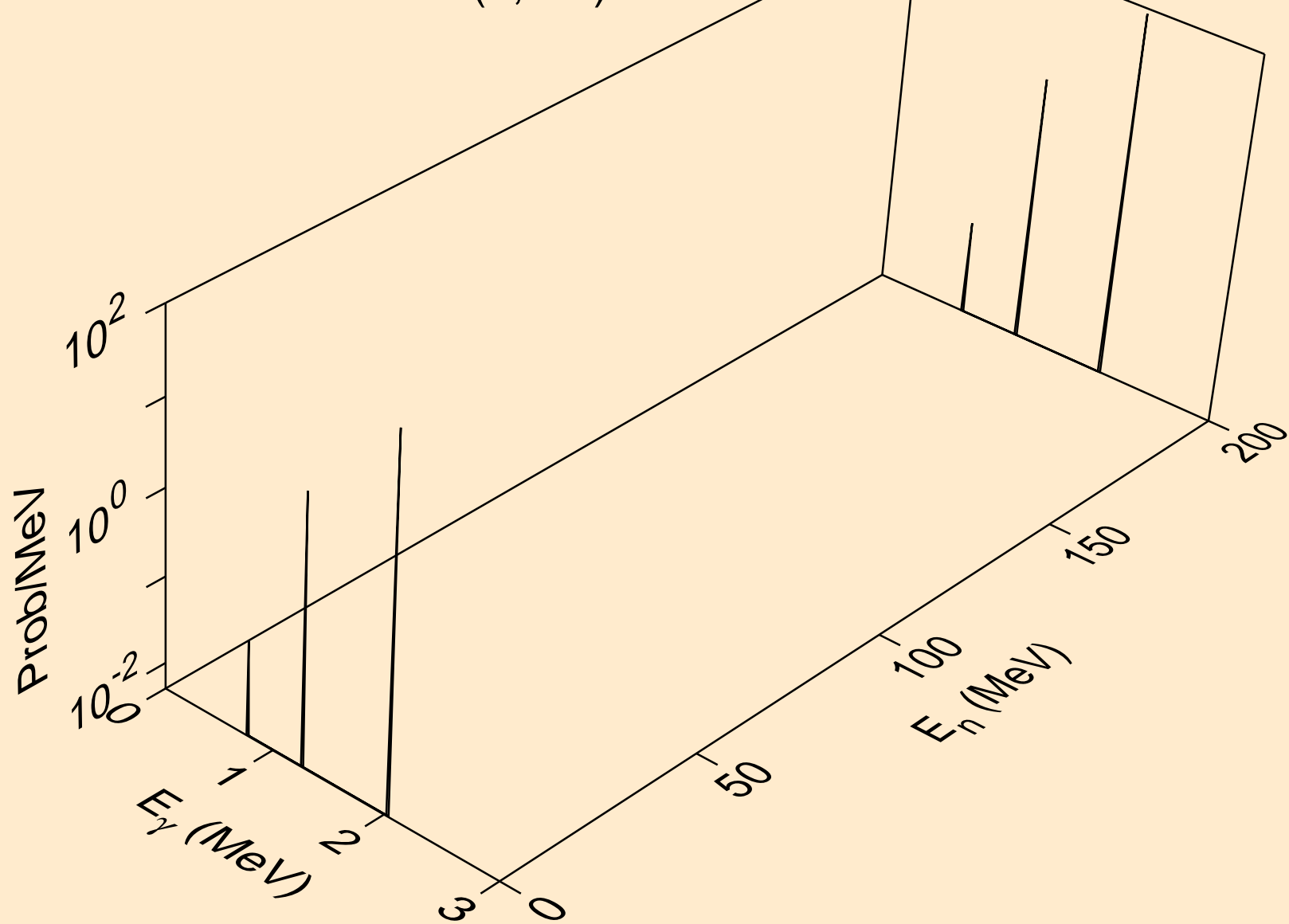

PD095M NEUTRON ACER TENDL-2024 LIBRARY; T=0.K
Photon emission for (n,n*9)

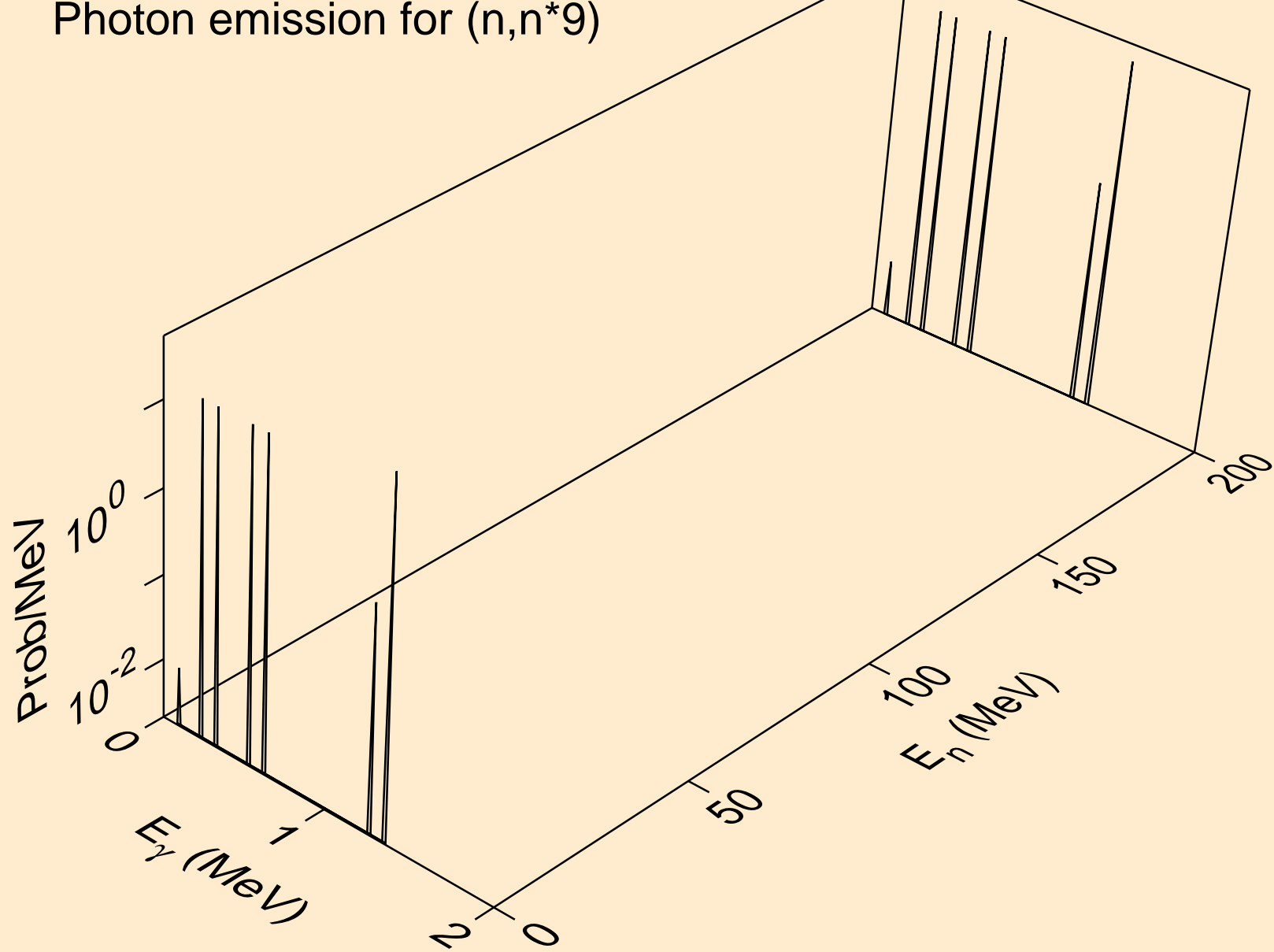

PD095M NEUTRON ACER TENDL-2024 LIBRARY; T=0.K
Photon emission for (n,n*10)

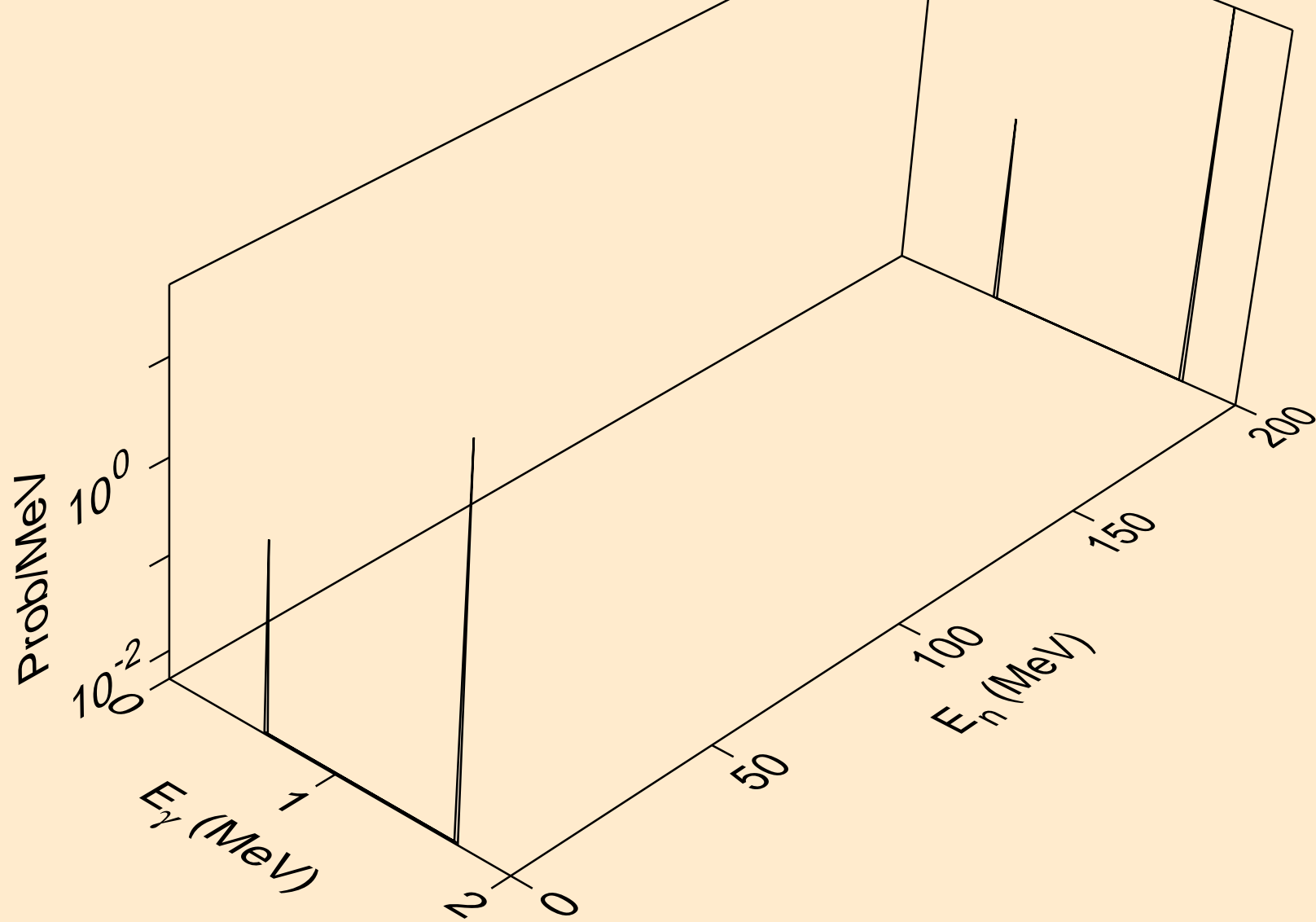

PD095M NEUTRON ACER TENDL-2024 LIBRARY; T=0.K
Photon emission for (n,n*11)

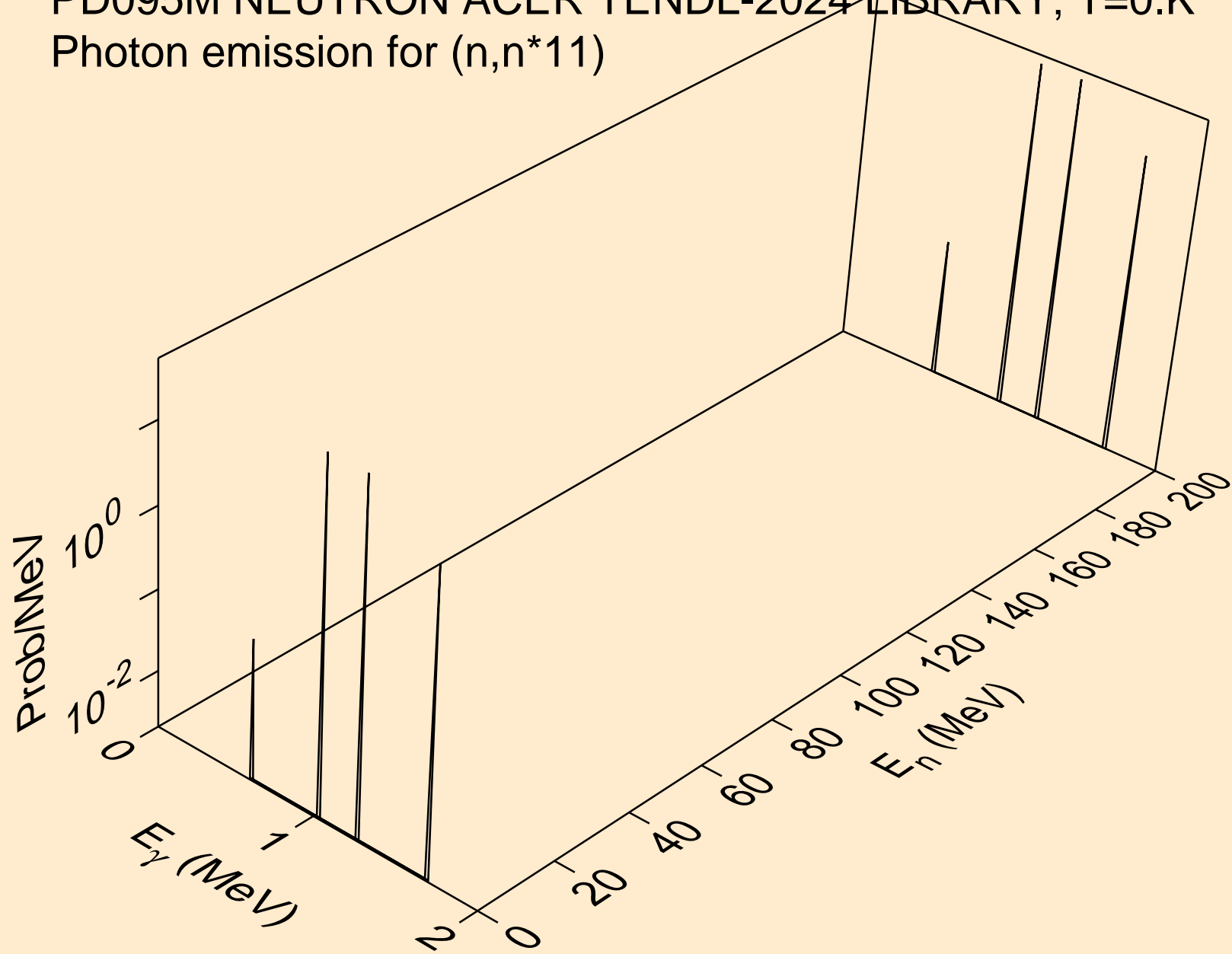

PD095M NEUTRON ACER TENDL-2024 LIBRARY; T=0.K
Photon emission for (n,n*12)

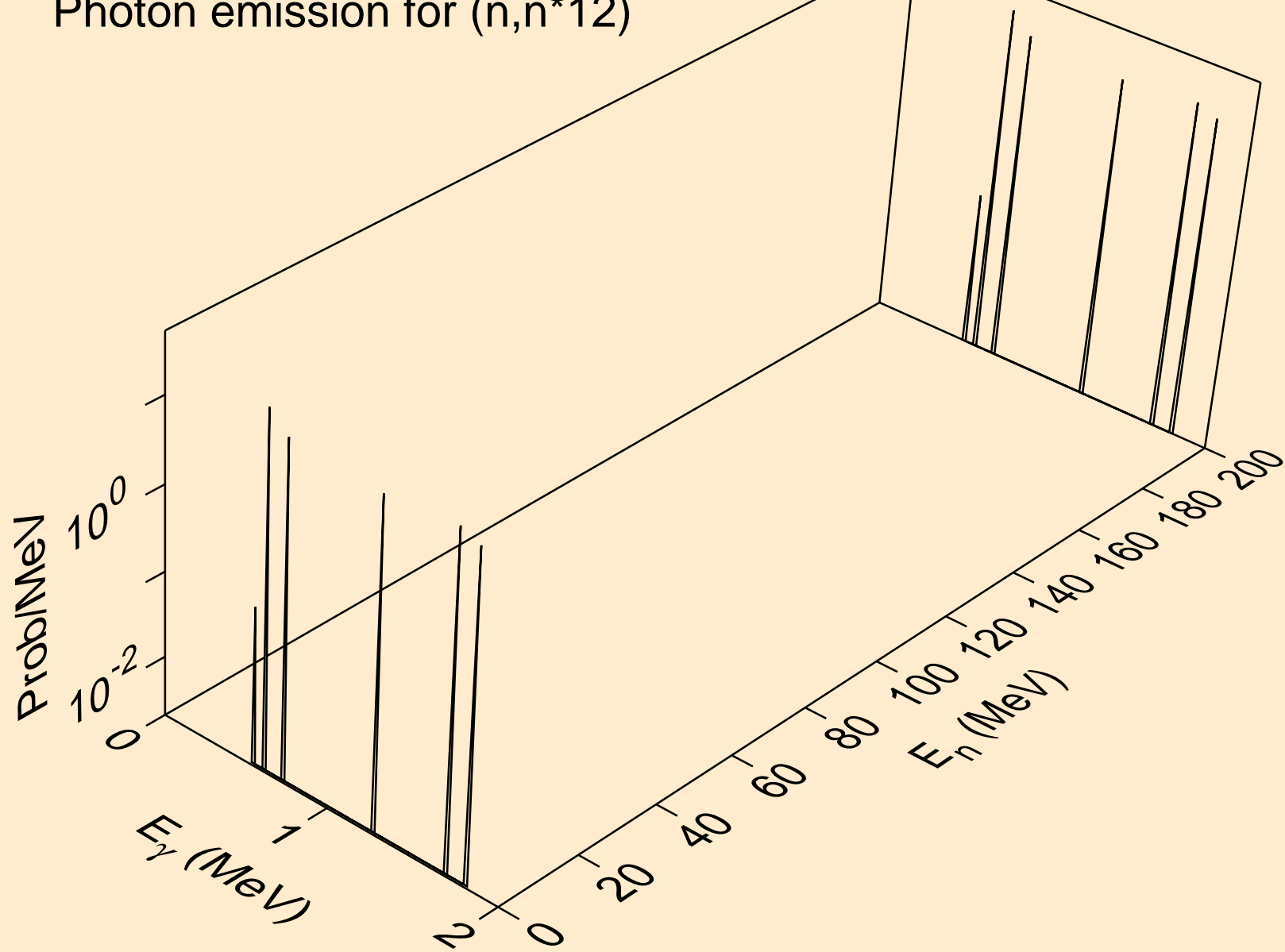

PD095M NEUTRON ACER TENDL-2024 LIBRARY; T=0.K
Photon emission for (n,n*13)

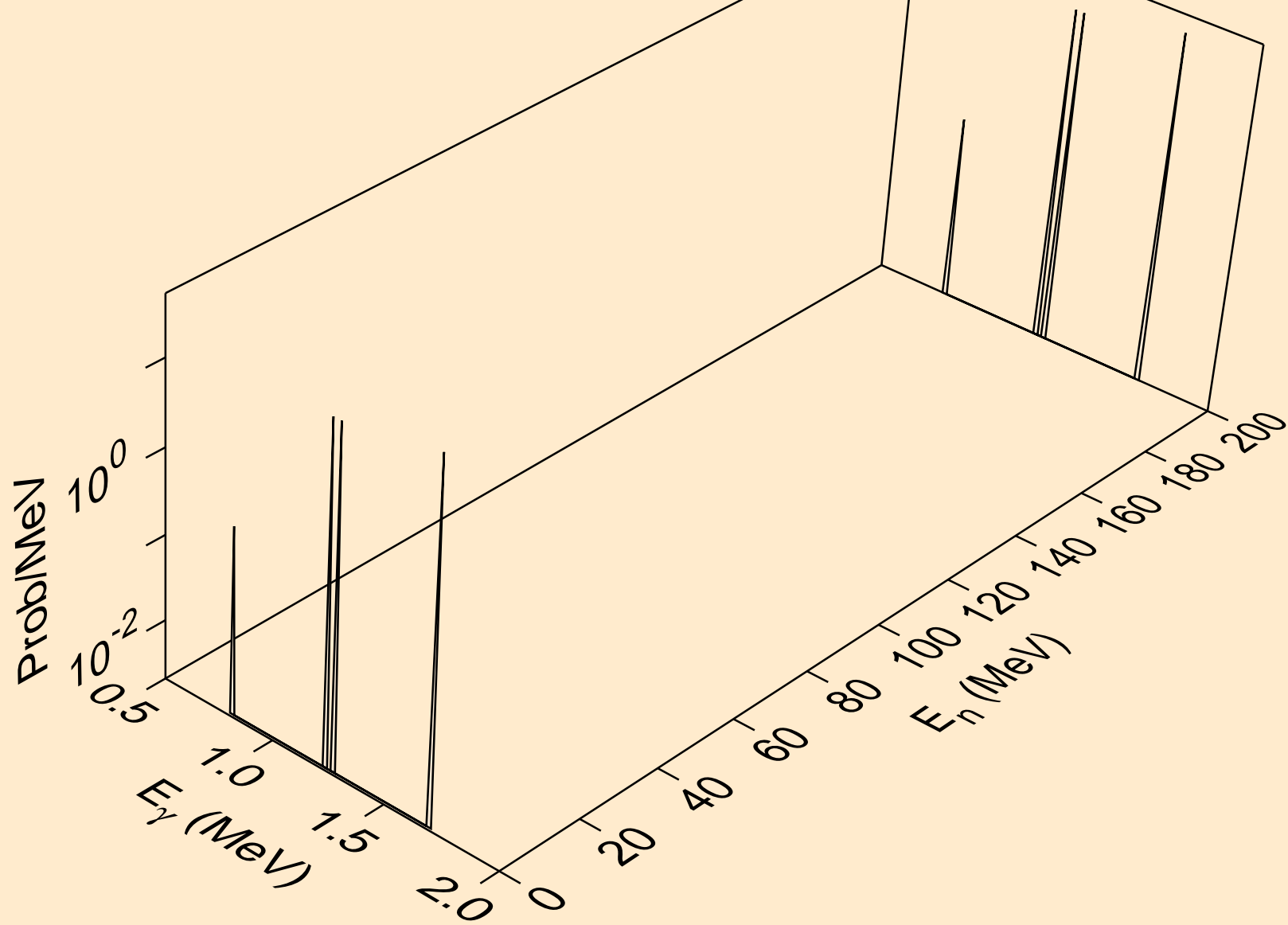

PD095M NEUTRON ACER TENDL-2024 LIBRARY; T=0.K
Photon emission for (n,n*14)

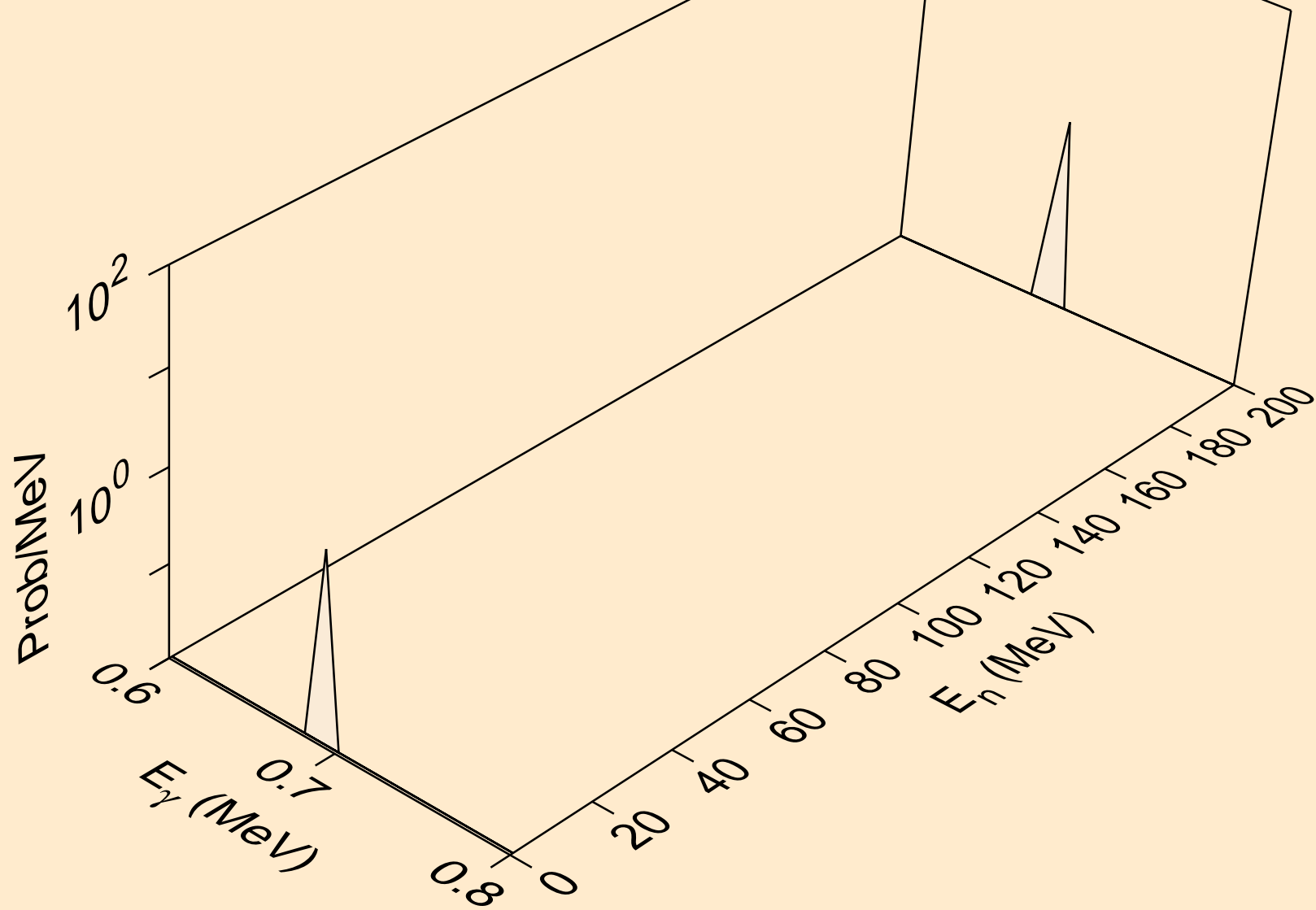

PD095M NEUTRON ACER TENDL-2024 LIBRARY; T=0.K
Photon emission for (n,n*15)

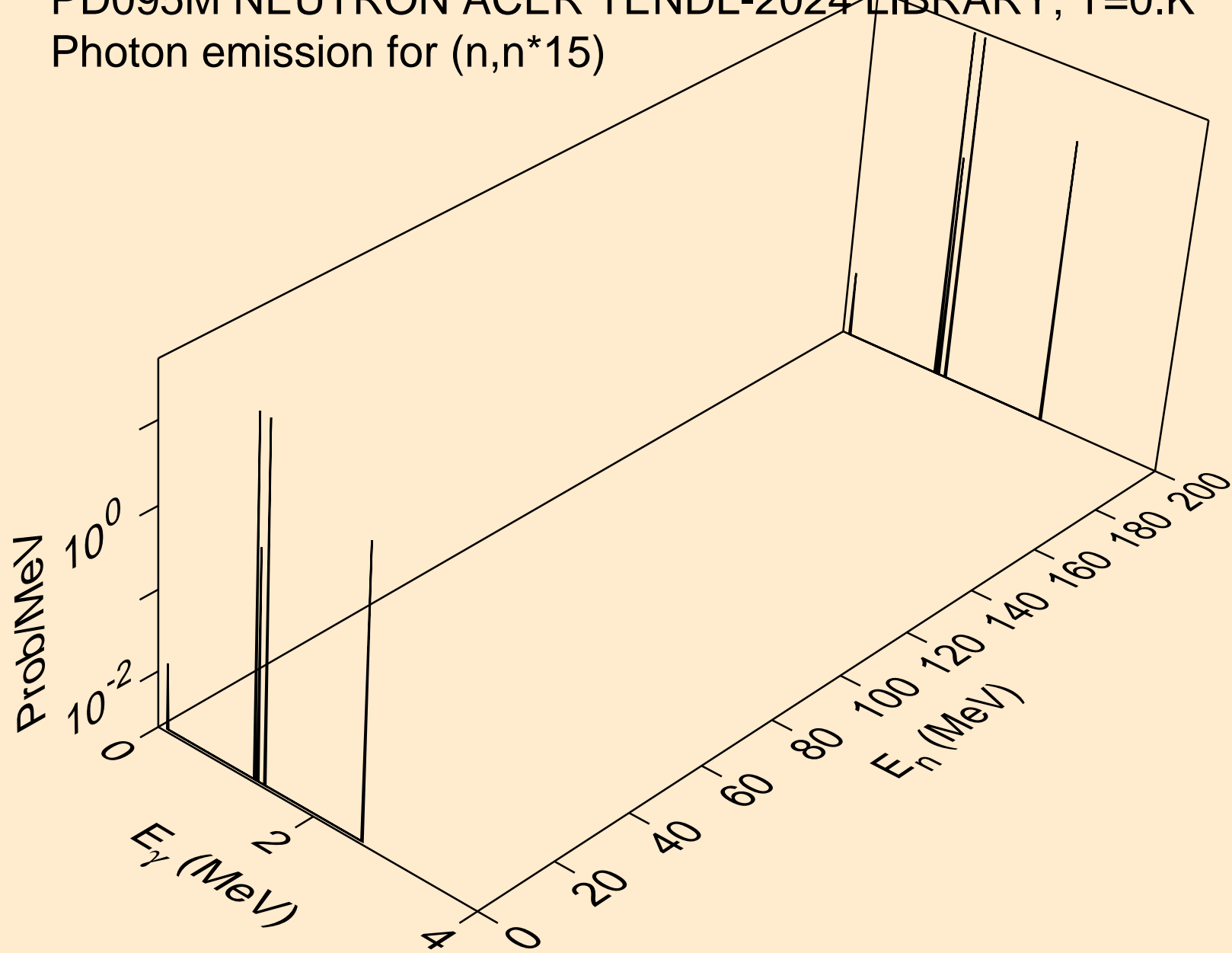

PD095M NEUTRON ACER TENDL-2024 LIBRARY; T=0.K
Photon emission for (n,n*16)

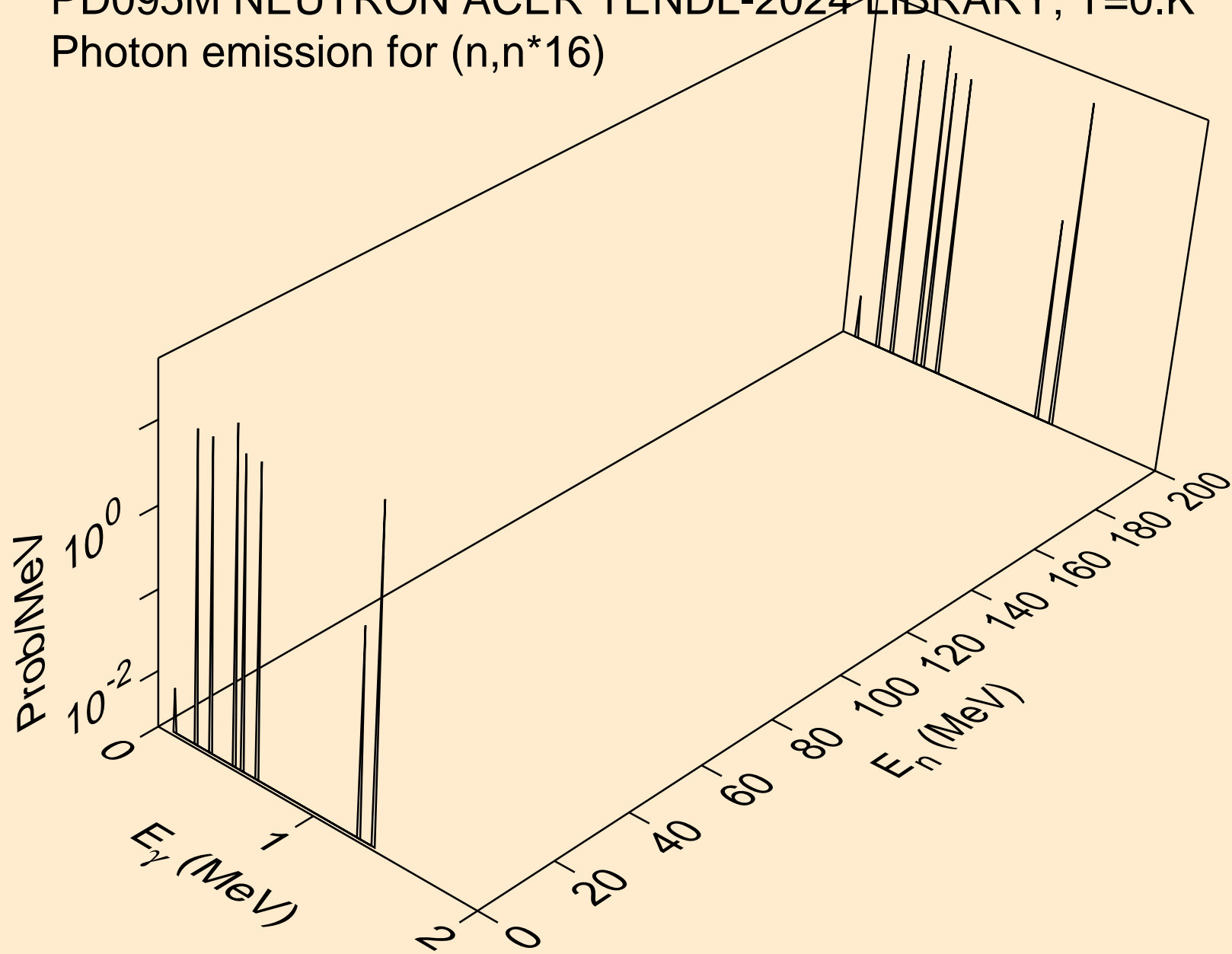

PD095M NEUTRON ACER TENDL-2024 LIBRARY; T=0.K
Photon emission for (n,n*17)

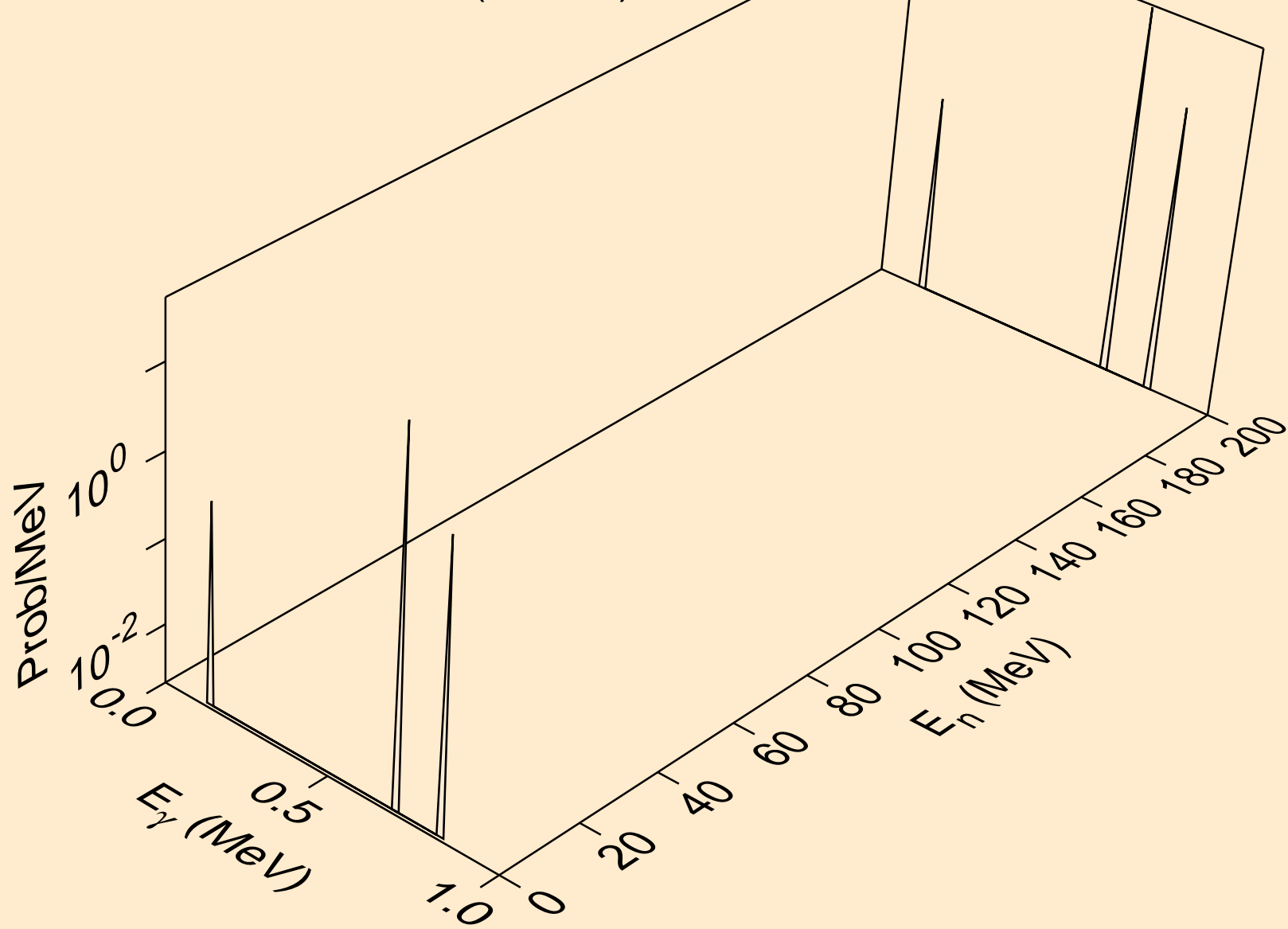

PD095M NEUTRON ACER TENDL-2024 LIBRARY; T=0.K
Photon emission for (n,n*c)

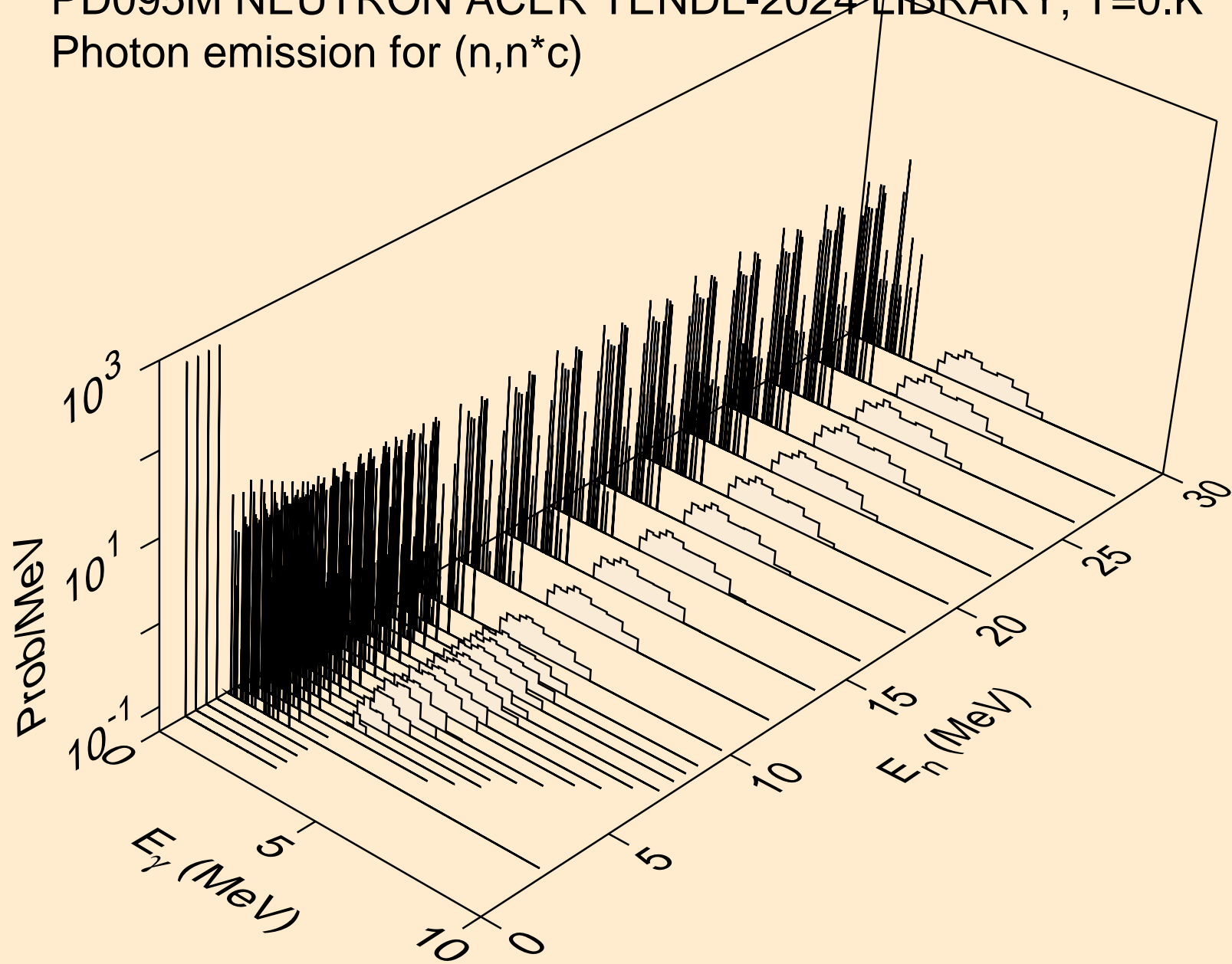

PD095M NEUTRON ACER TENDL-2024 LIBRARY; T=0.K
Photon emission for (n,gma)

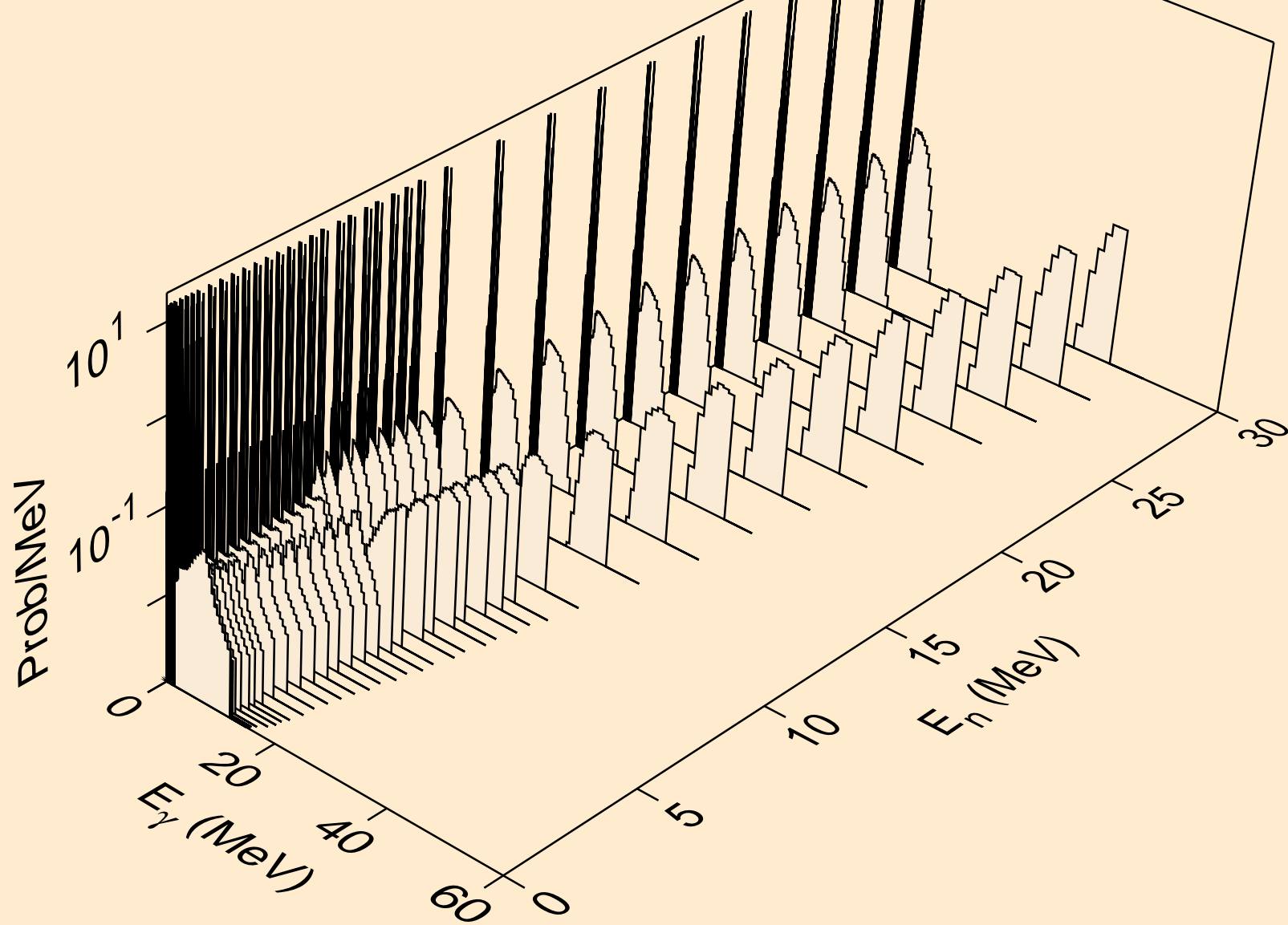

PD095M NEUTRON ACER TENDL-2024 LIBRARY; T=0.K
Photon emission for (n,p)

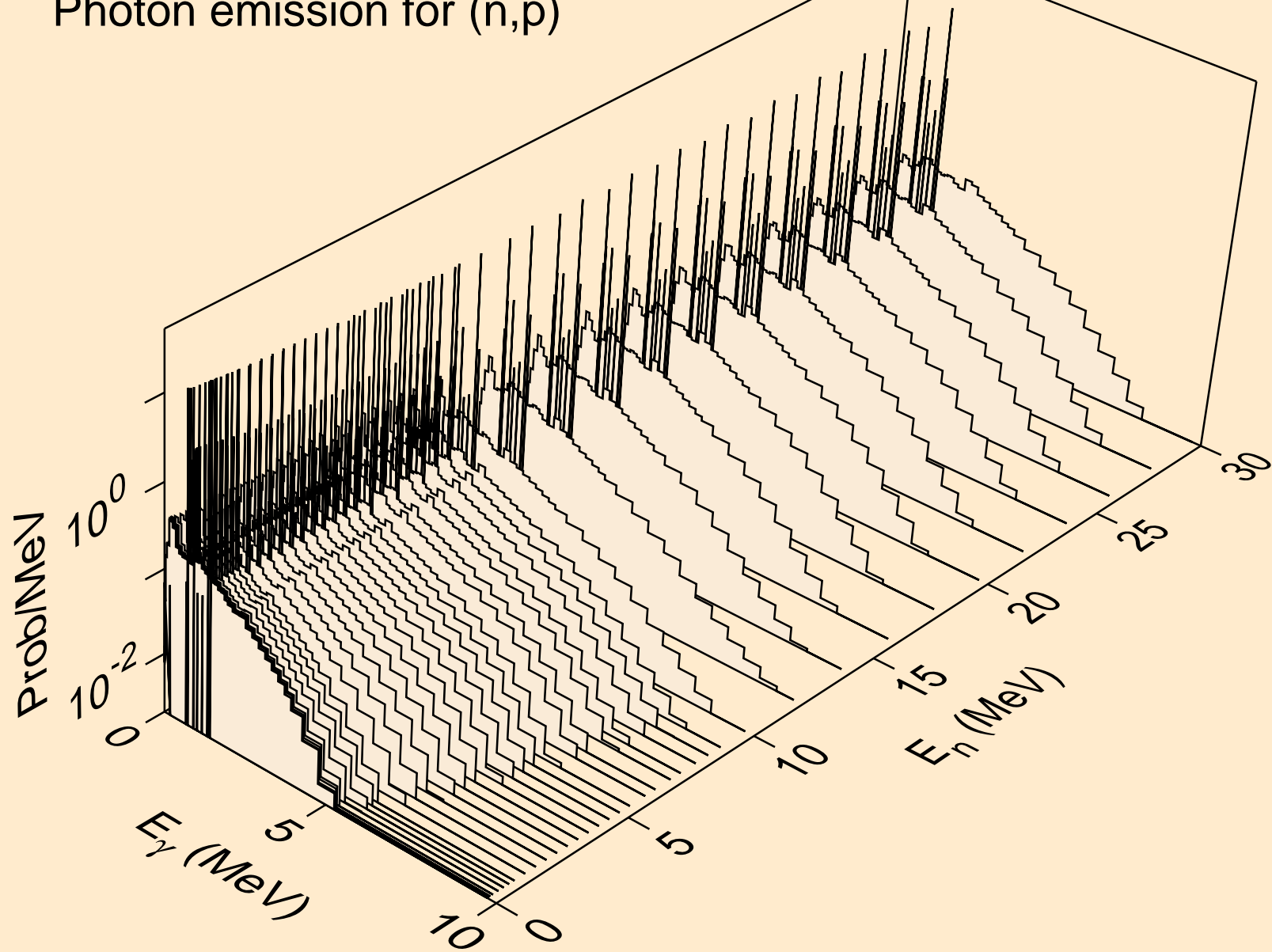

PD095M NEUTRON ACER TENDL-2024 LIBRARY; T=0.K
Photon emission for (n,d)

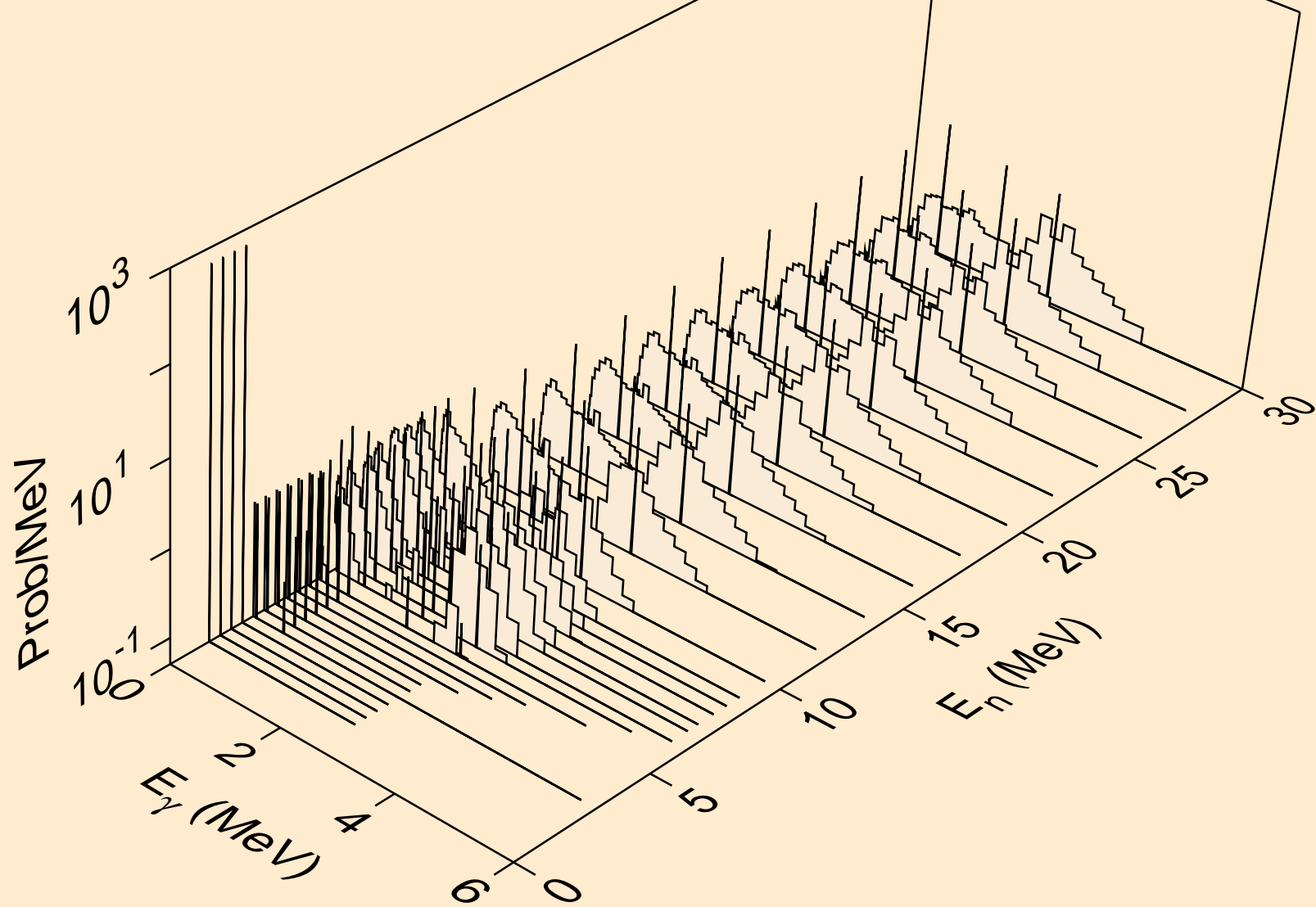

PD095M NEUTRON ACER TENDL-2024 LIBRARY; T=0.K
Photon emission for (n,t)

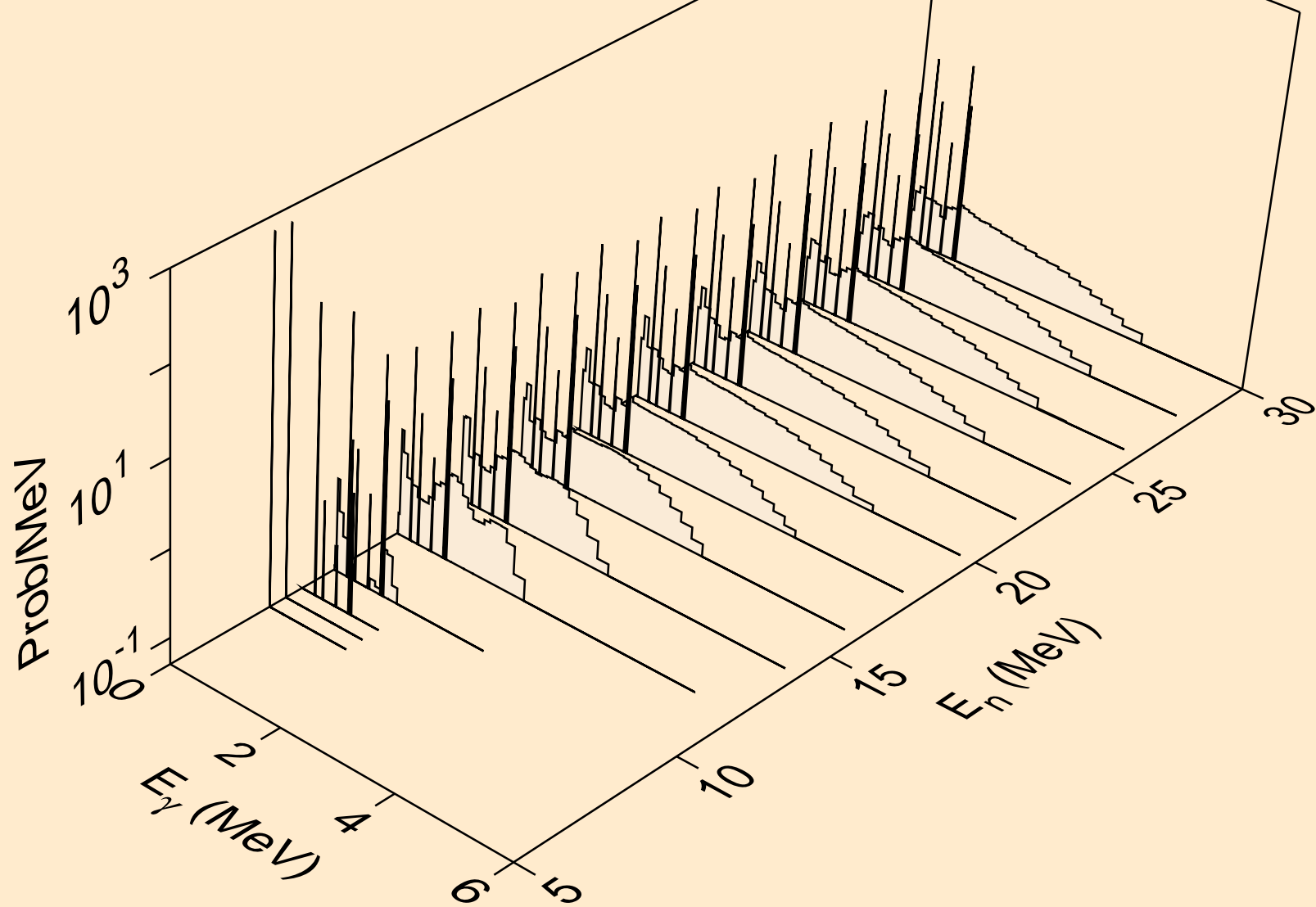

PD095M NEUTRON ACER TENDL-2024 LIBRARY; T=0.K
Photon emission for (n,he3)

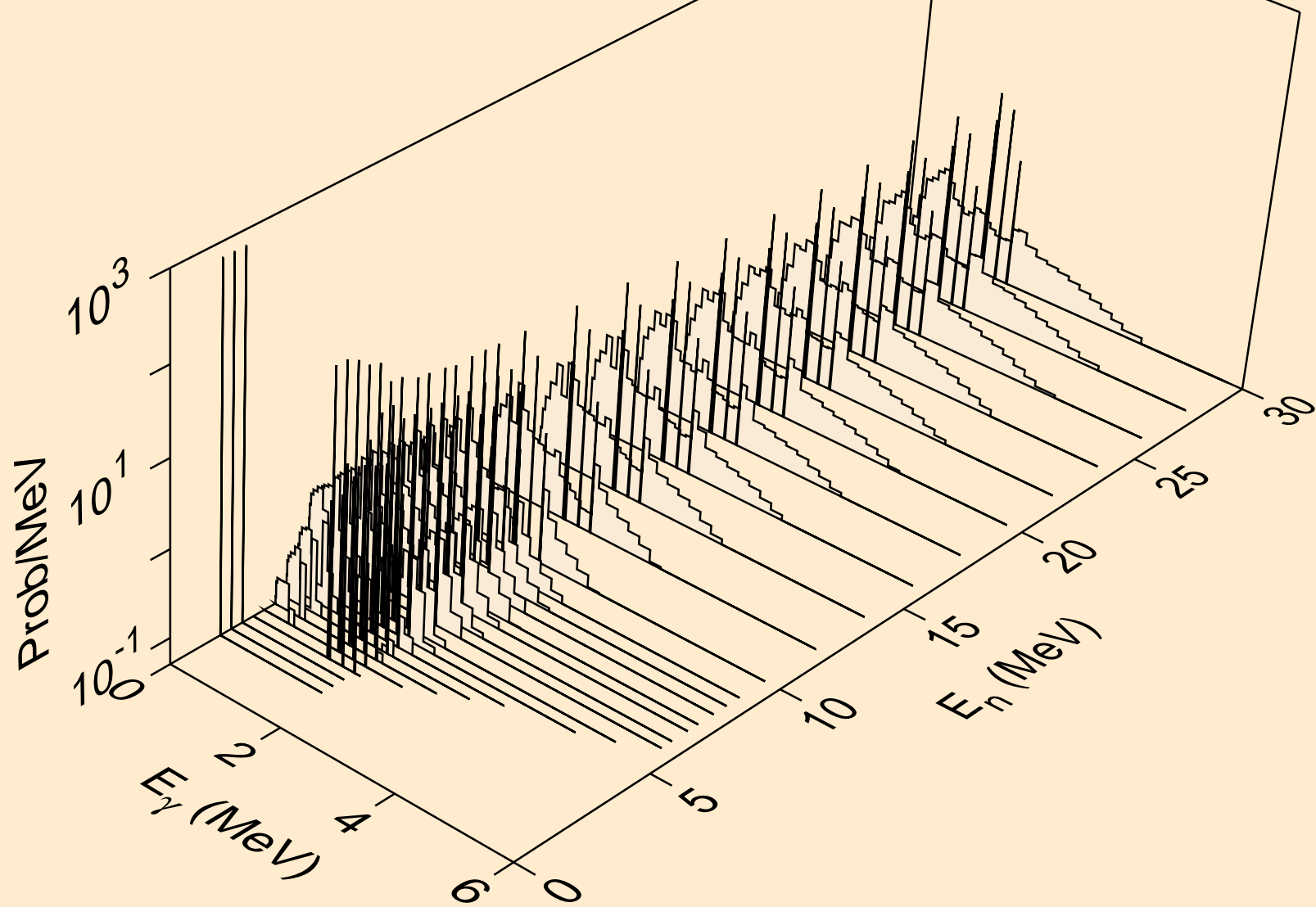

PD095M NEUTRON ACER TENDL-2024 LIBRARY; T=0.K
Photon emission for (n,a)

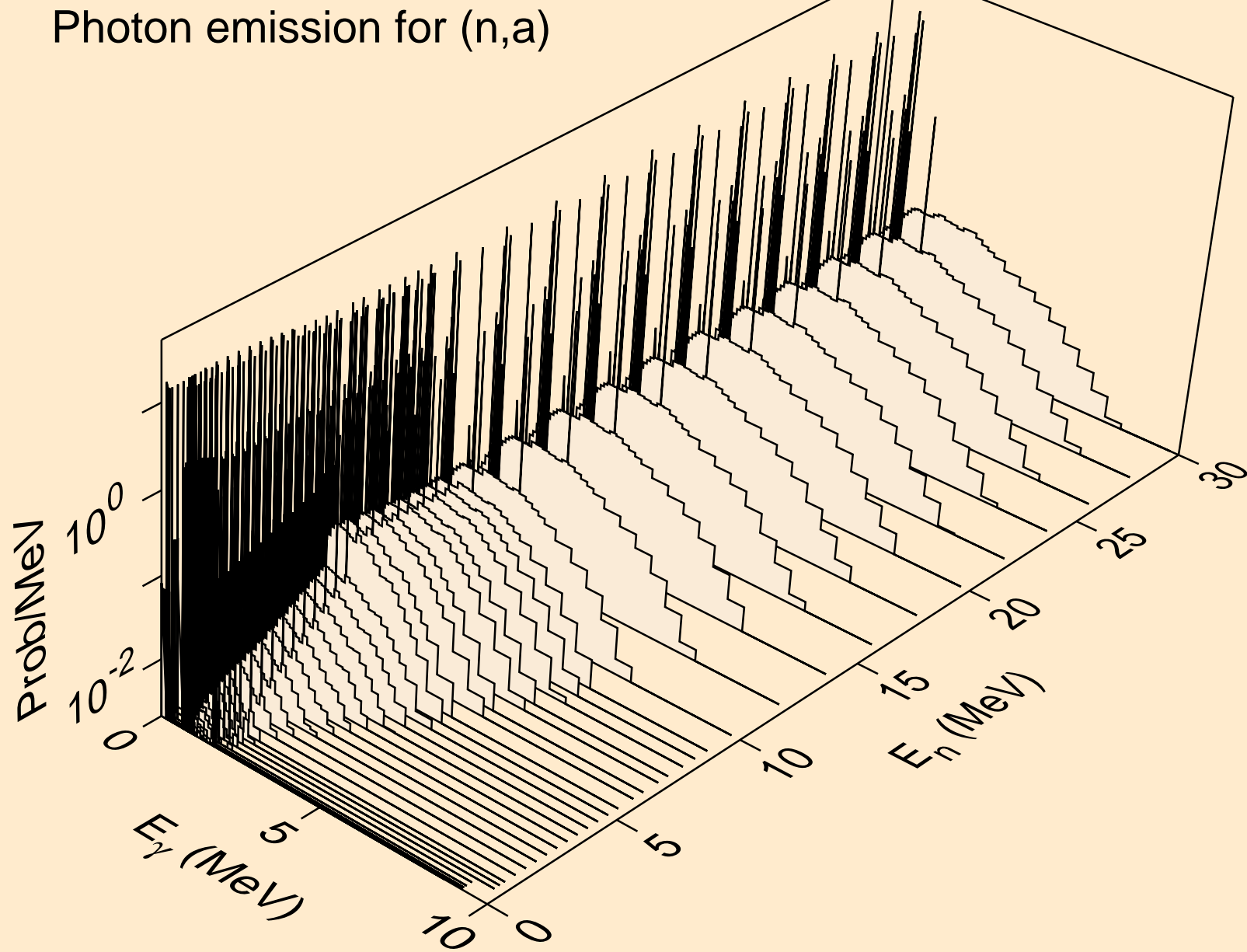

PD095M NEUTRON ACER TENDL-2024 LIBRARY; T=0.K
Photon emission for (n,2a)

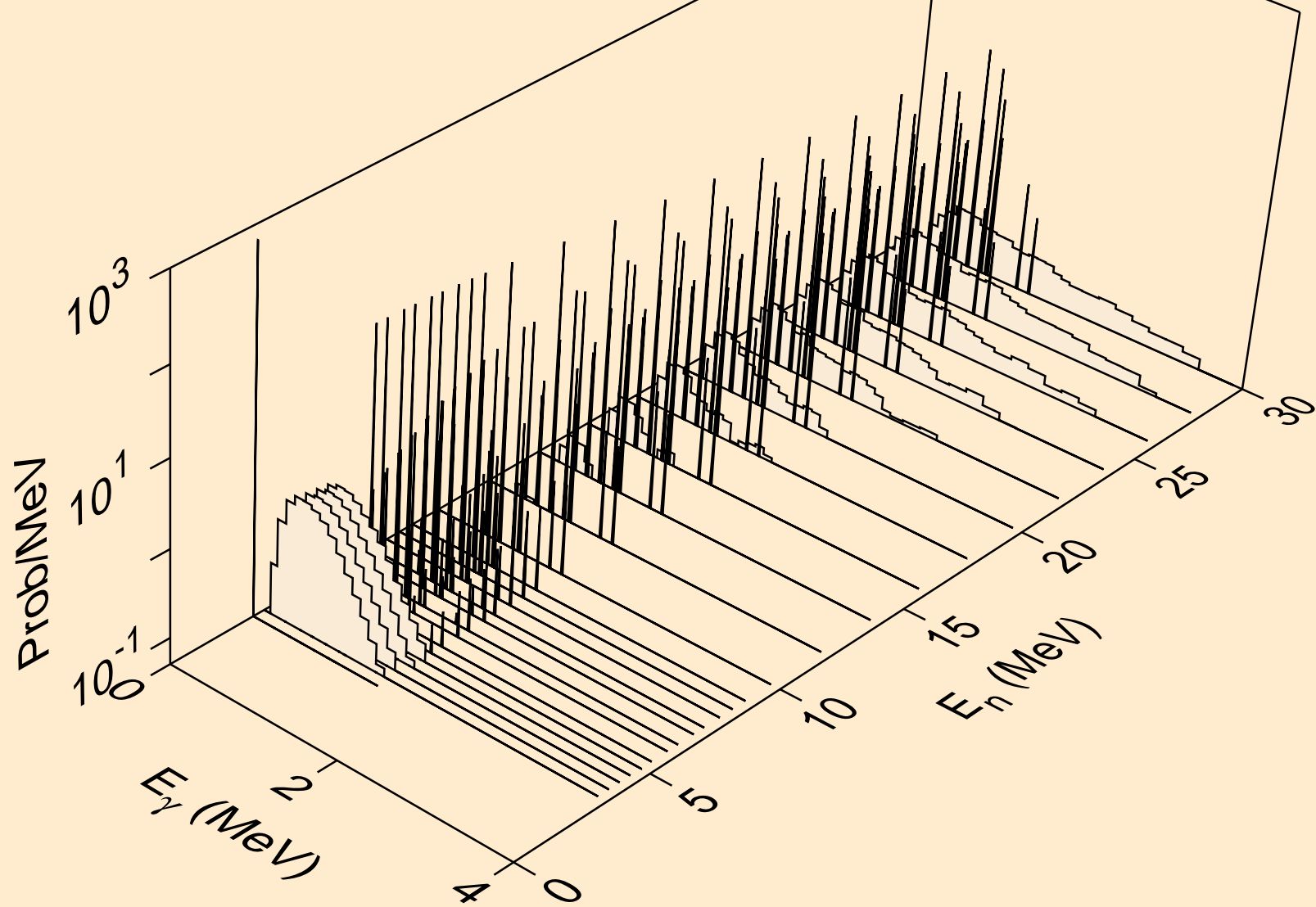

PD095M NEUTRON ACER TENDL-2024 LIBRARY; T=0.K
Photon emission for (n,3a)

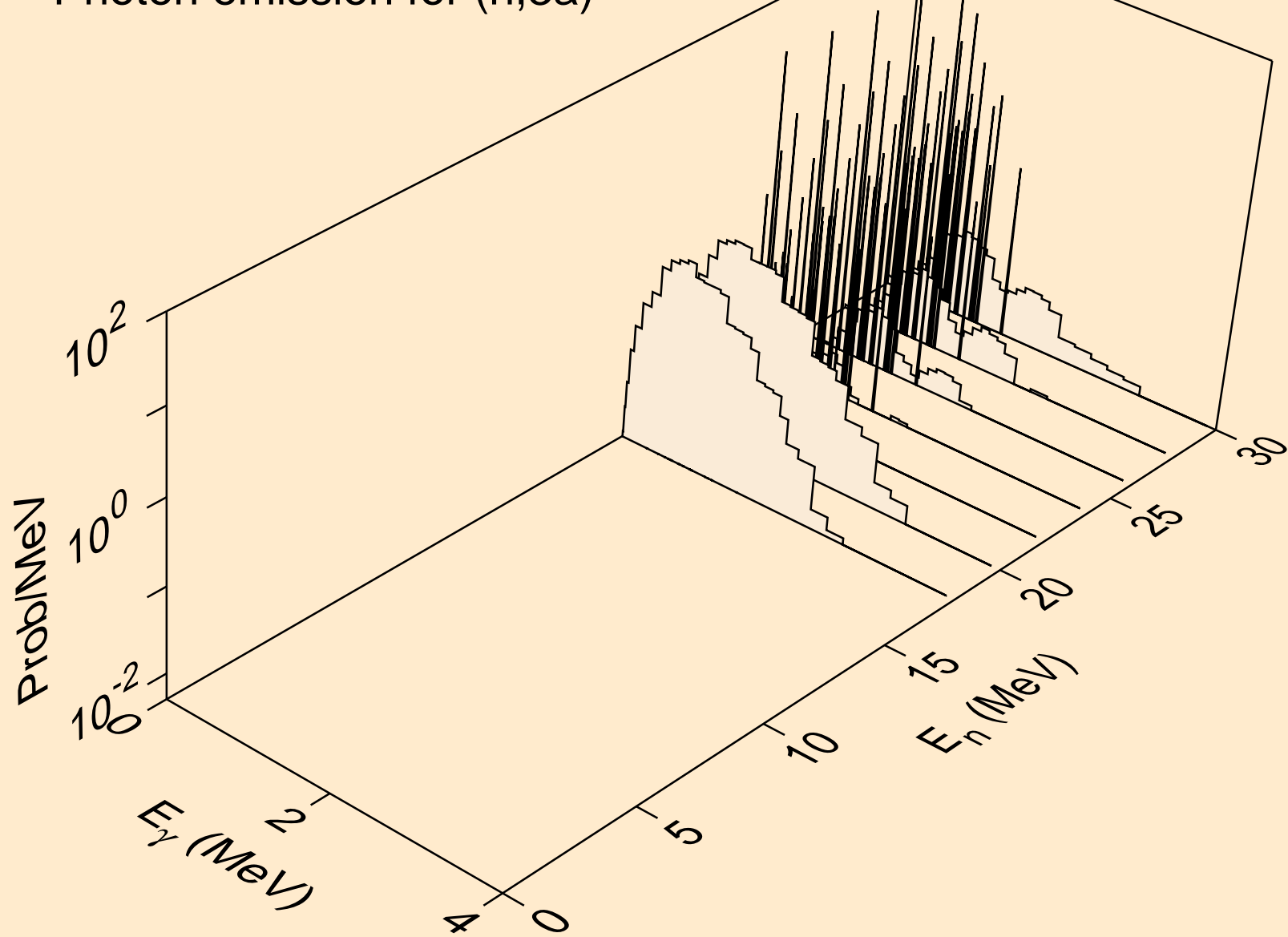

PD095M NEUTRON ACER TENDL-2024 LIBRARY; T=0.K
Photon emission for (n,2p)

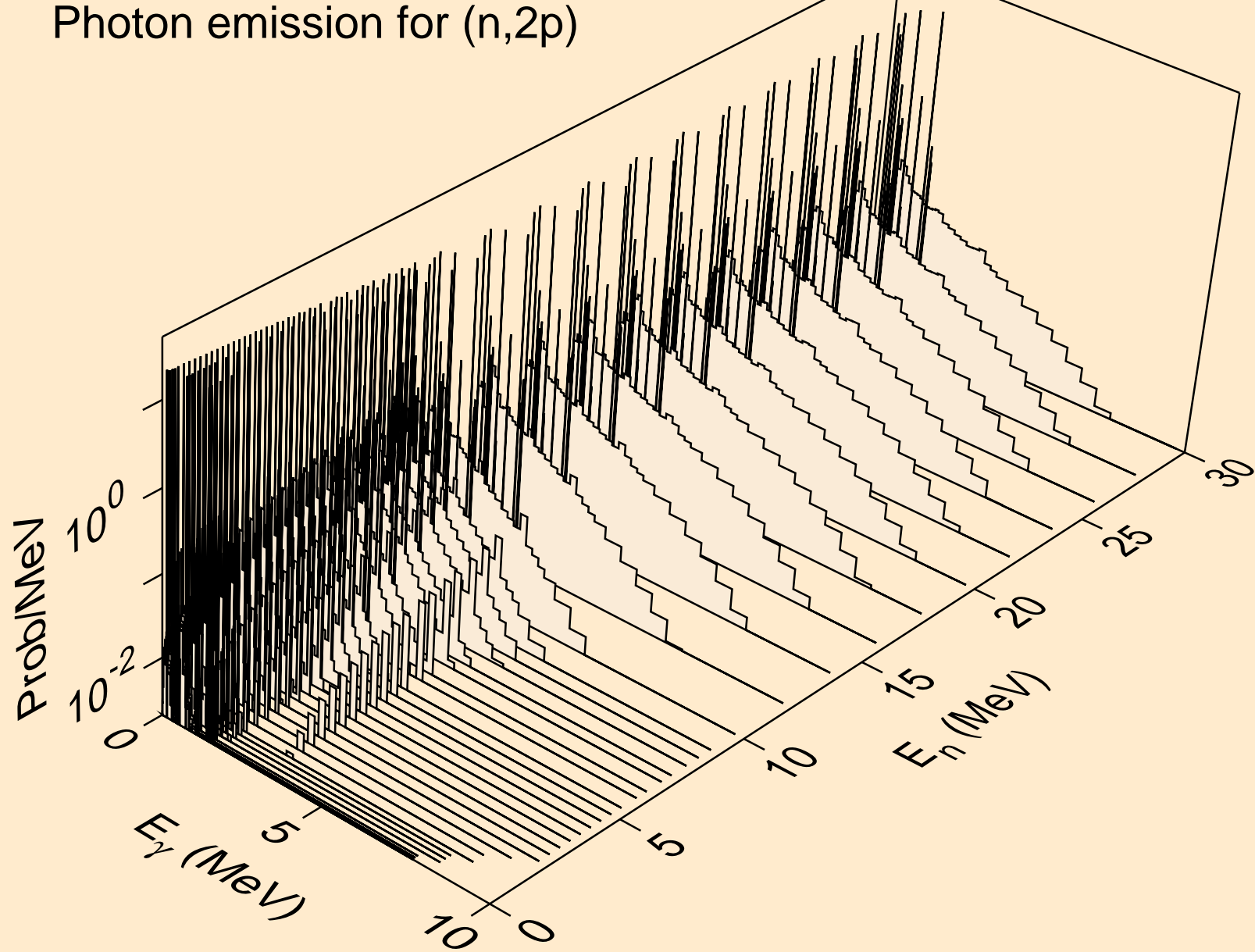

PD095M NEUTRON ACER TENDL-2024 LIBRARY; T=0.K
Photon emission for (n,p)

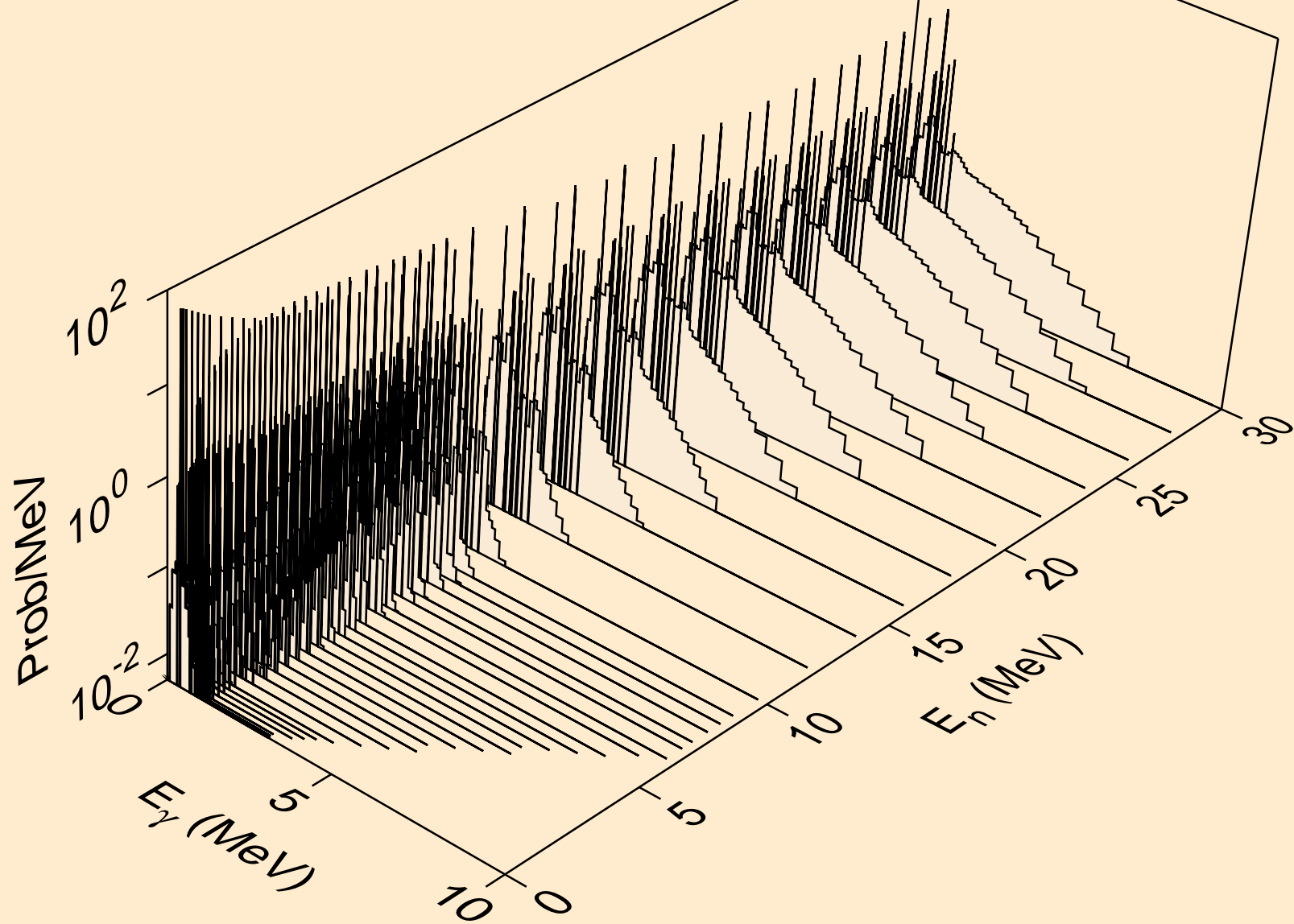

PD095M NEUTRON ACER TENDL-2024 LIBRARY; T=0.K
Photon emission for (n,pd)

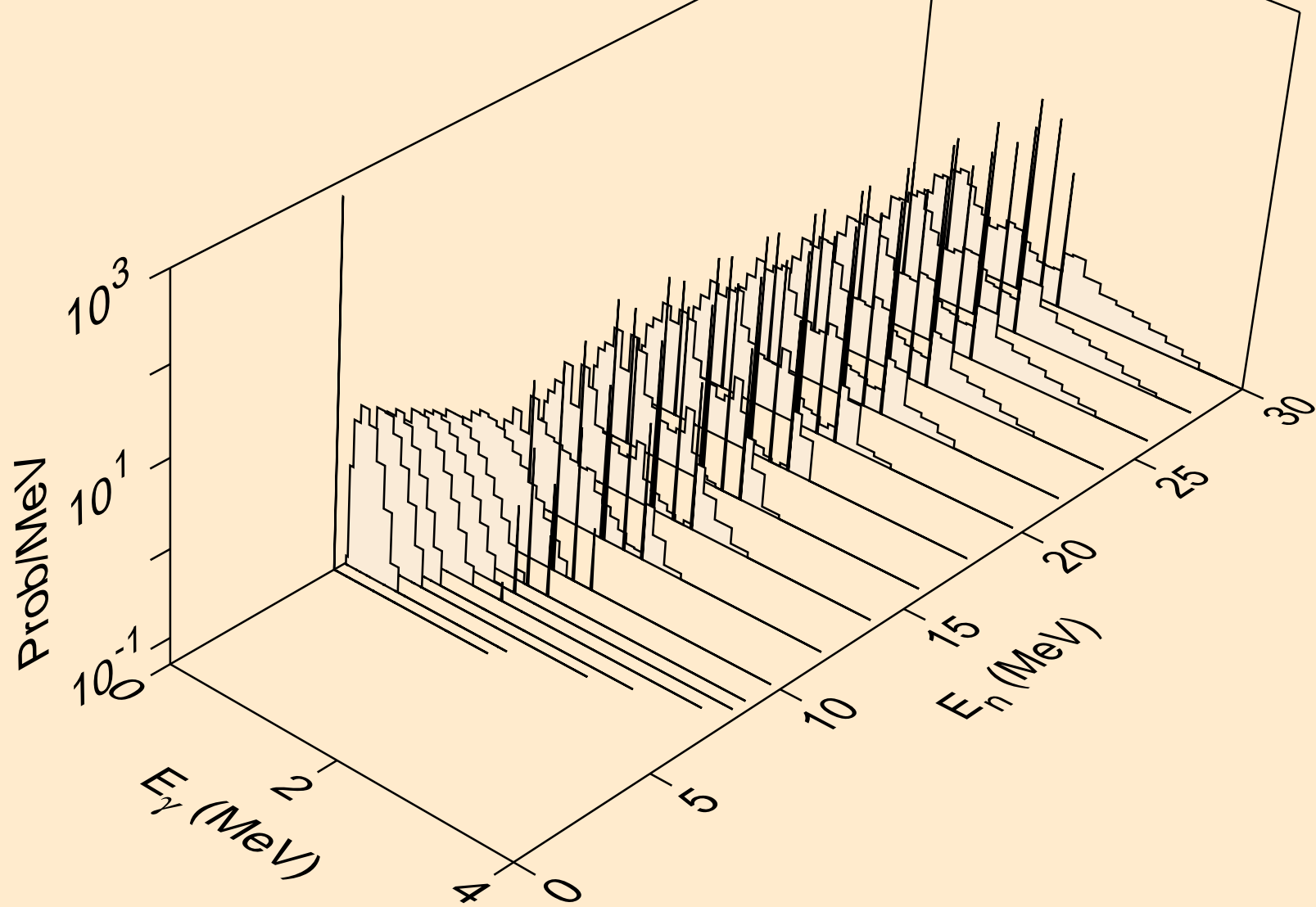

PD095M NEUTRON ACER TENDL-2024 LIBRARY; T=0.K
Photon emission for (n,pt)

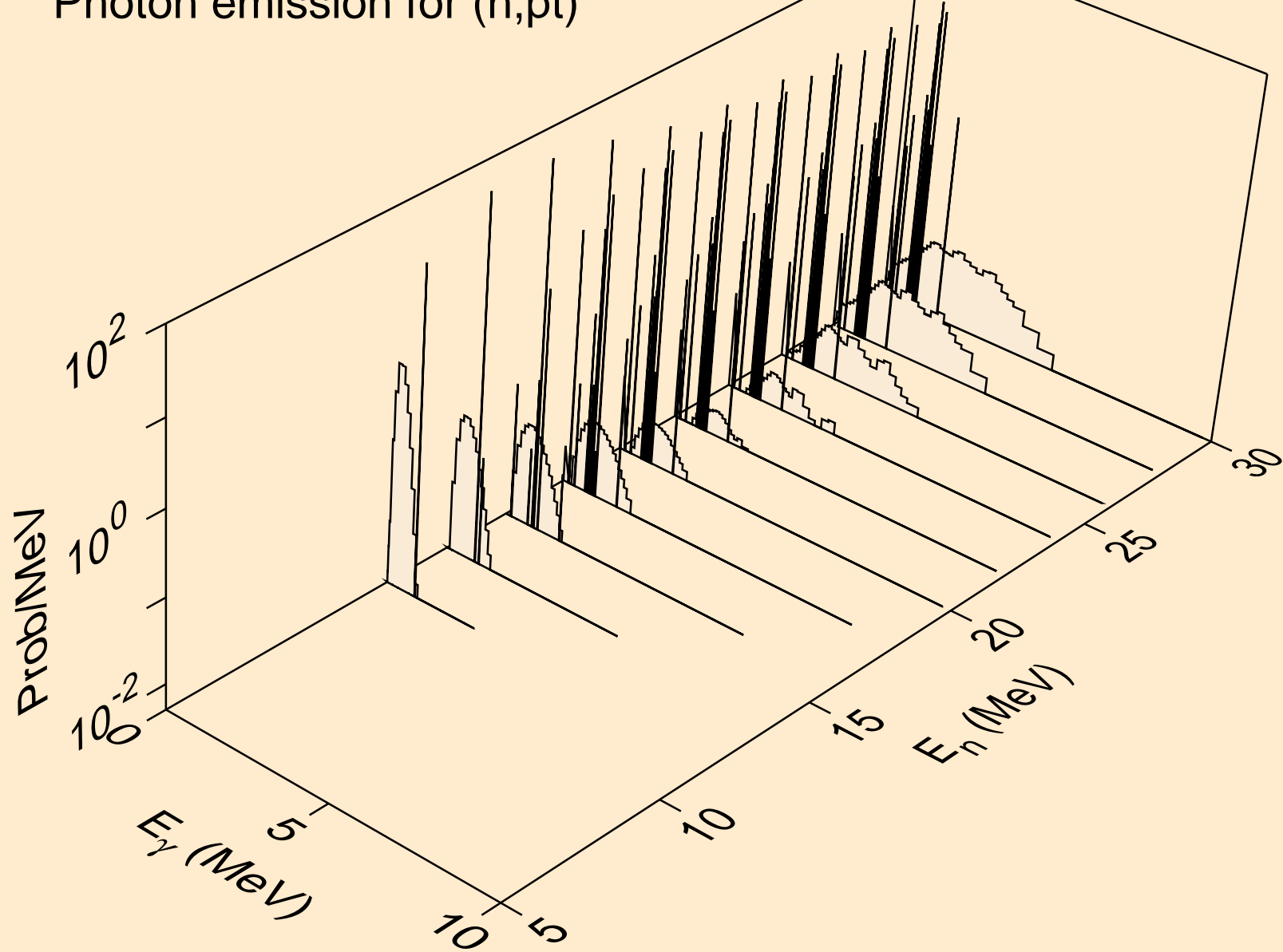

PD095M NEUTRON ACER TENDL-2024 LIBRARY; T=0.K
Photon emission for (n,da)

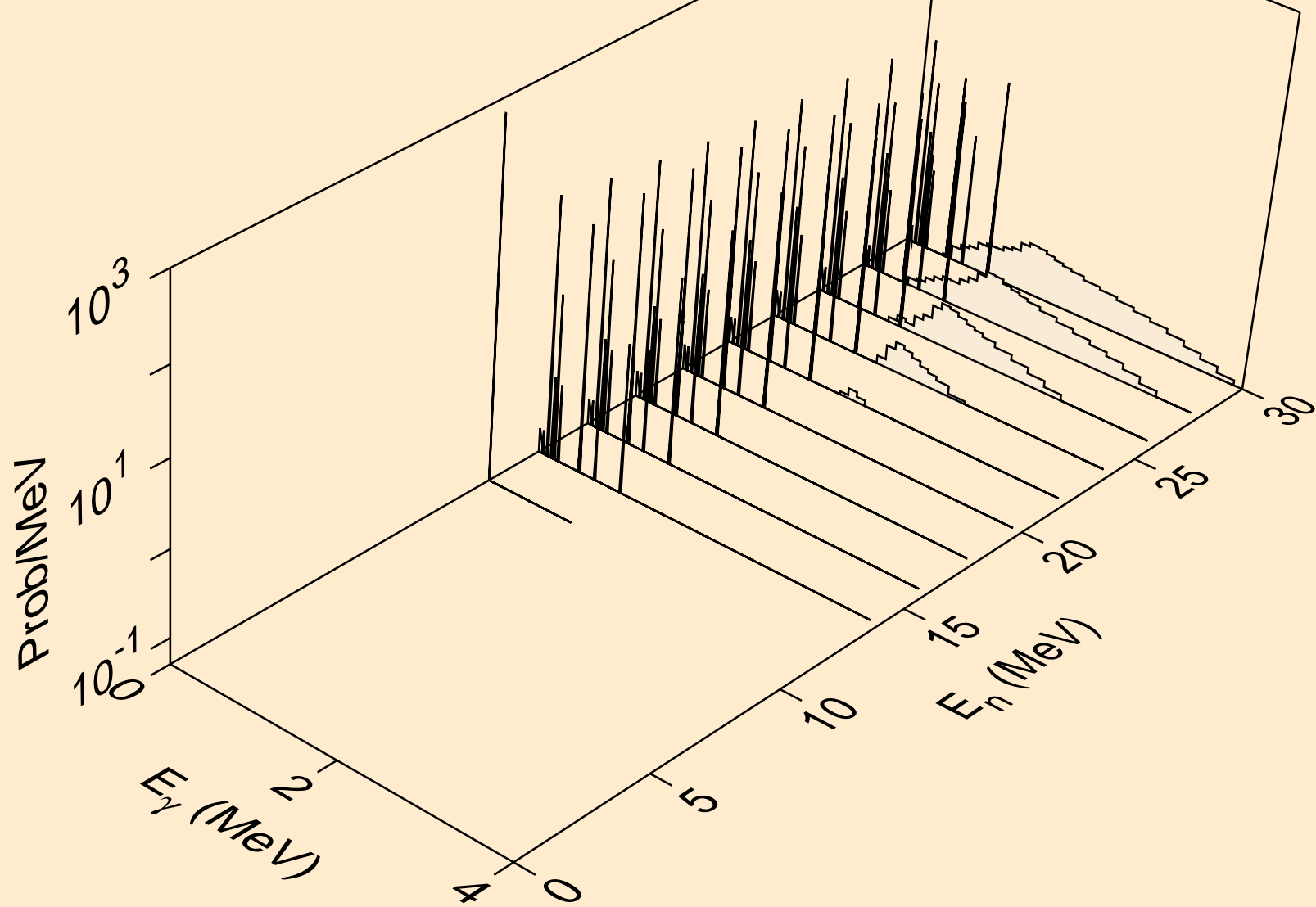

PD095M NEUTRON ACER TENDL-2024 LIBRARY; T=0.K
14 MeV photon spectrum

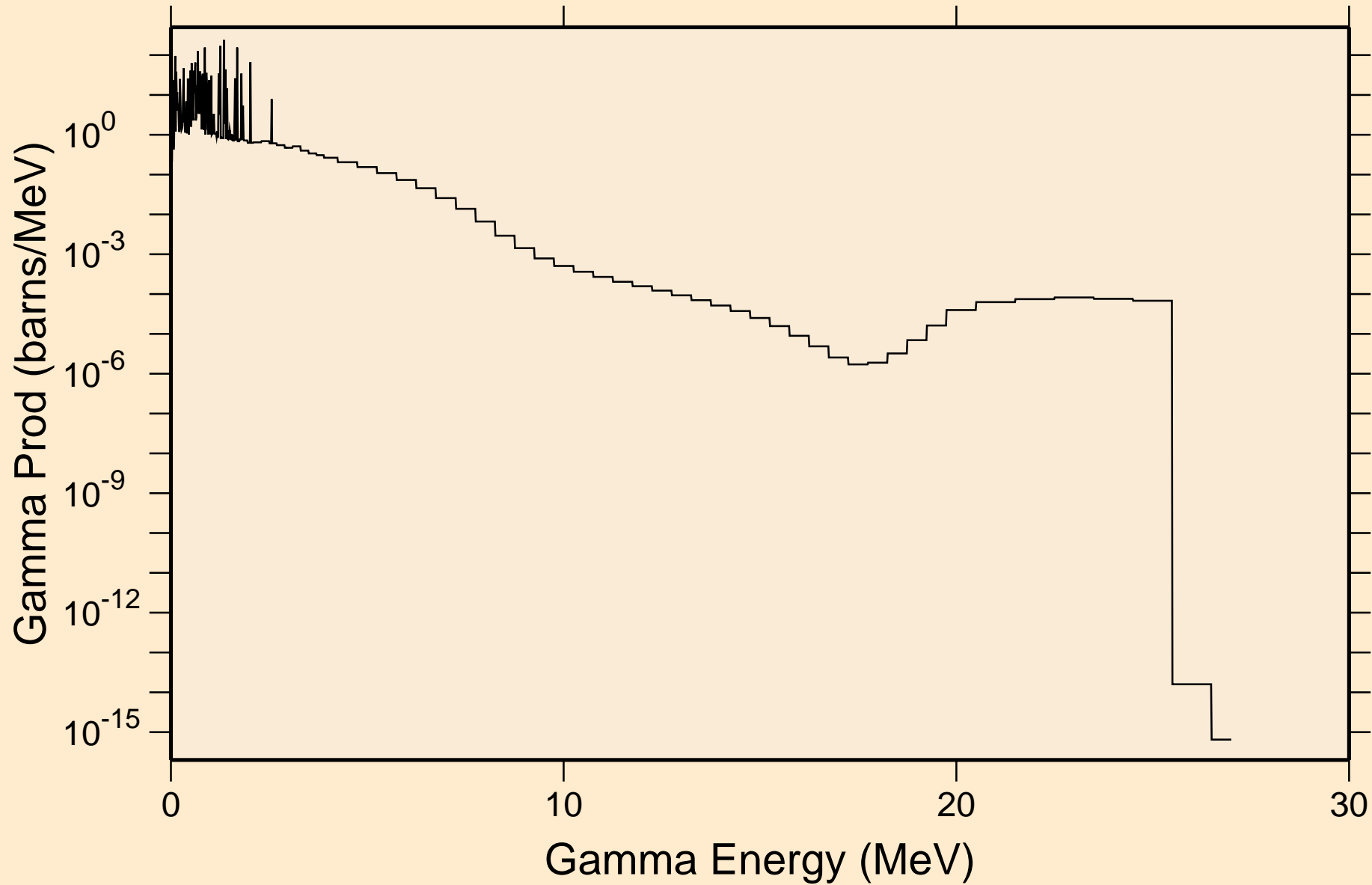

PD095M NEUTRON ACER TENDL-2024 LIBRARY; T=0.K
Particle heating contributions

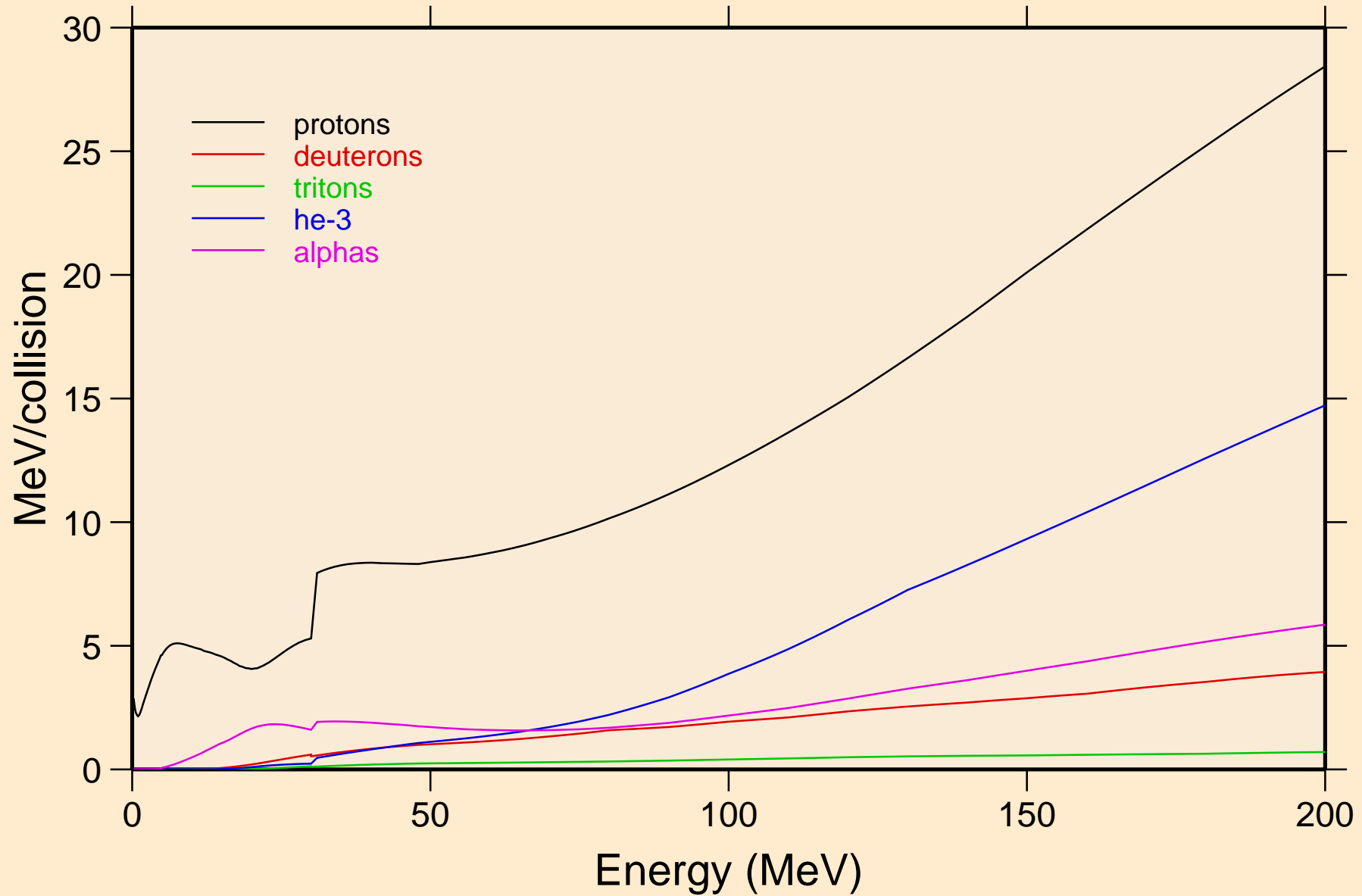

PD095M NEUTRON ACER TENDL-2024 LIBRARY; T=0.K
Recoil Heating

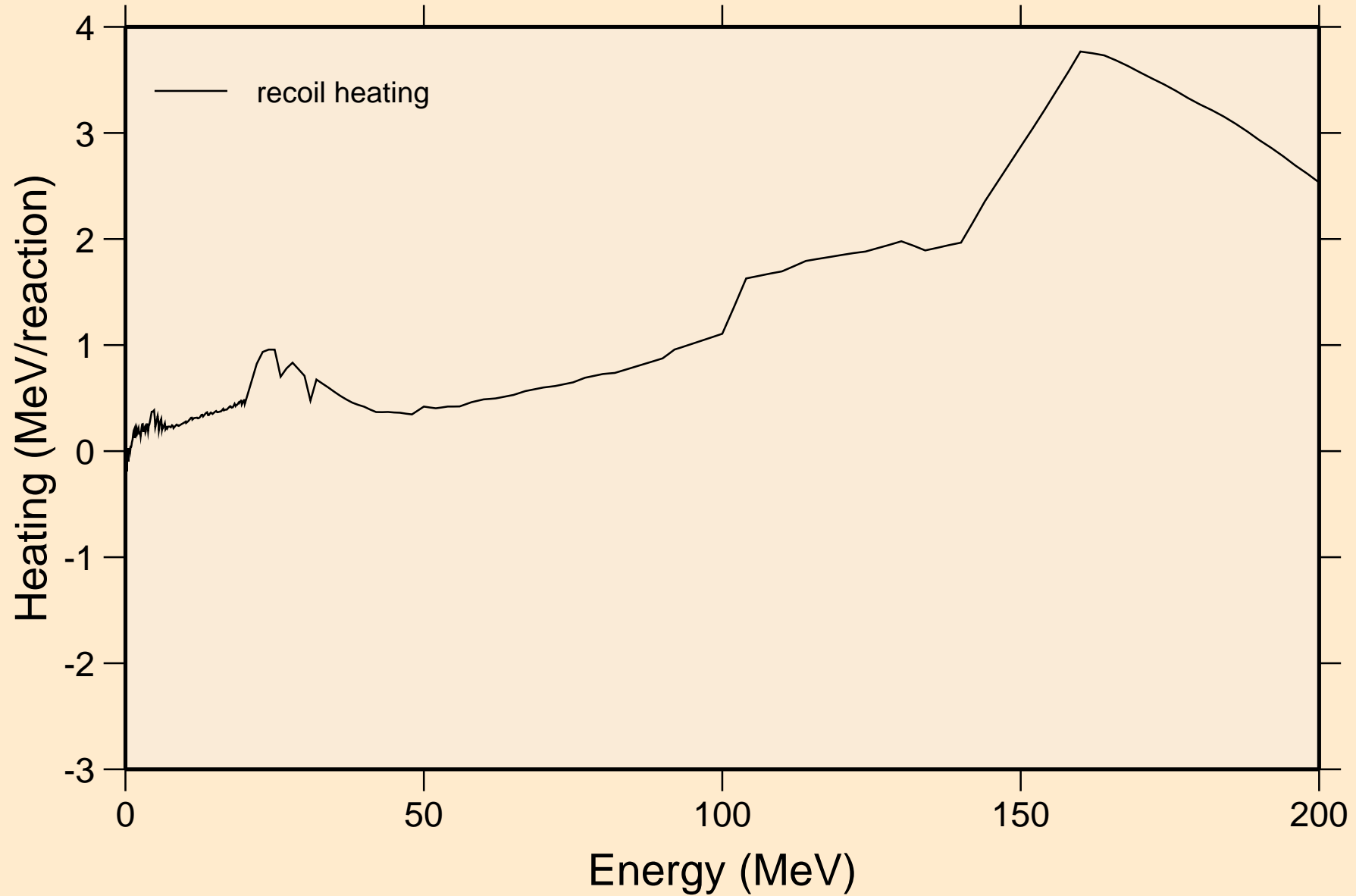

PD095M NEUTRON ACER TENDL-2024 LIBRARY; T=0.K
Particle production cross sections

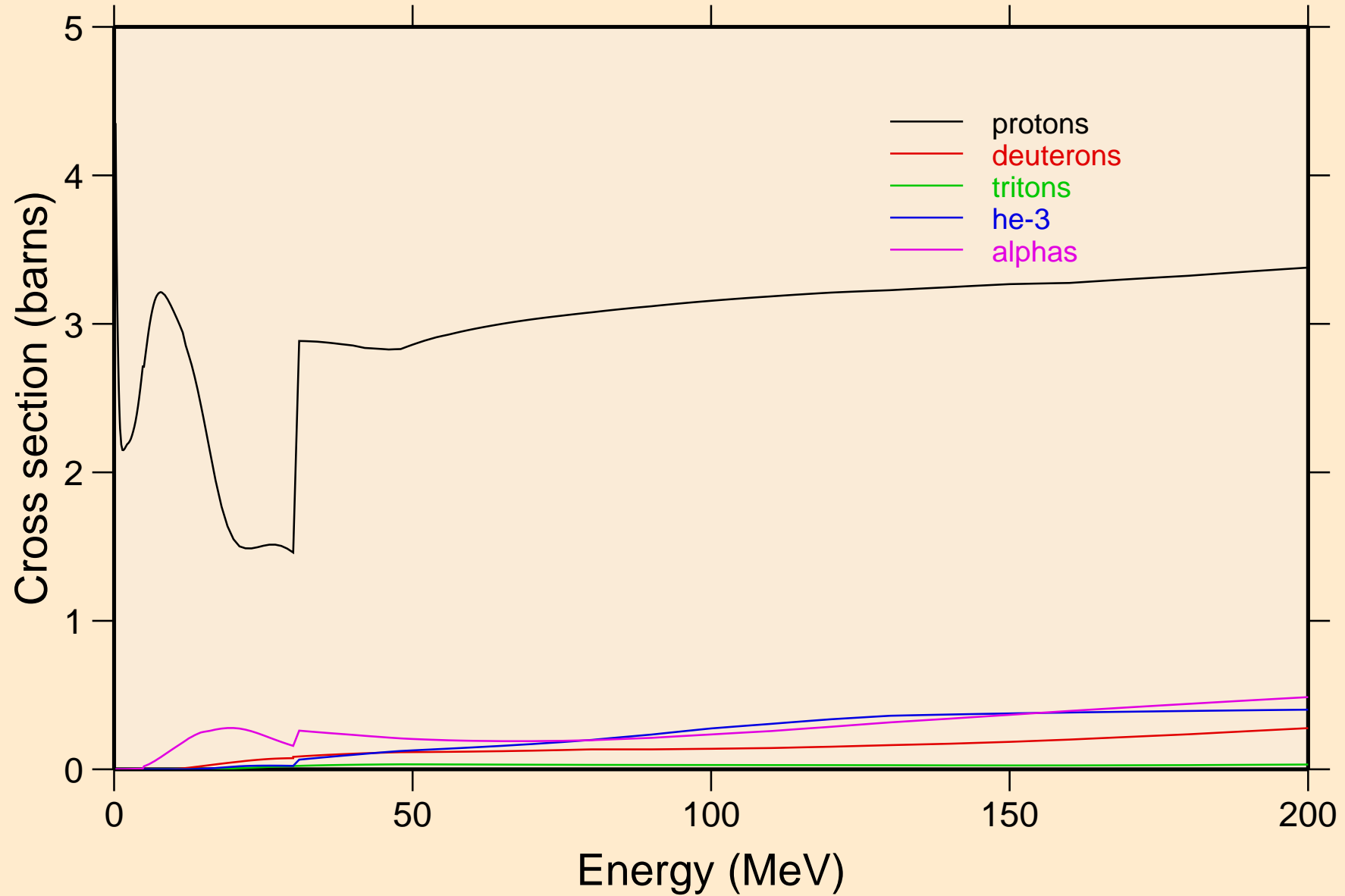

PD095M NEUTRON ACER TENDL-2024 LIBRARY; T=0.K
protons from (n,x)

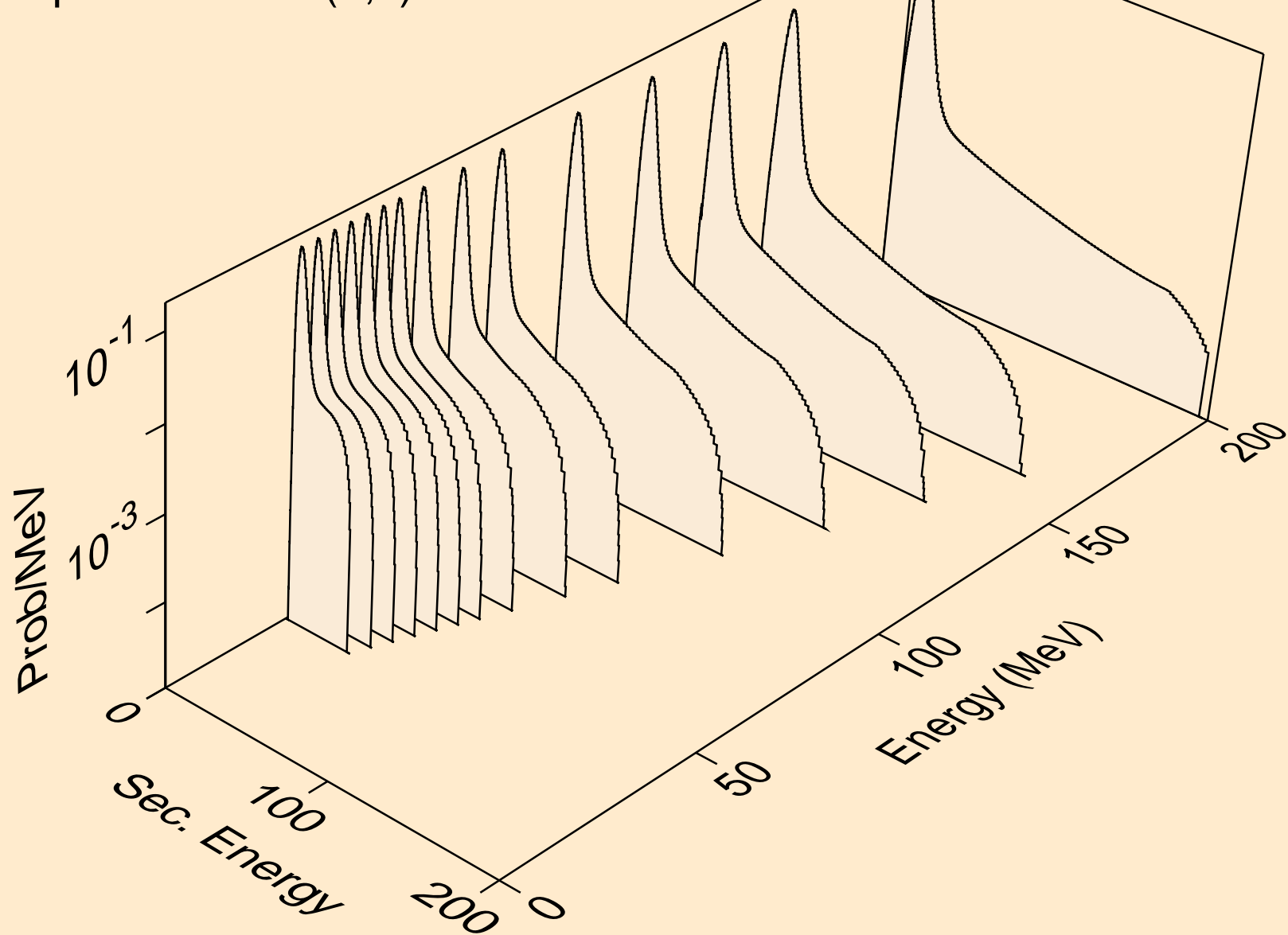

PD095M NEUTRON ACER TENDL-2024 LIBRARY; T=0.K
protons from (n,n*)p

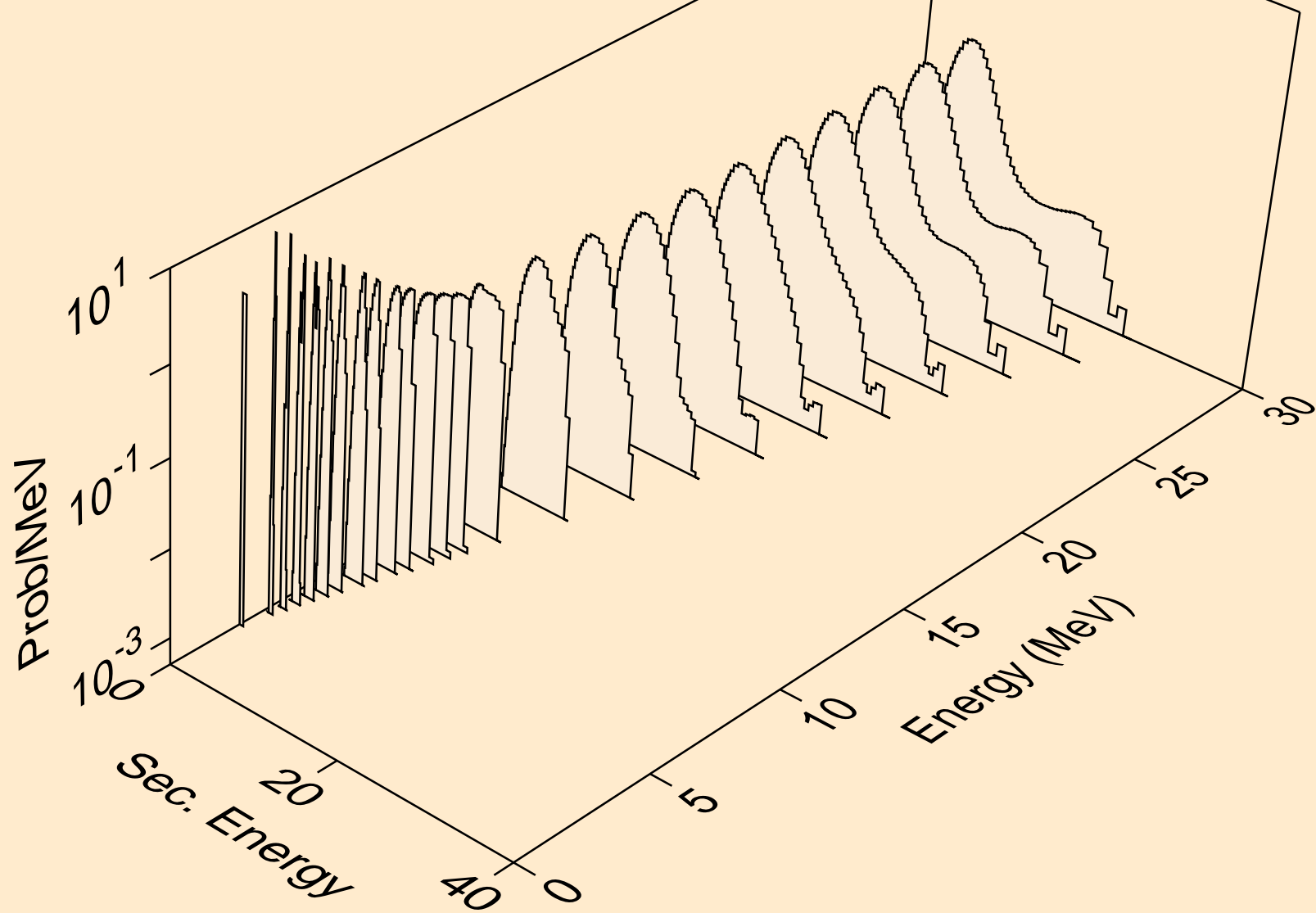

PD095M NEUTRON ACER TENDL-2024 LIBRARY; T=0.K
protons from (n,2np)

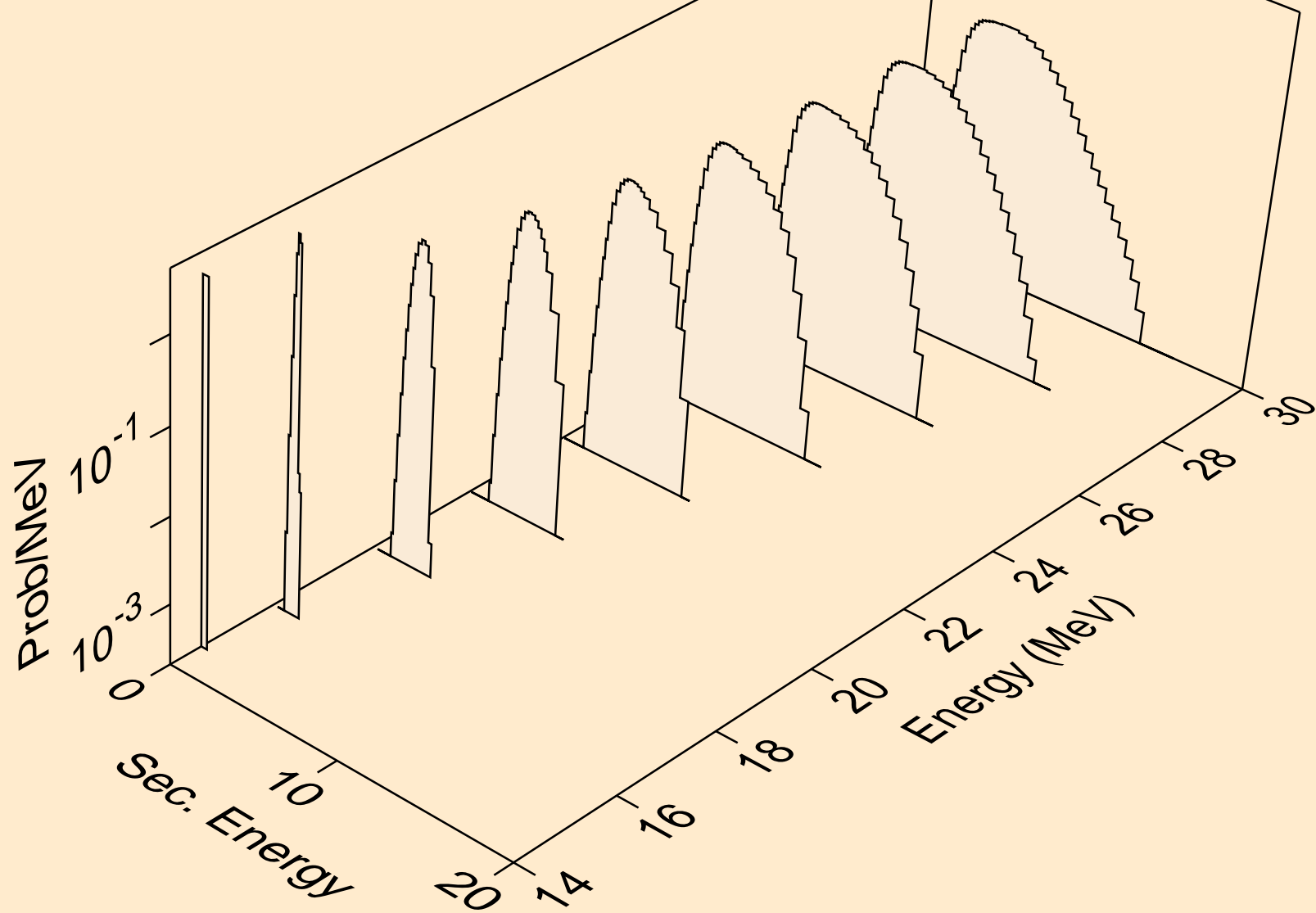

PD095M NEUTRON ACER TENDL-2024 LIBRARY; T=0.K
protons from (n,n2p)

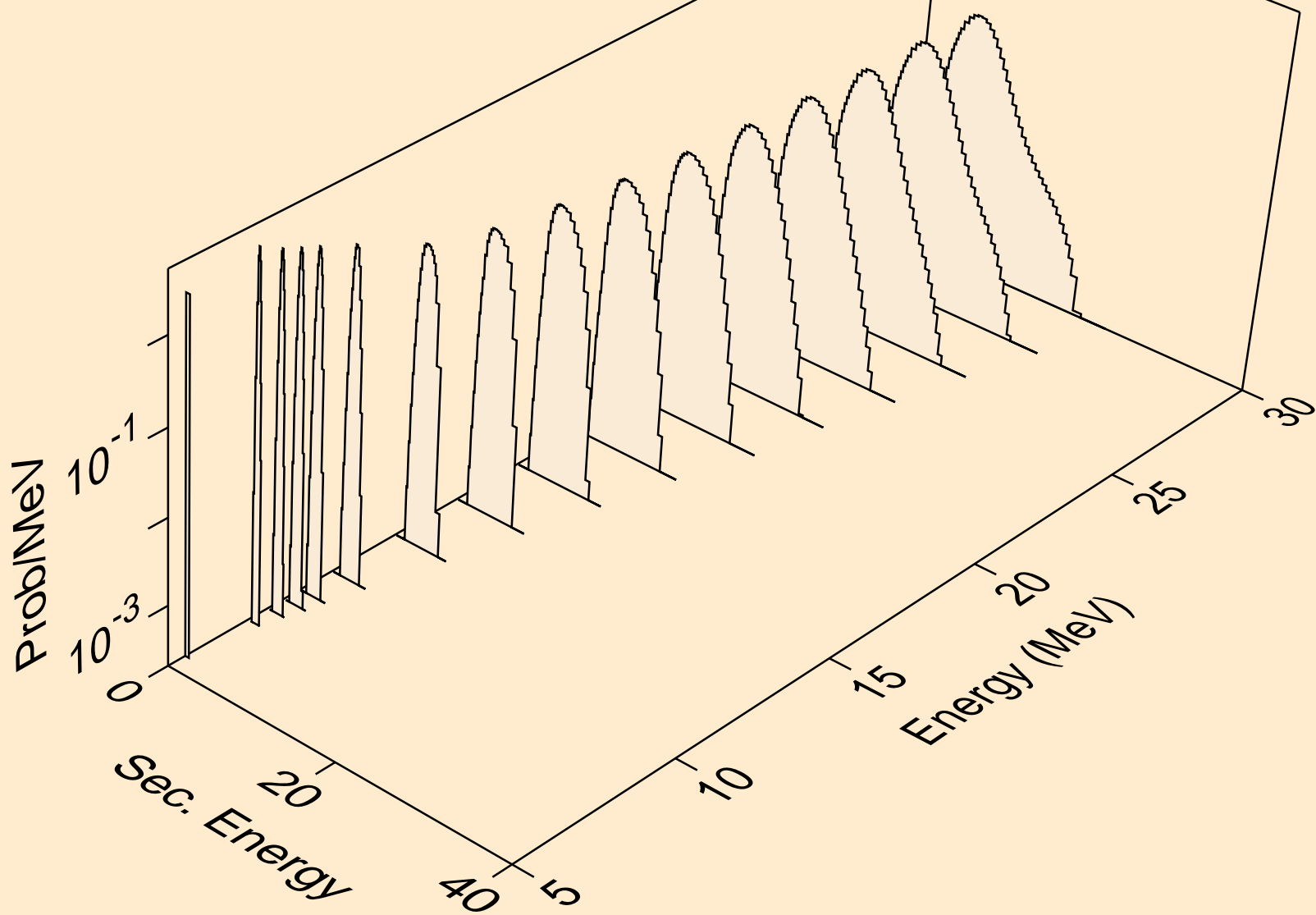

PD095M NEUTRON ACER TENDL-2024 LIBRARY; T=0.K
protons from (n,npa)

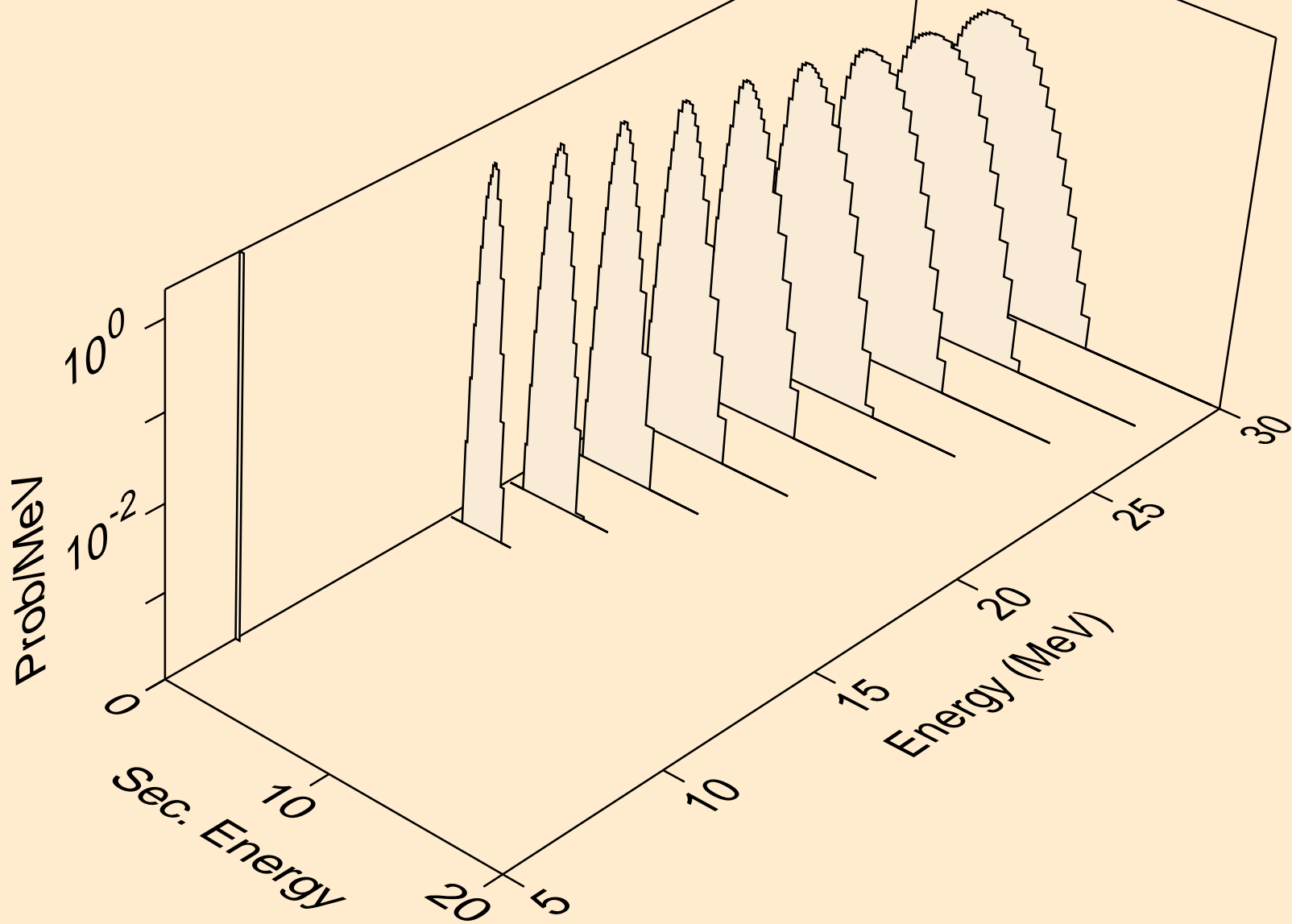

PD095M NEUTRON ACER TENDL-2024 LIBRARY; T=0.K
protons from (n,p)

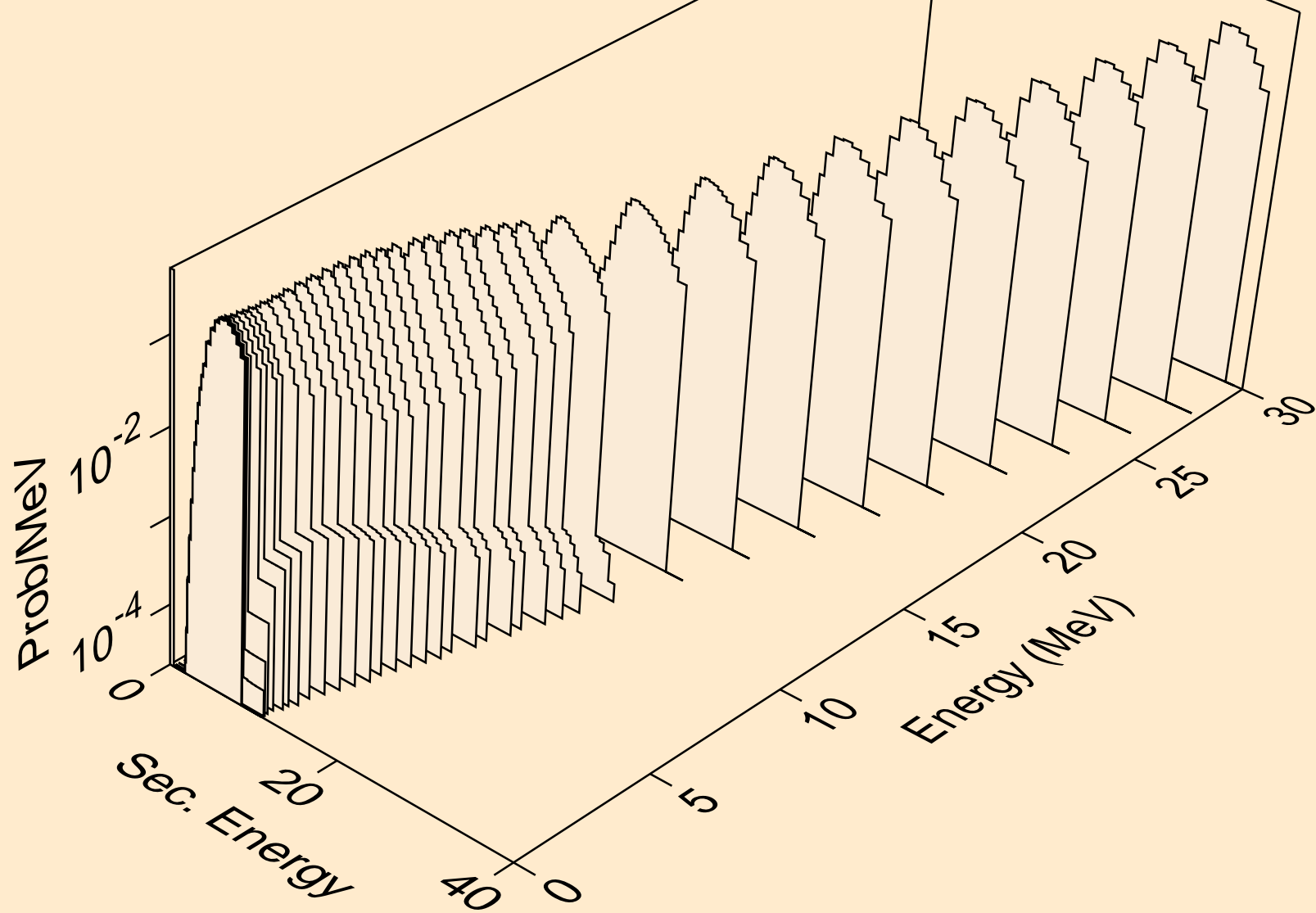

PD095M NEUTRON ACER TENDL-2024 LIBRARY; T=0.K
protons from (n,2p)

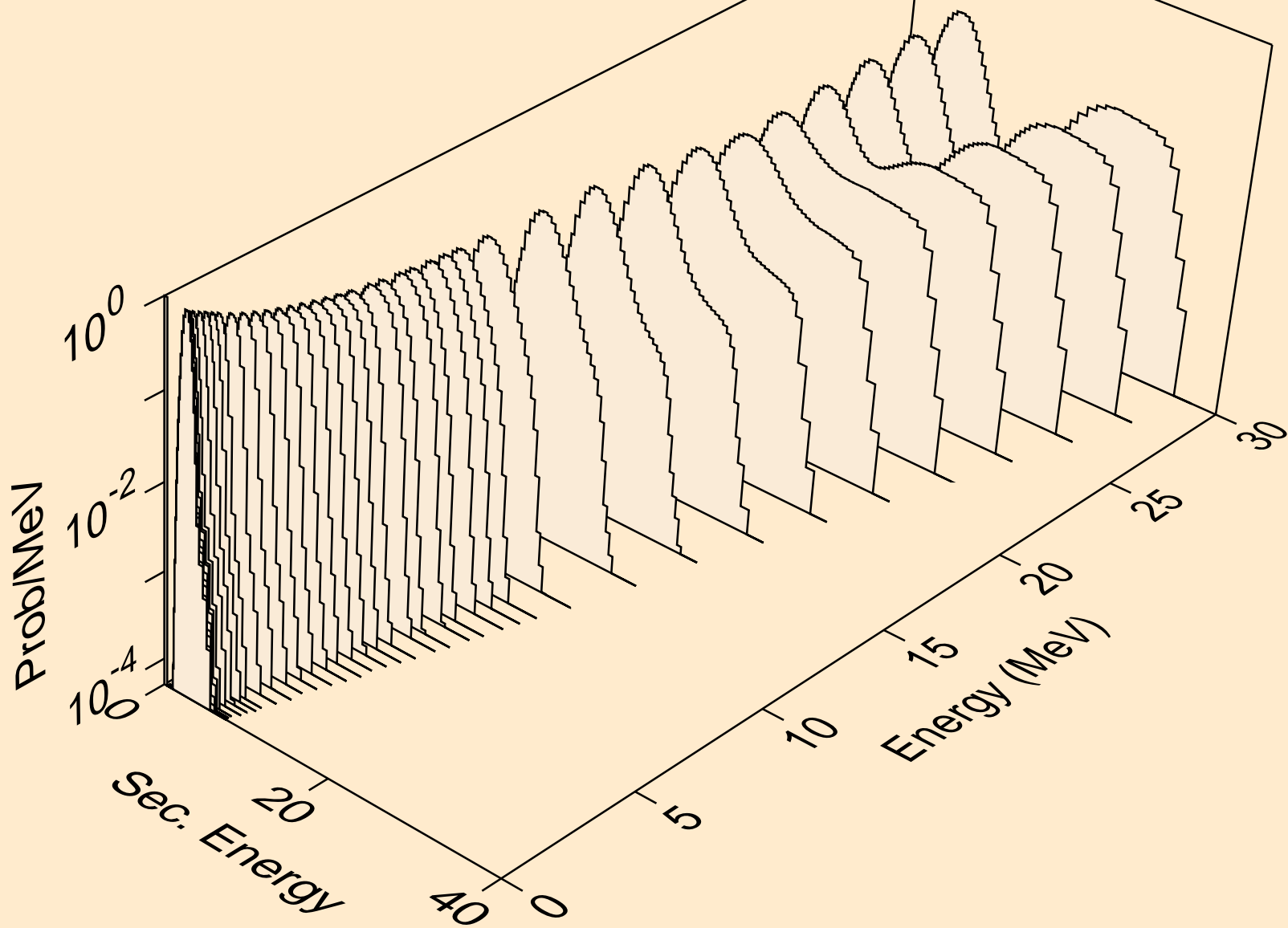

PD095M NEUTRON ACER TENDL-2024 LIBRARY; T=0.K
protons from (n,p)

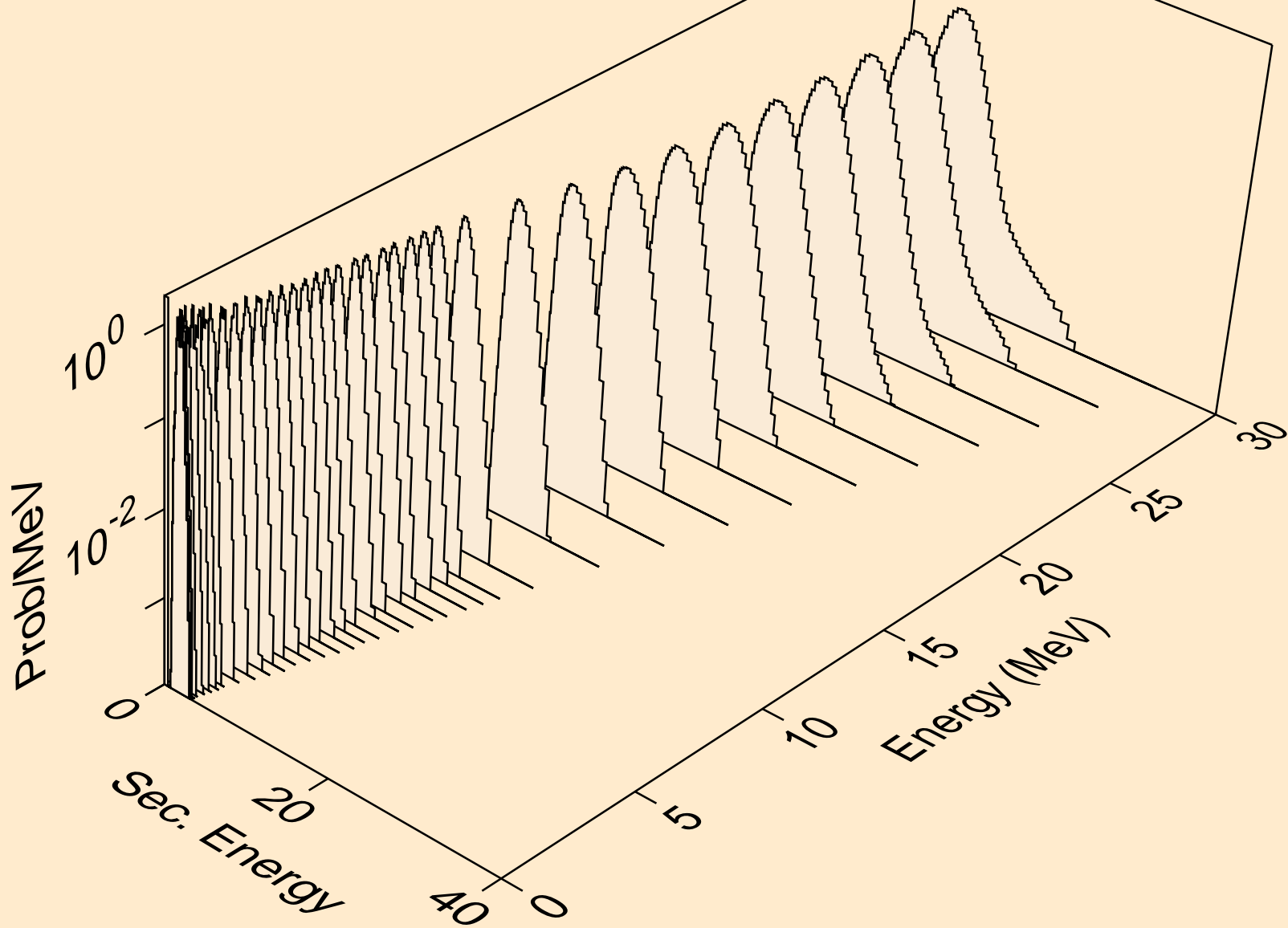

PD095M NEUTRON ACER TENDL-2024 LIBRARY; T=0.K
protons from (n,pd)

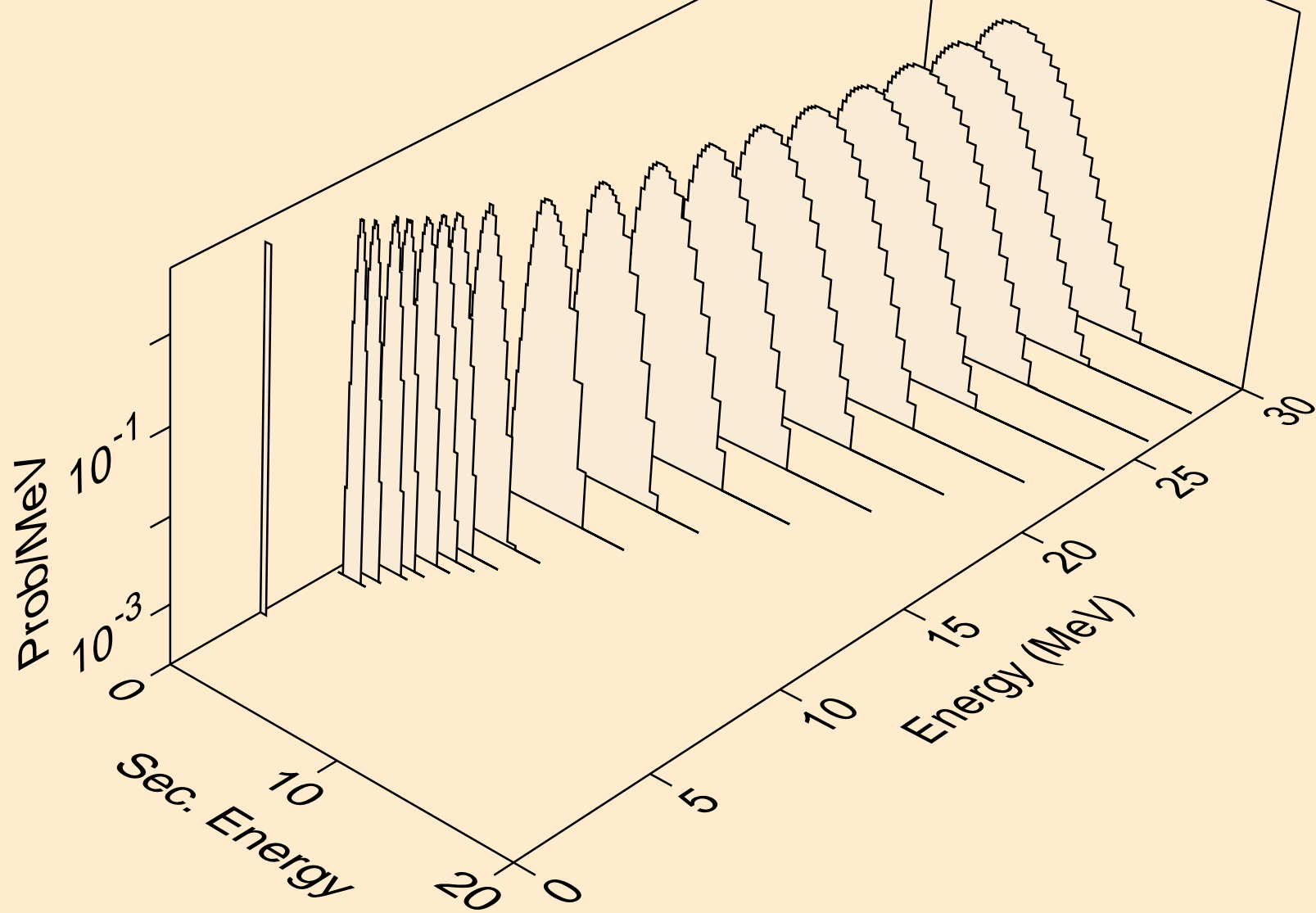

PD095M NEUTRON ACER TENDL-2024 LIBRARY; T=0.K
protons from (n,pt)

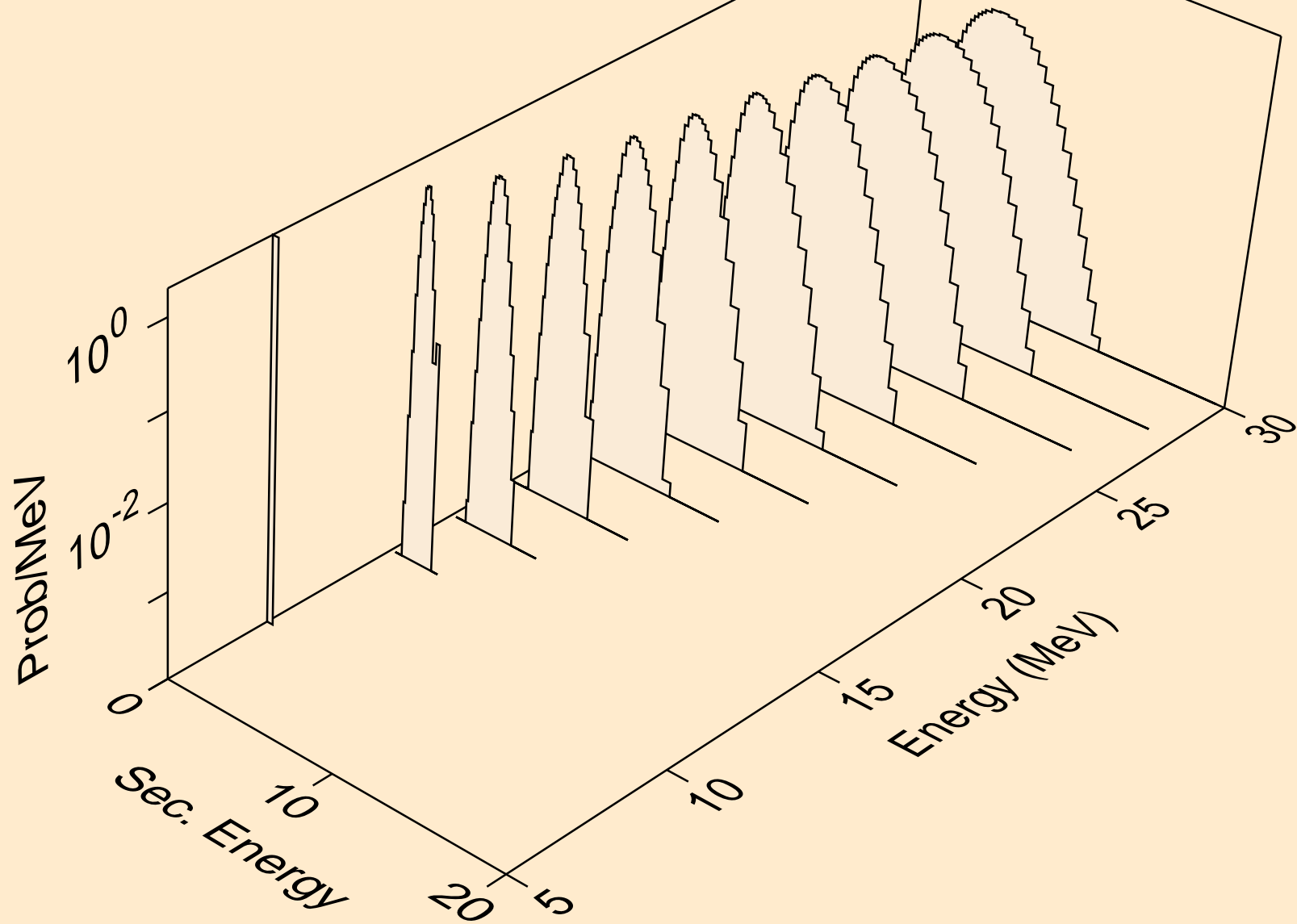

PD095M NEUTRON ACER TENDL-2024 LIBRARY; T=0.K
deuterons from (n,x)

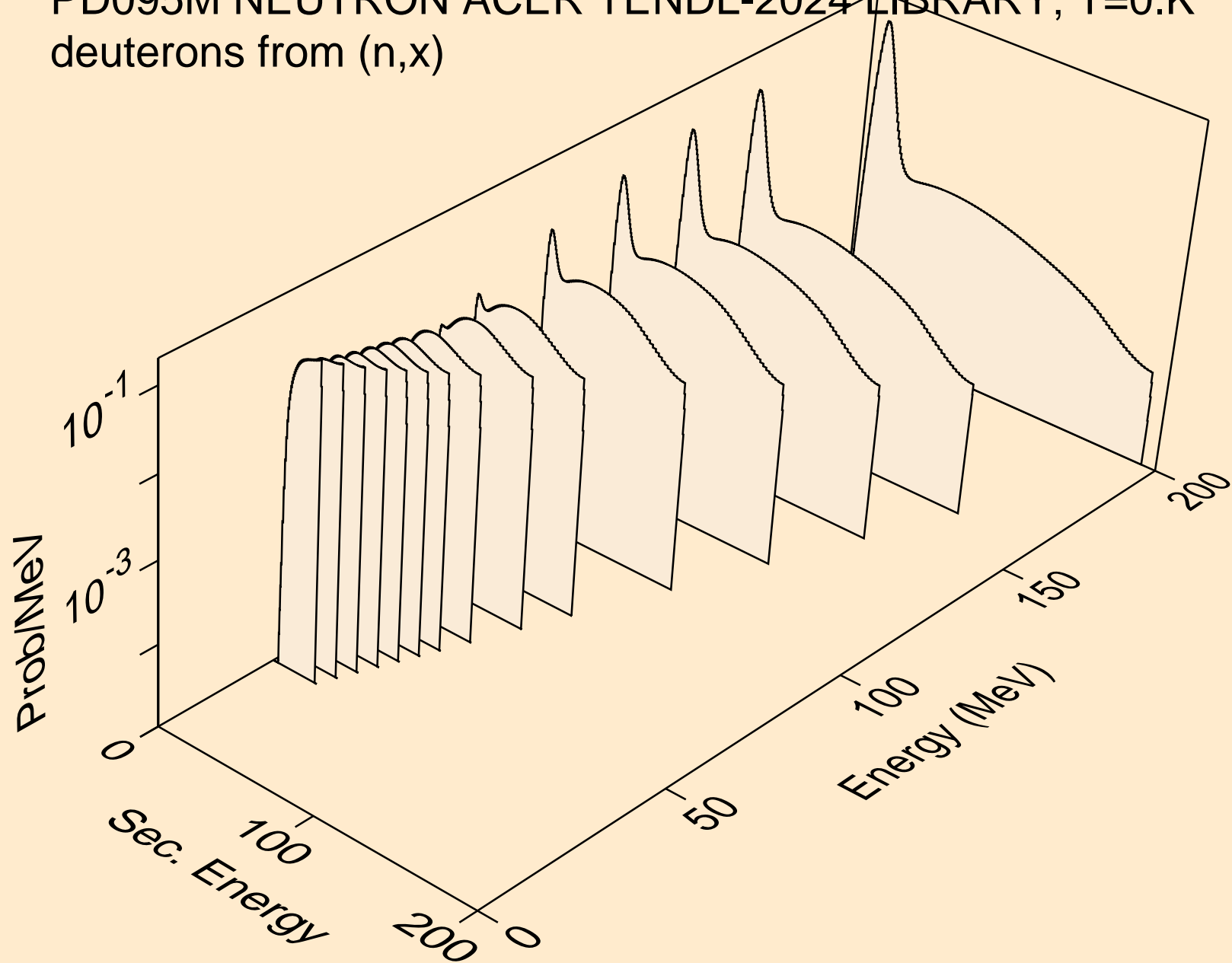

PD095M NEUTRON ACER TENDL-2024 LIBRARY; T=0.K
deuterons from (n,n*)d

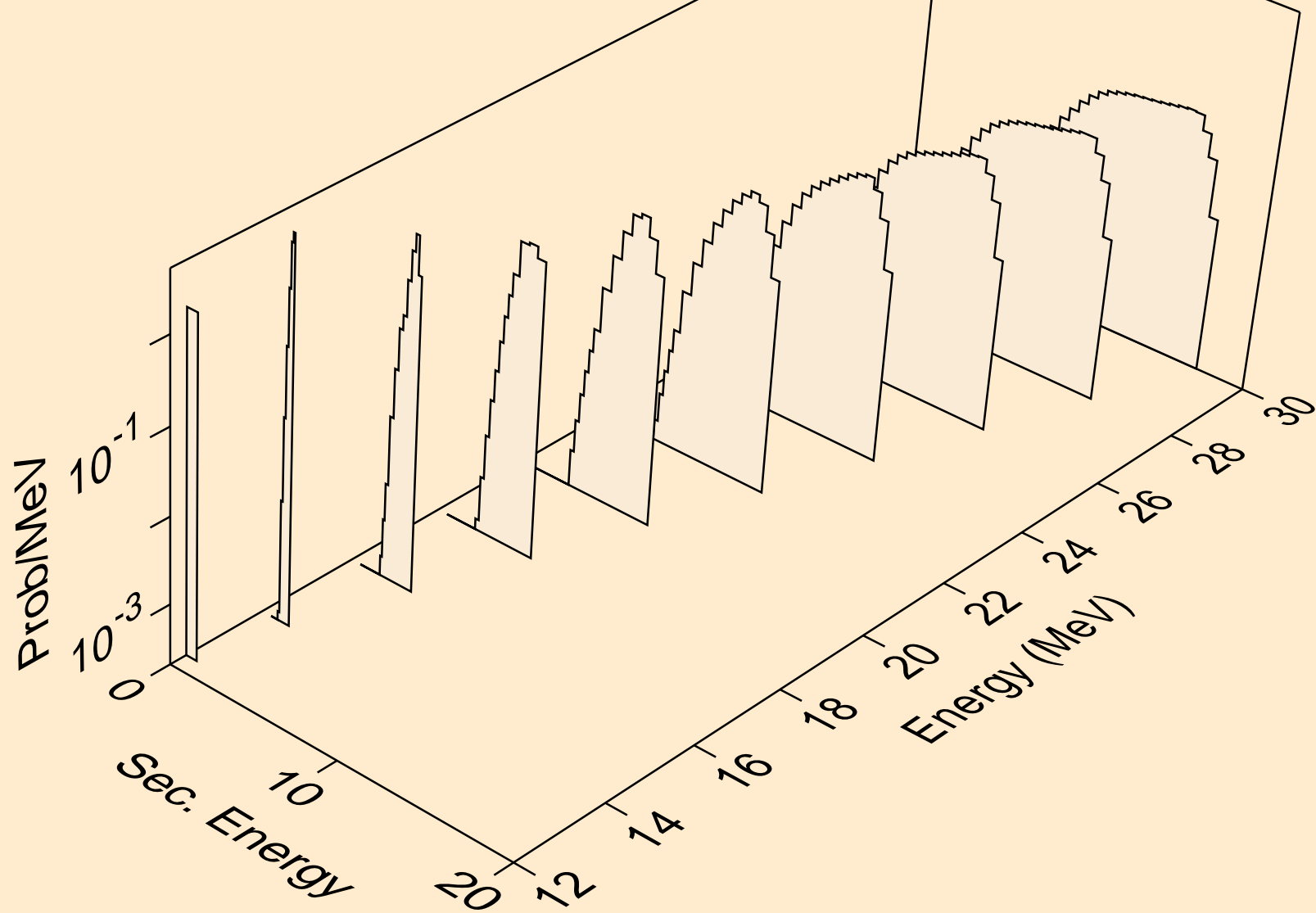

PD095M NEUTRON ACER TENDL-2024 LIBRARY; T=0.K
deuterons from (n,d)

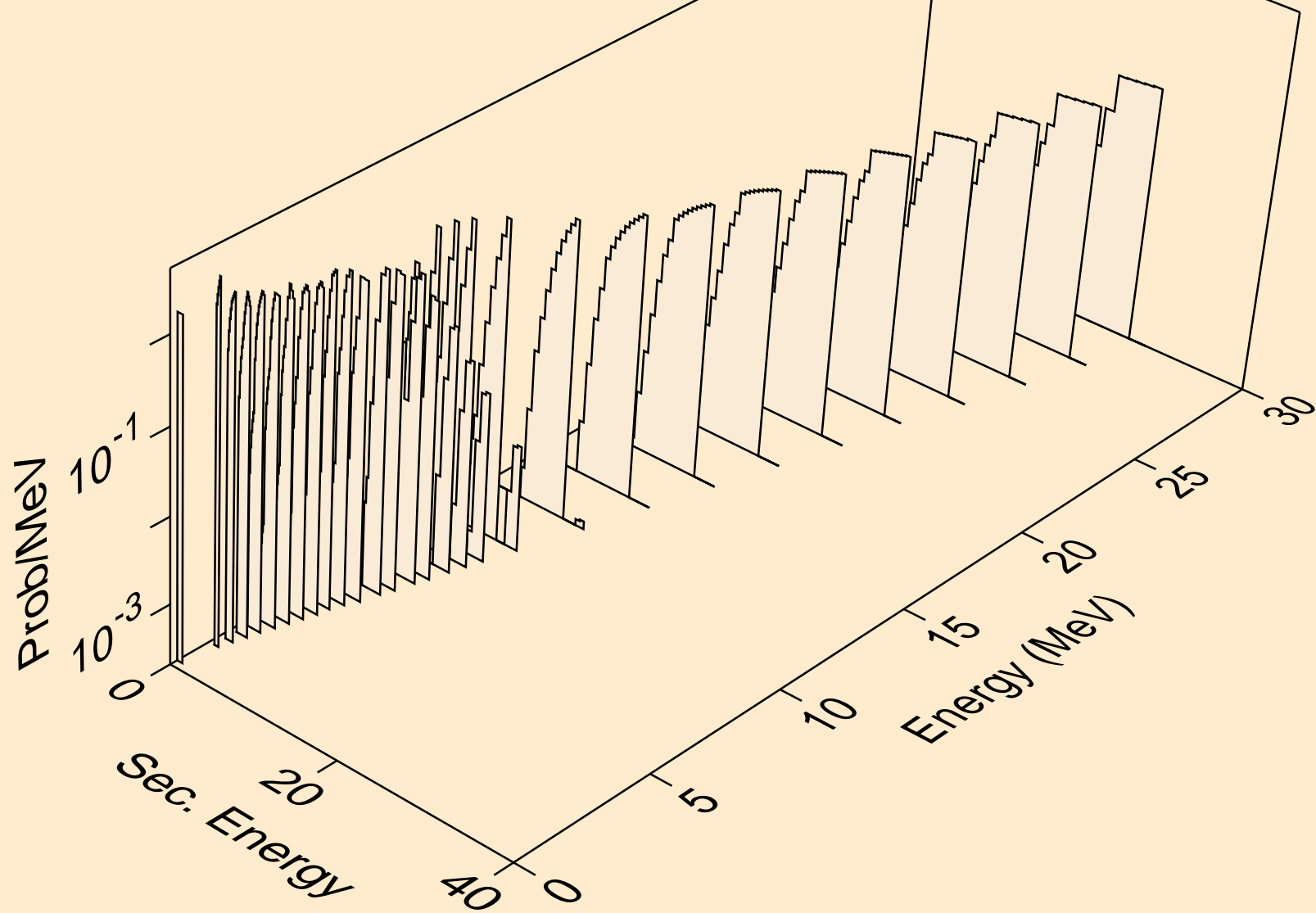

PD095M NEUTRON ACER TENDL-2024 LIBRARY; T=0.K
deuterons from (n,pd)

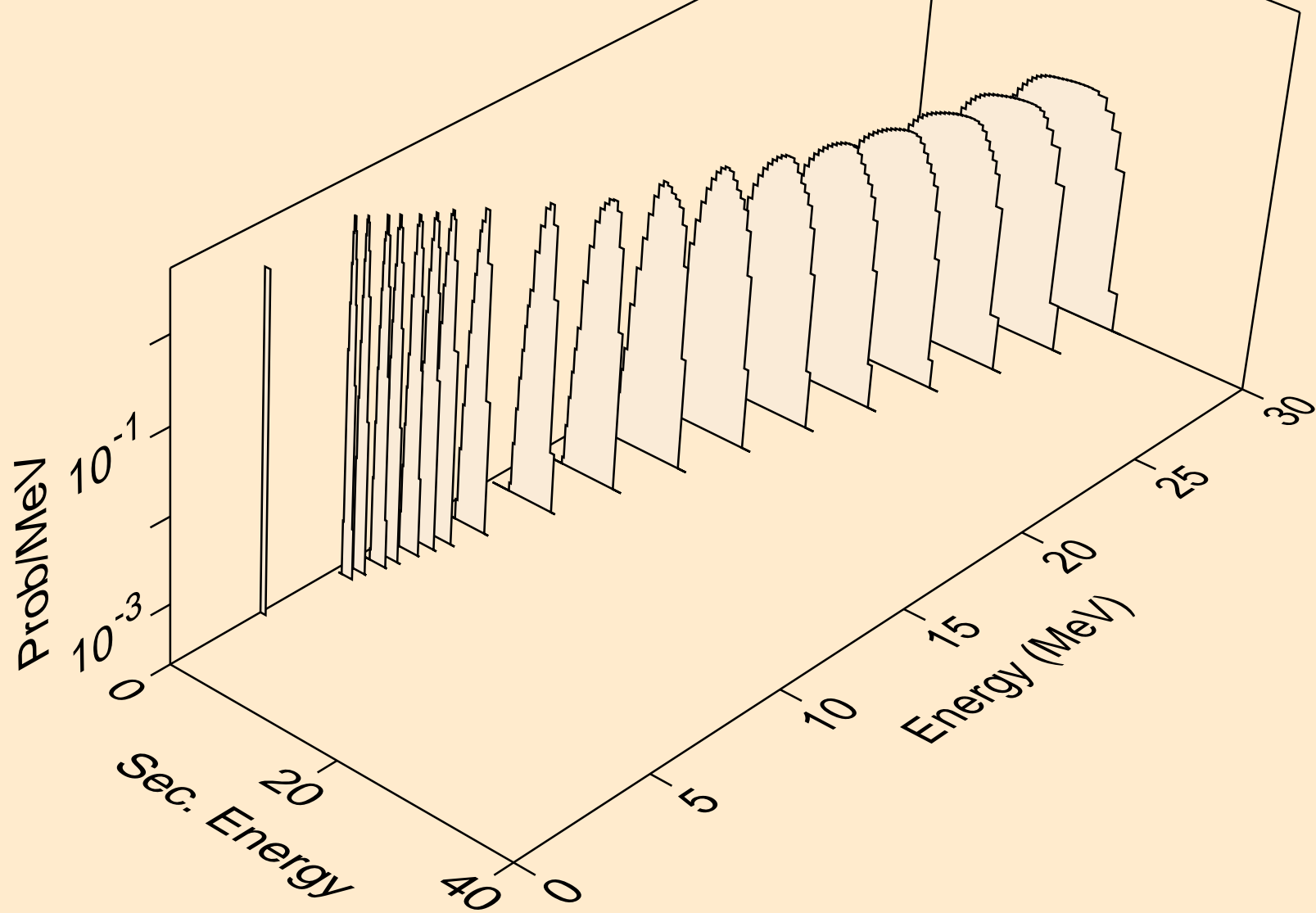

PD095M NEUTRON ACER TENDL-2024 LIBRARY; T=0.K
deuterons from (n,da)

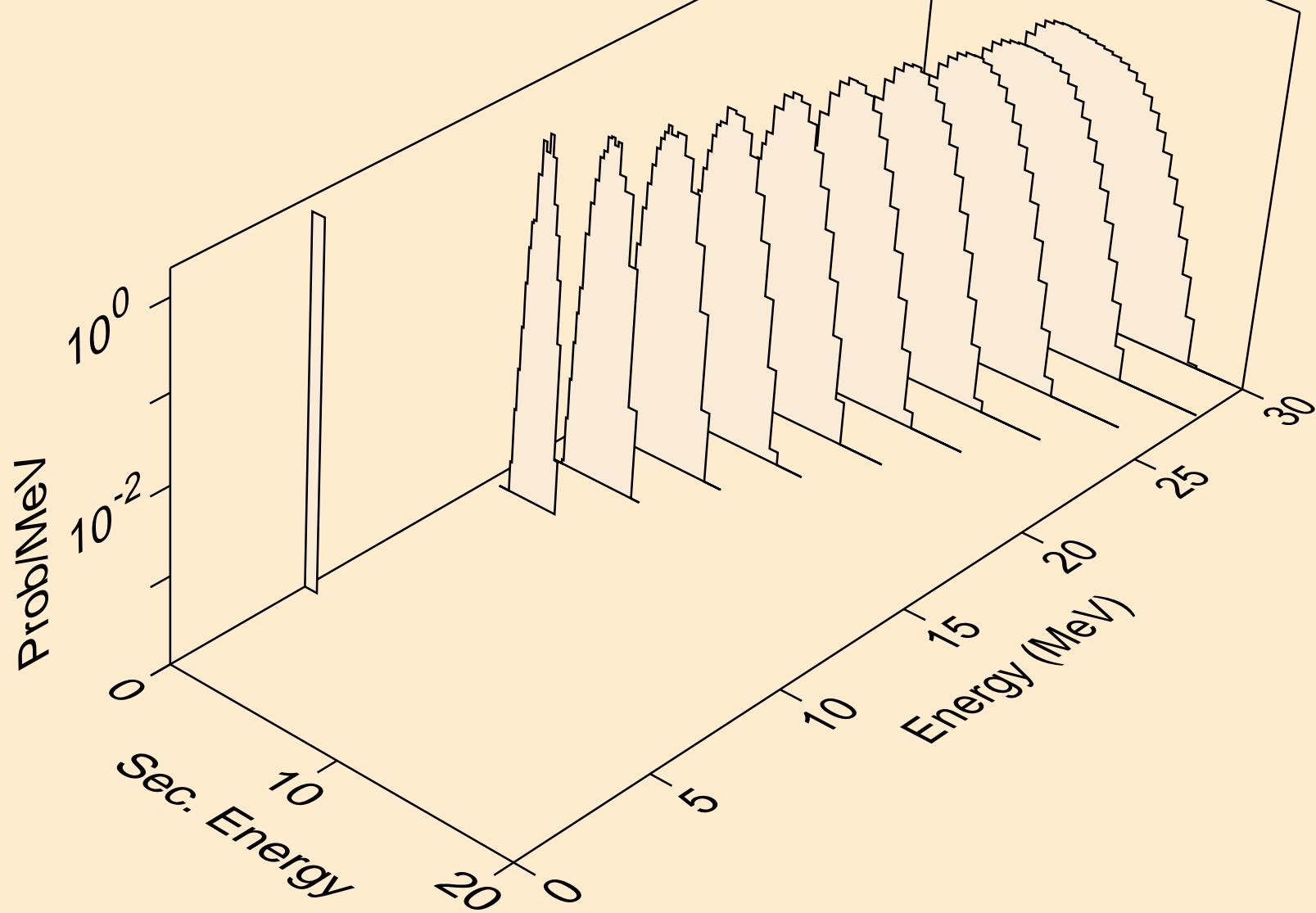

PD095M NEUTRON ACER TENDL-2024 LIBRARY; T=0.K
tritons from (n,x)

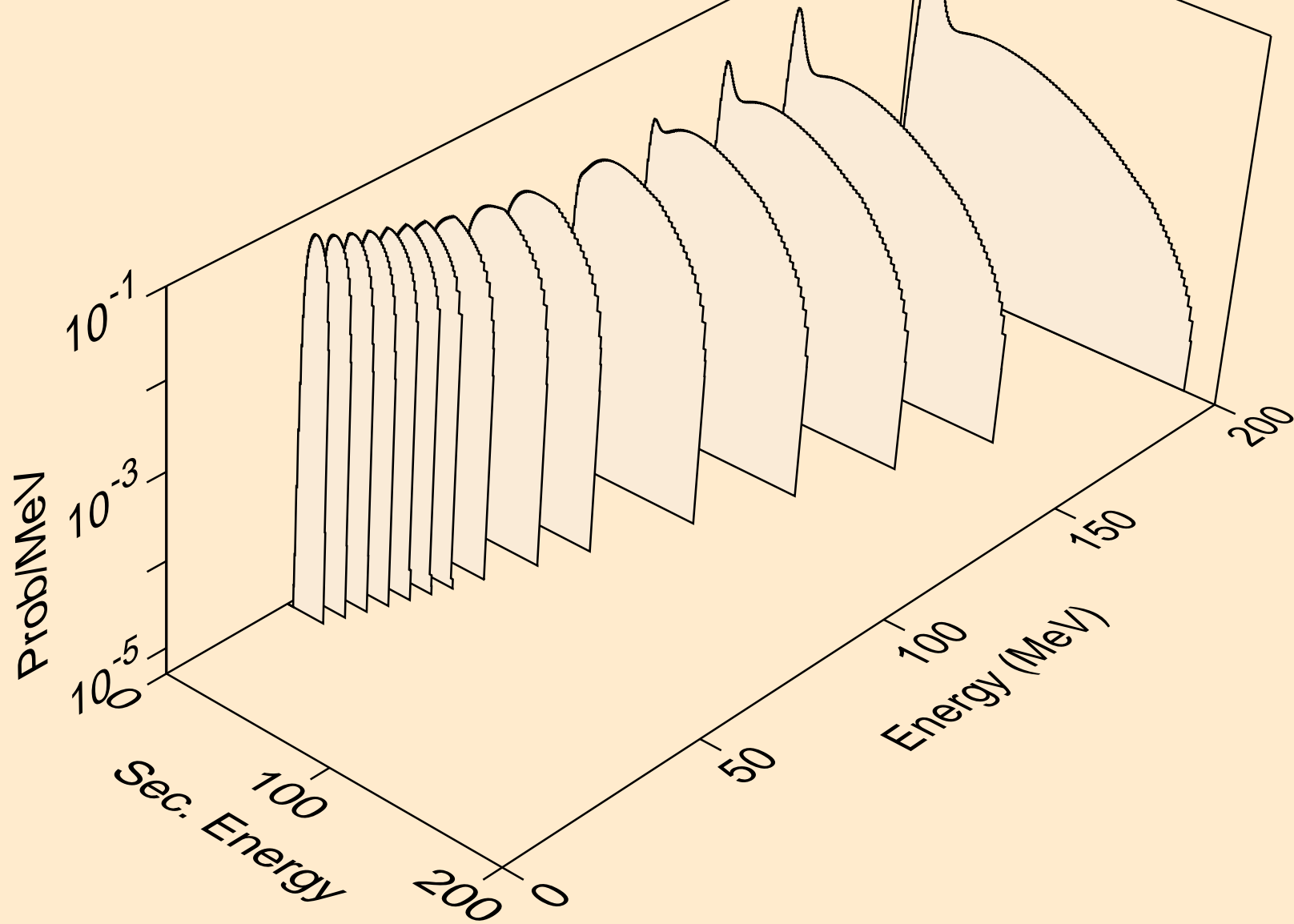

PD095M NEUTRON ACER TENDL-2024 LIBRARY; T=0.K
tritons from (n,n*)t

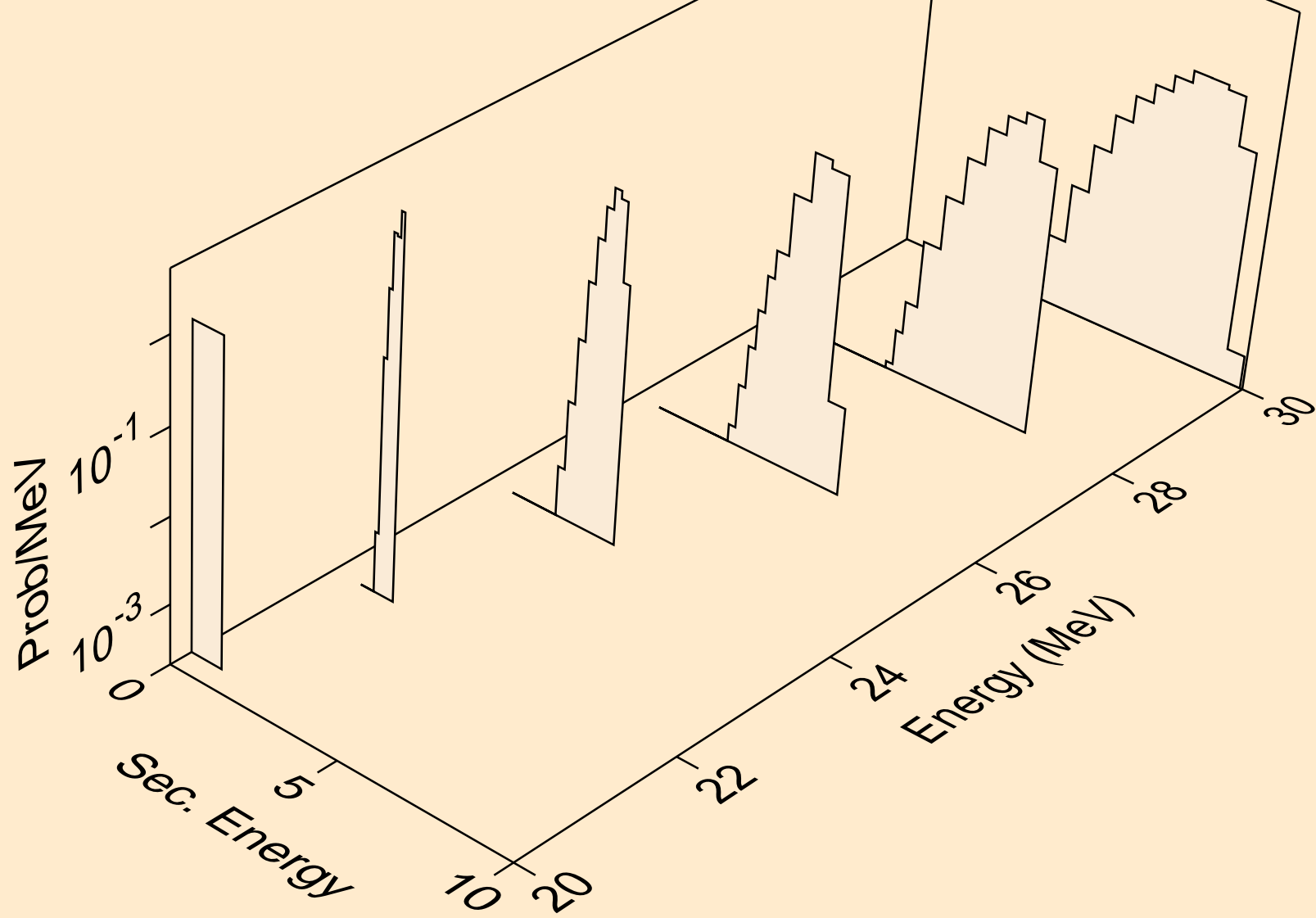

PD095M NEUTRON ACER TENDL-2024 LIBRARY; T=0.K
tritons from (n,t)

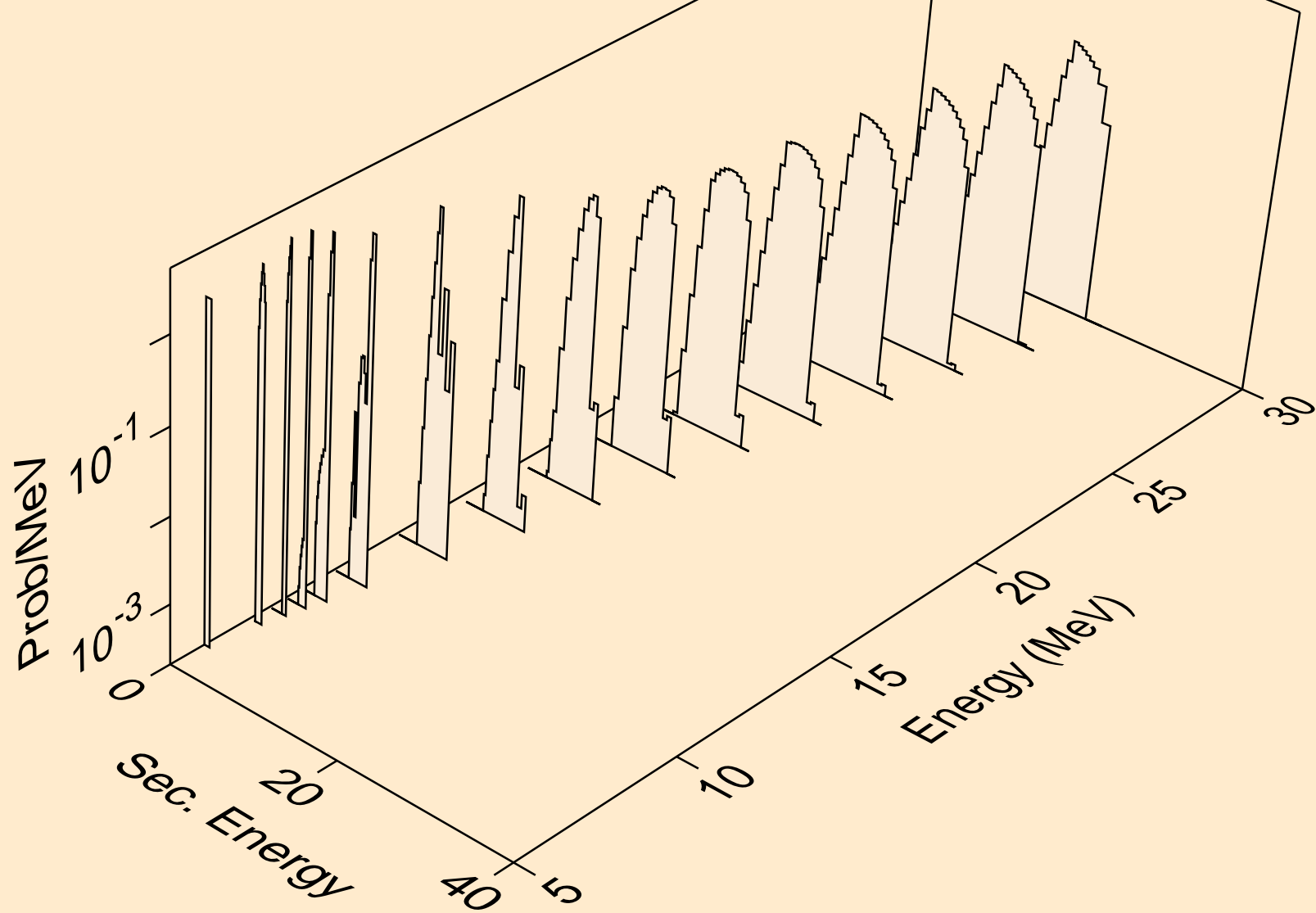

PD095M NEUTRON ACER TENDL-2024 LIBRARY; T=0.K
tritons from (n,pt)

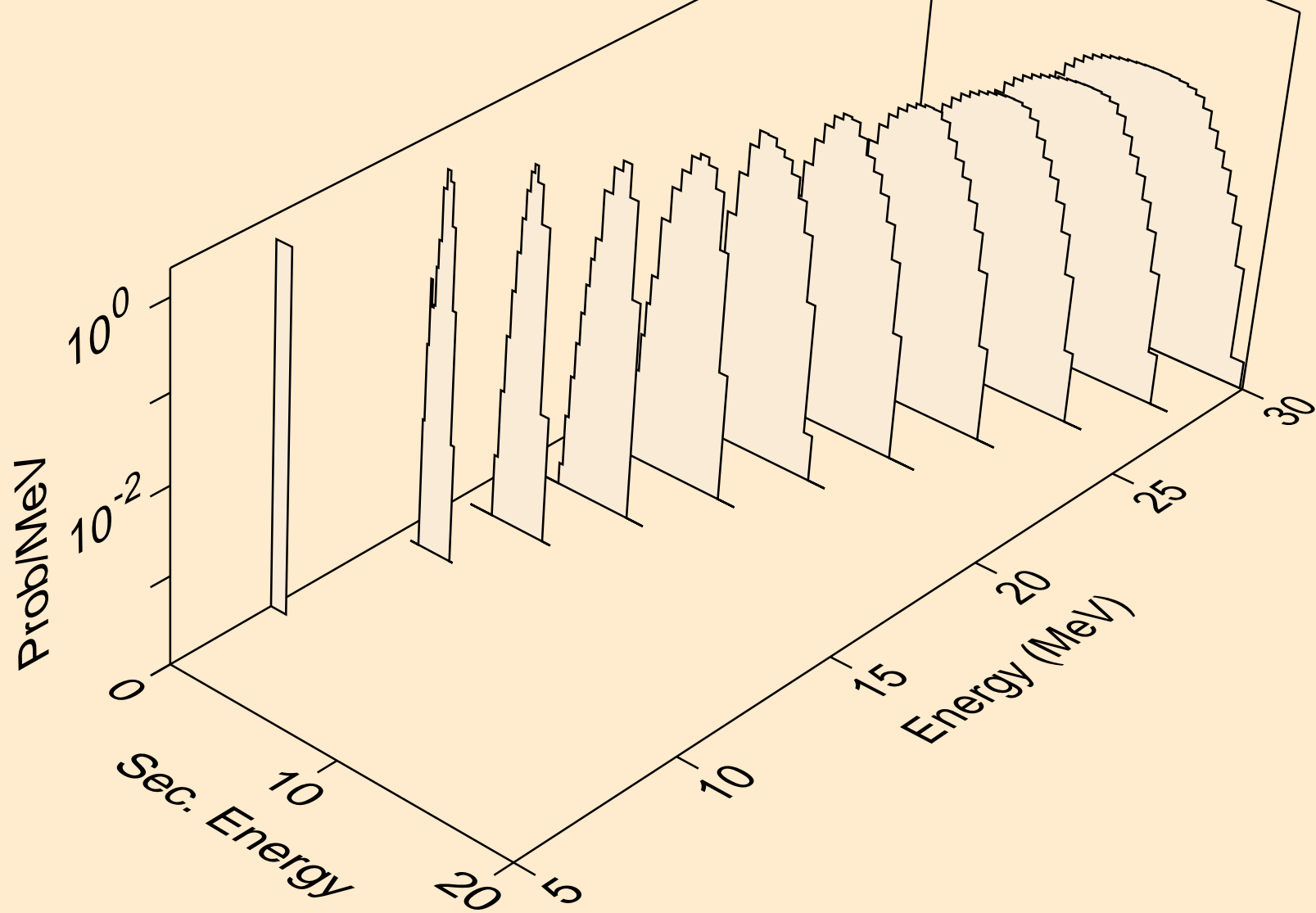

PD095M NEUTRON ACER TENDL-2024 LIBRARY; T=0.K
he3s from (n,x)

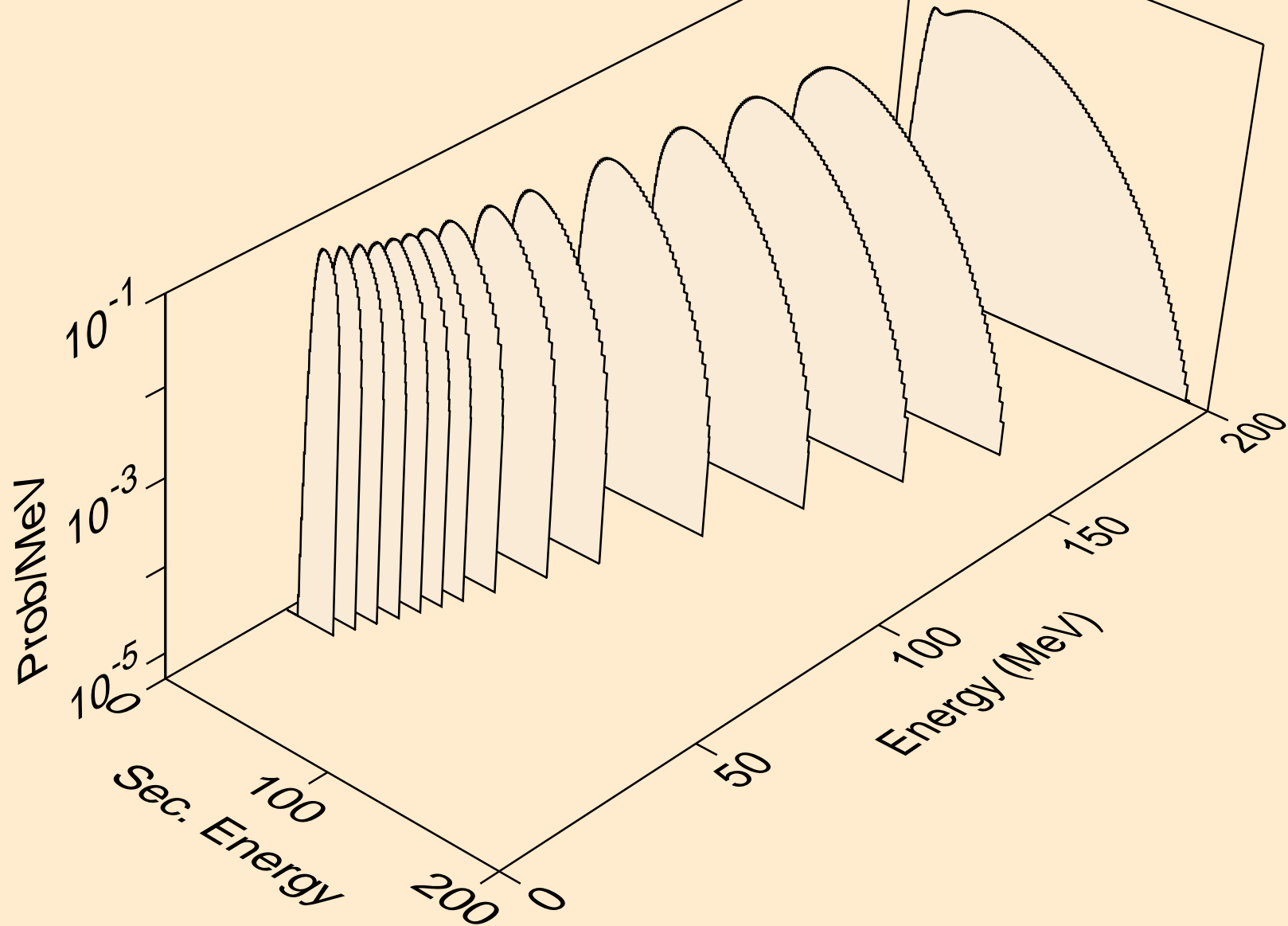

PD095M NEUTRON ACER TENDL-2024 LIBRARY; T=0.K
he3s from (n,n*)he3

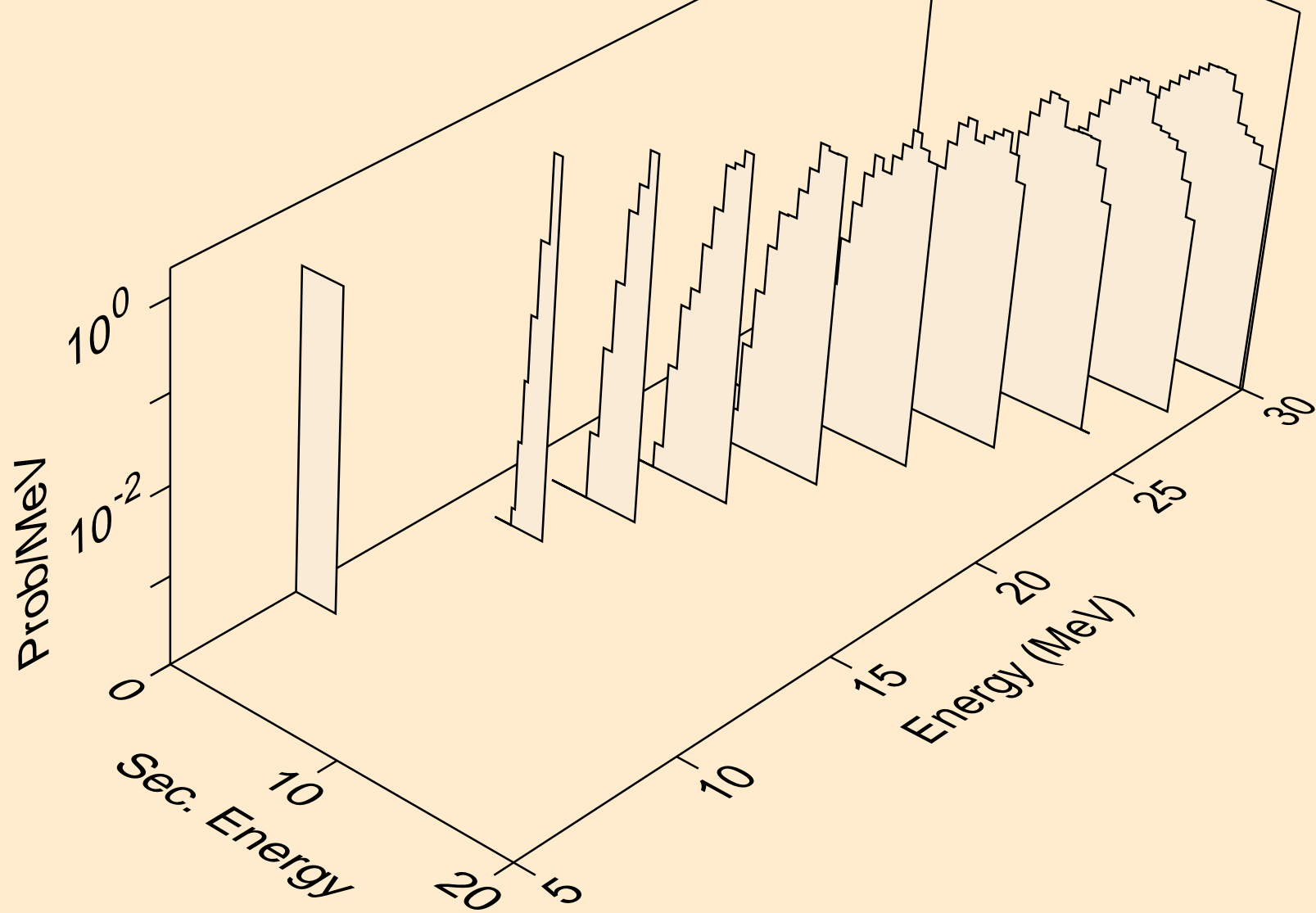

PD095M NEUTRON ACER TENDL-2024 LIBRARY; T=0.K
he3s from (n,he3)

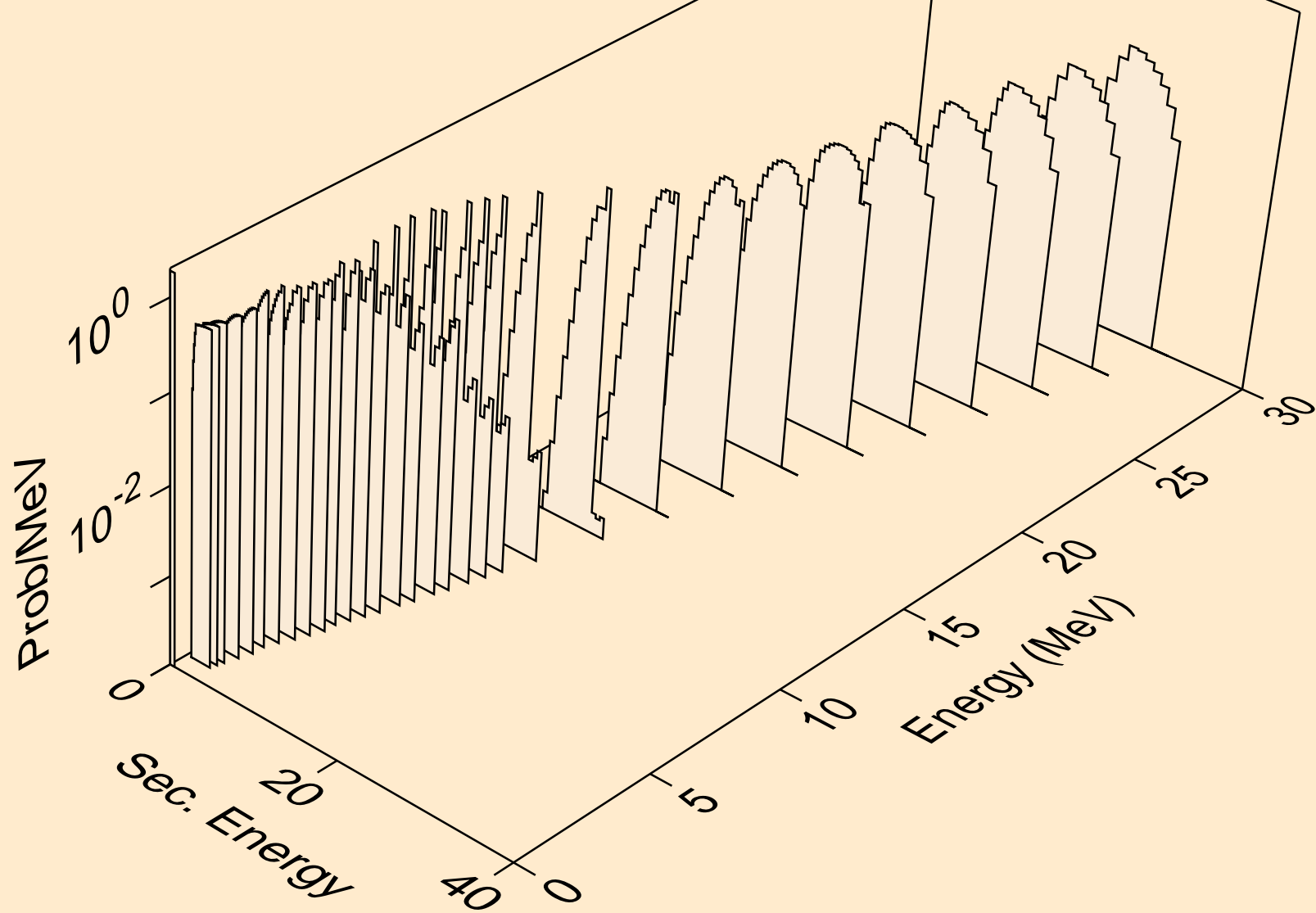

PD095M NEUTRON ACER TENDL-2024 LIBRARY; T=0.K
alphas from (n,x)

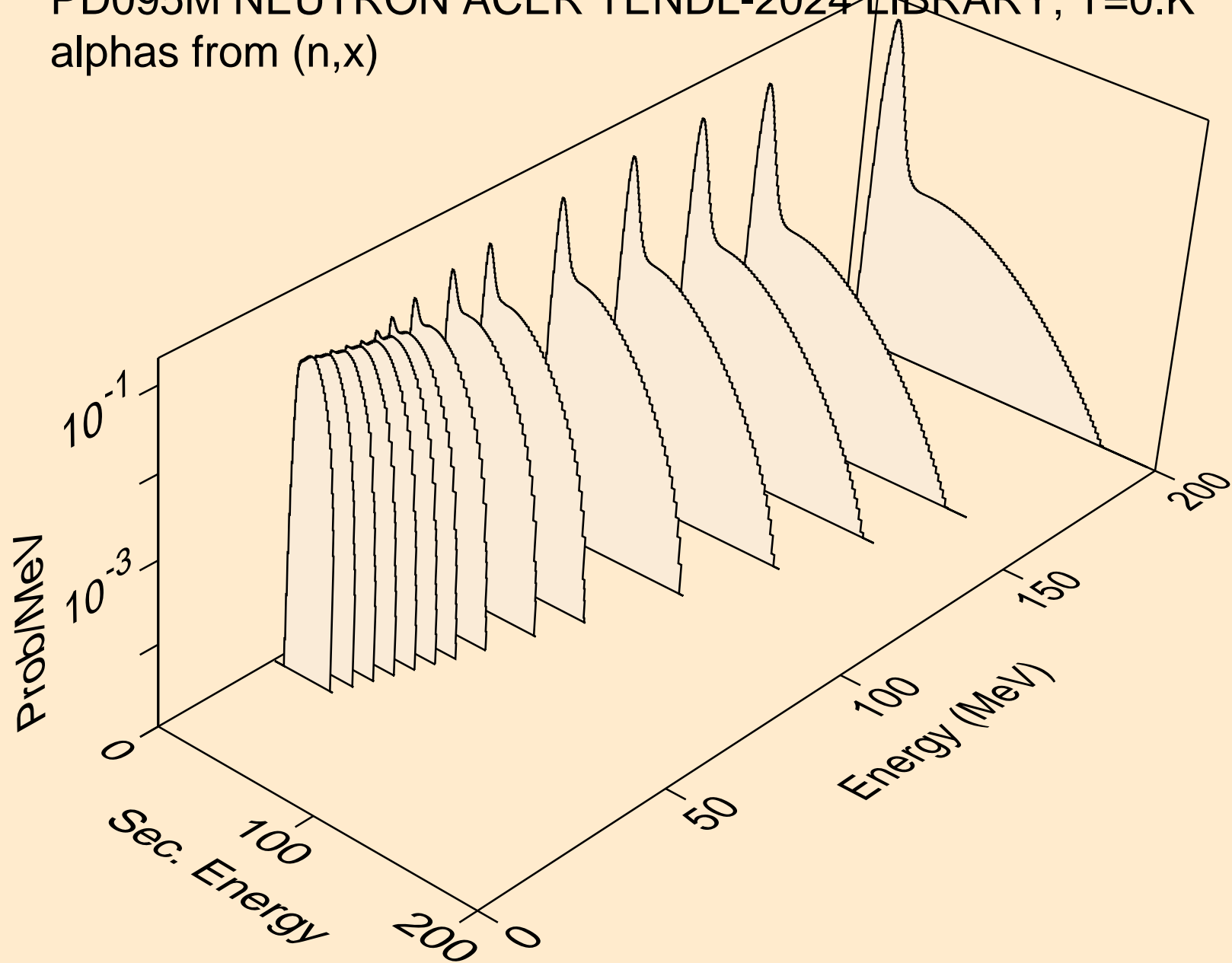

PD095M NEUTRON ACER TENDL-2024 LIBRARY; T=0.K
alphas from (n,n*)a

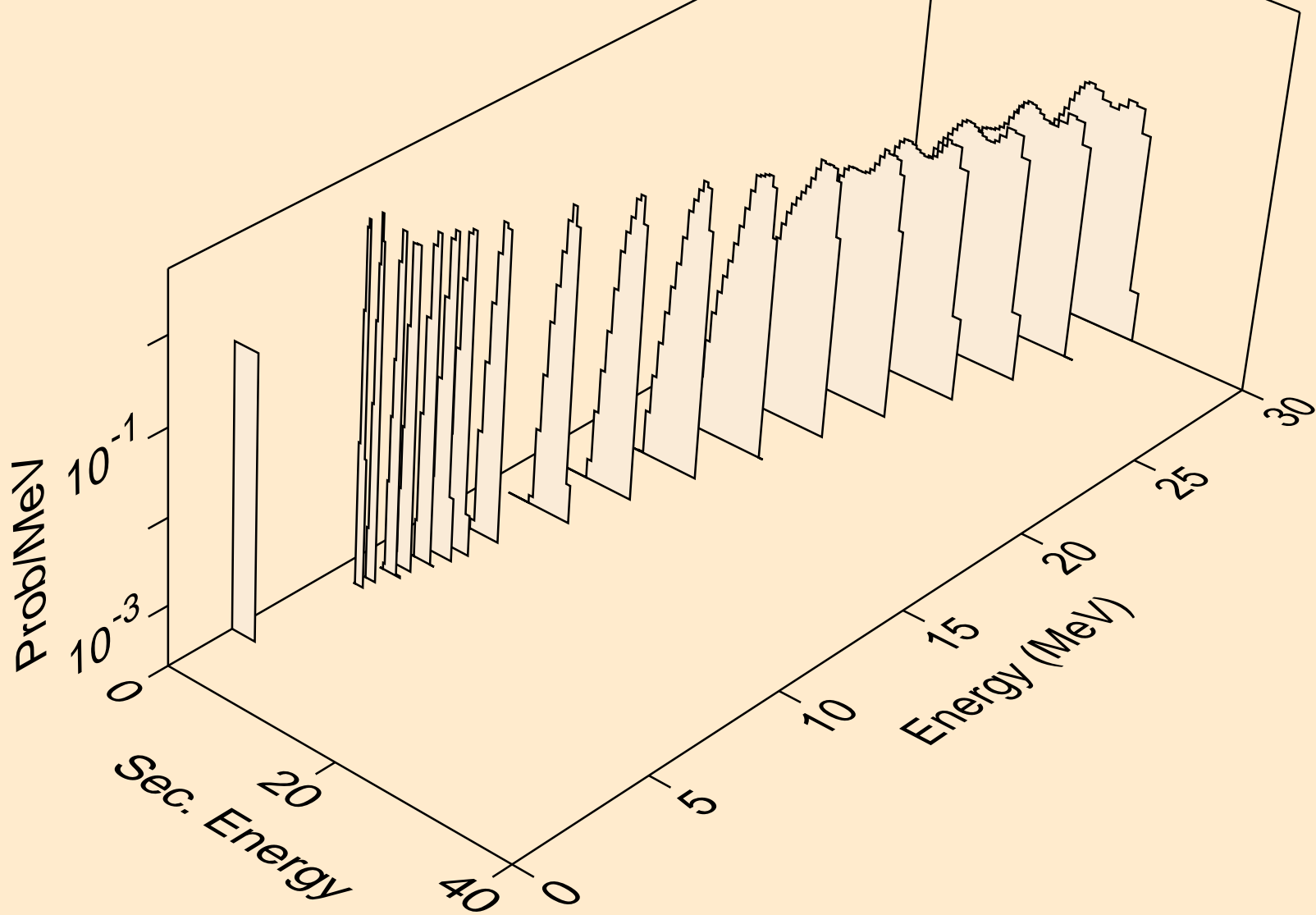

PD095M NEUTRON ACER TENDL-2024 LIBRARY; T=0.K
alphas from (n,2n)a

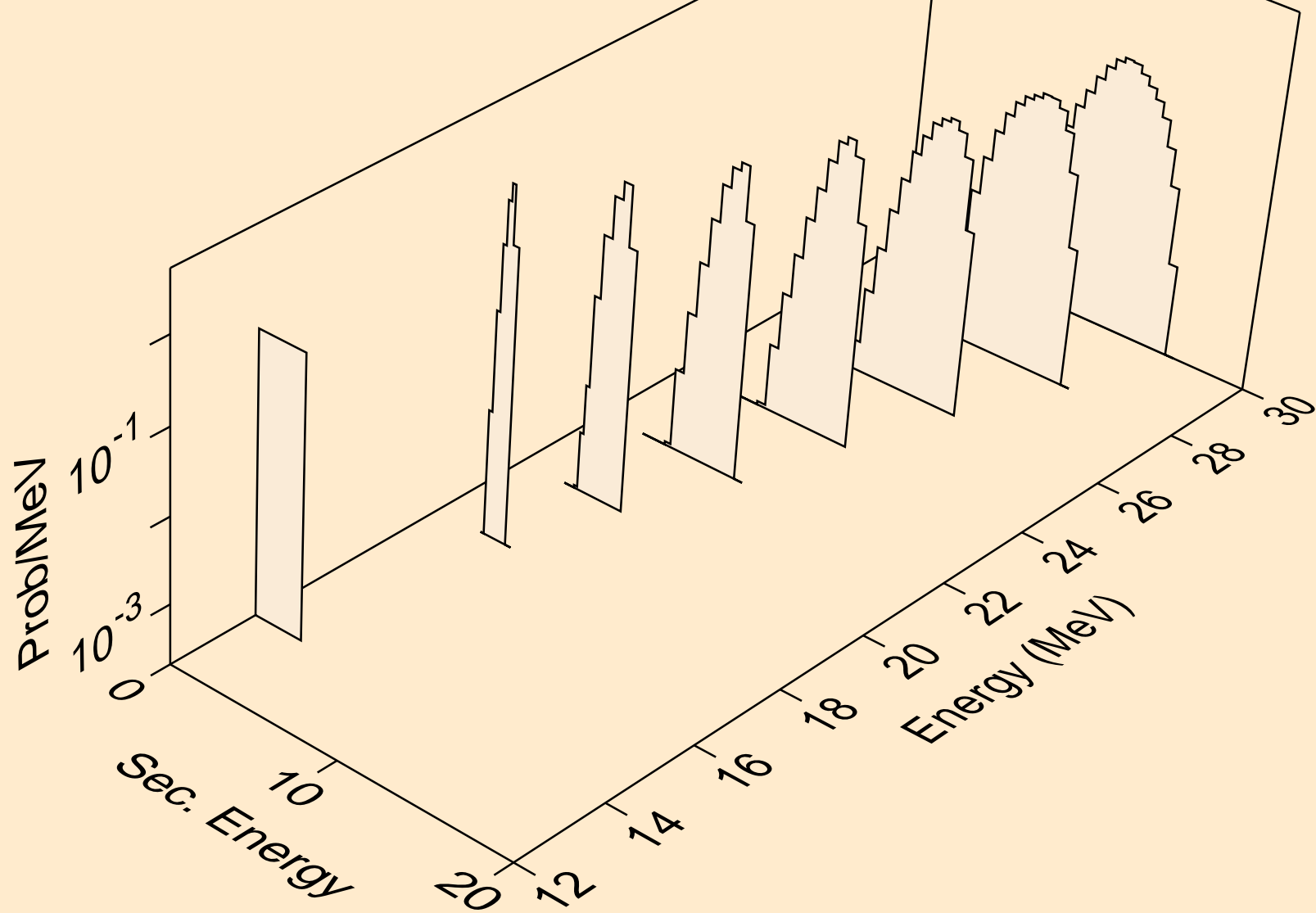

PD095M NEUTRON ACER TENDL-2024 LIBRARY; T=0.K
alphas from (n,n*)2a

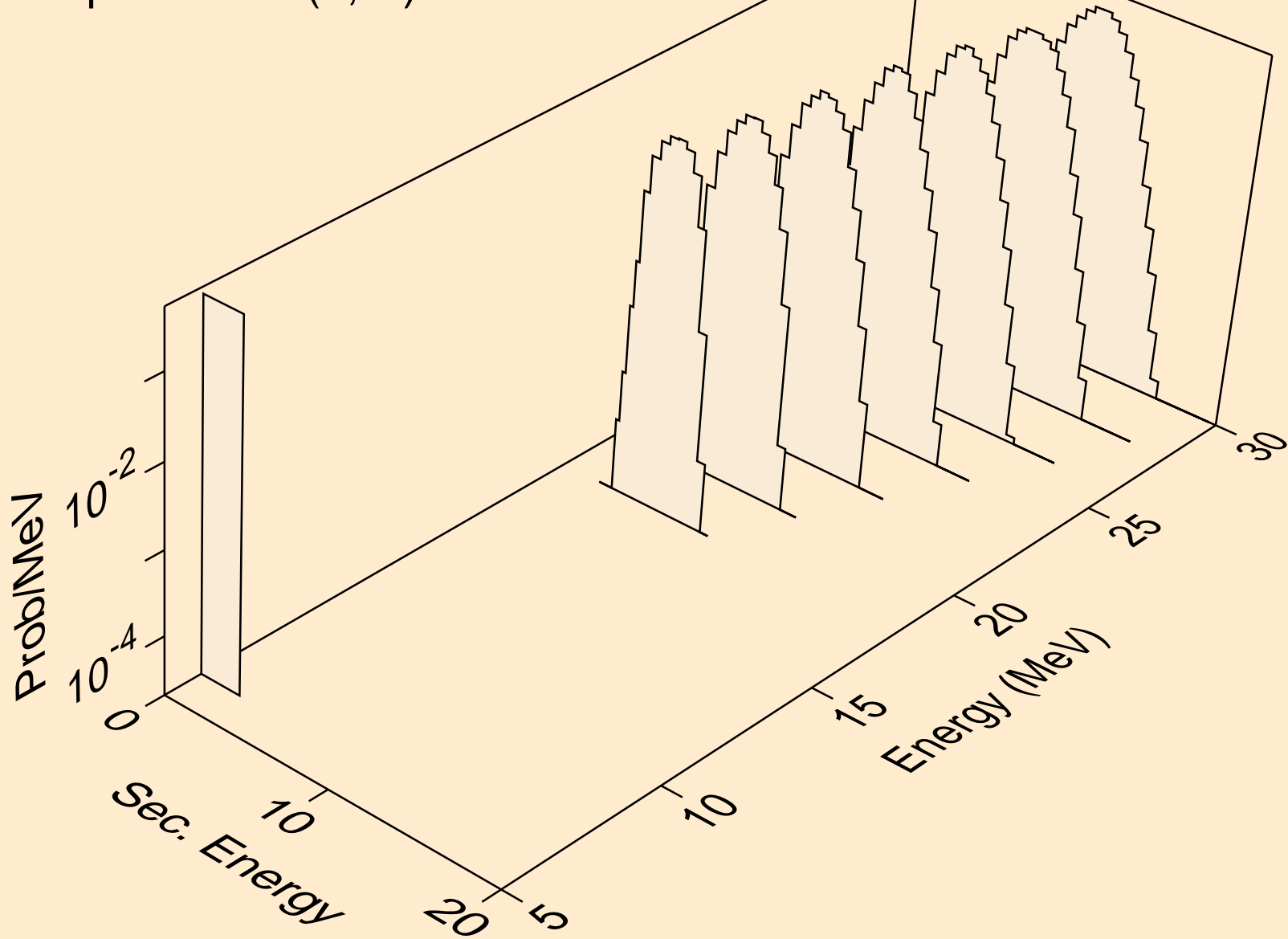

PD095M NEUTRON ACER TENDL-2024 LIBRARY; T=0.K
alphas from (n,npa)

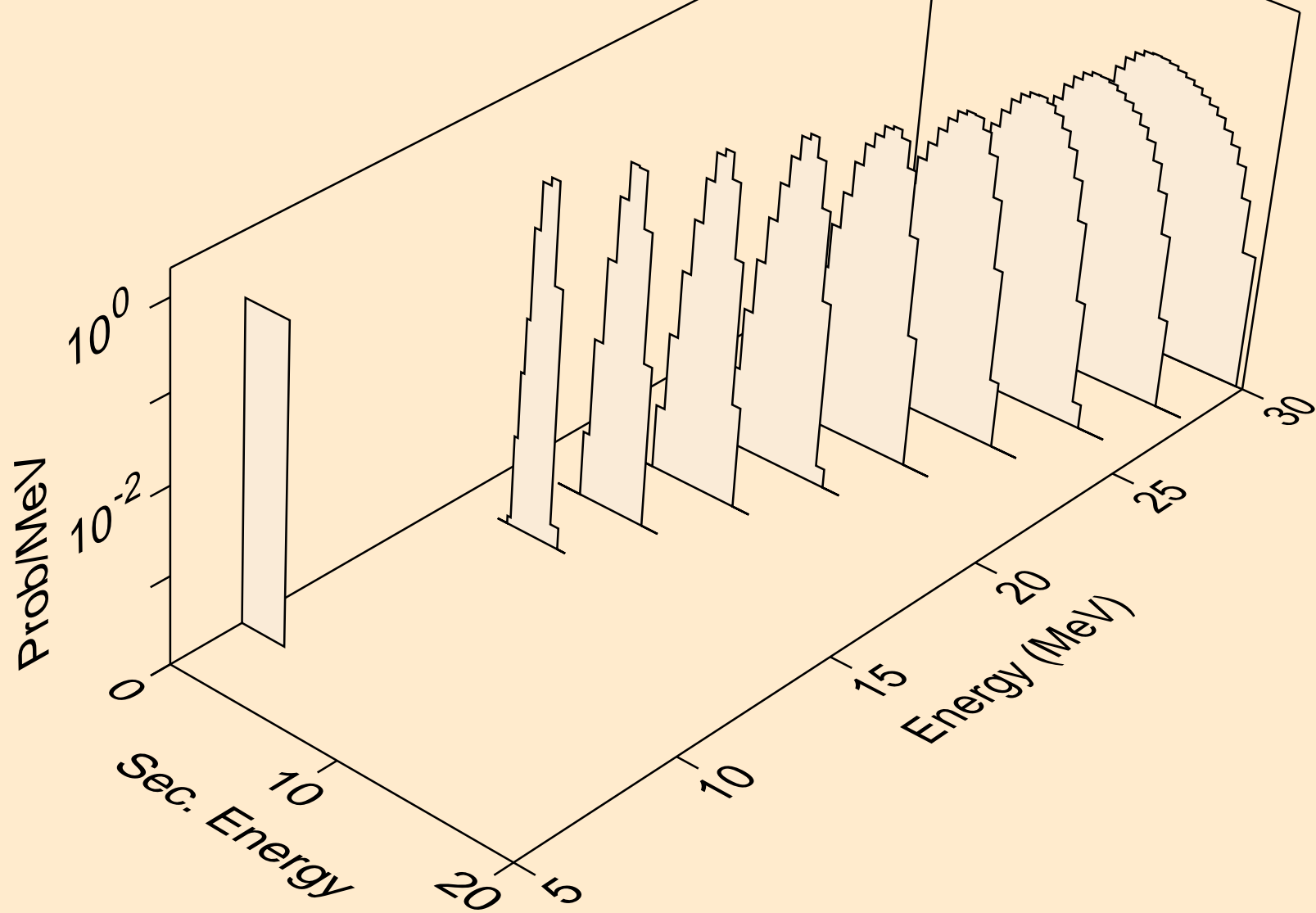

PD095M NEUTRON ACER TENDL-2024 LIBRARY; T=0.K
alphas from (n,a)

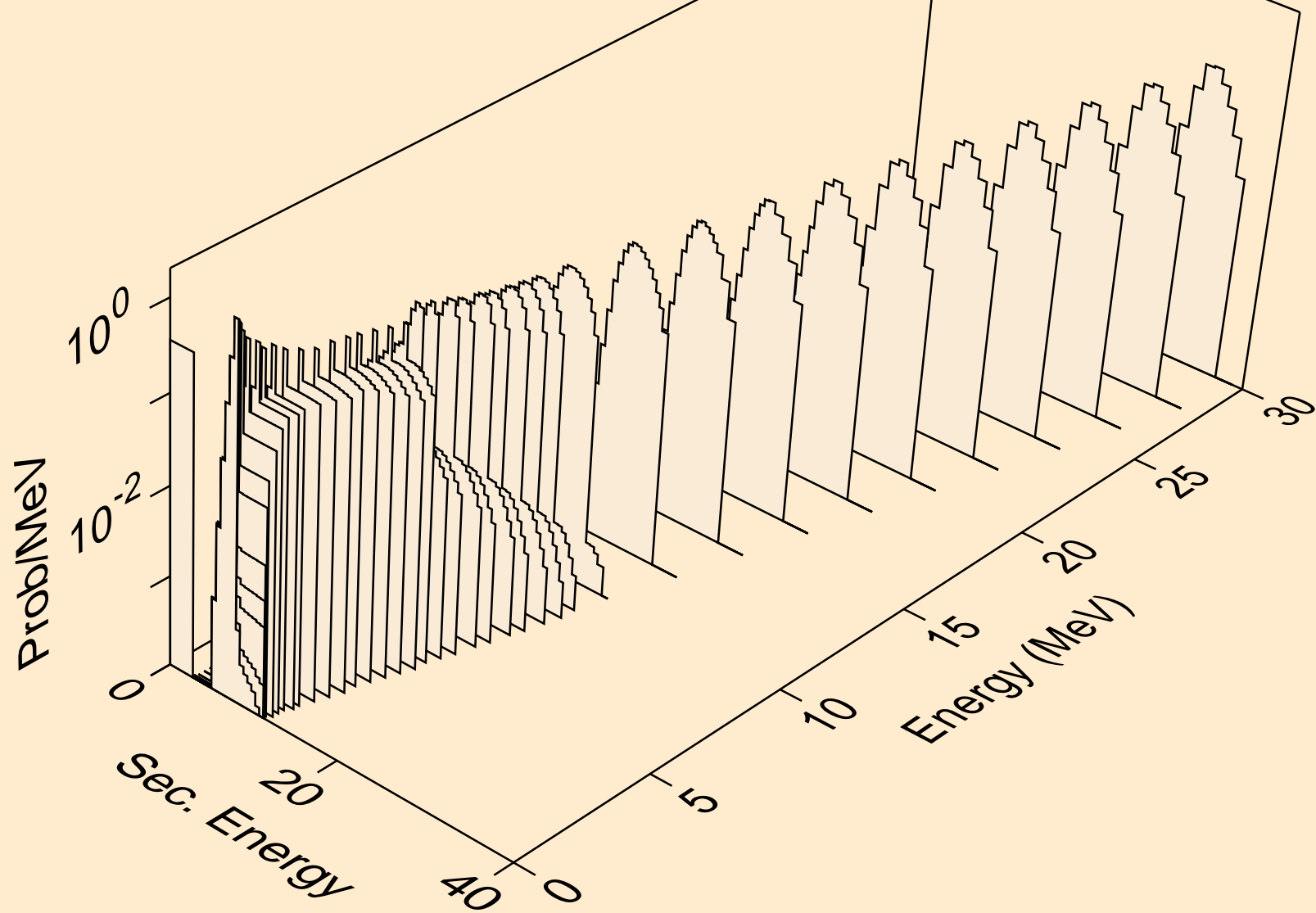

PD095M NEUTRON ACER TENDL-2024 LIBRARY; T=0.K
alphas from (n,2a)

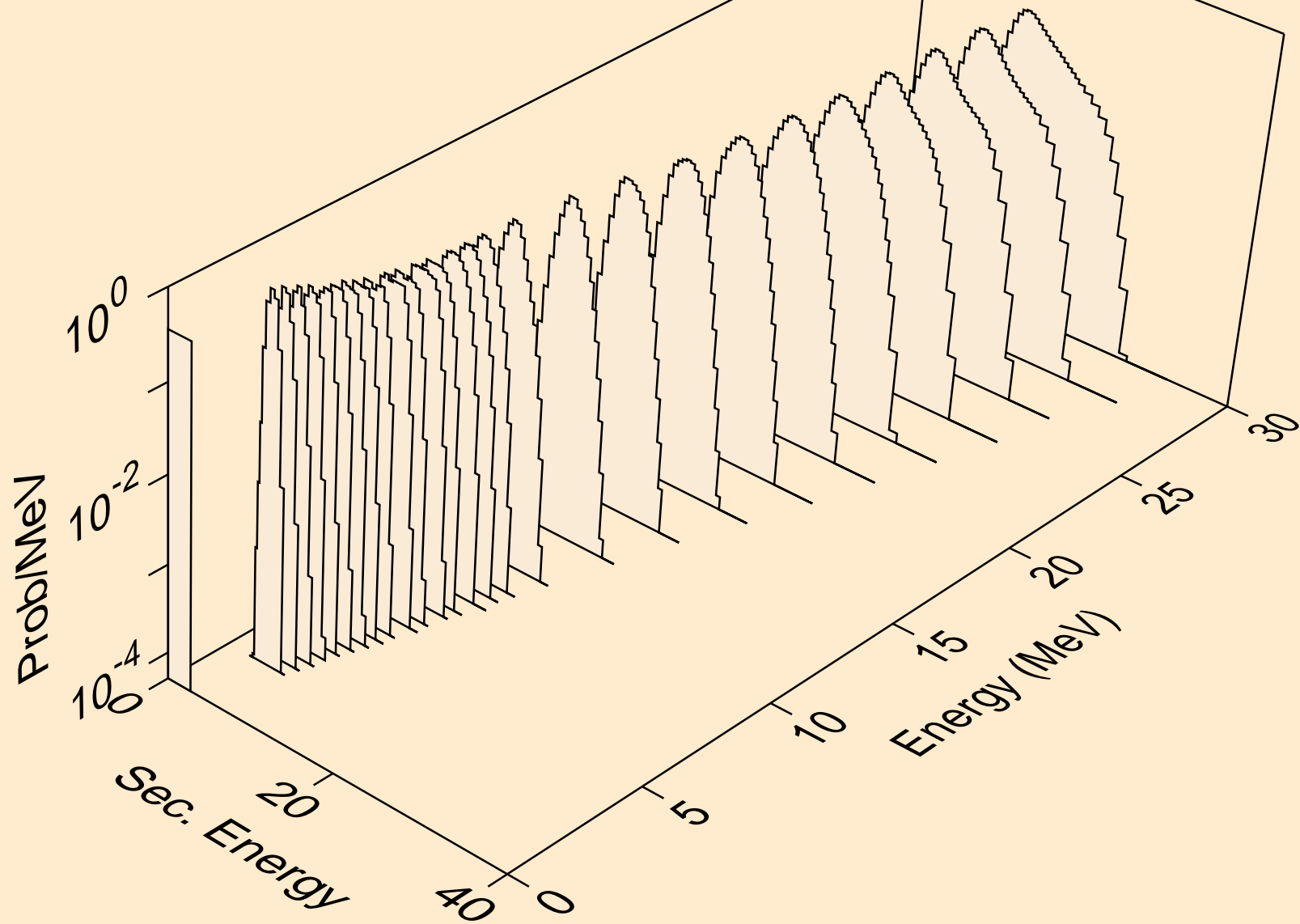

PD095M NEUTRON ACER TENDL-2024 LIBRARY; T=0.K
alphas from (n,3a)

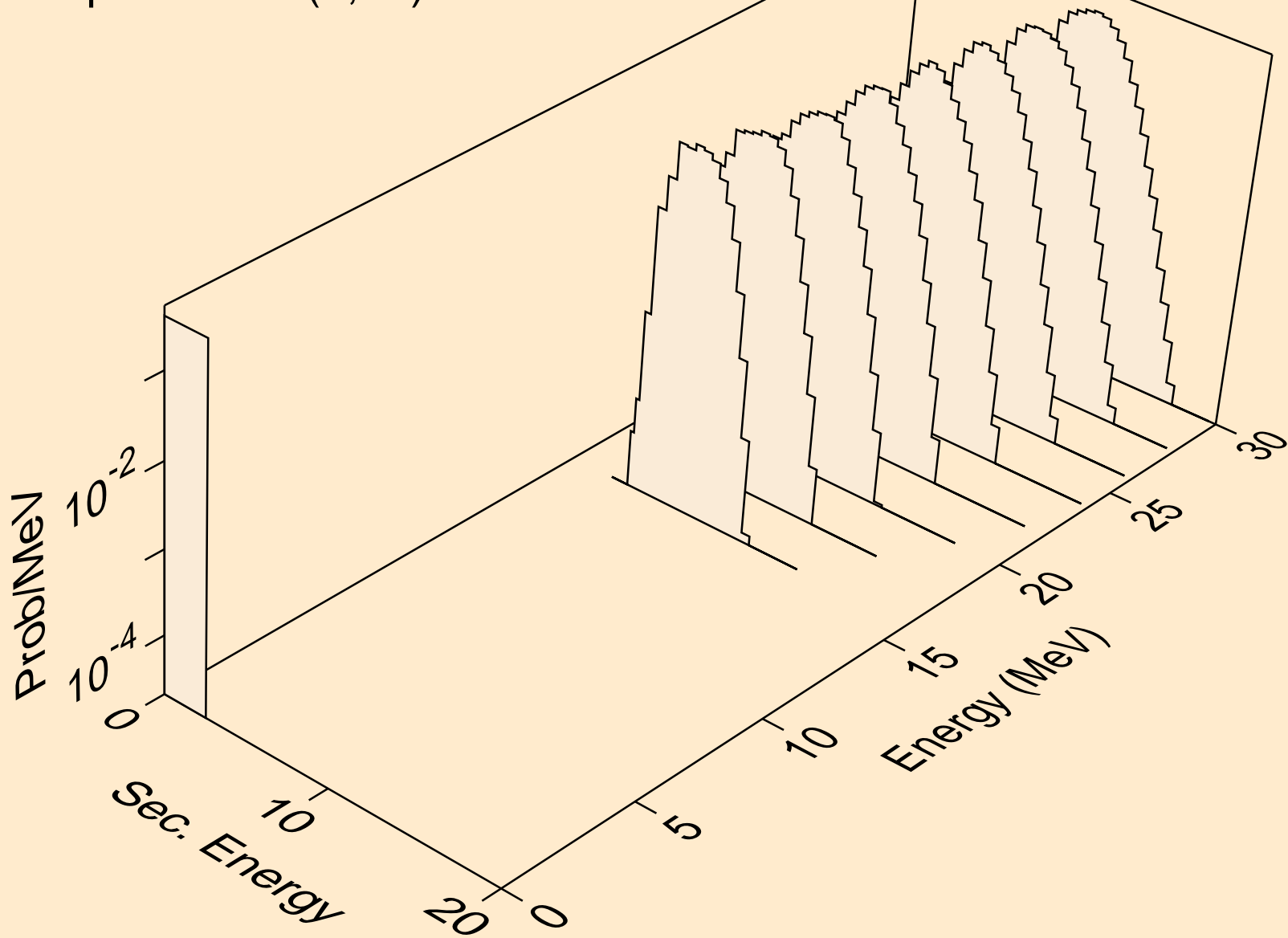

PD095M NEUTRON ACER TENDL-2024 LIBRARY; T=0.K
alphas from (n,pa)

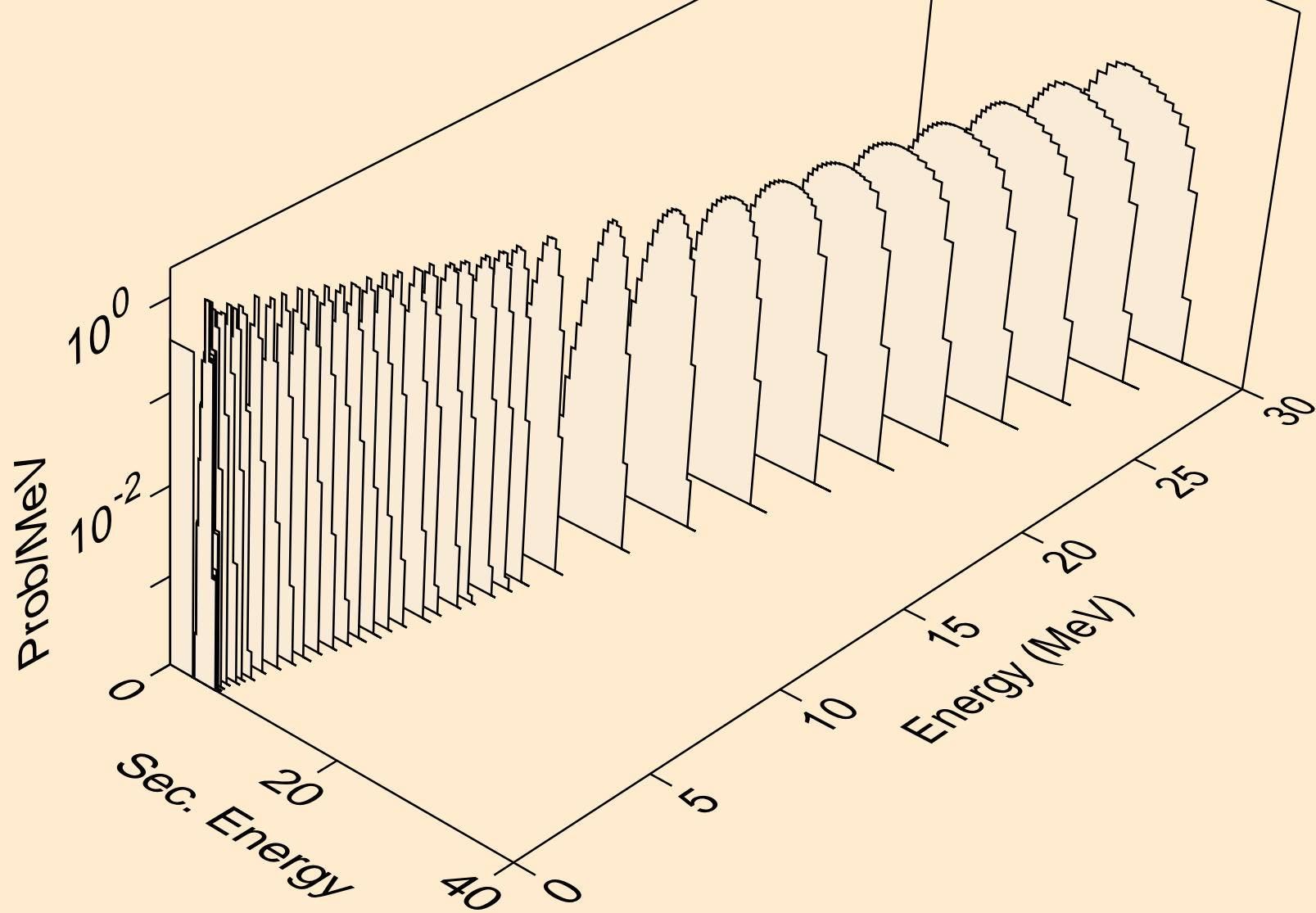

PD095M NEUTRON ACER TENDL-2024 LIBRARY; T=0.K
alphas from (n,da)

