

PD097 NEUTRON ACER TENDL-2024 LIBRARY; T=0.K
Principal cross sections

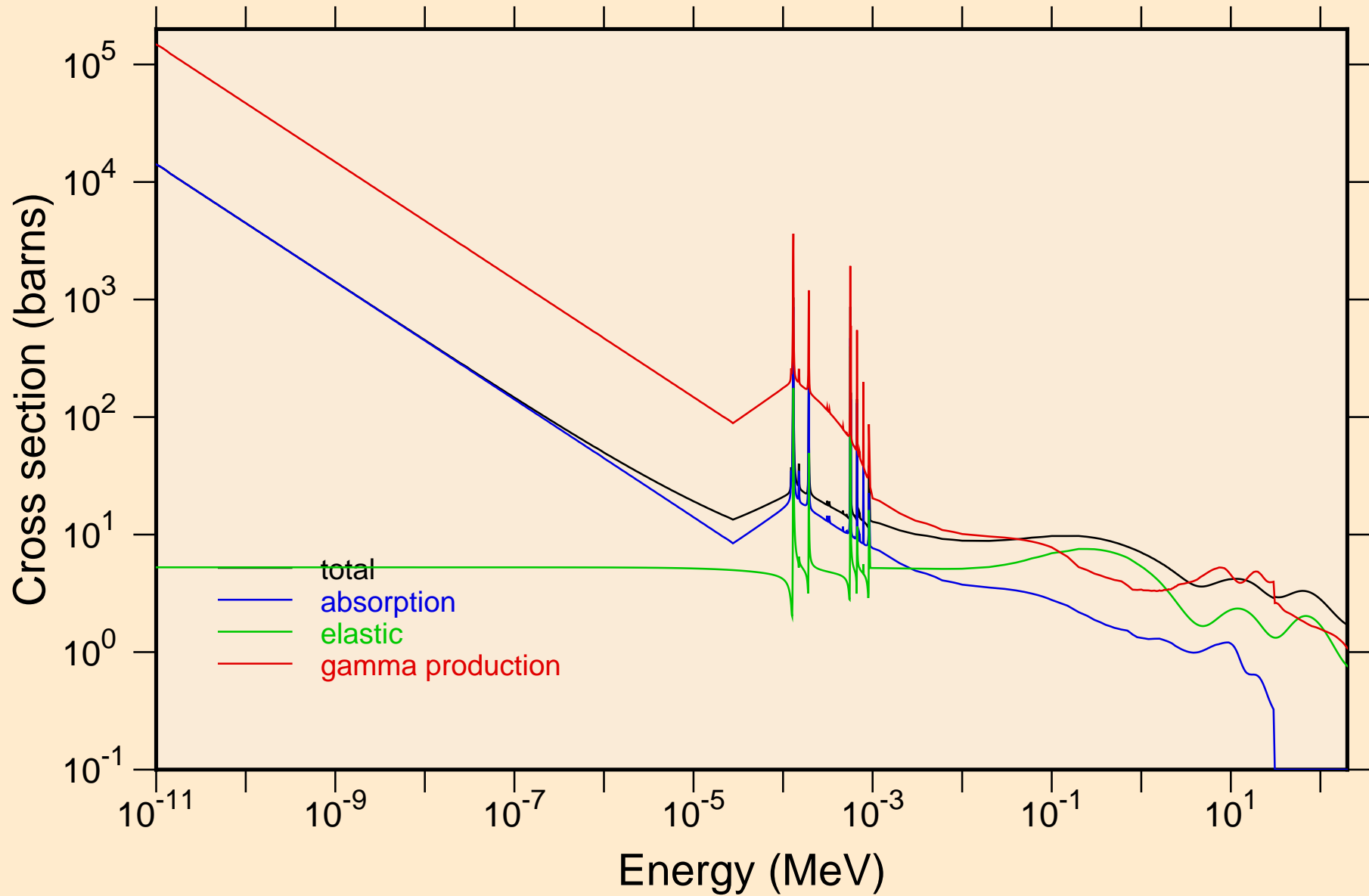

PD097 NEUTRON ACER TENDL-2024 LIBRARY; T=0.K
resonance total cross section

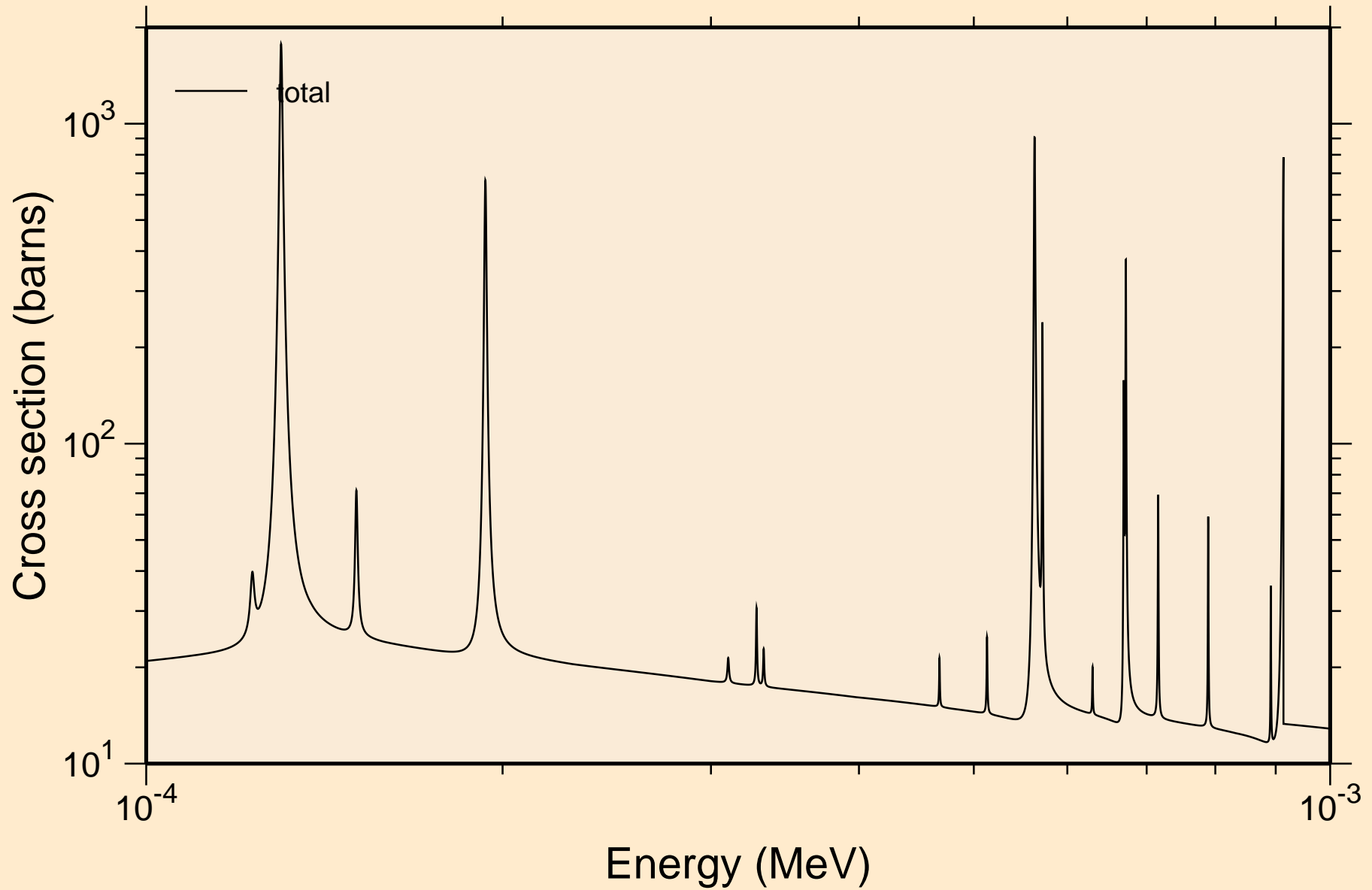

PD097 NEUTRON ACER TENDL-2024 LIBRARY; T=0.K
resonance total cross section

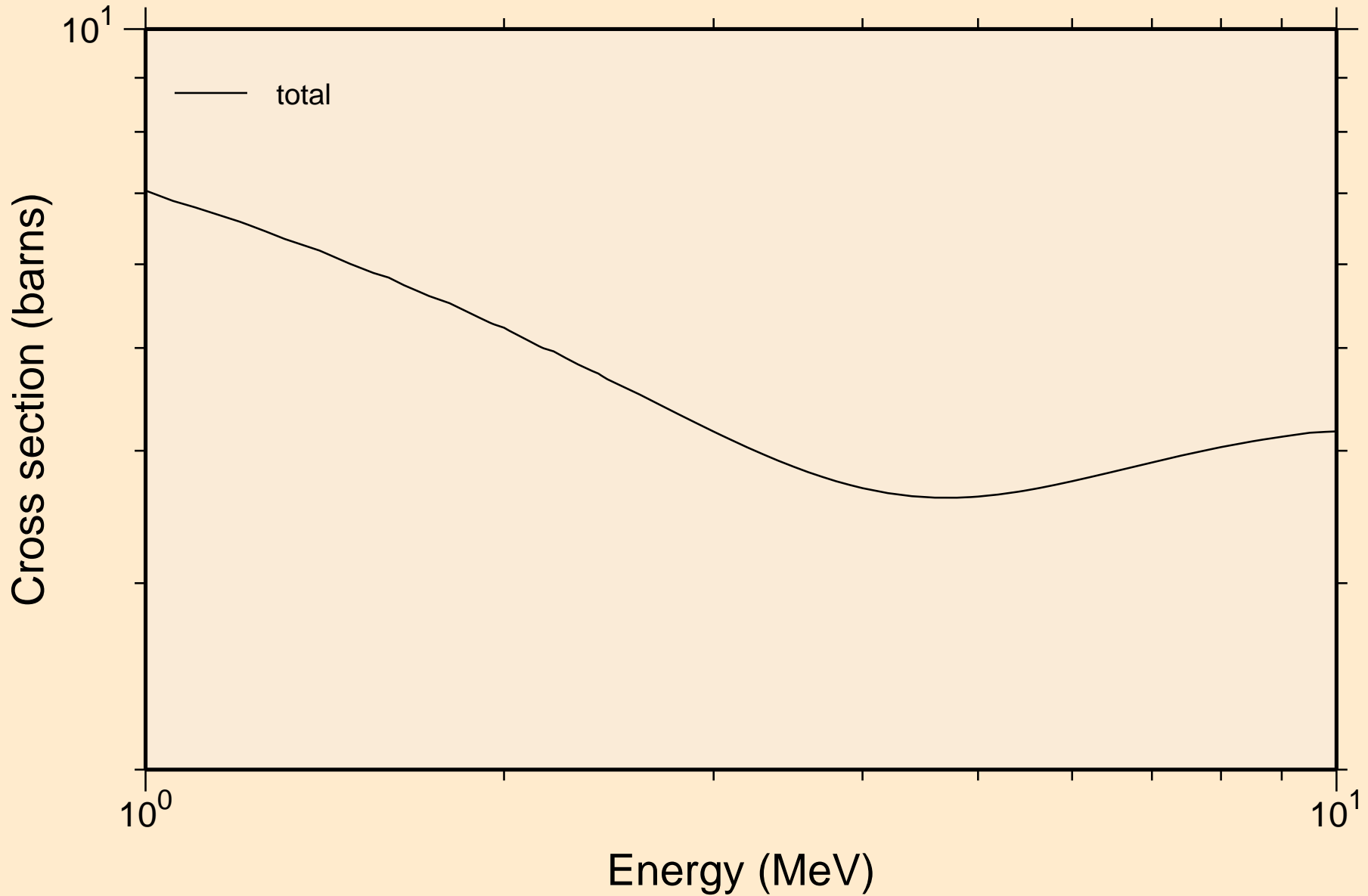

PD097 NEUTRON ACER TENDL-2024 LIBRARY; T=0.K
resonance absorption cross sections

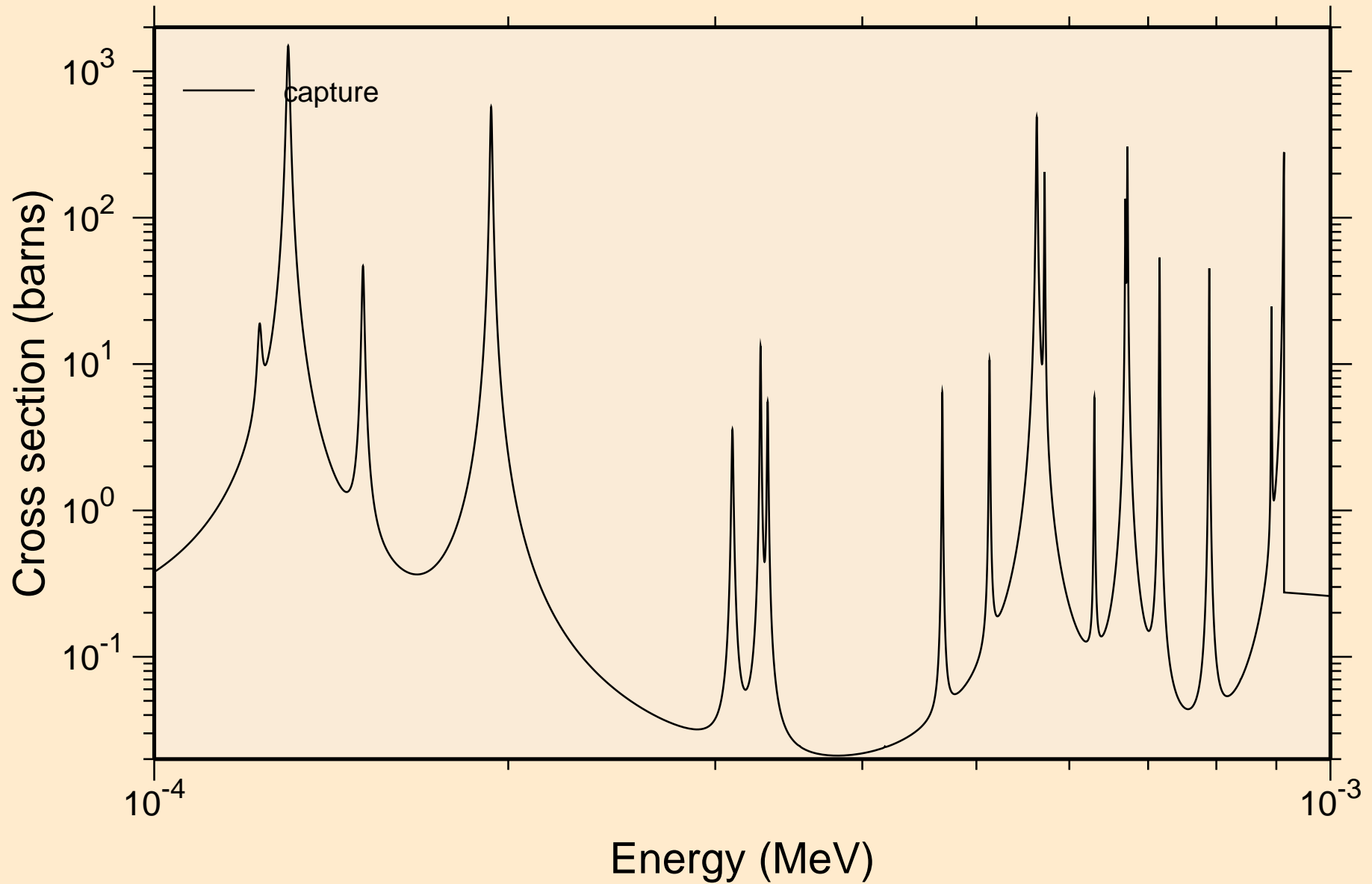

PD097 NEUTRON ACER TENDL-2024 LIBRARY; T=0.K
resonance absorption cross sections

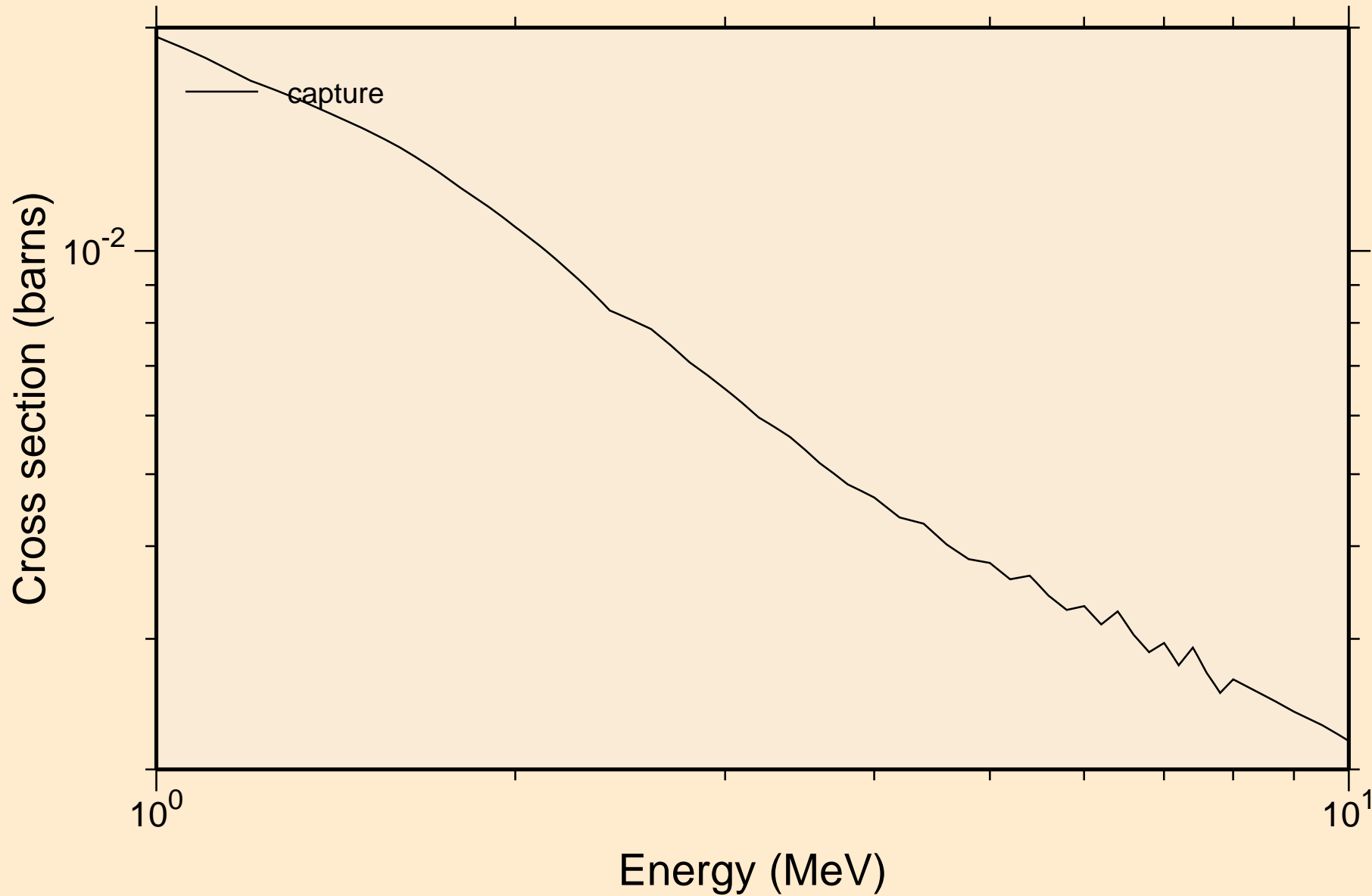

PD097 NEUTRON ACER TENDL-2024 LIBRARY; T=0.K
Heating

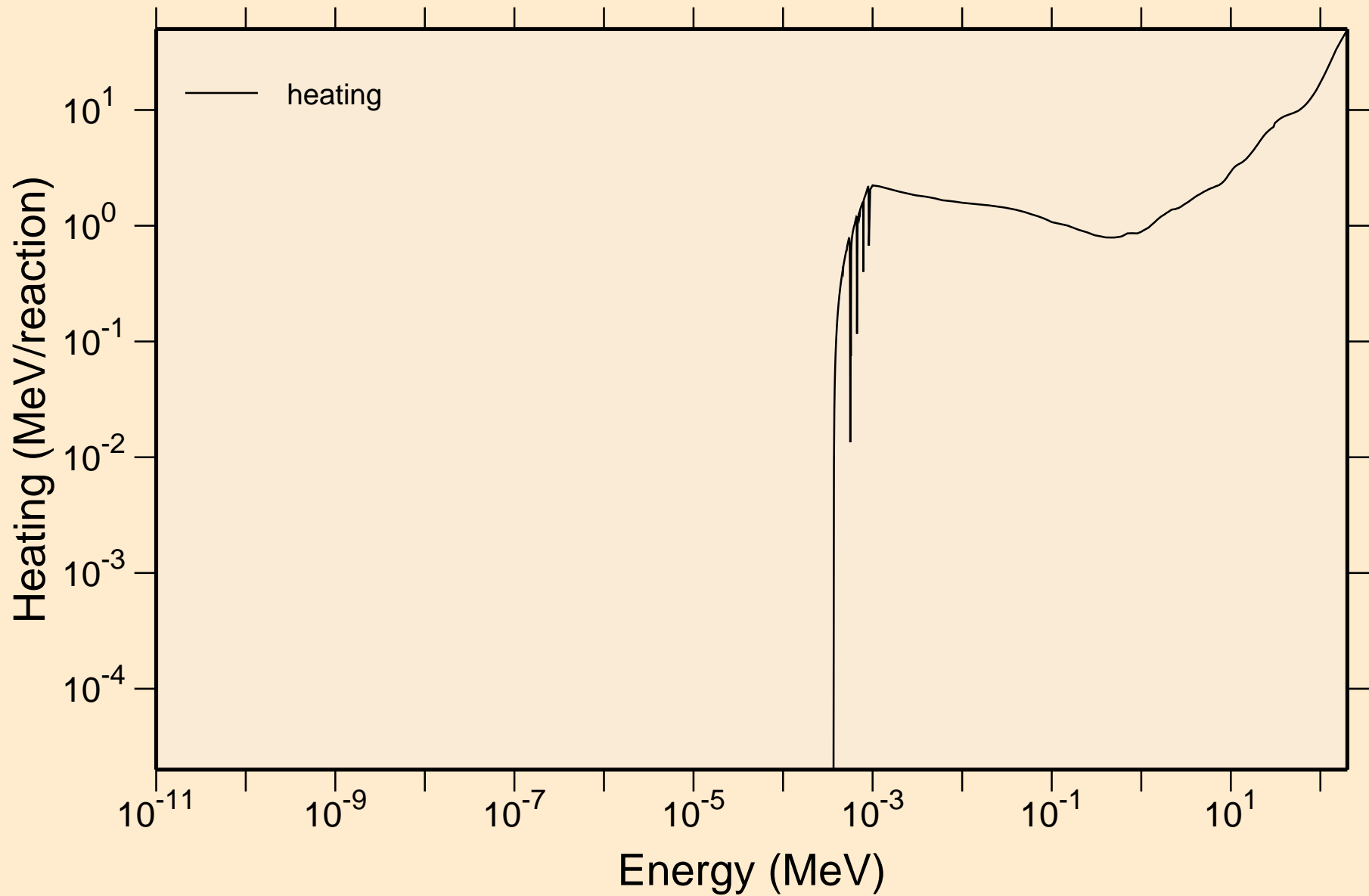

PD097 NEUTRON ACER TENDL-2024 LIBRARY; T=0.K
Damage

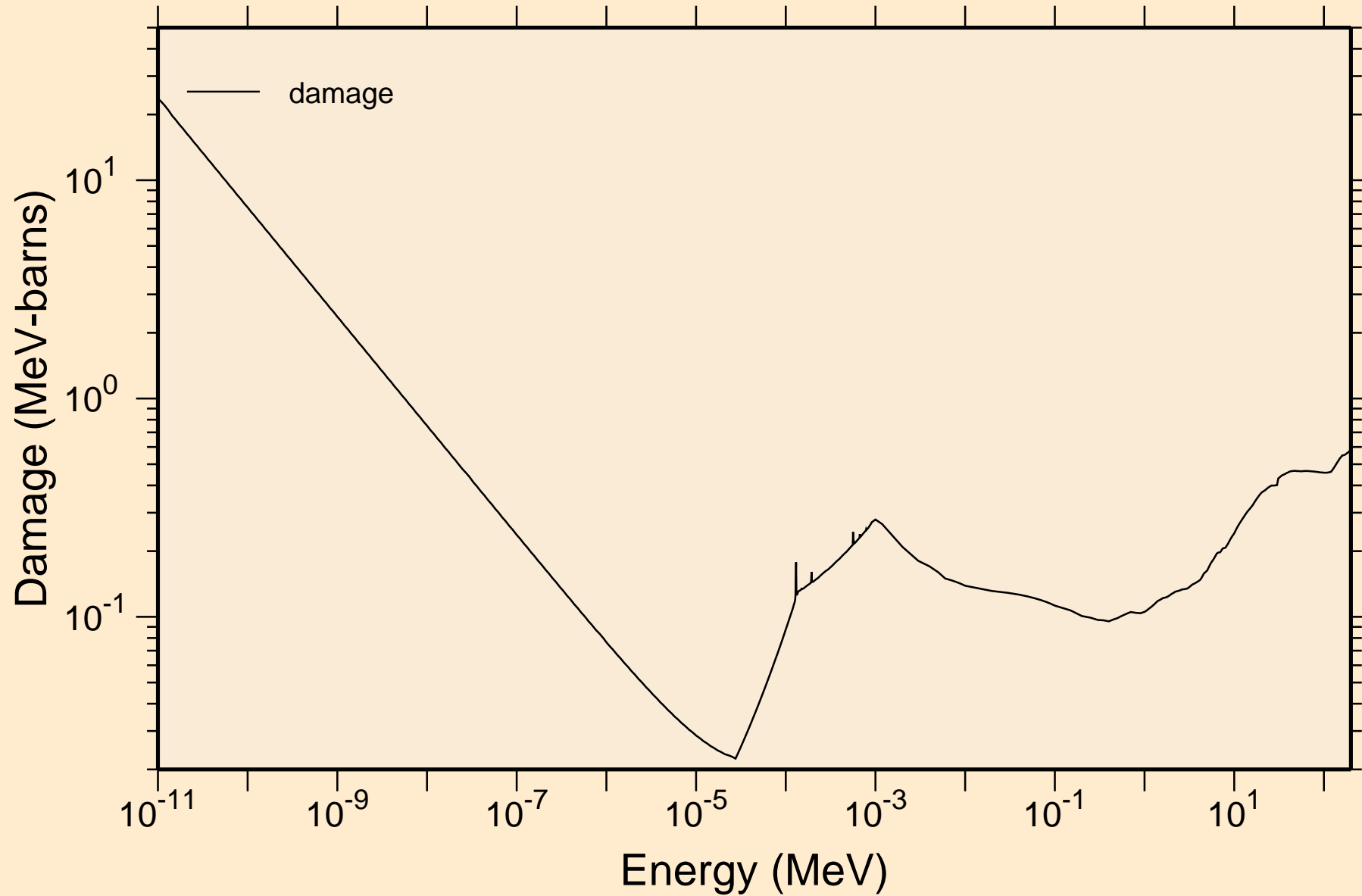

PD097 NEUTRON ACER TENDL-2024 LIBRARY; T=0.K
Non-threshold reactions

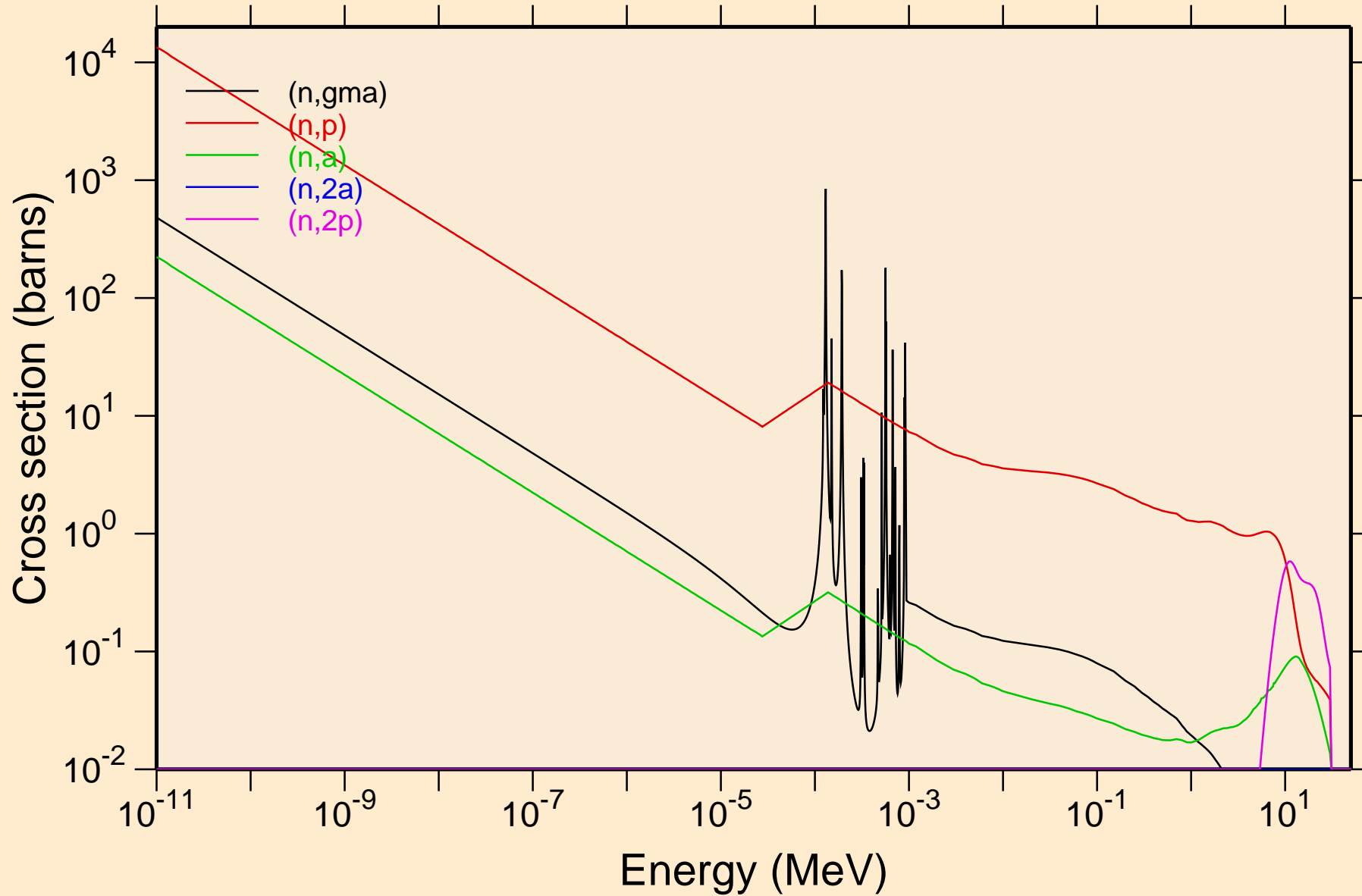

PD097 NEUTRON ACER TENDL-2024 LIBRARY; T=0.K
Non-threshold reactions

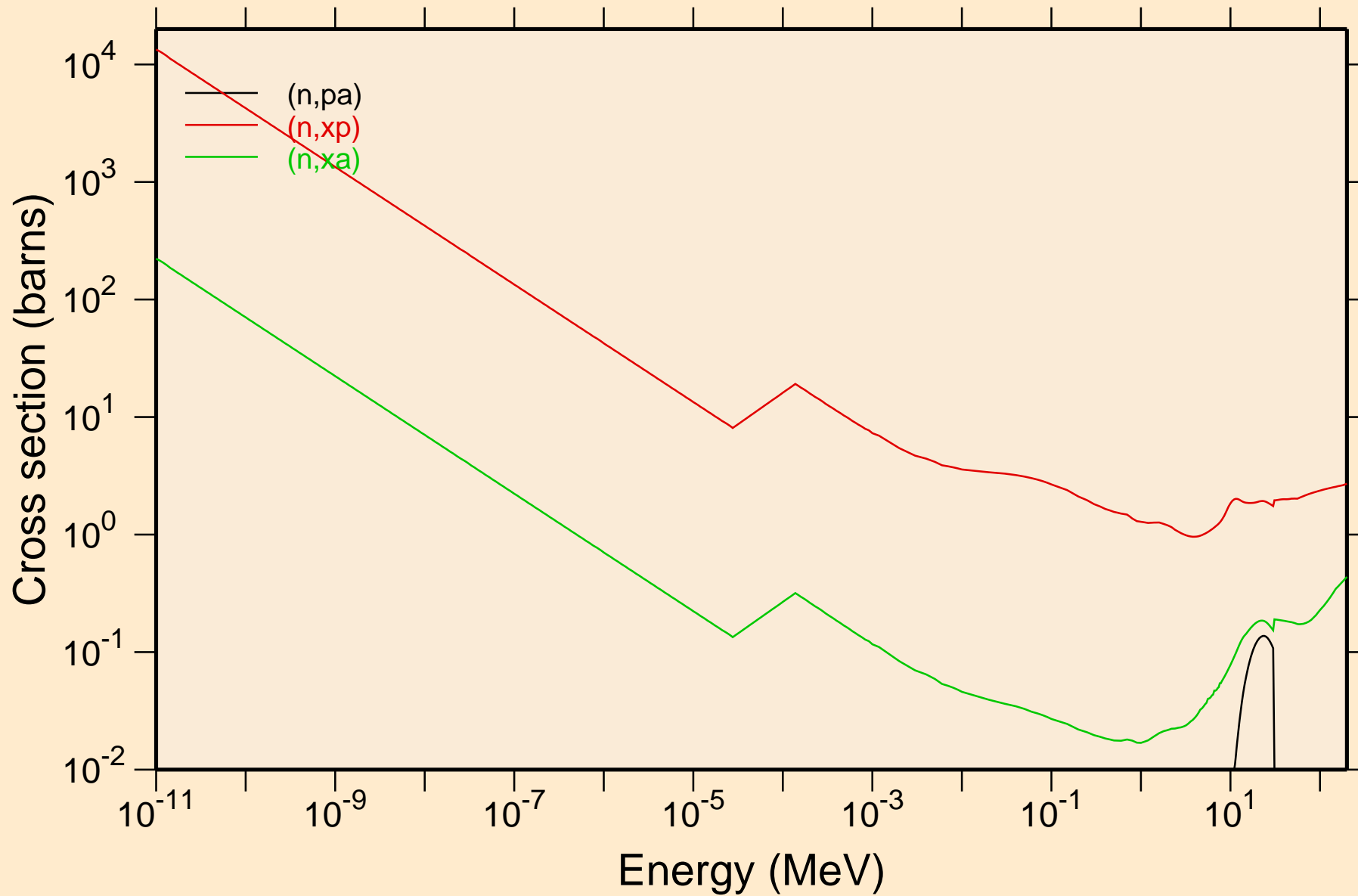

PD097 NEUTRON ACER TENDL-2024 LIBRARY; T=0.K

Principal cross sections

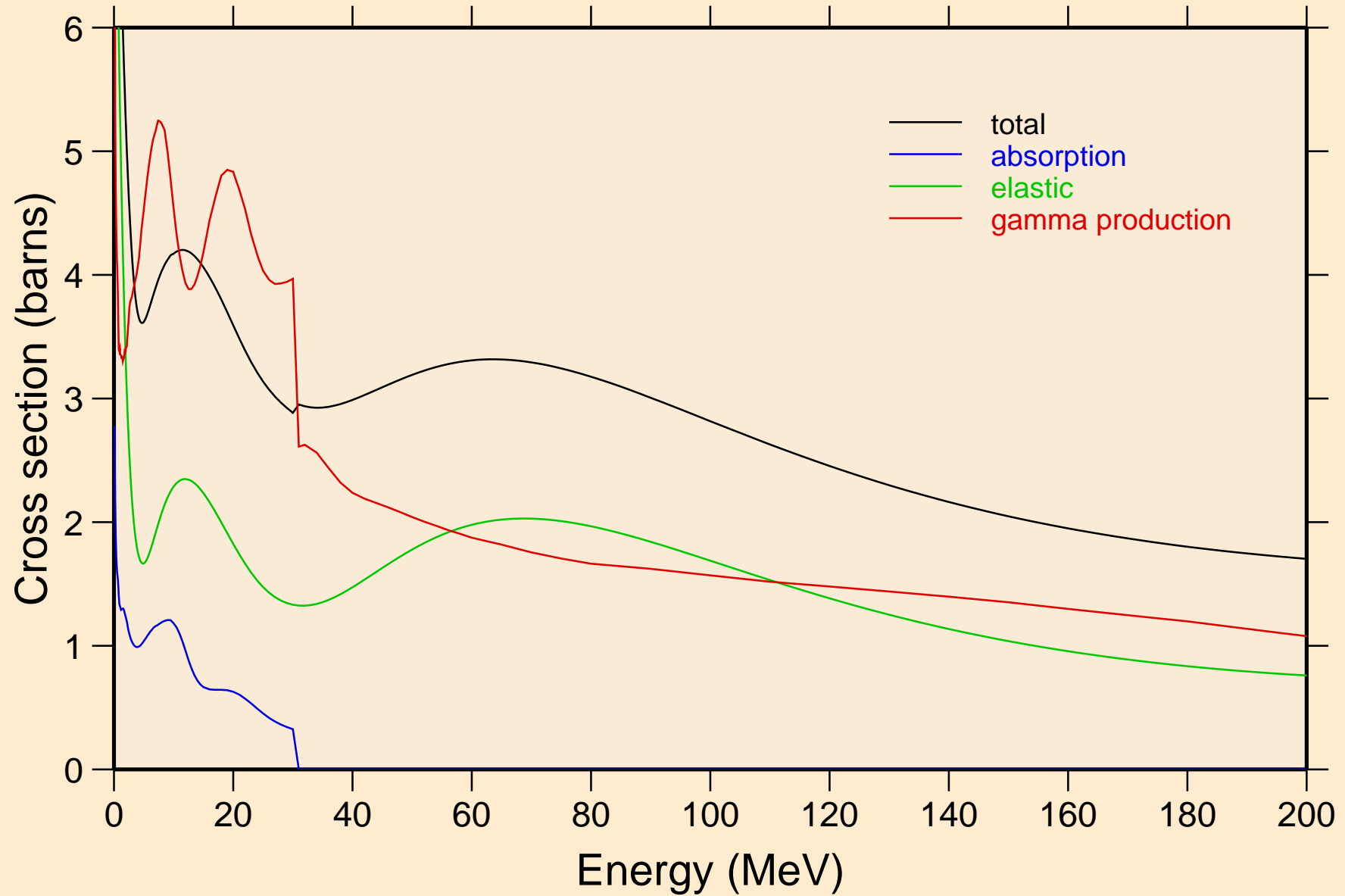

PD097 NEUTRON ACER TENDL-2024 LIBRARY; T=0.K

Heating

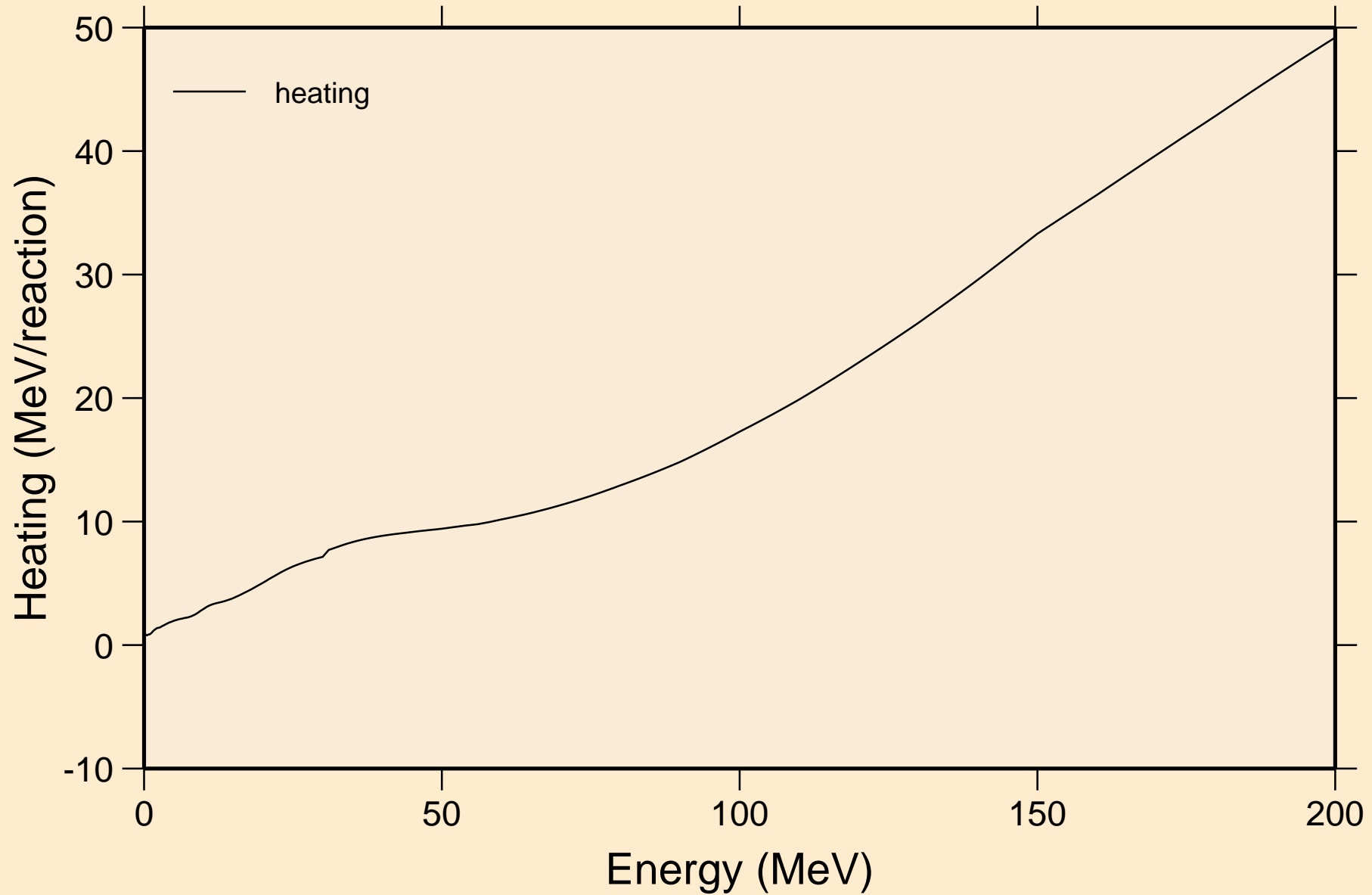

PD097 NEUTRON ACER TENDL-2024 LIBRARY; T=0.K
Damage

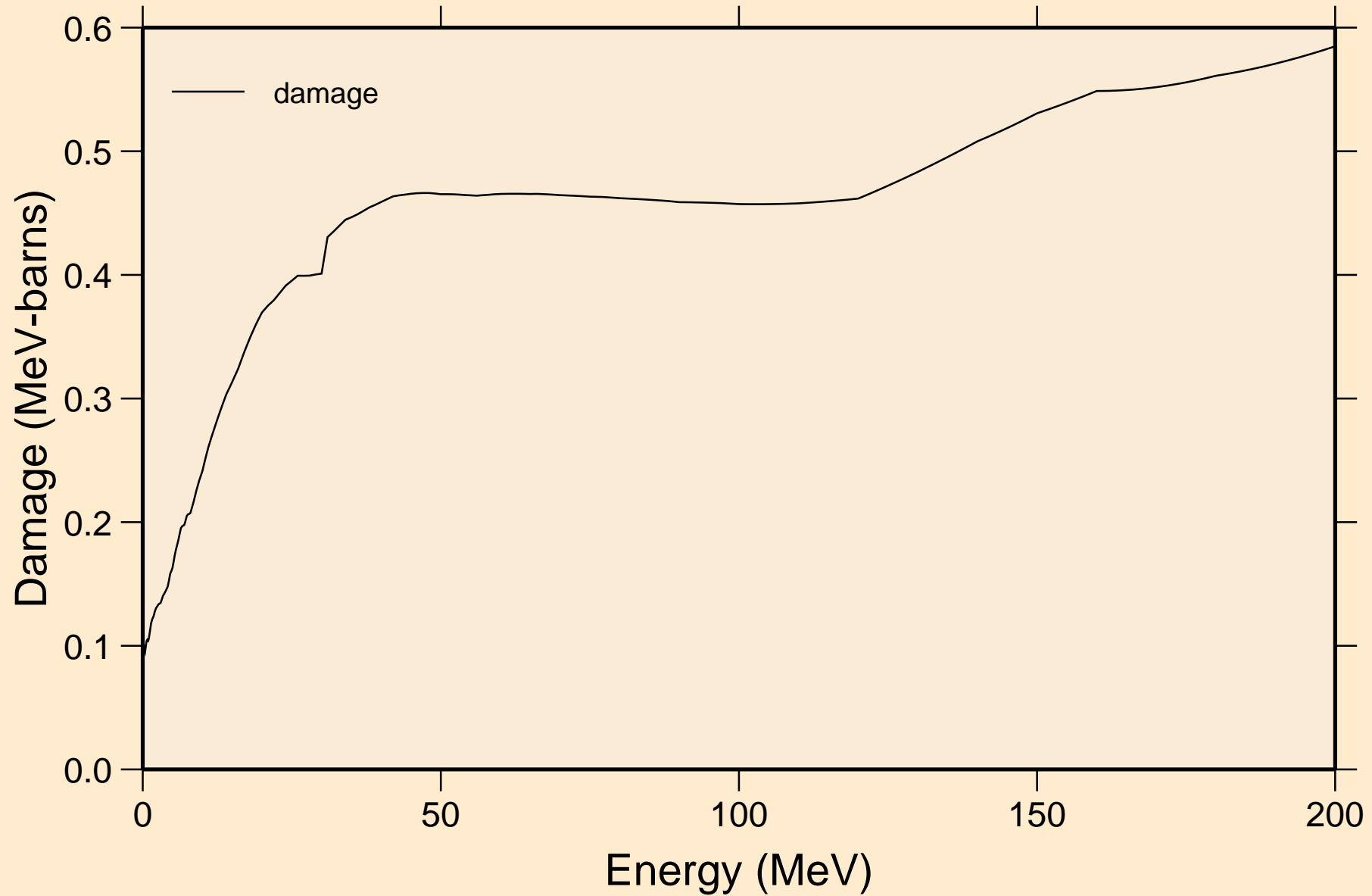

PD097 NEUTRON ACER TENDL-2024 LIBRARY; T=0.K
Non-threshold reactions

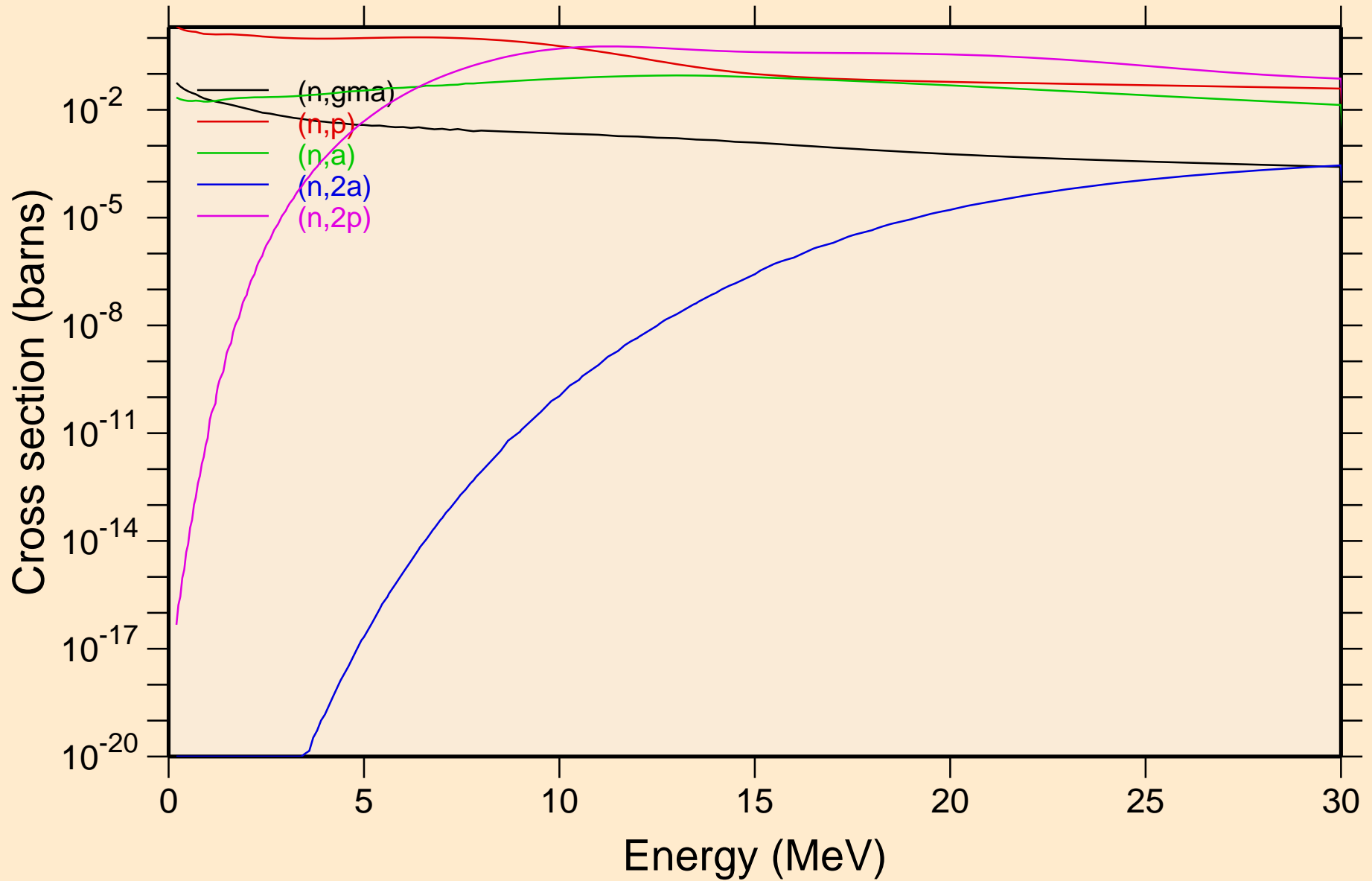

PD097 NEUTRON ACER TENDL-2024 LIBRARY; T=0.K
Non-threshold reactions

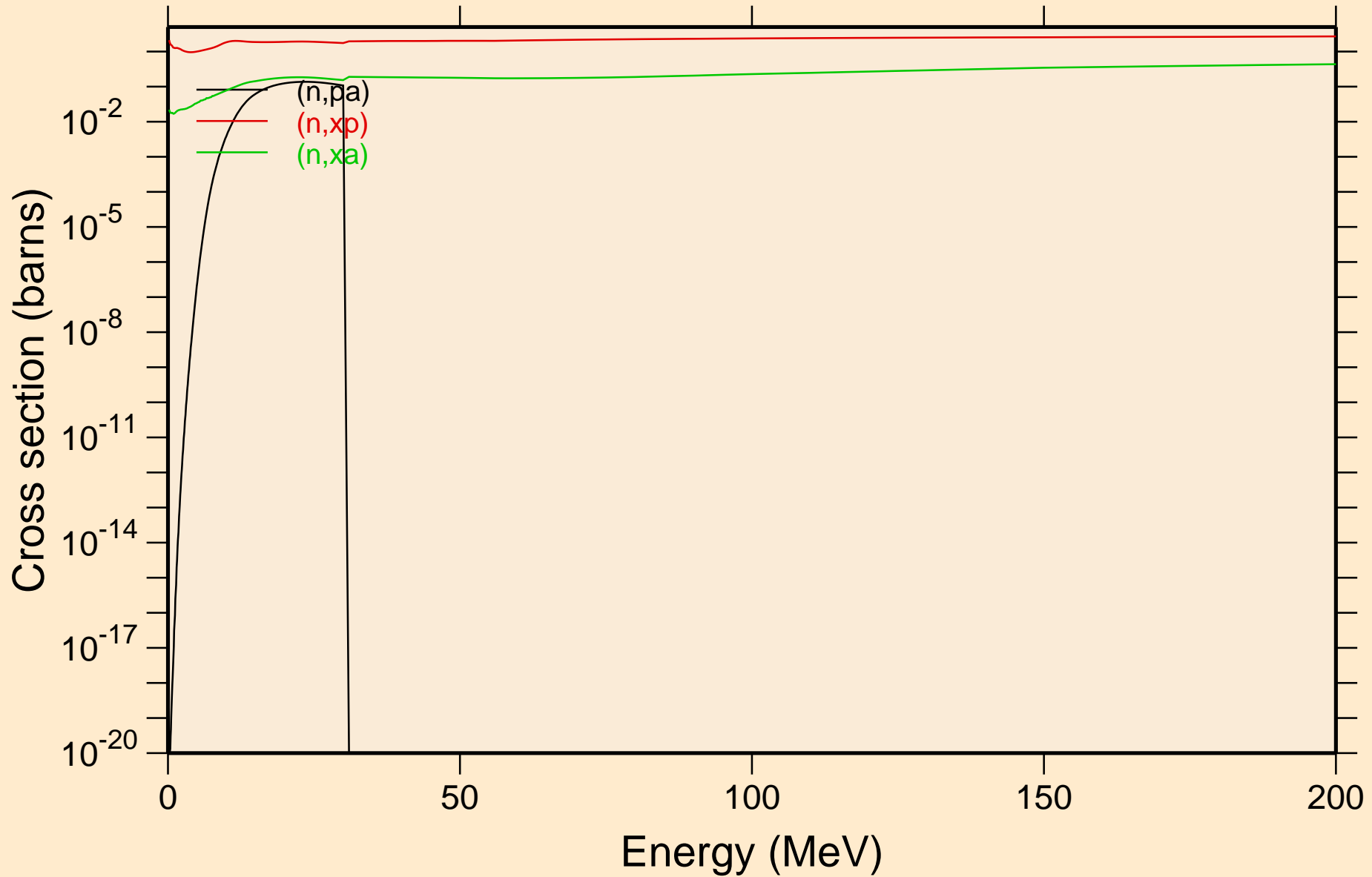

PD097 NEUTRON ACER TENDL-2024 LIBRARY; T=0.K
Inelastic levels

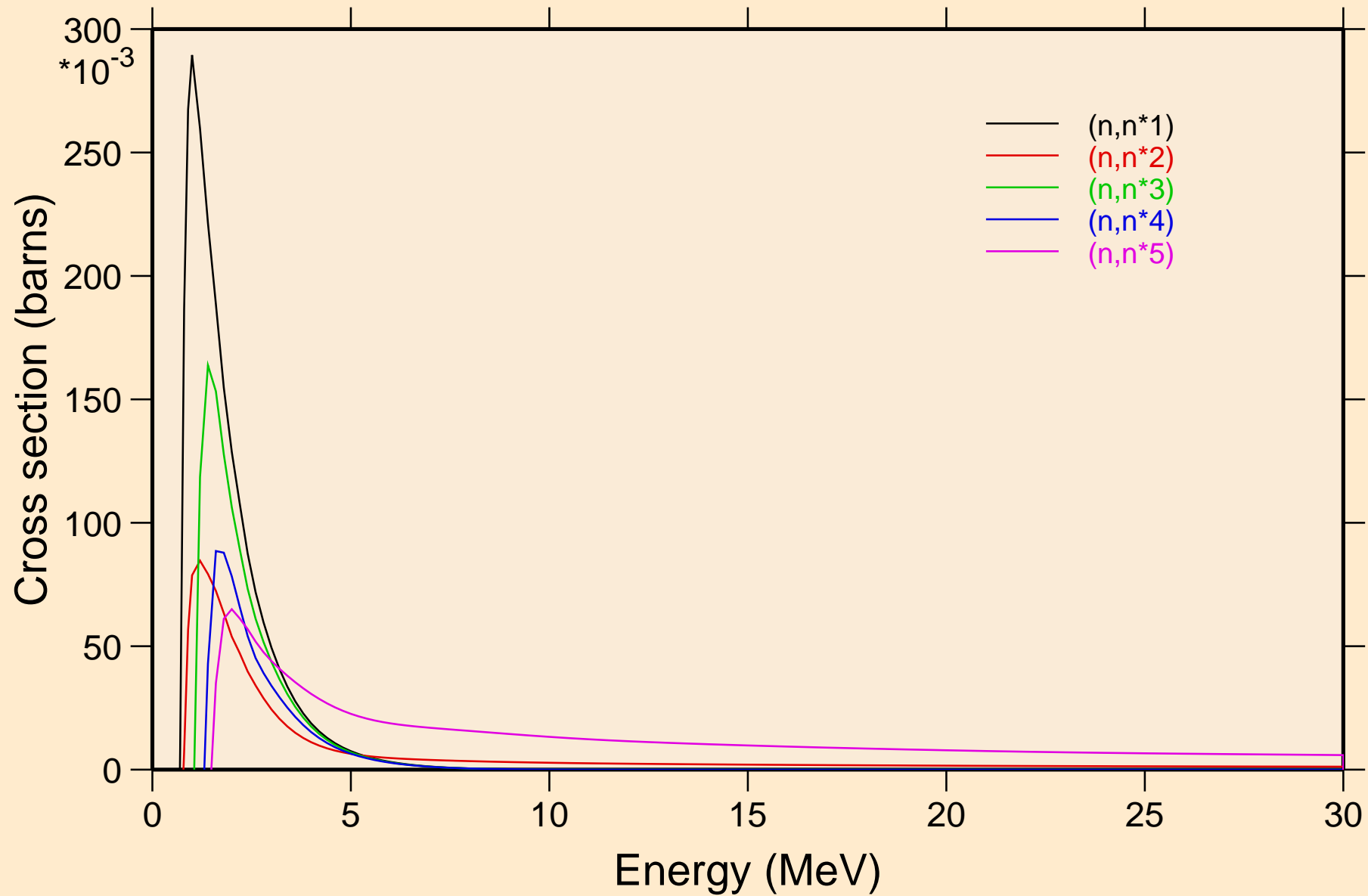

PD097 NEUTRON ACER TENDL-2024 LIBRARY; T=0.K
Inelastic levels

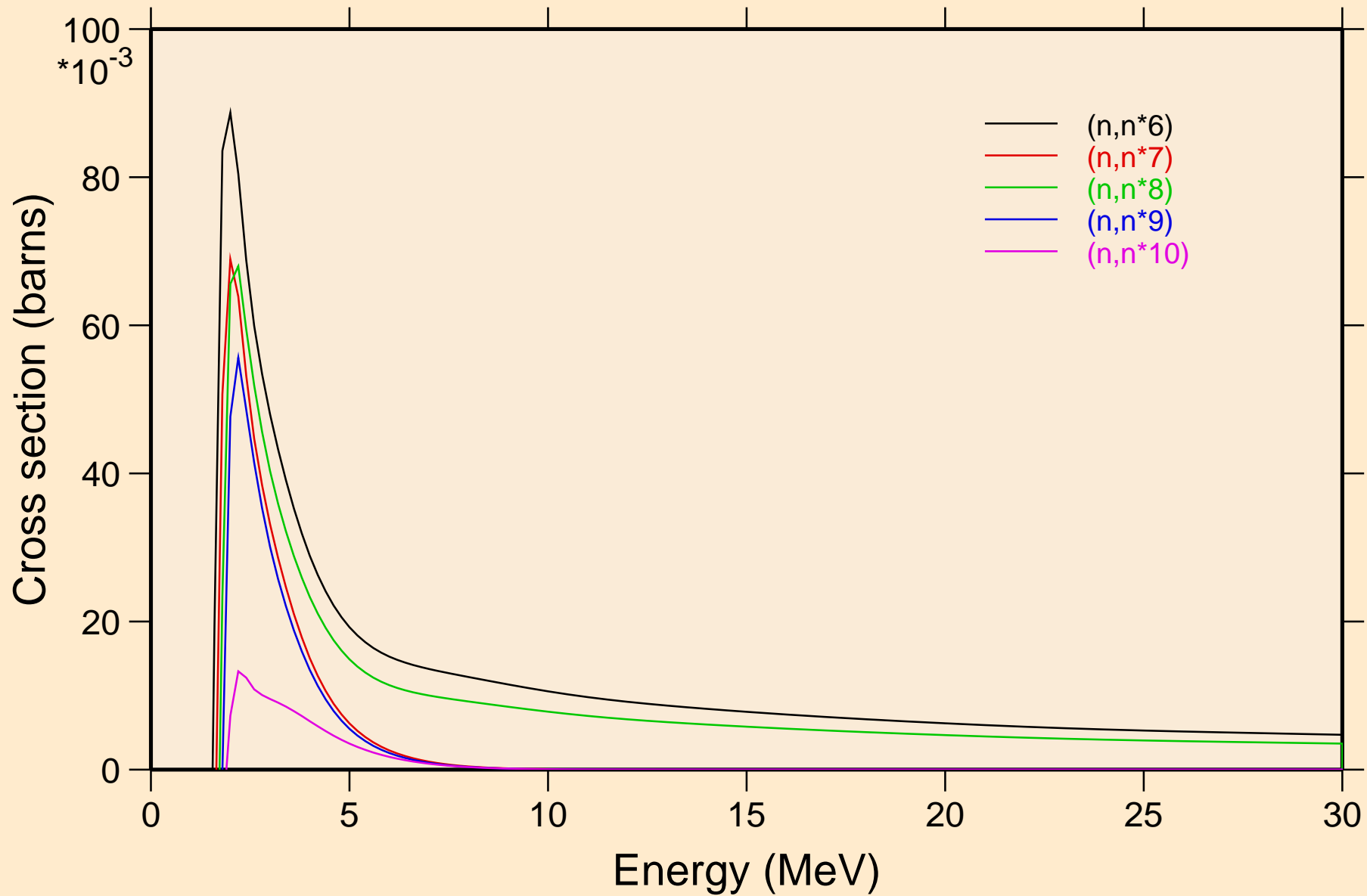

PD097 NEUTRON ACER TENDL-2024 LIBRARY; T=0.K
Inelastic levels

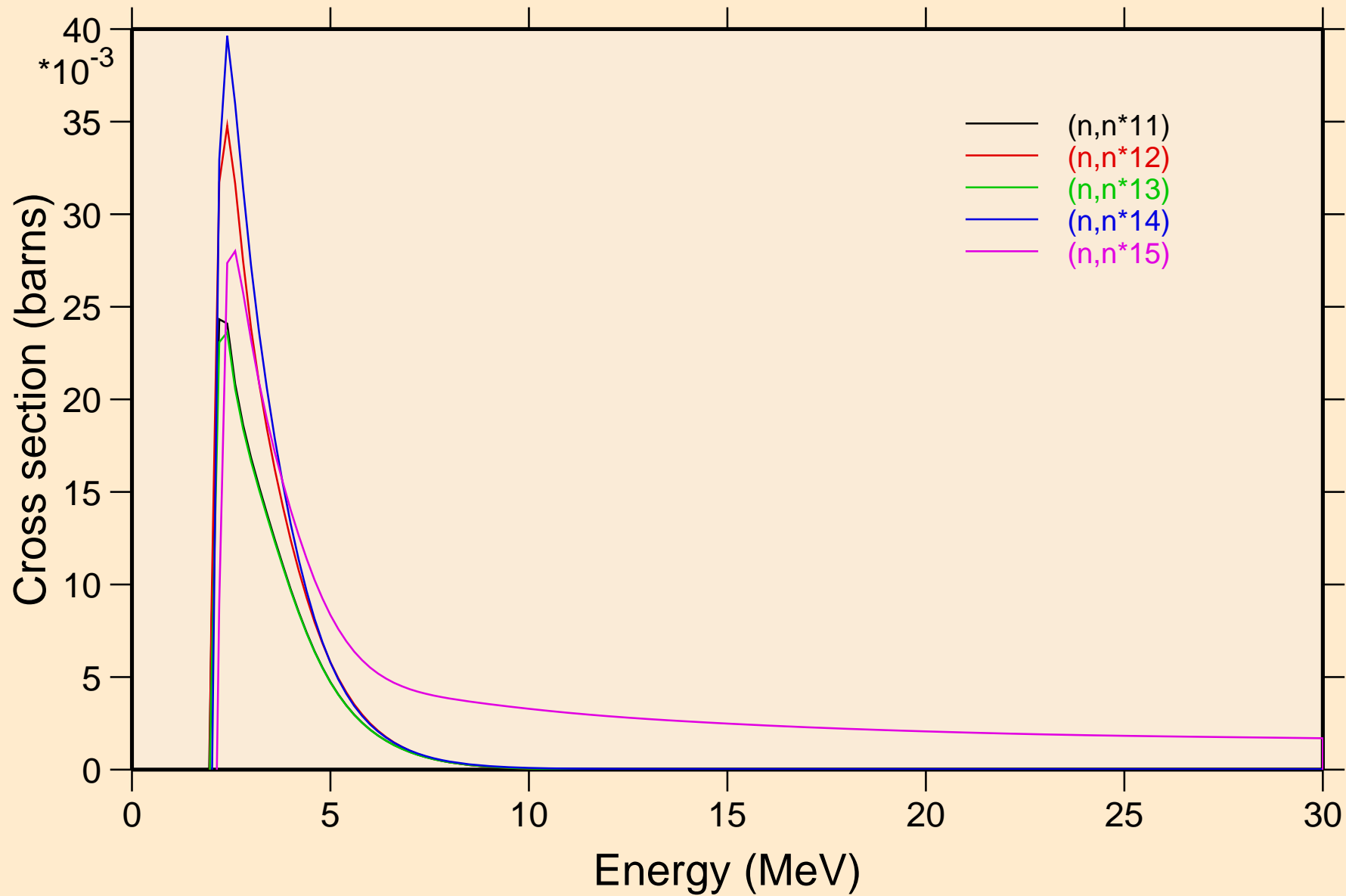

PD097 NEUTRON ACER TENDL-2024 LIBRARY; T=0.K
Inelastic levels

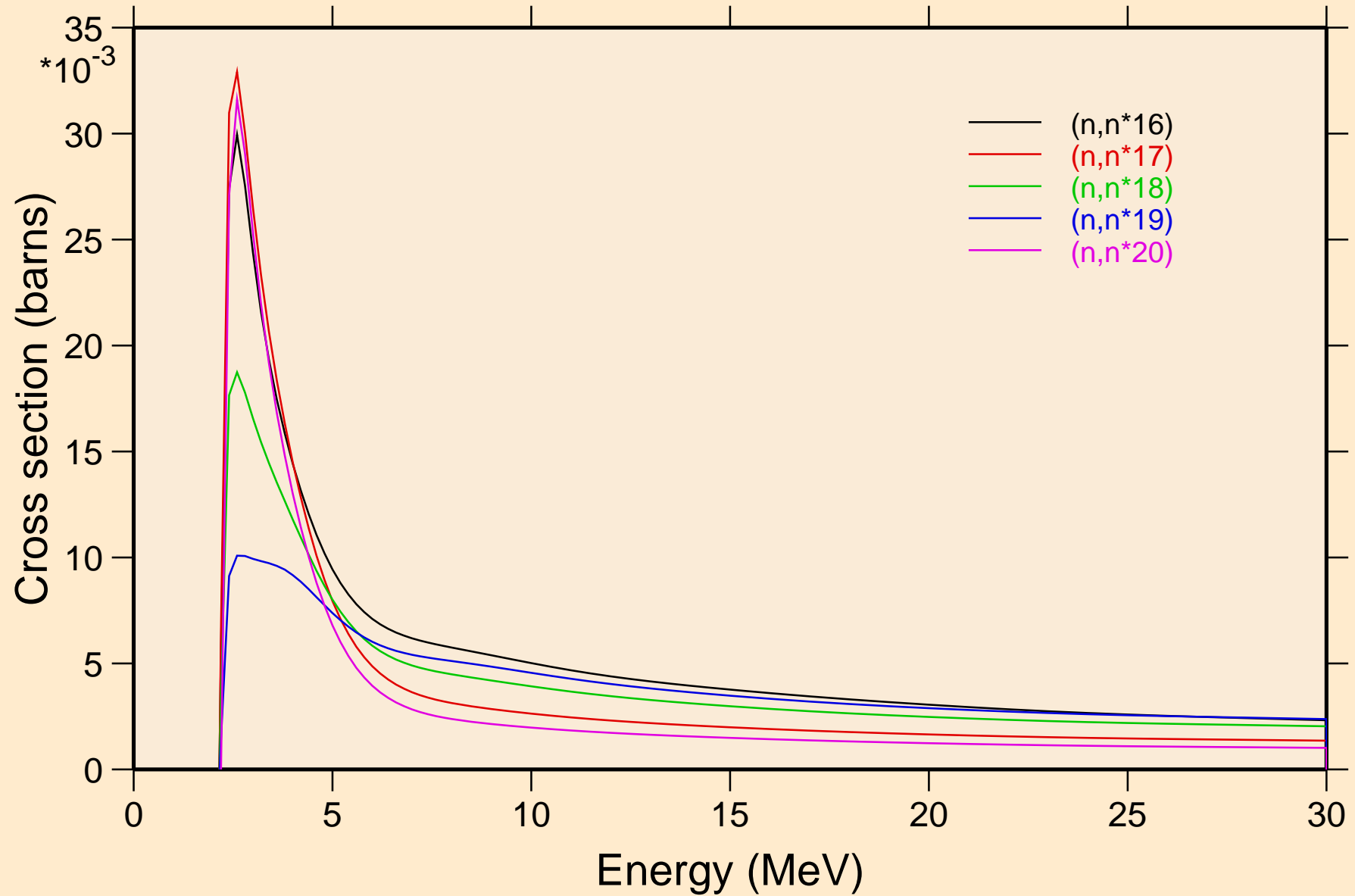

PD097 NEUTRON ACER TENDL-2024 LIBRARY; T=0.K
Inelastic levels

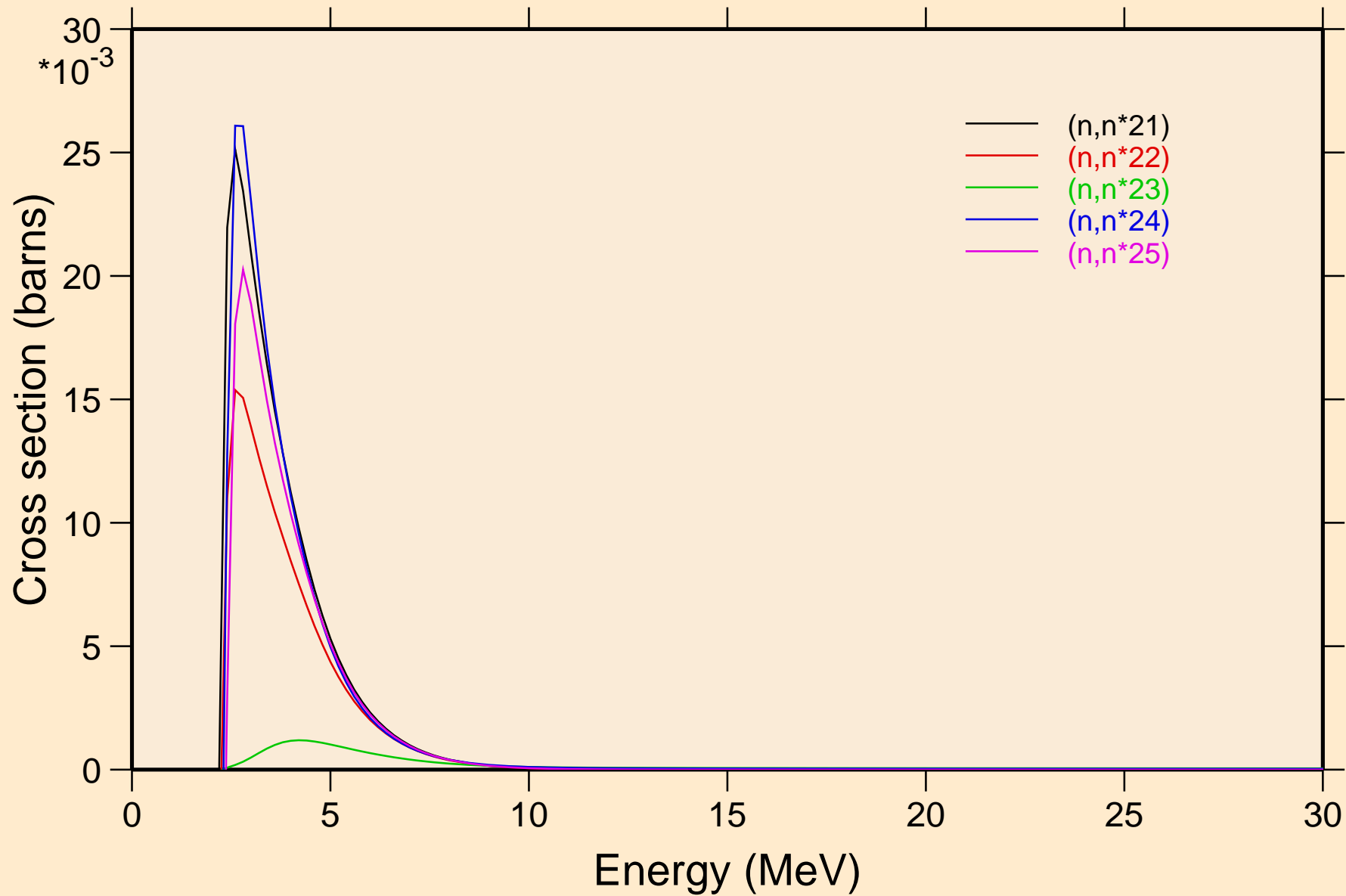

PD097 NEUTRON ACER TENDL-2024 LIBRARY; T=0.K
Inelastic levels

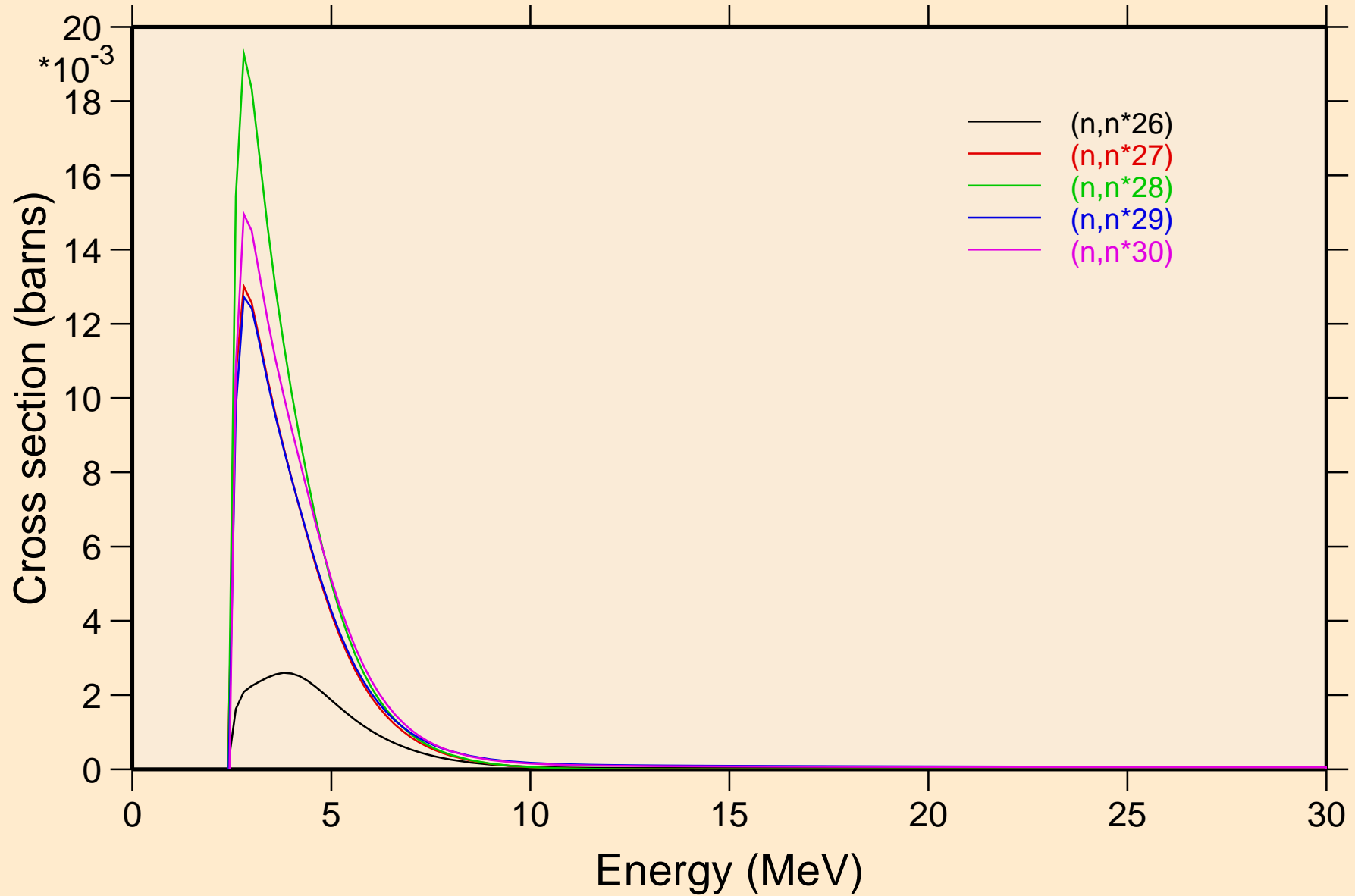

PD097 NEUTRON ACER TENDL-2024 LIBRARY; T=0.K
Threshold reactions

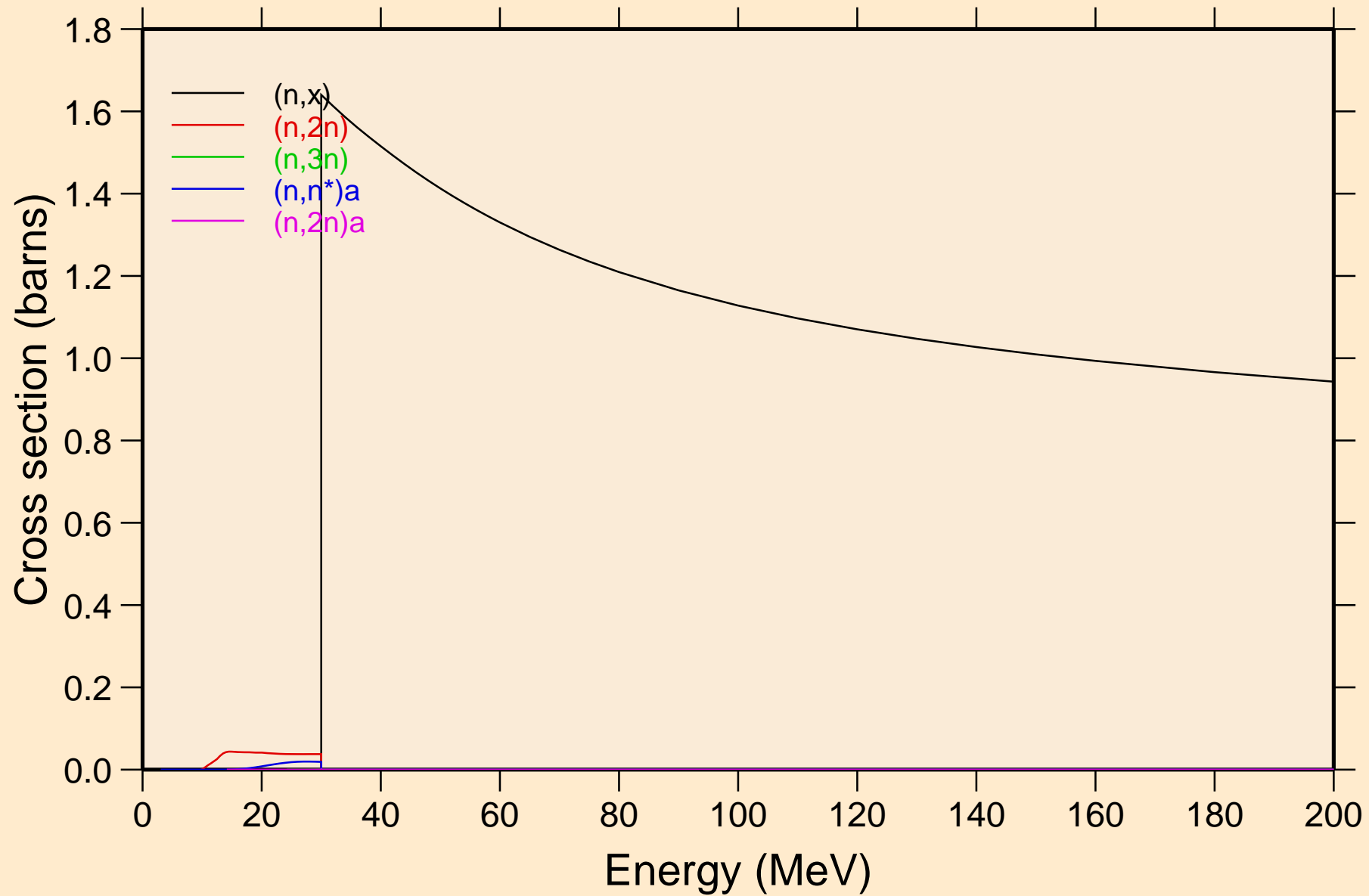

PD097 NEUTRON ACER TENDL-2024 LIBRARY; T=0.K
Threshold reactions

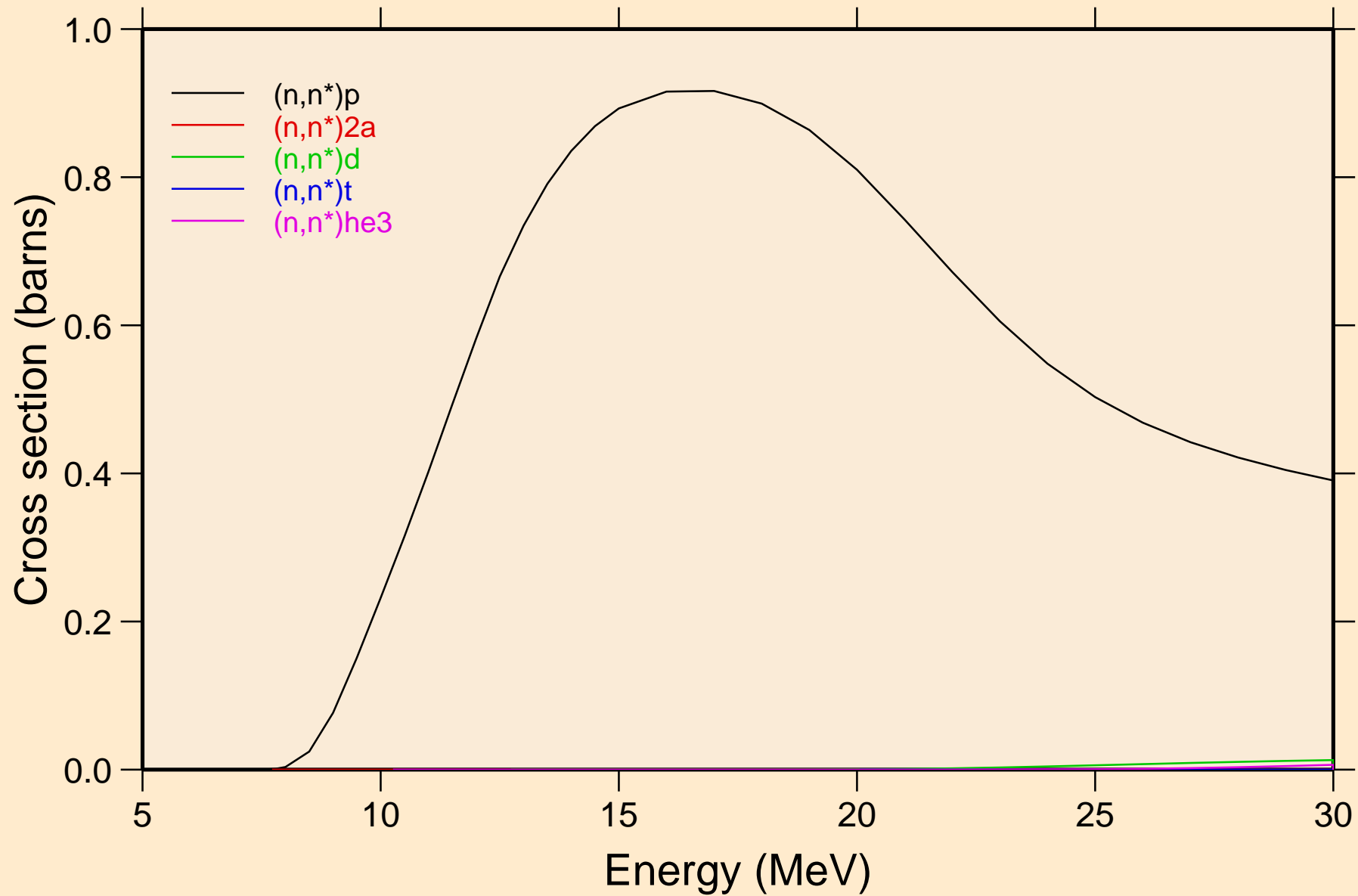

PD097 NEUTRON ACER TENDL-2024 LIBRARY; T=0.K
Threshold reactions

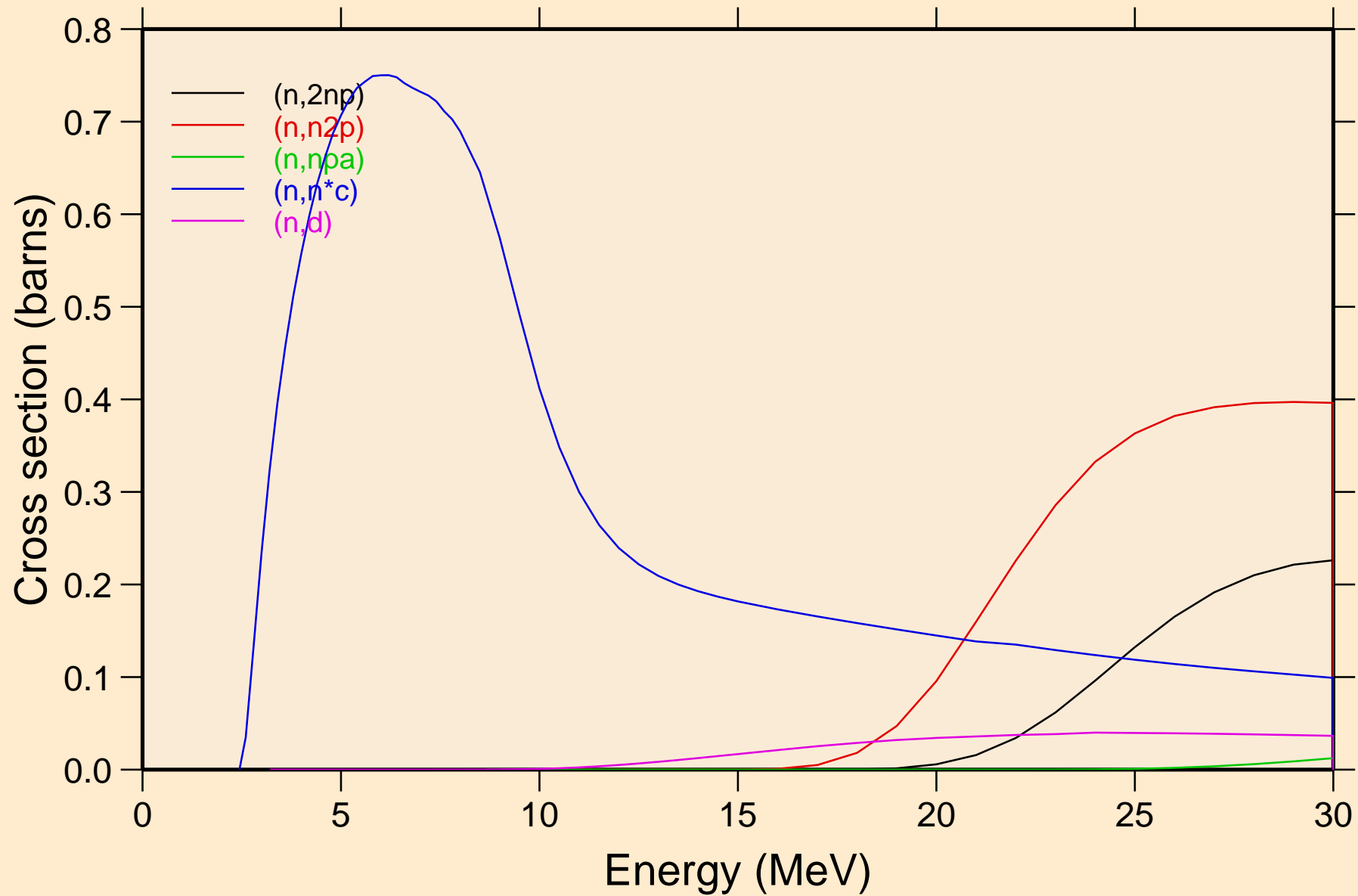

PD097 NEUTRON ACER TENDL-2024 LIBRARY; T=0.K
Threshold reactions

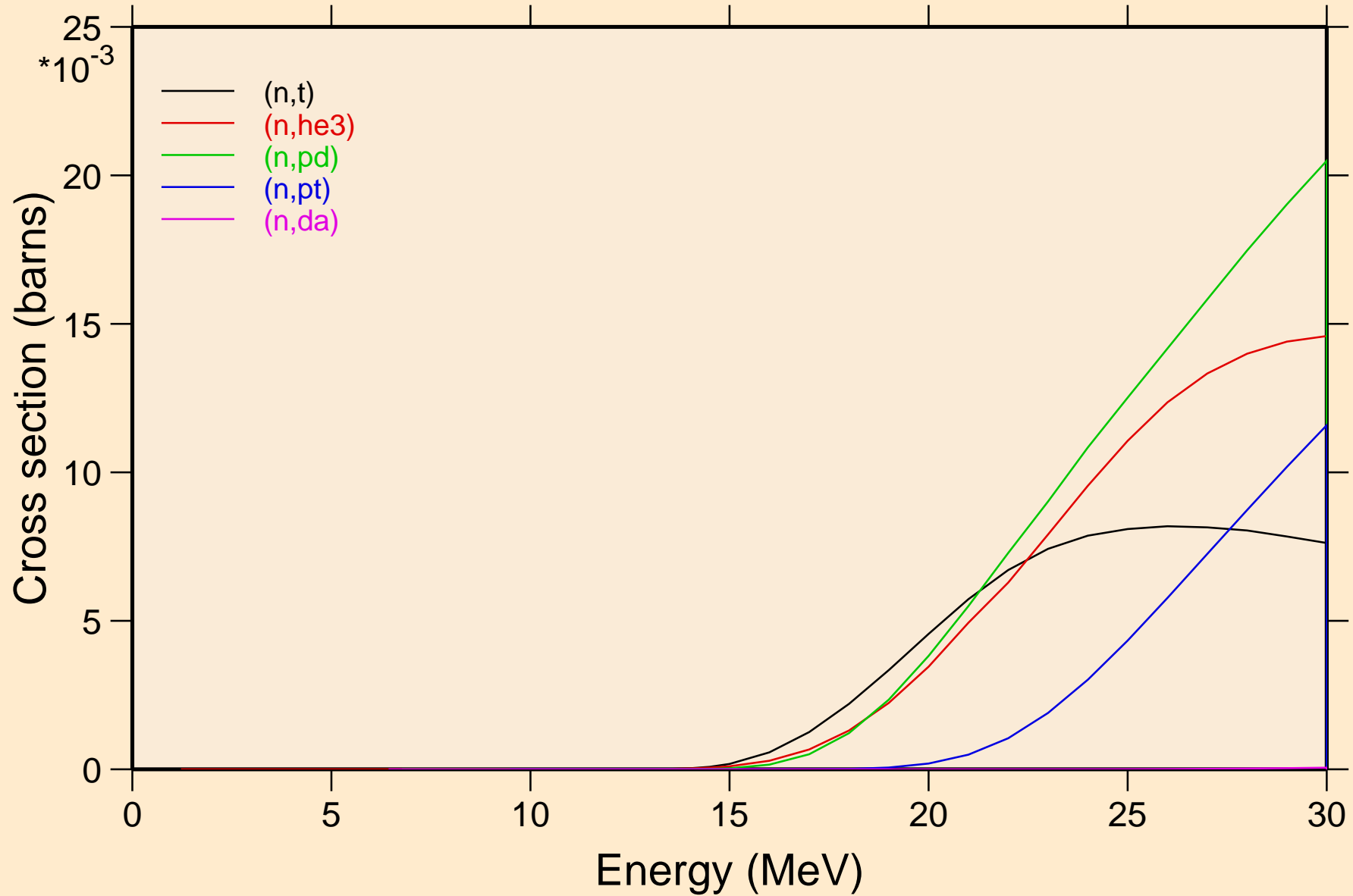

PD097 NEUTRON ACER TENDL-2024 LIBRARY; T=0.K
Threshold reactions

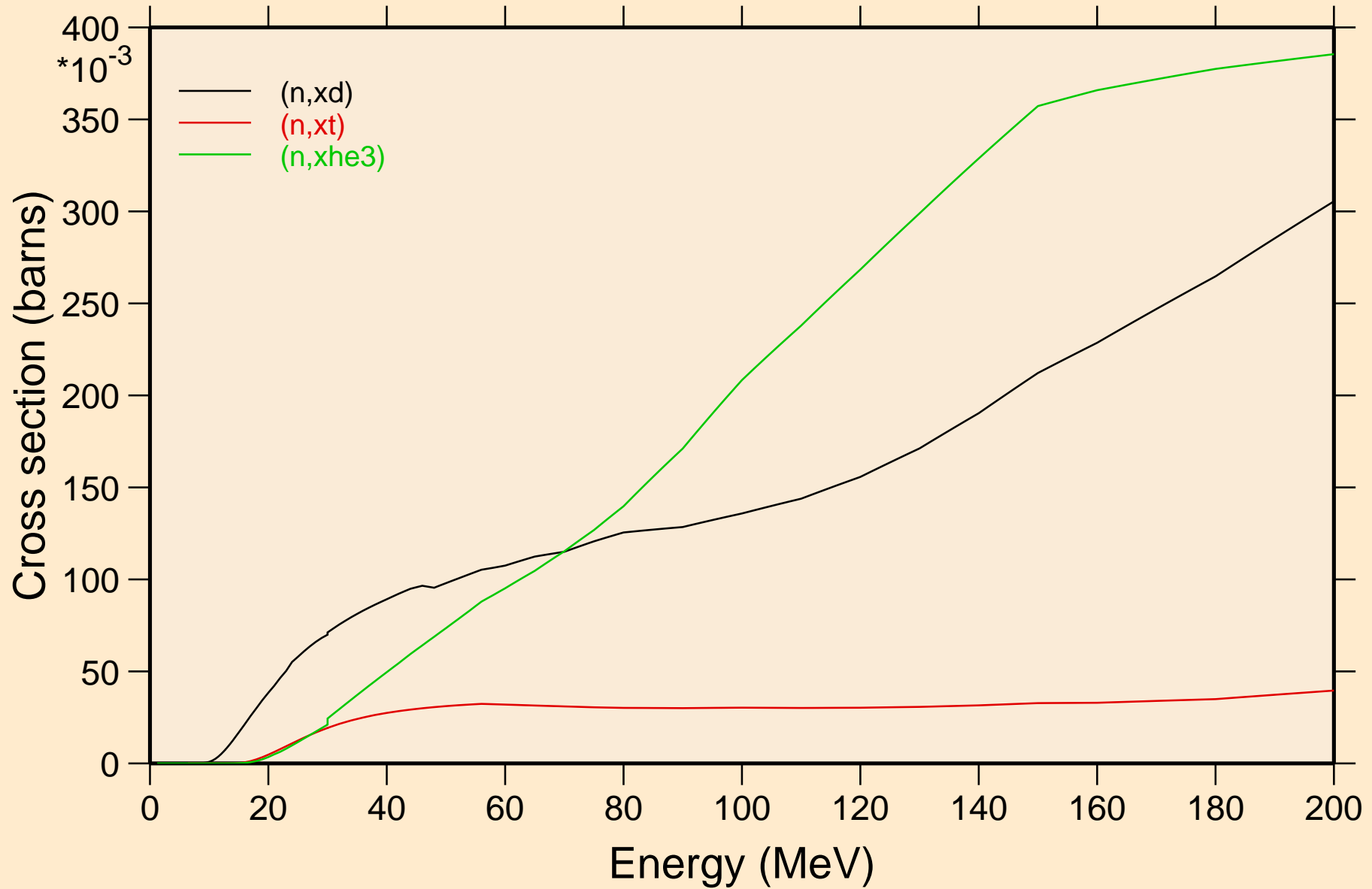

PD097 NEUTRON ACER TENDL-2024 LIBRARY; T=0.K
angular distribution for elastic

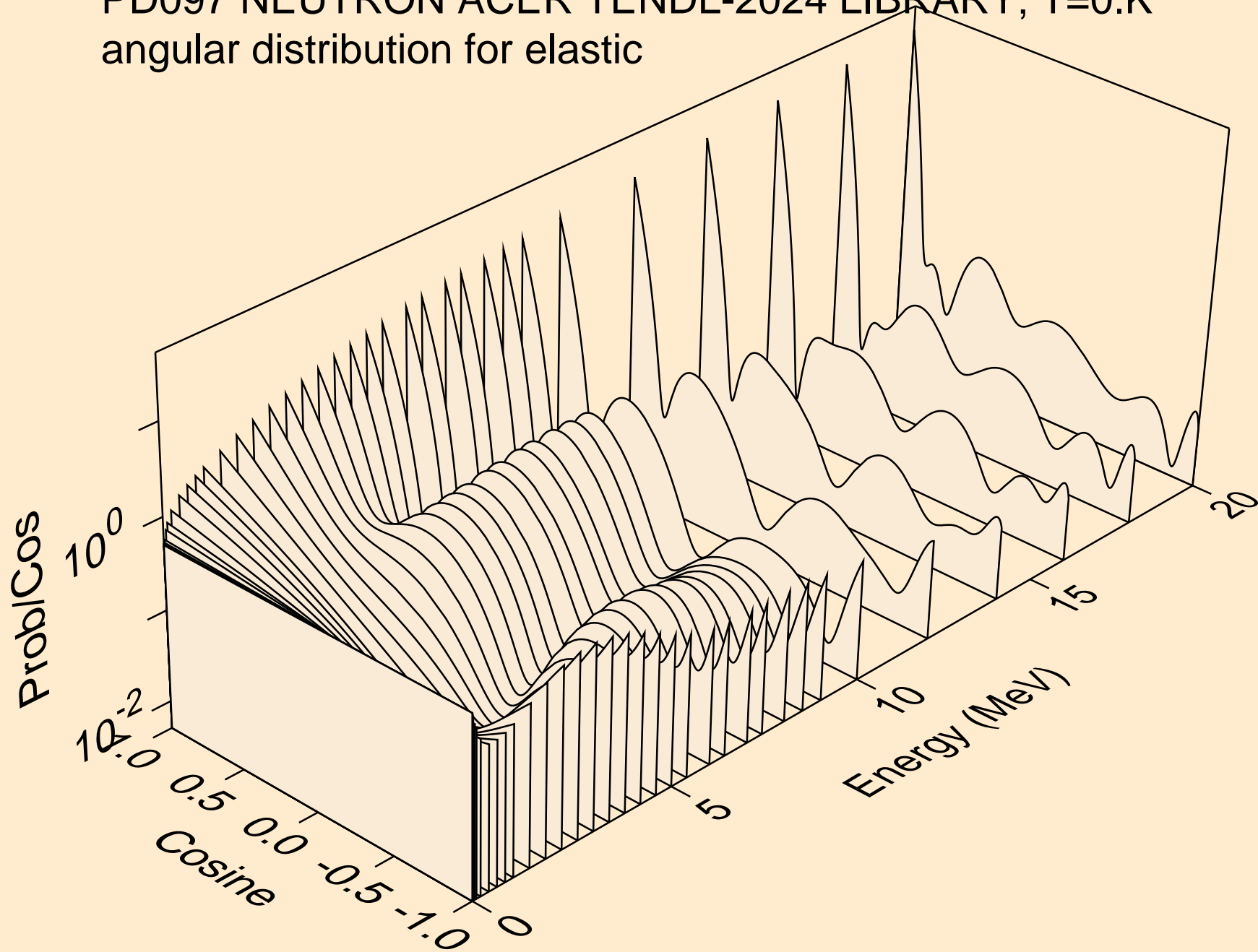

PD097 NEUTRON ACER TENDL-2024 LIBRARY; T=0.K
angular distribution for elastic

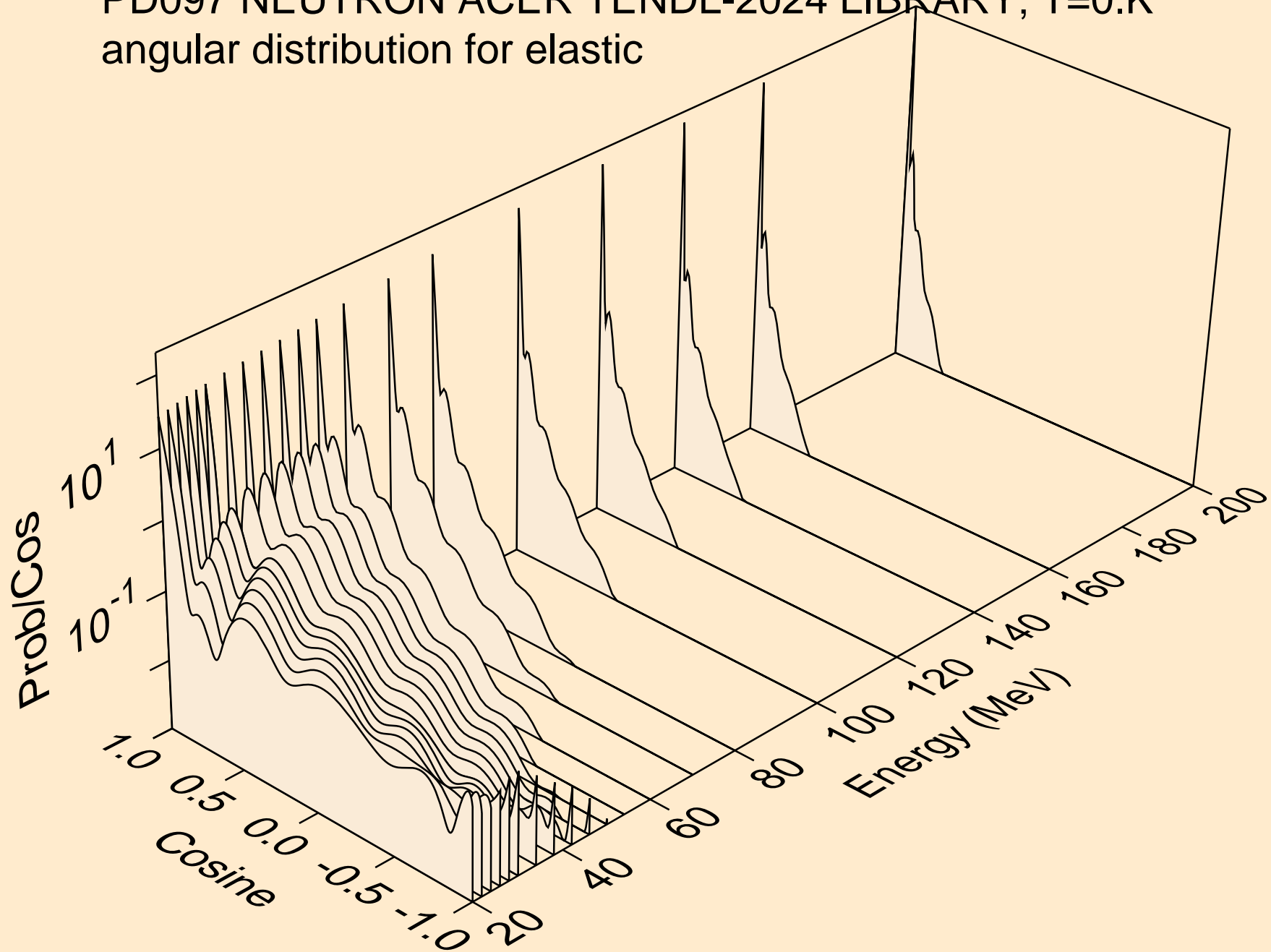

PD097 NEUTRON ACER TENDL-2024 LIBRARY; T=0.K
angular distribution for (n,n*1)

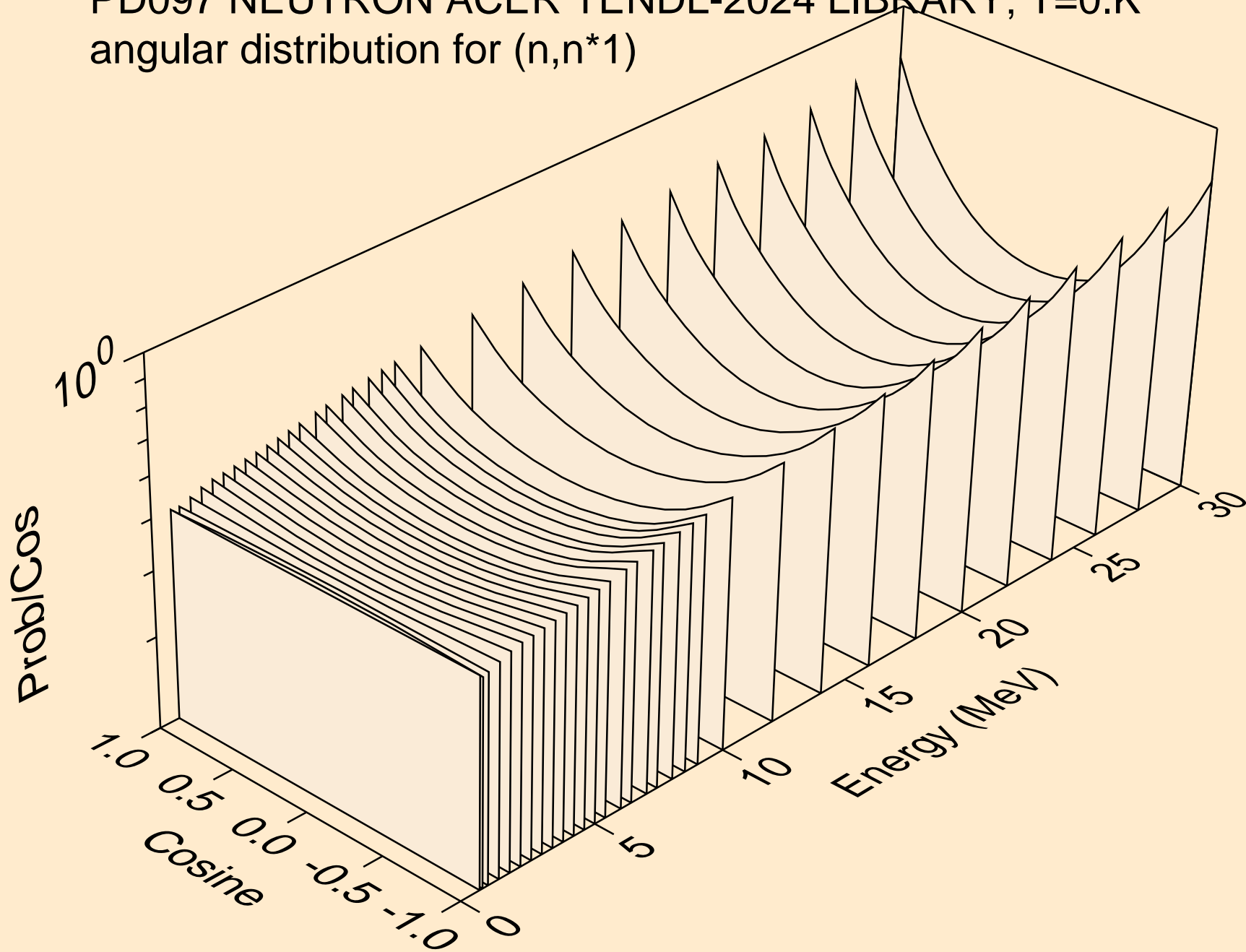

PD097 NEUTRON ACER TENDL-2024 LIBRARY; T=0.K
angular distribution for (n,n*2)

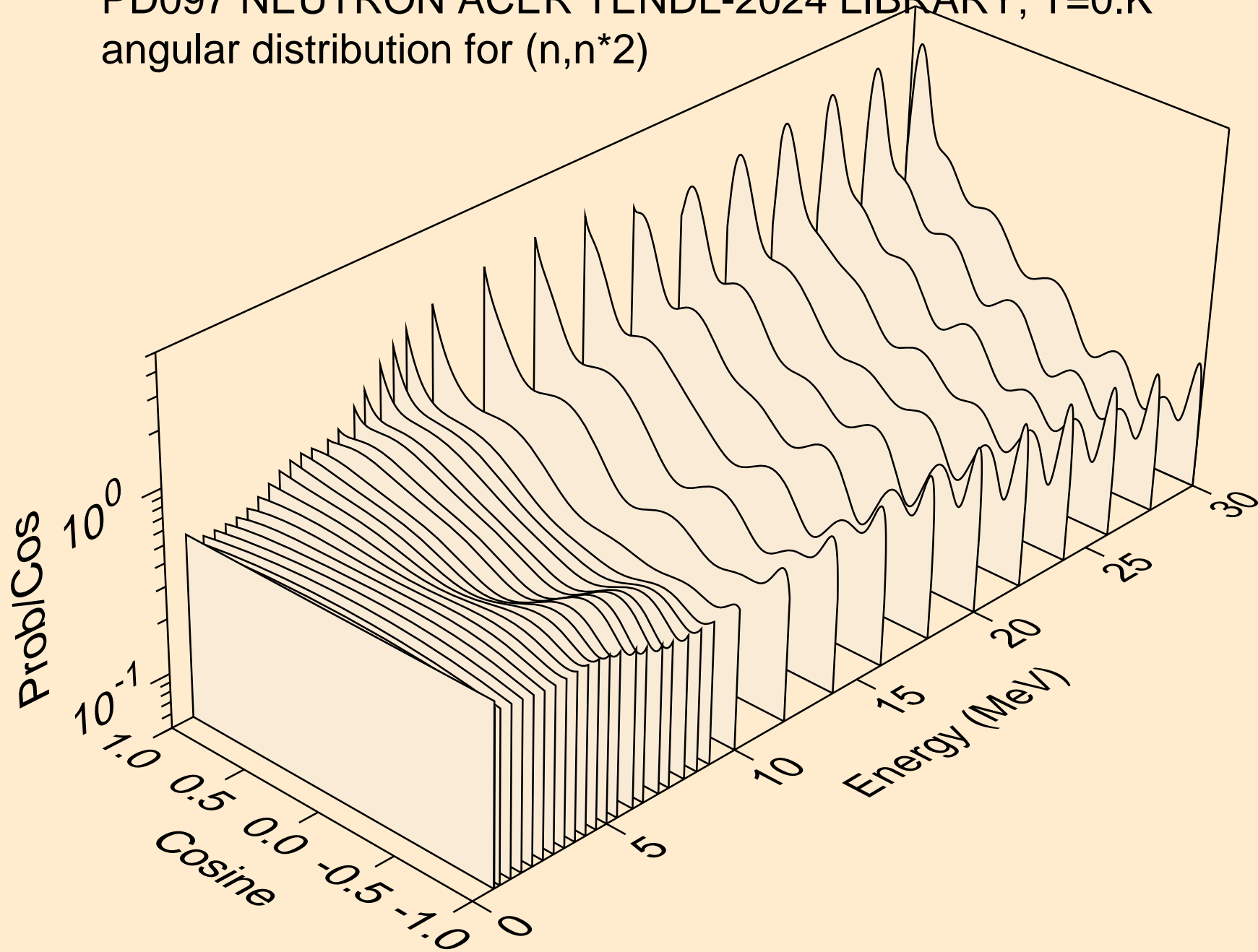

PD097 NEUTRON ACER TENDL-2024 LIBRARY; T=0.K
angular distribution for (n,n*3)

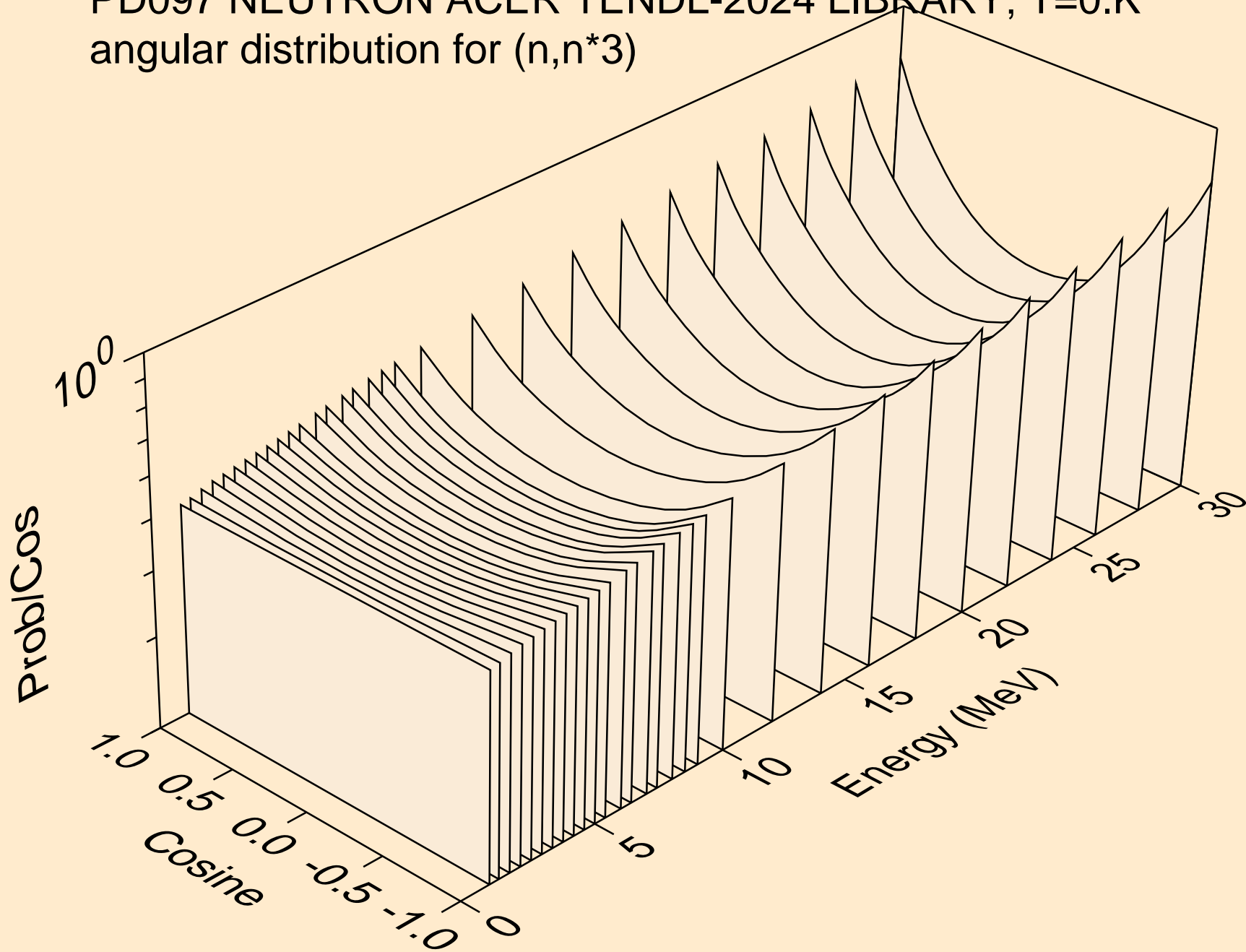

PD097 NEUTRON ACER TENDL-2024 LIBRARY; T=0.K
angular distribution for (n,n*4)

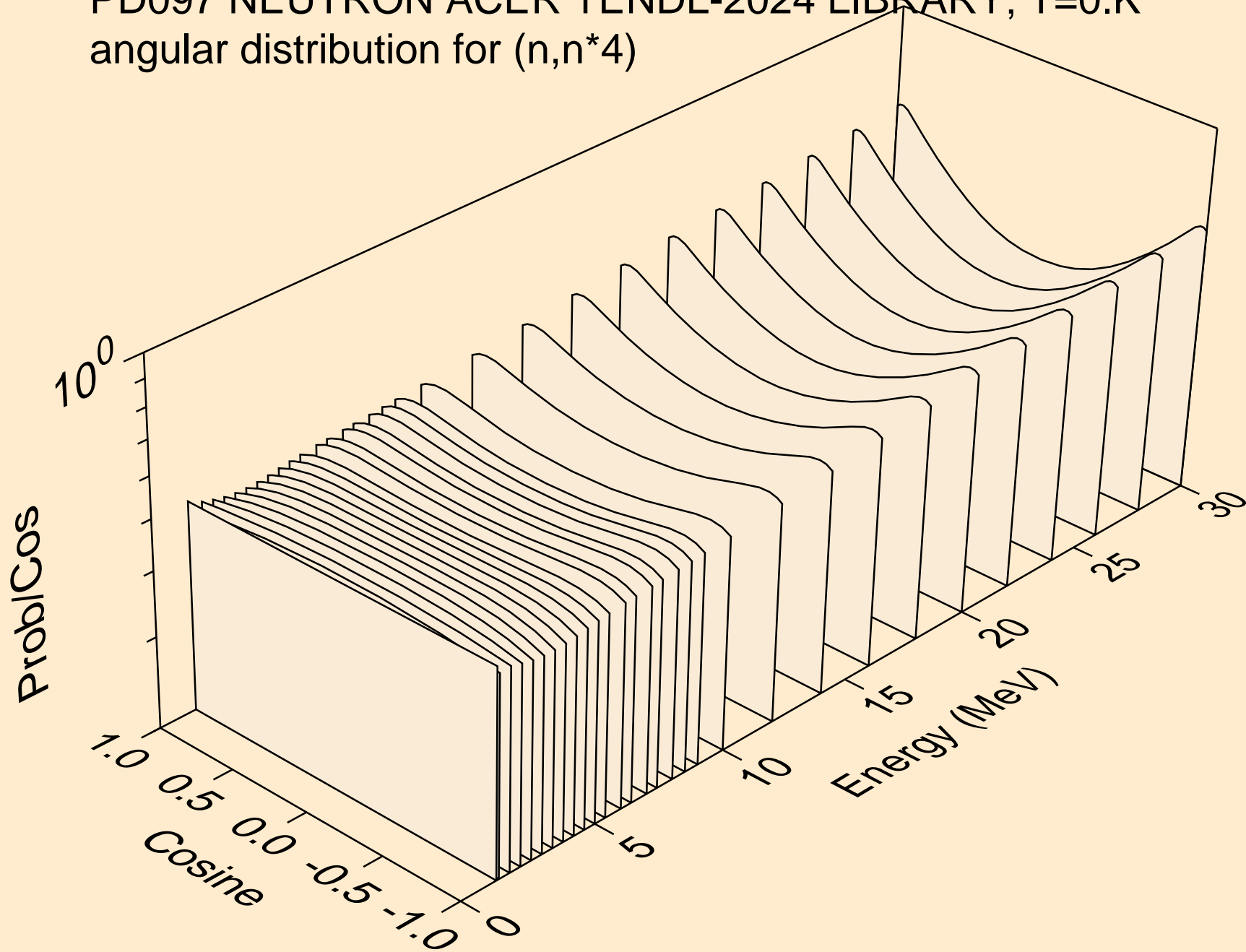

PD097 NEUTRON ACER TENDL-2024 LIBRARY; T=0.K
angular distribution for (n,n*5)

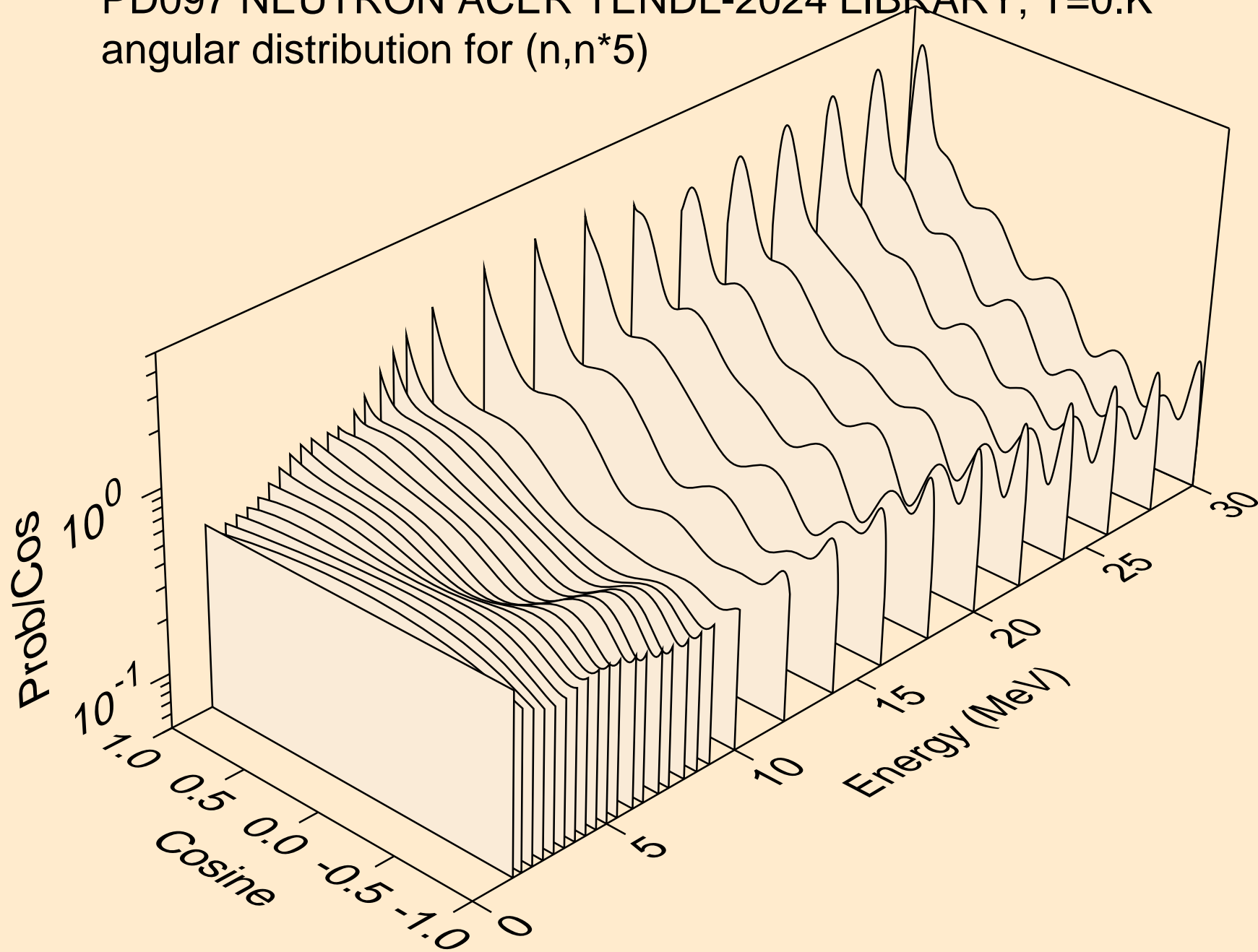

PD097 NEUTRON ACER TENDL-2024 LIBRARY; T=0.K
angular distribution for (n,n*6)

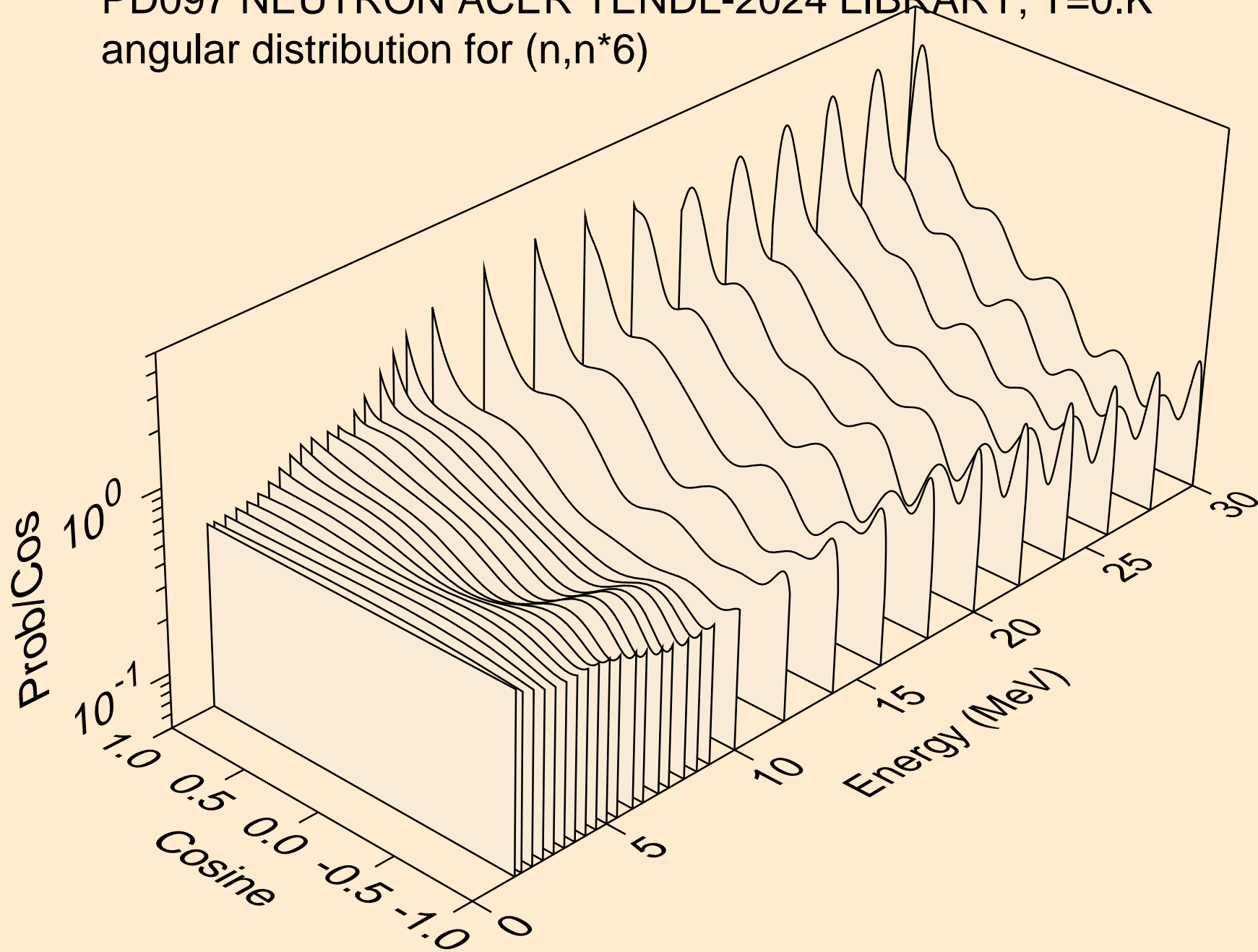

PD097 NEUTRON ACER TENDL-2024 LIBRARY; T=0.K
angular distribution for (n,n*7)

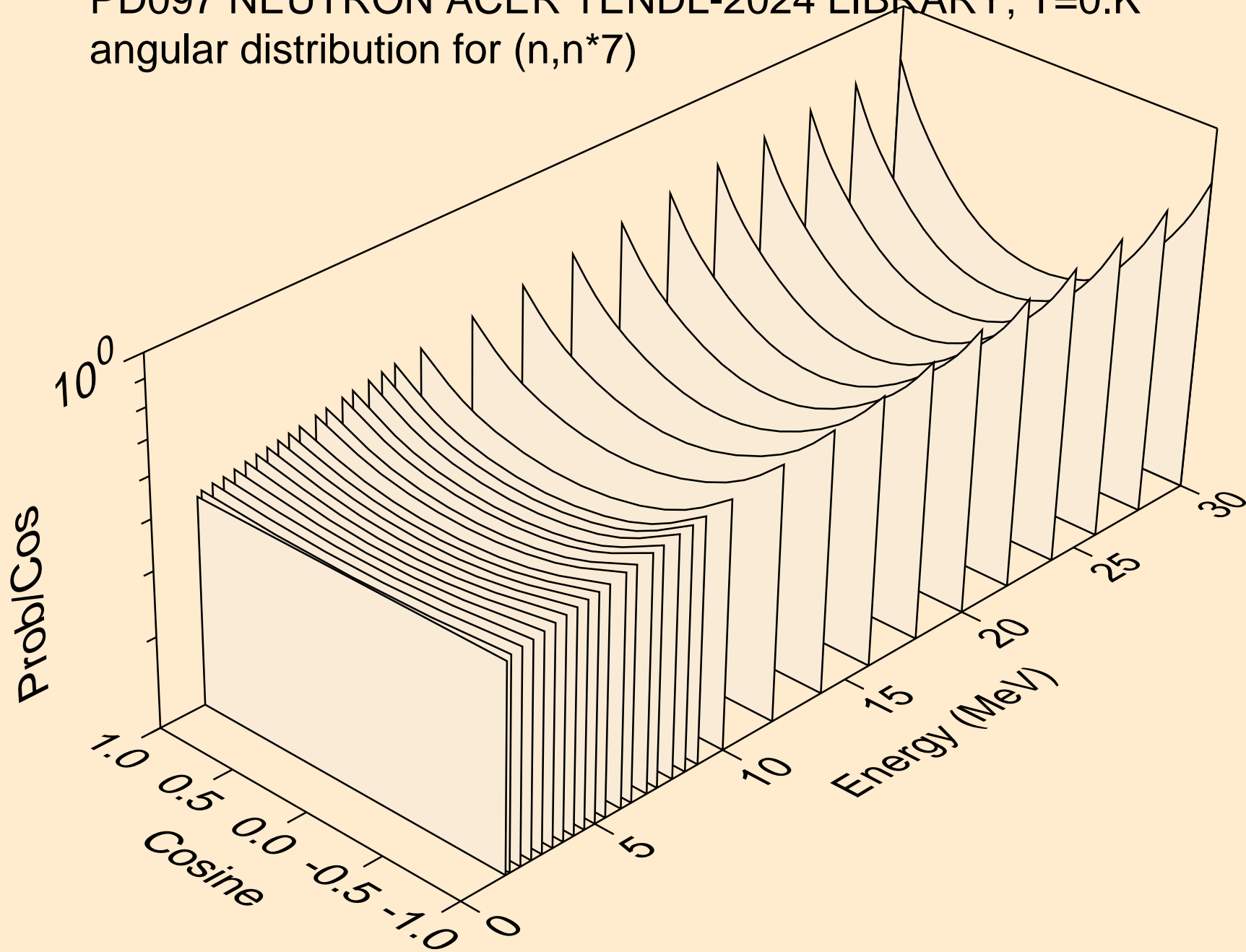

PD097 NEUTRON ACER TENDL-2024 LIBRARY; T=0.K
angular distribution for (n,n*8)

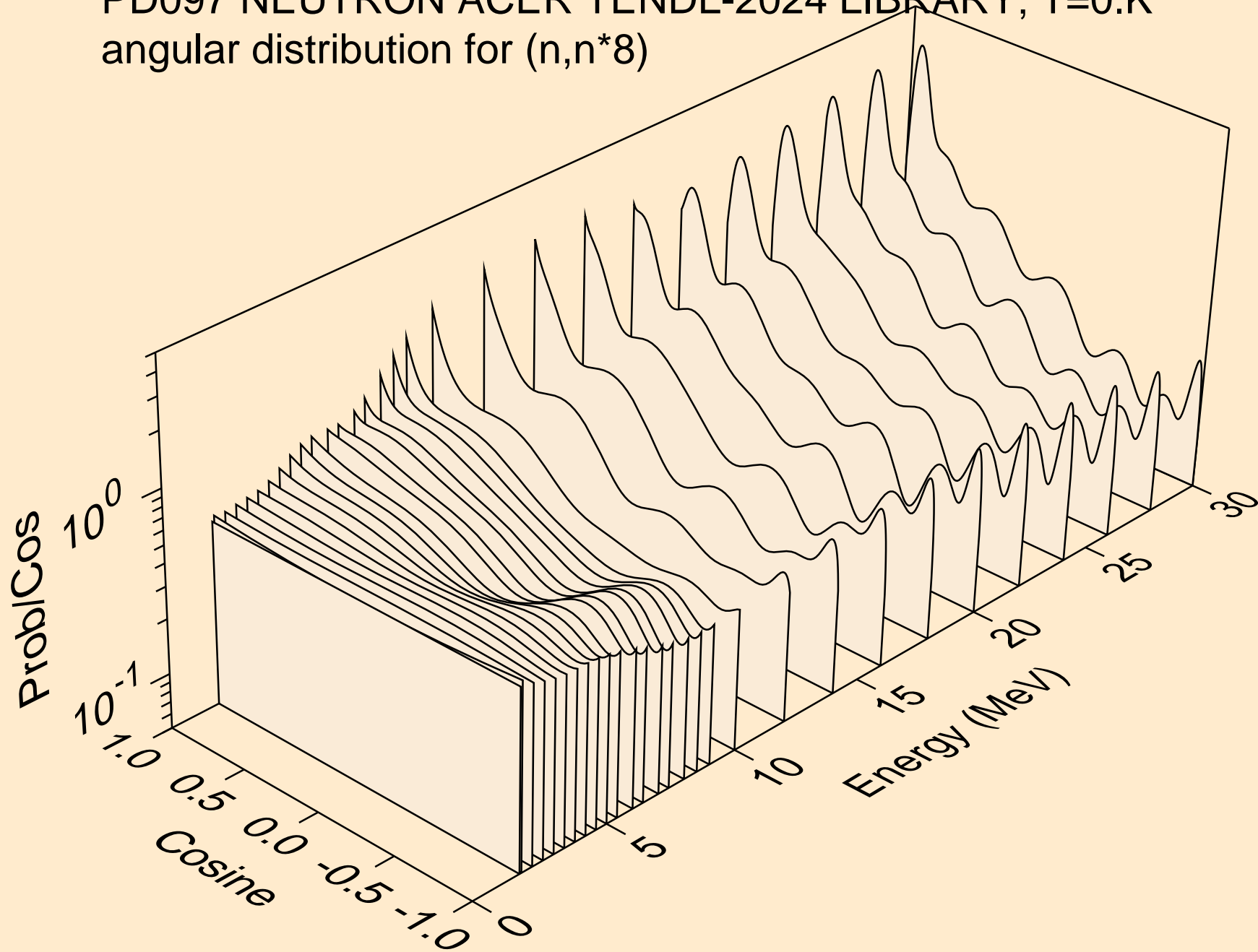

PD097 NEUTRON ACER TENDL-2024 LIBRARY; T=0.K
angular distribution for (n,n*9)

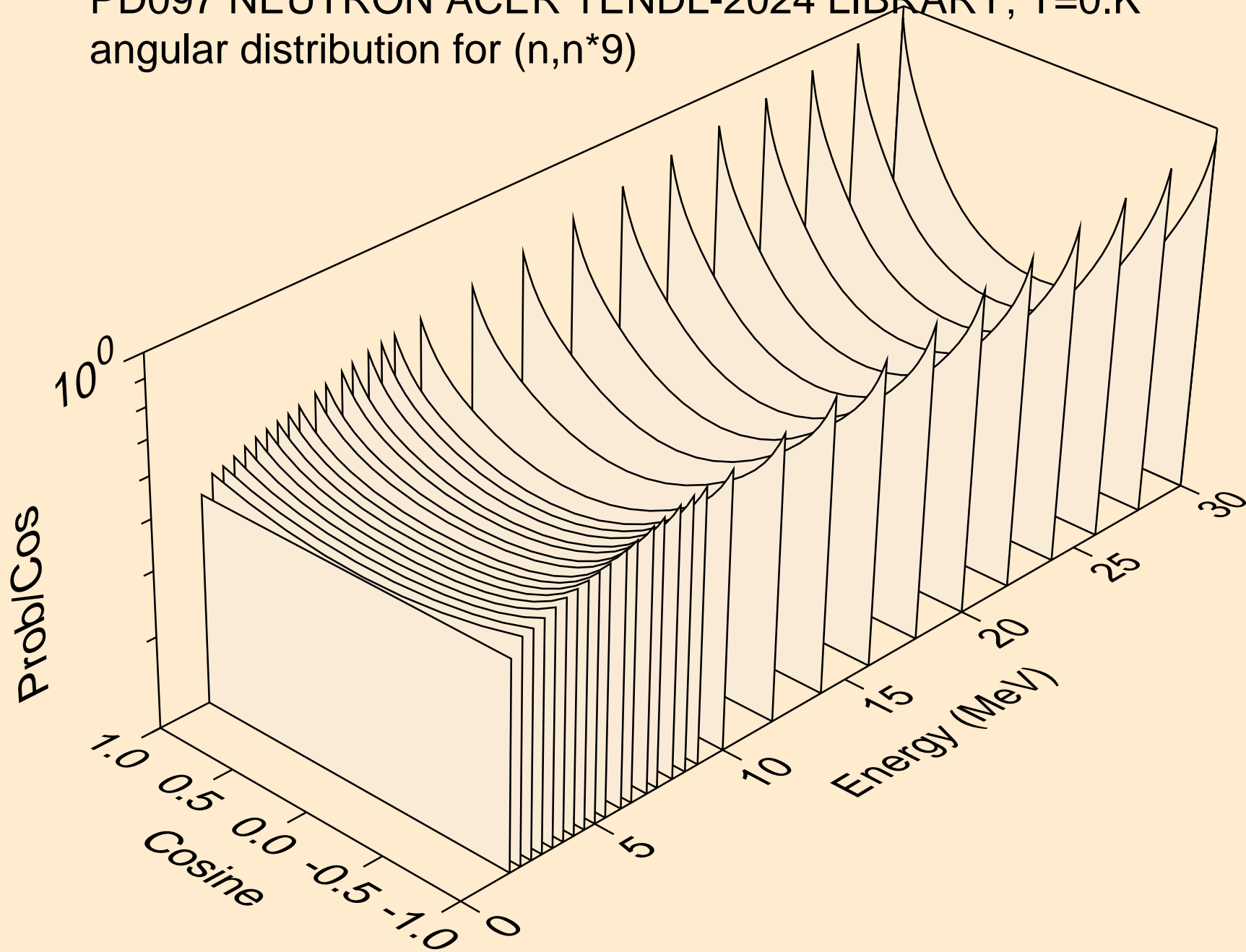

PD097 NEUTRON ACER TENDL-2024 LIBRARY; T=0.K
angular distribution for (n,n*10)

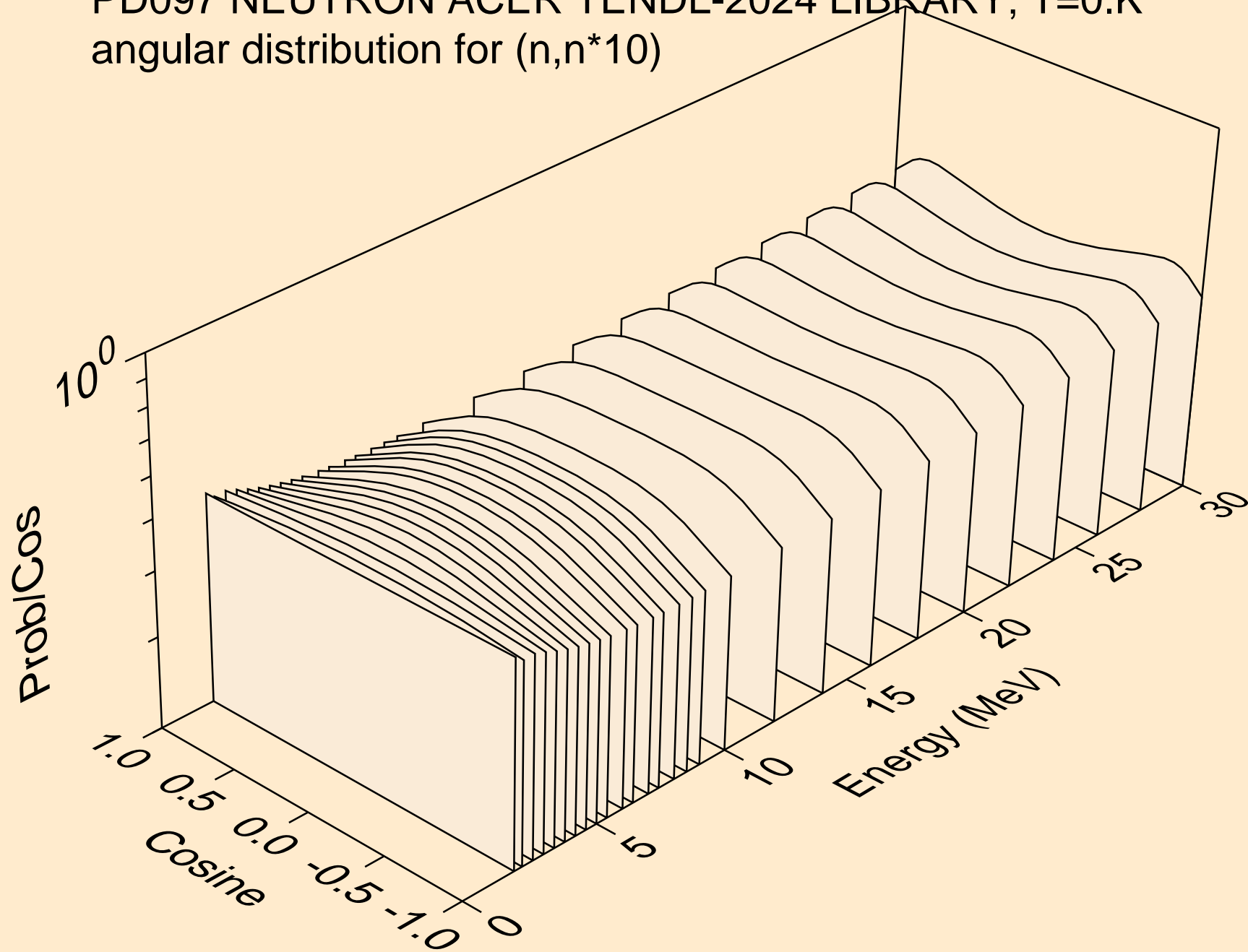

PD097 NEUTRON ACER TENDL-2024 LIBRARY; T=0.K
angular distribution for (n,n*11)

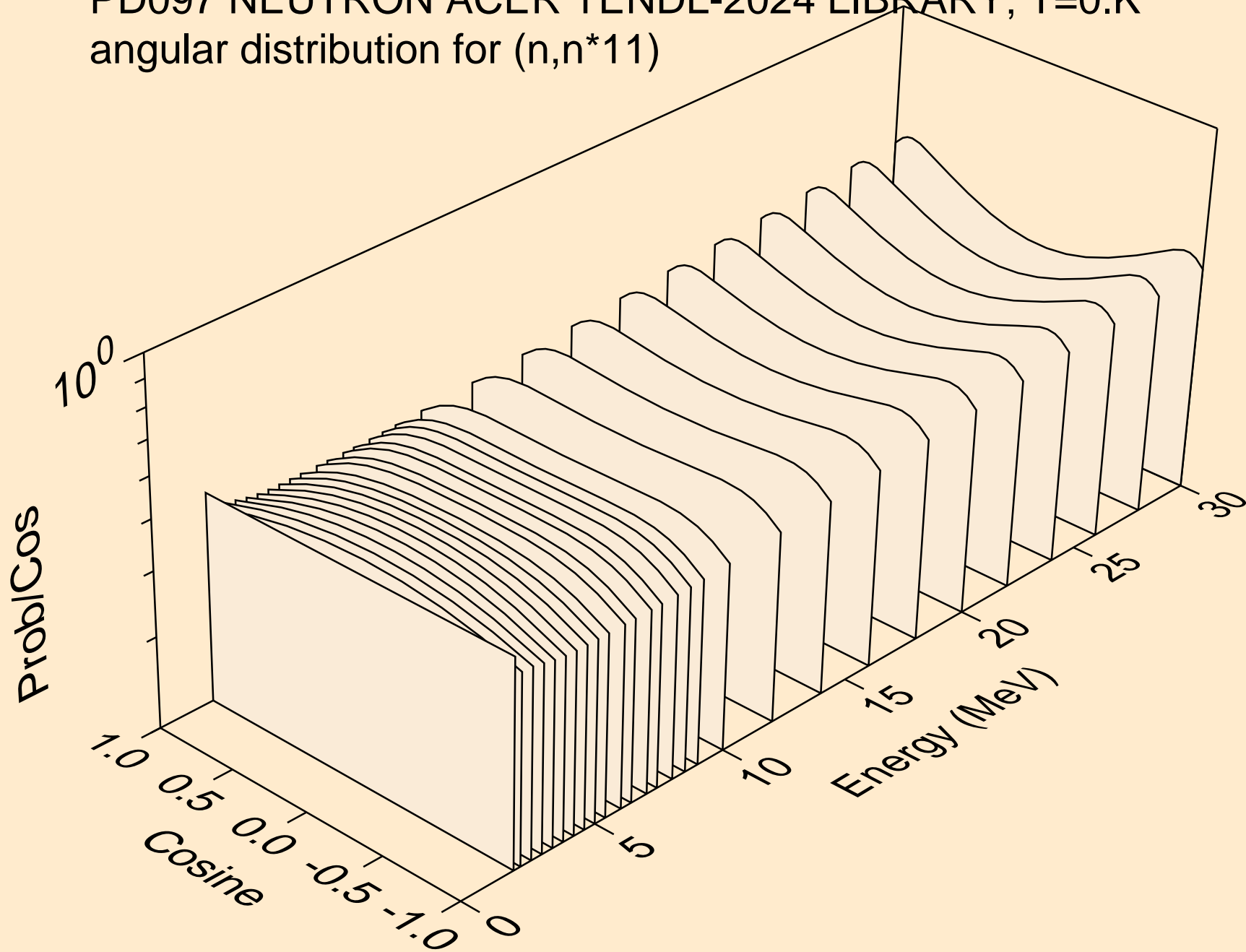

PD097 NEUTRON ACER TENDL-2024 LIBRARY; T=0.K
angular distribution for (n,n*12)

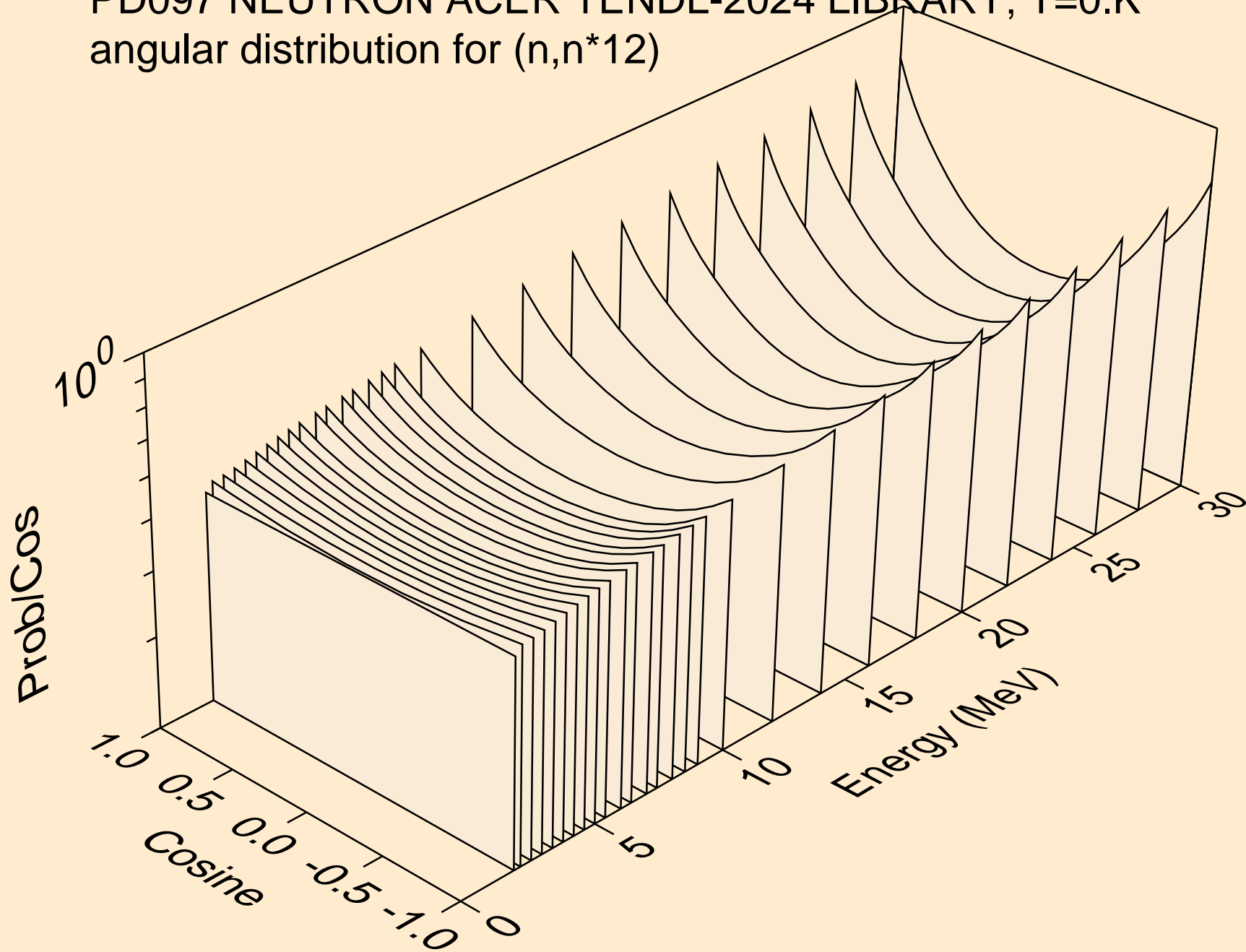

PD097 NEUTRON ACER TENDL-2024 LIBRARY; T=0.K
angular distribution for (n,n*13)

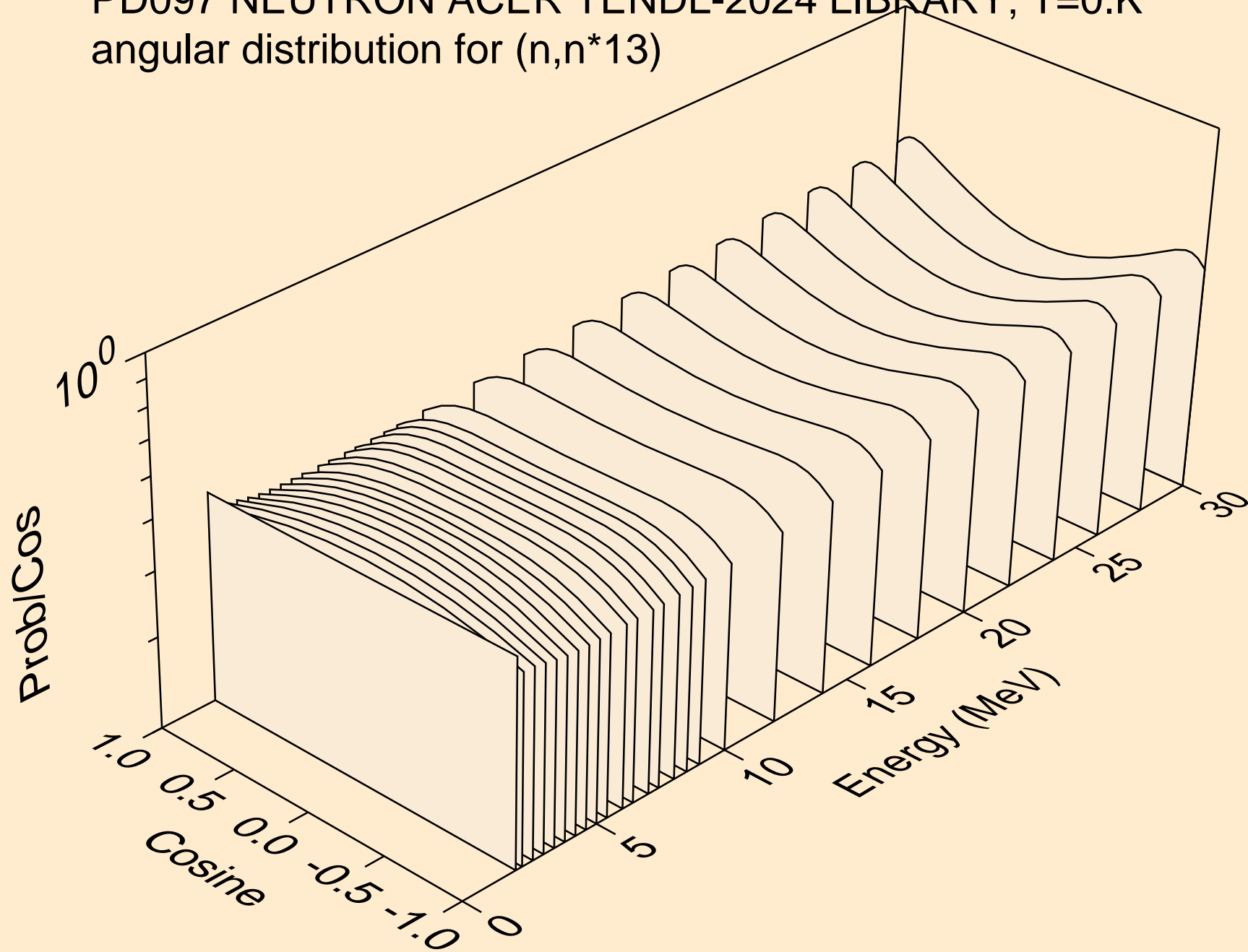

PD097 NEUTRON ACER TENDL-2024 LIBRARY; T=0.K
angular distribution for (n,n*14)

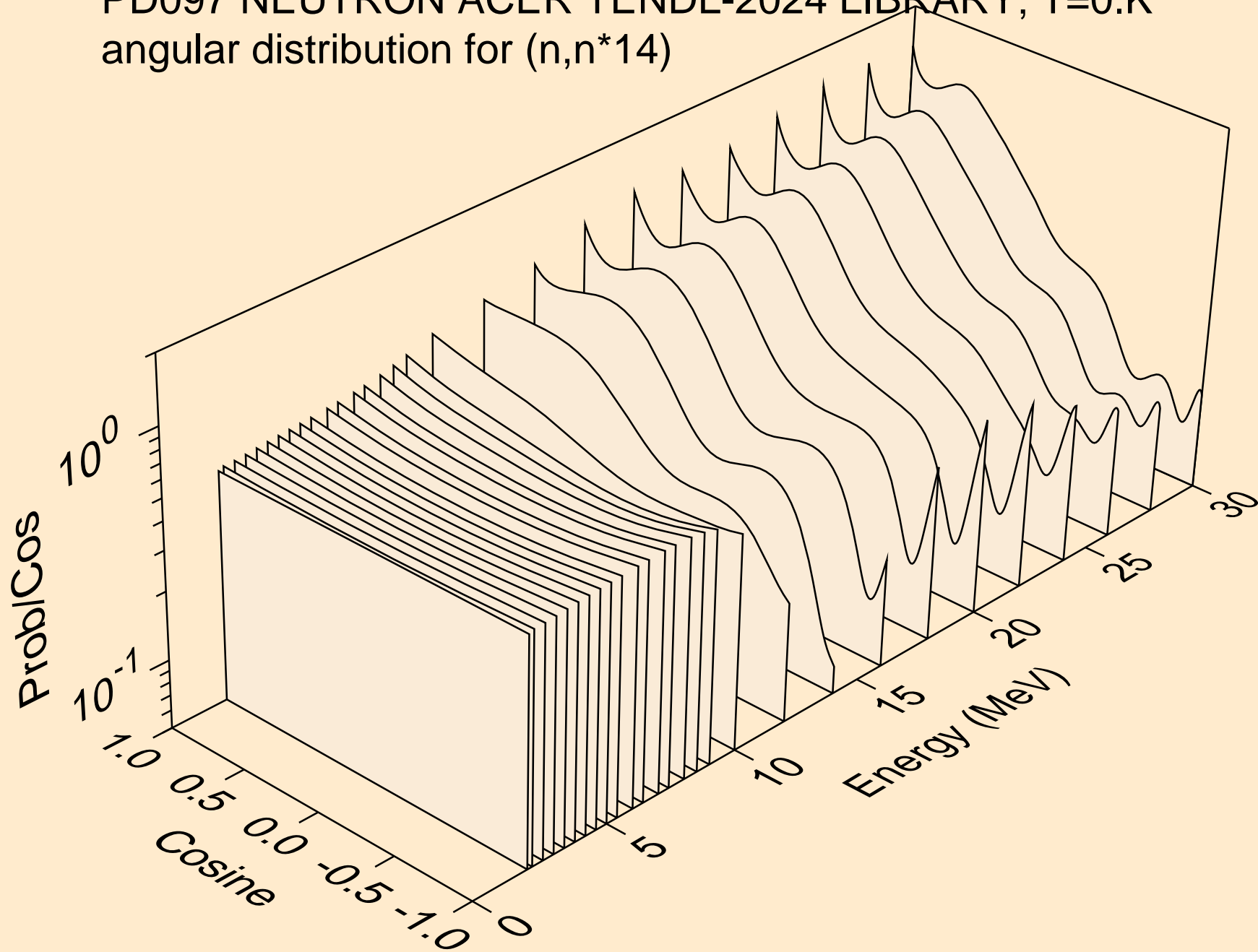

PD097 NEUTRON ACER TENDL-2024 LIBRARY; T=0.K
angular distribution for (n,n*15)

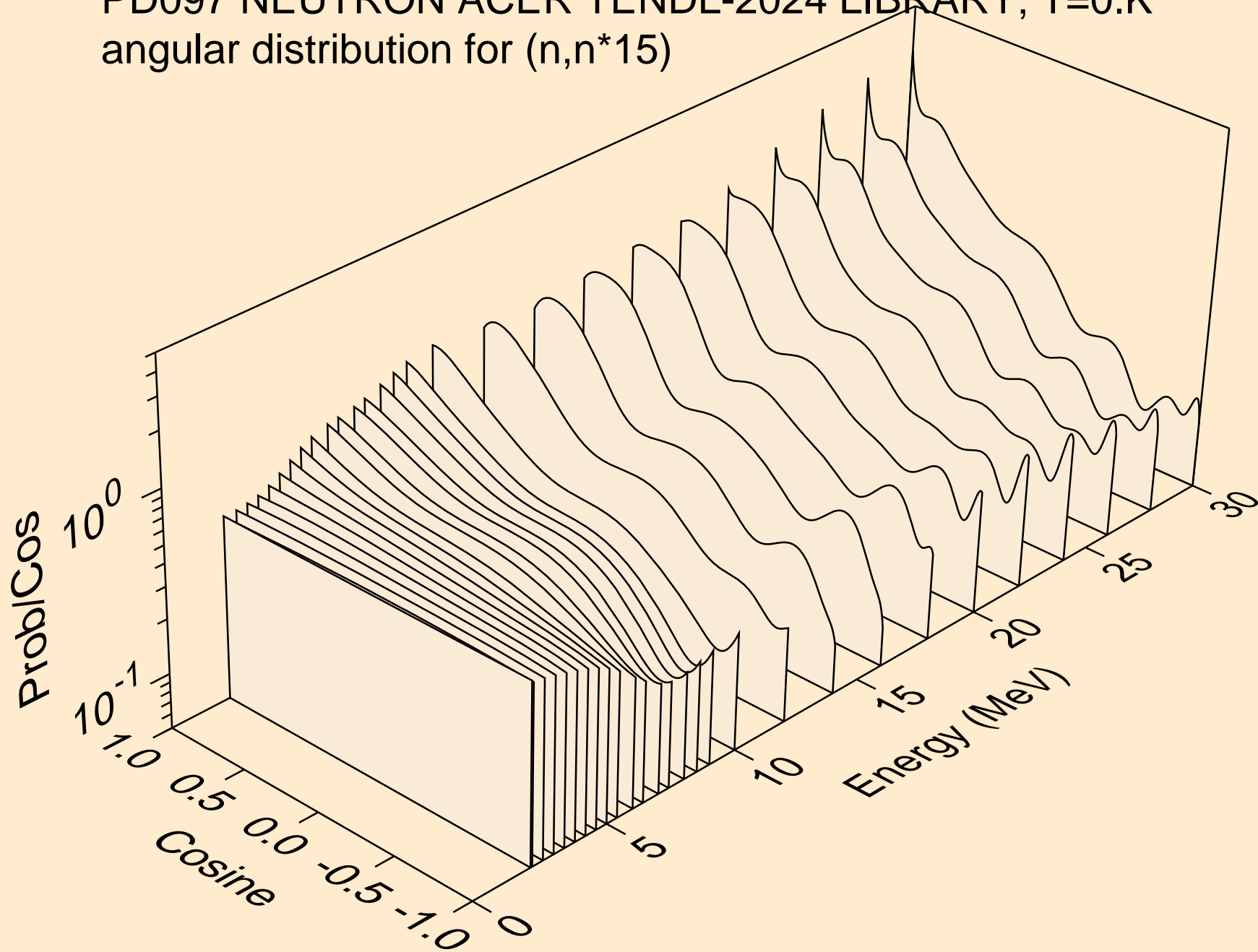

PD097 NEUTRON ACER TENDL-2024 LIBRARY; T=0.K
angular distribution for (n,n*16)

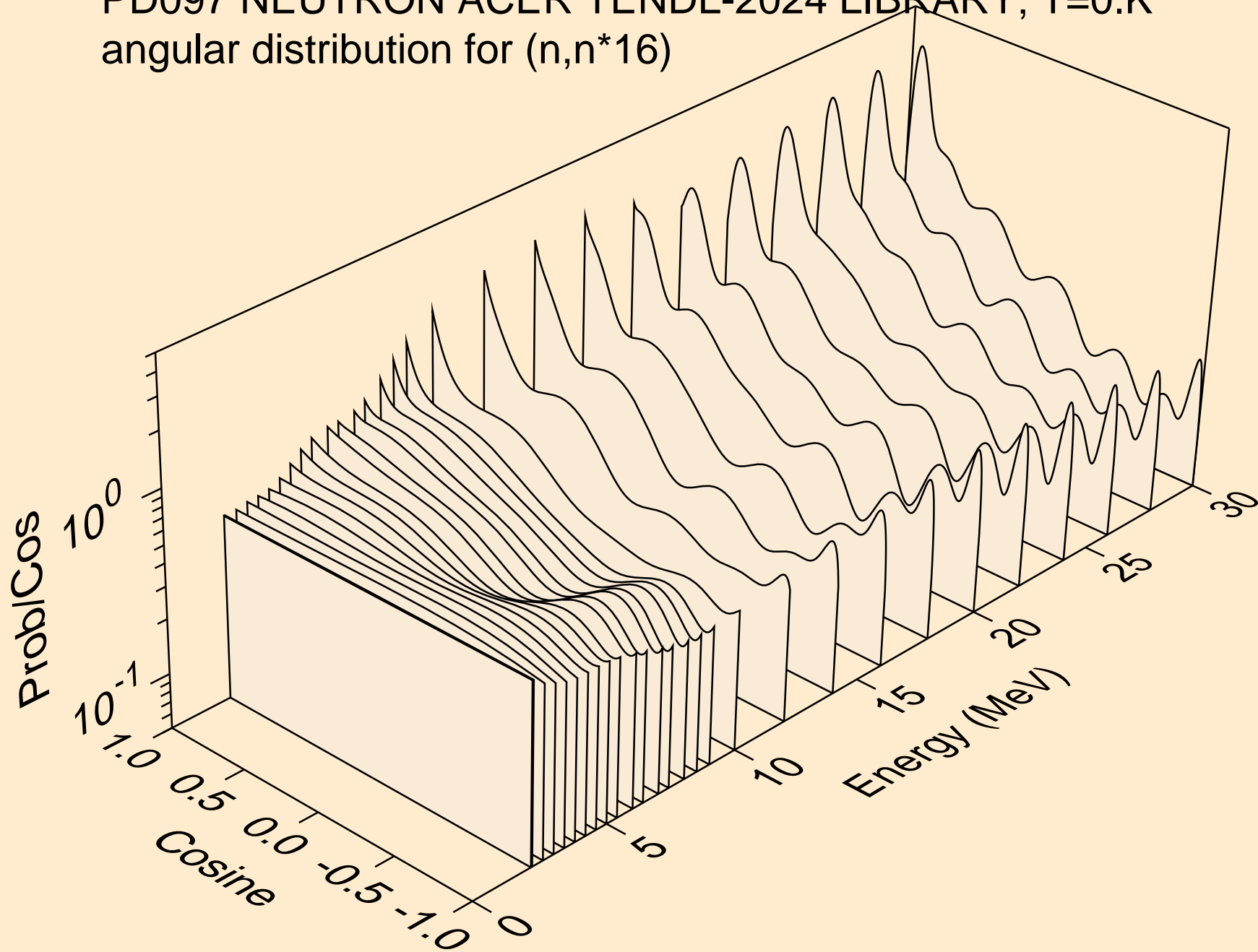

PD097 NEUTRON ACER TENDL-2024 LIBRARY; T=0.K
angular distribution for (n,n*17)

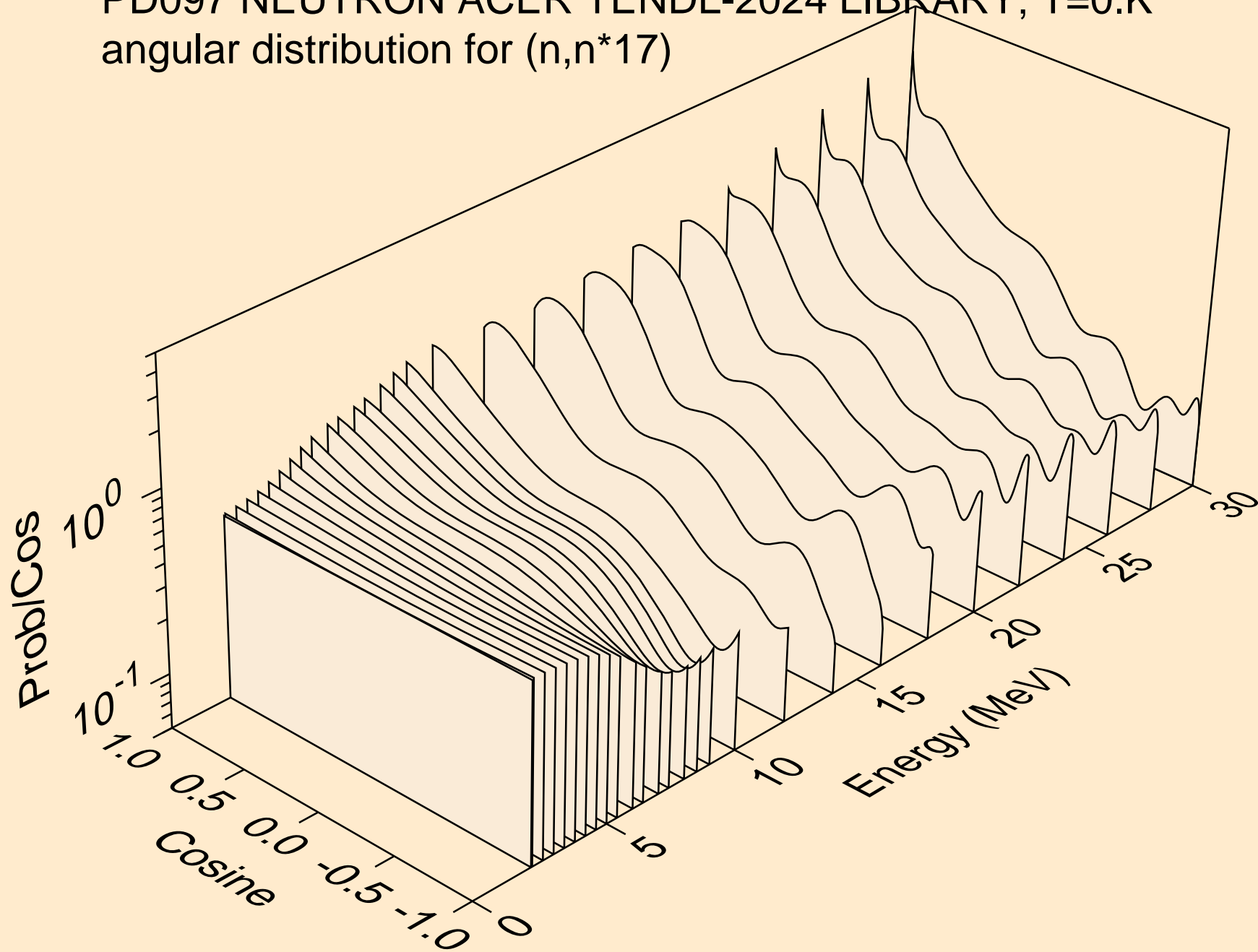

PD097 NEUTRON ACER TENDL-2024 LIBRARY; T=0.K
angular distribution for (n,n*18)

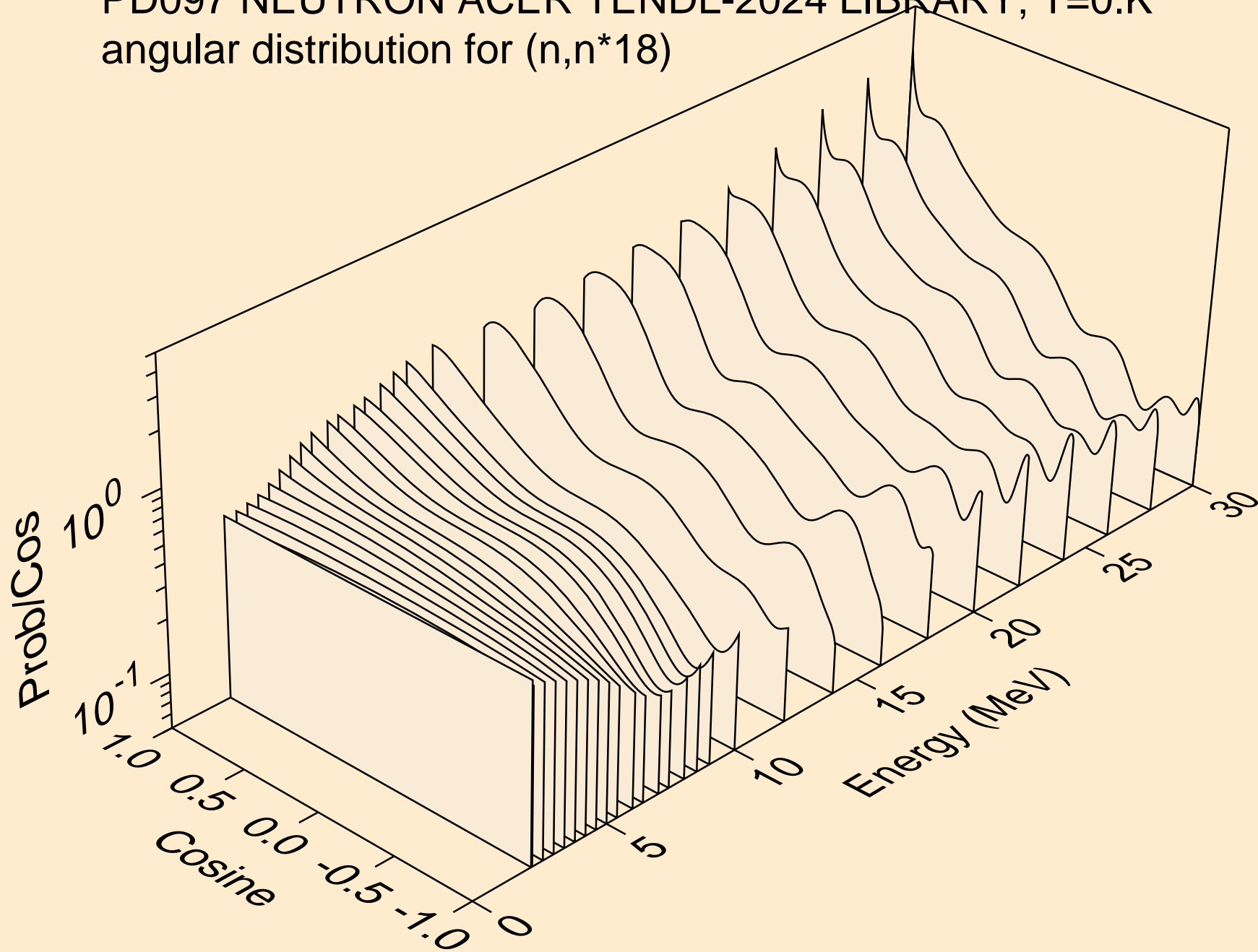

PD097 NEUTRON ACER TENDL-2024 LIBRARY; T=0.K
angular distribution for (n,n*19)

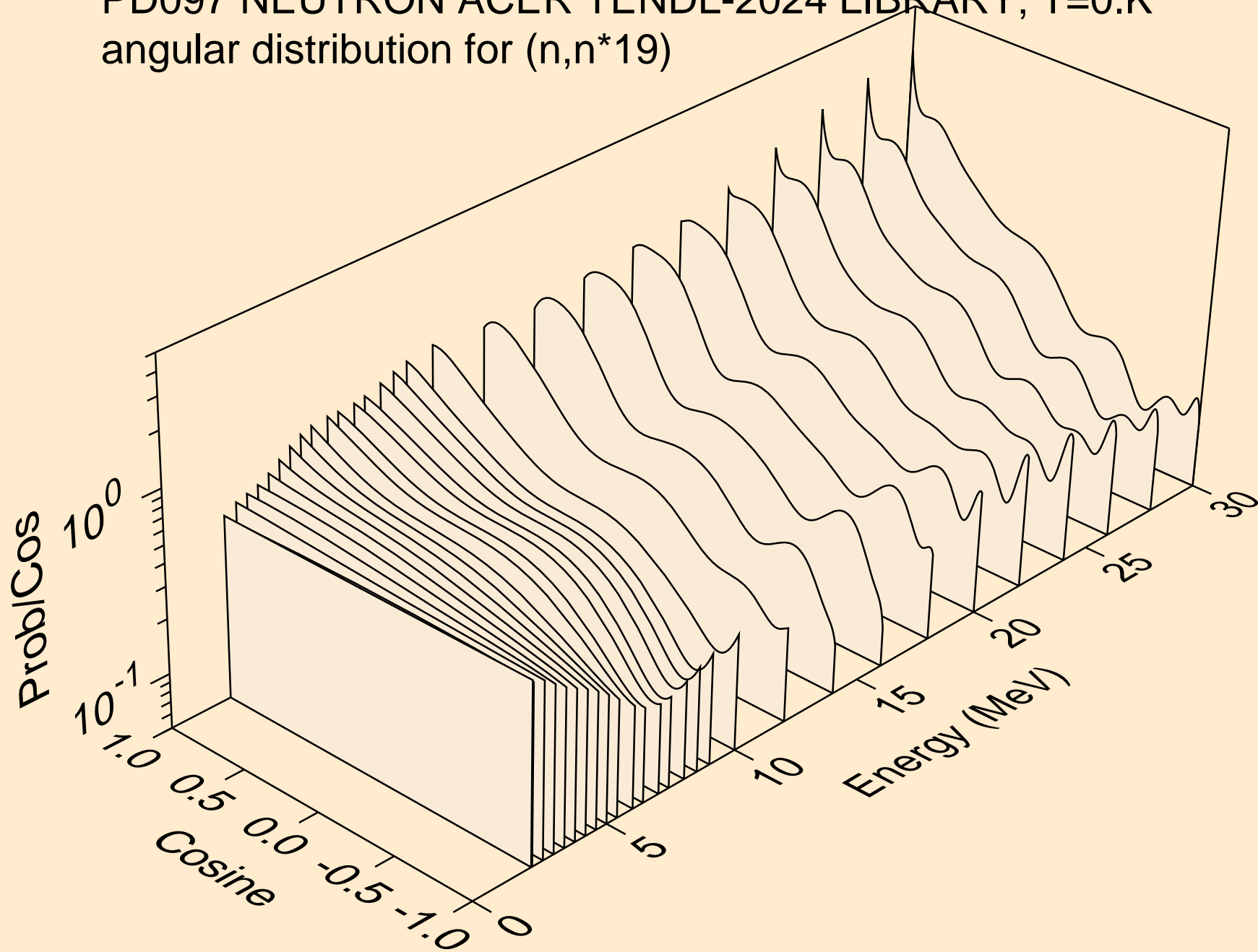

PD097 NEUTRON ACER TENDL-2024 LIBRARY; T=0.K
angular distribution for (n,n*20)

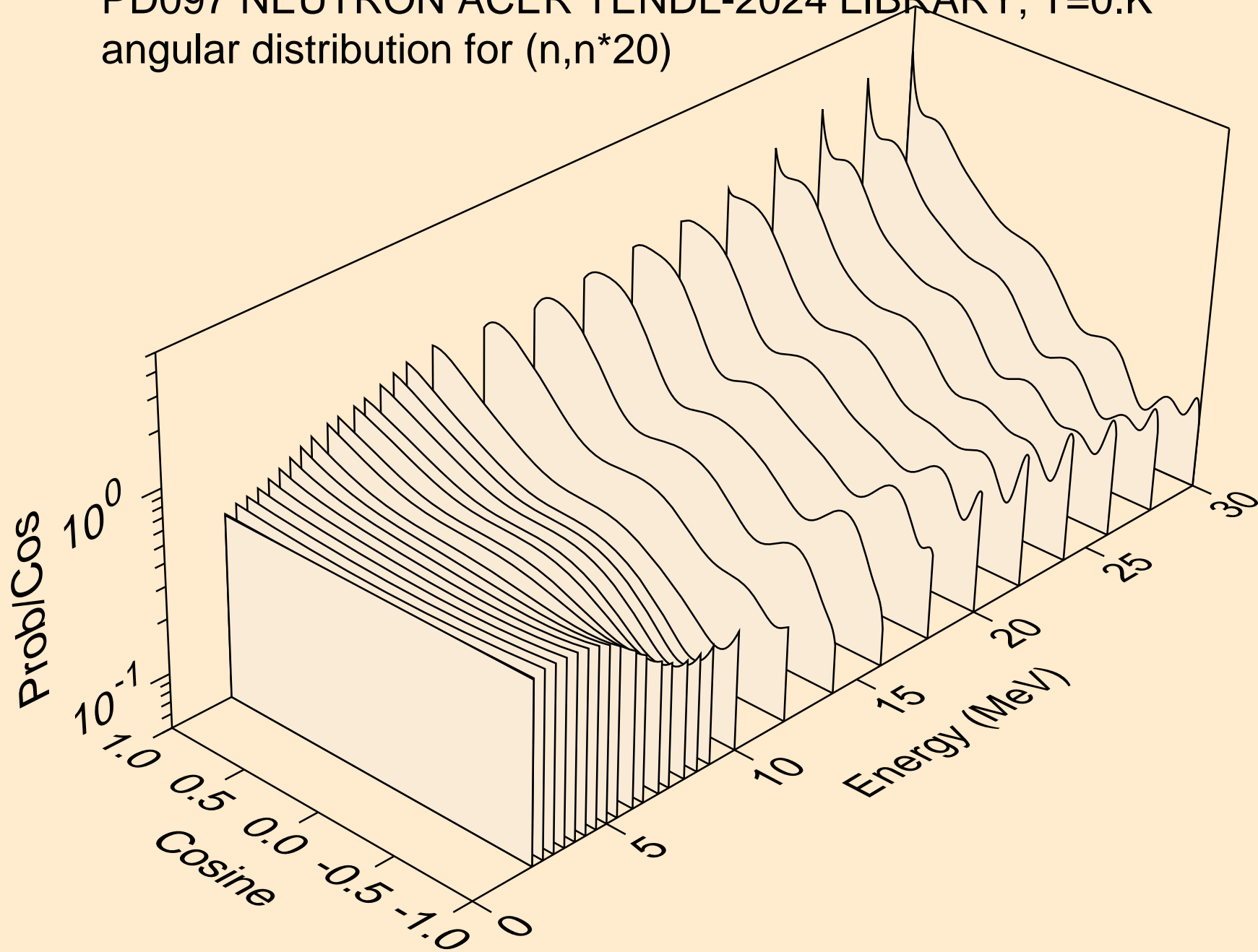

PD097 NEUTRON ACER TENDL-2024 LIBRARY; T=0.K
angular distribution for (n,n*21)

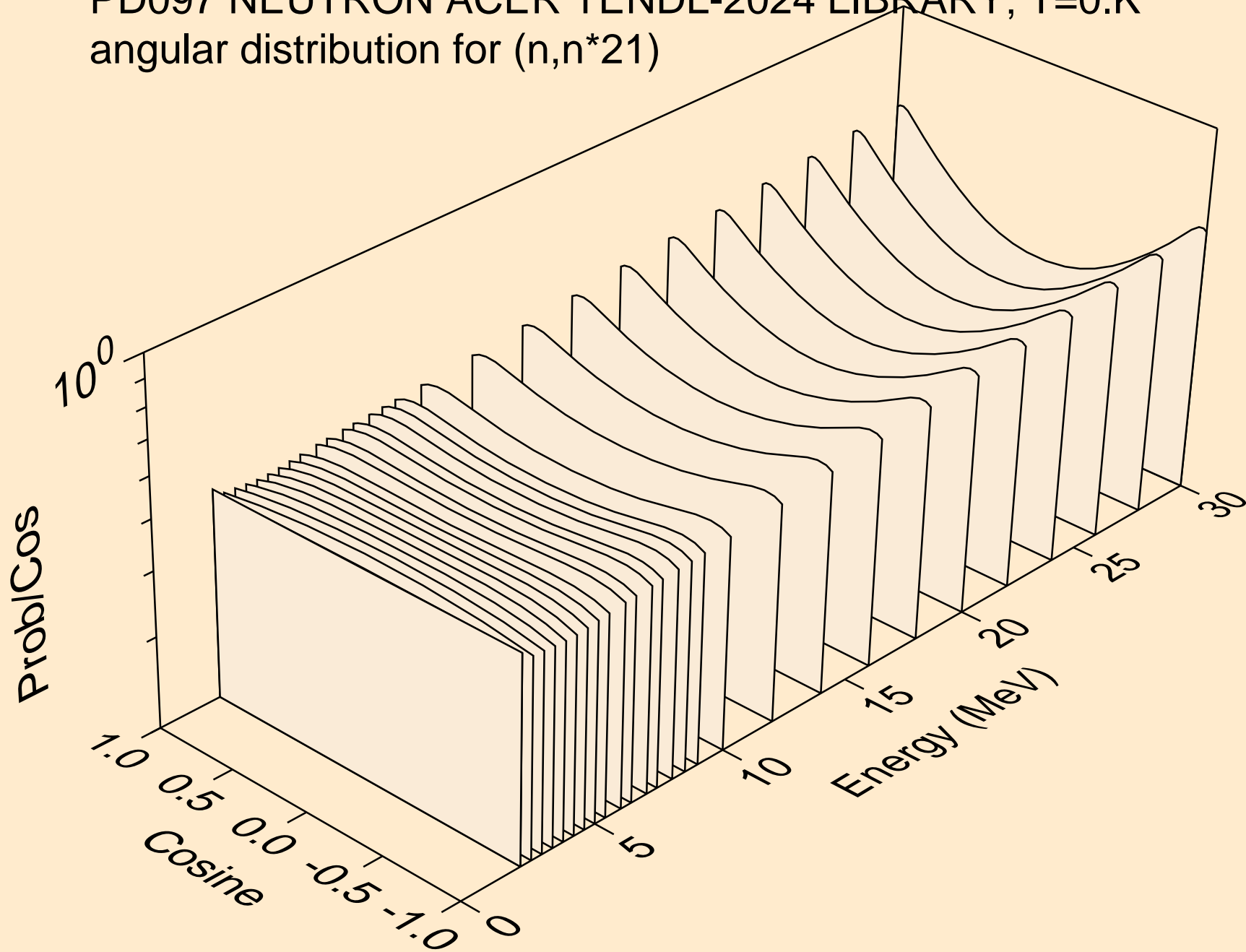

PD097 NEUTRON ACER TENDL-2024 LIBRARY; T=0.K
angular distribution for (n,n*22)

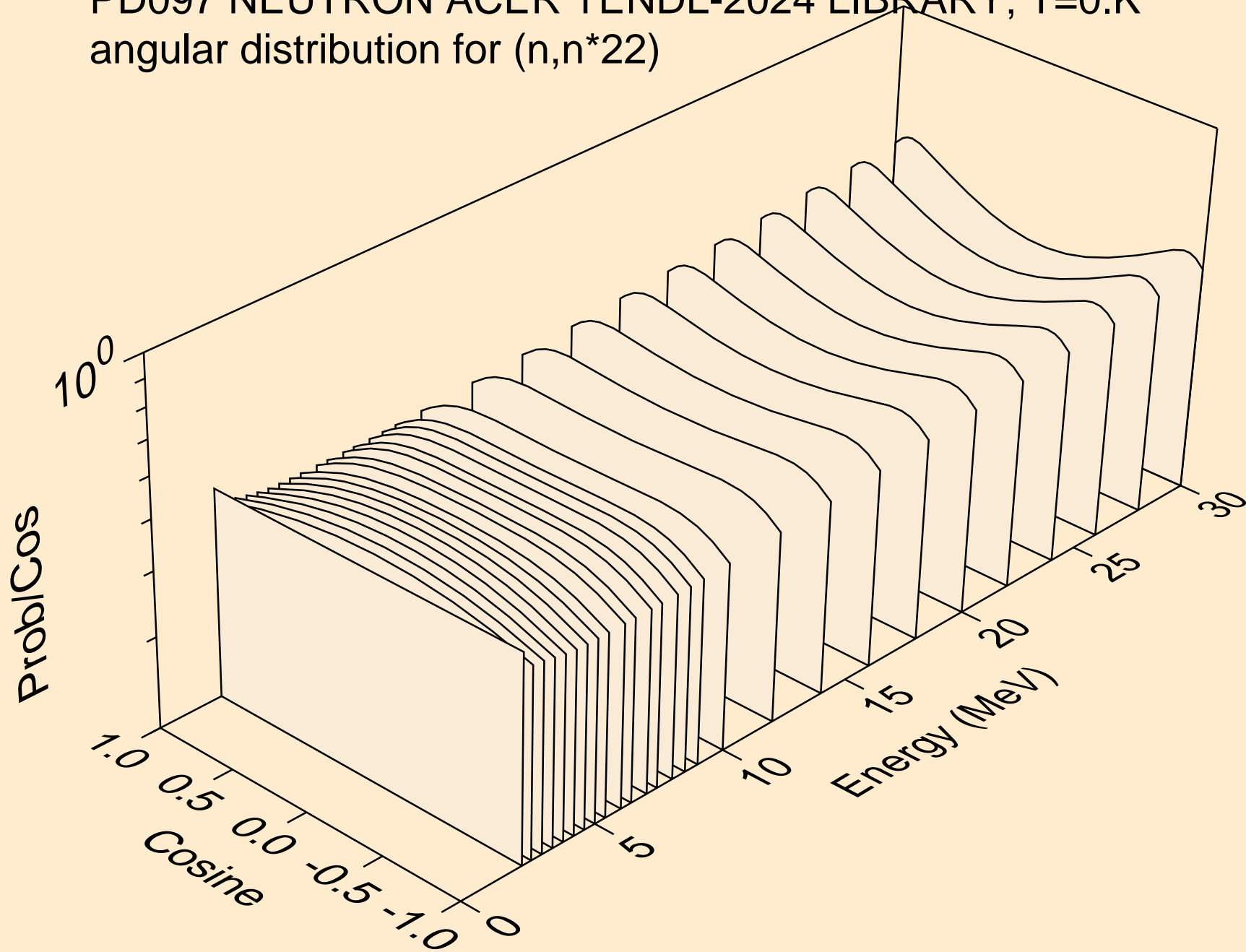

PD097 NEUTRON ACER TENDL-2024 LIBRARY; T=0.K
angular distribution for (n,n*23)

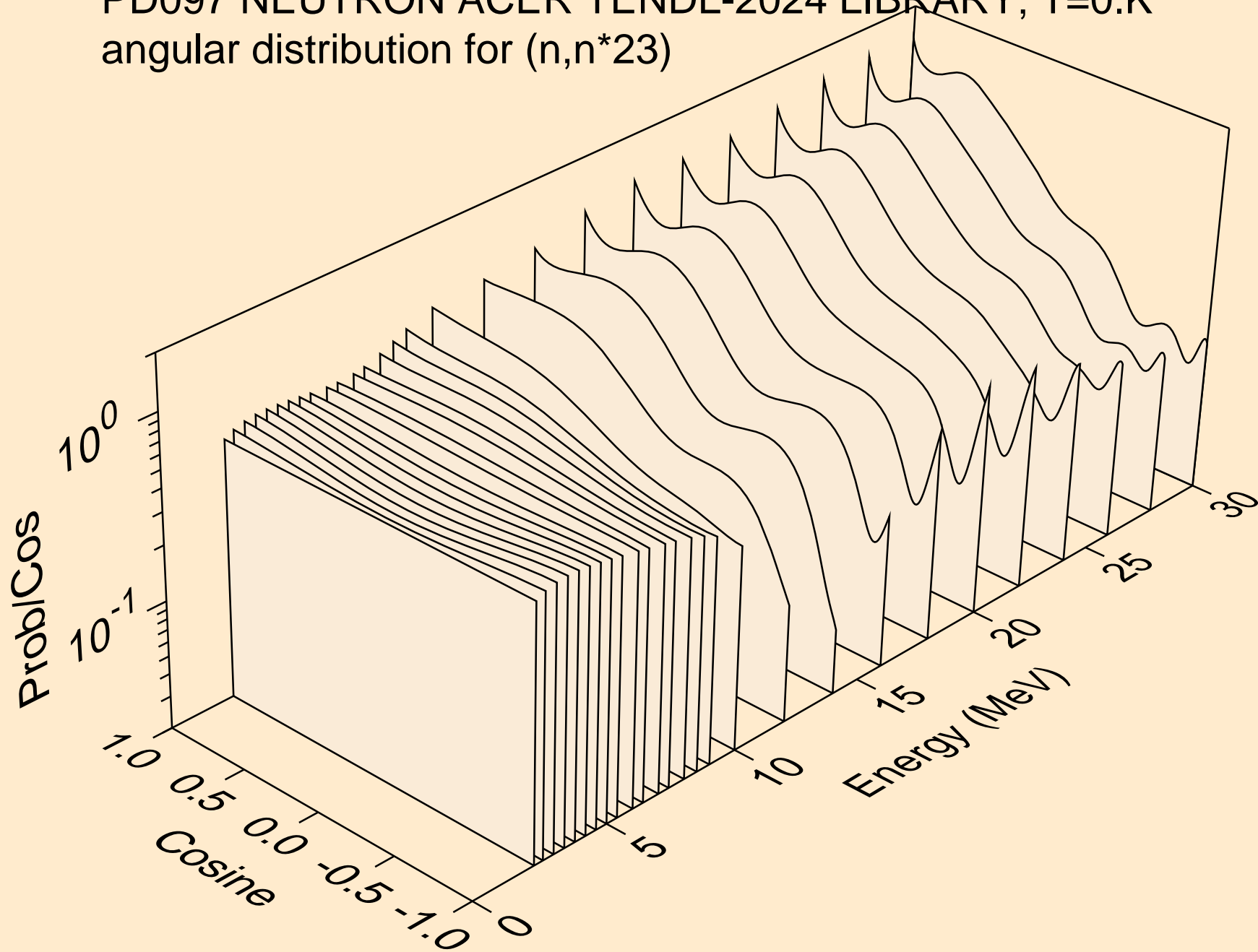

PD097 NEUTRON ACER TENDL-2024 LIBRARY; T=0.K
angular distribution for (n,n*24)

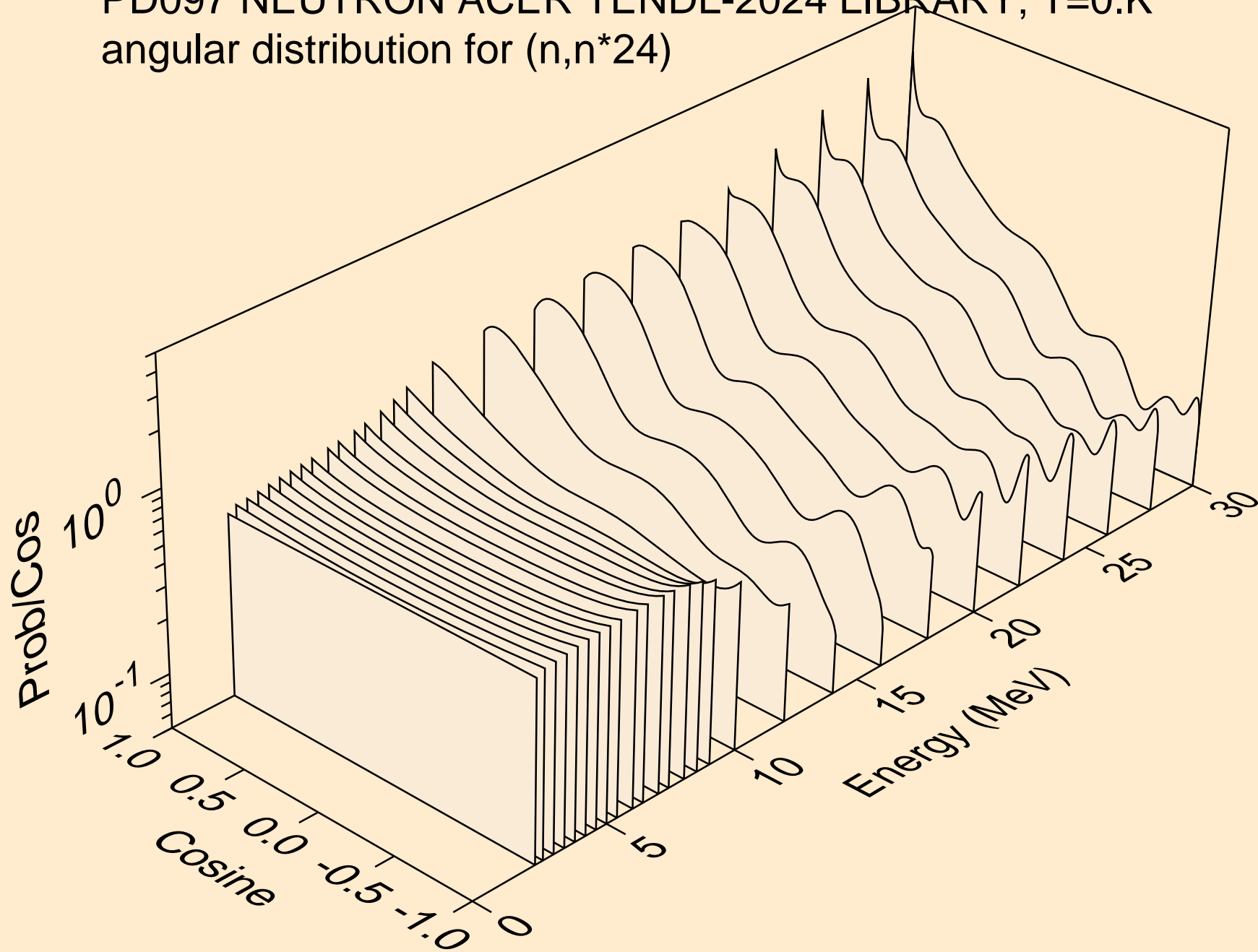

PD097 NEUTRON ACER TENDL-2024 LIBRARY; T=0.K
angular distribution for (n,n*25)

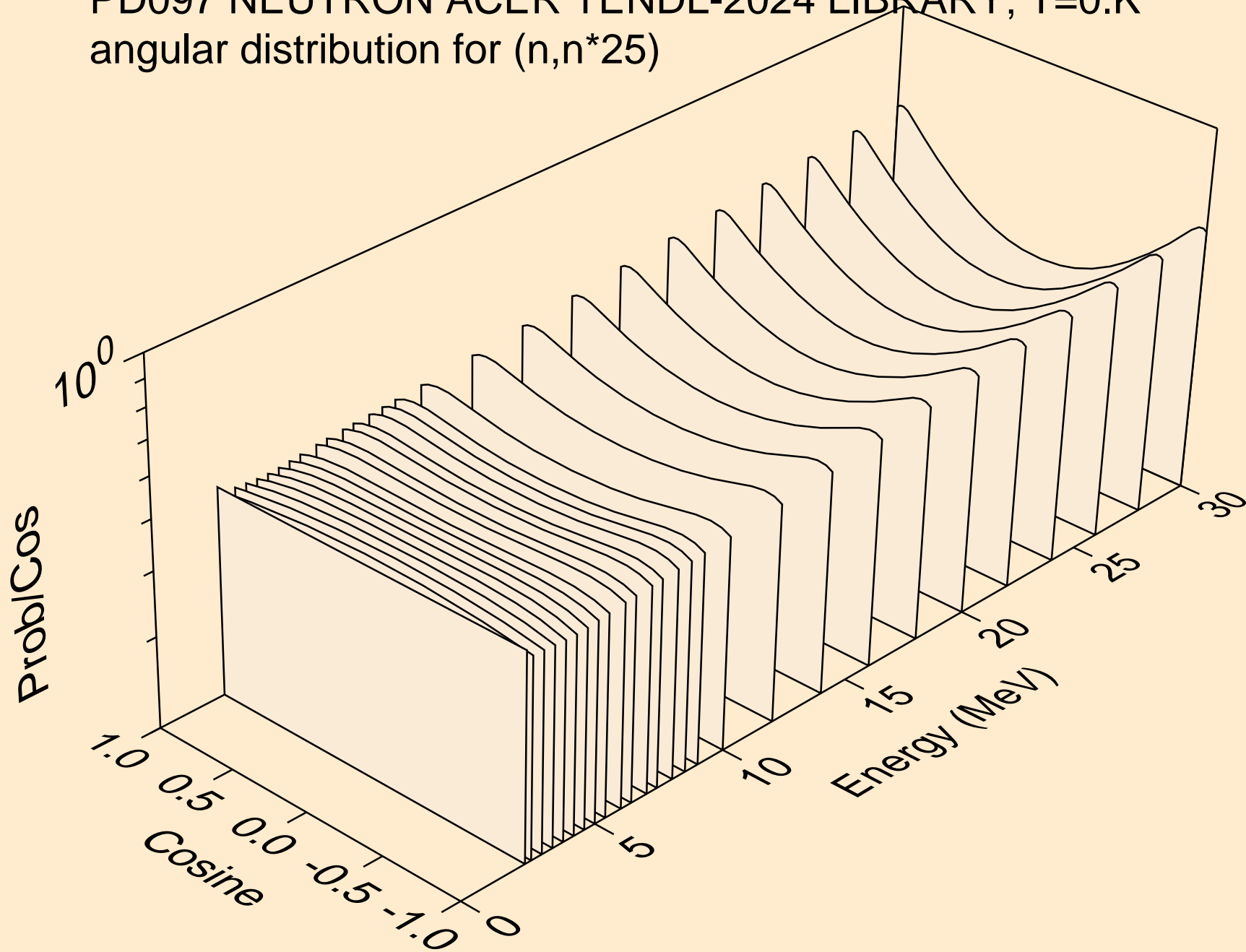

PD097 NEUTRON ACER TENDL-2024 LIBRARY; T=0.K
angular distribution for (n,n*26)

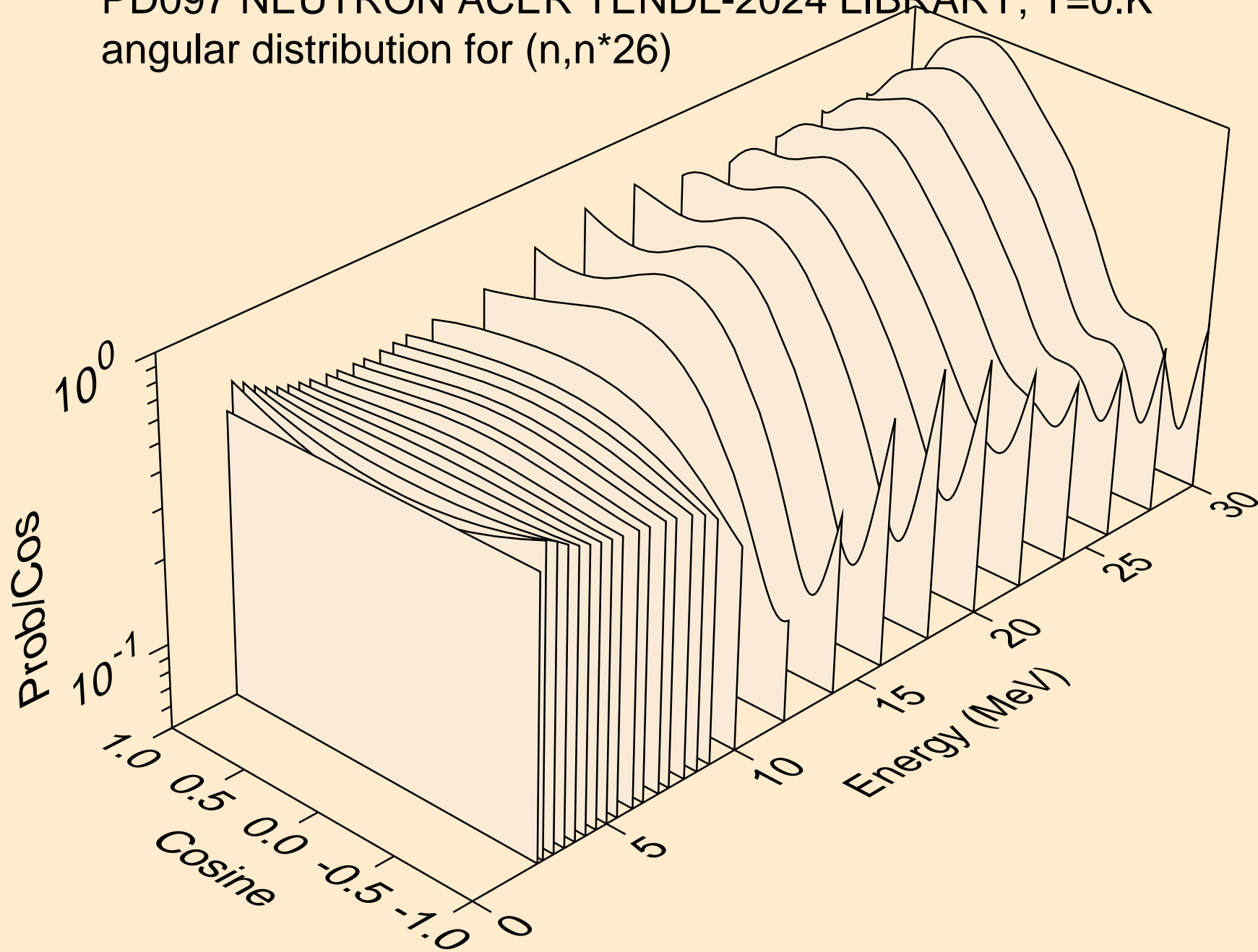

PD097 NEUTRON ACER TENDL-2024 LIBRARY; T=0.K
angular distribution for (n,n*27)

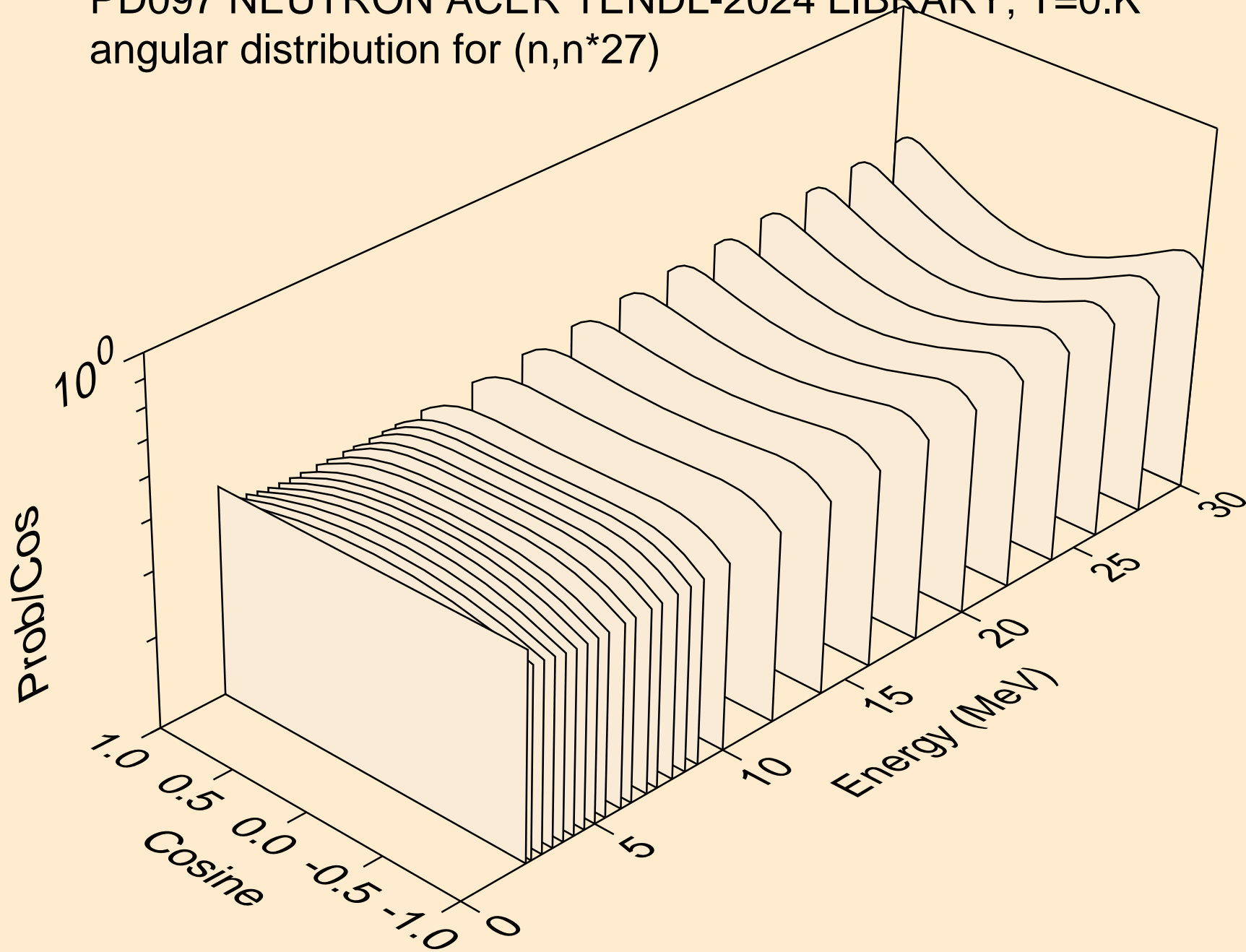

PD097 NEUTRON ACER TENDL-2024 LIBRARY; T=0.K
angular distribution for (n,n*28)

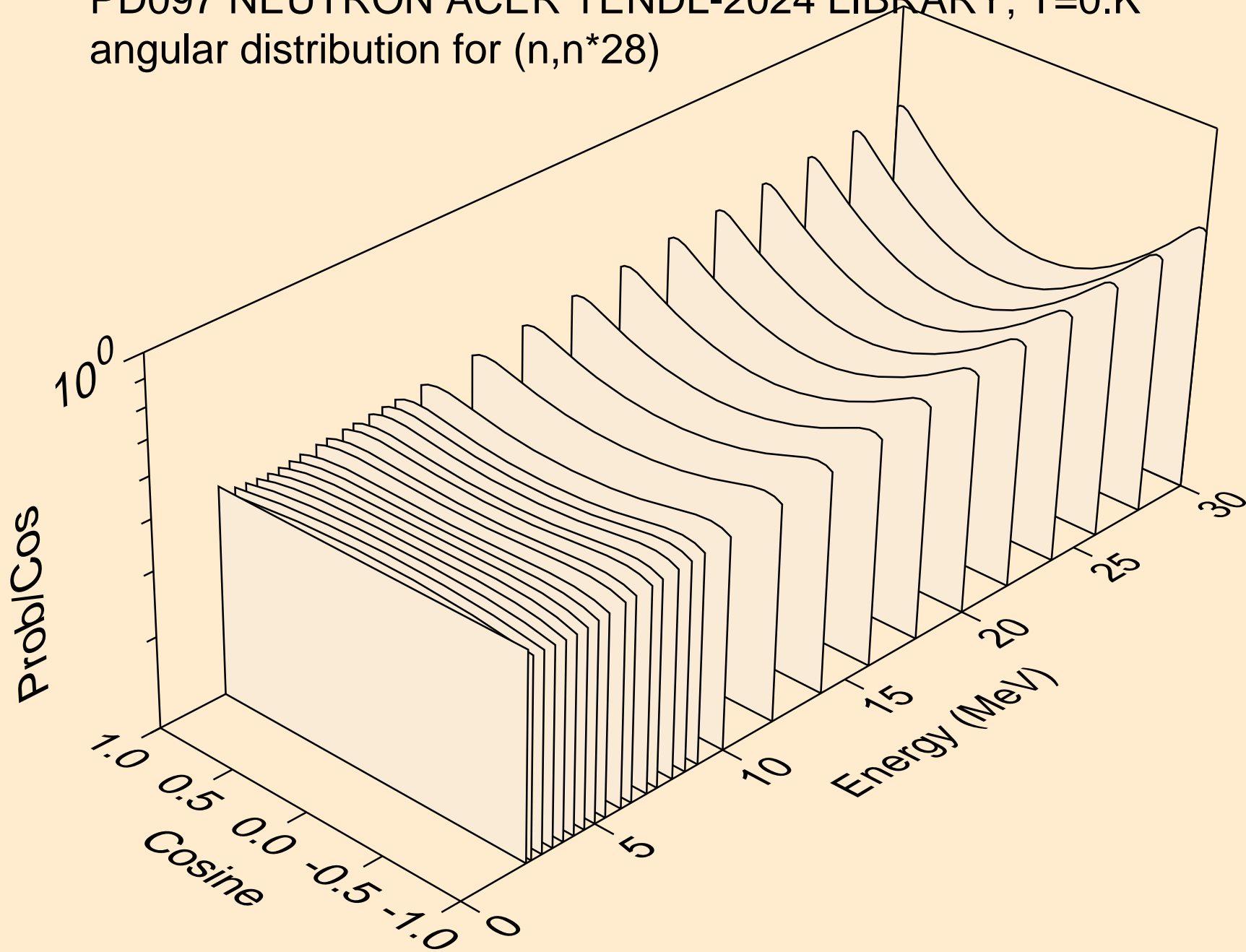

PD097 NEUTRON ACER TENDL-2024 LIBRARY; T=0.K
angular distribution for (n,n*29)

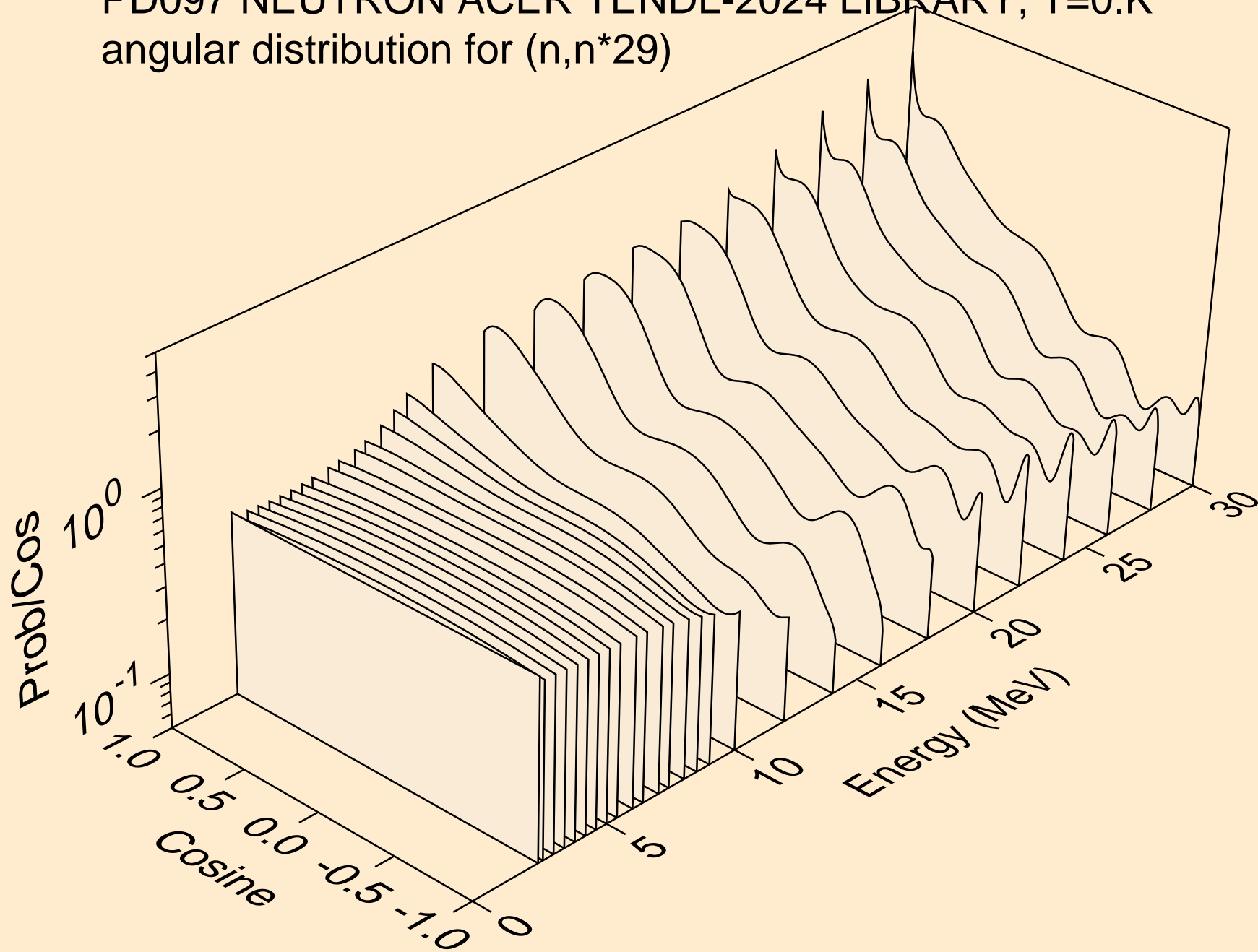

PD097 NEUTRON ACER TENDL-2024 LIBRARY; T=0.K
angular distribution for (n,n*30)

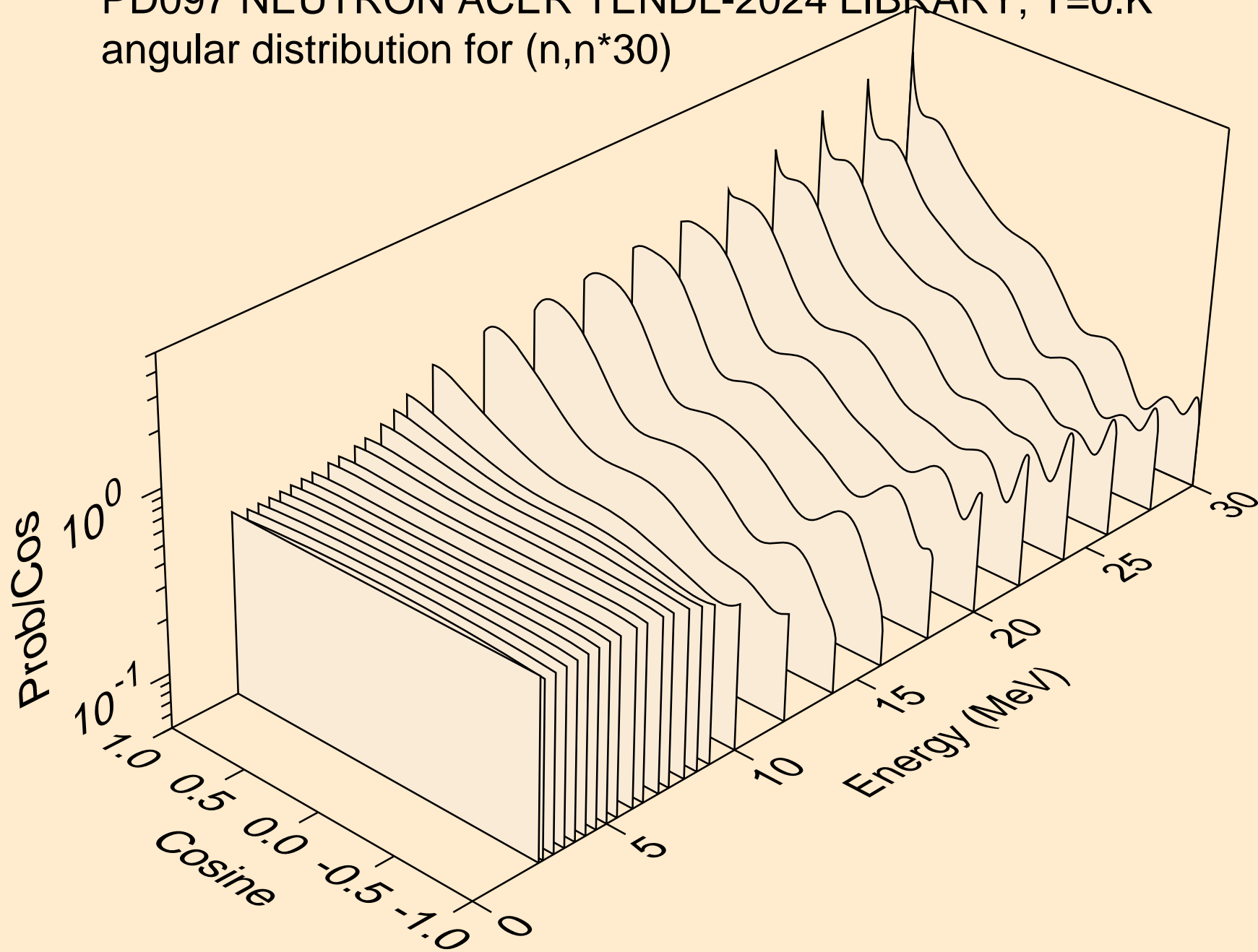

PD097 NEUTRON ACER TENDL-2024 LIBRARY; T=0.K
Neutron emission for (n,x)

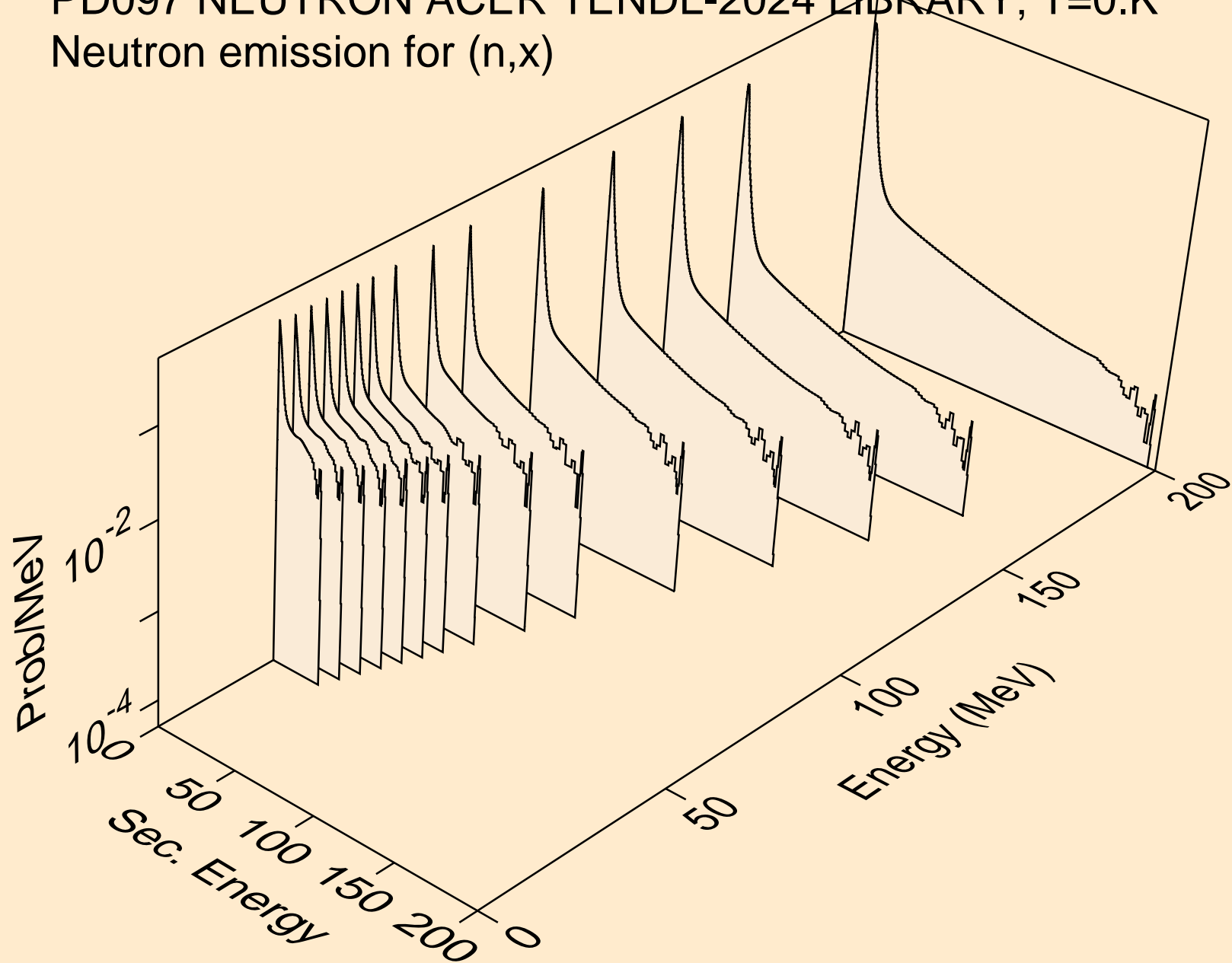

PD097 NEUTRON ACER TENDL-2024 LIBRARY; T=0.K
Neutron emission for (n,2n)

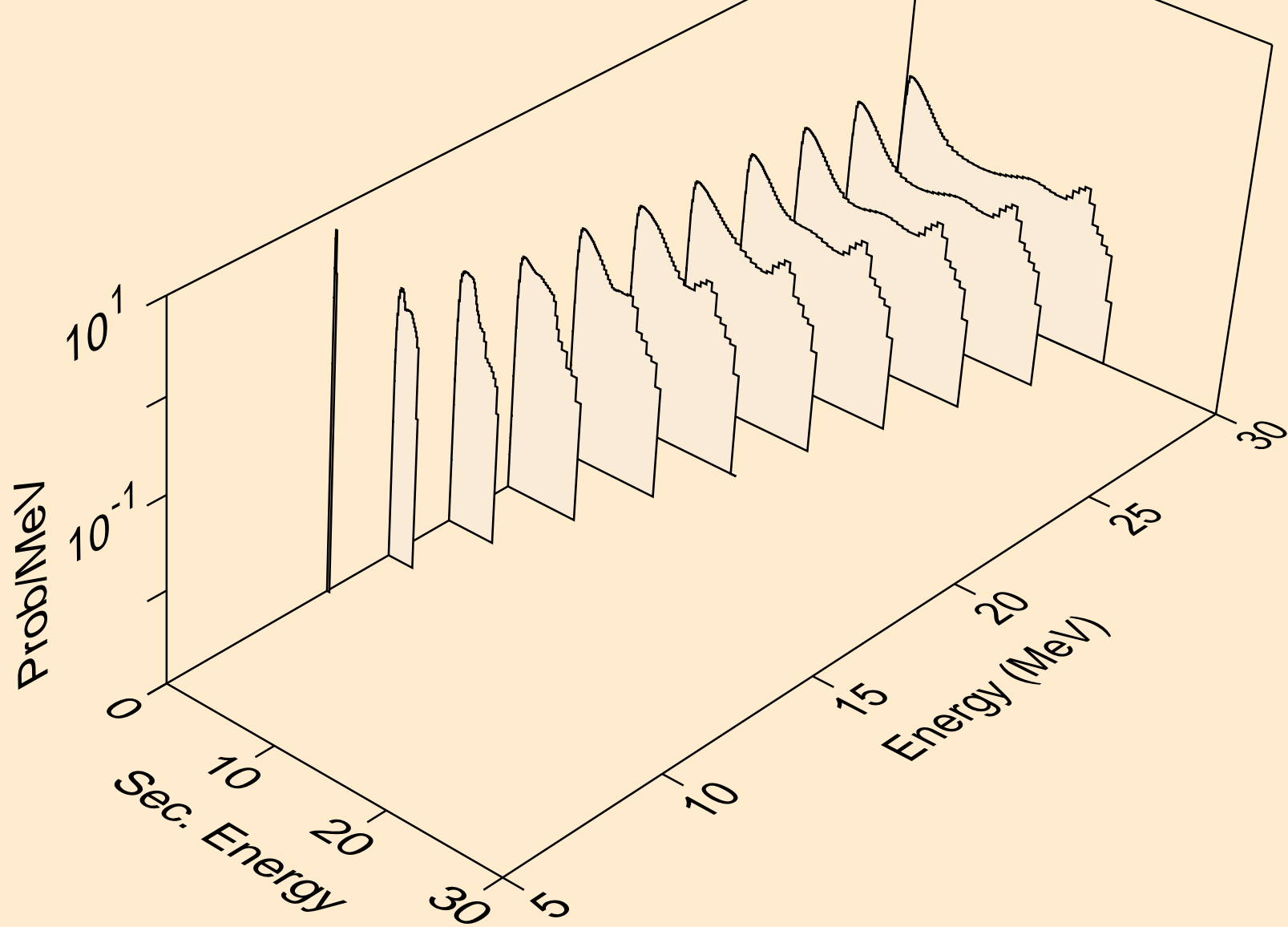

PD097 NEUTRON ACER TENDL-2024 LIBRARY; T=0.K
Neutron emission for (n,3n)

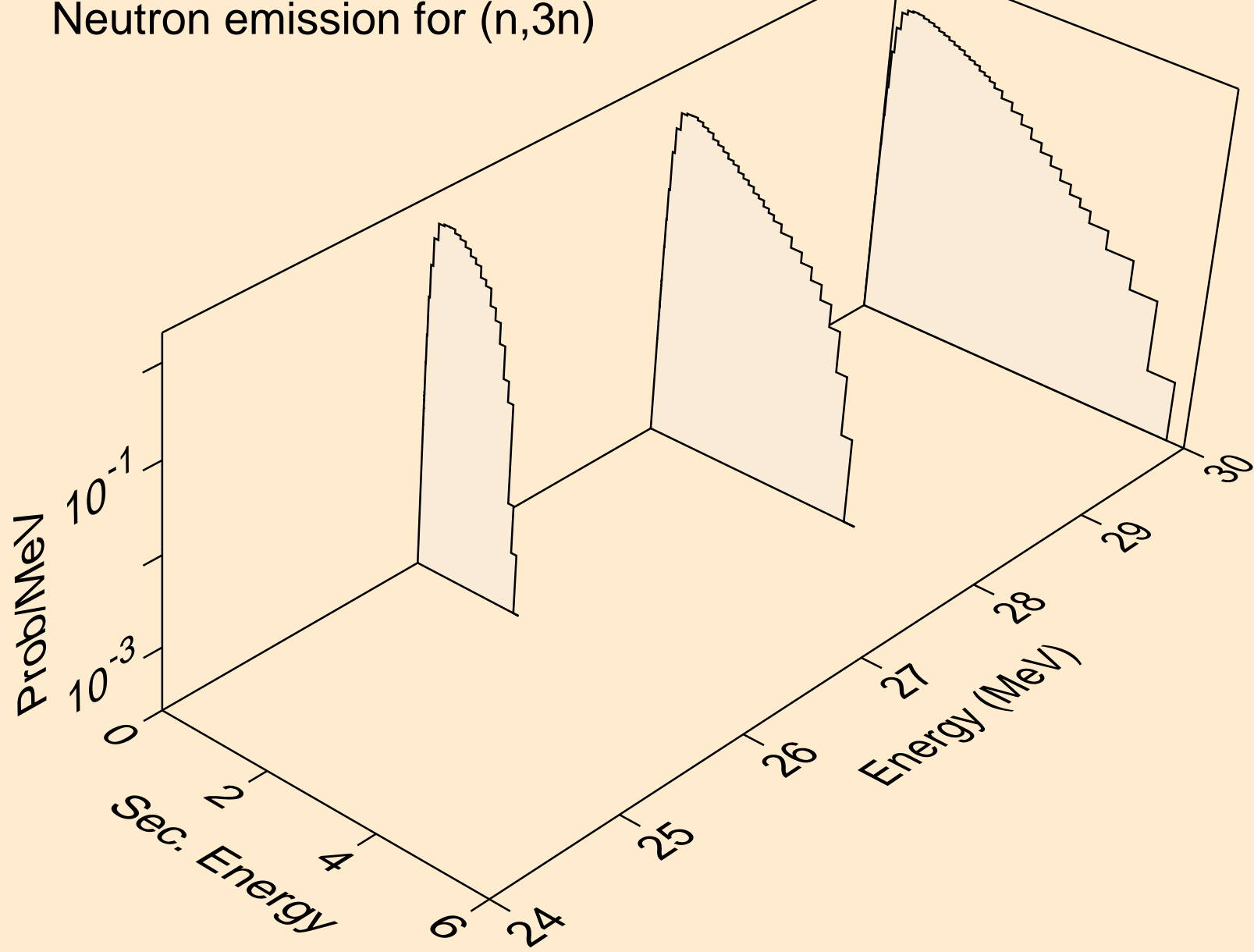

PD097 NEUTRON ACER TENDL-2024 LIBRARY; T=0.K
Neutron emission for (n,n*)a

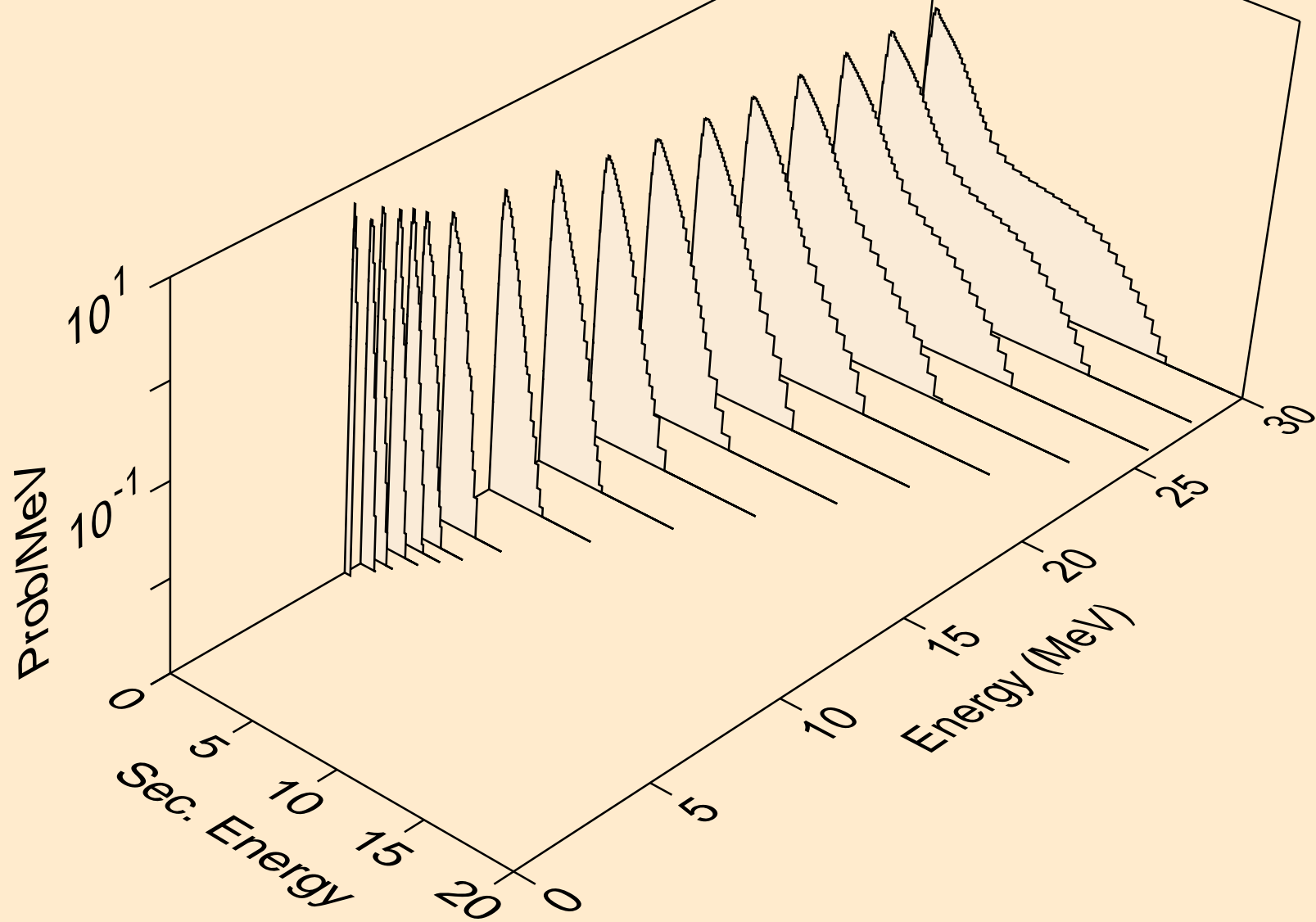

PD097 NEUTRON ACER TENDL-2024 LIBRARY; T=0.K
Neutron emission for (n,2n)_a

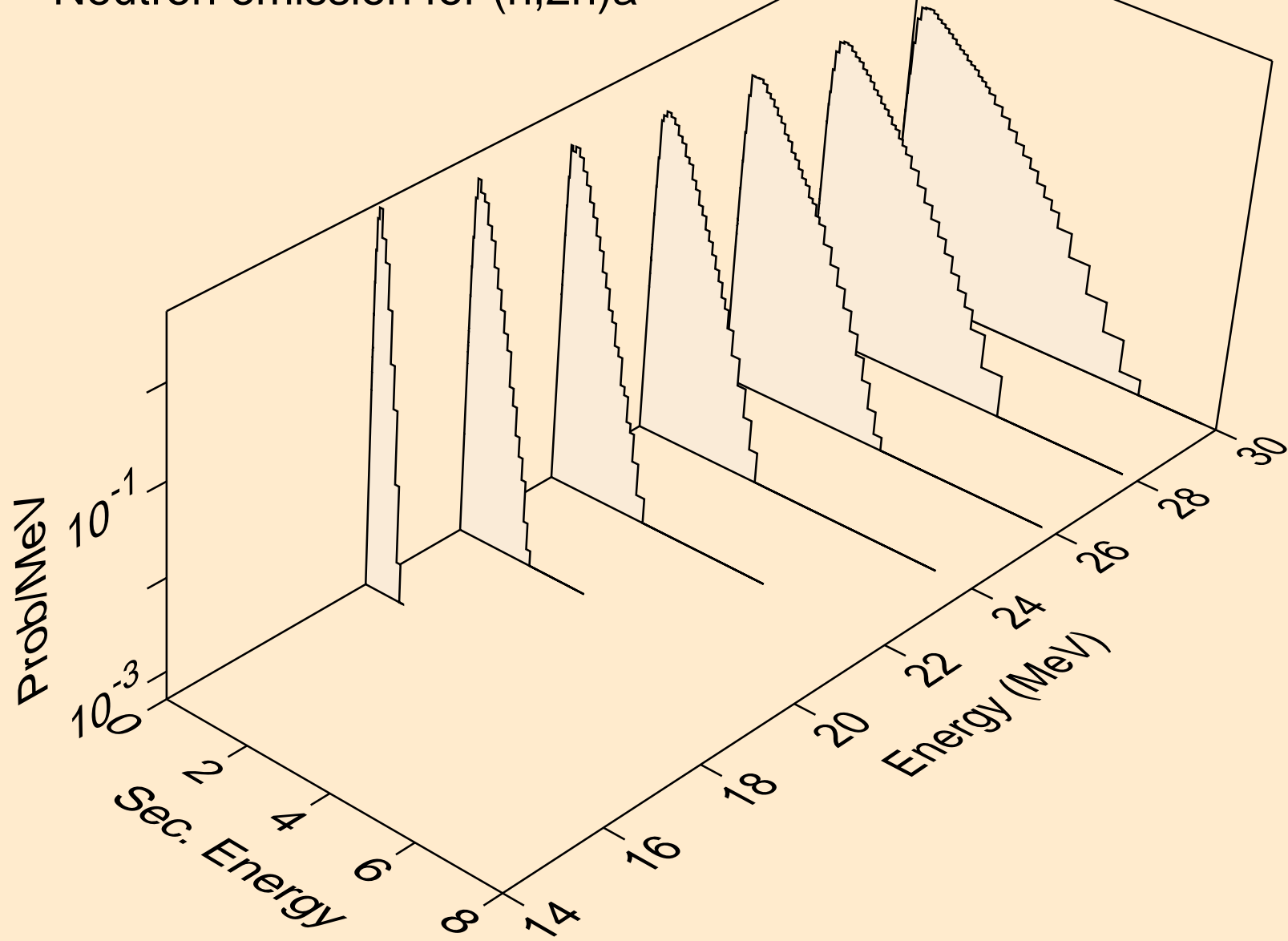

PD097 NEUTRON ACER TENDL-2024 LIBRARY; T=0.K
Neutron emission for (n,n*)p

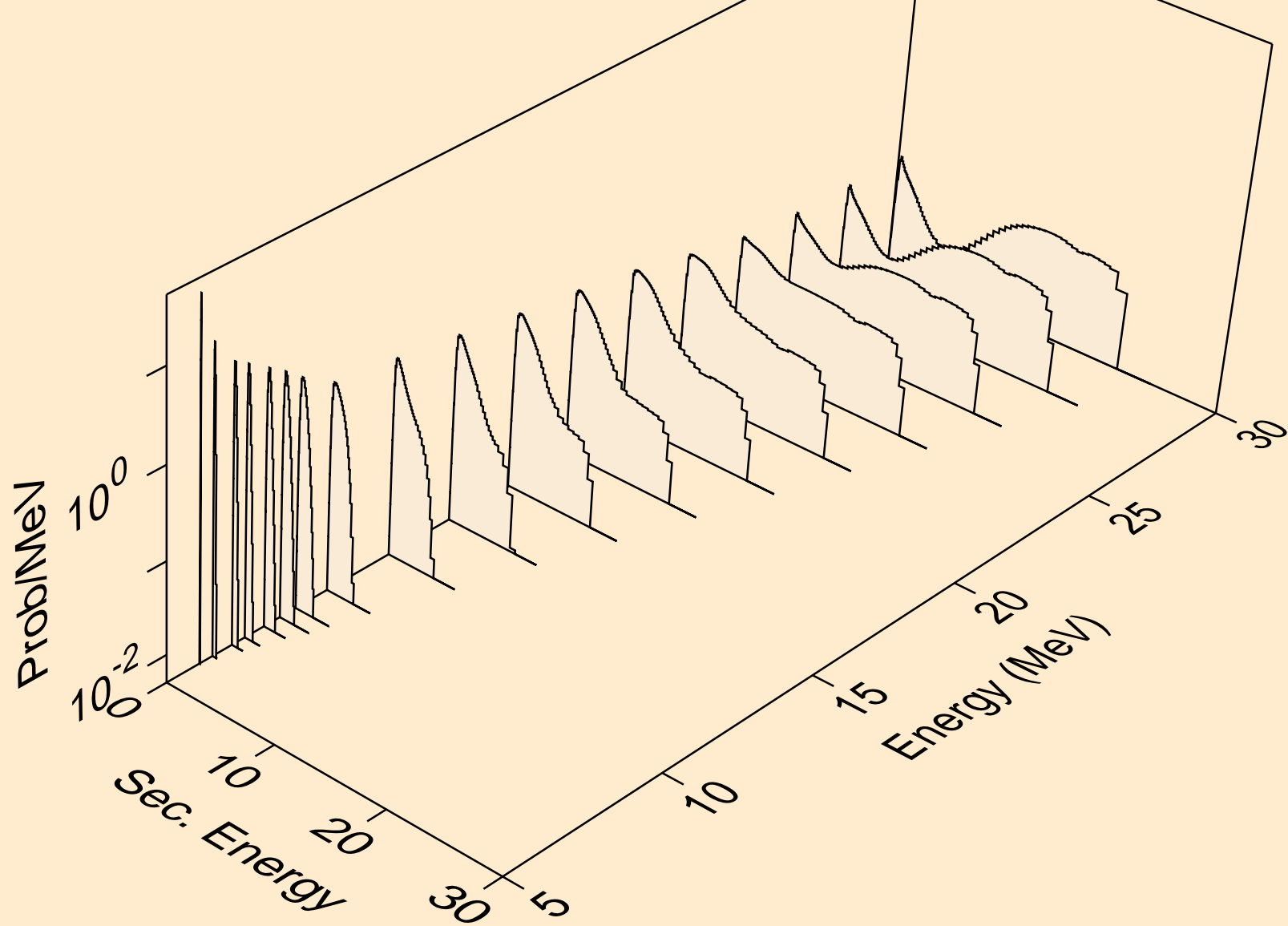

PD097 NEUTRON ACER TENDL-2024 LIBRARY; T=0.K
Neutron emission for (n,n*)2a

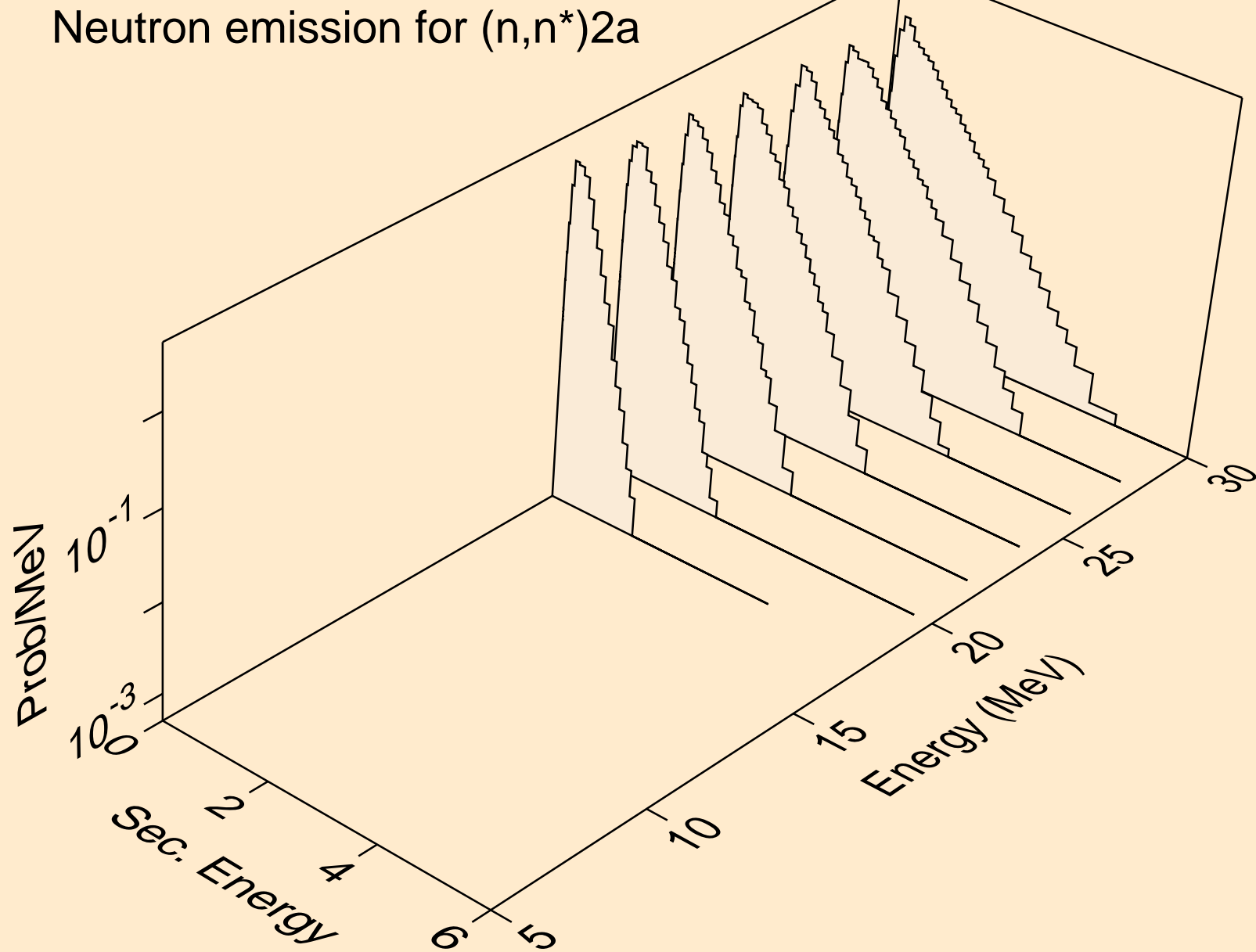

PD097 NEUTRON ACER TENDL-2024 LIBRARY; T=0.K
Neutron emission for (n,n*)d

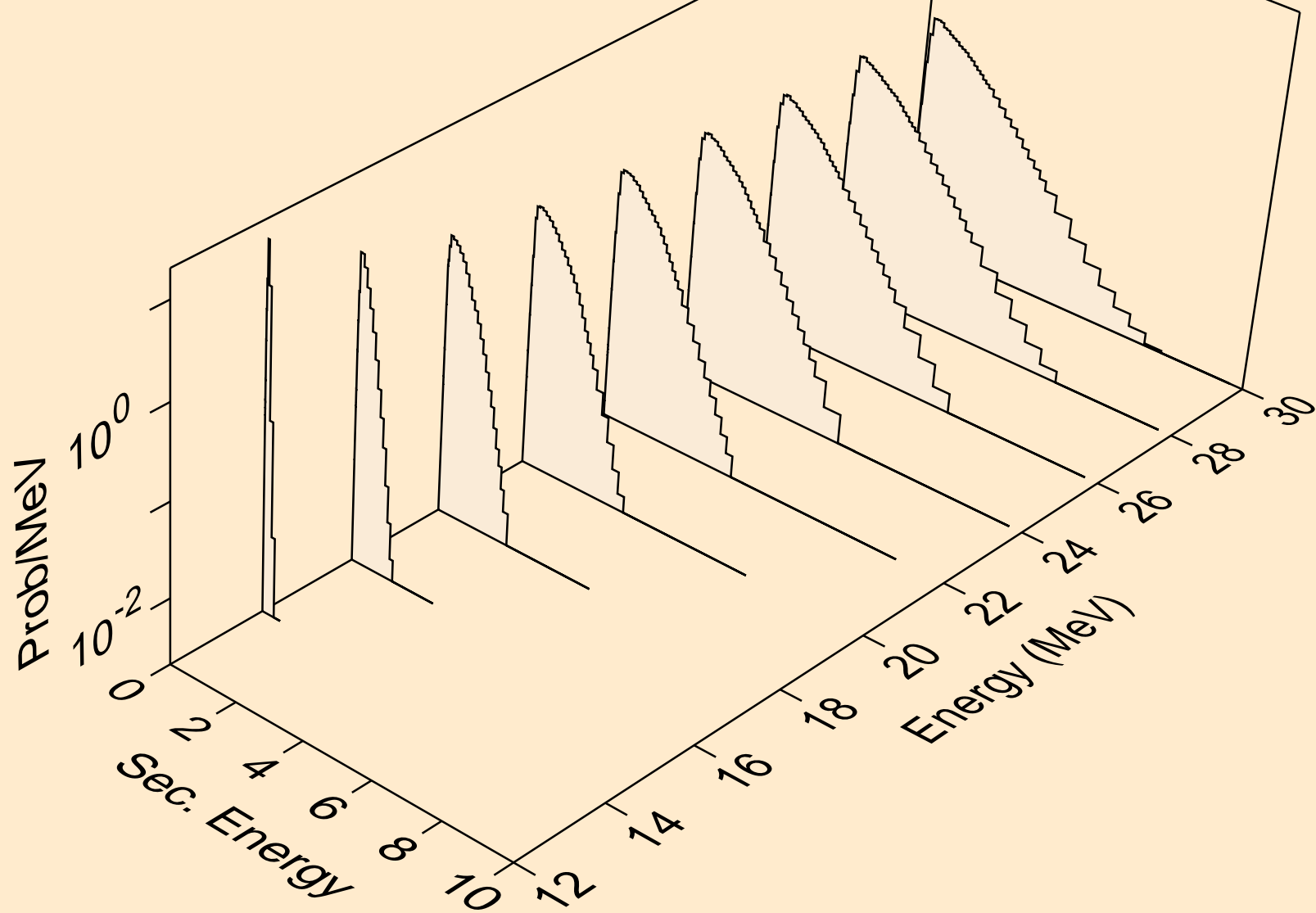

PD097 NEUTRON ACER TENDL-2024 LIBRARY; T=0.K
Neutron emission for (n,n*)t

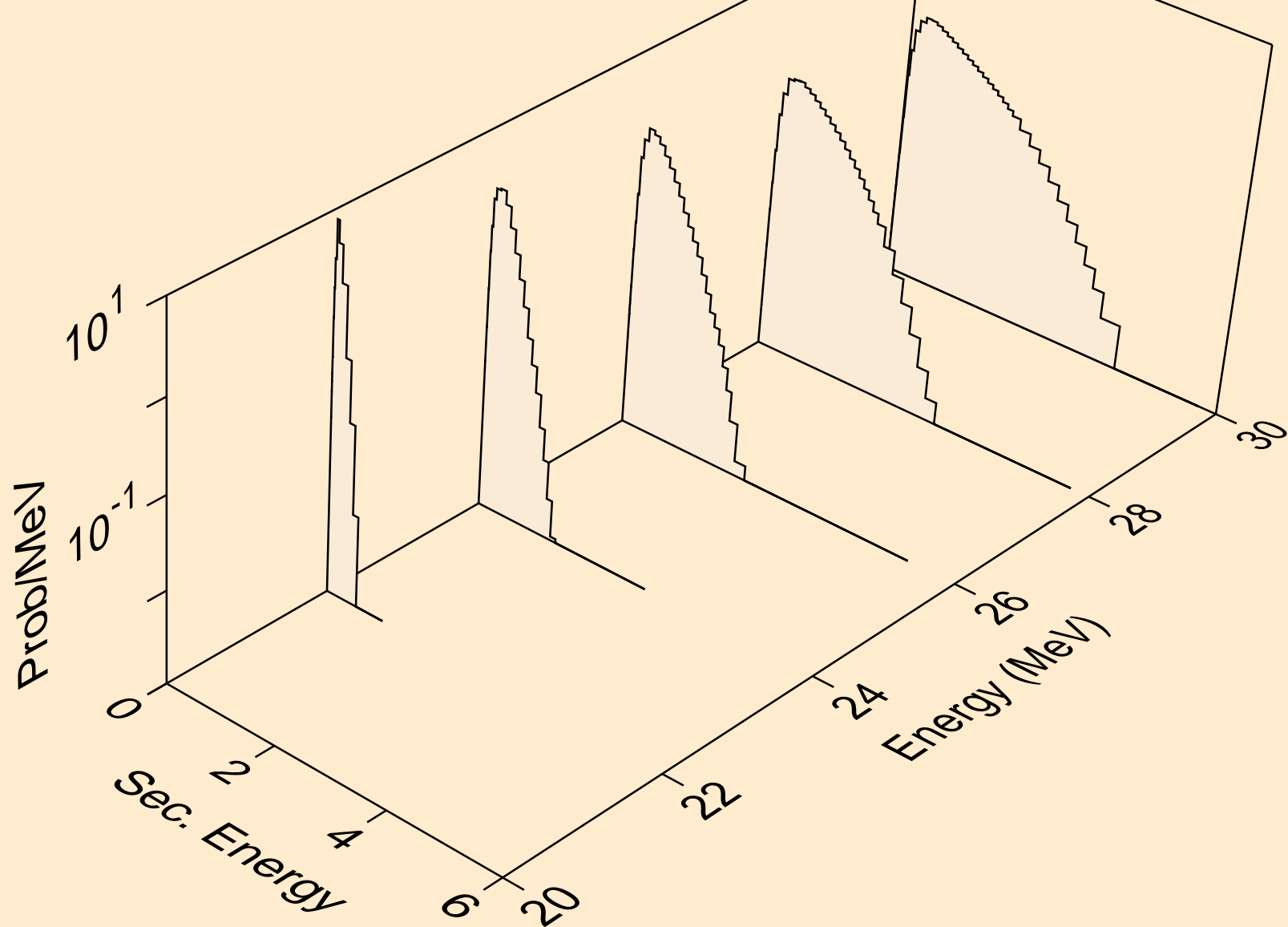

PD097 NEUTRON ACER TENDL-2024 LIBRARY; T=0.K
Neutron emission for (n,n*)he3

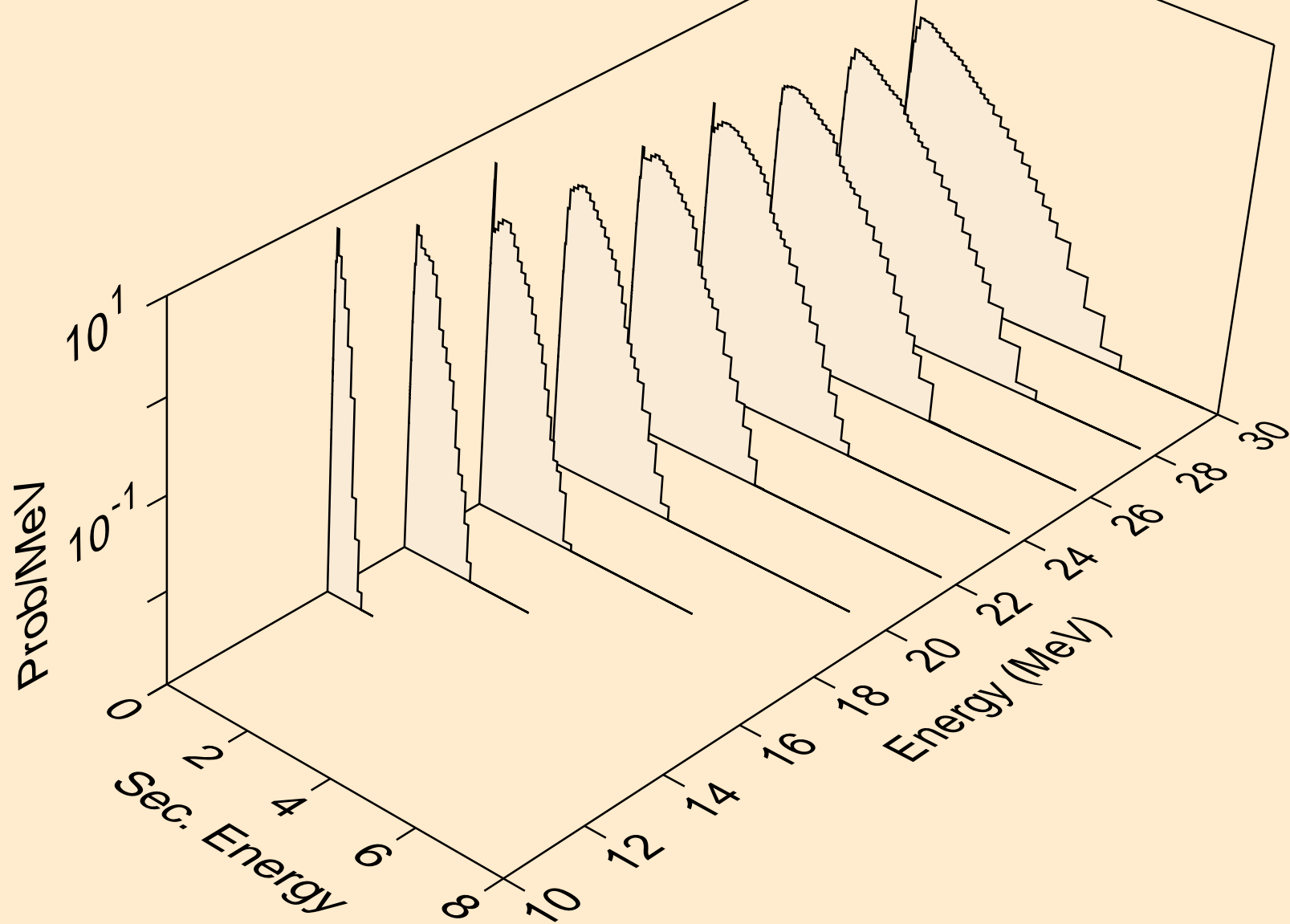

PD097 NEUTRON ACER TENDL-2024 LIBRARY; T=0.K
Neutron emission for (n,2np)

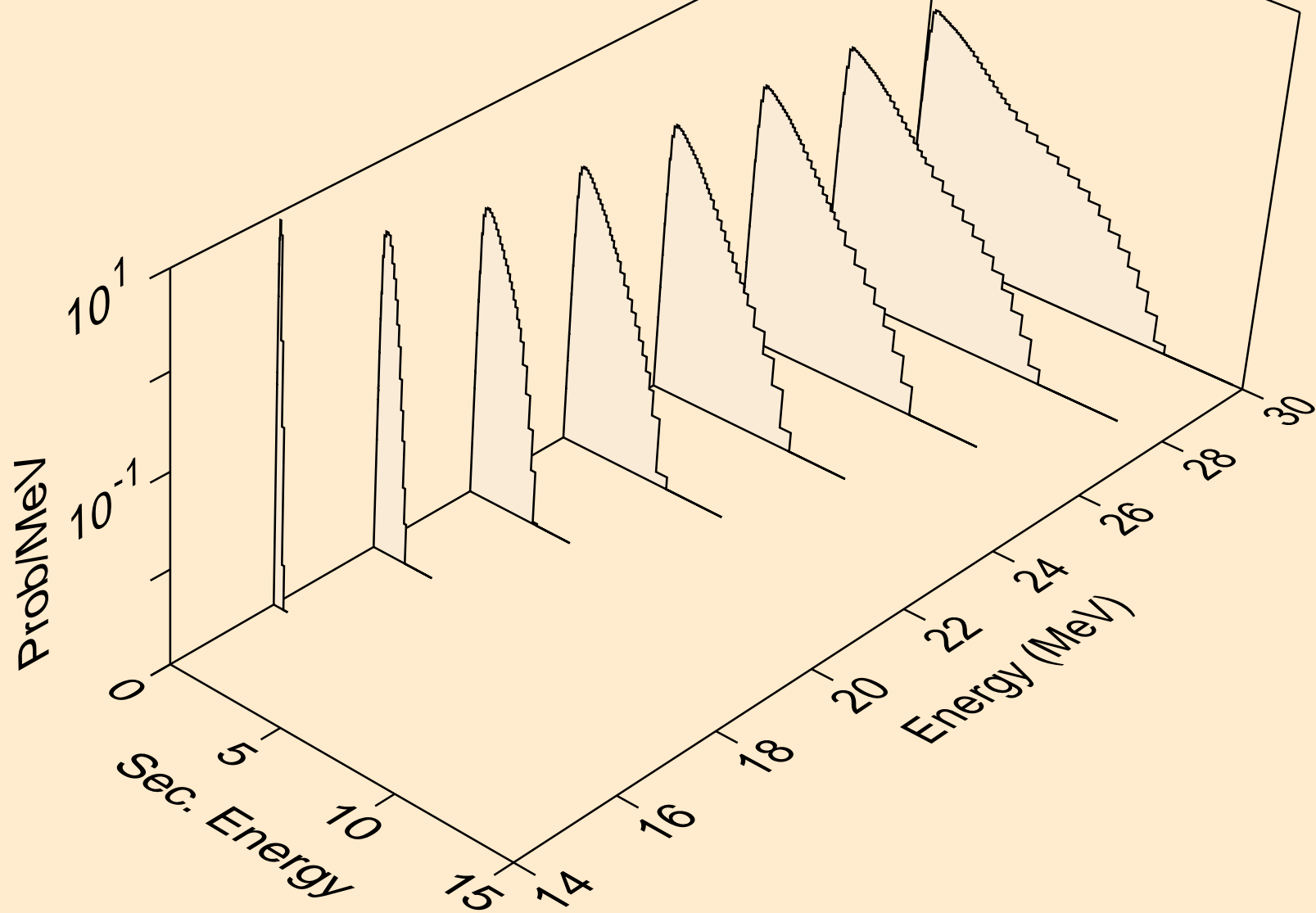

PD097 NEUTRON ACER TENDL-2024 LIBRARY; T=0.K
Neutron emission for (n,n2p)

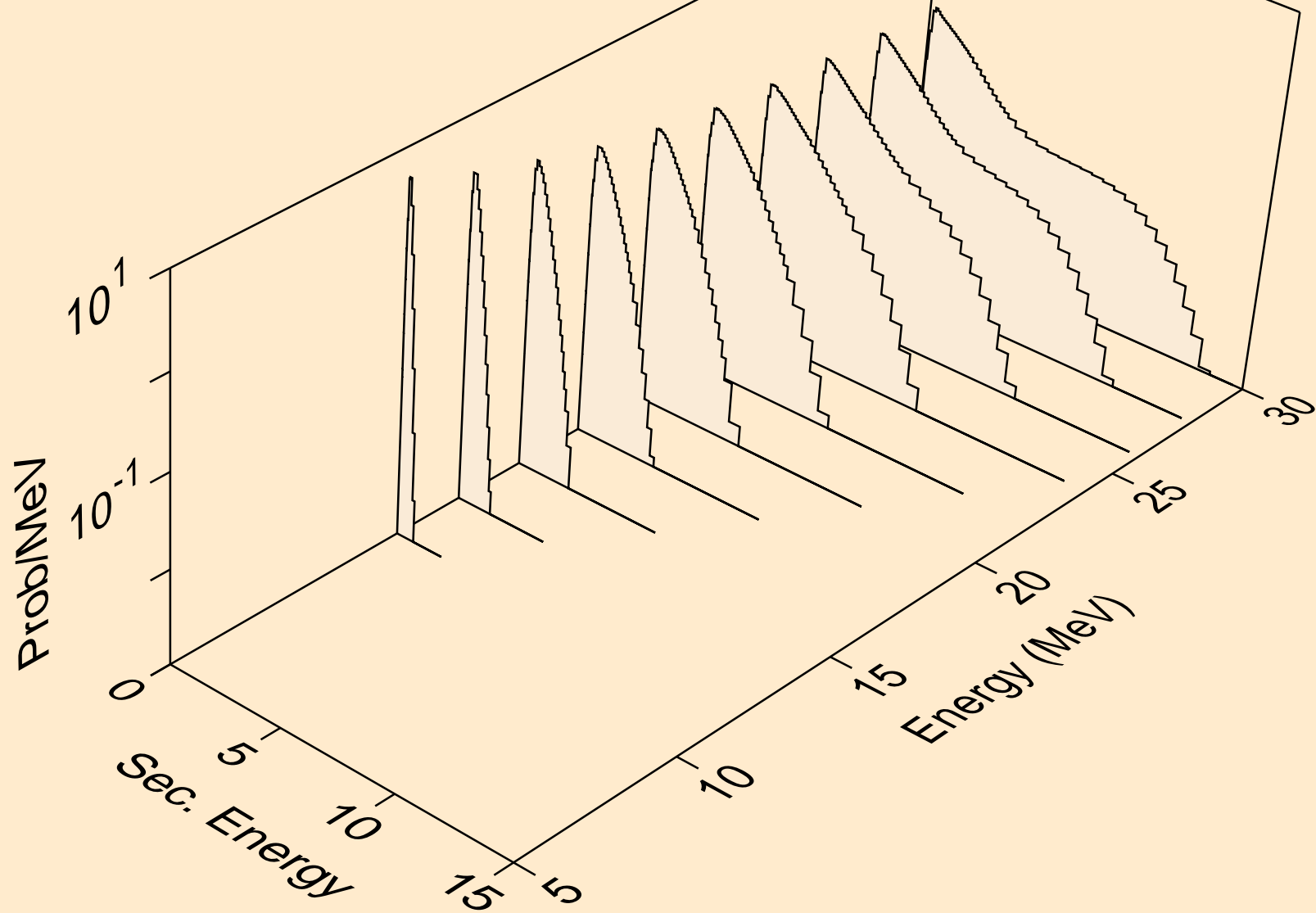

PD097 NEUTRON ACER TENDL-2024 LIBRARY; T=0.K
Neutron emission for (n,npa)

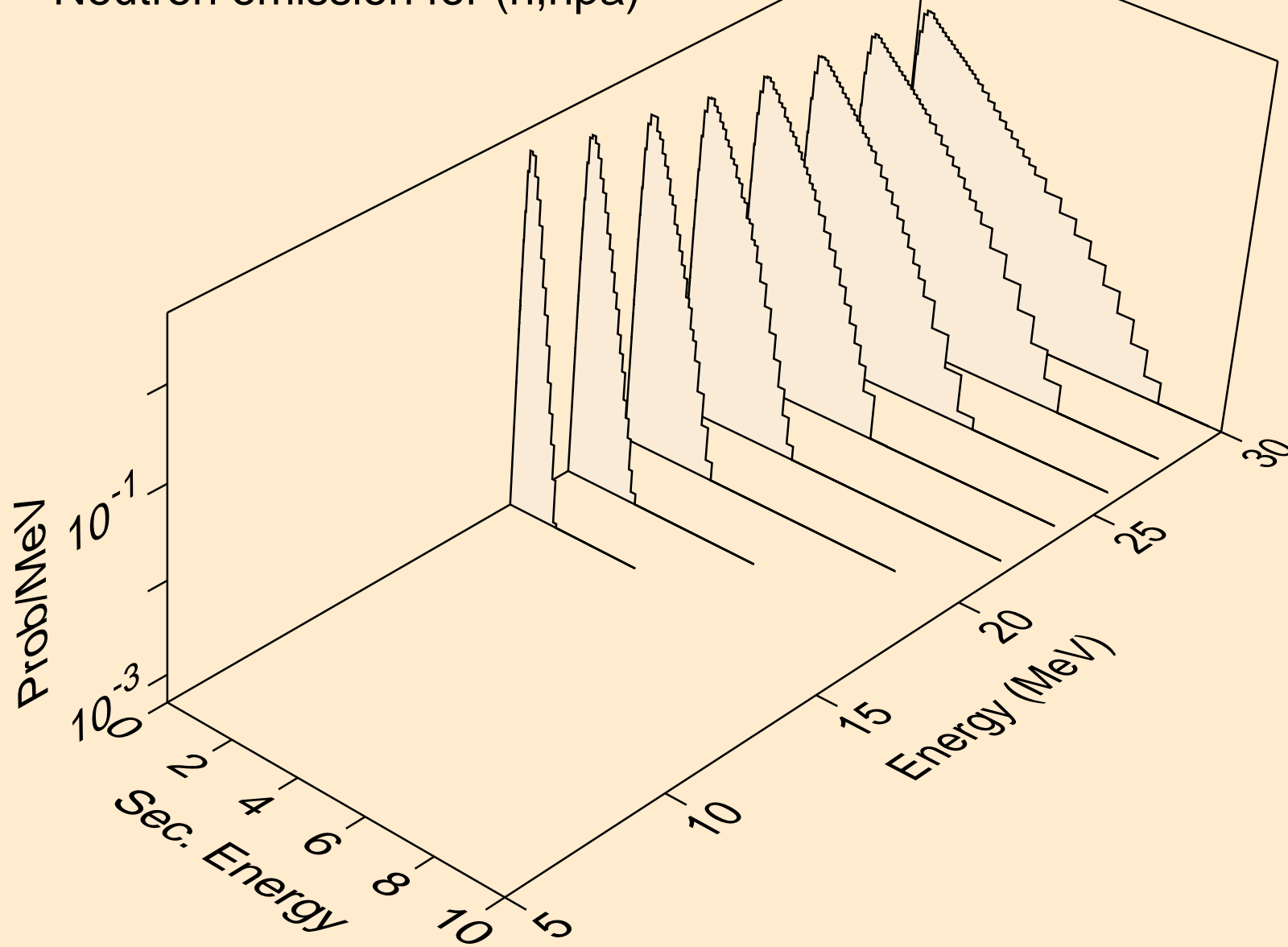

PD097 NEUTRON ACER TENDL-2024 LIBRARY; T=0.K
Neutron emission for (n,n*c)

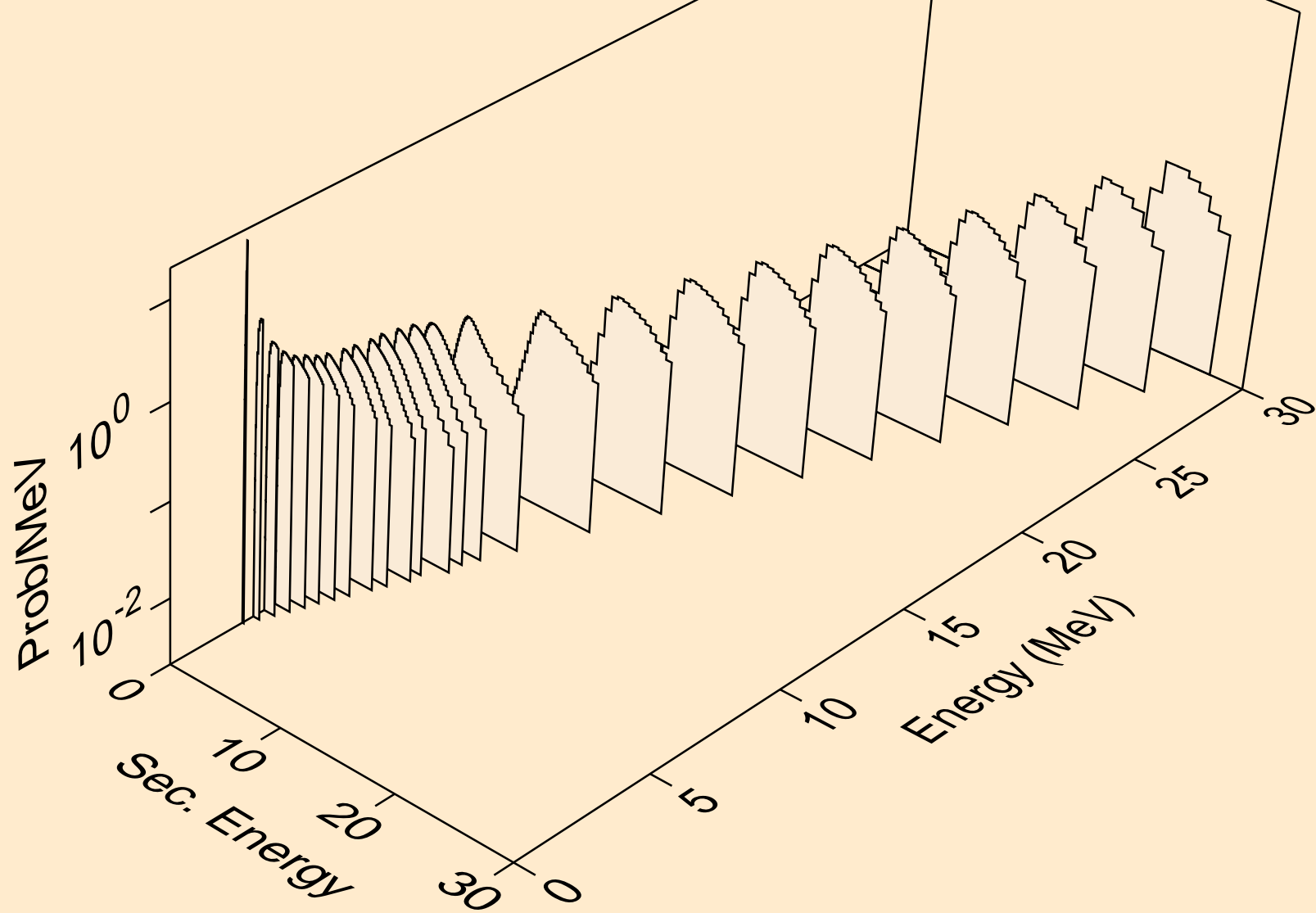

PD097 NEUTRON ACER TENDL-2024 LIBRARY; T=0.K
Photon emission for (n,x)

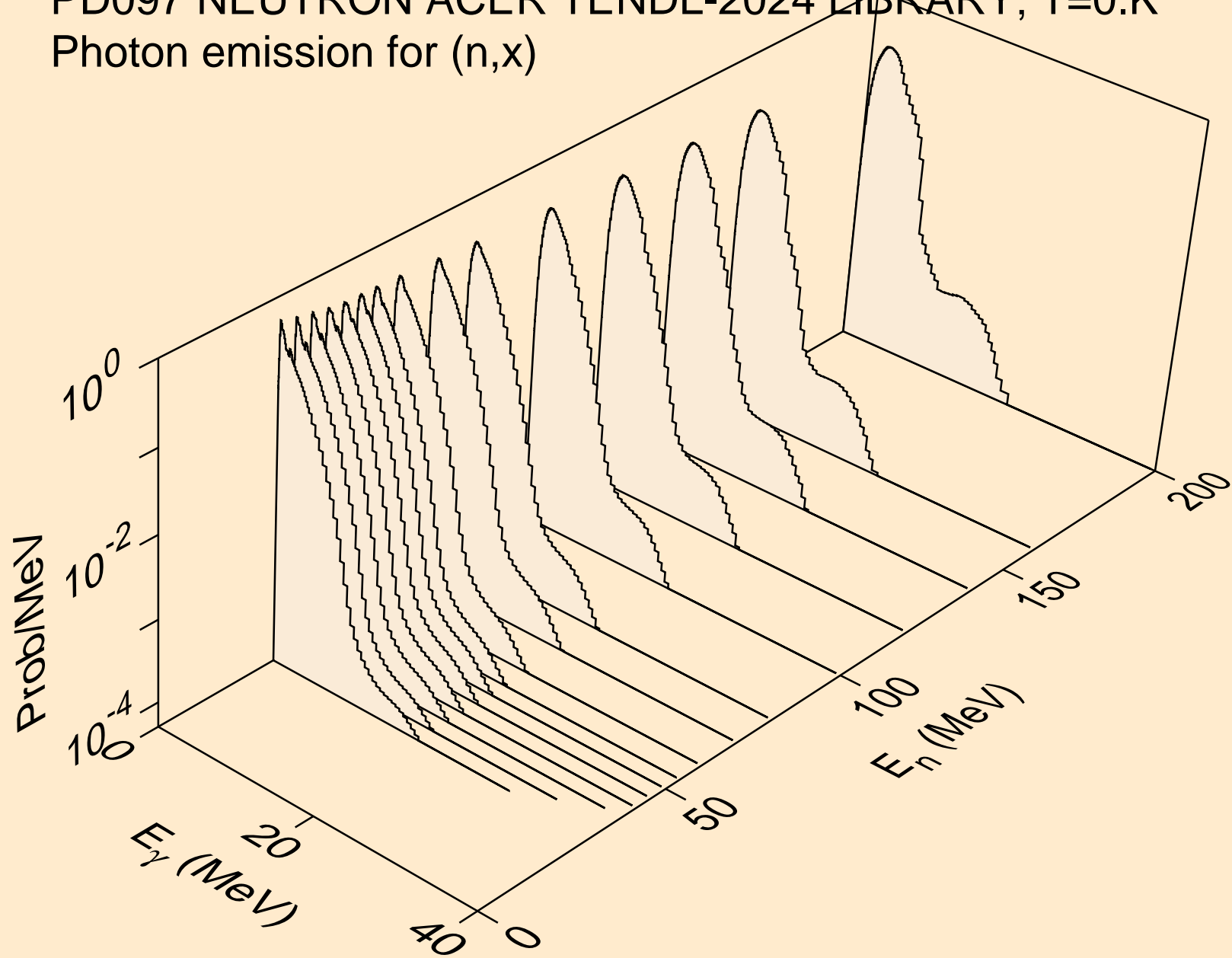

PD097 NEUTRON ACER TENDL-2024 LIBRARY; T=0.K
Photon emission for (n,2n)

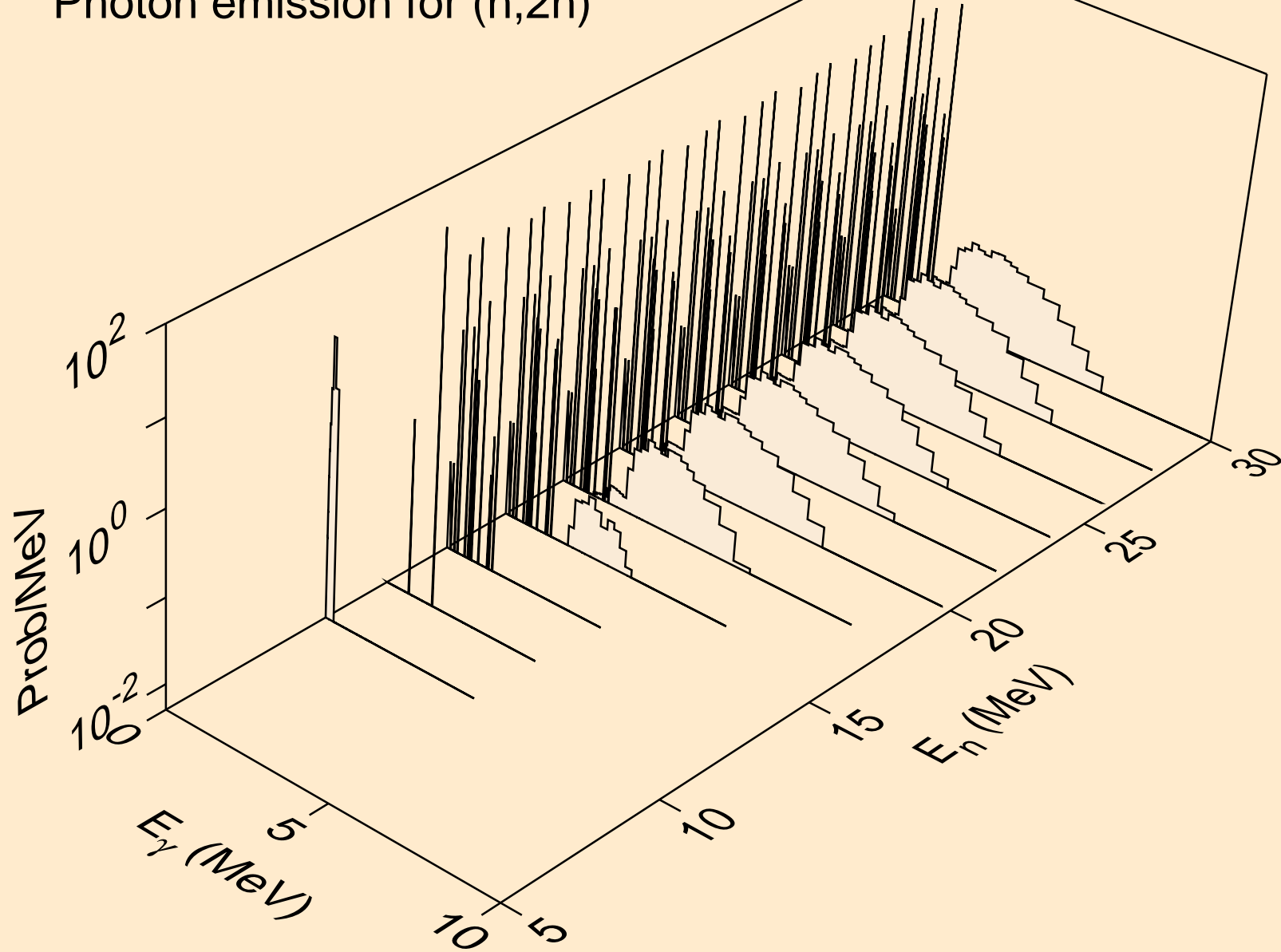

PD097 NEUTRON ACER TENDL-2024 LIBRARY; T=0.K
Photon emission for (n,3n)

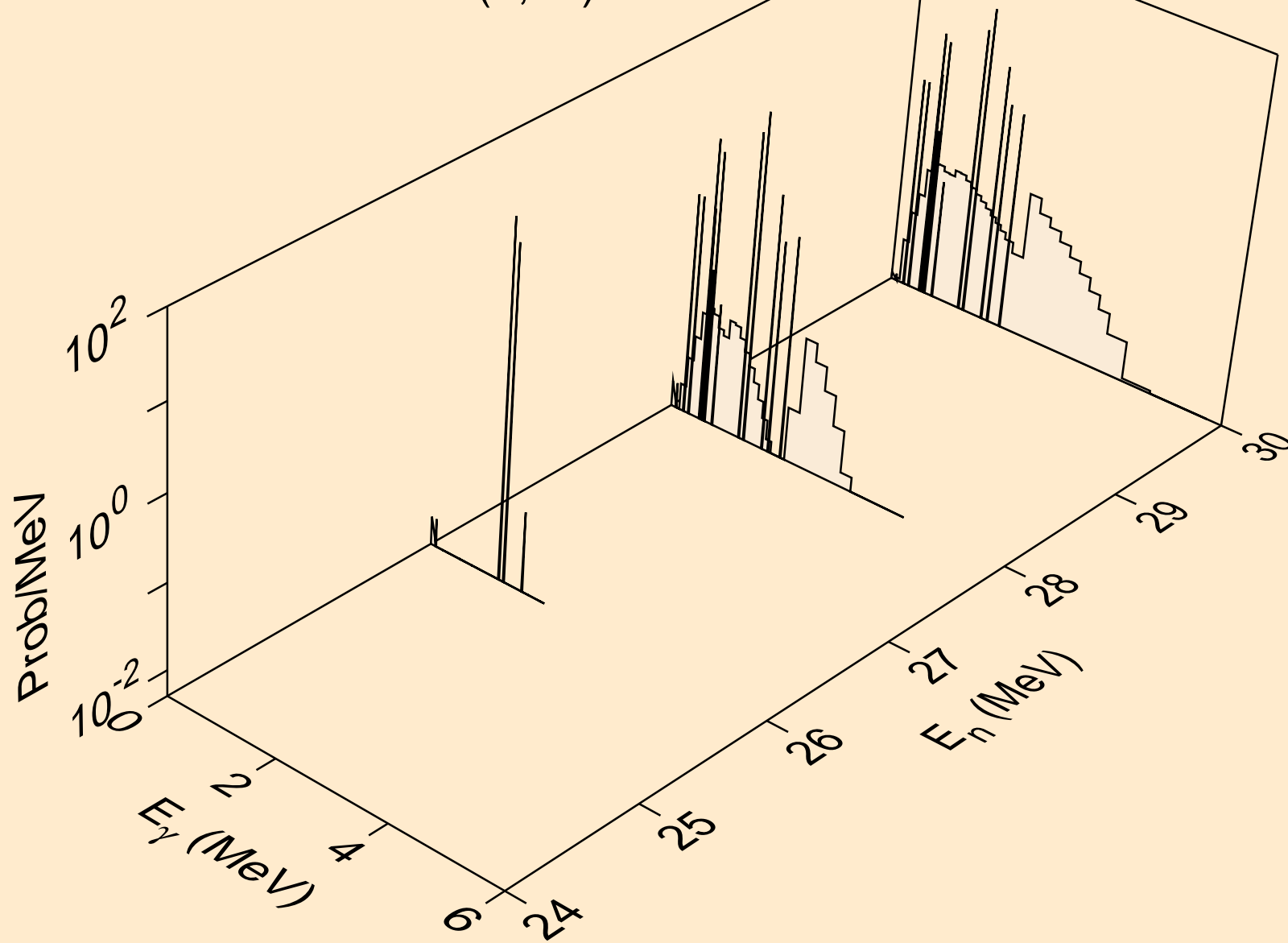

PD097 NEUTRON ACER TENDL-2024 LIBRARY; T=0.K
Photon emission for (n,n*)a

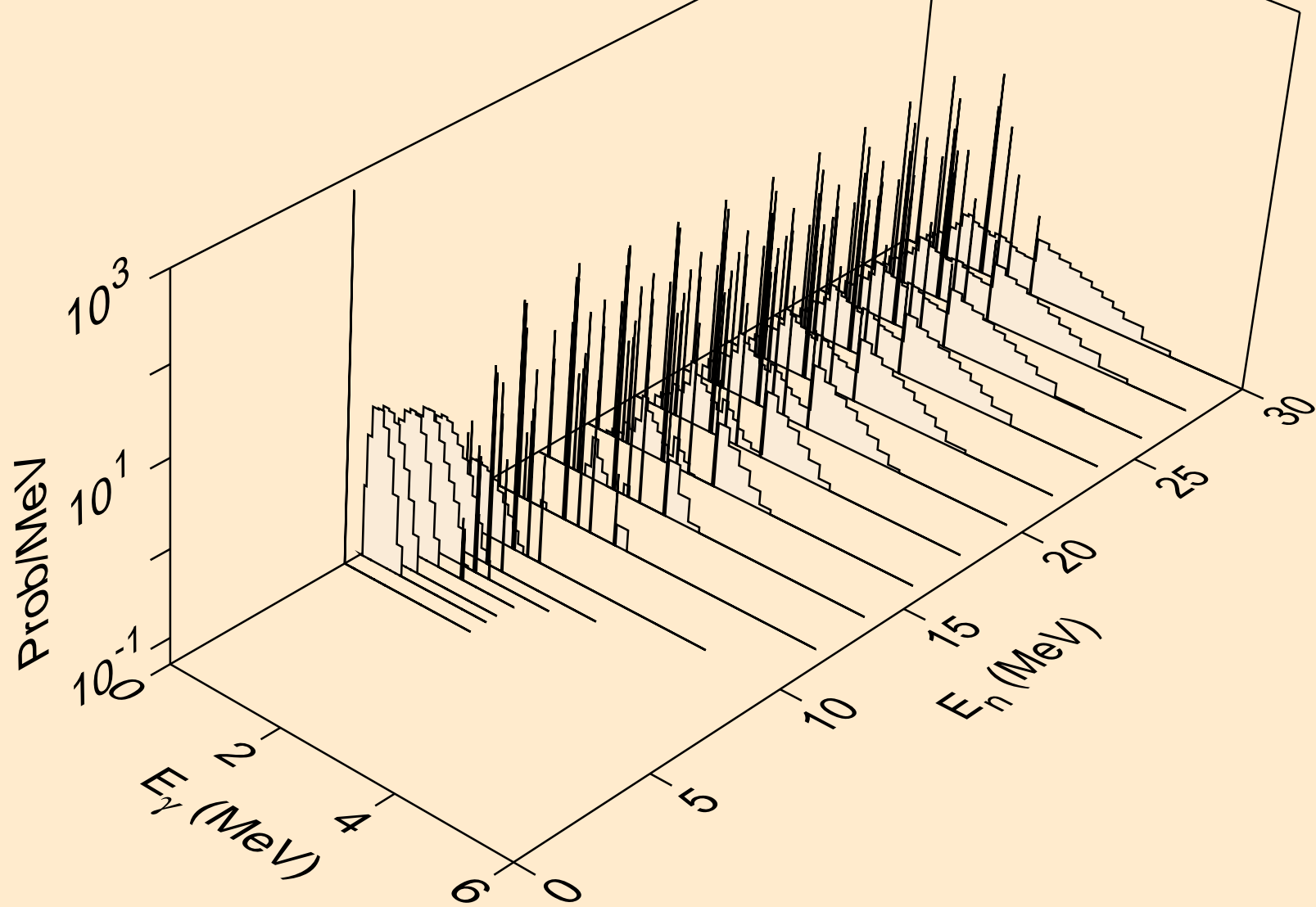

PD097 NEUTRON ACER TENDL-2024 LIBRARY; T=0.K
Photon emission for (n,2n)a

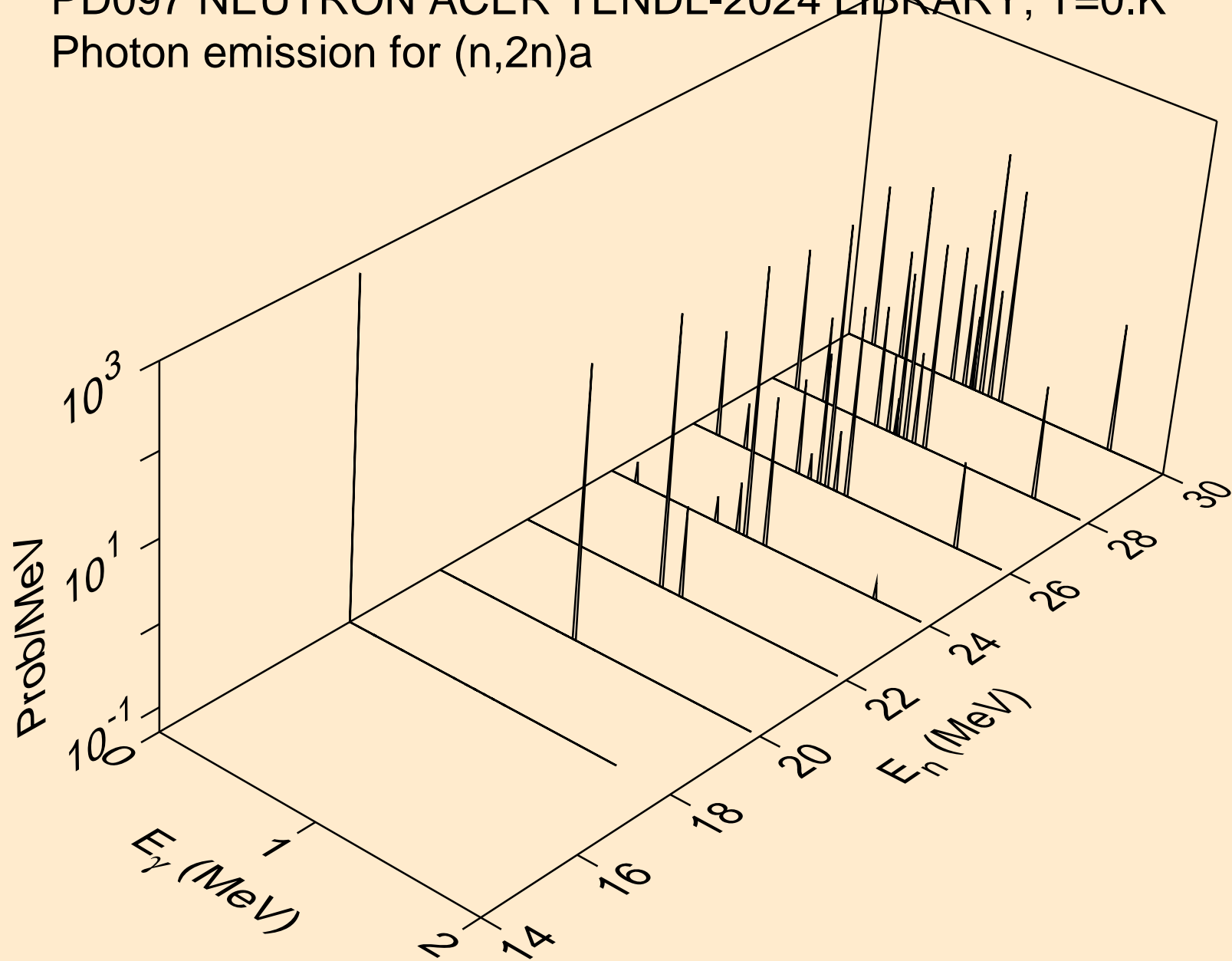

PD097 NEUTRON ACER TENDL-2024 LIBRARY; T=0.K
Photon emission for (n,n*)p

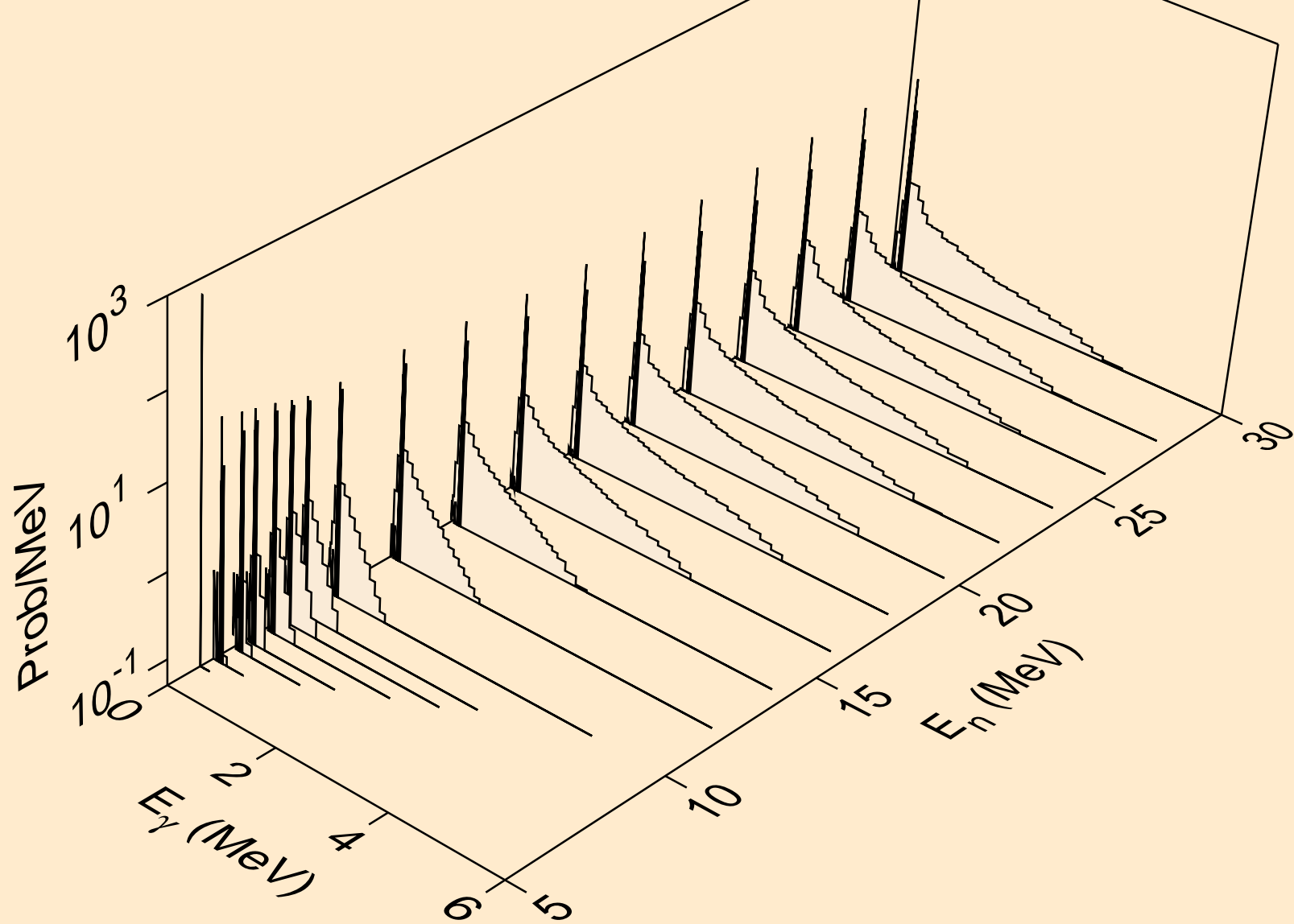

PD097 NEUTRON ACER TENDL-2024 LIBRARY; T=0.K
Photon emission for (n,n*)2a

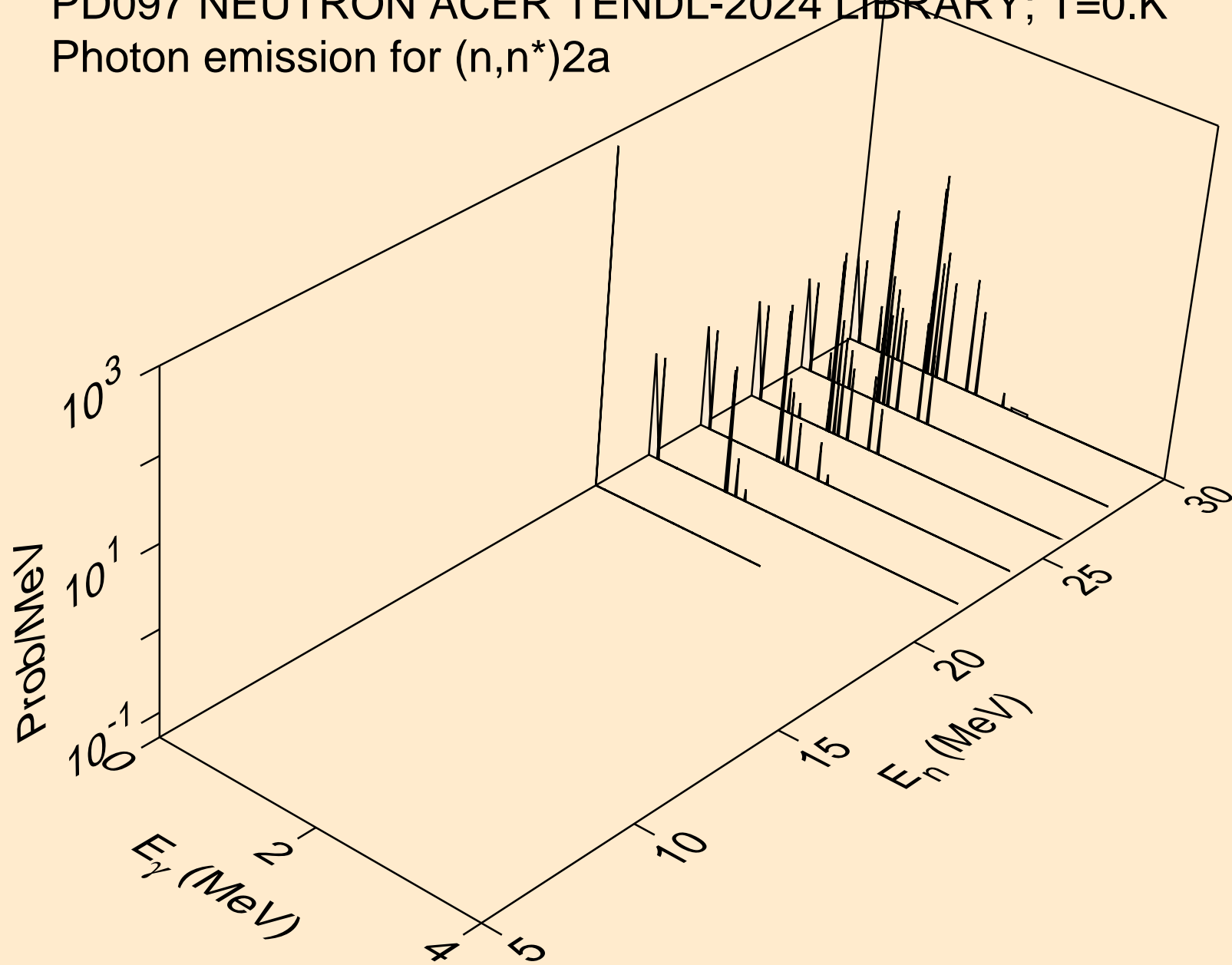

PD097 NEUTRON ACER TENDL-2024 LIBRARY; T=0.K
Photon emission for (n,n*)d

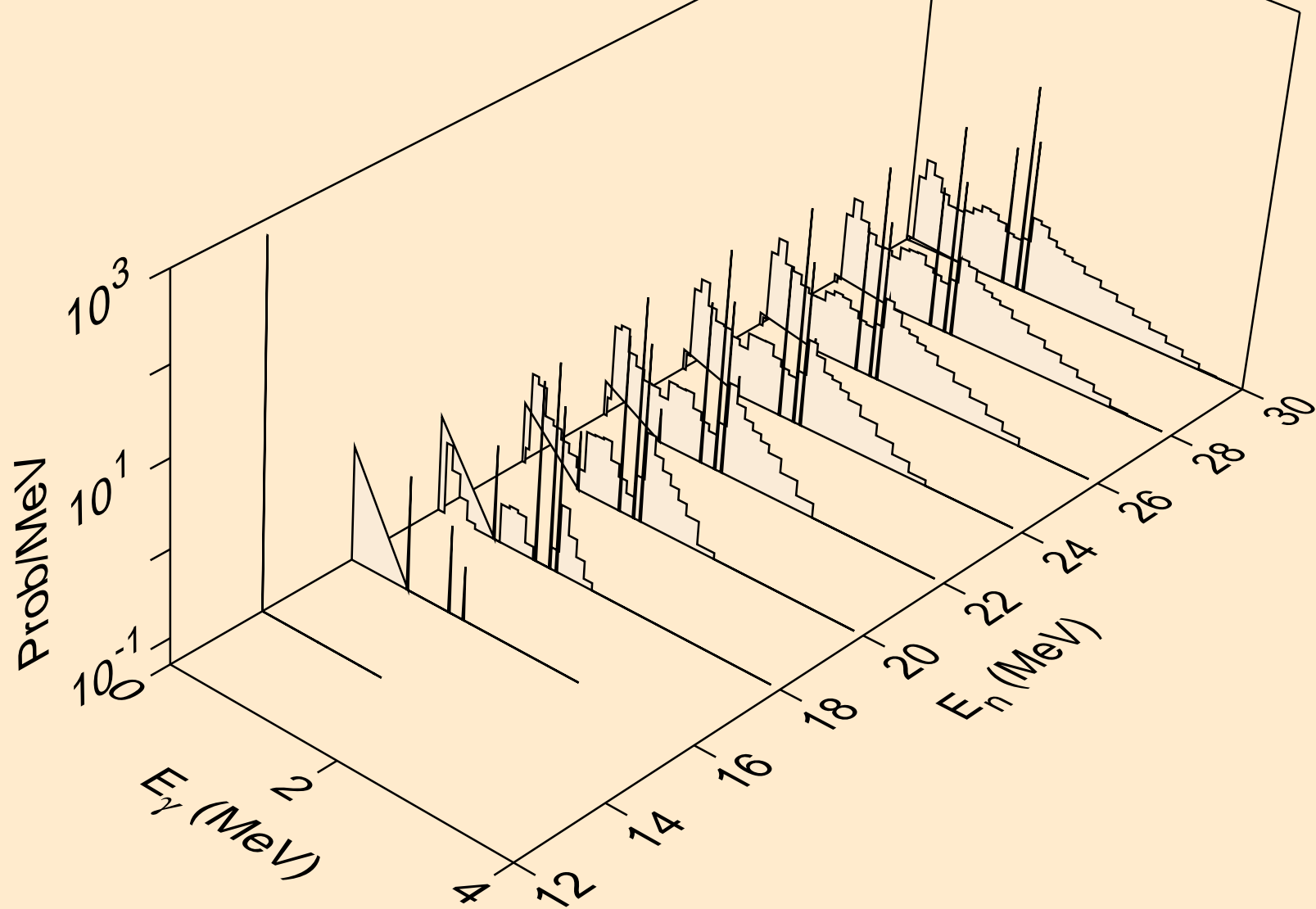

PD097 NEUTRON ACER TENDL-2024 LIBRARY; T=0.K
Photon emission for (n,n*)t

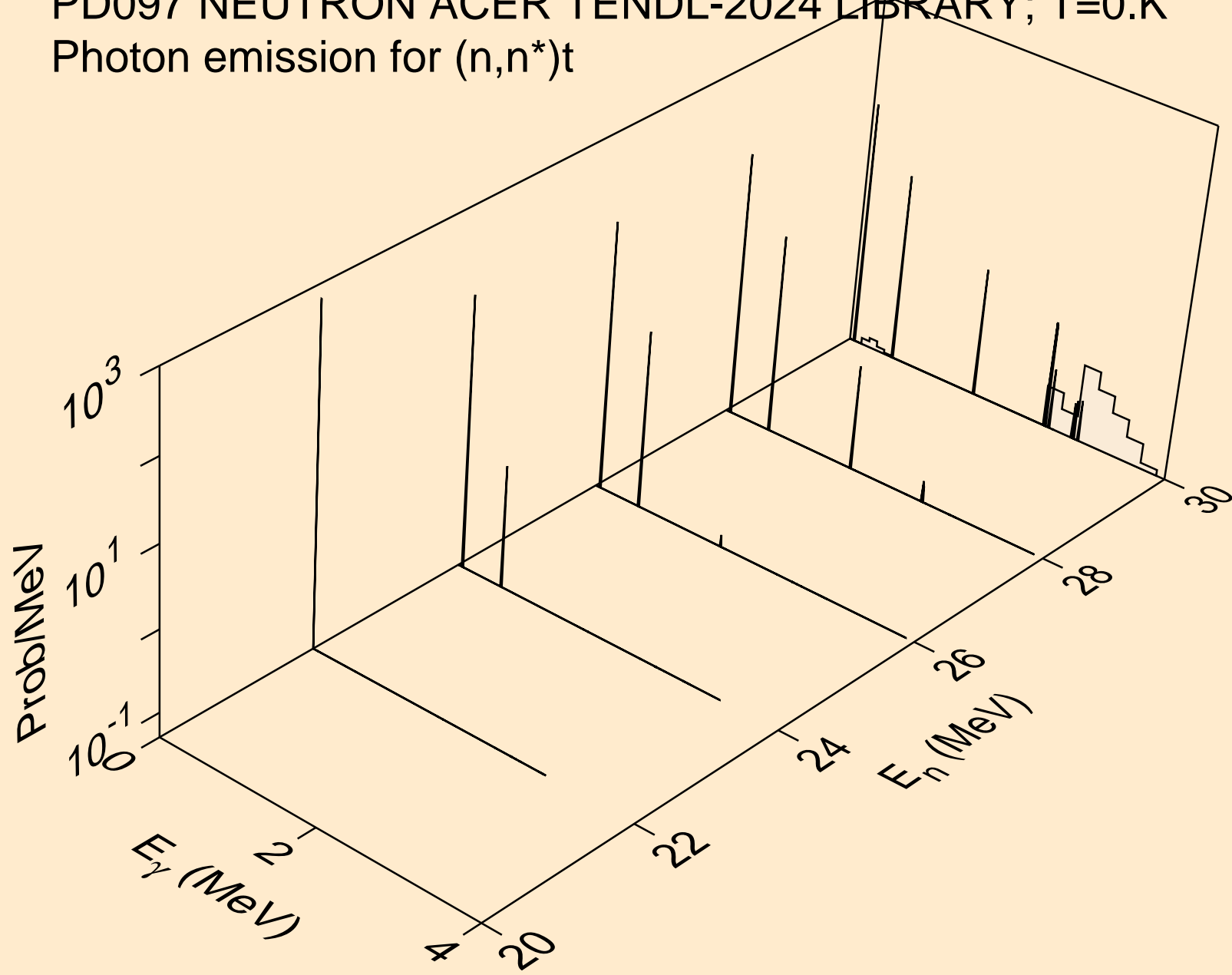

PD097 NEUTRON ACER TENDL-2024 LIBRARY; T=0.K
Photon emission for (n,n*)he3

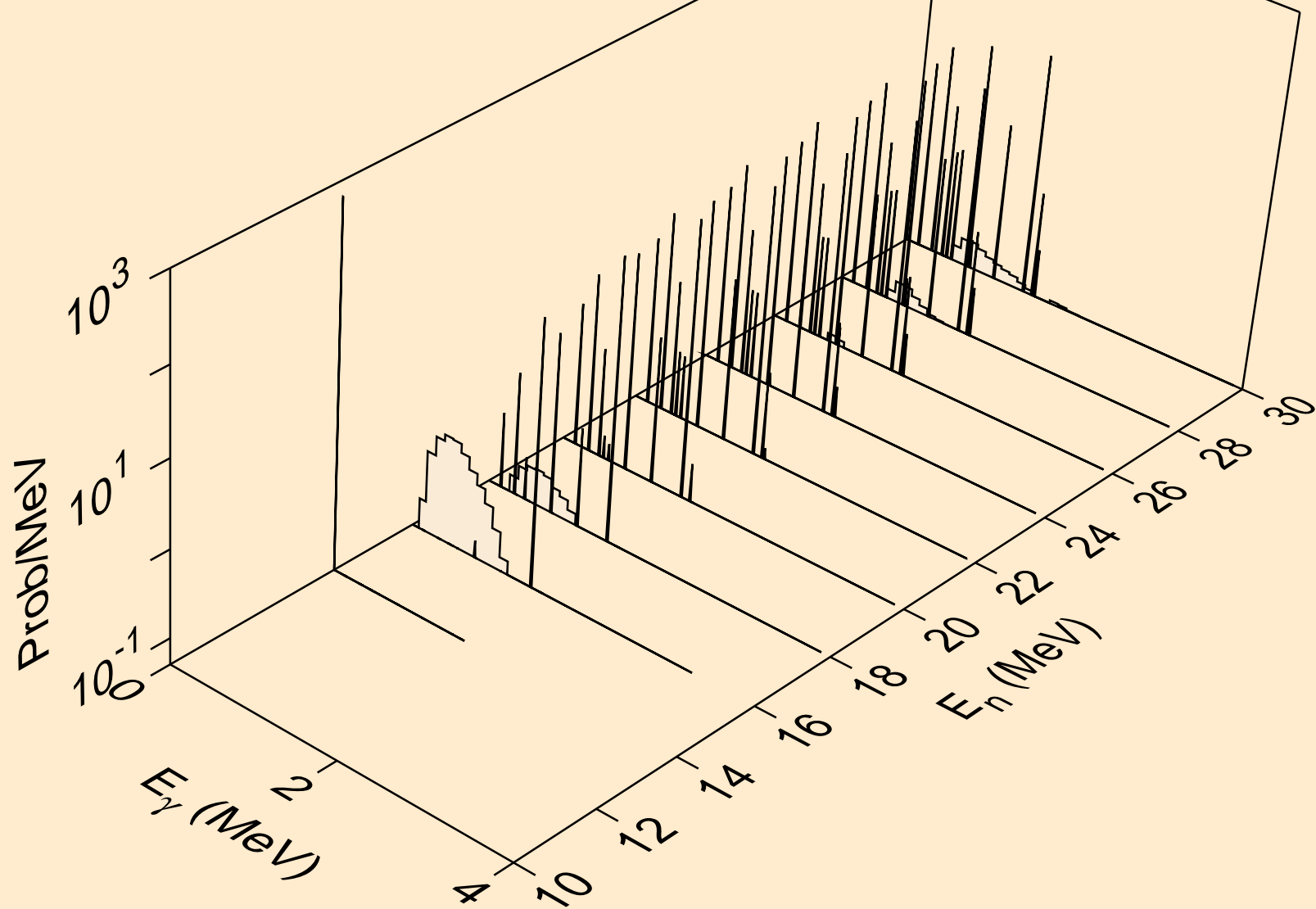

PD097 NEUTRON ACER TENDL-2024 LIBRARY; T=0.K
Photon emission for (n,2np)

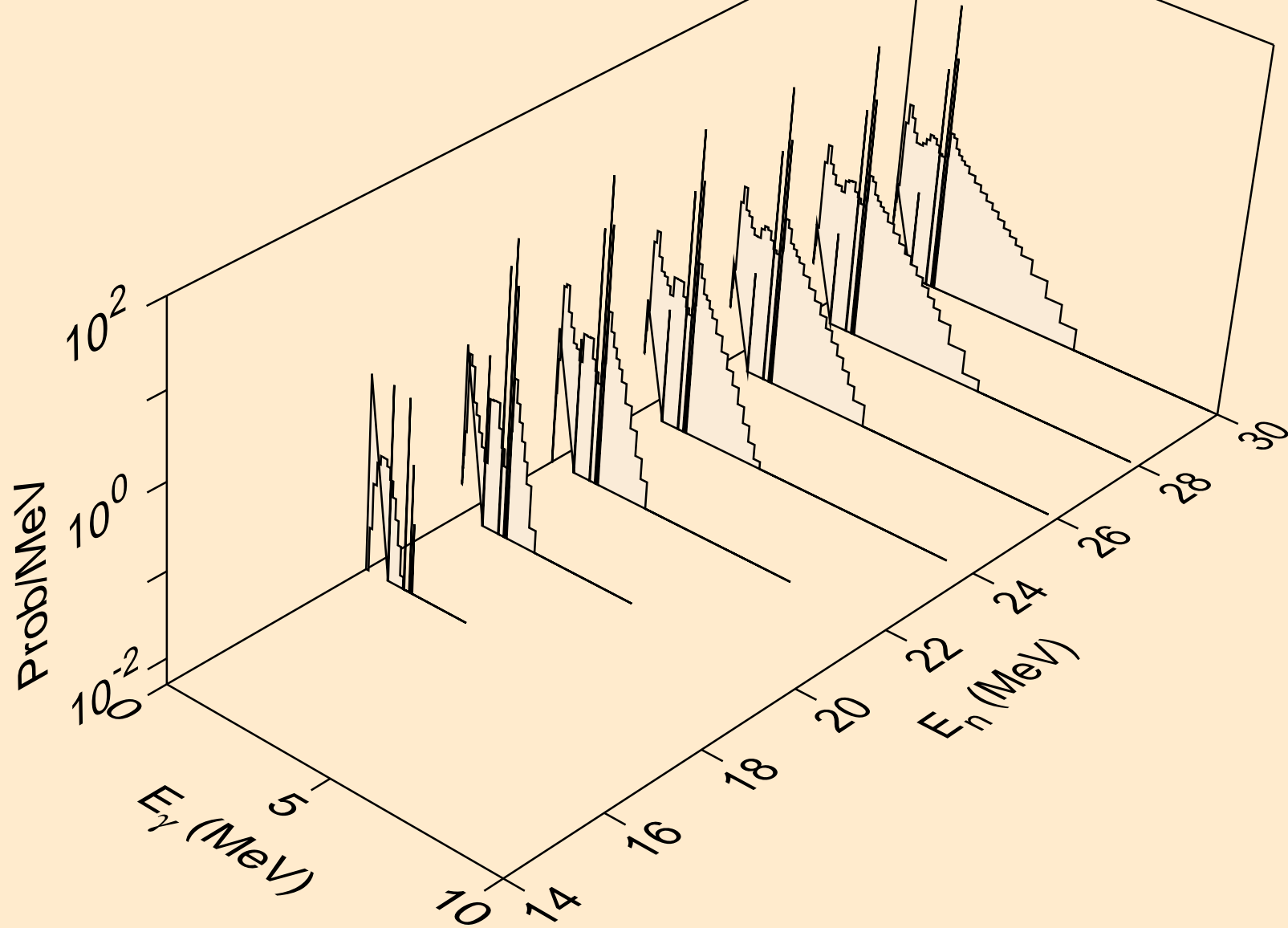

PD097 NEUTRON ACER TENDL-2024 LIBRARY; T=0.K
Photon emission for (n,n2p)

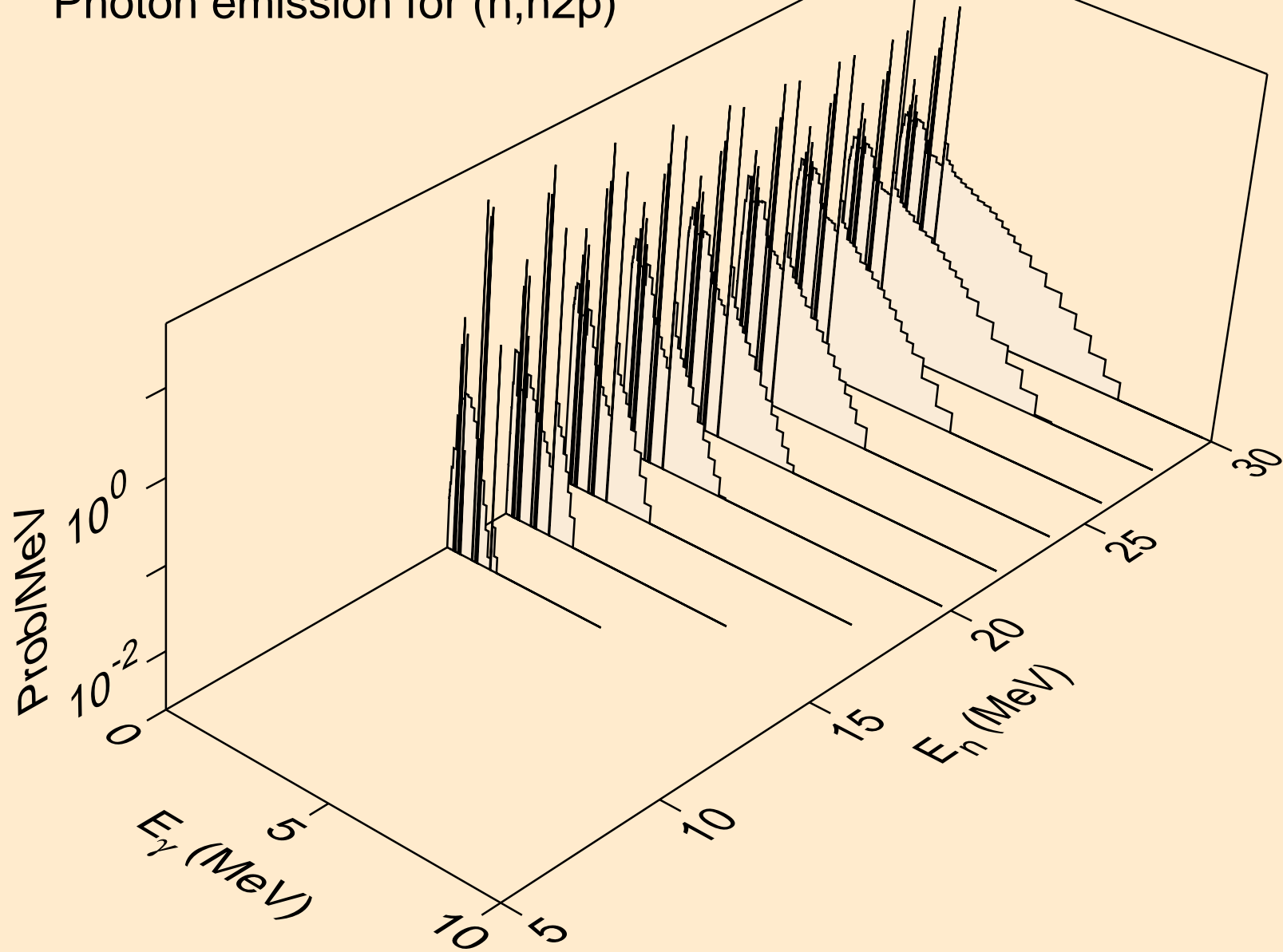

PD097 NEUTRON ACER TENDL-2024 LIBRARY; T=0.K
Photon emission for (n,npa)

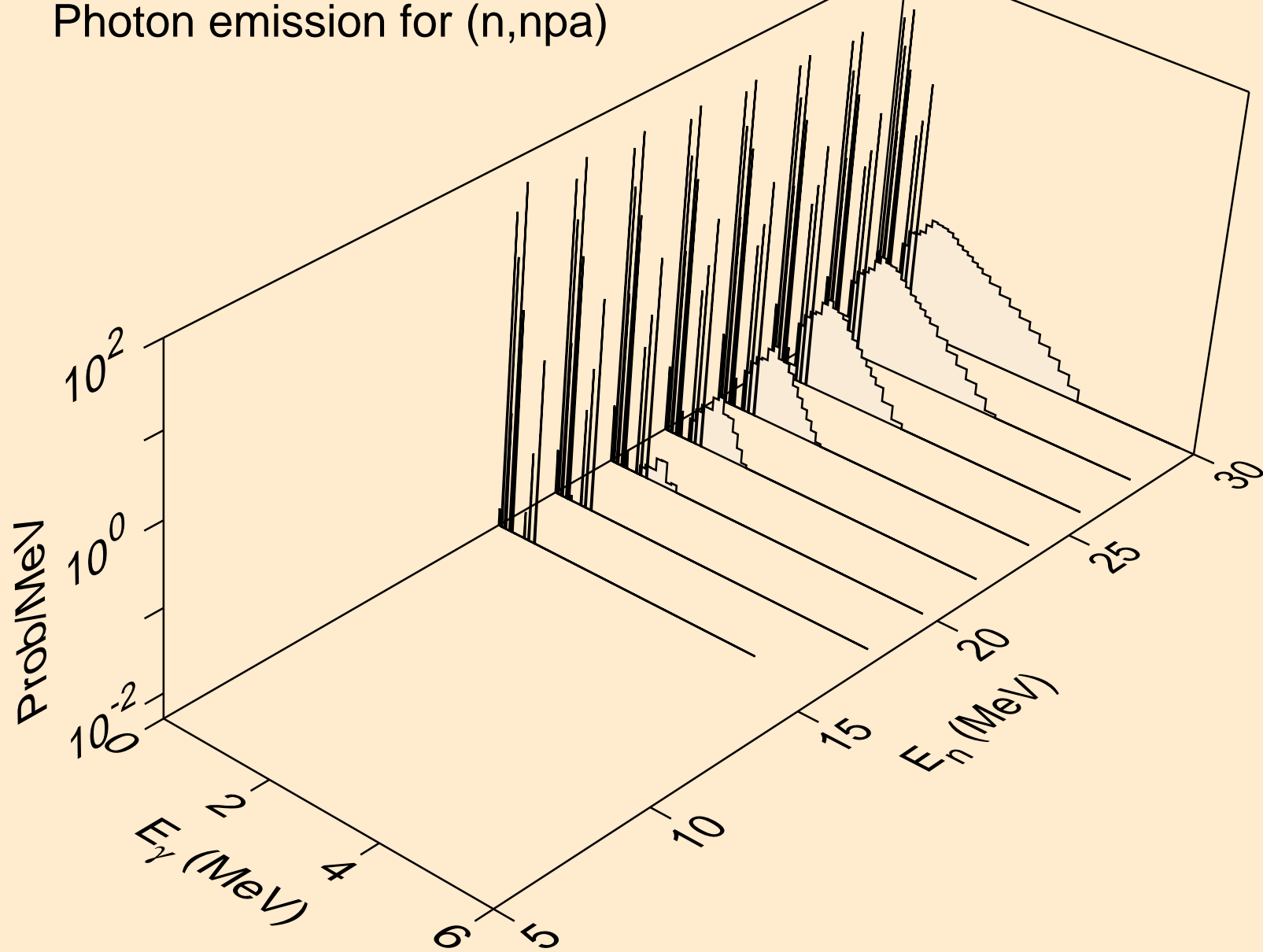

PD097 NEUTRON ACER TENDL-2024 LIBRARY; T=0.K
Photon emission for (n,n*c)

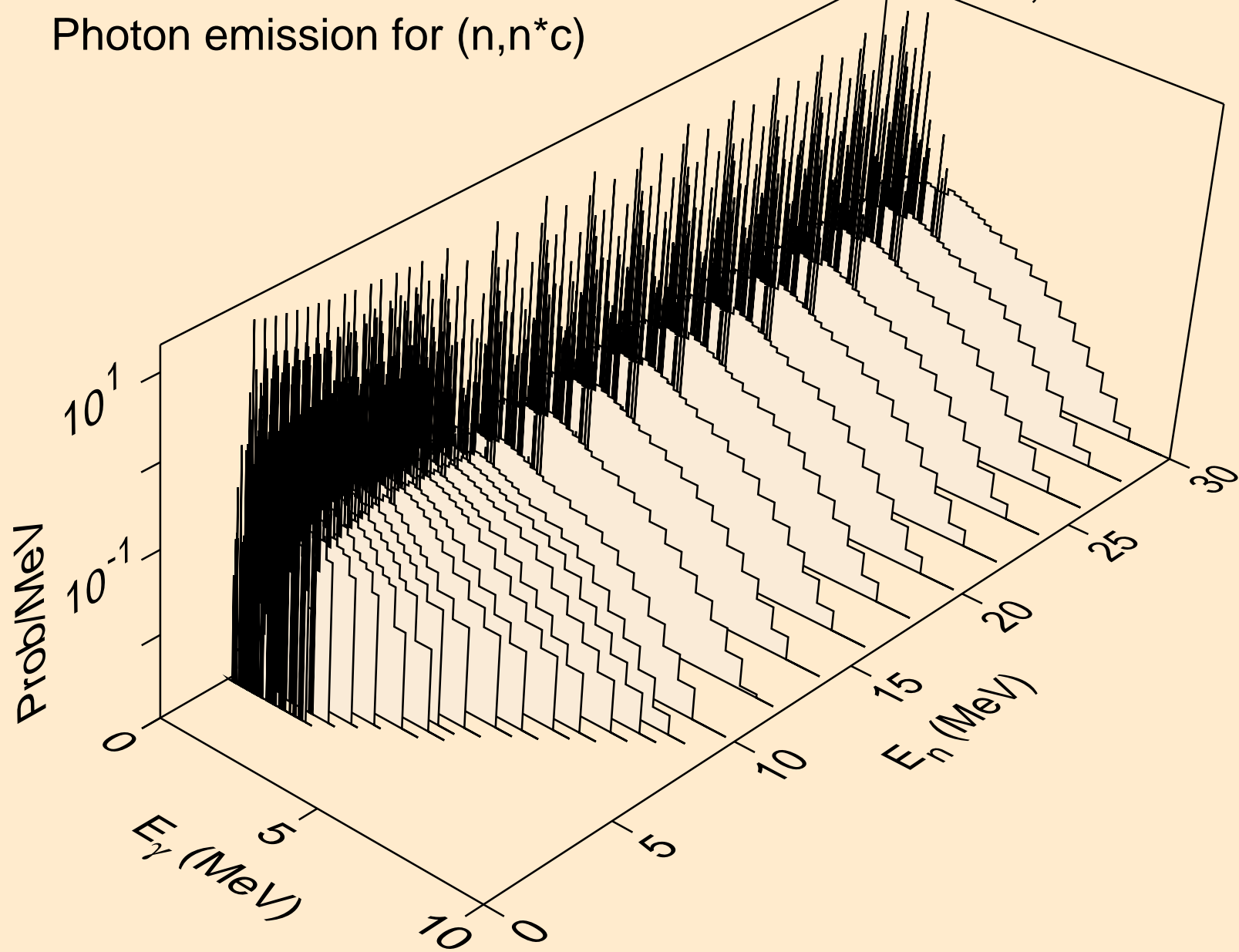

PD097 NEUTRON ACER TENDL-2024 LIBRARY; T=0.K
Photon emission for (n,gma)

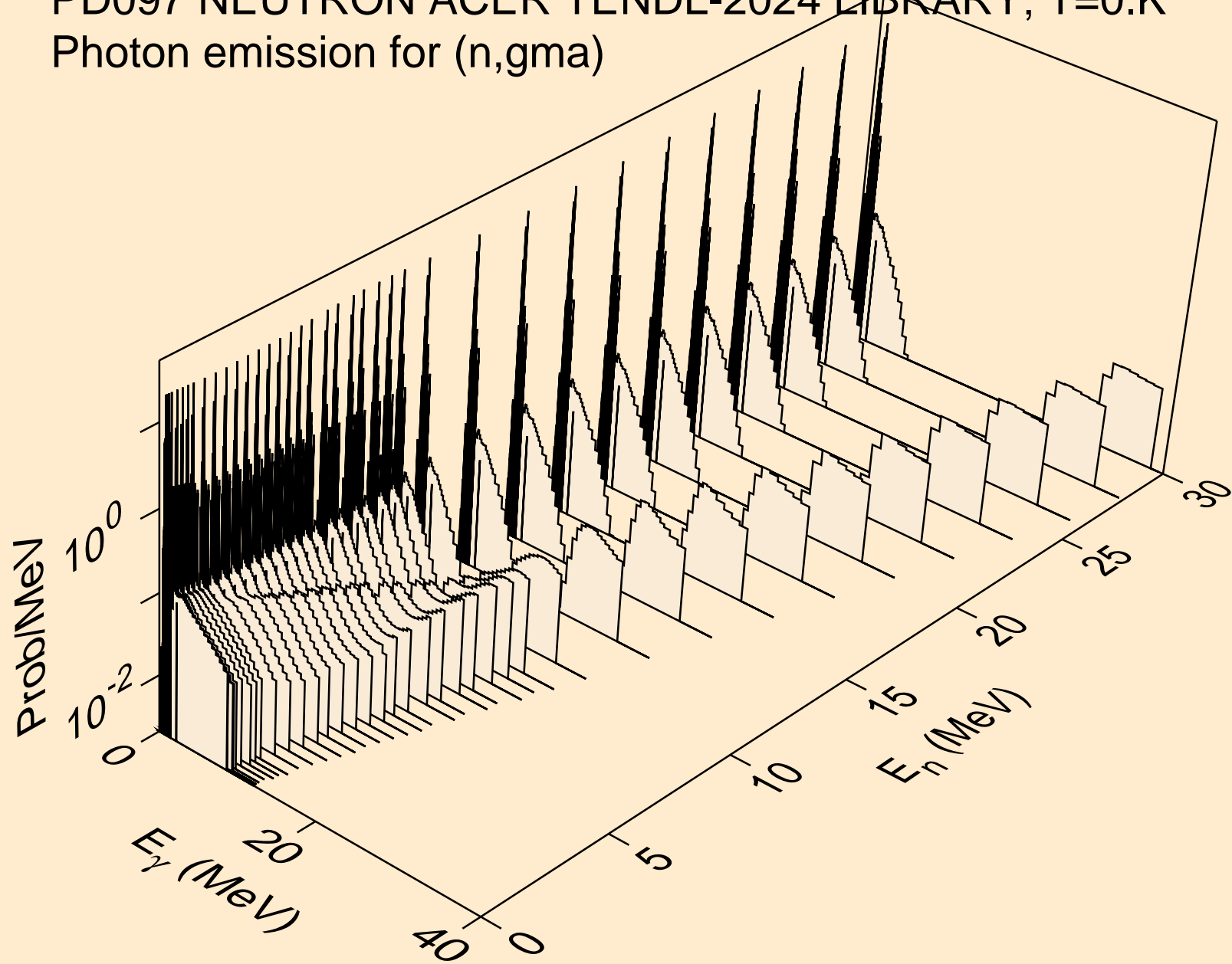

PD097 NEUTRON ACER TENDL-2024 LIBRARY; T=0.K
Photon emission for (n,p)

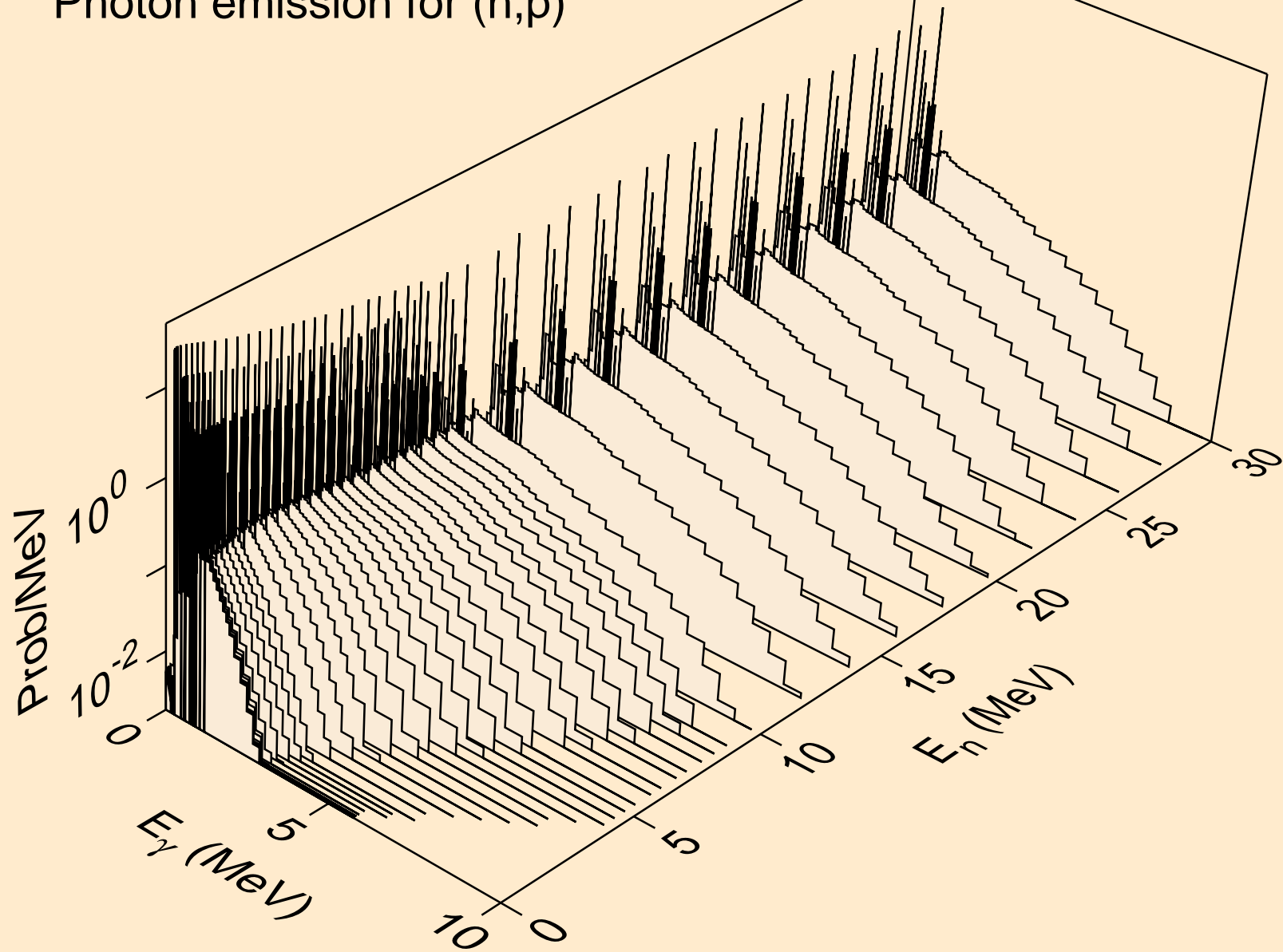

PD097 NEUTRON ACER TENDL-2024 LIBRARY; T=0.K
Photon emission for (n,d)

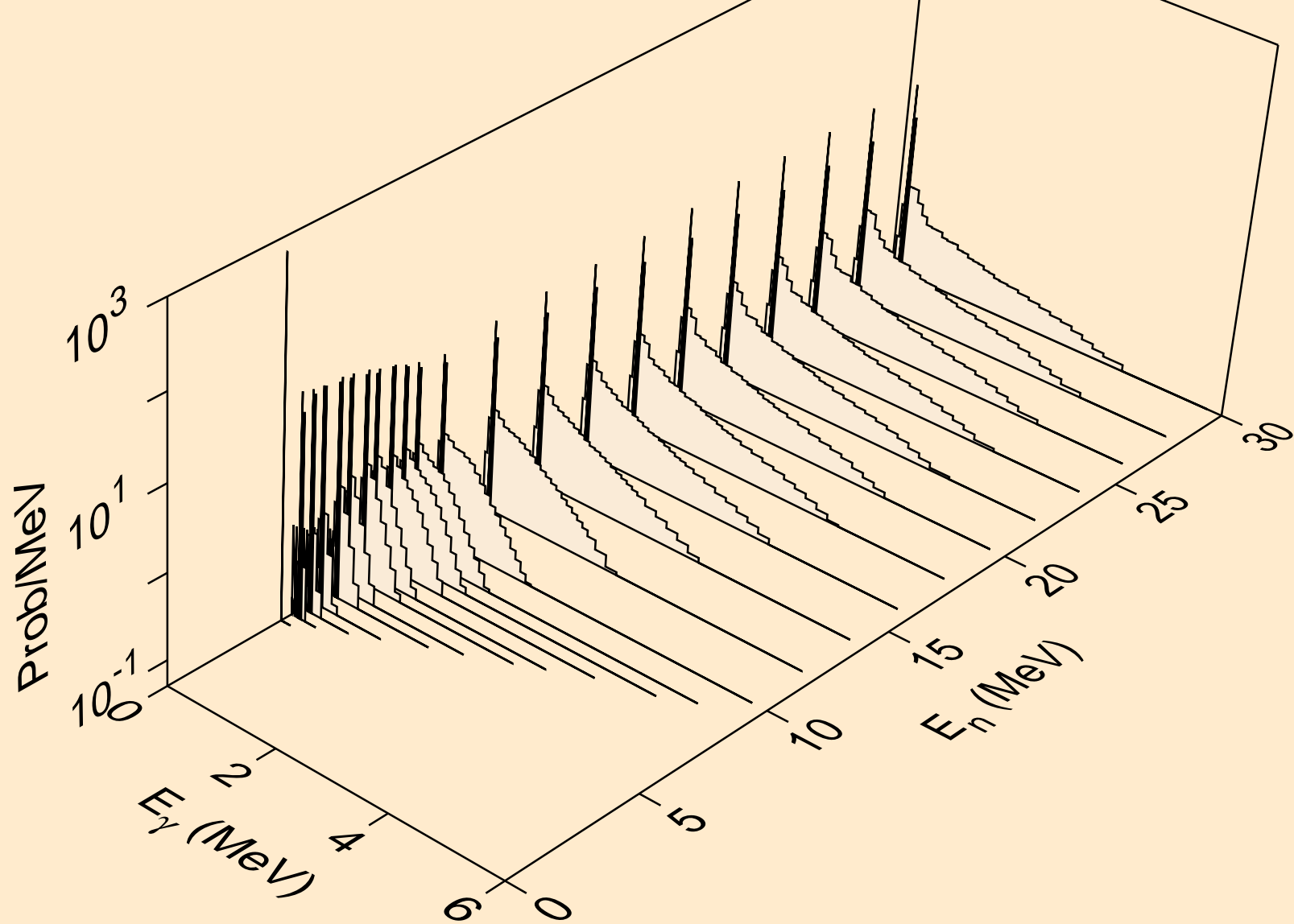

PD097 NEUTRON ACER TENDL-2024 LIBRARY; T=0.K
Photon emission for (n,t)

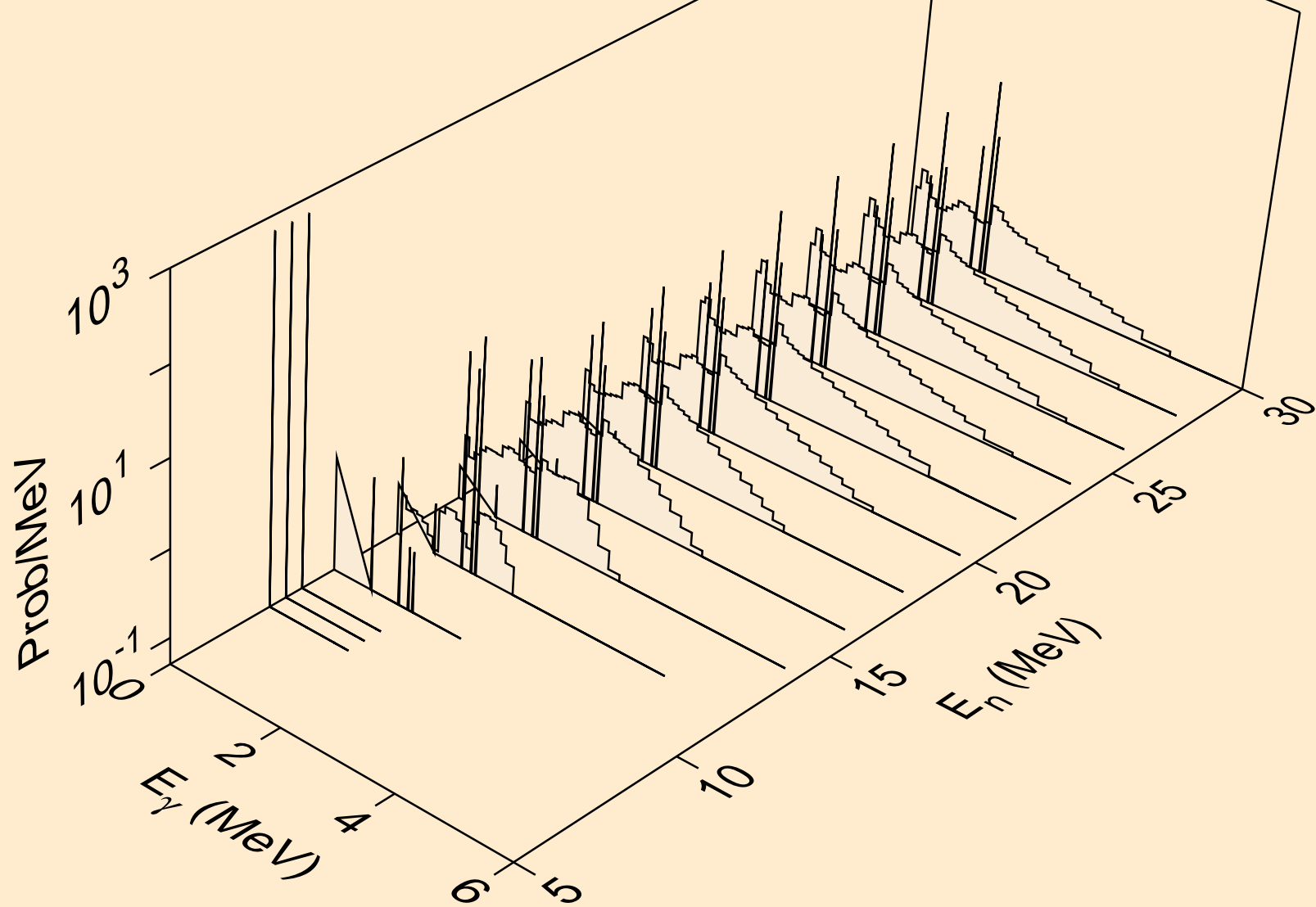

PD097 NEUTRON ACER TENDL-2024 LIBRARY; T=0.K
Photon emission for (n,he3)

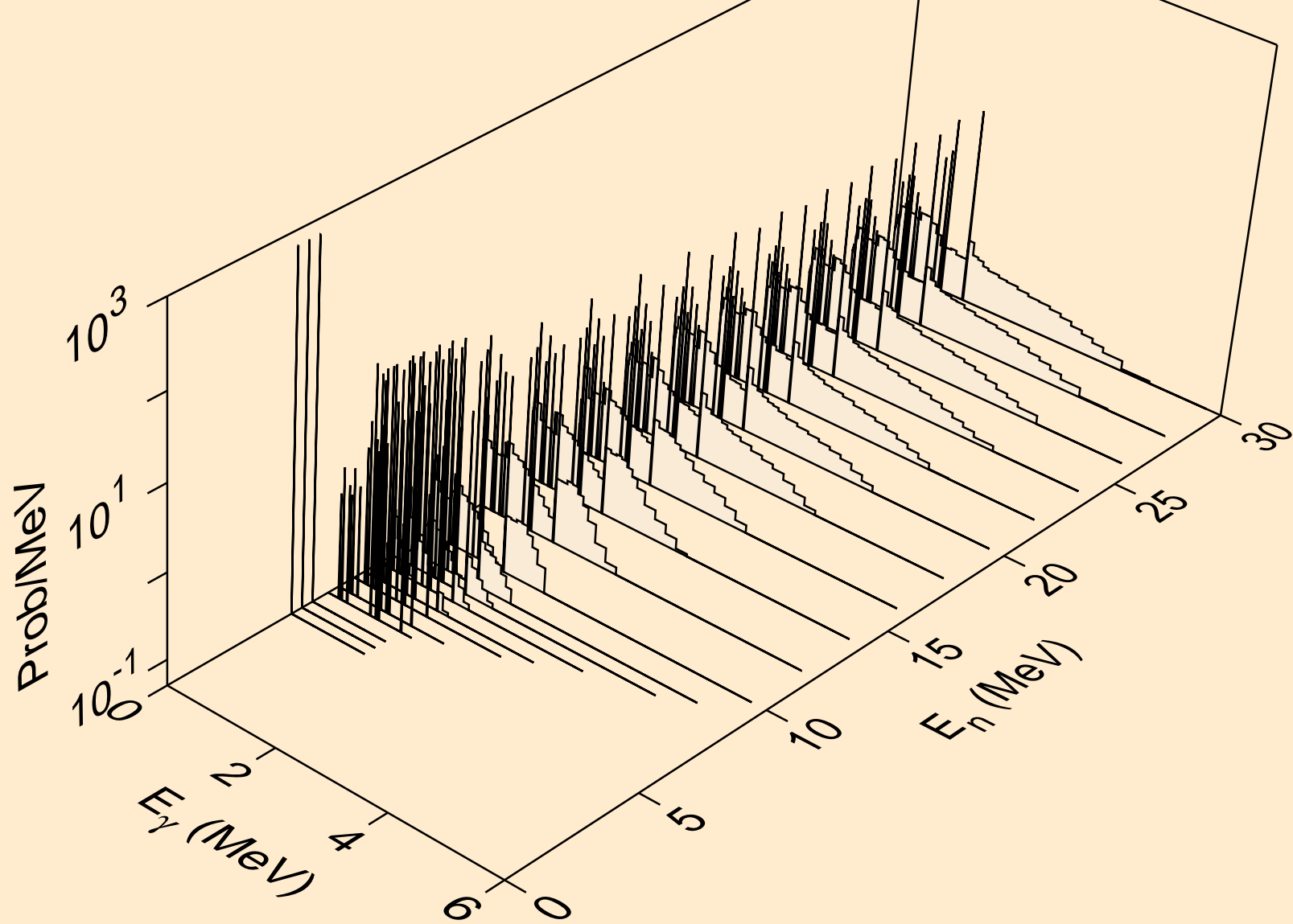

PD097 NEUTRON ACER TENDL-2024 LIBRARY; T=0.K
Photon emission for (n,a)

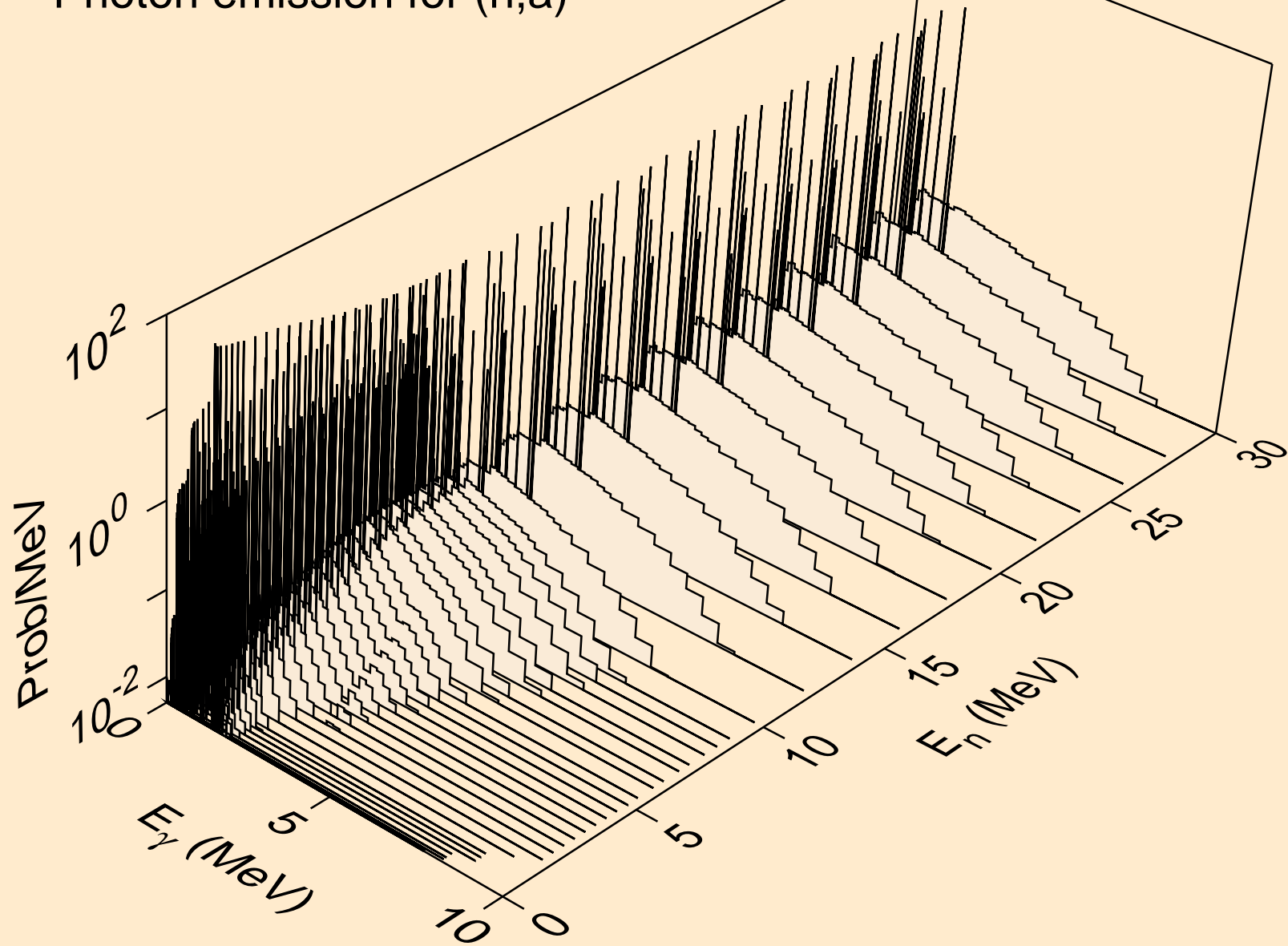

PD097 NEUTRON ACER TENDL-2024 LIBRARY; T=0.K
Photon emission for (n,2a)

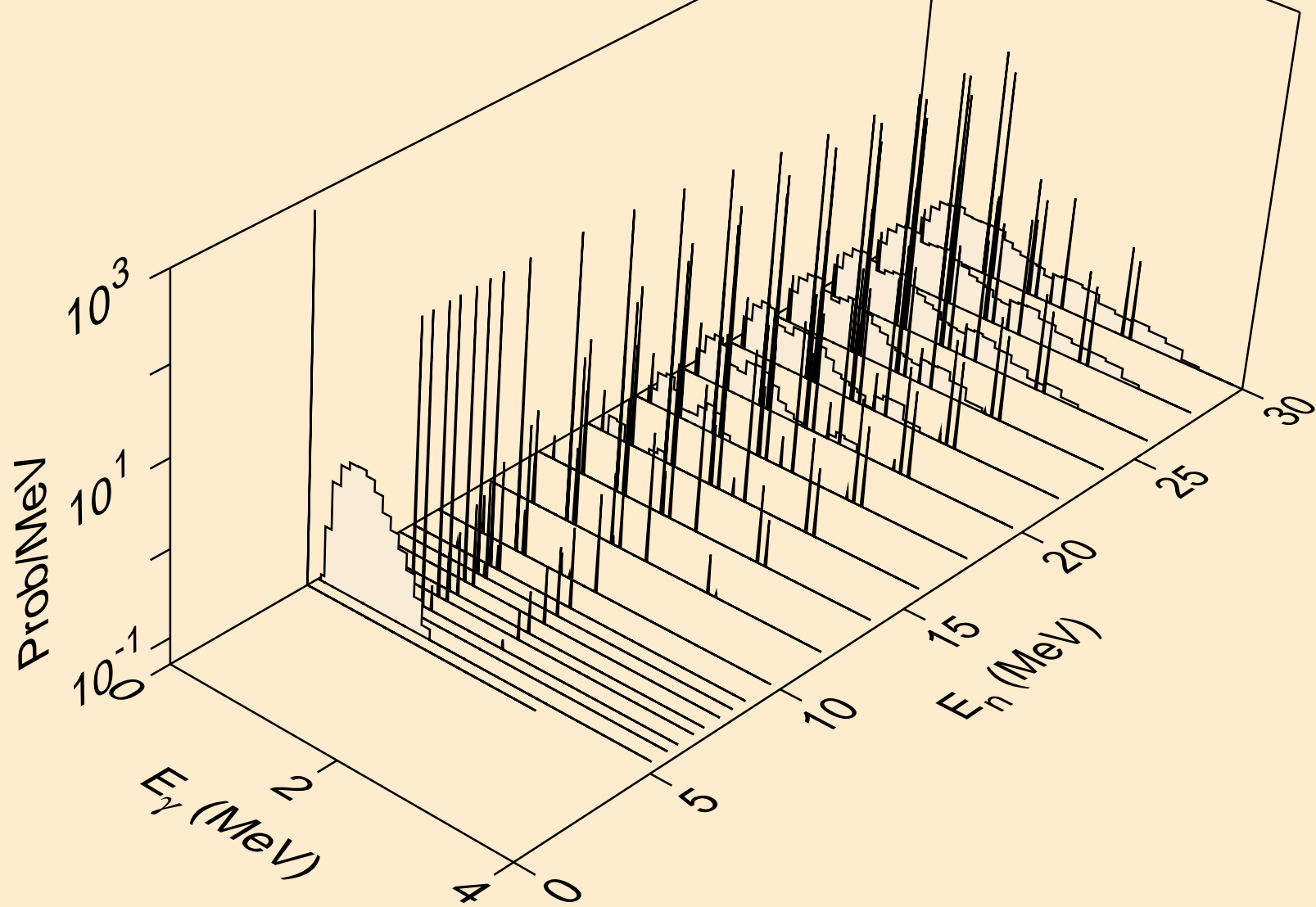

PD097 NEUTRON ACER TENDL-2024 LIBRARY; T=0.K
Photon emission for (n,2p)

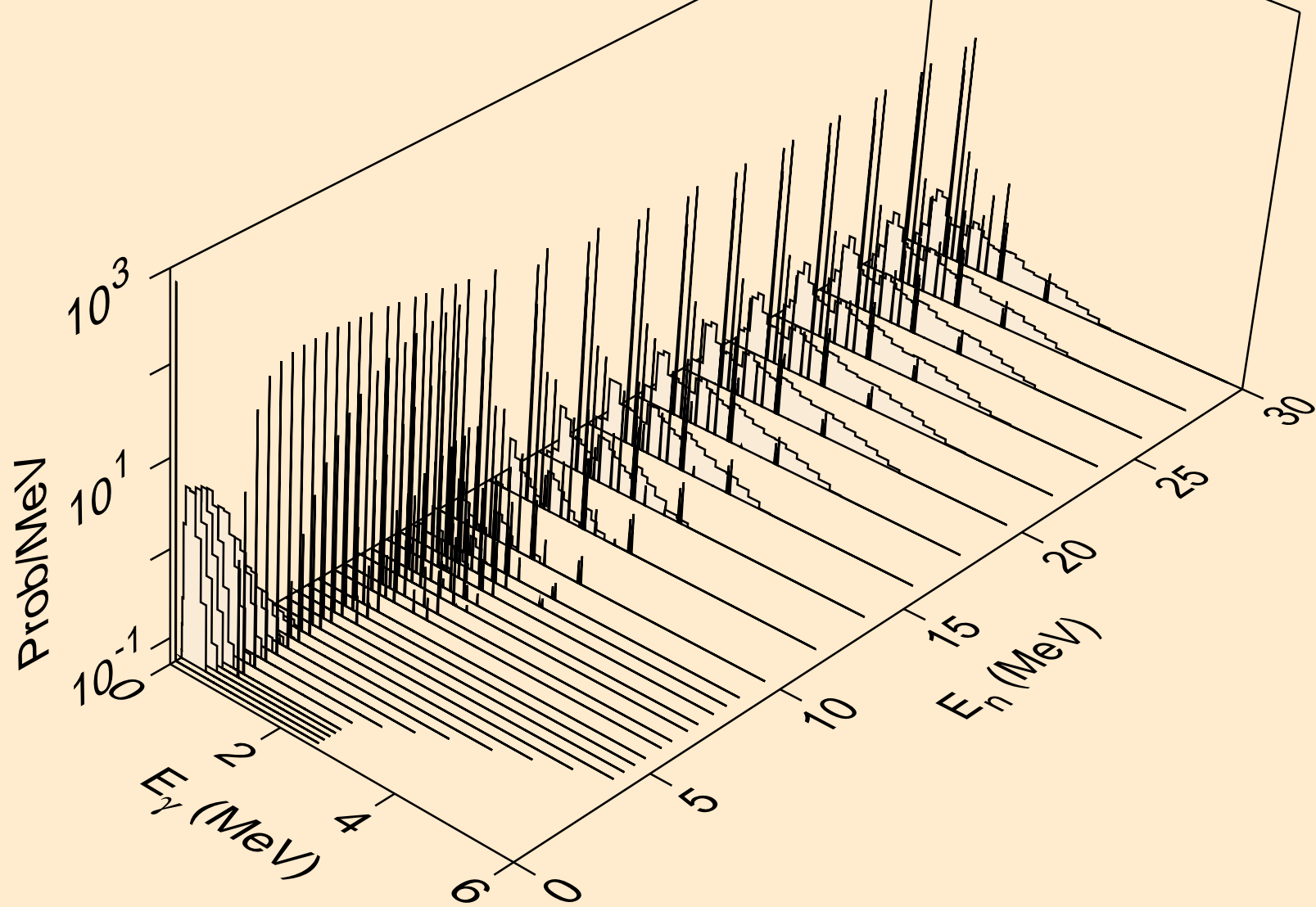

PD097 NEUTRON ACER TENDL-2024 LIBRARY; T=0.K
Photon emission for (n,p α)

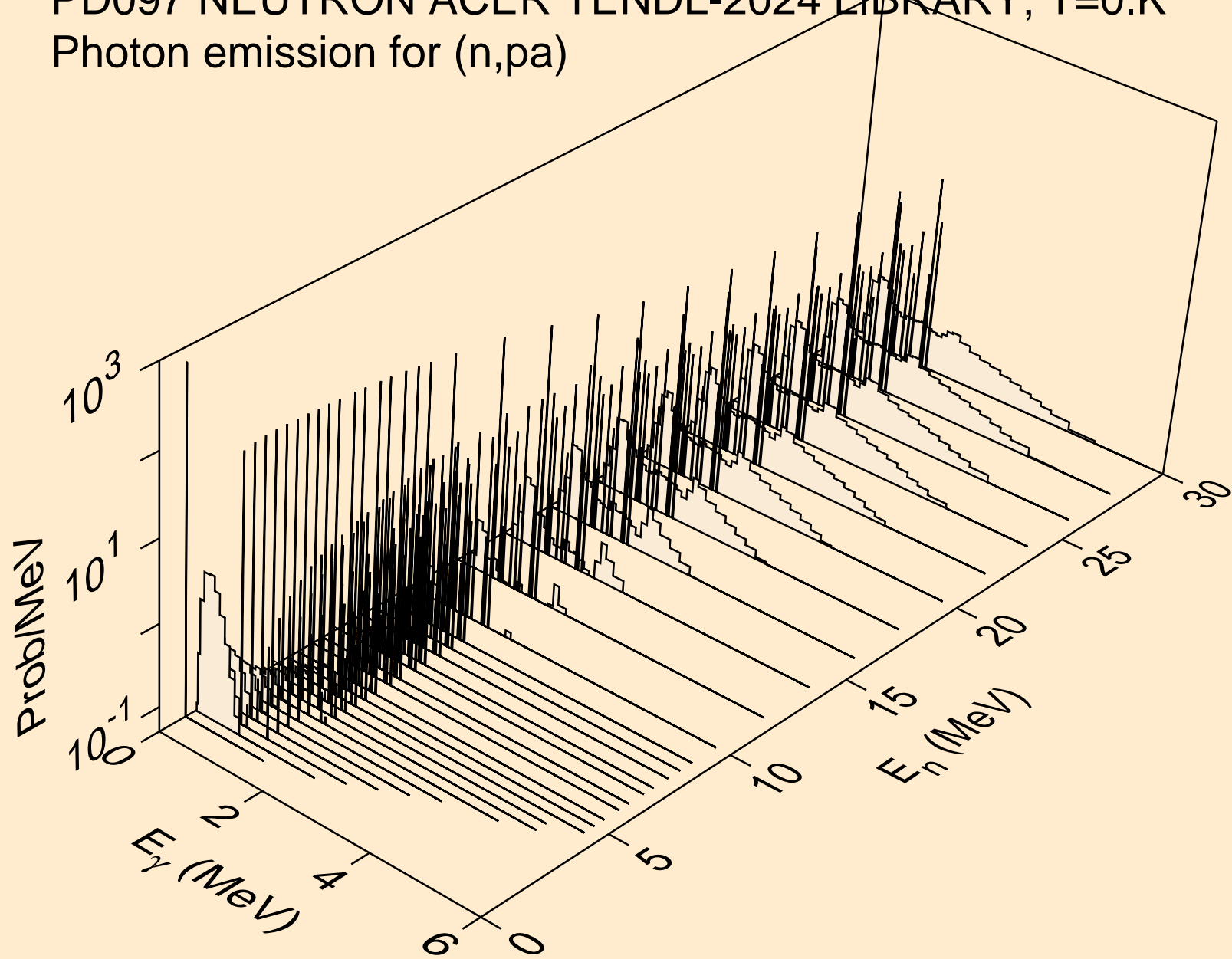

PD097 NEUTRON ACER TENDL-2024 LIBRARY; T=0.K
Photon emission for (n,pd)

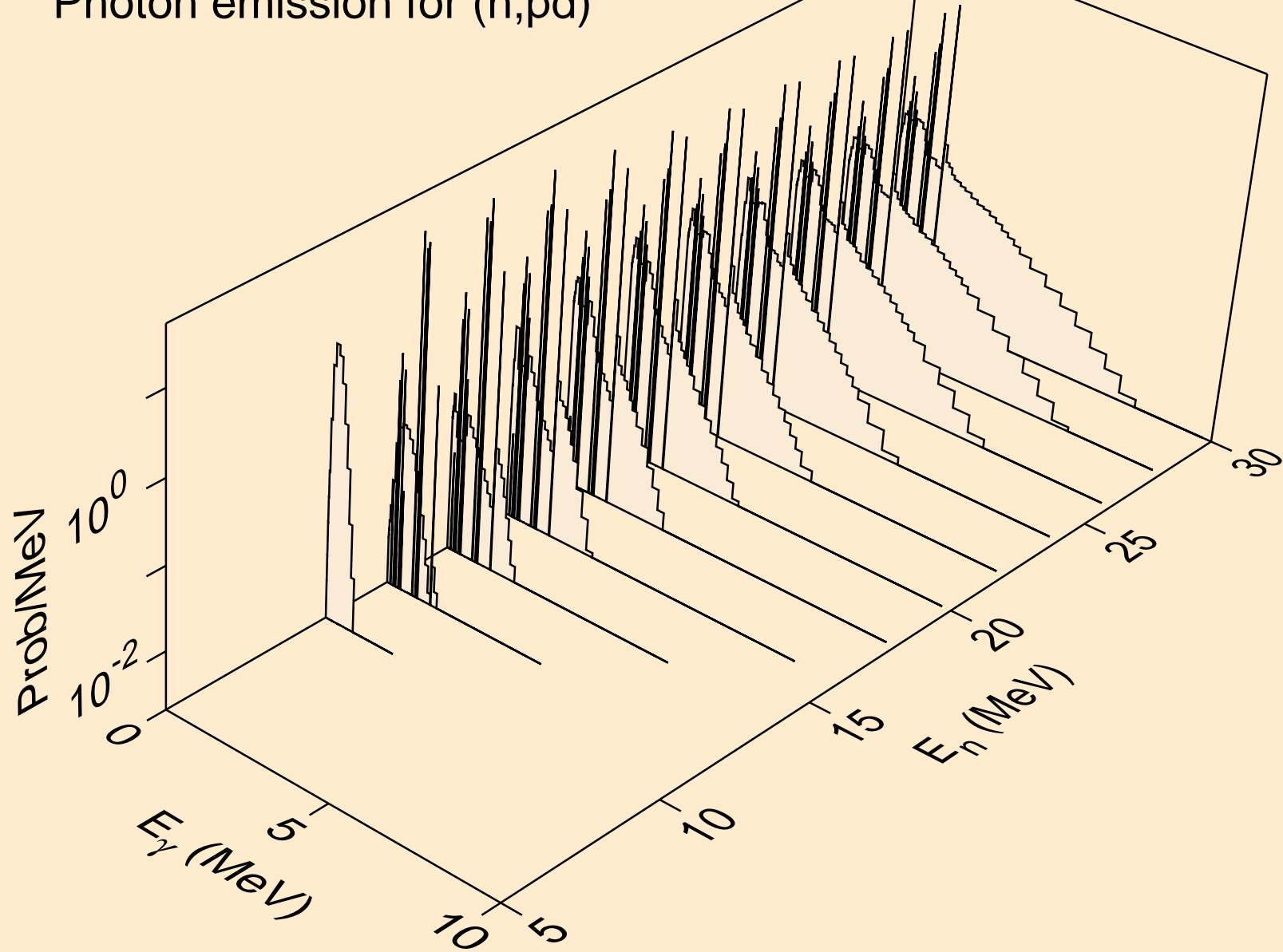

PD097 NEUTRON ACER TENDL-2024 LIBRARY; T=0.K
Photon emission for (n,pt)

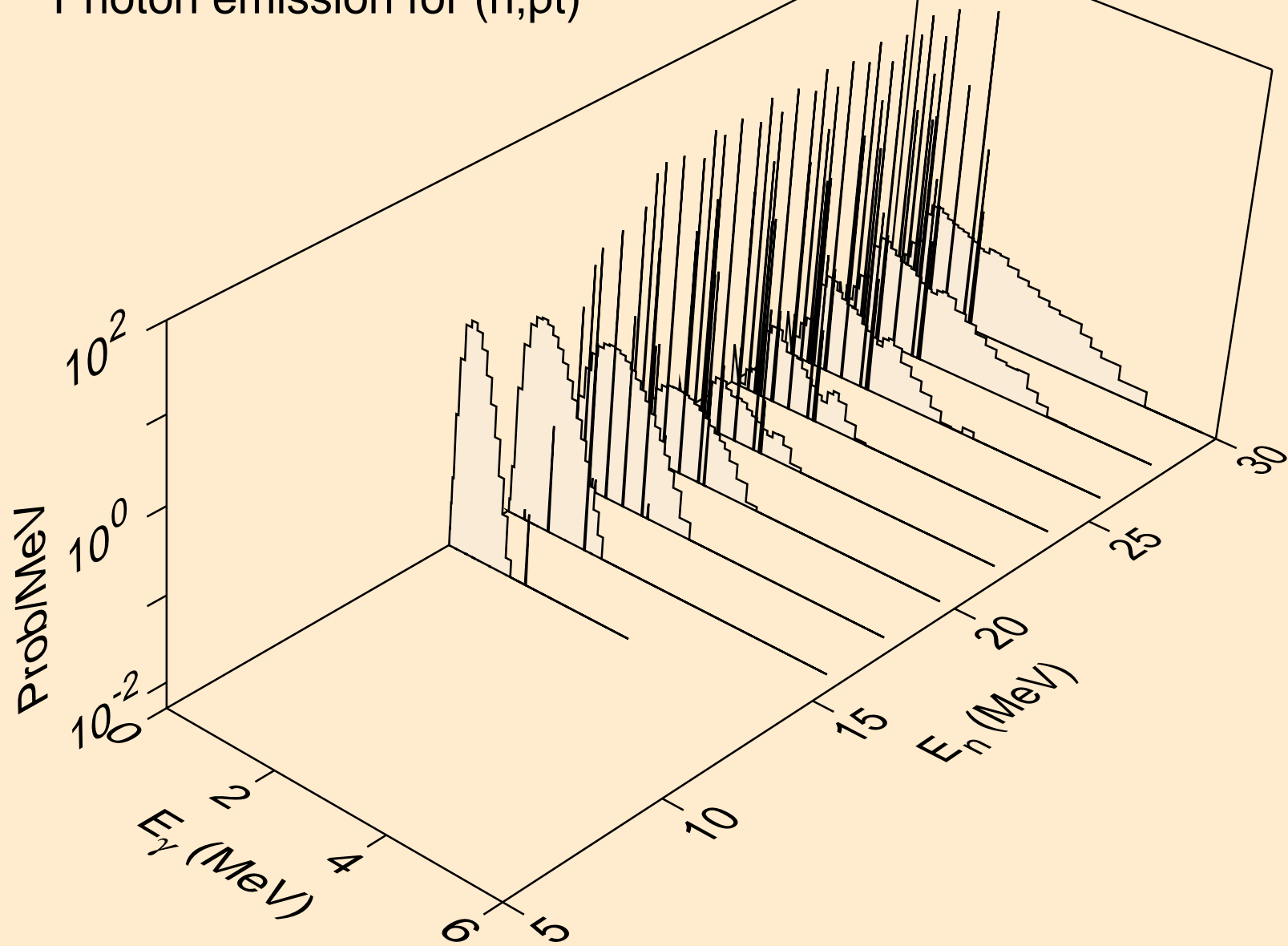

PD097 NEUTRON ACER TENDL-2024 LIBRARY; T=0.K
Photon emission for (n,da)

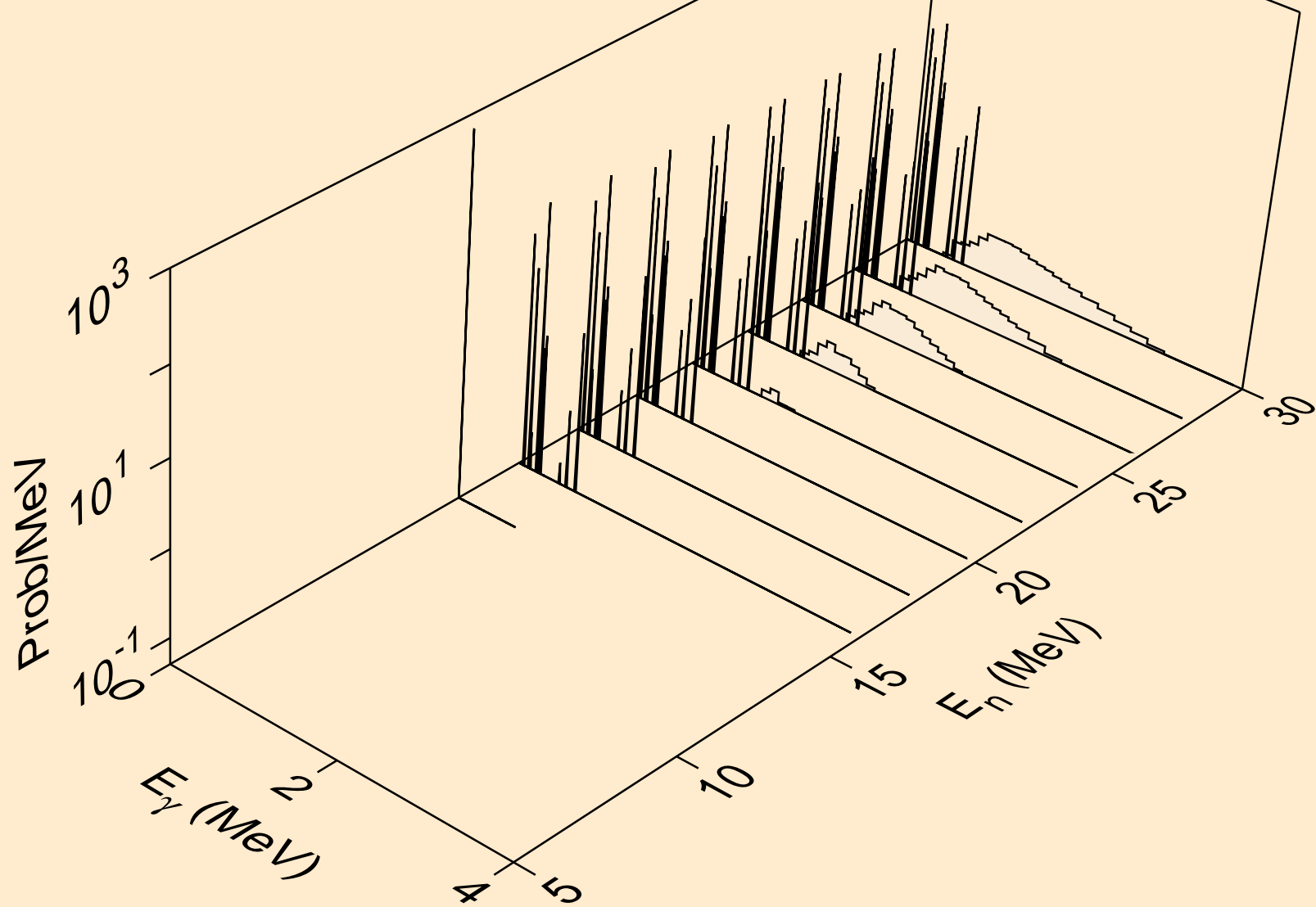

PD097 NEUTRON ACER TENDL-2024 LIBRARY; T=0.K
thermal capture photon spectrum

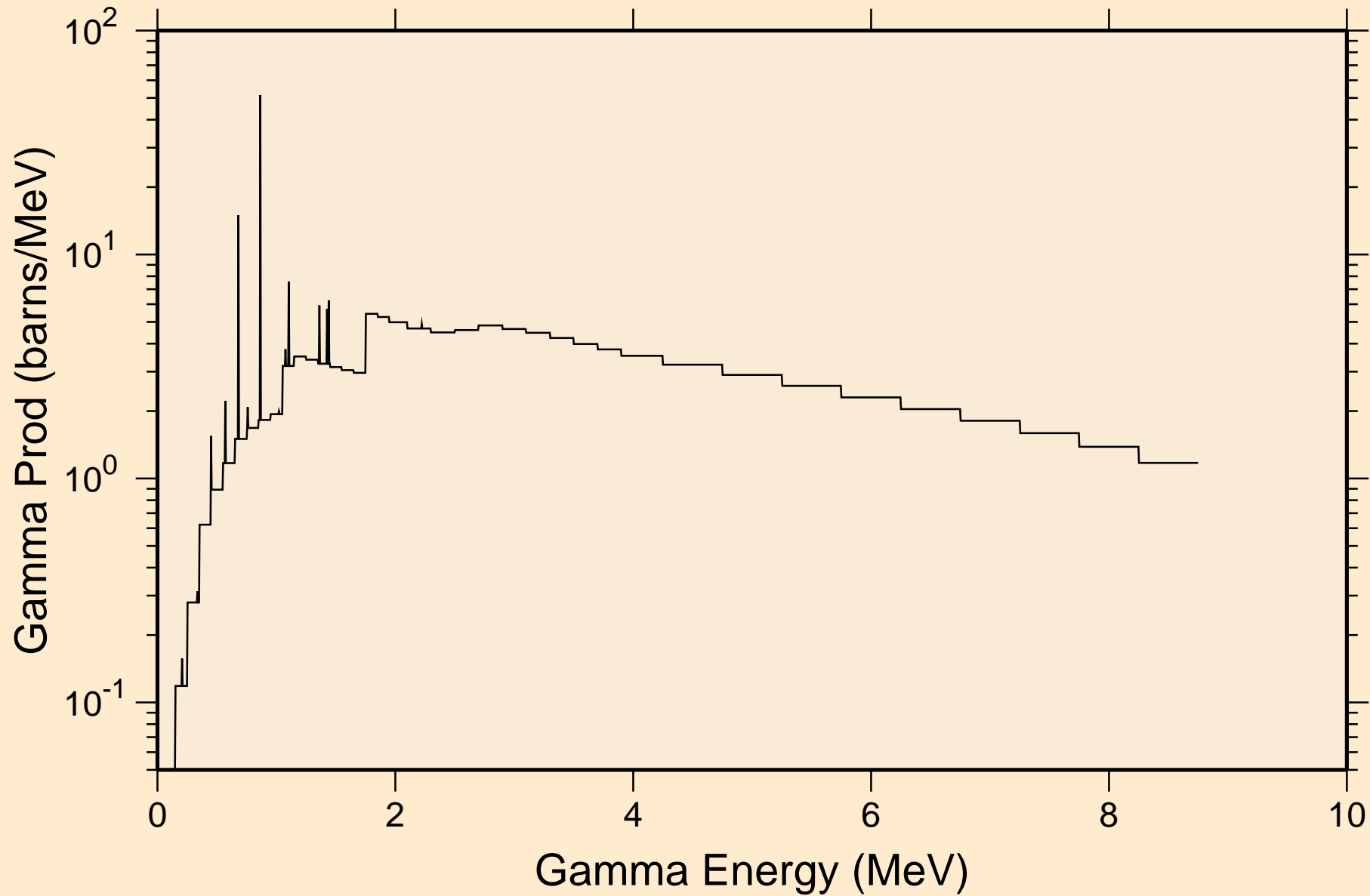

PD097 NEUTRON ACER TENDL-2024 LIBRARY; T=0.K
14 MeV photon spectrum

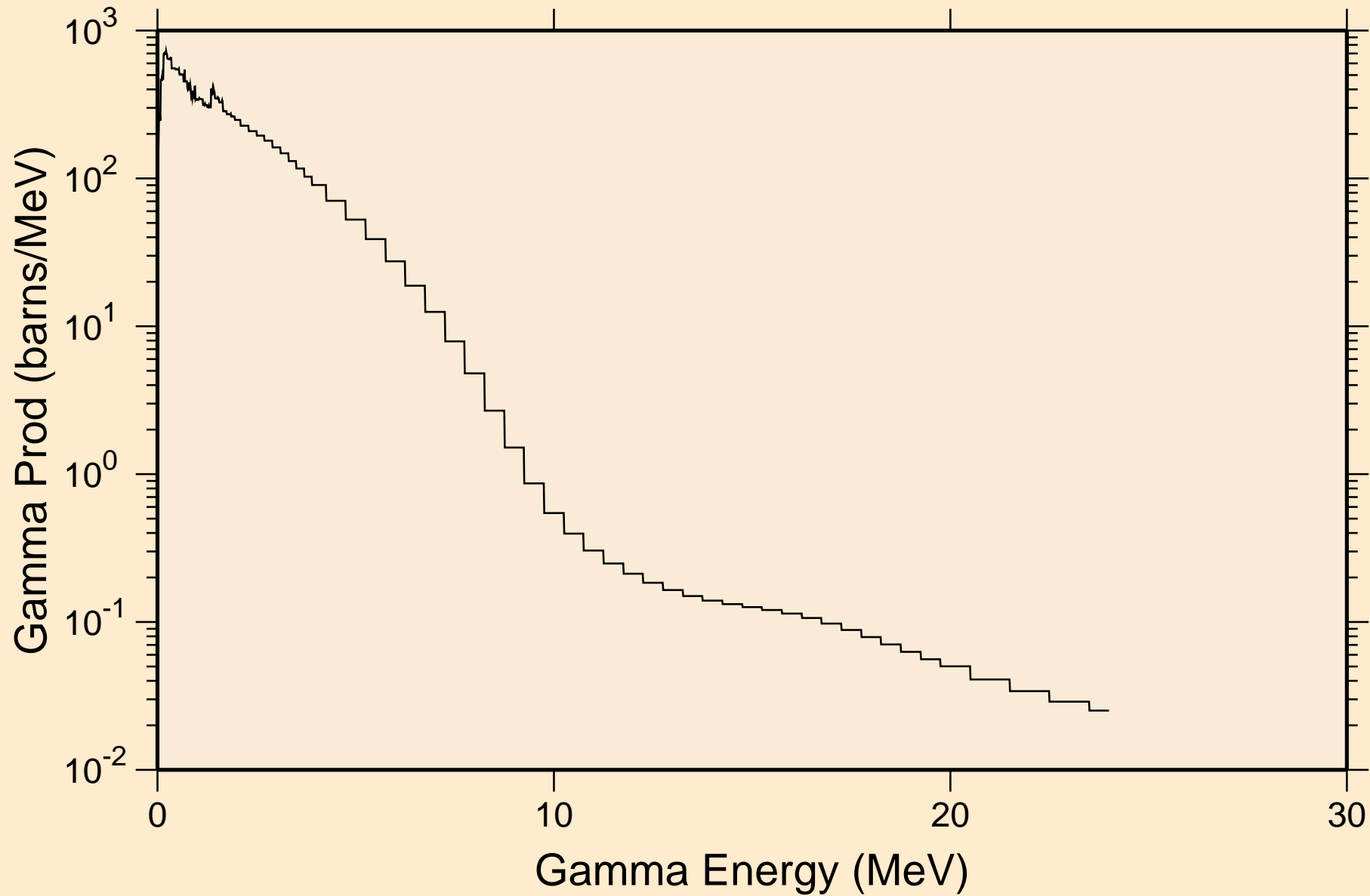

PD097 NEUTRON ACER TENDL-2024 LIBRARY; T=0.K
Particle heating contributions

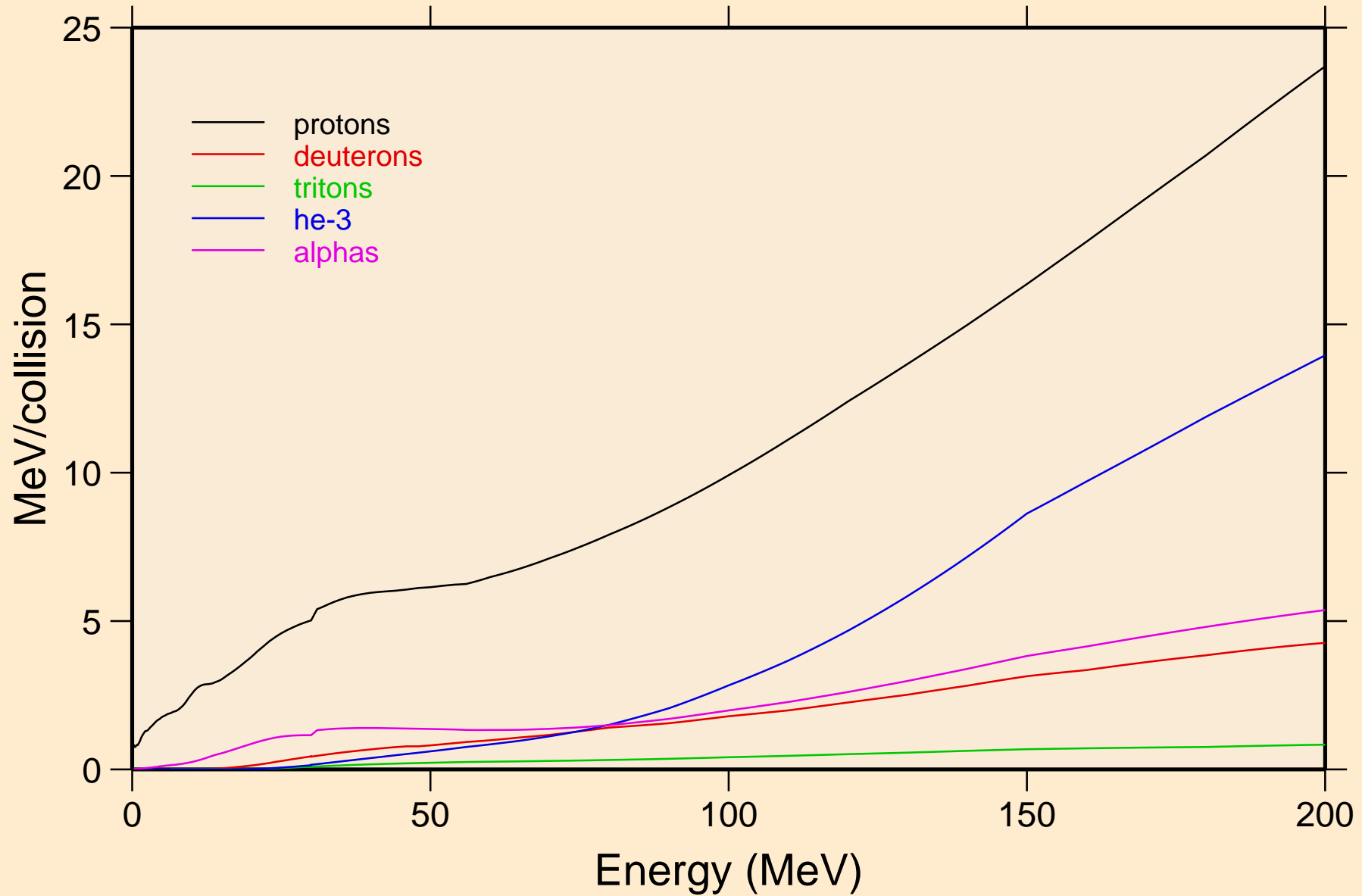

PD097 NEUTRON ACER TENDL-2024 LIBRARY; T=0.K
Recoil Heating

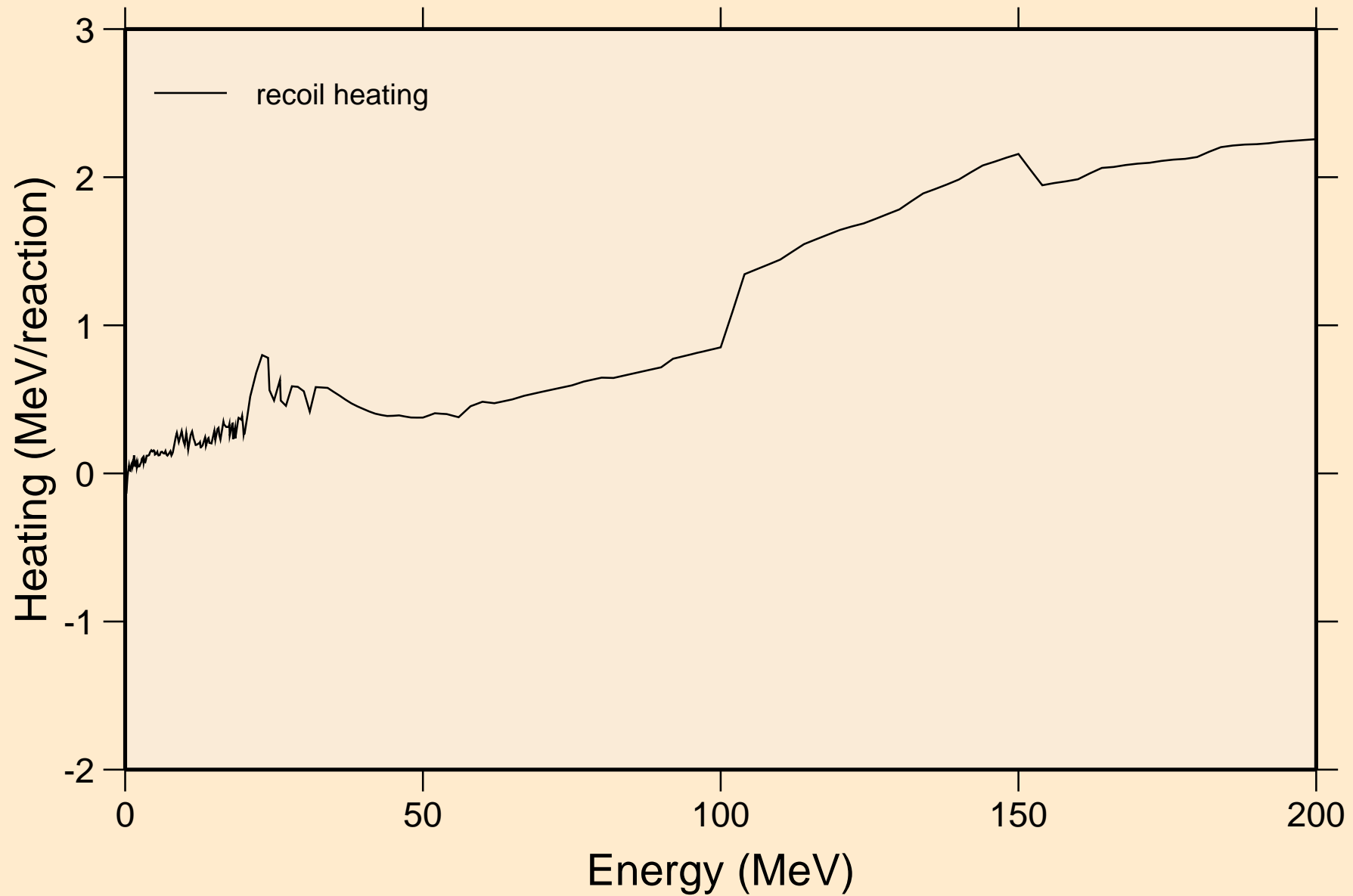

PD097 NEUTRON ACER TENDL-2024 LIBRARY; T=0.K
Particle production cross sections

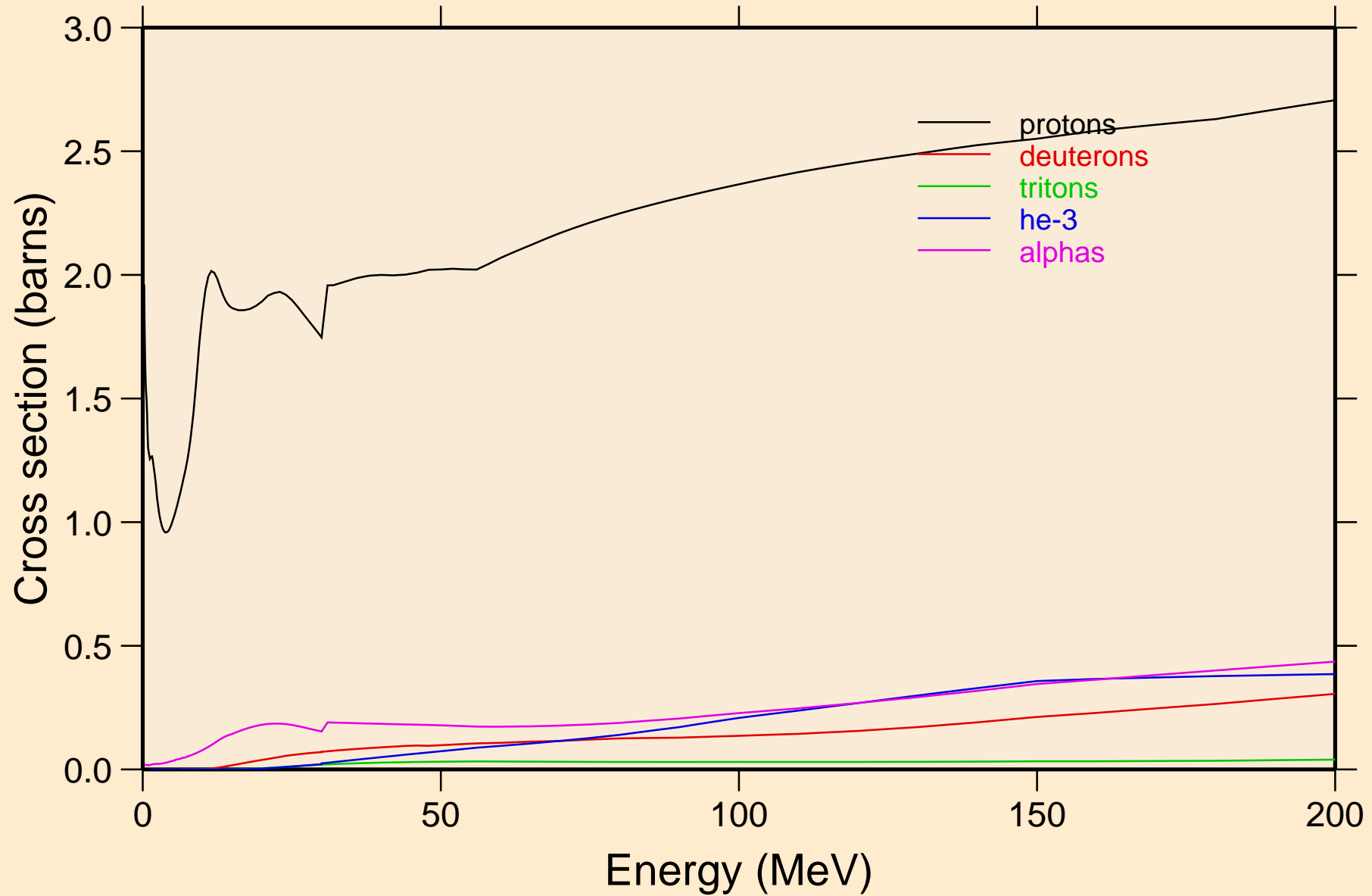

PD097 NEUTRON ACER TENDL-2024 LIBRARY; T=0.K
protons from (n,x)

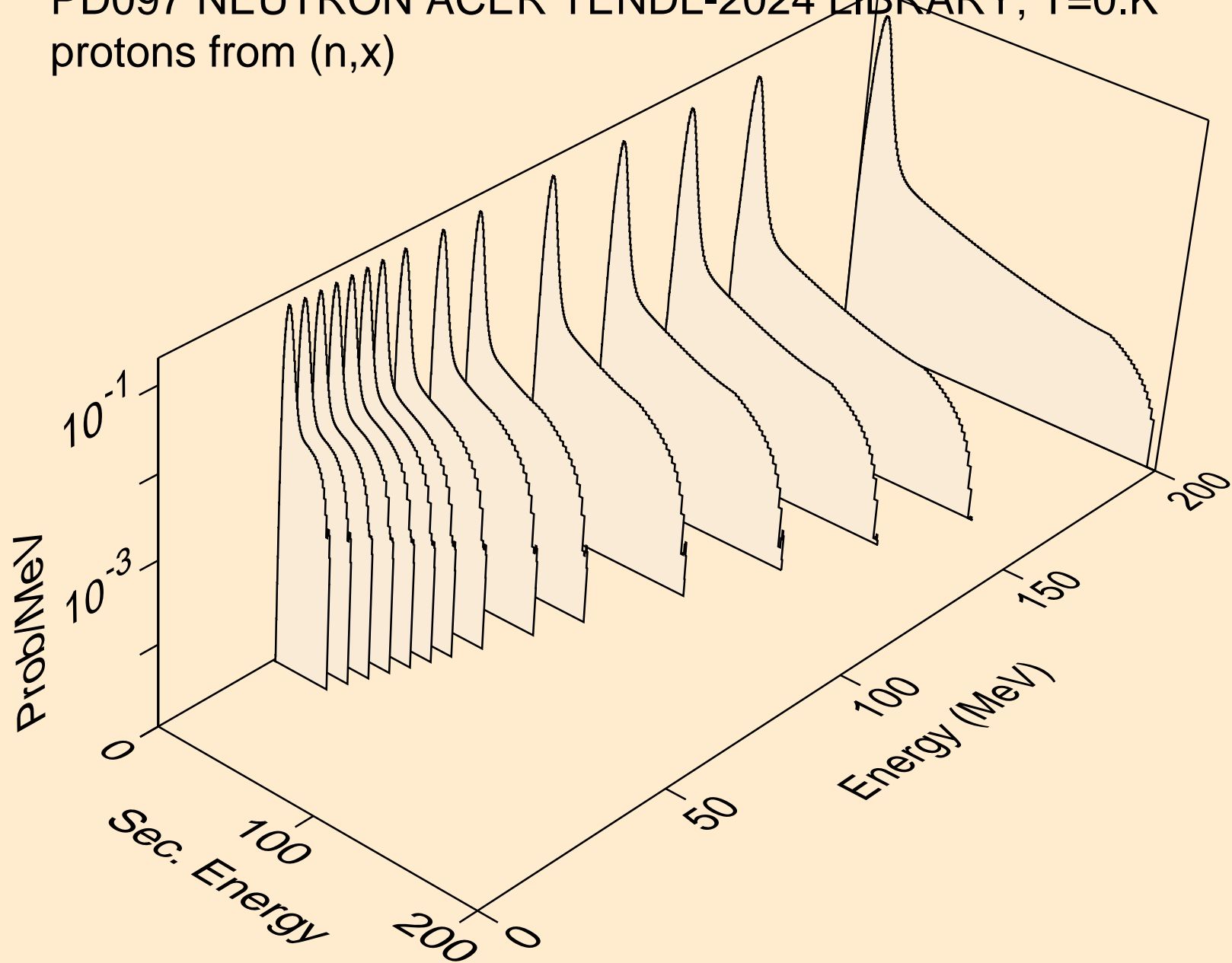

PD097 NEUTRON ACER TENDL-2024 LIBRARY; T=0.K
protons from (n,n*)p

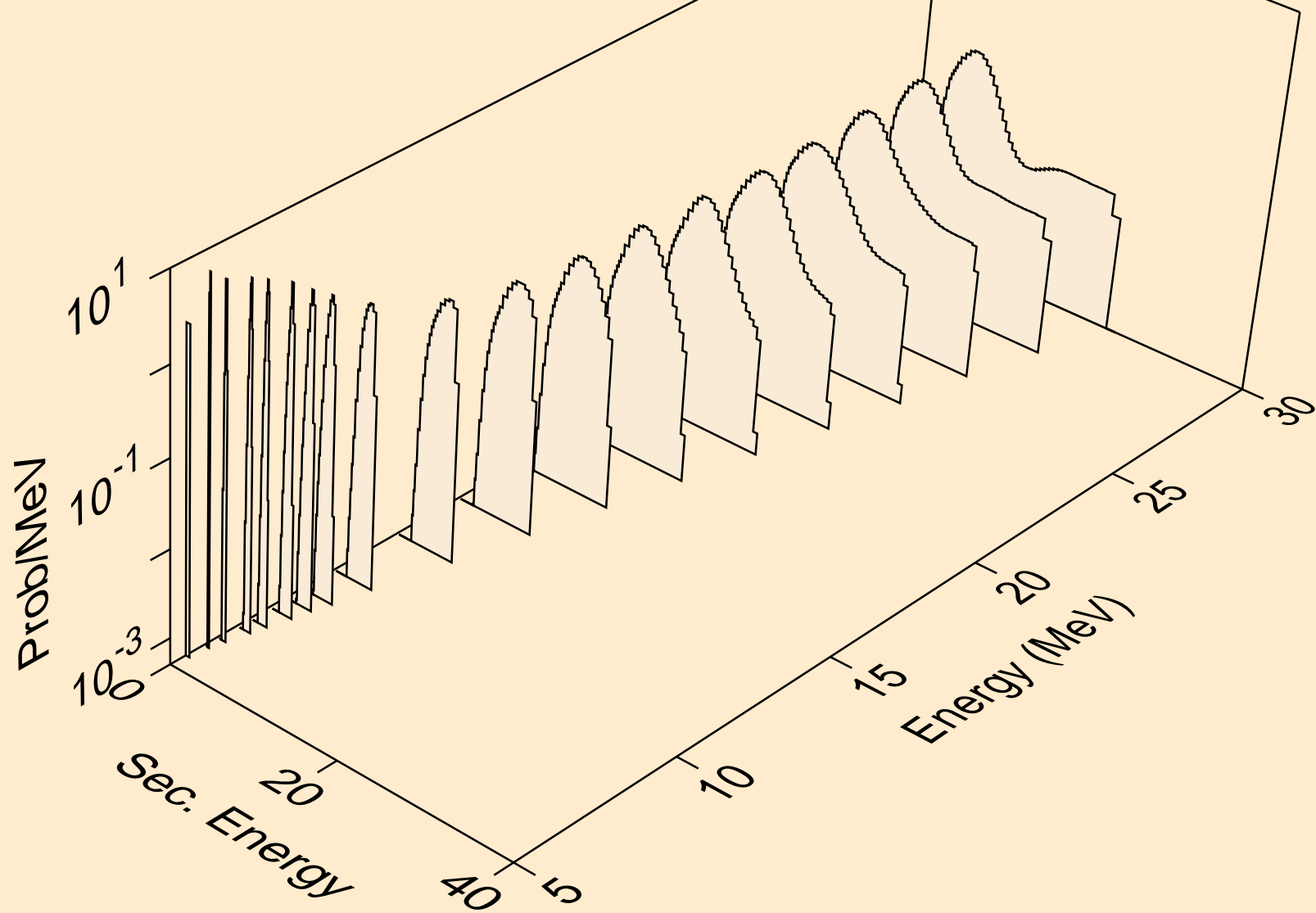

PD097 NEUTRON ACER TENDL-2024 LIBRARY; T=0.K
protons from (n,2np)

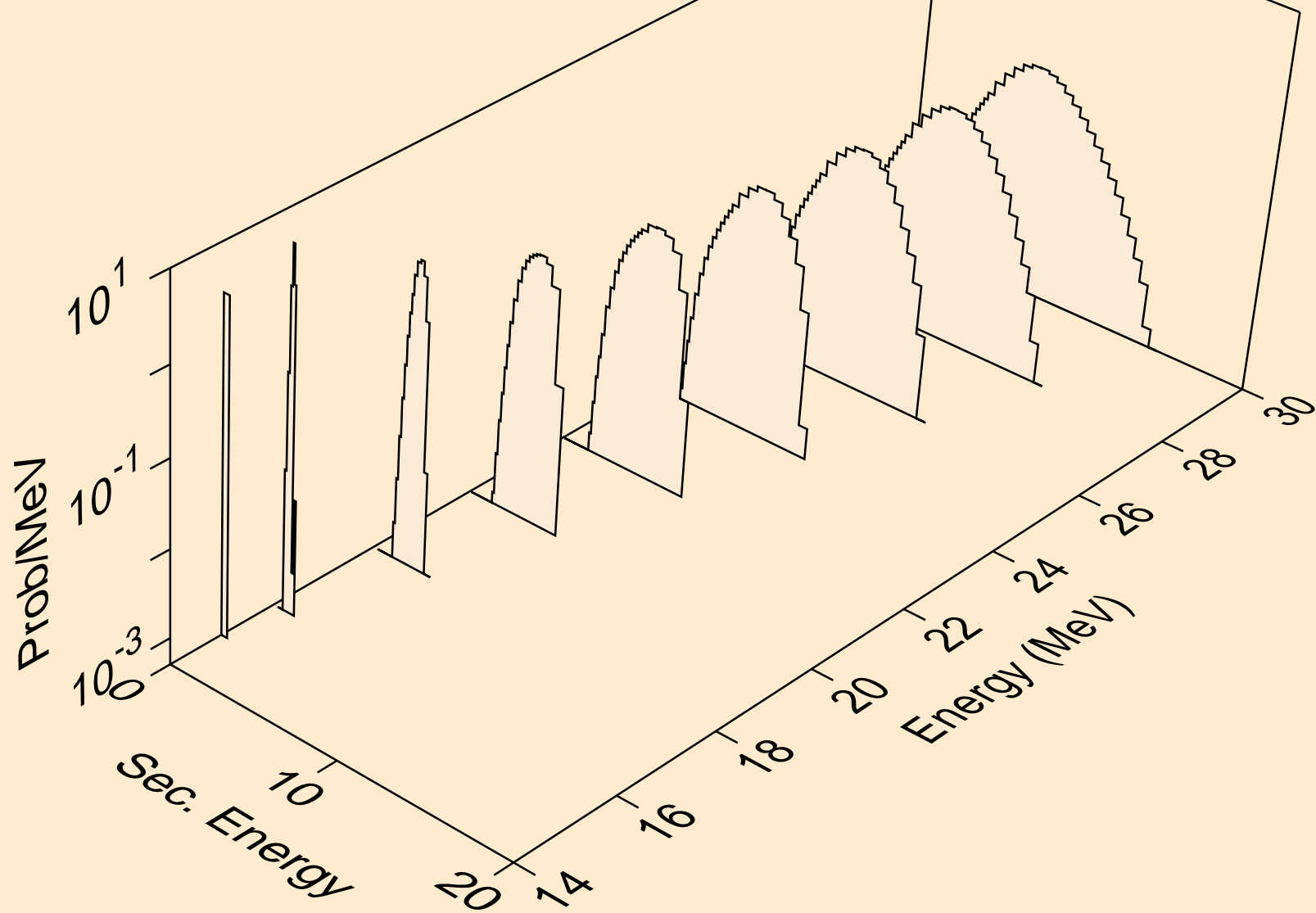

PD097 NEUTRON ACER TENDL-2024 LIBRARY; T=0.K
protons from (n,n2p)

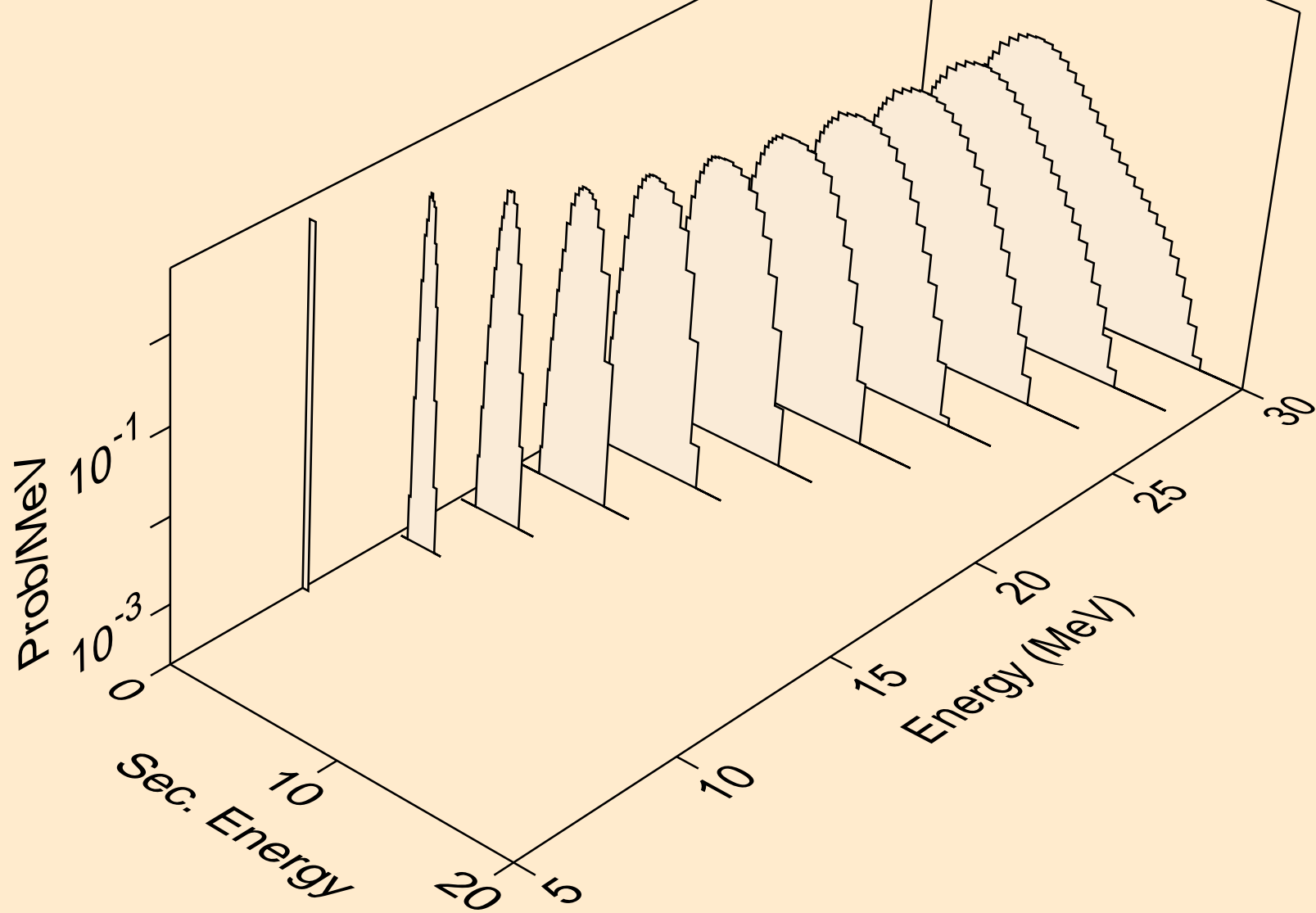

PD097 NEUTRON ACER TENDL-2024 LIBRARY; T=0.K
protons from (n,npa)

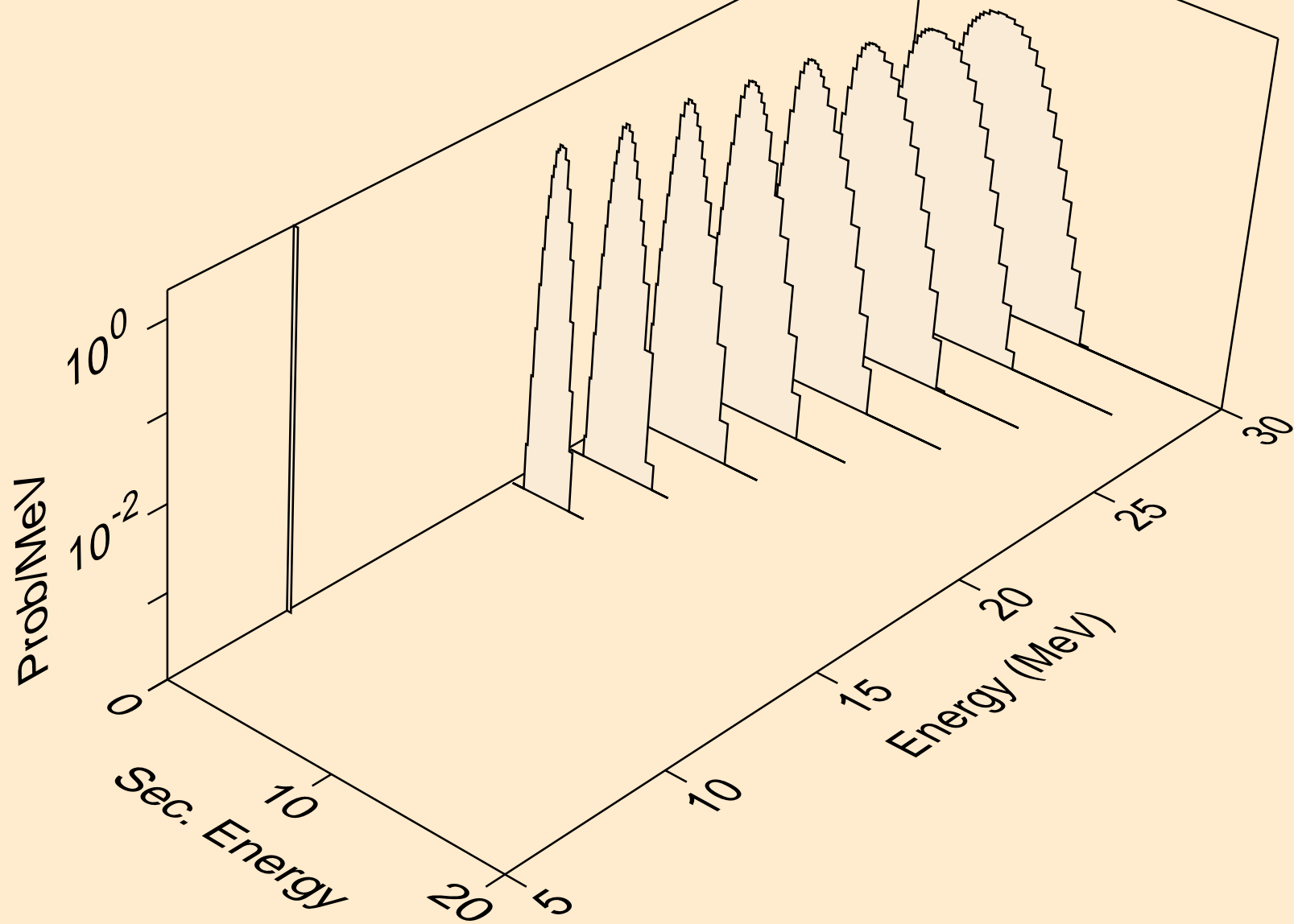

PD097 NEUTRON ACER TENDL-2024 LIBRARY; T=0.K
protons from (n,p)

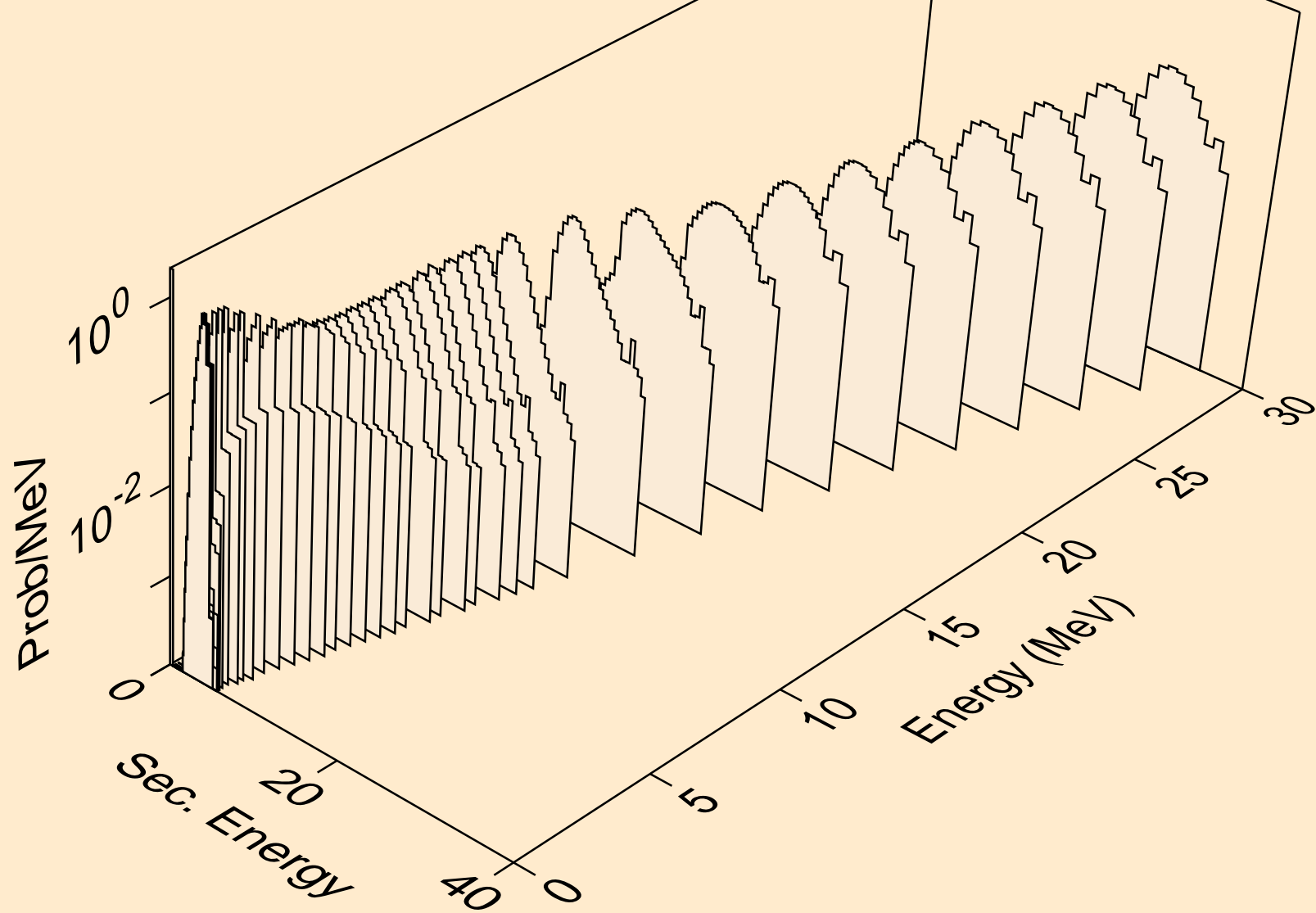

PD097 NEUTRON ACER TENDL-2024 LIBRARY; T=0.K
protons from (n,2p)

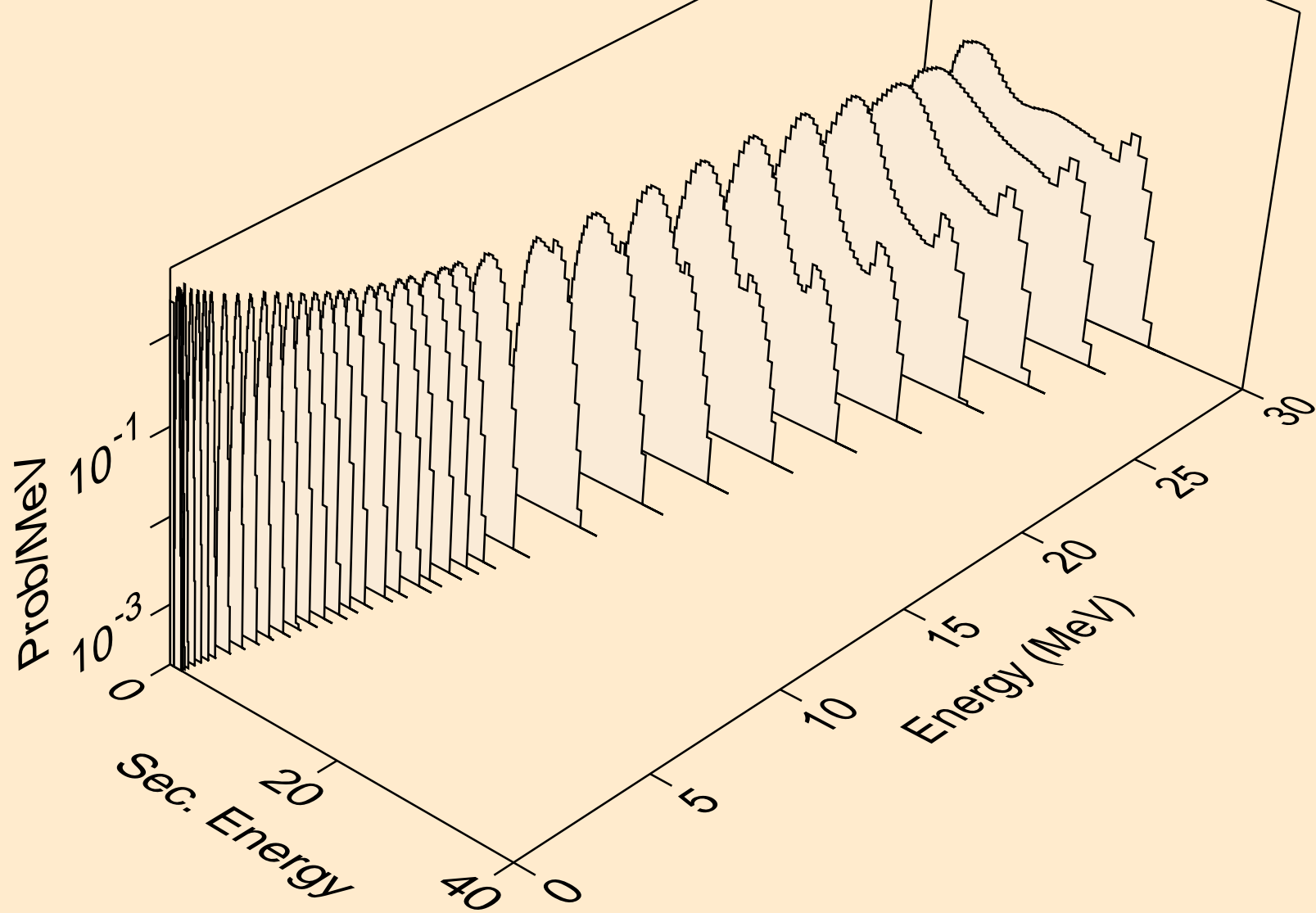

PD097 NEUTRON ACER TENDL-2024 LIBRARY; T=0.K
protons from (n,p)

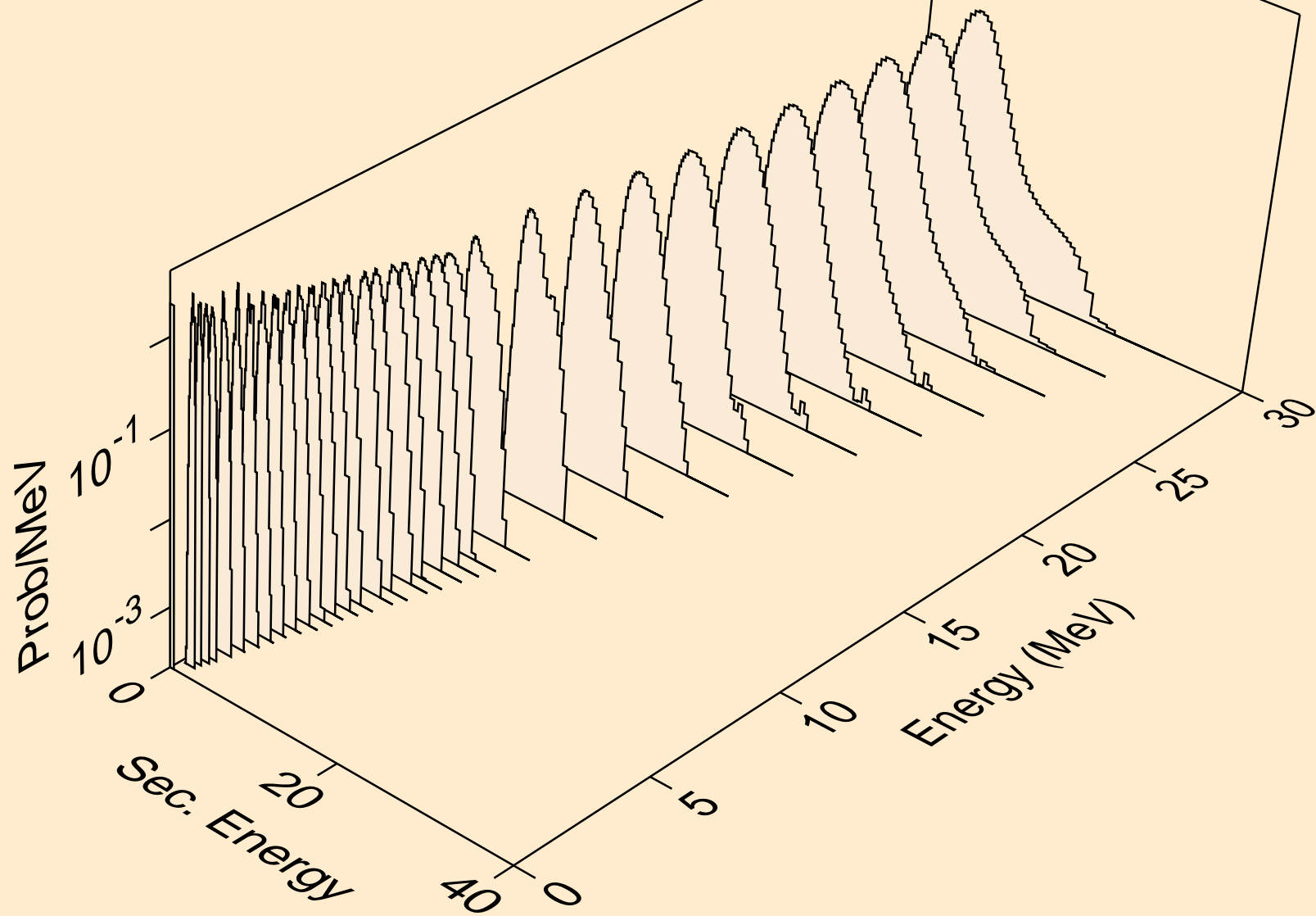

PD097 NEUTRON ACER TENDL-2024 LIBRARY; T=0.K
protons from (n,pd)

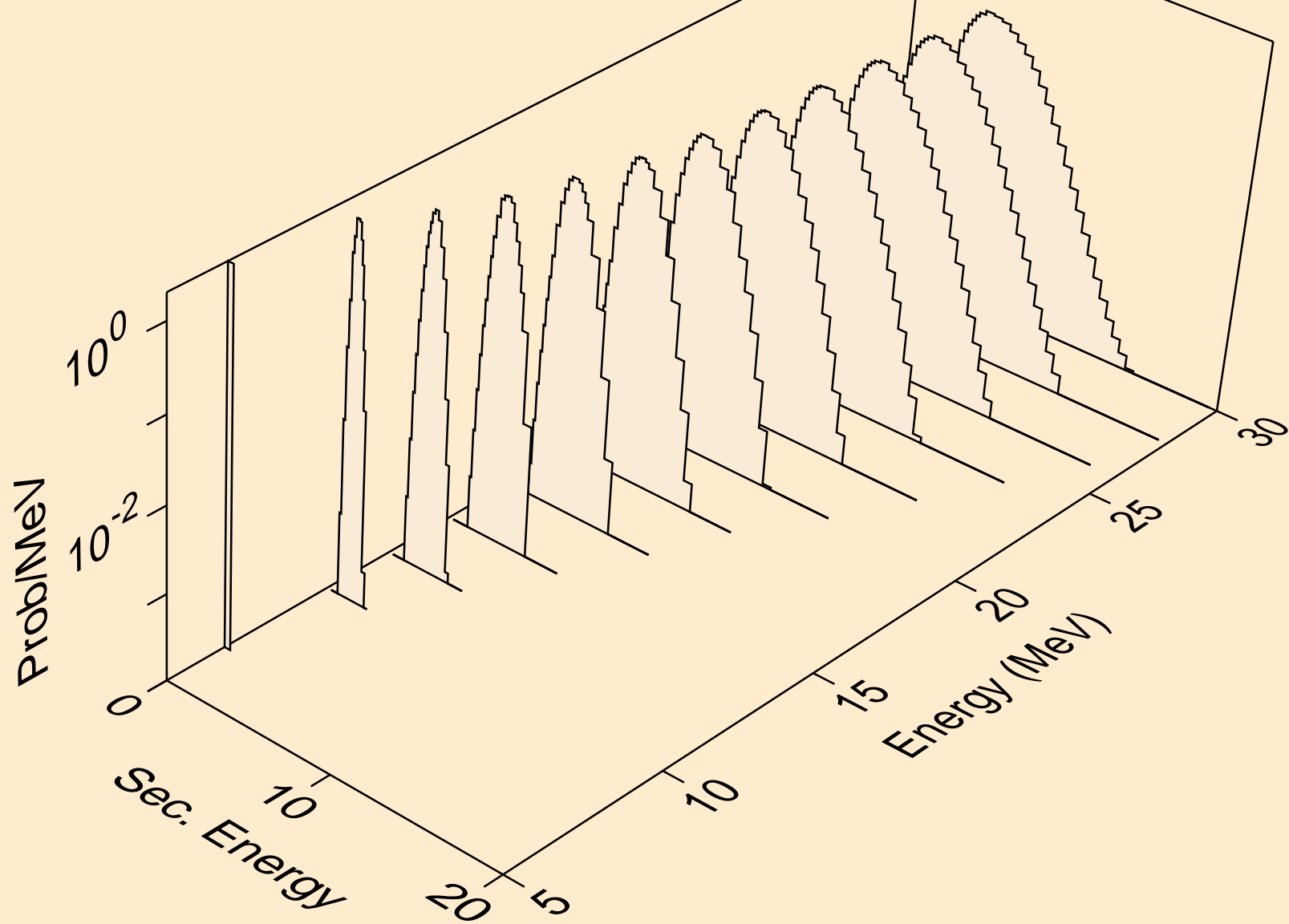

PD097 NEUTRON ACER TENDL-2024 LIBRARY; T=0.K
protons from (n,pt)

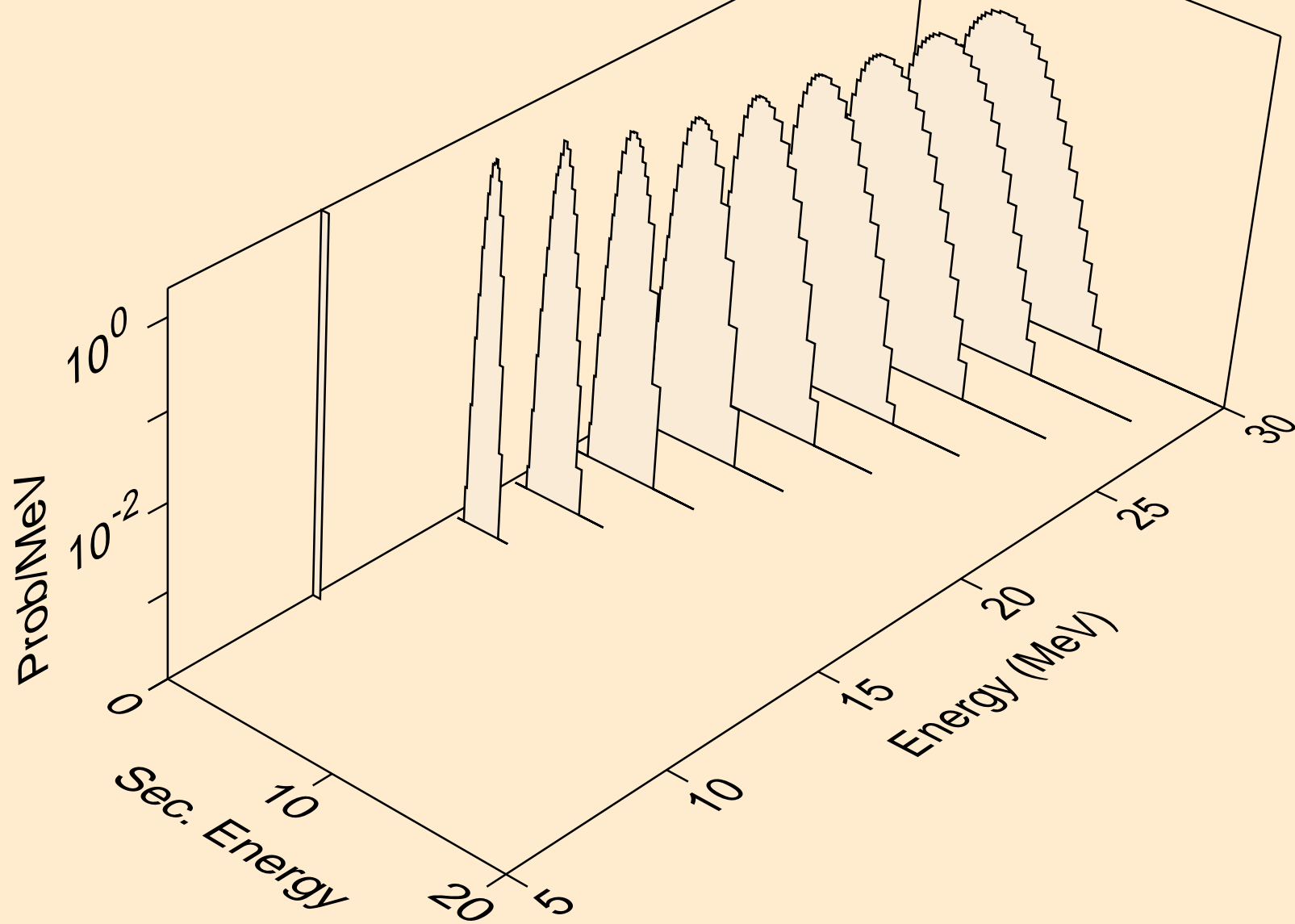

PD097 NEUTRON ACER TENDL-2024 LIBRARY; T=0.K
deuterons from (n,x)

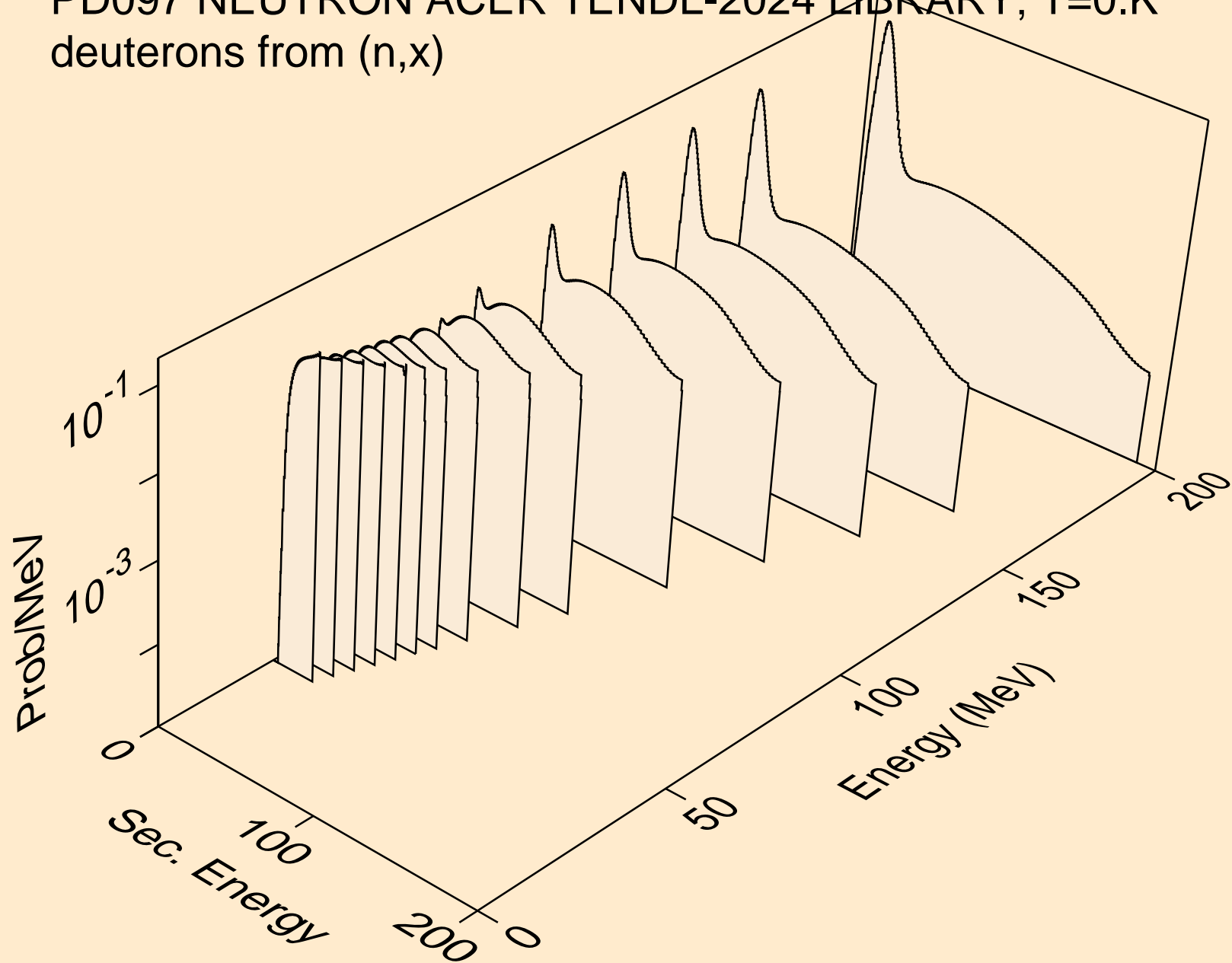

PD097 NEUTRON ACER TENDL-2024 LIBRARY; T=0.K
deuterons from (n,n*)d

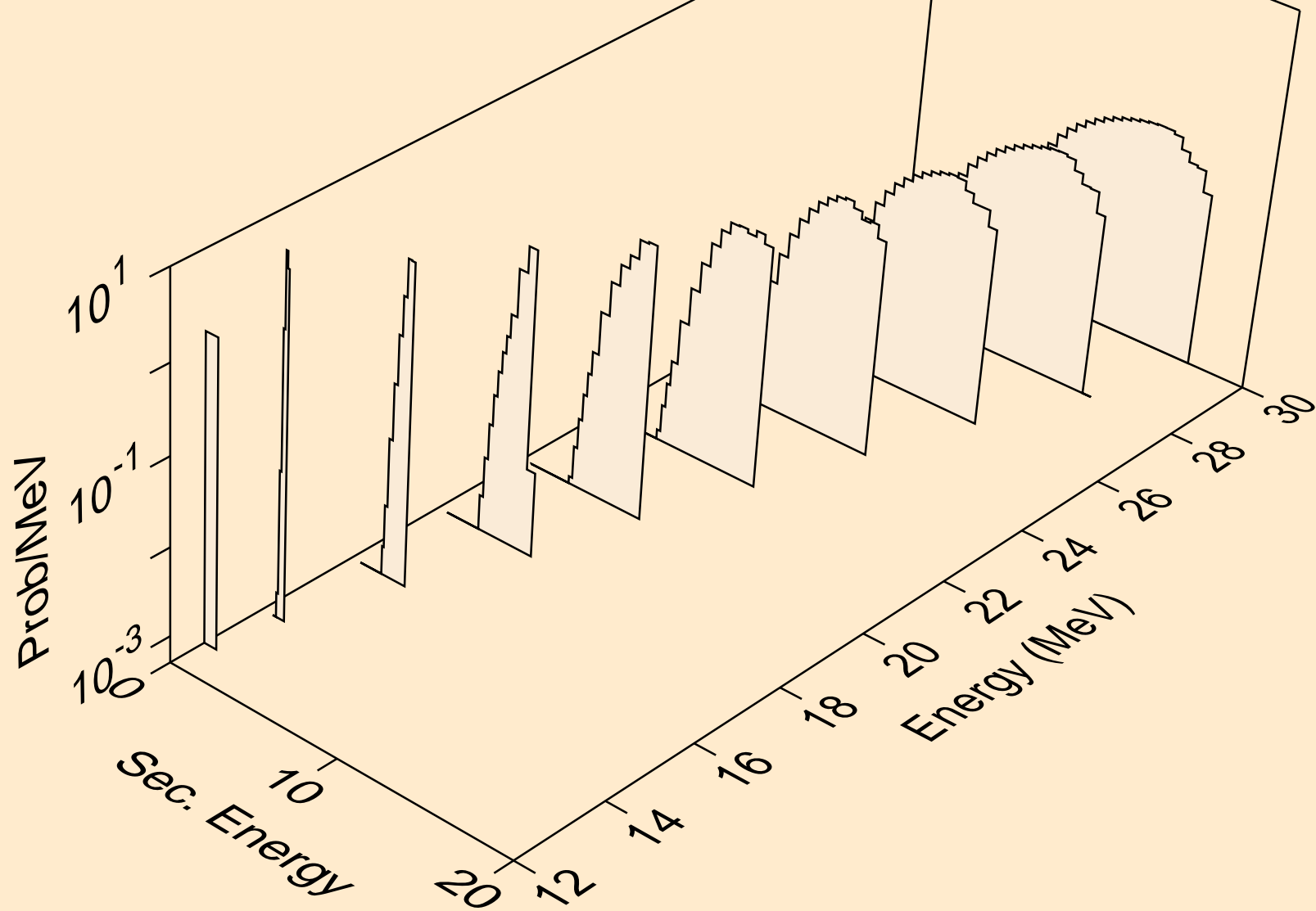

PD097 NEUTRON ACER TENDL-2024 LIBRARY; T=0.K
deuterons from (n,d)

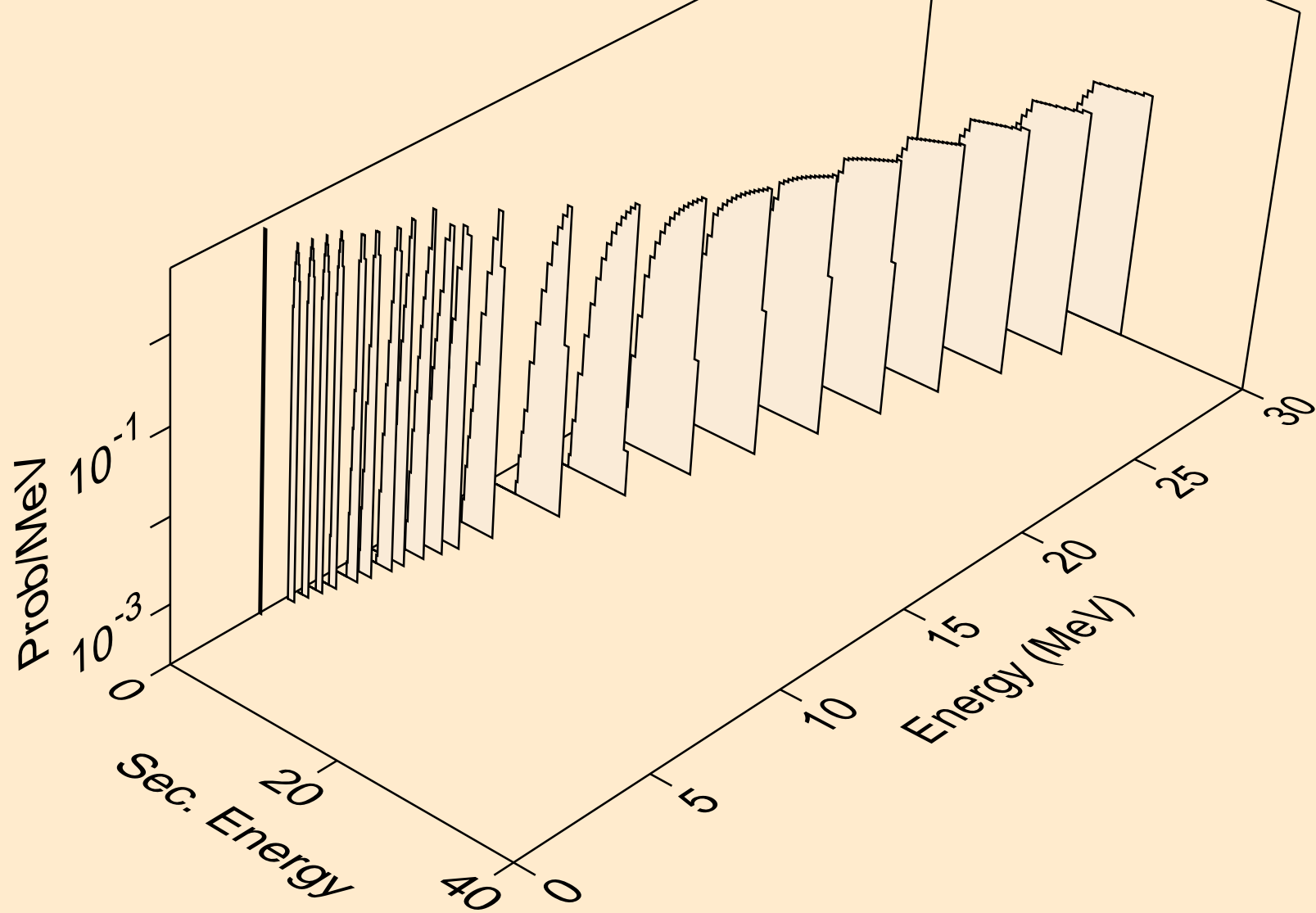

PD097 NEUTRON ACER TENDL-2024 LIBRARY; T=0.K
deuterons from (n,pd)

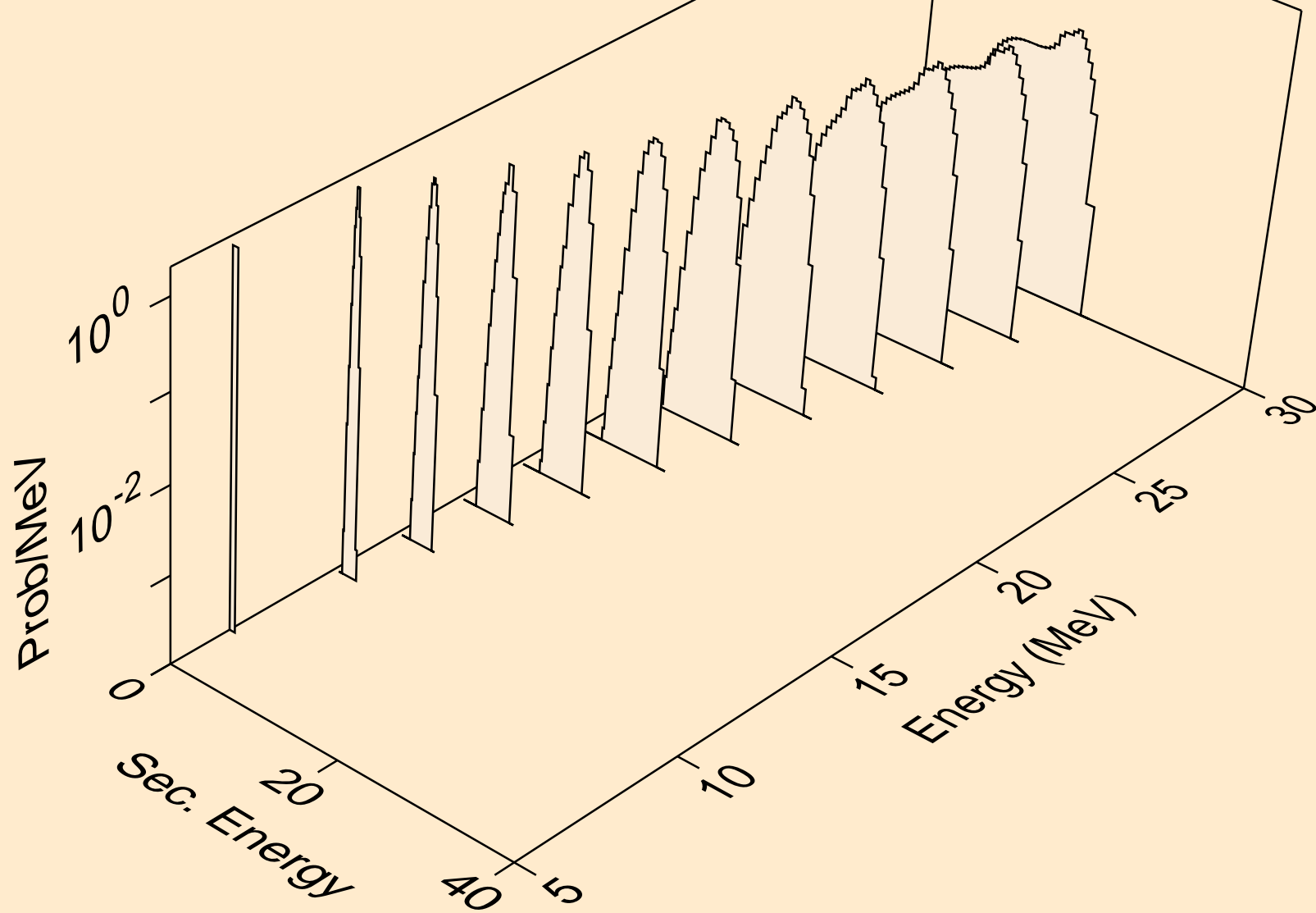

PD097 NEUTRON ACER TENDL-2024 LIBRARY; T=0.K
deuterons from (n,da)

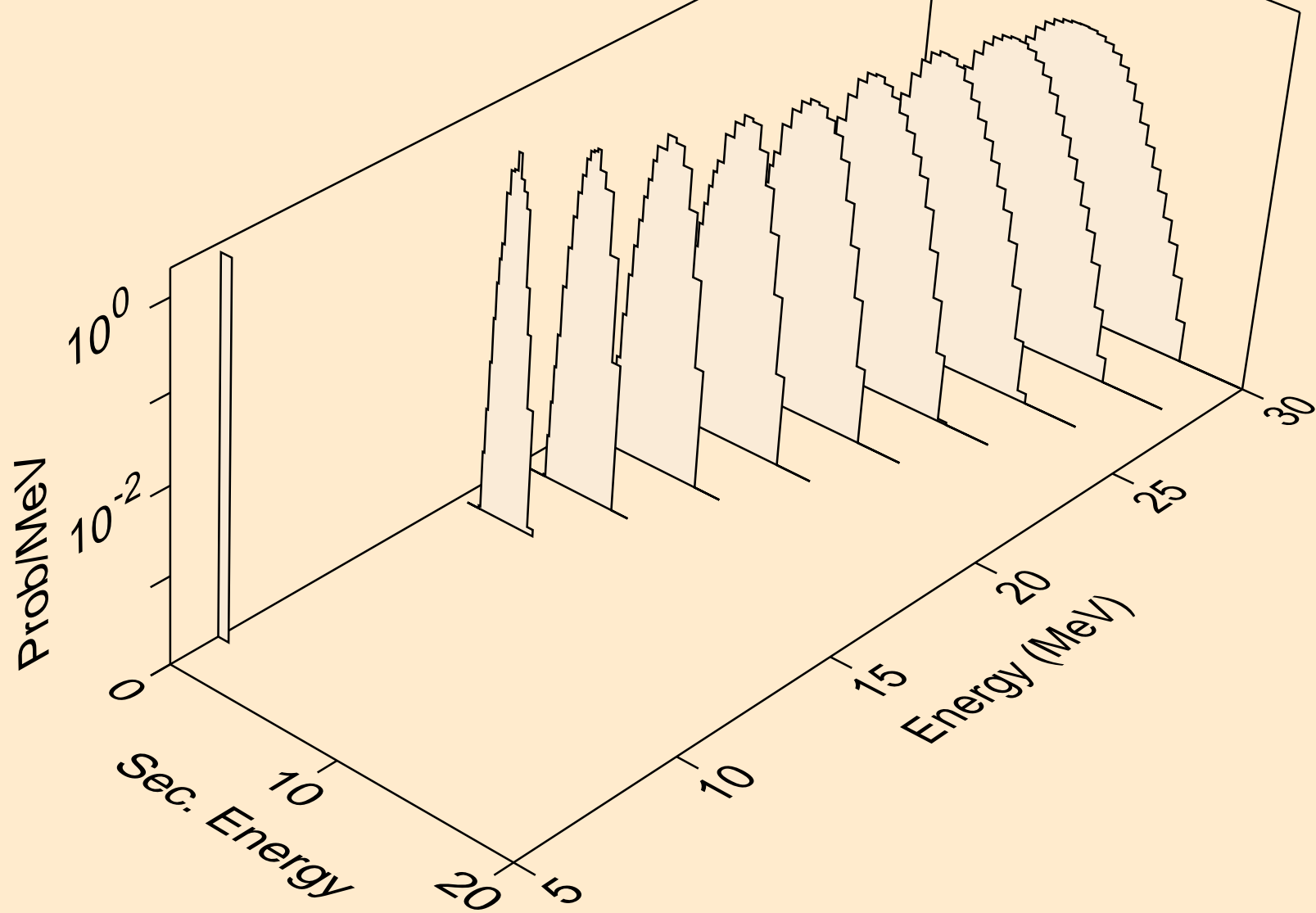

PD097 NEUTRON ACER TENDL-2024 LIBRARY; T=0.K
tritons from (n,x)

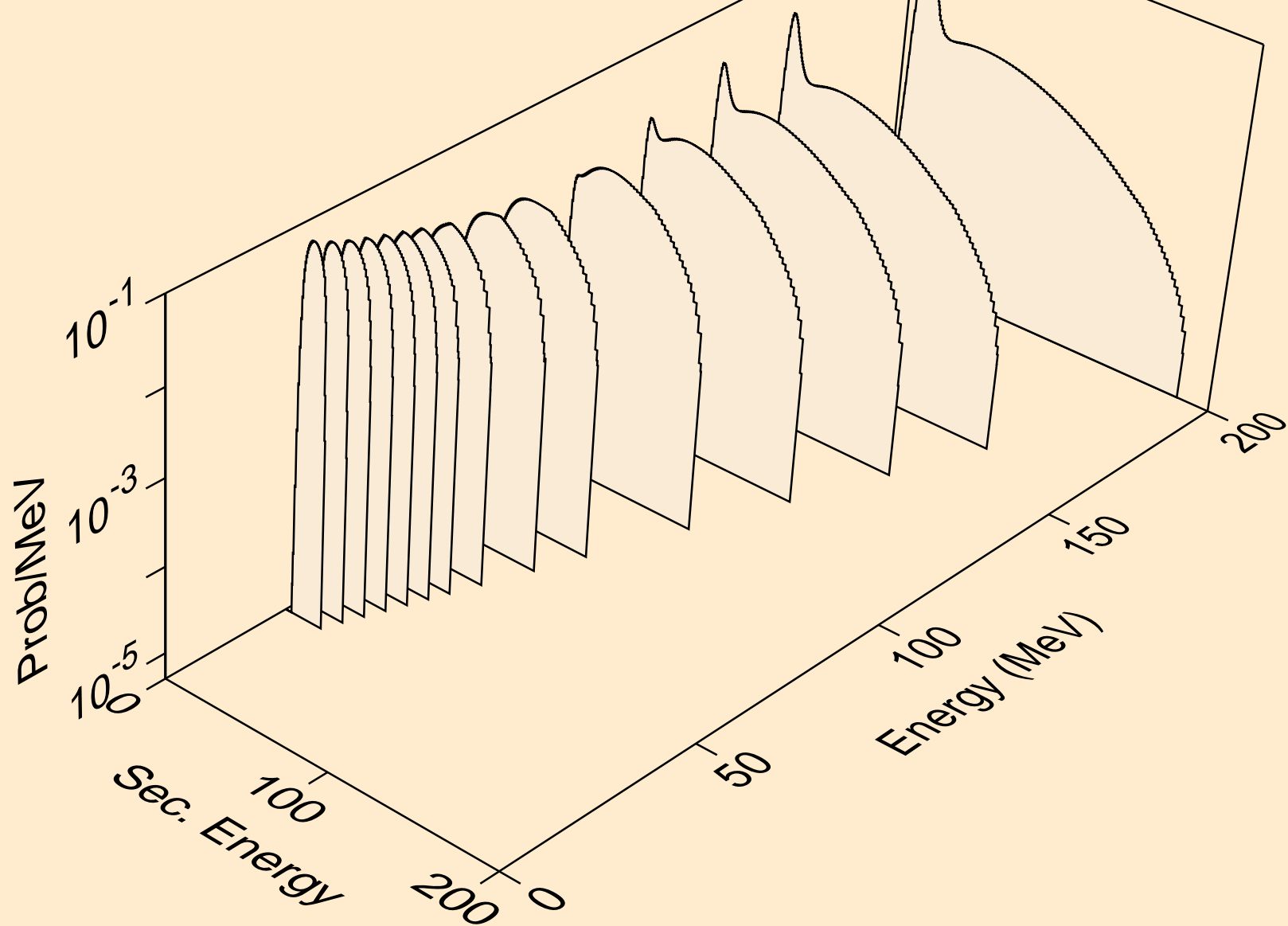

PD097 NEUTRON ACER TENDL-2024 LIBRARY; T=0.K
tritons from (n,n*)t

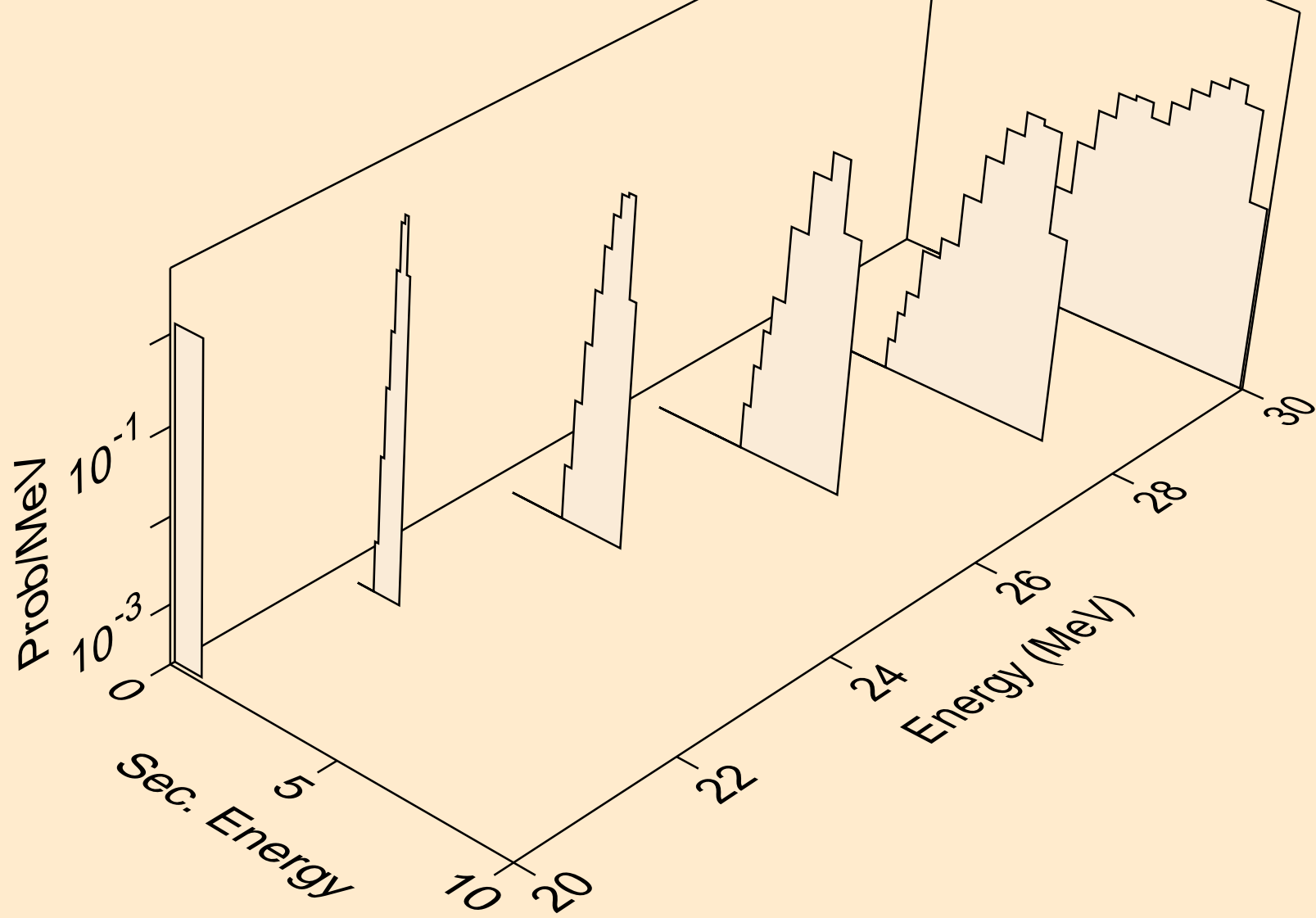

PD097 NEUTRON ACER TENDL-2024 LIBRARY; T=0.K
tritons from (n,t)

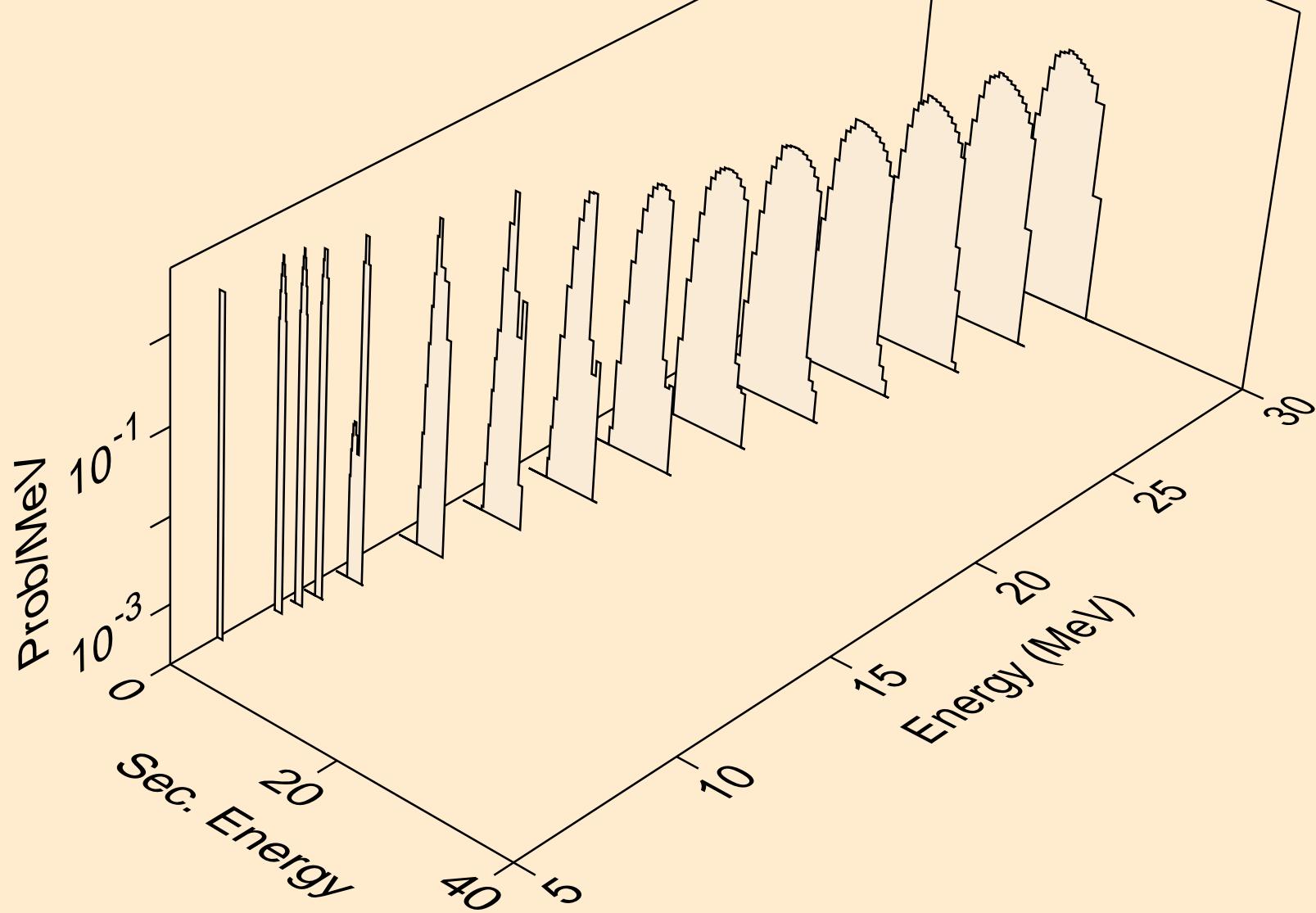

PD097 NEUTRON ACER TENDL-2024 LIBRARY; T=0.K
tritons from (n,pt)

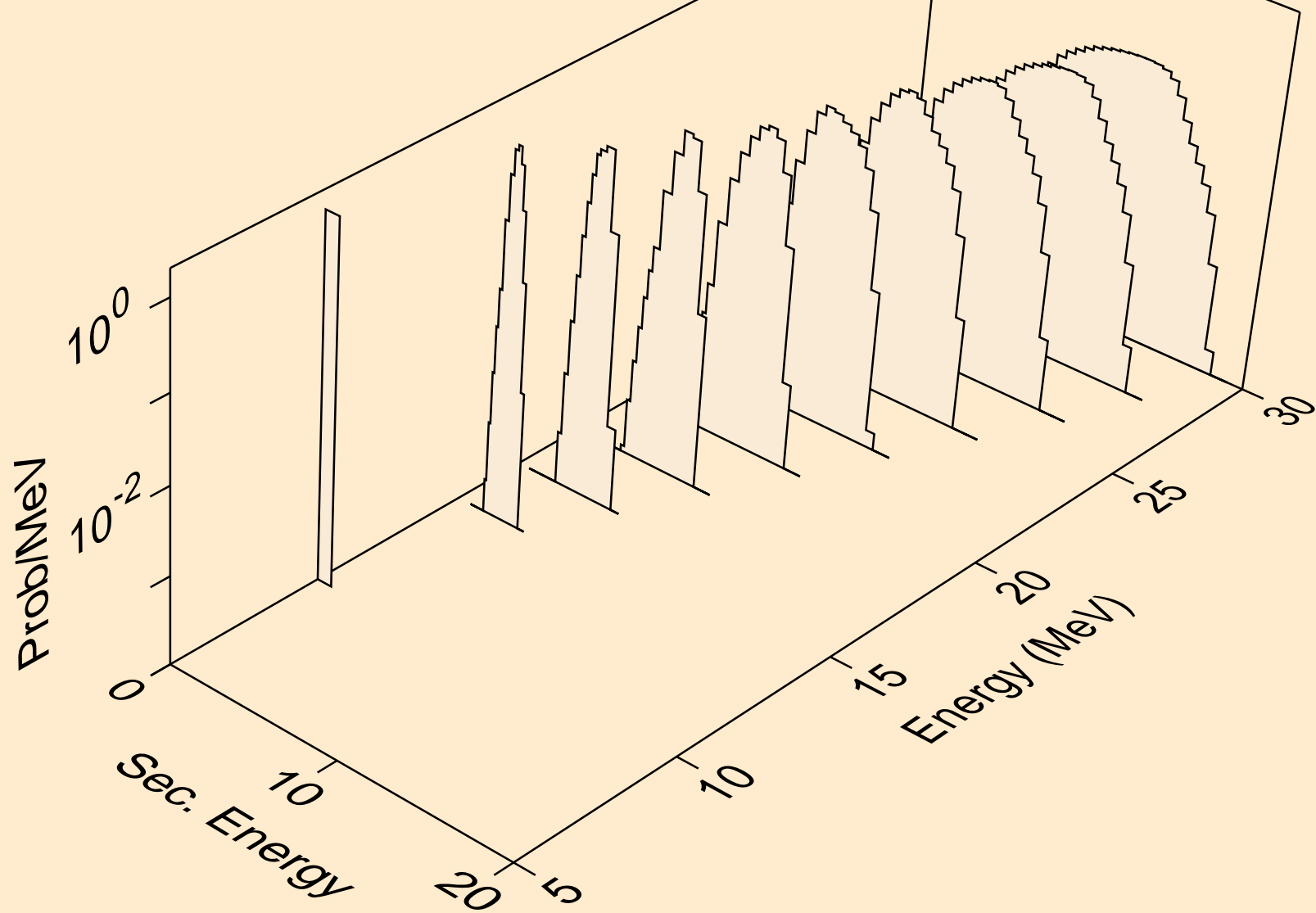

PD097 NEUTRON ACER TENDL-2024 LIBRARY; T=0.K
he3s from (n,x)

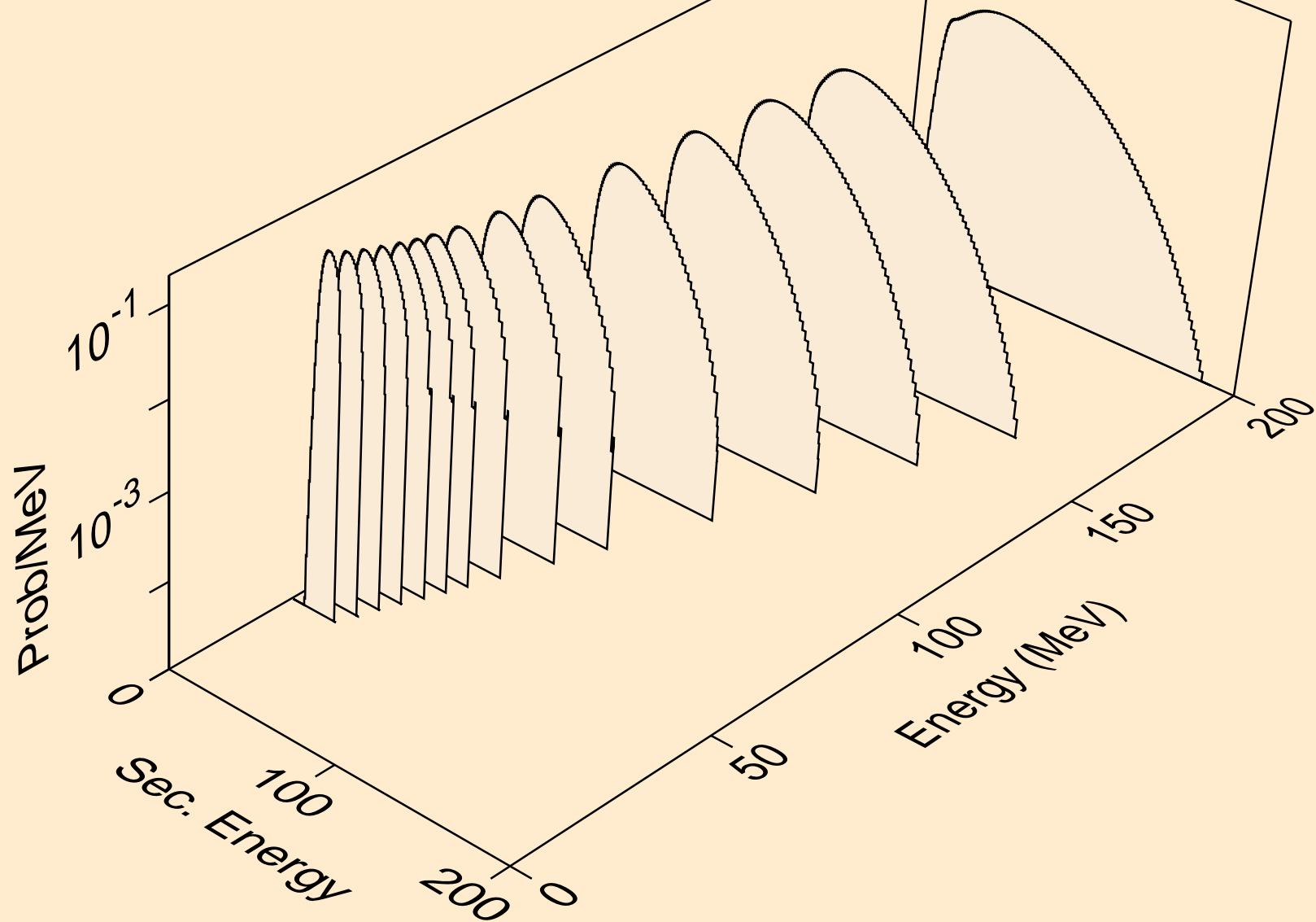

PD097 NEUTRON ACER TENDL-2024 LIBRARY; T=0.K
he3s from (n,n*)he3

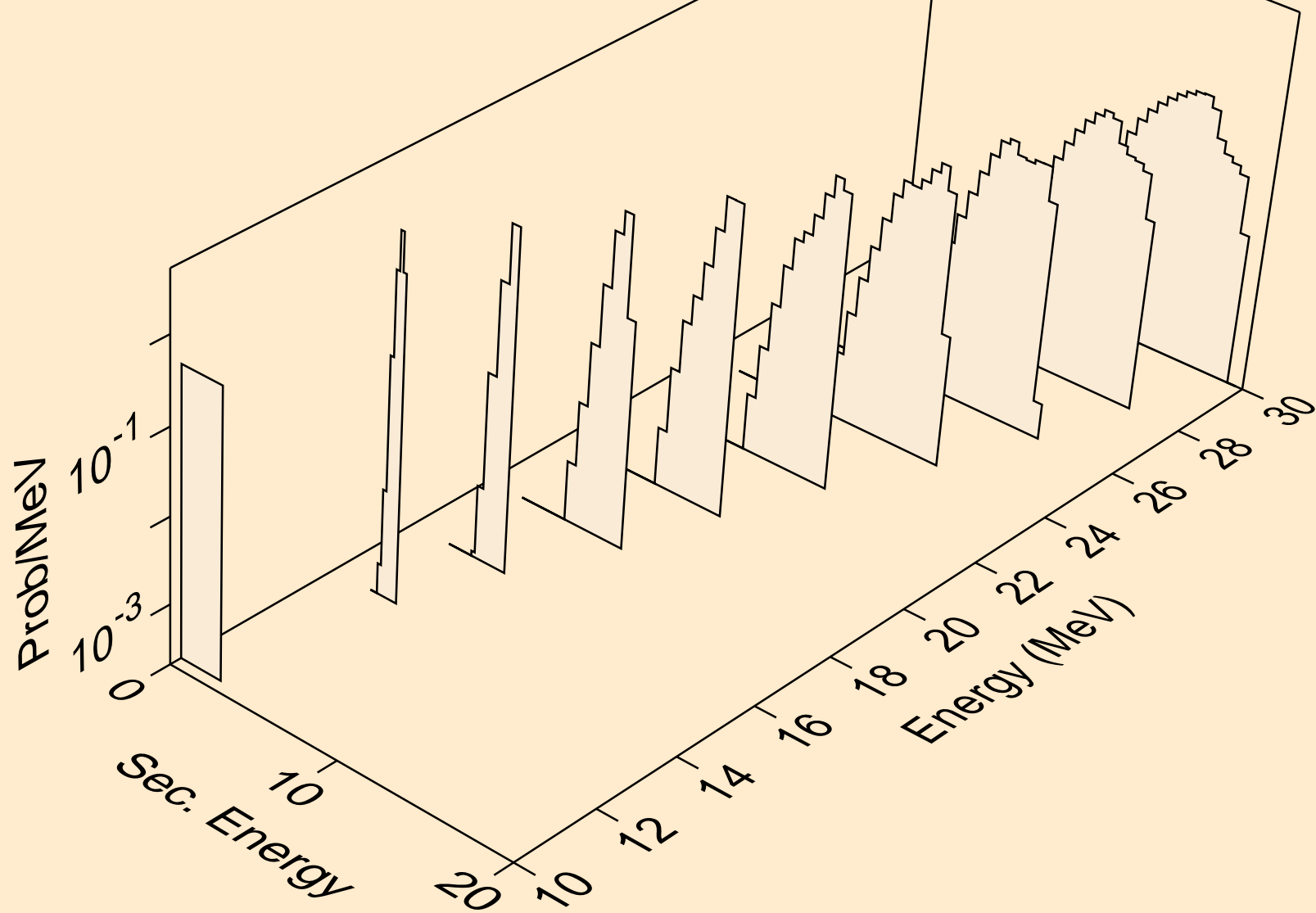

PD097 NEUTRON ACER TENDL-2024 LIBRARY; T=0.K
he3s from (n,he3)

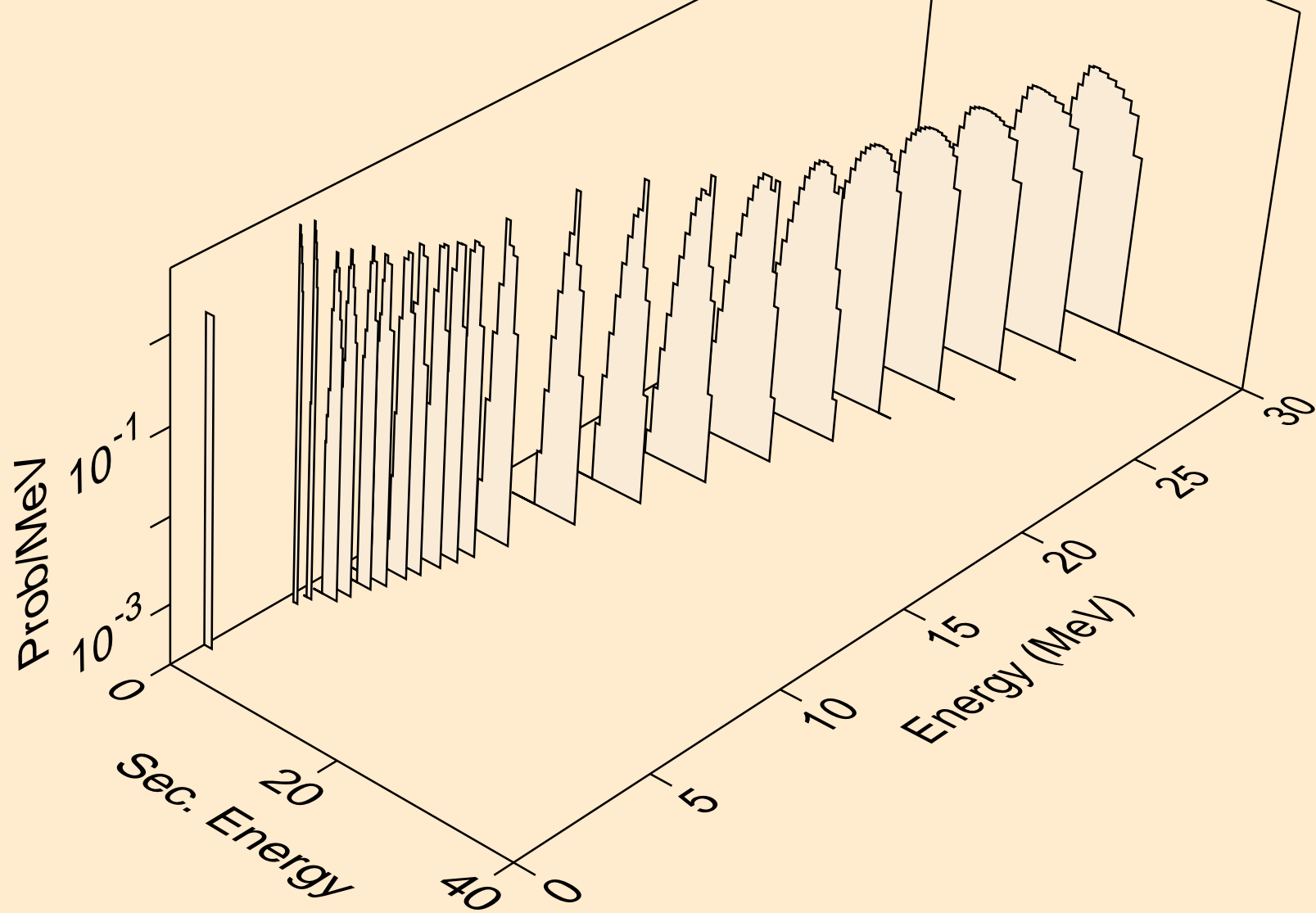

PD097 NEUTRON ACER TENDL-2024 LIBRARY; T=0.K
alphas from (n,x)

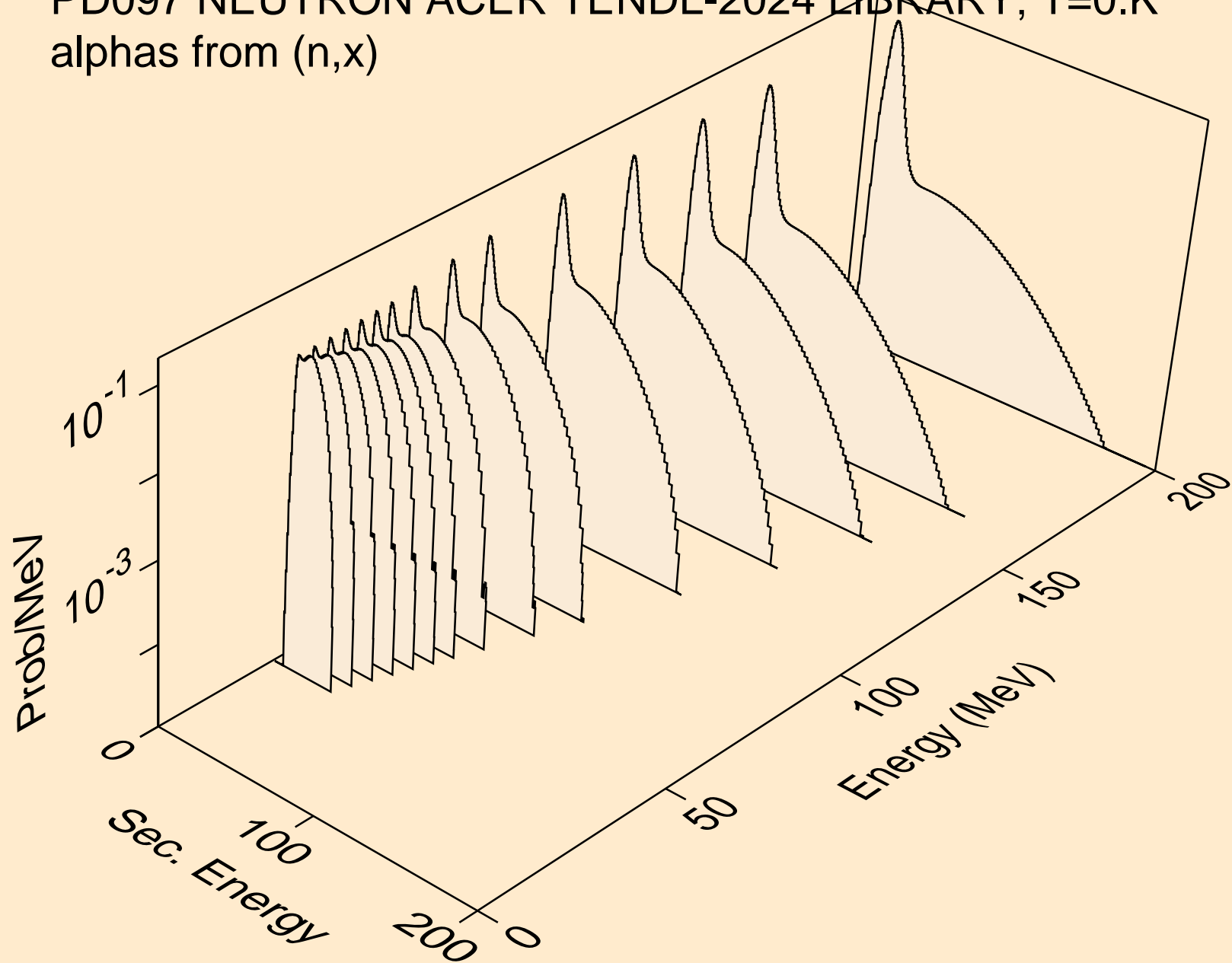

PD097 NEUTRON ACER TENDL-2024 LIBRARY; T=0.K
alphas from (n,n*)a

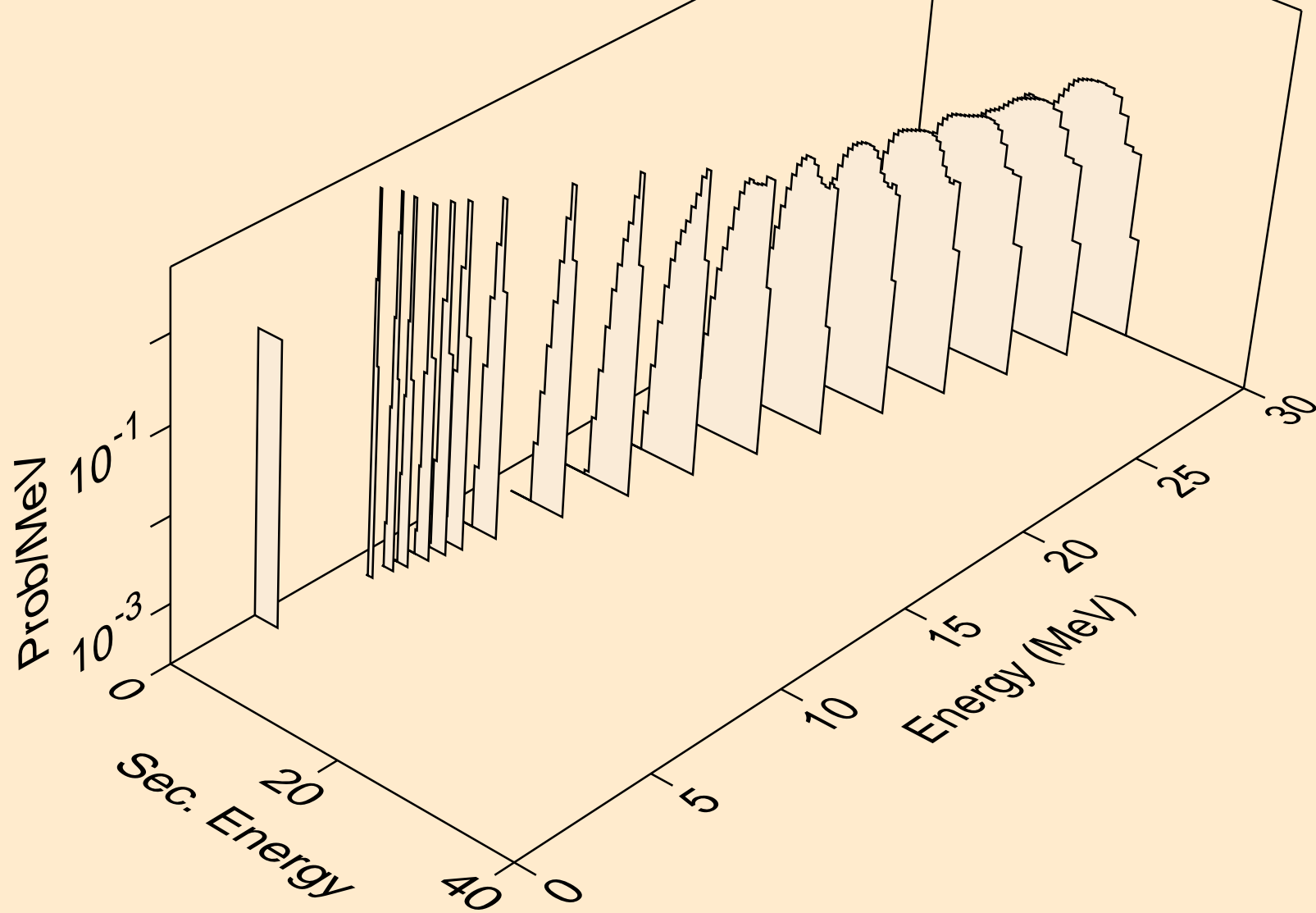

PD097 NEUTRON ACER TENDL-2024 LIBRARY; T=0.K
alphas from (n,2n)a

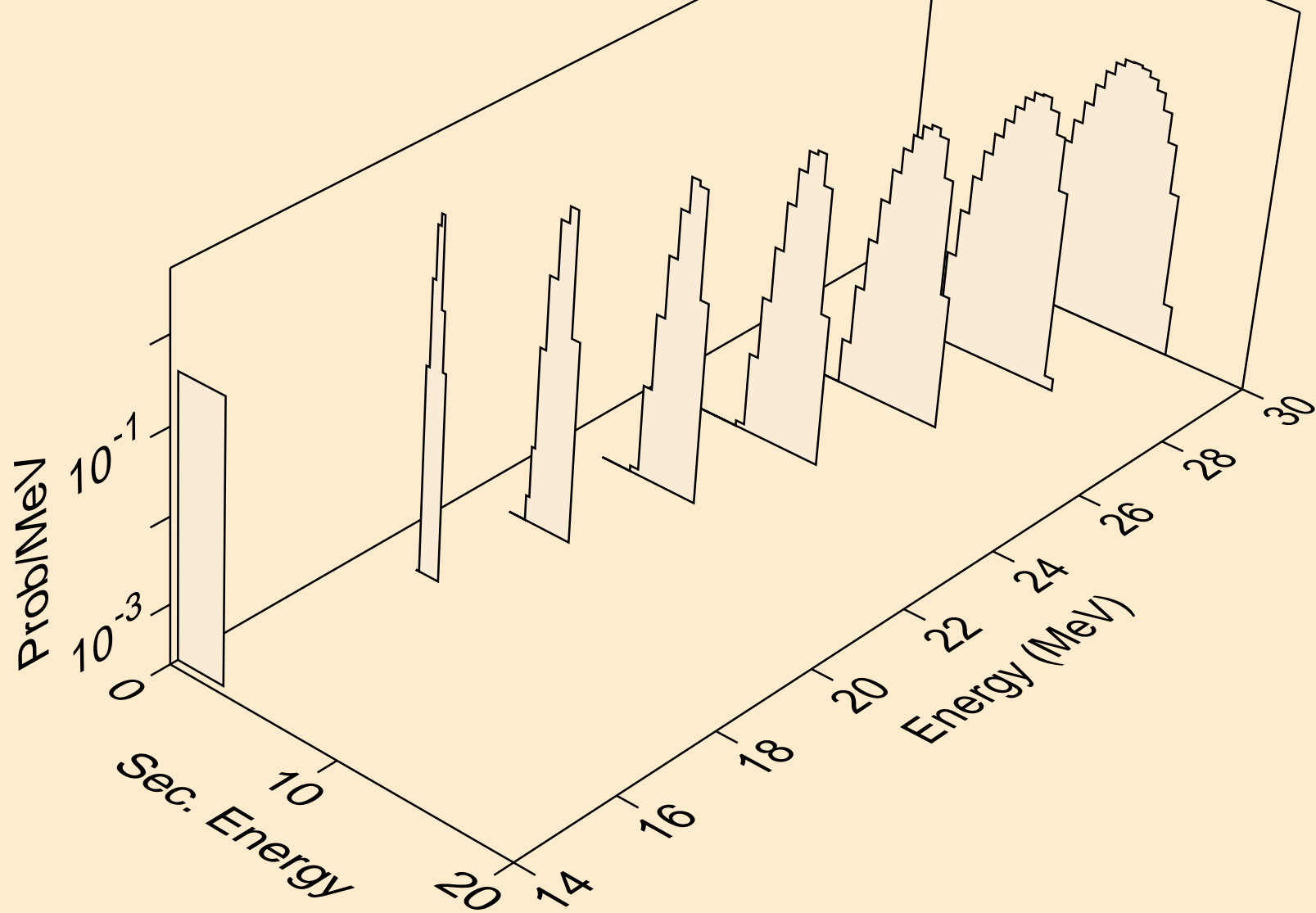

PD097 NEUTRON ACER TENDL-2024 LIBRARY; T=0.K
alphas from (n,n*)2a

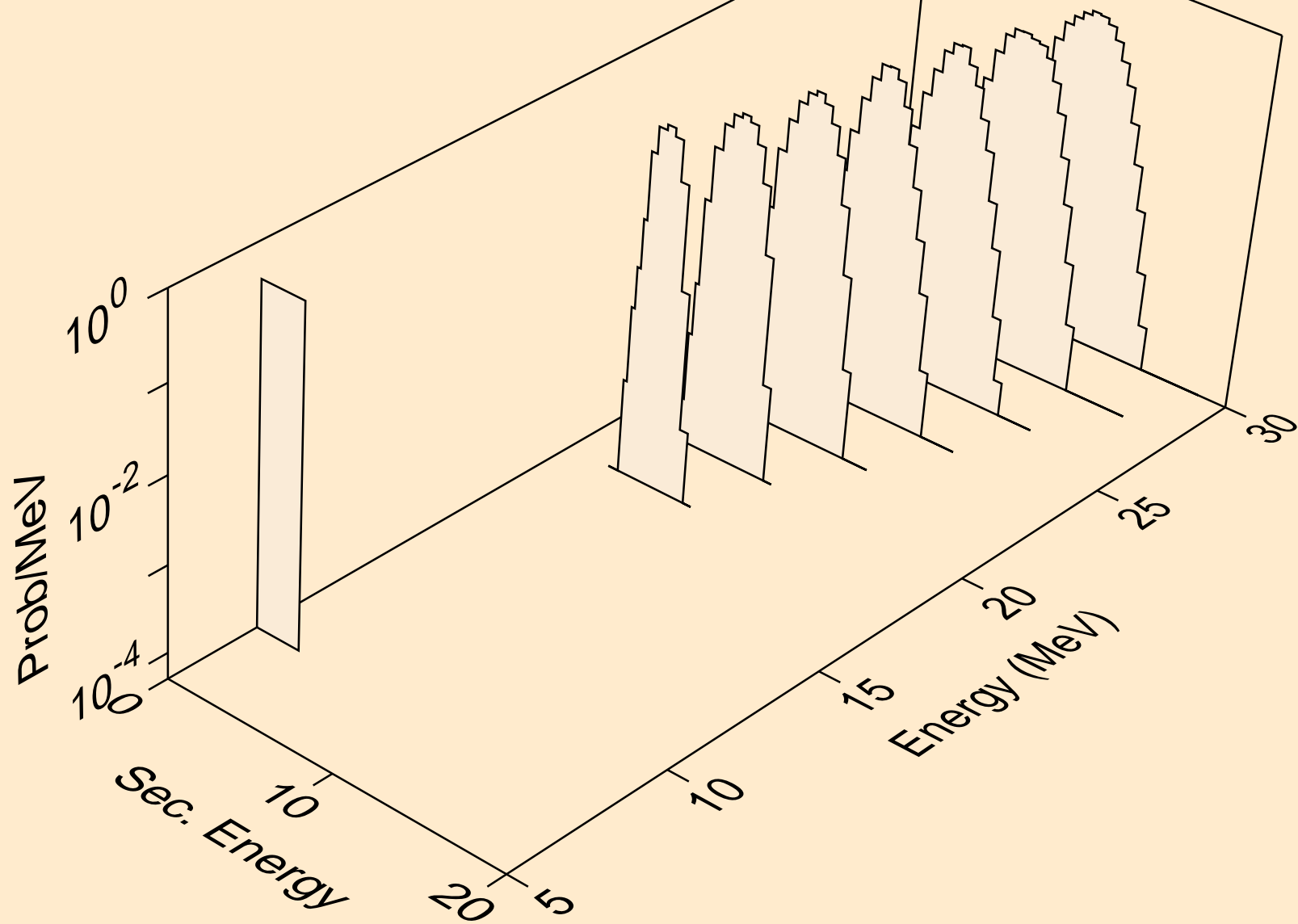

PD097 NEUTRON ACER TENDL-2024 LIBRARY; T=0.K
alphas from (n,npa)

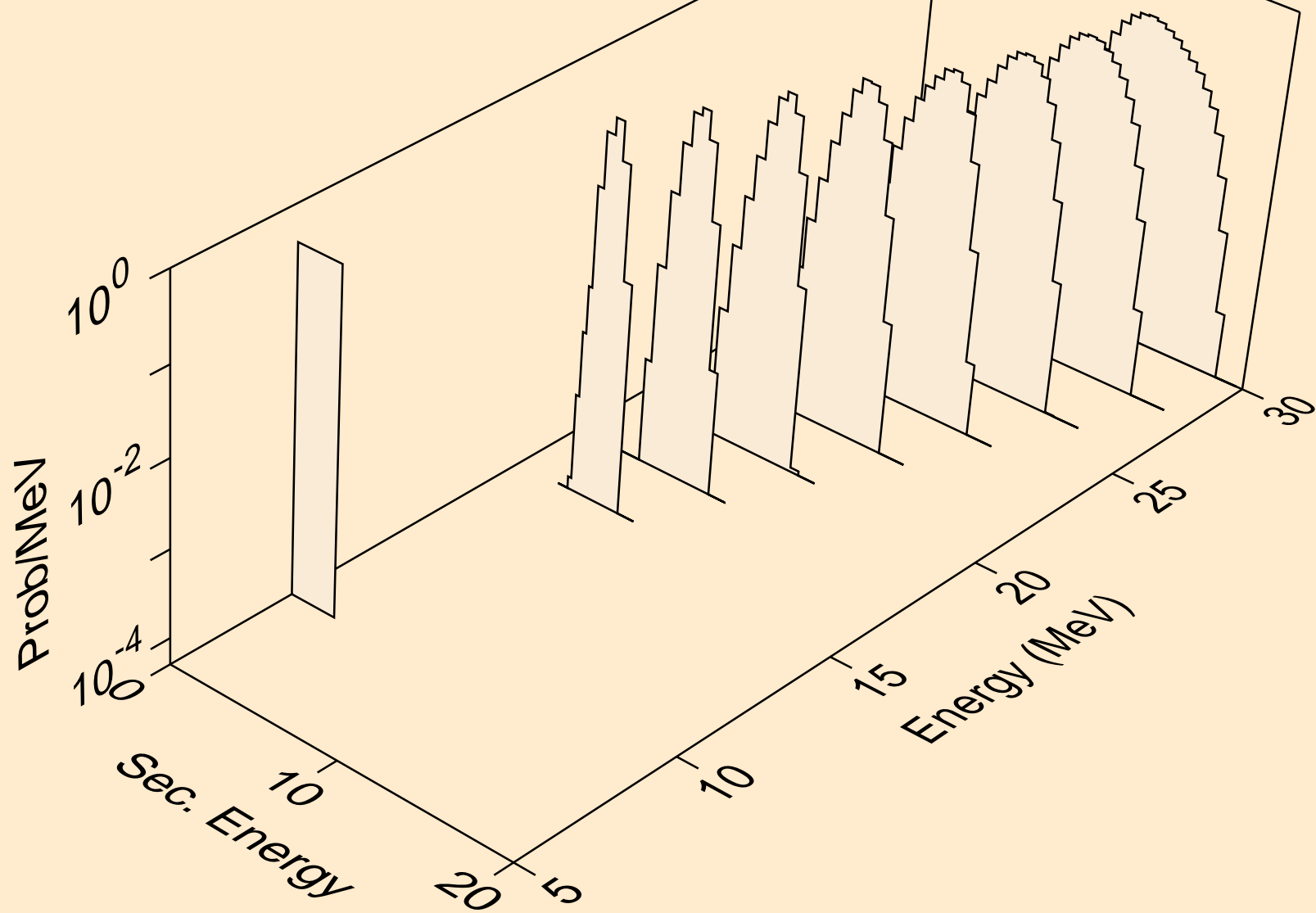

PD097 NEUTRON ACER TENDL-2024 LIBRARY; T=0.K
alphas from (n,a)

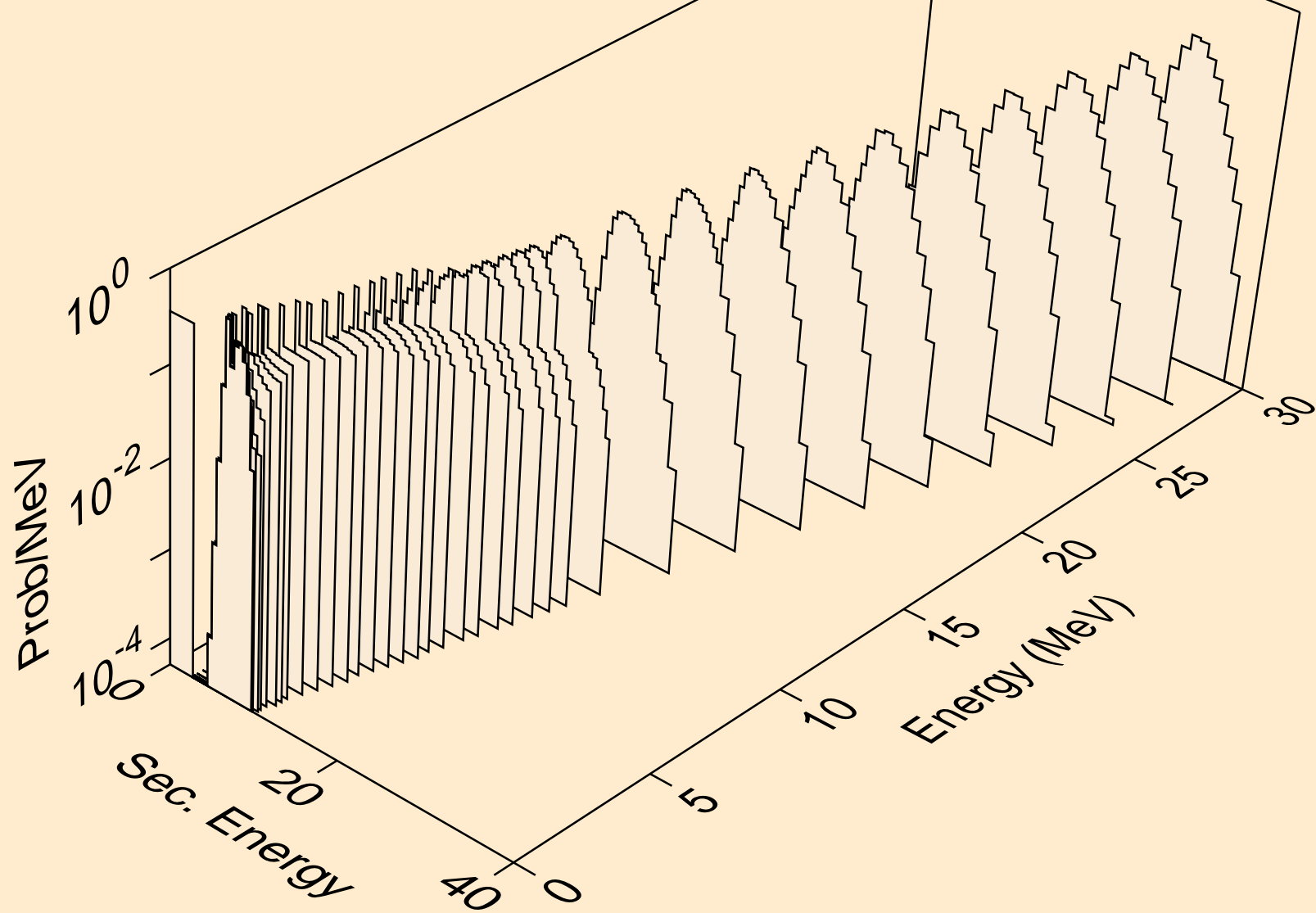

PD097 NEUTRON ACER TENDL-2024 LIBRARY; T=0.K
alphas from (n,2a)

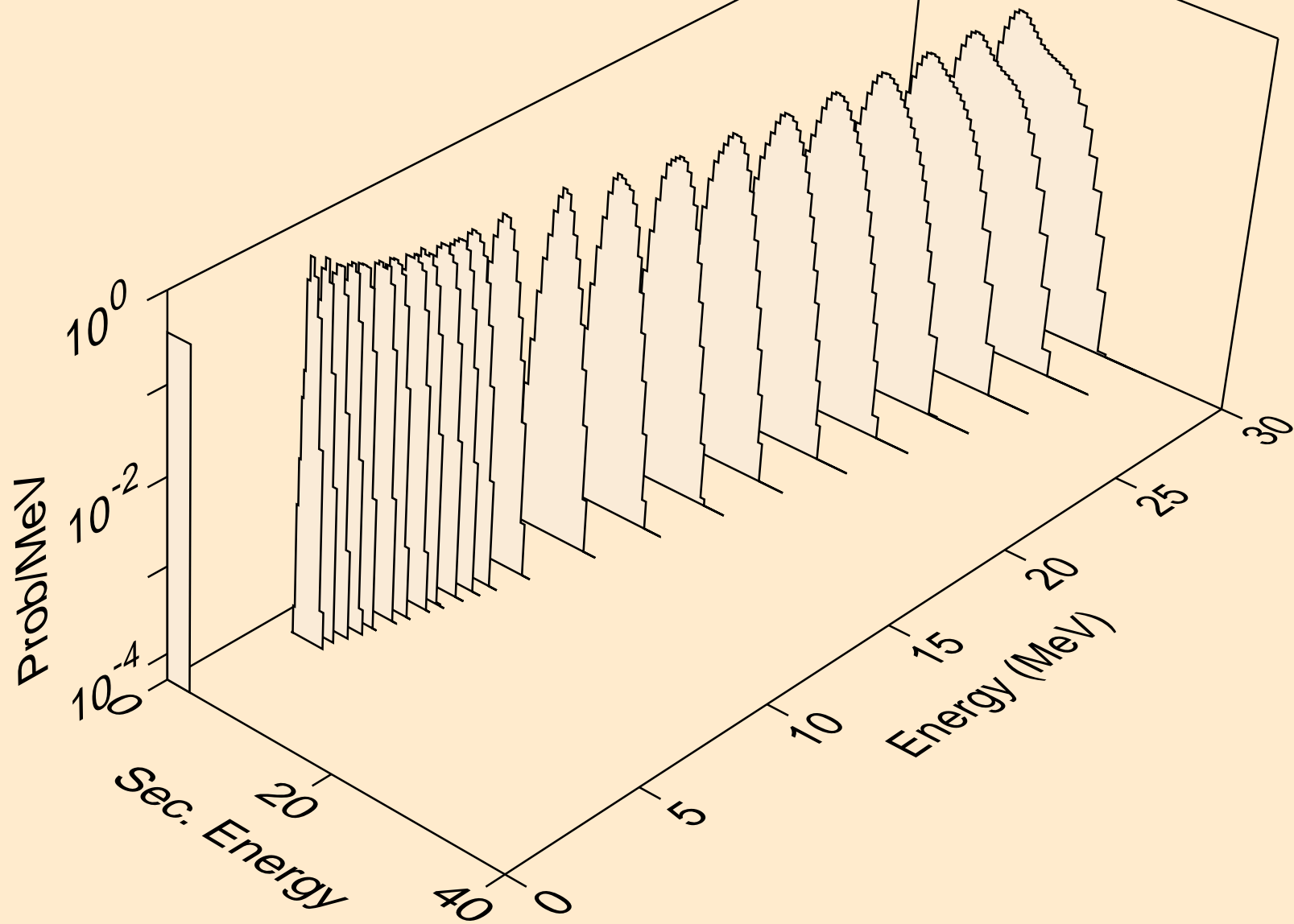

PD097 NEUTRON ACER TENDL-2024 LIBRARY; T=0.K
alphas from (n,pa)

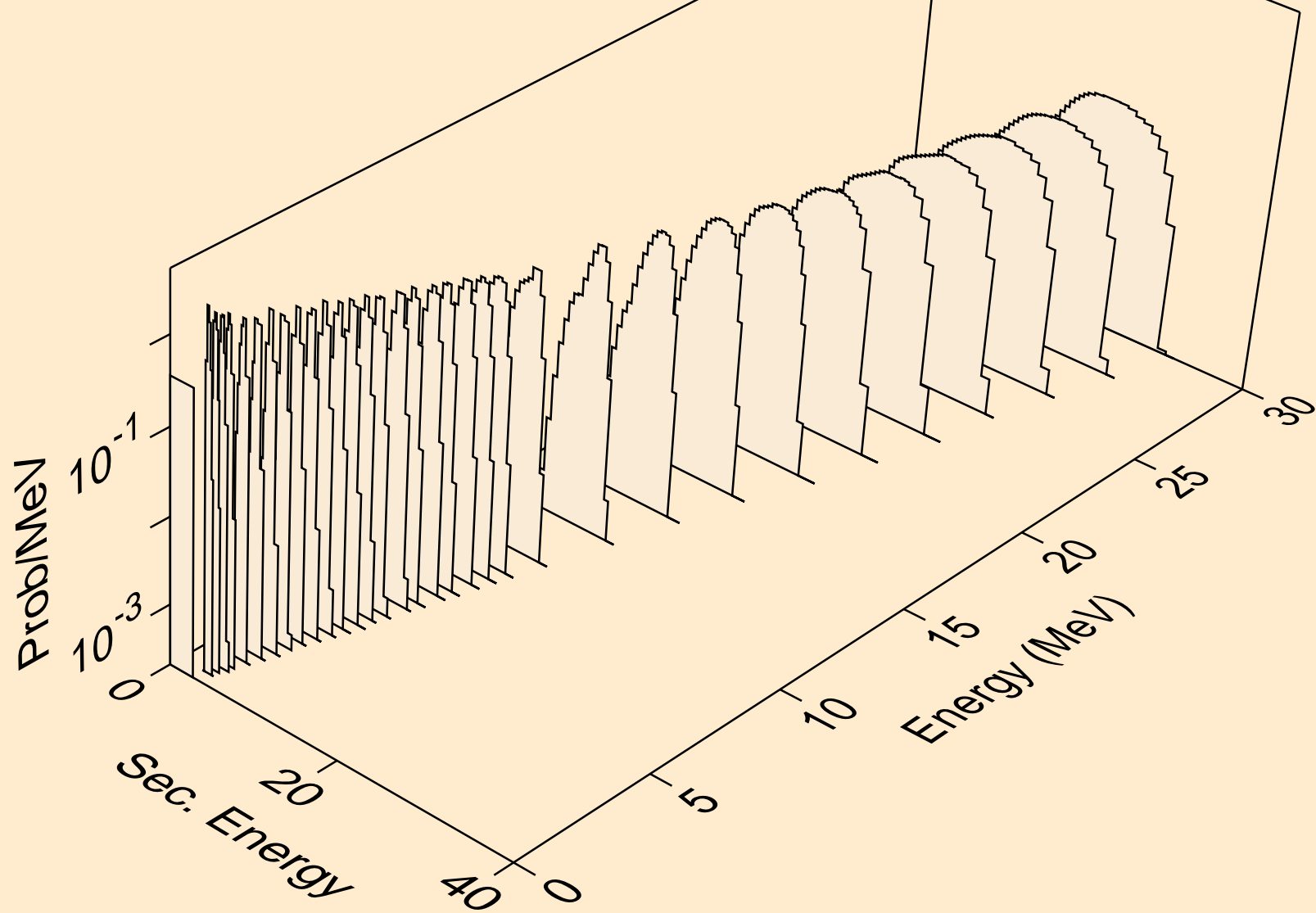

PD097 NEUTRON ACER TENDL-2024 LIBRARY; T=0.K
alphas from (n,da)

