

PT192 NEUTRON ACER TENDL-2024 LIBRARY; T=0.K
Principal cross sections

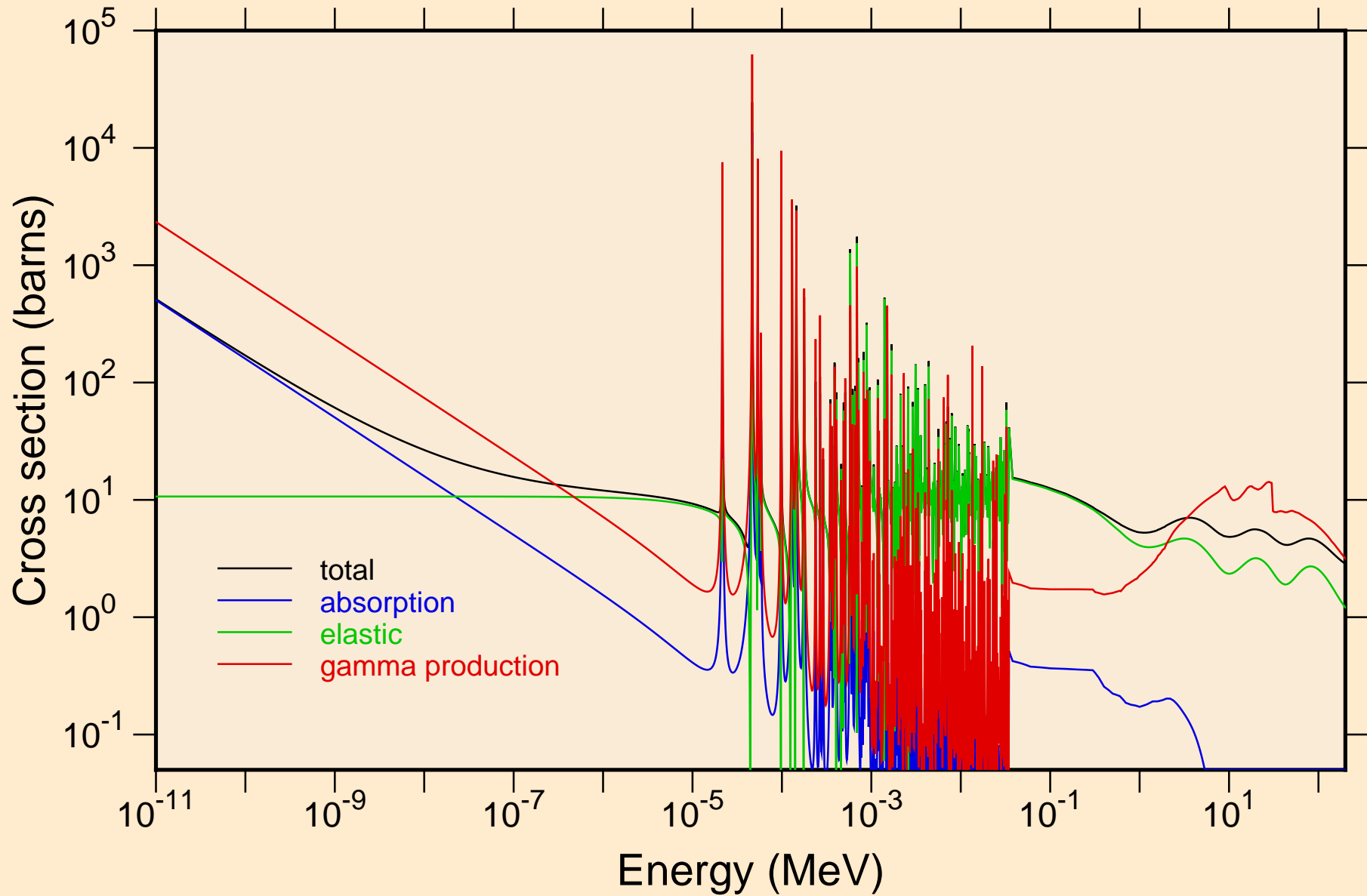

PT192 NEUTRON ACER TENDL-2024 LIBRARY; T=0.K
resonance total cross section

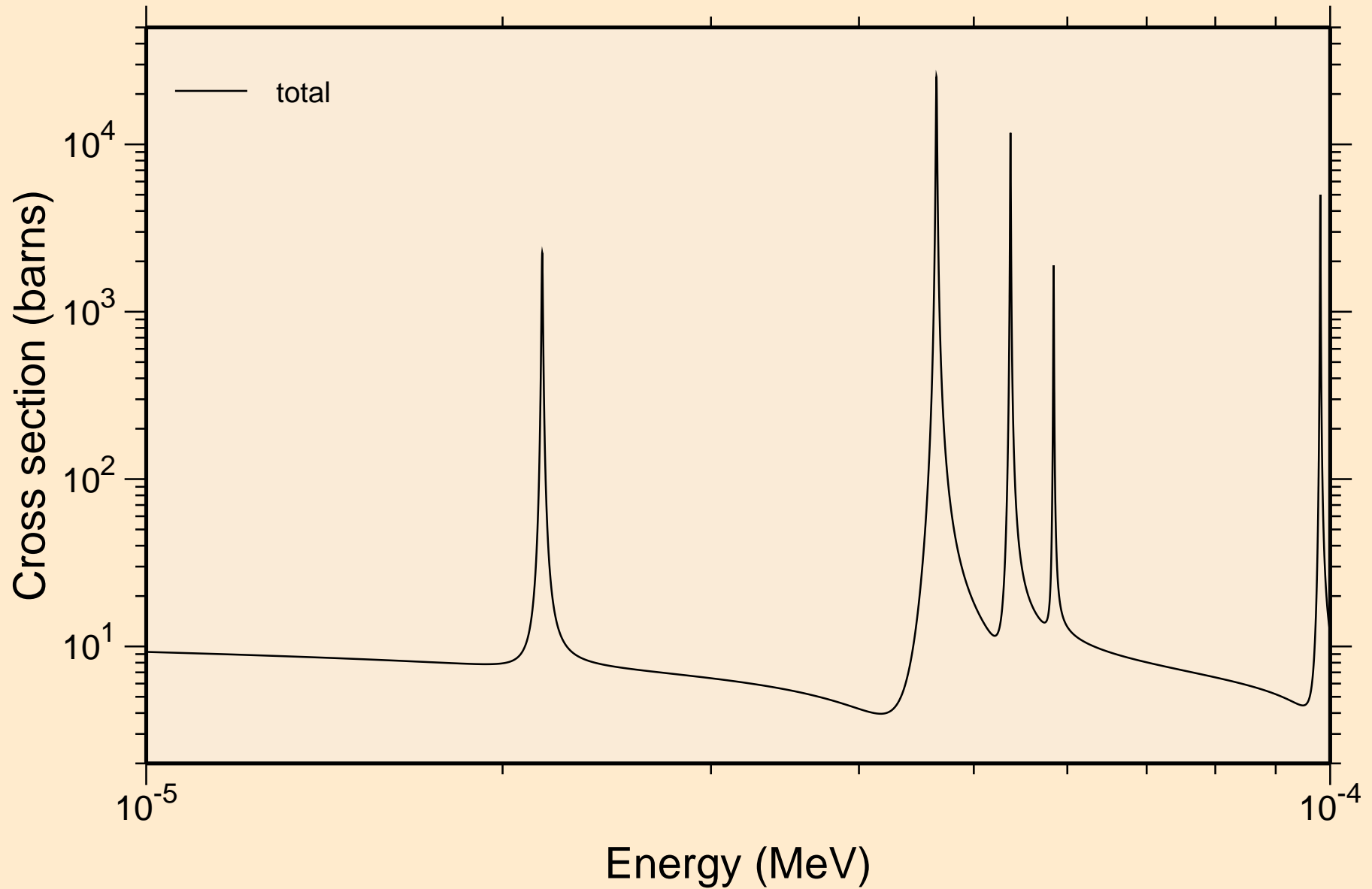

PT192 NEUTRON ACER TENDL-2024 LIBRARY; T=0.K
resonance total cross section

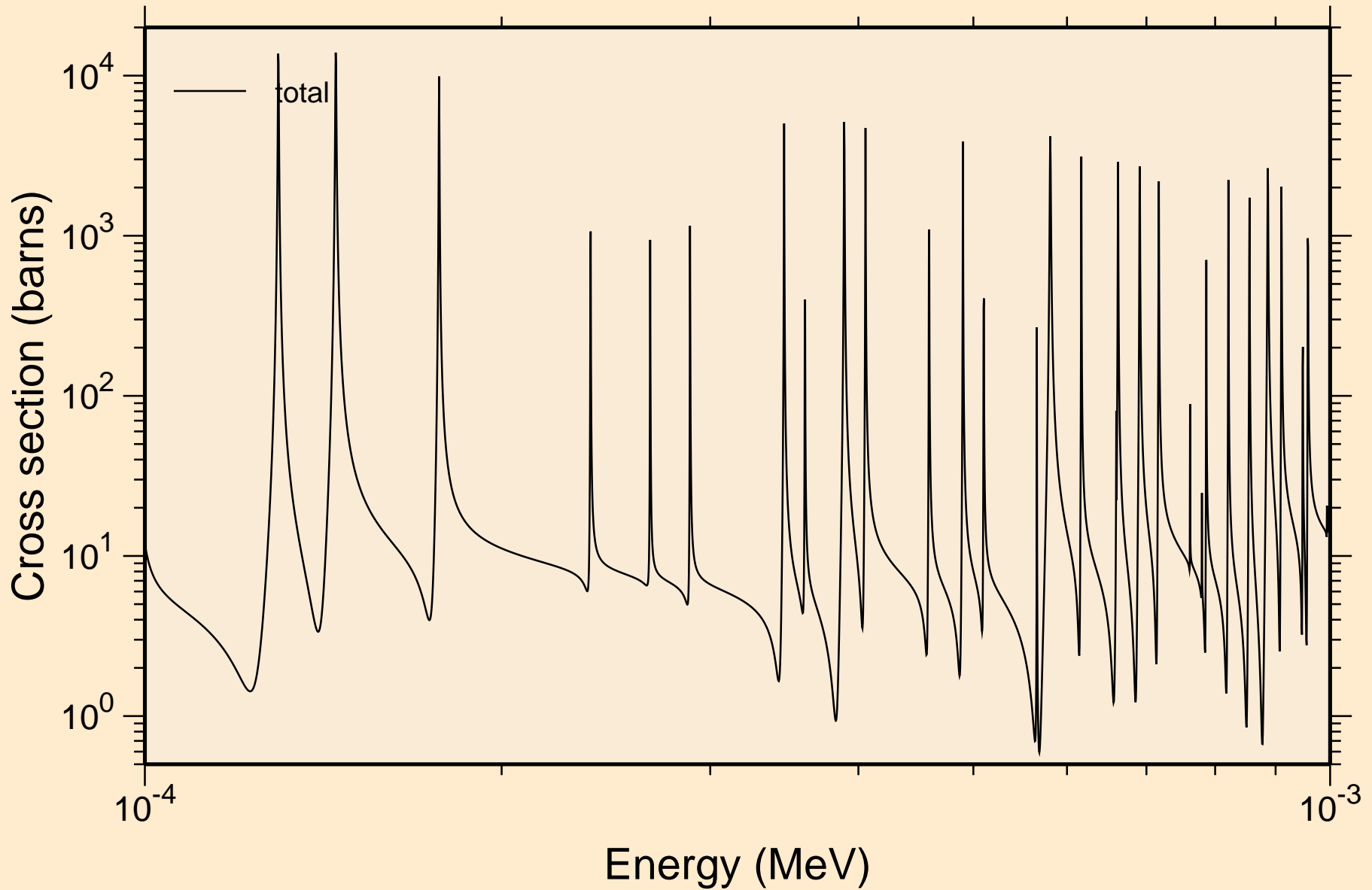

PT192 NEUTRON ACER TENDL-2024 LIBRARY; T=0.K
resonance total cross section

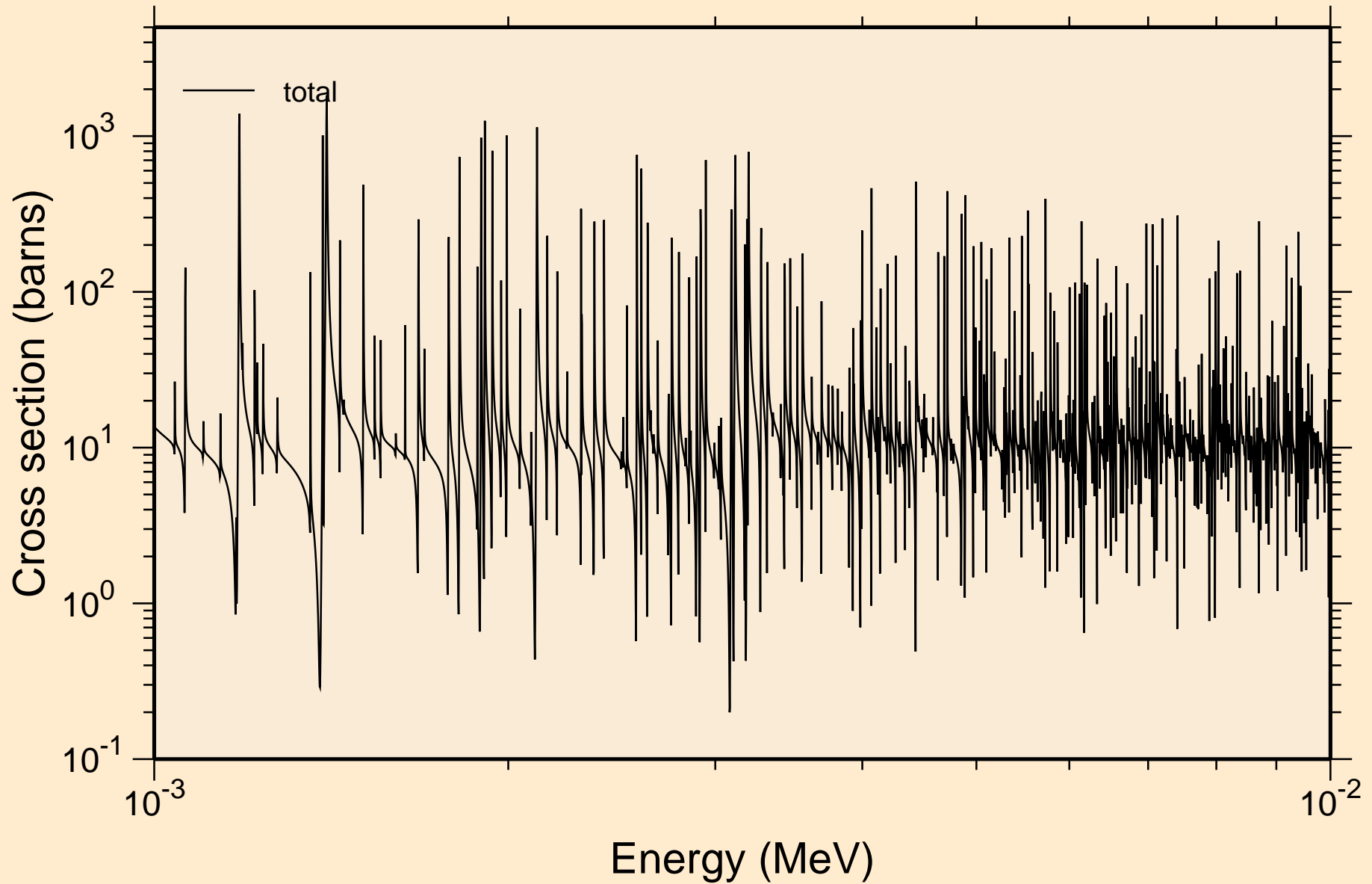

PT192 NEUTRON ACER TENDL-2024 LIBRARY; T=0.K
resonance total cross section

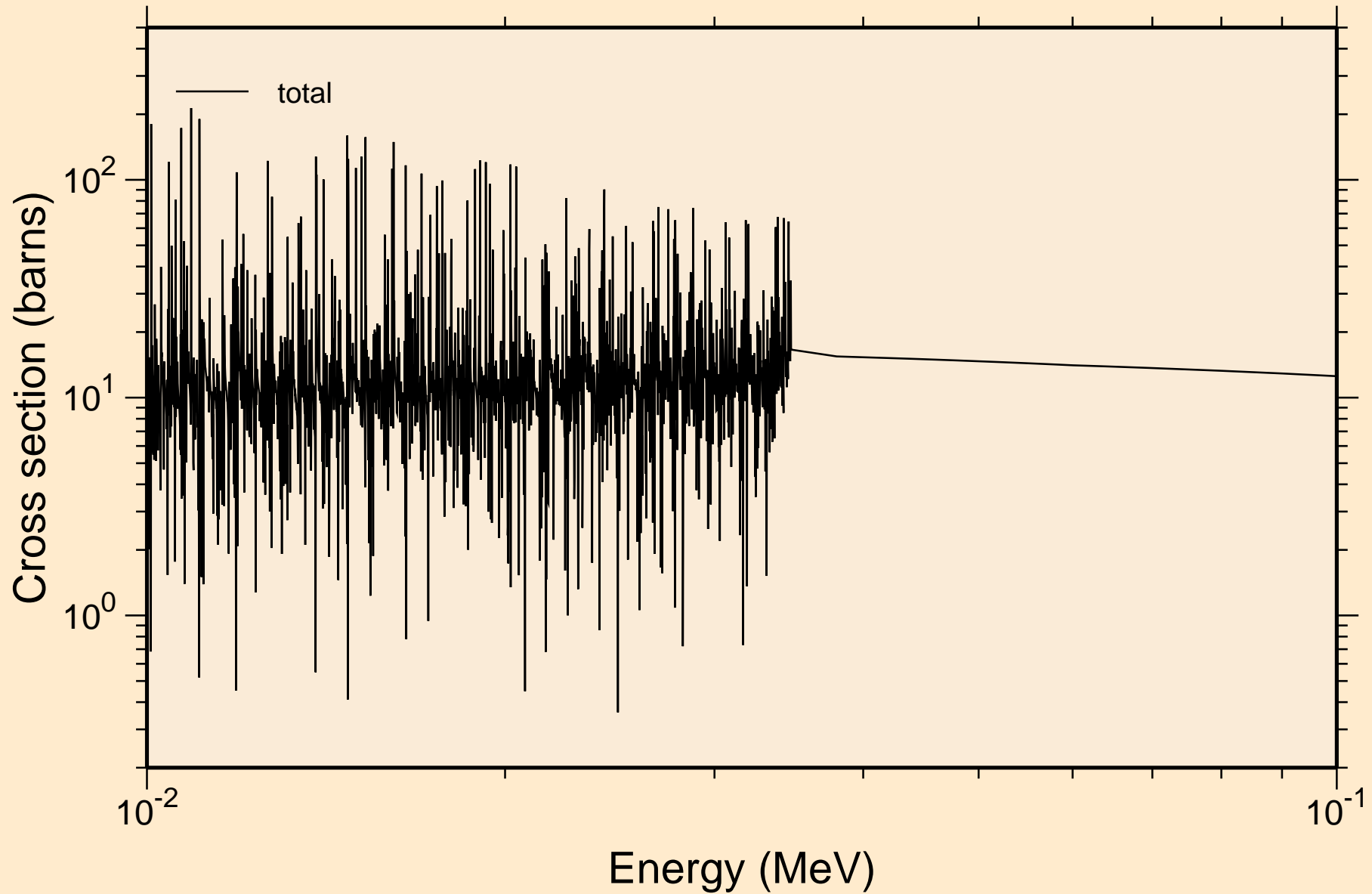

PT192 NEUTRON ACER TENDL-2024 LIBRARY; T=0.K
resonance total cross section

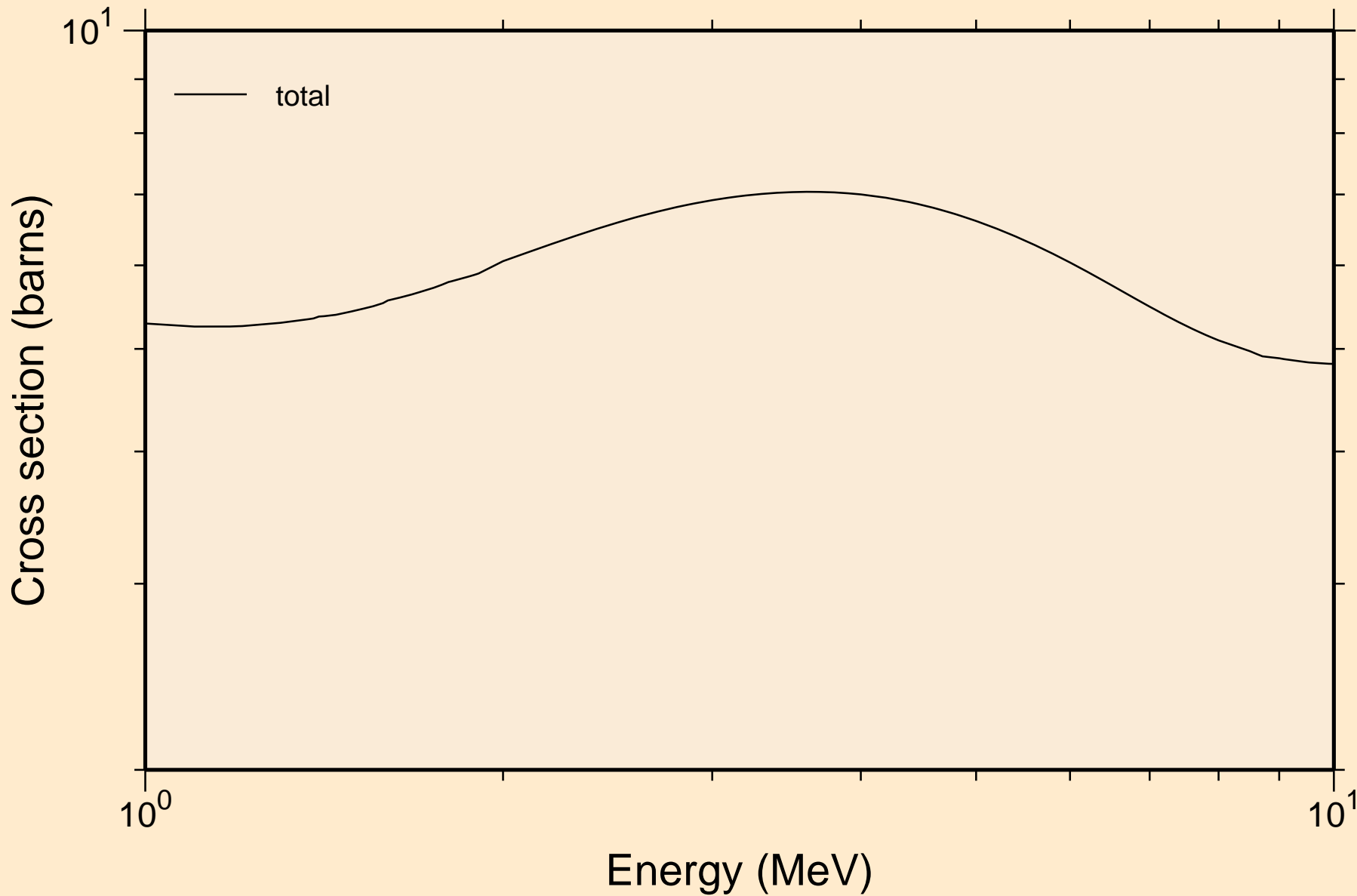

PT192 NEUTRON ACER TENDL-2024 LIBRARY; T=0.K
resonance absorption cross sections

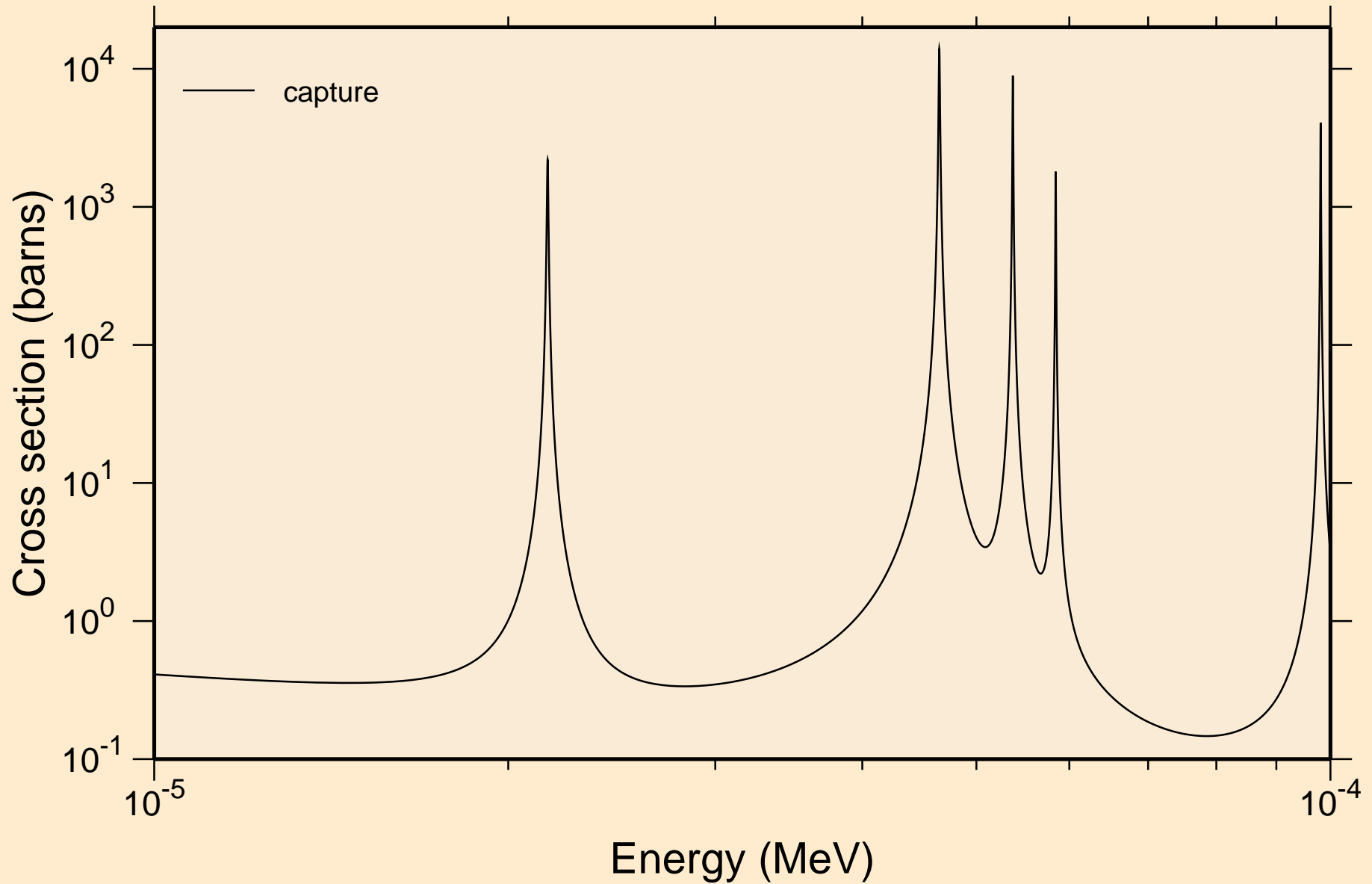

PT192 NEUTRON ACER TENDL-2024 LIBRARY; T=0.K
resonance absorption cross sections

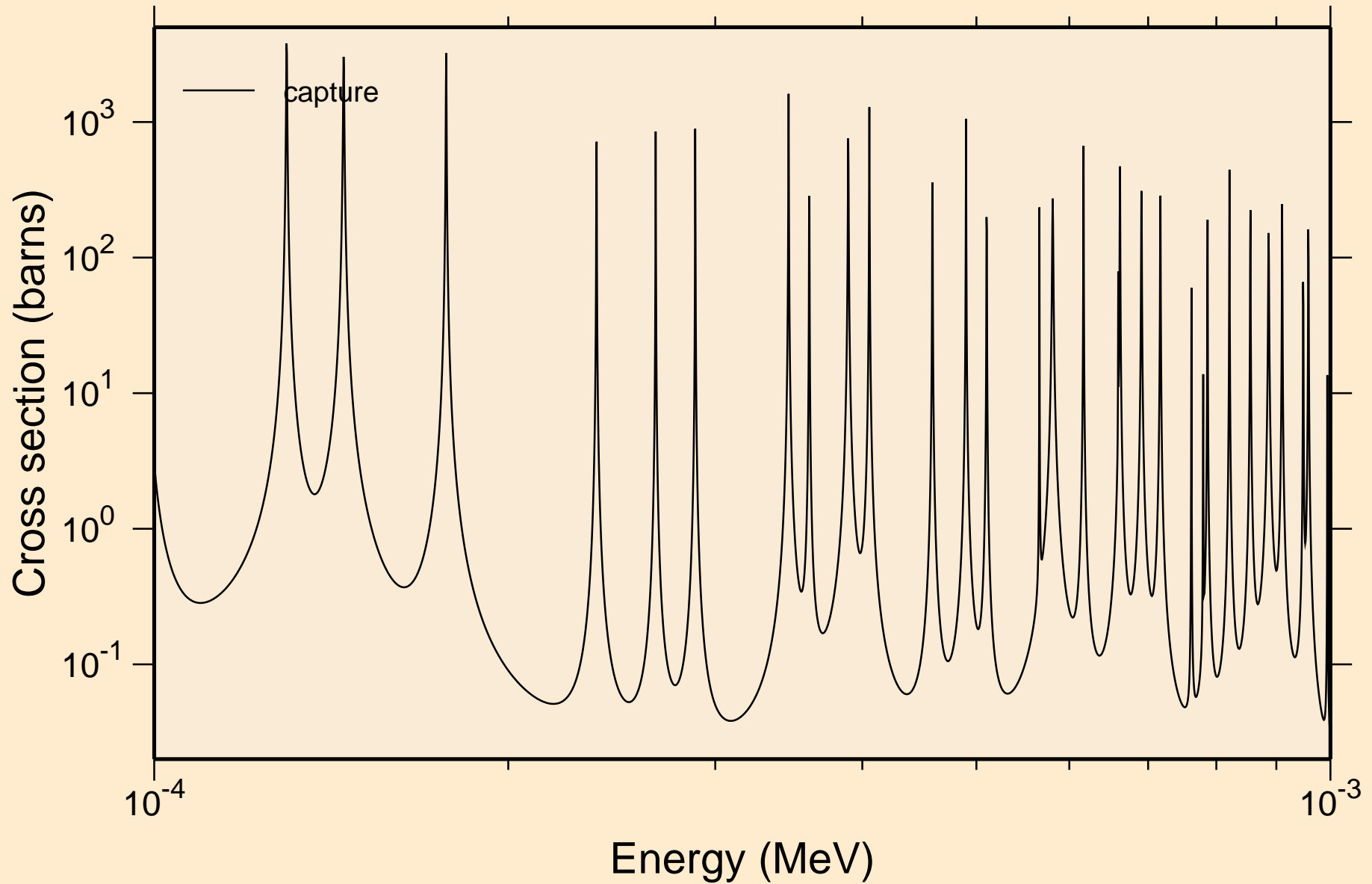

PT192 NEUTRON ACER TENDL-2024 LIBRARY; T=0.K
resonance absorption cross sections

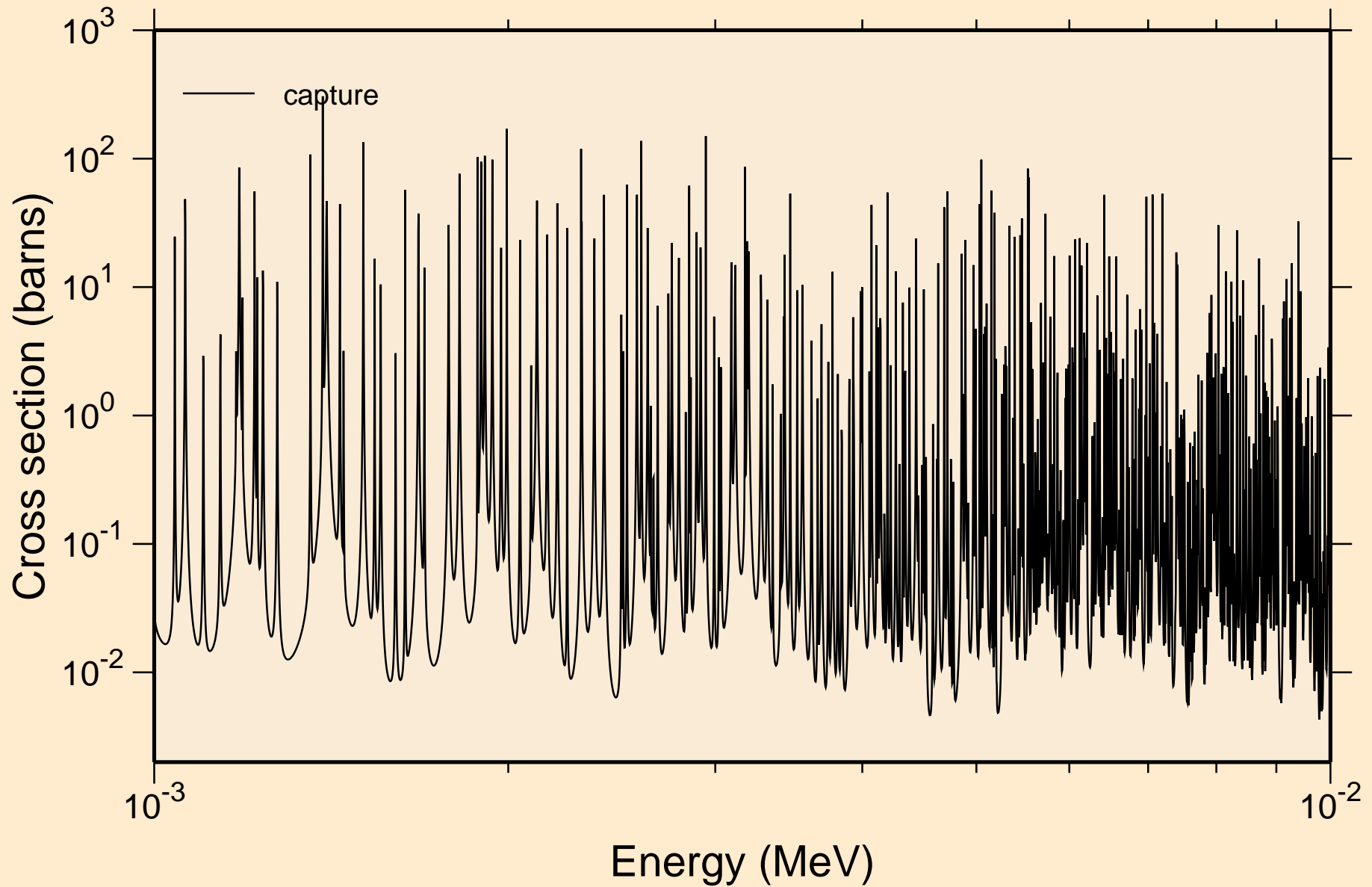

PT192 NEUTRON ACER TENDL-2024 LIBRARY; T=0.K
resonance absorption cross sections

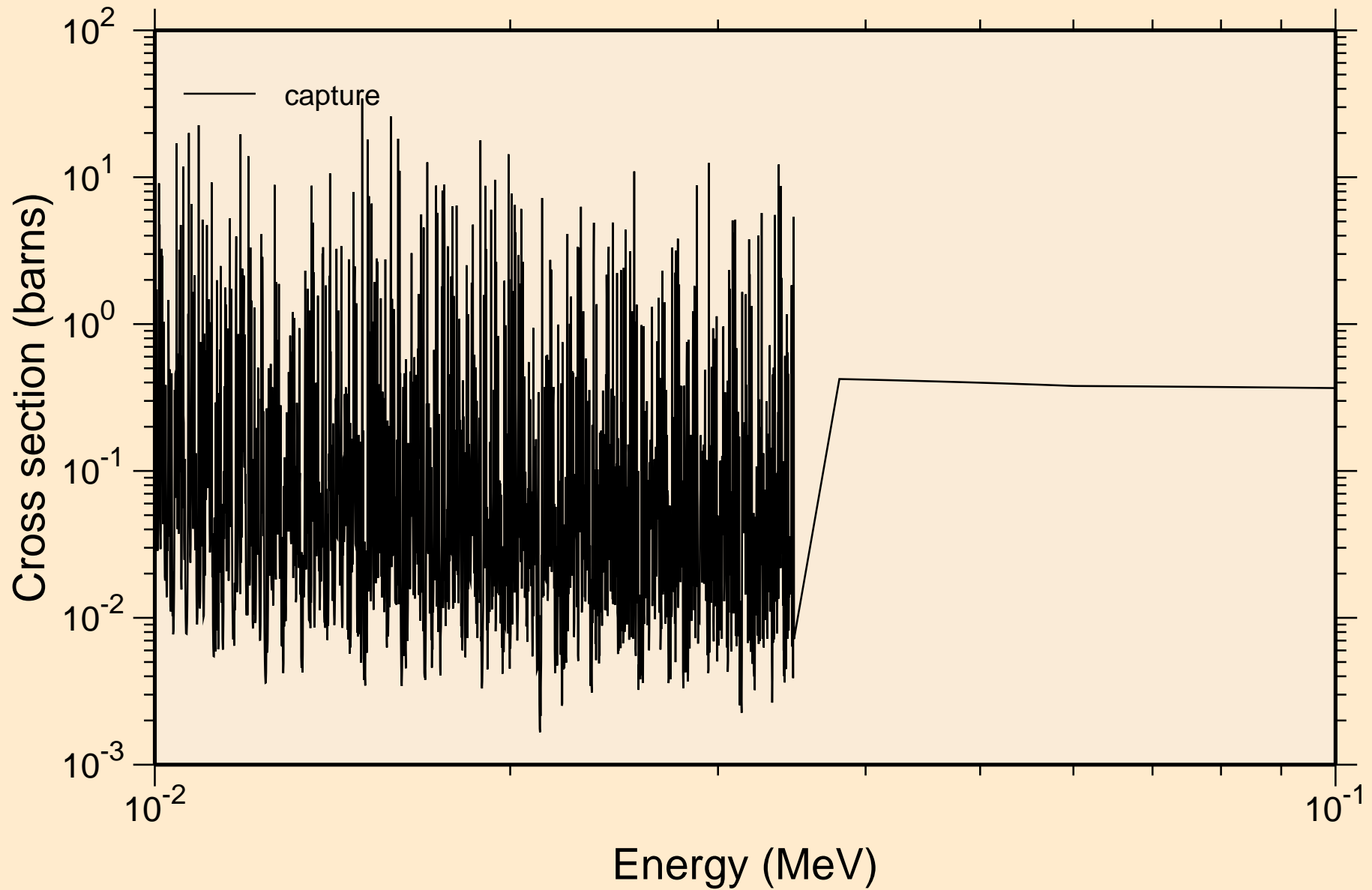

PT192 NEUTRON ACER TENDL-2024 LIBRARY; T=0.K
resonance absorption cross sections

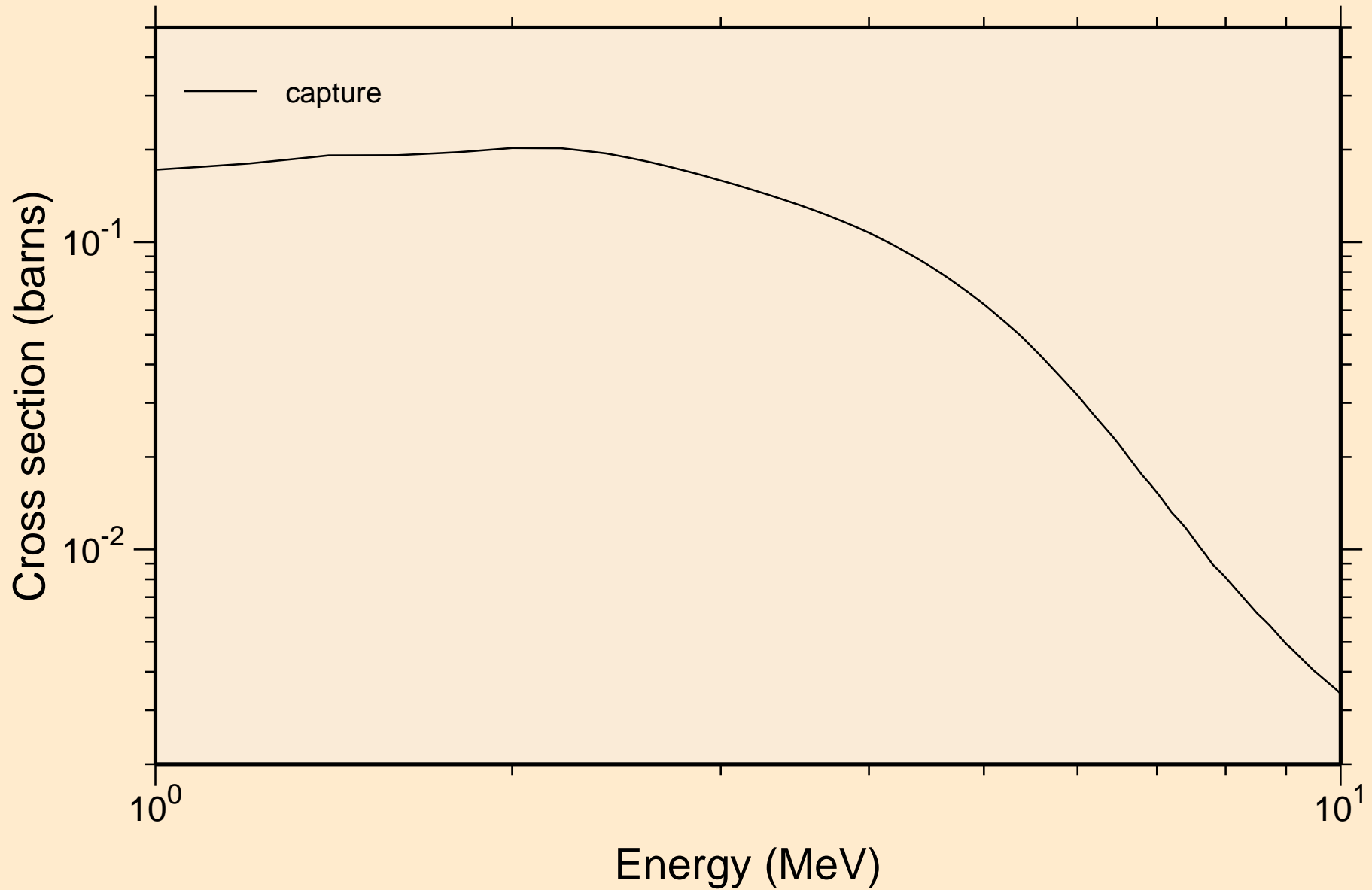

PT192 NEUTRON ACER TENDL-2024 LIBRARY; T=0.K
Heating

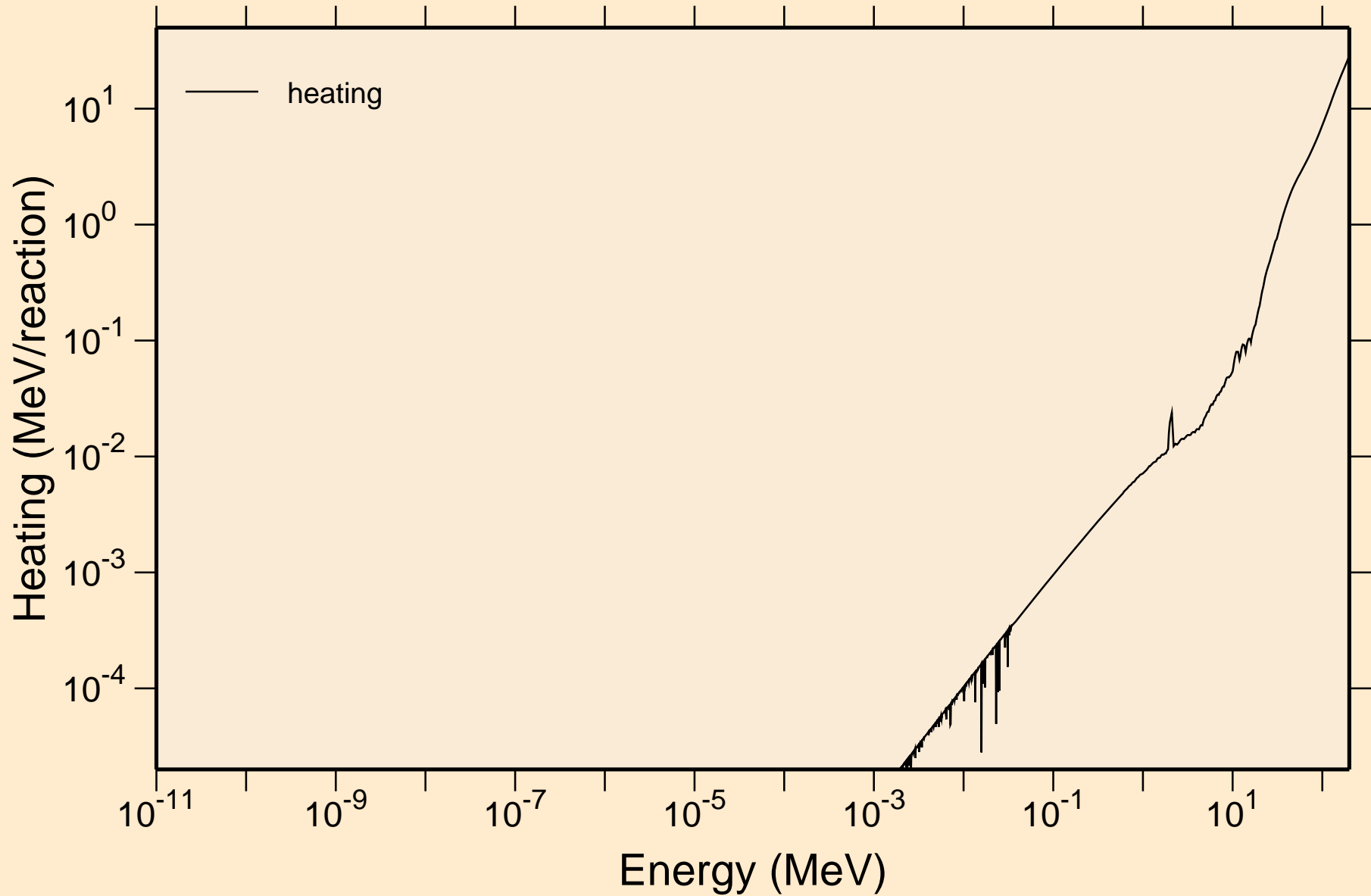

PT192 NEUTRON ACER TENDL-2024 LIBRARY; T=0.K
Damage

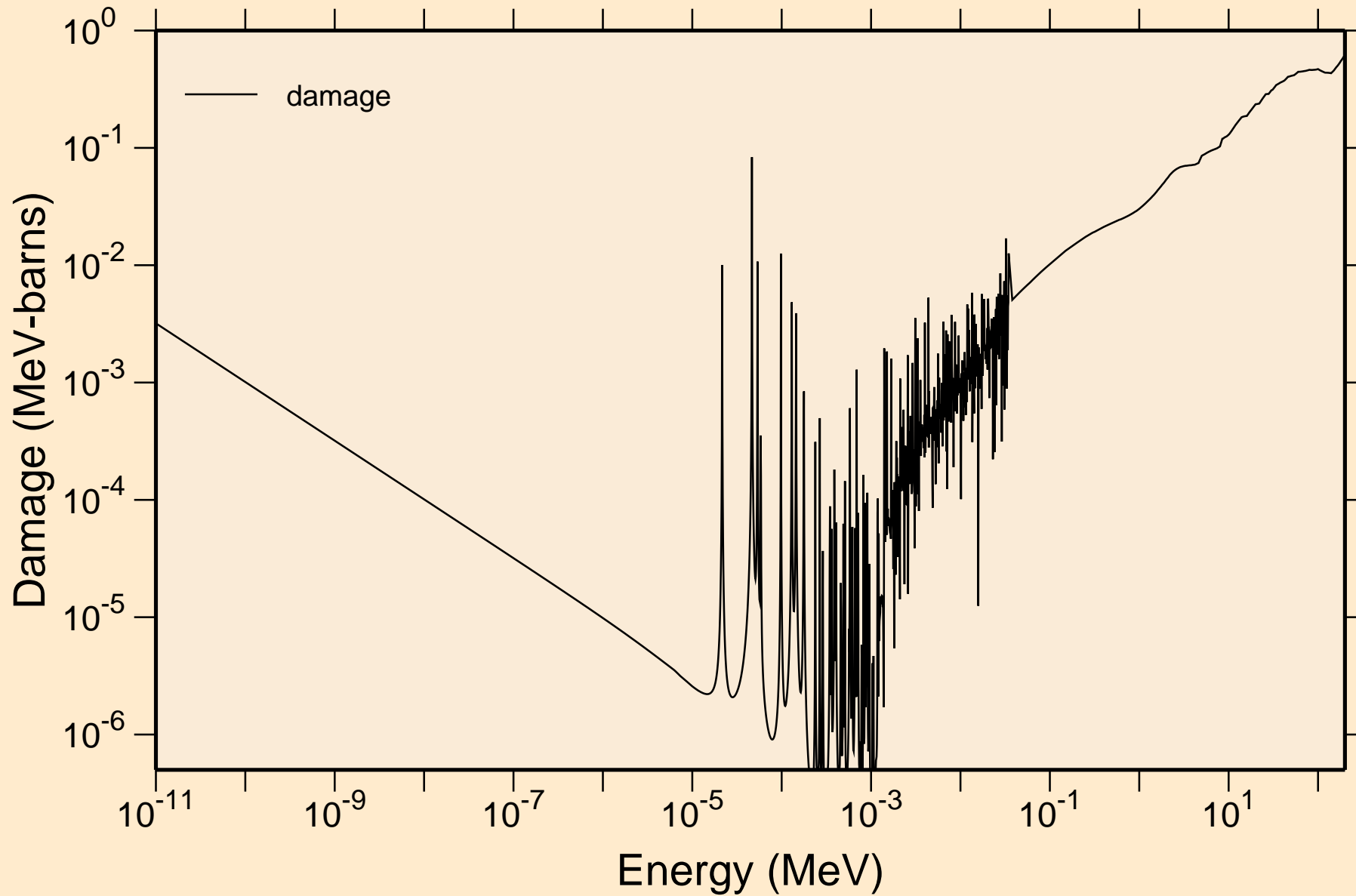

PT192 NEUTRON ACER TENDL-2024 LIBRARY; T=0.K
Non-threshold reactions

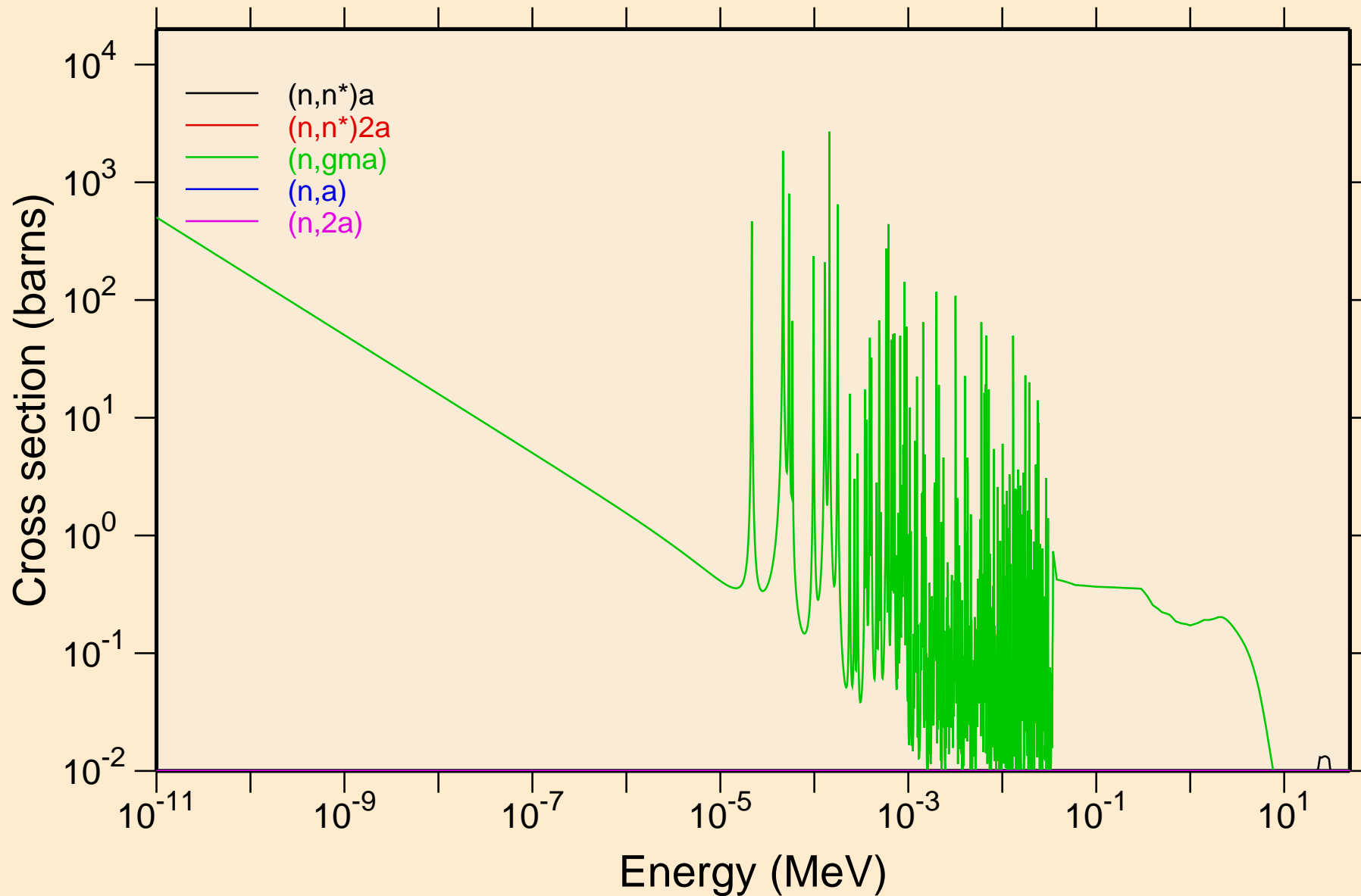

PT192 NEUTRON ACER TENDL-2024 LIBRARY; T=0.K
Non-threshold reactions

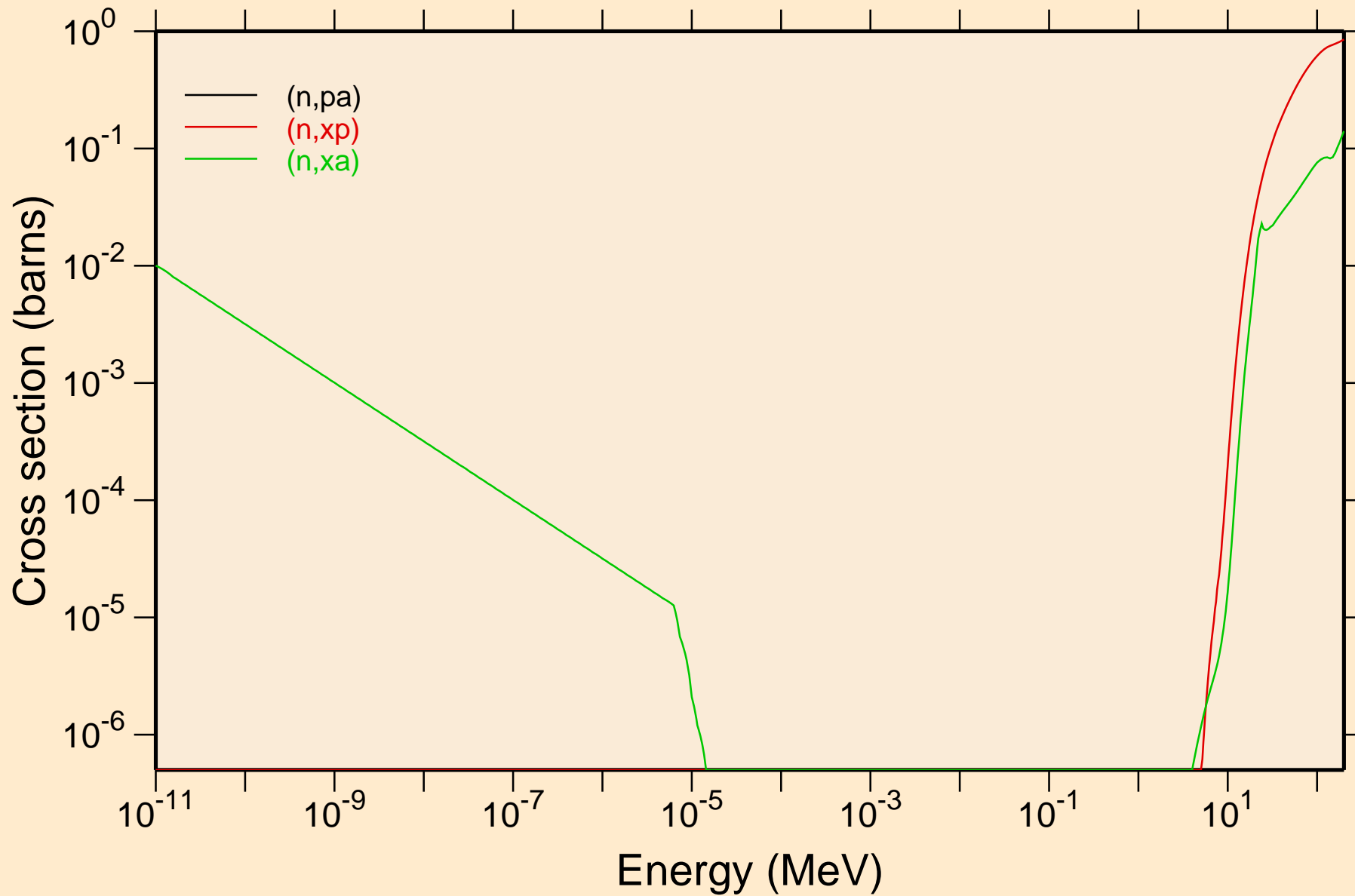

PT192 NEUTRON ACER TENDL-2024 LIBRARY; T=0.K
Principal cross sections

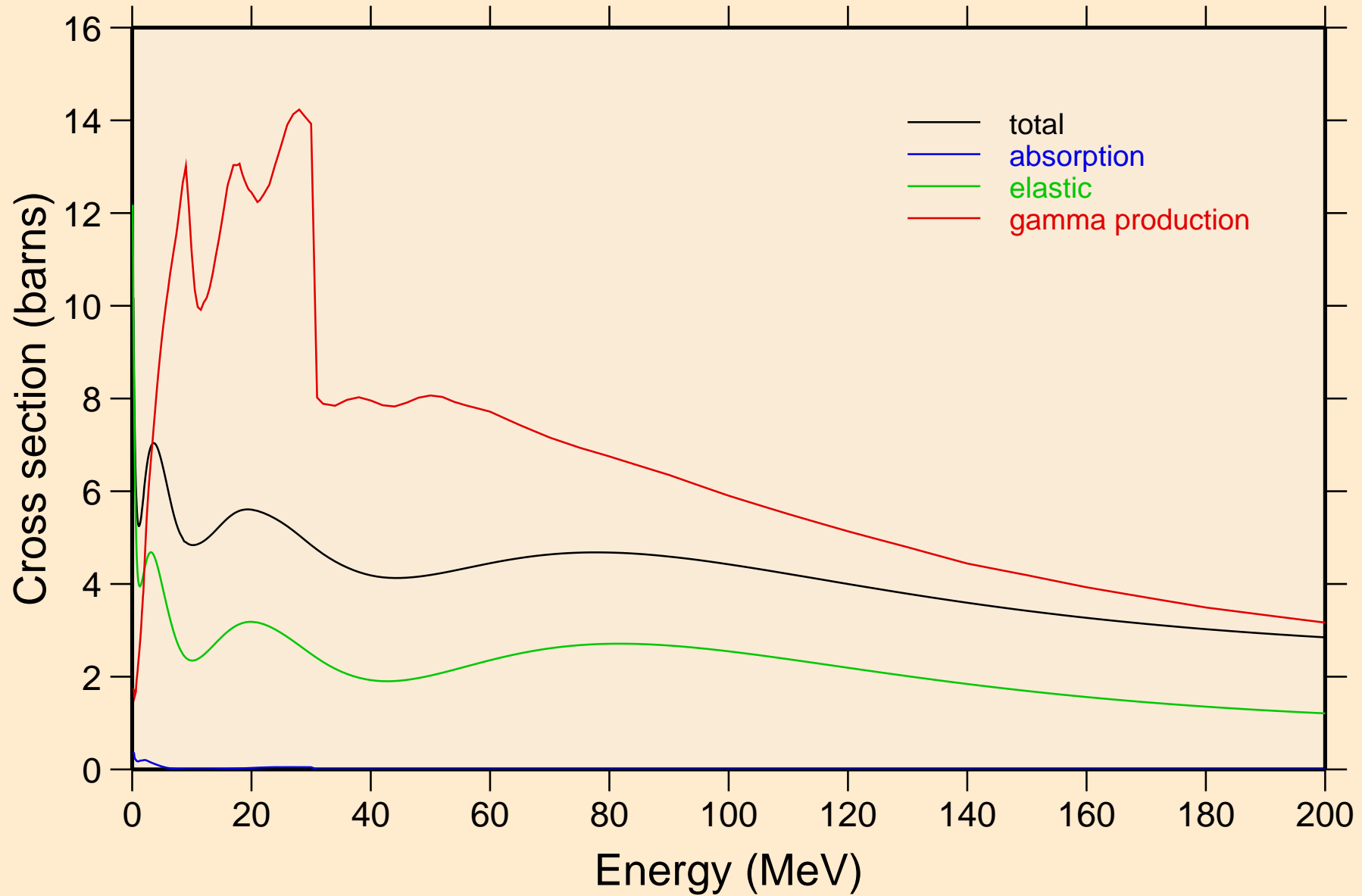

PT192 NEUTRON ACER TENDL-2024 LIBRARY; T=0.K

Heating

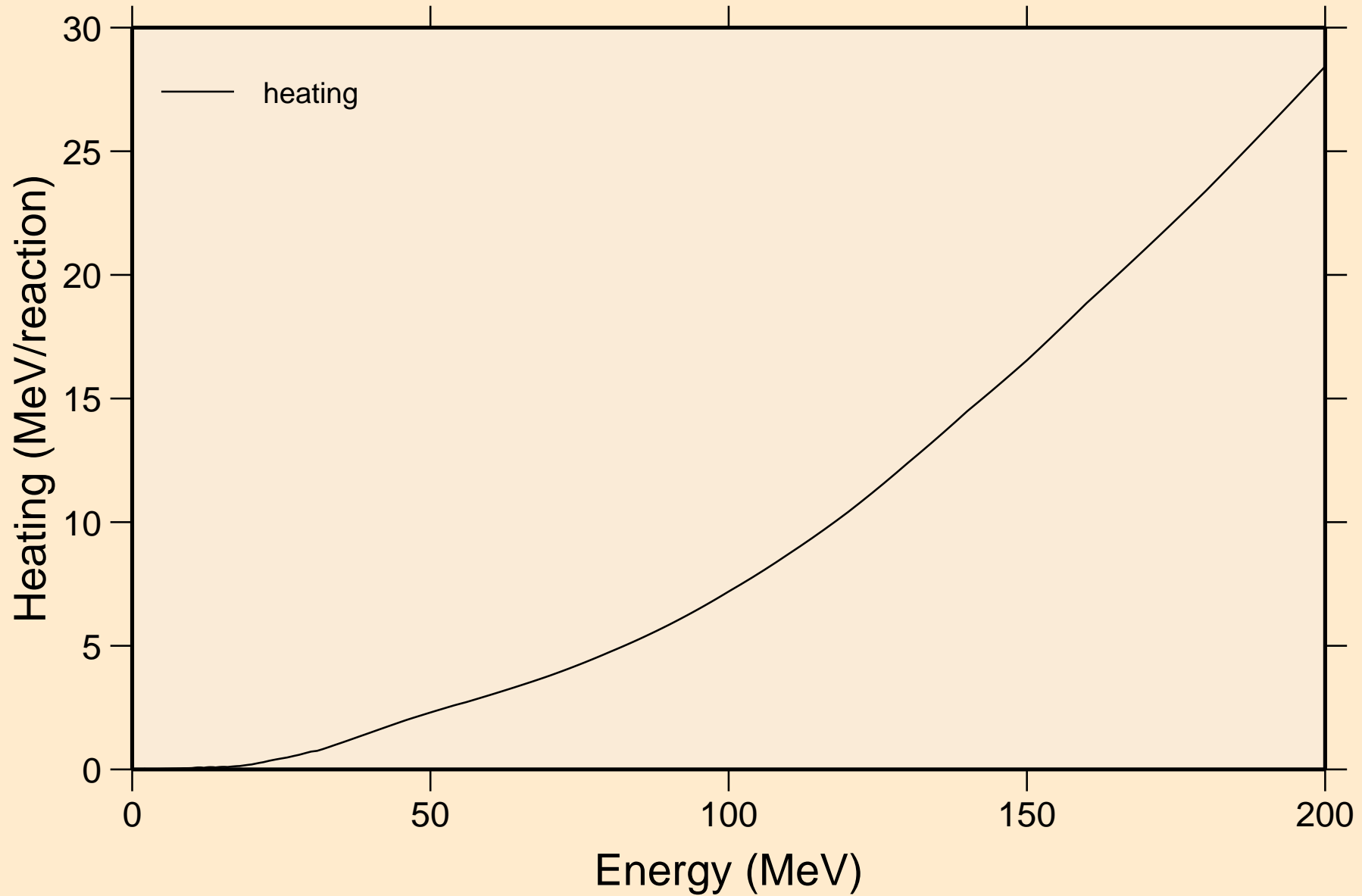

PT192 NEUTRON ACER TENDL-2024 LIBRARY; T=0.K
Damage

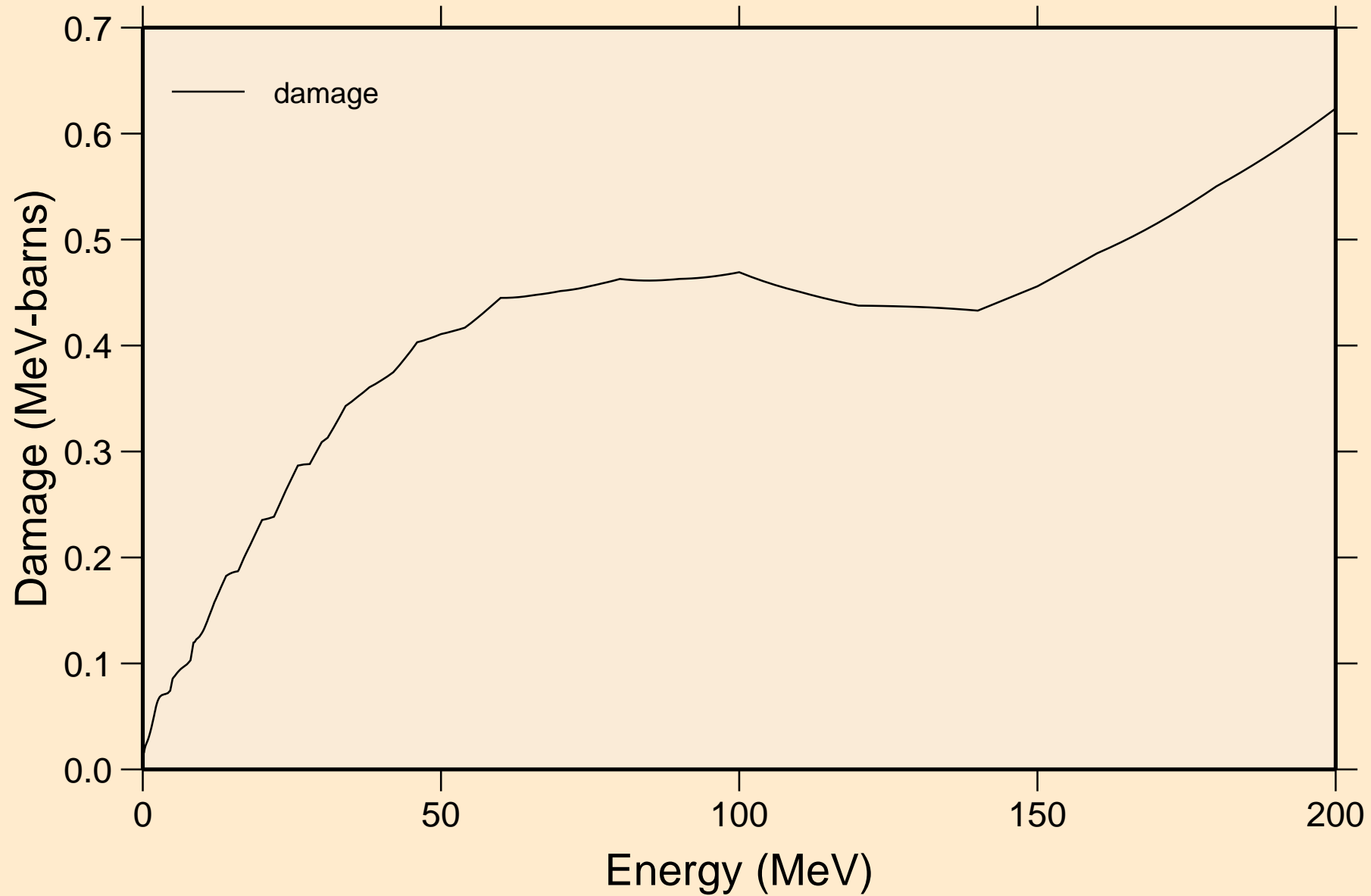

PT192 NEUTRON ACER TENDL-2024 LIBRARY; T=0.K
Non-threshold reactions

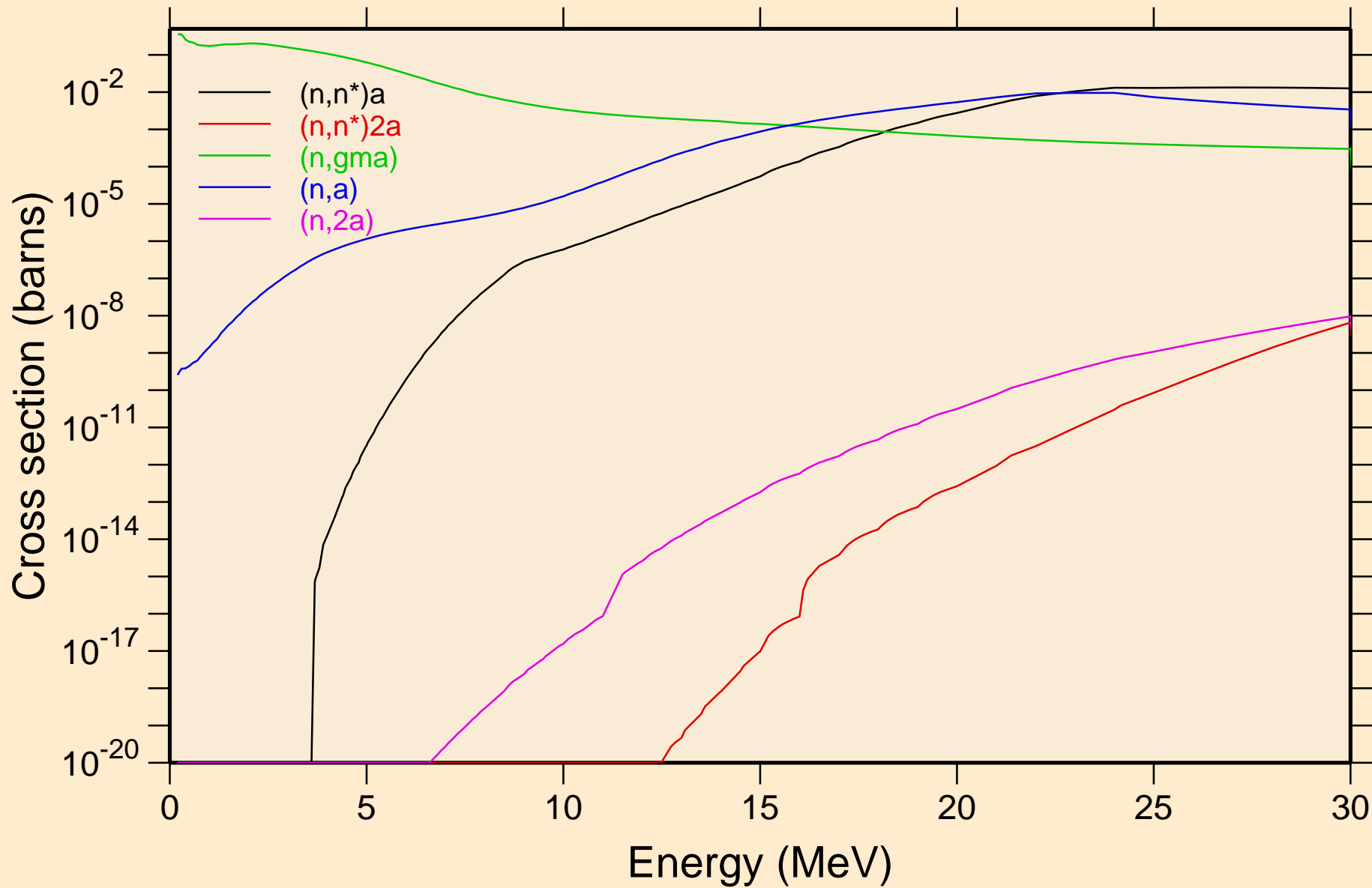

PT192 NEUTRON ACER TENDL-2024 LIBRARY; T=0.K
Non-threshold reactions

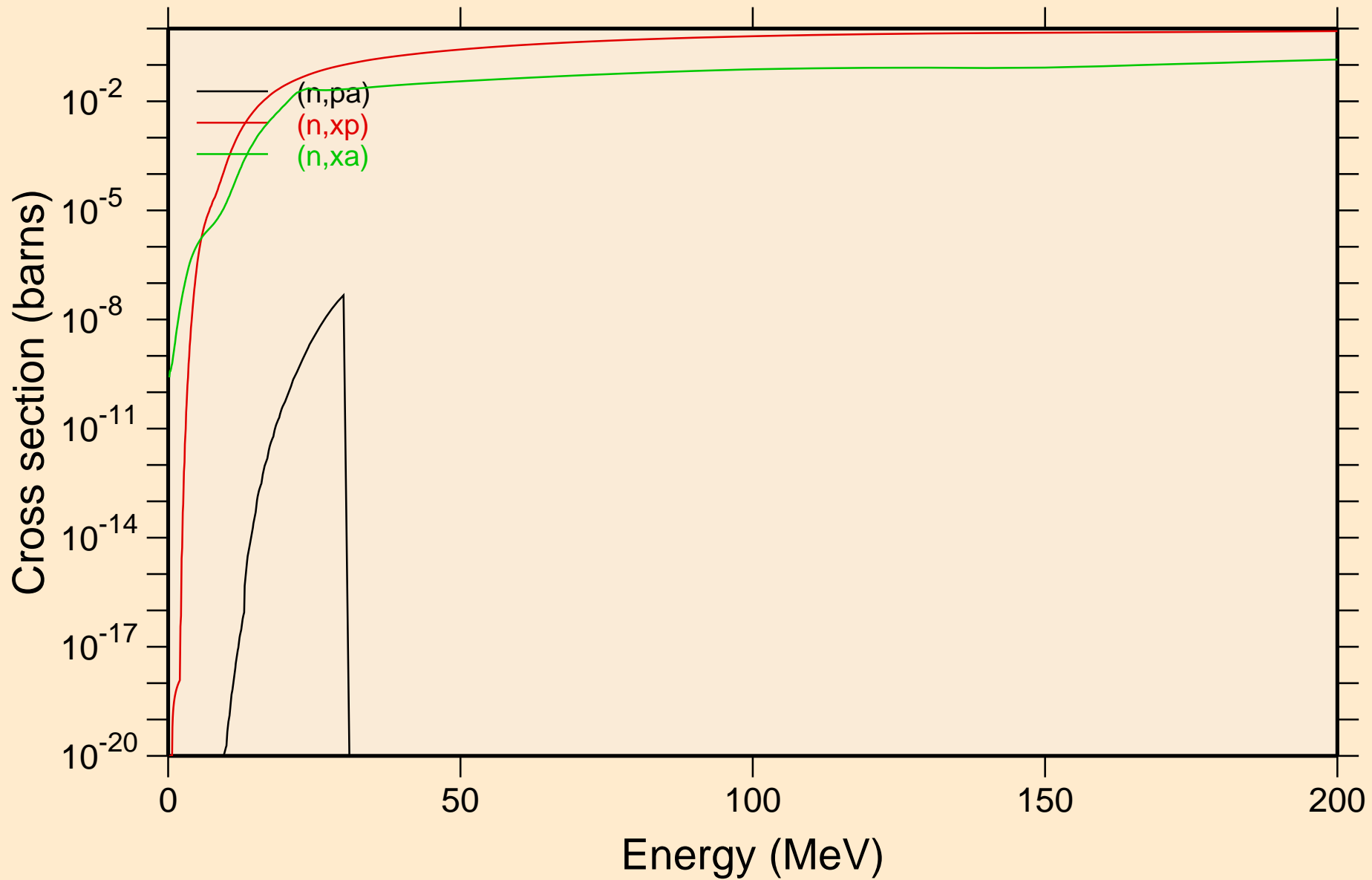

PT192 NEUTRON ACER TENDL-2024 LIBRARY; T=0.K
Inelastic levels

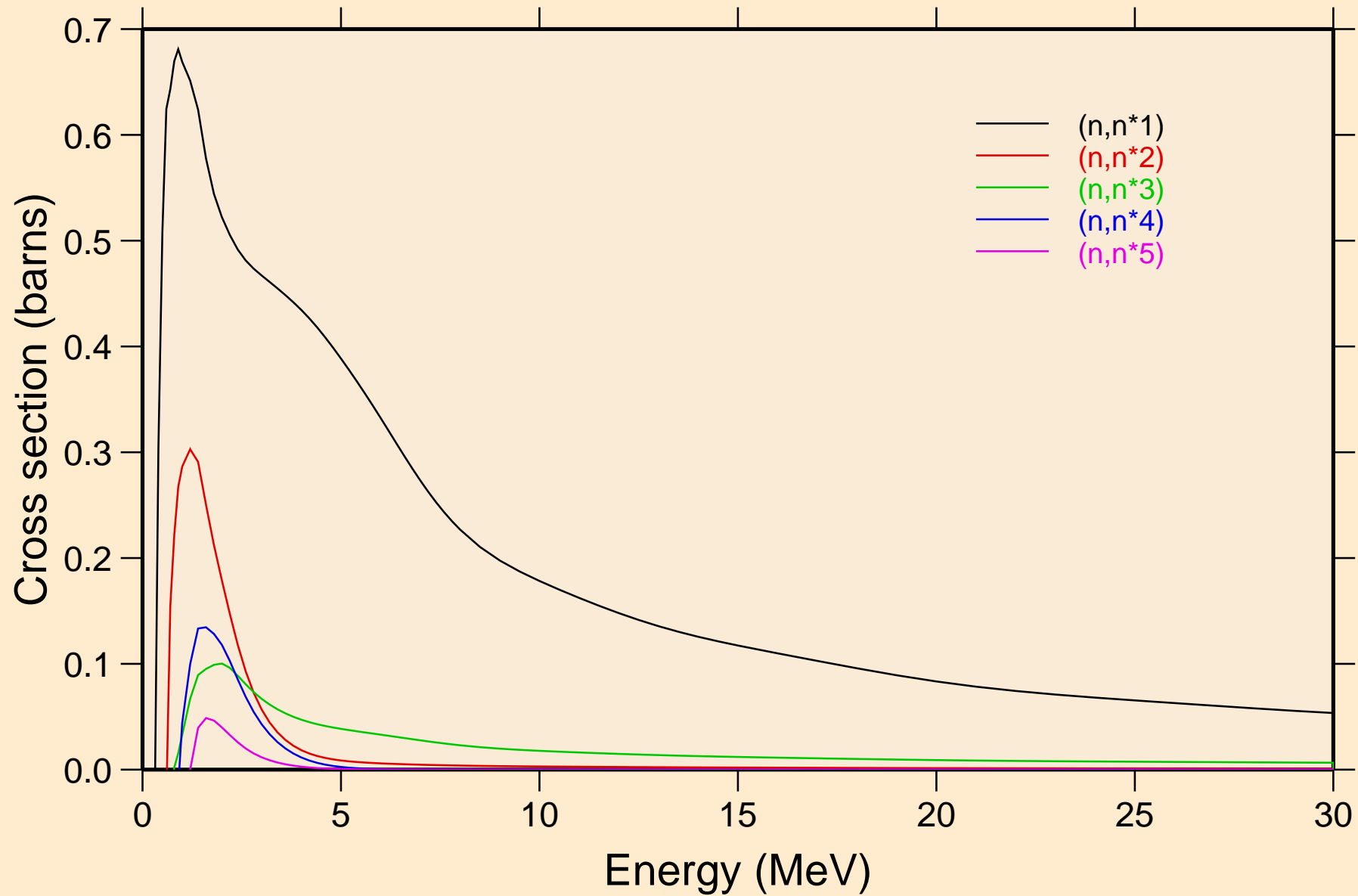

PT192 NEUTRON ACER TENDL-2024 LIBRARY; T=0.K
Inelastic levels

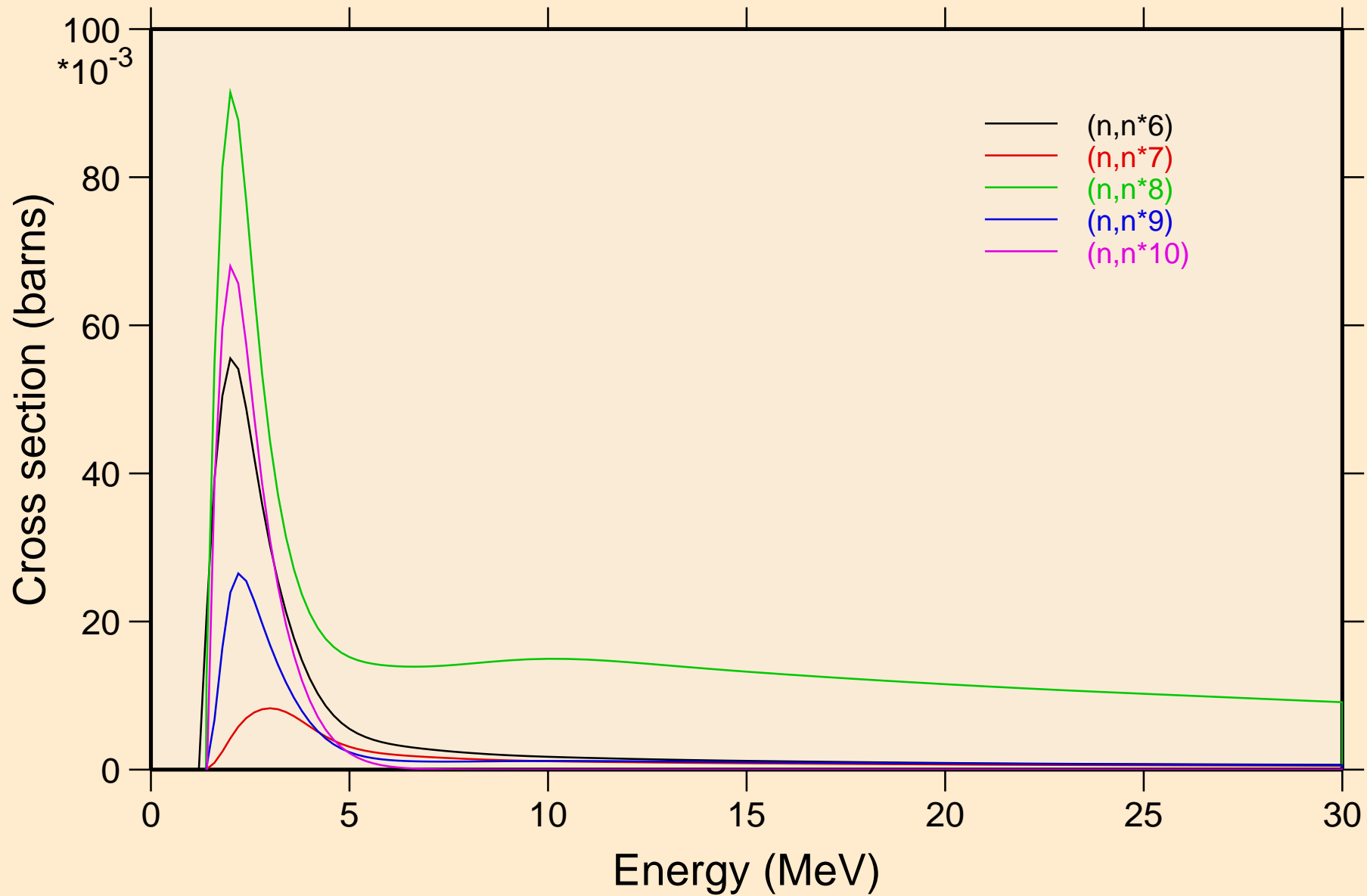

PT192 NEUTRON ACER TENDL-2024 LIBRARY; T=0.K
Inelastic levels

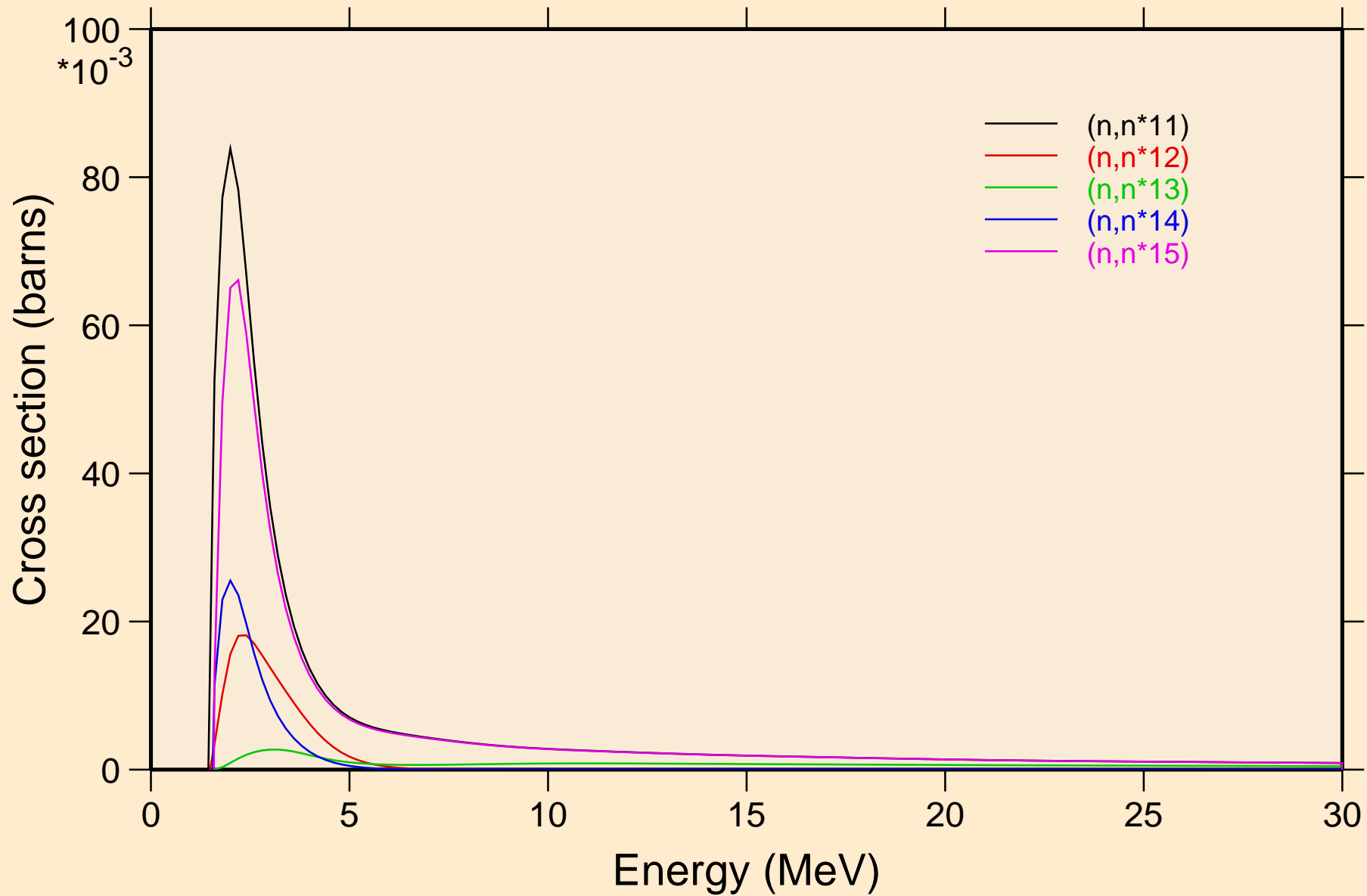

PT192 NEUTRON ACER TENDL-2024 LIBRARY; T=0.K
Inelastic levels

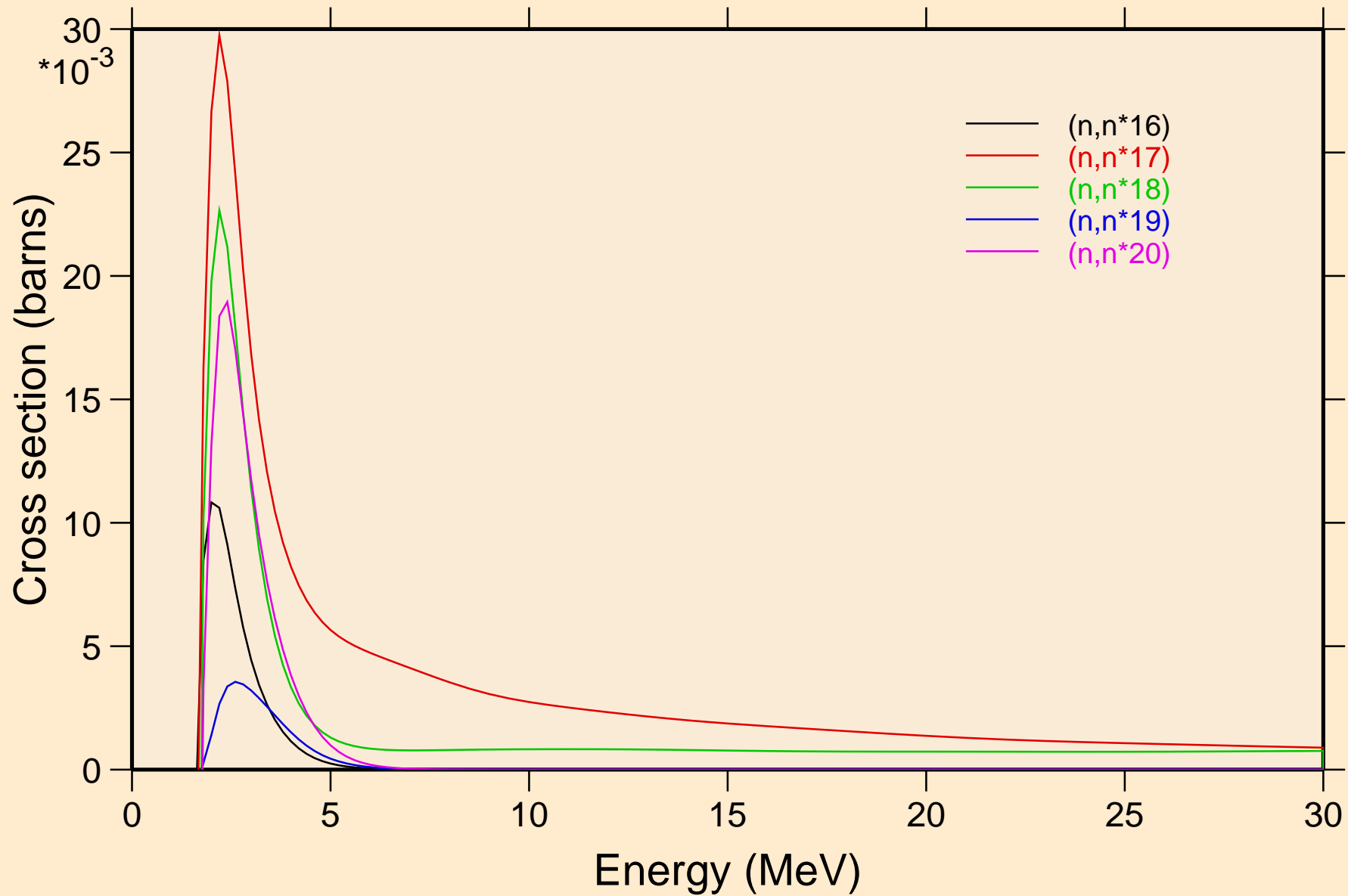

PT192 NEUTRON ACER TENDL-2024 LIBRARY; T=0.K
Inelastic levels

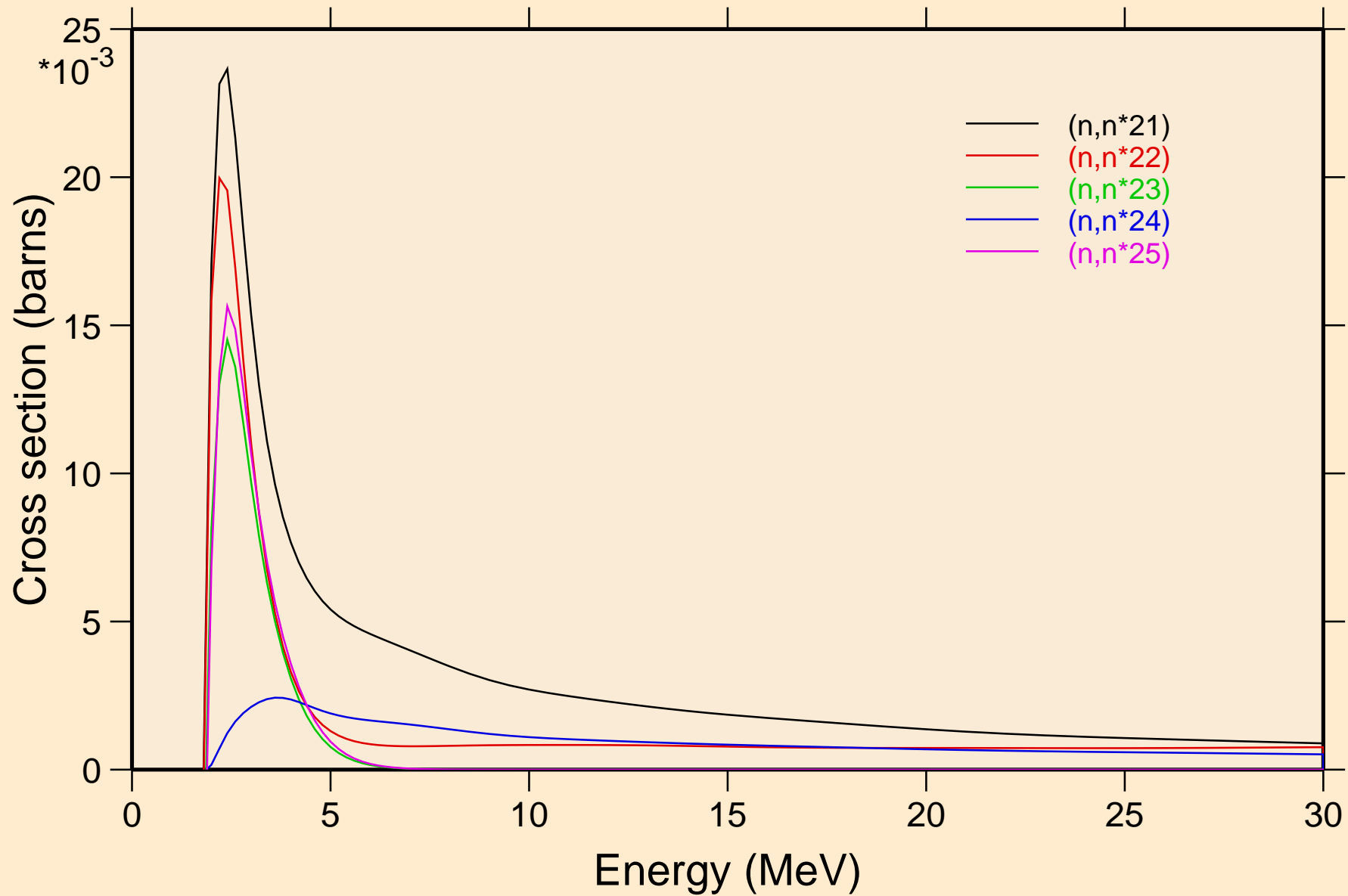

PT192 NEUTRON ACER TENDL-2024 LIBRARY; T=0.K
Inelastic levels

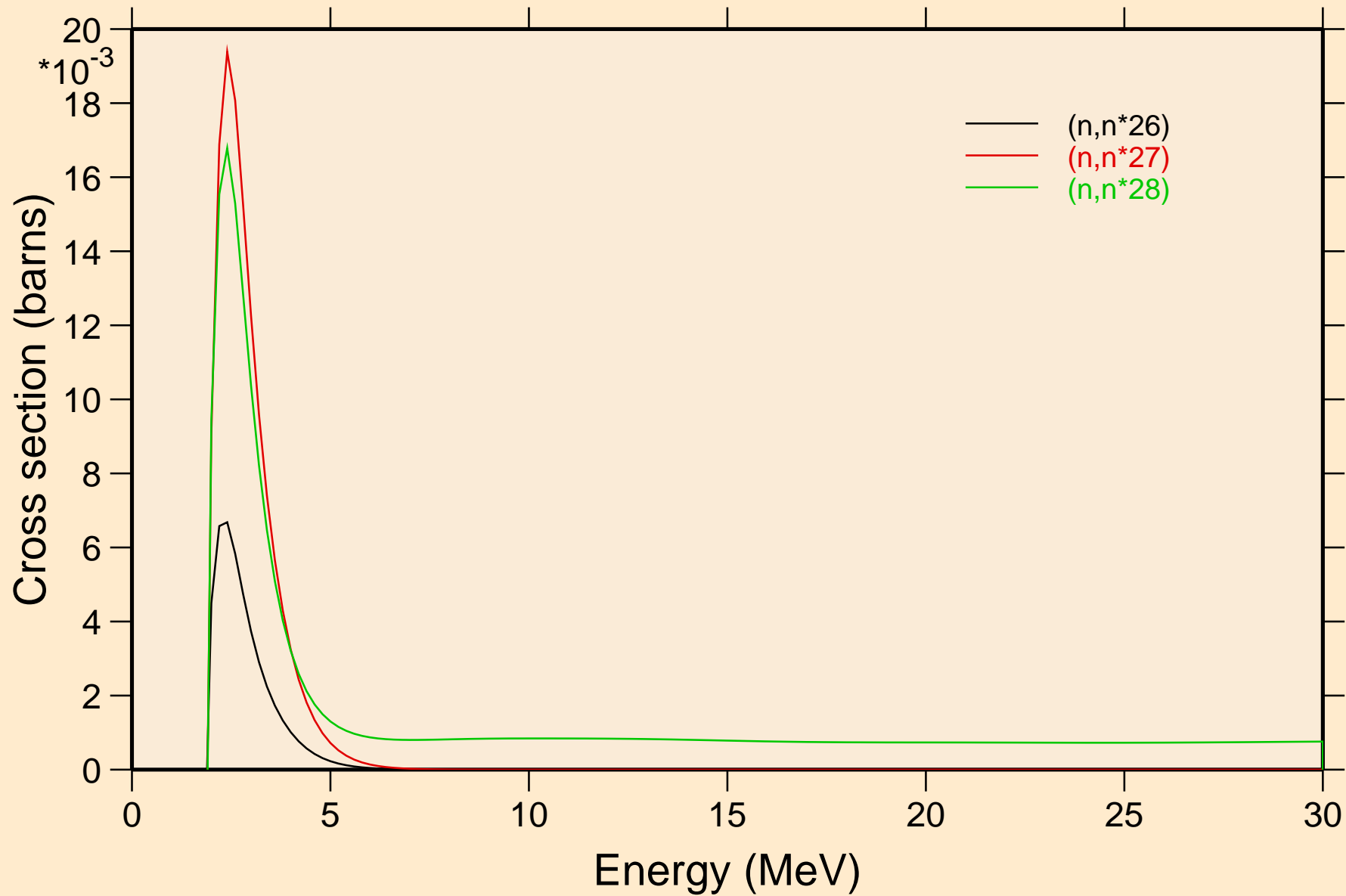

PT192 NEUTRON ACER TENDL-2024 LIBRARY; T=0.K
Threshold reactions

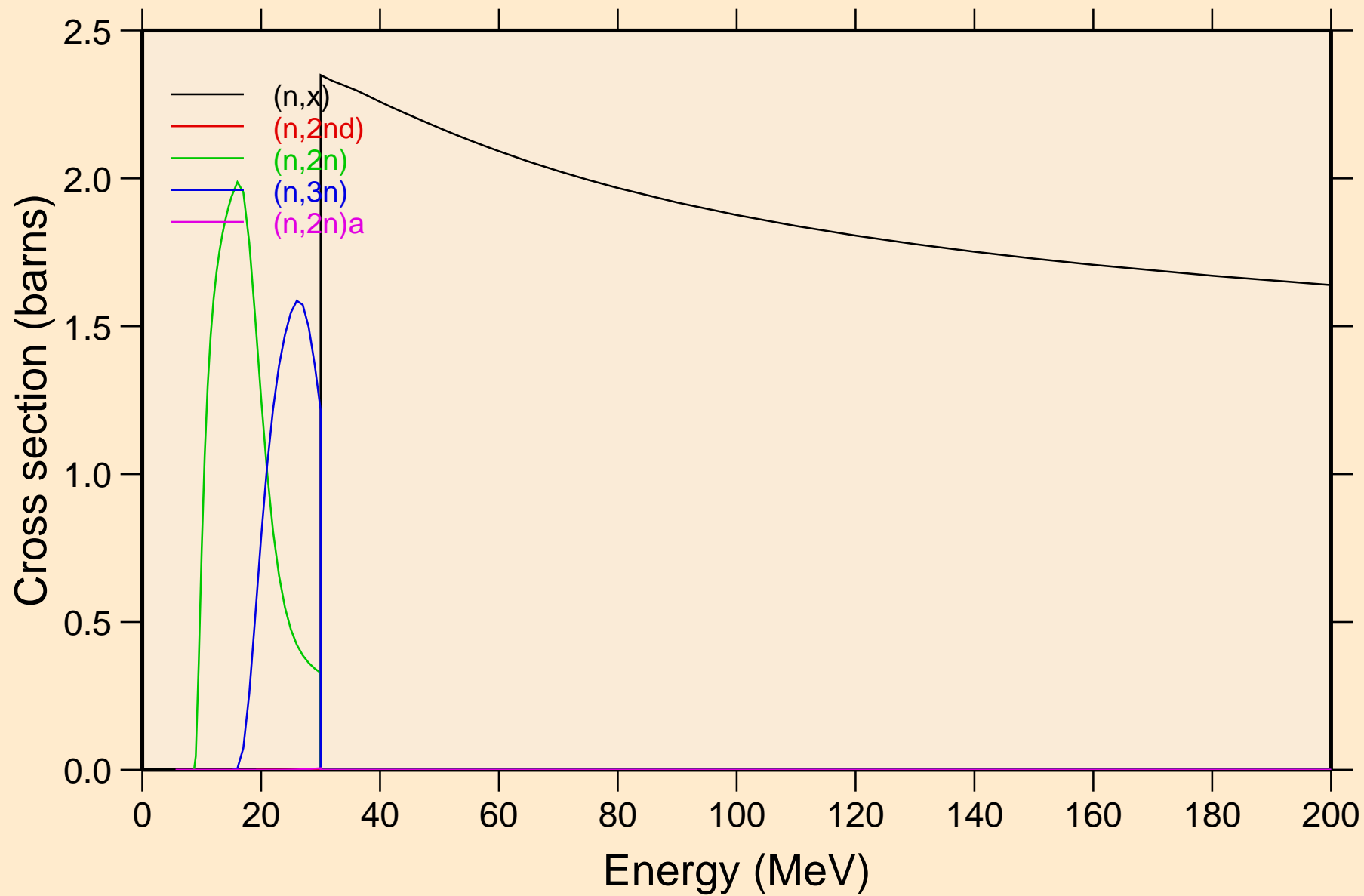

PT192 NEUTRON ACER TENDL-2024 LIBRARY; T=0.K
Threshold reactions

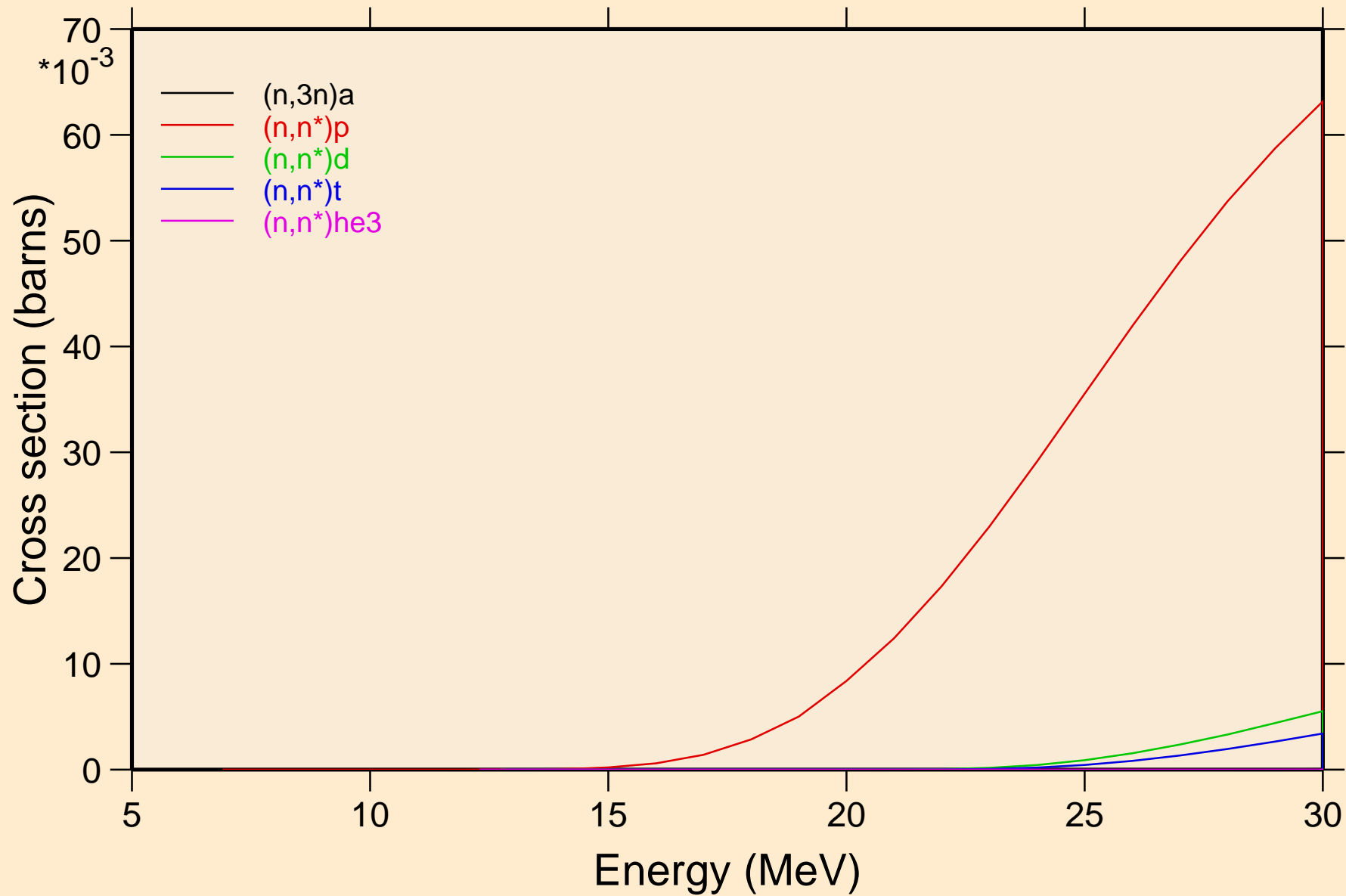

PT192 NEUTRON ACER TENDL-2024 LIBRARY; T=0.K
Threshold reactions

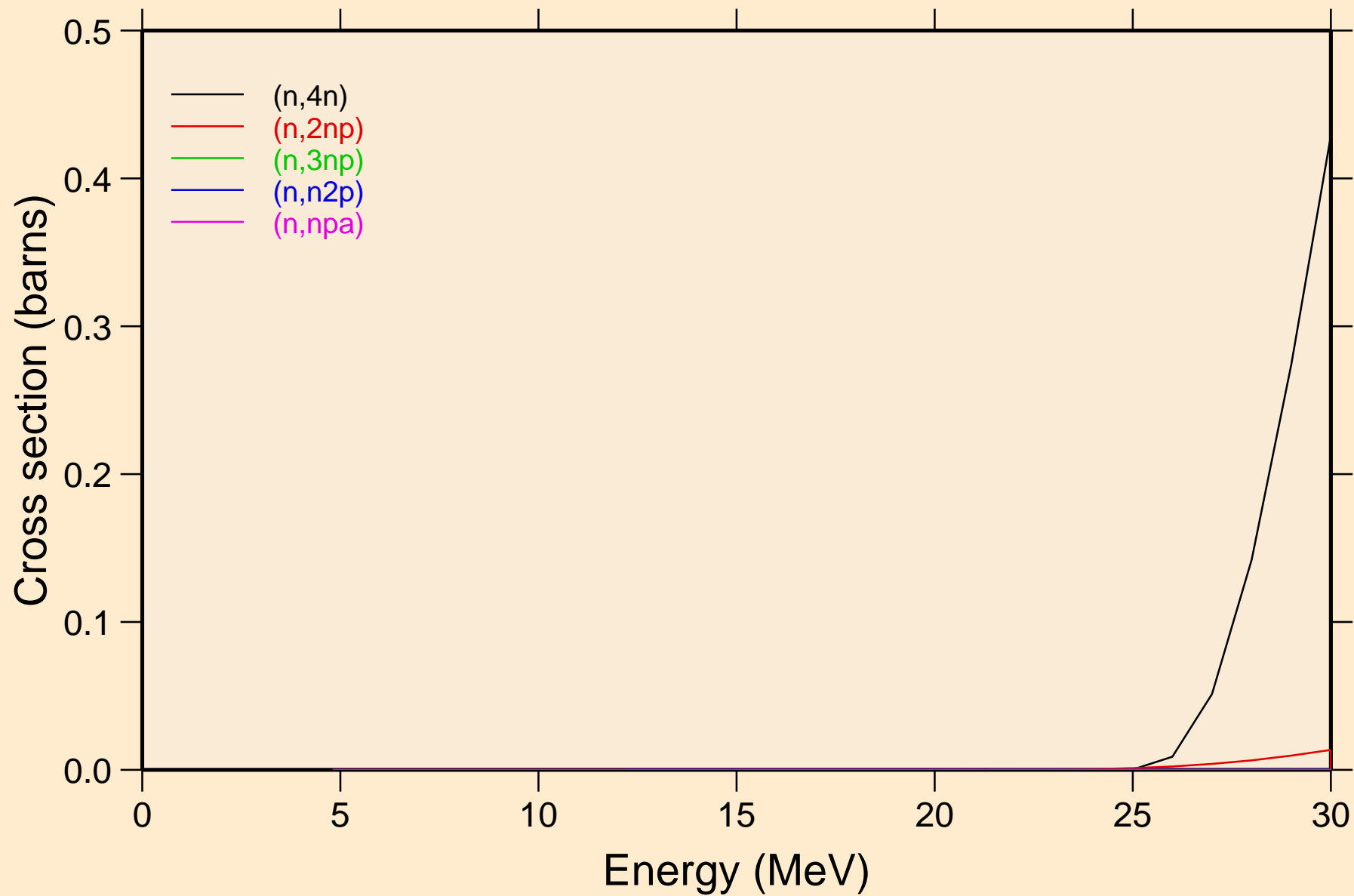

PT192 NEUTRON ACER TENDL-2024 LIBRARY; T=0.K
Threshold reactions

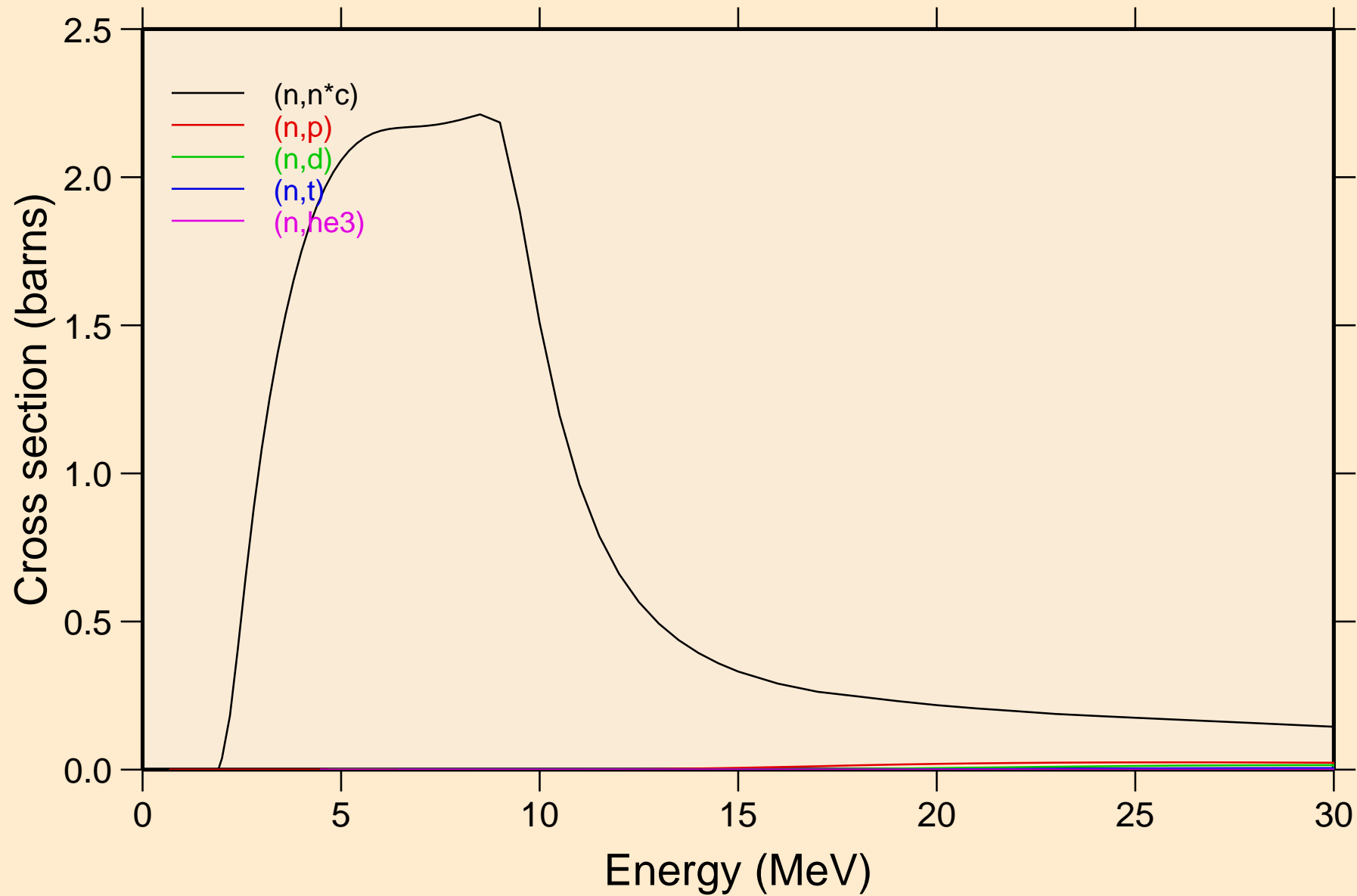

PT192 NEUTRON ACER TENDL-2024 LIBRARY; T=0.K
Threshold reactions

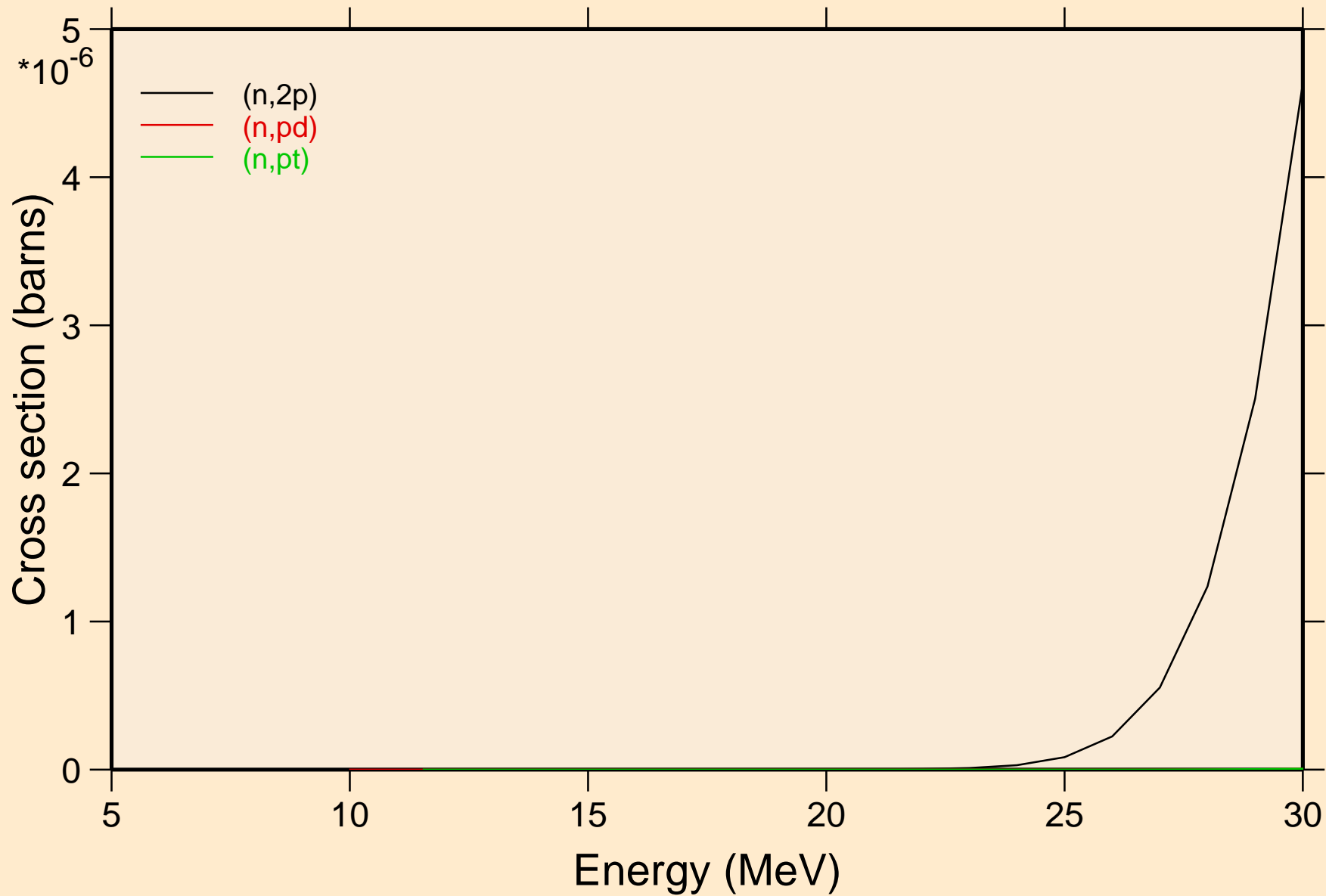

PT192 NEUTRON ACER TENDL-2024 LIBRARY; T=0.K
Threshold reactions

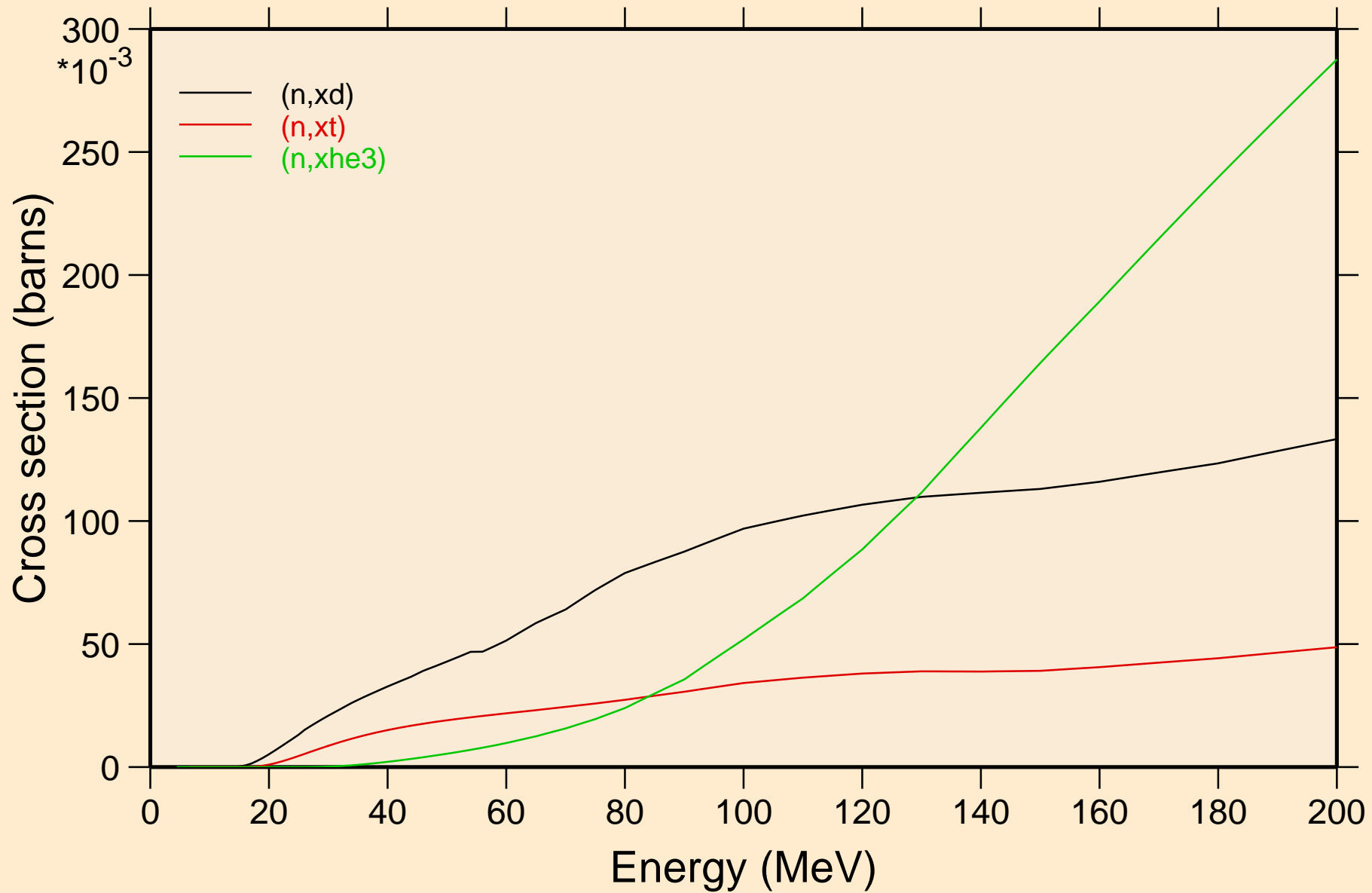

PT192 NEUTRON ACER TENDL-2024 LIBRARY; T=0.K
angular distribution for elastic

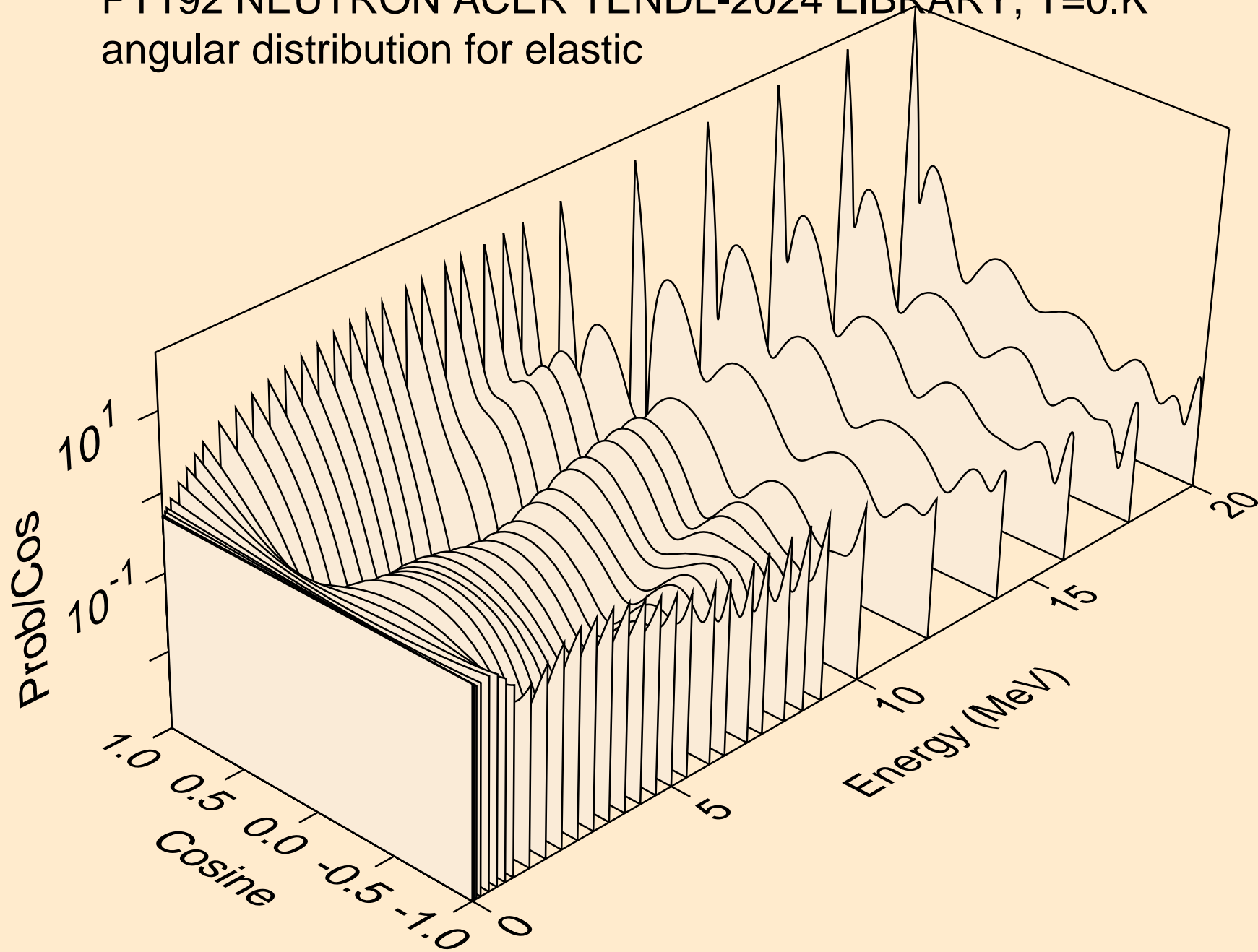

PT192 NEUTRON ACER TENDL-2024 LIBRARY; T=0.K
angular distribution for elastic

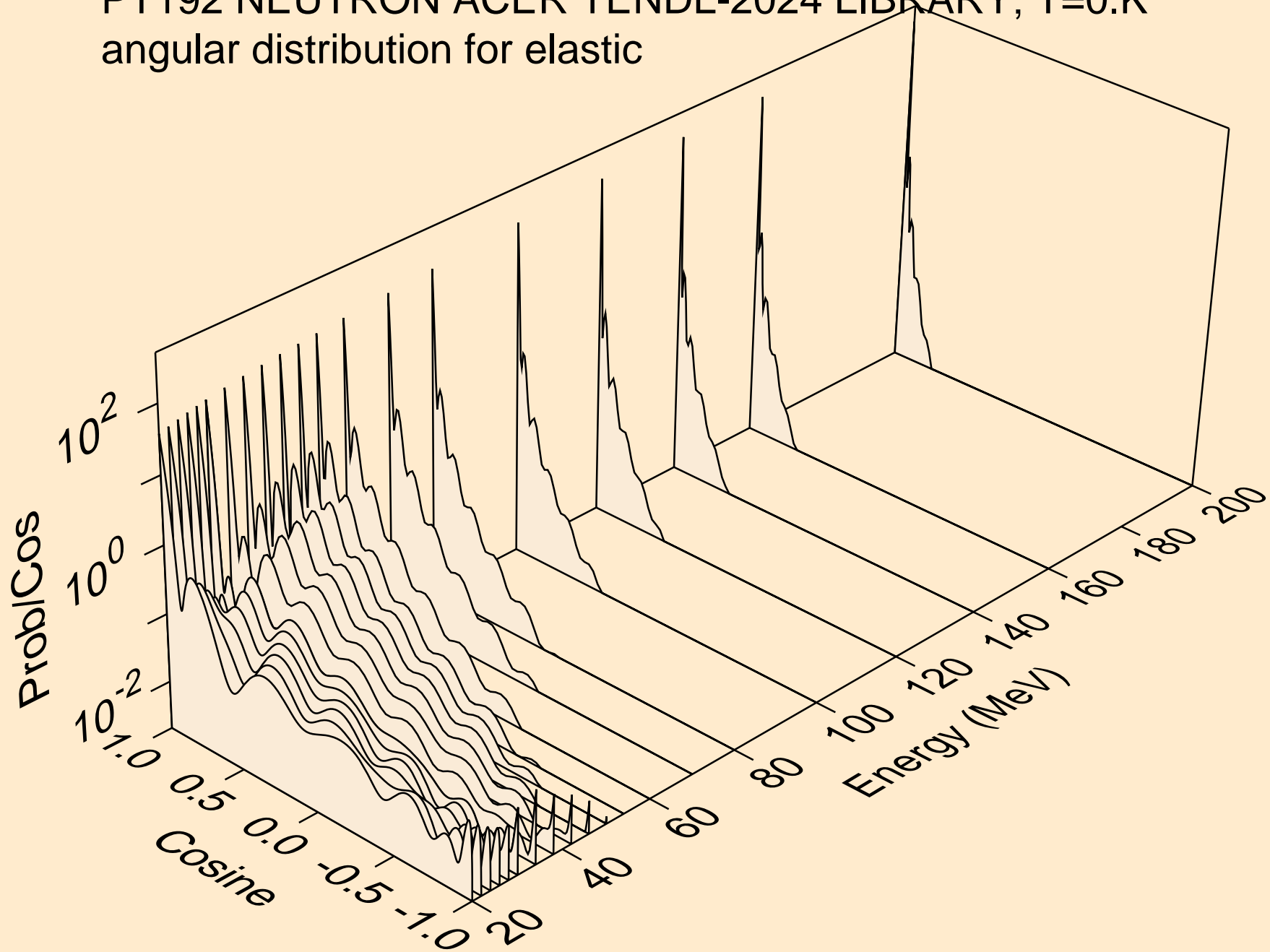

PT192 NEUTRON ACER TENDL-2024 LIBRARY; T=0.K
angular distribution for (n,n*1)

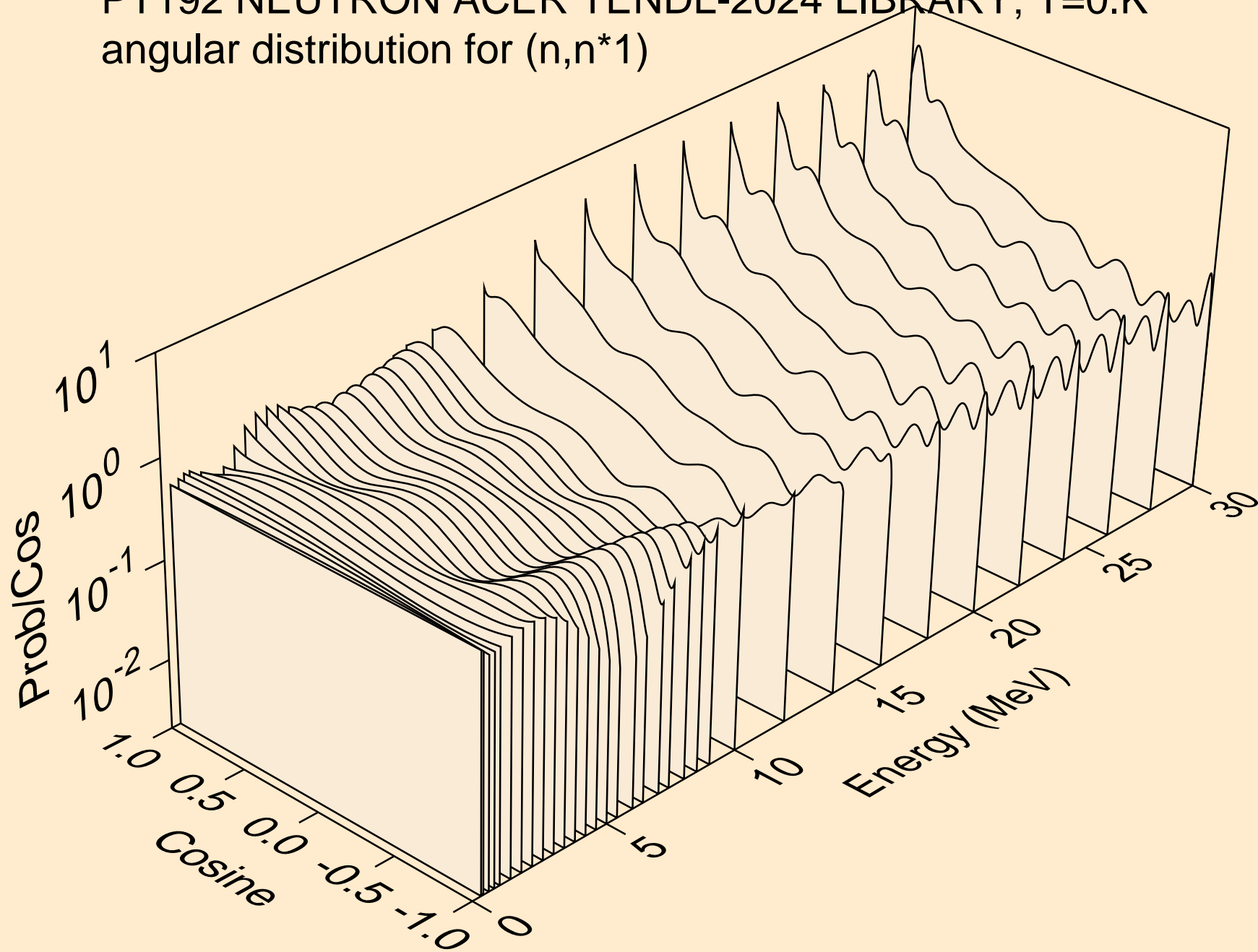

PT192 NEUTRON ACER TENDL-2024 LIBRARY; T=0.K
angular distribution for (n,n*2)

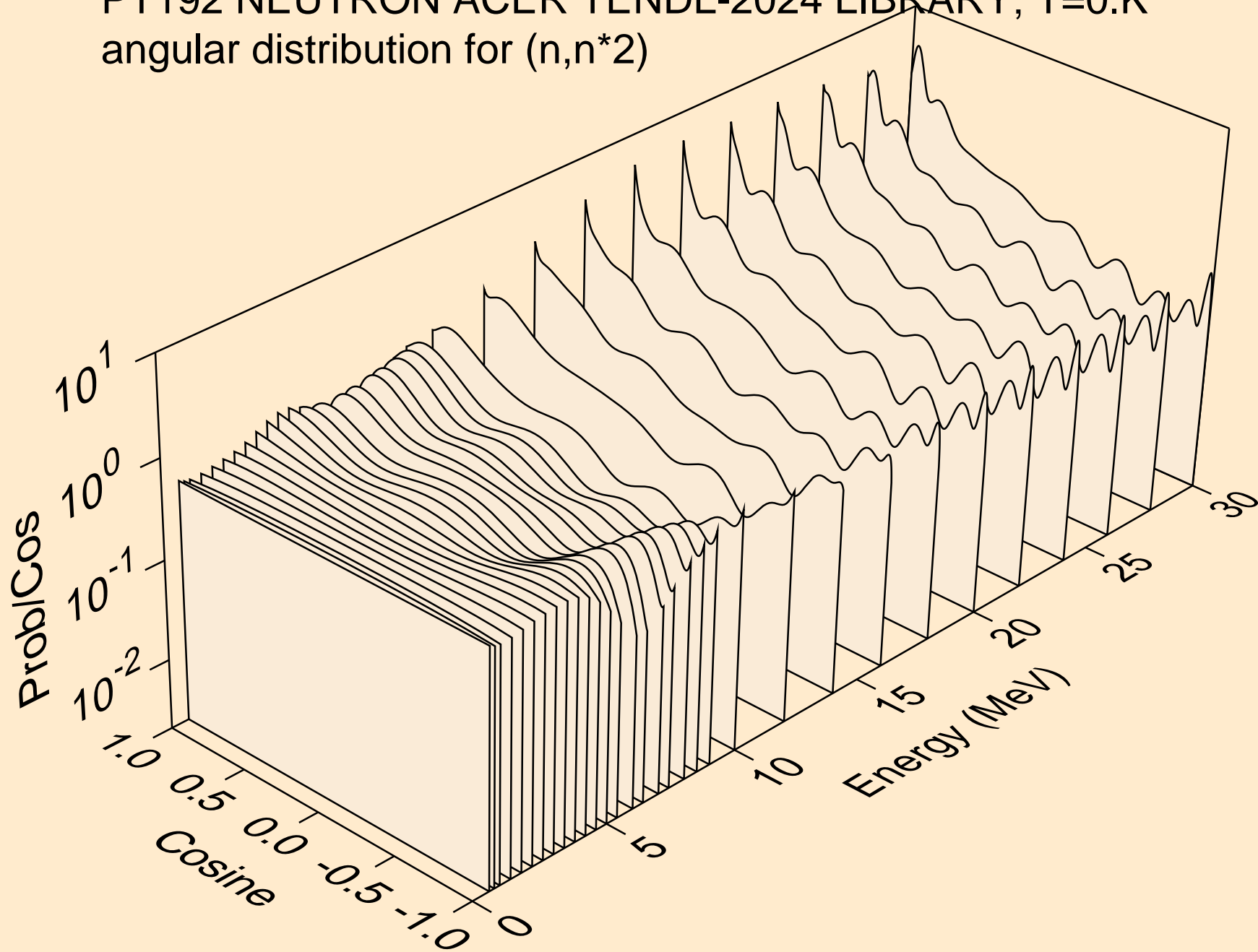

PT192 NEUTRON ACER TENDL-2024 LIBRARY; T=0.K
angular distribution for (n,n*3)

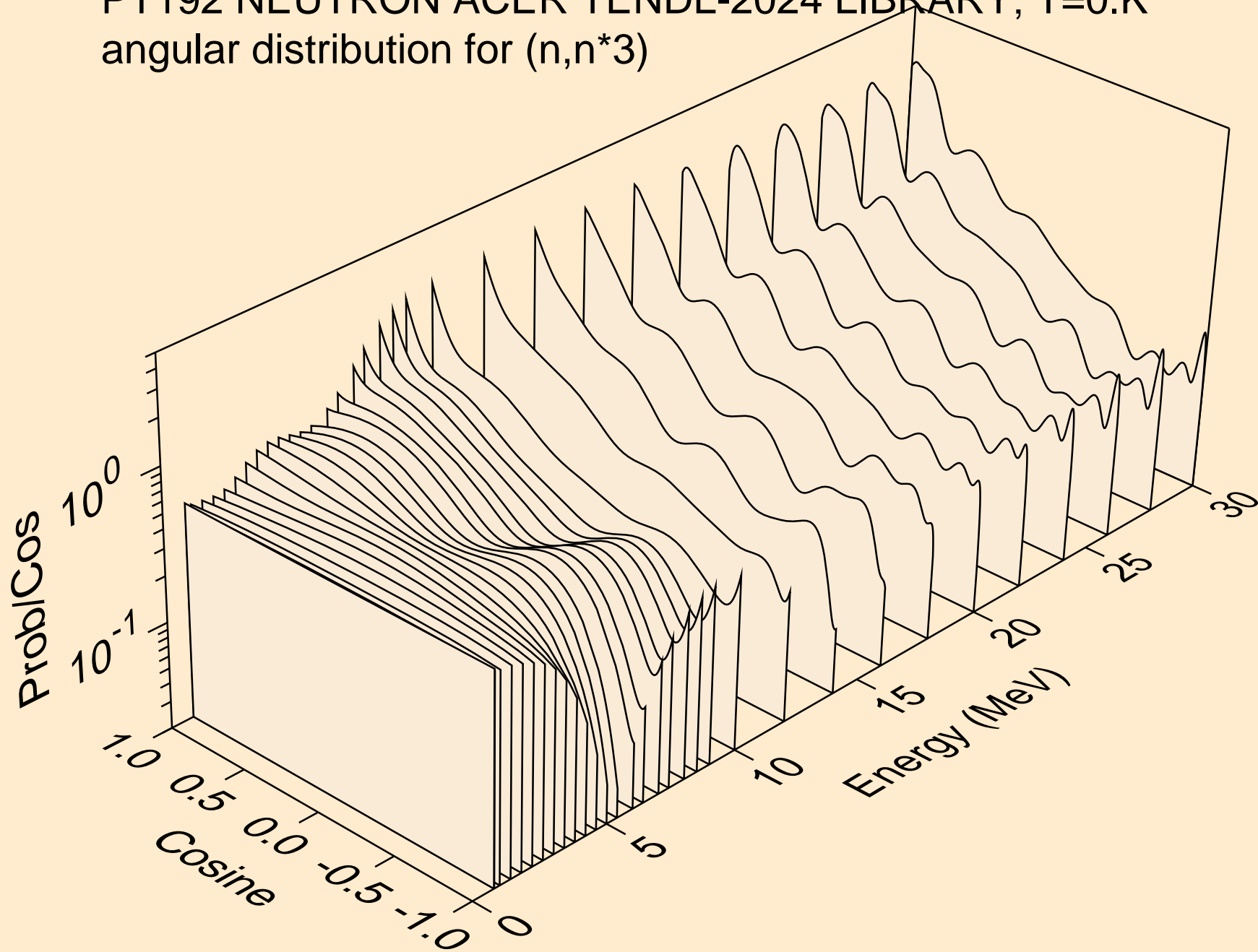

PT192 NEUTRON ACER TENDL-2024 LIBRARY; T=0.K
angular distribution for (n,n*4)

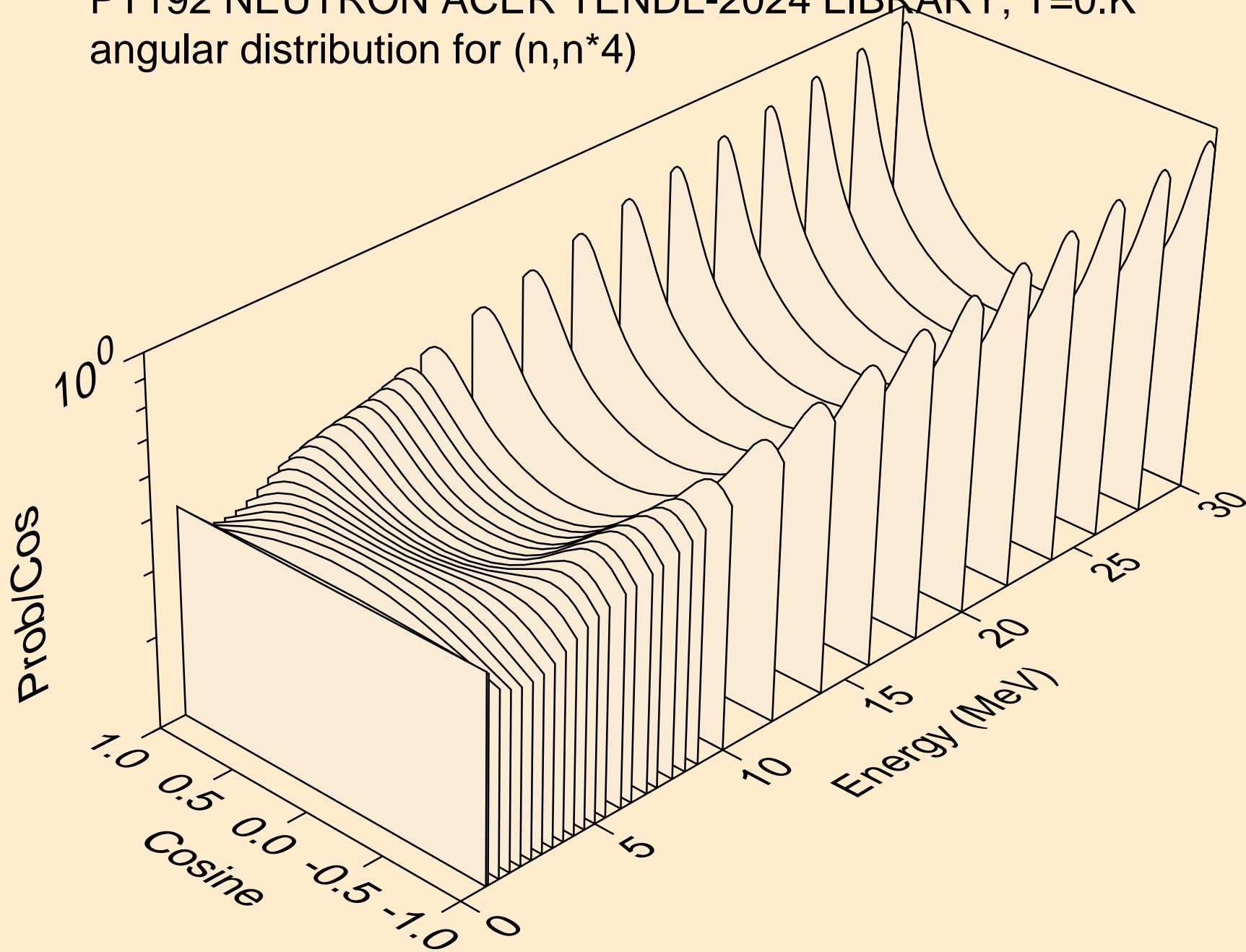

PT192 NEUTRON ACER TENDL-2024 LIBRARY; T=0.K
angular distribution for (n,n*5)

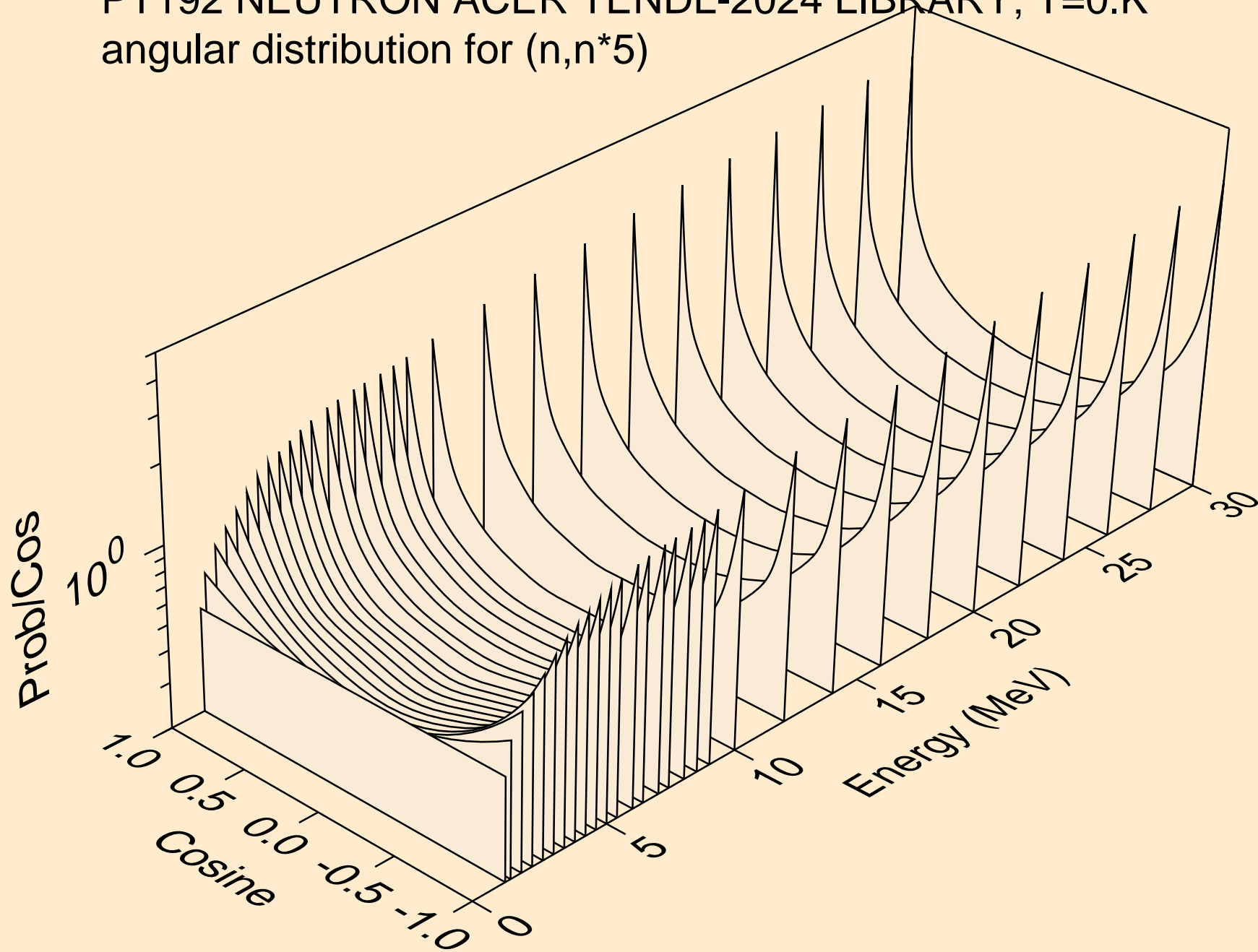

PT192 NEUTRON ACER TENDL-2024 LIBRARY; T=0.K
angular distribution for (n,n*6)

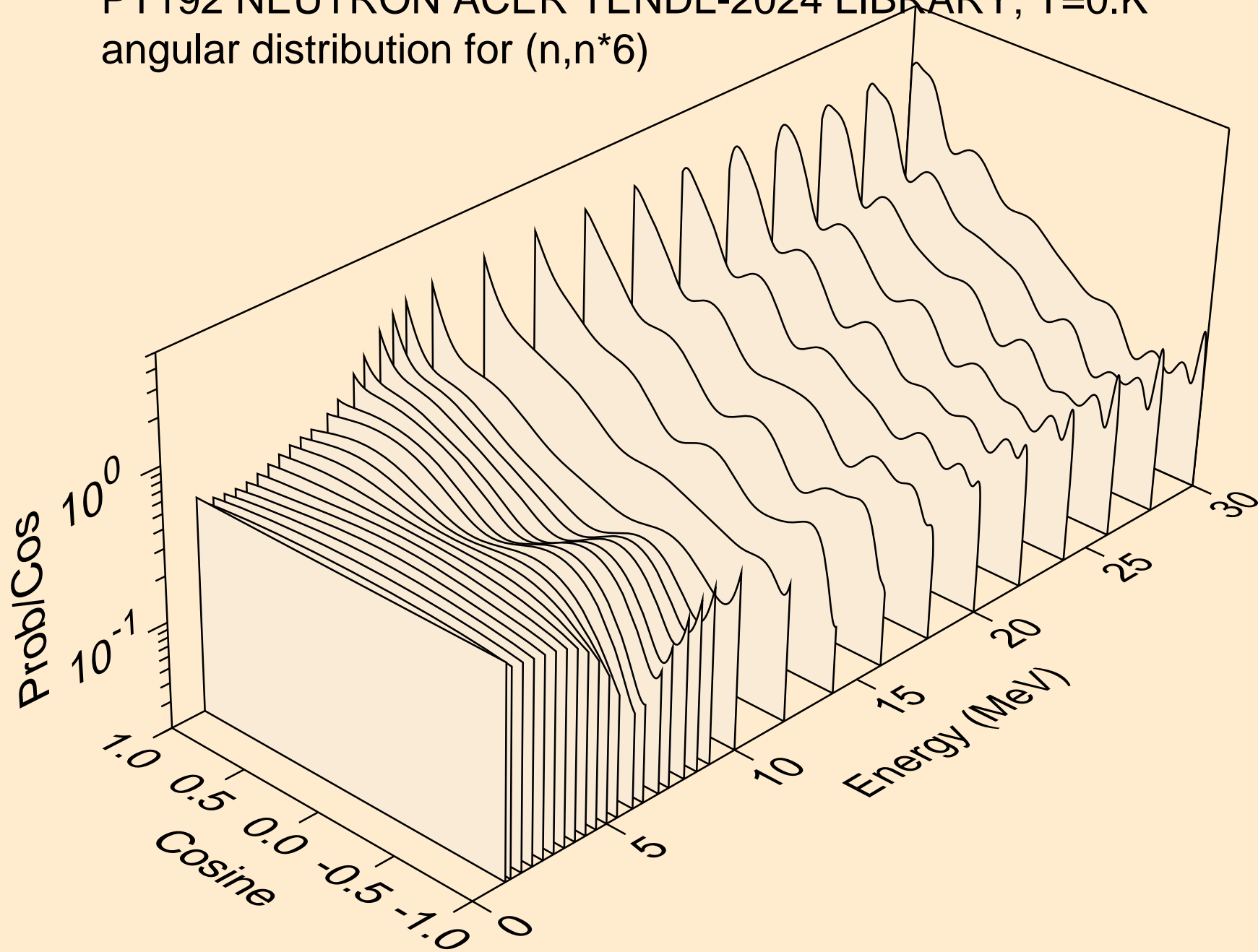

PT192 NEUTRON ACER TENDL-2024 LIBRARY; T=0.K
angular distribution for (n,n*7)

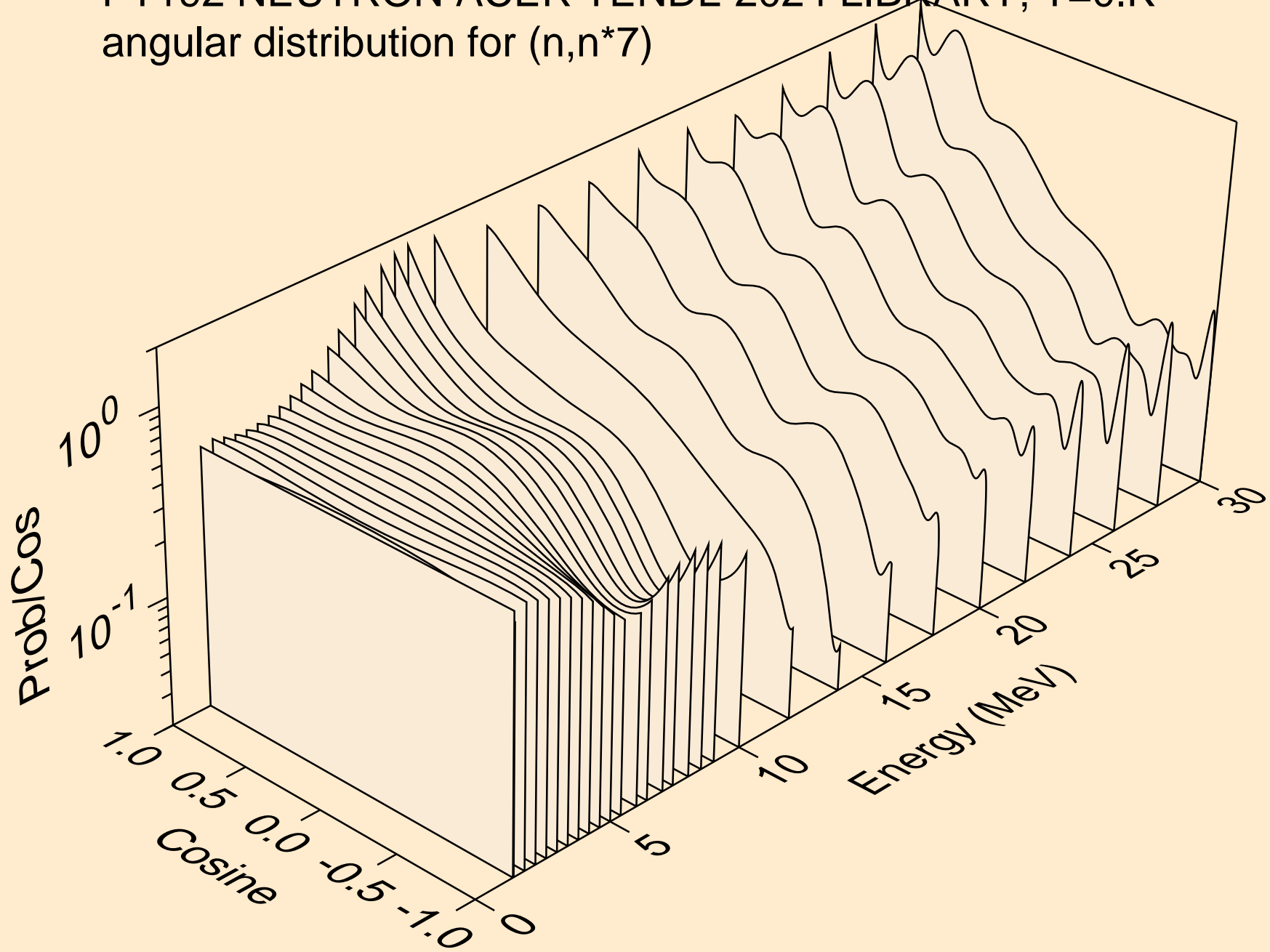

PT192 NEUTRON ACER TENDL-2024 LIBRARY; T=0.K
angular distribution for (n,n*8)

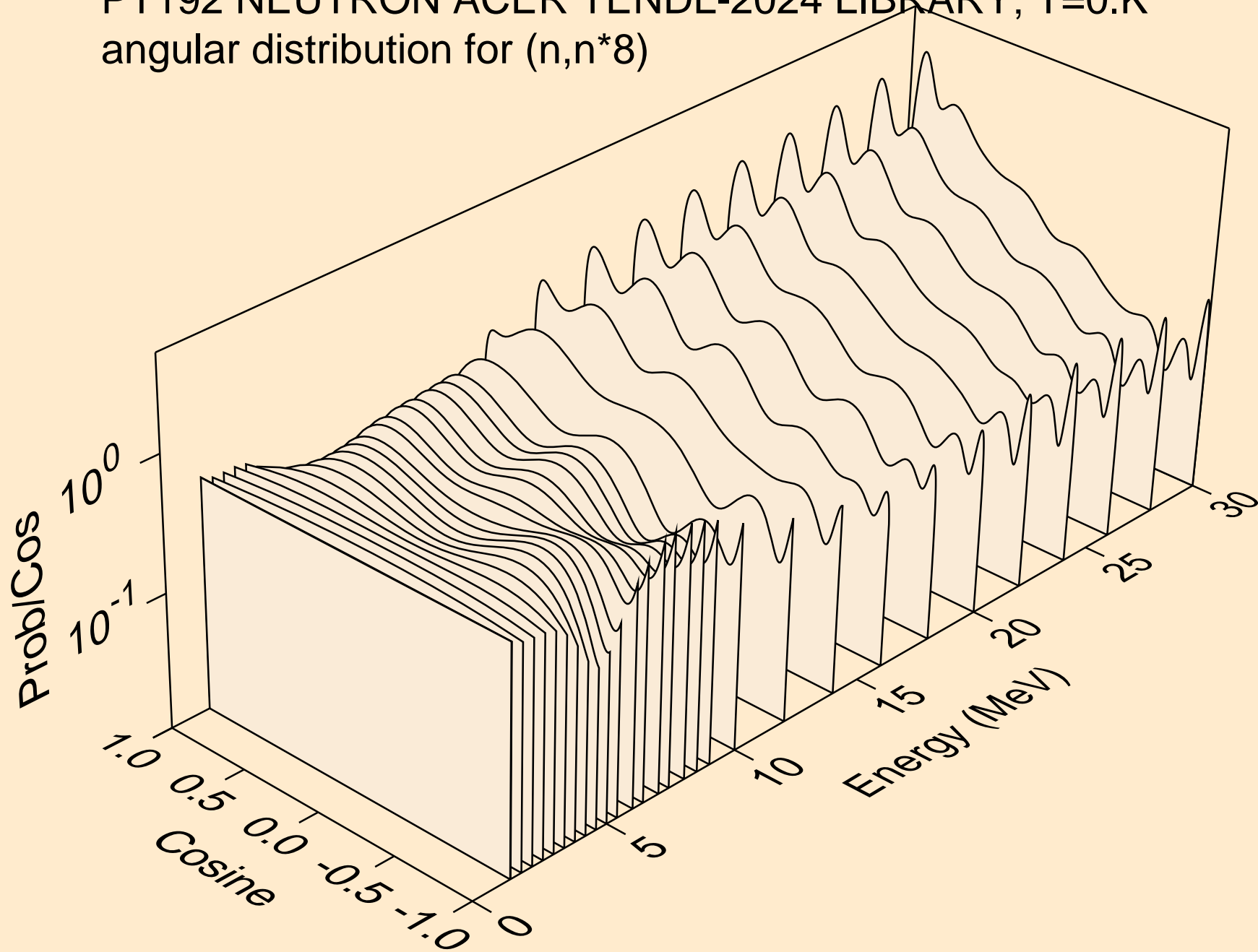

PT192 NEUTRON ACER TENDL-2024 LIBRARY; T=0.K
angular distribution for (n,n*9)

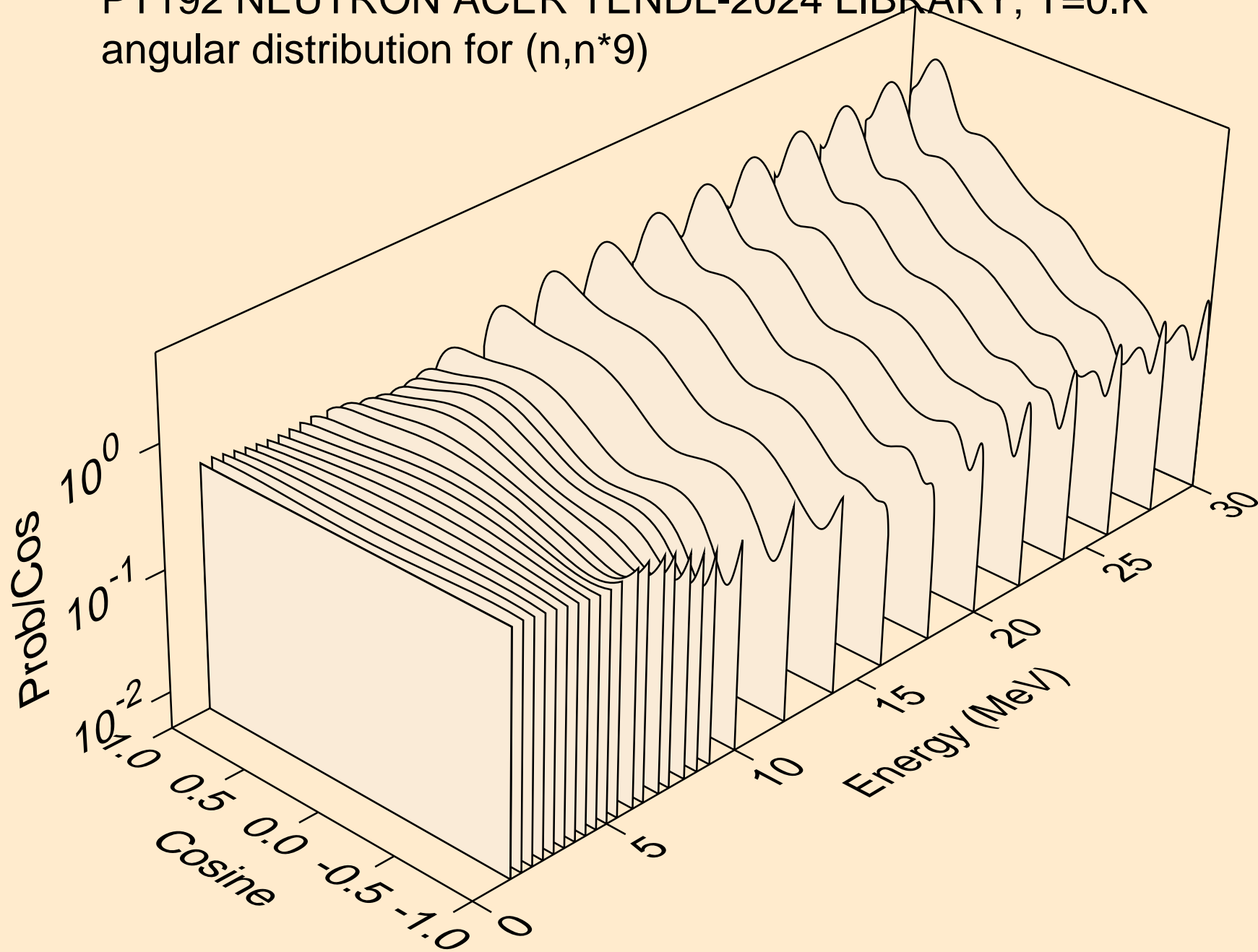

PT192 NEUTRON ACER TENDL-2024 LIBRARY; T=0.K
angular distribution for (n,n*10)

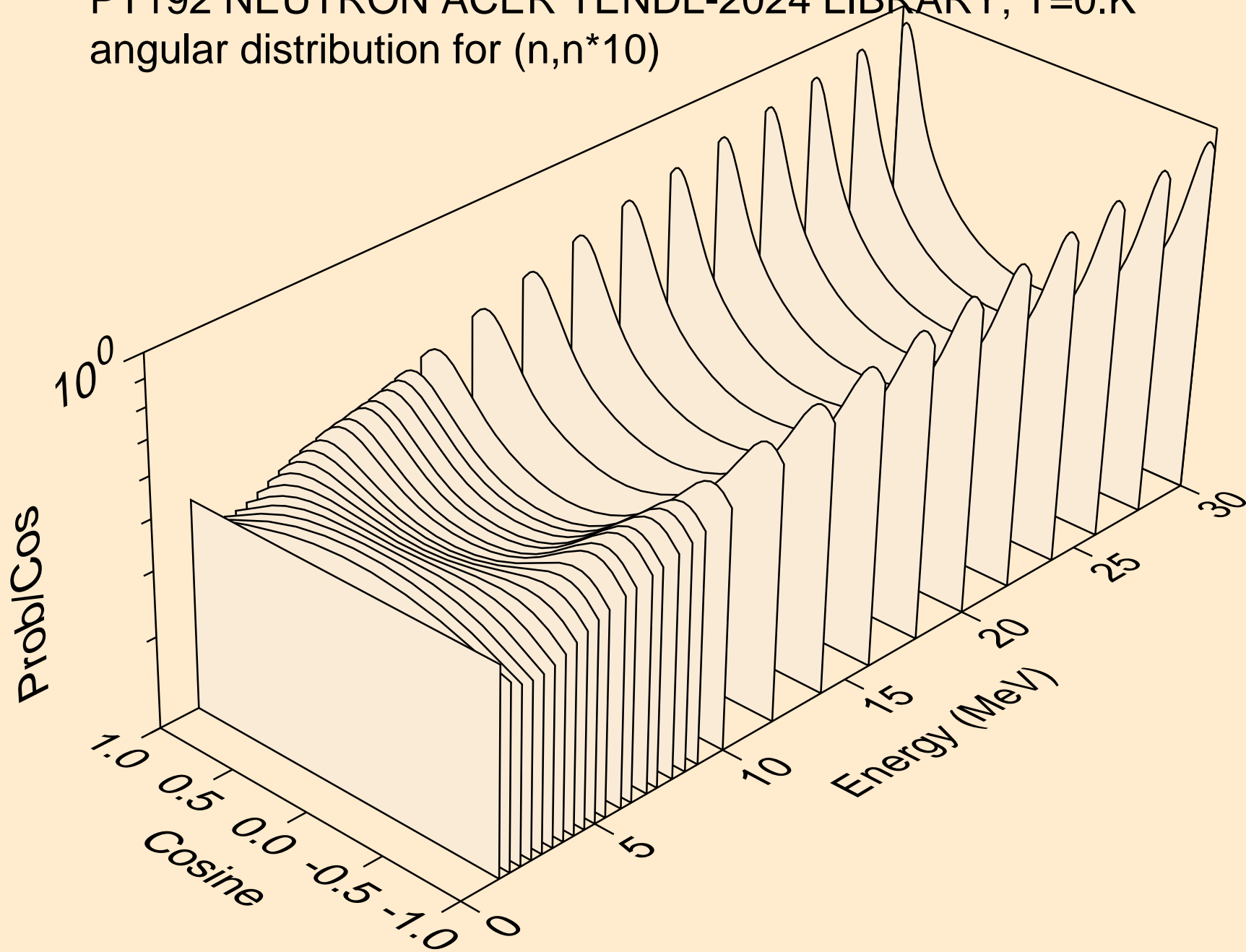

PT192 NEUTRON ACER TENDL-2024 LIBRARY; T=0.K
angular distribution for (n,n*11)

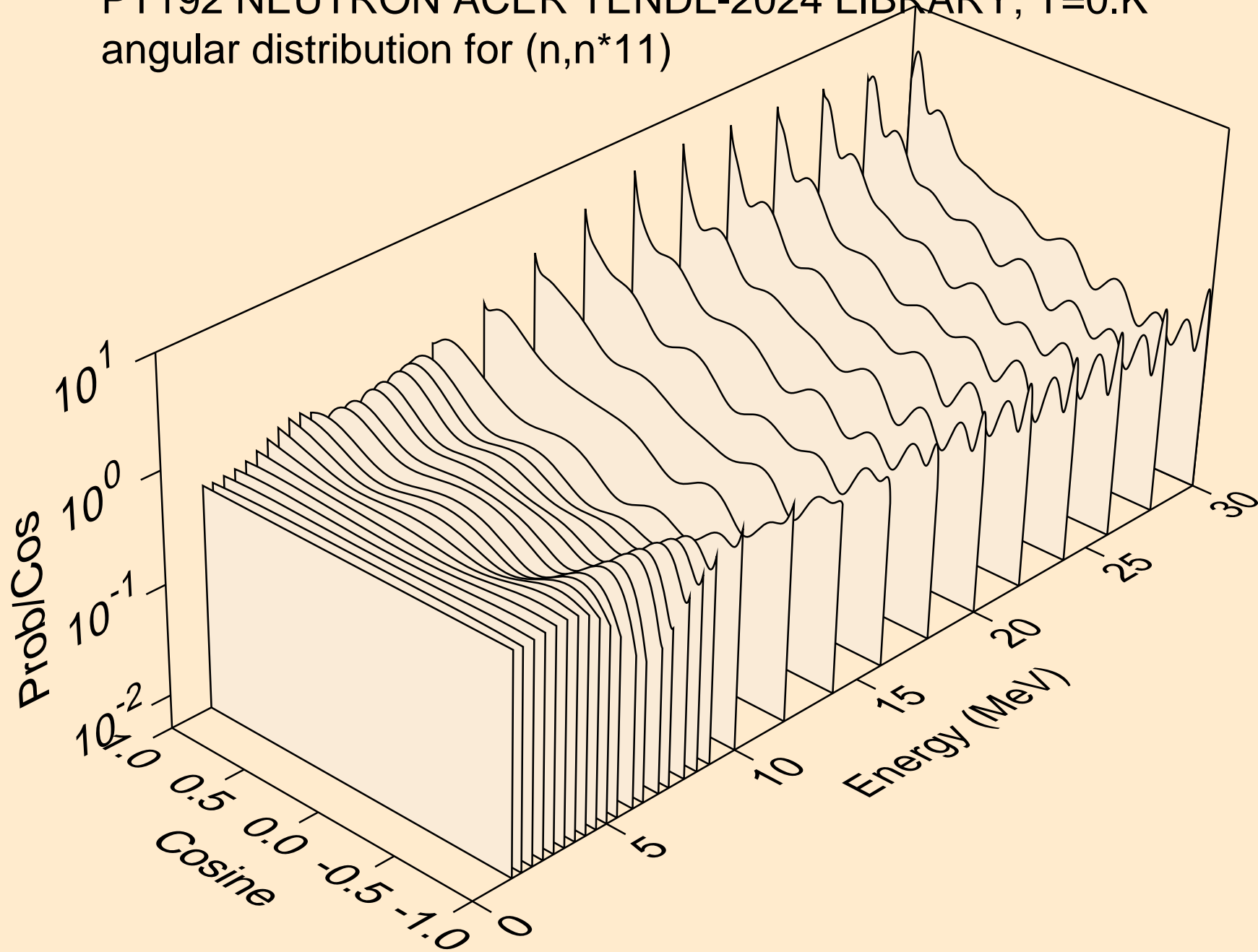

PT192 NEUTRON ACER TENDL-2024 LIBRARY; T=0.K
angular distribution for (n,n*12)

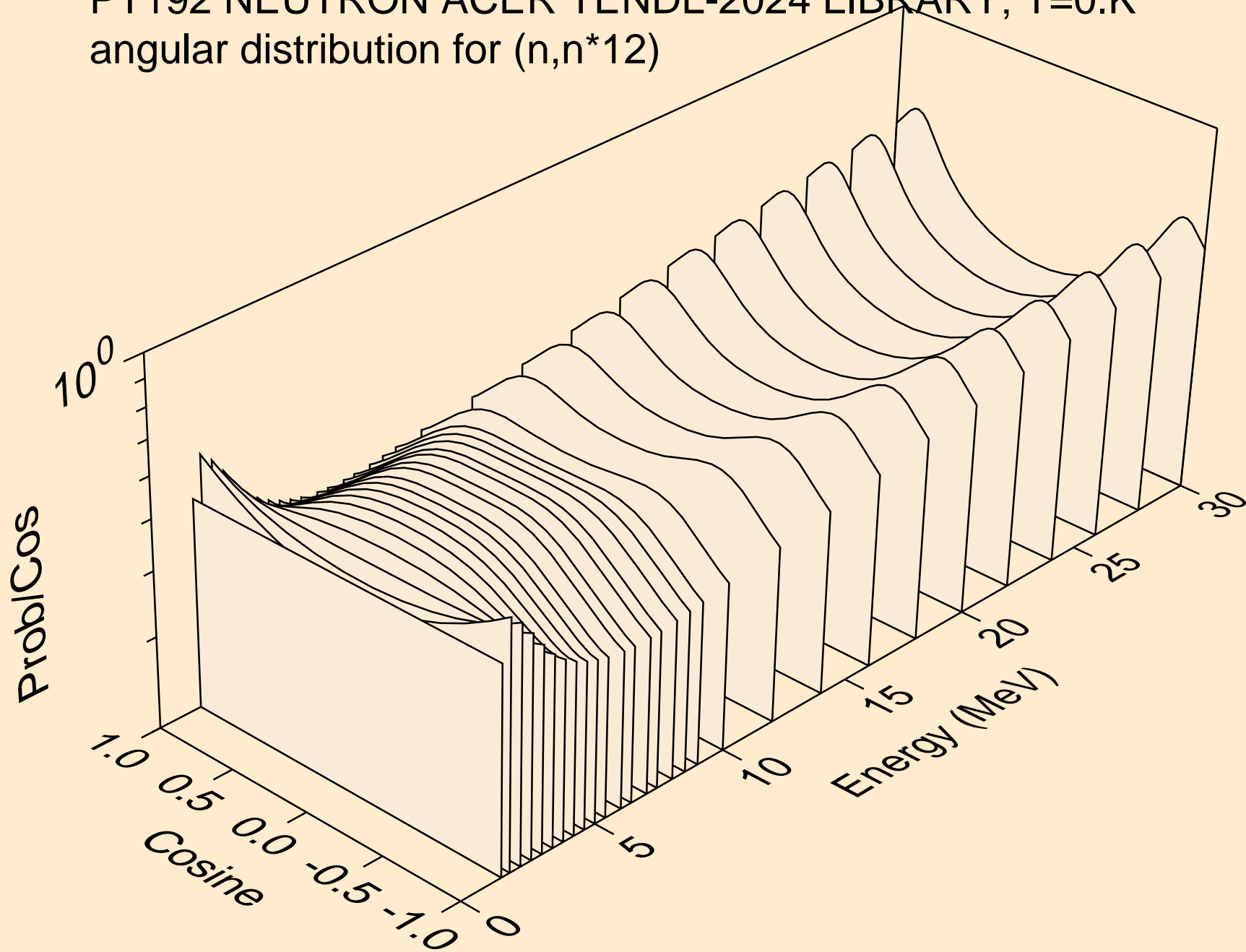

PT192 NEUTRON ACER TENDL-2024 LIBRARY; T=0.K
angular distribution for (n,n*13)

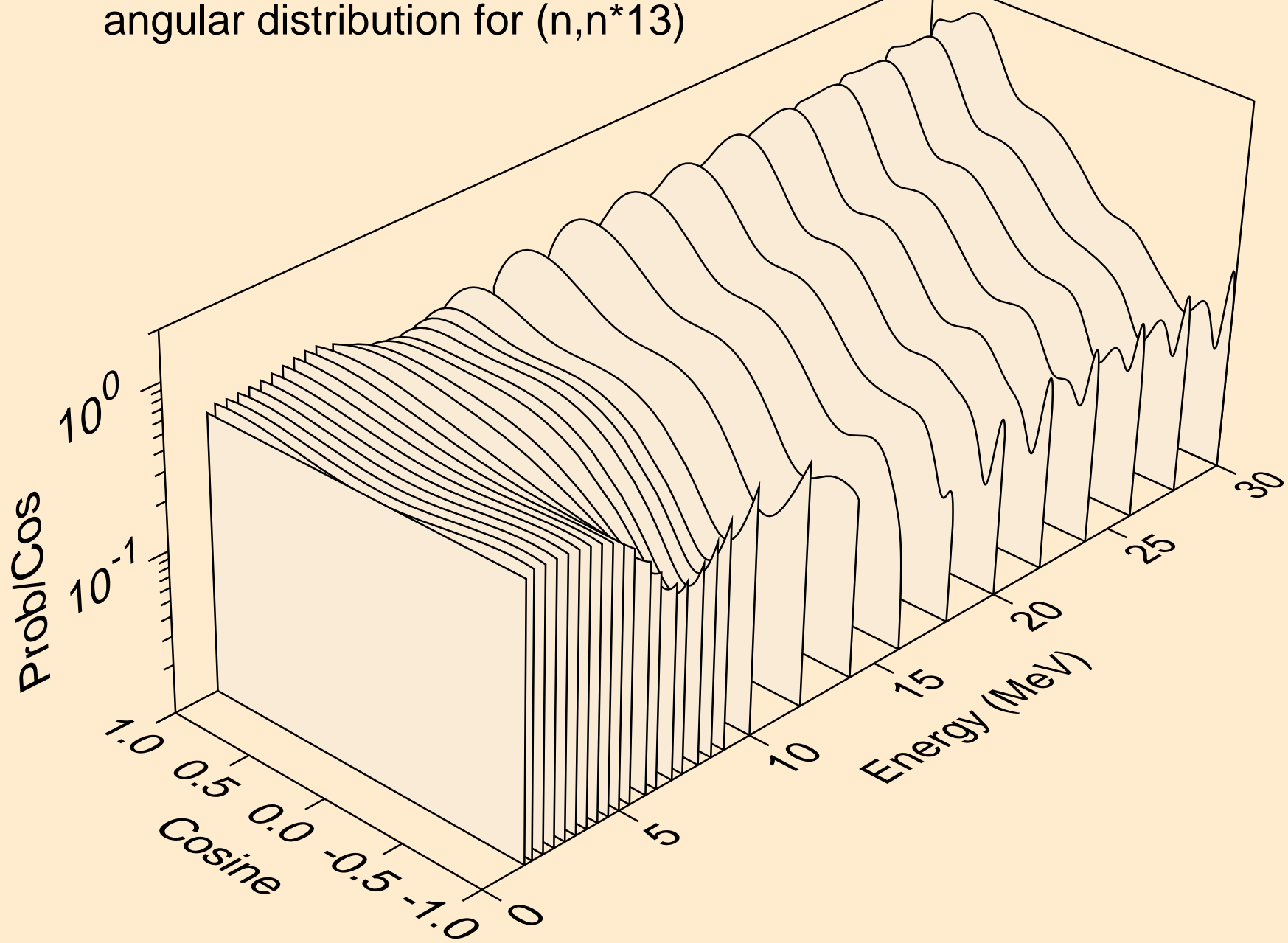

PT192 NEUTRON ACER TENDL-2024 LIBRARY; T=0.K
angular distribution for (n,n*14)

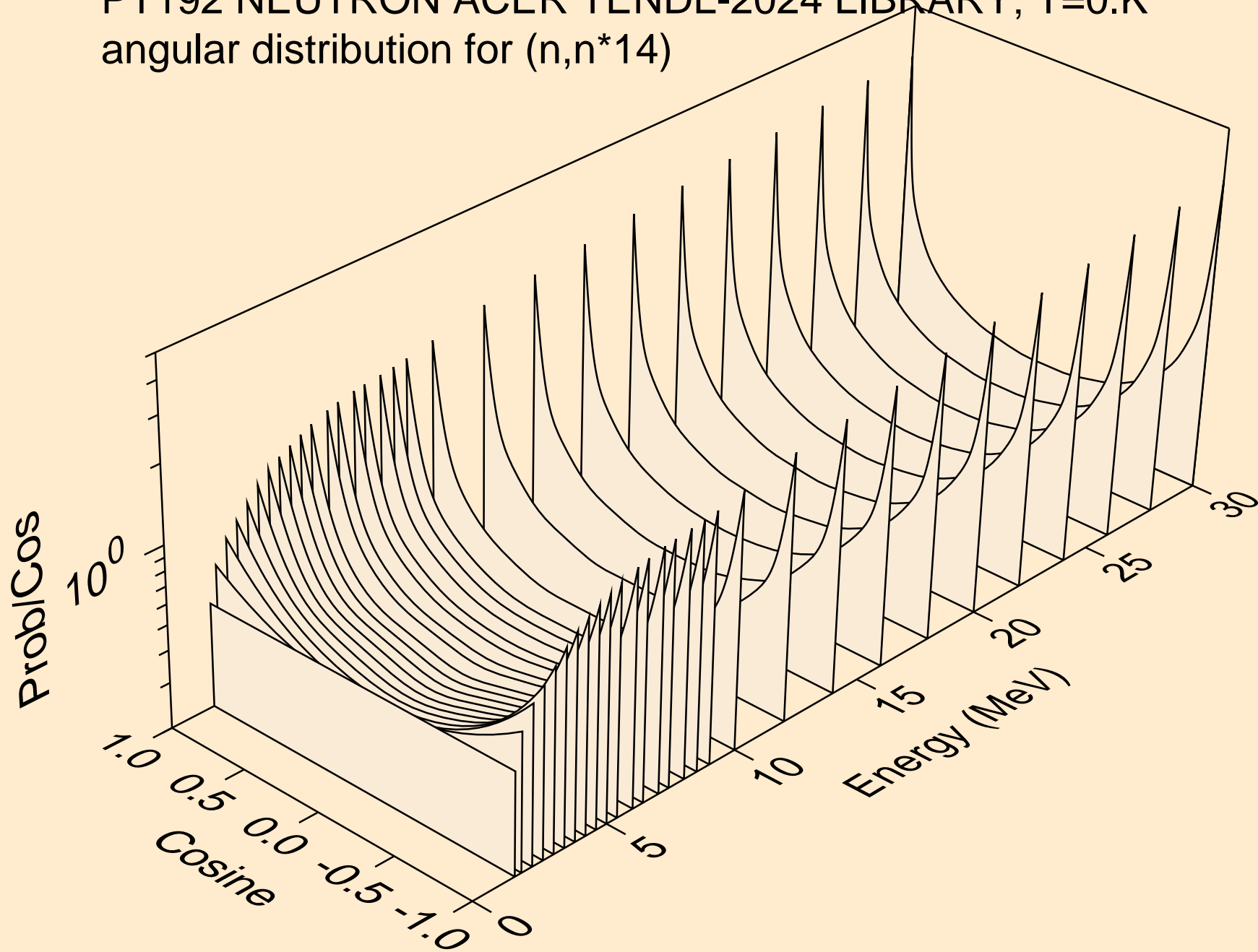

PT192 NEUTRON ACER TENDL-2024 LIBRARY; T=0.K
angular distribution for (n,n*15)

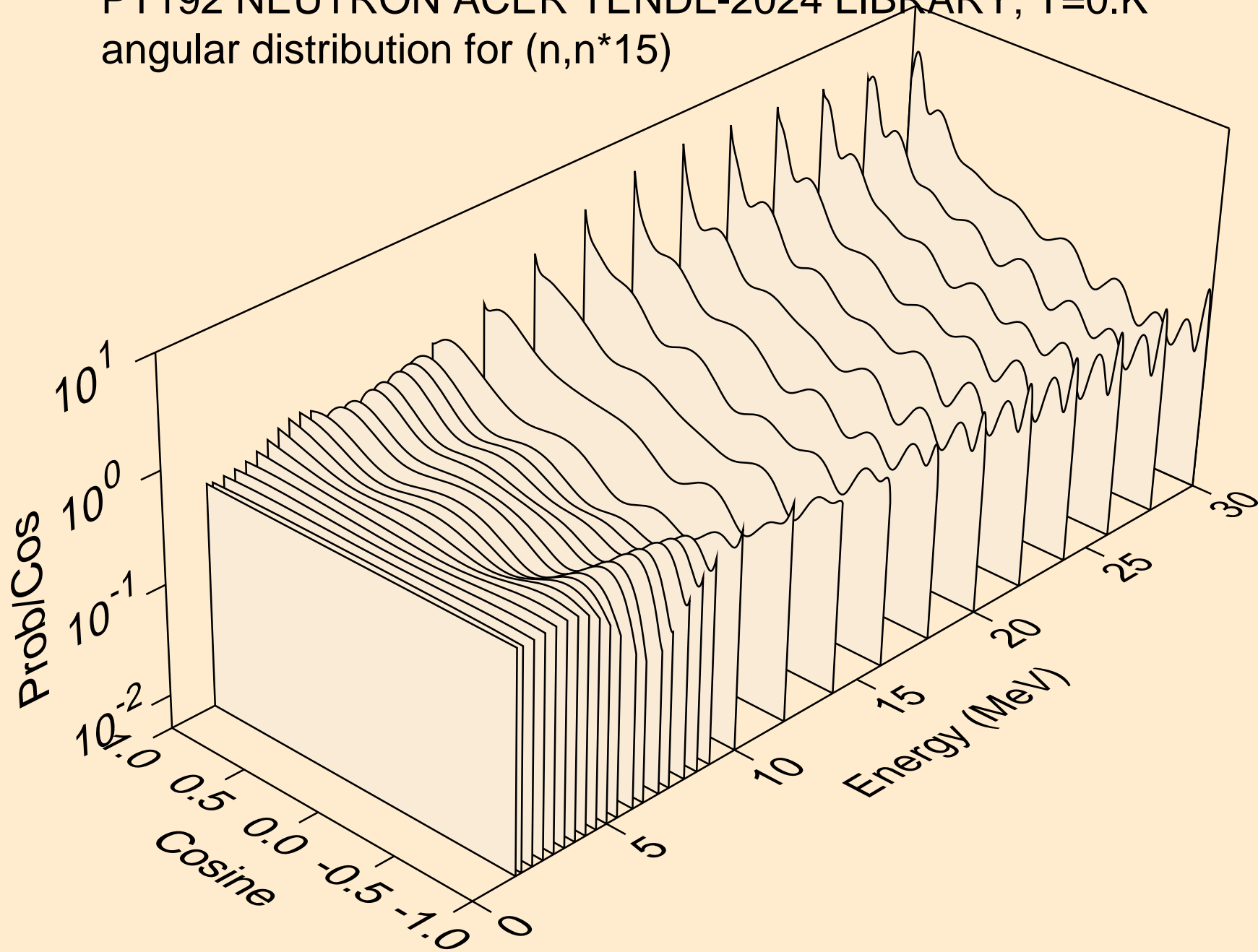

PT192 NEUTRON ACER TENDL-2024 LIBRARY; T=0.K
angular distribution for (n,n*16)

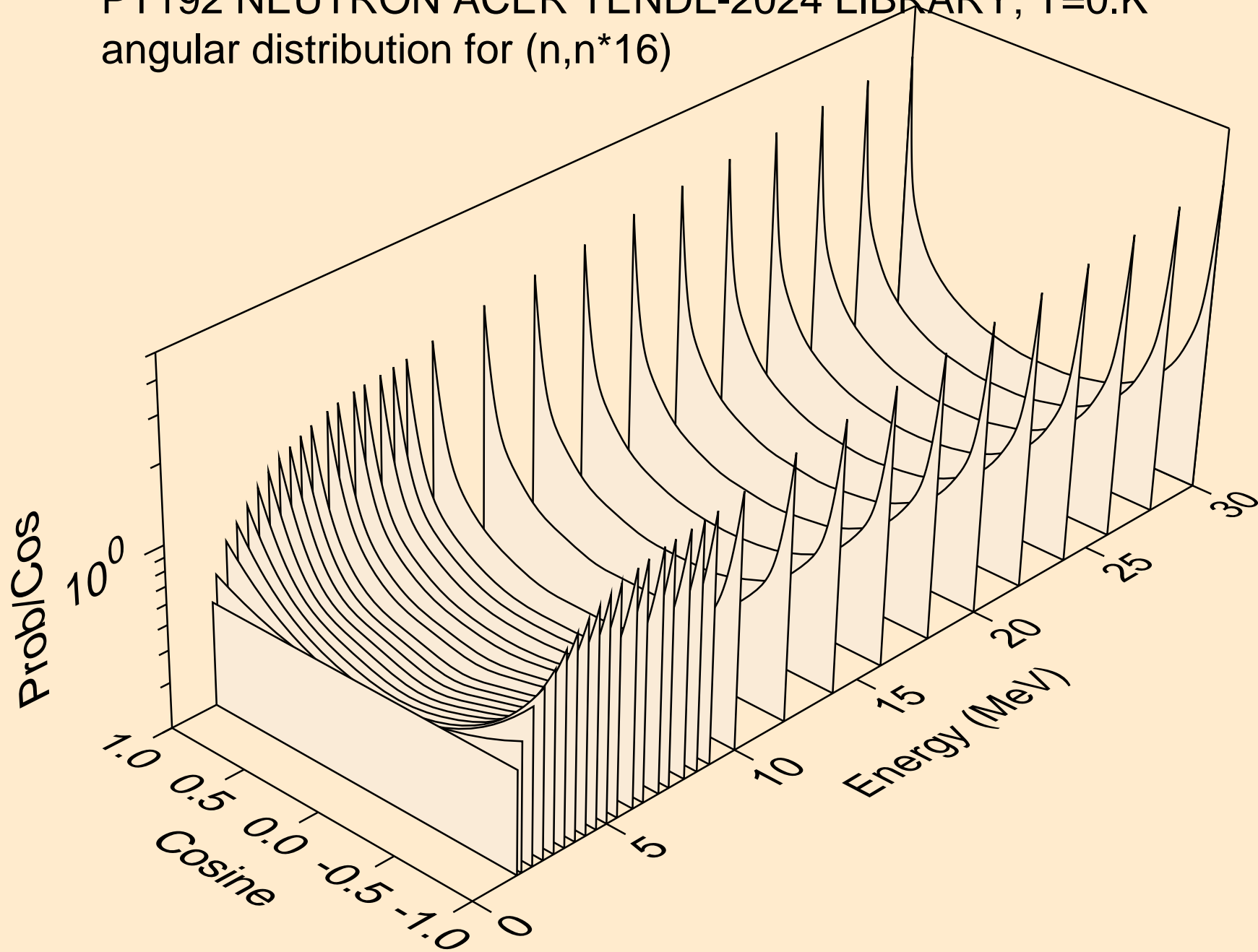

PT192 NEUTRON ACER TENDL-2024 LIBRARY; T=0.K
angular distribution for (n,n*17)

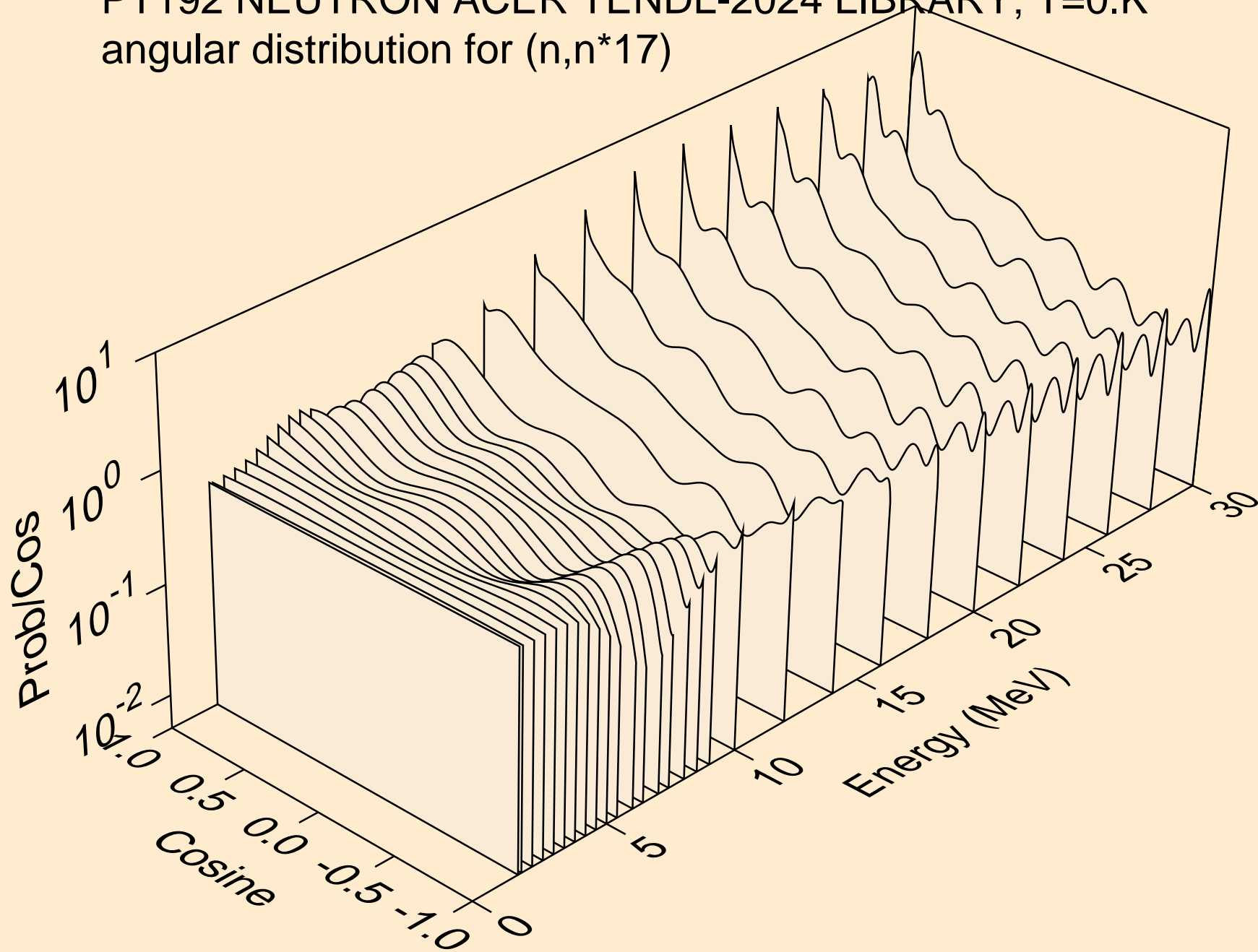

PT192 NEUTRON ACER TENDL-2024 LIBRARY; T=0.K
angular distribution for (n,n*18)

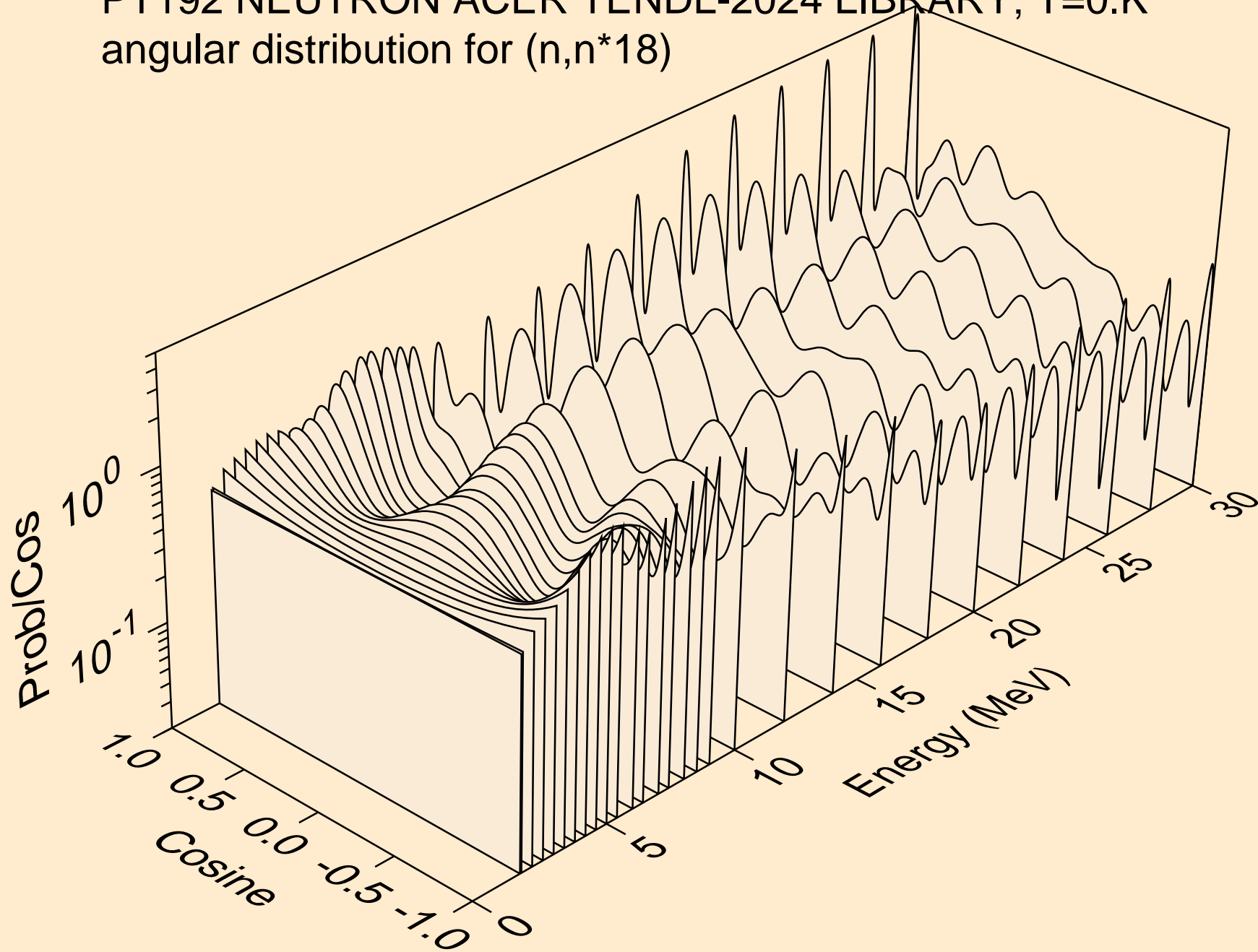

PT192 NEUTRON ACER TENDL-2024 LIBRARY; T=0.K
angular distribution for (n,n*19)

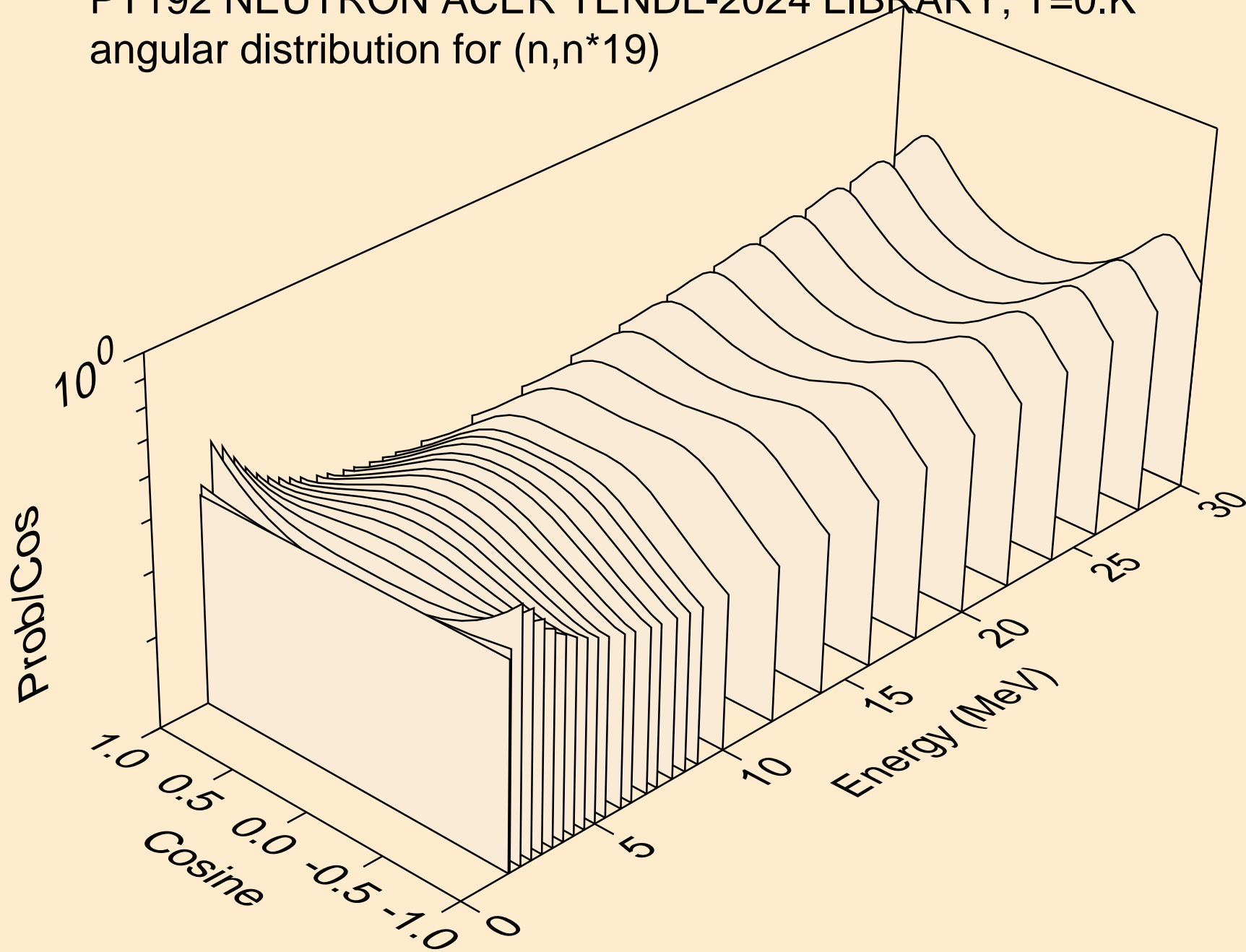

PT192 NEUTRON ACER TENDL-2024 LIBRARY; T=0.K
angular distribution for (n,n*20)

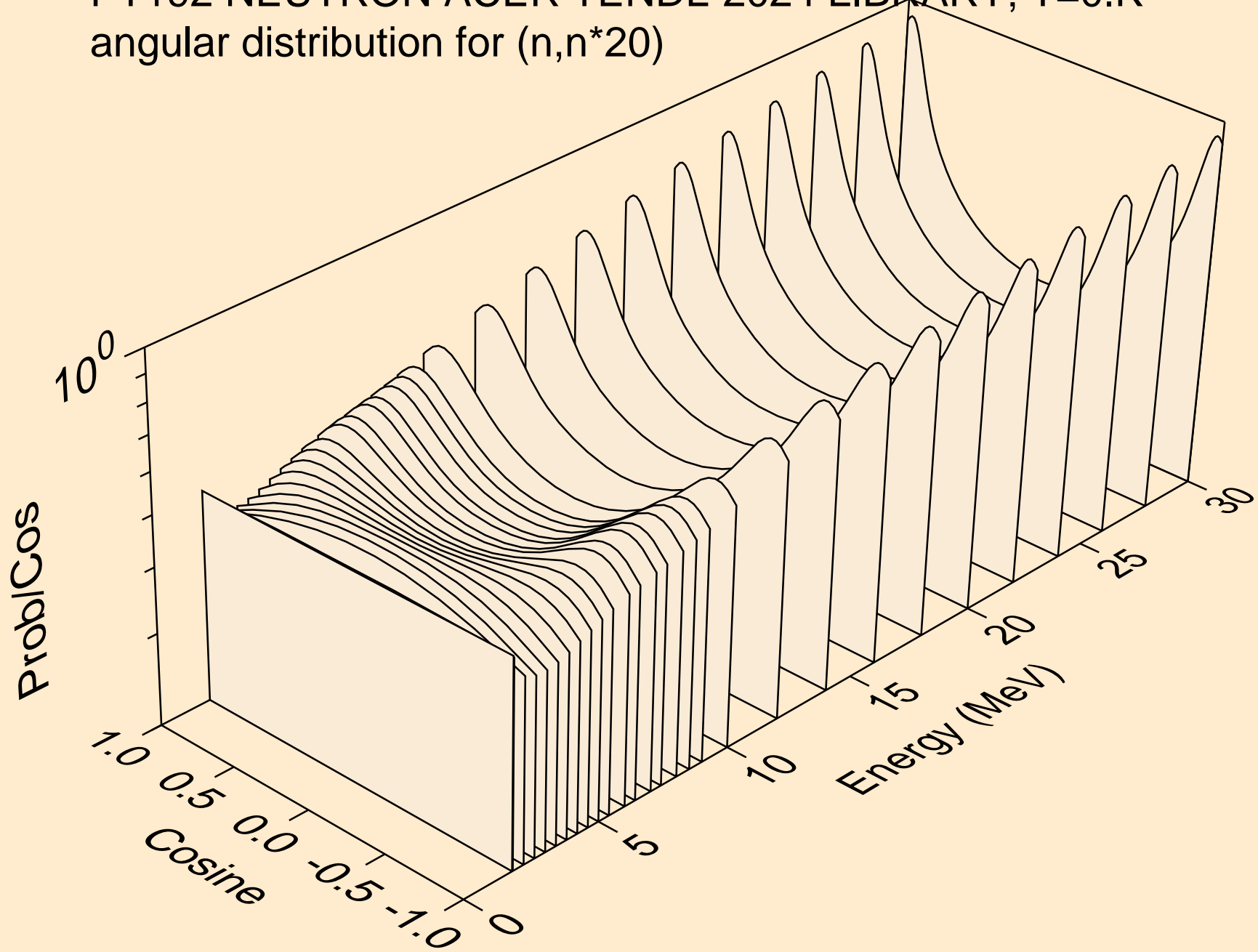

PT192 NEUTRON ACER TENDL-2024 LIBRARY; T=0.K
angular distribution for (n,n*21)

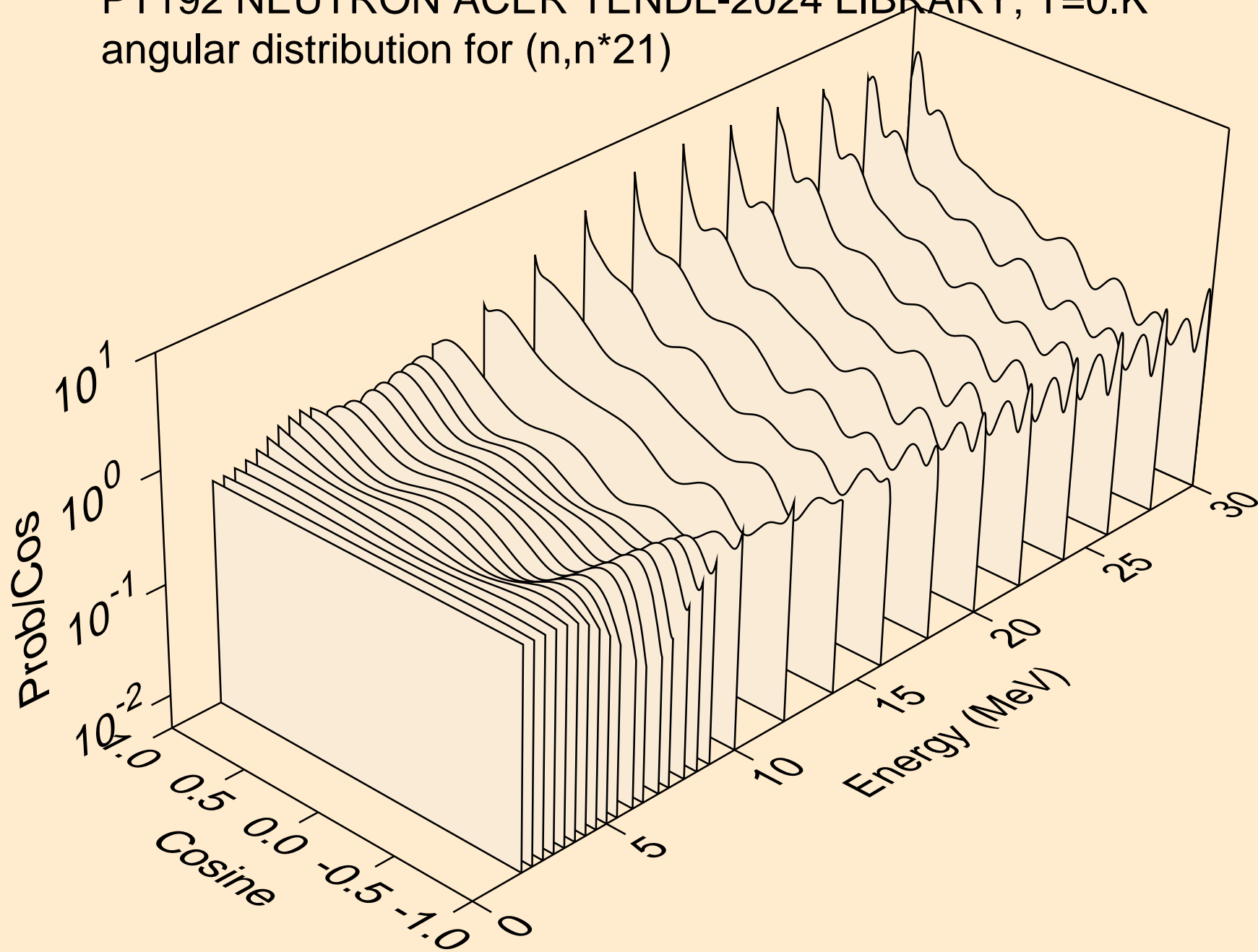

PT192 NEUTRON ACER TENDL-2024 LIBRARY; T=0.K
angular distribution for (n,n*22)

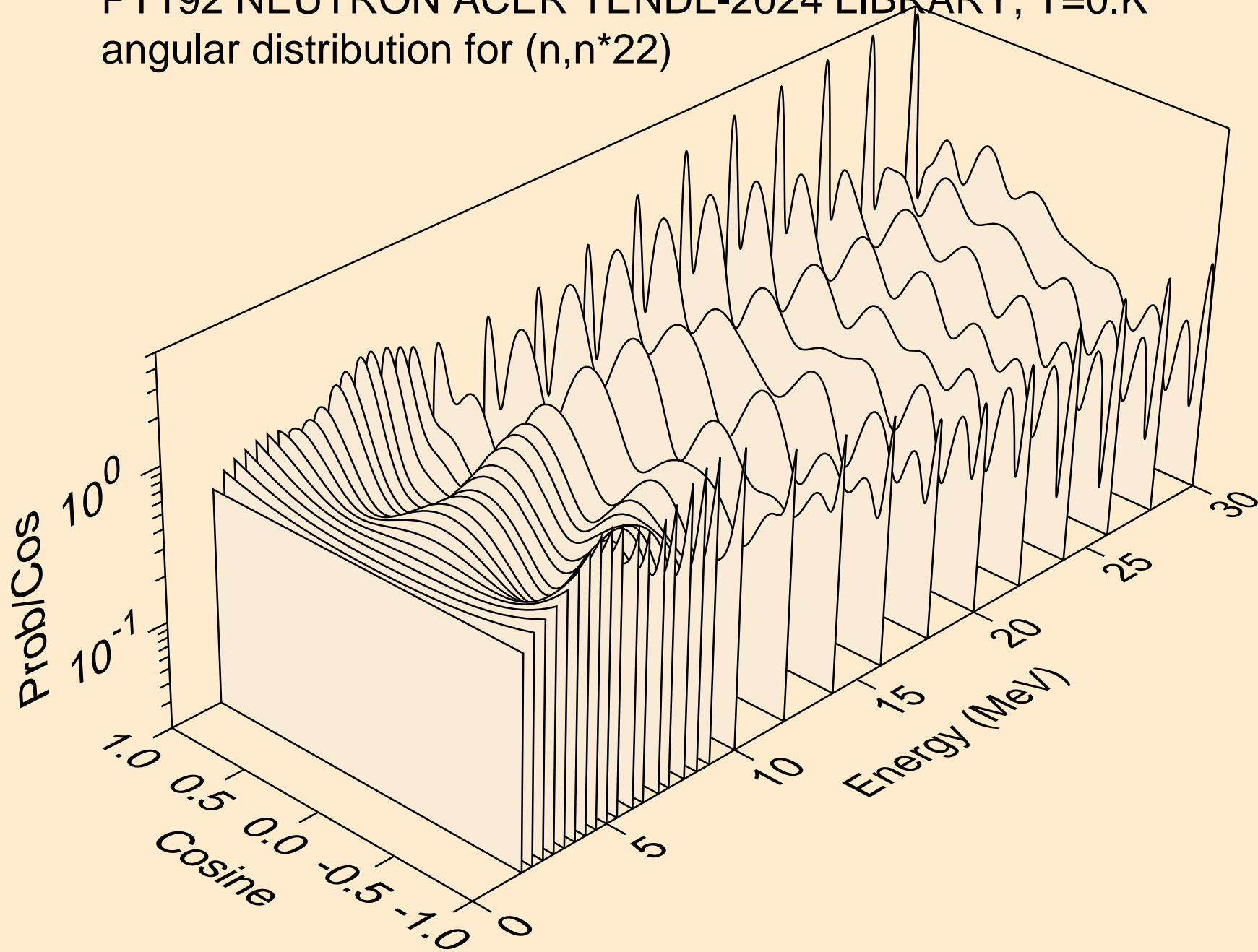

PT192 NEUTRON ACER TENDL-2024 LIBRARY; T=0.K
angular distribution for (n,n*23)

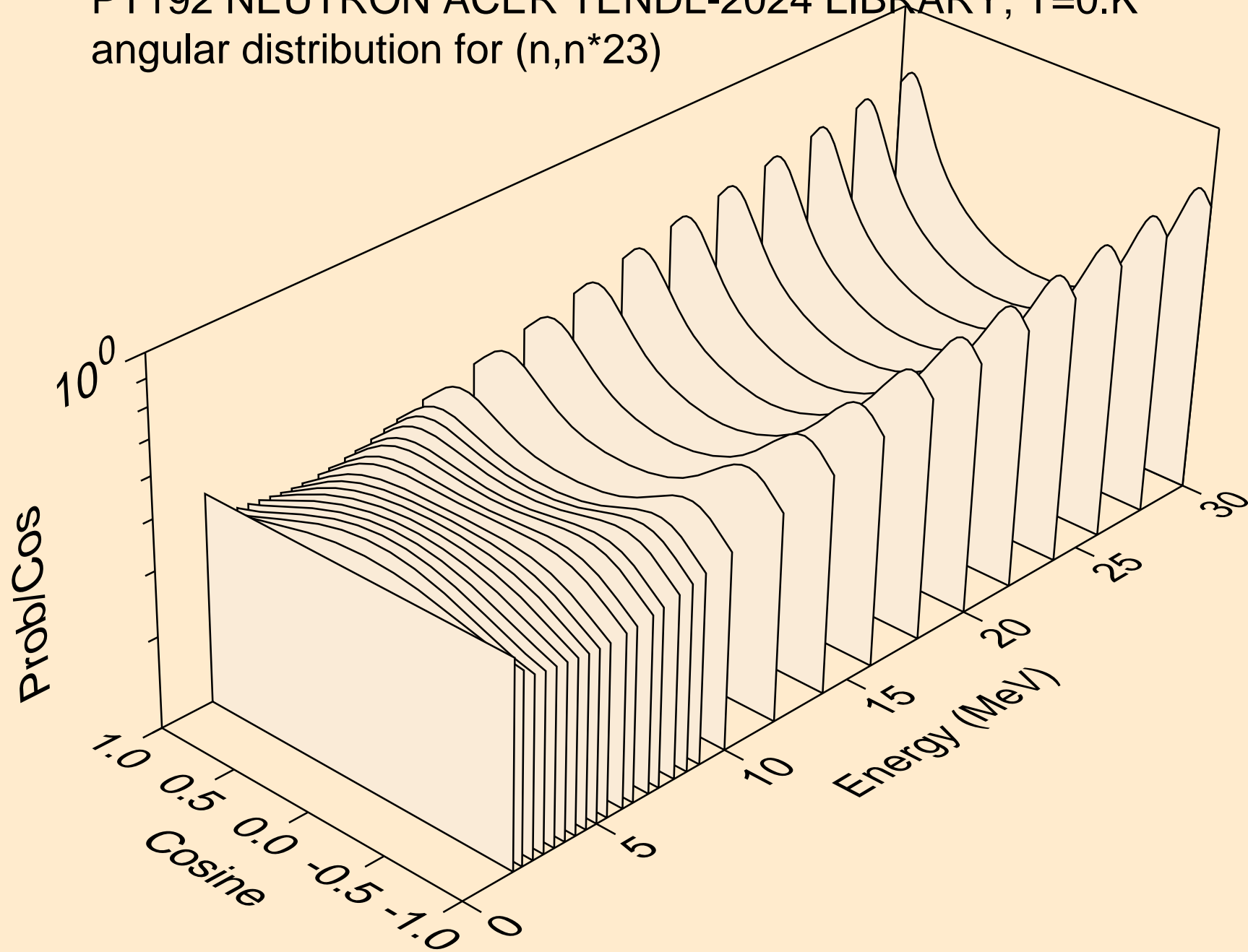

PT192 NEUTRON ACER TENDL-2024 LIBRARY; T=0.K
angular distribution for (n,n*24)

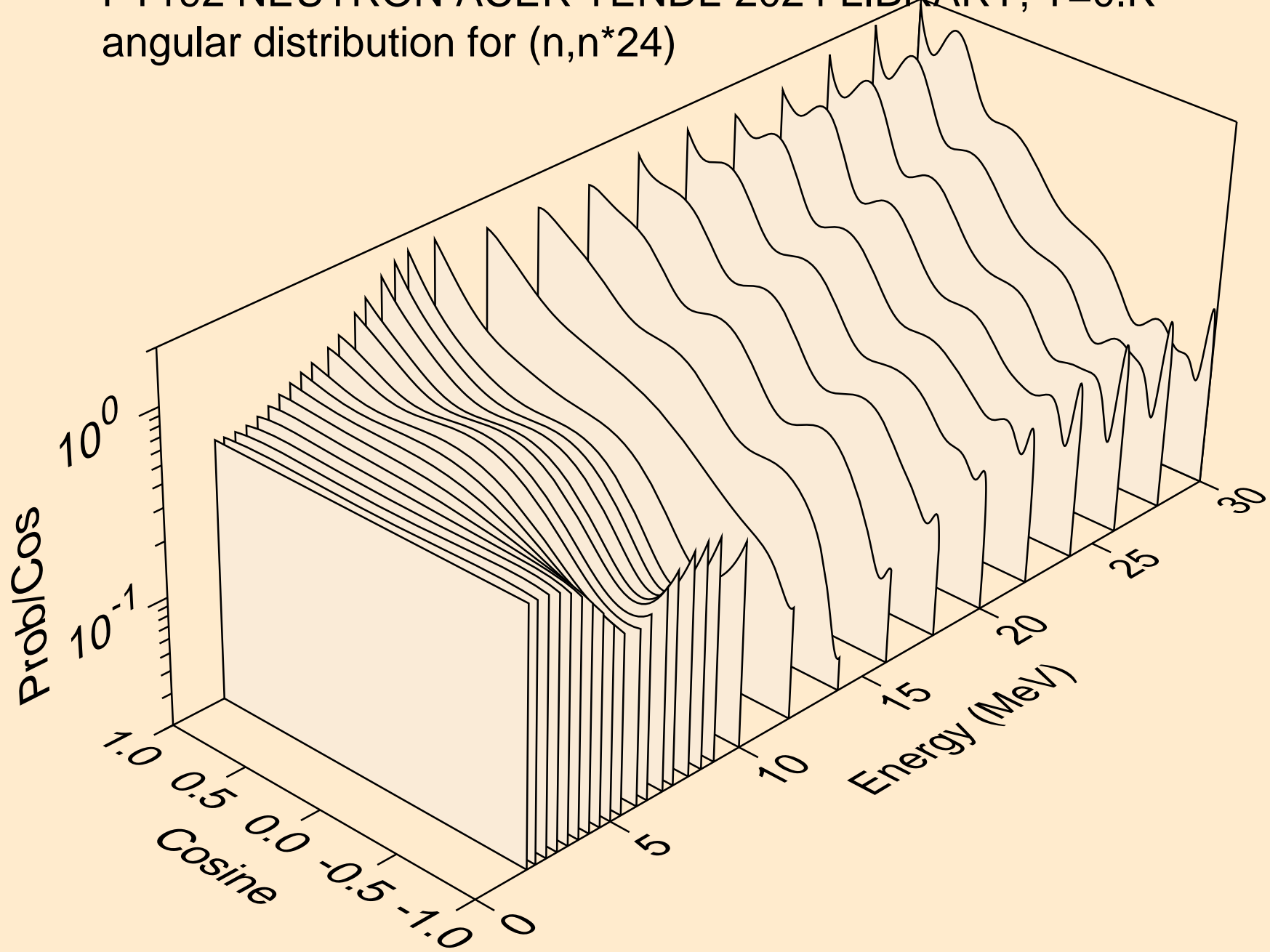

PT192 NEUTRON ACER TENDL-2024 LIBRARY; T=0.K
angular distribution for (n,n*25)

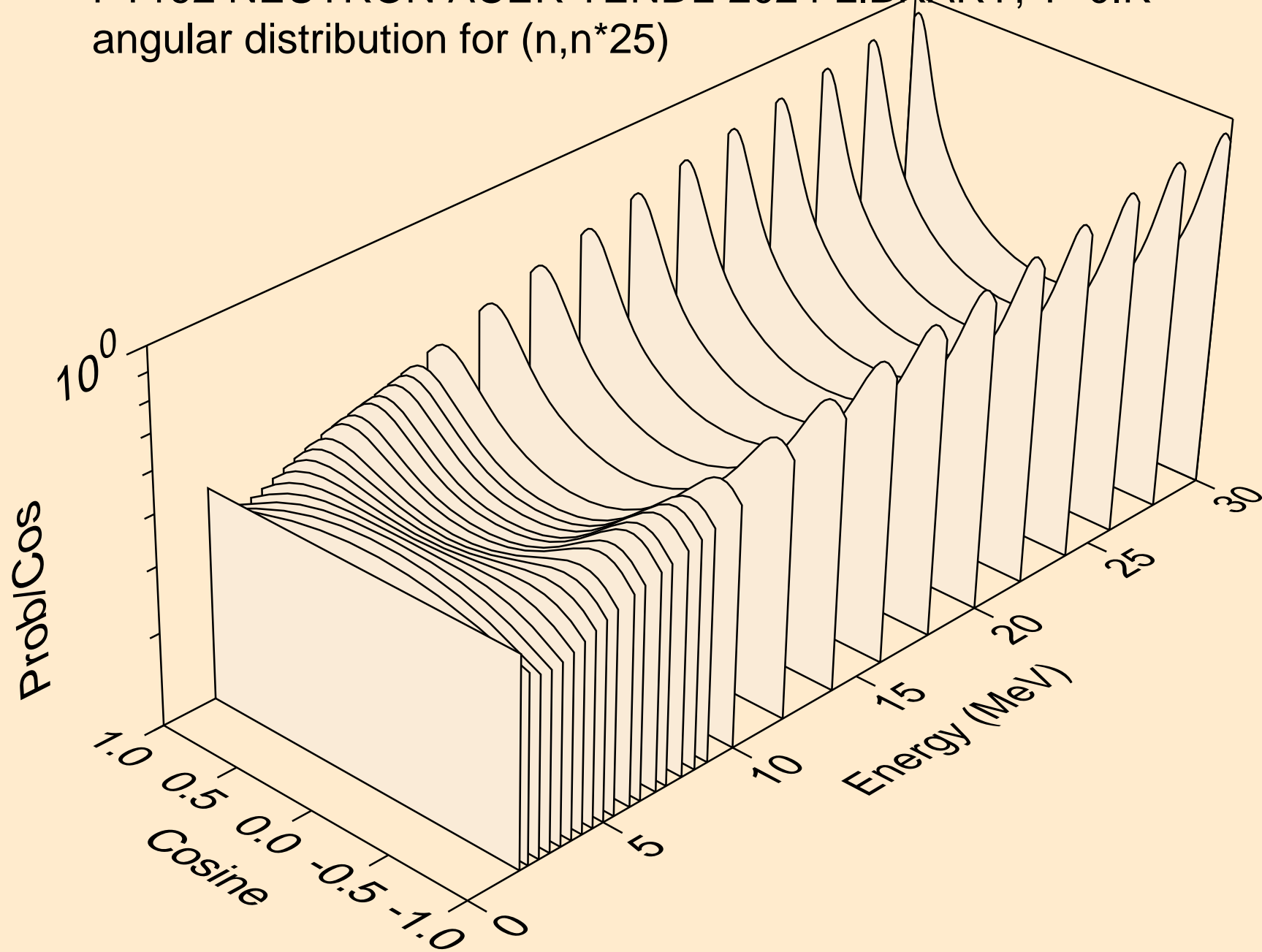

PT192 NEUTRON ACER TENDL-2024 LIBRARY; T=0.K
angular distribution for (n,n*26)

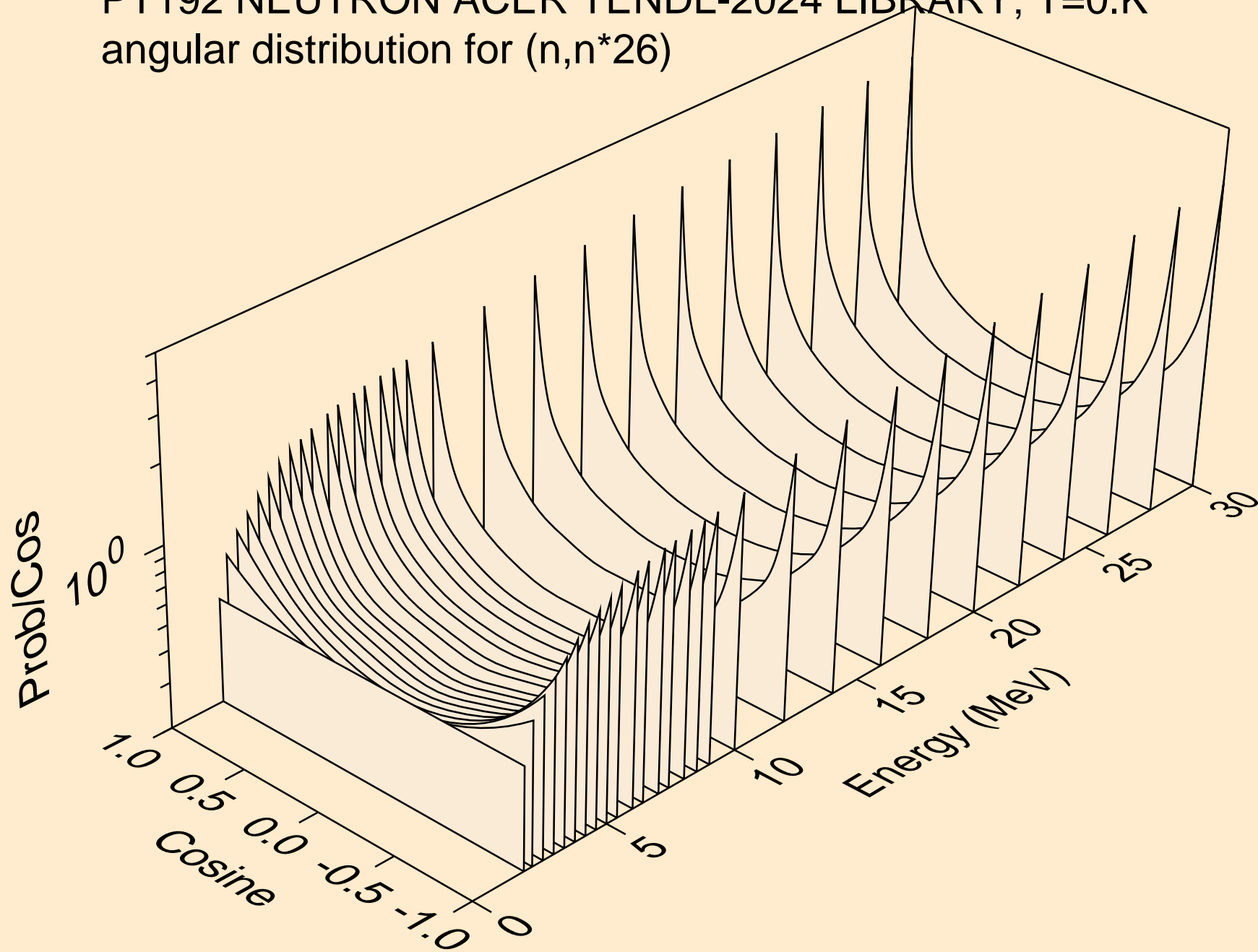

PT192 NEUTRON ACER TENDL-2024 LIBRARY; T=0.K
angular distribution for (n,n*27)

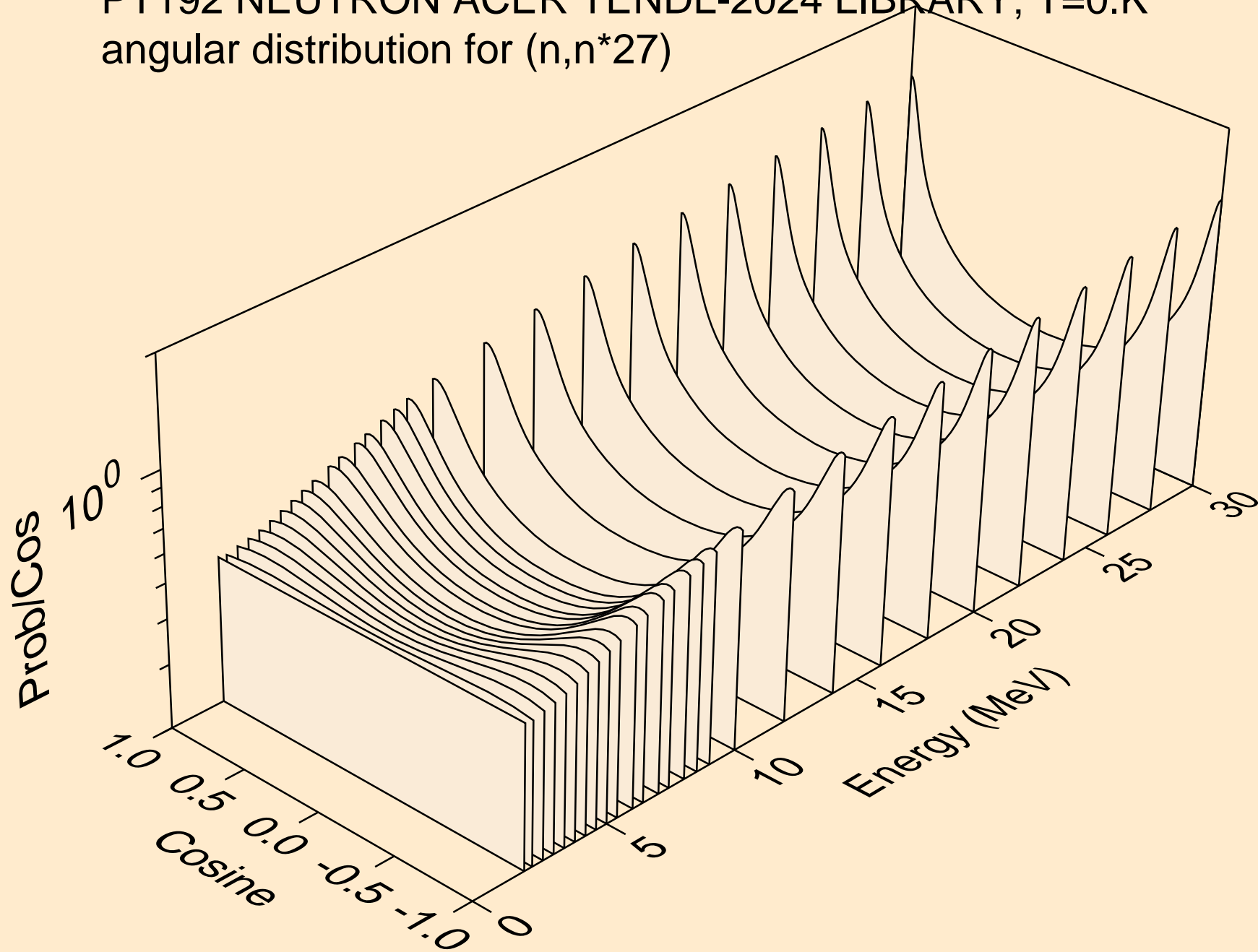

PT192 NEUTRON ACER TENDL-2024 LIBRARY; T=0.K
angular distribution for (n,n*28)

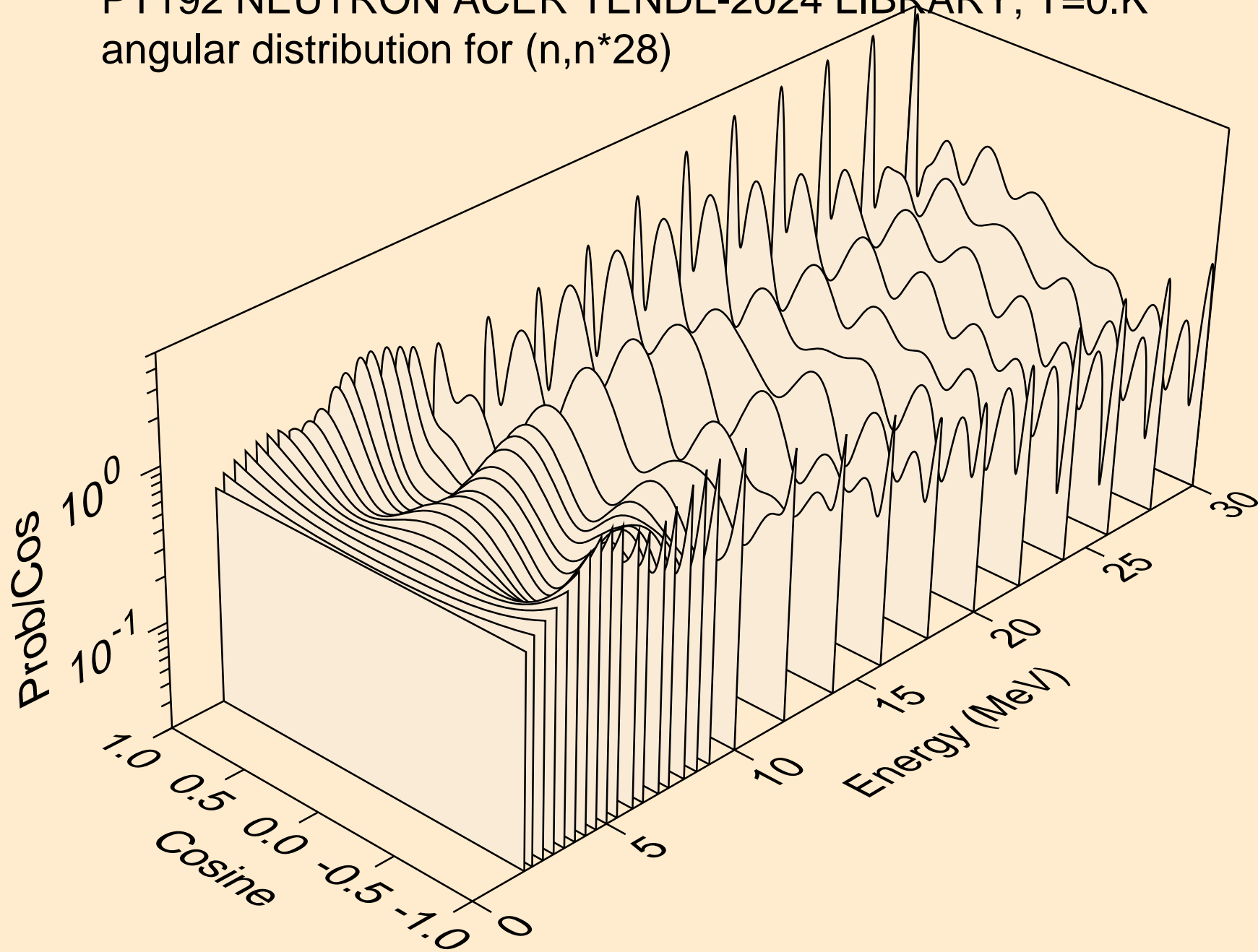

PT192 NEUTRON ACER TENDL-2024 LIBRARY; T=0.K
Neutron emission for (n,x)

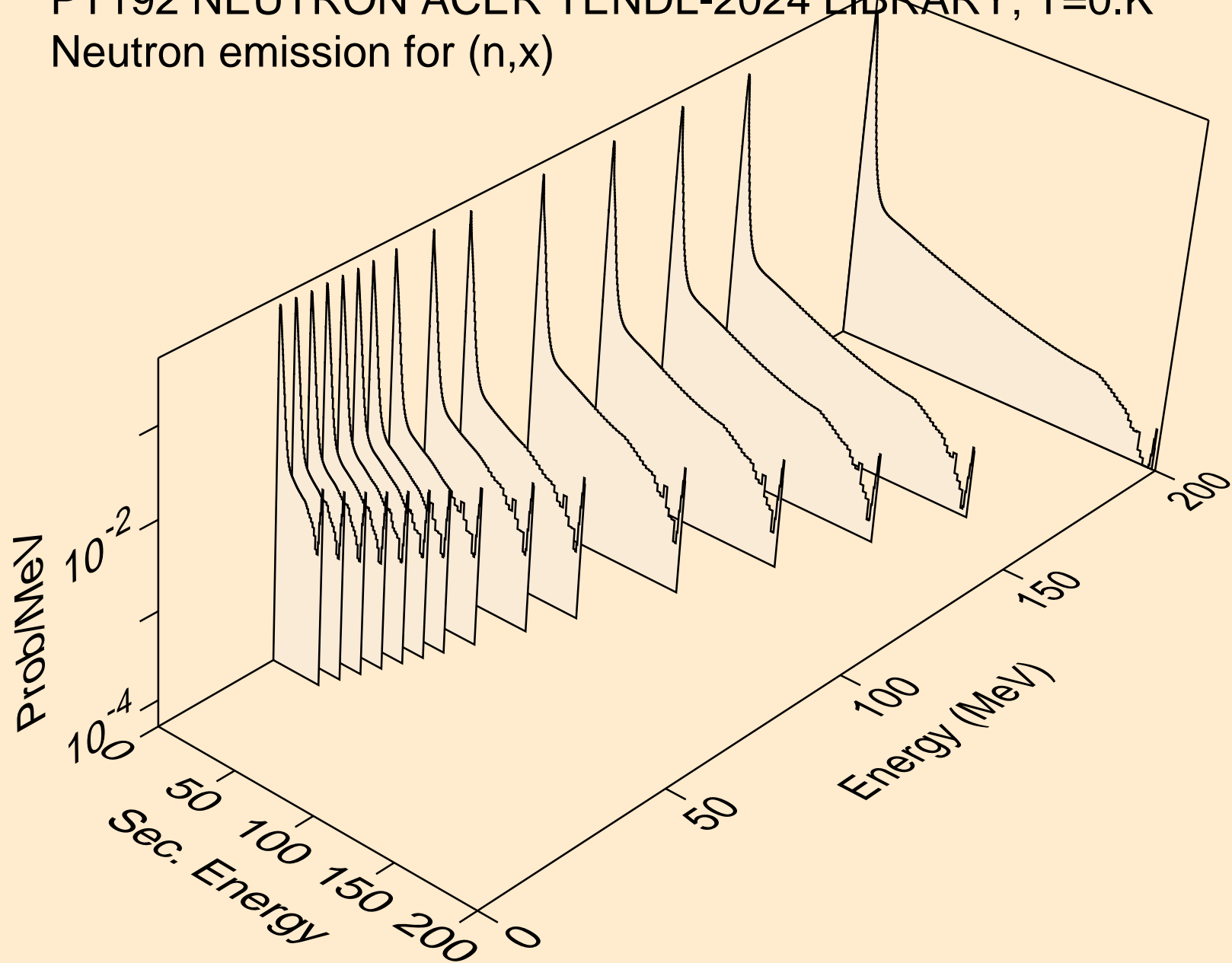

PT192 NEUTRON ACER TENDL-2024 LIBRARY; T=0.K
Neutron emission for (n,2nd)

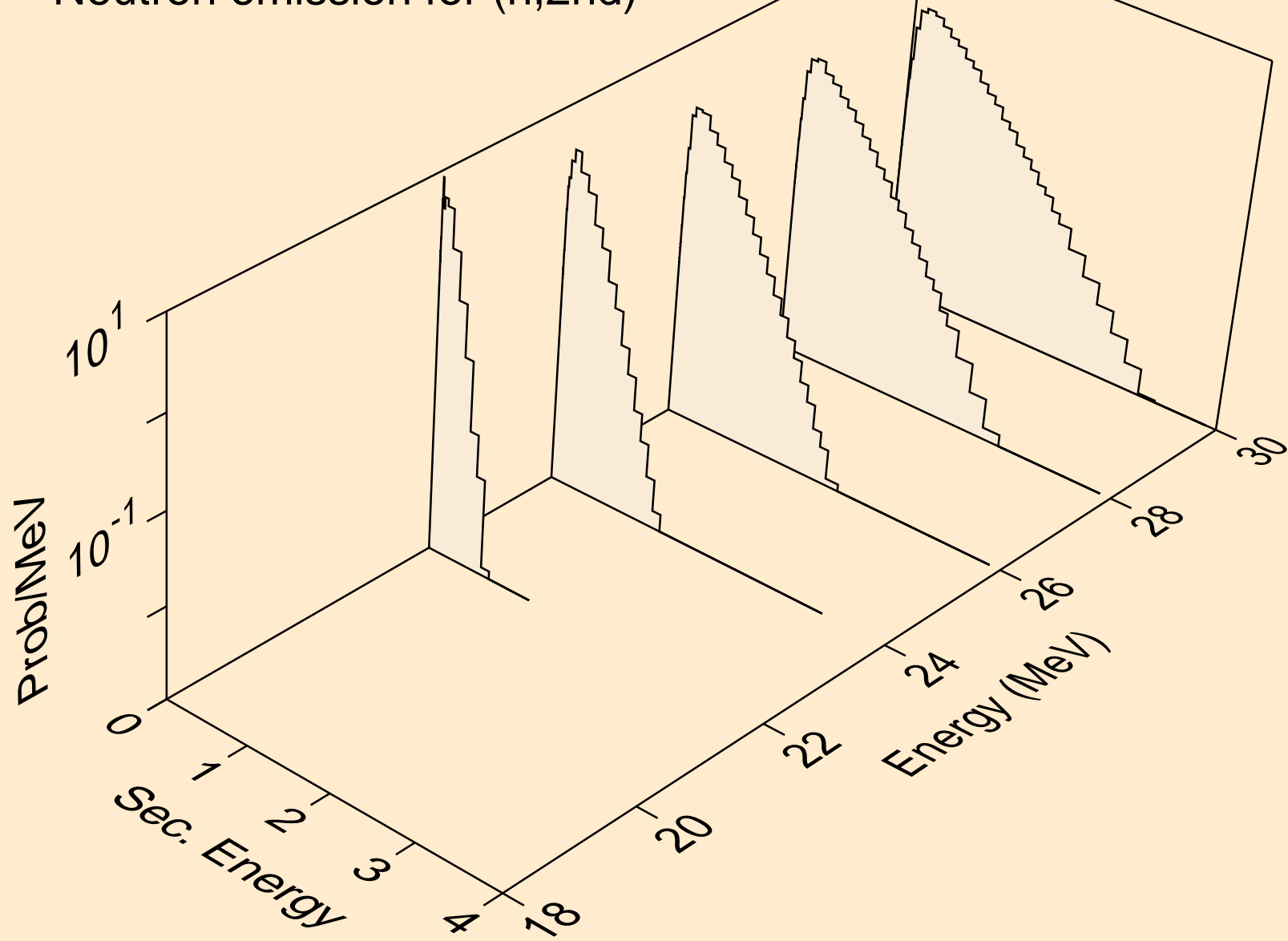

PT192 NEUTRON ACER TENDL-2024 LIBRARY; T=0.K
Neutron emission for (n,2n)

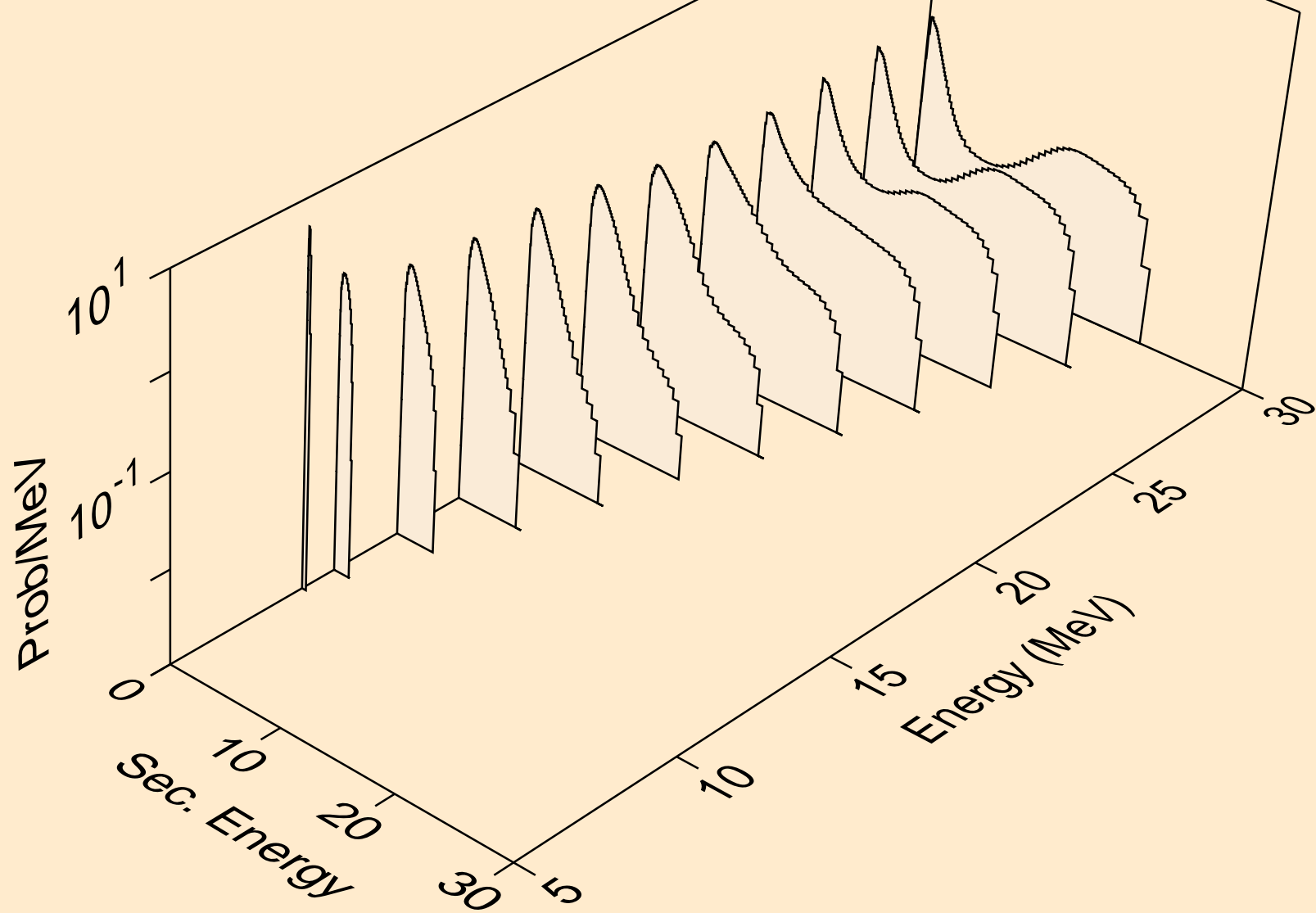

PT192 NEUTRON ACER TENDL-2024 LIBRARY; T=0.K
Neutron emission for (n,3n)

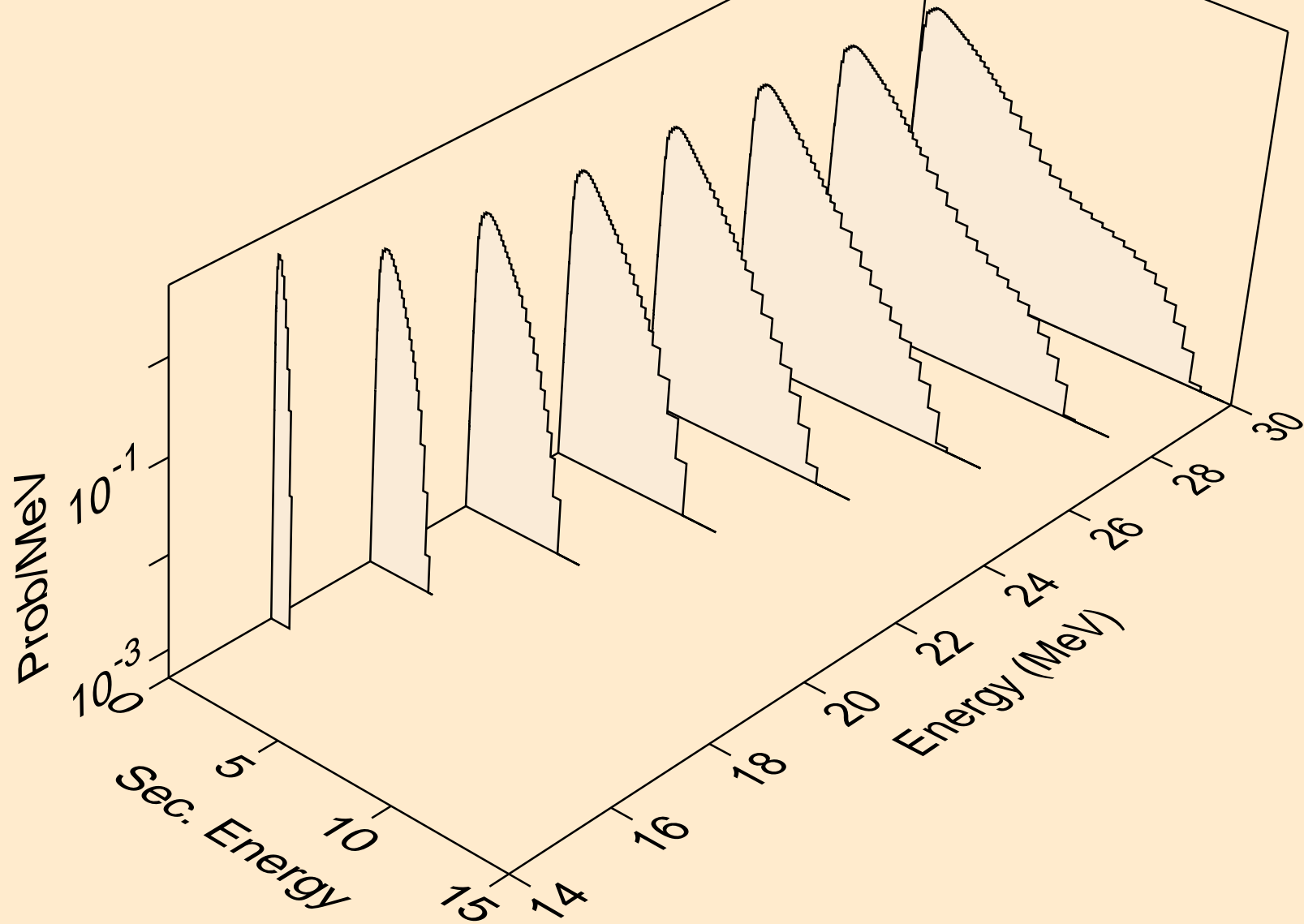

PT192 NEUTRON ACER TENDL-2024 LIBRARY; T=0.K
Neutron emission for (n,n*)a

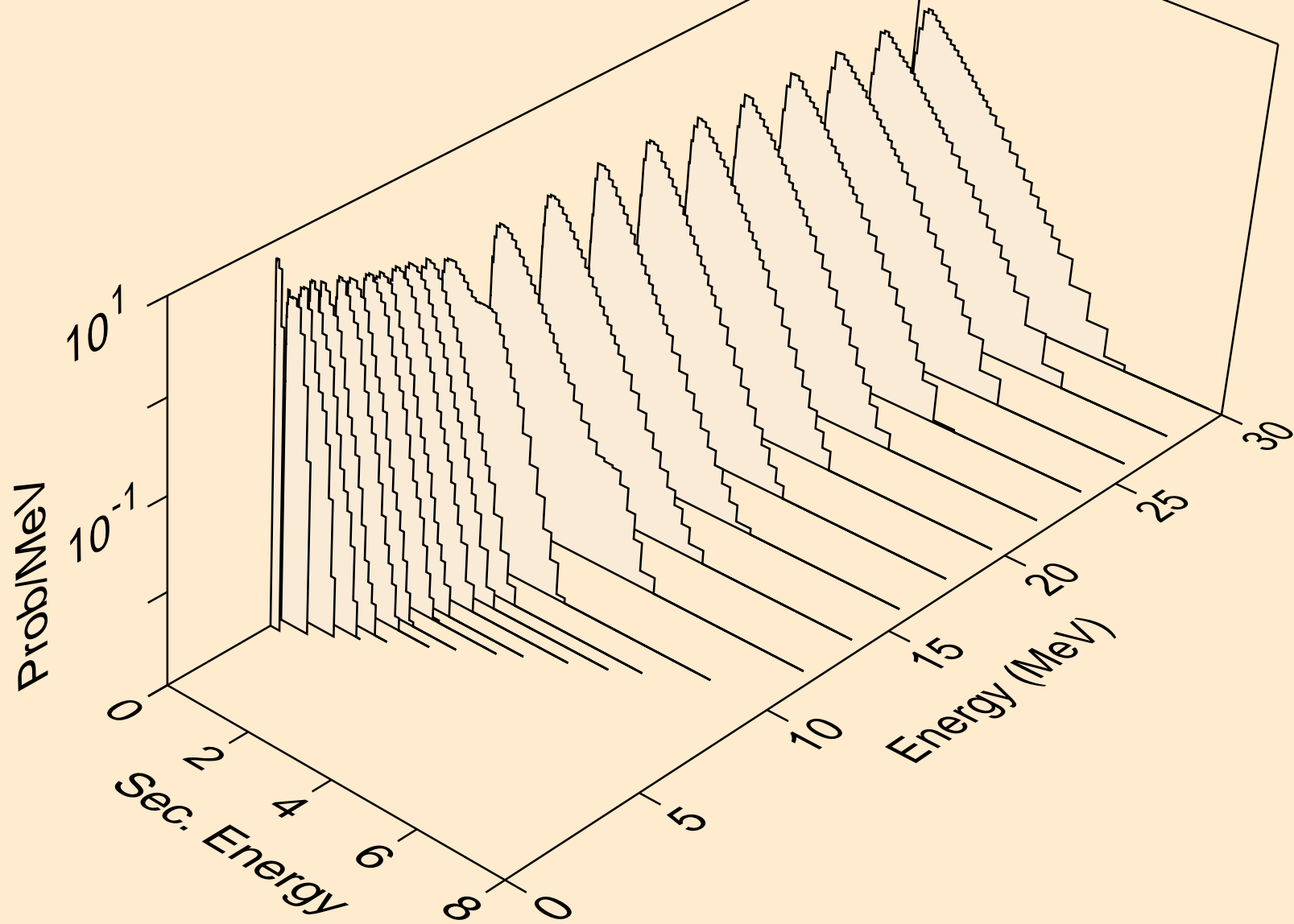

PT192 NEUTRON ACER TENDL-2024 LIBRARY; T=0.K
Neutron emission for (n,2n)_a

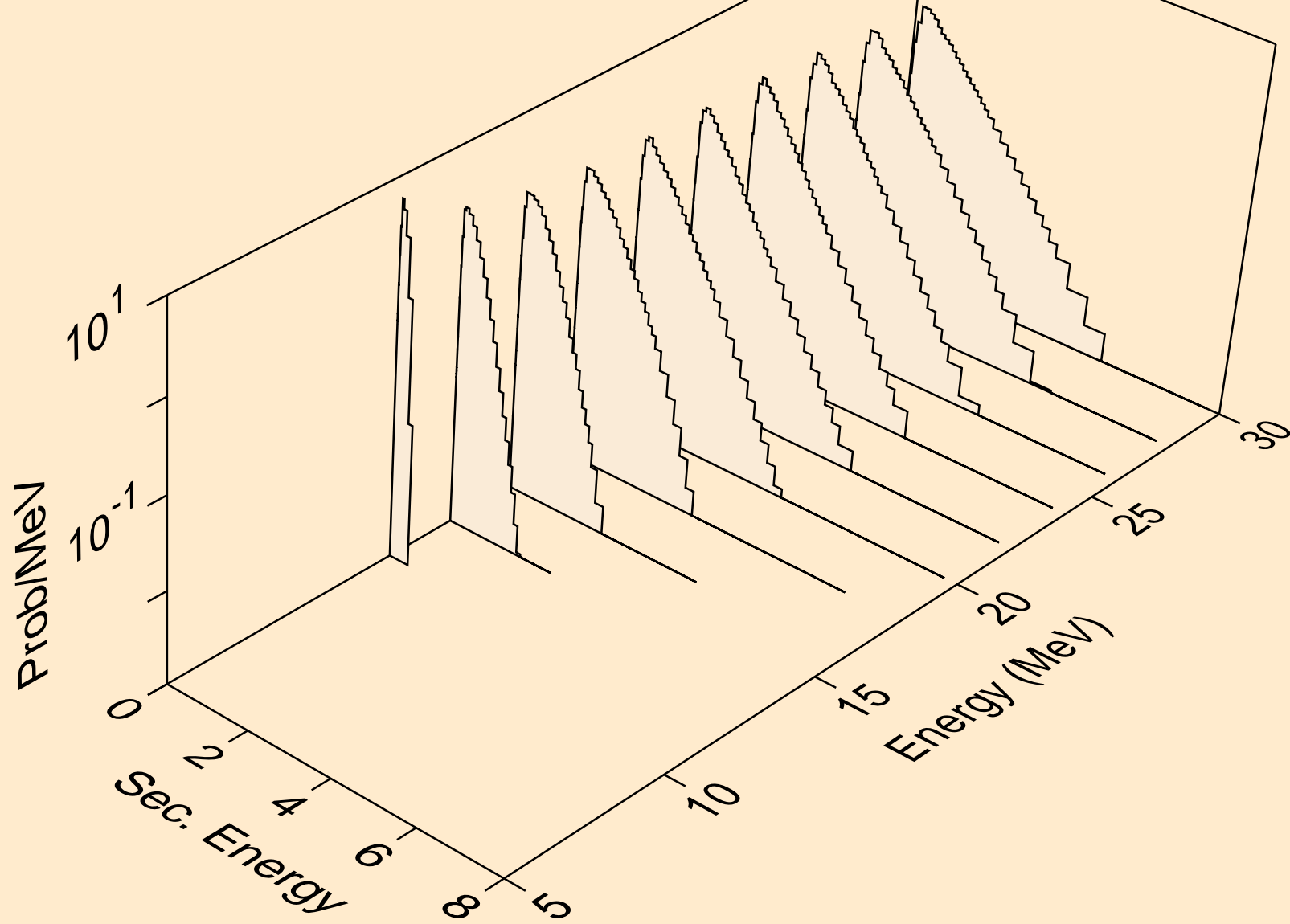

PT192 NEUTRON ACER TENDL-2024 LIBRARY; T=0.K
Neutron emission for (n,3n)a

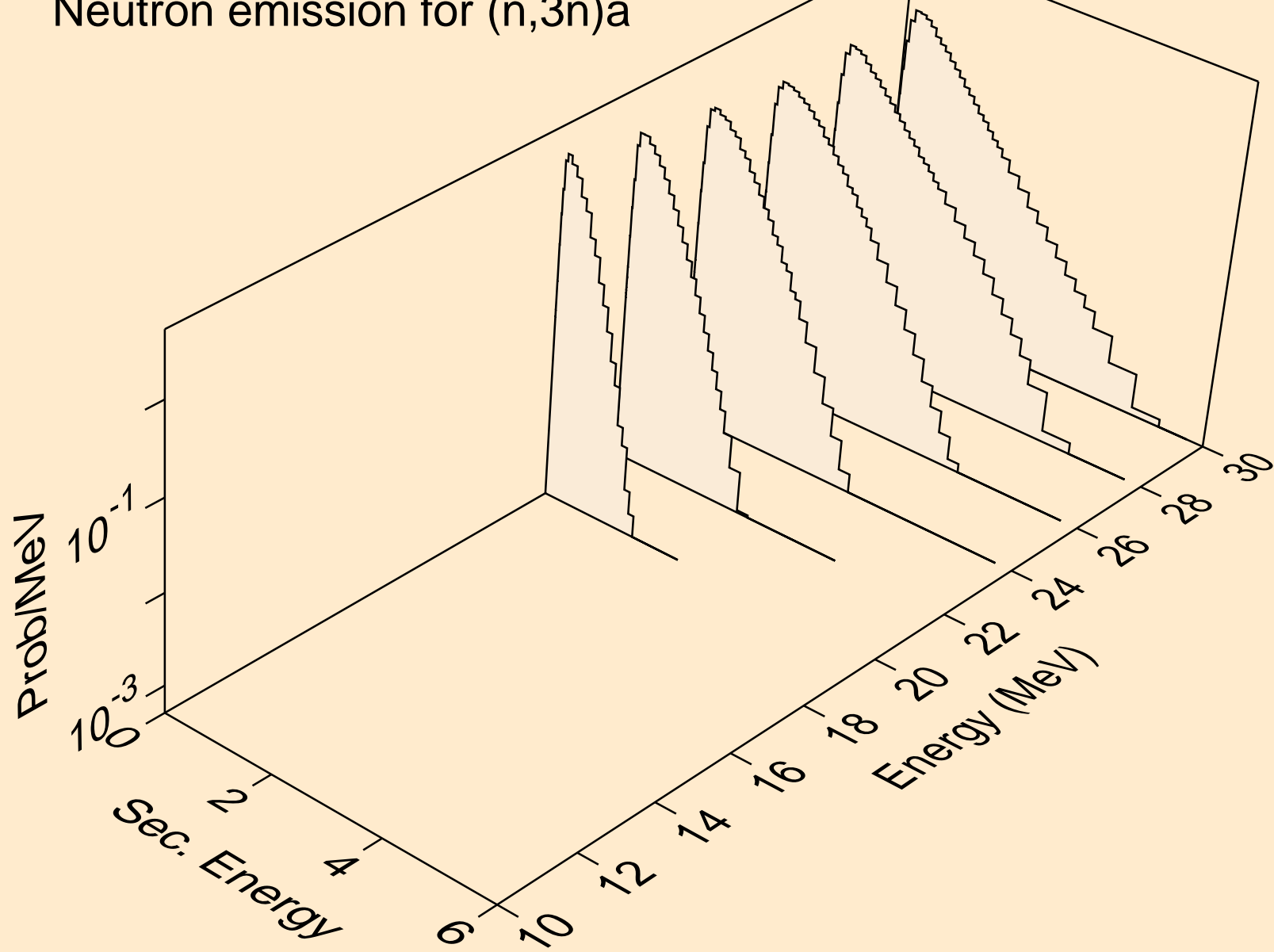

PT192 NEUTRON ACER TENDL-2024 LIBRARY; T=0.K
Neutron emission for (n,n*)p

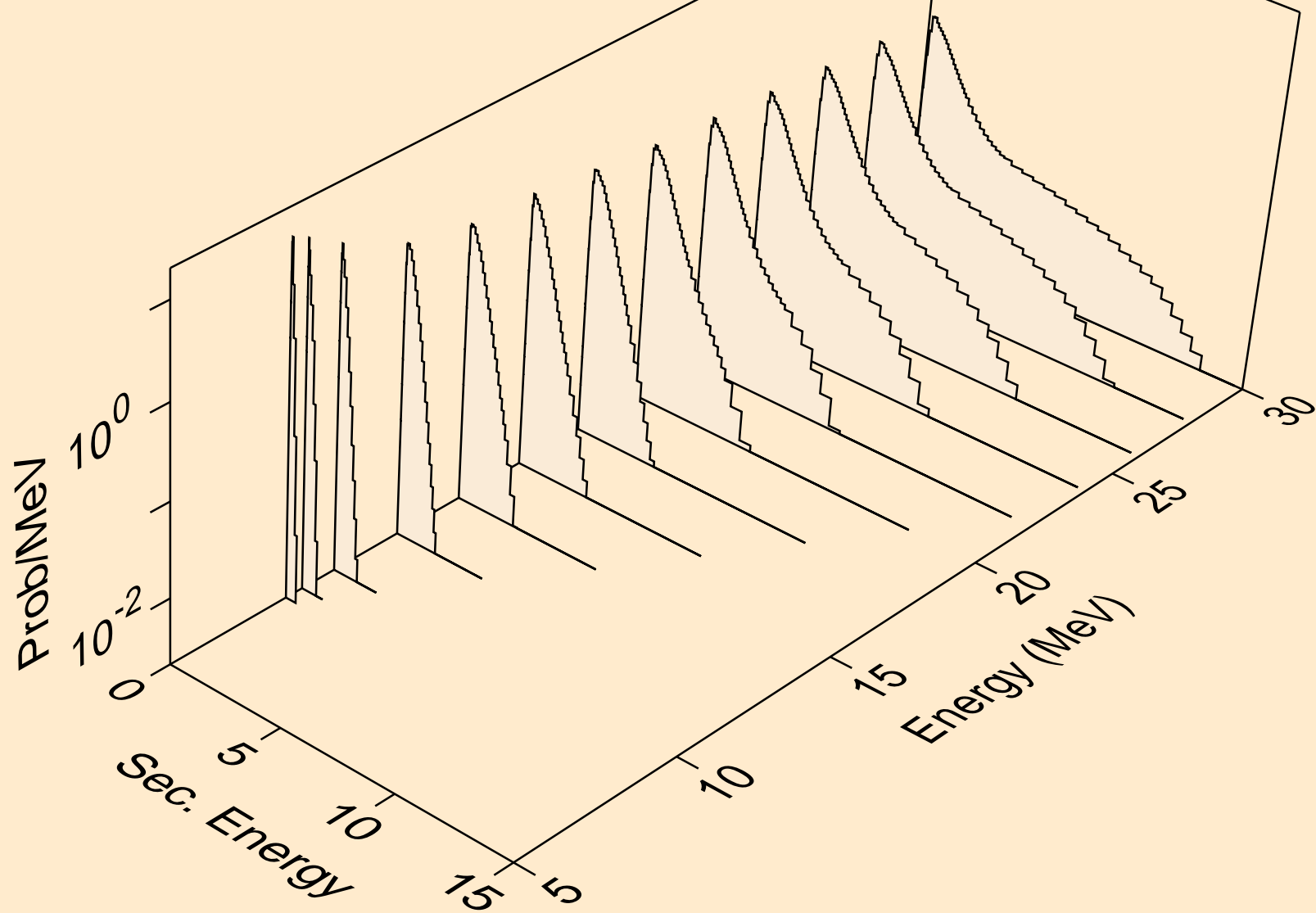

PT192 NEUTRON ACER TENDL-2024 LIBRARY; T=0.K
Neutron emission for (n,n*)2a

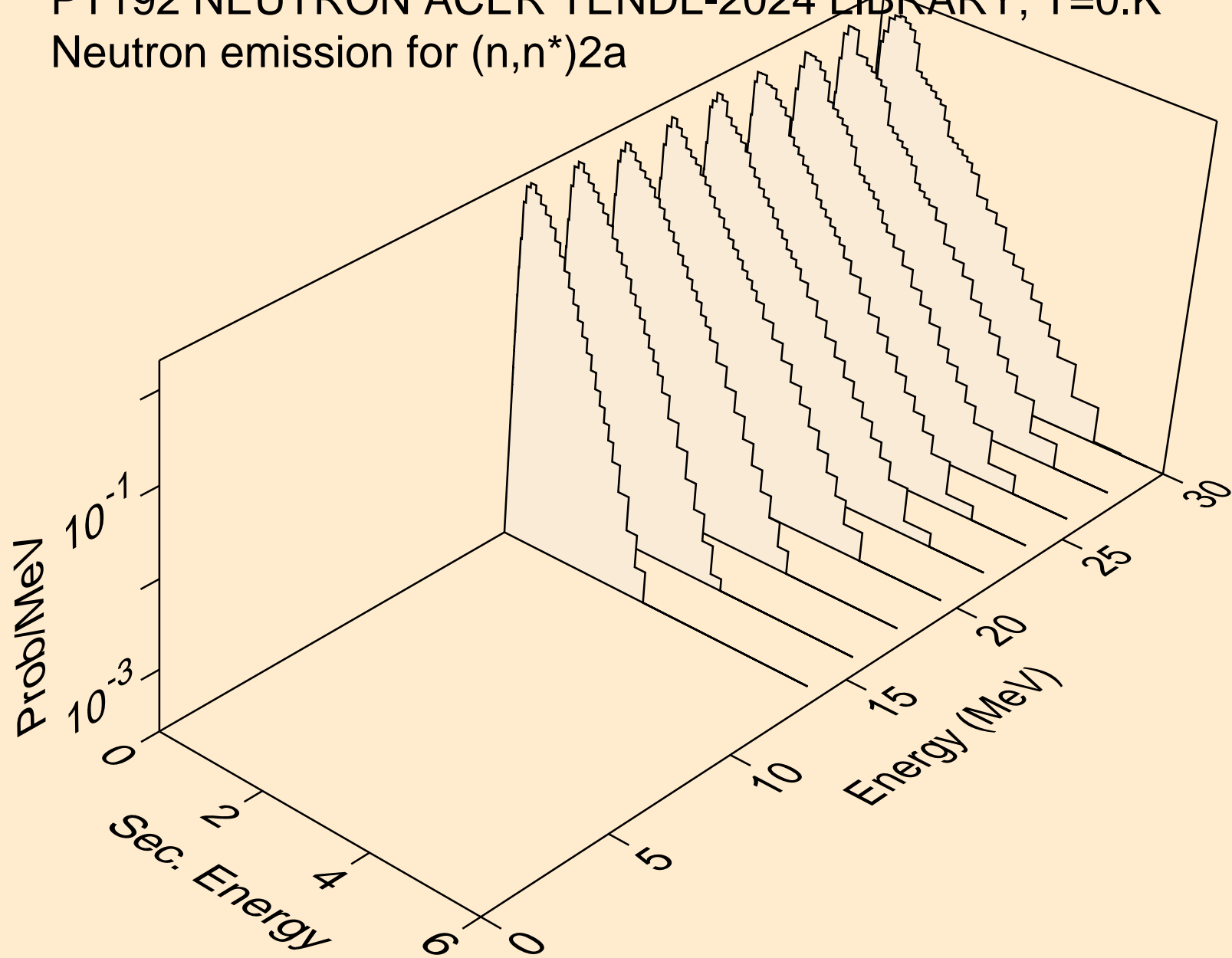

PT192 NEUTRON ACER TENDL-2024 LIBRARY; T=0.K
Neutron emission for (n,n*)d

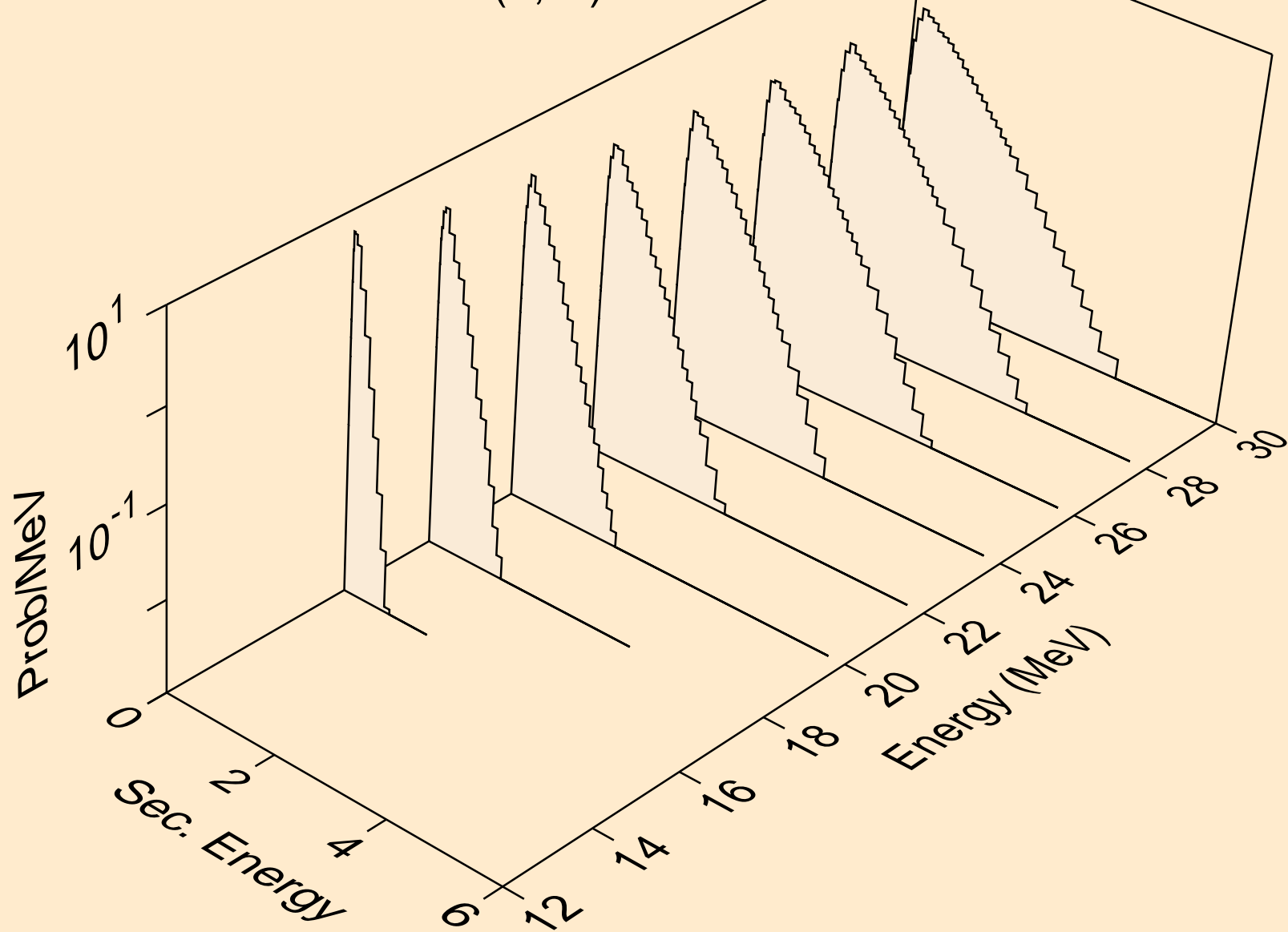

PT192 NEUTRON ACER TENDL-2024 LIBRARY; T=0.K
Neutron emission for (n,n*)t

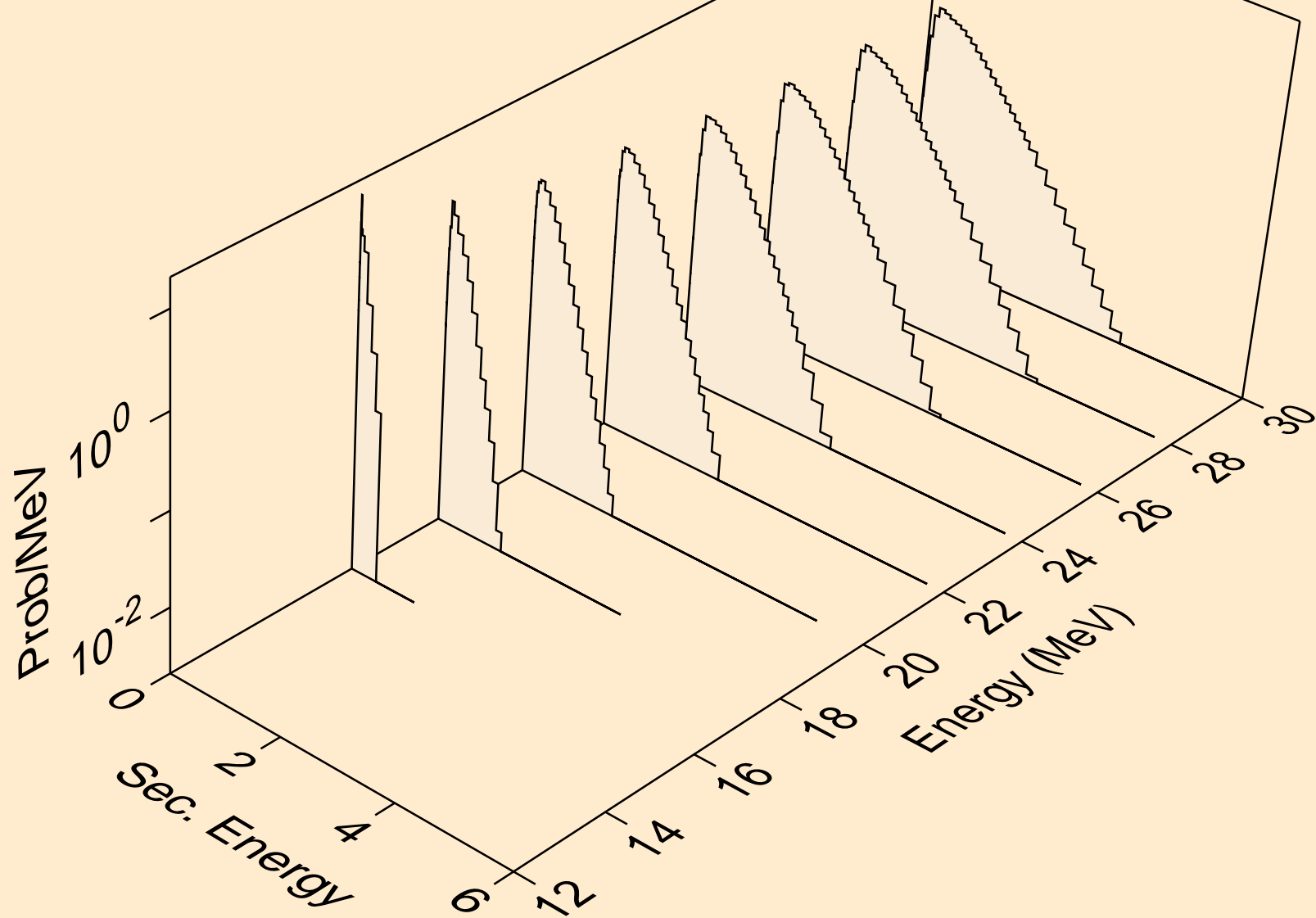

PT192 NEUTRON ACER TENDL-2024 LIBRARY; T=0.K
Neutron emission for (n,n*)he3

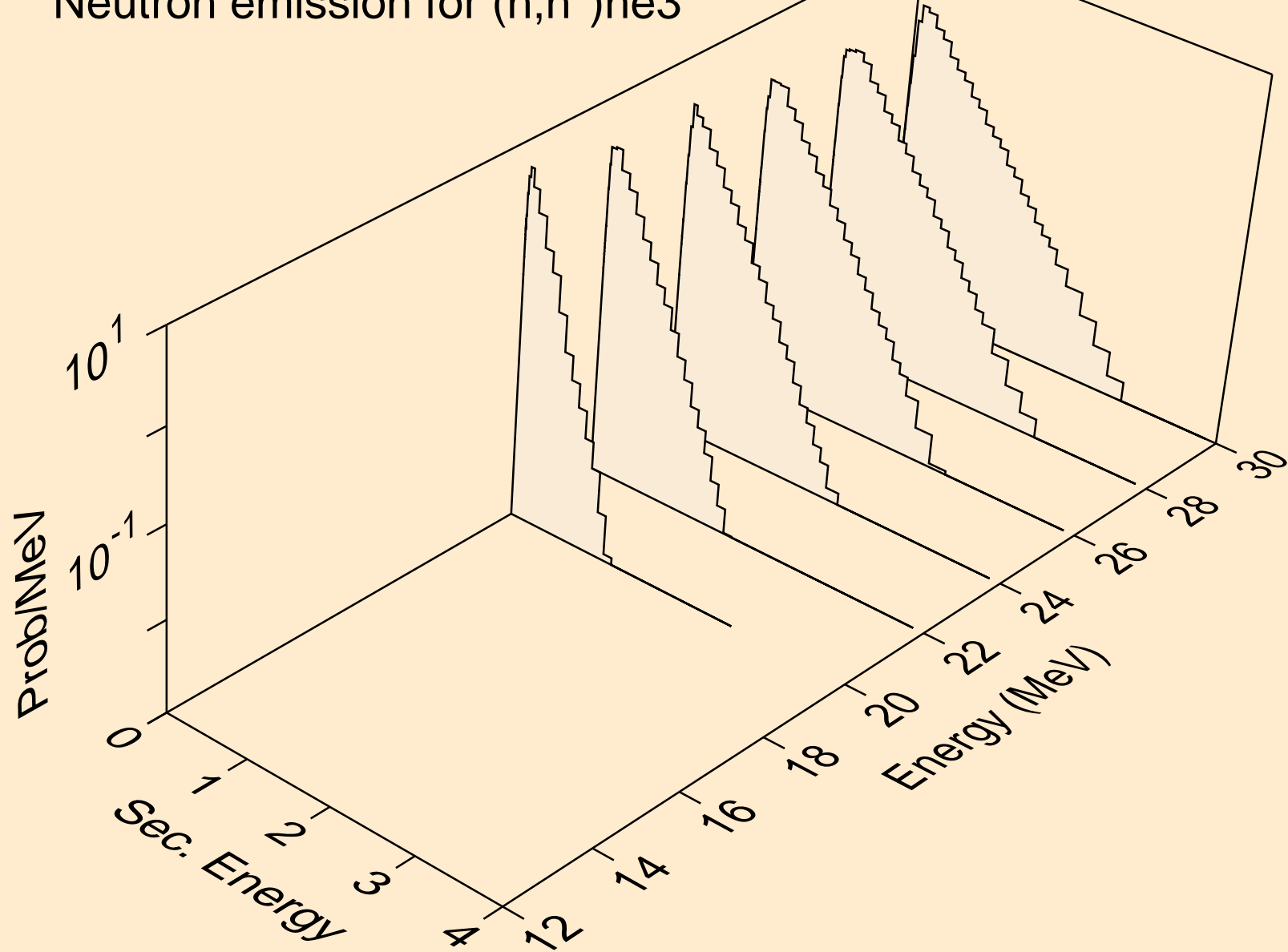

PT192 NEUTRON ACER TENDL-2024 LIBRARY; T=0.K
Neutron emission for (n,4n)

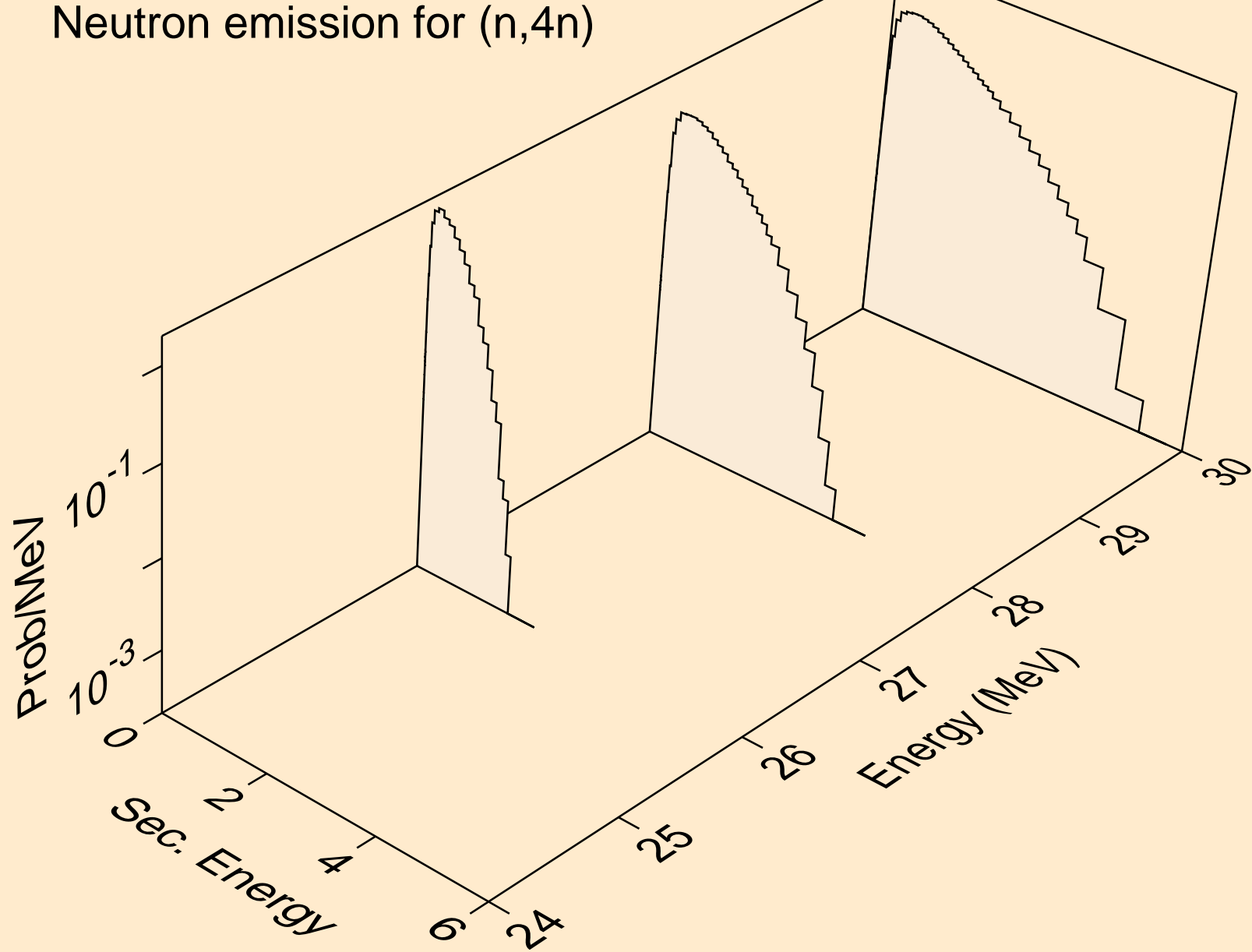

PT192 NEUTRON ACER TENDL-2024 LIBRARY; T=0.K
Neutron emission for (n,2np)

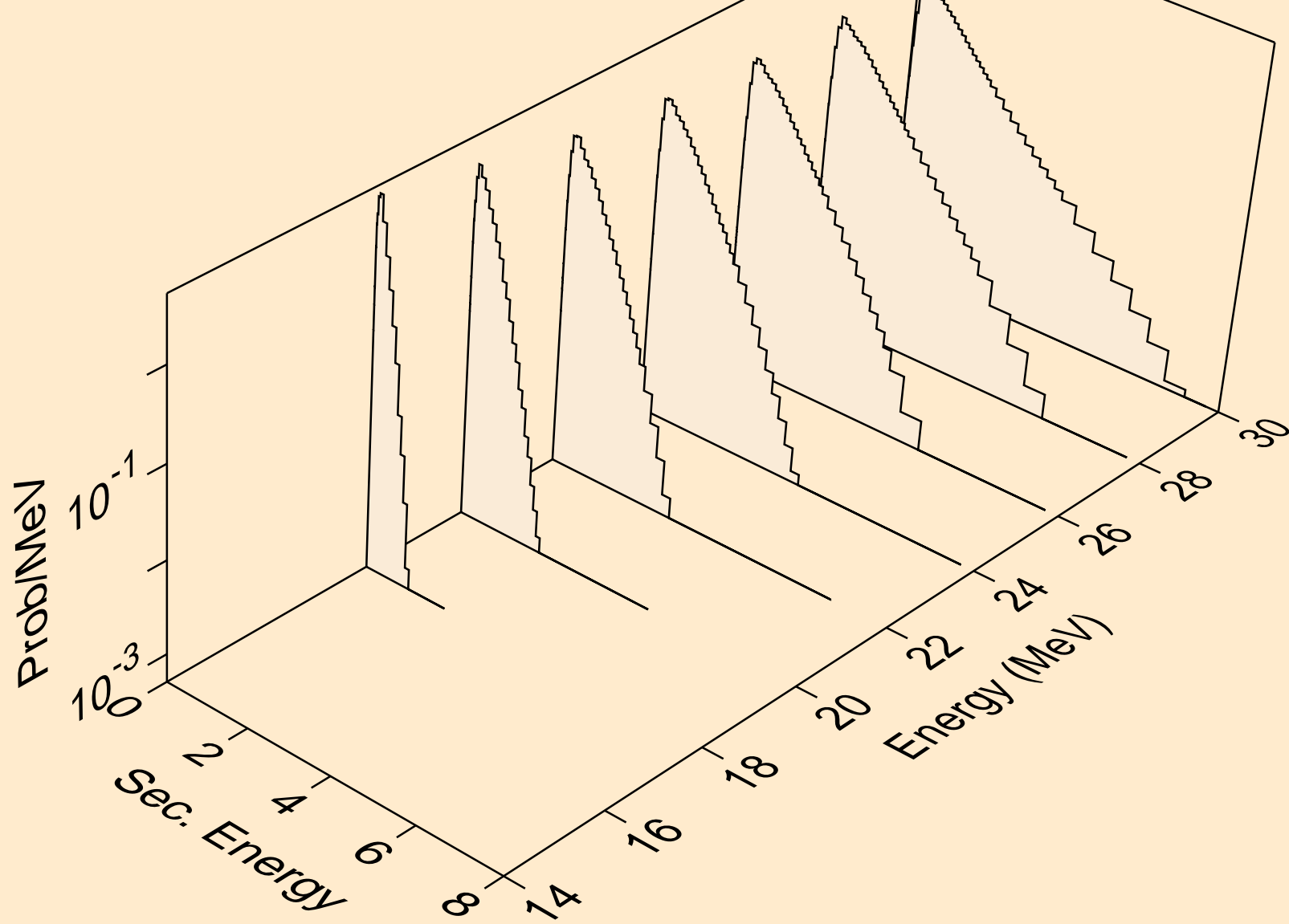

PT192 NEUTRON ACER TENDL-2024 LIBRARY; T=0.K
Neutron emission for (n,3np)

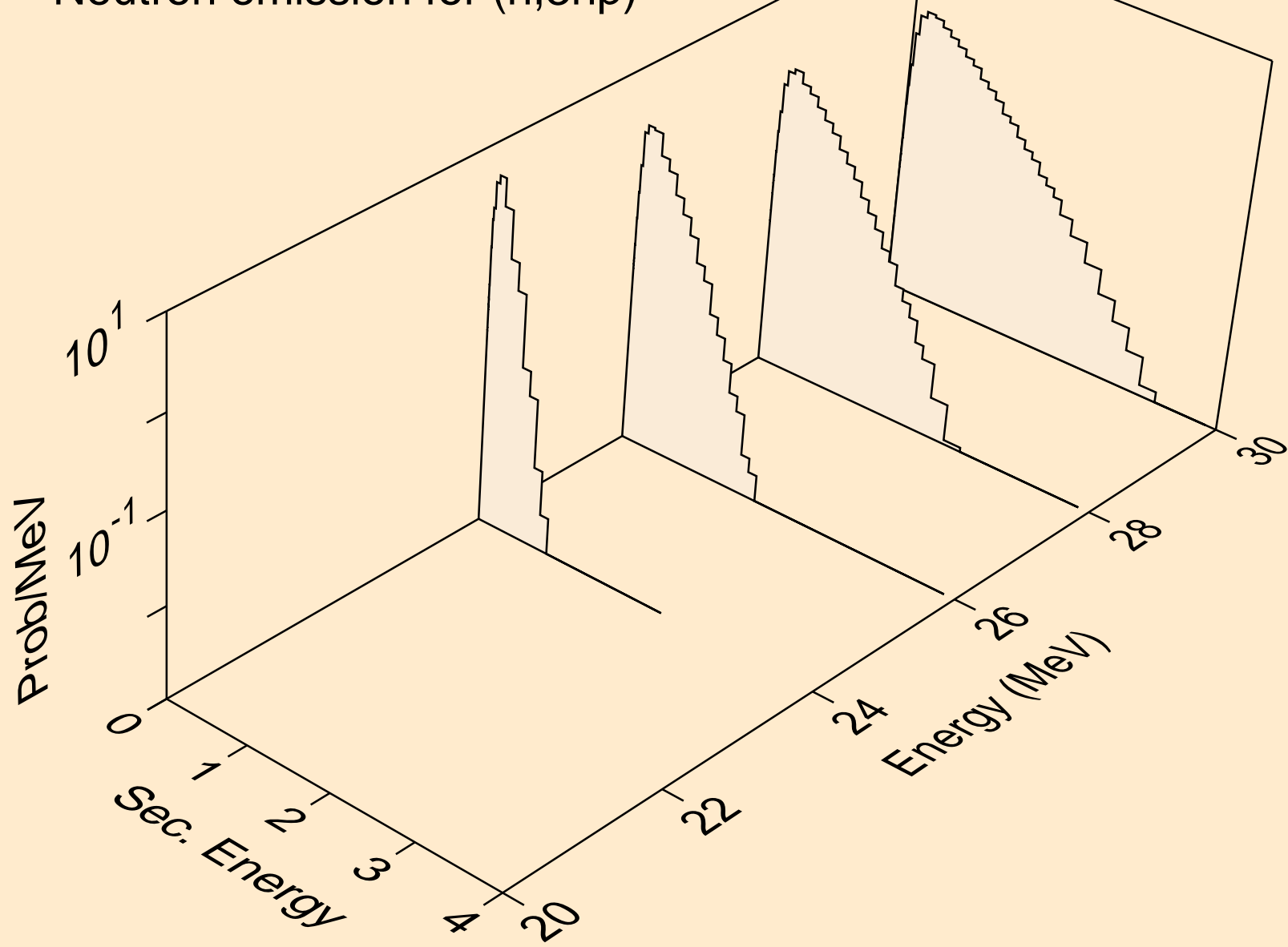

PT192 NEUTRON ACER TENDL-2024 LIBRARY; T=0.K
Neutron emission for (n,n2p)

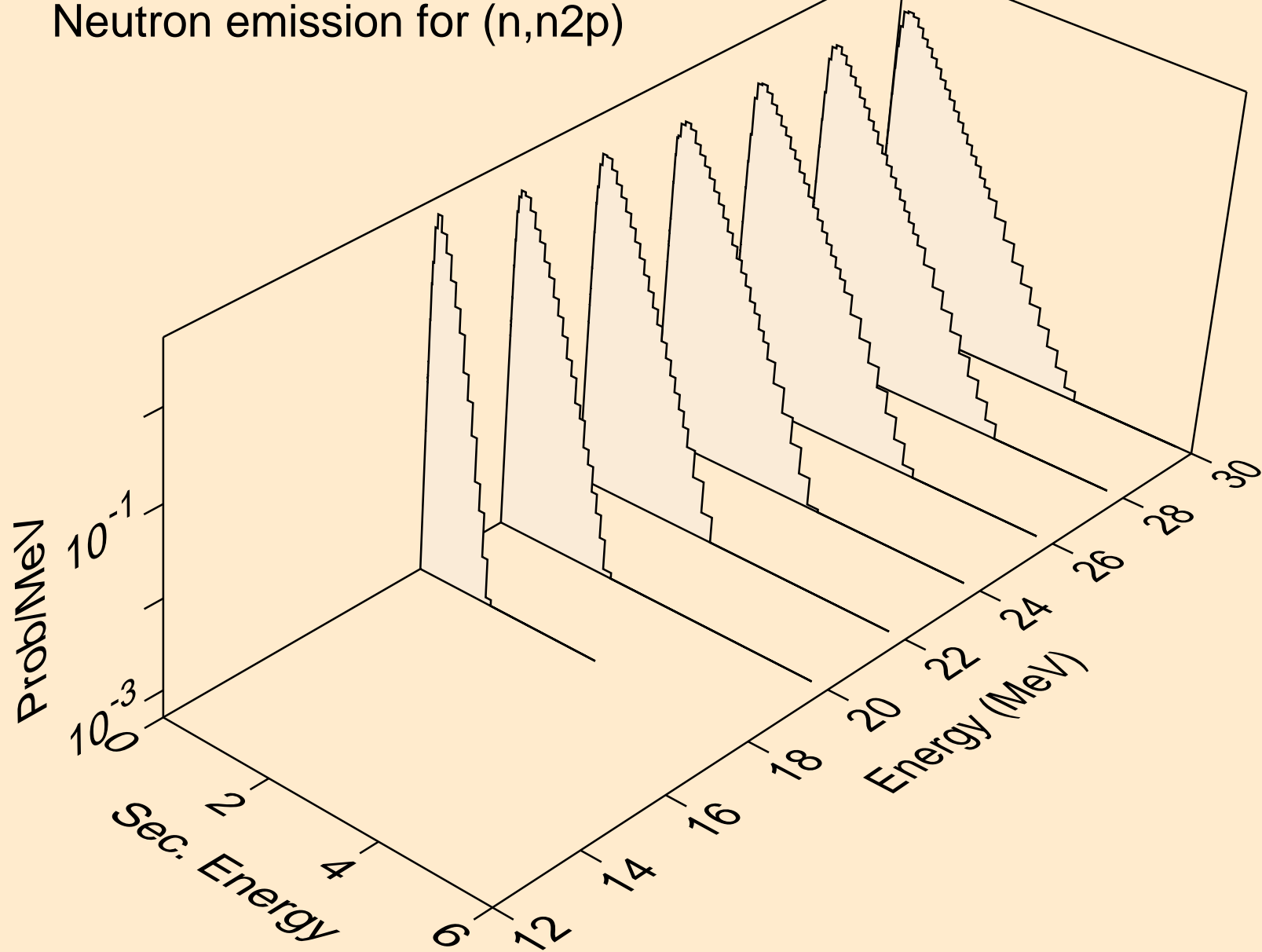

PT192 NEUTRON ACER TENDL-2024 LIBRARY; T=0.K
Neutron emission for (n,npa)

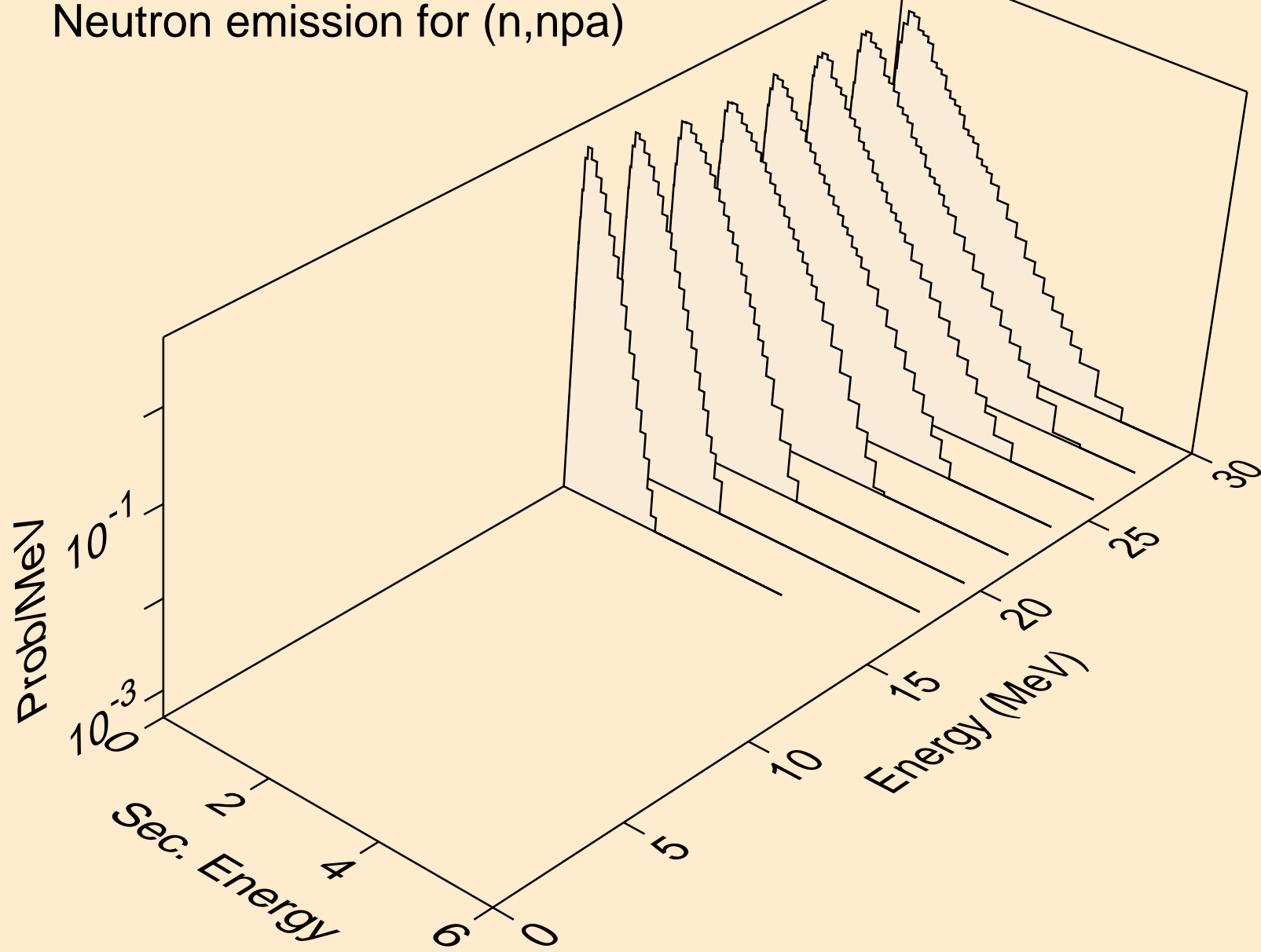

PT192 NEUTRON ACER TENDL-2024 LIBRARY; T=0.K
Neutron emission for (n,n*c)

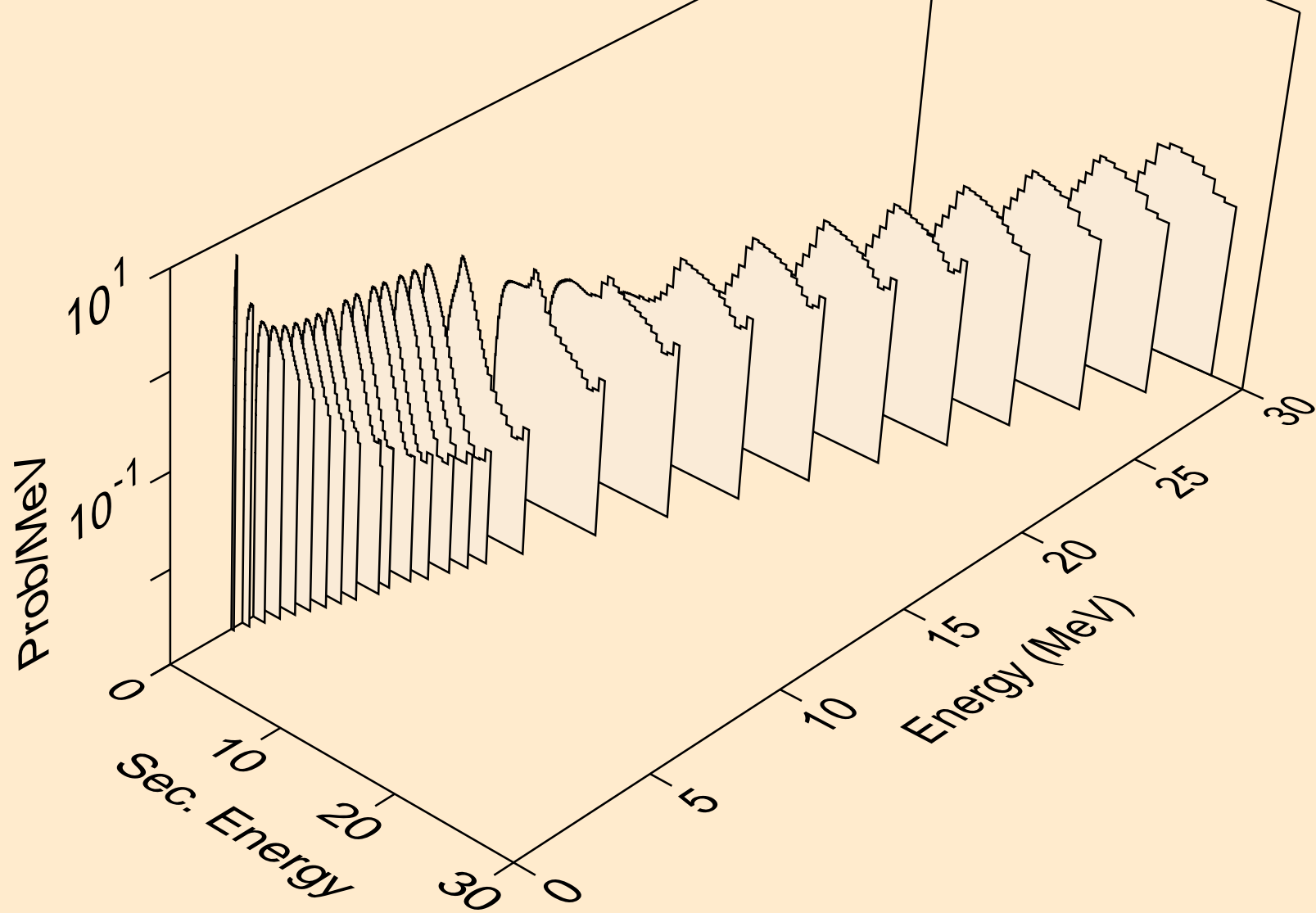

PT192 NEUTRON ACER TENDL-2024 LIBRARY; T=0.K
Photon emission for (n,x)

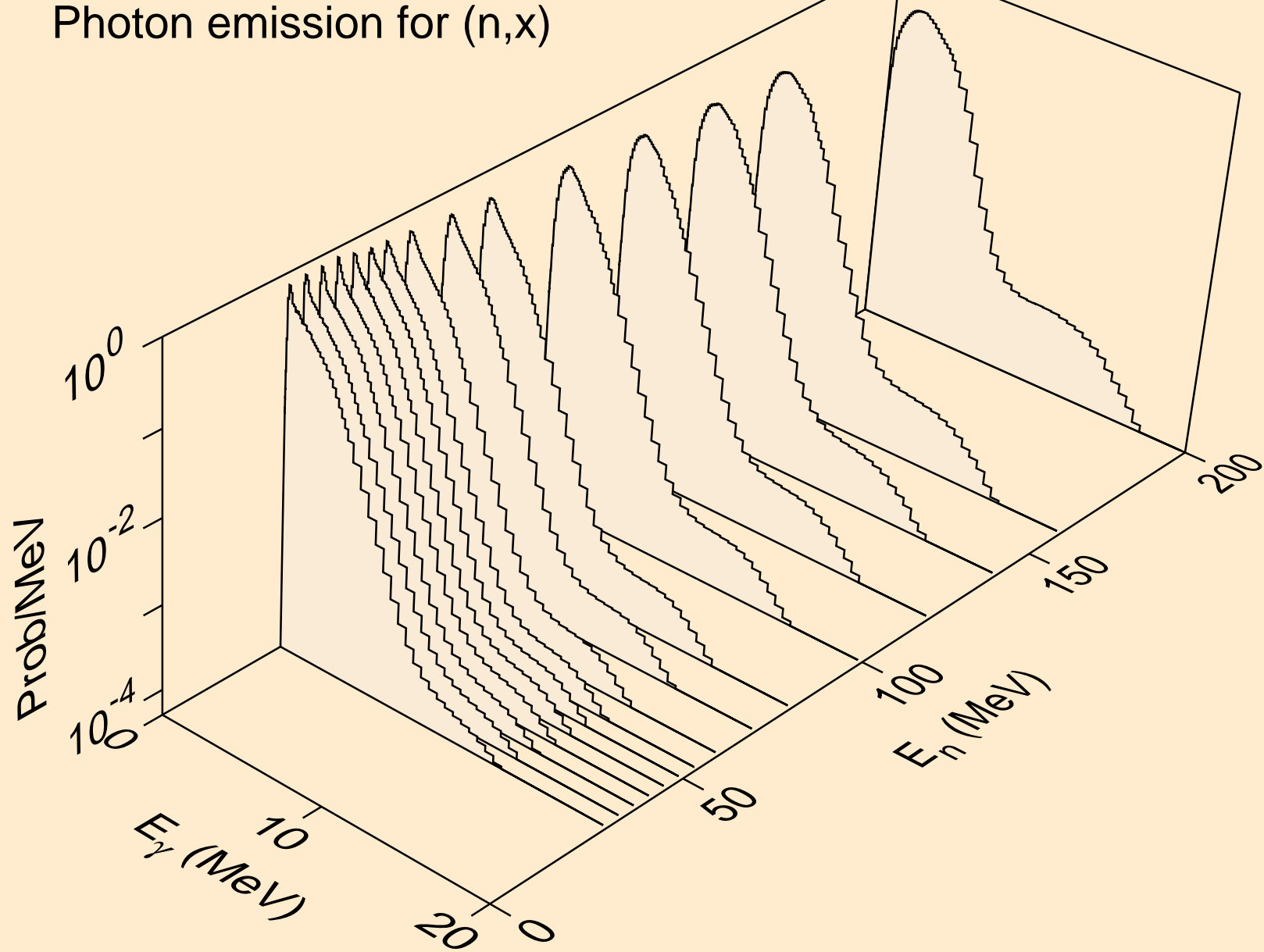

PT192 NEUTRON ACER TENDL-2024 LIBRARY; T=0.K
Photon emission for (n,2nd)

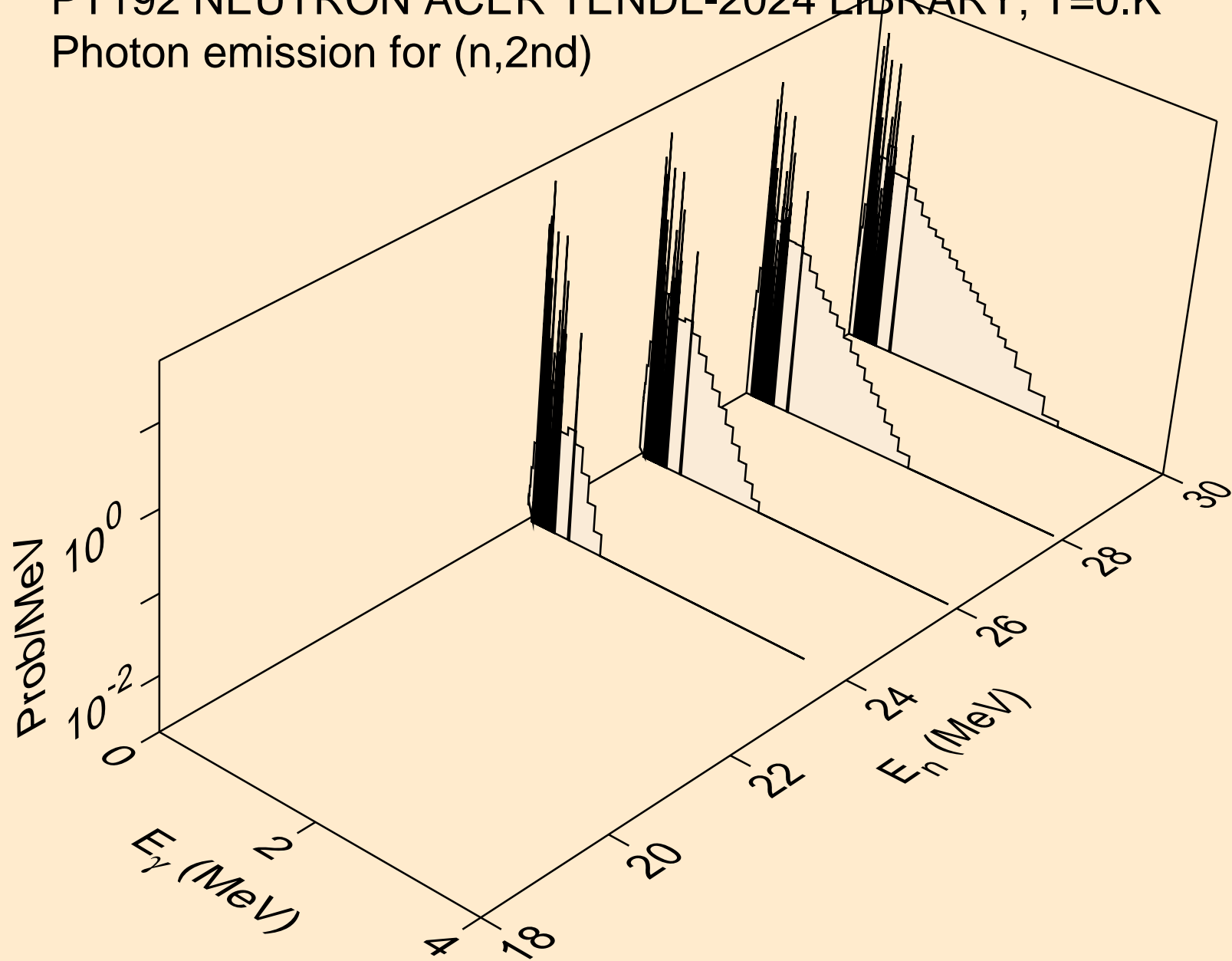

PT192 NEUTRON ACER TENDL-2024 LIBRARY; T=0.K
Photon emission for (n,2n)

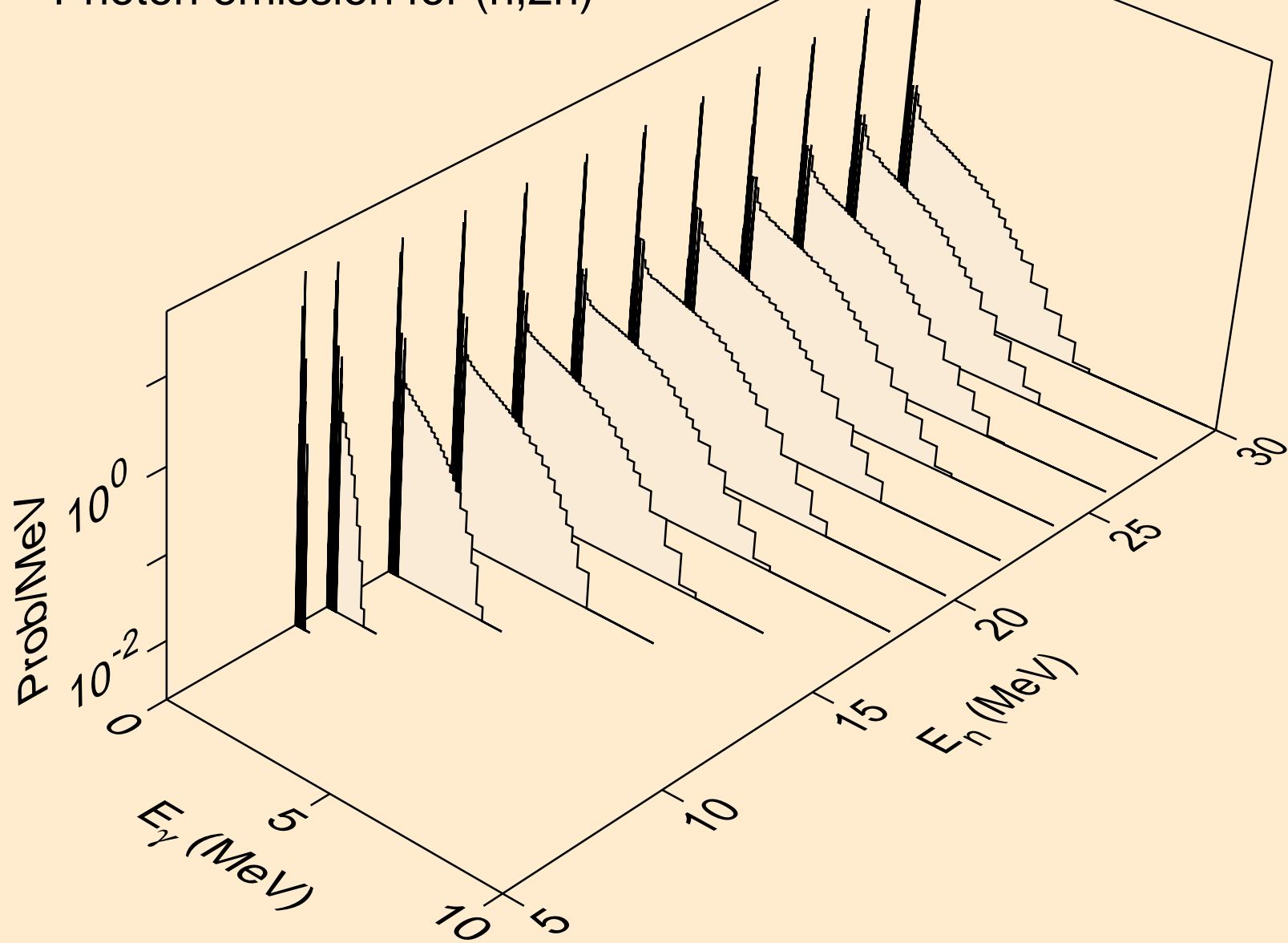

PT192 NEUTRON ACER TENDL-2024 LIBRARY; T=0.K
Photon emission for (n,3n)

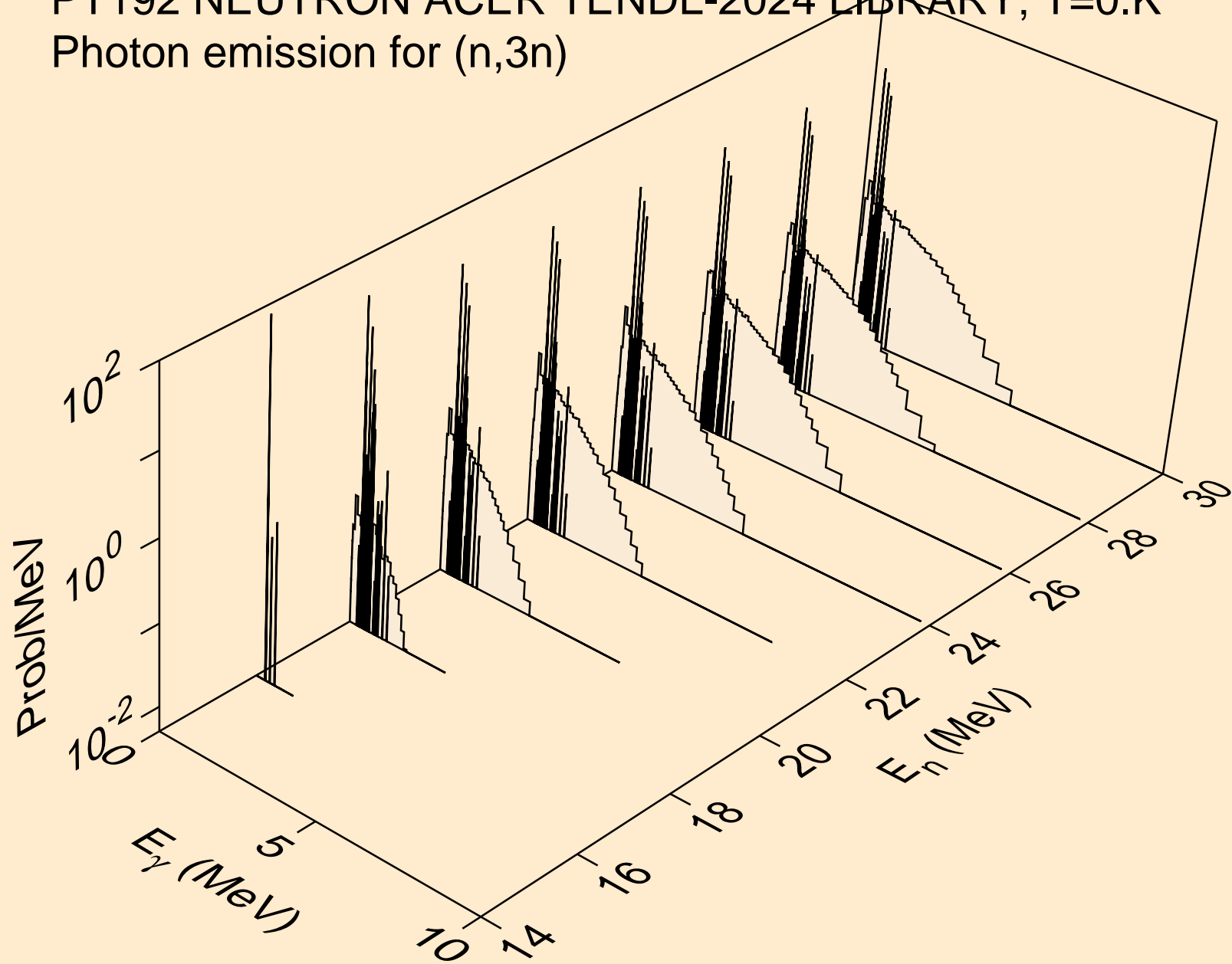

PT192 NEUTRON ACER TENDL-2024 LIBRARY; T=0.K
Photon emission for (n,n*)a

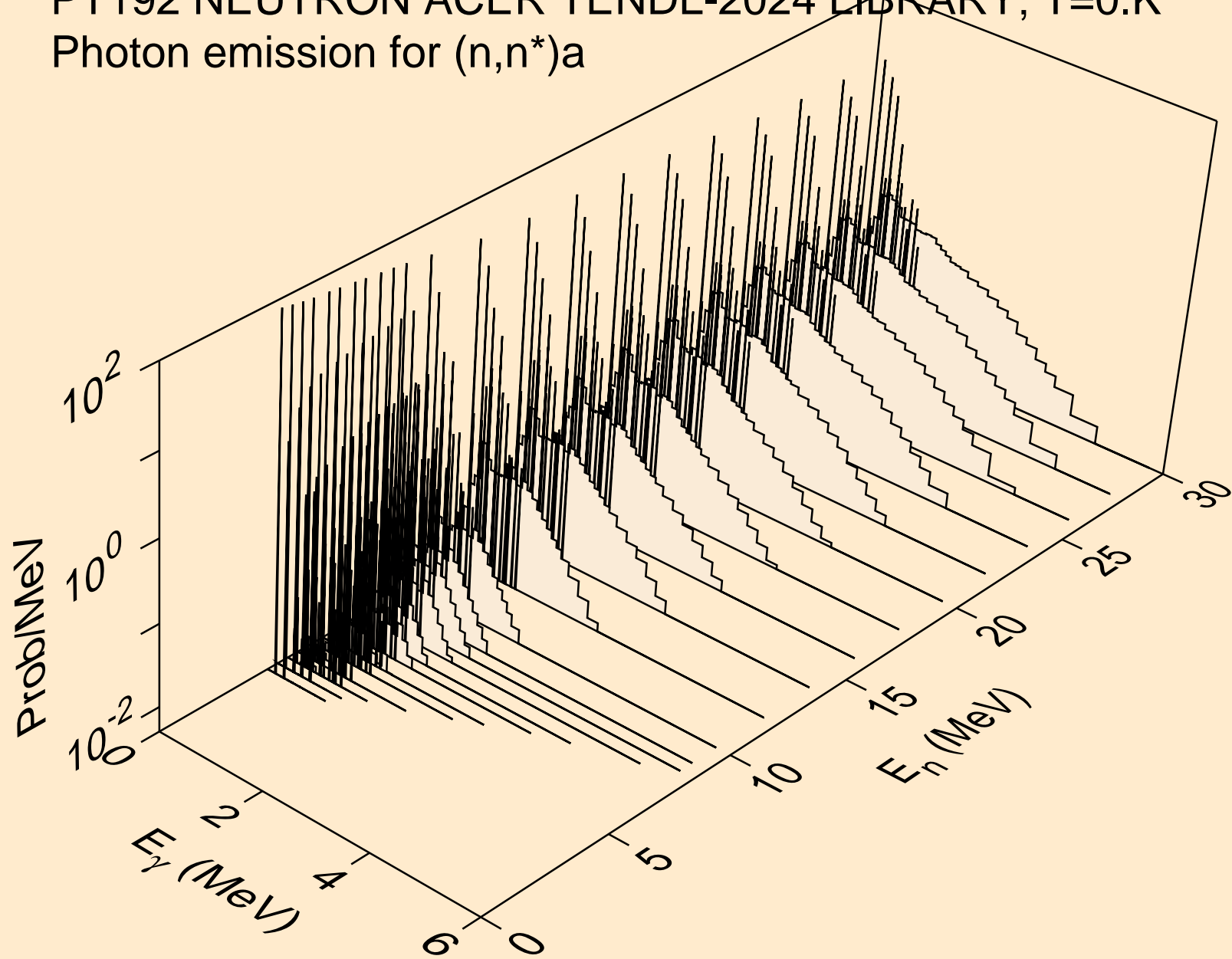

PT192 NEUTRON ACER TENDL-2024 LIBRARY; T=0.K
Photon emission for (n,2n)a

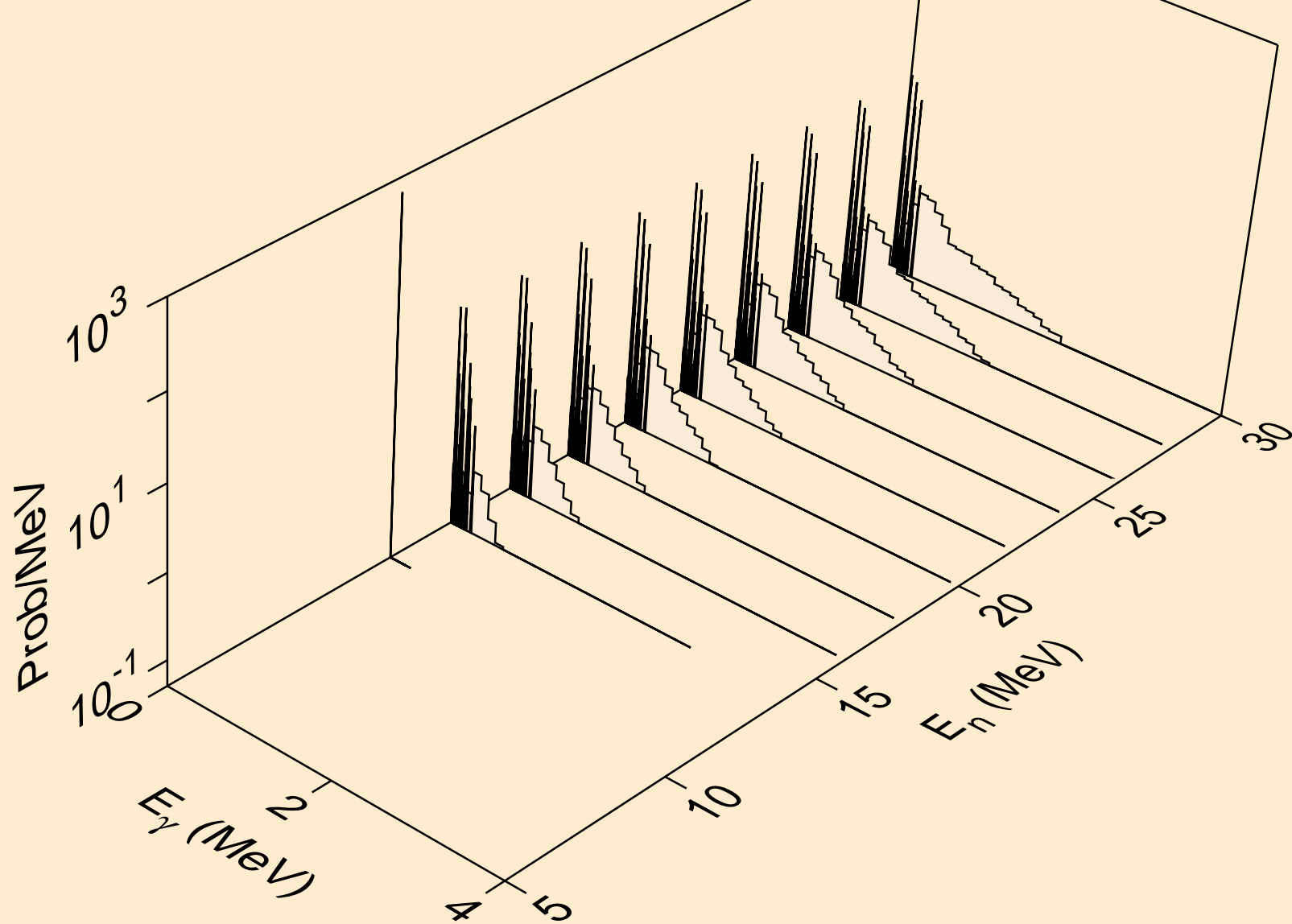

PT192 NEUTRON ACER TENDL-2024 LIBRARY; T=0.K
Photon emission for (n,3n)a

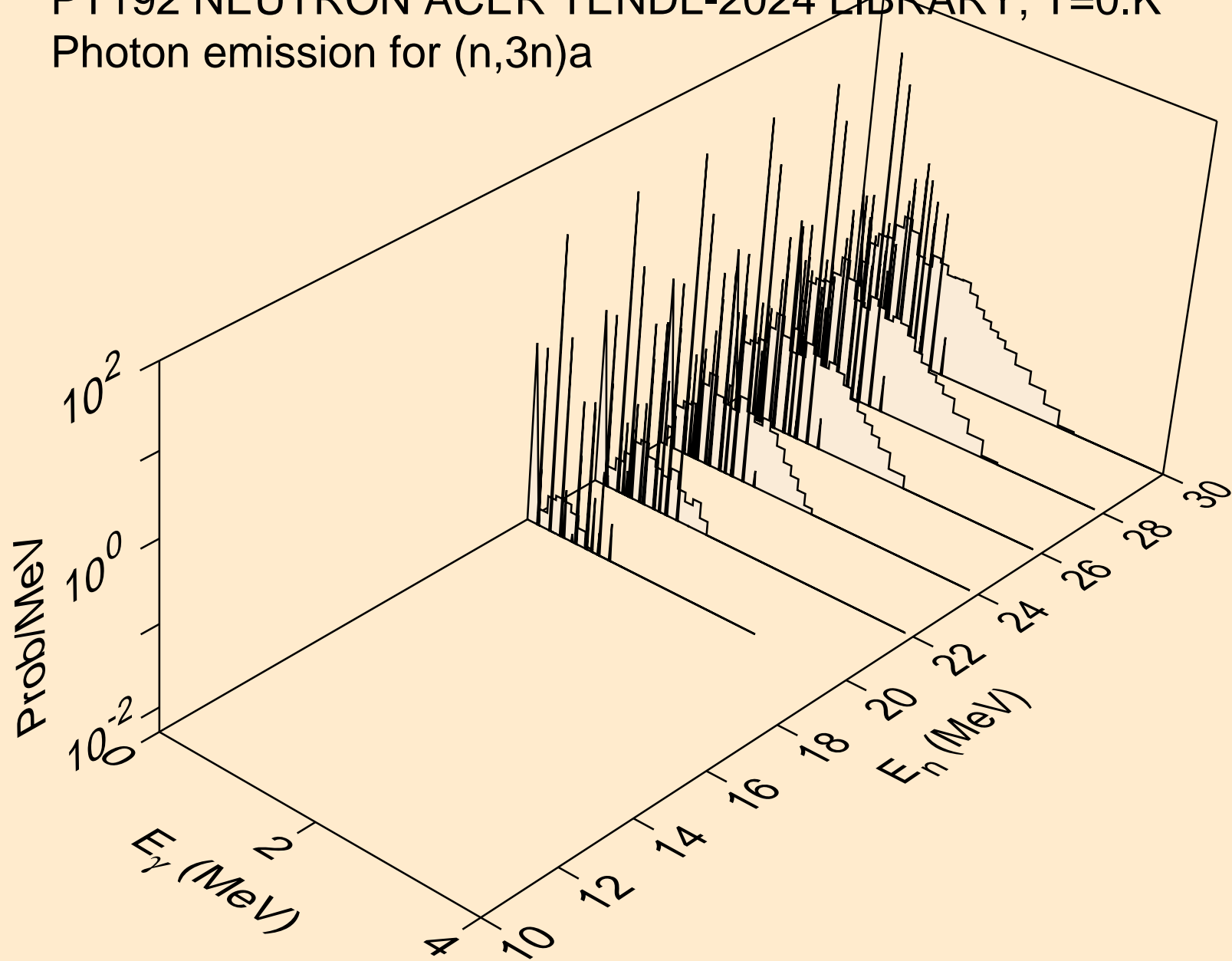

PT192 NEUTRON ACER TENDL-2024 LIBRARY; T=0.K
Photon emission for (n,n*)p

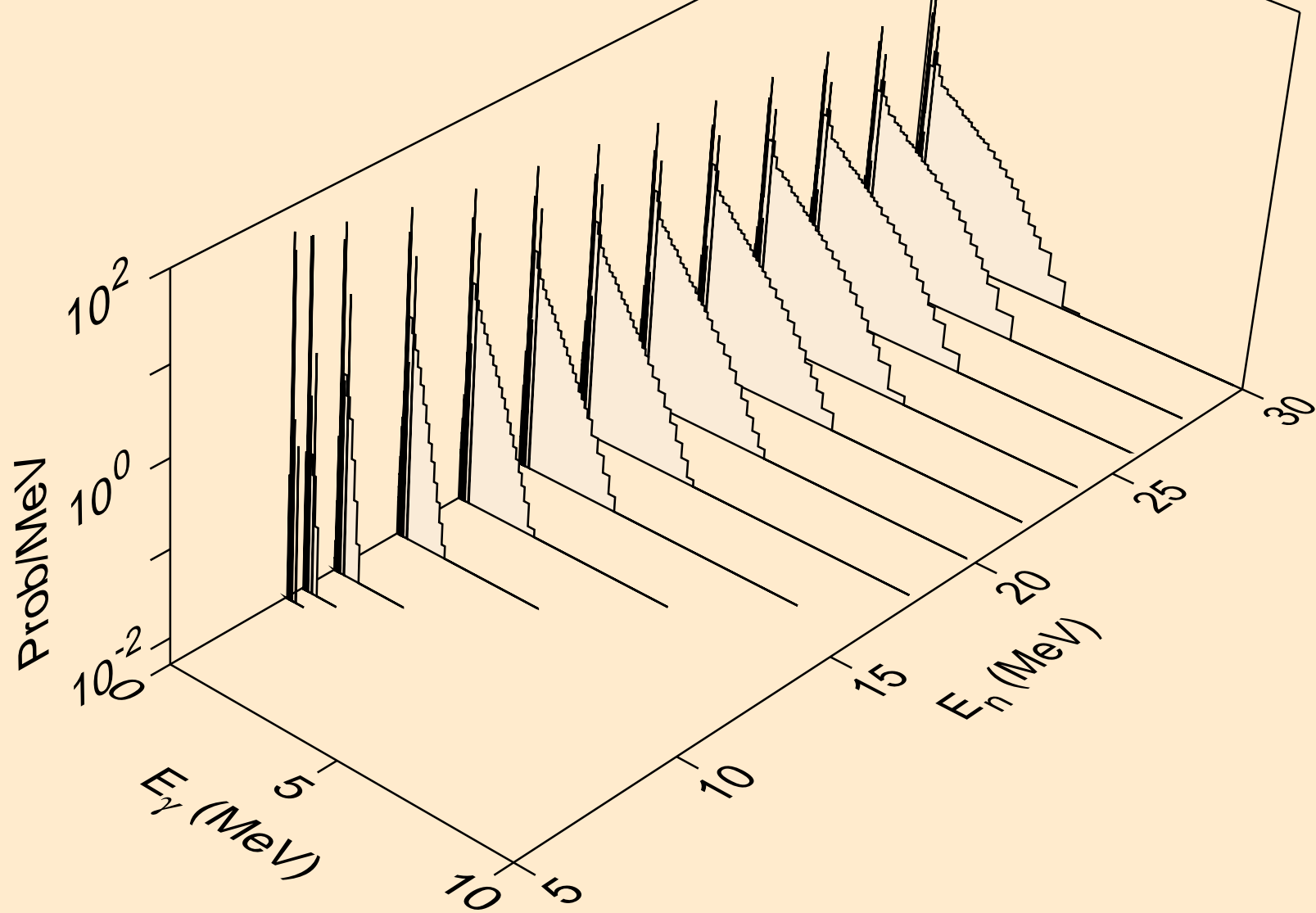

PT192 NEUTRON ACER TENDL-2024 LIBRARY; T=0.K
Photon emission for (n,n*)2a

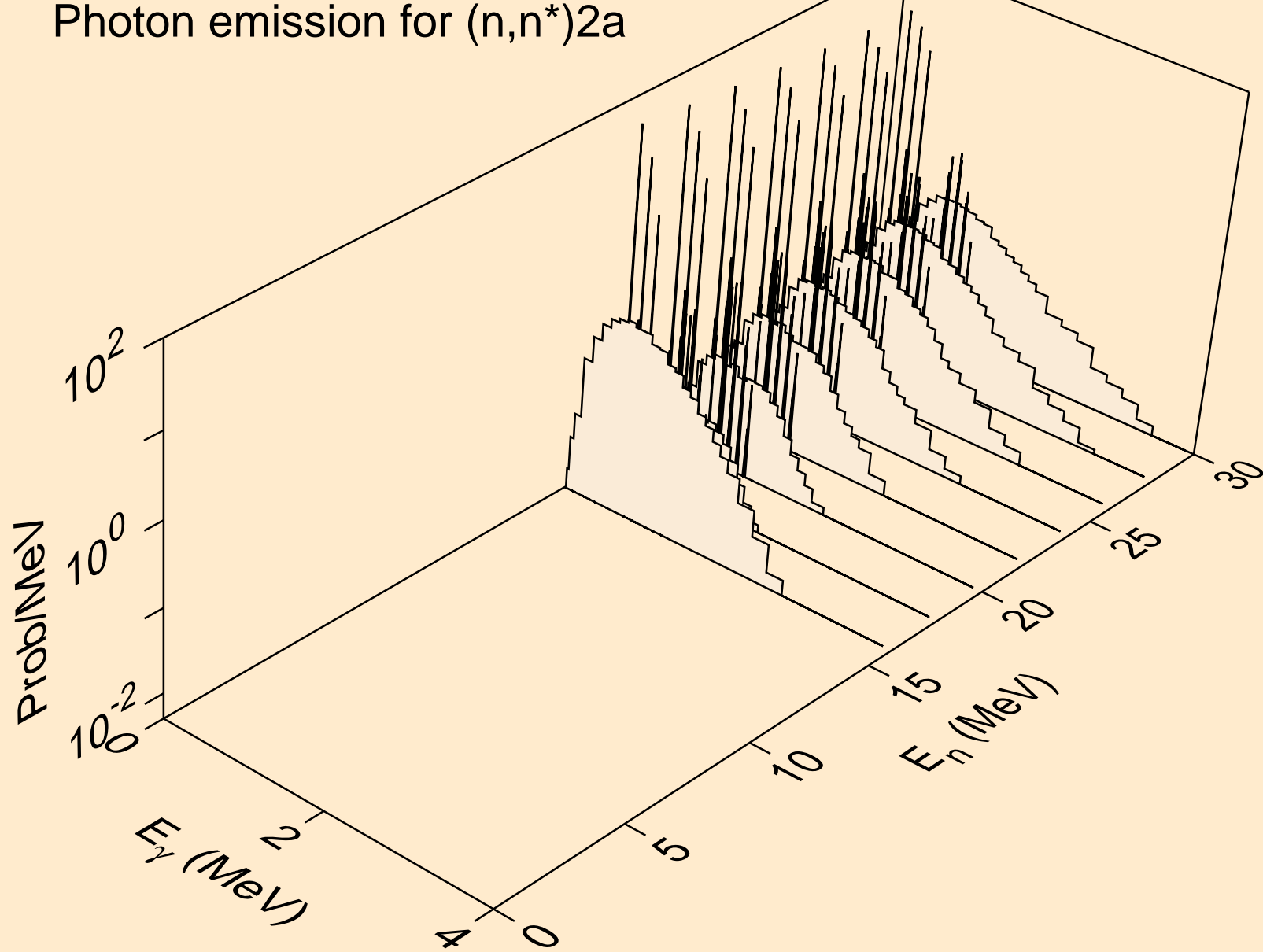

PT192 NEUTRON ACER TENDL-2024 LIBRARY; T=0.K
Photon emission for (n,n*)d

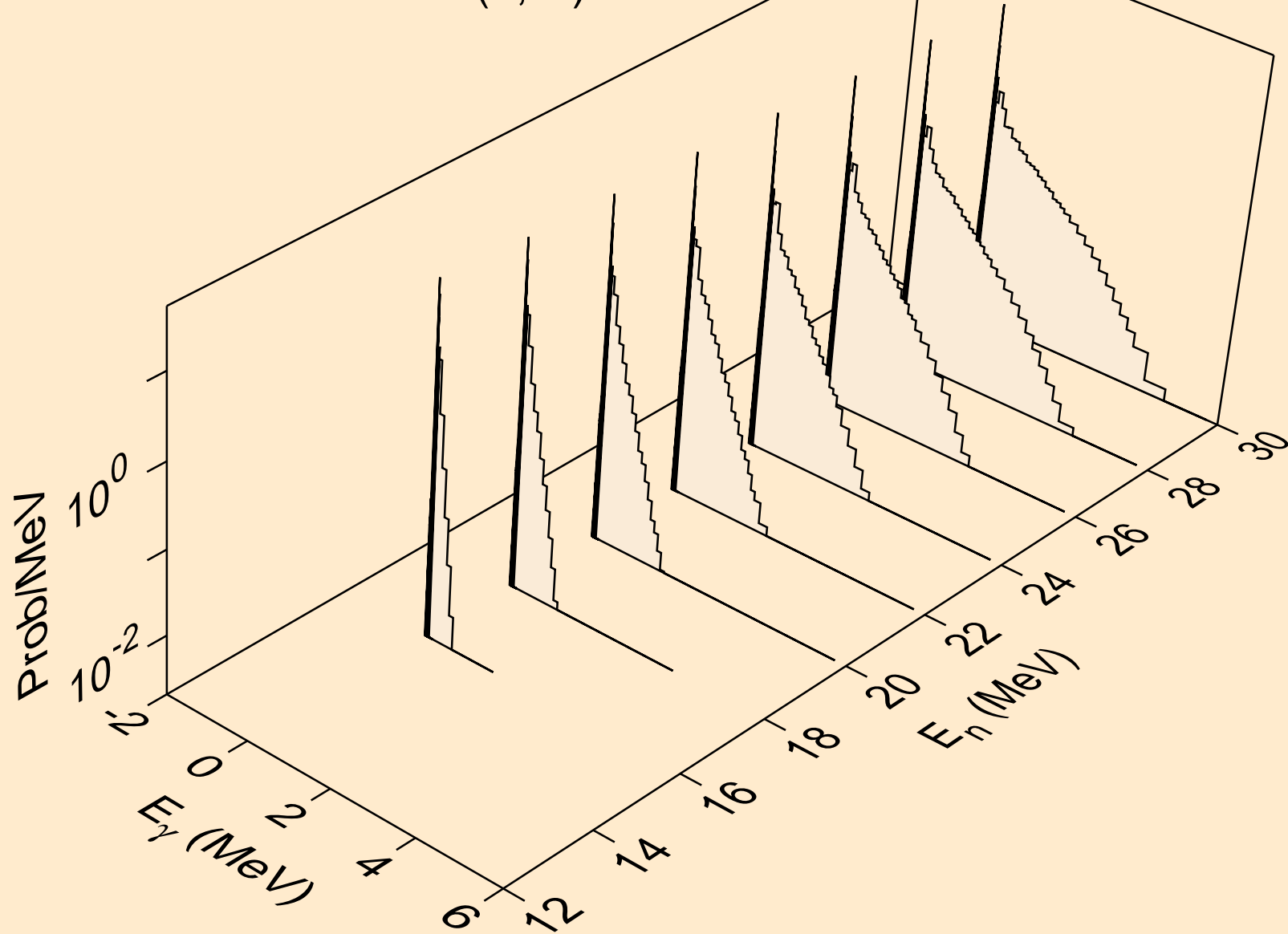

PT192 NEUTRON ACER TENDL-2024 LIBRARY; T=0.K
Photon emission for (n,n*)t

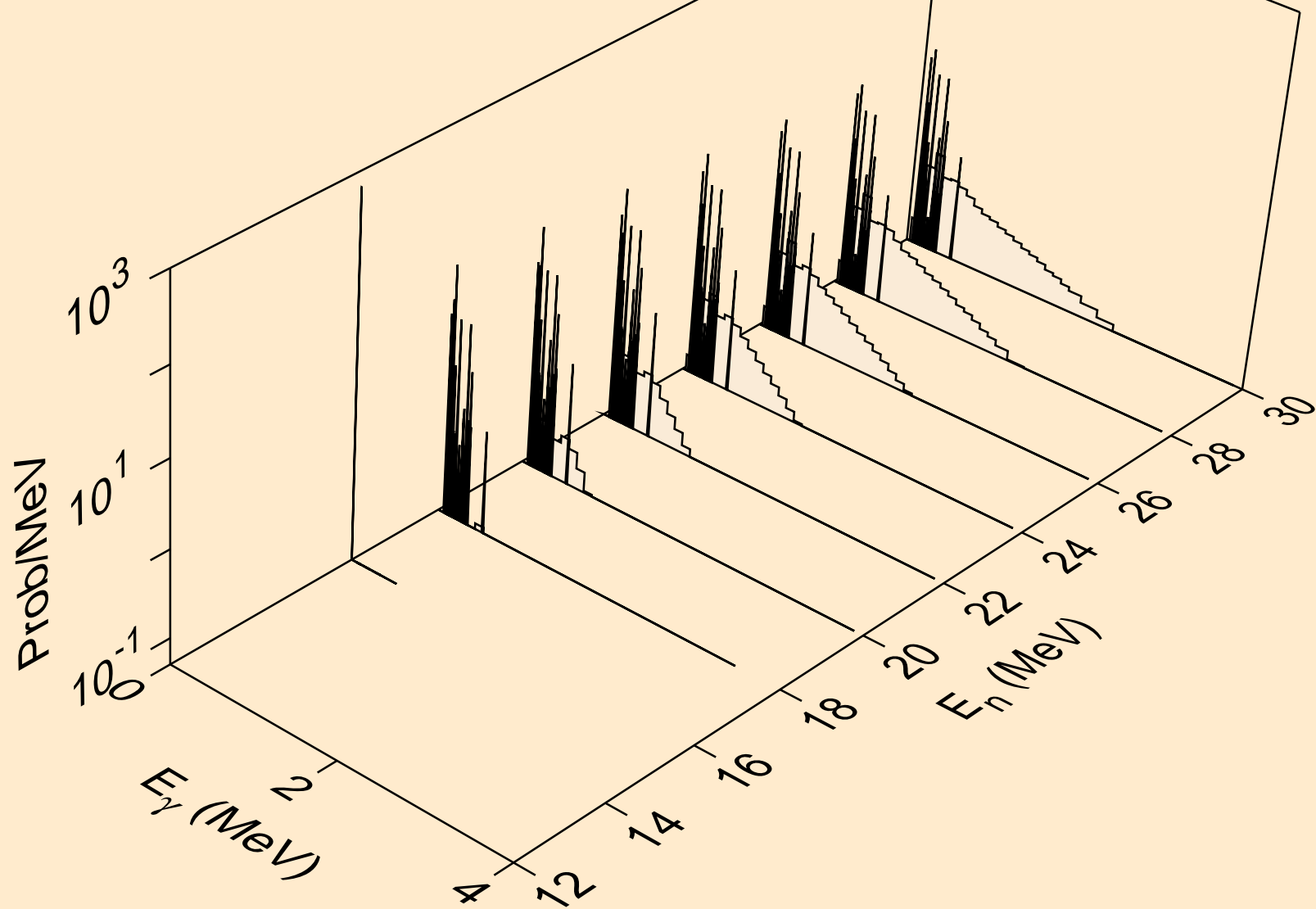

PT192 NEUTRON ACER TENDL-2024 LIBRARY; T=0.K
Photon emission for (n,n*)he3

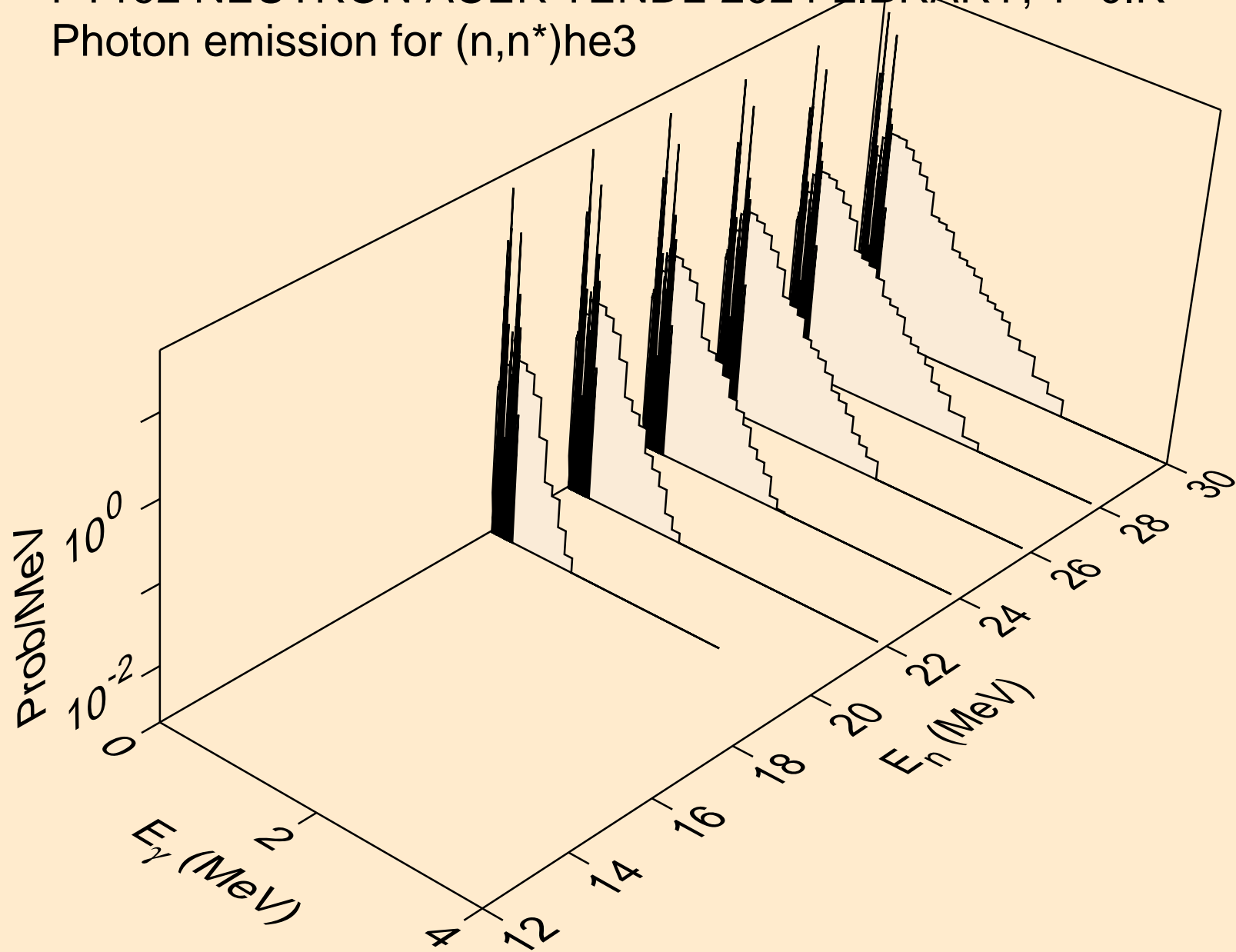

PT192 NEUTRON ACER TENDL-2024 LIBRARY; T=0.K
Photon emission for (n,4n)

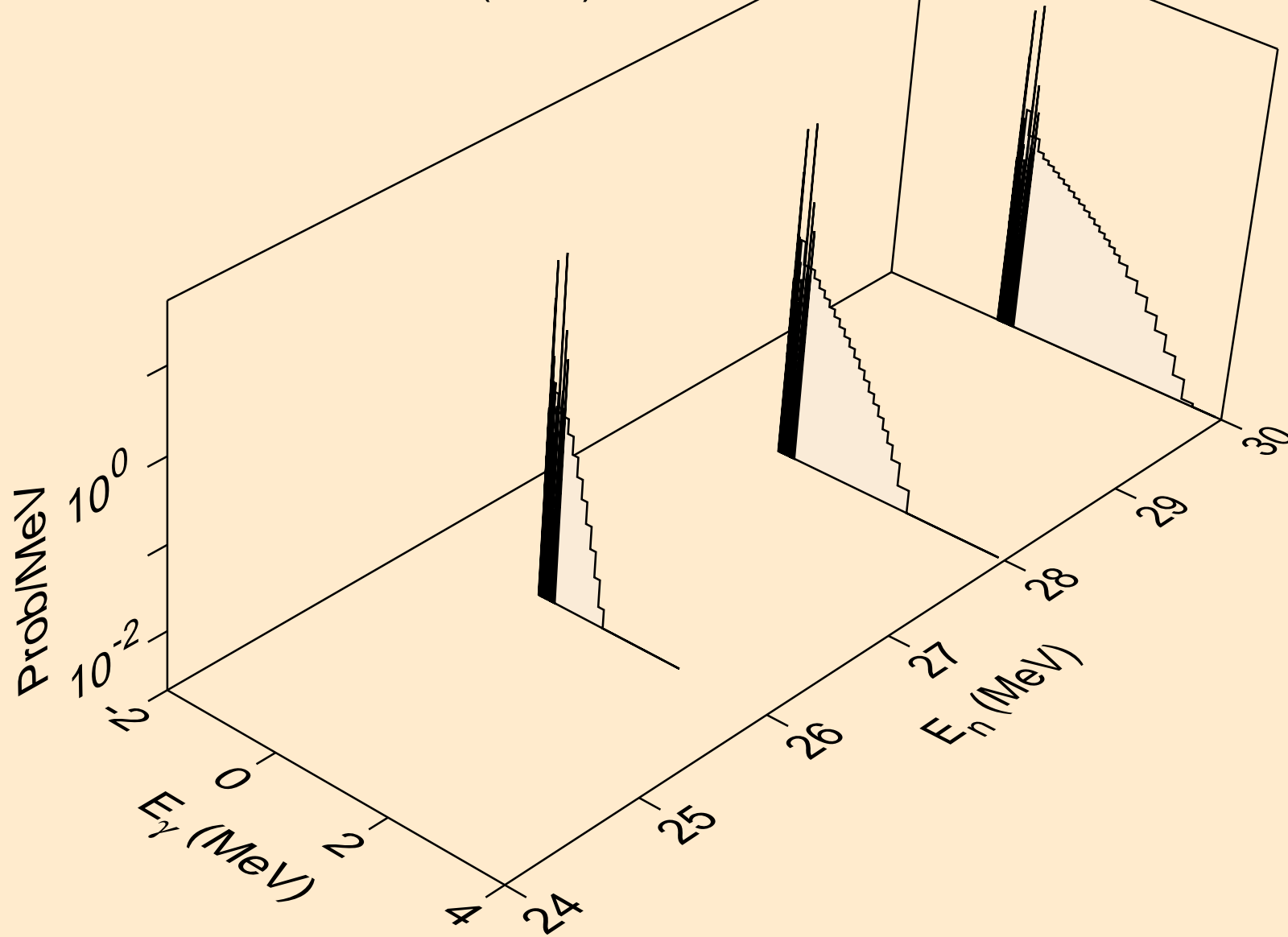

PT192 NEUTRON ACER TENDL-2024 LIBRARY; T=0.K
Photon emission for (n,2np)

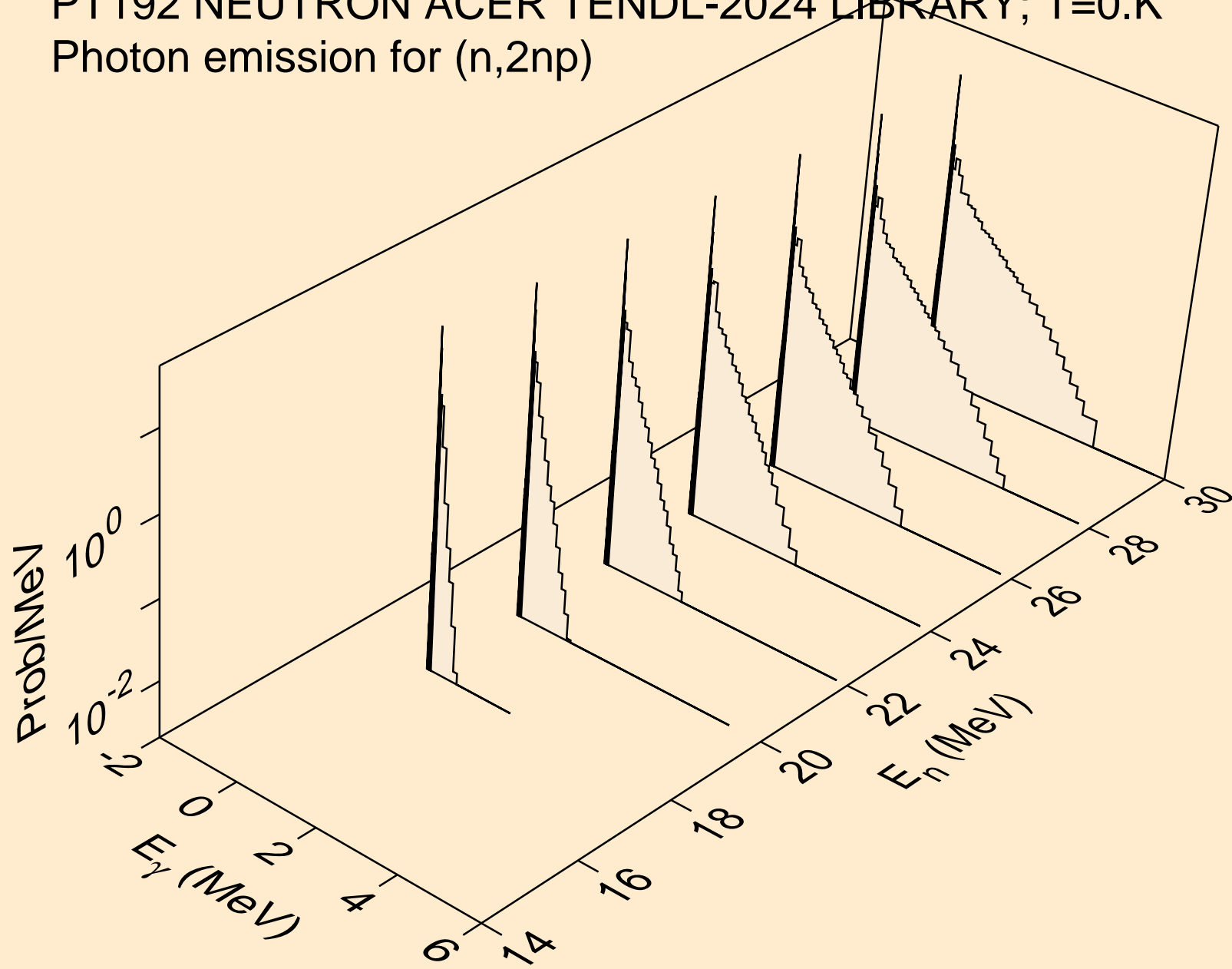

PT192 NEUTRON ACER TENDL-2024 LIBRARY; T=0.K
Photon emission for (n,3np)

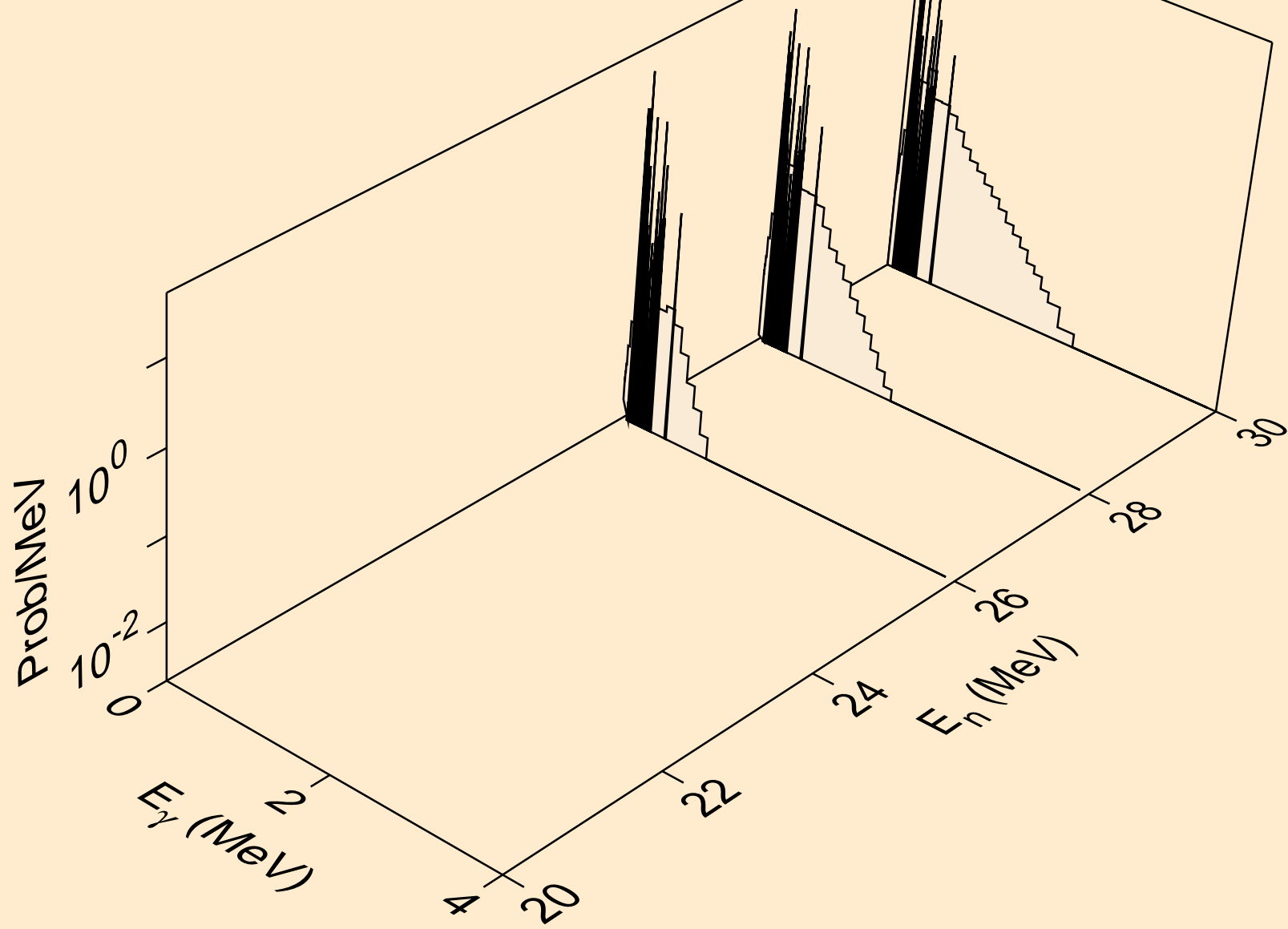

PT192 NEUTRON ACER TENDL-2024 LIBRARY; T=0.K
Photon emission for (n,n2p)

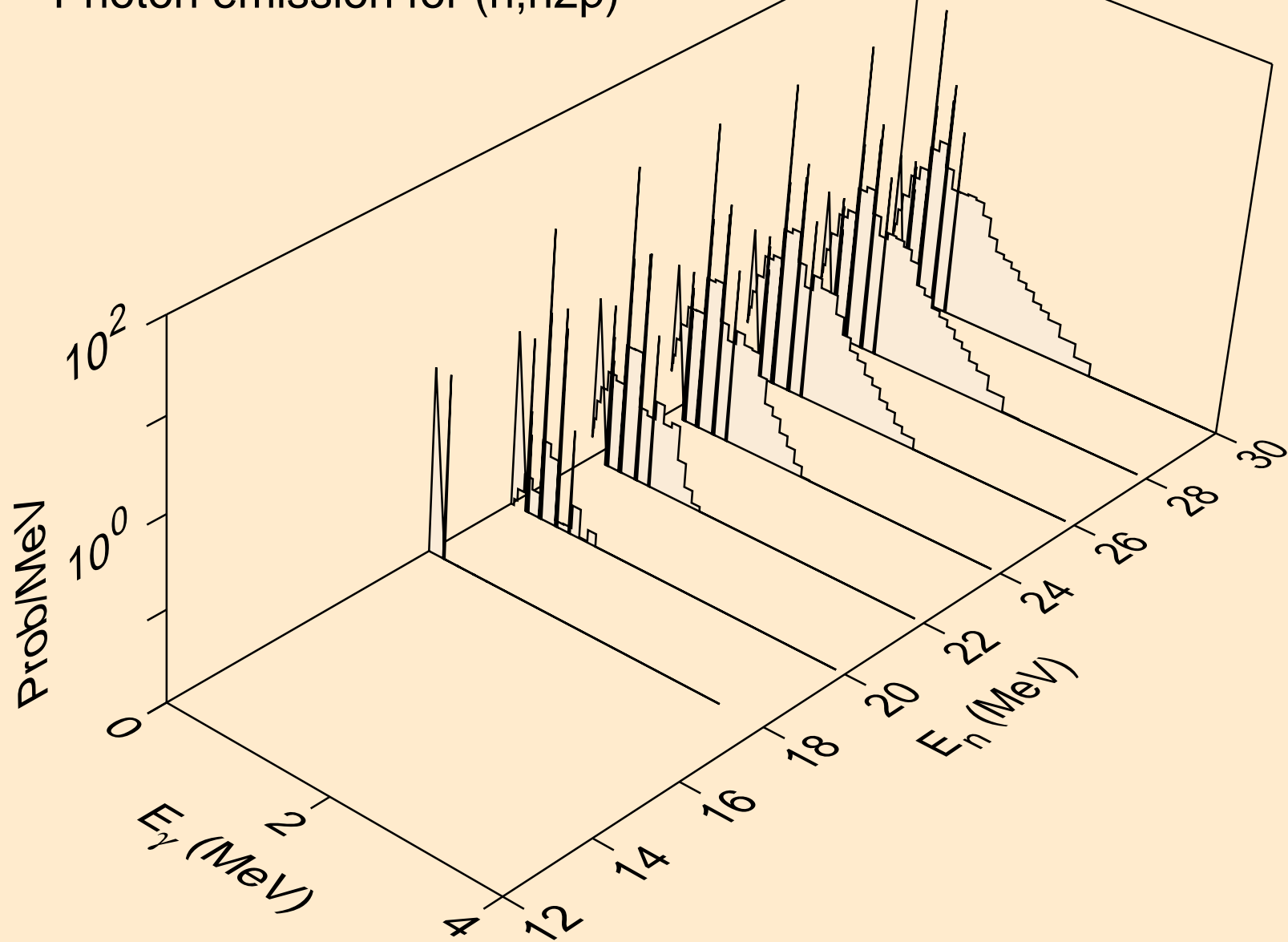

PT192 NEUTRON ACER TENDL-2024 LIBRARY; T=0.K
Photon emission for (n,npa)

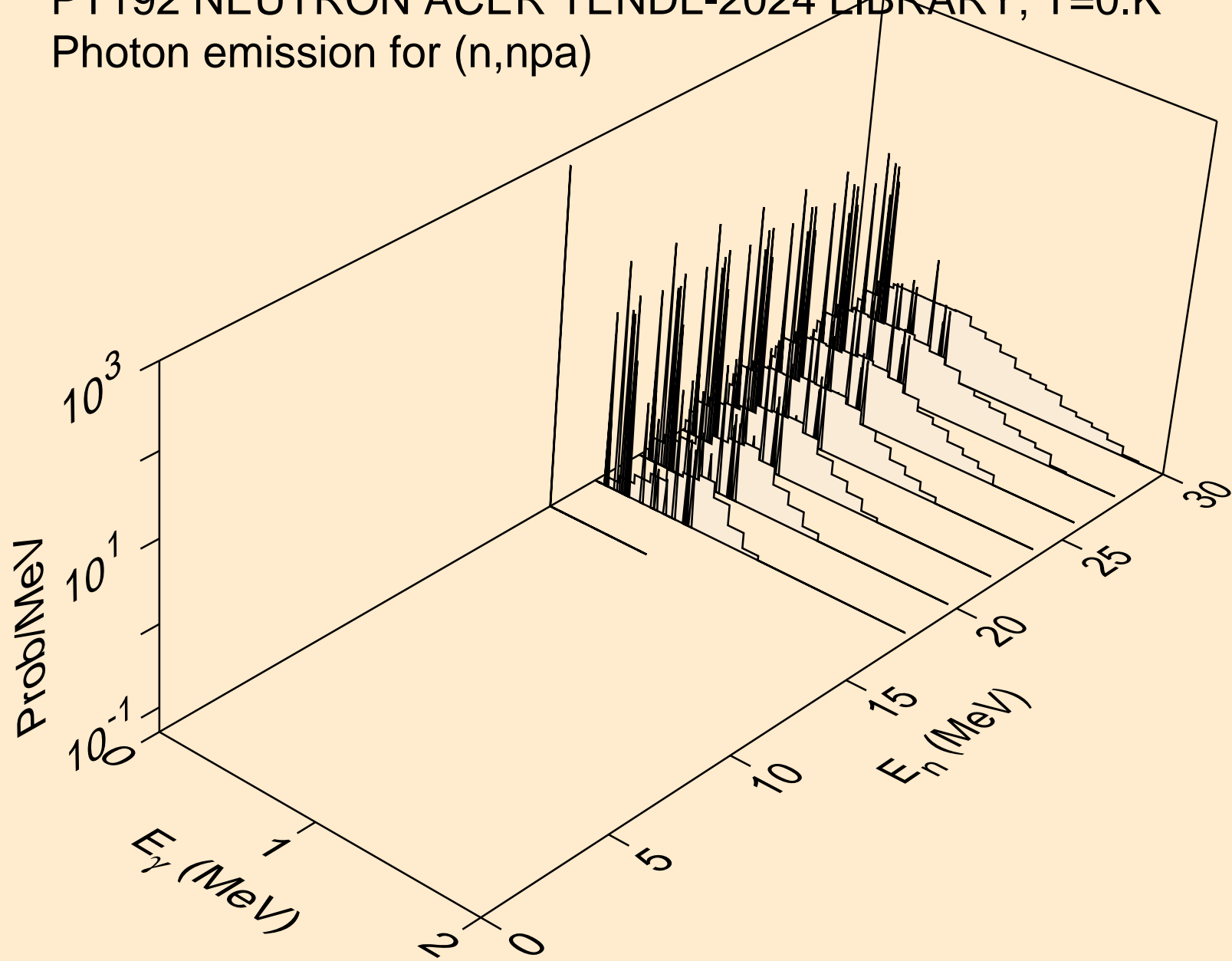

PT192 NEUTRON ACER TENDL-2024 LIBRARY; T=0.K
Photon emission for (n,n*c)

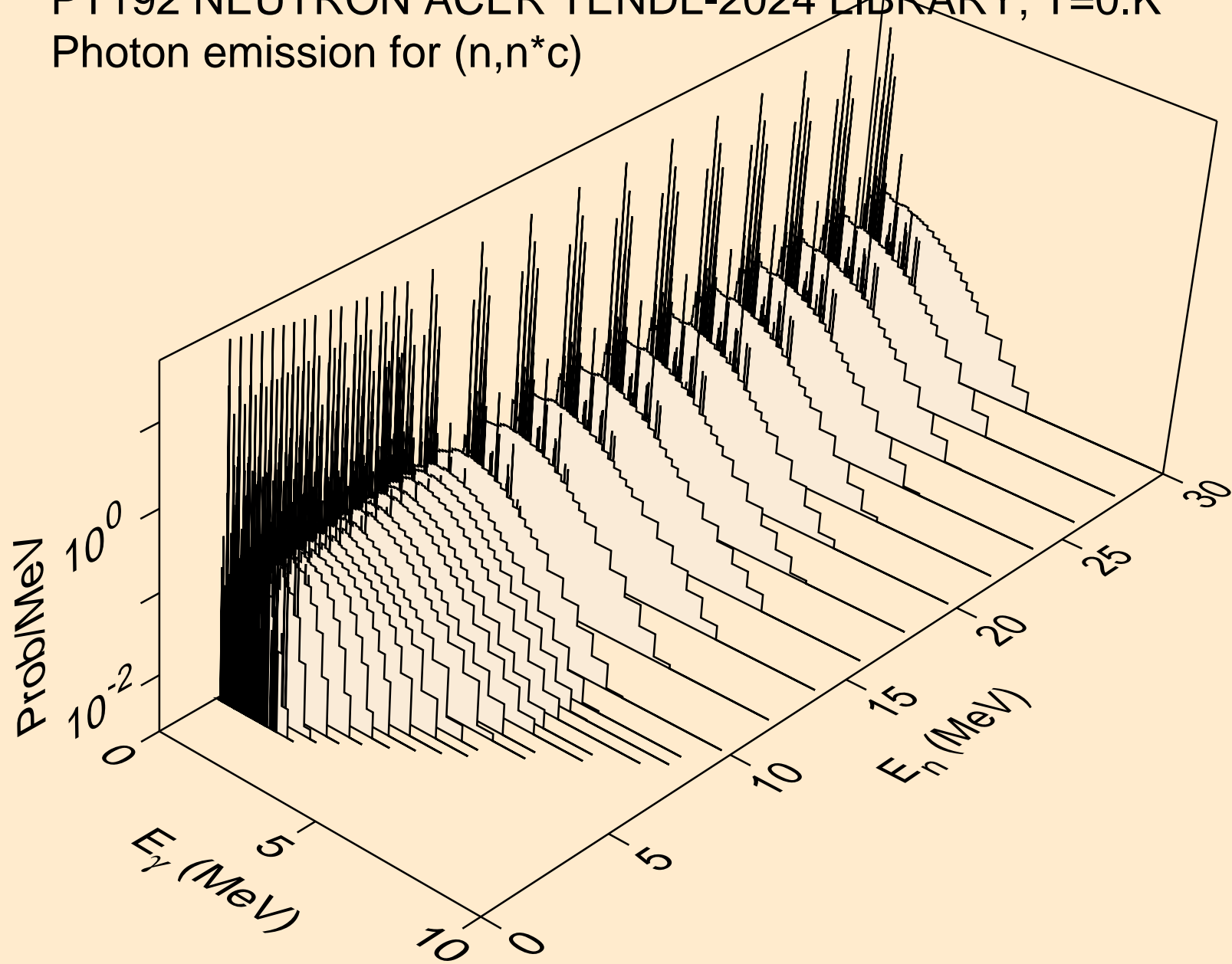

PT192 NEUTRON ACER TENDL-2024 LIBRARY; T=0.K
Photon emission for (n,gma)

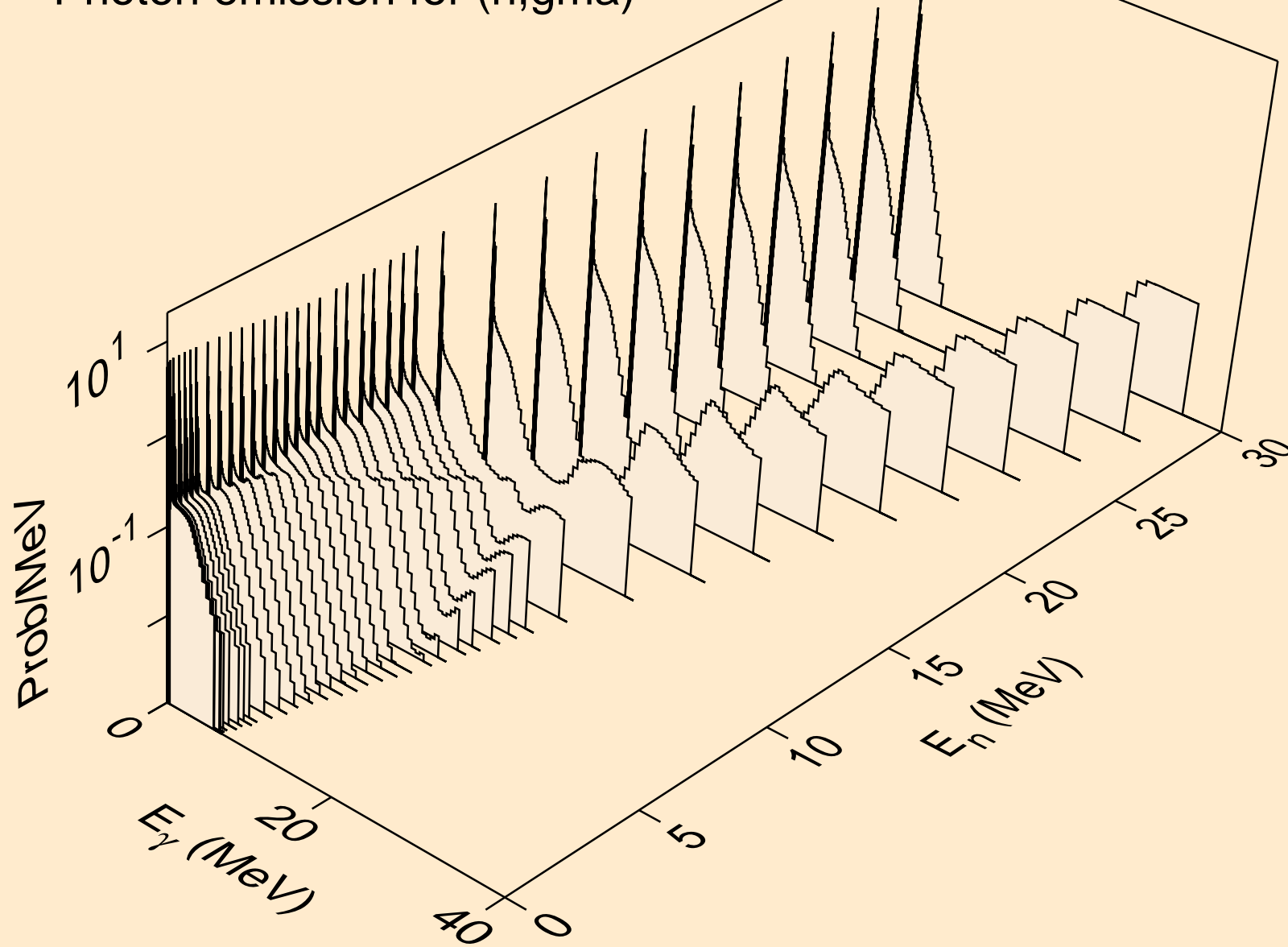

PT192 NEUTRON ACER TENDL-2024 LIBRARY; T=0.K
Photon emission for (n,p)

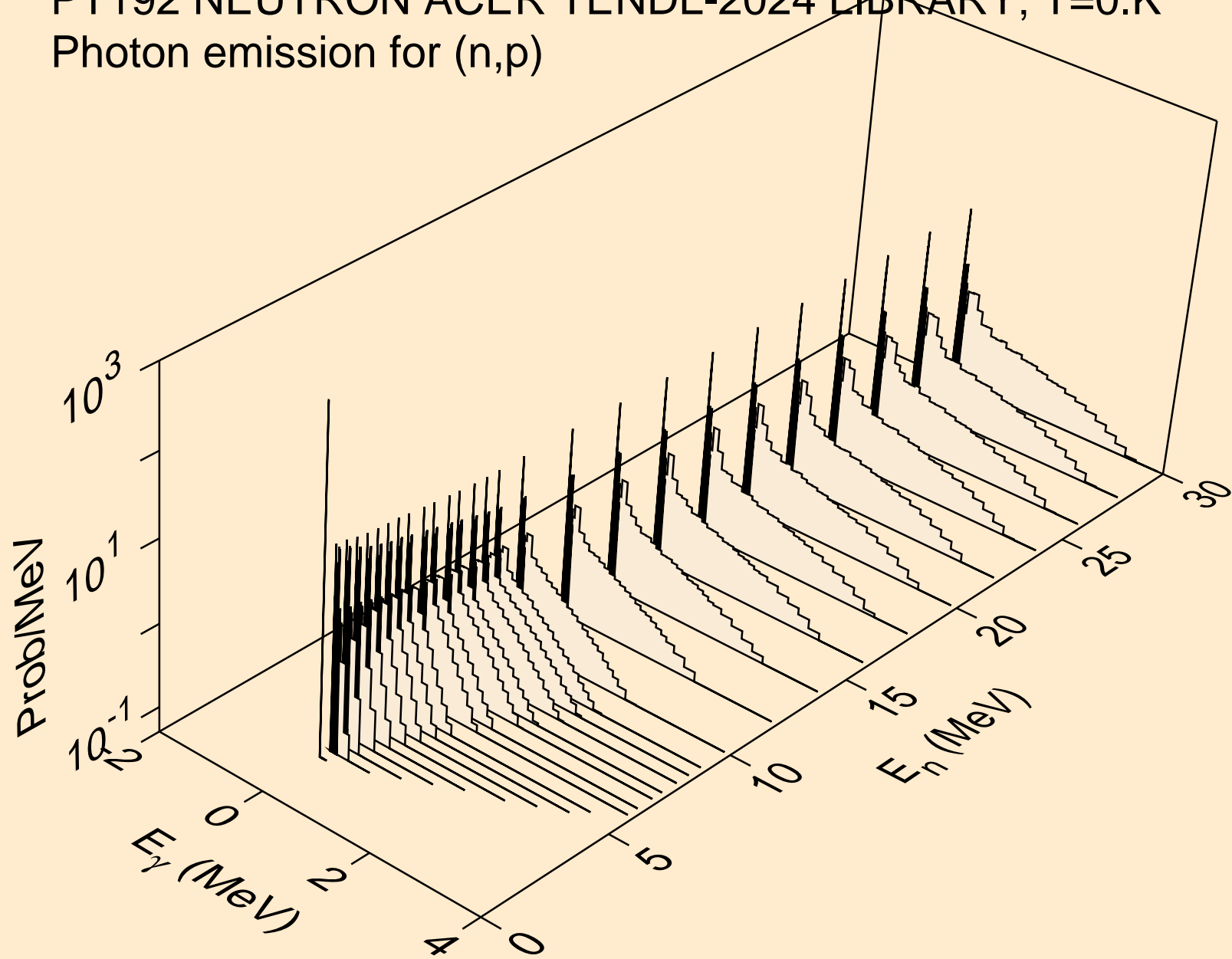

PT192 NEUTRON ACER TENDL-2024 LIBRARY; T=0.K
Photon emission for (n,d)

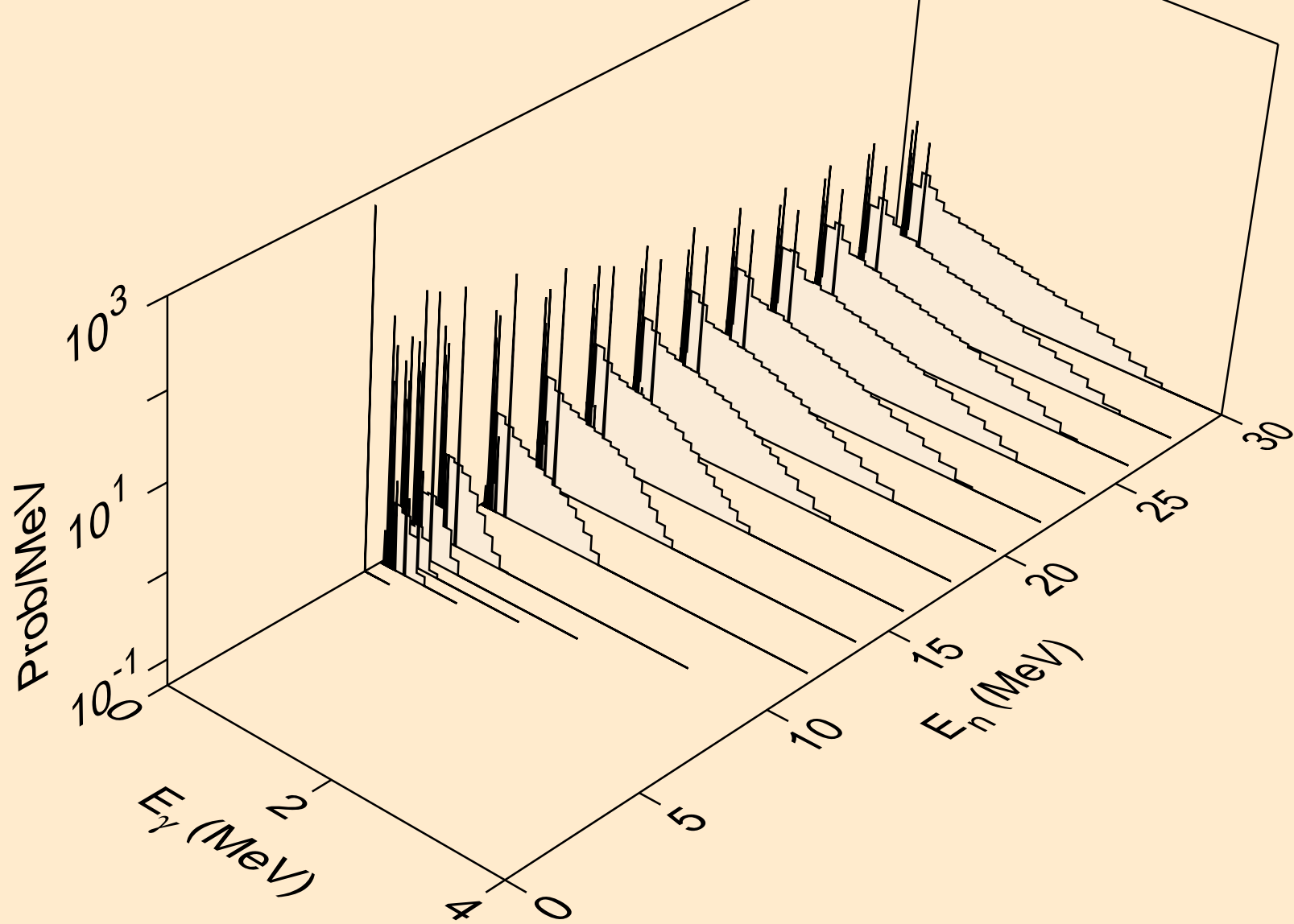

PT192 NEUTRON ACER TENDL-2024 LIBRARY; T=0.K
Photon emission for (n,t)

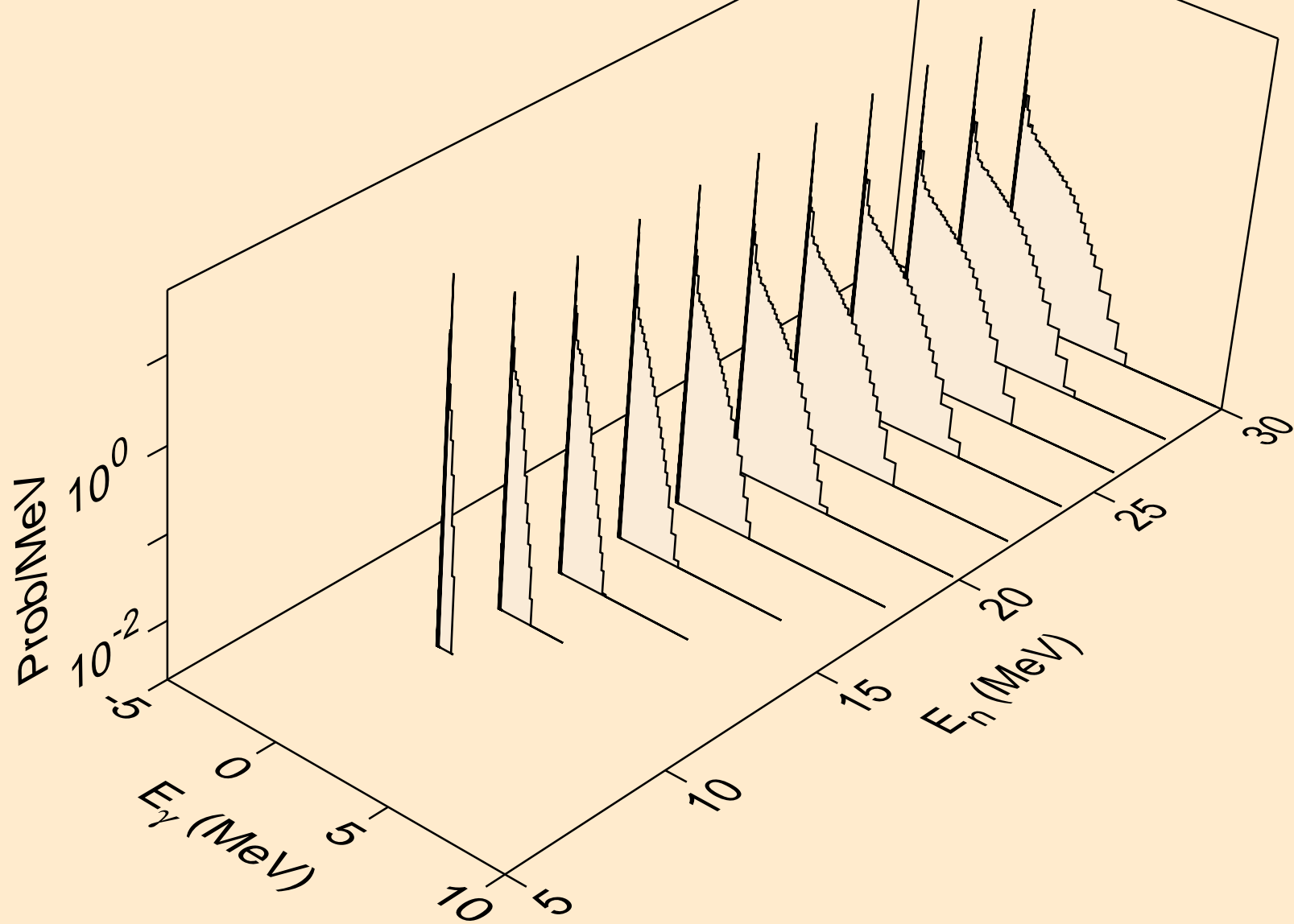

PT192 NEUTRON ACER TENDL-2024 LIBRARY; T=0.K
Photon emission for (n,he3)

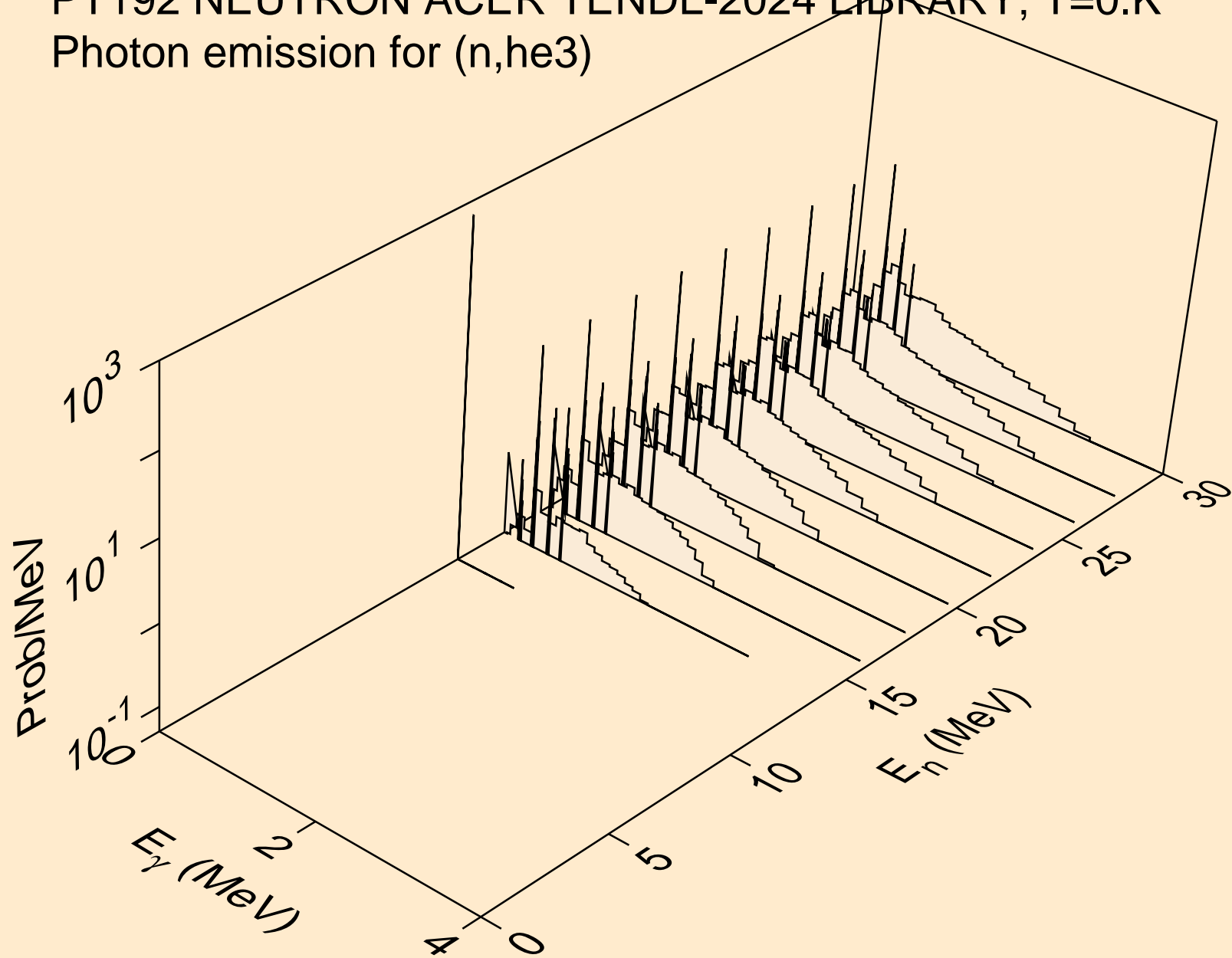

PT192 NEUTRON ACER TENDL-2024 LIBRARY; T=0.K
Photon emission for (n,a)

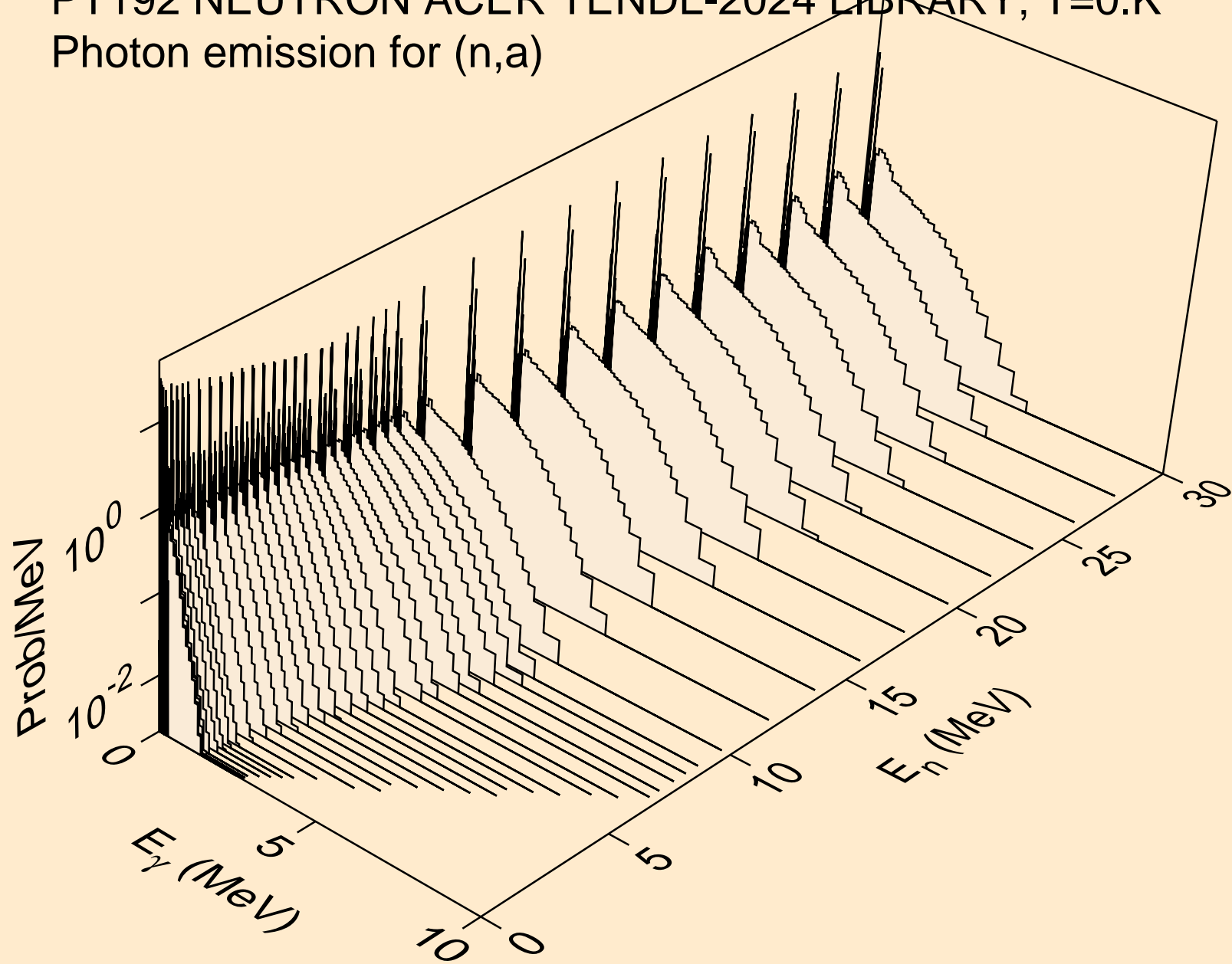

PT192 NEUTRON ACER TENDL-2024 LIBRARY; T=0.K
Photon emission for (n,2a)

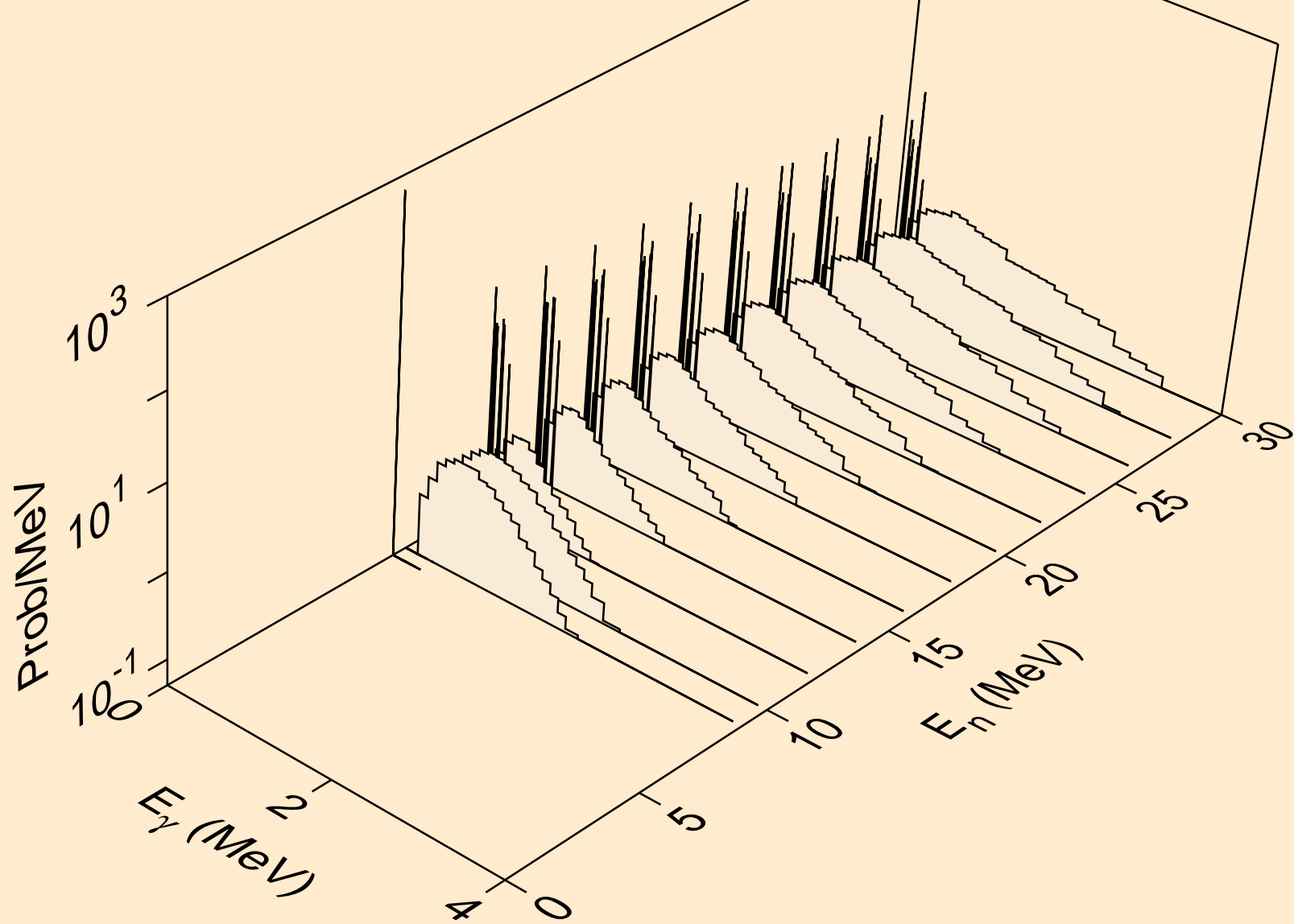

PT192 NEUTRON ACER TENDL-2024 LIBRARY; T=0.K
Photon emission for (n,2p)

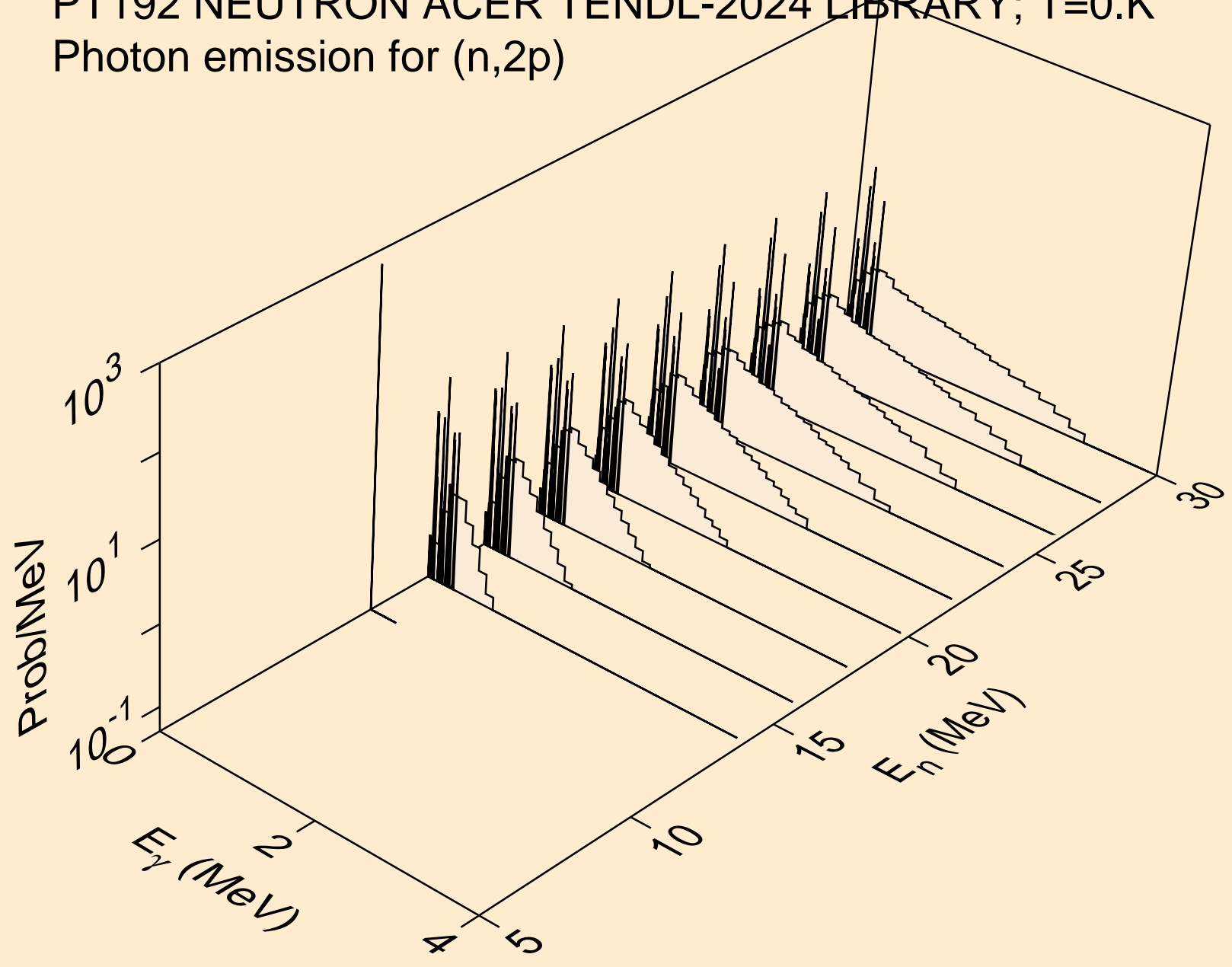

PT192 NEUTRON ACER TENDL-2024 LIBRARY; T=0.K
Photon emission for (n,p α)

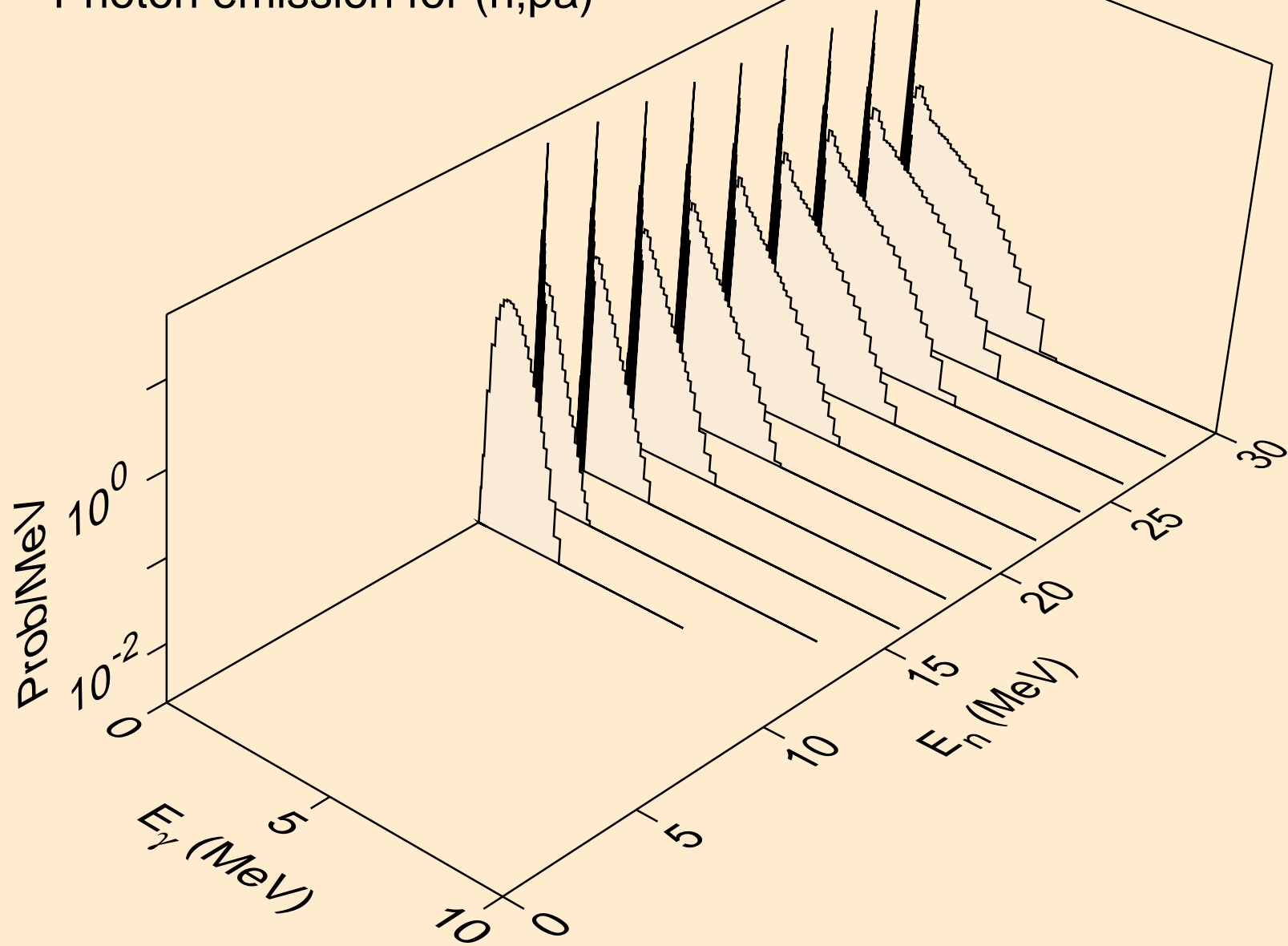

PT192 NEUTRON ACER TENDL-2024 LIBRARY; T=0.K
Photon emission for (n,pd)

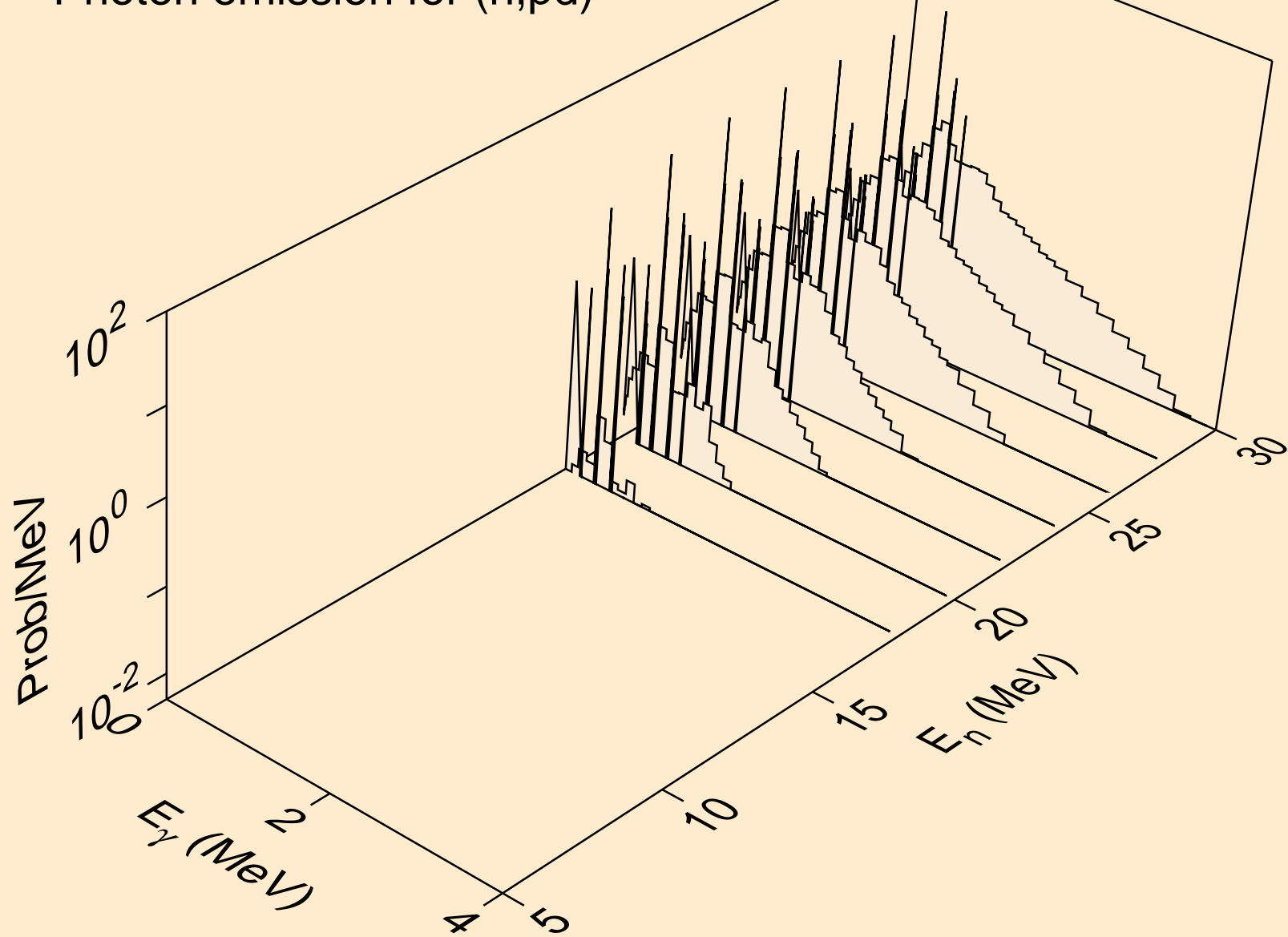

PT192 NEUTRON ACER TENDL-2024 LIBRARY; T=0.K
Photon emission for (n,pt)

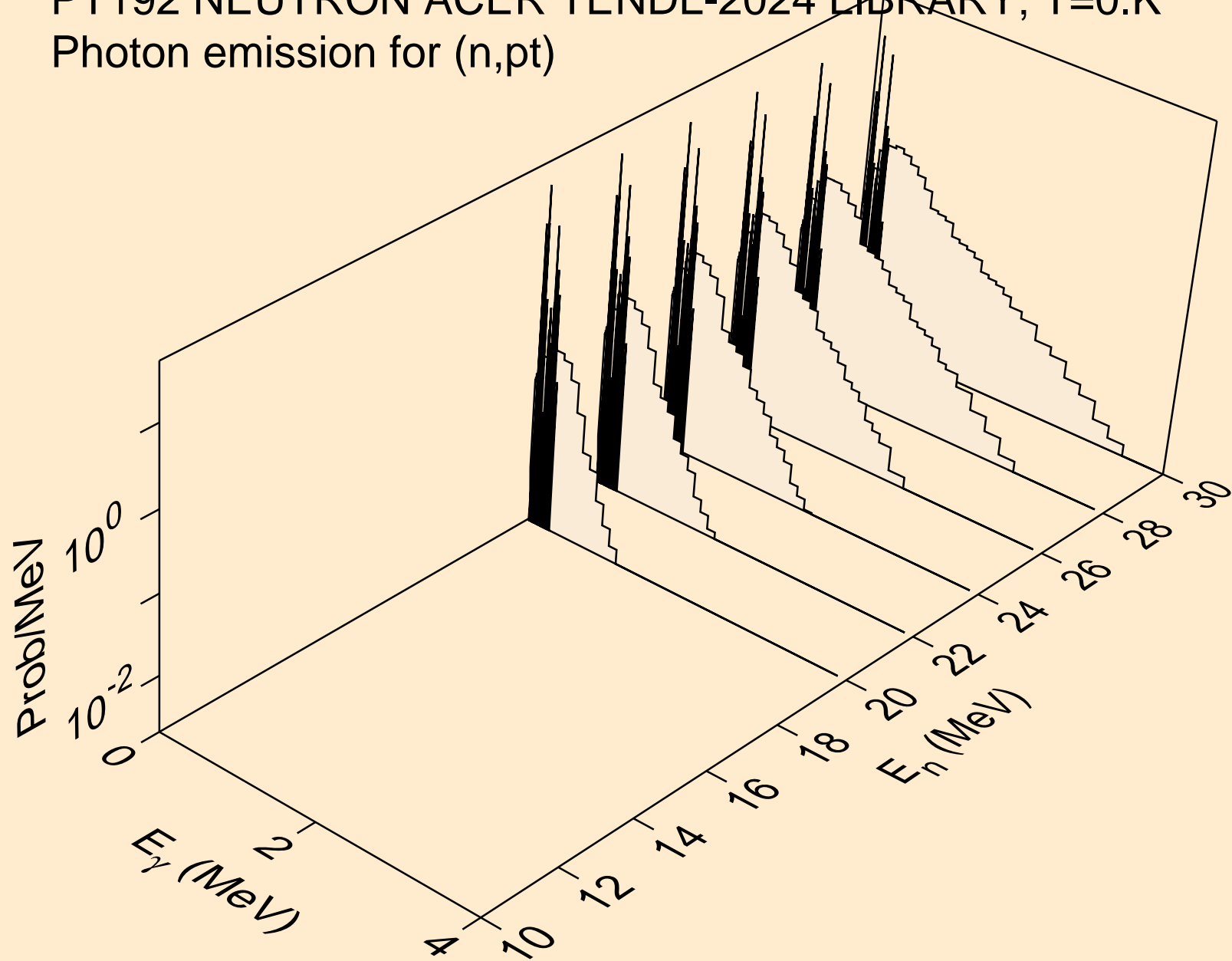

PT192 NEUTRON ACER TENDL-2024 LIBRARY; T=0.K
thermal capture photon spectrum

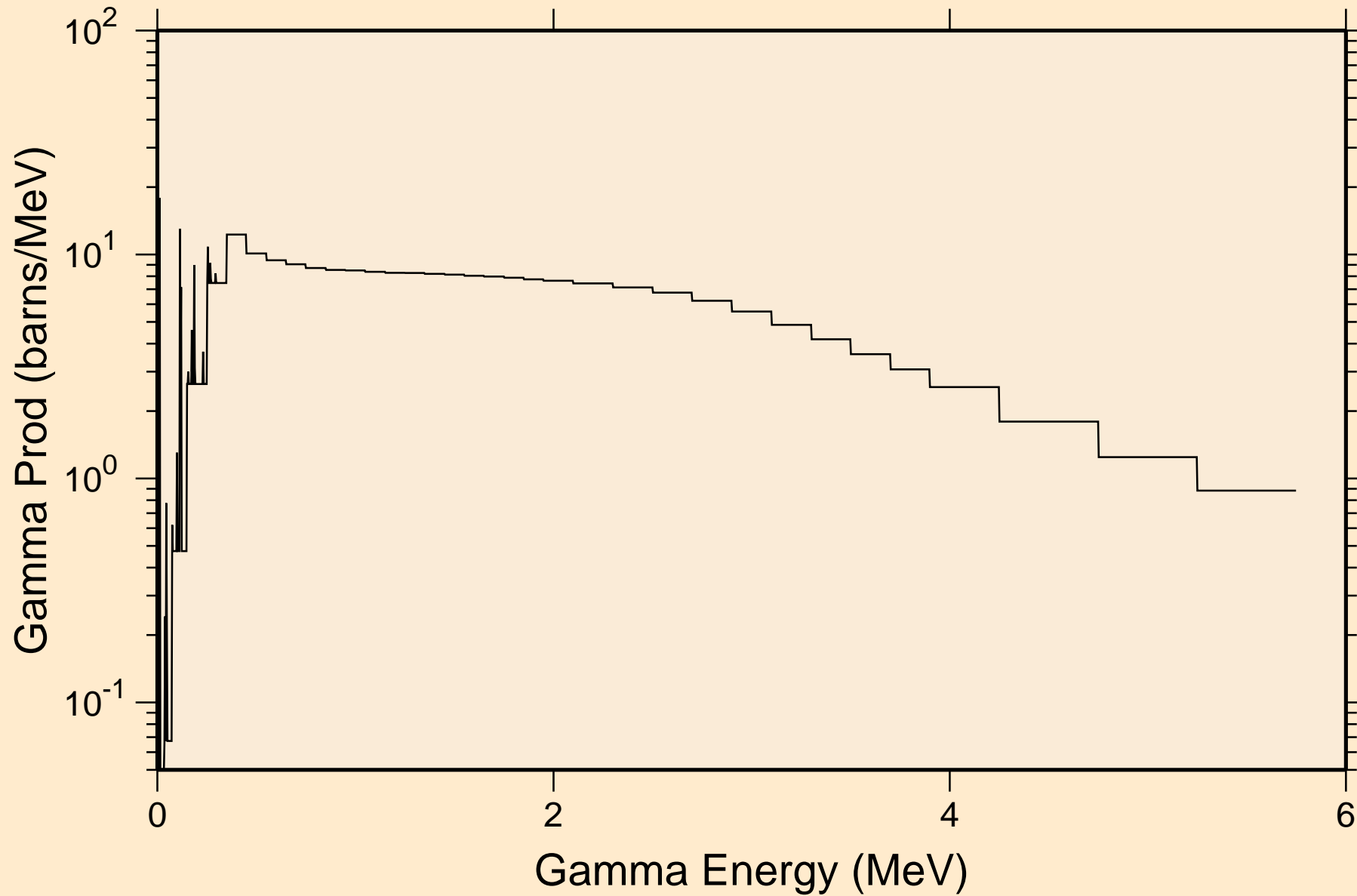

PT192 NEUTRON ACER TENDL-2024 LIBRARY; T=0.K
14 MeV photon spectrum

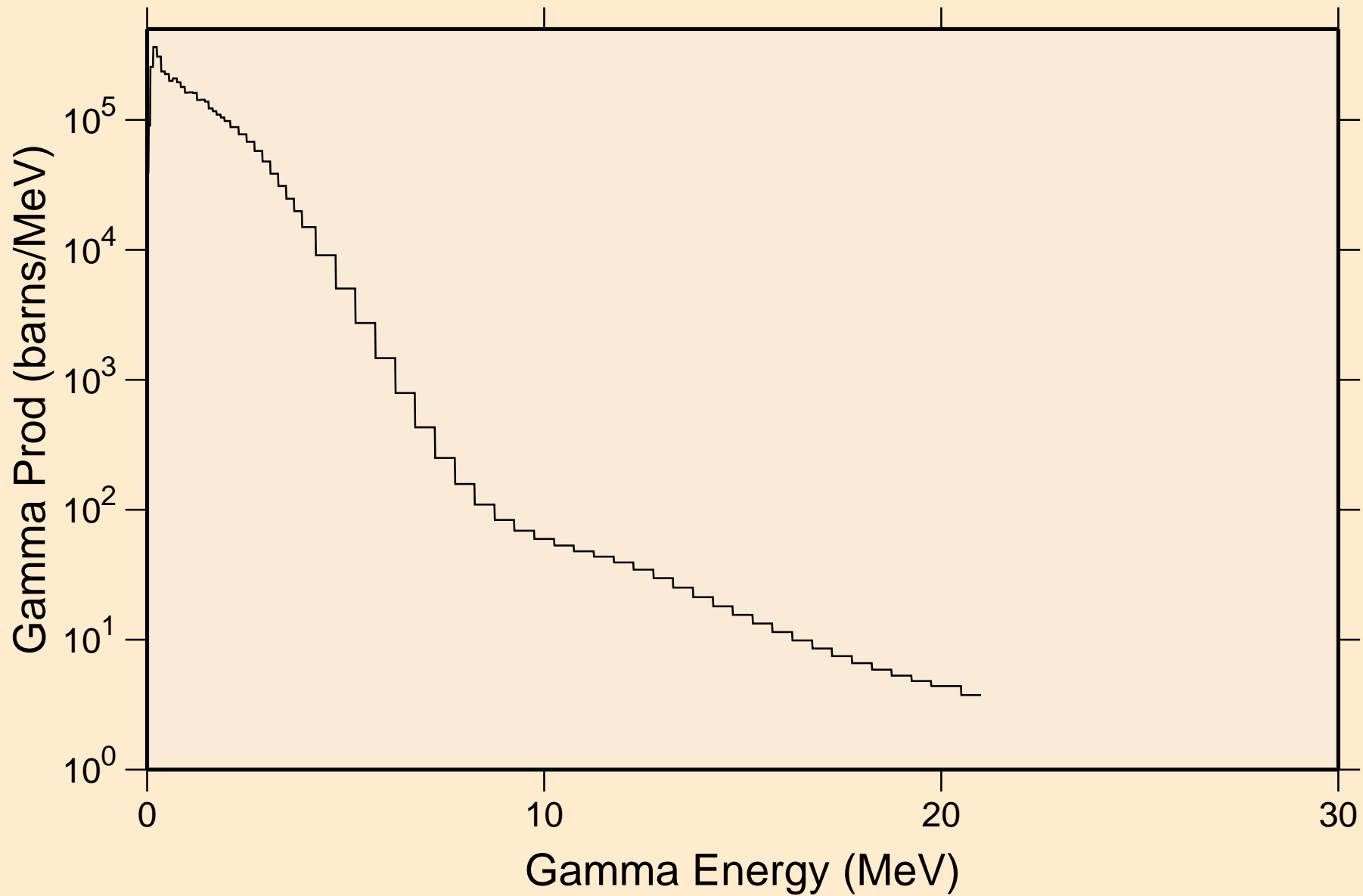

PT192 NEUTRON ACER TENDL-2024 LIBRARY; T=0.K
Particle heating contributions

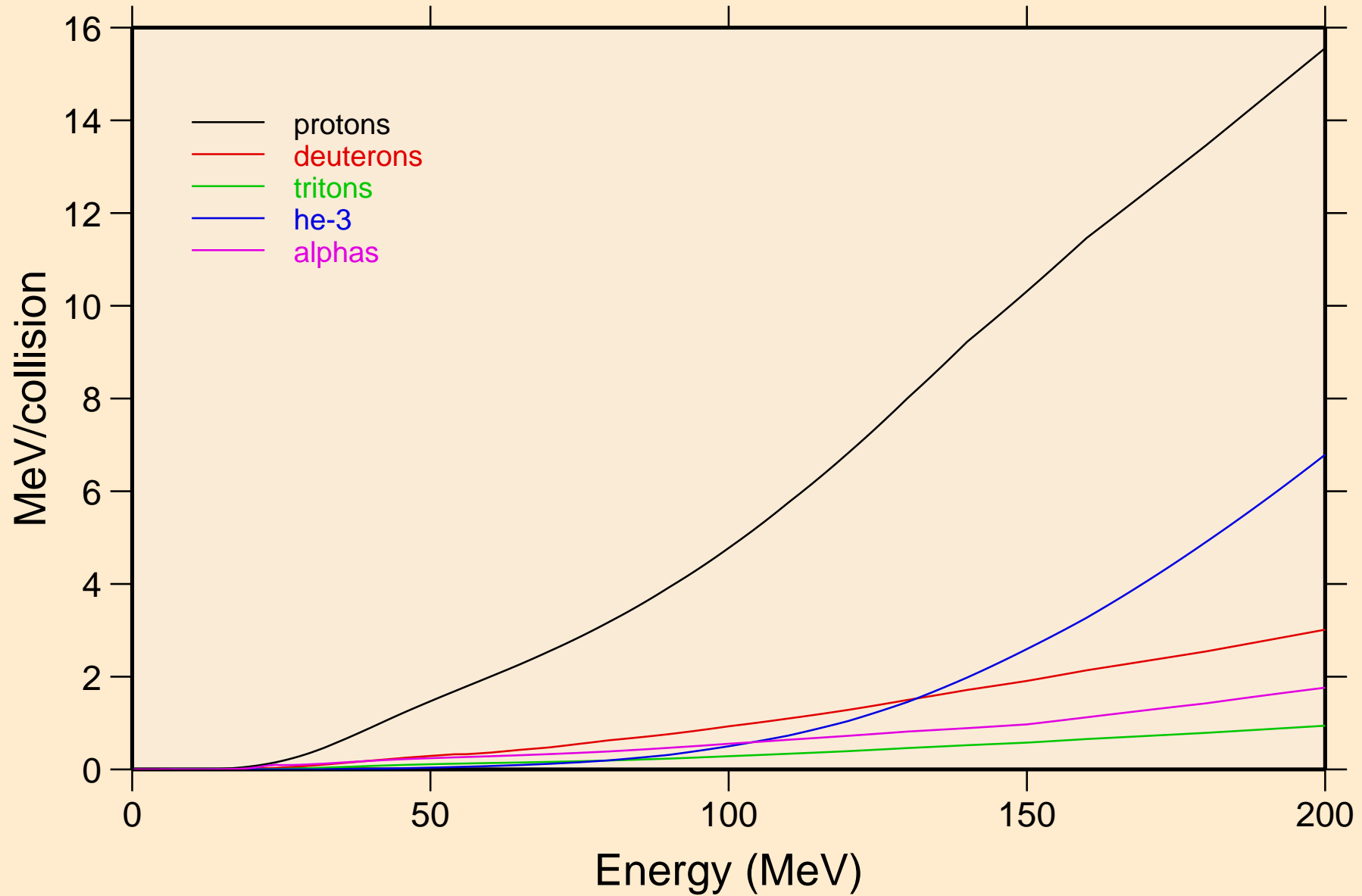

PT192 NEUTRON ACER TENDL-2024 LIBRARY; T=0.K
Recoil Heating

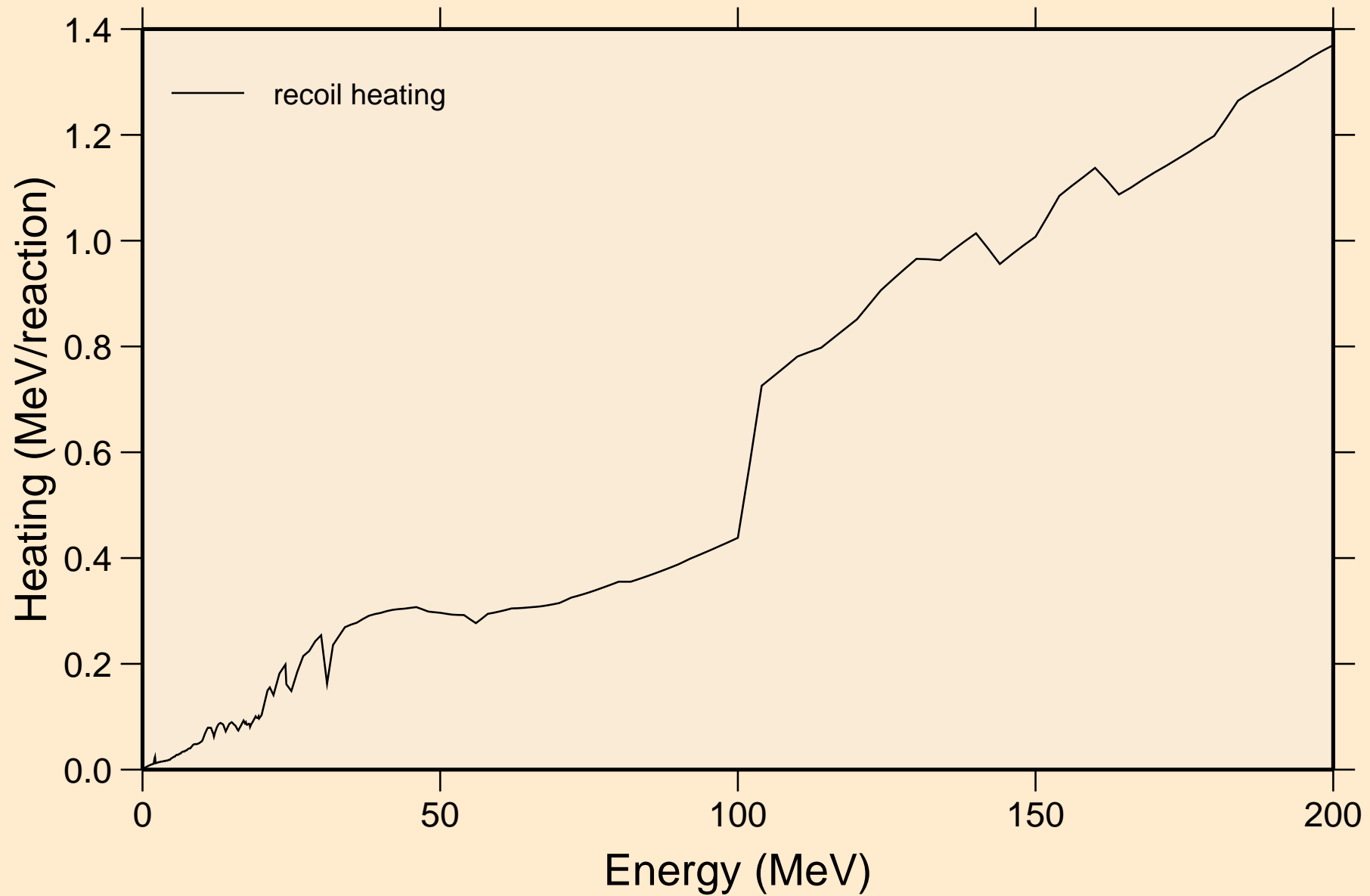

PT192 NEUTRON ACER TENDL-2024 LIBRARY; T=0.K
Particle production cross sections

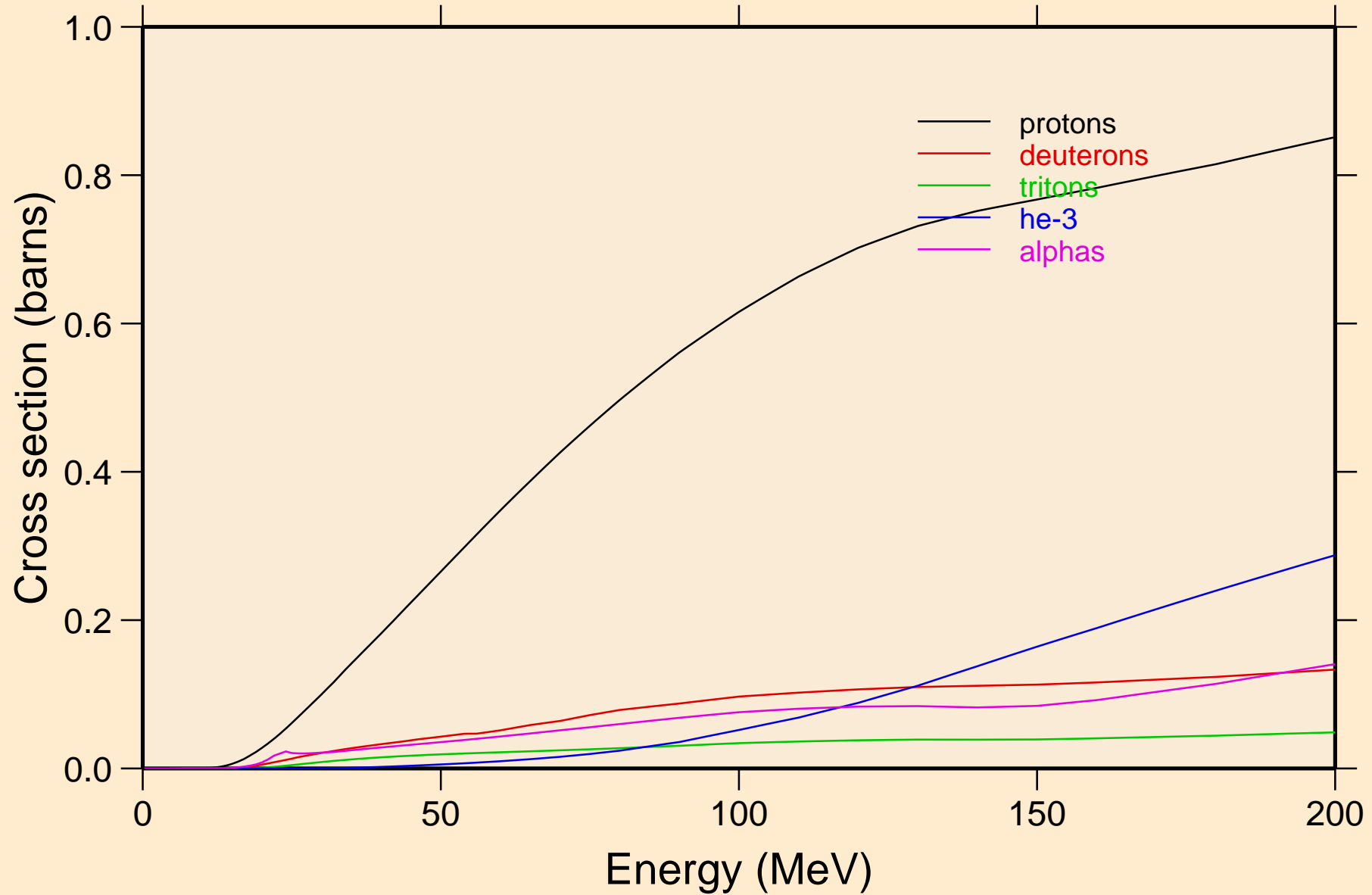

PT192 NEUTRON ACER TENDL-2024 LIBRARY; T=0.K
protons from (n,x)

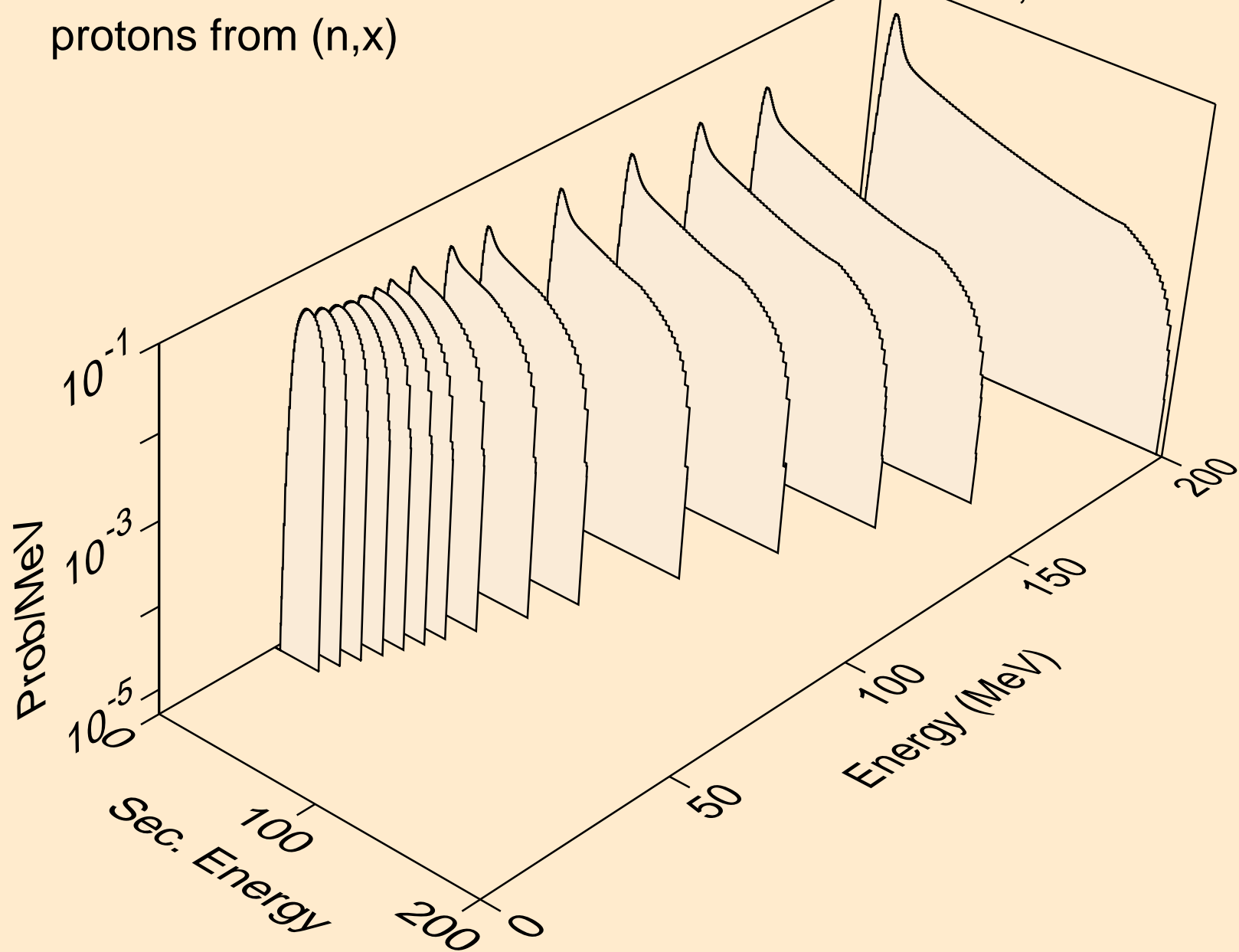

PT192 NEUTRON ACER TENDL-2024 LIBRARY; T=0.K
protons from (n,n*)p

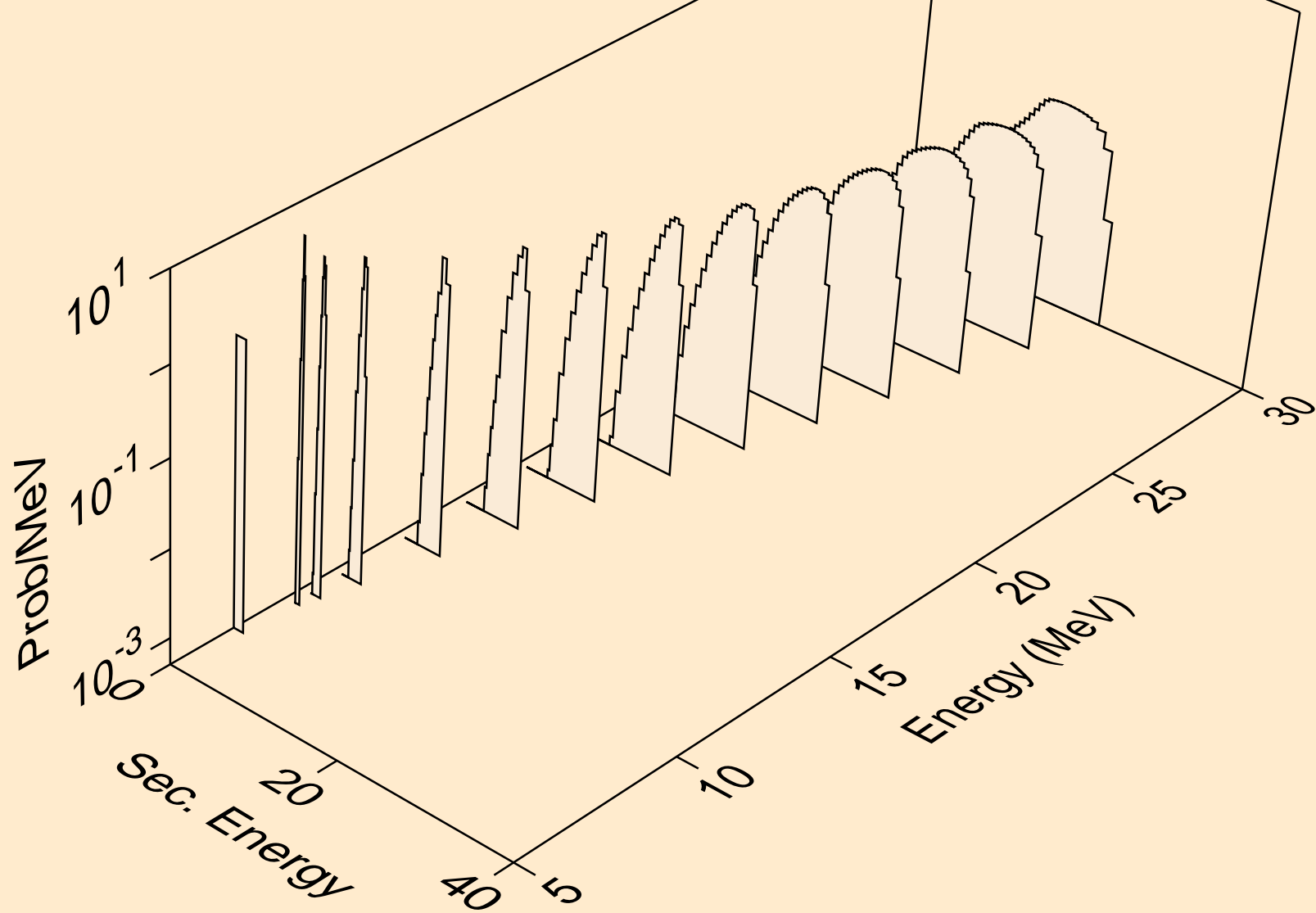

PT192 NEUTRON ACER TENDL-2024 LIBRARY; T=0.K
protons from (n,2np)

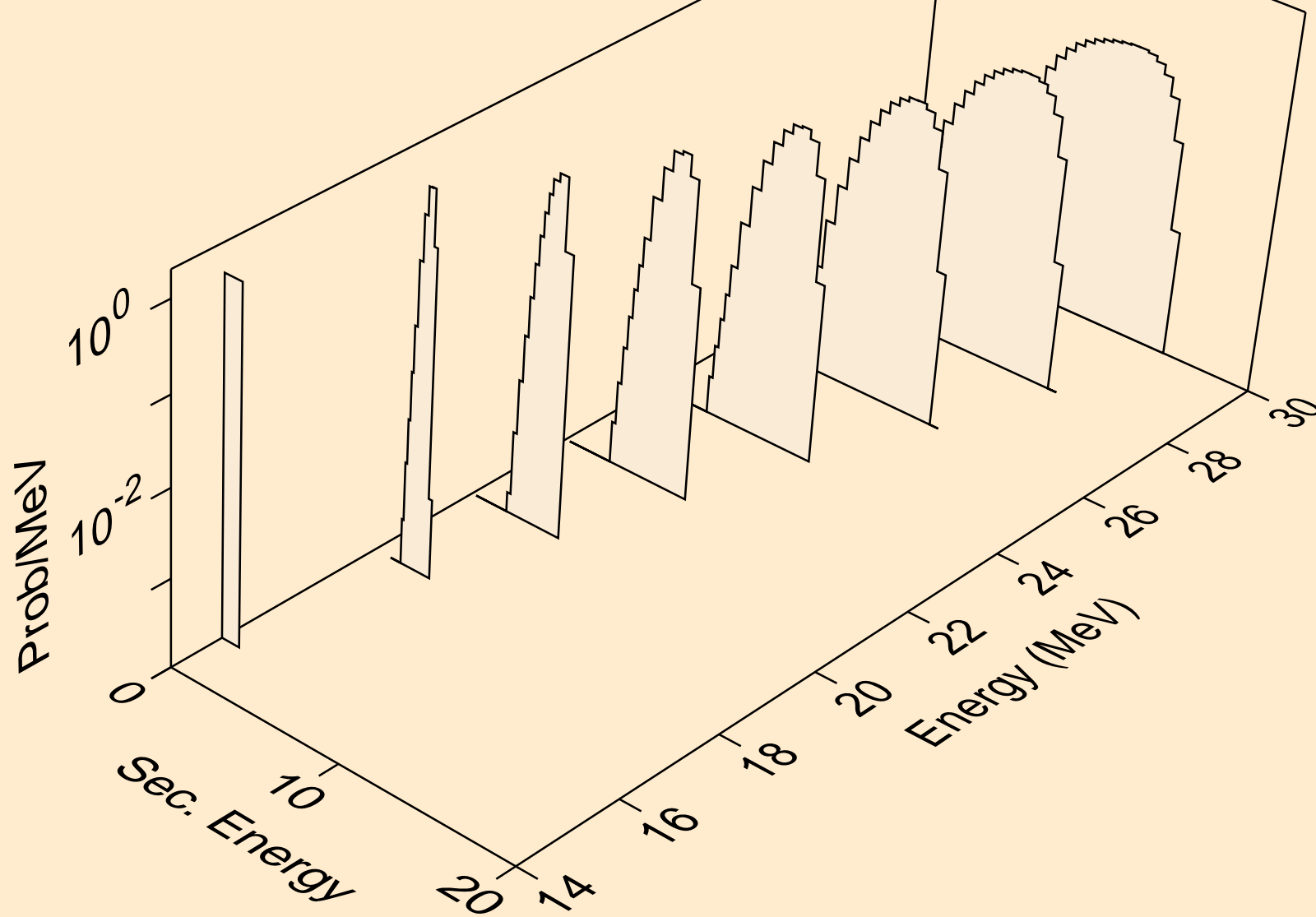

PT192 NEUTRON ACER TENDL-2024 LIBRARY; T=0.K
protons from (n,3np)

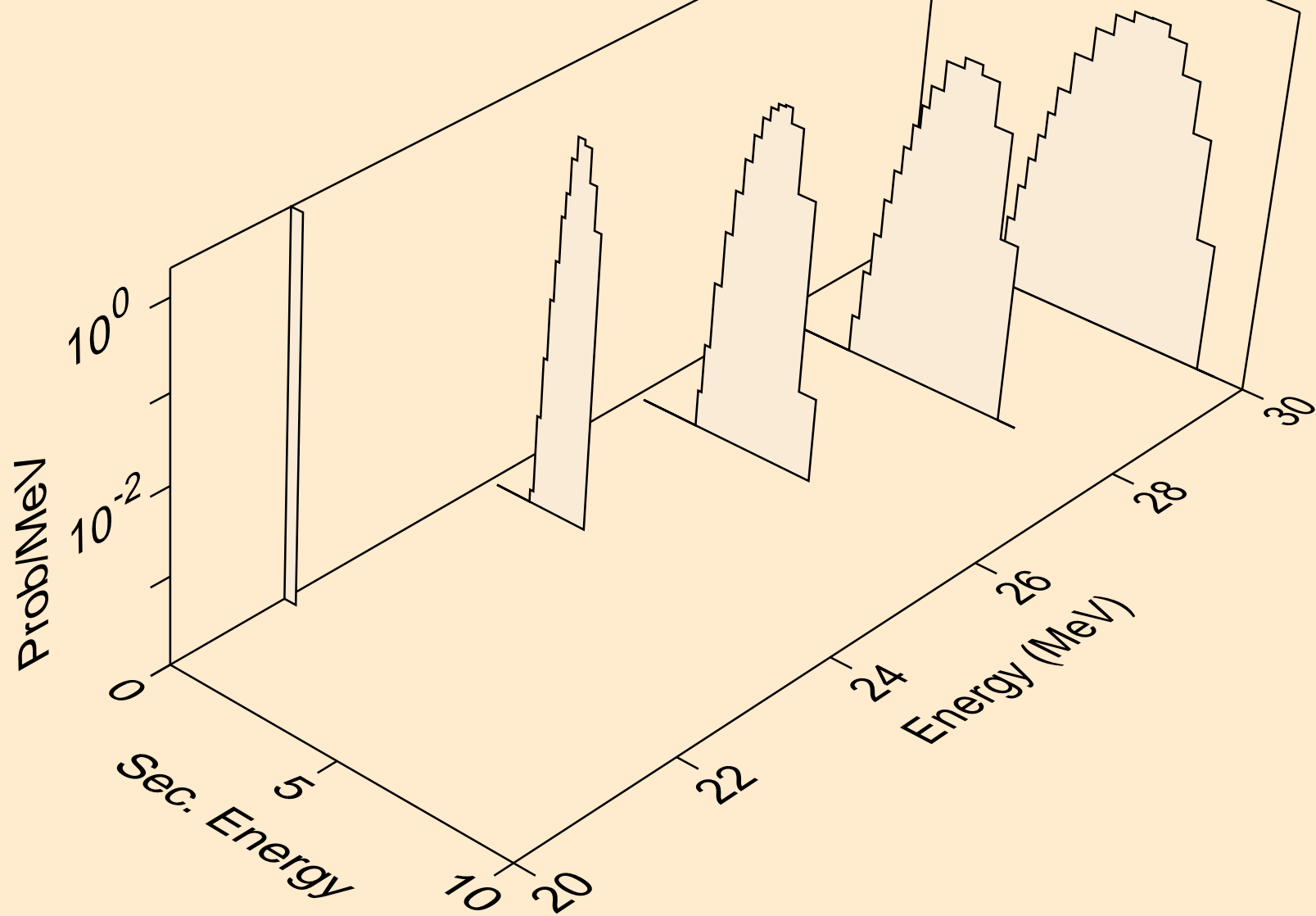

PT192 NEUTRON ACER TENDL-2024 LIBRARY; T=0.K
protons from (n,n2p)

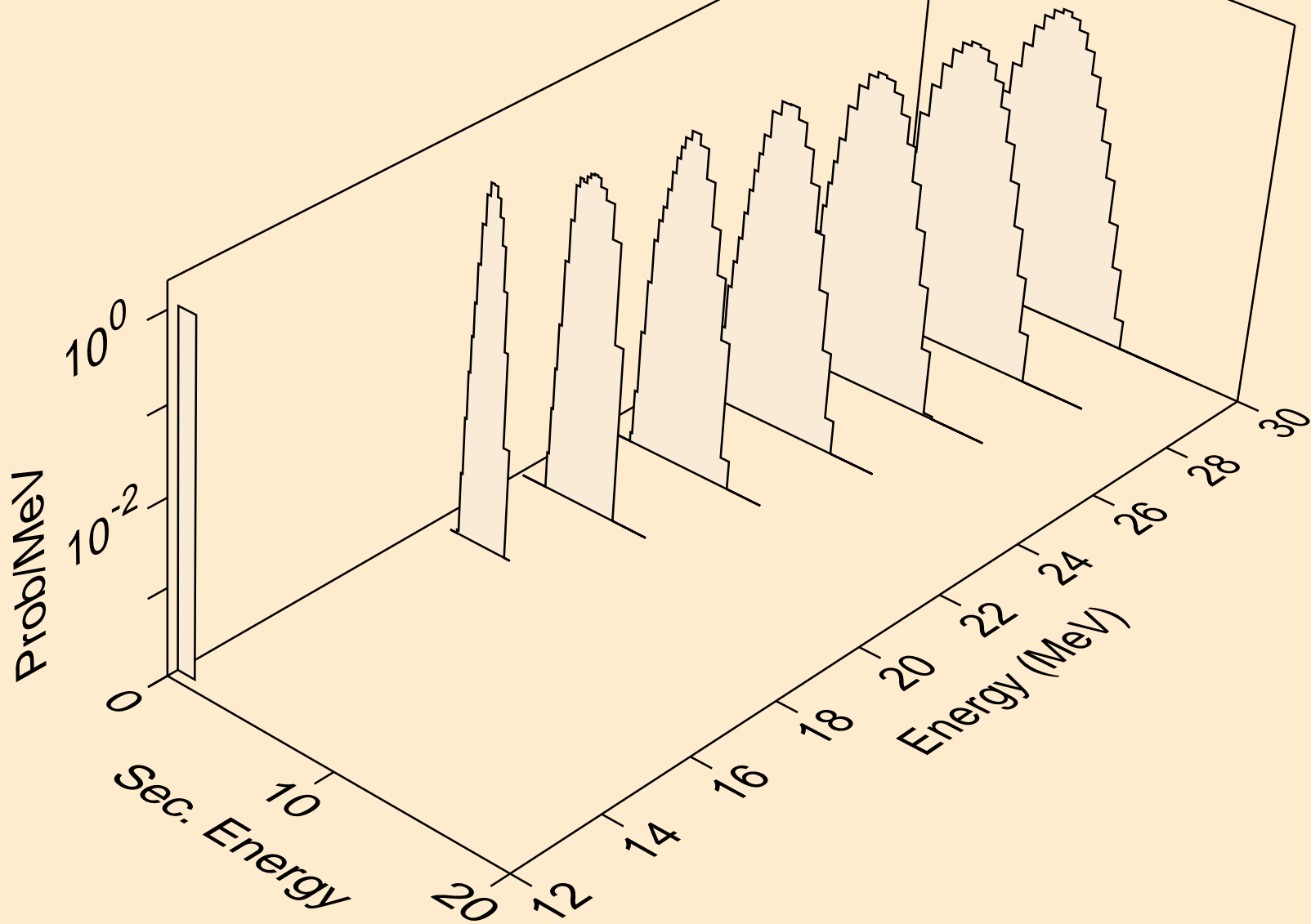

PT192 NEUTRON ACER TENDL-2024 LIBRARY; T=0.K
protons from (n,npa)

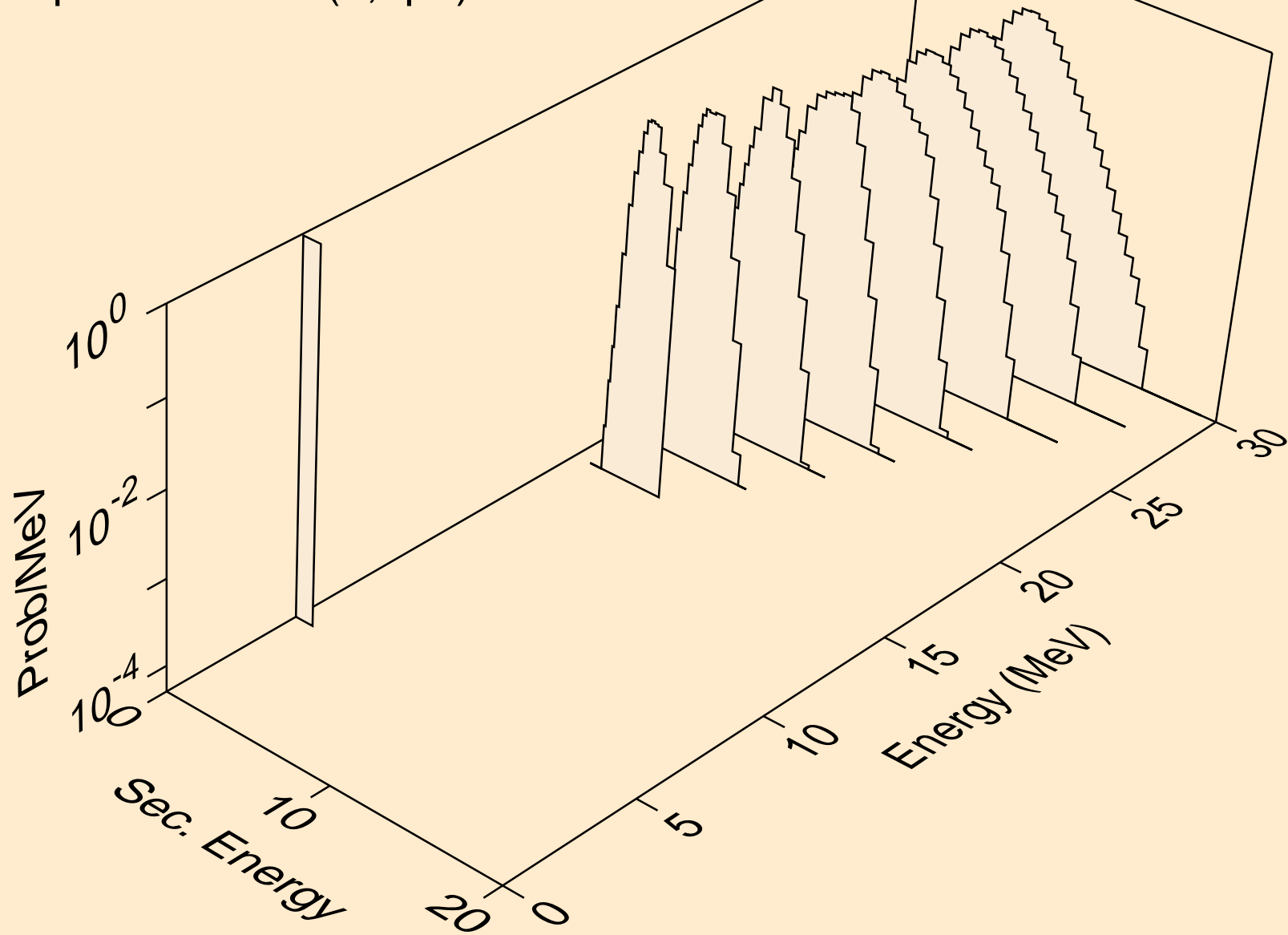

PT192 NEUTRON ACER TENDL-2024 LIBRARY; T=0.K
protons from (n,p)

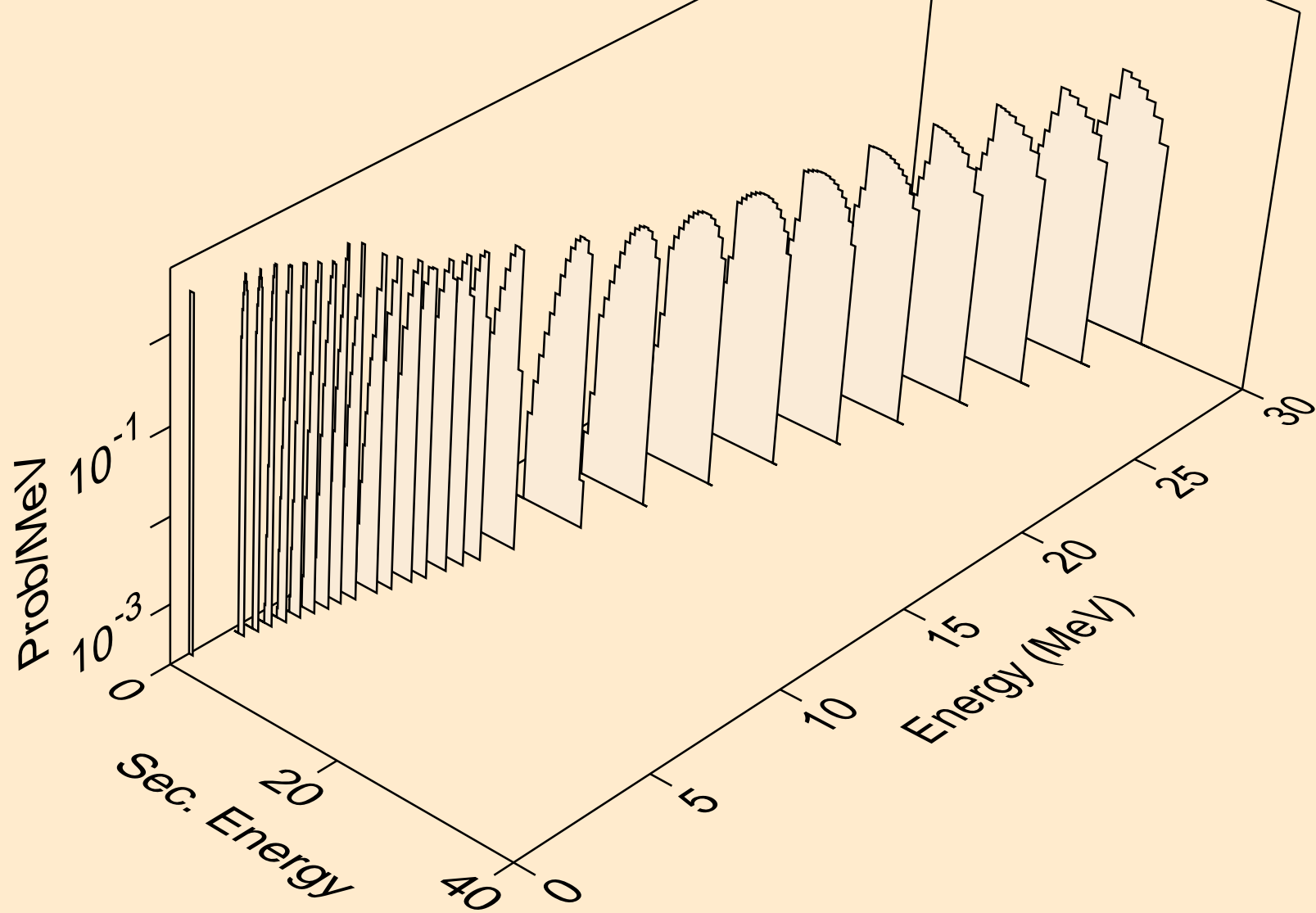

PT192 NEUTRON ACER TENDL-2024 LIBRARY; T=0.K
protons from (n,2p)

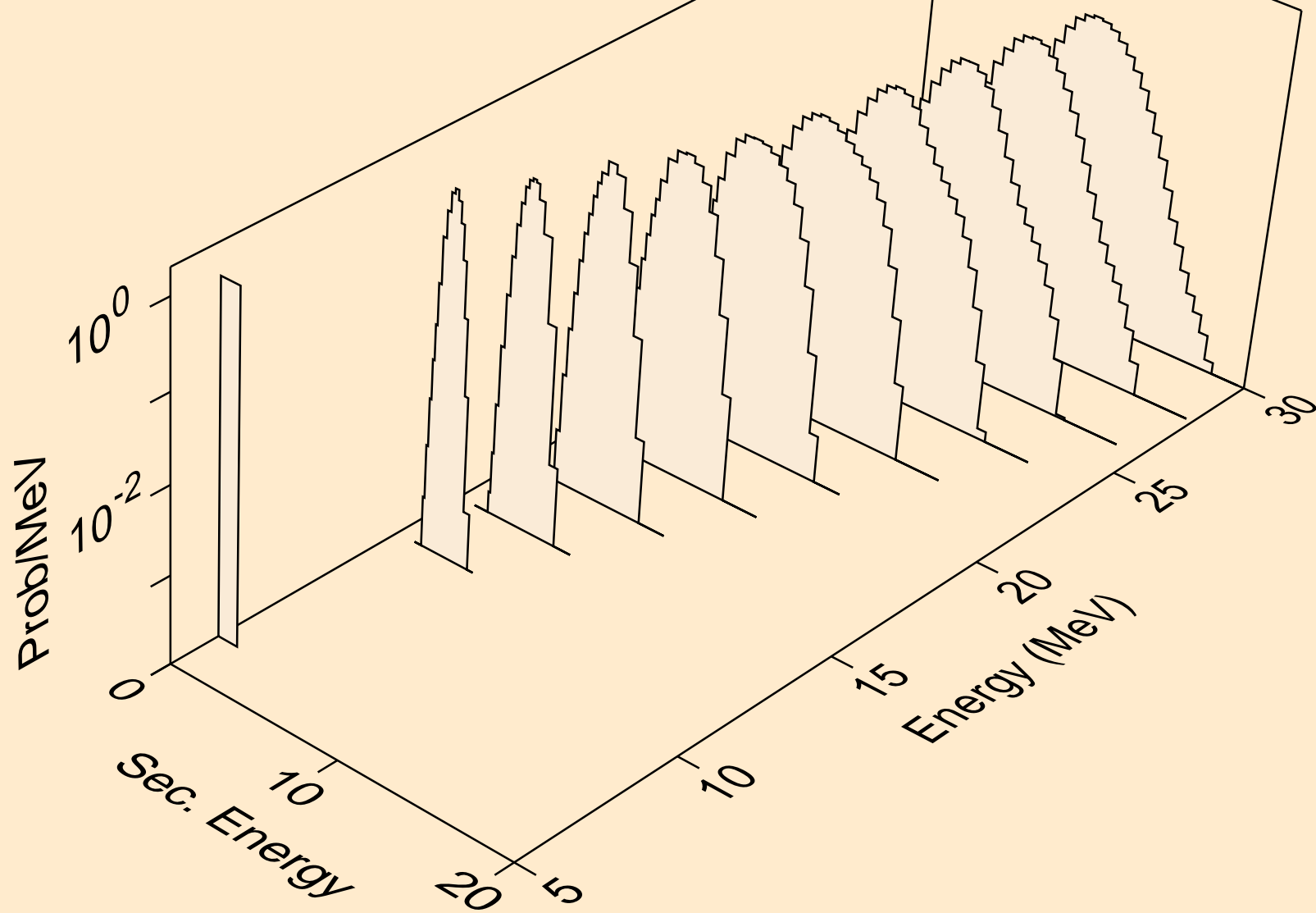

PT192 NEUTRON ACER TENDL-2024 LIBRARY; T=0.K
protons from (n,p)

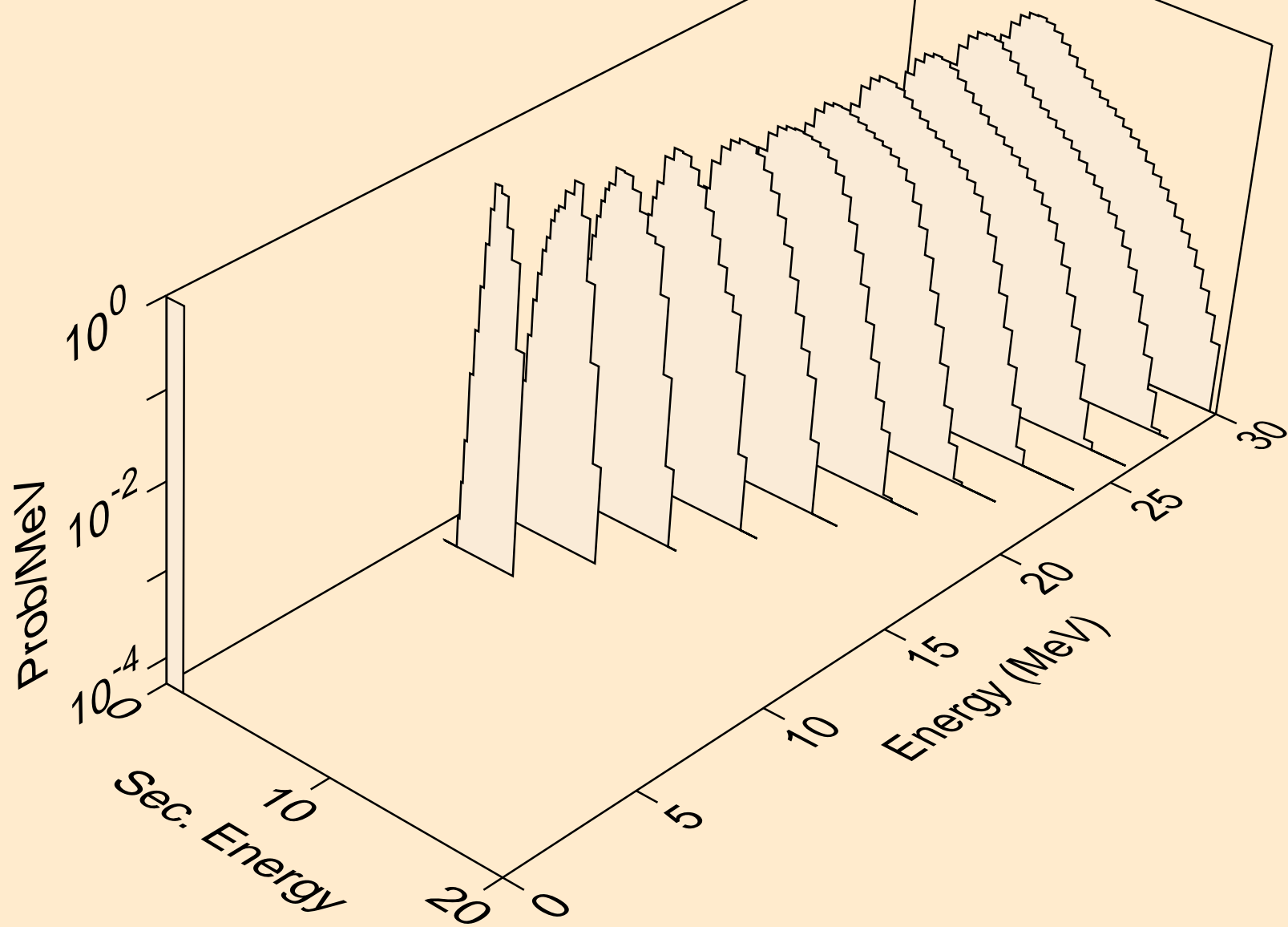

PT192 NEUTRON ACER TENDL-2024 LIBRARY; T=0.K
protons from (n,pd)

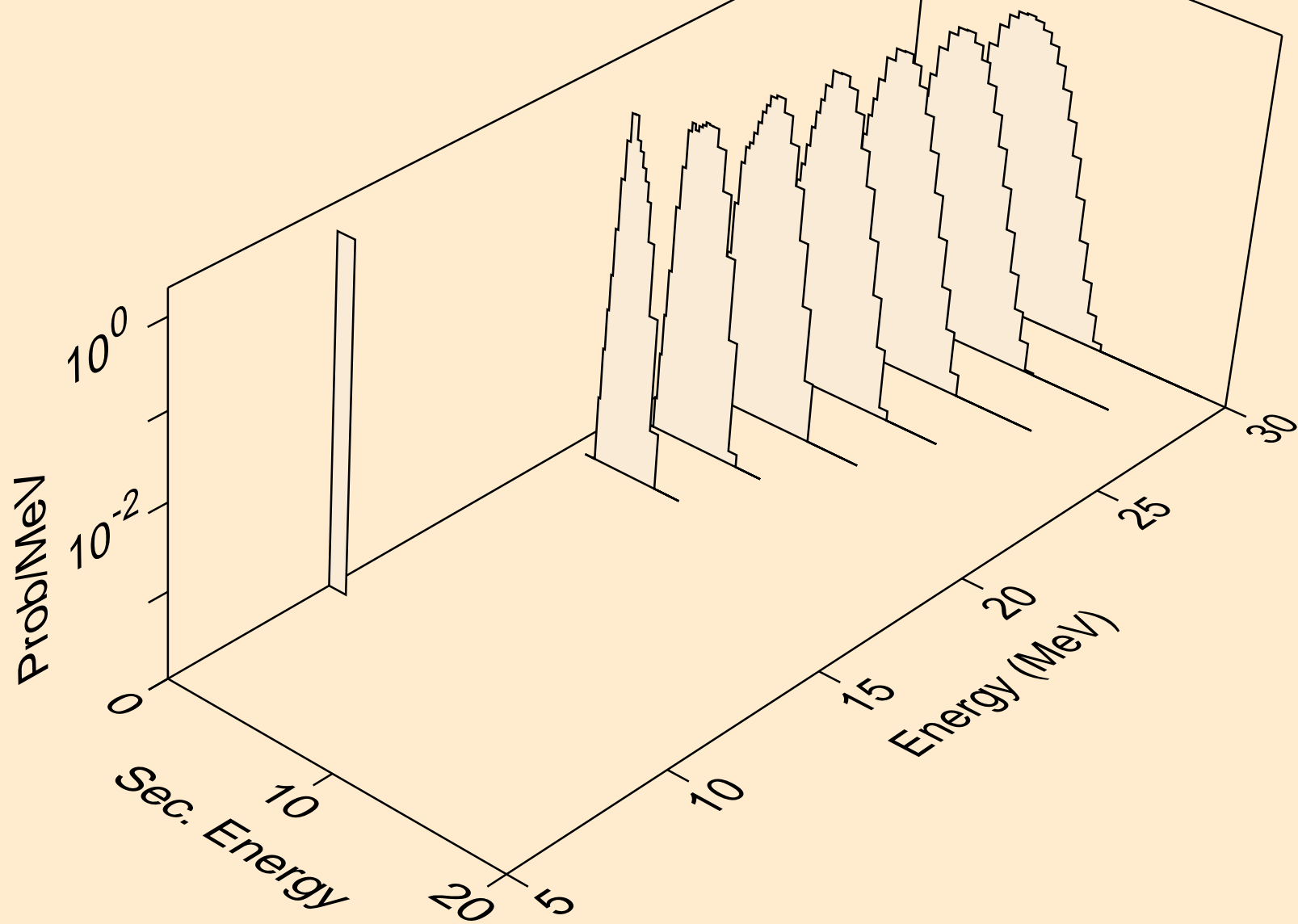

PT192 NEUTRON ACER TENDL-2024 LIBRARY; T=0.K
protons from (n,pt)

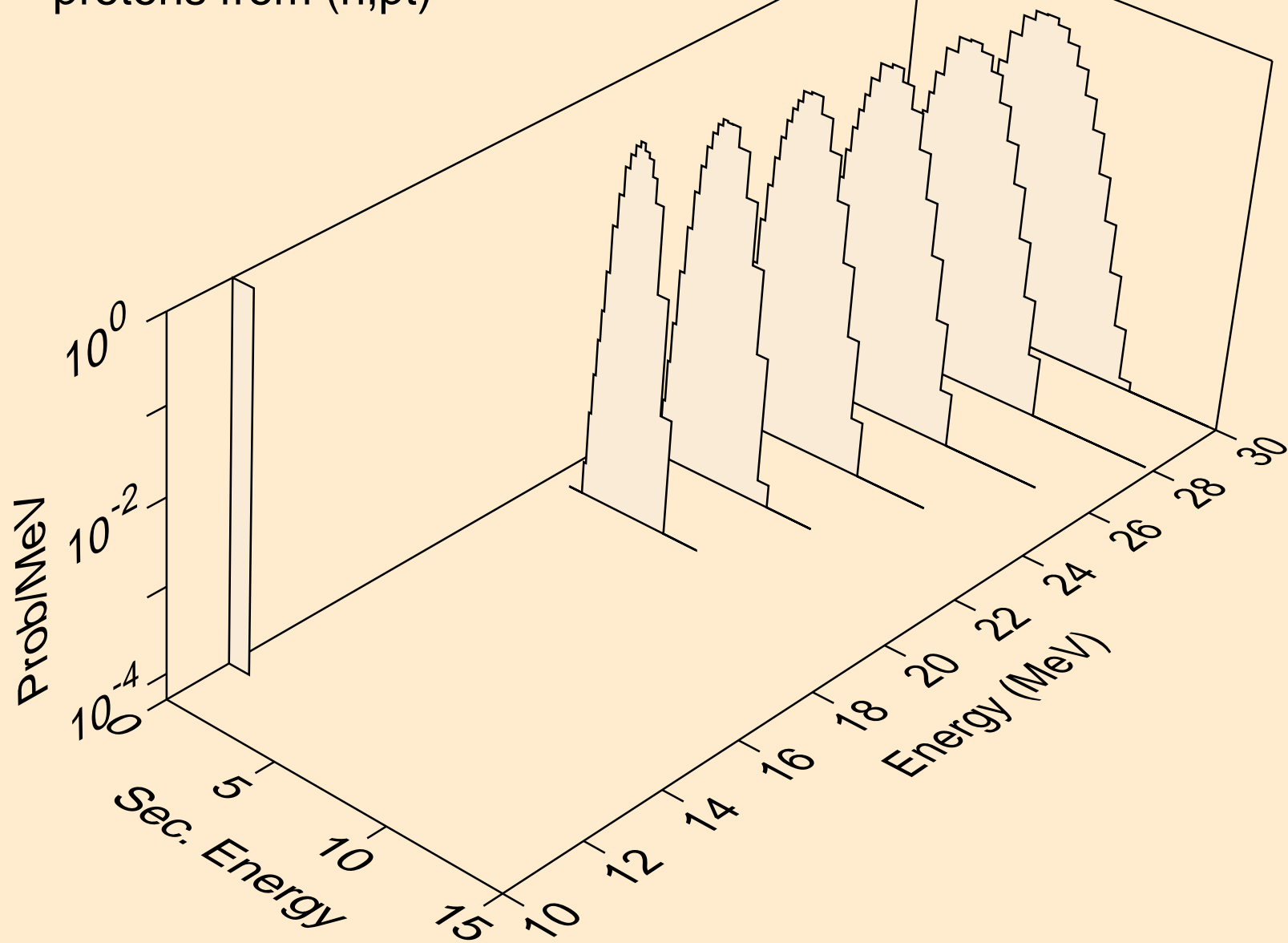

PT192 NEUTRON ACER TENDL-2024 LIBRARY; T=0.K
deuterons from (n,x)

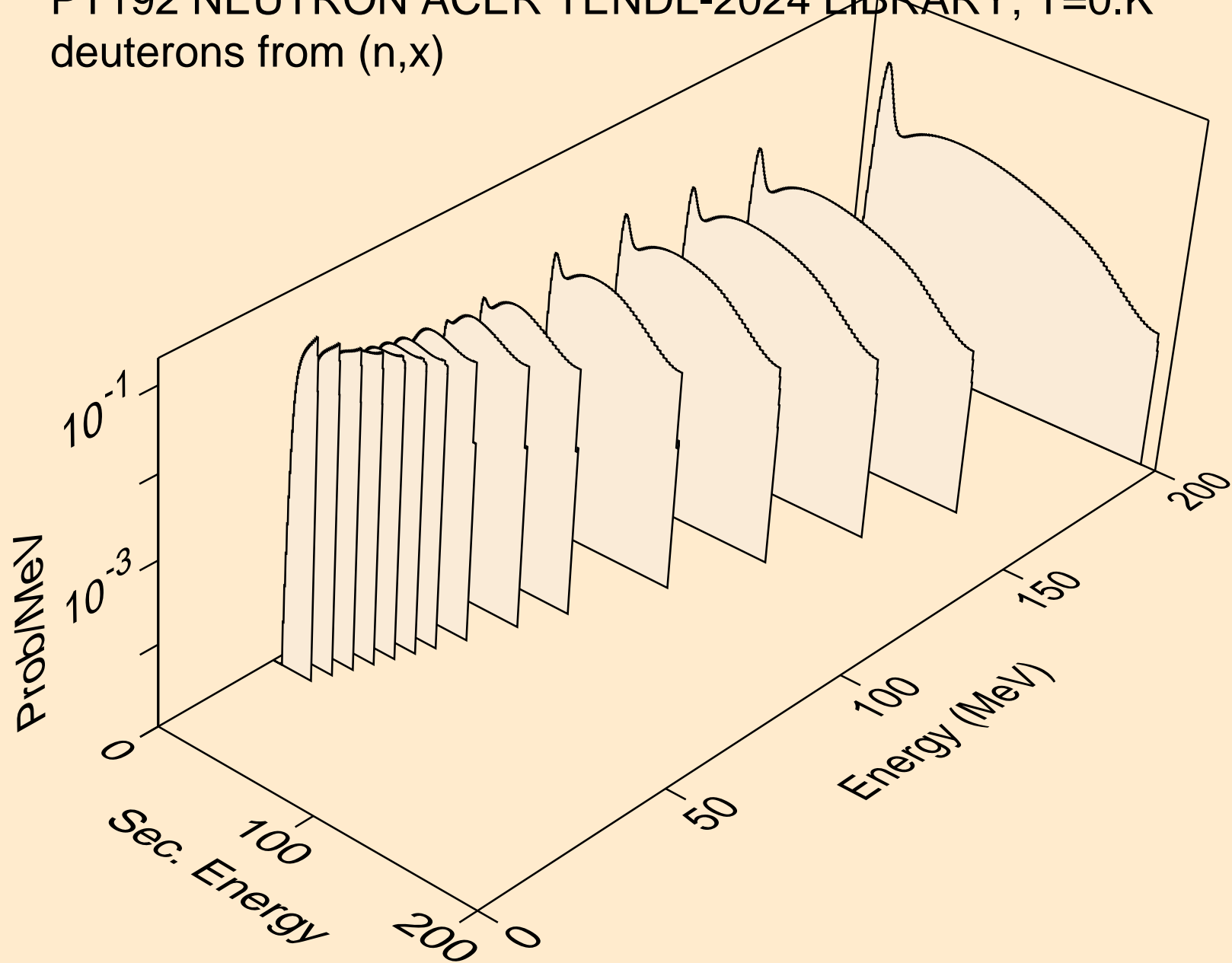

PT192 NEUTRON ACER TENDL-2024 LIBRARY; T=0.K
deuterons from (n,2nd)

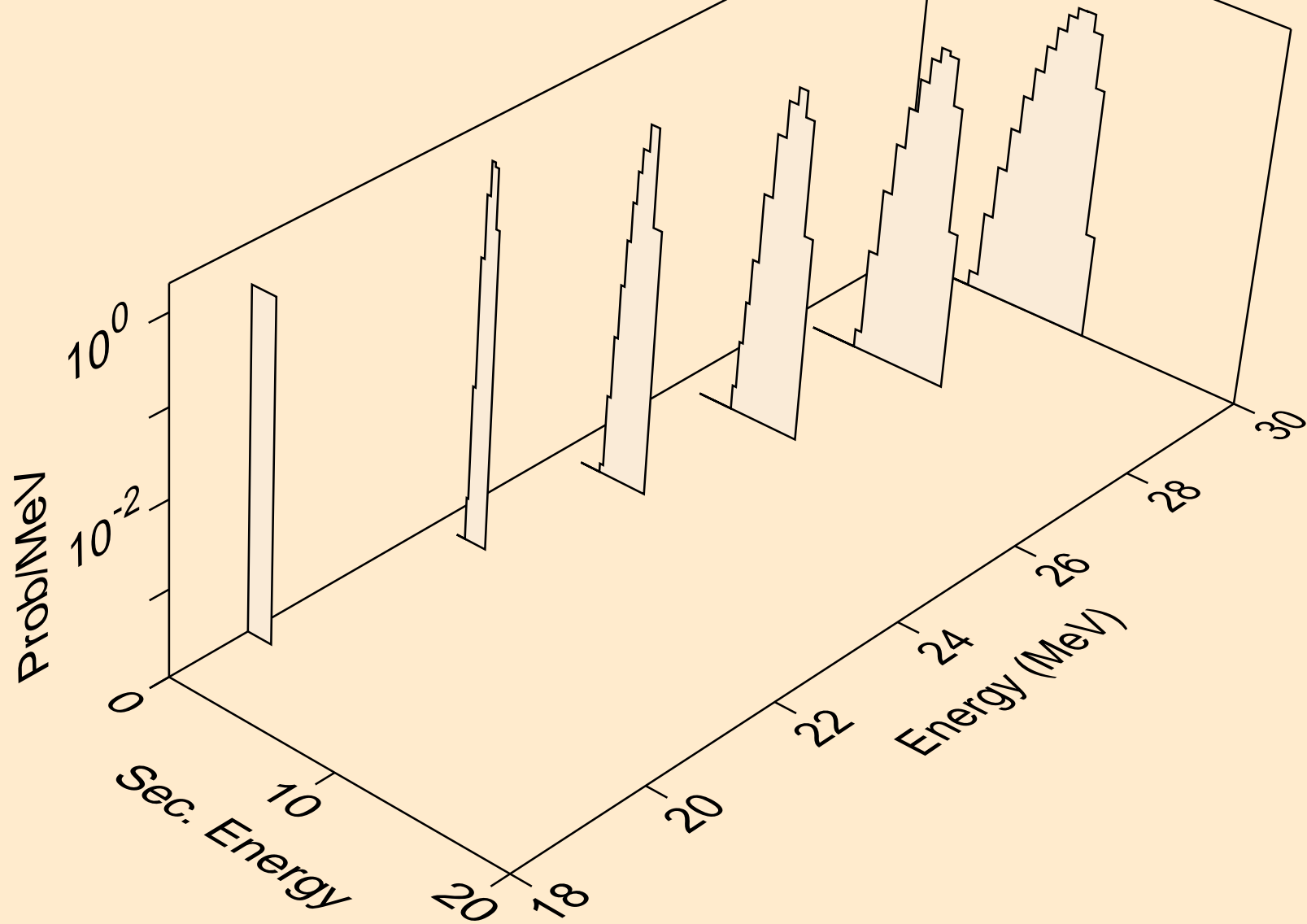

PT192 NEUTRON ACER TENDL-2024 LIBRARY; T=0.K
deuterons from (n,n*)d

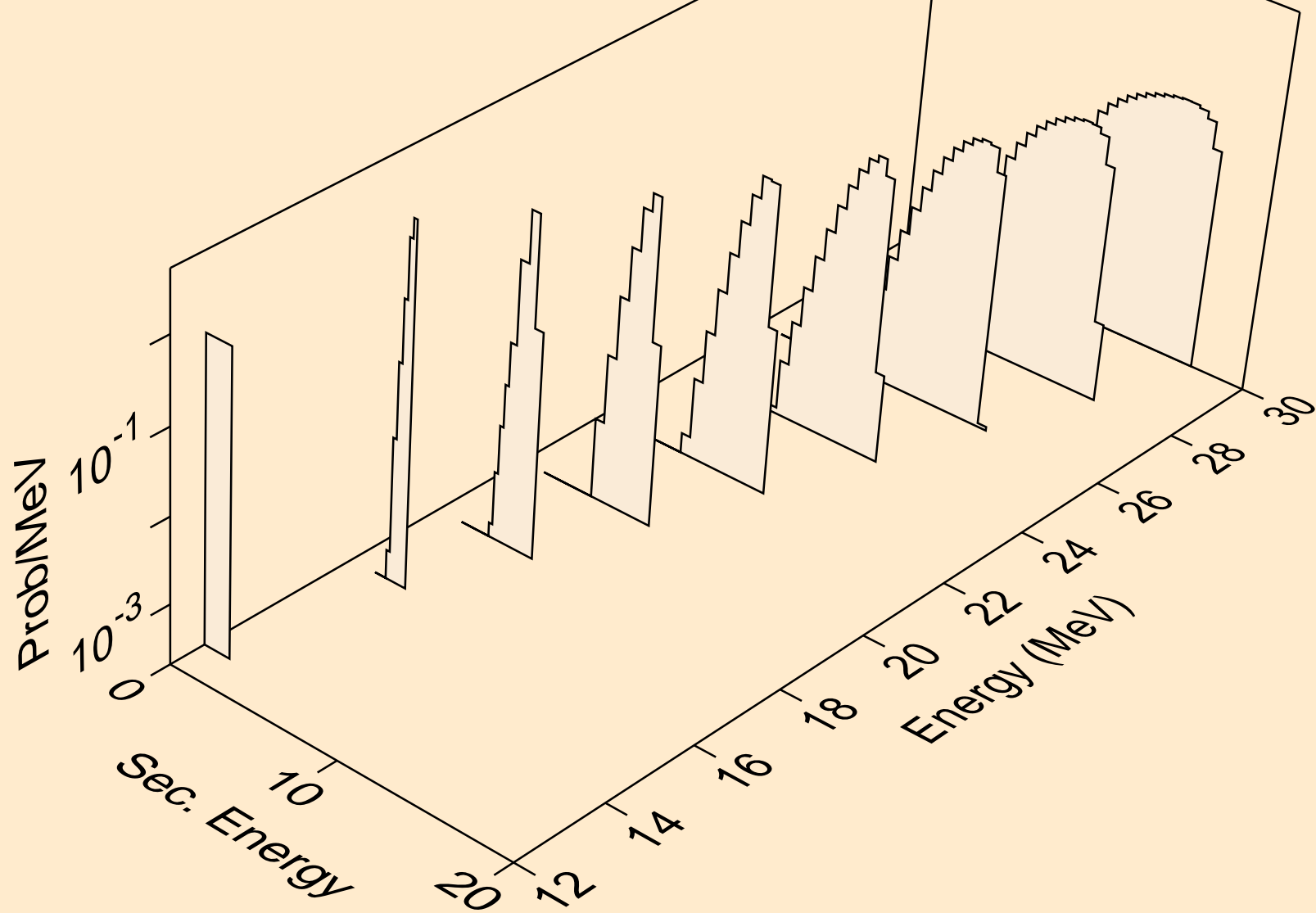

PT192 NEUTRON ACER TENDL-2024 LIBRARY; T=0.K
deuterons from (n,d)

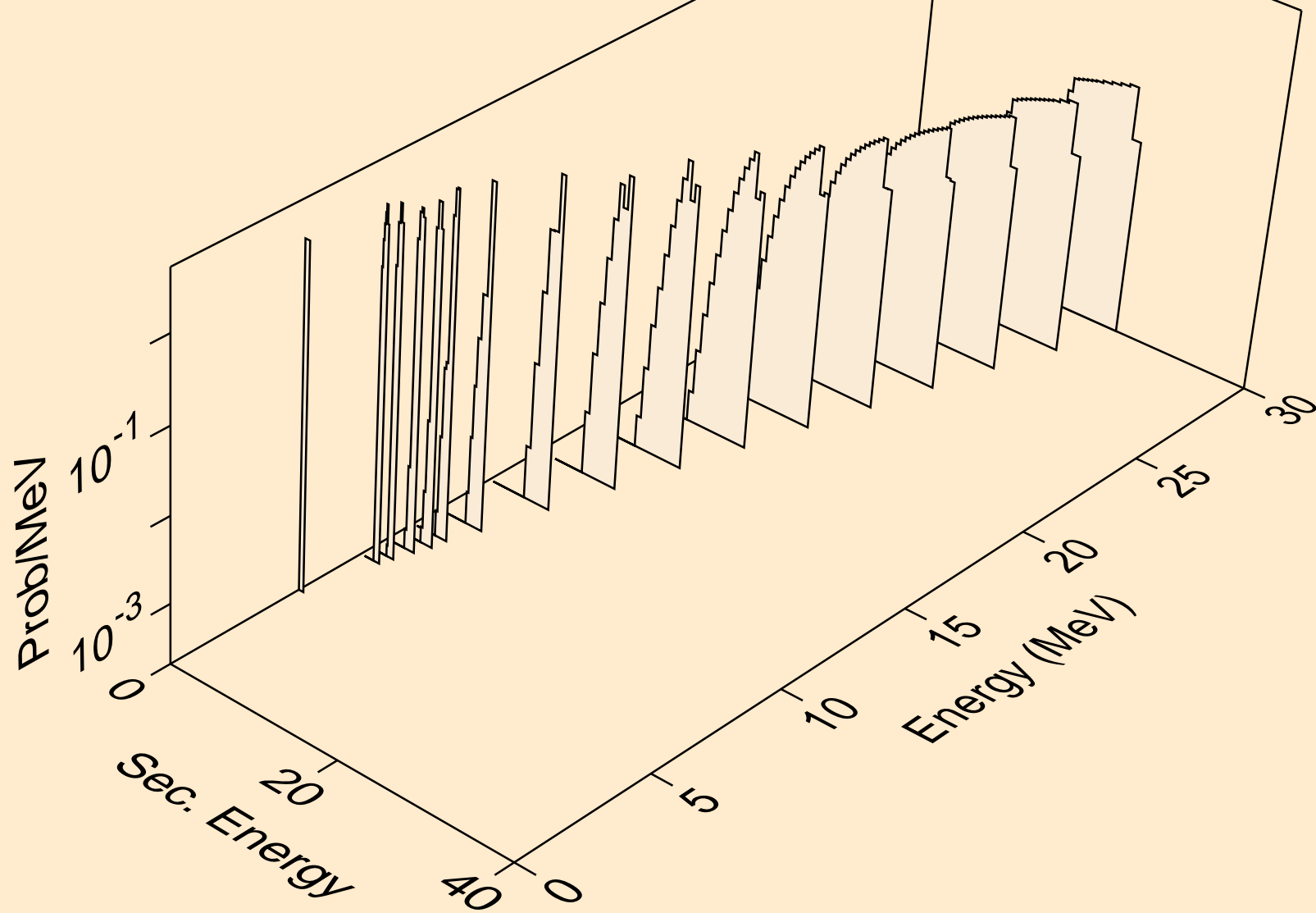

PT192 NEUTRON ACER TENDL-2024 LIBRARY; T=0.K
deuterons from (n,pd)

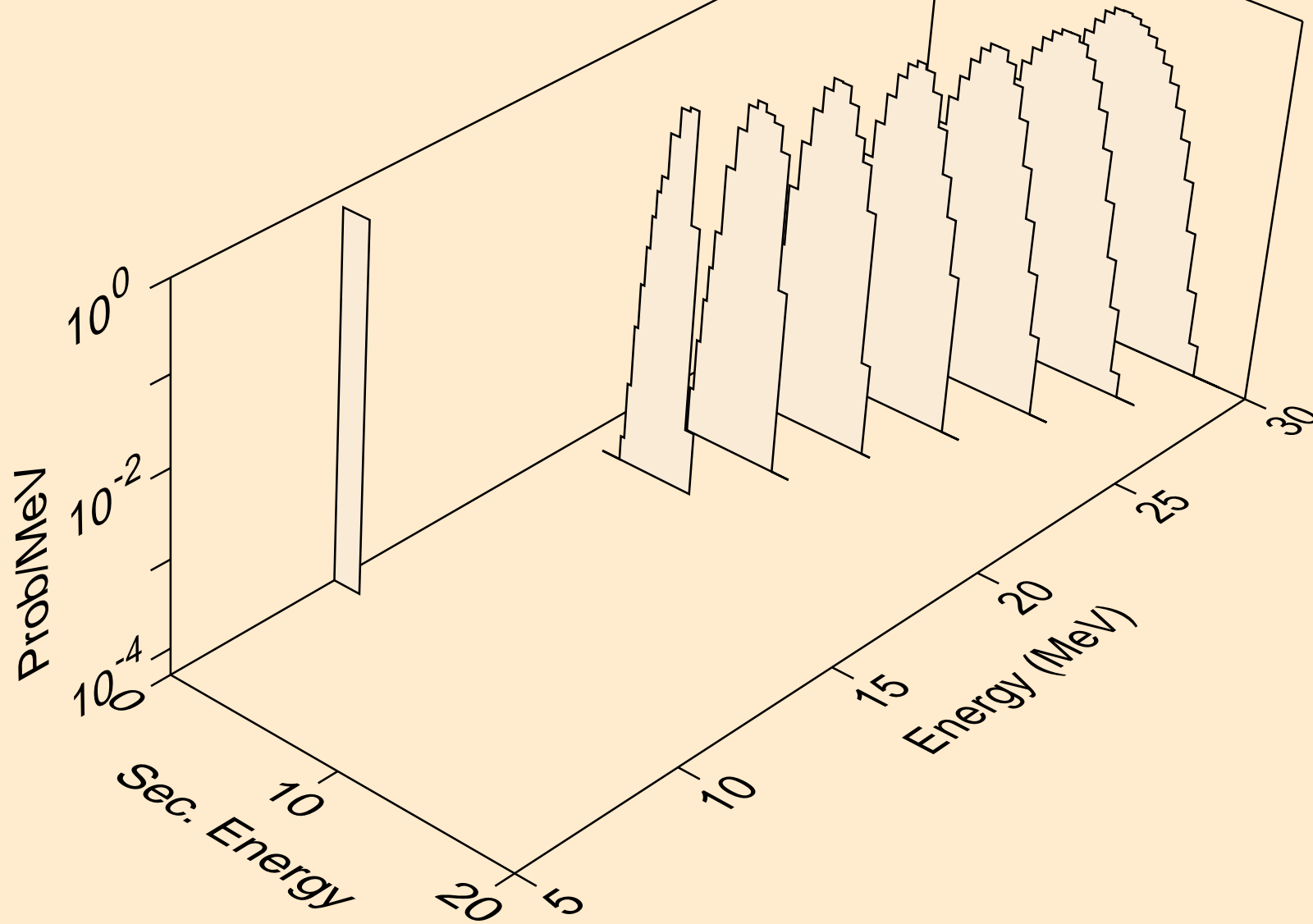

PT192 NEUTRON ACER TENDL-2024 LIBRARY; T=0.K
tritons from (n,x)

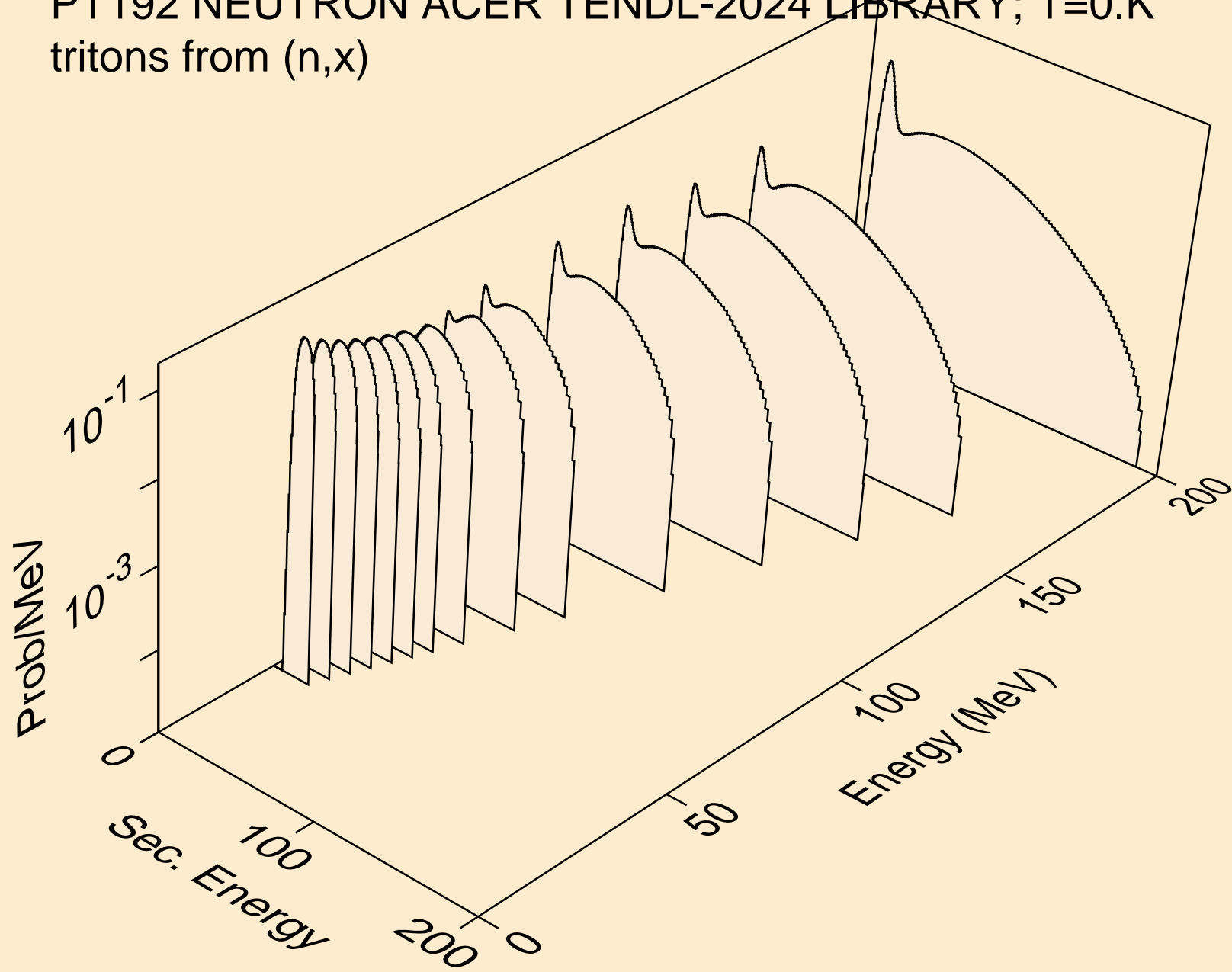

PT192 NEUTRON ACER TENDL-2024 LIBRARY; T=0.K
tritons from (n,n*)t

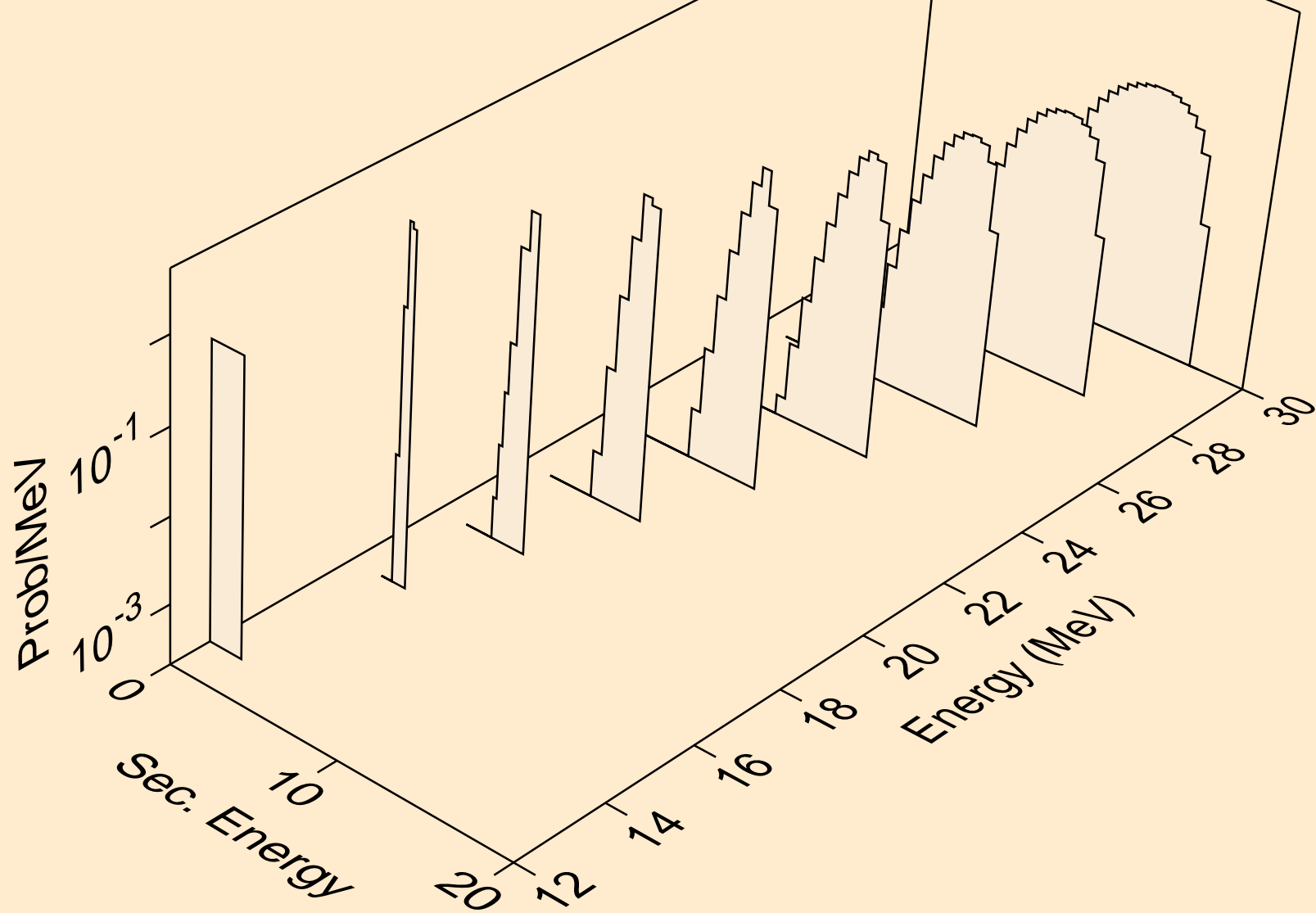

PT192 NEUTRON ACER TENDL-2024 LIBRARY; T=0.K
tritons from (n,t)

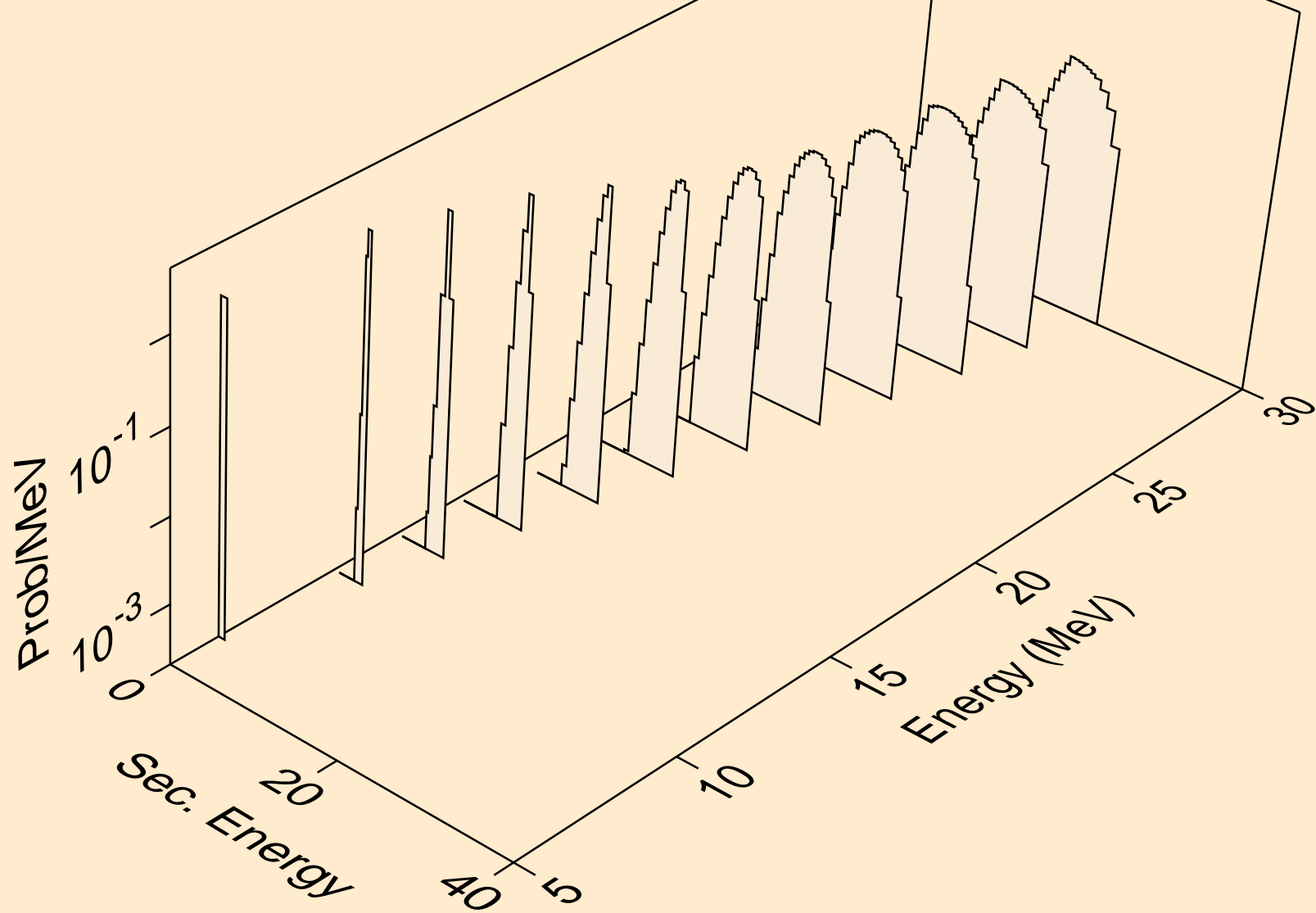

PT192 NEUTRON ACER TENDL-2024 LIBRARY; T=0.K
tritons from (n,pt)

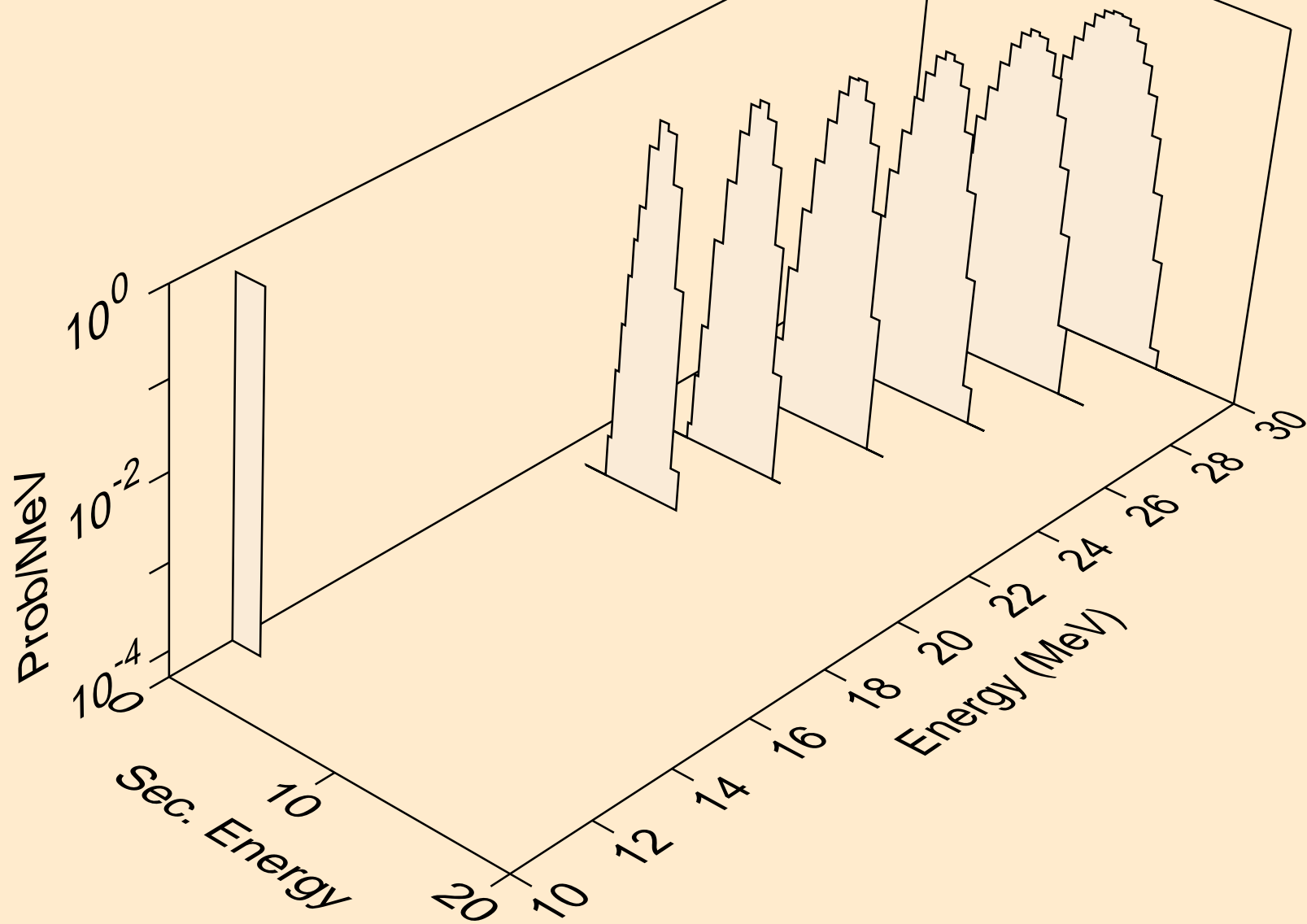

PT192 NEUTRON ACER TENDL-2024 LIBRARY; T=0.K
he3s from (n,x)

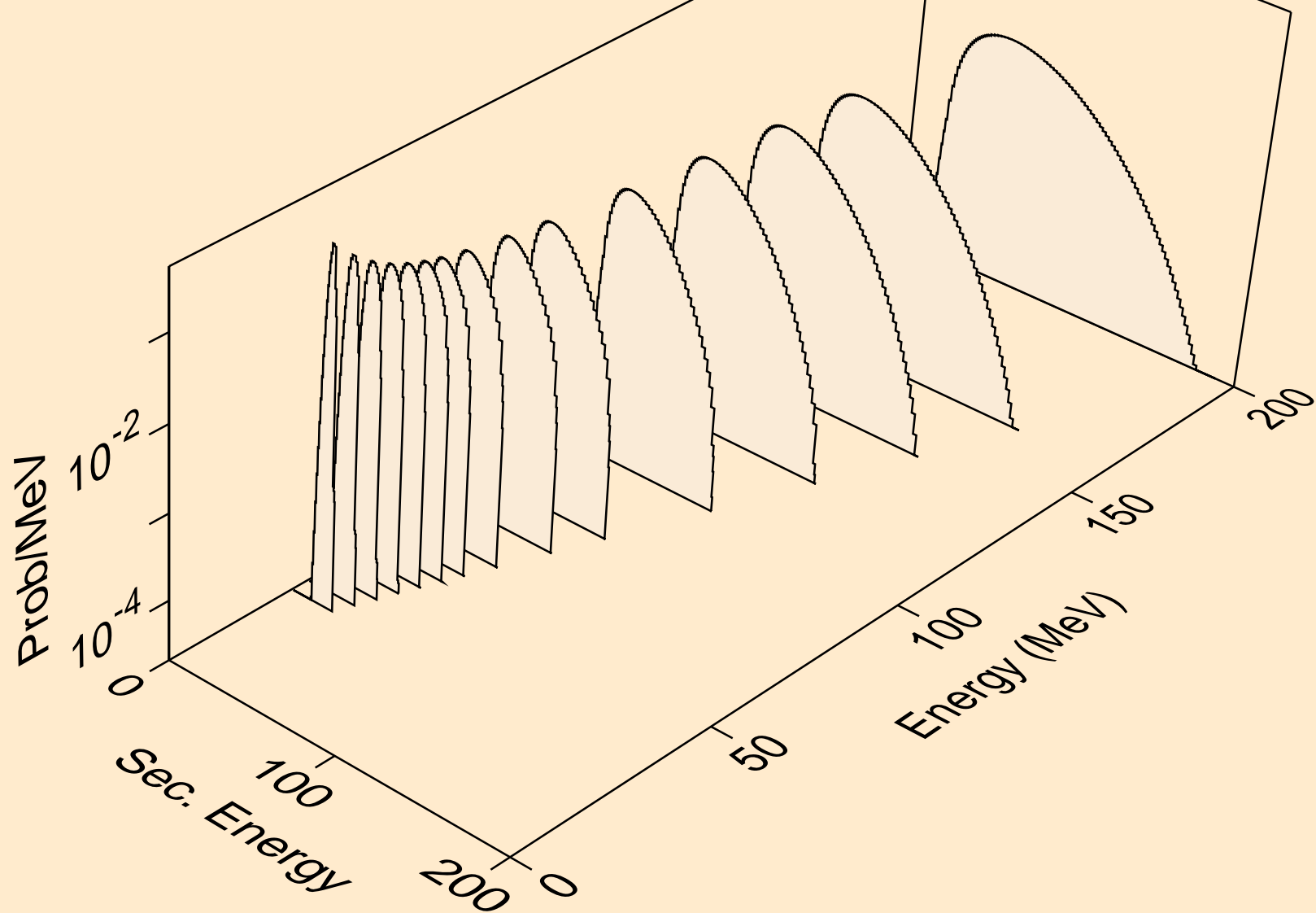

PT192 NEUTRON ACER TENDL-2024 LIBRARY; T=0.K
he3s from (n,n*)he3

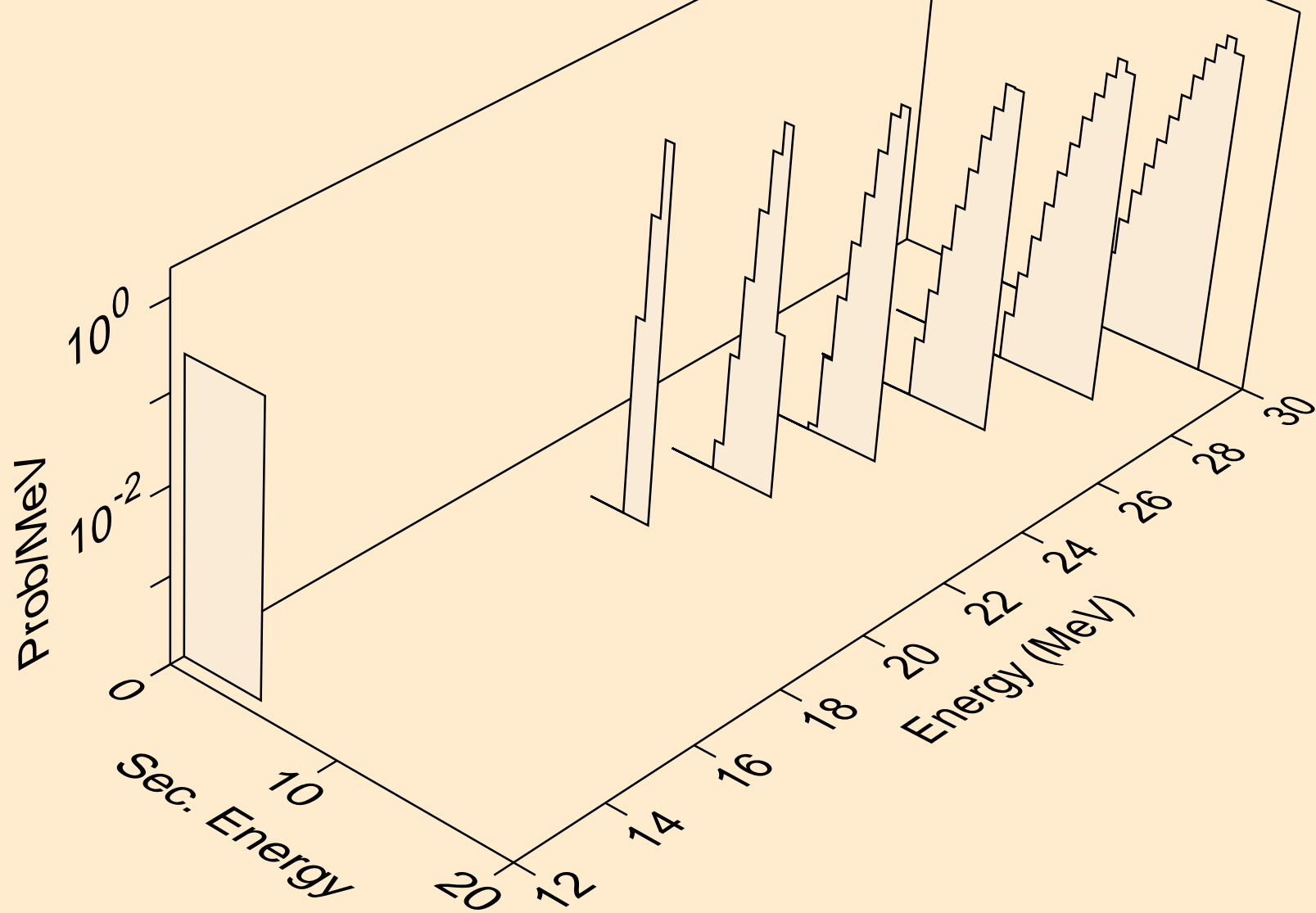

PT192 NEUTRON ACER TENDL-2024 LIBRARY; T=0.K
he3s from (n,he3)

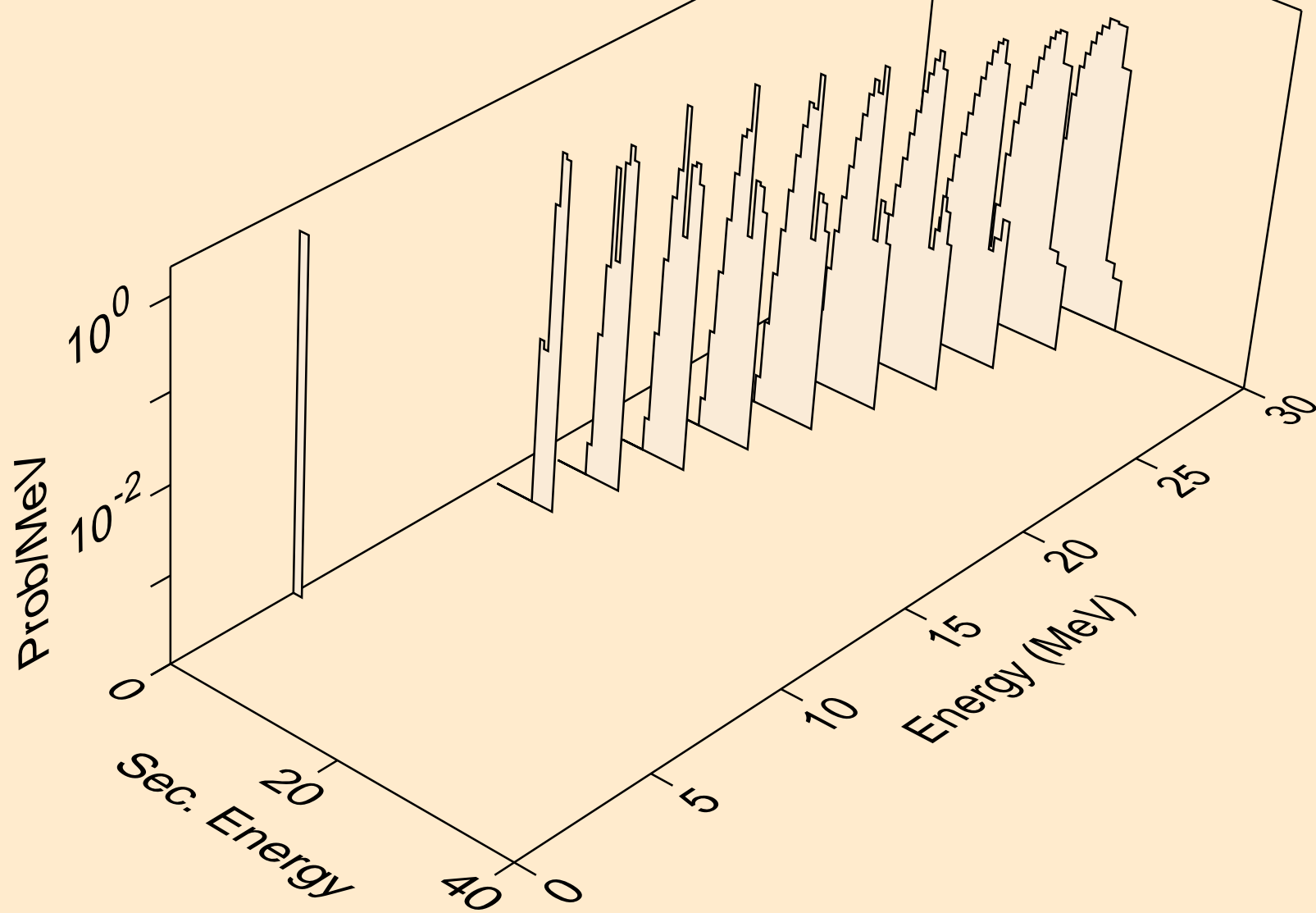

PT192 NEUTRON ACER TENDL-2024 LIBRARY; T=0.K
alphas from (n,x)

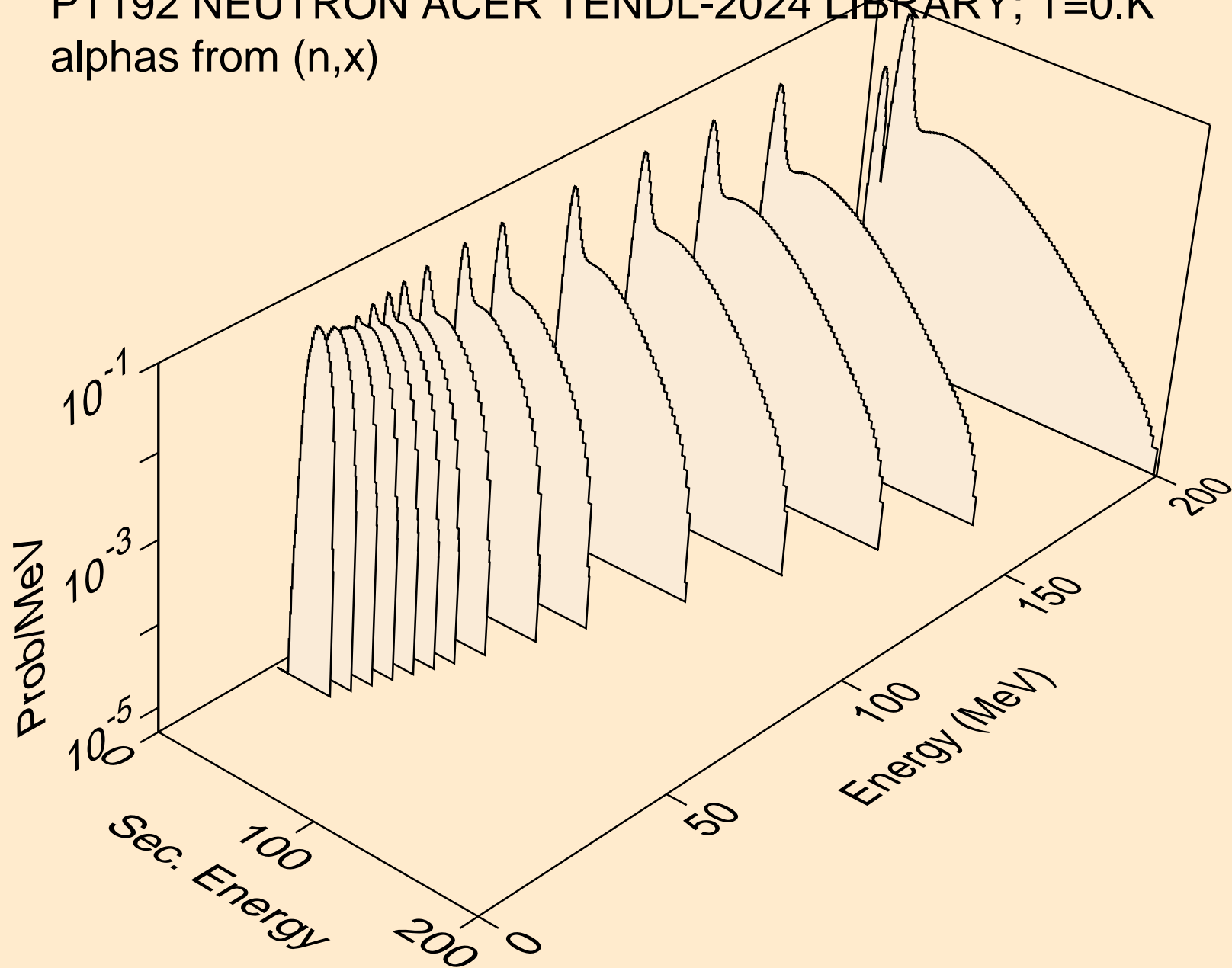

PT192 NEUTRON ACER TENDL-2024 LIBRARY; T=0.K
alphas from (n,n*)a

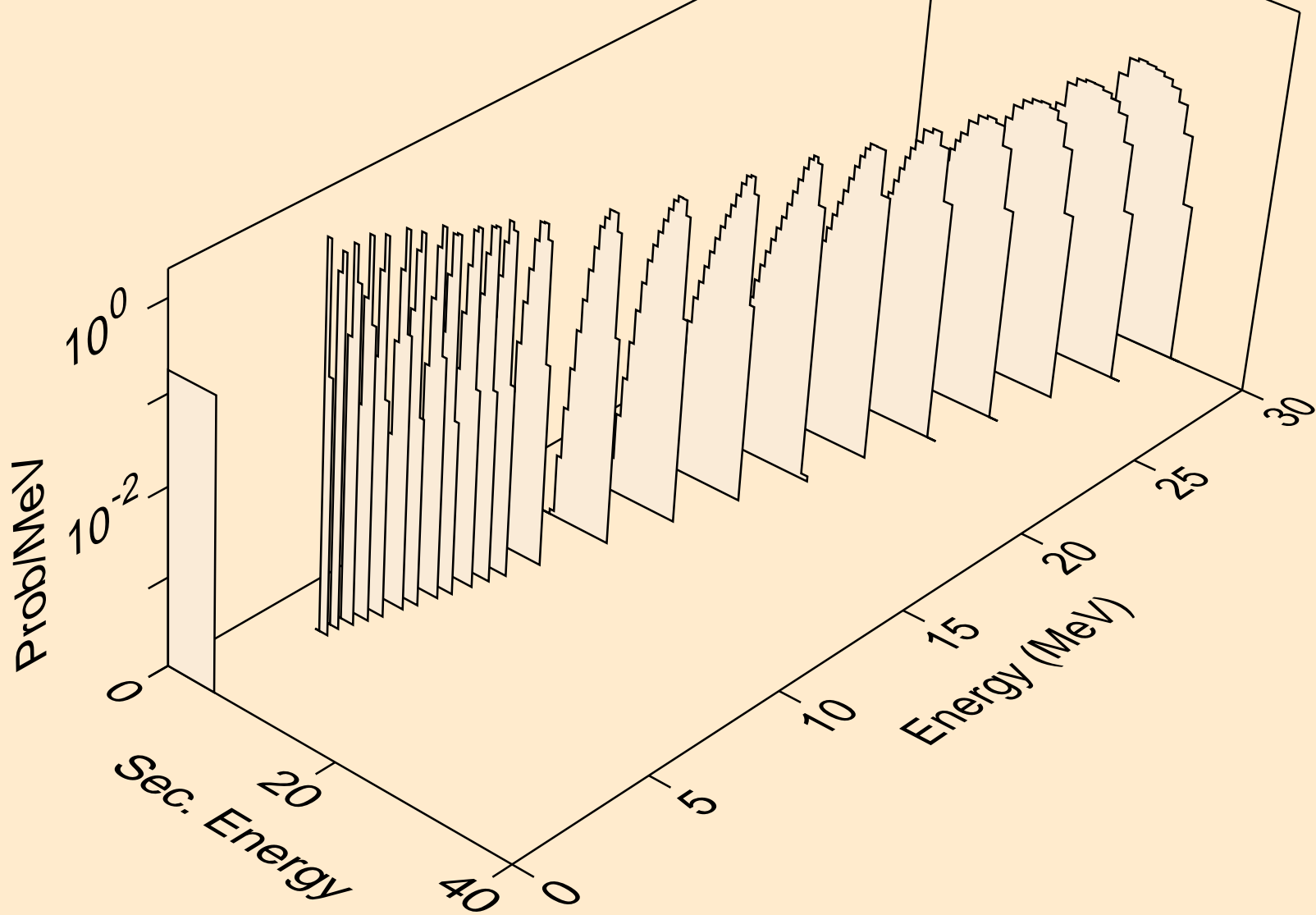

PT192 NEUTRON ACER TENDL-2024 LIBRARY; T=0.K
alphas from (n,2n)a

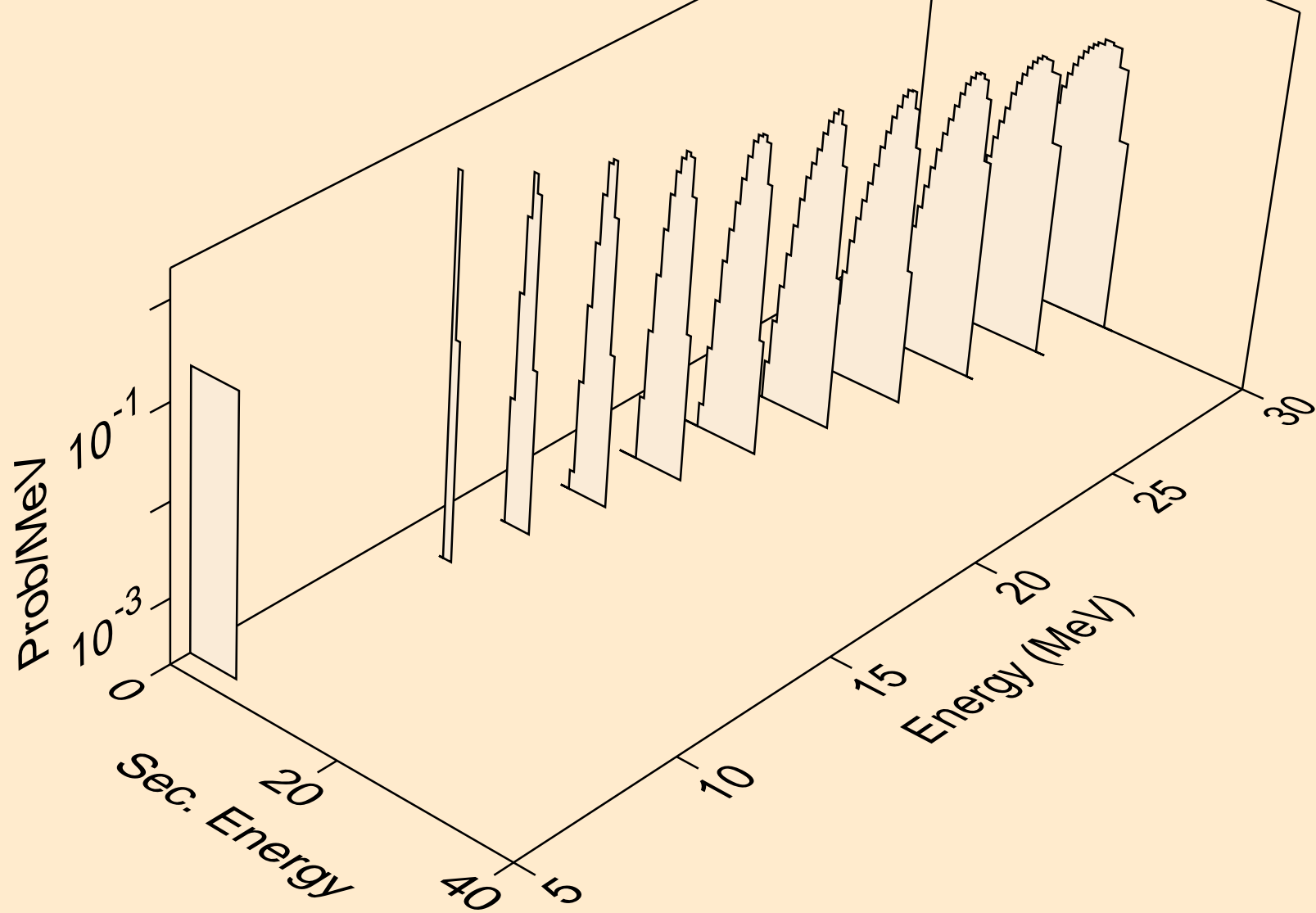

PT192 NEUTRON ACER TENDL-2024 LIBRARY; T=0.K
alphas from (n,3n)a

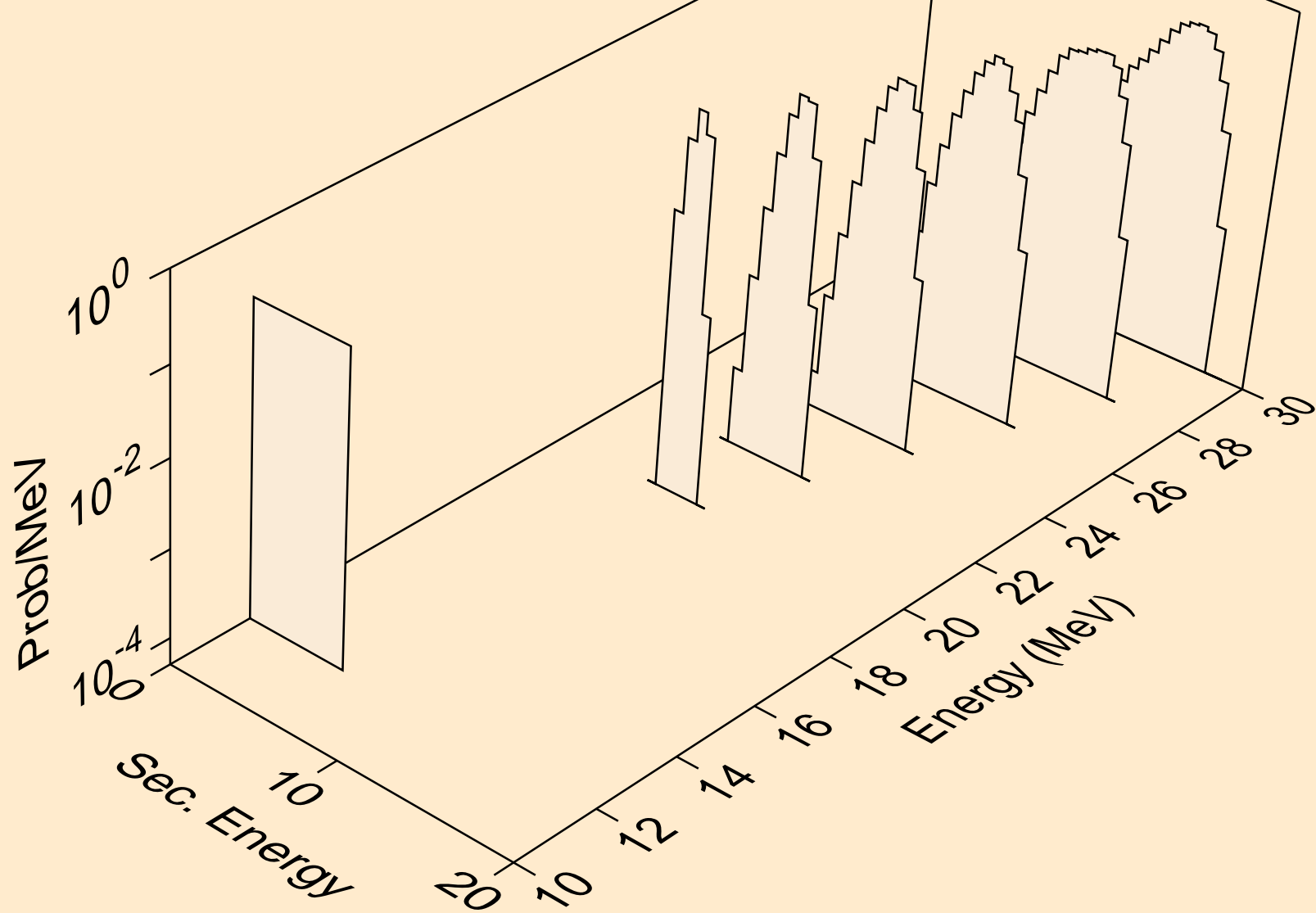

PT192 NEUTRON ACER TENDL-2024 LIBRARY; T=0.K
alphas from (n,n*)2a

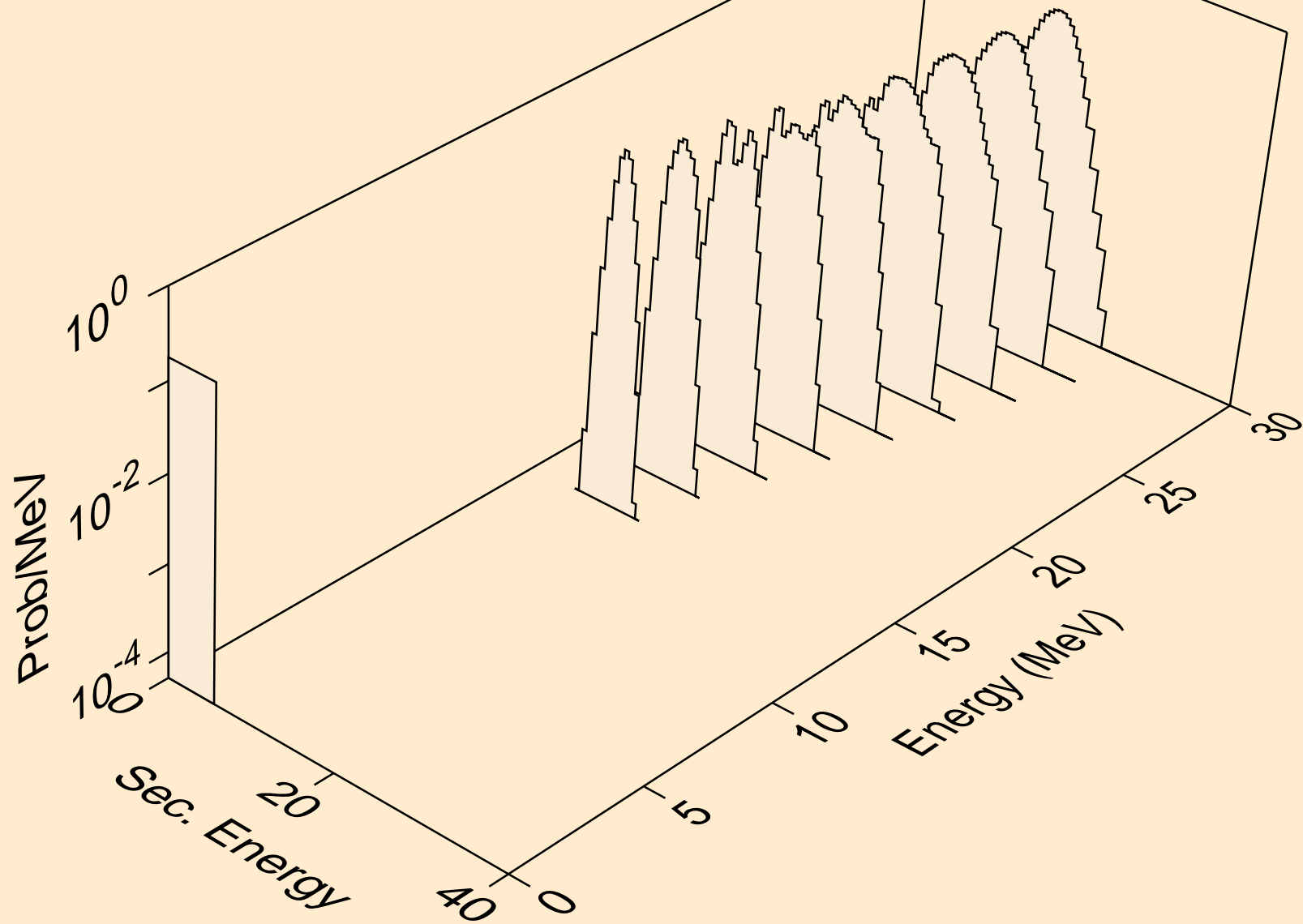

PT192 NEUTRON ACER TENDL-2024 LIBRARY; T=0.K
alphas from (n,npa)

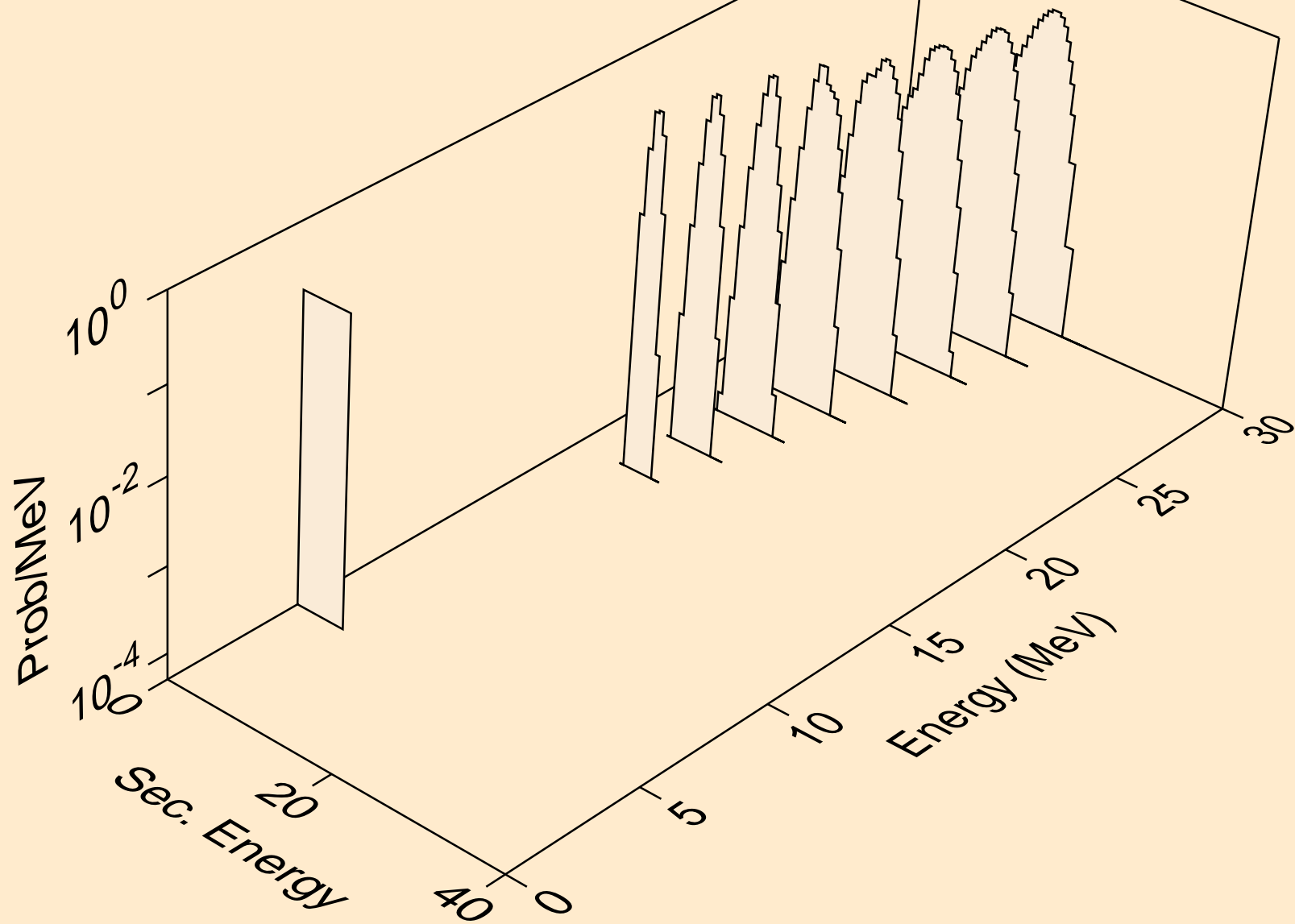

PT192 NEUTRON ACER TENDL-2024 LIBRARY; T=0.K
alphas from (n,a)

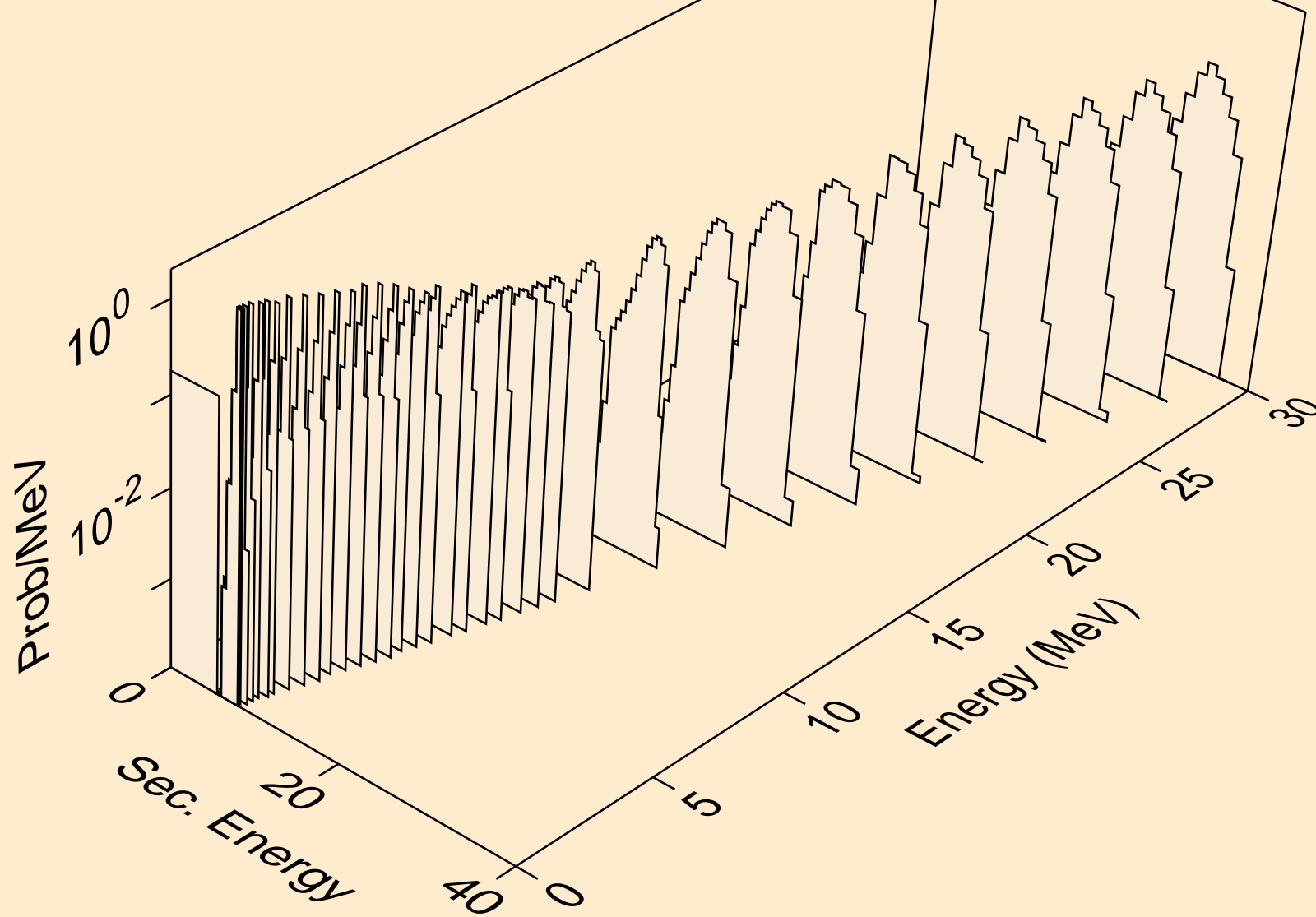

PT192 NEUTRON ACER TENDL-2024 LIBRARY; T=0.K
alphas from (n,2a)

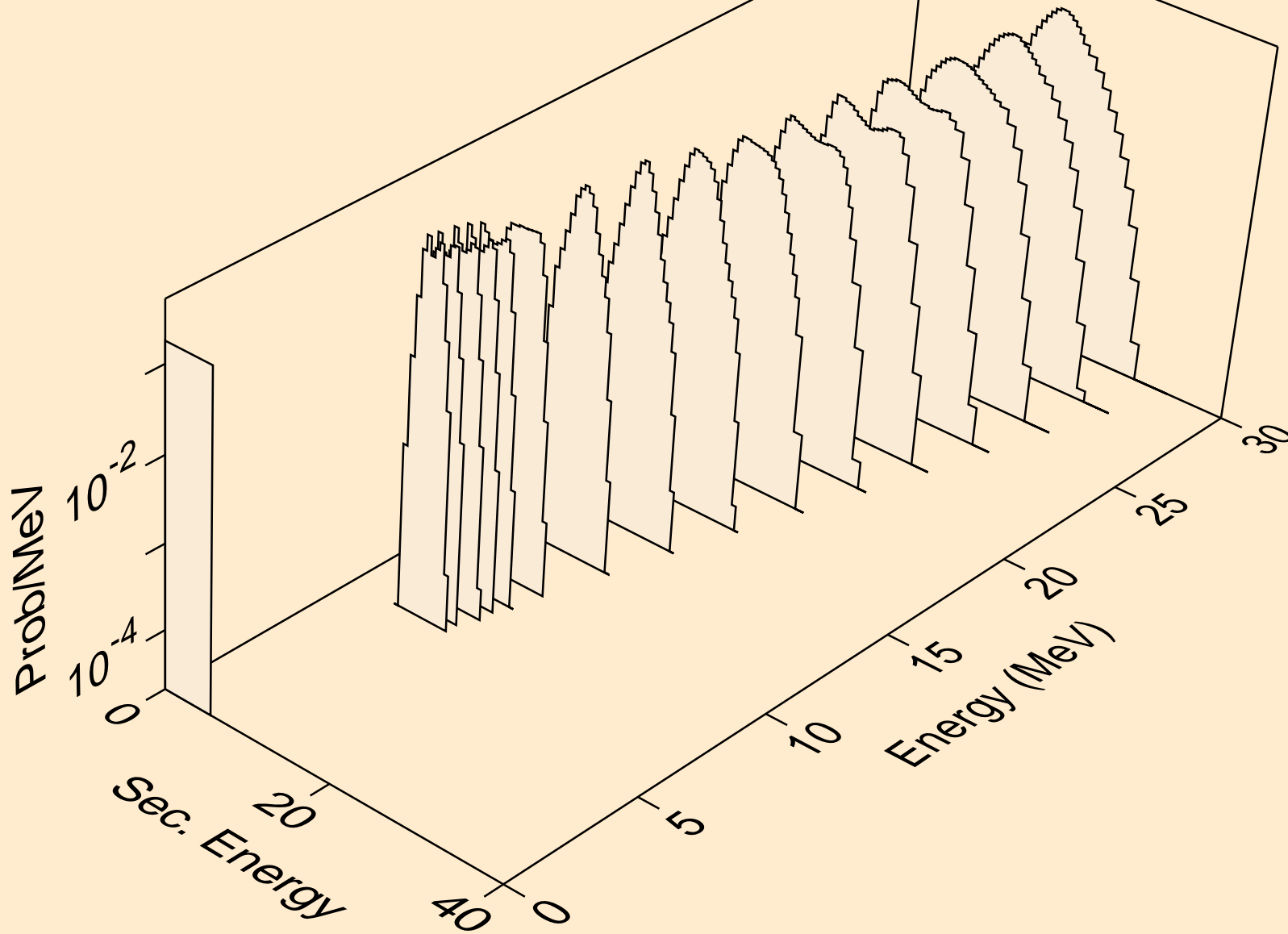

PT192 NEUTRON ACER TENDL-2024 LIBRARY; T=0.K
alphas from (n,pa)

