

RA233 NEUTRON ACER TENDL-2024 LIBRARY; T=0.K
Principal cross sections

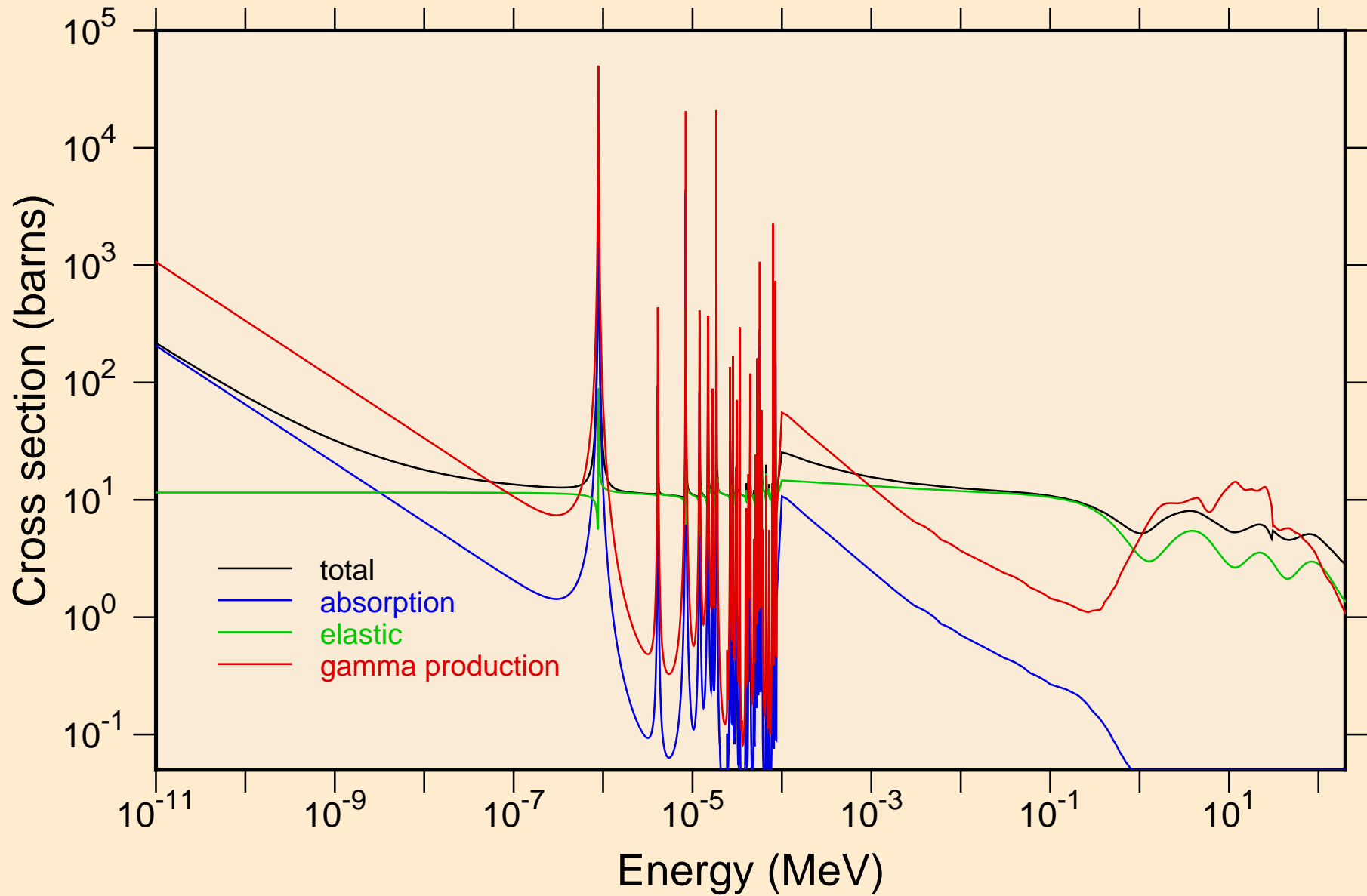

RA233 NEUTRON ACER TENDL-2024 LIBRARY; T=0.K
resonance total cross section

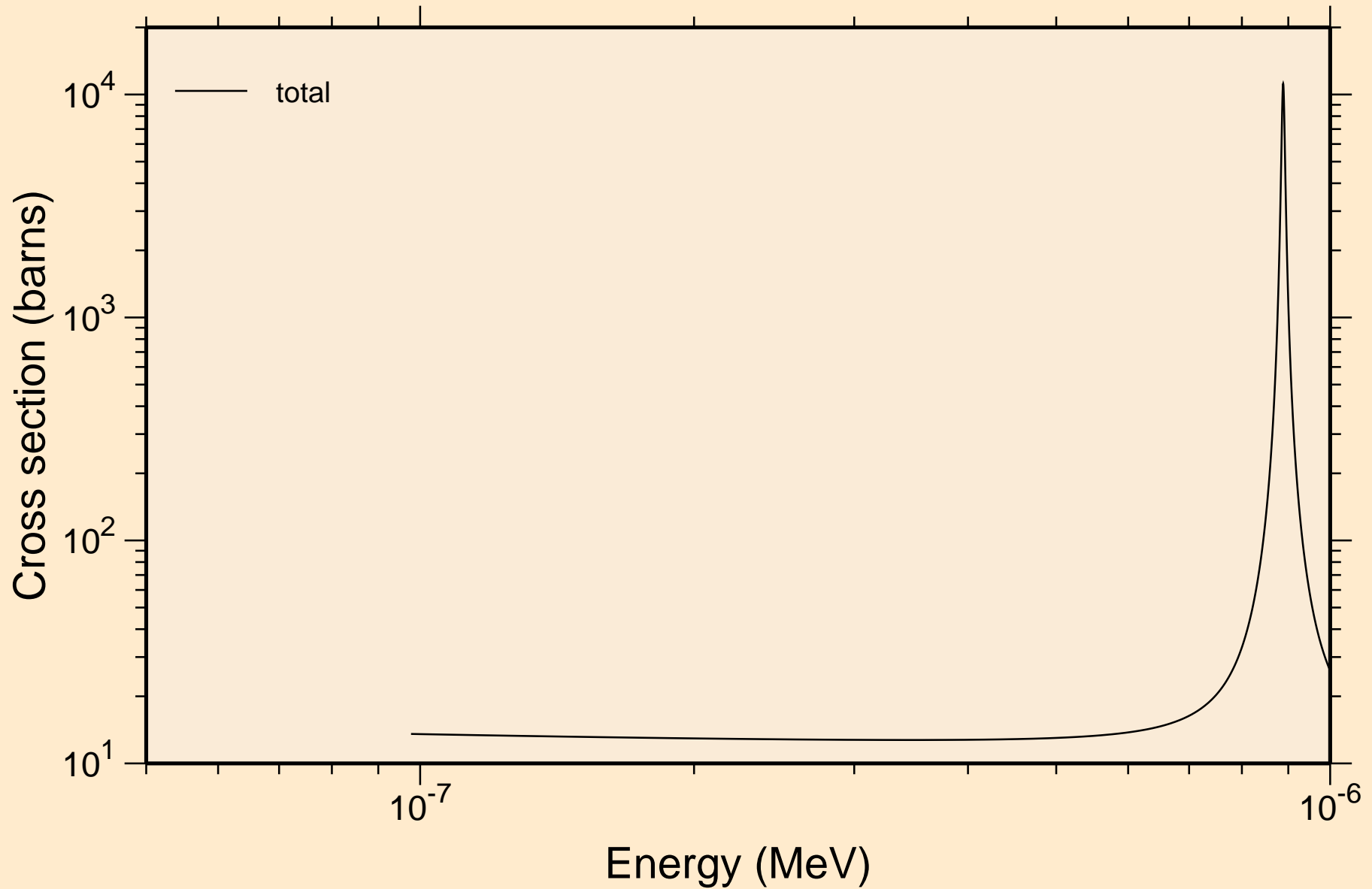

RA233 NEUTRON ACER TENDL-2024 LIBRARY; T=0.K
resonance total cross section

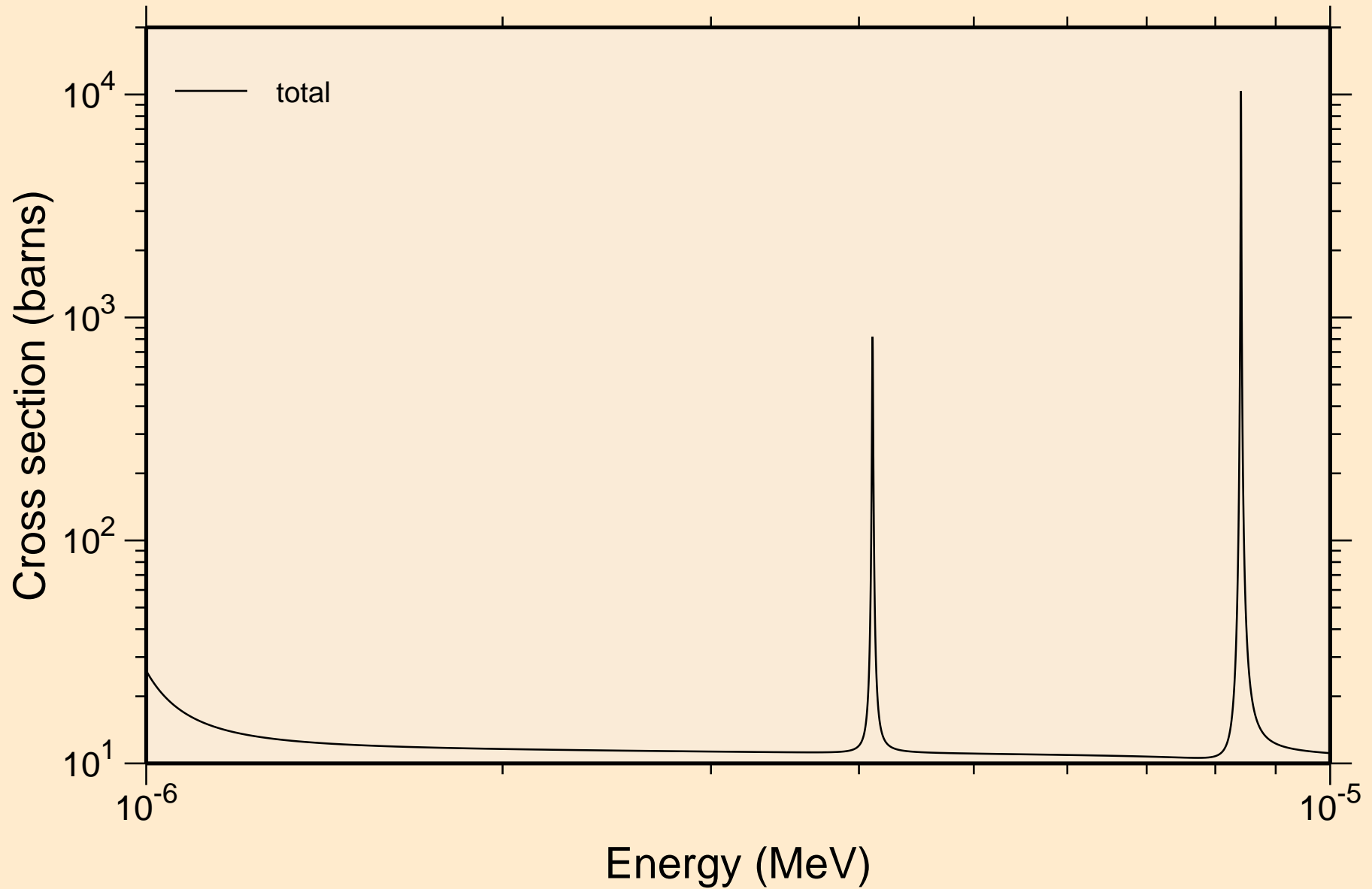

RA233 NEUTRON ACER TENDL-2024 LIBRARY; T=0.K
resonance total cross section

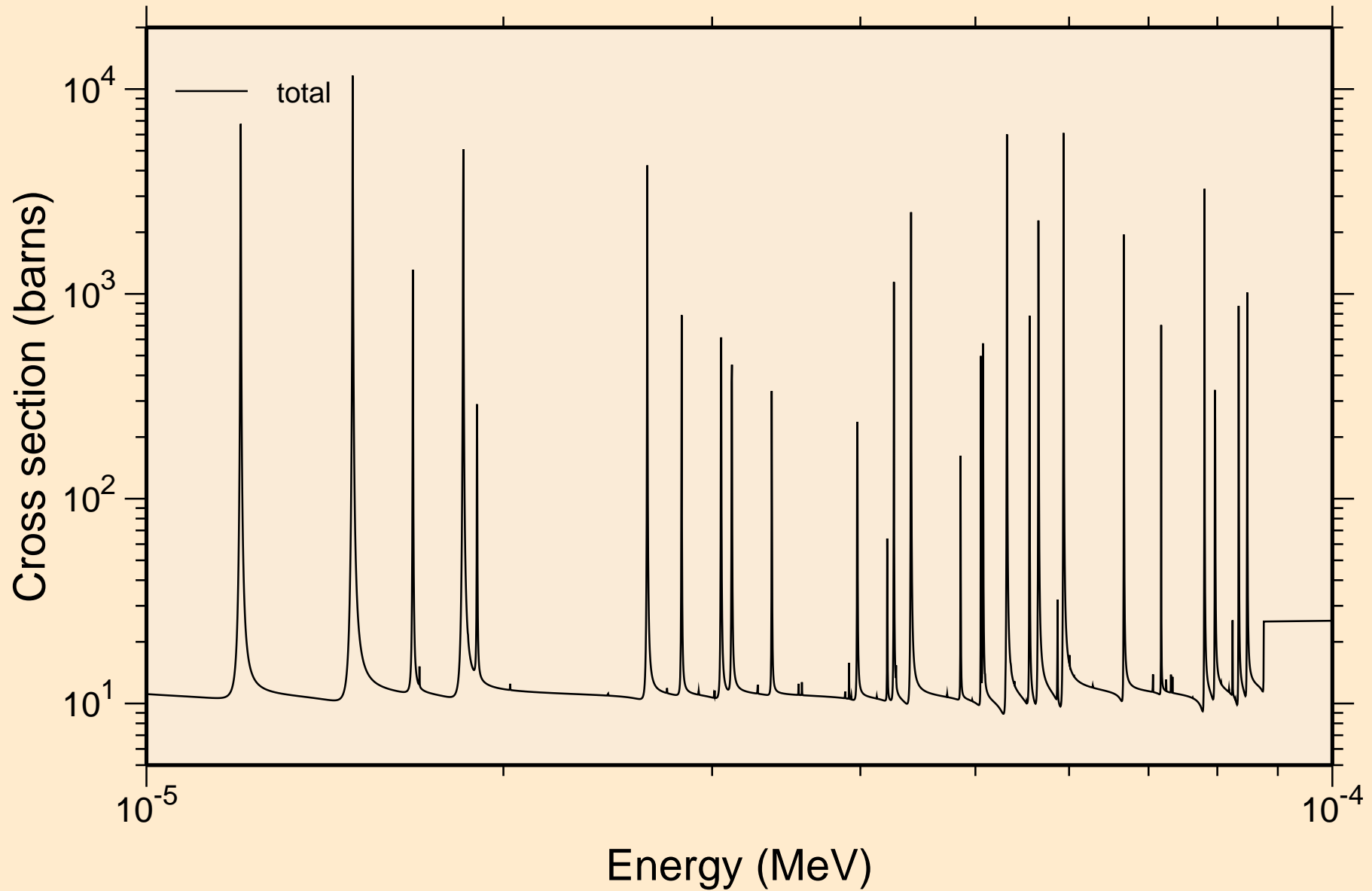

RA233 NEUTRON ACER TENDL-2024 LIBRARY; T=0.K
resonance total cross section

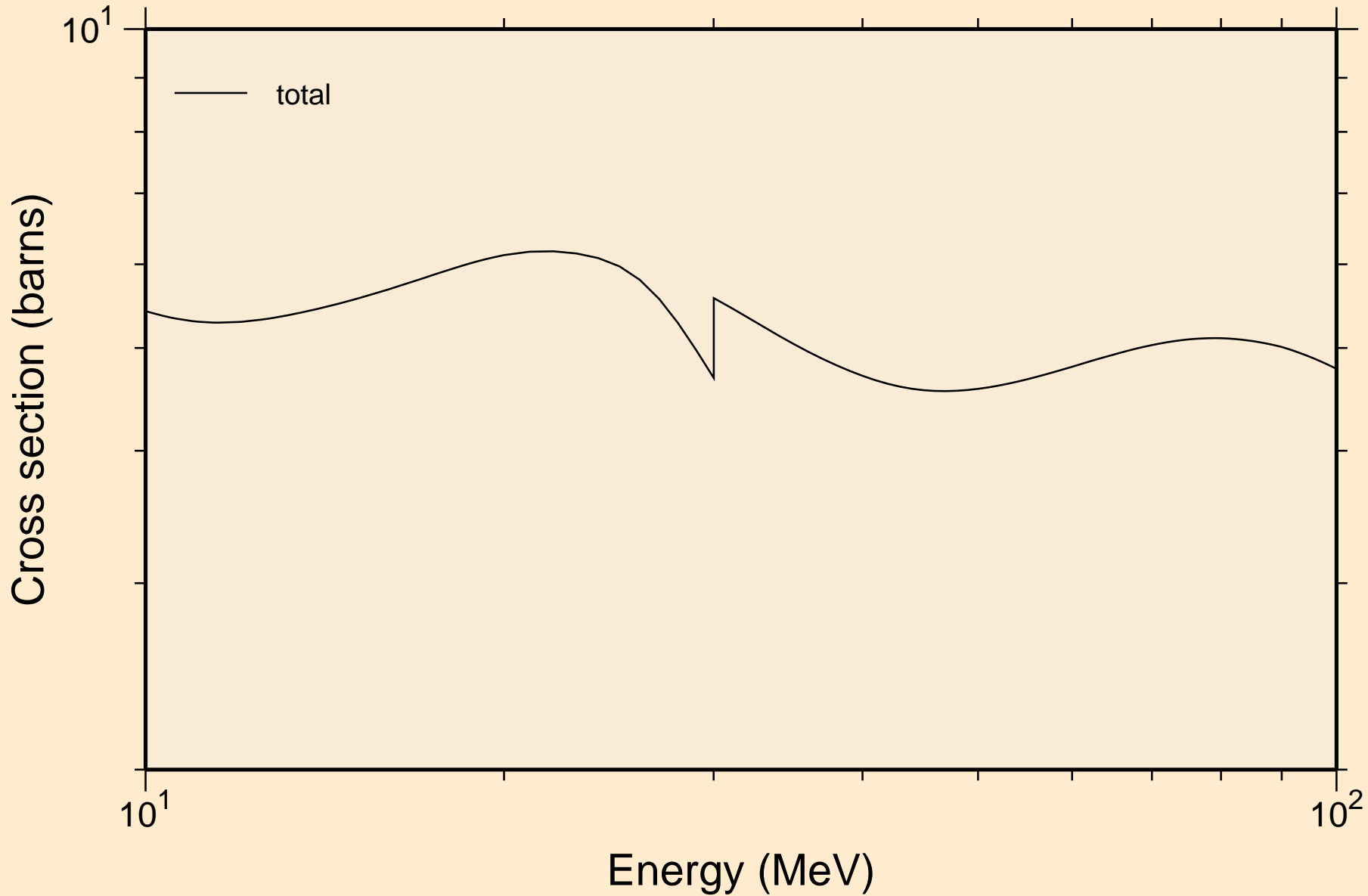

RA233 NEUTRON ACER TENDL-2024 LIBRARY; T=0.K
resonance absorption cross sections

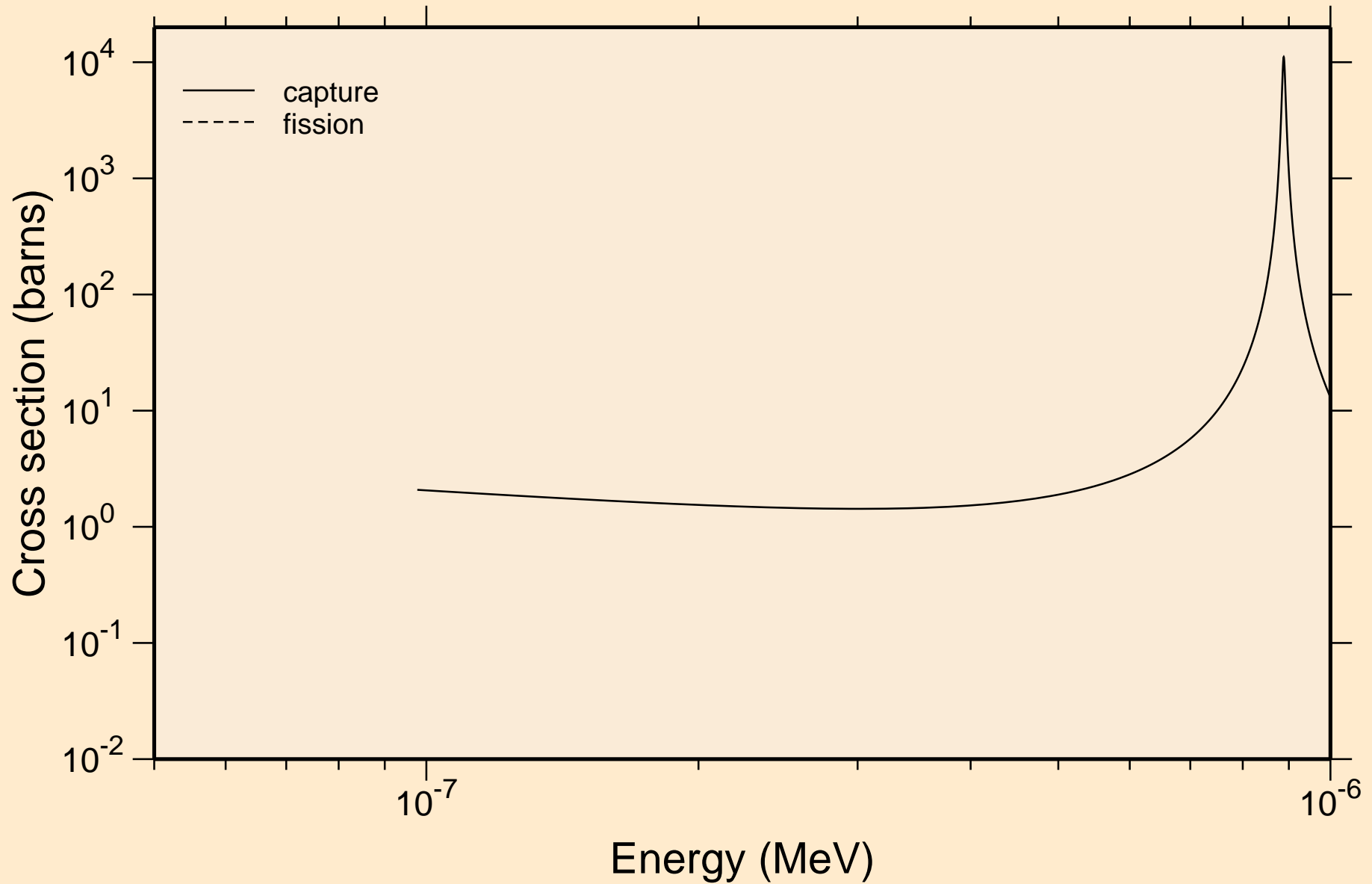

RA233 NEUTRON ACER TENDL-2024 LIBRARY; T=0.K
resonance absorption cross sections

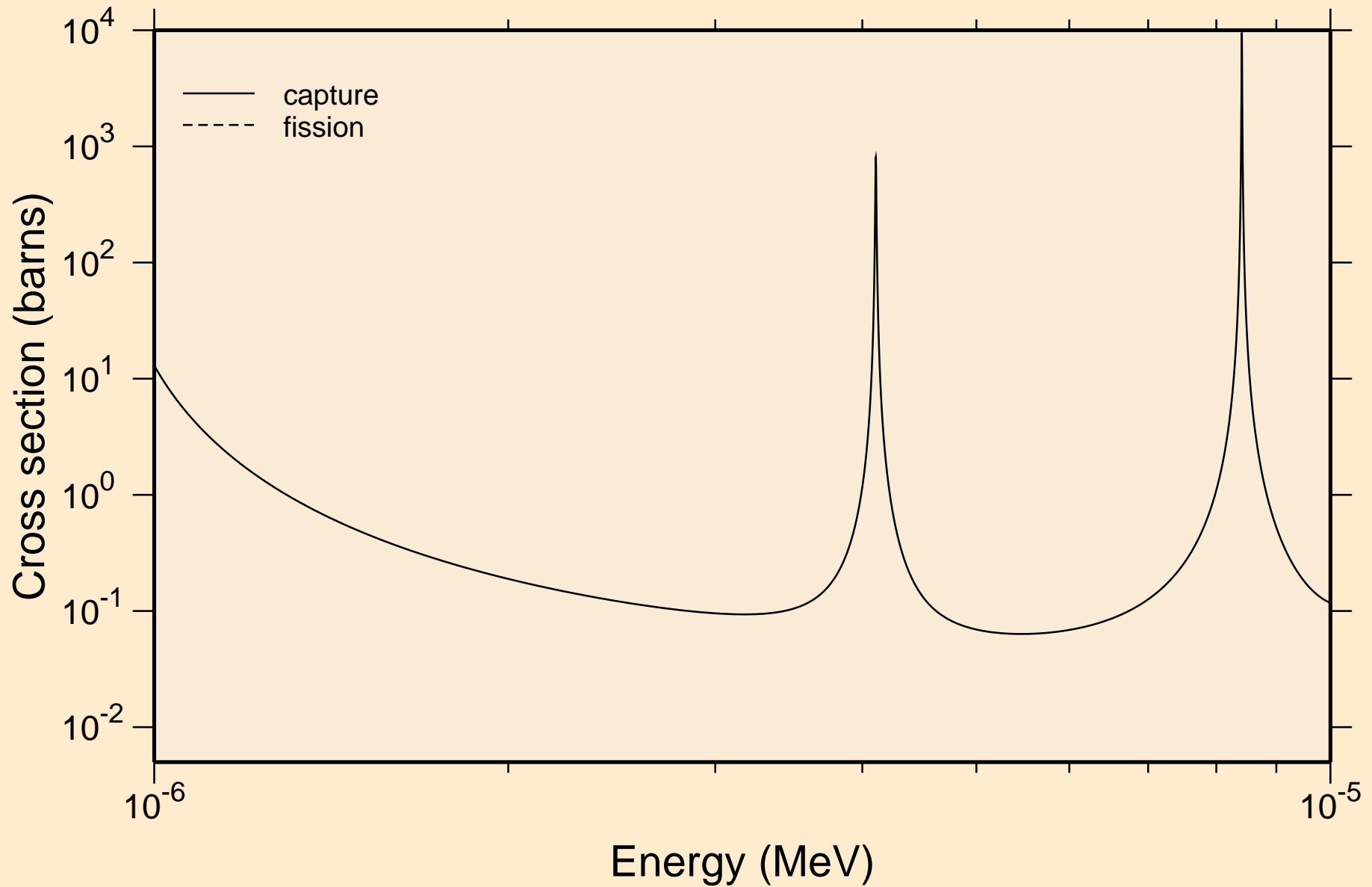

RA233 NEUTRON ACER TENDL-2024 LIBRARY; T=0.K
resonance absorption cross sections

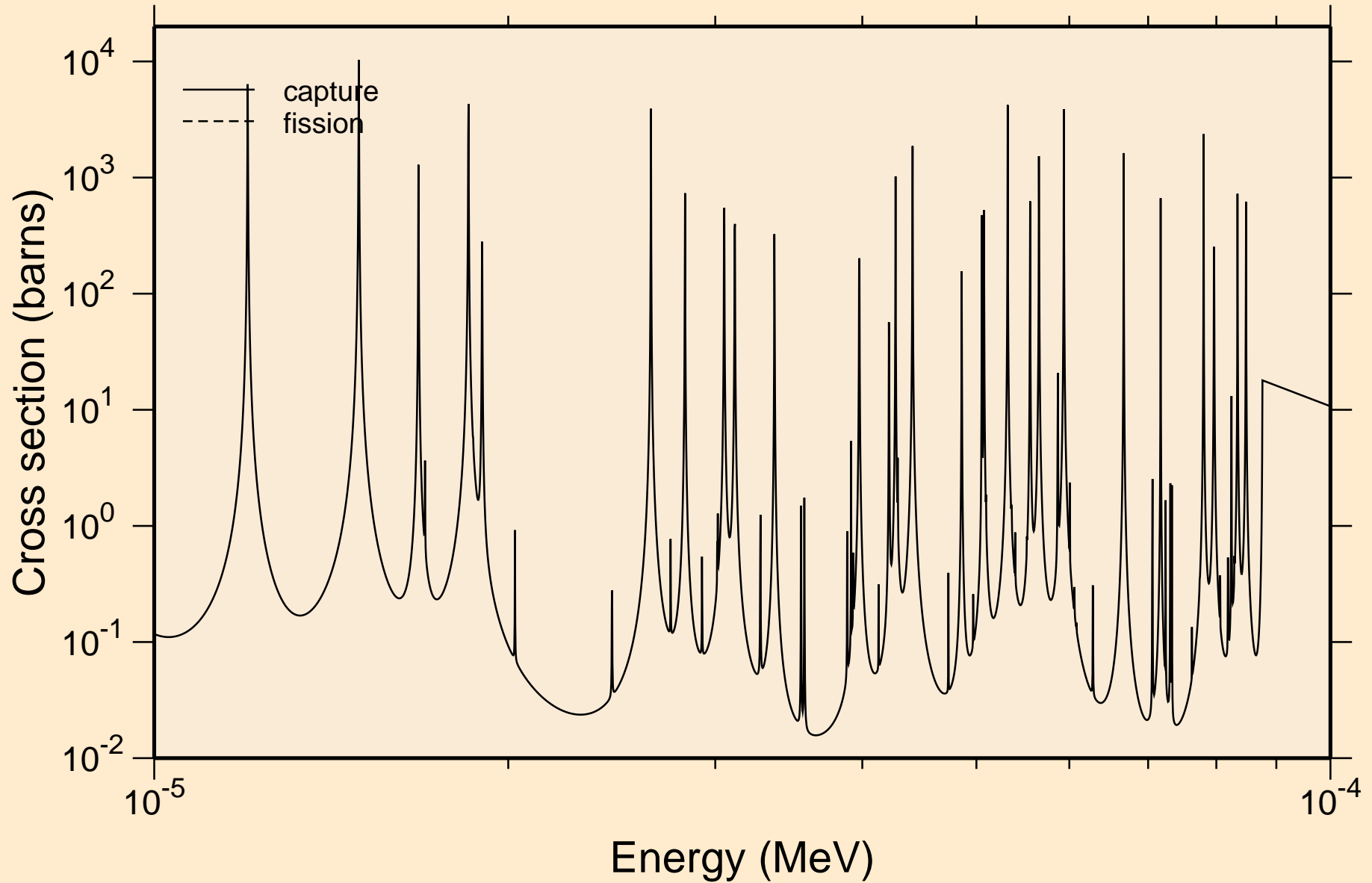

RA233 NEUTRON ACER TENDL-2024 LIBRARY; T=0.K
resonance absorption cross sections

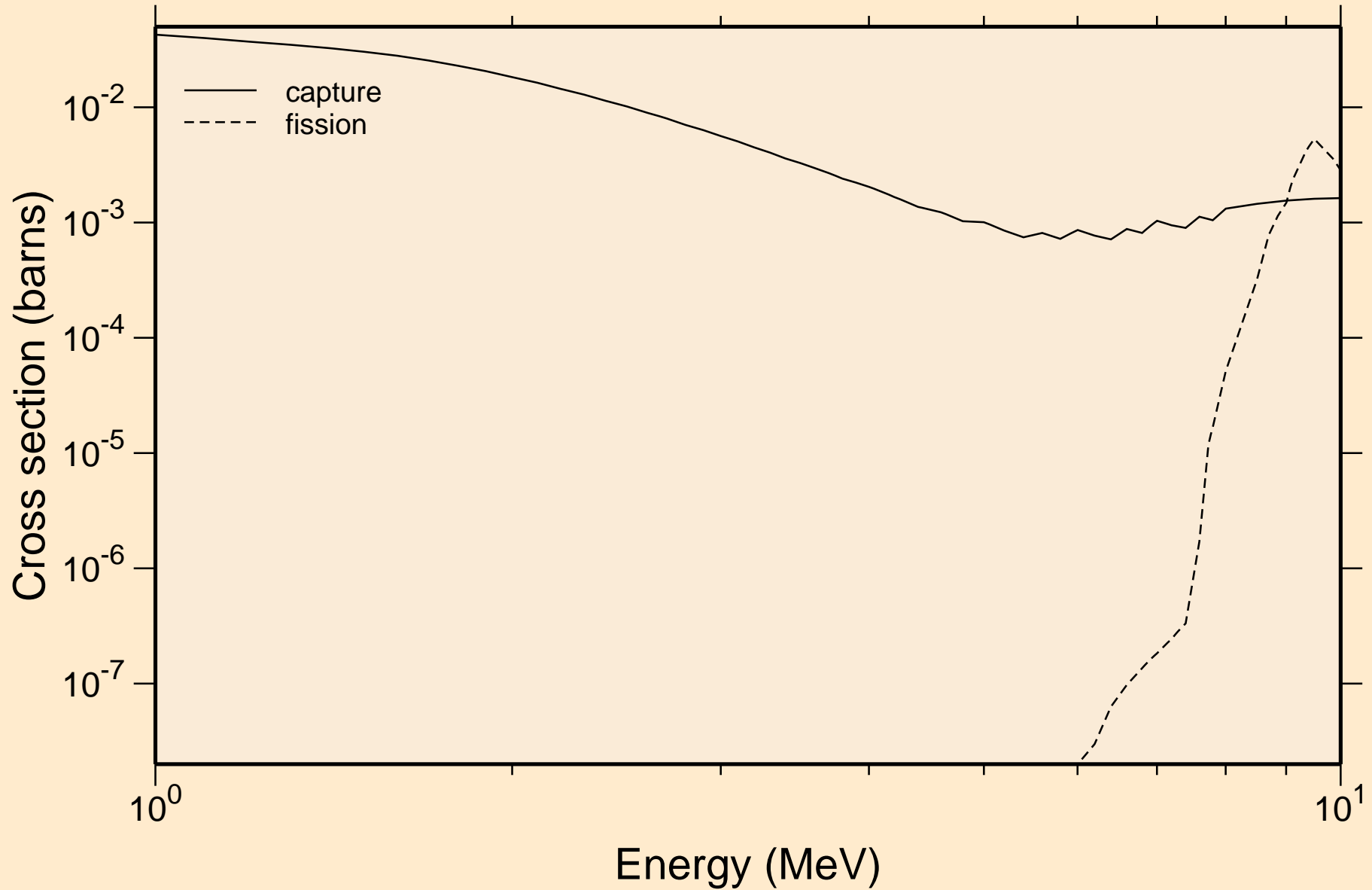

RA233 NEUTRON ACER TENDL-2024 LIBRARY; T=0.K
Heating

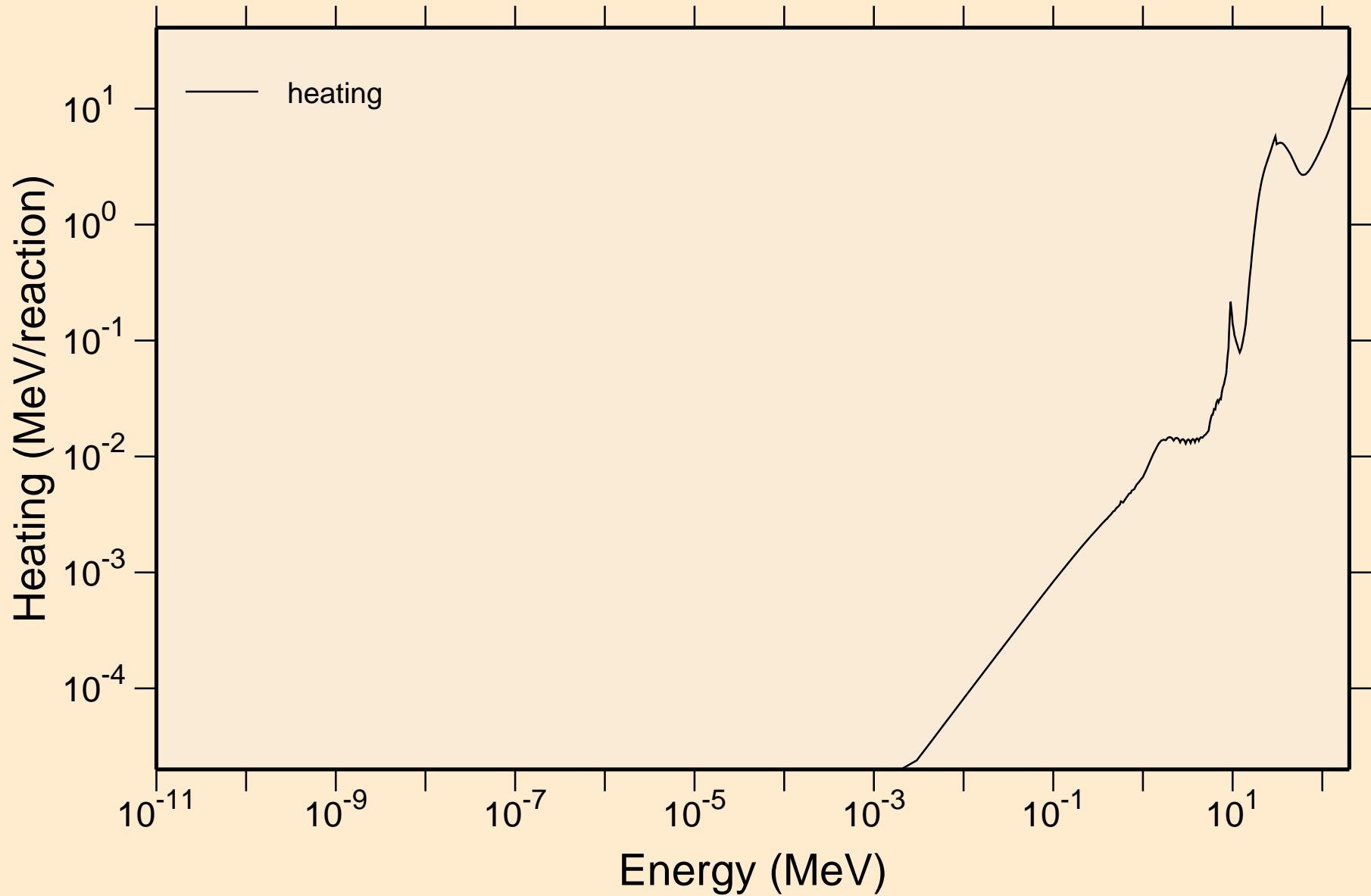

RA233 NEUTRON ACER TENDL-2024 LIBRARY; T=0.K

Damage

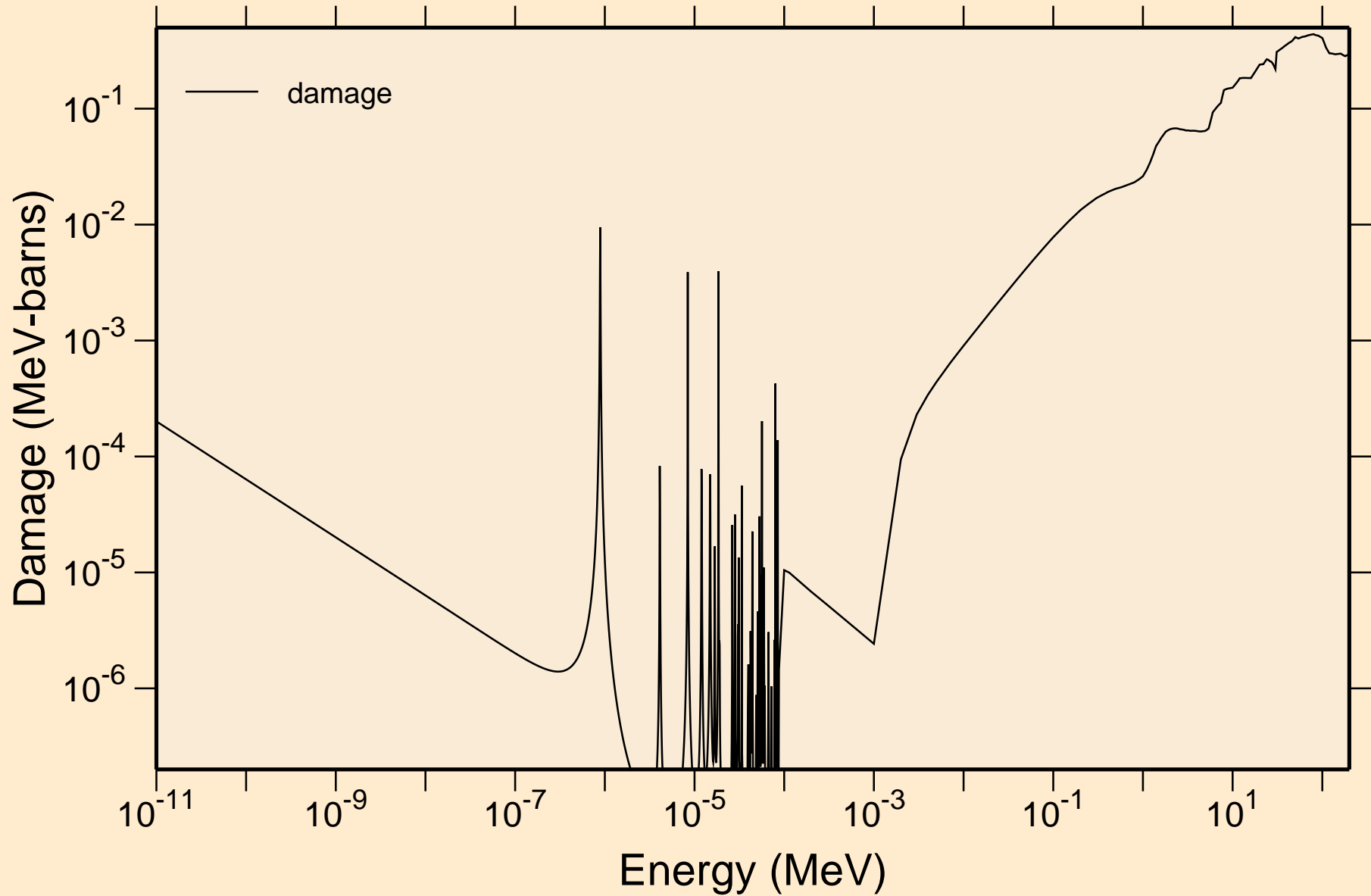

RA233 NEUTRON ACER TENDL-2024 LIBRARY; T=0.K

Non-threshold reactions

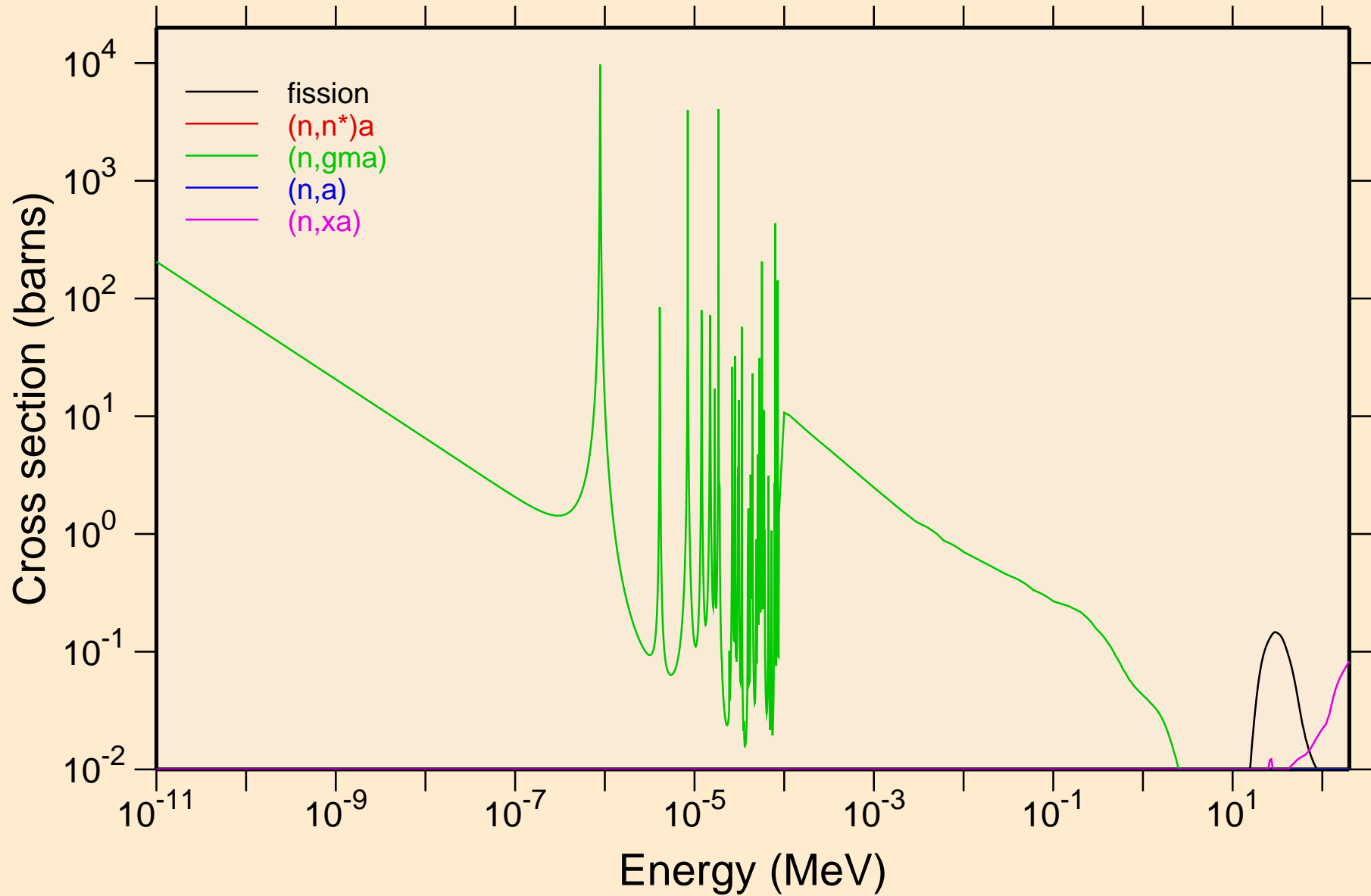

RA233 NEUTRON ACER TENDL-2024 LIBRARY; T=0.K

Principal cross sections

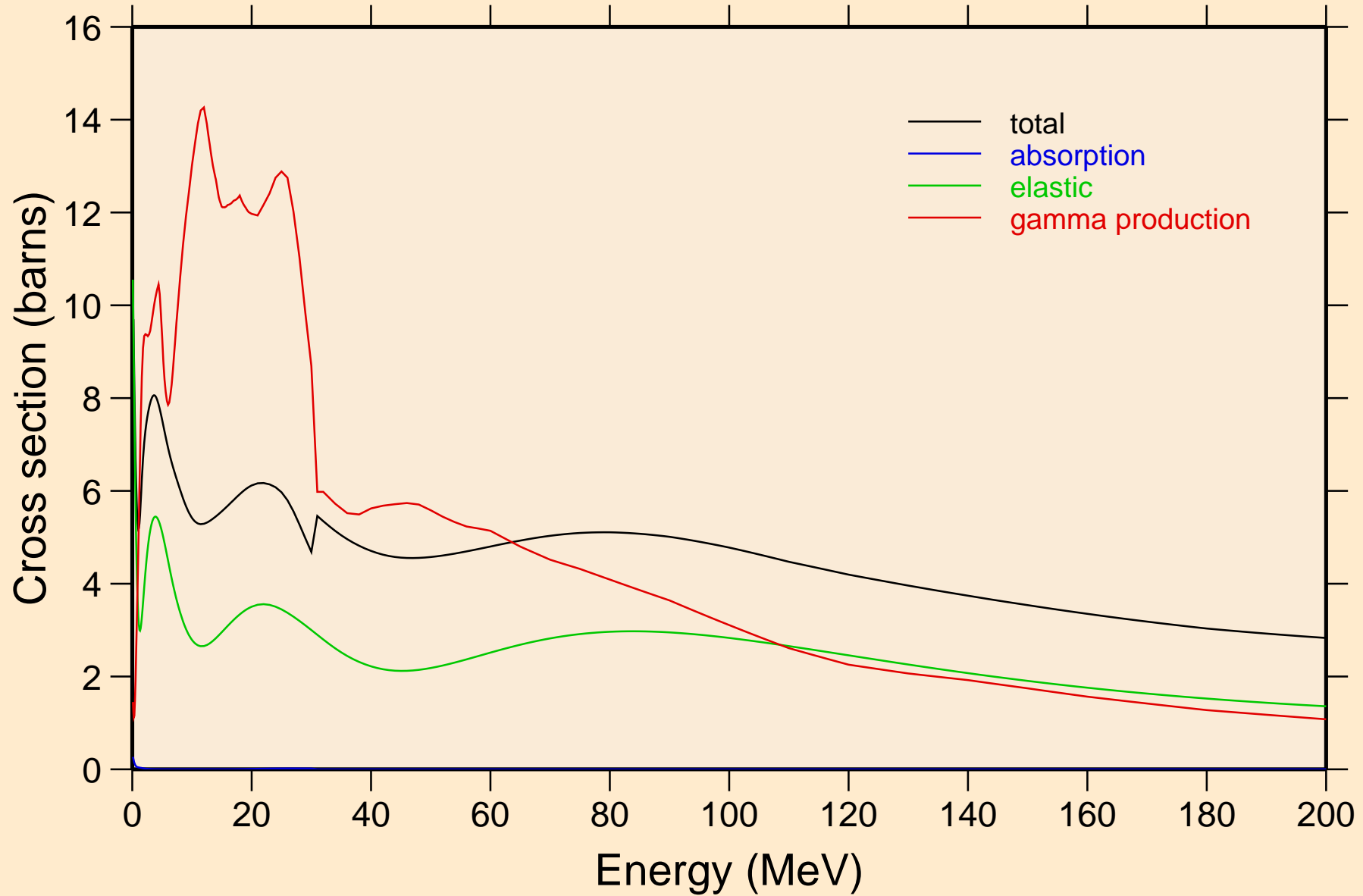

RA233 NEUTRON ACER TENDL-2024 LIBRARY; T=0.K

Heating

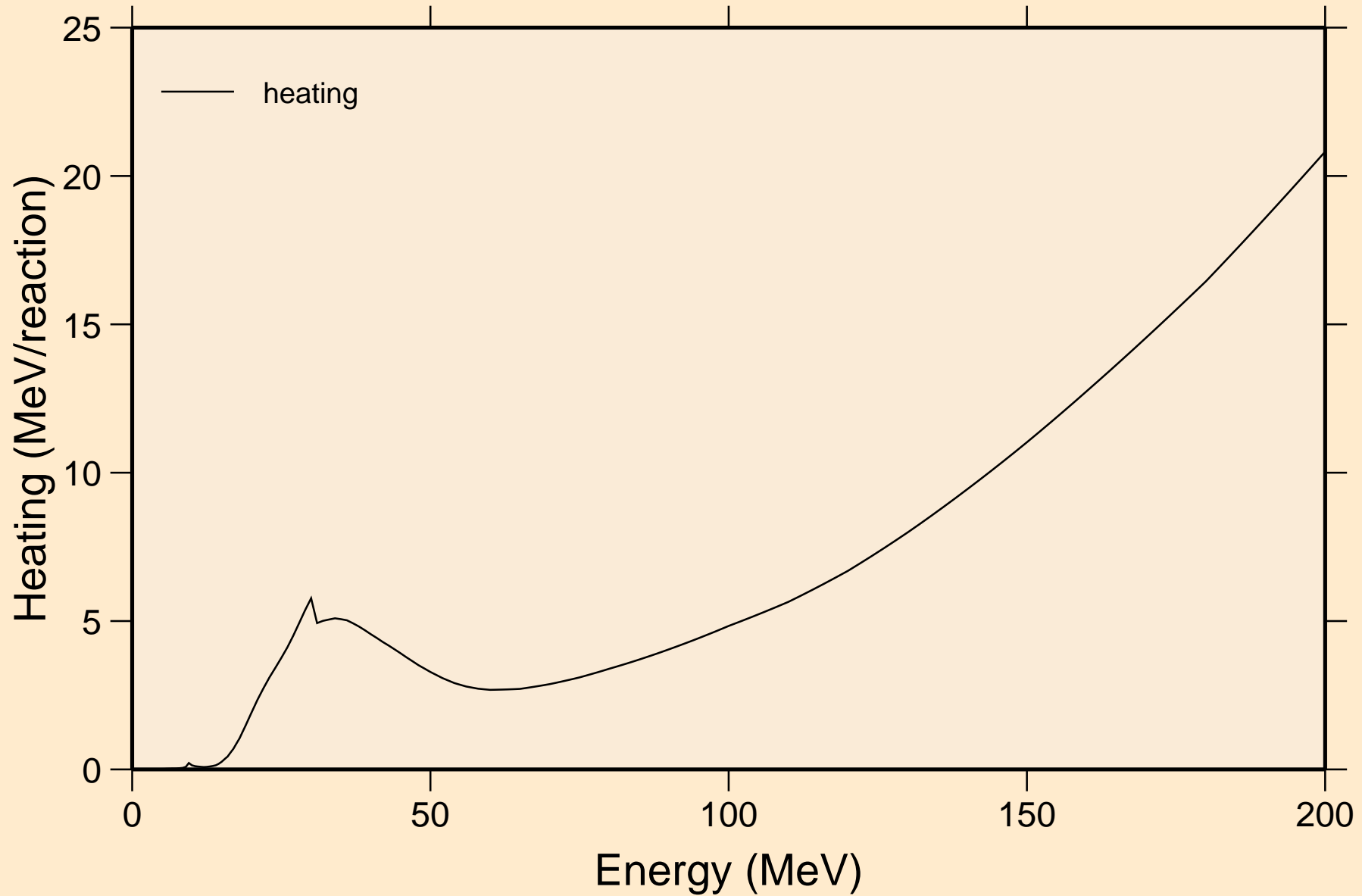

RA233 NEUTRON ACER TENDL-2024 LIBRARY; T=0.K

Damage

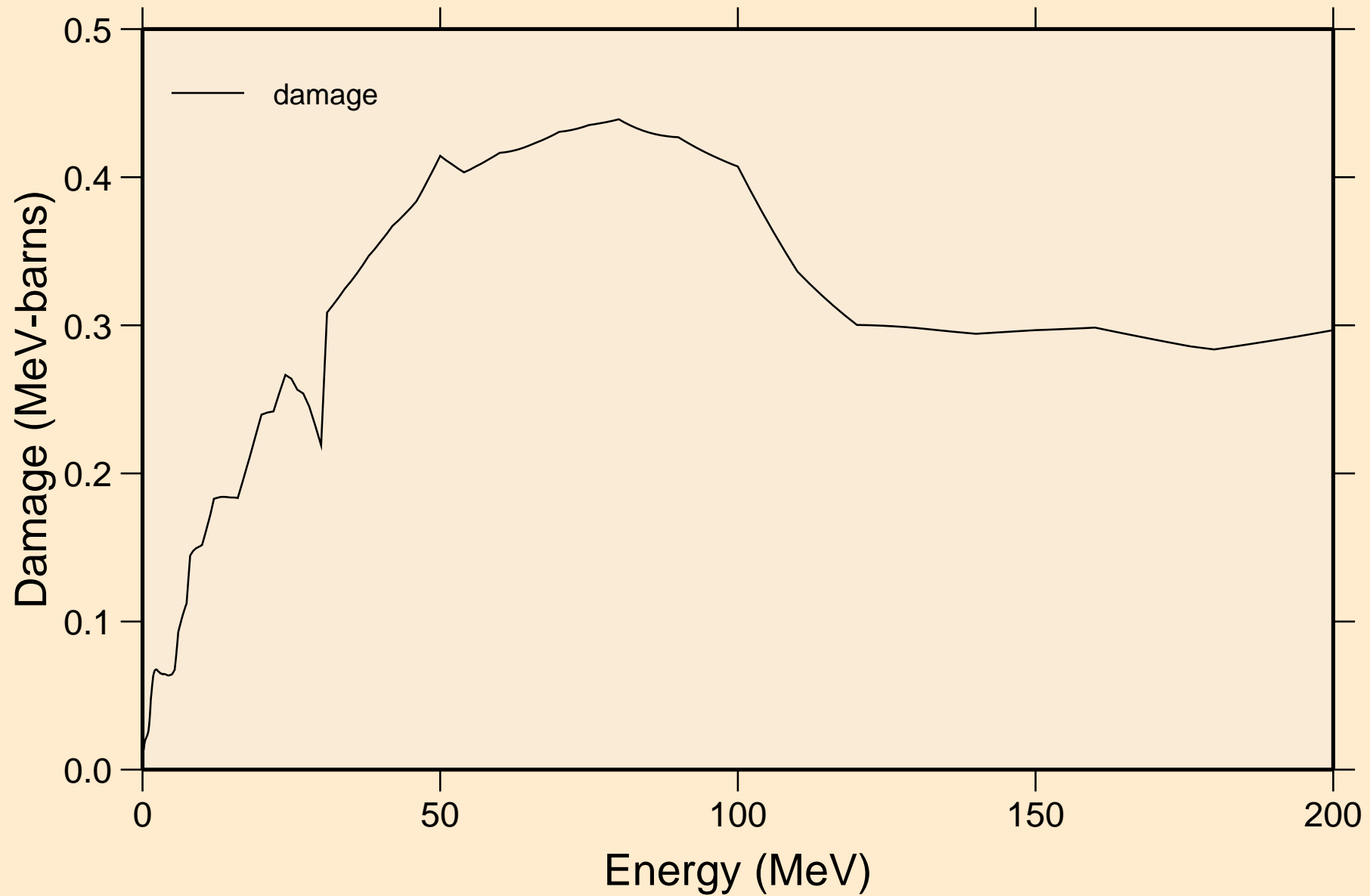

RA233 NEUTRON ACER TENDL-2024 LIBRARY; T=0.K
Non-threshold reactions

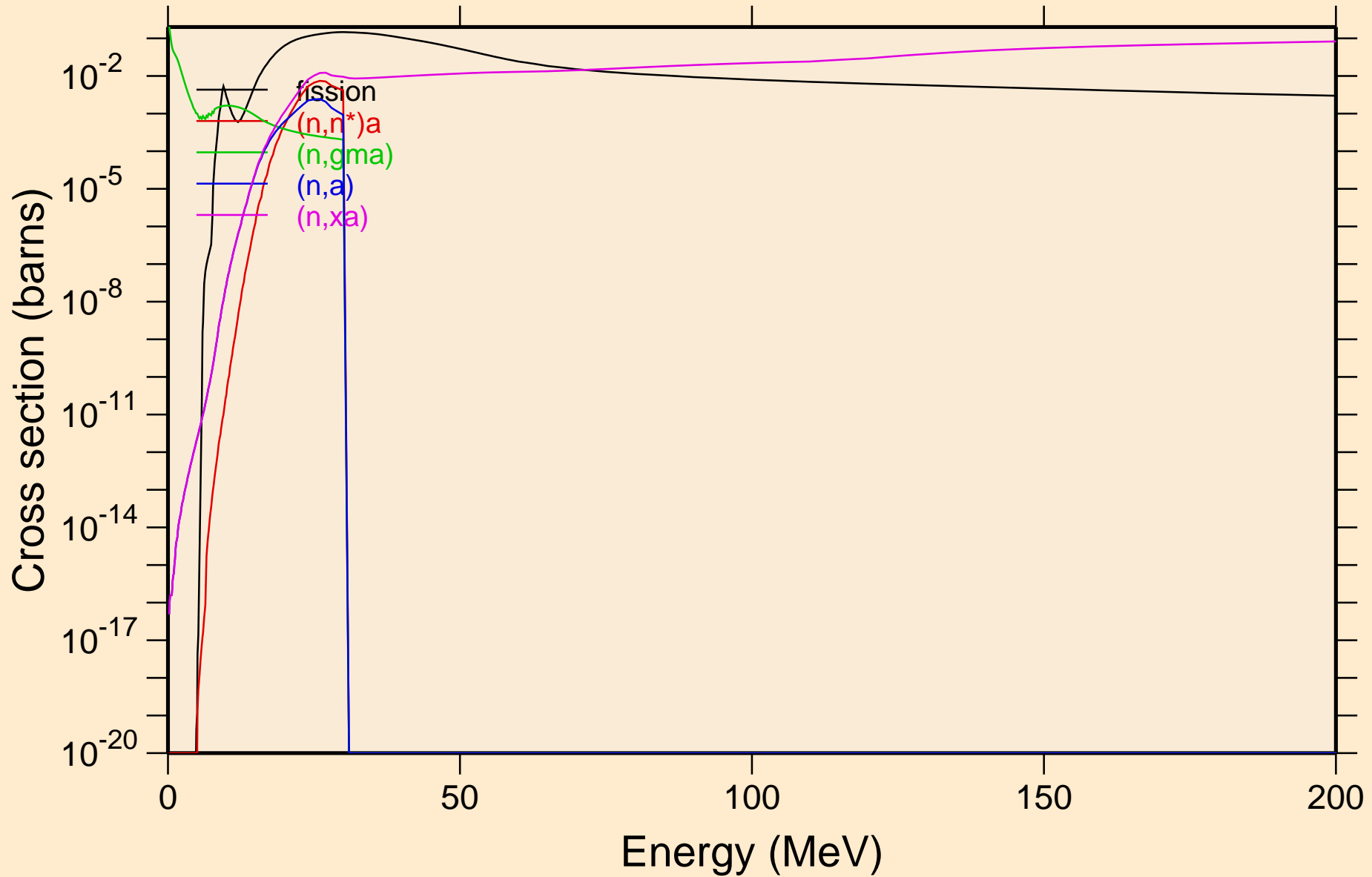

RA233 NEUTRON ACER TENDL-2024 LIBRARY; T=0.K
Inelastic levels

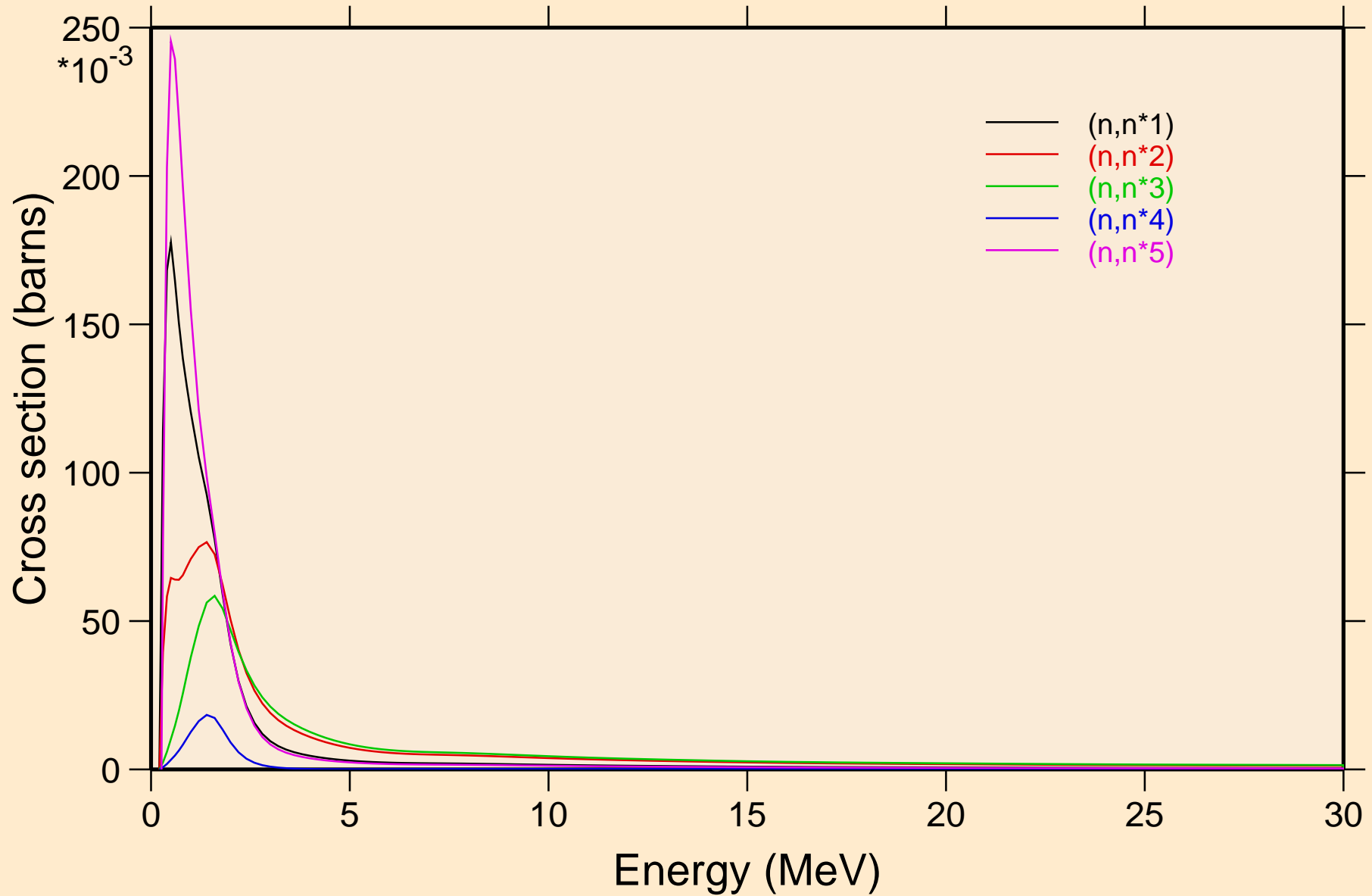

RA233 NEUTRON ACER TENDL-2024 LIBRARY; T=0.K
Inelastic levels

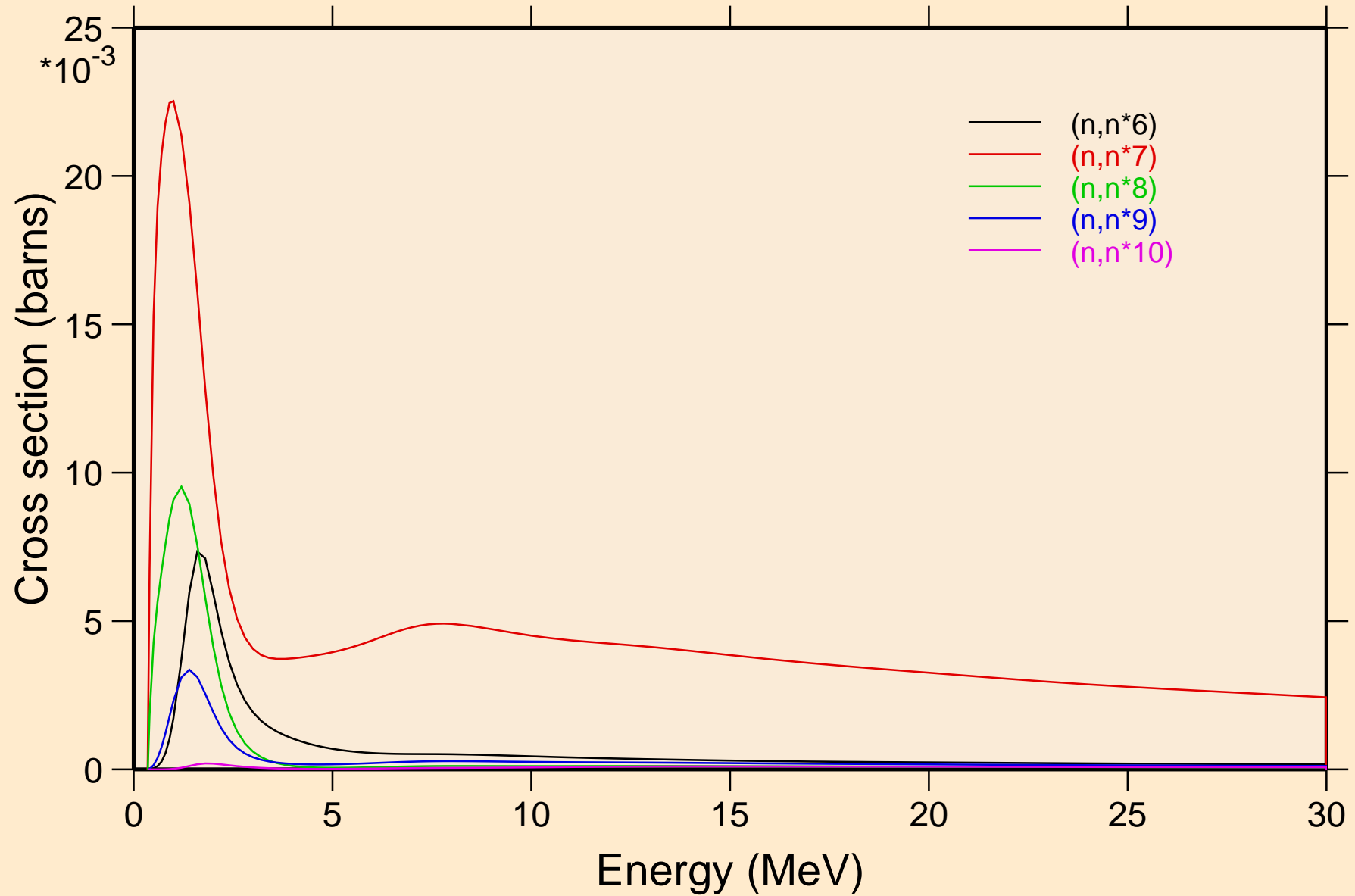

RA233 NEUTRON ACER TENDL-2024 LIBRARY; T=0.K
Inelastic levels

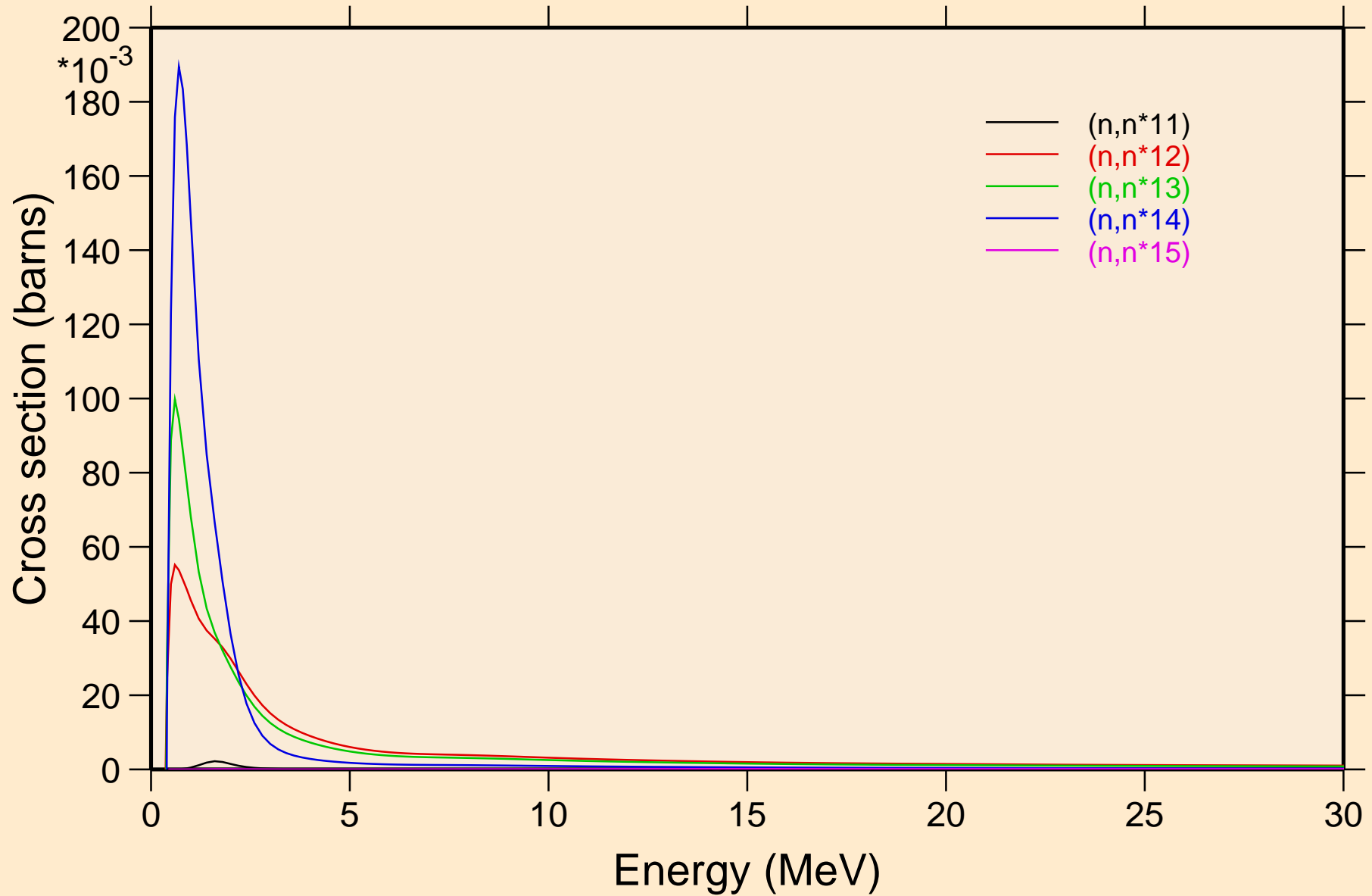

RA233 NEUTRON ACER TENDL-2024 LIBRARY; T=0.K
Inelastic levels

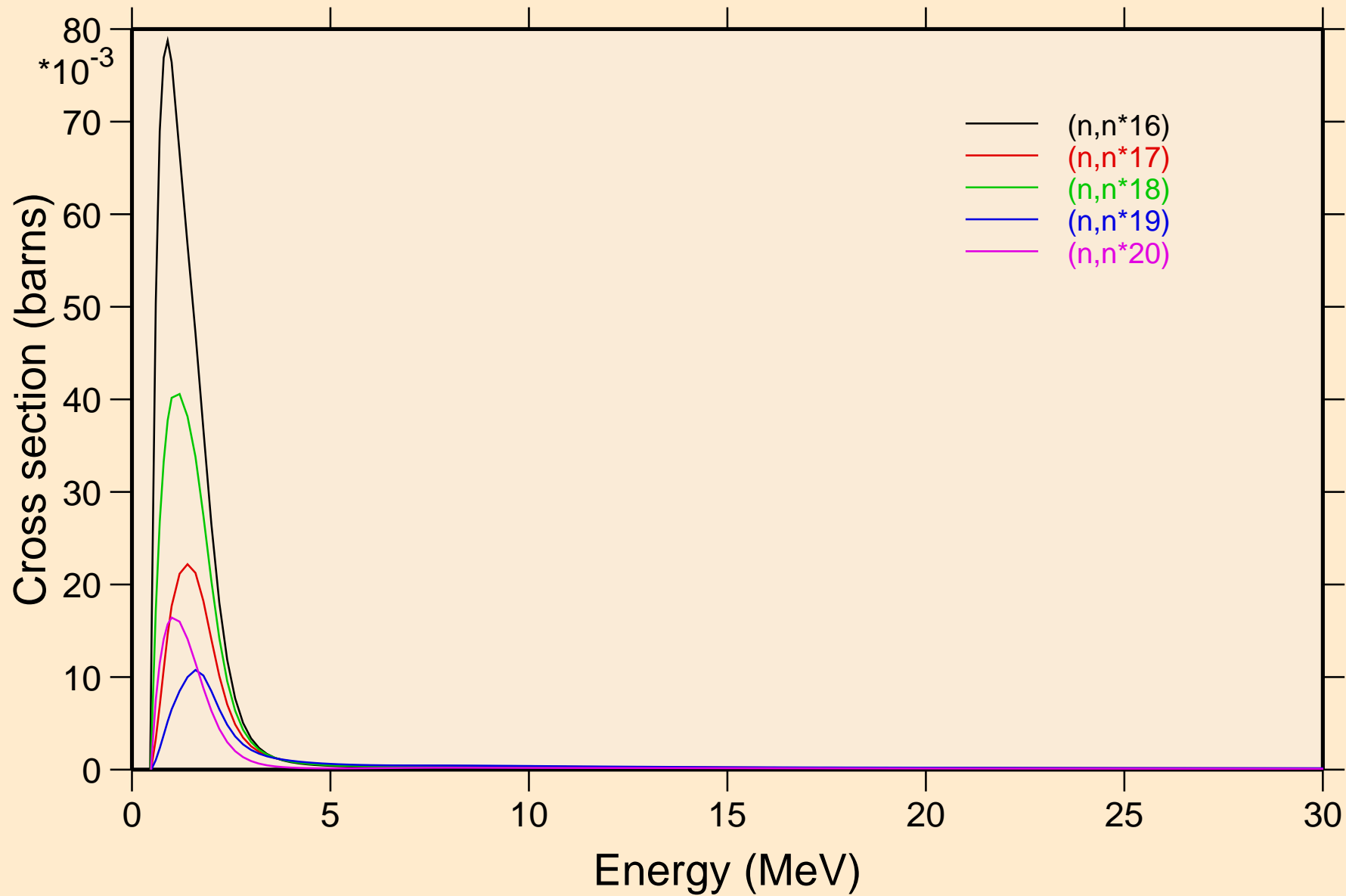

RA233 NEUTRON ACER TENDL-2024 LIBRARY; T=0.K
Inelastic levels

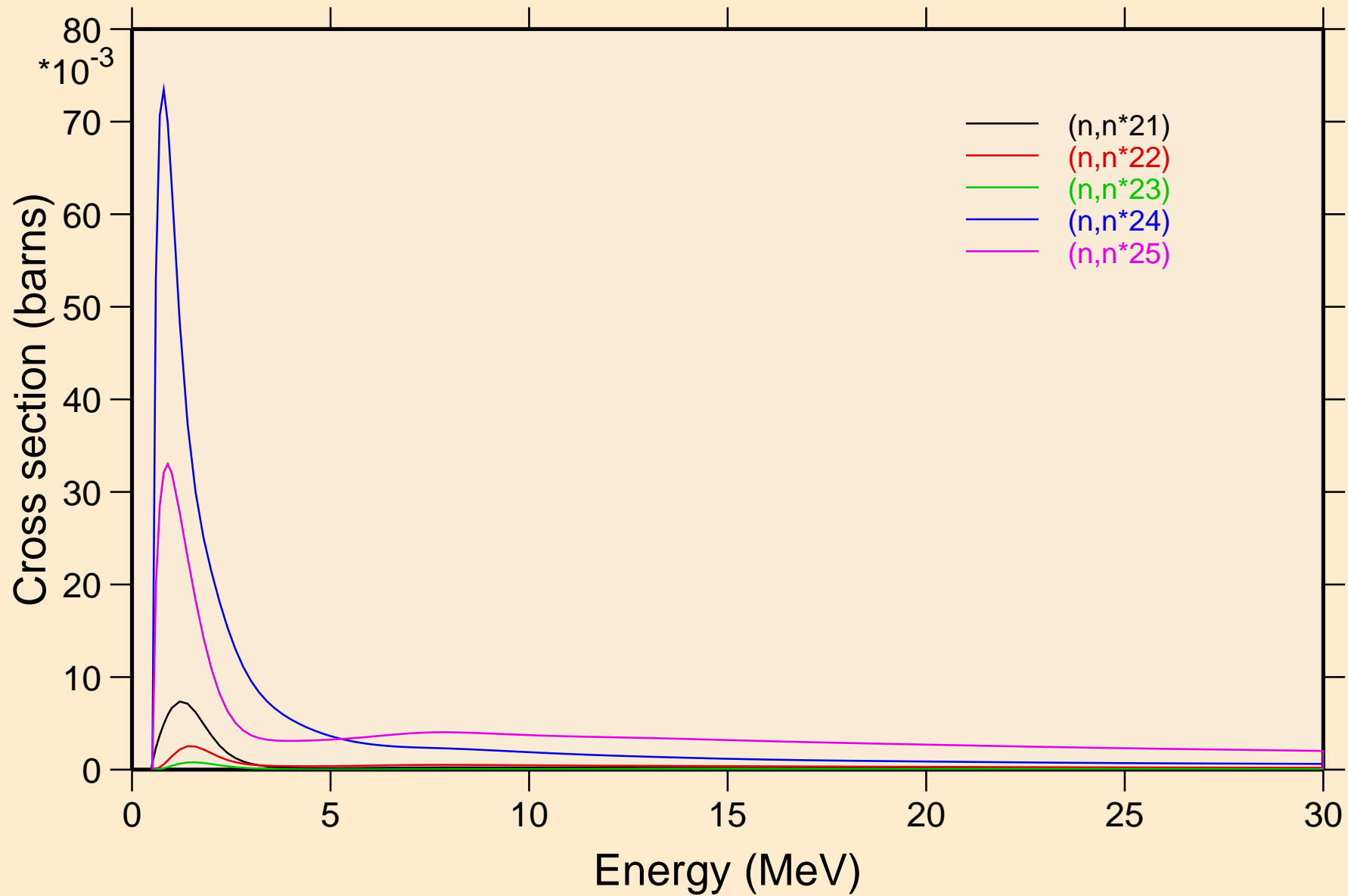

RA233 NEUTRON ACER TENDL-2024 LIBRARY; T=0.K
Inelastic levels

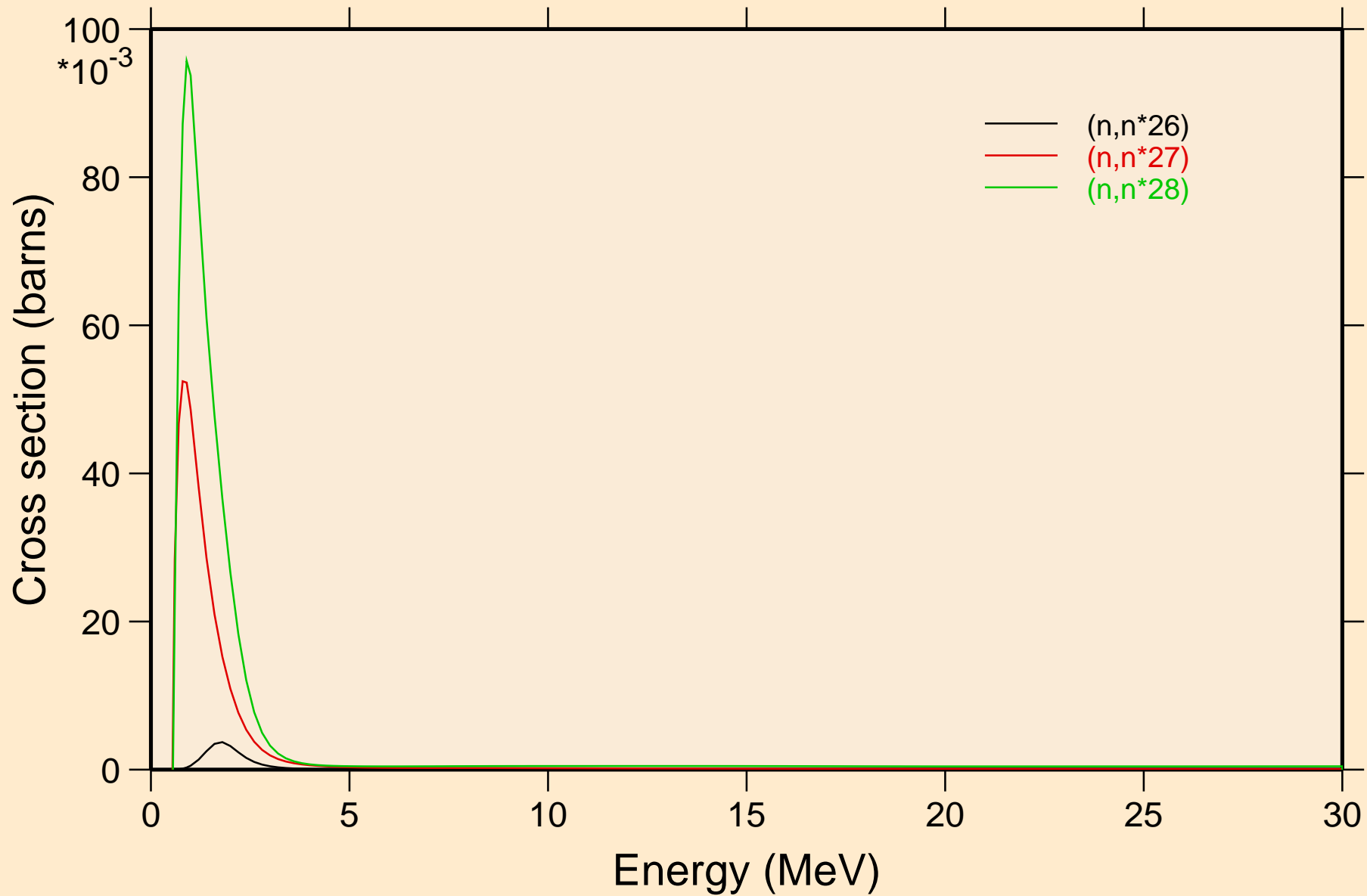

RA233 NEUTRON ACER TENDL-2024 LIBRARY; T=0.K

Threshold reactions

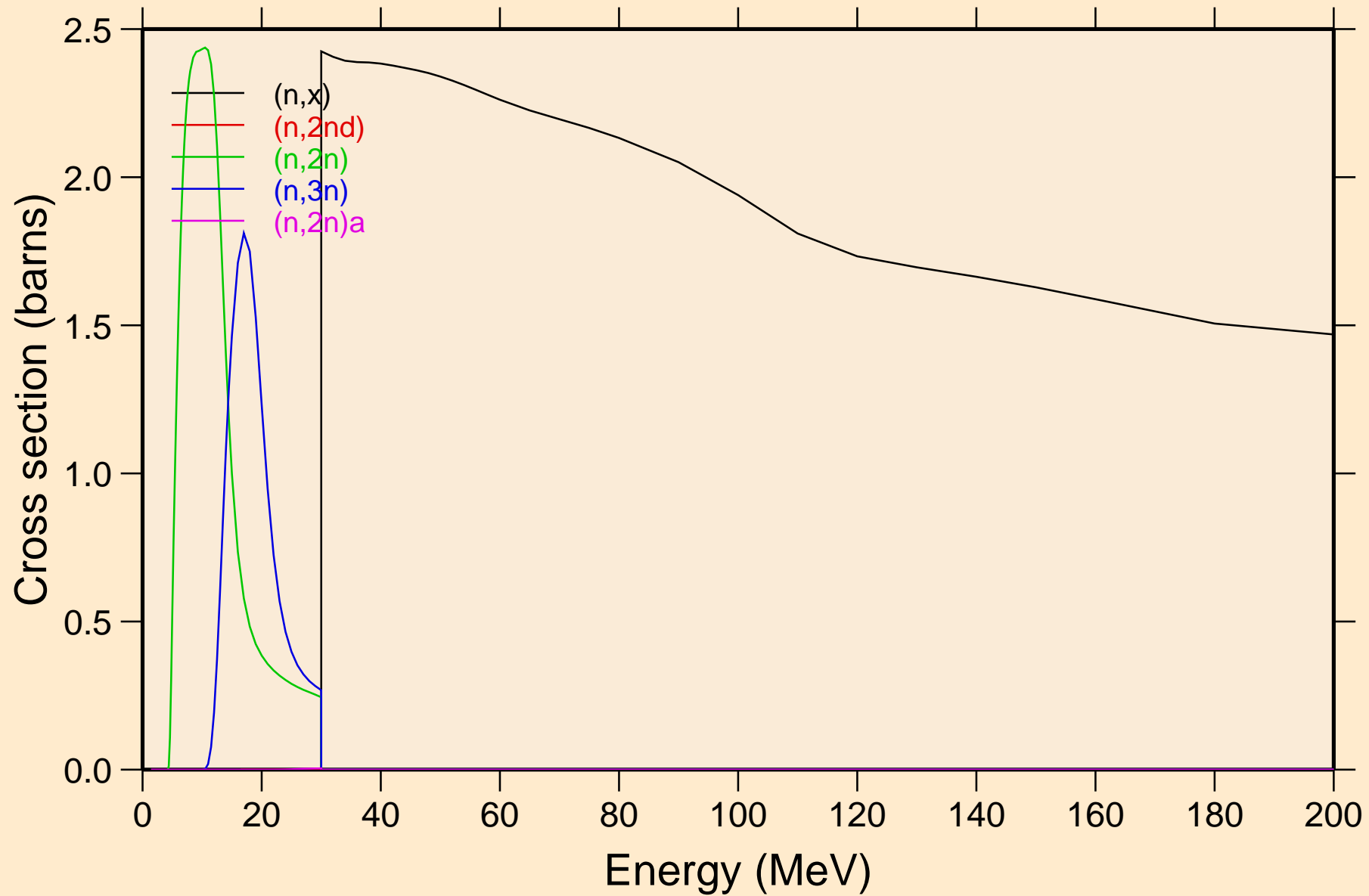

RA233 NEUTRON ACER TENDL-2024 LIBRARY; T=0.K

Threshold reactions

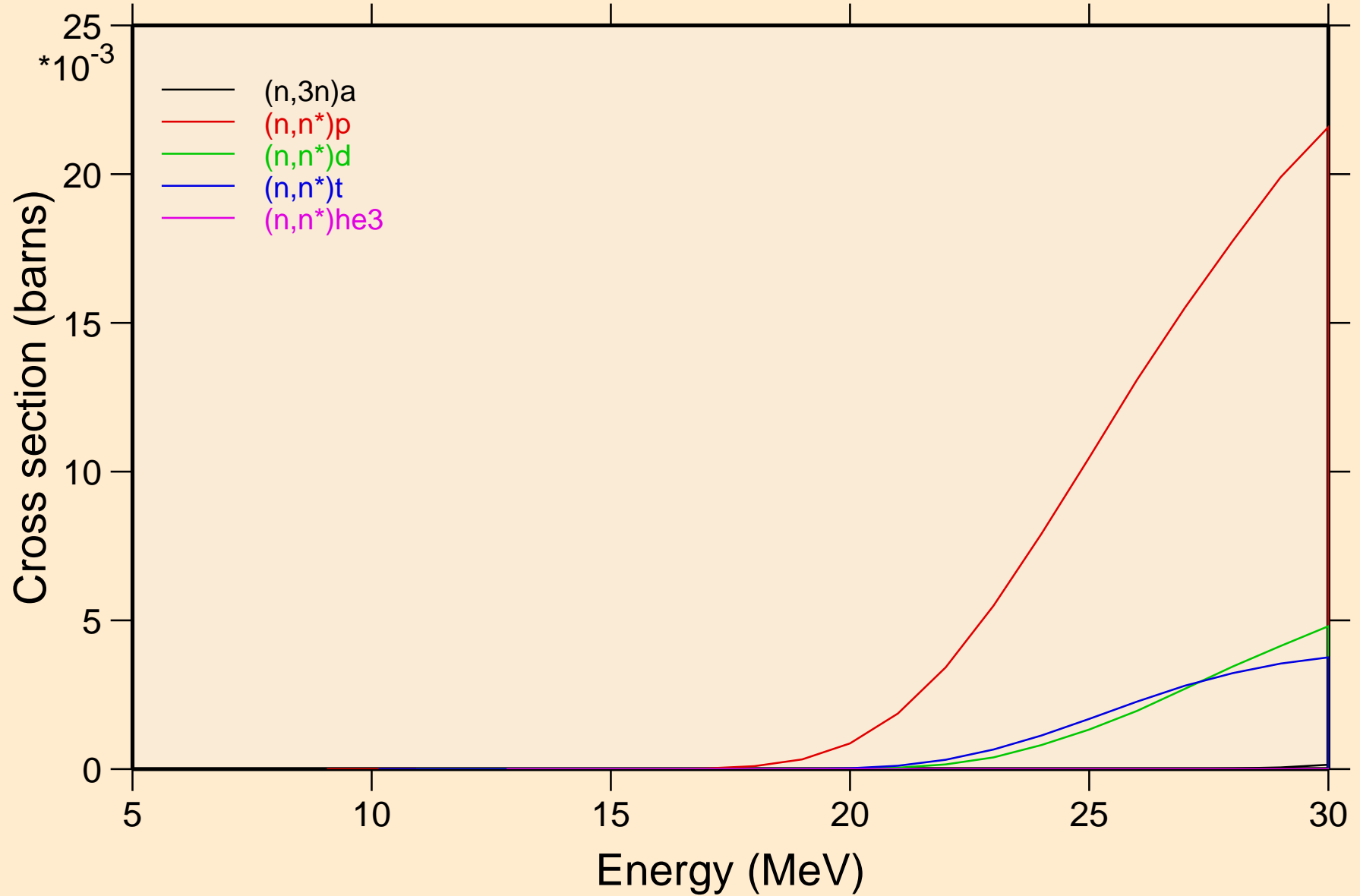

RA233 NEUTRON ACER TENDL-2024 LIBRARY; T=0.K
Threshold reactions

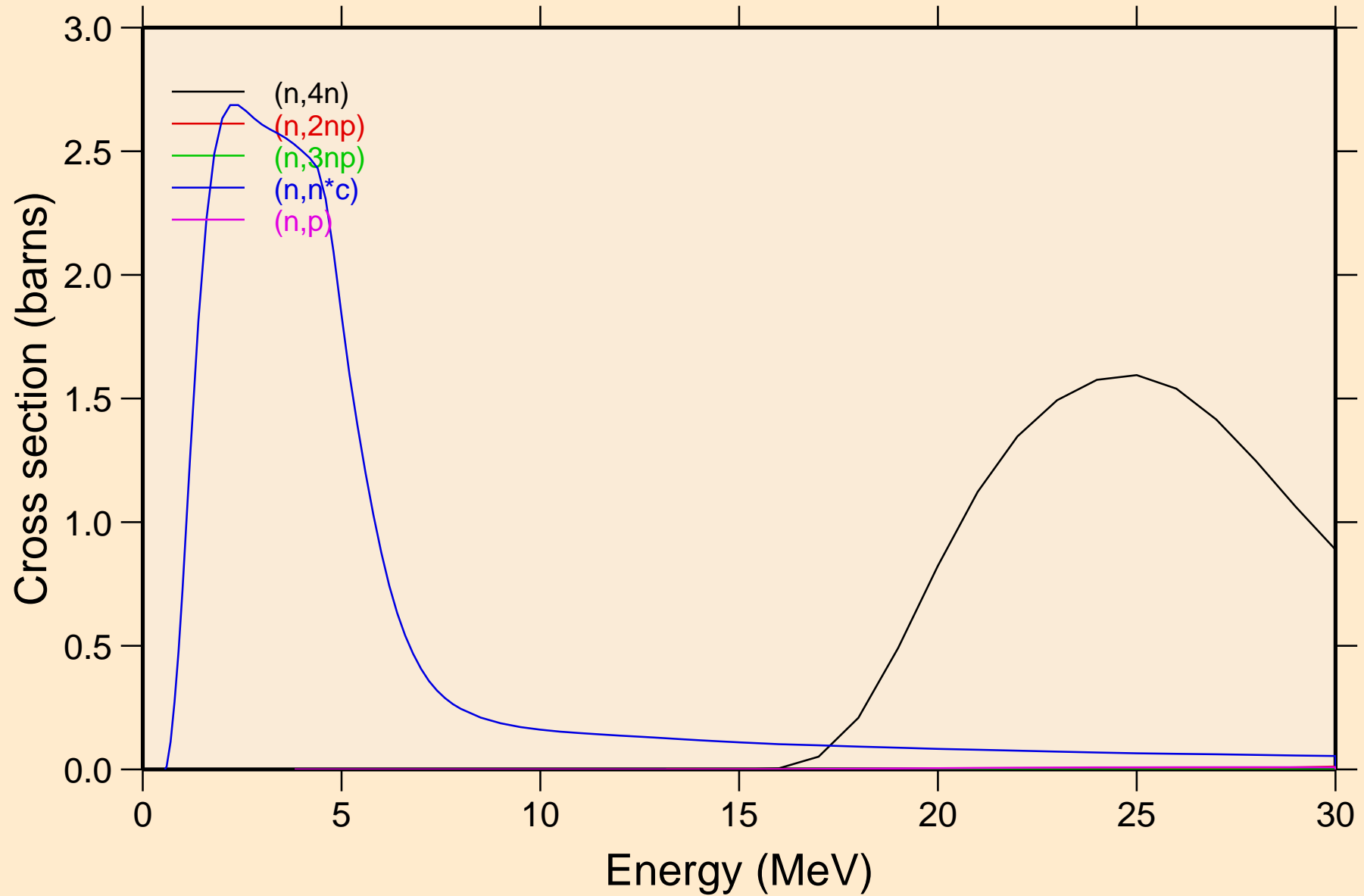

RA233 NEUTRON ACER TENDL-2024 LIBRARY; T=0.K
Threshold reactions

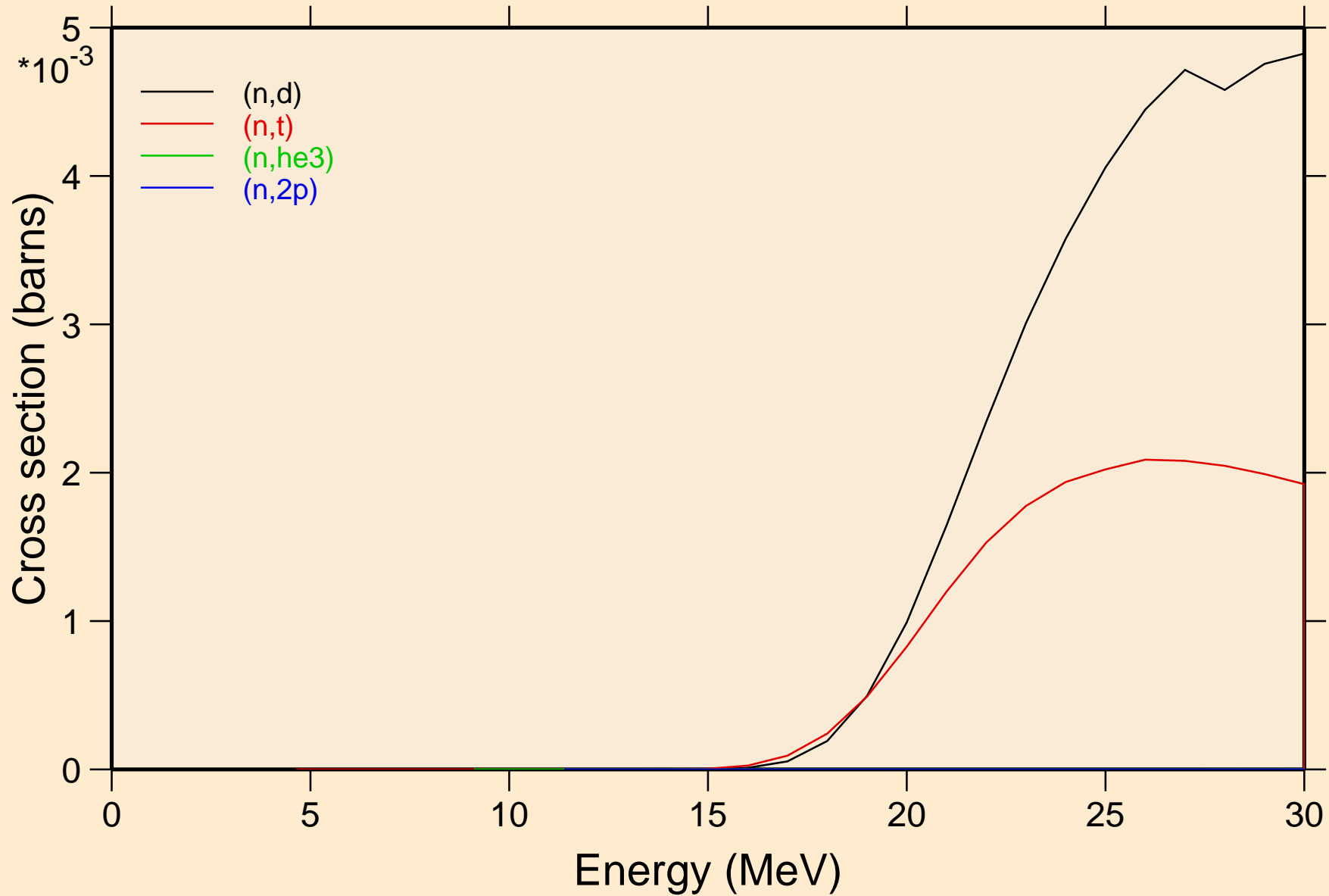

RA233 NEUTRON ACER TENDL-2024 LIBRARY; T=0.K
Threshold reactions

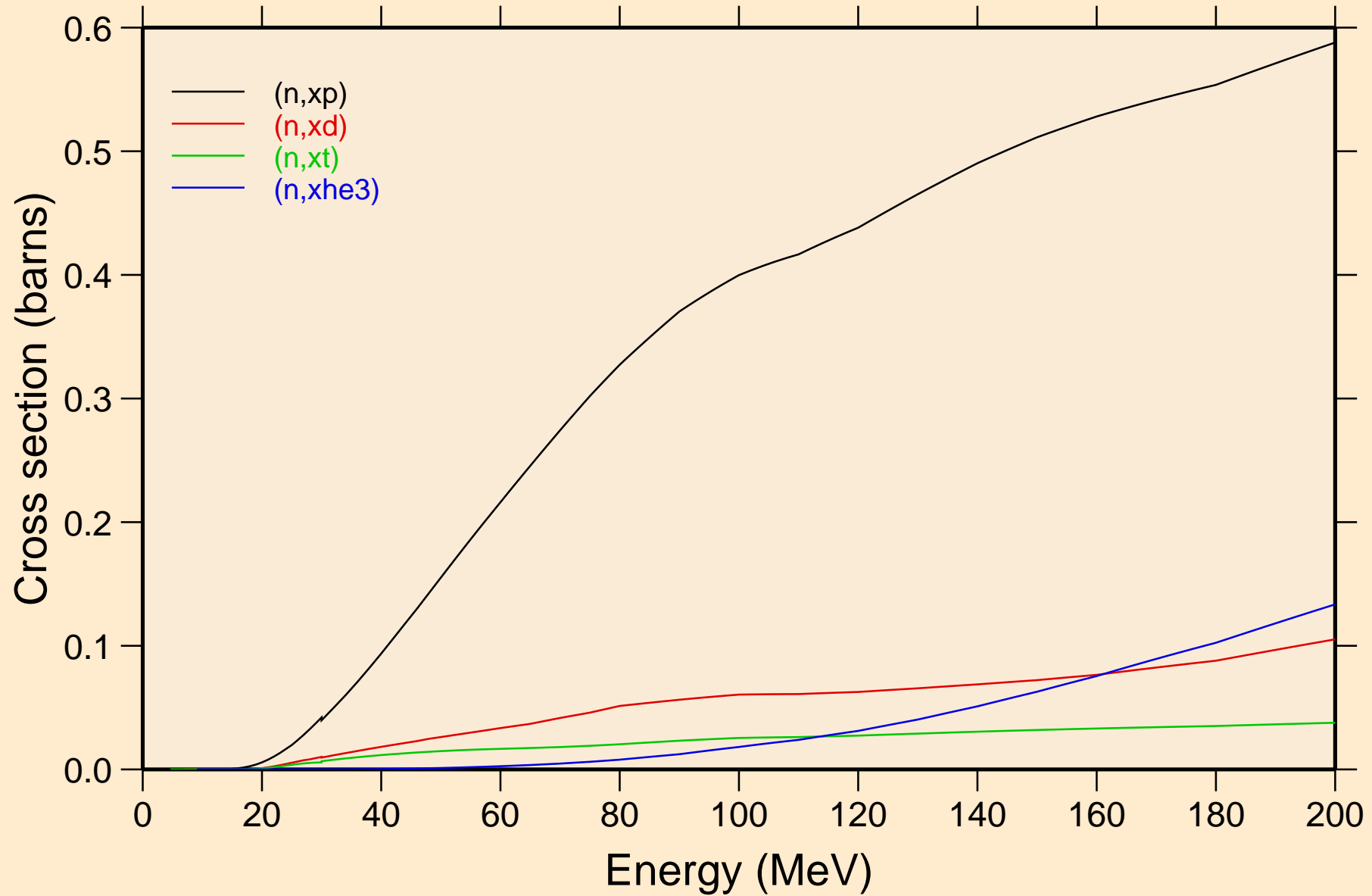

RA233 NEUTRON ACER TENDL-2024 LIBRARY; T=0.K
angular distribution for elastic

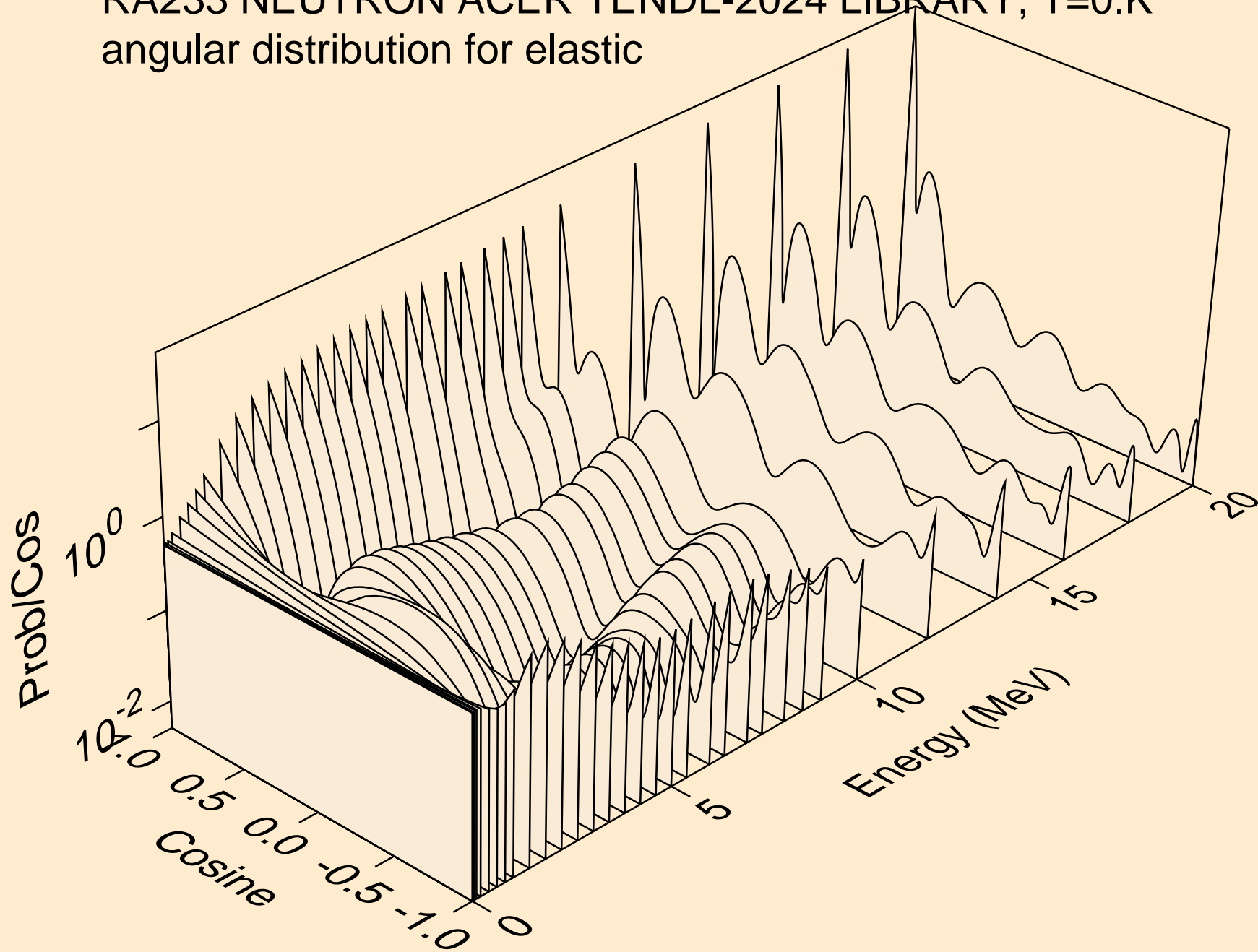

RA233 NEUTRON ACER TENDL-2024 LIBRARY; T=0.K
angular distribution for elastic

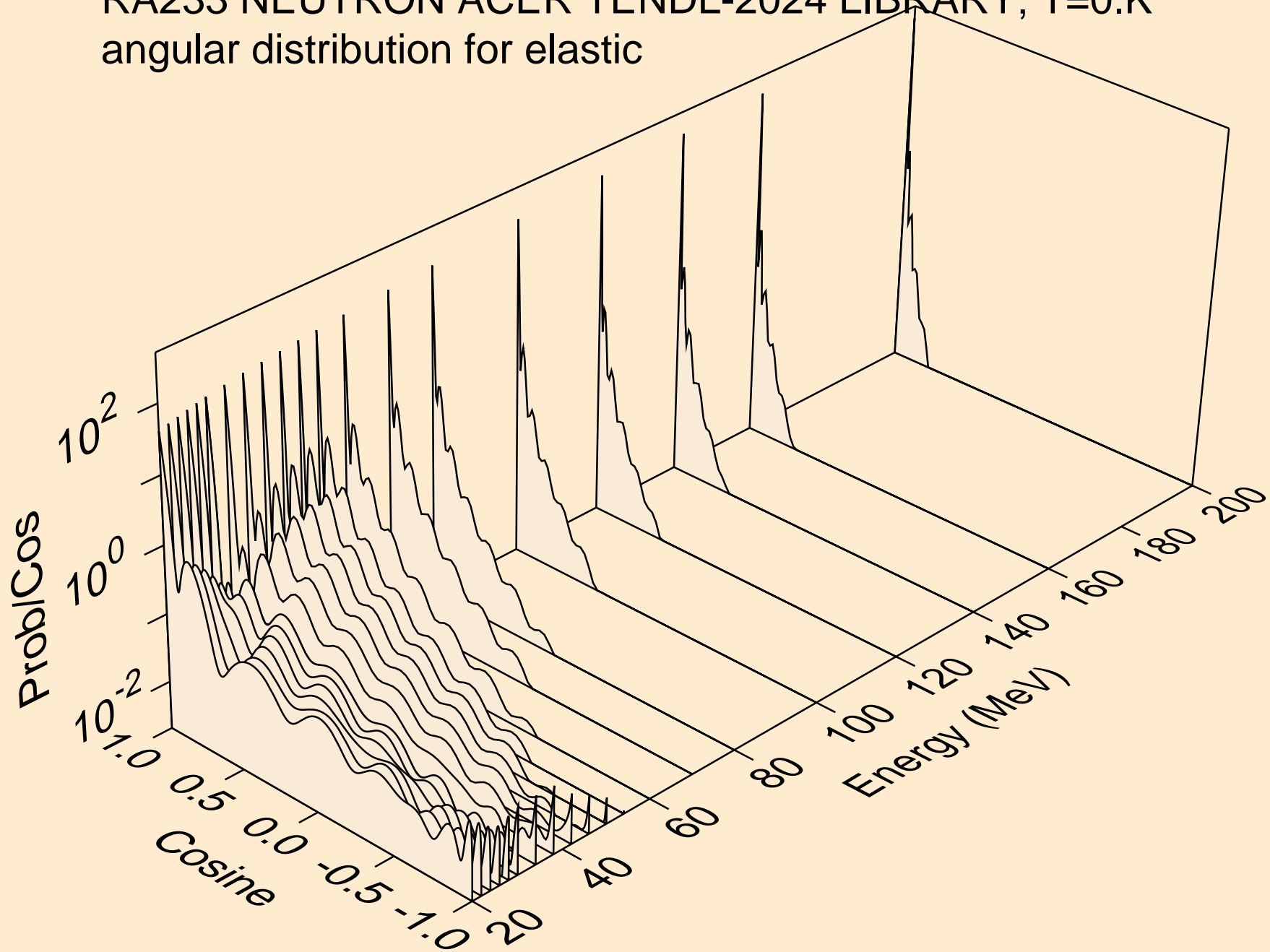

RA233 NEUTRON ACER TENDL-2024 LIBRARY; T=0.K
angular distribution for (n,n*1)

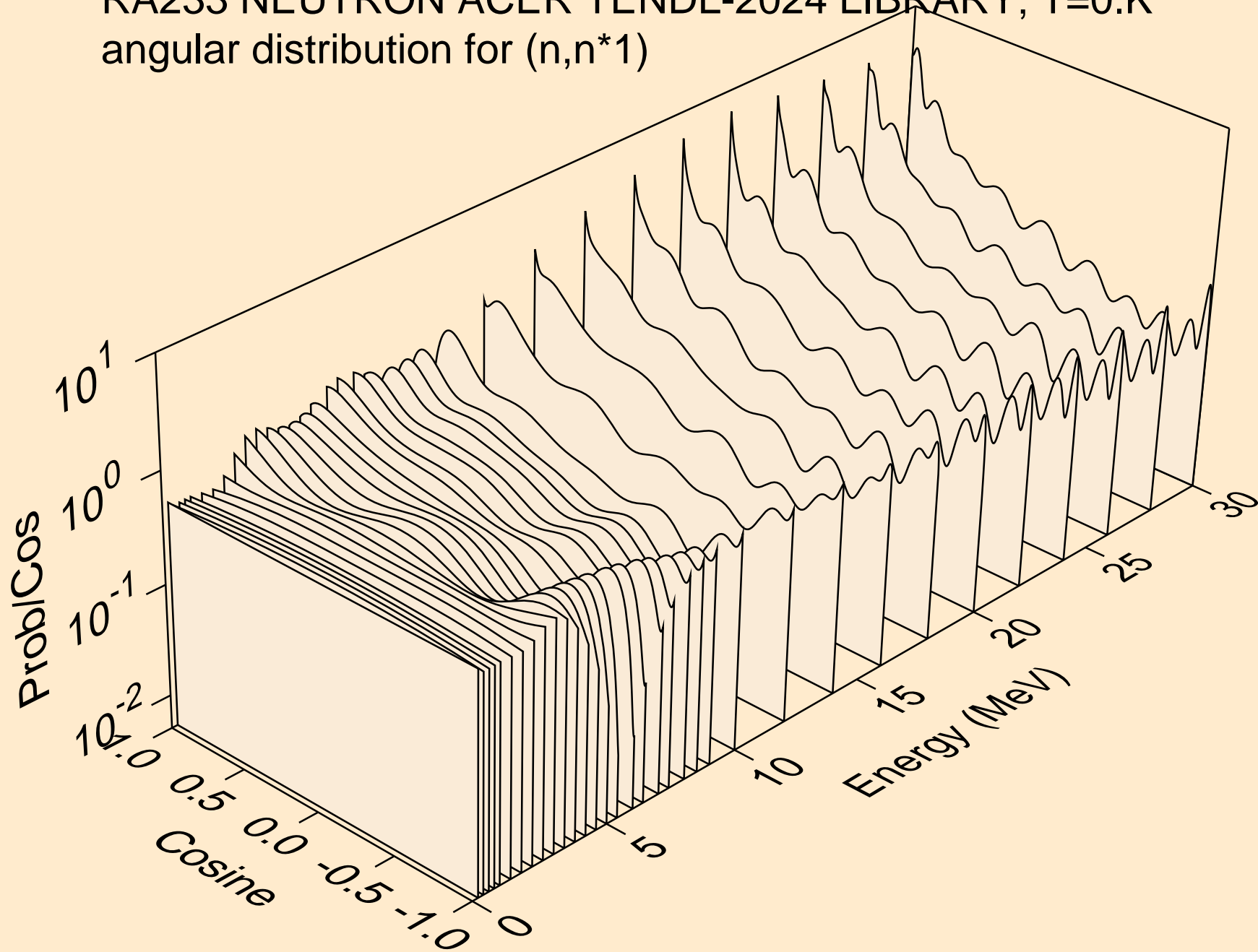

RA233 NEUTRON ACER TENDL-2024 LIBRARY; T=0.K
angular distribution for (n,n*2)

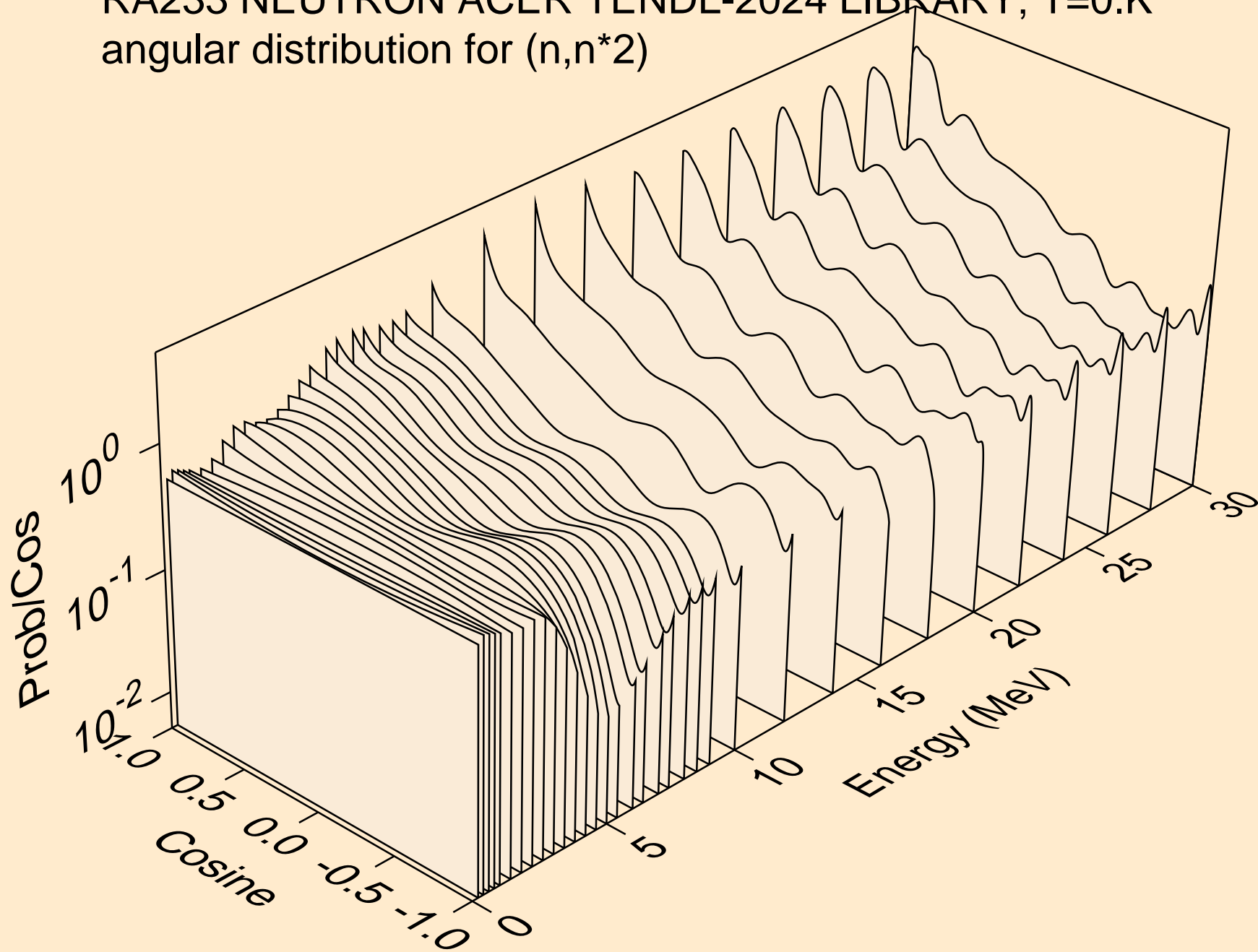

RA233 NEUTRON ACER TENDL-2024 LIBRARY; T=0.K
angular distribution for (n,n*3)

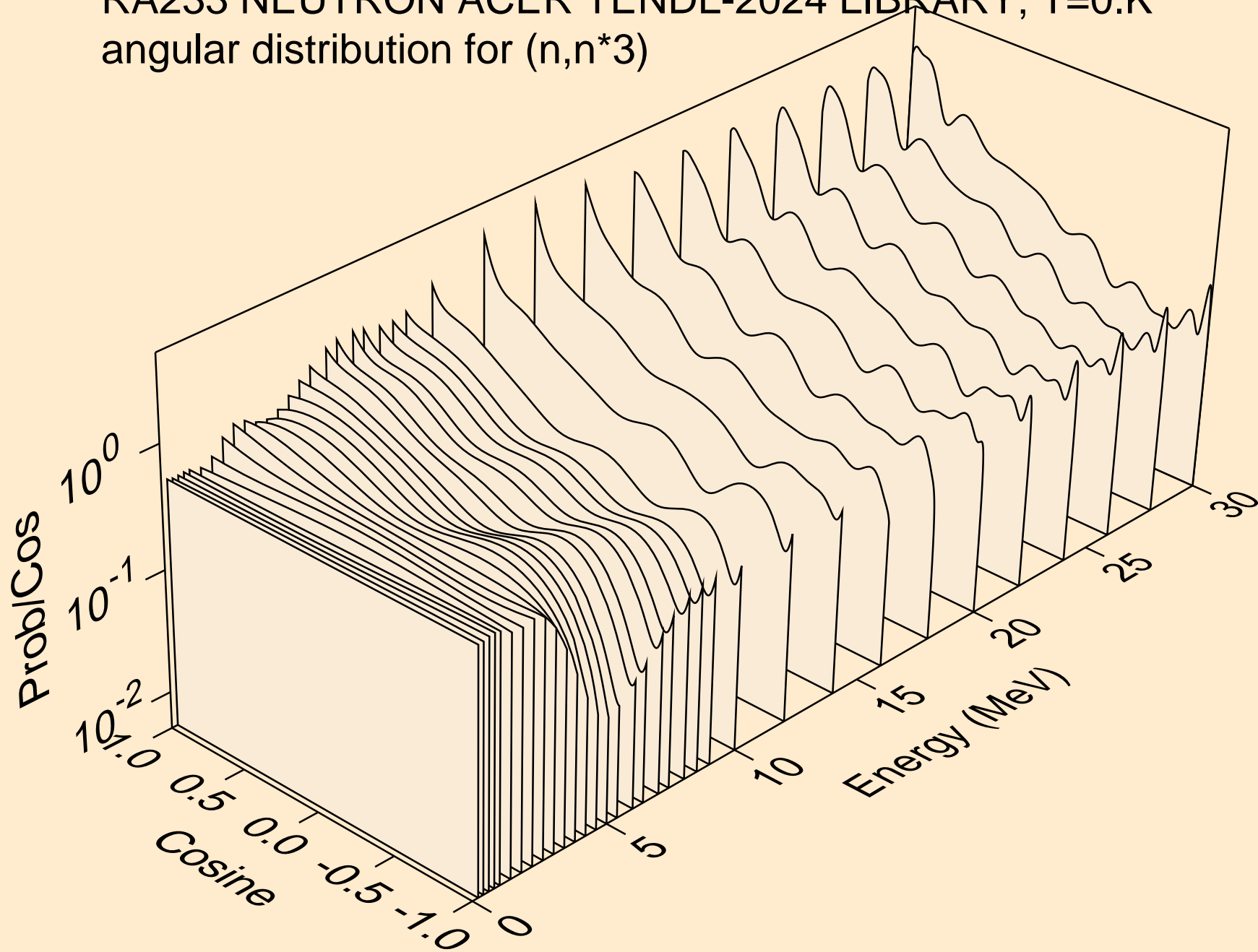

RA233 NEUTRON ACER TENDL-2024 LIBRARY; T=0.K
angular distribution for (n,n*4)

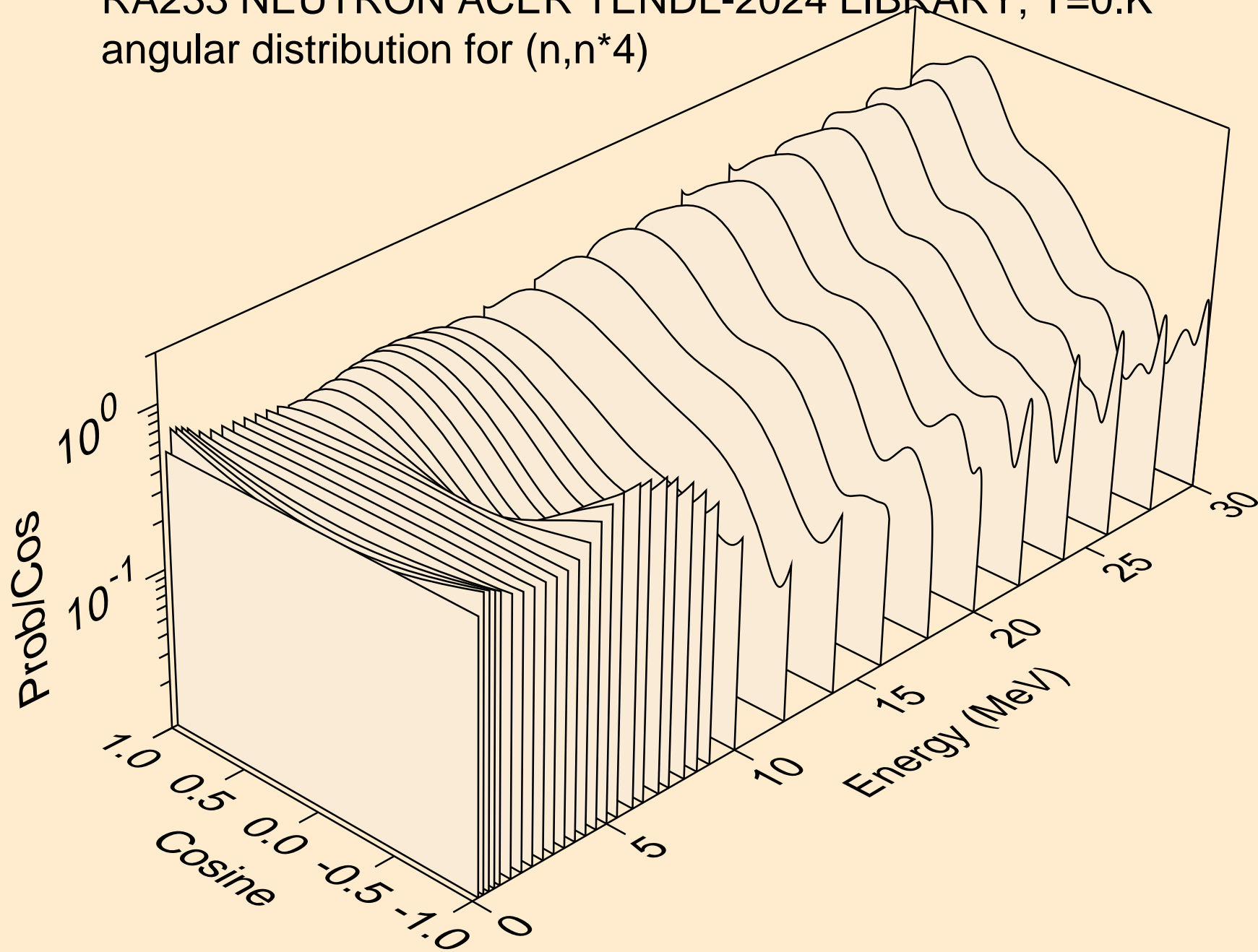

RA233 NEUTRON ACER TENDL-2024 LIBRARY; T=0.K
angular distribution for (n,n*5)

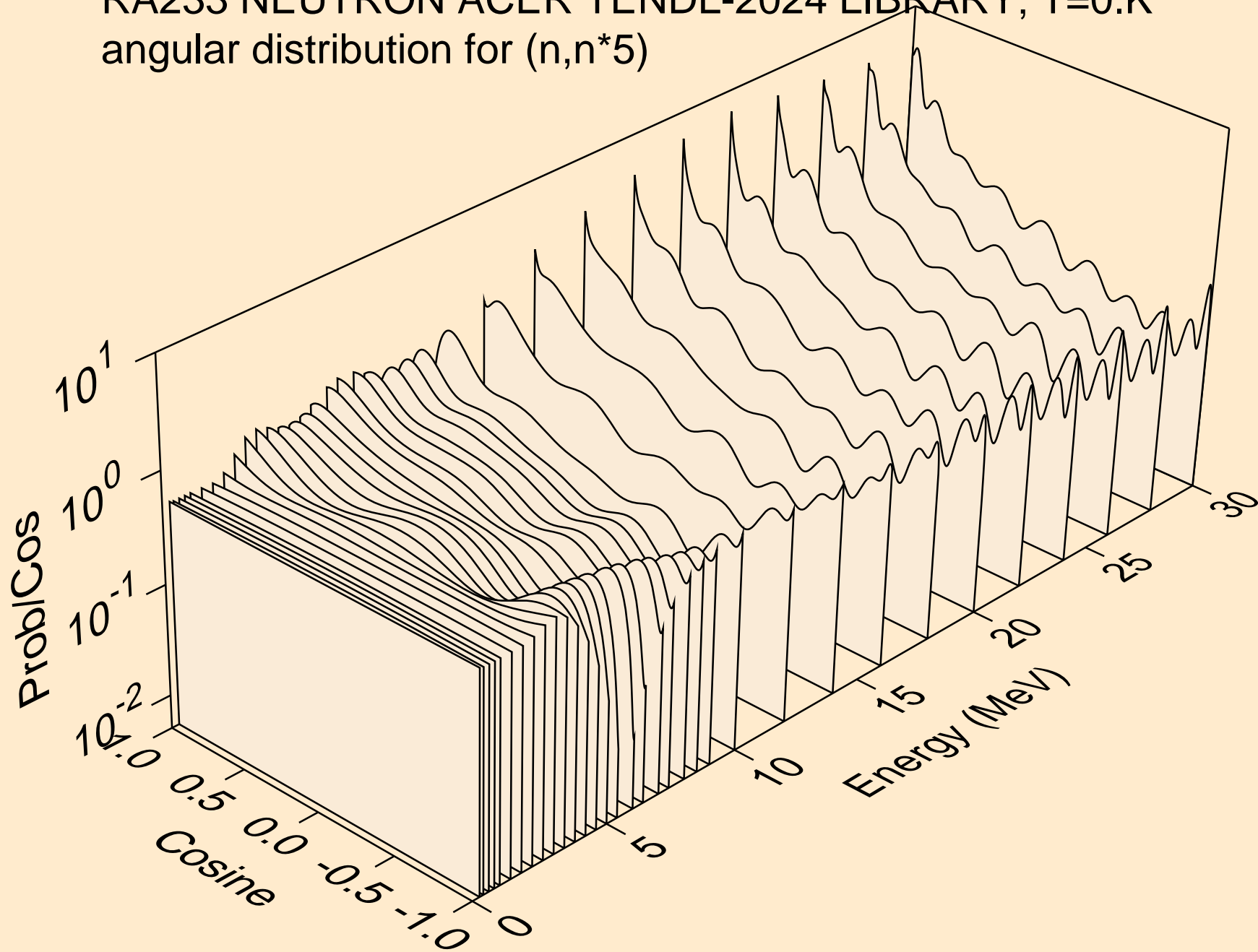

RA233 NEUTRON ACER TENDL-2024 LIBRARY; T=0.K
angular distribution for (n,n*6)

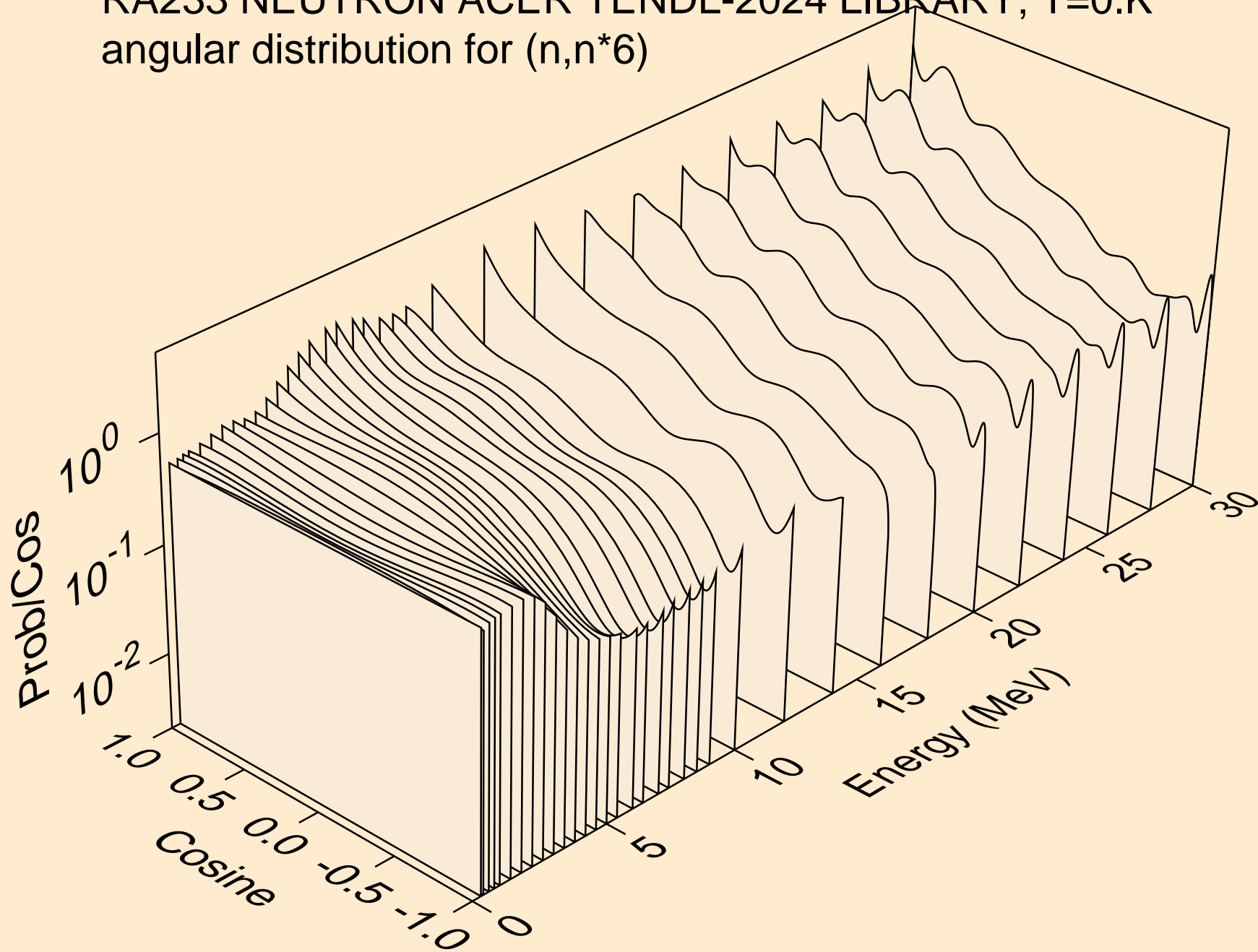

RA233 NEUTRON ACER TENDL-2024 LIBRARY; T=0.K
angular distribution for (n,n*7)

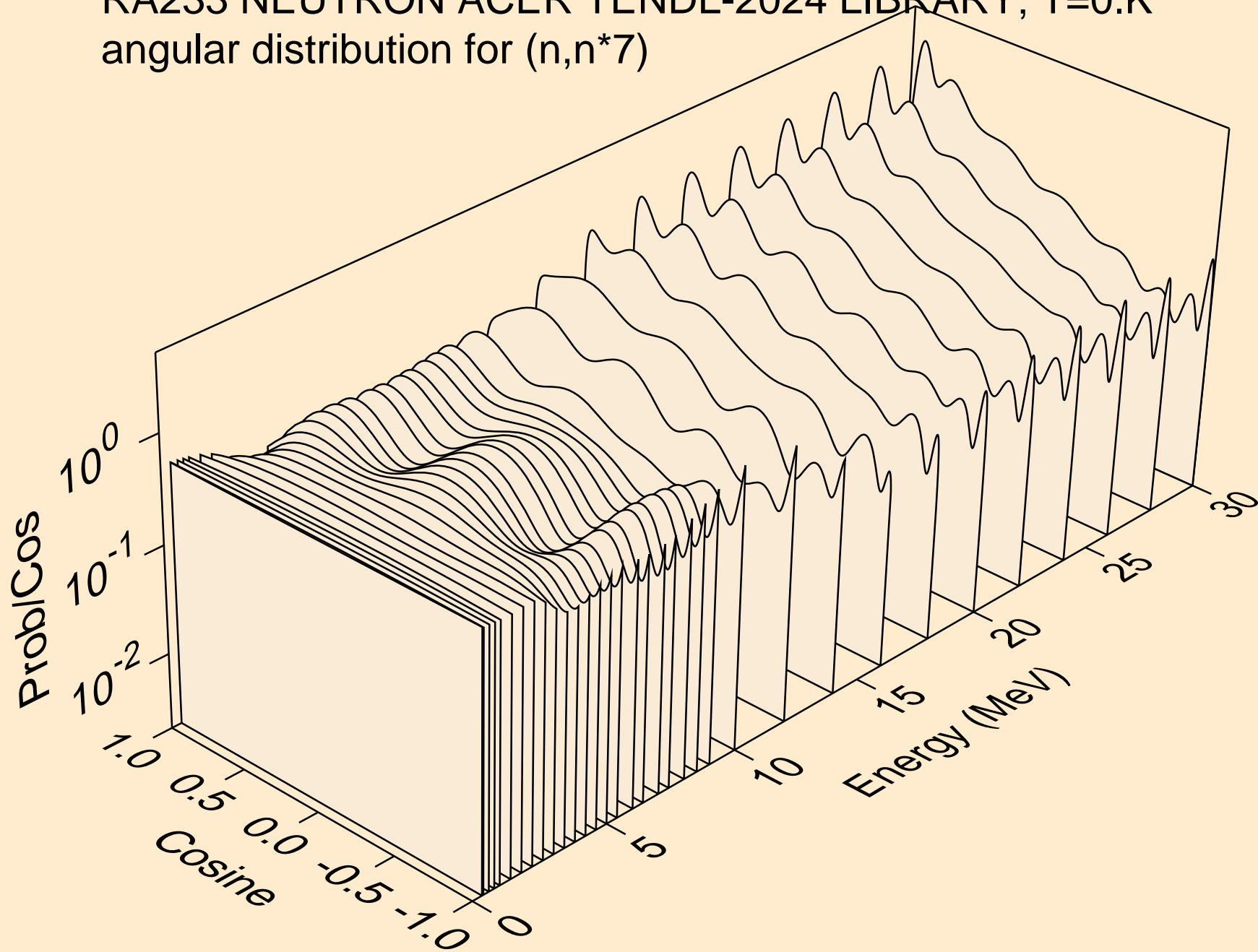

RA233 NEUTRON ACER TENDL-2024 LIBRARY; T=0.K
angular distribution for (n,n*8)

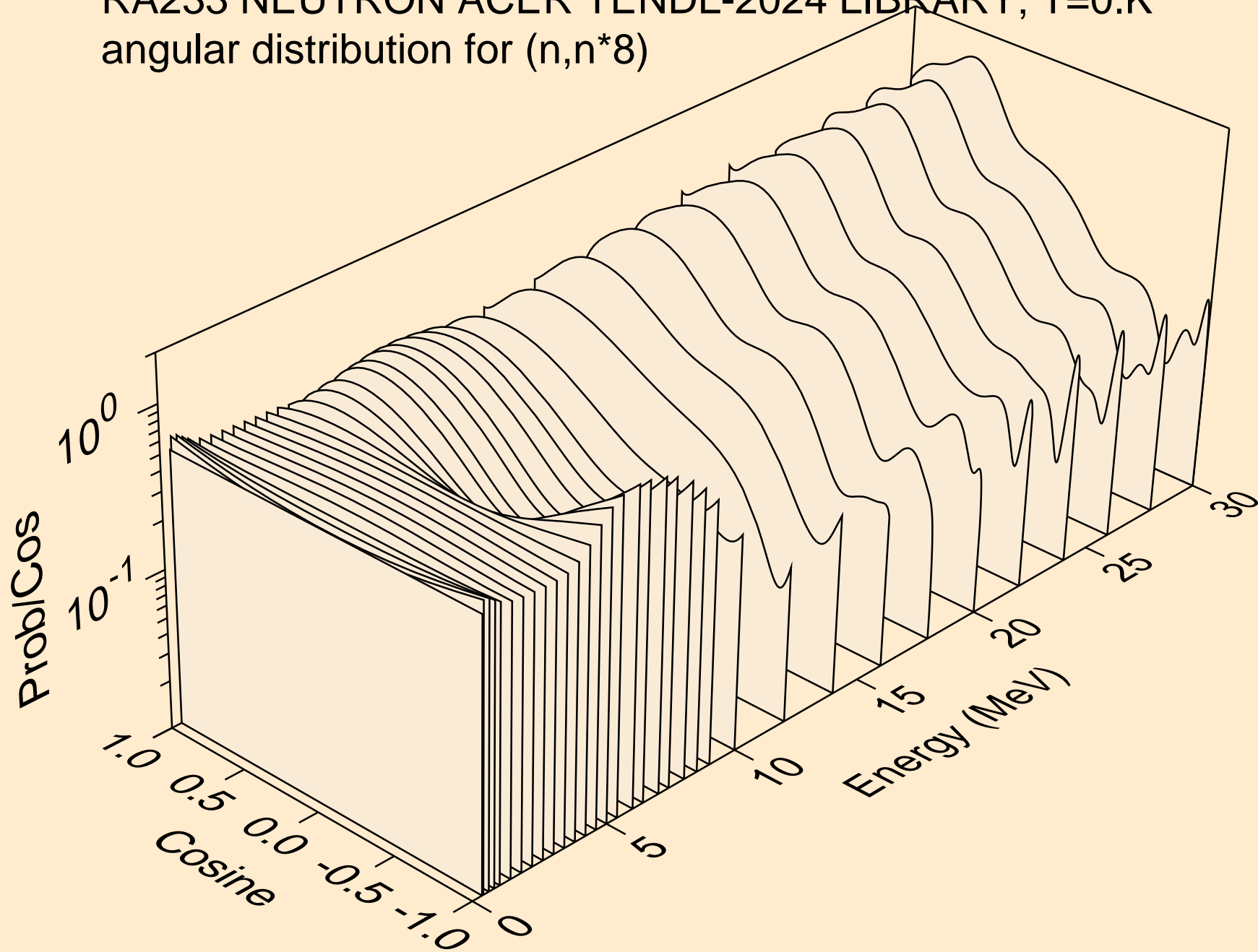

RA233 NEUTRON ACER TENDL-2024 LIBRARY; T=0.K
angular distribution for (n,n*9)

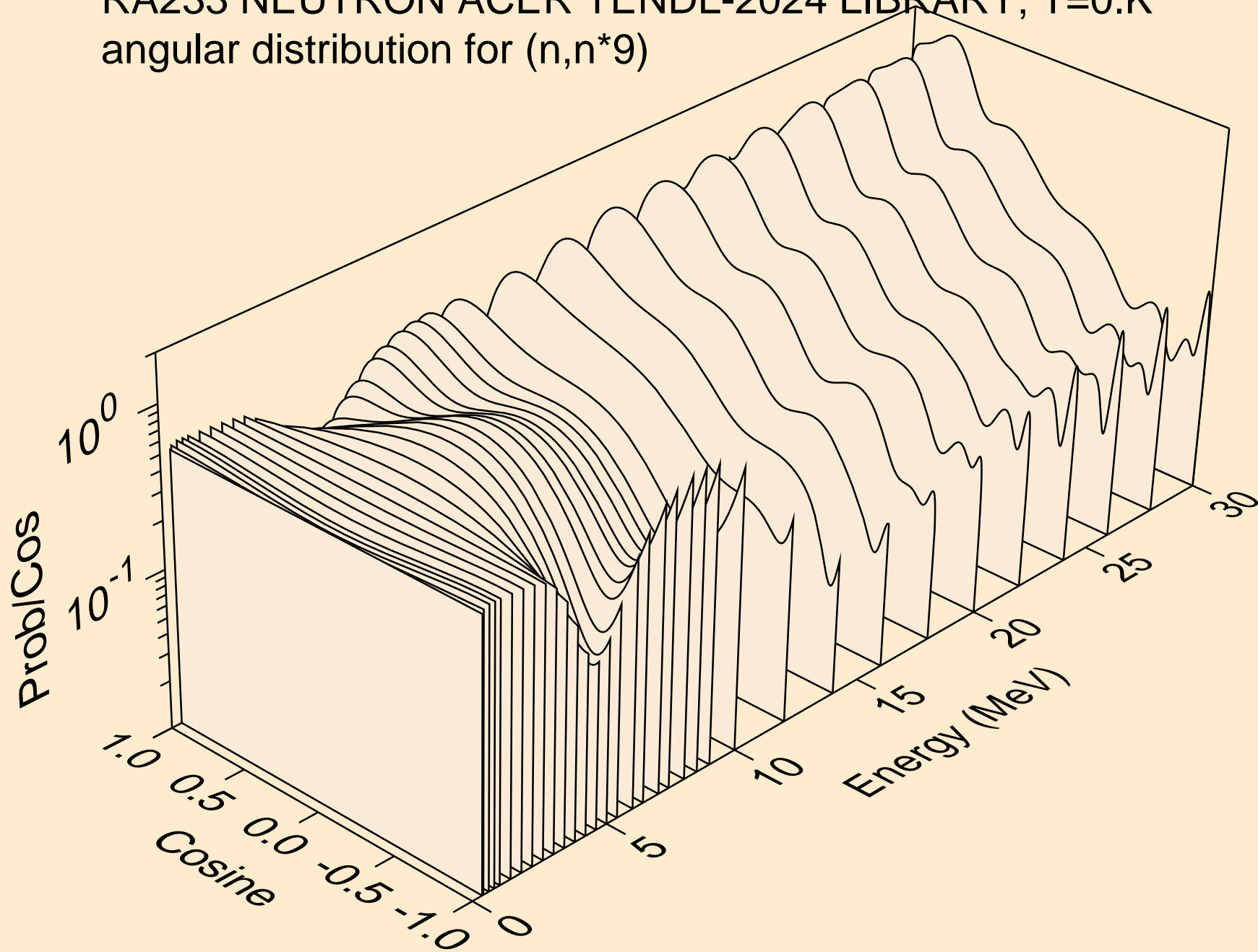

RA233 NEUTRON ACER TENDL-2024 LIBRARY; T=0.K
angular distribution for (n,n*10)

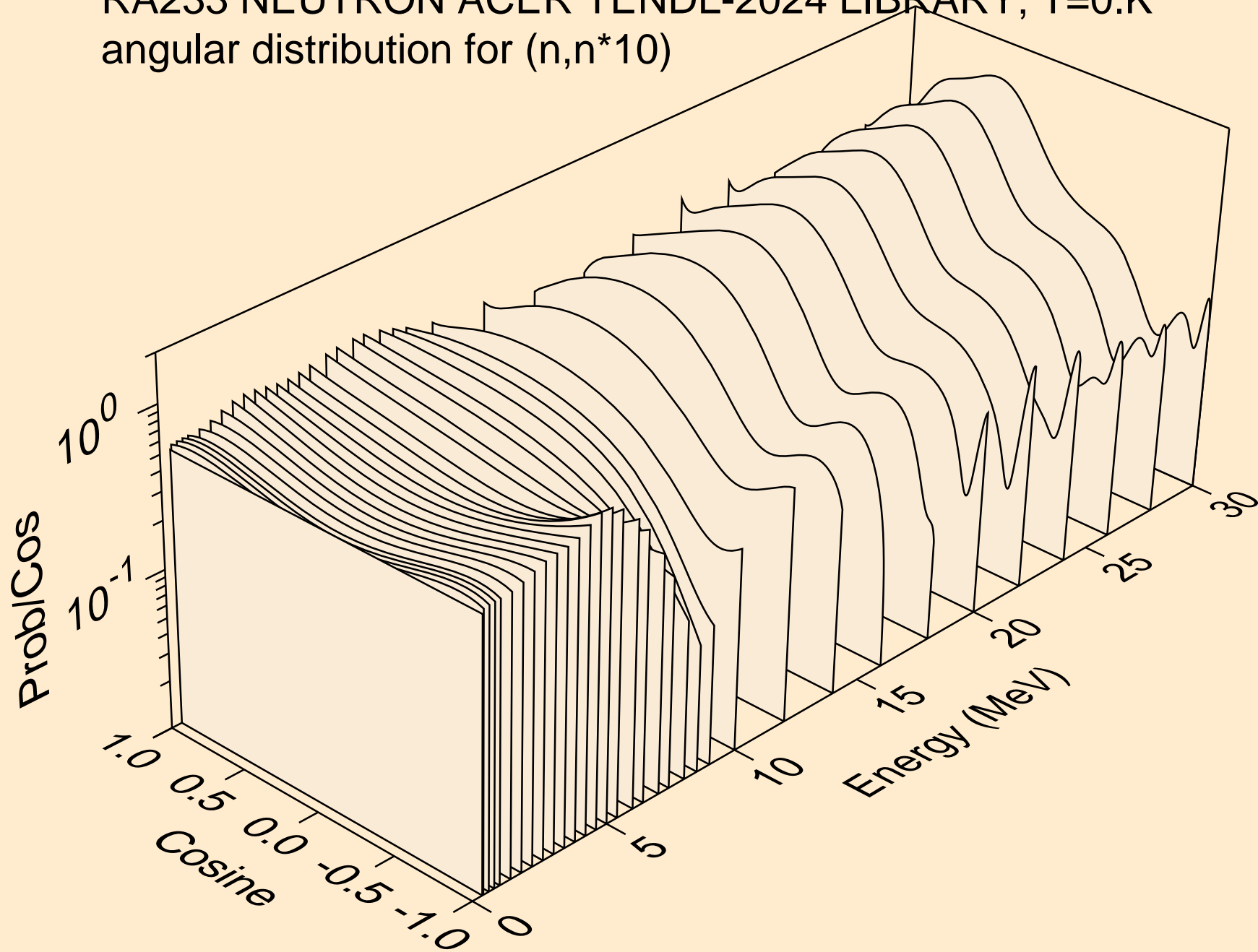

RA233 NEUTRON ACER TENDL-2024 LIBRARY; T=0.K
angular distribution for (n,n*11)

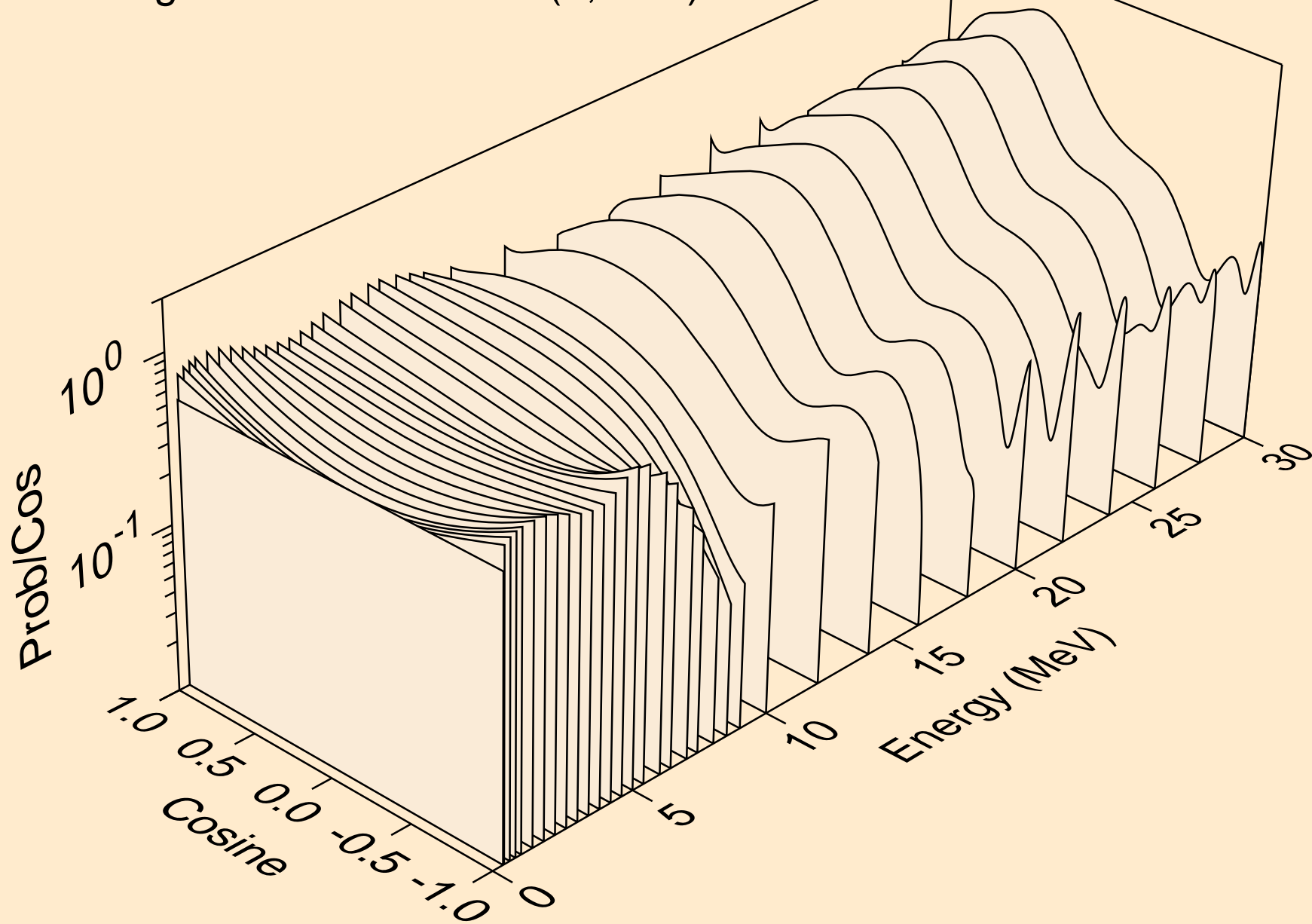

RA233 NEUTRON ACER TENDL-2024 LIBRARY; T=0.K
angular distribution for (n,n*12)

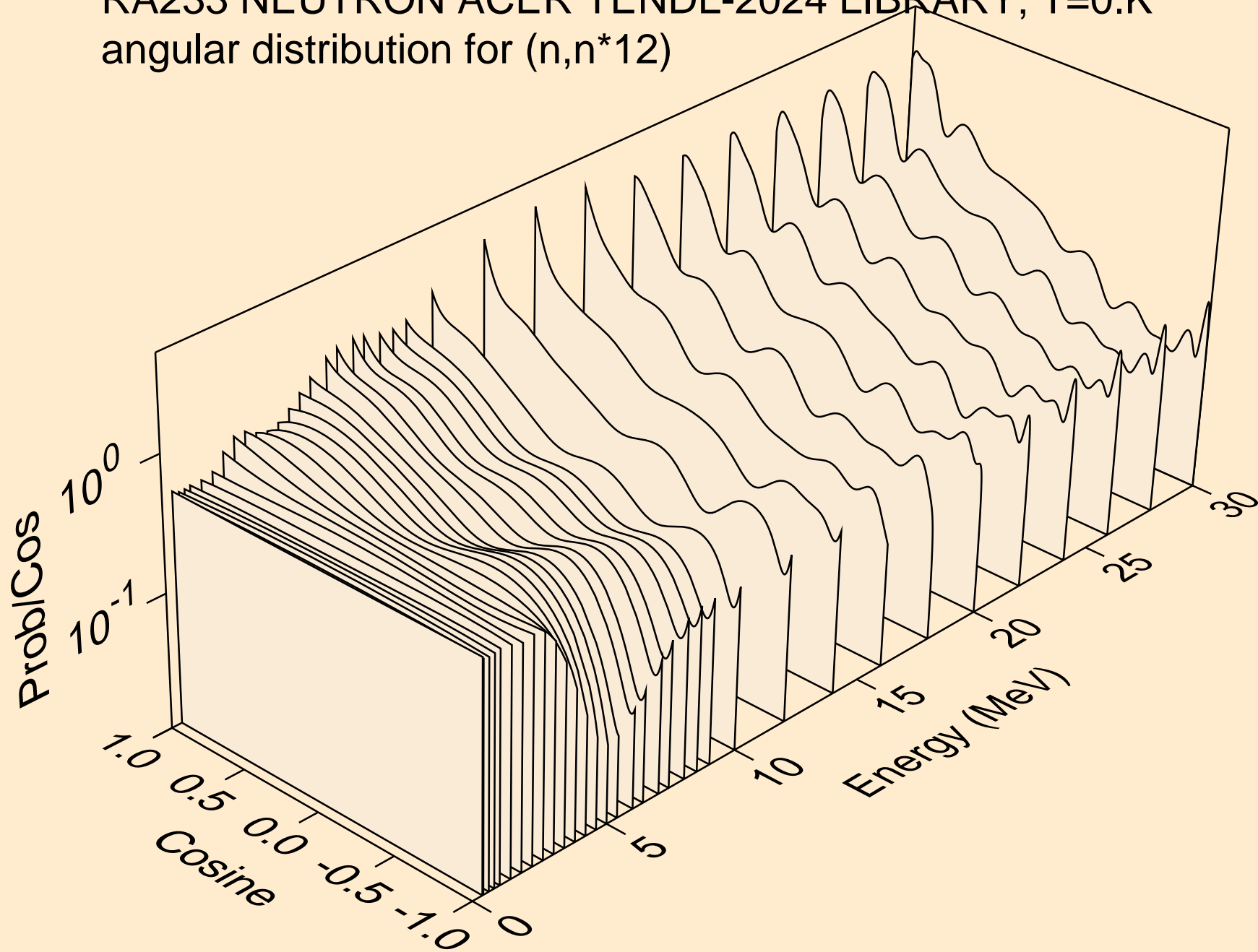

RA233 NEUTRON ACER TENDL-2024 LIBRARY; T=0.K
angular distribution for (n,n*13)

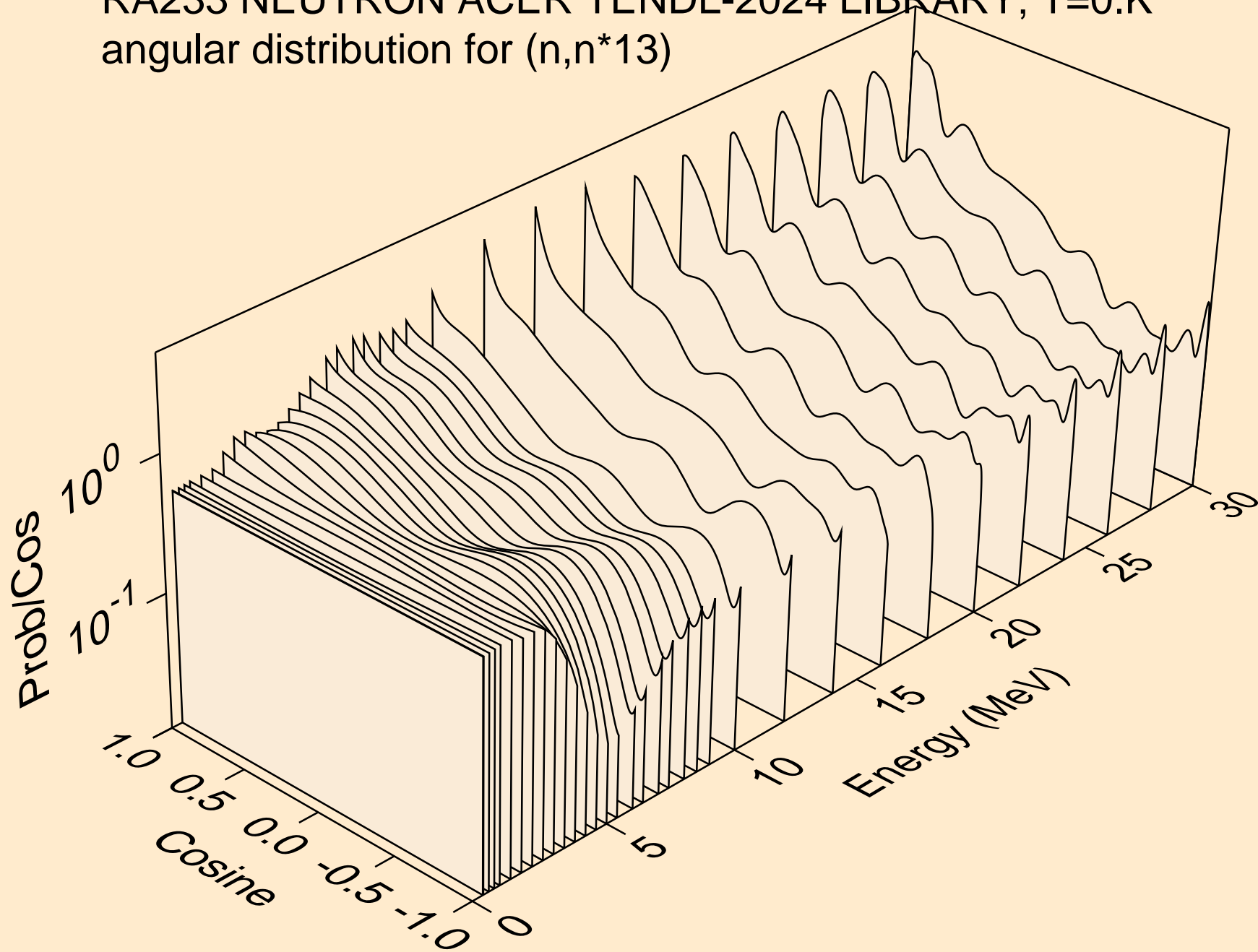

RA233 NEUTRON ACER TENDL-2024 LIBRARY; T=0.K
angular distribution for (n,n*14)

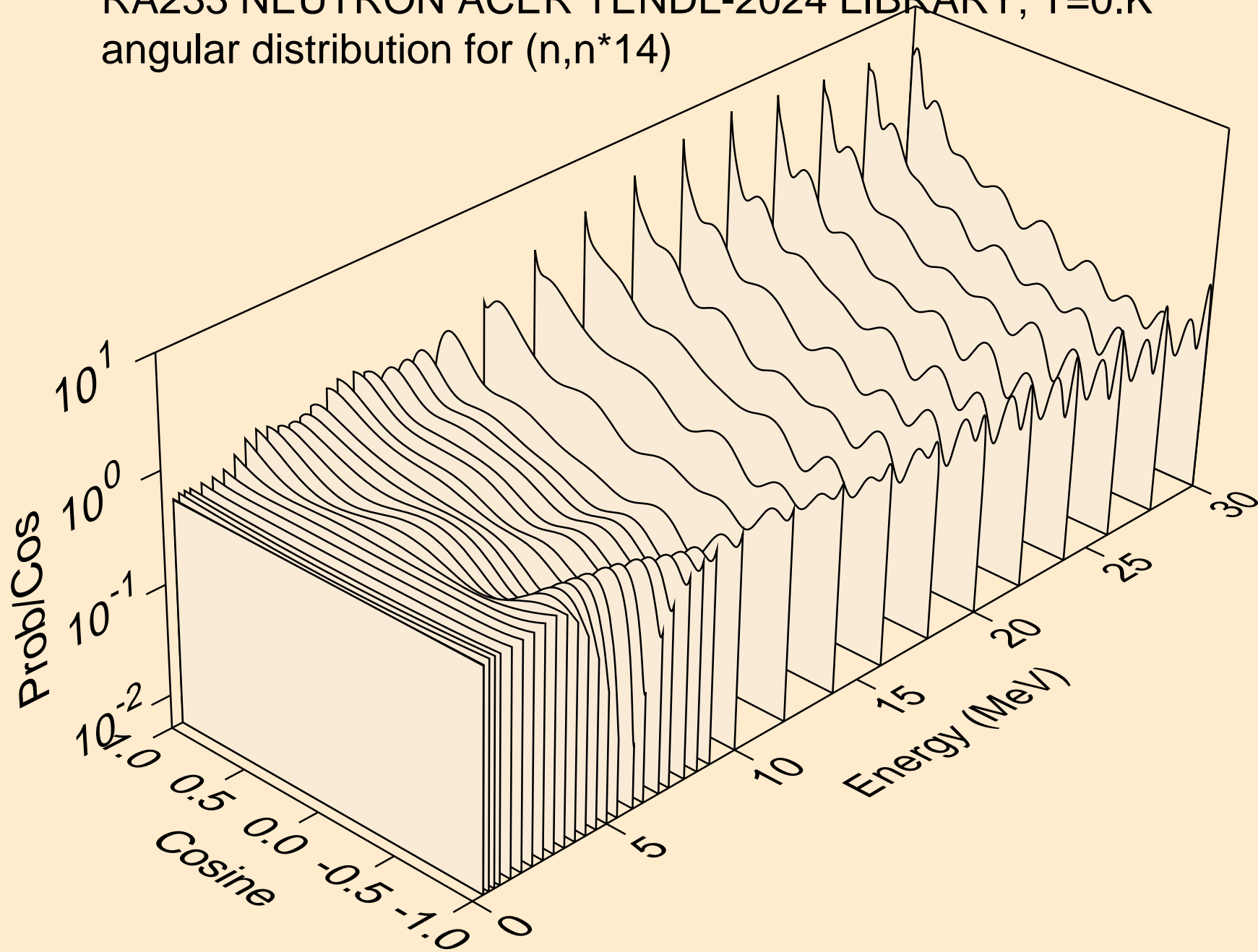

RA233 NEUTRON ACER TENDL-2024 LIBRARY; T=0.K
angular distribution for (n,n*15)

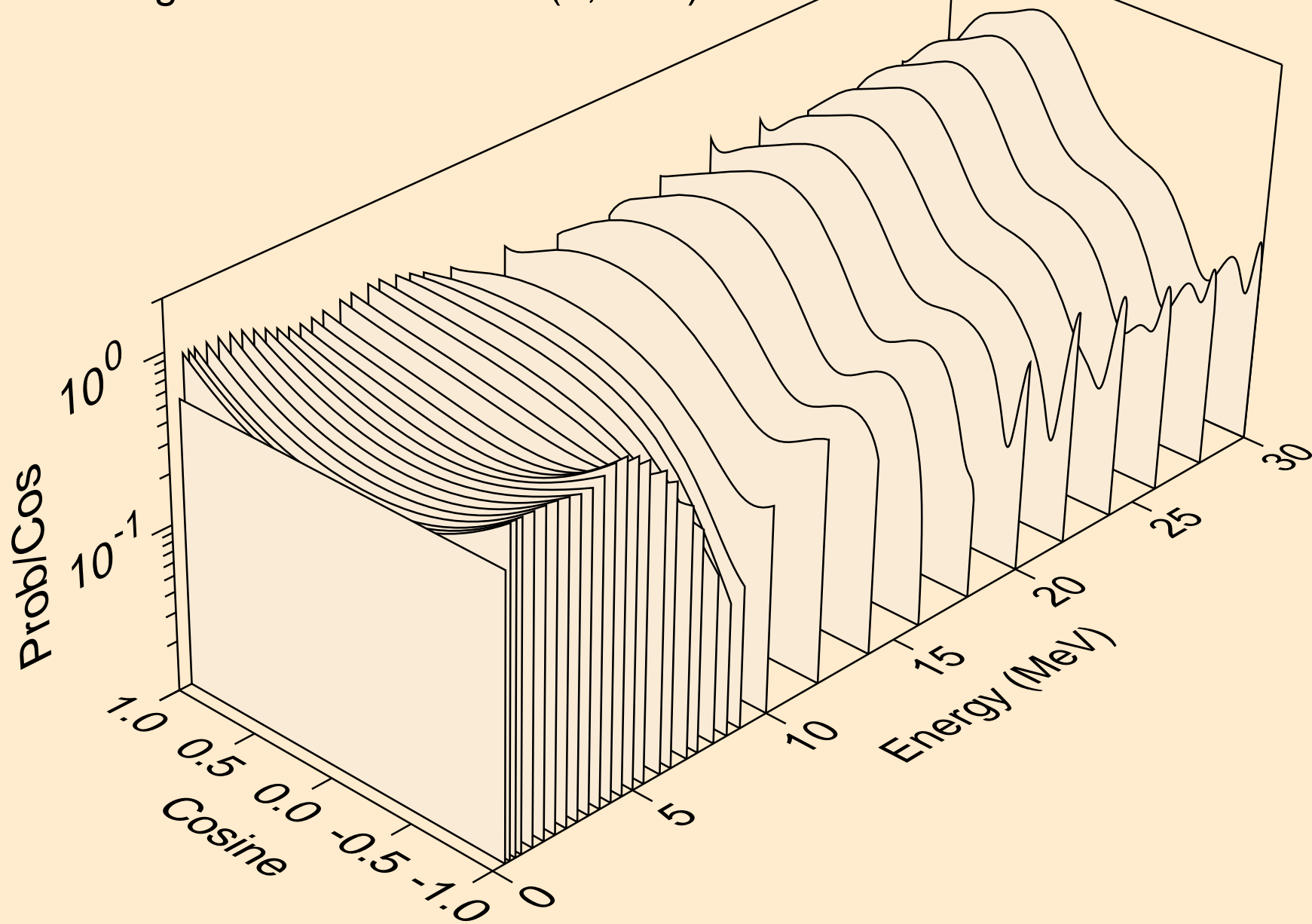

RA233 NEUTRON ACER TENDL-2024 LIBRARY; T=0.K
angular distribution for (n,n*16)

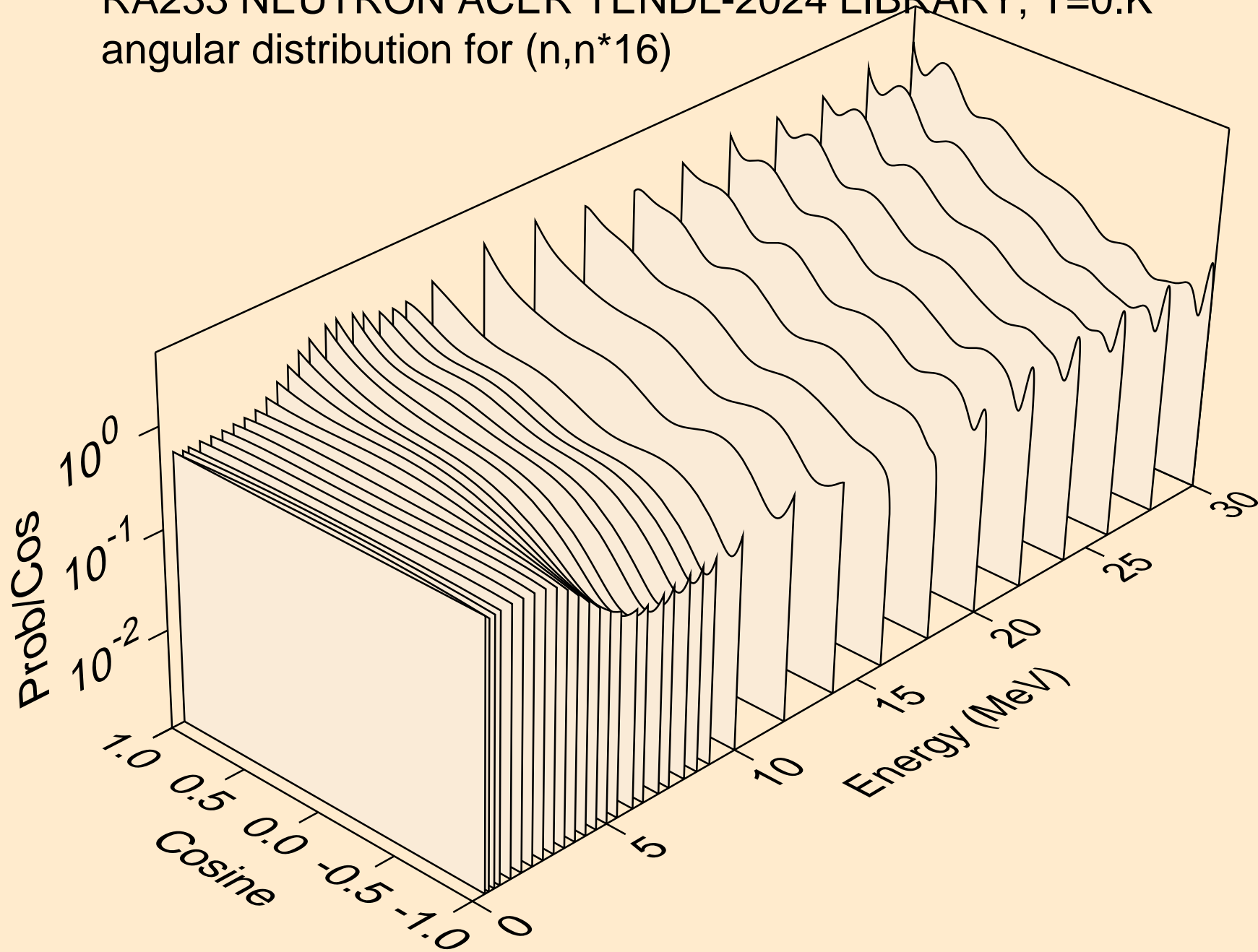

RA233 NEUTRON ACER TENDL-2024 LIBRARY; T=0.K
angular distribution for (n,n*17)

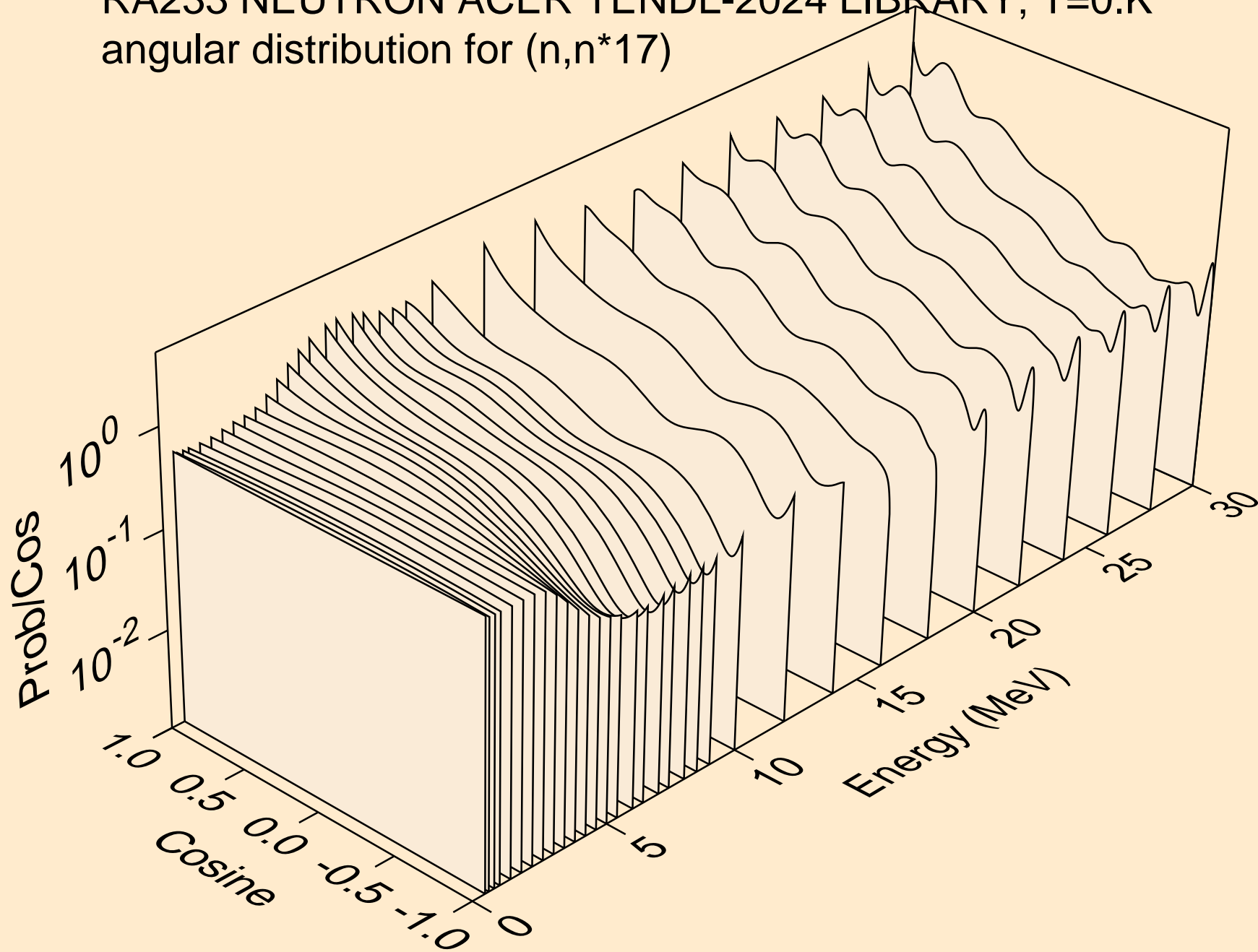

RA233 NEUTRON ACER TENDL-2024 LIBRARY; T=0.K
angular distribution for (n,n*18)

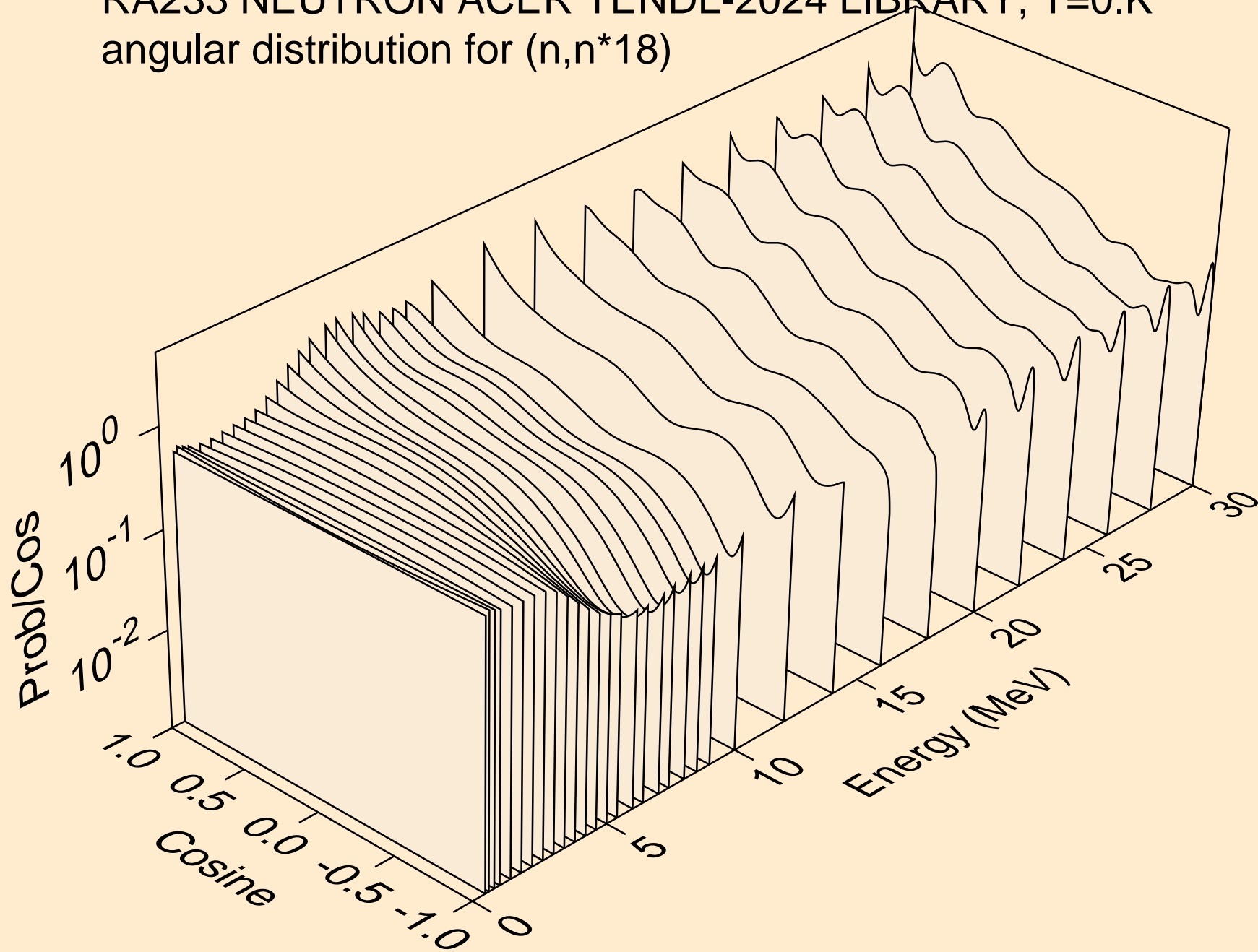

RA233 NEUTRON ACER TENDL-2024 LIBRARY; T=0.K
angular distribution for (n,n*19)

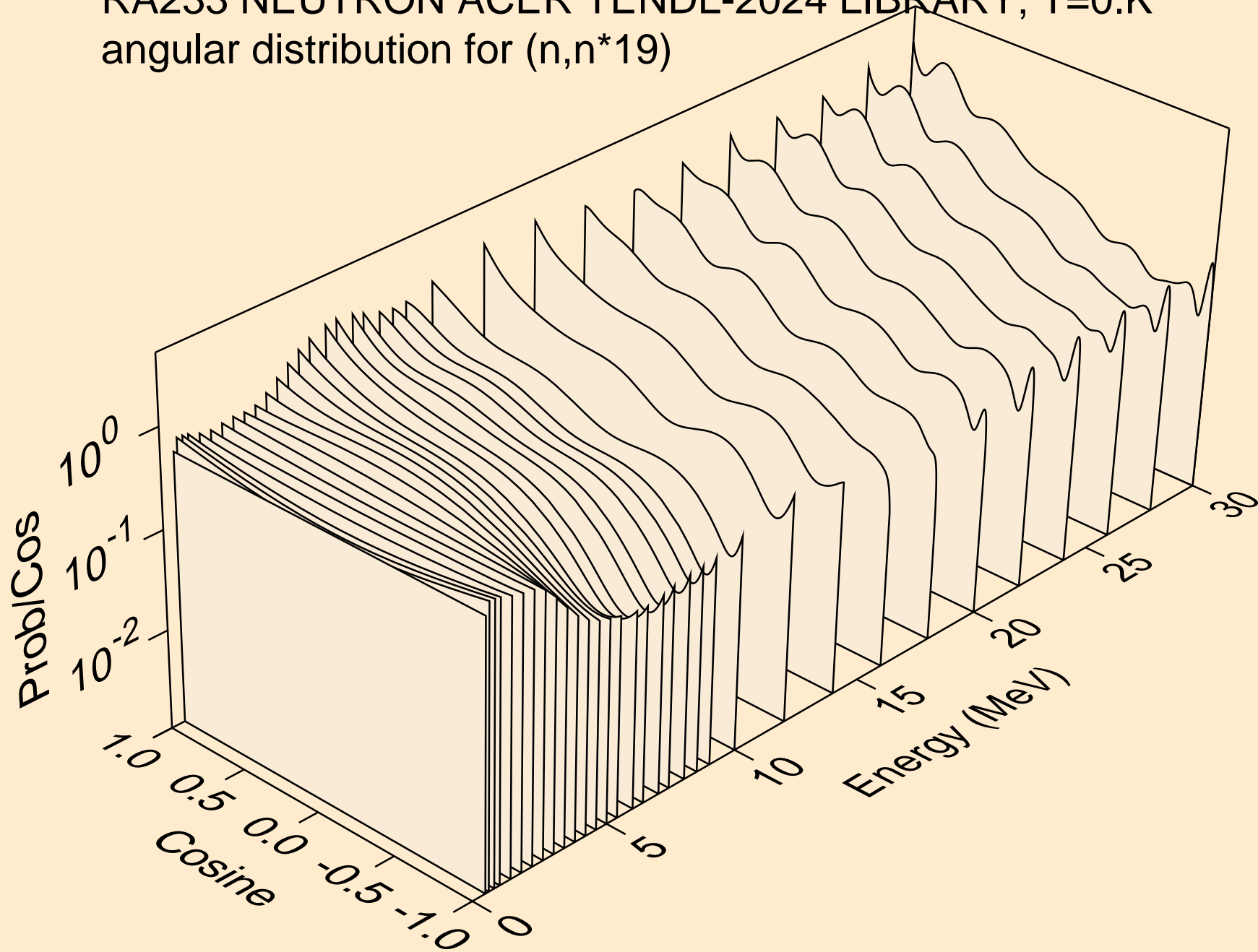

RA233 NEUTRON ACER TENDL-2024 LIBRARY; T=0.K
angular distribution for (n,n*20)

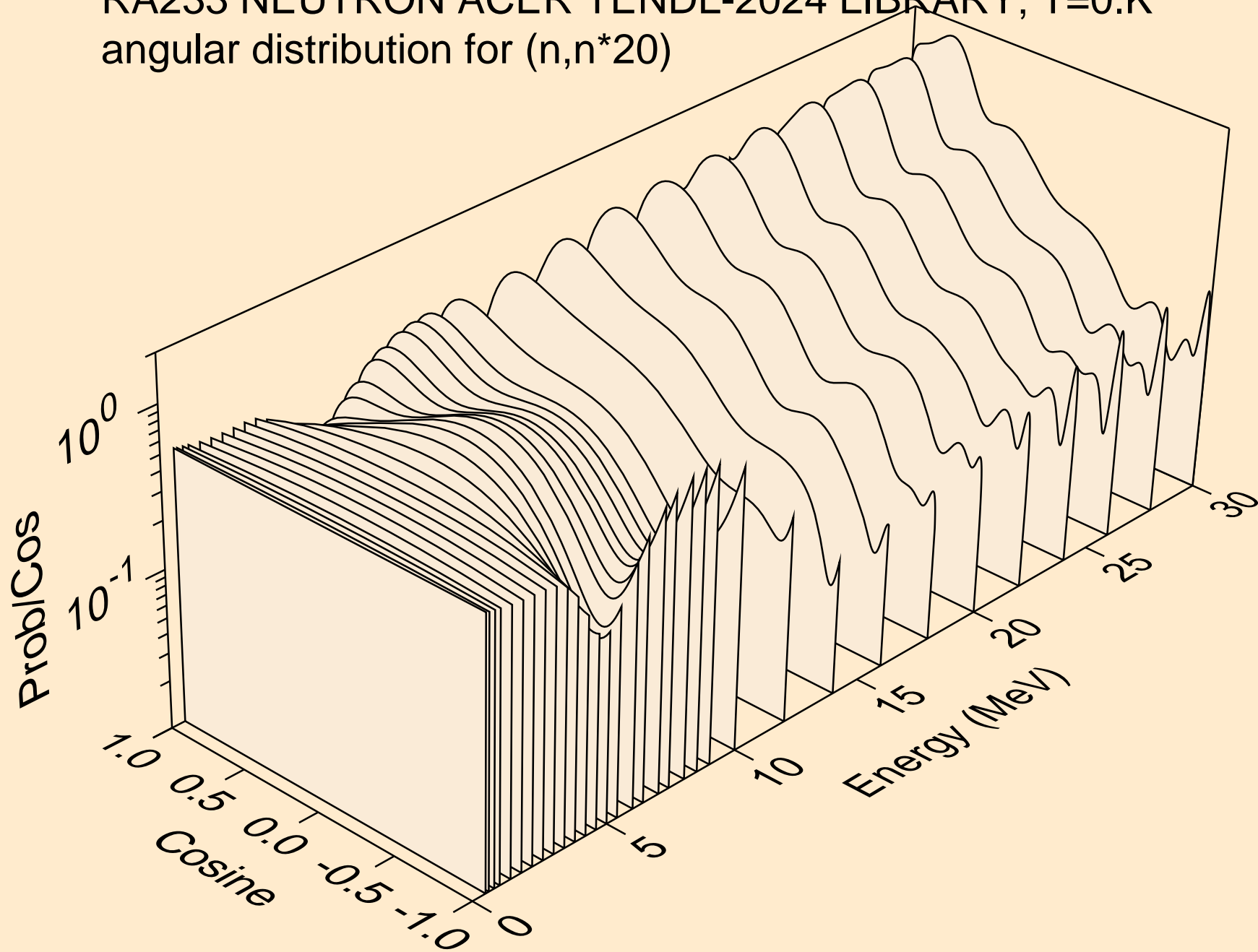

RA233 NEUTRON ACER TENDL-2024 LIBRARY; T=0.K
angular distribution for (n,n*21)

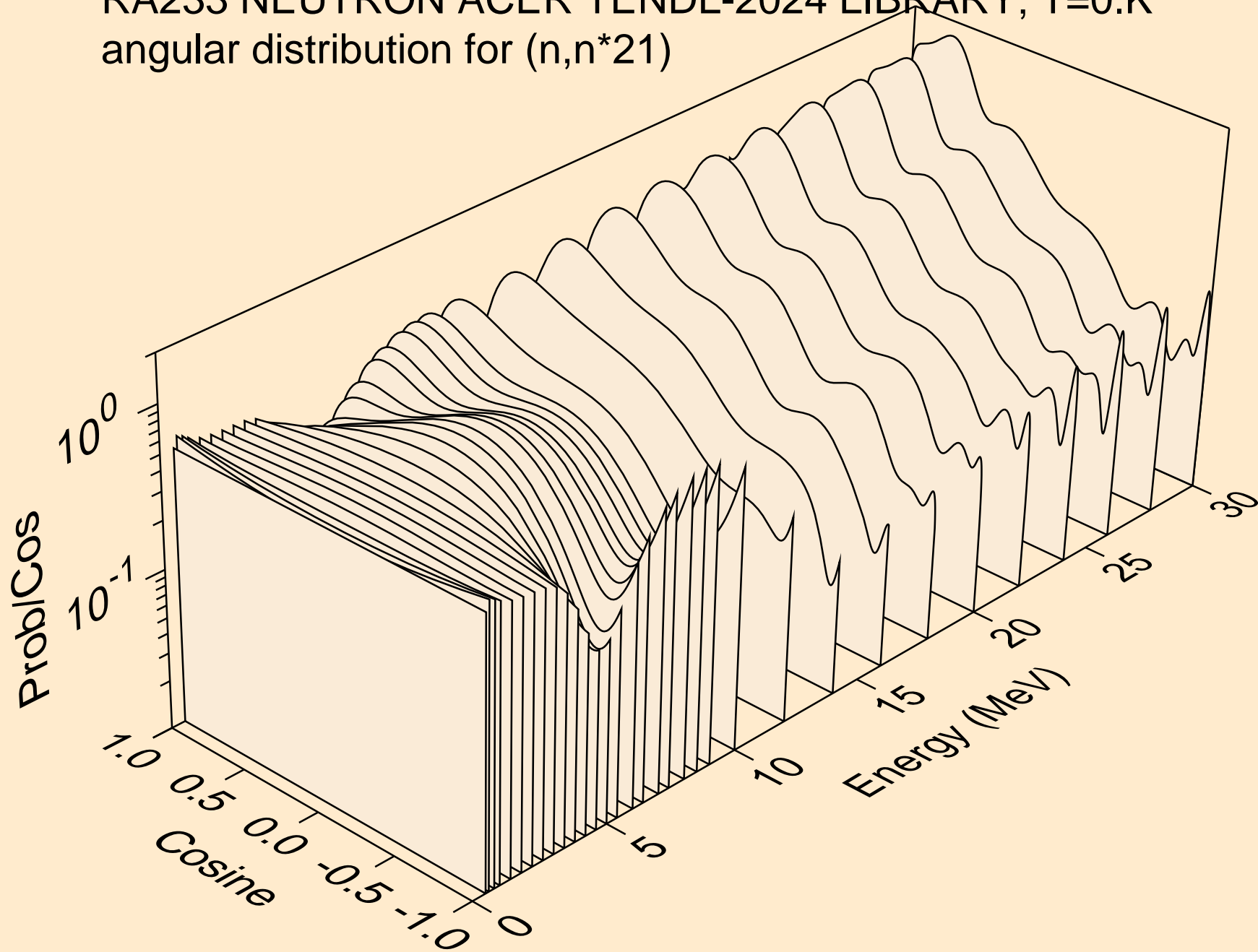

RA233 NEUTRON ACER TENDL-2024 LIBRARY; T=0.K
angular distribution for (n,n*22)

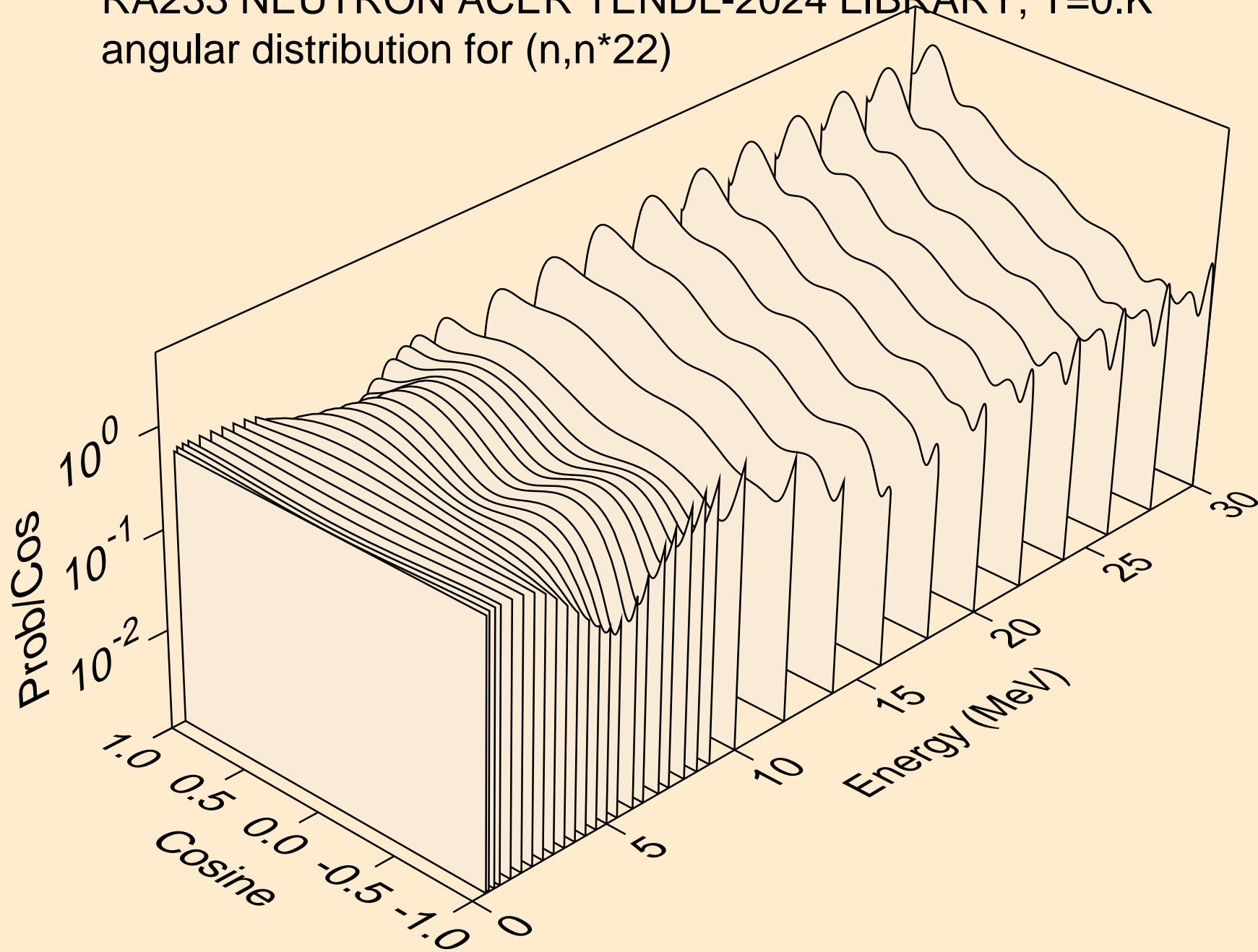

RA233 NEUTRON ACER TENDL-2024 LIBRARY; T=0.K
angular distribution for (n,n*23)

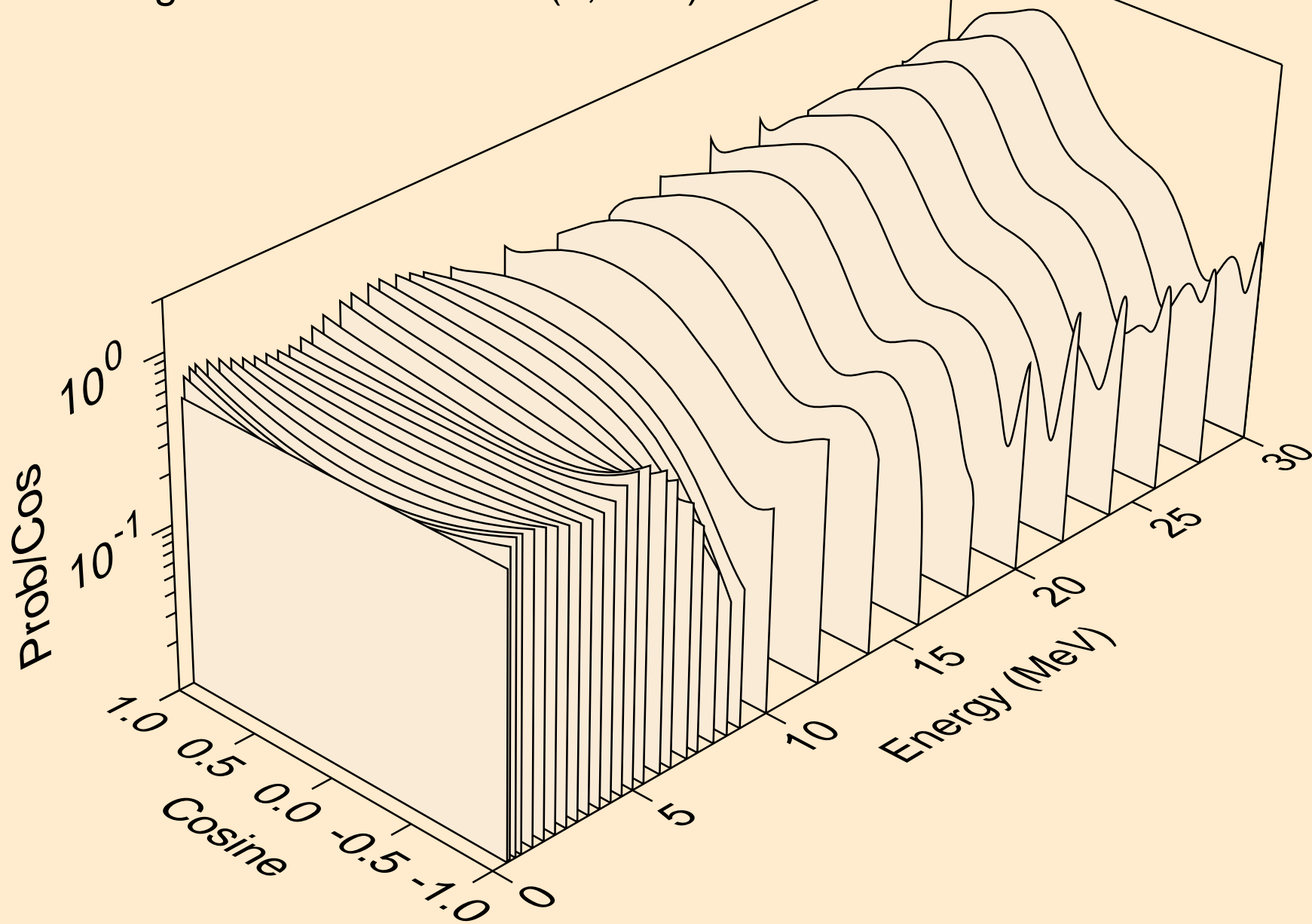

RA233 NEUTRON ACER TENDL-2024 LIBRARY; T=0.K
angular distribution for (n,n*24)

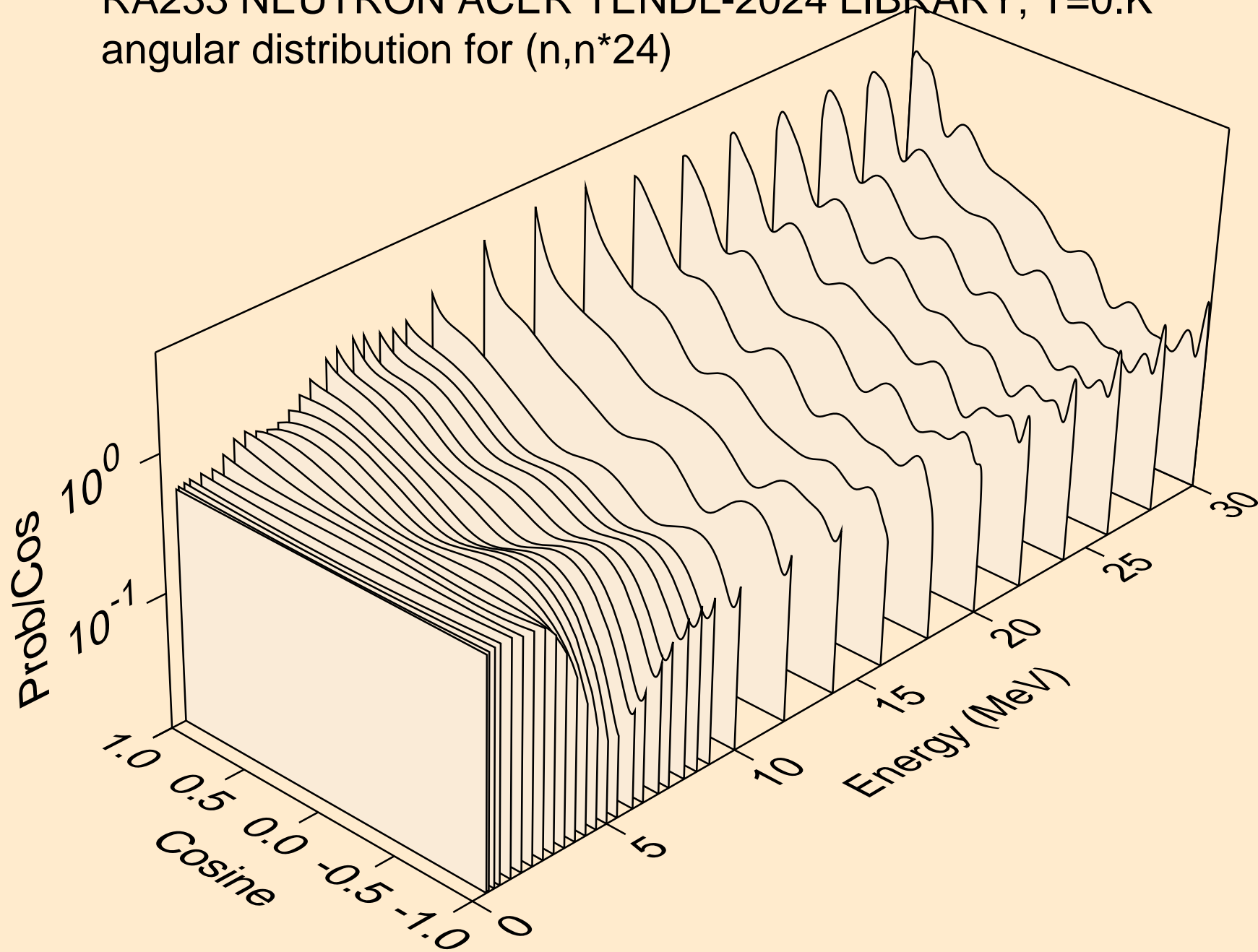

RA233 NEUTRON ACER TENDL-2024 LIBRARY; T=0.K
angular distribution for (n,n*25)

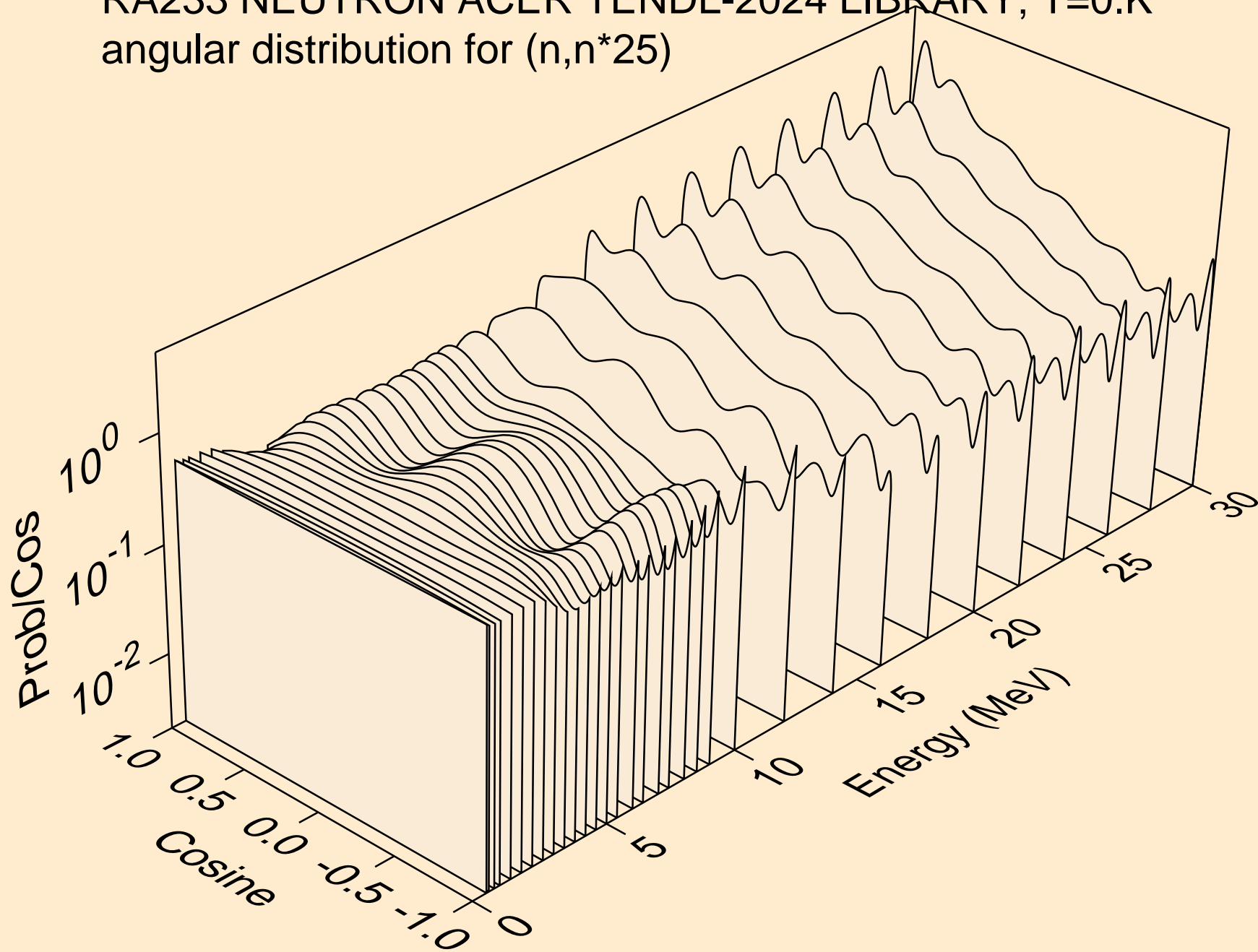

RA233 NEUTRON ACER TENDL-2024 LIBRARY; T=0.K
angular distribution for (n,n*26)

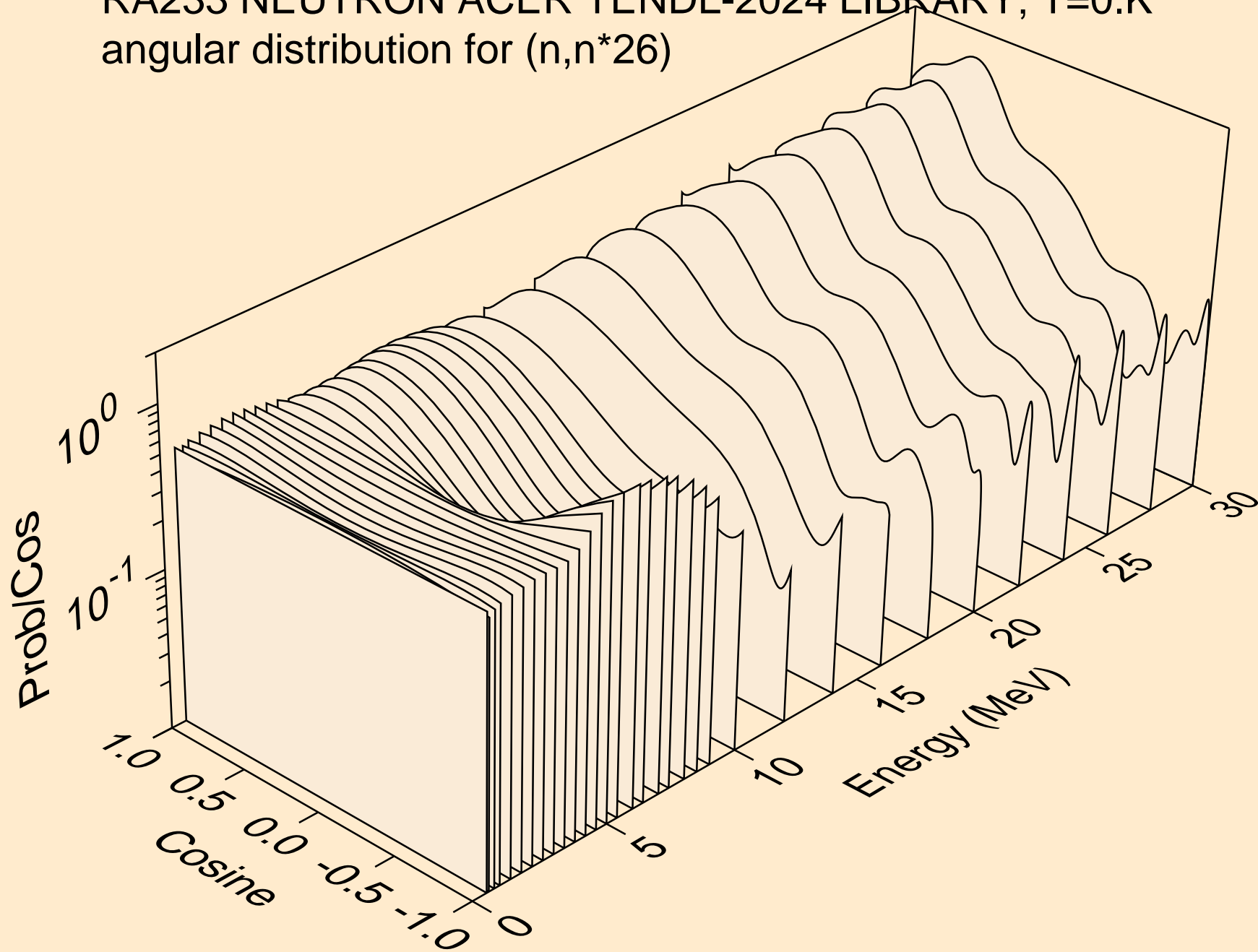

RA233 NEUTRON ACER TENDL-2024 LIBRARY; T=0.K
angular distribution for (n,n*27)

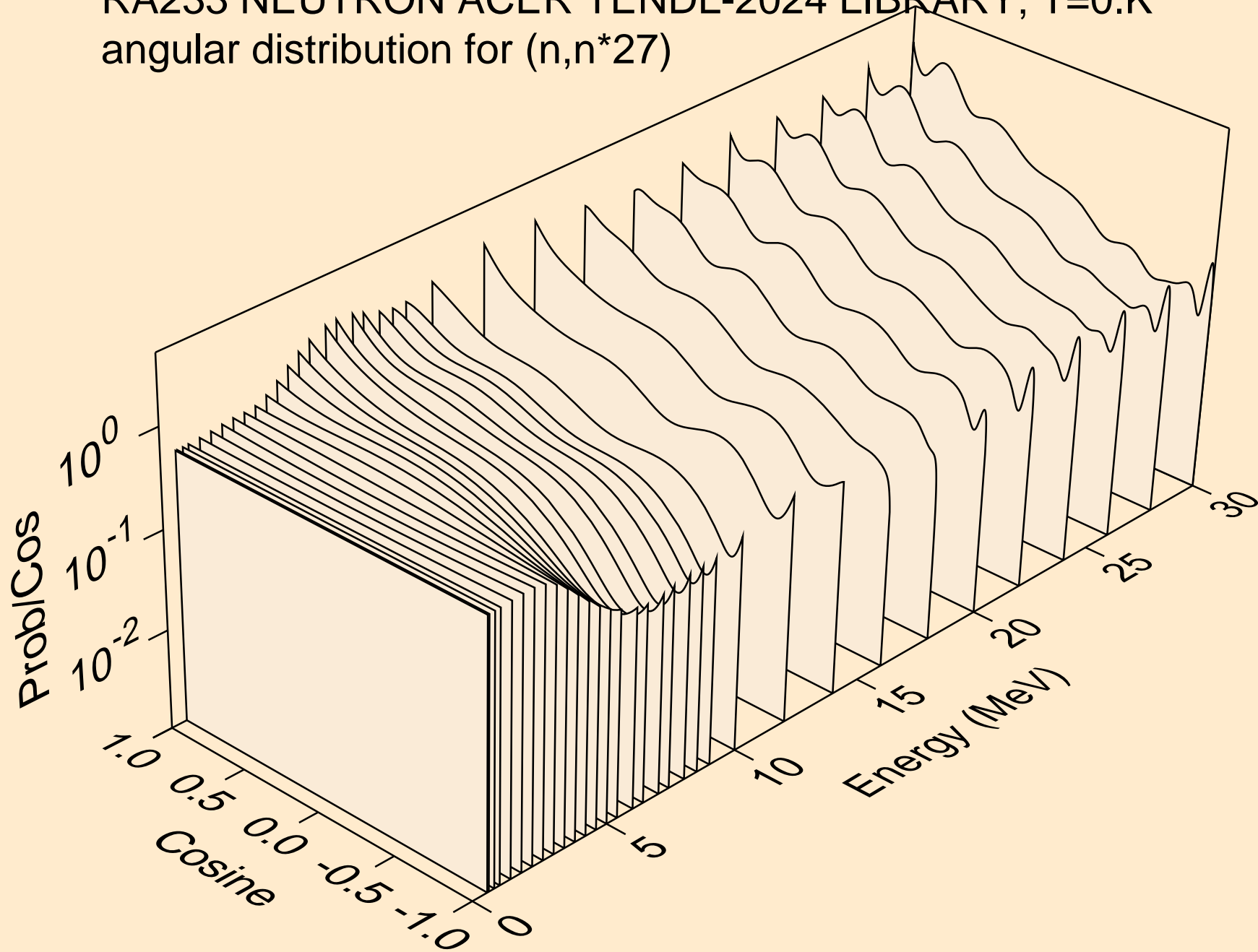

RA233 NEUTRON ACER TENDL-2024 LIBRARY; T=0.K
angular distribution for (n,n*28)

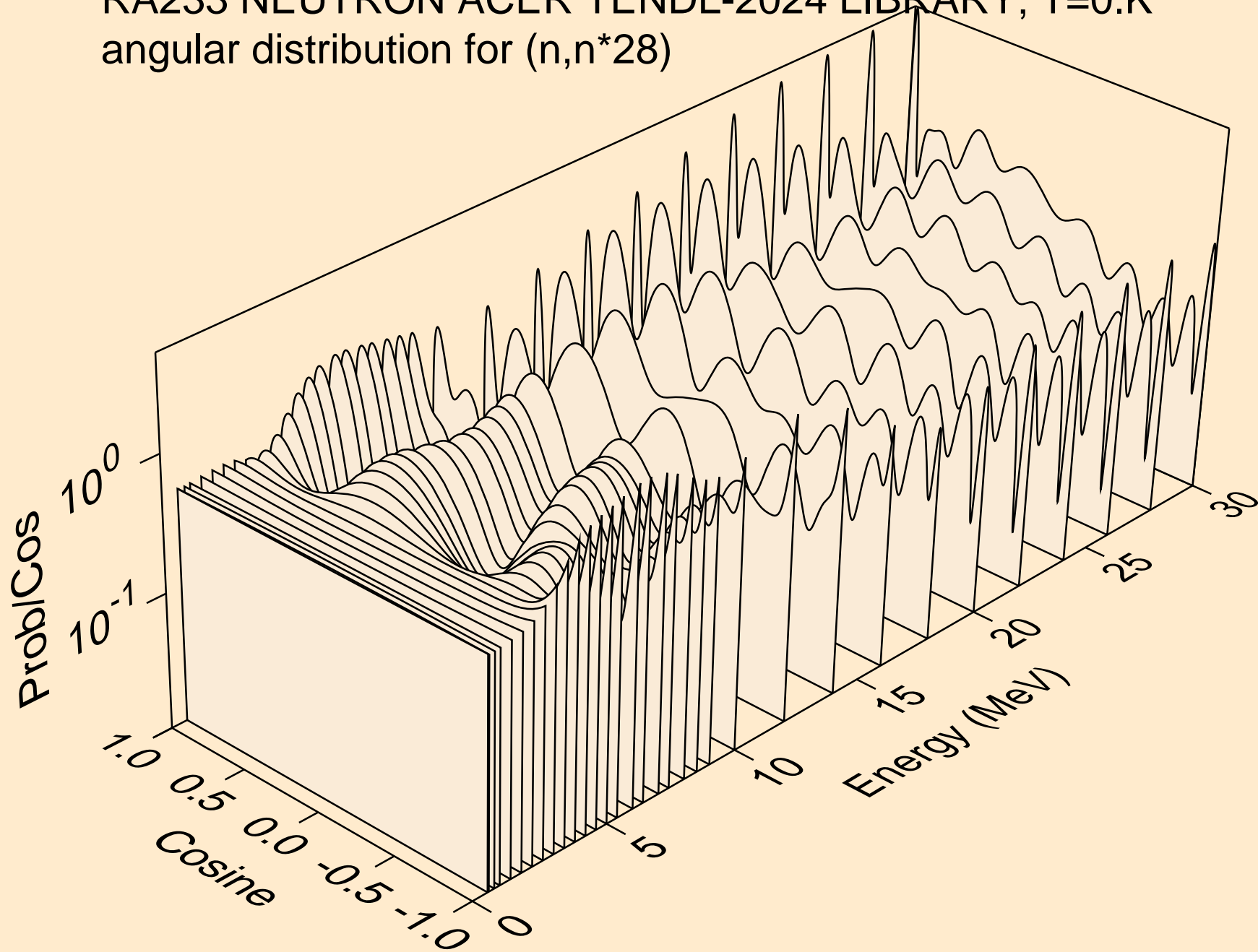

RA233 NEUTRON ACER TENDL-2024 LIBRARY; T=0.K

Total fission nubar

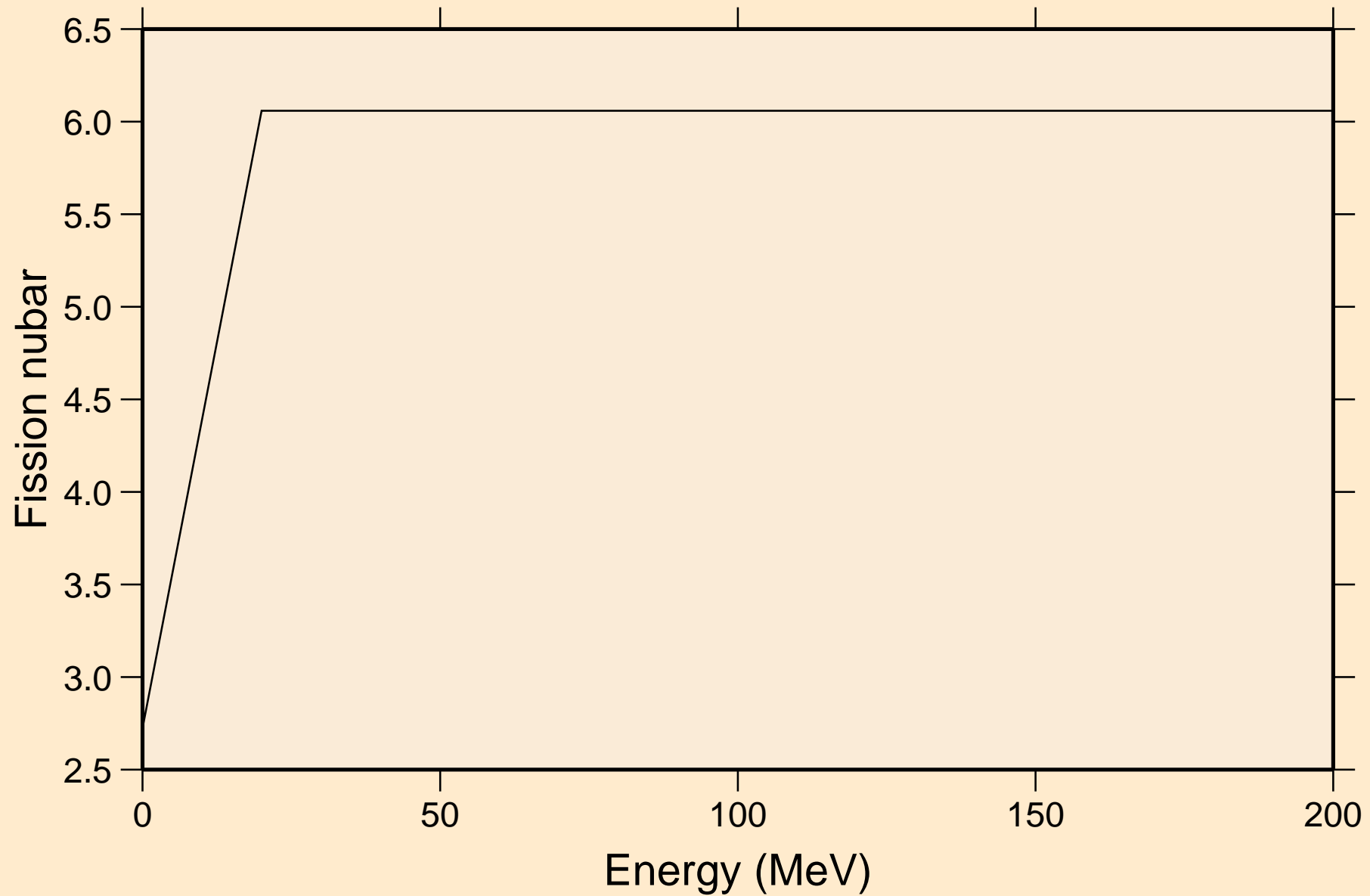

RA233 NEUTRON ACER TENDL-2024 LIBRARY; T=0.K
Neutron emission for (n,x)

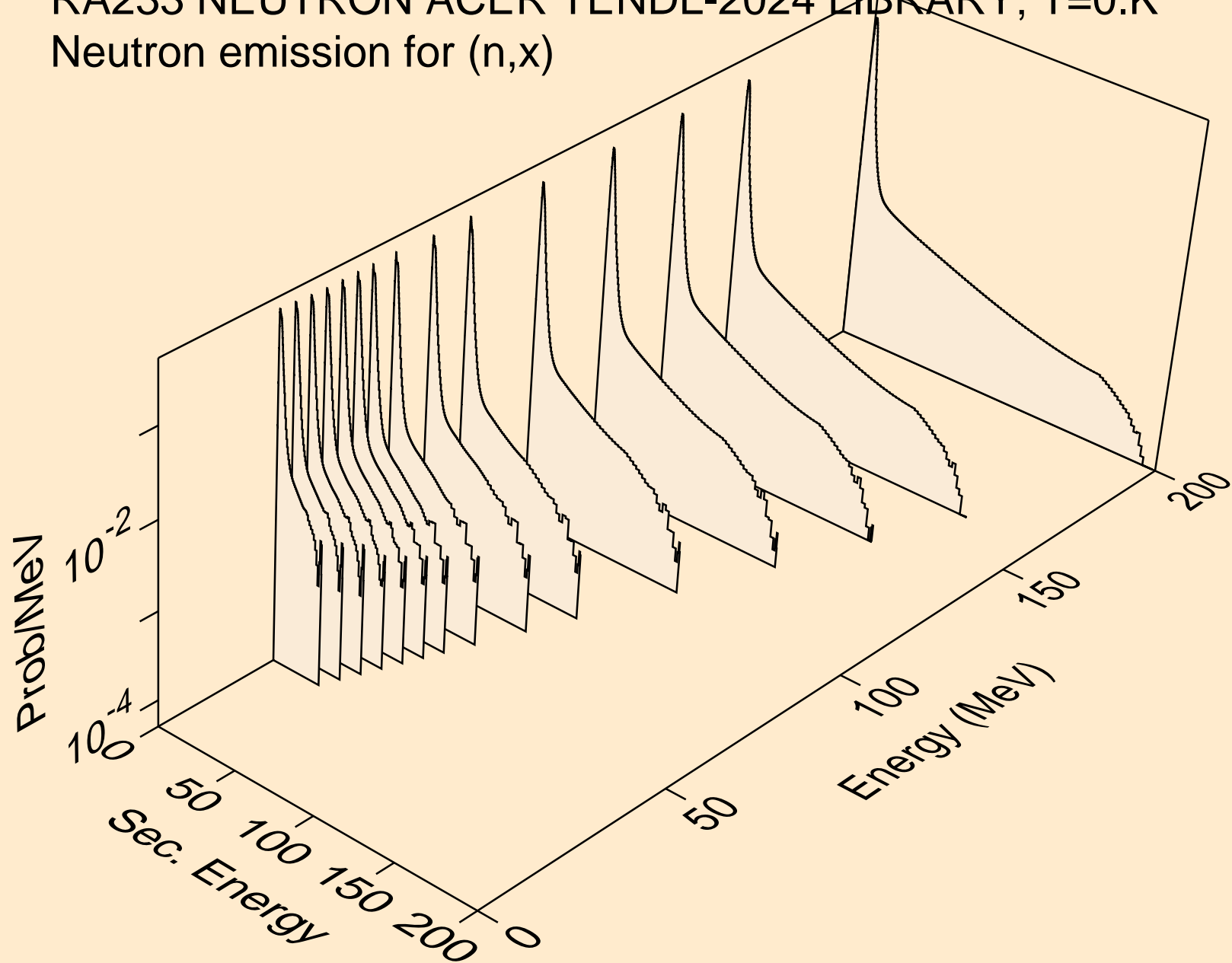

RA233 NEUTRON ACER TENDL-2024 LIBRARY; T=0.K
Neutron emission for (n,2nd)

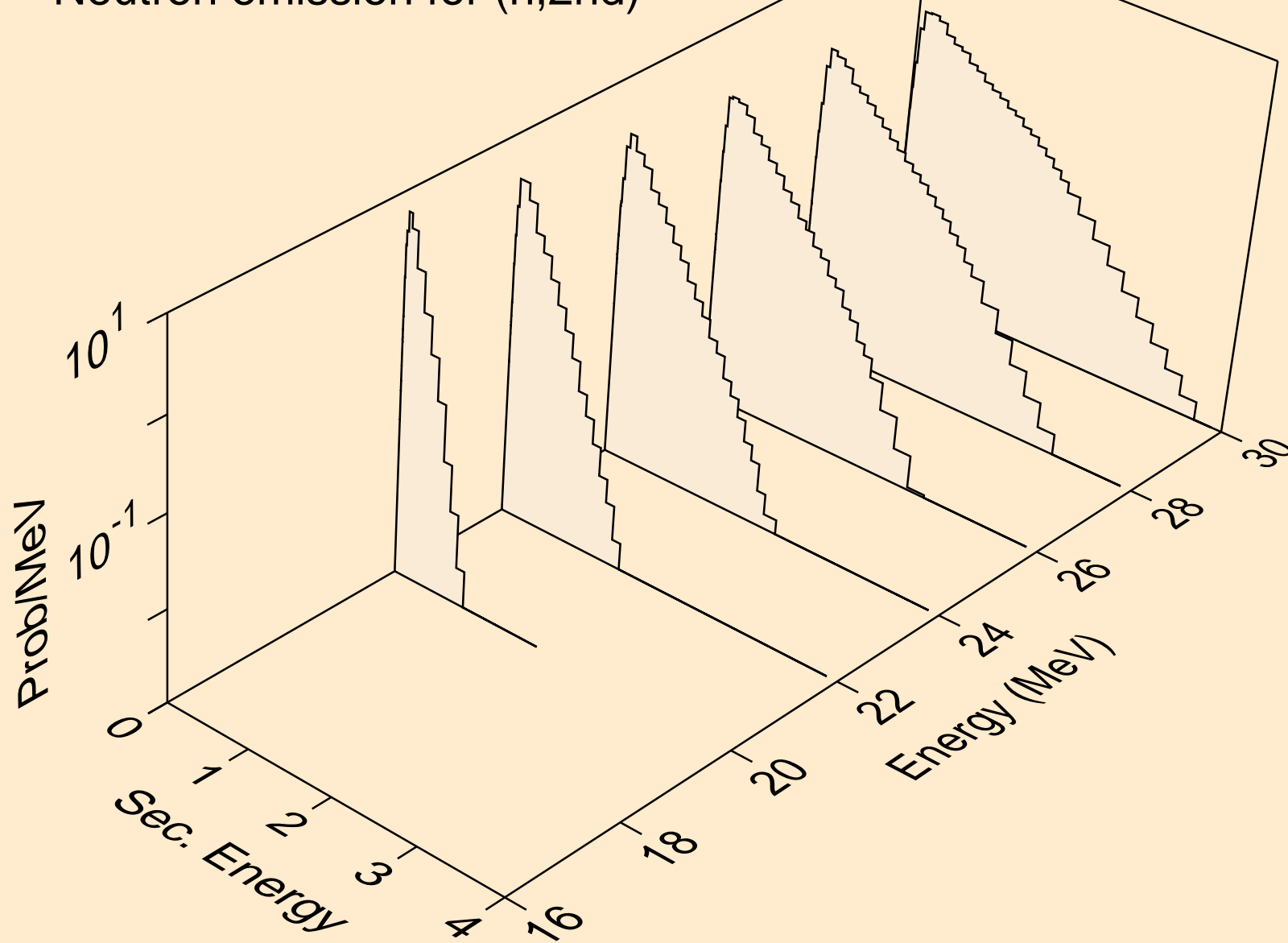

RA233 NEUTRON ACER TENDL-2024 LIBRARY; T=0.K
Neutron emission for (n,2n)

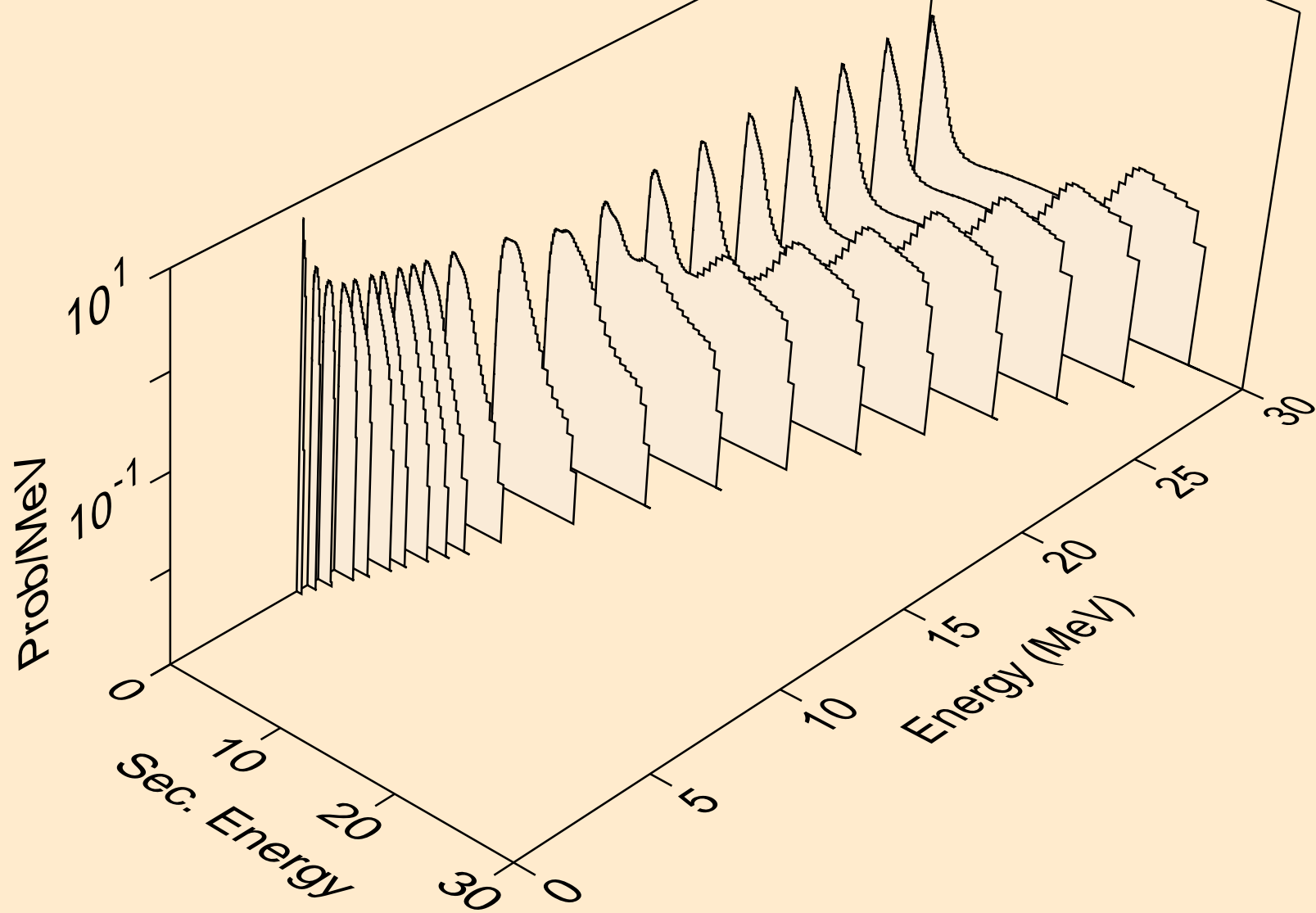

RA233 NEUTRON ACER TENDL-2024 LIBRARY; T=0.K
Neutron emission for (n,3n)

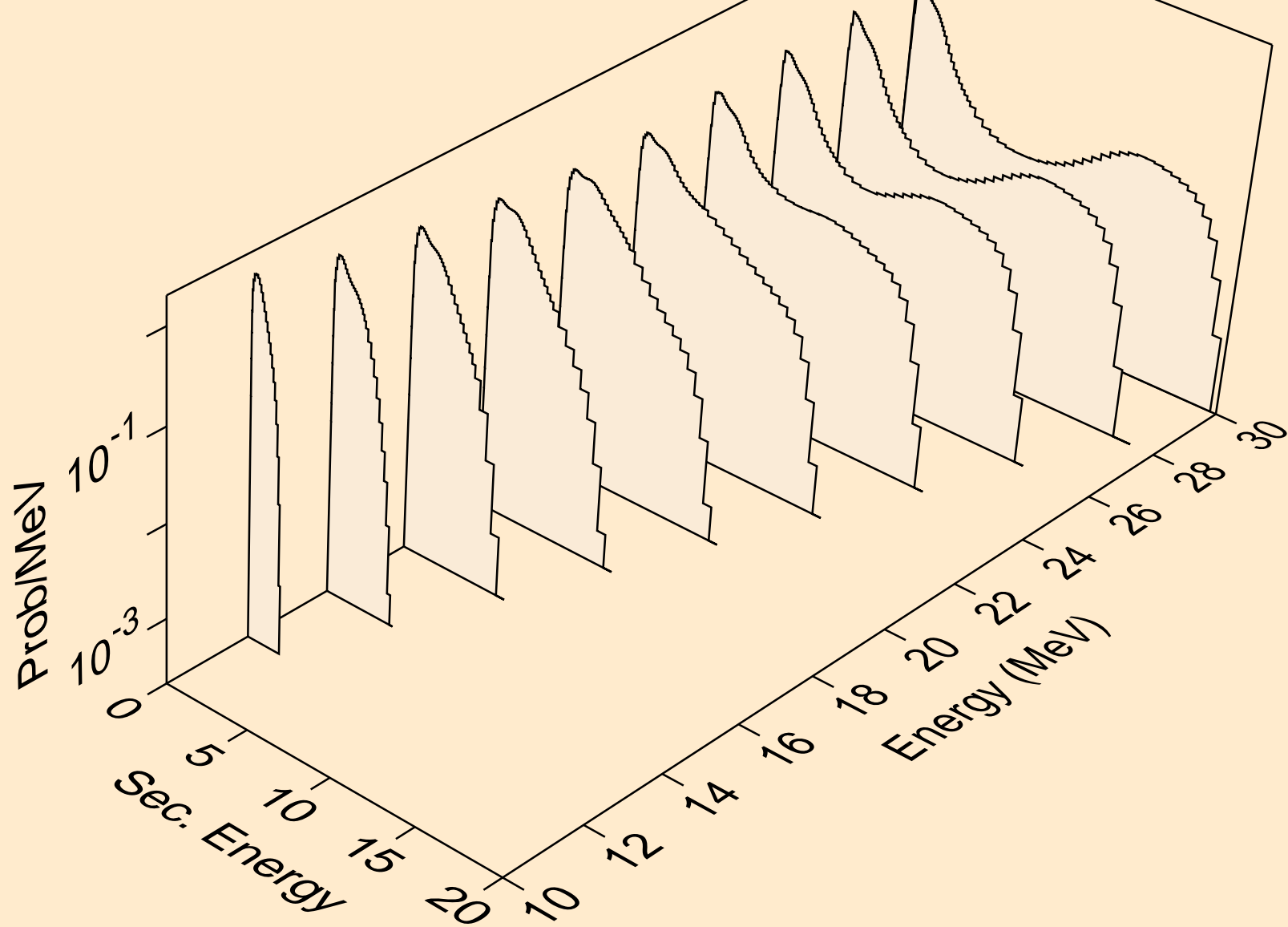

RA233 NEUTRON ACER TENDL-2024 LIBRARY; T=0.K
Neutron emission for fission

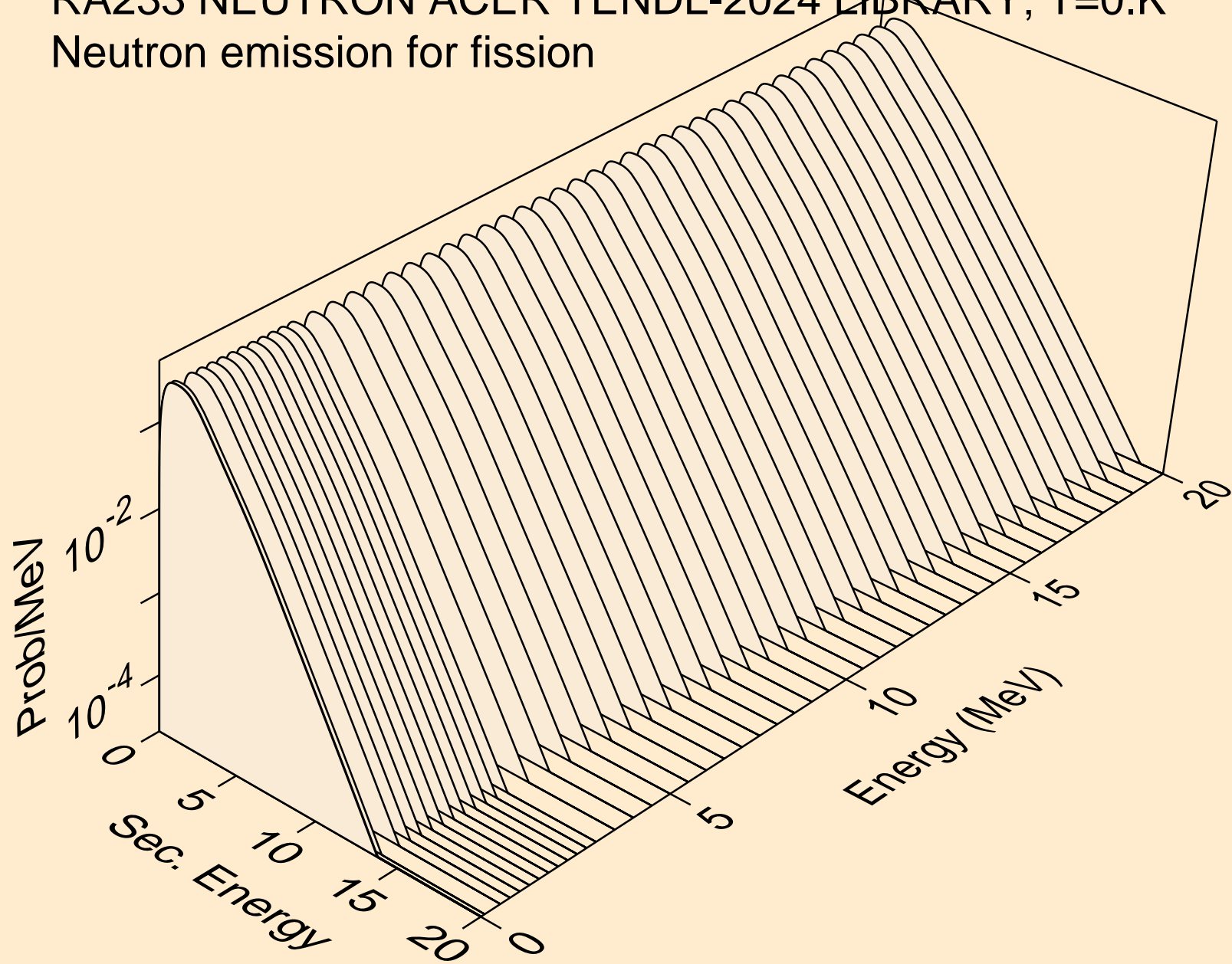

RA233 NEUTRON ACER TENDL-2024 LIBRARY; T=0.K
Neutron emission for (n,n*)a

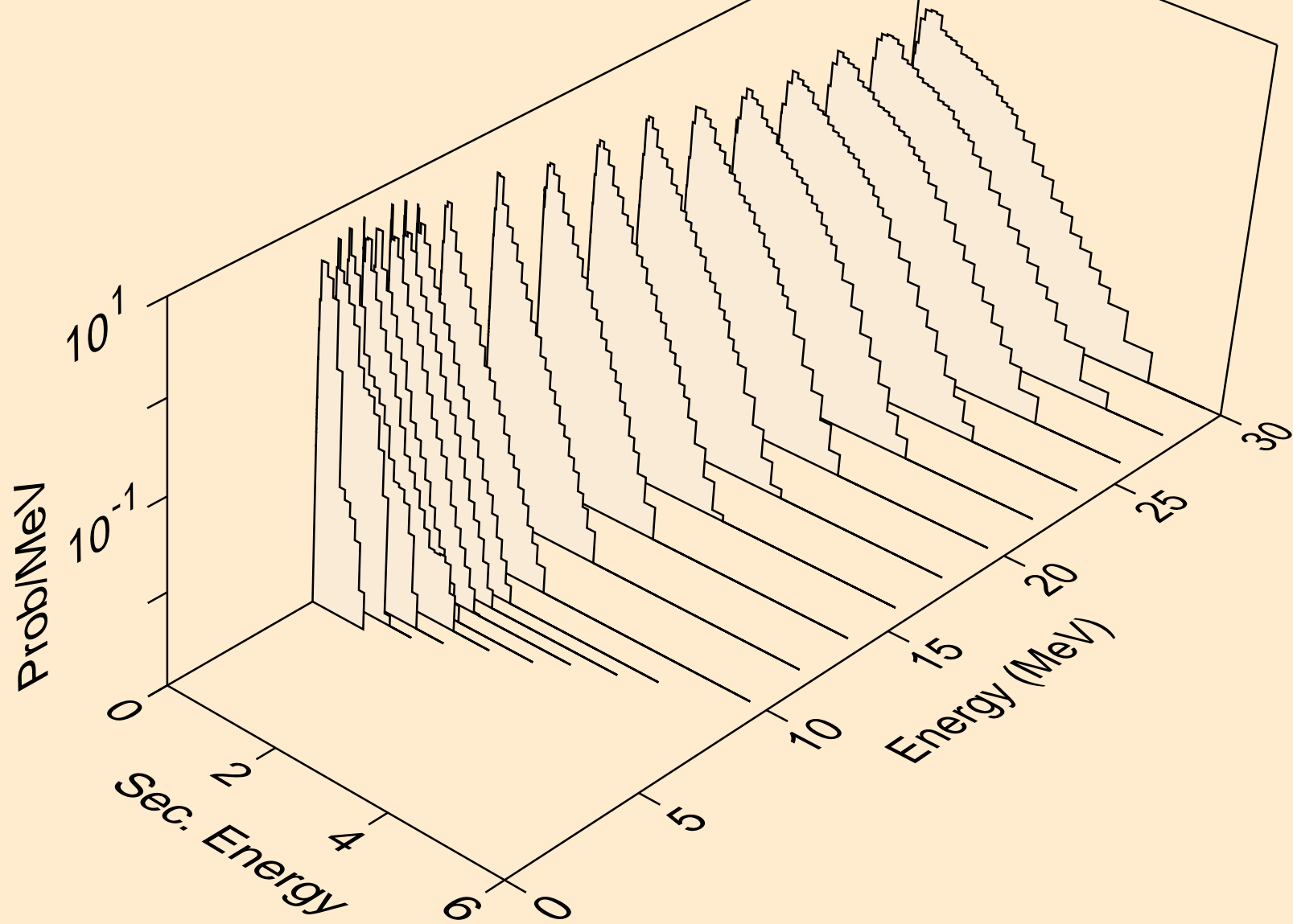

RA233 NEUTRON ACER TENDL-2024 LIBRARY; T=0.K
Neutron emission for (n,2n)a

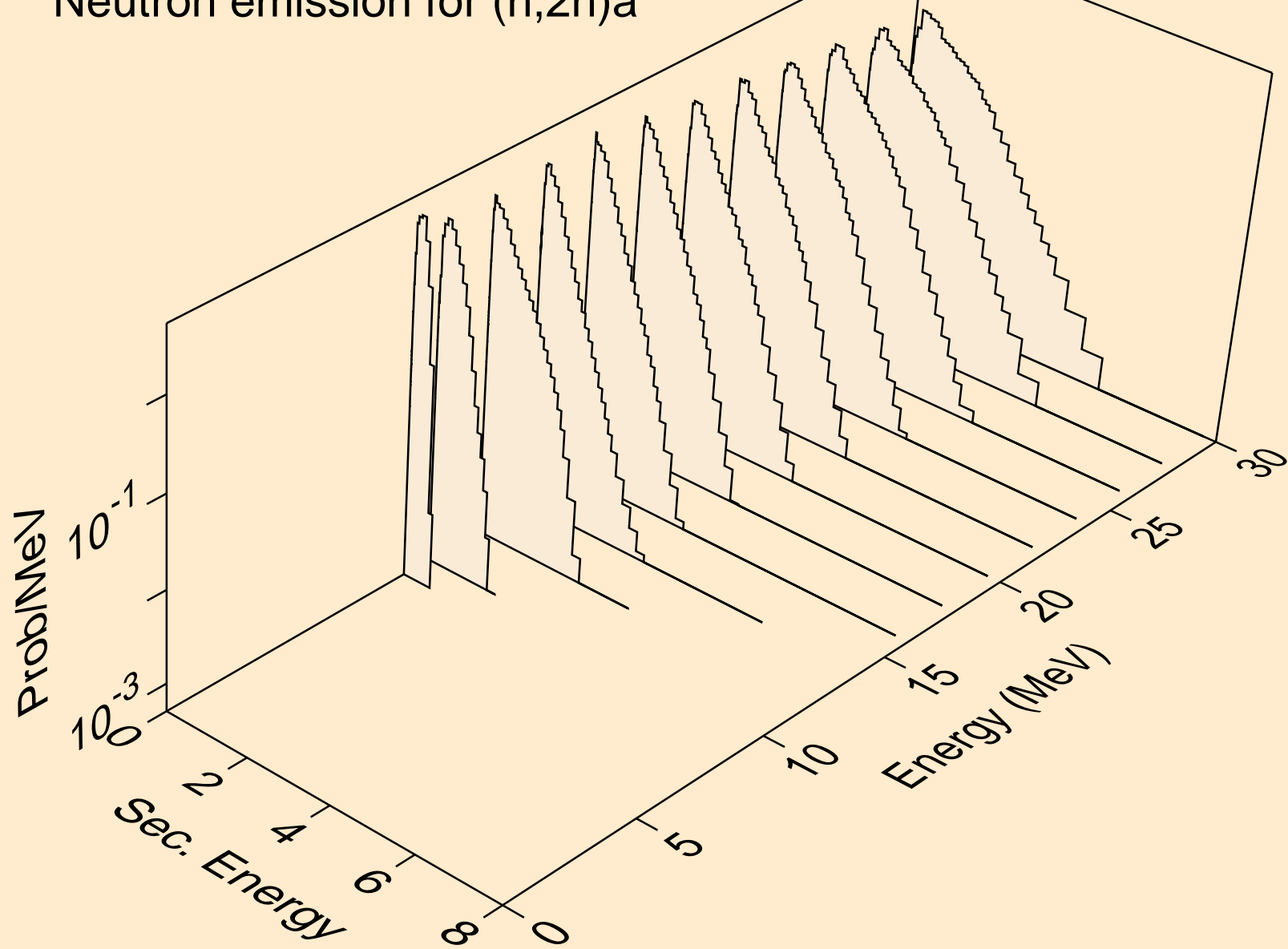

RA233 NEUTRON ACER TENDL-2024 LIBRARY; T=0.K
Neutron emission for (n,3n)a

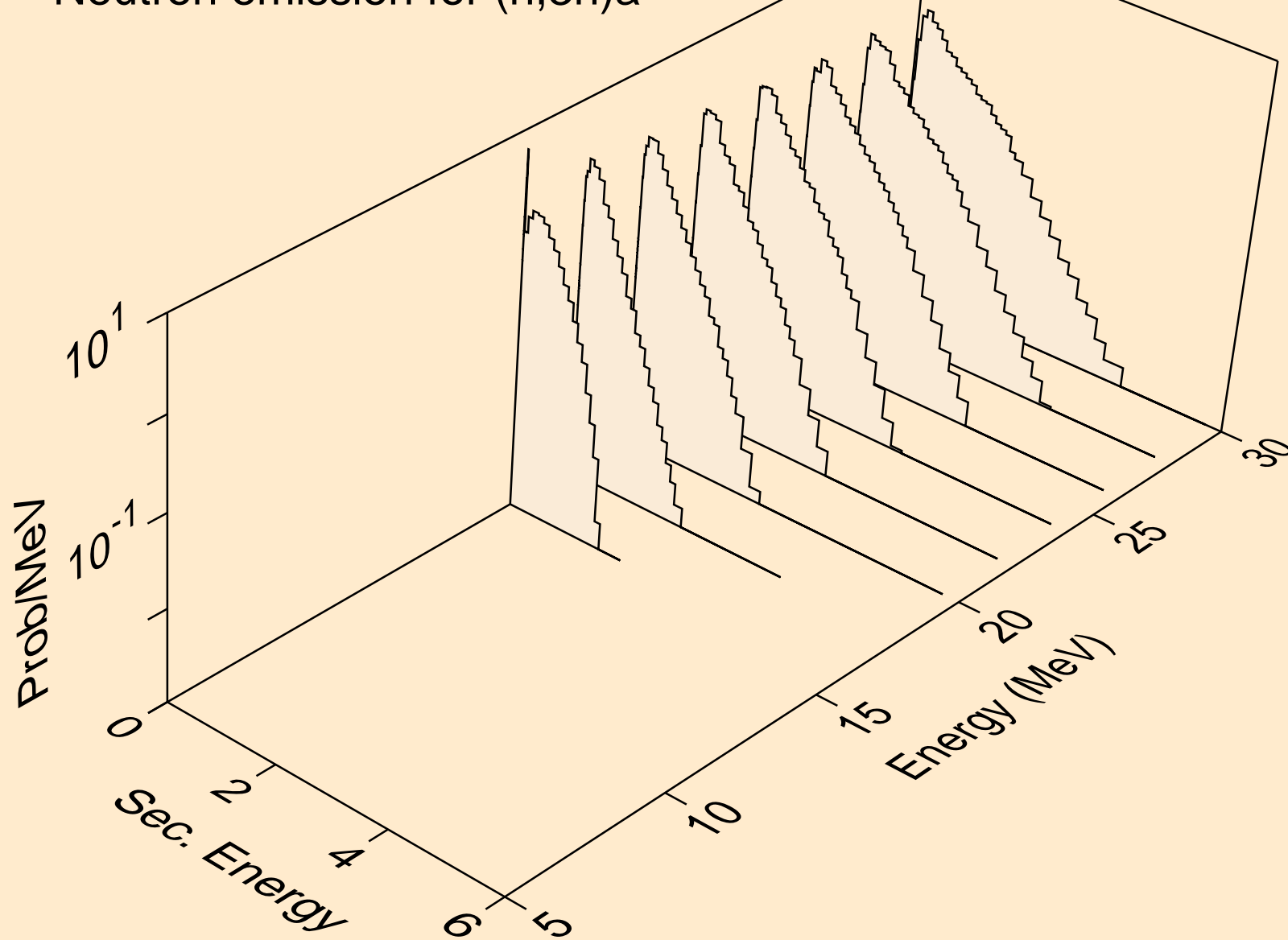

RA233 NEUTRON ACER TENDL-2024 LIBRARY; T=0.K
Neutron emission for (n,n*)p

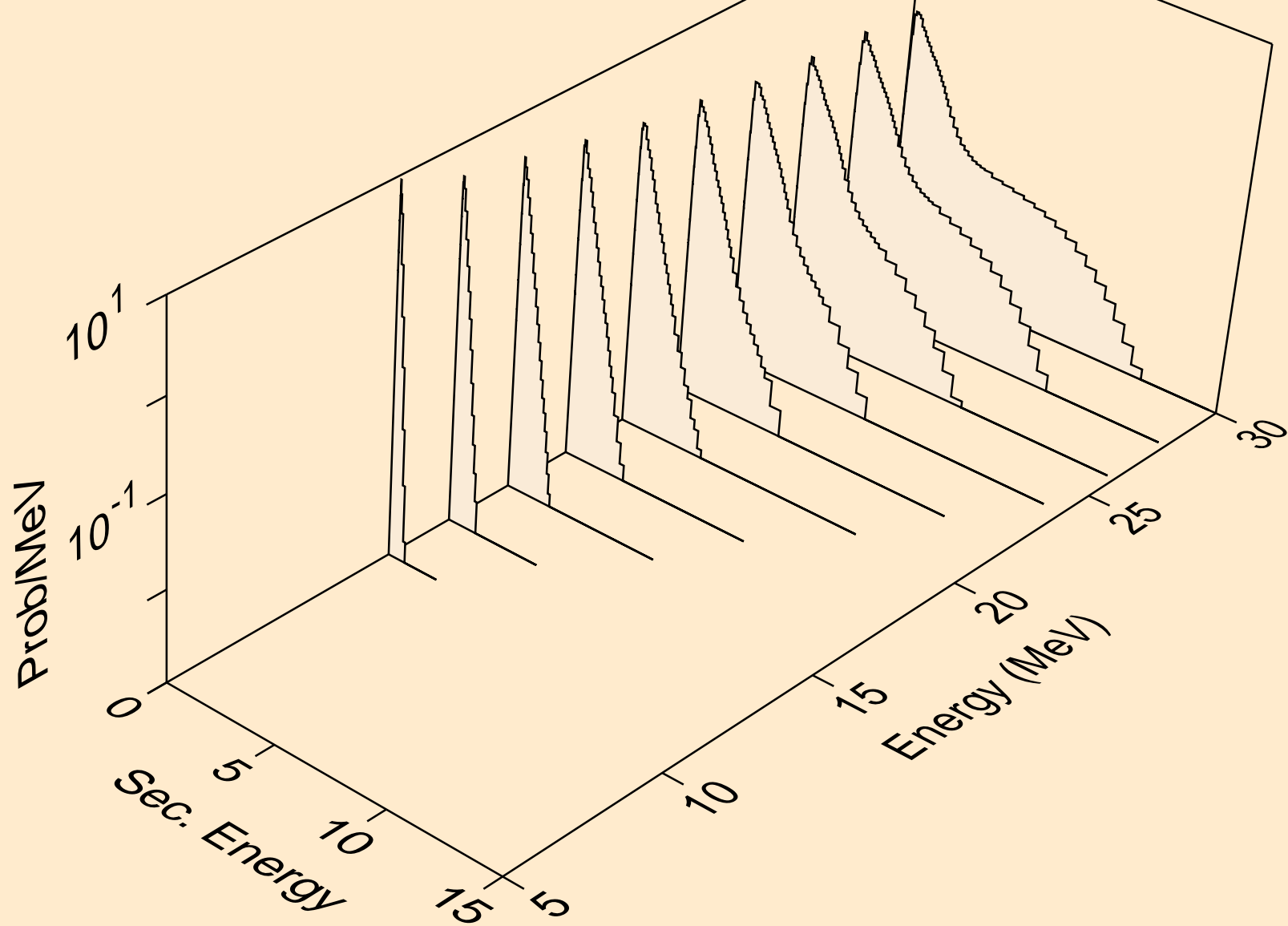

RA233 NEUTRON ACER TENDL-2024 LIBRARY; T=0.K
Neutron emission for (n,n*)d

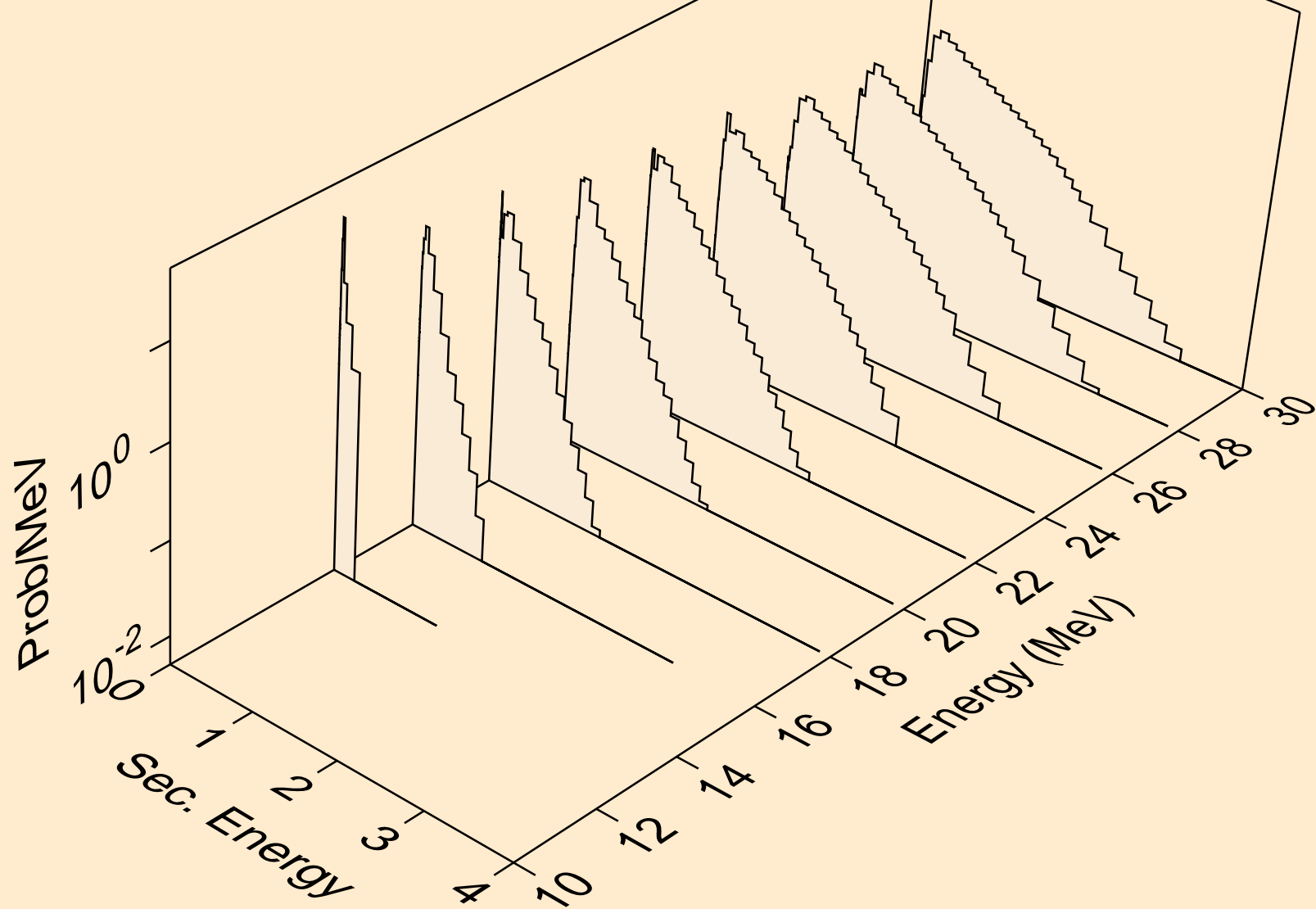

RA233 NEUTRON ACER TENDL-2024 LIBRARY; T=0.K
Neutron emission for (n,n*)t

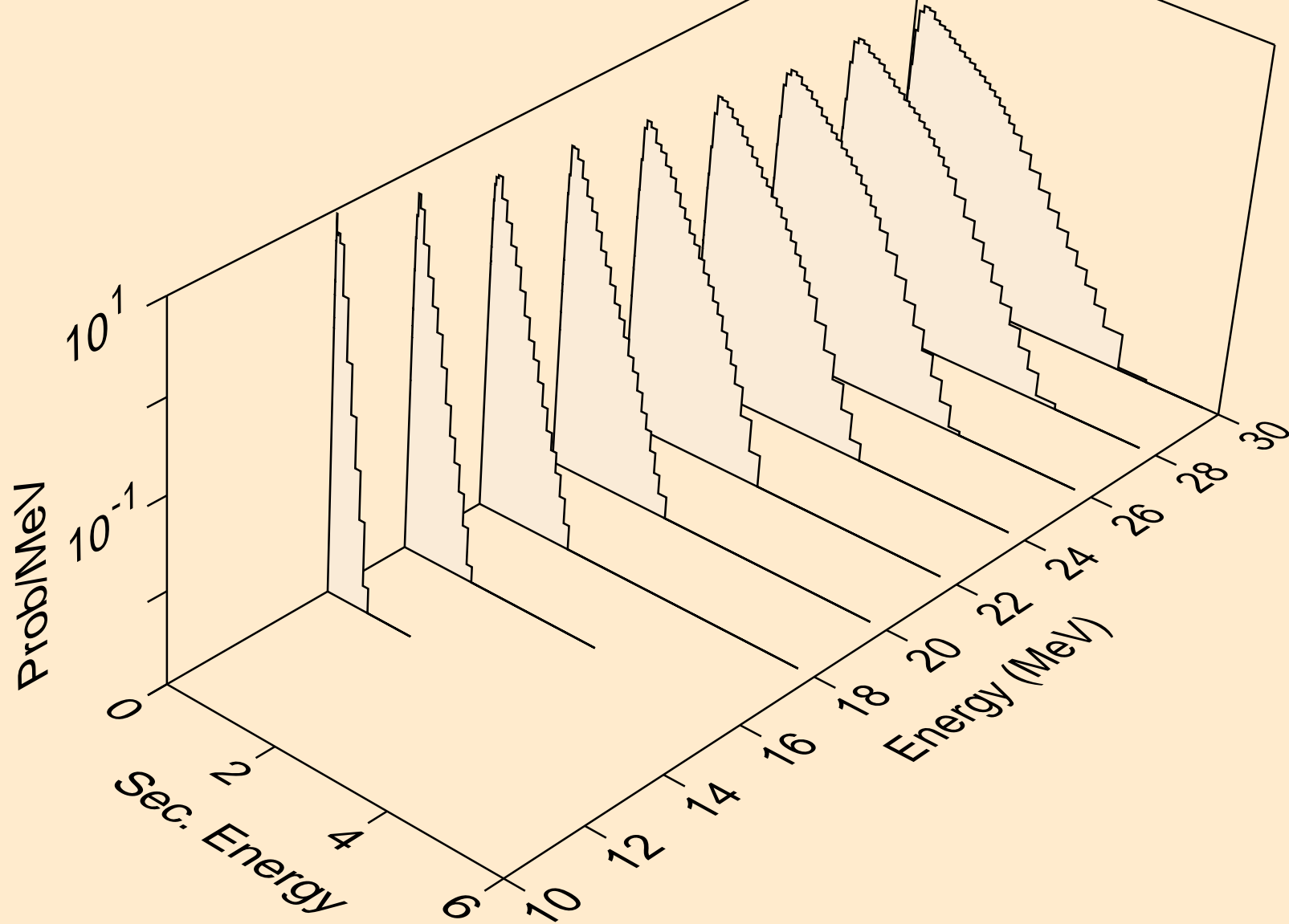

RA233 NEUTRON ACER TENDL-2024 LIBRARY; T=0.K
Neutron emission for (n,n*)he3

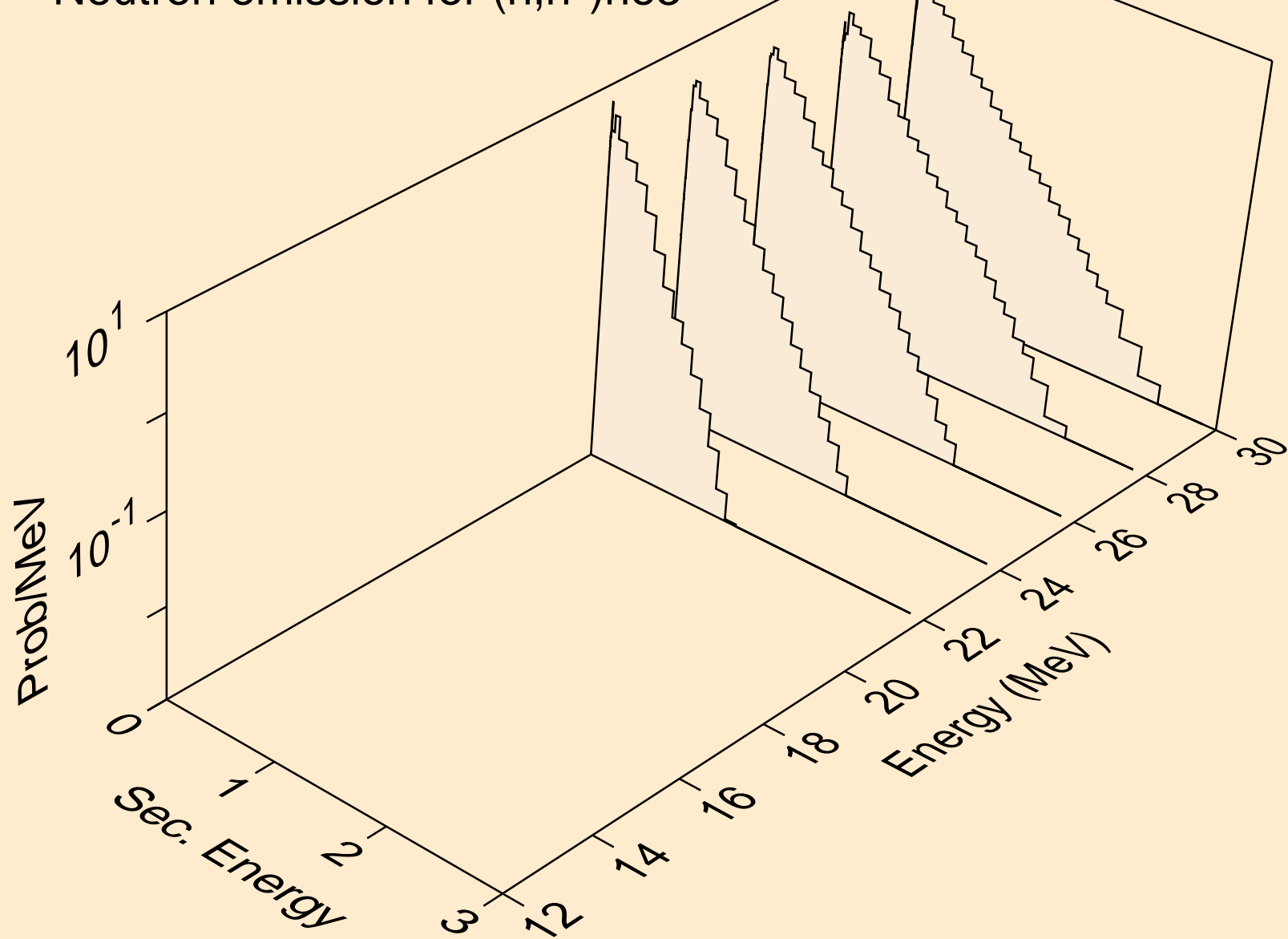

RA233 NEUTRON ACER TENDL-2024 LIBRARY; T=0.K
Neutron emission for (n,4n)

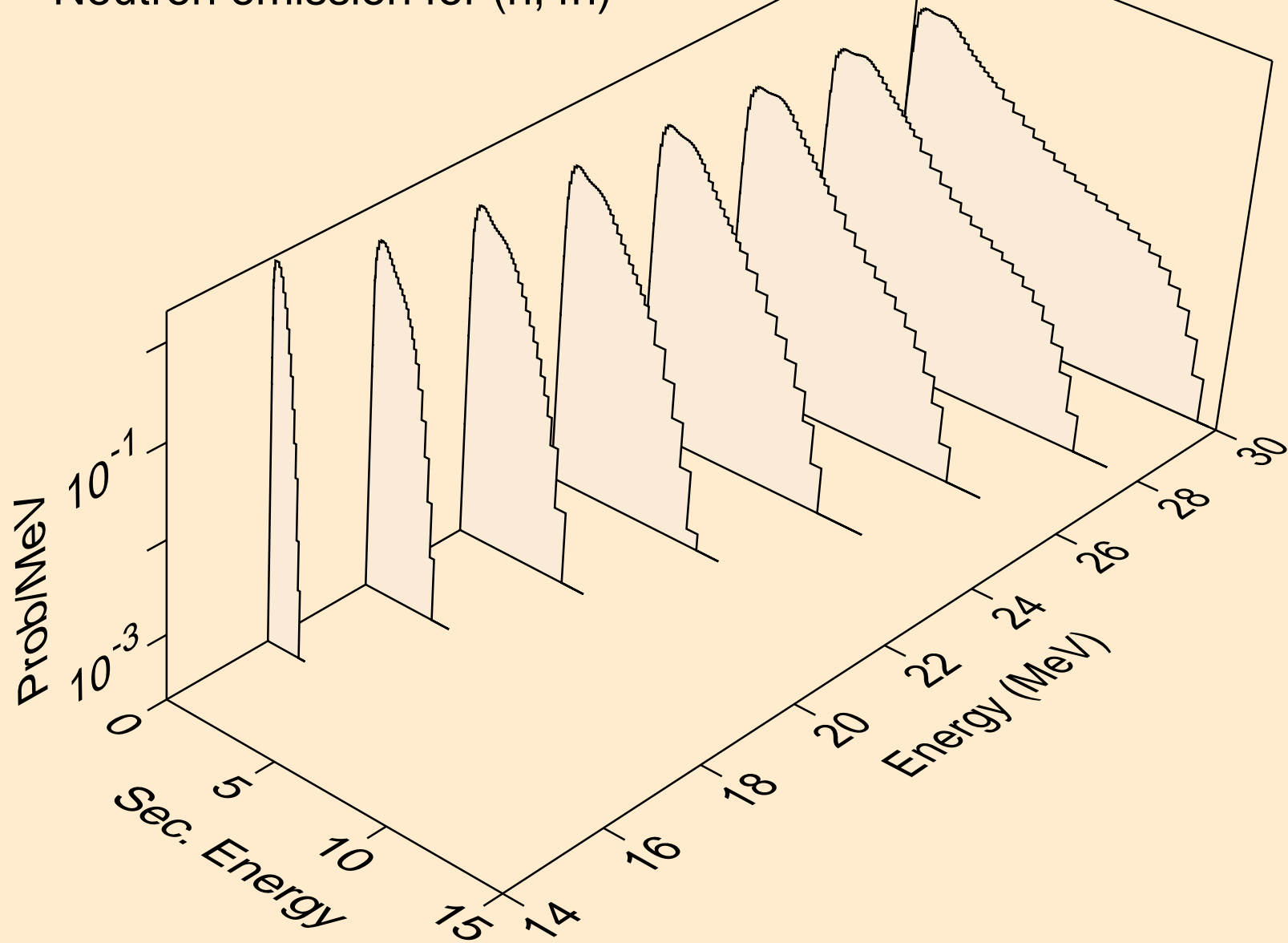

RA233 NEUTRON ACER TENDL-2024 LIBRARY; T=0.K
Neutron emission for (n,2np)

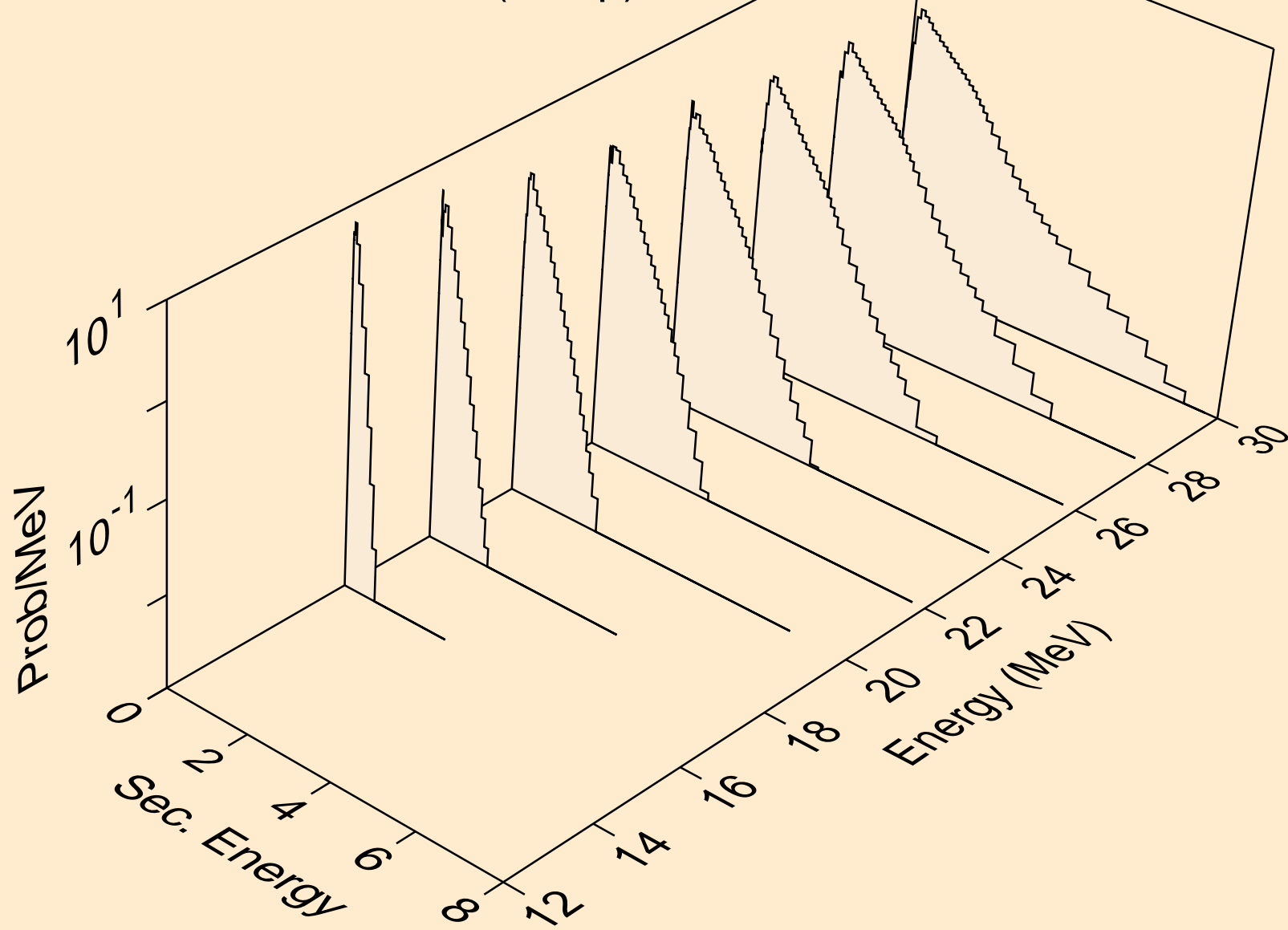

RA233 NEUTRON ACER TENDL-2024 LIBRARY; T=0.K
Neutron emission for (n,3np)

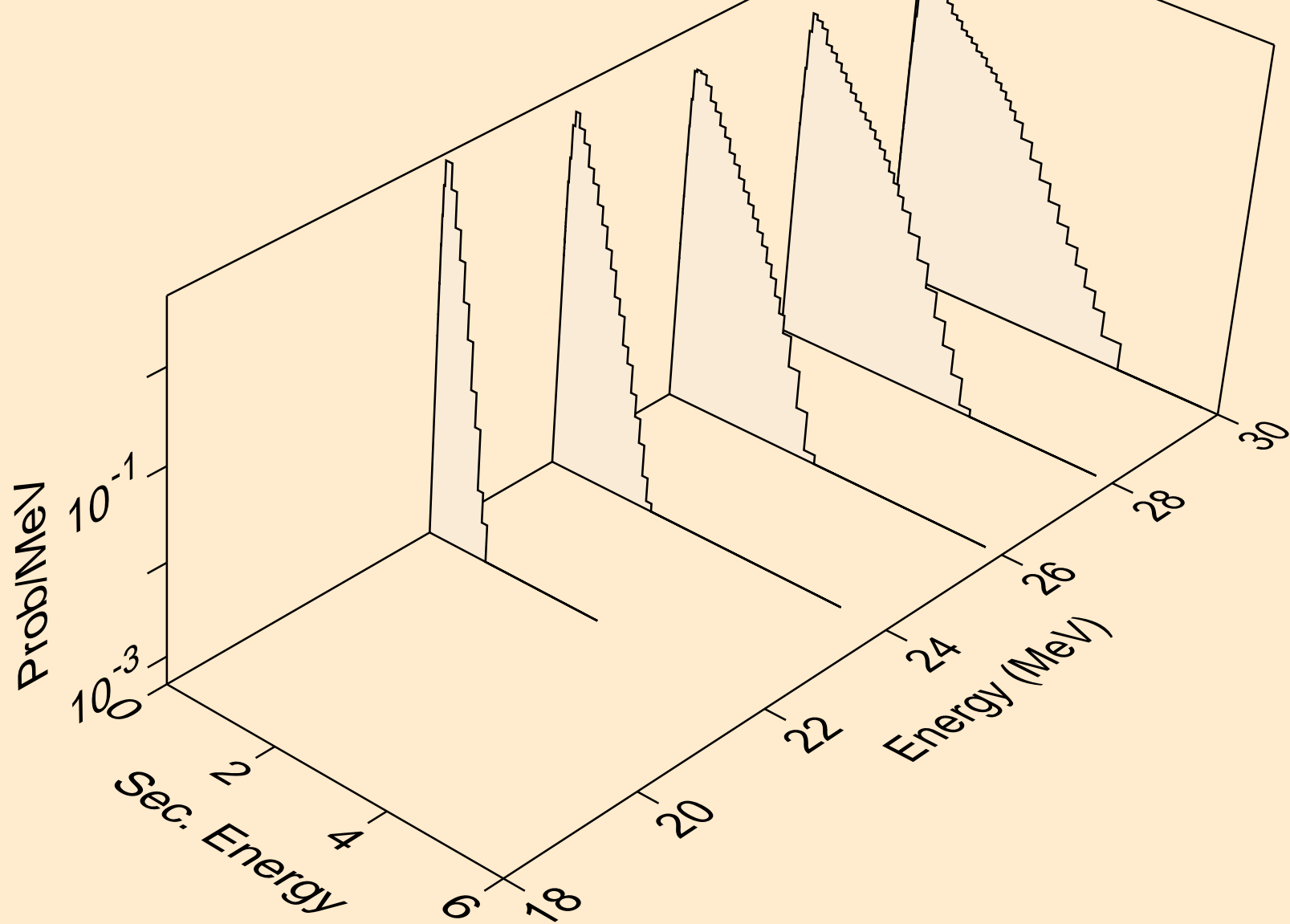

RA233 NEUTRON ACER TENDL-2024 LIBRARY; T=0.K
Neutron emission for (n,n*c)

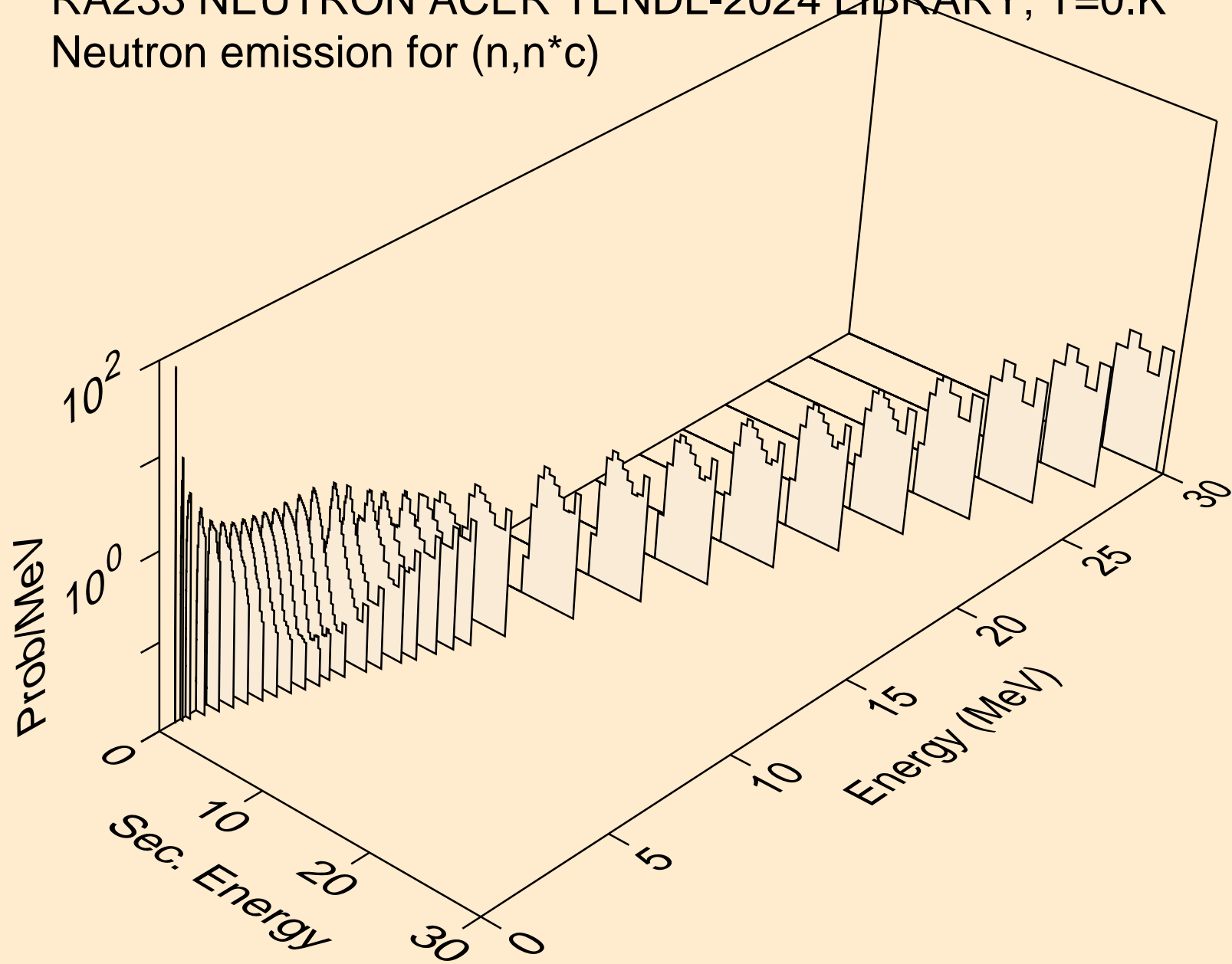

RA233 NEUTRON ACER TENDL-2024 LIBRARY; T=0.K

Delayed nubar

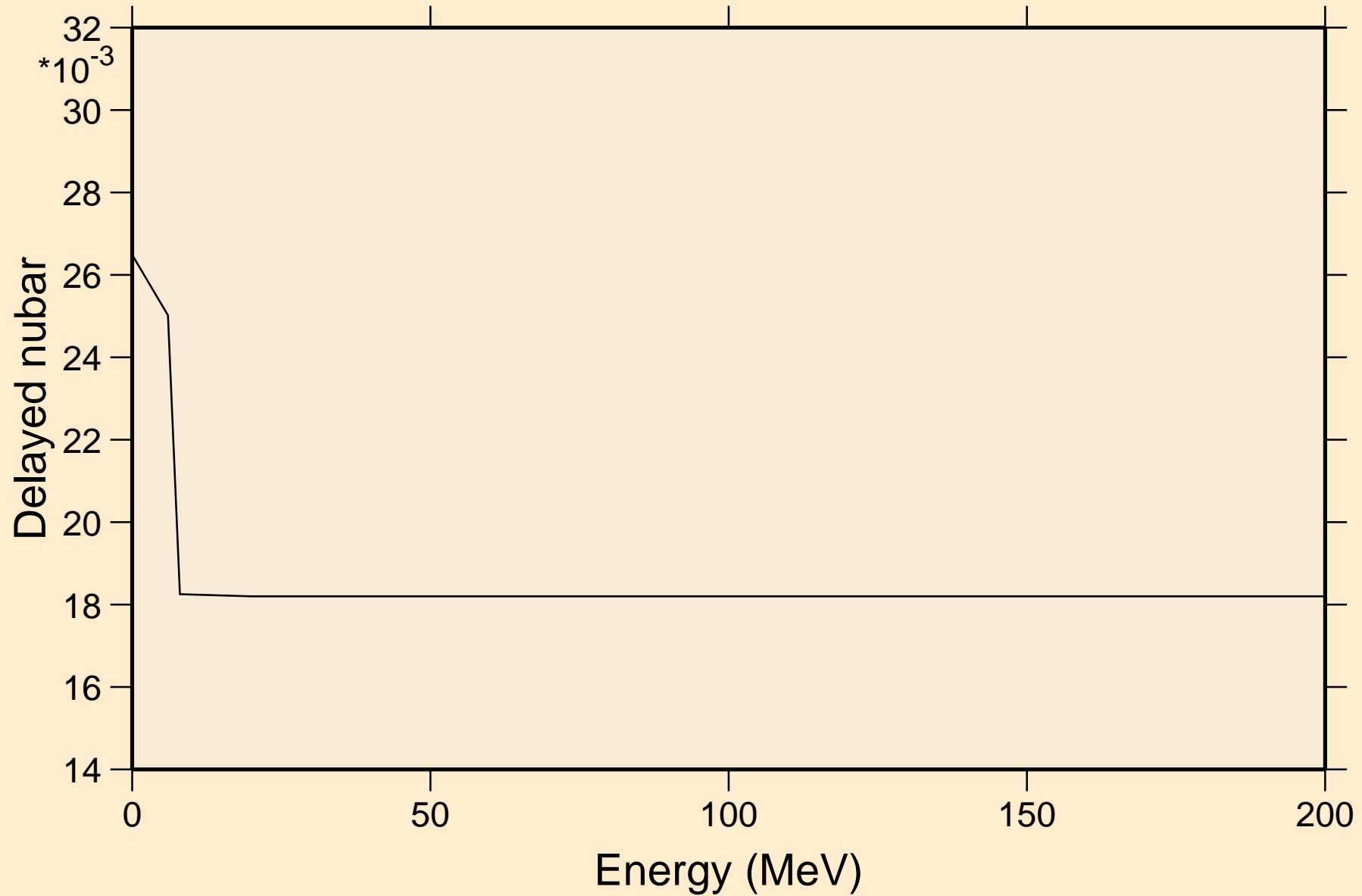

RA233 NEUTRON ACER TENDL-2024 LIBRARY; T=0.K

Delayed neutron spectra

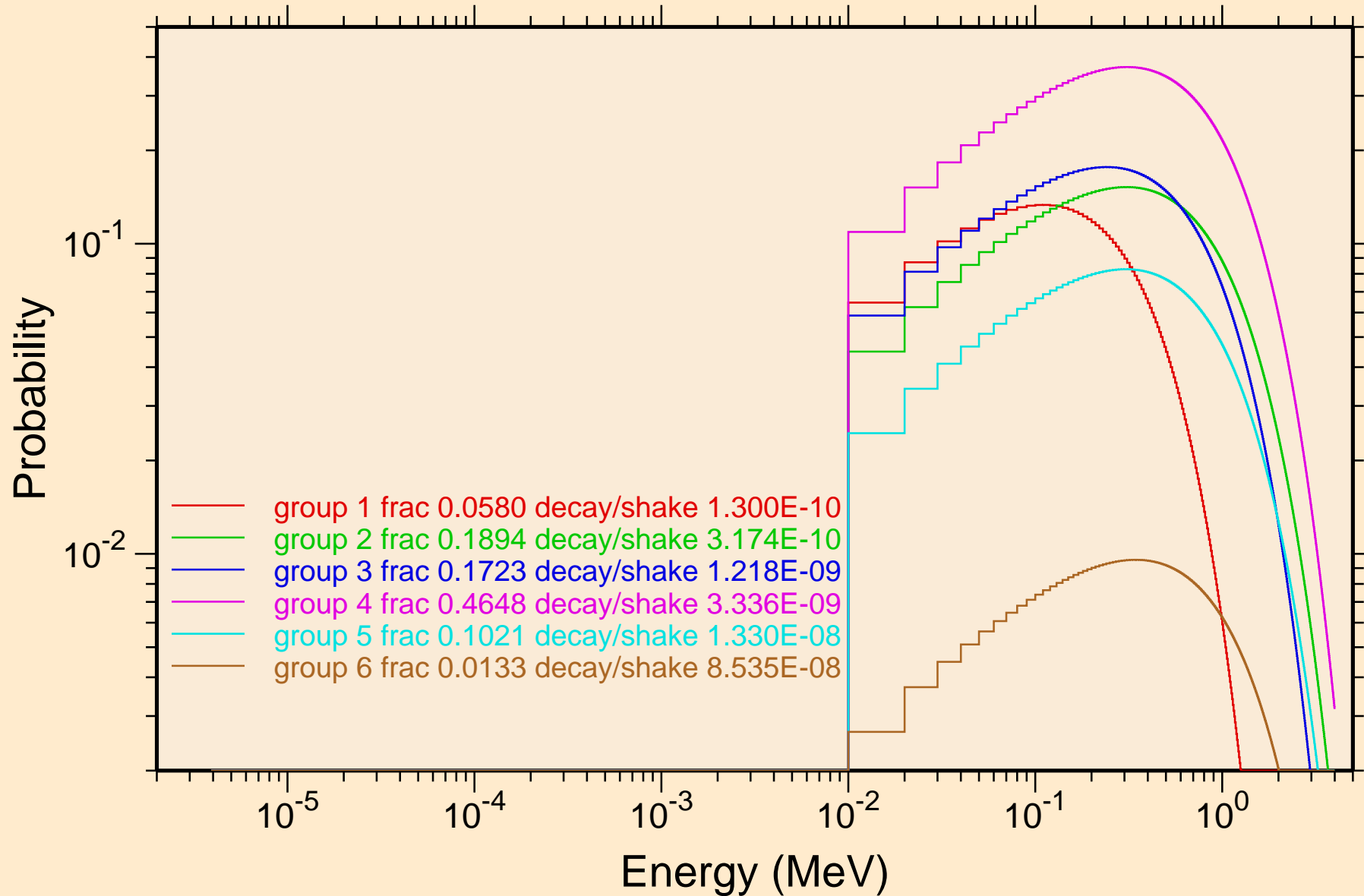

RA233 NEUTRON ACER TENDL-2024 LIBRARY; T=0.K
Photon emission for (n,x)

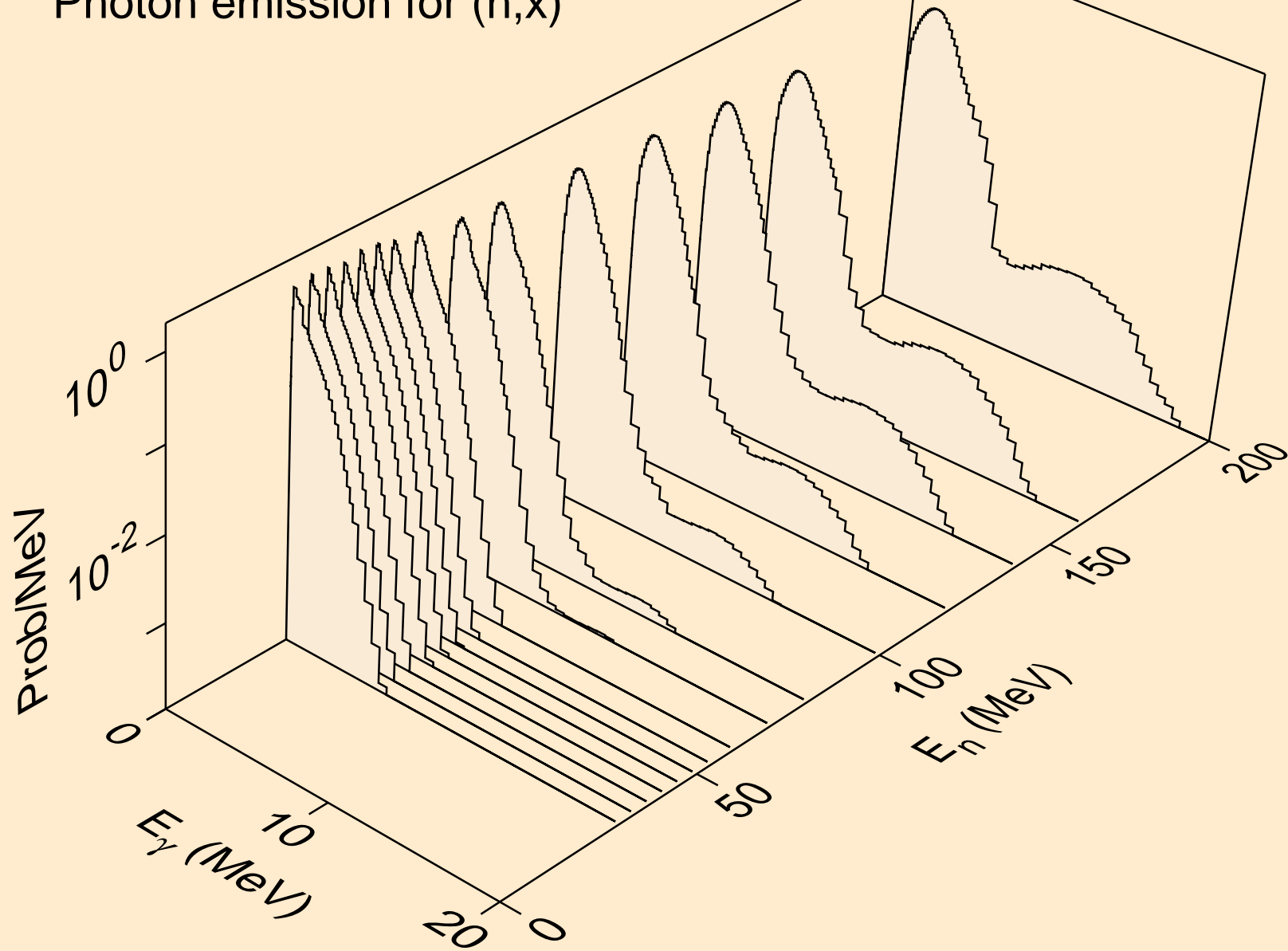

RA233 NEUTRON ACER TENDL-2024 LIBRARY; T=0.K
Photon emission for (n,2nd)

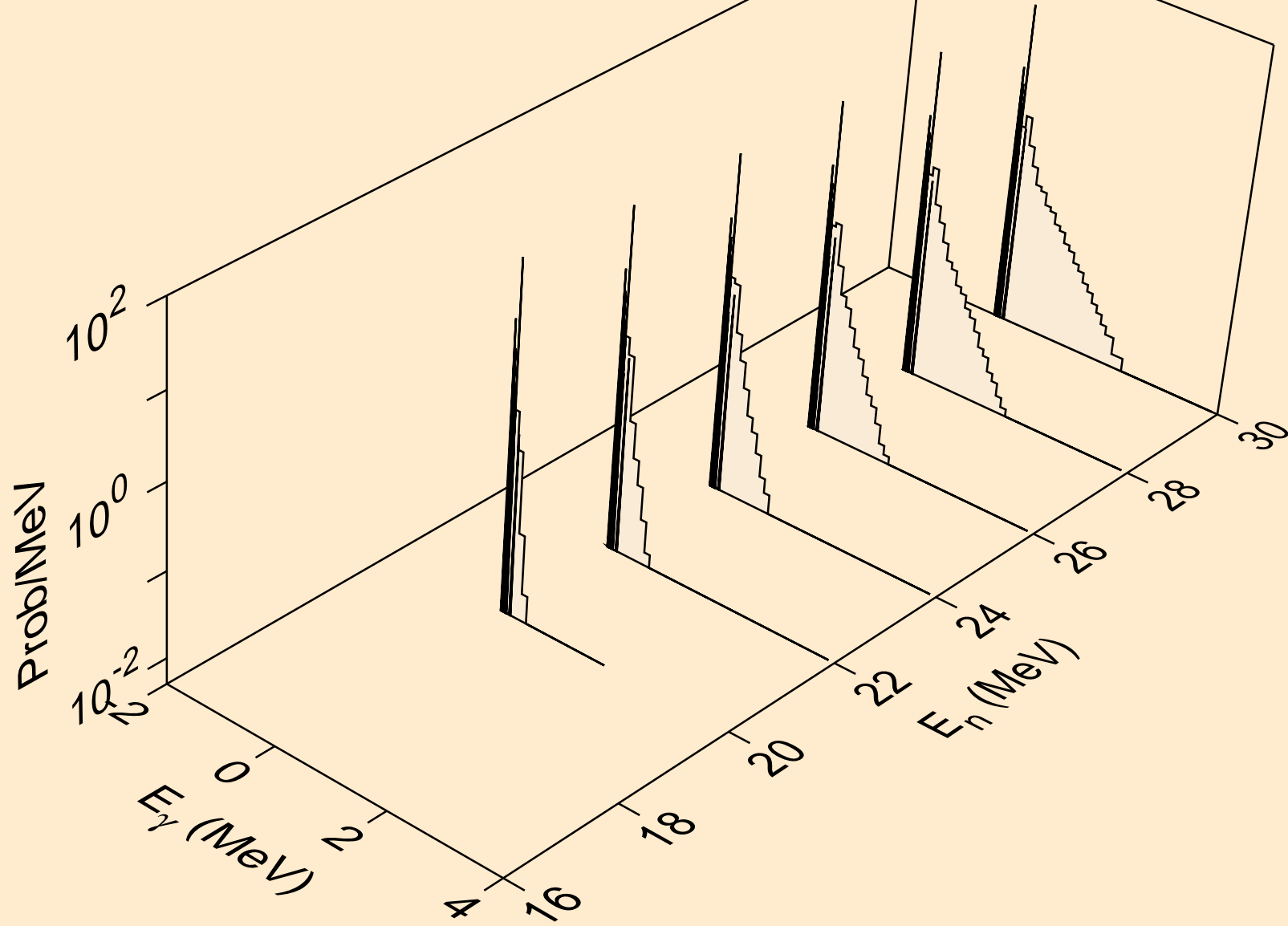

RA233 NEUTRON ACER TENDL-2024 LIBRARY; T=0.K
Photon emission for (n,2n)

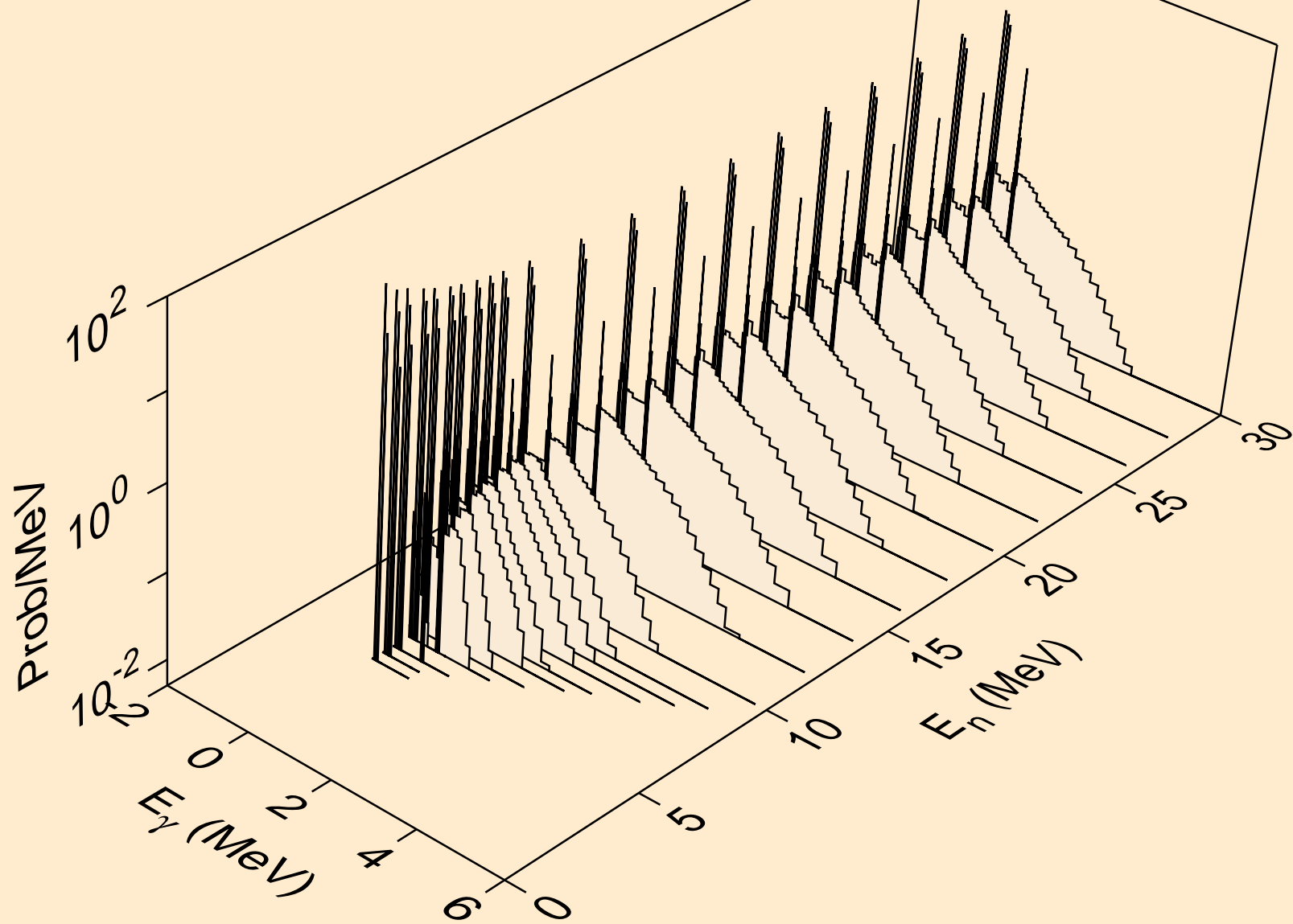

RA233 NEUTRON ACER TENDL-2024 LIBRARY; T=0.K
Photon emission for (n,3n)

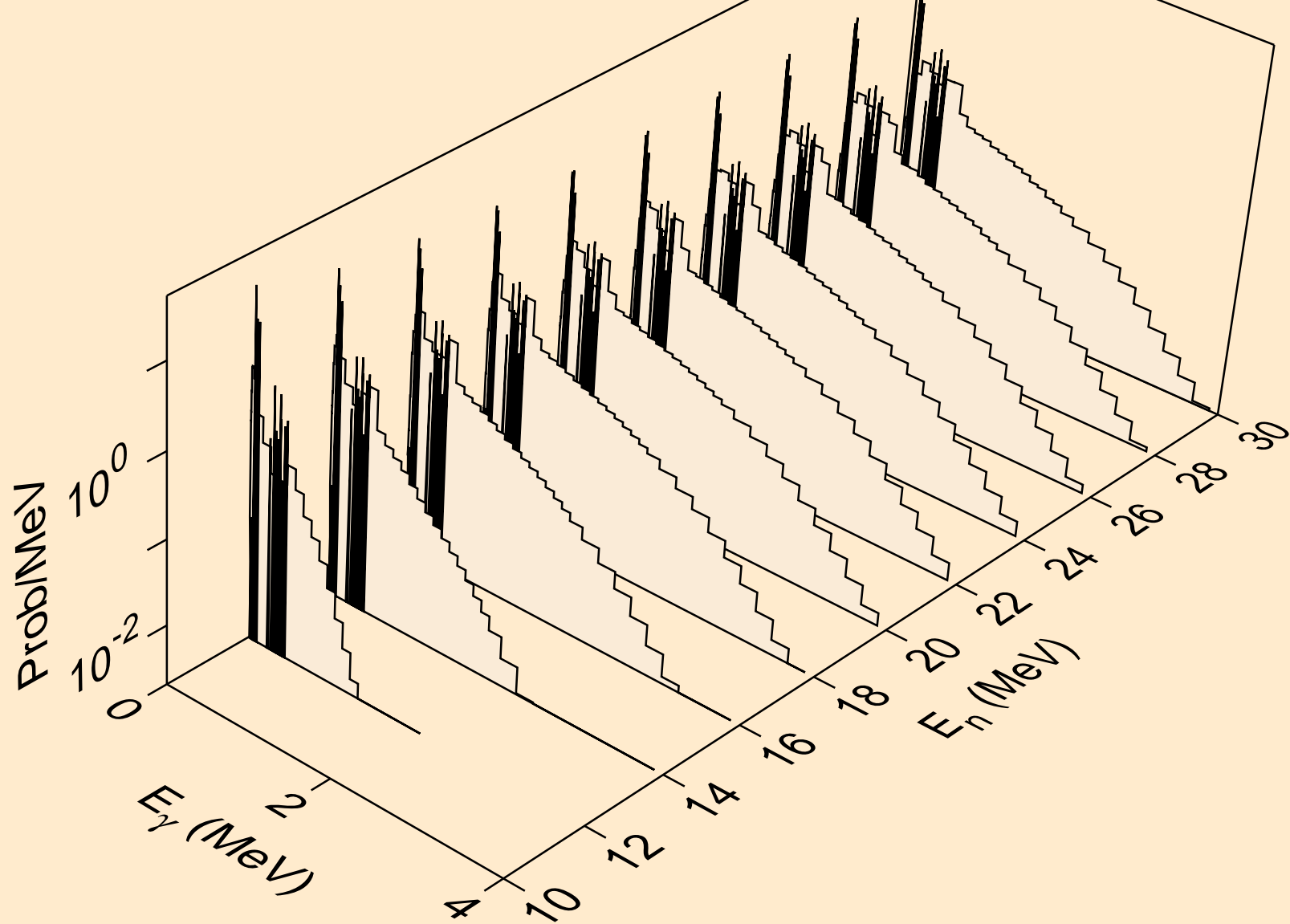

RA233 NEUTRON ACER TENDL-2024 LIBRARY; T=0.K
Photon emission for (n,n*)a

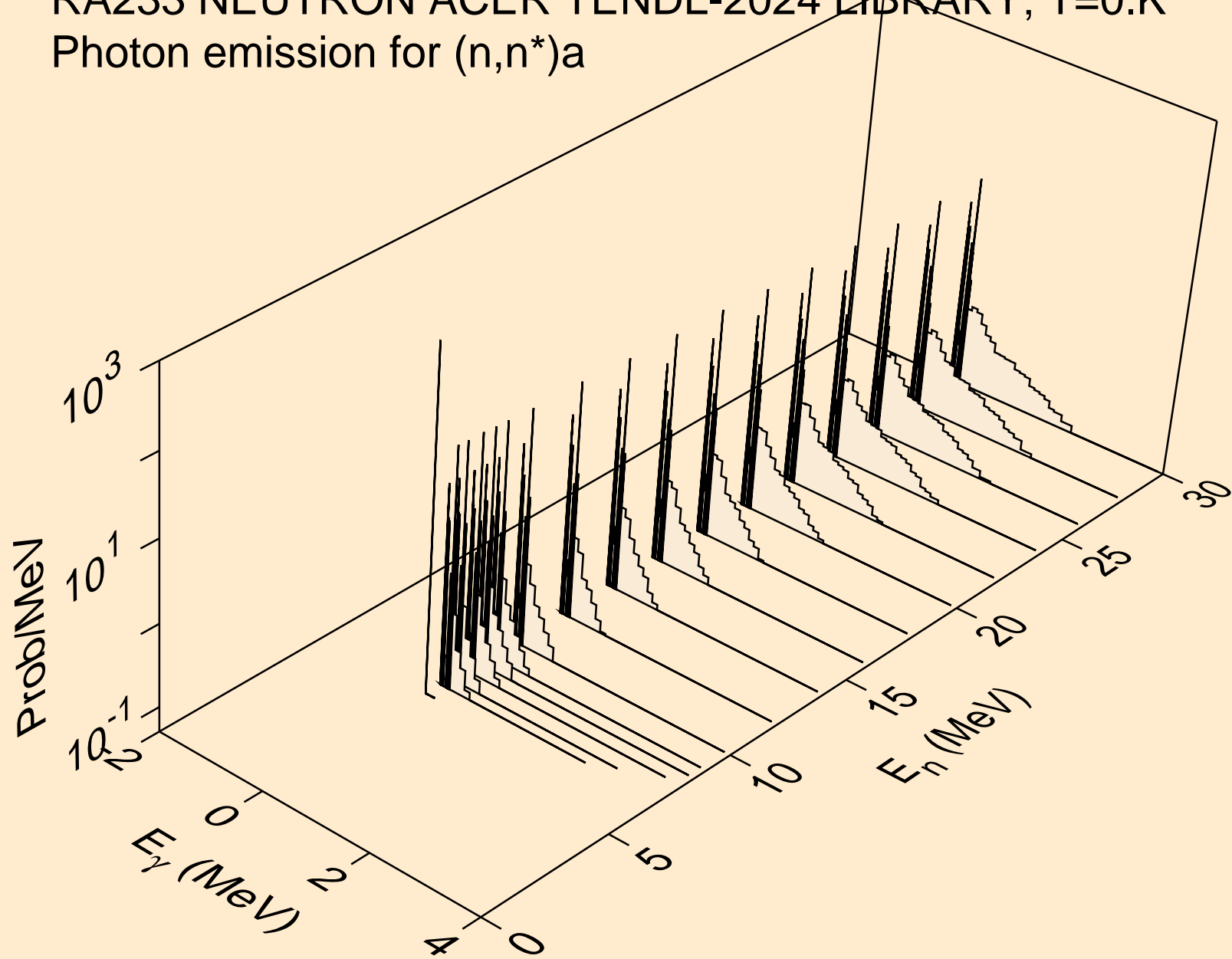

RA233 NEUTRON ACER TENDL-2024 LIBRARY; T=0.K
Photon emission for (n,2n)a

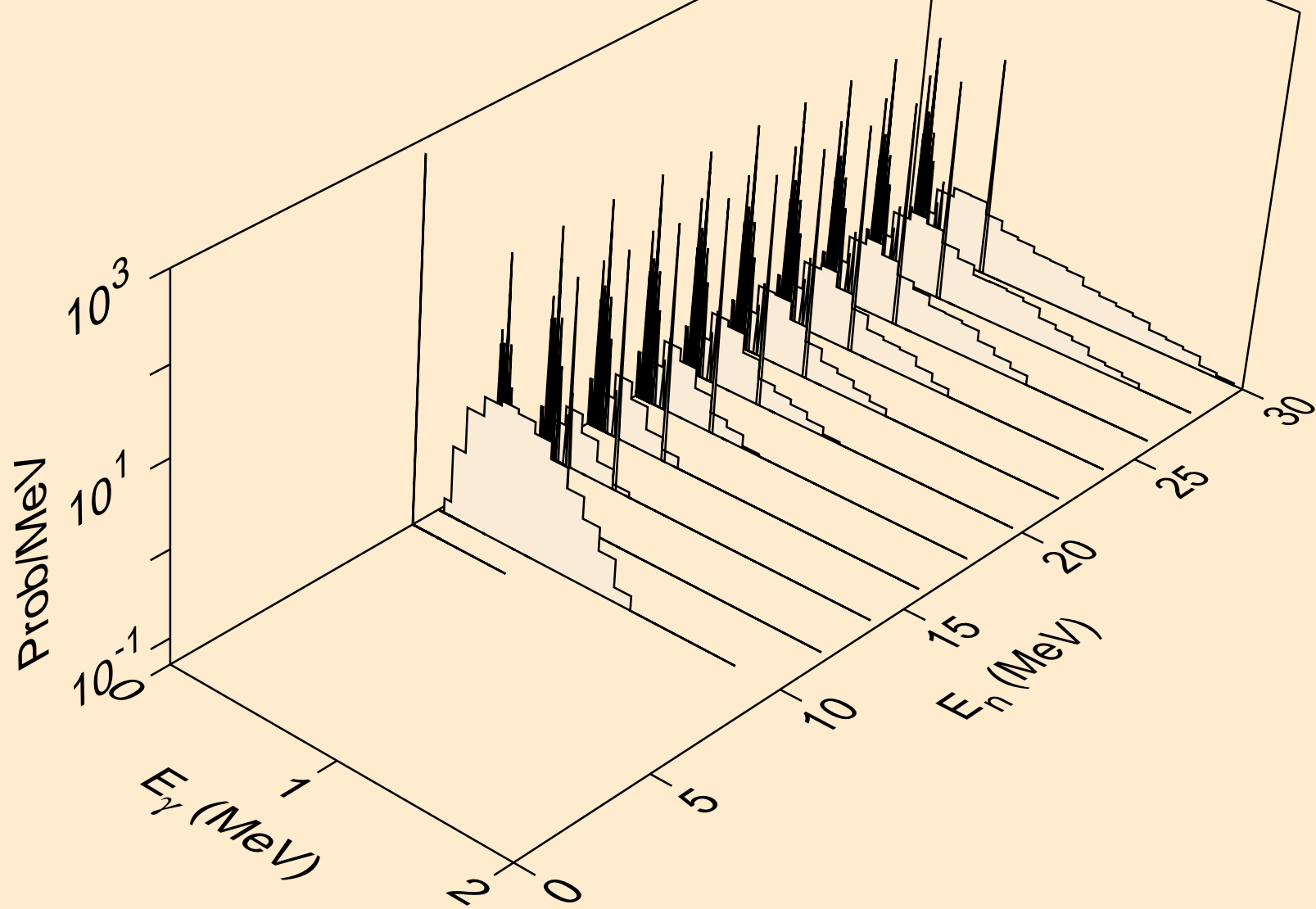

RA233 NEUTRON ACER TENDL-2024 LIBRARY; T=0.K
Photon emission for (n,3n)a

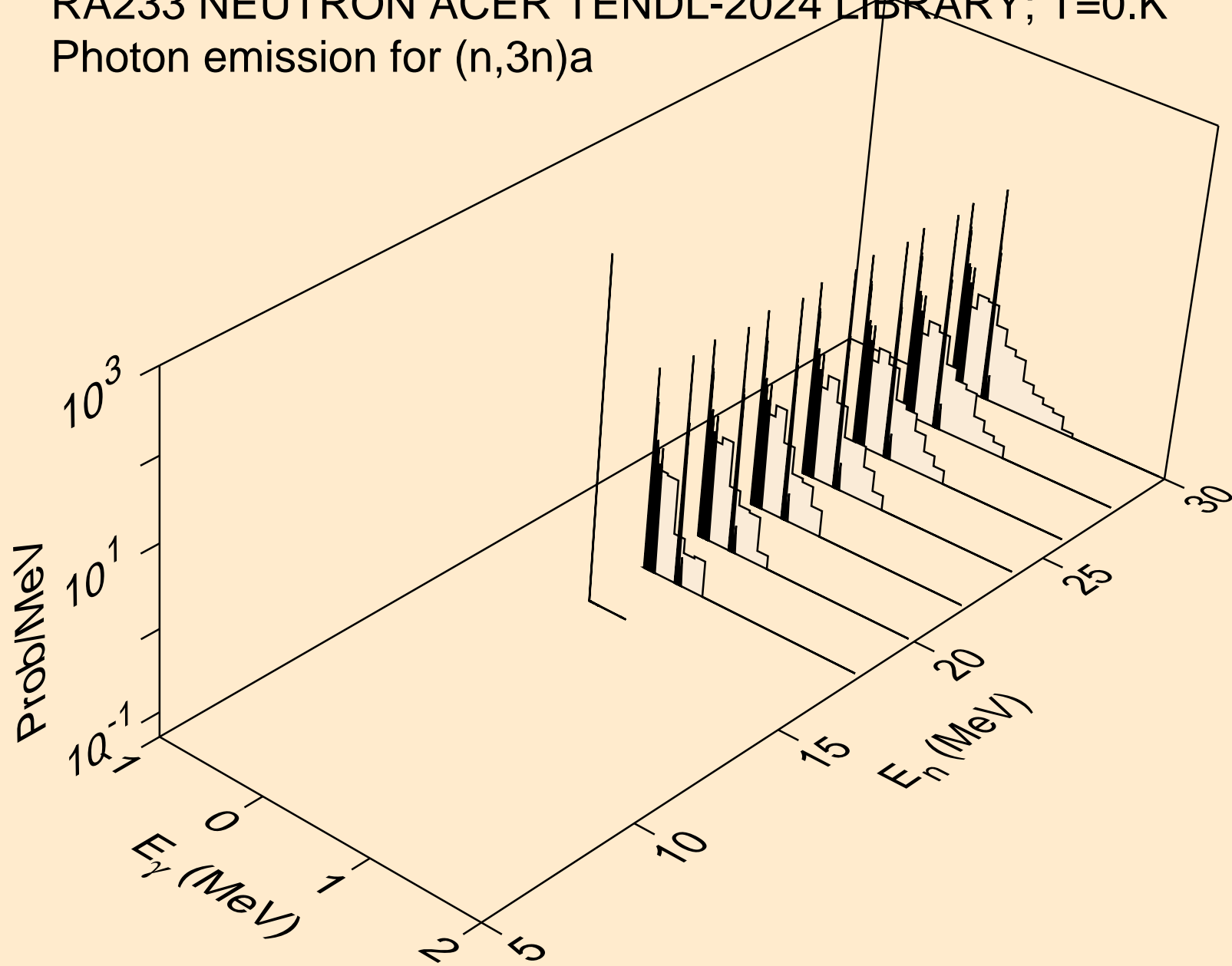

RA233 NEUTRON ACER TENDL-2024 LIBRARY; T=0.K
Photon emission for (n,n*)p

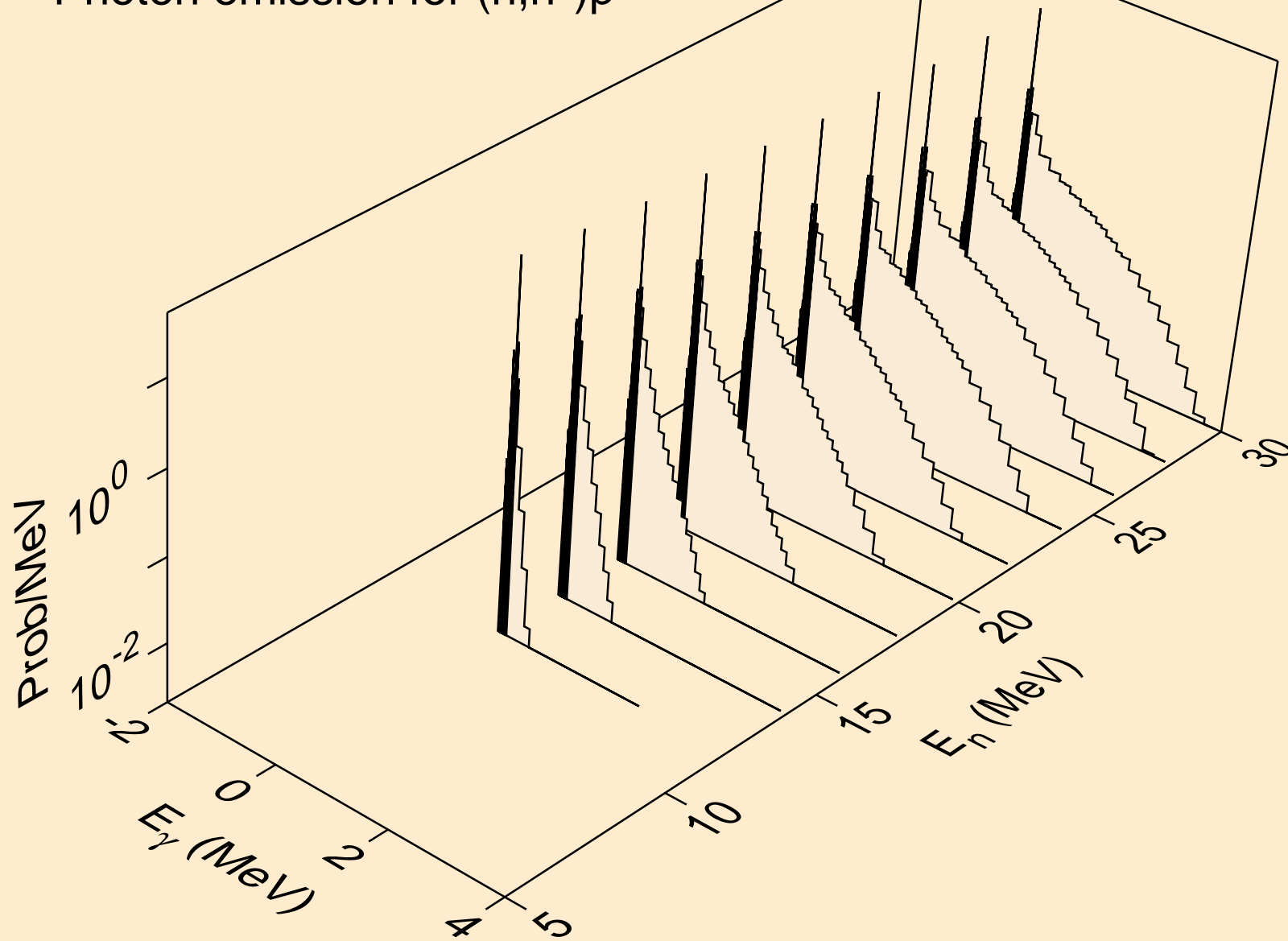

RA233 NEUTRON ACER TENDL-2024 LIBRARY; T=0.K
Photon emission for (n,n*)d

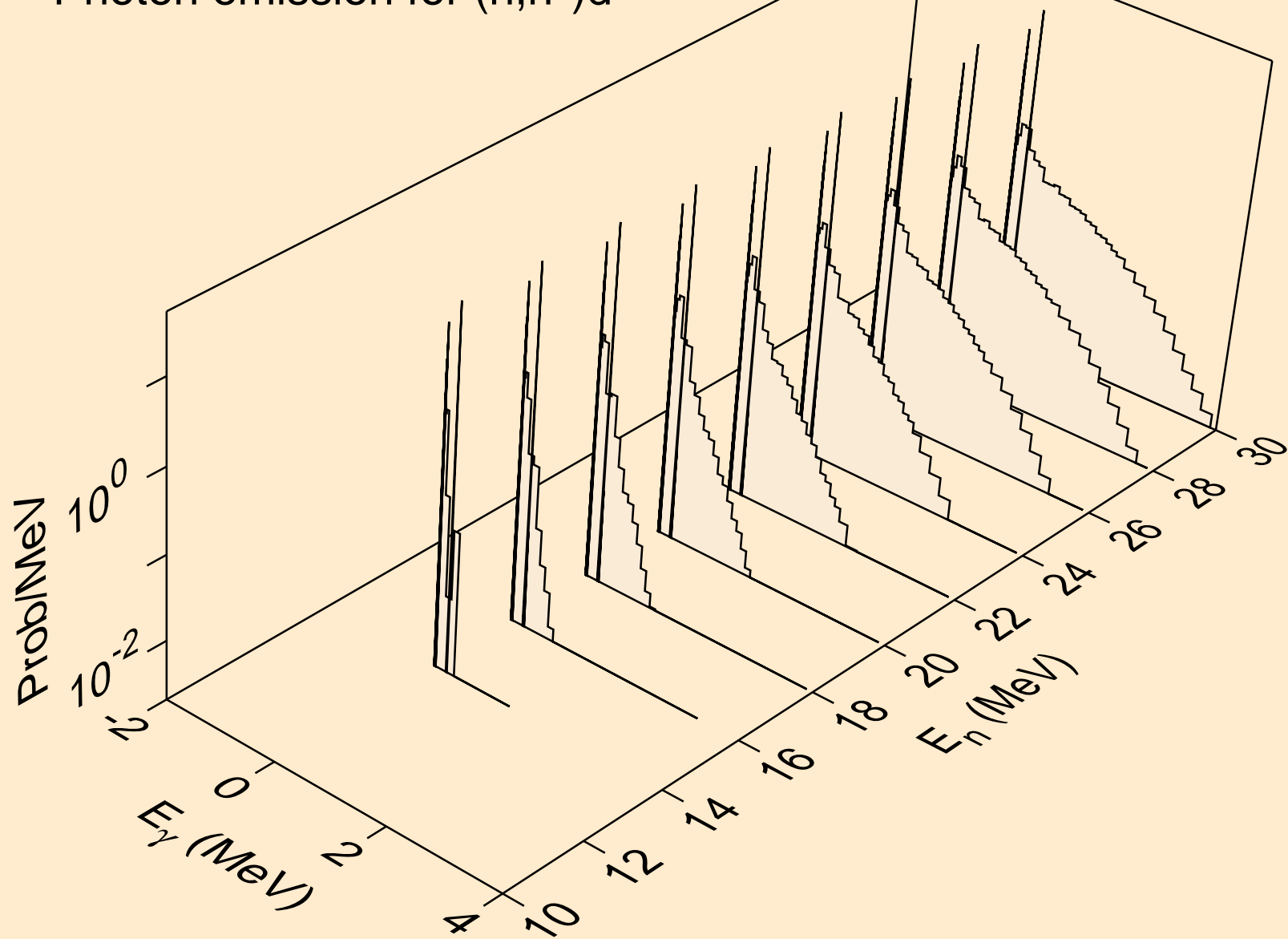

RA233 NEUTRON ACER TENDL-2024 LIBRARY; T=0.K
Photon emission for (n,n*)t

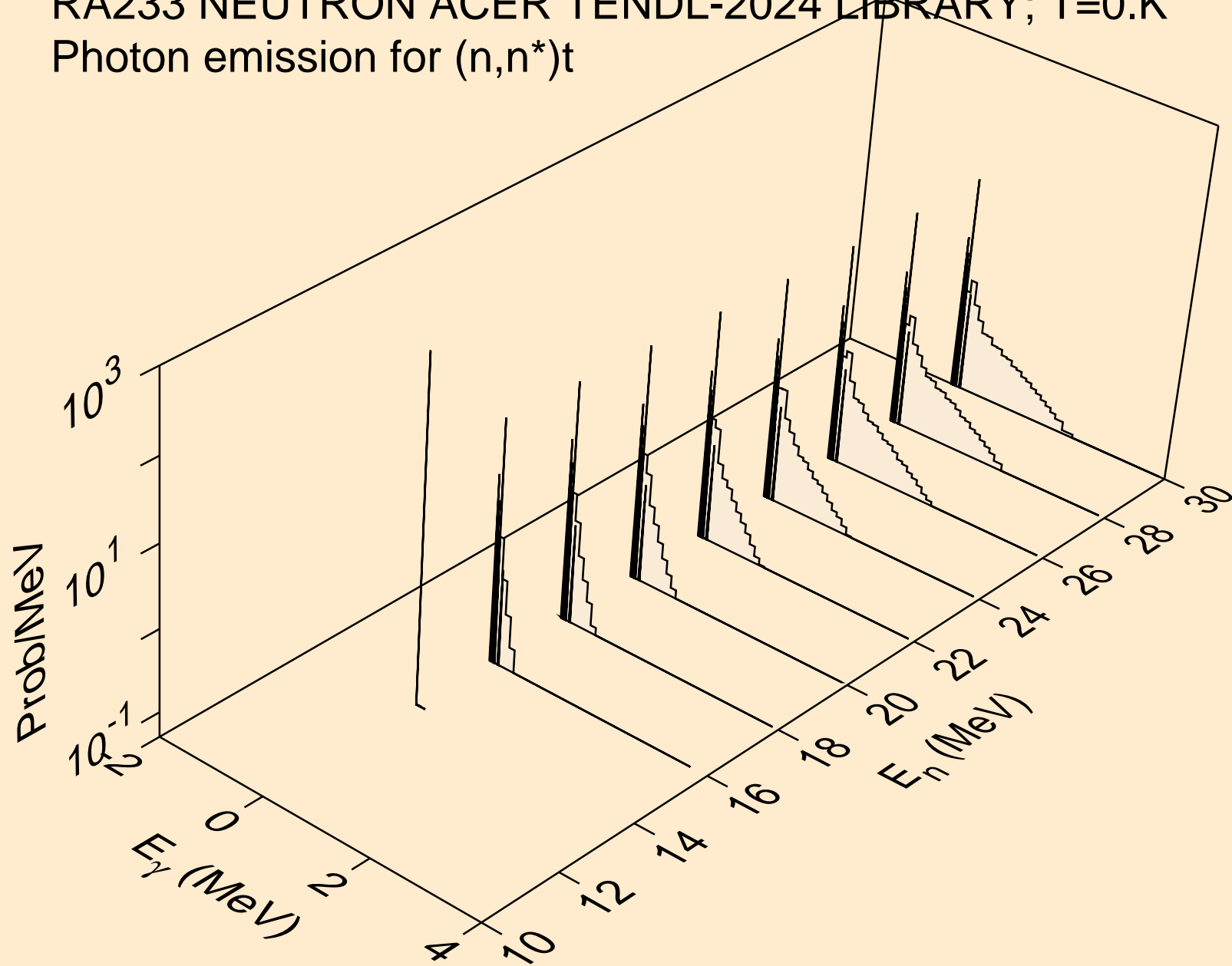

RA233 NEUTRON ACER TENDL-2024 LIBRARY; T=0.K
Photon emission for (n,n*)he3

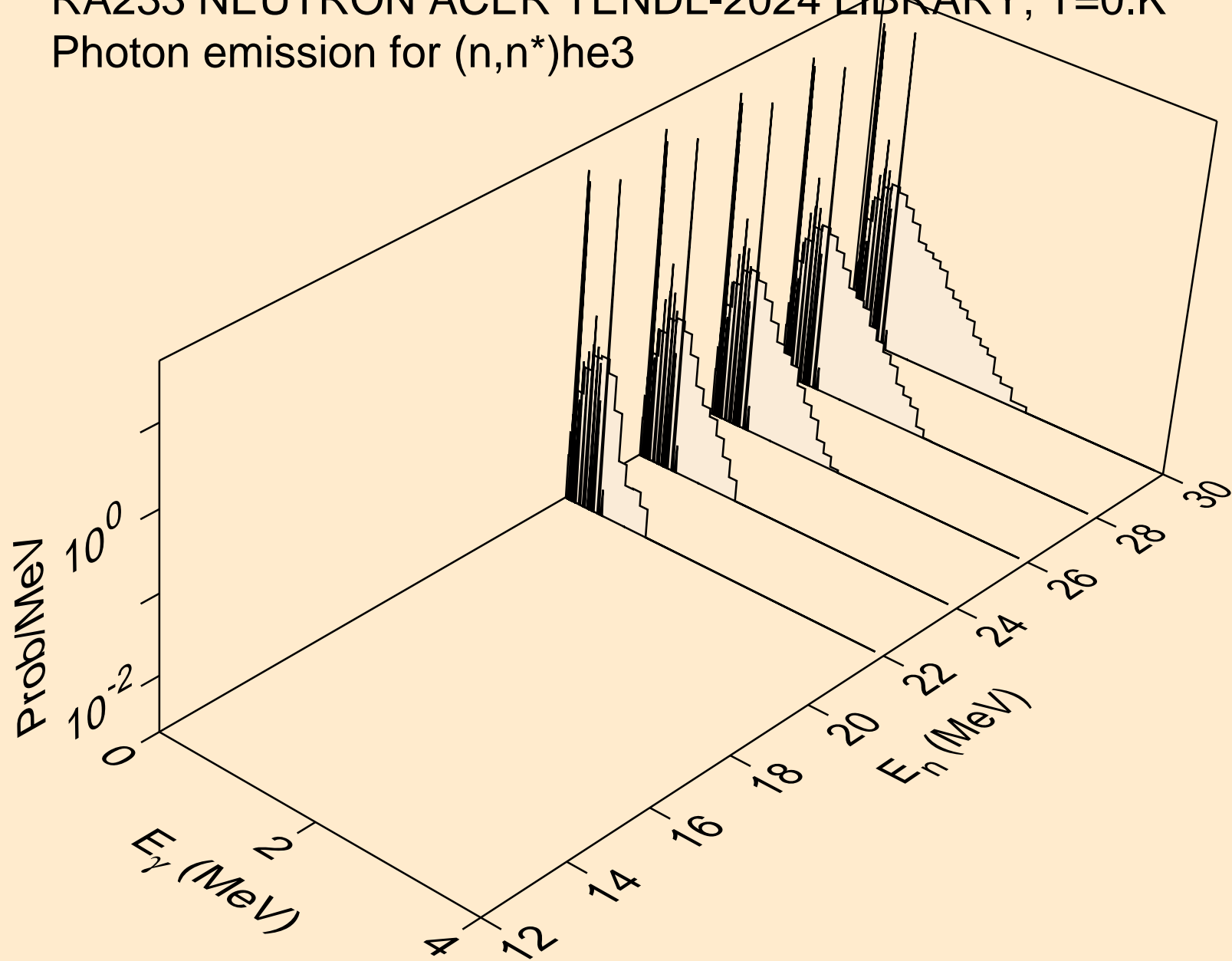

RA233 NEUTRON ACER TENDL-2024 LIBRARY; T=0.K
Photon emission for (n,4n)

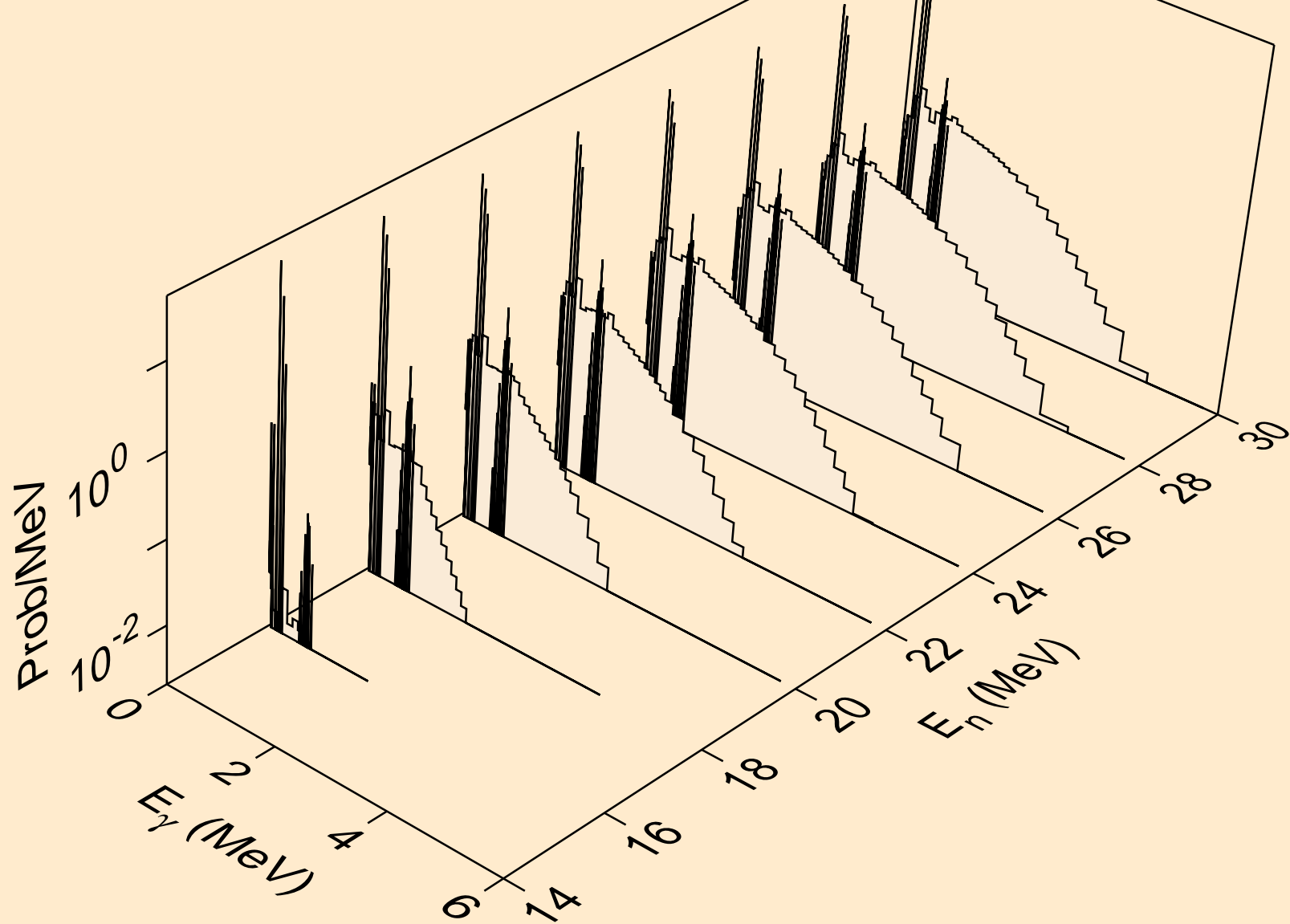

RA233 NEUTRON ACER TENDL-2024 LIBRARY; T=0.K
Photon emission for (n,2np)

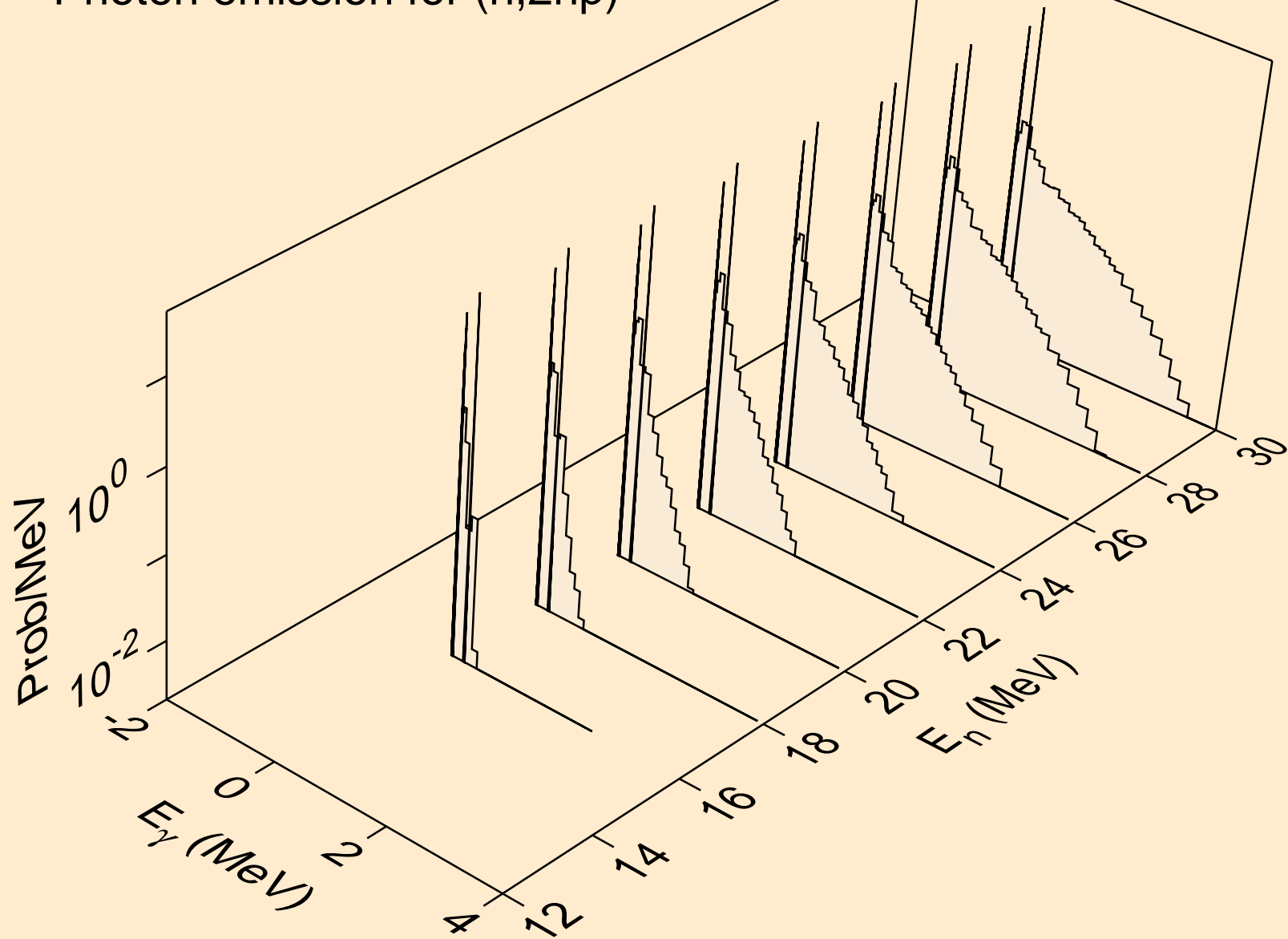

RA233 NEUTRON ACER TENDL-2024 LIBRARY; T=0.K
Photon emission for (n,3np)

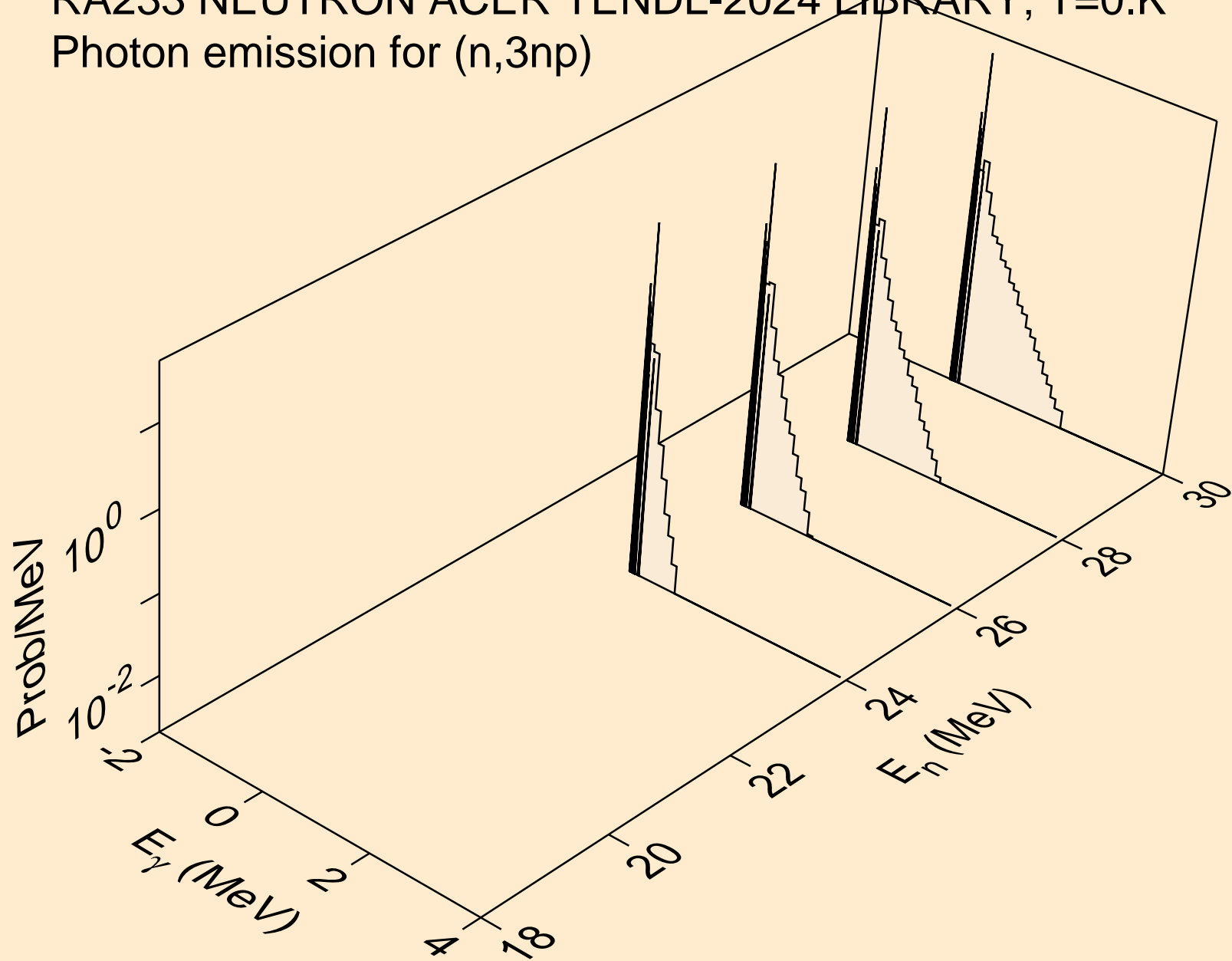

RA233 NEUTRON ACER TENDL-2024 LIBRARY; T=0.K
Photon emission for (n,n*c)

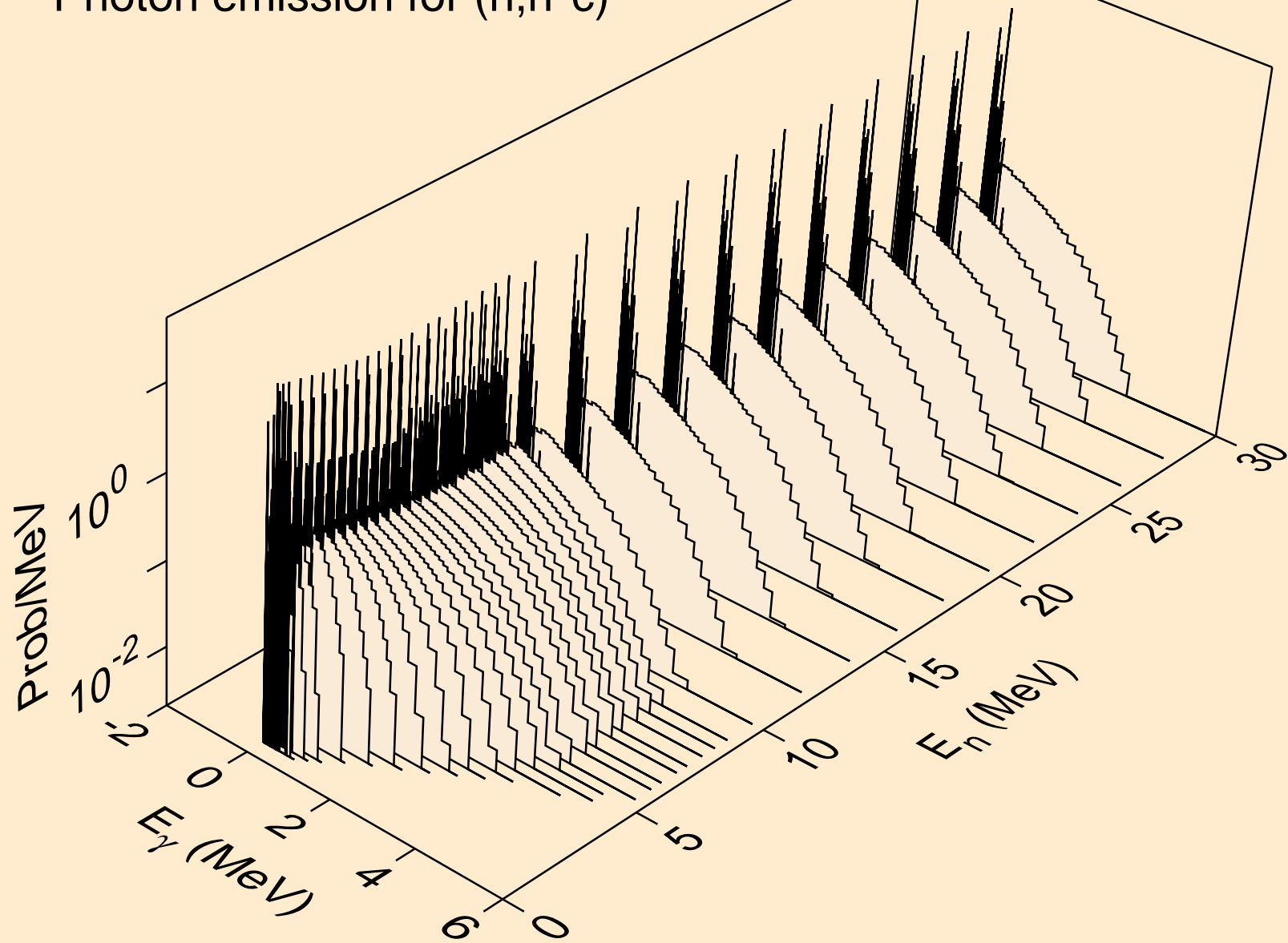

RA233 NEUTRON ACER TENDL-2024 LIBRARY; T=0.K
Photon emission for (n,gma)

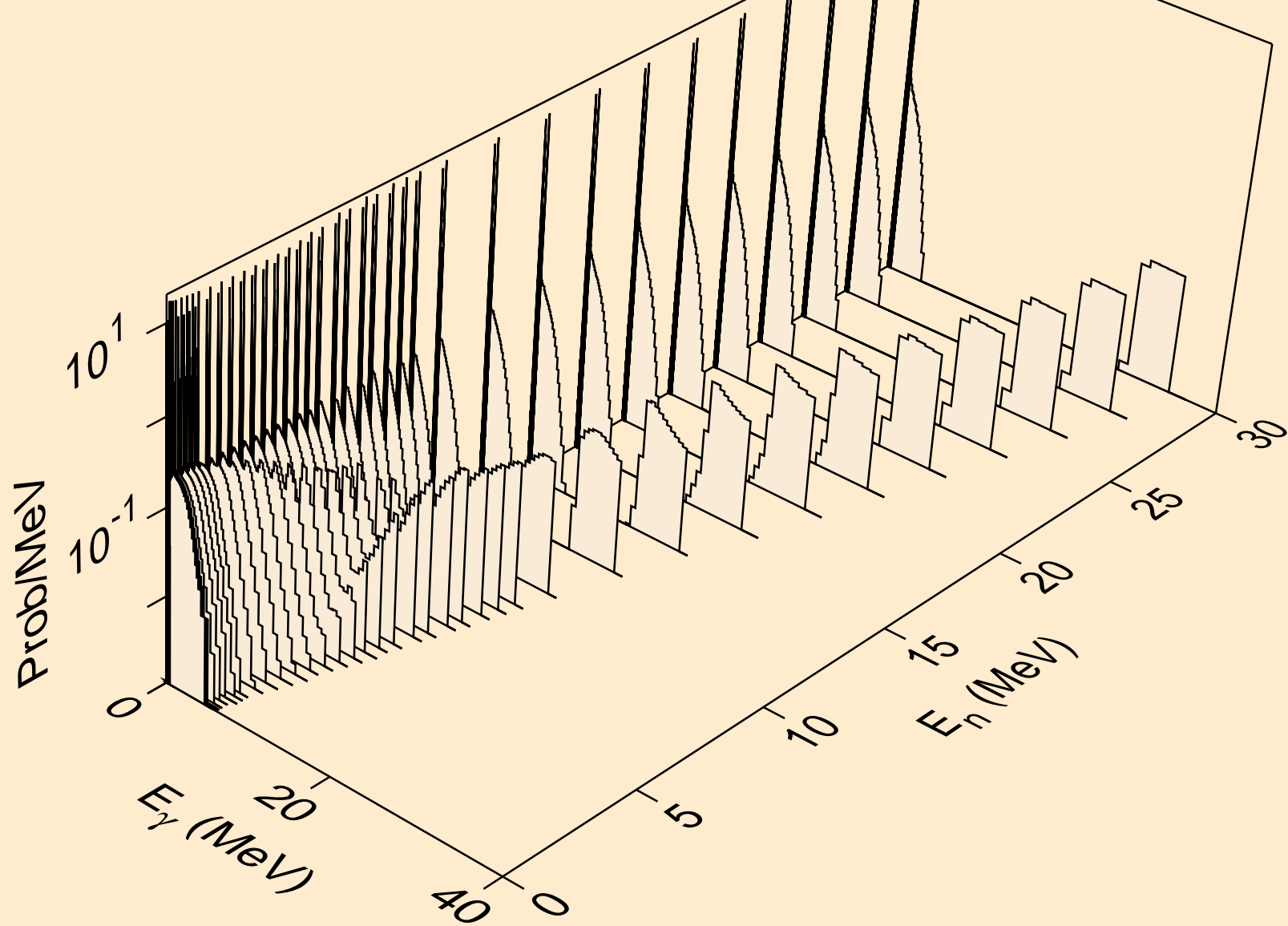

RA233 NEUTRON ACER TENDL-2024 LIBRARY; T=0.K
Photon emission for (n,p)

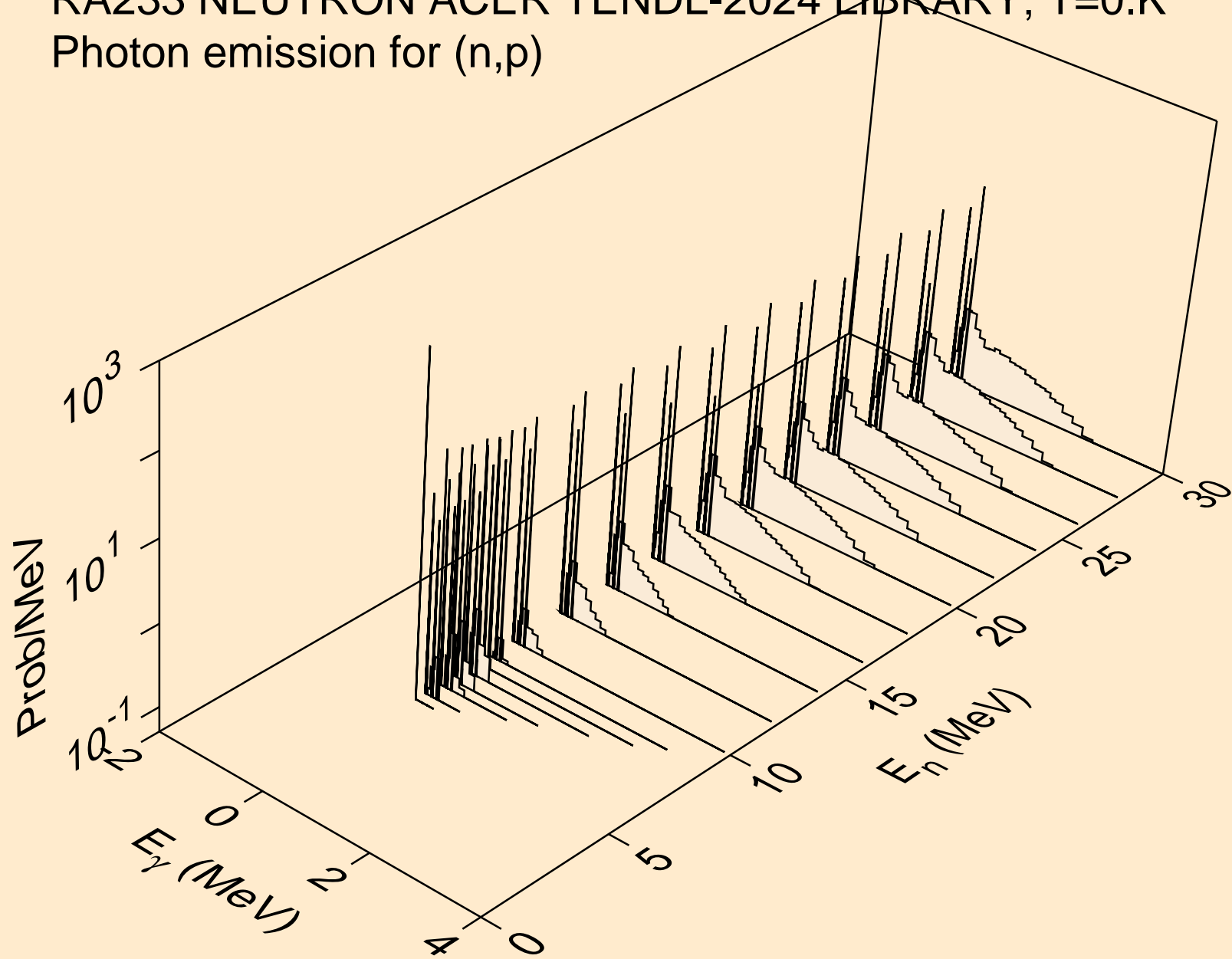

RA233 NEUTRON ACER TENDL-2024 LIBRARY; T=0.K
Photon emission for (n,d)

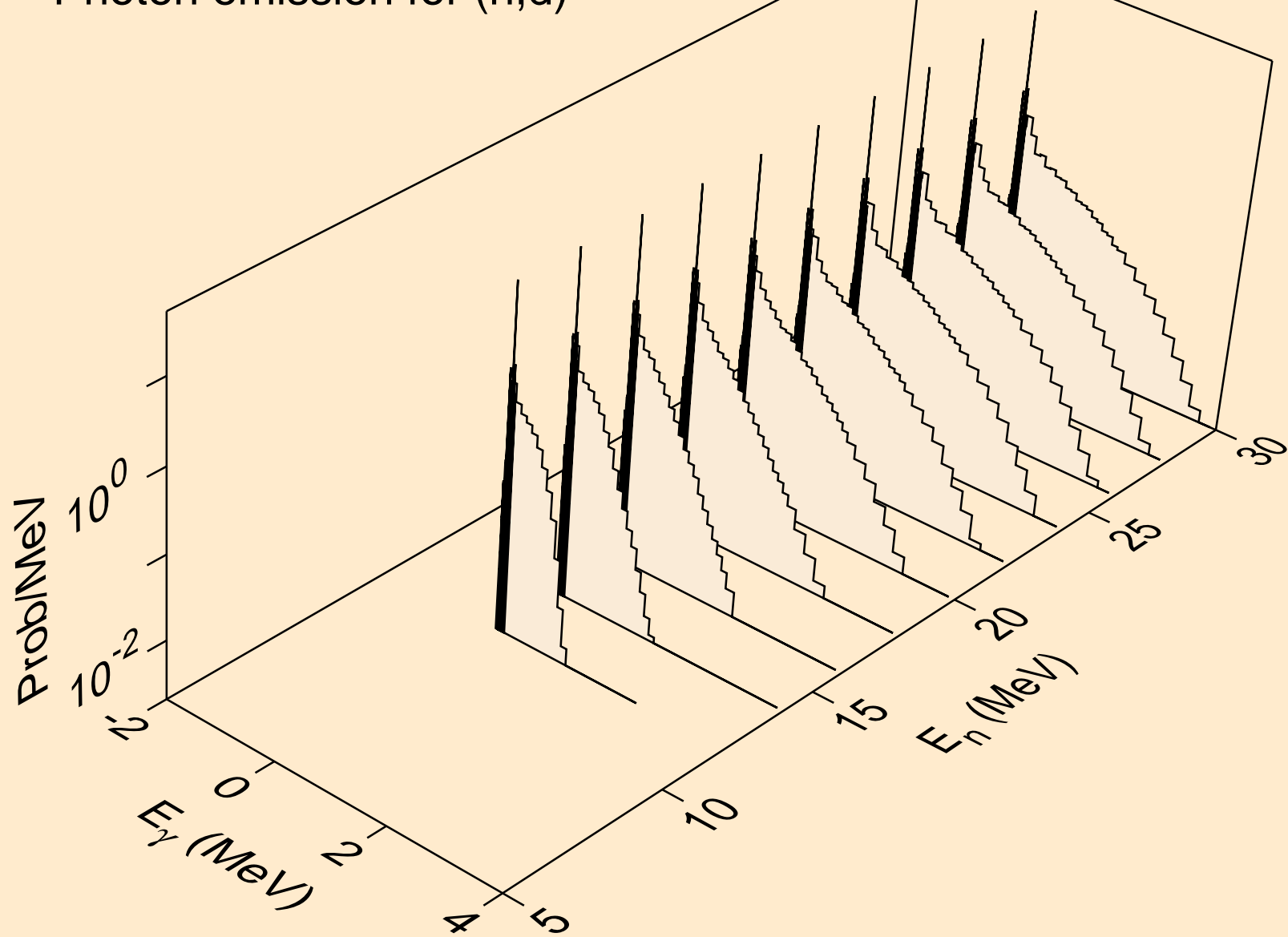

RA233 NEUTRON ACER TENDL-2024 LIBRARY; T=0.K
Photon emission for (n,t)

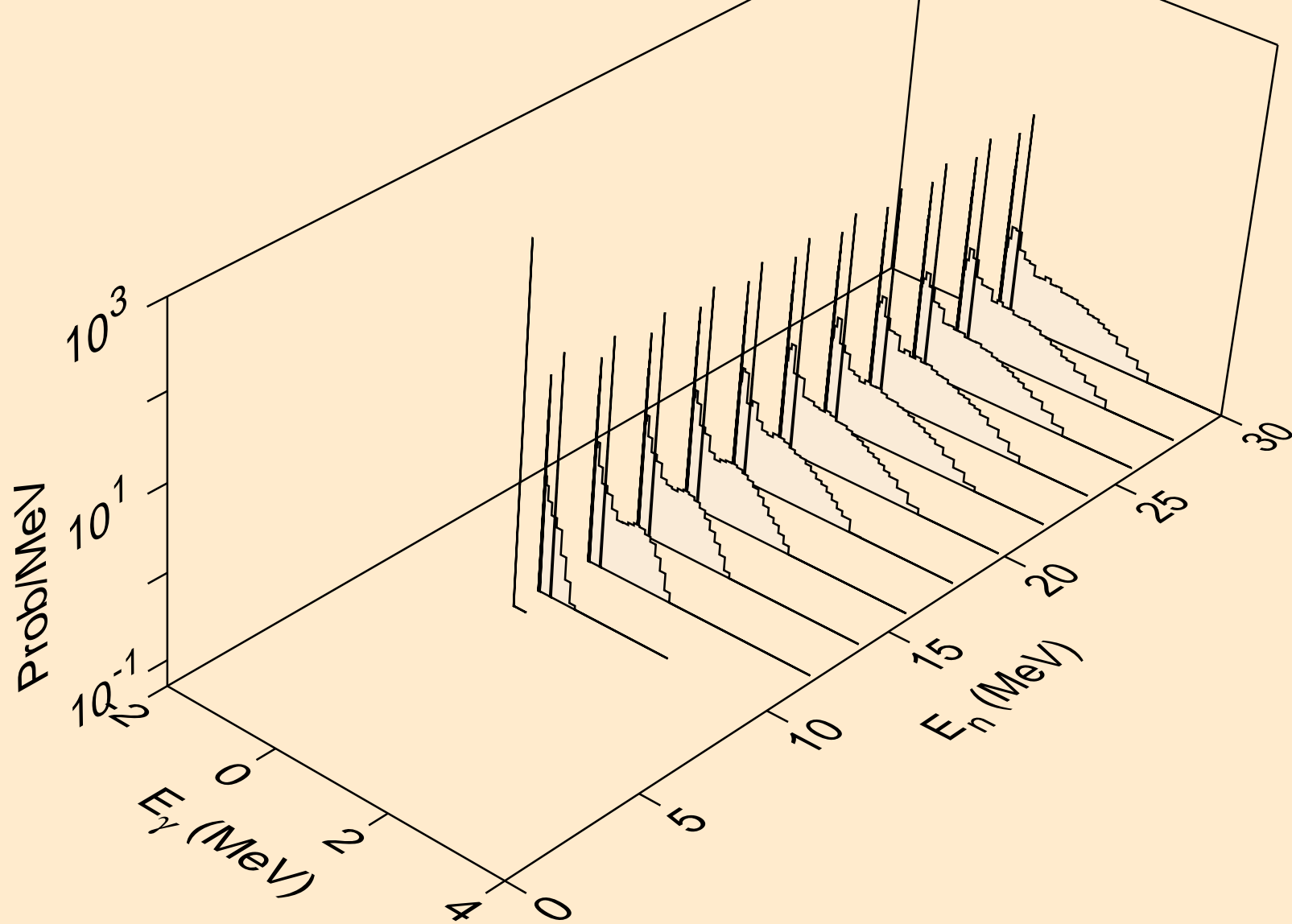

RA233 NEUTRON ACER TENDL-2024 LIBRARY; T=0.K
Photon emission for (n,he3)

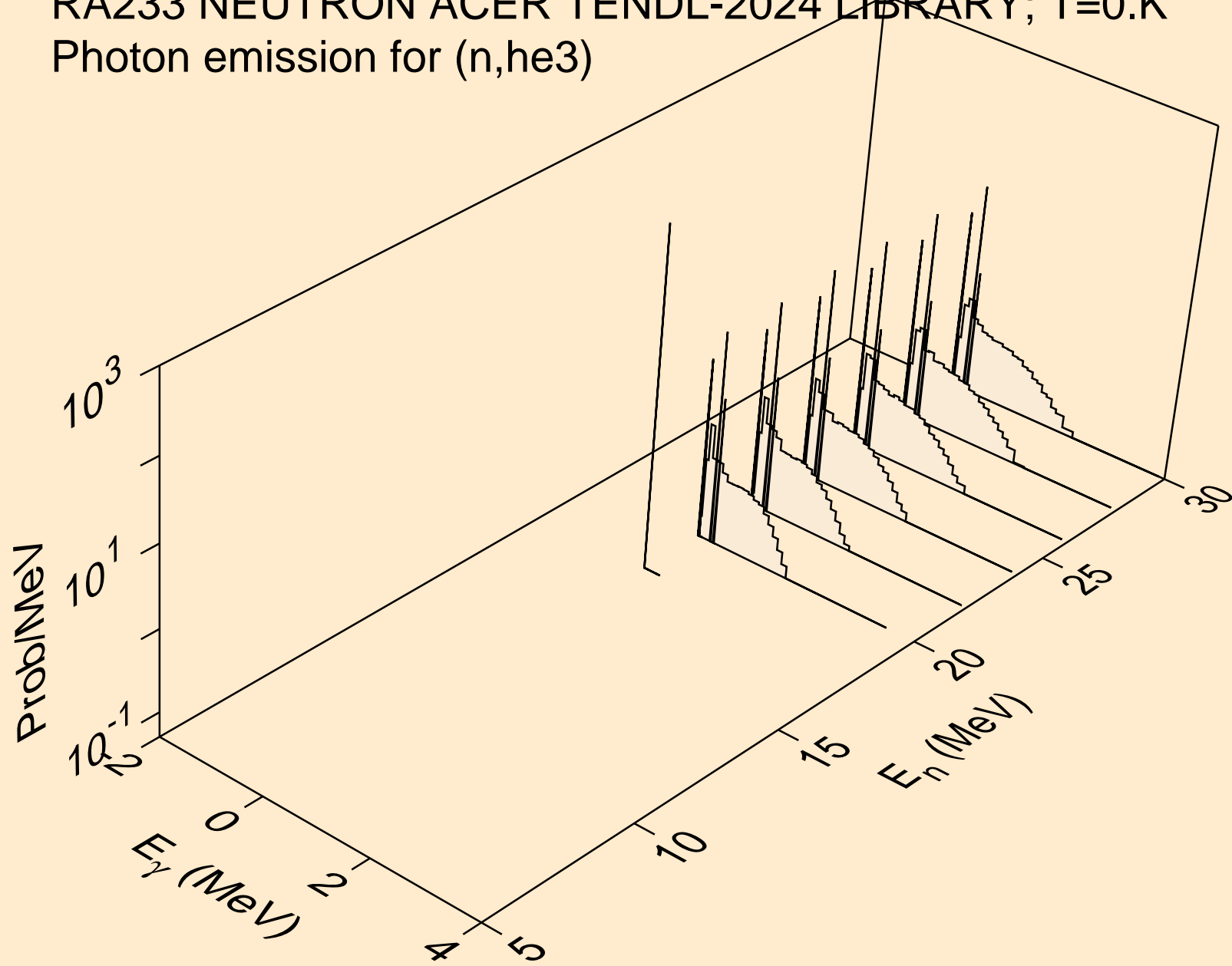

RA233 NEUTRON ACER TENDL-2024 LIBRARY; T=0.K
Photon emission for (n,a)

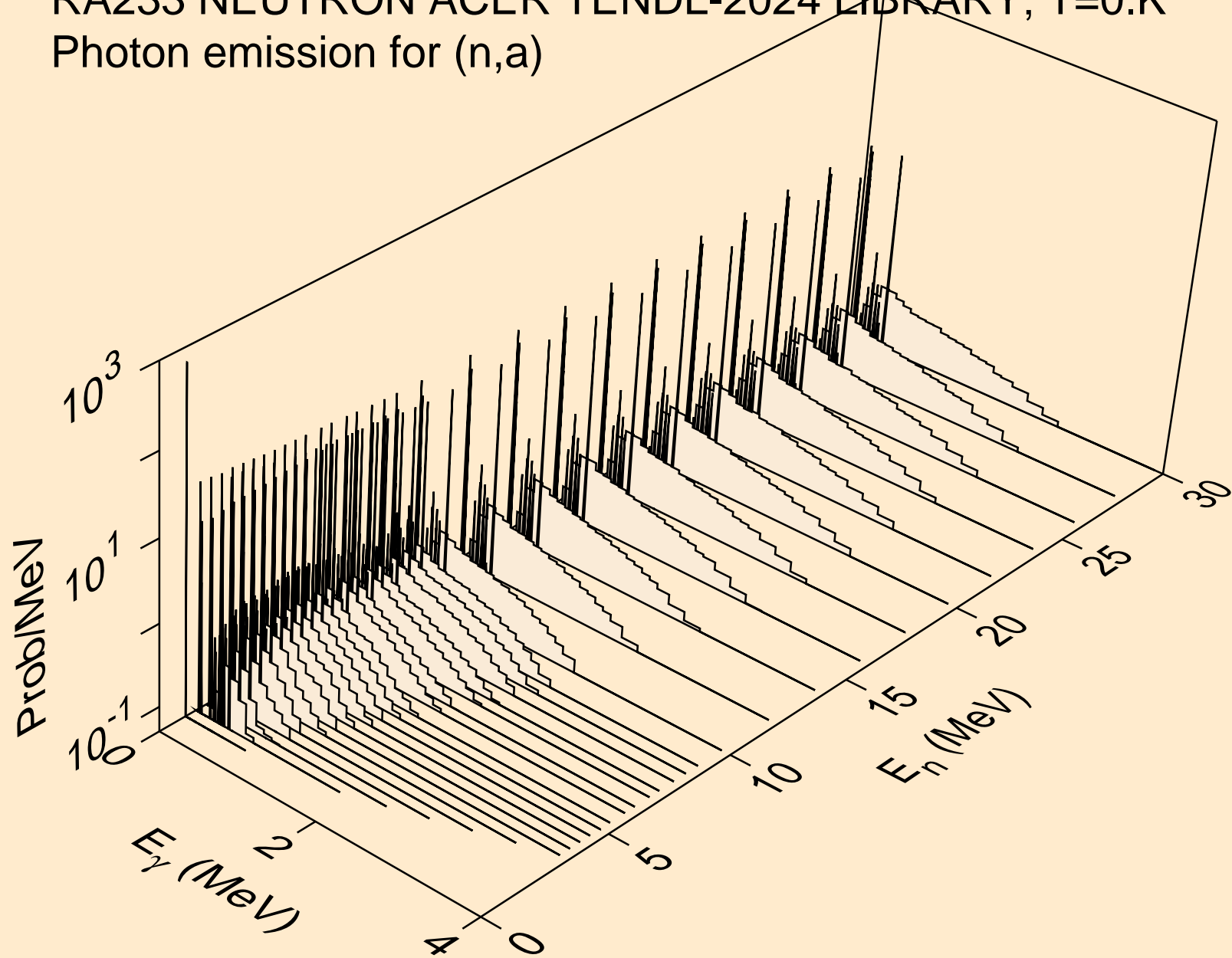

RA233 NEUTRON ACER TENDL-2024 LIBRARY; T=0.K
Photon emission for (n,2p)

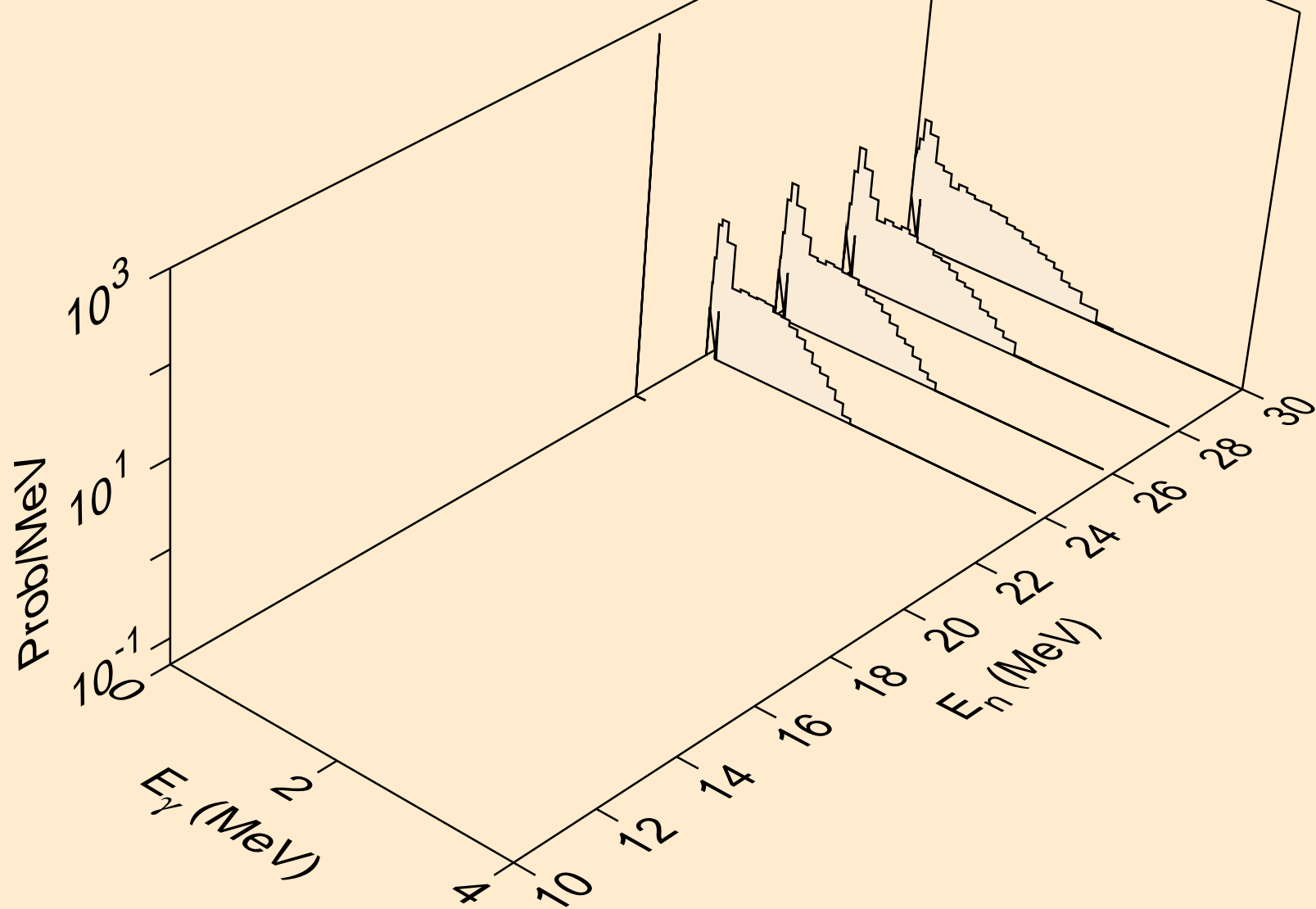

RA233 NEUTRON ACER TENDL-2024 LIBRARY; T=0.K
thermal capture photon spectrum

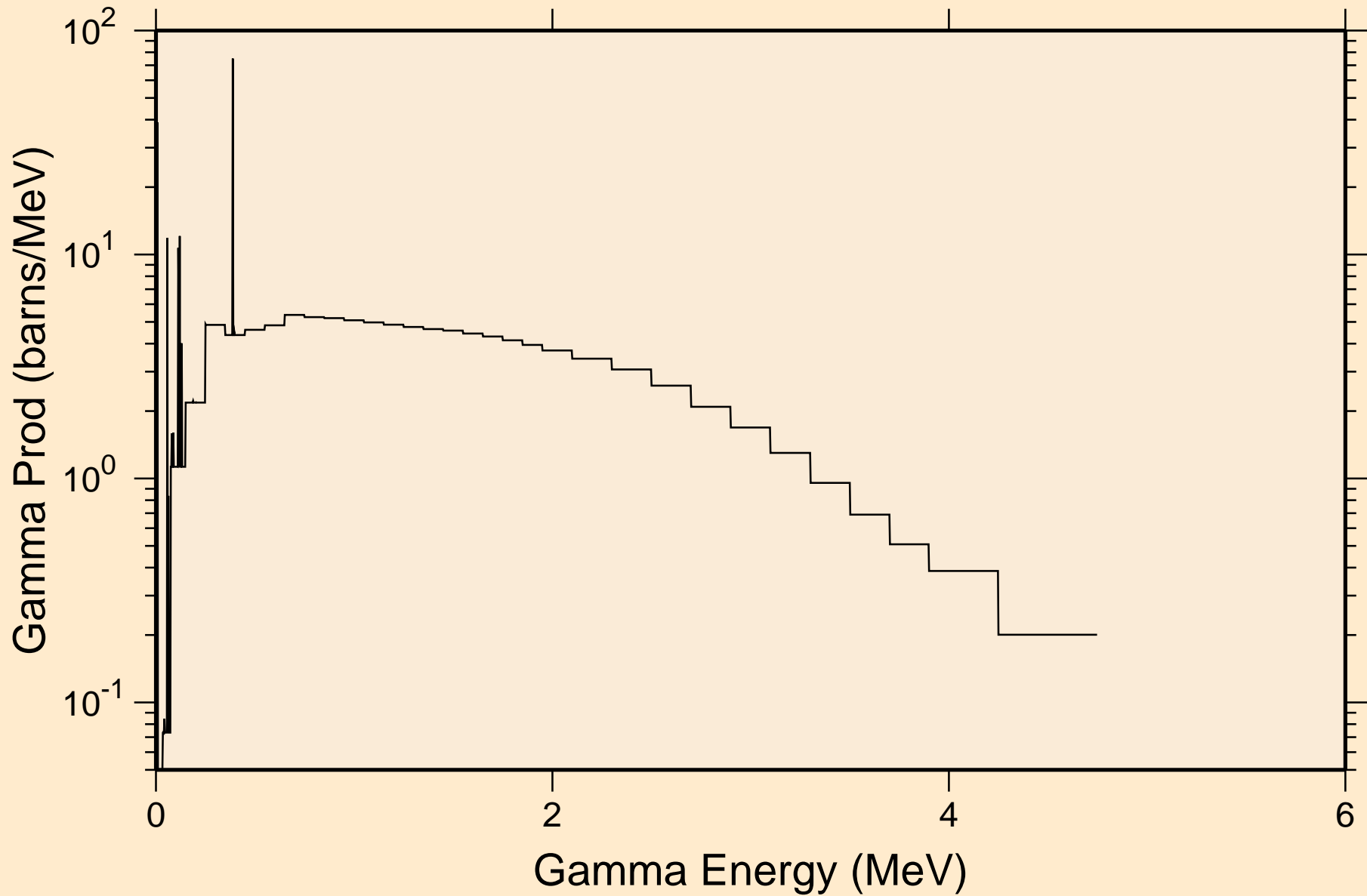

RA233 NEUTRON ACER TENDL-2024 LIBRARY; T=0.K
14 MeV photon spectrum

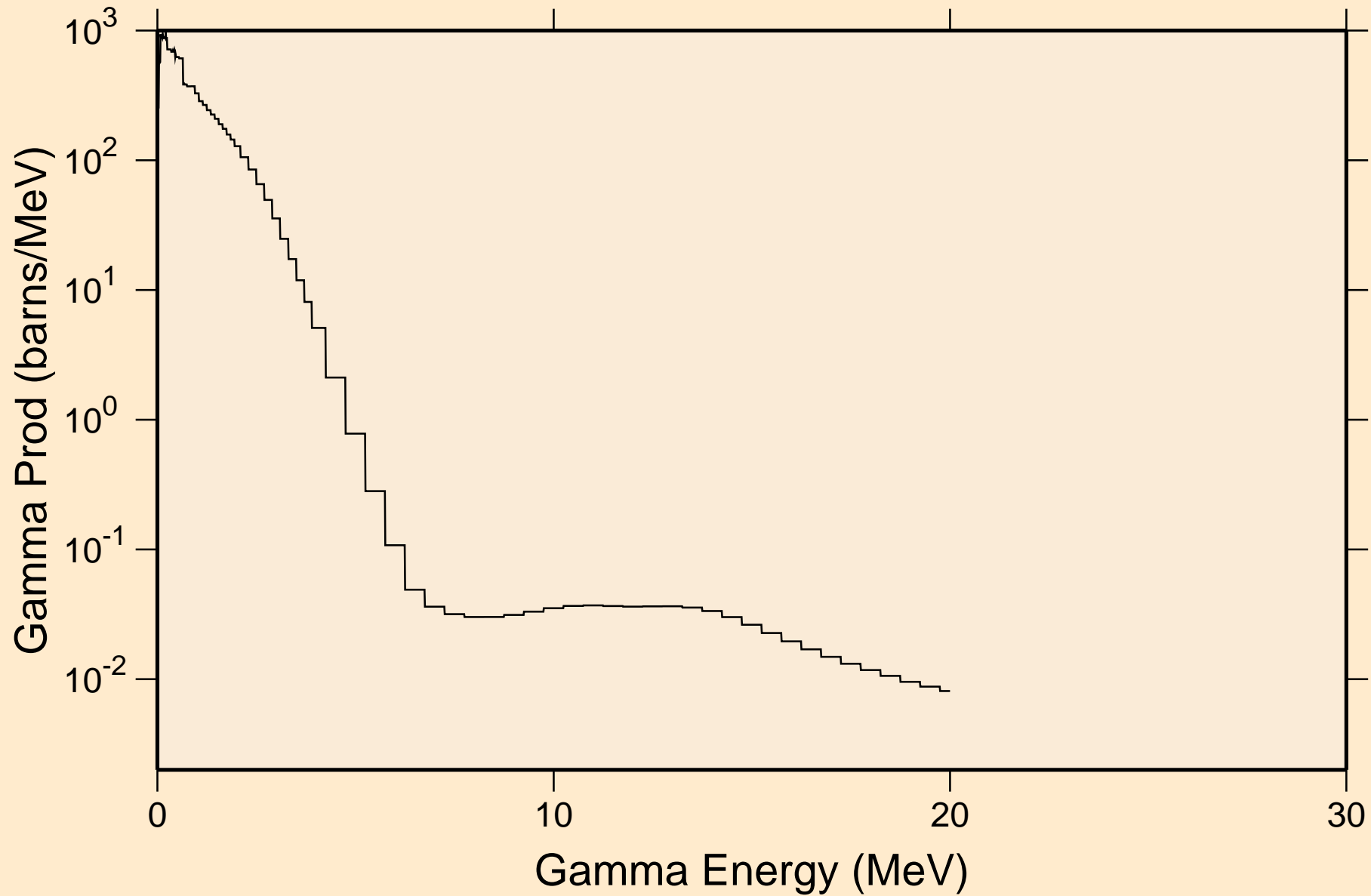

RA233 NEUTRON ACER TENDL-2024 LIBRARY; T=0.K

Particle heating contributions

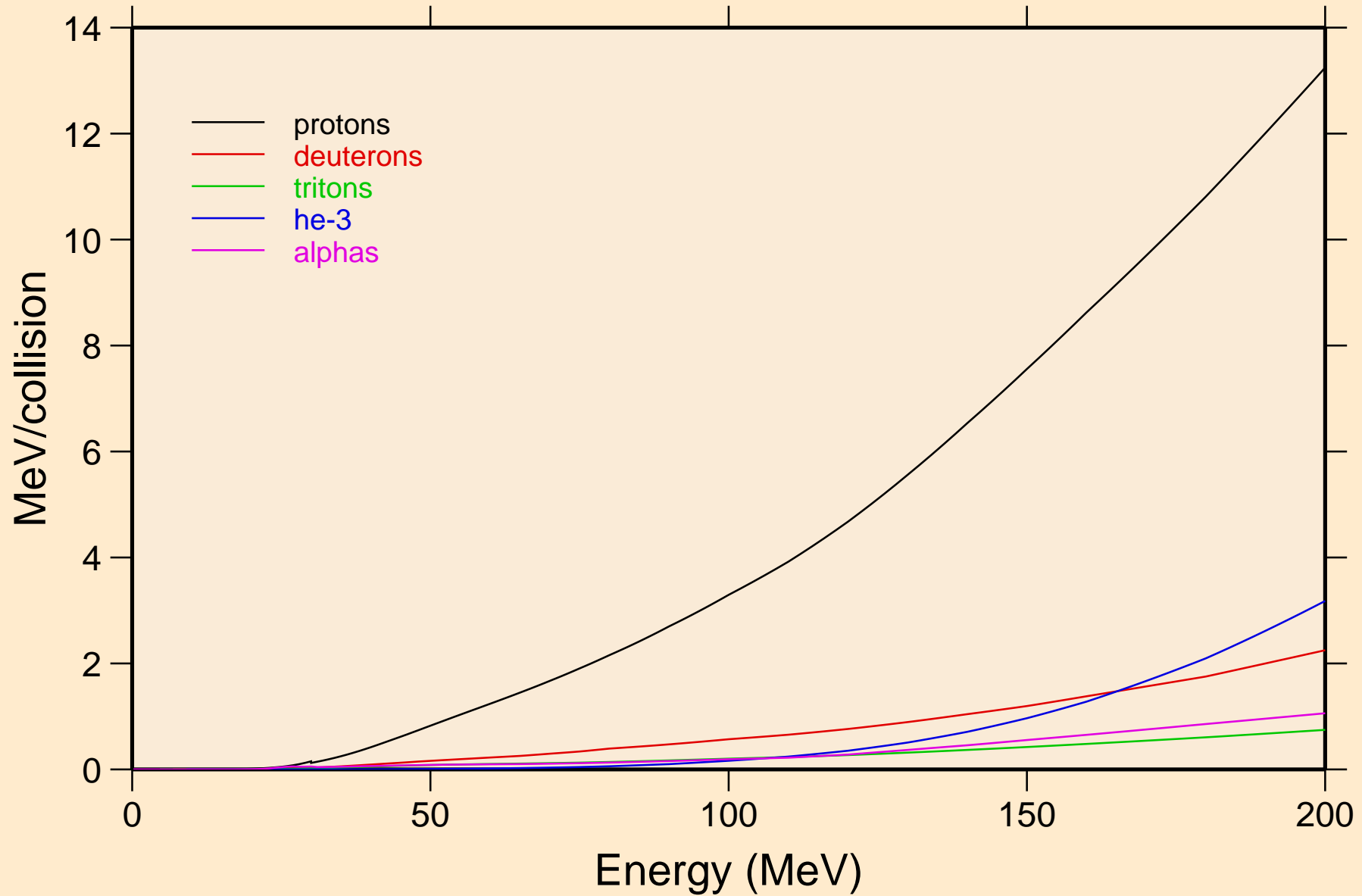

RA233 NEUTRON ACER TENDL-2024 LIBRARY; T=0.K
Recoil Heating

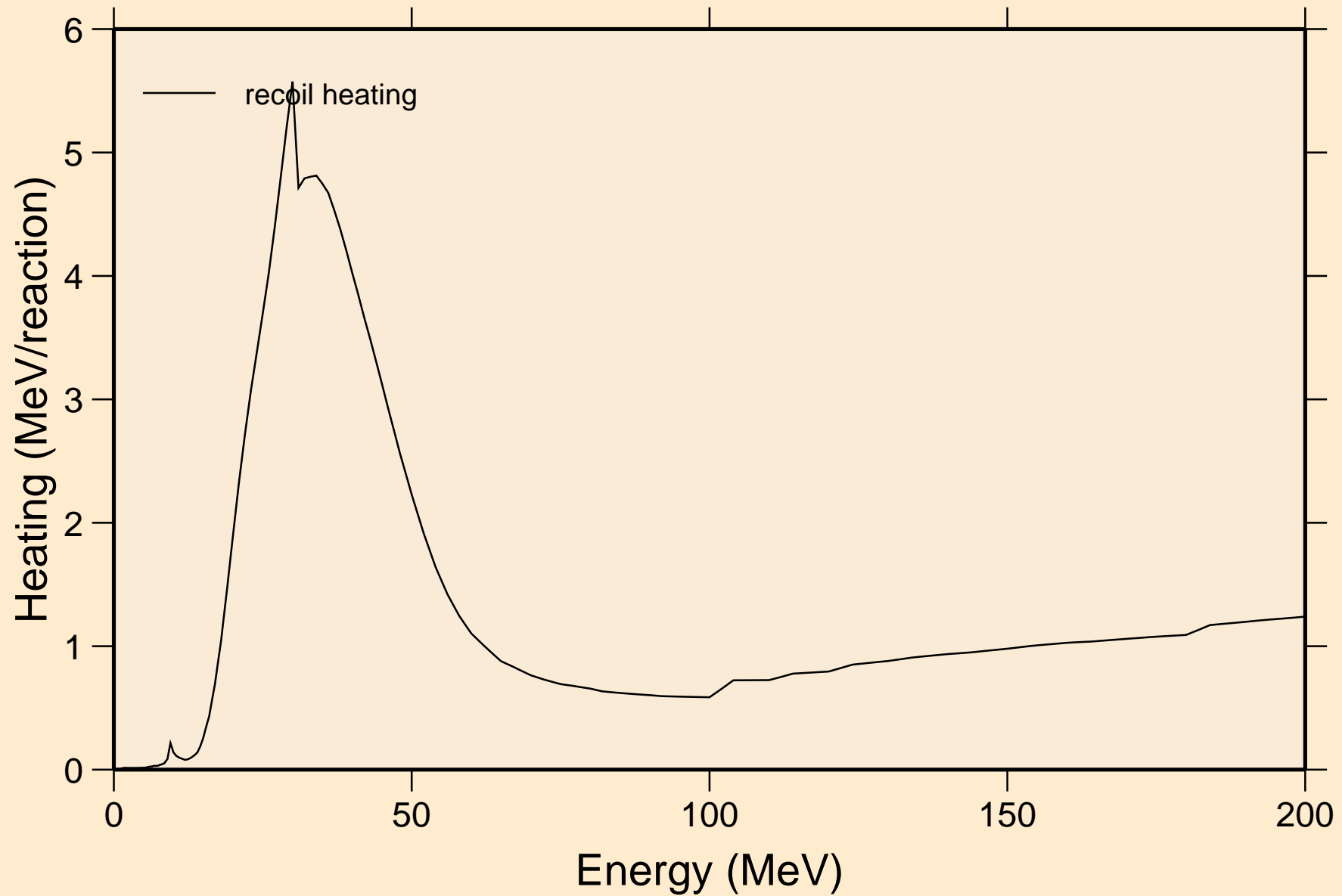

RA233 NEUTRON ACER TENDL-2024 LIBRARY; T=0.K
Particle production cross sections

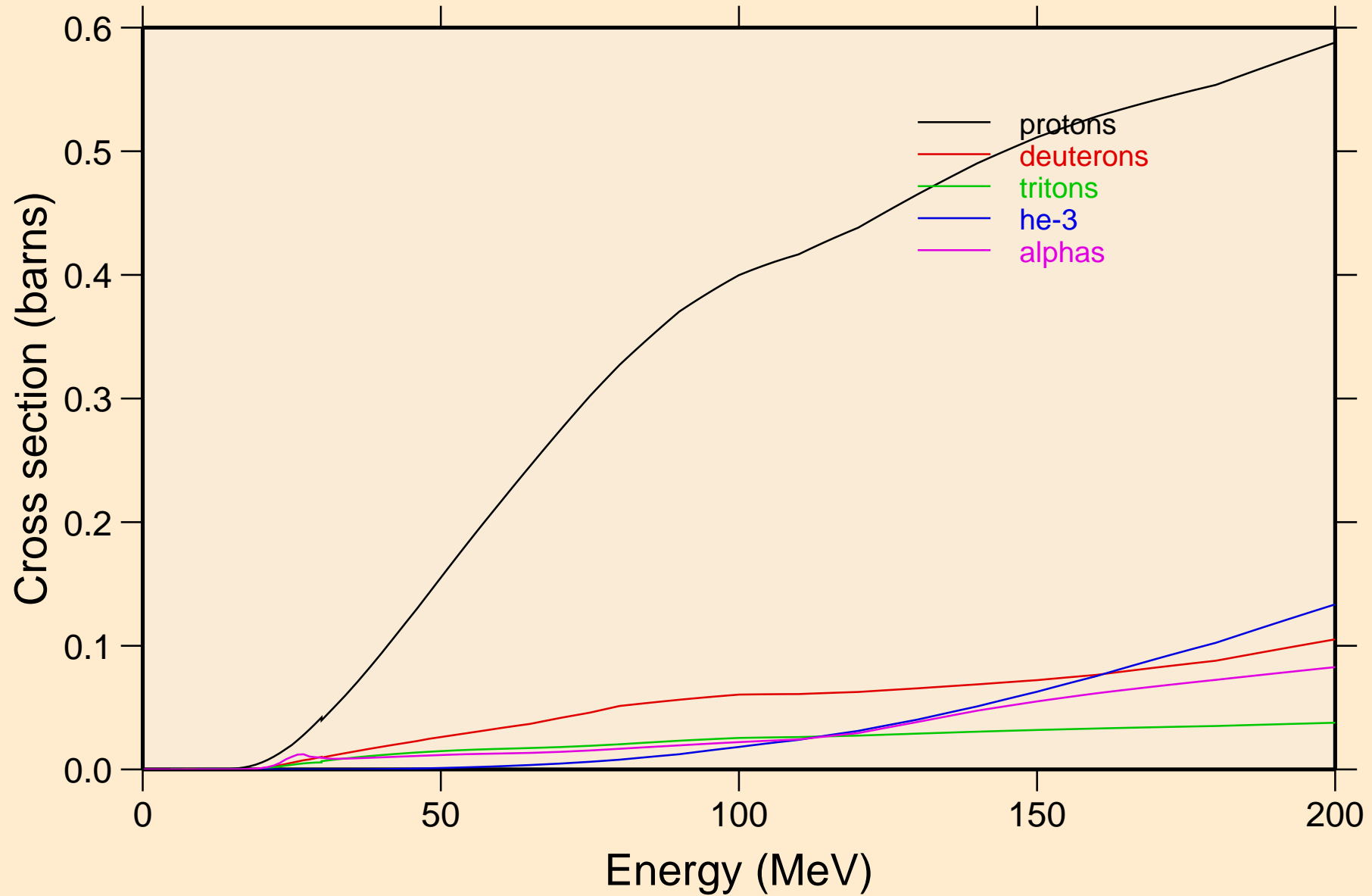

RA233 NEUTRON ACER TENDL-2024 LIBRARY; T=0.K
protons from (n,x)

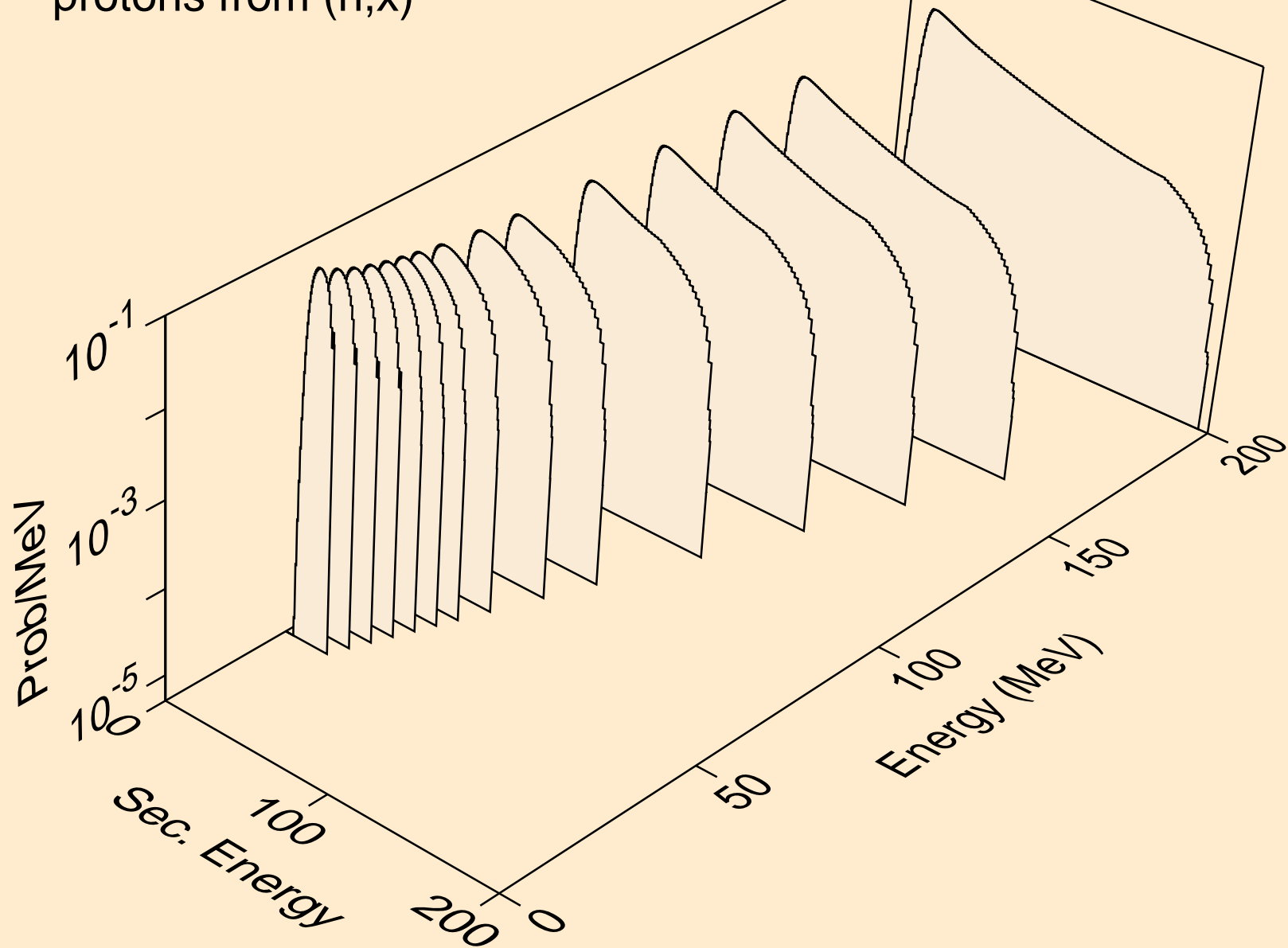

RA233 NEUTRON ACER TENDL-2024 LIBRARY; T=0.K
protons from (n,n*)p

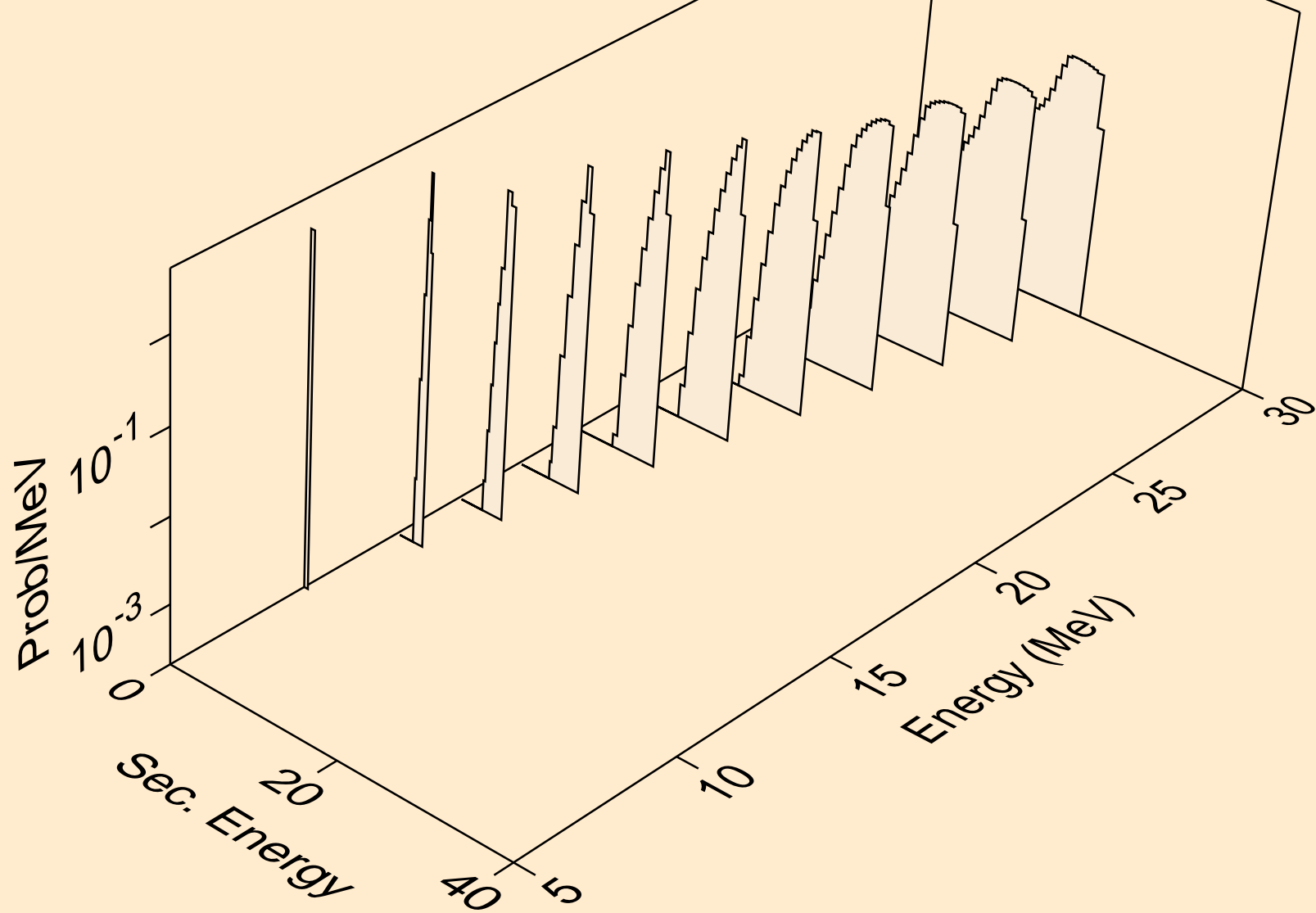

RA233 NEUTRON ACER TENDL-2024 LIBRARY; T=0.K
protons from (n,2np)

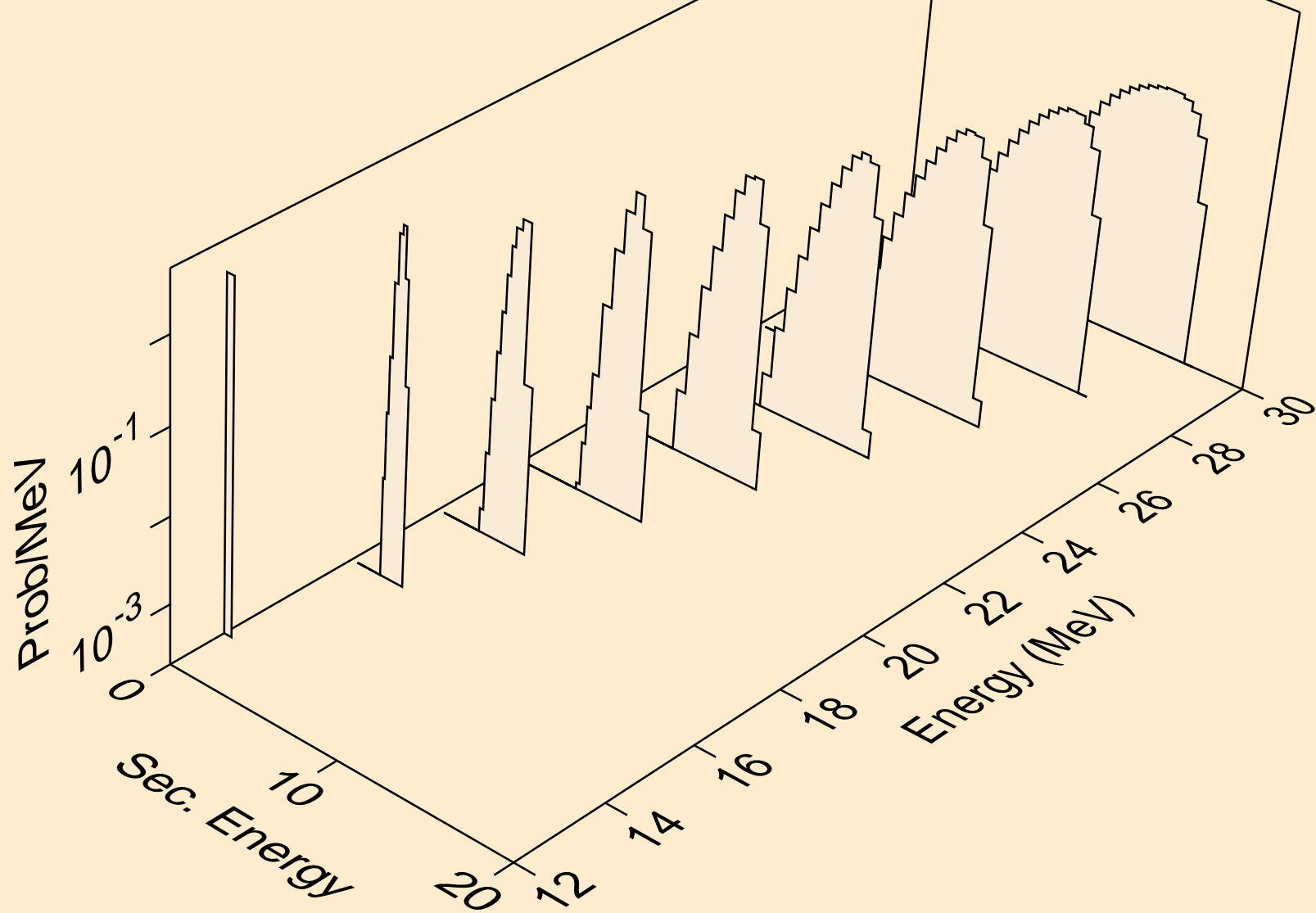

RA233 NEUTRON ACER TENDL-2024 LIBRARY; T=0.K
protons from (n,3np)

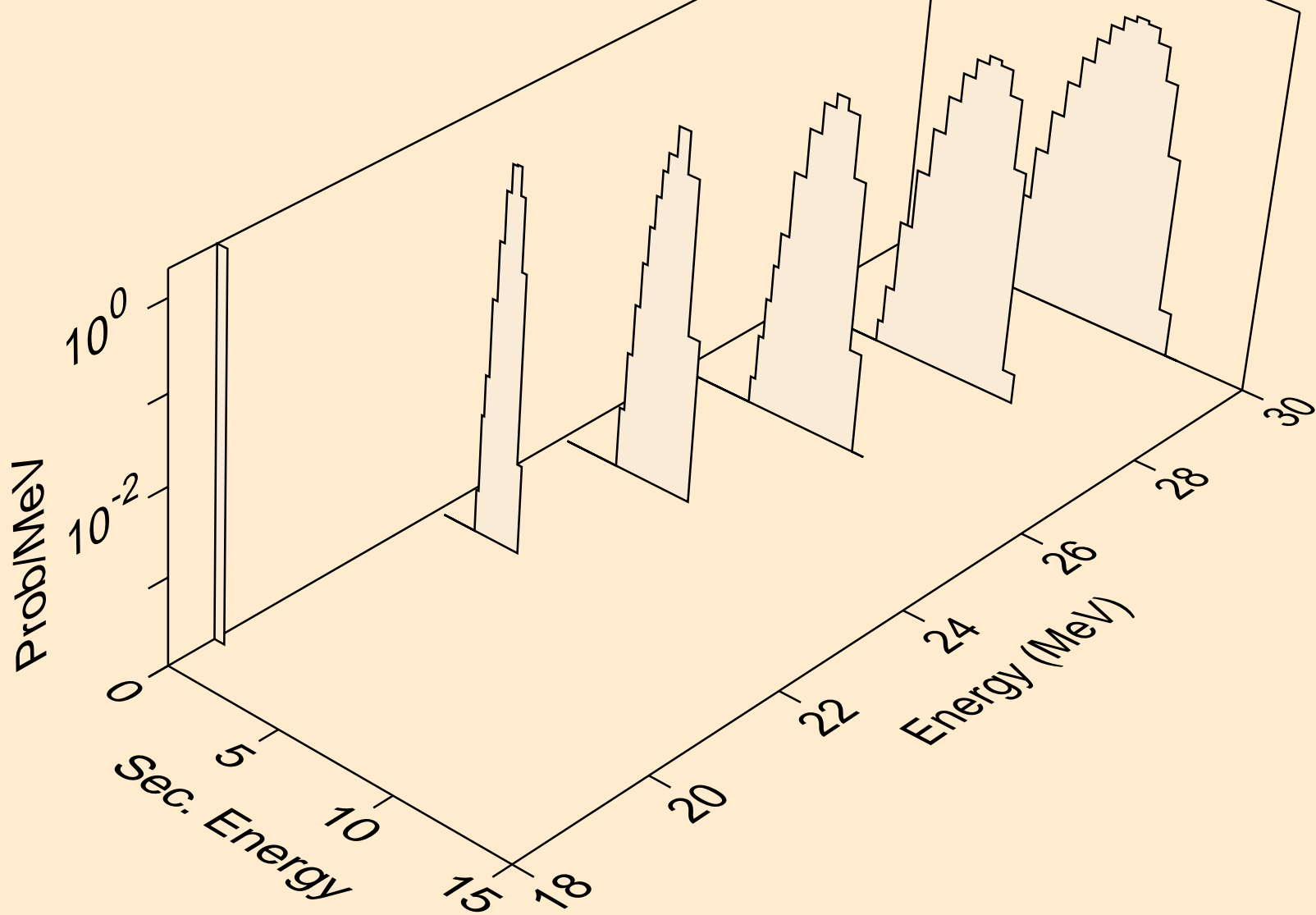

RA233 NEUTRON ACER TENDL-2024 LIBRARY; T=0.K
protons from (n,p)

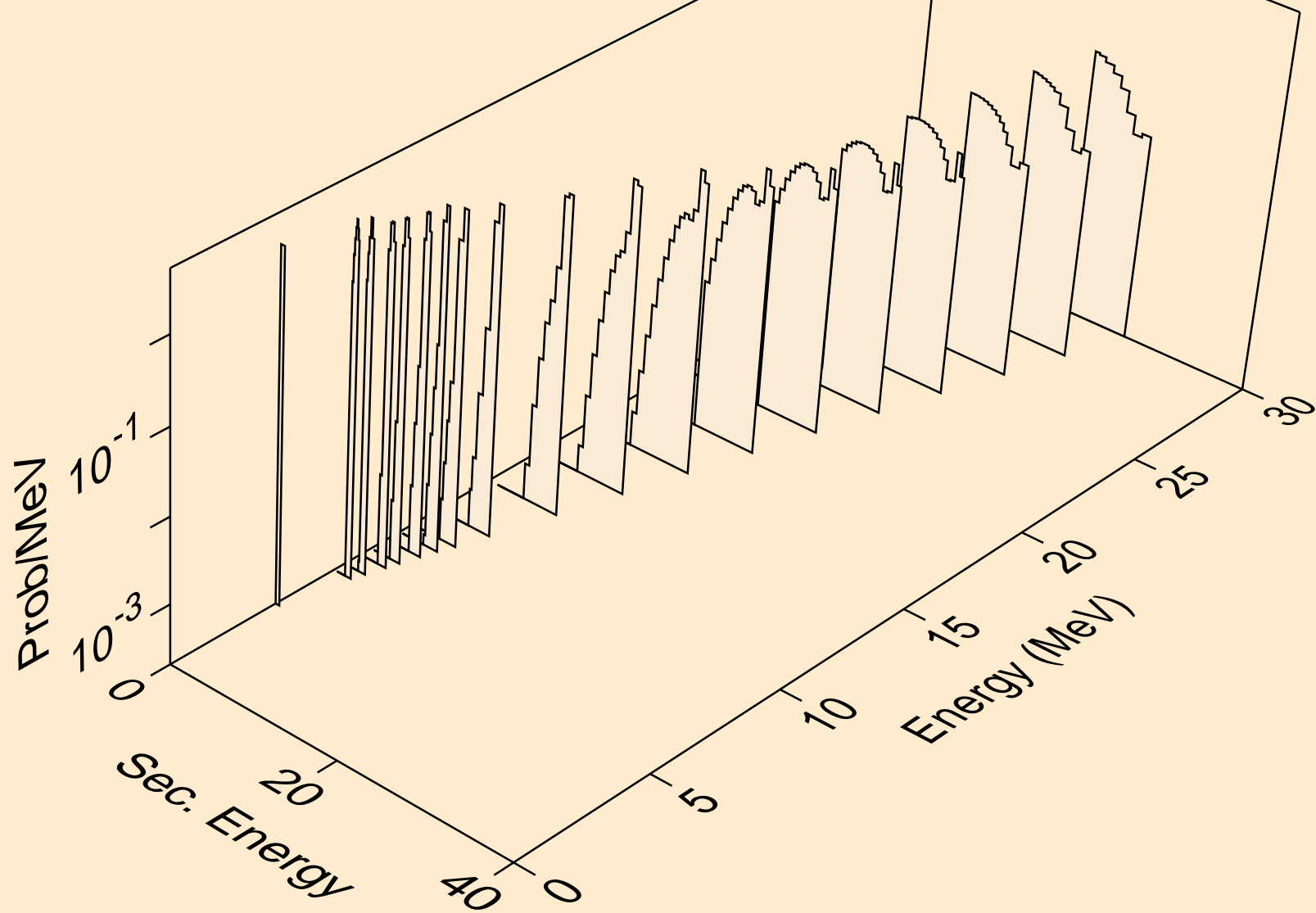

RA233 NEUTRON ACER TENDL-2024 LIBRARY; T=0.K
protons from (n,2p)

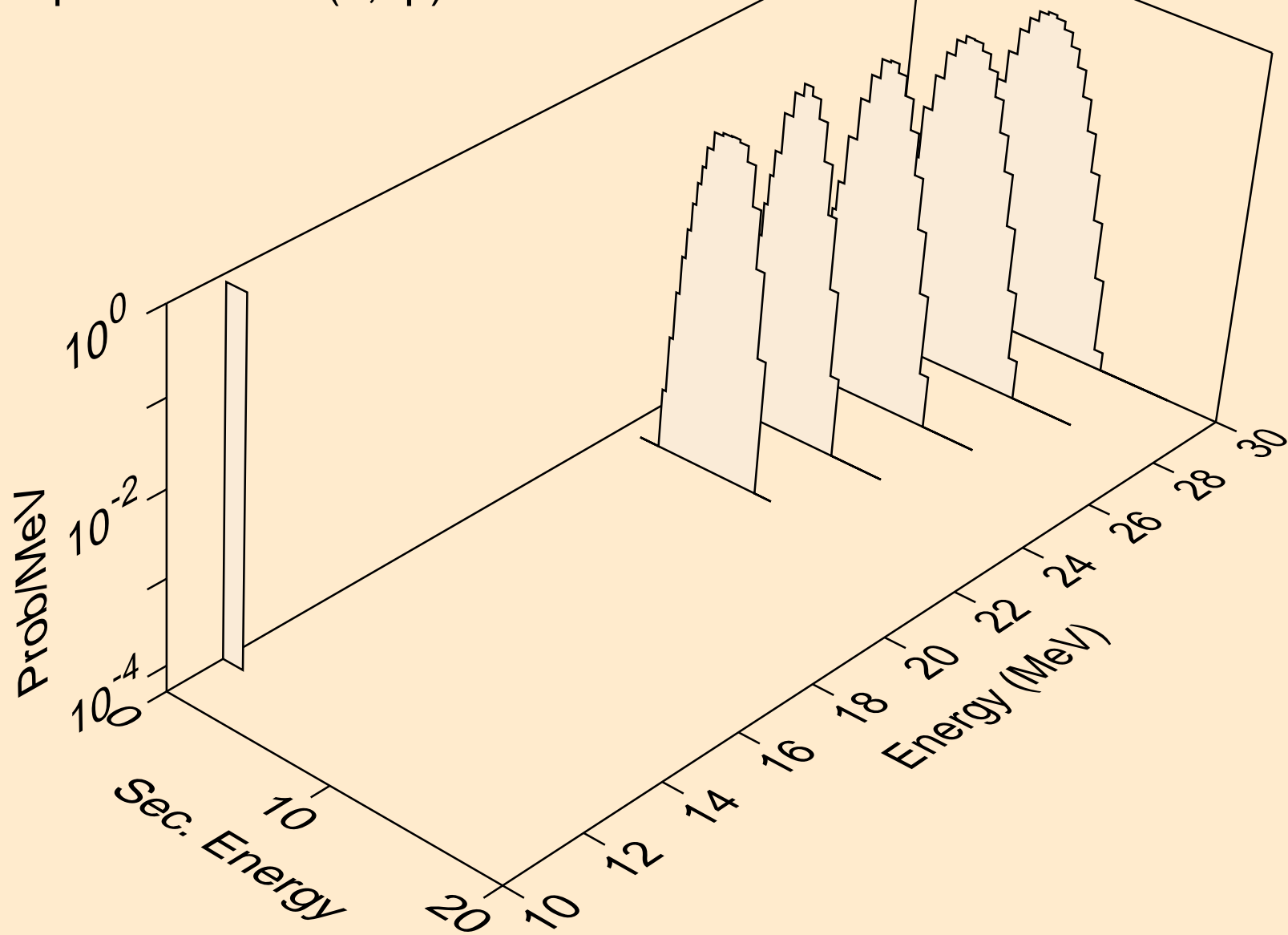

RA233 NEUTRON ACER TENDL-2024 LIBRARY; T=0.K
deuterons from (n,x)

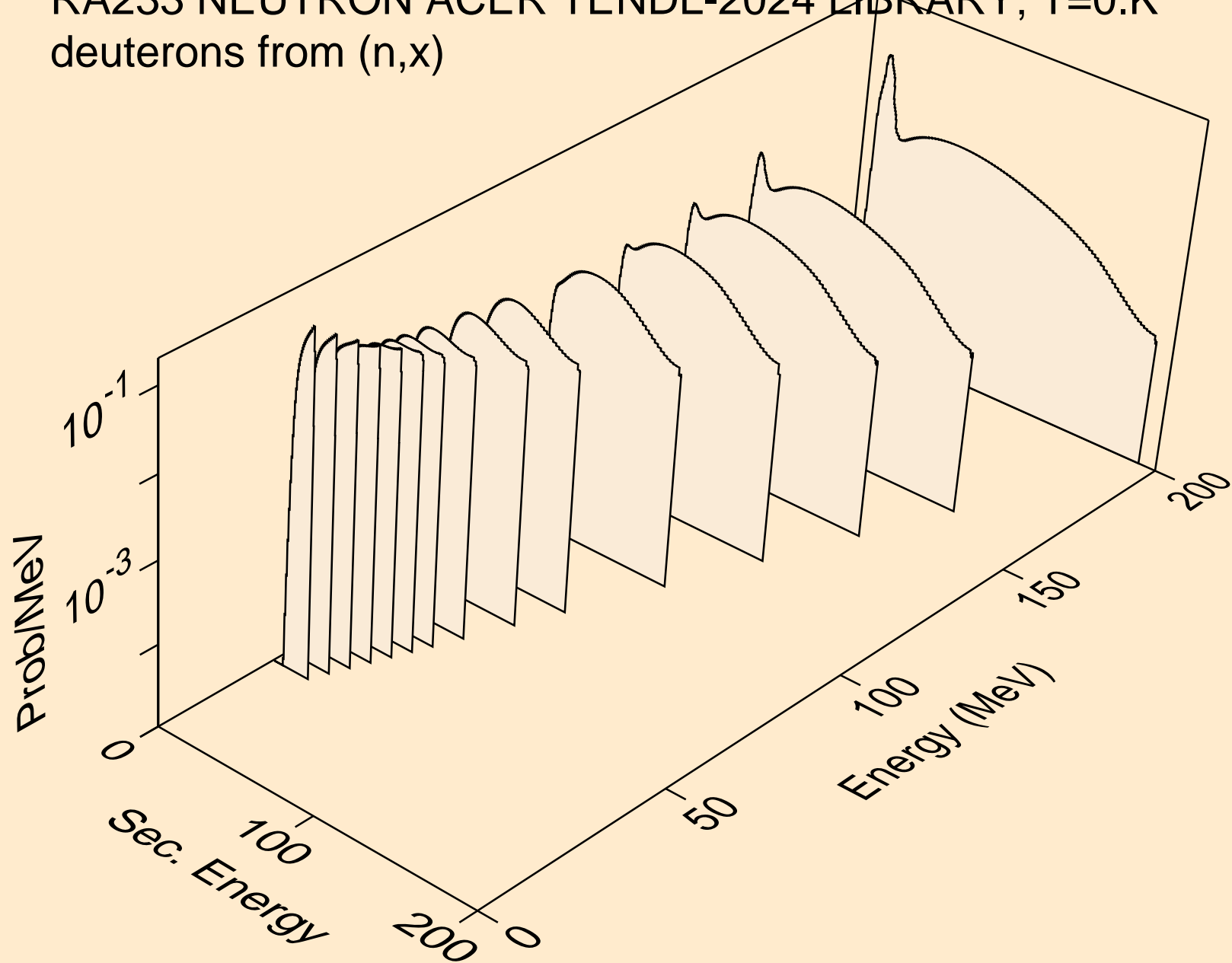

RA233 NEUTRON ACER TENDL-2024 LIBRARY; T=0.K
deuterons from (n,2nd)

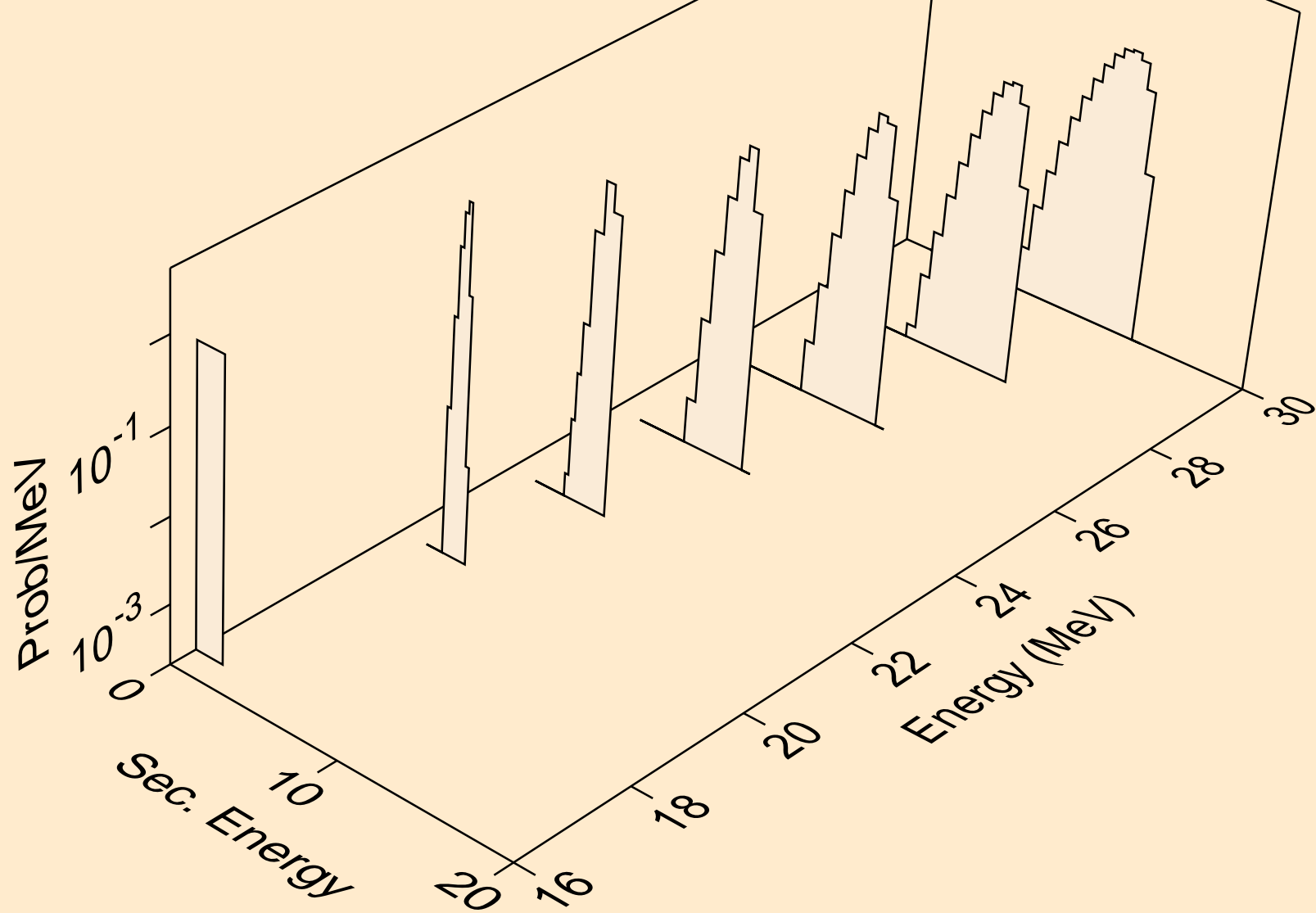

RA233 NEUTRON ACER TENDL-2024 LIBRARY; T=0.K
deuterons from (n,n*)d

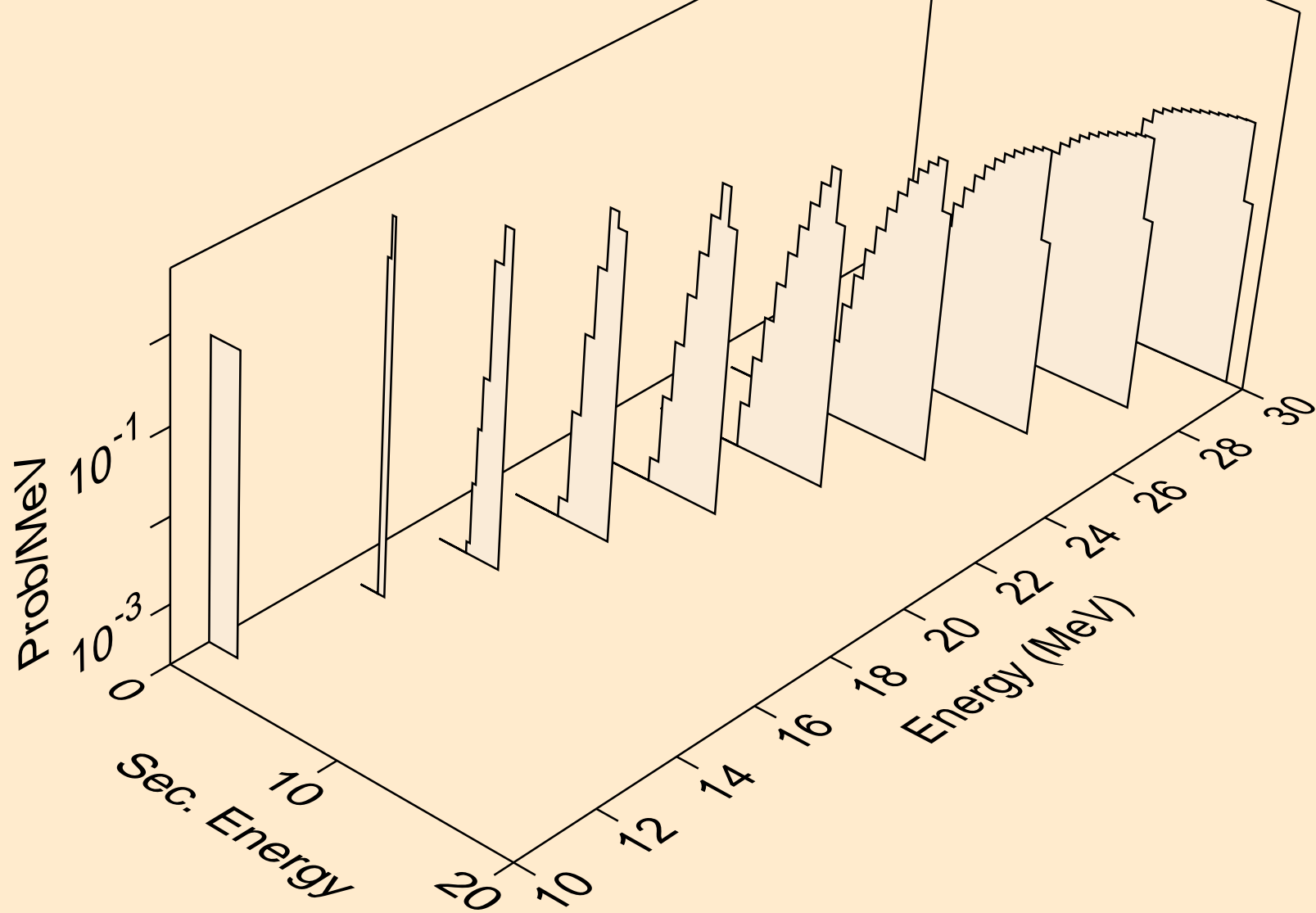

RA233 NEUTRON ACER TENDL-2024 LIBRARY; T=0.K
deuterons from (n,d)

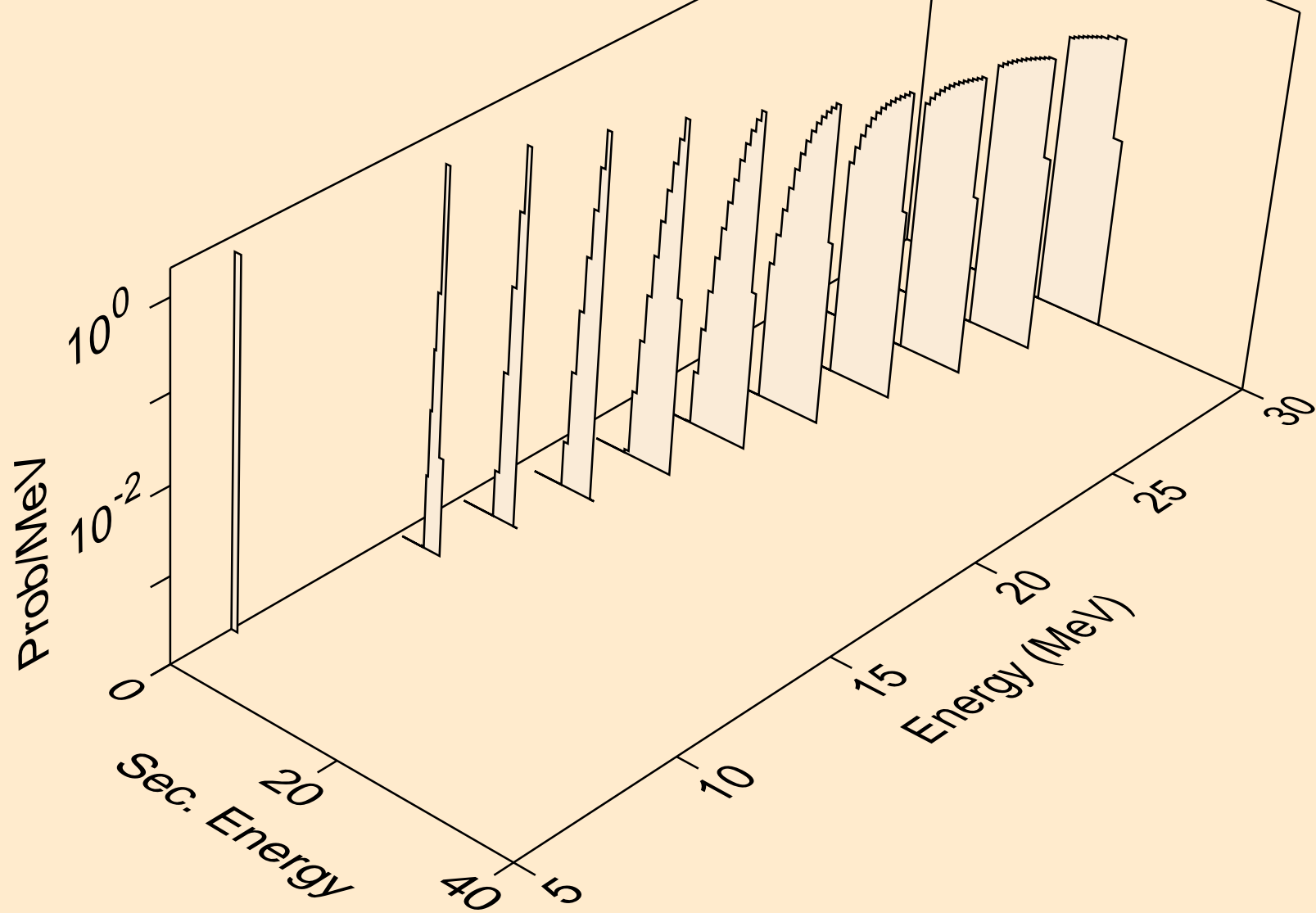

RA233 NEUTRON ACER TENDL-2024 LIBRARY; T=0.K
tritons from (n,x)

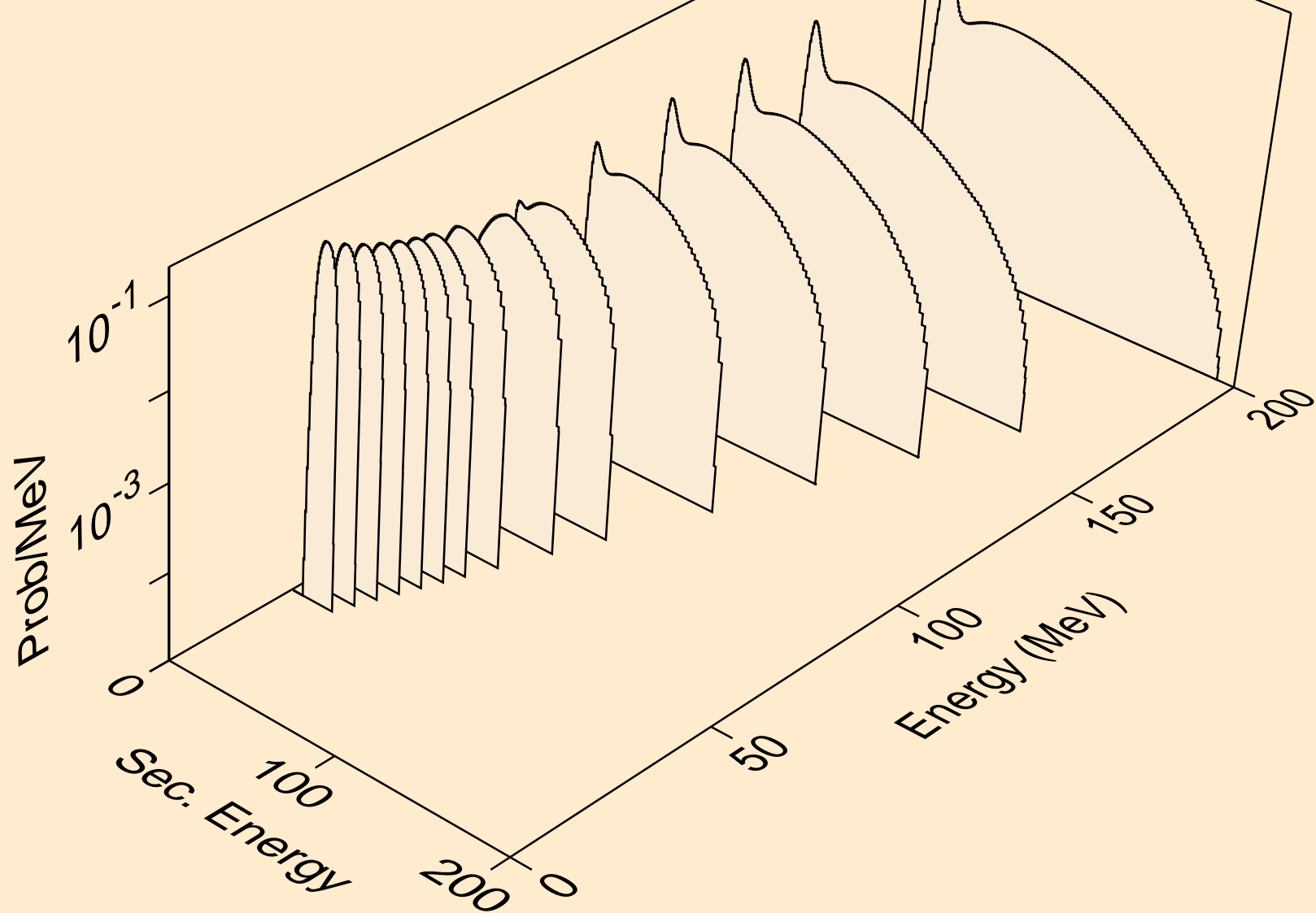

RA233 NEUTRON ACER TENDL-2024 LIBRARY; T=0.K
tritons from (n,n*)t

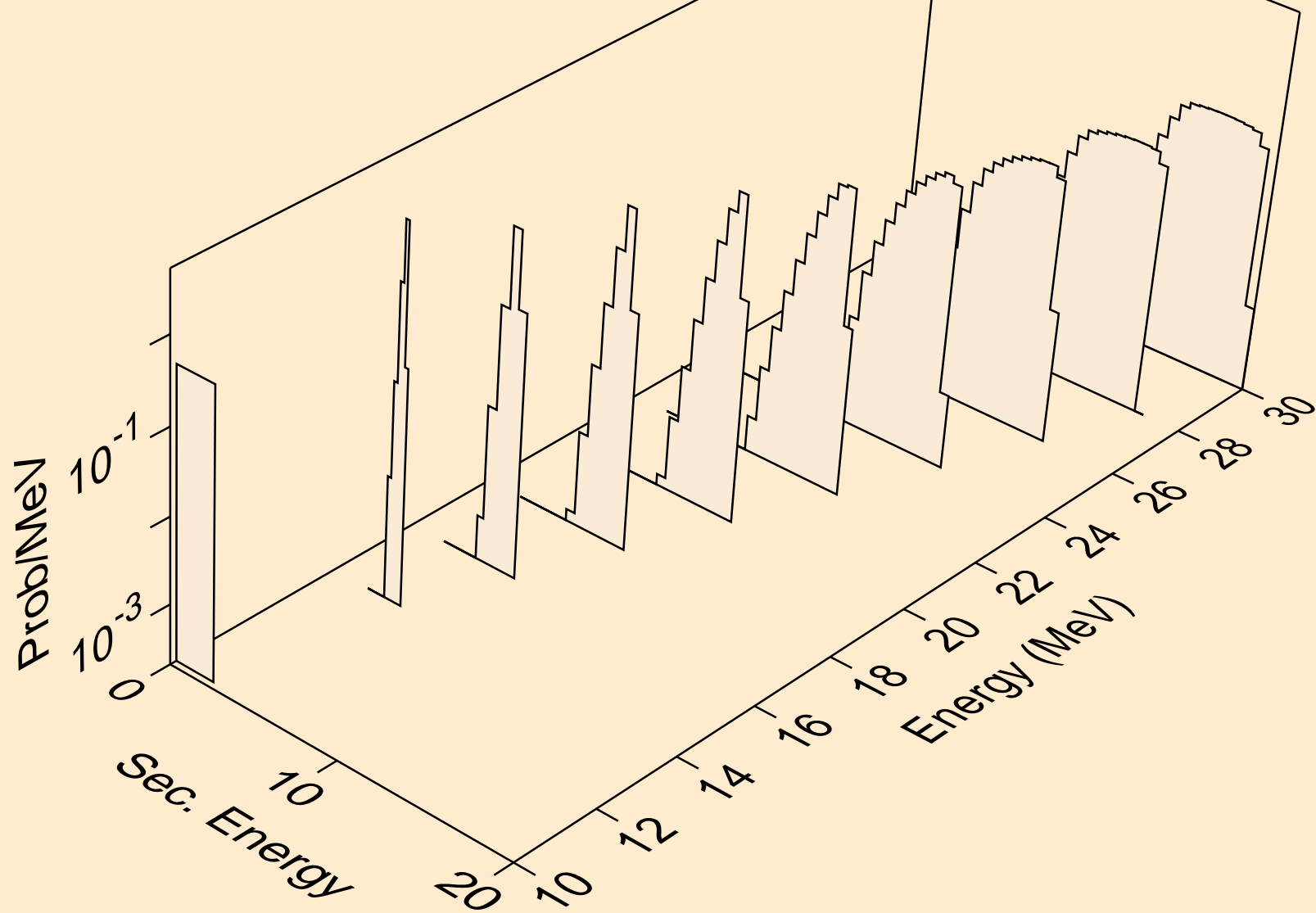

RA233 NEUTRON ACER TENDL-2024 LIBRARY; T=0.K
tritons from (n,t)

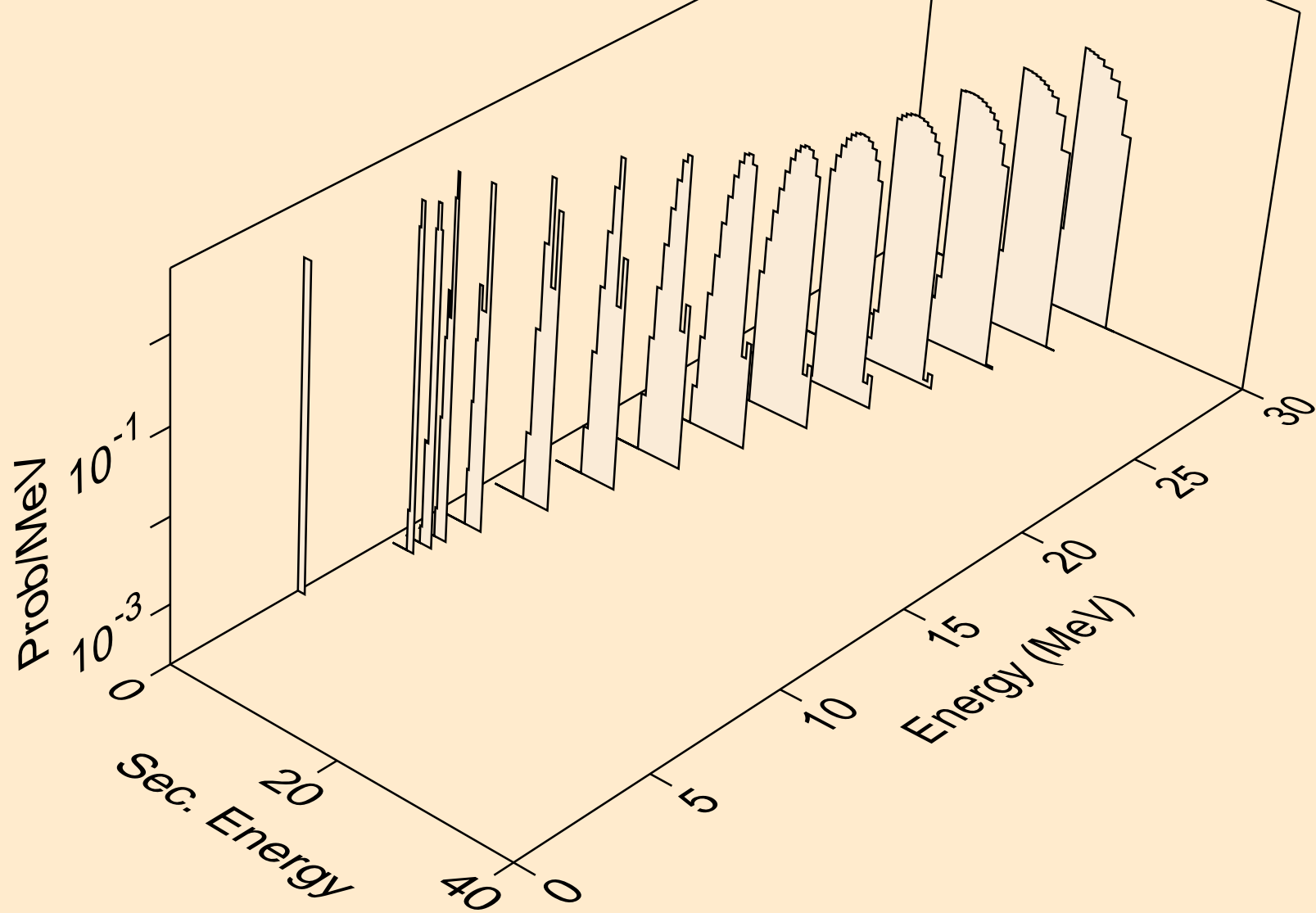

RA233 NEUTRON ACER TENDL-2024 LIBRARY; T=0.K
he3s from (n,x)

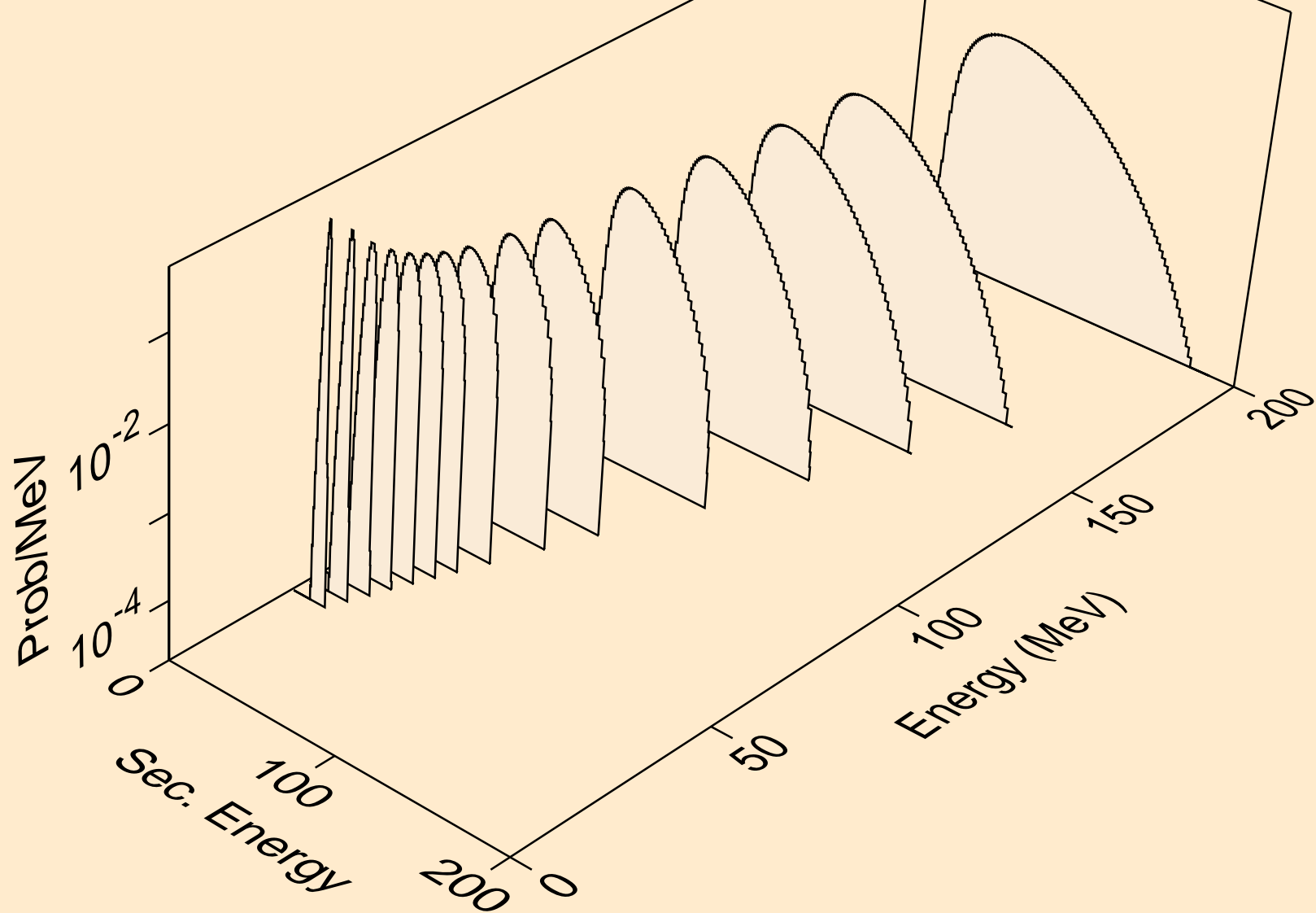

RA233 NEUTRON ACER TENDL-2024 LIBRARY; T=0.K
he3s from (n,n*)he3

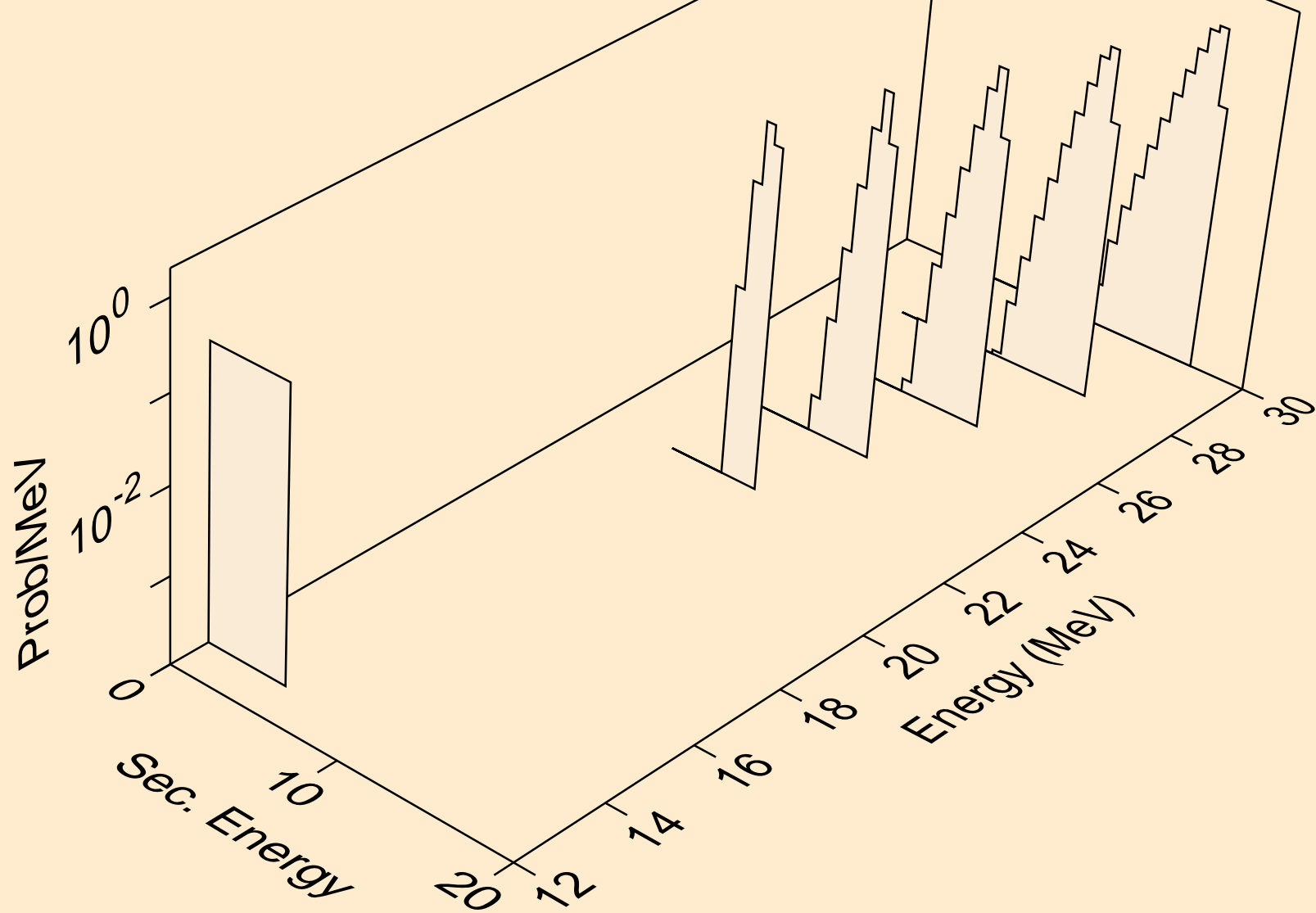

RA233 NEUTRON ACER TENDL-2024 LIBRARY; T=0.K
he3s from (n,he3)

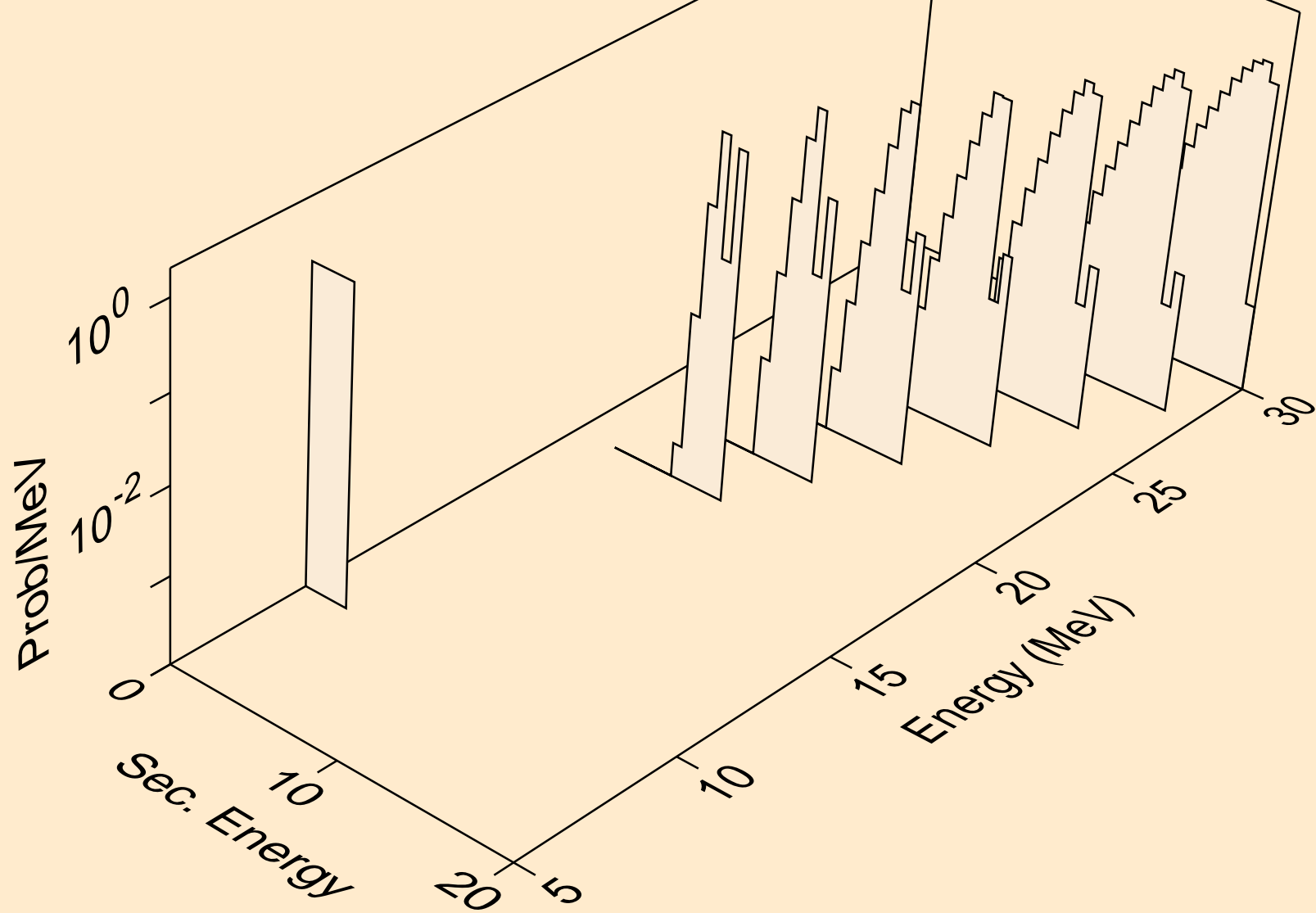

RA233 NEUTRON ACER TENDL-2024 LIBRARY; T=0.K
alphas from (n,x)

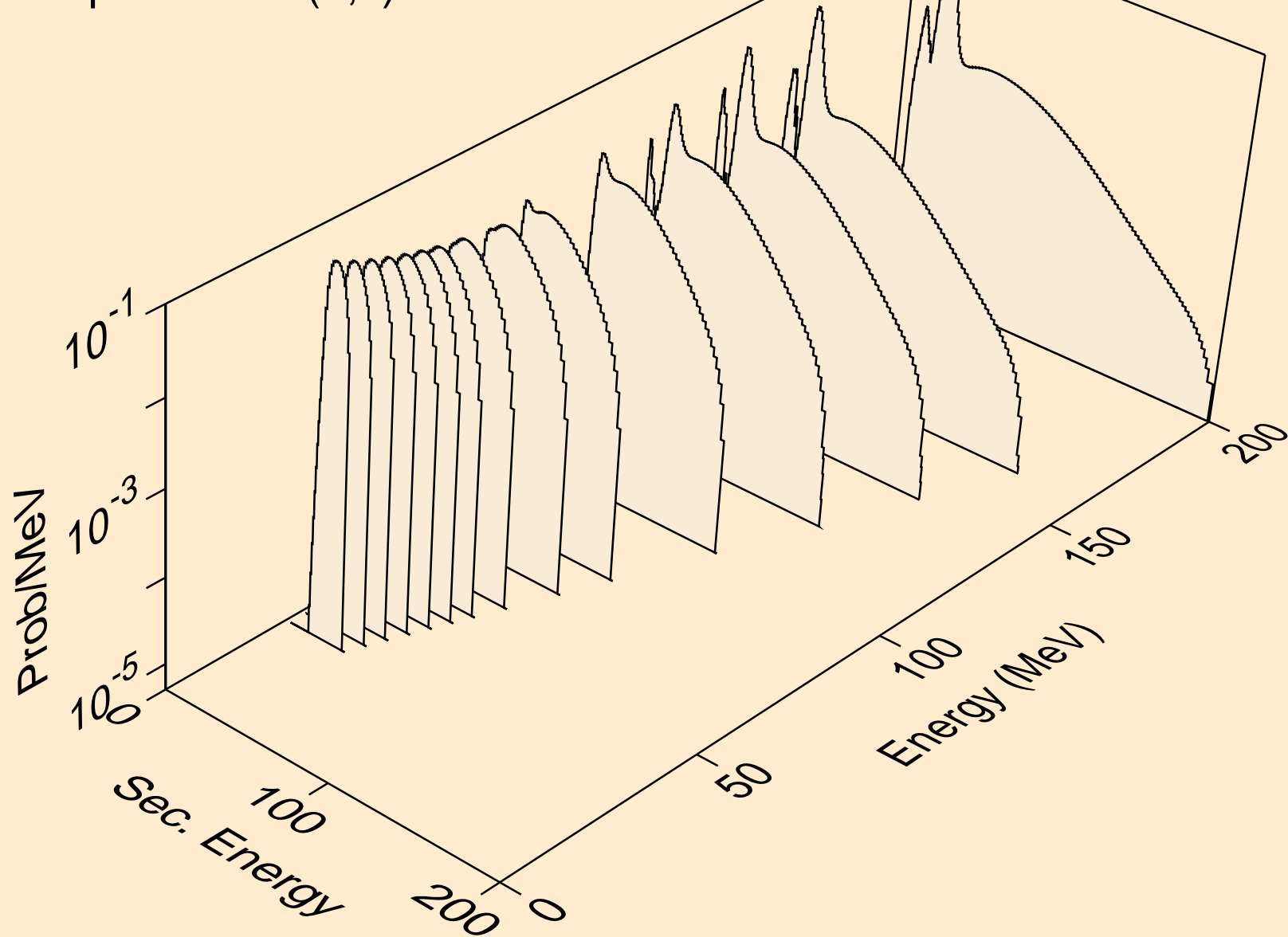

RA233 NEUTRON ACER TENDL-2024 LIBRARY; T=0.K
alphas from (n,n*)a

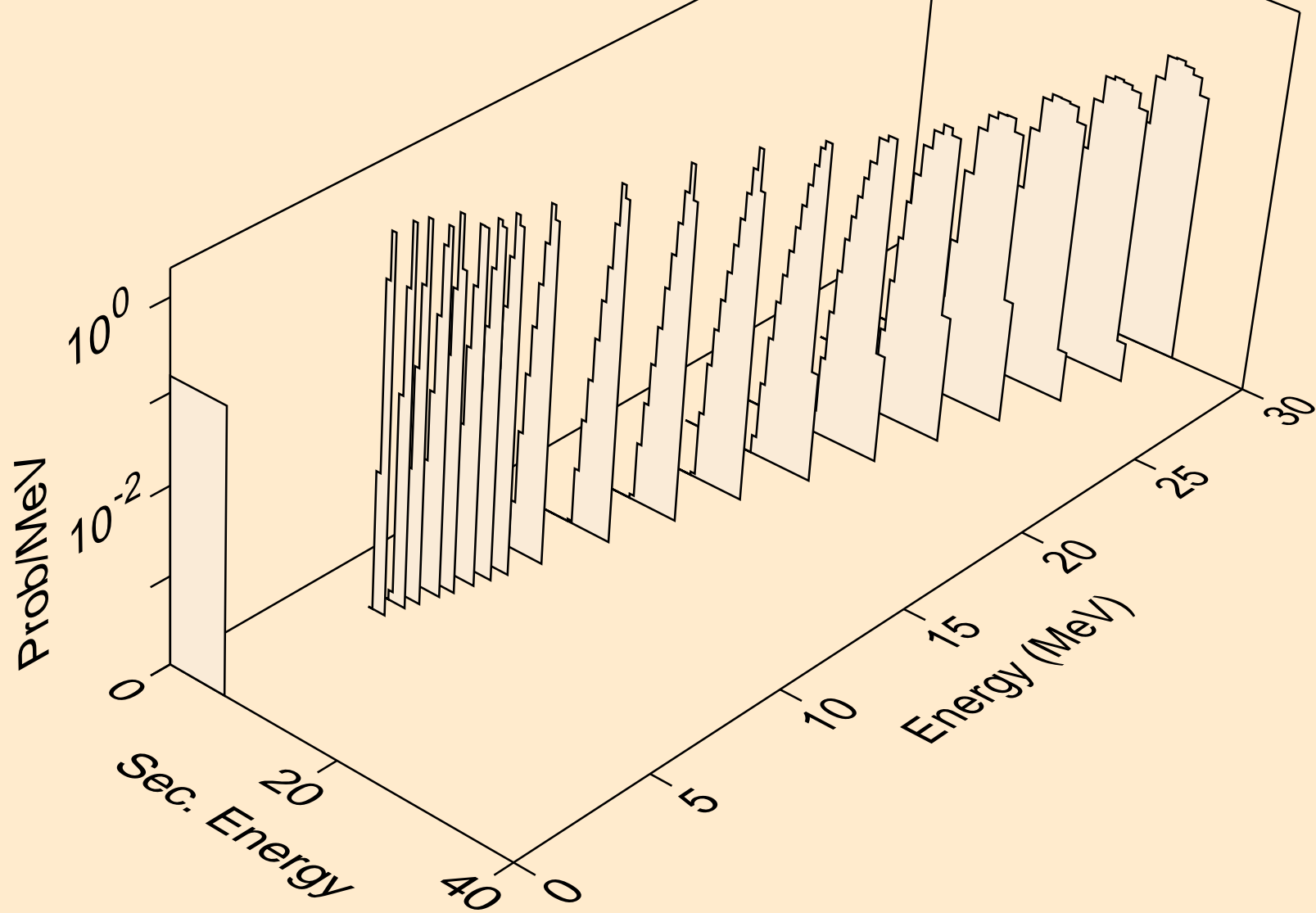

RA233 NEUTRON ACER TENDL-2024 LIBRARY; T=0.K
alphas from (n,2n)a

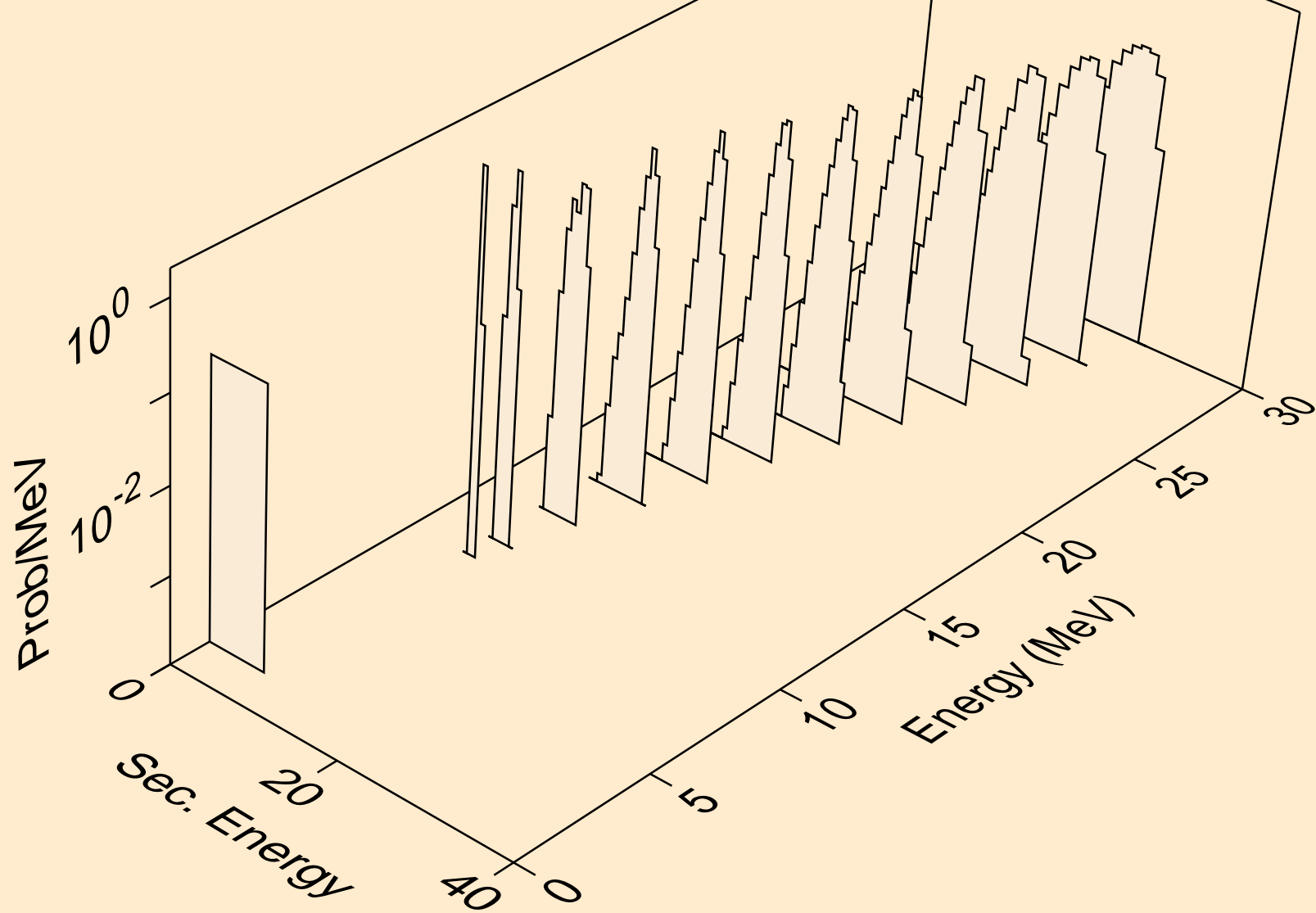

RA233 NEUTRON ACER TENDL-2024 LIBRARY; T=0.K
alphas from (n,3n)a

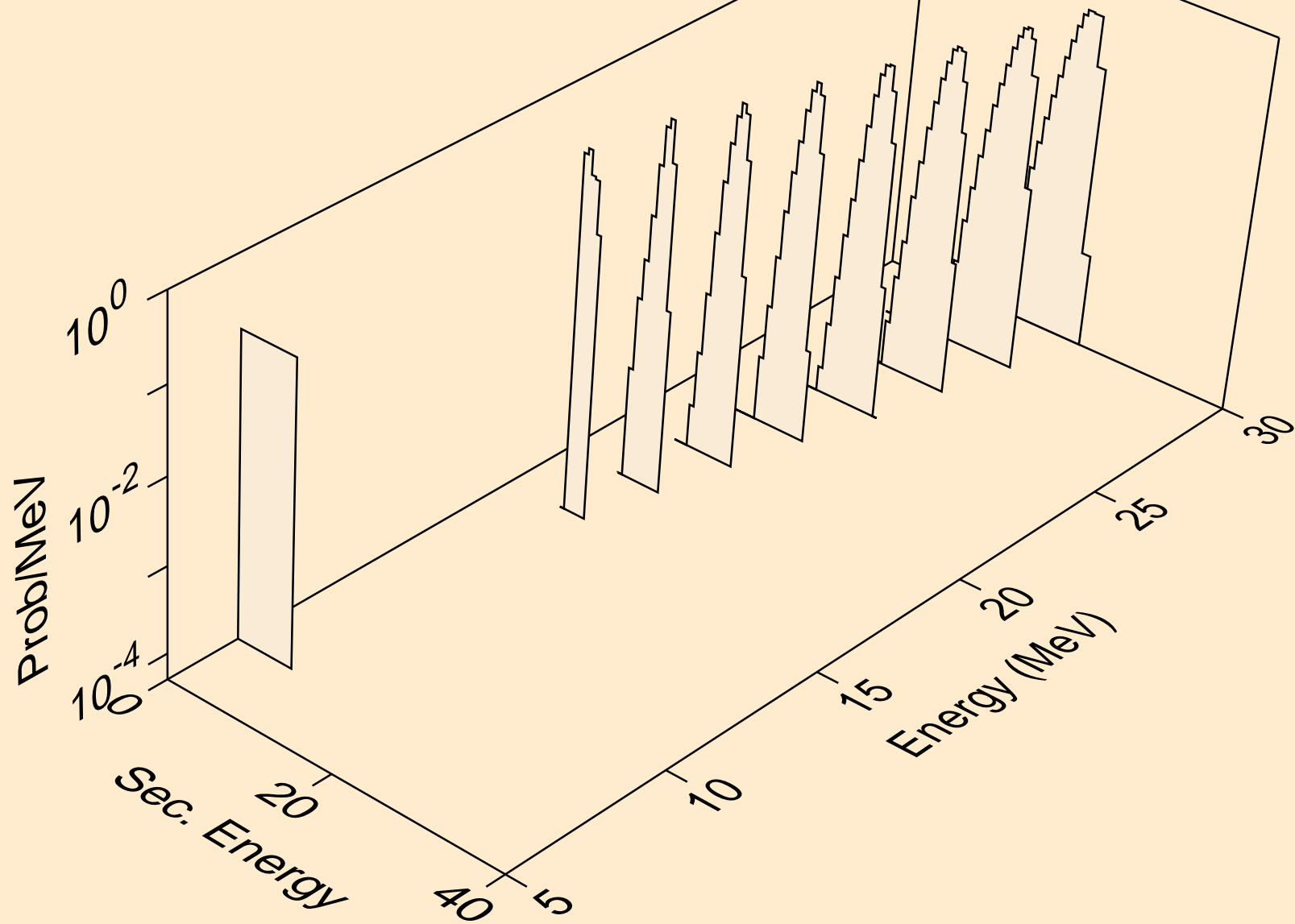

RA233 NEUTRON ACER TENDL-2024 LIBRARY; T=0.K
alphas from (n,a)

